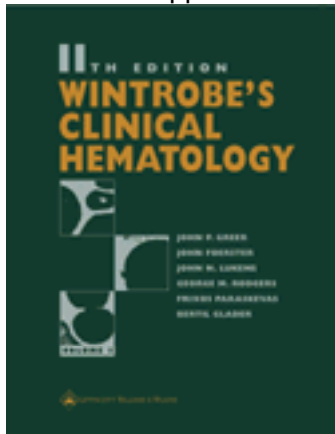


**Wintrobe's Clinical Hematology, 11th Ed**

by John P. Greer (Editor), John Foerster (Editor), John N. Lukens (Editor)

Publisher: Lippincott Williams & Wilkins Publishers; 11th edition (December 2003)



---

# Wintrobe's Clinical Hematology

---

## CONTENTS

[Editors](#)

[Contributors](#)

[Dedication](#)

[Preface](#)

---

[Volume 1](#)  
[Volume 2](#)

---

---

Volume 1

[Top](#)

---

## PART I LABORATORY HEMATOLOGY

[1. Examination of the Blood and Bone Marrow](#)  
*Sherrie L. Perkins*

[2. Clusters of Differentiation](#)  
*Frixos Paraskevas*

[3. Clinical Flow Cytometry](#)  
*Frixos Paraskevas*

[4. Cytogenetics](#)  
*Sheila N. J. Sait and Maria R. Baer*

[5. Molecular Biology and Hematology](#)  
*Rebecca L. Shattuck-Brandt and Stephen J. Brandt*

---



# PART II NORMAL HEMATOLOGIC SYSTEM

## Section 1. Hematopoiesis

### [6. Origin and Development of Blood Cells.](#)

*Maurice C. Bondurant and Mark J. Koury*

## Section 2. The Erythrocyte

### [7. Erythropoiesis.](#)

*Emmanuel N. Dessypris and Stephen T. Sawyer*

### [8. The Mature Erythrocyte.](#)

*Marilyn J. Telen and Russel E. Kaufman*

### [9. Destruction of Erythrocytes.](#)

*Bertil Glader*

## Section 3. Granulocytes and Monocytes

### [10. Neutrophilic Leukocytes.](#)

*Keith M. Skubitz*

### [11. The Human Eosinophil.](#)

*Paige Lacy, Allan B. Becker, and Redwan Moqbel*

### [12. Basophilic Leukocytes: Mast Cells and Basophils.](#)

*A. Dean Befus and Judah A. Denburg*

### [13. Mononuclear Phagocytes.](#)

*J. Brice Weinberg*

### [14. Phagocytosis.](#)

*Frixos Paraskevas*

## Section 4. Lymphocytes

### [15. Lymphocytes and Lymphatic Organs.](#)

*Frixos Paraskevas*

### [16. B Lymphocytes.](#)

*Frixos Paraskevas*

### [17. T Lymphocytes and Natural Killer Cells.](#)

*Frixos Paraskevas*

### [18. Effector Mechanisms in Immunity.](#)

*Frixos Paraskevas*

## Section 5. Hemostasis

### [19. Megakaryocytes and Platelets.](#)

*Kenneth Kaushansky and Gerald J. Roth*

### [20. Platelet Function in Hemostasis and Thrombosis.](#)

*David C. Calverley and Lori J. Maness*

### [21. Blood Coagulation and Fibrinolysis.](#)

*Kathleen Brummel-Ziedins, Thomas Orfeo, Nancy Swords Jenny, Stephen J. Everse, and Kenneth G. Mann*

### [22. Endothelium: Angiogenesis and the Regulation of Hemostasis.](#)

*Paul J. Shami and George M. Rodgers*

[21 Blood Coagulation and Fibrinolysis](#)

*Kathleen Brummel-Ziedins, Thomas Orfeo, Nancy Swords Jenny, Stephen J. Everse, and Kenneth G. Mann*

[22 Endothelium: Angiogenesis and the Regulation of Hemostasis](#)

*Paul J. Shami and George M. Rodgers*

---

## PART III THERAPEUTIC MODALITIES

[23 Red Cell, Platelet, and White Cell Antigens](#)

*Kathryn E. Weibert, Howard H. W. Chan, James William Smith, Nancy M. Heddle, and John G. Kelton*

[24 Transfusion Medicine](#)

*Susan A. Galel, James M. Malone, III, and Maureen K. Viele*

[25 Hematopoietic Stem Cell Transplantation](#)

*Richard A. Nash*

[26 Gene Therapy for Hematologic Disorders, Human Immunodeficiency Virus Infection, and Cancer](#)

*John F. Tisdale, Cynthia E. Dunbar, Jay N. Lozier, and Stacey A. Goodman*

---

## PART IV DISORDERS OF RED CELLS

### Section 1. Introduction

[27 Anemia: General Considerations](#)

*Bertil Glader*

### Section 2. Disorders of Iron Metabolism and Heme Synthesis

[28 Iron Deficiency and Related Disorders](#)

*Nancy C. Andrews*

[29 Sideroblastic Anemias](#)

*Sylvia S. Bottomley*

[30 Hemochromatosis](#)

*Corwin Q. Edwards*

[31 Porphyrria](#)

*Sylvia S. Bottomley*

### Section 3. Hemolytic Anemia

[32 Hereditary Spherocytosis and Other Anemias Due to Abnormalities of the Red Cell Membrane](#)

*William C. Mentzer and Bertil Glader*

[33 Hereditary Hemolytic Anemias Due to Enzyme Disorders](#)

*Bertil Glader*

[34 Mechanisms of Immune Destruction of Erythrocytes](#)

*Charles J. Parker*

[35 Autoimmune Hemolytic Anemias](#)

*Anne T. Neff*

[36 Alloimmune Hemolytic Disease of the Fetus and Newborn](#)

*Anne F. Eder and Catherine S. Manno*

[37 Paroxysmal Nocturnal Hemoglobinuria](#)

*Charles J. Parker and Russell E. Ware*

[38 Acquired Nonimmune Hemolytic Disorders](#)

*Michael R. Jeng and Bertil Glader*

### Section 4. Hereditary Disorders of Hemoglobin Structure and Synthesis

[37 Paroxysmal Nocturnal Hemoglobinuria](#)  
*Charles J. Parker and Russell E. Ware*

[38 Acquired Nonimmune Hemolytic Disorders](#)  
*Michael R. Jeng and Bertil Glader*

## Section 4. Hereditary Disorders of Hemoglobin Structure and Synthesis

[39 Abnormal Hemoglobins: General Principles](#)  
*John N. Lukens*

[40 Sickle Cell Anemia and Other Sickling Syndromes](#)  
*Winfred C. Wang*

[41 Unstable Hemoglobin Disease](#)  
*John N. Lukens*

[42 Thalassemias and Related Disorders: Quantitative Disorders of Hemoglobin Synthesis](#)  
*Caterina Borgna-Pignatti and Renzo Galanello*

## Section 5. Other Red Cell Disorders

[43 Megaloblastic Anemias: Disorders of Impaired DNA Synthesis](#)  
*Ralph Carmel*

[44 Acquired and Inherited Aplastic Anemia Syndromes](#)  
*Eva C. Guinan and Akiko Shimamura*

[45 Red Cell Aplasia](#)  
*Emmanuel N. Dessypris and Jeffrey M. Lipton*

[46 Congenital Dyserythropoietic Anemias](#)  
*Peter W. Marks and Bertil Glader*

[47 Anemias Secondary to Chronic Disease and Systemic Disorders](#)  
*Robert T. Means, Jr.*

[48 Anemias Unique to Pregnancy and the Perinatal Period](#)  
*Robert D. Christensen and Robin K. Ohls*

[49 Hemoglobins Associated with Cyanosis: Methemoglobinemia and Low-Affinity Hemoglobins](#)  
*John N. Lukens*

[50 Erythrocytosis](#)  
*Robert T. Means, Jr.*

# PART V DISORDERS OF HEMOSTASIS AND COAGULATION

## Section 1. Introduction

[51 Diagnostic Approach to the Bleeding Disorders...](#)  
*George M. Rodgers*

## Section 2. Thrombocytopenia

[52 Thrombocytopenia: Pathophysiology and Classification...](#)  
*Shirley Parker Levine*

[53 Thrombocytopenia Caused by Immunologic Platelet Destruction...](#)  
*Shirley Parker Levine*

[54 Thrombotic Thrombocytopenic Purpura and Other Forms of Nonimmunologic Platelet Destruction...](#)  
*Shirley Parker Levine*

[55 Miscellaneous Causes of Thrombocytopenia...](#)  
*Shirley Parker Levine*

## Section 3. Other Disorders of Primary Hemostasis

[56 Bleeding Disorders Caused by Vascular Abnormalities...](#)  
*Matthew M. Rees and George M. Rodgers*

[57 Thrombocytosis](#)  
*Shirley Parker Levine*

[58 Qualitative Disorders of Platelet Function...](#)  
*Shirley Parker Levine*

## Section 4. Coagulation Disorders

[59 Inherited Coagulation Disorders...](#)  
*Kenneth D. Friedman and George M. Rodgers*

[60 Acquired Coagulation Disorders...](#)  
*George M. Rodgers*

## Section 5. Thrombosis

[61 Thrombosis and Antithrombotic Therapy...](#)  
*Steven R. Deitcher and George M. Rodgers*

---

## PART VI NONMALIGNANT DISORDERS OF LEUKOCYTES, THE SPLEEN, AND/OR IMMUNOGLOBINS

[62 Diagnostic Approach to Malignant and Nonmalignant Disorders of the Phagocytic and Immune Systems](#)...  
*Thomas L. McCurley and John P. Greer*

[63 Neutropenia](#)  
*Raymond G. Watts*

[64 Qualitative Disorders of Leukocytes](#)  
*Keith M. Skubitz*

[65 Abnormalities of the Monocyte–Macrophage System: Lysosomal Storage Diseases](#)...  
*Margaret M. McGovern and Robert J. Desnick*

[66 Langerhans Cell Histiocytosis](#)  
*H. Stacy Nicholson*

[67 Infectious Mononucleosis and Other Epstein–Barr Virus–Related Disorders](#)...  
*Thomas G. Gross*

[68 Primary Immunodeficiency Syndromes](#)  
*Anthony R. Hayward*

[69 Acquired Immunodeficiency Syndrome](#)  
*Elaine M. Sloan and Jerome E. Groopman*

[70 Disorders of the Spleen](#)  
*Jeremy Goodman, Martin I. Newman, and William C. Chapman*

---

## PART VII HEMATOLOGIC MALIGNANCIES

### Section 1. General Aspects

[71 Hematopoietic–Lymphoid Neoplasms: Principles of Diagnosis](#)...  
*John B. Cousar*

[72 Complications of Hematopoietic Neoplasms](#)...  
*Madan H. Jagasia and Edward R. Arrowsmith*

[73 Principles and Pharmacology of Chemotherapy](#)...  
*Kenneth R. Hande*

[74 Immunotherapy](#)  
*Stanford J. Stewart*

[75 Supportive Care in Hematologic Malignancies](#)...  
*Madhuri Vusirikala*

### Section 2. Acute Leukemias

[76 Molecular Genetics of Acute Leukemia](#)...  
*Mary Ann Thompson*

[77 Classification and Differentiation of the Acute Leukemias](#)...  
*David R. Head*

[78 Acute Lymphoblastic Leukemia in Adults](#)...  
*Thai M. Cao and Steven E. Coutre*

[79 Acute Myeloid Leukemia in Adults](#)...  
*John P. Greer, Maria R. Baer, and Marsha C. Kinney*

[78 Acute Lymphoblastic Leukemia in Adults](#)

*Thai M. Cao and Steven E. Coutre*

[79 Acute Myeloid Leukemia in Adults](#)

*John P. Greer, Maria R. Baer, and Marsha C. Kinney*

[80 Acute Lymphoblastic Leukemia in Children](#)

*James A. Whitlock and Paul S. Gaynon*

[81 Acute Myelogenous Leukemia in Children](#)

*Robert J. Arceci and Richard Aplenc*

[82 Acute Promyelocytic Leukemia](#)

*Steven L. Soignet and Peter G. Maslak*

[83 Myelodysplastic Syndromes](#)

*Alan F. List, Avery A. Sandberg, and Donald C. Doll*

### Section 3. Myeloproliferative Disorders

[84 Chronic Myeloid Leukemia](#)

*Ian Rabinowitz and Richard S. Larson*

[85 Polycythemia Vera](#)

*Robert T. Means, Jr.*

[86 Myelofibrosis](#)

*Douglas A. Clark and Wilbur L. Williams*

[87 Systemic Mastocytosis](#)

*Alexandra S. Worobec and Dean D. Metcalfe*

### Section 4. Lymphoproliferative Disorders

[88 Diagnosis and Classification of Non-Hodgkin Lymphomas](#)

*Thomas L. McCurley and William R. Macon*

[89 Molecular Aspects of Non-Hodgkin Lymphomagenesis](#)

*Andreas Rosenwald, Louis M. Staudt, Justus Georg Duyster, and Stephan W. Morris*

[90 Non-Hodgkin Lymphomas in Adults](#)

*John P. Greer*

[91 Non-Hodgkin Lymphomas in Children](#)

*John T. Sandlund and Frederick G. Behm*

[92 Chronic Lymphocytic Leukemia](#)

*James B. Johnston*

[93 Hairy Cell Leukemia](#)

*James B. Johnston*

[94 Cutaneous T-Cell Lymphomas: Mycosis Fungoides and Sézary Syndrome](#)

*John A. Zic, Monika G. Kiripolsky, Katherine S. Hamilton, and John P. Greer*

[95 Hodgkin Disease](#)

*Richard S. Stein and David S. Morgan*

### Section 5. Plasma Cell Dyscrasias

[96 Practical Aspects of the Clinical Approach to Patients with Monoclonal Immunoglobulin Disorders](#)

*Philip R. Greipp and Rafael Fonseca*

[97 Monoclonal Gammopathy of Undetermined Significance and Smoldering Multiple Myeloma](#)

*Robert A. Kyle, S. Vincent Rajkumar, and John A. Lust*

[98 Multiple Myeloma](#)

*Angela Dispenzieri, Martha Q. Lacy, and Philip R. Greipp*

*Philip R. Greipp and Rafael Fonseca*

**97 Monoclonal Gammopathy of Undetermined Significance and Smoldering Multiple Myeloma**  
*Robert A. Kyle, S. Vincent Rajkumar, and John A. Lust*

**98 Multiple Myeloma**  
*Angela Dispenzieri, Martha Q. Lacy, and Philip R. Greipp*

**99 Immunoglobulin Light-Chain Amyloidosis (Primary Amyloidosis)**  
*Morie A. Gertz, Martha Q. Lacy, and Angela Dispenzieri*

**100 Waldenström Macroglobulinemia**  
*Rafael Fonseca and Thomas E. Witzig*

**101 Cryoglobulinemia, Heavy Chain Diseases, and Monoclonal Gammopathy-Associated Disorders**  
*Angela Dispenzieri and Morie A. Gertz*

**APPENDIX A: Normal Blood and Bone Marrow Values in Humans**

**APPENDIX B: Comparative Hematology**

**Color Plate**

2004 Lippincott Williams & Wilkins  
John P. Greer, John Foerster, John N. Lukens, George M. Rodgers, Frixos Paraskevas, and Bertil Glader  
Wintrobe's Clinical Hematology



## Contributing Authors

**Nancy C. Andrews, MD, PhD**

Associate Professor, Department of Pediatrics, Harvard Medical School, Associate Investigator, Department of Medicine, Howard Hughes Medical Institute and Children's Hospital, Boston, Massachusetts

**Richard Aplenc, MD, MSCE**

Assistant Professor of Pediatrics, Department of Pediatrics, University of Pennsylvania School of Medicine, Children's Hospital of Philadelphia, Philadelphia, Pennsylvania

**Robert J. Arceci, MD, PhD**

Director and King Fahd Professor of Pediatric Oncology, Department of Pediatric Oncology, Sidney Kimmel Comprehensive Cancer Center at John Hopkins, Baltimore, Maryland

**Edward R. Arrowsmith, MD, MPH**

Chattanooga Oncology and Hematology Associates, Chattanooga, Tennessee

**Maria R. Baer, MD**

Professor, Department of Medicine, Leukemia Section, University at Buffalo State University of New York School of Medicine and Biomedical Sciences, Roswell Park Cancer Institute, Buffalo, New York

**Allan B. Becker, MD, FRCPC**

Professor, Department of Pediatrics and Child Health, Section of Allergy and Clinical Immunology, University of Manitoba Faculty of Medicine, Health Sciences Centre, Winnipeg, Manitoba, Canada

**A. Dean Befus, PhD**

Professor and AstraZeneca Canada Inc.; Chair in Asthma Research, Department of Medicine, University of Alberta Faculty of Medicine and Dentistry, Edmonton, Alberta, Canada

**Frederick G. Behm**

Department of Pathology, St. Jude Children's Research Hospital, Memphis, Tennessee

**Maurice C. Bondurant, PhD**

Associate Professor, Department of Medicine, Vanderbilt University School of Medicine, Nashville, Tennessee

**Caterina Borgna-Pignatti, MD**

Professor of Pediatrics, Department of Clinical and Experimental Medicine/Pediatrics, University of Ferrara, Ferrara, Italy

**Sylvia S. Bottomley, MD**

Professor of Medicine, Department of Medicine, Hematology/Oncology Section, University of Oklahoma College of Medicine and Department of Veterans Affairs Medical Center, Oklahoma City, Oklahoma



**Stephen J. Brandt, MD**

Associate Professor, Departments of Medicine, Cell and Developmental Biology, and Cancer Biology, Division of Hematology/Oncology, Vanderbilt University School of Medicine, Nashville, Tennessee

**Kathleen Brummel-Ziedins, PhD**

Research Assistant Professor of Biochemistry, Department of Biochemistry, University of Vermont College of Medicine, Burlington, Vermont

**David C. Calverley, MD**

Assistant Professor of Medicine, Division of Hematology and Medical Oncology, University of Colorado Health Sciences Center School of Medicine, Denver, Colorado

**Thai M. Cao, MD**

Clinical Instructor of Medicine, Department of Medicine, Division of Bone Marrow Transplantation, Stanford University Medical Center, Stanford, California

**Ralph Carmel, MD**

Director of Research, Department of Medicine, New York Methodist Hospital, Brooklyn, New York, Professor of Medicine, Department of Medicine, Weill Medical College of Cornell University, New York, New York

**Howard H. W. Chan, MBChB, FRCPC**

Research Fellow, Transfusion Medicine, Departments of Hematology and Internal Medicine, McMaster University Faculty of Health Sciences, Hamilton, Ontario, Canada

**William C. Chapman, MD**

Professor of Surgery; Chief, Section of Transplantation, Washington University School of Medicine, St. Louis, Missouri

**Robert D. Christensen, MD**

Professor and Chairman, Department of Pediatrics, University of South Florida College of Medicine, All Children's Hospital, St. Petersburg, Florida

**Douglas A. Clark, MD**

New Mexico Cancer Center, Albuquerque, New Mexico

**John B. Cousar, MD**

Professor of Pathology, Department of Pathology, University of Virginia Health System, Charlottesville, Virginia

**Steven E. Coutre, MD**

Assistant Professor of Medicine (Hematology), Department of Medicine, Stanford University School of Medicine, Stanford, California

**Steven R. Deitcher, MD**

Head, Section of Hematology and Coagulation Medicine, Department of Hematology and Medical Oncology, The Cleveland Clinic Foundation, Cleveland, Ohio

**Judah A. Denburg, MD**

Professor, Department of Medicine, McMaster University School of Medicine, Hamilton,

Ontario, Canada

**Robert J. Desnick, PhD, MD**

Professor of Human Genetics and Pediatrics; Chairman, Department of Human Genetics, Mount Sinai School of Medicine of the City University of New York, New York, New York

**Emmanuel N. Dessypris, MD, FACP**

Professor of Medicine, Medical College of Virginia, Virginia Commonwealth University School of Medicine, Chief of Medicine, H.H. McGuire Veterans Affairs Medical Center, Richmond, Virginia

**Angela Dispenzieri, MD**

Assistant Professor, Department of Medicine, Division of Hematology, Mayo Clinic, Rochester, Minnesota

**Donald C. Doll, MD**

Professor of Medicine, Departments of Hematology and Medical Oncology, Ellis Fischel Cancer Center, University of Missouri Columbia School of Medicine, Columbia, Missouri

**Cynthia E. Dunbar, MD**

Section Chief, Molecular Hematopoiesis Section, Hematology Branch, National Heart, Lung, and Blood Institute, National Institutes of Health, Bethesda, Maryland

**Justus Georg Duyster, MD**

Internal Medicine III, Technical University of Munich, Munich, Germany

**Anne F. Eder, MD, PhD**

Assistant Professor, Department of Pathology and Laboratory Medicine, University of Pennsylvania School of Medicine, The Children's Hospital of Philadelphia, Philadelphia, Pennsylvania

**Corwin Q. Edwards, MD**

Professor, Department of Medicine, Associate Director, Internal Medicine Training Program, University of Utah School of Medicine, Director of Graduate Medical Education, LDS Hospital, Salt Lake City, Utah

**Stephen J. Everse, PhD**

Assistant Professor, Department of Biochemistry, University of Vermont College of Medicine, Burlington, Vermont

**John Foerster, MD, FRCPC**

Professor of Medicine, Division of Hematology/Oncology, University of Manitoba Faculty of Medicine, Director of Research, St. Boniface General Hospital, Winnipeg, Manitoba, Canada

**Rafael Fonseca, MD**

Associate Professor of Medicine, Department of Hematology, Mayo Medical School, Mayo Clinic, Rochester, Minnesota

**Kenneth D. Friedman, MD**

Medical Director, The Blood Center of Southeastern Wisconsin, Inc., Milwaukee, Wisconsin

**Renzo Galanello, MD**

Professor of Pediatrics, Dip. di Scienze Biomediche e Biotecnologie, University of Cagliari–Ospedale Microcitemie, Cagliari, Italy

**Susan A. Galel, MD**

Associate Professor, Department of Pathology, Stanford University School of Medicine, Stanford, California

**Paul S. Gaynon, MD**

Professor of Pediatrics, Children's Hospital of Los Angeles, Keck School of Medicine, University of Southern California, Los Angeles, California

**Morie A. Gertz, MD**

Professor of Medicine, Division of Hematology, Mayo Medical School, Chair, Division of Hematology, Mayo Clinic, Rochester, Minnesota

**Bertil Glader, MD, PhD**

Professor of Pediatrics, Division of Hematology/Oncology, Stanford University School of Medicine, Stanford, California

**Jeremy Goodman, MD**

Surgery Resident, Department of Surgery, Washington University School of Medicine, St. Louis, Missouri

**Stacey A. Goodman, MD**

Associate Professor of Medicine, Department of Medicine, Division of Hematology/Oncology, Vanderbilt University School of Medicine, Nashville, Tennessee

**John P. Greer, MD**

Professor of Medicine and Pediatrics, Departments of Medicine and Pediatrics, Division of Hematology/Oncology, Vanderbilt University School of Medicine, Nashville, Tennessee

**Philip R. Greipp, MD**

Professor of Medicine, Department of Hematology, Mayo Medical School, Mayo Clinic, Rochester, Minnesota

**Jerome E. Groopman, MD**

Professor of Medicine, Department of Medicine, Harvard Medical School/Beth Israel Deaconess Medical Center, Boston, Massachusetts

**Thomas G. Gross, MD, PhD**

Associate Professor of Pediatrics, Department of Hematology/Oncology, Ohio State University College of Medicine and Public Health, Children's Hospital, Columbus, Ohio

**Eva C. Guinan, MD**

Associate Professor of Medicine, Department of Pediatric Oncology, Dana–Farber Cancer Institute, Division of Pediatric Hematology/Oncology, Children's Hospital Boston, Boston, Massachusetts

**Katherine S. Hamilton, MD**

Assistant Professor, Department of Pathology, Vanderbilt University School of Medicine, Nashville, Tennessee

**Kenneth R. Hande, MD**

Professor of Medicine and Pharmacology, Department of Medicine, Division of Hematology/Oncology, Vanderbilt University School of Medicine, Nashville, Tennessee

**Anthony R. Hayward, MD, PhD**

Director, Division of Clinical Research, National Center for Research Resources, National Institutes of Health, Bethesda, Maryland

**David R. Head, MD**

Professor, Department of Pathology, Vanderbilt University School of Medicine, Nashville, Tennessee

**Nancy M. Heddle, MSc, FCSMLS**

Associate Professor, Department of Medicine, McMaster University Faculty of Health Sciences, Hamilton, Ontario, Canada

**Madan H. Jagasia, MBBS**

Assistant Professor of Medicine, Department of Medicine, Division of Hematology/Oncology, Vanderbilt University School of Medicine, Nashville, Tennessee

**Michael R. Jeng, MD**

Assistant Professor, Department of Pediatrics, Stanford University School of Medicine, Stanford, California

**Nancy Swords Jenny, PhD**

Research Assistant Professor, Department of Pathology, University of Vermont College of Medicine, Colchester, Vermont

**James B. Johnston, MBBCh, FRCPC**

Professor of Medicine, Department of Internal Medicine, Section of Hematology/Oncology, University of Manitoba Faculty of Medicine, Winnipeg, Manitoba, Canada

**Russel E. Kaufman, MD**

Professor and Director, The Wistar Institute, Philadelphia, Pennsylvania

**Kenneth Kaushansky, MD**

Professor and Chair, Department of Medicine, University of California, San Diego, School of Medicine, San Diego, California

**John G. Kelton, MD**

Dean and Vice-President, McMaster University Faculty of Health Sciences, Hamilton, Ontario, Canada

**Marsha C. Kinney, MD**

Professor of Pathology, Department of Pathology, University of Texas Health Science Center at San Antonio, San Antonio, Texas

**Monika G. Kiripolsky, BS**

Fourth-Year Medical Student, Department of Dermatology, Vanderbilt University School of Medicine, Nashville, Tennessee

**Mark J. Koury, MD**

Professor, Department of Medicine, Division of Hematology/Oncology, Vanderbilt

University School of Medicine, Nashville, Tennessee

**Robert A. Kyle, MD**

Professor of Medicine, Laboratory Medicine, and Pathology, Department of Internal Medicine, Mayo Medical School, Rochester, Minnesota

**Martha Q. Lacy, MD**

Assistant Professor of Medicine; Consultant, Department of Hematology, Mayo Clinic, Rochester, Minnesota

**Paige Lacy, PhD**

Assistant Professor, Department of Medicine, University of Alberta Faculty of Medicine and Dentistry, Edmonton, Alberta, Canada

**Richard S. Larson, MD, PhD**

Associate Professor, Department of Pathology, University of New Mexico School of Medicine, Albuquerque, New Mexico

**Shirley Parker Levine, MD**

Professor of Medicine, Department of Medicine, Division of Hematology, Albert Einstein College of Medicine of Yeshiva University/Montefiore Medical Center, Bronx, New York

**Jeffrey M. Lipton, MD, PhD**

Professor of Pediatrics, Division of Pediatric Hematology/Oncology and Stem Cell Transplantation, Albert Einstein College of Medicine of Yeshiva University/Schneider Children's Hospital, New Hyde Park, New York

**Alan F. List, MD**

Professor of Medicine, University of South Florida College of Medicine, Director, Hematologic Malignancies Program, H. Lee Moffitt Cancer Center and Research Institute, Tampa, Florida

**Jay N. Lozier, MD, PhD**

Consulting Hematologist, Department of Laboratory Medicine, Warren G. Magnuson Clinical Center, National Institutes of Health, Bethesda, Maryland

**John N. Lukens, MD**

Professor of Pediatrics, Emeritus, Division of Pediatric Hematology/Oncology, Vanderbilt University School of Medicine, Nashville, Tennessee

**John A. Lust, MD, PhD**

Associate Professor of Medicine, Department of Internal Medicine, Division of Hematology, Mayo Clinic, Rochester, Minnesota

**William R. Macon, MD**

Associate Professor of Pathology, Department of Laboratory Medicine and Pathology, Mayo Medical School, Consultant, Mayo Clinic, Rochester, Minnesota

**James M. Malone, III, MD**

Assistant Medical Director, Transfusion Service, Staff Physician, Departments of Pathology and Medicine (Hematology), Stanford University School of Medicine, Stanford, California

**Lori J. Maness, MD**

Instructor of Medicine, Division of Hematology and Medical Oncology, University of Colorado School of Medicine, Denver, Colorado

**Kenneth G. Mann, PhD**

Professor of Biochemistry and Medicine, Department of Biochemistry, University of Vermont College of Medicine, Burlington, Vermont

**Catherine S. Manno, MD**

Associate Professor of Pediatrics, Hematology Division, University of Pennsylvania School of Medicine, Children's Hospital of Philadelphia, Philadelphia, Pennsylvania

**Peter W. Marks, MD, PhD**

Instructor in Medicine, Department of Medicine, Brigham and Women's Hospital, Boston, Massachusetts

**Peter G. Maslak, MD**

Associate Member, Department of Clinical Laboratories, Leukemia Service, Memorial Sloan-Kettering Cancer Center, New York, New York

**Thomas L. McCurley, MD**

Associate Professor, Department of Pathology, Vanderbilt University School of Medicine, Nashville, Tennessee

**Margaret M. McGovern, MD, PhD**

Associate Professor of Human Genetics and Pediatrics; Vice Chair, Department of Human Genetics, Mount Sinai School of Medicine of the City University of New York, New York, New York

**Robert T. Means, Jr., MD**

Professor of Medicine; Director, Department of Medicine, Hematology/Oncology Division, Medical University of South Carolina College of Medicine, Ralph H. Johnson Veterans Affairs Medical Center, Charleston, South Carolina

**William C. Mentzer, MD**

Professor, Department of Pediatrics, University of California, San Francisco, School of Medicine, San Francisco, California

**Dean D. Metcalfe, MD**

Chief, Laboratory of Allergic Diseases, National Institute of Allergy and Infectious Diseases/National Institutes of Health, National Institutes of Health Clinical Center, Bethesda, Maryland

**Redwan Moqbel, PhD**

Professor, Department of Medicine, University of Alberta Faculty of Medicine and Dentistry, Edmonton, Alberta, Canada

**David S. Morgan, MD**

Assistant Professor, Department of Medicine, Division of Hematology/Oncology, Vanderbilt University School of Medicine, Nashville, Tennessee

**Stephan W. Morris, MD**

Professor, Departments of Pathology and Hematology–Oncology, St. Jude Children’s Research Hospital, Memphis, Tennessee

**Richard A. Nash, MD**

Associate Member, Fred Hutchinson Cancer Research Center, Associate Professor, University of Washington School of Medicine, Seattle, Washington

**Anne T. Neff, MD**

Assistant Professor, Department of Pathology and Medicine, Vanderbilt University School of Medicine, Nashville, Tennessee

**Martin I. Newman, MD**

Fellow, Department of Surgery, New York Presbyterian Hospital, New York, New York

**H. Stacy Nicholson, MD, MPH**

Professor of Pediatrics, Department of Pediatric Hematology/Oncology, Oregon Health Sciences University School of Medicine, Portland, Oregon

**Robin K. Ohls, MD**

Associate Professor, Department of Pediatrics, University of New Mexico School of Medicine, Albuquerque, New Mexico

**Thomas Orfeo, PhD**

Research Associate, Department of Biochemistry, University of Vermont College of Medicine, Burlington, Vermont

**Frixos Paraskevas, MD**

Associate, Institute of Cell Biology, University of Manitoba Faculty of Medicine, Cancer Care Manitoba, Winnipeg, Manitoba, Canada

**Charles J. Parker, MD**

Professor, Department of Medicine, University of Utah School of Medicine, Veterans Affairs Medical Center, Salt Lake City, Utah

**Sherrie L. Perkins, MD, PhD**

Professor, Department of Pathology, University of Utah School of Medicine, Salt Lake City, Utah

**Ian Rabinowitz, MD**

Assistant Professor, Department of Internal Medicine, University of New Mexico School of Medicine, Albuquerque, New Mexico

**Harvey A. Ragan, DVM**

Staff Pathologist, Department of Toxicology, Batelle, Pacific Northwest National Laboratory, Richland, Washington

**S. Vincent Rajkumar, MD**

Associate Professor of Medicine, Department of Hematology, Mayo Clinic, Rochester, Minnesota

**Matthew M. Rees, MD**

Rutherford Hospital, Rutherfordton, North Carolina

**George M. Rodgers, MD, PhD**

Professor of Medicine and Pathology, University of Utah School of Medicine, Health Sciences Center, Veterans Affairs Medical Center, Medical Director, Coagulation Laboratory, ARUP Laboratories, Salt Lake City, Utah

**Andreas Rosenwald, MD**

Institute of Pathology, University of Würzburg, Würzburg, Germany

**Gerald J. Roth, MD**

Professor, Department of Medicine, University of Washington School of Medicine, Seattle Veterans Affairs Hospital, Seattle, Washington

**Sheila N. J. Sait**

Clinical Cytogenetics Laboratory, Department of Pathology and Leukemia Section, Department of Medicine, Roswell Park Cancer Institute, Buffalo, New York

**Avery A. Sandberg, MD, DSc**

Professor, Department of Pathology, University of Arizona College of Medicine, Phoenix, Arizona

**John T. Sandlund, MD**

Associate Professor of Pediatrics, Department of Hematology–Oncology, St. Jude Children’s Research Hospital, Memphis, Tennessee

**Stephen T. Sawyer, PhD**

Professor, Department of Pharmacology and Toxicology, Virginia Commonwealth University School of Medicine, Richmond, Virginia

**Paul J. Shami, MD**

Associate Professor of Medicine, Division of Medical Oncology, University of Utah School of Medicine, Veterans Affairs Medical Center, Salt Lake City, Utah

**Rebecca L. Shattuck–Brandt, PhD, MEd**

Teacher, Science Department, University School of Nashville, Nashville, Tennessee

**Akiko Shimamura, MD, PhD**

Instructor in Pediatrics; Assistant in Medicine, Department of Pediatric Hematology/Oncology, Children’s Hospital, Dana–Farber Cancer Institute, Boston, Massachusetts

**Keith M. Skubitz, MD**

Professor, Department of Medicine, Division of Hematology, Oncology, and Transplantation, Musculoskeletal Tumor Program, University of Minnesota Medical School, Minneapolis, Minnesota

**Elaine M. Sloand, MD**

Assistant to the Director; Clinical Investigator, Hematology Branch, National Heart, Lung, and Blood Institute, Bethesda, Maryland

**James William Smith, BS, MLT**

Coordinator, Platelet Immunology Laboratory, Department of Medicine, McMaster University Faculty of Health Sciences, Canadian Blood Services, Hamilton, Ontario,



Canada

**Steven L. Soignet, BS, MD**

Consultant, Department of Medicine, Memorial Sloan-Kettering Cancer Center, New York, New York

**Louis M. Staudt, MD, PhD**

Chief, Lymphoid Malignancies Section, Metabolism Branch, Center for Cancer Research, National Cancer Institute, Bethesda, Maryland

**Richard S. Stein, MD**

Associate Professor of Medicine, Department of Medicine, Division of Hematology/Oncology, Vanderbilt University School of Medicine, Nashville, Tennessee

**Stanford J. Stewart, MD**

Vice President, Clinical Research, Corixa Corporation, South San Francisco, California

**Marilyn J. Telen, MD**

Wellcome Professor of Medicine; Chief, Division of Hematology, Department of Medicine, Division of Hematology, Duke University Medical Center, Durham, North Carolina

**Mary Ann Thompson, MD, PhD**

Assistant Professor, Department of Pathology, Division of Hematopathology, Vanderbilt University School of Medicine, Nashville, Tennessee

**John F. Tisdale, MD**

Senior Investigator, Molecular and Clinical Hematology Branch, National Institute of Diabetes and Digestive and Kidney Disorders, Bethesda, Maryland

**Maurene K. Viele, MD**

Clinical Associate Professor, Department of Pathology, Stanford University School of Medicine, Stanford, California

**Madhuri Vusirikala, MD**

Assistant Professor, Department of Medicine, Division of Hematology/Oncology, Vanderbilt University Medical Center, Nashville, Tennessee

**Winfred C. Wang, MD**

Professor, Department of Pediatrics, University of Tennessee, Memphis, College of Medicine, Member, Department of Hematology/Oncology, St. Jude Children's Research Hospital, Memphis, Tennessee

**Russell E. Ware, MD, PhD**

Professor, Department of Pediatrics, Duke University School of Medicine, Durham, North Carolina

**Raymond G. Watts, MD**

The Frederick W. Renneker, III Endowed Chair in Pediatric Education; Associate Professor, Department of Pediatrics, Division of Hematology/Oncology, University of Alabama School of Medicine, Birmingham, Alabama

**Kathryn E. Webert, BSc, MD, FRCPC**

Clinical Scholar, Department of Medicine, McMaster University Faculty of Health

Sciences, Canadian Blood Services, Hamilton, Ontario, Canada

**J. Brice Weinberg, MD**

Professor, Department of Medicine, Duke University School of Medicine, Durham  
Veterans Administration Hospital, Durham, North Carolina

**James A. Whitlock, MD**

Associate Professor of Pediatrics; Director, Division of Pediatric Hematology/Oncology,  
Vanderbilt University School of Medicine, Nashville, Tennessee

**Wilbur L. Williams, MD**

Associate Professor, Department of Laboratory Medicine, New Mexico VA Health Care  
System, Albuquerque, New Mexico

**Thomas E. Witzig, MD**

Professor of Medicine, Department of Hematology, Mayo Clinic, Rochester, Minnesota

**Alexandra S. Worobec, MD**

Adjunct Investigator, Laboratory of Allergic Diseases, National Institute of Allergy and  
Infectious Diseases, National Institutes of Health, Bethesda, Maryland

**John A. Zic, MD**

Assistant Professor of Medicine, Department of Medicine, Division of Dermatology,  
Vanderbilt University School of Medicine, Nashville Veterans Administration, Nashville,  
Tennessee



## Dedication

*To Dr. Maxwell M. Wintrobe*

## EDITORS

### EDITED BY

#### **JOHN P. GREER, MD**

PROFESSOR OF MEDICINE AND PEDIATRICS  
DEPARTMENTS OF MEDICINE AND PEDIATRICS  
DIVISION OF HEMATOLOGY/ONCOLOGY  
VANDERBILT, UNIVERSITY SCHOOL OF MEDICINE  
NASHVILLE, TENNESSEE

#### **JOHN FOERSTER, MD, FRCPC**

PROFESSOR OF MEDICINE  
DIVISION OF HEMATOLOGY/ONCOLOGY  
UNIVERSITY OF MANITOBA FACULTY OF MEDICINE; DIRECTOR OF RESEARCH  
ST. BONIFACE GENERAL HOSPITAL, WINNIPEG  
MANITOBA, CANADA

#### **JOHN N. LUKENS, MD**

PROFESSOR OF PEDIATRICS, EMERITUS  
DIVISION OF PEDIATRIC HEMATOLOGY/ONCOLOGY  
VANDERBILT UNIVERSITY SCHOOL OF MEDICINE  
NASHVILLE, TENNESSEE

#### **GEORGE M. RODGERS, MD, PHD**

PROFESSOR OF MEDICINE AND PATHOLOGY  
UNIVERSITY OF UTAH  
SCHOOL OF MEDICINE HEALTH SCIENCES CENTER  
VETERANS AFFAIRS MEDICAL CENTER; MEDICAL DIRECTOR  
COAGULATION LABORATORY, ARUP LABORATORIES  
SALT LAKE CITY, UTAH

#### **FRIXOS PARASKEVAS, MD**

ASSOCIATE, INSTITUTE OF CELL BIOLOGY  
UNIVERSITY OF MANITOBA; FACULTY OF MEDICINE  
CANCER CARE MANITOBA, WINNIPEG  
MANITOBA, CANADA

#### **BERTIL GLADER, MD, PHD**

PROFESSOR OF PEDIATRICS  
DIVISION OF HEMATOLOGY/ONCOLOGY  
STANFORD UNIVERSITY SCHOOL OF MEDICINE  
STANFORD, CALIFORNIA

### **Secondary Authors**

#### **JONATHAN PINE**

Acquisitions Editor  
Silverchair Science + Communications

#### **ALYSON FORBES**

Developmental Editor  
Silverchair Science + Communications

**TANYA LAZAR**  
Managing Editor  
Silverchair Science + Communications

**MARY ANN MCLAUGHLIN**  
Supervising Editor  
Silverchair Science + Communications

**LUCINDA EWING**  
Production Editor  
Silverchair Science + Communications

**JANE B. MCQUEEN**  
Production Editor  
Silverchair Science + Communications

**BEN RIVERA**  
Manufacturing Manager

**CHRISTINE JENNY**  
Cover Designer

## Preface

Blut ist ein ganz besonderer Saft.  
Goethe, 1808

Maxwell M. Wintrobe often cited Goethe, “Blood is a very special kind of fluid,” and the Eleventh Edition of *Wintrobe’s Clinical Hematology* is a testimony to Dr. Wintrobe’s legacy and commitment to the field of hematology. This edition extends the chronicle of progress to 60 years since the first edition of the book. The first six editions were the sole work of Dr. Wintrobe. When he retired from the editorship, Dr. Wintrobe recruited five former fellows to take over the task: Jack Athens, Tom Bithell, Dane Boggs, John Foerster, and Richard Lee. John Foerster remains an editor from the original group, and John Lukens joined the editorship in the eighth edition. John Greer, Frixos Paraskevas, and George Rodgers contributed to the ninth edition and became editors of the tenth edition. Bert Glader is a welcome addition to the present edition. Of the present group of editors, three (Foerster, Lukens, and Rodgers) worked directly with Dr. Wintrobe, whereas the other three (Glader, Greer, and Paraskevas) have been associated with Wintrobe-trained individuals.

Dr. Wintrobe recognized the work of predecessors and the foundation of clinical hematology in basic research. In *Blood, Pure and Eloquent. A Story of Discovery, of People and of Ideas* (1980), Dr. Wintrobe edited historical milestones in hematology and emphasized three lessons of history:

1. Research starts with an idea, which may take many directions before becoming a valid concept: “The path of progress is anything but straight. It is rough and rocky and often seems to wander endlessly and in all directions; it has many blind alleys and is strewn with the debris of false hopes, of failures, and discouragement. The course of research has been likened to the flow of a stream that ultimately becomes a rushing torrent.”
2. A sense of skepticism is warranted in the practice of medicine: “What was held to be the truth yesterday may not be so regarded today, and tomorrow the story may again be somewhat different.”
3. Perseverance is required to make progress: “... many look, but few see. It is the exceptional person who recognizes the unusual event or manifestation. Still fewer pursue it to a new understanding. Many may ask questions but few have the imagination, the energy, and the overpowering drive to persist in the search for an answer, especially when this must be done in the face of difficulties and failures and even in spite of scorn from their peers” (1).

Although his statements may seem pessimistic, Dr. Wintrobe optimistically recognized the importance of building on prior contributions and the relationship between clinical hematology and basic research. Hematology has many stories characterized initially by clinical observations that are now understood at a molecular genetic level (2,3). Sickle cell anemia, pernicious anemia, hemophilia, Burkitt lymphoma, acute promyelocytic leukemia, and chronic myeloid leukemia are among the most interesting topics in medicine. The speed of basic research to the clinical bedside was remarkable in the twentieth century, and it promises to be even faster and more widely applied in the future.

The Eleventh Edition of *Wintrobe’s Clinical Hematology* ushers in the twenty-first century with the same principles found in the prior editions and with the additional availability of the knowledge base through the Internet. The value of books has been questioned in this

new era. This edition retains the historical perspective of *Wintrobe's Clinical Hematology*, with extensive references; brings together the body of information on hematology in a single source; and bridges topics to the Internet with Web links cited by many of the authors in their chapters. As with other multiauthored textbooks, there are occasional redundancies, which are important observations that allow a chapter to stand alone, and there are cross references to other chapters that indicate the interdependence of the topics.

We appreciate each author's contribution to the book. We have brought together clinician educators, pathologists, and physician scientists to review their topics of expertise. All of the chapters except Dr. Wintrobe's introduction to the approach to hematologic problems either have been revised or are new with an emphasis on molecular aspects of hematology. This edition recognizes the transition from a morphologic classification of hematopoietic neoplasms to the World Health Organization's classification that incorporates molecular genetics.

We appreciate the efforts of Jonathan Pine, Senior Executive Editor at Lippincott Williams & Wilkins; Alyson Forbes, Developmental Editor, and Tanya Lazar, Managing Editor at Lippincott; Mary Ann McLaughlin, Supervising Editor at Lippincott; and Lucinda Ewing and Jane McQueen, Production Editors at Silverchair Science + Communications. Their unique combination of persistence and kindness and their commitment to the principles of prior editions brought the project to completion. We hope the readers find the information they seek in the Eleventh Edition of *Wintrobe's Clinical Hematology*.

Below, each of us acknowledges people who have assisted him in this endeavor.

Debbie Saurette, my faithful secretary and colleague, has provided invaluable services in the completion of this edition. My wife, Gisela, and our children David, Steven, and Susan, physicians all, have been a constant source of support and inspiration. Special thanks go to my mentors, Dr. L. G. Israels, whose enthusiasm for hematology and his ability to combine effectively clinical service, teaching, and research, drew me to this specialty as a medical student; Dr. M. M. Wintrobe, who taught me in his own unique way and gave me the opportunity to contribute to several editions of this great textbook; Dr. B. Benacerraf, who nurtured my interests in immunology; and my colleagues at the Mayo Clinic and elsewhere who have contributed valuable chapters to this text.

### **John Foerster**

I wish to thank Jennifer Lu, Kari Costa, Theresa McCann, and Annamarie Coelho for administrative help. I also wish to acknowledge the many outstanding authors I have had the privilege to work with in the preparation of this edition. Last, but not most of all, I want to acknowledge the understanding and support of my wife, Lou Ann; my children, Laurie, Anders, and Eric; their families; and our friends.

### **Bert Glader**

I wish to thank Billi Bean, my assistant and colleague; Patti Lee at the Eskin Library of the Vanderbilt University School of Medicine; my wife, Gay; and our children, Lesley, Adam, and Scott; my mentors, including Robert Collins, John Flexner, Stanley Graber, Sanford Krantz, and John Lukens; Ellen Benneyworth and other nurses; and our patients.

### **John P. Greer**

My contribution to this edition could not have been made without the understanding and unselfish support of my wife, Cauley Lukens. She and our children have weathered long hours and aborted vacations with encouragement and grace.

### **John N. Lukens**

I want to express my deeply felt gratitude and appreciation to my wife Maria for her support and unwavering encouragement throughout the period of writing and especially when deadline worries became unmanageable. Maria, as a pathologist, has also been the testing ground for fine-tuning of complex concepts, helping me to lift them from the unfathomable depths of technicality and into the light of understanding. I want to thank Ms. Lynne Savage for her expert secretarial assistance and perseverance when “last copy” was proved to be just another in a never-ending line of typing. Our librarian, Donna Pacholok, helped me navigate the complex connections with the Internet. My sincere thanks to several colleagues for providing literature assistance or photography from their own data: A. A. Anderson, G. G. Gao, J. E. Gretz, L.A. Herzenberg, H. Kogelberg, J. Lambris, D. Y. Mason, C. Morales, K. H. Roux, P. Nickerson, H. Seguchi, S. Shaw, and H. Zimmerman.

### **Frixos Paraskevas**

I acknowledge Robyn LeMon and Sherry Hartline for typing assistance, my numerous contributors for their hard work and timely submissions, and my family and friends for their support.

### **George M. Rodgers**

#### **REFERENCES**

- Wintrobe MM. Blood, pure and eloquent. A story of discovery, of people, and of ideas. New York: McGraw-Hill, 1980:720.
- Wintrobe MM. Hematology, the blossoming of a science: a story of inspiration and effort. Philadelphia: Lea & Febiger, 1985.
- Lichtman MA, Spivak JL, Boxer LA, et al., eds. Hematology: landmark papers of the twentieth century. San Diego: Academic Press, 2000.



## SPECIMEN COLLECTION

## RELIABILITY OF TESTS

## CELL COUNTS

### Aperture-Impedance Counters

### Optical Method Counters

### Combined Impedance and Optical Counters

## RED BLOOD CELL ANALYTIC PARAMETERS

### Volume of Packed Red Cells (Hematocrit)

### Hemoglobin Concentration

### Red Cell Count

### Mean Corpuscular Volume

### Mean Corpuscular Hemoglobin

### Mean Corpuscular Hemoglobin Concentration

### Red Cell Distribution Width

### Automated Reticulocyte Counts

## LEUKOCYTE ANALYSIS

### White Blood Cell Counts

### Leukocyte Differentials

## PLATELET ANALYSIS

## ADVANTAGES AND SOURCES OF ERROR WITH AUTOMATED HEMATOLOGY ANALYZERS

## MORPHOLOGIC ANALYSIS OF BLOOD CELLS

### Preparation of Blood Smears

### Routine Staining of Blood Smears

### Examination of the Blood Smear

### Other Means of Examining Blood

## BONE MARROW EXAMINATION

### Bone Marrow Aspiration and Biopsy

### Staining and Evaluation of Bone Marrow Aspirates and Touch Preparations

### Examination of Bone Marrow Histologic Sections

## SPECIAL STAINS

### Cytochemical Stains

### Immunocytochemical Stains

## OTHER LABORATORY STUDIES

### Cytogenetic Analysis

### Molecular Genetics

### Electron Microscopy

### Erythrocyte Sedimentation Rate

### Plasma and Blood Viscosity

### Total Quantity of Blood

## REFERENCES

Careful assessment of the blood elements is often the first step in assessment of hematologic function and diagnosis. Many hematologic disorders are defined by specific findings gleaned from blood tests. Examination of blood smears and hematologic parameters often yields important diagnostic information and allows broad differential diagnostic impressions to be formed, directing further, more specific testing. Careful examination of cellular morphology, in concert with quantification of the blood elements and evaluation of a variety of parameters relating to cellular size and shape, is required. This chapter introduces the fundamental concepts that underlie laboratory evaluation of the blood and outlines additional testing that may aid in evaluating a hematologic disorder,

including special stains and bone marrow examination. Limitations of such tests are also addressed.

Blood elements include erythrocytes, or red cells; leukocytes, or white cells; and platelets. Although detailed morphologic descriptions and functional characteristics of each of the cell types are included in subsequent chapters, basic features necessary for blood smear analyses are covered in this chapter. *Red cells* are the most numerous cells in the blood and are required for tissue respiration. Erythrocytes lack nuclei and contain hemoglobin, an iron-containing protein that acts in the transport of oxygen and carbon dioxide. *White blood cells* serve in immune function and include a variety of cell types that have specific functions and characteristic morphologic appearances. In contrast to red cells, white cells are nucleated. The five types of white blood cells seen normally in blood smears are neutrophils, lymphocytes, monocytes, eosinophils, and basophils. *Platelets* are cytoplasmic fragments derived from megakaryocytes in the bone marrow that function in coagulation and hemostasis.

Evaluation of the blood requires quantification of each of the cellular elements by either manual or automated methods. Automated methods, using properly calibrated equipment (1), are usually more precise than manual procedures. In addition, automated methods may provide additional data describing characteristics such as cell volume. However, the automated measurements describe *average* cell characteristics but do not adequately describe the scatter of individual values around the average. Hence, a bimodal population of small (microcytic) and large (macrocytic) red cells might register as a normal cell size. Therefore, a thorough examination of blood also requires microscopic evaluation of a stained blood film to complement the hematology analyzer data.

## SPECIMEN COLLECTION

Proper specimen collection is required for reliable and accurate laboratory data to be obtained on any hematologic specimen. Before a specimen is obtained, careful thought as to what studies are needed will aid in proper handling of the material and prevent collection of inadequate or unusable specimens. Communication with laboratory personnel who will analyze the specimen is often helpful in ensuring that specimens will be handled properly and that the requested testing can be performed.

A number of factors may affect hematologic measurements, and each specimen should be collected in a standardized manner to reduce variability. Factors such as patient activity, level of patient hydration, medications, sex, age, race, smoking, and anxiety may affect hematologic parameters significantly (2, 3 and 4). Similarly, the age of the specimen may affect the quality of the data collected (5). Thus, data such as patient age, sex, and time of specimen collection should be noted. Correlative clinical information is also extremely important in evaluating hematologic specimens. For example, a patient who has had severe diarrhea or vomiting before admission may be sufficiently dehydrated to have an erroneous increase in red blood cell concentration.

Most often, blood is collected by venipuncture into tubes containing anticoagulant. The three most commonly used anticoagulants are tripotassium or disodium salts of ethylenediaminetetraacetic acid (EDTA), trisodium citrate, and heparin. EDTA and disodium citrate act to remove calcium, which is essential for the initiation of coagulation, from the blood. Heparin acts by forming a complex with antithrombin III in the plasma to prevent the formation of thrombin. EDTA is the preferred anticoagulant for blood cell counts because it produces complete anticoagulation with minimal morphologic and physical effects on all types of blood cells (6). Heparin causes a bluish coloration of the background when a blood smear is stained with one of the Romanowsky dyes but does not affect cell size or shape. Heparin is most often used for prevention of red blood cell

hemolysis, for osmotic fragility testing, and for functional and immunologic analysis of leukocytes. Heparin does not completely inhibit white blood cell or platelet clumping. Trisodium citrate is the preferred anticoagulant for platelet and coagulation studies. Other anticoagulants have been identified that give results similar to EDTA, such as argatroban (7), although none has achieved widespread use in normal clinical settings

The concentration of the anticoagulant used may affect cell concentration measures if it is inappropriate for the volume of blood collected and may also distort cellular morphology. Most often, blood is collected directly into commercially prepared negative-pressure vacuum tubes (Vacutainer tubes; Becton Dickinson, Franklin Lakes, NJ), which contain the correct concentration of anticoagulant when filled appropriately, thereby minimizing error (8). Anticoagulated blood may be stored at 4° C for a 24-hour period without significantly altering cell counts or cellular morphology (5). However, it is preferable to perform hematologic analysis as soon as possible after the blood is obtained.

## RELIABILITY OF TESTS

In addition to proper acquisition of specimens, data reliability requires precise and reproducible testing methods. Both manual and automated testing of hematologic specimens must be interpreted in light of test precision. This becomes especially important when evaluating the significance of small changes. All laboratory tests are evaluated with respect to both accuracy and reproducibility. *Accuracy* is the difference between the measured value and the true value, which implies that a true value is known. Clearly, this may present difficulties when dealing with biologic specimens. The National Committee for Clinical Laboratory Standards and the International Committee for Standards in Haematology have attempted to develop standards to assess the accuracy of hematologic examination (9) and automated blood cell analyzers (10). Automated instrumentation requires regular quality assurance evaluations and careful calibration to reach expected performance goals and ability to collect reproducible data (1, 11).

## CELL COUNTS

Cell counts are important parameters in evaluating the blood. Cell counts may be determined either manually or by automated hematology analyzers. Whether performed by manual or automated methodologies, the accuracy and precision of the counts depend on proper dilution of the blood sample and precise sample measurement. Blood must be precisely aliquoted and diluted, so that cells are evenly distributed within the sample to be analyzed. Because blood contains large numbers of cells, sample dilution is usually required for accurate analysis. The type of diluent is dependent on the cell type to be enumerated. Thus, red cell counts require dilution with an isotonic medium, whereas in white cell or platelet counts, a diluent that lyses the more numerous red cells is often used to simplify counting. The extent of dilution also depends on the cell type. In general, red cell counts need more dilution than is required for the less abundant white blood cells. Errors in cell counts are caused primarily by errors in sample measurement, dilution, or enumeration of cells. The highest degree of precision occurs when a very large number of cells can be evaluated. Clearly, automated methods are superior to manual methods for counting large numbers of cells and minimizing statistical error. [Table 1.1](#) lists the comparable values of reproducibility for automated and manual (hemocytometer) counting methods.

**TABLE 1.1. Reproducibility of Blood Counting Procedures**

---

## Two Coefficients of Variation

| Cell Type Counted      | Hemocytometer <sup>a</sup><br>(%) | Automated Hematology<br>Analyzer (%) |
|------------------------|-----------------------------------|--------------------------------------|
| Red cells              | ±11.0                             | ±1.0                                 |
| White cells            | ±16.0                             | ±1.5                                 |
| Platelets <sup>b</sup> | ±22.0                             | ±2.0                                 |
| Reticulocytes          | ±33.9                             | ±5.0                                 |

<sup>a</sup> Minimum error. Usual error.

<sup>b</sup> Error may be greater with low ( $<35 \times 10^9/L$ ) or very high ( $>450 \times 10^9/L$ ) platelet counts.

Data derived from Bentley S, Johnson A, Bishop C. A parallel evaluation of four automated hematology analyzers. *Am J Clin Pathol* 1993;100:626–632; and Wintrobe M. A simple and accurate hematocrit. *J Lab Clin Med* 1929;15:287–289.

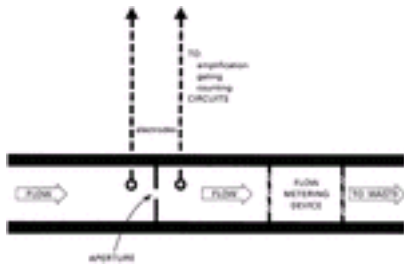
Manual counts are carried out after appropriate dilution of the sample in a *hemocytometer*, a specially constructed counting chamber that contains a specific volume. Cells may then be counted with a microscope. Red blood cells, leukocytes, and platelets may be counted by this method ( [13](#) ). Due to the inherent imprecision of manual counts and the amount of technical time required, most cell counting is now performed by automated or semiautomated instruments. These machines increase the accuracy and speed of analysis by the clinical laboratory, particularly as test entry, sampling, sample dilution, and analysis are incorporated into single systems with minimal human manipulation ( [12](#), [13](#) ). With increasing levels of automation, some hematology analyzers have now moved to complete automation, which can be coupled with other laboratory tests using the same tube of blood. There are a variety of different automated hematology analyzers available, dependent on the volume of samples to be tested and the needs of the physician group ordering testing. The analyzers range in price and workload capacity from those that would be appropriate for an individual physician's office or point-of-care facility to those needed in a busy reference laboratory with capacity for over 100 samples to be analyzed per hour ( [14](#) ).

Most automated hematology analyzers perform a variety of hematologic measurements, such as hemoglobin concentration (Hb), red cell size, and leukocyte differentials. Newer instruments may also perform more specialized testing, such as reticulocyte counts ( [15](#) ). The ability of the new analyzers to perform accurate white cell differential counts, particularly those that can perform a five-part differential (enumerating neutrophils, lymphocytes, monocytes, eosinophils, and basophils), has been a significant technologic advance over the past 10 years. Automated methods for white cell counts and differentials use several distinct technical approaches ( [16](#) ), including those that measure changes in electrical impedance and those that use differences in light scatter or optical properties, either alone or in combination ( [17](#) ). Another recent advance in hematology analyzers is incorporation of argon laser technology, allowing integration of some flow cytometric data using specific fluorochrome stains, such as T-cell subsets (CD4:CD8) or CD34 positive cells, with routine hematologic analyses ( [18](#) ).

### Aperture-Impedance Counters

This type of analyzer, which includes the Coulter (Beckman Coulter, Hialeah, FL), the

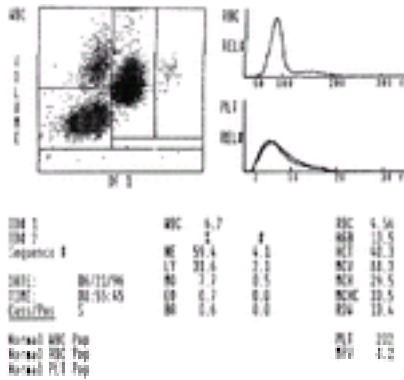
Sysmex (Baxter Diagnostics, Waukegan, IL), and some Cell-Dyn (Abbott Diagnostics, Santa Clara, CA) instruments, enumerates cells in a small aperture by measuring changes in electrical resistance as the cell passes through the orifice ( Fig. 1.1). A constant current passes between two platinum electrodes on either side of the orifice. The diluent that suspends the cells is more electrically conductive than are the cells. Hence, as each cell passes through the orifice, there is a momentary decrease in electrical conductance so that an electrical impulse is generated and recorded electronically. The drop in voltage is proportional to cell size, allowing average cell size to be determined simultaneously ( 19, 20 ).



**Figure 1.1.** Impedance type of automated hematology analyzer. As the cells pass through the aperture, they alter the current flow between the electrodes, generating an electronic pulse. Each pulse is recorded electronically. The magnitude of the pulse is proportional to the cell's volume.

Instruments using aperture-impedance technology require even cell suspensions so that cells pass individually through the electrical current. Distortion of the electrical pulses may occur when the cells do not pass through the center of the aperture or when more than one cell enters the aperture at a time. The data may be electronically adjusted to exclude distorted peaks, and both upper and lower limits of particle size can be set to exclude cellular clumps or debris. Using size limitation parameters, the instrument can be used to count particles of different sizes, thereby allowing different blood elements to be enumerated ( 21 ). Most of the modern analyzers can also be set to flag abnormal or suspect results, allowing for identification of those samples that need further, manual evaluation ( 22 ).

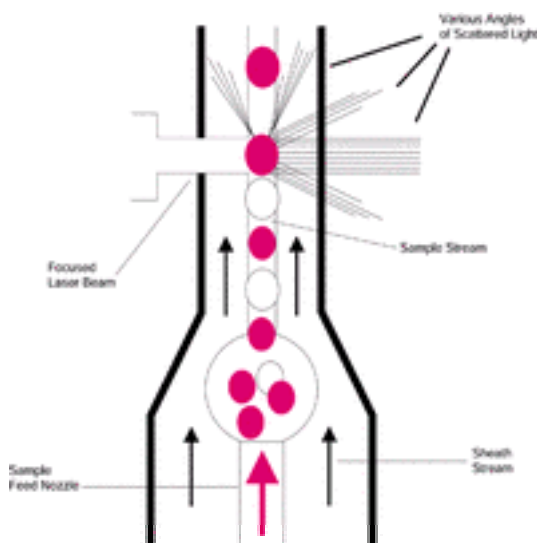
The Coulter-type counters are probably the most widely used example of hematology analyzers that use electrical impedance methods. Most models print data in numerical form as well as providing histograms of blood cell size ( Fig. 1.2). Newer models often combine impedance and optical methodologies (described below). Data generated include a three- or five-part white cell differential in addition to red cell counts, white cell counts, platelet counts, reticulocyte counts, hemoglobin, hematocrit (Hct), mean corpuscular volume (MCV), mean corpuscular hemoglobin (MCH), mean corpuscular hemoglobin concentration (MCHC), red cell distribution width (RDW), and mean platelet volume (MPV). This type of instrumentation fully analyzes up to 109 samples per hour, depending on the model used, and flags abnormal red and white cell populations, including blasts and atypical cells 23 .



**Figure 1.2.** Histograms and printout generated by the Coulter STKR automated hematology analyzer. BA, basophil; EO, eosinophil; HCT, hematocrit; HGB, hemoglobin; LY, lymphocyte; MCH, mean corpuscular hemoglobin; MCHC, mean corpuscular hemoglobin concentration; MCV, mean corpuscular volume; MO, monocyte; MPV, mean platelet volume; NE, neutrophil; PLT, platelet; RBC, red blood cell; RDW, red cell distribution width; WBC, white blood cell.

### Optical Method Counters

The other method commonly used in hematology analyzers depends on the light scatter properties of blood cells ( [24](#), [25](#) ). Some instruments that use this technology include the Technicon series (H6000, H\*1, H\*2, H\*3) (Bayer Diagnostic Division, Tarrytown, NY) and the Cell-Dyn instruments. In these systems, diluted blood passes through a flow cell detector placed in the path of a narrowly focused beam of light (usually a laser) ( [Fig. 1.3](#) ). When the blood cells pass through the counting chamber, they interrupt or alter the beam of light, thereby generating an electrical impulse that may be recorded. The pattern of light scattering using different angles of detection may also be used to determine cell size, volume, shape, and cell cytoplasmic complexity ( [17](#), [19](#) ). Optical systems count red cells, white cells, and platelets with precision equivalent to that observed in electrical impedance methods ( [26](#), [27](#) ). Similar to the impedance analyzers, many of the optical analyzers can process over 100 specimens per hour and have the capacity to flag abnormal parameters ( [26](#) ).



**Figure 1.3.** Optical type of automated hematology analyzer. A suspension of cells is



passed through a flow chamber and focused into a single cell sample stream. The cells pass through a chamber and interact with a laser light beam. The scatter of the laser light beam at different angles is recorded, generating signals that are converted to electronic signals giving information about cell size, structure, internal structure, and granularity. (Adapted from Cell-Dyn 3500 Operator's Manual. Santa Clara, CA: Abbott Diagnostics, 1993.)

## Combined Impedance and Optical Counters

Some of the newer hematology analyzers have combined impedance and optical methods together within one instrument, thereby allowing for optimal use and integration of the data generated by each method. Often, these are high-volume instruments, appropriate for larger hospitals and reference laboratories, and may be more expensive than some of the single-approach models. Examples of combined impedance and optical method analyzers include the Beckman Coulter Gen-S (Hialeah, FL) and Cell-Dyn 4000. Many of these newer instruments also provide an automated reticulocyte count and have improved precision of automated differential counts so as to lower the need for manual reviews by a technician ( [28](#) ).

## RED BLOOD CELL ANALYTIC PARAMETERS

Red blood cells are defined by three quantitative values: the volume of packed red cells or Hct, the Hb, and the red cell concentration per unit volume. Three additional indices describing average qualitative characteristics of the red cell population are also collected. These include mean MCV, MCH, and MCHC. All of these values are collected and calculated by automated counters, largely replacing many of the previously used manual or semiautomated methods of red blood cell characterization with certain exceptions as noted below.

### Volume of Packed Red Cells (Hematocrit)

The volume of packed red cells, or Hct, is the proportion of the volume of a blood sample that is occupied by red blood cells. The Hct may be determined manually by centrifugation of blood at a given speed and time in a standardized glass tube with a uniform bore, as was originally described by Wintrobe ( [29](#) ). The height of the column of red cells compared with that of the total blood sample after centrifugation yields the Hct. Macro (using 3-mm test tubes) methods with low-speed centrifugation or micro methods using capillary tubes and high-speed centrifugation may be used.

The manual method of measuring Hct has proved to be a simple and accurate method of assessing red cell status. It is easily performed with little specialized equipment, allowing it to be adapted for situations in which automated cell analysis is not readily available or for office use. However, several sources of error are inherent in the technique. The spun Hct measures the red cell concentration, not red cell mass. Therefore, patients in shock or with volume depletion may have normal or high Hct measurements due to hemoconcentration despite a decreased red cell mass. Technical sources of error in manual Hct determinations usually arise from inappropriate concentrations of anticoagulants ( [30](#) ), poor mixing of samples, or insufficient centrifugation ( [29](#) ). Another inherent error in manual Hct determinations arises from trapping of plasma in the red cell column. This may account for 1 to 3% of the volume in microcapillary tube methods, with macrotube methods trapping more plasma ( [31](#), [32](#) ). In addition, it should be noted that abnormal red cells (e.g., sickle cells, microcytic cells, macrocytic cells, or spherocytes) often trap higher volumes of plasma due to increased cellular rigidity, possibly accounting

for up to 6% of the red cell volume ( [31](#) ). Very high Hcts, as in polycythemia, may also have excess plasma trapping. Manual Hct methods typically have a precision [coefficient of variation (CV)] of approximately 2% ( [31](#) ).

Automated analyzers do not depend on centrifugation techniques to determine Hct, but instead calculate Hct by direct measurements of red cell number and red cell volume (Hct = red cell number/red cell volume). The automated Hct closely parallels manually obtained values, so that manual Hct methodology is used as the reference method for automated methods (with correction for the error induced by plasma trapping). Errors of automated Hct calculation are more common in patients with polycythemia ( [33](#) ) or abnormal plasma osmotic pressures ( [34](#) ). Manual methods of Hct determination may be preferable in these cases. The precision of most automated Hcts is less than 1% (CV) ( [28](#) ).

### Hemoglobin Concentration

Hemoglobin is an intensely colored protein, which allows its measurement by a variety of colorimetric and spectrophotometric techniques. Hemoglobin is found in the blood in a variety of forms, including oxyhemoglobin, carboxyhemoglobin, methemoglobin, and other minor components. These may be converted to a single stable compound, cyanmethemoglobin, by mixing blood with Drabkin solution, which contains potassium ferricyanide and potassium cyanide ( [35](#) , [36](#) ). Sulfhemoglobin is not converted but is rarely present in significant amounts. The absorbance of the cyanhemoglobin is measured in a spectrophotometer at 540 nm to determine hemoglobin. Similar methods are used in both manual methods and automated cell analyzers. Hb is expressed in grams per deciliter (g/dl) of whole blood. The main errors in measurement arise from dilution errors or increased sample turbidity due to improperly lysed red cells, leukocytosis, or increased levels of lipid or protein in the plasma ( [37](#) , [38](#) , [39](#) and [40](#) ). Using automated methods, the precision for hemoglobin determinations is less than 1% (CV) ( [25](#) ).

### Red Cell Count

Manual methods for counting red cells have proven to be very inaccurate, and automated counters provide a much more accurate reflection of red cell numbers ( [26](#) , [41](#) ). Both erythrocytes and leukocytes are counted in whole blood that has been diluted in an isotonic medium. As the number of red cells greatly exceeds the number of white cells (by a factor of 500 or more), the error introduced by counting both cell types is negligible. However, when marked leukocytosis is present, red cell counts and volume determinations may be erroneous unless corrected for white cell effects. The observed precision for red cell counts using automated hematology analyzers is less than 1% (CV) ( [28](#) ) compared with a minimal estimated value of 11% using manual methods ( [29](#) ).

### Mean Corpuscular Volume

The average volume of the red blood cells is a useful red cell index that is used in classification of anemias and may provide insights into pathophysiology of red cell disorders ( [42](#) ). The MCV is usually measured directly with automated instruments but may also be calculated from the erythrocyte count and the Hct by means of the following formula ( [29](#) ).

$$\text{MCV} = \text{Hct (L/L)} \times 1000 / \text{red cell count (10}^{12}\text{/L)}$$



The MCV is measured in femtoliters (fl, or  $10^{-15}$  L). Using automated methods, this value is derived by dividing the summation of the red cell volumes by the erythrocyte count. The CV in most automated systems is approximately 1% ( [28](#) ).

Agglutination of red blood cells, as in cold agglutinin disease, may result in a falsely elevated MCV ( [43](#) ). Most automated systems gate out MCVs above 360 fl, thereby excluding most red cell clumps, although this may falsely lower Hct determinations. In addition, severe hyperglycemia (glucose >600 mg/dl) may cause osmotic swelling of the red cells, leading to a falsely elevated MCV ( [34](#) , [44](#) ). The CV for automated MCV measurements is less than 1%, compared with approximately 10% for manual methods ( [32](#) ).

### Mean Corpuscular Hemoglobin

*MCH* is a measure of the average hemoglobin content per red cell. It may be calculated manually or by automated methods using the following formula [29](#).

$$\text{MCH} = \text{hemoglobin (g/L)} / \text{red cell count (10}^{12}\text{/L)}$$

MCH is expressed in picograms (pg, or  $10^{-12}$  g). Thus, the MCH is a reflection of hemoglobin mass. In anemias in which hemoglobin synthesis is impaired, such as iron deficiency anemia, hemoglobin mass per red cell decreases with a resultant decrease in MCH. MCH measurements may be falsely elevated by hyperlipidemia ( [38](#) ), as increased plasma turbidity may erroneously elevate the hemoglobin measurement. Leukocytosis may also spuriously elevate MCV values ( [37](#) ). Centrifugation of the blood sample to eliminate the turbidity followed by manual hemoglobin determination allows correction of the MCH value. The CV for automated analysis of MCH is less than 1% in most modern analyzers, compared with approximately 10% for manual methods ( [28](#) , [32](#) ).

### Mean Corpuscular Hemoglobin Concentration

The average concentration of hemoglobin in a given red cell volume or MCHC may be calculated by the following formula ( [29](#) ).

$$\text{MCHC} = \text{hemoglobin (g/dl)} / \text{Hct (L/L)}$$

The MCHC is expressed in grams of hemoglobin per deciliter of packed red blood cells. This represents measurement of Hb or the ratio of hemoglobin mass to the volume of red cells. With the exception of hereditary spherocytosis and some cases of homozygous sickle cell or hemoglobin C disease, MCHC values will not exceed 37 g/dl. This level is close to the solubility value for hemoglobin, and further increases in Hb may lead to crystallization. The accuracy of the MCHC determination is affected by factors that affect measurement of either Hct (plasma trapping or presence of abnormal red cells) or hemoglobin (hyperlipidemia, leukocytosis) ( [37](#) ). The CV for MCHC for automated methods ranges between 1.0 and 1.5% ( [28](#) ).

As noted above, the MCV, MCH, and MCHC reflect average values and may not adequately describe blood samples when mixed populations of cells are present. For example, in sideroblastic anemias, a dimorphic red cell population of both hypochromic and normochromic cells may be present, yet the indices may be normochromic and

normocytic. It is important to examine the blood smear as well as red cell histograms to detect such dimorphic populations. The MCV is an extremely useful value in classification of anemias ( [42](#) ), but the MCH and MCHC often do not add significant, clinically relevant information. However, the MCH and MCHC play an important role in laboratory quality control because these values will remain stable for a given specimen over time ( [19](#) ).

### Red Cell Distribution Width

The *RDW* is a red cell measurement that quantitates red cell volume heterogeneity that is provided by the more modern automated hematology analyzers and reflects the range of red cell sizes measured within a sample ( [45](#) ). *RDW* has been proposed to be useful in early classification of anemias because it becomes abnormal earlier in nutritional deficiency anemias than any of the other red cell parameters, especially in cases of iron deficiency anemia ( [42](#), [46](#), [47](#) ). *RDW* is particularly useful when characterizing microcytic anemias, particularly distinguishing between iron deficiency anemia (high *RDW*, normal to low MCV) and uncomplicated heterozygous thalassemia (normal *RDW*, low MCV) ( [42](#), [47](#), [48](#), [49](#) and [50](#) ). *RDW* is useful as a method for initial characterization of anemia, particularly microcytic anemias, although other tests are usually required to confirm the diagnosis ( [51](#) ). *RDW* is also useful in identifying red cell fragmentation, agglutination, or dimorphic cell populations (including patients who have had transfusions or have been recently treated for a nutritional deficiency) ( [47](#), [52](#) ).

### Automated Reticulocyte Counts

Determination of the numbers of reticulocytes or immature, nonnucleated red blood cells that contain RNA provides useful information about the bone marrow's capacity to synthesize and release red cells in response to a physiologic challenge, such as anemia. In the past, reticulocyte counts were performed manually using supravital staining with methylene blue. Reticulocytes will stain precipitated RNA that appears as a dark blue meshwork or granules (at least two per cell) allowing reticulocytes to be identified and enumerated by manual counting methods ( [53](#) ). Normal values for reticulocytes in adults are 0.5 to 1.5%, although they may be 2.5 to 6.5% in newborns (falling to adult levels by the second week of life). Because there are relatively low numbers of reticulocytes, the CV for reticulocyte counting is relatively large (10 to 20%). To increase accuracy of reticulocyte counting, alternative methods using flow cytometry and staining with acridine orange or thioflavin allow for many more cells to be analyzed, thereby increasing accuracy and precision of counts ( [15](#), [54](#), [55](#) ).

Stand-alone reticulocyte analyzers, such as the Sysmex R-2000 or ABX PENTRA 120 Retic (ABX Diagnostics, Montpellier, France), allow for determination of reticulocyte counts without requiring a full flow cytometer, affording increased accuracy over manual counts. Many of the newest automated hematology analyzers, such as the Coulter STKS, Coulter GenS or the Cell-Dyn 4000, have automated reticulocyte counting as part of the testing capabilities and allow reticulocyte counts to be included with routine complete blood count parameters. Comparisons of stand-alone instruments, integrated hematology analyzers, and flow cytometric methods show that these automated methods provide similar data with superior accuracy when compared to manual counting methods, with similar CVs of 5 to 8% ( [56](#), [57](#) and [58](#) ).

## LEUKOCYTE ANALYSIS

## White Blood Cell Counts

Leukocytes may be enumerated by either manual methods or automated hematology analyzers. Leukocytes are counted after dilution of blood in a diluent that lyses the red blood cells (usually acid or detergent). The much lower numbers of leukocytes present require less dilution of the blood than is needed for red blood cell counts (usually a 1:20 dilution, although it may be less in cases of leukocytopenia or more with leukocytosis). Manual counts are done using a hemocytometer or counting chamber. As with red cell counts, manual leukocyte counts have more inherent error, with CVs ranging from 6.5% in cases with normal or increased white cell counts to 15% in cases with decreased white cell counts. Automated methods characteristically yield CVs in the 1 to 3% range ( [26](#), [28](#) ). Automated leukocyte counts may be falsely elevated in the presence of cryoglobulins or cryofibrinogen ( [59](#) ), aggregated platelets ( [60](#) ), and nucleated red blood cells or when there is incomplete lysis of red cells, requiring manual counting. Falsely low neutrophil counts have also been reported due to granulocyte agglutination secondary to surface immunoglobulin interactions ( [61](#) ).

## Leukocyte Differentials

White cells are analyzed to find the percentage of each white blood cell type by doing a differential leukocyte count, providing important information in evaluation of the patient. Uniform standards for performing manual differential leukocyte counts on blood smears have been proposed by the National Committee for Clinical Laboratory Standards ( [62](#) ) to ensure reproducibility of results between laboratories. It is important to scan the smear at low power to ensure that all atypical cells and cellular distribution patterns are recognized. In wedge-pushed smears, leukocytes tend to aggregate in the feathered edge and side of the blood smear rather than in the center of the slide. Larger cells (blasts, monocytes) also tend to aggregate at the edges of the blood smear ( [63](#) ). Use of coverslip preparations and spinner systems tends to minimize this artifact of cell distribution. For wedge-push smears, it is recommended that a battlement pattern of smear scanning be used in which one counts fields in one direction, then changes direction and counts an equal number of fields before changing direction again to minimize distributional errors ( [41](#) ).

In manual leukocyte counts, three main sources of error are encountered: distribution of cells on the slide, cell recognition errors, and statistical sampling errors ( [57](#), [58](#) ). Poor blood smear preparation and staining are major contributors to cell recognition and cell distribution errors ( [63](#) ). Statistical errors are the main source of error inherent in manual counts, due to the small sample size in counts of 100 or 200 cells. The CV in manual counts is between 5 and 10% and is also highly dependent on the skill of the technician performing the differential. Accuracy may be improved by increasing the numbers of cells counted, but for practical purposes, most laboratories will do a differential on 100 white cells ( [64](#) ). Automated methods of differential counting tend to be more accurate because of the much larger numbers of cells evaluated, with CV of 3 to 5% ( [64](#), [65](#), [66](#) and [67](#) ).

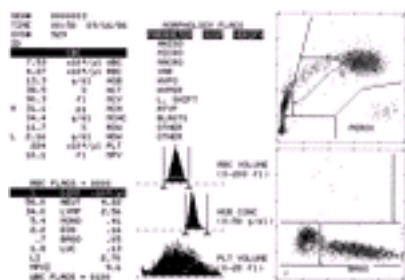
Automated methods of obtaining a leukocyte differential have been developed that markedly decrease the time and cost of performing routine examinations as well as increasing accuracy. However, automated analysis is incapable of accurately identifying and classifying all types of cells and is particularly insensitive to abnormal or immature cells. Therefore, most analyzers will identify possible abnormal white cell populations by flagging, indicating the need for examination by a skilled morphologist for confirmation ( [68](#) ). The automated instruments used for performing automated leukocyte differentials are

of two general types: those that perform cell identification on the basis of pattern recognition using stained blood smear slides and automated microscopy, and flow-through systems that identify cells on the basis of size, cell complexity, or staining characteristics.

Pattern recognition systems were first available in the early 1970s and included such instruments as the Hematrack, Coulter diff 3 and diff 4, Abbott's ADC 500, and the Leukocyte Automatic Recognition Counter (69, 70). This technology uses a blood film on a glass slide that was stained and loaded onto the instrument. A computer drives a microscopic mechanical stage until a dark staining area, corresponding to a leukocyte nucleus, is detected. Using data collected for each cell on cell size, nuclear and cytoplasmic coloration, and density, the computer matches the data patterns with specifications for each white cell type and identifies the cell. Most pattern recognition technology is hampered by many of the same limitations of accuracy—limited numbers of cells counted, difficulties in classifying abnormal cell types, and cell distribution characteristics—as manual counts (71). Although the automated pattern recognition systems do decrease technician time, they are significantly slower than the flow-through methods. Hence, pattern recognition systems are now rarely used, and the instruments are no longer manufactured.

Because of the ability to link the automated differential to the rest of the automated hematologic analysis, most recent methods use a flow-through system that generates a leukocyte differential as a part of the complete blood count (67, 72). Flow-through systems collect and analyze data from large numbers of white blood cells to provide a differential count that has a high degree of precision when compared to manual methods. White blood cell determination depends on both cell size and cytochemical staining characteristics (Technicon H6000, H\*1, H\*2, H\*3 series) (73) or on the basis of cell volume and internal complexity as measured by electrical impedance and light scatter characteristics [Coulter STKR and Gen-S series (58, 74), Cell-Dyn 4000 (28), Sysmex NE-8000 (75), Bayer Advia 120 (Bayer Diagnostic Division, Tarrytown, NY) (28), and Cobas-Helios (Roche Diagnostic Systems, Inc., Branchburg, NJ) (27) systems].

Systems that use myeloperoxidase staining characteristics of cells perform cell counts on specimens via continuous-flow cytometric analysis of blood samples in which the red cells have been lysed and white cells fixed. The cells are suspended in diluent and passed through a flow cell in a continuous stream so that single cells are analyzed for cell size (dark field light scatter) and cytochemical characteristics of myeloperoxidase staining (bright field detector). The data are plotted as a scattergram reflecting cell size (light scatter) on the y-axis and myeloperoxidase staining intensity or activity on the x-axis (Fig. 1.4), which gives rise to a six-part differential (neutrophils, lymphocytes, monocytes, eosinophils, basophils, and large unstained cells).



**Figure 1.4.** Histograms and printout generated by the H\*1 automated hematology analyzer. ANISO, anisocytosis; ATYP, atypical; BASO, basophils; CBC, complete blood count; CONC, concentration; DIFF, differential; EOS, eosinophils; HCT, hematocrit; HDW,

reticulocyte hemoglobin distribution width; HGB, hemoglobin; L. SHIFT, left shift; LUC, large unstained cell; LYMP, lymphocyte; MACRO, macrocyte; MCH, mean corpuscular hemoglobin; MCHC, mean corpuscular hemoglobin concentration; MCV, mean corpuscular volume; MICRO, microcyte; MONO, monocyte; MPV, mean platelet volume; NEUT, neutrophil; PEROX, peroxidase; PLT, platelet; RBC, red blood cell; RDW, red cell distribution width; VAR, variant; WBC, white blood cell.

The total white blood cell count as well as the neutrophil, lymphocyte, monocyte, and eosinophil counts are enumerated in the myeloperoxidase channel. Lymphocytes are characterized as small (low-scatter) unstained cells. Larger atypical lymphocytes, blasts, or circulating plasma cells fall into the large unstained cells channel. Neutrophils have stronger peroxidase staining and appear as larger cells. Eosinophils have very strong peroxidase activity but appear smaller than neutrophils because they tend to absorb some of their own light scatter. Monocytes have lower levels of peroxidase activity and are usually found between neutrophils and the large unstained cell areas. The system uses floating myeloperoxidase staining thresholds to bracket the neutrophil area, which helps adjust for individual sample differences in myeloperoxidase staining. To enumerate basophils, which are difficult to enumerate with automated flow-through techniques, the later models (Technicon H\*1, H\*2, and H\*3) use a basophil-nuclear lobularity channel. For this determination, red blood cells and white blood cells are differentially lysed, leaving bare leukocyte nuclei, with the exception of basophils, which are resistant to lysis and can then be counted based on cell size. Light scatter data obtained from the leukocyte nuclei may also help identify blasts, which have a lower light scatter than do mature lymphocyte nuclei. The nuclear lobularity index is a measurement of the number of mononuclear and polynuclear cells that may help identify immature neutrophils or nucleated red blood cells when correlated with mean peroxidase activity and cell count data. These abnormal cell populations generate a flag, indicating a need for morphologic review of the peripheral smear. Studies using these systems have shown good ability to identify acute leukemias ( [76](#), [77](#) and [78](#) ), myelodysplastic syndromes ( [79](#) ), and acute infection or inflammation ( [80](#) ). Analysis using this technique examines thousands of cells per sample, increasing statistical accuracy ( [64](#), [66](#) ). The H\*3 analyzers may perform 60 or more leukocyte differentials per hour.

The remaining instruments use leukocyte volume determinations based on electrical impedance or coupled with light scatter data to generate a leukocyte differential. Initially, this type of methodology gave rise to a three-part differential that enumerated only neutrophils, monocytes, and lymphocytes, exemplified by the Coulter S-Plus series of analyzers. This count was based on white cells that had been lysed, with subsequent collapse of the cellular cytoplasm around the nucleus and cytoplasmic granules ( [81](#) ). The cells were divided into three distinct size populations: large cells (neutrophils), intermediate cells (monocytes), and small cells (lymphocytes). When clear-cut size populations were not discernible, the machine generated a flag to indicate that the peripheral smear needed to be reviewed. This type of technology is best at enumerating neutrophils and lymphocytes, with high levels of correlation between manual and instrument determinations, but was less effective on monocytic counts because of lower cell numbers. In addition, other cell populations, including eosinophils, basophils, atypical lymphocytes, blasts, immature granulocytes, and plasma cells, tended to fall into the monocytic region or granulocyte region and confounded the data. Depending on the patient population studied (i.e., the percentage of normal vs. abnormal samples), the proportion of false negatives (samples in which a true abnormal population was not detected by the analyzer) varied from 4 to 16% ( [82](#), [83](#) ). This value is similar to those of the manual methods, in which the false negative rate is estimated to be 9% ( [71](#) ). The three-part differential is most useful as a screening tool.



The need for more detailed white cell analysis has led to development of the improved white cell differential analysis by combination of impedance methods with conductivity or light scatter measurements. This modification has greatly improved the ability of later model analyzers to provide full, five-part, differential white blood cell counts. The most commonly used hematology analyzers of this later generation include the Coulter STKS or Gen-S, the Sysmex NE-8000 or NE-9000, and the Cell-Dyn 3500 or 4000, although new upgrades and models appear with great rapidity ( [28](#), [84](#) ).

The Coulter STKS and Gen-S use electronic impedance to measure volume, high-frequency electromagnetic fields to measure conductivity, and light scatter with a monochromatic laser to determine cell cytoplasmic complexity or granule content, analyzing up to 144 specimens per hour. These generate a three-dimensional scatter plot ( [Fig. 1.2](#) ) that can separate the leukocytes into neutrophils, lymphocytes, monocytes, eosinophils, and basophils with flags for abnormal populations ( [58](#), [84](#) ). The Sysmex NE-8000 uses electrical impedance and electromagnetic data to identify the monocytes, neutrophils, and lymphocytes, then identifies eosinophils and basophils based on a proprietary lysing agent ( [85](#), [86](#) ). It may analyze up to 120 samples per hour. The Cell-Dyn 3000 identifies all of the leukocyte classes based on light scatter properties [small-angle forward light scatter, wide-angle light scatter, orthogonal light scatter, and depolarized light scatter ( [87](#) )]. The Cell-Dyn 3500 uses both impedance and laser light scatter at 0-, 10-, and 90-degree angles ( [90](#), [91](#) ). When compared among themselves and with the Technicon H\*1 or H\*2, all of the automated hematology analyzers mentioned above had excellent accuracy and precision for typical clinical laboratory usage with slight differences between the different technologies but a marked improvement over manual methods. Most studies find a poor correlation value for basophil counts ( [88](#) ), probably reflecting the very low levels of these cells available for manual counts. The Cobas analyzer uses a flow cytometric and light scatter technology that allows somewhat improved detection of band neutrophils over other systems with similar accuracy and precision with regard to other white and red blood cell parameters ( [27](#), [89](#) ). All of the above approaches appear to offer sensitive and efficient evaluation of leukocyte differentials, although instrument flags may require technician review for some cases ( [28](#) ).

In addition to their use in providing a differential count of white blood cells, the flow-through techniques of automated cell counting also can provide reproducible and accurate absolute numbers of each cell type because they analyze large cell populations ( [28](#) ). Use of percentages (as in the leukocyte differential) may mask some cytopenias or excessive numbers of cells. Absolute counts are used to define some disease states, such as chronic lymphocytic leukemia and chronic myelomonocytic leukemia. Absolute neutrophil counts are often useful when monitoring bone marrow recovery after chemotherapy or bone marrow transplant ( [90](#) ).

## PLATELET ANALYSIS

Platelets are anucleate cytoplasmic fragments that are 2 to 4 microns in diameter. As with the other blood components, they may be counted by either manual or automated methods. Manual methods involve dilution of blood samples and counting in a counting chamber or hemocytometer using phase contrast microscopy. Sources of error are similar to other manual counts and include dilution errors and low sample numbers. The CV, especially in patients with thrombocytopenia, may be greater than 15% ( [91](#), [92](#) ). Platelets are counted in automated hematology analyzers after removal of red cells by sedimentation or centrifugation or using whole blood. Platelets are identified by light scatter, impedance characteristics, or both ( [91](#), [93](#) ). These give highly reliable platelet

counts with a CV of less than 2%. Falsely low platelet counts may be caused by the presence of platelet clumps or platelet agglutinins ( [60](#) ) or adsorption of platelets to leukocytes ( [94](#) , [95](#) ). Fragments of red or white blood cells may falsely elevate the automated platelet count, but this usually gives rise to an abnormal histogram that identifies the spurious result ( [96](#) , [97](#) ).

Automated hematology analyzers also determine MPV, which has been correlated with several disease states ( [98](#) , [99](#) ). In general, MPV has an inverse relationship with platelet number, with larger platelet volumes seen in thrombocytopenic patients in whom platelets are decreased due to peripheral destruction (as in idiopathic thrombocytopenia purpura) ( [100](#) , [101](#) ). MPV is characteristically increased in hyperthyroidism ( [102](#) ) and myeloproliferative disorders ( [103](#) ). However, it should be noted that platelets tend to swell during the first 2 hours in EDTA anticoagulant, shrinking again with longer storage ( [104](#) , [105](#) ). Decreased MPV has been associated with megakaryocytic hypoplasia and cytotoxic drug therapy ( [101](#) , [106](#) ).

Reticulated platelets are newly released platelets that retain residual RNA, analogous to red cell reticulocytes. Reticulated platelet counts give an estimate of thrombopoiesis and may be useful in distinguishing platelet destruction syndromes from hypoplastic platelet production ( [107](#) , [108](#) ). Reticulated platelets are usually detected by flow cytometric methods using thiazole orange dyes that bind to RNA ( [109](#) , [110](#) ). Normal values vary between 3 and 20% ( [109](#) ), and 2.5- to 4.5-fold increases in reticulated platelet counts are seen in the clinical setting of idiopathic thrombocytopenia purpura ( [111](#) , [112](#) ). Increased reticulated platelets may herald the return of platelet production after chemotherapy ( [113](#) ). Although automated hematology analyzers offering reticulated platelet counts are not yet available, it is anticipated that this test may be incorporated in newer models, similar to the reticulocyte count.

## ADVANTAGES AND SOURCES OF ERROR WITH AUTOMATED HEMATOLOGY ANALYZERS

Clearly, the use of automated hematology analyzers has reduced laboratory costs and turnaround time coincident with improving the accuracy and reproducibility of blood counts. The CV for most of the parameters measured is in the range of 1 to 2%. This level of reproducibility is not achievable with the use of most manual techniques ( [Table 1.1](#) and [Table 1.2](#) ).

**TABLE 1.2. Reproducibility of Red Cell Indices**

| Index                                     | Method Used        | % Error ( $\pm 2$ Coefficients of Variation) |
|---|--------------------|--|
| Hemoglobin concentration                  | Spectrophotometric | 1.0–2.0                                      |
|   | Automated          | <1.0   |
| Mean corpuscular volume                   | Hemocytometer      | 9.5  |
|   | Automated          | <1.0   |
| Mean corpuscular hemoglobin               | Hemocytometer      | 10.0   |
|   | Automated          | 0.6–1.2                                      |
| Mean corpuscular hemoglobin concentration | Automated          | 1.0–1.5                                      |

From Bentley S, Johnson A, Bishop C. A parallel evaluation of four automated hematology analyzers. *Am J Clin Pathol* 1993;100:626–632; NCCLS. Reference and standard procedure for quantitative determination of haemoglobin in blood, 2nd ed. Document H15–A2. NCCLS, 1994; and International Committee for Standardization in Haematology. Recommendations for reference method for haemoglobinometry in human blood (ICSH Standard 1986) and specifications for international haemoglobincyanide reference preparation, 3rd ed. *Clin Lab Haematol* 1987;9:73–79, with permission.

---

Despite this high degree of accuracy, several potential errors may invalidate automated collection of data. Proper calibration of instrumentation is essential for collection of accurate data. Faulty current settings, which determine threshold counting values as well as variation in either the counting volumes or flow characteristics of a sample, negatively affect data accuracy. Electrical or mechanical failures or even minor voltage fluctuations may induce marked errors in data collection. Careful calibration of the instrumentation initially, followed by frequent evaluation of reproducibility by analysis of samples with known cell concentrations, is an essential quality control measure (114). Reference methods for instrument calibration have been developed by both the National Committee for Clinical Laboratory Standards and the International Committee for Standards in Haematology and are widely used by hospital and clinical laboratories to ensure regulatory compliance (6, 11, 21, 62).

Certain disease states are also associated with spuriously high or low results, although some of these are specific to a particular type of instrumentation (summarized in [Table 1.3](#)). Therefore, the individual values obtained from the automated hematology analyzer must be interpreted in context with the clinical findings. In addition, careful examination of the stained blood film often imparts additional information that may not be reflected in the average values that constitute the automated data. For example, decreased red blood cell counts, macrocytosis, and extremely high MCHC have been observed in patients with cold agglutinin disease with a higher thermal amplitude and in some patients with elevated serum viscosity (115). High levels of paraprotein may lead to falsely elevated hemoglobin levels, therefore affecting MCH and MCHC calculations (39). Many analyzers report spurious increases in hemoglobin levels when white cell counts exceed  $30 \times 10^9/L$  due to increased turbidity. This has been addressed in the Sysmex systems by use of two lysing agents and redesign of the flow system so that hemoglobin levels remain extremely accurate in the face of white blood cell counts as high as  $100 \times 10^9/L$  (116). Extremely high white cell counts may also falsely raise the red cell count and Hct as the white cell count is incorporated into the red cell count. High glucose levels (>400 to 600 mg/dl) and the associated hyperosmolarity cause red cell swelling and generate a high MCV and Hct with a falsely low MCHC (34, 117). The increased turbidity associated with hyperlipidemia may also cause falsely elevated hemoglobin determinations, MCH, and MCHC (37).

**TABLE 1.3. Disorders and Conditions That May Reduce the Accuracy of Blood Cell Counting** [a](#)

| Component | Disorder/Condition           | Effect on Cell Count  | Rationale  |
|-----------|------------------------------|-----------------------|--|
| Red cells | Microcytosis or schistocytes | May underestimate RBC | Lower threshold of RBC counting window is greater than microcyte size. |



|             |   |   |   |
|-------------|---|---|---|
|             | Howell–Jolly bodies   | May spuriously elevate platelet count (in whole blood platelet counters only) | Howell–Jolly bodies are similar in size to platelets.                   |
|             | Polycythemia  | May underestimate RBC   | Increased coincidence counting.   |
| White cells | Leukocytosis  | Overestimate RBC  | Increased coincidence counting.   |
|             | Acute leukemia and chronic lymphocytic leukemia, viral infections | May spuriously lower WBC  | Increased fragility of leukocytes, including immature forms.            |
|             | Chemotherapy of acute leukemia                                    | May artifactually increase platelet count                                     | Leukemic cell nuclear or cytoplasmic fragments identified as platelets. |
| Platelets   | Platelet agglutinins  | May underestimate platelet count, sometimes with spurious increase in WBC     | Platelet clumping. Aggregates may be identified as leukocytes.          |
| Plasma      | Cold agglutinins  | May underestimate RBC with spurious macrocytosis                              | Red cell doublets, triplets, and so forth have increased volume.        |
|             | Cryoglobulins, cryofibrinogens                                    | Variation in platelet count   | Protein precipitates may be identified as platelets.                    |

RBC, red blood cell count; WBC, white blood cell count.

<sup>a</sup> Some of these examples affect counts only when certain instruments are used. The effects depend on dilution, solutions used, and specimen temperatures.

Adapted from Koepke JA. Laboratory hematology. New York: Churchill Livingstone, 1984.

Despite the high level of accuracy and precision, the automated hematology analyzers usually have false–positive rates (flagging) of 10 to 25% of patients, requiring manual examination of the blood smear ( [28](#) ). Blood smear examination still plays an important role in characterizing samples that raise flags or show findings outside the parameters set in a particular laboratory. In addition, some cells require morphologic examination to identify, such as Sézary cells ( [118](#) ), and red cell morphology is best analyzed by direct smear examination ( [72](#) ).

## MORPHOLOGIC ANALYSIS OF BLOOD CELLS

Careful evaluation of a well–prepared blood smear is an important part of the evaluation of hematologic disease. Although a specific diagnosis may be suggested by the data obtained from an automated hematology analyzer, many diseases may have normal blood counts but abnormal cellular morphology. Examples of abnormal red cells that may be seen in the peripheral blood smear examination and are associated with specific disease states are found in [Table 1.4](#). However, morphologic analysis may be greatly hampered by poorly prepared or stained blood smears. Preparation of satisfactory blood smears requires careful attention to preparation of the blood smear and staining techniques and familiarity with the morphologic appearances of normal and pathologic cell types.

**TABLE 1.4. Pathologic Red Cells in Blood Smears**

| Red Cell Type                               | Description  | Underlying Change                                   | Disease State Associations  |
|---|--|---|---|
| Acanthocyte (spur cell)                     | Irregularly spiculated red cells with projections of varying length and dense center | Altered cell membrane lipids                        | Abetalipoproteinemia, parenchymal liver disease, postsplenectomy.                                     |
| Basophilic stippling                        | Punctuate basophilic inclusions  | Precipitated ribosomes (RNA)                        | Coarse stippling: lead intoxication, thalassemia. Fine stippling: a variety of anemias.               |
| Bite cell (degmacyte)                       | Smooth semicircle taken from one edge  | Heinz body pitting by spleen                        | Glucose-6-phosphate dehydrogenase deficiency, drug-induced oxidant hemolysis.                         |
| Burr cell (echinocyte) or crenated red cell | Red cells with short, evenly spaced spicules and preserved central pallor            | May be associated with altered membrane lipids      | Usually artifactual. Seen in uremia, bleeding ulcers, gastric carcinoma.                              |
| Cabot's rings                               | Circular, blue, threadlike inclusion with dots                                       | Nuclear remnant                                     | Postsplenectomy, hemolytic anemia, megaloblastic anemia.  |
| Ovalocyte (elliptocyte)                     | Elliptically shaped cell   | Abnormal cytoskeletal proteins                      | Hereditary elliptocytosis.  |
| Howell-Jolly bodies                         | Small, discrete, basophilic, dense inclusions; usually single                        | Nuclear remnant (DNA)                               | Postsplenectomy, hemolytic anemia, megaloblastic anemia.  |
| Hypochromic red cell                        | Prominent central pallor   | Diminished hemoglobin synthesis                     | Iron deficiency anemia, thalassemia, sideroblastic anemia.  |
| Leptocyte                                   | Flat, waferlike, thin, hypochromic cell  | —   | Obstructive liver disease, thalassemia.   |
| Macrocyte                                   | Red cells larger than normal (>8.5 $\mu\text{m}$ ), well-filled with hemoglobin      | Young red cells, abnormal red cell maturation       | Increased erythropoiesis. Oval macrocytes in megaloblastic anemia. Round macrocytes in liver disease. |
| Microcyte                                   | Red cells smaller than normal (<7.0 $\mu\text{m}$ )                                  | —   | Hypochromic red cell (see <a href="#">Chapter 27</a> )  |
| Pappenheimer bodies                         | Small, dense, basophilic granules  | Iron-containing siderosome or mitochondrial remnant | Sideroblastic anemia, postsplenectomy.  |
| Polychromatophilia                          | Grayish or blue hue often seen in macrocytes   | Ribosomal material                                  | Reticulocytosis, premature marrow release of red cells.   |

|                            |  |   |  |
|----------------------------|--|---|--|
| Rouleaux                   | Red cell aggregates resembling stack of coins  | Red cell clumping by circulating paraprotein  | Paraproteinemia.   |
| Schistocyte (helmet cell)  | Distorted, fragmented cell; two or three pointed ends                                      | Mechanical distortion in microvasculature by fibrin strands, disruption by prosthetic heart valve | Microangiopathic hemolytic anemia (disseminated intravascular coagulation, thrombotic thrombocytopenic purpura), prosthetic heart valves, severe burns). |
| Sickle cell (drepanocyte)  | Bipolar, spiculated forms, sickle-shaped, pointed at both ends                             | Molecular aggregation of HbS  | Sickle cell disorders, not including S trait.  |
| Spherocyte                 | Spherical cell with dense appearance and absent central pallor, usually decreased diameter | Decreased membrane redundancy   | Hereditary spherocytosis, immunohemolytic anemia.  |
| Stomatocyte                | Mouth or cuplike deformity   | Membrane defect with abnormal cation permeability   | Hereditary stomatocytosis, immunohemolytic anemia.   |
| Target cell (codocyte)     | Targetlike appearance, often hypochromic   | Increased redundancy of cell membrane   | Liver disease, postsplenectomy, thalassemia, hemoglobin disease.   |
| Teardrop cell (dacryocyte) | Distorted, drop-shaped cell  | —   | Myelofibrosis, myelophthisic anemia.   |

Adapted from Kjeldsberg C, ed. Practical diagnosis of hematologic disorders, 3rd ed. Chicago: ASCP Press, 2000.

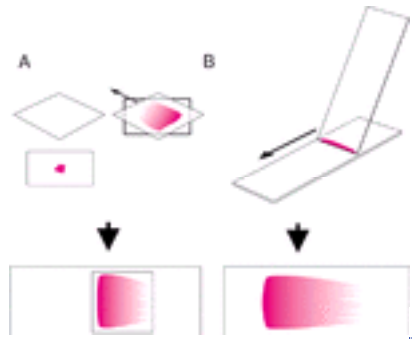
---

## Preparation of Blood Smears

Blood films may be prepared on either glass slides or coverslips. Each method has specific advantages and disadvantages. Blood smears are often prepared from samples of anticoagulated blood remaining from automated hematologic analysis. However, artifacts in cell appearance and staining may be induced by the anticoagulant. Optimal morphology and staining are obtained from noncoagulated blood, most often from a fingerstick procedure. Mechanical dragging of the cells across the glass of the slide or coverslip also distorts the cells; however, this artifact may be minimized with proper technique.

Coverslip smears ( [Fig. 1.5A](#)) are prepared using a good grade of flat, no. 1, 1/2-inch square (or 22 × 22 mm) coverslips that are free of lint, dust, and grease. Such coverslips allow optimal spreading of the blood over the surface and minimal artifact. Usually, high-quality coverslips do not require additional cleaning, although there may be some deterioration with age. Plastic “nonwettable” coverslips are not satisfactory for these preparations. The smear is prepared by holding the coverslip by two adjacent corners between the thumb and index finger. A small drop of either fresh or anticoagulated blood is placed in the center of the coverslip. The size of the drop of blood is critical. If the drop is too large, a thick smear results. If the drop of blood is too small, a very thin smear

is obtained. A second coverslip is then grasped in a similar fashion with the other hand, placed across the first coverslip, and rotated 45 degrees with a steady, rapid, and gentle motion. The two coverslips are then immediately pulled apart and allowed to air dry. If done properly, this procedure produces two coverslips with even dispersion of blood without holes or thick areas.



**Figure 1.5.** Preparation of blood smears. Blood smears may be prepared by the coverslip (A) or slide wedge method (B). Coverslip smears are prepared by placing a drop of blood in the center of a coverslip and spreading the blood by rotating a second coverslip over it. Wedge smears are prepared by placing a drop of blood on a slide and using a second slide to push the blood out along the length of the slide. (Adapted from Bauer JD. Clinical laboratory methods, 9th ed. St. Louis: C.V. Mosby, 1982:270.)

Blood smears may also be prepared on clean glass slides by the wedge method ( [Fig. 1.5B](#)). This often leads to irregular distribution of cells on the slide, a distinct disadvantage over the coverslip procedure. However, glass slides are less fragile and easier to handle and may be labeled more easily than coverslips. To prepare a slide blood smear, a drop of blood is placed in the middle of the slide approximately 1 to 2 cm from one end. A second spreader slide is placed at a 30- to 45-degree angle and moved backward to make contact with the blood drop. The blood drop will spread along the slide edge, then the spreader slide is moved rapidly forward. This technique creates a film of blood that is 3 to 4 cm long. Artifact may be introduced by irregular edges in the spreader and by the speed at which the spreader is moved. Glass slide preparations have increased incidence of accumulation of the larger white cells at the edges of the film, increasing cellular distribution errors. Fast movement of the spreader results in a more uniformly distributed population of cells.

Automated techniques for blood smear preparation have also been developed that produce very uniform blood smears. Two major types of instruments are used: those that use centrifugation and those that mechanically spread the blood. Centrifugation techniques are often most useful when a small number of cells must be concentrated in a small area, as in preparing smears of cells in fluids such as cerebrospinal fluid. Mechanical spreaders mimic the manual technique and are useful when large numbers of blood smears are prepared. In general, smears made by automated techniques are usually inferior to those made by an experienced technician.

### Routine Staining of Blood Smears

Blood smears are usually stained with either Wright or May-Grunwald-Giemsa stains. Both stains are modifications of the Romanowsky procedure ( [119](#)). The stain may be purchased commercially or may be made in the laboratory. The basic stain is formulated from methylene blue and eosin. The Wright stain formulation uses sodium bicarbonate to

convert methylene blue to methylene azure, which stains the cell. Giemsa stains use known quantities of acid bichromate to form the converted azure compounds. All types of Romanowsky stains are water insoluble but can be dissolved in methyl alcohol. The stain must be free of water, which induces red blood cell artifacts. Water artifacts may be avoided by fixation of slides or coverslips in anhydrous methanol before staining.

Optimal staining conditions must be established for each new batch of stain. The methylene blue conversion to azure compounds continues to occur while the stain is in the bottle, so staining conditions may change over time. Methyl azures are basic dyes that impart a violet–blue coloration when binding to the acidic components of the cell, such as nucleic acids and proteins. The eosin reacts with the basic cellular elements, imparting a reddish hue to cytoplasmic components and hemoglobin. A properly stained slide has a pink tint. The red cells will have an orange to pink coloration, and leukocytes have purplish–blue nuclei. The Romanowsky stains differentially stain leukocyte granules, which aids in morphologic analysis of the cells. Thus, neutrophil granules are slightly basic and stain weakly with the azurophilic component. The eosinophils contain a strongly basic spermine derivative and stain strongly with eosin. In contrast, basophil granules contain predominately acidic proteins and stain a deep blue–violet. No precipitate should overlie the cells because this indicates use of slides or coverslips that were not cleaned properly. Dust on slides may also induce artifacts. Staining solutions should be filtered or replaced weekly if used heavily.

Occasionally, an excessive blue coloration of the cells is seen. This may be caused by excessive staining times, improperly prepared or aged buffer that is too alkaline, old blood smears, or blood smears that are too thick. The quality of the staining may be improved by quick and vigorous rinsing with distilled water. If the areas of the slide between cells are staining, it usually indicates inadequate washing of the slide, heparin anticoagulation, or possible paraproteinemia. When the staining appears too pink or red, the usual problem is buffer that is too acidic. This results in pale–stained leukocyte nuclei, excessively orange–red blood cells, and bright red eosinophil granules. Other causes of excessive red coloration include inadequate staining times and excessive washing of the slide. Most often, problems with staining are caused by problems with the pH of the solutions, and new buffers often correct the problem.

### **Examination of the Blood Smear**

The blood smear should be initially examined under an intermediate power (10 to 20 × objective) to assess the adequacy of cellular distribution and staining. An estimate of the white blood cell count may also be made at this power, and scanning for abnormal cellular elements, such as blasts or nucleated red blood cells, can be performed. It is important to scan over the entire blood smear to ensure that abnormal populations, which may be concentrated at the edges of the smear, are not missed. Use of an oil immersion lens (50 or 63 ×) is usually sufficient for performing leukocyte differential counts, although a 100 × oil lens may be necessary for study of cellular inclusions or cytoplasmic granules. Systematic evaluation of the blood smear is essential so that all cell types are examined and characterized. Each cell type should be evaluated for both quantitative and qualitative abnormalities.

It is difficult to evaluate quantitative abnormalities of red cells on a blood smear; however, the red blood cells should be evaluated for variations in size, shape, and hemoglobin distribution and the presence of cellular inclusions. The red cells are usually unevenly distributed throughout the blood film. Optimal red cell morphology is seen in an area of the smear where the red cells are close together but do not overlap. Areas where the red cells are spread too thinly or thickly have increased artifacts. In some blood smears, the red cells appear to stick together, forming what appear to be stacks of red blood cells, termed *rouleaux*. This finding may be mimicked in normal patients in areas of the smear

where the red cells are too close together. However, if rouleaux persists in thinner areas of the blood film, it suggests the presence of a paraprotein coating the red cells and causing agglutination due to loss of normal electrostatic repulsion between red cells.

Red cells should be uniform in size and shape with an average diameter of 7.2 to 7.9  $\mu\text{m}$ . This may be evaluated by use of a micrometer or by comparison with the diameter of a small lymphocyte nucleus, which is approximately the same size or slightly smaller. Variation in red cell size is called *anisocytosis*. Cells that are larger than 9  $\mu\text{m}$  and well hemoglobinated are considered *macrocytes*. Less mature erythrocytes are macrocytic and have a bluish tint to the hemoglobin (polychromatophilia) or have fine basophilic stippling of the cell due to remnant RNA and ribosomes. *Microcytes* are cells with a diameter of less than 6  $\mu\text{m}$ .

Normal erythroid cells are round. Variations in red cell shape are called *poikilocytosis*. The red cell should have a pale central area with a rim of red to orange hemoglobin. Hypochromia reflects poor hemoglobinization and results in a very thin rim of hemoglobin or an increased area of central pallor. Abnormal distribution of hemoglobin may result in formation of a cell with a central spot of hemoglobin surrounded by an area of pallor, called a *target cell*. Abnormal hemoglobins may also form crystals. Spherocytes and macrocytes lack an area of central pallor because of increased thickness of the cell. Red cells may also contain inclusions, such as remnants of nuclear material (Howell-Jolly bodies), remnants of mitochondria or siderosomes (Pappenheimer bodies), or infectious agents (malarial parasites).

Platelet numbers and morphology are then evaluated. Platelets appear as small blue cytoplasmic fragments with red to purple granules. Platelets are usually 1 to 2  $\mu\text{m}$  in diameter with wide variation in shape. Platelet numbers may be estimated from the blood film. Normal platelet counts should have several (5 to 15) platelets per oil immersion field or approximately 1 platelet for 10 to 20 red blood cells. It should be noted that platelets may aggregate if uncoagulated blood or a fingerstick preparation is used, and this may cause the spurious impression of a low platelet count.

Leukocyte morphology and distribution are analyzed last. The number of leukocytes may be estimated by scanning the blood film at an intermediate power. Abnormal distribution of larger cells should be excluded by examination of the edges of the blood film in particular ( [62](#), [63](#) ). White cells at the edges of the blood smear may appear artifactually smaller (because of cellular shrinkage and poor spreading of the cell) or larger (because of cellular disruption). Care must be taken when making the smear because cells, particularly neoplastic cells, may be disrupted by too much mechanical pressure. Optimal morphology of the leukocytes requires that blood smears be made promptly. Significant artifact begins to be observed in blood that has been held for several hours and includes cytoplasmic vacuolation, nuclear karyorrhexis, and cytoplasmic disruption.

The white blood cells normally seen in the blood smear include neutrophils, eosinophils, basophils, lymphocytes, and monocytes. The presence of immature myeloid cells (myelocytes, metamyelocytes, promyelocytes, and blasts) is distinctly abnormal. At least 100 cells should be identified and counted to yield a manual white blood cell differential ( [62](#), [63](#) ). In addition to identifying relative populations of white cells by performing a differential count, the cells should be closely examined for morphologic abnormalities of the cytoplasm and nucleus. For example, infection or growth factor therapy often leads to increased prominence of the primary (azurophilic) granules in neutrophils, which is called *toxic granulation*. ( [120](#) ). In contrast, many myelodysplastic disorders are characterized by hypogranularity of neutrophils in addition to abnormal nuclear segmentation. Cytoplasmic

inclusions may be seen in some storage disorders or lysosomal disorders ( [63](#) ).

### Other Means of Examining Blood

Occasionally, it is necessary to examine fresh blood as a wet mount. Wet preparations are made by placing a drop of blood on a slide, covering the drop with a coverslip, and surrounding the coverslip with petroleum jelly or paraffin wax to seal the edges. If needed, the blood may be diluted with isotonic saline, or in some cases, it may be fixed with buffered glutaraldehyde for later examination. The blood may then be viewed with light or phase contrast microscopy. Wet mounts are used to detect sickling of red cells, spherocytes, and parasites within erythrocytes. Some organisms, such as spirochetes and trypanosomes, may be detected by movements. Dark field illumination enhances the refractile qualities of leukocyte granules or malarial pigment ( [121](#) ). Phase contrast microscopy accentuates the fine cellular details of cells, especially cytoplasmic granules and intracellular inclusions ( [122](#) ). Platelets are well visualized with phase contrast, and this aids in performance of manual platelet counts ( [21](#) ).

Supravital staining is performed on living, motile cells and helps avoid artifacts induced by smear preparation, fixation, and staining ( [123](#) , [124](#) ). However, such preparations are not permanent, a distinct disadvantage. Supravital stains are often used to detect red cell inclusions. These include crystal violet staining that detects Heinz bodies, which are denatured hemoglobin inclusions that appear as irregularly shaped purple bodies within the red cell. Brilliant cresyl blue may be used to precipitate and stain unstable hemoglobins, such as hemoglobin Zurich and hemoglobin H ( [125](#) ).

The most commonly used supravital stain is new methylene blue or brilliant cresyl blue, used for reticulocyte determinations. These stains allow visualization of the reticulin network of erythrocyte ribosomes in newly formed red blood cells ( [56](#) ). Reticulocyte counts are used in evaluation of new red cell production and are helpful in determining the hematopoietic activity of the bone marrow and marrow response to anemia ( [54](#) ). Reticulocytes are not identified positively on Wright–stained blood smears, although their presence is suggested by polychromatophilia of red blood cells. Recently, many automated hematology analyzers have incorporated staining to detect reticulocytes. These automated procedures appear to perform reticulocyte counting with a higher degree of precision than can be achieved manually ( [28](#) , [56](#) , [57](#) ). The degree of ribosomal staining may also be quantitated to allow assessment of reticulocyte age ( [55](#) ). Automated reticulocyte counts may have increased errors in the presence of Heinz bodies ( [126](#) ) or Howell–Jolly bodies ( [127](#) ) in the red cells. Normal reference values for reticulocytes are influenced by patient age and sex ( [128](#) ).

## BONE MARROW EXAMINATION

Diagnosis and management of many hematologic diseases depend on examination of the bone marrow. Bone marrow examination usually involves two separate, but interrelated, specimens ( [129](#) ). The first is a cytologic preparation of bone marrow cells obtained by aspiration of the marrow and a smear of the cells, allowing excellent visualization of cell morphology and enumeration of the marrow cellular elements. The second specimen is a needle biopsy of the bone and associated marrow, which allows optimal evaluation of bone marrow cellularity, fibrosis, infections, or infiltrative diseases.

There are several indications for performing a bone marrow examination. These include further workup of hematologic abnormalities observed in the peripheral blood smear,

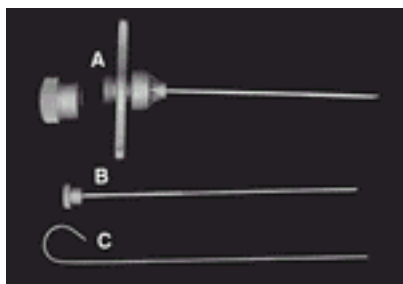


evaluation of primary bone marrow tumors, staging for bone marrow involvement by metastatic tumors, assessment of infectious disease processes including fever of unknown origin, and evaluation of metabolic storage diseases. Before a bone marrow examination is carried out, clear diagnostic goals about the information to be obtained from the procedure should be defined. Before the procedure, one should decide whether any special studies are needed so that all the necessary specimens may be collected and handled correctly. Clearly, the decision to perform a bone marrow examination as well as the choice of tests to be performed using the material should be made on an individualized basis.

Several sites may be used for bone marrow aspiration and biopsy (134). In part, the site chosen reflects the normal distribution of bone marrow with the age of the patient. At birth, hematopoietic marrow is found in all of the bones of the body. However, by early childhood, fat cells begin to replace the bone marrow hematopoietic cells in the extremities. In adults, hematopoiesis is limited to the axial skeleton and proximal portions of the extremities (135). Thus, younger children may have marrow examinations from the anterior medial tibial area, whereas adult marrow is best sampled from the sternum at the second intercostal space or from either the anterior or posterior iliac crest area. Sternal marrows do not allow a biopsy to be performed, and several possible complications, including hemorrhage and pericardial tamponade, may occur if the inner table of the sternum is penetrated by the needle at areas other than the second intercostal space. The sternal marrow space in an adult is only approximately 1 cm thick at the second intercostal space, so care must be taken to avoid penetrating the chest cavity. In contrast, little morbidity is associated with iliac crest aspiration and biopsy, and the posterior iliac crest is the most common site for bone marrow sampling. The anterior iliac crest may be used if previous radiation, surgery, or patient discomfort do not allow a posterior approach.

### Bone Marrow Aspiration and Biopsy

Bone marrow is semifluid and easily aspirated through a needle. Many types of needles have been used for performing marrow aspiration. Most are 14- to 18-gauge, and many have a removable obturator, which prevents plugging of the needle before aspiration, and a stylet that may be used to express the bone marrow biopsy sample (Fig. 1.6). Some models, primarily used for sternal bone marrow aspiration procedures, have adjustable guards that limit the extent of needle penetration.



**Figure 1.6.** Jamshidi bone marrow aspiration and biopsy needle. This type of hollow needle with a beveled tip (A) is satisfactory for percutaneous biopsy of the bone marrow. The needle is inserted with the obturator (B) in place. The biopsy is expressed from the needle using the stylet (C).

In most cases, marrow aspiration and biopsy may be carried out with little risk of patient discomfort, provided adequate local anesthesia is used. Apprehensive patients may be



sedated before the procedure, but this is usually not necessary. The procedure is performed under sterile conditions. The skin at the site of the biopsy is shaved, if necessary, and cleaned with a disinfectant solution. The skin, subcutaneous tissue, and periosteum in the area of the biopsy are anesthetized with a local anesthetic, such as 1% lidocaine, using a 25-gauge needle. Care must be taken to fully anesthetize the periosteum, where most of the bone pain fibers are located. After the anesthetic has taken effect, a small cut is made in the skin overlying the biopsy site, and the marrow aspiration needle is inserted through the skin, subcutaneous tissues, and bone cortex with a slight rotating motion. Entrance of the needle into the bone marrow cavity should be sensed as a slight give or increase in the speed of needle advancement. The needle obturator is removed, and the needle is attached to a 10- or 20-ml syringe. Aspiration of the marrow is achieved by rapid suctioning with the syringe so that 0.2 to 2.0 ml of bloody fluid is obtained ( [130](#) ). Aspiration may cause a very brief, sharp pain. If no pain is noted and no marrow is obtained, the needle may be rotated and suction applied again. If no marrow is obtained, another sampling site may be required.

The aspirated material is given to a technical assistant, who makes smears of the material and assesses the quality of the material by noting the presence of marrow spicules. The smears must be made quickly to avoid clotting in a manner similar to that described for blood smears. After several smears are made, the aspirate is allowed to clot for later fixation and processing by the histology laboratory. If additional material is needed for flow cytometry, cytogenetics, culture, or other special studies, additional aspirations may be performed by withdrawing the needle and repositioning it in a new site ( [130](#) ). Occasionally, a portion of an anticoagulated marrow aspirate is spun down to obtain a buffy coat, thereby concentrating the cellular elements in a very hypocellular specimen. EDTA is the best anticoagulant to use because it introduces the least amount of morphologic artifact to the specimen ( [131](#) , [132](#) ). In some instances, no marrow can be aspirated (dry tap). In these cases, it is essential to make smears from material at the tip of the needle and also to make touch preparations from the biopsy, as outlined below, to allow cytologic examination of the bone marrow elements ( [133](#) , [134](#) ).

The bone marrow biopsy may be performed using the same skin incision if the aspirate has been performed in the iliac crest area. A separate biopsy needle that is slightly larger than the needle used for aspiration may be used, or the same needle that was used for the bone marrow aspiration may be reused. Care must be taken to reposition the needle biopsy site away from the area where the aspiration was performed to avoid collection of a specimen with extensive artifact induced by the aspiration procedure. The biopsy needle may require more pressure to enter the bone because of the larger bore size. Once the needle is in place in the bone, the stylet may be inserted to give an approximation of the size of the bone core within the needle. The biopsy needle is rotated and gently rocked to free the biopsy from the surrounding bone and then advanced slightly farther. The biopsy is then removed from the bone by withdrawing the needle. The biopsy is expressed from the needle by the stylet. Touch preparations of the bone biopsy should be made, particularly if no aspirate was obtained, to allow cytologic examination of the bone marrow elements. The bony core is then fixed and processed for histologic examination.

Once the biopsy is completed, manual pressure is applied to the site for several minutes to achieve hemostasis. The site is then bandaged and the patient instructed to remain recumbent so as to apply further pressure for approximately 60 minutes. If a patient is thrombocytopenic, pressure bandages should be applied and the site checked frequently for prolonged bleeding.

### **Staining and Evaluation of Bone Marrow Aspirates and Touch Preparations**

The bone marrow aspirate or touch preparation slides are stained with either Wright or

May–Grunwald–Giemsa stains, similar to the procedure for blood smears. These stains allow excellent morphologic detail and allow differential counts to be performed ( [135](#) ). Unstained smears should be retained for possible special stains if indicated ( [129](#) ).

Evaluation of bone marrow aspirates gives little information about the total cellularity of the bone marrow because of fluctuations in cell counts induced by peripheral blood contamination of the bone marrow specimen ( [129](#) , [136](#) ). An overall impression of the cellularity may be given (i.e., cellular or paucicellular). More accurate evaluation of bone marrow cellularity requires examination of a bone marrow biopsy section, although the biopsy represents a tiny fraction of the total marrow and may also be subject to sampling error ( [137](#) ). The stained aspirate smear will have a central zone of dark marrow particles surrounded by a thinner area of dispersed bone marrow cells and red cells. Low-power examination allows evaluation of the adequacy of cellularity and of the presence of megakaryocytes. Tumor cells or granulomas may also be seen by scanning the aspirate smear at low power.

The aspirate smear allows cytologic examination of the bone marrow cells. A minimum of 500 nucleated cells should be evaluated under oil immersion magnification. Only intact cells are evaluated; all bare nuclei are excluded. Counting is performed in an area where few bare nuclei are present and the cells are not overlapping, found in clusters, or artifactually distorted. This is usually in the dispersed cell zone adjacent to the spicule. It should be noted that spicules may be absent in pediatric marrows, and marrow will appear as a uniform dispersion of cells. Reference ranges for the percentage of bone marrow cell types vary widely between laboratories and are used only as guides for what is to be expected in normal bone marrow samples ( [129](#) , [136](#) ). Results of differential counts from sternal bone marrow aspirate smears obtained from 12 healthy men at the University of Utah are presented in [Table 1.5](#) as an example of bone marrow differential count reference ranges. The proportions of each cell type and maturational sequence are determined from the differential counts. In addition, the myeloid to erythroid ratio may be calculated.

**TABLE 1.5. Differential Counts of Bone Marrow Aspirates from 12 Healthy Men**

|                             | Mean Observed (%) | Range (%) | 95% Confidence (%) |
|-----------------------------|-------------------|-----------|--------------------|
| Neutrophilic series (total) | 53.6              | 49.2–65.0 | 33.6–73.6          |
| Myeloblast                  | 0.9               | 0.2–1.5   | 0.1–1.7            |
| Promyelocyte                | 3.3               | 2.1–4.1   | 1.9–4.7            |
| Myelocyte                   | 12.7              | 8.2–15.7  | 8.5–16.9           |
| Metamyelocyte               | 15.9              | 9.6–24.6  | 7.1–24.7           |
| Band                        | 12.4              | 9.5–15.3  | 9.4–15.4           |
| Segmented                   | 7.4               | 6.0–12.0  | 3.8–11.0           |
| Eosinophilic series (total) | 3.1               | 1.2–5.3   | 1.1–5.2            |
| Myelocyte                   | 0.8               | 0.2–1.3   | 0.2–1.4            |
| Metamyelocyte               | 1.2               | 0.4–2.2   | 0.2–2.2            |
| Band                        | 0.9               | 0.2–2.4   | 0–2.7              |
| Segmented                   | 0.5               | 0–1.3     | 0–1.1              |
| Basophilic and mast cells   | <0.1              | 0–0.2     | —                  |
| Erythrocytic series (total) | 25.6              | 18.4–33.8 | 15.0–36.2          |
| Pronormoblasts              | 0.6               | 0.2–1.3   | 0.1–1.1            |

|                            |      |           |           |
|----------------------------|------|-----------|-----------|
| Basophilic                 | 1.4  | 0.5–2.4   | 0.4–2.4   |
| Polychromatophilic         | 21.6 | 17.9–29.2 | 13.1–30.1 |
| Orthochromatic             | 2.0  | 0.4–4.6   | 0.3–3.7   |
| Lymphocytes                | 16.2 | 11.1–23.2 | 8.6–23.8  |
| Plasma cells               | 1.3  | 0.4–3.9   | 0–3.5     |
| Monocytes                  | 0.3  | 0–0.8     | 0–0.6     |
| Megakaryocytes             | <0.1 | 0–0.4     | —         |
| Reticulum cells            | 0.3  | 0–0.9     | 0–0.8     |
| Myeloid to erythroid ratio | 2.3  | 1.5–3.3   | 1.1–3.5   |

Differences in cell differential results among infants, children, and adults exist ( [Table 1.6](#) ( [129](#), [138](#) ). In general, lymphocytes are more commonly seen in the marrow of children, especially those younger than 4 years of age, where they may compose up to 40% of the marrow cellularity ( [139](#), [140](#) and [141](#) ). Plasma cells are rare in the marrow of infants and children. Lymphocytes are much less numerous in adult bone marrows, usually making up less than 20% of adult marrow cellularity. Lymphocyte and plasma cell counts in adults tend to be quite variable, perhaps reflecting the tendency of these cells to be unevenly distributed in the bone marrow of adults. Often, lymphoid cells are found in nodular aggregates in older adults, and plasma cells tend to be associated with blood vessels ( [142](#), [143](#) ).

**TABLE 1.6. Changes in Differential Counts of Bone Marrow with Age**

|                            |            | Birth | 1 Mo–1 Yr | 1–4 Yr | 4–12 Yr | Adult |
|----------------------------|------------|-------|-----------|--------|---------|-------|
| Neutrophilic series        | Mean (%)   | 60    | 33        | 50     | 52      | 57    |
|                            | 95% limits | 42–78 | 17–47     | 32–68  | 35–69   | 39–79 |
| Eosinophilic series        | Mean (%)   | 3     | 3         | 6      | 3       | 3     |
|                            | 95% limits | 1–5   | 1–5       | 2–10   | 1–5     | 1–5   |
| Lymphocytes                | Mean (%)   | 14    | 47        | 22     | 18      | 17    |
|                            | 95% limits | 3–25  | 34–63     | 8–36   | 12–28   | 10–24 |
| Erythrocytic               | Mean (%)   | 14    | 8         | 19     | 21      | 0     |
|                            | 95% limits | 2–28  | 2–16      | 11–27  | 11–31   | 10–30 |
| Myeloid to erythroid ratio | Mean       | 4.3   | 4.0       | 2.6    | 2.5     | 2.6   |

The means and 95% confidence limits in this table were calculated by combining data published in Osgood, Seaman. The cellular composition of bone marrow as obtained by sternal puncture. *Physiol Rev* 1939;24:105–114; with the data in [Table 1.5](#).

During the first month of life, erythroid cells are prominent because of high levels of erythropoietin ( [129](#), [144](#) ); thereafter, the erythroid cells make up 10 to 40% of the marrow cells. Relatively few early erythroid precursors (normoblasts) are usually seen, and more mature forms predominate. Erythroid cells should be examined for abnormalities in morphology as well as iron content because these parameters are often deranged in pathologic states. The myeloid cells are usually the predominant element within the bone marrow, and more mature cells are most numerous. Increased numbers of immature myeloid cells usually indicate a disease process. Children tend to have higher numbers of

eosinophils and eosinophilic precursor cells than do adults, although many medications may increase the bone marrow eosinophil count. Megakaryocytes constitute the least abundant cell type seen in the bone marrow, usually making up less than 1% of the cells.

In addition to the hematopoietic cells mentioned above, a variety of other cells may be seen in bone marrow aspirates in varying proportions. These include macrophages, mast cells, stromal cells, osteoblasts, osteoclasts, and fat cells. Normally, these cells make up less than 1% of the total marrow cellularity; however, they may be increased in a variety of reactive and pathologic processes. Aspirate smears are excellent for evaluation of macrophage hemophagocytosis ( 145 ) or storage disorders ( 129 ). Osteoclasts and osteoblasts are most often seen in aspirates obtained from children in whom active bony remodeling is taking place and are distinctly abnormal when seen in adult aspirates ( 129 ).

### Examination of Bone Marrow Histologic Sections

Bone marrow core biopsies and the clot obtained from the aspiration procedure are usually fixed in formalin or in a coagulative fixative, such as B5. The bony core will require decalcification before histologic processing. The fixed materials are processed and embedded in paraffin or plastic, and sections are made for examination. Plastic embedding allows preparation of very thin (2- $\mu$ m) sections that allow optimal morphologic assessment but requires additional technical expertise and longer processing times (48 hours), making them impractical for most laboratories ( 146 ). Well-prepared, thin (3- to 4- $\mu$ m) sections from paraffin-embedded materials are usually sufficient for morphologic assessment and may be prepared using routine histologic methods. The bone marrow biopsy and clot sections are stained with either hematoxylin and eosin or Giemsa stains for morphologic examination.

Bone marrow biopsies are useful in evaluation of the cellularity of the bone marrow sampled. Several caveats must be kept in mind when assessing cellularity. Studies show variations in cellularity even within the same biopsy site ( 137 ) as well as between different anatomic sites. However, comparisons of the relative proportions of myeloid, erythroid, and megakaryocytic cells appear to be constant even in widely separated biopsy sites ( 147 , 148 ). In older patients, the subcortical area is often hypocellular, and care must be taken to obtain a large enough biopsy to allow evaluation of the marrow away from this area ( 137 ). The bone marrow biopsy section provides the best representation of the bone marrow and its anatomic relationships. The clot section, which is prepared from the bone marrow aspirate material, has a degree of inherent artifact because the bone marrow is removed from its normal relationship with bone, blood vessels, and other stromal elements. In particular, cellularity estimations may be falsely elevated by collapse of the normal stromal network ( 129 ).

In addition to providing information about the anatomic distribution and relationships of hematopoietic cells, the bone marrow biopsy is useful for evaluation of focal infiltrative processes such as carcinoma, lymphoma, other tumors, granulomatous inflammation, and fibrosis ( 149 , 150 , and 151 ). Occasionally, the marrow is so involved with an infiltrative process that no aspiration can be obtained (dry tap), and the biopsy provides the only diagnostic material ( 133 ). In addition, evaluation of other bone elements, such as bony trabeculae, blood vessels, and stroma, requires a biopsy specimen.

### SPECIAL STAINS

Several special stains may be performed on peripheral blood smears, bone marrow aspirate smears, bone marrow touch preparations, and bone marrow biopsy materials,

providing additional information about the cell lineage beyond what is obtained by standard staining with Romanowsky or hematoxylin and eosin stains. Special stains generally fall into two categories: cytochemical stains that use enzymatic reactions by the cell to impart staining and immunocytochemical stains that stain cell-specific antigen epitopes. These stains are particularly useful in characterization of primary hematologic or metastatic malignancies.

## Cytochemical Stains

Cytochemical stains are extremely useful in the diagnosis and classification of acute leukemias. They allow correct identification of myeloid and lymphoid acute leukemias ( [152](#) ), as well as providing the basis for subclassification of the acute myeloid leukemias by the French–American–British criteria and the World Health Organization classification ( [153](#) , [154](#) and [155](#) ). Cytochemical stains are usually performed on peripheral blood films, bone marrow aspirates, or touch preparations made from bone marrow, lymph node, or other tissue biopsies. Best results are obtained by using freshly obtained materials; however, some reactions may be carried out on materials that are several years old.

**MYELOPEROXIDASE** Primary granules of neutrophils and secondary granules of eosinophils contain myeloperoxidase ( [156](#) ). Monocytic lysosomal granules are faintly positive ( [157](#) ). Lymphocytes and nucleated red blood cells lack the enzyme. Originally, the stain depended on oxidation of benzidine by hydrogen peroxide ( [158](#) ); however, because benzidine is a potential carcinogen, alternative substrates have been identified. Suitable alternatives are 3-amino-9-ethylcarbazole ( [159](#) ) or 4-chloro-1-naphthol ( [160](#) ), which are oxidized by the myeloperoxidase to form a brown-colored precipitate in myeloperoxidase-containing cells. The myeloperoxidase enzyme is sensitive to light, and smears should be stained immediately or sheltered from light. Enzymatic activity in cells may diminish over time, so the stain should not be performed in blood smears older than 3 weeks. Permunt coverslip mounting medium (Fisher Scientific, Pittsburgh, PA) may cause fading of the stain, and its use should be avoided. Myeloperoxidase is also sensitive to heat and methanol treatment. Erythroid cells may stain for peroxidase after methanol treatment due to a nonenzymatic interaction between the staining reagents and hemoglobin. This is called the *pseudoperoxidase* or *Lepehne reaction*.

**SUDAN BLACK B** Sudan black B stains intracellular phospholipids and other lipids. The pattern of staining closely parallels the myeloperoxidase reaction, with positive staining of granulocytic cells and eosinophils, weak monocytic staining, and no staining of lymphocytes, although some positivity may be seen in azurophilic granules of lymphoblasts ( [161](#) ). Sudan black B has an advantage over myeloperoxidase in that it may be used to stain older blood or bone marrow smears, and there is little fading of the stain over time ( [162](#) ).

**SPECIFIC (NAPHTHOL AS-D CHLOROACETATE) ESTERASE** The specific (naphthol AS-D chloroacetate) esterase stain, also called the *Leder stain*, is used to identify cells of the granulocytic series ( [163](#) , [164](#) ). It fails to stain lymphocytes, and monocytes usually do not stain. Because of enzymatic stability in formalin-fixed, paraffin-embedded tissues, this stain is extremely useful for identifying granulocytes and mast cells in tissue sections ( [163](#) ). Thus, it is particularly helpful in diagnosis of extramedullary myeloid tumors (granulocytic sarcoma, chloroma) composed of myeloid blasts found in tissues ( [165](#) ). The esterase enzyme within the cell hydrolyzes the naphthol AS-D chloroacetate substrate ( [166](#) ). This reaction product is then coupled to a diazo salt to form a bright red-pink reaction product at the site of enzymatic activity. The enzyme activity is inhibited by the presence of mercury, acid solutions, heat, and iodine. These may give rise to false-negative staining results.

**NONSPECIFIC (ALPHA-NAPHTHYL BUTYRATE OR ALPHA-NAPHTHYL ACETATE)**



**ESTERASES** Nonspecific (alpha-naphthyl butyrate or alpha-naphthyl acetate) esterase stains are used to identify monocytic cells but do not stain granulocytes or eosinophils ( [166](#), [167](#) ). Mature T lymphocytes stain with a characteristic focal, dotlike pattern. In addition to monocytes, the stain reacts with macrophages, histiocytes, megakaryocytes, and some carcinomas. The alpha-naphthyl butyrate stain is considered to be more specific, although slightly less sensitive, than the alpha-naphthyl acetate stain ( [167](#) ). Differential staining with the different esterases is seen in megakaryoblasts, which do not stain with the alpha-naphthyl butyrate but stain with the alpha-naphthyl acetate substrate ( [168](#) ).

**TERMINAL DEOXYNUCLEOTIDYL TRANSFERASE** Terminal deoxynucleotidyl transferase (TdT) is an intranuclear enzyme that catalyzes the addition of deoxynucleotide triphosphates to the 3'-hydroxyl ends of oligonucleotides or polydeoxynucleotides without need for a template strand ( [169](#) ). TdT is found normally in the nucleus of thymocytes and immature lymphoid cells within the bone marrow but is not found in mature lymphocytes. Hence, it is a useful marker in identifying acute lymphoblastic leukemias and lymphoblastic lymphomas ( [169](#), [170](#) ). TdT activity is found in approximately 90% of acute lymphoblastic leukemias as well as in a small subset of acute myelogenous leukemias ( [171](#), [172](#) and [173](#) ). TdT levels may be measured biochemically ( [174](#) ) and by cytochemical staining with an immunofluorescent technique ( [175](#) ), by flow cytometry after permeabilization of cells ( [176](#), [177](#) ), or by immunohistochemical methods ( [178](#) ). Indirect immunofluorescent staining is very sensitive and may be applied to air-dried samples several weeks after collection ( [179](#) ). Immunohistochemical methods of TdT detection may be used on frozen ( [180](#) ) and paraffin-embedded tissue sections ( [181](#) ). A panel of myeloperoxidase (or Sudan black B), alpha-naphthyl butyrate esterase (or double esterase stain), and TdT staining is often used to characterize acute leukemias. More precise lineage assignment may be provided by flow cytometric analysis if fresh bone marrow or peripheral blood is available ( [182](#) ). However, because the French-American-British subclassification of acute myelogenous leukemias and the World Health Organization classification of the acute myelogenous leukemias—not otherwise specified are based on the cytochemical staining pattern of the blasts ( [153](#), [154](#) and [155](#) ), these stains are usually performed even when flow cytometric analysis is performed. In addition, cytochemical stains may be retrospectively performed on bone marrow or peripheral blood smears collected at the time of bone marrow examination when a diagnosis of acute leukemia was not suspected and fresh material was not collected for flow cytometric analysis.

**LEUKOCYTE ALKALINE PHOSPHATASE** Alkaline phosphatase activity is found in the cytoplasm of neutrophils, osteoblasts, vascular endothelial cells, and some lymphocytes. The alkaline phosphatase level of peripheral blood neutrophils is quantitated by the leukocyte alkaline phosphatase (LAP) score and is useful as a screening test to differentiate chronic myelogenous leukemia from leukemoid reactions and other myeloproliferative disorders ( [183](#) ). The LAP score is usually performed using the Kaplow procedure ( [184](#) ). This method uses a naphthol AS-BI phosphate as the substrate, which is coupled to fast violet B salt by the enzyme to produce a bright red reaction product that is visualized over neutrophils. The LAP score is determined by evaluation of the staining intensity (ranging from 0 to 4+) of 100 counted neutrophils or bands. Normal LAP scores range from 15 to 130, but there may be variation in these ranges between laboratories. Many different disease states may cause elevation or depression of the LAP score ( [Table 1.7](#) ). Patients with chronic myelogenous leukemia have low LAP scores (usually between 0 and 13). Paroxysmal nocturnal hemoglobinuria and some myelodysplastic syndromes may also be characterized by low LAP scores. Leukemoid reactions in response to infection and other myeloproliferative disorders (myelofibrosis with myeloid metaplasia and polycythemia vera) often have an elevated LAP score ( [183](#) ). There is rapid loss of alkaline phosphatase activity in samples drawn in EDTA anti-coagulant ( [185](#) ). The

test is optimally performed on fresh capillary blood fingerstick smears or on blood anticoagulated with heparin and should be performed within 48 hours after collection of the sample. The blood smears may be held in the freezer for 2 to 3 weeks with little loss of activity.

**TABLE 1.7. Conditions Associated with Abnormal Leukocyte Alkaline Phosphatase (LAP) Scores**

---

|   |
|---|
| Low LAP Score (<15)                         |
| CML   |
| Paroxysmal nocturnal hemoglobinuria         |
| Hematologic neoplasms (rare)                |
| Myelodysplastic syndromes                   |
| Rare infections or toxic exposures          |
| High LAP score (>130)                       |
| Infections                                  |
| Growth factor therapy                       |
| Myeloproliferative disorders other than CML |
| Inflammatory disorders                      |
| Pregnancy, oral contraceptives              |
| Stress                                      |
| Drugs (lithium, corticosteroids, estrogen)  |

CML, chronic myelogenous leukemia.

---

**ACID PHOSPHATASE** Acid phosphatase is found in all hematopoietic cells, but the highest levels are found in macrophages and osteoclasts ( [186](#) ). A localized dotlike pattern is seen in many T lymphoblasts, but this staining pattern is not reliable. The tartrate-resistant acid phosphatase (TRAP) is an isoenzyme of acid phosphatase that is found in high levels in the cells of hairy cell leukemia ( [187](#) ) and osteoclasts. Several methods of measuring TRAP activity have been described, but one using naphthol AS-BI phosphoric acid coupled to fast garnet GBC is reliable and reproducible ( [188](#) ). Not all cases of hairy cell leukemia stain for TRAP, and staining intensity may be variable. Positive TRAP staining may also be seen in some activated T lymphocytes, macrophages, and some histiocytes (such as Gaucher cells) ( [189](#) ).

**PERIODIC ACID-SCHIFF** The periodic acid-Schiff (PAS) stain detects intracellular glycogen and neutral mucopolysaccharides, which are found in variable quantities in most hematopoietic cells ( [190](#) ). PAS staining is seen in blasts of both acute lymphoblastic and acute myelogenous leukemias, although there is great variability between cases ( [152](#), [160](#), [198](#) ). Erythroleukemias demonstrate an intense diffuse cytoplasmic positivity with PAS, which may be helpful in diagnosis ( [191](#) ). In addition, PAS staining is very useful in demonstrating the abnormal glucocerebrosidase accumulation in Gaucher disease.

**IRON** Cellular iron is found as either ferritin or hemosiderin. It is identified in cells by the Perls' or Prussian blue reaction, in which ionic iron reacts with acid ferrocyanide to impart a blue color ( [192](#) ). The stain is used to identify iron in nucleated red blood cells (sideroblastic iron) and histiocytes (reticuloendothelial iron) or to identify Pappenheimer bodies in erythrocytes. Normally, red cell precursors contain one or more small (<1  $\mu$ m in diameter) blue granules in 20 to 50% of the cells. When increased numbers of these granules surround at least two-thirds of the nucleus of the red cell precursor, the cell is called a *ringed sideroblast* ( [155](#) ). The stain is best used on bone marrow aspirate smears but can also be used on blood films and aspirate clot tissue sections. Decalcification of the bone marrow core biopsy may lead to loss of iron from the cells, leading to a false impression of low iron.

**TOLUIDINE BLUE** Toluidine blue specifically marks basophils and mast cells by reacting with the acid mucopolysaccharides in the cell granules to form metachromatic complexes ( [166](#) ). Malignant mast cells or basophils may have low levels of acid mucopolysaccharides and may not react with this stain ( [193](#) ).

### Immunocytochemical Stains

Immunocytochemical staining is based on the use of an antibody that recognizes a specific antigenic epitope on a cell. There is a high level of specificity with immunologically based methods, allowing for more accurate diagnoses. In general, these types of stains may be applied to blood smears, bone marrow aspirates, cellular suspensions, or tissue sections. Not all antibody preparations are equally effective on all types of specimens, and staining procedures may vary dependent on the specimen type. A wide variety of antibodies specific to hematopoietic cellular antigens is available commercially. Some of the newer antibodies have replaced classical cytochemical stains and may be useful on older or fixed specimens.

Immunocytochemical staining of fresh blood or bone marrow cell suspensions and analysis by flow cytometry are becoming increasingly common in clinical laboratories ( [194](#) , [195](#) ). The flow cytometer detects both light scatter data and the presence of specific fluorochrome-labeled antibodies that have bound to the cell surface. Use of different fluorochromes can allow more than one antibody to be studied simultaneously on the same cell by means of different excitation wavelengths. The study of these cell surface markers allows rapid and accurate analysis of lymphomas and leukemias, enumeration of T-cell subsets, and identification of tumor cells. In addition, recent advances have allowed detection of intracytoplasmic or nuclear antigens, such as myeloperoxidase and TdT, by flow cytometric analysis ( [195](#) , [196](#) ). In many cases, particularly in the acute leukemias, the flow cytometric analysis of an acute leukemia provides important prognostic information that is not available through cytochemical staining ( [195](#) , [197](#) , [198](#) ). Clinical and technical aspects of flow cytometric analysis of hematologic tumors are covered in detail in [Chapter 3](#).

Immunohistochemical staining is the use of specific antibody probes on tissue sections or smears of blood and bone marrow. This allows the localization of a specific antigenic epitope to the cell surface, cytoplasm, or nucleus. The antigen binding may then be detected by immunofluorescence, which requires a special fluorescence microscope, or by enzymatic formation of a colored reaction product linked to the antigen-antibody complex. Immunoenzymatic staining techniques include immunoperoxidase, immunoalkaline phosphatase, and avidin-biotin techniques ( [199](#) ). These procedures allow study of the specimen with standard light microscopy and provide a permanent record of staining that may be reexamined. In the past, the repertoire of antibodies available for use on paraffin-embedded tissues was limited, and many antibodies required frozen sections of fresh tissues to be used. Over time, however, there has been a large increase in the number of antibodies that can be used on fixed and processed tissues, so frozen section analysis has limited usefulness in light of the severe drawbacks of frozen section morphology ( [200](#) ). Recently, several automated immunostaining instruments have become available that allow highly reproducible results and require less technician time and expertise ( [201](#) , [202](#) ).

Antibodies are routinely available that allow immunophenotyping of malignant lymphomas and leukemias in paraffin-embedded tissues and aid in recognition of malignant lymphoid infiltrates that may be confused with reactive processes ( [202](#) , [203](#) ). Many commonly used cytochemical stains, including myeloperoxidase ( [204](#) ), TdT ( [196](#) ), and TRAP ( [205](#) ), are



available as immunohistochemical stains that may then be applied to tissue sections as needed.

## OTHER LABORATORY STUDIES

### Cytogenetic Analysis

Many hematologic malignancies and premalignant conditions are associated with specific cytogenetic changes ( [206](#), [207](#), [208](#), [209](#) and [210](#) ). These include distinctive changes in chromosome number, translocations, and inversions of genetic material. These chromosomal changes are often associated with activation or increased transcription of oncogenes and may contribute to acquisition of a malignant phenotype ( [209](#), [211](#) ). Cytogenetic analysis has become important in diagnosing hematologic disorders, identifying specific prognostic subgroups, and monitoring for progression of disease or residual disease after therapy and is integral to the most current classification of hematologic malignancies, such as the World Health Organization classification ( [155](#), [212](#), [213](#) ). Both standard chromosomal preparations and fluorescent-labeled *in situ* hybridization techniques may be used for cytogenetic analysis of chromosomal changes ( [210](#), [214](#), [215](#) ). Further details about cytogenetic techniques and analysis are provided in [Chapter 4](#).

### Molecular Genetics

In addition to standard morphologic analysis and cytogenetics, technology has been developed that allows analysis of molecular changes in hematologic malignancies ( [212](#), [216](#), [217](#) ). By use of Southern blot and polymerase chain reaction (PCR) techniques, hematopoietic proliferations may be studied for genetic alterations associated with development of malignancy ( [217](#), [218](#) ). Molecular genetic analysis was initially used to identify monoclonality in lymphoid neoplasms by identifying either immunoglobulin (B-cell) or T-cell receptor gene rearrangements ( [219](#), [220](#) ). This finding is extremely useful in classification of lymphoproliferative disorders that may be difficult to diagnose on morphologic grounds alone or that lack specific phenotypic markers ( [221](#) ). In the past few years, there has been an explosion in the use of molecular techniques to detect translocations that previously had been detected only by conventional cytogenetics. Common tests include the *bcr-ab* translocations seen in chronic myelogenous leukemia and acute leukemia ( [222](#), [223](#), [224](#) and [225](#) ), *bcl-2* translocations characteristic of follicular lymphomas ( [226](#), [227](#) and [228](#) ), and the t(15;17) translocation associated with promyelocytic leukemia ( [229](#), [230](#) ). As molecular characterization and genetic profiling of specific hematologic disorders expand, such as through microarray analysis ( [231](#) ), it may be anticipated that more PCR and molecular tests will be developed. Molecular studies have an advantage over conventional morphologic and cytogenetic analyses in that they may detect very small populations of malignant cells (as few as 1 to 5% of the cells in a sample) and can lead to more rapid test completion (especially with PCR-based testing) ( [230](#), [234](#), [235](#) ). Molecular tests are most useful when a specific entity is being tested for or in monitoring residual disease as they do not provide effective screening capability for genetic alterations, as do conventional cytogenetics ( [217](#), [232](#), [233](#) ).

This degree of sensitivity makes molecular testing, particularly by PCR or *in situ* hybridization, very attractive for the purpose of monitoring for tumor persistence or recurrence after therapy. Previously, molecular genetic studies required collection of fresh or frozen diagnostic material; however, many of the newer assays can make use of

formalin-fixed materials with sensitivity similar to that of fresh or frozen materials ( [234](#), [235](#) ). This allows analysis to be performed on a wider range of cases, including archival materials. The topic of molecular genetics is covered in further detail in [Chapter 5](#).

## Electron Microscopy

The electron microscope allows examination of ultrastructural details of a cell. In the past, electron microscopy was used as a research tool and, occasionally, as a diagnostic tool for difficult hematologic diagnoses. However, with the advent of increasing numbers of specific immunocytochemical stains, the use of the electron microscope as a diagnostic tool for hematopathologic processes has been largely discontinued.

## Erythrocyte Sedimentation Rate

The erythrocyte sedimentation rate (ESR) is a common but nonspecific test that is often used as an indicator of active disease. It reflects the tendency of red blood cells to settle more rapidly in the face of some disease states, usually because of increases in plasma fibrinogen, immunoglobulins, and other acute-phase reaction proteins. In addition, changes in red cell shape or numbers may affect the ESR. Sickle cells and polycythemia tend to decrease the ESR, whereas anemia may increase it. ESR also increases with age in otherwise healthy people (although it tends to fall in adults older than the age of 75) ( [236](#), [237](#) ) and tends to be higher in women ( [237](#) ). People with liver diseases, carcinomas, or other serious diseases may have a normal to low ESR because of an inability to produce the acute-phase proteins.

A common cause of ESR elevation is infection, but monoclonal gammopathy must be ruled out in patients who have a persistent, unexplained elevation in ESR. Elevated ESRs are also seen with pregnancy, malignancies, collagen vascular diseases, rheumatic heart disease, and other chronic disease states, including human immunodeficiency virus infection ( [238](#) ). The ESR is a poor screening test in asymptomatic individuals, detecting elevations in 4 to 8% of adults and, hence, should not be used to screen asymptomatic people for disease ( [239](#) ). The test is probably best used in the clinical scenario of a patient with vague complaints to aid in the clinical decision to undergo further testing ( [240](#) ) or as a tool to follow the course of a disease state. ESR is most commonly used for monitoring the clinical course of temporal arteritis, rheumatoid arthritis, or polymyalgia rheumatica ( [241](#), [242](#) ). It may also be useful for monitoring for relapse of Hodgkin's disease or non-Hodgkin's lymphomas ( [243](#) ).

The ESR is measured by the Westergren or Wintrobe method or by a modification of these tests ( [244](#) ). Both are measured in millimeters per hour, but the normal values for each method vary because of differences in tube length and shape. Both methods require correction for patient anemia. Several technical variations to the method of ESR determination have been introduced, including micromethods, sedimentation at a 45-degree angle, and the zeta sedimentation rate. The zeta sedimentation rate measures erythrocyte packing in four 45-second cycles of dispersion and compaction in capillary tubes. This requires a special instrument, the Zetafuge (Coulter Electronics, Hialeah, FL), but gives reproducible results on very small amounts of blood that are not affected by anemia ( [245](#) ).

## Plasma and Blood Viscosity

Plasma viscosity measurements are advocated by some authors as being superior to ESR

measurements for monitoring disease states, particularly in autoimmune diseases and diseases characterized by the secretion of large amounts of immunoglobulin into the plasma (such as plasma cell dyscrasias) ( [246](#) , [247](#) ). Plasma viscosity measurements have the advantage of no red cell influences on the value obtained and yield a narrower reference range of normal values than observed with ESR ( [248](#) ). However, plasma viscosity is used more rarely than ESR, probably reflecting clinical familiarity with the latter test. Like ESR, plasma viscosity may increase with age ( [236](#) ). Direct measurement of acute-phase proteins, such as C-reactive protein, may also be used to monitor the course of inflammatory diseases ( [249](#) ). However, these tests are usually more expensive than ESR determinations and may not provide sufficient additional clinical information to justify the added expense ( [250](#) ).

Whole blood viscosity measurements are of limited clinical use because the measured blood viscosity may have little bearing on the viscosity of the blood in the circulation. Increased blood viscosity may contribute to the morbidity and mortality of patients with sickle cell disease, polycythemia, and ischemic vascular disease.

### Total Quantity of Blood

In most cases, the total number of erythrocytes is closely related to the red cell concentration of the blood or Hct. However, blood volume may not reflect erythrocyte concentration, including immediately after severe hemorrhage, severe dehydration, or over-hydration. To accurately assess the blood volume in these patients, plasma volume or red cell volume must be determined ( [251](#) ). The plasma volume is measured by dilution methods. A substance that is confined to the intravascular plasma compartment, such as Evans blue dye ( [252](#) ), <sup>131</sup>I-labeled albumin, or radioactive indium-labeled transferrin, is injected and the volume of distribution calculated from the degree of dilution of the injected substance over 15 to 30 minutes. Radiolabeled albumin is the most commonly used plasma label, but corrections must be made because the label is gradually removed from the circulation into the extravascular space, leading to errors of 10% or more in plasma volume determinations ( [253](#) ).

Total red cell volume is calculated by the Ashby technique, which uses radiolabeled red blood cells. A number of radioisotopes may be used, but <sup>51</sup>Cr and <sup>99m</sup>Tc are the most common ( [173](#) , [254](#) ). The red cell volume is then calculated by the dilution of the labeled cells over time using the following formula.

$$\text{Red cell volume} = \frac{\text{cpm of isotope injected}}{\text{concentration per unit volume in sample}} \times \text{ml red cell}$$

Usually, the measurements are made after a 15-minute interval, although longer periods may be needed with high blood viscosity due to high Hcts to ensure complete labeled cell mixing. Total red cell volume measurements must be corrected with splenic enlargement secondary to sequestration of the labeled cells within this organ. Red cell volume may also be calculated from the total plasma volume and measured Hct by means of the following equation.

$$\text{Red cell volume} = \text{Hct} \times \text{plasma volume} / 100 - \text{Hct}$$

Total plasma volume may be useful in monitoring fluid and blood replacement. Red cell volume measurements are used to document true polycythemia ( [255](#) , [256](#) ), although some

authors advocate the use of erythropoietin levels and red cell colony growth as less invasive surrogate tests for red cell volume or red cell mass measurements ( [257](#) ). Total blood volume may be calculated from the sum of total red cell volume and plasma volume measurements.

## REFERENCES

1. van Assendelft O, Houwen B. Calibration, control of hematology analyzers. *Adv for Administrators of the Laboratory* 2002;11:43-47.
2. Hellman N, Rubenstein L. The effects of age, sex, and smoking on erythrocytes and leukocytes. *Am J Clin Pathol* 1975;63:35-44.
3. Maes M, Scharpe S, Cooreman W, et al. Components of biological, including seasonal, variation in hematologic measurements and fibrinogen concentrations in normal humans. *Experientia* 1995;51:141-149.
4. Saxena S, Wong E. Heterogeneity of common hematologic parameters among racial, ethnic, and gender subgroups. *Arch Pathol Lab Med* 1990;114:715-719.
5. Wood B, Andrews J, Miller S, Sabath D. Refrigerated storage improves the stability of the complete blood cell count and automated differential. *Am J Clin Pathol* 1999;112:687-695.
6. Recommendations of the International Council for Standardization in Haematology for ethylenediaminetetraacetic acid anticoagulation of blood for blood cell counting and sizing. International Council for Standardization in Haematology: expert panel on cytometry. *Am J Clin Pathol* 1993;100:371-372.
7. Kumura T, Hino M, Yamane T, Tatsumi N. Argatroban as an anticoagulant for both hematologic and chemical tests. *J Clin Lab Anal* 2000;14:136-140.
8. Standard for Evacuated Tubes for Blood Specimen Collection, 2nd ed. ASH-1. Villanova, PA: NCLLS, 1980.
9. International Committee for Standardization in Hematology. Recommendation of measurement of human blood. *Am J Clin Pathol* 1977;68:505-507.
10. England J, Rowan R, van Assendelft O, et al. Guidelines for the evaluation of blood cell analysers including those used for the differential leukocyte and reticulocyte counting and cell marker applications. International Committee for Standardization in Haematology; prepared by the ICHS expert panel on cytometry. *Clin Lab Haematol* 1994;16:157-174.
11. NCCLS. Calibration and quality control of automated hematology analyzers; proposed standard. NCCLS document. 1999;H38-P.
12. Rothe M, Wingfield S, Barranco P, Carache S. Robotics in the hematology laboratory. An evaluation of the Sysmex HS-330. *Am J Clin Pathol* 1995;103:154-158.
13. Fodinger M, Speiser W, Karabentcheva S, et al. Evaluation of a total hematology analysis system (Sysmex HS-430). Benefits for large laboratories by reducing manual work load and optimizing screening efficiency for pathologic samples. *Am J Clin Pathol* 1995;104:503-509.
14. Chapman M. Hematology analyzers offer new technology and user-friendliness. *Lab Med* 2000;31:146-150.
15. Davis B, Bigelow N. Automated reticulocyte analysis. Clinical practice and associated new parameters. *Hematol Oncol Clin North Am* 1994;8:617-629.
16. Rice S, Aller R. Hematology analyzers. *CAP Today* 2000;14:34-40.
17. Groner W. Cell counting technologies. *Lab Hematol* 1997;3:302-308.

18. Kickle T. Clinical analyzers. *Advances in automated cell counting*. *Anal Chem* 1999;71:363R–365R.
19. Groner W, Simson E. *Practical guide to modern hematology analyzers*. Chichester, UK: John Wiley and Sons, 1995.
20. Jones A. Counting and sizing of blood cells using aperture–impedance systems. In: van Assendelft O, England J, eds. *Advances in hematologic methods: the blood count*. Boca Raton, FL: CRC Press, 1982.
21. ICHS recommendations for analysis of red cell, white cell and platelet size distribution curves. Methods for fitting a single reference distribution and assessing the goodness of fit. International Committee for Standardization in Haematology. ICSH expert panel on cytometry. *Clin Lab Haematol* 1990;12:417–431.
22. Thalhammer–Scherrer R, Knobl P, Korninger L, Schwarzingler I. Automated five–part white blood cell differential counts. Efficiency of software–generated white blood cell suspect flags of the hematology analyzers Sysmex SE–9000, Sysmex NE–8000, and Coulter STKS. *Arch Pathol Lab Med* 1997;121:573–577.
23. Gulati G, Kocher W, Schwarting R, et al. Suspect flags and regional flags on the Coulter–STKS. *Lab Med* 1999;30:675–690.
24. Groner W, Epstein E. Counting and sizing of blood cells using light scattering. In: van Assendelft O, England J, eds. *Advances in hematologic methods: the blood count*. Boca Raton, FL: CRC Press, 1982.
25. Mohandas N, Kim Y, Tycko D, et al. Accurate and independent measurement of volume and hemoglobin concentration of individual red cells by laser light scattering. *Blood* 1986;68:506–513.
26. Bentley S, Johnson A, Bishop C. A parallel evaluation of four automated hematology analyzers. *Am J Clin Pathol* 1993;100:626–632.
27. Bentley S, Johnson T, Sohler C, Bishop C. Flow cytometric differential leukocyte analysis with quantitation of neutrophil left shift. An evaluation of the Cobas–Helios analyzer. *Am J Clin Pathol* 1994;102:223–230.
28. Koenn M, Kirby B, Hare J, et al. Comparison of four automated hematology analyzers. *Clin Lab Sci* 2001;14:238–242.
29. Wintrobe M. A simple and accurate hematocrit. *J Lab Clin Med* 1929;15:287–289.
30. Lampasso J. Error in hematocrit value produced by excessive ethylenediaminetetraacetate. *Am J Clin Pathol* 1965;44:109–110.
31. Pearson T, Guthrie D. Trapped plasma in the microhematocrit. *Am J Clin Pathol* 1982;78:770–772.
32. Fairbanks V. Nonequivalence of automated and manual hematocrit and erythrocyte indices. *Am J Clin Pathol* 1980;73:55–62.
33. Guthrie D. PCV measurement in the management of polycythemic patients. *Clin Lab Haematol* 1982;4:257–265.
34. Beautyman W, Bills T. Osmotic error in red cell measurements of red cell volume. *Lancet* 1974;2:905–906.
35. NCCLS. Reference and standard procedure for quantitative determination of haemoglobin in blood, 2nd ed. Document H15–A2. NCCLS, 1994.
36. International Committee for Standardization in Haematology. Recommendations for reference method for haemoglobinometry in human blood (ICSH Standard 1986) and specifications for international haemoglobincyanide reference preparation, 3rd ed. *Clin Lab Haematol* 1987;9:73–79.
37. Cornbleet J. Spurious results from automated hematology cell analyzers. *Lab Med* 1983;14:509–514.
38. Gagne C, Auger P, Moorjani S, et al. Effect of hyperchylomicronemia on the measurement of

hemoglobin. *Am J Clin Pathol* 1977;68:584–586.

39. Linz L. Elevation of hemoglobin, MCH, and MCHC by paraprotein: how to recognize and correct the interference. *Clin Lab Sci* 1994;7:211–212.
40. Wallis J, Ford J. Incorrect haemoglobin estimation on the Coulter Counter S Plus IV in some patients with IgM paraproteinemia. *Clin Lab Haematol* 1987;9:95–96.
41. International Committee for Standardization in Hematology. Reference method for the enumeration of erythrocytes and leukocytes. *Clin Lab Haematol* 1994;16:131–138.
42. Bessman J, Williams L, Gardener F. Improved classification of anemias by the MCV and RDW. *Am J Clin Pathol* 1983;80:322–326.
43. Bessman J, Banks B. Spurious macrocytosis, a common clue to cold agglutinins. *Am J Clin Pathol* 1980;74:797–800.
44. Holt J, Dewandler M, Arvan D. Spurious elevation of the electronically determined mean corpuscular volume and hematocrit caused by hyperglycemia. *Am J Clin Pathol* 1982;77:561–567.
45. International Committee for Standardization in Haematology. Recommendations for the analysis of red cell, white cell and platelet size distribution curves I. General principles. *J Clin Pathol* 1982;35:1320–1322.
46. Morgan D, Peck S. The use of red cell distribution width in the detection of iron deficiency in chronic hemodialysis patients. *Am J Clin Pathol* 1988;89:513–515.
47. Roberts G, El Badawi S. Red blood cell distribution width index in some hematologic diseases. *Am J Clin Pathol* 1985;83:222–226.
48. Marsh W, Bishop J, Darcy T. Evaluation of red cell volume distribution width. *Hematol Pathol* 1987;1:117–123.
49. Aslan D, Gumruk F, Gurgey A, Altay C. Importance of RDW value in differential diagnosis of hypochromic anemias. *Am J Hematol* 2002;69:31–33.
50. Liu T, Seong P, Lin TK. The erythrocyte cell hemoglobin distribution width segregates thalassemia traits from other nonthalassemic conditions with microcytosis. *Am J Clin Pathol* 1997;107:601–607.
51. Brittenham G, Koepke J. Red cell volume distributions and the diagnosis of anemia. Help or hindrance? *Arch Pathol Lab Med* 1987;111:1146–1148.
52. Fossat C, David M, Harle J, et al. New parameters in erythrocyte counting. Value of histograms. *Arch Pathol Lab Med* 1987;111:1150–1154.
53. International Council for Standardization in Hematology, Expert Panel on Cytometry. Proposed reference method for reticulocyte counting based on the determination of the reticulocyte to red cell ratio. *Clin Lab Haematol* 1998;20:77–79.
54. Davis B, Bigelow N, Koepke J, et al. Flow cytometric reticulocyte analysis. Multiinstitutional interlaboratory correlation study. *Am J Clin Pathol* 1994;102:468–477.
55. Davis B, Ornvold K, Bigelow N. Flow cytometric reticulocyte maturity index: a useful laboratory parameter of erythropoietic activity in anemia. *Cytometry* 1995;22:35–39.
56. Siekmeier R, Bierlich A, Jaross W. Determination of reticulocytes: three methods compared. *Clin Chem Lab Med* 2000;38:245–249.
57. Lacombe F, Lacoste L, Vial J, et al. Automated reticulocyte counting and immature reticulocyte fraction measurement. Comparison of PENTRA 120 Retic, Sysmex R-2000, flow cytometry, and manual counts. *Am J Clin Pathol* 1999;112:677–686.
58. Picard F, Giquel C, Marnet L, et al. Preliminary evaluation of the new hematology analyzer COULTER

GEN-S in a university hospital. *Clin Chem Lab Med* 1999;37:681-686.

59. Gulati G, Piao Y, Song A, et al. Interference by cryoproteins in the blood with automated CBCs. *Lab Med* 1995;26:138-142.

60. Lombarts A, deKieviet W. Recognition and prevention of pseudothrombocytopenia and concomitant pseudoleukocytosis. *Am J Clin Pathol* 1988;89:634-639.

61. Robbins S, Conly M, Oettinger J. Cold-induced granulocyte agglutination. A cause of pseudoleukopenia. *Arch Pathol Lab Med* 1991;115:155-157.

62. NCCLS approved Standard H20-A. Leukocyte differential counting. National Committee for Clinical Laboratory Standards, 1992.

63. Hecker F, Lehmann H, Kao Y. *Practical microscopic hematology*, 4th ed. Philadelphia: Lea and Febiger, 1994.

64. Rumke C. The statistically expected variability in differential counting. In: Koepke J, ed. *Differential leukocyte counting*. Skokie, IL: College of American Pathologists, 1978.

65. Koepke J, Dotson M, Shifman M. A critical evaluation of the manual/visual differential cell counting. *Blood Cells* 1985;11:173-181.

66. Buttarello M, Gadotti M, Lorenz C, et al. Evaluation of four automated hematology analyzers: a comparative study of differential counts (imprecision and accuracy). *Am J Clin Pathol* 1992;97:345-352.

67. Krause J. Automated differentials in the hematology laboratory. *Am J Clin Pathol* 1990;93[Suppl 1]:S11-S16.

68. Hyun B, Gulati G, Ashton J. Differential leukocyte count: manual or automated, what should it be? *Yonsei Med J* 1991;32:282-291.

69. Rosvall R, Mengason A, Smith L, et al. Visual and automated differential leukocyte counts. A comparison study of three instruments. *Am J Clin Pathol* 1979;71:695-703.

70. Kingsley T. The automated differential: pattern recognition systems, precision and the spun smear. *Blood Cells* 1980;6:483-487.

71. Pierre R, Payne B, Lee W, et al. Comparison of four leukocyte differential methods with the National Committee for Clinical Laboratory Standards (NCCLS) reference method. *Am J Clin Pathol* 1987;87:201-209.

72. Gulati G, Hyun B, Ashton J. Advances of the past decade in automated hematology. *Am J Clin Pathol* 1992;98[Suppl 1]:S11-S16.

73. Miles Technicon H\*2 automated hematology analyzer. *Health Devices* 1992;21:387-419.

74. Cox C, Haberman T, Payne B. Evaluation of the Coulter Counter Model S-Plus IV. *Am J Clin Pathol* 1985;84:297-306.

75. Brigden M, Page N, Graydon C. Evaluation of the Sysmex NE-8000 automated hematology analyzer in a high-volume outpatient laboratory. *Am J Clin Pathol* 1993;100:618-625.

76. d'Onofrio G, Mancini S, Leone G, et al. Identification of blast cells in peripheral blood through automatic assessment of nuclear density. A new tool for monitoring patients with acute leukemia. *Br J Haematol* 1987;66:473-477.

77. den Ottolander G, Baelde H, Huibregtsten L, et al. The H\*1 automated differential counter in determination of bone marrow remission in acute leukemia. *Am J Clin Pathol* 1995;103:492-495.

78. Kershaw G, Robin H, Kroneberg H. Evaluation of the Technicon H-1 hematology analyzer. *Pathology* 1987;19:305-309.

79. Watson J, Ross D. Characterization of myelodysplastic syndromes by flow cytochemistry with the Technicon H\*1. *Med Technol* 1987;4:18-24.
80. Bentley S, Pegram M, Ross D. Diagnosis of infective and inflammatory disorders by flow cytometric analysis of blood neutrophils. *Am J Clin Pathol* 1987;88:177-181.
81. Miers M, Fogo A, Federspiel C, et al. Evaluation of the Coulter S-Plus IV three-part differential as a screening tool in a tertiary care hospital. *Am J Clin Pathol* 1987;87:745-751.
82. Ross D, Watson J, Davis P, Tracy S. Evaluation of the Coulter three-part differential screen. *Am J Clin Pathol* 1985;84:481-484.
83. Kalish R, Becker K. Evaluation of the Coulter S-Plus V three-part differential in a community hospital, including criteria for its use. *Am J Clin Pathol* 1986;86:751-755.
84. Kreofsky T, Wendland B, Schmidt V, et al. Evaluation of three hematology analyzers with five-part differential. *Am J Clin Pathol* 1992;98:365-366.
85. Van Wersch J, Bank C. A new development in haematological cell counting: the Sysmex NE 8000, automation for cell count and physical five-part leukocyte differentiation. *J Clin Chem Clin Biochem* 1990;28:233-240.
86. Devreese K, De Logi E, Francart C, et al. Evaluation of the automated haematology analyzer Sysmex NE-8000. *Eur J Clin Chem Clin Biochem* 1991;29:339-345.
87. Terstappen L, de Grooth B, Visscher K, et al. Four parameter white blood cell differential counting based on light scattering measurements. *Cytometry* 1988;9:39-43.
88. Vives-Corrans J-L, Besson I, Jou J, Gutierrez G. Evaluation of the Abbott Cell-DYN 3500 hematology analyzer in a University hospital. *Am J Clin Pathol* 1996;105:553-559.
89. Lacombe F, Cazux N, Briais A, et al. Evaluation of the leukocyte differential flags on an hematologic analyzer, the Cobas Argos 5 Diff. *Am J Clin Pathol* 1995;104:495-502.
90. Parnham D, Ready R, Stine K, et al. Comparison of manual and automated leukocyte counts for determination of the absolute neutrophil count: application to a pediatric oncology clinic. *Med Pediatr Oncol* 2002;38:183-186.
91. Yacko M, Swedlund J, Weil S. Multiple methods for platelet enumeration. *Am J Clin Pathol* 1987;87:109-112.
92. Lawrence J, Yomtovian R, Dillman C. The reliability of automated platelet counts: comparison with manual method and utility for prediction of clinical bleeding. *Am J Hematol* 1995;48:244-250.
93. Day H, Young E, Helfrich M. An evaluation of a whole blood platelet counter. *Am J Clin Pathol* 1980;73:588-593.
94. Dale N, Shumacher H. Platelet satellitism—new results with automated instruments. *Lab Med* 1982;13:300-304.
95. Criswell K, Brieder M, Bleavins M. EDTA-dependent platelet phagocytosis. A cytochemical, ultrastructural and functional characterization. *Am J Clin Pathol* 2001;115:376-384.
96. Akaware A, Ross D, Stass S. Spuriously elevated platelet counts due to microspherocytosis. *Am J Clin Pathol* 1982;77:220-221.
97. Hammerstrom J. Spurious platelet counts in acute leukemia with DIC due to cell fragmentation. *Clin Lab Haematol* 1992;14:239-243.
98. Threatte G. Usefulness of the mean platelet volume. *Clin Lab Med* 1993;13:937-950.
99. Jackson S, Carter J. Platelet volume: laboratory measurement and clinical application. *Blood Rev*



1993;7:104–113.

100. Corash L, Mok Y, Levin J, Baker G. Regulation of platelet heterogeneity: effects of thrombocytopenia on platelet volume and density. *Exp Hematol* 1990;18:205–212.

101. Niethammer A, Forman E. Use of platelet histogram maximum in evaluating thrombocytopenia. *Am J Hematol* 1999;60:19–23.

102. Graham S, Traub B, Mink I. Automated platelet-sizing parameters on a normal population. *Am J Clin Pathol* 1987;87:365–369.

103. Small B, Bettigole R. Diagnosis of myeloproliferative disease by analysis of the platelet volume distribution. *Am J Clin Pathol* 1981;76:685–691.

104. Threatte G, Adrados C, Ebbe S, Brecher G. Mean platelet volume: the need for a reference method. *Am J Clin Pathol* 1984;81:769–772.

105. McShine R, Sibinga S, Brozovic B. Differences between the effects of EDTA and citrate anticoagulants on platelet counts and mean platelet volume. *Clin Lab Haematol* 1990;12:277–285.

106. Bessman J, Gilmer P, Gardener F. Use of mean platelet volume improves detection of platelet disorders. *Blood Cells* 1985;11:127–135.

107. Kurata Y, Hayashi S, Kiyoi T, et al. Diagnostic value of tests for reticulated platelets, plasma glycoferritin, and thrombopoietin level for discriminating between hyperdestructive and hypoplastic thrombocytopenia. *Am J Clin Pathol* 2001;115:656–664.

108. Rapi S, Erimini A, Bartolini L. Reticulocytes and reticulated platelets: simultaneous measurement in whole blood by flow cytometry. *Clin Chem Lab Med* 1998;36:211–214.

109. Matic G, Chapman E, Zaiss M, et al. Whole blood analysis of reticulated platelets: improvements of detection and assay stability. *Cytometry* 1998;34:229–234.

110. Jousti-Korhonen L, Saiio S, Riikonen S, et al. Detection of reticulated platelets: estimating the degree of fluorescence of platelets stained with thiazole orange. *Eur J Haematol* 2000;65:66–71.

111. Koike Y, Yoneyama A, Shirai J. Evaluation of thrombopoiesis in thrombocytopenic disorders by simultaneous measurement of reticulated platelets of whole blood and serum thrombopoietin levels. *Thromb Haemost* 1998;79:1106–1110.

112. Saxon B, Blanchette V, Butchart S. Reticulated platelet counts in the diagnosis of acute immune thrombocytopenic purpura. *J Pediatr Hematol Oncol* 1998;20:44–48.

113. Stohlwetz P, Steigler P, Knobl P. The rise of reticulated platelets after intensive chemotherapy for AML reduces the need for platelet transfusions. *Ann Hematol* 1999;78:271–273.

114. Bentley S. Quality control and the leukocyte count. *Clin Lab Haematol* 1990;12[Suppl]:101–109.

115. Fishleder A, Hoffman G. Automated hematology: counts and indices. *Lab Med* 1984;21:1–12.

116. Hallawell R, O'Malley C, Hussein S, et al. An evaluation of the Sysmex NE-8000 hematology analyzer. *Am J Clin Pathol* 1991;96:594–601.

117. Savage R, Hoffman G. Clinical significance of osmotic matrix errors in automated hematology. The frequency of hyperglycemic osmotic matrix errors producing spurious macrocytosis. *Am J Clin Pathol* 1983;80:861–865.

118. Hoyer J. Leukocyte differential. *Mayo Clin Proc* 1993;68:1027–1028.

119. International Committee for Standardization in Haematology. ICSH reference method for staining of blood and bone marrow films by azure B and eosin Y (Romanowsky stain). *Br J Haematol* 1984;57:707–710.

120. Schmitz L, McClure J, Litz C, et al. Morphologic and quantitative changes in blood and bone marrow

- cells following growth factor therapy. *Am J Clin Pathol* 1994;101:67-75.
121. Hansen-Pruss O. The circulating cells as seen by dark-ground illumination. *Am J Clin Pathol* 1936;6:423-431.
122. Bessis M. Phase contrast microscopy and electron microscopy applied to the blood cells. *Blood* 1955;10:272-286.
123. Ackerman G, Bellios N. A study of the morphology of the living cells of blood and bone marrow in supra-vital films with the phase microscope. II. Blood and bone marrow from various hematologic dyscrasias. *Blood* 1955;10:1183-1203.
124. Schwind J. The supravital method in the study of the cytology of blood and bone marrow cells. *Blood* 1950;5:597-622.
125. Williamson D. The unstable haemoglobins. *Blood Rev* 1993;7:146-163.
126. Hinchliffe R. Errors in automated reticulocyte counts due to Heinz bodies. *J Clin Pathol* 1993;46:878-879.
127. Bowen D, Bentley N, Hoy T, Cavill I. Comparison of a modified thiazole orange technique with a fully automated analyzer for reticulocyte counting. *J Clin Pathol* 1991;44:130-133.
128. Tarello P, Humbert J, Mahassen P, et al. Reticulocytes: biological variations and reference limits. *Eur J Haematol* 1994;53:11-15.
129. Foucar K. *Bone marrow pathology*, 2nd ed. Chicago, IL: ASCP Press, 2001.
130. Bain B. Bone marrow aspiration. *J Clin Pathol* 2001;54:657-663.
131. Izadi P, Ortega J, Coates T. Comparison of buffy coat preparations to direct method for evaluation and interpretation of bone marrow aspirates. *Am J Hematol* 1993;43:107-109.
132. Gruppo R, Lampkin B, Granger S. Bone marrow cellularity determination: comparison of the biopsy, aspirate, and buffy coat. *Blood* 1977;49:39-31.
133. Humphries J. Dry tap bone marrow aspiration: clinical significance. *Am J Hematol* 1990;35:247-250.
134. James L, Stass S, Schumacher H. Value of imprint preparations of bone marrow biopsies in hematologic diagnosis. *Cancer* 1980;46:173-177.
135. Hyun B, Gulati G, Ashton, J. Bone marrow examination: techniques and interpretation. *Hematol Oncol Clin North Am* 1988;2:513-523.
136. Reich C, Kolb E. A quantitative study of the variations in multiple sternal marrow samples taken simultaneously. *Am J Med Sci* 1942;204:496-504.
137. Hartsock R, Smith E, Petty C. Normal variations with aging of the amount of hematopoietic tissue in bone marrow from the anterior iliac crest. A study made from 177 cases of sudden death by necropsy. *Am J Clin Pathol* 1965;43:326-331.
138. Geaghan S. Hematologic values and appearances in the healthy fetus, neonate and child. *Clin Lab Med* 1999;19:1-37.
139. Kotylo P, Fineberg N, Freeman K, et al. Reference ranges for lymphocyte subsets in pediatric patients. *Am J Clin Pathol* 1993;100:111-115.
140. Rosse C, Kraemer M, Dillon T, et al. Bone marrow cell populations of normal infants: the predominance of lymphocytes. *J Lab Clin Med* 1977;89:1225-1240.
141. Glaser K, Limarzi L, Poncher H. Cellular composition of the bone marrow in normal infants and children. *Pediatrics* 1950;6:789-824.

142. Gulati G, Ashton J, Hyun B. Structure and function of the bone marrow and hematopoiesis. *Hematol Oncol Clin North Am* 1988;2:495–511.
143. Thiele J, Zirbes T, Fischer R. Focal lymphoid aggregates (nodules) in bone marrow biopsies: differentiation between benign hyperplasia and malignant lymphoma—a practical guideline. *J Clin Pathol* 1999;52:294–300.
144. Krantz S. Erythropoietin. *Blood* 1991;77:419–434.
145. Fisman D. Hemophagocytic syndromes and infection. *Emerg Infect Dis* 2000;6:601–608.
146. Moosavi H, Lichtman M, Donnelly J, Churukian C. Plastic-embedded human marrow biopsy specimens. Improved histochemical methods. *Arch Pathol Lab Med* 1981;105:269–273.
147. Rubinstein M. Aspiration of bone marrow from the iliac crest: comparison of iliac crest and sternal bone marrow studies. *JAMA* 1948;137:1281–1285.
148. Westerman M. Bone marrow needle biopsy: an evaluation and critique. *Semin Hematol* 1981;18:293–300.
149. Ellis L, Jensen W, Westerman M. Needle biopsy of bone and marrow. An experience with 1445 biopsies. *Arch Intern Med* 1964;114:213–221.
150. Bearden J, Ratkin G, Coltman C. Comparison of the diagnostic value of bone marrow biopsy and bone marrow aspiration in neoplastic disease. *J Clin Pathol* 1974;27:738–740.
151. Pasquale D, Chikkappa G. Comparative evaluation of bone marrow aspirate particle smears, biopsy imprints, and biopsy sections. *Am J Hematol* 1986;22:381–389.
152. Hayhoe F. Cytochemistry of the acute leukemias. *Histochem J* 1984;16:1051–1059.
153. Bennett J, Catovsky D, Daniel M, et al. Proposals for the classification of the acute leukemias (FAB cooperative group). *Br J Haematol* 1976;33:451–458.
154. Bennett J, Catovsky D, Daniel M, et al. Proposed revised criteria for the classification of acute leukemia. *Ann Intern Med* 1984;103:626–629.
155. Jaffe E, ed. World Health Organization classification of tumours: tumours of haematopoietic and lymphoid tissues. Washington, D.C.: IARC Press, 2001.
156. Bainton D. Neutrophilic granules. *Br J Haematol* 1975;29:17–22.
157. Nichols B, Bainton D, Faraquhar M. Differentiation of monocytes. Origin, nature, and fate of their azurophilic granules. *J Cell Biol* 1971;50:498–515.
158. Kaplow L. Simplified myeloperoxidase stain using benzidine dihydrochloride. *Blood* 1965;26:215–219.
159. Kaplow L. Substitute for benzidine in myeloperoxidase stains. *Am J Clin Pathol* 1975;63:451.
160. Doe K, Gryzbac M, Schumacher H. A new modified rapid noncarcinogenic myeloperoxidase staining method using 4-chloro-1-naphthol. *Lab Med* 1988;19:374–375.
161. Sheehan H, Storey G. An improved method of staining leucocyte granules with Sudan Black B. *J Pathol* 1947;59:336–337.
162. Lillie R, Burtner H. Stable sudanophilia of human neutrophil leukocytes in relation to peroxidase and oxidase. *J Histochem Cytochem* 1953;1:8–26.
163. Leder L. The selective enzymocytochemical demonstration of neutrophil myeloid cells and tissue mast cells in paraffin sections. *Klin Wochenschr* 1964;42:553.

164. Moloney W, McPherson K, Fliegelman L. Esterase activity in leukocytes demonstrated by the use of naphthol AS-D chloroacetate substrate. *J Histochem Cytochem* 1960;8:200-207.
165. Traweek S, Arber D, Rappaport H, Brynes R. Extramedullary myeloid tumors. An immunohistochemical and morphologic study of 28 cases. *Am J Surg Pathol* 1993;17:1011-1019.
166. Yam L, Li C, Crosby W. Cytochemical identification of monocytes and granulocytes. *Am J Clin Pathol* 1971;55:283-290.
167. Li C, Lam K, Yam L. Esterases in human leukocytes. *J Histochem Cytochem* 1973;21:1-12.
168. Koike T. Megakaryoblastic leukemia. The characterization and identification of megakaryoblasts. *Blood* 1984;64:683.
169. Chilosi M, Pizzolo G. Review of terminal deoxynucleotidyl transferase. Biologic aspects, methods of detection, and selected diagnostic applications. *Appl Immunohistochem* 1995;3:209-221.
170. Kung P, Long J, Ratliff R, et al. Terminal deoxynucleotidyl transferase in the diagnosis of leukemia and malignant lymphoma. *Am J Med* 1978;64:788-794.
171. Bendetto P, Mertelsmann R, Szatrowski T, et al. Prognostic significance of terminal deoxynucleotidyl transferase activity in acute nonlymphoblastic leukemia. *J Clin Oncol* 1986;4:489-495.
172. Janossy G, Hoffbrand V, Greaves M, et al. Terminal deoxynucleotidyl transferase enzyme assay and immunologic membrane markers in the diagnosis of leukaemia: a multiparameter analysis of 300 cases. *Br J Haematol* 1980;44:221-234.
173. Jones J, Mollison P. A simple and efficient method of labeling red cells with sup99m Tc for determination of red cell volume. *Br J Haematol* 1978;38:141-147.
174. Beutler E, Kuhl W. An assay for terminal deoxynucleotidyl transferase in leukocytes and bone marrow. *Am J Clin Pathol* 1978;70:733-737.
175. Hecht T, Forman S, Winkler V, et al. Histochemical demonstration of terminal deoxynucleotidyl transferase in leukemia. *Blood* 1981;58:856-858.
176. Lai R, Hirsh-Ginsberg C, Bueso-Ramos C. Pathologic diagnosis of acute lymphocytic leukemia. *Hematol Oncol Clin North Am* 2000;14:1209-1235.
177. Syrjala M, Tiirikainen M, Jansson S, Krusius T. Flow cytometric analysis of terminal deoxynucleotidyl transferase. A simplified method. *Am J Clin Pathol* 1993;99:298-303.
178. Stass S, Dean L, Peiper S, Bollum F. Determination of terminal deoxynucleotidyl transferase on bone marrow smears by immunoperoxidase. *Am J Clin Pathol* 1982;77:174-176.
179. Barr R, Koedebakker M. Storage and transportation of samples for analysis of terminal transferase by indirect immunofluorescence. *Am J Clin Pathol* 1982;81:660-661.
180. Chilosi M, Pizzolo G, Fiore-Donati L, et al. Routine immunofluorescent and histochemical analysis of bone marrow involvement of lymphoma/leukemia: the use of cryostat sections. *Br J Cancer* 1983;48:763-775.
181. Orazi A, Cattoretti G, John K, Neiman R. Terminal deoxynucleotidyl transferase staining of malignant lymphomas in paraffin sections. *Mod Pathol* 1994;7:582-586.
182. Foon K, Todd R. Immunologic classification of leukemias and lymphomas. *Blood* 1986;68:1-31.
183. Kaplow L. Leukocyte alkaline phosphatase in disease. *CRC Crit Rev Clin Lab Sci* 1971;2:243-278.
184. Kaplow L. Cytochemistry of leukocyte alkaline phosphatase. *Am J Clin Pathol* 1963;39:439-449.
185. Kaplow L. Leukocyte alkaline phosphatase cytochemistry. Applications and methods. *Ann N Y Acad*

Sci 1968;155:511–520.

186. Yam L. Clinical significance of human acid phosphatases. A review. *Am J Med* 1974;56:604–616.
187. Li C, Yam L, Lam K. Studies of acid phosphatase in human leukocytes: demonstration of iso-enzyme specificity. *J Histochem Cytochem* 1970;18:901–910.
188. Janckila A, Li C, Lam K, Yam L. The cytochemistry of tartrate-resistant acid phosphatase. Technical considerations. *Am J Clin Pathol* 1978;70:45–55.
189. Mover S, Li C, Yam L. Semiquantitative evaluation of tartrate-resistant acid phosphatase activity of human blood cells. *J Lab Clin Med* 1972;80:711–717.
190. Wislocki G, Rheingold J, Dempsey E. The occurrence of the periodic acid-Schiff reaction in various normal cells of blood and connective tissue. *Blood* 1949;4:562–568.
191. Bennett J, Reed C. Acute leukemia cytochemical profile: diagnostic and clinical implication. *Blood Cells* 1975;1:101–113.
192. Gomori G. Microtechnical demonstration of iron. A criticism of methods. *Am J Pathol* 1936;12:655–663.
193. Horny H, Ruck P, Krober S, Kaiserling E. Systemic mast cell disease (mastocytosis). General aspects and histopathologic diagnosis. *Histol Histopathol* 1997;12:1081–1089.
194. Stetler-Stevenson M, Braylan R. Flow cytometric analysis of lymphomas and lymphoproliferative disorders. *Semin Hematol* 2001;38:111–123.
195. Braylan R, Orfao A, Borowitz M, Davis B. Optimal number of reagents required to evaluate hematolymphoid neoplasia: results of an international consensus meeting. *Cytometry* 2001;46:23–27.
196. Almars N, Iturraspe J, Benson N, et al. Flow cytometric analysis of terminal deoxynucleotidyl transferase. *Am J Clin Pathol* 1991;95:376–380.
197. Bradstock K, Matthews J, Benson E, et al. Prognostic value of immunophenotyping in acute myeloid leukemia. *Blood* 1994;84:1220–1225.
198. Pui H, Behm F, Crist W. Clinical and biologic relevance of immunologic marker studies in childhood acute lymphoblastic leukemia. *Blood* 1993;82:343–362.
199. Scanzini E. Immunohistochemical staining of fixed tissues. *Methods Mol Biol* 1998;104:133–140.
200. Hsi E, Yegappan S. Lymphoma immunophenotyping: a new era in paraffin-section immunohistochemistry. *Adv Anat Pathol* 2001;8:218–239.
201. Grogan T. Automated immunohistochemical analysis. *Am J Clin Pathol* 1992;98:S35–S38.
202. O'Leary T. Standardization in immunohistochemistry. *Appl Immunohistochem Molecul Morphol* 2001;9:1–2.
203. Perkins S, Kjeldsberg C. Immunophenotyping of lymphomas and leukemias in paraffin-embedded tissues. *Am J Clin Pathol* 1993;99:362–373.
204. Wong K, Chan J. Antimyeloperoxidase: antibody of choice for labeling of myeloid cells including diagnosis of granulocytic sarcoma. *Adv Anat Pathol* 1995;2:65–68.
205. Janckila A, Cardwell E, Yam L, Li C. Hairy cell identification by immunohistochemistry of tartrate-resistant acid phosphatase. *Blood* 1995;85:2839–2844.
206. Nowell P, Croce C. Chromosome translocations and oncogenes in human lymphoid tumors. *Am J Clin Pathol* 1990;94:229–237.
207. Green A. Transcription factors, translocations and haematological malignancies. *Blood Rev*

1992;6:118–124.

208. Rowley J. Recurring chromosome abnormalities in leukemia and lymphoma. *Semin Hematol* 1990;27:122–136.

209. Rowley J. The critical role of chromosome translocations in human leukemias. *Annu Rev Genet* 1998;32:495–519.

210. Bain B. Overview. Cytogenetic analysis in haematology. *Best Pract Res Clin Haematol* 2001;14:463–477.

211. Kagan J. Molecular biology of chromosomal aberrations in leukemia/lymphoma. *Hematol Pathol* 1993;7:159–210.

212. Misra R, Pinsky P, Srivastava S. Prognostic factors for hematologic cancers. *Hematol Oncol Clin North Am* 2000;14:907–924.

213. Mrozek K, Heinonen K, Bloomfield C. Clinical importance of cytogenetic in acute myeloid leukemia. *Best Pract Clin Haematol* 2001;14:19–47.

214. Schrock E, Padilla–Nash H. Spectral karyotyping and multicolor fluorescence in situ hybridization reveal new tumor–specific chromosomal aberrations. *Semin Hematol* 2000;37:334–347.

215. Mecucci C, Falzetti D, La Starza R. Metaphase FISH, microdissection and multicolor FISH. Application in haematology. *Haematologica* 1999;84:98–101.

216. Farkas D, Crisan D. DNA technology in the clinical laboratory. *Lab Med* 1992;23:721–770.

217. Bakkenist C, O’Leary J, Chetty R. The use of recent molecular biology techniques in pathology. *Adv Anat Pathol* 1995;2:306–313.

218. Look A, Downing J. Molecular biology of leukemia and lymphoma. *Rev Invest Clin* 1994;[Suppl]:124–134.

219. Cossman J, Zehnbaueer B, Garrett C, et al. Gene rearrangements in the diagnosis of lymphoma/leukemia. *Am J Clin Pathol* 1991;95:347–354.

220. Weiss L, Spagnolo D. Assessment of clonality in lymphoid proliferations. *Am J Pathol* 1993;142:1679–1682.

221. Sklar J, Longtine J. The clinical significance of antigen receptor gene rearrangements in lymphoid neoplasia. *Cancer* 1992;70:1710–1718.

222. Ayscue L, Ross D, Ozer H, et al. Bcr/abl recombinant DNA analysis versus karyotype in the diagnosis and therapeutic monitoring of chronic myeloid leukemia. *Am J Clin Pathol* 1990;94:404–409.

223. Chase A, Huntley B, Cross N. Cytogenetics of chronic myeloid leukemia. *Best Pract Clin Haematol* 2001;14:553–571.

224. Witte O. The role of Bcr–Abl in chronic myeloid leukemia and stem cell biology. *Semin Hematol* 2001;38:3–8.

225. Maru Y. Molecular biology of chronic myeloid leukemia. *Int J Hematol* 2001;73:308–322.

226. Bordeleau L, Berinstein N. Molecular diagnostics in follicular non–Hodgkin’s lymphoma: a review. *Semin Oncol* 2000;27:42–52.

227. Capello D, Gaidano G. Molecular pathophysiology of indolent lymphoma. *Haematologica* 2000;85:113–114.

228. Sarris A, Ford R. Recent advances in the molecular pathogenesis of lymphomas. *Curr Opin Oncol* 1999;11:319–321.

229. Zelent A, Guidez F, Melnick A, et al. Translocations of the RARalpha gene in acute promyelocytic leukemia. *Oncogene* 2001;20:7186–7103.
230. Randolph T. Acute promyelocytic leukemia (AML–M3)—Part 2: molecular defect, DNA diagnosis, and proposed models of leukemogenesis and differentiation therapy. *Clin Lab Sci* 2000;13:106–116.
231. Walker J, Flower D, Rigley K. Microarrays in hematology. *Curr Opin Hematol* 2002;9:23–29.
232. Sawyers C. Molecular studies in chronic myeloid leukemia patients treated with tyrosine kinase inhibitors. *Semin Hematol* 2001;38:15–21.
233. Hanson C. Clinical applications of molecular biology in diagnostic hematopathology. *Lab Med* 1993;24:562–578.
234. Greer C, Peterson S, Kiviat N, Manos M. PCR amplification from paraffin–embedded tissues. *Am J Clin Pathol* 1991;95:111–124.
235. Wan J, Trainor K, Brisco M, Morley A. Monoclonality in B–cell lymphoma detected in paraffin wax embedded sections using the polymerase chain reaction. *J Clin Pathol* 1990;43:888–890.
236. Caswell M, Pike L, Bull B, Stuart J. The effect of patient age on tests of the acute–phase response. *Arch Pathol Lab Med* 1993;117:906–910.
237. Bottinger L, Svedberg C. Normal erythrocyte sedimentation rate and age. *BMJ* 1967;2:85–87.
238. Schwartlander B, Bek B, Skarabis H, et al. Improvement of the predictive value of CD4+ lymphocyte counts by beta 2–microglobulin, immunoglobulin A and erythrocyte sedimentation rate. The Multicentre Cohort Study Group. *AIDS* 1993;7:813–821.
239. Sox H, Liang M. The erythrocyte sedimentation rate. Guidelines for rational use. *Ann Intern Med* 1986;104:515–523.
240. Stevens D, Tallis R, Hollis S. Persistent grossly elevated erythrocyte sedimentation rate in elderly people: one year follow–up of morbidity and mortality. *Gerontology* 1995;41:220–226.
241. Ward M. Clinical measure in rheumatoid arthritis: which are most useful in assessing patients? *J Rheumatol* 1993;21:17–21.
242. Zlonis M. The mystique of the erythrocyte sedimentation rate. A reappraisal of one of the oldest laboratory tests still in use. *Clin Lab Med* 1993;13:787–800.
243. Esteve J, Lopez–Guillermo A, Martinez–Frances A, et al. Presenting features, natural history, and prognostic features in non–Hodgkin’s lymphomas: analysis of 117 cases from a single institution. *Eur J Haematol* 1995;55:217–222.
244. International Committee for Standardization in Haematology. Recommendation for measurement of erythrocyte sedimentation rate of human blood. *J Clin Pathol* 1988;68:1203–1212.
245. Bull B, Brailsford J. The zeta sedimentation ratio. *Am J Clin Pathol* 1972;40:550–559.
246. Gudmundsson M, Bjelle A. Viscosity of plasma and blood in rheumatoid arthritis. *Br J Rheumatol* 1993;32:774–779.
247. Dinant G, van Wersch J, Goei–The H, Knottnerus J. Plasma viscosity and erythrocyte sedimentation rate in inflammatory and non–inflammatory rheumatic disorders. *Clin Rheumatol* 1992;11:66–71.
248. Lowe G. Should plasma viscosity replace the ESR? *Br J Haematol* 1994;86:6–11.
249. Thompson D, Milford–Ward A, Whicher J. The value of acute phase protein measurements in clinical practice. *Ann Clin Biochem* 1992;29:123–131.
250. Dinant G, de Kock C, van Wersch J. Diagnostic value of C–reactive protein measurement does not

justify replacement of the erythrocyte sedimentation rate in daily general practice. *Eur J Clin Invest* 1995;25:353–359.

251. Jones J, Wardrop C. Measurement of blood volume in surgical and intensive care practice. *Br J Anaesth* 2000;84:226–235.

252. El-Sayed H, Goodall S, Hainsworth R. Re-evaluation of Evans blue dye dilution method of plasma volume measurement. *Clin Lab Haematol* 1995;17:189–194.

253. Pearson T, Guthrie D, Simpson J, et al. Interpretation of measured red cell mass and plasma volume in adults: Expert Panel on Radionuclides of the International Council for Standardization in Haematology. *Br J Haematol* 1995;89:748–756.

254. Wright R, Tono M, Pollycove M. Blood volume. *Semin Nucl Med* 1975;5:63–70.

255. Ferrant A. What clinical and laboratory data are indicative of polycythemia and when are blood volume studies needed? *Nouv Rev Fr Hematol* 1994;36:151–154.

256. Messinezy M, Pearson T. Apparent polycythemia: diagnosis, pathogenesis and management. *Eur J Haematol* 1993;51:125–131.

257. Tefferi A. Diagnosing polycythemia vera: a paradigm shift. *Mayo Clin Proc* 1999;74:159–162.

2004 Lippincott Williams & Wilkins  
John P. Greer, John Foerster, John N. Lukens  
George M. Rodgers, Frixos Paraskevas, Bertil Glader  
Wintrobe's Clinical Hematology



CELL MEMBRANE AND PROTEINSType I ProteinsType II ProteinsGlycosylphosphatidylinositol AnchorType III Proteins (Multispan Proteins)PROTEIN FAMILIESImmunoglobulin SuperfamilyC-Type Lectin Superfamily (CL Domain)Cytokine Receptor Superfamily (Cytokine-Binding Domain)Tumor Necrosis Factor/Nerve Growth Factor Superfamily (TN Domain)Tumor Necrosis Factor/Nerve Growth Factor Receptor Superfamily or Type III (TR Domain)Tetraspan Transmembrane SuperfamilyIntegrin SuperfamilyScavenger Receptor Superfamily (SR Domain)Rhodopsin SuperfamilyComplement Control Proteins DomainFibronectin Type III Domain (F3)CD1 (LEU-6, CD1A-E)CD2 (T11, LEU-5, SRBC RECEPTOR)CD3 (T3, LEU-4)CD4 (T4, LEU-3A, 3B)CD5 (LEU-1)CD8 (T8, LEU-2)CD10 (COMMON ACUTE LYMPHOCTIC LEUKEMIA ANTIGEN, NEPRILYSIN)CD11a (LFA-1a; LYMPHOCYTE FUNCTION-ASSOCIATED ANTIGEN-1 a SUBUNIT; aL)CD11b (aM, CR3, MAC 1)CD11c (aX, P150, 95)CD11d (aD)CD13 (MY7, AMINOPEPTIDASE N)CD14 (LIPOPOLYSACCHARIDE RECEPTOR (LPS-R))CD15 (Lewisx, Lex), CD15s (Sialyl Lewisx, sLex)CD16 (FcγRIII)CD18 (β2 INTEGRIN)Leukocyte Adhesion DeficiencyCD19 (B4)CD20 (B1)CD21 (CR2, EPSTEIN-BARR VIRUS RECEPTOR, C3D RECEPTOR)CD22 (B5, LEU-14, SIALIC ACID-BINDING IMMUNOGLOBULIN SUPERFAMILY LECTIN (SIGLEC)-2)CD23 (LEU-20, BLAST-2, FcεR-II)CD25 (TAC ANTIGEN, α-CHAIN OF INTERLEUKIN (IL)-2 RECEPTOR)CD28CD29 (β1 INTEGRIN CHAIN, VERY LATE ANTIGEN (VLA) β-CHAIN, PLATELET GLYCOPROTEIN (GP) IIA)CD30 (Ki, BER-H2 ANTIGEN)CD31 (PLATELET ENDOTHELIAL CELL ADHESION MOLECULE-1 (PECAM-1))CD32 (FcγRII)CD33 (SIALIC ACID-BINDING IMMUNOGLOBULIN SUPERFAMILY LECTIN (SIGLEC)-3)CD34 (MY10, SGP90)CD35 (COMPLEMENT RECEPTOR (CR) 1; CR1, C3bR, C4bR)CD36 (PLATELET GLYCOPROTEIN IV)CD38 (ADENOSINE DIPHOSPHATE (ADP)-RIBOSYL CYCLASE, CYCLIC ADP-RIBOSE HYDROLASE)CD39 (E-NTPDase; ECTO-NUCLEOSIDE TRIPHOSPHATE DIPHOSPHOHYDROLASE, APYRASE, ECTO-ATPase)CD40CD41 (INTEGRIN αIIb SUBUNIT, PLATELET GLYCOPROTEIN IIb OF THE IIb/IIIa COMPLEX)CD42: CD42a (GP1X); CD42b (GP1ba); CD42c (GP1bβ); CD42d (GPV)CD42a (GP1X)CD42b (GP1ba)/CD42c (GP1bβ)CD42cCD42d (GPV)CD43 (LEUKOSIALIN, SIALOPHORIN, WASP; WISKOTT-ALDRICH SYNDROME PROTEIN)CD45 (LCA; LEUKOCYTE COMMON ANTIGEN, B220)

CD46 (COMPLEMENT MEMBRANE COFACTOR PROTEIN; MCP)  
 CD47 (INTEGRIN-ASSOCIATED PROTEIN (IAP), RH-ASSOCIATED PROTEIN, NEUROPHILIN)  
 CD48 (BLAST-1)  
 CD49: CD49a (VLA-1) TO CD49f (VLA-6)  
 CD50 (INTERCELLULAR ADHESION MOLECULE (ICAM) 3; ICAM RECEPTOR)  
 CD51 (αV: α SUBUNIT OF VITRONECTIN RECEPTOR; INTEGRIN αV SUBUNIT)  
 CD52 (CAMPATH-1)  
 CD54 (ICAM-1; INTERCELLULAR ADHESION MOLECULE-1)  
 CD55 (DAF; COMPLEMENT DECAY-ACCELERATING FACTOR)  
 CD56 (NCAM; NEURAL CELL ADHESION MOLECULE)  
 CD57 (HNK-1; HUMAN NATURAL KILLER CELL-1 ANTIGEN, LEU-7 ANTIGEN)  
 CD57 in Hematology-Immunology  
 CD58 (LFA-3; LEUKOCYTE FUNCTION ANTIGEN-3)  
 CD59 (COMPLEMENT PROTECTIN; MIRL; MEMBRANE INHIBITOR REACTIVE LYSIS; HRF-20; HOMOLOGOUS RESTRICTION FACTOR 20)  
 CD61 (INTEGRIN β3 SUBUNIT)  
 CD62 (SELECTINS)  
 CD62E (E-Selectin, ELAM)  
 CD62L (L-Selectin, LEGAM-1)  
 CD62P (P-Selectin, PADGEM)  
 CD64 (FCγRI)  
 CD66 (CARCINOEMBRYONIC ANTIGEN (CEA) FAMILY)  
 CD66a: C-CAM-1  
 CD66b (Carcinoembryonic Cell Adhesion Molecule (CEA-CAM)-8, Former CD67) and CD66c (CEA-CAM-6, NCA)  
 CD66d (CEA-CAM-3) and CD66e (CEA-CAM-5, Carcinoembryonic Antigen)  
 CD66f (PSG; Pregnancy-Specific Glycoprotein)  
 CD70 (CD27L)  
 CD71 (TRANSFERRIN RECEPTOR (TfR))  
 TfR and Hemochromatosis  
 CD73 (ECTO-5'-NUCLEOTIDASE, L-VAP-2; LYMPHOCYTE VASCULAR ADHESION PROTEIN-2)  
 CD74 (INVARIANT CHAIN, IC)  
 CD79A (MB1, IMMUNOGLOBULIN (I<sub>g</sub>)<sub>α</sub>) AND CD79b (B29, I<sub>g</sub>β)  
 CD80 (B7-1)  
 CD81 (TAPA-1; TARGET FOR ANTIPROLIFERATIVE ANTIBODY-1)  
 CD85: CD85a TO CD85m  
 Nomenclature  
 ILT: Immunoglobulin-Like Transcript-1  
 ILT-2  
 ILT-3  
 ILT-4  
 ILT-5  
 CD86 (B7-2, B70)  
 CD87 (αPAR; UROKINASE PLASMINOGEN ACTIVATOR RECEPTOR)  
 CD91 (α<sub>2</sub>-MACROGLOBULIN RECEPTOR; LOW-DENSITY LIPOPROTEIN (LDL) RECEPTOR-RELATED PROTEIN; LRP)  
 CD93 (C1qRP; C1q RECEPTOR FOR PHAGOCYTOSIS)  
 CD94  
 CD95 (Fas ANTIGEN; APO-1; TNF RECEPTOR SUPERFAMILY MEMBER 6; TNFRSF6)  
 CD99  
 CD100 (SEMAPHORIN 4D, SEMA4D)  
 CD110 (THROMBOPOIETIN RECEPTOR, MPL, TPOR)  
 CD117 (RECEPTOR FOR STEM CELL FACTOR, C-KIT)  
 CD122 (IL-2 RECEPTOR β-CHAIN)  
 CD123 (IL-3 RECEPTOR α-CHAIN)  
 CD124 (IL-4 RECEPTOR)  
 CD125 (IL-5 RECEPTOR α-CHAIN)  
 CD126: IL6 RECEPTOR  
 CD128 (IL-8 RECEPTOR α, CXCR1; CD128B: IL-8 RECEPTOR β, CXCR2)  
 CD129 (RECEPTOR FOR IL-9)  
 CD130  
 CD131 (COMMON β-CHAIN)  
 CD132 (COMMON γ-CHAIN)  
 CD133 (HEMATOPOIETIC STEM CELL ANTIGEN, PROM1; PROMININLIKE 1)  
 CD138 (SYNDECAN-1, HEPARAN SULFATE PROTEOGLYCAN)  
 CD140a (PDGFRα; PLATELET-DERIVED FACTOR RECEPTOR α) AND CD140b (PDGFRβ)  
 CD141 (FETOMODULIN, THROMBOMODULIN)  
 CD 142 (TISSUE FACTOR (TF), THROMBOPLASTIN)  
 CD143 [ANGIOTENSIN-CONVERTING ENZYME (ACE), KININASE II, PEPTIDYL DIPEPTIDASE A]  
 CD150 (SLAM; SIGNALING LYMPHOCYTE ACTIVATION MOLECULE)  
 CD151 (PETA-3; PLATELET-ENDOTHELIAL CELL TETRASPAN ANTIGEN-3)  
 CD152 (CTLA-4; CYTOTOXIC T LYMPHOCYTE-ASSOCIATED PROTEIN-4)  
 CD154 (CD40L)  
 CD156 (ADAM-8; A DISINTEGRIN AND METALLOPROTEASE-8, MS2 HUMAN)  
 CD156B (ADAM-17, TACE; TUMOR NECROSIS FACTOR-α-CONVERTING ENZYME)  
 CD157 (BST-1)  
 CD158  
 CD159A (NKG2A)  
 CD162 (PSGL-1; P-SELECTIN GLYCOPROTEIN LIGAND-1, PSGL)  
 CD164 (MVC 24, MGC-24V)  
 CD166 (ALCAM; ACTIVATED LEUKOCYTE CELL ADHESION MOLECULE, NEUROLIN, BEN)

CD169 [SIALOADHESIN (SN). SIALIC ACID-BINDING IG-LIKE LECTIN-1 (SIGLEC-1)]  
 CD170 (SIGLEC-5)  
 Siglec-6 (OB-BP1)  
 Siglec-7  
 Siglec-8  
 Siglec-9  
 Siglec-10  
 CD172a (SIRP- $\alpha$ : SIGNAL REGULATORY PROTEIN- $\alpha$ )  
 CD173 (BLOOD GROUP H TYPE 2)  
 CD174 (LEWIS Y)  
 CD175 (Tn)  
 CD176 [T ANTIGEN THOMSEN- FRIEDENREICH (TF) ANTIGEN]  
 CD178 [FAS IGM. CD95]. TUMOR NECROSIS FACTOR SUPERFAMILY-6 (TNFSF6)  
 CD179a (VPREB. VPREB1. IGVPB) AND CD179B (IGLL1. 25. 25 IMMUNOGLOBULIN OMEGA POLYPEPTIDE)  
 CD183 [CXCR3. GPR9. CKR-L2. IP-10-R. MONOKINE INDUCED BY ?-Interferon Receptor (MIG-R)]  
 CD184 (CXCR4. FUSIN. LESTR. NPY3R. HM89)  
 CD195 (CCR5)  
 CDW197 (CCR7)  
 CD204 (MACROPHAGE SCAVENGER RECEPTOR MSR-A)  
 CD205 (DEC-205)  
 CD206 (MRC1. MACROPHAGE MANNOSE RECEPTOR. MMR)  
 CD208 (DC-1 AMP. DENDRITIC CELL-LYSOSOME-ASSOCIATED MEMBRANE PROTEIN. LAMP-3)  
 CD209 (DC-SIGN: DENDRITIC CELL-SPECIFIC INTERCELLULAR ADHESION MOLECULE-3. GRABBING NONINTEGRIN)  
 CD210 (IL-10 RECEPTOR)  
 CD212 (IL-12 RECEPTOR- $\beta$ 1)  
 CD213a1 AND CD213a2 (IL-13 RECEPTOR- $\alpha$ 1 AND - $\alpha$ 2)  
 CDW217 (IL-17 RECEPTOR)  
 CD231 (TALLA-1: T-CELL ACUTE LYMPHOBLASTIC LEUKEMIA-ASSOCIATED ANTIGEN 1; TM4SF2: TRANSMEMBRANE 4 SUPERFAMILY MEMBER 2; MXS1: MEMBRANE COMPONENT X CHROMOSOME SURFACE MARKER 1)  
 CD232 (VESP-R: VIRUS-ENCODED SEMAPHORIN PROTEIN RECEPTOR)  
 CD233 (BAND 3: ERYTHROCYTE MEMBRANE PROTEIN BAND 3; AE-1: ANION EXCHANGER 1; DIEGO BLOOD GROUP; SLC4A SOLUTE CARRIER FAMILY 4. ION EXCHANGER MEMBER 1)  
 CD234 (FY-GLYCOPROTEIN. DUFFY ANTIGEN. DARC: DUFFY ANTIGEN RECEPTOR FOR CHEMOKINES)  
 CD235a (GLYCOPHORIN A). CD235b (GLYCOPHORIN B). CD235ab (GLYCOPHORIN A/B. CROSS-REACTIVE MABS)  
 CD236 (GLYCOPHORIN C/D) AND CD236R (GLYCOPHORIN C)  
 CD238 (KELL BLOOD GROUP)  
 CD239 (B-CAM: B-CELL ADHESION MOLECULE. LUTHERAN BLOOD GROUP)  
 CD240CE (Rh30CE): CD240D (Rh30D): CD240 DCE (Rh30D/CE CROSS-REACTIVE MABS): CD241 RhAG  
 CD242 [ICAM-4: INTERCELLULAR ADHESION MOLECULE-4. LANDSTEINER-WIENER (LW) BLOOD GROUP]  
 CD243 (MDR-1. MULTIDRUG RESISTANCE-1. P-GLYCOPROTEIN)  
 CD244 (2B4. NAIL: NATURAL KILLER CELL ACTIVATION-INDUCING LIGAND)  
 CD246 (ALK: ANAPLASTIC LYMPHOMA KINASE)  
 CD247 (CD32 ANTIGEN. ZETA POLYPEPTIDE)

## CELL MEMBRANE AND PROTEINS

The basic structure of the eukaryotic cell membrane is a phospholipid bilayer. Phospholipids are amphipathic (i.e., they consist of hydrophobic and polar (hydrophilic) groups). In the bilayer, the hydrophobic fatty chains interact facing each other, whereas the polar head groups face the outside of the cell (for the outer layer) or the inside of the cell (for the inner layer).

The cell membrane contains two groups of proteins: *integral* or *intrinsic*, which interact directly with the hydrophobic side chains of the phospholipids (they can be removed only by detergents) and *peripheral* or *extrinsic*, which are attached indirectly by interactions with the integral proteins or the polar groups of the phospholipids (they can be removed by high-salt solutions). Integral proteins are embedded within the cell membrane in a variety of ways listed below.

### Type I Proteins

These proteins are oriented with the  $-NH_2$  terminal outside the cell and the COOH terminal intracellularly and pass only once through the phospholipid bilayer. The transmembrane region of the protein contains 20 to 25 hydrophobic amino acids that interact with the hydrophobic tails of the membrane lipids.

## Type II Proteins

These proteins have the opposite orientation to type I (i.e., their  $-NH_2$  terminal is inside the cell, whereas the  $-COOH$  terminal faces the outside).

## Glycosylphosphatidylinositol Anchor

Some integral proteins interact with the membrane via a glycosylphosphatidylinositol (GPI) anchor that is attached by an amide bond of the protein (see [Chapter 18](#)).

## Type III Proteins (Multispan Proteins)

These proteins cross the phospholipid bilayer several times. Those having four transmembrane regions are of two different families: (a) the tetraspan (TM4) superfamily (SF) (i.e., CD9, CD37, CD53, CD63, CD81, and CD82) and (b) the “membrane-spanning” four domain (MS4A) family (i.e., CD20). Other proteins cross the membrane seven times [i.e., CD97, CD128 [interleukin (IL)-8R], the Duffy antigen (CD234), G protein-coupled receptors, chemokine receptors, and so forth]. The multidrug resistance protein (CD243) crosses the membrane 12 times.

## PROTEIN FAMILIES

In most of the leukocyte antigens, there are amino-acid sequences that are similar to those of other proteins. In 1983, Dayhof introduced the term *superfamily* (*SF*) for proteins with 50% or less sequence similarity and the term *family* for more than 50% identity. Amino acid homologies among various proteins sometimes are clustered in short sequences that form discrete structural units known as *domains*. Usually, a domain is defined by evidence of secondary and tertiary structure and in most cases it is encoded by a single exon. The best-known domains are those of the immunoglobulin (Ig) molecule, the complement control protein (CCP), epidermal growth factor (EGF), fibronectin (FN) type III, cytokine receptor, and C-type lectin. Extracellular regions of proteins may have a single domain, as in the case of Thy-1 (CD90) antigen, the smallest member of the IgSF, or several domains, as with the C3 receptor (CD35), which contains 30 CCP domains. In some cases, all domains are of the same type, but in others, there is a mixture of domains [i.e., the L-selectin (CD62L) contains C-type, EGF, and CCP domains]. If the segment of a protein is not a domain, then the term *repeat* is used. Smaller structures, which are still expected to form a folded unit, are called *motifs*.

## Immunoglobulin Superfamily

The IgSF was the first to be identified and is the largest group, with more than 100 members. The identities are clustered in sequences corresponding to the Ig fold. The *Ig fold* is the Ig domain that comprises two  $\beta$ -pleated sheets held together by a disulfide bond. The Ig molecule has the *C domain* (found in the constant regions of the Ig heavy and light chains), which has two  $\beta$ -pleated sheets, and the *V domain* (found in the variable regions). There are two IgSF C-domains, C-1 and C-2. The C-1 is similar to the C-domains of the Ig molecule both for its length between the cysteines of the disulfide bond and the organization of the  $\beta$  sheets. The C-2 has the same length as the C-domains of the Ig molecule but has a V-like pattern in the  $\beta$  strands. The strands of Ig domains are defined by the letters A, B, C, D, E, F, G, and A', C', and C?. The C-1 lacks A' strand and C-2 lacks A' and D. Analysis of the  $\beta$  sheet and loop topology of Ig domains with less than 25% residue identity separates several new types (i.e., c-, h-, s-, and v-).

## C-Type Lectin Superfamily (CL Domain)

Members of this family are called *C-type* because of their  $\text{Ca}^{2+}$ -dependent carbohydrate binding (hence “C”). A substantial number of members in this family are type II proteins. All three selectins (E, P, and L) and CD23 belong to this SF. In addition to the C-binding domain, the selectins contain CCP repeats. The C-domain contains a network of anti-parallel  $\beta$  strands and 2-amphipathic  $\alpha$  helices, which flank the  $\beta$  secondary structure.

Important members of this family are the selectins (see [CD62](#)), some natural killer (NK) cell receptors (NKG2), the eosinophilic major basic protein (member of the “C-type” SF but lacks the  $\text{Ca}^{2+}$ -binding residues).

## Cytokine Receptor Superfamily (Cytokine-Binding Domain)

*Type I:* This SF includes the receptors for IL-1, IL-2, IL-3, IL-4, IL-5, IL-6, IL-10, granulocyte-macrophage colony-stimulating factor (GM-CSF), granulocyte colony-stimulating factor, and erythropoietin. The cytokine receptors contain four kinds of domains: IgSF, FN type III, cytokine receptor, and CCP. FN type III is composed of two  $\beta$  sheets packed face to face, folded like the IgSF domains. The cytokine receptor domain has four cysteines and the W-S-X-W-S motif. The CCP structure has two antiparallel  $\beta$  sheets and a short section of triple-stranded  $\beta$  sheets.

*Type II:* Includes the receptors for interferon (IFN)- $\alpha$ , - $\beta$ , and - $\gamma$ .

## Tumor Necrosis Factor/Nerve Growth Factor Superfamily (TN Domain)

The TN domain comprises two sheets of eight antiparallel strands forming a “ $\beta$ -jellyroll.” Members of the family are CD70 (CD27L), CD153 (CD30L), CD154 (CD40L), CD178 [CD95L or Fas ligand (FasL)], tumor necrosis factor (TNF)- $\alpha$ , and lymphotoxin- $\beta$ .

## Tumor Necrosis Factor/Nerve Growth Factor Receptor Superfamily or Type III (TR Domain)

The extracellular region of these proteins contains a series of cysteine-rich repeats, or *TR domains*. These sequences are encoded by more than one exon. Members include CD27, CD30, CD40, CD95 (Fas), CD120a (TNFR1), and CD120b (TNFR2). The TR domain has two double-stranded  $\beta$  sheets. It binds the TN domain. A trimer of TN domain binds three TNFR molecules.

## Tetraspan Transmembrane Superfamily

The TM4 SF traverses the membrane four times with both the  $-\text{NH}_2$  and  $-\text{COOH}$  termini inside the cell. Members include CD9, CD37, CD53, CD63, CD81, and CD82. CD20, which also crosses the membrane four times, does not belong to this group.

## Integrin Superfamily

Members are heterodimers of an  $\alpha$ - and a  $\beta$ -chain (see [CD29](#), [CD41](#), [CD49](#), [CD61](#), and so forth).

## Scavenger Receptor Superfamily (SR Domain)

Members of this SF are CD5, CD6, and CD36. They have three similar domains in the extracellular region.

Scavenger receptors are distinguished into class A and B, each divided into types I and II. The type A macrophage scavenger receptor and CD36 (class B-I) belong to the family of multiligand lipoprotein receptors, which recognize oxidized low-density lipoprotein. Both classes are also receptors for advanced glycation end products (AGE), which are important physiologically and are involved in aging, diabetic complications, and so forth.

## Rhodopsin Superfamily

This SF contains more than 50 members that are characterized by the presence of seven hydrophobic sequences, indicating that they cross the membrane seven times. The  $-NH_2$  terminus is on the extracellular side, and the  $-COOH$  terminus is on the intracellular side of the membrane. These proteins couple to various G proteins. Leukocyte antigens that are members of this SF are CD88 (receptor for C5a anaphylatoxin) and CD128 (receptor for IL-8).

## Complement Control Proteins Domain

CCP has a  $\beta$ -sandwich structure with an ellipsoid shape. Several hydrophobic and aromatic residues are buried in the core. A hypervariable loop extends from one side and may be involved in protein binding. Several of the domains exist in complement receptors (CRs) [i.e., CD21 (CR2) has 15 to 16 CCPs whereas CD35 (CR1) has 30 CCPs].

## Fibronectin Type III Domain (F3)

FN type III domain is detected in many proteins. Its fold is similar to the Ig domains (i.e., a barrel of two  $\beta$  sheets). The RGD loop in FN, which binds integrins, is between strands F and G.

## CD1 (LEU-6, CD1A-E)

*Structure.* The CD1 family consists of two groups: Group I includes CD1a, CD1b, and CD1c; group II includes CD1d. Each of these proteins is encoded by genes CD1A, CD1B, CD1C, and CD1D.

CD1 molecules have significant homology to the major histocompatibility complex (MHC) molecules and are associated with the  $\beta_2$ -microglobulin. The  $\alpha_1$  and  $\alpha_2$  domains adopt an antigen-binding site. The  $\alpha_3$  domain is associated with  $\beta_2$ -microglobulin. The groove is formed by hydrophobic amino acids and thus has little or no potential for forming hydrogen bonds with its ligand (1, 2).

*Gene Locus.* 1q22.

*Molecular mass (kd).* CD1a: 49; CD1b: 45; CD1c: reduced, 43.

*Distribution.* CD1a: cortical thymocytes, DCs, epidermal Langerhans cells, astrocytes, cytokine-stimulated monocytes. CD1b: Langerhans cells. CD1c: thymocytes, B cells,



mantle zone and umbilical cord. CD1d: intestinal epithelium, kidney tubular epithelia, hepatocytes, thymus.

*Function:* CD1 antigens are antigen-presenting molecules for microbial antigens ([3](#), [4](#)). In this group belong the *Mycobacterium tuberculosis* mycolic acids and the lipoarabinomannan of *Mycobacterium leprae*.

These antigens are taken by antigen-presenting cells (APCs) and are delivered to acidic endosomes, where CD1b is detected (s). In the acidic endosomes, the  $\alpha$  helices of the CD1b groove unfold and allow binding of the lipid component, which is buried within the groove, and only the carbohydrate portion is left exposed to react with the T-cell receptor (TCR). (For further details, see [Chapter 18](#).)

## CD2 (T11, LEU-5, SRBC RECEPTOR)

*Structure.* CD2 is a member of the IgSF, forming a subfamily, which includes CD48, CD58, CD84, CD150 (SLAM), CS1, CD229 (Ly9), and CD244 (2B4). All members have two Ig domains, a membrane-distal V-like and a C2-like domain.

The cytoplasmic region of CD2 contains a unique proline-rich segment. It is essential for binding of the CD2-binding protein, regulation of T-cell adhesion, and activation of phosphoinositide 3-kinase (PI3K).

*Gene locus.* 1p13.

*Molecular mass (kd).* 50.

*Distribution.* Expressed on thymocytes, peripheral T cells, and NK cells. It is also expressed on a subpopulation of B cells and, in rare cases, of B-cell acute lymphoblastic leukemia (B-ALL) and B-cell chronic lymphocytic leukemia (B-CLL).

*Function:* CD2 mediates adhesion of T cells to APCs, activation of T cells, resulting in production of cytokines or induction of cytolysis by T or NK cells ([1](#), [2](#)). (For further details, see [Chapter 17](#).)

## CD3 (T3, LEU-4)

*Structure.* CD3 consists of a complex of five proteins that are always associated with the TCR on the surface of T cells. Three of them,  $\alpha$ ,  $\delta$ , and  $\epsilon$ , belong to the IgSF but  $\gamma$  and  $\zeta$  do not. Two heterodimers,  $\gamma$ - $\epsilon$  and  $\delta$ - $\epsilon$  are linked to TCR, as well as the  $\gamma$ - $\zeta$  (CD247) homodimer and  $\gamma$ - $\delta$  heterodimer. The extracellular regions of  $\gamma$ -,  $\delta$ -, and  $\epsilon$ -chains have one C-Ig-like domain, whereas the intracellular region has one immunoreceptor tyrosine-based activation motif (ITAM). The extracellular region of the  $\gamma$ -chain is only nine amino acids long, whereas the intracellular region has three ITAMs. The transmembrane region of the CD3 chain has a conserved negatively charged amino acid, complementary to the positive charge of the transmembrane region of the  $\alpha$ / $\beta$ -chains of the TCR.

*Gene Locus.* For  $\gamma$ ,  $\delta$ , and  $\epsilon$  on 11q23;  $\zeta$ ,  $\gamma$ :1q22

*Molecular mass (kd).* Reduced, 16, 20, 22, 25, 28; unreduced, 20, 25, 28, 32, 38.

*Distribution:* Present on thymocytes (double-positive stage), in mature T cells, and in the cytoplasm of immature T cells.

*Function:* Signal transduction ( [1](#) ). The ITAMs are phosphorylated on engagement of the TCR and adhesion molecules to the APC, thus becoming docking sites for protein tyrosine kinases (PTK) in the initiation of the signal transduction cascade. (For further details, see [Chapter 17](#).)

## CD4 (T4, LEU-3A, 3B)

*Structure.* Extracellular domain consists of four Ig domains (two V and two C). Cytoplasmic tail has three serine residues that can be potentially phosphorylated ( [1](#) ).

*Gene locus.* 12pter-p12.

*Molecular mass (kd).* Reduced, 59; unreduced, 59.

*Distribution:* Helper-inducer T cells, monocytes (lower density), hematopoietic stem cells, dendritic cells (DCs), and eosinophils (activated).

*Function:* Coreceptor for TCR. Binds to the MHC monomorphic portion of the class II molecules. CD4, as adhesion molecule, strengthens binding of TCR to target, augmenting the early phases of formation of the immunologic synapse ( [2](#) ). CD4 is located at the periphery of the synapse, whereas the TCR and the CD3-chains remain in the center; it also acts as activation molecule ( [3](#) ). Cytoplasmic tail is associated with PTK p56<sup>lck</sup>. It is the receptor for human immunodeficiency virus (HIV), binding to the C-terminal of the envelope glycoprotein (gp) 120. However, for the entry of HIV, the chemokine receptor CCR5 is required as co-receptor. Expression of CD4 is down-regulated as a result of binding to Nef protein, which directs it to lysosomes after it is internalized ( [4](#) ). CD4 expression in microglia may contribute to brain degeneration in HIV infection. (For further details, see [Chapter 17](#).)

## CD5 (LEU-1)

*Structure.* The extracellular region contains three scavenger receptor cysteine-rich domains, an ancient family of proteins that binds polyanions and lipoproteins. The cytoplasmic region contains multiple Ser/Thr and Tyr residues. Tyrosine 429 is critical for inhibitory function mediated by CD5, independent of an immunoreceptor tyrosine-based inhibitory motifs (ITIM) motif ( [1](#), [2](#) ).

*Gene locus.* 11q13.

*Molecular mass (kd).* 67.

*Distribution:* Thymocytes, T cells, NK cells, and a subpopulation of B cells (B<sub>1</sub>). It is expressed in the majority of cases of B-CLL. The CD5<sup>+</sup> B cells are increased in rheumatoid arthritis.

*Function:* Monoclonal antibodies to CD5 stimulate phosphorylation of intracellular



tyrosines and T-cell activation. However, CD5 may also mediate inhibitory effects. CD5<sup>+</sup> B cells produce autoantibodies. CD72 is the counter-receptor for CD5 ( [3](#), [4](#) and [5](#) ).

## CD8 (T8, LEU-2)

*Structure.* Heterodimer of CD8 $\alpha$ - and CD8 $\beta$ -chains. Each chain has one Ig-like domain (V) in the extracellular region, which is connected to the transmembrane region by a hingelike peptide rich in Pro, Ser, and Thr residues. The CD8 $\alpha$  gene predicts that the peptide contains nine cysteines, three in the V domain and two each in the hinge, transmembrane, and cytoplasmic regions. The cytoplasmic region consists of 29 highly basic amino acids and is associated with p56<sup>lck</sup> tyrosine kinase. The  $\alpha$ -chain binds to the monomorphic a<sub>3</sub> domain of class I HLA molecules.

*Gene locus.* 2p12 for both chains.

*Molecular mass (kd).* Reduced, 32; unreduced, 70.

*Distribution.* Thymocytes, T cells (cytotoxic), and subpopulation of NK cells (especially CD57<sup>+</sup>).

*Function.* CD8 acts as a coreceptor for TCR. It binds to the same HLA molecule as the TCR (see [Chapter 17](#)) ( [1](#), [2](#) ).

## CD10 (COMMON ACUTE LYMPHOCYTIC LEUKEMIA ANTIGEN, NEPRILYSIN)

*Structure.* Type II membrane protein (–NH<sub>2</sub> terminus intracellularly), member of membrane metalloproteinases (i.e., CD13, CD26, CD73, and so forth). The large extracellular region contains twelve cysteines. Other amino acids critical for other functions have been identified by site-directed mutagenesis, such as for substrate binding (Arg 102 and Arg 747), zinc coordination (Glu 646), and catalytic activity (His 583 and His 587) contained within a characteristic pentapeptide.

*Gene locus.* 3q25.1.

*Molecular mass (kd).* 90 to 110, depending on the cell or tissue source—lymphocytes, 100; neutrophils, 110. Variations are due to degree of glycosylation (there are six glycosylation sites) or splice variants.

*Distribution.* CD10 is expressed in normal and malignant cells of hematopoietic origin as well as in nonhematopoietic tissues. It is present in the pro-B and pre-B cells but not in mature B cells, except for germinal center B cells; it is also present in terminally differentiated neutrophils. In malignancies, it constitutes the main marker in more than 70% of B-ALL and in a small number of T-ALL, as well as in Burkitt and follicular lymphomas and a small number of multiple myelomas. Other tissues include the brush border of proximal tubules of kidney, biliary canaliculi, bronchial epithelium, fibroblasts, breast myoepithelium, placental microvilli, endometrial stromal cells, and nonhematopoietic tumors such as melanomas, gliomas, retinoblastomas, and so forth ( [1](#), [2](#) ).

*Function.* CD10 is a neutral endopeptidase, also known as *encephalinase*. Its substrates are important peptides such as bradykinin, enkephalins, angiotensin I, oxytocin, substance

P, and peptide f-MLP. Its activity depends on Zn binding, and it attacks peptide bonds involving the  $\alpha$ -NH<sub>2</sub> groups of hydrophobic amino acids. Target cells express both CD10 and the receptor for the peptide, which is hydrolyzed by the enzyme. It regulates B-cell proliferation and differentiation and reduces inflammatory responses and enkephalin-mediated analgesia. Bombesinlike peptides are potent mitogens for bronchial epithelia and are autocrine growth factors for small cell carcinomas of the lung. Their concentration increases in cigarette smokers as a result of CD10 inactivation by the smoke. CD10 degrades amyloid  $\beta$ -peptide, holding some promise for the treatment of Alzheimer disease (3, 4, 5, 6 and 7).

## CD11a (LFA-1a: LYMPHOCYTE FUNCTION-ASSOCIATED ANTIGEN-1 a SUBUNIT; aL)

*Structure.* CD11a forms a heterodimer with CD18 ( $\beta_2$  integrin), which is known as *LFA-1*. It is a type I transmembrane protein with more than 1000 amino acids in the extracellular region, whereas the cytoplasmic region consists only of 53 residues. The extracellular region can be divided into the *N*-terminal half and the remaining membrane-proximal region. The *N*-terminal half of the molecule contains seven repeats of four antiparallel  $\beta$  strands. The repeats are arranged like twisted blades of a propeller, and the whole structure is known as the  $\beta$ -propeller domain. Within the propeller is inserted, as a result of exon shuffling (between sheets 2 and 3), a 200-amino acid segment known as the *I domain* (for *inserted*). It is homologous to the A domain of von Willebrand factor (vWF), a molecule that mediates adhesion between platelets and subendothelial matrix. The I domain has a fold similar to a structure that has been identified in nucleotide binding of small G proteins and the  $\alpha$  subunits of the heterotrimeric G proteins. It is composed of six or seven  $\alpha$  helices and six  $\beta$  strands arranged in a Rossman type of fold.

The I domain contains a metal ion coordination site (or *MIDAS*, *metal ion-dependent adhesion site*), with a conserved sequence DXSXS, and with surrounding residues is the major ligand-binding site. CD18 regulates opening of the I domain of the aL subunit. Ca<sup>2+</sup> binding is mediated by strands in the lower surface of the  $\beta$ -propeller, and its removal activates ligand binding and destabilizes the  $\alpha/\beta$  subunit association. Ligand binding is supported by Mg<sup>2+</sup> or Mn<sup>2+</sup>. The remaining membrane-proximal part consists of four to six  $\beta$ -sandwich or  $\beta$ -barrel folds (1, 2).

*Gene locus.* 16p11.2.

*Molecular mass (kd).* Unreduced, 170; reduced, 180.

*Distribution.* LFA-1 is expressed on all leukocytes but not in platelets or nonhematopoietic tissues.

*Function.* Cell-surface and cytoplasmic molecules regulate LFA-1 function. Plasminogen activator receptor is associated with LFA-1, and cytoplasmic proteins known as *cytohesins* regulate ligand binding by interacting with the cytoplasmic region of  $\beta_2$  integrins. Signaling molecules [i.e., phospholipase C $\gamma$  1 (PLC $\gamma$  1)] and Ca<sup>2+</sup> increases have been implicated. LFA-1 ligands are the intercellular adhesion molecules (ICAMs)-1, -2, and -3. It participates in all immune and inflammatory interactions between cells of the immune system and other cells.

*In vivo,* LFA-1 mediates adherence of (a) T cells to APCs, B cells, endothelial cells, synovial cells, fibroblasts, and so forth; (b) cytotoxic T lymphocytes (CTL) and NK cells to

targets; and (c) macrophages to tumor cells, and so forth.

It contributes to the arrest, strong adhesion, and spreading of circulating lymphocytes on the endothelium, initiating transendothelial migration (see [Chapter 15](#)). Mutations of the  $\beta 2$ -chain (CD18) result in a profound immune deficiency known as *LAD-1* (leukocyte adhesion deficiency) as a result of lack of expression of LFA-1 (see [CD18](#)) ([3](#), [4](#) and [5](#)).

### CD11b ( $\alpha M$ , CR3, MAC 1)

*Structure.* Type I transmembrane proteins with a large extracellular region and a short intracellular region. The structure resembles that of the  $\alpha L$ -chain [i.e., seven repeating subunits forming a  $\beta$ -propeller domain, an I domain, and a MIDAS motif (see [CD11a](#))]. The heterodimer CD11b/CD18 is known as *CR3* ([1](#)). (See [Chapter 18](#).)

*Gene locus.* 16p11.2.

*Molecular mass (kd).* 165.

*Distribution.* Expressed on neutrophils, monocytes, macrophages, NK cells, subsets of T and B cells, and mast cells.

*Function.* CD11b possesses the ligand-binding site for iC3b (inactivated C3). Other ligands include fibrinogen, factor X, ICAM-1 (CD54), heparin, lipopolysaccharide (LPS), and CD23. The I domain is the major recognition site for at least four distinct ligands. Certain molecules, such as CD14, CD87, CD16, and CD32, are physically associated with the CD11b (i.e., co-capping), generating intracellular signaling. CD11b/CD18 on its own mediates phagocytosis of iC3b-opsonized bacteria in contrast to CR1, which requires cooperation with the Fc receptor. Mac-1 mediates adhesion and transmigration of neutrophils across the endothelium, homotypic adhesion of neutrophils, and chemotaxis. It can also bind to some yeasts without involvement of complement via its lectin domain, which also triggers the respiratory burst. In *LAD-1*, CD11b is not expressed, and patients suffer from serious bacterial infections (see [CD18](#)) ([2](#), [3](#), [4](#) and [5](#)).

### CD11c ( $\alpha X$ , P150, 95)

*Structure.* Similar to CD11a and CD11b. As a heterodimer with CD18 is known as *CR4*.

*Gene locus.* 16p11.2.

*Distribution.* Important receptor on macrophages, monocytes, neutrophils, DCs, NK cells, and hairy cell leukemia cells.

*Function.* Mediates leukocyte adhesion and spreading, chemotaxis, and fibrinogen binding. CD11c is strongly expressed in cells from hairy cell leukemia and, together with CD25, could be used for detection of minimal residual disease by flow cytometry ([1](#), [2](#) and [3](#)).

### CD11d ( $\alpha D$ )

CD11d is the newly added member of the  $\alpha$ -chains of  $\beta 2$  integrins and forms a heterodimer with CD18, contains an I domain like all other  $\alpha$ -chains of the  $\beta 2$  integrins, but it is more closely related to CD11b and CD11c. The I domain of  $\alpha D$  binds with high

affinity to vascular cell adhesion molecule-1 (VCAM-1), which is not a ligand for the other  $\alpha$ -chains of the  $\beta_2$  integrins. VCAM-1 is the ligand for  $\alpha_4$  integrins that lack I domain.  $\alpha_D$  also binds to ICAM-3 but not to the other two ICAMs. It is expressed on eosinophils and strongly on macrophages (foam cells) found in aortic fatty streaks that may develop into atherosclerotic plaques. CD11d/CD18 is constitutively expressed by synovial macrophages and strongly in synovium from patients with rheumatoid arthritis ( [1](#), [2](#) ).

## CD13 (MY7, AMINOPEPTIDASE N)

*Structure.* Type II membrane protein, which belongs to the family of metalloproteases (other members are CD10, CD26, CD73, and so forth). It exists as a non-covalently linked homodimer. The C-terminal domain contains the substrate binding site, and the N-terminal contains a pentapeptide, associated with the catalytic and the Zn-binding sites.

*Gene locus.* 15q25.

*Molecular mass (kd).* 150.

*Distribution.* It is expressed on normal myeloid and monocytic lineage cells and on most acute myelogenous leukemias (AMLs), as well as on a small number of lymphoblastic leukemias (5 to 10%). Expression of CD13 is regulated by cell-cell contact by stromal bone marrow cells. All CD13<sup>+</sup> blasts cultured *in vitro* on stromal cells from normal bone marrow lose CD13 expression. CD13 is expressed on renal proximal tubules, intestinal brush border, endothelial cells, fibroblasts, brain, osteoclasts, bone marrow stromal cells, and so forth ( [1](#), [2](#) ).

*Function.* CD13 is a receptor for the RNA corona viruses, which cause upper respiratory infections in humans, as in severe acute respiratory syndrome. CD13 removes unsubstituted N-terminal amino acids with neutral side chains from peptides. Peptide bond preceding Pro is resistant to CD13. Natural substrates are vasoactive peptides (bradykinin, angiotensin III), neuropeptide hormones, cytokines, IL-8, tuftsin, and so forth. Frequently, it is coexpressed and cooperates with other ectopeptidases (i.e., CD10 or CD26). It has been implicated in trimming peptides that protrude out of the groove of MHC molecules. In inflammatory conditions of the joints, CD13, CD10, and CD26 of synoviocytes provide an important source of peptide degradation.

CD13 regulates endothelial morphogenesis and cell motility, both critical in angiogenesis and in tumor progression. Endothelial cells release IL-8, which induces apoptosis of attached leukemic cells. Strong CD13 expression allows cells to survive by blocking apoptosis, probably as a result of IL-8 inactivation by the enzyme ( [3](#), [4](#), [5](#), [6](#) and [7](#) ).

## CD14 [LIPOPOLYSACCHARIDE RECEPTOR (LPS-R)]

*Structure.* CD14 is attached to the membrane by a C-terminal GPI anchor. The extracellular region contains ten sequences with similarities to the leucine-rich repeats. It is also found as a plasma protein (soluble or sCD14, 1 to 6  $\mu$ g/ml). There are two soluble forms: one released from the membrane and a second lacking the GPI anchor.

*Gene locus.* 5q23-31.

*Molecular mass (kd).* 53.

*Distribution.* CD14 is expressed on monocytes, macrophages, and weakly on granulocytes. It is also expressed in the liver, a primary organ in the acute phase response.

*Function.* CD14 binds bacterial LPS (endotoxin) and, as a component of a multimolecular complex, plays an important role in LPS-induced activation, inflammatory response, and innate immunity.

LPS is captured by a serum LPS-binding protein and is transported to CD14, which binds the complex. CD14, however, cannot trigger activation because it lacks an intracellular region. This function is mediated by one of a group of molecules known as *Toll-like receptors* (TLR), as they are structurally homologous to the Toll receptors of the fruit fly *Drosophila melanogaster*. One of the ten human TLRs, TLR4, is critical for transmission of LPS activation signals and requires a third molecule, MD2, linked to the extracellular region of TLR4. LPS links all three molecules and binds directly to all three members of the complex. The role of TLR4 has been conferred in TLR4 knock-out mice and in humans with TLR4 mutations. TLRs recognize pathogen-associated molecular patterns, and TLR4 specifically recognizes *Escherichia coli* LPS. TLR4 recruits an adaptor protein MyD88, which engages the IL-1 receptor-associated kinase, leading to activation of nuclear factor- $\kappa$ B (NF- $\kappa$ B) and production of cytokines (TNF- $\alpha$ , IL-1) and chemokines, as well as up-regulation of co-stimulatory molecules (CD80, CD86, and so forth). A conical lipid A interacts with TLR4, whereas cylindrical shapes interact with different TLRs for different responses. Soluble CD14 transfers LPS to high-density lipoproteins where it is neutralized. Liver expression of CD14 may function in the acute phase response. CD14 is also involved in the removal of apoptotic cells without inciting inflammation ([1](#), [2](#), [3](#) and [4](#)).

## CD15 (Lewis<sup>X</sup>, Le<sup>X</sup>), CD15s (Sialyl Lewis<sup>X</sup>, sLe<sup>X</sup>)

*Structure.* Antibodies, which recognize CD15, react with a trisaccharide:

Gal $\beta$ 4[Fuc $\alpha$ 1 $\beta$ 3]GlcNAc. The sialylated form (sLe<sup>X</sup>) has a sialic acid linked to Gal. These carbohydrate chains are O-linked on glycoproteins (known as *mucins* or *sialomucins*), which present them to the lectin domain of L-selectin. Three of these proteins, GlyCAM-1, CD34, and MAdCAM (defined by the antibody MECA-79) were given the name *peripheral lymph node addressin* (PNAd). Sialyl Lewis<sup>X</sup> is modified by sulfation by two sulfotransferases; one of them, GlcNAc-6-sulfotransferase, is highly restricted to high endothelial venules (HEVs), and such sulfated sLe<sup>X</sup> structures are very potent L-selectin ligands. Because L-selectin binding is highly dependent on sulfation of sLe<sup>X</sup>, these two sulfotransferases play a critical role in controlling the migration of lymphocytes across capillary endothelia. (See details in [Chapter 15](#).)

*Distribution.* Expressed on neutrophils, eosinophils, and monocytes but not on platelets, lymphocytes, and erythrocytes. CD15 is not (or is very weakly) detected on myeloid progenitors and AML blasts. This is due to the presence of strong 6'-sialyltransferase, which uses the precursor substrate at the expense of 3'-fucosyltransferase and prevents the synthesis of Le<sup>X</sup> and sLe<sup>X</sup>. CD15 is detected in HEV cells in association with L-selectin gp ligands.

*Function.* Sialylated and sulfated Le<sup>X</sup> displayed by mucins are the ligands for L-selectin in lymphocyte homing ([1](#), [2](#)). These posttranslational modifications of Le<sup>X</sup> are mediated by sulfotransferases that are highly restricted to HEV ([3](#)). Fucose and sialic acid are

critical components of the L-selectin ligands. These enzymes exert a fine-tuning of the influx of lymphoid cells in various inflammatory sites ( [4](#), [5](#), [6](#) and [7](#)). High serum levels of sLe<sup>X</sup> were found to be an independent predictor for liver metastasis in patients with gastric carcinoma ( [8](#)). CD15 has been detected in myeloma with phagocytic plasma cells ( [9](#)). In LAD type II [CDG-IIc (congenital disorders of glycosylation) in the newer classification], a guanosine diphosphate (GDP)-fucose transporter deficiency is due to a defect in GDP-fucose import into the lumen of the Golgi. Patients lack Le<sup>X</sup> and sLe<sup>X</sup>, and no H antigen is expressed on erythrocytes ( [6](#), [7](#), [8](#) and [9](#)).

## CD16 (FcγRIII)

*Structure.* CD16 exists in two isoforms: CD16a and CD16b. The extracellular region contains two type C2Ig-like domains. The transmembrane form, CD16a, requires coexpression with other molecules for efficient cell-surface expression. In macrophages, CD16 is associated with a homodimer of the γ subunit of the FcεR and in NK cells, is associated either with a homodimer of Fcε γ subunit or a heterodimer of the Fcεγ and the TCR-γ of the CD3 complex ( [1](#)). Soluble forms of both isoforms are formed by the action of serine proteases (CD16b) or metalloproteases (CD16a). The transmembrane region of CD16a has a conserved sequence of eight amino acids with a negatively charged aspartic acid unique to all FcR chains that associates with other molecules.

*Gene locus.* Both isoforms: 1q23.

*Molecular mass (kd).* Transmembrane (TM): 27; GPI: 21.

*Distribution.* CD16b (GPI-anchored) is expressed exclusively in neutrophils, whereas the transmembrane CD16a is expressed on macrophages and NK cells, some monocytes, and some T cells. FcγRIII has also been detected in kidney mesangial cells and placental trophoblasts. It is detected in the mantle zone of lymph nodes and interfollicular areas. The GPI-anchored is up-regulated by IFN-γ and GM-CSF and down-regulated by TNF-α. The transmembrane form is up-regulated by TNF-β.

*Function.* Interaction with the Ig Fc domain is mediated primarily by the membrane proximal Ig domain, which binds between the two Cγ<sub>2</sub> domains of the Fc fragment ( [2](#)). FcγRIIIa binds monomeric Ig and has higher affinity than FcγRIIIb.

One of the main functions of FcγRIII is ADCC (antibody-dependent cell cytotoxicity) (i.e., through NK cells). It also mediates phagocytosis and generates superoxide production when it is cross-linked on monocytes or macrophages. Signal transduction is initiated by the γ/γ-chains, which carry ITAM sequences. Residue 148 of FcγRIIIa may be substituted with either valine (V) or phenylalanine (F). NK cells homozygous for V (VV) bind IgG more strongly than NK cells from FF persons ( [3](#)). This is important because VV patients with lymphoproliferative diseases respond to chimeric anti-20 monoclonal antibody (rituximab) better than FF patients ( [4](#)). A substitution at position 48 by histidine is associated with recurrent viral infections ( [5](#)).

## CD18 (β<sub>2</sub> INTEGRIN)

*Structure.* CD18 is a transmembrane protein that forms heterodimers with CD11a, CD11b, or CD11c (α-chains). The extracellular region consists of an N-terminal region (NTR) followed by an I-like domain, a midregion, and, next to the membrane, a cysteine-rich



region (CRR). The interrelationships of these domains and regions to the overall function (i.e., cell-surface expression and ligand binding of the heterodimeric  $\beta_2$  integrins) is quite complex (1). The I-like domain of the  $\beta_2$  subunit contributes to the heterodimer formation by interacting with the  $\beta$ -propeller of the  $\alpha$  subunits (see [CD11a](#)) (2).

The binding of the ligand by the heterodimer is contributed by the I-like domain of  $\beta_2$  with contributions from the I-domain of the  $\alpha$  subunits.

By electron microscopy, the leukocyte integrins appear as having a globular “head” with two stalks joining the head to the cell membrane. The head is formed by the N-terminals of both chains, which includes the  $\beta$ -propeller and I-domains. Therefore, the ligand binds to the top of the head. One stalk is formed by the remaining portion of the  $\alpha$  subunit, whereas the second stalk is the CRR region of the  $\beta$  subunit. Normally, the integrin is restrained to a resting state. Activation changes the “closed” to an “open” conformation, which is achieved by movement of the subunits similar to the opening of a scissor.

*Gene locus.* 21q22.3.

*Molecular mass (kd).* 90.

*Distribution.* Neutrophils, monocytes, macrophages, T and B lymphocytes.

*Function.* As a common chain to all four leukocyte integrins, CD18 participates in a great variety of immunologic and inflammatory responses (3). LFA-1 plays a major role in interactions of lymphocytes with other cells: (a) endothelial (homing to peripheral lymphoid organs and migration to sites of inflammation); (b) T-cell interaction with APCs in the formation of the synapse (see [Chapter 17](#)); and (c) CD8<sup>+</sup> CTL with target cells. These interactions generate *outside-in* signals, which regulate reorganization of cytoskeletal elements, stimulate growth, and prevent apoptosis. The CD18 intracellular region interacts with several cytoskeletal proteins. The  $\beta_2$  integrins are also activated from signals generated by other receptors inside the cell (i.e., *inside-out* signaling). Engagement of TCR with antigen generates intracellular signals, which in turn act on LFA-1 at the cell surface, increasing its affinity, thus stabilizing further the T-cell interaction with APCs. Mac-1 (CD11b/CD18) regulates several functions of neutrophils (i.e., adhesion, migration, chemotaxis, phagocytosis, degranulation, and so forth). It cooperates with several other receptors such as LPS/LPS-binding protein (CD14) and with Fc $\gamma$ RIIIb (CD16) in ADCC.

Chemokines such as secondary lymphoid-tissue chemokine (SLC), Epstein-Barr virus (EBV)-induced molecule 1 ligand chemokine (ELC), and stromal cell-derived factor (SDF)-1a enhance LFA-1 affinity and induce lateral mobility of LFA-1 (4). Both of these changes result in a rapid arrest of lymphocytes rolling on the endothelial surface. LFA-1 function can be inhibited by small molecules (5), which bind to a pocket of the I domain, termed the *lovastatin-binding site* (L-site), named after the inhibitor of (3-hydroxy-3methyl 6-glutaryl-coA) HMG-coenzyme A. Several other compounds (hydantoin and so forth) bind to the same pocket and inhibit LFA-1 function.

### **Leukocyte Adhesion Deficiency**

Mutations of CD18 have been identified that impair the cell-surface expression of all  $\beta_2$  heterodimers. Migration of neutrophils and monocytes is absent or drastically reduced at extravascular sites of inflammation. This deficiency is invariably fatal within the first few

years of life. A variant form has been described with normal or moderately reduced levels of  $\beta_2$  integrins. In recombinant  $\beta_2$  integrins, substitution of Asp<sup>134</sup> resulted in loss of the adhesion properties of both a  $\mu\beta_2$  and a  $m\beta_2$ , and substitution of Asp<sup>128</sup> or Ser<sup>138</sup> resulted in loss of surface expression of  $\beta_2$  integrins.

## REFERENCES

1. Tan S-M, Hyland RH, Al-hamkhani A, et al. Effect of integrin  $\beta_2$  subunit truncations of LFA-1 (CD11a/CD18) and Mac-1 (CD11b/CD18) assembly surface expression, and function. *J Immunol* 2000;165:2574-2581.
2. Xiong Y-M, Zhang L. Structure-function of the putative I-domain within the integrin  $\beta_2$  subunit. *J Biol Chem* 2001;276:19340-19349.
3. Huang C, Zang Q, Takagi J. Structural and functional studies with antibodies to the integrin  $\beta_2$  subunit. *J Biol Chem* 2000;275:21514-21524.
4. Constantin G, Majeed M, Giagulli C, et al. Chemokines trigger immediate  $\beta_2$  integrin affinity and mobility changes: differential regulation and roles in lymphocyte arrest under flow. *Immunity* 2000;13:759-769.
5. Welzenbach K, Hommel V, Weitz-Schmidt G. Small molecule inhibitors induce conformational changes in the I domain and the I-like domain of lymphocyte function-associated antigen-1. *J Biol Chem* 2002;277:10590-10598.

## CD19 (B4)

*Structure.* The extracellular region contains two C-2 Ig-like domains. The cytoplasmic region is long and highly conserved and contains nine tyrosines. CD19 interacts with CD21 (CR2) through its extracellular and transmembrane regions, with CD81 (target for antiproliferative antibody-1) through the extracellular region only, and with surface IgM through the first 17 amino acids of the cytoplasmic region ( [1](#) ).

*Gene Locus.* 16p11.2.

*Molecular mass (kd).* 120.

*Distribution.* CD19 is the earliest recognizable marker of B cells and is retained until the B cell becomes a plasma cell, when it is lost. It is also expressed on follicular DCs.

*Function.* CD19 amplifies B-cell activation and is itself phosphorylated after engagement of the B-cell receptor (BCR; surface IgM). The amplification involves successive tyrosine phosphorylations of CD19 and stepwise recruitment of PTK Lyn, Fyn, PI3K, and so forth ( [2](#), [3](#) ). The CD19 large cytoplasmic region (240 residues) acts as scaffolding, linking several signaling molecules.

The CD19 complex lowers the threshold of antigen required for B-cell stimulation severalfold ( [3](#) ). CD19 is necessary for the BCR-mediated activation of Bruton kinase, which is linked to X-linked agammaglobulinemia (Bruton) ( [4](#) ).

## CD20 (B1)



*Structure.* CD20 spans the cell membrane four times, yet it does not belong to the tetraspan family of proteins (i.e., CD9, CD81, and so forth) but to the subfamily A, a new family named *membrane-spanning four domains* (MS4A). Other members are the  $\beta$ -chain of the high-affinity IgE receptor (i.e., Fc $\epsilon$ RI $\beta$ ), the HTm4 molecule, and sixteen other proteins recently added. MS4 proteins are divided into 12 subgroups: MS4A1 to MS4A12 ( [1](#) ).

CD20 is constitutively phosphorylated but is not glycosylated. Long *N*- and *C*-terminal ends are located within the cytoplasm, but only a minor portion of the molecule is exposed on the cell surface.

*Gene locus.* 11q13. The gene is near the site of the t(11;14)(q13;q32) translocation found in some B-cell malignancies ( [2](#) ). It is approximately 50 kb away from BCL-1, between the centromere of chromosome 11, and the 3' end of BCL-1, and its proximal location excludes it from being translocated to chromosome 14. The CD5 gene is in the proximity of CD20.

*Molecular mass (kd).* 33, 35, 37.

*Distribution.* CD20 is expressed on B cells after expression of CD19 and CD22 at approximately the pre-B-cell stage and remains throughout the B-cell life. It is strongly increased in germinal center B cells but then declines at the end of B-cell differentiation. It is not expressed on plasma cells and is only weakly expressed in B-CLL ( [3](#) ).

*Function.* CD20 is a Ca<sup>2+</sup> channel, and this property explains the role of CD20 in activation and proliferation of B lymphocytes ( [4](#) ). Engagement of CD20 by an antibody stimulates transmembrane Ca<sup>2+</sup> flux. CD20 is redistributed to membrane rafts on activation, where receptors and signaling molecules are gathered ( [5](#) ).

The CD20 in B-cell low-grade lymphomas is used as the target for immunotherapy with anti-CD20 chimeric monoclonal antibodies (rituximab) ( [6](#), [7](#) ). The antibody probably acts by a number of mechanisms (i.e., complement-mediated cytotoxicity, ADCC, and inhibition of proliferation or apoptosis) ( [8](#) ).

## CD21 (CR2, EPSTEIN-BARR VIRUS RECEPTOR, C3D RECEPTOR)

*Structure.* Member of the family of regulators of complement activation characterized by the CCP domains (also known as *short consensus repeats*). CCPs are present in many other proteins not related to complement regulation, such as blood clotting factor XIIIb subunit, IL-2 receptor, a vaccinia virus protein, and so forth ( [1](#) ).

CCP consists of 60 to 70 amino acids, with a core structure made of antiparallel  $\beta$  strands and short inter-CCP linker peptides. The extracellular region contains 15 (short isoform) or 16 (long isoform) CCPs. The first two CCPs form a V-shaped binding site for C3d, and variable orientations between them contribute to biologic diversity and specificity. The intracellular region contains tyrosine kinase phosphorylation sites ( [2](#) ).

*Gene locus.* 1q32.

*Molecular mass (kd).* 145.

*Distribution.* Present on B cells at the stage when they first become Ig<sup>+</sup>. It is lost on activation. Present on follicular DCs and in a small number of T cells.

*Function.* CD21 is the receptor (CR2) for the C3d fragment resulting from C3b fragmentation (see [Chapter 18](#)) ([3](#)). It is also the receptor for EBV, interacting with the viral capsid protein gp 350/220 and mediating internalization of the virus, for which the intracytoplasmic region is necessary ([4](#), [5](#)). CD21 is a component of the CD19/CD21/CD81 complex, which binds antigen-antibody-complement complexes and amplifies B-cell responses as a result of cross-linking of the complex with the BCR complex ([6](#)). It localizes immune complexes (ICs) on follicular DCs, facilitating antigen presentation and cellular interactions in the lymph node follicles where B cells express strongly CD21. The CD19/21/81 complex lowers the threshold for B-cell activation 100-fold. CD21 effectively links innate and adaptive immunity. It forms complexes with CD35 (CR1) on B cells distinct from the CD19 complexes, as well as with CD23. Their role in B-cell function is not clear.

## **CD22 [B5, LEU-14, SIALIC ACID-BINDING IMMUNOGLOBULIN SUPERFAMILY LECTIN (SIGLEC)-2]**

*Structure.* CD22 is a member of the *siglecs* family, which binds sialic acid (see [CD33](#), [CD164](#), [CD170](#), and so forth) and belongs to the IgSF ([1](#), [2](#)).

There are two isoforms, one of which is the predominant form (CD22B) and contains seven Ig-like domains in the extracellular region (one type V and six type C-2), and the other (CD22a) lacks domains 3 and 4 and has a truncated cytoplasmic region. CD22 recognizes only an  $\alpha 2\beta 6$ -linked sialyllactosamine. The ligand binds to the V domain, which includes an arginine conserved on all siglecs.

The cytoplasmic region contains six conserved Tyr residues, two of which are within sequences, which conform with ITAMs ([3](#)), whereas the other four form potential ITIMs ([4](#), [5](#)). When ITIMs are phosphorylated, they associate with SH<sub>2</sub>-containing phosphatases, SHP-1, SHP-2, or SHIP.

*Gene locus.* 19q13.1.

*Molecular mass (kd).* 140.

*Distribution.* Intracytoplasmic expression during the early B-cell development stages (pro- and pre-B cell) is a marker for B-lineage commitment. It is expressed on the cell surface during the mature cell stages and disappears on B-cell activation.

*Function.* CD22 is an adhesion molecule and possesses lectin activity mediated by the first N-terminal Ig-like domain ([5](#)). As lectin, it binds sialic acid linked by an  $\alpha 2,6$  bond to the penultimate galactose residue of glycoproteins. CD22 binds to CD45RO and CDw75, both possessing  $\alpha 2-6$ -linked sialic acids. Binding of CD22 lectin to its ligands does not require bivalent ions (i.e., Ca<sup>2+</sup> or Mg<sup>2+</sup>), which are necessary for C-lectins.

PTKs Lyn and Syk mediate phosphorylations after BCR ligation. Two carboxyterminal

ITIM tyrosines are required for SHP-1 phosphatase recruitment, which dephosphorylates signaling molecules and thus exerts an inhibitory effect (6). Other signaling molecules are also linked to CD22, such as SHIP (inositol phosphatase) and the adaptor molecules Shc (7).

CD22-deficient mice develop high titres of high-affinity autoantibodies (i.e., anti-double-stranded DNA, anticardiolipin, and so forth) (8).

CD22 is “masked” on resting B cells, unavailable for binding to its normal ligands. Release from this “masking” is necessary for CD22 to bind to its sialic acid ligands and exert the negative regulatory function on B-cell activation.

CD22 has been specifically targeted with monoclonal antibodies conjugated to cytotoxic RNAase for immunotherapy of lymphomas.

## CD23 (LEU-20, BLAST-2, FcεR-II)

*Structure.* Type II membrane protein (NH<sub>2</sub> terminal inside the cytoplasm). The extracellular region contains a C-lectin domain, three membrane proximal heptad repeats of hydrophobic residues forming an α-helical coiled-coil stalk as a trimer, and two clusters of cysteines (1, 2 and 3).

CD23 exists as two isoforms (CD23a and CD23b) resulting from two different transcription initiation sites. The CD23a promoter is stimulated only by IL-4, whereas the promoter of CD23b is stimulated by IL-4 and other stimuli (4). The isoforms differ by six cytoplasmic amino acids of the N-terminal cytoplasmic region: CD23a is restricted to B cells, and CD23b is expressed by other cells. CD23 is cleaved by an unknown metalloprotease releasing a soluble form (sCD23) of 37 kd, but all of them retain the lectin-binding head. CD23 is highly homologous to the C-lectin asialoglycoprotein receptor, pulmonary surfactant apoprotein, and mannose-binding protein.

*Gene locus.* 19p13.3.

*Molecular mass (kd).* 45.

*Distribution.* CD23 is expressed on several types of cells: B lymphocytes, where it appears to be associated with IgD; follicular DCs, especially those in the light zone of the germinal centers; transiently on some T cells in allergic individuals; Langerhans cells; monocytes; platelets; NK cells; nasopharyngeal carcinoma cells; B-CLL; and EBV-transformed B cells.

*Function.* CD23 is the low-affinity receptor for IgE (3). It also binds to CD21 and to the α-chains of the β<sub>2</sub> integrins. Soluble CD23 (or IgE-binding factors) enhance IgE synthesis. Oligomeric, but not monomeric, forms of CD23 enhance IgE production by facilitating presentation of IgE/Ag complexes (5). The CD23b isoform is involved in IgE-dependent activities in inflammation (i.e., phagocytosis of IgE-coated particles, release of IL-1 and TNF-α, and generation of superoxide) (6). Soluble CD23 (sCD23) exerts various cytokinelike activities. In mice with experimentally induced arthritis, antibodies to CD23 decrease the severity of the disease. In humans with rheumatoid arthritis, there is an increase of CD23 expression.

CD23 and CD5 coexpression is the signature phenotype of B-CLL. Overexpression of

CD23 in B-CLL is due to a deregulation of Notch 2 signaling ( [7](#) ). sCD23 is elevated in B-CLL and may have prognostic significance ( [8](#) , [9](#) ) because its levels are a reflection of tumor mass ( [10](#) ). sCD23 long doubling time is found in patients with slow progression of the disease, and short sCD23 doubling time is associated with aggressive disease. CD23b is the predominant isoform in B-CLL and is capable of presenting antigen to T cells ( [11](#) ). Based on specific marker expression, the B-CLL cells, irrespective of V gene mutations, exhibit features of activated antigen-experienced B cells ( [12](#) ).

## CD25 [TAC ANTIGEN, $\alpha$ -CHAIN OF INTERLEUKIN (IL)-2 RECEPTOR]

*Structure.* CD25 is the  $\alpha$ -chain of the IL-2 receptor, which with the  $\beta$ - (CD122) and  $\gamma$ - (common, CD132) chains, forms the high-affinity receptor ( [1](#) ).

The extracellular region contains two CCP domains and is rich in O-linked carbohydrates. The cytoplasmic region is short, consisting of only 13 amino acids. The ligand (IL-2)-binding site is located in the NTR.

*Gene locus.* 10p14.

*Molecular mass (kd).* 55.

*Distribution.* The IL-2R $\alpha$ -chain is expressed on activated, but not resting, T cells. It is strongly expressed on human T-cell leukemia virus type 1 T-cell leukemia. CD25 is also detected on B cells, monocytes, a subset of thymocytes, activated NK cells, myeloid precursors, activated eosinophils ( [2](#) ), and oligodendrocytes. CD25 is strongly expressed in hairy cell leukemia.

*Function.* CD25 binds IL-2 with low affinity ( $10^{-8}$  M) but with the trimolecular IL-2R, the affinity increases to  $10^{-11}$  M ( [3](#) ). The IL-2R complex mediates the functions of IL-2 (i.e., induces progression of cell cycle from G<sub>1</sub> through S, G<sub>2</sub>, and M phases), promoting proliferation and clonal expansion of T cells. Rapamycin and FK506 block the G<sub>1</sub>  $\rightarrow$  S progression and inhibit T-cell proliferation. The CD25 binds IL-2, but the signal transduction is mediated by the  $\beta$ - and  $\gamma$ -chains (see details of signal transduction in [Chapter 18](#)). The  $\gamma$ c interacts with Jak 3 kinase and calpain, whereas the  $\beta$ -chain interacts with Src kinases, Syk kinase, PI3K, and Jak 1. PI3K mediates the T-cell proliferation and prevention of apoptosis and is very likely recruited by Jak 1 kinase ( [4](#) ).

Mutations of the IL-2R $\gamma$ -chain lead to X-linked severe combined immunodeficiency (XSCID) in humans (see [CD132](#)). Because  $\gamma$ -chain is shared by several cytokines, the immunodeficiency is profound ( [5](#) ). Abnormalities of the IL-2R $\alpha$ -chain gene have also been identified in patients with lymphoproliferative T-cell deficiency.

Humanized anti-CD25 antibodies have been shown to reduce the incidence of renal and cardiac allograft rejection and decrease the severity of graft-versus-host disease (GVHD) in patients undergoing HLA-matched allogeneic bone marrow transplantation ( [6](#) ). CD25 is expressed on a subpopulation of CD4<sup>+</sup> T cells with immunosuppressive properties in mice. These CD25<sup>+</sup> T cells can delay or even prevent GVHD in allogeneic hematopoietic stem cell transplantation. Human CD4<sup>+</sup> CD25<sup>+</sup> regulatory T cells block *in vitro* the proliferative response of T cells to allogeneic stimuli ( [7](#) , [8](#) and [9](#) ). The suppressive activity

of these CD25<sup>+</sup> T cells is due to transforming growth factor (TGF)- $\beta$ <sub>1</sub>, and prevent a lethal autoimmune function in mice deficient in the IL-2R $\beta$  chain (10).

## CD28

*Structure.* CD28 is a disulfide-linked homodimer with a single Ig-like V domain in the extracellular region (1), with two cysteines shared by the Ig heavy and light chain variable domains. There are five potential glycosylation sites. A third cysteine residue is involved in the homodimer formation. The cytoplasmic region has the YMN<sub>M</sub> motif that mediates the binding of CD28 to the C-terminal SH<sub>2</sub> domain of the p85 subunit of PI3K (2), and the same motif was found to bind Grb2 (3). Mutation of the tyrosine in this motif prevents binding of PI3K and induction of Bcl-X<sub>L</sub> in response to CD28 co-stimulation, but proliferative responses are not affected (4, 5). Downstream from this motif are two proline-rich motifs, PRRP and PYAPPR. CD28 binds through proline residues to the SH<sub>3</sub> domains of Lck, triggering its activation.

*Gene locus.* 2q33.

*Molecular mass (kd).* Unreduced, 90; reduced, 44.

*Distribution.* Expressed constitutively on T cells and is up-regulated after activation. Plasma cells are CD28<sup>+</sup>.

*Function.* CD28 is a co-stimulatory receptor for T cells (6). Its engagement provides the second signal (first by TCR) required for expansion of T-cell clones. CD28 is an obligate co-stimulatory receptor because blocking its activation leads to anergy. Ligands for CD28 are the CD80 (B7-1) and B7-2 (CD86), which form homodimers (7). Both of these molecules are also ligands for CTLA-4 (CD152), which is an inhibitory receptor (8). Ligand binding to CD28 initiates multiple signaling events through PI3K, Lck, and Grb2 (9). The different proteins associated with CD28 regulate different functions [i.e., promotion of T-cell survival as a result of induction of the antiapoptotic protein Bcl-X<sub>L</sub>, the release of cytokines, which then stimulate clonal expansion (10, 11), differentiation, and expression of other molecules (i.e., CTLA-4 and CD40L, which regulate further interactions)]. Blockade of co-stimulation has been used in a number of experimentally induced diseases as well as in clinical trials. In allogeneic bone marrow transplantation, GVHD is reduced. In psoriasis vulgaris, it reduces disease activity (12). Trials in renal transplantation and autoimmune diseases are still in progress (13, 14 and 15).

## CD29 [ $\beta$ <sub>1</sub> INTEGRIN CHAIN, VERY LATE ANTIGEN (VLA) $\beta$ -CHAIN, PLATELET GLYCOPROTEIN (GP) IIA]

*Structure.* CD29 is the  $\beta$ -chain of heterodimers it forms with 11  $\alpha$  subunits. The heterodimers with six of these subunits (CD49a to CD49f,  $\alpha$ <sub>1</sub> to  $\alpha$ <sub>6</sub>) are known as *very late antigens* (VLAs) because they appear on T cells late after activation (1). In nonlymphoid tissues,  $\beta$ <sub>1</sub> is associated with  $\alpha$ <sub>7</sub>- to  $\alpha$ <sub>9</sub>-chains. In the extracellular region of the  $\beta$ <sub>1</sub> subunit, there is an I domain-like structure (see [CD11a](#)), which contains a specificity-determining loop with several amino acids critical for ligand and cation binding (2, 3). This domain undergoes conformational changes on activation after ligand and Mn

$2^+$  or  $Mg^{2+}$  binding.

The membrane proximal region is a cysteine-rich domain that regulates anchoring of the  $\beta_1$  subunit to the cytoskeleton and is highly conserved across species. The cytoplasmic region is short (50 residues) and, as a result of alternative splicing of messenger RNA (mRNA), there are structural variations of this region, generating size isoforms (4, 5). These isoforms ( $\beta_1$ -A, -B, -C1, -C2, -D, and -E) affect tissue distribution and changes in the regulation of ligand binding and signaling activity. All isoforms share the same first 26 amino acids of the cytoplasmic region but differ in the membrane distal region (6).

*Gene locus.* 10p11.2.

*Molecular mass (kd).* Reduced, 130; unreduced, 115.

*Distribution.* It is universally expressed on all leukocytes and most other cells in association with 13 different  $\alpha$  subunits. On memory T cells, it is present in higher densities as VLA1-VLA6. The  $\alpha_8$ - $\beta_1$  integrin is prominently expressed in the nervous system (7). Expression of the  $\beta_1$  isoforms varies. The  $\beta_1$ A variant is expressed on all tissues, the  $\beta_1$ B in the skin, liver, and skeletal muscle, and the  $\beta_1$ C and  $\beta_1$ C<sub>2</sub> in blood cells, and the  $\beta_1$ D is specific for skeletal and cardiac muscle.

*Function.* The  $\beta_1$  subunit associates with 13  $\alpha$  subunits through the specificity-determining loop of the I domain-like structure (8). The cytoplasmic domain of CD29 interacts with cytoskeletal proteins (i.e.,  $\alpha$ -actinin, paxillin, talin, and filamin) and thereby links the outside environment with the inside of the cell (9).

As heterodimers, the  $\beta_1$  integrins mediate cell-cell and cell-matrix adhesions. The heterodimers form receptors for the extracellular matrix proteins, such as FN, collagen, laminin, and vitronectin. The ligand binding is contributed by both  $\beta_1$ - and  $\alpha$ -chains and is located in the aminoterminal end, which, by electron microscopy, appears as a globular head, made up by both the  $\alpha$  and  $\beta$  subunits, standing more than 10 nm above the cell surface (10). In response to matrix ligands, they generate intracellular signals [i.e., tyrosine phosphorylation, elevation of intracellular  $Ca^{2+}$ , and activation of focal adhesion kinase (FAK), which then acts as a docking site for cytoskeletal proteins and signaling molecules].

In response to mechanical forces arising from collagen matrices,  $\beta_1$  maintains the viability of fibroblasts, mediated by PI3K through the Akt/protein kinase B (11). Other signals lead to cytoskeletal reorganization and gene expression regulating cell migration, proliferation, differentiation, and survival (outside-in signaling). The cytoplasmic  $\beta_1$  domain initiates inside-out signaling, modifying the conformation of the extracellular domain and increasing ligand-binding affinity. Two highly conserved motifs of the  $\beta_1$  cytoplasmic tail (NPXY) are critical for adhesion to FN and localization to focal adhesion sites. The 14 C-terminal amino acids of the cytoplasmic region of the  $\beta_1$  subunit are associated with a 200-amino acid phosphoprotein known as *ICAP-1* (integrin cytoplasmic domain-associated protein) (12), which is constitutively phosphorylated and promotes  $\beta_1$ -dependent cell migration.

The  $\beta_1$  integrins determine collective movement of malignant cell clusters (13). In such clusters, “forerunner cells” open a path for cells following behind the “guiding” cells. In



the absence of  $\beta_1$  integrin, cell dissemination follows an ameboid, crawling pattern.

For special functions of  $\alpha\beta_1$  heterodimers, see [CD49](#). The  $\alpha_7\beta_1$  heterodimer selectively binds to laminin and plays a role in skeletal muscle differentiation. The  $\alpha_8\beta_1$  is expressed predominantly in the nervous system and promotes axon growth in spinal cord, optic, and auditory systems ([7](#)). The  $\alpha_9\beta_1$  is detected in airway epithelium, basal layer of squamous epithelium, smooth and skeletal muscle, and hepatocytes ([14](#)). It binds to ADAM 15 (  *a disintegrin and metalloprotease*), and the interaction mediates binding of sperm to oocytes. (For ADAM family of proteins, see [CD156](#).) The  $\alpha_{10}\beta_1$  integrin is expressed on chondrocytes, hyaline cartilage of joints, trachea, bronchi, and aortic and atrioventricular valves and plays a role in cartilage development ([15](#)). The  $\alpha_{11}\beta_1$  integrin is expressed in the uterus, heart, and skeletal muscle ([16](#)). It is a receptor of interstitial collagens and has a role in organization of interstitial collagen matrices during development.

## CD30 (Ki, BER-H2 ANTIGEN)

*Structure.* CD30 is a member of the TNF receptor (TNFR) SF ([1](#)). The extracellular region contains cysteine-rich repeats (five or six), each containing approximately 40 amino acids. A hinge sequence separates the third from the fourth repeat and may have derived from another repeat. The hinge and a sequence proximal to the membrane is rich in Ser, Thr, and Pro, potential sites for O-glycosylation.

The cysteine-rich motifs are found in many receptors of growth factors and are involved in ligand binding. Mapping the epitopes on CD30 with monoclonal antibodies (Ki 1, Ki 2), it is visualized that the *N*- and *C*-terminals of the extracellular region are in close proximity, and as a result, the trimeric form of CD30 on Hodgkin and Reed-Sternberg (H-RS) cells assumes a flowerlike structure ([2](#)). The cytoplasmic region is large but has no death domain (DD) and no tyrosine kinase sequences.

It binds the TNFR-associated factor (TRAF)-1, TRAF-2, TRAF-3 (or CRAF-1), and TRAF-5. TRAFs are signal-transducing molecules associated with the CD40 and TNFR type 2 ([3](#), [4](#)). They bind to the *C*-terminal 36-66 residues, which contain three distinct sites or subdomains, D<sub>1</sub>, D<sub>2</sub>, and D<sub>3</sub>. Depending on the cell type, these molecules induce cell proliferation or cell death.

CD30 exists in a soluble form in the serum.

*Gene locus.* 1p36.

*Molecular mass (kd).* 120.

*Distribution.* Originally, CD30 was identified as *Ki-1 antigen* on Reed-Sternberg cells in Hodgkin lymphoma ([5](#)). It is not detected on resting peripheral blood B, T, and NK cells but is induced after activation. Monocytes and macrophages are negative, but cells around the lymph node follicles are CD30<sup>+</sup>. Epithelial cells and Hassall corpuscles in the thymic medulla are CD30<sup>+</sup>. It is detected in large cell lymphoma, or Ki-1/CD30<sup>+</sup> lymphoma (ALCL), which includes a number of lymphocytic neoplasms other than ALCL ([6](#)), including T-cell lymphomas. CD30 is expressed on T cells infected with HIV, and cross-linking of CD30 reactivates HIV production ([7](#)). Expression of CD30 is regulated by

co-stimulatory signals from CD28 and IL-4.

Embryonal carcinoma and mixed germ cell tumors are CD30<sup>+</sup>.

*Function.* CD30 is a pleiotropic molecule and activates different signaling pathways on different cells (8). It induces Ig secretion (EBV-derived cell lines), proliferation (T-cell Hodgkin disease-derived lines), cytolytic cell death (ALCL cell lines) (9), and lymphocyte trafficking. The ligand for CD30 (CD30L or CD153) is a member of the TNF family of cytokines. The molecular mechanism of CD30 activity is overproduction of NF- $\kappa$ B, which can be constitutive or a result of overexpression of CD30 (10, 11). Induction of NF- $\kappa$ B by CD30 is mediated by TRAF-2 and TRAF-5, which bind to two of the three subdomains of the cytoplasmic tail of CD30 (12). However, NF- $\kappa$ B can also be induced in the absence of TRAFs.

In H-RS cells, overexpression of CD30 leads to its self-aggregation and recruitment of TRAF-2 and TRAF-5 (13, 14). Overproduction of NF- $\kappa$ B induces IL-13 secretion (in the absence of TCR engagement), and by this autocrine mechanism, IL-13 promotes survival of Hodgkin cells. In contrast to Hodgkin cells, CD30 ligation induces apoptotic death of ALCL cells, probably by the inability of these cells to activate NF- $\kappa$ B production (15, 16). IL-13 exacerbates allergic inflammation, and in this case, it is secreted through interaction of CD30 on primed T cells with CD30L on eosinophils. This interaction is TCR independent and is mediated by TRAF-2 with downstream activation of the MAP kinase (MAPK) pathway and c-Jun induction (not NF- $\kappa$ B). IL-13 promotes airway inflammation and tumor progression (17). In H-RS cells, confocal immunofluorescence has shown that TRAF proteins are aggregated near the cell membrane and are co-localized with IKKa and IKBa, whereas in lymphoma cells, these proteins are diffusely distributed.

## CD31 [PLATELET ENDOTHELIAL CELL ADHESION MOLECULE-1 (PECAM-1)]

*Structure.* The extracellular region consists of six Ig-like domains of the C2 type, which are found in cell adhesion molecules (1, 2). Domain 2 contains a consensus recognition sequence for glycosaminoglycan binding. Both domain 2 and 6 are important for heterophilic adhesion. Domain 5 is incomplete as it lacks some of the  $\beta$  strands (3, 4).

The cytoplasmic region contains ITIM motifs characteristic of inhibitory receptors. It plays an important role in ligand interactions mediated by the extracellular region. Deletion of the C-terminal third of the cytoplasmic region converts the adhesion interactions mediated by CD31 from heterophilic to homophilic.

Another role of the cytoplasmic region is in signal transduction. It contains Ser and Tyr residues, which are phosphorylated after cell activation. The protein-tyrosine phosphatases, SHP-1 and SHP-2, bind to two Tyr-containing sequences (ITIMs) found in inhibitory receptors (5, 6).

Several alternatively spliced variants have been identified, all of them involving the transmembrane and cytoplasmic regions. The cytoplasmic region is required for CD31 to localize to cell-cell borders and support aggregation. It is encoded by seven short exons, which may represent discrete functional entities.



*Gene locus.* 17q23.

*Molecular mass (kd).* 130 to 140.

*Distribution.* CD31 is widely distributed among cells of the vascular compartment. In endothelial cells (approximately  $10^6$  copies/cell), it is concentrated at cell–cell junctions. It is expressed on platelets (approximately  $5 \times 10^3$ /cell), monocytes, neutrophils, a subset of naïve CD8<sup>+</sup> and CD4<sup>+</sup> T cells, bone marrow stem cells, and cell lines of myeloid and megakaryocytic lineage.

*Function.* CD31 mediates two basic cellular functions: (a) *adhesion*, which is homophilic (CD31–CD31) or heterophilic (CD31–another molecule); and (b) *signal transduction* through the protein tyrosine phosphatases SHP–1 and SHP–2, which bind to the cytoplasmic ITIMs (7).

- *Adhesion function.* CD31 is a key participant in extravasation of neutrophils and monocytes involving a homophilic interaction (i.e., CD31 of leukocyte and CD31 of the endothelial cell (8, 9 and 10)). CD31 mediates transmigration of CD34<sup>+</sup> cells across endothelium after activation by growth factors (11). Although heterophilic ligands have been identified, including the integrin  $\alpha\text{v}\beta_3$  and glycosaminoglycans found in heparin, these interactions could not be verified (12). Homophilic interaction, which causes CD31 aggregation, induces phosphorylation of Tyr residues on ITIMs, acting as docking sites for SHP–1 and SHP–2 protein tyrosine phosphatases. SHP–1 and SHP–2 are known as *inhibitory signaling molecules* because they dephosphorylate activating kinases, although depending on the cell type and the associated substrates, they can also transmit positive signals (13, 14). It is suggested that CD31 activation leads to modulation of affinities of integrins. This was shown for CR3 (CD11b/CD18), a  $\beta_2$  integrin on monocytes and neutrophils, and for  $\beta_1$  integrin modulating T–cell adhesions to endothelial cells. According to this view, homophilic interactions are always the primary event leading to CD31 activation and involvement of other adhesion molecules. Domains 1 and 2 of the extracellular region are implicated in the transendothelial migration of monocytes (diapedesis), whereas domain 6 is responsible for their passage through the extracellular matrix (interstitial migration).
- *CD31 as an inhibitory receptor.* The presence of ITIM sequences in CD31 places it in the subfamily of inhibitory receptors [i.e., KIRs (killer inhibitory receptors), Fc $\gamma$ RII (CD32), CTLA–4 (CD152), and so forth] (15). Indeed, CD31 exerts inhibitory regulation of signal transduction by TCR and production of autoantibodies by B cells (16). Mice deficient of CD31—lacking the normal inhibitory function of CD31—develop an autoimmune disease. CD31 is expressed on naïve T cells but is lost in memory T cells, which become more responsive to stimuli for production of IL–4.
- *Cellular functions.* In response to thrombin activation of platelets, CD31 is phosphorylated, associated with the cytoskeleton, and redistributed on the surface of the cell as the platelets spread (17). CD31 mediates responses of endothelial cells to H<sub>2</sub>O<sub>2</sub>, released by neutrophils, increases intracellular Ca<sup>2+</sup>, and induces secretion of prostacyclin, thus regulating responses of endothelial cells to oxidant–mediated injury (18). CD31 generates signals that cause release of normal cells attached to macrophages, thus preventing phagocytosis of viable cells. However, this mechanism is lost in apoptotic cells, which are phagocytosed (19).

- *Other functions.* CD31 plays a role in angiogenesis ( [20](#) ), in normal and neoplastic tissues, and in cardiovascular morphogenesis in mice. CD31 mediates the endothelial interactions (tube formation) or interactions of endothelial cells with surrounding cells. CD31 is the target in drug-induced thrombocytopenias ( [21](#) ). Antibodies to carbimazole bind to CD31 on the addition of the drug. In thrombocytopenias induced by quinidine, the antibodies react with CD31 as well as with gpIb/IX and gpIIb/IIIa.

## CD32 (Fc $\gamma$ RII)

*Structure.* CD32 is a member of the IgSF and contains in its extracellular region two Ig-like domains of the C2 type ( [1](#), [2](#), [3](#), [4](#), [5](#) and [6](#) ). There are three genes in the order, A-C-R, which encode six isoforms, IIa<sub>1-2</sub>, IIc, and IIb<sub>1-3</sub>, with the same extracellular but different cytoplasmic regions. Additional heterogeneity is introduced by polymorphisms caused by variations of a single residue. The cytoplasmic region of IIa and IIc contains an ITAM motif, whereas IIb has an ITIM ( [7](#) ). The Fc $\gamma$ RII is a low-affinity receptor for the Fc fragment of Ig.

*Gene locus.* 1q23.

*Molecular mass (kd).* 40.

*Distribution.* CD32 is expressed on monocytes (IIA, IIB, IIC), granulocytes (IIA, IIB, IIC), macrophages (IIA and IIB), B cells (IIB only), NK cells (IIA, IIB), endothelial cells, platelets (IIA), eosinophils (IIA), mast cells (IIA, IIB), and Langerhans cells. When activating and inhibitory receptors are coexpressed, the ratio of the expression determines the cellular response.

*Function:*

- *Fc $\gamma$ RIIA.* Cross-linking of the activating Fc $\gamma$ RIIA results in degranulation, phagocytosis, ADCC, transcription of cytokine genes, and release of inflammatory mediators ( [8](#), [9](#) ). These functions are indicative of the central role of these receptors in mediating inflammatory responses by cytotoxic IgG and IgG ICs. The initial event is translocation of the receptor to lipid rafts (i.e., membrane cholesterol-rich microdomains, which are of low density and are detergent resistant) (see [Chapter 17](#)) ( [10](#), [11](#) ). It is followed by phosphorylation of ITAMs by Src family of PTKs, such as Lyn, associated with the rafts, initiating the cascade for phagosome and superoxide formation ( [12](#), [13](#) ). The translocation of the receptor to the lipid rafts is followed by its degradation. A single tyrosine residue upstream of the ITAM motif is important for phagocytic signaling and interaction with the Syk kinase, which plays a critical role in phagocytosis ( [3](#) ). The next event is the formation of the phagolysosome, which depends on the cytoplasmic tail but not the ITAM sequence.
- *Fc $\gamma$ RIIB.* This isoform is expressed on B cells and functions as an inhibitory receptor ( [14](#), [15](#) ). Cross-linking of the receptor by the ligand induces raft reorganization and coalescence. The extracellular and transmembrane regions are important at this stage. The inhibitory activity of the IIB receptor is determined by the 13-amino acid sequence of the ITIM, which is necessary and sufficient to mediate cancellation of the activating signal initiated by the BCR. Phosphorylation of the ITIM leads to binding of inositol phosphatase SHIP (Src homology 2-containing inositol polyphosphate 5-phosphatase) or of the protein tyrosine phosphatase SHP-1 (Src homology 2-containing protein tyrosine phosphatase 1) (

16). The binding of one or the other phosphatase depends on a particular amino acid on either side of the single Tyr of the ITIM. SHIP inhibits  $Ca^{2+}$  mobilization and blocks ADCC, cytokine, and proinflammatory mediator release. Arrest of proliferation of B cells is mediated through inactivation of MAP kinases. The IIB receptor maintains peripheral tolerance for B cells. It interacts with immune complexes (ICs) on follicular DCs and triggers apoptosis of B cells during the selection process of centrocytes in the light zone (see [Chapter 16](#)). Fc $\gamma$ RIIB knock-out mice produce autoantibodies and develop autoimmune diseases as a result of loss of normal inhibitory function for B cells. They exhibit exaggerated IC-mediated organ damage (i.e., alveolitis, arthritis, systemic anaphylaxis). IIB receptor sets the threshold for responses by other receptors such as BCR (autoantibodies), Fc $\gamma$ RIIB (cutaneous anaphylaxis by ICs), or Fc $\epsilon$ RI (systemic IgE-mediated anaphylaxis).

- *Other functions.* The IIA receptor exists in two alleles, position 131 being His or Arg. The H-131 is the only Fc $\gamma$ R that recognizes IgG2 efficiently and is able, in the homozygous state, to clear IgG2 ICs, an essential function in systemic lupus erythematosus. The H-131 allele is decreased significantly in patients with lupus nephritis (17). The Fc $\gamma$ RIIB is important in treatment of malignancies by monoclonal antibodies (18). Trastuzumab (Herceptin) and rituximab (Rituxan) engage both activating (Fc $\gamma$ RIII) and inhibitory (Fc $\gamma$ RIIB) receptors. Ideally an antibody against tumors should bind preferentially to activating and minimally to inhibitory receptors.

### CD33 [SIALIC ACID-BINDING IMMUNOGLOBULIN SUPERFAMILY LECTIN (SIGLEC)-3]

*Structure.* CD33 is a member of a new family of sialic acid-binding proteins (1). There are 11 members in the Siglec family (2, 3), and four of them, Siglecs 5, 7, 8, and 10, share a high degree of sequence homology with CD33 (approximately 50 to 80%), forming a subfamily of CD33-related Siglecs. CD33 has the smallest extracellular region of all Siglecs, consisting of two Ig-like domains, one NH<sub>2</sub> terminal V-type followed by one C2 type (Siglec 1 has 17 Ig-like domains). The two Ig-like domains are linked by a disulfide bond, and the V domain interacts with sialic acid through an Arg conserved in all Siglecs, forming a salt bridge. The cytoplasmic region contains two Tyr, one (Y340) located within an ITIM motif and the other (Y358) within a SLAM-like motif (TEYSEV). SLAM (signaling lymphocyte activation molecule) allows the docking of SAP (SLAM-associated protein), which inhibits the binding of SHP-2 phosphatase and prolongs activation signaling.

CD33 has two serine phosphorylation sites catalyzed by protein kinase C, therefore it is also a phosphoprotein. Phosphorylation is augmented by IL-3 erythropoietin or GM-CSF (4). Inhibition of this pathway of CD33 activation shifts the dependence of CD33 function to its lectin activity.

*Gene locus.* 19q13.3.

*Molecular mass (kd).* 67.

*Distribution.* CD33 is a myelomonocytic marker that is absent in CD34<sup>+</sup> stem cells but expressed in the early precursors after CD34 (5). Its expression declines with myeloid differentiation and is weak in neutrophils. However, monocytes are strongly positive for CD33. It is a useful marker in distinguishing AML from ALL, but in occasional cases of mixed lineage acute leukemias, it is coexpressed with lymphoid markers.

*Function.* Each Siglec is expressed in a highly restricted manner [i.e., sialoadhesin in

macrophages, myelin-associated gp (MAG) in oligodendrocytes and Schwann cells, CD22 in B cells, and so forth]. Their ligands are sialic acids (i.e., acidic monosaccharides) found on cell-surface glycoconjugates. Although CD33 prefers an  $\alpha$ 2-6-linked sialyllactose, it can also bind to an  $\alpha$ 2-3 bond. The presence of ITIM sequence in its cytoplasmic region places CD33 among the family of inhibitory receptors (6). Ligand binding triggers phosphorylation of the two tyrosines, which act as docking sites for SHP-1 and SHP-2 phosphatases (7, 8); however, only Tyr340 is critical for binding of the two phosphatases. Recruitment of SHP-1 and SHP-2 down-regulates calcium mobilization induced by CD64 (Fc $\gamma$ RI).

The function of CD33 in myeloid differentiation is unknown. CD33 inhibits generation of DCs from monocytes or CD34<sup>+</sup> myeloid precursors (9). Anti-CD33 antibodies inhibit differentiation of normal CD34<sup>+</sup> cells in cultures supplied with stem cell factor and GM-CSF (10) or proliferation of chronic myelogenous leukemia (CML) cells in the presence of GM-CSF. Similarly, AML cells displaying a high degree of *in vitro* proliferation in the presence of GM-CSF were inhibited by anti-CD33 antibodies (11), inducing apoptosis of AML cells (12). Antibodies to CD33 acted synergistically with etoposide or cytosine arabinoside at suboptimal doses of the drug.

A humanized murine anti-CD33 antibody linked to calicheamicin (gemtuzumab) is in use (phase II trials) in the treatment of relapsed AML (13).

## CD34 (MY10, SGP<sup>90</sup>)

*Structure.* CD34 is a highly glycosylated type I transmembrane gp, member of the sialomucin family of proteins, and similar to leukosialin or CD43 (1). The extracellular region contains adhesion recognition sequences and has several N- and O-potential glycosylation sites in the first 130 amino acids (2, 3 and 4). This region is followed by a sequence, which has six cysteine residues and is expected to form a globular structure.

The cytoplasmic region has two PKC phosphorylation sites and one tyrosine phosphorylation site, which suggests that CD34 may be involved in signal transduction. A splice variant is generated by the insertion of an additional exon between exons 7 and 8. This introduces a stop codon and produces a truncated protein, retaining only 16 amino acids.

*Gene locus.* 1q32.

*Molecular mass (kd).* 116 (estimated by mobility of the natural protein). Based on amino acid sequence, it is only 40.

*Distribution.* It is expressed on hemopoietic stem cells with the capacity to repopulate bone marrow for all lineages (5, 6 and 7). However, CD34<sup>-</sup> stem cells also exist and have the potential for engraftment (8). CD34 expression disappears with differentiation to more mature stages of myelocytic and lymphocytic lineages. Its expression is up-regulated after PKC activation and is independent of transcription or translocation (9).

Outside the hemopoietic system, CD34 is expressed on endothelial cells (10). In murine tissues, CD34 is expressed in the vessels of all organs examined (11). CD34 is a major

counter-receptor for L-selectin ( [12](#)).

*Function.* The function of CD34 in hemopoiesis is still unknown. Interaction with L-selectin suggests that CD34 functions as an adhesion molecule and, possibly, through interaction with bone marrow stroma, mediates retention of stem cells in the bone marrow ( [13](#)). In hematopoietic differentiation, CD34 may prevent terminal differentiation, which occurs only after its down-regulation. TGF- $\beta$  <sub>1</sub> influences CD34<sup>+</sup> Lin<sup>-</sup> progenitor cell differentiation, maintaining these cells in an undifferentiated state ( [14](#)). Curiously, CD34 knock-out mice suffer from only minor hemopoietic defects. CD34 is a useful marker for phenotypic identification of various leukemias.

## CD35 [COMPLEMENT RECEPTOR (CR) 1: CR1, C3bR, C4bR]

*Structure.* CR1 is a single-chain, type I transmembrane glycoprotein, a member of the family of regulators of complement activation, which includes CR2 (CD21), decay-accelerating factor (DAF; CD55), membrane cofactor protein (MCP; CD46), and so forth (see [Chapter 18](#)) ( [1](#)). The extracellular region of the most common, A, allele, is composed of 30 domains known as *complement control protein (CCP) repeats* previously known as *short consensus repeats* (SCR), or *sushi domains* ( [2](#), [3](#)). One CCP domain contains 59 to 75 residues. Four cysteines and one tryptophan occupy an invariant position. Disulfide bonds are formed between the cysteines, 1?3 and 2?4. The disulfide bonds fold the CCP domain in a globular conformation with  $\beta$  sheets joined by hypervariable loops ( [4](#)). All CCP domains, except the two carboxyterminals, form larger units known as *long homologous repeats* (LHRs). Each LHR consists of seven domains. There are four allelic variants of CR1: CR1-1 (or A, four LHRs), CR1-2 (B, five LHRs), CR1-3 (C, three LHRs), and CR1-4 (D, six LHRs). Starting from the NH<sub>2</sub> terminal end, the LHRs are known as A, B, C, and D. CR1 carries the Knops blood group antigens (1% in whites and 40 to 50% in African populations).

The CCP domains are characteristic of complement control proteins, but they are also found in other proteins without complement control function, such as IL-2 receptor and factor XIIIb. The cytoplasmic region consists of 43 amino acids versus the 1930 of the extracellular region.

*Gene locus.* 1q32.

*Molecular mass (kd).* A: 190; B: 220; C: 160; D: 250.

*Distribution.* Expressed on blood cells except platelets, NK cells, and most T cells. Because of their numeric superiority, the erythrocytes express 90% of CR1 in the blood. The number of CR1 per cell are as follows: neutrophils, monocytes, B cells: 20,000 to 40,000; subpopulation of T cells, 1000 to 5000; erythrocytes, 100 to 1000. It is expressed on follicular DCs, podocytes, and astrocytes. CD35 is released from cells, and in picomolar concentrations, it is found in a soluble form in blood. Neutrophils and monocytes can rapidly up-regulate CR1 expression, released to the membrane from an intracellular compartment. Up-regulation is induced by anaphylatoxin C5a, endotoxin, cytokines, and so forth. Expression on B cells is detected on pre-B cells and increases with maturation. In contrast, in the myeloid lineage, CR1 is detected on mature cells (i.e., neutrophils and bands) but only in 1% of myelocytes.

*Function.* CR1 is a multifunctional molecule. Its ligands are C3b, C4b, and, with lower affinity, iC3b and C3dg. It is also a receptor for C1q ( [5](#)) and for mannan-binding lectin, a



protein of the innate immune system, which recognizes carbohydrates on pathogens (6). The C3b- and C4b-binding sites are in the first three CCPs of LHR A (site 1), LHR B (site 2), and LHRC (site 3). Site 1 binds only C4b, whereas site 2 and site 3 bind both C3b and C4b complement fragments (7, 8).

The erythrocyte CR1 serves as an *immune adherence receptor* for complexes opsonized with C3b/C4b (9). This property plays an important physiologic role for removal of ICs, which are delivered to the liver or spleen. Removal of ICs by erythrocytes prevents their deposition to other tissues (i.e., vessels or kidney) and thus protects them from IC-mediated tissue damage (10). Another important function of this “shuttle” service by the CR1 of erythrocytes is in immunologic defense. Bacteria and viruses opsonized by complement are captured by CR1 of erythrocytes and are prevented from leaving the bloodstream to invade susceptible tissues, while at the same time, they are delivered to tissue phagocytes to be destroyed. In this process, phagocytes remove the opsonized particle and CR1 while sparing the erythrocyte. Clearance of infectious agents by erythrocytes in animals was achieved very rapidly using antibodies specific for the pathogen, cross-linked with anti-CR1 antibodies (heteropolymers). The anti-CR1 antibody in these complexes takes the place of complement. CR1 contributes to regulation of complement as a result of its two properties: decay-accelerating activity (DAA) (11) and cofactor activity (CA). CR1 accelerates the decay of all convertases, that is, the classical (C4b2a) and alternative (C3bBb), by displacing C2a and Bb, respectively (1). CR1 acts as cofactor for factor I, a serine esterase that cleaves C3b and C4b to hemolytically inactive forms. As cofactor, it promotes cleavage by factor I of C3b to iC3b<sub>1</sub>, iC3b<sub>2</sub>, and to C3dg and C3c (1). Only CR1 can generate C3dg fragments. C4b is similarly cleaved by factor I with CR1 as cofactor. Site 1 contains the DAA for both C3 convertases, whereas for C5 convertases, LHR A and LHR C are required. The CA activity resides in site 2. CR1 enhances phagocytosis mediated by Fc receptors on monocytes, especially after activation by cytokines, and also triggers secretion of IL-1a, IL-1β, and prostaglandins from human monocytes. Individuals with the Hegelson blood group type have partial CR1 deficiency, that is, less than 50 copies of CR1/RBC, but no disease. In lupus erythematosus, however, reduced levels of CR1 correlate with disease activity.

As a result of its DAA and CA activities, CR1 inhibits inflammation induced by complement activation. Soluble CR1 has been used in clinical trials to reduce tissue damage in myocardial infarction, lung transplantation, adult respiratory distress syndrome, and in patients undergoing cardiopulmonary bypass (12).

Attachment to CR1 of the sialyl-Lewis<sup>X</sup> saccharide allows binding of CR1 to E and P selectins in inflamed endothelia, blocking extravasation of leukocytes while at the same time neutralizing complement by its DAA or CA activity. Mutations on site 1 generate CR1 with fourfold enhanced DAA activity for both C3 convertases, whereas other mutations, particularly replacement of Phe-82 (site 1) with Val, abrogates DAA.

CD35 and CD21 have a very important role in immunity. CD21 increases follicular retention and survival of B cells in germinal centers, and CD35 helps to trap antigen-antibody complexes on follicular DCs (13). However, CD35 only inhibits B-cell activation. Although the cytoplasmic region of CD35 has no signaling capacity, it is possible that it may associate with the Fc receptor (14).

## CD36 (PLATELET GLYCOPROTEIN IV)

*Structure.* CD36 is a member of scavenger receptor class B, which includes scavenger

receptor B-1, the receptor for cholesterol ester, and the lysosomal integral membrane protein II. It is a receptor for thrombospondin-1 (TSP-1), called *platelet gp IV* because it is detected in platelet granules ( [1](#) ). There are two transmembrane regions; one each on the C- and N-terminal ends of the molecule. The bulk of the protein is located extracellularly, whereas the two intracellular tails are short (9 to 13 amino acids). Most of the glycosylation sites are located within the N-terminal end, whereas the C-terminal is proline rich and contains six cysteines. The C-terminus has a sequence that may serve for signal transduction ( [2](#) ). TSP-1 binding is mediated by the sequence 93 to 120, oxidized low-density lipoprotein (oxLDL) binds to sequence 120 to 155, and apoptotic cells to residues 155 to 183.

*Gene locus.* 7a11.2.

*Molecular mass (kd).* 88/113.

*Distribution.* Expression is broad (i.e., detected in platelets, monocytes, macrophages, DCs, megakaryocytes, and erythroid precursors). Among other cells, it is expressed on the endothelium of small vessels (not large), epithelia of retina, breast, intestine, smooth and skeletal muscles, and adipocytes. CD36 is localized in caveolae (i.e., cholesterol- and sphingolipid-enriched membrane microdomains), which are considered to concentrate and integrate signaling molecules and are involved in cholesterol trafficking. Expression is up-regulated in monocytes by M-CSF, GM-CSF, IL-4, and native and modified LDL. It is down-regulated by corticosteroids, TGF- $\beta$  1, high-density lipoprotein, and LPS. A critical regulator is PPAR-?, a nuclear hormone receptor that functions as a transcriptional regulator of genes linked to lipid metabolism.

*Function.* CD36 is a multifunctional receptor ( [3](#) ). Several ligands have been identified: long-chain fatty acids (LCFAs), oxLDL ( [4](#), [5](#) and [6](#) ), anionic phospholipids ( [7](#) ), collagens I and IV, and TSP-1. CD36 binds to apoptotic cells ( [8](#), [9](#) ), *Plasmodium falciparum*-infected RBCs ( [10](#) ), retinal photoreceptor outer segments, and sickle red cells. In performing its function, CD36 acts in concert with other proteins (i.e., fatty acid-binding protein, caveolin, integrins, cytoskeletal proteins, and signaling molecules).

*Atherogenesis.* CD36 plays a critical role in the formation of foam macrophages ( [11](#) ). Entrapped LDL becomes oxidized by inflammatory stimuli and is taken up by CD36 expressing phagocytic cells, which become foam cells. The cycle is perpetuated as a result of generations of lipid by-products activating CD36 and PPAR-? ( [12](#) ) genes in a positive feedback loop. Mice deficient in CD36 are defective in uptake of oxLDL and foam cell formation ( [11](#) ).

*Phagocytosis of apoptotic cells.* CD36 is involved in the clearance of apoptotic cells in cooperation with a  $\sqrt{\beta}$  3 integrin. Phosphatidylserine, an anionic phospholipid on apoptotic cells, may act as the ligand for CD36 for phagocytosis of apoptotic cells. By this function, CD36 plays an important role during development, infection, and immunity. Another function of CD36 related to clearance of apoptotic cells is the removal of photoreceptor rod outer segments (ROS), which are shed daily and must be phagocytosed to maintain normal vision. ROS membranes contain anionic phospholipids that are removed by CD36 expressed on retinal pigment epithelium.

*Malaria and sickle cell disease.* RBCs infected with *P. falciparum* are cleared by macrophages ( [10](#) ). CD36 binds to infected RBCs, and their removal depends on a  $\sqrt{\beta}$  3 integrin. CD36 may also recognize RBCs with sickle hemoglobin. Because sickle cells

move slower, adhesive interactions develop between CD36 and TSP-1, which may contribute to pathology of sickle cell anemia.

*CD36 and transportation of LCFAs.* LCFAs are important for energy production. CD36 acts as transporter of LCFA to skeletal muscle and heart and contributes to lipid homeostasis.

*Antiangiogenic activity.* TSP-1 is a potent inhibitor of tumor angiogenesis ( [13](#)). CD36 mediates this function of TSP-1 as a result of activation of an apoptotic pathway via caspase-3.

*CD36 and diabetes.* AGEs derive from long exposure of protein to glucose and have been implicated in a number of degenerative diseases ( [14](#)). CD36 is one of the receptors of AGEs and mediates their endocytosis. Whether this process contributes to microvascular changes in diabetes remains to be seen.

## CD38 [ADENOSINE DIPHOSPHATE (ADP)-RIBOSYLCYCLASE, CYCLIC ADP-RIBOSE HYDROLASE]

*Structure.* CD38 is a non-lineage-restricted type II transmembrane protein (NH<sub>2</sub> terminus in the cytoplasm), which is an *ectoenzyme* ( [1](#)). The extracellular region is large and contains two hyaluronate (HA)-binding motifs, and a third present in the cytoplasmic region. The HA motifs may function for attachment to the extracellular matrix. There are 12 conserved cysteines, 11 of which are located in the extracellular region, and four of them play an essential role in the cyclic adenosine diphosphate (cADP) ribose synthetic and hydrolytic activity. The C-terminal part and particularly Cys-275 contribute to the *nicotinamide adenine dinucleotide* (NAD) glycohydrolytic activity. The disulfide bonds are important for the catalytic activity because 2-mercaptoethanol, which splits disulfide bonds, inhibits the enzymatic function of CD38. A conserved pair of amino acids, Gly-146/Asp-147, endows the ADP-ribosyl transferase activity to the CD38 protein. A number of leucines within the transmembrane and extracellular regions potentially form leucine zipper motifs that mediate association of CD38 with other proteins.

*Gene locus.* 4p15.

*Molecular mass (kd).* 45.

*Distribution.* In hematopoietic cells, CD38 expression is discontinuous, that is, it is switched on and off several times during cell differentiation. Uncommitted stem cells are CD38<sup>-</sup>, whereas committed CD34<sup>+</sup> cells are CD38<sup>+</sup>. B-cell progenitors are CD38<sup>+</sup>, but circulating naïve B cells are CD38<sup>-</sup>. In LN follicles, centroblasts are CD38<sup>+</sup>, giving rise to CD38<sup>+</sup> centrocytes in the light zone of germinal center. Centrocytes that survive apoptosis differentiate into memory B cells, which are CD38<sup>-</sup>, or plasma cells that are strongly CD38<sup>+</sup>. Early T-cell precursors of the subcortical area are CD38<sup>+</sup>; expression is maintained through the double-positive stage then declines in naïve single-positive T cells in the periphery that regain expression during activation. Myeloid precursors are CD38<sup>+</sup>, but neutrophils CD38<sup>-</sup>. It is expressed on monocytes, NK cells, erythroid progenitors, erythrocytes, and platelets. Outside of the hematopoietic system, it is detected in skeletal and heart muscle, proximal convoluted tubules of kidney, thyroid, brain, prostate (but not in benign prostatic hypertrophy), and vascular endothelium.



### Function:

- **Molecular mechanisms.** NAD<sup>+</sup> is an important coenzyme involved in many biological reactions ( [2](#), [3](#) and [4](#)). NADases catabolize NAD<sup>+</sup> by breaking the bond between the nicotinamide and the adenosine diphosphoribose (ADPR). CD38 has a complex enzymatic function involving two or three enzymatic pathways: (a) Its favorite function (97%) is the conversion of NAD<sup>+</sup> to ADPR ( *glycohydrolase activity*); (b) it cyclizes ADPR to cADP-ribose (cADPR) ( *cyclase activity*); and (c) it hydrolyzes cADPR to ADPR ( *hydrolase activity*) ( [5](#), [6](#) and [7](#)). cADPR is an important second messenger because it raises intracellular calcium independent of IP<sub>3</sub> through ryanodine-sensitive receptors in intracellular Ca<sup>2+</sup> store. CD38 also functions as transferase of cADPR to cysteine or arginine on target proteins. There is a serious topologic problem regarding the function of CD38: Its catalytic site is extracellular, whereas its substrate is in the cytoplasm. Because CD38 is internalized on ligation, it is conceivable that CD38 and its substrate will come together ( [8](#), [9](#), [10](#), [11](#) and [12](#)). Recently, it has been shown that a protein known as *connexin 43* (CX43) forms hexameric channels, which act as a transporter system for NAD<sup>+</sup> on the plasma membrane. These channels allow the entrance of NAD<sup>+</sup> into vesicles where CD38 catalyzes its conversion to cADPR, which in turn is actively transported to cytosol by “dimeric” or “tetrameric” CD38 channels. Other data indicate that cADPR is not required for initiation of its own signal transduction but is required for enhancing proliferation of already replicating cells. Extracellular regions altered by mutations do not affect the catalytic and signal transduction functions. The suggestion was made that CD38 is associated with an intermediary protein that communicates between CD38 and BCR extracellularly. This messenger protein, named *ARAF* ( *antigen receptor-associated protein*), is released after conformational changes occurring on ligation and associates with BCR. Thus, CD38 “borrows” the efficient signaling machinery of BCR.
- **Cellular functions.** Antibodies to CD38 act synergistically with submitogenic doses of endotoxin and augment proliferative responses of naïve B cells ( [13](#)). CD38- and IgM-mediated signal transduction are probably linked, because B cells unresponsive to IgM-mediated stimulation are also unresponsive to stimulations through CD38. Signal transduction through CD38 probably is regulated by Bruton’s kinase (Btk). Another example of the “functional” linkage with other molecules in signal transduction is its association in NK cells with CD16 ( [14](#)) for control of Ca<sup>2+</sup> fluxes and tyrosine phosphorylation. CD38 triggers cytotoxic responses in activated NK cells, whereas stimulation through CD38 induces cytokine production from T cells and prevents apoptosis of germinal center B cells ( [15](#)). As a cell marker, CD38 is used in phenotyping acute and chronic leukemias. In B-CLL, expression of CD38 is an important prognostic marker and a predictor of clinical outcome ( [16](#), [17](#), [18](#) and [19](#)). Quantification rather than percentages of positivity may have a better predictive value to identify B-CLL patients who are likely to progress ( [20](#)). Patients with CD38<sup>+</sup> B-CLL have a significantly more aggressive disease regardless of clinical stage ( [21](#)).

### CD39 (E-NTPDase: ECTO-NUCLEOSIDE TRIPHOSPHATE DIPHOSPHOHYDROLASE, APYRASE, ECTO-ATPase)

**Structure.** CD39 belongs to the growing family of ectoenzymes known as *ecto-apyrases* or *ecto-ATPases* or *E-NTPDases*. Their main function is to hydrolyze nucleoside triphosphates (NTP) or diphosphates (NDP) acting on the  $\alpha$  and  $\beta$  phosphate residues of

nucleotides. Members of this family are separated into two subgroups according to their membrane topography ( [1](#), [2](#), [3](#) and [4](#)). Group A includes E-NTPDases 1 to 4, and Group B includes ENTPD5 and putative member NTPD6 or CD39L2. CD39 and the other members have two transmembrane regions leading to the N- and C-termini inside the cell. The larger portion of the molecule forms an extracellular loop, which contains the catalytic activity. The enzymatic activity is determined by five conserved sequences known as *apyrase conserved regions* (ACRs). Mutations of ACRs affect the specificity of the enzyme, which is also regulated by the two transmembrane regions. Change of H59 in ACR1 converts CD39 to an ADPase. NTPDase5 is identical to protooncogene PCPH that mediates cellular responses to stress. It has only one transmembrane region because it lacks the C-terminal hydrophobic sequence. The putative NTPDase6 has only one ( N-terminal) transmembrane region.

CD39 has six putative glycosylation sites essential for its surface expression. Oligomers may be formed as a result of intermolecular cross-linking between cysteines, which affects catalytic activity. The new classification of these enzymes as proposed by Zimmerman et al. during the Second International Workshop on ecto-ATPases and related ecto-nucleotidases is presented in the table below.

A posttranslational modification of CD39 involves addition of palmitic acid within the N-terminal cytoplasmic region, which contains one Cys. This preferentially targets CD39 to membrane caveolae and may facilitate signal transduction.

*Gene locus.* 10q24.

*Molecular mass (kd).* 55 to 60.

*Distribution.* CD39 is present on the cell surface of activated B cells, NK cells, T cells, Langerhans and DCs, macrophages, polymorphonuclear cells (PMNs), platelets, and erythrocytes ( [5](#)). It is detected on endothelial cells, endocardium, and vascular smooth muscle. NTPDase2 is a specific marker of pericytes and is found in the adventitia of muscularized vessels and other cells of the subendocardial space. CD39L2 has a predominant expression in the heart. Not all members are located on the cell surface. NTPDase4 is located in the Golgi apparatus and lysosomal vacuoles.

*Function:* CD39 is not active within the compartments of the secretory pathway until it reaches the plasma membrane. Glycosylation is essential for its membrane localization. This mechanism prevents CD39 from depleting intracellular ATP stores while still being transported from the Golgi apparatus to the cell surface ( [6](#)). Nucleotides are released from the cytoplasm of cells into the extracellular space or lumen of intracellular organelles. In those locations, they influence a variety of physiologic functions such as platelet aggregation, vascular homeostasis, immune functions, and neuronal signaling interacting with extracellular receptors ( [7](#), [8](#)). Their function in the extracellular space or the lumen of intracellular organelles is regulated by the NTPDases ( [9](#)).

The specificity of these enzymes, which is determined by the ACRs, varies. Some hydrolyze primarily NTPs, whereas others attack diphosphates. NTPDase2 hydrolyzes primarily ATP rather than ADP; NTPDase 4 and 5 are uridine diphosphatases (UDPases). Enzymatic activities depend on millimolar concentrations of  $\text{Ca}^{2+}$  or  $\text{Mg}^{2+}$ . In the cardiovascular system, NTPDases regulate the actions of ATP on vascular tone, blood flow, and platelet aggregation (at sites of vascular damage or inflammation) ( [10](#)) and reverses platelet aggregation induced by ADP, collagen, or thrombin ( [11](#)). Mice deficient in CD39 exhibit increased cerebral infarct volumes and reduced postischemic perfusion (

[12](#)). Soluble CD39 rescues these mice from cerebral injury.

CD39 inhibits IL-1 release from stimulated endothelial cells, suppresses E-selectin expression, and protects endothelial cells from apoptosis ([13](#)).

In the immune system, blockade of ecto-ATPase activity results in loss of effector functions of B, T, and NK cells.

| Proposed New Nomenclature of E-NTPDases |                     |
|---|---------------------|
| New Classification                      | Old Classification  |
| NTPDase 1                               | CD39 ectopyrase     |
| NTPDase 2                               | CD39L1, ecto-ATPase |
| NTPDase 3                               | CD39L3, HB6         |
| NTPDase 4                               | UDPase, LLALP70     |
| NTPDase 5                               | CD39L4, ER-UDPase   |
| NTPDase 6                               | CD39L2              |

NOTE: Family name: E-NTPDases. Individual members: NTPDase 1-6.  
From Zimmermann H, Beaudoin AR, Bollen M, et al. Proposed nomenclature for two novel nucleotide hydrolyzing enzyme families expressed on the cell surface. In: van Duffel L, Lemmens R, eds. Ecto-ATPases and related ectonucleotidases. Maastricht: Shaker Publishing BV, 2000:1-8, with permission.

## CD40

*Structure.* CD40 is a type I transmembrane phosphorylated glycoprotein member of the TNF-R family, which includes NGFR, CD27, CD30, CD95 (FAS), CD120a (TNFR-I), CD120b (TNFR-II), CD134 (OX-40), and CDW137 (4-1BB).

The extracellular region contains 22 cysteines, which form four domains homologous to those of the TNF-R family ([1](#)). The cytoplasmic region mediates signaling through association with other molecules, such as members of the TRAF (TNF receptor-associated factor) family ([2](#)). CD40 interacts directly with TRAF-1, TRAF-2, and TRAF-3, involving sequence <sup>250</sup>PVQET, whereas TRAF-6 binds to a membrane-proximal site ([3](#), [4](#)). T-254 is essential for association of TRAF-2 and -3 with CD40. Other sequences of the cytoplasmic region of CD40 also influence the binding of TRAF-2 and -3. A cytoplasmic molecule known as *I-TRAF/TANK* associates with TRAF-1 and -2 and prevents their binding to CD40. Therefore, high levels of this protein may prevent ligand-dependent recruitment of TRAFs to CD40.

*Gene locus.* 20q12-q13.2.

*Molecular mass (kd).* 48.

*Distribution.* Expression of CD40 is ubiquitous: B cells, thymocytes, T cells, monocytes, DCs, hematopoietic progenitors, stromal cells, and basophils. In nonhematopoietic cells, it

is expressed by epidermal, epithelial, and endothelial cells, microglia, hepatocytes, smooth muscle cells, and so forth, as well as carcinomas of urinary bladder (although lacking in normal bladder epithelium), melanomas, and so forth.

*Function:*

- **Molecular mechanisms.** Binding of the CD40 ligand (CD154) triggers several cooperating signaling pathways. Five TRAFs ([1](#), [2](#), [3](#), [5](#) and [6](#)) associate via their TRAF domains to the cytoplasmic region of CD40 and initiate signaling cascades ([5](#), [6](#) and [7](#)). TRAFs form homotrimers, which are required for high-affinity interaction with trimeric CD40. Overall, TRAFs control the terminal phases of CD40-induced B-cell differentiation (i.e., germinal center formation, affinity maturation, and long-lived humoral immunity). Non-TRAF-binding domains of the cytoplasmic region are important in inducing early events such as B-cell proliferation, up-regulation of surface molecules, and early differentiation. A sequence of the cytoplasmic region proximal to membrane (N226-L235) mediates NF- $\kappa$ B activation and antibody secretion. The binding site for TRAF-6 is in proximity with the membrane, and TRAF-6 signals for NF- $\kappa$ B activation. A further downstream sequence (H236-Q257) up-regulates CD23, CD80, LFA-1, ICAM-1, and FAS. After association with TRAFs, signaling cascades lead to nuclear translocation of specific transcription factors. CD40 ligation activates expression of several genes as a result of activation of three major transcription factors: NF- $\kappa$ B, CRE (cAMP response element), and AP-1 ([8](#)). The binding sites of these factors are in the promoters of the genes activated by CD40. NF- $\kappa$ B up-regulates CD23, CD54, CD80 expression, and production of cytokines (IL-6, IL-12, GM-CSF, and so forth). CRE regulates activation of cytokine genes (IL-6, TNF- $\alpha$ , IL-12), whereas AP-1 regulates expression of CD25, CD54, and secretion of TNF- $\alpha$ . Screening gene expression with high-density oligonucleotide arrays shows that individual signaling pathways regulate some of the genes (“independent control”), whereas expression of other genes depends on cooperation between signaling pathways (“collective control”) ([9](#)).
- **Immune functions.** Absence of CD40/CD154 interactions results in gross impairment of T-dependent B-cell functions: (a) initiation and propagation of germinal center reaction; (b) B-cell activation; (c) B-cell proliferation (clonal expansion); and (d) B-cell differentiation and, with the addition of cytokines, especially IL-10, production of large amounts of antibodies ([10](#)). Ligation of CD40 induces production of IL-10 from macrophages. Withdrawal of CD40/CD154 stimulation leads to plasma cell differentiation while prolonged stimulation to memory B cells.
- **Inflammation.** CD40/CD154 interactions induces maturation of DCs, expression of cytokines and chemokines, adhesion, and co-stimulatory molecules. In turn, inflammatory mediators induce CD40 on endothelial cells and CD154 on both endothelial cells and platelets, leading to a cascade of events favoring thrombosis. CD40/CD154 interactions down-regulate thrombomodulin and induce tissue factor expression on endothelial cells *in vitro*, which render endothelial cells procoagulant ([11](#)).
- **Immune deficiency.** The hyper-IgM syndrome is due to mutations of CD154 (the CD40 ligand). See [CD154](#) and [Chapter 16](#).
- **Other.** T-cell activation of macrophages releases nitric oxide, which protects from *Candida albicans*-disseminated infections ([12](#)). CD40/CD40 ligand interaction was suggested to lead to salivary epithelia activation in Sjögren syndrome ([13](#)).

## CD41 (INTEGRIN $\alpha$ IIb SUBUNIT, PLATELET GLYCOPROTEIN IIb OF THE IIb/IIIa COMPLEX)

*Structure.* CD41 is the  $\alpha$ IIb subunit, which, with CD61, forms the  $\text{gpIIb-IIIa}$  complex, the most abundant platelet protein (1 to 2% of the total platelet protein; 50,000  $\text{gpIIb/IIa}$  complexes per platelet) ( [1](#), [2](#) ). The molecule is synthesized from one mRNA, but a posttranslational modification generates two fragments (125 kd and 22 kd) linked by one disulfide bond. The large fragment is located entirely outside the cell, whereas the small subunit forms the transmembrane and cytoplasmic regions. The large fragment contains four repeats, 30 amino acids long. Each repeat has Asp, Asn, and Gly residues properly spaced, characteristic of the  $\text{Ca}^{2+}$ -binding proteins, such as calmodulin. The overall folding is known as the *EF hand*.  $\text{Ca}^{2+}$  is necessary to maintain the heterodimeric complex.

The complex  $\alpha\text{IIb}/\beta_3$  (CD61, IIIa) is formed within the endoplasmic reticulum (ER), where the chains are separately synthesized. It is then transported to the Golgi apparatus for glycosylation and cleavage of the  $\alpha\text{IIb}$  subunit to its large and small fragments. The mature complex is exported to the cell membrane in the low-affinity state. Glycine<sup>418</sup>, a highly conserved residue that flanks the fourth  $\text{Ca}^{2+}$ -binding domain of  $\alpha\text{IIb}$ , is critical for the transport to the membrane, as some patients with Glanzmann thrombasthenia (GT) have shown (see below).

Activation of the  $\alpha\text{IIb}/\beta_3$  integrin complex probably involves several mechanisms, one of them through cytoplasmic proteins, which bind to the complex. Two such proteins have been detected. One, known as *calcium integrin-binding (CIB) protein*, binds through its hydrophobic C-terminal to the conserved N-terminal sequence of the cytoplasmic tail of the  $\alpha\text{IIb}$  subunit, converting the resting state to an active state ( [3](#), [4](#) ). CIB contains two functional C-terminal EF-hand domains and two N-terminal EF-hand-like sequences. These sequences are homologous to other EF hand-containing proteins such as calcineurin B and calmodulin. CIB has an N-terminal myristoyl group, which promotes its association with the cell membrane. A second cytoplasmic protein called *ancient ubiquitous protein 1* (Aup1) binds also to the conserved N-terminal tail of the  $\alpha\text{IIb}$  subunit and may play a role in inside-out signaling ( [5](#) ). Aup1 is ubiquitously expressed in human cells. It has structural similarities to acyltransferases, enzymes involved in phospholipid synthesis.

*Gene locus.* 17q21.32.

*Molecular mass (kd).* 140, unreduced.

*Distribution.* Megakaryocytes and platelets.

*Function.* The ligands for  $\alpha\text{IIb}/\beta_3$  are fibrinogen, FN, vitronectin, TSP, and vWF. Both subunits contribute to ligand recognition specificity and to affinity of binding ( [6](#), [7](#) ). A highly conserved sequence DXSXS in the  $\beta$  subunit is a portion of a structure analogous (but not identical) to MIDAS (see [CD61](#) and [CD11](#)) ( [8](#) ) found in a polypeptide of the  $\beta$  integrin. It is postulated that the binding pocket is formed by the MIDAS-like sequence of the  $\beta_3$  subunit and the second  $\text{Ca}^{2+}$ -binding site of the  $\alpha\text{IIb}$  subunit.

Binding of the ligand with high affinity requires that the integrin is brought from its “resting” low-affinity state to its high-affinity state after activation ( [9](#), [10](#) ). This requires “inside-out” signaling, provided by conformational changes. Charge reversal mutations seem to disrupt a potential salt bridge, which may link the two subunits and induce a



constitutive state of activation of the integrin. Under these conditions, the integrin is spontaneously associated with the cytoskeleton in the absence of ligand binding (i.e., the mutations induce a constitutive bidirectional transmembrane signaling). These findings imply that conserved sequences on each subunit act as a “hinge,” which normally constrains the integrins to a low-affinity state. Agonist stimulation increases intracellular  $\text{Ca}^{2+}$  such as from binding of thrombin through phosphoinositide hydrolysis.

CIB, a  $\text{Ca}^{2+}$ -binding protein, then attaches to the cell membrane and possibly mediates subunit separation for integrin activation (11). Under conditions of rapid blood flow, the gpIb/V/IX complex interacts with the A<sub>1</sub> domain of vWF, supporting tethering and rolling. This interaction elicits transient  $\text{Ca}^{2+}$  spikes through intracellular release of  $\text{Ca}^{2+}$ , resulting in reversible platelet adhesion (12, 13). gpIb activates aIIb/β<sub>3</sub> integrin, which, through PI3K activation, mobilizes  $\text{Ca}^{2+}$  from intracellular stores, which is subsequently followed by a transmembrane calcium flux, leading to irreversible platelet adhesion. During platelet aggregation after outside-in signaling, two tyrosines, Y<sup>747</sup> and Y<sup>759</sup>, which exist in the integrin cytoplasmic tyrosine domain, are phosphorylated. The spacing of the tyrosines is similar to that of the ITAM domains recognized by signaling molecules. Two proteins bind directly to these tyrosines: myosin, a cytoskeletal protein, and Shc, a signaling adaptor protein.

- **G7.** GT is an autosomal-recessive disease that results from a deficiency of the aIIb/β<sub>3</sub> integrin caused by mutations affecting either one of the two chains (14, 15 and 16). It is characterized by mucocutaneous bleeding (epistaxis and purpura) and severely reduced or absent platelet aggregation. One group has mutations around or within the  $\text{Ca}^{2+}$ -binding domains of the aIIb-chain, affecting the transport of the complex to the cell surface. Another group of mutations are close to the ligand-binding pocket. In the β<sub>3</sub> subunit, mutations are located within the cation-binding sphere (the MIDAS-like structure), which participates in ligand binding. Other mutations are located within the cytoplasmic regions and interfere with integrin activation.
- **Drugs interfering with aIIb/β<sub>3</sub> function.** A Fab fragment of a chimeric (human/mouse) monoclonal antibody, abciximab (ReoPro) binds to aIIb/β<sub>3</sub> and inhibits platelet aggregation. It acts as an antithrombotic agent, which blocks interaction of fibrinogen with aIIb/β<sub>3</sub>.

## **CD42: CD42a (GPIX); CD42b (GPIba); CD42c (GPIbB); CD42d (GPV)**

### **CD42a (GPIX)**

*Structure.* GPIX is a 17- to 22-kd, 160-amino acid protein member of the leucine-rich gp family detected in the a<sub>2</sub> gp of human serum. GPIX has one leucine-rich repeat or leucine gp repeat (LGR) and a sequence of 24 amino acids. Based on x-ray crystallography, it looks like a horseshoe with α-helices in the periphery and β strands in the center (1, 2). gpIX is acylated with myristic and palmitic acids and is a major myristoylated protein in megakaryocytes. The fatty acids may facilitate interaction with gpIb and lipids in the cell membrane.

The cytoplasmic region is six amino acids long with a membrane-proximal cysteine. Antiplatelet antibodies to quinine/quinidine are directed against GPIX.

*Gene locus.* 3q21.

*Molecular mass (kd).* 17 to 22.

*Distribution.* Megakaryocytes and platelets.

### **CD42b (GPIba)/CD42c (GPIb $\beta$ )**

gpIb consists of two chains,  $\alpha$  (CD42b) and  $\beta$  (CD42c), linked by a disulfide bond.

*Structure.* The CD42b-chain (610 amino acids) has an extracellular region containing seven LGRs and two hydrophilic areas, one rich in charged amino acids and one rich in serine and threonine residues containing the majority of O-linked sialylated hexasaccharide sites. These moieties are attached to the protein on every three to four amino acids and generate a rigid mucinlike stalk, called *macroglycopeptide*, which displaces the N-terminal ligand-binding globular domain by approximately 45 nm above the cell membrane. Three tyrosines (276, 278, and 279) are sulfated posttranslationally and seem to promote binding with vWF (3, 4). Mutations resulting in loss of these tyrosines abolish totally the binding to vWF in the presence of botrocetin. The crystal structure of the N-terminal domain has been determined.

*Gene locus.* 17pter-p12.

*Molecular mass (kd).* 67.

*Distribution.* Megakaryocytes, platelets.

### **CD42c**

*Structure.* CD42c is a 206-amino acid transmembrane protein with an LGR flanked by the same sequences as in the  $\alpha$ -chain and the  $\alpha_2$  glycoprotein. It is likely that the gene for LGR was duplicated in the  $\alpha$ -chain, whereas the  $\beta$ -chain retained its ancestral architecture. The extracellular region has nine cysteines, one of them forming the disulfide bond linking the two chains. Four of the cysteines are on the N-terminal side of LGR as compared to two for the GPIba. Two disulfide bonds between these cysteines form a cysteine knot, which is critical for the conformation that determines the binding of GPIb $\beta$  to GPIX. Residues 15 to 32 are important for interaction with GPIX. The extracellular region has one glycosylation site at Asp41.

The cytoplasmic region (34 amino acids) is rich in arginine and alanine residues, which may help in anchoring the protein to the membrane. A single Cys close to the membrane is a potential acylation site. RLS and RAGT sequences are likely targets for phosphorylation by cAMP-dependent protein kinase.

*Gene locus.* 22q11.21.

*Molecular mass (kd).* 20.

*Distribution.* Both chains are expressed in megakaryocytes and platelets.

## CD42d (GPV)

*Structure.* Single-chain transmembrane protein (544 amino acids), with 15 LGRs in the extracellular region and 16 amino acids in the cytoplasmic region. Thrombin binds to GPV.

*Gene locus.* 3q29.

*Molecular mass (kd).* 82.

*Distribution.* Platelets and megakaryocytes.

*Function of the GPIX–GPIb–GPV “complex”.* The complex plays a central role in primary hemostasis, being the key receptor for platelet adhesion for exposed subendothelium on damaged vessel walls under conditions of shear ([5](#), [6](#), [7](#), [8](#) and [9](#)). The proteins of the multimolecular “complex,” GPIX–GPIba–GPIbβ–GPV, are members of the leucine-rich family. GPIba is the largest and has the receptor sites for both vWF and thrombin; it links the complex through filamin to cytoskeleton ([10](#), [11](#)), which is essential for anchorage at high shear and for regulation of the interaction of the complex with vWF. The A<sub>1</sub> domain of vWF binds to GPIba NTR, which includes the seven LGRs, the disulfide-looped flanking regions, and the anionic sulfated tyrosine sequences ([12](#)).

The major function of the complex is to mediate initial adhesion of circulating platelets to vWF in subendothelial matrix of damaged vessels. This leads to translocation (“rolling”) and reversible aggregation, which becomes irreversible after activation of the αIIb/β<sub>3</sub> integrin ([13](#)).

Complex–vWF interaction is also involved in platelet thrombus formation under arterial or venous flow. The complex on the surface of free-flowing platelets binds to vWF on immobilized platelets (reversible binding), followed by irreversible aggregation if the αIIb/β<sub>3</sub> integrin is activated.

Ligand binding triggers signaling, some of which is mediated through the ? isoform of protein 14–3–3, which binds to four C-terminal amino acids of GPIba ([14](#)). Proteins 14–3–3 regulate several key signaling molecules like BCR, cbl, p85 unit of PI3K, the apoptotic protein BAD, and so forth.

Bernard–Soulier syndrome is characterized by prolonged skin bleeding time, enlarged platelets, and thrombocytopenia ([15](#)). Patients have frequent epistaxis, gingival bleeding, and so forth. The genetic defects are heterogeneous: (a) biosynthetic defects or (b) functional defects (failure to bind the ligand). Mutations of the genes of GPIba, GPIbβ, and GPIX have been detected ([16](#), [17](#)).

## REFERENCES

1. Lopez JA, Chung DW, Fujikawa K, et al. The α and β chains of human glycoprotein Ib are both transmembrane proteins containing a leucine-rich amino acid sequence. *Proc Natl Acad Sci U S A* 1988;85:2135–2139.
2. Hickey MJ, Williams SA, Roth GJ. Human platelet glycoprotein IX: an adhesive prototype of leucine-rich glycoproteins with flank-center-flank structure. *Proc Natl Acad Sci U S A* 1989;86:6773–6777.



3. Cruz MA, Diacovo TG, Emsley J, et al. Mapping the glycoprotein Ib-binding site on the von Willebrand factor A1 domain. *J Biol Chem* 2000;275:19098–19105.
4. Huizinga EG, Tsuji S, Ronijn RA, et al. Structures of glycoprotein Ib alpha and its complex with von Willebrand factor A1 domain. *Science* 2002;297:1176–1179.
5. Berndt MC, Shen Y, Depheide SM, et al. The vascular biology of the glycoprotein Ib-IX-V complex. *Thromb Haemost* 2001;86:178–188.
6. Kulkarni S, Dopheide SM, Yap CL, et al. A revised model of platelet aggregation. *J Clin Invest* 2000;106:783–791.
7. Dong J-F, Sae-Tung C, Lopez JA. Role of glycoprotein V in the formation of the platelet high affinity thrombin-binding site. *Blood* 1997;89:4355–4363.
8. Lopez JA, Dong J-F. Structure and function of the glycoprotein Ib-IX-V complex. *Curr Opin Hematol* 1997;4:323–329.
9. Savage B, Almus-Jacobs F, Ruggeri ZM. Specific synergy of multiple substrate-receptor interactions in platelet thrombus formation under flow. *Cell* 1998;94:657–666.
10. Williamson D, Pikorski I, Crammer SL, et al. Interaction between platelet glycoprotein Iba and filamin-1 is essential for glycoprotein Ib/IX receptor anchorage at high shear. *J Biol Chem* 2002;277:2151–2159.
11. Mistry N, Crammer SL, Yuan Y, et al. Cytoskeletal regulation of the platelet glycoproteinIb/V/IX von Willebrand factor interaction. *Blood* 2000;96:3480–3489.
12. Tait AS, Dong JF, Lopez JA, et al. Site directed mutagenesis of platelet glycoprotein Ib alpha demonstrating residues involved in the sulfation of tyrosines 276, 278, and 279. *Blood* 2002;99:4422–4427.
13. Grammer SC, Ulsemer P, Cooke BM, et al. Glycoprotein (GP) Ib/IX-transfected cells roll on a von Willebrand factor matrix under flow. *J Biol Chem* 1999;274:6097–6106.
14. Feng S, Christodoulides N, Resendez JC, et al. Cytoplasmic domains of GpIba and GpIbβ regulate 14–3-3?. *Blood* 2000;95:551–557.
15. Lopez JA, Andrews RK, Afshar-Khargan V, et al. Bernard-Soulier syndrome. *Blood* 1998;91:4397–4418.
16. Kenny D, Marateck PA, Gill JC, et al. The critical interaction of glycoprotein (GP) Ibβ with GPIX—a genetic cause of Bernard-Soulier syndrome. *Blood* 1999;93:2968–2975.
17. Lanza F, De La Salle C, Baas M-J, et al. A Leu 7 Pro mutation in the signal peptide of platelet glycoprotein (GP) IX in a case of Bernard-Soulier syndrome abolishes surface expression of the GPIb-IX complex. *Br J Haematol* 2002;118:260–266.

## **CD43 (LEUKOSIALIN, SIALOPHORIN, WASP: WISKOTT-ALDRICH SYNDROME PROTEIN)**

*Structure.* CD43 (WASP) is a transmembrane protein (502 amino acids), constituting the major sialoglycoprotein expressed on leukocytes and platelets (<sup>1</sup>). The extracellular region has an N-terminal hydrophobic region and is rich in prolines (15% of the entire sequence), with 46 serines and 47 threonines interspersed. There are several proline-containing sequences found in SH<sub>3</sub> domains of proteins involved in signaling and organization of cytoskeleton. Ser and Thr residues carry O-linked sialic acid (70–85), forming an extended (45 nm), rigid, acidic structure with a net negative charge. There are two WASP glycoforms, reflecting differences of the attached O-glycan structures. One, on resting T cells, has tetrasaccharides (115-kd glycoform), whereas activated T cells carry branched hexasaccharides (139-kd glycoform). The change results from the

enzymatic activity of an acetylglucosaminyltransferase. The cytoplasmic region is highly conserved and has constitutively phosphorylated Ser residues.

WASP belongs to a family of proteins regulating the organization of cytoskeleton. There are two groups: (a) WASPs and (b) WAVES (-1, -2, -3) ([2](#)). A homolog of WASP was detected in the brain and is known as *neural-WASF* or *N-WASF* (see details in [Chapter 14](#)).

*Gene locus.* X p 11-23.

*Molecular mass (kd).* 115; 130.

*Distribution.* WASP is present in hematopoietic cells, whereas N-WASP and WAVE are expressed ubiquitously. CD43 is expressed in thymocytes, T cells, activated B cells, plasma cells, NK cells, neutrophils, monocytes, macrophages, platelets, and stem cells.

*Function:*

- *Molecular mechanisms.* The WASP/WAVE family members play critical roles in rapid organization of cortical actin filaments in response to external stimuli ([3](#), [4](#)). The C-terminus consists of a verpolin homology region (V) followed by a cofilin homology and an acidic region (CA). The V motif interacts with monomeric G actin, whereas the CA interacts with the Arp 2/3 complex, bringing these two molecules together to initiate actin nucleation. N-WASP is key to formation of filopodia, whereas WAVE-2 is needed for formation of lamellipodia and membrane ruffles in response to outside stimuli, such as platelet-derived growth factor (PDGF). Several proteins bind to WASP through specific binding sites [i.e., Rho guanosine triphosphatases (GTPases) through the GTPase-binding domain, Cdc42/Rac through their interactive binding motif]. Other proteins with SH<sub>3</sub> domains bind to proline sequences (i.e., Ttk, PLC- $\gamma$ 1, Grb2, and so forth). WASP is distinguished into two homology domains, WH-1 (N-terminus) and WH-2 (C-terminus). N-WASP, through WH-1, binds phosphatidylinositol 4,5-bisphosphate and is anchored to the membrane. WH-1 also binds WIP (WASP-interacting protein), a proline-rich protein, and coordinates the signaling cascades. WH-1 recruits N-WASP to sites of actin polymerization. Cdc42/Rac stimulates protrusions at the leading edge, whereas Rho induces retraction at the tail end. Coordination of these two processes moves the cell toward the target.
- *Cellular functions.* Data in the literature are controversial in regard to the function of CD43 as an adhesive molecule. Some data suggest that CD43 promotes adhesion and cell interactions, whereas other data bring evidence to the opposite. The properties of CD43 (long, rigid, and negatively charged) are considered to oppose cell interactions (antiadhesive, steric barrier model) ([5](#)). However, CD43 also promotes adhesion, as shown in CD43-deficient mice, in which leukocytes are impaired in their ability to emigrate out of the vasculature ([6](#)). Sialoadhesin (CD169) has been shown to act as receptor for CD43 ([7](#)). Of the two glycoforms of CD43, the 130-kd, but not the 115-kd glycoform, carries the antiadhesive properties of the molecule. Interactions may also be facilitated by CD43 removal from the area of interaction either by proteolysis or capping. Indeed, CD43 is actively and selectively excluded from the immunologic synapse (i.e., the contact area between the T cell and the APC) ([8](#), [9](#) and [10](#)). However, when CD43 was technically allowed to remain in the synapse, it did not interfere with T-cell interaction and activation, which indicates that it does not impose a physical barrier. Actually, TCR engagement activates WASP, which is recruited for the movement and clustering of rafts, which are important for T-cell activation ([11](#)). T cells from WAS patients have impairment

of raft clustering. The importance of WASP in T-cell motility is shown by the change from the spherical to the polarized morphology, with CD43 co-localizing with the ezrin/moesin proteins in the uropod and cell-cell contact areas ( [12](#), [13](#) ). Memory T cells (CD45RO) express strongly CD43, which may facilitate interactions for their extravasation. Cell motility is profoundly disturbed in patients with WAS ( [14](#) ). WAS macrophages show no actin polymerization, defective phagocytosis ( [15](#) ), and no chemotaxis to CSF-1 stimuli. DCs are unable to traffic normally to T-cell areas and cannot extend dendritic processes ( [16](#) ). WASP is highly expressed on hematopoietic stem cells. Cross-linking by an antibody induces apoptosis of the most primitive, but not the more differentiated, cells ( [17](#) ). Thus, WASP and the other members of its family are critical for cell motility, cell trafficking, cell activation, and cell interactions. Disturbances in these functions provide an explanation of the symptoms and signs of patients with WAS (i.e., eczema, bleeding, and recurrent infections), which are manifestations of a defective WASP in a variety of cells and a variety of functions.

## CD45 (LCA: LEUKOCYTE COMMON ANTIGEN, B220)

*Structure.* CD45 is a protein tyrosine phosphatase previously known as the *leukocyte common antigen*. The extracellular region, which is an extended rod, has two domains: an *N*-terminal, mucinlike structure, with multiple Ser/Thr providing potential O-linked glycosylation sites, and a cysteine-rich domain (16 cysteines) followed by three FN type III domains. The cytoplasmic region (705 amino acids) is highly conserved (85% homology with other species). There are multiple phosphorylation sites, notably the sequence Lys-Lys-Arg-Ser immediately next to the membrane, a pro-ser-rich sequence and a glu-asp-ser sequence, which are potential sites for glycogen synthase kinase-3 and -5, respectively ( [1](#), [2](#) ).

The cytoplasmic region consists of the membrane proximal, first phosphatase domain (D1) and a second phosphatase domain (D2) in the carboxyl tail. When recombinant domains were studied *in vitro*, D1 is catalytically active and forms homodimers, whereas D2 has no catalytic activity and associates and stabilizes the D1.

The signature sequence essential for catalytic activity is HCSAGXGRXG, and the WPD loops are present in the D1, but not the D2, domain. The D2 is missing the Arg (R) involved in substrate binding.

There are multiple isoforms of CD45 as a result of alternative splicing, which is highly regulated. Of the eight exons of the gene, exons 3 to 8 encode the *N*-terminal O-glycosylated domain, which is affected by variable exon use.

The default pathway of splicing does not include exons 4, 5, and 6. Isoform expression has been studied with antibodies (CD45R). Antibodies that recognize epitopes encoded by exons 4, 5, and 6 have been termed *CD45RA*, *-B*, and *-C*, respectively. Antibodies that recognize CD45 deprived of contributions of 4, 5, or 6 are CD45RO. CD45R antibodies recognize more than one isoform. The significance of isoforms is in allowing different expression in various cells (see below) and association with distinct groups of surface molecules.

*Gene locus.* 1q31-32.

*Molecular mass (kd).* 180 to 220; 220 has all A, B, C epitopes; 180 lacks A, B, C. Isoforms

with one or two of the A, B, C epitopes have Mr in between the two extremes.

*Distribution:* Found in all hematopoietic cells except erythrocytes. B lymphocytes express the isoform with all ABC sequences. However, with activation, they express the low Mr isoforms. Most thymocytes express the low Mr isoforms but, during differentiation and positive selection, become CD45R<sup>+</sup>. Peripheral blood naïve T cells are CD45RA, whereas memory (activated) T cells are CD45RO. NK cells have 210 to 220 Mr isoforms; monocytes express the whole range of isoforms and so do the DCs.

*Function:* CD45 plays an essential role in lymphocyte activation. Src family members, lck and fyn, have been implicated in the initial increase of tyrosine phosphorylation on TCR stimulation. These kinases have two conserved Tyr residues, one within the kinase domain and a second in the carboxyterminal end. CD45 positively regulates TCR signaling by priming lck kinase through dephosphorylation of the C-terminal inhibitory tyrosine ( [3](#), [4](#) and [5](#) ). However, CD45 exerts negative regulation of PTKs at sites of adhesion by integrins. The totally opposite effects are regulated by a distinct topologic distribution of CD45 during TCR engagement. CD45 first is excluded from the immunologic synapse, where it may inhibit integrin activation and adhesive functions. Later, it is recruited back adjacent to TCR site, where it is able to maintain src-kinase activity ( [6](#) ) and eventually induces down-regulation of TCR ( [7](#), [8](#) ). CD45 suppresses JAK kinases and negatively regulates cytokine production ( [9](#) ). Different isoforms differentially regulate IL-2 production. Myeloma cells are CD45<sup>-</sup>, but a small number of immature cells are CD45<sup>+</sup>, and they proliferate in response to IL-6 ( [10](#), [11](#) ).

Deficiency of CD45 as a result of mutations of the CD45 gene results in SCID ( [12](#), [13](#) ).

## CD46 (COMPLEMENT MEMBRANE COFACTOR PROTEIN: MCP)

*Structure.* CD46 is a member of the complement control protein (CCP) family ( [1](#) ). Its extracellular region has four contiguous CCP domains, each 60 amino acids long. CCP domains 2, 3, and 4 have the C3b/C4b-binding site. An N-glycosylation site on CCP-2 is essential for measles virus (MV) binding ( [2](#) ). The CCP domain region is followed by a sequence rich in Ser/Thr and Pro. The protein exists in several isoforms defined by differences in the extracellular and cytoplasmic regions ( [3](#) ).

*Gene locus.* 1q32.

*Molecular mass (kd).* 52 to 58.

*Distribution.* It is expressed on all peripheral blood cells except erythrocytes and is expressed widely on other tissues. Predominance of certain isoforms has been noted in brain, kidney, salivary glands, and fetal heart.

*Function.* MCP was initially identified based on its ability to bind C3b or iC3 (C3 with broken thioester bond). MCP possesses “CA,” that is, binding of MPC promotes the degradation of C3b and C4b by a plasma serine protease, known as *factor i*, (see [Chapter 18](#)) ( [4](#) ). For the classical pathway, MCP is the cofactor for C4b cleavage, and for low level C3b deposition by the alternative pathway, MCP is sufficient to block alternative pathway activation.

Although the N-glycans of CCP domains 2 and 4 are not involved in ligand binding, they

are necessary for MCP protective function. Because the ratio of deposited C4b to MCP is greater than 10:1, one MCP molecule must cleave more than one C4b for cytoprotection ( 5 ). The isoform with a larger glycosylation domain binds C4b more efficiently than isoforms smaller in size and less glycosylated ( 6 ).

The CD46 is a receptor for MV and supports infection by the virus ( 7, 8 ). The MV-binding site is formed by CCP domains-1 and -2, and both are required for successful binding and infection ( 9 ). The two domains twist around the longitudinal axis of the molecule, forming an angle of approximately 100 degrees so that the sequences of each CCP that bind to MV are brought on the same face. In macrophages and monocytes, the replication of MV ( 10 ) is highly restricted, due to nitric oxide production triggered by IFN- $\alpha/\beta$ . Another MV receptor is CD150 (or SLAM), which uses overlapping but different sites ( 11 ).

CD46 is a receptor to a number of other pathogens, such as herpes virus 6 (binding site at CCPs 2 and 3) ( 12 ), the M protein of group A streptococci (binding site at CCPs 3 and 4) ( 13 ), and *Neisseria gonorrhoeae* (binding site, CCP-3).

CD46 is a co-stimulatory molecule for CD3-mediated T-cell proliferation, followed by morphologic changes, reorganization of the cytoskeleton, and acquisition of strong adhesive properties ( 14 ).

## CD47 [INTEGRIN-ASSOCIATED PROTEIN (IAP), RH-ASSOCIATED PROTEIN, NEUROPHILIN]

*Structure.* The CD47 protein was first identified during isolation of integrins and as a result was called *integrin-associated protein* (IAP). It consists of an extracellular region, which is a V-type IgSF domain, followed by five membrane-spanning regions and a C-terminal short cytoplasmic region ( 1 ). The protein does not bind directly to integrins but probably regulates their function. The sequence of CD47 is homologous or identical to a tumor-associated protein, AO3, and to a vaccinia virus-encoded protein (VA38) ( 2, 3 ).

Four alternatively spliced forms of the C-terminus exist as a result of variable usage of three exons. Most widely distributed are two isoforms, one with a long cytoplasmic tail (mainly in neural tissue) and a second with a short tail (bone marrow cells).

*Gene locus.* 3q13.1

*Molecular mass (kd).* 45 to 55 (unreduced).

*Distribution.* CD47 is ubiquitously expressed on hematopoietic cells, lymphocytes, neutrophils, monocytes, platelets, and erythrocytes (except Rh null) and is identical to antigen 1D8, a protein associated with Rh antigens ( 4 ). It is possible that CD47 and Rh polypeptides share a common pathway of cell-surface expression, and lack of IAP may contribute to the abnormal cation permeability of Rh-null erythrocytes.

*Function.* CD47 is associated with integrins  $\alpha\sqrt{\beta}_3$  but also with  $\alpha_2\beta_1$ , and  $\alpha\text{IIb}/\beta_3$  and is a receptor for TSP and cell-based ligand SIRPa (signal regulatory protein-a) ( 5 ). SIRPs are a family of transmembrane proteins (approximately 15 members) expressed on monocytes, macrophages, granulocytes, DCs, and bone marrow progenitors, but not on lymphocytes. SIRPs are divided into two groups according to the presence (SIRPa) or



absence (SIRPB) in the cytoplasmic region of four tyrosines, considered to be within an ITIM motif.

After phosphorylation, ITIMs act as docking sites for the SH<sub>2</sub> domain of SHP-1 or SHP-2 phosphatases and so influence signaling pathways. SIRP-a1 binds to SHP-2 and, as a result, was named *SHPS-1* (SHP-substrate 1). It now includes other ligands, such as BIT (brain Ig-like molecule), p84 [a neural adhesion molecule (NCAM)], and MFR (macrophage fusion receptor).

Binding to a  $\alpha\beta_3$  integrin (the vitronectin receptor) plays a key role in regulation of several functions of PMNs, such as Fc receptor-mediated phagocytosis (6), chemotaxis, respiratory burst, and migration of PMNs through endothelial and epithelial barriers (7). The key role of CD47-mediated regulation of PMN functions is reflected in its importance in host defense. Mice deficient in CD47 succumb to *E. coli* peritonitis with inocula that their heterozygous littermates survive (8). CD47 and SIRP-a interactions are also necessary for monocytes' crossing of cerebral endothelium, an important stage in the development of neuroinflammatory diseases (9). Through similar interactions and in cooperation with a  $\alpha_4\beta_1$  integrin, CD47 regulates migration of B cells through nonactivated endothelia (10). T cells are arrested on inflammatory vascular endothelium under flow through binding to TSP and the SIRP-a1 ligands or through up-regulation of a  $\alpha_4\beta_1$  integrins (11). CD47 ligation blocks Th1 differentiation (12) and inhibits production of IL-12 from macrophages (13), as well as production of IL-6 from monocytes. CD47 and a  $\alpha\beta_3$  integrin are both receptors for the  $\alpha_3$ -chain of the basement membrane collagen IV and for similar sequences on melanoma tumor cells. CD47/ $\alpha\beta_3$  binding inhibits proliferation of the tumor cells, and CD47 induces apoptosis of CLL cells (14). CD47 is a counter-receptor to MFR and is involved in homotypic macrophage adhesion, triggering the onset of fusion and formation of multinucleated giant cells (15).

A study of a recently identified patient with hereditary spherocytosis as a result of deficiency of band 4.2 showed that CD47 was practically absent (1%) in the patient's erythrocytes (16). Thus, CD47 is linked to band 4.2, but it is also linked to the Rh complex because it is absent in Rh-null individuals, who also have spherocytosis and stomatocytosis. Rh polypeptides interact with the red cell cytoskeleton.

CD47 in erythrocytes also acts as a marker for self (17). RBCs from mice deficient in CD47 injected in CD47<sup>+</sup> normal mice are removed from the circulation by splenic red pulp macrophages. In connection to this role of CD47 in red cell survival, it should be noted that nonobese diabetic mice, which are deficient in CD47, develop a lethal autoimmune hemolytic anemia at 180 to 280 days, whereas the CD47<sup>+</sup> nonobese diabetic mice do not (18). TSP potentially mediates adhesion of sickle red cells and reticulocytes to blood vessel wall under flow conditions (19, 20). This may provide a mechanism for vasoocclusion in sickle cell disease. CD47, as a counter-receptor to p84, an NCAM that promotes neurite growth and neocortical neurons, mediates synaptic adhesions.

The SIRPa1 and SIRPa2 are not detected in leukemic cells from AML and CML. CD47 regulates Ca<sup>2+</sup> influx in endothelial cells, and being a multiple transmembrane molecule, suggests that it may act as a Ca<sup>2+</sup> channel. Some of the multiple functions mediated by CD47 are triggered through activation of heterotrimeric G proteins (21) and is coprecipitated as a complex with the G $\alpha_i$  subunit. This is an unusual pathway for initiation of signal transduction because the only receptors that activate GTPases are proteins

with seven or eight transmembrane regions ( [22](#) ). It has been suggested that the five transmembrane regions of CD47 and two of the associated integrins generate the number associated usually with GTPase activation.

Fundamentally, ligation of CD47 triggers cytoskeletal reorganization, leading to cell adhesion, spreading, motility, chemotaxis, and migration ( [23](#) ).

## CD48 (BLAST-1)

*Structure.* CD48 is a member of the CD2 family and contains two Ig-like domains in the extracellular region, one V (membrane distal, D1) and one C2 type (membrane proximal, D2). D1 has no disulfide bonds, whereas D2 has two. Other members of the CD2 family include CD58, CD80, CD86, CD102, CD150, and CD244. It possesses a GPI membrane anchor. It is the same as BLAST-1, the first B-cell antigen, which is up-regulated after EBV infection. The genes of the members of the CD2 family most likely arose from gene duplication.

*Gene locus.* 1q21.3.

*Molecular mass (kd).* 45.

*Distribution.* Widely expressed on hematopoietic cells with the exception of granulocytes, platelets, and erythrocytes. CD48 expression is up-regulated by the IFNs and on B cells after EBV infection. It is induced at high levels on the surface of resting B lymphocytes after infection with EBV. CD48 was first designated *BLAST-1*, which is overexpressed in EBV-infected B cells due to an enhancer element upstream of the CD48 gene, and has an NF- $\kappa$ B-binding site ( [1](#) ). Elevated levels of a soluble form of CD48 are detected in the blood of patients with lymphoproliferative diseases and arthritis ( [2](#) ).

*Function.* CD48 is a low-affinity ligand for CD2 and interacts with the same site of CD2 that binds LFA-3 (CD58) ( [3](#) ). The interaction of CD2 with CD48 requires the same distance between interacting cells as the TCR and its ligand (i.e., the MHC-peptide complex) ( [4](#) ). The interaction of CD2 and CD48 is head to head, and the binding site on CD2 comprises an area of at least  $770\text{\AA}^2$  formed by residues of several  $\beta$  strands. Although this area is very similar to the high-affinity interactions in antibodies and in proteinases, the CD2/CD48 affinity is  $10^5$ -fold lower, and the CD48/CD2 dissociation rate is exceptionally fast ( [5](#) ). The limited binding strength is due to lack of sufficient complementarity and the presence of charged and polar residues. This type of easily reversible CD48/CD2 interaction allows proofreading by TCR of the MHC-peptide complexes and formation of new interactions ( [6](#) ).

A ligand for CD48 on epithelial cells has been shown to be the glycosaminoglycan-binding site of the hematopoietic form of CD44 (CD44H) ( [7](#) ). Another ligand for CD48 is the 2B4 (CD244) molecule on NK and T cells ( [8](#), [9](#) ), which has five to ten times stronger affinity than CD2. Both CD244 and CD2 are expressed on the same lymphocytes.

In NK cells, engagement of CD244 with CD48 triggers NK cell-mediated cytotoxicity, and on memory/activated CD8<sup>+</sup> T cells, it stimulates proliferation even of the nearby CD244<sup>-</sup> T cells. Another ligand for CD48 is a bacterial adhesion molecule known as *Fim H*, which is a mannose-binding lectin present at the distal tips of filamentous appendages on *E. coli* (type I fimbriae). It mediates adherence of bacterial cells to host cells through binding on

CD48 of mast cells, triggering release of TNF- $\alpha$  (10).

## CD49: CD49a (VLA-1) TO CD49f (VLA-6)

CD49 includes six distinct  $\alpha$  subunits ( $\alpha_1$  through  $\alpha_6$ ), noncovalently associated with the  $\beta_1$  subunit (CD29). The heterodimers are known as *VLA* (VLA-1 through VLA-6) because originally they were detected at a late stage of T-cell activation. They are generally known as  $\beta_1$  *integrins*, although the  $\beta_1$  subunit forms heterodimers with other  $\alpha$  subunits.

### *Structure:*

- *General features.* The  $\beta_1$  integrins are heterodimers of two noncovalently associated subunits:  $\alpha$  and  $\beta$ . Their extracellular region as seen by electron microscopy consists of a globular headpiece formed by both subunits, which is the ligand-binding site. Two long stalks connect the head with the interior of the cell. In the "resting" state, integrins have a "bent" conformation with the head closer to the cell membrane, but after activation, the integrin stands up with a switchblade-like movement.
- *$\alpha$  subunits.* The  $\alpha$  subunits can be separated into two groups: those with an I domain ( $\alpha_1$ ,  $\alpha_2$ ) and those that undergo posttranslational cleavage ( $\alpha_3$  through  $\alpha_6$ ) (1, 2, 3 and 4). In subunits  $\alpha_3$ ,  $\alpha_5$ , and  $\alpha_6$ , the cleavage generates one large and one small fragment linked by a disulfide bond. However,  $\alpha_4$  is unique in that it has a potential protease cleavage site but is only variably cleaved; it has one of the two cysteines, which forms the disulfide bond joining the fragments in the others. The *N*-terminal extracellular half of all  $\alpha$  subunits consists of seven short repeats with a FG-GAP consensus sequence (phenyl-alanine, glycine, glycine, alanine, proline). The repeats are folded into what is known as the  $\beta$  *propeller*, formed by a sheet of four polypeptide strands, slightly twisted like a blade of a propeller. The upper face of the propeller has the ligand-binding site and the putative  $Mg^{2+}$  ion;  $\alpha_1$  and  $\alpha_2$  subunits only have an insertion (240 amino acids) between repeats 2 and 3, known as the *I domain*. The I domain is located on top of the  $\beta$  propeller, linked to it by a hinge. The I domain consists of a  $\beta$  sheet in the center, surrounded by a helices, a structure known as *Rossmann fold*, similar to that found in nucleotide-binding enzymes, small G proteins, and the  $\alpha$  subunits of heterotrimeric G proteins. The top of the I domain contains a metal ion dependent adhesion site (MIDAS), which lies in the *C*-terminal end of the central  $\beta$  sheet. MIDAS contains a signature sequence DXSXS for cation binding, which is also coordinated by water molecules and a residue in the ligand. The remaining extracellular region forms the "leg" of the  $\alpha$  subunit that contains three large  $\beta$ -sandwich domains, the first one known as the "thigh," then "calf-1" and "calf-2." Between the thigh and calf-1 is a sequence called the "knee" (or "genu"). It is here that the "anthropomorphic" integrin bends toward the membrane, head down, for its resting state. The cytoplasmic tail is short, and a small conserved motif is important for adhesive activity.

*Gene loci.*  $\alpha_1$ , 5q11.1;  $\alpha_2$ , 5q23-31;  $\alpha_3$ , 17q23.3;  $\alpha_4$ , 2q31.32;  $\alpha_5$ , 12q11-q13;  $\alpha_6$ , 2q31.1.

*Molecular mass (kd).*  $\alpha_1$ , 200;  $\alpha_2$ , 150;  $\alpha_3$ , 150;  $\alpha_4$ , 145;  $\alpha_5$ , 160;  $\alpha_6$ , 150.

*Distribution.* All VLA antigens are detected on hematopoietic cells, and reports may vary, probably as a result of the nature of the sample, especially in relation to activation. Resting T cells express moderate amounts of VLA-4 and only traces of the others. All VLA antigens increase on T-cell activation to a different extent, especially the VLA-1



and VLA-2 integrins. Thymocytes are predominantly VLA-4-positive, B cells express primarily VLA-2 and VLA-4, monocytes are mainly VLA-3- and VLA-6-positive, with VLA-4 present in moderate amounts, and platelets are positive for VLA-6 and VLA-2; granulocytes express  $\alpha_5\beta_1$ . Outside the hematopoietic cells,  $\alpha_1$  is present abundantly on smooth muscle cells and  $\alpha_2$  on epithelial cells;  $\alpha_1$  and  $\alpha_2$  are detected on fibroblasts, osteoblasts, and chondrocytes, and  $\alpha_3$  is detected in glomeruli and blood vessels.

*Function.* The VLA  $\beta_1$  integrins are receptors for proteins of the extracellular matrix. As a result, they are involved in (a) assembly of extracellular matrix and its interactions with cells, (b) cell migration, (c) tissue repair, and (4) organogenesis. The  $\alpha_1$  and  $\alpha_2$  are the major collagen receptors (5, 6 and 7). They both recognize various types of collagens, primarily I, IV, and VI, but with different affinities:  $\alpha_1$  binds preferentially the network forming collagen IV, whereas  $\alpha_2$  binds better to fibrillar collagen type I (8, 9);  $\alpha_2$  and  $\alpha_6$  are also a laminin receptor.  $\alpha_3$  is a receptor for collagen, laminin, and FN;  $\alpha_4$  and  $\alpha_5$  are FN receptors.

VLA antigens, as receptors of matrix, mediate cellular functions induced by matrix, such as maturation, proliferation, migration, cytokine secretion, and so forth. FN and probably laminin modulate B-cell and thymocyte maturation and growth of bone marrow precursors.

Extracellular matrix components stimulate cytokine secretions from monocytes and macrophages. TSP-1, a matrix component, modulates several T-cell functions through  $\alpha_4$ : adhesion, chemotaxis, and matrix metalloproteinase (MMP) gene expression.

Fibroblast migration is regulated under physiologic conditions of  $\text{Ca}^{2+}$  and  $\text{Mg}^{2+}$  by the  $\alpha_2$  integrin, whereas the  $\alpha_1$  mediates adhesion and movement of intraepithelial lymphocytes through collagen (10). Migration of keratinocytes is mediated by the  $\alpha_2$  integrin, which induces MMP-1 (procollagenase) and “navigates” the cells through the collagenous matrix.

#### *Special functions:*

- *$\alpha_2$  Integrin.* In addition to being a receptor for collagen and laminin,  $\alpha_2$  is also a receptor for the echovirus, and binding is mediated by the I-domain.  $\alpha_2$  mediates platelet adhesion to both fibrillar and nonfibrillar collagen. It bears the alloantigenic determinant known as HPA-5. Alloimmunization against HPA-5 is associated with neonatal alloimmune thrombocytopenia and thrombocytopenia due to passively transferred platelet antibodies after transfusion of blood products. Silent polymorphisms of  $\alpha_2$  are associated with variation in the density of  $\alpha_2$  on platelets, which affects the rate of platelet attachment to type I collagen. A mutation, Thr799 Met of  $\alpha_2$ , gives rise to a new alloantigen, Sit<sup>a</sup> (11). This mutation causes diminished responses of platelets to collagen. Deficiency of  $\alpha_2$  gives rise to bleeding tendency and impaired reactivity to collagen.
- *$\alpha_3$  Integrin.*  $\alpha_3$  plays an important role in matrix remodeling, especially pericellular matrices. Two of its ligands are entactin and epiligrin, which are both ubiquitous glycoproteins, especially in basement membranes. Entactin acts as a bridging molecule for other components like FN. Overexpression of  $\alpha_3$  in cultured cells stimulates strong deposition of entactin and forms FN pericellular matrices.  $\alpha_3$  integrin is detected in glomeruli with a role in basement membrane modeling and

kidney organogenesis ( [12](#) ). An important development in the function of a  $\alpha_3$  integrin has been the discovery of its association with members of the tetraspanin family (i.e., CD9, CD82, CD151, and so forth). CD151 is associated through its extracellular region with  $\alpha_3$  and is a key player in the function of a  $\alpha_3$  for matrix remodeling. Loss of a  $\alpha_3$  and CD9 was found to be a significant prognostic factor in colon and endometrial carcinomas ( [13](#) ) with collapse of the  $\alpha_3$  tetraspanin cell-surface complex. CD151, as well as other tetraspanins, links  $\alpha_3$ , as adaptors to intracellular cytoskeleton, and signaling complexes such as phosphatidylinositol 4-kinase. Interference with the complex causes almost complete reduction of neutrophil motility to chemotactic stimulation ( [14](#) ).  $\alpha_3$  integrin is the receptor for the Kaposi sarcoma-associated herpes virus 8 and mediates entry of the virus into the cells.

- **$\alpha_4$  Integrin** .  $\alpha_4$  is a FN receptor and counter-receptor for VCAM-1. Bacterial protein invasins is a ligand for  $\alpha_4$  and mediates pathogen adherence directly to cells of the immune system. It supports tethering and rolling on VCAM-1 of leukocytes, especially monocytes, as a result of its clustering, and therefore enhancement of its avidity, by chemokines ( [15](#) ).  $\alpha_4$  is essential for migration of T cells to Peyer patches and, in cooperation with  $\alpha_4\beta_7$ , mediates adhesion and locomotion of B lymphoma cells on FN. Cross-talk between  $\alpha_4$  and LFA-1 increases the adhesion of T cells on ICAM-1 as a result of up-regulation of LFA-1 avidity.  $\alpha_4$  is a receptor for ADAM-28, a member of the ADAM family (a disintegrin and metalloprotease) expressed on lymphocytes. ADAMs, through their disintegrin domain, function as integrin antagonists very similar to the small peptide disintegrins contained in the venom of some vipers. This interaction may target metalloproteases on the cell surface.
- **$\alpha_5$  Integrin** . The main function of  $\alpha_5$  is the assembly of FN matrix. The binding of FN through the RGD site (Arg-Gly-Asp) is enhanced by its synergy sequence (Pro-His-Ser-Arg-Asn). PDGF- $\beta$  induces a transformed phenotype on fibroblasts and is associated with increase of  $\alpha_5$ . A similar phenotype was induced by overexpression of the  $\alpha_5$  and  $\alpha_2$  subunits. Adherence of FN to  $\alpha_5$  promotes a program of gene expression-dependent NF- $\kappa$ B activation, which coordinates angiogenesis and inflammation.
- **$\alpha_6$  Integrin** .  $\alpha_6$  is involved in the development of kidney tubules. A mutation of the  $\alpha_6$  gene, which causes complete absence of the  $\alpha_6$  subunit, was found in a patient with junctional epidermolysis bullosa ( [16](#) ). Astrocytes promote oligodendrocyte survival, and as shown in cultures *in vitro*, this protection is mediated by the  $\alpha_6\beta_1$  integrin.  $\alpha_6$  function is required for early stages of lens development, an effect mediated through the insulin growth factor-1 receptor.  $\alpha_6$  has been reported to promote cancer progression. This effect may be the result of enhanced expression of the vascular endothelial growth factor in breast carcinoma cells.  $\alpha_6$ , like  $\alpha_3$ , is associated with tetraspanins, and this complex promotes angiogenesis.

## CD50 [INTERCELLULAR ADHESION MOLECULE (ICAM) 3; ICAM RECEPTOR]

**Structure.** CD50 is a member of the ICAM family. It is a type I transmembrane protein with five heavily glycosylated Ig-like domains of the C2 type in the extracellular region. The first Ig-like domain binds to its ligand LFA-1. The cytoplasmic region contains serines, which are phosphorylated on activation. The molecule by electron microscopy appears as a straight rod approximately 15 nm in length.

*Gene locus.* 19.13.3.

*Molecular mass (kd).* 115 to 135.

*Distribution.* Expressed on most hematopoietic cells. It is highly expressed on naïve T cells and on DCs, Langerhans cells, and endothelial cells after activation.

*Function.* The ligands for ICAM-3 are the  $\beta_2$  integrin LFA-1 (low affinity) and DC-SIGN (DC-specific ICAM-3-grabbing nonintegrin) (high affinity) (1). DC-SIGN (CD209) is a type II membrane protein with a mannose-binding, C-type carbohydrate recognition domain at the C-terminus of the molecule. CD50 is involved in the initial interaction of T cells with the APCs during the exploratory contact of T cells with APC and before antigen recognition. ICAM-3, which is heavily glycosylated and carries N-linked high mannose oligosaccharides, binds on DCs to DC-SIGN but not, as expected, to the LFA-1. ICAM-3/DC-SIGN mediates the initial T-cell-APC interaction necessary for the TCR to scan the surface for identification of MHC-peptide complexes (2).

During this period, ICAM-3 redistributes to the contact area and takes a position in the periphery of the immunologic synapse, as compared to LAT (linker for activation of T cells), which positions itself to the center. During T-cell locomotion, ICAM-3 is concentrated in the uropod, where it interacts with moesin, a member of the ERM group (exrin, radixin, moesin), which connects surface molecules with the cytoskeleton (3). Moesin is co-localized with ICAM-3 to the distal end of the uropod, and its interaction with ICAM-3 is mediated by serine residues in its cytoplasmic region.

In addition to its adhesive properties, ICAM-3 is a co-stimulatory molecule (4). On ligation, it supports primary responses and induces phosphorylation of PTKs lck and fyn, intracellular  $\text{Ca}^{2+}$  increase, and expression of T-cell activation molecules CD69 and CD25 (5).

On polymorphonuclear leukocytes, ICAM-3 activates  $\beta_2$  integrins by an outside-in mechanism through PTK phosphorylation (6). It induces cell aggregation but without granule release (7).

CD50 is expressed on endothelial cells of skin vessels in cutaneous T-cell lymphomas but not in lymph nodes infiltrated by tumor cells (8). DC-SIGN binds with high affinity to the HIV envelope gp 120, both to the macrophage-tropic and T-cell-tropic viruses, and enhances transinfection of T cells (9). Binding of DC-SIGN to ICAM-3 is not necessary for HIV infection of T cells because the binding sites are different. ICAM-3 binding highly depends on N-glycosylation; furthermore, a DC-SIGN mutation abolishes the binding to ICAM-3 but not binding to HIV. Similarly, blocking DC-SIGN/ICAM-3 interactions by monoclonal antibodies does not interfere with DC-SIGN-mediated HIV transmission.

A related molecule, DC-SIGNR, strongly homologous to DC-SIGN, is expressed on liver sinusoidal cells and in lymph nodes but not on DCs. This molecule has also high affinity for ICAM-3 and HIV gp120 protein. It has been proposed that it be named *L-SIGN* for liver/lymph node-specific ICAM-3-grabbing nonintegrin.

LFA-1/ICAM-3 interaction triggers transmigration of infected, LFA-1-positive monocytes through mucosal epithelial cells overexpressing ICAM-3, particularly under inflammatory

conditions ( [10](#) ).

## CD51 (a $\nu$ : a SUBUNIT OF VITRONECTIN RECEPTOR, INTEGRIN a $\nu$ SUBUNIT)

*Structure.* CD51 is the a subunit of the integrin vitronectin receptor, a  $\nu\beta_3$  (CD51/CD61). The structure of a  $\nu$  subunit has been solved at a 3.1 Å resolution, both with and without ligand binding ( [1](#) ). The crystallographic data show a  $\beta$  propeller in the NH2 terminal half of the extracellular region, with seven blades corresponding to the seven FG-GAP repeats (Phe/Gly/Gly/Ala/Pro), each formed as a four-stranded antiparallel sheet. The a  $\nu$  subunit has no I domain, also referred to in the literature as *A domain*, because it is homologous to the A domain of vWF. The a  $\nu\beta_3$  with six Mn<sup>2+</sup> ion sites binds a ligand with an RGD sequence, in a crevice between the a  $\nu$  propeller and the A domain of the  $\beta_3$  subunit. Each residue of the ligand participates in the binding, which is associated with tertiary and quaternary changes in the a  $\nu\beta_3$  integrin structure, that is, the a  $\nu$  propeller and the  $\beta$ A domain move closer together at the peptide-binding site (see animation in Reference [2](#) ).

The a  $\nu$  leg consists of three  $\beta$ -sandwich, Ig-like domains, type C2, named “thigh,” followed by “calf-1” and “calf-2,” that are mostly hydrophobic. The a  $\nu$  leg folds back, forming a V-shaped structure, “genu,” between the thigh and calf-1, which is capped by a divalent cation. On activation, the a  $\nu$  unfolds, extending straight up, forming a cylinder 160 Å long and 20 Å wide (see also [CD49](#)). The proteolytic site that generates the heavy and light disulfide-linked chains is located within calf-2 ( [3](#) ). In the heterodimer, the a  $\nu$  propeller contacts the  $\beta$ A domain, forming the “head” of the integrin. The interface in the head between the two subunits is largely hydrophobic. Naturally occurring mutations causing  $\beta_2$  or  $\beta_3$  integrin deficiencies are located in the vicinity of the interface, whereas others are found in the propeller or  $\beta$ A domains.

*Gene locus.* 2q31-32.

*Molecular mass (kd).* 125 reduced; 150 unreduced.

*Distribution.* In combination with CD61 ( $\beta_3$ ), it is expressed on platelets but at lower levels than CD41/61. It is also detected on activated leukocytes, NK cells, macrophages, and neutrophils. In nonhematopoietic cells, it is present on endothelial cells, smooth muscle cells, and osteoclasts.

*Function.* CD51/CD61 is the vitronectin receptor, but it also binds to other RGD-containing proteins, such as fibrinogen, FN, vWF, laminin, TSP, and osteopontin. a  $\nu\beta_3$  serves also as receptor to adenovirus, foot and mouth disease virus, coxsackie Ag, and *Hantavirus*. It binds to tat regulatory protein of HIV, to fibroblast growth factor 2, and to a fragment from disintegrin ADAM-15. Most of the protein ligands have an RGD sequence. It is conceivable that some of these ligands use an “inactive” and others an “active” form of the integrin.

a  $\nu$  is detected in granulation tissue but not in the dermis or epithelium of normal skin from the same donor. It is also present in blood vessels during development or within tumors. Several studies in a variety of systems support the role of a  $\nu$  integrins in angiogenesis ( [4](#) ). a  $\nu\beta_3$  is expressed on activated endothelial cells, and disruption of its

function by antibodies or peptide antagonists disrupts blood vessel formation in chick chorioallantoic membrane, mouse retina, rabbit cornea, arthritic knee, and in tumor models, in which inhibition of new blood vessel formation caused tumor regression ( [5](#), [6](#) ).

$\alpha_v$  integrin facilitates survival of endothelial cells by angiogenic growth factor because blocking its function induces apoptosis of angiogenic cells.

Coxsackie virus Ag interacts with high affinity with  $\alpha_v\beta_3$  integrin ( [6](#) ). The binding site is located on the  $\beta_3$  subunit and does not require the RGD sequence present on CAV9 protein of the virus. The  $\beta_2$  microglobulin is involved in the binding. Another virus that uses the  $\alpha_v\beta_3$  integrin as receptor is a virulent strain of foot and mouth disease virus for cattle, serotype A<sub>12</sub> ( [7](#) ).

Because of the involvement of  $\alpha_v\beta_3$  in inflammatory angiogenesis, a humanized monoclonal antibody, Vitaxin (MEDI-522) is administered to patients with rheumatoid arthritis, and clinical trials are in progress ( [8](#) ). The antibody is specific for a conformational epitope formed by both  $\alpha_v$ - and  $\beta_3$ -chains and blocks binding of  $\alpha_v\beta_3$  to vitronectin and osteopontin.

## CD52 (CAMPATH-1)

*Structure.* CD52, also known as *CAMPATH-1*, is an unusually short protein (12 amino acids) linked to the membrane with a GPI anchor ( [1](#), [2](#) ). There are two CD52 proteins, CD52-I and CD52-II, which differ in the GPI anchor. CD52-I contains exclusively distearoyl-PI (phospholipase-sensitive GPI), whereas CD52-II contains a palmitoylated stearoyl-arachidonoyl-PI (phospholipase resistant). Both carry one N-linked oligosaccharide, which consists of sialylated polylactosamine units attached to a tetraantennary fucosylated mannose core. Because of its small size, it is likely that CD52 must exist as an aggregate or micelle to achieve high-affinity binding to the CAMPATH-1 antibody. CAMPATH antibody recognizes an epitope, which includes the GPI anchor and the last three amino acid residues of the core peptide.

*Gene locus.* 1p36.

*Molecular mass (kd).* 21 to 28.

*Distribution.* It is strongly expressed on lymphocytes ( $5 \times 10^5$  molecules/cell), monocytes, eosinophils, and peripheral blood DCs (but not on tissue DCs) ( [3](#) ).

It is also found in epithelial epididymal cells, seminal vesicles, and seminal plasma. It is not present in testicular sperm, but it is acquired either during the transit of the sperm in epididymis or after its capacitation, which takes place in the uterus (i.e., after ejaculation) ( [4](#), [5](#) ). This CD52 modulation on the sperm surface is probably related to acquisition of its fertilizing capacity.

In lymphocytes, the glycan is attached to Asp3, and the oligosaccharides are only tetraantennary, whereas the male genital tract contains bi-, tri-, and tetraantennary glycans.

*Function.* It is a major constituent of the sperm glycocalyx, and its acquisition by the

sperm during epididymal passage is one of the few well-defined modifications that occur to the sperm. It modifies surface charge and lectin-binding patterns. A sperm agglutination antigen (SAGA-1) has a core peptide that is identical to CD52, but the glycans are different. A sperm inhibitory monoclonal antibody was immortalized from an infertile woman with specificity against sperm glycoforms of CD52 (6). This unique CD52 glycoform is localized to the entire sperm surface and potentially could be used as a target of immunocontraceptive vaccine development (7).

CD52 has been used as the target antigen for treatment of lymphocyte malignancies (8, 9 and 10). Several properties of CD52 make it a particularly good target for immunotherapy. It is present in high density, it is not internalized, and is not present in CD34<sup>+</sup> stem cells.

The antibody CAMPATH-1H (a humanized monoclonal antibody), under the name *alemtuzumab*, has been used in B-CLL (11, 12), various T-cell malignancies, stem cell transplantation for prevention of GVHD, rheumatoid arthritis (13), and multiple sclerosis. Patients with rheumatoid arthritis or non-Hodgkin lymphoma (NHL) after treatment with CAMPATH-1H had CD52<sup>-</sup> T cells for several months, and the expression of other GPI-linked molecules (CD48, CD59, CD55) was also down-regulated (14, 15 and 16). PIG-A (phosphatidylinositol glycan complementation gene class A) T-cell clones were established from two patients. The function of CD52 in normal cells is not quite clear. Cross-linking CD52 by CAMPATH-1 antibody activates T cells *in vitro* and induces tyrosine phosphorylation.

## CD54 (ICAM-1: INTERCELLULAR ADHESION MOLECULE-1)

*Structure.* CD54 is closely related to CD50 (ICAM-3). It has five Ig-like domains type C2 in the extracellular region. Each C domain has two  $\beta$  sheets formed by seven antiparallel  $\beta$  strands. The C2 domains are present in Fc receptors and adhesion molecules (CD2, LFA-3, ICAMs, NCAM, and so forth), whereas the C1 domains are involved in antigen recognition (i.e., Igs). The first domain binds to LFA-1, whereas binding to Mac-1 is by the third Ig-like domain. The binding site for human rhinovirus is located in the loops joining strands B to F of domain 1, which also binds the malarial parasite, *P. falciparum*, in venular endothelial cells. The binding sites for LFA-1, fibrinogen, rhinoviruses, and malaria-infected erythrocytes are overlapping but not identical (1).

LFA-1 binding requires the presence of Ca<sup>2+</sup> or Mg<sup>2+</sup> and a dimeric ICAM-1, whereas the rhinoviruses bind to monomeric ICAM-1 and do not require divalent cations.

Electron microscopy shows that ICAM-1 is like a rod, 190 Å long, with a kink between domain 1 and 3 at approximately 76 Å from the amino end.

ICAM-1 is homologous to NCAM (CD56).

*Gene locus.* 9p13.3-13.2.

*Molecular mass (kd).* 90.

*Distribution.* CD54 has a wide distribution on hematopoietic and nonhematopoietic cells. Expression is moderate on activated T cells, B cells and monocytes and on hematopoietic progenitors (2). It is constitutively expressed on certain epithelia and endothelia, but expression is high in activated endothelial cells. Inflammatory cytokines, TNF, IL-1, and



IFN- $\gamma$ , enhance its expression.

*Function:* The ligands for ICAM-1 are the integrins LFA-1 and Mac-1, rhinoviruses, erythrocytes infected with *P. falciparum*, and fibrinogen. ICAM-1 has no RGD motif and binds to the integrins through a large extended surface. Dimerization, which is mediated through domain 1, enhances the binding to the I domain of the  $\alpha$ -chain at LFA-1 (3). Dimerization generates a competent surface for one LFA-1 molecule to bind more efficiently.

ICAM-1 is associated with ezrin, a member of the ERM family (ezrin/radixin/moesin), which is a linker between membrane molecules with actin cytoskeleton, and regulates cell adhesion and cortical morphogenesis (4). The ezrin-ICAM-1 association is regulated by signaling involving phosphoinositides.

In small blood vessels in the brain, ICAM-1 ligation induces tyrosine phosphorylation of the cytoskeletal protein, contactin, which leads to cytoskeletal changes and transmigration of T cells. ICAM-1 is a member of the group of molecules that orchestrates leukocyte transendothelial migration. The VLA-4 integrin functions early in leukocyte adhesion to the endothelium, and through cross-talk to the  $\beta_2$  integrins,  $\alpha_L/\text{MB}_2$ , triggers their clustering (i.e., increase of their avidity). Initial interaction with ICAM-1 assembles a docking structure, built through ezrin activation by the cytoskeleton, on which the leukocyte adheres firmly before transmigration (5). During this process, ICAM-1 is exclusively localized on the apical membrane of the activated endothelial cell.

ICAM-1 plays a role as an adhesion molecule in cell-cell interactions during the induction as well as in effector functions of the immune response, such as T-cell mediated cytotoxicity. ICAM is detected in approximately 50% of patients with myeloid and B-lymphoid, but not T-cell, malignancies, preferentially of an immature phenotype. High-grade NHLs express a higher level of CD54 than the lower grade ones.

CD54 is shed from malignant cells and is detected in a soluble form in the serum of patients with leukemia or lymphoma (6). Shedding is probably mediated through an MMP.

## CD55 (DAF: COMPLEMENT DECAY- ACCELERATING FACTOR)

*Structure.* CD55 (DAF) is a GPI-anchored protein, which belongs to the CCP family (1, 2 and 3). The extracellular region consists of four CCP domains of approximately 60 residues, each followed by a sequence rich in serines and threonines, which are heavily O-glycosylated. An N-glycosylation site exists between the first and second CCP domain. The GPI anchor is attached posttranslationally after removal of the hydrophobic domain.

The O-linked oligosaccharides are also added posttranslationally in the Golgi apparatus and account for approximately 26 kd of the molecular mass. Two-thirds of them are sialic acid.

Domains 2 to 4 adopt an extended helical conformation, and a positively charged surface area on domains 2 and 3 is the primary site for recognition of DAF by the C3 convertases (4, 5). Classical convertase requires CCP domains 2 and 3, whereas the alternative requires 2, 3, and 4 (6). Mutations to three tandem lysines (125 to 127) impair DAF control of alternative convertase, whereas mutations to Leu-147 and Phe-148 abolish the function to both convertases (7).



DAF serves as a receptor for a number of pathogens. Binding of echoviruses requires CCP domains 2 to 4 ( [8](#) ), coxsackie virus B<sub>3</sub> requires domain 2, and enterovirus 70 binds to domain 1. Many strains of *E. coli* bind to DAF via proteins present in their fimbriae. CD97, a seven-transmembrane protein, homologous to the secretin peptide hormone receptors, is a counter-receptor for DAF ( [9](#) ). CD97 is a member of the EGF-TM7 family, with EGF tandem repeats and a seven-transmembrane region found in G protein-coupled receptors ( [10](#) ). The function of CD55-CD97 interaction is not known. Several forms of DAF have been reported.

*Gene locus.* 1q32.

*Molecular mass (kd).* 70 (lymphocytes); 55 (erythrocytes).

*Distribution.* Ubiquitously distributed on all cells of the body in contact with serum or body fluids. Widely expressed on epithelia of the gut and genitourinary tract and in the central nervous system. Erythrocytes have approximately 3300 molecules of DAF/cell, which decreases with age. On neutrophils, there are 10,000/cell, and the number doubles within minutes after activation, likely as a result of release of molecules in storage.

*Function.* The C3 convertases are the central amplification enzymes of the complement cascade. The protection of self-tissues from the action of these enzymes is assigned to several CCPs of two functional groups: (a) inhibitors of the action of the convertases or (b) cofactors of the proteolytic enzyme, factor I. DAF does not inhibit the initial binding of C2 to a cell with deposited C4b but leads to the rapid release of C2a from its binding site on C4b, thus dissociating the classical C3 convertase. Similarly, Bb is rapidly released from the alternative C3 convertase. DAF, however, can associate with C4b and C3b on the cell surface without requiring C2 or factor B. DAF interacts directly with the type A domain of Bb, especially close to the  $\alpha$  helices 4 and 5 ( [11](#) ). The complement protective function of membrane DAF for cells is exerted only intrinsically (i.e., on C3 convertase assembled on the same cell as DAF). Soluble DAF cannot incorporate into cell membranes, and it has much lower efficiency in inhibiting complement activation on cell surfaces.

DAF function is abolished by deletions of the CCP-2 to -4 domains as well as the removal of the serine-threonine-rich region. It cooperates with MCP in protecting cells from autologous complement attack by enhancing its CA, especially in the presence of excess factors B and D.

Deficiency of DAF and other GPI-anchored proteins such as CD59, another member of CCPs, is associated with intravascular hemolysis in paroxysmal nocturnal hemoglobinuria (PNH). PNH is an acquired hematopoietic stem cell disorder, manifested not only with hemolysis but with venous thrombosis, aplastic anemia, and so forth. The genetic defect (point mutation, deletion, or insertion) of the PIG-A gene affects an enzyme, N-acetylglucosamine transferase, the product of the gene, which is involved in the first step of GPI anchor biosynthesis. In PNH, proteins dependent on a GPI anchor are absent in all hematopoietic cell lines. As a result, red cells are sensitive to lysis by complement activation (see [Chapter 18](#) for details). Absence of CD59 is more critical than CD55.

The echovirus 7 can cause aseptic meningitis in humans using DAF as receptor for attachment but not for virus entry. DAF does not bind to the "canyon" site, a depression on the viral capsid required for uncoating and entry of the virus.

Rare individuals have been identified with absent or low expression of DAF as an inherited condition based on the human erythrocyte blood group system, Cromer, which has been localized on DAF ([12](#)). The Inab phenotype is an inherited null allele (i.e., a DAF-null allele).

## CD56 (NCAM: NEURAL CELL ADHESION MOLECULE)

*Structure.* CD56 is an isoform of the NCAM. There are several isoforms (20 to 30) as a result of posttranslational modifications and differential splicing of mRNA encoded by the NCAM gene. Modifications affect glycosylation, acylation, sulfation, or phosphorylation. NCAMs have different modes of attachment to the membrane or to various cytoplasmic domains. The main isoforms are two transmembrane forms, one 140 kd (NCAM-A) and another 180 kd (NCAM-B) and one GPI-anchored, 120 kd (NCAM-C) ([1](#)).

A polysaccharide unusual for vertebrates, that is,  $\alpha$ -2,8 polysialic acid (PSA), attaches to the central part of the molecule and is expressed mostly during development of the nervous system ("embryonic" NCAM) and only in limited areas in mature central nervous system. The extracellular region consists of five tandem Ig-like domains (the first two type I and the other three type C2) and two FN III domains ([2](#)). A variable alternatively spliced exon, encoding approximately 10 amino acids, alters the structure of the fourth Ig domain so that NCAM inhibits axonal growth. An additional domain, called *muscle-specific domain* (MSD), because it is detected in myoblasts, is located between the two FN domains, and is rich in O-linked polysaccharides. The HNR-1 carbohydrate is attached to the MSD domain (see [CD57](#)). The leukocyte NCAM is structurally identical with the neural NCAM, but it does not mediate homophilic interactions, a property initially used to define the neural NCAM.

By electron microscopy, NCAM appears as a flexible rod, which has a hinged structure, and the bending regions are amino-terminal to the hinge. This hinge structure may facilitate transhomophilic binding in the presence of changes of cell shape ([3](#), [4](#)).

*Gene locus.* 11q23.1.

*Molecular mass (kd).* Transmembrane: 140 (NCAM-A), 180 (NCAM-B); GPI-anchored: 120 (NCAM-C).

*Distribution.* On hematopoietic cells, CD56 is restricted to NK cells and a subpopulation of T cells (approximately 5%). Among hematopoietic malignancies, it is detected in a broad spectrum of lymphoproliferative diseases predominantly of large granular lymphocytes. It is also expressed on rare cases of acute myeloid leukemia CD7<sup>+</sup>/CD56<sup>+</sup> (considered as precursor acute leukemia) ([5](#)), nasal cell lymphomas (associated with EBV infection), nonnasal lymphoma ([6](#)), and multiple myeloma ([7](#)). In AML, it has been identified in 15 to 20% of cases and has been associated with monocytic morphology, trisomy 8, t(8;21), t(15;17), and 11q23 rearrangements. CD56<sup>+</sup> malignancies with blastic morphology, skin infiltration, and myeloid or myelomonocytic phenotype have been reported.

In nonhematopoietic tissues, it is detected in embryonic and adult neural tissues throughout the central and peripheral nervous systems. It is widely expressed on neurons, glial cells, and skeletal muscle.

### Function:

- **Neural functions.** The neural NCAM is involved in homophilic interactions, involving all five Ig domains. The domains are paired (i.e., I with V, II with IV, and III with III). The homophilic binding follows an antiparallel direction of the two interacting NCAMs. PSA influences adhesion because, in NCAM with high PSA content, it keeps membranes of apposing cells apart. Removal of PSA results in tight adherence along the entire length of the membrane. NCAM is involved in neuronal migration, neuritic outgrowth, formation of the synapse, and promotion of its plasticity ( [8](#) ) associated with learning and memory. For neurite outgrowth, NCAM requires the cytoplasmic region as a neuronal receptor. In the extracellular region of NCAM, there is an ATP-binding site, and an ecto-type ATPase (see [CD39](#) ) activity is associated with NCAM ( [9](#) ). A second site close to the *N*-terminal end binds heparan sulfate proteoglycan, an interaction that modulates NCAM binding to extracellular matrix. This is important during the development of the nervous system for cell motility and growth ( [10](#) ). It requires a coordinated expression of NCAM and matrix MMPs.
- **NK cell functions.** CD56 is expressed only in NK cells and a small number of T cells. NK cells (interchangeably called *large granular lymphocytes*) are characterized by their large cytoplasmic granules. The CD56 of NK cells is not involved in homophilic or other adhesive interactions, although it is structurally identical to neural NCAM. CD56<sup>+</sup> NK cells are an important cellular component of the innate immune system and, as a major source of IFN- $\gamma$ , are involved in the early stages of defense against viral infections, as well as links of the innate and the adaptive immunity. NK cell-derived IFN- $\gamma$  drives T-cell differentiation to the Th1 pathway. NK cells are non-MHC-restricted cytotoxic cells, and this function is regulated by KIRs, which recognize HLA type of antigens (see [Chapter 17](#) ). CD56 is used as a marker in phenotyping hematologic malignancies. CD56<sup>+</sup> lymphomas include the EBV-positive sinonasal lymphoma and other aggressive nonnasal lymphomas. A neoplasm with the CD4<sup>+</sup>/CD56<sup>+</sup> phenotype with cutaneous manifestations, splenomegaly, and lymphadenopathy is considered to involve the type 2, or plasmacytoid DCs ( [11](#) ). CD56 is expressed in a small percentage of AML, sometimes with monocytoid morphology, t(8;21) translocation, or both. Normal plasma cells are CD56<sup>-</sup>, and its expression has been used to distinguish myeloma from monoclonal gammopathies of undetermined significance or reactive plasmacytosis. However, a small number of monoclonal gammopathies of undetermined significance cases have CD56<sup>+</sup> cells. CD56 expression correlates with osteolytic lesions in multiple myeloma. As an adhesion molecule, NCAM regulates adhesion of tumor cells to matrix ( [12](#) ).

### CD57 (HNK-1: HUMAN NATURAL KILLER CELL-1 ANTIGEN, LEU-7 ANTIGEN)

**Structure.** CD57 is a carbohydrate antigen, originally recognized by a monoclonal antibody human natural killer cell (HNK)-1 as a marker for human NK cells. The epitope recognized by the HNK-1 antibody is a trisaccharide synthesized in a stepwise manner by the addition of  $\beta$ <sub>1-3</sub>-linked glucuronic acid (GlcA), to a precursor disaccharide, N-acetyllactosamine. This is followed by the addition of a sulfate group to position 3 of the GlcA. The complete formula is: SO<sub>4</sub><sup>3</sup>GlcAB<sup>1,3</sup>Gal $\beta$ <sup>1,4</sup>GlcNAc. A  $\beta$ <sub>1-3</sub> glucuronyl transferase (GlcAT-P) adds the GlcA, whereas an HNK-1 sulfotransferase (HNK-1ST), adds the SO<sub>4</sub> group, directing the synthesis of the HNK-1 saccharide epitope on both glycoproteins and glycolipids ( [1](#), [2](#) and [3](#) ). The  $\beta$ <sub>1-3</sub> glucuronyl transferase is highly

specific for the *N*-terminal *N*-acetylglucosamine structure but has no preference on the number of acceptor sugar branches (i.e., bi-, tri-, or tetraantennary complexes).

*Gene locus.* 11q12-qter.

*Distribution.* The HNK-1 trisaccharide is widely distributed in glycoproteins, glycolipids, and proteoglycans. It is expressed on several cell adhesion molecules such as NCAM (second, third, and fifth Ig-like domains and MSD) (see [CD56](#)). The HNK-1 is preferentially added to *N*-glycans (over *O*-glycans in NCAM), such as on MAG, the P<sub>0</sub> myelin glycoprotein and the myelin-oligodendrocyte glycoprotein. The HNK-1 epitope is present on several glycolipids named *sulfoglucuronylglycolipid-1* and *-2*.

CD57 is found on migrating neuronal crest cells, cerebellum, and myelinating Schwann cells in motor, but not sensory, neurons.

HNK-1 was first detected on NK cells but is also present on cancer cells and was originally considered as an oncofetal antigen. It is detected in small cell carcinomas of the lung and the human neuroendocrine tumors of the amino precursor uptake and decarboxylation type (APUD). It has also been detected in neuroblastoma, medulloblastoma, retinoblastoma, and melanoma. Additionally, it has been shown to act as an autoantigen in peripheral demyelinating neuropathies associated with monoclonal IgM proteins.

*Function.* HNK-1 has been shown to serve several functions independently of the protein backbone. HNK-1 interacts with proteins of the extracellular matrix, such as laminin 1 and 2, and L- and P-selectins. HNK-1 associates with neural crest migration, neuron-to-gial cell adhesion, outgrowth of astrocytic processes, astrocyte migration, and outgrowth of neurites from motor neurons.

A neural recognition molecule that binds, as well as expresses, HNK-1 (i.e., acts both as receptor and ligand) is P<sub>0</sub>, a major glycoprotein of myelin in the peripheral nervous system, and HNK-1 might be involved in spiraling loops of Schwann cell processes in myelin formation.

HNK-1 was identified as the major target in peripheral neuropathies of patients with lymphoma secreting large amounts of HNK-1-binding IgM monoclonal proteins ([4](#)).

Mice deficient in HNK-1 epitope have gross defects in hippocampus-dependent spatial learning and memory formation (i.e., higher order brain functions) ([5](#)).

IL-6 possesses lectin activity and recognizes the HNK-1 epitope ([6](#), [7](#)). IL-6 binds to MAG and P<sub>0</sub>, and the binding is inhibited by oligosaccharides having the HNK-1 epitope. Site-directed mutagenesis disclosed three important sites of IL-6 functions, and only site 3 is the HNK-1 recognition site (see [Chapter 18](#)).

The implications of these new findings of IL-6 function relate to demyelinating diseases because IL-6 binds to important glycoproteins of the myelin, which display HNK-1 epitopes. IL-6 gene knock-out mice show suppression of experimental allergic encephalomyelitis.

## CD57 in Hematology-Immunology

CD57 was discovered by immunologists as a marker of NK cells (hence, the name HNK-1 for human NK cell-1). Neuropathologists investigated its role in their own field because the HNK-1 was associated with MAG, and it could be related to demyelinating diseases. CD57 is sometimes coexpressed with CD56 (HNK-1 epitope is attached to NCAM:CD56), and it is also present alone in T cells, referred to as *T-large granular lymphocytes*. CD57<sup>+</sup> T cells are increased after bone marrow or kidney transplantation (<sup>8</sup>), in acquired immunodeficiency syndrome (AIDS) (<sup>9</sup>), in rheumatoid arthritis (<sup>10</sup>), and with aging. CD57<sup>+</sup> leukemias are actually associated frequently with rheumatoid arthritis. The CD57<sup>+</sup> HLADR<sup>BRIGHT</sup> cell is functionally considered as natural suppressor cell (<sup>11</sup>). Nucleosides isolated from these cells induce apoptosis in human carcinoma cells. Whether these apoptosis-inducing nucleosides are the same as the inhibitor of cytotoxic functions produced by CD57<sup>+</sup> cells from patients with AIDS or after bone marrow transplantation is not known. CD57<sup>+</sup> T cells produce increased amounts of INF- $\gamma$ . Increases of CD8<sup>+</sup> CD57<sup>+</sup> cells in normal individuals correlate with asymptomatic human cytomegalovirus (CMV) infection (<sup>12</sup>). CD57<sup>+</sup> T cells give rise to leukemias, which are associated with neutropenia, autoantibodies, rheumatoid arthritis, splenomegaly, and constitutional symptoms (<sup>13</sup>).

## REFERENCES

1. Bakker H, Friedmann I, Oka S, et al. Expression cloning of a cDNA encoding a sulfotransferase involved in the biosynthesis of the HNK-1 carbohydrate epitope. *J Biol Chem* 1997;272:29942-29946.
2. Ong E, Yeh J-C, Ding Y, et al. Expression cloning of a human sulfotransferase that directs the synthesis and HNK-1 glycan on the neural cell adhesion molecule and glycolipids. *J Biol Chem* 1998;273:5190-5195.
3. Tokayachi, Akashima T, Ookubs R, et al. Molecular cloning and characterization of UDP-GlcNAc: Lactosylceramide  $\beta$ 1,3-N-Acetylglucosaminyltransferase ( $\beta$  <sub>3</sub> GN-Ts) an essential enzyme for the expression of HNK-1 and Lewis X epitopes on glycolipids. *J Biol Chem* 2001;276:22032-22040.
4. Bollensen E, Steck AJ, Schachner M. Reactivity with peripheral myelin glycoprotein P<sub>0</sub> in serum from patients with monoclonal IgM gammopathy and polyneuropathy. *Neurology* 1988;38:1266-1270.
5. Yamamoto S, Oka S, Inoue M, et al. Mice deficient in nervous system-specific carbohydrate epitope HNK-1 exhibit impaired synaptic plasticity and spatial learning. *J Biol Chem* 2002;277:27227-27231.
6. Cebo C, Durier V, Lagant P, et al. Function and molecular modeling of the interaction between human interleukin 6 and its HNK-1 oligosaccharide ligands. *J Biol Chem* 2002;277:12246-12252.
7. Somers W, Stahl M, Seehra JS. 1-9 Å crystal structure of interleukin 6: implications for a novel mode of receptor dimerization and signaling. *EMBO J* 1997;16:989-997.
8. Fregoya I, Guttman RD, Jean R. HNK-1+ (Leu-7) and other lymphocyte subsets in long-term survivors with renal allotransplants. *Transplantation* 1985;39:25-29.
9. Sadat-Sowti B, Debre P, Mollet L, et al. An inhibitor of cytotoxic functions produced by CD8<sup>+</sup> CD57<sup>+</sup> T lymphocytes from patients suffering from AIDS and immunosuppressed bone marrow recipients. *Eur J Immunol* 1994;24:2882-2888.
10. Duprey D'Angeac A, Monier S, Jorgensen C, et al. Increased percentages of CD3<sup>+</sup>, CD7<sup>+</sup> lymphocytes in patients with rheumatoid arthritis. Correlation with duration of disease. *Arthritis Rheum* 1993;36:608-612.
11. Li X, Xu J, Guo M, et al. Apoptotic cell death of human gastric tumor induced by nucleosides from

CD57<sup>+</sup> HLA-DR<sup>BRIGHT</sup> natural suppressor cell line. *Int J Oncol* 1999;14:687–694.

12. Wong EC, Taylor-Wiedeman J, Perera P, et al. Subsets of CD8<sup>+</sup>, CD57<sup>+</sup> cells in normal, healthy individuals: correlations with human cytomegalovirus (HCMV) carrier status, phenotypic and functional analyses. *Clin Exp Immunol* 1993;94:297–305.

13. Chan WC, Link S, Mawle A, et al. Heterogeneity of large granular lymphocyte proliferations: delineation of two major subtypes. *Blood* 1986;68:1142–1153.

## CD58 (LFA-3; LEUKOCYTE FUNCTION ANTIGEN-3)

*Structure.* CD58 is a ligand for CD2 and a member of the CD2 family. The extracellular region consists of two Ig-like domains: a V-type (membrane distal) and a C2 type. There are two CD58 isoforms: a transmembrane and a GPI-anchored. CD58 is the major ligand for CD2, and the two interact with the large surfaces of their N-terminal domains (1, 2).

Electrostatic forces, rather than complementarity shapes, play a prominent role in the interaction. The crystal structure of the first CD58, with and without its carbohydrate, supports the “handshake” model of interaction in which the two domains approach each other from opposite ends.

The crystal structure studies support the suggestion that both genes arose from duplication of an ancestral gene. The binding affinity is low (kd, 10 to 20 μm) due to high dissociation constant (3, 4).

*Gene locus.* 1p13.

*Molecular mass (kd).* 45 to 70.

*Distribution.* CD58 is expressed on most hematopoietic cells (including erythrocytes) and nonhematopoietic cells (i.e., fibroblasts, endothelial, and epithelial cells). Expression is high on DCs and monocytes. It is detected on medullary (but not cortical) thymus epithelial cells. Soluble CD58 is detected in the serum and in the synovial fluids from patients with rheumatoid arthritis.

*Function.* CD58 mediates interactions between T cells and APCs. As a GPI-anchored molecule, CD58 has increased lateral mobility and thus may be able to concentrate in smaller areas of cell-cell contacts.

CD2/CD58 interactions deliver a co-stimulatory signal but only on memory CD4<sup>+</sup> T cells. Repeated interactions of these cells involving CD58 lead to production of high levels of IL-5 and low IFN-γ (a Th2 cytokine pattern) while simultaneously leading to the expression of CD60. The features of CD2/CD58 interactions provide functionally stable contacts (in contrast to CD2/CD48), suitable for interactions between T or NK cells and their targets (5).

## CD59 (COMPLEMENT PROTECTIN; MIRL: MEMBRANE INHIBITOR REACTIVE LYSIS; HRF-20: HOMOLOGOUS RESTRICTION FACTOR 20)

*Structure.* CD59 is an inhibitor of the formation of the membrane attack complex (MAC) of complement and is attached to the membrane by a GPI anchor. There are ten cysteines in the extracellular region, resulting in extensive intrachain disulfide bonding,



and a single glycosylation site.

The topology of CD59 is similar to snake venom neurotoxins, that is, like a disk with the cysteines clustered in the hydrophobic center from which four loops extend outward ( [1](#) ). The site, which binds to C8 and C9, is located in the N-terminal half ( [2](#) ).

CD59 is also homologous to herpes Saimiri viral protein VSB-15.

*Gene locus.* 11p13.

*Molecular mass (kd).* 19.

*Distribution.* CD59 is widely distributed in blood cells (leukocytes, erythrocytes, and platelets), endothelial and epithelial cells, trophoblast placenta, and spermatozoa. It is also detected in neurons and glial cells, where it is up-regulated in neurodegenerative diseases, that is, Alzheimer and Huntington chorea, both associated with chronic complement activation ( [3](#) ). It is detected in body fluids, plasma, urine, seminal fluid, saliva, amniotic fluid, and so forth.

*Function.* CD59 inhibits the formation of MAC after the C5b-7 insertion stage ( [4](#) ). It incorporates into the forming MAC and blocks C9 polymerization, binding to a conformational epitope in human C8  $\alpha$ -chain. It also binds to the b domain of C9 in the "hinge" region, which unfolds when C9 is inserted into the membrane.

CD59 inhibits MAC formation of human C5b67 complex only if either C8 or C9 is human. This is the basis of homologous restriction, indicating that CD59 interacts with both C8 and C9. CD59 hinders partial unfolding of C9 necessary for C9 oligomerization, multiple C9 membrane incorporations, and large MAC ring formation. The small size MAC (C5b8 with single C9) forms ion channels with a size comparable to other ion channels (0.7 to 1.0 nm); however, these small MACs are not "leaky," probably as a result of "plugging" by the CD59. CD59 not only blocks formation of large MACs (5 to 10 nm in diameter) but also blocks leaky small MACs ( [5](#) ).

Among the CCPs that protect from complement-mediated cell damage, CD59 is more important than DAF (CD55) or MCP (CD46). Absence of DAF is not associated with intravascular hemolysis, so absence of CD59 is the key factor in PNH. Study of the expression of GPI-anchored proteins by flow cytometry suggested that immunophenotyping of monocytes and granulocytes is better in assessing the size of PNH clone, and CD59 evaluation is more accurate than CD55 ( [6](#), [7](#) ). A patient with PNH was shown to have a defect in CD59 gene consisting of single-base deletions at amino acids 16 and 96 from the N-terminus.

In patients with diabetes, CD59 is subject to glycation, and as a result, CD59 loses its inhibitory function of MAC formation, and red cells become sensitive to MAC lysis ( [8](#) ). In addition to cell lysis, MAC stimulates proliferation of fibroblasts, smooth muscle, and mesangial cells by releasing growth factors, like fibroblast and PDGFs.

CD59 is associated with a creatinine transporter, which plays an important role in muscle metabolism, and during sepsis, there is an increase of free creatine from myocellular sources, triggered by CD59 ( [9](#) ).



## CD61 (INTEGRIN $\beta_3$ SUBUNIT)

*Structure.* CD61 is the  $\beta_3$  subunit that forms two heterodimers, one with a  $\nu$  (vitronectin receptor) and a second with  $\alpha\text{IIb}$  subunit (platelet integrin receptor for fibrinogen, vWF, and so forth).

The crystal structure of the  $\alpha\nu\beta_3$  integrin has been analyzed.  $\alpha\nu\beta_3$  consists of an ovoid head formed by the NH<sub>2</sub> terminals of the two subunits.

The  $\beta_3$  subunit has a “head,” one “leg,” and a “knee,” and forms with the  $\alpha\nu$  subunit an “anthropomorphic” structure (1). The head consists of the BA domain, which is made from a  $\beta$  sheet surrounded by eight helices (2, 3, 4 and 5). There is a MIDAS motif on top of the BA domain, which has a metal-binding sequence DXSXS similar to the MIDAS motif of the  $\alpha$  subunits with an A(I) domain. Adjacent to the MIDAS with the Mn<sup>2+</sup> stimulatory site, there is the ADMIDAS sequence with a Ca<sup>2+</sup>-binding inhibitory site.

Another domain called *hybrid* is an Ig-like type I domain, which is formed by two sequences distantly located in the primary structure (one on each side of the BA domain). The BA domain is inserted between loops of the hybrid domain. The  $\beta_3$  subunit contributes to the interface of the heterodimeric ovoid head. The interface is largely hydrophobic, and it does not have “specificity-determining” residues, which may account for the association of  $\beta_3$  with  $\alpha\nu$  or  $\alpha\text{IIb}$ .

The  $\beta_3$  leg is formed by several domains: a PSI domain (plexin, semaphorin, integrin) and hybrid domains. The integrin PSI domain has seven cysteines, six of them forming disulfide bonds between themselves, whereas one forms a long-range disulfide bond to the C-terminal cysteine-rich EGF domain. The PSI domain is followed by four EGF-like domains called *integrin EGF* (I-EGF).

The typical EGF domains have six cysteines, but the cysteines in I-EGF are seven, with the extra ones forming interdomain disulfide bonds between consecutive I-EGFs. The  $\beta_3$  leg ends with a tail domain (BTD). The knee of the  $\beta$  subunit ( $\beta$  genu) lies in the PSI/I-EGF1-2 region.

*Gene locus.* 17q21.3.

*Molecular mass (kd).* 90 to 105.

*Distribution.* Detected in platelets, megakaryocytes, monocytes, macrophages, and endothelial cells.

*Function.* In the resting state, the integrin assumes a bent, compact, V-shaped position with one leg of the V ending to the head, whereas the other to the tail. The tip of the V corresponds to the “knee” (genu). In the presence of Mn<sup>2+</sup>, the integrin stands up and takes the extended conformation with a head and two legs (1, 6).

Because the  $\alpha\nu$  chain in the  $\alpha\nu\beta_3$  integrin has no I(A) domain, the A domain of the  $\beta$ -chain mediates both the ligand binding and the heterodimer formation. The ligand residues Arg-Gly-Asp (RGD) fit into a crevice between the propeller (see [CD51](#) or [CD41](#))

and the  $\beta A$  domains.

Inside-out signals activate integrins and change the affinity for their ligands from low to high (i.e., enable the integrin to bind the ligand). Activation induces conformational changes and reorientation of the  $\beta A$  and propeller domains, which may be facilitated by the fact that the residues, which bind the ligand as well as the metal and form the heterodimer, are very close together.

It has been proposed that the conformational changes occurring in  $\beta A$ , propeller, and MIDAS may be visualized as a bell being pulled down by a rope (the *bell-rope mode*). This movement is triggered probably by the hybrid domain, which “pulls” down a linker sequence (the “rope”) at the C-terminus of the  $\beta A$  domain and opens the ligand-binding site. Binding of the ligand with high affinity triggers outside-in signaling, which initiates the integrin functions, such as platelet aggregation and adhesion to injured surfaces.

The  $\beta_3$ -chain is associated with two  $\alpha$ -chain partners:  $\alpha_V$  (CD51) and  $\alpha_{IIb}$  (CD41). All integrin  $\alpha$ -chains are divided into two groups, those with an I(A) domain (see [CD11](#), [CD49a](#), CD49b), and those without (CD41, CD49–CD49f, CD51).

Both  $\alpha_{IIb}\beta_3$  and  $\alpha_V\beta_3$  are important platelet integrins functioning as receptors for fibrinogen, vitronectin, vWF, and so forth. Therefore, they have a major role in hemostasis.

Seen by electron microscopy,  $\alpha_{IIb}\beta_3$  binds to its ligands in different locations (i.e., for fibrinogen, the site is located to the distal end of the molecule, for FN, two-thirds from the NH<sub>2</sub> terminus, and for vWF, near the central module) ([7](#)).

The contributions of the various domains of  $\beta_3$  to the expression, ligand binding, and function have been studied from mutations, natural or targeted. Mutations result in GT, which, depending on the severity of its symptoms, is divided into type I (severe, <5% of normal  $\alpha_{IIb}\beta_3$ ) and type II (moderate  $\alpha_{IIb}\beta_3$  deficiency, 10 to 20% of normal) ([8](#), [9](#) and [10](#)). There are 40,000 to 80,000  $\alpha_{IIb}\beta_3$  molecules/platelet and only approximately 100 of a  $\alpha_V\beta_3$ .

Mutations in  $\beta_3$  may not affect the function of both integrins as one would have expected. A Leu196 Pro mutation within  $\beta_3$  MIDAS in a patient with type II GT affected the expression and functions of  $\alpha_{IIb}\beta_3$  and a  $\alpha_V\beta_3$ . The mutation interfered with  $\alpha_{IIb}\beta_3$  expression (transport to the surface) but not adhesion to fibrinogen. However, the  $\alpha_V\beta_3$  functions were inhibited, that is, platelet spreading, formation of focal contacts, phosphorylation of p125<sup>FAK</sup>, and clot retraction ([11](#)).

In another patient, His280Pro in  $\beta_3$  impaired  $\alpha_{IIb}\beta_3$  but not a  $\alpha_V\beta_3$  expression, whereas a Ser162Leu markedly impaired ligand binding in  $\alpha_{IIb}\beta_3$  but not in a  $\alpha_V\beta_3$  ([12](#)).

The cytoplasmic tail of  $\beta_3$  has two tyrosines (Y747 and Y759), which are potential sites of phosphorylation and substrates for Src kinases mediating outside-in signaling. Subsequent interactions with other signaling molecules, such as Syk and Csk kinases, modulate effector functions of the integrins (i.e., reorganization of cytoskeleton, adhesion to fibrinogen, platelet spreading, and so forth) ([13](#), [14](#)). The inside-out signals, which modulate ligand-binding affinity, utilize small GTPases such as Rap1b ([15](#)).

Because of the importance of these two integrins in hemostasis, drugs and monoclonal antibodies have been used in clinical medicine to modulate their function. After vascular injury, the  $\beta_3$  integrins are up-regulated in endothelial cells. Their activation, through a series of complex cellular interactions, contributes to restenosis after percutaneous coronary interventions. Abciximab is a chimeric monoclonal antibody and is used for thrombotic complications in angioplasty and other conditions in which platelet activation and deposition on the endothelium are involved ( [16](#) ).

The  $\beta_3$  integrins contain a thiol isomerase activity predicted from the CXXC motif in each of the I-EGF motifs of the  $\beta_3$ -chain ( [17](#) ) involved in disulfide exchange reactions.

Four  $\beta_3$  polymorphisms have been identified to be associated with neonatal alloimmune thrombocytopenic purpura. One, responsible for the alloantigen system Pen<sup>a</sup>/Pen<sup>b</sup>, results from G526A mutation, and the second, Thr140Ile, is associated with the Duv<sup>a+</sup> alloantigen ( [18](#) ). Both of these involve the RGD-binding site. The third is associated with the Oe<sup>d</sup> alloantigen (Lys611 deletion) ( [19](#) ) and the fourth, Leu33Pro, with the platelet alloantigens PI<sup>A1</sup> and PI<sup>A2</sup>.

## CD62 (SELECTINS)

Selectins constitute a family of molecules that allow leukocytes to attach to vascular endothelium and migrate across the vessel wall. There are three members in the family: E-selectin, limited to endothelial cells (CD62E); L-selectin, expressed on all neutrophils, monocytes, and the majority of B and T cells (CD62L); and P-selectin, expressed on endothelium and platelets (CD62P) ( [1](#), [2](#) ).

### CD62E (E-Selectin, ELAM)

*Structure.* The extracellular region consists of an N-terminal C-type lectin module (lec) followed by an EGF-like module (epidermal growth factor) and six CCP domains.

The lectin module is analogous to other C-type  $\text{Ca}^{2+}$ -dependent animal lectins, therefore the function of E-selectin is regulated by carbohydrate-protein interactions. The C-type lectin fold consists of two antiparallel  $\beta$  strands, two  $\alpha$  helices, and a number of irregular loops, some of them involved in the monosaccharide binding mediated by  $\text{Ca}^{2+}$ .

The EGF fold is very similar to other EGF modules, with six cysteines forming disulfide bonds, which maintain a compact structure. These EGFs are similar to clotting factor IX EGF domain and do not contribute directly to the binding of ligand but are necessary, probably because they are required to maintain the conformation of the lec domain. Crystal structure of E-selectin has shown that there is very little interaction between the EGF and lec domains. The selectin CCP domains have six conserved cysteines. The role of CCP domains in selectin function is not clear, but deletion of CCP domains drastically affects the E-selectin function.

*Gene locus.* 1q22-25, closely linked to the genes of the other selectins and the complement receptor genes.

*Molecular mass (kd).* 97 to 115.

*Distribution.* E-selectin is expressed on endothelial cells, but it is not stored in cellular granules and is up-regulated by inflammatory cytokines (i.e., IL-1, TNF- $\alpha$ , and endotoxin), reaching maximal levels within 3 to 4 hours.

E-selectin is constitutively expressed in postcapillary venules of the skin.

*Function.* CD62E binds the ligand within a finite region of the lectin domain in the vicinity of the bound  $\text{Ca}^{2+}$ . CD62E (and all selectins) binds the tetrasaccharide sLe<sup>X</sup> [Siaa2 $\beta$ 3Gal $\beta$ 1 $\beta$ 4(Fuca1 $\beta$ 3)GlcNac] with fucose being a critical component (3).

The majority of the interactions between sLe<sup>X</sup> and E-selectin are electrostatic (i.e., hydrogen bonds, water bridges, and a  $\text{Ca}^{2+}$  metal ion bond). The  $\text{Ca}^{2+}$  is bound probably by the 2- and 3-hydroxyls of fucose.

Synthesis of the carbohydrate ligands requires the enzymatic function of glycosyltransferases. The epithelial  $\alpha$ 1,3-fucosyl transferase (FucT-III) synthesizes the E-selectin sLe<sup>X</sup> ligand (4). FucT-VII plays a critical role in constructing ligands for E- and P-selectins.

After stimulation by inflammatory cytokines, E-selectin can support rolling and tethering of PMN and contributes to a later stage influx into inflamed tissues. Rolling adhesions on E-selectin are stronger than those on P-selectin.

Recently, memory T cells expressing the cutaneous lymphocyte-associated antigen, a carbohydrate epitope also detected on P-selectin glycoprotein ligand-1 (PSGL-1), were shown to be able to bind on both E- and P-selectins.

The CD8<sup>+</sup> type 1 cytotoxic cells migrate to inflamed skin through E-selectin using PSGL-1 and play a critical role for tissue-specific homing of T cells to skin. CD44 is an E-selectin ligand for primitive CD34<sup>+</sup> hematopoietic cells (5). CD44 may be considered as a "bone marrow homing receptor" for transplanted bone marrow stem cells and tissue distribution of myeloid progenitors.

E-selectin reduces the velocity of rolling sufficiently so that  $\beta_2$  integrin further decreases the velocity so that the leukocyte comes slowly to an arrest. In the absence of E-selectin,  $\beta_2$  integrins are unable to decelerate rolling smoothly, and after a long period of time, the cells come to an abrupt arrest.

Lack of E-selectin in a child with recurrent infections implicates its role in leukocyte recruitment in areas of inflammation (6). The E-selectin was not detectable on the endothelial cells, although E-selectin mRNA was present. A proteolytically cleaved soluble E-selectin was elevated in blood.

### **CD62L (L-Selectin, LECAM-1)**

*Structure.* CD62L has an extracellular region that consists of a C-type ( $\text{Ca}^{2+}$ -dependent) module (Iec), an EGF module, and two CCP domains. An amino acid spacer between the

second CCP domain and the membrane contains a proteolytic cleavage site. The cytoplasmic region is short.

*Gene locus.* 1q23–25.

*Molecular mass (kd).* 65 to 74 (lymphocytes); 95 (neutrophils).

*Distribution.* Expressed in most hemopoietic cells, neutrophils, monocytes, and eosinophils, and in the majority of naïve T and B cells but only in a minority of activated T cells and NK cells. It is lost on activation because of proteolytic cleavage and is detected in peripheral blood in a soluble form.

*Function.* L-selectin recognizes glycoproteins, which collectively are referred to as *peripheral lymph node addressins* (PNA<sub>d</sub>) and are expressed on the luminal aspect of HEV. The L-selectin ligands require O-linked carbohydrates with posttranslational modifications for optimal binding (i.e., sialylation, fucosylation, and carbohydrate sulfation, all of which can be found in the sLe<sup>X</sup> tetrasaccharide).

The essential modification is sulfation on the C6 position of either Gal or GlcNAc carried out by two sulfotransferases, which belong to the GST subfamily of carbohydrate sulfotransferases. These O-glycan branches extend from a trisaccharide known as *core 2* and require an enzyme known as *core 2-β 1,6-N acetylglucosaminyl transferase* (C2GnT). They are further modified by a 2,3-sialyltransferase, an α-1,3-fucosyltransferase VIII (FucT-VIII), and a sulfotransferase, but the order of modifications is not known. These oligosaccharides decorate several proteins, such as GlyCAM-1 (which was found to be a secreted molecule), a glycoform of CD34, MadCam, podocalyxin-like protein, and so forth.

All these proteins, for simplicity called *PNA<sub>d</sub>*, are recognized (and copurified) by a monoclonal antibody, MECA-79 (see details in [Chapter 15](#)) independent of sialylation and fucosylation.

Three sulfotransferases have been isolated; one transfers a sulfate group to Gal-6 and the other two on GlcNAc-6 positions. One, known as *LSS7*, or L-selectin ligand sulfotransferase, is HEV-restricted and is involved in the synthesis of L-selectin ligand and the MECA-79 epitope, required for lymphocytic homing ([7](#)).

The function of L-selectin is capture (“tethering”) and rolling. Rolling of leukocytes consists of stepwise and smooth components. The former corresponds to dissociation of bonds between a cluster of receptors and their ligands. The latter corresponds to the elongation of the microvillous tethers. Rolling, although oscillating, is remarkably uniform under all conditions of shear stress ([8](#), [9](#)). Inflammation, which up-regulates L-selectin expression, tends to augment tether formation.

Ligands for L-selectin are induced in sites of chronic inflammation, as shown with MECA-79 antibody staining ([10](#)). HEV-like vessels have been detected in synovium, skin, gut, lungs, and so forth under various inflammatory conditions. MECA-79 epitopes have also been detected in intramuscular capillaries and venules in patients undergoing rejection of heart allografts ([11](#)). Two new monoclonal antibodies, G72 and G152, have now been developed with specificity to 6-sulfo sLe<sup>X</sup>, which is accepted as the L-selectin ligand.

## CD62P (P-Selectin, PADGEM)

*Structure.* The extracellular region contains an N-terminal C-lectin domain, an EGF domain, and nine CCP domains that form an extended rod 48 nm long (<sup>12</sup>). Alternative splicing results in variants lacking the seventh CCP domain or producing a soluble form.

The cytoplasmic tail is short and attaches to cytoskeleton through interaction with moesin that is essential for leukocyte rolling and directs targeting of P-selectin to specialized organelles and to lysosomes. The binding site is a groove on the surface of the C-domain formed by three of the domain's strands.

*Gene locus.* 1q21-q24.

*Molecular mass (kd).* 140.

*Distribution.* Expressed on megakaryocytes, platelets, and endothelial cells. It is stored in secretory granules in platelets and is translocated to the membrane on activation. After a short expression on the surface, it is internalized and degraded within lysosomes (<sup>13</sup>).

*Function.* The ligand for P-selectin is PSGL-1 (CD162), although it binds also to E- and L-selectins. It mediates the interactions of leukocytes and platelets with the endothelial cells (<sup>14</sup>). PSGL-1 is a mucinlike transmembrane homodimer. The extracellular region consists of 15 decameric repeats rich in prolines and threonines.

Binding to P-selectin requires the sLe<sup>X</sup> oligosaccharide at residue 16, one or more sulfated Tyr, and four acidic residues closer to the N-terminus. Engagement of T cells on P-selectin induces tyrosine phosphorylation of p125 FAK and, in neutrophils, enhances tyrosine phosphorylation activation of MAPK and stimulation of IL-8 secretion.

P-selectin mediates the rolling of neutrophils and their recruitment to areas of inflammation, especially in the early stages of leukocyte recruitment. Heparin, which is used in human disease as an anticoagulant and antithrombotic agent, has in addition antiinflammatory activity in experimental animals mediated through inhibition of P- and L-selectins (<sup>15</sup>). The 6-O sulfate group of glucosamine units of heparin is critical for antiinflammatory as well as anticoagulation therapy.

## REFERENCES

1. Kansas GK. Selectins and their ligands: current concepts and controversies. *Blood* 1996;88:3259-3287.
2. Vestweber D, Blanks JE. Mechanisms that regulate the function of the selectins and their ligands. *Physiol Rev* 1999;79:181-213.
3. Lowe JB. Glycosylation in the control of selectin counter-receptor structure and function. *Immunol Rev* 2002;186:19-36.
4. Weninger W, Ulfman LH, Cheng G, et al. Specialized contributions by alpha (1,3)-fucosyltransferase-IV and FucT-VII during leukocyte rolling in dermal microvessels. *Immunity* 2000;12:665-676.
5. Dimitroff CJ, Lee JY, Rafii S, et al. CD44 is a major E-selectin ligand on human hematopoietic progenitor cells. *J Cell Biol* 2001;153:1277-1286.
6. De Lisser HM, Christofidou-Solomidou M, Sun J, et al. Loss of endothelial surface expression of

E-selectin in a patient with recurrent infections. *Blood* 1999;94:884–894.

7. Hammerich S, Bistrup A, Singer MS, et al. Sulfation of L-selectin ligands by an HEV-restricted sulfotransferase regulates lymphocyte homing to lymph nodes. *Immunity* 2001;15:237–247.
8. Chen S, Springer TA. An automatic braking system that stabilizes leukocyte rolling by an increase in selectin bond number with shear. *J Cell Biol* 1999;144:185–200.
9. Dvir O, Steeber DA, Schwarz US, et al. L-selectin dimerization enhances tether formation to properly spaced ligand. *J Biol Chem* 2002;277:21130–21139.
10. Hickey MJ, Forster M, Mitchell D, et al. L-selectin facilitates emigration and extravascular locomotion of leukocytes during acute inflammatory responses in vivo. *J Immunol* 2000;165:7164–7170.
11. Toppilla S, Paavonen T, Nieminen MS, et al. Endothelial L-selectin ligands are likely to recruit lymphocytes into human heart transplants. *Am J Pathol* 1999;155:1303–1310.
12. Moore KL. Structure and function of P-selectin glycoprotein ligand-1. *Leuk Lymphoma* 1998;29:1–15.
13. Blagoveshchenskaya AD, Norcott JP, Cutler DF. Lysosomal targeting of P-selectin is mediated by a novel sequence within its cytoplasmic tail. *J Biol Chem* 1998;273:2729–2737.
14. Yong J, Furie BC, Furie B. The biology of P-selectin glycoprotein ligand-1: its role as a selectin counter-receptor in leukocyte-endothelial and leukocyte-platelet interaction. *Thromb Haemost* 1999;81:1–7.
15. Wang L, Brown JR, Varke A, et al. Heparin's anti-inflammatory effects require glucosamine 6-o-sulfation and are mediated by blockade of L- and P-selectins. *J Clin Invest* 2002;110:127–136.

## CD64 (Fc $\gamma$ RI)

*Structure.* CD64 is the high-affinity receptor for IgG (binds monomeric IgG) and is a member of the Fc $\gamma$ R family, which has nine transmembrane and three soluble members (1, 2, and 3). The Fc $\gamma$ RI family is a heterogeneous group of proteins as a result of multiple genes (A, B, C) and alternative splicing. The A gene encodes the high-affinity Fc $\gamma$ RIa. The B and C genes have a stop codon in the exon that encodes the third Ig domain and transcribes soluble proteins with one or two domains (Fc $\gamma$ RIb<sub>1</sub>, Fc $\gamma$ RIc).

The extracellular region of Fc $\gamma$ RIa contains three Ig-like domains of the C2 type. Only the first two are homologous to those of the other FcRs. The third domain confers the high affinity to Fc $\gamma$ RI.

The cytoplasmic region contains no sequences known to be involved in signaling. The receptor forms a heterodimer with the FcR  $\gamma$ -chain, which is essential for its expression and signal transduction with an ITAM sequence in its cytoplasmic tail.

*Gene locus.* 1q21.1.

*Molecular mass (kd).* Fc $\gamma$ RIa, 72.

*Distribution.* Fc $\gamma$ RI is constitutively expressed on monocytes and macrophages. It can be induced by IFN- $\gamma$  on neutrophils, eosinophils, and glomerular mesangial cells. Fc $\gamma$ RI is also expressed on DCs.

*Function.* Fc $\gamma$ RI binds monomeric IgG as well as aggregated IgG. The C2 domain of IgG binds directly to Fc $\gamma$ RI, but the C3 stabilizes the interaction. Crucial for the interaction is a sequence in the N-terminal region of the C2 domain present in human IgG1 and IgG3 high-affinity binding and another region in the hinge of IgG. The binding of IgG to Fc $\gamma$ RI



involves only one heavy chain.

Cross-linking of Fc $\gamma$ RI on monocytes induces phosphorylation of PLC- $\gamma$  and Syk kinases (4).

CD64 is important for phagocytosis of opsonized targets and ICs as well as for antibody-mediated cytotoxicity (5).

The importance of Fc $\gamma$ RI in body defenses, however, was questioned when four individuals within a family were identified as lacking Fc $\gamma$ RI without manifesting immunologic problems. The defect was due to the change of a single nucleotide within the exon encoding domain 1, resulting in a change to a termination codon.

Signals lead to cytoskeletal remodeling mediated by the small GTPase, Rac, leading to activation of the Arp 2/3 complex (see Chapter 14). PI3K is involved in several steps during signaling in phagocytosis. FcRs in general, and Fc $\gamma$ RI in particular, have been used in clinical medicine in immunotherapies. Fc $\gamma$ Rs are important in mediating ADCC when antibodies are used for treatment of malignancies (i.e., CAMPATH, CD20) (6). Biospecific molecules (BSMs) improve the recruitment of Fc $\gamma$ R activation. BSMs have one side specific for the target, whereas the other is directed against the FcR. Several BSMs have developed and are used for cancer immunotherapy. Antibodies directed against viruses direct the pathogen to the phagocyte (antibody-dependent enhancement).

A BSM (MDX-240), specific for gp41 of HIV and Fc $\gamma$ RI, decreased virus production and diminished formation of HIV proviral DNA in macrophages. Fc $\gamma$ R plays a role also in autoimmune diseases for clearance of ICs but also in mediating IC tissue damage (7). Cross-linking Fc $\gamma$ RI and Fc $\gamma$ RII on macrophages stimulates secretion of matrix MMP-1. Because such complexes exist in atherosclerotic plaques, the study suggests that MMP-1 potentially may contribute to plaque rupture in arterial walls, triggering an acute coronary event (8).

## CD66 [CARCINOEMBRYONIC ANTIGEN (CEA) FAMILY]

The CEA family of proteins consists of two subfamilies: (a) CEA-CAM (carcinoembryonic cell adhesion molecules, C-CAM) with eight members; and (b) PSG (pregnancy-specific glycoprotein), with 11 members (1, 2).

The CEA-CAM group has eight isoforms as a result of alternative splicing, but also by differential glycosylation, and variation in the number and sequence of the C2 domains. The usual C2 domain has approximately 178 amino acids, but some isoforms have domains with 71 or 31 residues (non-C2 domains). Those very small domains are specific for the C-CAM family.

### CD66a: C-CAM-1

*Structure.* C-CAM-1 is a transmembrane protein with four Ig-like domains in the extracellular region. The N-terminal is of V-type, and the other three are of C2 type. It is heavily glycosylated with more than 60% of the mass contributed by the N-linked glycans, which bear sLe<sup>X</sup> (CD15) types of structures. C-CAM-1 occurs in two isoforms: C-CAM-1L with a long cytoplasmic region (71 to 73 amino acids) and C-CAM-1S with a short one (10 to 12 amino acids), as a result of alternative splicing leading to a stop codon. C-CAM-1L contains two tyrosine residues in an ITIM motif (YXXL), spaced 21

residues apart.

*Gene locus.* 19q13.2.

*Molecular mass (kd).* 140 to 180.

*Distribution.* C-CAM-1 is present in hematopoietic cells, mature granulocytes (up-regulated after activation) ( [1](#) ), macrophages, T cells, and NK cells, stratified epithelia (contact cell boundaries), simple epithelia (apical brush border), liver (bile canaliculi), and kidney (proximal tubules). Generally, C-CAM-1L is found in apical and lateral surfaces, whereas C-CAM-1S is located exclusively in the apical surfaces. Lateral localization requires homophilic antiparallel binding between adjacent cells mediated by the N-domain.

*Function.* C-CAM-1 is an adhesion molecule but is also involved in numerous other functions such as proliferation, tumor growth, angiogenesis, epithelial cell polarization, and apoptosis. It is also a receptor for gonococci and *E. coli* ( [3](#) ).

The presence of the ITIM motif and recruitment SHP-1 and SHP-2 phosphatases suggests that its basic signal transduction mechanism is inhibitory (see below) ( [4](#) ).

In cell adhesion, the C-CAM-1L (but not C-CAM-1S) associates with cytoskeletal proteins paxillin (neutrophils, epithelial cells), as well as G-actin and tropomyosin ( [5](#), [6](#) ). The association with the cytoskeleton and its localization in the cellular boundaries, where it participates with neighboring cells in homophilic interaction, is mediated by Rho GTPases.

C-CAM-1 is an inhibitor of tumor growth, and it is found down-regulated in several human malignancies ( [7](#), [8](#) ). Transfection of several tumor cell lines from different species with C-CAM-1 complementary DNA (cDNA) resulted in inhibition of tumor growth.

Essential for tumor inhibition is the long cytoplasmic tail (C-CAM-1L). SHP-1 and SHP-2 tyrosine phosphatases are recruited and required for the inhibition of  $\text{Ca}^{2+}$  influx. In normal cells, the Rho GTPases direct the adhesion molecule to its proper destination, the cell boundaries, where it establishes homophilic interactions with neighboring cells. A link possibly exists between C-CAM-1 interaction with cytoskeleton and tumor growth. This is suggested by the fact that only C-CAM-1L, but not C-CAM-1S, is tightly associated with the cytoskeleton and functions as tumor cell growth inhibitor. Relocalization of C-CAM-1L contributes to loss of contact inhibition and proliferation.

The S to L isoform rates are different between quiescent and proliferating cells, with the S to L ratio being lower in proliferating cells ( [9](#) ).

It has also been suggested that C-CAM-1 inhibits tumor angiogenesis through the release of an inhibitor of endothelial cell growth and migration ( [10](#) ). However, other data indicate that C-CAM-1 supports the vascular endothelial growth factor function.

Melanoma cells expressing C-CAM-1 could not be killed by cytotoxic NK cells because the NK cells engaged in homophilic interaction with the melanoma cell, which inhibited the NK-cell cytotoxicity ( [11](#) ). Another important function of C-CAM-1 is in the inhibition of activated decidual lymphocyte functions ( [12](#) ). The decidual lymphocytes consist predominantly of NK cells, which make up 70 to 80% of the lymphocytes in this location.

They are strongly CD56<sup>+</sup> and CD16<sup>-</sup>. On activation, they become C-CAM-1-positive. The extravillous trophoblast expresses constitutively C-CAM-1, and interaction with C-CAM-1<sup>+</sup> NK cells inhibits cytotoxicity. This mechanism may provide an explanation for the survival of the semiallogeneic fetus from attack of maternal NK cells.

C-CAM-1 has also been implicated in the function of insulin (13). Binding of insulin to its receptor leads to phosphorylation of C-CAM-1, which then binds to Shc, an adaptor protein, and interrupts the signaling pathway of insulin. C-CAM-1 down-regulates cell proliferation triggered by insulin, but C-CAM-1 also regulates insulin clearance (14). Phosphorylated C-CAM-1 binds to the insulin receptor and mediates insulin clearance by endocytosis in hepatic cells. Interference with C-CAM-1 phosphorylation in the liver leads to impaired insulin clearance and hyperinsulinemia.

C-CAM is used by *N. Gonorrhoeae* to induce neutrophil apoptosis. Gonococci express the opacity (opa) proteins, which are adhesins, and mediate binding of gonococci to the C-CAM family of proteins and the heparan sulfate proteoglycans, syndecan-1 and syndecan-4. Shuffling of the HV domains of opa by the gonococcus generates variants with new specificities.

The gonococci actively release membrane material ("blebs"), which, through a TLR, activate NF- $\kappa$ B and stimulate up-regulation of C-CAM expression and opa-mediated neisserial binding. This interaction plays a central role in the pathogenic process because urethral exudate consists primarily of PMNs with internalized opa<sup>+</sup> bacteria, which induce cell death. To fully protect themselves, gonococci also inhibit T-cell activation (15, 16).

The CEA members have been considered as targets for immunotherapy of cancer. Vaccines targeting CEA have been developed and used in clinical trials to stimulate humoral responses or cytotoxic responses. For humoral immunity, an antiidiotypic, anti-CEA antibody (AB2) is used mixed in alum. For the CTL response, a pox virus-based vector is used, incorporating CEA with or without co-stimulatory molecules. Another approach uses DCs loaded with a peptide from CEA. These vaccines are safe and immunologically active.

#### **CD66b [Carcinoembryonic Cell Adhesion Molecule (CEA-CAM)-8, Former CD67] and CD66c (CEA-CAM-6, NCA)**

*Structure.* The extracellular region in both members consists of three Ig-like domains, the N-terminal of type V and the other two of type C2, all heavily glycosylated (11 to 12 N-glycosylation sites). The molecular weight of CD66b is shifted from 95 to 40 after deglycosylation.

*Gene locus for both:* 19q13.2.

*Molecular mass (kd):* 95 and, after deglycosylation, 40.

*Distribution.* Present in neutrophils. CD66c is detected on epithelia. Soluble forms of both are present in plasma.

*Function.* CD66b exhibits only heterophilic adhesion with CD66c (C-CAM-6) and CD66e (C-CAMe). CD66c is capable of both homophilic and heterophilic (with CD66b) adhesions (16, 17). Subtle differences in the N-domain sequences determine the specificity for homophilic and heterophilic interactions as well as the interactions with opa proteins of

gonococci. Both regulate adhesions of neutrophils to endothelial cells, which are blocked by CD18 antibodies.

Cross-linking of CD66b/CD66c/CD66a promotes their clustering with participation of the  $\beta_2$  subunit of the  $\alpha_M$  integrin. This leads to  $\beta_2$  integrin activation and, in turn, alteration of the affinity of  $\beta_1$  integrin, which enhances the adhesion of neutrophils to FN. CD66a and CD66b are receptors for galectin-3 and enhance neutrophil adhesion to laminin through galectin-3.

Expression of CD66c in colorectal carcinomas is inversely related to the degree of cellular differentiation. CD66c (but not CD66b) is a receptor for the opa proteins of *N. gonorrhoeae* and mediates the nonopsonized internalization of the bacteria by neutrophils (see above).

### **CD66d (CEA-CAM-3) and CD66e (CEA-CAM-5, Carcinoembryonic Antigen)**

*Structure.* The extracellular region of CD66d consists of only one V-type Ig-like domain. It is a transmembrane protein, and the cytoplasmic region (as with CD66a) is either long or short. The long cytoplasmic tail contains two tyrosine motifs (YXXL), which resemble the ITAM sequences. There are three splice variants, one of which alters the reading frame and leads to loss of the ITAM motifs.

The extracellular domain in CD66e attaches to the membrane by a GPI anchor.

*Gene locus.* CD66d, 19q13.2; CD66e, 19q13.1-13.2.

*Molecular mass (kd).* CD66d consists of six C2 type and one V-type Ig-like heavily glycosylated domains. It is attached to 35; CD66e is attached to 180 to 200.

*Distribution.* CD66d is expressed on hematopoietic cells, and its expression in neutrophils is up-regulated after activation. It is also detected in a variety of epithelia. CD66e has not been detected in hematopoietic cells but is expressed in epithelia.

*Function.* CD66d is phosphorylated and participates in signal transduction, leading to neutrophil activation. It forms a complex with calprotectin in neutrophils ([19](#)), but the function of this interaction is unknown. Calprotectin is a heterodimer formed by two  $\text{Ca}^{2+}$ -binding proteins that cross-link two homologous or heterologous target proteins.

CD66d mediates phagocytosis of opa<sup>+</sup> gonococci ([20](#)) (see details in [CD66a](#)).

CD66e is involved in both homophilic and heterophilic interactions; it binds to Kupffer cells in the liver and stimulates secretion of various cytokines. The detection of CD66e is useful as a marker for malignancies, and its determination in the serum has been used to monitor tumor progression.

### **CD66f (PSG: Pregnancy-Specific Glycoprotein)**

*Structure.* CD66f is a member of the second subfamily of the CEA family of molecules, which consists of 11 members. It has one N-terminal V-type domain and two to three type C2 Ig-like domains.

*Gene locus.* 19q13.2.

*Molecular mass (kd).* 54 to 72.

*Distribution.* It is produced by the syncytiotrophoblast in the placenta and is found in fetal liver and myeloid cells ( [21](#) ). It is detected around the second or third week of pregnancy and increases as pregnancy progresses. It is also produced by the testes, intestine, and cultured fibroblasts.

*Function.* CD66f exerts an embryotrophic activity (i.e., has a stimulatory effect on embryogenesis in preimplantation embryos *in vitro*) ( [22](#) ). The RGD sequence has been implicated in giving positional cues and locomotive signals during development. PSG may have a role in embryo–maternal communication, but its role during early pregnancy remains to be elucidated.

## REFERENCES

1. Skubitz KM, Campbell KD, Skubitz APN. CD66a, CD66b, CD66c, and CD66d each independently stimulate neutrophils. *J Leuk Biol* 1996;60:106–117
2. Beauchemin N, et al. Redefined nomenclature for members of the carcinoembryonic antigen family. *Exp Cell Res* 1999;252:243–249.
3. Gray–Owen SD, Dehio C, Houde A, et al. CD66 carcinoembryonic antigens mediate interaction between Opa–expressing *Neisseria gonorrhoeae* and human polymorphonuclear phagocytes. *EMBO J* 1997;16:3435–3445.
4. Chen T, Zimmermann W, Parker J, et al. Biliary glycoprotein (BGP, CD66a, CEACAM1) mediates inhibitory signals. *J Leuk Biol* 2001;70:335–340.
5. Sadekova S, Lamarche–Vane N, Li X, et al. The CEACAM1–L glycoprotein associates with the actin cytoskeleton and localizes to cell–cell contact through activation of Rho–like GTPases. *Mol Biol Cell* 2000;11:65–77.
6. Schumann D, Chen C–J, Kaplan B, et al. Carcinoembryonic antigen cell adhesion molecule 1 directly associates with cytoskeleton protein actin and tropomyosin. *J Biol Chem* 2001;276:47421–47433.
7. Estrera VT, Luo W, Phan D, et al. The cytoplasmic domain of C–CAM–1 tumor suppressor is necessary and sufficient for suppressing the tumorigenicity of prostate cancer cells. *Biochem Biophys Res Comm* 1999;263:797–803.
8. Turbide C, Kunath T, Daniels E, et al. Optimal ratios of biliary glycoprotein isoforms required for inhibition of colonic tumor cell growth. *Cancer Res* 1997;57:2781–2788.
9. Singer BB, Sheffrahn I, Obrink B. The tumor growth–inhibiting cell adhesion molecule CEA–CAM (C–CAM) is differently expressed in proliferating and quiescent epithelial cells and regulates cell proliferation. *Cancer Res* 2000;60:1236–1244.
10. Volpert O, Luo W, Liu T–J, et al. Inhibition of prostate tumor angiogenesis by the tumor suppressor CEACAM1. *J Biol Chem* 2002;277:35696–35702.
11. Markel G, Lieberman N, Katz G, et al. CD66a interactions between human melanoma and NK cells: a novel class I MHC–independent inhibitory mechanism of cytotoxicity. *J Immunol* 2002;168:2803–2810.
12. Markel G, Wolf D, Hanna J, et al. Pivotal role of CEACAM1 protein in the inhibition of activated decidual lymphocyte functions. *J Clin Invest* 2002;110:943–953.
13. Poy MN, Ruch RJ, Fernström MA, et al. Shc and CEACAM1 interact to regulate the mitogenic action

of insulin. J Biol Chem 2002;277:1076–1084

14. Poy M, Yan Y, Rezai K, et al. CEACAM1 regulates insulin clearance in liver. Nat Genet 2002;30:270–276.
15. Normack S, Albiger B, Johnsson AB. Gonococci cause immunosuppression by engaging a co-inhibitory receptor on T lymphocytes. Nat Immunol 2002;3:210–211.
16. Bouton IC, Gray–Owen SD. Neisserial binding to CEACAM1 arrests the activation and proliferation of CD4<sup>+</sup> T lymphocytes. Nat Immunol 2002;3:229–236.
17. Skubitz KM, Kuroki M, Jantscheff P, et al. CD66b. J Biol Regul Homeost Agents 1999;13:242–243.
18. Skubitz KM, Kuroki M, Jantscheff P, et al. CD66c. J Biol Regul Homeost Agents 1999;13:244–245.
19. Streichert T, Ebrahimnejad A, Ganzer S, et al. The microbial receptor CEACAM3 is linked to the calprotein complex in granulocytes. Biochem Biophys Res Commun 2001;289:191–197.
20. Chen T, Bolland S, Chen I, et al. The CGM1a (CEACAM3/CD66d)–mediated phagocytic pathway of *Neisseria gonorrhoeae* expressing opacity proteins is also the pathway to cell death. J Biol Chem 2001;276:17413–17419.
21. Skubitz KM, Kuroki M, Jantscheff P, et al. CD66f. J Biol Regul Homeost Agents 1999;13:250–251.
22. Wu S–M, Arnold LL, Rene J, et al. Effect of pregnancy–specific B1–glycoprotein on the development of pre-implantation embryo. Proc Soc Exp Biol Med 1999;220:169–177.

## CD70 (CD27L)

**Structure.** CD70 is a member of the TNF SF and a type II membrane protein. Its extracellular region contains four cysteines forming two disulfide bonds (1?3 and 2?4). CD70 is homologous to TNF– $\alpha$  and is the ligand for CD27 ( [1](#) ).

**Gene locus.** 19p13.

**Molecular mass (kd).** 21.

**Distribution.** Resting T and B cells do not express CD70, which is induced after activation (i.e., in small numbers of B cells in germinal centers and in memory B cells). It is expressed on B–cell malignancies [i.e., B–CLL (50%), follicle center cell lymphomas (33%), large cell lymphomas (71%), and Burkitt lymphoma cells].

**Function.** CD70 expression on T cells is restricted, but it occurs after priming by APCs ( [2](#) ). CD70/CD27 interactions play a role in B–cell differentiation to plasma cells and Ig production. In cooperation with IL–4 and CD40 signaling, it promotes plasma cell differentiation and IgE secretion ( [3](#) ).

The CD27/CD70 interaction involves a distinct step, as compared with CD40/CD154 (CD40 ligand) interaction. It blocks IL–10–mediated apoptosis of differentiating B cells and directs their differentiation to plasma cells and Ig synthesis ( [4](#) ). The CD27/CD70 interactions normally are transient and may be harmful if they are prolonged, as shown by a model in which CD70 expression was constitutively expressed on B cells in CD70 transgenic mice. In these animals, peripheral T cells increased in numbers, while, at the same time, they were differentiated to an effector type with IFN– $\gamma$  production ( [5](#) ).

Whereas B cells gradually decline as a result of IFN– $\gamma$  production from effector T cells, B



cells from patients with common variable immunodeficiency type I (i.e., low in CD70<sup>+</sup> B cells) remain subnormal even after T-/B-cell interaction *in vitro*, suggesting that there is probably a B-cell signaling defect in these patients (6). An unusual CD70 expression is that in glioblastoma, where expression is inducible by irradiation. CD70<sup>+</sup> glioma cells co-cultured *in vitro* with peripheral blood mononuclear cells induced T- and B-cell apoptosis and shedding of CD27 from the mononuclear cells (7) (see further details in [Chapter 18](#)).

## CD71 [TRANSFERRIN RECEPTOR (TfR)]

CD71 is the receptor for transferrin (TfR). TfR-mediated endocytosis brings the transferrin-iron complex to endocytic vesicles, where iron is unloaded by a decrease in the endosomal pH.

*Structure.* TfR is a type II transmembrane protein that forms a homodimer linked by two disulfide bonds. It consists of a large extracellular region (residues 89 to 760), a single transmembrane region (residues 68 to 88), and the N-terminal cytoplasmic region (residues 1 to 67) (1).

The large extracellular globular domain is separated from the membrane by a thin stalk and forms proteoparticles when it is reconstituted in phospholipids, a property that may facilitate its sequestration from other proteins within endosomes for its subsequent return to the cell surface.

The stalk contains a single O-linked oligosaccharide attached to Thr-104 near the transmembrane region. Removal of the oligosaccharide or targeted mutation of Thr-104 enhances susceptibility of the TfR to proteolysis at Arg-100 and its release in a soluble form (2). It is likely that the oligosaccharide may protect TfR from proteolytic cleavage. The soluble TfR resulting from cleavage at Arg-100 is a homodimer but is not disulfide linked. This cleavage occurs in the endocytic compartment and is constitutively mediated by a matrix MMP of the ADAM family

A second TfR, known as *TfR-2*, exists in two alternatively spliced forms,  $\alpha$  and  $\beta$ . TfR-2 $\alpha$  cannot fully compensate for TfR-1 because its affinity for transferrin is 25-fold lower than that of TfR-1. Furthermore, TfR-2 $\alpha$  does not bind the HFE protein of hemochromatosis (see below).

The cytoplasmic region is short (residues 1 to 67) and contains the internalization motif YTRF.

*Gene locus.* 3q26.2.

*Molecular mass (kd).* 90 to 95 (reduced); 180 to 190 (unreduced).

*Distribution.* TfR is ubiquitously expressed on all cells of the body and especially on proliferating cells. It is regulated in response to iron availability. The regulation is mediated by regulatory proteins interacting with mRNA. A hairpin structure on 3' UTR of mRNA is recognized by transacting proteins known as *iron-regulatory proteins* (*IRP*) that control the rate of mRNA translation or stability. The iron-regulatory proteins regulate the iron homeostasis within the cell, once it is brought by the TfR, as well as other iron-binding proteins such as ferritin (iron storage).



*Function:* For transferrin to take up iron, it has to be transported from the intestinal lumen across the enterocyte to its basolateral surface by the transporter DMT-1 (divalent metal transporter-1), cross the villous lumen surface, and then be taken by ferroportin to the basolateral surface. All iron is changed to the ferric (oxidized) state to be taken up by transferrin.

Transferrin transports the iron to the cells of the body, and needy cells are recognized by expression of TfR on their surface. TfR dimer binds two transferrin molecules. The apical domain of TfR provides the interface with two of the domains from transferrin. The complex is internalized through receptor-mediated endocytosis (clathrin-coated pits) and is transported to endocytic vesicles where iron is discharged at the low pH of the endosomes. Once in the cytosol, iron enters a chelatable pool from which it is used by several enzymes or is stored in ferritin. When cellular iron is plentiful, it stimulates the assembly of new ferritin baskets, thus controlling its own storage capacity within the cell.

The apotransferrin remains bound to TfR in the acidic milieu, and the complex is recruited to the cell surface, where apotransferrin is released in the extracellular fluid.

### **TfR and Hemochromatosis**

A second ligand for TfR is the hemochromatosis protein HFE. It is encoded by a gene in chromosome 6 linked to human class I MHC cluster. The protein, also known as HLA-H, is homologous to MHC class I molecules, such as HLA-A2 and the nonclassical HLA-G ( [3](#), [4](#) ). It is predicted to consist of three domains, a <sub>1</sub>, a <sub>2</sub>, and a <sub>3</sub>. Interaction of HFE with TfR involves the a <sub>1</sub> and a <sub>2</sub> domain helices of HFE and the two helices of the helical domain of TfR ( [5](#), [6](#) ).

Binding of HFE to TfR induces conformational changes of TfR that affect the movement and position of the helical domain in relation to the other domains of TfR, and this, in turn, affects transferrin binding.

The normal function of HFE in iron metabolism is not quite clear.

HFE is localized widely in the body but especially in the major sites of iron metabolism (i.e., intestine and liver). It is detected in the basolateral surfaces of epithelial cells of the stomach and colon, the sinusoidal lining cells of the liver, and in the deep crypt enterocytes of the small intestine, where it localizes with the TfR and probably modulates the uptake of transferrin-bound iron ( [7](#) ).

The effects of binding of HFE to the TfR are controversial regarding the affinity of transferrin binding to TfR and its ability for endocytosis and delivery of transferrin-bound iron. Because HFE binds near the transferrin-binding site, it inhibits the uptake of transferrin ( [8](#) ). Thus, some data suggest that HFE is a negative modulator of TfR function ( [9](#), [10](#) ).

Hereditary hemochromatosis (HH) is one of the most common autosomal-recessive disorders in whites and is characterized by defective regulation of dietary iron absorption, leading to excessive iron accumulation in various organs ( [11](#), [12](#) and [13](#) ). The carrier frequency has been estimated to be 1 in 8 to 1 in 10 in North America. In 83% of patients with HH, a single-base transition of G to A results in the mutation C260Y (numbering begins at the first residue of the mature protein), which disrupts the intradomain disulfide

bond of the  $\alpha_3$  domain of HLA-H and changes its tertiary structure (<sup>14</sup>). This abrogates its interaction with the  $\beta_2$ -microglobulin. As a result, the mutant HFE is retained in the ER, fails to undergo late Golgi processing, and is degraded and prevented from being expressed on the cell surface (<sup>15</sup>).

Some cases of hemochromatosis have been reported that are due to a truncation mutation (Y250X) of the TfR-2 (or *type 3 HH*, to distinguish it from the HH with HFE mutations known as *type 1* and the juvenile-onset HH or *type 2*) (<sup>16</sup>). TfR-2 does not bind to HFE.

## REFERENCES

1. Lawrence CM, Ray S, Babyonyshev M, et al. Crystal structure of the ectodomain of human transferrin receptor. *Science* 1999;286:779–782.
2. Rutledge EA, Root BJ, Lucas JL, et al. Elimination of the O-linked glycosylation site at Thr104 results in the generation of a soluble human-transferrin receptor. *Blood* 1994;83:580–586.
3. Feder JN, Gnirke A, Thomas W, et al. A novel MHC class I-like gene is mutated in patients with hereditary haemochromatosis. *Nat Genet* 1996;13:399–408.
4. Feder JN, Tsuchihashi Z, Irrinki A, et al. The hemochromatosis founder mutation in HLA-H disrupts  $\beta_2$ -microglobulin interaction and cell surface expression. *J Biol Chem* 1997;272:14025–14028.
5. Lebron JA, Bennet MJ, Vaughn DE, et al. Crystal structure of the hemochromatosis protein HFE and characterization of its interaction with transferrin receptor. *Cell* 1998;93:111–123.
6. Bennett MJ, Lebron JA, Bjorkman PJ. Crystal structure of the hereditary haemochromatosis protein HFE complexed with transferrin receptor. *Nature* 2000;403:46–53.
7. Waheed A, Parkkila S, Saarnio J, et al. Association of HFE protein with transferrin receptor in crypt enterocytes of human duodenum. *Proc Natl Acad Sci U S A* 1999;96:1579–1584.
8. Lebron JA, West AP, Bjorkman PJ. The hemochromatosis protein HFE competes with transferrin for binding to the transferrin receptor. *J Mol Biol* 1999;294:239–245.
9. Salter-Cid L, Brunmark A, Li Y, et al. Transferrin receptor is negatively modulated by the hemochromatosis protein HFE: implications for cellular iron homeostasis. *Proc Natl Acad Sci U S A* 1999;96:5434–5439.
10. Feder JN, Penny DM, Irrinski A, et al. The hemochromatosis gene product complexes with the transferrin receptor and lowers its affinity ligand binding. *Proc Natl Acad Sci U S A* 1998;95:1472–1477.
11. Bacon BR, Powell LW, Adams PC, et al. Molecular medicine and hemochromatosis: at the crossroads. *Gastroenterology* 1999;116:193–207.
12. Britton RS, Fleming RE, Parkkila S, et al. Pathogenesis of hereditary hemochromatosis: genetics and beyond. *Semin Gastrointest Dis* 2002;13:68–79.
13. Enns C. Pumping iron: the strange partnership of the hemochromatosis protein, a class I MHC homologue, with the transferrin receptor. *Traffic* 2001;2:167–174.
14. Lebron JA, Bjorkman PJ. The transferrin receptor binding site on HFE, the class I MHC-related protein mutated in hereditary hemochromatosis. *J Mol Biol* 1999;289:1109–1118.
15. Waheed A, Grubb JH, Zhou XY, et al. Regulation of transferrin-mediated iron uptake by HFE, the protein defective in hereditary hemochromatosis. *Proc Natl Acad Sci U S A* 2002;99:3117–3122.
16. Camachella C, Roetto A, Cali A. The gene TFR2 is mutated in a new type of haemochromatosis

mapping to 7q22. Nat Genet 2000;25:14–15.

## CD73 (ECTO-5'-NUCLEOTIDASE, L-VAP-2: LYMPHOCYTE VASCULAR ADHESION PROTEIN-2)

*Structure.* CD73 or ecto-5'-nucleotidase (5'-NT) is a GPI-anchored protein member of a large family of enzymes involved in the hydrolysis of nucleotides; some of them are membrane bound (i.e., ecto-nucleotidases), whereas others are within the cell (cytosolic) ([1](#)).

These enzymes exist throughout evolution from bacteria to mammals, indicating a common evolutionary origin, and residues in the catalytic domain are strongly conserved. Nucleotides in general in mammals are hydrolyzed by membrane-bound ecto-enzymes, which include ATPases, apyrases (CD39), and 5'-NT (CD73) (for a new classification, see [CD39](#)).

The protein forms a dimer, and intact disulfide bridges are essential for enzyme activity. In addition to the membrane-bound enzyme, there are three human cytosolic 5'-NT (see below).

*Gene locus.* 6q14–q21.

*Molecular mass (kd).* 70.

*Distribution.* CD73 expression is detected on T cells (CD4<sup>+</sup>, 10%; CD8<sup>+</sup>, 50%) and B cells (75%), medullary thymocytes, and cortical thymocytes. The number of 5'-NT B cells in adult peripheral blood as compared to those in fetal or cord blood is double (69% vs. 32%), and the enzymatic activity per positive cell also doubles.

As a result of its pattern of expression during T- and B-cell development, CD73 is considered as a lymphocyte maturation marker. It is detected on follicular DCs of the germinal centers ([2](#)), thymic medullary reticular cells, and epithelial cells.

Expression of 5'-NT is abnormally low or completely devoid in lymphocytes from patients with congenital X-linked agammaglobulinemia, SCID, WAS, common variable immunodeficiency, selective IgA deficiency, Omenn syndrome, and AIDS.

CD73 is expressed in placenta, liver, and kidney, and in the brush border of jejunal and ileal enterocytes.

It is also expressed in adult T-cell leukemia and cutaneous T-cell lymphomas, and in CD10<sup>+</sup> ALL, is associated with poor prognosis in children and adults.

*Function.* 5'-NT hydrolyzes exclusively nucleoside 5'-monophosphate (AMP) and has no activity for 2'- and 3'-monophosphates. The final hydrolysis products are nucleoside and phosphate.

- *Lymphocyte functions.* Enzymatic activity of CD73 generates nucleosides, which reenter the cell and are reutilized, supplying the cell with purine requirements for cell division, even when *de novo* purine synthesis is blocked by aminopterin ([3](#)). Nucleotides, which normally are available only intracellularly, may become available from apoptotic cells and are used as substrates for 5'-NT outside the cell.

Nucleotides cannot cross the membrane, but with removal of the phosphate group by 5'-NT, nucleosides reenter the cell and join in the metabolic pool. The function of 5'-NT is known as the *purine salvage pathway* and could provide the total purine requirements of mitogen-stimulated human T cells or rapidly dividing human B lymphoblastoid cells. In certain lymphoid organs with high cell turnover and high levels of apoptosis (thymus, germinal centers), 5'-NT plays an important role, contributing to the salvage mechanism. In the thymic cortex, extracellular levels of nucleosides must be delicately regulated (4). Although, in principle, they may contribute to a salvage pathway, deoxyadenosine is lymphotoxic, and in the absence of its deamination by adenosine deaminase, leads to SCID. 5'-NT activity is barely detectable in the thymic cortex, so that adenosine levels are kept very low. CD73 acts as a co-stimulatory molecule in T-cell stimulation in naïve (CD45RA<sup>+</sup>) T cells, but the enzymatic activity is not required for T-cell activation, as shown by site-directed mutagenesis replacing codons His92 and His194 with alanine. CD73 mediates adhesion of B lymphocytes to follicular DCs in the light zone of the germinal center. It also promotes lymphocyte adhesion to vascular endothelial cells (CD73 is also known as *lymphocyte-vascular adhesion protein 2*), mediated through activation of the LFA-1 integrin (5).

- *5'-NT functions in nonlymphoid cells.* CD73 is expressed on endothelial, epithelial, and mesenchymal cells, and on cells of the nervous system. Vascular permeability is affected by normal activities (i.e., by transendothelial PMN migrations, inflammatory conditions, or ischemia). Nucleotides and nucleosides are released from cells and are converted by 5'-NT to adenosine. Adenosine activates the adenosine receptor A<sub>2B</sub> and leads to endothelial cell functional reorganization, promoting endothelial barrier function (6, 7). This function minimizes increased vascular permeability in inflammatory conditions, as well as maintaining vascular integrity during the normal function of cell migration. Adenosine protects tissues from hypoxic or ischemic damage through activation of the A<sub>1</sub> and possibly A<sub>2A</sub> adenosine receptors. Brief periods of ischemia, known as *ischemic preconditioning*, protect tissues from prolonged ischemic damage after infarction. Adenosine production during the ischemic preconditioning period is increased as a result of enhanced CD73 activity, which in turn results from transcriptional regulation of the CD73 gene by a hypoxia-inducible factor released during preconditioning (8). This factor binds to the CD73 gene promoter. In the nervous system, CD73 serves in the release of neurotransmitter in cholinergic synapses. After injury, it is up-regulated in microglial cells, Schwann cells, and so forth. The extracellular hydrolysis of nucleotides is of functional importance during synaptic transmission, but also in the survival and differentiation of neural cells *in vitro* and probably during neuronal development.
- *Cytosolic 5'-NT.* There are three cytosolic 5'-NT (c5'-NT), cN-I, cN-II, and dNT-1, and one mitochondrial dNT-2. cN-I is not detected in peripheral blood leukocytes, but aberrant expression in malignant cells is associated with a nucleoside analog resistance in chemotherapy (9). cN-I is responsible for most of the adenosine production in hypoxic and ischemic heart disease. CN-II hydrolyses guanine- and hypoxanthine-containing nucleotides.

## CD74 (INVARIANT CHAIN, IC)

*Structure.* CD74 type II integral membrane protein (i.e., N-terminal intracellularly). There are four distinct forms of CD74 as a result of alternative initiation of translation (p35) or alternative splicing (p41). A sequence in CD74 is homologous to the repetitive sequences of thyroglobulin. Alternative initiation of translation from this form generates another variant (p43) (1).

In the extracellular region, the membrane-proximal sequence has the class II-binding site

(amino acids 81 to 109) and the C-terminal is a largely  $\alpha$ -helical sequence and contributes to the formation of trimers (residues 163 to 183), whereas the transmembrane sequence contributes to the stability of the trimers and its trimerization (2).

The transmembrane region exists as a left-handed  $\alpha$ -helical coiled coil, and Gln47 forms strong interhelical contacts within the trimers; it is also implicated in lysosomal targeting after internalization from the plasma membrane, in addition to dileucine signals from the cytoplasmic tail.

From the cytoplasmic region (residues 1 to 30), the EQLP sequence is essential for targeting the invariant (Ii) chain to the endosomal compartment, and in its absence, the Ii is directed to the membrane (3). The cytoplasmic region contains two dileucine-like signals required for trans-Golgi network sorting and endosomal targeting.

A single peptide (residues 81 to 104) of the p33 form binds to class II molecules and has been called CLIP (class II-associated invariant chain peptide). The CLIP peptides bind to the peptide-binding groove of the class II molecule (4). Synthetic CLIP inhibits peptide loading to the human class II *in vitro*.

Deletion or truncation of the region of Ii containing CLIP results in failure of association of the Ii and the MHC class II molecule. Expression of Ii has been detected on the cell membrane independent of concomitant expression at class II antigens.

*Gene locus.* 5q32.

*Molecular mass (kd).* 33, 33, 41, 43.

*Distribution.* CD74 is expressed intracellularly in MHC class II-expressing cells, moderately in B cells, and weakly on monocytes, some activated T cells, and epithelial cells.

*Function.* Ii transports class II molecules to the endosomal compartments for loading with antigenic peptides. In this function, it acts as a chaperon, that is, facilitates the assembly of class II dimer by binding and stabilizing partially folded subunits, preventing their misfolding during the assembly process. Chaperon duties of Ii for MHC II are discharged by CLIP, which binds to the groove of MHC II. In the absence of Ii, the class II polypeptide chains remain permanently aggregated in the ER. The transporting function of CD74 is regulated by the 16-residue N-terminal sequence of the cytoplasmic tail, which contains the ER retention signal. After leaving the ER, the Ii/class II complex traverses the Golgi, where sialic acid is added to the N-linked glycans on all three chains.

The next destination of the complex is the endocytic compartment and, specifically, vesicles, selectively enriched in class II molecules, which serve as intermediates in the transport of newly synthesized class II molecules to the cell surface. Those are distinct from conventionally defined endosomes and lysosomes. They have been called *class II-enriched vesicles* (CIIV) or MHC II vesicles (MIIC). MIIC appear more lysosomelike than CIIV. Release of CLIP from MHC II for peptide loading is mediated by HLA-DM.

Unlike classical HLA molecules, the HLA-DM, which are structurally related to MHC class II, reside in the MIIC vesicles but not on the cell surface. They catalyze the dissociation of CLIP by binding to class II molecules transiently in the acidic environment (5). DM

exerts an editing effect on peptides loaded to class II.

Once dislodged from MHC class II, Ii is degraded by a cysteine protease, cathepsin S. Cathepsin S activity is tightly linked to Ii degradation and the trafficking of the Ii/class II complexes (6).

The invariant chain coprecipitates with a fraction of CD1d molecules when both are expressed in the same cell (7). It directs CD1d to an intracellular compartment that overlaps with Lamp-1<sup>+</sup> late endosomes/lysosomes. In knock-out Ii<sup>-/-</sup> mice, CD1d does not associate with the Ii chain, which it normally does in the ER, and is unable to present to Va14<sup>+</sup> NKT cells “self” lipids, structurally homologous to  $\alpha$ -galactosyl ceramide. This translates into a defect of CD1d function with failure to select, activate, and expand the population of CD1d-dependent NKT cells, which regulate responses of adaptive immunity against mycobacterial infections (8).

A secreted form of the invariant chain, which lacks the sequences for targeting to the endosomal compartment but contains the CLIP sequence, inhibits T-cell activation in an *in vitro* system. This form acts directly on APCs and inhibits antigen presentation to T cells (9).

A 65-amino acid fragment of the p41 splice variant binds to the active site of cathepsin L and facilitates the maintenance of a pool of the mature enzyme in the endosomal compartment of macrophages and DCs. A complex of this fragment with cathepsin L is detected in cultured supernates of APCs, and the complex is up-regulated by inflammatory stimuli (IFN- $\gamma$ , LPS). This complex may have an important role in elastin degradation during inflammation.

## CD79A [MB1, IMMUNOGLOBULIN (Ig) $\alpha$ ] AND CD79b (B29, Ig $\beta$ )

*Structure.* CD79a and CD79b form a disulfide-linked heterodimer, which is noncovalently associated with the membrane Ig (mIg) on B cells. Recent evidence indicates that there is only one heterodimer per BCR (1).

Both CD79a and CD79b have one Ig-like domain in the extracellular region, type C2 for CD79a and type V for 79b.

A point mutation (pro to leu) in the extracellular region of the Iga impairs the ability of the Iga/ $\beta$  heterodimer to bind to mIgM.

The transmembrane regions of Iga and Ig $\beta$  have Glu and Gln residues, respectively, opposing the polar retention sequence TFAST of the transmembrane region of the  $\mu$ -chain, forming contact points. The same transmembrane regions of Iga and Ig $\beta$  associate with other Ig isotypes.

The cytoplasmic regions of each molecule have an ITAM, which links them to signaling molecules.

*Gene locus.* 79a, 19q13.2; 79B, 17q23.

*Molecular mass (kd).* 79a, 33; 79b, 38.



*Distribution.* Both are restricted to B lymphocytes, first appearing on the surface of pro-B cells and remaining throughout the stages of B-cell differentiation, except in plasma cells. This may be the reason that normal plasma cells and some myeloma cell lines lack expression of surface Ig ( [2](#), [3](#) ).

*Function.* The Iga- and Igβ-chains are important during B-cell development and B-cell function.

- *B-cell development.* In Igβ<sup>-/-</sup> transgenic mice, B-cell development is blocked at the pro-B cell stage. The expression of Iga/Igβ during B-cell development is distinct from Ig expression and occurs before Ig gene rearrangements. Iga/Igβ expression precedes the completion of Ig gene rearrangements, and pro-B cells express both Iga- and Igβ-chains, whereas the μ-chain is first detected at the pre-B cell stage. In the absence of either molecule, B-cell development is arrested ( [4](#) ). Mutations of the Iga-chain result in complete arrest of B-cell development ( [5](#) ). The Iga/Igβ complex associates with the pro-BCR and, later, pre-BCR complexes before the light chain genes start to rearrange. Several functions of the pro-B cell stage (i.e., expression of the early B-cell marker CD19, interactions with bone marrow stromal cells, and early stages of V<sub>H</sub>DJ<sub>H</sub> gene rearrangements) are independent of Iga/Igβ.
- *Expression of BCF.* Display of the BCR on the cell membrane requires an intact Iga/Igβ heterodimer, because mIgM cannot travel to the cell membrane without the association in the ER with Iga/Igβ. Mutation in the extracellular region of Iga abolishes the association of Iga with IgM and its ability to be recognized by the ER quality control system for export, through the secretory pathway, to the membrane.
- *Antigen internalization.* mIg binds antigen and triggers the internalization of the mIg-antigen complex. The efficacy of this function is ascribed to the Iga/Igβ heterodimer ( [6](#) ). Antigen presentation is not effective in the absence of Iga/Igβ, and the cytoplasmic region of the Igβ-chain can restore this function of mIg ( [7](#) ).
- *Signaling.* BCR consists of the mIg, which constitutes the antigen-specific module, and the Iga/Igβ heterodimer, which is the signal transduction module ( [8](#) ). The cytoplasmic region of mIgM is only three amino acids long and is therefore unable to link to intracellular signaling molecules. Cross-linking of IgM stimulates phosphorylation of the ITAMs in the Iga/Igβ-chains. The Src PTKs, Lyn, and Fyn phosphorylate these ITAMs with initial preference for the N-terminal ITAM tyrosines of Iga and Igβ, followed by the C-terminal tyrosines. Coupling of Syk to distal signaling molecules requires the linker protein BLNK ( [9](#) ).
- *CD79 as a marker for B-lymphocytic malignancies.* Because CD79 is restricted to B lineage, its detection has been suggested for identification of B-cell malignancies by flow cytometry or histochemistry ( [10](#) ). Although results originally were encouraging, with wider use of the technique, it was found that CD79 is weakly expressed in precursor T-cell lymphoblastic lymphomas ( [11](#) ), T-ALL ( [12](#) ), and precursor T-cell lymphoma as well ( [13](#) ) (see more details in [Chapter 16](#) ).

## CD80 (B7-1)

*Structure.* CD80 belongs to a family of co-stimulatory molecules critical in T-cell activation and immune regulation. T-cell activation and immunity require the delivery of two signals: one antigen-specific (signal 1) and a second co-stimulatory or antigen-nonspecific (signal 2) ( [1](#), [2](#) ).



The extracellular region of CD80 contains two Ig-like domains, N-terminal V-type and a membrane-proximal C1 type. The  $\beta$  strands of V domain form two  $\beta$  sheets with three and six strands. Overall, this domain is structurally similar to the CD2 N-terminal domain.

A conserved hydrophobic sequence of CTLA-4 and CD28<sup>99</sup> provides a large surface in the interaction with a high degree of complementarity. Neighboring CD80 molecules form homodimers by side-to-side contacts (3) or possibly larger multimers bridging neighboring homodimers. A strong contact area between the T cell and the APC increases the avidity of interaction as a result of oligomerization.

Despite structural similarities between the V domain of CD80 and the first domain of CD2, CD80 interacts with CTLA-4 at right angles, which provides strong adhesion in contrast to CD2.

The C domain is linked to the membrane by eight hydrophilic residues, forming the stalk.

The transmembrane region has three cysteines, which may be involved in covalent interactions with other membrane proteins.

*Gene locus.* 3q13.3–q21.

*Molecular mass (kd).* 60.

*Distribution.* CD80 is detected on various cells with APC function (i.e., macrophages, DCs, B cells, Langerhans cells) after CD40/CD40L interaction. Adjuvants strongly up-regulate CD80 expression, which may form the basis of their potentiation of the immune response. CD80 is down-regulated by IL-10, TGF- $\beta$ , and cross-linking of CD32 (FcR $\gamma$ -II).

*Function.* CD80 binds with low affinity to CD28 and high affinity to CTLA-4 (CD152) (4). Through CD28, it delivers a co-stimulatory signal and, through CD152, an inhibitory signal. The co-stimulatory signal or signal 2 is not antigen specific or MHC restricted but is essential in triggering T-cell activation. In the absence of signal 2, T cells become anergic or unresponsive. CD80/CD28 co-stimulation results in T-cell proliferation (clonal expansion), secretion of cytokines, and promotion of cell survival (increase of expression of antiapoptotic protein Bcl-X<sub>L</sub>) (5).

Co-stimulation is not required under strong and sustained antigenic stimulation, whereas it is essential for low levels of antigen because it decreases the threshold of T-cell activation. It is important for naïve, but not for primed, T cells, especially after prolonged, frequent, and intense exposures to antigen.

CD80/CD28 interaction regulates Th1/Th2 balance, is essential for Ig class switching and germinal center formation, and has an interdependent relationship with the CD40/CD40L pathway (6). CD80/CD28 and CD40/CD40L interactions are synergistic; the former up-regulates CD40L, and, in turn, the latter up-regulates CD80, thus strongly amplifying co-stimulatory functions. CD80/CD28 co-stimulation directly augments CD8<sup>+</sup> CTL responses in the absence of CD4<sup>+</sup> T-cell-derived cytokines (7).

In the thymus, CD80 may block negative selection and allow development of autoreactive cells. Perinatal blockade of CD80 also inhibits clonal deletion of lethal autoreactive T cells

in mice ( [8](#) ).

CD80/CD28 co-stimulation is essential in the control of the development of spontaneous autoimmune diabetes in nonobese diabetic mice by immunoregulatory T cells ( [9](#) ). CD80-mediated co-stimulation has been studied extensively in transplantation and tumor immunity ( [10](#) ). Blockade of the CD80/CD28 pathway by CTLA-4 Ig, a high-affinity inhibitor of CD80-mediated co-stimulation, induces long-term tolerance in some models.

CD80 expression was detected on T cells from skin lesions of patients with psoriasis and mycosis fungoides ( [11](#) ).

## CD81 (TAPA-1: TARGET FOR ANTIPROLIFERATIVE ANTIBODY-1)

*Structure.* CD81 is a member of the tetraspanin family, which spans the cell membrane four times. The extracellular region consists of two loops, a small (SEL or EC1) between transmembrane (TM) regions TM1 and TM2 and a large (LEL or EC2) between TM3 and TM4. LEL domain contains four invariant cysteines, two of which define the conserved sequence Cys-Cys-Gly. Each LEL is composed of five  $\alpha$ -helices (A through E). The first and last form a stalk supporting a mushroom-shaped head domain. The head is stabilized by two disulfide bridges. Two hydrophobic patches in the head are indicative of a design for the purpose of protein-protein interactions in keeping with the propensity of CD81 to form multimolecular complexes with other tetraspanins and integrins. The sequence between TM2 and TM3 is the most conserved region in all tetraspanins, whereas LEL is the most variable. It is encoded by exon 6, containing within it the CCG sequence detected in all tetraspanins.

*Gene locus.* 11p15.5.

*Molecular mass (kd).* 26.

*Distribution.* It is detected on most human tissues, except RBCs and platelets.

*Function.* CD81 is associated in a multimolecular complex within the CD19, CD21 co-receptor, which reduces the number of BCRs necessary to trigger B-cell activation ( [1](#), [2](#) ). It delivers a co-stimulatory signal for thymocyte proliferation through IL-2 induction and, in peripheral T cells, stimulates preferentially a Th2 cytokine response ( [3](#) ).

An important property of CD81, and of all tetraspanins, is the formation of multimolecular complexes with other tetraspanins, as well as with integrins forming the "tetraspan web," a kind of molecular "organizer" ( [4](#) ). These tetraspanin complexes are facilitators of several functions related to cell adhesion and migration ( [5](#), [6](#) ). Some associations of tetraspanins with integrins are selective (i.e., CD81/ $\alpha_4\beta_1$ , CD51/ $\alpha_5\beta_1$ , and CD151/ $\alpha_6\beta_1$ ) ( [7](#) ). CD81 and CD151 are responsible for associating these integrins to other tetraspanins, probably through interactions with other tetraspanins.

All tetraspanins tested have palmitate attached on cysteines, and palmitoylation sites are conserved among members of the family. Palmitoylation is critical for formation of the "tetraspan web," as well as for targeting to subcellular compartments and the maintenance of cell morphology.

The tetraspanin prototype complexes (i.e., CD81/ $\alpha_3\beta_1$ ) form discrete units independent

of lipid microdomains, although they may also associate with microdomains resembling lipid rafts ( [8](#) ).

The complexes with integrins are concentrated on punctate adhesion structures, which resemble the Rac-dependent, peripheral focal complexes and point contacts, related to cell migration. The CD81 and  $\alpha_3\beta_1$  integrin clusters associate with talin and MARCKS and enhance tyrosine phosphorylation of the FAK or PI4K, forming complexes at the cell periphery. This signaling pathway plays a key role for cell motility and is distinct from the more conventional integrin signaling through FAK.

Tetraspanins link integrins to PKC with the extracellular large loop associating with the integrins, and the first two transmembrane regions and cytoplasmic tails connecting with PKC, which is activated and phosphorylates the  $\alpha_3$  integrin cytoplasmic tail ( [9](#) ).

CD81 forms important adhesion complexes with the tetraspanins CD9 and CD151 ( [10](#), [11](#) ) and regulates integrin activation and adhesiveness, which control cell motility into matrix. Migration is accompanied by remodeling of the extracellular matrix (i.e., degradation of the preexisting and deposition of new components) and formation of capillary-like cords by migrating endothelial cells. The complexes are detected in the endothelial lateral junctions, a location important for the functions they regulate.

Polarized epithelial cells form strong intercellular adhesion, such as desmosomes and tight junctions, which are cadherin dependent. Tetraspanin-integrin complexes support the cadherin-independent step of intercellular adhesions involving clustering of the appropriate receptors to bring about cell-cell and cell-matrix interactions ( [12](#) ). Both are strongly expressed in human keratinocytes along the filopodia and the lateral and apical surfaces and inhibit keratinocyte migration ( [13](#) ).

In nervous tissue, tetraspanin-integrin complexes contribute differentiation of immature neurons to assume polarized morphology, with extensions of distinct mature neurons and dendrites.

The functionally relevant complexes in this system are between the tetraspanins CD81, CD151, and the  $\alpha_3\beta_1$  integrin. The neurite outgrowth depends on engagement of  $\alpha_3\beta_1$  because it takes place only on laminin-5 substrate, the  $\alpha_3\beta_1$  ligand, but not on laminin-1 ( [14](#) ).

CD81 in complex with CD9 promotes myogenesis; it stimulates myoblast differentiation, fusion, and myotube formation and maintenance ( [15](#) ).

CD81 participates in an intercellular trafficking communication system mediated by exosomes, which are small membrane vesicles (50 to 90 nm) ( [16](#) ). They were originally detected in association with terminally differentiating reticulocytes containing CD71. Subsequently, they have been identified in platelets, DCs, cytotoxic and activated T cells, and so forth. B cell-derived exosomes carrying MHC class II molecules have been identified on the surface of DCs. CD81-containing exosomes released from activated T cells were taken up by CD81<sup>-</sup> cells co-cultured with T cells. The functional importance of intercellular CD81 transfer by exosomes remains to be seen, but existing data suggest that exosomes play an immunoregulatory role in the immune system.

Members of a small new family of proteins are the latest group of proteins, which are major partners of CD81 and CD9, and form highly specific stoichiometric complexes.

These proteins belong to the IgSF and contain the Glu-Try-Ile motif (EWI with the amino acid letter code), which is not present in the usual IgSF members. They are EWI-2, EWI-3 (or PGRL for prostaglandin regulatory-like protein or IgSF-3) ([17](#), [18](#)), EWI-F (or FPRP for prostaglandin Fa<sub>2</sub> receptor regulatory protein or CD9P-1) ([19](#)), and EWI-101 (or CD101).

EWI-2 is detected in every tissue tested so far. EWI-2 has an especially strong association with CD81 and CD9 and is a candidate for involvement in diverse functions ascribed to CD81 and CD9, such as tumor cell metastasis, nervous system development, cell proliferation, myogenesis, oocyte fertilization (CD9), and hepatitis C pathogenesis (see below). PGRL and FPRP have similar sequences and are negative regulators of PG and PGF<sub>2a</sub> receptors. PGs are inflammatory mediators produced from arachidonic acid by the action of cyclooxygenases (COX-1 and COX-2). PGE<sub>2</sub> is abundant in the thymus, its production being regulated by cortical and medullary epithelial cells, and facilitates differentiation of T cells from double-negative thymocytes. Inhibition of PGE<sub>2</sub> synthesis impairs adhesion of CD4<sup>+</sup>8<sup>+</sup> thymocytes to stroma. PGE<sub>2</sub> from macrophages suppresses Th1 responses and augments Th2 responses. The role of PGRL and FRL on regulation of prostaglandin receptors through CD81/CD9 remains to be determined.

The chronic hepatitis C virus binds through its E2 envelope protein to the major ECL of human C81 ([20](#)).

Cross-linking of CD81 on NK cells by E2 inhibits cytokine and IFN- $\gamma$  production and NK cell cytotoxicity (granule release) ([21](#)). Insufficient production of IFN- $\gamma$  by NK cells in response to IL-12 and IL-15 could alter development of Th1 responses. A Th1 versus Th2 imbalance has been recently described in hepatitis C virus-infected individuals.

## CD85: CD85a TO CD85m

### Nomenclature

Under the cluster designation CD85 are 13 members, which act as receptors for MHC; they belong to the IgSF and are known by two additional terminologies: (a) Ig-like transcripts (ILTs) and (b) leukocyte Ig-like receptors (LIRs). They also are termed *monocyte/macrophage inhibitory receptors* (MIRs). They are encoded by genes forming a cluster in human chromosome 19q13.4, the leukocyte receptor complex (some disagree that the group of these genes is, genetically speaking, a “complex”). The leukocyte receptor complex contains two ILT gene clusters (separated by a group of genes with unknown function), and further telomeric to the second cluster is the KIR cluster. The gene for the Fc receptor for IgA (CD89) is on the telomeric side of the KIR cluster.

Between the two ILT clusters are the genes for two other receptors, LAIR1 and LAIR2 (leukocyte-associated Ig-like receptor). The ILTs/LIRs are detected on B cells, monocytes, macrophages, DCs, and so forth, whereas the KIRs are expressed on NK and T cells.

In the ILT/LIR/MIR system, some proteins have two (or even three) designations (i.e., ILT1/LIR-7, ILT2/LIR-1), whereas others have only one (i.e., ILT7, LIR-8, and so forth) ([1](#), [2](#), [3](#) and [4](#)).

The MHC receptors in general can be separated functionally into two categories: *inhibitory* or *activating*. The former have a long cytoplasmic tail with one or more ITIM motifs, which attract protein tyrosine phosphatases. The latter have a short cytoplasmic

tail, lack ITIMs, and have a positively charged amino acid within their transmembrane region, and for signaling, they associate with ITAM-containing adaptor proteins like DAP12 or FcR $\gamma$ -chain (for ILTs). All these molecules show 63 to 84% identity with the prototypic LIR-1 sequence. The ILTs/LIRs are structurally related to human Fc $\alpha$ R (CD89). (See table in [CD39](#) for classification proposed during the seventh HLDA workshop, Harrogate UK, June 2000. See also <http://www.gene.ucl.ac.uk/nomenclature/genefamily/lilr.html>; <http://www.ncbi.nlm.nih.gov/prov/>; and Andre P, Biassoni R, Colonna M, et al. New nomenclature for MHC receptors. *Nat Immunol* 2001;2:661.)

### **ILT: Immunoglobulin-Like Transcript-1**

ILT1 (LIR-7) has a short cytoplasmic tail and is selectively expressed on myeloid cells. It is associated with Fc $\epsilon$ RI $\gamma$  rather than DAP12 and delivers an activating signal with Ca<sup>2+</sup> mobilization and release of serotonin.

It has been detected on macrophages and the synovium of patients with rheumatoid arthritis. In the same patients, however, ILT4, an inhibitory receptor, is also detected. It is likely that activating and inhibitory receptors regulate the activation of infiltrating leukocytes.

### **ILT-2**

ILT2 (LIR1, CD85d) is the prototype of this group and contains four extracellular Ig domains and a cytoplasmic tail with four ITIM motifs. Two alternatively spliced forms exist, one lacking ITIMs. The cytoplasmic region is fully hydrophobic. ILT2 recognizes a broad range of class I molecules as compared to KIRs because it binds to many alleles of the HLA-A and -B and is not limited to one allele in each locus. It recognizes HLA-G1 and HLA-E, the nonclassical HLA molecules.

Through its N-terminal Ig domain, it interacts with the nonpolymorphic  $\alpha$ 3 domain of class I MHC. On engagement with its ligand, ILT2 associates with SHP-1 phosphatase, delivering an inhibitory signal.

The cytoplasmic region of ILT2 has four tyrosines, but only two are within ITIM consensus sequences. The docking sites for SHP-1 are tyrosine 644 (SIYATL) and tyrosine 614 (VTYAQL), whereas tyrosine 533 plays a pivotal role in promoting phosphorylation of the SHP-1 docking sites.

Recruitment of SHP-1 phosphatase reduces phosphorylation of TCR $\gamma$ -chain and LAT (see [Chapter 17](#)). As a result, ILT2 inhibits rearrangements of actin cytoskeleton. The inhibitory effect is concentrated at the APC-T cell interface because the TCR and ILT2 are polarized at the immunologic synapse. Cross-linking of ILT2 inhibits antigen-specific T-cell proliferation and increase of secretion of IL-10 and TGF- $\beta$  cytokines, which down-regulate immune responses. When ILT2 is not engaged, antigen-specific CD4<sup>+</sup> T-cell activation leads to IL-2, IFN- $\gamma$ , IL-13 production, and T-cell proliferation.

ILT2 is detected on the surface of only a small number of CD3<sup>+</sup> T cells, but it is present in the cytoplasm of all T cells. It inhibits CD3/TCR-mediated activation of both CD4<sup>+</sup> and CD8<sup>+</sup> T-cell clones and down-regulates antigen recognition by CD8<sup>+</sup> T cells. ILT2 is detected not only on NK and T cells but also on myeloid and naïve B cells. It inhibits Ca<sup>2+</sup> mobilization, triggered by BCR on B cells and on monocytic cells by surface-expressed

HLA class II molecules. It is likely that ILT2 regulates the B-cell triggering threshold and inhibits killing by NK and T cells.

Human CMV infects 70 to 90% of adults. It occurs early in life and lasts as a latent infection for a lifetime. CMV triggers the synthesis of a protein, UL18, which is homologous to class I MHC; it is associated with  $\beta_2M$ , and binds endogenous peptides on its peptide groove (5). It is displayed as class I decoy molecule on the surface of CMV-infected cells, which may have become targets for KIRs because of down-regulation of their MHC as a result of the infection. ILT2 inhibitory receptor binds to UL18 with greater than 1000-fold higher affinity than normal MHC, thus compensating for the very low levels of UL18 expression. Interaction of ILT2 with class I MHC at the molecular level resembles the interaction of CD4 with MHC class II, rather than KIR with class I MHC. ILT2 and CD4 interact with the nonpolymorphic domains of MHC, whereas KIR interacts with the polymorphic groove area. CMV infects monocytes, which are strongly ILT2<sup>+</sup>, and UL18 expression may limit antiviral monocytic functions as a result of the strong inhibitory signals from ILT2/UL18 interactions. A subpopulation of these monocytes is a major source of IFN- $\alpha$ , which is necessary for CMV-induced NK-cell cytotoxicity.

ILT2 was also detected in some cutaneous lymphoma cell lines and circulating malignant CD4<sup>+</sup> T cells, which usually express KIR (CD158k) receptors. The ILT2<sup>+</sup> CD4<sup>+</sup> Sézary cells were less susceptible to anti-CD3 induced cell death.

### ILT-3

ILT3 (LIR5) is closely related to Fc $\alpha$ R and is expressed on B cells and DCs. It is inhibitory to APC function, is involved in antigen uptake, and targets ligands into processing and peptide-loading compartments.

### ILT-4

ILT4 (LIR2) exists as six alternatively spliced variants, some with short cytoplasmic tails, which lack ITIMs. It binds tyrosine phosphatase SHP-1. Co-ligation with FcR $\gamma$ I (CD64) inhibits Ca<sup>2+</sup> mobilization and tyrosine phosphorylation of the associated  $\gamma$ -chain and Syk kinase.

It inhibits monocyte activation signals and regulates cytolytic and inflammatory responses that might be triggered against self-antigens by monocytes (6). It binds to HLA-G, a nonclassical class I antigen expressed by human trophoblasts of the placenta, protecting the developing embryo.

### ILT-5

ILT5 (LIR3) shows striking diversity, with amino acid variants clustered in several distinct sequences of the extracellular region. Alternatively spliced forms exist, which lack ITIMs.

## REFERENCES

1. Volz A, Wende H, Laun K. Genesis of the ILT/LIR/MIR clusters within the human leukocyte receptor complex. *Immunol Rev* 2001;181:39-51.
2. Barten R, Torkar M, Haude A, et al. Divergent and convergent evolution of NK-cell receptors. *Trends Immunol* 2001;22:52-57.



3. Borges L, Cosman D. LIRs/ILTs/MIRs, inhibitory and stimulating Ig-superfamily receptors expressed in myeloid and lymphoid cells. *Cytokine Growth Factor Rev* 2000;11:209–217.
4. Andre P, Biassoni R, Colonna M, et al. New nomenclature for MHC receptors. *Nat Immunol* 2001;2:661.
5. Chapman TL, Heikema AP, Bjorkman PJ. The inhibitory receptor LIR-1 uses a common binding interaction to recognize class I MHC molecules and the viral homolog UL18. *Immunity* 1999;11:603–613.
6. Fanger NA, Cosman D, Peterson L, et al. The MHC class I binding proteins LIR-1 and LIR-2 inhibit Fc receptor-mediated signaling in monocytes. *Eur J Immunol* 1998;28:3423–3434.

## CD86 (B7-2, B70)

*Structure.* CD86 is a member of the IgSF, related structurally and functionally to CD80. It consists of two Ig-like domains, an *N*-terminal V-type and a membrane-proximal C2 type. As with CD80, certain amino acids in the  $\beta$  strand G in the IgV domain and in the  $\beta$  strand A of the IgC domain are critical for binding to CD28 and CTLA-4. However, the whole GFC' face of the IgV and ABED sheet of the IgC provides the complete requirements for binding.

The cross-linked IgV domain of CD86 has the most potent co-stimulatory activity at concentrations approximately 100-fold lower than cross-linked whole CD86 for proliferative activity and cytokine secretion. This indicates that variants or even truncated forms may regulate co-stimulation.

The crystal structure of a CD86/CTLA-4 complex has been solved at a 3.2-Å resolution. Direct observation of the complex shows that each molecule binds by its front sheet. The CD86 strands G, F, C, C', and C $\beta$  form a shallow concave surface, and the FG loop of CTLA-4, which corresponds to the complementarity-determining region, CDR3-like segment, packs against it (1). CD86 interacts with dimers of CTLA-4 or CD28. CTL-4 and CD28 are homodimers, and the residues contributing to homodimer formation of CTLA-4 are distally located from those contributing to the CD86/CTLA-4 interface. More significantly, they are conserved, indicating that homodimerization has an important biologic function. CD86 interacts with other homodimers, thus forming an alternating periodic structure within the immunologic synapse that is able to provide distinct signaling mechanisms. Oligomerization of CD86 increases high affinity for binding the counter-receptors (1).

*Gene locus.* 3q21.

*Molecular mass (kd).* 80.

*Distribution.* CD86 is strongly expressed on resting monocytes and DCs and is weakly expressed on B and T cells and on eosinophils, which after activation by IL-3 are B7<sup>+</sup>. In other tissues, CD86 is expressed in salivary gland epithelia of patients with Sjögren syndrome (2), in bronchial epithelial cells after lung transplantation, and in glomerular endothelium from cats submitted to renal ischemia. Kidney biopsies from patients with interstitial nephritis showed expression of CD86 (and CD80) by the renal epithelial cells (3). CD86 expression is up-regulated in B cells by IL-4 and in monocytes by IFN- $\gamma$  and is down-regulated by IL-10. Soluble CD86 has been detected in blood from certain cases of AML or B-CLL.

*Function.* In general, CD86 (as well as CD80) provides the second signal for T-cell



activation and has overlapping roles with CD80 in co-stimulation (4). B7 co-stimulation is critical for CD4<sup>+</sup> and CD8<sup>+</sup> cell activation and differentiation. Naïve, but not activated, T cells are highly dependent on Th2, but not Th1, cytokine production.

However, the strength and duration of CD28 engagement and cross-linking determine the differential effects of co-stimulation on the cytokine profile (strength of signal hypothesis).

Naïve T cells exposed *in vitro* to DCs in the absence of antigenic stimulation become CD86<sup>+</sup>. Similarly, T cells from peripheral blood of patients with thyroiditis or neoplastic ascites are also CD86<sup>+</sup>. CD86<sup>+</sup> T cells reside in T-cell areas of lymph nodes or migrate to areas of inflammation in the periphery, where they may be able to provide co-stimulation to naïve T cells.

CD86 and CD80 play a critical role in cross-priming of CD8<sup>+</sup> T cells. Cross-priming implies the sensitization to an exogenous antigen of CD8<sup>+</sup> T cells by APCs (DCs) that have endocytosed the antigen. The initial step in cross-priming is the activation of APCs by CD4<sup>+</sup> T cells through a CD40L/CD40 interaction, which in turn up-regulates co-stimulatory molecules CD86 or CD80. In the second step, the APCs directly prime CD8<sup>+</sup> T cells for CTL function (5).

For humoral immunity, CD86 is important for initiating antibody response, even in the absence of the action of adjuvants, which enhance antibody responses by up-regulating expression of CD80. Class-switch and germinal center formation depend on CD86 expression.

Salivary gland epithelial cells from patients with Sjögren syndrome (autoimmune epithelitis) constitutively express CD86 (and CD80), which can stimulate T-cell proliferation and IL-2 production, and release soluble forms of CD86 (2). The findings suggest that epithelial cells potentially have a role in antigen presentation and thus regulate immune responses locally.

Results from mice deficient in CD86 have shown that co-stimulation is critical for the induction, as well as the effector phases, of experimental allergic encephalomyelitis.

The roles of the two co-stimulatory molecules differ. Anti-CD80 antibody reduces the incidence of the disease, whereas the anti-CD86 antibody increases disease severity. The anti-CD80 allowed the generation of Th2 clones, which, on transfer to other animals, prevented induction of the disease and abrogated established disease. The effect of these clones was, at least partially, due to IL-4 secretion (6).

Activated (but not resting) eosinophils express HLA-DR antigens and CD86 (but not CD80). They are capable of stimulating proliferation of T cells in response to superantigen toxic shock syndrome toxin 1 (7). T-cell clones to tetanus toxoid or influenza hemagglutinin also proliferate in response to antigenic peptides presented by activated eosinophils but not in response to naïve antigens. Activated eosinophils apparently have antigen-presenting but not antigen-processing capacity.

The heat labile enterotoxin from *E. coli* and the closely related cholera toxin have adjuvant activity for both systemic and mucosal immunity. These properties are due to

the up-regulation of B7 molecules ( [8](#) ).

## CD87 (uPAR: UROKINASE PLASMINOGEN ACTIVATOR RECEPTOR)

*Structure.* Plasminogen is activated to plasmin by three systems, one of which is called the *extrinsic*, and involves two activators: the tissue type (tPA) and the urokinase type (uPA). uPA is a disulfide-linked two-chain (A and B) protein with serine proteinase activity. CD87 is the receptor for this enzyme and binds to its chain.

Urokinase plasminogen activator receptor (uPAR) is a GPI-anchored protein, which consists of three cysteine-rich domains, D<sub>1</sub>, D<sub>2</sub>, and D<sub>3</sub>.

In addition to uPA, CD87 is a receptor for several other proteins, that is, vitronectin, kininogen, gp130, and integrins. uPA cleaves plasminogen at the Arg<sup>560</sup>-Val<sup>561</sup> bond, and cleavage of uPAR occurs at a similar bond, Arg<sup>83</sup>-Val<sup>84</sup>, of the linker sequence between D<sub>1</sub> and D<sub>2</sub>, with D<sub>1</sub> containing the uPA-binding site.

*Gene locus.* 19q13.

*Molecular mass (kd).* 35 to 59 (unreduced).

*Distribution.* CD87 is expressed on monocytes, granulocytes, activated T cells, and a subset of activated NK cells, and widely on nonhematopoietic tissues.

*Function.* uPAR is a pleiotropic molecule involved in multiple basic process, that is, adhesion, chemotaxis, and cell migration, which make uPAR an important player in inflammation, metastasis, and tissue repair ( [1](#) ).

- *uPA-uPAR interaction.* Proteolytically active uPA is generated by “reciprocal zymogen activation,” that is, uPA binds to uPAR and activates cell-bound plasminogen for generation of plasmin. Through a positive feedback mechanism, plasmin converts uPA to a two-chain active enzyme that is susceptible to inhibition by the plasminogen activator inhibitor (PAI), which binds to the uPAR/uPA complex. The entire trimolecular complex is internalized by the low-density lipoprotein receptor-related protein (LRP) (see [CD91](#)); the uPA-PAI-1 is destroyed in the lysosomes, whereas uPAR recycles back to the cell surface ( [2](#) ). uPA binds to uPAR by its aminoterminal region of the A chain, whereas the catalytic domain is located in the B chain, cleaves the receptor, and releases the ligand-binding D<sub>1</sub> domain. uPA bound to uPAR activates plasminogen, and it forms plasmin at pericellular locations, at focal contact sites with extracellular matrix proteins, and at the leading edge of migrating monocytes. This is a fundamental mechanism, which underlies several types of cell migration.
- *Chemotaxis.* uPA cleaves uPAR at two sites in the D<sub>1</sub>-D<sub>2</sub> linker sequence ( [3](#) ). Cleavage at the first site exposes residues 88 to 92 (SRSRY), which require a transmembrane adaptor to stimulate chemotaxis. The second site is at position 89/90 (i.e., within the chemotactic epitope) and destroys its chemotactic activity. The fact that intact GPI-linked uPAR, as well as the soluble uPAR, possesses chemotactic activity suggests that this activity depends on an adaptor molecule, which connects them to intracellular signaling pathways. The matrix MMP-12 cleaves uPAR, releases D<sub>1</sub> from D<sub>2</sub>/D<sub>3</sub>, and exposes the chemotactic epitope, which is down-regulated by the PAI-1 ( [4](#) ).

- *uPAR–integrin associations* ( [5](#), [6](#) and [7](#)). The  $\beta_2$  integrins are transmembrane uPAR partners; uPAR binds to a site of the  $\alpha$ -chain of Mac-1 (CD11b), close to the fibrinogen-binding site, and inhibits the fibrinogen binding. uPAR and Mac-1 are located in proximity on human monocytes and form functional complexes ( [8](#)). MAC/uPAR association regulates the procoagulant and fibrinolytic functions of monocytes. Binding of uPAR to MAC-1 is mediated by non-I domain sites (atypical ligand), and the same interaction occurs with procoagulant factor X. Saturation of uPAR with uPA blocks factor X binding. Interaction of uPAR with MAC-1 is mediated by a site close to fibrinogen binding, which is degraded by the complex. uPAR/MAC-1 interactions are also important for the healing process in sites of inflammation, which facilitates leukocyte migration. uPAR is associated with other integrins (i.e.,  $\alpha_3\beta_1$ ,  $\alpha_V\beta_3$ ,  $\alpha_4\beta_1$ , and so forth) ( [9](#)). uPAR/ $\alpha_3\beta_1$  integrin complexes stimulate uPA expression and enhance plasminogen activation. In turn, uPA proteolytically processes laminin-5, a major matrix protein, and reduces cell motility.
- *uPAR and adhesior.* Cell adhesion to extracellular matrix by uPAR is regulated by uPA-induced oligomerization and the increase of its affinity, as well as exposure of novel binding sites for vitronectin.
- *uPAR in cancer and human disease.* The enzyme seprase (gelatinolytic protease) and the uPA-uPAR system form complexes on the leading invasive edge of the tumor cells and degrade the extracellular matrix, promoting the metastatic ability of malignant cells ( [10](#), [11](#)). Expression of uPAR is positively correlated with the rate of recurrence and mortality in patients, with adenocarcinomas of the endometrium constituting a useful prognostic marker ( [12](#)). In leukemias, uPAR is fragmented on leukemic cells, and the soluble uPAR level correlates with the number of AML cells and with poor response to chemotherapy ( [13](#)). uPAR is up-regulated in leukocytes of patients with HIV infection, and a high level of soluble uPAR in the serum is a major negative prognostic factor in HIV infection, independently of clinical status, viremia levels, and CD4<sup>+</sup> T-cell counts ( [14](#)).

## CD91 [ $\alpha$ -MACROGLOBULIN RECEPTOR; LOW-DENSITY LIPOPROTEIN (LDL) RECEPTOR-RELATED PROTEIN: LRP]

The low-density lipoprotein receptor family consists of several members, and one of them is LRP1 or CD91. LRP1 is the receptor for native  $\alpha_2$ -macroglobulin ( $\alpha_2$ M). Activated or structurally modified  $\alpha_2$ M binds to the  $\alpha_2$ \*M receptor or a  $\alpha_2$ M signaling receptor (a  $\alpha_2$ MSR).

*Structure.* The mature LRP is a heterodimer consisting of an extracellular 515-kd chain ( $\alpha$ -chain) and an 85-kd transmembrane  $\beta$ -chain.

It consists of 31 complement type repeats arranged in four groups known as the *ligand-binding domain* (LBD). Each LBD is followed by an EGF-precursor homologous domain (EGF-phd), which consists of two EGF-like repeats separated from a third by a spacer region, which contains the YWTD motif.

Receptors that undergo endocytosis use any of four potential endocytosis signals that target surface proteins to clathrin-coated pits: (a) tyrosine-based motifs, (b) NPXY, (c) dileucine motifs, (d) serine phosphorylation, and (e) attachment of ubiquitin moieties.

The tail of LRP (of 100 amino acids) contains two NPXY motifs, one YXXF (F is any

hydrophobic amino acid) and two dileucine motifs.

LRP does not conform to the “one receptor, one ligand” dictum, like the low-density lipoprotein receptor, but to “*one receptor, multiple ligands*” ( [1](#) ). As a multiligand receptor, LRP binds to “remnant” lipoproteins, that is, lipoproteins modified by hydrolases and by association and dissociation of proteins (apolipoproteins) (i.e., apoE, a  $\alpha_2$ -macroglobulin/protease complexes, plasminogen activator/inhibitor complexes, toxins, clotting factors, lipases, lactoferrin, the amyloid precursor protein, and so forth).

Binding of one ligand does not inhibit binding of another, and ligands cross-compete for the same site.

A receptor-associated protein, a protein that functions intracellularly as a chaperon protein, facilitates LRP folding and trafficking within the secretory pathway.

*Gene locus.* 12q13–q14.

*Molecular mass (kd).* 600;  $\alpha$ -chain, 515;  $\beta$ -chain, 85.

*Distribution.* CD91 is widely distributed in tissues of the body but is expressed most abundantly in the liver, brain, lung, and placenta.

*Function.* Proteinase catabolism. CD91 was originally identified as a receptor for a  $\alpha_2$ M, best known as a proteinase inhibitor and a carrier of specific growth factors, including TGF- $\beta$  and NGF- $\beta$ . a  $\alpha_2$ M has three distinct binding sites: (a) for growth factors, including TGF- $\beta$  and NGF- $\beta$ , (b) for  $\beta$  amyloid peptide, and (c) for LRP.

As a proteinase inhibitor, it functions as a molecular “trap,” which is sprung when proteinases attempt to cleave a highly susceptible to proteolysis sequence, the “bait region,” triggering a conformational change that entraps the proteinase. Entrapment forms covalent bonds with the trapped proteinase, which is inactivated. The complex binds to the  $\alpha_2$ MR and is endocytosed.

a  $\alpha_2$ MR internalizes the uPA-PAI-1 complex, including the uPAR (see [CD87](#)).

a  $\alpha_2$ M binds  $\beta$  amyloid peptide and delivers it to CD91 for internalization. a  $\alpha_2$ M gene polymorphisms have been associated with late onset of Alzheimer disease, and a  $\alpha_2$ M is expressed by microglia near amyloid plaques; LRP protects neuroblastoma cells from the toxic effects of  $\beta$  amyloid ( [2](#), [3](#) ).

Tissue factor, an integral membrane glycoprotein (CD142), is an essential cofactor in initiating the extrinsic pathway of blood coagulation. In response to injury, it gains access to the plasma, and its function is regulated by the tissue factor pathway inhibitor. Tissue factor pathway inhibitor binds to an unknown surface molecule, and then LRP mediates the cellular degradation of the complex ( [4](#) ).

Heat shock proteins (HSPs) are released from cells in stress. The HSPs perform the chaperon function for peptides, leading to their processing and presentation by MHC molecules. The complexes enter the APC but use the endogenous pathway of antigen presentation to CD8<sup>+</sup> T cells (cross-priming or cross-presentation) ( [5](#) ).

All HSPs use CD91 as a receptor to enter the APC, even though they have no homology with each other (6). Because HSPs are released from necrotic but not apoptotic cells, CD91 is a sensor of necrotic cell death.  $\alpha_2\text{M}$  forms complexes nonselectively with a great variety of proteins, and the captured proteins are rapidly removed from the circulation and delivered through CD91 to macrophages (7).

Antigen complexed with  $\alpha_2\text{M}$  induces 500-fold higher titers of IgG antibody in the absence of adjuvant.

CD91 functions as receptor for apoptotic cells (8) through the family of collectins, that is, proteins of innate immunity such as surfactants and the mannose-binding lectin, which facilitate removal of microorganisms through opsonin-mediated phagocytosis. C1q is structurally and functionally related to collectins. SP-A and SP-D bind to apoptotic cells and facilitate their removal through CD91 (9).

### CD93 (C1qRP: C1q RECEPTOR FOR PHAGOCYTOSIS)

*Structure.* The C1q receptor for phagocytosis (C1qRp) is organized in distinct domains. The large extracellular domain consists of a C-lectin-type domain, followed by a carbohydrate-binding domain, five EGF domains, and a membrane-proximal heavily glycosylated mucinlike domain (1). The cytoplasmic tail is short (47 amino acids) and contains a tyrosine kinase recognition motif. In addition to phagocytosis, C1q generates  $\text{H}_2\text{O}_2$  and singlet  $\text{O}_2$ .

*Gene locus.* 22p11.2.

*Molecular mass (kd).* 126 (reduced); 97 (unreduced).

*Distribution.* It is expressed on endothelial cells, monocytes, and neutrophils but not on many tissue macrophages. It is detected on  $\text{CD34}^+$  stem cells, platelets, and microglial cells, as well as on immature DCs, where it is down-regulated with maturation (2).

*Function.* The best known function of C1q is the triggering of activation of the classical pathway of complement (see Chapter 18). However, C1q mediates other functions independent of the complement cascade activation, such as enhancement of phagocytosis, stimulation of respiratory burst, chemotaxis (3), antibody-mediated cell cytotoxicity, antibody production from B cells, and intercellular adhesion (4).

The C1qRp protein (CD93) has been reported to enhance phagocytosis by monocytes and neutrophils (5) and modulates intercellular adhesion binding through a ligand on vascular endothelial cells.

- *C1q binding proteins.* C1q is a hexameric structure that, on electron micrographs, appears as a “bouquet of flowers” (Chapter 18). Each monomer is composed of a globular head (gC1q) and a collagenous fibril-like region (cC1q). At least two proteins have been identified that interact with distinct C1q domains; one, gC1qR, binds to the globular heads of C1q, and a second, cC1qR, binds to the collagenous fibrillar structures (6, 7). The gC1qR is a highly acidic 33-kd protein forming a trimer and binds with the  $N$ -terminal domain to the C1q (8). The protein is highly

acidic (28 Glu, 20 Asp), suggesting that interactions with C1q may be primarily ionic. It has a protein kinase phosphorylation site and a tyrosine kinase recognition site. gC1qR is expressed on resting platelets and at higher concentrations on microparticles formed after platelet activation and aggregation (9). These particles, which contain αIIb/β3 integrin, coagulation factors, TSP, and so forth, provide an important surface of initiation of coagulation. gC1qR binds to a great variety of proteins, such as vitronectin, thrombin, fibrinogen, high-molecular-weight kininogen, several proteins from viruses, and pathogenic bacteria. gC1qR as a “receptor” on platelets and endothelial cells plays an important role in blood coagulation with participation to a complex assembled by kininogen (10). The activation of this complex is independent of factor XII, although factor XII can also interact with this complex because it also binds to gC1qR through its aminoterminal region (11).

- *cC1qR (calreticulin)*. The mature protein consists of 400 amino acids and is divided into three domains: (a) the *N*-terminal or *N domain*, which forms a β globular sheet and contains the rubella virus-binding site, as well as the α integrin and steroid receptor-binding site; (b) a proline-rich or *P domain* with a nuclear localization site; and (c) the *C*-terminal or *C domain*, which is rich in acidic residues and binds Ca<sup>2+</sup> (12).

C1q binding to calreticulin (CRT) is mediated through sequences in its *N*-terminal half that show similarity to the putative C1q-binding region of the CH<sub>2</sub> domain of IgG.

CRT is an important chaperon in the ER, together with its membrane-bound homolog calnexin.

Several other functions have been attributed to CRT, such as adhesion (activates integrins), Ca<sup>2+</sup> binding and storage, development (cardiac, neuronal), assembly of MHC class I molecules, gene expression (androgen-sensitive gene in prostatic cancer), and so forth. CRT has been implicated as an extracellular protein in autoimmunity (13). Autoantibodies are detected in 40% of patients with systemic lupus erythematosus and Sjögren syndrome.

## CD94

*Terminology.* CD94 is a C-type lectin that forms disulfide-linked heterodimers with members of important NK-cell receptor proteins known as *NKG2* (see Chapter 17). In these heterodimers, the CD94 is the invariant chain, encoded by a single gene, whereas the *NKG2* group is a multigene family of at least five proteins designated *NKGs A through E*. The cytoplasmic tails of the *NKG2* proteins are either long (A/B) or short (C and E), corresponding to inhibitory or activating receptors, respectively. The inhibitory function of A/B depends on two ITIM sequences present in the cytoplasmic tail, which, on activation, recruit the phosphatases SHP-1 and SHP-2, which inhibit activation. The activating receptors do not have ITAMs but associate with a short ITAM-containing protein DAP12.

*Structure.* CD94 is a C-type lectin (i.e., it has a roughly spherical C-type module (C<sub>L</sub>) of approximately 120 amino acids and a Ca<sup>2+</sup>-dependent carbohydrate-reorganizing domain (CRD) (1, 2, 3 and 4). Some lack most of the conserved Ca<sup>2+</sup>-binding residues, and the C-type domain has been renamed the *C-type lectin-like NK receptor domain*, or *NKD*.

CD94 is a type II transmembrane protein with a very short cytoplasmic tail.

*Gene locus.* 12p13.3–13.1. The CD94 and *NKG2* genes are closely linked with the human



“NK gene complex.”

*Molecular mass (kd)*. 30.

*Distribution*. Expressed on NK cells and a subpopulation of  $\gamma\delta$  and  $\alpha\beta$  T cells. After CD3 stimulation, some  $CD4^+$  T cells express CD94/NKG2A receptors, which are up-regulated by IL-10 and TGF- $\beta$ . Expression of CD94/NKG2A on  $CD8^+$  T cells is induced during T-cell antigenic stimulation.

*Function*. CD94 forms heterodimers with NKG2A/B (inhibitory) and with NKG2C and E (activating). The ligands for CD94/NKG2A are the nonclassical (class Ib) HLA-E molecules (5) loaded with a peptide from the leader sequence of the MHC class I heavy chain of most HLA class I (6, 7). When an MHC molecule is missing from the cell surface, there is no leader peptide to be loaded on the HLA-E. This is recognized by the cell surface, surveying CD94/NKG2 receptors, as “missing self.” Under such circumstances, activating receptors assume the task of killing the cell. HLA molecules are “lost” as a result of malignant transformation or virus infections (missing self hypothesis, see [Chapter 17](#) for details). However, in normal cells, the presence of HLA-E loaded with peptides is a signal for intervention by inhibitory CD94/NKG2 receptors to inhibit killing.

An interesting point for HLA-E is that the loading of signal peptides is dependent on transporter associated with antigen processing (TAP), in contrast to classical class I HLA molecules, which may accept signal sequence peptides without help from TAP (with a few exceptions). (TAP is the complex that transports the peptides to the ER to be loaded to the HLA molecules—see [Chapter 18](#).) Variation in sialyl Lewis<sup>X</sup> expression by tumor cells seems to be recognized by CD94 receptors on NK cells, but the mechanism remains unknown. CD94 receptor binds more efficiently to sialyl Lewis<sup>X</sup> that is densely attached to carrier glycans (8).

The UL-40 glycoprotein of CMV is ligand for HLA-E and is recognized by the inhibitory receptors CD94/NKG2A; that prevents killing of CMV-infected cells (9).

## **CD95 (Fas ANTIGEN; APO-1; TNF RECEPTOR SUPERFAMILY, MEMBER 6, TNFRSF6)**

*Structure*. CD95 is a member of the TNF family of receptors, which includes two TNFRs (TNFR1 and TNFR2), the receptor for lymphotoxin- $\beta$ , the NGF receptor (NGFR), CD40, CD27, and CD30.

CD95 is a transmembrane type I protein with an extracellular region consisting of three cysteine-rich domains (CRDs). The CRDs are stabilized by extensive intrachain disulfide bonds. Each CRD contributes to ligand binding; however, CRD1 is the primary ligand-binding site. CRD1 also mediates the preligand CD95 oligomerization and is known as *PLAD* (preligand assembly domain) (see below).

The cytoplasmic region contains a death domain (DD) mediating protein-protein associations.

*Gene locus*. 10q24.1.



*Molecular mass (kd):* 45 (reduced).

*Distribution:* Fas is constitutively expressed on CD4<sup>+</sup>/CD8<sup>+</sup> (double-positive) human thymocytes, but Fas does not contribute to negative selection in the thymus because lpr/lpr mice (with defects in the apoptotic pathway, see below) have normal negative selection. Peripheral blood T and B lymphocytes express CD95 after activation, but Fas normally is detected on neutrophils, monocytes, and fibroblasts.

*Signaling:* Nonligated CD95 exists on the cell membrane in a preassociated form mediated by PLAD (1, 2, 3 and 4). This association, mediated by CRD1 before ligand binding, is necessary for the recruitment of signaling proteins. In the next step, through actin reorganization, the Fas recruits the Fas-associated DD (FADD), a cytoplasmic adaptor protein with a C-terminal DD and an N-terminal death effector domain (DED) (5, 6, 7 and 8).

FADD, through its own DD, interacts with the DD of Fas and, through DED, with the DED of procaspase-8 to form the *death-inducing signaling complex* (DISC).

Oligomerization of procaspase 8 leads to proximity-induced autocatalytic activation, followed by direct or indirect downstream activation of executionary caspases (i.e., caspase-3).

Fas cross-linking activates two sphingomyelinases, a neutral sphingomyelinase (NSM) located at the cytoplasmic membrane and an acidic sphingomyelinase (ASM) located in acidic membrane subdomains (9, 10). The ASM pathway leads to accumulation of ceramide, a diffusible messenger for apoptosis in hematopoietic cells, generated from hydrolysis of sphingomyelin.

Ceramide is targeted to the Golgi apparatus and induces the synthesis of disialoganglioside GD3, a glycosphingolipid containing two sialic acid residues. GD3 induces 75% loss of mitochondria, leading to apoptosis.

In patients with Niemann-Pick disease, who are genetically deficient in ASM activity, the cells do not undergo normal Fas-mediated apoptosis because GD3 accumulation is impaired.

The role of ASM in Fas-mediated apoptosis has been shown for some but not all cells.

Fas signaling triggers T-cell co-stimulation through NF- $\kappa$ B and MAPK activation, leading to IL-2 secretion.

*Function:* CD95 is the major receptor for apoptosis, which morphologically is accompanied by condensation of cytoplasm, loss of plasma membrane microvilli, segmentation of the nucleus, and extensive degradation of chromosomal DNA into oligomers of approximately 180 bp.

Fas-mediated apoptosis occurs after primary activation of T cells (activation-induced apoptosis) and progressive differentiation of T cells is associated with increasing susceptibility to apoptosis, a mechanism contributing to maintenance of peripheral T-cell tolerance and prevention of the development of autoreactive T cells after activation.

- *Autoimmune lymphoproliferative syndrome (ALPS)* ( [11](#), [12](#) ) is characterized by massive lymphadenopathy and splenomegaly in children, accompanied by autoimmune hemolytic anemia, thrombocytopenia, other autoimmune manifestations, and polyclonal hypergammaglobulinemia. ALPS is associated with mutations of the CD95 gene (ALPS type Ia) or the CD95 ligand gene (CD178, ALPS type Ib) and a more severe clinical phenotype presumed to be caused by an undefined inherited gene defect in the absence of mutations in the CD95 or CD95L genes (ALPS type II). Type Ia corresponds to lpr and type Ib to gld murine syndromes. One major difference between ALPS and the murine model is the multiorgan autoimmune disease with renal involvement seen in mice, whereas autoimmune cytopenias predominate in ALPS. Chronic neutropenia is often associated with LGL leukemia. In these patients, the level of Fas ligand is elevated, and it has been shown that it triggers apoptosis of normal neutrophils *in vitro* ( [13](#) ). Levels of Fas ligand return to normal in treated patients at the same time as the disappearance of neutropenia. B<sup>-</sup> and T-cell lymphomas have been reported in families with ALPS and germ-line mutations of Fas. Fas mutations have been detected in other malignancies such as nasal T-cell lymphomas (7 out of 14) ( [14](#) ), mycosis fungoides ( [15](#) ), testicular germ cell tumors, and so forth. In chronically sun-exposed skin, CD95 is up-regulated in keratinocytes (solar elastosis, no dysplasia). However, in actinic keratosis, there is a loss of Fas proportional to the degree of dysplasia. In cases of myelodysplastic syndrome, the CD34<sup>+</sup> erythroid progenitors proliferate normally in cultures with erythropoietin, but further differentiation leads to Fas-mediated apoptosis, which may be responsible for impaired erythropoiesis ( [16](#) ).

## CD99

*Structure.* CD99 is a transmembrane protein with limited similarity in the extracellular region to collagenlike proteins.

*Gene locus.* CD99 is encoded by MIC2 gene located in the pseudoautosomal region at the end of the short arm of X chromosome (MIC2X). MIC2 maps to the band between Xp22.3 and Xpter, and it escapes lyonization. A homologous locus was found on the Y chromosome in the euchromatin region Yq11.1-Ypter (MIC2Y). MIC2X and MIC2Y have closely related or identical sequences. MIC2Y is the most proximal autosomal locus to testis-determining factor ( [1](#) ).

*Molecular mass (kd).* 32.

*Distribution.* Within the hematopoietic cells, CD99 is expressed on all cell types except neutrophils. Expression is particularly high in subsets of plasma cells, in medullary cords of LN, and in cortical thymocytes. It is strongly expressed on Xg(a<sup>+</sup>) but low in Xg(a<sup>-</sup>) erythrocytes. It is commonly expressed in AML, pulmonary, neuroendocrine, and gastrointestinal tumors.

*Function.* CD99 is involved in adhesion of erythrocytes to T cells in spontaneous rosette formation. It also triggers homotypic aggregation of double-positive thymocytes, which is Mg<sup>2+</sup>-dependent and requires intact cytoskeleton, suggesting that it is likely to be mediated by an integrin. Indeed, ligation of CD99 up-regulates affinity/avidity of the α<sub>4</sub>β<sub>1</sub> integrin shown to be instrumental in adhesion of activated T cells to vascular endothelium ( [2](#) ). It regulates their extravasation in inflammatory sites. CD99 is constitutively expressed in lateral contacts of vascular endothelial cells, which are

particularly active in the final step of transmigration of leukocytes. The CD99-mediated adhesion is operative after deep penetration of the migrating cells into the interendothelial junctions just before transmigration is completed.

CD99 transmigration is mediated through regulation of the function of integrins in the uropod. CD99 regulates LFA-1/ICAM-1-mediated adhesion of lymphocytes and triggers production of the Th1 type of cytokines. It induces up-regulation of TCR and MCH class I and class II molecules in thymocytes.

Engagement of CD99 induces apoptosis of Ewing sarcoma cells, although in this case, the apoptotic pathway follows mitochondrial permeability and transition pore opening, with a reduction of  $\Delta\psi_m$  and caspase activation.

CD99 transports MHC class I molecules from the trans-Golgi compartment to the cell membrane (3).

An intriguing function of CD99 involves its role in the generation of Hodgkin's Reed-Sternberg (H-RS) phenotype. Down-regulation of CD99 with antisense CD99 expression constructs, introduced in B-cell lines, induces morphologic (multiple nuclei) and immunologic (CD15 expression and decreased class I expression) characteristics of H-RS cells (4, 5).

These changes were believed to be induced through Rac, a member of the Rho family of proteins, which are involved in cytoskeletal organization. Constitutively active Rac rescues the CD99-deficient cells from morphologic abnormalities.

Viral latent membrane protein 1, which is essential for EBV transformation of normal B lymphocytes, plays a role in down-regulation of CD99 and leads to generation of H-RS cells (6).

## CD100 (SEMAPHORIN 4D, SEMA4D)

*Structure:* *Semaphorin* (abbreviated SEMA) derives from the word "semaphore" used in railway track crossings to send signals of an approaching train. (Originally: Greek *sema*, sign, and *phero*, carry, convey.) Semaphorins are a large family of proteins consisting of more than 20 members, divided into eight subfamilies or subclasses: two invertebrates, five vertebrates, and one viral. CD100 is a member of subfamily 4. All semaphorins are defined by the presence of a signature domain, the *sema domain* at the aminoterminal. Semaphorins originally were characterized in the nervous system, where they were implicated in repulsive axon guidance and, more recently, in cardiac and skeletal development, angiogenesis, and tumor growth and metastasis. CD100 is the first semaphorin to be detected in the immune system (1, 2).

The extracellular region consists of an aminoterminal signal sequence, followed by a sema domain, which is a 500-amino acid sequence with 17 highly conserved cysteines; next is an Ig-like type C2 domain, and a lysine-rich stretch.

The cytoplasmic tail has tyrosine and multiple serine phosphorylation sites.

The transmembrane protein is proteolytically cleaved to release a soluble CD100 (sCD100). Proteolysis is well regulated and depends strictly on activation of T or B cells.

It is probably mediated by an MMP.

*Gene locus.* 9q22–q31.

*Molecular mass (kd).* 300 (unreduced); 150 (reduced); 120 (soluble).

*Distribution.* CD100 is detected on T and B lymphocytes (especially after activation), NK cells, and myeloid cells, but not in RBCs, eosinophils, or endothelial cells. CD100 is also detected in the germinal centers (dark and light zones) but not in the mantle zone. It is present in lymphoid and myeloid leukemia cells.

Generally, it is not expressed in follicular NHL but is detected in high-grade small noncleaved B-cell NHL and in T-cell lymphomas.

*Function.* There are two receptors for CD100: (a) plexin B1 and (b) CD72.

Plexin B1 is a member of the plexin family of proteins, which are receptors for semaphorins, either alone or in combination with neuropilins (3). Plexin B1 is expressed in human brain, kidney, and liver and is the high-affinity receptor for CD100. Plexin B1 is linked to Rac, a small GTP-binding protein involved in cell morphology, aggregation, and cytokinesis.

CD72 is a low-affinity lymphocytic receptor for CD100 (4, 5). CD72 contains an ITIM in its cytoplasmic tail recruiting phosphatase SHP-1 and acts as an inhibitory receptor. CD100 blocks the association of CD72 with SHP-1 phosphatase, turning off the negative signals, which explains the enhancement of B-cell responses by CD100. CD100 promotes aggregation and survival of B lymphocytes and inhibits spontaneous or chemokine-induced migration.

In humoral immunity, CD100 enhances proliferative B-cell responses and Ig production.

Soluble CD100 is released from activated lymphocytes (6, 7).

CD100 (Sema 4D) triggers invasive growth, a complex program characterized by dissociation of cells, growth, and branching morphogenesis (cells form tubules arranged like branches). This response was earlier detected by the scatter factors, a group of proteins with striking homology to plexins. The prototype of scatter factors is the hepatocyte growth factor (HGF) receptor (MET) encoded by the MET oncogene. Plexin B1 associates with MET, and binding of CD100 to plexin B1 stimulates tyrosine kinase activity of MET, resulting in phosphorylation of both plexin B1 and MET.

## **CD110 (THROMBOPOIETIN RECEPTOR, MPL, TPOR)**

*Structure.* Member of hematopoietin receptor family. Encoded by the c-mpl gene, the homolog to the v-mpl virus oncogene of the murine myeloproliferative leukemia. There are two cytokine receptor domains in the extracellular region and two cytokine receptor box motifs in the intracellular region.

*Gene locus.* 1p34.

*Molecular mass (kd).* Unreduced, 85 to 92.

*Distribution.* Hematopoietic stem cells. Megakaryocyte progenitors as well as on megakaryocytes and platelets.

*Function.* CD110 regulates thrombopoiesis. Biochemically, it prevents apoptosis and stimulates growth and differentiation ( [1](#), [2](#), [3](#) and [4](#)). Mutations of CD110 have been detected in some patients with congenital amegakaryocytic thrombocytopenia. Binding of thrombopoietin causes dimerization of CD110 and phosphorylation of JAK kinases and STAT transcription factors. MPL is markedly reduced or absent in platelets from patients with polycythemia vera and in most of the patients with idiopathic myelofibrosis. This finding may distinguish polycythemia vera from other conditions with erythrocytosis ( [5](#)). CD110 (MPL) is expressed on the common myeloid progenitor but not on the common lymphoid progenitor ( [6](#)).

## CD117 (RECEPTOR FOR STEM CELL FACTOR, C-KIT)

*Structure.* Encoded by protooncogene c-kit and belongs to the class III tyrosine kinase receptor family. It is a transmembrane protein with five extracellular Ig-like domains (four C2 and one V). The intracellular region contains a tyrosine kinase domain that is split by a unique insertion of 77 amino acids and a consensus ATP-binding site. It is closely related to CSF-1 receptor (c-fms) and PDGF receptor.

*Gene locus.* 4q12.

*Molecular mass (kd).* Reduced, 145; unreduced, 145.

*Distribution.* Hematopoietic progenitors (except B-lineage precursors). Present on mast cells, melanocytes, spermatogonia, and oocytes.

*Function.* Stem cell factor or c-kit ligand binds to CD117. Binding of the ligand (Steel factor) triggers a variety of reactions, such as dimerization and internalization of the receptor, autophosphorylation and phosphorylation of other substrates, activation of MAPK and PLC- $\beta$ , and protooncogene transcription. CD117 is crucial in hematopoiesis, activation, and development of mast cells. It prolongs survival of melanocytes and is necessary for survival and differentiation of type A spermatogonia. In humans, mutations of CD117 gene result in piebaldism, a disorder of pigmentation, in systemic mastocytosis, or in mast cell leukemia. Deletion or defects of CD117 gene in W mice result in anemia, lack of mast cells, pigmentation defects, and infertility ( [1](#), [2](#) and [3](#)).

## CD122 (IL-2 RECEPTOR, $\beta$ -CHAIN)

Details in [Chapter 18](#).

*Structure.* CD122 is a cell-surface glycoprotein. The extracellular region contains one cytokine receptor domain [i.e., two pairs of conserved cysteines and the sequence Try/Ser/X/Try/Ser (WSXWS)] and one FN III domain. The cytoplasmic region contains serine-rich, acidic, and proline-rich domains. CD122 is associated with CD25 ( $\alpha$ -chain) and CD132 ( $\gamma$ -chain) to form the high-affinity IL-2 receptor. In the trimeric complex, CD25 binds the ligand (IL-2) and CD122/CD132 transmit the signal.

*Gene locus.* 22q11.2.

*Molecular mass (kd)*. Reduced, 75; unreduced, 75.

*Distribution*. T cells, B cells, NK cells, monocytes, and macrophages.

*Function*. Binds IL-2 with low affinity as well as IL-15 ([1](#), [2](#)). Transmits growth signals (serine-rich domain is important). Two intracellular pathways of signal transduction for protooncogene induction: tyrosine phosphorylation (mediated by src-PTKs) and induction of c-myc. CD122 is associated with tyrosine kinases Syk, Lck, and JAK-1, as well as the transcription factor STAT-1. The IL-2 signaling follows several pathways. One involves Src kinases, with the path to the nucleus followed through Ras activation and MAPK cascade. A second is mediated by the P13K pathway and a third by the JAK kinases-STAT transcription factors. Stimulates growth and differentiation and cytokine secretion.

### CD123 (IL-3 RECEPTOR, $\alpha$ -CHAIN)

*Structure*. The *N*-terminal is homologous to that of IL-5 and GM-CSF receptors. The extracellular region contains also a cytokine-receptor domain and a FN III domain.

*Gene locus*. Yp11.3 and Xp22.3.

*Distribution*. Hematopoietic progenitors, monocytes, and B cells.

*Function*. Binding of IL-3 results in tyrosine phosphorylation and promotes proliferation and differentiation of hematopoietic cells. It affects early stages of hematopoietic cell differentiation, especially at pluripotential stem cell stage ([1](#)).

### CD124 (IL-4 RECEPTOR)

See details in [Chapter 18](#).

*Structure*. Type I transmembrane protein of the hemopoietin receptor SF with a cytokine type I module (i.e., an *N*-terminal domain with two conserved disulfide bonds and a second with the domain, WSXWS motif, and membrane-proximal FN III domain). The cytoplasmic region is rich in Ser/Pro. Soluble form has been detected. It is also a component of the IL-13 receptor complex.

*Gene locus*. 16p12.1.

*Molecular mass (kd)*. Reduced, 140.

*Distribution*. Present on B cells, T cells, hematopoietic progenitors, and bone marrow stroma. Also on mast cells, macrophages, epithelial cells, fibroblasts, and neuroblasts.

*Function*. The IL-4R  $\alpha$ -chain binds IL-4 with high affinity and forms a heterodimer with the common  $\beta$ -chain ( $\beta$ c) (CD132), which is required for activation of the signaling pathways ([1](#), [2](#)). The  $\alpha$ -chain is associated with JAK-1 kinase and the  $\beta$ c-chain with JAK-3. On binding of IL-4, the  $\alpha$ -chain is phosphorylated and, through a unique sequence in its cytoplasmic region (shared also by the insulin receptor), binds a phospho-protein (see [Chapter 18](#)), which links the receptor to the PI3K pathway and other signaling pathways (Ras) leading to cell proliferation. Expression of many IL-4-responsive genes is

mediated through the STAT-6 transcription factor activation. Functions of IL-4 include regulation of growth and differentiation of B cells, and it is a switch factor for IgE. It stimulates growth of T cells and mast cells and diverts T-cell differentiation to the Th2 pathway.

### **CD125 (IL-5 RECEPTOR, $\alpha$ -CHAIN)**

*Structure.* Type I membrane protein containing in its extracellular region a cytokine type I module and three FN III domains. The cytoplasmic domain is short and rich in proline. Soluble IL-5R has been detected.

*Gene locus.* Chromosome 3p26.

*Distribution.* Widespread in hematopoietic cells, especially eosinophils and basophils.

*Function.* It binds IL-5. Signals are transduced by the nonbinding  $\gamma$ -chain shared by other IL receptors. IL-5 activates the PI3K pathway and Vav protein. It stimulates eosinophil differentiation and B-cell growth and differentiation and enhances IgA production ( [1](#) ).

### **CD126: IL6 RECEPTOR**

See [Chapter 18](#).

### **CD128 (IL-8 RECEPTOR $\alpha$ , CXCR1; CD128B: IL-8 RECEPTOR $\beta$ , CXCR2)**

*Structure.* Two receptors have been described, one with low and one with high affinity. Both have seven transmembrane regions and belong therefore to the rhodopsin SF of G protein-linked receptors.

*Gene locus.* 2q35.

*Molecular mass (kd).* Reduced, 58 to 67.

*Distribution.* Neutrophils, basophils, lymphocytes, keratinocytes, and melanoma cells.

*Function.* Binding of IL-8 induces chemotaxis of neutrophils, basophils, and T lymphocytes. Activates neutrophils and basophils and increases their adhesion to endothelial cells. Elicits respiratory burst. Signals transduced through IL-8R are similar to those transduced by other chemoattractant receptors. Increases cytosolic  $\text{Ca}^{2+}$  and activates PKC ( [1](#) ).

### **CD129 (RECEPTOR FOR IL-9)**

*Structure.* The extracellular region contains one cytokine family domain and one FN III domain. Soluble forms exist. The receptor is associated with the  $\gamma$ -chain of the IL-2R.

*Distribution.* Found on T cells (helper), macrophages, and mast cell lines.

*Function.* Binds IL-9, which stimulates growth of T cells, mast cells, and megakaryoblastic



leukemia cell lines ( [1](#)).

## CD130

See [Chapter 18](#).

## CD131 (COMMON $\beta$ -CHAIN)

*Structure.* Type I transmembrane protein. The extracellular domain contains two repeats of class I cytokine receptors.

*Gene locus.* 22q13.1.

*Molecular mass (kd).* Unreduced, 120 to 140.

*Distribution.* Present on early hematopoietic progenitors and pre-B cells.

*Function.*  $\beta$ c (common) subunit, associates with the  $\alpha$ -chains of IL-3R (CD123), GM-CSFR (CD116), and IL-5R (CD125) ( [1](#)). It functions in signal transduction and is associated with the JAK-2 kinase. On binding of the cytokine to its receptor, the  $\beta$ c is phosphorylated and allows docking on its cytoplasmic region of signal transducing molecules with SH<sub>2</sub> domains such as PI3K, Shc, and Grb2 adaptor molecules, and so forth. Some cases of pulmonary alveolar proteinosis have a reduced expression of  $\beta$ c-chain and in one patient, a mutation was detected ( [2](#)). Some of these patients develop AML, but all leukemic cells do not express the  $\beta$ c-chain. Targeted deletion of  $\beta$ c-chain gene in mice generates a pulmonary alveolar proteinosis-like syndrome.

## CD132 (COMMON $\gamma$ -CHAIN)

*Structure.* The extracellular region contains the four conserved cysteines and the WSXWS motif characteristic of class I cytokine receptors. The intracellular region contains two subdomains of the Src homology region 2 (SH<sub>2</sub>), which are, however, insufficient to initiate downstream signal transduction.

*Gene locus.* Chromosome Xq13.1.

*Molecular mass (kd).* 64.

*Distribution.* Hematopoietic cell progenitors of T, NK, and B cells as well as the mature lymphocytes, neutrophils, and macrophages.

*Function.* It is a subunit for several cytokine receptors (i.e., IL-2, IL-4, IL-7, IL-9, and IL-15). The  $\gamma$ c-chain is not involved in ligand binding but in signal transduction. JAK-3 kinase is constitutively associated with  $\gamma$ c and is activated after binding of any cytokine sharing the  $\gamma$ c-chain with their receptors. JAK-1 as well as Syk and Ick tyrosine kinases are activated by some of these cytokines. The JAK kinases phosphorylate members of the STAT family of transcription factors. The  $\gamma$ c-chain is critical for growth, maturation, and function of T and NK lymphocytes. This has been shown by experiments of nature (i.e., mutations of the  $\gamma$ c gene). Such mutations have been detected on all patients with XSCID, which constitutes 40 to 50% of all primary SCIDs. The mutations result in total absence of or abnormal  $\gamma$ c-chains and affect all eight exons of the gene. XSCID is

characterized by profound lack of T and NK cells, but the number of B cells is either normal or slightly elevated. However, these B cells do not function normally (serum Igs are absent or diminished) even in the presence of normal T cells. They are, however, capable of class switching *in vitro* after stimulation with anti-CD40 antibodies. Bone marrow transplantation in the first 3 months of life offers greater than 95% chance of survival ([1](#), [2](#) and [3](#)).

## CD133 (HEMATOPOIETIC STEM CELL ANTIGEN, PROML1: PROMININLIKE 1)

*Structure.* CD133 is a glycoprotein that spans the cell membrane five times (pentaspan) and is the first member to define this new family of proteins, which is distributed in several species from worms to humans. The extracellular region consists of two large loops, whereas the intracellular region consists of two small loops. The presence of tyrosines in the intracellular region suggests that the molecule may be involved in signal transduction. Cysteine residues are detected in the transmembrane domains.

*Gene locus.* 4p16.2–p12.

*Molecular mass (kd).* 120.

*Distribution.* It is expressed on primitive hematopoietic progenitors, which stain bright for CD34 and are also positive for CD117 (c-kit) and HLA-DR but are still negative for erythroid markers. It is also expressed in epithelium of developing embryos, endothelial cell precursors, retina, and neural stem cells. The protein is detected with certain antibodies in AMLs and in myelodysplastic syndrome. A mutation of the gene has been detected in a patient with retinal degeneration.

*Function.* Presently unknown ([1](#), [2](#), [3](#) and [4](#)).

## CD138 (SYNDECAN-1, HEPARAN SULFATE PROTEOGLYCAN)

*Structure.* CD138 is a heparan sulfate proteoglycan consisting of a core protein, which, in its extracellular region, contains five sites for attachment of glycoaminoglycans, heparan sulfate in the distal three and chondroitin sulfate in the two proximal to the membrane. Its cytoplasmic region contains three tyrosines. It belongs to a family of syndecans that share similar transmembrane and intracellular regions but differ in the extracellular region, suggesting that they are tissue specific ([1](#), [2](#)).

*Gene locus.* 2p23.

*Molecular mass (kd).* 85 to 92, unreduced.

*Distribution.* Syndecan-1 is expressed strongly on plasma cells and myeloma cells and in the mouse on pre-B cells but not on mature B cells. It is also present on embryonic mesenchymal cells, vascular smooth muscle cells, endothelial, neural, and epithelial cells.

*Function.* It is an important regulator of myeloma cell behavior. On the cell membrane, it mediates adhesion between myeloma cells and collagen type I. On a subpopulation of motile myeloma cells, it is localized on the uropod, promoting homotypic cell adhesion ([3](#)). Cell-bound syndecan-1 promotes myeloma cell growth through binding of various cytokines and heparin-binding proteins, like the HGF produced by mesenchymal cells and

myeloma cells (4). HGF thus acts as a paracrine and autocrine growth factor for myeloma cells. It binds to its receptor, c-Met kinase, a receptor tyrosine kinase, and furthermore stimulates activation of PI3K and the Ras pathway (5). Syndecan-1 is shed from the cell membrane and is highly elevated in a soluble form in the bone marrow of patients with myeloma (6). In the soluble form, it inhibits myeloma cell growth by inducing apoptosis and trapping HGF. However, this effect of syndecan-1 is concentration dependent because at low concentrations, it again promotes cell growth. Soluble syndecan-1 mediates decreased osteoclast and increased osteoblast activity. Thus, the action of syndecan-1, whether bound on myeloma cells or in the soluble form, exerts a complex regulatory role in myeloma.

## **CD140a (PDGFR $\alpha$ : PLATELET-DERIVED FACTOR RECEPTOR $\alpha$ ) AND CD140b (PDGFR $\beta$ )**

*Structure.* The PDGFR- $\alpha$  and - $\beta$  are PTKs, subclass III, the members of which are characterized by several Ig-like domains in their extracellular region. The PDGFR are assembled as dimers of two polypeptide chains, which give rise to three isoforms, a receptor (homodimer),  $\beta$  receptor (homodimer), and  $\alpha\beta$  (heterodimer). Dimerization of the receptor chains is induced by their ligand, which is the PDGF, a disulfide-linked dimer of two chains, A and B. It exists as three isoforms, AA, BB, and AB. Ligand binding induces noncovalent dimerization of the receptor chains. AA induces only PDGFR- $\alpha$ , BB induces both PDGFR- $\alpha$  and PDGFR- $\beta$ , and PDGF-AB induces all three receptors,  $\alpha$ ,  $\beta$ , and  $\alpha\beta$ . PDGF forms two large loops, 1 and 3, pointing in one direction, and a smaller loop, 2, in the opposite direction. The site for binding to the receptor is contributed by loops 1 and 3, but loop 2 is also involved.

Each receptor chain contains five extracellular Ig domains, a transmembrane region, and an intracellular tyrosine kinase domain, which is split in two by an inserted sequence. This insertion contains a tyrosine that can be autophosphorylated and triggers the binding to intracellular signaling proteins. The site for high-affinity binding of PDGF-AA to the receptor is formed by Ig domains 2 and 3 and, for PDGF-BB binding, by domains 1 and 2. Domain 2 is probably the most important for ligand binding. Domain 4 mediates receptor dimerization.

*Gene locus.* CD140a, 4q11-q13; CD140b, 5q31-q32.

*Molecular mass (kd).* CD140a, 170; CD140b, 180.

*Distribution.* The PDGF ligand is expressed by many types of cells. The  $\alpha$ -granules of platelets are the major source of PDGF. The receptors for PDGF are also expressed by a variety of cells and normally mediate the growth-promoting and other functions of PDGF. These soluble receptors can compete for ligand binding.

*Function.* The three PDGF receptors mediate overlapping but not identical signals.

- *Signal transduction* (1, 2). Dimerization of the receptors is the key event in PDGFR activation. The first step is autophosphorylation of the receptor chains. A tyrosine located within the kinase domain is important in kinase activation. Autophosphorylation provides docking sites for signaling molecules. The PI3K is important for actin reorganization and directs all cell movement, whereas PLC- $\gamma$  is involved in activation of Na<sup>+</sup>/H<sup>+</sup> exchanger. Grb-2 links the receptors to Ras molecules, leading to its activation and stimulation of cell growth.
- *Cellular processes.* (a) cell motility, (b) cell growth, (c) cell differentiation, (d)

inhibition of apoptosis, and (e) cell transformation.

- *In vivo* functions. The  $\beta$  receptor affects development of blood vessels, and the  $\alpha$  receptor regulates development of alveoli and oligodendrocytes in the brain and spinal cord. PDGF and its receptors have been implicated in mesangial glomerulonephritis, idiopathic fibrosis of the lungs, kidney fibrosis, cirrhosis of the liver, scleroderma, myelofibrosis, and so forth (3). Involvement of PDGF and its receptors in the atherosclerosis process has been confirmed experimentally. The B-chain of PDGF is the *c-sis* protooncogene, and PDGF and its receptors promote growth and mitogenic functions and have a role in human malignant diseases (3).

## CD141 (FETOMODULIN, THROMBOMODULIN)

*Structure.* Single-chain type I membrane protein divided into five domains. The N-terminal domain is a C-type lectin domain similar to the hepatic asialoglycoprotein receptor and members of the selectin family. The next domain consists of six EGF-like repeats. Two of these repeats bind thrombin, and three are necessary for activation of protein C. The fifth is intracytoplasmic and contains potential phosphorylation sites and a cysteine that may be involved in forming polymers.

*Gene locus.* 20p12-cen.

*Molecular mass (kd).* 75, unreduced; 105, reduced.

*Distribution.* Present on endothelial cells, platelets, megakaryocytes, monocytes, smooth muscle cells, and synovial cells.

*Function.* CD141 is a component of a natural anticoagulant system. It binds thrombin with high affinity, leading to activation of protein C, which, in turn, inactivates factors V and VIII. Thrombomodulin-thrombin complexes are endocytosed, resulting in removal of thrombin from the endothelial surface. The lectin domain of thrombomodulin regulates endocytosis of the complex (1, 2 and 3).

## CD 142 [TISSUE FACTOR (TF), THROMBOPLASTIN]

*Structure.* CD 142 is a transmembrane type I protein. The extracellular region consists of two type III fibronectin (FN) domains, joined at an angle of approximately 120 degrees (1). There are four cysteines forming two disulfide loops. The membrane proximal loop is important for TF function and the binding with high affinity to factor VII. The cytoplasmic tail has a single cysteine, which serves as an acceptor for palmitate or stearate, covalently linked via a thioester bond (2). Factor VII consists of a GAMMA-carboxyglutamic acid-rich domain (Gla), a hydrophobic or aromatic stalk, two epidermal growth factor domains, and a serine protease domain homologous to trypsin. The Gla domain has several  $\text{Ca}^{2+}$  binding sites and three conserved hydrophobic residues. All domains make contact with TF, but the EGF-1 and the protease domains contribute most of the binding. The TF positions and orients VIIa protease and its catalytic center at 80 Å above the cell surface to allow optimal interactions with the substrate and the scissile peptide. The hydrophobic residues of the Gla domain point away and anchor VIIa to the membrane by insertion into the outer phospholipid layer. TF is homologous to class I cytokine receptors based on the conservation of the cysteines in the N-terminal domain and the WSXWS sequence of the C-terminal domain.

*Gene locus.* 1p21.

*Molecular mass (kd).* 45.

*Distribution.* CD 142 is expressed on the cell surface of a variety of cells that are physically separated from the circulating blood, and only vascular injury may initiate activation of coagulation. Blood cells and vascular endothelial cells normally do not express TF. It is detected in keratinocytes, glomerular epithelial cells (cytoplasmic inclusions), astrocytes, myocardium, stromal cells of the liver, pancreas, and spleen. In general, it is distributed around blood vessels, capsules surrounding various organs, and epithelial surfaces (i.e., it is strategically located with a distinct evolutionary advantage, forming a hemostatic barrier in cases of emergency). Expression of TF in monocytic cells is induced by inflammatory activation (i.e., cytokines, LPS, immune complexes, anaphylatoxin, etc.). Similar stimuli also induce TF expression in endothelial cells.

*Function.* CD142 is a receptor for factor VII and initiates the extrinsic pathway of coagulation. The initial proteolytic process after the binding of factor VII to TF consists of the conversion of factor VII to VIIa. The physiologically relevant protease for this change is likely Xa, which cleaves VII at the Arg152-Ile153 bond. TF acts as cofactor for Xa-mediated activation of TF-bound VII. The factor X substrate of TF-VIIa complex appears to be preferentially cleaved if associated with phospholipid. TF probably maintains a basal level of IXa and Xa from trace amounts of TF detectable normally in plasma.

TF-VIIa complex produces intracellular signaling, such as changes of  $Ca^{2+}$  concentration, tyrosine phosphorylation, MAPK activation, etc. TF plays important roles in venous and arterial thrombosis. It is detected in the macrophage foam cells of the atherosclerotic plaques and thus predisposes for arterial thrombosis. Induction of TF in monocytes by homocysteine may be a contributing factor in the mechanism by which high levels of homocysteine predispose to thrombosis (3). Its role in disseminated intravascular coagulation (DIC) has been documented in patients with sepsis and overwhelming infections, contributing to multiple organ failure and death. The release of elastase from activated neutrophils may be a contributing factor (4). TF directly augments macrophage activation by VIIa independently of the effects on the coagulation proteins (5, 6).

TF-VIIa complexes have been detected in the joints of patients with rheumatoid arthritis and may contribute to the chronic destructive process of the disease (7). TF is expressed on the surface of a variety of tumor cells, and the expression sometimes correlates with the grade of malignancy and metastatic potential (8, 9). Another possible role of TF in tumor survival is its contribution to angiogenesis as a result of its function in the maintenance of the integrity of the vascular wall (10). In tumors, TNF-alpha induces TF in the endothelial cells of the tumor vessels, and in the case of tumor necrosis, thrombosis may be triggered by the TF.

TF-induced coagulation is regulated by a protein that inhibits TF (TFPI) (11, 12). TFPI consist of an aminoterminal acidic region followed by three tandem Kunitz-type protease inhibitory domains and a basic carboxyl-terminal region. TFPI inhibits Xa especially in the complex Xa-Va- $Ca^{2+}$  embedded in a phospholipid layer (prothrombinase complex). However, Xa-independent inhibition also exists.

## **CD143 [ANGIOTENSIN-CONVERTING ENZYME (ACE), KININASE II, PEPTIDYL DIPEPTIDASE A]**

*Structure.* Single polypeptide of type I transmembrane protein. It exists in two forms: one present on somatic cells (1306 amino acids) and a second in germ cells (testis) (732 amino acids). The two forms are generated as a result of differences in the transcription of a single gene initiated from two different promoters.

*Gene locus.* 17q23.

*Molecular mass (kd).* Somatic, 170 to 180; germinal, 90 to 110.

*Distribution.* The somatic form is present on endothelial cells, strongest in arterioles, and practically lacking in large arteries and veins. Expression is stronger in the blood vessels of the lung than in the kidney. It is also expressed on epithelial cells of proximal renal tubules and on several locations in the brain (basal ganglia, substantia nigra, and so forth). Finally, it is detected on mesenchymal cells, activated macrophages, and so forth. The germinal form is found only on differentiating germinal cells.

*Function.* CD143 acts as a dipeptide hydrolase with substrates of the angiotensin II and bradykinin, important vasoactive peptides (<sup>1</sup>, <sup>2</sup>). It is necessary for spermatozoa to successfully penetrate the egg. The level of CD143 is regulated by glucocorticoids and thyroid hormones.

## **CD150 (SLAM: SIGNALING LYMPHOCYTE ACTIVATION MOLECULE)**

*Structure.* Single polypeptide transmembrane type I protein with two extracellular highly glycosylated Ig-like domains. The cytoplasmic region contains three tyrosines, potential sites for binding of SH<sub>2</sub> domains of signaling molecules. SLAM belongs to the CD2 subfamily of the IgSF. It includes CD2, CD48, CD58, CD150, CD229 (Ly-9), and CD244 (2B4). Two new members structurally related to SLAM have recently been described: SF2000 and SF2001.

*Gene locus.* 1p98 for CD2/CD58; 1q22 for the rest.

*Molecular mass (kd).* 70.

*Distribution.* It is expressed on thymocytes, B cells, T cells, and DCs.

*Function.* In T cells, SLAM ligation stimulates IFN- $\gamma$  and IL-2 secretion and, in B cells, proliferation and Ig secretion (<sup>1</sup>). A critical role for the function of SLAM is played by another molecule known as *SAP* (SLAM-associated protein) (<sup>2</sup>). SAP binds with high affinity to SLAM and controls its function. It inhibits binding of the protein tyrosine phosphatase SHP-2 and thus prolongs phosphorylation of SLAM and other signaling molecules. SAP also recruits and activates the PTK Fyn-T, establishing a new signal pathway involving the inositol phosphatase SHIP, adaptor molecules Dok 2, Dok 1, and Shc, and the Ras GAP protein. The importance of SAP in the control of T-cell activation is further emphasized by the identification of mutations on SAP gene as the underlying mechanism in X-linked lymphoproliferative disease (<sup>3</sup>, <sup>4</sup>). X-linked lymphoproliferative disease is a fatal disease that usually follows EBV infection and is characterized by fulminant infectious mononucleosis, B-cell lymphomas, and dysgammaglobulinemia.

## **CD151 (PETA-3: PLATELET-ENDOTHELIAL CELL TETRASPAN)**



## ANTIGEN-3)

*Structure.* Member of the TM4 SF (i.e., proteins with four transmembrane domains) ( [1](#) ). Short N- and C-termini end in the cytoplasm, whereas the extracellular region forms two loops, one 15 and the other 109 amino acids long. The TM4 family consists of over 20 members: CD9, CD37, CD53, CD63, CD81, CD82, and so forth.

*Gene locus.* 11p15.5.

*Molecular mass (kd).* 32, unreduced.

*Distribution.* Platelets, megakaryocytes, epithelial, and endothelial cells, Schwann cells, skeletal, smooth, and cardiac muscle ( [2](#) ). In the skin, it is expressed mostly in the basal cells of the epidermis. High levels of CD151 are detected in bile ducts, terminal bronchioles, and pancreatic intralobular ducts. CD151 is also localized in endosomal/lysosomal vesicles.

*Function.* CD151 associates with members of the  $\beta 1$  and  $\beta 3$  integrin family, as well as other members of the TM4 family ( [3](#) ). CD151 is involved in homotypic cell adhesions. Association with integrins and widespread expression in endothelia suggest that CD151 may be involved in adhesion events ( [4](#) ). Its presence in epithelia is restricted to the basal layers, suggesting that it may be involved in anchoring the cells to the basal lamina. Antibodies to CD151 induce platelet activation. Presence of high levels of CD151 on lung cancer cells is associated with poor prognosis.

## CD152 (CTLA-4: CYTOTOXIC T LYMPHOCYTE-ASSOCIATED PROTEIN-4)

*Structure.* Disulfide-linked homodimer with a single Ig-like domain in the extracellular region of each polypeptide ( [1](#) ). Structurally, it is similar to CD28 and reacts with the same ligands, CD80 and CD86. The two genes are less than 150 kb apart, suggesting that they share a common ancestor. The cytoplasmic tail is short (36 amino acids) and contains two tyrosine-based motifs. It is 100% conserved between species, suggesting that this domain is important for function.

*Gene locus.* 2q33.

*Molecular mass (kd).* 33 reduced; 50 unreduced.

*Distribution.* Expressed on activated but not resting T lymphocytes. Ligation of CD28 strongly induces expression of CTLA-4. Even at the peak of its induction, most of CD152 is found intracellularly as a result of rapid internalization. One of the Tyr motifs (Y201) mediates internalization as a result of interaction with clathrin-associated adaptor complex, AP-2, which regulates endocytosis. The same motif associates with complex AP-1, which redirects excess of CD152 from Golgi to lysosomes for degradation, and when phosphorylated, serves as a docking site for signaling molecules.

*Function.* CTLA-4 inhibits T-cell responses ( [2](#), [3](#), [4](#) and [5](#) ). Blocking antibodies to CTLA-4 augments the immune response, enhances clearance of tumors and parasites, and exacerbates autoimmune disease activity. CTLA-4-deficient mice develop a massive lymphoproliferative disorder resulting in tissue destruction and death of the animals early in their life. The inhibitory effect of CTLA-4 results from multiple effects: (a) competition



for B7 ligands (as a result of its higher affinity compared to CD28); (b) inhibition of production of cyclin D3, thus arresting progression through the cell cycle; (c) inhibition of IL-2 gene transcription (resulting from decreased accumulation of NF- $\kappa$ B in the nuclei); and (d) association with phosphatase SHP-2, which dephosphorylates TCR-CD28 activation complexes, thus blocking signal transduction. CTLA-4 plays a role in T-cell differentiation and predisposition toward Th2 development.

## CD154 (CD40L)

*Structure.* CD154 is a member of the TNF SF. It is a type II transmembrane protein (NH<sub>2</sub> terminal inside the cell). It forms a trimer similar to TNF, and from its crystal structure, it is predicted that it binds three CD40 molecules (1, 2 and 3).

*Gene locus:* Xq26.

*Molecular mass (kd):* 33.

*Distribution.* CD154 is expressed on activated CD4<sup>+</sup> and CD8<sup>+</sup> T cells, monocytes, basophils, mast cells, eosinophils, and activated DCs.

*Function.* CD40/CD154 interactions regulate several aspects of the immune response, humoral and cell-mediated, by providing co-stimulatory signals: (a) it drives germinal center formation, B-cell proliferation, differentiation and Ig isotype switching; (b) it activates APC functions; (c) it stimulates T-cell priming and T-cell differentiation; (d) it stimulates cytokine production from monocytes (IL-1, TNF- $\alpha$ , IL-6, and IL-8), DCs, and macrophages (IL-12) (4); and (e) it activates NK cells. CD154 associates with two of the adaptor molecules known as TRAFs, TRAF-2 and TRAF-3. The former is critical for activation of NF- $\kappa$ B and the latter for isotype switching. CD40L is constitutively expressed by malignant B cells in lymphomas and on T and B cells in Hodgkin disease. CD40/CD40L interactions may provide survival signals to H-RS cells (5).

## CD156 (ADAM-8: A DISINTEGRIN AND METALLOPROTEASE-8, MS2 HUMAN)

*Structure.* CD156 is a member of a large family of proteins (more than 30 members) known as ADAM family (a disintegrin and metalloprotease). It is a type I transmembrane protein with a long extracellular region consisting of five domains, which include a prometalloprotease domain, a metalloprotease domain, and a disintegrin domain (1, 2). The cytoplasmic region has an SH<sub>3</sub> domain (the SH<sub>3</sub> domain is involved in protein-protein interactions). It binds proline-rich protein sequences. The prometalloprotease domain must be removed by a protease for an active enzyme to be generated.

*Gene locus.* 10q26.3.

*Molecular mass (kd):* 60.

*Distribution.* Expressed on polymorphonuclear leukocytes and macrophages.

*Function.* The ADAM family of proteins performs several functions in a variety of cells and in several species. ADAMs 1 to 7 are expressed in reproductive organs and function

in sperm-egg adhesion and fusion ( [2](#) ). ADAM-8 is involved in the degradation of vascular basement membrane. Through interactions of the disintegrin domain (competing with or binding to integrins), the ADAM proteins exert cell to cell and cell to matrix adhesion. It is important in PMN infiltration in areas of inflammation, and some members cleave and release important cell surface-bound molecules such as TNF- $\alpha$  (see [CD156b](#)), IL-6 receptors, Fas ligand, and so forth.

## CD156B (ADAM-17, TACE: TUMOR NECROSIS FACTOR- $\alpha$ -CONVERTING ENZYME)

*Structure.* Transmembrane I protein, a structure similar to CD156.

*Gene locus.* 2p25.

*Molecular mass (kd).* 100 to 120.

*Distribution.* Expressed on all cells examined.

*Function.* CD156b is a Zn-dependent metalloprotease. It is essential for “shedding” from the cell surface of TNF- $\alpha$  and TGF- $\alpha$  or other important molecules ( [1](#) ). Enzymes of the ADAM family with “ectodomain shedding” properties of cell-surface molecules are known as *sheddases*. ADAM-17 participates in a great variety of normal and pathologic processes. It releases the growth hormone-binding protein, a circulating high-affinity binding protein generated by proteolysis of the extracellular domain of the GH receptor. It cleaves the extracellular region of Notch-1 receptor and plays an important role in activation of Notch pathway. Tumor necrosis factor- $\alpha$ -converting enzyme (and probably other members of the ADAM family) cleaves the amyloid precursor protein of Alzheimer disease and releases a large soluble form amyloid-B peptide, which aggregates and forms the amyloid plaques of the disease ( [2](#) ). Tumor necrosis factor- $\alpha$ -converting enzyme also cleaves normal or cellular prion (PrP<sup>c</sup>) by its constitutive hydrolytic pathway and prevents the formation of the insoluble protease-resistant prion (PrP<sup>res</sup>) resulting in neurodegenerative diseases ( [3](#) ). TACE mediates cleavage and shedding of fractalkine (CX3CL1) chemokine that functions as an adhesion molecule for leukocytes and chemoattractant in inflammatory reactions ( [4](#) ).

## CD157 (BST-1)

*Structure.* CD157 is a single-chain GPI-anchored protein and is structurally and functionally similar to CD38.

*Gene locus.* 4p15.

*Molecular mass (kd).* 42 to 45.

*Distribution.* Expressed on B-cell progenitors before Ig gene rearrangements, as well as on T-cell progenitors. Also present on granulocytes, monocytes and macrophages, bone marrow stromal cells, endothelial cells, follicular DCs, and synovial cells from patients with rheumatoid arthritis.

*Function.* CD157 is a bifunctional ectoenzyme with two consecutive activities: (a) ADP-ribosyl cyclase, that is, it synthesizes cADP-ribose (cADPR) ( [1](#) ), and (b) cADPR

hydrolase, (i.e., it converts cADPR to ADPR). As a cyclase, it splits NAD to nicotinamide and cADPR, which then is hydrolyzed to ADPR by the hydrolase activity. cADPR induces potent mobilization of  $\text{Ca}^{2+}$  from intracellular stores by two possible mechanisms: endocytosis of the ectoenzyme or channel formation ( [2](#) ). CD38 has also been detected intracellularly on ER and nuclear membranes. CD157 regulates pre-B cell growth and is down-regulated on mature B cells.

## CD158

*Structure.* The CD158 contains 14 proteins, which, during the seventh HLDA workshop, were given a homogeneous CD nomenclature (i.e., CD158a through k and 158z). They belong to the KIRs. One family has two Ig-like domains in their extracellular region (KIR2D), and a second family has three (KIR3D). Each family is subdivided according to the length of its cytoplasmic tail: long (KIR2DL or KIR3DL) or short (KIR2DS) (see [Chapter 17](#)) ( [1](#), [2](#) ). The KIRDL members have two ITIMs in their cytoplasmic tail and functionally are inhibitory (i.e., CD158a or KIRDL1, and so forth). The KIRDS have no ITIM but have a positively charged amino acid (arginine or lysine) in their transmembrane domain, which is necessary to link to an adaptor with ITAM (DAP 12) for recruiting PTKs for activation.

*Gene locus.* 19q13.42.

*Molecular mass (kd).* Varies from 50 to 58, 70 or 140.

*Distribution.* NK cells and certain subpopulations of T cells.

*Function.* NK cells recognize HLA class I molecules and deliver signals that inhibit NK-cell function, avoiding killing normal cells. However, NK cells lyse targets that have lost some HLA molecules, as occurs with tumor cells or virus-infected cells. The ligand for CD158a is HLA-Cw4 and related alleles, whereas CD158b interacts with HLA-Cw3. Ligand binding to KIR2DL phosphorylates the ITIMs and recruits SHP-1 or SHP-2 tyrosine phosphatases, which initiate inhibitory signal cascade.

## CD159A (NKG2A)

*Structure.* Type II transmembrane protein (NH<sub>2</sub> terminal intracellularly), which belongs to the C-lectin family of proteins ( [1](#) ). The NKG2 family binds proteins rather than sugars. NKG2A forms a covalently linked heterodimer with CD94. The cytoplasmic tail of NKG2A contains ITIMs, which recruit SHP-1 or SHP-2 phosphatases, and, as a result, the CD94/NKG2A receptor is inhibitory.

*Gene locus.* 12p13.2 to p12.3.

*Molecular mass (kd).* 48 (reduced); 70 (unreduced)

*Distribution.* The NKG2A is detected on NK cells and on some T cells, and the NKG2D is detected on NK cells,  $\alpha\beta^+$  and  $\gamma\delta$  T cells, and macrophages.

*Function.* The NKG2 proteins recognize nonclassical HLA class I molecules (i.e., HLA-E) ( [2](#) ). HLA-E binds peptides from leader sequences of classical HLA class I molecules. The NKG2C and E form heterodimers with CD94 but lack ITIMs and are activating. The

NKG2D forms a homodimer and is also an activating receptor. Activating receptors have a charged amino acid in their transmembrane domain, which links them to adaptor proteins possessing ITAMs. NKG2D recognizes stress-induced MICA and MICB.

## CD162 (PSGL-1: P-SELECTIN GLYCOPROTEIN LIGAND-1, PSGL)

*Structure.* CD162 is a disulfide-linked homodimer. The extracellular regions consist of a selectin-binding domain and 15 decameric repeats. PSGL-1 is extensively glycosylated with sialic acid and fructose containing O-linked glycans and sulfated on tyrosines. CD162 binds to P-selectin through the O-glycan attached to the threonine residue 16 of the mature protein but also to L- and E-selectin (1). All selectins bind to a tetrasaccharide known as *sialyl Lewis x* (sLe<sup>x</sup>) and its isomer *sialyl Lewis a* (sLe<sup>a</sup>). L- and P-selectin (but not E-) bind also to sulfated carbohydrates (i.e., heparan sulfate). A crucial role for the addition of the carbohydrates is played by two enzymes,  $\alpha$ -2,3-sialyltransferase followed by an  $\alpha$ -1-3-fucosyl transferase (Fuc T-VII) (see [CD62](#) and [Chapter 15](#)).

*Gene locus.* Chromosome 12q24.

*Molecular mass (kd).* 250 to 160 unreduced; 120 reduced.

*Distribution.* Expressed on granulocytes, monocytes, most T cells, and some B cells. Some CD34<sup>+</sup> bone marrow cells are also positive. PSGL-1 is concentrated on the tips of microvilli, and PSGL-1 is down-regulated after leukocyte activation.

*Function.* It facilitates tethering and rolling of leukocytes, and when dimerized, it strengthens the bonds with P-selectin, which are important in shear flow (2). Binding of P-selectin to its ligand induces phosphorylation of signaling proteins such as the Ras MAPK pathway. It also stimulates IL-8 secretion, and so it further propagates the signaling cascade required for migration of leukocytes.

## CD164 (MVC 24, MGC-24V)

*Structure.* It is a type I transmembrane protein of 178 amino acids, rich in serines and threonines (20%). The extracellular region contains two mucin domains (I and II) separated by a nonmucin cysteine-rich domain. At least 16% of the serines/threonines can serve for attachment of O-linked glycans. The carbohydrate component of the molecule (both O-linked and N-linked) constitutes 70% of the molecular mass of the mature protein. It is intriguing that CD164 has a cytokine-binding pocket. The intracellular region is short and hydrophilic and contains the YHTL motif of the type YXXF (letter code for amino acids, F, a hydrophobic residue). These motifs can be detected on the membrane proteins of endocytic vesicles. They bind the  $\gamma$  subunit of adaptor proteins involved in sorting proteins within transport vesicles. CD164 forms a homodimer of two disulfide-linked monomers.

*Gene locus.* 6q21.

*Molecular mass (kd).* 80 to 100.

*Distribution.* It is expressed on hematopoietic progenitors, which include clonogenic myeloid and erythroid cells, and more primitive precursors, generally CD34<sup>+</sup> CD38<sup>-</sup> strong (1, 2). It is also expressed on bone marrow stromal cells.

*Function:* CD164 belongs in the sialomucin adhesion receptor family, which includes CD34, CD162 (PSGL-1), CD43, GlyCAM, and so forth, with an adhesion receptor function. It also inhibits progression into cell cycle of primitive hematopoietic progenitors (CD34<sup>+</sup>/38<sup>-</sup>) (1, 2) and prevents development of myeloid and erythroid differentiated cells *in vitro* (3). Each of these functions is mediated by different glycosylated epitopes of the protein.

## **CD166 (ALCAM: ACTIVATED LEUKOCYTE CELL ADHESION MOLECULE, NEUROLIN, BEN)**

*Structure.* Type I transmembrane protein, member of IgSF with five extracellular immunoglobulin-like domains. Two V (N-terminal) and three C type. The cytoplasmic tail is short, but approximately 50% of its amino acids are positively charged residues. The CD166 binds to CD6 but is also involved in homophilic interactions. The molecule can be considered as consisting of two functional modules: *ligand binding*, comprising the V<sub>1</sub> domain, and *oligomerization module*, comprising the membrane-proximal C<sub>2</sub>-C<sub>3</sub> domains. Both are needed for stable adhesion, although ligand binding in itself is independent of the C domains. The homophilic binding requires lateral homooligomerization through the C<sub>1</sub>-C<sub>2</sub> domains.

*Gene locus.* 3q13.1.

*Molecular mass (kd).* 100 to 105.

*Distribution.* It is expressed on hematopoietic cells. On lymphocytes and monocytes, it is expressed only after polyclonal activation, and in the synovium of rheumatoid arthritis patients. It is also present on a subpopulation of CD34<sup>+</sup> bone marrow cells and stromal cells (1), metastasizing melanoma cells (2), neuronal cells, mesenchymal stem cells, and osteoblastic cells. It is detected in the endothelium of yolk sac and dorsal aorta but not in adult aorta.

*Function:* It is involved in various physiologic processes such as hematopoiesis, immune response, thymus development, vasculoangiogenesis, neural cell migration, osteogenesis, and so forth. CD166 is an adhesion molecule mediating interactions between identical or different cells through homophilic (CD166-CD166) or heterophilic (CD166-CD6) interactions (3-5). The adhesions are dynamically regulated through actin cytoskeleton, which is essential for clustering of the CD166 molecule. CD166 plays an important role in melanocytic tumor progression.

## **CD169 [SIALOADHESIN (SN), SIALIC ACID-BINDING IG-LIKE LECTIN-1 (SIGLEC-1)]**

*Structure.* Type I transmembrane protein with a large extracellular region consisting of 17 Ig-like domains (one V at the NH<sub>2</sub>-terminal and 16 C<sub>2</sub> domains) (1). It is a member of a family of proteins that bind sialic acid and containing ligands, specifically, the N-acetylneuraminic acid (Neu5Ac) portion of 3'-sialyllactose. The binding site is located in the V-domain (arginine 97) in the F strand of the  $\beta$  sheet. Two groups of aromatic amino acids (tryptophan) are involved in hydrophobic interactions.

*Gene locus.* 20p13.

*Molecular mass (kd).* Approximately 200.

*Distribution.* Sn is expressed strongly on perifollicular macrophages in the spleen and sinusoidal and subcapsular macrophages in lymph nodes, as well as on stromal macrophages of bone marrow, and moderately on liver, gut, and lung macrophages. Inflammatory macrophages from rheumatoid synovium are strongly positive ( [2](#) ).

*Function.* The NH<sub>2</sub> terminal V domain binds sialylated ligands, recognizing sialic acid in the α-2,3 glycosidic linkage of N- and O-glycans. Sn belongs to the Siglec family of sialic acid-binding lectins. Other members of the Siglec family are CD22 (Siglec-2) on B cells, CD33 (Siglec-3) on myeloid cells and monocytes, MAG (Siglec-4A) on Schwann cells and oligodendrocytes, Siglecs-5, -6, -7, -8, and -9 on various hematopoietic cells, and Siglec-10 on human DCs. Apart from Sn, the cytoplasmic regions of other Siglecs contain ITIMs and are involved in inhibitory functions (see [CD33](#)). Except for Sn, most of the other members are naturally masked (interacting with neighboring sialic acids) and are normally unmasked after cell activation or exposure to sialidases. Counter-receptors for Sn are the sialomucins, CD43 and CD162 (P-SGL-1) ( [3](#) ). The Sn from certain sources binds to the cysteine-rich domains of the mannose receptor. Macrophages interact through the Sn ligands on hematopoietic cells, mediating cell interactions important for hematopoiesis and their scavenging function. Neutrophils express high levels of Sn ligands. CD43 on T cells acts as counter-receptor for Sn, promoting cell-cell interactions. Sn binds strongly to autologous RBCs in a sialic acid-dependent manner. The reasons that RBCs escape adhesive interactions with the macrophages remain to be determined.

## CD170 (SIGLEC-5)

During the seventh HLDA Workshop, CD170 was assigned to Siglec-5. The Siglec family, however, contains several members, and only five have been assigned a CD number: CD22, CD33, CD83, CD169, and CD170. The other members, Siglec-4a and -4b and Siglec-6 to -10, will likely be assigned their own numbers or be incorporated into one of the existing numbers (i.e., CD170 with a letter subscript: a, b, and so forth). In this section, Siglecs-5 to -10 are briefly summarized ( [1](#) ).

CD170 (Siglec-5) consists of four extracellular Ig-like domains, one V (NH<sub>2</sub>-terminal) and three Cs. The V domain contains the sialic acid-binding site, with an Arg residue being essential, as for sialoadhesin (CD169). It expresses a high degree of homology with CD33 (subfamily CD33). However, Siglec-5 recognizes α2,3- and α2,6-linked sialic acids, in contrast to all other Siglecs, which bind either one but not both. The cytoplasmic tail contains two conserved tyrosines within potential ITIM sequences. All Siglec genes map to chromosome 19q13.41-43, closely linked to CD33. It is expressed at high levels on peripheral blood neutrophils (absent in immature stages of myeloid cells), on monocytes, and on B cells ( [2](#) ). The highly conserved ITIM-like motifs suggest that Siglec-5 may be involved in signaling as an inhibitory receptor, a member of the growing family of myeloid inhibitory receptors. These receptors are engaged with broadly expressed host-specific ligands and exert a protective effect by triggering inhibition of cytolytic functions of effector cells against the host.

## Siglec-6 (OB-BP1)

Siglec-6 consists of three Ig-like domains, one NH<sub>2</sub>-terminal V and two C<sub>2</sub>. The cytoplasmic tail has two conserved tyrosines. The first tyrosine is within an ITIM, whereas the sequence of the second matches that found in SLAM, which is the docking site for



SAP (see [CD150](#)). It is expressed in spleen cells, B cells, small intestine, and strongly in cyto- and syncytiotrophoblasts of the placenta. Siglec-6 selectively binds to sialyl-Tn (CD175s), a disaccharide formed by premature sialylation of N-acetylgalactosamine (see [CD175](#)). It is the only Siglec that binds a protein, leptin.

### **Siglec-7**

Siglec-7 contains one V and two C<sub>2</sub> Ig-like domains in the extracellular region and two tyrosines in the cytoplasmic tail. It exhibits a high degree of homology with CD33, CD170, and Siglec-6 ([3](#)). It is expressed on granulocytes (low levels), monocytes (intermediate levels), NK cells, and CD8<sup>+</sup> T cells (high levels). It recognized the α2,3- or α2,6-glycosidic linkage. The gene is located on chromosome 19q13.41-43.

### **Siglec-8**

Siglec-8 is expressed on eosinophils, the only Siglec family member so far to be identified on these cells ([4](#)).

### **Siglec-9**

Siglec-9 contains three extracellular Ig-like domains (one V and two C<sub>2</sub>). The cytoplasmic tail contains two tyrosines. Only one is within an ITIM. The sequence around the second tyrosine is similar to that on the SLAM (CD150) docking site for SAP. Siglec-9 recognizes sialic acid in either α2,3- or α2,6-glycosidic linkage to galactose and is expressed strongly on neutrophils and monocytes ([5](#)) and weakly on B cells, NK cells, and a subset of CD8<sup>+</sup> T cells.

### **Siglec-10**

Siglec-10 is a transmembrane protein with five extracellular Ig-like domains (one V and four C<sub>2</sub>) ([6](#)). The cytoplasmic tail contains three potential ITIMs. Siglec-10 is expressed on monocytes, B cells, NK cells, and eosinophils.

## **REFERENCES**

1. Crocker PR, Varke A. Siglecs, sialic acids and innate immunity. *Trends Immunol* 2001;22:337-342.
2. Cornish AL, Freeman S, Forbes G, et al. Characterization of Siglec-5, a novel glycoprotein expressed on myeloid cells related to CD33. *Blood* 1998;92:2123-2132.
3. Angata T, Varki A. Siglec-7: a sialic acid-binding lectin of the immunoglobulin superfamily. *Glycobiology* 2000;10:431-438.
4. Floyd H, Ni J, Cornish AL, et al. Siglec-8. A novel eosinophil-specific member of the immunoglobulin superfamily. *J Biol Chem* 2000;275:861-865.
5. Zhang JQ, Nicoll G, Jones C, et al. Siglec-9, a novel sialic acid binding member of the immunoglobulin superfamily expressed broadly on human blood leukocytes. *J Biol Chem* 2000;275:22121-22126.
6. Munday J, Kerr S, Ni J, et al. Identification, characterization, and leukocyte expression of Siglec-10, a novel human sialic acid-binding receptor. *Biochem J* 2001;355:489-497.



## CD172a (SIRP- $\alpha$ : SIGNAL REGULATORY PROTEIN- $\alpha$ )

*Structure.* SIRP- $\alpha$  belongs to a new family of inhibitory/activating receptors. These molecules are also known as SHPS-1 (src homology 2 domain-containing phosphatase substrate-1). The extracellular region of SIRP- $\alpha$  has three Ig-like domains, whereas the cytoplasmic region contains two ITIMs. There are approximately 15 members in this family in humans, which can be divided into two groups depending on the presence (SIRP- $\alpha$ ) or absence (SIRP- $\beta$ ) of the ITIMs. The ITIMs interact with protein tyrosine phosphatases SHP-1 and SHP-2 and thus are involved in negative regulation of signaling cascades. Members like SIRP- $\beta$  that lack ITIMs function as activating receptors.

*Gene locus.* 20p13.

*Distribution.* Strong expression on monocytes, granulocytes, DCs, myeloid progenitors, and stem cells (CD34<sup>+</sup> CD117<sup>+</sup>), and on a subset of B cells. Expression is negative or reduced in AML and blasts of CML. It is also expressed in neuronal tissues.

*Function.* The ligand for SIRP- $\alpha$  is CD47, an IAP with multiple functions (1). Interaction of CD47 on T cells with SIRP- $\alpha$  on DCs inhibits maturation of DCs, decreases IFN- $\gamma$  production, and impairs development of Th1 cells. SIRP- $\alpha$  negatively regulates signaling by receptor of growth hormone (2), insulin, and EGF.

SIRP- $\beta$  is expressed in monocytes and DCs and lacks ITIM sequences. SIRP- $\beta$  associates with DAP-12, which contains an ITAM and acts as an activating myeloid receptor (3).

## CD173 (BLOOD GROUP H TYPE 2)

*Structure.* Blood group antigens ABH derive from a common precursor that shows no ABH specificity. According to the terminal disaccharide structure of this precursor chain, they are distinguished into type 1 to type 6. Type 2 is the most common, with a structure of Gal $\beta$ <sub>1</sub> ?4GlcNAc $\beta$ <sub>1</sub> ?X. The determinant H is generated by the enzyme H transferase that attaches  $\alpha$ -fucose to carbon-2 of the terminal  $\beta$ -galactose unit. H substrate is the immediate precursor of A and B antigens. Their specific determinants are generated by the addition of N-acetylgalactosamine (for A) or galactose (for B) to terminal galactose of substance H by appropriate transferase products of genes A or B. Differences between type 1 and type 2 ABH groups in the precursor substance are the linkage between galactose and N-acetylglucosamine (i.e., 1?4 for type 2 and 1?3 for type 1). In addition, in type 2, the terminal chain is perpendicular to the membrane, whereas in type 1, it is more or less parallel. Type 2 blood group H substance is CD173, the trisaccharide Fuca-1?2Gal $\beta$ <sub>1</sub> ?3GalNAc, which can be carried by a glycolipid or a glycoprotein (1). The gene (FUT-1) for the  $\alpha$ 1,2-fucosyltransferase, which generates the H determinant (H gene), is on chromosome 19q13.3.

*Distribution.* In addition to RBCs, H type 2 antigens are detected in hematopoietic CD34<sup>+</sup> cells carried by a 170-kd protein. It is also detected in pancreas, small intestine, mammary epithelium, and basal cell carcinomas. Peripheral blood lymphocytes are negative for CD173. Soluble forms of CD173 are present in plasma and urine.

## CD174 (LEWIS Y)

**Structure.** The Lewis y (Le<sup>y</sup>) determinant is based on type 2 chain core structure and carries two fucoses: one Fuca1?2 to the terminal galactose, and a second Fuca1?3 to the subterminal N-acetyl glucosamine (see also [CD173](#)). There are several genes regulating the expression of the antigens of the Lewis system, encoding fucosyl transferases. The Le<sup>y</sup> antigen is generated by the transfer of a fucose to an already fucosylated H-substance intermediate. Le<sup>y</sup> expression always depends on the secretor status of the individual.

**Gene locus.** The genes for the fucosyltransferases for the Le antigen system are located on chromosome 19p13.3 (FUT-3, FUT-5, and FUT-6), chromosome 11q21 (FUT-4), and 9q34.4 (FUT-7).

**Distribution.** Le<sup>y</sup> glycolipids have been isolated from adenocarcinomas of the mammary glands and gastrointestinal tract, as well as from glycoproteins found in water-soluble substances of saliva, gastric mucosal mucins, and ovarian cyst fluids. They are expressed on granulocytes and small intestinal epithelial cells. Oligosaccharides carrying Le<sup>y</sup> structure are present in milk and urine. Le<sup>y</sup> has also been detected on *Helicobacter pylori*. This may represent a molecular mimicry phenomenon.

**Function.** The function of Le<sup>y</sup> antibody is not well understood, but Le<sup>x</sup> is involved in cell differentiation and embryonic development. Some members of the Le family are important ligands for adhesion molecules such as selectins. Adhesion of tumor cells on the endothelia involves Le members and therefore may play an important role in hematogenous metastasis. Human epithelial tumors and leukemias have increased levels of transcripts from FUT-3 and FUT-6 genes.

## CD175 (Tn)

**Structure.** The T antigen, also called *Thomsen-Friedenreich antigen*, appears *in vitro* in stored blood samples as a result of bacterial contamination and *in vivo* during infections. The T determinant is the disaccharide Galβ1?3GalNAc. The Tn antigen is the precursor to T antigen, formed by the transfer of an α-GalNAc transferase of N-acetyl galactosamine to Ser or Thr of a protein (i.e., GalNAca1?O-Ser/Thr). The addition of a galactose to Tn antigen by a galactose-transferase generates the T antigen (i.e., Galβ1?3GalNAc-O-Ser/Thr). The T antigen is a common structure of glycoconjugates. In stored blood, it appears after bacterial contamination. It is also detected *in vivo* during infections with bacteria or viruses. Appearance of T antigen is caused by neuraminidases released by microorganisms and is known as the *T transformation*. T and Tn saccharides are carried by A and B glycoporphins. A sialylated form of Tn (STn) also exists, formed by the addition of sialic acid to Tn determinant (i.e., Neu5Aca2?6GalNAc).

**Distribution.** Strong T-antigen expression is detected in malignant carcinomas of breast, stomach, and colon, teratocarcinomas, and acute leukemias ([1](#), [2](#)).

**Function.** T and Tn antigens represent precursors of biosynthetic pathways of glycoconjugates. Appearance of T antigens, Tn antigens, or both (T or Tn transformation) causes polyagglutination. The transformation usually is not accompanied by pathologic symptoms. However, leukopenia, thrombocytopenia, and hemolytic anemia have been observed. It has been suggested that Tn transformation may affect a hemopoietic stem cell because it affects not only red cells but also other blood cells. However, whereas the former (i.e., T) is acquired, the latter (i.e., Tn) is usually persistent and is believed to be

due to a somatic mutation. These mutations affect genes involved in biosynthesis of glycoconjugates, altering the structure of red cell membranes. STn is one of the ligands for Siglec-6 (see [CD170](#)). Both T and Tn have been used as markers in malignancies. Detection of STn and Tn antigens on carcinoma cells or in the serum of patients indicates poor prognosis and distant metastases in colorectal, breast, and gastric cancers ([3](#)).

## CD176 [T ANTIGEN, THOMSEN– FRIEDENREICH (TF) ANTIGEN]

*Structure.* The T or TF antigen (or epitope, glycotope) is generated from the addition, by a  $\beta$ 1 $\rightarrow$ 3 galactose transferase in the presence of a UDP-Gal, of a second galactose molecule to its precursor Tn (i.e., GalNAc $\alpha$ 1 $\rightarrow$ O-Ser/Thr), forming the disaccharide: Gal $\beta$ 1 $\rightarrow$ 3GalNAc $\alpha$ 1 $\rightarrow$ O-Ser/Thr (see [CD175](#)) ([1](#)). The T antigen generates the M or N histo-blood groups by the action of a-N-acetyl-neuraminic acid transferase.

*Distribution.* TF and its precursor Tn are accepted as tumor antigens, which are “cryptic” or “masked” in normal tissues, preventing their detection. The application of monoclonal antibodies (rather than lectins, which possess broader carbohydrate specificity) has permitted its detection in some normal tissues [i.e., pancreatic duct, apical membranes of renal distal and collecting tubules, salivary glands, stomach, and placenta (first and second trimester)]. T antigen has also been detected during the development of lungs and kidneys, placing it in the category of CEAs ([2](#)).

*Function.* Detection of the TF antigen has been used as a diagnostic and prognostic marker in various malignancies ([3](#), [4](#)). It has been suggested that it may serve as a target for immunotherapy. It mediates adhesion of malignant cells to vascular endothelium ([5](#)). However, others consider TF antigen as a differentiation-related antigen rather than a carcinoma-associated antigen.

## CD178 [FAS LIGAND, CD95L, TUMOR NECROSIS FACTOR SUPERFAMILY-6 (TNFSF6)]

*Structure.* FasL is a cytokine and type II transmembrane protein that belongs to the TNF family. The NH<sub>2</sub>-terminal cytoplasmic region is rich in proline, and the extracellular region has two cysteines in similar positions as TNF- $\alpha$  and TNF- $\beta$  with which FasL is highly homologous. The FasL is a homotrimer and is likely to have the same topology as TNF- $\alpha$ /TNF- $\beta$ .

*Gene locus.* 1q23.

*Molecular mass (kd).* 40.

*Distribution.* FasL is expressed primarily on activated T cells and nonactivated NK cells ([1](#)), as well as other cells and tissues such as neutrophils, astrocytes, microglia, mature erythroblasts, breast epithelia, placenta, and vascular endothelial cells. It is constitutively expressed on cells of immunologically privileged sites, such as stromal cells of retina and Sertoli cells of testis ([2](#), [3](#), [4](#), [5](#) and [6](#)). FasL is detected in a number of malignancies, including multiple myeloma and myeloid leukemias.

*Function.* After engagement of the TCR of a cytotoxic T cell, FasL appears on its surface (or is released in microvesicles) and reacts with Fas (CD95) on the target to bring about its demise by apoptosis ([7](#)). Expression of FasL on tumors and leukemias can induce

death of T cells expressing Fas, considered as a tumor counterattack resulting in their escape from immune attack (8). Soluble FasL is elevated in patients with NK-cell (large granular lymphocyte) leukemia or NK lymphoma in patients with hemophagocytic syndrome, Diamond-Blackfan anemia, and aplastic anemia (9). Most of the patients with high levels of FasL are neutropenic because neutrophils are sensitive to FasL killing. FasL has been implicated in the negative control of erythroid differentiation. The *gld* inbred strain of mice have a spontaneous point mutation in the FasL gene (Ph273Leu) and suffer from an ALPS characterized by lymphadenopathy, splenomegaly, accumulation of CD4<sup>-</sup>/CD8<sup>-</sup> (double-negative) T cells, and presence of high titers of autoantibodies.

## CD179a (VPREB, VPRED1, IGVPB) AND CD179B (IGLL1, ?5, ?5 IMMUNOGLOBULIN OMEGA POLYPEPTIDE)

See also [Chapter 16](#).

*Structure.* CD179a (or VpreB) and CD179b (or ?5) form the surrogate light (L) chain (SL) of the pre-BCR complex. The SL with the  $\mu$  (IgM) heavy chain forms the pre-BCR. VpreB (CD179a) contains one V-like, and ?5 (CD179b) contains one C-like Ig domain. The VpreB lacks the sequence that corresponds to the J segment of the L-chain of mature B cells (B7 strand), which is present in the ?5-chain. This B strand in ?5 controls the folding of VpreB, the exit through the secretory pathway, and the assembly of SL by acting as an intramolecular chaperon (1). The SL chain is disulfide-linked to membrane-bound  $\mu$ -chain to form the pre-BCR, which is associated with Iga (CD79a) and Ig $\beta$  (CD79b) heterodimer to form the pre-BCR complex.

*Gene loci.* 22q11.22 (CD179a) and 22q11.23 (CD179b).

*Molecular mass (kd).* CD179a, 16 to 18; CD179b, 22.

*Distribution.* Both proteins are expressed in the early stages of B-cell development and are detected on the surface of large and small pre-B cells.

*Function.* Pre-BCR complex interacts with several proteins on stromal cells (clusterin, matrix glycoprotein scl-1, and so forth) that promote survival, pre-B-cell proliferation, or both. Once the pre-BCR is formed, they cluster on lipid rafts, which promote activation of the PTK Lyn and phosphorylation of Ig $\beta$ -chain (2). This interaction leads to assembly of a number of signaling proteins in the raft essential for Ca<sup>2+</sup> signaling, which leads to an orderly maturation of B cells, that is, turning off (a) genes of the Ig gene rearrangement machinery ensuring allelic exclusion and (b) the SL genes (3). Mutations of the genes of ?5 give rise to a syndrome similar to Bruton agammaglobulinemia (4). The availability of monoclonal antibodies for the VpreB-chain allows a more refined classification of B-ALL (5).

## CD183 [CXCR<sub>3</sub>, GPR9, CKR-L2, IP-10-R, MONOKINE INDUCED BY ?-Interferon Receptor (MIG-R)]

*Structure.* CD183 is a seven-transmembrane domain protein member of the G protein-coupled receptors. The extracellular domain consists of three extracellular loops, which bind the chemokine ligand. The intracellular region is composed of three loops. The C-terminus transduces the chemokine signal and regulates the expression of the receptor. All chemokine receptors have a conserved amino acid sequence DRYLAIV in

the second intracellular loop, which interacts with the G protein.

*Gene locus.* Xq13.

*Molecular mass (kd).* 40.

*Distribution.* CD183 is strongly expressed on activated/memory T cells but not in naïve T cells ( [1](#) ) and have a predilection for homing to inflammatory lesions. CD183 is also expressed by medullary thymocytes, DCs, plasmacytoid monocytes, eosinophils, and CD34<sup>+</sup> hematopoietic progenitors activated by GM-CSF ( [2](#) ). CD183 is lacking on normal B cells but is expressed in all patients with B-CLL. In nonhematopoietic cells, CXCR<sub>3</sub> is detected on endothelial cells of small vessels of the skin, liver, and kidney, and on vessels of all lymphoid organs.

*Function.* There are three chemokines acting as ligands for CXCR<sub>3</sub>: Mig (monokine induced by  $\gamma$ -IFN, CXCL-9); IP-10 (IFN-inducible protein 1b, CXCL-10); and I-TAC (inducible T-cell  $\alpha$ -chemoattractant, CXCL-11). The activated Th1 type of cells strongly positive for CXCR<sub>3</sub> migrate to inflammation sites, such as rheumatoid joint, lesions of multiple sclerosis, sarcoidosis, hepatitis C, and autoimmune thyroids. CXCR<sub>3</sub> ligands secreted from alveolar macrophages in AIDS patients with alveolitis attract CD8<sup>+</sup>/CXCR<sub>3</sub><sup>+</sup> T cells secreting IFN- $\gamma$  (consistent with Tc1 phenotype) ( [3](#) ). CXCR<sub>3</sub> expressed on endothelial cells of small vessels plays an important role in regulation of new blood vessel formation, which is fundamental for a variety of processes, such as wound healing and tumor growth. The ligands of CXCR<sub>3</sub> are angiostatic (i.e., oppose the angiogenic chemokines such as IL-8, GRO- $\alpha$ , and so forth) ( [4](#) ). Expression of CXCR<sub>3</sub> on endothelial cells is cell cycle-dependent, induced on activation, especially when they exhibit a high proliferative rate. CXCR<sub>3</sub> has also been detected on stellate hepatic cells and glomerular mesangial cells in culture, where ligands of CXCR<sub>3</sub> stimulate cell proliferation and up-regulate the expression of the receptor. These data suggest a role of CXCR<sub>3</sub> in tissue fibrosis.

CXCR<sub>3</sub> expression in B-CLL, but not in mantle cell lymphoma, is involved in chemotaxis of B cells ( [5](#) ) and may be used as a diagnostic marker ( [6](#) ). The intracellular signaling pathways after ligand binding to CXCR<sub>3</sub> involve phosphorylation of Src kinases and activation of PI3K and the Ras/ERK pathway ( [7](#) ). Continuous stimulation of CXCR<sub>3</sub> results in its own regulation as a result of rapid internalization induced primarily by the I-TAC ligand, and it occurs under physiologic settings.

## **CD184 (CXCR<sub>4</sub>, FUSIN, LESTR, NPY3R, HM89)**

*Structure.* CD184 is a seven-transmembrane domain protein linked to G protein. It has numerous Ser/Thr phosphorylation sites in the intracellular regions and cysteine residues in the NH<sub>2</sub>-terminal region, likely forming disulfide bonds. Binding of its ligand requires the NH<sub>2</sub>-terminus of the CXCR<sub>4</sub>, whereas the activation is mediated by a distinct region of the second extracellular loop.

*Gene locus.* Chromosome 2q21.

*Molecular mass (kd).* 40.

*Distribution.* In contrast to other chemokine receptors, CXCR<sub>4</sub> is the only receptor expressed not only among hematopoietic cells but also widely on other tissue cells. It is detected on B and T cells, monocytes, neutrophils, platelets, macrophages, DCs, precursors of all lineages (1), endothelial and epithelial cells, and cells of nerve tissue.

*Function.* The only ligand of CXCR<sub>4</sub> is SDF-1, which was isolated from a bone marrow stromal cell line. Its gene has structural features considered characteristic of a “housekeeping” gene and is the only one among CXC chemokine genes to reside on chromosome 10, whereas all the others are on chromosome 4. CXCR<sub>4</sub> is involved in a wide variety of essential functions in embryogenesis, brain development, vascularization, hematopoiesis (2, 3), and cell migration. On binding, the ligand induces internalization of CXCR<sub>4</sub> and triggers a number of signaling pathways involving focal adhesion components and downstream diverse kinases (4). In hematopoiesis, CD184 mediates transendothelial migration of CD34<sup>+</sup> stem cells and promotes B-cell lymphopoiesis and myelopoiesis in the bone marrow. In the thymus, SDF-1 is produced by epithelial cells, and its receptor is up-regulated on thymocytes by IL-7 to mediate their survival, expansion, and differentiation (5, 6). The CXCR<sub>4</sub>/SDF-1 couple induces the development of new blood vessels, neuronal migration, and cerebellar development. CXCR<sub>4</sub> functions as a co-receptor for the T-cell-tropic HIV (7). The gp120 binds specifically to CXCR<sub>4</sub> of T cells. The binding site of gp120 differs from the site that permits the entry of the virus (“fusin” or co-receptor). Finally, CXCR<sub>4</sub> has been implicated in metastasis of breast (8) and prostatic carcinomas and migration of the myeloid and lymphoid leukemia (9).

## CD195 (CCR5)

*Structure.* CD195 is a seven-transmembrane domain protein linked to G proteins. The conformation of the extracellular regions is maintained by two disulfide bonds, one linking the first and second extracellular loops, and a second linking the N-terminus and the third ECL. Conformational integrity is required for ligand binding and receptor activation. The second ECL is a major determinant for chemokine binding. CCR5 is the co-receptor for macrophage-tropic HIV-1. Sulfated tyrosines in the NH<sub>2</sub>-terminal region of CCR5 interact with the HIV-1 gp120 envelope protein for the binding and entry of HIV (1). Other studies show that negatively charged and aromatic amino acids (some tyrosines being sulfated) are used for chemokine and HIV binding (2). For optimal CCR5 expression, a basic amino acid sequence and a cysteine cluster in the C-terminal intracellular region are required (3).

*Gene locus.* 3p21.

*Distribution.* CCR5 is expressed on activated (memory) cells, B cells, macrophages, and DCs as well as microglial cells. T cells collected from inflammatory sites and rheumatoid joints are predominantly (>80%) CCR5<sup>+</sup>. These cells are mostly CD45RO<sup>+</sup>, a phenotype consistent with activated memory T cells. The CCR5 (and CXCR<sub>3</sub>) may represent markers of inflammatory T cells, particularly of the Th1 type (4). Only small numbers of T cells within lymph nodes and peripheral blood are CCR5<sup>+</sup>.



*Function.* CCR5 is the receptor for several chemokines: MIP-1a (macrophage inflammatory protein-1a, CCL3), MIP-1B (CCL4), RANTES (regulated on activation, normal T cell expressed and secreted, CCL5), MCP-2 (macrophage chemotactic protein 2, CCL8), and MCP-4 (CCL13). These chemokines and CCR5 play a major role in inflammatory responses ( [5](#) ). CCR5 is expressed primarily on Th1 cells that are involved in a number of inflammatory conditions, whereas virtually all T cells are CCR5<sup>+</sup>. Binding of the ligands (especially RANTES) results in phosphorylation of the CCR5 and association with JAK1 kinase, promoting the association of the STAT-6 transcriptional factor with CCR5. CCR5 is expressed on monocytes and immature DCs, which accounts for their capacity to extravasate and migrate into inflamed tissues. CCR5 is a major co-receptor for HIV-1 (macrophage-tropic on R5). Individuals lacking CCR5 because of homozygosity for the deletion mutant CCR5<sup>Δ32</sup> (“knock-out”) allele show almost complete resistance to HIV infection.

## CDW197 (CCR7)

*Structure.* A seven transmembrane domain-protein linked to G proteins.

*Gene locus.* 17q12-q21.2.

*Distribution.* CCR7 is strongly expressed on the vast majority of CD4<sup>+</sup> T cells in the peripheral blood. In the lymphoid organs, CCR7 is detected on resting CD4<sup>+</sup> and CD8<sup>+</sup> T cells but usually not on activated T cells. Loss of CCR7 is usually accompanied by expression of the CCR5 receptor. T cells from skin, gut, lung, and liver are enriched in CCR7<sup>-</sup> cells ( [1](#) ). CCR7 is expressed on mature DCs ( [2](#) ).

*Function.* There are two ligands for CCR7: (a) SLC, also known as TCA-4 (thymus-derived chemotactic agent 4), 6C kine, or exodus-2; and (b) ELC, also known as MIP-3B or exodus-3. SLC and ELC are designated *CCL21* and *CCL19*, respectively. SLC is expressed by the cells of HEV, and binding to its receptor CCR7 arrests rolling T cells via activation of  $\beta_2$  integrin, which interacts with ICAM-1 around HEV (perivascular) ( [3](#) ). ELC, produced by cells in the paracortex, is transcytosed to the luminal surface of HEV and is detected in HEV vesicles and so cooperates with SLC for efficient T-cell homing through CCR7 ( [4](#) ). T cells, through ELC/CCR7 interactions, are retained in the paracortical area (see [Chapter 14](#)). The importance of CCR7 in lymphocyte homing was shown by CCR7<sup>-/-</sup> mice, which are deficient in CCR7. These mice have increased numbers of T cells in peripheral blood, whereas the number of T cells in lymph nodes is reduced. A CCR7-independent homing pathway was recently shown with the use of FTY720, a novel immunosuppressant that induces marked reduction of T cells in blood ( [5](#) ). Treatment of CCR7-deficient mice with FTY720 accelerated T-cell homing and reduced the number of T cells in the blood. CCR7 is also important for the recruitment of antigen-loaded mature DCs to the paracortical areas, with the action of SCL expressed in the lymphatic endothelium. In this respect, CCR7 is crucial for establishing the functional microenvironments for cell interactions in the immune response. CCR7 mediates emigration of T cells from neonatal thymus. It is strongly expressed on H-RS cells, consistent with the interfollicular homing of these cells in classical Hodgkin disease, and mediates infiltration of lymphoid organs by leukemic cells in adult T-cell leukemia ( [6](#), [7](#) ).

## CD204 (MACROPHAGE SCAVENGER RECEPTOR, MSR-A)

*Structure.* Transmembrane type II glycoprotein forming a trimer. The extracellular region (



C-terminal) contains a cysteine-rich domain (scavenger receptor domain), a collagenlike domain, and an  $\alpha$ -helical coiled-coil domain, important for the formation of the trimer. The collagenous domain mediates adhesions between the macrophage scavenger receptor (MSR-A) and denatured forms of type I and III collagens (1). Proximal to the membrane is a spacer, followed by the transmembrane region and the intracellular NH<sub>2</sub>-terminal region.

*Gene locus.* 8p22.

*Distribution.* MSR is expressed on tissue macrophages and the high endothelial cells of postcapillary venules of lymph nodes.

*Function.* MSR-A belongs to a large family of scavenger receptors consisting of at least six classes. The best known are class A (I, II, III) and class B (CD36). MSR-A (type I and II) has broad ligand specificity (2). They bind oxidized, low-density lipoprotein, polyribonucleotides, sulfated polysaccharides, bacterial cell wall LPSs,  $\beta$ -amyloid, and so forth. Their biologic activities include host defense (innate immunity), atherosclerosis (foam cell formation), cell-cell interaction, disorders of the nervous system, phagocytosis of apoptotic cells, and so forth. Macrophages adhere through MSR-A to basement membranes of vessels altered during aging by nonenzymatic glycation of the proteins [advanced glycation end products (AGE)]. Oxidized LDL is phagocytosed by macrophages and transformed to foam cells (3, 4 and 5). Because the ligands for MSR-A are altered endogenous or foreign molecules, the receptor's main function is the removal of unwanted or potentially dangerous products. Engagement by ligands of MSR-A induces release of inflammatory cytokines.

## CD205 (DEC-205)

*Structure.* The extracellular region consists of an N-terminus cysteine-rich domain, FN type II domain followed by ten C-type lectin domains, one transmembrane, and a short intracellular region. The membrane-proximal region contains the sequence FSSVRY, which resembles the coated pit localization sequences. The distal or late endosome targeting is directed by the last three (EDE) amino acids of the cytosolic tail. This distal targeting sequence does not affect endocytosis or membrane recycling.

*Gene locus.* 2q24.

*Molecular mass (kd).* 205, reduced.

*Distribution.* DCs of all organs and Langerhans cells (skin), epithelial cells of thymic cortex, and intestinal villi. Low levels present on B cells, macrophages, T cells, bone marrow stromal cells, and epithelia of the lung.

*Function.* DEC-205 is an endocytic receptor used by DCs to deliver antigen captured from the extracellular space to late endosomes or lysosomes rich in MHC class II molecules (1). This contrasts with other receptors, such as the structurally homologous mannose receptor and the B-cell antigen receptor, which delivers captured antigens to the early endosomes. DEC-205 is a more efficient receptor, enhancing antigen presentation by 100-fold (2). A DEC-205<sup>+</sup> cell with dendritic morphology that was isolated from nonparenchymal liver cells promotes differentiation of regulatory T cells (Tr) secreting IL-10, IFN- $\gamma$ , and TGF- $\beta$  but not IL-2 or IL-4 (i.e., a cytokine pattern consistent with Tr1-like cell) (3). These liver-derived DEC-205<sup>+</sup> cells prolong cardiac allograft survival by an antigen-specific mechanism regulating donor-specific tolerance. The

liver-derived DEC-205<sup>+</sup> DCs home to the paracortical T-cell areas in the lymph node.

## CD206 (MRC1, MACROPHAGE MANNOSE RECEPTOR, MMR)

*Structure.* The extracellular region has an N-terminal cysteine-rich domain, followed by a FN type II repeat and eight C-type lectin domains, which recognize carbohydrates (carbohydrate recognition domains, CRD) with high content of mannose and fructose (1, 2). In two other receptors (i.e., DEC-205 and phospholipase A<sub>2</sub> receptor), the C-lectin domains do not have conserved amino acids necessary for Ca<sup>2+</sup>-dependent sugar. The N-terminal cysteine-rich and FN II domains increase the rigidity of the molecule, which has an extended conformation (3). Of the eight CDRs, CRD4 and CRD5 are the most crucial for mannose binding, yet they are in the middle of the receptor. This may be a more favorable place because, in the clathrin-coated pits filled with fluid, the mannose receptor is surrounded by ligands. CRD4 has a structure containing two  $\alpha$ -helices and two small antiparallel  $\beta$  sheets (4). CRDs 4, 5, and 7 are required for phagocytosis.

*Gene locus.* 10p13.

*Molecular mass (kd).* 166.

*Distribution.* CD206 is expressed mainly in macrophages and immature DCs, hepatic and lymphatic endothelial cells, mesangial cells, retinal pigmented epithelium, and inflammatory skin DCs (different from Langerhans cells). IFN- $\gamma$  decreases and IL-4 increases its expression.

*Function.* The main biologic functions of CD206 are (a) innate immunity: phagocytosis of bacteria, mycobacteria, yeast, and so forth (5); (b) adaptive immunity: antigen presentation; (c) removal of biologically active molecules from tissue fluids that may be potentially dangerous: myeloperoxidase, tissue plasminogen activator, lysosomal hydrolases; (d) removal of certain anterior pituitary hormones, such as lutropin and thyrotropin, clearing them from the circulation after they have acted on their targets; and (e) retinal epithelium: removal of proteins from outer segments of retinal rods.

## CD208 (DC-LAMP: DENDRITIC CELL-LYSOSOME-ASSOCIATED MEMBRANE PROTEIN, LAMP-3)

*Structure.* Type I transmembrane protein member of the family of lysosome-associated membrane proteins (LAMP), which has two other members, LAMP-1 and LAMP-2, and is homologous to CD68. The extracellular region of LAMP-1 and LAMP-2 consists of two homologous lysosome-luminal domains separated by a proline-rich hinge region. In each of the domains, there are two conserved disulfide bonds and several O- and N-glycans, followed by the transmembrane and a short cytoplasmic region. The DC-LAMP has only one of these domains located in the membrane-proximal region. LAMP-1 and LAMP-2 carry large numbers of "sialyl-Le<sup>X</sup>," which serves as a ligand for E-selectin present on endothelial cells.

*Gene locus.* 3q26.3.

*Molecular mass (kd).* 70 to 90.

*Distribution.* Expressed only on interdigitating DCs located in the paracortical areas of the

lymphoid organs and represents a specific marker for these cells. It is not expressed on immature DCs and first appears in the more mature stages, within acidic vesicles that intersect with endosomal components. These vesicles are rich in class II MHC molecules and HLA-DM ( [1](#) ). MIIC is considered to be the site for efficient peptide loading on class II molecules. DC-LAMP is not detected in Langerhans cells, considered to be immature DCs, or other dermal DCs. LAMP-1 and LAMP-2 are strongly expressed on malignant metastatic tumors ( [2](#) ).

*Function.* Probably involved in antigen presentation of class II MHC and remodeling of endosome/lysosome compartments by facilitating the translocation of class II to the cell surface. The genes of the LAMP molecules are on different chromosomes, LAMP-1 on 13q34, LAMP-2 on Xq24, and LAMP-3 (DC-LAMP) on 3q26, suggesting that they have diverged early in evolution and probably perform different functions.

## CD209 (DC-SIGN: DENDRITIC CELL-SPECIFIC INTERCELLULAR ADHESION MOLECULE-3 GRABBING NONINTEGRIN)

*Structure.* Type II transmembrane protein ( *N*-terminal cytoplasmic) that belongs to Ca<sup>2+</sup>-dependent C-type lectins for ligand binding. The extracellular region consists of seven and a half tandem repeats of highly conserved 23-amino acid sequences. In the C-terminus, there is a globular carbohydrate recognition domain (CRD) consisting of twelve  $\beta$ -strands, arranged in three  $\beta$  sheets, and two  $\alpha$ -helices, one on each end of the  $\beta$ -sheet platform. There are two sites for Ca<sup>2+</sup> binding on the CRD, but only site 1 is important for ligand binding ( [1](#), [2](#) and [3](#) ). The repeats in the extracellular region fold into  $\alpha$ -helices and contribute to the formation of tetramers of DC-SIGN. The cytoplasmic tail contains dileucine motifs (which may mediate internalization) and an YXXY sequence, a site for tyrosine phosphorylation.

*Gene locus.* 19p13.3.

*Molecular mass (kd):* 44.

*Distribution.* Expressed on DCs in all mucosal surfaces and lymphoid tissues and in a small subset in peripheral blood. It is present in the fetus, which indicates that antigenic or environmental stimuli are not necessary for its expression ( [4](#) ). Macrophages are DC-SIGN negative, but IL-13 induces its expression. Expression of DC-SIGN on DCs is stimulated by IL-4 and negatively regulated by IFN- $\gamma$  and TGF- $\beta$  ( [5](#) ). DC-SIGN is detected in placenta and in the rectum throughout the entire thickness of the mucosa ( [6](#), [7](#) ).

*Function.* The ligands for DC-SIGN are ICAM-3 and the envelope HIV protein gp120. DC-SIGN binds with high affinity to highly complex mannose oligosaccharides in ICAM-3 and the HIV-gp120 but not to single mannose present at the end of oligosaccharide chains, as found in bacteria, which is the ligand for the macrophage mannose receptor. The clustering of CRD in the DC-SIGN tetramer facilitates binding to multiple high mannose-containing oligosaccharides spaced at appropriate distances, which provides specificity. DC-SIGN functions as a receptor for antigen presentation to naïve T cells, which strongly express ICAM-3, but not to activated T cells, which are weakly positive or negative for ICAM-3 ( [8](#), [9](#) ). Antigen internalized by DC-SIGN is targeted to late endosomes/lysosomes. DC-SIGN as receptor for gp120 protein of HIV binds multiple viral particles and enhances T-cell infection *in trans* ( [10](#), [11](#) ). How the virus escapes degradation after DC-SIGN-mediated internalization is not clear. The HIV protein Nef

causes up-regulation of DC-SIGN to the cell surface, thus enhancing adhesion of several T cells around the DCs and facilitating virus transmission to T cells.

DC-SIGN R (DC-SIGN-related) is highly homologous to DC-SIGN protein (77%) with similar structure, specificity, and function. It has been detected in endothelial cells in approximately one-third of the capillaries in the terminal ileum. The same molecule has been found in liver on sinusoidal cells and in lymph nodes (called *L-SIGN*).

## CD210 (IL-10 RECEPTOR)

*Structure.* The IL-10 receptor (IL-10R) consists of two subunits, IL-10R1 and IL-10R2. It belongs to a cytokine II receptor family related to the IFN- $\gamma$ R. The family includes tissue factor, the IFN- $\gamma$ , and IFN- $\alpha$  receptors ( [1](#) ).

The extracellular region of IL-10Ra (IL-10R1) consists of two FN type III domains followed by the transmembrane and the cytoplasmic regions. IL-10R1 binds with high affinity to IL-10.

IL10RB (CRF2-4), originally described as *CRF2-4* (class II cytokine receptor family) or *orphan receptor* and a member of the IFN receptor family, is now shown to be an essential component of the IL-10R and is involved in signal transduction ( [2](#) ).

*Gene locus.* IL-10a, 11q23.3; IL-10B, 21q22.1.

*Molecular mass (kd).* IL-10Ra, 90 to 120; IL-10RB

*Distribution.* The IL-10a is expressed on most hemopoietic cells and in certain other tissues after induction. IL-10B is detected in most cells and tissues.

*Function.* Binding of IL-10 to IL-10Ra initiates signaling through the IL-10RB by engaging the Jak family of tyrosine kinases. Activation of the transcription factor STAT-3 is indispensable, but other pathways must be involved. The functions of IL-10 mediated by the IL-10R are multiple (i.e., inhibition of the production of inflammatory cytokines, IL-1, IL-6, IL-12, and TNF from macrophages and T cells). As well, it inhibits production of both CC and CXC chemokines implicated in inflammatory reactions. IL-10 has an important role in controlling systemic inflammatory responses, imposing some limits in the deployment of certain steps of innate or adaptive antipathogen responses, especially Th1 response by inhibition of INF- $\gamma$  production. IL-10 enhances Ig production and isotype switching and can be used in the treatment of certain immune deficiencies, such as common variable immunodeficiency and X-linked hyper IgM syndrome.

## CD212 (IL-12 RECEPTOR- $\beta$ $_1$ )

*Structure.* The IL-12R consists of two  $\beta$  subunits,  $\beta$   $_1$  (CD212) (high affinity) and  $\beta$   $_2$  (low affinity) ( [1](#), [2](#) ). Both chains have a high degree of homology with the gp130 chain. The extracellular region of  $\beta$   $_1$  consists of five FN III domains, followed by a transmembrane region and a short cytoplasmic tail. The  $\beta$   $_2$  subunit is a transmembrane type I protein, and its cytoplasmic tail contains three tyrosines, suggesting that  $\beta$   $_2$  is the signal-transducing component.

*Gene locus.*  $\beta_1$ , 19p13.1.

*Molecular mass (kd).*  $\beta_1$ , 100;  $\beta_2$ , 130.

*Distribution.* It is expressed on activated  $CD4^+$  and  $CD8^+$  T cells and  $CD56^+$  NK cells and macrophages. Expression of the  $\beta_2$  subunit is inhibited by IL-4 and induced by IFN- $\gamma$  (see below for significance). T cells from patients with Sézary syndrome with a heavy tumor burden do not express IL-12R under *in vitro* stimulation, indicating that treatment of these patients at a late stage of the disease with IL-12 will not be effective, although treatment is effective at an early stage of the disease (3).

*Function.* IL-12R mediates the functions of IL-12, which is a pleiotropic cytokine, and stimulates the production of several cytokines from T and NK cells (i.e., IFN- $\gamma$ , TNF- $\alpha$ , GM-CSF, IL-2, and so forth). The IL-12R  $\beta_2$ -chain alone can transmit the IL-12 signals through the JAK2, Tyk 2 kinases, and STAT-4 protein. The most distinctive function of IL-12 is the regulation of Th1 versus Th2 differentiation. IL-12 stimulates early IFN- $\gamma$  production (from NK and T cells), which maintains IL-12R  $\beta_2$ -chain expression and the IL-12 signal, promoting Th1 differentiation. In patients with tuberculoid but not lepromatous leprosy, the IL-12R  $\beta_2$  is up-regulated, and this explains why only the former patients have resistance to *M. leprae* because of a strong Th1 response (4). IL-4 inhibits IL-12R  $\beta_2$ , thus reducing or eliminating IL-12 signaling, and thus allows  $CD4$ -activated T cells to become Th2. Mutations in IL-12R have been associated with severe idiopathic mycobacterial and salmonella infections (5). IL-12 has also been implicated in the pathogenesis of experimental and human diseases (i.e., experimental allergic encephalomyelitis and multiple sclerosis). Synovial fluids from patients with rheumatoid arthritis have high levels of IL-12, and an abundance of IL-12-containing macrophages has been detected in colon biopsies from patients with inflammatory bowel disease. In patients with asthma (a Th2 response), IL-12 is reduced in bronchial biopsies.

## **CD213a<sub>1</sub> AND CD213a<sub>2</sub> (IL-13 RECEPTOR- $\alpha_1$ AND - $\alpha_2$ )**

*Structure.* The receptor complex that binds IL-13 consists of different polypeptide chains, and its composition varies with the type of cell (1). There are three (or probably four) combinations of a  $\alpha_1$ - and a  $\alpha_2$ -chains with the IL-4R $\alpha$  and the  $\gamma_c$  (common) chain: Type I consists of IL-13R $\alpha_1$ /IL-13a<sub>2</sub> and IL-4R $\alpha$ ; type II consists of IL-13R $\alpha_1$  and IL-4R $\alpha$ ; and type III is similar to type II with the participation of the  $\gamma_c$ -chain. The affinity of binding of IL-13 to IL-13R $\alpha_1$  is low, but for the IL-13R $\alpha_1$ /IL-4R $\alpha$  complex, is high, and, furthermore, the complex transmits signals by IL-13 or IL-4 (i.e., it is both an IL-13 and IL-4 receptor). The IL-13R $\alpha_2$  binds IL-13 with high affinity but does not bind IL-4 (2).

- a  $\alpha_1$ -chain. In the extracellular region, the first two domains form the cytokine type I module (i.e., four conserved cysteines in the first and the WSXWS motif in the second). The cytoplasmic region contains a proline-rich domain proximal to the membrane and two tyrosines, which are involved in signal transduction (3).
- a  $\alpha_2$ -chain. The extracellular region has the cytokine I module, but the cytoplasmic region is short and is not involved in signal transduction. It contains a dileucine motif, which mediates internalization through clathrin pits, and a tyrosine motif, which plays a role in ligand binding (4).

*Gene locus.* IL-13Ra<sub>1</sub>, Xq24l; IL-13Ra<sub>2</sub>, Xq13.1.

*Molecular mass (kd).* IL-13Ra<sub>1</sub>, 75; IL13Ra<sub>2</sub>, 65.

*Distribution.* The α<sub>1</sub> receptor is widely expressed in human tissues (heart, brain, placenta, muscle, kidney, and so forth) and on hematopoietic and nonhematopoietic tumors. α<sub>1</sub> is detected on RS cells in Hodgkin lymphoma ( [5](#), [6](#) ). Transcripts of the α<sub>2</sub> receptor have been detected in B cells, basophils, eosinophils, monocytes, endothelial, and epithelial cells and in breast and pancreatic tumors.

*Function.* The IL-13R signal transduction involves the JAK-1, TYK-2, and STAT-6 pathway and mediates IL-13 and IL-4 functions. IL-13 promotes B-cell proliferation and enhances the antigen-presenting function of phagocytes. It blocks secretion of inflammatory cytokines from monocytes (IL-6, IL-8, IL-12, and so forth), and on endothelial cells, it increases expression of adhesion molecules (VCAM-1). IL-13 plays a central role in allergic asthma, inducing airway hyperresponsiveness, mucus overproduction, increase of IgE, and so forth ( [7](#) ).

## CDW217 (IL-17 RECEPTOR)

*Structure.* The structure of IL-17R is not yet fully characterized ( [1](#), [2](#) ). Isolated cDNA from peripheral blood leukocytes indicates that it is a type I transmembrane protein, quite unrelated to receptors of other known families. Two IL-17Rs have been described: IL-17R and IL-17Rh1 (homolog). Another receptor, IL-17BR, is probably the same as IL-17Rh1. Several cysteines in the extracellular regions of IL-17R and IL-17Rh1 are conserved, as well as structures in the intracellular tail, suggesting that both use similar signaling pathways. The intracellular tail of IL-17R is long and physically connected to TRAF ( [3](#) ). IL-17RB has a much shorter intracytoplasmic tail than IL-17R.

*Gene locus.* IL-17R, 22q11.1; IL-17RB, 3p21.1; IL-17Rh1, 3p21.

*Molecular mass (kd).* IL-17R, 130 to 158.

*Distribution.* IL-17R is widely distributed in hematopoietic (NK cells, macrophages, neutrophils, and so forth) and nonhematopoietic cells (vascular endothelial cells, fibroblasts, synoviocytes, keratinocytes, epithelial cells, and so forth).

*Function.* IL-17R mediates the functions of IL-17 but binds IL-17A with low affinity. The IL-17 receptors promote secretion of IL-6, IL-8, IL-1, TNF-α, and nitric oxide and activate NF-κB (i.e., their main function is proinflammatory) ( [4](#) ).

IL-17 recruits neutrophils via IL-8 ( [5](#) ), which stimulates bronchial epithelial cells to release IL-6 and may play a role in severe exacerbations of asthma. IL-17 receptors are up-regulated in synovial endothelial cells and chondrocytes in patients with rheumatoid arthritis ( [6](#) ), and IL-17 is crucial for osteoclastic bone resorption ( [7](#) ).

IL-17 promotes cardiac and renal allograft rejection and through IL-8 may contribute to gastric inflammation in *Helicobacter* infection ( [8](#) ). IL-17R-deficient mice have a 100% mortality from pneumonia by *Klebsiella pneumoniae*, thus implicating a role of IL-17 in host defense. It is interesting to note that the locus 3p21 undergoes deletion in several



cancers and frequently in CML.

### **CD231 (TALLA-1: T-CELL ACUTE LYMPHOBLASTIC LEUKEMIA-ASSOCIATED ANTIGEN 1; TM4SF2: TRANSMEMBRANE 4 SUPERFAMILY MEMBER 2; MXS1: MEMBRANE COMPONENT X CHROMOSOME SURFACE MARKER 1)**

*Structure.* Cell-surface glycoprotein member of the transmembrane 4 SF (tetraspanins). CD231 contains four transmembrane domains and two extracellular domains (<sup>1</sup>).

*Gene locus.* Xq11.

*Molecular mass (kd).* 150 (unreduced); 32 to 45 (reduced).

*Distribution.* Expression on cells of T lymphoblastic leukemia, neuroblastoma cells, and RNA detected in cerebral cortex and hippocampus.

*Function.* Unknown. The gene was found inactivated in X-linked mental retardation (<sup>2</sup>).

### **CD232 (VESP-R: VIRUS-ENCODED SEMAPHORIN PROTEIN RECEPTOR)**

*Structure.* Type I transmembrane glycoprotein, member of the plexin family. The extracellular region contains (a) a subdomain highly similar to the semaphorin (“sema”) domain, thus shared by both receptor and ligand; (b) two plexin repeats (i.e., cysteine-rich sequences), also known as *MET-related sequences*, present in the oncoprotein MET (a receptor tyrosine kinase); (c) an IPT/TIG domain; and an Ig-like domain.

*Gene locus.* 12q23.3.

*Molecular mass (kd).* 220.

*Distribution.* T and B cells, monocytes, DCs, and brain, lung, placenta, heart, and so forth.

*Function.* Virus-encoded semaphorin protein receptor (VESPR) is a member of the family of proteins referred to as *plexins*, which are receptors for semaphorins, a family with more than 20 members (<sup>1</sup>, <sup>2</sup>). They are known for their role in neuronal, cardiac, and skeletal development, in the immune response (semaphorin CD100), and so forth but are expressed also by certain viruses. The plexins are now grouped into the A, B, C, and D subfamilies. VESPR is plexin C1, is induced by vaccinia virus, and is the receptor to the viral semaphorin A39R (<sup>3</sup>). The role of VESPR induction for pathogenesis of the infection is not clear. Recombinant A39R stimulated secretion of proinflammatory cytokines from monocytes and up-regulated ICAM-1 expression.

### **CD233 (BAND 3: ERYTHROCYTE MEMBRANE PROTEIN BAND 3; AE-1: ANION EXCHANGER 1; DIEGO BLOOD GROUP; SLC4A SOLUTE CARRIER FAMILY 4, ION EXCHANGER MEMBER 1)**

*Structure.* Band 3 is the most abundant erythrocyte protein (25% of total membrane protein) and is present in the erythrocyte membrane at  $1.2 \times 10^6$  copies per cell. It is a member of the anion exchanger gene family. It consists of two structurally and



functionally distinct domains: an aminoterminal 43-kd cytoplasmic domain and a 55-kd membrane domain (1, 2 and 3). The amino terminal domain interacts with the cell cytoskeleton through ankyrin and binds protein 4-1 and 4-2, hemoglobin, enzymes of the glycolytic cycle, and the PTK p72<sup>SYK</sup>. The carboxyterminal membrane domain spans the membrane 12 to 14 times, carries a number of blood group antigens, and especially the fourth segment is heavily glycosylated. The membrane domain is the anion exchanger (4). The extreme C-terminal tail ends intracellularly, and amino acids 886 to 890, LDADD, are the binding site of carbonic anhydrase II (5). Tyrosine-904, adjacent to the binding of CAII, is phosphorylated by p72<sup>SYK</sup>, which seems to be triggered by a decrease in the cell volume. CD233 interacts with glycophorin A (GPA), which facilitates movement of CD233 to the cell surface. Band 3 exists as a dimer, but ankyrin binding forces a tetramer assembly.

*Gene locus.* 17q21-q22.

*Molecular mass (kd).* 95 to 110.

*Distribution.* Band 3 is expressed in the erythrocyte plasma membrane, and a truncated form (missing the first 65 residues) is detected in the basolateral membrane of the  $\alpha$ -intercalated cells of the distal tubules and collecting ducts of the kidneys.

*Function.* CD233 is a major protein organizer center of the erythrocyte and, as a result, regulates several of its functions. Its major function is clearing from the body the CO<sub>2</sub> produced in the tissues. CO<sub>2</sub> enters the red cells, where it is hydrated by CAII to carbonic acid. The HCO<sub>3</sub><sup>-</sup> diffuses out to the plasma in exchange for Cl<sup>-</sup> (Hamburger shift). In the lungs, the opposite takes place, with HCO<sub>3</sub><sup>-</sup> being transported back to the erythrocytes to be dehydrated by CAII. The bicarbonate transport by CD233/CAII across the membrane takes place within 50 milliseconds. The CD233/CAII complex functions as a HCO<sub>3</sub><sup>-</sup> transport metabalon (i.e., an enzyme complex whose members channel metabolites from one site to the next) (6). In the kidneys, CD233 is involved in acid secretion and thus regulates pH homeostasis.

Other functions of CD233 include regulation of glucose metabolism, ion transport, maintenance of erythrocyte morphology, and removal of senescent cells (7).

Some mutations, such as amino acid substitutions, affect the overall folding of CD233 (i.e., band 3 Tuscaloosa, P327R), which is essential for the secondary structure of the erythrocyte, whereas other substitutions (i.e., band 3 Memphis, K56E) cause reduction in anion transport. Mutations or total loss of CD233 in humans leads to hereditary spherocytosis and renal tubular acidosis. Other mutations cause Southeast Asian ovalocytosis as a result of tight binding to ankyrin and increased erythrocyte rigidity, which resists invasion by malaria parasites (8). Ovalocytosis is asymptomatic and results from deletion of nine amino acids in the boundary between the cytoplasmic region and the first transmembrane segment. This causes entanglement of the skeletal network from inhibition of normal spectrin unwinding (9). One human is known with lack of CD233 who has severe anemia and nephrocalcinosis (10). Other mutations result in the Diego blood group system. The most prevalent Diego antigens (from approximately 18) are Di<sup>b</sup> and Di<sup>a</sup>.

**CD234 (FY-GLYCOPROTEIN, DUFFY ANTIGEN, DARC: DUFFY ANTIGEN**

## RECEPTOR FOR CHEMOKINES)

**Structure.** The Duffy antigen is a seven-transmembrane molecule that is a receptor for certain chemokines and malarial parasites. The aminoterminal end is extracellular (approximately 62 residues), contains two to three glycosylation sites, and is rich in acidic amino acid residues containing the blood groups Fy<sup>a</sup> and Fy<sup>b</sup>. The molecule has three extracellular loops with cysteine residues, three intracellular loops, and ends with the C-terminal cytoplasmic tail (28 residues), composed with approximately 50% serine and threonine residues, which are possibly targets for phosphorylation ( [1](#) ).

**Gene locus.** 1q21–q22.

**Molecular mass (kd).** 35.

**Distribution.** Erythroid cells, postcapillary venule endothelium, endothelial cells of red pulp spleen, and bone marrow sinusoids are main sites of CD234 expression. It is detected in the Purkinje neurons of the cerebellum and on neurons in diverse regions of the brain and spinal cord (i.e., hippocampus, dental nucleus, pontine nuclei, paraventricular nucleus, anterior horn, anteromediolateral cell column, and Clark column). Neurons that express CD234 are projection neurons or connecting neurons in different regions.

**Function.** CD234 binds human malarial parasite *Plasmodium vivax* and the simian parasite *Plasmodium knowlesi*. It also binds to members of the CXC chemokine family (i.e., IL-8, melanoma growth-stimulating activity, and neutrophil-activating polypeptide-2), and CC chemokine family members, MPC-1 and RANTES ( [2](#) ). CD234 is not coupled to trimeric G proteins, and ligand binding does not trigger intracellular signaling. As a result, it has been suggested that it should not be considered as a receptor but only as a binding protein: Duffy antigen chemokine-binding protein.

Ligands for CD234 on the malarial parasite are known as *erythrocyte-binding proteins*. The binding is mediated by the N-terminal cysteine-rich region II, which is conserved in these proteins, and referred to as *Duffy binding-like domain* after the *P. vivax* Duffy-binding protein ( [3](#), [4](#) ). Binding to CD234 is required for an irreversible junction between the merozoites and erythrocytes and is followed by the entry of the parasite into the Duffy-positive erythrocyte ( [5](#) ). The early steps of the Duffy binding-like domain ligand interaction with CD234 involve attachment, apical reorientation, and junction formation. In *P. falciparum*, a Duffy binding-like domain mediates adherence to multiple host receptors, including PECAM-1/CD31, CD36, and so forth, contributing to the virulence of this parasite ( [6](#) ). CD234 may play a role in angiogenesis in response to MIP-2 chemokine. The role of CD234 in the function of nervous and immune systems remains to be elucidated.

## CD235a (GLYCOPHORIN A), CD235b (GLYCOPHORIN B), CD235ab (GLYCOPHORIN A/B, CROSS-REACTIVE MABS)

**Structure.** GPA and glycophorin B (GPB) are sialoglycoproteins encoded by two closely linked genes, GYPA and GYPB, respectively. A third gene, GYPE, encodes glycophorin E. Some of the structural features of these proteins are listed in the table below ( [1](#) ). Glycophorins A and B determine the serologic groups M and N, depending on the amino acids at positions 1 and 5 (see [table](#) below) ( [2](#), [3](#) and [4](#) ).

| Molecular  |                 |     |   | Serology |    |                   |              |
|------------|-----------------|-----|---|----------|----|-------------------|--------------|
| Gene Exons | No. of Residues | kd  | No. of Molecules/<br>RBCs × 10 <sup>5</sup> | CHO (%)  | M  | N                 | S s          |
| GPA        | 7               | 131 | 37  | 50–90    | 60 | S-1; G-5 L-1; E-5 | —            |
| GPB        | 5               | 72  | 24  | 0.8–3.0  | 50 | —                 | Weak M29 T29 |
| GPE        | 4               | 59  | 20  | —        | —  | S-1; G-5          | —            |

CHO, chinese hamster ovary; GP, glycophorin; RBC, red blood cell.

Variants of these molecules arise from crossover between introns 3 of GYPA and GYPB, gene replacement events, or from deletions or alterations in the glycans attached to threonine or serine. Complete deletions of the genes result in lack of GPA or GPB. When MN group is not detected, the phenotype is known as En(a<sup>-</sup>) (5).

- GPA: The extracellular region is heavily glycosylated, and although GPA constitutes 1.6% of the protein mass of the red cell, it provides approximately 67% of the neuraminic acid content. It contains only one N-linked tetrasaccharide at asparagine -26, whereas the rest are O-linked (serine or threonine). The intracellular region (residues 96 to 131) has a high content of acid amino acids and prolines.
- GPB: Highly homologous to GPA-group N with identical sequences in the first part of the extracellular region. It lacks N-linked carbohydrate. Cytoplasmic region is eight amino acids long.

*Gene locus.* The three genes are tandemly located (5'-GYPA-GYPB-BYPE-3') on chromosome 4q28-31.

*Distribution.* Red cells and red cell precursors.

*Function.* The morphology and other functions of the red cells in individuals with deficiency of GPA and GPB are normal.

Red cells with the EN(a<sup>-</sup>) phenotype are resistant to *P. falciparum* malaria.

## CD236 (GLYCOPHORIN C/D) AND CD236R (GLYCOPHORIN C)

*Structure.* Glycophorin C (GPC) is encoded by a gene, GYPC, in chromosome 2. The same gene encodes a truncated form, which is glycophorin D (GPD). The GPC protein has 128 amino acids (14 kd). Glycosylation, however, generates a posttranslational 32-kd protein. The GPD is shorter by 22 residues at the N-terminus. The GPC or GPD defines the Gerbich blood group antigens, which are Ge:1, Ge:2, Ge:3, and Ge:4 (1, 2 and 3). The most common phenotype expresses all four antigens, but some people lack one or more of these determinants as a result of deletions of one or more exons. In some individuals with the Leach phenotype (Ge1<sup>-</sup>2<sup>-</sup>3<sup>-</sup>4<sup>-</sup>), both GPC and GPD are not expressed (4). Lack of expression results from deletions of exons 3 and 4 which generate proteins without the transmembrane region. In another case, DNA sequence alterations resulted in

frameshift and a premature stop codon formation, preventing expression of the aberrant protein. Other variants [i.e., Yusef (Yus) type (Ge<sup>1-2-3+4+</sup>) or Gerbich (Ge) type (Ge<sup>1-2-3-4+</sup>)], result from deletions of exons 2 or 3, respectively, generating a single protein expressed on the cell membrane with truncated extracellular regions. In the Ge and Yus phenotypes, GPD is not produced.

*Gene locus.* 2q14-21.

*Molecular mass (kd).* GPC, 32; GPD, 23.

*Function.* GPC is a minor component of red cell membrane (approximately 4% of the membrane sialoglycoproteins). Individuals with the Leach phenotype have elliptocytosis (4), suggesting that GPC and GPD contribute to the maintenance of the shape of red cells. GPC deficiency leads to deficiency of protein 4.1 and disruption of the junctional complexes, which weakens membrane deformability and stability.

## CD238 (KELL BLOOD GROUP)

*Structure and Function.* Type II transmembrane protein, member of the family of zinc metalloproteins with neutral endopeptidase activity. Other members include neutral endopeptidase EC.3.4.24.11 [common acute lymphoid leukemia antigen (CALLA-CD10)], endothelin-converting enzyme-2 and the PEX gene product for the M13 subfamily of neutral endopeptidases (neprilysin family). The homology of Kell and CALLA is most striking in the segment preceding the active catalytic site. The C-terminal extracellular region with 665 amino acids contains 15 cysteines and the transmembrane one. The intracellular N-terminal consists of 47 amino acids with the first one being blocked, suggesting that it is pyroglutamic acid.

All 23 Kell antigens are located on the same Kell protein encoded by the KEL gene, with point mutations accounting for the polymorphism (1, 2). For example, K1 phenotype is due to a C to T substitution in exon 6 that predicts a change T193M. This change prevents N-glycosylation in one of the five consensus glycosylation sites. In the Kp(a+) phenotype, there is weakened expression of Kell antigens.

This is due to a point mutation (R281W), which causes retention of Kell protein, in the pre-Golgi compartment and thus reduction of its expression on the cell surface (3). Lack of Kell protein is known as *Kc* or *Knull phenotype* (4, 5). Several different molecular defects have been identified. A mutation (G to A) in intron 3 causes aberrant splicing and a transcript without exon 3. Exon 3 encodes the transmembrane domain of Kell protein and thus abolishes the translation of the C-terminal segment in which all Kell antigens are located. The extracellular region displays two heptad arrays of leucine zipper motifs (starting amino acids 583 and 590) involved in protein-protein interactions, and several zinc-binding sites are present. The consensus sequence HEXXH is found in endopeptidases and is mandatory for catalytic activity.

The Kell protein is probably present as an oligomer and is also associated by a disulfide bond with the XK protein (Kell-72 to XK347) (6). The XK protein, which carries the Kx antigen, is a 37-kd polypeptide that spans the red cell membrane ten times and has structural characteristics of a membrane transporter. The XK protein is absent in patients with the McLeod syndrome, which is associated also with a depression of all Kell antigens (7, 8). In the McLeod phenotype, there is absence of the K<sub>x</sub> ubiquitous erythrocyte antigen and decrease of the Kell antigen, resulting from mutations, some of them

disrupting GT sequences present at RNA splice sites, as well as within exon 3 (i.e., the 746C > G mutations encoding the substitution R222G) (<sup>9</sup>). In the Ko phenotype, the XK protein is increased. The gene for XK protein is located in X chromosome. The McLeod syndrome locus is closely linked to loci that are defective in chronic granulomatous disease and muscular dystrophy of the Duchenne type, and individuals with the McLeod phenotype express various combinations with some features from these syndromes. They also have mild hemolytic anemia and acanthocytic red cells. Kell protein functions as an endopeptidase and shares substrates with the endothelin-converting enzymes (<sup>10</sup>). Kell has a narrow endopeptidase activity because it cleaves only big endothelin-3 (ET-3) to yield ET-3. ET-3 is a potent bioactive peptide, which maintains vascular tone and has multiple other biologic roles. The allele for the Kell protein (K) is known as *Cellano* (*k*). This polymorphism is due to a point mutation resulting in substitution of M193T, which converts K to k. The Kell protein is second in importance after RLD as an immunogen in hemolytic disease of the newborn.

*Gene locus.* 7q33–35.

*Molecular mass (kd).* 93.

*Distribution.* Expressed primarily in red cells but also in myeloid progenitors, testis, and weakly in other tissues (<sup>11</sup>).

## **CD239 (B-CAM: B-CELL ADHESION MOLECULE, LUTHERAN BLOOD GROUP)**

*Structure.* B-cell adhesion molecule (B-CAM) is a transmembrane type I glycoprotein. The extracellular region contains (a) Ig-like domains, linked by disulfide bonds, which, starting from N-terminus, are two V type and three C<sub>2</sub> type; and (b) consensus motifs for binding to integrins (<sup>1</sup>). The intracellular domain is short (59 residues) and has consensus motifs for Src SH<sub>3</sub>-domain binding. These features suggest that B-CAM possibly functions as a receptor and signal transduction molecule. B-CAM is encoded by the same gene that encodes the Lutheran (Lu) blood group antigens (<sup>2</sup>). B-CAM and Lu antigens derive from alternatively spliced transcripts of the same gene on chromosome 19q13.2. B-CAM lacks the majority of the cytoplasmic tail of Lu glycoprotein. Lu gene is organized into 15 exons, and alternative splicing of exon 13 generates two transcript splice forms: a 2.5-kb (short cytoplasmic tail, B-CAM) and a 4.0-kb (long cytoplasmic tail, Lu glycoproteins). Antibodies generated against the Lu or B-CAM proteins react with both proteins, which is indicative that both antigenic determinants are present on the same molecule. Lu glycoproteins carry the same Ig-like domains in the extracellular region as B-CAM. The Lu glycoproteins' polymorphism is due to substitution mutations: R77H (i.e., Lu<sup>b</sup> or Lu<sup>2</sup>?Lu<sup>d</sup> or Lu<sup>1</sup>) in domain 1 (<sup>3</sup>). There are approximately 18 antigens in the Lu blood group system, and at least one Lu antigen is located in each Ig-like domain (<sup>4</sup>).

*Gene locus.* 19q13.2–13.3.

*Molecular mass (kd).* 85.

*Distribution.* B-CAM is widely expressed in normal tissues and highly expressed in ovarian and epithelial carcinomas. B-CAM is closely related to MUC18, an antigen whose expression in melanomas correlated with tumor progression (<sup>5</sup>). Lu glycoproteins are expressed in erythrocytes.

*Function.* B-CAM/Lu proteins are receptors for the extracellular matrix protein laminin ( [6](#) ). Lu glycoproteins are intercellular adhesion molecules and may contribute to vasoocclusion in sickle cell disease. Sickle cells bind to laminin isoforms containing the  $\alpha 5$ -chain, which are present in the subendothelium and bone marrow sinusoids.

### **CD240CE (Rh30CE); CD240D (Rh30D); CD240 DCE (Rh30D/CE CROSS-REACTIVE MABS); CD241 RhAG**

*Structure.* The Rh antigens are encoded by two closely linked genes, the RHD and RHCE, encoding the RhD and RhCE (also known as RhCcEe) 33-kd proteins, respectively, which are highly homologous (90% amino acid identity) ( [1](#), [2](#) ). A third polypeptide, known as *Rh-associated glycoprotein* (RhAG) (synonym, Rh50), is encoded by a third gene *RHAG* (synonym, RH50) ( [3](#), [4](#) ). RhAG is 36% homologous to RhD and RhCE and does not carry serologically detectable Rh antigens but is essential for the expression of the other two on the cell surface ( [5](#), [6](#), [7](#) and [8](#) ). The predicted transmembrane topologies of the Rh proteins indicate that all three span the cell membrane 12 times, with only short loops connecting the transmembrane sections. Thus, the bulk of the proteins is “hidden” within the lipid bilayer. Both N- and C-termini are located in the cytoplasm. The Rh system is the most complex and polymorphic, compared to other blood group systems, with 50 different antigens so far described. The majority of the alleles originate from exon exchange or gene conversion. The D antigen consists of a collection of conformational epitopes over the entire RhD protein that defines the Rh<sup>+</sup> individuals (85% of the population). The D epitopes depend on residues located on extracellular loops 3, 4, and 6. In Rh<sup>-</sup> people, the RHD gene is not expressed. The weak <sup>-</sup>D (D<sup>u</sup>) phenotype never induces antibodies in pregnancy. Amino acid substitutions have been detected in the intracellular and transmembranous regions.

The C and c alleles differ in three positions in exon 2, whereas the E/e dimorphism is located in the fourth extracellular loop. Amino acids 103 and 226 are crucial for C/c and E/e antigenicities, respectively ( [9](#) ).

The RhD and RhCE polypeptides are modified posttranslationally with the addition of palmitylate to free sulfhydryls on cysteine residues.

Two Rh-deficiency phenotypes exist, *Rh nul* (amorph type, Rh-deficiency syndrome) due to silent alleles and *Rh moa* due to the presence of a suppressor gene, which is a mutant allele of the RHAG gene, impairing the synthesis of the RhAG glycoprotein ( [10](#) ). The Rh-null individuals not only lack RhD but are deficient in other proteins, Landsteiner-Wiener (LW), Duffy antigen, and CD47.

The Rh proteins are associated with other membrane proteins (i.e., glycophorin, LW protein, Duffy antigen, CD47, and RhAG).

The RhAG gene resembles the Rh genes, expressed only on erythroid cells. The RhAG protein has 12 membrane-spanning domains and directly interacts with the Rh proteins. All these proteins form a cluster, with the Rh proteins important for the integrity of the red cell membrane. The core of this complex is a tetramer made of two Rh proteins and two RhAG proteins.

*Gene locus.* RHD/RHCE, 1p36.2-34.1; RHAG, 6p21.1-p11.



*Molecular mass (kd).* D, 33; CE, 33; RhAG: 45–100.

*Distribution.* Expressed on cells of the erythroid series with increasing density during differentiation.

*Function.* Rh antigens are clinically the second most important of all blood groups, second only to ABO. The D antigen is highly immunogenic, and Rh incompatibility is a major cause of hemolytic disease of the newborn, which triggered the discovery of this blood group in 1939. In Rh deficiency, the individual has stomatocytosis, spherocytosis, increased osmotic fragility, altered phospholipid asymmetry, and mild hemolytic anemia. On the basis of their structure, the Rh proteins were believed to perform a transporter function ( [11](#), [12](#) and [13](#) ). RhAG shared homology with ammonium transporters in microorganisms.

It has now been conclusively demonstrated that RhAG as well as an Rh homolog, RhCG (synonym, RhGK), which is expressed only in kidney and testis, function as ammonium transporters ( [14](#), [15](#) ). The RhCG protein is a 58-kd membrane glycoprotein, and its gene contains 11 exons. The RhCG is the first nonerythroid Rh protein with similar membrane topology (i.e., spans the membrane 12 times).

## **CD242 [ICAM-4: INTERCELLULAR ADHESION MOLECULE-4, LANDSTEINER-WIENER (LW) BLOOD GROUP]**

*Structure.* Type I transmembrane protein, with two Ig-like domains in the extracellular region, which contains four N-glycosylation sites and six cysteines. Two alleles, Lw<sup>a</sup> and Lw<sup>b</sup>, differ in amino acid 70, Gln versus Arg, respectively.

*Gene locus.* 19p13.3.

*Molecular mass (kd).* 42.

*Distribution.* Red cells.

*Function.* The LW blood group is ICAM-4 ( [1](#) ). Like the other ICAM molecules, LW binds to LFA-1 and mediates adhesion. Its expression depends on the expression of the Rh proteins ( [2](#) ). In Rh-null individuals, LW proteins are not detected.

## **CD243 (MDR-1: MULTIDRUG RESISTANCE-1, P-GLYCOPROTEIN)**

*Structure.* P-glycoprotein (P-gp) consists of 1280 amino acids and belongs to the SF of ATP-binding cassette transporters ( [1](#), [2](#), [3](#) and [4](#) ). This SF is divided into seven subfamilies.

Multidrug resistance-1 or P-gp belongs to the multidrug resistance-TAP subfamily, and it consists of two structurally homologous halves, each with six transmembrane domains, one ATP-binding site, and the highly conserved “Walker A” and “Walker B” motifs. The two halves are linked by a flexible linker peptide. Both N- and C-termini are located inside the cell. There are three glycosylation sites in the first exolooop and four phosphorylation sites in the intracellular region.



Deletion of the linker peptide results in a nonfunctional protein, although it is still expressed in the membrane ( [5](#) ). Both nucleotide-binding sites are also essential for the function of the protein. The drug-binding site is within or near the transmembrane segments 5, 6 and 11, 12 and the extracellular loops connecting them.

As seen from above the cell surface (2.5 nm resolution by electron microscopy), P-gp is a cylinder with a central aqueous pore approximately 5 nm in diameter, which is open to the extracellular space but closed at the cytoplasmic face of the membrane ( [6](#) ). Two lobes of approximately 3 nm each are exposed at the cytoplasmic face of the membrane corresponding to the nucleotide-binding domains.

*Gene locus.* 7q21.1.

*Molecular mass (kd).* 170.

*Distribution.* Ubiquitous.

*Function.* P-gp is an active transporter with broad specificity for hydrophobic compounds. P-gp is best known for its role in the development of resistance to multiple cytotoxic drugs in cancer cells, which requires ATP hydrolysis ( [7](#), [8](#) ). There are two independent ATP hydrolysis events in a single catalytic cycle of P-gp. Binding of the drug and ATP is followed by the first hydrolysis event, which is accompanied by a conformational change bringing release of the substrate and ADP. This allows a second ATP binding and hydrolysis event, which returns the molecule to its original state for another ligand and ATP binding.

Various models have been suggested for the action of P-gp. Experimental evidence supports the “drug pump” of the “flippase” model (i.e., substrate is “flipped” from the inner to the outer membrane leaflet).

P-gp is probably important for its physiologic role in excretion of xenobiotics. Suitable for this role is its location on the mucosal surfaces of jejunum, ileum, and colon, and in the brush border and biliary face of proximal tubule cells and hepatocytes, respectively. P-gp may also play a role in forming the blood-brain barrier because it is located in the luminal surface of the capillary endothelial cells in the brain. P-gp can be seen to serve as a barrier for the entry of toxic compounds into the body and to protect cells from toxic substances that have left the circulation to enter the interstitial space. P-gp was shown recently to limit oral absorption and brain entry of protease inhibitors in HIV-1 patients ( [9](#) ).

Drug resistance development in hematologic malignancies is associated with increased expression of P-gp or other multidrug resistance genes ( [10](#) ). Reversal of the resistance may be achieved by blocking P-gp-mediated drug efflux with “modulators” such as verapamil, which inhibits the transport function without interrupting the catalytic function, and cyclosporin A, which inhibits transport by interfering with both substrate recognition and ATP hydrolysis.

## **CD244 (2B4, NAIL: NATURAL KILLER CELL ACTIVATION-INDUCING LIGAND)**

*Structure.* CD244 belongs to the CD2 subset of the IgSF because of the homology of its

extracellular region [other members are CD2, CD48, CD58, CD84, CD229 (Ly9), and CD150 (SLAM)]. The extracellular region contains one V and one C<sub>2</sub> domain, distal and proximal to the membrane, respectively (1). The C<sub>2</sub> domain has two conserved cysteines forming a disulfide bond. The cytoplasmic region contains four novel tyrosine-containing motifs (TxYxxV/I), which are similar to the ITIM. The CD244 gene contains nine exons; five of them encode the cytoplasmic region, and the remainder encodes the rest of the molecule. Differential exon usage leads to splice variants of the CD244, varying in the extracellular region, which has eight potential N-glycosylation sites.

*Gene locus.* 1q22.

*Molecular mass (kd).* 70.

*Distribution.* CD244 is expressed in NK cells, approximately 80% of CD8<sup>+</sup> T cells, 75% of  $\gamma\delta$  T cells, basophils, and monocytes.

*Function.* CD244 is the high-affinity receptor for CD48 (2, 3) and was originally identified as an activating receptor of NK cells (4). CD244 ligated by CD48 leads to rapid CD244 phosphorylation and enhances lysis of targets by NK cells and the release of cytokines. CD244 associates with several signaling molecules, such as the tyrosine phosphatase SHP-2 (5) (in NK cells), but in other cell types, CD244 binds SHP-1. The novel tyrosine motif is the target for phosphorylation by Lck, which follows linkage to LAT and signal transduction with similar pathways as the TCR (i.e., Ras, Raf, ERK, and so forth), leading to regulation of lytic function and cytokine production (6). SAP contains one SH<sub>2</sub> domain, and CD244 recruits SAP to its novel tyrosine-based motif.

In patients with X-linked lymphoproliferative disease due to a defect in SAP (7, 8), the interaction of CD244 with CD48 inhibits NK-cell activation and the killing of EBV-infected cells (9). It appears that CD244-mediated NK-cell activation requires a functional association with SAP, which prevents association with SHP-2 (10). In CD8<sup>+</sup> T cells, CD244 stimulates granzyme release and perforin expression, IFN- $\gamma$  production, and down-regulation of chemokine receptor CCR7.

## **CD246 (ALK: ANAPLASTIC LYMPHOMA KINASE)**

*Structure.* The anaplastic lymphoma kinase (ALK) is a PTK (similar to the insulin receptor subfamily). The normal ALK is a transmembrane protein of 1620 amino acids, which has a low-density lipoprotein and a MAM domain in the extracellular region and the tyrosine kinase catalytic domain in the intracellular region. The gene for ALK is located in 2p23. A protein known as *nucleophosmin* (NPM, B23) is located in chromosome 5q35. The NPM is a multifunctional nucleolar protein and expresses the following activities: (a) nucleic acid binding, (b) ribonuclease, (c) chaperone, and (d) oligomerization.

A nonpolar region in the N-terminus, as well as an acidic segment in the center, mediates the chaperone activity. The cytoplasmic region has a core region of several acidic residues as well as several potential phosphorylation sites (Thr/Ser). The 37 C-terminal amino acids are important for nucleic acid binding and include five aromatic amino acids (two highly conserved Trp), whereas the center of the molecule is required for ribonuclease activity. Oligomerization and chaperone activity are highly correlated, and the monomeric forms are not molecular chaperones. The secondary structure of NPM is predominantly  $\beta$  sheet (40 to 50%) with some  $\alpha$ -helix. NPM shares several structural

features with the small HSPs.

In ALCLs, a t(2;5)p23;q35 translocation fuses the genes of ALK and NPM, and the fusion gene encodes the protein NPM-ALK, consisting of the N-terminal and transmembrane regions of NPM and the cytoplasmic regions of ALK ( [1](#), [2](#), [3](#) and [4](#) ).

*Gene locus.* ALK, 2p23; NPM, 5q35; NPM-ALK, t(2;5)p23;q35.

*Molecular mass (kd).* ALK, 200; NPM, 37; NPM-ALK, 80.

*Distribution:*

- ALK: mRNA is detected in the brain and spinal cord and in neurons of specific regions of the nervous system, such as thalamus, midbrain, olfactory bulb, and ganglia of embryonic and neonatal mice ( [5](#), [6](#) ). ALK is not expressed in lymphocytes.
- NPM: Ubiquitous—localized only in the nucleus.
- NPM-ALK: In cells of ALCL, in approximately 50 to 60% of the patients ( [7](#) ). With fluorescence techniques, the localization of the chimeric protein is difficult to determine, as fluorescence varies depending on the specificity of the antibodies (ALK or NPM, C- or N-terminal epitopes). However, with variant ALCLs (i.e., other than NPM as partner of ALK), fluorescence is detected in the cytoplasm.

*Function:*

- ALK: Development of nervous tissue.
- NPM: Multifunctional nucleolar protein with DNA binding, chaperone, and ribonuclease activities (see above) ( [8](#) ). NPM is a histone chaperone and mediates nucleosome, and ribosome biogenesis, and decondensation of sperm chromatin. The chaperone activities depend on the strongly acidic segments, and for its functions, it shuttles between nucleus and cytoplasm. It plays a role in normal and abnormal growth. It is the target of CDK2/cyclin E in the initiation of centrosome duplication ( [9](#) ). Its gene is also the target of c-Myc, thus linking the increase of NPM with cell growth.
- NPM-ALK: NPM is the most common partner for ALK, but in some patients, other genes fuse with ALK: (a) TFG (TRK-fused gene), which generates three chimeric proteins: short, long, and extra-long; (b) TPM3; (c) CLTCL (clathrin heavy chain polypeptide) ( [10](#) ); (d) ATIC; and (e) MSN (moesin) ( [11](#) ).

RTKs normally are activated as a result of dimerization by the ligand, but with the NPM-ALK, the kinase is constitutively activated as a result of oligomerization of NPM, which thus imitates the ligand in bringing aggregation of the kinase.

The kinase activity of NPM-ALK depends also on its interaction with Hsp90, which maintains its folding and promotes its maturation ( [12](#) ). For the mitogenic effect, NPM-ALK utilizes PLC- $\beta$ , stimulating proliferation ( [13](#) ). It also activates PI3K/AKT, triggering antiapoptotic signals ( [14](#) ), which through activation of STAT-3 increase the transcription of the antiapoptotic protein Bcl-X<sub>L</sub> ( [15](#) ).

## CD247 (CD32 ANTIGEN, ZETA POLYPEPTIDE)

*Structure.* Member of the invariant components of the TCR complex (i.e., CD3  $\alpha$ ,  $\delta$ ,  $\epsilon$ , and  $\zeta$ ). A nonglycosylated protein 163 amino acids long, with a short extracellular region (nine amino acids) and a unique positive charge (lysine at position 9). The  $\zeta$ -chains exist as a disulfide-linked homodimer (90%) or heterodimer (with the  $\eta$ -chain) (10%). Recently, it was suggested that the  $\zeta$ -chain exists in a tetrameric form. The intracellular region contains seven tyrosines as potential phosphorylation sites, six of them arranged in ITAMs (i.e., the  $\zeta$ -chain has three ITAMs) ( [1](#) ).

*Gene locus.* 1q22–q23.

*Molecular mass (kd).* 16.

*Distribution.* T cells, with TCR, NK cells in association with CD16 (Fc $\gamma$ RIII), and basophils with Fc $\epsilon$ R.

*Function.* It couples the TCR to the signal transduction pathways, even in the absence of the other invariant chains ( $\alpha$ ,  $\delta$ ,  $\epsilon$ ) of the TCR complex ( [2](#) ). Important in this context is the fact that  $\zeta$ -chain remains in the center of the contact area between T cell and APC [i.e., within SMAC (supramolecular activation cluster)], which contributes to the immunologic synapse, whereas the CD4, which initiates the early phase of T-cell activation, moves to the periphery ( [3](#) ). The short extracellular region loosely interacts with the TCR, as shown with mutation K9D. Activation of T cells leads to release of microvesicles (exosomes), which carry TCR/CD3/ $\zeta$ -chain, but their function remains to be determined. Patients with low TCR expression and defects of humoral and cell-mediated response have impaired association of TCR with  $\zeta$ -chain. The  $\zeta$ -chain has also been shown to be down-regulated in tumor infiltration cells or peripheral blood T cells in patients with malignancies. It has been hypothesized that low  $\zeta$ -chain expression may underlie a poor T-cell response against the tumor as a result of the importance of this molecule in signal transduction and T-cell activation. CD3- $\zeta$ -chain is significantly reduced in patients with Hodgkin disease during the active stage ( [4](#) ). In patients with gastric carcinoma, low levels of CD3- $\zeta$ -chain were found to represent an independent prognostic marker. In myeloid malignancies, recovery of CD3- $\zeta$  levels correlated with successful remission induction ( [5](#) ).

2004 Lippincott Williams & Wilkins  
John P. Greer, John Foerster, John N. Lukens  
George M. Rodgers, Frixos Paraskevas, Bertil Glader  
Wintrobe's Clinical Hematology

**HISTORY**[New Era: Modern Flow Cytometry](#)**PRINCIPLES AND INSTRUMENTATION**[Fluidics](#)[Light Source and Light Beam](#)[Signals: Collection and Sensors](#)[Signal Processing](#)[Cell Sorting](#)[Fluorochromes and Conjugates](#)[Flow Cytometer Settings](#)[Reporting Results](#)**FLOW CYTOMETRY IN HEMATOLOGY**[Sample Preparation](#)[Immunophenotyping](#)[Staging of B-Cell Lymphoma](#)[Minimal Residual Disease by Flow Cytometry](#)[Platelet Function](#)[Erythropoiesis and Red Blood Cell Disorders](#)[Intracellular Cytokines](#)[Major Histocompatibility Complex–Peptide Tetramers](#)[Phagocytosis](#)[Cell Cycle Analysis](#)[Detection of Apoptosis](#)[HLA Cross-Match by Flow Cytometry](#)**APPENDIX: IMMUNOPHENOTYPING HEMATOLOGIC MALIGNANCIES IN THE FUTURE: DEFINING THE IMMUNOPHENOTYPIC****SIGNATURE****REFERENCES****HISTORY**

Flow cytometry (FC) is the measurement of numerous cell properties (cytometry) as the cells move in single file (flow) in a fluid column and interrupt a beam of laser light. The method allows the quantitative and qualitative analysis of several properties (multiparameter) of cell populations from body fluids.

Quantitative cytometry has its origins in the 1930s in the pioneering work of nucleic acid measurements of the cell by Caspersson (<sup>1</sup>). The need to make measurements of large cell populations rapidly and accurately stimulated the development of instruments that were the forerunners of present day flow cytometers. Light scattering was used as an indicator of the presence of a particle. A significant discovery was the report by Coons and Kaplan of the conjugation of fluorescein to antibodies (<sup>2</sup>), which opened the field of detection of tissue antigens by specific antibodies using fluorescence. The next important development took advantage of the low electrical conductivity of a cell with respect to saline solutions. The rise of electrical impedance was used as a measure of cell volume as cells, suspended in saline, passed through an orifice [Coulter counters (Beckman Coulter, Hialeah, FL)] (<sup>3</sup>). In the early 1960s, Kametsky developed a *rapid cell spectrophotometer*

( 4 ). The instrument measured cell size (by light scattering at 410 nm) and DNA content (by absorption at 260 nm) using computer technology to make accurate statistical analysis of data possible.

## New Era: Modern Flow Cytometry

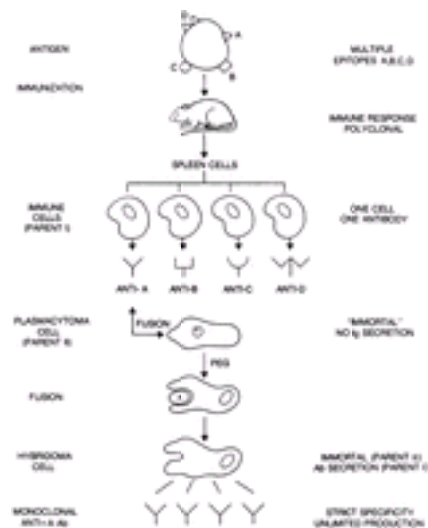
The need for multiparameter analysis was satisfied by the introduction of fluorescent dyes for measurement of total DNA content in the detection of cancer cells and fluorescent antibodies specific for cell-surface markers in the separation of cell subpopulations. One of the early commercially available flow cytometers, the Hemalog D (Technicon; Bayer Diagnostic, Tarrytown, NY) found wide applications in hematology laboratories for differential blood counts. Light scattering was combined with absorption measurements at different wavelengths using dyes and chromogenic substrates of enzyme action to identify the blood cell populations.

**FLUORESCENT ACTIVATED CELL SORTER** The modern technology of FC is based on two seminal discoveries born of academic curiosity to obtain answers for fundamental questions in immunology. First came the birth of the fluorescent activated cell sorter by Herzenberg and colleagues ( 5 , 6 and 7 ), which was used to separate plasma cells based on intracellular fluorescence. This was followed by the demonstration that antigen-binding lymphocytes are the precursors of antibody-producing cells ( 8 ), and the allotype ( 9 ) and isotype ( 10 ) of an antibody molecule are the same as those detected on the surface immunoglobulin (Ig) of the lymphocytes. Human T and B cells were also studied by fluorescent activated cell sorter analysis ( 11 , 12 ), but highly specific antibodies and their conjugation with fluorescent dyes were difficult to prepare. Herzenberg's cytometer was trademarked by Becton Dickinson (Franklin Lakes, NJ) approximately a decade later. The earlier one-laser, water-cooled cytometers evolved into the modern three-laser sorter with multiple detectors referred to as the *Hi-D fluorescent activated cell sorter* ( 13 ). Now, other light sources besides the argon lasers (488 nm) are used, such as krypton (407 nm) and dye lasers (595 nm). The number of dyes available allows the simultaneous measurement of up to 11 colors of fluorescence ( 14 ). Of course, in a routine laboratory, the use of more than three or four fluorochromes demands a greater involvement in quality control, optimization, and color compensations. The name *polychromatic FC* has been suggested for the use of larger numbers of fluorochromes ( 15 ). The modern flow cytometer is a remarkable instrument that combines a blend of modern technologies such as fluidics, lasers, optics, analog and digital electronics, and computer software. With such combinations, it can measure cell size, structure, and cellular contents, as well as any particle down to a size of approximately 0.1  $\mu\text{m}$ . Its detection limit is approximately 1000 molecules of a dye (i.e.,  $1 \times 10^{-18}$  g/cell). It has been calculated that this is the amount of dye present in 1 g of water, if 1 g of the dye is evenly distributed in a volume of water with the dimensions of 3000 km  $\times$  3000 km  $\times$  300 m ( 16 ). The flow cytometer consists of three main compartments: (a) sample handling-flow cell and associated fluidics; (b) light sensing-light source, optics, and detectors of light scatter and fluorescence; and (c) signal processing-data collection and analysis ( 17 ).

**MONOCLONAL ANTIBODIES** The second important discovery complemented the first with the development of monoclonal antibodies by the Nobel Prize-winning discovery of Kohler and Milstein in 1975 ( 18 ). Fusion of an antibody-producing normal mouse spleen lymphocyte with a plasmacytoma (myeloma) cell generates a hybrid cell, called *hybridoma*, capable of producing unlimited quantities of monoclonal antibodies. Monoclonal antibodies revolutionized modern medicine from the laboratory to the bedside. Some of the problems related to the commercial impact of this discovery were briefly outlined by Cesar Milstein ( 19 ). The production of monoclonal antibodies is a relatively simple procedure, as shown in [Figure 3.1](#). A mouse is injected with an antigen having several distinct epitopes. The



mouse immune system responds to each epitope (A to D) by producing antibodies specific for each epitope (anti-A to anti-D). Each antibody is produced by the progeny of a single antigen-specific lymphocyte. The progeny of this lymphocyte is a *clone*, and, as a result, the antibody produced is *monoclonal*. Mouse spleen suspension is mixed in a test tube with plasmacytoma cells, which have no capacity to produce Ig. Addition of a fusion agent, such as polyethylene glycol, generates hybrids, each formed from the fusion of one antibody-producing lymphoid/plasmacytic cell and one plasmacytoma cell. The fused cell inherits the property of producing an antibody of a single specificity (monoclonal) from the antibody-producing cell (parent I). At the same time, it also inherits from parent II the property to be “immortal.” The fused cell is called *hybridoma*.



**Figure 3.1.** Production of hybridomas. Ig, immunoglobulin; PEG, polyethylene glycol.

The advantages of monoclonal antibodies are their homogeneity, predictable specificity and affinity, and availability in very large quantities. Monoclonal antibodies have become an indispensable tool for diagnostic procedures, especially in FC, in bacteriology, for tumor localization by means of radioimmunoassays, and so forth. The application of monoclonal antibodies by investigators created a crisis, which resulted from a plethora of designations given for the same molecule. The confusion called for a universal notation for cell antigens and the establishment of Workshops on Human Leukocyte Differentiation Antigens (HLAD). The first HLAD Workshop convened in Paris in 1982, and the last was the seventh HLAD Workshop in Harrogate, United Kingdom in June 2000 ([20](#), [21](#) and [22](#)). The molecules are given a number following the designation *CD* (clusters of differentiation) (see [Chapter 2](#)). The seventh HLAD Workshop added 110 new specificities, the last number being 247, the  $\nu$ -chain of T cells. However, some gaps in the numbering still remain (i.e., between CDw197 and CD200). Also, multiple specificities are included under one designation [i.e., 13 for CD85 (CD85a to CD85m), the ILT/LIR family (Ig-like transcripts/leukocyte inhibitory receptors) and 14 for CD158s, the KIR family of receptors (killer-cell Ig-like receptors such as CD158d to CD158k with some numbers consisting of two specificities, i.e., CD158b1 to CD158b2 and so forth)]. Access to CD nomenclature and brief descriptions of CDs are available online at PROW: Protein Reviews on the Web: <http://www.ncbi.nlm.nih.gov/prow/>.

## PRINCIPLES AND INSTRUMENTATION

### Fluidics

For reliable analysis, the specimen must be a monodisperse suspension. Failure to meet this requirement results in technical inaccuracies and causes blocking of the flow. From a reservoir, isotonic fluid under pressure is forced into a tubing that delivers it to the flow



cell. The flow cell is called by some the “heart of the flow cytometer.” The isotonic fluid within the flow cell generates a fluid column with laminar flow and a high flow rate of 10 m/second. This is known as *sheath fluid*. The sample is introduced in the flow cell by a computer-driven syringe in the center of the sheath fluid, thus creating a coaxial stream within a stream, the *sample core stream*. The shape of the tip of the sample insertion needle affects the orientation of the cell, which in turn may affect measurements. For example, an asymmetrically shaped tip improves orientation of epithelial cells and sperm cells, resulting in more accurate measurements. There is no mixing of the sheath and sample streams. The pressure of the sheath stream hydrodynamically aligns the cells so that they are presented to the light beam in single file (i.e., one at a time). The cells trigger the scattering of the light and, at the same time, are excited by the beam and emit fluorescent light. As the flow cell narrows, the velocity of the fluid increases and the diameter of the sample stream decreases to a very narrow cross section of the approximate size of the cells being measured. The velocity of the core stream is controlled by the sheath pressure, and its diameter is controlled by both the sheath pressure and the volumetric sample delivery rate. Resolution and sensitivity depend on both of these parameters, and their control is paramount for good analysis. Resolution is expressed as the *coefficient of variation* [CV; i.e., the relative standard deviation of the signal produced by identical cells or particles ( $CV = 100 \times \text{standard deviation}/\text{mean of the peak}$ )]. *Sensitivity*, on the other hand, is a product of the intensity of the excitation, which is determined by the time spent by the cell in the excitation focus (which depends on the flow velocity) and the shape of the laser beam. Resolution is a function of the diameter of the sample core, whereas sensitivity changes with its velocity. Under constant sheath pressure, increasing the sample delivery increases the core diameter. This results in poor resolution. Under constant sample delivery rate, an increase in the sheath pressure results in increase of the velocity of the sample, which decreases the sensitivity.

### Light Source and Light Beam

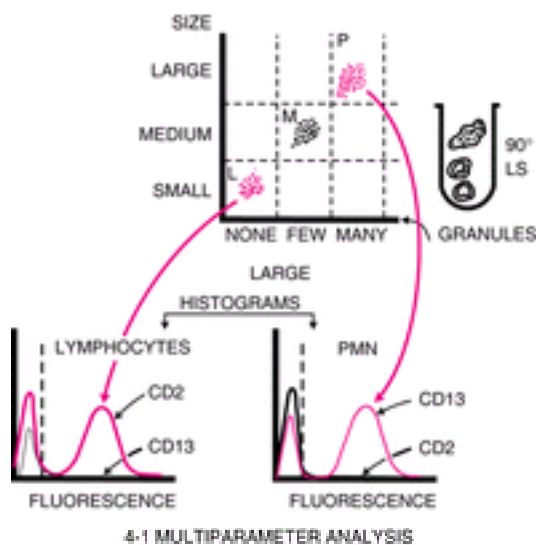
Sensitivity and resolution also depend on the shape and intensity of the laser beam. The diameter of the beam is approximately 650  $\mu\text{m}$ , but it is narrowed by two cylindrical lenses that reduce the dimensions significantly. The first lens (vertical) results in an elliptical beam with a longer vertical dimension (perpendicular to the axis of flow) and a shorter horizontal dimension (along the axis of flow). The second lens (horizontal) changes the beam so that its horizontal dimension is longer than the vertical. Lengthening the horizontal axis increases the resolution of the instrument as determined by the CV and the amount of light illuminating the particle. Shortening the axis enhances sensitivity because the intensity of light over the sample core stream is increased. Thus, depending on whether resolution is more important (DNA quantitation) than sensitivity (immunophenotyping, platelet counts), the horizontal axis should be kept longer or shorter, respectively. The vertical axis controls the discrimination between two closely spaced cells such as doublets (<sup>23</sup>). Cells can be close together as a result of clumping or a fast running sample. In such cases, the beam should be as narrow vertically as possible. The particles intersect the beam within the flow cell (closed flow) or after they exit the flow cell (sense-in-air). At the intersection (interrogation point), two events take place: *light scattering* and *emission of fluorescent light*, assuming that the particle is tagged by a fluorescent dye.

### Signals: Collection and Sensors

Alignment is critical because the light intensity is higher at the center of the beam, and the particle should intersect the beam at its center. In the newer instruments, the need for daily mechanical alignment has been eliminated.

**LIGHT SCATTERING** *Light scattering* is the result of laser light reflecting and refracting

off the cells (24). Light scatter signals are used to set the threshold for separating platelets, erythrocytes, and debris from viable leukocytes. Light scattered along the axis of the beam is known as *forward angle scatter* (FS), and light scattered at greater angles is known as *90-degree light scatter or side scatter* (SS). Light scattering is related to the intrinsic properties of the cell such as size and granularity. It is not necessary to treat the cells with any reagents. Extrinsic properties of the cell are those requiring the aid of external reagents to be revealed, such as DNA content with the use of fluorescent dyes. The FS has been shown to be proportional to the size of the cell. Typically, FS is light scattered between 1 to 10 degrees. FS is very useful in discriminating between cells and debris of cells. Other properties of the cell besides size may influence FS, such as the index of refraction and the absorptive properties of the cell. The index of refraction is higher in fixed and stained cells. Discrimination between live and dead cells is better at lower angles (0.5- to 12.5-degree). Live cells scatter more light than apoptotic cells, and best separation occurs between angles 0.5 and 12.5 degrees (25). The sensor for FS is usually placed beside the flow cell on the other side of the entry of the beam. A beam “dump” prevents the high-intensity laser beam from entering the sensor. SS is due to light reflected from internal structures of the cell and correlates with granularity of the cell. The SS is collected together with the fluorescent light at right angles to the beam. The light collection optics and sensors for SS and fluorescence are described later in this chapter. As a result of differences in cell size and granularity, light scattering (FS and SS) separates blood cells into three major populations: lymphocytes, monocytes, and granulocytes. In a two-parameter histogram (Fig. 3.2) of FS versus SS (when red blood cells have been lysed during sample preparation), we distinguish the three main leukocyte populations. For routine flow cytometric analysis of peripheral blood and bone marrow, this histogram can be used to gate for a particular cell population under study, or either one of these parameters could be used in combination with a fluorochrome (see below).



**Figure 3.2.** Analysis of human peripheral blood cells by flow cytometry. Blood cells are separated on the basis of their size, which scatters light in a forward direction, as well as on the basis of their granularity, which scatters light at a 90-degree angle (LS). Lymphocytes (L) (small and nongranular) occupy the lower left area of the screen, polymorphonuclear leukocytes (P) (large with many granules), the upper right. The monocytes (M) are detected in an intermediate position. Identification of these populations is achieved with monoclonal antibodies specific for markers present in one but not the other population. For example, the lymphocyte population shows strong fluorescence for the antibody to CD2 (a T-cell marker) (continuous line) but not for the CD13 (a myeloid-cell marker) (interrupted line). The opposite is true for the polymorphonuclear neutrophil (PMN) population. The vertical interrupted line separates the background fluorescence (at left) from specific fluorescence (at right) in the histogram.

**MULTICOLOR ANALYSIS** Certain dyes (fluorochromes) absorb at longer wavelengths. This is known as *fluorescence*. Distinct wavelengths for excitation (absorption of light) and emission are used in clinical laboratories usually have two lasers; one is a helium-neon laser that emits light at 488-nm wavelength (blue to blue-green). The argon-ion laser is another commonly used fluorochromes and dyes. A second laser, such as a krypton (633 nm), helium-cadmium (325 nm), or red diode laser, provides more power, the fluorescence signal increases (and thus the background is reduced). For the fluorochrome to be useful, the emission wavelength must be longer than the excitation light (the difference is known as Stokes shift) so the light can be separated. The light that is scattered at wide angles (SS) is collected together at right angles to the laser beam by a photodiode array. Optical filters are used in a flow cytometer to separate the different spectral components for the quantitation of the respective fluorochromes. Two types of optical filters are used in FC: absorption filters and interference filters. Absorption filters are usually made of colored glass. They absorb the light with the desired wavelength. As a result of light absorption, the filter becomes fluorescent, especially after light absorption of short wavelengths. Interference filters attenuate or reflect the unwanted light. This is accomplished by depositing a specific series of metals and dielectrics onto the substrate. Interference filters: the band pass, notch, long pass, short pass, and dichroic filters are designed to reflect a specific range of light wavelengths. The individual components of light are separated using dichroic filters that pass light of a certain wavelength (long and short pass filters), which reflect some wavelengths while allowing others to pass. A dichroic filter at a 45-degree angle to the collected light path directs the side scatter (SS) sensor while allowing the fluorescent light (higher wavelengths) to pass. Subsequently, the light passes through a filter that absorbs any light that has passed through the first dichroic filter. The light is then separated successively by a series of dichroic filters (Fig. 3.3). The incident light is directed by a dichroic filter to the SS sensor. Subsequently, the fluorescent light is separated by a combination of filters into its individual components, corresponding to wavelengths of light emitted from the fluorochromes used. FS, forward angle scatter. (From Epics XL Reference Manual, Coulter Corporation, 1993, with permission.)

**Figure 3.3.** Filter configuration for four fluorescence sensors. Side scatter (SS) and fluorescent light (FL) are collected together and then separated by the use of a series of filters. Combinations of absorption and interference dichroic filters allow the separation of the incident (488 nm) from emitted (fluorescent) light. The incident light is directed by a dichroic filter to the SS sensor. Subsequently, the fluorescent light is separated by a combination of filters into its individual components, corresponding to wavelengths of light emitted from the fluorochromes used. FS, forward angle scatter. (From Epics XL Reference Manual, Coulter Corporation, 1993, with permission.)

The sensors convert the photons to electrical impulses that are proportional to the

number of photons received, which in turn are proportional to the number of fluorochrome molecules bound to the cell. The fluorescent emissions are of low intensity and thus necessitate the use of photomultiplier (PMT) tubes to be detected. The PMT produces photoelectrons, which are released by the interaction of photons with the photocathode. The photoelectrons are accelerated onto the surface of a dynode through a voltage potential and successively release enough electrons to generate an electrical impulse.

## Signal Processing

The electrical impulses are analog signals that are converted to digital signals with converters. The sensor may process either the brightest signal emitted from the cell or all signals, which measure total cell fluorescence. Electrical pulses are very weak and must be amplified. Amplification is either linear or logarithmic.

The linear form of data presentation more accurately represents differences in fluorochrome concentrations between cells. In linear amplification, the output signal is directly proportional to the input signal. Each channel represents the same increment in signal value. Thus, a peak at channel 200 represents an intensity twice that of a histogram peak at channel 100 (i.e., the relationship is straightforwardly linear). Histograms using linear amplification find applications in quantitation of fluorescence of DNA, RNA, and light scatter of cell size and granularity.

In logarithmic amplification, the output is proportional to the logarithm of the input pulse. This is important when we need to review cell populations that vary widely in their characteristics, such as cell-surface markers. Because the logarithmic amplification compresses a wide input range, populations with similar intensities cannot be resolved. Immunophenotyping is the most common application of logarithmic amplification.

The digitized data are stored either as histograms or as list-mode. When data are collected as histograms, the abscissa represents a preassigned parameter (i.e., intensity of fluorescence), and the ordinate represents the number of cells analyzed. More widely used is the list-mode method of data collection. In this method, various parameters (e.g., scatter, fluorescence, and so forth) are stored as a list. The software then allows the data to be reanalyzed and presented as histograms. This form of analysis allows for the reprocessing of data, especially in complex specimens with heterogeneous cell populations.

An important aspect of FC is the selection of only a certain cell population for analysis. This is called *gating* and is done electronically. In other words, the software allows the selection of cells within a limited range of certain parameters to be analyzed. Gates are rectilinear, amorphous, or numeric. The amorphous are the most versatile because they can be of any shape or form and allow better selection of cells.

## Cell Sorting

Some flow cytometers may physically separate the cells (sorting) based on differences of any measurable parameter. Sorting is achieved by droplet formation. The basic components of any sorter are a droplet generator, a droplet charging and deflecting system, a collection component, and the electronic circuitry for coordinating the timing and generation of droplet-charging pulses. Fundamentally, the flow chamber is attached to a piezoelectric crystal, which vibrates at a certain frequency so that when the fluid carrying the cells passes through the nozzle, forming a jet in air with a velocity of 15 m/second, the vibration causes the jet to break up in precisely uniform droplets, typically 30,000 to 40,000/second. Each droplet, when separated from the jet, can be charged and then deflected by a steady electric field and is collected to a receptacle. Almost every

cell is isolated in a separate droplet.

When a cell is analyzed and a decision for sorting is made, until the proper electrical charge pulse is applied to the droplet containing this cell, there is a transit time that is determined by several factors, such as flow velocity, droplet separation, and the cell preparation that sometimes may cause perturbations of the jet. Sophisticated circuitry coordinates all functions during this transit time so that the electrical charge pulse is applied to the selected droplet. If two cells are so close together in flow that they cannot be isolated, the sorting is aborted. Poor sample preparation may cause doublets or coincident cells that cannot be recognized as separate cells. This results in contamination of the sorted fraction.

## Fluorochromes and Conjugates

For a fluorochrome to be used in clinical practice, it must meet certain requirements (26). The light absorption spectrum should match the wavelength of the light emitted from the argon ion laser, which is 488 nm (Table 3.1). They should have a reasonably high *extinction coefficient*, a measure of the probability of absorbing a photon of light and therefore being “bright.” Extinction coefficients vary between fluorochromes. They should have a high *quantum yield*, a measure of the efficiency of the conversion of the absorbed light to emitted light. For example, the quantum yield of fluorescein is 0.50 (i.e., fluorescein has a probability of emitting one photon, on average, for two photons absorbed), whereas the quantum yield of R-phycoerythrin is 0.98 (i.e., it emits one photon for every photon absorbed). Because R-phycoerythrin also has a very high extinction coefficient ( $2 \times 10^6$  L/mole·cm at maximum absorption) as compared to fluorescein (67,000 L/mole·cm), it is a much more sensitive fluorochrome. The fluorescence intensity from a fluorochrome is proportional to the product of the extinction coefficient and quantum yield. Other desirable properties are lack of interaction with cellular or biologic components and very little overlap with the spectrum of other fluorochromes to be used concomitantly. Fluorochromes that bind to organic matter give high background or nonspecific fluorescence, which sometimes may create problems in analysis of weakly fluorescent cells. For fluorochromes with spectral overlaps, a careful selection and appropriate filters minimize the problem. Furthermore, *compensation* [i.e., subtraction of signals (fluorescence) from detectors that are not supposed to detect this fluorochrome] minimizes the problem.

TABLE 3.1. Spectral Properties of Certain Fluorochromes

| Parameter                   | Probe            | Absorption Maximum | Extinction Maximum | Emission Maximum | Quantum Yield |
|-----------------------------|------------------|--------------------|--------------------|------------------|---------------|
| Covalently Labeled Reagents | FITC-NH-Ab       | 490                | 67                 | 520              | 0.10-0.40     |
|                             | Phycoerythrin    | 480-565            | 1960               | 578              | 0.98          |
|                             | TRITC-amines     | 554                | 85                 | 573              | 0.28          |
| Phenotyping                 | XRITC-NH-Ab      | 580                | —                  | 604              | 0.08          |
|                             | Texas Red-NH-Ab  | 596                | 85                 | 620              | 0.01          |
|                             | Allophycocyanin  | 650                | 700                | 660              | 0.68          |
| DNA-RNA Content             | Propidium iodide | 536                | 6                  | 623              | 0.09          |
|                             | Ethidium bromide | 510                | 3                  | 595              | —             |
| Reticulocyte count          | Thiazole orange  | 453                | 26                 | 480              | 0.08          |

FITC, fluorescein isothiocyanate; TRITC, tetra-rhodamine isothiocyanate; XRITC, X-rhodamine isothiocyanate.

Modified from Waggoner AS. Fluorescent probes for cytometry. In: Melamed MR, ed. Flow cytometry and sorting, 2nd ed. New York: Wiley-Liss, 1990:209-225.

---

The fluorochromes most commonly used for conjugation with monoclonal antibodies are

1. *Fluorescein isothiocyanate* (FITC) has a molecular weight of 389 d and an absorption maximum at 495 nm. With excitation by 488 nm, it emits fluorescence with a maximum around 520 nm. Approximately three to five molecules of FITC are usually conjugated for each antibody molecule. Higher numbers result in fluorescence quenching, which occurs when fluorochromes are in close proximity and reduces the brightness of the labeled species. FITC is a popular fluorochrome because of its reasonably high extinction coefficient and quantum yield, its water solubility, and its emission at 515 to 520 nm, which can even be detected by the human eye. Among its disadvantages are its relative photoinstability, loss of fluorescence below a pH of 8, and its wavelength of excitation, which produces autofluorescence.
2. *Phycoerythrin* is a member of the natural dyes of phycobili-proteins, which derive from *Cyanobacteria* or red algae. In nature, it transfers light energy to chlorophyll during photosynthesis. It has a molecular weight of 240 kd (larger than the antibody molecule) with 34 phycoerythrobilin fluorochromes per molecule. Its absorption maximum is 564 nm, and its emission maximum is approximately 576 nm. R-phycoerythrin is more suitable than the B form because it is more efficiently excited at 488 nm. For conjugation to the antibody molecule, certain cross-linking groups are used. Phycobili-proteins are water soluble, fluorescent at neutral pH, readily conjugated with antibodies, and have high quantum yields.
3. *Texas red* is a sulfonyl chloride derivative of sulforhodamine 101 with a molecular weight of 605 d. It is a more soluble rhodamine derivative with an absorption maximum of 596 nm. Its emission maximum is 620 nm. In multicolor analysis using Texas red and phycoerythrin, it is recommended that a dual-laser flow cytometer be used.
4. *Allophycocyanin* is a member of the phycobiliprotein family. It has a 105-kd molecular weight and six phycocyanobilin chromophores per molecule, which are similar to phycoerythrobilin, the chromophore of phycoerythrin. Allophycocyanin absorbs maximally at 650 nm and emits at 660 nm. It can be excited by a dye laser or a helium-neon laser.
5. *Peridinin-chlorophyll-a protein* is a dinoflagellate protein, can be excited at 488 nm, and emits light at greater than 600 nm. It is easily bleached and can be used only by low-power bench-top instruments. New fluorochromes are continuously introduced, such as Cas B and Cas Y excited by krypton lasers (407 nm), APC, the Alexa series (430, 595), and ECD (or Red 613). ECD has some overlap with PE channel but is brighter than Cy5PE.
6. *Tandem fluorochromes* are two fluorochromes covalently conjugated. Only one of them absorbs light at 488 nm from the argon ion laser that is most commonly used in single-laser flow cytometers. Energy from this fluorochrome is transferred to the second fluorochrome, which cannot be directly excited at 488 nm. This second fluorochrome, in turn, emits fluorescent light at a wavelength higher than that of the first one. For example, in a covalent conjugate of cyanin with phycoerythrin, 488-nm light excites phycoerythrin, which transfers the energy to the cyanin molecule. Cyanin, in turn, emits light at a longer wavelength than phycoerythrin (at 670 nm). The efficiency of energy transfer between the two fluorochromes is very effective, with less than 5% of the light absorbed by phycoerythrin being lost as fluorescence at 575 nm. These tandem fluorochromes allow the use of one argon ion laser (488

nm), and, thus, the need for dual lasers is eliminated. Tandem fluorochromes have opened the way for three-color fluorescence systems in combination with FITC and phycoerythrin using one laser light source. Texas red can also be conjugated to phycoerythrin, giving a tandem fluorochrome with an emission maximum above 600 nm.

Monoclonal antibodies with exquisite specificity are conjugated with fluorochromes. The structure recognized by the antibody is known as an *epitope*; any complex protein possesses several epitopes, and it is possible that several monoclonal antibodies produced against the same protein may detect different epitopes and give different results. These antibodies are recognized as being specific for a marker, but their binding may be different, and the number of cells detected may also differ.

Sensitivity of immunophenotyping depends on qualities of the monoclonal antibody, such as its specificity and affinity, and on the properties of the fluorochromes. Minimizing the background fluorescence by decreasing the nonspecific binding of the conjugates to the cells is mandatory. Nonspecific binding of the antibody is mediated through its Fc fragment and is especially prominent on cells expressing Fc receptors (natural killer cells, monocytes, neutrophils, B cells). Interaction of Fc receptors with Igs is non-species-specific. Therefore, all monoclonal antibodies (usually mouse Igs) bind to human cells to different extents depending on their class. The nonspecific binding may be reduced by pretreating the samples with human plasma to saturate the Fc receptors with human Ig. Strong nonspecific binding can occur with samples containing malignant cells, such as lymphoma cells in lymph node preparations. Nonspecific binding may also be the result of conjugates with high dye to antibody ratio, which results in the formation of aggregates. Each antibody molecule has an optimum number of fluorochrome molecules that yields maximum fluorescence as a result of specific binding with minimum nonspecific binding. The size of the conjugate is also important, particularly with the phycobiliproteins. Conjugates with large size are insoluble. Thus, conjugation of phycoerythrin (240 kd) to IgM (900 kd) has not been successful.

### Flow Cytometer Settings

In modern flow cytometers, basic features are not adjustable. However, a number of variables need to be set by the operator, such as setting the PMT sensitivity, the gains, selection of linear versus logarithmic amplification, color compensation, and so forth ( [27](#) ).

Increasing the voltage applied to the PMTs increases the sensitivity and the value of the signal collected. When the voltage changes, all populations change by the same number of channels, thus there is no change in the relationship of two peaks or populations.

Changing the gain settings, however, alters the relationship of different populations. Increase of the gains spreads populations located close together farther apart. Although this may appear as an advantage, it is a disadvantage for certain populations with relatively bright fluorescence. It may push them to the maximum channel (i.e., 1024 channel) and thus make them unable to be included in the analysis. At the maximum channel, the value measured is equal to or greater than the maximum.

Color compensation is required when two fluorochromes used have overlapping spectral properties. For example, FITC emits light over a wide range of wavelengths and thus is detected by other than the green PMT (i.e., the yellow and the red PMTs). Subtraction of the color detected by other than the green PMTs is known as *color compensator*. Compensation is usually done by compensation beads labeled by individual fluorochromes.

The voltages are set first with individual beads, followed by a run with all beads mixed. It



is then determined whether the voltages are accurate.

Finally, it is important to set the thresholds, which exclude small-sized particles such as erythrocytes, platelets, and cell debris. Occasionally, debris with strong SS and weak FC signals is encountered, probably from disintegrated neutrophils.

## Reporting Results

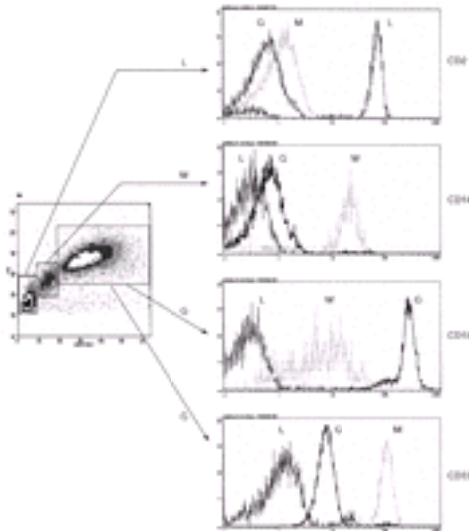
One method of reporting the results for specific subpopulations, such as CD4<sup>+</sup> cells, is as a percentage of the total lymphocytes. This presupposes that lymphocytes can be well separated from monocytes by FC and SS. If the total CD3<sup>+</sup> population can be determined, then the subpopulation can be reported as a percentage of that population. Most flow cytometers cannot provide absolute numbers because they do not measure fluid volumes. A computerized system has been used to report results in an attempt to obtain diagnostic and prognostic information in leukemias ([28](#)).

## FLOW CYTOMETRY IN HEMATOLOGY

Some common practical applications of FC in hematology are described briefly here. Detailed descriptions of these and other applications can be found in several monographs ([29](#), [30](#) and [31](#)).

### Sample Preparation

For cell-surface marker analysis, the sample is incubated with the appropriate monoclonal antibodies, and the red blood cells are lysed with lysing reagents (several are commercially available; some also contain fixatives). Nonspecific binding of the monoclonal antibody is determined by a species- and isotype-matched Ig without antibody activity that is conjugated to the same fluorochrome. This control is set to exclude 98 to 99% of all cells. The data are usually collected in list-mode. In a routine analysis, the first histogram displays the data of FS versus SS. In normal blood or bone marrow samples, three main leukocyte types are distinguished: lymphocytes, monocytes, and granulocytes ([Fig. 3.4](#)). On simple inspection, this histogram also shows whether the sample is normal or abnormal. Appropriate gating (rectangular or amorphous) allows the analysis of the various populations. In the presence of one large population (as in cases of leukemias or lymphomas), detailed analysis is possible by selecting with small gates (“bitmaps”) cells that are small or large (FS) versus cells that are nongranular, moderately granular, or heavily granular (SS). Thus, a differential count based on “intrinsic” cell properties is achieved. Although in the majority of cases, cell separation based on light scattering is adequate, to answer special questions, it is necessary to combine other approaches such as a combination of one light scatter parameter with fluorescent antibodies against a cell-surface marker. Frequently, CD45, a marker expressed by mature leukocytes, is used.



**Figure 3.4.** Two-parameter analysis (forward angle scatter vs. side scatter) of normal peripheral blood. Three populations are distinctly separated. These populations can be identified as lymphocytes (L), monocytes (M), and granulocytes (G) using lineage-specific (or associated) markers such as CD2 (lymphocytes), CD14 (monocytes), and CD15 and CD33 (granulocytes). Expression of CD15 is weaker in monocytes (vs. granulocytes) and varies widely among them (*broad peak*, i.e., large coefficient of variation). In contrast, expression of CD33 is stronger and more homogeneous (*narrow peak*, small coefficient of variation) in monocytes as compared with granulocytes. Thus, a marker not only identifies a cell simply as a result of its presence or absence, but also as a result of its intensity and heterogeneity of expression as defined by the coefficient of variation. The horizontal line separates the positive cells (to the *right*) from the negative (to the *left*). For comparison, each histogram to the right shows all three cell populations.

## Immunophenotyping

**NORMAL HEMATOPOIESIS** The development of monoclonal antibodies against cell-surface markers of blood cells and their conjugation with certain fluorochromes markedly contributed to the application of FC to the study of normal hematopoiesis ([32](#), [33](#), [34](#), [35](#) and [36](#)). Multiparameter FC has been used for characterization of normal hematopoietic differentiation. The changes in the expression of lineage-specific or lineage-associated cell-surface and cytoplasmic markers provided data for the reconstruction of the differentiation pathways along distinct lineages. Uncommitted hematopoietic progenitors reside within the population of bone marrow cells that are strongly CD34<sup>+</sup> and CD38<sup>-</sup>. CD38 is expressed in early progenitors with potential for lineage commitment as assessed functionally and by lineage-associated antigens ([35](#)). A detailed description of differentiation of the hematopoietic lineages is given in [Chapter 6](#), [Chapter 16](#), and [Chapter 17](#). This chapter provides a brief outline of the appearance of lineage-specific and lineage-associated markers.

### **Lymphocytic Differentiation**

**B Lineage** Commitment to B-cell differentiation is indicated by the appearance of CD19 and CD10 ([Chapter 16](#)) ([33](#)). Expression of CD19 is B cell-specific, whereas CD10 is also expressed at the early stages of T-cell differentiation. Expression of CD34 and CD10 ceases by the time the cell expresses IgM on its surface. Appearance of surface IgM is also associated with other B-cell markers such as CD20, CD21, and CD22. B cells make up approximately 20% of peripheral blood lymphocytes, and the typical phenotype is CD19<sup>+</sup>, CD20<sup>+</sup>, CD21<sup>+</sup>, and CD22<sup>+</sup>. B-cell activation is associated with the reappearance of CD10 marker in B cells of the germinal center. CD23 is also considered an activation

marker. With further differentiation, expression of CD45 declines and disappears at the stage of plasma cell. Plasma cells may also lose expression of CD19, while at the same time becoming strongly positive for CD38. A phenotype  $CD45^{-}/CD38^{3+}/CD138^{+}/CD19^{-}$  is the signature of a plasma cell.

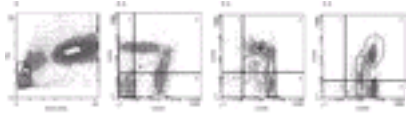
**T Lineage** Pre-T cells express CD34, CD7, and CD2 while still in the bone marrow. When these T-cell progenitors migrate to the thymus, the characteristic phenotype of the subcortical thymocyte develops in contact with thymic stroma. T cells in the subcapsular cortex are the most immature, and their phenotype is  $CD34^{+}/CD2^{+}/CD7^{+}/CD4^{\pm}/CD8^{\pm}$  (“double negatives”). Coexpression of CD4 and CD8 with CD1 is detected in the next stage (“double positives”) (Chapter 17), followed by the gradual appearance of CD3 and the  $\alpha/\beta$  T-cell receptor (TCR). Subsequently, the  $CD4^{+}/CD8^{+}$  thymocytes give rise to the single-positive CD4 and CD8 cells. The majority of peripheral blood lymphocytes (approximately 60 to 80%) are  $CD2^{+}/CD3^{+}/CD7^{+}$  and express either CD4 or CD8. A small number are  $CD4^{-}/CD8^{-}$ , but these are not immature cells because they express the TCR.

**Erythroid Differentiation** On commitment to the erythroid lineage, CD71 appears on the cell surface with loss of CD34 and CD33 and decrease of CD45 (32). With further differentiation, expression of CD71 declines as the expression of glycophorin is up-regulated. CD45 disappears in the final stages.

**Myeloid Differentiation** CD33 is one of the earliest antigens to appear (34). The  $CD34^{+}CD33^{+}$  cells can give rise to burst-forming unit erythroid and colony-forming unit granulocyte-monocyte. Immature myeloid cells become  $CD13^{+}$  followed by the appearance of CD15 and CD11b. Only at the final stages are CD16 and CD10 expressed. Granulocytes are strongly positive for CD15 and only weakly positive for CD33, with a heterogeneous distribution or large CV. CD13 and CD11b are of intermediate expression. In contrast, monocytes are strongly CD33 positive [with small CV (i.e., homogeneous expression in the population)] but weakly CD15 positive and CD4 positive. Expression of CD4 easily distinguishes monocytes from  $CD4^{+}$  T cells. In the monocytes, expression of CD4 is weak with a large CV, whereas in the T cells, expression of CD4 is strong with a small CV. Thus, intensity of fluorescence and CV are important parameters, in our experience, for cell identification. The signature phenotype for monocytes is  $CD33^{high}$ ,  $CV\text{-small}/CD15^{low}$ ,  $CV\text{-large}/CD4^{low}$ ,  $CV\text{-large}$ .

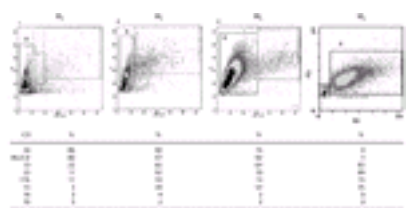
**IMMUNOPHENOTYPING OF HEMATOLOGIC MALIGNANCIES** Markers specific for hematologic malignancies exist only when a new protein is encoded by a gene resulting from the fusion of two normal genes (i.e., bcr/abl). However, diagnosis by immunophenotype can still be accurately made by the usual leukocyte antigens and other proteins expressed on the cell surface (Ig light chains). It is based on the presence of a marker in numbers significantly larger than normal or on the presence of an aberrant phenotype resulting from (a) expression of a marker on a lineage on which it is not normally expressed, or (b) asynchronous antigen expression (i.e., presence of a marker at a stage of differentiation where it does not normally belong). Diagnosis based on large numbers of cells expressing a specific marker may lead to erroneous diagnoses, as past experience has taught us. The classic example is the common acute lymphocytic leukemia (ALL) antigen or CALLA (CD10), which was first believed to be specific for leukemic cells but later was found on bone marrow B-cell progenitors and on peripheral B cells (germinal center), as well as on cells from other lineages and even on nonhematopoietic cells. If the bone marrow is replaced by leukemic cells, the diagnosis is straightforward because the number of  $CD10^{+}$  cells in normal adult bone marrow is less than 5% of the lymphoid cells. Earlier, some investigators accepted a number of  $CD10^{+}$  cells greater than 20 to 30% of the bone marrow cells as an abnormal finding suggestive or diagnostic of ALL. It has been shown, however, that in children with thrombocytopenic purpura, the number of  $CD10^{+}$  cells may be up to 60% in the absence of ALL (37). As shown in Figure 3.5, the bone

marrow contains large numbers of CD10<sup>+</sup> cells, which are heterogeneous in terms of expression of CD10, CD20, or CD45. Furthermore, with the decline of CD10 expression, the CD20 and CD45 density increases, which is evidence of maturation. Therefore, high levels of one particular marker may not necessarily indicate a neoplastic disease. The same applies for the CD34 marker associated with immature hematopoietic cells.



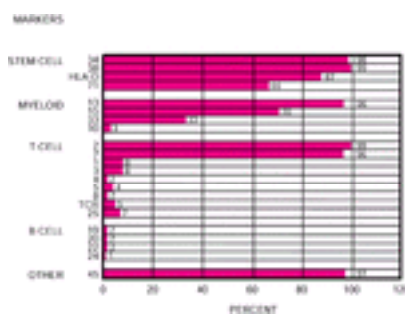
**Figure 3.5.** The patient had idiopathic thrombocytopenic purpura, and the bone marrow showed increased numbers of immature lymphoid cells (23%). By flow cytometry, these cells are CD10<sup>+</sup>. Some are CD10<sup>-</sup>, whereas the remaining cells express CD20. As CD10 expression declines, the expression of CD20 increases and merges with the cells, which are CD20<sup>+</sup> but CD10<sup>-</sup>. This is a pattern characteristic of B-cell maturation. A similar pattern is shown with expression of CD45. SS, side scatter.

More than the high percentage of a rare cell marker, it is the composite phenotype that should be considered. For example, the association of CD34 with another marker not normally seen, such as CD7, CD4, or CD56, is more suggestive of a proliferative disorder (see [Appendix](#)). These very rare phenotypes confirm the diagnosis whether one accepts that leukemia is a “frozen window” of normal hematopoiesis, and therefore the cells with the unusual phenotype correspond to normally infrequent cells, or whether one believes that the phenotype is aberrant as a result of interlineage or intralineage “infidelity” indicative of misprogramming or illegitimate gene expression. These rare markers, however, have a very important application after diagnosis if they can be used as patient-specific probes for monitoring minimal residual disease. For example, the expression of CD56 on CD34<sup>+</sup> blasts could be readily identified in one out of 10<sup>4</sup> blasts in 20% of cases of childhood acute myelogenous leukemia (AML) ([38](#)). In progenitor cells of chronic myelogenous leukemia in chronic, accelerated, and blastic phases, CD56 is again coexpressed with CD34 ([39](#)). Despite these difficulties, immunophenotypic diagnosis of leukemia has increasingly become an indispensable tool in laboratories, although the morphologic diagnosis and classification still remain the indisputable standard for the study of patients with hematopoietic malignancies. In the following situations, immunophenotyping is clearly important: (a) determination of lineage (myeloid vs. lymphoid) if it cannot be decided on the basis of morphology and cytochemistry, (b) distinction between B- and T-cell acute leukemias, (c) detection of mixed lineage leukemias, and (d) detection of monoclonality in B-cell lymphoproliferative disorders on the basis of expression of Ig light chains. The application of increasingly greater numbers of monoclonal antibodies allows a more precise classification and will make it possible to associate genetic subgroups with a distinct immunophenotype such as leukemias with t(8;21), t(15;17), and so forth ([40](#)). Light scattering can provide useful information. [Figure 3.6](#) shows representative examples of AML of the first four French/American/British (FAB) classifications, FAB M0 to M3. The light scattering histograms show gradual increase of SS from M0 to M3, indicative of the gradual increase in the granularity of the leukemic cells. Immunophenotyping reveals that expression of the stem cell marker (CD34) is retained even in some M2 leukemias. Furthermore, the M2 group is immunophenotypically heterogeneous in the expression of other markers, such as CD4. The significance of these immunophenotypic findings remains to be determined.

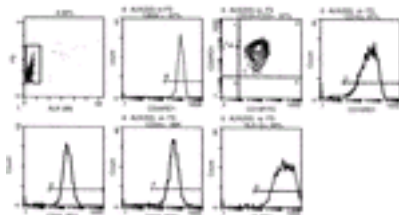


**Figure 3.6.** Light scatter histograms and the phenotype are shown using the main myeloid markers with examples from the four French/American/British (M0 to M3) classes of acute myelogenous leukemia. The phenotype refers to the main cell population (A) in each forward angle scatter (FS) versus side scatter (SS) histogram. Numbers are percentages.

Immunophenotypic analysis of acute leukemias allows the identification of mixed lineage leukemias. [Figure 3.7](#) shows the phenotype of a patient with AML–FAB M1 with the aberrant expression of CD2 and CD7. Rare forms of leukemia can only be identified by analysis of cell–surface markers. [Figure 3.8](#) shows the phenotype of a case of ALL of B lineage with the expression of CD2. This case of biphenotypic leukemia reveals the existence of common lymphoid precursors that have also been detected in fetal liver ([41](#)) (see below). Immunophenotyping has advanced our understanding of the origin of acute leukemias, but the impact on various clinical aspects, such as prognosis and therapy, still needs to be better evaluated.



**Figure 3.7.** Phenotype of bone marrow cells from a patient with acute myelogenous leukemia (French/American/British–M1). The bone marrow contains one main population (98%) of cells that are heterogeneous in size, and only the larger cells are slightly granular. These cells show distinct evidence of myeloid differentiation and the coexpression of two lymphoid (T–cell) markers, CD2 and CD7. Although CD7 may be accepted here as a stem cell marker, the expression of CD2 is certainly aberrant. This is an example of mixed lineage leukemia. TCR, T–cell receptor.

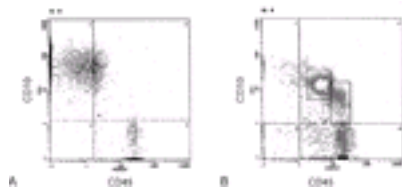


**Figure 3.8.** The phenotype of a case of acute lymphocytic leukemia that shows the expression of CD2 on all blasts. Mixed lineage leukemias can only be identified by immunophenotyping. The clinical significance of such cases remains to be evaluated. FITC, fluorescein isothiocyanate; FS, forward angle scatter; SS, side scatter.

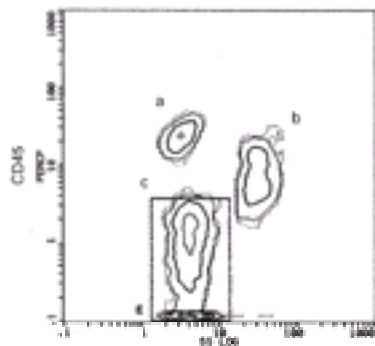
The use of three or more monoclonal antibodies permits a more precise identification of the phenotype of a cell population. This is particularly important when a marker is expressed not only on the leukemic cells, but also on normal cells. For example, CD33 is expressed on all stages of myeloid differentiation. Gating on the basis of light scattering, which excludes the most granular (and, therefore, the most mature) cells, is not sufficient. Combination of CD33 with CD34 identifies the most immature cells (those likely to represent the leukemic blasts), and their identification may further be improved with the addition of a third marker such as CD4, CD7, or HLA–DR, which have now been identified as markers of primitive hematopoietic progenitors (stem cells) ([42](#), [43](#)). The use of CD45 with a combination of two other monoclonal antibodies further facilitates the identification



of blasts because it is known that CD45 is either lacking or expressed only weakly in the most immature hematopoietic cells and increases in density with maturation ( 44 , 45 , 46 and 47 ). In [Figure 3.9A](#), the blasts from a case of ALL show weak expression of CD45. The presence of relatively large numbers of CD10<sup>+</sup> cells after treatment may indicate residual disease or bone marrow regeneration. A combination of CD10 with CD45 in this case reveals that, in contrast to the diagnostic pattern, CD10 expression is heterogeneous, and, as CD10 is down-regulated, expression of CD45 is up-regulated, suggesting bone marrow regeneration ( [Fig. 3.9B](#) ). A two-parameter histogram of CD45 versus SS ( [Fig. 3.10](#) ) allows the selection of all immature cells that are low in CD45 and that are also low in SS because they lack granularity.



**Figure 3.9.** A two-parameter histogram, CD10 and CD45, identifies two different populations of CD10<sup>+</sup> cells. **A:** CD10<sup>+</sup> blasts from a patient with acute lymphocytic leukemia show no or little coexpression of CD45. **B:** CD10<sup>+</sup> cells after chemotherapy show progressive increase of CD45 as CD10 is down-regulated. These cells are normal, regenerating CD10<sup>+</sup> cells.



**Figure 3.10.** A two-parameter histogram [CD45 vs. side scatter (SS)] shows the presence of cells with low CD45 expression and low SS, which represent immature cells from a patient with acute leukemia. The ungated histogram clearly shows three main populations: ( *a* ) small numbers of cells with strong CD45 expression and low SS (lymphocytes); ( *b* ) high to intermediate CD45 expression and high SS (granulocytes); and ( *c* ) low SS with decreasing expression of CD45. These are immature cells, and gating can be used to determine their phenotype.

The combination of two to three monoclonal antibodies may be used for the detection of residual disease. Combinations of monoclonal antibodies must be used cautiously because, for certain markers, the presence of one antibody may interfere with the detection of another, probably on the basis of steric hindrance. Evaluation of the density of a specific marker has been attempted to determine whether it can be used as a prognostic indicator. Quantitative variation of CD10 in ALL has been demonstrated ( 48 , 49 ). Patients with levels of CD10 less than the median of the CD10<sup>+</sup> group had a higher rate of failure. Overexpression of CD10 suggested the diagnosis of ALL even with low CD10<sup>+</sup> numbers. Different CD10 levels were associated with different chromosomal abnormalities; for example, high CD10 levels were associated with hyperdiploid cells and

low CD10 levels with the t(4;11) translocation (48). Quantitative ratios of two markers may also be used to identify stage of differentiation. Parallel quantification of CD24 and CD45 allows identification of B-cell differentiation stage and may also be relevant clinically (50). High CD24 and low CD45 values are found in ALL, and, in these patients, low CD24 to CD45 ratios were associated with good prognosis.

**Acute Lymphocytic Leukemia** Immunophenotyping of cases of ALL is one of the most important applications of FC and provides an easy and definite diagnosis and a distinction between B-ALL and T-ALL (51).

**B-Cell Acute Lymphocytic Leukemia** Diagnosis of ALL in children by FC is based primarily on the expression of CD34, CD19, HLA-DR, and CD10. Expression of CD45 (low or negative) and CD24 (strong) is particularly useful not only at diagnosis but also during the follow-up period of bone marrow regeneration for detection of residual disease. From an earlier study, 69% of the cases are CD34<sup>+</sup> and 75% are CD10<sup>+</sup> (52). In our experience, the combination of CD45, CD34, CD10, and CD24 is particularly useful in two-parameter histograms for the identification of normal B blasts of regenerating cells versus leukemic blasts. Other B-lineage-specific markers are cytoplasmic detection of CD79a (mb1) (53), CD22, and TdT. Monoclonal antibodies specific for the V-preB and  $\gamma^5$  subunits of the pre-BCR reacted with cells in 53 of 56 cases classified as non-B non-T-ALL, thus identifying them as B-cell ALL (54). In a small number of cases, CD2 is coexpressed with other B-cell markers (55). CD2<sup>+</sup> B-cell precursors have been identified in fetal life (41). These leukemias may represent malignancies derived from such an early B-lymphocytic precursor. Approximately 1 to 2% of B-ALL in children express surface Ig absence of CD34 and TdT, with some expressing an L3 morphology.

**T-Cell Acute Lymphocytic Leukemia** T-cell ALL comprises approximately 15 to 20% of childhood ALL. The phenotype of T-ALL corresponds to early stages of T-cell differentiation within the thymus. Cases corresponding to stage I of T-cell differentiation are CD34<sup>+</sup>/CD7<sup>+</sup>/CD2<sup>+</sup>, and some of them are also CD10<sup>+</sup>. This phenotype corresponds to the pre-T cell, a precursor detected in the bone marrow. More mature phenotypes are characterized by lack of CD34 and CD10, and, through a transitional stage, which is negative for CD4 and CD8 (stage II), the cell normally becomes double positive (i.e., CD4<sup>+</sup>/CD8<sup>+</sup> and CD1<sup>+</sup>) (stage III). The cells are also TdT positive. Expression of cytoplasmic CD3 is specific for T-cell lineage. Expression of several T-cell markers may not be detected (i.e., CD2, CD4, or CD8). However, if the cells are CD7 positive and other T-cell or myelomonocytic markers are absent, the phenotype is diagnostic of T-ALL. CD7 is the most important marker for T-ALL. However, in our experience, it is the composite phenotype that is important for diagnosis. It has been suggested that diagnosis of T-ALL should not be made in the absence of CD7 expression (51).

**Acute Myelogenous Leukemia** Markers useful for the diagnosis and classification of AML are CD34, CD117, CD33, CD13, CD15, CD4, CD11b, HLA-DR, and cytoplasmic myeloperoxidase. Immunophenotyping contributes to diagnosis in cases that are difficult to diagnose morphologically.

**Acute Myelogenous Leukemia with Minimal Myeloid Differentiation** The cells are agranular and show low FS and SS. They strongly express CD34, HLA-DR, and usually CD38 and CD117 (c-kit), as well as CD33, CD13, or both (56).

**Acute Myelogenous Leukemia without Maturation** The blasts have low FS and SS, they are CD45<sup>+</sup> and HLA-DR<sup>+</sup>, and a high proportion of them are CD38<sup>+</sup> and CD117<sup>+</sup>. Antigens associated with more mature stages of myeloid differentiation (i.e., CD15, CD11b, CD16) are not expressed. A minimum of 3% of blasts demonstrate expression of myeloperoxidase.

**Acute Myelogenous Leukemia with Granulocyte Differentiation** Maturation at least to the level of promyelocytes and myelocytes is evident. The cells show a stronger SS pattern, and CD45 is moderately to weakly positive, whereas HLA-DR is negative. If there are small numbers of immature cells, they can be separated by their FS/SS properties with or



without CD45 combination from the more mature leukemic cells. CD33 expression decreases as more mature markers gain in intensity (i.e., CD15, CD11b). Intracellular myeloperoxidase is strong.

**Acute Myelogenous Leukemia with Monocytic Differentiation** In the monocytic type of AML, the blasts are large with strong FS signal. They are strongly CD33<sup>+</sup> and express CD13 and HLA-DR. They are usually negative for CD34, CD117, and CD11b. CD64 and CD14 are monocytic-related markers and may help in diagnosis, as does expression of CD4. In the myelomonocytic type of leukemia, markers of immature cells are negative. The typical phenotype is expression of CD33, CD13, CD11b, CD4, and HLA-DR.

**Megakaryoblastic Leukemia** The blasts are positive for CD41 (αIIb) and CD61 (β<sub>3</sub>), which are the α- and β-chains, respectively, of integrin αIIb/β<sub>3</sub>, one of the main platelet integrins.

**Acute Myelogenous Leukemia with Recurrent Genetic Abnormalities** In a group of AMLs, there are certain genetic abnormalities that recur regularly. These forms of AML often have a high rate of complete remission and favorable prognosis (see reference [166](#)). Most commonly identified abnormalities are reciprocal translocations: t(8;21), inv 16 or t(16;16), t(15;17).

**Acute Myelogenous Leukemia: t(8;21)(q22;q22), AML1/ETO** In some patients (diagnosed as M2 AML by the FAB classification), there is a translocation t(8;21)(q22;q22), one of the most common karyotypic abnormalities in AML ([57](#)). The blast cells in these cases are CD34<sup>+</sup>CD19<sup>+</sup> and HLA-DR<sup>+</sup> and express weakly CD13 and CD33 ([58](#)). CD56 is often expressed but not as often as CD19. The nonblastic cells have a more mature phenotype (i.e., CD11<sup>+</sup>/CD15<sup>+</sup>) without immature markers. In AML with a similar translocation in children, CD19 was detected in 81% of the cases and CD56 in 63% ([59](#)). The CD19/CD56 markers are coexpressed. This translocation involves the AML1 gene at 21q22 and ETO in 8q22.

**Acute Promyelocytic Leukemia (AML t15;17)(q22;q12)** Acute promyelocytic leukemia (APL) is diagnosed in less than 10% of all AML cases. A variant of APL is known as *microgranular M3* (or *hypogranular*) because the granulation is significantly less than in the traditional M3. Accurate diagnosis of APL is important because of the danger of potentially fatal disseminated intravascular coagulation, which can be initiated by procoagulants contained in the granules. Background fluorescence is high, probably as a result of proteins associated with the granules. In APL, the CD33 expression is strong, whereas CD13 is heterogeneous. The early myeloid markers, CD34 and HLA-DR, are negative, as well as the mature marker CD15. Frequently, there is coexpression of CD2 or CD19.

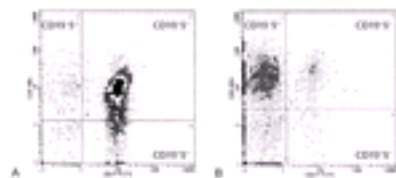
**CD7 + Leukemia** Leukemias positive for CD7 but negative for CD4/CD8 were identified as hematopoietic malignancies involving immature cells ([60](#)). Subsequently, CD7 expression was identified in patients with classical AML phenotype ([61](#)). CD7 expression was detected in cases of undifferentiated cells with only CD13<sup>+</sup> expression ([62](#)), and we had a case in which CD7 was the only marker. It is now clear that CD7 is a marker of very primitive hematopoietic precursors detected during the stages of liver hematopoiesis ([63](#)) and on normal human myeloid progenitors ([43](#), [64](#), [65](#)), as well as on B-lineage precursors ([66](#)). Cell lines derived from fetal bone marrow B-cell precursors transformed by the Epstein-Barr virus express CD7 and correspond to pre-B or early B stage of differentiation ([67](#)).

**Down Syndrome** Children with Down syndrome have an increased incidence of acute leukemia, commonly AML (approximately 10 to 20 times that of the general population). Some patients, however, develop myeloproliferation that resembles leukemia and undergoes spontaneous durable remission ([68](#)). A unique myelodysplastic syndrome referred to as *transient abnormal myelopoiesis* (TAM) has been reported in children with Down syndrome. The phenotypic characteristic of TAM is the expression of platelet-associated antigens, CD9, CD36, CD41, and CD42 ([69](#)). In some cases, CD33 and

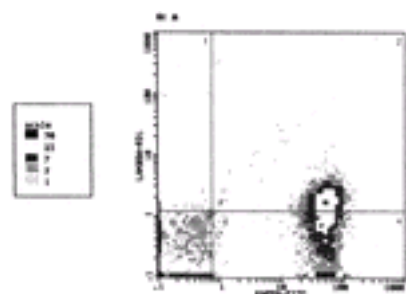
HLA-DR or CD3 and CD7 are also detected, whereas the TCRB is clonally rearranged (70). TAM is sometimes called *acute megakaryocytic leukemia*. The phenotype is frequently mixed with expression of megakaryocytic/platelet myeloid or T-cell markers. The abnormality in TAM seems to involve a multilineage precursor (71).

**Lymphoproliferative Disorders** FC contributes significantly to the study of lymphoproliferative disorders through (a) identification of clonality and (b) identification of cell lineage (72, 73). Clonality for B cells requires the demonstration of light-chain restriction if surface Ig is expressed. A panel of lineage-specific antibodies provides the answer to the question of cell lineage.

**B-Cell Chronic Lymphocytic Leukemia** In B-cell chronic lymphocytic leukemia (B-CLL), there are two important and characteristic markers in the majority of the cases (i.e., CD5 and CD23), usually used in combination with CD19 (to exclude T-cell lineage). CD23 expression differentiates B-CLL from mantle cell lymphoma. The combination of CD5/CD23 could also be used for easy identification of residual disease. As shown in Figure 3.11A, all cells are CD5<sup>+</sup>/CD19<sup>+</sup> at diagnosis. These cells are monoclonal, as shown in Figure 3.12, because they express only  $\kappa$ -light chains. During therapy, however, residual leukemic cells can be detected easily by FC. As shown in Figure 3.11B, the majority of the cells in this patient are normal T cells (i.e., CD5<sup>+</sup>/CD19<sup>-</sup>). However, a small cluster of cells with the CD5<sup>+</sup>/CD19<sup>+</sup> cells located in the same position as the leukemic cells at diagnosis indicates residual disease. The antibody FMC-7 is useful for identification of prolymphocytic leukemia or prolymphocytoid changes of B-CLL. The term *prolymphocytoid transformator* has been applied to cases of CLL with increased numbers of nucleolated lymphocytes (74, 75). Increased numbers of FMC-7<sup>+</sup> cells are sometimes noted in patients with B-CLL in the absence of morphologic changes of prolymphocytic leukemia. It appears that immunologic changes are regulated independent of morphology. In 78 cases of B-CLL with atypical phenotypes, 61% showed increased FMC-7 expression (75).



**Figure 3.11.** A two-parameter histogram of peripheral blood from a patient with B-cell chronic lymphocytic leukemia. **A:** At the time of diagnosis, all cells are CD5<sup>+</sup>CD19<sup>+</sup>. **B:** Four months after treatment, a very small number of CD5<sup>+</sup>/CD19<sup>+</sup> cells still remains.

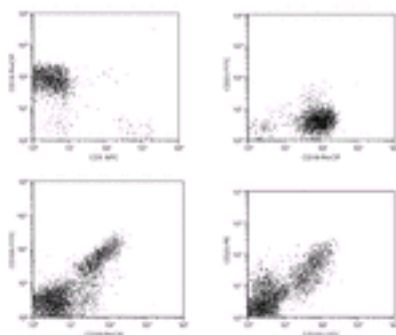


**Figure 3.12.** Two-parameter histogram ( $\lambda$  vs.  $\kappa$ ) identifies a mono-clonal population of B cells from a patient with B-cell chronic lymphocytic leukemia. There are no  $\kappa$ <sup>+</sup> cells. The small number of cells weakly coexpressing  $\kappa$ -chains together with strong  $\lambda$  expression is likely due to artifacts (passive immunoglobulin adsorption or nonspecific binding of the anti- $\lambda$  monoclonal antibody).

Somatic mutations of the CD79b gene in patients with B-CLL affect the expression of its protein ( [76](#) ). CD79b is one of the chains that, together with CD79a, form the co-receptor for surface Ig. Surface Ig is not expressed in the absence of the co-receptor. This may explain the fact that mIg expression is markedly decreased or even undetectable in B-CLL. Expression of CD11c in B-CLL is somewhat controversial and may indicate variants of B-CLL, as is the case with FMC-7 ( [77](#), [78](#) ). Recently, the expression of CD38 in B-CLL has raised significant discussion about whether it can be used as a prognostic factor and whether it identifies a group of patients in whom the genes in the B cell have undergone somatic hypermutations. It was first reported that patients with high percentages of CD38<sup>+</sup> cells had V genes that were unmutated ( [79](#) ) and that these patients had a more aggressive form of disease ( [80](#) ). The majority of the reports consider CD38 expression as a predictor of poor clinical outcome and an important prognostic marker ( [81](#), [82](#), [83](#), [84](#) and [85](#) ). High levels of CD38 and unmutated genes predicted shorter survival ( [80](#), [86](#) ). Others pointed out that p53 dysfunction has predictive value and all CD38<sup>+</sup> patients had p53 dysfunction, but the two are not associated ( [87](#) ). In a multivariate analysis of prognostic factors in B-CLL, deletion of chromosome 11q23, atypical morphology, and more than 30% CD38<sup>+</sup> cells are associated with the presence of unmutated Ig VH genes and poor prognosis ( [88](#) ). CD27 has been shown to be expressed in normal memory B cells, which carry somatically mutated Ig VH genes ( [89](#) ). CD27 is also expressed in B-CLL ( [90](#) ), but whether CD27 in B-CLL is also associated with mutated genes has not been examined. High-grade lymphoma developing in patients with B-CLL is known as *Richter transformation* or *Richter syndrome lymphoma*. It is considered to be clonally related to, or evolving from, the original B-CLL clone.

Phenotypically, the cells are CD5<sup>-</sup> ( [91](#) ).

**Hairy Cell Leukemia** Hairy cell leukemia shows a unique phenotype with characteristic expression of CD103 ( [92](#) ), the  $\alpha E$ -chain, which forms a heterodimer with the  $\beta 7$ -chain. Expression of the integrin  $\alpha E\beta 7$  is important for homing of lymphocytes to the Peyer patches. A small subpopulation of B cells expresses a  $\alpha E\beta 7$ . CD11c may not be unique to hairy cell leukemia, but its expression is strong. The hairy cell leukemia cells are CD5<sup>-</sup>/CD23<sup>-</sup> and express CD25 ( [Fig. 3.13](#) ).



**Figure 3.13.** The phenotype of hairy cell leukemia differs from the phenotype of chronic lymphocytic leukemia in several aspects. The hairy cell leukemia cell is CD5<sup>-</sup>/CD23<sup>-</sup>, and it is positive for CD11c, CD25, and CD103. CD103 is the  $\alpha E$  ( *E* for epithelial associated) of the  $\alpha E\beta 7$  integrin.  $\alpha E\beta 7$  binds to E-cadherin on epithelial cells and is important for homing of lymphocytes to intestinal epithelia. APC, allophycocyanin; FITC, fluorescein isothiocyanate; PerCP, peridinin-chlorophyll-a protein. (Courtesy Dr. Carmen Morales.)

**Mantle Cell Lymphoma** Mantle cell lymphoma has a characteristic genetic marker as well as an immunophenotype. In our experience and in that of others ( [93](#) ), FC has shown that

the distinguishing phenotype is CD5<sup>+</sup>/CD23<sup>-</sup>. CD10 distinguishes mantle cell lymphoma (CD10<sup>-</sup>) from follicular cell lymphoma (CD10<sup>+</sup>).

**Marginal Cell Lymphoma** The majority of the B cells in the marginal zone of the spleen are memory B cells (both T-dependent and T-independent specific for type I antigens). The marginal zone of the lymph node is a rim of lymphocytes located in the outer zone of the mantle of the secondary lymphoid follicles. Marginal zone B cells are larger than naïve B cells and express high levels of IgM. These lymphocytes are negative for CD5, CD23, and CD10, which differentiate marginal lymphoma from other B-cell lymphomas (94). The marginal zone B cells are hypermutated, indicative of their postfollicular center nature (95). A B cell known as *monocytoid B cell* is detected in large numbers in Hodgkin disease and in lymphadenopathies caused by *Toxoplasma gondii*. It has the same phenotype as the marginal zone B cell but has not undergone mutations (i.e., is a naïve B cell) (96).

**Follicular Cell Lymphoma** Follicular lymphoma (FL) is characterized by the t(14;18)(q32;q21) translocation. The BCL-2 oncogene at chromosome 18q21 is juxtaposed to the Ig heavy chain gene locus at 14q32. As a result of the translocation, the BCL-2 is deregulated (97). The phenotype that distinguishes FL from other B-cell lymphomas in the majority of cases is CD10<sup>+</sup>CD5<sup>-</sup>CD23<sup>-</sup>. A combination of CD10 with antibodies to light chains provides evidence of monoclonality. A variant of FL known as *floral FL* has been shown to express CD5 (98).

**Burkitt Lymphoma** In addition to the usual markers associated with B cells, the tumor cells are CD10<sup>+</sup> and sIgM<sup>+</sup>.

**Peripheral T-Cell Lymphoma** The usefulness of FC in T-cell proliferative diseases is to confirm the nature of the lineage. Clonality markers for T cells, equivalent to light chains on B cells, do not exist (99). Clonality may be suspected by phenotypic abnormalities of major T-cell markers such as CD4, CD8, or both. For example, expression by all cells of only one of these markers instead of the normal ratio or the expression of both on the same cell is strong evidence of an “abnormal” population. Lack of CD7 is suggestive of malignancy but is not conclusive. In adult T-cell leukemia/lymphoma (human T-cell leukemia virus type 1 infection), CD25 is expressed in high levels. In a study of 50 cases of peripheral T-cell lymphomas, one to five aberrations were detected in 92% of the cases. Abnormal expressions most frequently involved CD3 (66%), followed by CD7 (58%) (85). Unique expressions of a particular marker in other T-cell lymphoproliferative diseases include the CD30 (large cell lymphoma, cutaneous or noncutaneous) and the CD4 in Sézary syndrome. However, immunophenotyping is only contributory to the diagnosis. A rare T-cell lymphoma, known as *hepatosplenic T-cell lymphoma*, is a malignancy of the T cells and is CD4<sup>-</sup>/CD8<sup>-</sup>/CD16<sup>+</sup> (100).

## Staging of B-Cell Lymphoma

The standard practice for determining the stage of non-Hodgkin lymphoma is the morphologic examination of bone marrow. Results from the application of FC for this purpose remain controversial. One study questioned the usefulness of FC because in only 3 of 273 samples did FC improve the diagnosis, and two of these cases were morphologically suspicious (101). Considering the cost difference between FC and morphologic examination of bone marrow, FC does not offer significant advantages (102). In this study, FC on peripheral blood provided results that were as good as those from the bone marrow. On the other hand, FC was found to be superior to morphology in patients with low bone marrow involvement because the morphologic evaluation can detect only cases with greater than 5% bone marrow involvement. These results need to be reevaluated with larger numbers (103). It is likely that improvements in the protocols for FC evaluation are needed, as shown by another study in which CD19-based gating was successfully used to detect light-chain restriction (104). Although morphology and FC provided concordant results in 82% of the cases, all 18 samples were positive by FC

except for one with discrepant results.

### Minimal Residual Disease by Flow Cytometry

It is well known that, in patients with complete remission as shown by morphology, relapses frequently occur due to persistence of small numbers of leukemic cells that remain undetectable by morphology or cytochemistry ( [105](#) ). Several reports in the literature regarding the feasibility of FC for detection of minimal residual disease show a disappointing level of agreement. Some of the reasons are methodology, differences in interpretation, and, more specifically, the inability to identify clonogenic cells by immunophenotyping ( [105](#), [106](#), [107](#) and [108](#) ). There is also no consistency among centers in identification of leukemia-associated phenotypes. Expression of myeloid-associated antigens in ALL and lymphoid-associated antigens in AML varies greatly (i.e., 7 to 54% in the former case and 4 to 60% in the latter) ( [106](#) ). Another possibility is that the expression of lymphoid markers such as CD7, CD4, and CD2 in cases of AML is not, strictly speaking, an aberration, but rather leukemias arising from progenitors expressing these markers normally, as has been shown for CD7 and CD4. However, in some cases in which a “leukemic phenotype” can be confirmed, FC is a convenient method to detect rare leukemic cells. Asynchronous antigen expression is useful when two markers are normally well separated by their expression at distinct maturational stages but are coexpressed in the leukemic cell, such as CD34 and CD20 in B-ALL ( [52](#) ). This particular combination does not apply to all cases because only 38% of B-ALLs are CD20<sup>+</sup> ( [52](#) ). In our experience with certain markers, their density and, therefore, intensity of fluorescence are strikingly higher in the leukemic population as compared to normal. For example, intensity of CD24 expression is much stronger in B-ALL blasts than in normal pre-B cells. In combination with CD10, the CD10<sup>+</sup>/CD24<sup>+</sup> blasts are in a unique position on the histogram, well separated from CD10<sup>+</sup>/CD24<sup>+</sup> normal B cells during bone marrow regeneration ( *unpublished observations* ). Fluorescence intensity has been used successfully to identify leukemic cells in B-ALL, and the leukemic nature of these cells was confirmed by polymerase chain reaction and Ig heavy chain gene rearrangements ( [109](#) ).

In general, in spite of methodologic differences, FC is sensitive enough to detect small numbers of leukemic cells. Among 53 ALL patients, persistence of gradual increase of the number of leukemic cells in the bone marrow is associated with a higher incidence of relapse (90% vs. 22%) and a shorter disease-free survival (median of 12 months vs. not reached) ( [108](#) ).

Detection of minimal residual disease by FC requires carefully controlled technique, proper marker protocols, and significant expertise for definition of the leukemic phenotype at diagnosis, and the interpreter must be able to later identify this phenotype on rare residual leukemic cells.

### Platelet Function

FC offers distinct advantages in the study of platelet activation in whole blood with minimal manipulation ( [110](#) ). Platelet activation is detected by antibodies specific for epitopes exposed after granule secretion (i.e., P-selectin) or ligand binding. Ligands induce conformational changes to their receptors; fibrinogen, for example, induces conformational changes to its receptor GPIIb/IIIa (CD41/CD61) integrin ( [111](#) ). In either case, these activation-specific antibodies do not react with resting platelets. Antibodies against the GPIb-IX-V complex (CD42a, a, β), the receptor for von Willebrand factor, bind to resting



platelets and only very weakly to activated platelets ( [112](#)). On activation, there are changes in the size and granularity of platelets as reflected in the reduction of forward light scatter (size) and granularity (SS). Because activation of platelets may occur during preparation for FC, samples need to be handled with specific procedures and inhibitory compounds.

As a result of activation, intracellular  $\text{Ca}^{2+}$  increases rapidly. Clinically approved  $\text{Ca}^{2+}$  indicators are Fluo-3 and Fura Red (Molecular Probes, Eugene, OR). Binding of free intracellular  $\text{Ca}^{2+}$  to Fluo-3 increases the intensity in green wavelengths and decreases wavelengths in the red range (Fura Red). The ratio between the two intensities gives the relative  $\text{Ca}^{2+}$  concentration ( [113](#)). Microparticles frequently overlap with nonspecific background or “electronic” noise but technically may be separated with the use of an antiplatelet antibody and linear SS.

In thrombocytopenia patients, FC helps to determine whether the low platelet count is the result of accelerated destruction or decreased production. With normal bone marrow capacity, loss of platelets triggers compensatory platelet production. Newly released platelets are larger and contain RNA, which can be detected by thiazole orange (reticulated platelets) ( [114](#)). Diagnosis of idiopathic thrombocytopenic purpura by detecting platelet-bound IgG is difficult because Ig bound to platelets is found in other conditions and because platelets have Fc receptors that may carry normal Ig ( [115](#)).

Interaction of platelets with leukocytes is increased in inflammatory conditions and has also been detected in cardio-pulmonary bypass, acute coronary syndrome, and so forth. Such interactions are easily detected by FC because the “cluster” has the scatter properties of leukocytes that bear both leukocyte- and platelet-specific markers ( [116](#)).

Platelet studies by FC have been used in clinical conditions, such as Glanzmann thrombasthenia, to demonstrate the degree of lack of GPIIb/IIIa on the cell surface (see [Chapter 2, sections CD41 and CD61](#)). In family members who may be heterozygotes, FC has the advantage of determining the subpopulation of platelets with lack of GPIIb/IIIa.

## Erythropoiesis and Red Blood Cell Disorders

Reticulocytes can be differentiated from mature red blood cells on the basis of their RNA content. Usually, counts of reticulocytes are done using thiazole orange dye. Analysis of data requires discrimination from mature red blood cells and platelets ( [117](#)). The intensity of green fluorescence provides accurate estimates if the “discriminator” value is set appropriately to exclude fluorescence of mature erythrocytes. The threshold level, or discriminator, is set from normal blood with known reticulocyte values. The fluorescence increases on binding to RNA, with thiazole orange by a factor of 3000, with other dyes, such as thioflavin T, by a factor of 100. The excitation and emission maxima for thiazole orange in complex with RNA are 500 nm and 533 nm, respectively. Gating is usually set on size (FS), and fluorescence intensity is recorded on a logarithmic scale. Measurements of the immature reticulocyte fraction (IRF) provide an accurate assessment of erythropoietic activity. IRFs are reticulocytes recently released and have a higher RNA content. IRF measurements allow for detection of significant changes in red blood cell production after bone marrow transplantation or chemotherapy. Several methods, including FC, are used to obtain IRFs ( [118](#)).

Feto-maternal hemorrhage can be detected by FC with the use of anti-hemoglobin F antibodies (F cells) ( [119](#)). Enumeration of F cells is important in sickle cell anemia and thalassemia, in which patients receive treatment intended to stimulate increase of F cells,

which is usually associated with clinical improvement. Monitoring levels of F cells is important for optimal treatment schedules because some of the drugs used have toxic side effects. F cell levels may be of prognostic value in myelodysplasia, and, therefore, their levels need to be monitored ( [120](#) ).

In paroxysmal nocturnal hemoglobinuria, the glycosylphosphatidylinositol-anchored proteins CD55 (decay-accelerating factor) and CD59 (membrane inhibitor of reactive lysis) are decreased. The decay-accelerating factor is an inhibitor of the classical C3 convertase and inhibits its function by splitting C4b and C2a. CD59, on the other hand, is a regulator of the membrane attack complex. It prevents insertion of the C9 component during the formation of the membrane attack complex and blocks polymerization of C9 (see [Chapter 18](#) ).

FC has distinct advantages over other methods in the study of red blood cells: sensitivity, ability to quantitate fractions of red cells with defects, and accurate monitoring during the management of the patient ( [118](#) ). It can also identify the lack of markers on leukocytes at the same time. FC allows the analysis of markers on red blood cells and leukocytes with the use of triple-staining techniques ( [121](#) ). Decreased expression of CD55 does not always correlate with *in vivo* hemolysis, whereas loss of CD59 is associated with a high degree of hemolysis ( [122](#) ).

### **Intracellular Cytokines**

FC has recently been used in monitoring cytokine production. These methods have distinct advantages but also several disadvantages ( [123](#) ). Functional subsets of T cells can be identified by this method, which allows the identification of cells producing more than one cytokine.

A disadvantage of this method is the permeabilization of the cells, which increases nonspecific fluorescence. Blocking the Fc receptors with polyclonal Ig tends to minimize the problem. A specificity control also requires blocking the intracellular cytokine by an unlabeled anticytokine antibody. Positive controls are available commercially. Cells need to be activated for increased production of cytokines. Usually, a polyclonal activator is used, such as phorbol myristate acetate and ionomycin, but this raises the question of immunologic specificity. Cell-surface markers like CD4 are down-regulated during activation, which makes cell identification difficult. Because the amount of cytokines produced is small, it is customary to block their secretion with the use of brefeldin A so that the cytokine is retained within the Golgi apparatus.

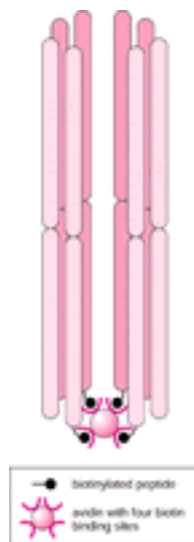
One of the main applications of this methodology is the identification of Th1 versus Th2 cell populations ( [124](#), [125](#) ). Despite the limitations of this approach, the reported results seem to be consistent with pathogenic mechanisms of human disease. These studies have identified T-cell subsets producing predominantly transforming growth factor- $\beta$  ( [126](#) ) as well as the immunoregulatory T cells, which secrete mainly interleukin-10 ( [127](#) ).

### **Major Histocompatibility Complex–Peptide Tetramers**

The innovation of HLA class I tetramers has revolutionized our understanding of cytotoxic T cells. Soluble HLA molecules are made in *Escherichia coli* by recombinant technology. A 15-amino acid peptide containing a single lysine residue is attached to the COOH terminus of an HLA-A<sub>2</sub> molecule. The lysine-containing peptide is biotinylated by the BirA enzyme. Folding of the HLA heavy chain is achieved in the presence of  $\beta_2$



microglobulin and the ligand peptide of HLA-A<sub>2</sub>. Biotinylation of the tag peptide at the COOH terminus correctly orients the HLA molecule for recognition by the TCR, which binds to the NH<sub>2</sub> terminus of the HLA. Tetramers are produced by mixing the HLA tagged with the biotinylated peptide with phycoerythrin-labeled deglycosylated avidin. Because avidin has four biotin-binding sites, it produces tetramers of HLA molecules that bind to the T cells with appropriate TCR ( Fig. 3.14). The tetramers have far greater avidity for T cells than the sum of the individual affinities of the four HLA molecules ( 128 , 129 and 130 ). Variations of this method have been developed with covalently bound peptides ( 131 ) or using silent mutated sequences, which bacteria prefer in order to initiate synthesis of the HLA molecule ( 132 ). Tetramers for HLA class II are now available ( 133 , 134 ). Tetramer studies have been done mainly on major histocompatibility complex class I-mediated responses in viral infections ( 135 ) and malignancies ( 136 , 137 ). These studies have shown that the CD8<sup>+</sup> T-cell antigen-specific responses involve 40 to 80% of the circulating CD8<sup>+</sup> T cells, which persist for many years. Class I HLA tetramers are also used in bacterial infections and autoimmune diseases ( 138 ).



**Figure 3.14.** For formation of HLA class I or class II tetramers, the HLA molecules are tagged with a lysine-carrying peptide in their C-terminus. The molecules are biotinylated (i.e., biotin is attached on the lysine of the tag peptide). Addition of phycoerythrin-labeled avidin, which has four biotin-binding sites, associates four HLA molecules to form a tetramer.

Low frequency cytotoxic T cells have been detected by this method in some individuals who lyse chronic myelogenous leukemia cells ( 139 ). The HLA tetramer assay has been applied to detect cytotoxic T lymphocytes specific for Epstein-Barr virus ( 140 ) or cytomegalovirus ( 141 ) in recipients and donors of stem cell transplants. The technique can also be used *in situ* ( 142 ) to detect with exquisite specificity cytotoxic T cells in Epstein-Barr virus-exposed individuals ( 143 ). A new application of the tetramer technology is the simultaneous detection of antigen-specific T cells and identification of cytokine secretion. Tetramers with proper agonist peptides have the capacity to stimulate T-cell activation programs secreting interferon- $\gamma$ , tumor necrosis factor- $\alpha$ , or both ( 144 ).

In an important new application, tetramers conjugated with a tumor-specific antibody

targeted tumor cells (CEA<sup>+</sup> cell lines, CD20<sup>+</sup> B-cell lymphoma cells) to be attacked and lysed by antigen-specific cytotoxic T lymphocytes (145). These studies open the field for use of tetramers for specific immunotherapy. Tetramer assays can be combined with detection of intracellular cytokine, opening the way for the study of antigen-specific immune responses (146, 147).

Tetramers made from CD1d have been tested for the detection of CD1-restricted T cells. CD1 is an HLA-like molecule that presents lipids or glycolipids to T cells. CD1d tetramers identified natural killer T cells unambiguously (148). Natural killer T cells have been implicated in the defense against certain infectious diseases as well as in the regulation of insulin-dependent diabetes mellitus.

## Phagocytosis

All aspects of phagocytosis can be studied by FC (i.e., opsonization of the particle to be phagocytosed, engulfment, and oxidative burst) (149). The particles used are bacteria, zymosan, fungi, or latex labeled with FITC. For opsonization, the particles are incubated in serum that is normal or from a patient who has recovered from a specific infection. Oxidative burst is studied with substances that are converted from nonfluorescent to fluorescent products under the influence of the intracellular reactive oxygen radicals. This conversion reflects the amount of oxidative burst induced. Among the most common substances are 2',7'-dihydrochlorofluorescein diacetate, dichlorofluorescein, and dihydrorhodamine-123/rhodamine-123.

Dihydrorhodamine-123/rhodamine-123 is a more sensitive indicator system. Lymphocytes and nonlymphocytes are discriminated by FS and SS. The number of phagocytosing nonlymphoid cells is calculated as a percentage of gated cells. The parameter *phagocytosis product* is defined as the percentage of phagocytosing nonlymphocytes multiplied by the mean number of targets per phagocytosing nonlymphocyte.

## Cell Cycle Analysis

Cell cycle analysis is the simplest method to reveal the frequency of cells in each cell cycle phase. Cells are permeabilized and stained with the nucleic and specific fluorochrome, propidium iodide or 4'6'-diamidino-2-phenylindole. The results are displayed as DNA content-frequency histograms, which show the proportions of cells in the respective phases of the cell cycle. Univariate analysis of DNA content is most frequently used in clinical studies of tumors or proliferative disorders. The proportion of cells in the S- and G<sub>2</sub>/M-phases is considered indicative of the increased proliferative potential, which in tumors is accepted as a poor prognostic feature. This simple analysis does not provide information about cell kinetics (i.e., the duration of cell cycle or doubling time). Cells in G<sub>2</sub>- and M-phases have the same DNA content and cannot be discriminated by univariate analysis. For this purpose, mitotic markers can be used (150). DNA replication is measured by a bivariate analysis of DNA content versus incorporation of 5-bromo-2'-deoxyuridine (BrdU) (151). Live cells are exposed to this thymidine analog, which is incorporated into DNA as the cell divides. BrdU is detected by a monoclonal antibody tagged by fluorescein. The DNA content is measured by propidium iodide. In the histogram, green versus red fluorescence provides information not only on the DNA content, but also on the number of cells in division.

## Detection of Apoptosis

During apoptosis, there are changes in the cell size (smaller) and nuclear fragmentation.

Shrinkage of the cell, which occurs early in apoptosis, can be detected by FS ( [152](#) ). Late in apoptosis, the SS also decreases. However, light scatter is not specific for apoptosis, and it should be combined with other methods.

Detection of phosphatidylserine in the outer leaflet of the cell membrane can be determined with annexin-V conjugated with fluorescein, which binds with high affinity to phosphatidylserine ( [153](#) ).

Other methods of evaluation of the apoptotic process by FC include measurements of mitochondrial transmembrane potential,  $\Delta\psi_m$ . This is measured by rhodamine-123, a lipophilic green fluorochrome that permeates normal membranes and accumulates in the mitochondria. High intensity of green fluorescence indicates normal mitochondrial transmembrane potential. The combination with propidium iodide discriminates apoptotic from live cells. The permeable membrane of apoptotic cells allows penetration of propidium iodide (red-staining), whereas rhodamine-123 penetrates only normal membranes (green-staining) ( [154](#) ).

Another method is based on the detection of DNA fragmentation. The 3'-OH ends of the DNA breaks are detected by a fluorochrome-tagged deoxynucleotide. The BrdUTP is the most advantageous, and when it is attached to the DNA breaks, it is detected by a specific antibody ( [155](#) ). The attachment of BrdUTP is mediated by the enzyme deoxynucleotide transferase (TdT). The method is known as TUNEL ( TdT-mediated deoxy uridine triphosphate-biotin nick- end labeling).

### HLA Cross-Match by Flow Cytometry

For a successful cross-match, the detection of antidonor antibodies in the recipient and antirecipient antibodies in the donor is critical. FC is one of the most sensitive techniques for the detection of IgG antibodies ( [156](#), [157](#) ). Another advantage of FC versus the cytotoxic method, in addition to sensitivity, is the multiparameter analysis. T and B cross-matches for antibody activity against class I or class II can effectively be distinguished. T and B cells are identified by appropriate monoclonal antibodies. A human IgG anti-HLA antibody, bound to the cells, is detected by anti-human IgG antibody conjugated with fluorescein ( [Fig. 3.15](#) ). A significant shift of fluorescence over the control is a positive result, indicating that anti-HLA human IgG is bound to the cells. If both T and B cells are positive, transplantation is contraindicated ( [158](#) ).

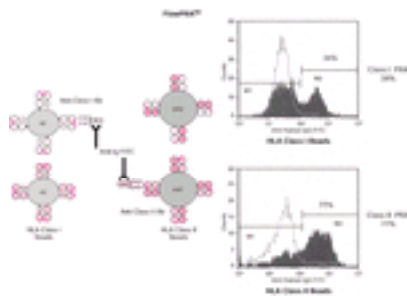


**Figure 3.15.** Flow cross-match. Testing for antidonor HLA antibodies is based on incubation of the recipient's serum with donor cells expressing HLA class I or class II antigens. The binding of the antibody is detected by fluorescein-conjugated anti-human immunoglobulin (Ig) by flow cytometry. FITC, fluorescein isothiocyanate; MHC, major histocompatibility complex; PE, phycoerythrin; PerCP, peridinin-chlorophyll-a protein. (Courtesy of Dr. Peter Nickerson, Director, Immunogenetics Laboratory, Winnipeg Centre,

Manitoba, Canada.)

In earlier years, a panel of cells of known HLA type were tested against the patient's serum. This was known as *panel-reactive antibody*, or *PRA*. The percentage of positive reactions (i.e., the number of cells in the panel that reacted with the serum) was called *percentage PRA*. By this method, the specificity of the antibody is known as well as the possibility of obtaining a negative cross-match. PRA values predict the possibility of a positive cross-match between the recipient and prospective donors (i.e., a PRA value of 50% indicates that a positive cross-match will occur with 50% of organ donors). Thus, PRA value and specificity would exclude certain potential donors and expedite organ allocation.

Flow cytometric PRA using cells was introduced in an attempt to replace the serologic method, but several problems were encountered. Recently, microparticles coated with purified HLA class I or class II proteins have been introduced instead of cells ([159](#), [160](#)). In the test, 20 to 50  $\mu$ l of the patient's serum is added to a mixture of HLA class I and class II beads. After 30 minutes of incubation, they are washed, and a goat anti-human IgG fluorescein-conjugated reagent is added. The mixture is washed again after a short incubation, and the beads are passed through the cytometer. The beads of class I and class II antigens can run simultaneously ([Fig. 3.16](#)).



**Figure 3.16.** Flow panel-reactive antibody (PRA). Beads coated with purified HLA class I or class II molecules are incubated with the patient's serum. After washing, fluorescein-conjugated anti-human immunoglobulin (Ig) is added (**A**). The beads are examined by flow cytometry for identification of the presence of anti-HLA antibodies (**B**). Multiple single-antigen-coated beads of different color are now mixed in the same tube for the simultaneous detection of anti-HLA antibodies of different specificities. FITC, fluorescein isothiocyanate. (Courtesy of Dr. Peter Nickerson, Director, Immunogenetics Laboratory, Winnipeg Centre, Manitoba, Canada.)

The flow cytometric PRA can detect more antibody than the cytotoxic method and, in addition, can detect class I and especially class II antibodies simultaneously, which is difficult with the customary methods. Once the presence of anti-HLA antibody is established, the identification of the specificity can be accomplished with flow-specific beads (i.e., expressing a particular HLA antigen) ([158](#)). These improvements in detection of anti-HLA antibodies have also shown that detection of antidonor antibody during the posttransplant period has a poor prognosis ([161](#)) and identifies patients in need of new approaches to treatment ([162](#)).

The last step in the evolution of this technology is the use of single-antigen bead panel. These single antigen beads are coated with different color and are mixed in one tube for the simultaneous detection of HLA antibodies against eight different antigens per test ([163](#)).

163). In a group of ten patients who had rejected a kidney transplant, this method identified antibodies to 31 of 35 antigens that were mismatched in the donor.

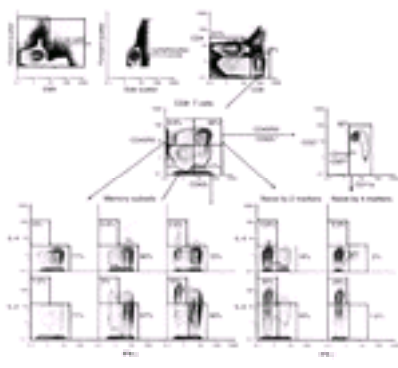
Three methods, antiglobulin-enhanced complement-dependent cytotoxicity (AHG-CDC), enzyme-linked immunosorbent assay, and FC were compared in 264 sera from 88 patients (164). Discordant results were found in 32 sera. None of the 32 sera was positive by AHG-CDC, 20 of 32 were positive by enzyme-linked immunosorbent assay, and 32 of 32 were positive by FC. In another group of 302 patients who exhibited 0% PRA by AHG-CDC, 25% had class I or class II antibodies detectable by FC. These striking differences between the two methods will certainly redefine the concept of sensitization in organ transplantation.

## APPENDIX: IMMUNOPHENOTYPING HEMATOLOGIC MALIGNANCIES IN THE FUTURE: DEFINING THE IMMUNOPHENOTYPIC SIGNATURE

Clinical flow cytometry has been in existence for just over 25 years, but its applications are still growing (13). At this point, it has gone from the cell surface deep inside the cell to intracellular molecules and signaling pathways and is poised to explore the genome. The prospects for combinations of immunophenotyping with molecular phenotyping have been reviewed (165).

In the clinical setting of studying hematologic disorders, flow cytometry has not yet reached its potential, mainly because of the limitations of the number of fluorochromes used with the one-laser or two-laser cytometers. Some laboratories have now reached the concomitant use of 11 (14) or 12 (13) markers combined with the two parameters of light scattering. Less information is obtained when reagents are used alone or combined in small sets (i.e., “two two-color stains are not equivalent to one four-color stain”) (14).

The possibility of identifying larger numbers of cell-surface markers combined with the identification of intracellular molecules is exemplified in Figure 3.17. It shows the analysis of naïve and memory CD8<sup>+</sup> T cells activated by phorbol myristate acetate, ionomycin, and monensin. Dead cells were separated by ethidium monoazide bromide, and the viable cells were examined for 10-color 12-parameter (two scatters) cytometric analysis (14).



**Figure 3.17.** Immunophenotypic analysis of CD8<sup>+</sup> human T cells by 10-color 12-parameter fluorescent-activated cell sorter analysis. Human peripheral blood mononuclear cells were incubated with phorbol acetate, myristate, ionomycin, and monensin and then stained for detection of several markers and intracellular cytokines. The analysis demonstrates the separation of naïve versus memory CD8<sup>+</sup> T cells by phenotype and their differences in production of interleukin (IL)-2, IL-4, and interferon

(IFN)-?. Naïve CD8<sup>+</sup> T cells do not produce IFN-?. However, separation by two markers shows IFN-?-producing cells in the naïve T cells as a result of contamination by memory cells. EMA, ethidium monoazide bromide. (Courtesy of Dr. Leonard A. Herzenberg, Professor, Department of Genetics, Stanford University School of Medicine, CA. From Herzenberg LA, DeRosa SC, Herzenberg LA. Monoclonal antibodies and the FACS: complementary tools for immunobiology and medicine. Immunol Today 2000;21:383-390, with permission.)

Analysis to this extent is not yet available in most of the clinical laboratories. However, with the development of new instruments and new fluorochromes, flow cytometry is poised to define precisely the immunophenotypic signature for the disease or for the patient. This will be a kind of proteomics by flow cytometry to complement the new technology of functional genomics by the microarrays. The examples presented here are an attempt to outline, albeit crudely, some of the principles that may significantly add to a complete immunophenotype. In the future, immunophenotype will include not only protein identification, but also quantitative and functional aspects of their expression. [Figure 3.17](#) is a glimpse into the future. In the examples shown here, we have used two- to four-color analysis with two scatter parameters. We define (a) the lineage of the malignant cell (not always possible with the available data); (b) “asynchronous” intralineaage expressions (i.e., detected in a stage of differentiation in which it does not belong) or “aberrant” interlineage expressions; (c) intensity of fluorescence, which provides a gross but still useful parameter of expression of a particular marker; and (d) degree of homogeneity in the expression of the marker as measured by the CV. This distinguishes the homogeneous expression of a marker by the clonal malignant cell from the usually heterogeneous expression by the normal cells as a result of their normal differentiation. As some examples show, however, there is frequently a differentiation potential within the malignant clone, and the heterogeneity of the marker could be used as a unique characteristic of the patient rather than of the lineage or the stage of differentiation.

## CASE 1: Acute Myelogenous Leukemia

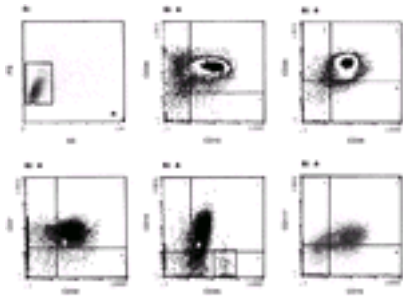


Figure. No caption available.

---

|                            |   |
|----------------------------|---|
| Size                       | Small to medium.  |
| Granularity                | Nongranular with only the larger cells weakly granular.   |
| Immunophenotypic signature | Stem cell: CD34 <sup>+</sup> , CD117 <sup>+</sup> , CD7 <sup>+</sup> ; myeloid: CD33 <sup>+</sup> , CD15 <sup>+</sup> , CD11b <sup>+</sup> .  |
| Comments                   | Immature myeloid precursor with expression of CD7.<br>Asynchronous expression of markers (i.e., coexpression of CD117 <sup>+</sup> /CD15 <sup>+</sup> ) constitutes an important component of the signature for this patient.<br>FS, forward angle scatter; SS, side scatter. |

---



## CASE 2: Acute Myelogenous Leukemia with Maturation

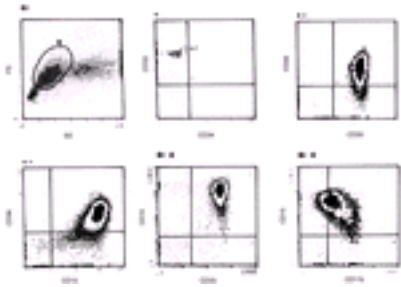


Figure. No caption available.

|                            |  |
|----------------------------|--|
| Size                       | Medium.  |
| Granularity                | Medium (monocytic area).   |
| Immunophenotypic signature | Stem cell: CD34 <sup>-</sup> , CD117 <sup>-</sup> ; myeloid: CD33 <sup>+</sup> /CD15 <sup>+</sup> , CD11b <sup>+</sup> ; others: CD56 <sup>+</sup> .   |
| Comments                   | AML with maturation. Aberrant expression of CD56.<br>Heterogeneous expression of CD15 (CV 102.6) as compared to CD33 (CV 46.7). Probably indicates some degree of differentiation and forms an important component of identification of this clone.<br>Note: CD33 <sup>+</sup> cells in histogram 2 accumulated along the vertical axis.<br>FS, forward angle scatter; SS, side scatter. |

### CASE 3: B-cell Acute Lymphocytic Leukemia

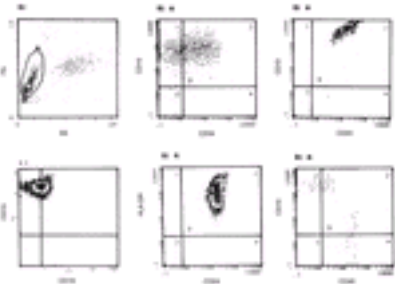


Figure. No caption available.

|                            |  |
|----------------------------|--|
| Size                       | Small to medium.   |
| Granularity                | None in small cells; rare in larger cells.   |
| Immunophenotypic signature | Stem cell: CD34 $\pm$ , CD38 $^+$ ; B-lymphoid: CD10 $^{3+}$ , CD24 $^{2+}$ , CD19 $^-$ , CD20 $^-$ ; other: HLA-DR $^{2+}$ , CD45 $^-$ .  |
| Comments                   | Very strong CD10 expression (small CV). Most of the cells are CD34 $^-$ and CD19 $^-$ , and all of them are CD20 $^-$ and CD45 $^-$ . Heterogeneous HLA-DR expression (large CV). Double: CD10/CD24, CD10/CD20, and CD10/CD38 (not shown) will be very useful for minimal residual disease.<br><br>Note: CD10 $^+$ cells in histogram 6 clustered along vertical axis.<br>FS, forward angle scatter; SS, side scatter. |

## CASE 4: B-cell Acute Lymphocytic Leukemia

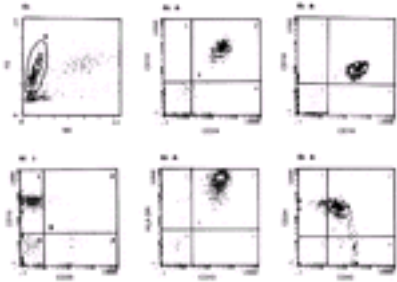


Figure. No caption available.

---

|                            |  |
|----------------------------|--|
| Size                       | Heterogeneous.   |
| Granularity                | None.  |
| Immunophenotypic signature | Stem cell: CD34 <sup>-</sup> ; B-lymphoid: CD10 <sup>2+</sup> , CD24 <sup>2+</sup> , CD19 <sup>+</sup> , CD22 <sup>+</sup> , CD20 <sup>-</sup> ; other: HLA-DR <sup>3+</sup> , CD45 <sup>+</sup> .             |
| Comments                   | Some evidence of maturation (i.e., CD34 <sup>-</sup> , intermediate CD10 and CD24 expression with expression of CD45). Comparison with Case 3 makes the point.<br>FS, forward angle scatter; SS, side scatter. |

---

## CASE 5: B-cell Acute Lymphocytic Leukemia

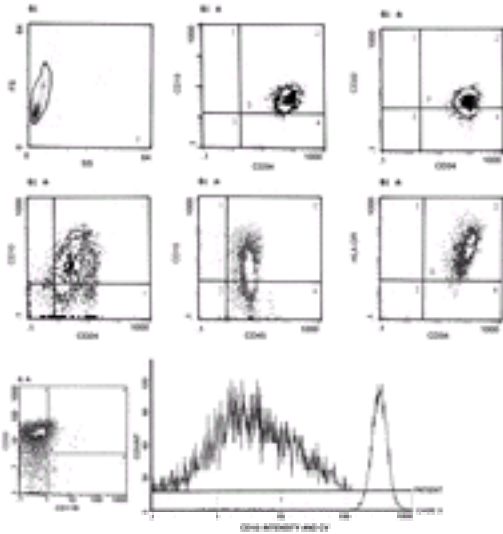


Figure. No caption available.

|                            |  |
|----------------------------|--|
| Size                       | Small.   |
| Granularity                | None.  |
| Immunophenotypic signature | Stem cell: CD34 <sup>2+</sup> , HLA-DR <sup>2+</sup> , CD71 <sup>-</sup> ; B-lymphoid: CD10 <sup>2+</sup> , CD19 <sup>+</sup> , CD24 <sup>+</sup> , CD22 <sup>+</sup> , CD20 <sup>-</sup> , cCD79a <sup>-</sup> ; myeloid: CD33 <sup>+</sup> , CD13 <sup>±</sup> , CD11b <sup>-</sup> .  |
| Comments                   | The striking heterogeneity (very large CV) of CD10 expression is the most characteristic point in this patient. For comparison, see single-parameter histograms with the usual acute lymphocytic leukemia. CD24 expression is also heterogeneous and, relative to the usual cases, weak. The striking type of CD10/CD24 expression combined with CD33 is the main characteristic of this case.<br>FS, forward angle scatter; SS, side scatter. |

## CASE 6: B-cell Acute Lymphocytic Leukemia

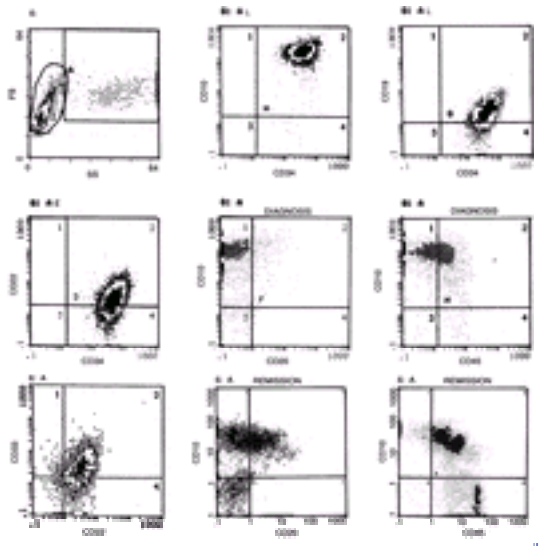


Figure. No caption available.

|                            |   |
|----------------------------|---|
| Size                       | Small to large.   |
| Granularity                | Light on the larger cells.  |
| Immunophenotypic signature | Stem cell: CD34 <sup>2+</sup> , CD117 <sup>-</sup> ; B-lymphoid: CD10 <sup>3+</sup> , CD24 <sup>2+</sup> , CD19 <sup>+</sup> , CD22 <sup>+</sup> , CD20 <sup>-</sup> ; myeloid: CD33 <sup>+</sup> .   |
| Comments                   | Characteristic feature is the strikingly strong expression of CD10 and CD34, placing the cell in the upper right corner of the histogram where no normal cells are usually located. Therefore, the CD10/CD34 combination will be very useful for minimal residual disease, as will the almost total lack of CD45. Expression of CD33 is another characteristic of this immunophenotype. The combinations CD10/20 and CD10/45 are shown for both diagnosis and remission. Although CD10 intensity is lower in remission as compared to diagnosis, the most critical criterion is the pattern of differentiation in remission, which does not exist in the leukemic population.<br>FS, forward angle scatter; SS, side scatter. |

## CASE 7: Acute Monocytic Leukemia

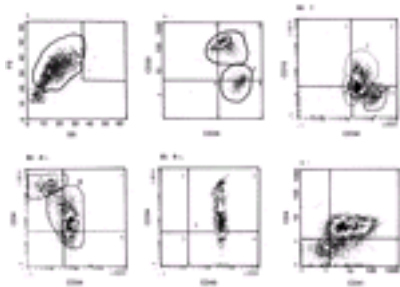


Figure. No caption available.

|                            |   |
|----------------------------|---|
| Size                       | Heterogeneous.  |
| Granularity                | Heterogeneous; large cells, heavily granular.   |
| Immunophenotypic signature | Stem cell: CD34 <sup>+</sup> , CD117 <sup>±</sup> , CD38 <sup>2+</sup> ; myeloid: CD33 <sup>2+</sup> , CD15 <sup>+</sup> , CD13 <sup>±</sup> , CD11b <sup>+</sup> (not shown); monocytic: CD14 <sup>+</sup> , CD4 <sup>+</sup> , HLA-DR <sup>2+</sup> ; others: CD45 <sup>+</sup> , CD2 <sup>+</sup> (not shown).   |
| Comments                   | Acute leukemia with monocytic phenotype. Characteristics in this case are the two cell populations: (a) CD34 <sup>2+</sup> , CD4 <sup>-</sup> , CD15 <sup>-</sup> and (b) CD34 <sup>+</sup> , CD4 <sup>+</sup> , CD15 <sup>+</sup> , CD45 <sup>2+</sup> . Heterogeneity of CD34 expression (CV 166.7). CD4 and CD41 expression show pattern of differentiation.<br>FS, forward angle scatter; SS, side scatter. |

## CASE 8: Bone Marrow Regeneration versus Acute Lymphocytic Leukemia

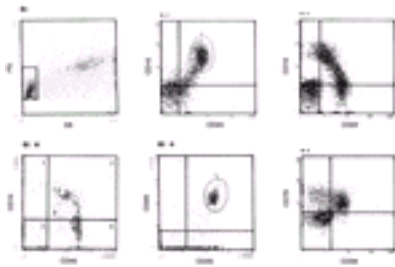


Figure. No caption available.

|                            |  |
|----------------------------|--|
| Size                       | Small.   |
| Granularity                | None.  |
| Immunophenotypic signature | Stem cell: CD34 <sup>+</sup> ; B-lymphoid: CD10 <sup>2+</sup> ?CD10 <sup>+</sup> , CD22 <sup>+</sup> , CD21 <sup>+</sup> , CD20 <sup>+</sup> , cCD79 <sup>+</sup> .  |
| Comments                   | This 3-month-old child was suspected to have leukemia by morphology. However, the strong regeneration pattern by immunophenotype could not support the diagnosis. In addition, expression of CD45 and CD20 is strong, which is not usually seen in B-cell acute lymphocytic leukemia. This case shows that strong pattern of differentiation by several markers is very helpful in distinguishing normal bone marrow regeneration from a proliferative disease, especially when morphology indicates a relatively large number of immature cells. The child is now 4 years old and has no signs of leukemia.<br>FS, forward angle scatter; SS, side scatter. |

## REFERENCES

1. Caspersson TO, Schultz J. Nucleic acid metabolism of the chromosomes in relation to gene reproduction. *Nature* 1938;142:294.
2. Coons AH, Kaplan MH. Localization of antigen in tissue cells. II. Improvements in a method for the detection of antigen by means of fluorescent antibody. *J Exp Med* 1950;91:1.
3. Coulter WH. High speed automatic blood cell counter and cell size analyzer. *Proc Natl Electronics Conf* 1956;12:1034.
4. Kamensky LA, Melamed MR, Derman H. Spectrophotometer: new instrument for ultrarapid cell analysis. *Science* 1965;150:630-631.
5. Hulet HR, Bonner WA, Barret J, Herzenberg LA. Cell sorting: automated separation of mammalian cells as a function of intracellular fluorescence. *Science* 1969;166:747-749.
6. Bonner WA, Hulet HR, Sweet RG, Herzenberg LA. Fluorescence activated cell sorting. *Rev Sci Instrum* 1972;43:404-409.



7. Herzenberg LA, Sweet RG, Herzenberg LA. Fluorescence-activated cell sorting. *Sci Am* 1976;234:108-117.
8. Julius MH, Masuda T, Herzenberg LA. Demonstration that antigen-binding cells are precursors of antibody-producing cells after purification with a fluorescence-activated cell sorter. *Proc Natl Acad Sci U S A* 1972;69:1934-1938.
9. Jones PP, Cebra JJ, Herzenberg LA. Restriction of gene expression in B lymphocytes and their progeny. I. Commitment to immunoglobulin allotype. *J Exp Med* 1974;139:581-599.
10. Jones PP, Craig SW, Cebra JJ, Herzenberg LA. Restriction of gene expression in B lymphocytes and their progeny. II. Commitment to immunoglobulin heavy chain isotype. *J Exp Med* 1974;140:452-469.
11. Kreth HW, Herzenberg LA. Fluorescence-activated cell sorting of human T and B lymphocytes. I. Direct evidence that lymphocytes with a high density of membrane-bound immunoglobulin are precursors of plasmacytes. *Cell Immunol* 1974;12:396-406.
12. Bobrove AM, Strober S, Herzenberg LA, DePamphilis JD. Identification and quantitation of thymus derived lymphocytes in human peripheral blood. *J Immunol* 1974;112:520-527.
13. Herzenberg L, Parks D, Sahaf B, Perez O, et al. The history and future of the fluorescence activated cell sorter and flow cytometry: a view from Stanford. *Clin Chem* 2002;48:10,1819-10,1827.
14. Herzenberg LA, DeRosa SC, Herzenberg LA. Monoclonal antibodies and the FACS: complementary tools for immunobiology and medicine. *Immunol Today* 2000;21:383-390.
15. Baumgarth N, Roederer M. A practical approach to multicolor flow cytometry for immunophenotyping. *J Immunol Methods* 2000;243:77-97.
16. Steen HB. Characteristics of flow cytometers. In: Melamed MR, ed. *Flow cytometry and sorting*, 2nd ed. New York: Wiley-Liss, 1990:11-25.
17. Boek G. Current status of flow cytometry in cell and molecular biology. *Int Rev Cytol* 2001;204:239-298.
18. Kohler G, Milstein C. Continuous cultures of fused cells secreting antibody of predefined specificity. *Nature* 1975;256:495-497.
19. Milstein C. With the benefit of hindsight. *Immunol Today* 2000;21:359-364.
20. Mason DY. The 7th workshop and conference on human leukocyte differentiation antigens (hla7). *Tissue Antigens* 2000;55:5-112.
21. Mason DY, Andre P, Bensussan A, et al. CD antigens 2001. *Intern Immunol* 2001;13:1095-1098.
22. Mason DY, Andre P, Bensussan A, et al. CD antigens 2001. *J Leukoc Biol* 2001;70:685-690.
23. Wood JCS. Clinical flow cytometry instrumentation. In: Bauer KD, ed. *Clinical flow cytometry. Principles and application*. Baltimore: Williams & Wilkins, 1993:71-92.
24. McCoy JP Jr. Basic principles of flow cytometry. *Hematol Oncol Clin North Am* 2002;16:229-243.
25. Loken MR, Herzenberg LA. Analysis of cell populations with a fluorescence activated cell sorter. *Ann N Y Acad Sci* 1975;254:163-171.
26. Loken MR. Immunofluorescence techniques. In: Melamed MR, ed. *Flow cytometry and sorting*, 2nd ed. New York: Wiley-Liss, 1990:341-353.
27. Redelman D. Flow cytometric analyses of cell phenotypes. In: Stewart CC, Nicholson JKA, eds. *Immunophenotyping*. New York: Wiley-Liss, 2000:49-81.
28. Valet GK, Hoffkes HG. Automated classification of patients with chronic lymphocytic leukemia and

- immunocytoma from flow cytometric three color immunophenotypes. *Cytometry* 1997;30:275–288.
29. Bauer KD, Duque RE, Shankey TV, eds. *Clinical flow cytometry. Principles and application*. Baltimore: Williams & Wilkins, 1993.
  30. Stewart CC, Nicholson JKA, eds. *Immunophenotyping*. New York: Wiley–Liss, 2000.
  31. Laerum OD, Bjerknes R, eds. *Flow cytometry in hematology*. London: Academic Press, 1992.
  32. Loken MR, Shah VO, Dattilio KL, Civin CI. Flow cytometric analysis of human bone marrow. I. Normal erythroid development. *Blood* 1987;69:255–263.
  33. Loken MR, Shah VO, Dattilio KL, Civin CI. Flow cytometric analysis of human bone marrow. II. Normal B lymphocyte development. *Blood* 1987;70:1316–1324.
  34. Terstappen LW, Safford M, Loken MR. Flow cytometric analysis of human bone marrow. III. Neutrophil maturation. *Leukemia* 1990;4:657–663.
  35. Terstappen LW, Huang S, Safford M, et al. Sequential generations of hematopoietic colonies derived from single nonlineage-committed CD34<sup>+</sup>CD38<sup>-</sup> progenitor cells. *Blood* 1991;77:1218–1227.
  36. Huang S, Terstappen LW. Lymphoid and myeloid differentiation of single human CD34<sup>+</sup>, HLA-DR<sup>+</sup>, CD38<sup>-</sup> hematopoietic stem cells. *Blood* 1994;83: 1515–1526.
  37. Cornelius AS, Campbell D, Schwartz E, Poncz M. Elevated common acute lymphoblastic leukemia antigen expression in pediatric immune thrombocytopenic purpura. *Am J Pediatr Hematol Oncol* 1991;13:57–61.
  38. Coustan-Smith E, Behm FG, Hurwitz CA, et al. N-CAM (CD56) expression by CD34<sup>+</sup> malignant myeloblasts has implications for minimal residual disease detection in acute myeloid leukemia. *Leukemia* 1993;7:853–858.
  39. Lanza F, Bi S, Castoldi G, Goldman JM. Abnormal expression of N-CAM (CD56) adhesion molecule on myeloid and progenitor cells from chronic myeloid leukemia. *Leukemia* 1993;7:1510–1575.
  40. Weir EG, Borowitz MJ. Flow cytometry in the diagnosis of acute leukemia. *Semin Hematol* 2001;38:124–138.
  41. Uckun FM. Regulation of human B cell ontogeny. *Blood* 1990;76:1908–1923.
  42. Zauli G, Furlini G, Vitale M, et al. A subset of human CD34<sup>+</sup> hematopoietic progenitors express low levels of CD4, the high-affinity receptor for human immunodeficiency virus type 1. *Blood* 1994;84:1896–1905.
  43. Chabannon C, Wood P, Torok-Storb B. Expression of CD7 on normal human myeloid progenitors. *J Immunol* 1992;149:2110–2113.
  44. Caldwell CW, Patterson WP. Relationship between CD45 antigen expression and putative stages of differentiation in B-cell malignancies. *Am J Hematol* 1991;36:111–115.
  45. Behm FG, Raimondi SC, Schell MJ, et al. Lack of CD45 antigen on blast cells in childhood acute lymphoblastic leukemia is associated with chromosomal hyperdiploidy and other favorable prognostic features. *Blood* 1992;79:1011–1016.
  46. Borowitz MJ, Guenther KL, Shults KE, Stelzer GT. Immunophenotyping of acute leukemia by flow cytometric analysis. Use of CD45 and right-angle light scatter to gate on leukemic blasts in three-color analysis. *Am J Clin Pathol* 1993;100:534–540.
  47. Rainer RO, Hodges L, Seltzer GT. CD45 gating correlates with bone marrow differential. *Cytometry* 1995;22:139–145.
  48. Look AT, Melvin SL, Brown LK, et al. Quantitative variation of the common acute lymphoblastic

leukemia antigen (gp100) on leukemic marrow blasts. *J Clin Invest* 1984;73:1617–1628.

49. Lavabre-Bertrand T, Janossy G, Ivory K, et al. Leukemia-associated changes identified by quantitative flow cytometry. I. CD10 expression. *Cytometry* 1994;18:209–217.
50. Lavabre-Bertrand T, Duperray C, Brunet C, et al. Quantification of CD24 and CD45 antigens in parallel allows a precise determination of B-cell maturation stages: relevance for the study of B-cell neoplasias. *Leukemia* 1994;8:402–408.
51. Riley RS, Massey D, Jackson-Cooke C, Idowu M, et al. Immunophenotypic analysis of acute lymphocytic leukemia. *Hematol Oncol Clin North Am* 2002;16:245–299.
52. Hurwitz CA, Loken MR, Graham ML, et al. Asynchronous antigen expression of B lineage acute lymphoblastic leukemia. *Blood* 1988;72:299–307.
53. Buccheri V, Mihaljevic B, Matutes E, et al. mb-1: a new marker for B-lineage lymphoblastic leukemia. *Blood* 1993;82:853–857.
54. Tsuganezawa K, Kiyokawa N, Matsuo Y, et al. Flow cytometric diagnosis of cell lineage and developmental stage of acute lymphoblastic leukemia by novel monoclonal antibodies specific for human pre-B-cell receptor. *Blood* 1998;92:4317–4324.
55. Uckun FM, Cajl-Peczalska KJ, Ledbetter JA, Koller B. Biphenotypic leukemic lymphocyte precursors in acute lymphoblastic leukemia and their putative normal counterparts in human fetal hematopoietic tissues. *Blood* 1989;73:1003–1015.
56. Todd WMC. Acute myeloid leukemia and related conditions. *Hematol Oncol Clin North Am* 2002;16:301–309.
57. Koeffler HP. Syndromes of acute non-lymphocytic leukemia. *Ann Intern Med* 1987;107:748–758.
58. Kita K, Nakase K, Miwa H, et al. Phenotypic characteristics of acute myelocytic leukemia associated with the t(8;21)(q22;q22) chromosomal abnormality: frequent expression of immature B cell antigen CD19 together with stem cell antigen CD34. *Blood* 1992;80:470–477.
59. Hurwitz CA, Raimondi SC, Head D, et al. Distinctive immunophenotypic features of t(8;21)(q22;q22) acute myeloblastic leukemia in children. *Blood* 1992;80:3182–3188.
60. Kurtzberg J, Waldman TA, Davey MP, et al. CD7<sup>+</sup>, CD4<sup>-</sup>, CD8<sup>-</sup> acute leukemia: a syndrome of malignant pluripotent lymphohematopoietic cells. *Blood* 1989;73:381–390.
61. Jensen AW, Hokland M, Jörgensen H, et al. Solitary expression of CD7 among T-cell antigens in acute myeloid leukemia: identification of a group of patients with similar T-cell receptor  $\beta$  and  $d$  rearrangements and course of disease suggestive of poor prognosis. *Blood* 1991;78:1292–1300.
62. Bassan R, Biondi A, Benvestito S, et al. Acute undifferentiated leukemia with CD7<sup>+</sup> and CD13<sup>+</sup> immunophenotype. *Cancer* 1992;69:396–404.
63. Barcena A, Muench MO, Roncaroloz MG, Spits H. Tracing the expression of CD7 and other antigens during T- and myeloid-cell differentiation in the human fetal liver and thymus. *Leuk Lymphoma* 1995;17:1–11.
64. Barcena A, Muench MO, Galy AHM, et al. Phenotypic and functional analysis of T cell precursors in the human fetal liver and thymus: CD7 expression in the early stages of T- and myeloid-cell development. *Blood* 1993;82:3401–3414.
65. Tien H-F, Chou C-C, Wang C-H, et al. Putative normal counterparts of leukaemic cells from CD7-positive acute myeloid leukaemia can be demonstrated in human haematopoietic tissues. *Br J Haematol* 1996;94:501–506.
66. Grümayer ER, Griesinger F, Hummell DS, et al. Identification of novel B-lineage cells in human fetal bone marrow that co-express CD7. *Blood* 1991;77:64–68.

67. Panzer-Grümayer ER, Panzer S, Wolf M, et al. Characterization of CD7<sup>+</sup>CD19<sup>+</sup> lymphoid cells after Epstein-Barr virus transformation. *J Immunol* 1993;151:92-99.
68. Homans AC, Verissimo AM, Vlachá V. Transient abnormal myelopoiesis of infancy associated with trisomy 21. *Am J Pediatr Hematol Oncol* 1993;5:392-399.
69. Kwong YL, Cheng G, Tang TS, et al. Transient myeloproliferative disorder in a Down's neonate with rearranged T-cell receptor  $\beta$  gene and evidence of in vivo maturation demonstrated by dual-color flow cytometric DNA ploidy analysis. *Leukemia* 1993;7:1667-1671.
70. Yamura-Yagi K, Hara J, Tawa A, Kawa-Ha K. Phenotypic characteristics of acute megakaryocytic leukemia and transient abnormal myelopoiesis. *Leuk Lymphoma* 1994;13:393-400.
71. Litz CE, Davies S, Brunning RD, et al. Acute leukemia and the transient myeloproliferative disorder associated with Down syndrome: morphologic, immunophenotypic, and cytogenetic manifestations. *Leukemia* 1995;9:1432-1439.
72. Ben-Ezra J. B cell lymphoproliferative disorders. *Hematol Oncol Clin North Am* 2002;16:321-337.
73. Carey JL. Immunophenotyping of chronic lymphoid leukemias and related non-Hodgkin's leukemia. In: Stewart CC, Nicholson JKA, eds. *Immunophenotyping*. New York: Wiley-Liss, 2000:181-210.
74. Galton DAG, Maclennan ICM. Clinical patterns in B lymphoid malignancy. *Clin Haematol* 1982;11:561.
75. Scott CS, Limbert HJ, Roberts BE, Stark AN. Prolymphocytoid variants of chronic lymphocytic leukaemia: an immunological and morphological survey. *Leuk Res* 1987;11:135-140.
76. Thompson AA, Talley JA, Do HN, et al. Aberrations of the B-cell receptor B29 (CD79b) gene in chronic lymphocytic leukemia. *Blood* 1997;90:1387-1394.
77. Wormsley SB, Baerd SM, Gadol N, et al. Characteristics of CD11c<sup>+</sup>CD5<sup>+</sup> B-cell leukemia and the identification of novel peripheral blood B-cell subsets with chronic lymphoid leukemia immunophenotypes. *Blood* 1990;76:123-130.
78. Hanson CA, Gribbin TE, Schnitzer B, et al. CD11c (Leu-M5) expression characterizes a B-cell chronic lymphoproliferative disorder with features of both chronic lymphocytic leukemia and hairy cell leukemia. *Blood* 1990;76:2360-2367.
79. Damle RN, Wasil T, Fais F, et al. Ig V gene mutation status and CD38 expression as novel prognostic indicators in chronic lymphocytic leukemia. *Blood* 1999;94:1840-1847.
80. Hamblin TJ, Davis Z, Gardiner A, et al. Unmutated Ig V<sub>H</sub> genes are associated with a more aggressive form of chronic lymphocytic leukemia. *Blood* 1999;94:1848-1854.
81. Del Poeta G, Maurillo L, Vendetti A, et al. Clinical significance of CD38 expression in chronic lymphocytic leukemia. *Blood* 2001;98:2633-2639.
82. Ibrahim S, Keating M, Do K-A, et al. CD38 expression is an important prognostic factor in B-cell chronic lymphocytic leukemia. *Blood* 2001;98:181-186.
83. D'Arena G, Musto P, Cascarilla N, et al. CD38 expression correlates with adverse biological features and predicts poor clinical outcome in B-cell chronic lymphocytic leukemia. *Leuk Lymphoma* 2001;42:109-114.
84. Durig J, Naschar M, Schmücker U, et al. CD38 expression is an important prognostic marker in chronic lymphocytic leukemia. *Leukemia* 2002;16:30-35.
85. Hamblin TJ, Orchard JA, Ibotson RE, et al. CD38 expression and immunoglobulin variable region mutations are independent prognostic variables in chronic lymphocytic leukemia, but CD38 expression may vary during the course of the disease. *Blood* 2002;99:1023-1029.

86. Kröber A, Seiler T, Benner A, et al. V<sub>H</sub> mutation status, CD38 expression level, genomic aberrations, and survival in chronic lymphocytic leukemia. *Blood* 2002;100:1410–1416.
87. Lin K, Sherrington PD, Dennis M, et al. Relationship between p53 dysfunction, CD38 expression, and Ig V<sub>H</sub> mutation in chronic lymphocytic leukemia. *Blood* 2002;100:1404–1409.
88. Oscier DG, Gardiner AC, Mould SJ, et al. Multivariate analysis of prognostic factors in CLL: clinical stage, IG V<sub>H</sub> gene mutational status, and loss or mutation of the p53 gene are independent prognostic factors. *Blood* 2002;100:1177–1184.
89. Klein U, Rajewsky K, Küppers R. Human immunoglobulin (Ig) M<sup>+</sup>IgD<sup>+</sup> peripheral blood B cells expressing the CD27 cell surface antigen carry somatically mutated variable region genes: CD27 as a general marker for somatically mutated (memory) B cells. *J Exp Med* 1998;188:1679–1689.
90. Ranheim EA, Cantwell MJ, Kipps TJ. Expression of CD27 and its ligand, CD70, on chronic lymphocytic leukemia B cells. *Blood* 1995;85:3556–3565.
91. Cherepakhin V, Baird SM, Meisenholder GW, Kipps TJ. Common clonal origin of chronic lymphocytic leukemia and high grade lymphoma of Richter's syndrome. *Blood* 1993;82:3141–3147.
92. Robbins BA, Ellison DJ, Spinosa JC, et al. Diagnostic application of the two-color flow cytometry in 161 cases of hairy cell leukemia. *Blood* 1993;82:1277–1287.
93. Argatoff LH, Connors JM, Klasa RJ, et al. Mantle cell lymphoma: a clinicopathologic study of 80 cases. *Blood* 1997;89:2067–2078.
94. Berger F, Felman P, Thieblemont C, et al. Non-MALT marginal zone B-cell lymphomas: a description of clinical presentation and outcome in 124 patients. *Blood* 2000;95:1950–1956.
95. Tierens A, Delabie J, Michiels L, et al. Marginal-zone B cells in the human lymph node and spleen show somatic hypermutations and display clonal expansion. *Blood* 1999;93:226–234.
96. Stein K, Hummel M, Korbjuhn P, et al. Monocytoid B cells are distinct from splenic marginal zone cells and commonly derive from unmutated naïve B cells and less frequently from postgerminal center B cells by polyclonal transformation. *Blood* 1999;94:2800–2808.
97. Yang E, Korsmeyer SJ. Molecular thanatopsis: a discourse on the BCL2 family and cell death. *Blood* 1996;88:386–401.
98. Tiesinga JJ, Wu C-D, Inghirami G. CD5<sup>+</sup> follicle center lymphoma. Immunophenotyping detects a unique subset of “floral” follicular lymphoma. *Am J Clin Pathol* 2000;114:912–921.
99. Jamal S, Picker LJ, Aquirio DB, et al. Immunophenotypic analysis of peripheral T cell neoplasms. A multiparameter flow cytometric approach. *Am J Clin Pathol* 2001;116:512–526.
100. Cooke CB, Krenacs L, Stetler-Stevenson M, et al. Hepatosplenic T-cell lymphoma: a distinct clinicopathologic entity of cytotoxic T-cell origin. *Blood* 1996;88:4265–4274.
101. Naughton MJ, Hess JL, Zutter MM, Bartlett NL. Bone marrow staging in patients with non-Hodgkin's lymphoma. Is flow cytometry a useful test? *Cancer* 1998;82:1154–1159.
102. Hanson CA, Kurita PJ, Katzmann JA, et al. Immunophenotypic analysis of peripheral blood and bone marrow in the staging of B-cell malignant lymphoma. *Blood* 1999;94:3889–3896.
103. Duggan PR, Easton D, Luider J, Auer IA. Bone marrow staging of patients with non-Hodgkin lymphoma by flow cytometry. *Cancer* 2000;88:894–899.
104. Kawano-Yamamoto C, Muroi K, Izumi T, et al. Two-color flow cytometry with a CD19 gate for the evaluation of bone marrow involvement of B-cell lymphoma. *Leuk Lymphoma* 2002;43:2133–2137.
105. Campana D, Coustan-Smith E, Janossy G. The immunologic detection of minimal residual disease in

acute leukemia. *Blood* 1990;76:163–171.

106. Orfao A, Ciudad J, Almeida J, San Miguel JF. Residual disease detection of leukemia. In: Stewart CC, Nicholson JKA, eds. *Immunophenotyping*. New York: Wiley-Liss, 2000:239–259.

107. Sievers EL, Loken MR. Detection of minimal residual in acute myelogenous leukemia. *J Pediatr Hematol Oncol* 1995;17:123–133.

108. Ciudad J, San Miguel JF, Lopez-Berges MC, et al. Prognostic value of immunophenotypic detection of minimal residual disease (MRD) in acute lymphoblastic leukemia. *J Clin Oncol* 1998;16:3774–3781.

109. Dworzak MN, Stolz F, Fröschl G, et al. Detection of residual disease in pediatric B-cell precursor acute lymphoblastic leukemia by comparative phenotype mapping: a study of five cases controlled by genetic methods. *Exp Hematol* 1999;27:673–681.

110. Michelson AD. Flow cytometry: a clinical test of platelet function. *Blood* 1996;87:4925–4936.

111. Faraday N, Goldschmidt-Clermont P, Dise K, Bray PF. Quantitation of soluble fibrinogen binding to platelets by fluorescence-activated flow cytometry. *J Lab Clin Med* 1994;123:728–740.

112. Michelson AD. Thrombin-induced down-regulation of the platelet membrane of glycoprotein Ib-IX complex. *Semin Thromb Hemost* 1992;18:18–27.

113. Hickerson DHM, Bode AP. Flow cytometry of platelets for clinical analysis. *Hematol Oncol Clin North Am* 2002;16:421–454.

114. Ault KA. Flow cytometric measurements of platelet function and reticulated platelets. *Ann N Y Acad Sci* 1993;677:293–308.

115. Israels ED, Nisli G, Paraskevas F, Israels LG. Platelet Fc receptors as a mechanism for Ag-Ab complex-induced platelet injury. *Thromb Diath Haemorrh* 1973;29:434–444.

116. Ault KA. The clinical utility of flow cytometry in the study of platelets. *Semin Hematol* 2001;38:160–168.

117. Riley RS, Ben-Ezra JM, Tidwell A, Romagnoli G. Reticulocyte analysis by flow cytometry and other techniques. *Hematol Oncol Clin North Am* 2002;16:373–420.

118. Lacombe F, Lacoste L, Vial J, et al. Automated reticulocyte counting and immature reticulocyte fraction measurement. Comparison of ABX PENTRA 120 Retic Sysmex R-2000 flow cytometry and manual counts. *Am J Clin Pathol* 1999;112:677–686.

119. Davis BH. Diagnostic advances in defining erythropoietic abnormalities and red blood cell diseases. *Semin Hematol* 2001;38:148–159.

120. Craig JE, Sampietro M, Oscier DG, et al. Myelodysplastic syndrome with karyotype abnormality is associated with elevated F-cell production. *Br J Haematol* 1996;93:601–605.

121. Hernandez-Campo PM, Marten-Ayusa M, Almeida J, et al. Comparative analysis of different flow cytometry-based immunophenotypic methods for the analysis of CD59 and CD55 expression on major peripheral blood cell subsets. *Cytometry* 2002;50:191–201.

122. Iwamoto N, Kawaguchi T, Nagakura S, et al. Markedly high population of affected reticulocytes negative for decay-accelerating factor and CD59 in paroxysmal nocturnal hemoglobinuria. *Blood* 1995;85:2228–2232.

123. Pala P, Hussell T, Openshaw PJM. Flow cytometric measurement of intracellular cytokines. *J Immunol Methods* 2000;243:107–124.

124. Muraille E, Leo O. Revisiting the Th1/Th2 paradigm. *Scand J Immunol* 1998;47:1–9.

125. Maino VC, Picker LJ. Identification of functional subsets by flow cytometry: intracellular detection of

cytokine expression. *Cytometry* 1998;34:207–215.

126. Fukaura H, Kent SC, Pietruszewicz MJ, et al. Induction of circulating myelin basic protein and proteolipid protein-specific transforming growth-factor- $\beta$ -1 secreting Th3 T cells by oral administration of myelin in multiple sclerosis patients. *J Clin Invest* 1996;98:70–76.

127. Groux H, O'Garra A, Bigler M, et al. A CD4<sup>+</sup> T-cell subset inhibits antigen-specific T-cell responses and prevents colitis. *Nature* 1997;389:737–742.

128. Altman JD, Moss PAH, Goulder PJR, et al. Phenotypic analysis of antigen-specific T lymphocytes. *Science* 1996;274:94–96.

129. McMichael AJ, O'Callaghan CA. A new look at T cells. *J Exp Med* 1998;187:1367–1371.

130. Kalergis AM, Goyarts EC, Palmieri E, et al. A simplified procedure for the preparation of MHC/peptide tetramers: chemical biotinylation of an unpaired cysteine engineered at the C-terminus of MHC-1. *J Immunol Methods* 2000;234:61–70.

131. Crawford F, Kozono H, White J, et al. Detection of antigen-specific T cells with multivalent soluble class II MHC covalent peptide complexes. *Immunity* 1998;8:675–682.

132. Sato Y, Sahara H, Tsukahara T, et al. Improved generation of HLA class I/peptide tetramers. *J Immunol Methods* 2002;271:177–184.

133. Novak EJ, Liu AW, Nepom GT, Kwok WK. MHC class II tetramers identify peptide-specific human CD4<sup>+</sup> T cells proliferating in response to influenza A antigen. *J Clin Invest* 1999;104:R63–R67.

134. McMichael AJ, Kelleher A. The arrival HLA class II tetramers. *J Clin Invest* 2000;104:1669–1670.

135. Appay V, Nixon DF, Donahoe SM, et al. HIV-specific CD8<sup>+</sup> T cells produce antiviral cytokines but are impaired in cytolytic function. *J Exp Med* 2000;192:63–75.

136. Lee PP, Yee C, Savage PA, et al. Characterization of circulating T cells specific for tumor-associated antigens in melanoma patients. *Nat Med* 1999;5:677–685.

137. Maeurer MJ, Necker A, Salter RD, et al. Improved detection of melanoma antigen-specific T cells expressing low or high levels of CD8 by HLA-A2 tetramers presenting a Melan-A/Mart-1 peptide analogue. *Int J Cancer* 2002;97:64–71.

138. Ogg GS, Dunbar PR, Romero P, et al. High frequency of skin-homing melanocyte-specific cytotoxic T lymphocytes in autoimmune vitiligo. *J Exp Med* 1998;188:1203–1208.

139. Molldrem JJ, Lee PP, Wong C, et al. A PR-1 human leukocyte antigen-A2 tetramer can be used to isolate low frequency cytotoxic T lymphocytes from healthy donors that selectively lyse chronic myelogenous leukemia. *Cancer Res* 1999;59:2675–2681.

140. Falco DA, Nepomuceno RR, Krams SM, et al. Identification of Epstein-Barr virus-specific CD8<sup>+</sup> T lymphocytes in the circulation of pediatric transplant recipients. *Transplantation* 2002;74:501–510.

141. Lacey SF, Callez-Hawkins G, Crooks M, et al. Characterization of cytotoxic function of CMV-pp65-specific CD8<sup>+</sup> T lymphocytes identified by HLA tetramers in recipients and donors of stem-cell transplants. *Transplantation* 2002;74:722–732.

142. Skinner PJ, Caniels MA, Schmidt CS, Jameson SC, et al. Cutting edge: in situ tetramer staining of antigen-specific T cells in tissues. *J Immunol* 2000;165:613–617.

143. Burrows SR, Kienzle N, Winterhalter A, et al. Peptide-MHC class I tetrameric complexes display exquisite ligand specificity. *J Immunol* 2000;165:6229–6234.

144. Wei C-H, Uhlin M, Masucci MG, Levitsky V. Tetramer binding and secretion of interferon- $\gamma$  in response to antigenic stimulation are compatible with a range of affinities of MHC:TCR interaction and



distinct programs of cytotoxic T-lymphocyte activation. *Hum Immunol* 2002;63:821-833.

145. Robert B, Guillaume P, Luescher I, et al. Antibody-conjugated MHC class I tetramers can target tumor cells for specific lysis by T lymphocytes. *Eur J Immunol* 2000;30:3165-3170.

146. Bleesing JJH, Fleisher TA. Cell function-based flow cytometry. *Semin Hematol* 2001;38:169-178.

147. Collins DP, Leubering BJ, Shaut DM. T-lymphocyte functionality assessed by analysis of cytokine receptor expression, intracellular cytokine expression, and femtomolar detection of cytokine secretion by quantitative flow cytometry. *Cytometry* 1998;33:249-255.

148. Banlagha K, Weiss A, Beavis A, et al. In vivo identification of glycolipid antigen-specific T cells using fluorescent CD1d tetramers. *J Exp Med* 2000;191:1895-1903.

149. Lehman AK, Söhnes S, Halstensen A. Phagocytosis: measurement by flow cytometry. *J Immunol Methods* 2000;243:229-242.

150. Juan G, Traganos F, Darzynkiewicz Z. Identification of mitotic cells by flow cytometry. *Methods Cell Biol* 2001;63:343-354.

151. Gratzner HG. Monoclonal antibody to 5-bromo- and 5-iododeoxyuridine: a new reagent for detection of DNA replication. *Science* 1982;218:474-475.

152. Ormerod JG, Cheetham FPM, Sun X-M. Discrimination of apoptotic thymocytes by forward light scatter. *Cytometry* 1995;21:300-304.

153. Van Engeland M, Nieland LJW, Ramaeckers FCS, et al. Annexin V affinity assay: a review on an apoptosis detection system based on phosphatidylserine exposure. *Cytometry* 1998;31:1-9.

154. Darzynkiewicz Z, Bedner E, Smolewski P. Flow cytometry in analysis of cell cycle and apoptosis. *Semin Hematol* 2001;38:179-193.

155. Li X, Darzynkiewicz Z. Labeling DNA strand breaks with BrdUTP: detection of apoptosis and cell proliferation. *Cell Prolif* 1995;28:571-579.

156. Bryan CF, Baier KA, Nelson PW, et al. Long term graft survival is improved in cadaveric renal retransplantation by flow cytometric crossmatching. *Transplantation* 1998;66:1827-1832.

157. Bray RA, Gebel HM. Transplantation immunophenotyping. In: Stewart CC, Nicholson JKA, eds. *Immunophenotyping*. New York: Wiley-Liss, 2000:321-332.

158. Bray RA. Flow cytometry in human leukocyte antigen testing. *Semin Hematol* 2001;38:194-200.

159. Bray RA, Cook DJ, Gebel HM. Flow cytometric detection of HLA allo-antibodies using class I coated microparticles. *Hum Immunol* 1997;55[Suppl 1]:36.

160. Pei R, Wang G, Tarsitani C, et al. Simultaneous HLA class I and class II antibodies screening with flow cytometry. *Hum Immunol* 1998;59:313-322.

161. Christiaans MHL, Overhof-de Roos R, Nieman F, et al. Donor-specific antibodies after transplantation by flow cytometry. *Transplantation* 1998;65:427-433.

162. Kiball P, Rhodes C, King A, et al. Flow cross matching identifies patients at risk for post-operative elaboration of cytotoxic antibodies. *Transplantation* 1998;65:444-446.

163. Pei R, Lee J-H, Shih N-J, et al. Single human leukocyte antigen flow cytometry beads for accurate identification of human leukocyte antigen antibody specificities. *Transplantation* 2003;75:43-49.

164. Gebel HM, Bray RA. Sensitization and sensitivity. Defining the unsensitized patient. *Transplantation* 2000;69:1370-1374.

165. Goolsby CL, Thompson E, Mosiman V. Combined immunophenotyping and molecular phenotyping. In:

Steward CC, Nicholson JKA, eds. Immunophenotyping. New York: Wiley-Liss, 2000:407-427.

166. Jaffe ES, Harris NL, Stein H, Vardiman JW, eds. WHO classification of tumors: pathology and genetics of tumors of haematopoietic and lymphoid tissues. Lyon, France: IARC Press, 2001.

2004 Lippincott Williams & Wilkins  
John P. Greer, John Foerster, John N. Lukens  
George M. Rodgers, Frixos Paraskevas, Bertil Glader  
Wintrobe's Clinical Hematology

BACKGROUNDHISTORYCYTOGENETIC METHODSSamplesSample Processing and Cell CultureHypotonic TreatmentFixationSlide PreparationStainingMicroscopyKaryotypingAutomated KaryotypingCYTOGENETIC NOMENCLATURENUMERICAL CHROMOSOMAL ABNORMALITIESSTRUCTURAL CHROMOSOMAL ABNORMALITIESDeletionIsochromosomeIsodicentric ChromosomeInversionRing ChromosomeTranslocationDicentric ChromosomeAdditionInsertionDuplicationDouble MinutesMarker ChromosomesCONSTITUTIONAL VERSUS ACQUIRED CHROMOSOME CHANGESCYTOGENETIC DEFINITION OF CLONALITYPRIMARY VERSUS SECONDARY ACQUIRED CHROMOSOME CHANGESMOLECULAR CYTOGENETIC ANALYSIS OF CASES WITH NORMAL KARYOTYPESCLINICAL APPLICATIONS OF CYTOGENETICSDiagnosisClassificationEtiologyPrognosisAssignment of TreatmentSpecific TherapiesResidual DiseaseEngraftmentCONCLUSIONREFERENCES

*Cytogenetics* is the study of chromosome structure. Cytogenetic analysis has become increasingly important in the diagnosis, classification, management, and scientific investigation of hematopoietic and lymphoid disorders. Classic cytogenetic analysis studies cells in metaphase, or dividing cells. However, with the advent of molecular cytogenetic techniques such as fluorescence *in situ* hybridization (FISH), cytogenetic analysis now includes the study of interphase, or nondividing, cells.

Cytogenetic techniques established over the last five decades have become a routine part of the analysis of abnormal hematopoiesis and lymphopoiesis and, hence, play a prominent role in the clinical practice of hematology and oncology. The use of cytogenetics in the diagnosis and management of each disease depends on selection of the appropriate tissue and cell type for analysis, availability of cells for karyotyping, and proper interpretation of cytogenetic findings.

From a scientific point of view, the identification of recurring chromosomal abnormalities has guided the search for genes involved in malignant transformation and has helped to elucidate alterations in the structure and expression of these genes. Identification of genes involved and elucidation of their structural changes have, in turn, led to an understanding of mechanisms of malignant transformation that is beginning to foster the development of targeted therapies.

This chapter focuses on cytogenetic methodology and terminology, general principles of cytogenetics, and the application of cytogenetic analysis in hematology and hematologic oncology. Cytogenetic findings in specific diseases are discussed in greater detail in the chapters devoted to these diseases.

## BACKGROUND

Because cytogenetic analysis is the study of chromosome structure, it requires that chromosomes be visualized microscopically as discrete structures. Every human cell contains deoxyribonucleic acid (DNA) packaged into chromosomes, normally consisting of 22 pairs of autosomes and 1 pair of sex chromosomes. Chromosome morphology varies markedly during the cell cycle, which is the process of cell replication.

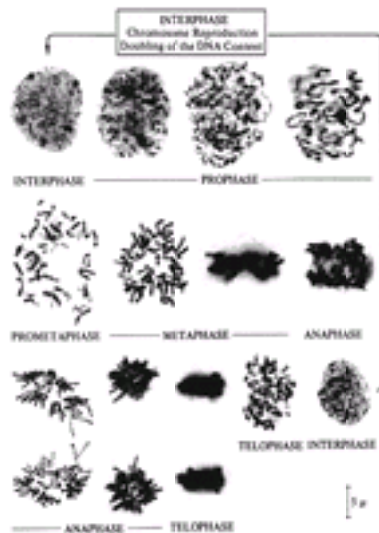
The cell cycle consists of interphase, the period between cell divisions, and mitosis, or cell division. Cells that are in a resting state and not cycling are said to be in  $G_0$ .

*Interphase* is the portion of the cell cycle in which the nucleus is most metabolically active and undergoes chromosome duplication in preparation for mitosis. Interphase includes three distinct stages:  $G_1$  phase (gap one), S phase (synthesis of DNA), and  $G_2$  phase (gap two).

*Mitosis* (M phase), or cell division, is divided into five phases: prophase, prometaphase, metaphase, anaphase, and telophase. During prophase, the chromatin, which has already doubled, undergoes progressive coiling and thickening. In prometaphase, the nuclear membrane breaks down, releasing the chromosomes into the cytoplasm, and the chromosomes move to the center of the cell, or the equatorial plane. During metaphase, the chromosomes line up in the center, or metaphase plate. This is when the chromosomes are the most contracted and the least metabolically active. Anaphase occurs when the centromere divides, leading to the separation of the chromatids (sister chromosomes). Once separated, the chromatids move to the opposite ends of the cells. In telophase, the final stage of mitosis, the chromosomes uncoil, the nuclear membrane reappears around each set of chromosomes, and the nucleus takes on the morphology seen in interphase. During, or directly after, telophase, new cell membranes are formed (cytokinesis) and divide the cytoplasm, creating two identical daughter cells.

The appearance of cells during the different phases of the cell cycle is shown in [Figure 4.1](#). Interphase chromosomes are uncoiled and cannot be resolved as discrete structures. Chromosomes first become visible as discrete structures during prophase. Prometaphase chromosomes are almost maximally condensed and are visualized as two identical

chromatids. Maximal chromosome condensation occurs during metaphase. The chromosomes then become less condensed during anaphase and telophase; individual chromosomes can no longer be visualized. Cytogenetic analysis must be performed on cells in prometaphase or metaphase.



**Figure 4.1.** Mitotic cycle in cultured human lymphocytes. (From Therman E, Susman M. Human chromosomes, 3rd ed. New York: Springer-Verlag, with permission.)

Successful cytogenetic analysis depends on a number of factors. Cells must be available in adequate numbers. Analysis must be performed on viable cells that are undergoing division. Sufficient numbers of cells must be present in the phases of the cell cycle in which chromosome morphology is appropriate for analysis. Chromosomes must be separated from one another within the cell so that each chromosome can be resolved as a distinct entity. Finally, each chromosome must be able to be identified and characterized as normal or abnormal. For cytogenetic analysis of malignancies, it is critical that the analysis be performed on malignant cells rather than on coexisting normal cells.

The ability to study chromosomes depended on the development of methods for growing normal and malignant cells in tissue culture, arresting cells at the appropriate phases of the cell cycle, and separating chromosomes from each other within cells.

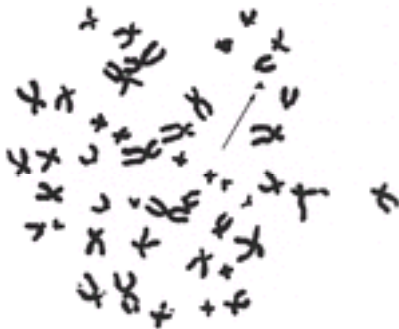
## HISTORY

The presence of 46 chromosomes in normal human cells was demonstrated for the first time in 1956, first by Tjio and Levan and subsequently by Ford and Hamerton (<sup>1</sup>, <sup>2</sup>). Normal male cells were found to contain 2 copies of each of 22 autosomes and 1 copy of each of the sex chromosomes, X and Y. Normal female cells contained 2 copies of each of the 22 autosomes and of the X chromosome, and contained no Y chromosome.

Associations between abnormal numbers of chromosomes and congenital anomalies were initially reported in 1959. Three copies of one of the smallest human chromosomes, rather than the normal two, were found in cells of children with Down syndrome (<sup>3</sup>). The presence of two copies of the X chromosome, along with one copy of the Y chromosome, was reported in cells of males with Klinefelter syndrome (<sup>4</sup>), and a single copy of the X

chromosome, without a Y chromosome, was found in cells of females with Turner syndrome ( [5](#) ). The era of clinical cytogenetics had thus begun.

In 1960, before banding techniques became available (see below), Nowell and Hungerford reported the first chromosomal anomaly associated with cancer ( [6](#) ). The presence of an unusually small chromosome was detected as a consistent abnormality in unbanded bone marrow metaphases from patients with chronic myelogenous leukemia (CML) ( [Fig. 4.2](#) ). This small chromosome was called the *Philadelphia chromosome*, after the city in which it was discovered. The Philadelphia chromosome was initially abbreviated Ph<sup>1</sup>; the designation Ph<sup>1</sup> was subsequently changed to Ph ( [7](#) ).



**Figure 4.2.** An unbanded metaphase spread from bone marrow cells of a patient with chronic myelogenous leukemia, with the Philadelphia chromosome ( *arrow* ). (From Sandberg AA. The chromosomes in human cancer and leukemia, 2nd ed. New York: Elsevier, 1956, with permission.)

In the late 1960s, the staining of metaphase spreads with quinacrine mustard was found to produce unique patterns of fluorescence on each chromosome ( [8](#) ). This was the first chromosome banding technique, and the first banded human karyotype was published in 1970 ( [9](#) ). However quinacrine banding (Q-banding) required fluorescence microscopy and could be cumbersome, as the fluorescence tended to “quench” rapidly. Other banding techniques were subsequently developed that produced similar bands using pretreatment with alkali and saline followed by staining with Giemsa, a compound that had been developed to stain blood smears for the identification of the protozoan that causes malaria ( [10](#) ). Light microscopy could be used to visualize Giemsa banding (G-banding), which soon became the most commonly used banding technique. The nomenclature for chromosome bands was established in 1971 ( [7](#) ).

Banding allows chromosomes to be visualized as a continuous series of light and dark regions. *Bands* are defined as regions of chromosomes that are distinguished from adjacent regions by virtue of appearing darker or lighter with one or more banding techniques. Unique banding patterns thus allow chromosomes to be distinguished from one another. Identification of individual chromosomes had not previously been possible.

The use of chromosome banding allowed more accurate and precise identification and description of cytogenetic abnormalities. In 1973, Rowley reported that the recurring cytogenetic abnormality described earlier in CML was a reciprocal translocation between chromosomes 9 and 22, t(9;22)(q34;q11) ( [11](#) ). Ph was an abnormally small chromosome 22 resulting from translocation with chromosome 9. The use of chromosome banding also resulted in a rapid increase in the numbers of recurring cytogenetic abnormalities

reported. The t(8;21) in acute myeloid leukemia (AML) was reported in 1973 ( [12](#) ), and the t(15;17) in acute promyelocytic leukemia (APL) was described in 1977 ( [13](#) ).

The late 1970s saw the development of high-resolution banding procedures ( [14](#) ). High-resolution banding is achieved by analyzing the more elongated prophase and prometaphase chromosomes. Banding of these longer chromosomes allows visualization of 500 to 2000 bands on chromosomes, whereas metaphase banding yields only approximately 300 bands. The availability of sufficiently large numbers of prophase and prometaphase cells for analysis is achieved by cell cycle synchronization. Cells are cultured with methotrexate (MTX), which arrests DNA synthesis. MTX acts by inhibiting dihydrofolate reductase, the enzyme that catalyzes conversion of folic acid to tetrahydrofolic acid, which is a coenzyme for one-carbon unit transfers, including methylation of deoxyuridylic acid to thymidylic acid. Inhibition of DNA synthesis arrests the cell cycle in interphase. The cell cycle block is subsequently released by transferring the cells to an MTX-free, thymidine-rich medium. Cells enter mitosis simultaneously and are arrested in prophase and prometaphase by brief colchicine treatment. High-resolution banding allowed the identification of more subtle chromosome rearrangements, resulting in the identification of abnormal karyotypes in larger numbers of cases ( [15](#) ) and the recognition of subtle structural chromosomal abnormalities such as inv ( [16](#) )(p13q22) in AML ( [16](#) ).

The last 20 years have seen a very rapid expansion of the number of recurring cytogenetic abnormalities reported in malignant cells, as documented in the serial editions of Mitelman's *Catalog of Chromosome Aberrations in Cancer* ( [17](#) ). Cytogenetic databases are now available on-line. The two most commonly used are the *Mitelman Database of Chromosome Aberrations in Cancer* (Mitelman F, Johansson B, Mertens F, eds., 2002) at <http://cgap.nci.nih.gov/Chromosomes/Mitelman> and the *Atlas of Genetics and Cytogenetics in Oncology and Haematology* at <http://www.infobiogen.fr/services/chroncancer/>. The majority of cytogenetic abnormalities have been described in hematologic malignancies. Data on cytogenetic abnormalities in lymphomas and solid tumors are limited in comparison, reflecting the difficulty of obtaining analyzable dividing cells from lymph nodes and tumor tissue compared to bone marrow samples.

In the 1980s, molecular technology was combined with cytogenetic methodology to create molecular cytogenetic techniques, or *in situ* hybridization. The most widely used is FISH, in which specific DNA or RNA sequences indirectly or directly labeled with fluorochromes are made to bind to the complementary target sequences within metaphase or interphase cells and are subsequently visualized by fluorescence microscopy ( [18](#) , [19](#) ). Four major types of DNA sequences are used as probes in clinical FISH studies. Locus-specific probes are used to detect the presence and location of a particular gene. Centromeric probes are highly repetitive sequences that detect alpha satellite DNA primarily located in the centromeres. Subtelomeric probes contain unique sequences from the telomere region of chromosomes. Whole chromosome paints are mixtures of numerous unique and repetitive sequences homologous to many sites on a single chromosome ( [20](#) ). Chromosome painting is performed by hybridizing cells with pooled DNA probes for sorted human chromosomes ( [20](#) ). These chromosome-specific probes label entire chromosomes and are particularly useful in identifying the origin of chromosomal material that is not identifiable in banded metaphases. FISH can be performed simultaneously with different probes labeled with different fluorochromes, permitting the detection of several target sequences. Applications of FISH are demonstrated in the sections [Numerical Chromosomal Abnormalities](#) and [Structural Chromosomal Abnormalities](#).

Competitive genomic hybridization, described in the early 1990s, is a molecular



cytogenetic technique that allows efficient screening of cells for losses and gains of chromosomal material ( [21](#), [22](#) ). Genomic DNA from the cells to be studied (test DNA) is labeled with a fluorochrome, and DNA from normal cells (control DNA) is labeled with a different colored fluorochrome. Labeled test DNA and genomic DNA are simultaneously hybridized to metaphase chromosome spreads from normal cells. The fluorescent signals generated by the test DNA and the control DNA along the normal chromosomes are compared as a means of detecting and identifying chromosomal material that has been lost or gained in the test DNA. Computerized image analysis is used to measure and compare signal intensities.

Finally, recently developed specialized imaging procedures have allowed for the simultaneous visualization of all the chromosomes in a cell. These techniques, called *multiplex fluorescence in situ hybridization* ( [23](#) ) and *spectral karyotyping* ( [24](#) ), use combinatorial labeling and digital imaging microscopy to create a unique color for each chromosome within a cell, so that all chromosomes, each with unique labeling, can be detected simultaneously. These techniques have become extremely useful in identifying the chromosomal origins of marker chromosomes and genetic material that are otherwise unidentified.

## CYTOGENETIC METHODS

Conventional cytogenetic techniques are described in a number of books ( [25](#), [26](#), [27](#) and [28](#) ). The techniques are briefly summarized here.

### Samples

For successful cytogenetic analysis of malignancies, it is critical that malignant cells, rather than contaminating normal cells, be studied. Bone marrow is the tissue of choice for cytogenetic analysis of leukemias, myelodysplastic syndromes (MDSs), and myeloproliferative disorders. In cases of leukemia in which marrow cannot be aspirated, blood may be used if it contains more than 10% blasts. A bone marrow core biopsy sample can sometimes be processed successfully to allow study of cells in mitosis. Blood is generally not appropriate for cytogenetic analysis of MDSs.

A sample of 1 to 2 ml of bone marrow is generally adequate for cytogenetic analysis. The sample must be aspirated into a sterile syringe coated with preservative-free sodium heparin to prevent clotting and then transferred into a sterile tube containing preservative-free heparin or a medium such as RPMI 1640, McCoy's 5A, or Hanks' balanced salt solution with preservative-free heparin. Antibiotics (penicillin, streptomycin) may be added to the transport medium. When peripheral blood is to be studied, 10 ml of blood should be drawn aseptically into a sterile heparinized syringe and transferred to a sterile tube also containing heparin.

Cytogenetic analysis of lymphomas is performed on lymph node tissue. Lymph nodes obtained aseptically are transported in sterile tubes containing medium and antibiotics. They are then transferred to sterile Petri dishes with medium, where they are minced using sterile scissors and then triturated using a Pasteur pipette, creating a cell suspension. Processing of this cell suspension is similar to that of bone marrow and blood cells.

Samples should be processed for cytogenetic analysis as soon as possible after they are obtained. Delays in processing may compromise cell viability. Additionally, normal cells may survive better than malignant cells, so that only normal karyotypes are obtained. The likelihood of successful analysis of acute lymphocytic leukemia (ALL) samples, in

particular, is adversely affected by delays in processing. Samples with very high numbers of cells are also less likely to be successfully studied following delays in processing ( [27](#) ). If bone marrow or blood samples cannot be processed immediately or must be mailed overnight to be processed, cell viability can be maintained by keeping samples at room temperature in culture medium. Lymph nodes may be refrigerated. Cytogenetic samples should not be frozen.

### Sample Processing and Cell Culture

Marrow, blood, or lymph node cells are centrifuged and then resuspended in a medium such as RPMI 1640 or McCoy's 5A. They are then counted with a Coulter counter or a hemocytometer and resuspended at  $1 \times 10^6$  cells/ml of medium, which is the optimal cell concentration for cell culture for cytogenetic analysis.

Cytogenetic analysis may be performed on uncultured or cultured cells. Chromosome preparations from cells that have not been cultured are called *direct preparations*, whereas preparations from cultured cells are called *indirect preparations*. Bone marrow cells can be studied in direct preparations because dividing cells are present in bone marrow aspirates. The advantage of direct preparations is that they allow rapid karyotyping of the cells that are undergoing division *in vivo*. The disadvantages of direct preparations are that they have a low mitotic index because *in vivo* cell proliferation rates are generally low and that chromosome morphology is generally poor. Additionally, compared to indirect preparations, direct preparations more often yield normal rather than abnormal metaphases ( [29](#) ). The normal metaphases seen in direct preparations may derive from erythroblasts ( [30](#), [31](#) ). In APL, in particular, analysis of indirect preparations demonstrates the t(15;17) translocation in virtually all cases ( [32](#) ), but direct preparations often yield normal karyotypes ( [33](#) ). Cell culture increases the mitotic rate, improves chromosome morphology, and generally promotes proliferation of malignant cells, but normal cells may also proliferate in culture. To maximize the likelihood of successfully karyotyping the abnormal population, both direct and indirect preparations should be studied, several culture conditions should be used including cell cycle synchronization, and cell cultures should be harvested at several different times.

Mitogens may be useful in stimulating proliferation of abnormal cells in some circumstances. In particular, unstimulated chronic lymphocytic leukemia (CLL) cells have a very low mitotic rate, and cytogenetic analysis in cases of CLL studied without mitogens often reveals normal metaphases that are derived from coexisting normal cells rather than from CLL cells. The use of B-cell mitogens increases the frequency with which cytogenetic abnormalities are detected in cases of CLL. To optimize the success of cytogenetic analysis, B-cell CLL cells should be cultured with a polyclonal B-cell activator such as 12-O-tetradecanoylphorbol-13-acetate, Epstein-Barr virus, lipopolysaccharide, or protein A to stimulate B-cell proliferation ( [34](#) ). T-cell CLL cells may be cultured with a combination of phytohemagglutinin (PHA), 12-O-tetradecanoylphorbol-13-acetate, and pokeweed mitogen to stimulate cell division. CLL cells should be cultured for long periods of time, in the range of 3 to 5 days. The likelihood of successful cytogenetic analysis in cases of multiple myeloma is also increased by cell culture with combinations of cytokines, including granulocyte-macrophage colony-stimulating factor, interleukin-3, and interleukin-6 ( [35](#) ).

Cells are incubated (direct preparations) or cultured (indirect preparations) in a medium such as RPMI 1640 or McCoy's 5A supplemented with fetal calf serum, L-glutamine, penicillin, and streptomycin; mitogens are added in selected cases. The cell density should be  $1 \times 10^6$  cells/ml of medium. Colchicine (Colcemid) is used to arrest cells in metaphase. In direct preparations, colchicine is added to the cell suspension without prior

cell culture, and cells are harvested after incubation in medium with colchicine at 37° C for 1 hour. In overnight colchicine-treated cultures, cells are cultured overnight in medium with colchicine and are harvested the next morning. In short-term cultures, cells are cultured in medium without colchicine at 37° C, generally for 24 to 72 hours. Before harvesting cells after short-term culture, colchicine is added to the cultures, usually at 0.01 µg or 0.02 µg/ml for 1 hour. Longer colchicine exposure times result in greater numbers of metaphases, but longer colchicine exposure times and higher colchicine concentrations compromise chromosome morphology.

Cell cycle synchronization in the early stages of cell division yields elongated chromosomes, allowing high-resolution chromosome banding. To achieve cell cycle synchronization, cell division is blocked by incubation with an antimetabolite, and the block is then released, producing synchronization of cell division in early mitosis, when chromosomes are longer than in metaphase. Moreover, because cell division is synchronized, the duration of colcemid treatment can be significantly reduced, resulting in better chromosome morphology. The most commonly used technique is MTX synchronization. MTX, an inhibitor of thymidine biosynthesis, arrests cells in S phase. Cells are initially cultured in medium without MTX. MTX is added after an initial culture period; after approximately 17 hours, most of the dividing cells have accumulated in S phase. At this point, thymidine is added to the culture, releasing the MTX block. The cells then proceed synchronously to mitosis. Colchicine is then added for 10 to 15 minutes, and the cells are harvested. Shortened colcemid treatment, in addition to MTX synchronization, produces elongated chromosomes, allowing detection of subtle abnormalities such as small deletions and rearrangements.

To increase the likelihood of successful cytogenetic analysis and identification and accurate characterization of abnormal clones, a variety of culture conditions should be used, including synchronization of cell division. Optimizing cell density and using different culture conditions are particularly important in maximizing the likelihood of successful cytogenetic analysis of ALL cells.

Stimulated peripheral blood is most often used to establish the constitutional karyotype. Peripheral blood cells are cultured at  $1 \times 10^6$  cells/ml in culture medium supplemented with 2% PHA, a T-cell mitogen. Colchicine is added after 72 to 96 hours, generally at a concentration of 0.01 µg/ml. Cultures are harvested after 1 hour of colchicine exposure.

### **Hypotonic Treatment**

After colchicine treatment, hypotonic treatment is used to produce cell swelling, allowing chromosomes to spread within cells. Chromosome spreading serves to optimize visualization of each chromosome and to minimize overlapping of chromosomes in metaphase spreads. A dilute solution of KCl (0.075 mol) may be used for hypotonic treatment; other hypotonic solutions are also in use. After colchicine treatment, cells are centrifuged, resuspended in prewarmed hypotonic solution, and incubated at 37° C. The optimal duration of incubation in hypotonic medium varies; it is generally in the range of 10 to 45 minutes.

### **Fixation**

After the hypotonic treatment, cells are fixed in a modified Carnoy fixative (3:1 methanol to acetic acid volume per volume). Fixation causes denaturation and precipitation of proteins and nucleic acids, resulting in hardening of chromatin, which enhances morphology. The cells are centrifuged, gently resuspended in fixative, incubated at room temperature, and then centrifuged again. This is repeated until a cell suspension that is only slightly cloudy is obtained. Slides may be prepared immediately for cytogenetic

analysis, or the cells may be stored in fixative and prepared for analysis at a later time.

## Slide Preparation

Fixed cells are dropped onto cleaned glass slides under several different conditions. The angle at which the pipette and slide are held is varied. Slides may be wet, cold, or dry and are then dried with steam, air, or flame. After the slides are dried, they are examined for cell density and quality of metaphase spreads by phase contrast microscopy. If the slides are not optimal, new slides are made, altering the density of the cell suspension or the dropping technique, as appropriate.

## Staining

Since 1968, several protocols have been developed that yield staining of chromosome regions with variable intensity based on their nucleotide and protein composition. Staining with these dyes produces a unique banding pattern on each chromosome that is specific for that chromosome.

Q-banding, the first banding method developed, uses quinacrine mustard or quinacrine dihydrochloride to create fluorescent transverse bands when excited with the proper wavelength of light. Quinacrine is a fluorescent dye that intercalates into the DNA helix. Q-band analysis requires fluorescence microscopy. Moreover, Q-bands fade over time, and Q-banding is therefore not conducive to routine work.

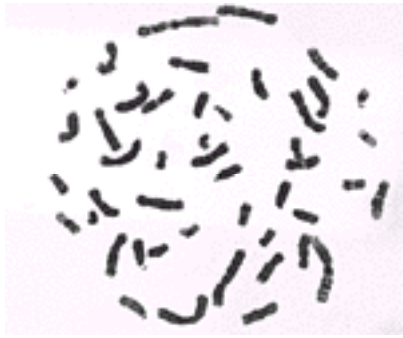
G-banding uses pretreatment with an enzyme (trypsin) followed by staining with the Giemsa dye to also produce transverse bands, called *G-bands*, which are identical to Q-bands. G-banding is generally preferred over Q-banding because G-band analysis is performed by light microscopy and G-banding is permanent. G-banding is the most widely used banding technique for routine chromosomal analysis. Other G-banding techniques use stains other than Giemsa, such as Wright and Leishman's stains.

The most widely used G-banding technique is called *GTG banding* (G-bands by trypsin using Giemsa). In this technique, air-dried slides aged by heating in an oven are treated with a dilute solution of the proteolytic enzyme trypsin (0.05% trypsin for 5 to 10 minutes) and then stained with Giemsa. The relative importance of DNA and proteins in G-banding is not well understood. Treating chromosomes with a hot alkaline solution before Giemsa staining produces bands that are the reverse of G-bands, called *R-bands*. R-banding methods are useful for analyzing rearrangements involving the terminal ends of the chromosomes.

In contrast to Q-, G-, and R-banding, which produce bands distributed along the entire length of each chromosome, other staining methods are adapted to demonstrate specific chromosomal structures, including constitutive heterochromatin (C-banding), telomeric regions (T-banding), and nucleolus-organizing regions (NOR-banding). C-bands are primarily in the centromeric regions of chromosomes. C-band size and position are unique for each chromosome. C-banding is particularly useful in studying chromosomal translocations involving the centromeric regions.

## Microscopy

After banding, slides are scanned under a light microscope to locate chromosome spreads that are of adequate quality for karyotyping ( [Fig. 4.3](#)). The coordinates of these metaphases are recorded.



**Figure 4.3.** Banded metaphase.

For cytogenetic analysis to be considered adequate, at least 20 chromosome spreads should be analyzed. In particular, whereas abnormal clones are sometimes demonstrated by analysis of small numbers of cells, demonstration of 20 normal chromosome spreads is required for a case to be considered cytogenetically normal. Demonstration of 20 out of 20 normal metaphases excludes the presence of 14% abnormal cells with 95% confidence ( [36](#) ).

Cytogenetic analysis of cases of ALL presents particular difficulties. Chromosome spreading is more difficult to accomplish, chromosome morphology is fuzzy, and bands are often suboptimal. Thus, metaphase spreads are often considered nonanalyzable. Two morphologically different populations of metaphases may be present. When two populations are present, the population with better spreading and better chromosome morphology often represents cells with normal karyotypes. If the metaphases that are easiest to study are selected for analysis, the case is inaccurately characterized as cytogenetically normal. Therefore, it is imperative to examine both populations.

### **Karyotyping**

Chromosomes are counted in each of the chosen metaphase spreads to determine whether they are present in normal numbers. Chromosomes are then identified and characterized as structurally normal or abnormal. To facilitate analysis, chromosomes from each metaphase spread are arranged in a prescribed order, called a *karyotype* ( [Fig. 4.4A](#) and [Fig. 4.4B](#) ). On completion of the microscopic analysis, the cells are ready to be photographed or electronically imaged, printed, and karyotyped. The selected metaphases are photographed onto black and white film, and prints are generated. Karyotyping is performed by cutting out chromosomes from the photographic prints of each chromosome spread and arranging them in prescribed order. Once the karyotype is finalized, the chromosomes are pasted onto a sheet of paper.



**Figure 4.4.** Normal male (A) and female (B) karyotypes.

The ability to detect subtle cytogenetic abnormalities depends heavily on the experience of the cytogeneticist. Examples of subtle structural abnormalities that may be easily missed by cytogeneticists without extensive experience include  $inv(16)(p13q22)$  and  $t(9;11)(p21;q23)$ , both of which are clinically significant cytogenetic abnormalities seen in AML. The ability to accurately karyotype metaphases with multiple or complex abnormalities is also a function of experience. Cytogenetic analysis of cancer cells should optimally be performed in laboratories staffed by groups of cytogeneticists with expertise in this specialized area.

### Automated Karyotyping

In recent years, automated karyotyping systems have become available, greatly increasing the efficiency of karyotyping in laboratories that handle large numbers of samples. Automated karyotyping relies on computerized image analysis. Software programs have been created that allow chromosome spreads identified by light microscopy to be karyotyped on a computer screen. The karyotype is then printed directly from the computer. Both chromosome spread and karyotype images are archived as digital files.

Automated karyotyping obviates the need to photograph metaphases, develop film, print negatives, and cut and paste chromosomes. The number of steps and the amount of time required for cytogenetic analysis are thereby significantly decreased, allowing more rapid analysis and reduction of labor costs.

## CYTOGENETIC NOMENCLATURE

Human chromosome nomenclature was initially established at an international conference in 1960. It has been serially updated to include terminology developed to describe chromosomal abnormalities, chromosome bands, high-resolution bands, and, most recently, results of FISH analysis. The most recent guidelines for cytogenetic nomenclature were published in 1995 (7).

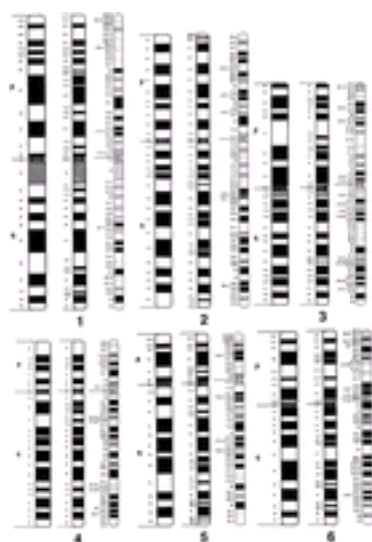
For karyotypic analysis, each chromosome is visualized as two chromatids that are joined at a central constriction called the *centromere*. The centromere is the region where the chromosome attaches to the spindle during mitosis. The centromere divides the chromosome into two arms: a short arm, designated the p-arm (*p* stands for *petit*), and a

long arm, designated the q-arm ( *q* was chosen simply because it is the letter after *p*). By convention, chromosomes are always shown with the p-arm on top.

Chromosomes were initially described based on their size and the position of the centromere. Size was characterized as large, medium, or small. The position of the centromere was used to classify chromosomes as metacentric, acrocentric, or submetacentric. A chromosome with the centromere in the middle is designated as *metacentric*, one with the centromere closer to one end is *submetacentric*, and one in which the centromere is almost at one end is called *acrocentric*.

In 1963, before the advent of chromosome banding, human chromosomes were divided into seven groups, A through G, based on their size and the position of the centromere. Group A includes chromosomes 1, 2, and 3, which are large, metacentric chromosomes. Group B includes chromosomes 4 and 5, which are large and submetacentric. Group C chromosomes, including numbers 6 through 12 and the X chromosome, are medium-sized and metacentric or submetacentric. Group D, chromosomes 13 through 15, includes medium-sized acrocentric chromosomes with satellites. Group E, chromosomes 16 through 18, consists of small metacentric (chromosome 16) and submetacentric (chromosomes 17 and 18) chromosomes. Group F chromosomes, numbers 19 and 20, are small and metacentric. Group G chromosomes, including 21, 22, and Y, are small and acrocentric; 21 and 22 have satellites, whereas the Y chromosome does not. Without chromosome banding, chromosomes within some groups could not be distinguished. Banding allowed the chromosomes in each group to be uniquely identified and distinguished from each other.

Nomenclature was subsequently established to describe the structure of individual chromosomes. The term *landmark* is used to designate distinct morphologic features important in identifying chromosomes. Landmarks include the centromere, the ends of the chromosomes (called *telomeres*), and prominent chromosome bands. *Chromosome regions* are defined as areas lying between adjacent landmarks. The number of regions on the short and long arms of individual chromosomes ranges between one and four. Regions of each chromosome arm are numbered sequentially, moving outward from the centromere toward the telomere ( [Fig. 4.5](#)).



**Figure 4.5.** Diagrams of normal human G-banded chromosomes showing banding at the 400, 550, and 850 band levels of resolution. (Adapted from ISCN 1995. Basel: Karger, 1995.)



*Bands* are defined as chromosome segments that are clearly distinguishable from adjacent segments by virtue of appearing lighter or darker with the use of one or more banding techniques. Chromosome regions, defined above, are divided into bands. The bands within regions are also numbered sequentially, also moving outward on each arm from the centromere toward the telomere ( [Fig. 4.5](#)). To designate chromosome bands, one specifies the chromosome number, the chromosome arm, the region number, and the band number within the region, given in order, without spacing or punctuation. For example, 1p31 (chromosome 1, short arm, region 3, band 1) designates the first band of the third region of the short arm of chromosome 1.

High-resolution banding divides chromosome bands into sub-bands, which are light and dark regions constituting finer structure within chromosome bands. Sub-bands are also numbered from the centromere toward the telomere of each arm. Sub-band numbers are given after band numbers, separated by decimal points. For example, band 1p31 includes sub-bands 1p31.1, 1p31.2, and 1p31.3. [Figure 4.5](#) shows normal human chromosomes with sub-bands as well as bands.

Karyotypes are described according to the International System for Human Cytogenetic Nomenclature ( [7](#)). The description of a karyotype starts with the total number of chromosomes, including the sex chromosomes. The total number of chromosomes is followed by a list of the sex chromosomes present in the cell and then a list of abnormalities of autosomes listed in ascending numerical order. This system represents a change from older nomenclature, in which numerical chromosomal abnormalities were listed first, followed by structural abnormalities. A normal male karyotype is 46,XY, and a normal female karyotype is 46,XX. Common abbreviations and symbols used in describing karyotypes are listed and defined in [Table 4.1](#).

**TABLE 4.1. Common Symbols and Abbreviations Used in the Description of Chromosomes and Chromosomal Abnormalities**

| Symbol or Abbreviation | Meaning  |
|------------------------|--|
| add                    | Additional material of unknown origin  |
| Brackets &lsqb; &rsqb; | Surround numbers of cells  |
| c                      | Constitutional anomaly   |
| cen                    | Centromere   |
| Comma (,)              | Separates chromosome numbers, sex chromosomes, and chromosomal abnormalities |
| Decimal point (.)      | Denotes sub-bands  |
| del                    | Deletion   |
| der                    | Derivative chromosome  |
| dic                    | Dicentric chromosome   |
| dmin                   | Double minute  |
| dup                    | Duplication  |
| i                      | Isochromosome  |
| idic                   | Isodicentric   |
| ins                    | Insertion  |
| inv                    | Inversion  |

|                   |  |
|-------------------|--|
| mar               | Marker chromosome  |
| Minus (-)         | Loss   |
| p                 | Short arm of chromosome  |
| Parentheses ( )   | Surround chromosomes and breakpoints   |
| Plus (+)          | Gain   |
| q                 | Long arm of chromosome   |
| Question mark (?) | Questionable identification of a chromosome or chromosome structure                        |
| r                 | Ring chromosome  |
| Semicolon (;)     | Separates chromosomes and breakpoints in rearrangements involving more than one chromosome |
| Slash (/)         | Separates clones   |
| t                 | Translocation  |
| ter               | Terminal (end of chromosome)   |

---

Chromosomal abnormalities may be numerical or structural and may be constitutional or acquired. The term *numerical chromosomal abnormality* refers to a karyotype with an abnormal number of chromosomes. Numerical chromosomal abnormalities may include chromosome losses or chromosome gains. Structural chromosomal abnormalities are alterations in the structure of individual chromosomes, including loss, rearrangement, or gain of chromosome segments. Numerical and structural chromosomal abnormalities may coexist in malignant cells.

## NUMERICAL CHROMOSOMAL ABNORMALITIES

A cell with a normal complement of chromosomes is called *diploia*. Cells with 46 chromosomes, but with numerical chromosomal abnormalities (for example, the loss of one chromosome and the gain of another) are called *pseudodiploia*. The presence of an abnormal number of chromosomes is called *aneuploidy*. Cells with more than 46 chromosomes are called *hyperdiploia*, whereas the presence of fewer than 46 chromosomes is called *hypodiploidy*. Loss of one copy of a chromosome results in monosomy for that chromosome; loss of both copies results in nullisomy. Gain of an additional copy of a chromosome results in trisomy for the chromosome that has been gained. When two additional copies of a chromosome are gained, it is referred to as *tetrasomy*.

Chromosome loss is indicated in the karyotype by a minus sign followed by the number of the missing chromosome, whereas chromosome gain is indicated by a plus sign followed by the number of the chromosome that has been gained. The number of chromosomes in the cell, given in the karyotype, reflects the chromosomes that have been lost or gained. For example, 45,XY,-7 indicates a male cell with loss of one copy of chromosome 7 (monosomy 7); 47,XX,+8 indicates a female cell with an extra copy of chromosome 8 (trisomy 8); and 48,XY,+13,+13 indicates a male cell with two additional copies of chromosome 13 (tetrasomy 13).

The chromosomes that are most commonly lost in acquired cytogenetic changes include 5, 7, X, and Y (<sup>37</sup>). Loss of the Y chromosome may be seen as an age-related phenomenon in bone marrow cells of normal males (<sup>38</sup>), but it also occurs as a primary cytogenetic abnormality (<sup>39</sup>) as well as a secondary change, particularly in AML with t(8;21) (<sup>40</sup>). Loss of a chromosome has as its obvious molecular consequence loss of one

copy of the genetic material on that chromosome. The genes whose loss is critical in the monosomies that are seen as recurring cytogenetic abnormalities in AML and MDS have not been identified.

The most common acquired trisomy is +8, seen in AML, MDS, and CML in blast transformation ( [37](#) ). Trisomy 8 occurs as both a primary and a secondary cytogenetic abnormality in AML. Other trisomies in myeloid disorders include +4, +6, +9, +11, +13, +19, +21, and +22 ( [37](#), [41](#), [42](#) ), whereas the most common trisomies in ALL are +4, +6, +10, +14, +17, +18, +20, +21, and +X ( [43](#) ).

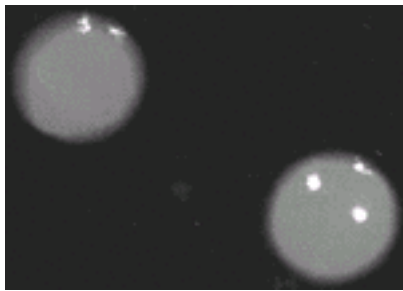
The obvious molecular consequence of a trisomy is the presence of an additional copy of all of the genetic material on a chromosome. Nevertheless, the relationship between trisomies and malignant transformation has remained unclear. A partial tandem duplication of the ALL-1 or MLL gene at 11q23 has been demonstrated by molecular techniques in one of the three copies of chromosome 11 in AML with trisomy 11, although all three copies appear structurally normal by conventional cytogenetic analysis ( [44](#), [45](#) ). Exons 2 through 6 or 8 of the ALL-1 gene are duplicated, and the partially duplicated ALL-1 gene encodes novel partially duplicated RNA and protein species. Demonstration of partial tandem duplication of ALL-1 as a consistent finding in AML with trisomy 11 represents the first identification of a specific molecular change associated with a recurrent trisomy in human cancer. Molecular abnormalities have not yet been demonstrated in association with other trisomies. In particular, trisomy 8 has been shown not to be associated with abnormalities in structure or expression of the c-myc oncogene at 8q24 ( [46](#) ).

Numerical chromosomal abnormalities are particularly common in childhood and adult ALL, and their presence is prognostically significant ( [43](#), [47](#) ). *Near-haploic* or *hypodiploid ALL* is defined by multiple chromosome losses ( [48](#) ). Hypodiploid ALL most commonly has 45 chromosomes ( [49](#) ). Hyperdiploid ALL is divided into *moderate hyperdiploidy*, defined by the presence of 47 to 50 chromosomes ( [50](#) ); *massive hyperdiploidy*, which is more than 50 chromosomes ( [51](#) ); and *near triploidy* or *near tetraploidy*, defined by a marked increase in chromosome number, in the range of 69 to 96 chromosomes ( [52](#) ). Hyperdiploidy and moderate hyperdiploidy are common in childhood ALL, representing 27% and 16% of cases, respectively. Hyperdiploidy is prognostically favorable, whereas moderate hyperdiploidy correlates with an intermediate prognosis ( [43](#) ). In contrast, near haploidy and hypodiploidy are prognostically unfavorable ( [48](#), [49](#) ).

FISH with probes hybridizing with the centromeric regions of specific chromosomes allows the detection of numerical chromosomal abnormalities in interphase cells ( [53](#) ). FISH may be performed on blood smears as well as on bone marrow samples prepared for cytogenetic examination ( [54](#) ). Moreover, the presence or absence of numerical chromosomal abnormalities, determined by FISH, may be directly correlated with cellular morphology and cell-surface antigen expression ( [55](#), [56](#) ).

FISH with a probe specific for the centromere of chromosome 12 ( [Fig. 4.6](#) ) is more sensitive than conventional cytogenetic analysis for detecting trisomy 12, the most common cytogenetic abnormality in CLL ( [57](#), [58](#) ). Based on analysis of normal controls, fresh and archived CLL samples are considered to be positive for trisomy 12 by FISH if three chromosome 12 signals are present in more than 4% and 7% of cells, respectively ( [57](#), [58](#) ). The incidence of trisomy 12 in the largest published study of CLL cases studied by FISH was 35%, compared to only 6% by conventional cytogenetic analysis ( [55](#) ). Moreover, patients with trisomy 12 detected by FISH had shorter survival times than those without

trisomy 12 ( [58](#) ).



**Figure 4.6.** Trisomy 12 in an interphase cell ( *right* ) demonstrated by fluorescence *in situ* hybridization with a chromosome 12 centromeric probe. An interphase cell with two chromosome 12 signals is also seen ( *left* ). See [Color Plate](#).

Multiple myeloma cells are also difficult to karyotype because of low proliferative rates even with B-cell mitogens ( [35](#) ), and FISH demonstrates a significantly higher incidence of aneuploidy than is found with conventional cytogenetic analysis ( [59](#) ). Interphase FISH analysis of myeloma cells from 32 patients with probes for chromosomes 1, 3, 7, 8, 11, 12, 16, 17, 18, and X demonstrated aneuploidy in 90% ( [59](#) ). Chromosome gain was more common than chromosome loss; chromosomes 3, 7, and 11 were most frequently gained. The X chromosome was most frequently lost in females but not males. Chromosome 17 loss was also common.

In contrast to CLL and myeloma cells, myeloid cells can generally be karyotyped with ease, and results of conventional cytogenetic and FISH analysis of AML cells with numerical chromosomal abnormalities such as monosomy 7 and trisomy 8 are more similar than is the case for CLL ( [60](#), [61](#) ). FISH may be used to demonstrate numerical chromosomal abnormalities in cases in which they are not demonstrated by conventional cytogenetic analysis, in which only one metaphase with the abnormality is detected by conventional cytogenetic analysis, or in which conventional cytogenetic analysis is inadequate ( [61](#) ).

## STRUCTURAL CHROMOSOMAL ABNORMALITIES

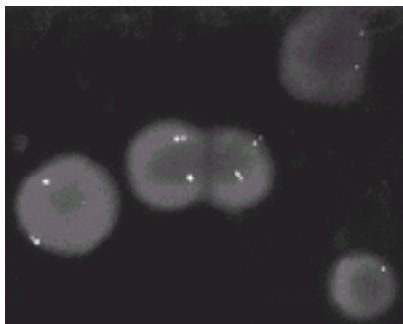
A variety of structural chromosomal changes may be present in tumor cells. Precisely defined terms are used to describe these changes. Structural chromosomal abnormalities seen in hematopoietic and lymphoid neoplasms include deletions, isochromosomes, isodicentric chromosomes, inversions, rings, translocations, dicentric chromosomes, additions, insertions, duplications, double minutes, and marker chromosomes.

### Deletion

A *chromosomal deletion* (del) is loss of a chromosome segment. Deletions may be either interstitial or terminal. In an interstitial deletion, an internal chromosome segment is lost, and the chromosome segments that are proximal and distal to the deleted segment become juxtaposed. In a terminal deletion, the tip of a chromosome arm is deleted. del(5q) and del(7q) refer to any deletions of the long arm of chromosome 5 and chromosome 7, respectively. In contrast, del(5)(q13q33) specifically designates an interstitial deletion of the long arm of chromosome 5 between band q13 and band q33, and del(7)(q22) designates a terminal deletion of chromosome 7 with a break at band q22 and loss of all

chromosomal material between band 7q22 and the 7q telomere.

Common chromosome deletions include del(5q), del(7q), and del(20q) in AML and MDS; del(13q) in MDS; del(6q) and del(9p) in ALL; and del(13q) in CLL ( [37](#)). del(13q) in CLL, studied by FISH, is illustrated in [Figure 4.7](#). The critical molecular changes associated with most chromosome deletions are unknown, but it is hypothesized that chromosomal deletions result in loss of tumor-suppressor genes ( [62](#)). Genes on 5q that may be deleted in del(5q) include a number of growth factor and growth factor receptor genes, including granulocyte-macrophage colony-stimulating factor, interleukin-3, interleukin-4, interleukin-5, interleukin-9, the macrophage colony-stimulating factor receptor c-fms, and the glucocorticoid receptor ( [62](#)). In some cases of MDS with del(5q), the c-fms gene has been found to be deleted from both the del(5q) chromosome and the copy of chromosome 5 without visible structural abnormalities ( [63](#)). The smallest commonly deleted region on 5q is the small segment of band 5q31 that has been demonstrated to contain the early growth response-1 protein gene ( [64](#)) or the interferon regulatory factor-1 gene ( [65](#)). A case of AML has been described with deletion of one interferon regulatory factor-1 allele as part of a del(5q) and an inactivating rearrangement of the other allele in the structurally normal chromosome 5 ( [65](#)). Of note, del(9p) in ALL has been associated with deletion of the interferon genes ( [66](#), [67](#)). The retinoblastoma gene is deleted in del(13), and the remaining retinoblastoma gene on the cytogenetically normal copy of chromosome 13 may be inactivated ( [68](#)). The commonly deleted region in del(6q) in ALL is 6q21; the critical gene has not been identified ( [69](#)).



**Figure 4.7.** del(13q) is demonstrated by fluorescence *in situ* hybridization with locus-specific probes to two regions of chromosome 13q in two cells ( *left* and *center*). A normal cell is also seen ( *right*). See [Color Plate](#).

## Isochromosome

An *isochromosome* (i) is a structurally abnormal chromosome that consists of two chromosome arms positioned as mirror images of each other. Isochromosomes may be monocentric (one centromere) or dicentric (two centromeres). A dicentric isochromosome is called an *isodicentric* chromosome (see below). The most common isochromosomes in hematologic malignancies are i(11q), i(17q), and i(21q) in AML; i(7q), i(9q), and i(17q) in ALL; i(9q), i(17q), and i(22q) in CML; and i(X)(q13), i(17q), and i(21q) in MDS, whereas i(1q), i(6p), i(7q), i(8q), i(9p), i(17q), and i(21q) are recurring isochromosomes in lymphoproliferative disorders and lymphomas ( [70](#)).

Isochromosome formation leads to both loss and gain of genetic material. As an example, i(17q), which occurs frequently as a secondary cytogenetic abnormality in blast crisis of

CML, consists of two chromosome 17 long arms, without short arms. Cells with  $i(17q)$  generally also have one normal chromosome 17; thus, they have one copy of 17p and three copies of 17q. One important molecular consequence of  $i(17q)$  formation is loss of genetic material on 17p, including the p53 tumor-suppressor gene. Cells with  $i(17q)$  have a single copy of p53, which is on the structurally normal chromosome 17. This copy of the p53 gene often has point mutations or other molecular changes that result in p53 inactivation ( [71](#), [72](#) ).  $i(17q)$  with inactivating molecular changes in the remaining copy of the p53 gene may also be seen in AML and MDS ( [73](#), [74](#) ).  $i(17q)$  also occurs as a secondary chromosomal abnormality in ALL ( [75](#) ).

### Isodicentric Chromosome

An *isodicentric chromosome* (idic) is an isochromosome in which there are two copies of the centromere. Isodicentric chromosomes are rare. An example is  $idic(7p)$  in AML ( [76](#) ).  $idic(7p)$  consists of two copies of the short arm and the centromere of chromosome 7, positioned as mirror images of each other.

### Inversion

A *chromosomal inversion* (inv) is a structural chromosome change consisting of a 180-degree rotation of a chromosome segment. Inversions may be pericentric or paracentric. In pericentric inversions, the segment that undergoes 180-degree rotation includes the centromere. In paracentric inversions, the inverted segment is entirely within either the short or the long arm of the chromosome and does not include the centromere.  $inv(16)(p13q22)$  is a pericentric inversion, whereas  $inv(3)(q21q26)$  is paracentric. Both of these inversions occur in AML ( [37](#) ). Another example of a paracentric inversion is  $inv(14)(q11q32)$ , which is the most consistent chromosomal change found in T-cell CLL and T-cell prolymphocytic leukemia ( [77](#), [78](#) ).

The molecular consequence of chromosome inversion is juxtaposition of genes on the long and short arm of a chromosome (pericentric inversion) or on the same arm of a chromosome (paracentric inversion) that are not normally juxtaposed.  $inv(16)(p13q22)$ , a structural chromosomal abnormality seen in AML ( [16](#) ), is a pericentric inversion that juxtaposes MYHII, the smooth muscle myosin heavy chain gene at 16p13 with the core-binding factor- $\beta$  (CBF- $\beta$ ) gene at 16q22 ( [79](#) ). The reciprocal chromosomal translocation  $t(16; 16)(p13;q22)$  juxtaposes the same two genes from the two different copies of chromosome 16, rather than the same chromosome 16.  $inv(3)(q21q26)$  is a paracentric inversion, also found in AML, that juxtaposes the ribophorin I gene at 3q21 and the EVI I gene at 3q26. Again, the  $t(3;3)(q21;q26)$  juxtaposes the same two genes from the two different copies of chromosome 3, rather than the same chromosome 3.  $inv(11)(p13q23)$  is an uncommon pericentric inversion in ALL cells that has been shown not to involve the MLL or ALL-1 gene at 11q23 ( [80](#) ).

$inv(16)$  in AML, illustrated in [Figure 4.8](#), is associated with bone marrow eosinophilia ( [16](#) ). Moreover, eosinophil morphology is abnormal, with large irregular granules that stain a deep purple with May-Grünwald-Giemsa stain and also stain with naphthol-AS-D-chloroacetate-esterase, in contrast to normal eosinophils ( [16](#) ). Interphase FISH was used to demonstrate the chromosome inversion in bone marrow eosinophils from patients with AML with  $inv(16)$  ( [81](#) ).



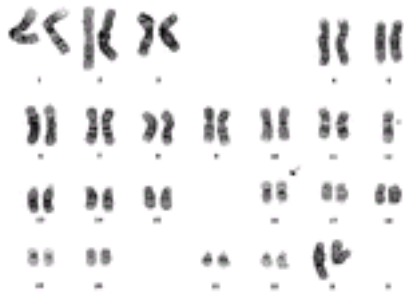


Figure 4.8. Karyotype demonstrating  $\text{inv}(16)(\text{p}13\text{q}22)$ .

### Ring Chromosome

A *ring chromosome* ( $r$ ) is an abnormal chromosome in which breaks have occurred in both the short and the long chromosome arms, and the breakpoints in the short and long arms have joined together, creating a closed circle, or ring. Ring chromosomes are uncommon in hematologic malignancies; they have been reported primarily in AML and CML. There are only rare reports of ring chromosomes in lymphoid malignancies (<sup>37</sup>).

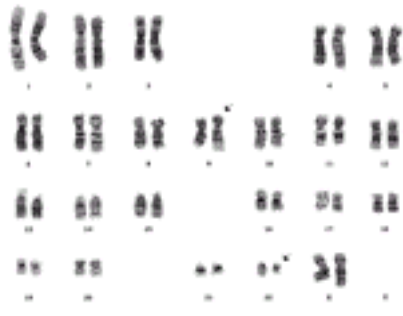
### Translocation

A *chromosomal translocation* is a relocation of material from one chromosome to a different chromosome. Translocations are usually reciprocal. A reciprocal translocation is an exchange of material between different chromosomes. Reciprocal translocations generally occur between two chromosomes, but rarely may involve more than two chromosomes. Nonreciprocal translocations are also rare.

Large numbers of chromosomal translocations have been described in hematopoietic and lymphoid neoplasms. In many instances, the associated molecular changes have been identified, and mechanisms of malignant transformation have been elucidated (<sup>82</sup>). Some translocations result in synthesis of novel fusion proteins. Examples include the  $\text{t}(9;22)$  in CML, which results in synthesis of an aberrant tyrosine kinase, and a variety of translocations in AML and ALL, which result in synthesis of aberrant transcription factors. Alternatively, translocations may result in relocation of an oncogene to a locus that is highly transcribed in a particular cell type, resulting in activation of the oncogene. Examples include the  $\text{t}(8;14)(\text{q}24;\text{q}32)$  in Burkitt lymphoma, the  $\text{t}(8;14)(\text{q}24;\text{q}11)$  in T-cell ALL, and the  $\text{t}(14;18)(\text{q}32;\text{q}21)$  in follicular non-Hodgkin lymphoma.

The  $\text{t}(9;22)(\text{q}34;\text{q}11)$  in CML, illustrated in [Figure 4.9](#), is a reciprocal translocation between the long arms of chromosome 9 and chromosome 22, with breakpoints at 9q34 and 22q11. The significant molecular change in  $\text{t}(9;22)(\text{q}34;\text{q}11)$  is a relocation of the *abl* oncogene from 9q11 to the *bcr* locus on 22q11 (<sup>83</sup>, <sup>84</sup>). A novel *bcr/abl* fusion gene is created that encodes novel fusion *bcr/abl* RNA and protein species (<sup>85</sup>). *bcr/abl* expression results in increased tyrosine kinase activity, which appears to be sufficient to induce malignant transformation (<sup>86</sup>, <sup>87</sup>).

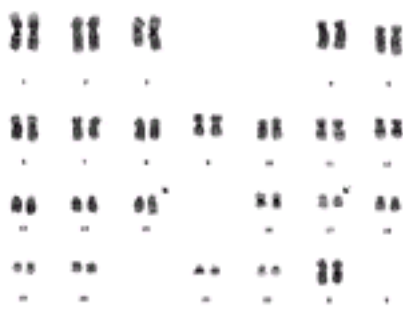




**Figure 4.9.** Karyotype demonstrating t(9;22)(q34;q11).

Variant translocations may be seen in CML ( [88](#), [89](#), [90](#) and [91](#)). Simple variant translocations are translocations between 22q11 and a chromosome breakpoint other than 9q34, but with bcr/abl fusion at the molecular level. An example is t(17;22)(p13;q11) with bcr/abl rearrangement. Complex variant translocations are three-way translocations between 9q34, 22q11, and a third chromosome breakpoint. An example is t(3;9;22)(q13;q34;q11), which is a three-way translocation between 3q13, 9q34, and 22q11, also with bcr/abl fusion.

A number of translocations in acute leukemia result in synthesis of aberrant transcription factors. In the t(8;21) in AML, the AML-1 or CBF- $\alpha$  gene on chromosome 21 is juxtaposed to the ETO gene on chromosome 8 ( [92](#), [93](#)). The product of the normal CBF- $\alpha$  gene dimerizes with the product of the normal CBF- $\beta$  gene, which is the gene on 16q22 that is involved in inv(16). CBF- $\alpha$  and CBF- $\beta$  form the heterodimeric transcription factor CBF. The AML-1/ETO fusion product is an aberrant CBF- $\alpha$  protein. Reciprocal translocations with 11q23 breakpoints in AML and ALL also result in the synthesis of fusion proteins that are aberrant transcription factors. The gene at 11q23 that is involved in 11q23 translocations is ALL-1 or MLL, and reciprocal chromosome breakpoints include 1p32, 1q21, 4q21, 6q27, 9p22, 10p12, 17q21, 19p13.1, and 19p13.3 ( [94](#), [95](#) and [96](#)). In the t(15;17)(q22;q11-12) in APL, illustrated in [Figure 4.10](#), the retinoic acid receptor (RAR)- $\alpha$  gene from chromosome 17 is fused to the PML gene at 15q22. A hybrid PML/RAR- $\alpha$  gene is created, encoding an aberrant transcription factor that inhibits promyelocyte differentiation ( [97](#), [98](#), [99](#), [100](#), [101](#) and [102](#)).



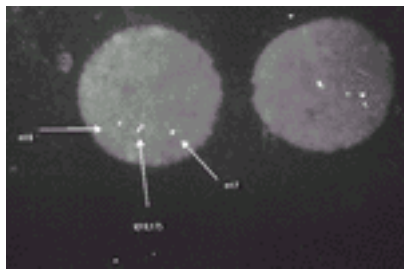
**Figure 4.10.** Karyotype demonstrating t(15;17)(q22;q12).

Examples of translocations resulting in oncogene activation include t(8;14)(q24;q32) in Burkitt lymphoma, t(8;14)(q24;q11) in T-cell ALL, and t(14;18)(q32;q21) in follicular non-Hodgkin lymphomas. In t(8;14)(q24;q32), the c-myc oncogene at 8q24 is juxtaposed to the immunoglobulin heavy chain gene at 14q32, resulting in dysregulation of c-myc transcription ( [103](#)). In t(8;14)(q24;q11), the c-myc oncogene is activated by juxtaposition

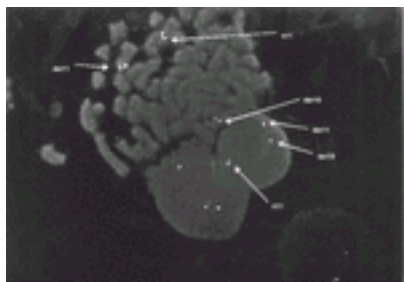
to the T-cell receptor  $\alpha/\delta$  locus ([104](#)). In  $t(14;18)(q32;q21)$ , the BCL-2 gene at 18q21, which inhibits apoptosis, is overexpressed by virtue of juxtaposition to the immunoglobulin heavy chain gene at 14q32 ([105](#)).

*Robertsonian translocations* are whole arm transfers, almost always between acrocentric chromosomes, that usually occur as constitutional chromosomal abnormalities ([106](#)). They are very rarely seen as acquired abnormalities associated with malignancy ([107](#)).

Two-color probe systems have been created for the identification of chromosome translocations by FISH ([108](#), [109](#)). Some of these are available commercially and are used in clinical cytogenetics laboratories. FISH may be used to rapidly identify translocations such as  $t(15;17)$ ; a fusion signal is seen, representing juxtaposition of the two probes in the translocation region ([Fig. 4.11](#)). Early confirmation of the diagnosis of APL can help guide the choice of induction therapy. A commercially available locus-specific probe to the MLL gene serves to confirm involvement of this gene in 11q23 chromosome translocations; splitting of the signal is seen ([Fig. 4.12](#)). The chromosomal origins of translocations can also be demonstrated with the use of paint probes. FISH with translocation breakpoint probes is also being explored as a technique for monitoring residual disease after therapy ([110](#), [111](#), [112](#) and [113](#)).



**Figure 4.11.** PML-retinoic acid receptor (RAR)- $\alpha$  fusion demonstrated in an interphase cell (*left*) by fluorescence *in situ* hybridization with locus-specific probes for the PML and RAR- $\alpha$  genes. A normal cell is also seen (*right*). See [Color Plate](#).



**Figure 4.12.** Chromosomal translocation involving the MLL gene on chromosome 11 (11q23) demonstrated by fluorescence *in situ* hybridization with a locus-specific probe for MLL. The normal MLL gene is seen as overlapping or adjacent red and green signals. When MLL is involved in a translocation, the red and green signals separate. See [Color Plate](#).

## Dicentric Chromosome

A *dicentric chromosome* (dic) is a structurally abnormal chromosome that has two centromeres. Dicentric chromosomes result from reciprocal translocations in which one of the resulting derivative chromosomes contains the centromeres of both of the chromosomes involved in the translocation. FISH can be helpful in confirming the identity of the centromeres and the other chromosomal material in dicentric chromosomes. Examples of dicentric chromosomes include dic(9;12)(p1?1;p1?2), dic(7;12)(p11;p11), and dic(9;20)(p11;q11.?1) in ALL ( [114](#), [115](#) and [116](#) ).

## Addition

A *chromosomal addition* (add) is a gain of chromosomal material of unknown origin, in contrast to a gain of chromosomal material of known origin, which is called a *translocation* ( [7](#) ). A plus sign after a chromosome arm is a general designation indicating the gain of chromosomal material, resulting in lengthening of the arm. For example, 14q+ indicates the presence of additional chromosomal material on 14q. An abnormal chromosome 14 with extra material on its long arm is a common finding in CLL ( [34](#) ). The abnormal chromosome 14 in CLL can often be identified as resulting from a reciprocal translocation involving the 14q32 breakpoint, such as t(11;14)(q13;q32). However, when a reciprocal translocation is not identified, the designation 14q+ is used to describe an abnormal chromosome 14 with extra chromosomal material of unknown origin on its long arm.

## Insertion

*Insertion* (ins) is the presence of a chromosome segment in a new position within the same or another chromosome. Insertions are very uncommon. In some instances, structural chromosomal abnormalities that were previously described as insertions have been reinterpreted as translocations. For example, ins(3;3)(q26;q21q26), which describes insertion of the segment of chromosome 3 between bands q21 and q26 into the other chromosome 3 at band 3q26, has been reinterpreted as a reciprocal translocation, t(3;3)(q21;q26) ( [37](#) ).

## Duplication

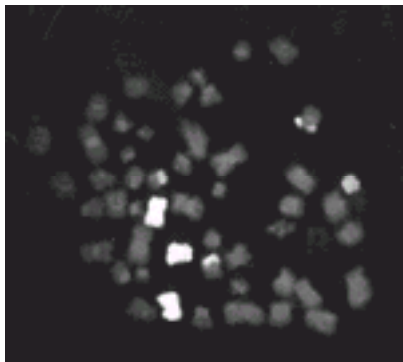
*Duplication* (dup) is the presence of an extra copy of a segment of a chromosome, so that there are two copies of the duplicated segment, juxtaposed with one another within the chromosome. An example of a duplication is dup(1)(q31p12), which is an uncommon secondary chromosomal abnormality in ALL ( [37](#) ). A chromosome duplication results in a structurally abnormal chromosome, whereas a molecular duplication such as the partial tandem duplication of the MLL gene ( [117](#) ) or the FLT-3 gene ( [118](#), [119](#) ) is detectable only by molecular techniques.

## Double Minutes

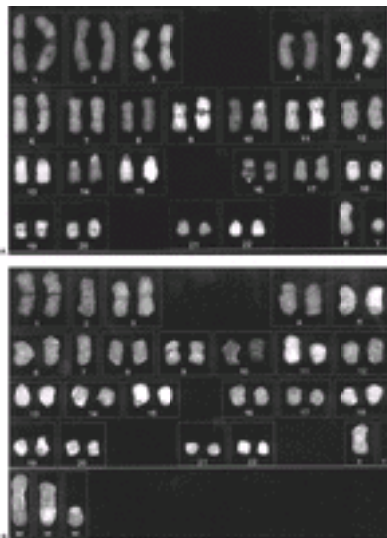
*Double-minute chromosomes* (dmin) are marker chromosomes without centromeres or banding patterns, which usually result from gene amplification. They are small spherical structures that usually occur in pairs, similar in appearance to diplococci. Double-minute chromosomes are more common in solid tumors than in hematologic or lymphoid malignancies ( [37](#) ). Double-minute chromosomes in AML have been shown to contain amplified copies of the c-myc gene ( [120](#) ) or the ALL-1 gene ( [121](#) ) or identified material from chromosome 19 ( [122](#) ).

## Marker Chromosomes

The term *marker* (*mar*) is used to designate a structurally abnormal chromosome that has no part that can be identified. Karyo types may include one or more markers. The presence of one marker chromosome in a karyotype is designated by +mar. The presence of several different markers is indicated by +mar1, +mar2, +mar3, and so forth. The presence of multiple copies of the same marker is indicated by multiplication signs, as in +marx2, +marx3, and so on (7). The use of FISH with chromosome paint probes to study marker chromosomes is illustrated in [Figure 4.13](#), and the use of spectral karyotyping to study marker chromosomes is illustrated in [Figure 4.14](#).



**Figure 4.13.** A metaphase spread showing the use of whole chromosome paints to confirm the origin of marker chromosomes. Chromosome 11 (*green*) is present as three intact chromosomes and as two translocation regions. Chromosome 20 (*red*) is seen as one intact chromosome and as a translocation region. See [Color Plate](#).



**Figure 4.14.** Spectral karyotype of a normal male cell (A) and of a cell with marker chromosomes (B). See [Color Plate](#).

## CONSTITUTIONAL VERSUS ACQUIRED CHROMOSOME CHANGES

Numerical and structural chromosomal abnormalities may be either constitutional or

acquired. *Constitutional chromosomal abnormalities* are abnormalities that are present in all or almost all cells in the body and exist at the earliest stage of embryogenesis. Acquired chromosomal abnormalities are abnormalities that develop in somatic cells, usually in association with malignant transformation.

The constitutional karyotype of 99% of people is normal ( [106](#) ). Constitutional chromosomal abnormalities may be associated with congenital genetic syndromes (e.g., trisomy 21 with Down syndrome) or may be normal variants that are not associated with somatic changes. The most common constitutional abnormality found in apparently normal patients is a pericentric inversion of chromosome 9,  $\text{inv}(9)(\text{p}11\text{q}13)$ , which is present in approximately 1% of the population. Other constitutional abnormalities include reciprocal translocations, pericentric inversions of chromosomes other than chromosome 9, and Robertsonian translocations ( [116](#) ). A constitutional abnormality is designated by *c* in a karyotype ( [7](#) ). For example, the karyotype of cells from a female with Down syndrome is  $47,\text{XX},+21\text{c}$ .

Blood samples are used to determine constitutional karyotypes. Peripheral blood lymphocytes are stimulated to divide by culturing them with the T-cell mitogen PHA. Blood cells are cultured for 72 or 96 hours in medium with fetal calf serum and PHA. The cells are then processed for cytogenetic analysis using a standard technique. To confirm that an abnormality is constitutional, PHA-stimulated lymphocytes may be studied either at the time of active disease or in remission. Constitutional abnormalities are also present in a patient's malignant cells, and, unlike acquired abnormalities associated with malignant transformation, they remain present when cytogenetic studies are performed after treatment of the malignancy (e.g., when remission bone marrow is studied after treatment of acute leukemia).

Acquired chromosomal abnormalities may develop in cells that previously had a normal karyotype or may develop as new changes in patients with constitutional chromosomal abnormalities. The karyotype  $47,\text{XX},+21$  designates an acquired trisomy 21 in female cells with a normal constitutional karyotype. In contrast,  $47,\text{XX},+21\text{c}$  describes a cell from a female with Down syndrome without acquired cytogenetic abnormalities. The karyotype  $47,\text{XX},\text{t}(8;21)(\text{q}22;\text{q}22),+21\text{c}$  would be that of a cell of a female with Down syndrome with an acquired  $\text{t}(8;21)(\text{q}22;\text{q}22)$ .

## CYTOGENETIC DEFINITION OF CLONALITY

Once acquired chromosomal abnormalities develop in a cell, the cell and its progeny may have a proliferative or a survival advantage, creating a clone, which is a cell population derived from a single progenitor cell. Cytogenetically, a *clone* is defined by a minimum of two mitotic cells with the gain of the same chromosome or with the same structural abnormality, or three mitotic cells with the loss of the same chromosome. Cytogenetic changes occurring in an insufficient number of cells to define a clone are considered to be random changes. Alternatively, if apparently random changes are ones that can be detected by FISH, FISH may be used to determine their frequency in larger numbers of metaphase spreads and in interphase cells.

## PRIMARY VERSUS SECONDARY ACQUIRED CHROMOSOME CHANGES

Acquired chromosomal abnormalities may be either primary or secondary. Primary cytogenetic abnormalities are aberrations that are often found as sole chromosomal changes in malignancies. Moreover, they are often associated with specific tumor types. Examples of primary cytogenetic abnormalities include  $\text{t}(8;21)(\text{q}22;\text{q}22)$  and  $\text{inv}(16)(\text{p}13\text{q}22)$  in AML,  $\text{t}(15;17)(\text{q}22;\text{q}11-21)$  in APL,  $\text{t}(9;22)(\text{q}34;\text{q}11)$  in CML, and  $\text{t}(8;14)(\text{q}24;\text{q}32)$  in Burkitt lymphoma. Secondary chromosomal abnormalities are changes

that generally occur not by themselves but in addition to primary changes. The chromosomes most commonly involved in secondary cytogenetic abnormalities in acute leukemia include 1, 5, 7, 8, 9, 21, 22, X, and Y ( [37](#) ). Secondary changes include del(5q), del(7q), -7, +8, del(9q), +21, +22, -X, and -Y. Secondary abnormalities associated with blast transformation of CML include +8, i(17q), +t(9;22)(q34), and +19, occurring in addition to t(9;22)(q34;q11). Development of i(17q) correlates with the loss of activity of the tumor-suppressor gene p53.

Primary cytogenetic abnormalities are changes that are thought to be associated with the pathogenesis of malignant transformation, whereas secondary chromosomal changes likely correlate with tumor progression. Some secondary changes, such as +8, occur in association with a variety of primary changes. Other secondary changes are associated with specific primary abnormalities. Examples include the association of del(9q), -X, and -Y with t(8;21). Thus, it appears that certain secondary changes may confer a proliferative or survival advantage to any cell, whereas others may confer an advantage only to cells with specific primary abnormalities. Trisomy 8 is an example of a chromosomal abnormality that may occur as either a primary or a secondary cytogenetic change.

The prognostic significance of secondary chromosomal abnormalities is unclear. Several studies have addressed the prognostic significance of secondary chromosomal abnormalities with t(15;17)(q22;q21) in APL ( [123](#) , [124](#) , and [125](#) ). Secondary chromosomal abnormalities are present in approximately one-third of APL patients. An adverse prognostic significance was demonstrated in one recent study ( [123](#) ) but not in two others ( [124](#) , [125](#) ). Secondary chromosomal abnormalities present at diagnosis may alter the prognosis of Ph<sup>+</sup> ALL, which has a poor prognosis ( [126](#) ). The presence of monosomy 7, in particular, as a secondary abnormality worsens the prognosis of Ph<sup>+</sup> ALL ( [126](#) , [127](#) ). The presence of secondary chromosomal abnormalities worsens the prognosis of Ph<sup>+</sup> CML ( [128](#) ).

## MOLECULAR CYTOGENETIC ANALYSIS OF CASES WITH NORMAL KARYOTYPES

Although AML, ALL, and MDS cases with normal karyotypes are categorized as having an intermediate response to treatment ( [175](#) , [176](#) and [177](#) , [187](#) ), treatment response and clinical course are actually heterogeneous. In AML, recurring molecular abnormalities have been identified that define subsets of karyotypically normal cases with adverse prognoses. These include internal tandem duplications of the FLT-3 and MLL genes and FLT-3 mutations ( [117](#) , [118](#) and [119](#) ).

Recent studies have applied spectral karyotyping and FISH with specific probes to the analysis of karyotypically normal cases. Using FISH with eight locus- and chromosome-specific probes, Cuneo et al. ( [129](#) ) did not find abnormalities in 55 adult *de novo* AML cases, but they found abnormalities in 8 (30%) of a group of 27 elderly patients with AML and patients with AML after MDS. Abnormalities included 5q31, 7q31, and 17p13/p53 deletions and trisomy 8. Using FISH with specific probes, Rigolin et al. ( [130](#) ) found abnormalities in 18 (18%) of 101 karyotypically normal MDS cases. Abnormalities included trisomy 8, del(5)(q31), del(7)(q31), monosomy 7, and del(17)(p13) and were an independent predictor of worse prognosis. Using spectral karyotyping, Zhang et al. ( [131](#) ) detected abnormalities in 2 (7%) of 28 karyotypically normal AML cases; the abnormalities included a cryptic 11q23 translocation and a minor monosomy 7 clone. Competitive genomic hybridization is currently being applied to the analysis of normal karyotypes.



These techniques are research tools; their clinical application has not been validated.

## CLINICAL APPLICATIONS OF CYTOGENETICS

### Diagnosis

The presence of a clonal chromosomal abnormality serves to establish the diagnosis of a clonal bone marrow disorder. Cytogenetic analysis is particularly helpful in the establishing the diagnosis of MDS in patients who present with mild cytopenias and in whom the bone marrow aspirate shows minimal or no dysplasia. Similarly, the presence of t(9;22) provides early confirmation of the diagnosis of CML in patients presenting with slight elevations of the granulocyte count.

### Classification

In contrast to the earlier French–American–British classification of hematologic malignancies, the more recent World Health Organization classification of neoplastic diseases of the hematopoietic and lymphoid tissues ([132](#)) considers cytogenetic analysis to be an essential element of the diagnostic evaluation of neoplastic diseases and incorporates cytogenetic findings into the definition of a number of subtypes. Specifically, the presence of t(8;21), inv(16), t(15;17), and 11q23 abnormalities serves to define distinct subsets of AML, and in the presence of t(8;21), inv(16), or t(15;17), the diagnosis of AML is made regardless of the percentage of marrow blasts. Similarly, isolated presence of del(5q) serves to define a distinct subset of MDS.

The presence of specific chromosomal abnormalities also serves to define disease entities that are amenable to specific therapies (see the section [Specific Therapies](#)). The prime example is the use of the t(15;17) to distinguish APL from other subtypes of AML. In the t(15;17)(q22; q11–12) in APL, the RAR- $\alpha$  gene from chromosome 17 is fused to the PML gene at 15q22, creating a hybrid PML/RAR- $\alpha$  gene that encodes an aberrant transcription factor that inhibits promyelocyte differentiation ([97](#), [98](#), [99](#), [100](#), [101](#), and [102](#)). Classic hypergranular APL is easy to distinguish on the basis of morphology, but hypogranular APL is more difficult to diagnose ([133](#)). Both hypergranular and hypogranular APL with t(15;17)(q22;q11–21) respond to induction therapy with all-*trans*-retinoic acid. The converse problem is the presence of classic APL morphology but the absence of the t(15;17) by conventional cytogenetic analysis ([134](#)). In a study of 60 such patients ([134](#)), molecular analyses revealed PML/RAR- $\alpha$  rearrangements in 42, presence of promyelocytic leukemia zinc finger/RAR- $\alpha$  rearrangements in 11, and t(5;17) in 2; only 5 had no evidence of RAR- $\alpha$  rearrangement. In t(11;17)(q23;q21), the RAR- $\alpha$  gene from chromosome 17 is fused to the promyelocytic leukemia zinc finger gene at 11q23, which encodes a transcription factor, rather than to the PML gene at 15q22. The ALL-1 or MLL gene at 11q23 is not involved. APL with t(11;17)(q23;q21) rather than t(15;17) is resistant to all-*trans*-retinoic acid induction therapy ([135](#), [136](#)).

The t(9;22)(q34;q11) translocation is present in the bone marrow and peripheral blood cells of approximately 95% of patients who are diagnosed with CML on the basis of their clinical presentation. Patients whose cells do not carry the translocation and in whom the corresponding gene rearrangement is not detected by molecular techniques have an atypical clinical picture, commonly with anemia, thrombocytopenia, or massive splenomegaly, and early disease acceleration and shorter survival ([137](#), [138](#) and [139](#)). Cases of chronic myeloid leukemia without the translocation should not be classified as CML, but rather as chronic myelomonocytic leukemias or atypical myeloproliferative syndromes. The presence of t(9;22) demonstrated by cytogenetic, molecular cytogenetic, or molecular biologic techniques also provides the data necessary for the decision to treat with



imatinib mesylate (Gleevec), the inhibitor of the bcr-abl tyrosine kinase ( [140](#), [141](#) and [142](#) ).

## Etiology

A variety of environmental and occupational exposures have been associated with an increased risk of AML, and there is a high frequency of cytogenetic abnormalities in these cases ( [143](#), [144](#), [145](#), [146](#), [147](#), [148](#), [149](#) and [150](#) ). Cytogenetic abnormalities associated with occupational exposure to organic solvents, petroleum products, and pesticides include -7, del(7q), and del(5q) ( [144](#), [145](#) and [146](#), [149](#) ). Smoking is associated with -7, del(7q), -Y, and +13 in AML and with t(9;22)(q34;q11) in ALL ( [150](#) ).

The incidence of clonal cytogenetic abnormalities in cases of AML in patients treated with chemotherapy or radiation therapy for prior malignancies (therapy-related AML) is very high, ranging from 75 to 90% in various series ( [151](#), [152](#) and [153](#) ). Abnormalities of chromosomes 5 or 7 are seen in most cases of leukemia in patients previously treated with alkylating agent-based chemotherapy regimens. del(5q), del(7q), or -7 has been detected in 72 to 83% of cases of AML in patients with Hodgkin disease, multiple myeloma, ovarian carcinoma, and other malignancies treated with regimens containing mechlorethamine, melphalan, nitrosoureas, or cyclophosphamide, with or without radiation therapy ( [153](#) ). t(3;21)(q26;q22) has also been reported as another recurring chromosomal abnormality associated with alkylating agent therapy ( [154](#) ).

Acute monocytic or myelomonocytic leukemias with cytogenetic abnormalities involving 11q23 are seen as cases of treatment-related leukemia associated with therapy with topoisomerase inhibitors, such as anthracyclines and epipodophyllotoxins, rather than alkylating agents ( [155](#), [156](#) and [157](#) ). These leukemias have developed after therapy for non-small cell carcinoma of the lung, small cell carcinoma of the lung, ovarian carcinoma, neuroblastoma, osteosarcoma, and ALL ( [155](#), [156](#) and [157](#) ). Development of AML with abnormalities of 11q23 is highly associated with epipodophyllotoxin therapy in patients with T-cell ALL; the cytogenetic findings at the time of development of AML differ from those seen at presentation of ALL ( [157](#) ). Like most *de novo* acute leukemias with 11q23 abnormalities, treatment-related acute leukemias with 11q23 abnormalities involve the ALL-1 gene, also called MLL or HRX ( [158](#), [159](#), [160](#) and [161](#) ).

Rare cases of acute leukemia that develop in patients treated with chemotherapy for prior malignancies have chromosomal abnormalities that are usually seen in *de novo* leukemia, such as t(8;21), inv(16), and t(15;17) ( [162](#), [163](#) ). Whereas treatment-related leukemias with abnormalities of 5, 7, or 11q23 have a poor prognosis, treatment-related leukemias with chromosomal abnormalities typically seen in *de novo* disease have a more favorable prognosis ( [162](#), [163](#) ).

## Prognosis

An extensive literature documents the prognostic significance of recurring chromosomal abnormalities in AML ( [164](#), [165](#), [166](#), [167](#), [168](#), [169](#), [170](#), [171](#), [172](#), [173](#), [174](#), [175](#) and [176](#) ), ALL ( [43](#), [47](#), [48](#), [49](#), [50](#), [51](#) and [52](#), [178](#), [179](#), [180](#), [181](#), [182](#), [183](#), [184](#), [185](#), [186](#) and [187](#) ), MDS ( [188](#), [189](#), [190](#) and [191](#) ), CML ( [128](#) ), CLL ( [192](#), [193](#) ), and non-Hodgkin lymphoma ( [194](#), [195](#), [196](#) and [197](#) ). The prognostic significance of recurring chromosomal abnormalities in each disease is detailed in the chapters devoted to each of these diseases in this book and is not reiterated here.

Recent studies have addressed the impact of these chromosomal abnormalities on

treatment outcome after allogeneic bone marrow transplantation for AML in first remission or at later times ( [175](#), [198](#), [199](#) and [200](#)). The chromosomal abnormalities that are prognostically unfavorable with respect to outcome of chemotherapy are also prognostically unfavorable with respect to outcome of transplantation.

## Assignment of Treatment

Because of the demonstrated prognostic significance of cytogenetic findings in acute leukemia ( [43](#), [47](#), [48](#), [49](#), [50](#), [51](#) and [52](#), [164](#), [165](#), [166](#), [167](#), [168](#), [169](#), [170](#), [171](#), [172](#), [173](#), [174](#), [175](#), [176](#), [177](#), [178](#), [179](#), [180](#), [181](#), [182](#), [183](#), [184](#), [185](#), [186](#) and [187](#)), they are in increasing use in guiding the management of acute leukemia patients. In particular, they guide the choice of postremission therapy. Patients with AML with the prognostically favorable abnormalities t(8;21) and inv(16) may be managed with chemotherapy rather than transplantation, with the expectation of prolonged disease-free survival and a high cure rate. Conversely, the presence in pretreatment marrow samples of chromosomal abnormalities that predict a low likelihood of long-term disease-free survival with chemotherapy-based treatment strategies is used as a basis for proceeding to bone marrow transplantation in first complete remission. Outcome for patients with unfavorable cytogenetics does appear to be improved by allogeneic stem cell transplantation ( [175](#)). In particular, treatment outcome for Ph<sup>+</sup> ALL patients is superior after allogeneic bone marrow transplantation, compared to the results of chemotherapy ( [201](#), [202](#)).

Given the importance of cytogenetic findings in acute leukemia for determining prognosis and guiding management, recent studies have sought to compare the sensitivity of molecular cytogenetic and molecular techniques to that of conventional cytogenetic analysis in detecting abnormalities. Cytogenetics and the reverse-transcriptase polymerase chain reaction are almost always concordant in the detection of t(8;21) and inv(16) ( [203](#)), although the t(8;21)-associated gene rearrangement may sometimes be detected in AML with a normal karyotype ( [204](#)). 11q23 abnormalities do not always involve the MLL gene, and the MLL gene may be rearranged in the absence of 11q23 chromosomal abnormalities ( [205](#)).

## Specific Therapies

The most striking aspect of recent progress in the therapy of hematologic malignancies is the development of specific therapies, targeting genetic abnormalities identified at the cytogenetic, molecular cytogenetic, or molecular level. All-*trans*-retinoic acid is an effective agent in the treatment of APL with t(15;17), but APL with t(11;17)(q23;q21) rather than t(15;17) is resistant to all-*trans*-retinoic acid induction therapy ( [135](#), [136](#)). Imatinib mesylate is a specific inhibitor of the BCR-ABL tyrosine kinase that has activity in Ph<sup>+</sup> CML and ALL ( [140](#), [141](#) and [142](#)). Imatinib mesylate also inhibits the platelet-derived growth factor and kit kinases and was recently shown to have activity in chronic myeloproliferative disorders with t(5;12)(q33;p13), in which rearrangement of the platelet-derived growth factor receptor  $\beta$  gene on chromosome 5q33 results in its constitutive activation ( [206](#)).

## Residual Disease

Cytogenetic analysis of remission bone marrow after therapy for acute leukemia generally shows the exclusive presence of normal metaphases ( [207](#), [208](#) and [209](#)). In one study, however, one or more abnormal metaphases identical to those present in pretreatment marrow were found in first remission marrow samples of 20 of 71 patients (28%), and all of

these patients subsequently relapsed, as compared to 50% of patients whose remission marrows did not show metaphases with chromosomal abnormalities that had been present in pretreatment marrow ( [210](#) ). Most recently, FISH has been found to detect residual disease in posttreatment samples ( [110](#) , [111](#) , [112](#) and [113](#) , [211](#) , [212](#) , [213](#) , [214](#) and [215](#) ). FISH can be used to evaluate both metaphase and interphase cells. In hypermetaphase FISH, cells are cultured with colchicine for 24 hours, producing large numbers of metaphases that are of insufficient quality to be evaluated by banding studies but are suitable for residual disease analysis by FISH ( [213](#) ).

## Engraftment

Cytogenetic techniques are used to monitor engraftment of donor cells and persistence or recurrence of host cells after sex-mismatched allogeneic bone marrow transplantation. FISH with probes for the X or Y chromosome allows efficient screening of large numbers of cells with respect to donor or host origin ( [216](#) , [217](#) , [218](#) and [219](#) ).

## CONCLUSION

Cytogenetic analysis has become increasingly sophisticated and has played a progressively larger role in the diagnosis and management of hematologic and lymphoid disorders over the last four decades. This role is expected to expand as a reflection of technical innovations that facilitate cytogenetic analysis and greater knowledge of the clinical and molecular implications of chromosomal abnormalities.

## REFERENCES

1. Tjio JH, Levan A. The chromosome number of man. *Hereditas* 1956;42:1-16.
2. Ford CE, Hamerton JL. The chromosomes of man. *Nature* 1956;178:1020-1023.
3. Lejeune J, Gautier M, Turpin MR. Etude des chromosomes somatiques de neuf enfants mongoliens. *CR Acad Sci (Paris)* 1959;248:1721-1722.
4. Jacobs PA, Strong JA. A case of human intersexuality having a possible XXY sex-determining mechanism. *Nature* 1959;183:302-303.
5. Ford CE, Miller OJ, Polani PE, et al. A sex-chromosome anomaly in a case of gonadal dysgenesis (Turner's syndrome). *Lancet* 1959;1:711-713.
6. Nowell PC, Hungerford DA. A minute chromosome in human chronic granulocytic leukemia. *Science* 1960;132:1497.
7. ISCN. An international system for human cytogenetic nomenclature. Mitelman F, ed. Switzerland: S Karger, 1995.
8. Capersson T, de la Chapelle S, Foley GE, et al. Chemical differentiation along metaphase chromosomes. *Exp Cell Res* 1968;49:219.
9. Caspersson T, Lomakka G, Zech L. The 24 fluorescence patterns of human metaphase chromosomes. Distinguishing characters and variability. *Hereditas* 1971;67:89-102.
10. Drets ME, Shaw MW. Specific banding patterns of human chromosomes. *Proc Natl Acad Sci U S A* 1971;68:2073-2077.
11. Rowley JD. A new consistent chromosomal abnormality in chronic myelogenous leukemia identified by quinacrine fluorescence and Giemsa staining. *Nature* 1973;243:290-293.

12. Rowley JD. Identification of a translocation with quinacrine fluorescence in a patient with acute leukemia. *Ann Genet* 1973;16:109–112.
13. Rowley JD, Golomb HM, Dougherty C. 15/17 translocation, a consistent chromosomal change in acute promyelocytic leukemia. *Lancet* 1977;1:549–550.
14. Yunis JJ. High resolution of human chromosomes. *Science* 1976;191:1268–1270.
15. Yunis JJ, Bloomfield CD, Ensrud K. All patients with acute nonlymphocytic leukemia may have a chromosomal defect. *N Engl J Med* 1981;305:135–139.
16. LeBeau MM, Larson RA, Bitter MA, et al. Association of an inversion of chromosome 16 with abnormal marrow eosinophils in acute myelomonocytic leukemia. *N Engl J Med* 1983;309:630–636.
17. Mitelman F. *Catalog of chromosome aberrations in cancer*, 5th ed. New York: Wiley–Liss, 1994.
18. Pinkel D, Straume T, Gray JW. Cytogenetic analysis using quantitative, high-sensitivity, fluorescence hybridization. *Proc Natl Acad Sci U S A* 1986;83:2934.
19. Cremer T, Landegent J, Bruckner A, et al. Detection of chromosome aberrations in the human interphase nucleus by visualization of specific target DNAs. *Hum Genet* 1986;74:346–352.
20. Guan XY, Meltzer PS, Trent JM. Rapid generation of whole chromosome painting probes (WCPs) by chromosome microdissection. *Genomics* 1994;101–107.
21. Kallioniemi A, Kallioniemi OP, Sudar D, et al. Comparative genomic hybridization for molecular cytogenetic analysis of solid tumors. *Science* 1992;258:818–821.
22. du Manoir S. Detection of complete and partial chromosome gains and losses by comparative genomic *in situ* hybridization. *Hum Genet* 1993;90:590–610.
23. Speicher MR, Ballard SG, Ward DC. Karyotyping human chromosomes by combinatorial multi-fluor FISH. *Nat Genet* 1996;12:368–375.
24. Schröck E, du Manoir S, Veldman T, et al. Multicolor spectral karyotyping of human chromosomes. *Science* 1996;273:494–497.
25. Sandberg AA. *The chromosomes in human cancer and leukemia*. New York: Elsevier Science, 1990.
26. Barch MJ, Knutson J, Spurbeck JC (eds). *The ACT Cytogenetics Laboratory Manual*, 3rd ed. New York: Raven Press, 1997.
27. Rooney DE, Czepulkowski BH. *Human cytogenetics: a practical approach*, 2nd ed. New York: Oxford University Press, 1992.
28. Wegner RD. *Diagnostic cytogenetics*. New York: Springer–Verlag New York, 1999.
29. Knuutila S, Vuopio P, Elonen E, et al. Culture of bone marrow reveals more cells with chromosomal abnormalities than the direct method in patients with hematologic disorders. *Blood* 1981;58:369–375.
30. Keinänen M, Knuutila S, Bloomfield CD, et al. The proportion of mitoses in different cell lineages changes during short-term culture of normal bone marrow. *Blood* 1986;67:1240–1243.
31. Keinänen M, Knuutila S, Bloomfield CD, et al. Bone marrow cytogenetics. The lineage of dividing cells changes during the first few hours in culture. *Leukemia* 1987;1:32–37.
32. Larson RA, Kondo K, Vardiman JW, et al. Evidence for a 15;17 translocation in every patient with acute promyelocytic leukemia. *Am J Med* 1984;76:827–841.
33. Fitzgerald PH, Morris CM, Giles LM. Direct versus cultured preparation of bone marrow cells from 22

patients with acute myeloid leukemia. *Hum Genet* 1982;60:281–283.

34. Block AMW. Cytogenetic analysis of B-cell chronic lymphoproliferative disorders: new technology, complexities and promises. *Prog Clin Biol Res* 1991;368:145–173.

35. Lai JL, Zandecki M, Mary JY, et al. Improved cytogenetics in multiple myeloma: a study of 151 patients including 117 patients at diagnosis. *Blood* 1995;85:2490–2497.

36. Hook EB. Exclusion of chromosomal mosaicism: tables of 90%, 95%, and 99% confidence limits and comments on use. *Am J Hum Genet* 1977;29:94–97.

37. Heim S, Mitelman F. *Cancer cytogenetics*. Second edition. Wiley-Liss, New York, 1995.

38. United Kingdom Cancer Cytogenetics Group. Loss of the Y chromosome from normal and neoplastic bone marrows. *Genes Chromosomes Cancer* 1992;5:83–88.

39. Riske CB, Morgan R, Ondreyco S, Sandberg AA. X and Y chromosome loss as sole abnormality in acute non-lymphocytic leukemia (ANLL). *Cancer Genet Cytogenet* 1994;72:44–47.

40. Groupe Français de Cytogénétique Hématologique. Acute myelogenous leukemia with an 8;21 translocation. A report on 148 cases from the Groupe Français de Cytogénétique Hématologique. *Cancer Genet Cytogenet* 1990;44:169–179.

41. Slovak ML, Traweek ST, Willman CL, et al. Trisomy 11: an association with stem/progenitor cell immunophenotype. *Br J Haematol* 1995;90:266–273.

42. Döhner H, Arthur DC, Ball ED, et al. Trisomy 13: a new recurring chromosome abnormality in acute leukemia. *Blood* 1990;76:1614–1621.

43. Pui CH, Crist WM, Look AT. Biology and clinical significance of cytogenetic abnormalities in childhood acute lymphoblastic leukemia. *Blood* 1990;76:1449–1463.

44. Caligiuri MA, Strout MP, Schichman SA, et al. Partial tandem duplication of ALL1 as a recurrent molecular defect in acute myeloid leukemia with trisomy 11. *Cancer Res* 1996;56:1418–1425.

45. Caligiuri MA, Strout MP, Oberkircher AR, et al. The partial tandem duplication of ALL1 in acute myeloid leukemia with normal cytogenetics or trisomy 11 is restricted to one chromosome. *Proc Natl Acad Sci U S A* 1997;94:3899–3902.

46. Diaz MO, LeBeau MM, Harden A, Rowley JD. Trisomy 8 in human hematologic neoplasia and the c-myc and c-mos oncogenes. *Leuk Res* 1985;9:1437–1442.

47. Groupe Français de Cytogénétique Hématologique. Cytogenetic abnormalities in adult acute lymphoblastic leukemia: correlations with hematologic findings and outcome. A collaborative study of the Groupe Français de Cytogénétique Hématologique. *Blood* 1996;87:3135–3142.

48. Pui CH, Carroll AJ, Raimondi SC, et al. Clinical presentation, karyotypic characterization, and treatment outcome of childhood acute lymphoblastic leukemia with a near-haploid or hypodiploid less than 45 line. *Blood* 1990;75:1170–1177.

49. Pui CH, Williams DL, Raimondi SC, et al. Hypodiploidy is associated with a poor prognosis in childhood acute lymphoblastic leukemia. *Blood* 1987;70:247–253.

50. Raimondi SC, Roberson PK, Pui CH, et al. Hyperdiploid (47–50) acute lymphoblastic leukemia in children. *Blood* 1992;79:3245–3252.

51. Pui CH, Raimondi SC, Dodge RK, et al. Prognostic importance of structural chromosomal abnormalities in children with hyperdiploid (50 chromosomes) acute lymphoblastic leukemia. *Blood* 1989;73:1963–1967.

52. Pui CH, Carroll AJ, Head D, et al. Near-triploid and near-tetraploid acute lymphoblastic leukemia of childhood. *Blood* 1990;76:590–596.

53. Anastasi J, Le Beau MM, Vardian JW, Westbrook CA. Detection of numerical chromosomal abnormalities in neoplastic hematopoietic cells by *in situ* hybridization with a chromosome-specific probe. *Am J Pathol* 1990;136:131-139.
54. Bentz M, Schroder M, Herz M, et al. Detection of trisomy 8 on blood smears using fluorescence *in situ* hybridization. *Leukemia* 1993;7:752-757.
55. van Lom K, Hagemeyer A, Smit EME, Lowenberg B. *In situ* hybridization on May-Grunwald Giemsa-stained bone marrow and blood smears of patients with hematologic disorders allows detection of cell-lineage-specific cytogenetic abnormalities. *Blood* 1993;82:884-888.
56. Kibbelaar RE, van Kamp H, Dreef EJ, et al. Combined immunophenotyping and DNA *in situ* hybridization to study lineage involvement in patients with myelodysplastic syndromes. *Blood* 1992;79:1823-1828.
57. Anastasi J, Le Beau MM, Vardian JW, et al. Detection of trisomy 12 in chronic lymphocytic leukemia by fluorescence *in situ* hybridization to interphase cells: a simple and sensitive method. *Blood* 1992;79:1796-1801.
58. Escudier SM, Pereira-Leahy JM, Drach JW, et al. Fluorescent *in situ* hybridization and cytogenetic studies of trisomy 12 in chronic lymphocytic leukemia. *Blood* 1993;81:2702-2707.
59. Drach J, Schuster J, Nowotny H, et al. Multiple myeloma: high incidence of chromosomal aneuploidy as detected by interphase fluorescence *in situ* hybridization. *Cancer Res* 1995;55:3854-3859.
60. Jenkins RB, Le Beau MM, Kraker WJ, et al. Fluorescence *in situ* hybridization: a sensitive method for trisomy 8 detection in bone marrow specimens. *Blood* 1992;79:3307.
61. Kibbelaar RE, Mulder JWR, Dreef EJ, et al. Detection of monosomy 7 and trisomy 8 in myeloid neoplasia: a comparison of banding and fluorescence *in situ* hybridization. *Blood* 1993;82:904-913.
62. Johansson B, Mertens F, Mitelman F. Cytogenetic deletion maps of hematological neoplasms: circumstantial evidence for tumor suppressor loci. *Genes Chromosomes Cancer* 1993;8:205-218.
63. Boulwood J, Rack K, Kelly S, et al. Loss of both CSF1R (FMS) alleles in patients with myelodysplasia and a chromosome 5 deletion. *Proc Natl Acad Sci U S A* 1991;88:6176-6180.
64. Le Beau MM, Espinosa R, Neuman WL, et al. Cytogenetic and molecular genetic delineation of the smallest commonly deleted region of chromosome 5 in malignant myeloid diseases. *Proc Natl Acad Sci U S A* 1993;90:5484-5488.
65. Willman C, Sever CE, Pallavicini MG, et al. Deletion of IRF-1, mapping to chromosome 5q31.1, in human leukemia and preleukemic myelodysplasia. *Science* 1993;259:968-971.
66. Diaz MO, Rubin CM, Harden A, et al. Deletions of interferon genes in acute lymphoblastic leukemia. *N Engl J Med* 1990;322:77-82.
67. Einhorn S, Grandér D, Björk O, et al. Deletion of  $\alpha$ -,  $\beta$ -, and  $\gamma$ -interferon genes in malignant cells from children with acute lymphocytic leukemia. *Cancer Res* 1990;50:7781-7785.
68. Hansen MF, Morgan R, Sandberg AA, Cavenee WK. Structural alterations at the putative retinoblastoma locus in some human leukemias and preleukemia. *Cancer Genet Cytogenet* 1990;49:15-23.
69. Hayashi Y, Raimondi SC, Look AT, et al. Abnormalities of the long arm of chromosome 6 in childhood acute lymphoblastic leukemia. *Blood* 1990;76:1626-1630.
70. Mertens F, Johansson B, Mitelman F. Isochromosomes in neoplasia. *Genes Chromosomes Cancer* 1994;10:221-230.
71. Ahuja H, Bar-Eli M, Arlin Z, et al. The spectrum of molecular alterations in the evolution of chronic myelocytic leukemia. *J Clin Invest* 1991;87:2042-2047.

72. Feinstein E, Cimino G, Gale RP, et al. p53 in chronic myelogenous leukemia in acute phase. *Proc Natl Acad Sci U S A* 1991;88:6293–6297.
73. Fenaux P, Jonveaux P, Quiquandon I, et al. p53 gene mutations in acute myeloid leukemia with 17p monosomy. *Blood* 1991;78:1652–1657.
74. Lai JL, Preudhomme C, Zandecki M, et al. Myelodysplastic syndromes and acute myeloid leukemia with 17p deletion. An entity characterized by specific dysgranulopoiesis and a high incidence of p53 mutations. *Leukemia* 1995;9:370–381.
75. Pui CH, Carroll AJ, Raimondi SC, et al. Isochromosomes in childhood acute lymphoblastic leukemia: a collaborative study of 83 cases. *Blood* 1992;79:2384–2391.
76. Beverstock GC, de Meijer PHEM, ten Bokkel Huinink D, et al. A case of iso-dicentric 7p as sole abnormality in a patient with acute myeloid leukemia. *Cancer Genet Cytogenet* 1996;89:132–135.
77. Zech L, Godal T, Hammarström L, et al. Specific chromosome markers involved with chronic T lymphocyte tumors. *Cancer Genet Cytogenet* 1986;21:67–77.
78. Matutes E, Brito-Babapulle V, Swansbury J, et al. Clinical and laboratory features of 78 cases of T-prolymphocytic leukemia. *Blood* 1991;78:3269–3274.
79. Liu P, Tarle SA, Hajra A, et al. Fusion between transcription factor CBFβ/PEBP2B and a myosin heavy chain in acute myeloid leukemia. *Science* 1993;261:1041–1044.
80. Raimondi SC, Frestedt JL, Pui CH, et al. Acute lymphoblastic leukemias with deletion of 11q23 or a novel inversion (11)(p13q23) lack *MLL* gene rearrangements and have favorable clinical features. *Blood* 1995;86:1881–1886.
81. Haferlach T, Winkermann M, Löffler H, et al. The abnormal eosinophils are part of the leukemic cell population in acute myelomonocytic leukemia with abnormal eosinophils (AML M4Eo) and carry the pericentric inversion 16: a combination of May-Grunwald-Giemsa staining and fluorescence *in situ* hybridization. *Blood* 1996;87:2459–2463.
82. Rabbitts TH. Chromosomal translocations in human cancer. *Nature* 1994;372:143–149.
83. Heisterkamp N, Stephenson JR, Groffen J, et al. Localization of the c-abl oncogene adjacent to a translocation breakpoint in chronic myelocytic leukaemia. *Nature* 1983;306:239–242.
84. Groffen J, Stephenson JR, Heisterkamp N, et al. Philadelphia chromosome breakpoints are clustered within a limited region, bcr, on chromosome 22. *Cell* 1984;36:93–99.
85. Shtivelman E, Lifshitz B, Gale RP, Canaani E. Fused transcript of abl and bcr genes in chronic myelogenous leukemia. *Nature* 1985;315:550–554.
86. Muller AJ, Young JC, Pendergast AM, et al. BCR first exon sequences specifically activate the BCR/ABL tyrosine kinase oncogene of Philadelphia chromosome-positive human leukemias. *Mol Cell Biol* 1991;11:1785–1792.
87. Daley GQ, Van Etten RA, Baltimore D. Induction of chronic myelogenous leukemia in mice by the P210bcr/abl gene of the Philadelphia chromosome. *Science* 1990;247:824–830.
88. Hagemeijer A, Bartram CR, Smit EME, et al. Is the chromosomal region 9q34 always involved in variants of the Ph1 translocation? *Cancer Genet Cytogenet* 1984;13:1–16.
89. Morris CM, Rosman I, Archer SA, et al. A cytogenetic and molecular analysis of five variant Philadelphia translocations in chronic myeloid leukemia. *Cancer Genet Cytogenet* 1988;35:179–197.
90. Dubé I, Dixon J, Beckett T, et al. Location of breakpoints within the major breakpoint cluster region (*bcr*) in 33 patients with *bcr*-rearrangement-positive chronic myeloid leukemia (CML) with complex or absent Philadelphia chromosomes. *Genes Chromosomes Cancer* 1989;1:106–111.



91. Tosi S, Cabot G, Giudici G, et al. Detection of the breakpoint cluster region-ABL fusion in chronic myeloid leukemia with variant Philadelphia chromosome translocations by *in situ* hybridization. *Cancer Genet Cytogenet* 1996;81:1-4.
92. Erickson P, Gao J, Chang KS, et al. Identification of breakpoints in t(8;21) acute myelogenous leukemia and isolation of a fusion transcript, AML1/ETO, with similarity to a drosophila segmentation gene, runt. *Blood* 1992;80:1825-1831.
93. Meyers S, Downing JR, Hiebert SW. Identification of AML-1 and the (8;21) translocation protein (AML-1/ETO) as sequence specific DNA-binding proteins: the runt homology domain is required for DNA binding and protein-protein interactions. *Mol Cell Biol* 1993;13:6336-6345.
94. Cimino G, Nakamura T, Gu Y, et al. An altered 11-kilobase transcript in leukemic cell lines with the t(4;11)(q21;q23) chromosome translocation. *Cancer Res* 1992;52:3811-3813.
95. Corral J, Forster A, Thompson S, et al. Acute leukemias of different lineages have similar MLL gene fusions encoding related chimeric proteins resulting from chromosomal translocation. *Proc Natl Acad Sci U S A* 1993;90:8538-8542.
96. Thirman MJ, Gill HJ, Burnett RC, et al. Rearrangement of the *MLL* gene in acute lymphoblastic and acute myeloid leukemias with 11q23 chromosomal translocations. *N Engl J Med* 1993;329:909-914.
97. Alcalay M, Zangrilli D, Pandolfi PP, et al. Translocation breakpoint of acute promyelocytic leukemia lies within the retinoic acid receptor a locus. *Proc Natl Acad Sci U S A* 1991;88:1977-1981.
98. De The H, Chomienne C, Lanotte M, et al. The t(15;17) translocation of acute promyelocytic leukaemia fuses the retinoic acid receptor a gene to a novel transcribed locus. *Nature* 1990;347:558-561.
99. De The H, Lavau C, Marchio A, et al. The PML-RARa fusion mRNA generated by the t(15;17) translocation in acute promyelocytic leukemia encodes a functionally altered RAR. *Cell* 1991;66:675-684.
100. Kakizuka A, Miller WH, Umesono K, et al. Chromosomal translocation t(15;17) in human acute promyelocytic leukemia fuses RARa with a novel putative transcription, PML. *Cell* 1991;66:663-674.
101. Longo L, Pandolif PP, Biondi A, et al. Rearrangements and aberrant expression of the retinoic acid receptor a gene in acute promyelocytic leukemias. *J Exp Med* 1990;172:1571-1575.
102. Grignani F, Ferrucci PF, Testa U, et al. The acute promyelocytic leukemia-specific PML-RARa fusion protein inhibits differentiation and promotes survival of myeloid precursor cells. *Cell* 1993;74:423-431.
103. Croce CM, Nowell PC. Molecular basis of human B cell neoplasia. *Blood* 1985;65:1-14.
104. Erikson J, Finger L, Sun L, et al. Deregulation of c-myc by translocation of the a-locus of the T-cell receptor in T-cell leukemias. *Science* 1986;232:884-886.
105. Lee MS. Molecular aspects of chromosomal translocation t(14;18). *Semin Hematol* 1993;30:297-305.
106. Tawn ET, Earl R. The frequencies of constitutional chromosome abnormalities in an apparently normal adult population. *Mutat Res* 1992;283:69-73.
107. Fan YS, Baer MR, Jani Sait S, et al. An acquired Robertsonian translocation in a patient with a myelodysplastic syndrome following treatment of multiple myeloma. *Cancer Genet Cytogenet* 1988;30:133-137.
108. Tkachuk DC, Westbrook CA, Andreeff M, et al. Detection of *bcr-abl* fusion in chronic myelogenous leukemia by *in situ* hybridization. *Science* 1990;250:559-562.
109. Sacchi N, Magnani I, Kearney L, et al. Interphase cytogenetics of the t(8;21)(q22;q22) associated with acute myelogenous leukemia by two-color fluorescence *in situ* hybridization. *Cancer Genet Cytogenet* 1995;79:97-103.
110. Zhao L, Kantarjian H, Van Oort J, et al. Detection of residual proliferating cells by fluorescence *in*

*in situ* hybridization in CML patients in complete remission after interferon treatment. *Leukemia* 1993;7:168–171.

111. El-Rifai W, Ruutu T, Vetterranta K, et al. Minimal residual disease after allogeneic bone marrow transplantation for chronic myeloid leukemia: a metaphase–FISH study. *Br J Haematol* 1996;92:365–369.

112. Zhao L, Chang KS, Estey EH, et al. Detection of residual leukemic cells in patients with acute promyelocytic leukemia by the fluorescence *in situ* hybridization method: potential for predicting relapse. *Blood* 1995;85:495–499.

113. El-Rifai W, Ruutu T, Vetterranta K, et al. Follow-up of residual disease using metaphase–FISH in patients with acute lymphoblastic leukemia in remission. *Leukemia* 1997;11:633–638.

114. Huret JL, Heerema NA, Brizard A, et al. Two additional cases of t(9;12) in acute lymphocytic leukemia (ALL): prognosis in ALL with dic(9;12). *Leukemia* 1990;4:423–425.

115. UKCCG–United Kingdom Cancer Cytogenetics Group. Translocations involving 9p and/or 12p in acute lymphoblastic leukemia. *Genes Chromosomes Cancer* 1992;5:255–259.

116. Rieder H, Schnittger S, Bodenstern H, et al. dic(9;20): a new recurrent chromosome abnormality in adult acute lymphoblastic leukemia. *Genes Chromosomes Cancer* 1995;13:54–61.

117. Dohner K, Tobis K, Ulrich R, et al. Prognostic significance of partial tandem duplications of the MLL gene in adult patients 16 to 60 years old with acute myeloid leukemia and normal cytogenetics: a study of the Acute Myeloid Leukemia Study Group Ulm. *J Clin Oncol* 2002;20:3254–3261.

118. Schnittger S, Schoch C, Dugas M, et al. Analysis of FLT3 length mutations in 1003 patients with acute myeloid leukemia: correlation to cytogenetics, FAB subtype, and prognosis in the AMLCG study and usefulness as a marker for the detection of minimal residual disease. *Blood* 2002;100:59–66.

119. Frohling S, Schlenk RF, Breitruck J, et al. Prognostic significance of activating FLT3 mutations in younger adults (16 to 60 years) with acute myeloid leukemia and normal cytogenetics: a study of the AML Study Group Ulm. *Blood* 2002;100:4372–4380.

120. Slovak ML, Ho JP, Pettenati MJ, et al. Localization of amplified MYC gene sequences to double minute chromosomes in acute myelogenous leukemia. *Genes Chromosomes Cancer* 1994;9:62–67.

121. Streubel B, Valent P, Jäger U, et al. Amplification of the MLL gene on double minutes, a homogeneously staining region, and ring chromosomes in five patients with acute myeloid leukemia or myelodysplastic syndrome. *Genes Chromosomes Cancer* 2000;27:380–386.

122. Sait SNJ, Qadir MU, Conroy JM, et al. Double minute chromosomes in acute myeloid leukemia and myelodysplastic syndrome: identification of new amplification regions by fluorescence *in situ* hybridization and spectral karyotyping. *Genes Chromosomes Cancer* 2002;34:42–47.

123. Hiorns LR, Swansbury GJ, Mehta J, et al. Additional chromosome abnormalities confer worse prognosis in acute promyelocytic leukaemia. *Br J Haematol* 1997;96:314–321.

124. Schoch C, Haase D, Haferlach T, et al. Incidence and implication of additional chromosome aberrations in acute promyelocytic leukemia with translocation t(15;17)(q22;q21): a report on 50 patients. *Br J Haematol* 1996;94:493–500.

125. Slack JL, Arthur DC, Lawrence D, et al. Secondary cytogenetic changes in acute promyelocytic leukemia: prognostic importance in patients treated with chemotherapy alone and association with the intron 3 breakpoint of the PML gene. A Cancer and Leukemia Group B study. *J Clin Oncol* 1997;15:1786–1795.

126. Rieder H, Ludwig WD, Gassmann W. Prognostic significance of additional chromosome abnormalities in adult patients with Philadelphia chromosome positive acute lymphoblastic leukaemia. *Br J Haematol* 1996;95:678–691.

127. Russo C, Carroll A, Kohler S, et al. Philadelphia chromosome and monosomy 7 in childhood acute lymphoblastic leukemia: a Pediatric Oncology Group study. *Blood* 1991;77:1050–1056.

128. Sokal JE, Gomez GA, Baccarini M, et al. Prognostic significance of additional cytogenetic abnormalities at diagnosis of Philadelphia chromosome-positive chronic granulocytic leukemia. *Blood* 1988;72:294-298.
129. Cuneo A, Bigoni R, Cavazzini F, et al. Incidence and significance of cryptic chromosome aberrations detected by fluorescence *in situ* hybridization in acute myeloid leukemia with normal karyotype. *Leukemia* 2002;16:1745-1751.
130. Rigolin GM, Bigoni R, Milani R, et al. Clinical importance of interphase cytogenetics detecting occult chromosome lesions in myelodysplastic syndromes with normal karyotype. *Leukemia* 2001;15:1841-1847.
131. Zhang FF, Murata-Collins JL, Gaytan P, et al. Twenty-four-color spectral karyotyping reveals chromosome aberrations in cytogenetically normal acute myeloid leukemia. *Genes Chromosomes Cancer* 2000;28:318-328.
132. Harris NL, Jaffe ES, Diebold J, et al. World Health Organization classification of neoplastic diseases of the hematopoietic and lymphoid tissues: report of the Clinical Advisory Committee meeting-Airlie House, Virginia, November 1997. *J Clin Oncol* 1999;17:3835-3849.
133. Golomb HM, Rowley JD, Vardiman JW, et al. "Microgranular" acute promyelocytic leukemia: a distinct clinical, ultrastructural and cytogenetic entity. *Blood* 1980;55:253-259.
134. Grimwade D, Biondi A, Mozziconacci MJ, et al. Characterization of acute promyelocytic leukemia cases lacking the classic t(15;17): results of the European Working Party. Groupe Francais de Cytogenetique Hematologique, Groupe de Francais d'Hematologie Cellulaire, UK Cancer Cytogenetics Group and BIOMED 1 European Community-Concerted Action "Molecular Cytogenetic Diagnosis in Haematological Malignancies." *Blood* 2000;96:1297-1308.
135. Guidez F, Huang W, Tong JH, et al. Poor response to all-trans retinoic acid therapy in a t(11;17) PLZF/RARa patient. *Leukemia* 1994;8:312-317.
136. Licht JD, Chomienne C, Goy A, et al. Clinical and molecular characterization of a rare syndrome of acute promyelocytic leukemia associated with translocation (11;17). *Blood* 1995;85:1083-1094.
137. Fitzgerald PH, Beard MEJ, Morris CM, et al. Ph-negative chronic myeloid leukemia. *Br J Haematol* 1987;66:311-314.
138. Kurzrock R, Kantarjian HM, Shtalrid M, et al. Philadelphia chromosome-negative chronic myelogenous leukemia without breakpoint cluster region rearrangement: a chronic myeloid leukemia with a distinct clinical course. *Blood* 1990;75:445-452.
139. Dobrovic A, Morley AA, Seshadri R, Januszewicz EH. Molecular diagnosis of Philadelphia negative CML using the polymerase chain reaction and DNA analysis: clinical features and course of M-bcr negative and M-bcr positive CML. *Leukemia* 1991;5:187-190.
140. Druker BJ, Sawyers CL, Kantarjian H, et al. Activity of a specific inhibitor of the BCR-ABL tyrosine kinase in the blast crisis of chronic myeloid leukemia and acute lymphoblastic leukemia with the Philadelphia chromosome. *N Engl J Med*. 2001;344:1038-1042.
141. Druker BJ, Talpaz M, Resta DJ, et al. Efficacy and safety of a specific inhibitor of the BCR-ABL tyrosine kinase in chronic myeloid leukemia. *N Engl J Med* 2001;344:1031-1037.
142. Ottmann OG, Druker BJ, Sawyers CL, et al. A phase 2 study of imatinib in patients with relapsed or refractory Philadelphia chromosome-positive acute lymphoid leukemias. *Blood* 2002;100:1965-1971.
143. Mitelman F, Nilsson PG, Brandt L, et al. Chromosome pattern, occupation, and clinical features in patients with acute nonlymphocytic leukemia. *Cancer Genet Cytogenet* 1981;4:197-214.
144. Mitelman F, Brandt L, Nilsson P. Relation among occupational exposure to potential mutagenic/carcinogenic agents, clinical findings, and bone marrow chromosomes in acute nonlymphocytic leukemia. *Blood* 1978;52:1229-1237.
145. Golomb HM, Alimena G, Rowley JD, et al. Correlation of occupation and karyotype in adults with

acute nonlymphocytic leukemia. *Blood* 1982;60:404–411.

146. Fourth International Workshop on Chromosomes in Leukemia. The correlation of karyotype and occupational exposure to potential mutagenic/carcinogenic agents in acute nonlymphocytic leukemia. *Cancer Genet Cytogenet* 1984;11:326–331.

147. Sandler DP, Collman GW. Cytogenetic and environmental factors in the etiology of the acute leukemias in adults. *Am J Epidemiol* 1987;126:1017–1032.

148. Crane MM, Keating MJ, Trujillo JM, et al. Environmental exposure in cytogenetically defined subsets of acute nonlymphocytic leukemia. *JAMA* 1989;262:634–639.

149. Cuneo A, Fagioli F, Pazzi I, et al. Morphologic, immunologic and cytogenetic studies in acute myeloid leukemia following occupational exposure to pesticides and organic solvents. *Leuk Res* 1992;16:789–796.

150. Sandler DP, Shore DL, Anderson JR, et al. Cigarette smoking and risk of acute leukemia: associations with morphology and cytogenetic abnormalities in bone marrow. *J Natl Cancer Inst* 1993;85:1994–2003.

151. Bloomfield CD. Chromosome abnormalities in secondary myelodysplastic syndromes. *Scand J Hematol* 1986;45:82–90.

152. Kantarjian HM, Keating MJ, Walters RS, et al. Therapy-related leukemia and myelodysplastic syndrome: clinical, cytogenetic, and prognostic features. *J Clin Oncol* 1986;4:1748–1757.

153. Pedersen-Bjergaard J, Philip P, Larsen SO, et al. Chromosome aberrations and prognostic factors in therapy-related myelodysplasia and acute myeloid leukemia. *Blood* 1990;76:1083–1091.

154. Rubin CM, Larson RA, Anastasi J, et al. t(3;21)(q26;q22): a recurring chromosomal abnormality in therapy-related myelodysplastic syndrome and acute myeloid leukemia. *Blood* 1990;76:2594–2598.

155. Pedersen-Bjergaard J, Philip P, Ravn V, et al. Therapy-related acute non-lymphocytic leukemia of FAB type M4 or M5 with early onset and t(9;11)(p21;q23) or a normal karyotype: a separate entity? *J Clin Oncol* 1988;6:395–397.

156. Ratain MJ, Kaminer LS, Bitran JD, et al. Acute nonlymphocytic leukemia following etoposide and cisplatin combination chemotherapy for advanced non-small-cell carcinoma of the lung. *Blood* 1987;70:1412.

157. Pui CH, Behm FG, Raimondi SC, et al. Secondary acute myeloid leukemia in children treated for acute lymphoid leukemia. *N Engl J Med* 1989;321:136–142.

158. Gill-Super H, McCabe N, Thirman M, et al. Rearrangement of the MLL gene in therapy-related acute myeloid leukemia in patients previously treated with agents targeting DNA-topoisomerase II. *Blood* 1993;82:3705–3711.

159. Hunger S, Tkachuk D, Amylon M, et al. HRX involvement in *de novo* and secondary leukemias with diverse chromosome 11q23 abnormalities. *Blood* 1993;81:3197–3202.

160. Felix C, Hosler M, Winick N, et al. ALL-1 gene rearrangements in DNA topoisomerase II inhibitor-related leukemia in children. *Blood* 1995;85:3250–3256.

161. Domer PH, Head DR, Renganathan N, et al. Molecular analysis of 13 cases of MLL/11q23 secondary acute leukemia and identification of topoisomerase II consensus-binding sequences near the chromosomal breakpoint of a secondary leukemia with the t(4;11). *Leukemia* 1995;9:1305–1312.

162. Fenaux P, Lucidarme D, Lai JL, Bauters F. Favorable cytogenetic abnormalities in secondary leukemia. *Cancer* 1989;63:2505–2508.

163. Quesnel B, Kantarjian H, Pedersen-Bjergaard J, et al. Therapy-related acute myeloid leukemia with t(8;21), inv(16), and t(8;16): a report on 25 cases and review of the literature. *J Clin Oncol* 1993;11:2370–2379.

164. Fourth International Workshop on Chromosomes in Leukemia. Clinical significance of chromosomal

- abnormalities in acute non-lymphocytic leukemia. *Cancer Genet Cytogenet* 1984;11:332-350.
165. Berger R, Bernheim A, Ochoa-Noguera ME, et al. Prognostic significance of chromosomal abnormalities in acute nonlymphocytic leukemia: a study of 343 patients. *Cancer Genet Cytogenet* 1987;28:293-299.
166. Keating MJ, Smith TL, Kantarjian H, et al. Cytogenetic pattern in acute myelogenous leukemia: a reproducible determinant of outcome. *Leukemia* 1988;2:403-412.
167. Samuels BL, Larson RA, LeBeau MM, et al. Specific chromosomal abnormalities in acute nonlymphocytic leukemia correlate with drug susceptibility *in vivo*. *Leukemia* 1988;2:79-83.
168. Yunis JJ, Lobell M, Arnesen MA, et al. Refined chromosome study helps define prognostic subgroups in most patients with primary myelodysplastic syndrome and acute myelogenous leukaemia. *Br J Haematol* 1988;68:189-194.
169. Fenaux P, Preudhomme C, Lai JL, et al. Cytogenetics and their prognostic value in *de novo* acute myeloid leukemia: a report on 283 cases. *Br J Haematol* 1989;73:61-67.
170. Arthur DC, Berger R, Golomb HM, et al. The clinical significance of karyotype in acute myelogenous leukemia. *Cancer Genet Cytogenet* 1989;40:203-216.
171. Schiffer CA, Lee EJ, Tomiyasu T, et al. Prognostic impact of cytogenetic abnormalities in patients with *de novo* acute nonlymphocytic leukemia. *Blood* 1989;73:263-270.
172. Dastugue N, Payen C, Lafage-Pochitaloff M, et al. Prognostic significance of karyotype in *de novo* adult acute myeloid leukemia. *Leukemia* 1995;9:1491-1498.
173. Kalwinsky DK, Raimondi SC, Schell MJ, et al. Prognostic importance of cytogenetic subgroups in *de novo* pediatric acute nonlymphocytic leukemia. *J Clin Oncol* 1990;8:75-83.
174. Martinez-Climent JA, Lane NJ, Rubin CM, et al. Clinical and prognostic significance of chromosomal abnormalities in childhood acute myeloid leukemia *de novo*. *Leukemia* 1995;9:95-101.
175. Slovak ML, Kopecky KJ, Cassileth PA, et al. Karyotypic analysis predicts outcome of preremission and postremission therapy in adult acute myeloid leukemia: a Southwest Oncology Group/Eastern Cooperative Oncology Group Study. *Blood* 2000;96:4075-4083.
176. Grimwade D, Walker H, Harrison G, et al. Medical Research Council Adult Leukemia Working Party. The predictive value of hierarchical cytogenetic classification in older adults with acute myeloid leukemia (AML): analysis of 1065 patients entered into the United Kingdom Medical Research Council AML11 trial. *Blood* 2001;98:1312-1320.
177. Byrd JC, Mrózek K, Dodge RK, et al. Pretreatment cytogenetic abnormalities are predictive of induction success, cumulative incidence of relapse, and overall survival in adult patients with *de novo* acute myeloid leukemia: results from Cancer and Leukemia Group B (CALGB 8461). *Blood* 2000;100:4325-4336.
178. Bloomfield CD, Secker-Walker LM, Goldman AI, et al. Six-year follow-up of the clinical significance of karyotype in acute lymphoblastic leukemia. *Cancer Genet Cytogenet* 1989;40:171-185.
179. Crist W, Carroll A, Shuster J, et al. Philadelphia chromosome positive childhood acute lymphoblastic leukemia: clinical and cytogenetic characteristics and treatment outcome. A Pediatric Oncology Group study. *Blood* 1990;76:489-494.
180. Fletcher JA, Lynch EA, Kimball VM, et al. Translocation (9;22) is associated with extremely poor prognosis in intensively treated children with acute lymphoblastic leukemia. *Blood* 1991;77:435-439.
181. Secker-Walker LM, Craig JM, Hawkins JM, et al. Philadelphia positive acute lymphoblastic leukemia in adults: age distribution, BCR breakpoint and prognostic significance. *Leukemia* 1991;5:196-199.
182. Westbrook CA, Hooberman AL, Spino C, et al. Clinical significance of the BCR-ABL gene in adult lymphoblastic leukemia: a Cancer and Leukemia Group B study (8762). *Blood* 1992;80:2983-2990.
183. Preti HA, O'Brien S, Giralt S, et al. Philadelphia chromosome-positive adult acute lymphocytic

- leukemia: characteristics, treatment results, and prognosis in 41 patients. *Am J Med* 1994;97:60–65.
184. Raimondi SC, Behm FG, Roberson PK, et al. Cytogenetics of pre-B-cell acute lymphoblastic leukemia with emphasis on prognostic implications of the t(1;19). *J Clin Oncol* 1990;8:1380–1388.
185. Crist WM, Carroll AJ, Shuster JJ, et al. Poor prognosis of children with pre-B acute lymphoblastic leukemia is associated with the t(1;19)(q23;p13): a Pediatric Oncology Group study. *Blood* 1990;76:117–122.
186. Pui CH, Frankel LS, Carroll AJ, et al. Clinical characteristics and treatment outcome of childhood acute lymphoblastic leukemia with the t(4;11)(q21;q23): a collaborative study of 40 cases. *Blood* 1991;77:440–447.
187. Wetzler M, Dodge RK, Mrozek K, et al. Prospective karyotype analysis in adult acute lymphoblastic leukemia: the Cancer and Leukemia Group B experience. *Blood* 1999;93:3983–3993.
188. Yunis JJ, Rydell RE, Oken MM, et al. Refined chromosome analysis as an independent prognostic indicator in *de novo* myelodysplastic syndromes. *Blood* 1986;67:1721–1730.
189. Billström R, Thiede T, Hansen S, et al. Bone marrow karyotype and prognosis in primary myelodysplastic syndromes. *Eur J Haematol* 1988;41:341–346.
190. Morel P, Hebbar M, Lai JL, et al. Cytogenetic analysis has strong independent prognostic value in *de novo* myelodysplastic syndromes and can be incorporated in a new scoring system: a report on 408 cases. *Leukemia* 1993;7:1315–1323.
191. Toyama K, Ohyashiki K, Yoshida Y, et al. Clinical implications of chromosomal abnormalities in 401 patients with myelodysplastic syndromes: a multicentric study in Japan. *Leukemia* 1993;7:499–508.
192. Han T, Henderson ES, Emrich LJ, Sandberg AA. Prognostic significance of karyotypic abnormalities in B cell chronic lymphocytic leukemia: an update. *Semin Hematol* 1987;24:257–263.
193. Juliusson G, Oscier DG, Fitchett M, et al. Prognostic subgroups in B-cell chronic lymphocytic leukemia defined by specific chromosomal abnormalities. *N Engl J Med* 1990;323:720–724.
194. Kristoffersson U, Heim S, Johnsson A, et al. Prognostic implication of cytogenetic findings in 106 patients with non-Hodgkin lymphoma. *Cancer Genet Cytogenet* 1987;25:55–64.
195. Levine EG, Arthur DC, Frizzera G, et al. Cytogenetic abnormalities predict clinical outcome in non-Hodgkin's lymphoma. *Ann Intern Med* 1988;108:14–20.
196. Schouten HC, Sanger WG, Weisenburger DD, et al. Chromosomal abnormalities in untreated patients with non-Hodgkin's lymphoma: associations with histology, clinical characteristics, and treatment outcome. *Blood* 1990;75:1841–1847.
197. Offit K, Wong G, Filippa DA, et al. Cytogenetic analysis of 434 consecutively ascertained specimens of non-Hodgkin's lymphoma: clinical correlations. *Blood* 1991;77:1508–1515.
198. Ferrant A, Doyen C, Delannoy A, et al. Karyotype in acute myeloblastic leukemia: prognostic significance in a prospective study assessing bone marrow transplantation in first remission. *Bone Marrow Transplant* 1995;15:685–690.
199. Gale RP, Horowitz MM, Weiner RS, et al. Impact of cytogenetic abnormalities on outcome of bone marrow transplants in acute myelogenous leukemia in first remission. *Bone Marrow Transplant* 1995;16:203.
200. Slovak ML, Kopecky KJ, Wolman SR, et al. Cytogenetic correlation with disease status and treatment outcome in advanced stage leukemia post bone marrow transplantation: a Southwest Oncology Group study (SWOG-8612). *Leuk Res* 1995;19:381–388.
201. Forman SJ, O'Donnell MR, Nademanee AP, et al. Bone marrow transplantation for patients with Philadelphia chromosome-positive acute lymphoblastic leukemia. *Blood* 1987;70:587–588.
202. Barrett AJ, Horowitz MM, Ash RC, et al. Bone marrow transplantation for Philadelphia

chromosome-positive acute lymphoblastic leukemia. *Blood* 1992;79:3067–3070.

203. Mrozek K, Prior TW, Edwards C, et al. Comparison of cytogenetic and molecular genetic detection of t(8;21) and inv(16) in a prospective series of adults with *de novo* acute myeloid leukemia: a Cancer and Leukemia Group B Study. *J Clin Oncol* 2001;19:2482–2492.

204. Sarriera JE, Albitar M, Estrov Z, et al. Comparison of outcome in acute myelogenous leukemia patients with translocation (8;21) found by standard cytogenetic analysis and patients with AML1/ETO fusion transcript found only by PCR testing. *Leukemia* 2001;15:57–61.

205. Ibrahim S, Estey EH, Pierce S, et al. 11q23 abnormalities in patients with acute myelogenous leukemia and myelodysplastic syndrome as detected by molecular and cytogenetic analyses. *Am J Clin Pathol* 2000;114:793–797.

206. Apperley JF, Gardembas M, Melo JV, et al. Response to imatinib mesylate in patients with chronic myeloproliferative diseases with rearrangements of the platelet-derived growth factor receptor beta. *N Engl J Med* 2002;347:481–487.

207. Testa JR, Mintz U, Rowley JD, et al. Evolution of karyotypes in acute nonlymphocytic leukemia. *Cancer Res* 1979;39:3619–3626.

208. Lawler SD, Summersgill B, Clink HM, McElwain TJ. Cytogenetic follow-up study of acute non-lymphocytic leukaemia. *Br J Haematol* 1980;44:395–405.

209. Hagemeyer A, Hählen K, Abels J. Cytogenetic follow-up of patients with nonlymphocytic leukemia. II. Acute nonlymphocytic leukemia. *Cancer Genet Cytogenet* 1981;3:109–124.

210. Freireich EJ, Cork A, Stass SA, et al. Cytogenetics for detection of minimal residual disease in acute myeloblastic leukemia. *Leukemia* 1992;6:500–506.

211. Nylund SJ, Ruutu T, Saarinen U, et al. Detection of minimal residual disease using fluorescence DNA *in situ* hybridization: a follow-up study in leukemia and lymphoma patients. *Leukemia* 1994;8:587–594.

212. Nylund SJ, Ruutu T, Saarinen U, Knuutila S. Metaphase fluorescence *in situ* hybridization (FISH) in the follow-up of 60 patients with haematopoietic malignancies. *Br J Haematol* 1994;88:778.

213. Seong DC, Kantarjian HM, Ro JY, et al. Hypermetaphase fluorescence *in situ* hybridization for quantitative monitoring of Philadelphia chromosome-positive cells in patients with chronic myelogenous leukemia during treatment. *Blood* 1995;86:2343–2349.

214. Bernell P, Arvidsson I, Jacobsson B, Hast R. Fluorescence *in situ* hybridization in combination with morphology detects minimal residual disease in remission and heralds relapse in acute leukemia. *Br J Haematol* 1996;95:666–672.

215. El-Rifai W, Ruutu T, Elonen E, et al. Prognostic value of metaphase-fluorescence *in situ* hybridization in follow-up of patients with acute myeloid leukemia in remission. *Blood* 1997;89:3330–3334.

216. Wessman M, Ruutu T, Volin L, Knuutila S. *In situ* hybridization using a Y-specific probe: a sensitive method for distinguishing residual male recipient cells from female donor cells in bone marrow transplantation. *Bone Marrow Transplant* 1989;4:283–286.

217. Durnam DM, Anders KR, Fisher L, et al. Analysis of the origin of marrow cells in bone marrow transplant recipients using a Y-chromosome-specific *in situ* hybridization assay. *Blood* 1989;74:2220–2226.

218. Wessman M, Popp S, Ruutu T, et al. Detection of residual host cells after bone marrow transplantation using non-isotopic *in situ* hybridization and karyotype analysis. *Bone Marrow Transplant* 1993;11:279–284.

219. Nagler A, Slavin S, Yarkoni S, et al. Detection of minimal residual disease after sex-mismatch bone marrow transplantation in chronic myelogenous leukemia by fluorescence *in situ* hybridization. *Cancer Genet Cytogenet* 1994;73:130–133.



John P. Greer, John Foerster, John N. Lukens  
George M. Rodgers, Frixos Paraskevas, Bertil Glader  
Wintrobe's Clinical Hematology

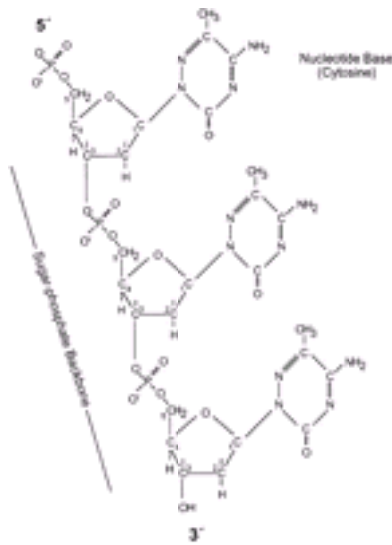
**BASIC PRINCIPLES**[DNA Chemistry and Structure](#)[From Chromosomes to Genes](#)[Genomic Diversity](#)[Pathologic Changes in the Genome](#)**GENE DISCOVERY AND MOLECULAR ANALYSIS**[Restriction Enzymes and Vectors](#)[Molecular Cloning](#)[Isolation of Genes without Prior Knowledge of Sequence](#)[Genomics](#)**MOLECULAR DIAGNOSTICS**[Southern Blot Analysis](#)[Northern Blot Analysis](#)[In Situ Hybridization](#)[Microarray Analysis](#)[Polymerase Chain Reaction](#)**ANALYSIS OF GENE FUNCTION****ACKNOWLEDGMENTS****REFERENCES****BASIC PRINCIPLES**

Current practice in hematology has been profoundly influenced by advances in molecular biology. These have produced an understanding of disease at the most fundamental level, had a tremendous impact on diagnostic capabilities, and led to a large number of recombinant proteins for therapy. The contribution that hematology has played in the development of this knowledge has been significant. The thalassemias, for example, were the first genetic disorders analyzed with the tools of molecular biology, and current knowledge of genomic organization and transcriptional control has come in part through studies of the  $\beta$ -globin gene cluster. Further, a hematologic disorder, sickle cell anemia, was the first for which a molecular description was obtained, and the initial attempt at human gene therapy involved hematopoietic cells from patients with an inherited immunodeficiency.

**DNA Chemistry and Structure**

The human genome is comprised of  $3.1 \times 10^9$  base (3.1 gigabase) pairs of DNA packaged into 23 pairs of chromosomes. Less than 2% actually encodes proteins, with the remainder believed to regulate DNA replication, transcriptional activity, attachment to the nuclear matrix, and packaging (1). The deoxyribonucleotide building blocks of DNA are covalently joined by phosphodiester bonds linking the fifth carbon on one pentose ring (5') to the third carbon on the adjacent pentose ring (3') (Fig. 5.1). This configuration imparts a directionality to each polynucleotide chain, with the double helical structure of DNA resulting from pairing of strands that run in opposite, or antiparallel, directions. The energy underlying their interaction comes from interstrand base pairing between adenine (A) and thymine (T), involving two hydrogen bonds, and guanine (G) and cytosine (C), mediated by three hydrogen bonds. The two strands form a right-handed helix with a

major and a minor groove.



**Figure 5.1.** Structure of DNA. DNA is comprised of two complementary polynucleotide chains, each possessing a sugar–phosphate backbone in which the 5' position of one pentose ring is linked by a phosphodiester bond to the 3' position of the adjacent base. Sequence shown here is CCC.

Messenger RNA (mRNA) transcribed from DNA specifies an amino acid sequence through a series of base pair triplets, or codons ( [Table 5.1](#)). This type of protein–coding mechanism has two important features. First, its degeneracy, with almost every amino acid represented by several codons, minimizes the effect of DNA mutation by reducing the probability that any single base change will produce an amino acid substitution. Second, although the code is translated in nonoverlapping triplets from a fixed starting point, three translational reading frames potentially exist for each nucleotide sequence. Thus, insertion or deletion of a single base alters the amino acid sequence encoded from that point and, in some cases, results in synthesis of a truncated protein product.

|                     |         | Second Base Position |     |     |         |         |     |     |         |         |     |     |         |         |     |     |     |
|---------------------|---------|----------------------|-----|-----|---------|---------|-----|-----|---------|---------|-----|-----|---------|---------|-----|-----|-----|
|                     |         | U                    |     |     | C       |         |     | A   |         |         | G   |     |         |         |     |     |     |
| First Base Position | U       | UUU                  | UUC | UUA | UUG     | UUU     | UUC | UUA | UUG     | UUU     | UUC | UUA | UUG     | UUU     | UUC | UUA | UUG |
|                     |         | Phe (6)              |     |     |         | Phe (6) |     |     |         | Phe (6) |     |     |         | Phe (6) |     |     |     |
|                     |         | UUU                  | UUC | UUA | UUG     | UUU     | UUC | UUA | UUG     | UUU     | UUC | UUA | UUG     | UUU     | UUC | UUA | UUG |
|                     |         | Phe (6)              |     |     |         | Phe (6) |     |     |         | Phe (6) |     |     |         | Phe (6) |     |     |     |
| C                   | CUU     | CUC                  | CUA | CUG | CUU     | CUC     | CUA | CUG | CUU     | CUC     | CUA | CUG | CUU     | CUC     | CUA | CUG |     |
|                     | Leu (6) |                      |     |     | Leu (6) |         |     |     | Leu (6) |         |     |     | Leu (6) |         |     |     |     |
|                     | CUU     | CUC                  | CUA | CUG | CUU     | CUC     | CUA | CUG | CUU     | CUC     | CUA | CUG | CUU     | CUC     | CUA | CUG |     |
|                     | Leu (6) |                      |     |     | Leu (6) |         |     |     | Leu (6) |         |     |     | Leu (6) |         |     |     |     |
| A                   | AUU     | AUC                  | AUA | AUG | AUU     | AUC     | AUA | AUG | AUU     | AUC     | AUA | AUG | AUU     | AUC     | AUA | AUG |     |
|                     | Ile (3) |                      |     |     | Ile (3) |         |     |     | Ile (3) |         |     |     | Ile (3) |         |     |     |     |
|                     | AUU     | AUC                  | AUA | AUG | AUU     | AUC     | AUA | AUG | AUU     | AUC     | AUA | AUG | AUU     | AUC     | AUA | AUG |     |
|                     | Ile (3) |                      |     |     | Ile (3) |         |     |     | Ile (3) |         |     |     | Ile (3) |         |     |     |     |
| G                   | GUU     | GUC                  | GUA | GUG | GUU     | GUC     | GUA | GUG | GUU     | GUC     | GUA | GUG | GUU     | GUC     | GUA | GUG |     |
|                     | Val (4) |                      |     |     | Val (4) |         |     |     | Val (4) |         |     |     | Val (4) |         |     |     |     |
|                     | GUU     | GUC                  | GUA | GUG | GUU     | GUC     | GUA | GUG | GUU     | GUC     | GUA | GUG | GUU     | GUC     | GUA | GUG |     |
|                     | Val (4) |                      |     |     | Val (4) |         |     |     | Val (4) |         |     |     | Val (4) |         |     |     |     |

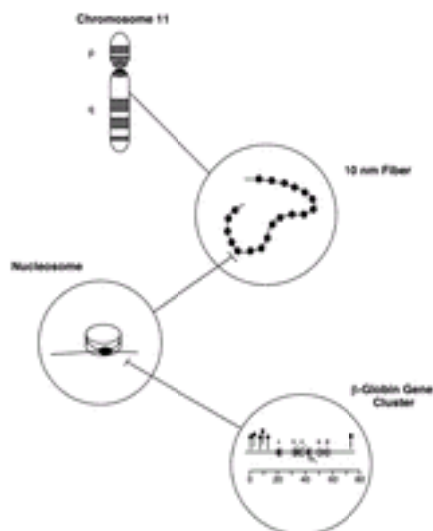
**TABLE 5.1. Genetic Code**

### From Chromosomes to Genes

Before the development of molecular–based methods to characterize DNA structure, light microscopy revealed that the human genome is packaged into 46 chromosomes. Each chromosome, present as a pair, is unequally divided by a centromere into short and long arms, designated *p* and *q*, respectively. It was also recognized that the chromosomes

were not uniform in appearance and that their distinctive banding patterns could be used to resolve specific pairs. With further refinements in staining technique, recurring abnormalities were recognized in the complement of chromosomes, or *karyotype*, of malignant cells. In fact, the first specific cytogenetic abnormality associated with a human neoplasm came from analysis of blasts of patients with chronic myelogenous leukemia (2). The association between the Philadelphia chromosome, named for the city in which it was discovered, and this disease provided one of the earliest indications of the clonal nature of cancer.

Even the smallest human chromosome contains more than  $5 \times 10^7$  base pairs, which, if fully extended, would stretch some 1.4 cm. Because the average nucleus is microns in diameter, the cell compacts these large DNA molecules into a protein-bound form termed *chromatin*. The fundamental unit of chromatin is the *nucleosome*, which is comprised of a short stretch of DNA associated with highly basic histone proteins acting in part to neutralize the negative charge of the nucleic acid. Two copies each of histones H2A, H2B, H3, and H4 make up a protein octamer core around which the DNA is wrapped. Nucleosomes are separated by less highly protein-bound linker DNA that varies in length from 8 to 114 base pairs. As a result of this organization, a 10-nm chromatin fiber is formed whose appearance under electron microscopy has been likened to beads on a string. In turn, the 10-nm fiber is coiled into a 30-nm fiber possessing approximately six nucleosomes per turn. In addition to histones, there are nonhistone proteins associated with chromatin that function in DNA packing, replication, and transcription. The end result is that chromatin contains up to twice as much protein as DNA (Fig. 5.2).



**Figure 5.2.** Genomic organization from the gene to the chromosome. DNA complexed with histones and nonhistone proteins is packaged into a highly organized structure whose core unit is the nucleosome. As a result of this organization, a 10-nm chromatin fiber is evident on electron microscopy that resembles beads on a string. This is assembled into a chromosome, each of which possesses a short (*p*) and long (*q*) arm. Transcriptionally active regions of DNA are less protein-bound and show hypersensitivity to digestion with

DNase I. These DNase I hypersensitive sites are denoted in the bottom panel by



An additional challenge in genomic organization comes in copying the ends, or *telomeres*, of chromosomes. Because DNA polymerases are unable to replicate the termini of DNA

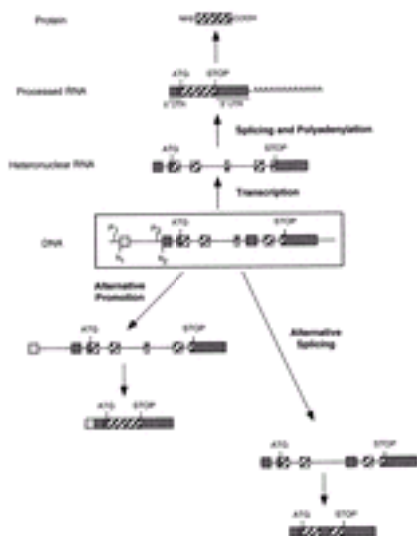
molecules, long stretches of a tandemly repeated sequence, 5'-TTAGGG-3' in humans, are maintained in this region to ensure that essential subtelomeric genes are not deleted during DNA replication. The number of these repeats decreases with every somatic cell division, whereas, with some important exceptions (3), telomere length is maintained by the action of an unusual RNA-dependent DNA polymerase, telomerase, in cells that become immortalized or transformed.

The structure of the genome is dynamic, with some regions only transiently complexed with protein. Transcribed DNA is known to have an altered structure as evidenced by an increased sensitivity to cleavage with the enzyme deoxyribonuclease (DNase) I. This DNase hypersensitivity is also a property of origins of replication and centromeres. The DNA-binding affinity of histones can be altered by acetylation, and recent work has revealed that certain transcriptional coactivators possess histone acetyltransferase activity.

The small fraction of the human genome that encodes proteins shows the most complex organization, as exemplified by the globin genes. In the adult, the tetrameric hemoglobin A molecule is comprised of two nonidentical  $\alpha$ - and  $\beta$ -chains. The human  $\alpha$ -globin genes are located on chromosome 16, whereas the  $\beta$ -globin genes are clustered on chromosome 11. The  $\beta$ -globin gene cluster actually contains five functional genes ( $\epsilon$ , G $\gamma$ , A $\gamma$ ,  $\delta$ , and  $\beta$ ) spanning over 50 kilobase pairs of DNA (Fig. 5.2). Each gene contains protein-coding segments, or *exons*, which are interrupted by sequences, *introns*, that must be removed from the transcribed mRNA before translation. In addition, each contains a promoter and other regulatory regions upstream of its transcriptional start site essential for its proper expression. This organization is illustrated diagrammatically in Figure 5.2.

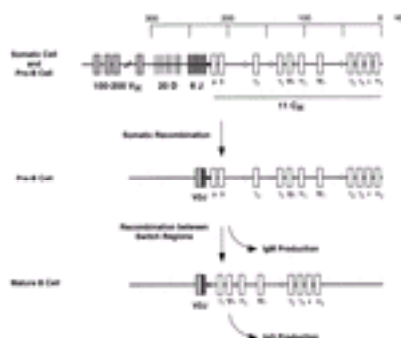
## Genomic Diversity

The early view of the genome of one gene encoding one protein was upset by the discovery of introns in 1977 (4, 5). It soon became apparent that multiple proteins could be derived from a single gene either through utilization of multiple promoters or an "exon shuffling" mechanism in which different exons are spliced in or out of the transcribed RNA. These processes are illustrated schematically in Figure 5.3. The amino acid sequence of the encoded protein is thus necessarily altered when exons are substituted, added, or deleted. In addition, even when the coding region is unaffected, the abundance of a protein can be altered as a result of changes in the rate of transcription or in the stability of the transcribed mRNA.



**Figure 5.3.** Generation of multiple proteins from a single gene: alternative splicing and alternative promotion. After transcription, heteronuclear RNA is processed by removal of the noncoding introns (splicing) and by addition of a polyadenylic acid tail (polyadenylation). This processed or messenger form of RNA is then translated into protein in the cytoplasm of the cell. Translation begins at a start codon (ATG) and terminates at one of several possible stop codons, leaving regions of the RNA 5' and 3' to the coding region untranslated (UTR). Variation in RNA and, consequently, protein sequence can occur if there is more than one promoter or if portions of the protein coding regions (exons) are differentially incorporated into the final, processed form of RNA.

A further level of complexity exists for the antigen-receptor genes, those encoding T-cell receptors and immunoglobulins, in which somatic recombination accompanies immune cell differentiation ( Fig. 5.4) ( 6 ). The class to which an immunoglobulin belongs is specified by the type of heavy chain gene used in its synthesis— $\mu$ ,  $\alpha$ ,  $\delta$ , and  $\epsilon$ . Each heavy chain contains  $N$ -terminal variable ( $V_H$ ) and  $C$ -terminal constant ( $C_H$ ) regions encoding the variable and constant domains of the immunoglobulin molecule, respectively. The constant domain is invariant for every antibody of a given type, whereas the variable domain, which is subdivided into three hypervariable regions, is responsible for antigen recognition and binding. The heavy chain also contains a hinge region important for the characteristic Y shape of the assembled molecule.



**Figure 5.4.** Intrachromosomal gene rearrangement: somatic recombination in the immunoglobulin (Ig) heavy chain locus. The Ig heavy chain is generated by the joining of a single V gene to a D segment, which is fused to a J gene. This process of somatic recombination occurs in the immature B cell. VDJ-joining triggers expression of the  $C_\mu$

gene. Ig class switching occurs through further recombination involving switch regions, designated by the open and closed circles.

The genes that encode the antigen receptors are present as discrete, noncontiguous segments distributed over large distances at their particular chromosomal locations. The immunoglobulin heavy chain locus, for example, is comprised of at least two megabase pairs of DNA on chromosome 14 and includes more than 100 V genes, each with its own leader sequence and promoter region, at least 12 functional diversity (or D) genes, six functional joining (or J) genes, and nine functional C genes. Additional nontranscribed versions of each of these, termed *pseudogenes*, also exist. Each V gene contains two exons, and each C gene contains multiple exons, corresponding to the constant, hinge, and transmembrane domains, and cytoplasmic tail.

To assemble a functional heavy chain molecule, intrachromosomal gene rearrangements join selected V, D, and J genes, following which the recombined VDJ locus is fused to a specific C gene. As a result of these events, the arrangement of DNA in a B cell that produces a specific immunoglobulin molecule becomes distinct from that of all other somatic or germ cells, and up to 38,880 (or  $60 \times 12 \times 6 \times 9$ ) different heavy chains can be generated by this mechanism alone. Further variability is introduced by addition of nucleotides at the junctions between segments, by alternative splicing of the mRNA, and, in the immunoglobulin—but not T-cell-receptor genes—by somatic mutation. In this way, the organism becomes capable of mounting an immune response of extraordinary specificity.

Somatic recombination represents a specialized strategy to achieve genomic diversity. In the germline, recombination is accomplished by meiosis. Interchromosomal exchange of DNA occurs in this process as the result of the two copies of each chromosome coming into register. The crossing-over events facilitated by this mechanism cause a shuffling but, normally, no loss of genetic information. The greater the distance between two genes, the higher the probability that they will become separated after meiosis, whereas genes in such proximity that they consistently cosegregate are said to be *linked*. In addition to meiosis, random mutation can alter DNA sequence, both in coding and noncoding regions. If not deleterious, these sequence polymorphisms are inherited and in this way increase genetic diversity.

### Pathologic Changes in the Genome

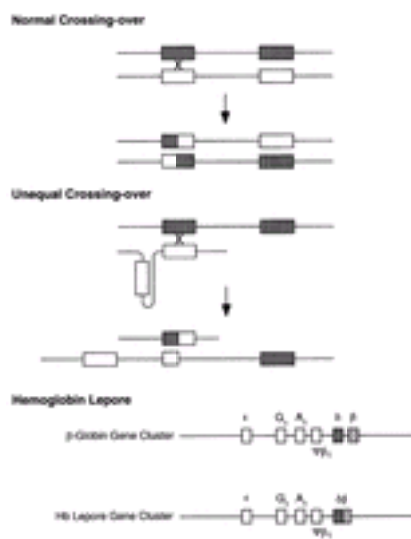
The processes that promote genomic diversity are also prone to error. These are manifested as translocations of chromosomal segments, deletions, insertions, or inversions of smaller regions, or mutations of individual nucleotides. The proteins affected may be altered in their expression or have diminished or even novel function. Burkitt lymphoma, thalassemia, and sickle cell disease are specific examples of disorders resulting from pathologic alterations in the genome.

Even under normal circumstances, it is estimated that only one in three lymphoid progenitor cells productively rearranges its antigen-receptor genes and successfully develops into a mature lymphocyte. If rearrangement occurs between rather than within chromosomes, as in Burkitt lymphoma, a cell may obtain a growth or survival advantage. The endemic form of Burkitt lymphoma is associated with a translocation of the *c-myc* protooncogene on chromosome 8 to the immunoglobulin heavy chain locus on chromosome 14 so that it is effectively decapitated and fused to the  $J_H$  gene promoter. In other patients, the *c-myc* locus is brought under the regulatory control of the powerful immunoglobulin enhancer. Both types of translocations cause unscheduled or



dysregulated expression of c-myc protein.

The thalassemias provide another example of hematologic illness with a genetic basis. The underlying defect in this group of diseases lies in the synthesis rather than the sequence of the globin protein made. Hemoglobin (Hb) Lepore is particularly illustrative of the errors that occur when there is unequal crossing-over between nonallelic members of a gene cluster, which in this case differ in sequence by only 7% overall. This nonreciprocal rearrangement generates recombinant chromosomes in which one has a duplication and the other a deletion of the sequences between the genes involved, effectively fusing them together. The protein ultimately synthesized contains *N*-terminal sequence derived from the  $\delta$ -globin gene and *C*-terminal sequence from the  $\beta$ -globin gene. The unequal crossing-over events believed to cause this form of thalassemia are illustrated in [Figure 5.5](#).



**Figure 5.5.** Mutation resulting from abnormal crossing-over: hemoglobin (Hb) Lepore. Genetic recombination occurs physiologically during meiosis and requires precise alignment of the corresponding sequences in homologous chromosomes. Abnormal alignment can occur when there are two or more copies of homologous genes, as in the  $\beta$ -globin gene cluster. Hb Lepore likely results from this kind of misalignment, as illustrated.

Finally, disease can result from the substitution of even one base pair. This can effect an amino acid substitution, which changes the properties of the encoded protein, as illustrated by the sickle cell mutation, or a stop codon that terminates protein chain elongation (nonsense mutation). The first molecularly characterized disorder, sickle cell anemia, results from a missense mutation in the sixth codon of the  $\beta$ -globin gene, causing the substitution of the amino acid valine for glutamic acid (<sup>7</sup>) ([Fig. 5.6](#)). The abnormal Hb molecule resulting from this mutation shows a marked decrease in solubility when deoxygenated and becomes polymerized into ropelike fibers. These structures are responsible for the abnormal cell shape characteristic of this disease and the hemolytic and vasoocclusive phenomena that produce its clinical manifestations. At least 300 other point mutations in the  $\alpha$ - or  $\beta$ -globin genes have also been described.



**Figure 5.6.** Mutation resulting from base substitution: hemoglobin S (sickle hemoglobin). Hemoglobin S results from a homozygous A to T transversion in codon 6 of the human  $\beta$ -globin gene, causing the substitution of valine (Val) for glycine (Gly) in the resulting protein. Glu, glutamic acid; Pro, proline.

## GENE DISCOVERY AND MOLECULAR ANALYSIS

### Restriction Enzymes and Vectors

Molecular analysis of hematologic disease has been greatly facilitated by the use of a number of powerful techniques and the knowledge of gene structure and expression gained from their application. A pivotal discovery was that of *restriction enzymes*, endonucleases that cut double-stranded DNA at specific sequences. By reducing the genome to experimentally manipulable pieces, or *restriction fragments*, these enzymes made it possible to clone and propagate genes. Restriction endonucleases recognize specific four- to eight-base pair sequences that in many cases are palindromic, or have the same order of bases read from either strand. *EcoRI*, for example, recognizes the sequence



and cleaves between G and A with the creation of two new ends:



Although the DNA in this example is left with overhanging ends, other enzymes can generate blunt ends, depending on their recognition sequence. Since the discovery of the first restriction enzyme in 1970, hundreds have been characterized and made commercially available ([8](#)).

In addition to restriction endonucleases, a variety of other nucleic acid-modifying enzymes are used in preparing recombinant DNA. One of the more commonly used is T4 DNA ligase, which catalyzes the formation of a phosphodiester bond between two free ends of DNA. The ends created by *EcoRI*, for example, can be rejoined by the action of this enzyme.

Another important tool of the molecular biologist is the *vector*. In its simplest form, it is the vehicle by which a foreign DNA molecule is introduced into bacteria, amplified, and ultimately purified. Standard vectors contain multiple restriction enzyme sites to simplify subcloning of DNA fragments, an antibiotic resistance gene for selection of cells that have taken up the vector, and a sequence (or origin) permitting replication in the bacterial host. Additional features allow some vectors to replicate in eukaryotic cells and serve as templates for *in vitro* transcription. Cells are rendered capable of taking up this or other forms of DNA by treatment with divalent cations or exposure to a pulsed electrical field. These methods are applicable to both prokaryotic and eukaryotic cells.

## Molecular Cloning

A frequent objective in molecular biology is the isolation of a gene or its mRNA, and a number of the techniques required for what is termed *molecular cloning* were pioneered for the globin genes. Depending on whether the nucleic acid of interest is DNA or RNA, the initial step in this process involves generating a genomic or complementary DNA (cDNA) library, respectively. For the former, the source of DNA is the entire genome, which is initially reduced to smaller fragments by restriction enzyme digestion. As many genes are interrupted by introns and span substantial distances, it is usually desirable to obtain large DNA fragments for this purpose. Their size is determined by the frequency with which a given restriction site occurs in the genome and the proportion of these sites actually cleaved by the enzyme. For example, genomic DNA is frequently digested for library construction with *Sau3AI*, which recognizes the sequence GATC. The frequency with which any specific four-base pair sequence occurs is  $1/4 \times 1/4 \times 1/4 \times 1/4$ , or  $1/256$ , so that complete digestion with *Sau3AI* would produce fragments that are, on average, 256 base pairs in length. The extent of digestion can be controlled, however, so that products in the range of 15 to 20 kilobase pairs can be produced. These are then introduced into a vector that can replicate in bacteria, typically one derived from bacteriophage  $\lambda$ . The complete collection of these fragments constitutes a genomic library.

The original source of nucleic acid for construction of a cDNA library is mRNA, which must first be converted to its corresponding DNA form by an RNA-dependent DNA polymerase (reverse transcriptase). Because mRNA in eukaryotic cells is polyadenylated, it is frequently purified with a homopolymeric thymidine [oligo(dT)] affinity resin. Either oligo(dT) or random hexanucleotides are used as primers for the enzyme, resulting in synthesis of a DNA/RNA hybrid. Ribonuclease H is used to digest the RNA component, followed by DNA polymerase to fill in the gaps, resulting in replacement of the RNA strand by its DNA counterpart. Next, T4 DNA ligase is added to join any regions still unlinked, and the ends of the newly synthesized cDNA are ligated to synthetic oligonucleotide linkers containing specific restriction enzyme sites. The resulting pool of clones subcloned into a vector constitutes the cDNA library.

Synthetic oligonucleotides, larger DNA fragments, or in some cases antibodies can be used for screening the library. If a portion of the protein-coding region is known, oligonucleotide mixtures encompassing all or the most likely nucleotide sequences can be synthesized based on this amino acid sequence. For the peptide sequence methionyl–glutamyl–threonyl–serine, for example, up to  $1 \times 2 \times 4 \times 6$ , or 48, different oligonucleotides might be used, as there is one codon for Met, two for Glu, four for Thr, and six for Ser. The cDNA from another species can also be used for screening if the corresponding sequence is conserved evolutionarily.

The conditions under which a nucleic acid probe is used to screen a library, as well as nucleic acid hybridization in general, are affected by the processes of DNA strand separation (denaturation) and renaturation. The temperature at which a molecule of DNA becomes denatured is dependent on the proportion of G + C and, to a lesser extent, by the number of A + T base pairs. For mammalian genomes with GC contents, typically, of 40% the temperature at which half their DNA denatures, or the *melting temperature* ( $T_m$ ), is approximately  $87^\circ \text{C}$ . The composition of DNA also dictates the  $T_m$  of smaller, double-stranded oligonucleotides and can be estimated from the following equation:

$$T_m = 2(A + T) + 3(G + C)$$

where  $A$ ,  $T$ ,  $G$ , and  $C$  represent the specific number of these nucleotides in the probe.

Renaturation is affected by DNA composition as well. The two strands of the DNA duplex base pair in their entirety. However, if two polynucleotides are mixed that are not completely complementary, both the  $T_m$  of the renatured molecule and its rate of reassociation are decreased in proportion to the mismatch between the two molecules. The process by which such molecules renature is termed *annealing* or, in an analytical context, *hybridization*. Hybridization can be carried out with nucleic acids in solution or immobilized on filters. For library screening, radioactive nucleotides are typically incorporated into the oligonucleotide or cDNA probe, and the bacterial colonies containing the desired clone are visualized with autoradiography.

### Isolation of Genes without Prior Knowledge of Sequence

Often there is insufficient information, particularly with disease-related genes, to permit the use of standard library screening techniques in molecular cloning. Using a combination of genetic and physical maps, it has proven possible to isolate genes from their location within the genome without prior knowledge of their sequence or function. This approach, termed *positional cloning*, relies on the segregation of a trait or disease over several generations of kindreds and uses the technique of linkage analysis to identify the gene's probable chromosomal location (9). This is followed by isolation and analysis of the genes from this region for mutations that cosegregate with the disease. The availability of the complete sequence of the human genome has greatly facilitated the application of this method.

The development of yeast artificial chromosome and, more recently, bacterial artificial chromosome vectors has played a major role in the development of this technology (10). It had proven difficult previously to incorporate fragments larger than 10 to 15 kilobase pairs into plasmid vectors, both because of the difficulties in generating large circular DNAs and because of their relatively inefficient uptake by bacterial cells. The use of yeast artificial chromosomes, which can accommodate fragments larger than 500 kilobase pairs, became possible after the *cis*-acting sequence elements required for chromosome stability in yeast were defined. This technology has also been applied to bacterial artificial chromosome vectors, which have proven particularly useful for sequence analysis of large DNA fragments. The utility of positional cloning strategies is borne out by the success in a number of genetic disorders in identifying the genes involved.

### Genomics

Knowledge of nucleotide sequence underlies all understanding of a gene's normal function, as well as how it might be altered in disease. The most common method for DNA sequence analysis is the *chain-termination method* developed by Sanger in which a DNA polymerase catalyzes the synthesis of new DNA strands of varying lengths, each originating with a specific oligonucleotide primer complementary to the single-stranded DNA template (11). Chain elongation is terminated at all possible positions by incorporation of a dideoxynucleotide triphosphate lacking a 3' hydroxyl group. In practice, four independent reactions are carried out with a mixture of deoxynucleotide triphosphates plus a limiting amount of one dideoxynucleotide triphosphate. The ratio of deoxynucleotides to dideoxynucleotides is adjusted to allow for incorporation of the dideoxynucleotide along the whole length of the molecule. The products of the four reactions are fractionated by size using denaturing polyacrylamide gel electrophoresis, and the DNA sequence is determined from an autoradiogram of the gel if a radiolabeled nucleotide is incorporated or by fluorography if fluorescent nucleotides are used. The

Sanger method is still widely used, although DNA sequence analysis has been made more amenable to automation and less expensive to carry out ( [12](#) ).

Once the nucleotide sequence of a gene is established, one of the first ways in which it is analyzed involves some type of computer-assisted database search ( [13](#) ). This can reveal whether the gene has previously been isolated, either in its full-length form or as an anonymous sequence, if homologs exist in other species, and, frequently, some indication of function. The GenBank database maintained at the National Center for Biotechnology Information of the National Library of Medicine contains all publicly available information on gene and protein sequences. User-friendly search engines, the most widely used being the Basic Local Alignment Search Tool, or BLAST ( [14](#) ), enable interrogation of the compiled database and are accessible over the World Wide Web ( <http://www.ncbi.nlm.nih.gov/> ).

As a result of a concerted effort worldwide, a draft sequence of the human genome was obtained in 2000, with over 90% available in its final form in September 2002 ( [15](#) ). Unexpectedly, a total of only 30,000 to 35,000 genes appear to be present in our genome, although, as a result of alternative splicing, this is sufficient to encode more than 100,000 proteins. It has also been found that protein-coding regions are unevenly distributed through the genome, with some chromosomes and chromosomal regions being more gene dense than others.

In addition, effort has been made to comprehensively sequence cDNAs, termed *expressed sequence tags*, from a number of different sources of RNA, and estimates indicate that more than half of all human genes are represented in the expressed sequence tag databases. The complete sequencing of the genomes of several model organisms has also been accomplished, including the 1.8-megabase pair genome of *Haemophilus influenzae*, the 1.66-megabase pair genome of *Methanococcus jannaschii*, and the 4.6-megabase pair genome of *Escherichia coli*.

## MOLECULAR DIAGNOSTICS

Molecular techniques have revolutionized the diagnosis of disease, particularly in inherited disorders. Two of the earliest applications of these methods were in the prenatal diagnosis of  $\alpha$ -thalassemia ( [16](#) ) and in identification of the causative mutations in  $\beta$ -thalassemia ( [17](#) ). Since that time, highly sensitive and specific techniques have been developed to analyze abnormalities in both RNA and DNA.

### Southern Blot Analysis

*Southern blot analysis*, named for its originator, E. M. Southern ( [18](#) ), enables the copy number, organization, and internal structure to be determined for any gene. The technique involves immobilization of nucleic acids on a filter as described above for library screening, except that total genomic DNA represents the target of the probe rather than a library of individual clones. Briefly, high-molecular-weight genomic DNA is treated, typically, with a panel of restriction enzymes, and the resulting digests are fractionated by agarose gel electrophoresis. These restriction fragments are denatured within the gel and transferred, or blotted, to a filter replica. The gene of interest is then identified by hybridization with a labeled probe and its structure analyzed from the hybridization patterns.

Although supplanted by the polymerase chain reaction (PCR) for most purposes, Southern blot analysis has been invaluable in diagnosis of a number of hematologic

disorders. The mutation in sickle cell anemia, for example, can be specifically recognized with this technique. Substitution of T for A in codon 6 of the  $\beta$ -globin gene in Hb S results in the loss of an *Mst*II restriction site as shown:

Hb ACCTGAGGAG  
Hb SCCTG 7GGAG  
*Mst*II CCTNAGG

As a result, the size of the hybridizing band in Southern blot analysis of *Mst*II-digested DNA differs for an individual with this mutation and one with a normal  $\beta$ -globin sequence.

A similar approach can also be used to determine genetic relatedness and to analyze the extent of chimerism after allogeneic bone marrow transplantation, although PCR has effectively replaced Southern blot analysis for both these applications. It was recognized that differences in nucleotide sequence can exist naturally between individuals, and provided they alter a restriction enzyme recognition site and a probe to the region is available, such restriction fragment length polymorphisms are detectable by Southern blot analysis. Southern blot analysis can also be carried out using probes for highly polymorphic regions consisting of tandemly repeated nucleotide units of 20 to 40 base pairs ( [19](#) ). The number of these variable number of tandem repeats varies between individuals as a result of recombination, resulting in unique bands on hybridization analysis.

### Northern Blot Analysis

Because mRNA is susceptible to alkaline hydrolysis and does not bind well untreated to nitrocellulose, Southern's method for DNA analysis could not be applied directly to mRNA. With the inclusion of a denaturant like glyoxal or formaldehyde in the gel, it became possible with what is now termed *Northern blot analysis* to similarly analyze RNA fractionated by agarose gel electrophoresis and transferred to a filter ( [20](#) ). Although it is infrequently used in diagnostics, an important attribute of this technique is its ability to quantitate the abundance of specific RNA species.

### *In Situ* Hybridization

Northern blot analysis relies on hybridization of a labeled probe to RNA immobilized on a solid support. By incubating the probe with specially prepared cells or tissue sections, information can also be obtained about the specific location and identity of the cell types that transcribe that mRNA. This technique, termed *in situ hybridization*, can be used for the localization of viruses or viral messages ( [21](#) ) in addition to cellular transcripts ( [22](#) ).

*In situ* hybridization can also be used to assign a gene to an individual chromosome and to localize it within a particular subchromosomal segment ( [23](#) ). If the DNA probe is biotinylated, avidin-conjugated fluorescent molecules can be used to amplify the hybridization signal in an application of the technique termed *fluorescent in situ hybridization* ( [24](#) ). The fluorescent *in situ* hybridization technique has been invaluable in detecting loss, gain, or rearrangement of specific chromosomal regions in tumor cells.

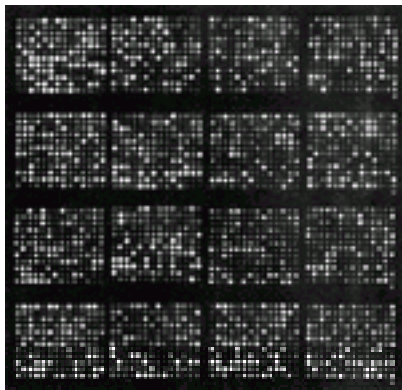
*Comparative genomic hybridization* is an adaptation of *in situ* hybridization in which a genome-wide analysis is carried out to identify regions with tumor-specific gains or losses ( [25](#) ). This technique involves hybridization of metaphase cell preparations with equal amounts of subject and reference DNA labeled with dyes that fluoresce in the red and green wavelengths. Regions that hybridize equally well with subject and reference



DNA appear yellow (red + green), whereas regions hybridized with under- or overrepresented DNA appear red or green.

### Microarray Analysis

An increasingly applied approach to characterizing gene expression uses nucleic acids spotted or stamped on inert supports, or *microarrays* ([26](#)). This microarray technique involves extraction of RNA from a biologic sample, its conversion to cDNA with incorporation of either fluorescent nucleotides or tags that can be detected later by fluorescence, hybridization of these labeled cDNAs to a very large number of cDNAs or oligonucleotides affixed to a glass slide or filter, and laser scanning of the hybridized array. A reference RNA is similarly processed but labeled with a different fluorochrome, and the two cDNA populations are mixed and competitively hybridized to the array. Spots appear yellow (red + green) if the subject and reference cDNAs hybridize equally and red or green if there is a difference in the abundance of one or the other cDNA ([Fig. 5.7](#)). The technique provides information on the abundance of as many different RNAs as there are unique cDNAs or oligonucleotides on the array, which can number in the tens of thousands. Microarray experiments generate a massive amount of data and require sophisticated informatic methods to extract biologically useful information ([27](#)).



**Figure 5.7.** Microarray analysis. Shown is a portion of a complementary DNA (cDNA) microarray that has been competitively hybridized with cDNA made from human leukemic cell RNA and labeled with the fluorochrome Cy3 and cDNA prepared from a pool of human RNAs (reference RNA) and labeled with a different fluorochrome, Cy5. Each spot corresponds to one of a total of 11,000 cDNAs affixed on this array. Its color (red, green, or yellow) on laser-scanning analysis provides information about the abundance of specific RNAs in the leukemic blasts. See [Color Plate](#).

Gene expression profiling has been used to identify the involvement of specific genes, microorganisms, or pathways in disease. Microarray analysis has, in addition, led to new, molecular-based classifiers for known diseases (class discovery) and for previously unclassified disorders (class prediction). In addition to their use in large-scale gene expression analysis, microarrays have been used to screen for genomic imbalances (array comparative genomic hybridization), small mutations, insertions, or deletions, and for single-nucleotide polymorphisms. Besides nucleic acids, array technologies are being developed for proteins, protein-binding molecules, and even small tissue sections.

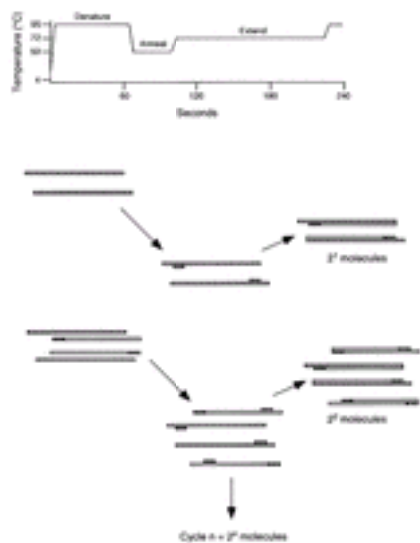
### Polymerase Chain Reaction

Although Southern blot analysis and, particularly, fluorescent *in situ* hybridization are



useful diagnostically, their application is largely restricted to circumstances in which there are sizeable deletions or rearrangements, and they are not generally useful for detecting small insertions, deletions, or base substitutions. PCR, first reported by Mullis and colleagues in 1986 (28), has been essential for this purpose and has found wide utility in numerous areas of cell and molecular biology.

PCR is, fundamentally, a method to amplify genomic or cDNA sequence. In its usual application, two oligonucleotides oriented in opposite directions and complementary to sequences at either end of the region of interest function as primers for a DNA polymerase in the manner described above for sequencing. A reaction mixture containing a DNA template, primers, and deoxynucleotide triphosphates is heated to a temperature of 94 to 95° C to effect DNA strand separation and then cooled to allow the oligonucleotides to anneal. Primer extension is effected at high temperature, typically 72° C, by inclusion of a heat-stable DNA polymerase, and these reactions, which comprise one complete cycle, are then repeated some 20 to 40 times. As a result of its exponential nature,  $2^n$  copies are generated of the sequence encompassed by the two primers, where  $n$  represents the total number of cycles carried out. The technique is extraordinarily sensitive and capable of detecting, for example, the presence of a single malignant cell within a million normal ones. PCR is outlined in schematic form in Figure 5.8.



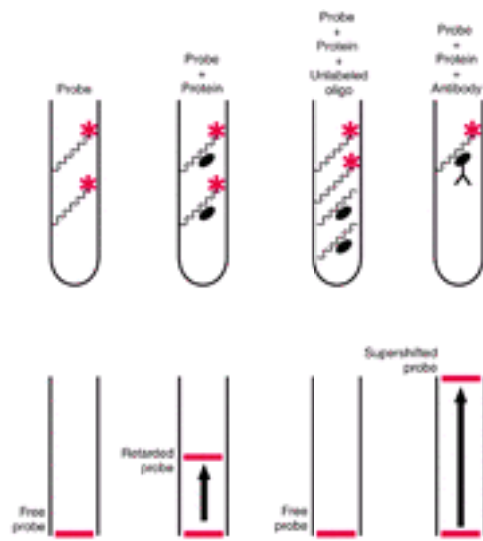
**Figure 5.8.** Polymerase chain reaction. The polymerase chain reaction is a method to exponentially amplify defined regions of DNA. The technique consists of a series of repeated steps (cycles) involving, in sequence, denaturation of the DNA target, binding (or annealing) of specific oligonucleotides (primers) complementary to the region of interest and delimiting the region to be amplified, and DNA synthesis (or extension) from the primers by the action of a heat-stable DNA polymerase. Denaturation, annealing, and extension are carried out at different temperatures (top) in a dedicated piece of equipment known as a *thermal cycler*. A total of two molecules are synthesized after the first cycle, four molecules after the second cycle, and  $2^n$  after  $n$  cycles, where  $n$  represents the total number of cycles.

PCR is often combined with other techniques, including some of those described earlier, to determine whether the amplification products contain a mutation. Although dideoxynucleotide sequencing can be carried out to confirm mutations, restriction enzyme digestion, allele-specific oligonucleotide hybridization, and single-strand conformation

polymorphism analysis represent more efficient methods to screen for their presence. The first approach takes advantage of the sequence specificity of restriction enzyme digestion and was illustrated in the example of sickle cell disease above. The approach is simplified and more widely applicable, however, if a short fragment of amplified DNA is analyzed rather than the entire genome. The second method involves hybridization of an allele-specific oligonucleotide to PCR product immobilized on a filter. Because the  $T_m$  of a short oligonucleotide is dependent on the extent of complementarity, conditions can be controlled so that only exact matches result in binding of a labeled probe to the DNA sample immobilized. In single-strand conformation polymorphism analysis, the DNA of interest is denatured by heat or alkali treatment and, with a control sample, subjected to electrophoresis in a nondenaturing polyacrylamide gel (29). The technique relies on a mutation affecting the secondary structure and thereby the electrophoretic mobility of either of the denatured strands relative to that of the control.

## ANALYSIS OF GENE FUNCTION

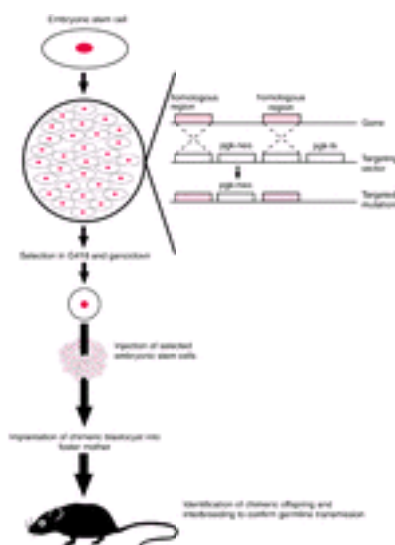
Clues to a gene's function are sometimes apparent from its amino acid sequence. The ability of transcription factors, a class of proteins essential for regulated gene expression and frequently targeted by leukemia-associated translocations, to act as sequence-specific DNA-binding proteins can be detected with the widely used *electrophoretic mobility shift assay*. In this technique, also referred to as a *gel* or *band shift assay*, short double-stranded oligonucleotides of defined sequence are labeled, typically radioactively, and mixed with purified transcription factor or nuclear extracts (30). The mixtures are fractionated electrophoretically under nondenaturing conditions, and if a protein-DNA complex formed, the mobility of the labeled probe is retarded (Fig. 5.9). Specificity is assured by the ability of unlabeled oligonucleotide to compete with the labeled probe for binding and by the elimination or further retardation ("supershift") of the labeled band by an antibody to a component of the complex.



**Figure 5.9.** Electrophoretic (or gel) mobility shift assay of DNA binding activity. A radiolabeled, double-stranded DNA probe is mixed (A) with putative DNA-binding protein in the form of purified protein or nuclear extract, and the resulting mixture is subjected to electrophoresis under nondenaturing conditions. Protein-DNA complexes are detected on an autoradiograph of the dried gel (B) as a result of retardation of the labeled probe. Specificity of binding is ensured by elimination of the retarded band by an excess of unlabeled probe in the binding mixture and by its elimination or further retardation ("supershift") by an antibody to the protein constituents of the binding complex.

Even when knowledge of a protein's actions is known, it may be desirable to determine its function within a cellular or even organismal context. Once the nucleotide sequence of a gene has been determined, it is often possible to selectively inhibit its actions through use of synthetic oligonucleotides or RNA species complementary to the encoded message. Although these antisense reagents may not always be specific, they are believed to inhibit the translation or accelerate the destruction of the transcript targeted and are predictably more effective against proteins of short half-lives ( 31 ). A more potent and potentially more specific approach involves the use of double-stranded RNA molecules from 21 to 23 base pairs in length that are complementary to the RNA of interest ( 32 ). These small, interfering RNAs effect posttranscriptional silencing by a series of steps that culminate in degradation of the targeted mRNA by cellular ribonucleases. In addition to their use in probing gene function, both antisense inhibition and RNA interference are under investigation for therapeutic purposes.

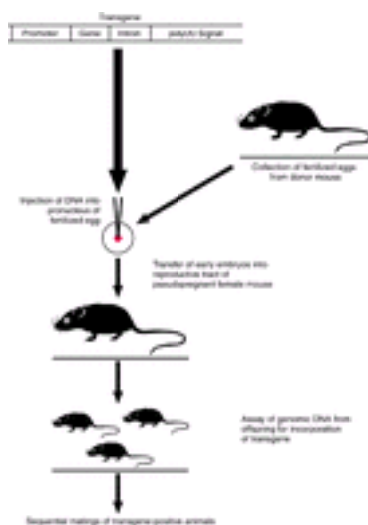
A more secure method of inhibiting protein function involves the germline inactivation of its gene such that a functional product is never expressed ( Fig. 5.10 ). This approach, referred to as *gene targeting* or *knock-out*, involves the introduction into pluripotent embryonic stem (ES) cells of a targeting vector containing, typically, a neomycin resistance gene flanked by sequences of exact homology to the gene of interest and linked to a viral thymidine kinase gene ( 33 ). ES cells in which homologous recombination at the targeted locus occurs integrate the neomycin resistance gene without the thymidine kinase gene and, as a result, are resistant to concurrent selection with the neomycin analog G418 and the drug ganciclovir. Cells surviving this “positive-negative” selection are microinjected into blastocysts of mice, which are then implanted into a foster mother. Any chimeric offspring that result, usually identified on the basis of coat color, are interbred. If the targeted ES cells have contributed to the germline, mice homozygous for this induced mutation can be generated by breeding, provided that the gene is not required in embryonic development. The technology to create knock-out mice has provided important insights into the *in vivo* function of numerous genes and led to the development of mouse models for a number of hematologic disorders. The establishment of human ES cell lines ( 34 ), with their ability to differentiate into hematopoietic progenitors ( 35 ), suggests that these cells could be useful therapeutically.



**Figure 5.10.** Generation of mice with targeted mutation (knock-out mice). Embryonic stem cells are pluripotent, or capable of contributing to every cell type in the animal. They are

transduced in culture with a targeting vector (*inset*) in which a neomycin resistance gene (*neo*) driven off a phosphoglycerate kinase (*pgk*) promoter is flanked by portions of the gene to be targeted. Linked to this is a *pgk*-promoted thymidine kinase (*tk*) gene, which converts the drug ganciclovir to a toxic, phosphorylated product. In embryonic stem cells that undergo homologous recombination (*arrows*), the *pgk-neo* gene is incorporated into the targeted locus, thereby inactivating it, without insertion of the *pgk-tk* gene. These cells are selected in culture by their resistance to both the neomycin analog G418 and ganciclovir, analyzed by Southern blot analysis to verify disruption of the targeted gene, and injected into blastocysts of mice with a distinctive coat color. These are implanted into a foster mother, and the chimeric mice resulting are identified by coat color. Mice are then mated to verify germline transmission of the targeted mutation.

A complementary approach to elucidating a gene's function involves its selective overexpression, either *in vivo* in transgenic animals ( Fig. 5.11) or *in vitro* with a plasmid or viral vector. The transgene is constructed to contain all components necessary for efficient and tissue- or cell type-specific expression, including a promoter, polyadenylation site, and, typically, one or more introns. It is introduced by microinjection into fertilized eggs, which are implanted into the reproductive system of a pseudopregnant female mouse. If successful, the transgene becomes incorporated into the germline of the resulting offspring. Sequential matings of these animals, termed *founders*, are typically carried out with nontransgenic mice and then with heterozygotes to generate a line homozygous for the transgene. In addition to analysis of any phenotype resulting from expression of the introduced gene, transgene copy number and tissue distribution are usually determined ( 36 ).



**Figure 5.11.** Generation of transgenic mice. The transgene construct, which contains a promoter, the coding sequences of the gene of interest, a polyadenylation signal, and, typically, one or more introns, is microinjected into the pronucleus of a fertilized egg. The resulting embryos are surgically transplanted into the reproductive tract of a pseudopregnant female mouse. The pups born are tested for incorporation of the transgene by Southern blot or polymerase chain reaction analysis of genomic DNA, usually from their tails. Sequential matings of transgene-positive animals (founders) are then carried out to verify that the transgene can be passed through the germline and to establish a line of mice homozygous for the transgene.

A variety of vectors are used to transduce cells with specific genes, either in transient

fashion or for derivation of permanent cell lines. This approach is rapid, avoids potential toxicities resulting from expression of a transgene during embryonic development, and is useful in targeting expression to specific cell types when a tissue-specific promoter is unavailable. The techniques used in this approach are the same as those used in gene therapy and are described in detail in [Chapter 26](#).

Although the technology can be expected to change, it is a safe prediction that molecular biology will continue to impact the practice of hematology.

## ACKNOWLEDGMENTS

This was supported in part by National Institutes of Health grant R01 HL49118 (to Stephen J. Brandt) and by a Merit Review Award from the Department of Veterans Affairs (to Stephen J. Brandt).

## REFERENCES

1. Gardiner K. Human genome organization. *Curr Opin Genet Dev* 1995;5:315–322.
2. Nowell PC, Hungerford DA. A minute chromosome in human granulocytic leukemia. *Science* 1960;132:1197–1200.
3. Lundblad V, Wright WE. Telomeres and telomerase: a simple picture becomes complex. *Cell* 1996;87:369–375.
4. Jeffreys AJ, Flavell RA. The rabbit  $\beta$ -globin gene contains a large insert in the coding sequence. *Cell* 1977;12:1097–1108.
5. Breathnach R, Mandel JL, Chambon P. Ovalbumin gene is split in chicken DNA. *Nature* 1977;270:314–319.
6. Schwartz RS. Jumping genes and the immunoglobulin V gene system. *N Engl J Med* 1995;333:42–44.
7. Pauling L, Itano HA, Singer SJ, et al. Sickle cell anemia, a molecular disease. *Science* 1949;110:543–548.
8. Roberts RJ, Macelis D. REBASE—restriction enzymes and methylases. *Nucleic Acids Res* 1997;25:248–262.
9. Collins FS. Positional cloning moves from the perditional to traditional. *Nat Genet* 1995;9:347–350.
10. Burke DT, Carle GF, Olson MV. Cloning of large segments of exogenous DNA into yeast by means of artificial chromosome vectors. *Science* 1987;236:806–812.
11. Sanger F, Nicklen S, Coulson AR. DNA sequencing with chain-terminating inhibitors. *Proc Natl Acad Sci U S A* 1977;74:5463–5467.
12. Ansorge W, Sproat B, Stegemann J, et al. Automated DNA sequencing: ultrasensitive detection of fluorescent bands during electrophoresis. *Nucleic Acids Res* 1987;15:4593–4602.
13. Boguski MS. Hunting for genes in computer data bases. *N Engl J Med* 1995;333:645–647.
14. Altschul SF, Gish W, Miller W, et al. Basic local alignment search tool. *J Mol Biol* 1990;215:403–410.
15. Guttmacher AE, Collins FS. Genomic medicine—a primer. *N Engl J Med* 2002;347:1512–1520.
16. Kan YW, Golbus MS, Dozy AM. Prenatal diagnosis of alpha-thalassemia: clinical application of molecular hybridization. *N Engl J Med* 1976;295:1165–1167.

17. Orkin SH, Kazazian HH, Antonarakis SE, et al. Linkage of  $\beta$ -thalassemia mutations and  $\beta$ -globin gene polymorphisms with DNA polymorphisms in human  $\beta$ -globin gene cluster. *Nature* 1982;296:627–631.
18. Southern EM. Detection of specific sequences among DNA fragments separated by gel electrophoresis. *J Mol Biol* 1975;98:503–517.
19. Housman D. Human DNA polymorphism. *N Engl J Med* 1995;332:318–320.
20. Alwine JC, Kemp DJ, Stark GR. Method for detection of specific RNAs in agarose gels by transfer to diazobenzyloxymethyl-paper and hybridization with DNA probes. *Proc Natl Acad Sci U S A* 1977;74:5350–5354.
21. Gowans EJ, Arthur J, Blight K, et al. Application of in situ hybridization for the detection of virus nucleic acids. *Methods Mol Biol* 1994;33:395–408.
22. Lehmann R, Tautz D. In situ hybridization to RNA. *Methods Cell Biol* 1994;44:575–598.
23. Adinolfi M, Crolla J. Nonisotopic in situ hybridization. *Clinical cytogenetics and gene mapping applications. Adv Hum Genet* 1994;22:187–255.
24. van Ommen G-JB, Breuning MH, et al. FISH in genome research and molecular diagnostics. *Curr Opin Genet Dev* 1995;5:304–308.
25. Kallioniemi A, Kallioniemi OP, Sudar D, et al. Comparative genomic hybridization for molecular cytogenetic analysis of solid tumors. *Science* 1992;258:818–821.
26. Mohr S, Leikauf GD, Keith G, et al. Microarrays as cancer keys: an array of possibilities. *J Clin Oncol* 2002;20:3165–3175.
27. Butte A. The use and analysis of microarray data. *Nat Rev Drug Discov* 2002;1:951–960.
28. Mullis K, Faloona F, Scharf S, et al. Specific enzymatic amplification of DNA in vitro: the polymerase chain reaction. *Cold Spring Harb Symp Quant Biol* 1986;51:263–273.
29. Orita M, Iwahana H, Kanazawa H, et al. Detection of polymorphisms of human DNA by gel electrophoresis as single-strand conformation polymorphisms. *Proc Natl Acad Sci U S A* 1989;86:2766–2770.
30. Rosenthal N. Recognizing DNA. *N Engl J Med* 1995;333:925–927.
31. Wagner RW. Gene inhibition using antisense oligodeoxynucleotides. *Nature* 1994;372:333–335.
32. Elbashir SM, Harborth J, Lendeckel W, et al. Duplexes of 21-nucleotide RNAs mediate RNA interference in cultured mammalian cells. *Nature* 2001;411:494–498.
33. Majzoub JA, Muglia LJ. Knockout mice. *N Engl J Med* 1996;334:904–907.
34. Thomson JA, Itskovitz-Eldor J, Shapiro SS, et al. Embryonic stem cell lines derived from human blastocysts. *Science* 1998;282:1145–1147.
35. Kaufman DS, Hanson ET, Lewis RL, et al. Hematopoietic colony-forming cells derived from human embryonic stem cells. *Proc Natl Acad Sci U S A* 2001;98:10716–10721.
36. Shuldiner AR. Transgenic animals. *N Engl J Med* 1996;334:653–655.

2004 Lippincott Williams & Wilkins  
John P. Greer, John Foerster, John N. Lukens  
George M. Rodgers, Frixos Paraskevas, Bertil Glader  
Wintrobe's Clinical Hematology

BLOOD CELLSHEMATOPOIETIC ORGANSDevelopment of Hematopoietic OrgansStructure of Hematopoietic OrgansSome Functional Aspects of Bone Marrow AnatomyStroma of Hematopoietic OrgansHEMATOPOIETIC STEM CELLSAge of MorphologistsAdvent of Hematopoietic Progenitor TransplantationHematopoietic Repopulating UnitDefinitive Evidence for a Pluripotent Stem CellIn Vitro Assays for Hematopoietic Stem CellsHuman Hematopoiesis in Animal Hosts after XenograftsEnrichment of Hematopoietic Stem CellsStem Cells in CultureQuestion of Stem Cells with Potential to Form Other Tissues in Addition to Hematopoietic ElementsCOMMITTED HEMATOPOIETIC PROGENITOR CELLSMultilineage ProgenitorsSingle Lineage ProgenitorsTerminal Phases of DifferentiationTHEORIES OF COMMITMENTExtrinsic Regulation versus Stochastic MechanismsMolecular Mechanisms of DifferentiationRole of Particular Transcription FactorsREPLICATION POTENTIAL OF COMMITTED PROGENITORS: A QUESTION OF IMPORTANCE FOR LEUKEMIAHEMATOPOIETIC GROWTH FACTORSHematopoietic Growth Factor ReceptorsFactors That Act on Multilineage ProgenitorsGranulocyte and Macrophage Growth FactorsMegakaryocyte Growth FactorsGrowth Factors for B LymphocytesGrowth Factors for Erythroid CellsIN VIVO SIGNIFICANCE OF KNOWN HEMATOPOIETIC GROWTH FACTORSMECHANISMS OF ACTION OF HEMATOPOIETIC GROWTH FACTORSInduction of DifferentiationMitogenesisPrevention of ApoptosisREFERENCES**BLOOD CELLS**

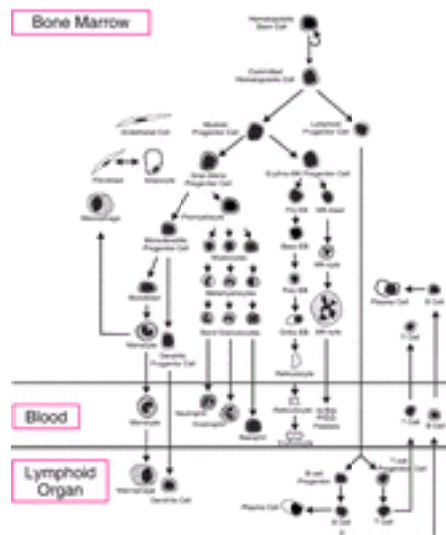
The blood contains several different types of cells. Each of these cell types is quite distinct in appearance, and each has a specific biologic function. *Erythrocytes* are anucleate, biconcave discoid cells filled with hemoglobin, the major protein that binds oxygen. The erythrocytes transport the respiratory gases oxygen and carbon dioxide. *Granulocytes* and *monocytes* are cells that can exit from blood vessels and migrate among the cells of many tissues. These two cell types play key roles in inflammation and phagocytosis. *Platelets* are very small, anucleate cells that contain molecules required for hemostasis. In addition, platelets provide hemostasis through their abilities to adhere,



aggregate, and provide a surface for coagulation reactions. Lymphocytes mediate highly specific immunity against microorganisms and other sources of foreign macromolecules. B lymphocytes confer immunity through the production of specific, soluble antibodies, whereas T lymphocytes direct a large variety of immunity functions, including killing cells that bear foreign molecules on their surface membranes. Despite these extreme structural and functional differences among the cells of the blood, strong evidence exists that all of the blood cells are the progeny of a single type of cell: the hematopoietic stem cell (HSC). The processes involved in the production of all of the various cells of the blood from the HSCs are collectively called *hematopoiesis*. These processes of hematopoiesis include the self-renewal of stem cells, the commitment of most progeny of stem cells to differentiate ultimately into a particular cell type, and the proliferation of the progenitor cells and their differentiation along a pathway leading to a particular kind of mature blood cell. A process implicitly prerequisite to the generation of mature cells is the maintenance of a local environment permissive for the survival of at least some portion of each cell lineage (e.g., the production of necessary protein survival factors or growth factors).

Hematopoiesis begins early during embryogenesis, and the process undergoes many changes through fetal and neonatal development. Unlike some organ systems that form in early life and are not continually replaced, turnover and replenishment of the hematopoietic system continue throughout life. The cells of the blood have finite lifespans, which vary depending on the cell type. In humans, granulocytes and platelets have lifespans of only a few days, whereas some lymphocytes can exist for many months. Thus, cells are replaced as the older cells are removed and the newly formed, mature cells are added. The numbers of the various cell types in the blood are normally kept in relatively constant ranges. In particular, variations in the erythrocyte number are normally minimal, and values 50% above or below the norm for the population have significant health effects. Although the numbers of other blood cell types are not nearly as constant as the number of erythrocytes, the production processes of other blood cells are also highly regulated. The regulation of hematopoiesis is complex. For each cell lineage, there are particular regulatory growth factors that play a key role in fostering the production of cells of that lineage. Lineage-specific regulation is necessary because of the widely varying lifespans and widely varying functions of the different mature blood cell types. However, there are also regulatory factors that influence overall hematopoiesis by working on very early progenitor cells: the HSCs or cells that have not undergone commitment to a single lineage, or both.

This chapter presents an overview of hematopoiesis in humans. However, much of the experimental work on hematopoiesis has been done using mice, and many of the conclusions presented here are based on that work. All cell lineages that compose the blood are discussed. There are, in addition to the blood cells, several cell types that are derived from the HSCs but are not found in the blood. The final steps of differentiation of these latter cells occur in the tissues in which they reside. Such cells include dendritic cells of the lymphoid tissues and the skin (Langerhans cells), specialized macrophages of all types, and mast cells. [Figure 6.1](#) is an illustration of the cell types associated with hematopoiesis and their distribution among bone marrow, blood, and lymphatic tissues.



**Figure 6.1.** The cells of the blood and lymphoid organs and their precursors in the bone marrow. EB, erythroblast; MK, megakaryocyte.

## HEMATOPOIETIC ORGANS

### Development of Hematopoietic Organs

During prenatal development, the sites of hematopoiesis change several times ([1](#), [2](#), [3](#), [4](#), [5](#), [6](#), [7](#) and [8](#)). The hematopoietic tissue arises from the mesodermal germ layer that forms at the time of gastrulation in vertebrate embryos. Beginning in late gastrulation, two types of hematopoiesis are established. The first is termed *primitive hematopoiesis*. It arises in the blood islands of the extraembryonic yolk sac on embryonic day 7.5 in mice and day 19 in humans and continues through day 13 in mice and week 8 in humans. The second is termed *definitive hematopoiesis*. It arises slightly later than the primitive hematopoiesis and begins in the splanchnopleura/aorta-gonad-mesonephros of the developing embryo. Primitive hematopoiesis is transient, lasting during the respective embryonic periods described above, whereas definitive hematopoiesis persists throughout postnatal life. These two forms of hematopoiesis also differ in that the primitive blood cells are mainly erythrocytes, whereas the definitive blood cells are all types including granulocytes, lymphocytes, monocytes, and platelets as well as erythrocytes. The primitive erythrocytes are nucleated and have reduced erythropoietin (EPO) requirements during their development compared to definitive erythroid cells ([9](#)), and their hemoglobin is composed of the embryonic forms of the “alpha family” and “beta family” of globin chains ([10](#)). The definitive erythrocytes, on the other hand, are anucleate and require EPO for survival during differentiation, and their hemoglobins contain the fetal and adult forms of globins.

Primitive hematopoiesis arises in the yolk sac blood islands where visceral endoderm induces both endothelial and blood cell development in the adjacent mesoderm. This induction appears to be mediated by a member of the hedgehog family of proteins (Indian hedgehog) and leads to the expression of bone morphogenic protein (BMP)-4 in the developing mesodermal cells ([11](#)). BMP-4 expression, in turn, leads to the development of both endothelial cells that assemble to form blood vessels and the primitive blood cells located in these blood vessels ([8](#), [11](#)). Slightly later in development, but in a similar manner, BMP-4 is expressed in the endothelial cells in the ventral portion of the developing dorsal aorta and the subjacent mesoderm. This BMP-4 induction of definitive hematopoiesis occurs at embryonic days 10 to 13 in mice and weeks 4 to 6 in humans.

Thus, the BMP-4 induction of definitive hematopoiesis is later by approximately 2 days in mice and approximately 2 weeks in humans as compared to the analogous BMP-4 induction at the initiation of primitive hematopoiesis. Like primitive hematopoiesis, the first definitive hematopoiesis occurs in newly formed blood vessels, specifically in the ventral part of the dorsal aorta and in the proximal vitelline and umbilical arteries.

By embryonic day 10.5 in mice, long-term repopulating HSCs that can rescue lethally irradiated adult mice can be found in the splanchnopleura/aorta-gonad-mesonephros region (12). These HSCs increase in number and can be found by day 11 in the fetal liver and yolk sac blood islands. However, their origin appears to be in the ventral wall of the dorsal aorta where both endothelial and hematopoietic cells are present. Furthermore, multiple cellular markers are displayed by both the endothelial and hematopoietic cells. These include CD34, FLT3 ligand (FL), Flk-1, TAL-1, GATA-2, LMO-2, AML-1, and CD31 [PECAM-1 (platelet-endothelial cell adhesion molecule-1)] (6, 7, 13, 14 and 15). The close physical and temporal association of endothelial and hematopoietic cells during their differentiation in the embryo, as well as the numerous shared markers, has led to the concept of a common mesodermal cell type termed the *hemangioblast*. Studies with embryonic stem cells *in vitro* also support the existence of the hemangioblast, but direct evidence of this cell type *in vivo* has not been demonstrated (15, 16). Alternative possibilities are that mesodermal cells in the splanchnopleura/aorta-gonad-mesonephros directly differentiate into endothelial or hematopoietic cells without a hemangioblast stage or, more likely, that some endothelial cells are hemato-genic and give rise to hematopoietic cells (17, 18 and 19).

Once the definitive hematopoietic cells have been formed, they rapidly seed the fetal liver, which is the major site of hematopoiesis in the midgestational period. The spleen also participates in hematopoiesis during this period. The erythrocytes produced in the fetal liver of mammals are anucleate like the erythrocytes of the adult, and they have the same alpha family hemoglobin chains as in adults, but, in the case of humans and some other species, the beta family chains of the hemoglobin are a fetal type that is different from the major type of  $\beta$ -globin chain in adults. In the latter phases of mammalian fetal development, the bone marrow becomes the main site of hematopoiesis. In the human, the bone marrow is the exclusive site of postnatal hematopoiesis under normal circumstances, whereas in the mouse, the spleen is also a hematopoietic organ throughout life. In humans, during late fetal development, erythrocytes begin to be produced that contain adult types of beta family chains in their hemoglobin molecules, and by the end of the first year of postnatal life, this type of erythrocyte is the only one normally produced.

From naturally occurring and experimentally induced mutations in various murine genes known to be expressed in developing hematopoietic cells, a number of proteins that regulate blood cell development have been identified. Among these are several proteins that are required at various stages of hematopoietic development (i.e., the null state leads to prenatal death) (6, 8). Among those proteins that are essential for blood island development in the yolk sac are the vascular endothelial growth factor receptor Flk-1 and the transcription factor TAL-1, which are expressed in both the endothelial and the hematopoietic cells, and GATA-1 and Rbtl-1, which are transcription factors required for primitive erythroid cell development. Definitive hematopoietic cells have additional proteins that are required for their development. These proteins include transcription factors GATA-2, c-myb, AML-1, and GATA-3 that are required by hematopoietic cells when they first are formed in the dorsal aorta. Other transcription factors or growth factors and their respective cell-surface receptors are required during prenatal hematopoiesis for the survival and growth of more differentiated cell types. Examples are the myeloid transcription factor PU.1, the erythroid transcription factor EKLF (erythroid Kruppel-like factor), stem cell factor (c-kit ligand) and its receptor c-kit, and EPO and its

receptor.

## Structure of Hematopoietic Organs

The hematopoietic organs can be considered in terms of several operational components. First, there is the anatomic structure—the three-dimensional organization of different tissue types and their component cells; for example, the structure of the blood vessels in proximity to the hematopoietic cells. A second operational component of hematopoietic organs is the stroma. *Stroma* is the term used to refer to the various cells as well as the extracellular macromolecules that occupy the hematopoietic tissue along with the hematopoietic cells. The stromal cells include specialized fibroblasts, adipocytes, macrophages, and lymphocytes, as well as the endothelial cells of capillaries and sinuses (only the macrophages and lymphocytes are derived from HSCs). The stroma thus constitutes the microenvironment in which the hematopoietic progenitor cells grow and differentiate, and there is strong evidence that various stromal cells as well as extracellular matrix molecules play critical and diverse roles in hematopoiesis. Third, there are the hematopoietic progenitor cells: the HSCs and their progeny that become the blood cells of all lineages. The characterization of the hematopoietic progenitor component and its various differentiation processes are the main focus of this chapter.

## Some Functional Aspects of Bone Marrow Anatomy

Studies of the marrow by electron microscopy have greatly refined our knowledge about the structures present and the topologic associations between the various cell types ( [20](#), [21](#), [22](#) and [23](#) ). Largely, the roles of the anatomic features of hematopoietic organs are unknown. However, some functions of the cells of the venous sinuses within the marrow are understood in general terms. The venous structure of the marrow cavity is a complex maze of sinuses that eventually drains into central veins. In the marrow or fetal liver of mammals, hematopoietic progenitors differentiate outside the sinuses, unlike in the marrow of birds, in which hematopoiesis occurs within the sinuses. The sinuses of the marrow in mammals are formed by a continuous layer of endothelial cells that, on the extraluminal side, are partially covered by a discontinuous layer of adventitial reticular cells: fibroblast (myofibroblast) cells that have processes forming a network throughout the extraluminal space of the marrow cavity. The endothelial cells of the sinuses are thought to play a role in the selective exiting of mature blood cells from the marrow into the bloodstream. These mature cells apparently pass through the cytoplasm of the endothelial cells rather than between cells at their borders ( [22](#), [23](#) ). The mechanisms involved in this remarkable process are not well understood. The endothelial cells are also presumed to play a specific role in the movement of circulating hematopoietic progenitor cells from the blood into the marrow stroma (homing).

## Stroma of Hematopoietic Organs

The stroma consists of myofibroblasts (adventitial reticular cells); adipocytes, which are derived from the myofibroblasts; macrophages; lymphocytes and plasma cells; the endothelial cells of the marrow sinuses; and stem cells of various types other than the HSCs. These other stem cell types can give rise to mesodermal-derived cells ( [24](#) ), endothelial cells ( [25](#) ), or even diverse cell types associated with multiple embryonic germ layers ( [26](#) ). In addition to the cellular components, the stroma contains a large variety of extracellular macromolecules including fibronectin, collagens, thrombospondin, tenascin, and others. One very critical type of interaction between the marrow stromal cells and the hematopoietic progenitor cells is the synthesis and presentation by stromal cells of hematopoietic growth factors. One example has been discovered from studies of mice that have mutations in either of two particular genes ( [27](#) ): the white spotting locus

(nonfunctional allele  $W$ ) and the steel locus (nonfunctional allele  $Sl$ ). Each of these genes is essential for hematopoiesis. Mouse embryos that are homozygous for null alleles of either of these genes die at an early stage of embryogenesis without forming any blood cells. However, mice have been found and bred that bear mutant alleles of each of the two genes that retain partial function ( $W^v$  and  $Sl^d$  alleles). Heterozygous mice of the  $Sl/Sl^d$  or the  $W/W^v$  genotypes are phenotypically similar, with a lack of cutaneous pigment, sterility, and congenital anemia (27). Reciprocal bone marrow transplantation studies between normal, wild-type mice and heterozygous mice,  $Sl/Sl^d$  and  $W/W^v$ , revealed that  $W/W^v$  mice have defective HSCs but a functional microenvironment that can support transplants of normal stem cells. Conversely, the  $Sl/Sl^d$  mice have functional stem cells and can thus serve as donors for marrow transplants, but these mice have a defective microenvironment (stroma) for hematopoiesis; thus, their defect cannot be corrected by the receipt of stem cells from normal donor mice. Detailed understanding of the function of these two genes was achieved after the cloning of the genes at the  $W$  and  $Sl$  loci. The  $W$  gene encodes the cell-surface receptor protein Kit (gene designated *c-kit*) (28, 29), and the  $Sl$  gene encodes the ligand for that receptor, which is variably called *steel factor*, *kit ligand* (KL), or *stem cell factor* (30, 31 and 32). The Kit protein is a cell-surface receptor on hematopoietic progenitor cells for the growth factor product of the  $Sl$  gene expressed by stromal cells. KL is produced in two forms due to alternative splicing of the mRNA: a soluble form and an integral membrane form (33, 34). It has been shown that the stromal cell membrane-bound form of KL can stimulate hematopoietic progenitor cells by cell-cell contact and thus may be as important functionally as the soluble form. Activation of the Kit receptor is essential for the survival and development of immature hematopoietic progenitors. Kit and KL are also produced in certain other developing tissues, hence their roles in pigmentation and gonadal function. In addition to the production of KL, stromal cells produce a large number of other hematopoietic growth factors, some of which also exist in soluble and membrane-bound forms, including FL (26, 35, 36) and macrophage colony-stimulating factor [colony-stimulating factor-1 (CSF-1)] (37, 38, 39 and 40).

Besides providing a source of growth factors, the stroma of hematopoietic organs has other functions in hematopoiesis. Interactions with stromal elements play a role in the egress of mature blood cells from the hematopoietic organs. Stromal elements are important in the “trafficking” of immature hematopoietic cells or HSCs into and out of hematopoietic organs and the blood. This trafficking occurs during embryonic development as the primary organs of hematopoiesis change. Also, some HSCs and other immature progenitors migrate continuously between bone marrow and blood in normal adult animals (41). The processes by which hematopoietic cells leave the bloodstream and specifically move into hematopoietic organs are collectively called *homing*. Homing occurs not only for hematopoietic progenitor cells that are circulating normally, but also for such cells that are introduced into the bloodstream artificially through stem cell transplantation. It is not clear whether the homing mechanisms are the same for transplanted cells and for those circulating normally, although in both cases an adhesive interaction between circulating progenitors and the endothelial cells of the venous sinuses is followed by a transmigration of the progenitors through the endothelium.

The molecular interactions between the hematopoietic cells and the stromal cells or extracellular matrix involve ligand-receptor relationships between so-called adhesion molecules on the surfaces of the hematopoietic and stromal cells or between such molecules on the cell surfaces with specific domains within certain extracellular matrix molecules [see reviews (42, 43)]. There are many cytoadhesion molecules known, and they generally can be classified into several families: sialomucins, selectins, integrins, and members of the immunoglobulin superfamily (42). CD44 is an additional adhesion



molecule, not belonging to one of the above families. Numerous interactions are possible, and there appears in some cases to be redundancy in the systems involved in trafficking, homing, and the other processes within the hematopoietic microenvironment.

Integrins are heterodimeric molecules composed of two subunits,  $\alpha$  and  $\beta$ , joined noncovalently. Sixteen types of  $\alpha$  subunits and eight types of  $\beta$  subunits are known, although only a few of the possible heterodimer combinations have been found on hematopoietic or stromal cells and implicated in hematopoiesis. The integrins are transmembrane proteins, each subunit having extracellular and intracellular domains. The integrin subunits  $\alpha_4$  and  $\beta_1$  clearly have important functions in hematopoiesis. Although they each can pair with certain other subunits of the heterologous type, the  $\alpha_4\beta_1$  pair [very late antigen (VLA)-4] appears to be the most important. Chimeric mouse embryos, in which the integrin  $\alpha_4$  subunit gene was deleted in a substantial portion of the cells, formed no  $\alpha_4$ -null erythrocytes, almost no B-lymphoid cells, and few myeloid cells ( [44](#), [45](#) ). *In vitro* hematopoietic colony formation of  $\alpha_4$ -null cells appeared normal, so the defect is likely due to impaired interaction of the hematopoietic progenitors with the stroma. Likewise, chimeric mouse embryos containing  $\beta_1$ -null cells demonstrated an essential role for the  $\beta_1$  integrin subunit during hematopoietic development ( [46](#) ).  $\beta_1$  integrin is not essential for the generation of hematopoietic progenitor cells in the aorta-gonad-mesonephros or the yolk sac or for their differentiation *in vitro*, but it is necessary for their colonization of the fetal liver, spleen, and bone marrow during embryogenesis. HSCs rendered  $\beta_1$ -null by conditional gene ablation are unable to colonize hematopoietic organs or to rescue lethally irradiated mice on transplantation ( [46](#) ). Nevertheless, conditional deletion of the  $\beta_1$  gene in adult mice does not lead to defects in stem cell retention in the marrow or in hematopoiesis ( [47](#) ).

The integrin  $\alpha_4\beta_1$  (VLA-4) is widely expressed on hematopoietic progenitor cells, and it binds to the vascular cell adhesion molecule (VCAM)-1, an adhesion molecule of the immunoglobulin superfamily present on stromal cells, macrophages, and venous sinus endothelium in bone marrow [reviewed in ( [48](#) )]. VLA-4 also binds to fibronectin ( [42](#), [48](#), [49](#) ). Treatment of animals with antibodies to VLA-4 or VCAM-1 induces release (mobilization) of HSCs and more differentiated progenitor cells from the bone marrow ( [50](#), [51](#) ) and inhibits hematopoietic progenitor cell homing after transplantation ( [52](#), [53](#) ). However, like the conditional deletion of the  $\beta_1$  integrin subunit gene, conditional deletion of the VCAM-1 gene ( [54](#), [55](#) ) does not disrupt bone marrow retention of HSCs or hematopoiesis, although it affects migration, specifically of T cells, to the bone marrow ( [54](#) ). Thus, these VLA-4 and VCAM-1 experiments indicate that molecules critical for homing in the transplant model or in mobilization by growth factors or drugs may not be essential for maintaining adult hematopoiesis because of overlapping functions of adhesion receptors. Yet, individual cytoadhesion molecules may play very specific roles such as that of VCAM-1 in T-lymphocyte homing.

The selectin family of cytoadhesion molecules has functions in the lymphocyte homing to lymphoid tissues and in leukocyte rolling and adhesion to activated endothelial cells. The selectin family members are designated E, P, and L. HSCs have receptors for the selectins, and they can exhibit the rolling phenomenon similar to that of leukocytes ( [56](#), [57](#) ). Some data also indicate that the selectins might be important for stem cell transmigration across endothelium ( [58](#) ) and homing. Mice in which genes for two or all three selectins have been deleted are viable, although several aspects of their marrow hematopoiesis are abnormal ( [59](#), [60](#) ). These mice also are defective in hematopoietic progenitor cell homing to the bone marrow but not the spleen after transplantation ( [59](#), [61](#) ).

).

The adhesion molecules of all families are transmembrane proteins, and many can act as receptors that activate specific intracellular signaling pathways. These adhesion molecules/receptors, in turn, may be regulated by other intracellular signaling pathways ( [48](#), [62](#), [63](#) ). Thus, the interactions of the hematopoietic cells with stromal cells and matrix can be highly modulated by the adhesion receptors, both in transmitting signals from the microenvironment into the cell and in translating the state of intracellular signaling pathways into changes in the number and affinities of adhesion molecules. Activation of Kit by its ligand (KL) modulates adhesion functions that are apparently mediated by integrins  $\alpha_4\beta_1$  (VLA-4) and  $\alpha_5\beta_1$  (VLA-5) ( [50](#), [64](#), [65](#) ). Another example is the chemotactic cytokine (chemokine) receptor CXCR4 and its ligand stromal-derived factor-1a (SDF-1). SDF-1 is the only known chemokine that elicits directed chemotactic response in HSCs ( [66](#), [67](#) ). Mice lacking SDF-1 or CXCR4 have defective hematopoiesis in fetal bone marrow ( [68](#), [69](#) ). Antibodies against CXCR4 block engraftment of severe combined immunodeficiency (SCID) mouse bone marrow by transplanted CD34-enriched HSCs and hematopoietic progenitor cells ( [70](#), [71](#) ). SDF-1 is expressed on bone marrow endothelium and appears to induce binding of circulating progenitors to the vascular endothelium by activating the integrins lymphocyte function-associated antigen, VLA-4, and VLA-5 ( [72](#), [73](#) and [74](#) ).

The stroma also contains an extracellular matrix that provides a structural network to which hematopoietic progenitors and stromal cells are anchored. This matrix is composed of various fibrous proteins, glycoproteins, and proteoglycans that are produced by the stromal cells ( [75](#) ). These include collagens (types I, III, IV, V, and VI) ( [76](#), [77](#) and [78](#) ), fibronectin ( [79](#), [80](#), [81](#), [82](#) and [83](#) ), laminin ( [84](#) ), hemonectin ( [85](#), [86](#) and [87](#) ), tenascin ( [88](#) ), thrombospondin ( [89](#), [90](#), [91](#), [92](#) and [93](#) ), and proteoglycans ( [86](#), [94](#), [95](#), [96](#) and [97](#) ). Several of the adhesion molecules on hematopoietic cells specifically bind to sites on particular matrix macromolecules. For example, HSCs and more mature progenitors bind to fibronectin, primarily through interaction with the integrin receptors  $\alpha_4\beta_1$  and  $\alpha_5\beta_1$  ( [42](#), [48](#), [49](#), [75](#), [98](#) ). Another cytoadhesion molecule that interacts with several matrix macromolecules is CD44, which binds with glycosaminoglycans (hyaluronic acid being the major CD44 ligand) ( [99](#) ). The *proteoglycans*, proteins with extensive sulfation such as heparan sulfate and chondroitin sulfate, are extracellular matrix proteins that may contribute to adhesion between the stroma and the hematopoietic progenitor cells ( [86](#), [94](#), [95](#), [96](#) and [97](#) ). The proteoglycans can also concentrate soluble growth factors. For example, granulocyte-macrophage colony-stimulating factor (GM-CSF) binds to heparan sulfate in the marrow matrix ( [100](#), [101](#) ).

## HEMATOPOIETIC STEM CELLS

### Age of Morphologists

The ideas in this chapter have evolved from a long history of experimental work and often conflicting interpretations by many investigators. Fascinating accounts of much of this history are presented in *Blood, Pure and Eloquent*, edited by M.M. Wintrobe ( [102](#), [103](#) ). One milestone in understanding the origins and development of blood cells was the realization by Ernst Neumann and Giulio Bizzozero in the mid-nineteenth century that the bone marrow is a site of red blood cell production in adult animals and that such production is a continuous process throughout postnatal life. Another major advance made in the late nineteenth century by Paul Erlich and later by Artur Pappenheim and others was the



application of synthetic dyes and various staining/fixing techniques to blood and marrow preparations and the consequent precise morphologic characterization and classification of cells of the blood and marrow.

A third milestone in hematology was the development of the idea of a pluripotent stem (ancestral) cell that gives rise to all of the mature blood cell types through extensive proliferation and multiple differentiation steps. By use of refined staining methods, Pappenheim observed various transitional cells and organized them into a relational scheme—a tree whose various branches when traced backward converged to a type of mononuclear cell that had none of the distinct features of the end-stage blood cells or the transitional stages. He proposed the notion that this cell was so morphologically primitive that it could be the common ancestor of all blood cells. Although most morphologists between 1900 and 1940 accepted the idea of ancestral cells in a hematopoietic series leading to progressively more mature types, there was much debate about how many ancestral cell types there were. Many workers believed that lymphocytes had a separate origin from myeloblasts and thus that there were dual or perhaps plural ancestral cells. Reviews of the conflicting concepts of the origin of hematopoietic cells as of the late 1930s are presented in detail in *Handbook of Hematology*, edited by Downey ( [104](#) ).

### **Advent of Hematopoietic Progenitor Transplantation**

In the late 1940s and the 1950s, experimental hematologists applied several new approaches to the study of hematopoiesis. Among them were radiation exposure followed by grafting of hematopoietic tissue, use of chromosome cytogenetics, and use of radioactive materials. Lorenz et al. ( [105](#) ) showed that mice and guinea pigs may be protected against otherwise lethal whole-body irradiation by injections of bone marrow from other animals of their respective species. In similar experiments, Ford et al. ( [106](#) ) used bone marrow from donor mice that had a morphologically identifiable chromosomal marker to show that hematopoiesis in the irradiated recipient mice was reconstituted by cells from the donor marrow—that is, the protected animals were chimeras with respect to their hematopoietic tissues. The experiments of Ford et al. did not settle the question about how many types of ancestral cells there were, but experiments generating radiation chimeras have since been used with great power to study the nature of stem cells and their progeny.

Till and McCulloch ( [107](#) ) used radiation/grafting experiments to prove directly the existence of an ancestral cell that has multilineage potential. They examined spleens of mice at 1 week after transplantation and found growth of macroscopic colonies containing cells of multiple hematopoietic lineages. These colonies were the progeny of individual transplanted cells that were called *colony-forming units spleen* (CFU-S). Because the cells in these spleen colonies could, in turn, be injected into secondary, irradiated mice and give rise to spleen colonies, the CFU-S apparently replicated themselves within the colonies. When the observation time for CFU-S assays was extended from 1 week to 2 weeks after transplantation, a series of evanescent colonies was found, and those appearing on later days had greater self-replication and multilineage differentiation capacities ( [108](#) , [109](#) ). Although early studies could not demonstrate the clonal growth of lymphoid cells in the spleen colonies ( [110](#) , [111](#) ), a recent study indicates that most such colonies derived from CFU-S do contain lymphoid progenitors as well as myeloid progenitors ( [112](#) ). However, several studies showed that cells with the capacity for long-term hematopoietic reconstitution of irradiated mice can be separated from most CFU-S by their size and density ( [113](#) ). Thus, many CFU-S, although multipotent, do not have long-term repopulating capacity.

## Hematopoietic Repopulating Unit

Investigators sometimes use the terminology *long-term hematopoietic repopulating unit*. Its operational definition is a cell or group of cells that provide long-term hematopoietic reconstitution of ablated animals, including repopulation of all myeloid and lymphoid cell lineages. This function, if it can be accomplished by a single cell, is the operational definition of a pluripotent HSC. The identification of hematopoietic repopulating units requires hematopoietic cell transplantation into an ablated host. The most suitable experimental animal is the mouse. However, the analyzed cells are not spleen colonies but rather the reconstituted hematopoietic tissues after an extended period of time after transplantation.

To make progress in the purification and characterization of hematopoietic repopulating units, it was essential to develop quantitative assays to measure them. To quantify hematopoietic repopulating units by transplantation, it is necessary to transplant serial dilutions of a test cell population into a group of animals. Even if repopulating units are present in the transplant inoculum, ablated animals receiving no short-term sustaining progenitor cells would die with a lack of hematopoiesis before the transplanted cells could reconstitute the animal. Therefore, “competitive repopulation assays” ([114](#), [115](#) and [116](#)) are used in which the recipient animals survive in the short-term because they contain or are given an additional source of progenitor cells that can be distinguished from the donor test population. In one form of this assay, one mixes various dilutions of the test population of hematopoietic cells bearing a distinguishable genetic marker with a constant number of hematopoietic cells (source of short-term reconstituting support cells) from a congenic mouse strain. One then transplants the mixtures into ablated host mice of the congenic strain used to procure the supportive cells. The reconstituted mice are hematopoietic chimeras with progenitor cells derived from both of the hematopoietic cell sources in the transplant. Using the genetic marker, one can determine the fraction of hematopoietic cells derived from each cell genotype in the chimeric animals at various time points after transplantation. From these ratios and the known dilutions of test cells given in the transplants, one can calculate the number of hematopoietic repopulating units in the test population by binomial correlation and covariance methods ([114](#)) or by using limiting dilution analysis and Poisson statistics ([115](#), [116](#)). A variation of this assay uses limiting dilutions of genotypically distinct donor cells to transplant into stem cell-deficient  $W/W^v$  mice that can be used as hosts rather than hematopoietically ablated mice ([117](#)). A second variation uses, as hosts, mice that have been transplanted previously and thus have a reduced or weakened endogenous stem cell competition capacity ([115](#)).

Using these competitive repopulation assays in mice, it has been shown that the hematopoietic repopulating unit is extremely rare, with an incidence in murine marrow of 1 per  $10^4$  ([115](#)) to 1 per  $10^5$  nucleated cells ([114](#)). As discussed in the section [Definitive Evidence for a Pluripotent Stem Cell](#), the minimal hematopoietic repopulating unit has been proved to be a single, pluripotent stem cell (HSC). Thus, the competitive repopulation assays can be used to measure enrichment of murine HSCs after purification schemes ([118](#)) and also to analyze possible replication of HSCs during *in vitro* culture.

## Definitive Evidence for a Pluripotent Stem Cell

Animal reconstitution experiments with hematopoietic cells that were individually marked genetically have verified the existence of HSCs and demonstrated their capacity for extensive self-renewal ([119](#), [120](#) and [121](#)). In these marking experiments, hematopoietic cells were infected *in vitro* with a recombinant retrovirus that was able to integrate its

DNA (provirus) into a cell but could not replicate and spread to other cells. The one-time, random integration of the provirus into the DNA of an individual cell provides a specific marker for the progeny of that cell that develop in an animal after transplantation. Random integration assures that each provirus has unique flanking sequences of DNA and thus has a high probability of yielding a DNA fragment of a distinguishable size after cutting with a restriction enzyme that does not cut the provirus. Several months after transplantation of the genetically marked cells and establishment of hematopoiesis, it is typically observed that all types of cells in the blood and lymphoid organs contain progeny of an individually marked cell, proving that it was pluripotent. Often, these clones of marked cells continue to contribute to all of the hematopoietic lineages in the animal for an extended period. Also, when these primary recipient animals are subsequently used as donors for secondary recipient animals, frequently the same clones of HSCs are apparent in these secondary recipients. This persistence can even be demonstrated in tertiary recipients ( [119](#), [120](#) ). Thus, clearly many HSCs reproduce themselves (self-renew) over a long period. Yet not all clones of HSCs are so long lived; some produce progeny for varying periods and then apparently become extinct. Finally, marked clones have been observed to begin contributing to hematopoiesis after some period of posttransplantation latency, indicating that dormancy is possible. Thus, these studies have demonstrated that, after transplantation, some HSCs contribute continuously to hematopoiesis for a long time—in mice, apparently for the whole lifetime of the animal. Other HSCs contribute and then become extinct, and finally, some may remain dormant for some period and then contribute. Additional transplantation studies of marked HSCs in mice ( [116](#) ) have suggested that polyclonal hematopoiesis is more common and that long-term contribution by individual stem cells is more rare than the earlier studies indicated ( [119](#), [120](#) ). To what extent these possible behaviors are manifest in a normal, nontransplanted mouse or in larger animals is not yet clear. Mice differ from humans and other large animals in the demand for hematopoietic cell production, in lifespan, in the turnover of stem cells, and in other factors ( [122](#), [123](#) ). Studies using retroviral insertion site analyses for larger animals, particularly nonhuman primates, have recently shown progress ( [122](#), [124](#) ). It appears likely that questions about the longevity of function of stem cell clones and about the overall kinetics of hematopoietic cell production in a primate model may soon be answered.

### ***In Vitro* Assays for Hematopoietic Stem Cells**

There are many scientific questions about hematopoietic progenitor cells that can only be pursued with cell culture-based manipulations of such cells. Also, with the advent of hematopoietic tissue transplantation in humans, there is great need for an *in vitro* assay that identifies human cells capable of long-term hematopoiesis in patients. To infer that any *in vitro* assay measures HSCs, one must correlate the properties of the cells analyzed *in vitro* with those of repopulating units tested *in vivo*. Such comparisons can presently only be done for mouse cells because *in vivo* assays of repopulating units transplanted into hosts of the same species as the test cells are not feasible or are not fully proven for other species. Progress in the development of murine xenograft models to assay human stem cells may lead to satisfactory quantification in the future (see [Human Hematopoiesis in Animal Hosts after Xenografts](#)).

*In vitro* systems have been developed for culturing murine and human hematopoietic cells, and the assayed human cells are presumed to represent the same stages in the hematopoietic hierarchy as their mouse cell counterparts. *Culture of Hematopoietic Cells*, edited by R.I. Freshney, I.B. Pragnell, and M.G. Freshney ( [125](#) ), is a good reference book describing many of the cell culture methods for assaying hematopoietic progenitor cells alluded to in the foregoing sections. One type of *in vitro* assay, which is an assay for early-stage hematopoietic progenitors, quantifies cells in a test population that are capable of initiating long-term hematopoiesis in culture after seeding them onto irradiated stromal cell monolayers [human ( [126](#), [127](#) ); mouse ( [128](#), [129](#) )]. Such cells are called

*long-term culture-initiating cells*, or LTC-ICs ( [126](#) ). LTC-ICs can initiate cell cultures that sustain production of multilineage progenitors for many weeks. This continued production of hematopoietic progenitors of multiple lineages in individual cultures is measured after several weeks by harvesting the cultured cells and doing secondary assays for various types of lineage-committed progenitors. By using a limiting dilution assay and Poisson statistics, one can accurately quantify LTC-ICs in a test cell population. In the long-term cultures, islands or colonies of hematopoietic cells can be recognized morphologically *in situ* and have been termed *cobblestone area-forming cells*, or CAFCs ( [128](#) ). Some investigators use limiting dilution assays in long-term cultures and count CAFCs as the endpoint of the assay ( [127](#), [128](#) and [129](#) )—that is, they examine mouse cell cultures on day 8 (day 8 CAFCs) or day 28 (day 28 CAFCs) ( [128](#) ) or after 6 weeks (6-week CAFCs) ( [130](#) ).

Assays of murine bone marrow cells for LTC-ICs and for day 28 CAFCs yield estimates of 1 to 4 LTC-ICs or CAFCs per  $10^5$  marrow mononuclear cells—a value comparable to that obtained for HSCs in repopulation assays ( [114](#), [115](#) ). A modification of the mouse LTC-IC assay ( [131](#), [132](#) ) has led to a demonstration that some LTC-ICs form lymphoid as well as myeloid progenitors *in vitro*. However, evidence obtained more recently indicates that LTC-ICs do not correspond 1:1 to hematopoietic repopulating units. For example, several studies have shown that *ex vivo* expansion of hematopoietic cell populations with growth factors in culture leads to a loss of *in vivo* repopulating cells ( [133](#) ), although measured LTC-ICs do not decrease in parallel. Some studies have suggested that *in vitro* culture leads to loss of homing due to down-regulation of certain adhesion molecules ( [133](#) ). One study suggests that there is an unknown defect in repopulating function correlated with S/G<sub>2</sub>/M phases of the cell cycle ( [134](#) ) and that noncycling stem cells from tissue sources quickly enter the cell cycle under most *in vitro* culture conditions. Measured LTC-IC numbers are not dependent on the initial cell cycle status. Finally, HSCs are so-called side population (SP) cells, a phenotype indicating that they have low levels of labeling by flow cytometry when stained with the Hoechst dye 33342 due to the presence of a verapamil-sensitive (efflux) transporter ( [135](#), [136](#), [137](#) and [138](#) ). Transplantable human HSC activity in human fetal liver cells, detectable in nonobese diabetic (NOD)/SCID mice (see below), is associated exclusively with the SP cells, whereas a large majority of LTC-ICs in the fetal liver lack the SP phenotype ( [139](#) ). In bone marrow and liver of adult mice and some other studied species, LTC-ICs are highly enriched in SP cells, but even in those tissue sources, a smaller majority of LTC-ICs are in the non-SP fraction ( [136](#), [140](#) ).

## Human Hematopoiesis in Animal Hosts after Xenografts

Two animal models have been explored that can support xenografts of human hematopoietic cells and support multilineage, long-term human hematopoiesis. Murine models that are commonly used are derivatives of the NOD/SCID strain ( [141](#), [142](#), [143](#) and [144](#) ) or strains deficient in the RAG1 or RAG2 genes necessary for T- and B-cell receptor rearrangements ( [145](#), [146](#) ). Another system, useful for such xenografts, is a fetal ovine system ( [147](#), [148](#) ).

NOD/SCID/ $\beta_2$ -microglobulin<sup>null</sup> mice have recently been used for supporting proliferation and differentiation of primitive human hematopoietic progenitors ( [141](#), [142](#), [143](#) and [144](#) ). Such murine systems now appear to offer the best estimates of human stem cell numbers in a transplanted cell population—more accurate than *in vitro* culture methods for enumerating such cells. Using a limiting dilution protocol and analyzing the fraction of

mice that achieve long-term engraftment of both lymphoid and myeloid human cells, one can quantify SCID repopulating units in a source of human cells. One issue remains problematic in determining whether SCID repopulating units are the equivalent of human HSCs. The multilineage hematopoiesis in these mice can only be evaluated for 4 to 5 months at most, because the animals later develop thymic lymphomas. This limited period for evaluation of engraftment may result in some progenitors being scored as stem cells that cannot self-renew and could not support long-term engraftment in humans. Further backcrossing of the NOD/SCID derivative mice with other strains may lead to further improvement in the longevity of engraftment evaluation.

### Enrichment of Hematopoietic Stem Cells

There are approximately 1 to 4 HSCs per 100,000 nucleated cells in hemopoietic tissues, and it has not been possible to isolate a pure population of HSCs. However, several procedures have been developed to enrich greatly the proportion of HSCs in isolated cell populations from mouse and human sources. Although there are variations used by different investigators, each procedure consists of a series of steps that discriminate and select cells based on experimentally determined properties of stem cells (128, 129, 149, 150, 151, 152, 153 and 154). In general, the steps consist of combinations of the following:

1. Density gradient isolation of low-density mononuclear cells (excludes erythrocytes and mature granulocytes).
2. Fractionation of cells based on sedimentation rate by elutriation.
3. Flow cytometry sorting using forward and perpendicular light scatter windows to exclude many large blasts, monocytes, and granulocytes.
4. Incubation of cells with a panel of antibodies to specific antigens on differentiated cell types and subsequent removal of the cells bearing those antigens (see Table 6.1 for listing of antibodies used for this removal). After removal of the antigen-bearing cells, the remaining population is referred to as *lineage negative* or  $Lin^-$ .

**TABLE 6.1. Summary of Reagents and Procedures That Discriminate Cell Populations Enriched in Stem Cells**

| Stem Cells  | Other Cells  |
|---|--|
| Negative selection: removal of lineage-committed ( $Lin^+$ ) cells bearing antigens listed below  |  |
| Negative  | Human: CD2 (T cells), CD3 (T cells), CD19 (B cells), CD14 (monocytes), CD15 (granulocytes), CD16 (natural killer cells), glycoporphin A (erythroid cells), CD24, CD56, CD66b |
| Negative  | Mouse: Mac-1(monocytes, macrophages, granulocytes), B220 (B cells), GR-1 (granulocytes), TER119 (erythroid cells), Lyt-1 (CD5, T cells)                                      |
| Positive selection: collection of cells bearing certain antigens  |  |
| Human cells: CD34 antigen; most stem cells in unstimulated bone marrow are negative, but stem cells that have been “mobilized” are positive; stem cells from fetal liver or umbilical cord blood are positive | More than 99% of total marrow cells are CD34 negative, yet among the positive cells, only a small fraction are stem cells  |



Mouse cells (some strains); most are Sca (Ly-6A/E)<sup>+</sup>

Most are Sca<sup>-</sup>, but as in the case of CD34, a large fraction of the Sca<sup>+</sup> cells are not stem cells

| Stem Cells   | Some Contaminating Cells |
|--|--------------------------|
| Other discriminatory properties  |                          |
| A verapamil-sensitive ability to efflux Hoechst 33342 due to an ABC transporter protein (ABCG2/Bcrp1) (termed <i>side population cells</i> ) (references <a href="#">138</a> , <a href="#">139</a> ) |                          |
| Positive   | Negative                 |
| Another verapamil-sensitive ABC transporter (MDR-1) responsible for efflux of rhodamine 123 (references <a href="#">138</a> , <a href="#">139</a> )  |                          |
| Positive   | Negative                 |
| HLA-DR display (human)   |                          |
| Low  | High                     |
| Thy-1 (CD90) antigen display (mouse, human)  |                          |
| Positive   | Negative                 |
| Wheat germ agglutinin binding (mouse)  |                          |
| Low  | High                     |

- Isolation of cells that display on their surfaces an antigen associated with stem cells but not widely expressed on other hematopoietic cells. In humans, CD34 (My10) has been commonly used (see paragraph at the end of this section). In some strains of mice, the Sca antigen (Ly-6A/E) is selectively expressed on stem cells. Kit is highly expressed on stem cells of both mice and humans but is widely distributed on other cell types.
- Flow cytometry sorting of cells based on retention of rhodamine 123 or Hoechst dye 33342 (SP cells) or on binding of fluoresceinated wheat germ agglutinin or of fluoresceinated antibodies to Thy-1 (human) or to HLA-DR antigen. Stem cells stain at low levels with rhodamine 123, Hoechst 33342, or fluoresceinated wheat germ agglutinin. They display little HLA-DR antigens but most express Thy-1 antigen.

[Table 6.1](#) summarizes reactivity of HSCs to antibodies and other molecules commonly used in their enrichment. Recent evidence showed that many HSCs in normal bone marrow of adult animals do not express CD34 ([155](#)). In adult mice, its expression is, however, induced in virtually all HSCs mobilized into the blood by growth factors, and this appears also to be the case in humans. CD34 is expressed on HSCs of human and murine fetal livers ([156](#), [157](#)) and likely on all HSCs from tissues from fetuses or neonates, including HSCs of umbilical cord blood ([155](#)).

### Stem Cells in Culture

Repopulation studies in irradiated mice, as well as experience with bone marrow transplantation in humans, provide strong evidence that HSCs can replicate and expand extensively *in vivo* (self-renewal). Obviously, it would be very useful if transplantable HSCs could be expanded substantially *in vitro*. Such expansion has not yet been achieved. In studies of murine bone marrow cells in culture, repopulating units (HSCs) generally decline substantially relative to input numbers over a period of 1 to 4 weeks in culture ([150](#), [158](#), [159](#)), even though clonal analysis does indicate that some HSC clones proliferate ([158](#)). In cultures of murine and human HSCs, there is a loss of repopulating activity

associated with the entrance of the cells into the active cell cycle ( [134](#) ). The reason for this loss due to cell cycle activation is not clear. Another phenomenon that occurs during culture *in vitro*, however, is the reduction of expression of several adhesion molecules on the cell surface and a resulting loss of ability of progenitors to home to the hematopoietic organs ( [133](#), [160](#) ). Whether the cell cycle effect is related to the loss of adhesion molecules is not clear.

In contrast to our current inability to expand transplantable HSCs *in vitro*, the various studies all indicate that one can greatly expand more mature types of progenitors, including those with multilineage or single lineage potential. Thus, cell expansion technology may be useful to obtain high numbers of hematopoietic progenitor cells that may support patients in the short term after high-dose chemotherapy or marrow transplantation.

### **Question of Stem Cells with Potential to Form Other Tissues in Addition to Hematopoietic Elements**

During the last several years, data have been reported that suggest a “plasticity” in the differentiation potential of stem cells for various tissues. Interpretations were made that HSCs can give rise to muscle cells, neural cells, and liver parenchymal cells. Conversely, some experiments suggested that “muscle stem cells” or stem cells for other types of tissues could reconstitute the hematopoietic cells of lethally irradiated mice. For detailed discussions of this area of investigation, the reader is referred to several recent reviews ( [161](#), [162](#), [163](#), and [164](#) ). More recent studies have provided strong evidence that some of the interpretations of the earlier data concerning stem cell plasticity were wrong, whereas others must be reevaluated more stringently. Kawada and Ogawa ( [165](#) ) did secondary transplants of lethally irradiated mice with hematopoietic reconstituting cells isolated from muscles of mice that had previously been lethally irradiated and reconstituted with bone marrow of donors whose cells could be distinguished from these primary hosts. The results showed that the muscle-derived hematopoietic reconstituting cells in the secondary recipients were derived from the original donor strain for the primary transplant; that is, they were derived from the bone marrow HSCs transplanted from the original (primary) donors that were itinerant in the muscles, not from any “true” muscle stem cells of the secondary donors (donors for the secondary transplants). Wagers et al. ( [166](#) ) have examined the ability of single, marked HSCs to give rise to cells of nonhematopoietic types in mice made chimeric in the hematopoietic tissues by amplification of those single stem cells. These workers found no evidence that the HSCs contributed to nonhematopoietic cells, except possibly to extremely rare, individual hepatocytes. It remains to be tested fully whether the apparent origin of the hepatocytes from HSCs was due to differentiation or possibly due to a rare fusion of hepatocytes with hematopoietic cells. Likewise, the study did not fully address the possibility that HSCs could, in some tissues, be recruited to differentiate into other cell types under the stress of acute tissue injury. However, that possibility was tested in the case of acute recoverable intestinal injury, and no regenerating intestinal epithelium could be shown to be derived from HSCs.

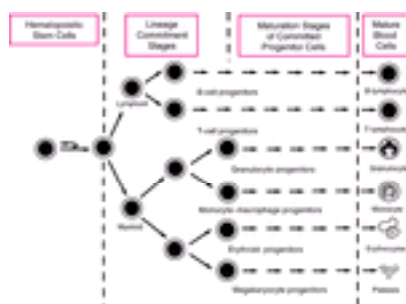
Thus, current evidence indicates that traditionally defined stem cells for a particular tissue type do not likely transdifferentiate interchangeably under normal conditions *in vivo*. Broader questions, however, remain as to whether there are stem cells more primitive than HSCs in bone marrow and elsewhere that can give rise to tissue-specific stem cells or whether tissue-specific stem cells might be induced to dedifferentiate and reprogram into another type under conditions not yet understood. Reyes et al. ( [167](#) ) have purified and expanded cells *in vitro* from the bone marrow of adult mice, termed *mesodermal progenitor cells*, that can differentiate *in vitro* into various cells of limb-bud mesodermal origin and also appear to form cells of visceral mesoderm (endothelial cells).



In follow-up studies ( 168 ), evidence was obtained that, after expansion under defined growth conditions, single cells of this type contributed to many somatic cell types of all three embryonic germ layers when injected into an early blastocyst. When the expanded cells were transplanted into a nonirradiated host, they contributed to hematopoietic cells as well as epithelial cells of the liver, lung, and gut. The authors of these studies now refer to these cells as *multipotent adult progenitor cells*, and cells with similar properties *in vitro* were also isolated from human tissues. These very recent findings thus indicate that a cell type exists in marrow and other tissues at an unknown frequency that can give rise to HSCs through a differentiation process. If so, our ideas and research on generation and self-renewal of HSCs will include extensive new possibilities.

## COMMITTED HEMATOPOIETIC PROGENITOR CELLS

*Committed hematopoietic progenitor cells* are progeny of HSCs that have begun to differentiate and can no longer convey long-term reconstitution of all hematopoietic lineages in ablated animals—that is, committed cells cannot give rise to HSCs. The term *commitment* is also used to denote other irreversible differentiation events that lead to further limitation of potential for development into terminal cell types. The latter idea is consistent with the observation that cell colonies grown *in vitro* from individual progenitor cells (or spleen colonies grown *in vivo*) contain a single mature cell type or limited combinations of mature cell types. Figure 6.2 is an illustration depicting recognized stages of committed hematopoietic lineages. Each progenitor cell stage depicted in Figure 6.2 represents a cell that gives rise to a definite, limited repertoire of mature cells as observed in various *in vitro* and *in vivo* assays. Although space in Figure 6.2 does not permit the representation of cell proliferation, the cells undergo multiple cell divisions between the stages shown. Thus, small numbers of HSCs give rise to greater numbers of the earlier committed progenitors that in turn are amplified through cell division at each subsequent point in the differentiation process. According to this scheme, each successive stage has a more restricted differentiation potential, and there is a succession of commitment steps. Just as the molecular processes in cells that determine whether a stem cell undergoes self-renewal or commitment to differentiate are not understood, neither are the molecular events that lead to subsequent commitment steps.



**Figure 6.2.** Diagram of hematopoietic cell differentiation. Hematopoietic stem cells can duplicate themselves during cell division (self-replicate), as indicated by the curved arrow. Most descendants of the stem cells are committed to differentiate. This commitment process occurs through a series of steps or stages, each of which leads to further restriction of lineage choice, until finally, the descendent cells are limited to a single lineage. After lineage commitment, the progenitor cells continue to differentiate and mature into the terminally differentiated cells found in the blood. The diagram shows only the steps of commitment and does not depict the proliferation of cells that occurs throughout the process. The amplification of cell numbers accompanying differentiation is very large. (From Koury M, Bondurant M. Prevention of programmed death in hematopoietic progenitor cells by hematopoietic growth factors. *News Physiol Sci* 1993;8:170–174, with permission.)

## Multilineage Progenitors

When the HSCs give rise to progeny that are committed to differentiate, early generations of these progeny have the potential to give rise to descendants representing multiple lineages. The majority of the murine CFU-S are examples of hematopoietic progenitors that are not capable of long-term reconstitution of ablated animals but are multipotential because they can grow into a spleen colony containing multiple cell lineages *in vivo*. Under culture conditions in semisolid medium with adequate supportive growth factors, these progenitor cells can form colonies of multiple cell lineages *in vitro* (169, 170). Similar multilineage colonies can also be demonstrated *in vitro* in human hematopoietic cell populations (171). When the hematopoietic cells reach maturity, the lineage composition of the colonies can be determined by picking out the colonies and spreading the cells on microscope slides followed by conventional staining techniques or by immunostaining using lineage marker antibodies. Not all multilineage colonies that appear in *in vitro* or *in vivo* assays contain all cell lineages; several combinations of cell lineages are characteristic. For example, some colonies contain granulocytes, erythrocytes, macrophages, and megakaryocytes (GEMM colonies), other colonies contain granulocytes and macrophage (GM colonies), and so forth. Table 6.2 lists a variety of hematopoietic progenitor stages that are defined by *in vitro* assays. Table 6.3 lists the names and abbreviations of growth factors and their receptors that are discussed in this chapter.

**TABLE 6.2. Listing of Hematopoietic Progenitors Defined *In Vitro***

| Name  | Abbreviation                       | Progenitor Stage/Potential   | Factors  |
|---|------------------------------------|--|--|
| Cobblestone area-forming cell   | CAFC (No.) <sup>a</sup>            | Mouse CAFC (28-40), possibly stem cell<br>Mouse CAFC (<28), multilineage | Irradiated marrow forming cell stromal cell layer; medium for long-term marrow culture, including horse serum and hydrocortisone |
| Long-term culture-initiating cell   | LTC-IC                             | Multilineage, possibly stem cell   | As above for CAFC  |
|   | LTC-IC <sub>ML</sub>               | Multilineage, myeloid and lymphoid, possibly stem cell                   |  |
| CFU that produces colonies with myeloid and lymphoid cells  | B-Mix                              | Multilineage, possibly stem cell   | Kit ligand, IL-7, EPO (IL-11 or G-CSF)   |
| CFU that produces colonies of neutrophils, eosinophils, erythrocytes, macrophages, megakaryocytes, and mast cells in various combinations | CFU-GEMM<br>CFU-myeloid restricted | Multilineage, myeloid  | Kit ligand, IL-11, GM-CSF, EPO, or often pokeweed mitogen-stimulated spleen cell-conditioned medium and EPO                      |
| CFU that produces colonies of granulocytes and macrophages  | CFU-GM                             | Granulocytes and macrophages   | Kit ligand, GM-CSF   |
| CFU that produces   |                                    |  |  |

|                            |          |  |   |
|----------------------------|----------|--|---|
| Erythrocytes               | CFU-E    | Late stage, restricted to erythrocytes                   | EPO, IGF-1                              |
| Erythrocytes               | BFU-E    | Early stage, restricted to erythrocytes                  | EPO, Kit ligand, IGF-1                  |
| Granulocytes               | CFU-G    | Restricted to granulocytes                               | G-CSF                                   |
| Macrophages                | CFU-M    | Restricted to macrophages                                | CSF-1                                   |
| Megakaryocytes             | CFU-MK   | Restricted to megakaryocytes                             | TPO, IL-3, Kit ligand                   |
| B lymphocytes              | CFU-preB | Restricted to B cells                                    | Kit ligand, IL-7                        |
| Dendritic/Langerhans cells | CFU-DL   | Restricted to dendritic/Langerhans cells and macrophages | GM-CSF, tumor necrosis factor- $\alpha$ |

BFU-E, burst-forming unit erythroid; CFU, colony-forming unit; EPO, erythropoietin; G-CSF, granulocyte colony-stimulating factor; GM-CSF, granulocyte-macrophage colony-stimulating factor; IGF-1, insulinlike growth factor-1; IL, interleukin.

NOTE: Besides added factors, medium for progenitor cell growth usually contains fetal calf serum and bovine serum albumin. The combinations of factors shown are generally not the only ones that support colony development from the indicated progenitors. However, some factor combinations may be inhibitory or may influence the lineage spectrum of colonies that appear.

<sup>a</sup> No. indicates day after plating colony counted.

**TABLE 6.3. Abbreviations for Growth Factors and Their Receptors**

| Factor   | Abbreviation                           | Receptor  |
|--|--|---|
| Erythropoietin                                   | EPO                                    | EPOR  |
| Kit ligand                                       | KL                                     | Kit   |
| Interleukin-1, -2, etc.                          | IL-1, IL-2, etc.                       | IL-1, IL-2, etc. receptor                       |
| Granulocyte colony-stimulating factor            | G-CSF                                  | G-CSF receptor                                  |
| Granulocyte-macrophage colony-stimulating factor | GM-CSF                                 | GM-CSF receptor                                 |
| Macrophage colony-stimulating factor             | M-CSF, CSF-1                           | CSF-1R  |
| Interferon- $\alpha$ , - $\beta$ , - $\gamma$    | IFN- $\alpha$ , - $\beta$ , - $\gamma$ | IFN- $\alpha$ , - $\beta$ , - $\gamma$ receptor |
| Thrombopoietin                                   | TPO                                    | Mpl   |
| Leukemia inhibitory factor                       | LIF                                    | LIF receptor                                    |
| Oncostatin M                                     | OSM                                    | OSM receptor                                    |
| Ciliary neurotropic factor                       | CNTF                                   | CNTF receptor                                   |
| Transforming growth factor- $\alpha$             | TGF- $\alpha$                          | ERBB1 (EGF receptor)                            |
| Insulinlike growth factor                        | IGF-1                                  | IGF-1R  |
| FLT3 ligand                                      | FL                                     | Flk-2/FLT3                                      |
| Flk-1 ligand, vascular endothelial growth factor | VEGF                                   | Flk-1   |

The observation that colonies with various combinations of lineages occur has been interpreted in several ways (models) in explaining how cells are committed to become a particular type of blood cell ( [172](#) ). The data favor the idea that there are multiple commitment steps and that these steps lead to loss of specific lineage potential in a definite order. The first lineage commitment step separates lymphoid from myeloid potential, then granulocyte/macrophage potential is separated from erythroid/megakaryocyte potential, and so on, until finally, a descendant cell has only one lineage capability. This idea of successive commitment steps is embodied in [Figure 6.2](#). Although this idea is probably generally correct, there are variant models that differ somewhat in their interpretation ( [172](#) ). Also, it must be remembered that *in vitro* growth conditions may not be permissive for all possible lineages to appear in a colony. Thus, caution must be exercised in interpreting the exact lineage commitment pathways. Multilineage progenitors, CFU-S and *in vitro*-derived multilineage colonies, had been thought to be incapable of generating lymphoid cells. However, several relatively recent studies have shown that lymphoid cells are produced by several such progenitors, but that they were not observed previously because growth factor support for colony development was not permissive for descendent lymphoid cells ( [112](#), [131](#), [173](#) ).

### Single Lineage Progenitors

The descendants of the multilineage colony-forming cells are ultimately restricted to a single lineage potential. The more mature, single lineage-committed progenitor cells are assayed *in vitro* by their ability to form colonies. These progenitor cells include ( [Table 6.2](#) ) CFU-G, CFU-M, CFU-E, CFU-MK ( [174](#), [175](#) and [176](#) ), CFU-preB ( [131](#), [177](#) ), and CFU-DL ( [178](#), [179](#) ) for colony-forming units granulocyte, macrophage, erythrocyte, megakaryocyte, B lymphocyte, and dendritic/Langerhans cell, respectively. In some lineages, it is possible to observe stages of maturity within the lineage-committed progenitors. For example, the single lineage producing burst-forming unit erythroid (BFU-E) is a more immature erythroid progenitor than the CFU-E, forming colonies of many more mature erythroid cells after a longer period of time than the CFU-E.

### Terminal Phases of Differentiation

Cells in the final stages of hematopoiesis are sufficiently differentiated that they can be identified by morphology using light microscopy with preparations of hematopoietic tissue. These cells are erythroblasts, myelocytes, monocytes, and megakaryocytes, and, because of the vastly amplifying cell divisions that occur by the time the final stages are reached, these cells are by far the most prevalent cells seen in hematopoietic tissues. They are only capable of a few cell divisions, on the order of one to four, yet they are undergoing dramatic specialized changes associated with terminal phases of differentiation/maturation. The erythroblasts rapidly accumulate hemoglobin and begin to assemble a unique membrane skeleton that later maintains the shape and deformation properties of the mature erythrocytes. The nucleus of the erythroblast becomes condensed and is extruded from the cell, leaving an irregular, organelle-containing reticulocyte. Subsequently, over the course of a few days, extensive remodeling occurs within the reticulocyte that eliminates the internal organelles and changes the membrane so that the biconcave erythrocyte is formed. This remodeling process involves extensive, selective proteolysis and is not yet well understood. In myelocytes, granules that contain specific proteolytic enzymes are formed in the cytoplasm. The nuclei undergo a condensation process that ultimately results in a multilobular nucleus that is retained in the mature cell. Maturing monocyte precursors undergo similar changes. The terminal-stage megakaryocytes replicate their DNA and undergo several nuclear divisions without cytokinesis; thus, they become polyploid. Dense granules and  $\alpha$ -granules form in the cytoplasm, and the cytoplasm becomes highly compartmentalized by demarcation

membranes. Platelets form as small portions of the demarcated megakaryocyte cytoplasm separate from the whole cell.

## THEORIES OF COMMITMENT

### Extrinsic Regulation versus Stochastic Mechanisms

There are two contrasting ideas about the general nature of the commitment process. Evidence for and against each of these two views has been reviewed by Metcalf ([180](#)) and Enver et al. ([181](#)). One view is that a commitment step is determined from outside the cell by a specific signal or combination of signals. Most likely, these signals are initiated by ligands for which the cell has specific receptors. When activated, these receptors generate signals that cause specific initial changes in gene expression. In turn, these resultant changes initiate a sequence of further irrevocable changes in expression of genes that characterize a subsequent differentiation state. The hematopoietic cell and its progeny may then proceed through a predefined program of changes until, at some point, new signals are received that redirect another sequence of gene expression changes—a second commitment step and so on. In this deterministic model of commitment, the choices of the alternative possible pathways of differentiation are regulated by either interaction with ligands on stromal cells and matrix or interactions with soluble hematopoietic growth factors. A second model of commitment proposes that the critical, irreversible gene expression changes that establish the alternative differentiation events are stochastic; the alternative initial changes are probabilistic, and the probabilities for the alternative changes are unaffected by the cellular environment. A stochastic model for commitment to differentiation versus self-renewal of stem cells was first proposed by Till et al. ([182](#)). Later, Ogawa and Porter ([183](#)) proposed that commitment of multipotential hematopoietic progenitors to individual myeloid lineages is also a stochastic process. The role proposed for hematopoietic growth factors in the stochastic model is that of providing a permissive or selective environment for progenitor cell growth. The factors support survival or proliferation of the progenitors that bear the cognate receptors on the cell surface.

One often reads statements about a growth factor “inducing cells to differentiate along some pathway.” However, definitive proof that any hematopoietic growth factor can induce differentiation is lacking. In one experimental approach to resolving this issue, populations of undifferentiated, multipotential hematopoietic cells (usually an immortal cell line) are cultured in the presence of one or another mixture of test growth factors. After a time period of several days, a cell population emerges that is composed of a high percentage of cells recognizable as one or several particular lineages, and the lineage composition of the emergent population depends on the particular growth factors used in the culture ([184](#), [185](#)). In such experiments, the initial population of undifferentiated hematopoietic cells is undergoing cell division and cell death at unknown comparative rates. Because a differentiated population takes several days to become predominant, it is difficult to determine if the cells were induced to differentiate by the test growth factors or were rather selected for survival or growth by permissive conditions.

Another basic approach to attempt to distinguish between the models of commitment is to plate hematopoietic progenitor cells such that each culture initially contains a single cell. One then can micromanipulate the two daughter cells after an initial cell division and replat them individually into cultures with the same or different growth factors. Several studies of this type have been done ([172](#), [186](#), [187](#), [188](#) and [189](#)), and it has been shown that a significant fraction of paired daughter cells each gives rise to subsequent progeny representing different combinations of lineages. The type of progeny of these asymmetric divisions does not appear to be influenced by cytokines ([189](#)). Thus, so far, experiments

manipulating single cells have yielded data consistent with the stochastic model of lineage commitment. Yet such experiments require analysis of the fate of hundreds of cell pairs under various conditions, and experiments have not yet been done that have completely resolved the issue. Whether cytokines can have any direct influence on differentiation is not clear. It is clear that *in vitro*, many cells do commit to differentiation into particular lineages and do differentiate without a detectable influence of cytokines. This latter conclusion was recently supported by a study that showed that clones of a multipotential cell line, when engineered to express a gene that protects the cells from apoptosis (*bcl-2*), can undergo spontaneous differentiation into multiple lineages in the absence of any added growth factors ( [190](#) ).

## Molecular Mechanisms of Differentiation

From a molecular mechanistic standpoint, based on current ideas about gene transcription, it is easier to propose molecular schemes to explain a deterministic model of commitment than a stochastic one. One can suppose that a receptor signal activates a specific transcription factor (among several possible ones), and that specific factor turns on or represses a gene, which, in turn, activates or suppresses other specific genes. Irreversible sequences of gene expression can be hypothesized that are fixed in daughter cells of the original, affected cell ( [191](#) ). One is less accustomed to thinking about how transcription of alternative genes might be stochastic and how such alternatives might result then in different sequences of gene transcriptional changes that are passed on to progeny cells. Two familiar examples, of course, are the stochastic gene rearrangements that occur in lymphocytes to form the T-cell and B-cell antigen receptors. No such rearrangements of genetic material are known to occur in connection with commitment of other hematopoietic progenitors, but the possibility does exist for as yet unidentified genes. Another way in which expression of critical genes might be stochastic is through competition of transcription factors for the genetic elements that control the expression of the genes or through competition at some critical time between nuclear matrix-associated proteins for sites on the DNA in the vicinity of various genes. Aside from the binding of transcription factors, there are modifications of DNA and chromatin structure that regulate gene expression either reversibly or irreversibly. These modifications include DNA methylation and chromatin acetylation and methylation. How the specificity of these processes for particular gene regions is controlled has yet to be determined.

## Role of Particular Transcription Factors

Some specific transcription factors exhibit hematopoietic lineage-restricted expression, and some are known to be essential for the complete differentiation of individual lineages. Among the transcription factors that have been shown to influence lineage decisions are several members of the homeobox (HOX) family and the Ikaros proteins ( [192](#) , [193](#) ). Also, the mammalian Polycomb group of genes that regulates expression of various HOX genes probably plays roles in lineage decisions ( [194](#) ). Two examples of transcription factors whose lineage associations are more fully understood are GATA-1, which is essential for terminal erythrocyte and megakaryocyte differentiation, and PU.1, which is essential for B-lymphocyte as well as macrophage development ( [163](#) , [195](#) ). Specific factors not only play a direct role in the expression of lineage-specific genes but, in some cases, appear to antagonize transcription factors important for other lineages; thus, they can repress the expression of genes characteristic of other lineages. For example, GATA-1 can suppress PU.1 activity, and PU.1 can suppress GATA-1 activity by direct protein interactions that block the function of each other ( [163](#) ). PU.1 and GATA-1 play positive roles in the transcription of their own genes (autoregulatory loops) ( [196](#) , [197](#) ). Thus, hypothetically, an excess of GATA-1 over PU.1 could down-regulate PU.1 expression at the level of transcription, and excess PU.1 could likewise down-regulate GATA-1. In



multipotent cells, it is known that there is expression at low levels of sets of genes characteristic of multiple hematopoietic lineages ( [198](#) ). Thus, commitment appears to occur not only by up-regulation of a single lineage program of gene expression but also by the irreversible suppression of competing differentiation programs. Because of observations such as those described above for GATA-1 and PU.1 and because the forced overexpression of particular transcription factors can cause lineage switches in certain *in vitro* cell systems, some investigators have proposed that the transcription factor profile (stoichiometry relationships) of multipotent cells directs their lineage commitment decisions through cross-antagonism mechanisms ( [163](#) , [199](#) ). How variations in transcription factor stoichiometry occur could be either by extrinsic signals or by stochastic mechanisms. It should be pointed out that much of the evidence for this model was obtained in permanent cell lines that may not accurately represent normal primary cells, and also, many of the observations occurred in cells in which the expression of specific transcription factors at high levels was forced through genetic manipulations. Although these studies can provide useful information about the functions of specific transcription factors, it is premature to determine whether stoichiometric relationships among some of these factors in primitive cells are a major determinant of commitment and, if so, which factors are involved. In one of the best-studied cases, GATA-1, it is clear that erythroid lineage commitment and progression of differentiation to the proerythroblast stage occur in hematopoietic cells in which the gene has been deleted ( [195](#) ).

## REPLICATION POTENTIAL OF COMMITTED PROGENITORS: A QUESTION OF IMPORTANCE FOR LEUKEMIA

During hematopoiesis, the numbers of more differentiated cells are amplified by cell divisions of the progenitors. Experience with *in vitro* cultures and with *in vivo* transplants indicates that, for most lineages, progenitor cells at each stage of development have an upper limit to the number of cell divisions that their progeny can undergo before terminal maturation occurs; the further along the commitment differentiation pathway the progenitor is, the lower the cell division potential becomes. However, such a limitation is not clear in some lineages. For example, lymphocytes may have vast, if not unlimited, proliferation potential. It is possible to achieve continuous proliferation of explanted T cells in culture if they are constantly provided interleukin (IL)-2 and cognate antigen ( [200](#) ). Also, there is evidence of long-term persistence and great amplification of B- and T-cell clones *in vivo*. Even in the cases of other lineages besides lymphocytes, it is not yet clear how flexible the overall amplification may be or to what degree it can be controlled by environmental influences. Some progenitors of granulocytes and macrophages can give rise to quite large numbers of progeny in the presence of combinations of growth factors ( [201](#) , [202](#) ). Likewise, there is evidence that committed erythroid progenitor cells can be greatly expanded in culture while maintaining an immature phenotype in serum-free medium in the presence of high levels of KL and EPO or the presence of those two factors plus dexamethasone and  $\beta$ -estradiol ( [203](#) , [204](#) and [205](#) ). Even greater expansion of chicken erythroid progenitors can be achieved in the presence of transforming growth factor- $\alpha$  ( [206](#) ). To what degree the cell amplification process varies *in vivo* due to physiologic conditions is not known. Even less is known about the degree of amplification that occurs at the earliest stages of development.

One possible mechanism for limiting cell division potential is the successive shortening of the repetitive DNA at the ends of chromosomes (telomeres) at each cell division due to lack of ability of the DNA replication mechanism to replicate the very ends of the DNA. Without a special mechanism to maintain the telomeres, the chromosome ends would be shortened to the point of losing essential genetic material after a certain number of DNA replicative cycles. The cell presumably could sense these telomeric shortenings and



prevent further replication (207). Some eukaryotic cells have an enzyme (telomerase) that can regenerate the repetitive DNA at chromosome ends and is believed to be responsible for telomere maintenance. Generally, cells of tumors and of immortal cell lines have demonstrable telomerase activity, whereas cells of most somatic tissues do not (207). However, this presumed distinction between immortal cells (including cancer) and normal cells does not always apply. Telomerase activity is present in some peripheral blood leukocytes and some bone marrow cells of normal human beings, including cell fractions enriched in granulocytes, T lymphocytes, and B lymphocytes/monocytes (208, 209 and 210).

The mechanism of control of cell division potential is important in considering the properties of leukemic cells *in vivo*. Depending on the kind of leukemia, the cell populations usually express markers of one or more normal hematopoietic cell lineages. Even though the combination of markers expressed may not correspond to those of known normal progenitors, they usually indicate that some degree of lineage commitment has occurred. However, some portion at least of the leukemia cell population exhibits the property of unlimited cell division potential—a property not known to exist, at least in normal committed myeloid progenitors. Thus, how cell division potential is restricted in normal hematopoietic progenitors and how this control is abrogated in some leukemic cells is a question of great theoretical and, possibly, practical importance.

## HEMATOPOIETIC GROWTH FACTORS

In the course of development of *in vitro* assays for the various multilineage and single lineage hematopoietic colony-forming cells, it became clear that several different growth factors exist, each capable of supporting a particular spectrum of hematopoietic cell types. Initially, most of these factors were discovered to exist in “conditioned media” that had been used to culture specific cell lines or specific primary cell types. Such conditioned media were necessary or greatly stimulatory for hematopoietic cell colony growth. An example of a conditioned medium source is medium from pokeweed mitogen-stimulated murine spleen cells (125). The number of known hematopoietic growth factors has now expanded greatly and undoubtedly will continue to increase. The known growth factors have been purified, and the genes that encode them have been cloned. These growth factors, which are glycoproteins, are now available as pure, recombinant factors due to the successful cloning and expression of their genes at high levels in modified eukaryotic cells. The availability in abundance of pure growth factors has led to the identification and cloning of genes for their specific cell receptors. Conversely, in some cases, discovery of a putative receptor molecule through molecular cloning has led to the identification of previously unidentified growth factors.

### Hematopoietic Growth Factor Receptors

Based on certain structural and functional features of the receptors for hematopoietic growth factors, two families of ligands/receptors have been recognized: the cytokine receptor family and the tyrosine kinase receptor family (Table 6.4). It was noted by Bazan (211), through modeling of the secondary structures of receptors for several hormones and hematopoietic growth factors, that predicted structural similarities existed among a particular receptor group. This group is called the *cytokine family of receptors*. These receptors have an approximately 200-amino acid extracellular binding segment composed of two discrete folded domains (modules) of approximately 100 amino acids. These modules share significant sequence and similar predicted secondary structure. Predicted secondary structure of these domains includes seven beta strands folded into antiparallel beta sandwiches with a similar topology. Bazan (211) proposed a model of cytokine binding to these receptors in which the cytokine fits into a generic structural framework formed by the relatively conserved topology of the  $\beta$ -sheet faces and the connecting

loops between the beta strands. Because the member receptors of the cytokine group have these structural similarities, it was expected that the binding domains of their ligands, the cognate growth factors, would have some common structural features, which is the case. Several of the cytokine growth factors have had their structures determined by x-ray crystallography: growth hormone, IL-2, macrophage colony-stimulating factor (CSF-1), GM-CSF, interferon- $\gamma$ , granulocyte colony-stimulating factor (G-CSF), IL-10, IL-5, IL-4, and murine leukemia inhibitory factor. The determined structure in each case includes a topologic feature consisting of a “bundle” of a helices ([212](#), [213](#), [214](#), [215](#) and [216](#)). There are variations in how these structures are formed from portions of the peptide chains, but they are, nevertheless, similar. For reviews of this cytokine growth factor/receptor group, see references [217](#), [218](#), and [219](#). The receptor protein chains have a single membrane-spanning domain, and their intracellular domains have no areas of amino acid homology to tyrosine kinases or guanosine triphosphate-binding domains that are found in other classes of signal-transducing receptors. Most of the functional receptors for the cytokine growth factors consist of complexes of two or more protein chains of the cytokine receptor family ([Table 6.4](#)), and functional receptors for different cytokine growth factors sometimes contain a common cytokine receptor peptide chain. For example, IL-3, GM-CSF, and IL-5 receptors consist of a ligand-specific  $\alpha$ -chain and a common gp140  $\beta_c$  subunit. Similarly, the so-called IL-6 family of cytokines ([Table 6.4](#)) uses receptor complexes consisting of one or two common gp130 chains plus an additional ligand-specific subunit ([220](#)). Although receptors of several subunits are common among the cytokine receptor group, several members apparently consist of a single cytokine family protein chain. These are the receptors for EPO, thrombopoietin (TPO), G-CSF, growth hormone, and prolactin.

**TABLE 6.4. Classification of Hematopoietic Factors Based on Their Receptor Types**

|  |  |
|--|--|
| Hematopoietic growth factors using cytokine type of receptors  |  |
| Cytokines with receptors consisting of a single unique peptide chain.  |  |
| Erythropoietin, thrombopoietin, granulocyte colony-stimulating factor, growth hormone, <a href="#">a</a> prolactin hormone <a href="#">a</a>   |  |
| Cytokines with receptors consisting of complexes containing gp130, which serves as the signal transducer, plus an additional ligand-binding subunit.   |  |
| IL-6, IL-11, IL-12, leukemia inhibitory factor, oncostatin M, ciliary neurotropic factor <a href="#">a</a>   |  |
| Cytokines with receptors consisting of a ligand-specific $\alpha$ subunit and a common gp140 $\beta_c$ subunit.  |  |
| IL-3, granulocyte-macrophage colony-stimulating factor, IL-5   |  |
| Cytokines with receptors consisting of a common $\gamma_c$ subunit and ligand-specific $\alpha$ and/or $\beta$ subunits.   |  |
| IL-2, IL-4, IL-7, IL-9, IL-15  |  |
| Cytokines with receptors consisting of two or more unique subunits.  |  |
| IFN- $\alpha$ , IFN- $\beta$ , IFN- $\gamma$   |  |
| Hematopoietic growth factors using receptors of the tyrosine kinase (RTK) superfamily  |  |
| Factors using RTKs of the epidermal growth factor (EGF) family (sometimes called <i>type I receptors</i> ).  |  |
| TGF- $\alpha$ , which uses EGF receptor [EGFR (ERBB1)]; TGF- $\alpha$ has a profound effect on primitive hematopoietic progenitors of some avian species; no effect on hematopoietic cells of mammals has been documented. |  |
| Factors using RTKs of the insulin family (sometimes called <i>type II</i> ).   |  |
| Insulinlike growth factor-1  |  |

Factors using RTKs of a subfamily of the platelet-derived growth factor family with five immunoglobulin-like domains (sometimes called *type III*).

Kit ligand, colony-stimulating factor-1, FLT3 ligand

Factors using RTKs of another subfamily of the platelet-derived growth factor family with seven extracellular immunoglobulin-like domains (sometimes called *type V*).

Flk-1 ligand (vascular endothelial growth factor)

Expression of several additional RTKs has been reported on hematopoietic cells. These include receptors designated *TIE*, *TEK*, and *MRK*. The effects of their ligands have not been reported.

gp, glycoprotein; IFN, interferon; IL, interleukin; TGF, tumor growth factor.

<sup>a</sup> Members of the cytokine superfamily that do not have known effects on hematopoietic cells.

---

The signal transduction mechanisms for the cytokine family of receptors are currently being investigated by many groups ( [217](#), [218](#) and [219](#) ). In general, each of these receptors interacts with several intracellular proteins. When their ligand binds, they activate one or more members of the Janus kinase (JAK) family of protein tyrosine kinases. They also bind the Shc proteins, which become phosphorylated on tyrosine and initiate a cascade of further tyrosine phosphorylations on other proteins. Also, when bound to ligand, these receptors activate the enzyme phosphoinositol 3-OH kinase. It is not yet fully understood what the roles of each of these receptor functions are in causing the final cellular effects. In the case of JAK kinase activation, it is clear that one result is subsequent activation of a STAT ( signal transducer and activator of transcription) family protein that moves from the cytoplasm to the nucleus and acts as a transcription factor through sequence-specific binding to DNA. In the case of most cytokine receptors, the *ras* signaling pathway is also activated.

The second group of known hematopoietic growth factors consists of members whose receptors are themselves protein tyrosine kinases ( [221](#) ) ( [Table 6.4](#) ). The factors of this group that are best understood in hematopoiesis are KL and CSF-1. The respective receptors are products of the *c-kit* and *c-fms* protooncogenes. One widely distributed receptor tyrosine kinase/ligand system that is important in hematopoiesis is insulinlike growth factor (IGF)-1 and its receptor IGF-1R. IGF-1 has specifically been shown to be important for erythroid cell differentiation *in vitro* in culture systems without added serum ( [222](#) ), although it is probably important for other lineages as well. The receptor tyrosine kinase FLK-2/FLT3 (mouse) or STK-1 (human) has been identified on early hematopoietic progenitors ( [223](#), [224](#) and [225](#) ), and its cognate ligand, FL ( [226](#) ), has multiple effects in hematopoiesis ( [26](#), [225](#), [227](#), [228](#) and [229](#) ). Finally, there are reports of expression of additional receptor tyrosine kinases on some hematopoietic cells, but their significance in hematopoiesis has not been extensively studied. These include FLK-1 ( [230](#), [231](#) ), MRK ( [232](#) ), and TIE and TEK ( [233](#), [234](#) ). In chickens, the Erb-B receptor, through binding of transforming growth factor- $\alpha$ , has a profound effect on expansion of early erythroid progenitors ( [206](#) ).

The receptor tyrosine kinases comprise a large group of receptors that have been subdivided into types based on structure ( [221](#), [235](#) ) ( [Table 6.4](#) ). Kit, CSF-1R, and FLK-2/FLT3 are receptors of a subfamily of the platelet-derived growth factor receptor family [or type IV ( [235](#) )] that are characterized by five immunoglobulin-like domains in the extracellular portion. FLK-1 is a member of the other subfamily of the platelet-derived

growth factor receptor family [or type V ( [235](#) )] that has seven such immunoglobulin domains. The genes for the related type III and type V receptors are clustered together in three locations in the human genome ( [235](#) ). IGF-1R is a member of the insulin family of receptor tyrosine kinases.

The intracellular mechanisms by which the receptor tyrosine kinases trigger their biologic effects are, like those of cytokine receptors, under intense investigation ( [236](#) , [237](#) ). Interestingly, many of the same intracellular pathways appear to be stimulated by both types of receptors—for example, Shc activation and phosphoinositol 3-OH kinase activation. It remains to be elucidated whether or how these various receptors can initiate specific intracellular functions not common to all of the other receptors.

## Factors That Act on Multilineage Progenitors

*In vitro* cultures of hematopoietic colony-forming cells have continued to be very useful in defining growth factor effects on various lineages of cells ( [26](#) , [238](#) , [239](#) , [240](#) , [241](#) and [242](#) ). Many of the hematopoietic growth factors exhibit positive growth effects on HSCs or progenitors with multilineage potential, or both. These include KL, GM-CSF, G-CSF, CSF-1, IL-3, IL-4, IL-6, IL-11, IL-12, FL, leukemia inhibitory factor, oncostatin M, and TPO ( [243](#) , [244](#) , [245](#) and [246](#) ). In addition, some members of this same group can support differentiation of certain cell types to late stages or even to full maturity. For example, G-CSF, GM-CSF, CSF-1, IL-3, KL, and IL-6 can all support formation of small neutrophilic granulocytic colonies, and CSF-1 and GM-CSF can also support macrophage colonies and mixed granulocyte/macrophage colonies ( [243](#) ). Other members of this group do not support formation of colonies of mature hematopoietic cells alone but exert their effects in combinations with other factors. They may affect only early-stage progenitors, and their partner factors support the later differentiation, or they may act simultaneously with other factors on cells at any development stage that yields enhanced cell production as a result of a combination of different stimulatory signals. Such enhancement or potentiating effects are not restricted to those factors that have no effect alone but are rather observed with particular combinations of all members of the group listed above.

Potential of hematopoietic cell production in *in vitro* assays by combinations of growth factors can occur in two basic ways. A combination of growth factors may allow proliferation and differentiation of individual cells that would otherwise die or remain dormant in the presence of a single factor. Second, potentiation can occur by enhanced proliferation in the presence of the combined factors. The latter effect appears to apply to the examples of the combined effect of KL with G-CSF, GM-CSF, IL-3, IL-6, or EPO on expansion of populations of progenitors ( [203](#) , [247](#) , [248](#) ). The numbers of colonies formed in the presence of the combinations are not increased greatly, but there is a large increase in the size of the colonies. The proliferation of HSCs, however, appears to be an example of a requirement of a combination of factors for recruitment of dormant cells into proliferation and differentiation ( [172](#) , [243](#) , [249](#) , [250](#) and [251](#) ).

When growth factors with effects on multilineage progenitors act alone or in combination, the result of early rounds of proliferation and differentiation is the generation of progeny that become committed individually to form different lineages of mature cells. For some lineages, the resultant single lineage progenitors cannot complete differentiation and maturation without lineage-specific factors; late committed erythroid progenitors (CFU-E) require EPO, or they die. Likewise, appearance of lymphoid cells requires IL-7, and maturation of megakaryocytes and formation of platelets is greatly enhanced by TPO. Thus, the full development of hematopoietic cells from stem cells or early-stage progenitors requires the action of growth factors (alone or in combination) that support the multilineage progenitors and, in addition, growth factors that support terminal

differentiation of committed single lineage progenitors.

## Granulocyte and Macrophage Growth Factors

In addition to affecting multilineage progenitors, several growth factors also support terminal differentiation of granulocytes and macrophages. GM-CSF supports growth and development of both granulocytes and monocytes/macrophages ( [174](#), [252](#), [253](#) ). G-CSF, CSF-1, and IL-5 selectively support differentiation of neutrophilic granulocytes, monocytes/macrophage ( [174](#), [252](#) ), and eosinophilic granulocytes ( [254](#), [255](#) ), respectively. Dendritic/Langerhans cells arise from progenitor cells that also give rise to monocytes. *In vitro* culture of these progenitors in the presence of tumor necrosis factor- $\alpha$  plus GM-CSF or IL-3 favors generation of dendritic cells ( [178](#), [179](#), [256](#), [257](#), [258](#) and [259](#) ). Mast cell differentiation is supported by KL ( [260](#), [261](#), [262](#) and [263](#) ).

G-CSF, GM-CSF, and CSF-1 not only support differentiation of late-stage progenitors, but also can activate the resulting mature blood cells, stimulating such functions as phagocytosis ( [264](#), [265](#), [266](#), [267](#), [268](#) and [269](#) ). KL also activates mature mast cells, causing them to release histamine ( [260](#) ).

IL-5 is produced by T lymphocytes, whereas GM-CSF, G-CSF, KL, and CSF-1 are produced by multiple cell types including fibroblasts, endothelial cells, and macrophages. Thus, all of the cell types that produce the granulocyte and macrophage growth factors are distributed throughout the body, and T cells and macrophages are concentrated at the site of inflammation. Circulating late-stage granulocyte and macrophage progenitors as well as mature granulocytes and macrophages could thus be exposed to these factors at areas of inflammation as well as in the bone marrow stroma. It is plausible that these growth factors may play important roles in activation of granulocytes and macrophages as well as supporting final maturation stages at locations of inflammation. There is no evidence at present that production of granulocytes or macrophages is regulated systemically through a mechanism that senses the mature cell numbers in the body and causes elaboration of a factor that works in the marrow.

## Megakaryocyte Growth Factors

*In vitro* colony assays have been developed for quantifying megakaryocyte progenitor cells, termed *colony-forming units megakaryocyte* (CFU-MK). As in the case of other early committed progenitors, the growth of such colonies is augmented by several of the CSFs with multilineage activity such as IL-3, IL-6, GM-CSF, KL, and IL-11 ( [176](#), [270](#), [271](#) ). However, in the case of platelets, there is evidence that their production is regulated by the number of platelets in the blood. Reduction of platelet numbers in rodents by antiplatelet antibodies or by exchange transfusion of platelet-poor blood causes an increase in the number of megakaryocytes in the hemopoietic tissues as well as an increase in their size and ploidy; platelet transfusion decreases these parameters ( [176](#) ). Such manipulations do not affect CFU-MK numbers in the hematopoietic tissues ( [272](#) ). These observations led to the speculation that the differentiation of megakaryocytes and the production of platelets are controlled by an unidentified thrombopoietic factor that is induced by thrombocytopenia ( [176](#), [273](#) ).

A growth factor has been identified that has some properties of a physiologic regulator of platelet production. This factor, TPO, exerts its effect through the activation of a cytokine receptor termed *Mpl*. ( [274](#), [275](#) and [276](#) ). *Mpl* was identified earlier as the viral oncogene product of the mouse retrovirus, myeloproliferative leukemia virus ( [277](#) ).



Recombinant TPO increases megakaryocyte and platelet numbers *in vivo* and stimulates CFU-MK growth *in vitro* ( [278](#), [279](#) ). Mice that bear homozygous, nonfunctional alleles of the *c-mpl* gene are viable but have greatly diminished platelet number ( [244](#) ). This latter result indicates that TPO is not essential for all platelet production but that it is a strong *in vivo* regulator. There is evidence that TPO production is regulated by blood platelet number ( [279](#) ) and that platelet number regulates the mRNA for TPO in the marrow and spleen but not in the liver and kidney ( [280](#) ). It is not yet clear that the modulation of TPO mRNA in these organs is responsible for the regulation of overall TPO protein levels. Several studies indicate that TPO is constitutively synthesized in the liver and that its level in blood is determined by its removal from circulation by binding to c-Mpl receptor on platelets and bone marrow megakaryocytes ( [274](#) ).

### Growth Factors for B Lymphocytes

Methods for culture of B lymphocytes and their progenitor cells were originally described by Whitlock and Witte ( [281](#) ). Subsequently, a colony assay for B-cell progenitors, CFU-preB, was described, in which it was found that IL-7 is a very potent growth stimulatory factor for such progenitors ( [177](#) ). The role of IL-7 in lymphoid cell development *in vivo* was demonstrated by generating mice in which the genes for the IL-7 receptor are nonfunctional. Such mice have a profound reduction in thymic and peripheral lymphoid cellularity with defects in both B- and T-cell development ( [282](#) ). Because of the realization of the importance of IL-7 in B-cell growth *in vitro*, it has been incorporated into culture media when examining the lineage potential of early multilineage progenitors ( [131](#), [132](#), [173](#) ). Progenitors with both myeloid and lymphoid potential can now be observed and quantified, and it has become clear that such progenitors are more prevalent than previously thought. Thus, it appears that loss of this potential occurs at stages significantly beyond the commitment of the HSC to differentiate.

### Growth Factors for Erythroid Cells

The physiologic regulator of erythrocyte production is EPO, and this regulation is very precise, keeping the red cell mass within very narrow limits ( [283](#) ). EPO acts on committed erythroid progenitors to support the later phases of erythroid differentiation ( [283](#) ). The regulation is achieved by EPO's action to modulate apoptosis of these progenitors. The production of EPO is regulated by the O<sub>2</sub> activity in the vicinity of specialized EPO-producing cells in the kidney. These cells are peritubular cells, located in the renal cortex ( [284](#), [285](#) and [286](#) ). By sensing O<sub>2</sub> activity, they essentially measure the oxygen delivery capacity of the blood, and they adjust EPO production to achieve the number of erythrocytes needed for normal tissue O<sub>2</sub> tension. The liver also contains specialized cells that can produce EPO in an oxygen-dependent manner, although in adult animals, the contribution of the liver to total EPO production is much less than that of the kidney. In the specialized kidney and liver cells, the transcription of the EPO gene is controlled by an oxygen-dependent transcription factor, hypoxia-inducible factor, that interacts with DNA sequences corresponding to the 3' untranslated sequence of the mRNA and also with sequences in the promoter region ( [287](#) ). In addition, tissue specificity of expression in the kidney requires specific, *cis*-acting DNA sequences far upstream (between 6 kilobase pairs and 14 kilobase pairs) of the coding sequence ( [288](#), [289](#) ).

KL is also specifically required for erythroid cell development as shown by its requirement for growth of human BFU-E *in vitro* under serum-free conditions ( [290](#) ). The Kit receptor is present on multilineage progenitors and on the BFU-E, and it persists on erythroid progenitors up to the proerythroblast stage. KL thus has a stimulatory effect on erythroid

progenitors throughout most early stages, including those of the CFU-E and proerythroblast, when EPO stimulation becomes essential for further development. IGF-1 also appears to have a specific role in erythroid development, as it also appears necessary for proper erythroid differentiation in serum-free cultures ( [222](#), [291](#) ). Other multilineage growth factors, such as IL-3 and GM-CSF, have a stimulatory effect on BFU-E growth *in vitro*, although there does not appear to be a specific requirement for these factors.

## ***IN VIVO* SIGNIFICANCE OF KNOWN HEMATOPOIETIC GROWTH FACTORS**

With the exception of EPO, the growth factors were initially discovered and studied because of their support of hematopoietic cells *in vitro*. An important question is what is their physiologic role *in vivo*? This question has been studied by several approaches, but perhaps the most revealing is to understand the phenotype of animals resulting from loss of function mutations in the genes for the growth factors or their specific receptors. Mice bearing spontaneous mutations in some of the growth factor genes have been identified. In additional cases, mutant animals were created by using the genetic engineering technique of homologous recombination-directed mutagenesis (gene knock-out) in murine embryonic stem cells and using these cells to generate mouse strains bearing the mutation ( [253](#) ).

[Table 6.5](#) summarizes the phenotypes of mice bearing loss of function mutations for several growth factors. Of the factors with effects on multilineage cells, the significance of KL is the most clear. As discussed in the section [Stroma of Hematopoietic Organs](#), the spontaneous mutations at the W locus and the Sl locus affect Kit and its ligand, respectively, and complete loss of function of either is lethal at an early embryonic stage. Certain partially functional alleles in these genes are compatible with life, but animals bearing them have hematopoietic deficits in several cell lineages. The gene encoding CSF-1 is the gene that is defective in the spontaneous mutant *op/op* mice. These young mice lack teeth and develop osteopetrosis due to failure to develop osteoclasts derived from macrophages ( [292](#) ). They also have great deficiencies in macrophage populations in some but not all tissues. Interestingly, with age, the *op/op* mice undergo significant correction of their macrophage deficiency. GM-CSF-deficient mice appear to have numerically normal production of granulocytes and monocytes. However, they have alveolar proteinosis because of defective functioning of alveolar macrophages ( [293](#), [294](#) ). This condition leads to bacterial and fungal pneumonias. In summary, CSF-1 appears to be important for normal production of some macrophage types, and GM-CSF is important for the function of alveolar macrophages. Nevertheless, the production of some macrophages, even in the absence of function of both genes ( [295](#) ), indicates that there are yet unknown regulators that are important for monocyte/macrophage production and function. G-CSF function is important for maintenance of normal neutrophil numbers and granulocyte/macrophage progenitors in the bone marrow. Only 20 to 30% of normal neutrophil numbers are present in mice lacking G-CSF; they have reduced capacity to mobilize neutrophils on demand; and deficient mice are more susceptible to some bacterial infections ( [296](#) ). Although IL-3 is one of the most potent stimulators of hematopoietic colony growth *in vitro*, several mouse strains lack functional IL-3  $\alpha$ -receptor subunits and no IL-3 binding or demonstrable function in the cells of the animals. However, such animals are hematologically normal ( [297](#) ). Mice deficient in the Flk-2/FLT3 receptor develop into healthy animals with largely normal mature cell populations derived from hematopoietic tissues. They do have some specific deficiencies in primitive B-cell progenitors and in the transplantability of their stem cells ( [298](#) ). Mice deficient in the ligand for FLT3 have a more severe phenotype than those deficient in the receptor itself ( [299](#) ). The physiologic role of other multilineage factors remains to be



clarified.

**TABLE 6.5. Phenotypes Caused by Nonfunctional Mutations in Genes for Hematopoietic Growth Factors or Their Receptors**

| Factor   | Observed Effects   |
|--|--|
| Kit ligand   | No functional alleles: embryonic death associated with no production of fetal hematopoietic cells and other developmental failures. Partially functional allele: deficiency of hematopoiesis, anemia, and also other defects in pigmentation and in gametogenesis. |
| IL-3<br>Granulocyte-macrophage colony-stimulating factor             | Lack of function does not appear to affect hematopoiesis. Alveolar proteinosis.  |
| Colony-stimulating factor-1<br>Granulocyte colony-stimulating factor | Osteopetrosis, alveolar proteinosis. Neutrophil deficiency; approximately 20% of normal numbers; impaired mobilization of neutrophils; demonstrated to be susceptible to some infections.  |
| IL-5<br>Thrombopoietin   | Eosinophil deficiency. Platelet deficiency, approximately 10% of normal numbers.   |
| Erythropoietin   | Embryonic death; failure to produce fetal erythrocytes due to apoptosis of the late progenitors in the fetal liver; production of some embryonic blood cells.  |
| FLT3 ligand  | Deficiencies in immune system and in myeloid progenitors; more severe defects in the case of knock-out of the ligand than knock-out of the receptor (FLT3).  |
| IL-7   | Reduced thymic and peripheral lymphoid cellularity, including B- and T-cell development.   |

IL, interleukin.

Mutant mice have been generated that lack function of factors affecting more restricted lineages. Mice lacking IL-7 exhibit a profound reduction in B- and T-cell development ( [282](#) ), and those lacking TPO only have approximately 10% of the normal number of platelets ( [244](#) ). Loss of function of EPO or the EPO receptor leads to embryonic death at approximately day 13 of gestation due to failure of production of fetal erythrocytes ( [300](#) , [301](#) ).

Thus, with some exceptions, the hematopoietic grow factors discovered because of their effects *in vitro* appear to be important *in vivo* in maintaining some aspects of hematopoiesis or in the function of some subclasses of mature hematopoietic cells. The roles of some of the factors that affect progenitors with multilineage potential have not yet been fully evaluated *in vivo*. The evidence from mutant mice also indicates that there are as yet undiscovered factors—in particular, factors that regulate production and function of macrophages and related cells.

## MECHANISMS OF ACTION OF HEMATOPOIETIC GROWTH FACTORS

The process by which mature blood cells are formed from specific progenitor cells of the hematopoietic organs has largely been analyzed by *in vitro* culture of bone marrow or other cells in semisolid media in the presence of various combinations of growth factors. In such experiments, individual progenitor cells undergo multiple rounds of cell division and concomitant differentiation over a period of time, eventually producing colonies of mature cells. The roles of growth factors in the processes of colony development and differentiation into mature cells are unknown. Because colony formation requires cell proliferation and differentiation, “stimulation” of colony formation has been inferred to be synonymous with initiation of cell cycling or induction of a differentiation program in progenitor cells, or both. However, there is another mechanism of growth factor support of hematopoietic cell development: promotion of cell survival by prevention of programmed cell death (apoptosis). This function has only been recognized more recently as a definite, specific function of growth factors and hormones.

In this chapter, evidence has been presented for the existence of pluripotent stem cells, multilineage progenitors, and single lineage-committed progenitors representing a continuum of immature to mature phases. Also, numerous growth factors have been discussed; some act on all of the above types of progenitors, some act on only stem cells and multilineage cells, and some act on late stages of lineage-committed cells and are apparently necessary during the final differentiation phases. Thus, it is possible that in some instances, growth factors cause proliferation in a particular type of progenitor, whereas in another instance, a growth factor acts to prevent apoptosis. The developmental stage of a cell may determine its response to a growth factor. Finally, combinations of factors may be required for a particular cell response.

### **Induction of Differentiation**

With the exception of the Indian hedgehog and BMP4 inductions of hematopoiesis in embryonic development, little evidence exists that growth factors are directly responsible for inducing the gene expression changes that are critical for the commitment of cells to a particular lineage pathway. Although some hematopoietic growth factors are known to activate certain transcription factors, no data have yet proved that those specific transcription factors directly control a differentiation step. Nevertheless, ongoing research into the possible roles of particular transcription factors and growth factor receptors in directing differentiation (see section [Theories of Commitment](#)) may clearly establish such roles for some of them in the future.

### **Mitogenesis**

It is difficult to determine whether a particular growth factor is a mitogen for a specific type of normal hematopoietic progenitor cell—that is, to determine whether it causes the cell to enter an active cell cycle from an initially resting state. To make such a determination requires that one has a nearly pure population of the cells in question, that the cells remain alive for at least 24 hours without the test factor (to distinguish proliferation effects from survival effects), and that culture conditions can be found such that the test factor can be assessed in the absence of other factors or such that each factor can be assessed independently. These conditions can occasionally be met using purified populations of explanted, late-stage hematopoietic progenitors (<sup>302</sup>), but they cannot yet be achieved with stem cells or early multilineage progenitors. In lieu of using normal progenitors, numerous studies have used transformed hematopoietic cell lines that are dependent on a hematopoietic growth factor for continuous growth. One can often put such cells into a quiescent cell cycle state without initiating apoptosis by transient growth factor depletion. Thus, although such lines can meet the above criteria, they may be abnormal. Their transformed phenotype may be the result of selection for mutations in

genes that control the cell cycle or apoptosis.

As indicated above, the notion that a growth factor acts as a mitogen implies that the target cell exists in an inactive cell cycle state without the factor. Such a state appears to apply to some hematopoietic progenitors *in vivo* but not to others. For the majority of progenitor types, we do not have a firm answer as to their ability to exist in such an inactive state. One type of evidence indicates that many HSCs are quiescent: *In vivo*, or when freshly isolated, most of them are resistant to 5-fluorouracil, an agent that selectively kills cells that are undergoing DNA synthesis ( [131](#), [303](#), [304](#) and [305](#) ). However, recent experiments designed to measure the cell cycle status of LTC-ICs in humans indicate that circulating and bone marrow-derived LTC-ICs are different in this regard; a high percentage of bone marrow LTC-ICs appear to be in cycle ( [306](#) ), whereas circulating LTC-ICs are quiescent. For committed progenitors of most types, there is little evidence that they can remain latent. In the mouse, they are sensitive to killing by 5-fluorouracil treatment over a 2-day period ( [131](#), [303](#) ). Studies of the cycling status of several stages of committed erythroid progenitor cell types have been done by <sup>3</sup>H-thymidine (or hydroxyurea) suicide methods in which a high dose of these agents is given in a pulse and kills cells that are in active DNA synthesis during the pulse. One then assays the fraction of particular progenitors surviving such a pulse by colony formation or other biologic assays. In the committed erythroid lineage, early progenitor populations (the BFU-E) on average have a smaller fraction of cells in DNA synthesis at a given time (approximately 30%) than the later stage CFU-E (approximately 70 to 80%), suggesting that some BFU-E may spend time in a latent state or may be cycling slower ( [307](#), [308](#), [309](#) and [310](#) ). There is also some evidence that exposure of BFU-E to EPO can increase the fraction of such cells in DNA synthesis ( [309](#), [310](#) ), although other studies have concluded that EPO has no effect on the cell cycle status of BFU-E ( [307](#), [308](#) ). In the case of CFU-E, the fraction of cells in DNA synthesis is unmodified by EPO exposure. However, EPO is absolutely necessary for the survival of CFU-E and for progression of CFU-E into mature erythrocytes.

One case in which mitogenic effects of a growth factor have been clearly demonstrated on primary normal progenitors is that of CSF-1 action on macrophage progenitors from mouse bone marrow ( [302](#) ). These cells require CSF-1 for survival, but at low levels of CSF-1, they remain alive but are quiescent in regard to cell cycle. Higher doses of CSF-1 induce these quiescent progenitors to reenter the cell cycle and proliferate. Thus, these two effects of CSF-1 are separable, and the observed effect on cells depends on the dose of growth factor. Potentially, each of these effects could come into play *in vivo*, depending on the concentration of CSF-1 in the target cell's environment.

## Prevention of Apoptosis

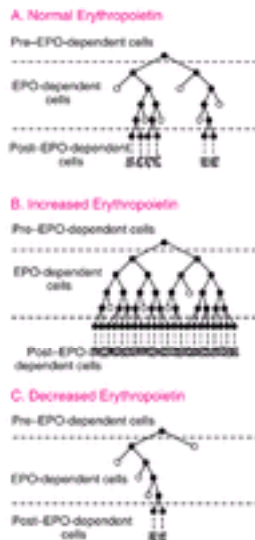
A large body of evidence suggests that most or all normal hematopoietic progenitor cells require specific growth factors to prevent apoptosis ( [311](#), [312](#), [313](#), [314](#), [315](#), [316](#) and [317](#) ). There appears to be several mechanisms by which growth factors can prevent apoptosis, and more than one of these mechanisms can be supported simultaneously by a single growth factor operating on a cell. One general mechanism of apoptosis suppression is the increased synthesis of antiapoptotic proteins encoded by the members of the *bcl-2* gene family ( [318](#), [319](#), [320](#), [321](#), [322](#), [323](#), [324](#), [325](#), [326](#), [327](#), [328](#), [329](#), [330](#) and [331](#) ). In neutrophils and macrophages, the antiapoptotic proteins Mcl-1 and A1 are regulated ( [322](#), [323](#), [324](#) and [325](#), [332](#) ). In progenitors of macrophages, megakaryocytes, erythrocytes, eosinophils, and B and T lymphocytes, the anti-apoptotic protein Bcl-x plays a key role in survival at particular developmental stages ( [318](#), [319](#), [320](#) and [321](#), [326](#), [328](#), [329](#), [330](#), [331](#) and [332](#) ). A second mechanism of apoptosis suppression by growth factors is the activation of the protein

kinase Akt-1 through the activation of phosphoinositol 3-OH kinase (333). It is not fully understood how Akt-1 prevents apoptosis, but one possible way is through phosphorylation and inactivation of BAD, an apoptosis-promoting member of the Bcl-2 protein family (333). Still other mechanisms undoubtedly exist by which growth factor receptors send antiapoptotic signals.

In control of erythrocyte production, much evidence suggests that the physiologically relevant function of EPO is regulation of apoptosis in late-stage progenitors, not regulation of cell cycling (312, 334, 335 and 336). As stated above, there is mixed evidence for a proliferative function of EPO in human BFU-E (307, 308, 309 and 310), and there is some evidence that EPO is mitogenic for some erythroid cell lines (337, 338). *In vivo*, most CFU-E and proerythroblasts are in DNA synthesis (i.e., the majority of these progenitors are in S phase of the cell cycle) regardless of the EPO levels in the animals from which they were obtained. In other words, CFU-E and proerythroblasts, which are the cells with the greatest number of EPO receptors and are highly dependent on EPO, are in active cell cycle under all conditions; therefore, EPO does not induce them into cell cycle. Several studies using CFU-E and proerythroblasts of mice and humans have shown that they undergo prompt apoptosis in the absence of EPO (312, 334, 335 and 336). In a proerythroblast population, the fraction of cells that undergoes apoptosis is dependent on the concentration of EPO over an extensive range of concentrations (335). Studies using cultures of purified human CFU-E under serum-free conditions with added combinations of pure growth factors indicated that the number of cell divisions that occur during late erythroid maturation depends on the concentration of KL, but that EPO by itself can keep the cells alive (291). Finally, studies of mice in which either the EPO gene or the EPO receptor gene has been knocked-out show that the homozygous fetuses die because of failure of definitive erythropoiesis. In the livers of these fetuses, CFU-E develop, but there is evidence of extensive apoptosis of erythroid cells (300, 301).

EPO causes increased transcription of the *bcl-x* gene during late stages of erythroid differentiation, and it also stimulates the Akt kinase pathway. One recent study suggests that the induction of *bcl-x* by EPO is sufficient to explain completely the antiapoptotic function of the hormone in erythroid progenitors (339), although this conclusion warrants further study. It is not yet known how EPO or other hematopoietic growth factors induce transcription of *bcl-x*, although roles for several transcription factors have been suggested (340, 341, 342, 343 and 344).

A model of erythropoiesis has been proposed based on EPO preventing apoptosis in late-stage erythroid progenitors (Fig. 6.3) (312, 345). In the model, it is postulated that there is a period during the differentiation of red cell progenitors during which EPO is required to prevent apoptosis. This period includes the CFU-E and subsequent proerythroblast stages and, possibly, the immediate predecessors of the CFU-E, the mature BFU-E. The model also requires that individual progenitors within the EPO-dependent population exhibit a range of sensitivities to EPO such that there is an extended dose range of EPO over which individual progenitors may survive and continue proliferation and differentiation. Thus, the level of EPO ultimately controls erythrocyte production by regulating the number of dependent progenitors that survive or die.



**Figure 6.3.** Model of erythropoiesis based on erythropoietin (EPO) suppression of programmed cell death (apoptosis). Erythroid progenitor cells enter a period of development in which they are dependent on EPO for survival (EPO-dependent cells). Surviving viable cells are indicated by solid dots; cells undergoing programmed cell death caused by insufficient EPO are indicated by open circles. Before entering the EPO-dependent period, the progenitors can survive without EPO (pre-EPO-dependent cells). Cells surviving transit through the EPO-dependent period can complete maturation into reticulocytes without EPO and ultimately become red cells (post-EPO-dependent cells). The number of cell generations encompassed by the EPO-dependent period is uncertain, but the stages of colony-forming unit erythrocyte and proerythroblast are in the EPO-dependent period. The model implies that the cells are heterogeneous in their concentration requirement for EPO, during the period of EPO dependence. (From Koury MJ, Bondurant MC. Control of erythrocyte production: the roles of programmed cell death (apoptosis) and erythropoietin. *Transfusion* 1990;30:673-674. Reprinted with permission from *Transfusion*, published by the American Association of Blood Banks.)

The two examples discussed here, CSF-1/macrophage progenitors and EPO/erythroid progenitors, indicate that different cellular mechanisms may be important in the regulation of particular types of progenitors. Also, different growth factors or combinations may activate different cellular mechanisms in a given cell type (e.g., KL plus EPO supports survival and proliferation of human CFU-E, whereas EPO by itself supports survival without proliferation) ([291](#)). For most progenitor types and growth factor combinations, we do not yet know which cellular functions are regulated because pure cell systems are not readily available. It is also not known how the cellular processes of proliferation, apoptosis, and differentiation are related mechanistically or if apoptosis regulation by growth factors is achieved by a mechanism common to all cell types and all factors or if there are several different mechanisms.

## REFERENCES

1. Kelemen E, Calvo W, Flidner. Atlas of human hemopoietic development. Berlin: Springer-Verlag New York, 1979.
2. Charbord P, Tavian M, Coulombel L, et al. Early ontogeny of the human hematopoietic system. *C R Seances Soc Biol Fil* 1995;189:617-627.
3. Tavian M, Coulombel L, Luton D, et al. Aorta-associated CD34+ hematopoietic cells in the early human embryo. *Blood* 1996;87:67-72.

4. Zon LI. Developmental biology of hematopoiesis. *Blood* 1995;86:2876–2891.
5. Palis J, Segel GB. Developmental biology of erythropoiesis. *Blood Rev* 1998;12:106–114.
6. Medvinsky AL, Dzierzak EA. Development of the definitive hematopoietic hierarchy in the mouse. *Dev Comp Immunol* 1998;22:289–301.
7. Cumano A, Godin I. Pluripotent hematopoietic stem cell development during embryogenesis. *Curr Opin Immunol* 2001;13:166–71.
8. Marshall CJ, Thrasher AJ. The embryonic origins of human haematopoiesis. *Br J Haematol* 2001;112:838–850.
9. Palis J, Yoder MC. Yolk-sac hematopoiesis: the first blood cells of mouse and man. *Exp Hematol* 2001;29:927–936.
10. Wood WG. Haemoglobin synthesis during human fetal development. *Br Med Bull* 1976;32:282–287.
11. Baron MH. Induction of embryonic hematopoietic and endothelial stem/progenitor cells by hedgehog-mediated signals. *Differentiation* 2001;68:175–185.
12. Medvinsky A, Dzierzak E. Definitive hematopoiesis is autonomously initiated by the AGM region. *Cell* 1996;86:897–906.
13. Hirschi KK, Goodell MA. Common origins of blood and blood vessels in adults? *Differentiation* 2001;68:186–192.
14. Speck NA. Core binding factor and its role in normal hematopoietic development. *Curr Opin Hematol* 2001;8:192–196.
15. Choi K. Hemangioblast development and regulation. *Biochem Cell Biol* 1998;76:947–956.
16. Orkin SH, Zon LI. Hematopoiesis and stem cells: plasticity versus developmental heterogeneity. *Nat Immunol* 2002;3:323–328.
17. Jaffredo T, Gautier R, Eichmann A, et al. Intraaortic hematopoietic cells are derived from endothelial cells during ontogeny. *Development* 1998;125:4575–4583.
18. Nishikawa S, Nishikawa S, Kawamoto H, et al. *In vitro* generation of lymphohematopoietic cells from endothelial cells purified from murine embryos. *Immunity* 1998;8:761–769.
19. Oberlin E, Taviani M, Blazsek I, et al. Blood-forming potential of vascular endothelium in the human embryo. *Development* 2002;129:4147–4157.
20. Lichtman MA. The ultrastructure of the hemopoietic environment of the marrow: a review. *Exp Hematol* 1981;9:391–410.
21. Weiss L. The histopathology of the bone marrow. *Clin Orthop* 1967;52:13–23.
22. DeBruyn PPH. Structural substrates of bone marrow function. *Semin Hematol* 1981;18:179–193.
23. Lichtman MA, Packman CH, Constone LS. Molecular and cellular traffic across the marrow sinus wall. In: Tavassoli M, ed. *Blood cell formation: the role of the hemopoietic microenvironment*. Clifton: Humana Press, 1989:87–140.
24. Pittenger MF, Mackay AM, Beck SC, et al. Multilineage potential of adult human mesenchymal stem cells. *Science* 1999;284:143–147.
25. Reyes M, Dudek A, Jahagirdar B, et al. Origin of endothelial progenitors in human post-natal bone marrow. *J Clin Invest* 2002;109:337–346.

26. Gilliland G, Griffin JD. The roles of FLT3 in hematopoiesis and leukemia. *Blood* 2002;100:1532–1542.
27. Russel ES. Hereditary anemias of the mouse: a review for geneticists. *Adv Genet* 1979;20:357–459.
28. Chabot B, Stephenson DA, Chapman VM, et al. The proto-oncogene c-kit encoding a transmembrane tyrosine kinase receptor maps to the mouse W locus. *Nature* 1988;335:88–89.
29. Geissler EN, Ryan MA, Housman DE. The dominant-white spotting (W) locus of the mouse encodes the c-kit proto-oncogene. *Cell* 1988;55:185–192.
30. Copeland NG, Gilbert DJ, Cho BC, et al. Mast cell growth factor maps near the steel locus on mouse chromosome 10 and is deleted in a number of steel alleles. *Cell* 1990;63:175–183.
31. Huang E, Nocka K, Beier DR, et al. The hematopoietic growth factor KL is encoded by the Sl locus and is the ligand of the c-kit receptor, the gene product of the W locus. *Cell* 1990;63:225–233.
32. Zsebo KM, Williams DA, Geissler EN, et al. Stem cell factor is encoded at the Sl locus of the mouse and is the ligand for the c-kit tyrosine kinase receptor. *Cell* 1990;63:213–224.
33. Anderson DM, Lyman SD, Baird A, et al. Molecular cloning of mast cell growth factor, a hematopoietin that is active in both membrane bound and soluble form. *Cell* 1990;63:235–243.
34. Flanagan JG, Chan DC, Leder P. Transmembrane form of the kit ligand growth factor is determined by alternative splicing and is missing in the Sl<sup>d</sup> mutant. *Cell* 1991;64:1025–1035.
35. Hannum C, Culpepper J, Campbell D, et al. Ligand for FLT3/FLK2 receptor tyrosine kinase regulates growth of hemopoietic stem cells and is encoded by variant RNAs. *Nature* 1994;368:643–648.
36. McClanahan T, Culpepper J, Campbell D, et al. Biochemical and genetic characterization of multiple splice variants of the Flt3 ligand. *Blood* 1996;88:3371–3382.
37. Uemura N, Ogawa K, Takahashi K, et al. Binding of membrane anchored macrophage colony-stimulating factor (M-CSF) to its receptor mediates specific adhesion between stromal cells and M-CSF receptor-bearing hematopoietic cells. *Blood* 1993;82:2634–2640.
38. Tsuboi I, Revol V, Blanchet JP, et al. Role of the membrane form of human colony-stimulating factor-1 (CSF-1) in proliferation of multipotent hematopoietic FDCP-mix cells expressing human CSF-1 receptor. *Leukemia* 2000;14:1460–1466.
39. Ladner MB, Martin GA, Noble JA, et al. Human CSF-1 gene: gene structure and alternative splicing of mRNA precursors. *EMBO J* 1987;6:2693–2698.
40. Cerretti DP, Wignall J, Anderson D, et al. Human macrophage-colony stimulating factor: alternative RNA and protein processing from a single gene. *Mol Immunol* 1988;25:761–770.
41. Wright DE, Wagners AJ, Gulati AP, et al. Physiological migration of hematopoietic stem and progenitor cells. *Science* 2001;294:1933–1936.
42. Chan JYH, Watt SM. Adhesion receptors on haematopoietic progenitor cells. *Br J Haematol* 2001;112:541–557.
43. Bouvard D, Brakebusch C, Gustafsson E, et al. Functional consequences of integrin gene mutations in mice. *Circ Res* 2001;89:211–223.
44. Arroyo AG, Yang JT, Rayburn H, et al.  $\alpha 4$  Integrins regulate the proliferation/differentiation balance of multilineage hematopoietic progenitors *in vivo*. *Immunity* 1999;11:555–566.
45. Arroyo AG, Taverna D, Whittaker CA, et al. *In vivo* roles of integrins during leukocyte development and traffic: insights from the analysis of mice chimeric for  $\alpha 5$ ,  $\alpha v$ , and  $\alpha 4$  integrin. *J Immunol* 2000;165:4667–4675.
46. Potocnik AJ, Brakebusch C, Fassler R. Fetal and adult hematopoietic stem cells require  $\beta 1$  integrin



function for colonizing fetal liver spleen, and bone marrow. *Immunity* 2000;12:653–663.

47. Brakebusch C, Fillatreau S, Potocnik AJ, et al.  $\beta$ 1 integrin is not essential for hematopoiesis but is necessary for the T cell-dependent IgM antibody response. *Immunity* 2002;16:465–477.

48. Levesque JP, Simmons PJ. Cytoskeleton and integrin-mediated adhesion signaling in human CD34+ hemopoietic progenitor cells. *Exp Hematol* 1999;27:579–586.

49. Yin Z, Giacomello E, Gabriele E, et al. Cooperative activity of  $\alpha$ 4 $\beta$ 1 and  $\alpha$ 4 $\beta$ 7 integrins in mediating human B-cell lymphoma adhesion and chemotaxis on fibronectin through recognition of multiple synergizing binding sites within the central cell-binding domain. *Blood* 1999;93:1221–1230.

50. Papayannopoulou T, Priestley GV, Nakamoto B. Anti-VLA4/VCAM-1-induced mobilization requires cooperative signaling through the kit/mkit ligand pathway. *Blood* 1998;91:2231–2239.

51. Papayannopoulou T, Nakamoto B. Peripheralization of hemopoietic progenitors in primates treated with anti-VLA4 integrin. *Proc Natl Acad Sci U S A* 1993;90:9374–9378.

52. Papayannopoulou T, Craddock C, Nakamoto B, et al. The VLA4/VCAM-1 adhesion pathway defines contrasting mechanisms of lodgment of transplanted murine hemopoietic progenitors between bone marrow and spleen. *Proc Natl Acad Sci U S A* 1995;10:9647–9651.

53. Zanjani ED, Flake AW, Almeida-Porada G, et al. Homing of human cells in the fetal sheep model: modulation by antibodies activating or inhibiting very late activation antigen-4-dependent function. *Blood* 1999;94:2515–2522.

54. Koni PA, Joshi SK, Temann UA, et al. Conditional vascular cell adhesion molecule 1 deletion in mice: impaired lymphocyte migration to bone marrow. *J Exp Med* 2001;193:741–754.

55. Leuker CE, Labow M, Müller W, et al. Neonatally induced inactivation of the vascular cell adhesion molecule 1 gene impairs B cell localization and T cell-dependent humoral immune response. *J Exp Med* 2001;193:755–768.

56. Etzioni A, Doerschuk CM, Harlan JM. Of man and mouse, leukocyte and endothelial adhesion molecule deficiencies. *Blood* 1999;94:3281–3288.

57. Greenberg AW, Kerr WG, Hammer DA. Relationship between selectin-mediated rolling of hematopoietic stem and progenitor cells and progression in hematopoietic development. *Blood* 2000;95:478–486.

58. Naiyer AJ, Dy J, Ahn J, et al. Stromal derived factor-1-induced chemokinesis of cord blood CD34(+) cells (long-term culture-initiating cells) through endothelial cells is mediated by E-selectin. *Blood* 1999;94:4011–4019.

59. Robinson SD, Frenette PS, Rayburn H, et al. Multiple, targeted deficiencies in selectins reveal a predominant role for P-selectin in leukocyte recruitment. *Proc Natl Acad Sci U S A* 1999;96:11452–11457.

60. Frenette PS, Mayadas TN, Rayburn H, et al. Susceptibility to infection and altered hematopoiesis in mice deficient in P- and E-selectins. *Cell* 1996; 84:563–574.

61. Frenette PS, Subbarao S, Mazo IB, et al. Endothelial selectins and vascular cell adhesion molecule-1 promote hematopoietic progenitor homing to bone marrow. *Proc Natl Acad Sci U S A* 1998;95:14423–14428.

62. Giancotti FG, Ruoslahti E. Integrin signaling. *Science* 1999;285:1028–1033.

63. Liu S, Kiosses WB, Rose DM, et al. A fragment of paxillin binds the alpha 4 integrin cytoplasmic domain (tail) and selectively inhibits alpha 4-mediated cell migration. *J Biol Chem* 2002;277:20887–20894.

64. Kapur R, Cooper R, Zhang L, et al. Cross-talk between  $\alpha$ 4 $\beta$ 1/ $\alpha$ 5 $\beta$ 1 and c-Kit results in opposing effect on growth and survival of hematopoietic cells via the activation of focal adhesion kinase, mitogen-activated protein kinase, and Akt signaling pathways. *Blood* 2001;97:1975–1981.

65. Takahira H, Gotoh A, Ritchie A, et al. Steel factor enhances integrin-mediated tyrosine

phosphorylation of focal adhesion kinase (pp125FAK) and paxillin. *Blood* 1997;89:1574–1584.

66. Aiuti A, Webb IJ, Bleul C, et al. The chemokine SDF-1 is a chemoattractant for human CD34+ hematopoietic progenitor cells and provides a new mechanism to explain the mobilization of CD34+ progenitors to peripheral blood. *J Exp Med* 1997;185:111–120.

67. Wright DE, Bowman EP, Wagers AJ, et al. Hematopoietic stem cells are uniquely selective in their migratory response to chemokines. *J Exp Med* 2002;195:1145–1154.

68. Nagasawa T, Hirota S, Tachibana K, et al. Defects of B-cell lymphopoiesis and bone-marrow myelopoiesis in mice lacking the CXC chemokine PBSF/SDF-1. *Nature* 1996;382:635–638.

69. Zou YR, Kottmann AH, Kuroda M, et al. Function of the chemokine receptor CXCR4 in haematopoiesis and in cerebellar development. *Nature* 1998;393: 595–599.

70. Peled A, Petit I, Kollet O, et al. Dependence of human stem cell engraftment and repopulation of NOD/SCID mice on CXCR4. *Science* 1999;283:845–848.

71. Kollet O, Spiegel A, Peled A, et al. Rapid and efficient homing of human CD34+CD38<sup>-/low</sup>CXCR4<sup>+</sup> stem and progenitor cells to the bone marrow and spleen of NOD/SCID and NOD/SCID/B2m<sup>null</sup> mice. *Blood* 2001;97:3283–3291.

72. Imai K, Kobayashi M, Wang J, et al. Selective secretion of chemoattractants for haemopoietic progenitor cells by bone marrow endothelial cells: a possible role in homing of haemopoietic progenitor cells to bone marrow. *Br J Haematol* 1999;106:905–911.

73. Peled A, Grabovsky V, Habler L, et al. The chemokine SDF-1 stimulates integrin-mediated arrest of CD34(+) cells on vascular endothelium under shear flow. *J Clin Invest* 1999;104:1199–1211.

74. Peled A, Kollet O, Ponomaryou T, et al. The chemokine SDF-1 activates the integrins LFA-1, VLA-4 and VLA-5 on immature human CD34(+) cells: role in transendothelial/stromal migration and engraftment of NOD/SCID mice. *Blood* 2000;95:3289–3296.

75. Yoder MC, Williams DA. Matrix molecule interactions with hematopoietic stem cells. *Exp Hematol* 1995;23:961–967.

76. Penn PE, Jiang DZ, Fei RG, et al. Dissecting the hematopoietic microenvironment: IX. Further characterization of murine bone marrow stromal cells. *Blood* 1993;81:1205–1213.

77. Bentley SA. Collagen synthesis by bone marrow stromal cells: a quantitative study. *Br J Haematol* 1982;50:491–497.

78. Gay RE, Prince CW, Zuckerman KS, et al. The collagenous hemopoietic microenvironment. In: Tavassoli M, ed. *Handbook of the hematopoietic microenvironment*. Clifton: Humana Press, 1996:369–398.

79. Lerat H, Lissitzky JC, Singer JW, et al. Role of stromal cells and macrophages in fibronectin biosynthesis and matrix assembly in human long-term marrow cultures. *Blood* 1993;82:1480–1492.

80. Teixido J, Hemler ME, Greenberger J, et al. Role of beta 1 and beta 2 integrins in the adhesion of human CD34hi stem cells to bone marrow stroma. *J Clin Invest* 1992;90:358–367.

81. Kerst J, Sanders J, Slaper-Cortenbach C, et al.  $\alpha$ 4B1 and  $\alpha$ 5B1 are differentially expressed during myelopoiesis and mediate the adherence of human CD34+ cells to fibronectin in an activation-dependent way. *Blood* 1993; 81:344–351.

82. Hynes RO. Integrins: versatility, modulation, and signaling in cell adhesion. *Cell* 1992;69:11–25.

83. Williams DA, Rios M, Stephens C, et al. Fibronectin and VLA 4 in haematopoietic stem cell-microenvironment interactions. *Nature* 1991;352:438–441.

84. Zuckerman KS, Prince CW, Gay S. The hematopoietic extracellular matrix. In: Tavassoli M, ed. *Handbook of the hematopoietic microenvironment*. Clifton, NJ: Humana Press, 1996:399–432.

85. Campbell AD, Long MW, Wicha MS. Haemonectin: a bone marrow adhesion protein specific for cells of granulocytic lineage. *Nature* 1987;329:744–746.
86. Uhlman DL, Luikart SD. The role of proteoglycans in the adhesion and differentiation of hematopoietic cells. In: Long MW, Wicha MS, eds. *The hematopoietic microenvironment*. Baltimore and London: The Johns Hopkins University Press, 1993:232–245.
87. White H, Torry N, Panayotou G. Haemonectin, a granulocytic–cell–binding protein, is released to the plasma glycoprotein fetuin. *Eur J Biochem* 1993;213:523–528.
88. Klein G, Beck S, Muller C. Tenascin is a cytoadhesive extracellular matrix component of the human hematopoietic microenvironment. *J Cell Biol* 1993;123:1027–1035.
89. Long MW, Dixit VM. Thrombospondin functions as a cytoadhesion molecule for human hematopoietic progenitor cells. *Blood* 1990;75:2311–2318.
90. Stomski FC, Gani JS, Bates RC, et al. Adhesion to thrombospondin by human embryonic fibroblasts is mediated by multiple receptors and includes a role for glycoprotein 88 (CD36). *Exp Cell Res* 1992;198:85–92.
91. Li WX, Howard RJ, Leung LL. Identification of SVTCG in thrombospondin as the conformation–dependent, high affinity binding site for its receptor, CD36. *J Biol Chem* 1993;268:16179–16184.
92. Suchard SJ, Burton MJ, Dixit VM, et al. Human neutrophil adherence to thrombospondin occurs through a CD11/CD18–independent mechanism. *J Immunol* 1991;146:3945–3952.
93. Dixit VM, Long MW. The role of thrombospondin in human hematopoietic progenitor cell cytoadhesion. In: Long MW, Wicha MS, eds. *The hematopoietic microenvironment*. Baltimore and London: The John Hopkins University Press, 1993:206–216.
94. Wight TN, Kinsella MG, Keating A, et al. Proteoglycans in human long–term bone marrow cultures: biochemical and ultrastructural analyses. *Blood* 1986;67:1333–1343.
95. Siczkowski M, Clarke D, Gordon MY. Binding of primitive hematopoietic progenitor cells to marrow stromal cells involves heparan sulfate. *Blood* 1992;80:912–919.
96. Minguell JJ, Hardy C, Tavassoli M. Membrane–associated chondroitin sulfate proteoglycan and fibronectin mediate the binding of hemopoietic progenitor cells to stromal cells. *Exp Cell Res* 1992;201:200–207.
97. Bruno E, Luikart SD, Long MW, Hoffman R. Marrow–derived heparan sulfate proteoglycan mediates the adhesion of hematopoietic progenitor cells to cytokines. *Exp Hematol* 1995;23:1212–1217.
98. Verfaillie C, Benis A, Iida J, et al. Adhesion of committed human hematopoietic progenitors to synthetic peptides from the C–terminal heparan–binding domain of fibronectin: cooperation between the integrin  $\alpha 4\beta 1$  and the CD44 adhesion receptor. *Blood* 1994;84:1802–1811.
99. Ghaffari S, Smadja–Joffe F, Oostendorp R, et al. CD44 isoforms in normal and leukemic hematopoiesis. *Exp Hematol* 1999;27:978–993.
100. Gordon MT, Riley GP, Watt SM, et al. Compartmentalization of a haematopoietic growth factor (GM–CSF) by glycosaminoglycans in the bone marrow microenvironment. *Nature* 1987;326:403–405.
101. Roberts R, Gallagher J, Spooncer E, et al. Heparan sulphate bound growth factors: a mechanism for stromal cell mediated haemopoiesis. *Nature* 1988;332:376–378.
102. Tavassoli MV. Bone marrow: the seedbed of blood. In: Wintrobe MM, ed. *Blood, pure and eloquent: a story of discovery, of people, and of ideas*. New York: McGraw–Hill, 1980:57–79.
103. Lajitha LG. The common ancestral cell. In: Wintrobe MM, ed. *Blood, pure and eloquent: a story of discovery, of people, and of ideas*. New York: McGraw–Hill, 1980:80–95.

104. Downey H. Handbook of hematology. New York: Hoeber, 1938.
105. Lorenz E, Uphoff D, Reid TR, Shelton E. Modification of irradiation injury in mice and guinea pigs by bone marrow injections. J Natl Canc Inst 1951;12:197-201.
106. Ford CE, Hamerton JL, Barnes DWH, Loutit JF. Cytological identification of radiation chimeras. Nature 1956;177:452-454.
107. Till JE, McCulloch EA. A direct measurement of the radiation sensitivity of normal mouse bone marrow cells. Radiat Res 1961;14:213-222.
108. Curry JL, Trentin JJ. Hematopoietic spleen colony studies I: growth and differentiation. Dev Biol 1967;15:395-400.
109. Magli MC, Iscove NN, Odartchenko N. Transient nature of early hematopoietic spleen colonies. Nature 1982;295:527-529.
110. Siminovitch L, McCulloch EA, Till JE. The distribution of colony-forming cells among spleen colonies. J Cell Comp Physiol 1963;62:327-336.
111. Wu AM, Till JE, Siminovitch L, et al. A cytological study of the capacity for differentiation of normal hemopoietic colony-forming cells. J Cell Physiol 1967;69:177-184.
112. Lepault F, Ezine S, Gagnerault MC. T- and B-lymphocyte differentiation potentials of spleen colony-forming cells. Blood 1993;81:950-955.
113. Jones RJ, Wagner JE, Celano P, et al. Separation of pluripotent hematopoietic stem cells from spleen colony-forming cells. Nature 1990;347:188-189.
114. Harrison DE, Jordan CT, Zhong RK, et al. Primitive hematopoietic stem cells: direct assay of most productive population by competitive repopulation with simple binomial, correlation and covariance calculations. Exp Hematol 1993;21:206-219.
115. Szilvassy SJ, Humphries RK, Lansdorp PM, et al. Quantitative assay for totipotent reconstituting hematopoietic stem cells by a competitive repopulation strategy. Proc Natl Acad Sci U S A 1990;87:8736-8740.
116. Zhong R, Astle CM, Harrison DE. Distinct developmental patterns of short-term and long-term functioning lymphoid and myeloid precursors defined by competitive limiting dilution analysis *in vivo*. J Immunol 1996;157:138-145.
117. Orlic D, Fischer R, Nishikawa S, et al. Purification and characterization of heterogeneous pluripotent hematopoietic stem cell populations expressing high levels of c-kit receptor. Blood 1993;82:762-770.
118. Jordan CT, Astle CM, Zawadzki J, et al. Long-term repopulating abilities of enriched fetal liver stem cells measured by competitive repopulation. Exp Hematol 1995;23:1011-1015.
119. Jordan CT, Lemischka IR. Clonal and systemic analysis of long-term hematopoiesis in the mouse. Genes Dev 1990;4:220-232.
120. Capel B, Hawley RG, Mintz B. Long- and short-lived murine hematopoietic stem cell clones individually identified with retroviral integration markers. Blood 1990;75:2267-2270.
121. Keller G, Snodgrass R. Life span of multipotential hematopoietic stem cells *in vivo*. J Exp Med 1990;171:1407-1418.
122. Shi PA, Hematti P, von Kalle C, Dunbar CE. Genetic marking as an approach to studying *in vivo* hematopoiesis: progress in the non-human primate model. Oncogene 2002;21:3274-3283.
123. Abkowitz JL, Golinelli D, Harrison DE, et al. *In vivo* kinetics of murine hemopoietic stem cells. Blood 2000;96:3399-3405.

124. Kim HJ, Tisdale JF, Wu T, et al. Many multipotential gene-marked progenitor or stem cell clones contribute to hematopoiesis in nonhuman primates. *Blood* 2000;96:1-8.
125. Freshney RI, Pragnell IB, Freshney MG. *Culture of hematopoietic cells*. New York: Wiley-Liss, 1994.
126. Sutherland HJ, Lansdorp PM, Henkelman DH, et al. Functional characterization of individual human hematopoietic stem cells cultured at limiting dilution on supportive marrow stromal layers. *Proc Natl Acad Sci U S A* 1990;87:3584-3588.
127. Murray L, Chen B, Galy A, et al. Enrichment of human hematopoietic stem cell activity in the CD34<sup>+</sup>Thy-1<sup>+</sup>Lin<sup>-</sup> subpopulation from mobilized peripheral blood. *Blood* 1995;85:368-378.
128. Ploemacher RE, van der Sluijs JP, van Beurden CAJ, et al. Use of limiting-dilution type long-term marrow cultures in frequency analysis of marrow-repopulating and spleen colony-forming hematopoietic stem cells in the mouse. *Blood* 1991;78:2527-2533.
129. Neben S, Anklesaria P, Greenberger J, et al. Quantitation of murine hematopoietic stem cells *in vitro* by limiting dilution analysis of cobblestone area formation on a clonal stromal cell line. *Exp Hematol* 1993;21:438-443.
130. Kusadasi N, Oostendorp RAJ, Koevoet WJLM, et al. Stromal cells from murine embryonic aorta-gonad-mesonephros region, liver and gut mesentery expand human umbilical cord blood-derived CAFC (week 6) in extended long-term cultures. *Leukemia* 2002;16:1782-1790.
131. Lemieux ME, Rebel VI, Lansdorp PM, et al. Characterization and purification of a primitive hematopoietic cell type in adult mouse marrow capable of lymphomyeloid differentiation in long-term marrow "switch" cultures. *Blood* 1995;86:1339-1347.
132. Lemieux ME, Eaves CJ. Identification of properties that can distinguish primitive populations of stromal cell-responsive lympho-myeloid cells from cells that are stromal cell-responsive but lymphoid-restricted and cells that have lympho-myeloid potential but are also capable of competitively repopulating myeloablated recipients. *Blood* 1996;88:1639-1648.
133. Szilvassy SJ, Meyerrose TE, Ragland PL, et al. Homing and engraftment defects in *ex vivo* expanded murine hematopoietic cells are associated with downregulation of  $\beta 1$  integrin. *Exp Hematol* 2001;29:1494-1502.
134. Glimm H, Oh IH, Eaves CJ. Human hematopoietic stem cells stimulated to proliferate *in vitro* lose engraftment potential during their S/G<sub>2</sub>/M transit and do not reenter G<sub>0</sub>. *Blood* 2000;96:4185-4193.
135. Goodell MA, Brose K, Paradis G, et al. Isolation and functional properties of murine hematopoietic stem cells that are replicating *in vivo*. *J Exp Med* 1996;183:1797-1806.
136. Goodell MA, Rosenzweig M, Kim H, et al. Dye efflux studies suggest that hematopoietic stem cells expressing low or undetectable levels of CD34 antigen exist in multiple species. *Nat Med* 1997;3:1337-1345.
137. Scharenberg CW, Harkey MA, Torok-Storb BJ. The ABC G2 transporter is an efficient Hoechst 33342 efflux pump and is preferentially expressed by immature hematopoietic progenitors. *Blood* 2002;99:507-512.
138. Zhou S, Morris JJ, Barnes Y, et al. Bcrp1 gene expression is required for normal numbers of side population stem cells in mice, and confers relative protection to mitoxantrone in hematopoietic cells *in vivo*. *Proc Natl Acad Sci U S A* 2002;99:12339-12344.
139. Uchida N, Fujisaki T, Eaves A, et al. Transplantable hematopoietic stem cells in human fetal liver have a CD34<sup>+</sup> side population (SP) phenotype. *J Clin Invest* 2001;108:1071-1077.
140. Uchida N, Leung FYK, Eaves CJ. Liver and marrow of adult *mdr-1a/1b*<sup>-/-</sup> mice show normal generation, function, and multi-tissue trafficking of primitive hematopoietic cells. *Exp Hematol* 2002;30:862-869.
141. Ishikawa F, Livingston AG, Wingard JR, et al. An assay for long-term engrafting human hematopoietic

- cells based on newborn NOD/SCID/b-2 microglobulin<sup>null</sup> mice. *Exp Hematol* 2002;30:488-494.
142. Glimm H, Eisterer W, Lee K, et al. Previously undetected human hematopoietic cell populations with short-term repopulating activity selectively engraft NOD/SCID-b2 microglobulin-null mice. *J Clin Invest* 2001;107:199-206.
143. Christianson SW, Greiner DL, Hesselton R, et al. Enhanced human CD4<sup>+</sup> T cell engraftment in B2-microglobulin deficient NOD-scid mice. *J Immunol* 1997;158:3578-3586.
144. Kollet O, Peled A, Byk T, et al. B<sub>2</sub>-microglobulin deficient NOD/SCID mice are excellent recipients for studying human stem cell function. *Blood* 2000;95:3102-3105.
145. Shultz LD, Lang PA, Christianson SW, et al. NOD/LtSz-Rag1 null mice: an immunodeficient and radioresistant model for engraftment of human hematolymphoid cells, HIV infection, and adoptive transfer of NOD mouse diabetogenic T cells. *J Immunol* 2000;164:2496-2507.
146. Mazurier F, Fontanellas A, Salesse S, et al. A novel immunodeficient mouse model-Rag2 x common cytokine receptor  $\gamma$  chain double mutants requiring exogenous cytokine administration for human hematopoietic stem cell engraftment. *J Interferon Cytokine Res* 1999;19:533-541.
147. Zanjani E, Paltavicini M, Ascensao J, et al. Engraftment and long-term expression of human fetal hemopoietic stem cells in sheep following transplantation *in utero*. *J Clin Invest* 1992;89:1178-1188.
148. Srour E, Zanjani E, Cornette K, et al. Persistence of human multilineage, self-renewing lymphohematopoietic stem cells in chimeric sheep. *Blood* 1993;82:3333-3342.
149. DiGiusto DL, Lee R, Moon J, et al. Hematopoietic potential of cryopreserved and *ex vivo* manipulated umbilical cord blood progenitor cells evaluated *in vitro* and *in vivo*. *Blood* 1996;87:1261-1271.
150. Rebel V, Dragowska W, Eaves C, et al. Amplification of Sca-1<sup>+</sup>Lin<sup>-</sup>WGA<sup>+</sup> cells in serum-free cultures containing steel factor, interleukin-6, and erythropoietin with maintenance of cells with long-term *in vivo* reconstituting potential. *Blood* 1994;83:128-136.
151. Sutherland HJ, Eaves C, Eaves AC, et al. Characterization and partial purification of human marrow cells capable of initiating long-term hematopoiesis *in vitro*. *Blood* 1989;74:1563-1570.
152. Jones R, Collector M, Barber J, et al. Characterization of mouse lymphohematopoietic stem cells lacking spleen colony-forming activity. *Blood* 1996;88:487-491.
153. Spangrude G, Heimfeld S, Weissman I. Purification and characterization of mouse hematopoietic stem cells. *Science* 1988;241:58-62.
154. Spangrude G, Brooks D. Mouse stem variability in the expression of the hematopoietic stem cell antigen Ly-6A/E by bone marrow cells. *Blood* 1993;82:3327-3332.
155. Ogawa M. Changing phenotypes of hematopoietic stem cells. *Exp Hematol* 2002;30:3-6.
156. Uchida N, Fujisaki T, Eaves AC, et al. Transplantable hematopoietic stem cells in human fetal liver have a CD34<sup>+</sup> side population (SP) phenotype. *J Clin Invest* 2001;108:1071-1077.
157. Sanchez MJ, Holmes A, Miles C, et al. Characterization of the first definitive hematopoietic cells in the AGM and fetal livers of the mouse embryo. *Immunity* 1996;5:513-525.
158. Fraser C, Szilvassy S, Eaves C, et al. Proliferation of totipotent hemopoietic stem cells *in vitro* with retention of long term competitive *in vivo* reconstituting ability. *Proc Natl Acad Sci U S A* 1992;89:1968-1972.
159. van der Sluijs J, van den Bos C, Baert M, et al. Loss of long-term repopulating ability in long-term bone marrow culture. *Leukemia* 1993;7:725-732.
160. Berrios VM, Dooner GJ, Nowakowski G, et al. The molecular basis for the cytokine-induced defect in

- homing and engraftment of hematopoietic stem cells. *Exp Hematol* 2001;29:1326–1335.
161. Wulf GG, Jackson KA, Goodell MA. Somatic stem cell plasticity: current evidence and emerging concepts. *Exp Hematol* 2001;29:1361–1370.
162. Blau HM, Brazelton TR, Weimann JM. The evolving concept of a stem cell: entity or function? *Cell* 2001;105:829–841.
163. Graf T. Differentiation plasticity of hematopoietic cells. *Blood* 2002;99:3089–3101.
164. Lemischka I. A few thoughts about the plasticity of stem cells. *Exp Hematol* 2002;30:848–852.
165. Kawada H, Ogawa M. Bone marrow origin of hematopoietic progenitors and stem cells in murine muscle. *Blood* 2001;98:2008–2013.
166. Wagers AJ, Sherwood RI, Christensen JL, et al. Little evidence for developmental plasticity of adult hematopoietic stem cells. *Science* 2002;297:2256–2259.
167. Reyes M, Lund TLT, Aguiar D, et al. Purification and *ex vivo* expansion of postnatal human marrow mesodermal progenitor cells. *Blood* 2001;98:2615–2625.
168. Jiang Y, Jahagirdar BN, Reinhardt RL, et al. Pluripotency of mesenchymal stem cells derived from adult marrow. *Nature* 2002;418:41–49.
169. Johnson GR, Metcalf D. Pure and mixed erythroid colony formation *in vitro* stimulated by spleen conditioned medium with no detectable erythropoietin. *Proc Natl Acad Sci U S A* 1977;74:3879–3882.
170. Nakahata T, Ogawa M. Identification in culture of a class of hemopoietic colony-forming units with extensive capability to self-renew and generate multipotential hemopoietic colonies. *Proc Natl Acad Sci U S A* 1982;79:3843–3847.
171. Fauser A, Messner H. Proliferative state of human pluripotent hemopoietic progenitors (CFU-GEMM) in normal individuals and under regenerative condition after bone marrow transplant. *Blood* 1979;54:1197–1200.
172. Ogawa M. Differentiation and proliferation of hematopoietic stem cells. *Blood* 1993;81:2844–2853.
173. Ball TC, Hirayama F, Ogawa M. Lymphohematopoietic progenitors of normal mice. *Blood* 1995;85:3086–3092.
174. Metcalf D. Control of granulocytes and macrophages: molecular, cellular and clinical aspects. *Science* 1991;254:529–533.
175. Eaves A, Eaves C. Erythropoiesis in culture. *Clin Hematol* 1984;13:371–391.
176. Hoffman R. Regulation of megakaryocytopoiesis. *Blood* 1989;74:1196–1212.
177. Suda T, Okada S, Suda J, et al. A stimulatory effect of recombinant murine interleukin-7 (IL-7) on B-cell colony formation and an inhibitory effect of IL-1a. *Blood* 1989;74:1936–1941.
178. Reid CDL, Stackpoole A, Meager A, et al. Interactions of tumor necrosis factor with granulocyte-macrophage colony stimulating factor and other cytokines in the regulation of dendritic cell growth *in vitro* from early bipotent CD34<sup>+</sup> progenitors in human bone marrow. *J Immunol* 1992;149:2681–2688.
179. Szaboics P, Avigan D, Gezelter S, et al. Dendritic cells and macrophages can mature independently from a human bone marrow-derived post-colony-forming unit intermediate. *Blood* 1996;87:4520–4530.
180. Metcalf D. Lineage commitment and maturation in hematopoietic cells: the case for extrinsic regulation. *Blood* 1998;92:345–348.



181. Enver T, Heyworth CM, Dexter TM. Do stem cells play dice? *Blood* 1998;92:348–352.
182. Till JE, McCulloch EA, Siminovich L. A stochastic model of stem cell proliferation, based on the growth of spleen colony-forming cells. *Proc Natl Acad Sci U S A* 1964;51:29–36.
183. Ogawa M, Porter PN, Nakahata T. Renewal and commitment to differentiation of hemopoietic stem cells: an interpretive review. *Blood* 1983;61:823–829.
184. Cross MA, Heyworth CM, Murrell AM, et al. Expression of lineage restricted transcription factors precedes lineage-specific differentiation in a multipotent haemopoietic progenitor cell line. *Oncogene* 1994;9:3013–3016.
185. Heyworth CM, Alauldin M, Cross MA, et al. Erythroid development of the FDCP-Mix A4 multipotent cell line is governed by the relative concentrations of erythropoietin and interleukin 3. *Br J Haematol* 1995;91:15–22.
186. Suda T, Suda J, Ogawa M. Disparate differentiation in mouse hemopoietic colonies derived from paired progenitors. *Proc Natl Acad Sci U S A* 1984;81:2520–2524.
187. Suda J, Suda T, Ogawa M. Analysis of differentiation of mouse hemopoietic stem cells in culture by sequential replating of paired progenitors. *Blood* 1984;64:393–399.
188. Leary AG, Strauss LC, Civin CI, et al. Disparate differentiation in hemopoietic colonies derived from human paired progenitors. *Blood* 1985;66:327–332.
189. Mayani H, Dragowska W, Lansdorp PM. Lineage commitment in human hemopoiesis involves asymmetric cell division of multipotent progenitors and does not appear to be influenced by cytokines. *J Cell Physiol* 1993;157:579–586.
190. Fairbairn LJ, Cowling GJ, Reipert BM, et al. Suppression of apoptosis allows differentiation and development of a multipotent hemopoietic cell line in the absence of added growth factors. *Cell* 1993;74:823–832.
191. Weintraub H. Assembly and propagation of repressed and derepressed chromosomal states. *Cell* 1985;42:705–711.
192. Payne KJ, Crooks GM. Human hematopoietic lineage commitment. *Immunol Rev* 2002;187:48–64.
193. Lopez RA, Schoetz S, DeAngelis K, et al. Multiple hematopoietic defects and delayed globin switching in Ikaros null mice. *Proc Natl Acad Sci U S A* 2002;99:602–607.
194. Lessard J, Schumacher A, Thorsteinsdottir U, et al. Functional antagonism of the Polycomb-group genes *ee* and *Bmi1* in hemopoietic cell proliferation. *Genes Dev* 1999;13:2691–2703.
195. Shivdasani RA, Orkin SH. The transcriptional control of hematopoiesis. *Blood* 1996;87:4025–4039.
196. Chen H, Ray-Gallet D, Zhang P, et al. PU.1(Spi-1) autoregulates its expression in myeloid cells. *Oncogene* 1995;11:1549–1560.
197. Tsai SF, Strauss E, Orkin SH. Functional analysis and *in vivo* footprinting implicate the erythroid transcription factor GATA-1 as a positive regulator of its own promoter. *Genes Dev* 1991;5:919–931.
198. Hu M, Krause D, Greaves M, et al. Multilineage gene expression precedes commitment in the hemopoietic system. *Genes Dev* 1997;11:774–785.
199. Nerlov C, Tenen DG, Graf T. Regulatory interactions between transcription factors and their role in hematopoietic lineage determination. In: Zon LI, ed. *Hematopoiesis: a developmental approach*. Oxford: Oxford University Press, 2001:363–367.
200. Kimoto M, Fathman CG. Antigen-reactive T-cell clones I: transcomplementing hybrid I-A-region gene products function effectively in antigen presentation. *J Exp Med* 1980;152:759–770.

201. Pragnell IB, Wright EG, Lorimore SA, et al. The effect of stem cell proliferation regulators demonstrated with an *in vitro* assay. *Blood* 1988;72:196–201.
202. Bradley TR, Hodgson GS. Detection of primitive macrophage progenitor cells in mouse bone marrow. *Blood* 1979;54:1446–1450.
203. Muta K, Krantz SB, Bondurant MC, et al. Stem cell factor retards differentiation of normal human erythroid progenitor cells while stimulating proliferation. *Blood* 1995;86:572–580.
204. Bondurant MC, Yamashita T, Muta K, et al. *c-myc* expression affects proliferation but not terminal differentiation or survival of explanted erythroid progenitor cells. *J Cell Physiol* 1996;168:255–263.
205. Panzenbock B, Bartunek P, Mapara MY, et al. Growth and differentiation of human stem cell factor/erythropoietin-dependent erythroid progenitor cells. *Blood* 1998;92:3658–3668.
206. Hayman MJ, Meyer S, Martin F, et al. Self-renewal and differentiation of normal avian erythroid progenitor cells: regulatory roles of the TGF $\alpha$ /c-ErbB and SCF/c-kit receptors. *Cell* 1993;74:157–169.
207. Kim NW, Piatyszek MA, Prowse KR, et al. Specific association of human telomerase activity with immortal cells and cancer. *Science* 1994;266:2011–2015.
208. Broccoli D, Young JW, de Lange T. Telomerase activity in normal and malignant hemopoietic cells. *Proc Natl Acad Sci U S A* 1995;92:9082–9086.
209. Counter CM, Gupta J, Harley CB, et al. Telomerase activity in normal leukocytes and in hematologic malignancies. *Blood* 1995;85:2315–2320.
210. Autexier C, Grieder CW. Telomerase and cancer: revisiting the telomere hypothesis. *Trends Biochem Sci* 1996;21:387–391.
211. Bazan JF. Structural design and molecular evolution of a cytokine receptor superfamily. *Proc Natl Acad Sci U S A* 1990;87:6934–6938.
212. Sprang S, Bazan J. Cytokine structural taxonomy and mechanisms of receptor engagement. *Curr Opin Struct Biol* 1993;3:815–827.
213. Boulay JL, Paul WE. Hematopoietin sub-family classification based on size, gene organization and sequence homology. *Curr Biol* 1993;3:573–581.
214. Mitsui Y, Senda T, Shimazu T, et al. Structural functional and evolutionary implications of the three dimensional crystal structure of murine interferon. *Pharmacol Ther* 1993;58:93–132.
215. Kaushansky K, Karplus PA. Hematopoietic growth factors: understanding functional diversity in structural terms. *Blood* 1993;82:3229–3240.
216. Robinson RC, Grey LM, Staunton D, et al. The crystal structure and biological function of leukemia inhibitory factor: implication for receptor binding. *Cell* 1994;77:1101–1116.
217. Ihle JN, Witthuhn BA, Quelle FW, et al. Signaling through the hematopoietic cytokine receptors. *Annu Rev Immunol* 1995;13:369–398.
218. Ihle JN. Cytokine receptor signaling. *Nature* 1995;377:591–594.
219. Ihle JN. Signal transducers and activators of transcription. *Cell* 1996;84:331–334.
220. Kishimoto T, Akira S, Narazaki M, et al. Interleukin-6 family of cytokines and gp130. *Blood* 1995;86:1243–1254.
221. Hardie DG, Hanks S. *The protein kinase factsbook*, vol 2. San Diego: Academic Press, 1995.
222. Sawada K, Krantz SB, Dessypris EN, et al. Human colony-forming units-erythroid do not require accessory cells, but do require direct interactions with insulin-like growth factor I and/or insulin for

erythroid development. *J Clin Invest* 1989;83:1701–1709.

223. Rosnet O, Mattei MG, Marchetto S, et al. Isolation and chromosomal localization of a novel FMS-like tyrosine kinase gene. *Genomics* 1991;9:380–385.

224. Matthews W, Jordan C, Wiegand G, et al. A receptor tyrosine kinase specific to hematopoietic stem and progenitor cell-enriched populations. *Cell* 1991;65:1143–1152.

225. Small D, Levenstein M, Kim E, et al. STK-1, the human homolog of Flk-2/flt-3, is selectively expressed in CD34+ human bone marrow cells and is involved in the proliferation of early progenitor/stem cells. *Proc Natl Acad Sci U S A* 1994;91:459–463.

226. Lyman S, James L, Bos T, et al. Molecular-cloning of a ligand for the flt-3/flk-2 tyrosine kinase receptor: a proliferative factor for primitive hematopoietic cells. *Cell* 1994;75:1157–1167.

227. Zeigler F, Bennett B, Jordan C, et al. Cellular and molecular characterization of the role of the FLK-2/FLT-3 receptor tyrosine kinase in hematopoietic stem cells. *Blood* 1994;84:2422–2430.

228. Muench MO, Roncarolo MG, Menoan S, et al. FLK-2/FLT-3 ligand regulates the growth of early myeloid progenitors isolated from human fetal liver. *Blood* 1995;85:963–972.

229. McKenna HJ, deVries P, Brasel K, et al. Effect of flt3 ligand on the ex vivo expansion of human CD34+ hematopoietic progenitor cells. *Blood* 1995;86:3413–3420.

230. Mathews W, Jordan C, Gavin M, et al. A receptor tyrosine kinase cDNA isolated from a population of enriched primitive hematopoietic cells and exhibiting close genetic linkage to c-kit. *Proc Natl Acad Sci U S A* 1991;88:9026–9030.

231. Broxmeyer HE, Cooper S, Li ZH, et al. Myeloid progenitor cell regulatory effects of vascular endothelial cell growth factor. *Int J Hematol* 1995;62:203–215.

232. Yee K, Bishop TR, Mather C, et al. Isolation of a novel receptor tyrosine kinase cDNA expressed by developing erythroid progenitors. *Blood* 1993;82:1335–1343.

233. Iwama A, Hamaguchi I, Hashiyama M, et al. Molecular cloning and characterization of mouse TIE and TEK receptor tyrosine kinase genes and their expression in hematopoietic stem cells. *Biochem Biophys Res Commun* 1993;195:301–309.

234. Batard P, Sansilvestri P, Scheinecker C, et al. The Tie receptor tyrosine kinase is expressed by human hematopoietic progenitor cells and by a subset of megakaryocyte cells. *Blood* 1996;87:2212–2220.

235. Rosnet O, Stephenson D, Matter MG, et al. Close physical linkage of the FLT1 and FLT3 genes on chromosome 13 in man and chromosome 5 in mouse. *Oncogene* 1993;8:173–179.

236. Fanti N, Johnson D, Williams L. Signaling by receptor tyrosine kinases. *Annu Rev Biochem* 1993;62:453–481.

237. Kazlauskas A. Receptor tyrosine kinases and their targets. *Curr Opin Genet Dev* 1994;4:5–14.

238. Matsunaga T, Hirayama F, Yonemura Y, et al. Negative regulation by interleukin-3 (IL-3) of mouse early B-cell progenitors and stem cells in culture: transduction of the negative signals by Bc and BIL-3 proteins of IL-3 receptor and absence of negative regulation by granulocyte-macrophage colony-stimulating factor. *Blood* 1998;92:901–907.

239. Matsunaga T, Kato T, Miyazaki H, et al. Thrombopoietin promotes the survival of murine hematopoietic long-term reconstituting cells: comparison with the effects of FLT3/FLK-2 ligand and interleukin-6. *Blood* 1998;92:452–461.

240. Yagi M, Ritchie KA, Sitnicka E, et al. Sustained *ex vivo* expansion of hematopoietic stem cells mediated by thrombopoietin. *Proc Natl Acad Sci U S A* 1999;96:8126–8131.

241. Metcalf D. Lineage commitment in the progeny of murine hematopoietic progenitor cells: influence

- of thrombopoietin and interleukin 5. *Proc Natl Acad Sci U S A* 1998;95:6408–6412.
242. Zandstra PW, Lauffenburger DA, Eaves CJ. A ligand–receptor signaling threshold model of stem cell differentiation control: a biologically conserved mechanism applicable to hematopoiesis. *Blood* 2000;96:1215–1222.
243. Metcalf D. Hematopoietic regulators: redundancy or subtlety? *Blood* 1993;82:3515–3523.
244. Alexander WS, Roberts AW, Nicola NA, et al. Deficiencies in progenitor cells of multiple hematopoietic lineages and defective megakaryocytopoiesis in mice lacking the thrombopoietin receptor c-Mpl. *Blood* 1996;87:2162–2170.
245. Yonemura Y, Kaushansky K, Ogawa M. Thrombopoietin, the ligand for the Mpl receptor, synergizes with Steel factor and other early acting cytokines in supporting proliferation of primitive hematopoietic progenitors in mice. *Blood* 1996;87:4544–4551.
246. Young JC, Bruno E, Luens KM, et al. Thrombopoietin stimulates megakaryocytopoiesis, myelopoiesis, and expansion of CD34+Thy-1+Lin- primitive progenitor cells. *Blood* 1996;88:1619–1631.
247. McNiece IK, Langley K, Zsebo KM. Recombinant human stem cell factor (rhSCF) synergizes with GM-CSF, G-CSF, IL-3 and Epo to stimulate human progenitor cells of myeloid and erythroid lineages. *Exp Hematol* 1991;19:226–231.
248. Metcalf D, Nicola NA. Direct proliferative actions of stem cell factor on murine bone marrow cells *in vitro*. Effects of combination with colony-stimulating factors. *Proc Natl Acad Sci U S A* 1991;88:6239–6243.
249. Leary AG, Zeng HQ, Clark SC, et al. Growth factor requirements for survival in G<sub>0</sub> and entry into the cell cycle of primitive human hemopoietic progenitors. *Proc Natl Acad Sci U S A* 1992;89:4013–4017.
250. Miura N, Okada S, Zsebo KM, et al. Rat stem cell factor and IL-6 preferentially support the proliferation of c-kit-positive murine hemopoietic cells rather than their differentiation. *Exp Hematol* 1993;21:143–149.
251. Migliaccio G, Migliaccio AR, Valinsky J, et al. Stem cell factor induces proliferation and differentiation of highly enriched murine hematopoietic cells. *Proc Natl Acad Sci U S A* 1991;88:7420–7424.
252. Metcalf D, Nicola NA. The hemopoietic colony stimulating factors: from biology to clinical applications. Cambridge: Cambridge University Press, 1995.
253. Metcalf D. The granulocyte–macrophage regulators: reappraisal by gene inactivation. *Exp Hematol* 1995;23:569–572.
254. Yamaguchi Y, Suda T, Suda J, et al. Purified interleukin-5 supports the terminal differentiation and proliferation of murine eosinophilic precursors. *J Exp Med* 1988;167:43–56.
255. Dickason RR, Huston DP. Creation of a biologically active interleukin-5 monomer. *Nature* 1996;379:652–655.
256. Santiago-Schwarz F, Belilos E, Diamond B, et al. TNF in combination with GM-CSF enhances the differentiation of neonatal cord blood stem cells into dendritic cells and macrophages. *J Leukoc Biol* 1992;52:274–281.
257. Caux C, Dezutter-Dambuyant C, Schmitt D, et al. GM-CSF and TNF- $\alpha$  cooperate in the generation of dendritic Langerhans cells. *Nature* 1992;360:258–261.
258. Rosenzweig M, Canque B, Gluckman JC. Human dendritic cell differentiation pathway from CD34+ hematopoietic precursor cells. *Blood* 1996;87:535–544.
259. Caux C, Vanbervliet B, Massacrier C, et al. Interleukin-3 cooperates with tumor necrosis factor  $\alpha$  for the development of human dendritic/Langerhans cells from cord blood CD34+ hematopoietic progenitor cells. *Blood* 1996;87:2376–2385.
260. Lukacs NW, Kunkel SL, Strieter RM, et al. The role of stem cell factor (c-kit ligand) and inflammatory

cytokines in pulmonary mast cell activation. *Blood* 1996;87:2262–2268.

261. Wershil BK, Tsai M, Geissler EN, et al. The rat c-kit ligand, stem cell factor, induces c-kit receptor-dependent mouse mast cell activation *in vivo*. Evidence that signaling through the c-kit receptor can induce expression of cellular function. *J Exp Med* 1992;175:245–255.

262. Valent P, Spanbloch E, Sperr WR, et al. Induction of differentiation of human mast cells from bone marrow and peripheral blood mononuclear cells by recombinant human stem cell factor/kit ligand in long-term culture. *Blood* 1992;80:2237–2245.

263. Irani AA, Nilsson G, Miettinen U, et al. Recombinant human stem cell factor stimulates differentiation of mast cells from dispersed human fetal liver cells. *Blood* 1992;80:3009–3021.

264. Fleischman J, Golde DW, Weisbart RH, et al. Granulocyte macrophage colony stimulating factor enhances phagocytosis of bacteria by human neutrophils. *Blood* 1986;68:708–711.

265. Vadas MA, Nicola NA, Metcalf D. Activation of antibody dependent cell mediated cytotoxicity of the human neutrophils and eosinophils by separate colony stimulating factors. *J Immunol* 1983;130:795–799.

266. Handman E, Burgess AW. Stimulation by granulocyte-macrophage colony stimulating factor of *Leishmania tropica* killing by macrophages. *J Immunol* 1979;122:1134–1137.

267. Wing EJ, Waheed A, Shaddock RK, et al. Effect of colony stimulating factor on murine macrophages. *J Clin Invest* 1982;69:270–276.

268. Avalos BR, Hedzlat C, Baldwin GC, et al. Biological activities of human G-CSF and characterization of the human G-CSF receptor. *Blood* 1987;70:165a.

269. Wing EJ, Ampel NM, Waheed A, et al. Macrophage CSF (M-CSF) enhances the capacity of murine macrophages to secrete oxygen reduction products. *J Immunol* 1985;135:2052–2056.

270. Broudy VC, Lin NL, Kaushansky K. Thrombopoietin (c-mpl ligand) acts synergistically with erythropoietin, stem cell factor, and interleukin-11 to enhance murine megakaryocyte colony growth and increases megakaryocyte ploidy *in vitro*. *Blood* 1995;85:1719–1726.

271. Banu N, Wang JF, Deng B, et al. Modulation of megakaryocytopoiesis by thrombopoietin: the c-Mpl ligand. *Blood* 1995;86:1331–1338.

272. Burstein SA, Adamson JW, Erb SK, et al. Megakaryocytopoiesis in the mouse: response to varying platelet demand. *J Cell Physiol* 1981;109:333–341.

273. Williams N, Eger RR, Jackson HM, et al. Two-factor requirement for murine megakaryocyte colony formation. *J Cell Physiol* 1982;110:101–104.

274. Kuter DJ, Begley CG. Recombinant human thrombopoietin: basic biology and evaluation of clinical studies. *Blood* 2002;100:3457–3469.

275. Kaushansky K. Thrombopoietin: the primary regulator of platelet production. *Blood* 1995;86:419–431.

276. Debili N, Wendling F, Cosman D, et al. The Mpl receptor is expressed in the megakaryocytic lineage from late progenitors to platelets. *Blood* 1995;85:391–401.

277. Souyri M, Vignon I, Penciolelli JF, et al. A putative truncated cytokine receptor gene transduced by the myeloproliferative leukemia virus immortalizes hematopoietic progenitors. *Cell* 1990;63:1137–1147.

278. Farese AM, Hunt P, Boone T, et al. Recombinant human megakaryocyte growth and development factor stimulates thrombocytopoiesis in normal nonhuman primates. *Blood* 1995;86:54–59.

279. Wendling F, Maraskovsky E, Debili N, et al. cMpl ligand is a humoral regulator of megakaryocytopoiesis. *Nature* 1994;369:571–574.

280. McCarty JM, Sprugel KH, Fox NE, et al. Murine thrombopoietin mRNA levels are modulated by

platelet count. *Blood* 1995;86:3668–3675.

281. Whitlock CA, Witte ON. Long term culture of B lymphocytes and their precursors from murine bone marrow. *Proc Natl Acad Sci U S A* 1982;79:3608–3612.

282. Peschon JJ, Morrissey PJ, Grabstein KH, et al. Early lymphocyte expansion is severely impaired in interleukin-7 receptor-deficient mice. *J Exp Med* 1994;180:1955–1960.

283. Koury MJ, Bondurant MC. The molecular mechanism of erythropoietin action. *Eur J Biochem* 1992;210:649–663.

284. Koury ST, Bondurant MC, Koury MJ. Localization of erythropoietin synthesizing cells in murine kidneys by *in situ* hybridization. *Blood* 1988;71:524–527.

285. Lacombe C, DaSilva JL, Bruneval P, et al. Peritubular cells are the site of erythropoietin synthesis in the murine hypoxic kidney. *J Clin Invest* 1988;81:620–623.

286. Koury ST, Koury MJ, Bondurant MC, et al. Quantitation of erythropoietin-producing cells in kidneys of mice by *in situ* hybridization: correlation with hematocrit, renal erythropoietin mRNA and serum erythropoietin concentration. *Blood* 1989;74:645–651.

287. Wang GL, Jiang BH, Rue EA, et al. Hypoxia-inducible factor 1 is a basic-helix-loop-helix-PAS-PA heterodimer regulated by cellular O<sub>2</sub> tension. *Proc Natl Acad Sci U S A* 1995;92:5510–5514.

288. Semenza GL, Koury ST, Nejfelt MK, et al. Cell-type-specific and hypoxia-inducible expression of the human erythropoietin gene in transgenic mice. *Proc Natl Acad Sci U S A* 1991;88:8725–8729.

289. Koury ST, Bondurant MC, Semenza GL, et al. The use of *in situ* hybridization to study erythropoietin gene expression in murine kidney and liver. *Microsc Res Tech* 1993;25:29–39.

290. Dai CH, Krantz SB, Zsebo KM. Human burst-forming units-erythroid need direct interaction with stem cell factor for further development. *Blood* 1991;78:2493–2497.

291. Muta K, Krantz SB, Bondurant MC, et al. Distinct roles of erythropoietin, insulin-like growth factor I, and stem cell factor in the development of erythroid progenitor cells. *J Clin Invest* 1994;94:34–43.

292. Wiktor-Jedrzejczak W, Ratajczak MZ, Ptasznik A, et al. CSF-1 deficiency in the op/op mouse has differential effects on macrophage populations and differentiation stages. *Exp Hematol* 1992;20:1004–1010.

293. Dranoff G, Crawford AD, Sadelain M, et al. Involvement of granulocyte-macrophage colony-stimulating factor in pulmonary homeostasis. *Science* 1994;264:713–716.

294. Stanley E, Lieschke GJ, Grail D, et al. Granulocyte-macrophage colony-stimulating factor-deficient mice show no major perturbation of hematopoiesis but develop a characteristic pulmonary pathology. *Proc Natl Acad Sci U S A* 1994;91:5592–5596.

295. Lieschke GJ, Stanley E, Grail D, et al. Mice lacking both macrophage- and granulocyte-macrophage colony-stimulating factor have macrophages and co-existent osteopetrosis and severe lung disease. *Blood* 1994;84:27–35.

296. Lieschke GJ, Grail D, Hodgson G, et al. Mice lacking granulocyte colony stimulating factor have chronic neutropenia, granulocyte and macrophage progenitor deficiency, and impaired neutrophil mobilization. *Blood* 1994;84:1737–1746.

297. Hara T, Ichihara M, Takagi M, et al. Interleukin-3 (IL-3) poor-responsive inbred mouse strains carry the identical deletion of a branch point in the IL-3 receptor alpha-subunit gene. *Blood* 1995;85:2331–2336.

298. Mackarehtschian K, Hardin JD, Moore KA, et al. Targeted disruption of the flk2/flt3 gene leads to deficiencies in primitive hematopoietic progenitors. *Immunity* 1995;3:147–161.

299. McKenna HJ, Stocking KL, Miller RE, et al. Mice lacking flt3 ligand have deficient hematopoiesis affecting hematopoietic progenitor cells, dendritic cells, and natural killer cells. *Blood* 2000;95:3489–3497.

300. Wu H, Liu X, Jaenisch R, Lodish HF. Generation of committed erythroid BFU-E and CFU-E progenitors does not require erythropoietin or the erythropoietin receptor. *Cell* 1995;83:59-67.
301. Lin CS, Lim SK, D'Agati V, et al. Differential effects of an erythropoietin receptor gene disruption on primitive and definitive erythropoiesis. *Genes Dev* 1996;10:154-164.
302. Tushinski RJ, Stanley ER. The regulation of mononuclear phagocyte entry into S phase by colony stimulating factor CSF-1. *J Cell Physiol* 1985;122:221-228.
303. Hodgson GS, Bradley TR. Properties of haematopoietic stem cells surviving 5-fluorouracil treatment: evidence for a pre-CFU-S cell. *Nature* 1979;281:381-382.
304. Lerner C, Harrison DE. 5-Fluorouracil spares hemopoietic stem cells responsible for long-term repopulation. *Exp Hematol* 1990;18:114-118.
305. Berardi AC, Wang A, Levine JD, et al. Functional isolation and characterization of human hematopoietic stem cells. *Science* 1995;267:104-108.
306. Ponchio L, Conneally E, Eaves C. Quantitation of the quiescent fraction of long-term culture-initiating cells in normal human blood and marrow and the kinetics of their growth factor-stimulated entry into S-phase *in vitro*. *Blood* 1995;86:3314-3321.
307. Iscove NN. The role of erythropoietin in regulation of population size and cell cycling of early and late erythroid precursors in mouse bone marrow. *Cell Tissue Kinet* 1977;10:323-334.
308. Hara H, Ogawa M. Erythropoietic precursors in mice under erythropoietic stimulation and suppression. *Exp Hematol* 1977;5:141-148.
309. Adamson JW, Torok-Stor B, Lin N. Analysis of erythropoiesis by erythroid colony formation in culture. *Blood Cells* 1978;4:89-103.
310. Dessypris EN, Krantz SB. Effect of pure erythropoietin on DNA synthesis by human marrow day 15 erythroid burst-forming units in short-term liquid culture. *Br J Haematol* 1984;56:295-306.
311. Williams GT, Smith CA, Spooncer E, et al. Haemopoietic colony stimulating factors promote cell survival by suppressing apoptosis. *Nature* 1990;343:76-79.
312. Koury MJ, Bondurant MC. Erythropoietin retards DNA breakdown and prevents programmed death in erythroid progenitor cells. *Science* 1990;248:378-381.
313. Rodriguez-Tarduchy G, Collins M, Lopez-Rivas A. Regulation of apoptosis in interleukin-3-dependent hemopoietic cells by interleukin-3 and calcium ionophores. *EMBO J* 1990;9:2997-3002.
314. Yamaguchi Y, Suda T, Ohta S, et al. Analysis of the survival of mature human eosinophils: interleukin-5 prevents apoptosis in mature human eosinophils. *Blood* 1991;78:2542-2547.
315. Duke RC, Cohen JJ. IL-2 addiction: withdrawal of growth factor activates a suicide program in dependent T cells. *Lymphokine Res* 1986;5:289-299.
316. Keller JR, Ortiz M, Ruscetti FW. Steel factor (c-kit ligand) promotes the survival of hematopoietic stem/progenitor cells in the absence of cell division. *Blood* 1995;86:1757-1764.
317. Tushinski RJ, Oliver IT, Gilbert LJ, et al. Survival of mononuclear phagocytes depends on a lineage-specific growth factor that the differentiated cells selectively destroy. *Cell* 1982;28:71-81.
318. Wagner KU, Estefania C, Rucker E, et al. Conditional deletion of the Bcl-x gene from erythroid cells results in hemolytic anemia and profound splenomegaly. *Development* 2000;127:4949-4958.
319. Silva M, Grillot D, Benito A, et al. Erythropoietin can promote erythroid progenitor survival by repressing apoptosis through Bcl-X<sub>L</sub> and Bcl-2. *Blood* 1996;88:1576-1582.
320. Motoyama N, Wang F, Roth KA, et al. Massive cell death of immature hematopoietic cells and



neurons in Bcl-x-deficient mice. *Science* 1995;267:1506-1510.

321. Gregoli P, Bondurant M. The roles of Bcl-X<sub>L</sub> and apopain in the control of erythropoiesis by erythropoietin. *Blood* 1997;90:630-640.

322. Akgul C, Moulding DA, Edwards SW. Molecular control of neutrophil apoptosis. *FEBS Lett* 2001;487(3):318-322.

323. Epling-Burnette PK, Zhong B, Bai F, et al. Cooperative regulation of Mcl-1 by Janus kinase/stat and phosphatidylinositol 3-kinase contribute to granulocyte-macrophage colony-stimulating factor-delayed apoptosis in human neutrophils. *J Immunol* 2001;166(12):7486-7495.

324. Liu H, Perlman H, Pagliari LJ, et al. Constitutively activated Akt-1 is vital for the survival of human monocyte-differentiated macrophages. Role of Mcl-1, independent of nuclear factor (NF)-kappa B, Bad, or caspase activation. *J Exp Med* 2001;194:113-126.

325. Huang HM, Huang CJ, Yen JJ. Mcl-1 is a common target of stem cell factor and interleukin 5 for apoptosis prevention activity via MEK/MAPK and PI3/Akt pathways. *Blood* 2000;96:1764-1771.

326. Sevilla L, Zaldumbide A, Carlotti F, et al. Bcl-X<sub>L</sub> expression correlates with primary macrophage differentiation, activation of functional competence and survival and results from synergistic transcriptional activation by Ets2 and Pu.1. *J Biol Chem* 2001;276:17800-17807.

327. Shinjyo T, Kuribara R, Inukai T, et al. Downregulation of Bim, a proapoptotic relative of Bcl-2, is a pivotal step in cytokine-initiated survival signaling in murine hematopoietic progenitors. *Mol Cell Biol* 2001;21:854-864.

328. Ioannidis V, Beermann F, Clevers H, et al. The beta-catenin-TCF-1 pathway ensures CD4(+)CD8(+) thymocyte survival. *Nat Immunol* 2001;2(8):691-697.

329. Rogers PR, Song J, Gramaglia I. OX40 promotes Bcl-x<sub>L</sub> and Bcl-2 expression and is essential for long-term survival of CD4 T cells. *Immunity* 2001;15(3):445-455.

330. Sanz C, Benet I, Richard C, et al. Antiapoptotic protein Bcl-x<sub>L</sub> is up-regulated during megakaryocytic differentiation of CD34(+) progenitors but is absent from senescent megakaryocytes. *Exp Hematol* 2001;29(6):728-735.

331. Wurster AL, Rodgers VL, White MF, et al. Interleukin-4-mediated protection of primary B cells from apoptosis through Stat6-dependent up-regulation of Bcl-x<sub>L</sub>. *J Biol Chem* 2002;277(30):27169-27175.

332. Moulding DA, Akgul C, Derouet M, et al. Bcl-2 family expression in human neutrophils during delayed and accelerated apoptosis. *J Leukoc Biol* 2001;70:783-792.

333. delPeso L, Gonzalez-Garcia M, Page C, et al. Interleukin-3-induced phosphorylation of BAD through the protein kinase Akt. *Science* 1997;278:678-689.

334. Boyer SH, Bishop TR, Rogers OC, et al. Roles of erythropoietin, insulin-like growth factor 1, and unidentified serum factors in promoting maturation of purified murine erythroid colony-forming units. *Blood* 1992;80:2503-2512.

335. Kelley LL, Koury MJ, Bondurant MC, et al. Survival or death of individual proerythroblasts results from differing erythropoietin sensitivities: a mechanism for controlled rates of erythrocyte production. *Blood* 1993;82:2340-2352.

336. Muta K, Krantz SB. Apoptosis of human erythroid colony-forming cells is decreased by stem cell factor and insulin-like growth factor-1 as well as erythropoietin. *J Cell Physiol* 1993;156:264-271.

337. Tsuda H, Sawada T, Sakaguchi M, et al. Mode of action of erythropoietin in an Epo dependent murine cell line. I. Involvement of adenosine 3':5'-cyclic adenosine monophosphate not as a second messenger but as a regulator of a cell growth. *Exp Hematol* 1989;17:211-217.

338. Spivak JL, Pham T, Isaacs M, et al. Erythropoietin is both a mitogen and a survival factor. *Blood*

1991;77:1228–1233.

339. Dolznig H, Habermann B, Stangl K, et al. Apoptosis protection by the EPO target Bcl-X<sub>L</sub> allows factor-independent differentiation of primary erythroblasts. *Curr Biol* 2002;12:1076–1085.

340. Socolovsky M, Fallon AE, Wang S, et al. Fetal anemia and apoptosis of red cell progenitors in Stat5a<sup>-/-</sup>5b<sup>-/-</sup> mice: a direct role for Stat 5 in Bcl-X<sub>L</sub> induction. *Cell* 1999;98:181–191.

341. Silva M, Benito A, Sanz C, et al. Erythropoietin can induce the expression of Bcl-x<sub>L</sub> through STAT5 in erythropoietin-dependent progenitor cell lines. *J Biol Chem* 1999;274:22165–22169.

342. Glasgow JN, Wood T, Perez-Polo JR. Identification and characterization of nuclear factor kappaB binding sites in the murine bcl-x promoter. *J Neurochem* 2000;75:1377–1389.

343. Sevilla L, Aperlo C, Dulic V, et al. The Ets2 transcription factor inhibits apoptosis induced by colony-stimulating factor 1 deprivation of macrophages through a Bcl-X<sub>L</sub>-dependent mechanism. *Mol Cell Biol* 1999;19:2624–2634.

344. Sugars KL, Budhram-Mahadeo V, Packham G, et al. A minimal Bcl-x promoter is activated by Brn-3a and repressed by p53. *Nucleic Acids Res* 2001;29:4530–4540.

345. Koury MJ, Bondurant MC. Control of erythrocyte production. The roles of programmed cell death (apoptosis) and erythropoietin. *Transfusion* 1990;30:673–674.

2004 Lippincott Williams & Wilkins  
John P. Greer, John Foerster, John N. Lukens  
George M. Rodgers, Frixos Paraskevas, Bertil Glader  
Wintrobe's Clinical Hematology

## CONCEPT OF THE ERYTHRON

### ERYTHROID CELLS

[Commitment of Stem Cell Progeny to Erythroid Differentiation](#)

[Erythroid Progenitors](#)

[Erythroid Precursors](#)

[Stages of Normoblastic Differentiation](#)

[Proliferation and Maturation of the Erythron](#)

### BIOSYNTHESIS OF HEMOGLOBIN

[Globin Synthesis](#)

[Heme Biosynthetic Pathway](#)

### CONTROL OF ERYTHROPOIESIS

[Tissue Oxygen](#)

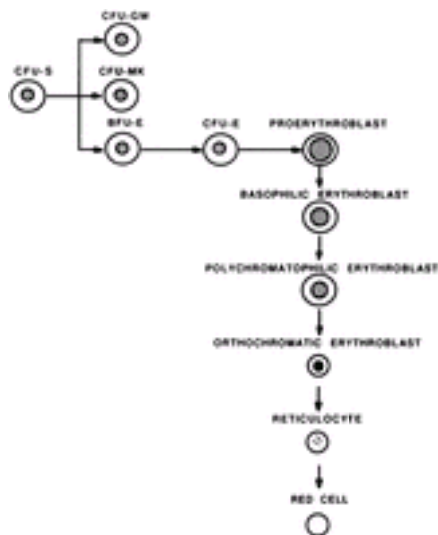
[Erythropoietin](#)

### REFERENCES

## CONCEPT OF THE ERYTHRON

The entire process by which red cells are produced in the bone marrow is termed *erythropoiesis*. For descriptive purposes, this process can be divided into various stages, including the *commitment* of pluripotent stem cell progeny into erythroid differentiation, the *erythropoietin-independent* or *early phase* of erythropoiesis and the *erythropoietin-dependent* or *late phase* of erythropoiesis. Under normal conditions, the whole process of erythropoiesis results in a red cell production rate such that the red cell mass in the body stays constant. This indicates that there must be control mechanisms by which the size of the red cell mass is tightly regulated. These control mechanisms are better understood for the later rather than the earlier phases of erythropoiesis. The glycoprotein hormone *erythropoietin* (EPO) has been established as the major humoral regulator of red cell production ([1](#), [2](#)).

Erythropoiesis involves a great variety and number of cells at different stages of maturation, starting with the first stem cell progeny committed to erythroid differentiation and ending with the mature circulating red cell ([Fig. 7.1](#)). The whole mass of these erythroid cells has been termed the *erythron* ([3](#)), a concept that emphasizes the functional unity of the red cells, their morphologically recognizable marrow precursors, and the functionally defined progenitors of erythroid precursors. The concept of erythron as a tissue has thus far contributed significantly to the understanding of the physiology and pathology of erythropoiesis.



**Figure 7.1.** Schematic representation of the various stages of erythroid differentiation. BFU-E, burst-forming unit erythroid; CFU-E, colony-forming unit erythroid; CFU-GM, colony-forming unit granulocyte-monocyte; CFU-MK, colony-forming unit megakaryocyte; CFU-S, colony-forming unit spleen.

## ERYTHROID CELLS

### Commitment of Stem Cell Progeny to Erythroid Differentiation

The work of Till and McCulloch (4) has provided experimental evidence for the presence in the bone marrow of cells capable of both self-renewal and production of progenies with potential for differentiation into red cells, granulocytes, and megakaryocytes. Injection of murine bone marrow cells into a sublethally irradiated syngeneic mouse leads to the formation of colonies of hematopoietic cells in the spleen of the recipient mouse after 8 to 12 days. The day 12 colonies contain cells of all three hematopoietic lineages and, in addition, cells that maintain their self-renewal capacity in the sense that they are capable of restoring hematopoiesis in a second group of sublethally irradiated mice. The cell that gives rise to these colonies was termed *colony-forming unit spleen*, and represents a cell identical or closely related to multipotent hematopoietic stem cell (5). Recently, the pluripotent murine hematopoietic stem cell has been purified and characterized (6). The murine stem cells morphologically resemble small immature lymphocytes, and injection of as few as 30 of these cells can rescue 50% of sublethally irradiated mice. These stem cells can restore not only the hematopoiesis but also the lymphopoiesis of the recipient mice (6).

Factors that affect commitment of stem cell progeny into a specific differentiation pathway are poorly understood and generally undefined. Although expression of lineage-specific transcription factors is the earliest molecular event associated with commitment toward a specific line, the stimuli responsible for their expression remain undefined. It is generally accepted that commitment and differentiation are irreversible events. A differentiated cell cannot regress to an undifferentiated stage or change into another differentiation pathway. Under normal conditions, once commitment occurs, differentiation proceeds fully to the stage of mature cell, which, in the case of blood cells, has a limited lifespan. Thus, differentiation is a process that leads to cell death. These concepts are generally well proven for the mature, morphologically recognizable hematopoietic cells and their progenitors, such as the marrow erythroblasts and their erythroid progenitors, but whether they apply equally well to more immature cells is less

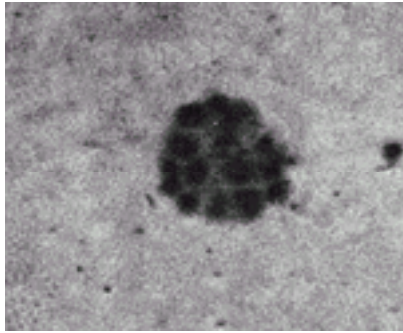
well known.

There are three major theories that address the process of commitment of stem cell progeny into a specific differentiation pathway (7). According to the *stochastic theory*, commitment is a random event that progressively restricts the potential for differentiation (4). This theory allows for regulatory factors to act only at later stages of hematopoiesis. This model derives its experimental support from the nonnormal (non-Poisson) distribution of lineage-specific cells in colony-forming unit spleen-derived colonies (4) and in colonies derived from multilineage progenitor cells (8), as well as from the identification *in vitro* of progenitor cells with bipotent differentiation potential such as erythroid/megakaryocytic, erythroid/eosinophil, or neutrophil/erythroid (9, 10 and 11). The second theory, that of *hemopoietic-inductive microenvironment*, proposes that commitment of stem cell progeny to a specific pathway depends on the environment that surrounds each hematopoietic stem cell (12). This model is based on the sequential analysis of colony type in spleen colonies (colony-forming unit spleen) and received further support by recent experiments with purified stem cells (6). The third theory proposes that commitment depends on *humoral factors* that compete among themselves at the stem cell progeny level in promoting differentiation toward one specific pathway (13, 14).

## Erythroid Progenitors

Erythroblasts in the bone marrow are generated from proliferating and differentiating earlier, more immature erythroid cells termed *erythroid progenitors*. These progenitor cells cannot be identified morphologically, but they are detectable functionally by their ability to form *in vitro* colonies of erythroblasts (15). The development of tissue culture techniques for cloning hematopoietic progenitor cells in semisolid culture media *in vitro* has led to the recognition and assay in the human and murine bone marrow of at least two erythroid progenitors, the *colony-forming unit erythroia* (CFU-E), and the *burst-forming unit erythroia* (BFU-E). Under the influence of EPO, these progenitors can grow in semisolid culture media and give rise to colonies of well-hemoglobinized erythroblasts.

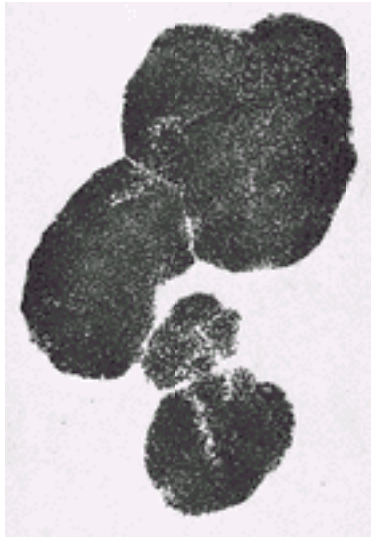
**COLONY-FORMING UNIT ERYTHROID** The CFU-E is an erythroid cell closely related to the proerythroblast (16). Under the influence of low concentrations of EPO, it gives rise (in 2 days in murine and in 5 to 8 days in human marrow) to colonies of 8 to 32 well-hemoglobinized erythroblasts (17, 18 and 19) (Fig. 7.2). The clonal origin of these colonies has been demonstrated by glucose-6-phosphate dehydrogenase-isoenzyme analysis (20). Morphologically, CFU-Es purified from progenitor cell cultures appear as immature cells with fine nuclear chromatin, a well-defined, large nucleolus, high nuclear-cytoplasmic ratio, a perinuclear clear zone, and basophilic cytoplasm with pseudopods (21). On electron microscopy, this cell appears as a primitive blast with dispersed nuclear chromatin, a prominent nucleolus, and an agranular cytoplasm containing clumps of mitochondria and frequent pinocytotic vesicles (21).



**Figure 7.2.** A day 7 colony-forming unit erythroid-derived colony of erythroblasts containing 16 cells.

The number of CFU-Es in the human marrow ranges from 50 to 400/ $1 \times 10^5$  light-density, nonadherent, nucleated cells and varies significantly with the methods used for cell separation and the culture conditions. The majority of the CFU-Es are in a phase of active DNA synthesis (S-phase) as demonstrated by a 70 to 90% killing of cells after short exposure to  $^3\text{H}$ -thymidine *in vitro* ( $^3\text{H}$ -thymidine suicide) or after administration of cycle-specific chemotherapeutic agents *in vivo* ([22](#), [23](#) and [24](#)). The size of CFU-E compartment in intact animals depends on the levels of circulating EPO. Anemia associated with high EPO levels or administration of EPO leads to expansion of the CFU-E compartment, whereas transfusion-induced polycythemia leads to low EPO levels and to significant reduction of the CFU-E compartment ([24](#)). From a number of *in vitro* studies, it has been well established that the CFU-E is the most EPO-sensitive cell, carrying the highest density of EPO receptors (EPORs) on its surface, and it is also absolutely dependent on EPO for its survival. In the absence of EPO, CFU-Es undergo programmed cell death (apoptosis) ([21](#), [25](#), [26](#), [27](#) and [28](#)).

**BURST-FORMING UNIT ERYTHROID** The BFU-E is an erythroid progenitor that is much more immature than the CFU-E, and it is more closely related to the multipotent hematopoietic stem cell, as indicated by its cell size and buoyant density and the relatively low percentage of these cells in active DNA synthesis (0 to 25%) ([23](#), [24](#), [29](#), [30](#)). BFU-E can be separated from CFU-E by its slower velocity sedimentation at unit gravity ([31](#)). Morphologically, the BFU-E appears as a very immature blast cell with slightly oval, moderately basophilic cytoplasm with occasional pseudopods, very fine nuclear chromatin, and large nucleoli ([27](#)). On electron microscopy, the cytoplasm is abundant and contains polyribosomes, and the nucleus contains small amounts of clumped heterochromatin and prominent nucleoli ([27](#)). In the presence of EPO and under the influence of other factors acting on early hematopoietic cells, such as interleukin-3 (IL-3), granulocyte-macrophage colony-stimulating factor, thrombopoietin, and stem cell factor, it gives rise in 5 to 7 days in mice and in 14 to 16 days in humans to clusters of many erythroid colonies containing a total of 500 to more than 5000 well-hemoglobinized erythroblasts ([Fig. 7.3](#)). The clonal origin of the BFU-E-derived erythroblasts has been demonstrated by characterization of the type of hemoglobin produced by cells in single colonies in co-culture experiments of bone marrow cells from a patient with homozygous hemoglobin C and marrow cells from another patient with homozygous hemoglobin S disease ([32](#)).



**Figure 7.3.** A day 15 human bone marrow burst-forming unit erythroid-derived burst (group of colonies) or erythroblasts containing over 1000 cells.

The BFU-E can be considered as a progenitor of the CFU-E. Indeed, after 6 to 7 days in culture, cells generated from human BFU-E have all the functional characteristics of CFU-E (21). The concentration of BFU-E in the human bone marrow varies from 10 to  $50/1 \times 10^5$  nucleated cells; however, this number fluctuates widely depending on the cell separation methods and the culture conditions. In contrast to CFU-E, BFU-Es are also detectable in the peripheral blood at a concentration of 0.02 to 0.05% of light-density (<1.077), mononuclear blood cells (33, 34 and 35). From both *in vitro* and *in vivo* experiments, it has been well established that the early stages of BFU-E proliferation and differentiation are EPO-independent (24, 27, 30). BFU-Es can survive *in vitro* (for 48 to 72 hours) in the absence of EPO, but they are absolutely dependent on IL-3 for their survival (27). Only 20% of blood BFU-Es express a very low density of EPORs detectable by autoradiography (27). The size of BFU-E compartment in the marrow of animals remains unaffected by the acute changes in the levels of circulating EPO induced by anemia or transfusional polycythemia (24). Anemia can induce an increase in the cycling of BFU-Es without affecting their numbers (36, 37), and *in vitro* EPO can induce BFU-Es into DNA synthesis (38). In humans, chronic administration of EPO is associated with an increase in the concentration and cycling status of marrow BFU-Es; however, these changes are also seen in granulocytic-monocytic, megakaryocytic (CFU-MK), and multilineage-progenitors, indicating that, at the early progenitor cell level, the marrow responds to EPO as an organ in a non-lineage-specific manner (39). All this evidence indicates that the early stages of erythropoiesis at the BFU-E level are EPO-independent, and dependence on EPO develops at a stage between BFU-E and CFU-E (27). The distinction between early (BFU-E) and late (CFU-E) erythroid progenitors, although valid, is by itself artificial. There are a variety of cells between BFU-E and CFU-E that form a continuum of erythroid progenitors at different stages of differentiation with properties between those of BFU-E and those of CFU-E. As an example, a subclass of erythroid progenitors termed *mature* BFU-Es has been described in human and murine marrow (22, 23). These cells share properties from both CFU-E and BFU-E. They have a proliferative potential lower than BFU-E but higher than CFU-E, their cycling status is also intermediate between CFU-E and BFU-E, and they do not exhibit IL-3-dependence, but they show relative EPO-dependence (22, 23, 26). Thus, it becomes clear that, during erythroid development, early progenitors of high proliferative potential in a relatively low cycling status with absolute dependence on IL-3 and responsiveness to but not dependence on EPO differentiate progressively through various



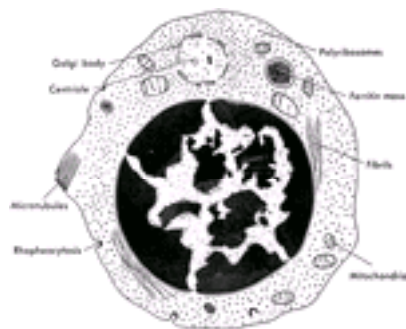
stages into later progenitors of low proliferative potential with a high cycling status that are IL-3-independent and totally EPO-dependent.

## Erythroid Precursors

*Erythroblast* is a term first used by Ehrlich to refer to all forms of nucleated red cells, pathologic as well as normal. He classified erythroblasts into two main categories: a normal series, the *normoblasts*, and a pathologic series, the *megaloblasts*. He had observed the latter in pernicious anemia during relapse, as well as in early embryonic blood. The term *megaloblast* is used in this book in the pathologic sense given by Ehrlich. These abnormal cells are described and discussed in [Chapter 43](#).

The least mature recognizable erythrocyte precursor cell is known as the *pronormoblast* or *proerythroblast*. Cells characteristic of subsequent stages of maturation are called *normoblasts* or *erythroblasts*. The various stages of maturation, in order of increasing maturity, are known as *pronormoblasts*, *basophilic normoblasts*, *polychromatophilic normoblasts*, and *orthochromatic normoblasts*. Morphologic characteristics of each stage, as seen with ordinary light microscopy after staining with Romanowsky dyes, are widely agreed on. Cytoplasmic maturation can be assessed by the change in staining characteristics, as the deep blue color from the high RNA content of immature cells gives way to the red color characteristic of hemoglobin. Nuclear maturation is evaluated by the disappearance of nucleoli and the condensation of chromatin as nuclear activity ceases. The use of these features in defining stages of maturation is described in more detail in ensuing paragraphs.

Electron microscopy has added a number of details to the understanding of normoblast structure ( [Fig. 7.4](#)). At the pronormoblast stage, ferritin can be found in the cytoplasm. On electron microscopy, this large, iron-containing protein has the characteristic appearance of a tetrad, making positive identification possible. Ferritin may appear as isolated molecules within the cytoplasm, or it may be found in pinocytotic vesicles or in larger structures (often surrounded by a membrane) that have been called *siderosomes*. The sources and metabolic fate of ferritin are discussed in [Chapter 28](#). Its morphologic importance depends on the fact that the presence of ferritin helps to distinguish erythrocyte precursors from other immature cells.



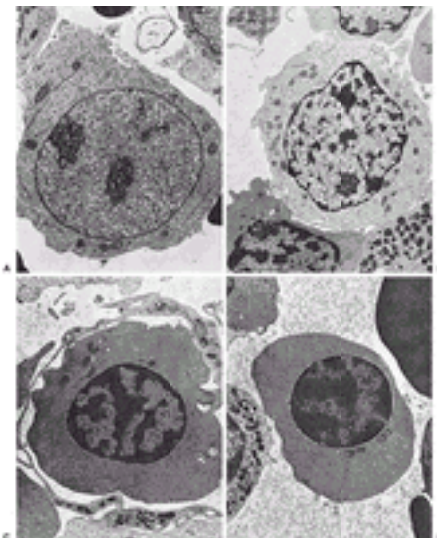
**Figure 7.4.** Schematic diagram of the ultrastructure of the normoblast as visualized by electron microscopy. (Courtesy of Dr. Marcel Bessis.)

The cytoplasm of erythrocyte precursors contains ribosomes, but, for the most part, these remain free within the cytoplasm rather than being part of a well-defined endoplasmic reticulum. In the stages that are actively synthesizing hemoglobin, the ribosomes are found in units known as *polyribosomes*; these consist of two to eight

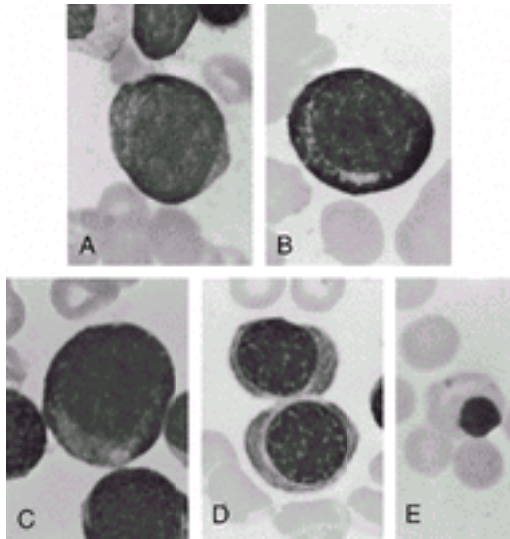
individual ribosomes joined together by a strand of messenger RNA (mRNA). Ribosomal RNA accounts in large part for the deep blue staining that is characteristic of younger cells (pronormoblast to polychromatophilic erythroblast). Mitochondria in erythroid cells are round or oval, and the cristae are less distinct than in other cell lines. They are most numerous in the earlier stages of maturation. Many small vesicles that are approximately 50 nm in diameter are seen throughout the cytoplasm. They have a single membrane with an indistinct inner layer, and they sometimes contain ferritin particles (40). These vesicles are believed to arise by a process termed *pinocytosis* or *rhopheocytosis* (Fig. 7.4), whereby macromolecular substances are brought into the cell. The vesicle is formed from an invagination of the cell membrane, followed by closure to form a vacuole, which later separates from the membrane. Other cytoplasmic structures found in the young normoblast include a Golgi apparatus and occasional, randomly oriented microtubules. The latter are of unknown function but may represent remnants of the marginal band, a cytoskeletal structure characteristic of erythrocytes of lower species (41). Alternatively, they may be remnants of mitotic spindles (40).

### Stages of Normoblastic Differentiation

The pronormoblast or proerythroblast is a round or oval cell of moderate to large size (14 to 19  $\mu\text{m}$  diameter) (Fig. 7.5A and Fig. 7.6A). It possesses a relatively large nucleus, occupying perhaps 80% of the cell, and a rim of basophilic cytoplasm. The nucleus of the youngest cells in this group may differ little from that of the myeloblast. Nucleoli are present and may be prominent. There is a very thin or delicate membrane penetrated by pores, which connect the nucleoplasm to the cytoplasm (40).



**Figure 7.5.** Maturation of normoblasts as seen with transmission electron microscopy. Pronormoblast (A), basophilic normoblast (B), polychromatophilic normoblast (C), and orthochromatophilic normoblast (D). (Courtesy of Dr. Carl Kjeldsberg.)



**Figure 7.6.** Normoblasts. Pronormoblast (A); basophilic normoblast (B); early (C) and late (D) polychromatophilic normoblasts; orthochromatic normoblast with stippling (E). Magnification,  $\times 1000$ ; Wright stain. See [Color Plate](#).

At this stage, only very small amounts of hemoglobin are present that cannot be detected by Giemsa stain. With the electron microscope at very high magnification ( $\times 100,000$ ), ferritin molecules may be detected. As compared with that of myeloblasts and lymphoblasts, the cytoplasm has a tendency to be more homogeneous and condensed and may appear granular. A small, pale area may be found in the cytoplasm, probably corresponding to the Golgi apparatus (<sup>40</sup>). The nuclear chromatin is somewhat more coarse than that in myeloblasts or lymphoblasts. A number of mitochondria are seen in the cytoplasm with supravital stains or electron microscopy.

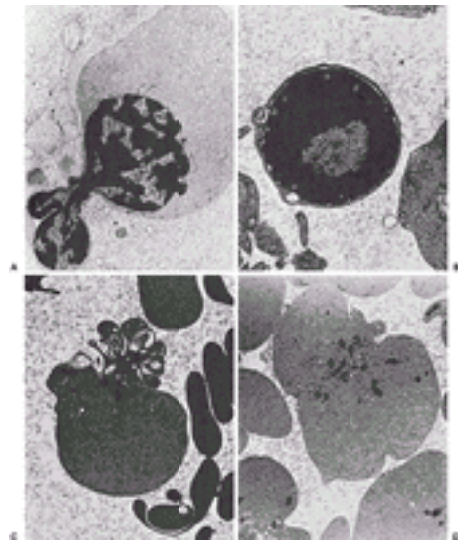
The basophilic normoblast or basophilic erythroblast is similar to the pronormoblast except that the nucleoli are no longer visible and the cell is somewhat smaller (12 to 17  $\mu\text{m}$  in diameter) ( [Fig. 7.5B](#) and [Fig. 7.6B](#)). Condensation of chromatin (formation of heterochromatin) begins in this stage. On light microscopy, the chromatin may appear coarse and granular; thus, there is little resemblance to the myeloblast. The nuclear structure may assume a wheel-spoke arrangement, and there tends to be sharp contrast between chromatin and parachromatin. The ribosomes reach their maximum number during this stage, and, as a consequence, the cytoplasm is deeply basophilic, even more so than in the pronormoblast. The color changes during subsequent stages reflect the increasing cytoplasmic concentration of acidophilic hemoglobin and the decreasing number with eventual disappearance of ribosomal RNA.

The first faint blush of hemoglobin, as indicated by one or more pink areas near the nucleus in dry fixed preparations, introduces the next stage, which is called the *polychromatophilic normoblast or erythroblast* ( [Fig. 7.5C](#), [Fig. 7.6C](#), and [Fig. 7.6D](#)). Increasing condensation of nuclear chromatin is observed during this stage. Irregular masses of chromatin are formed, which may stain very deeply. Nucleoli are not visible. The nucleus is smaller (7 to 9  $\mu\text{m}$ ) as is the cell as a whole (12 to 15  $\mu\text{m}$ ). The maximum number of mitochondria is found in the early phases of this stage, but as hemoglobin becomes more plentiful, mitochondria decrease in number.

When the cytoplasm possesses almost its full complement of hemoglobin, the cell is termed an *orthochromatic normoblast or erythroblast* ( [Fig. 7.5D](#) and [Fig. 7.6E](#)). Strictly speaking, normoblasts are rarely orthochromatic in the sense that their color is the same as that of mature red cells, but this term is convenient in distinguishing the more

acidophilic from the distinctly polychromatophilic stage. The orthochromatic normoblast is the smallest of the nucleated erythrocyte precursors (8 to 12  $\mu\text{m}$  in diameter).

In this stage, the nucleus undergoes pyknotic degeneration, the chromatin becomes greatly condensed, and the nucleus shrinks. The nucleus may appear to be an almost homogenous mass. It may assume various bizarre forms such as buds, rosettes, clover leaves, or double spheres, or only a faint ring may remain. The changing pattern of the nuclear chromatin is not an artifact produced by fixation as it has been shown by studies with the electron microscope ([42](#)). Distortions of this process have been described. Finally, the nucleus is extruded ([43](#)) ([Fig. 7.7](#)).



**Figure 7.7.** Formation of reticulocytes. **A:** Normoblast expelling nucleus; **B:** normoblast nucleus after expulsion, with rim of cytoplasm; **C:** reticulocyte immediately after expulsion of nucleus; **D:** reticulocyte. (Courtesy of Dr. Carl Kjeldsberg.)

After the nucleus has been extruded, the cell is known as a *reticulocyte*. These cells are somewhat larger than mature erythrocytes, perhaps 20% greater in volume ([44](#)). They contain certain cytoplasmic organelles, such as ribosomes, mitochondria, and the Golgi complex ([Fig. 7.7C](#) and [Fig. 7.7D](#)), and have special staining characteristics. Methyl alcohol or similar fixative agents used in staining cause a uniform precipitation of the ribosomal RNA. Such cells may appear uniformly blue or gray (diffuse basophilia), or various basophilic shades may be intermingled with pink-staining portions (polychromatophilia or polychromasia). Certain supravital staining techniques (see [Chapter 1](#)) cause the ribosomal RNA to precipitate or aggregate into a network of strands or clumps that have been termed *reticulum*. The presence of “reticulum” led to the term *reticulocyte*. Both terms are misleading because true endoplasmic reticulum does not exist in reticulocytes.

The “reticulum” may appear as a narrow band traversing the cell, it may be evenly distributed throughout the cell, or it may be so densely packed as to give the appearance of a nucleus. Generally speaking, the amount of reticulum in reticulocytes decreases as the cells mature, and, in “old” reticulocytes, only a few granules or scattered threads may be found ([45](#)). The shape and density of the network also depend, however, on a number of physical factors. Thus, the stronger the concentration of the dye, the larger and less broken up is the reticulum. Drying of the film tends to produce a fine reticulum ([46](#)).

Heating tends to destroy the reticulum, with only rods and granules being demonstrable. A change in the pH of the staining mixture toward the acid side results in a finely granular reticulum, whereas treatment with dilute alkali produces a stippled form (47).

With transmission electron microscopy, the mitochondria in reticulocytes are found to be grouped together, whereas the ribosomes are more evenly distributed (48) (Fig. 7.7C and Fig. 7.7D). There may or may not be visible ferritin molecules and pinocytotic vesicles in the cytoplasm. After supravital staining with cresyl blue, the ribosomes agglutinate into a network, and the mitochondria become swollen and distorted and their cristae disappear. As the reticulocyte matures, the various organelles decrease in number. Usually the mitochondria disappear first and the ribosomes last. At times, “autophagic vacuoles” (auto-phagosomes or secondary lysosomes) are found. These structures contain the degenerated organelles and may represent a mechanism whereby the unneeded cellular components are discarded.

The shape of the reticulocyte, as revealed by the scanning electron microscope, differs considerably from that of the mature erythrocyte. The reticulocyte is irregular and polylobulated, and regions of apparent cytoplasmic retraction may be found (Fig. 7.8). Only in the late stages does the bilaterally indented disc shape of the mature red corpuscle appear.



**Figure 7.8.** Reticulocyte as seen by scanning electron microscope.

Reticulocytes are more adhesive than adult corpuscles and move about in currents at a much slower rate than do mature cells (49). They appear to have a coating of globulin, at least part of which is transferrin (50). Their specific gravity is lower than that of adult corpuscles (51), and they tend to collect in the upper portions of suspensions of corpuscles. They vary in their resistance to hypotonic solutions (52). They have metabolic pathways that are lacking in mature red cells, including an intact tricarboxylic acid cycle (53).

### **Proliferation and Maturation of the Erythron**

Within the erythron, cellular maturation and proliferation proceed simultaneously. All identifiable erythroid progenitors and the morphologically identifiable erythrocyte precursors are functionally destined to mature; thus, they are incapable of self-maintenance. Maintenance of the erythron at a given size and its expansion on demand are functions of the stem cell compartment (see Chapter 6). A scheme of the proliferation of the erythron and its various stages of development is presented in Figure 7.1. It takes approximately 12 to 15 days for a cell at the BFU-E stage to mature into



erythroblasts. Within 6 to 8 days, a BFU-E proliferates and differentiates into a CFU-E, which needs another 5 to 7 days to proliferate and develop into basophilic erythroblasts, a period during which the CFU-E undergoes three to five successive divisions. Probably, three to five cell divisions also occur during the maturation of erythroid precursors ( [54](#) ). Thus, 8 to 32 mature red cells are derived from each pronormoblast. Cell division ceases at the stage of polychromatophilic erythroblasts. Orthochromatic normoblasts cannot synthesize DNA and, therefore, cannot divide.

Two events may decrease the theoretic yield of cells. One of these is the death of the cell before or shortly after its release from the marrow (ineffective erythropoiesis) ( [Chapter 27](#) ). The second is a skipped cell division, a phenomenon that results in a large hemoglobin-poor cell ( [Chapter 27](#) ). These events occur to only a limited extent in normal subjects but may occur much more frequently under pathologic circumstances.

The biochemical events that occur at the stem cell progeny during its commitment to erythroid differentiation are unknown. The same holds true for the earlier identifiable erythroid progenitor BFU-E. This cell is totally IL-3-dependent and shows a small number of EPORs ( [27](#) ). Within 72 hours in culture, these cells become fully dependent on EPO (mature BFU-Es) and, in its presence, proliferate and differentiate into CFU-Es ( [21](#) , [27](#) ). At this stage, a number of differentiation events can be detected. From studies in murine erythroid cells, it has been established that EPO induces an increase in the synthesis of RNA and that this is closely followed by the induction of murine  $\beta$ -globin gene transcription ( [55](#) ). Other biochemical events associated with terminal erythroid differentiation include increased uptake of calcium and glucose, synthesis of transferrin receptors, increased iron uptake, hemoglobin synthesis, and appearance of erythrocyte membrane proteins (band 3 and 4.1) ( [56](#) , [57](#) , [58](#) and [59](#) ). Hemoglobin synthesis continues as the cell matures further into the stage of basophilic erythroblast, and, at the polychromatophilic erythroblast stage, enough hemoglobin has accumulated in the cytoplasm to give the cell the mild acidophilic reaction detected by Romanowsky stains. Hemoglobin synthesis continues through the orthochromatic stage and persists at a very low rate in the reticulocyte after denucleation. Mature red cells, being devoid of ribosomes, are unable to synthesize hemoglobin.

As previously noted, morphologic evidence of nuclear degeneration (heterochromatin formation) can be seen as early as the basophilic normoblast stage. By the orthochromatic stage, the nucleus is completely inactive, unable to synthesize either DNA or RNA. The factors leading to cessation of nuclear activity are not fully understood, but there is evidence that they may be related to intracellular hemoglobin concentration ( [60](#) ). Hemoglobin is found within the nucleus, possibly gaining entrance through pores in the nuclear membrane ( [60](#) , [61](#) and [62](#) ). After reaching a critical concentration (possibly 20 g/dl) ( [60](#) ), nuclear hemoglobin may react with nucleohistones, thereby bringing about chromosomal inactivation and nuclear condensation. According to this hypothesis, the number of cell divisions and the ultimate erythrocyte size are related to the rate of hemoglobin synthesis. For example, microcytic cells are produced in iron deficiency because it takes longer to reach the critical hemoglobin concentration and the generation time is unaffected; hence, more cell divisions occur before nuclear inactivation, and the resulting cell is small. In contrast, the macrocytes observed when erythropoiesis is stimulated may be the end results of an EPO-induced acceleration of hemoglobin synthesis, which in turn leads to an earlier onset of nuclear degeneration and a reduced number of cell divisions. Also consistent with this hypothesis is the observation that the mean corpuscular hemoglobin concentration remains relatively constant in a variety of mammalian species, even though erythrocyte size varies greatly ( [63](#) ).

After the nucleus degenerates, it is extruded from the cell ( [64](#) ). This process, which has

been observed in living normoblasts by phase contrast microscopy ( [65](#) ), is completed in 5 to 60 minutes. During the extrusion process, mitochondria and cytoplasmic vesicles accumulate near the nuclear border ( [40](#), [66](#) ). The role of these structures in nuclear extrusion is not entirely clear, but supravital staining with Janus green B, a mitochondrial toxin, inhibits denucleation ( [64](#) ). The extruded nucleus carries with it a rim of cytoplasm, including ribosomes, hemoglobin, and occasional mitochondria.

Enucleation is a process similar to cytokinesis and does not seem to depend on either the presence of extracellular matrix proteins or accessory cells ( [67](#) ). Among the various cytoskeletal proteins, filamentous actin plays an important role in the process of enucleation, accumulating between the extruding nucleus and incipient reticulocyte. Supporting the major role of filamentous actin in the process of enucleation is the fact that low concentrations of cytochalasin D cause complete inhibition of enucleation ( [67](#) ).

Within the marrow, denucleation may sometimes occur as the erythroblast traverses the endothelial cell that forms the sinus wall ( [68](#) ). The normoblast cytoplasm and small organelles (ribosomes and mitochondria) squeeze through endothelial, cytoplasmic pores 1 to 4  $\mu\text{m}$  in diameter, but the more rigid nucleus cannot conform to this pore size. The nucleus thus becomes caught and “pitted” from the cell. Passage through the endothelial pores is not essential to denucleation, however, because the whole process can be observed *in vitro* ( [65](#), [67](#) ).

Soon after denucleation, the nucleus is engulfed by a macrophage. The cell may remain within the marrow as a reticulocyte for several days. Factors controlling release into the circulation are discussed in [Chapter 6](#). After release, the reticulocyte may be sequestered for 1 to 2 days in the spleen ( [69](#) ). Here, additional maturation may occur, and the composition of the membrane lipids may be altered.

As the reticulocyte matures to an adult erythrocyte, it loses its ability to synthesize hemoglobin ( [70](#) ). Both particulate and soluble RNA fractions appear to be catabolized by a ribonuclease. The resulting oligonucleotides are probably further degraded by phosphodiesterases and phosphatases to pyrimidine nucleotides. A specific pyrimidine 5'-nucleotidase found in reticulocytes dephosphorylates these nucleotides, and the free pyrimidine bases then can leak out of the cell ( [71](#) ). If the pyrimidine 5'-nucleotidase is lacking because of hereditary deficiency ( [71](#) ) or lead poisoning ( [72](#) ), RNA degradation is greatly retarded, and basophilic stippling due to retained RNA aggregates becomes very prominent.

## BIOSYNTHESIS OF HEMOGLOBIN

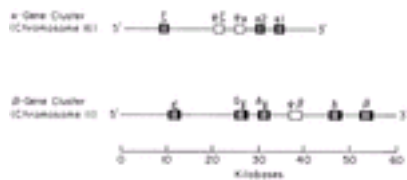
Because hemoglobin accounts for approximately 90% of the dry weight of the erythrocyte, the biosynthesis of hemoglobin is intimately related to erythropoiesis. As detailed in the previous section, many of the morphologic criteria used in staging the maturation of erythrocyte precursors are related to hemoglobin production and content. Furthermore, the initial events associated with the differentiation of CFU-Es into erythrocyte precursors include the activation of genes relating to hemoglobin synthesis ( [55](#) ).

Three complex metabolic pathways are required for synthesis of hemoglobin, corresponding to the three structural components of hemoglobin: protein (globin), protoporphyrin, and iron. The first two of these are discussed in the pages to follow. Iron metabolism is described in [Chapter 28](#).



## Globin Synthesis

**GLOBIN GENES AND THE STRUCTURE OF CHROMATIN** Distinct structural genetic loci exist for each of the known normal polypeptide chains in hemoglobin. Thus, there are  $\alpha$ ,  $\beta$ ,  $\gamma$ ,  $\delta$ , and  $\epsilon$  genes. In most human populations, the  $\alpha$  genetic locus is duplicated, and there are four (two pairs) of identical  $\alpha$  genes in normal subjects (73, 75). There are also at least two different pairs of  $\gamma$  genes, one ( $\gamma^G$ ) coding for a  $\gamma$ -chain with glycine at position 136 (H14) and another ( $\gamma^A$ ) coding for a  $\gamma$ -chain with alanine at the same position (76). In contrast, there appears to be only one pair of genes coding for  $\beta$ - and  $\delta$ -chains, respectively. (See also Chapter 8 and Chapter 42.) Genetic evidence has indicated that the  $\alpha$  and  $\beta$  genes are not linked, and it is now clear that they are located on different chromosomes (77). The  $\alpha$ -gene cluster (approximately 30 kb) is located on the short arm of chromosome 16 and contains also the locus encoding for the  $\gamma$ -chain (78). The  $\beta$ -gene cluster (approximately 50 kb) is located on chromosome 11 and includes the genes for the  $\gamma^G$ -,  $\gamma^A$ -,  $\delta$ -, and  $\epsilon$ -globins (78, 79). A schematic representation of the  $\alpha$ - and  $\beta$ -gene clusters is shown in Figure 7.9.



**Figure 7.9.** Organization of the human globin gene clusters on chromosomes 16 and 11. Solid areas within genes represent coding sequences; open areas represent intervening sequences. Each cluster includes pseudogenes ( $\alpha^1$ ,  $\alpha^2$ ,  $\beta^0$ ), which have sequence homology to functional genes but include mutations that prevent their expression.

Only 5 to 10% of the genetic material in erythroblasts is transcriptionally active, and the globin structural genes are included in this fraction (80). These active genetic regions of DNA make up the open portion, or euchromatin, of nuclear material, whereas unexpressed genes are included in the condensed, or heterochromatin, fraction. Differentiation of erythroid progenitors to erythroblasts is accompanied by the activation of the genes involved in erythroid differentiation, including the globin genes (55, 81). The modulation of expression of genes is imposed by chromatin structure, which includes not only strands of DNA but also histone and nonhistone proteins. The structure of chromatin by electron microscopy has been compared to beads on a string (80, 81). The beads represent nucleosomes, each of which consists of eight histone molecules, an octamer, associated with approximately 200 base pairs of DNA. These nucleosomes are distributed randomly along the DNA double helix and are joined by “spacer regions” of DNA, 40 to 100 base pairs long, associated with a specific histone (H1). In general, the association with histones is believed to limit accessibility to the genetic material by RNA polymerase, thereby preventing or retarding transcription. However, most current evidence suggests that active globin genes in erythroid cells are incorporated into structures at least resembling nucleosomes (80). Genes that are not transcriptionally active are closely associated with chromatin and may have an increased number of methylated nucleotides (82, 83 and 84). Under these conditions, the genes are insensitive to nuclease digestion. Activation of these genes is associated with modification of the chromatin structure induced by transacting factors. Thus, genes associated with erythroid development are resistant to nuclease digestion in nonerythroid or early noncommitted hematopoietic cells. As the cell matures within the erythroid line of differentiation, these genes are progressively activated as indicated by the appearance of nuclease-sensitive sites in areas encoding for globin genes that include also a number of regulatory sequences (80,

[81](#), [85](#), [86](#)).

**TRANSCRIPTION AND MESSENGER RNA PROCESSING** Synthesis of RNA takes place under the influence of large complex enzymes (or groups of enzymes) called *RNA polymerases* ([87](#)). Three such enzymes (or groups of enzymes) have been described: type I(A), which transcribes the genes for most ribosomal RNA and is found largely in the nucleolus; type II(B), which transcribes genes for “unique sequence” RNAs, including the globin messenger; and type III(C), which transcribes genes for transfer RNA (tRNA) plus a low molecular weight (MW) (S) fraction of ribosomal RNA. Types II(B) and III(C) RNA polymerase are found in the nucleoplasm outside of the nucleolus. Of the two DNA strands in the double helix, only one, the “sense strand,” appears to be translated *in vivo*. Globin mRNA, like most eukaryotic mRNAs, is synthesized in a precursor form that is two to three times as long as the molecule that ultimately serves as the template for protein synthesis ([73](#), [80](#), [81](#)). These precursor molecules are called *heterogeneous nuclear RNAs*. They have relatively short half-lives, on the order of 15 to 30 minutes. The heterogeneous nuclear RNA molecule undergoes “processing” to be converted into the final mRNA ([88](#)). Processing includes at least three posttranscriptional events: “capping” at the 5' end of the molecule, polyadenylation at the 3' end, and “splicing,” which results in removal of so-called intervening sequences or introns. The last are untranslated sequences of unknown function that interrupt a translated sequence ([89](#)). In mouse  $\beta$ -globin heterogeneous nuclear RNA, for example, a long intervening sequence occurs between the codons for amino acids 104 and 105. This “unnecessary” segment must be “edited out.” The final mRNA molecule contains 675 to 750 nucleotides. The primary structure of mRNA can be divided into four regions: the 5' untranslated region (which includes the cap), the translated or coding region, the 3' untranslated region, and the polyadenosine region. The “cap” is characterized by an atypical 5'-triphosphate-5' linkage with guanosine-5-triphosphate (GTP) and methylation of adjacent nucleotides. This structure appears to be essential for maximal translational activity, presumably because it affects the initiation of translation; however, its exact role has not been determined. The cap is followed by an untranslated region of 36 nucleotide bases in  $\alpha$ -globin mRNA and 53 bases in  $\beta$ -globin mRNA. The difference may explain the observation that  $\beta$ -mRNA is translated more efficiently than  $\alpha$ -mRNA ([80](#), [81](#)). Normally, this relatively inefficient translation of the  $\alpha$ -chain is compensated for by an increased amount of  $\alpha$ -mRNA. The translated sequence begins with an initiator sequence of three bases (AUG) followed by a sequence of triplet codons, each of which corresponds to an amino acid in globin, according to the genetic code. The translated sequence ends with a terminator codon (UAA), which is followed by a noncoding area of undefined function. Finally, the molecule ends with a polyadenosine region, of variable length, that probably affects the stability or half-life of the molecule. The number of adenosine residues appears to decrease as mRNA ages ([90](#)); in older reticulocytes, mRNA may contain little or no polyadenosine.

**TRANSLATION** Translation is a ribosomal process whereby a polypeptide chain is synthesized according to the pattern provided by the sequence of codons in mRNA. The process has been divided into four major stages: activation, initiation, elongation, and termination. The activation step involves formation of an ester linkage between amino acids and specific tRNAs in the cytoplasm. This process requires adenosine triphosphate, magnesium, and specific enzymes known as *aminoacyl-tRNA synthetases*. Initiation of polypeptide chain formation occurs when a special, methionine-bearing, initiator tRNA (tRNA<sup>met</sup><sub>f</sub>) becomes aligned with the initiator codon (AUG) in mRNA on the ribosome ([80](#), [81](#)). This complex step requires at least eight protein initiation factors ([91](#)). One of these [erythrocyte initiation factor (eIF)-2] forms a complex with GTP and tRNA<sup>met</sup><sub>f</sub>, which attaches to the small (40S) ribosomal subunit. Next, mRNA and the larger (60S) ribosomal subunit are added under the influence of other initiation factors. The methionine molecule that begins the polypeptide chain at the *N*-terminal is eventually cleaved from the protein. As the polypeptide chain elongates, specific amino acid-bearing tRNAs become attached to the ribosomes ([80](#), [81](#)). Each tRNA has an anticodon

sequence corresponding to the specific codon in mRNA. As each tRNA is positioned, its amino acid becomes attached by a peptide bond to another amino acid previously bound to the ribosome. Formation of the peptide bond is a property of peptidyl transferase activity associated with the large ribosomal subunit. At least two factors are required for ribosomal binding of tRNA. The other (“translocase”) is necessary for the movement of codons along the ribosome, a process using energy from GTP. A single mRNA molecule may have several ribosomes attached to form polyribosomes. When the terminator codon (UAA) is reached, the polypeptide chain is completed and released from the ribosome.

This termination step requires GTP and one or more “releasing factors” ( [91](#) ).

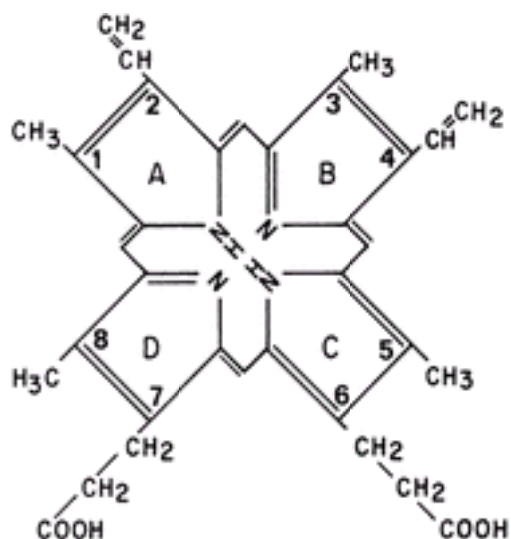
**TETRAMER FORMATION** Once the polypeptides are released from the ribosomes, they quickly and spontaneously form  $\alpha\beta$  dimers and a  $2\beta_2$  tetramers. Apparently, no enzymes or cofactors are involved in this process.

**REGULATION OF GLOBIN SYNTHESIS** Heme is of particular importance in controlling the rate of globin synthesis ( [92](#), [93](#) ). It stimulates globin synthesis in intact reticulocytes and cell-free systems, and, in its absence, polyribosomes disaggregate ( [94](#), [95](#) and [96](#) ). The major effect of heme is exerted on the chain-initiation step in translation. In the absence of heme, an inhibitor of globin synthesis accumulates ( [97](#), [98](#) ). This inhibitor acts by phosphorylating the initiation factor (eIF-1) that promotes binding of tRNA<sup>met</sup><sub>F</sub> to ribosomes ( [99](#), [100](#) ). Heme not only inactivates the inhibitor ( [100](#) ) but also stimulates an enzyme that dephosphorylates eIF-2 ( [80](#) ). Heme may also exert effects on transcription, on mRNA processing, or on both ( [101](#) ). In mouse erythroleukemia cells, hemin behaves as an inducer. The role of heme in mammalian protein synthesis appears to extend beyond the erythrocyte; heme-dependent factors for the initiation of protein synthesis have been demonstrated in liver and brain ( [102](#), [103](#) ).

## Heme Biosynthetic Pathway

Strictly defined, *heme* is the ferrous iron complex of protoporphyrin IX; however, the term *heme* is also used in the generic sense to indicate iron protoporphyrin IX without regard to the oxidation state of the iron. Thus, hemoglobin, peroxidase, and cytochrome *c* are all “heme” proteins even though the iron is ferrous in hemoglobin, ferric in peroxidase, and either ferric or ferrous in cytochrome *c* ( [104](#), [105](#), [106](#), [107](#), [108](#) and [109](#) ).

Protoporphyrin IX is a tetrapyrrole, a complex structure (“macrocycle”) made up of four pyrrole rings joined together ( [Fig. 7.10](#) ). The four pyrrole rings are designated A, B, C, and D. At the periphery of the tetrapyrrole, there are eight sites where side chains may be located. Positions 1 and 2 are on the A ring, 3 and 4 on the B ring, and so forth. The four bridge carbons (methene groups) are designated a,  $\beta$ ,  $\gamma$ , and d. Thus, protoporphyrin IX may be described as 1,3,5,8 methyl, 2,4-vinyl-6,7, propionic acid-porphyrin, or porphine. Porphine, the so-called parent compound, is a hypothetical tetrapyrrole with only hydrogen atoms at the eight peripheral positions.



**Figure 7.10.** The chemical structure of protoporphyrin IX.

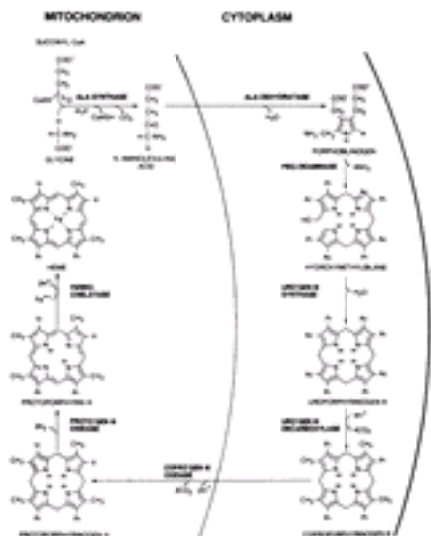
The designation *protoporphyrin IX* arises from the fact that, of the 15 possible isomers of protoporphyrin, the ninth one that Hans Fischer (who developed the foundations of porphyrin chemistry) and his co-workers synthesized was the same as the protoporphyrin that they prepared from heme. The IX isomer is the only one found in nature.

Porphyrins, by definition, are cyclicly conjugated tetrapyrroles. As such, they have a number of common properties. They are very stable, essentially flat molecules. The macrocyclic ring itself has little or no affinity for water. Porphyrins might be compared to phonograph records—both are flat, have a hole in the middle, and tend to stack and stick together. In the case of phonograph records, the sticking together is largely electrostatic; in stacked porphyrins, the attractive forces are the consequence of p bonding (interchange of p electrons) as well as van der Waals forces.

All porphyrins are intensely colored and have many common light absorption characteristics. All have an extremely intense absorption band at approximately 400 nm, the so-called Soret band. In addition, they all have four absorption bands in the visible region of the spectrum. All porphyrins fluoresce, but fluorescence is characteristically lost when metals are bound to form metalloporphyrins. Exceptions include Mg-porphyrins and Zn-porphyrins, which fluoresce despite their metal content ([Chapter 44](#)).

Of all the known porphyrins only five are of importance in human physiology and pathophysiology: uroporphyrin (two isomers), coproporphyrin (two isomers), and protoporphyrin (one isomer).

If, under appropriate conditions, a porphyrin is reduced to the fullest extent (e.g., with sodium amalgam or sodium borohydride), a total of six hydrogen atoms are added to the molecule—four to the bridge carbon positions and two to the pyrrole rings. (Compare the structures of protoporphyrinogen III and protoporphyrin IX in [Figure 7.11](#).) The fully reduced compounds are called porphyrinogens. They are colorless, do not fluoresce, cannot bind metal ions, and are extremely unstable with regard to oxidation. Only the fully reduced compounds, uroporphyrinogen and coproporphyrinogen, are true intermediates in heme biosynthesis. Once these porphyrinogens are oxidized to their corresponding porphyrins, they can no longer function as substrates for the heme biosynthetic enzymes and must eventually be excreted in the urine and stool.



**Figure 7.11.** Heme biosynthetic pathway. Ac, acetate; ALA, d-aminolevulinic acid; CoA, coenzyme A; CoAS, succinyl-CoA; CoASH, uncombined coenzyme A; COPRO'GEN, coproporphyrinogen; PBG, porphobilinogen; PLP, pyridoxal 5'-phosphate; Pr, propionate; PROTO'GEN, protoporphyrinogen; URO'GEN, uroporphyrinogen; Vi, vinyl. (Modified from Bottomley SS, Eberhard Muller U. Pathophysiology of heme synthesis. *Semin Hematol* 1988;25:282.)

Uroporphyrinogen and coproporphyrinogen can occur in four isomeric forms. Of these, only two are known to occur naturally in mammalian tissues, namely, the I and III isomer forms. Without exception, all biologically functional tetrapyrroles are derived from uroporphyrinogen III. Uroporphyrinogen I and coproporphyrinogen I are useless by-products of heme synthesis. They are biologic anomalies and can be thought of as biochemical mistakes (see [Chapter 31](#)). Once formed, most uroporphyrinogen I is enzymically decarboxylated to coproporphyrinogen I and excreted as the oxidized compound, coproporphyrin I.

The difference between the type I and type III isomers is apparent on examination of the D ring. In the type I isomer, the 7 and 8 positions are occupied by acetate and propionate, respectively (as are positions 1 and 2, 3 and 4, and 5 and 6). In the type III isomer, the order in the D ring is reversed, and propionate and acetate are at positions 7 and 8, respectively. In the case of protoporphyrin IX, propionate is at position 7, and position 8 is occupied by a methyl group derived from the decarboxylation of an acetate group.

The first committed step in the biosynthesis of heme ( [Fig. 7.11](#) ) is the condensation of glycine and succinyl coenzyme A to yield d-aminolevulinic acid (ALA). This reaction is highly exergonic, because it involves the cleavage of the thio-ester bond of succinyl coenzyme A and is essentially irreversible. These features suggest that the enzyme catalyzing this reaction (ALA synthase) plays a key regulatory role in the biosynthesis of heme. Indeed, considerable experimental evidence supports this contention.

In the next reaction, two molecules of ALA undergo condensation, catalyzed by the enzyme ALA dehydratase or dehydratase, to yield the monopyrrole porphobilinogen with the concomitant loss of two molecules of water. This is the only known biologic reaction in which two identical molecules combine in such a way that the product is not simply a dimer but a distinctly different molecule. The product, porphobilinogen, is the primary building block for all natural tetrapyrroles, including the hemes, the chlorophylls, and the



vitamin B<sub>12</sub> derivatives (cobalamins).

The third reaction occurs in the presence of a pair of enzymes acting in concert (uroporphyrinogen I synthase or porphobilinogen deaminase and uroporphyrinogen III cosynthase or uroporphyrin III synthase). Four molecules of porphobilinogen condense to yield first an intermediate compound called *hydroxymethylbilane* (HMB), which, under the action of uroporphyrin III synthase, is rapidly converted to the first macrocyclic precursor of all tetrapyrroles, uroporphyrinogen III.

While remaining fully reduced, uroporphyrinogen III then undergoes a series of four decarboxylation steps catalyzed by the enzyme uroporphyrinogen decarboxylase. All four acetate side chains are sequentially decarboxylated at positions 1, 3, 5, and 8, yielding in turn CO<sub>2</sub> and methyl groups. All of the intermediate decarboxylation products have been isolated and identified. The final product of this series of decarboxylation reactions is coproporphyrinogen III, again a fully reduced tetrapyrrole.

Coproporphyrinogen III is transported by an unknown mechanism from the cytosol into the mitochondrion for the three subsequent reactions that yield heme. First, the propionic acid side chains at positions 2 and 4 are oxidatively decarboxylated by the enzyme coproporphyrinogen oxidase, resulting in the formation of vinyl groups. The product of this reaction is protoporphyrinogen IX. Protoporphyrinogen IX undergoes spontaneous oxidation to protoporphyrin *in vitro*, but, *in vivo*, an enzyme, protoporphyrinogen IX oxidase, is required to catalyze this reaction.

Protoporphyrin IX next combines with ferrous iron to yield the final product, the metalloporphyrin ferrous-protoporphyrin IX (heme). This reaction is catalyzed by the enzyme ferrochelatase or heme synthase.

**BIOSYNTHESIS OF  $\alpha$ -AMINOLEVULINIC ACID** The first committed precursor of protoporphyrin IX is an aminoketone, ALA ( [110](#) ). Isotopic labeling studies demonstrated that the precursors of ALA are succinyl-coenzyme A (CoA) and glycine ( [111](#) ). Succinyl-CoA is generated mainly by the oxidative decarboxylation of  $\alpha$ -ketoglutarate in the citric acid cycle. The direct formation of ALA from succinyl-CoA and glycine was first demonstrated in avian erythrocytes and in photosynthetic bacteria ( [112](#), [113](#) ). The enzyme responsible for catalyzing the condensation of succinyl-CoA and glycine is ALA synthase (EC 2.3.1.37). The products of the condensation reaction are ALA, CO<sub>2</sub>, and uncombined CoA. That pyridoxal phosphate is a cofactor in the reaction was first suggested by nutritional studies in pigs ( [114](#) ). Subsequently, the specific defect in heme biosynthesis caused by pyridoxine deficiency was demonstrated ( [115](#), [116](#) ). The deficient synthesis of heme from glycine in erythrocytes from pyridoxine-deficient animals was corrected by the addition of pyridoxal phosphate ( [116](#) ), whereas the synthesis of heme from exogenously supplied ALA was normal in the pyridoxine-deficient cell and was unaffected by the addition of pyridoxal phosphate ( [116](#) ). In mammalian cells, ALA synthase first appears in the cytosol where it is synthesized on polyribosomes ( [117](#) ). The enzyme is then transported by an unknown mechanism to its functional site inside the mitochondria. In the process, the enzyme is modified so that the apparent MW of the mitochondrial enzyme is much less than that of the cytosol enzyme. The cytosol enzyme is probably a precursor of the mitochondrial enzyme and either is multimeric or exists in association with other proteins ( [118](#) ). The genes encoding for human ALA synthase have been identified and cloned ( [119](#) ). There are two forms of this enzyme, one specific for erythroid cells and the other present in all other tissues. The erythroid-specific enzyme is encoded by a gene present in chromosome X, whereas the nonerythroid form of the enzyme is encoded by a gene on chromosome 3 ( [120](#), [121](#) ). An alternative way of generating ALA

similar to one found in plants may exist in mammals. Plants form ALA directly from a five-carbon precursor by a transamination reaction ( [102](#), [122](#) ) starting with  $\alpha$ -ketoglutaric acid. This reaction is not confined to plants because an enzyme catalyzing such a transamination has been found in mammalian liver, as well as in plants, algae, and bacteria. The mammalian enzyme, alanine-dioxoalate aminotransferase, has been highly purified from mitochondria ( [102](#) ). The capacity of this enzyme to form ALA is far greater than that of ALA synthase from the same mitochondria, but its physiologic significance in mammals remains unknown.

**BIOSYNTHESIS OF PORPHOBILINOGEN** The monopyrrole porphobilinogen is well established as a precursor of the hemes, the chlorophylls, and the cobalamins ( [123](#) ). Because all known forms of life require at least one of these classes of tetrapyrroles, it follows that porphobilinogen is biologically ubiquitous. Porphobilinogen is formed by the condensation of two molecules of ALA and the loss of two water molecules. The enzyme that catalyzes this reaction is ALA dehydrase (EC 4.2.1.24). Throughout the animal kingdom, ALA dehydrase is a soluble enzyme found in the cytosol ( [105](#) ). It is abundant in tissues such as bone marrow and liver where heme biosynthesis is active. It is also active in mature, circulating erythrocytes, even though these cells are not actively synthesizing heme. Its persistence results from the enzyme's inherent stability. It is inhibited by heavy metals, particularly lead, and under properly controlled conditions can serve as an index of environmental pollution by lead ( [124](#), [125](#) ). The mammalian enzyme is an octamer of 31-kd subunits containing eight atoms of zinc required for stability and activity ( [120](#) ). Free sulfhydryl groups (-SH) are also essential for activity of ALA dehydrase from all sources ( [118](#), [126](#) ), and these -SH groups seem to be protected by the zinc. Three isoforms of this enzyme have been reported, and the gene encoding for the enzyme has been identified and located on chromosome 9 ( [127](#), [128](#) ). The quantity of enzyme present in most organisms greatly exceeds the amount needed by the organism to synthesize ALA ( [108](#) ). Thus, it would appear not to play a regulatory role in heme synthesis. However, several of the characteristics of ALA dehydrase are similar to those "expected" of regulatory enzymes. It is, for instance, inhibited by heme ( [105](#), [129](#) ), and its kinetic properties suggest that the binding of the first molecule of ALA to the enzyme surface influences the affinity of the enzyme for the second molecule of ALA ( [130](#) ).

**BIOSYNTHESIS OF UROPORPHYRINOGENS I AND III** Porphobilinogen is a rather unstable, chemically reactive molecule. Within a few hours, a solution of porphobilinogen exposed to air and light develops a deep orange-red color. The color results from the formation of porphobilin, a poorly defined mixture of mono-, di-, and tripyrrolic oxidation products ( [105](#) ). This phenomenon can be observed in the urine of patients with acute intermittent porphyria, who excrete large quantities of porphobilinogen ( [Chapter 31](#) ). If porphobilinogen is incubated in solution at an acid pH, nonenzymic condensation occurs and uroporphyrinogen is formed ( [105](#) ). All four possible isomers of uroporphyrinogen are formed under these conditions. The reaction is often referred to as a "head-to-tail" condensation because of the apparent orientation of the precursor molecules. The penultimate reaction product apparently is an open-chain tetrapyrrole called *HMB*. On loss of the amino group attached to ring A, the  $-\text{CH}_2^+$  can attack the free  $\alpha$ -position on the D-ring pyrrole, thus forming the tetrapyrrole macrocycle. *In vivo* at neutral pH, this series of reactions is catalyzed by the cytosolic enzyme HMB synthase, formerly known as *uroporphyrinogen I synthase* or *porphobilinogen deaminase* (EC 4.3.1.8.). Two tissue-specific isoenzymes have been reported for HMB synthase, an erythroid tissue-specific and a nonerythroid form, both of which are products of a single gene located on chromosome 11q23 ( [105](#), [131](#), [132](#) and [133](#) ). *In vivo*, however, this enzyme works in concert with a second enzyme, uroporphyrinogen III cosynthase ( [134](#) ), to form uroporphyrinogen III, the precursor of all known functional tetrapyrroles. The molecular mechanism by which uroporphyrinogen III cosynthase effects the "turning around" of the D ring has been studied intensively ( [105](#), [135](#), [136](#) ). Uroporphyrinogen III cosynthase does



not actually isomerize uroporphyrinogen I: The cosynthase does not use uroporphyrinogen I as a substrate nor does it use porphobilinogen. The molecular mechanism involved in this reaction has been clarified by nuclear magnetic resonance spectroscopy ( [123](#), [135](#), [136](#), [137](#) and [138](#) ). Studies involving this technique have made it apparent that HMB synthase first catalyzes the head-to-tail condensation of four porphobilinogen molecules, yielding the aminomethyl tetrapyrrole. The tetrapyrrole is then deaminated, yielding a macrocycle that has been termed *preuroporphyrinogen* ( [137](#), [138](#) ). Two structures for preuroporphyrinogen have been proposed ( [137](#), [139](#) ). Filtration experiments have shown that preuroporphyrinogen is released from the surface of uroporphyrinogen I synthase and serves as the substrate for uroporphyrinogen III cosynthase ( [138](#) ). The cosynthase opens the bond linking the methylene bridge carbon to the D ring, allowing the D ring to rotate 180 degrees about the carbon-nitrogen bond linking rings A and D. A new carbon-carbon bond is formed linking rings C and D (1,3-sigmatropic shift). The carbon-nitrogen bond then opens, and a new carbon-carbon bond is formed linking rings A and D (1,5-sigmatropic shift) and yielding uroporphyrinogen III ( [138](#) ).

**BIOSYNTHESIS OF COPROPORPHYRINOGEN III** The formation of coproporphyrinogen III is accomplished by the enzymic decarboxylation of the four acetic acid side chains of uroporphyrinogen III ( [106](#), [140](#) ), a reaction catalyzed by what has been assumed to be a single cytosolic enzyme, uroporphyrinogen decarboxylase (EC 4.1.1.37). The decarboxylation proceeds in a clockwise fashion, starting with the acetic acid on the D ring of uroporphyrinogen III and continuing with the successive decarboxylations of the acetic acid residues on rings A, B, and C ( [141](#) ). The precise definition of the substrate for the enzyme, as well as for the reaction product, remains unsettled. Partially decarboxylated porphyrins containing seven, six, and five carboxyl groups are demonstrable in small amounts in both the urine and feces of humans. All of these partially decarboxylated porphyrinogens also can serve as substrates for uroporphyrinogen decarboxylase ( [141](#) ). Although uroporphyrinogen I and uroporphyrinogen III appear to be used equally well as substrates ( [142](#), [143](#), [144](#) and [145](#) ), there does appear to be isomer preference for the 7-carboxyl substrate (the I isomer is the preferred) ( [144](#), [146](#) ) and the 5-carboxyl substrate (the III isomer is the preferred) ( [112](#) ). Multiple "substrates" and multiple "reaction products" suggest that multiple enzymes may be involved in the four decarboxylation steps. However, studies with purified preparations of uroporphyrinogen decarboxylase have shown that this enzyme catalyzes all four decarboxylations ( [145](#), [147](#), [148](#), [149](#) and [150](#) ).

**BIOSYNTHESIS OF PROTOPORPHYRINOGEN IX** The formation of protoporphyrinogen IX from coproporphyrinogen III is catalyzed by the enzyme coproporphyrinogen oxidase, a mitochondrial enzyme distributed in two fractions, a major fraction in the intermembrane space and a minor one in the inter-membrane-matrix complex ( [151](#) ). This enzyme has an absolute requirement for molecular oxygen ( [152](#), [153](#) ). It sequentially and oxidatively decarboxylates the propionic acid side chains in rings A and B of coproporphyrinogen III to form vinyl groups ( [154](#) ). At the same time, the propionic acid groups in pyrrole rings C and D are not decarboxylated. It has been assumed that they are essential for binding of the substrate to coproporphyrinogen oxidase ( [118](#) ), but more recent studies make this assumption unlikely ( [155](#) ). For coproporphyrinogen III to be metabolized, it must cross the outer mitochondrial membrane. It is not known if crossing the membrane is the result of a passive transfer or an energy-requiring step.

**BIOSYNTHESIS OF PROTOPORPHYRIN IX** The product of the coproporphyrinogen III oxidase reaction is protoporphyrinogen IX. To serve as a substrate for the final enzyme in the pathway, heme synthase (ferrochelatase), protoporphyrinogen IX must first be oxidized to protoporphyrin IX, the only time in the heme biosynthetic pathway that the oxidized porphyrin serves as substrate. Although protoporphyrinogen IX is easily oxidized nonenzymatically to protoporphyrin *in vitro*, an enzyme is required to catalyze this reaction *in vivo*. A membrane-associated, mitochondrial, oxidizing

enzyme—protoporphyrinogen IX oxidase—was first found in yeast ( [156](#) ) and later was demonstrated in mammalian cells, including rat liver, human fibroblasts, reticulocytes, and leukocytes ( [157](#) ). The enzyme is heat labile and is inactivated by proteolytic digestion.

**BIOSYNTHESIS OF HEME** The insertion of ferrous iron into protoporphyrin IX to form heme is catalyzed by the enzyme heme synthase (ferrochelatase, protoheme ferrolyase, EC 4.99.1.1). Heme synthase is either tightly bound to or is an integral part of the inner mitochondrial membrane ( [158](#) ). Heme synthase activity has been partially purified from avian erythrocytes ( [158](#) , [159](#) ), human and rat liver ( [158](#) , [160](#) ), rabbit reticulocytes ( [161](#) ), human bone marrow ( [162](#) ), microorganisms ( [163](#) ), and plant tissues ( [164](#) , [165](#) ). Although no cofactors have clearly been demonstrated to be required by heme synthase, a number of studies have suggested a role for pyridoxal-5-phosphate ( [166](#) ). It seems clear that the *in vivo* substrates for heme synthase are ferrous iron and protoporphyrin. However, *in vitro*, the enzyme catalyzes the incorporation of several metals (iron, cobalt, and zinc) into several dicarboxylic porphyrins (protoporphyrin, mesoporphyrin, and deuteroporphyrin) ( [105](#) ). Under strictly anaerobic conditions, the ferrous iron–protoporphyrin chelate can be formed nonenzymatically ( [156](#) , [167](#) ). This finding has led to the speculation that nonenzymic formation of heme may occur *in vivo*, but most evidence supports a catalytic role for the enzyme heme synthase. In addition, there is evidence that heme synthase may play a regulatory role in the biosynthesis of heme.

#### **REGULATION OF THE HEME BIOSYNTHETIC PATHWAY**

***d-Aminolevulinic Acid Synthase*** The regulation of a biosynthetic pathway is generally effected at the first enzymic reaction synthesizing a precursor compound committed to ultimate incorporation into the final product ( [168](#) ). Frequently, such reactions are strongly exergonic and essentially irreversible. These generalizations hold true for the heme biosynthetic pathway. Control of the pathway is exerted through ALA synthase. The amount of ALA synthase present is regulated by induction and repression of enzyme synthesis ( [118](#) ). In higher organisms, this enzyme has a short half-life, allowing a rapid response to changes in the demand for heme and, thus, ALA ( [169](#) ). Most studies involving the induction of mammalian ALA synthase have used hepatic tissue as the source of the enzyme, but ALA synthase has also been shown to be inducible in Friend leukemic cells ( [170](#) , [171](#) ), adrenal gland ( [172](#) ), kidney ( [173](#) , [174](#) ), and bone marrow ( [175](#) ). Hepatic ALA synthase may be induced by a number of chemicals, drugs, and nonglucocorticoid steroids ( [118](#) ). The amount of enzyme may increase by a factor as great as 300 ( [176](#) ). Conclusive immunochemical data have demonstrated that inducing agents do not merely increase the activity of preformed ALA synthase; rather, they bring about an increase in the absolute amount of enzyme ( [177](#) ). Compounds that inhibit protein synthesis block the expected effects of inducing agents ( [161](#) , [178](#) ). In erythroid cells, however, the erythroid-specific dALA synthase is constitutively produced at such high levels that this step in heme synthesis does not seem to be rate-limiting, and enzymes involved in later steps of the heme biosynthetic pathway may play a more important regulatory role ( [179](#) ). Heme plays a critical central role in the regulation of ALA synthase activity. Heme directly inhibits the catalytic activity of the preformed enzyme in a classic example of negative feedback inhibition ( [140](#) , [180](#) ). In addition, the concentration of heme within the cell appears to regulate the synthesis of this enzyme ( [181](#) ). When the amount of heme is high, new synthesis of the enzyme is repressed. When the amount of heme is low, new synthesis of the enzyme is induced. Thus, agents that interfere with the synthesis of heme can lead to the induction of ALA synthase, and agents that induce the synthesis of hemoproteins can produce a similar effect ( [182](#) , [183](#) ). Agents that exert these effects on the induction of ALA synthase are clinically important, for they can precipitate acute attacks in patients with acute intermittent porphyria and other closely related disorders of porphyrin metabolism ( [Chapter 31](#) ).

***Secondary Control Mechanisms*** The regulation of heme biosynthesis appears to be sufficiently important in nature that additional control points have been incorporated

during the process of evolution. Although the actual *in vivo* importance of the several secondary control mechanisms has not been fully established, available evidence suggests that they may play some role.

***d-Aminolevulinic Acid Dehydrase*** ALA dehydrase from many species is inhibited by heme ( [184](#) ). When ALA synthase is present in excess, ALA dehydrase becomes the regulatory enzyme in the heme biosynthetic pathway. The demonstration of an alternative route for the synthesis of ALA (see above) indicates consistency in nature, because control points come after rather than before “committed” compounds are formed.

***Uroporphyrinogen I Synthase*** Uroporphyrinogen I synthase, partially purified from human erythrocytes, consumes porphobilinogen and forms uroporphyrinogen I in accordance with classic Michaelis–Menten kinetics. The addition of uroporphyrinogen III cosynthase increases the affinity for the substrate of the dual enzymatic system, but the maximum velocity of the reaction leading to the synthesis of uroporphyrinogen III is decreased ( [136](#) ). The changes in affinity for the substrate of the dual enzyme system suggest that a conformational modification of uroporphyrinogen I synthase is produced on its association with the cosynthase ( [185](#) ). These findings, coupled with studies using crude liver homogenates, suggest that enhanced porphyrin synthesis from porphobilinogen occurs when cosynthase is inactivated ( [186](#) ). Thus, the activity of uroporphyrinogen I synthase increases when the activity of the cosynthase decreases. The mechanism of this regulatory effect of cosynthase on uroporphyrinogen I synthase is unknown.

***Heme Synthase*** This enzyme also exhibits characteristics suggesting that it may play a regulatory role in heme biosynthesis. Heme synthase is subject to both substrate inhibition by protoporphyrin IX ( [187](#) ) and feedback inhibition by heme ( [188](#) ). Heme synthase can also be induced by several agents ( [189](#) , [190](#) ). Finally, studies using Friend leukemia cells ( [171](#) ) and cultured human skin fibroblasts ( [191](#) ) have suggested a rate-limiting step in the formation of heme at the level of heme synthase.

## CONTROL OF ERYTHROPOIESIS

It is evident that a well-balanced mechanism exists that maintains the erythron within “normal” limits and mediates the response to a variety of normal and abnormal situations. In broad outlines, this control system operates in the following manner. Alterations in the concentration of hemoglobin in the blood lead to changes in tissue oxygen tension within the kidney. In response to hypoxia, the kidney secretes a hormone called *EPO*. This hormone induces erythroid progenitor cells to differentiate into pronormoblasts, thereby bringing about expansion of the erythroid marrow and an increase in red cell production. This, in turn, leads to an increase in the size of the erythron and an increase in tissue oxygen levels. Each of the major steps in this process is discussed in greater detail in the sections that follow.

### Tissue Oxygen

Tissue oxygen tension depends on the relative rates of oxygen supply and demand. Oxygen supply is a complex function of interacting but semi-independent variables, including (a) blood flow, (b) blood hemoglobin concentration, (c) hemoglobin oxygen saturation, and (d) hemoglobin oxygen affinity. Each of these functions may be altered to compensate for a deficiency in one of the others. For example, in severe anemia, cardiac output and respiratory rate may increase, and hemoglobin oxygen affinity may be reduced through the 2,3-diphosphoglycerate effect. Conversely, in respiratory insufficiency, secondary polycythemia occurs.

Despite the influence of cardiovascular and respiratory adjustments, tissue oxygen tension decreases roughly in proportion to the degree of anemia. Conversely, induced polycythemia of moderate degree leads to normal or increased tissue oxygen tension and

to increased tolerance to hypoxia. These changes occur despite the increase in blood viscosity that accompanies polycythemia, suggesting that peripheral vascular resistance decreases to compensate for increased viscosity. However, with advanced degrees of polycythemia, the increase in viscosity may be great enough to negate the advantages of increased oxygen-carrying capacity.

Tissue hypoxia is the fundamental stimulus to erythropoiesis, as was first suggested by Miescher in 1893. This concept has been amply confirmed ( [1](#) ). However, it now seems clear that hypoxia does not exert its effects by a direct action on the marrow, as Miescher believed, but instead acts by inducing the elaboration of a hormone, EPO. The nature of the tissue oxygen receptors has been recently described (see [Site and Regulation of Erythropoietin Production](#)). These receptors are located within the kidney because production of EPO can be induced by renal artery constriction or by hypoxic perfusion of the isolated kidney.

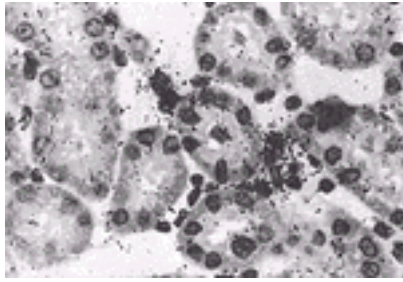
## Erythropoietin

**STRUCTURE OF ERYTHROPOIETIN** EPO is a glycoprotein hormone produced by the kidney, and it is the major humoral regulator of red cell production. EPO was originally purified from the urine of patients with aplastic anemia ( [192](#) ). It has an MW of 34,000 daltons as determined electrophoretically and contains 30% carbohydrate, of which 11% consists of sialic acid, 11% total hexose, and 8% *N*-acetylglucosamine ( [193](#) ). The potency of EPO is expressed in units, with one unit being equal to the amount of EPO present in one-tenth of the International Reference Preparation ( [194](#) ). This unit had been originally defined as the amount of EPO that produced in the starved rat the same erythropoietic response (increase in serum EPO level) as 5  $\mu$ mol of cobalt ( [1](#) ). The potency of the purified human urinary EPO has been determined to be 70,400 U/mg of protein or 50,000 U/mg of total weight ( [192](#) ). Purification of human urinary EPO has allowed the isolation and cloning of the human genomic DNA encoding for human EPO ( [195](#) ). The gene encoding EPO has been localized on human chromosome 7 (7 pter-q22) ( [196](#) ). The EPO gene exists as a single copy in a 5.4-kb DNA fragment and contains four introns and five exons for the 193-amino acid polypeptide ( [195](#) ). The gene also includes a 27-amino acid signal peptide (leader sequence), which is cleared during EPO secretion, and a 166-amino acid peptide with an MW of 18,398 ( [195](#) ). The C-terminal arginine is absent from both recombinant and natural hormone, presumably because of posttranslational modification by a carboxypeptidase ( [197](#) ). The human EPO contains four cysteine residues linked by disulfide bonds, which, when reduced or alkylated, lead to significant loss of activity ( [198](#) , [199](#) ). Recombinant EPO synthesized by mammalian cells is highly glycosylated, and the carbohydrate structure of the recombinant hormone is similar to but distinct from that of the natural hormone ( [197](#) ). Recombinant EPO has an MW of 30,000 by velocity sedimentation ( [200](#) ) and contains approximately 39% carbohydrate ( [201](#) ); however, recombinant EPO migrates slightly slower on sodium dodecyl sulfate-electrophoresis than urinary EPO, which suggests a slightly higher apparent MW of 40,000 compared to an MW of 34,000 of the native urinary EPO ( [202](#) ). The discrepancy between the electrophoretically obtained apparent MWs of natural and recombinant hormone is almost certainly due to distinctly different glycosylation of recombinant EPO in the Chinese hamster ovary cell line compared to the glycosylation of native EPO in kidney cells. Recombinant EPO must have additional carbohydrate, less negatively charged carbohydrates, or both compared to urinary EPO to result in reduced electrophoretic mobility. Glycosylation of the hormonal peptide is absolutely necessary for its *in vivo* activity. The bulk of glycosylation of EPO is at a single site of *N*-linked carbohydrate. Asialated EPO and non-glycosylated recombinant EPO produced in bacteria have no activity *in vivo*, which can be at least partially attributed to rapid clearance of the

hormone by the liver via the galactose receptors of hepatic cells ( [200](#), [203](#) ). The importance of glycosylation of EPO to EPO's *in vivo* activity and half-life led to modification of the EPO gene/protein to make a more effective pharmaceutical. The gene coding for EPO was modified by adding a second site of N-linked glycosylation, such that when the gene is expressed in Chinese hamster ovary cells, the amount of carbohydrate attached to the modified EPO peptide is almost doubled. The new product was called *darbepoetin* or *novel erythroid-stimulating protein*. Darbepoetin is highly related to EPO, such that it binds to the same receptor, but it has a longer *in vivo* half-life than recombinant EPO so that fewer injections/week than recombinant EPO are required for therapeutic use ( [204](#) ). Studies on the amino acid sequences of human and murine EPO have shown a very high degree of conservation of the molecule structure in these two species ( [205](#), [206](#) ). Which part(s) of the EPO molecule is primarily responsible for its function is not known, although results of studies with monoclonal antibodies have indicated that the amino acids in positions 99 to 129 may play an important role in the binding of EPO to cell membrane ( [207](#) ).

**SITE AND REGULATION OF ERYTHROPOIETIN PRODUCTION** Almost 50 years ago, Jacobson et al. established that the kidney is the major organ of EPO production in adult rats ( [208](#) ). Also, humans with end-stage renal failure were found to have low serum EPO concentrations, which were restored to normal after successful renal transplantation ( [209](#) ). The cloning of the murine EPO gene has allowed studies on the production of EPO-specific mRNA in anemic mice. Induction of anemia leads, within 1 hour, to the appearance of EPO-encoding mRNA in the kidney and liver of anemic mice and rats ( [210](#), [211](#) ). After bleeding, the EPO-mRNA in the kidney increases 500 to 1000 times compared to normal kidney, whereas the liver produces only 7% of the total EPO-mRNA ( [211](#) ). In no tissue other than the kidneys and the liver is EPO-mRNA detectable, even in the presence of severe anemia ( [211](#) ). These changes in EPO-mRNA were followed by parallel changes in serum EPO concentration determined by radioimmunoassay, indicating that EPO production in response to anemia represents *de novo* synthesis rather than release of preformed hormone ( [212](#) ). More recent evidence indicates that the anemia-induced increase in EPO-mRNA is at least partially due to an increased transcription ( [213](#) ). Murine EPO-mRNA was detected by ribonuclease protection assay at 14 days of gestation in the liver and almost a week later in the kidneys, which assume a major role in EPO production after birth ( [214](#) ). In cases of paraneoplastic erythrocytosis, EPO-mRNA has been detected in the neoplastic cells ( [215](#), [216](#) ). Specialized cells producing EPO have been identified in renal and hepatic parenchyma by the technique of *in situ* hybridization using radioactive probes specific for EPO-mRNA ( [Fig. 7.12](#) ) ( [217](#), [218](#) and [219](#) ). These rare EPO-producing cells are found in the interstitium of the renal parenchyma, outside the tubular basement membrane, mostly in the inner cortex and outer medulla. The nature of these intestinal peritubular EPO-producing cells remains controversial; however, the bulk of experimental evidence indicates that these cells are fibroblastlike type I interstitial cells ( [220](#), [221](#) ). In liver, mRNA is detected in hepatocytes. The number of the interstitial renal EPO-producing cells increases in response to anemia, indicating that increased demands for EPO are met by an increase in the number of EPO-producing cells rather than by an increased synthesis of EPO by a preset number of cells ( [212](#) ). Thus, it appears that EPO is synthesized *de novo* in response to hypoxia and that there is no detectable storage of the hormone. Increased levels of circulating EPO do not seem to exert any negative effect on EPO production.





**Figure 7.12.** *In situ* hybridization of murine kidney using a probe specific for murine EPO-mRNA. EPO-producing cells are found in the interstitium, covered heavily with grains. Arrows indicate peritubular interstitial cells not producing EPO. (Courtesy of Dr. Stephen Koury.)

The mechanism by which hypoxia leads to EPO synthesis has only recently been understood. Results of several studies have shown that the EPO gene contains sequences that are oxygen sensitive and are involved in the regulation of EPO gene expression ( [222](#) ). By the use of plasmid constructs, transgenic mice, and cell transfection, it has been shown that these oxygen-sensitive sequences, located at the region flanking the 3' end of the EPO gene, can confer to cells the ability to respond to hypoxia by an increase of the protein encoded by the reporter gene ( [223](#) ). In the same area of the EPO gene, an enhancer has been identified with sequences suggesting that it belongs to the family of the nuclear hormone receptor superfamily ( [224](#) ). The ligand for this oxygen-sensitive enhancer was identified as a protein of 120 kd termed *hypoxia inducible factor 1* (HIF-1) ( [225](#), [226](#) and [227](#) ). This DNA-binding protein is tightly regulated by the oxygen tension and is considered to be the physiologic regulator of EPO transcription ( [228](#) ). HIFs are heterodimeric, helix-loop-helix, transcription factors consisting of two subunits, HIF-1a and HIF-1β. The concentration and transcriptional activity of HIF-1a increase in a geometric fashion on exposure to hypoxia. In addition to EPO, a large number of genes (glucose transporters, glycolytic enzymes, vascular endothelial growth factors, and many others) are activated during hypoxia to aid the cell in adapting to hypoxic conditions ( [229](#) ). HIF-1a is constitutively expressed under normoxic conditions, but it is rapidly degraded via the ubiquitin proteasome complex after it is tagged with the protein of von Hippel-Lindau. Binding of the protein of von Hippel-Lindau to HIF-1a requires hydroxylation of the latter by a proline hydroxylase ( [230](#), [231](#), [232](#) and [233](#) ). Prolylhydroxylase is an oxygen- and iron-dependent enzyme. Under hypoxic condition, little or no proline hydroxylation takes place; thus, the protein of von Hippel-Lindau does not bind to HIF-1a, which accumulates, heterodimerizes with HIF-β, and recruits the p300/CREB-binding protein transcriptional coactivator, and the whole complex binds to EPO enhancer to promote EPO gene transcription. Recruitment of p300 is inhibited by asparagine hydroxylation that is catalyzed by an oxygen-sensitive asparaginyl-hydroxylase ( [234](#) ). It seems that these two amino acid hydroxylases, by their dependence on normal intracellular oxygen for their function, act as the oxygen sensor in the EPO-producing interstitial cells in the kidney, and they regulate the function of HIF-1 at least at two distinct points ( [233](#) ).

#### **ACTION OF ERYTHROPOIETIN**

**Erythropoietin Receptors** EPO binds to specific molecules on the cell surface, the EPORs. Expression of both EPO and EPORs is necessary for adult life. Deletion of either the genes that code for EPO or the EPOR in mice results in identical phenotypes of fetal death at day 12 to 13 as a result of severe anemia ( [235](#) ). Arguably, the most important control point of erythropoiesis is the interaction of EPO with the receptor for EPO. The activation of the EPOR generates an intracellular signal in immature erythroid cells that promotes the survival of these cells that would otherwise undergo apoptosis. EPO may also promote proliferation. A direct instructive effect of EPO on either primitive hematopoietic cells or mature erythroid cells to direct differentiation is not supported by

most data. Specific EPORs are expressed on hematopoietic cells that respond to EPO and have been identified on human (21) and murine erythroid cells (236), erythroleukemic cell lines (237), fetal liver tissue rich in erythroid elements, in mouse and rat placenta (238, 239), and in megakaryocytes (240, 241). The density of EPORs on erythroid cells is relatively small (approximately 1000 molecules/cell) and varies correlating with the cell's responsiveness to and dependence on EPO (241). EPORs are detectable by autoradiography on human BFU-Es; their density increases as the BFU-E matures to CFU-E (27). Erythroid cells at a stage between CFU-E and proerythroblast seem to have the highest density of EPORs, which decrease as the proerythroblast matures and eventually disappear at the stage of orthochromatic erythroblast (27, 236). EPORs are not expressed on reticulocytes or red cells. Whereas functional EPORs were detected in mouse and rat placenta (238, 239), these placental EPORs apparently cannot function to transport significant amounts of EPO from the maternal circulation to the circulation of the fetus. The deletion of the EPO gene in a mouse fetus results in severe anemia and death at days 12 to 13 postinception (235). If sufficient EPO from the mother were transported across the placenta to the fetus, one would expect normal birth of the mice missing the EPO gene (EPO<sup>-/-</sup>) but death by anemia shortly afterward. Thus, the fetal death of EPO<sup>-/-</sup> mice proves that fetal EPO production is necessary for survival. The detection of receptors for EPO in megakaryocytes (240, 241) is understandable because EPO concentration can affect platelet levels. In contrast, the physiologic significance of the presence of receptors for EPO in neurons, the kidneys, endothelial cells, embryonic muscles, and breast cancer cells is not yet established. Receptors for EPO may be required for normal embryonic development of the brain because the brains from day 12-EPOR<sup>-/-</sup> mice are abnormal (242). Cloning of murine erythroleukemia EPOR gene revealed a DNA sequence encoding a 507-amino acid peptide of 62 kd with a single membrane-spanning domain in a direction such that the amino-terminal site is located extracellularly and the carboxy-terminal site is located intracytoplasmically (243). The EPOR has undergone glycosylation and phosphorylation before being incorporated into the cell membrane as a 70- to 78-kd protein (243). Cells transfected with this gene express both high- and low-affinity EPORs (243). The human EPOR gene has been localized in the long arm of chromosome 19 (244). After the cloning of the EPOR gene, other receptor genes were cloned that were similar in sequence, such that it is now recognized that the EPOR is related to a large family of receptors, the hematopoietic receptor superfamily, that includes receptors from interleukins 2 through 9, granulocyte colony-stimulating factor, and granulocyte-macrophage colony-stimulating factor, and receptors for other factors such as growth hormone and prolactin that do not modulate hematopoietic cells (245). After binding of EPO to its receptor, the hormone is rapidly endocytosed and degraded (241, 246). Whether the receptor is also degraded or recycles to the membrane is not known, although experimental evidence favors degradation (237). Crystallographic studies confirm that, as is the case for other members of the hematopoietic superfamily of receptors, one molecule of EPO may simultaneously bind to two receptors for EPO. It is clear that activation of the receptors by the hormone leads to formation of receptor homodimers (247); however, evidence suggests that EPOR dimers likely exist even before the binding of EPO. EPO binding shifts and stabilizes an active receptor conformation that brings the two EPORs in closer contact (248, 249). Tyrosine phosphorylation of the EPOR (250) is the first observable event after EPO binding. Because the EPOR lacks a kinase domain, a tyrosine protein kinase must associate with the receptor. The tyrosine protein kinase JAK2, a member of the Janus family of kinases, is a very likely candidate to be the primary EPOR-associated kinase because it can bind to conserved sequence of amino acids found in cytoplasmic domains of the EPOR (251, 252) and other receptors related in a sequence to the receptors for EPO. JAK2 is also implicated as the only significant EPOR-interacting kinase because



deletion of the JAK2 kinase gene in mice results in a phenotype of day 12 to 13 fetal death and severe anemia that mirrors the phenotype after either deletion of EPO gene or the gene coding the receptor for EPO ( [253](#) ). To summarize the current view of this research, two EPOR molecules bind to one EPO molecule. JAK2 kinase molecules associated with each receptor are activated by the physical process of bringing the inactive (or low-activity) kinases in close proximity by a shift in receptor conformation, such that these low-activity kinases cross-phosphorylate each other to gain full activity. The activated JAK2 kinase then phosphorylates all eight tyrosine residues of the EPOR cytoplasmic domain. These phosphorylated tyrosine residues of the receptor become docking sites for signaling molecules that may be phosphorylated by JAK2 to become active, such as the signal-transducing activators of transcription (STAT) proteins. STAT1 and STAT5 become phosphorylated, dimerize, and are transported to the nucleus to mediate gene transcription. Alternatively, the translocation of active signaling molecules from the cytoplasm to the plasma membrane via docking to the phosphorylated EPOR activates a signaling cascade. Examples include the translocation of phosphatidylinositol-3-kinase (PI3-kinase) from the cytoplasm to phosphorylate plasma membrane lipids at the cell surface ( [254](#) ). Domains of the receptor for EPO, the specific tyrosine residues of the receptor, or both are apparently important in activation of distinctive signaling pathways. For example, tyrosine residue 343 is required for EPO-dependent activation of STAT5 signaling ( [255](#) ), whereas the distal end as well as tyrosine residue 479 of the EPOR are required for activation of both PI3-kinase and MAP kinase cascade. The importance of EPOR tyrosine phosphorylation is difficult to reconcile with a study that showed that transgenic mice expressing receptors for EPO without any cytoplasmic tyrosine residues are essentially normal regarding erythropoiesis and hematocrit ( [256](#) ). Thus, the tyrosine residues of the receptor for EPO are likely important in more subtle ways than previously believed. This is suggested also by the fact that all eight tyrosines are conserved in both number and alignment between the murine and human EPOR genes. If these residues served no important purpose, one would expect differences in either tyrosine numbers or alignment between the mouse and human genes. The distal end of the EPOR acts as a negative regulatory domain to which tyrosine protein phosphatases dock to phosphorylated tyrosine residues to attenuate EPO signaling. This is suggested by the findings in a transgenic mouse created to express a truncated human receptor EPO, replacing the murine EPOR. This mouse was found to have a severe erythrocytosis, mimicking the disease state noted in humans with polycythemia vera who have elevated red cell mass due to mutations in the negative regulatory domain of the EPOR gene ( [257](#) ). The role of the transcription factor, STAT5, in signaling after phosphorylation and activation by binding to the receptor for EPO is controversial. STAT5 is expressed from two very similar genes, STAT5a and STAT5b. In transgenic mice in which both genes for STAT5a and STAT5b were deleted or “knocked-out” (STAT5a/b-/- mice), STAT5a/b was found to be neither essential nor significant for erythropoiesis ( [258](#) ). However, other investigators obtained and studied the same STAT5a/b-/- mice and reported a marked fetal anemia in the STAT5-/- mice and lesser but significant anemia in newborn and adult STAT5-/- mice ( [259](#) ). Erythropoiesis in STAT5a/b-/- mice was then reexamined by the initial investigators, who reported that the hematocrit was slightly reduced at fetal and newborn stages, but comparison of photographs of the STAT5-/- fetus did not appear to be significantly different from wild-type fetus ( [260](#) ). Thus, STAT5 seems to have some role in erythropoiesis, different from the initial conclusion that STAT5 has no effect, but it also plays a less significant role in fetal erythropoiesis than was initially claimed ( [259](#) ). EPO is known to weakly activate STAT1 and to strongly activate STAT5 in primary erythroid cells, such that STAT1 activation may partially compensate for STAT5 and explain why deletion of STAT5 in mice results in a relatively mild inhibition of erythropoiesis ( [261](#) ). A large body of evidence now shows that both the MAP kinase cascade and PI3-kinase cascade are activated after EPO activation of the EPOR. Although EPO may act to (a) promote the survival of immature progenitors by preventing apoptosis or programmed cell death, (b)

drive the proliferation of progenitor cells, and (c) direct the differentiation of progenitor cells along erythroid maturation, it is not clear if some intracellular signaling pathways distinctly activate only one of these events. Some data suggest that the EPO-dependent activation of the MAP kinase pathway is more important in directing proliferation, whereas the PI3-kinase pathway is equally important in survival and proliferation ( [254](#) ).

**Mechanism of Action** EPO is a hormone that promotes erythroid differentiation ( [1](#) ). The role of EPO during the very early stages of erythropoiesis is still undefined. Cell lines with features of multipotent hematopoietic progenitor cells ( [262](#), [263](#) ) and purified human blood BFU-Es ( [27](#) ) express a small number of EPORs, suggesting a possible role of EPO for their survival and differentiation. Although, *in vivo*, the BFU-E pool is unaffected by acute changes of the level of serum EPO and BFU-Es are EPO-independent for their survival, they can respond to EPO by increasing their cycling, which is part of the process of erythroid differentiation ( [38](#) ). Chronic administration of recombinant EPO to humans with end-stage renal disease results in global stimulation of the bone marrow with an increase in the concentration and cycling of all types of hematopoietic progenitors, but this effect is most likely indirect ( [39](#) ). The erythroid cell that is the most sensitive to EPO is a cell between the CFU-E and the proerythroblast ( [27](#), [236](#) ), and this erythroid cell can be considered the primary target of EPO action. These cells express the highest density of EPORs on their membrane and are absolutely dependent on EPO for their survival ( [27](#), [264](#), [265](#) ). Studies on murine splenic erythroid cells infected with the anemia strain of Friend virus ( [266](#) ) have shown that binding of EPO is followed by a series of biochemical events, including increase in Ca<sup>2+</sup> uptake ( [267](#) ), internalization of the hormone ( [246](#) ), increase in total RNA synthesis ( [268](#) ), glucose and iron uptake ( [241](#) ), rate of transcription of the  $\alpha$ - and  $\beta$ -globin gene ( [211](#), [269](#) ), expression of transferrin receptors ( [270](#) ), and eventually increase of hemoglobin synthesis as well as of membrane bands 3 and 4.1 ( [265](#), [271](#) ). All of these changes result in an increased rate of erythroid differentiation, ending with an increase in the reticulocyte production and an eventual increase in the red cell mass. One of the most impressive effects of EPO on the erythroid cells is the ability of the hormone to maintain the viability of these cells irrespective of any effect on cycling and differentiation ( [264](#), [265](#) ). In the absence of EPO, erythroid cells die. It has been shown that EPO retards the cleavage of DNA that occurs normally in CFU-Es ( [272](#) ). In the absence of EPO, DNA cleavage is rapid and proceeds to cell death. The pattern of rapid DNA cleavage occurring in erythroid cells deprived of EPO is characteristic of cells undergoing apoptosis (programmed cell death) ( [272](#) ). In the presence of EPO, cell death is avoided and the erythroid cells are allowed to differentiate and form red cells. These findings suggest that the hormone promotes erythroid differentiation simply by allowing cell survival, which is a prerequisite for both cell proliferation and maturation. This model also suggests that, under normal conditions, a large number of generated CFU-Es are not surviving, but, under conditions of high EPO levels, expansion of the erythroid marrow is seen simply by allowing survival of more CFU-Es, resulting in an increased rate of red cell production. Within the same context, once the red cell mass is restored to normal, the ensuing decrease of EPO levels leads to a rapid turn-off of erythropoiesis by allowing programmed cell death to occur ( [272](#) ). The observation that relatively mature erythroid precursor cells continue to develop in fetal mice in which either the gene for EPO or the gene coding for the EPOR has been deleted ( [235](#) ) supports the model that EPO acts primarily by promoting survival of more mature erythroid cells and that EPO has no or a less significant role in proliferation of erythroid progenitors or in directing erythroid differentiation of immature hematopoietic cells. These abundant erythroid cells (proerythroblasts near the CFU-E stage of erythroid development) from spleens of either EPO<sup>-/-</sup> or EPOR<sup>-/-</sup> mice undergo apoptosis or programmed death unless these spleen cells are either cultured *in vitro* in EPO (EPO<sup>-/-</sup> mice) or forced by transfection with complementary DNA to express the EPOR (EPOR<sup>-/-</sup> mice) and then cultured in the presence of EPO. Thus, neither EPO nor receptors for EPO are necessary for the

proliferation and differentiation of stem cells and early progenitor cells into relatively mature erythroid cells. Both EPO and the receptors for EPO, however, are absolutely required for erythroid cells to survive the transition from proerythroblasts/CFU-Es to mature erythroblasts, suggesting a clear role of EPO in directing the survival of these cells. In addition to erythroid cells, EPO affects megakaryocytes and their progenitors CFU-MKs. EPO acts as a colony stimulation factor for murine CFU-MK (273), whereas, in humans, it potentiates the effect of megakaryocyte colony-stimulating factors present in lymphocyte-conditioned medium (274). It also promotes the differentiation of murine megakaryocytes (275), which express EPORs (276), and, when injected at high doses into mice, it increases platelet production (277). In patients with end-stage renal disease treated with EPO, a minor increase in the platelet count, averaging approximately 30,000/ $\mu$ l, has been noted (278). EPO does not seem to contribute in a significant way to the regulation of platelet counts because anephric patients can maintain a normal platelet count (278). Its various effects on megakaryopoiesis and thrombopoiesis may be explained by the extensive homology between EPO and thrombopoietin, the major humoral regulator of platelet mass (279).

**ASSAYS FOR ERYTHROPOIETIN AND LEVELS IN HEALTH AND DISEASE** The presence of EPO in serum, urine, or other body fluids can be detected by bioassays or immunoassays. Historically, EPO was detected by the polycythemic mouse assay in which the serum sample was injected with  $^{59}\text{Fe}$  into polycythemic mice and the amount of  $^{59}\text{Fe}$  incorporated into newly released red cells was measured (1, 280, 281). This method has low sensitivity and is affected by factors influencing erythropoiesis *in vivo* that are present in the injected sample. *In vitro* bioassays have been described (280, 281), but none has received wide clinical application. Radioimmunoassays for EPO were developed initially by using purified human urinary EPO as antigen and standard (282, 283, 284, 285, 286 and 287); these have been replaced by purified human recombinant EPO (284, 285 and 286). Using the same principles of immunologic detection of the protein, an enzyme-linked immunosorbent assay was developed, which is commercially available and currently used as the method for determining serum EPO concentrations. The immunoassays have the advantages of being quick, accurate, relatively inexpensive, and capable of quantifying very low EPO levels ordinarily not detectable by bioassays. Normal serum EPO levels, although variable with the type of assay, usually range between 5 and 30 mU/ml. An inverse correlation has been established between the logarithm of serum EPO concentration and the concentration of hemoglobin in the blood (282, 285); however, the magnitude of the increase in the serum EPO concentration in response to anemia is variable among individuals. A disadvantage of the immunoassays is that they detect immunoreactive but not necessarily bioactive hormone. Thus, in renal failure, when serum EPO levels are low or undetectable by bioassays, the immunoassays detect higher levels (284, 286, 287). The clinical utility of a single serum EPO measurement has not yet been well established. A low value in the presence of anemia, not associated with renal failure, indicates an abnormal response to anemia, but a normal or elevated level of EPO does not allow any firm conclusion as to whether the increase is appropriate for the severity of anemia. A better approach in interpreting serum EPO levels is a comparison of EPO response to various degrees of anemia between groups of patients with anemia of established etiology. Using such an approach, a blunted EPO response has been described in patients with rheumatoid arthritis (288), solid and hematopoietic malignancies (289, 290), sickle cell disease (291), and acquired immunodeficiency syndrome (292) and in premature neonates (293). Conflicting results have also been published regarding the use of serum EPO levels in the differential diagnosis of polycythemia (74, 294, 295 and 296). In the presence of an increased red cell mass, an elevated serum EPO value indicates that the polycythemia is secondary to chronic stimulation of the marrow by the hormone, which excludes the diagnosis of polycythemia vera. A normal value in an individual case of polycythemia, however, cannot rule out secondary polycythemia. In this group of patients

with polycythemia, there is such an overlap in serum EPO levels that a single EPO value cannot always distinguish with confidence between polycythemia rubra vera and secondary polycythemia ([295](#)).

## REFERENCES

1. Krantz SB, Jacobson L. Erythropoietin and the regulation of erythropoiesis. Chicago: Chicago University Press, 1970.
2. Erslev AJ, Adamson JW, Eschbach JW, Winearls GC. Erythropoietin, molecular, cellular and clinical biology. Baltimore: The Johns Hopkins University Press, 1991.
3. Boycott AE. The blood as a tissue. Hypertrophy and atrophy of the red cell corpuscles. Proc R Soc Med 1929;23:15.
4. Till JE, McCulloch EA, Siminovitch L. A stochastic model of stem cell proliferation based on the growth of spleen colony-forming cells. Proc Natl Acad Sci U S A 1964;51:29.
5. Till JE, McCulloch EA. Direct measurement of the radiation sensitivity of normal mouse bone marrow cells. Radiat Res 1961;14:213.
6. Spangrude GJ, Heinfield S, Weissman IL. Purification and characterization of mouse hematopoietic stem cells. Science 1988;241:58.
7. Porter Pharr P, Ogawa M. Pluripotent stem cells. In: Golde DW, Takaku F, eds. Hematopoietic stem cells. New York: Marcel Dekker Inc, 1985:3.
8. Nakahata T, Gross AJ, Ogawa M. A stochastic model of self-renewal and commitment to differentiation of the primitive hematopoietic stem cells in culture. J Cell Physiol 1982;113:455.
9. Fauser AA, Messner HA. Granuloerythropoietic colonies in human bone marrow, peripheral blood and cord blood. Blood 1978;52:1243.
10. McLeod DL, Shreeve MM, Axelrod AA. Induction of megakaryocyte colonies with platelet formation in vitro. Nature 1976;261:491.
11. Nakahata T, Spicer SS, Ogawa M. Clonal origin of human erythro-eosinophil colonies in culture. Blood 1982;59:857.
12. Curry JC, Trentin JJ. Hematopoietic spleen colony studies. I. Growth and differentiation. Dev Biol 1967;15:395.
13. Van Zant G, Goldwasser E. Competition between erythropoietin and colony-stimulating factor for target cells in mouse marrow. Blood 1979;53:946.
14. Van Zant G, Goldwasser E. Simultaneous effects of erythropoietin and colony-stimulating factor on bone marrow cells. Science 1977;198:733.
15. Eaves JC, Eaves AC. Erythropoiesis. In: Golde WD, Takaku F, eds. Hematopoietic stem cells. New York: Marcel Dekker Inc, 1985.
16. Gregory CJ, Tepperman AD, McCulloch EA, Till JE. Erythropoietin progenitors capable of colony formation in culture: response of normal and genetically anemic W/W<sup>w</sup> mice to manipulations of the erythron. J Cell Physiol 1974;84:1.
17. Ogawa M, Parnley TR, Bank LH, Spicer SS. Human marrow erythropoiesis in culture. I. Characterization of methylcellulose colony assay. Blood 1976;48:407.
18. Stephenson JR, Axelrad AA, McLeod DL, Shreeve MM. Induction of colonies of hemoglobin synthesizing cells by erythropoietin *in vitro*. Proc Natl Acad Sci U S A 1971;68:1542.

19. Tepperman AD, Curtis JE, McCulloch EA. Erythropoietin colonies in cultures of human marrow. *Blood* 1974;44:659.
20. Prchal JF, Adamson JW, Steinman L, Fialkov PT. The single cell origin of human erythroid colonies. *J Cell Physiol* 1976;89:489.
21. Sawada K, Krantz SB, Kans JS, et al. Purification of human colony-forming units-erythroid and demonstration of specific binding of erythropoietin. *J Clin Invest* 1987;80:357.
22. Gregory CJ, Eaves AC. Human marrow cells capable of erythropoietic differentiation *in vitro*. Definition of three erythroid colony responses. *Blood* 1977;49:855.
23. Gregory CJ, Eaves AC. Three stages of erythropoietic progenitor cell differentiation distinguished by a number of physical and biologic properties. *Blood* 1978;51:527.
24. Iscove NN. The role of erythropoietin in regulation of population size and cell cycling of early and late erythroid precursors in mouse bone marrow. *Cell Tissue Kinet* 1977;10:323.
25. Krantz SB. Erythropoietin. *Blood* 1991;77:419.
26. Braun JL, Greenberg HM, Robinson SH. Hemopoietic progenitor cells in short term culture: effects of erythropoietin and endotoxin contamination of erythropoietin preparations. *Exp Hematol* 1979;7:189.
27. Sawada K, Krantz SB, Dai C-H, et al. Purification of human blood burst-forming units-erythroid and demonstration of the evolution of erythropoietin receptors. *J Cell Physiol* 1990;142:219.
28. Sawada K, Krantz SB, Dessypris EN, et al. Human colony forming units-erythroid do not require accessory cells, but do require direct interaction with insulin-like growth factor I and/or insulin for erythroid development. *J Clin Invest* 1989;83:1701.
29. Humphries RK, Eaves AC, Eaves JC. Characterization of a primitive erythropoietic progenitor found in mouse marrow before and after several weeks in culture. *Blood* 1979;53:746.
30. Wagemaker G. Induction of erythropoietin responsiveness *in vitro*. In: Golde DW, Cline JM, Metcalf D, Fox CF, eds. Hemopoietic cell differentiation. New York: Academic Press, 1978:109.
31. Ogawa M, MacEachern DM, Avila L. Human marrow erythropoiesis in culture. II. Heterogeneity in the morphology time course of colony formation and sedimentation velocities of the colony forming cells. *Am J Hematol* 1977;3:29.
32. Papayannopoulou T, Brice M, Stamatoyannopoulos G. Hemoglobin F synthesis *in vitro*. Evidence for control at the level of primitive erythroid stem cells. *Proc Natl Acad Sci U S A* 1977;74:2923.
33. Clark BJ, Housman D. Characterization of an erythroid precursor cell of high proliferative capacity in normal human peripheral blood. *Proc Natl Acad Sci U S A* 1977;74:1105.
34. Hara H, Ogawa M. Erythropoietic precursors in murine blood. *Exp Hematol* 1977;5:159.
35. Nathan DG, Chess L, Hillman DG, et al. Human erythroid burst forming unit: T-cell requirement for proliferation *in vitro*. *J Exp Med* 1978;147:324.
36. Peschle C. Erythropoiesis. *Am Rev Med* 1980;31:303.
37. Peschle C, Cillo C, Migliaccio G, Lettieri F. Fluctuations of BFU-E and CFU-E cycling after erythroid perturbations: correlations with variation of pool size. *Exp Hematol* 1980;8:96.
38. Dessypris EN, Krantz SB. Effect of pure erythropoietin on DNA synthesis by day 15-human marrow BFU-E in short term liquid culture. *Br J Haematol* 1984;56:295.
39. Dessypris EN, Graber SE, Krantz SB, Stone JW. Effects of recombinant erythropoietin on the concentration and cycling status of human marrow hematopoietic progenitor cells *in vivo*. *Blood*

1988;72:2060.

40. Tanaka Y, Goodman JR. Electron microscopy of human blood cells. New York: Harper & Row, 1972.
41. Grasso JA. Cytoplasmic microtubules in mammalian erythropoietic cells. *Anat Rec* 1966;156:397.
42. Rebeck JW, Woods HL. Electron microscope studies of blood cells. *Blood* 1948;3:175.
43. Hahoe FGJ, Hynes J. An abnormality of erythroblastic karyokinesis. *J Pathol Bacteriol* 1951;63:403.
44. Killmann SA. On the size of normal human reticulocytes. *Acta Med Scand* 1964;176:529.
45. Heath CW, Daland GA. The life of reticulocytes. *Arch Intern Med* 1930;46:533.
46. Dacie JV, White JC. Erythropoiesis. *J Clin Pathol* 1959;2:1.
47. Orten JM. The properties and significance of the reticulocyte. *Yale J Biol Med* 1934;6:519.
48. Bessis M. Living blood cells and their ultrastructure. Translated by RI Weed. New York: Springer-Verlag New York, 1973.
49. Davidson LSP. The basophilic substance of the erythrocyte. *Edinburgh Med J* 1930;37:425.
50. Sutherland DA, et al. The direct Coombs test and reticulocytes. *Br J Haematol* 1963;9:68.
51. Key JA. Studies of erythrocytes with special reference to reticulum, polychromatophilia and mitochondria. *Arch Intern Med* 1921;28:511.
52. Daland GA, Zetzel L. The resistance of reticulocytes to hypotonic solutions of sodium chloride and of plasma. *Am J Med Sci* 1936;191:467.
53. Gasko O, Danon D. The metabolism of maturing reticulocytes. *Br J Haematol* 1972;23:525.
54. Schumacher HR, Erslev AJ. Bone marrow kinetics. In: Szirmai E, ed. Nuclear hematology. New York: Academic Press, 1956:89.
55. Bondurant MC, Lind RN, Koury MJ, Ferguson ME. Control of globin gene transcription by erythropoietin in erythroblasts from Friend virus-infected mice. *Mol Cell Biol* 1985;5:675.
56. Koury MJ, Bondurant MC, Atkinson JB. Erythropoietin control of terminal erythroid differentiation: maintenance of cell viability, production of hemoglobin, and development of the erythrocyte membrane. *Blood Cells* 1987;13:217.
57. Miller BA, Scaduto RC Jr, Tillotson DL, et al. Erythropoietin stimulates a rise in intracellular free calcium concentration in single early human erythroid precursors. *J Clin Invest* 1988;82:309.
58. Sawyer ST, Krantz SB. Erythropoietin stimulates  $^{45}\text{Ca}^{2+}$  uptake in Friend virus-infected erythroid cells. *J Biol Chem* 1984;259:2769.
59. Sawyer ST, Krantz SB. Transferrin receptor number synthesis, and endocytosis during erythropoietin-induced maturation of Friend virus-infected erythroid cells. *J Biol Chem* 1986;261:9187.
60. Stohlman F. Kinetics of erythropoiesis. In: Gordon AS, ed. Regulation of hematopoiesis, vol. 1. New York: Appleton-Century-Crofts, 1970:317.
61. Orlic D. Ultrastructural analysis of erythropoiesis. In: Gordon AS, ed. Regulation of hematopoiesis, vol. 1. New York: Appleton-Century-Crofts, 1970:271.
62. Tooze J, Davies HG. The occurrence and possible significance of hemoglobin in the chromosomal regions of mature erythrocyte nuclei of the newt *Triturus cristatus*. *J Cell Biol* 1963;16:501.
63. Wintrobe MM. Variations in the size and hemoglobin content of erythrocytes in the blood of various

vertebrates. *Folia Haematol* 51:32.

64. Awai M, et al. Studies on the mechanism of denucleation of the erythroblast. *Acta Haematol* 1968;39:193.
65. Rind H. Kinetik der erythroblastenentkernung. *Folia Haematol* 1956;74:262; *ibid* 1959;76:293.
66. Skutelsky E, Danon D. An electron microscopic study of nuclear elimination from the late erythroblast. *J Cell Biol* 1967;33:625.
67. Koury ST, Koury MJ, Bondurant MC. Cytoskeletal distribution and function during the maturation and enucleation of mammalian erythroblasts. *J Cell Biol* 1989;109:3005.
68. Tavassoli M, Crosby WH. Fate of the nucleus of the marrow erythroblast. *Science* 1973;179:912.
69. Song SH, Groom AC. Sequestration and possible maturation of reticulocytes in the normal spleen. *Can J Physiol Pharmacol* 1972;50:400.
70. Izak G, et al. Ribonucleic acid production and breakdown in synchronized erythroid cohorts from actinomycin treated animals. *J Lab Clin Med* 1971;77:923.
71. Valentine WN, et al. Hereditary hemolytic anemia with human pyrimidine 5'-nucleotidase deficiency. *J Clin Invest* 1974;54:866.
72. Paglia DE, Valentine WN, Dahlgren JG. Effects of low-level lead exposure on pyrimidine 5'-nucleotidase and other erythrocyte enzymes. Possible role of pyrimidine 5'-nucleotidase in the pathogenesis of lead-induced anemia. *J Clin Invest* 1975;56:1164.
73. Collins FS, Weissman SM. The molecular genetics of human hemoglobin. *Prog Nucleic Acid Res Mol Biol* 1984;31:315.
74. Casadevall N. Determination of serum erythropoietin. Its value in the differential diagnosis of polycythemia. *Nouv Rev Fr Hematol* 1994;36:173.
75. Lehman H, Carrell RW. Differences between  $\alpha$ - and  $\beta$ -thalassemia. Possible duplication of the  $\alpha$ -chain gene. *Br Med J* 1968;4:748.
76. Shroeder WA, et al. Evidence for multiple structural genes for the  $\gamma$  chain of human fetal hemoglobin. *Proc Natl Acad Sci U S A* 1968;60:537.
77. Diesseroth A, et al. Hemoglobin synthesis in somatic cell hybrids: independent segregation of the human  $\alpha$ - and  $\beta$ -globin genes. *Science* 1976;191:1262.
78. Diesseroth A, et al. Localization of the human  $\alpha$  globin structural gene to chromosome 16 in somatic cell hybrids by molecular hybridization assay. *Cell* 1977;12:205.
79. Fritsch EF, Lawn RM, Maniatis T. Molecular cloning and characterization of the human  $\beta$ -like globin gene cluster. *Cell* 1980;19:959.
80. Nienhuis AW, Benz EJ Jr. Regulation of hemoglobin synthesis during the development of the red cell. *N Engl J Med* 1977;297:1318.
81. Nienhuis AW, Marriettis T. Structure and expression of globin genes in erythroid cells. In: Stamatoyannopoulos G, Nienhuis AW, Leder P, Majerus PW, eds. *The molecular basis of blood diseases*. Philadelphia: WB Saunders, 1987:28.
82. Ley TJ, Chiang YL, Haidaris D, et al. DNA methylation and regulation of the human  $\beta$ -globin-like genes in mouse erythroleukemia cells containing human chromosome 11. *Proc Natl Acad Sci U S A* 1984;81:5618.
83. Mavilio F, Giampaolo A, Care A, et al. Molecular mechanisms of hemoglobin switching: selective under-methylation and expression of globin genes in embryonic, fetal, and adult erythroblasts. *Proc Natl*



Acad Sci U S A 1983;80:6907.

84. McGhee JD, Ginder GD. Specific DNA methylation sites in the vicinity of the chicken beta-globin genes. *Nature* 1979;280:418.

85. Papayannopoulou THE, Brice M, Kurachi S, et al. Chromosomal structure determines the predominant expression of fetal globin by fetal erythroid cells. *Blood* 1984;64:62a.

86. Wright S, deBoer E, Grosveld FG, Flavell RA. Regulated expression of the human beta-globin gene family in murine erythroleukemia cells. *Nature* 1983;305:333.

87. Chambon P. Eukaryotic nuclear RNA polymerases. *Annu Rev Biochem* 1975;44:613.

88. Perry RP. Processing of RNA. *Annu Rev Biochem* 1976;45:605.

89. Leder P. Discontinuous genes [editorial]. *N Engl J Med* 1978;298:1079.

90. Merkel CG, et al. Shortening of the poly (A) region of mouse globin messenger RNA. *J Biol Chem* 1976;251:5512.

91. Weissbach H, Ochoa S. Soluble factors required for eukaryotic protein synthesis. *Annu Rev Biochem* 1976;45:191.

92. Adamson SD, et al. Factors affecting the rate of protein synthesis in lysate systems from reticulocytes. *Arch Biochem Biophys* 1968;125:671.

93. Bruns GP, London IM. The effect of hemin on the synthesis of globin. *Biochem Biophys Res Commun* 1965;18:236.

94. Lodish HF. Translational control of protein synthesis. *Annu Rev Biochem* 1976;45:39.

95. Waxman HS, et al. Studies with <sup>59</sup>Fe-labelled hemin on the control of polyribosome formation in rabbit reticulocytes. *Biochim Biophys Acta* 1967;145:353.

96. Waxman HS, Rabinovitz M. Control of reticulocyte polyribosome content and hemoglobin synthesis by heme. *Biochim Biophys Acta* 1966;129:369.

97. Balkow K, et al. Hemin control of globin synthesis: effect of a translational repressor on Met-tRNA<sub>S</sub> binding to the small ribosome subunit and its relation to the activity and availability of an initiation factor. *Biochim Biophys Acta* 1973;324:397.

98. Howard GA, et al. Studies on cessation of protein synthesis in a reticulocyte lysate-free system. *Biochim Biophys Acta* 1970;213:237.

99. Kramer G, et al. Specificity of the protein kinase activity associated with the hemin-controlled repressor of rabbit reticulocyte protein synthesis. *Proc Natl Acad Sci U S A* 1976;73:3078.

100. Ranue RS, et al. Regulation of protein synthesis in rabbit reticulocyte lysates. Characteristics of inhibition of protein synthesis by a translational inhibitor from heme-deficient lysates and its relationship to the initiation factor which binds Met-tRNA. *Proc Natl Acad Sci U S A* 1976;73:2720; 1978;75:745.

101. Ross J, Sautner D. Induction of mRNA accumulation by hemin in cultured erythroleukemic cells. *Cell* 1976;8:513.

102. Lohr JB, Friedman HC. New pathway for d-aminolevulinic acid biosynthesis: formation from α-ketoglutaric acid by two partially purified plant enzymes. *Biochem Biophys Res Commun* 1976;69:908.

103. Raffel C, et al. Role for heme in mammalian protein synthesis: activation of an initiation factor. *Proc Natl Acad Sci U S A* 1974;71:4020.

104. Bottomley SS, Eberhard Muller U. Pathophysiology of heme synthesis. *Semin Hematol* 1988;25:282.

105. Burnham BF. The chemistry of the porphyrins. *Semin Hematol* 1968;5:296.
106. Burnham BF, Lascelles J. Control of porphyrin biosynthesis through a negative-feedback mechanism. *Biochem J* 1963;87:462.
107. Dolphin D, ed. The porphyrins, vol. 1-7. New York: Academic Press, 1978, 1979.
108. Lascelles J. Tetrapyrrole biosynthesis and its regulation. New York: WA Benjamin Inc, 1964.
109. Smith KM, ed. Porphyrins and metalloporphyrins. Amsterdam: Elsevier Science, 1975.
110. Shemin D, Russell C. d-Aminolevulinic acid, its role in the biosynthesis of porphyrins and purines. *J Am Chem Soc* 1973;75:4873.
111. Gibson KD, et al. Initial stages in the biosynthesis of porphyrins. II. The formation of d-aminolaevulinic acid from glycine and succinyl-coenzyme A by particles from chicken erythrocytes. *Biochem J* 1958;70:71.
112. Brown EG. The relationship of the tricarboxylic acid cycle to the synthesis of d-aminolaevulinic acid in avian erythrocyte preparations. *Biochem J* 1958;70:313.
113. Gibson KD. Biosynthesis of d-aminolaevulinic acid by extracts of *Rhodospseudomonas spheroides*. *Biochem Biophys Acta* 1958;28:451.
114. Cartwright GE, Wintrobe MM. Studies on free erythrocyte protoporphyrin, plasma iron and plasma copper in normal and in pyridoxine-deficient swine. *J Biol Chem* 1948;172:557; *Harvey Lect* 1951;45:87.
115. Lascelles J. Synthesis of porphyrins by cell suspensions of *Tetrahymena vorax*: effect of members of the vitamin B group. *Biochem J* 1957;66:65.
116. Shulman JP, Richert DA. Heme synthesis in vitamin B6 and pantothenic acid deficiencies. *J Biol Chem* 1957;226:181.
117. Whiting MJ. Synthesis of d-aminolaevulinate synthase by isolated liver polyribosomes. *Biochem J* 1976;158:391.
118. Gidari AS, Levere RD. Enzymatic formation and cellular regulation of heme synthesis. *Semin Hematol* 1977;14:145.
119. Bawden MJ, et al. Sequence of human d-aminolevulinic acid synthase cDNA. *Nucleic Acids Res* 1987;15:8563.
120. Astrin KH, Desnik RJ, Bishop DF. Assignment of human  $\alpha$ -aminolevulinic acid synthase to chromosome 3. *Cytogenet Cell Genet* 1988;46:573.
121. Astrin KH, Bishop DF. Assignment of human erythroid d-aminolevulinic acid synthase to X-chromosome. *Cytogenet Cell Genet* 1989;51:953.
122. Jurgenson JE, et al. Biosynthesis of d-aminolevulinic acid in the unicellular rhodophyte, *Cyanidium caldarium*. *Biochem Biophys Res Commun* 1976;69:149.
123. Battersby AR. The discovery of nature's biosynthetic pathways. *Experientia* 1978;34:1.
124. Cheh AM, Nielsens JB. The d-aminolevulinic acid dehydratases: molecular and environmental properties. *Struct Bond* 1976;29:123.
125. Hammond PB. The relationship between inhibition of d-aminolevulinic acid dehydratase by lead and lead mobilization by ethylenediamine tetraacetate (EDTA). *Toxicol Appl Pharmacol* 1973;26:466.
126. Shemin D. d-Aminolevulinic acid dehydratase. In: Boyer PD, ed. *The enzymes*, 3rd ed. New York: Academic Press, 1972:323.

127. Polturi VR, et al. Chromosomal localization of the structure gene for human ALA dehydratase to 9q34 by in situ hybridization. *Hum Genet* 1987;76:236.
128. Wetmur JG, et al. Human d aminolevulinate dehydratase. Nucleotide sequence of a full length cDNA clone. *Proc Natl Acad Sci U S A* 1986;83:7703.
129. Coleman DL. Purification and properties of d-aminolevulinate dehydratase from tissue of two strains of mice. *J Biol Chem* 1966;244:5511.
130. Nandi DL, Shemin D. Studies on d aminolevulinic acid dehydratase of *Rhodopseudomonas spheroides*. III. Mechanism of porphobilinogen synthesis. *J Biol Chem* 1968;243:12398.
131. Bogorad L, Granick S. The enzymic synthesis of porphyrins from porphobilin-ogen. *J Biol Chem* 1958;233:501.
132. Grandchamp B, et al. Tissue specific expression of porphobilinogen deaminase, two isoenzymes from a single gene. *Eur J Biochem* 1987;162:105.
133. Wang J, et al. Regional gene assignment of human porphobilinogen synthase and esterase A4 to chromosome 11q-11qter. *Proc Natl Acad Sci U S A* 1981;78:5734.
134. Levin EY. Uroporphyrinogen III cosynthetase from mouse spleen. *Biochemistry* 1968;7:3781; *J Biol Chem* 1967;242:4248.
135. Battersby AR, et al. Biosynthesis of the natural (type-III) porphyrins: proof that rearrangement occurs after head-to-tail bilane formation. *J Chem Soc Chem Commun* 1977:113.
136. Frydman RB, Feinstein G. Studies on porphobilinogen deaminase and uroporphyrinogen III cosynthetase from human erythrocytes. *Biochim Biophys Acta* 1974;350:358.
137. Burton G, et al. The structure of pre-uroporphyrinogen. Exploration of an enzyme mechanism by <sup>13</sup>C and <sup>15</sup>N NMR spectroscopy. *J Am Chem Soc* 1979;101:3114.
138. Jordan PM, et al. Pre-uroporphyrinogen. A substrate for uroporphyrinogen III cosynthase. *J Chem Soc Chem Commun* 1979:204.
139. Burton G, et al. <sup>13</sup>C-NMR evidence of a new intermediate, pre-uroporphyrinogen, in the enzymic transformation of porphobilinogen into uroporphyrinogens I and III. *J Chem Soc Chem Commun* 1979:202.
140. Burnham BF, Lascelles J. Control of porphyrin biosynthesis through a negative-feedback mechanism. *Biochem J* 1963;87:462.
141. Jackson AH, et al. Macrocytic intermediates in the biosynthesis of porphyrins. *Philos Trans R Soc Lond* 1976;273:191.
142. Kushner JP, et al. An inherited enzymatic defect in porphyria cutanea tarda: decreased uroporphyrinogen decarboxylase activity. *J Clin Invest* 1976;58:1089.
143. Kushner JP, et al. The role of iron in the pathogenesis of porphyria cutanea tarda. II. Inhibition of uroporphyrinogen decarboxylase. *J Clin Invest* 1975;56:661.
144. Rasmussen GL, Kushner JP. The enzymatic decarboxylation of the naturally occurring isomers of uroporphyrinogen by human erythrocytes. *J Lab Clin Med* 1979;93:54.
145. Romeo G, Levin EY. Uroporphyrinogen decarboxylase from mouse spleen. *Biochim Biophys Acta* 1971;230:330.
146. Garcia RC, et al. Porphyrin biosynthesis. X. Porphyrinogen carboxy-lyase from avian erythrocytes. Further properties. *Biochim Biophys Acta* 1973;309:203.
147. Cornford P. Transformation of porphobilinogen into porphyrins by preparations from human

erythrocytes. *Biochem J* 1964;91:64.

148. DeVerneuil H, et al. Purification and properties of uroporphyrinogen decarboxylase from human erythrocytes. *J Biol Chem* 1983;258:2454.

149. Elder GH, Tovey JA. Uroporphyrinogen decarboxylase activity of human tissues. *Biochem Soc Trans* 1977;5:1470.

150. Mauzerall D, Granick S. Porphyrin biosynthesis in erythrocytes. III. Uroporphyrinogen and its decarboxylase. *J Biol Chem* 1958;232:1141.

151. Grandchamp B, et al. The mitochondrial localization of coproporphyrinogen III oxidase. *Biochem J* 1978;176:97.

152. Battle AM del C, et al. Purification and properties of co-proporphyrinogen-lyase. *Biochem J* 1965;97:731.

153. Sano S, Granick S. Mitochondrial coproporphyrinogen oxidase and protoporphyrin formation. *J Biol Chem* 1961;236:1173.

154. Jackson AH, Games DE. The later stages of porphyrin synthesis. *Ann N Y Acad Sci* 1975;244:591.

155. Jackson AH, et al. Mesoporphyrinogen-VI: a substrate for coproporphyrinogen oxidase. *J Chem Soc Chem Commun* 1976;1:322.

156. Kassner RJ, Walchak H. Heme formation from Fe(II) and porphyrin in the absence of ferrochelatase activity. *Biochim Biophys Acta* 1973;304:294.

157. Poulson R. The enzymic conversion of protoporphyrinogen IX to protoporphyrin IX in mammalian mitochondria. *J Biol Chem* 1976;251:3730.

158. Jones MS, Jones OTG. The structural organization of haem synthesis in rat liver mitochondria. *Biochem J* 1969;113:507.

159. Schwartz HC, et al. Studies on the biosynthesis of heme from iron and protoporphyrin. *Blood* 1959;14:486.

160. Lockhead AC, Goldberg A. The enzymic formation of haem by human and rat tissues. *Biochem J* 1961;78:146.

161. Schwartz HC, et al. The biosynthesis of hemoglobin from iron, protoporphyrin and globin. *J Clin Invest* 1961;40:188.

162. Bottomley SS. Characterization and measurement of heme synthase in normal human bone marrow. *Blood* 1968;31:314.

163. Porra RJ, Ross BD. Haem synthase and cobalt porphyrin synthase in various micro-organisms. *Biochem J* 1965;94:557.

164. Jones OTG. Ferrochelatase of spinach chloroplasts. *Biochem J* 1968;107:113.

165. Pora RL, Lascelles J. Studies on ferrochelatase: the enzymic formation of haem in protoplastids, chloroplasts and plant mitochondria. *Biochem J* 1968;108:343.

166. Labbe RF, Nielsen L. Clinical-biochemical interpretations of erythrocyte protoporphyrin: ferrochelatase-pyridoxal phosphate studies. In: Doss M, ed. *Porphyrins in human disease*. Basel: Karger, 1976:141.

167. Tokunaga R, Sano S. Comparative studies on nonenzymic and enzymic protoheme formation. *Biochim Biophys Acta* 1972;264:263.

168. Stadtman ER. Allosteric regulation of enzyme activity. *Adv Enzymol Relat Areas Mol Biol* 1966;28:41.

169. Marver HS, et al. d-Aminolevulinic acid synthetase. II. Induction in rat liver. *J Biol Chem* 1966;241:4323.
170. Ebert PS, Ikawa Y. Induction of d-aminolevulinic acid synthetase during erythroid differentiation of cultured leukemia cells. *Proc Soc Exp Biol Med* 1974;146:601.
171. Sassa S. Sequential induction of heme pathway enzymes during erythroid differentiation of mouse Friend leukemia virus-infected cells. *J Exp Med* 1976;143:305.
172. Condie LW, et al. Studies on adrenal d-aminolevulinic acid synthetase. *Arch Biochem Biophys* 1976;172:123.
173. Barnes R, et al. Ferrochelatase and d-aminolaevulate synthetase in brain, heart, kidney and liver of normal and porphyric rats. The induction of d-amino-laevulate synthetase in kidney cytosol and mitochondria by allyl-isopropylacetamide. *Biochem J* 1971;124:633.
174. Yoda B, et al. Induction of d-aminolevulinic acid synthetase in the kidney of chicks treated with porphyrinogenic drugs. *Biochim Biophys Acta* 1974;372:478.
175. Bottomley SS, Smithee GA. Effect of erythropoietin on bone marrow d-amino-levulinic acid synthetase and heme synthetase. *J Lab Clin Med* 1969;74:445.
176. Granick S, Urata G. Increase in activity of d-aminolevulinic acid synthetase in liver mitochondria induced by feeding of 3,5 dicarbethoxyl-1, 4-dihydrocollidine. *J Biol Chem* 1963;238:821.
177. Whiting MJ, Granick S. d-Aminolevulinic acid synthetase from chick embryo liver mitochondria. II. Immunochemical correlation between synthesis and activity in induction and repression. *J Biol Chem* 1976;251:1347.
178. Granick S. The induction in vitro of the synthesis of d-aminolevulinic acid synthetase in chemical porphyria: a response to certain drugs, sex hormones, and foreign chemicals. *J Biol Chem* 1966;241:1359.
179. Sutherland GR, et al. d-Aminolevulinic acid synthase is at 3p21 and thus not the primary defect in X-linked sideroblastic anemia. *Am J Hum Genet* 1988;43:331.
180. Scholnick PL, et al. Soluble d-aminolevulinic acid synthetase of rat liver. II. Studies related to the mechanism of enzyme action and heme inhibition. *J Biol Chem* 1972;247:4132.
181. Sassa S, Granick S. d-Aminolevulinic acid synthetase and the control of heme and chlorophyll synthesis. In: Vogel JH, ed. *Metabolic pathways, vol. V, Metabolic regulation*. New York: Academic Press, 1971.
182. DeMatteis F. Drug interactions in experimental hepatic porphyria. *Enzyme* 1973;16:266.
183. DeMatteis F, Gibbs AH. Stimulation of the pathway of porphyrin synthesis in the liver of rats and mice by griseofulvin, 3, 5-diethoxy-carbonyl-1-1, 4-dihydrocollidine and related drugs. Evidence for two basically different mechanisms. *Biochem J* 1975;146:285.
184. Callissano P, et al. Control of haem synthesis by feedback inhibition on human erythrocyte d-aminolaevulate dehydratase. *Biochem J* 1966;101:550.
185. Frydman RB, et al. Biosynthesis of uroporphyrinogens. Interaction among 2-aminomethyl-dipyrromethane and the enzymatic system. *Biochemistry* 1978;17:110.
186. Kushner JP, et al. The role of iron in the pathogenesis of porphyria cutanea tarda. *J Clin Invest* 1972;51:3044.
187. Tephly TR, et al. Effect of drugs on heme synthesis in the liver. *Metabolism* 1971;20:200.
188. Jones MS, Jones OTG. Permeability properties of mitochondrial membranes and the regulation of heme biosynthesis. *Biochem Biophys Res Commun* 1970;41:1072.

189. Tephly TR, et al. The regulation of heme synthesis related to drug metabolism. *Drug Metab Dispos* 1973;1:259.
190. Wagner GS, Tephly TR. The role of ferrochelatase in the regulation of heme synthesis by drugs and metals. *Pharmacologist* 1973;15:170.
191. Bloomer JR, et al. Study of factors causing excess protoporphyrin accumulation in cultured skin fibroblasts from patients with protoporphyria. *J Clin Invest* 1977;60:1354.
192. Miyake T, King CKH, et al. Purification of human erythropoietin. *J Biol Chem* 1977;252:5558.
193. Dordal MS, Wang FF, et al. The role of carbohydrate in erythropoietin action. *Endocrinology* 1985;116:2293.
194. Cotes MP, Bangham DR. The international reference preparation of erythropoietin. *Bull World Health Organ* 1966;35:751.
195. Lin F-K, Suggs S, et al. Cloning and expression of the human erythropoietin gene. *Proc Natl Acad Sci U S A* 1985;82:7580.
196. Watkins PC, Eddy R, et al. Regional assignment of the erythropoietin gene to human chromosome region 7pter6q22. *Cell Genet* 1986;42:214.
197. Recny MA, Scoble HA, et al. Structural characterization of natural human urinary and recombinant DNA-derived erythropoietin. *J Biol Chem* 1987;262:17156.
198. Browne JK, Cohen AM, et al. Erythropoietin: gene cloning, protein structure, and biological properties. *Cold Spring Harb Symp Quant Biol* 1986;51:693.
199. Davis JM, Arakawa T, et al. Characterization of recombinant human erythropoietin produced in Chinese hamster ovary cells. *Biochemistry* 1987;26:2633.
200. Sytkowski AJ. Denaturation and renaturation of human erythropoietin. *Biochem Biophys Res Commun* 1980;96:143.
201. Wang FF, Kung CKH, et al. Some chemical properties of human erythropoietin. *Endocrinology* 1985;116:2286.
202. Sawyer ST. Receptors for erythropoietin: distribution, structure, and role in receptor-mediated endocytosis in erythroid cells. In: Harris JR, ed. *Blood cell biochemistry. Volume 1: Erythroid cells*. New York: Plenum Press, 1990:365.
203. Goldwasser E, et al. On the mechanism of erythropoietin-induced differentiation. XII. The role of sialic acid in erythropoietin action. *J Biol Chem* 1974;249:4202.
204. Egrie JC, Brown JK. Development and characterization of novel erythropoiesis stimulating protein (NESP). *Nephrol Dial Transplant* 2001;16[Suppl 3]:3.
205. McDonald J, Lin FK, et al. Cloning sequencing and evolutionary analysis of the mouse erythropoietin gene. *Mol Cell Biol* 1986;6:842.
206. Shoemaker CB, Mitscock LD. Murine erythropoietin gene: cloning, expression and human gene homology. *Mol Cell Biol* 1986;6:849.
207. Sytkowski AJ, Donahue KA. Immunochemical studies of human erythropoietin using site specific anti-peptide antibodies. *J Biol Chem* 1987;262:1161.
208. Jacobson LO, Goldwasser E, et al. Role of the kidney in erythropoiesis. *Nature* 1957;179:633.
209. Denny WF, Flanigan, et al. Serial erythropoietin studies in patients undergoing renal homotransplantation. *J Lab Clin Med* 1966;67:386.

210. Beru N, McDonald J, et al. Expression of the erythropoietin gene. *Mol Cell Biol* 1986;6:2571.
211. Bondurant MC, Koury MJ. Anemia induces accumulation of erythropoietin mRNA in the kidney and liver. *Mol Cell Biol* 1986;6:2731.
212. Koury ST, Koury MJ, et al. Quantitation of erythropoietin-producing cells in kidneys of mice by in situ hybridization: correlation with hematocrit, renal erythropoietin mRNA, and serum erythropoietin concentration. *Blood* 1989;74:645.
213. Schuster SJ, Badiavas EV, et al. Stimulation of erythropoietin gene transcription during hypoxia and cobalt exposure. *Blood* 1989;73:13.
214. Koury MJ, Bondurant MC, et al. Erythropoietin messenger RNA levels in developing mice and transfer of <sup>125</sup>I-erythropoietin by the placenta. *J Clin Invest* 1988;82:154.
215. Trimble M, Caro J, et al. Secondary erythrocytosis due to a cerebellar hemangioblastoma. Demonstration of mRNA in the tumor. *Blood* 1991;78:599.
216. Ascensao JL, Gaylis F, et al. Erythropoietin production by a human germ cell line. *Blood* 1983;62:1132.
217. Koury ST, Bondurant MC, et al. Localization of erythropoietin synthesizing cells in murine kidneys by in-situ hybridization. *Blood* 1988;71:524.
218. Koury ST, et al. Localization of cells producing erythropoietin in murine liver by in situ hybridization. *Blood* 1991;77:2497.
219. Lacombe C, DaSilva JL, et al. Peritubular cells are the site of erythropoietin synthesis in the murine hypoxic kidney. *J Clin Invest* 1988;81:620.
220. Bachman S, Hir ML, Echart KU. Co-localization of erythropoietin mRNA and ecto-5'-nucleotidase immunoreactivity in peritubular cells of rat renal cortex indicates that fibroblasts produce erythropoietin. *J Histochem Cytochem* 1993;41:335.
221. Maxwell PH, Osmond MK, et al. Identification of the renal erythropoietin producing cells using transgenic mice. *Kidney Int* 1993;44:1149.
222. Goldberg MA, Dunning SP, et al. Regulation of the erythropoietin gene: evidence that the oxygen sensor is a heme protein. *Science* 1988;242:1412.
223. Semenza GL, Koury ST, et al. Cell type specific and hypoxia inducible expression of the human erythropoietin gene in transgenic mice. *Proc Natl Acad Sci U S A* 1991;88:8725.
224. Beck I, Ramirez S, et al. Enhancer element at the 3' flanking region controls transcriptional response to hypoxia in the human erythropoietin gene. *J Biol Chem* 1991;266:15563.
225. Semenza GL, Nejfelt MK, et al. Hypoxia-inducible nuclear factors bind to an enhancer element located 3' to the human erythropoietin gene. *Proc Natl Acad Sci U S A* 1991;88:5680.
226. Wang GL, Semenza GL. Characterization of hypoxia inducible factor 1 and regulation of DNA binding activity by hypoxia. *J Biol Chem* 1993;268:21513.
227. Wang GL, Semenza GL. General involvement of hypoxia inducible factor 1 in transcriptional response to hypoxia. *Proc Natl Acad Sci U S A* 1993;90:4304.
228. Semenza GL. Regulation of erythropoietin production: new insights into molecular mechanisms of oxygen homeostasis. *Hematol Oncol Clin North Am* 1994;8:863.
229. Semenza GL. Regulation of mammalian oxygen homeostasis by hypoxia-inducible factor 1. *Annu Rev Cell Dev Biol* 1999;15:551.
230. Ivan M, Kondo K, et al. HIF alpha targeted for VHL-mediated destruction by proline hydroxylation:



implications for O<sub>2</sub> sensing. *Science* 2001;292:464.

231. Jaakkola P, Mole DR, et al. Targeting of HIF- $\alpha$  to the von Hippel Lindau ubiquitylation complex by O<sub>2</sub> regulated prolyl hydroxylation. *Science* 2001;292:468.

232. Bruick RK, McKnight SL. A conserved family of prolyl-4-hydroxylases that modify HIF. *Science* 2001;294:1337.

233. Bruick RK, McKnight SL. Oxygen sensing gets a second wind. *Science* 2002;295:807.

234. Lando D, Peet DJ, et al. FIH-1 is an asparaginyl hydroxylase enzyme that regulates the transcriptional activity of hypoxia-inducible factor. *Genes Dev* 2002;16:1466.

235. Wu H, Liu X, et al. Generation of committed erythroid BFU-E and CFU-E progenitors does not require erythropoietin or the erythropoietin receptor. *Cell* 1995;83:59.

236. Sawyer ST, Koury MJ. Erythropoietin requirements during terminal erythroid differentiation: the role of surface receptors for erythropoietin. *J Cell Biol* 1987;105:1077.

237. Sawyer ST, Hankins WD. Erythropoietin receptor metabolism in erythropoietin-dependent cell lines. *Blood* 1988;72:132.

238. Koury MJ, Bondurant MC, et al. Erythropoietin messenger RNA levels in developing mice and transfer of <sup>125</sup>I-erythropoietin by the placenta. *J Clin Invest* 1988;82:154.

239. Sawyer ST, Krantz SB, et al. Receptors for erythropoietin in mouse and human erythroid cells and placenta. *Blood* 1989;74:103.

240. Berridge MV, Fraser JK, et al. Effects of recombinant erythropoietin on megakaryocytes and on platelet production in the rat. *Blood* 1988;72:970.

241. Sawyer ST. Receptors for erythropoietin. Distribution, structure, and role in receptor-mediated endocytosis in erythroid cells. In: Harris JR, ed. *Blood cell biochemistry*, vol. I. New York: Plenum Publishing, 1990:365.

242. Yu X, Shacka JJ, et al. Erythropoietin receptor signaling is required for normal brain development. *Development* 2002;129:505.

243. D'Andrea AD, Lodish HF, et al. Expression cloning of the murine erythropoietin receptor. *Cell* 1989;57:277.

244. Winkelman JC, Penny LA, et al. The gene for the human erythropoietin receptor: analysis of the coding sequence and assignment to chromosome 19p. *Blood* 1990;76:24.

245. Bazan JF. A novel family of growth factor receptors: a common binding domain in the growth hormone, prolactin, erythropoietin and IL-6 receptors, and the p75 IL-2 receptor beta-chain. *Biochem Biophys Res Commun* 1989;164:788.

246. Sawyer ST, Krantz SB, et al. Binding and receptor-mediated endocytosis of erythropoietin in Friend virus infected erythroid cells. *J Biol Chem* 1987;262: 5554.

247. Youssoufian H, Longmire C, Neumann D, et al. Structure, function and activation of the erythropoietin receptor. *Blood* 1993;81:2223.

248. Livnah O, Enrico A, et al. Crystallographic evidence for preformed dimers of erythropoietin receptor before ligand activation. *Science* 1996;273:464.

249. Kubatzky KF, Ruan W, et al. Self assembly of the transmembrane domain promotes signal transduction through the erythropoietin receptor. *Curr Biol* 2001;11:110.

250. Dusanter Fournier I, Casadevall N, Lacombe C, et al. Erythropoietin induces the tyrosine

- phosphorylation of its own receptor in human erythropoietin responsive cells. *J Biol Chem* 1992;267:10670.
251. Witthuhn BA, Quelle SW, Silvennoinen O, et al. JAK2 associates with the erythropoietin receptor and is tyrosine phosphorylated and activated following stimulation with erythropoietin. *Cell* 1993;74:227.
252. Parganas E, Wang D, Stravopodis D, et al. Jak2 is essential for signaling through a variety of cytokine receptors. *Cell* 1998;93:385–395.
253. Neubauer H, Cumano A, et al. Jak2 deficiency defines an essential developmental checkpoint in definitive hematopoiesis. *Cell* 1998;93:397.
254. Sawyer ST, Jacobs–Helber SM. Unraveling distinct intracellular signals that promote survival and proliferation: study of erythropoietin, stem cell factor, and constitutive signaling in leukemic cells. *J Hematother Stem Cell Res* 2000;1:21.
255. Damen JE, Wakao H, et al. Tyrosine 343 in the erythropoietin receptor positively regulates erythropoietin–induced cell proliferation and Stat5 activation. *EMBO J* 1995;14:5557.
256. Zang H, Sato K, et al. The distal region and receptor tyrosines of the Epo receptor are non–essential for in vivo erythropoiesis. *EMBO J* 2001;20:3156.
257. Divoky V, Liu Z, et al. Mouse model of congenital polycythemia: homologous replacement of murine gene by mutant human erythropoietin receptor gene. *Proc Natl Acad Sci U S A* 2001;98:986.
258. Teglund S, McKay C, et al. Stat5a and Stat5b proteins have essential and nonessential, or redundant, roles in cytokine responses. *Cell* 1998;93:841.
259. Socolovsky M, Fallon AE, et al. Fetal anemia and apoptosis of red cell progenitors in Stat5a<sup>–/–</sup>5b<sup>–/–</sup> mice: a direct role for Stat5 in Bcl-X(L) induction. *Cell* 1999;98:18.
260. Zang H, Sato K, et al. The distal region and receptor tyrosines of the Epo receptor are non–essential for in vivo erythropoiesis. *EMBO J* 2001;20:3156.
261. Penta K, Sawyer ST. Erythropoietin induces the tyrosine phosphorylation, nuclear translocation, and DNA binding of STAT1 and STAT5 in erythroid cells. *J Biol Chem* 1995;270:31282.
262. Sakaguchi M, Koishihara Y, et al. The expression of functional erythropoietin receptors on an interleukin–3 dependent cell line. *Biochem Biophys Res Commun* 1987;146:7.
263. Tsao CJ, Tojo A, et al. Expression of the functional erythropoietin receptors on interleukin 3–dependent murine cell lines. *J Immunol* 1988;140:89.
264. Koury MJ, Bondurant MC. Maintenance by erythropoietin of viability and maturation of murine erythroid precursor cells. *J Cell Biol* 1988;137:65.
265. Koury MJ, et al. Erythropoietin control of terminal erythroid differentiation: maintenance of cell viability, production of hemoglobin and development of the erythrocyte membrane. *Blood Cells* 1971;13:217.
266. Koury MJ, Sawyer ST, et al. Splenic erythroblasts in anemia–inducing Friend disease: a source of cells for studies of erythropoietin–mediated differentiation. *J Cell Physiol* 1984;121:526.
267. Sawyer ST, Krantz SB. Erythropoietin stimulates <sup>45</sup>Ca<sup>+</sup> uptake in Friend virus infected cells. *J Biol Chem* 1984;259:2769.
268. Koury MJ, Bondurant MC, et al. Specific differentiation events induced by erythropoietin in cells infected in vitro with the anemia strain of Friend virus. *Proc Natl Acad Sci U S A* 1982;71:635.
269. Bondurant MC, Lind RN, et al. Control of globin gene transcription by erythropoietin in erythroblasts from Friend virus–infected mice. *Mol Cell Biol* 1985;5:675.
270. Sawyer ST, Krantz SB. Transferring receptor number, synthesis, and endocytosis during erythropoietin–induced maturation of Friend virus–infected erythroid cells. *J Biol Chem* 1986;261:9187.

271. Koury MJ, Bondurant MC, et al. The role of erythropoietin in the production of principal erythrocyte proteins other than hemoglobin during terminal erythroid differentiation. *J Cell Physiol* 1986;126:259.
272. Koury MJ, Bondurant MC. Erythropoietin retards DNA breakdown and prevents programmed death in erythroid progenitor cells. *Science* 1990;248:273.
273. Clark DA, Dessypris EN. Effects of recombinant erythropoietin on murine megakaryocytic colony formation in vitro. *J Lab Clin Med* 1986;108:423.
274. Dessypris EN, Gleaton JH, et al. Effect of human recombinant erythropoietin on human marrow megakaryocyte colony formation in vitro. *Br J Haematol* 1987;65:265.
275. Ishibashi T, Koziol JA, et al. Human recombinant erythropoietin promotes differentiation of murine megakaryocytes in vitro. *J Clin Invest* 1987;79:286.
276. Fraser JK, Tan AS, et al. Expression of specific high affinity binding sites for erythropoietin on rat and mouse megakaryocytes. *Exp Hematol* 1989;17:10.
277. McDonald TP, Cottrell MB, et al. High doses of recombinant erythropoietin stimulate platelet production in mice. *Exp Hematol* 1987;15:719.
278. Eschbach JW, Abdulhadi MH, et al. Recombinant human erythropoietin in anemic patients with end-stage renal disease. Results of a phase III multicenter clinical trial. *Ann Intern Med* 1989;111:992.
279. Lok SI, Kaushansky K, Holly RD, et al. Cloning and expression of murine thrombopoietin cDNA and stimulation of platelet production in vivo. *Nature* 1994;369:565.
280. Caro J, Erslev AJ. Erythropoietin assays and their use in the study of anemias. *Contrib Nephrol* 1988;66:54-60.
281. Kazal LA, Erslev AJ. The measurement of erythropoietin. *Ann Clin Lab Sci* 1975;5:91.
282. Cotes PM. Immunoreactive erythropoietin in serum. I. Evidence for the validity of the assay method and the physiologic relevance of estimates. *Br J Haematol* 1982;50:427.
283. Garcia JF. The radioimmunoassay of human plasma erythropoietin. In: Gordon AS, Condorelli M, Peschle C, eds. *Regulation of erythropoiesis*. Milan: Il Ponte, 1972:132.
284. Sherwood JB, Goldwasser E. A radioimmunoassay for erythropoietin. *Blood* 1979;54:885.
285. Egrie JC, Cotes MP, et al. Development of radioimmunoassays for human erythropoietin using recombinant erythropoietin as tracer and immunogen. *J Immunol Methods* 1987;99:235.
286. Egrie JC, Lane J. Development of a radioimmunoassay for erythropoietin using recombinant erythropoietin derived reagents. In: Rich JN, ed. *Molecular and cellular aspects of erythropoietin and erythropoiesis*. Berlin: Springer-Verlag, 1987:395.
287. Sherwood JB, et al. The heterogeneity of circulating human serum erythropoietin. *Endocrinology* 1988;122:1472.
288. Baer AN, Dessypris EN, et al. Blunted erythropoietin response to anemia in rheumatoid arthritis. *Br J Haematol* 1987;66:559.
289. Miller CB, et al. Decreased erythropoietin response in patients with anemia of cancer. *N Engl J Med* 1990;322:1689.
290. Beguin Y, Yerna M, Loo M, et al. Erythropoiesis in multiple myeloma: defective red cell production due to inappropriate erythropoietin production. *Br J Haematol* 1992;82:648.
291. Sherwood JB, et al. Sick cell anemia patients have low erythropoietin levels for their degree of anemia. *Blood* 1986;67:46.

292. Spivak JL, Burns DC, Fuchs E, et al. Serum immunoreactive erythropoietin in HIV-infected patients. *JAMA* 1989;261:3104.
293. Brown MS, et al. Decreased response of plasma immunoreactive erythropoietin to available oxygen in anemia of prematurity. *J Pediatr* 1984;105:793.
294. Koeffler HP, Goldwasser E. Erythropoietin radioimmunoassay in evaluating patients with polycythemia. *Ann Intern Med* 1981;94:44.
295. Cotes MP, et al. Determination of serum immunoreactive erythropoietin in the investigation of erythrocytosis. *N Engl J Med* 1986;315:283.
296. Birgegard G, Wide L. Serum erythropoietin in the diagnosis of polycythemia and after phlebotomy treatment. *Br J Haematol* 1992;81:603.

2004 Lippincott Williams & Wilkins  
John P. Greer, John Foerster, John N. Lukens  
George M. Rodgers, Frixos Paraskevas, Bertil Glader  
Wintrobe's Clinical Hematology

EVOLUTION OF OUR UNDERSTANDING OF THE ERYTHROCYTESTRUCTURAL FEATURESShape and DimensionsDeformabilityERYTHROCYTE MEMBRANE AND CYTOSKELETONMembrane StructureUltrastructureChemical Composition of the MembraneMembrane ProteinsHEMOGLOBIN AND ERYTHROCYTE FUNCTIONEvolution and Structure of HemoglobinOntogeny of HemoglobinsModifications of Normal HemoglobinLaboratory Analysis of HemoglobinsStructure of GlobinAssembly of HemoglobinOxygen TransportCarbon Dioxide TransportNitric Oxide: Another Allosteric Effector of HemoglobinOxidative Denaturation of Hemoglobin: Its Reversibility and PreventionMethemoglobin ReductionEnzymes Reacting with Products of the Reduction of OxygenGlutathione MetabolismEnergy MetabolismREFERENCES**EVOLUTION OF OUR UNDERSTANDING OF THE ERYTHROCYTE**

Erythrocytes were first described in the seventeenth century. The Dutch microscopist, Leeuwenhoek, took note of them, as did Malpighi, who mistook them for fat globules “looking like a rosary of red coral.” For many years, erythrocytes were not believed to be of any importance. The presence of iron in blood was demonstrated by Lemery in the seventeenth century, but not until 1851 did Funke isolate hemoglobin in crystalline form. The functional significance of red corpuscles was only appreciated, however, when Hoppe–Seyler demonstrated that hemoglobin has the property of readily taking up and discharging oxygen. This, then, was considered the primary or even sole function of the red cell (along with CO<sub>2</sub> exchange) until the late twentieth century. Now, however, our understanding of erythrocyte function has broadened to include O<sub>2</sub>, CO<sub>2</sub>, and nitric oxide (NO) exchange as well as immune clearance and, possibly, clearance of other soluble blood components such as cytokines.

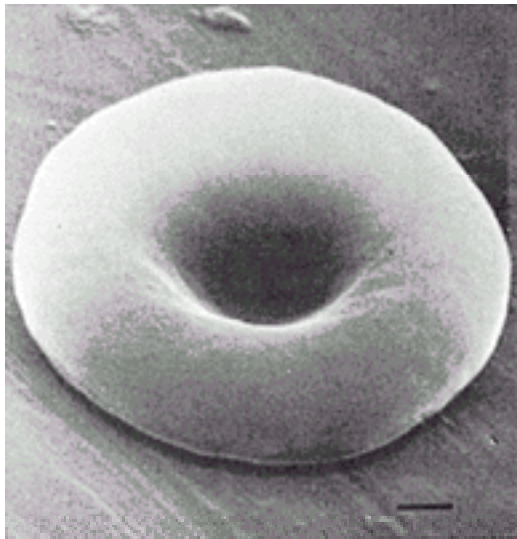
**STRUCTURAL FEATURES**

The uniquely anuclear mature human erythrocyte is one of the most highly specialized of cells. Lacking such cytoplasmic organelles as nucleus, mitochondria, or ribosomes, the red cell is unable to synthesize new protein, carry out the oxidative reactions associated with

mitochondria, or undergo mitosis. More than 95% of the cytoplasmic protein is hemoglobin. The remainder includes those enzymes required for energy production and for the maintenance of hemoglobin in a functional, reduced state. However, the erythrocyte expresses a perhaps surprising number of proteins that subserve functions we associate with other cells, including a variety of transport proteins, adhesion molecules, receptors, and signaling pathways. Thus, the red cell is now recognized to perform a number of crucial and complex functions in the human body.

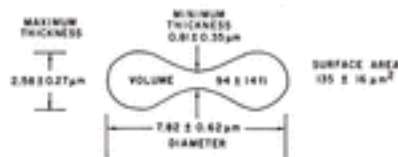
### Shape and Dimensions

At rest, the normal human erythrocyte is shaped like a flattened, bilaterally indented sphere, a shape often referred to as a *biconcave disk* ( [Fig. 8.1](#)). In fixed, stained blood smears, only the flattened surfaces are observed; hence, on fixed blood films, the erythrocyte appears circular, with a diameter of approximately 7 to 8 microns and an area of central pallor corresponding to the indented regions.



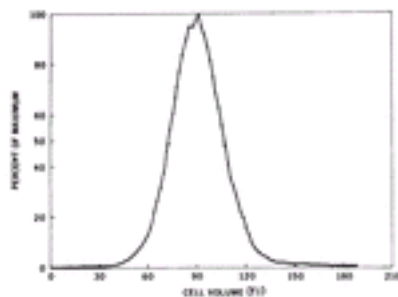
**Figure 8.1.** The normal mature erythrocyte as visualized by the scanning electron microscope ( $\times 9800$ ). (Courtesy of Dr. Wallace N. Jensen.)

The dimensions of the red cell in the living state have been estimated by measurements made in photomicrographs ( [Fig. 8.2](#)) ( [1](#), [2](#) and [3](#)). For this purpose, the cells are suspended in isotonic solutions and photographed on edge. With ordinary light microscopy, the potential error associated with imprecision of focus is approximately 0.50 microns. This value can be reduced to 0.02 microns by means of holography with the interference microscope ( [2](#)). Dimensions obtained by the latter method are somewhat smaller than those reported in earlier studies ( [1](#)). With drying and staining, the cell shrinks so that diameters measured in fixed preparations are somewhat smaller than those of cells in isotonic solutions. The painstaking studies of Price-Jones yielded an average normal value for red cell diameter of 7.2 to 7.4 microns ( [4](#)).



**Figure 8.2.** Dimensions of a cross section of the erythrocyte in isotonic solution. Values are means  $\pm$  one standard deviation. (From Evans E, Fung YC. Improved measurements of erythrocyte geometry. *Microvasc Res* 1972;4:335, with permission.)

Indirect measurements of cell volume are consistent with values obtained using the microscopic method. Average values for the mean cellular volume in normal subjects range from 85 to 91 fl, depending on the combination of methods used. The variation in cell size can be documented by means of a frequency distribution curve of red cell volumes generated from the output of a Coulter counter (Fig. 8.3). Although some studies have suggested that red cell volumes are lognormally distributed (5), the size distribution is symmetric (6). Ninety-five percent of normal red cells are between approximately 60 and 120 fl in volume (5). However, some workers have challenged these values using transmission electron microscopy and stereology. They estimate that the true volume of mature red cells is only 44 fl, and that only 51% of the volume of the red cell column observed in a hematocrit tube is occupied by erythrocytes (7). It is interesting that these newer methods also calculate that erythrocytes have 44% more membrane surface area than necessary to accommodate cytoplasmic contents in a sphere (7), a figure very close to that estimated using earlier techniques (8).



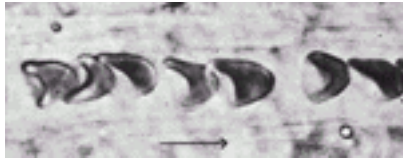
**Figure 8.3.** Frequency distribution curve of erythrocyte volume. The cells are normally distributed about a mean volume of 90 fl. (Modified from Bessman JD, Johnson RK. Erythrocyte volume distribution in normal and abnormal subjects. *Blood* 1975;46:369.)

Total hemoglobin content and red cell volume vary considerably more than does hemoglobin concentration (9). It has been proposed that mature red cell size and hemoglobin content are primarily dependent on erythroid precursor cell size at the last cell division during erythropoiesis. Reticulocytes are 24 to 35% larger than mature red cells, although they have similar total hemoglobin content (and thus a lower hemoglobin concentration) (10).

The disk shape is well suited to erythrocyte function. The ratio of surface to volume approaches the maximum possible value in such a shape (11), thereby facilitating both gas transfer and deformability as the red cell traverses the microcirculation (12). When red cell movements within small blood vessels were observed by cinemamicrography (13), the plane of the biconcave disk was found to be oriented in the direction of flow. The



leading edge became pointed and the following edge blunted ( [Fig. 8.4](#)); thus, the shape was similar to that of a parachute or torpedo viewed from the side. When deformed in this way, the erythrocyte can pass through a vessel of approximately 4 microns in maximum diameter. Erythrocyte shape may also vary between large and small vessels and under conditions of high or low shear stress. Circulating erythrocytes rarely appear to be biconcave disks in the murine abdominal aorta, whereas typical biconcave discoid shapes were common in the inferior vena cava ( [14](#)).



**Figure 8.4.** Human erythrocytes flowing through a vessel approximately 7  $\mu\text{m}$  in diameter. Direction of flow is indicated by the arrow. (From Skalak R, Branemark P-I. Deformation of red blood cells in capillaries. *Science* 1969;164:717, with permission.)

## Deformability

The erythrocyte is remarkable for its ability to maintain membrane integrity while exhibiting extreme deformability under normal physiologic circumstances ( [15](#)). Without undergoing extensive remodeling, the erythrocyte membrane withstands high shear stresses, rapid elongation and folding in the microcirculation, and deformation as the erythrocyte passes through the small fenestrations of the spleen. Cell deformability depends on both the membrane and the cytoplasm; however, the cytoplasm of normal erythrocytes (as opposed to sickled erythrocytes, for example) acts as an ideal liquid and, at physiologic concentration, has very low viscosity ( [15](#)). Thus, it is the elasticity and viscosity of the membrane that are crucial for deformability.

At least three sets of circumstances result in a spherical erythrocyte shape: osmotic (hypotonic) swelling, discocyte–echinocyte transformation, and discocyte–stomatocyte transformation. To a point, all three types of shape change are reversible. Osmotic swelling ( [1](#)) occurs when erythrocytes are suspended in hypotonic solutions. Under such circumstances, the cell acquires water and swells, first becoming cup-shaped and then spherical. These changes are associated with an increase in volume, whereas the cell–surface area remains the same or increases only slightly ( [2](#)).

Discocyte–echinocyte transformation ( [16](#)) takes place when intracellular adenosine triphosphate (ATP) is depleted ( [17](#)), when intracellular calcium content is increased ( [18](#)), when the cell is exposed to stored plasma, high pH, anionic detergents, lysolecithin, or fatty acids, or when the cell is washed and placed between a glass (not plastic) slide and coverslip ( [1](#)). ATP depletion reversibly transforms erythrocytes to spiculated spherocytocytes; restoration of ATP leads to gradual resumption of normal shape ( [17](#)). Transformation because of ATP depletion or other factors proceeds through several recognizable stages ( [Fig. 8.5](#)). First, the disk becomes irregularly contoured (echinocyte I); second, crenations (regularly spaced spicules or projections) appear on the flat surface (echinocyte II); third, the cell becomes ovoid or spherical, with approximately 30 evenly spaced spicules projecting from the surface (echinocyte III); fourth, the cell becomes more distinctly spherocytic, with tiny spicules (spherocytocyte I); and ultimately, these spicules become so small that they can be appreciated only with the scanning electron

microscope (spherocyte II) ( [19](#) ). The last stage is irreversible and is sometimes referred to as a “prelytic” sphere.



**Figure 8.5.** Shape transformations of the discoid erythrocyte. Erythrocytes may undergo transformation from a biconcave disk to an echinocyte or to a stomatocyte. Each transformation occurs via different intermediate shape changes. (From Bull BS, Brailsford D. Red blood cell shape. In: Agre P, Parker JC, eds. Red blood cell membranes—structure, function, clinical implications. New York: Marcel Dekker Inc, 1989, with permission.)

Discocyte–stomatocyte transformation ( [20](#) ) occurs when red cells are exposed to low pH, cationic detergents such as *polysorbate 80*, or phenothiazines. As the change proceeds, the cell loses the indentation on one side, and the opposite dimple increases in depth, producing a bow tie, then cup-shaped cell. Because such cells appear on fixed smears to have a mouthlike “stoma” instead of a round area of central pallor, they are known as *stomatocytes*. As the change progresses, the cells become spherostomatocytes and, finally, spherocytes with only a small hilum remaining at the former site of the stoma. Such cells lack the small spicules that characterize the end-stage prelytic spherocyte resulting from discocyte–echinocyte transformation.

Although many circumstances can lead to transformation of the red cell from a disk to a sphere, some of them appear to act through effects on the erythrocyte plasma membrane anion transporter (AE1, described more fully below) ( [21](#) ). AE1 also provides a critical linkage to the membrane skeleton, and it is the interrelationship of these two functions that is proposed to account for these shape transformations. Spherocytic transformation is linked to the ratio of chloride ion influx and efflux ( $Cl^-_i/Cl^-_o$ ), and many if not all conditions that lead to spherocytic transformation alter this ratio. It is thus theorized that the same conformational change that determines whether AE1 facilitates the inward or outward flow of  $Cl^-$  also alters the interaction of AE1 with ankyrin (and thus with spectrin), major components of the erythrocyte cytoskeleton.

Thus far, the factors acting within the membrane to maintain its elastic properties, as well as those that act on it, are still only partially understood. Among the factors that affect membrane deformability and stability are membrane lipid content, cytoskeletal proteins, and transmembrane proteins.

A large body of evidence supports the role of lipid type and distribution in maintenance of membrane integrity and normal function, and abnormalities in distribution of lipids between the inner and outer leaflets are associated with changes in mechanical properties of membranes as well as with the strength of association between the membrane and the cytoskeleton ( [22](#) ). The cytoskeleton, formed by a latticelike network of proteins, undoubtedly contributes to the bending energy necessary for assumption of the biconcave shape, as well as to membrane stability ( [23](#) ). Abnormalities in cytoskeletal proteins cause a variety of pathologically shaped red cells, including spherocytes and elliptocytes ( [24](#) ). Abnormalities of both expression and function of transmembrane proteins, such as AE1, also affect membrane mechanical properties ( [25](#), [26](#) ). In addition, proteins adsorbed to the outer surface of the red cell, especially albumin, may also play a role in both maintaining normal cell shape and effecting changes in that shape under some conditions. Red cells suspended in isotonic medium tend toward an echinocytic shape

until albumin is added, and increasing amounts of albumin move cells toward the discoid shape ( [27](#) ).

## ERYTHROCYTE MEMBRANE AND CYTOSKELETON

### Membrane Structure

The central feature of membrane structure is a matrix formed by a double layer of phospholipids. The lipid bilayer hypothesis, first proposed in 1925 ( [28](#) ) and refined by Danielli and Davson in 1935 ( [29](#) ), is now generally accepted ( [30](#) , [31](#) ). Lipid molecules in the bilayer are oriented with the nonpolar groups directed toward one another, forming hydrophobic interactions. The hydrophilic polar-head groups are directed outward, where they interact with the aqueous environment on both the cytoplasmic and plasma surfaces.

The best-accepted concept of how proteins fit into the lipid membrane structure is the so-called fluid mosaic model ( [32](#) ). The lipid bilayer may be thought of as a two-dimensional, viscous solution. Within this “sea of lipids” float globular proteins, some that penetrate the membrane completely and others that penetrate the membrane only partially and may be exposed at only one surface. Some proteins appear to have considerable lateral mobility, but in the red cell, many proteins interact with other membrane components, giving them a degree of immobility. Some proteins traverse the lipid bilayer once, whereas others have multiple membrane-spanning domains. On the cytoplasmic side of the membrane lies a network of structural proteins that form a cytoskeleton. Certain membrane-spanning proteins appear to interact with various cytoskeletal proteins ( [33](#) ). Some transmembrane proteins also appear to become covalently linked to lipid ( [34](#) ), and the so-called glycosylphosphatidylinositol-anchored class of proteins have no membrane-spanning domain but instead have their own phospholipid “tails” by which they are attached to the membrane ( [35](#) ).

### Ultrastructure

In thin sections of erythrocyte membrane fixed with either osmium tetroxide or potassium permanganate, three distinct layers are observed. Two electron-dense (osmophilic) layers approximately 2.5 nm (25 Å) in thickness are separated by an electron-penetrable layer approximately 2.0 nm thick, for a total thickness of some 7.0 nm ( [36](#) ). This appearance has often been cited in support of the lipid bilayer structure, with the electron-dense areas representing either membrane protein layers or the polar ends of the phospholipids ( [37](#) ).

With air-dried, metal-shadowed red cell membranes, features of the surface are made apparent ( [38](#) ). In such preparations, plaques approximately 3.0 nm thick and 10 to 50 nm in diameter are randomly distributed over the surface. These observations have been used to suggest the existence of lipid-protein subunits.

Still another technique used in electron microscopic analysis of membranes is that of “freeze-cleaving” ( [39](#) ). Erythrocytes are frozen rapidly at  $-150^{\circ}$  C and fractured with a razor blade. The cleavage plane follows pathways of least resistance, often exposing large areas of membrane. These surfaces are replicated with condensed carbon and platinum, and the replicas are examined with the electron microscope. Two types of membrane surfaces are observed with this technique. Both surfaces are characterized by the presence of particles approximately 10 nm in diameter. The two surfaces differ in that one has four to five times as many of these particles as the other (2600 to 3800/ $\mu\text{m}^2$  as

compared with 575 to 1400/ $\mu\text{m}^2$ ). Membrane cleavage likely occurs in the nonpolar region between the two lipid layers, the particles representing proteins suspended in the lipid layer, as predicted by the fluid mosaic model.

The “quick-freezing” and “deep-etching” method of examining unfixed erythrocytes by electron microscopy has succeeded in providing a three-dimensional picture of the membrane cytoskeleton, whose proteins are organized into structured but deformable arrays (40).

### Chemical Composition of the Membrane

Much that is known about red cell membranes is derived from studies of the insoluble portion of the cell remaining after hemolysis induced by osmotic rupture. This material has been called *stroma* and, if the membrane remains intact after hemolysis, red cell “ghosts.” It consists largely of components of the membrane, including the cytoskeleton. With careful attention to pH and osmolarity, one can prepare ghosts with only small amounts of residual hemoglobin (44). Approximately 230 to 300 mg of such relatively hemoglobin-free material can be extracted from 0.1 liter of erythrocytes. Such preparations contain approximately 52% protein, 40% lipid, and 8% carbohydrate by weight (44). Most of the carbohydrate is accounted for by the oligosaccharide portion of glycoproteins, but a small fraction (approximately 7%) is carried by glycolipids (44, 45).

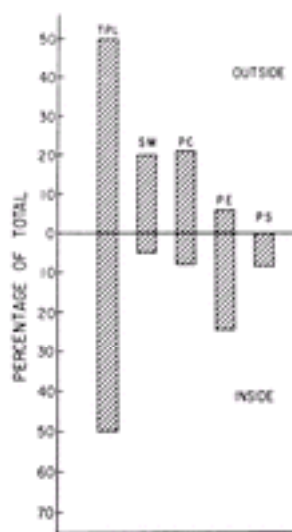
**LIPID COMPOSITION** Virtually all of the lipids in the mature erythrocyte are found in the membrane (41). Qualitative and quantitative analyses have been performed, and the data have been the subject of several reviews (43, 44, 45, 46 and 47). These results are summarized in Table 8.1. Values in children differ only slightly from those found in adults (48).

**TABLE 8.1. Lipids of the Normal Human Erythrocyte Membrane**

| Lipid                               | Molar Concentration (45)      |            | Weight Concentration (44)  |            |
|-------------------------------------|-------------------------------|------------|----------------------------|------------|
|                                     | $\mu\text{mol}/10^{10}$ cells | % of Total | mg/ $10^{10}$ cells        | % of Total |
| Phospholipids                       |                               |            |                            |            |
| Phosphatidylcholine (lecithin)      | 1.30                          |            | 1.0                        |            |
| Phosphatidylethanolamine (cephalin) | 1.20                          |            | 0.9                        |            |
| Sphingomyelin                       | 1.00                          |            | 0.8                        |            |
| Phosphatidylserine                  | 0.60                          |            | 0.4                        |            |
| Lysolecithin                        | 0.04                          |            | —                          |            |
| Others                              | 0.07                          |            |                            |            |
| Total phospholipids                 | 4.20                          | 49.5       | 3.1 (1.7–3.2) <sup>a</sup> | 69         |
| Cholesterol                         | 4.00                          | 47.1       | 1.3 (1.1–1.4) <sup>a</sup> | 29         |
| Glycolipids (globoside)             | 0.21                          | 3.4        | 0.1                        | 2          |
| Total lipids                        | 8.41                          | 100        | 4.5 (3.9–5.2) <sup>a</sup> | 100        |

<sup>a</sup> Range in parentheses.

The majority of erythrocyte membrane lipids are either phospholipids or unesterified cholesterol, which are present in approximately equimolar quantities. Four classes of compounds account for most of the phospholipid: phosphatidylcholine (lecithin), phosphatidylethanolamine (PE), sphingomyelin, and phosphatidylserine ( [Table 8.1](#)). Two fatty-acid side chains are attached to all of these lipids except sphingomyelin, which has only one. In addition, trace amounts of other phospholipids containing only one fatty acid (“lysophospholipids,” e.g., lysolecithin) or having a vinyl ether (plasmalogens) in place of a fatty acid are found. Phospholipids are distributed asymmetrically between the two lipid layers of the membrane ( [49](#), [50](#)). Eighty percent or more of the aminophosphatides (PE and phosphatidylserine) lie within the inner (cytoplasmic) monolayer, whereas the choline-containing lipids (phosphatidylcholine and sphingomyelin) are the major components of the outer monolayer ( [Fig. 8.6](#)). Little or no phosphatidylserine is detectable in the outer lipid layer of normal, nonenescent red cells. The functional importance of the asymmetric distribution of phospholipids in the two erythrocyte membrane lipid layers is not completely understood, although study of certain pathologic conditions and experimental models has provided clues to both the role and regulation of this asymmetry. For example, when erythrocytes containing hemoglobin S and little or no hemoglobin A are subjected to reduced oxygen tension ( $PO_2$ ), the outer lipid layer shows increased amounts of PE and phosphatidylserine, whereas the distribution of sphingomyelin is unchanged ( [45](#)). The change in lipid sidedness correlates with loss of the ability to undergo echinocyte transformation, implicating a role for lipid distribution in regulating shape and also implying that the regulation of distribution of some phospholipids may be independent of the regulation of distribution of others. Maintenance of normal asymmetry results in improved mechanical membrane stability under applied shear stress and further appears to supply additional means for cytoskeleton attachment to the lipid bilayer through spectrin–phosphatidylserine interaction ( [26](#)).



**Figure 8.6.** Distribution of erythrocyte phospholipids between the inner and outer layers of the membrane. PC, phosphatidylcholine; PE, phosphatidylethanolamine; PS, phosphatidylserine; SM, sphingomyelin; TPL, total phospholipid. (From Rothman JE, Lenard J. Membrane asymmetry. *Science* 1977;195:743, with permission.)

The lateral mobility of lipids in the outer membrane layer exceeds that of lipids in the inner layer. Although cholesterol is known to restrict lipid lateral mobility ( [51](#)), the outer lipid layer likely is relatively enriched in cholesterol ( [52](#)). Some investigators believe that lipids in the inner layer are restricted in their mobility because of interactions of phospholipids with cytoskeletal proteins ( [26](#), [53](#), [54](#)). An additional effect on lipid mobility and membrane deformability may come from the fact that the fatty acids found in erythrocyte phospholipids also are not distributed evenly between the two bilayers ( [49](#), [55](#)).

, <sup>56</sup> and <sup>57</sup>). Overall, approximately one-half of the fatty acids in the membrane are unsaturated ( [Table 8.2](#)). Unsaturated fatty acids, however, and particularly the polyunsaturated acyl chains with four or more double bonds, are a disproportionately large part of the inner leaflet phospholipids, PE and phosphatidylserine. In contrast, phosphatidylcholine, which is predominantly in the outer lipid layer, contains most of the shorter-chain saturated fatty acids. Sphingomyelin is especially enriched in fatty acids with a chain length longer than 20. Membranes rich in sphingomyelin are less “fluid” than those with relatively larger amounts of lecithin ( <sup>58</sup>). An increased ratio of sphingomyelin to lecithin is found in abetalipoproteinemia and probably accounts for the erythrocyte abnormalities associated with that disorder ( <sup>55</sup>).

**TABLE 8.2. Fatty Acids in Erythrocyte Phospholipids**

| Fatty Acid        | Molecular Designation <sup>a</sup> | Percent |
|-------------------|------------------------------------|---------|
| Saturated         |                                    |         |
| Palmitic          | 16:0                               | 24.5    |
| Stearic           | 18:0                               | 19.0    |
| Others            | —                                  | 3.1     |
| Total saturated   | —                                  | 46.6    |
| Unsaturated       |                                    |         |
| Oleic             | 18:1                               | 16.4    |
| Linoleic          | 18:2                               | 11.2    |
| Arachidonic       | 20:4                               | 15.1    |
| Others            | —                                  | 10.3    |
| Total unsaturated | —                                  | 53.0    |

<sup>a</sup> The first number indicates the number of carbons; the second, the number of double bonds.

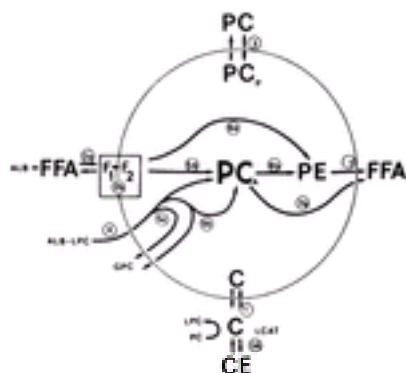
From Ways P, Hanahan DJ. Characterization and quantification of red cell lipids in normal man. *J Lipid Res* 1964;5:318, with permission.

The neutral lipid of the erythrocyte consists almost entirely of free, nonesterified cholesterol ( <sup>58</sup>). The distribution of cholesterol in the two membrane layers has been extremely difficult to study, at least in part because the translocation rate of cholesterol between the two layers is extremely rapid. Although findings in one report suggested that cholesterol is somewhat over-represented in the outer lipid layer ( <sup>53</sup>), further data need to be gathered. Cholesterol has a pronounced effect on membrane fluidity ( <sup>59</sup>, <sup>60</sup>). It interacts with phospholipids to form what has been called an “intermediate gel state.” Thus, as compared with pure phospholipid membranes, membranes containing cholesterol are less fluid, that is, more viscous. Relatively modest increases in membrane cholesterol content decrease membrane deformability ( <sup>61</sup>). Abnormally high levels of cholesterol lead to distortions in red cell shape: Bizarre spicules form (“spur cells”), deformability of the cells is reduced, and they are destroyed in the spleen. Glycolipids (or glycosphingolipids) make up a small fraction of the total lipids of the erythrocyte membrane ( <sup>42</sup>). These glycolipids resemble sphingomyelin in that the lipid base is a unit known as *ceramide*, consisting of sphingosine and a long-chain fatty acid. Attached to the base is a variable number of hexose molecules. The predominant erythrocyte glycolipid, globoside (GL-4), contains four hexose units: ceramide-glucose-galactose-galactose-N-acetylgalactosamine. Globoside appears to be a component only of plasma membranes and is not present in the membranes of intracellular organelles such as mitochondria. In this respect, it differs from cholesterol



and the phospholipids, which are distributed widely. Globoside is particularly characteristic of the red cell membrane but has also been isolated from plasma membranes of several other cell types. Normal human red cells also contain ceramide glycolipids with one glucose (GL-1), one glucose and one galactose (GL-2), and one glucose and two galactose (GL-3) molecules attached. The relative proportions of the glycolipids are as follows: GL-4, 69%; GL-3, 12%; GL-2, 14%; and GL-1, 5% (42). In addition, fucose-containing ceramide glycolipids are present in trace amounts. These are of interest because they are surface structures that have antigenic activity corresponding to the A, B, H, and Lewis blood groups. They are not the exclusive bearers of these antigens, however, because glycoproteins with similar hexose arrangements have similar antigenic properties.

**LIPID TURNOVER AND ACQUISITION** The mature erythrocyte is unable to synthesize lipids *de novo*; therefore, any lipid loss must be compensated for by renewal from pathways of interchange with the plasma (Fig. 8.7) (57). Quantitatively, the most important of these pathways is the transfer of cholesterol and phosphatidylcholine (lecithin) from plasma lipoproteins to red cells (pathways 1 and 3 in Fig. 8.7). The rates of transfer are functions of the relative plasma and red cell levels of these lipids and are indirectly affected by the activity of the cholesterol esterifying enzyme in plasma, lecithin-cholesterol acyltransferase (LCAT) (62). This enzyme catalyzes the reaction in which a fatty acid in the 2 position of lecithin is transferred to free cholesterol, forming cholesterol ester and lysolecithin (Fig. 8.7, reaction 1A). Neither of the LCAT reaction products can enter the membrane. In patients with congenital LCAT deficiency, membrane cholesterol and lecithin are increased, and the red cells are target shaped (63).



**Figure 8.7.** Pathways of lipid acquisition and turnover in the mature red cell membrane. Alb, albumin; C, cholesterol; CE, cholesterol ester; FFA, free fatty acid; GPC, glycerylphosphoryl choline; LCAT, lecithin-cholesterol acyltransferase; LPC, lysophosphatidyl choline; LPE, lysophosphatidyl ethanolamine; PC, phosphatidyl choline (lecithin); PE, phosphatidyl ethanolamine. Reactions and pathways are as follows: 1. Exchange of C with plasma lipoprotein. 1A. The LCAT reaction. 2a. Transfer of FFA from Alb to membrane. 2b. Penetration of FFA to a metabolically active site. 3. Exchange of PC with plasma lipoprotein. 4. Transfer of LPC from Alb to membrane. 5a.  $LPC + FFA \rightarrow PC$ . 5b.  $2LPC \rightarrow FFA + GPC$ . 5c.  $LPC \rightarrow FFA + GPC$ . 6a.  $LPE + FFA \rightarrow PE$ . 6b.  $PC + LPE \rightarrow LPC + PE$ . 7.  $PE \rightarrow LPE + FFA$ . 7b.  $PC \rightarrow LPC + FFA$ . (From Shohet SB. Hemolysis and changes in erythrocyte membrane lipids. N Engl J Med 1972;286:577, with permission.)

The exchange of cholesterol and lecithin between red cells and plasma is also affected by the plasma bile salt concentration (64). If erythrocytes are incubated in normal plasma to which bile salts have been added, the cells acquire cholesterol, and this change is accompanied by an increase in surface area and the formation of target cells. Although the mechanism of bile salt action is not fully understood, at least two properties appear important: Bile salts inhibit the LCAT reaction, and, in addition, they bring about a shift in the distribution of free cholesterol between plasma and cell. Phospholipids also may be added to the membrane by three other reactions. Albumin-bound lysophospholipid may be transferred to the membrane (Fig. 8.7, pathway 4) and acylated (Fig. 8.7, reactions 5a



and 6a) to form a complete phospholipid ( 57 ). Of lesser quantitative importance is the transfer and conjugation of two lysophospholipid molecules to yield a phospholipid ( Fig. 8.7, reaction 5b) and glycerylphosphorylcholine, which returns to the plasma ( 65 ). Finally, some PE is produced by transacylation of a fatty acid from lecithin to lyso-PE ( Fig. 8.7, reaction 6b). A congenital defect in the last reaction results in the formation of cells that possess increased membrane lecithin and decreased membrane PE ( 66 ). These changes are associated with the clinical picture of nonspherocytic hemolytic anemia. The fatty acid composition, but not the major relative proportions of the phospholipid classes, may be altered by diet ( 67, 68 ). With low-fat diets, linoleic acid levels decrease. With diets high in linoleic acid, the amount of red cell linoleic acid increases. These changes occur relatively slowly, over approximately 4 to 6 weeks. The levels of myristic, arachidonic, and oleic acids in plasma membrane lipids are also affected by diet.

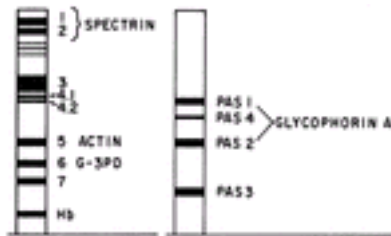
## Membrane Proteins

Early in the history of membrane biochemistry, erythrocytes became the model system for the study of plasma membranes because they lacked organelle and nuclear membranes, making the plasma membranes easy to isolate. Solubilization of membrane proteins can be accomplished by the addition of detergent. Detergent usually is added to red cell ghosts, made relatively hemoglobin-free after hypotonic lysis of red cells ( 41 ). However, different erythrocyte membrane proteins are variably soluble in detergents. Nonionic detergents, which do not denature most proteins, efficiently solubilize some membrane proteins but leave several others, especially those with strong attachments to the cytoskeleton, unsolubilized. Use of an ionic detergent, most commonly sodium dodecyl sulfate (SDS), accomplishes solubilization of essentially all membrane proteins, although at the cost of denaturing the proteins, in some cases irreversibly.

Proteins extracted from membranes by detergent solubilization can be separated and analyzed with relatively high resolution by means of electrophoresis in polyacrylamide gels ( 42, 69 ). Such gels are stained by protein stains, usually Coomassie Brilliant Blue or silver stain, or by reagents that react with carbohydrate, such as periodic acid-Schiff (PAS). Alternatively, proteins are first labeled with a variety of radioactive reagents, and then the gels are exposed to x-ray film, a process known as *autoradiography*. One radiolabeling method is radioiodination of tyrosine residues performed using intact erythrocytes. This method radiolabels many of the membrane proteins that have extracellular domains but fails, naturally, to label cytoskeletal proteins. Failure to be radioiodine-labeled also occurs, however, among membrane proteins such as glycoporphin C, because they lack available extracellular tyrosine residues. Each of these methods thus yields a different picture of membrane proteins, as different proteins are stained or radiolabeled by each of these methods, and no method identifies all proteins. Additional methods of identifying proteins in gels include coupling of surface structures to small molecules such as avidin (that can then be stained using a biotin-conjugate) or <sup>3</sup>H-containing sugars (a nontyrosine but carbohydrate-dependent method of radiolabeling). Finally, many important membrane proteins are not expressed in sufficient quantity to be distinguishable among the many proteins of the membrane, although immunologic methods of detecting them, such as Western blotting ( 70 ), can readily identify many of these.

On Coomassie-stained gels, seven major bands are usually identified, whereas PAS stains four major bands and several minor ones ( Fig. 8.8). Some workers, however, have been able to differentiate as many as 40 proteins using the Coomassie technique ( 71 ). Originally, the seven major protein bands were referred to by their numeric designations ( Table 8.3). As further refinements in SDS-polyacrylamide gel electrophoresis have produced greater resolution, other bands have been given decimal or alphanumeric designations, such as bands 2.1 and 4.2, sometimes with even further divisions such as

4.1a and 4.1b. At present, many of these proteins are no longer identified by this numeric nomenclature because they have been given specific names as their chemical structures have been defined and their complementary DNAs (cDNAs) and genes have been cloned.



**Figure 8.8.** Polyacrylamide gel electrophoresis of erythrocyte membrane proteins. In this system, polypeptides migrate according to molecular size with the smaller molecules moving the farthest. Gels were stained with Coomassie Brilliant Blue ( *left*) and periodic acid–Schiff (PAS) reaction ( *right*). G–3PD, glyceraldehyde–3–phosphate dehydrogenase; Hb, hemoglobin. (From Steck TL. The organization of proteins in the human red blood cell membrane. *J Cell Biol* 1974;62:1, with permission.)

| Glycophorin Designation | Molecular Weight | Percent Protein | Name                             | Relationship to Membrane |
|-------------------------|------------------|-----------------|----------------------------------|--------------------------|
| 1                       | 240,000          | 11.0            | Spectrin                         | Peripheral               |
| 2, 3                    | 170,000          | 11.0            | Actin                            | Peripheral               |
| 4                       | 90,000-100,000   | 24.0            | Anion channel (Cl <sup>-</sup> ) | Integral                 |
| 4.1                     | 70,000           | 4.2             | Protein kinase                   | Integral                 |
| 4.2                     | 71,000           | 3.0             | Cloned membrane protein          | Integral                 |
| 4.3                     | 40,000-70,000    | 3.0             | Actin                            | Peripheral               |
| 5                       | 44,000           | 4.5             | Chromoglycin 2                   | Peripheral               |
| 6                       | 31,000           | 4.5             | Chromoglycin 1                   | Peripheral               |
| 7                       | 70,000           | 3.4             | Glycophorin B                    | Integral                 |
| 8.1, 8.2, 8.3           | 90,000           | 6.7             | Glycophorin A                    | Integral                 |

**TABLE 8.3. Major Membrane Polypeptides**

Likewise, the PAS–stainable proteins are now well characterized. The major PAS–stained bands contain three proteins, two of which form both hetero– and homomultimers. These three proteins have been termed *glycophorins*, or *sialoglycoproteins*, with letter designations that vary according to the investigator ( [Table 8.4](#)) ( [69](#), [72](#), [73](#), [74](#) and [75](#)). Glycophorins A (GPA) and B are proteins that are derived from highly homologous genes and form both homo– and heterodimers. Glycophorins C and D are two proteins produced by a single gene and are structurally unrelated to GPA and glycophorin B.

**TABLE 8.4. Nomenclature of Periodic Acid–Schiff (PAS)–Staining Erythrocyte Glycoproteins**

| Fairbanks et al. ( <a href="#">69</a> ) | Furthmayr ( <a href="#">75</a> ) | Dahr et al. ( <a href="#">74</a> ) | Anstee et al. ( <a href="#">72</a> ) |
|---|----------------------------------|------------------------------------|--------------------------------------|
| PAS–1                                   | Glycophorin A homodimer          | MN SGP                             | SGP–a                                |
| PAS–2                                   | Glycophorin C <sup>a</sup>       | Component D                        | SGP–B                                |
| —                                       | Glycophorin D                    | Component E                        | SGP–?                                |
| PAS–3                                   | Glycophorin B                    | Ss SGP                             | SGP–d                                |
| PAS–4                                   | Glycophorin AB heterodimer       | MN/Ss heterodimer                  | SGP–a/d heterodimer                  |

SGP, sialoglycoprotein.

<sup>a</sup> Depending on the resolution of the gel, the PAS-2 region may contain glycophorin A monomer, glycophorin C, and glycophorin B homodimer.

---

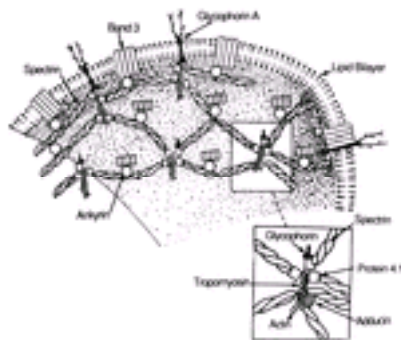
Historically, membrane proteins were characterized by whether they were stainable by protein-binding or carbohydrate-specific dyes. Now, however, they are classified on the basis of their functions or their relationship to the membrane. One common classification of membrane proteins comprises the categories of integral membrane proteins and peripheral membrane proteins (<sup>32</sup>). Integral membrane proteins are most often globular and amphipathic; in their folded, three-dimensional form, they have distinct hydrophobic and hydrophilic domains. Of the major Coomassie-stainable proteins, only bands 3, 4.5, and 7 are integral membrane proteins. These proteins have one or more membrane-spanning domain. Band 3 has several extracellular domains, of which some are highly glycosylated. Band 4.5 is the glucose transporter. Less is known about band 7, a protein that has a small extracellular and relatively larger cytoplasmic domain. All other Coomassie-stained bands are situated within the cell, either as part of the cytoskeleton or bound in a more or less loose fashion to the inner leaflet of the membrane. All the PAS-stainable proteins are integral membrane proteins. Integral membrane proteins require detergent for removal from the membrane, whereas peripheral membrane proteins can often be extracted from “ghosts” by manipulation of the pH and ion content of buffers and tend to be soluble in neutral aqueous buffers. Proteins attached by phosphatidylinositol anchors to the outer membrane layer also require detergents or other reagents capable of disrupting the lipid bilayer for solubilization (<sup>35</sup>).

**TRANSMEMBRANE PROTEINS** The two predominant erythrocyte transmembrane proteins are GPA and AE1 (formerly known as *Band 3*). However, although AE1 appears to play a number of crucial roles in red cell biology, the importance of GPA is less clear. GPA is the principal PAS-stainable glycoprotein of erythrocyte membranes. There are between  $0.5$  and  $1.0 \times 10^6$  copies of this protein per erythrocyte (<sup>76</sup>), accounting for approximately 85% of PAS-positive membrane protein. When analyzed by SDS-polyacrylamide gel electrophoresis, GPA forms homodimers, heterodimers with glycophorin B, and higher order multimers of up to several hundred kilodaltons. The monomeric form migrates anomalously, with an apparent molecular weight of 36,000 to 39,000, presumably because of its highly glycosylated state; approximately 60% of its weight is attributable to carbohydrate. Most of the carbohydrate is in the form of 15 O-glycosidically linked tetrasaccharides. The two sialic acid residues of each of these many O-glycosidically linked oligosaccharides account for 60% of the surface negative charge of the red cell. The other two components of these tetrasaccharides are one *N*-acetyl-galactosamine residue and one galactose residue. In addition, GPA bears one complex N-glycosidically linked oligosaccharide. GPA also bears blood group antigens. The N-terminus of GPA bears the M or N antigen, depending on whether serine and glycine or leucine and glutamic acid are in amino acid positions one and five, respectively. Although the antigenic polymorphism of the MN system thus depends on amino acid sequence differences, many human antibodies to these antigens do not recognize these antigens if sialic acid has been removed from the three O-linked oligosaccharides normally attached to amino acids two, three, and four. GPA has also been found to be a binding site for several pathogens, including *Plasmodium falciparum*. The complete amino acid sequence of GPA was determined in 1978 (<sup>77</sup>), and several investigators have since cloned the cDNA and explored the genomic structure of the glycophorin genes. GPA comprises 131 amino acids, of which 70 reside extracellularly, 22 within a single membrane-spanning domain, and the rest within the cytoplasm. The gene for GPA resides on chromosome 4 (<sup>78</sup>) and is organized into six exons that encode the leader peptide and mature protein,

along with a seventh exon encoding 3' untranslated messenger RNA (mRNA) ( [79](#), [80](#) ). Numerous variants of GPA have been described and may cause production of alloantibodies after transfusion. Rarely, some persons lack this protein totally. Although absence of GPA causes no clinically significant hematologic problems, persons with this deficiency may make antibodies that render blood transfusion difficult, given the general unavailability of blood from other GPA-deficient donors. In addition, some evidence suggests that the cytoplasmic C-terminal portion of GPA attaches loosely to the cytoskeleton via the cytoskeletal protein band 4.1 ( [81](#), [82](#) ) and also is expressed as part of a macromolecular complex that includes a dimer of AE1 (see below) and as many as six GPA dimers. In experimental systems, GPA also acts as a chaperone to facilitate AE1 expression ( [83](#) ), and, in humans, absence of GPA is associated with altered glycosylation of AE1 ( [84](#) ). Glycophorin B, the second most abundant PAS-staining protein, is present on the erythrocyte in one-tenth to one-third the copy number of GPA ( [76](#) ). Also encoded by a gene on chromosome 4, glycophorin B is highly homologous to GPA. The N-terminus of glycophorin B carries the "N" amino acid sequence of GPA and continues to be largely homologous to GPA for the first 27 amino acids, so that glycophorin B always expresses the N antigen. At amino acid 29, within a region of glycophorin B less homologous to GPA, expression of methionine or threonine accounts for the S and s blood group antigens, respectively. The intramembranous portion of glycophorin B is likewise highly homologous to that of GPA, but glycophorin B lacks a large cytoplasmic domain corresponding to that of GPA. Like GPA, glycophorin B is encoded by a single-copy gene on chromosome 4; the GPA and B genes thus appear to have arisen from a single ancestral gene. A third related gene, encoding a protein that is expressed weakly or not at all, has also been described as belonging to this gene family. AE1, which is the erythrocyte anion channel or anion exchange protein, is expressed on erythrocytes in approximately the same copy number as GPA. Human erythroid AE1 cDNA has been cloned ( [85](#), [86](#) ). Deduced cDNA sequence and confirmatory biochemical analyses have demonstrated that AE1 most likely traverses the membrane 12 times. Although it has several extracellular domains, the fourth is the major bearer of carbohydrate. This domain is heavily glycosylated and bears carbohydrate blood group antigens, including I and i and the antigens of the ABO major blood group system. Variations in the degree of glycosylation of this domain among individual protein molecules apparently account for the broad range of molecular weight (95,000 to 105,000) deduced for this protein from SDS gels. Gross changes in glycosylation of AE1 are also seen in certain inherited red cell abnormalities: AE1 bears increased sialic acid when GPA is absent, whereas glycosylation of AE1 is reduced in HEMPAS (hereditary erythroblastic multinuclearity with positive acidified serum test). Within the membrane, AE1 exists predominantly as a dimer, possibly in a macromolecular complex that includes GPA and the Rh proteins ( [83](#), [87](#), [88](#) ). Its primary function appears to be  $\text{Cl}^-/\text{HCO}_3^-$  exchange. AE1 also interacts with the erythroid cytoskeleton by binding ankyrin and binds NO, possibly facilitating its transit across the erythrocyte plasma membrane ( [89](#) ). Complete absence of erythroid AE1 has been described in humans as resulting in a severe form of hereditary spherocytosis, as well as renal tubular acidosis with nephrocalcinosis. In addition, at least 24 different mutations of the membranous or cytoplasmic domain of AE1 have been described as leading to hereditary spherocytosis. In all, mutations of the AE1 gene account for approximately 30% of all cases of hereditary spherocytosis in whites ( [90](#) ). The Rh proteins are also important integral membrane proteins. Although present in only 100,000 copies per cell ( [76](#) ), these proteins are clearly important both to erythrocyte biology and to transfusion medicine. The RhD protein is the most immunodominant determinant of red cells outside the ABO antigens and is thus the only non-ABO determinant routinely taken into account when blood is selected for nonalloimmunized recipients. Absence of all Rh proteins, as in the Rh-null syndrome, is associated with multiple erythrocyte defects and mild hemolytic anemia ( [91](#) ). The proteins that carry the D, C (or c), and E (or e) Rh antigens are highly homologous to one another ( [92](#) ) and traverse the membrane multiple times ( [92](#) ). Two Rh genes situated very near each other

on chromosome 1 encode the proteins that bear Rh antigens; in the normal situation, one gene encodes the D antigen, and the other encodes a protein that bears both the E/e and C/c antigens ( 93 ). However, in the membrane, the Rh proteins are part of a multimeric protein complex, including both structurally related and unrelated proteins ( 94 ). The function of this complex remains unknown, although it has been shown that the Rh-null syndrome occurs most frequently as a result of lack of expression of Rh50, one of the proteins in this complex, rather than a defect at the *Rh* gene locus itself ( 95 ). Recombinant Rh50 expressed in yeast and in *Xenopus* oocytes has been shown to facilitate ammonium transport ( 96 , 97 ), although some evidence also suggests that Rh proteins play a role in CO<sub>2</sub> transport ( 98 ).

**CYTOSKELETAL PROTEINS** The most abundant of the peripheral proteins are those that make up the so-called spectrin-actin cytoskeletal complex. These proteins, which can be extracted in the presence of ethylenediaminetetraacetic acid and other chelating agents or by reducing ionic strength and raising pH, account for approximately 35% of the membrane protein. The complex includes large  $\alpha$ - and  $\beta$ -spectrin polypeptide chains (bands 1 and 2 on gel electrophoresis; molecular weight, approximately 240,000 and 225,000, respectively) and the smaller actin chain corresponding to band 5. The relationship between the integral and peripheral proteins of the membrane is illustrated in Figure 8.9. Study of the erythrocyte cytoskeleton has led to the realization that similar spectrin-based skeletal structures are important not only in preserving erythrocyte integrity in the face of the shear stresses of the circulatory system and spleen, but also in the function of more complex nucleated cells ( 99 , 100 ).



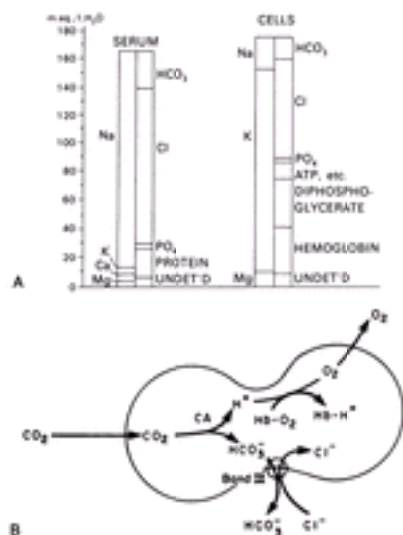
**Figure 8.9.** Model of the relationship between integral and cytoskeletal membrane proteins. Cytoplasmic domains of several integral membrane proteins interact with several cytoskeletal proteins. (From Gardner K, Bennett GV. Recently identified erythrocyte membrane-skeletal proteins and interactions. In: Agre P, Parker JC, eds. Red blood cell membranes—structure, function, clinical implications. New York: Marcel Dekker Inc, 1989, with permission.)

Spectrin proteins are long, rod-shaped molecules that self-associate into a two-dimensional network with the help of many other cytoskeletal proteins ( 33 ). The two forms of spectrin are homologous to each other, and both are composed primarily of 106-amino acid repeats ( Fig. 8.10 ); however, they are encoded by genes on two different chromosomes, chromosome 1 ( $\alpha$ -spectrin) and chromosome 14 ( $\beta$ -spectrin) ( 101 , 102 and 103 ). Each spectrin molecule appears to be folded over on itself an average of three times. The  $\alpha$ - and  $\beta$ -spectrin molecules form heterodimers by aligning in antiparallel pairs. These heterodimers then form tetramers by head-to-head association ( 33 ). Incorporation of these tetramers into the latticework of the cytoskeleton then occurs with the interaction of other peripheral membrane proteins ( Fig. 8.9 ) ( 33 ).





membrane at a rate proportional to their solubility in organic solvents. Polar solutes appear to cross the membrane at specialized sites. The erythrocyte membrane has a number of specialized transport proteins, including the anion transporter (AE1, band 3), several cation transporters, a glucose transporter, a urea transporter, and a water channel. Erythrocytes have an abundant and highly active water channel protein, aquaporin-1, which contributes as much as 85% of the osmotic water permeability pathway (110). Aquaporin-1, originally described as CHIP-28 (channel-forming integral protein-28 kd), occurs as a homotetrameric protein that expresses on its extracellular domain both ABH and Colton blood group antigens and is inhibitable by a variety of mercurial compounds (111). Red cells lacking aquaporin-1 have only slightly reduced lifespan *in vivo* (110). Anions appear to cross the membrane by one of two discrete pathways. The first represents an exchange reaction in which an internal anion is exchanged for an external anion. This rapid exchange is mediated by the band 3 anion exchange protein and plays an important role in the chloride-bicarbonate exchanges that occur as the red cell moves between the lungs and tissues (Fig. 8.11B) (112). The second anion pathway represents considerably slower ionic diffusion, accounting for net loss or gain of anions. This process is approximately 100 times as rapid as cation diffusion but 10,000 times slower than the cation exchange reaction.

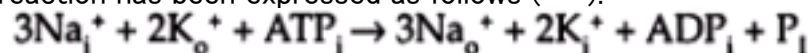


**Figure 8.11. A:** Intracellular electrolyte composition of the erythrocyte as compared with serum. **B:** Role of band 3 in anion and CO<sub>2</sub> transport. The ability of band 3 to accelerate anion transport across the membrane allows rapid equilibration of bicarbonate with the extracellular plasma and concomitant influx of chloride ion. ATP, adenosine triphosphate; CA, carbonic anhydrase; Hb, hemoglobin. (A is from Guest GM. Organic phosphates of the blood and mineral metabolism in diabetic acidosis. *Am J Dis Child* 1942;64:401, with permission. B is from Kopito RR, Lodish HF. Structure of the murine anion exchange protein. *J Cell Biochem* 1985;29:1, with permission.)

Glucose and other monosaccharides constitute an important exception to the generalization regarding nonpolar solutes, in that monosaccharides easily cross the membrane barrier, whereas the more lipid-soluble disaccharides do not. The speed of the process depends on molecular structure. Only D-isomers are transported; L-isomers are not. Of the common D-hexoses, glucose is transported most rapidly, followed by mannose, galactose, xylose, and arabinose. The concentration of solute at the half maximal transport rate (K<sub>m</sub>) is 6.2 mM for glucose and 18.5 mM for mannose. Fructose is not transported under physiologic conditions (K<sub>m</sub> >200 mM). Glucose enters the erythrocyte by facilitated diffusion, mediated by a transmembrane protein designated the *glucose transporter*, encoded by the gene *GLUT1* (113). This protein constitutes approximately 5% of erythrocyte membrane protein and accounts for a diffusely migrating



band (band 4.5) in Coomassie-stained polyacrylamide gels of erythrocyte membrane proteins. (Although a single protein, the glucose transporter is heterogeneously glycosylated, causing its apparent molecular weight to range from 45,000 to 75,000.) The protein appears to occur in the membrane as a homotetramer. The glucose transporter has an asymmetric effect on glucose transit across the membrane: Glucose influx exhibits a higher  $V_{max}$  and a lower  $K_m$  than does glucose efflux. The transport of glucose into the erythrocyte provides the energy substrate for anaerobic glycolysis; however, the energy requirement of the erythrocyte appears relatively low, and the efficiency of glucose transport is relatively high. Therefore, glucose transport does not appear to be rate-limiting for glucose use ( [114](#), [115](#) ). It is interesting that heterozygosity for a defective glucose transport protein has been reported to result in a heritable seizure disorder ( [116](#) ). The erythrocyte membrane is only slightly permeable to the major monovalent cations, sodium and potassium, and their movement depends greatly on an energy-requiring transport mechanism. Within the human erythrocyte, potassium is the predominant cation, and sodium is a relatively minor constituent, whereas the relationship is reversed in plasma ( [Fig. 8.11A](#) ). Cation concentrations within the erythrocyte are approximately 130 mM  $K^+$  and 8 mM  $Na^+$ , whereas the plasma contains approximately 140 mM  $Na^+$  and 4 mM  $K^+$ . The preservation of these gradients is the result of the cation transport process. The steady-state cation concentrations within the erythrocyte are the result of an equilibrium between passive diffusion (“leak”) and active transport (“pump”). With respect to sodium, the direction of leak is inward and the direction of pump is outward; in contrast, potassium leaks out and is pumped in. The major cation pump represents a process in which sodium inside the cell is exchanged for potassium on the outside and energy is supplied by ATP. For each molecule of ATP converted to adenosine diphosphate (ADP), three sodium ions are pumped out and two potassium ions enter ( [117](#) ). The overall reaction has been expressed as follows ( [118](#) ):



where subscript i indicates *intracellular* and subscript o indicates *extracellular* (outside). In this process, the erythrocyte experiences a net loss of one positive charge per cycle.

Some of this loss may be compensated by outward movement of an anion (most likely  $Cl^-$ ), but this cation pump also contributes to the low resting potential of human erythrocytes ( [119](#) ). Active  $Na^+$  and  $K^+$  transport depends on the activity of the membrane protein Na-K ATPase. This protein may exist in the membrane as part of a multienzyme complex, including glyceraldehyde-2-phosphate dehydrogenase and phosphoglycerate kinase ( [120](#) ). The pump protein itself comprises two noncovalently linked polypeptides. The  $\alpha$  subunit has a molecular weight of approximately 112,500 daltons and contains the catalytically active domain; the  $\beta$  subunit, which has a molecular weight of approximately 45,000 daltons, is likely to be important to regulation of the molecule’s function ( [121](#), [122](#) ). A small proteolipid  $\gamma$ -chain of approximately 10,000 daltons also copurifies with the protein but does not appear to be required for ATPase activity ( [123](#) ). The  $\alpha$  subunit contains both ATP- and ouabain-binding, as well as ATPase activity. The complete amino acid structure for the  $\alpha$ -chain of human Na-K ATPase has been determined ( [124](#) ). It is compatible with a protein structure that includes eight membrane-spanning domains, making the  $\alpha$  subunit an integral membrane protein, as would be expected of an active membrane transport protein. The  $\beta$  subunit is also an integral membrane protein, with at least one transmembrane domain ( [125](#) ). Most of the  $\beta$  subunit protein appears to be extracellular, whereas the nonmembrane-spanning domains of the  $\alpha$  subunit are primarily cytoplasmic. In the membrane, the Na-K ATPase may exist as oligomers of the  $\alpha$ ,  $\beta$ , and  $\gamma$  units in a ratio of 1:1:1. The erythrocyte also has a urea transporter that transports urea rapidly across the membrane and helps preserve red cell osmotic stability and deformability ( [126](#) ). Although this transporter has similar characteristics to the renal urea transporter, they appear to arise from related but

distinct genes ( [127](#), [128](#) ).

**MEMBRANE AND MEMBRANE-ASSOCIATED ENZYMES** At least 50 enzymes are either membrane proteins or are bound to the erythrocyte membrane in some fashion; certain enzymes are both free in the cytoplasm and associated with the membrane. Their functions range from facilitating transport of a variety of molecules necessary to the erythrocyte to playing important roles in producing and using energy from glucose metabolism. Some erythrocyte enzymes are externally oriented and can therefore react with substrates in the red cell environment. Certain hydrolytic enzymes, including glycosidases and acid phosphatases, are among the externally oriented enzymes ( [129](#) ). A classic example of an externally oriented enzyme is acetylcholinesterase.

Acetylcholinesterase was the first of several membrane proteins discovered to be missing from the affected erythrocytes of patients with paroxysmal nocturnal hemoglobinuria ( [Chapter 37](#) ) ( [130](#), [131](#) ). It belongs to a class of proteins that are attached to the membrane by a phosphatidylinositol-glycan anchor, so that the entire polypeptide portion of the molecule is extracellular ( [35](#) ). Although the role of acetylcholinesterase on the red cell remains obscure ( [132](#) ), some other proteins in this class are complement regulatory proteins; it is the absence of these proteins that causes the hemolysis typical of paroxysmal nocturnal hemoglobinuria ( [131](#) ). Among the enzymes required for the production and use of ATP are three enzymes that are believed to form a membrane-bound enzyme complex: aldolase, glyceraldehyde-3-phosphate dehydrogenase, and phosphoglycerate kinase. Together, these three enzymes convert fructose diphosphate to 3-phosphoglycerate with the production of ATP.

Glyceraldehyde-3-phosphate dehydrogenase is the enzyme present in greatest amount in membrane preparations and is seen as band 6 in polyacrylamide gels.

Glyceraldehyde-3-phosphate dehydrogenase is also found in the erythrocyte cytoplasm and can be demonstrated to bind to a cytoplasmic segment of band 3. Although the exact physiologic role of membrane binding for this enzyme remains unclear, its possible role in regulating metabolic responses to cell injury and stress is intriguing ( [133](#) ). ATP is not only generated by membrane-bound enzymes but also is used by membrane-bound molecules, among which are adenyl cyclase, which catalyzes the conversion of ATP to cyclic adenosine monophosphate, protein kinases, and ATPases. The latter are involved in several transport functions, as was discussed previously. Protein kinases are enzymes that phosphorylate other proteins in the presence of ATP by forming phosphoserine, phosphothreonine, or phosphotyrosine bonds. Phosphorylation is a major step in the regulation of a variety of target molecules, including structural proteins and enzymes. Erythrocytes contain numerous protein kinases, including both cytosolic and membrane-bound cyclic adenosine monophosphate-dependent kinases, cytosolic and membrane-bound cyclic adenosine monophosphate-independent protein kinases, protein kinase C, and a calcium-regulated protein kinase. Both membrane-bound and cytosolic kinases may phosphorylate membrane proteins ( [134](#) ). In general, phosphorylated structural proteins demonstrate lower-affinity binding to their target proteins than do unphosphorylated proteins. For example, phosphorylation of protein 4.1 leads to a decreased affinity for spectrin and a decreased ability of 4.1 to promote spectrin-actin association ( [33](#) ). Phosphorylation of spectrin, however, leads to little if any change in spectrin self-association or in association of spectrin with other molecules such as ankyrin and actin ( [33](#) ). Exactly how such processes regulate cell shape and membrane integrity has not been well worked out as yet. In the case of protein 4.1, dephosphorylation because of ATP depletion, an event that might be associated with stress, would be predicted to lead to a more rigid spectrin-actin network and reduced membrane deformability ( [135](#) ). Phosphorylation of enzymes can likewise lead to activation of a variety of metabolic pathways; often, phosphorylation of one molecule leads to activation of both an enzyme system and the molecules that down-regulate activity of that system. Enzymes that use and degrade ATP are also found in the membrane, although they are not present in large enough quantity to account for bands seen in Coomassie-stained polyacrylamide gels of membrane proteins. Like protein kinases,

ATPases phosphorylate membrane proteins, but instead of forming phosphoserine or phosphothreonine bonds, they form acyl bonds as transient intermediates in the catalytic cycle. Important and well-studied ATPases of the erythrocyte membrane include Na-K ATPase, Ca-Mg ATPase, and Mg ATPase. The Na-K ATPase is also known as the *sodium pump* or *sodium-potassium pump* ( [124](#) ). This enzyme is responsible for maintaining the high internal potassium and low internal sodium concentration of both erythrocytes and other mammalian cells. In the process of regulating the concentration of these cations, Na-K ATPase also effects regulation of cellular volume and maintains the potassium-dependent activation of some intracellular enzymes ( [136](#) ). Na-K ATPase is also known as the *ouabain-inhibitable ATPase*, because the enzyme is specifically sensitive to inhibition by ouabain. Finally, the mature erythrocyte is capable of responding to its environment through classical signaling mechanisms. It has a wide range of signaling molecules ( [137](#) ) and is affected by exogenous stimuli such as epinephrine ( [138](#) , [139](#) ). An adrenergic signaling mechanism has been implicated in the process producing abnormal adhesion of sickle red cells to endothelial components ( [140](#) ).

## HEMOGLOBIN AND ERYTHROCYTE FUNCTION

Hemoproteins have been used by nature for processes as diverse as electron transfer down electrochemical gradients in the respiratory chain to the harvesting of light energy in photosynthesis. Hemoglobins are one of the most widespread and specialized hemoproteins existing in nature and have been found in prokaryotes, fungi, plants, and animals. These proteins permit the reversible binding of O<sub>2</sub> to heme while keeping the iron in the +2 state. They also facilitate the exchange of carbon dioxide between the lungs and the tissues. Recent studies have also demonstrated the importance of hemoglobin in control of vascular tone mediated by NO. In vertebrates, hemoglobin is the major constituent of the red cell cytoplasm, accounting for approximately 90% of the dry weight of the mature cell.

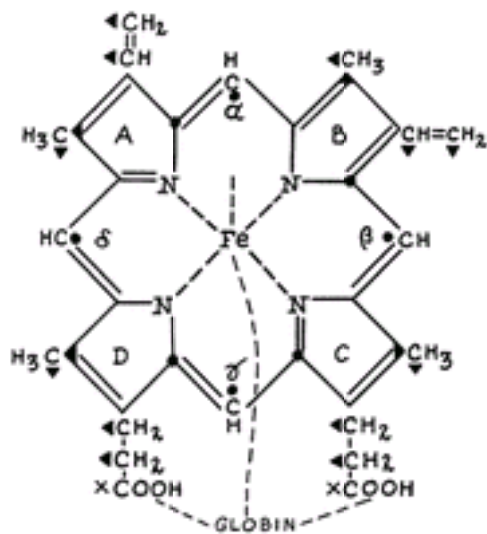
In most invertebrates, oxygen-carrying pigment is transported freely in the plasma rather than within cells. This is a relatively inefficient delivery system. Hemoglobin, as a protein free in the plasma, would exert an osmotic pressure approximately five times greater than that produced by the plasma proteins. By the inclusion of this pigment in corpuscles, the viscosity of the blood can be maintained at a low level, water is not drawn from the tissues by it, and the flow of blood containing such a large amount of protein is made possible. Furthermore, free hemoglobin is not maintained in the circulation and is subject to oxidative denaturation. Attempts to make hemoglobin substitutes have revealed that infusion of free hemoglobin or its derivatives causes a significant increase in blood pressure due to the scavenging of NO produced by vascular endothelium.

In a human at rest, approximately 250 ml of oxygen are consumed and 200 ml of carbon dioxide are produced per minute. During exercise, these quantities increase tenfold. If the respiratory gases were carried in physical solution in the plasma, human activity would be restricted to only one-fiftieth of that possible in the presence of hemoglobin-containing red cells. Hemoglobin permits the transportation of one hundred times more oxygen than could be carried by the plasma alone.

### Evolution and Structure of Hemoglobin

Vertebrate hemoglobin is a conjugated protein with a molecular weight near 64,500 daltons. The hemoglobin molecule is roughly spherical with a maximum molecular diameter of approximately 6.4 nm. It is a tetramer, consisting of two pairs of similar polypeptide chains called *globins*, that exhibits a diad axis of symmetry. To each of the four chains is

attached a prosthetic group, *heme*, a complex of iron and protoporphyrin ( [Fig. 8.12](#)).



**Figure 8.12.** Chemical structure of heme and its manner of union with globin to form hemoglobin. The carbon atoms derived from the  $\alpha$  carbon of glycine are represented by  $\cdot$ ; those supplied from the methyl carbon of acetate by  $s$ , and those derived from the carboxyl group of acetate by  $\times$ . The unmarked carbons are those derived from either the methyl carbon atom of acetate or from the carboxyl atom. (Prepared by Dr. G.E. Cartwright.)

Human hemoglobins share a common ancestry with a simpler, single-chain molecule that was similar to myoglobin. The divergence of the invertebrate and vertebrate globin genes occurred over 670 million years ago, and the divergence of the  $\alpha$  and non- $\alpha$  globin genes probably descended from a common gene over 450 million years ago ( [141](#) ). Such an evolution would explain the high degree of homology between the  $\alpha$ - and non- $\alpha$ - ( $\epsilon$ ,  $\gamma$ ,  $\beta$ , and  $\delta$ ) chains, as well as the extraordinary similarities among the non- $\alpha$  globins. The non- $\alpha$  globin gene family is sometimes designated the  $\beta$  *globin gene family*. The  $\alpha$  and non- $\alpha$  peptide chains most likely arose because of gene duplication, after which time the genes for these individual proteins evolved independently ( [142](#) ). Likewise, the  $\beta$ ,  $\delta$ ,  $\gamma$ , and  $\epsilon$  globins probably also arose as a result of gene duplications ( [143](#) ). The occurrence of subunit cooperativity brought with it the advantage of increased physiologic effectiveness of the hemoglobin molecule and added a new pressure on further evolution of the hemoglobin chains ( [144](#) ). The  $\alpha$  and non- $\alpha$  globins of vertebrates are approximately 50% identical with each other.

### Ontogeny of Hemoglobins

Hemoglobin expression during ontogeny is characterized by three developmental periods: embryonic, fetal, and adult. In each developmental period, the oxygen delivery requirements are different, and erythroid development has evolved to meet these needs. The genes that encode the  $\alpha$  globin gene family are on chromosome 16, whereas the genes encoding the members of the non- $\alpha$  globin gene family are on chromosome 11 ( [145](#), [146](#) ). These genes are developmentally and coordinately regulated, and, through the production of different pairs of globins, different hemoglobins are produced to permit their appropriate expression during different developmental periods. The  $\alpha$  globin gene cluster is capable of producing two types of globins,  $\gamma$  and  $\alpha$ . The  $\gamma$  is an embryonic globin chain

produced during the first 8 weeks of fetal development, whereas  $\alpha$  is produced during the remainder of fetal and adult developmental periods (147). The  $\beta$  globin gene family members include the embryonic globin  $\epsilon$ , the fetal globin  $\gamma$ , and two globins expressed primarily during the adult period,  $\delta$  and  $\beta$ . A detailed description of the organization and structure of these genes is presented in Chapter 7 (148).

The transition from one developmental period to another is accompanied by the sequential and coordinate expression of the genes in each family. During early embryonic development, the expression of  $\gamma$  and  $\epsilon$  globin genes leads to the production and assembly of these globins into the embryonic hemoglobin Gower-1 ( $\gamma_2\epsilon_2$ ) (149).  $\alpha$  and  $\gamma$  globins are also produced at low levels during this period, and this permits the production of two other embryonic hemoglobins, designated Gower-2 and Portland (150). Gower-2 is composed of  $\alpha$  and  $\epsilon$  globin chains ( $\alpha_2\epsilon_2$ ), and Portland is assembled from  $\gamma$  and  $\gamma$  chains ( $\gamma_2\gamma_2$ ). These embryonic hemoglobins display subunit cooperativity and serve as physiologic oxygen carriers in erythroid cells derived from yolk sac hematopoietic progenitors (151). Embryonic erythrocytes carrying these hemoglobins have an affinity for oxygen similar to fetal blood.

After the eighth week of development, erythropoiesis shifts from the yolk sac to the fetal liver, and the embryonic hemoglobins normally become detectable in fetal blood (152). Embryonic hemoglobins are replaced with hemoglobin F ( $\alpha_2\gamma_2$ ), which remains as the predominant hemoglobin until after birth. The  $\gamma$ -chains are encoded by pairs of genes located near the normal  $\beta$  globin gene on chromosome 11. The two  $\gamma$  genes encode nearly identical proteins: G $\gamma$  has a glycine at the codon position where A $\gamma$  has an alanine (153, 154). In addition, many A $\gamma$  genes also encode a threonine-for-isoleucine substitution at position 75 of the protein (155, 156). During fetal life, G $\gamma$  constitutes approximately 75% of  $\gamma$ -chains, whereas hemoglobin F in adults contains approximately 60% A $\gamma$  chains (157, 158). This has no known physiologic significance.

Red cells containing hemoglobin F have higher oxygen affinity than adult red cells. This permits the fetus to compete effectively for oxygen in the maternal blood. However, hemoglobin lysates from adult and fetal cells have nearly identical oxygen affinity when dialyzed against saline or a neutral buffer (159). This property of fetal hemoglobin is due to amino acid differences in the amino terminus of the  $\gamma$ -chains that impair binding of 2,3-diphosphoglycerate (2,3-DPG), an allosteric modifier of oxygen binding (160). Hemoglobin F also has an enhanced alkaline Bohr effect (161) whereby oxygen affinity is increased as hemoglobin passes through the pulmonary vasculature.

At approximately 20 weeks of fetal development, the site of erythropoiesis begins to switch from the liver and spleen to the bone marrow, where progenitors show increased expression of adult globins,  $\alpha$  and  $\beta$ . Hemoglobin A may constitute 5% of  $\beta$ -family globin expression during this time. Beginning at the thirtieth week and proceeding to the time of birth, a significant switch from fetal to adult erythropoiesis takes place, such that at the time of birth, fetal hemoglobin constitutes approximately 80% of the total hemoglobin. Over the next 25 to 30 weeks after birth, fetal hemoglobin concentration decreases by approximately 10% every 2 weeks until it reaches its normal adult level of less than 2% by 30 weeks of age (162). Neonates with hemoglobinopathies or erythropoietic stress can have a greatly prolonged production of hemoglobin F, sometimes extending into adulthood (163). The proportion of hemoglobins produced during the different developmental periods is summarized in Table 8.5.



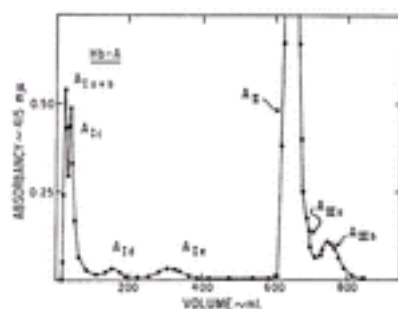
**TABLE 8.5. Normal Human Hemoglobins**

| Name                      | Designation    | Molecular Structure  | Proportion |              |
|---------------------------|----------------|----------------------|------------|--------------|
|                           |                |                      | Adults (%) | Newborns (%) |
| Adult hemoglobin          | A              | $\alpha_2\beta_2$    | 97.0       | 20.0         |
| Hemoglobin A <sub>2</sub> | A <sub>2</sub> | $\alpha_2\delta_2$   | 2.5        | 0.5          |
| Fetal hemoglobin          | F              | $\alpha_2\gamma_2$   | <1.0       | 80.0         |
| Portland                  | —              | $\gamma_2\gamma_2$   | 0          | 0            |
| Gower-1                   | —              | $\gamma_2\epsilon_2$ | 0          | 0            |
| Gower-2                   | —              | $\alpha_2\epsilon_2$ | 0          | 0            |

Hemoglobin A,  $\alpha_2\beta_2$ , is the predominant adult hemoglobin and normally constitutes approximately 96% of the total adult hemoglobin. A minor adult hemoglobin, A<sub>2</sub>, is produced beginning at 35 weeks of gestation but has little physiologic relevance. Hemoglobin A<sub>2</sub> is composed of  $\alpha$  globins and the minor adult globin  $\delta$ . It normally constitutes less than 3.5% of total adult hemoglobin; however, it is typically increased in  $\beta$ -thalassemias and may be increased in other conditions, to be described later. Clinically, its major importance is its value in diagnosing  $\beta$ -thalassemias (164).

### Modifications of Normal Hemoglobin

Analysis of human red cell hemolysates by cation-exchange chromatography reveals several negatively charged minor hemoglobins that are designated A<sub>Ia</sub>, A<sub>Ib</sub>, and A<sub>Ic</sub>, corresponding to their order of elution. These hemoglobins are formed by the nonenzymatic interaction of glucose with the  $\alpha$ -amino groups of valine residues at the N-termini of the  $\beta$ -chains of hemoglobin (165). They account for the so-called hemoglobin A<sub>3</sub> fraction on starch-block electrophoresis (Fig. 8.13) (166).



**Figure 8.13.** Column chromatograph of hemoglobin (Hb) A on IRC-50. The main component, A<sub>II</sub>, corresponds to the HbA<sub>1</sub> demonstrated by starch-block electrophoresis, A<sub>III</sub> corresponds to HbA<sub>2</sub>, and A<sub>I</sub> corresponds to A<sub>3</sub>. (Courtesy of Dr. Robert L. Hill.)

The best characterized of the acquired variants is hemoglobin A<sub>Ic</sub>, which constitutes approximately 3.5% of the hemoglobin in normal subjects and may be increased two- to

threefold in individuals with diabetes mellitus. Its level is directly proportional to the time-integrated mean blood glucose concentration over the life of the red cell, typically the preceding 2 to 3 months (167). In the nonenzymatic glycosylation of hemoglobin A, a molecule of glucose forms a Schiff base with the N-terminus of the β-chain, then undergoes an Amadori rearrangement to a stable ketamine, 1-amino, 1-deoxy fructose (168, 169). With special techniques, two different derivatives can be detected in the A<sub>Ia</sub> fraction. In so-called hemoglobin A<sub>Ia1</sub>, a fructose 1,6-diphosphate molecule is attached to the β-chain, whereas in hemoglobin A<sub>Ia2</sub>, glucose-6-phosphate occupies the same site (167). Hemoglobin A<sub>Ib</sub> has not yet been fully characterized, but it appears to be a glycosylated, nonphosphorylated derivative. Levels of hemoglobins A<sub>Ia</sub> and A<sub>Ib</sub>, like hemoglobin A<sub>Ic</sub>, are also increased in persons with hyperglycemia. Recently, hemoglobin A<sub>Id3</sub> has been identified and found to be due to the addition of glutathione (GSH) to the β-chain of hemoglobin (170).

Because the glycosylated hemoglobins are synthesized throughout the lifespan of the red cell, older cells contain a higher proportion of these modified hemoglobins than younger ones (171). Preferential destruction of older cells explains the observation that the proportion of these hemoglobins is reduced in hemolytic anemia (172). Because the rate of synthesis of hemoglobin A<sub>Ic</sub> depends on the blood glucose level, the concentration of hemoglobin A<sub>Ic</sub> at any one time is proportional to the average blood sugar over the previous 2 to 3 months (173). For this reason, the level of glycosylated hemoglobins is now used widely as a measure of glucose control in diabetic patients, as well as a tool for diagnosis of diabetic states (173, 174 and 175). In contrast, the hemoglobin A<sub>Ia</sub> components are not significantly increased in diabetes (Table 8.6), presumably reflecting the fact that their phosphorylated substituents are not increased in the red cells of patients with diabetes (167).

**TABLE 8.6. Glycosylated Hemoglobins in Normal and Diabetic Individuals**

| Hemoglobin  | β-Terminal Group         | Average Concentration (%) |                          |
|---|--------------------------|---------------------------|--------------------------|
|   |                          | Normal                    | Diabetes                 |
| A <sub>Ia1</sub>                                    | Fructose 1,6-diphosphate | 0.19                      | 0.20                     |
| A <sub>Ia2</sub>                                    | Glucose-6-phosphate      | 0.19                      | 0.22                     |
| A <sub>Ib</sub> <sup>a</sup>                        | Unknown                  | 0.48                      | 0.67                     |
| A <sub>Ic</sub>                                     | Glucose                  | 3.30                      | 7.50                     |
| A <sub>Ia</sub> + A <sub>Ib</sub> + A <sub>Ic</sub> | —                        | 6.50 ± 1.50 <sup>a</sup>  | 11.0 ± 2.90 <sup>a</sup> |

NOTE: Totals are greater than the sum of the components because of differences in technique in the two studies.

<sup>a</sup> Mean ± one standard deviation, 20 normal subjects and 75 adult diabetics. (Trivelli LA, Ranney HM, Lai HT. Hemoglobin components in patients with diabetes mellitus. N Engl J Med 1971;284:353.)

Clinical laboratories currently use a variety of assays to detect and quantify glycated



hemoglobins, including cation-exchange chromatography, high-pressure liquid chromatography, immunoassays, and boronate affinity methods ( [176](#) ). Commonly encountered hemoglobin variants, such as hemoglobin S, hemoglobin C, hemoglobin E, and hemoglobin F, can interfere with these assays and may help explain discordant assay results ( [176](#) ).

## Laboratory Analysis of Hemoglobins

Normal and variant hemoglobins can be detected and quantified by standard clinical laboratory techniques. The clinical utility in these measurements includes the identification of variants as well as determination of the levels of normal hemoglobins. Standard cellulose acetate electrophoresis performed at alkaline pH or isoelectric focusing can detect most of the common variants ( [177](#) ). Usually, confirmation can be achieved by citrate agar electrophoresis, isoelectric focusing, or high-performance liquid chromatography. The analysis of hemoglobin A<sub>2</sub> and fetal hemoglobin levels deserves special attention because the levels of these components are indicative of common conditions affecting hemoglobin synthesis. Hemoglobin A<sub>2</sub> normally constitutes less than 3.5% of the total hemoglobin in adults. In most cases of  $\beta$ -thalassemia and some  $\alpha$ -thalassemia, hemoglobin A<sub>2</sub> levels may be increased, ranging from 3.6 to 8.0% ( [178](#), [179](#) ). The subtle increase in hemoglobin A<sub>2</sub> characteristic of these conditions cannot be quantified accurately by electrophoretic methods. Instead, most laboratories use ion-exchange resin microchromatography ( [180](#) ). It is a common error to use hemoglobin electrophoresis as the sole method to rule out  $\beta$ -thalassemia, and most large laboratories add the chromatographic quantification of hemoglobin A<sub>2</sub> as part of their routine hemoglobin analysis.

Hereditary persistence of fetal hemoglobin and  $\delta$ - $\beta$ -thalassemia are types of  $\beta$ -thalassemia caused by deletion of  $\delta$  and  $\beta$  globin genes but distinguished from typical  $\beta$ -thalassemia by more balanced  $\alpha$  and non- $\alpha$  globin chain synthesis due to an increase in  $\gamma$  globin production. In both of these thalassemias, hemoglobin A<sub>2</sub> levels are reduced due to deletion of  $\delta$  globin genes.

Elevated levels of hemoglobin F can be caused by thalassemias, disorders of hematopoiesis, or hereditary disorders of globin synthesis such as hereditary persistence of fetal hemoglobin and  $\delta$ - $\beta$ -thalassemia ( [181](#) ). Diagnosis requires the precise measurement of hemoglobin F levels, which can be achieved in clinical laboratories by taking advantage of the resistance of hemoglobin F to alkali denaturation ( [182](#) ). This resistance to alkali denaturation of fetal hemoglobin is due to the greater stability under these conditions of  $\alpha$ - $\gamma$  globin dimers compared to  $\alpha$ - $\beta$  globin dimers ( [183](#) ). In lysates exposed to alkali under controlled conditions, only fetal hemoglobin remains undenatured, and its concentration can be quantified after the other denatured hemoglobins are removed from solution ( [184](#), [185](#) and [186](#) ). Routine electrophoretic procedures do not completely separate hemoglobin F from A, but a more adequate separation can be accomplished at pH 6.0 in agar gel ( [187](#) ).

In adults, fetal hemoglobin is unevenly distributed in erythrocytes, being restricted to between 0.1 and 7.0% of total cells ( [188](#) ). Cells containing fetal hemoglobin are designated F or A/F cells, wherein the hemoglobin F concentration is normally between 14 and 25% of the total hemoglobin ( [189](#) ). In certain thalassemias and in hereditary persistence of fetal hemoglobin, the number of F cells is increased. This condition can be detected by acid treatment of erythrocytes on a glass slide followed by elution of other unstable hemoglobins (Kleihauer-Betke technique). Counterstaining can identify hemoglobin

F-containing cells ( [190](#) ).

Examination of normal blood by the Kleihauer–Betke method demonstrates both colorless cells and fetal hemoglobin-containing (light pink) cells that vary in intensity. By comparison, analysis of cord blood mixed with adult blood demonstrates that true fetal cells in cord blood stain intensely, reflecting the high level of fetal hemoglobin in fetal cells. This assay can be performed on maternal blood to detect fetomaternal hemorrhage or other contamination of the maternal circulation with fetal blood. This method is easily performed in small laboratories, but some larger laboratories are now using flow cytometry with a phycoerythrin-conjugated antiglycophorin antibody to detect fetomaternal hemorrhage ( [191](#) ).

### Structure of Globin

Proteins have at least four levels of structural organization ( [192](#) ): (a) *primary structure*, or the linear sequence of amino acids; (b) *secondary structure*, which describes how the amino acids within segments of the protein are spatially organized (e.g., by folding into an  $\alpha$ -helix or  $\beta$ -pleated sheet); (c) *tertiary structure*, which refers to the steric relationships of sequence domains separate from each other when analyzed as part of the linear sequence of the protein; and (d) *quaternary structure*, or the way in which several polypeptide chains join to form a single molecule.

The exact primary structure of all normal globin chains has been determined based on the DNA sequence of the individual globin genes ( [Table 8.7](#) ) ( [193](#) ), and the polypeptide chains in hemoglobin differ from one another in amino acid sequence. The  $\alpha$ -chain contains 141 amino acids and the non- $\alpha$ -chains, 146. The members of the non- $\alpha$ -chain family are more similar than any member of the non- $\alpha$ -chain and the  $\alpha$ -chain family. The  $\delta$ -chain differs from the  $\beta$ -chain in only 10 of its 146 amino acid residues, whereas the  $\gamma$ - and  $\beta$ -chains differ by 39 amino acids.

**TABLE 8.7. Primary and Secondary Structure of Hemoglobin Polypeptide Chains**

| Helix No. | Amino Acid Sequence <sup>a</sup> |          |         |          |          | Helix No. | Amino Acid Sequence <sup>a</sup> |          |         |          |          |     |    |
|-----------|----------------------------------|----------|---------|----------|----------|-----------|----------------------------------|----------|---------|----------|----------|-----|----|
|           | No.                              | $\alpha$ | $\beta$ | $\gamma$ | $\delta$ |           | No.                              | $\alpha$ | $\beta$ | $\gamma$ | $\delta$ | No. |    |
| NA1       | 1                                | Val      | Val     | Gly      | Val      | 1         | E17                              | 68       | Asn     | Asp      | Asp      | Asp | 73 |
| NA2       | 2                                | Leu      | His     | His      | His      | 2         | E18                              | 69       | Ala     | Gly      | Ala      | Gly | 74 |
| NA3       | —                                | —        | Leu     | Phe      | Leu      | 3         | E19                              | 70       | Val     | Leu      | Ile      | Leu | 75 |
| A1        | 3                                | Ser      | Thr     | Thr      | Thr      | 4         | E20                              | 71       | Ala     | Ala      | Lys      | Ala | 76 |
| A2        | 4                                | Pro      | Pro     | Glu      | Pro      | 5         | EF1                              | 72       | His     | His      | His      | His | 77 |
| A3        | 5                                | Ala      | Glu     | Glu      | Glu      | 6         | EF2                              | 73       | Val     | Leu      | Leu      | Leu | 78 |
| A4        | 6                                | Asp      | Glu     | Asp      | Glu      | 7         | EF3                              | 74       | Asp     | Asp      | Asp      | Asp | 79 |
| A5        | 7                                | Lys      | Lys     | Lys      | Lys      | 8         | EF4                              | 75       | Asp     | Asn      | Asp      | Asn | 80 |
| A6        | 8                                | Thr      | Ser     | Ala      | Thr      | 9         | EF5                              | 76       | Met     | Leu      | Leu      | Leu | 81 |
| A7        | 9                                | Asn      | Ala     | Thr      | Ala      | 10        | EF6                              | 77       | Pro     | Lys      | Lys      | Lys | 82 |
| A8        | 10                               | Val      | Val     | Ile      | Val      | 11        | EF7                              | 78       | Asn     | Gly      | Gly      | Gly | 83 |
| A9        | 11                               | Lys      | Thr     | Thr      | Asn      | 12        | EF8                              | 79       | Ala     | Thr      | Thr      | Thr | 84 |
| A10       | 12                               | Ala      | Ala     | Ser      | Ala      | 13        | F1                               | 80       | Leu     | Phe      | Phe      | Phe | 85 |
| A11       | 13                               | Ala      | Leu     | Leu      | Leu      | 14        | F2                               | 81       | Ser     | Ala      | Ala      | Ser | 86 |

|     |                    |        |                 |         |
|-----|--------------------|--------|-----------------|---------|
| A12 | 14 Try Try Try Try | 15 F3  | 82 Ala Thr Gln  | Gln 87  |
| A13 | 15 Gly Gly Gly Gly | 16 F4  | 83 Leu Leu Leu  | Leu 88  |
| A14 | 16 Lys Lys Lys Lys | 17 F5  | 84 Ser Ser Ser  | Ser 89  |
| A15 | 17 Val Val Val Val | 18 F6  | 85 Asp Glu Glu  | Glu 90  |
| A16 | 18 Gly — — —       | — F7   | 86 Leu Leu Leu  | Leu 91  |
| AB1 | 19 Ala — — —       | — F8   | 87 His His His  | His 92  |
| B1  | 20 His Asn Asn Asn | 19 F9  | 88 Ala Cys Cys  | Cys 93  |
| B2  | 21 Ala Val Val Val | 20 FG1 | 89 His Asp Asp  | Asp 94  |
| B3  | 22 Gly Asp Glu Asp | 21 FG2 | 90 Lys Lys Lys  | Lys 95  |
| B4  | 23 Glu Glu Asp Ala | 22 FG3 | 91 Leu Leu Leu  | Leu 96  |
| B5  | 24 Tyr Val Ala Val | 23 FG4 | 92 Arg His His  | His 97  |
| B6  | 25 Gly Gly Gly Gly | 24 FG5 | 93 Val Val Val  | Val 98  |
| B7  | 26 Ala Gly Gly Gly | 25 G1  | 94 Asp Asp Asp  | Asp 99  |
| B8  | 27 Glu Glu Glu Glu | 26 G2  | 95 Pro Pro Pro  | Pro 100 |
| B9  | 28 Ala Ala Thr Ala | 27 G3  | 96 Val Glu Glu  | Glu 101 |
| B10 | 29 Leu Leu Leu Leu | 28 G4  | 97 Asn Asn Asn  | Asn 102 |
| B11 | 30 Glu Gly Gly Gly | 29 G5  | 98 Phe Phe Phe  | Phe 103 |
| B12 | 31 Arg Arg Arg Arg | 30 G6  | 99 Lys Arg Lys  | Arg 104 |
| B13 | 32 Met Leu Leu Leu | 31 G7  | 100 Leu Leu Leu | Leu 105 |
| B14 | 33 Phe Leu Leu Leu | 32 G8  | 101 Leu Leu Leu | Leu 106 |
| B15 | 34 Leu Val Val Val | 33 G9  | 102 Ser Gly Gly | Gly 107 |
| B16 | 35 Ser Val Val Val | 34 G10 | 103 His Asn Asn | Asn 108 |
| C1  | 36 Phe Tyr Tyr Tyr | 35 G11 | 104 Cys Val Val | Val 109 |
| C2  | 37 Pro Pro Pro Pro | 36 G12 | 105 Leu Leu Leu | Leu 110 |
| C3  | 38 Thr Try Try Try | 37 G13 | 106 Leu Val Val | Val 111 |
| C4  | 39 Thr Thr Thr Thr | 38 G14 | 107 Val Cys Thr | Cys 112 |
| C5  | 40 Lys Gln Gln Gln | 39 G15 | 108 Thr Val Val | Val 113 |
| C6  | 41 Thr Arg Arg Arg | 40 G16 | 109 Leu Leu Leu | Leu 114 |
| C7  | 42 Tyr Phe Phe Phe | 41 G17 | 110 Ala Ala Ala | Ala 115 |
| CD1 | 43 Phe Phe Phe Phe | 42 G18 | 111 Ala His Ile | Arg 116 |
| CD2 | 44 Pro Glu Asp Glu | 43 G19 | 112 His His His | Asn 117 |
| CD3 | 45 His Ser Ser Ser | 44 GH1 | 113 Leu Phe Phe | Phe 118 |
| CD4 | 46 Phe Phe Phe Phe | 45 GH2 | 114 Pro Gly Gly | Gly 119 |
| CD5 | 47 Asp Gly Gly Gly | 46 GH3 | 115 Ala Lys Lys | Lys 120 |
| CD6 | 48 Leu Asp Asn Asp | 47 GH4 | 116 Glu Glu Glu | Glu 121 |
| CD7 | 49 Ser Leu Leu Leu | 48 GH5 | 117 Phe Phe Phe | Phe 122 |
| CD8 | — Ser Ser Ser      | 49 H1  | 118 Thr Thr Thr | Thr 123 |
| D1  | 50 His Thr Ser Ser | 50 H2  | 119 Pro Pro Pro | Pro 124 |
| D2  | 51 Gly Pro Ala Pro | 51 H3  | 120 Ala Pro Glu | Gln 125 |
| D3  | — Asp Ser Asp      | 52 H4  | 121 Val Val Val | Met 126 |
| D4  | — Ala Ala Ala      | 53 H5  | 122 His Gln Gln | Gln 127 |
| D5  | — Val Ile Val      | 54 H6  | 123 Ala Ala Ala | Ala 128 |
| D6  | — Met Met Met      | 55 H7  | 124 Ser Ala Ser | Ala 129 |
| D7  | — Gly Gly Gly      | 56 H8  | 125 Leu Tyr Tyr | Tyr 130 |
| E1  | 52 Ser Asn Asn Asn | 57 H9  | 126 Asp Gln Gln | Gln 131 |
| E2  | 53 Ala Pro Pro Pro | 58 H10 | 127 Lys Lys Lys | Lys 132 |
| E3  | 54 Gln Lys Lys Lys | 59 H11 | 128 Phe Val Met | Val 133 |
| E4  | 55 Val Val Val Val | 60 H12 | 129 Leu Val Val | Val 134 |
| E5  | 56 Lys Lys Lys Lys | 61 H13 | 130 Ala Ala Thr | Ala 135 |

|     |                    |        |                              |         |
|-----|--------------------|--------|------------------------------|---------|
| E6  | 57 Gly Ala Ala Ala | 62 H14 | 131 Ser Gly Gly <sup>b</sup> | Gly 136 |
| E7  | 58 His His His His | 63 H15 | 132 Val Val Val              | Val 137 |
| E8  | 59 Gly Gly Gly Gly | 64 H16 | 133 Ser Ala Ala              | Ala 138 |
| E9  | 60 Lys Lys Lys Lys | 65 H17 | 134 Thr Asn Ser              | Asn 139 |
| E10 | 61 Lys Lys Lys Lys | 66 H18 | 135 Val Ala Ala              | Ala 140 |
| E11 | 62 Val Val Val Val | 67 H19 | 136 Leu Leu Leu              | Leu 141 |
| E12 | 63 Ala Leu Leu Leu | 68 H20 | 137 Thr Ala Ser              | Ala 142 |
| E13 | 64 Asp Gly Thr Gly | 69 H21 | 138 Ser His Ser              | His 143 |
| E14 | 65 Ala Ala Ser Ala | 70 HC1 | 139 Lys Lys Arg              | Lys 144 |
| E15 | 66 Leu Phe Leu Phe | 71 HC2 | 140 Tyr Tyr Tyr              | Tyr 145 |
| E16 | 67 Thr Ser Gly Ser | 72 HC3 | 141 Arg His His              | His 146 |

<sup>a</sup> Amino acids are indicated by a three-letter code. Uncharged amino acids: Ala, alanine; Asn, asparagine; Cys, cystine; Gln, glutamine; Gly, glycine; Ile, isoleucine; Leu, leucine; Met, methionine; Phe, phenylalanine; Pro, proline; Ser, serine; Thr, threonine; Try, tryptophan; Tyr, tyrosine; Val, valine. Charged amino acids: Arg, arginine (+1); Asp, aspartic acid (-1); Glu, glutamic acid (-1); His, histidine (+1); Lys, lysine (+1).

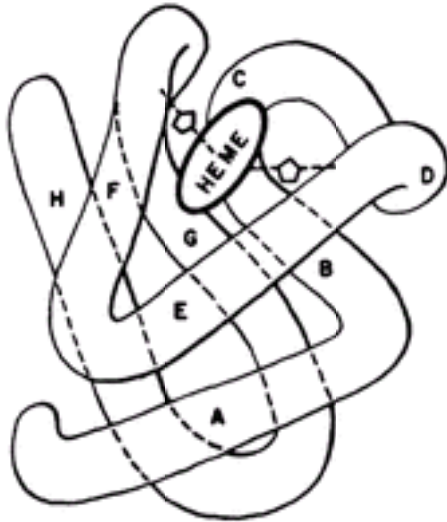
<sup>b</sup> The two normal  $\gamma$ -chain genes differ from each other in that the  $\gamma^G$  gene encodes glycine at this position, whereas the  $\gamma^A$  gene encodes alanine.

Despite the differences in the primary structure of non- $\alpha$  globin chains, their secondary structures are remarkably similar. Each has eight helical segments designated by the letters A through H ( [Table 8.7](#) ) ( [194](#) ). The helices of all the non- $\alpha$ -chain members are of identical length; however, a significant difference exists between the  $\alpha$  and non- $\alpha$  globin chains in the region of the D helix, which contains seven amino acids in the  $\delta$ -,  $\epsilon$ -,  $\delta$ -, and  $\beta$ -chains, but only two amino acids in the  $\alpha$ -chain. Because of the size of the D helix in the  $\alpha$  globin chains, many do not assign it a helix designation. The helices make up approximately 75% of the molecule. Interspersed between them are seven nonhelical segments: NA, AB, CD, EF, FG, GH, and HC. This arrangement is important structurally, because the helices are relatively rigid and linear, whereas the nonhelical segments allow bending.

A given amino acid in a hemoglobin polypeptide may be denoted either by its sequential number or by a helical number. In the sequential system, the  $N$ -terminal amino acid is assigned the number 1, and each succeeding amino acid receives the next higher number until the  $C$ -terminal is reached. With this system, amino acids are numbered from 1 to 141 in the  $\alpha$ -chain and from 1 to 146 in the  $\beta$ -,  $\delta$ -, and  $\epsilon$ -chains. In the helical system, each amino acid is designated by a letter and a number that indicate the helix and the position in the helix, respectively. The helical system is gradually gaining favor, because it illustrates the homology between chains and has more structural significance. For example, the histidine to which heme attaches is amino acid 87 in the  $\alpha$ -chain and 92 in the  $\beta$ -,  $\delta$ -, and  $\epsilon$ -chains; the helical designation for this histidine, F8, is the same in all the normal chains.

The tertiary and quaternary structures of hemoglobin have been studied by x-ray diffraction techniques, especially by Perutz and his co-workers ( [194](#) , [195](#) ). In aqueous solutions and in crystals, the polypeptide chains assume a structure in which the polar amino acids face the molecular surface where they interact with water, rendering the molecule soluble. The groups directed toward the inner core of the molecule are all nonpolar, and the hydrophobic (van der Waals) bonding that occurs between them makes

the structure stable. The resulting roughly spherical, tertiary structure is similar for all the normal hemoglobin polypeptides ( [Fig. 8.14](#) ) as well as for certain other heme proteins such as myoglobin.



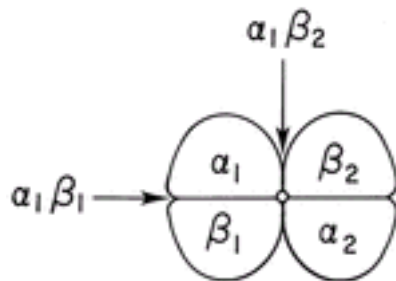
**Figure 8.14.** The tertiary structure of a single globin polypeptide chain. The helical segments, labeled A through H, are relatively linear; bending of the chains occurs between helices. Heme is suspended in a crevice between the E and F helices. (Courtesy of C.A. Finch.)

The heme pocket is the site of many dynamic interactions involving oxygen binding to hemoglobin. Heme is suspended in a nonpolar crevice between the E and F helices ( [Fig. 8.14](#) ), and helices B, G, and H constitute the floor of the pocket. Heme iron forms a covalent bond with the imidazole nitrogen of the “proximal” histidine at F8. In addition, heme forms van der Waals bonds with many other parts of the molecule and, in this way, makes an important contribution to tertiary structure. If heme is extracted, the central helical regions C, D, E, and F unfold with a consequent decrease in solubility ( [196](#) ). Not surprisingly, some unstable hemoglobins ( [Chapter 41](#) ) result from amino acid substitutions in the residues that line the heme pocket ( [197](#) ).

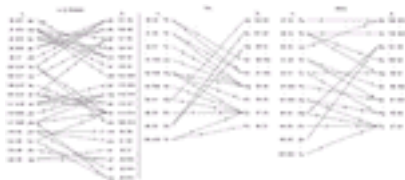
The binding of oxygen to the iron molecule causes the hemoglobin molecule to undergo conformational changes that affect the binding of oxygen to other heme sites. The mechanism for this property can be explained in part by the interactions in the heme pocket. The two histidines of globin (E7, F8) are located immediately above and below iron, which is in the plane of the pyrrole ring in oxyhemoglobin ( [198](#) ). In deoxyhemoglobin, the bond between the imidazole nitrogen of the proximal histidine and iron undergoes considerable strain, displacing iron from the plane of the ring. This strain is conveyed to other parts of the molecule and is in part responsible for the tense state of deoxyhemoglobin ( [199](#) ). The addition of two molecules of oxygen, which are bound to the iron atom in the heme ring by end-on geometry, results in the formation of a hydrogen bond between the oxygen atom not bound directly to the iron and the imidazole nitrogen of the histidine at E7 (the “distal” histidine) ( [199](#) ). The binding of oxygen to iron changes the electron spin state of iron and relaxes the covalent bond with the proximal histidine, permitting the iron to move into the plane of the ring and relaxing the molecule, contributing to the relaxed state ( [200](#) ). The overall conformational changes to hemoglobin appear to be the greatest after three molecules of O<sub>2</sub> have been added. In general,

proteins that undergo an allosteric change from the tense to a relaxed state are better able to interact with substrate in the relaxed state.

When four polypeptide chains combine to form the hemoglobin molecule, each chain lies approximately at the vertices of a regular tetrahedron. With high-resolution x-ray diffraction, the nature of the contacts between chains has been explored in detail for horse hemoglobin (194). Contacts between like chains (i.e.,  $\alpha_1\alpha_2$  and  $\beta_1\beta_2$ ) are limited and of little importance. The two major contacts between unlike chains have been named  $\alpha_1\beta_1$  and  $\alpha_1\beta_2$ , respectively (Fig. 8.15). (The  $\alpha_2\beta_2$  contact is the same as  $\alpha_1\beta_1$ .) The  $\alpha_1\beta_1$  contact point is extensive and moves relatively little (<0.1 nm) when hemoglobin is oxygenated. The  $\alpha_1\beta_2$  contact is smaller and smoother, and movement on oxygenation is relatively great (as much as 0.7 nm). As a result, there are two quaternary structures for hemoglobin: one for the deoxygenated form and one for the liganded or oxygenated form. The main difference between the two is the nature of the  $\alpha_1\beta_2$  contact (Fig. 8.16).



**Figure 8.15.** Diagram of hemoglobin tetramer illustrates two types of  $\alpha\beta$  contact points: a relatively extensive one ( $\alpha_1\beta_1$  or  $\alpha_2\beta_2$ ) and one that is smaller ( $\alpha_1\beta_2$  or  $\alpha_2\beta_1$ ). The actual molecular contact points are detailed in Figure 8.16.



**Figure 8.16.** Quaternary structure of hemoglobin. At left is the most extensive contact,  $\alpha_1\beta_1$ , in which 16 amino acids in the  $\alpha$ -chain form bonds with 18 amino acids in the  $\beta$ -chain. The  $\alpha_1\beta_1$  contact does not change significantly on oxygenation. The smaller  $\alpha_1\beta_2$  contact, center and right, has two forms, depending on whether the hemoglobin is in the oxygenated (Oxy) or deoxygenated (Deoxy) form. At  $\alpha_1\beta_2$ , 10 or 11 amino acids in the  $\alpha$ -chain form bonds with nine in the  $\beta$ -chain. Plain lines indicate van der Waals bonds; broken lines indicate hydrogen bonds. Numbers on lines give the number of atoms in contact. (From Perutz MF, Muirhead H, Cox JM, et al. Stereochemistry of cooperative effects in haemoglobin. Nature 1968;219:29, with permission.)

## Assembly of Hemoglobin

Much of our overall knowledge of the synthesis of proteins was learned from the study of globins, and many of the specific details of the synthesis of globins are described in Chapter 7. Assembly of the hemoglobin tetramer from the monomers, however, has received relatively little attention, although an understanding of the process can provide

some insight into the laboratory evaluation of hemoglobins.

In general, there is little posttranscriptional regulation of the synthesis of globins, although factors such as the availability of heme can affect translation of globin mRNA ( [201](#) ). Aside from several variants, such as hemoglobin Lepore, that are synthesized at a slower rate, the synthesis rates of most normal or mutant globins are the same ( [202](#) ). Nevertheless, individuals with  $\beta$ -chain variants often express less of the variant hemoglobin than hemoglobin A. This observation has been attributed to an increased rate of catabolism of newly synthesized globin chains due to decreased solubility, defective heme binding, or abnormal subunit assembly. The best data indicate that the variations seen in most stable hemoglobin variants result from differences in subunit assembly ( [183](#) , [203](#) ).

After translation of globin mRNA and globin chain synthesis, heme associates with globins, and a globin chains pair with members of the  $\beta$  globin family. In large part, this binding is a consequence of the different charges on a globins, which are positively charged ( $pI = 8.1$ ), and  $\beta$  globins, which are negatively charged ( $pI = 6.6$ ) ( [204](#) ). The greater the charge difference, the greater the electrostatic attraction. Positively charged variants, such as  $\beta_C$ , and the uncharged  $\beta_S$  bind to a globin and assemble into  $\alpha$ - $\beta$  dimers at approximately half the rate of  $\beta_A$  during *in vitro* mixing experiments ( [203](#) ). Conversely, more negatively charged variants, such as  $\beta_{N\text{-Baltimore}}$ , bind with a greater association rate. This phenomenon has been suggested as an explanation for the ratio of 60:40 seen for hemoglobin A and hemoglobin S in heterozygotes for  $\beta_S$ . Likewise, the percentage of N-Baltimore is increased over hemoglobin A.

In conditions of a globin deficiency, this competition is more pronounced, and the percentage of the more positively charged variant is further reduced. Patients heterozygous for  $\beta_S$  and  $\alpha$ -thalassemia carry percentages of hemoglobin S of approximately 35%, 30%, and 25%, corresponding to one-, two-, or three-gene  $\alpha$ -thalassemia ( [205](#) ).

Hemoglobin A<sub>2</sub> is reduced in certain  $\alpha$ -thalassemias and in iron deficiency, which causes an acquired reduction in a globin synthesis as a result of decreased heme synthesis. Under these conditions, the more positively charged  $\delta$  globin would be expected to compete less well with the normal  $\beta$  globin. In contrast, during  $\beta$  globin deficiency associated with  $\beta$ -thalassemia,  $\delta$  globin would be expected to compete more effectively for a globin chains, and the predicted increase in hemoglobin A<sub>2</sub> is observed ( [206](#) ).

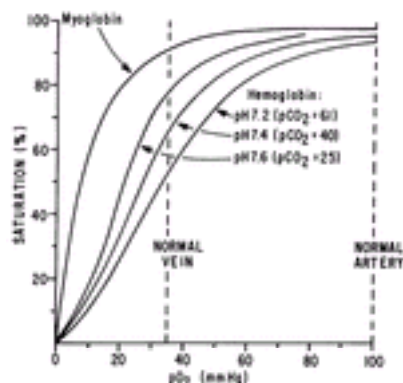
## Oxygen Transport

To function as the primary medium of exchange of oxygen and carbon dioxide, hemoglobin must fulfill the four requirements first delineated by Barcroft ( [207](#) ). It must be capable of transporting a large quantity of oxygen, it must be highly soluble, it must take up and release oxygen at “appropriate pressures,” and it must also be a good buffer. Normal hemoglobin fulfills these requirements well, although many abnormal variants fail to meet one or more of these conditions.

When fully saturated, each gram of hemoglobin binds 1.39 ml of oxygen. The degree of saturation is related to the  $PO_2$ , which normally ranges from 100 mm Hg in arterial blood to approximately 35 mm Hg in veins. The relation between  $PO_2$  and hemoglobin oxygen saturation is described by the oxygen dissociation curve of hemoglobin ( [Fig. 8.17](#) ). The characteristics of this curve are related in part to properties of hemoglobin itself and in part to the environment within the erythrocyte, with pH, temperature, and concentration



of 2,3-DPG being the most important factors affecting oxygen affinity.



**Figure 8.17.** Oxygen dissociation curve of hemoglobin at three values for pH, compared with that of myoglobin. PO<sub>2</sub>, partial pressure of oxygen; PCO<sub>2</sub>, partial pressure of carbon dioxide.

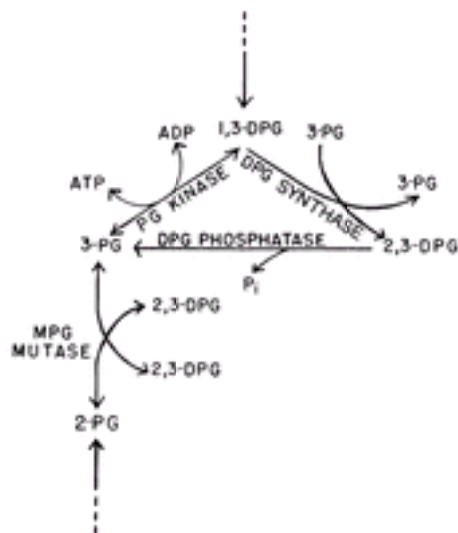
Oxygen affinity of a particular hemoglobin is generally expressed in terms of the PO<sub>2</sub> at which 50% saturation occurs, the so-called P<sub>50</sub>. When measured in whole erythrocytes, this value averages approximately 26 mm Hg in normal, nonsmoking males and slightly higher in normal, nonsmoking females (208). When oxygen affinity increases, the dissociation curve shifts leftward, and the value for P<sub>50</sub> is reduced. Conversely, with decreased oxygen affinity, the curve shifts to the right, and P<sub>50</sub> is increased.

The oxygen dissociation curve of single-subunit heme polypeptides (e.g., myoglobin) is hyperbolic, and oxygen affinity is considerably greater than that of hemoglobin (Fig. 8.17). Such a compound would function poorly in oxygen transport because little oxygen would be released until the tissue PO<sub>2</sub> was very low. For example, at the usual tissue PO<sub>2</sub> of 40 mm Hg, myoglobin would remain over 90% saturated. In contrast, the oxygen dissociation curve of hemoglobin is distinctly sigmoidal; the steepest part of its slope occurs at levels of PO<sub>2</sub> corresponding to those found in tissues. This difference between the hemoglobin and myoglobin curves is the result of interaction between the four heme-polypeptide units of hemoglobin. Although called *heme-heme interaction* in the past, *subunit cooperativity* better describes the process whereby the binding of oxygen by one subunit increases the oxygen affinity of other subunits; no direct interaction among heme moieties is involved. This allosteric property of hemoglobin permits rapid changes in oxygen affinity during the time the red blood cell passes through the capillary bed.

The change in oxygen affinity with pH is known as the *Bohr effect* (209, 210). Hemoglobin oxygen affinity is reduced as the acidity increases (Fig. 8.17). Because the tissues are relatively rich in carbon dioxide and red cell carbonic anhydrase readily converts carbon dioxide to carbonic acid, the pH is lower there than in arterial blood; therefore, the Bohr effect facilitates transfer of oxygen to tissues. In the lungs, as oxygen is taken up and carbon dioxide is released, the pH rises and the oxygen affinity curve shifts to the left. This event, termed the *alkaline Bohr effect*, increases the oxygen affinity of hemoglobin, helping to maximize oxygen uptake. Thus, the Bohr effect links and enhances the transport of both oxygen and carbon dioxide.

Another important factor affecting the oxygen affinity of hemoglobin is the concentration of 2,3-DPG (211, 212, 213 and 214). The molecule can insert into the pocket between β

globin subunits in tetrameric hemoglobin and reduces oxygen affinity. 2,3-DPG is synthesized from glycolytic intermediates by means of a pathway known as the *Rapoport-Luebering shunt* ( Fig. 8.18). In the erythrocyte, 2,3-DPG is the predominant phosphorylated compound, accounting for approximately two-thirds of the red cell phosphorus, whereas, in contrast, it is present in only trace amounts in other tissues.



**Figure 8.18.** The synthesis of 2,3-diphosphoglycerate (2,3-DPG) or 3-phosphoglycerate (3-PG) and adenosine triphosphate (ATP) from 1,3-diphosphoglycerate (1,3-DPG) by the Rapoport-Luebering cycle. ADP, adenosine diphosphate; MPG, XX; P<sub>i</sub>, XX. (From Bunn HF, Forget BG. Hemoglobin: molecular, genetic and clinical aspects. Philadelphia: WB Saunders, 1986, with permission.)

The production of 2,3-DPG depends on the rate of formation of its precursor, 1,3-DPG, and the relative amounts of 1,3-DPG going into the Rapoport-Luebering shunt and into the ATP-forming glycolytic pathway. Actual 2,3-DPG concentration also depends on the rate of hydrolysis of 2,3-DPG. Although several steps in the glycolytic pathway may be sensitive to changing conditions, such as pH, ADP-ATP, and nicotinamide adenine dinucleotide (NAD-NADH) ratios, and the concentration of inorganic phosphorus, it is the relative concentrations of ATP and ADP that appear most directly linked to the rate of 2,3-DPG production. A relative increase in the amount of ADP is associated with an increase in the production of 3-phosphoglycerate and a decrease in 2,3-DPG. Oxidants such as methylene blue and pyruvate increase 2,3-DPG synthesis by affecting the NAD-NADH ratio.

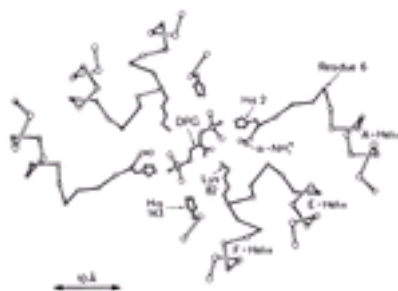
Two multifunctional enzymes are important to the synthesis and degradation of 2,3-DPG. Both enzymes are capable of promoting three reactions: the synthesis of 2,3-DPG from 1,3-DPG; the breakdown of 2,3-DPG into 3-PG, water, and phosphorus; and the conversion of 3-PG to 2-PG. The structures of these enzymes and their relative activities have been described extensively ( [215](#) , [216](#) , [217](#) , [218](#) and [219](#) ).

The most important function of 2,3-DPG is its effect on the oxygen affinity of hemoglobin. In the deoxygenated state, hemoglobin A can bind 2,3-DPG in a molar ratio of 1:1, a reaction leading to reduced oxygen affinity and improved oxygen delivery to tissues. The increased oxygen affinity of fetal hemoglobin appears to be related to its lessened ability to bind 2,3-DPG. The cellular concentration of 2,3-DPG also affects intracellular pH, because 2,3-DPG is a highly charged, impermeant anion. Hemoglobin, also an

impermeant anion, and 2,3-DPG together lower the intracellular concentration of chloride relative to the extracellular concentration. This effect, in turn, lowers intracellular pH relative to extracellular pH, which, by the Bohr effect, also lowers oxygen affinity and thus increases oxygen delivery to tissues ( [220](#) ).

The increased oxygen affinity of stored blood is accounted for by reduced levels of 2,3-DPG ( [221](#) ). Transfusion of such blood results in an *in vivo* increase in oxygen affinity that returns toward normal in 7 to 12 hours as the function of the glycolytic pathway is restored. The reduction in 2,3-DPG levels in stored blood can be mitigated by adding inosine or phosphate to the storage solutions ( [222](#) ). The actual clinical impairment in oxygen delivery due to low 2,3-DPG levels remains disputed, but it would be expected to have its greatest impact when large transfusions are required in critically ill individuals. In such situations, some centers administer fresh blood ( [223](#) ), although this practice remains uncommon.

Changes in 2,3-DPG levels play a significant role in adaptation to hypoxia. In some situations associated with hypoxemia, 2,3-DPG levels in red cells increase, oxygen affinity is reduced, and delivery of oxygen to tissues is facilitated. Such situations include abrupt exposure to high altitude, anoxia resulting from pulmonary or cardiac disease, blood loss, and anemia ( [224](#), [225](#) and [226](#) ). Increased 2,3-DPG levels also play a role in adaptation to exercise ( [227](#) ). The compound is not essential to life, however; an individual who lacked the enzymes necessary for 2,3-DPG synthesis was perfectly well except for mild polycythemia. Heme-heme interaction, the Bohr effect, and the effect of 2,3-DPG have been explained on a molecular basis in a model proposed by Perutz ( [228](#) ). In the completely deoxygenated state, hemoglobin assumes a quaternary structure termed T (“taut” or “tense”). This structure is stabilized by salt bridges involving the carboxy terminals of the peptide chains. The deoxy form is also stabilized by the presence of 2,3-DPG, which joins the  $\beta$ -chains as shown in [Figure 8.19](#).

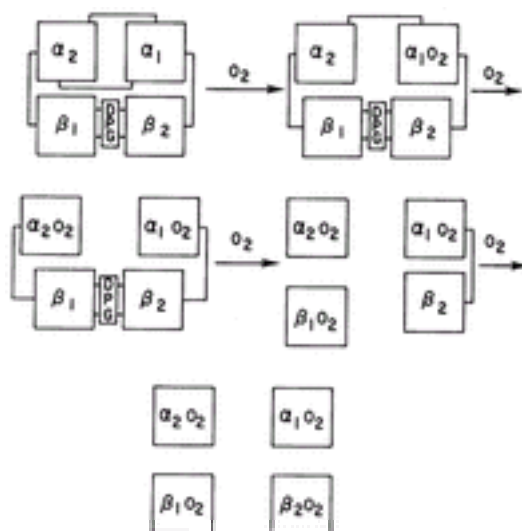


**Figure 8.19.** The 2,3-diphosphoglycerate (2,3-DPG) binding site. Part of one  $\beta$ -chain is at upper left, the other at lower right. Salt bridges are found between the phosphates of 2,3-DPG and positively charged groups at 1 Val ( $\alpha\text{-NH}_3^+$ ), 2 His, and 143 His. The 82 Lys of one chain is also involved. (From Arnone A. X-ray diffraction study of binding of 2,3-diphosphoglycerate to human deoxyhemoglobin. *Nature* 1972;237:146, with permission.)

The tertiary structure of deoxygenated subunits also differs from that of the oxygenated form. In the deoxy form, heme iron is in a high-spin state and, in this form, is displaced slightly from the plane of the porphyrin ring. The penultimate tyrosine is wedged firmly between the F and H helices. When oxygen is added, iron changes to a low-spin state and moves to a position in plane with the porphyrin ring, a distance of approximately 0.2 nm, pulling the attached F helix with it. This movement narrows the space between the F and

H helices, expelling the penultimate tyrosine from its pocket. The C-terminal amino acid moves with the tyrosine, thereby breaking the salt bridges with adjacent chains.

Fully oxygenated hemoglobin assumes the R or “relaxed” structure ( [Fig. 8.20](#)). The exact series of events that bring about this change, along with the change in oxygen affinity that accompanies it, has been difficult to ascertain, in part because of the large number of variables that need to be controlled (e.g., temperature, pH, 2,3-DPG concentration, and hemoglobin concentration) and the extraordinarily large number of thermodynamic measurements that need to be made. Nevertheless, at least some of the molecular events that contribute to this shift in quaternary structure and oxygen affinity have been delineated ( [229](#), [230](#)). Hemoglobin appears to exist in a third molecular form, intermediate between the T and R conformations. Achievement of the R conformation occurs when at least one oxygen molecule is bound on each side of the  $\alpha_1\beta_2$  interaction; however, significant subunit cooperativity also exists within each  $\alpha_1\beta_1$  dimer of the T-state tetramer. Conversion to the R form is also accompanied by expulsion of the 2,3-DPG and disruption of the salt bridges and hydrophobic interactions at the  $\alpha_1\beta_2$  contact point ( [Fig. 8.20](#)). Oxygen affinity then becomes much increased, and oxygen is added to the remaining  $\beta$ -chain or chains. Because hemoglobin A has four subunits, it might be expected that the switch from the T to the R state would occur in four distinct steps. Experimentally, it appears to switch abruptly. This is best explained by the relationship of the four subunits. The  $\alpha$ - and  $\beta$ -chains in the dimers have many more contacts than the two dimers with each other, and the dimers can move onto each other. As oxygen is either loaded or unloaded onto the hemoglobin tetramer, tension is created, and the point where the two dimer subunits slide onto each other is determined by the concentration of the allosteric mediators in the cell, including pH,  $\text{Cl}^-$  concentration, and 2,3-DPG levels.



**Figure 8.20.** Diagrammatic representation of the subunit interaction in hemoglobin as oxygen is added. Deoxyhemoglobin ( *upper left*), with low oxygen affinity, is in the T (taut) conformation, constrained by salt bridges ( *interconnecting lines*) and the 2,3-diphosphoglycerate (2,3-DPG) molecule. As  $\text{O}_2$  is added, salt bridges are broken, and, eventually, the DPG molecule is expelled, resulting in the R (relaxed) configuration with higher oxygen affinity.

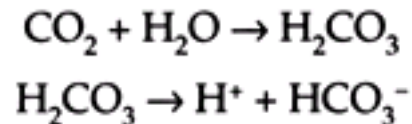
The alkaline Bohr effect is explained by rupture of the salt bridges involving the  $\beta$ -chain C-terminal histidine and the  $\alpha$ -N-terminal valine. When these bridges are broken, the pK of the dissociation of hydrogen ion is reduced. It has also been suggested that

approximately 25% of the alkaline Bohr effect may be accounted for by histidine at a122 ( [231](#) ).

Alterations in the oxygen dissociation curve occurring in various hemoglobinopathies are discussed later in this book in [Chapter 41](#), [Chapter 49](#), and [Chapter 50](#).

### Carbon Dioxide Transport

Transport of carbon dioxide by red cells, unlike that of oxygen, does not occur by direct binding to heme ( [232](#) ). In aqueous solutions, carbon dioxide undergoes a pair of reactions:

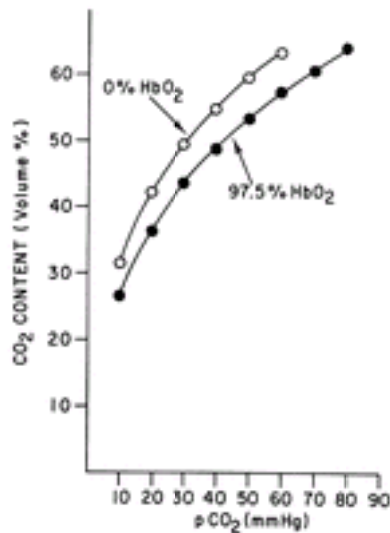


Carbon dioxide diffuses freely and rapidly into the red cell, where the presence of the enzyme carbonic anhydrase facilitates the first of these two reactions. The  $\text{H}^+$  liberated in the second reaction is accepted by deoxygenated hemoglobin, a process facilitated by the Bohr effect. The bicarbonate formed in this sequence of reactions diffuses freely across the red cell membrane, and a portion is exchanged with plasma  $\text{Cl}^-$ , a phenomenon called the *chloride shift*. The bicarbonate is carried in plasma to the lungs, where ventilation keeps the  $\text{CO}_2$  tension ( $\text{PCO}_2$ ) low, resulting in reversal of the above reactions and excretion of  $\text{CO}_2$  in the expired air. Approximately 85% of tissue carbon dioxide is processed in this way, and 5% is carried in simple solution.

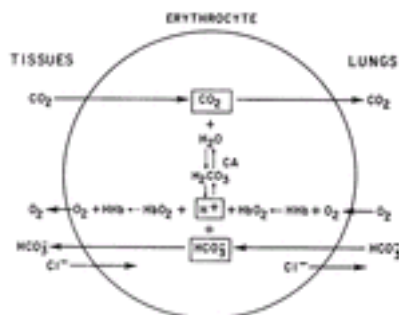
The remainder of the  $\text{CO}_2$  is bound to the *N*-terminal amino group of each polypeptide chain by a carbamino complex, the result of an attack by the electron-poor carbon atom of  $\text{CO}_2$  on the electron-rich terminal amino acids. This nonenzymatic process varies directly with pH. Approximately 10% of  $\text{CO}_2$  is bound to deoxygenated hemoglobin, forming carbaminohemoglobin ( $\text{Hb-NH-COO}^-$ ).

Earlier, the effect of  $\text{CO}_2$  on oxygen affinity was noted and attributed to the Bohr effect. An additional, more direct effect results from  $\text{CO}_2$  binding to hemoglobin. At a given pH, carbaminohemoglobin has a lower affinity for oxygen than has hemoglobin in the absence of  $\text{CO}_2$ . This is believed to be a result of the stabilization of the T state through additional bonds, especially involving arginine 141 ( [233](#) ).

The carbon dioxide dissociation curve is analogous to the oxygen dissociation curve in that it depicts the relationship between  $\text{PCO}_2$  and  $\text{CO}_2$  content ( [Fig. 8.21](#) ). It is somewhat more nearly linear than the oxygen curve, especially in the physiologic range ( $\text{PCO}_2$ , 40 to 60 mm Hg). Blood containing deoxyhemoglobin has greater affinity for  $\text{CO}_2$  than does oxygenated blood because of the Bohr effect. The shift in the  $\text{CO}_2$  dissociation curve related to this phenomenon, known as the *Haldane effect*, facilitates  $\text{CO}_2$  binding in the tissues and release in the lungs ( [Fig. 8.22](#) ).



**Figure 8.21.** The carbon dioxide dissociation curve of whole blood. The curve is relatively linear between partial pressure of carbon dioxide ( $\text{PCO}_2$ ) 40 and 60 mm Hg. The difference between the curves of oxygenated and deoxygenated blood is known as the *Haldane effect*.  $\text{HbO}_2$ , oxyhemoglobin.



**Figure 8.22.** Interrelations of oxygen and carbon dioxide transport in the erythrocyte. Arrows to the left indicate direction of reactions taking place in the tissues; those to the right, in the lungs. In the tissue,  $\text{CO}_2$  diffuses into the red cell, and its hydration is catalyzed by carbonic anhydrase (CA). Dissociation of the resulting carbonic acid produces bicarbonate and a proton ( $\text{H}^+$ ). The bicarbonate is exchanged for chloride in the plasma. The proton is accepted by oxyhemoglobin ( $\text{HbO}_2$ ), a reaction that, by means of the Bohr effect, facilitates the dissociation of oxygen. These reactions are reversed in the lungs because of the low partial pressure of carbon dioxide and high partial pressure of oxygen.

Carbonic anhydrase is the second most abundant cytoplasmic protein of the erythrocyte. It is a zinc-containing enzyme for which three separately encoded isoenzymes, CAI, CAII, and CAIII, are recognized. The predominant form in the human erythrocyte is CAI, although CAII is also found. Largely absent from fetal erythrocytes, erythrocyte CAI expression reaches adult levels during the first year of life, in a manner analogous to the expression of adult hemoglobin (hemoglobin A) ( [234](#), [235](#) ). All three isoenzymes of carbonic anhydrase have similar structures, and all appear encoded by genes on chromosome 8. CAI, however, contains within its active site a unique histidine that appears to stabilize the enzyme- $\text{HCO}_3^-$  complex, thus effecting the maximal rate of  $\text{CO}_2$  hydration ( [236](#), [237](#),



[238](#) and [239](#)).

Although carbonic anhydrase clearly facilitates carbon dioxide metabolism, its presence in erythrocytes does not appear to be essential. Hereditary absence of CAI has been reported to occur without hematologic sequelae, and acquired deficiency is often seen with hyperthyroidism ([240](#), [241](#)). CAII deficiency is likewise without hematologic effect, although it is associated with the syndrome of renal tubular acidosis and cerebral calcifications ([242](#), [243](#)); enzyme activity with characteristics similar to those of CAIII is found to be increased in CAII-deficient erythrocytes ([244](#)). Also, complete inhibition of carbonic anhydrase by acetazolamide has little effect on carbon dioxide transport, at least under basal conditions ([245](#)). Nevertheless, carbonic anhydrase does appear to equalize the rate of hydration of carbon dioxide with the rate of protonation of hemoglobin, thus bringing into balance the rates of oxygen and carbon dioxide exchange. This equalization may be especially advantageous when the system is stressed, such as during exercise ([246](#)).

### Nitric Oxide: Another Allosteric Effector of Hemoglobin

The discovery of NO as an important regulator of vascular and smooth muscle tone has provided many insights into our understanding of vascular physiology. NO is produced by the vascular endothelium and relaxes muscles surrounding vessels, thereby controlling blood pressure. Subsequently, it was determined that free hemoglobin could act as a scavenger of NO and inactivate it, explaining the observation that the infusion of free hemoglobin results in significant elevations of blood pressure. This reaction occurs because the oxygenated heme irons scavenge NO in a reaction yielding methemoglobin. More recent studies have revealed a new relationship between NO and hemoglobin ([247](#)).

Early studies of the interaction of hemoglobin with NO predicted that a function of hemoglobin was to eliminate or limit the biologic activity of NO and did not predict any functional impact on hemoglobin other than the oxidation of heme iron. This model did not explain how NO could be maintained at observed levels based on its known low levels of production. This was clarified with the discovery of S-nitrosohemoglobin (SNO-Hb) ([248](#)). When free hemoglobin is incubated with NO or S-nitrosothiols (SNOs), SNOs rapidly form on the two 93 $\beta$  cysteines of hemoglobin rather than reacting with the oxygenated heme groups as might be expected. The infusion of this SNO-Hb results in no increase in blood pressure ([247](#)).

In the pulmonary circulation, coincident with oxygenation of hemoglobin, NO is added to hemoglobin, and, rather than oxidizing the heme iron, it binds to the iron or forms SNO-Hb through the reactive sulfhydryl groups of cysteine 93 $\beta$  of hemoglobin ([249](#), [250](#)). This function for cysteine 93 $\beta$  may explain why this amino acid is invariant in mammals and birds. Reactivity of NO with the SH groups of cysteine 93 $\beta$  is controlled by the allosteric transition of hemoglobin and the spin state of heme iron. Thus, oxygen binding and conversion to the R state increase reactivity ([248](#)).

Likewise, loss of oxygen in the peripheral tissues results in transition of hemoglobin to the T state and release of NO. NO is either bound to small thiols or to the anion exchanger AE1. The latter is facilitated because hemoglobin can bind to the red blood cell membrane through specific, high-affinity binding to the amino-terminal cytoplasmic domain of the chloride/bicarbonate anion exchange protein AE1 (band 3 protein) ([251](#)). The amino terminus of AE1 inserts into the cleft usually occupied by 2,3-DPG ([251](#)). NO-mediated vasodilatory activity is released from AE1 by deoxygenation and binds to receptors on the



vascular endothelium to induce vasodilation. SNO-Hb is therefore detected in arterial but not in venous blood.

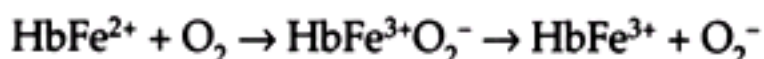
### Oxidative Denaturation of Hemoglobin: Its Reversibility and Prevention

Oxyhemoglobin in solution gradually undergoes autooxidation, becoming methemoglobin (HbFe<sup>3+</sup>). The rate of oxidation is enhanced by conditions such as increased temperature, decreased pH, presence of organic phosphate and of metal ions, and partial oxygenation of hemoglobin. To bind oxygen reversibly, however, the iron in the heme moiety must be maintained in the reduced (ferrous, Fe<sup>2+</sup>) state, despite exposure to a variety of endogenous and exogenous oxidizing agents. The red cell maintains several metabolic pathways to prevent the action of these oxidizing agents and to reduce the hemoglobin iron if it becomes oxidized. Under certain circumstances, these mechanisms fail, and hemoglobin becomes nonfunctional. At times, hemolytic anemia supervenes as well. These abnormalities are particularly likely to occur (a) if the red cell is exposed to certain oxidant drugs or toxins (see [Chapter 38](#) and [Chapter 49](#)), (b) if the intrinsic protective mechanisms of the cell are defective (see [Chapter 33](#)), or (c) if genetic abnormalities of the hemoglobin molecule affect globin stability or the heme crevice (see [Chapter 41](#)).

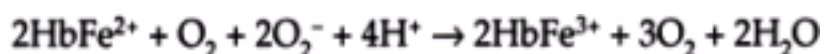
The oxidation of hemoglobin occurs in a stepwise fashion from fully reduced hemoglobin to fully oxidized hemoglobin. Intermediate forms are called *valence hybrids*. In deoxyhemoglobin, the heme iron is in the “high-spin” ferrous state, in which six electrons are in the outer shell, four of which are unpaired. When oxygen is added, one of these electrons is partially transferred to the bound oxygen. Usually, when oxygen is given up, oxyhemoglobin dissociates into partially deoxygenated hemoglobin and molecular oxygen:



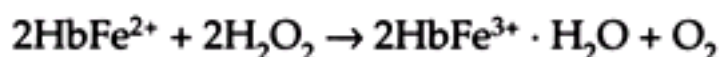
A superoxide anion rather than molecular oxygen may dissociate, however, thus oxidizing the Fe to the ferric state, producing methemoglobin:



This type of dissociation is particularly likely if water gains access to the heme crevice. Methemoglobin formation may also occur *in vivo* as the result of exposure to superoxide anions:

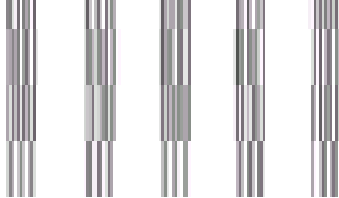


The formation of methemoglobin may also result from a direct reaction of reduced hemoglobin with the reduction product of the superoxide ion, peroxide:

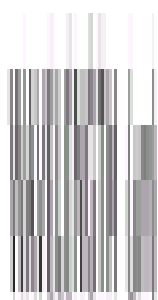


As a result of these processes, methemoglobin is formed in normal cells at the rate of approximately 0.5 to 3.0% per day ([252](#)).

Methemoglobin is unable to bind oxygen. It has a distinctive, pH-dependent spectrum ([Fig. 8.23](#); [Table 8.8](#)) and, in concentrations greater than 10% of the total hemoglobin,



brownish hue that does not disappear on vigorous shaking in  $\text{H}_2\text{O}$  is present *in vivo* in concentrations greater than 1.5 to 2.0 g/dl, is cyanotic. Methemoglobin combines readily with cyanide to form a pigment so stable that it is used in laboratory procedures for



**Figure 8.23.** Change in hemoglobin spectrum as oxyhemoglobin changes to methemoglobin. The numbers 1 through 6 represent curves taken in sequence as oxidation proceeds. Note in particular the disappearance of the band at 575  $\mu\text{m}$  and the appearance of the band at 631  $\mu\text{m}$ .

**TABLE 8.8. Spectral Characteristics of Hemoglobin (Hb) and Its Derivatives**

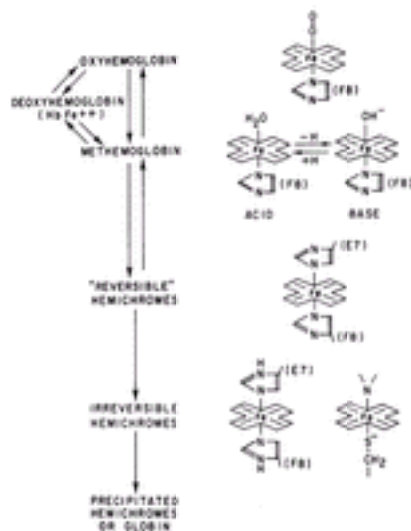
| Derivative             | Formula   | Spectral Bands |     |     |      |     |      |
|------------------------|---|----------------|-----|-----|------|-----|------|
|                        |   | d              | e   | d   | e    | d   | e    |
| Deoxyhemoglobin        | $\text{Hb}(\text{d}^6)_2$                       | 430            | 133 | 555 | 12.5 | —   | —    |
| Oxyhemoglobin          | $\text{Hb}(\text{d}^5_{1/2})\text{O}_2^-$       | 415            | 125 | 541 | 13.8 | 577 | 14.6 |
| Acid methemoglobin     | $\text{Hb}(\text{d}^5_{5/2})\text{H}_2\text{O}$ | 405            | 179 | 500 | 10.0 | 631 | 4.4  |
| Alkaline methemoglobin | $\text{Hb}(\text{d}^5_{1/2})\text{OH}^-$        | 410            | 120 | 540 | 11.0 | 575 | 9.2  |
| Cyanomethemoglobin     | $\text{Hb}(\text{d}^5_{1/2})\text{CN}$          | 419            | 124 | 540 | 12.5 | —   | —    |
| Hemichromes            | $\text{Hb}(\text{d}^5_{1/2})\text{X}$           | 411            | 105 | 534 | 14.7 | 565 | 12.5 |
| Carboxyhemoglobin      | $\text{Hb}(\text{d}^6_0)\text{CO}$              | 419            | 191 | —   | —    | 569 | 13.4 |
| Sulfhemoglobin         | $\text{Hb}(\text{d}^6)\text{S}$                 | 421            | 86  | —   | —    | 618 | 24.0 |

e, millimolar extinction coefficient; d, wavelength in nm.

From Antonini E, Buroni M. Hemoglobin and methemoglobin. In: Surgenor DM, ed. The red blood cells, vol. II. New York: Academic Press, 1975, with permission.

As oxidative denaturation continues, methemoglobin is converted to derivatives known as *hemichromes* ( Fig. 8.24 ) ( [253](#) ). Hemichromes also may form directly from hemoglobin without methemoglobin as an intermediate. The hemichromes are low-spin, ferric compounds with a greenish hue and a characteristic spectrum ( Table 8.8; Fig. 8.23 ). They

are formed when the sixth coordination position of iron becomes covalently attached to a ligand within the globin molecule, a change that requires alteration of tertiary protein structure. Probably the most common internal ligand is the so-called distal histidine at E7 ( Fig. 8.24). The compound so formed has been called a “reversible” hemichrome because relatively mild treatment with reducing agents and dialysis under anaerobic conditions converts it to deoxyhemoglobin. It may not be reversible *in vivo*, however, because it cannot be reduced by methemoglobin reductase.



**Figure 8.24.** Stages in the oxidative denaturation of hemoglobin. Names of the stages are given on the left, proceeding from the most reduced form at the top to the most oxidized at the bottom. Partial structures are illustrated on the right. The heme group is denoted by a planar cross. For a more complete description, refer to the text.

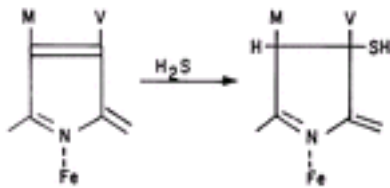
In contrast, the “irreversible” hemichromes cannot be converted back to normal hemoglobin again *in vivo* or *in vitro*, implying that more severe distortions of tertiary protein structure have occurred. In one of the irreversible hemichromes, the histidine imidazole groups are protonated (i.e., they participate in hydrogen bonding). The other irreversible hemichrome is characterized by a mercaptide and nitrogenous linkage at the fifth and sixth positions ( Fig. 8.24). Presumably, the mercaptide link is provided by a cysteine residue in the globin chain, perhaps at  $\beta 93$ .

As these changes occur in the vicinity of the heme group, oxidative changes also occur in other parts of the hemoglobin molecule. Once the cell's supply of GSH is exhausted, the titratable sulfhydryl groups at  $\beta 93(\text{F9})\text{Cys}$  are oxidized, often forming a mixed disulfide with GSH ( 254 ). This change is reversible; however, as further alterations in globin conformation occur, normally protected or “buried” sulfhydryl groups at  $\beta 112(\text{G14})\text{Cys}$  and  $\alpha 104(\text{G11})\text{Cys}$  become exposed and are oxidized, changes that disrupt the  $\alpha_1\beta_2$  contacts. These changes facilitate dissociation of polypeptide chains, first into  $\alpha\beta$  dimers and finally into monomers ( 253 ). In some instances, heme may dissociate from globin, particularly in the case of certain unstable hemoglobins.

The end products of these changes are precipitated hemichromes and precipitated heme-free globin. In intact erythrocytes, these precipitates take the form of globular inclusions known as *Heinz bodies*, which are not visible with ordinary Wright stain but can be seen easily after supravital staining with crystal violet or brilliant cresyl blue. Heinz

bodies may become attached to the cell membrane and shorten red cell survival.

Another nonfunctional hemoglobin derivative occasionally formed during the oxidative denaturation of hemoglobin is sulfhemoglobin. It is a relatively stable pigment and, once formed, cannot be converted to hemoglobin *in vivo*. Instead, it tends to remain within the cell throughout the cell's life. Sulfhemoglobin is bright green and has a distinctive spectrum characterized by an absorption band at approximately 618 nm (Table 8.8). It is a ferrous compound with one sulfur atom attached to each heme group. The sulfur is probably attached to a  $\beta$ -carbon in the porphyrin ring, forming a thiochlorin (Fig. 8.25) (254, 255).



**Figure 8.25.** The probable structure of sulfhemoglobin. One of the four pyrrole rings in heme is illustrated at the left. Sulfur added at the  $\beta$  carbon forms a thiochlorin, accounting for the spectral changes characteristic of sulfhemoglobin.

Although the exact mode of synthesis of sulfhemoglobin remains to be established, proposed models suggest that methemoglobin is first converted to ferrylhemoglobin in the presence of hydrogen peroxide (255, 256):



With the addition of a sulfur-containing compound, such as hydrogen sulfide, the iron in ferrylhemoglobin is reduced, and sulfur is incorporated into the porphyrin ring:



Although the iron in sulfhemoglobin is reduced, it binds oxygen with an affinity one-hundredth that of unmodified hemoglobin.

Known mechanisms for preventing or reversing oxidative denaturation of hemoglobin in the erythrocyte include (a) the methemoglobin reductases, (b) superoxide dismutase, (c) GSH peroxidase, and (d) catalase.

### Methemoglobin Reduction

Most methemoglobin in erythrocytes is reduced through the action of an enzyme, cytochrome  $b_5$  methemoglobin reductase, which acts in the presence of two electron carriers, cytochrome  $b_5$  and NADH. Only a small amount of methemoglobin is reduced by all other pathways of methemoglobin reduction together (Table 8.9). These other pathways involve two compounds that cause the reduction of methemoglobin nonenzymatically, ascorbic acid and GSH, as well as a second enzyme, nicotinamide adenine dinucleotide phosphate (NADPH)-flavin reductase. Deficiency of cytochrome  $b_5$  reductase, but not of NADPH-flavin reductase, is associated with methemoglobinemia,

confirming that cytochrome  $b_5$  reductase is the most important physiologic means of reducing methemoglobin (257). *In vitro* evidence also confirms that cytochrome  $b_5$  reductase is the rate-limiting factor in methemoglobin reduction (258).

**TABLE 8.9. Proportion of Methemoglobin Reduction by Various Erythrocyte Systems**

| Erythrocyte Component  | Percentage of Methemoglobin Reduced (%) |
|--|---|
| Cytochrome $b_5$ reductase                                   | 67                                      |
| Ascorbic acid  | 16                                      |
| Glutathione  | 12                                      |
| Nicotinamide adenine dinucleotide phosphate flavin reductase | 5                                       |
| Total  | 100                                     |

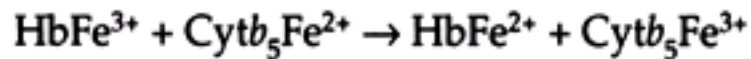
Modified from Scott EM. Congenital methemoglobinemia due to DPNH-diaphorase deficiency. In: Beutler E, ed. Hereditary disorders of erythrocyte metabolism. New York: Grune & Stratton, 1968.

Cytochrome  $b_5$  reductase has been referred to by several other names, including *diaphorase 1*, *DPNH dehydrogenase 1*, *NADH dehydrogenase*, *NADH methemoglobin reductase*, and *NADH methemoglobin-ferrocyanide reductase*. Work in the 1940s established a relationship between the reduction of methemoglobin and the metabolism of lactate to pyruvate, thus implying an important role for NADH (259). Eventually, two methemoglobin-reducing enzymes were isolated. The NADH-dependent enzyme, which was absent from several patients with methemoglobinemia, has been shown to be a flavoprotein, with one mole of flavin adenine dinucleotide (FAD) per mole of apoenzyme. Its molecular weight is approximately 34,000 daltons. The corresponding cDNA has been identified, and the gene localized to chromosome 22 (260, 261). Most likely, erythrocyte cytochrome  $b_5$  reductase and hepatic cytochrome  $b_5$  reductase are the products of a single gene.

The reduction of methemoglobin by highly purified cytochrome  $b_5$  reductase in the presence of NADH is extremely slow, implying that another factor is most likely required as an electron carrier. *In vitro*, this role can be filled by dyes or by ferrocyanide. *In vivo*, cytochrome  $b_5$  acts as the intermediate electron carrier (262). Erythrocyte cytochrome  $b_5$  greatly accelerates reduction of methemoglobin by cytochrome  $b_5$  reductase and can also serve as a substrate for hepatic microsomal cytochrome  $b_5$  reductase. Congenital methemoglobinemia resulting from a deficiency in cytochrome  $b_5$  has been described (263). cDNA for human liver cytochrome  $b_5$  has been cloned; it encodes a protein of 134 amino acids (264). Erythrocyte cytochrome  $b_5$  probably results from proteolytic cleavage of the membrane-attached protein present in erythroid precursor microsomes, an event that then yields a soluble cytochrome  $b_5$  protein.

The process by which cytochrome  $b_5$  reductase and cytochrome  $b_5$  reduce hemoglobin in the presence of NADH probably involves three steps. In the first, NADH binds to the

FAD-reductase complex, and, in the presence of hydrogen ion, the NAD is converted to NAD<sup>+</sup>, and the FAD becomes FADH<sub>2</sub>. In the second step, cytochrome *b*<sub>5</sub>-Fe<sup>3+</sup> is reduced to cytochrome *b*<sub>5</sub>-Fe<sup>2+</sup>, and the FADH<sub>2</sub> reverts to FAD. Finally, methemoglobin forms a bimolecular complex with reduced cytochrome *b*<sub>5</sub> through electrostatic interactions between negatively charged groups around the cytochrome heme and positively charged groups around the heme moieties of methemoglobin. The reduction of methemoglobin then takes place and can be represented as follows:

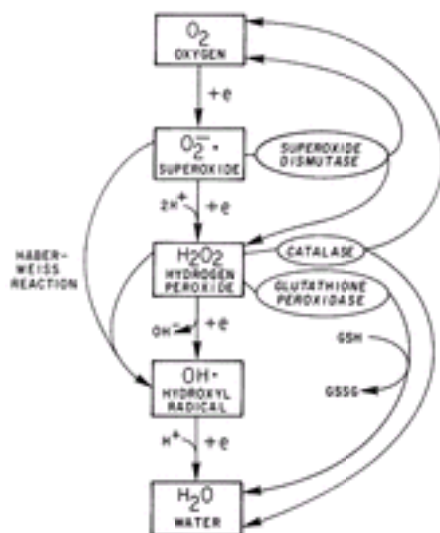


Of lesser physiologic importance is the enzyme system that depends on NADPH for its activity. It probably accounts for only approximately 5% of the methemoglobin-reducing activity of normal red cells ( [Table 8.9](#)), and its hereditary deficiency does not lead to methemoglobinemia ( [265](#)). The lack of physiologic activity may result from the absence of an intermediate electron carrier analogous to cytochrome *b*<sub>5</sub>. If methylene blue is supplied as the carrier, however, the NADPH-dependent enzyme becomes highly effective in methemoglobin reduction. This property is used in the therapy of methemoglobinemia from various causes.

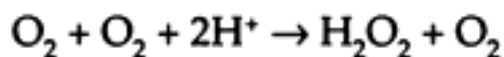
### Enzymes Reacting with Products of the Reduction of Oxygen

As molecular oxygen undergoes successive univalent reductions, a variety of reactive species are generated. These species constitute the oxidizing agents most likely to be responsible for the oxidative denaturation of hemoglobin, and they may damage other cellular components as well, especially lipid-containing elements such as the cell membrane ( [266](#), [267](#)). A variety of mechanisms have evolved in respiring organisms to deal with these potential toxins, and some are found within the erythrocyte.

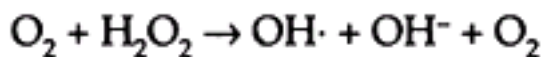
Superoxide anions are produced in biologic tissues from several sources, including oxyhemoglobin itself, as well as oxidative reactions catalyzed by flavin enzymes, such as xanthine oxidase ( [267](#), [268](#)). In addition, many drugs and toxins have oxidant activity and appear to generate superoxide ( [269](#)). Once superoxide has been generated in aqueous solution, additional toxic products of oxygen may form spontaneously ( [Fig. 8.26](#)). Thus, superoxide can undergo spontaneous dismutation, yielding peroxide and oxygen:



**Figure 8.26.** Steps in the univalent reduction of oxygen and enzymatic pathways affecting the intermediates. The enzymatic pathways, shown on the right, provide the means for processing these intermediates without formation of the highly reactive hydroxyl radical. This potent oxidant can be formed by the reaction shown on the left if superoxide and peroxide concentrations are sufficient and if catalytic quantities of transition metals are present. GSH, glutathione; GSSG, oxidized glutathione.

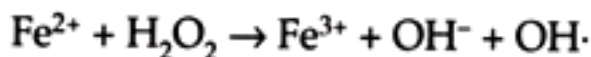


In addition, in the presence of catalytic quantities of transition metals, superoxide and peroxide may react to form the highly reactive hydroxyl radical (OH·):



Any of these oxygen derivatives may exert toxic effects on cellular components. As previously noted, superoxide appears to induce methemoglobin formation ( [270](#), [271](#) ). It may also bring about cell lysis via its effect on membranes ( [272](#) ). Hydrogen peroxide is the most stable intermediate in the reduction of oxygen. Although hydrogen peroxide has often been shown to induce the oxidative denaturation of hemoglobin *in vitro*, whether it does so directly or by giving rise to other products, such as the hydroxyl radical, is not clear.

The hydroxyl radical is one of the most potent redox agents known ( [267](#) ). Because it is generated by the radiolysis of water, it is believed to account for many of the effects of radiation in biologic tissue. However, it may also be generated from superoxide and peroxide, as described previously, and from peroxide in the presence of certain metals:

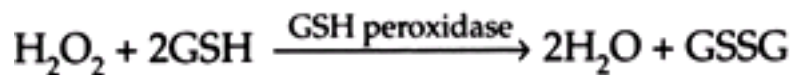


Thus, enzymes that scavenge superoxide and peroxide may be viewed as mechanisms for preventing the accumulation of these intermediates in sufficient quantities to allow the hydroxyl radical to form ( [268](#) ).

The superoxide dismutases are enzymes that catalyze the dismutation of superoxide to oxygen and peroxide. Although this reaction occurs spontaneously, the presence of the



enzyme speeds the reaction to a rate as much as 109 times faster than the spontaneous rate ( [268](#) ). In the erythrocyte, superoxide dismutase is a soluble, cuprozinc enzyme with a molecular weight of approximately 32,000 daltons. The enzyme accounts for most of the copper content of the red cell, and, before its enzymatic function was determined, it was called *erythrocuprein* or *hemocuprein*. The primary structure of human copper–zinc superoxide dismutase has been determined, and the gene has been mapped to chromosome 21 ( [273](#) ). Although superoxide dismutase prevents the formation of methemoglobin *in vitro* under conditions in which superoxide forms, the relative importance of this reaction *in vivo* remains to be established ( [270](#), [271](#) ). Once hydrogen peroxide is formed, two enzymes catalyze the decomposition of hydrogen peroxide in erythrocytes. The most important of these enzymes is GSH peroxidase, which is a component of the following reaction ( [274](#), [275](#) ):



where *GSSG* is oxidized glutathione. The enzyme is effective at very low concentrations of peroxide ( $K_m = 1 \times 10^{-6}$  M) ( [267](#) ).

GSH peroxidase is the major human selenoprotein, which probably accounts for the antioxidant properties of selenium as a micronutrient ( [268](#), [276](#) ). Human cells grown in the absence of selenium express significantly reduced GSH peroxidase activity, despite normal GSH peroxidase mRNA and transcription levels. The gene for GSH peroxidase probably is on chromosome 3, although two homologous genes also appear to be present in the human genome ( [277](#), [278](#) ). The importance of GSH peroxidase is exemplified by the fact that a genetic defect in the enzyme may lead to a drug–sensitive hemolytic anemia ( [279](#) ).

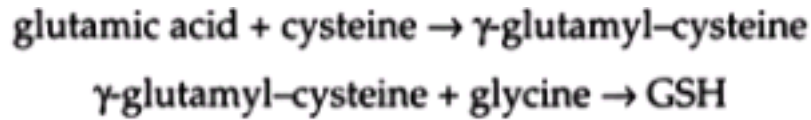
Catalase, a heme enzyme, decomposes hydrogen peroxide to water and molecular oxygen ( [280](#) ). It appears to be less important to the red cell than peroxidase, presumably because it is effective only when the peroxide concentration is relatively high ( [281](#) ). Individuals with hereditary acatalasemia do not develop methemoglobinemia or hemolytic disease; an increase in GSH peroxidase levels may compensate in part for the lack of catalase ( [282](#) ). Some evidence suggests, however, that erythrocyte catalase may be important in preventing oxidant damage to somatic tissues ( [283](#) ). Also, the level of catalase increases with physical conditioning, suggesting a physiologically significant role for erythrocyte catalase ( [284](#) ).

Catalase consists of a tetramer composed of 60,000–dalton subunits, with four heme groups per tetramer. It is encoded by a gene on chromosome 11 ( [285](#) ). Catalase is a major component of erythrocyte band 4.5 seen on Coomassie–stained gels of erythroid membrane proteins, as the enzyme interacts with the membrane in a calcium– and pH–dependent manner ( [286](#) ). Catalase also comprises a major reservoir of erythrocyte protein–bound NADPH. Each tetrameric molecule of erythrocyte catalase contains four molecules of tightly bound NADPH. Although not essential for enzymatic conversion of peroxide to oxygen, the NADPH appears to protect catalase from inactivation by peroxide ( [287](#) ).

### Glutathione Metabolism

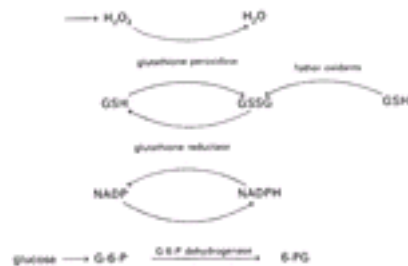
GSH is the principal reducing agent in erythrocytes and the essential cofactor in the GSH

peroxidase reaction. Reduced GSH is a tripeptide ( $\gamma$ -glutamyl-cysteinyl-glycine). Two ATP-dependent enzymatic reactions are required for the *de novo* synthesis of GSH:



The first reaction is catalyzed by glutamyl-cysteine synthetase, the second reaction by GSH synthetase. Both reactions can take place in normal erythrocytes ( [288](#) ). The capacity of red cells to synthesize GSH normally exceeds the rate of turnover by 150-fold.

In the course of reactions protecting hemoglobin from oxidation, GSH is oxidized, forming GSSG, which consists of two GSH molecules joined by a disulfide linkage, and mixed disulfides with hemoglobin. GSSG rapidly leaves the erythrocyte ( [289](#) ). Thus, maintaining a continuous supply of GSH requires a system to reduce the oxidized forms of GSH. Such a system is provided by GSH reductase, which catalyzes the reduction of GSSG by NADPH, a product of the pentose phosphate pathway ( [Fig. 8.27](#) ). GSH reductase also catalyzes the reduction of hemoglobin-GSH disulfides, yielding GSH and hemoglobin ( [290](#) ).



**Figure 8.27.** Glutathione metabolism in the erythrocyte. G-6-P, glucose-6-phosphate; GSH, glutathione; GSSG, oxidized glutathione; NADP, nicotinamide adenine dinucleotide phosphate; NADPH, nicotinamide adenine dinucleotide phosphate; 6-PG, 6-phosphogluconate.

The primary structure of GSH reductase is known because the protein has been isolated and sequenced, and the cDNA has been cloned and sequenced ( [291](#) , [292](#) and [293](#) ). The gene for GSH reductase maps to chromosome 8. GSH reductase is a flavoprotein consisting of two identical peptide chains of 478 amino acids. Because of its flavin component, the activity of GSH reductase depends on the dietary intake of riboflavin. Erythrocyte GSH reductase activity may be increased by administration of riboflavin, even in apparently normal subjects ( [294](#) , [295](#) ). The enzyme is inhibited by hexavalent chromium in concentrations as low as 5 to 25  $\mu\text{g}/\text{ml}$  ( [296](#) ).

Abnormally high levels of GSH have been noted in patients with a variety of diseases and conditions ( [297](#) ). Neonatal erythrocytes have a higher level of GSH than do adult erythrocytes. Increased GSH has also been noted in inherited pyrimidine 5'-nucleotidase deficiency and in association with many dyserythropoietic anemias. The molecular bases of the increased levels of GSH in these conditions remain unclear.



the right or above arrows representing reactions. Cofactors are shown in boldface to the left of the arrows or above the enzymes. ADP, adenosine diphosphate; Ald, aldolase; ATP, adenosine triphosphate; DPGM, diphosphoglyceratemutase; Ep, epimerase; G6PD, glucose-6-phosphate dehydrogenase; HK, hexokinase; LDH, lactate dehydrogenase; NAD-NADH, nicotinamide adenine dinucleotide; NADP-NADPH, nicotinamide adenine dinucleotide phosphate; PFK, phosphofructokinase; PGD, phosphoglyceraldehyde dehydrogenase; 6PGD, 6-phosphogluconate dehydrogenase; PGI, phosphoglucose isomerase; PGK, phosphoglycerate kinase; PGM, phosphoglyceromutase; PK, pyruvate kinase; PRI, phosphoribose isomerase; TPI, triosephosphate isomerase; TRA, transaldolase; TRK, transketolase.

Three important products are formed by the anaerobic glycolytic pathway: NADH, a cofactor in the methemoglobin reductase reaction; ATP, the major high-energy phosphate nucleotide that powers the cation pump; and 2,3-DPG, a regulator of hemoglobin function ( Fig. 8.28). For each molecule of glucose that enters the pathway, two molecules of NADH are generated ( Fig. 8.29, reaction 6). The yields of ATP and 2,3-DPG vary depending on the activity of the Rapoport-Luebering shunt ( Fig. 8.29, reactions 7b and 7c), a side pathway unique to the red cell. Two molecules of ATP are used in the early steps of glycolysis ( Fig. 8.29, reactions 1 and 3), and a maximum of four molecules is produced late in the pathway (two in reaction 7a and two in reaction 10). Thus, at maximum efficiency, a net yield of two molecules of ATP may be expected for each molecule of glucose catabolized. This net yield may be decreased, however, to the extent that 2,3-DPG is formed ( Fig. 8.29, reactions 7b and 7c). For this reason, the DPG-forming step is sometimes referred to as an *energy clutch*.

Of the eleven enzymes in the glycolytic pathway, three appear to be particularly important in regulation of glycolytic rate. These are hexokinase, phosphofructokinase, and pyruvate kinase ( Fig. 8.29, reactions 1, 3, and 10). Hexokinase is the least active enzyme in the series and is therefore often rate-limiting ( Table 8.10). It is inhibited by its product, glucose-6-phosphate, and is stimulated by one of its substrates, Mg-ATP. The activity of phosphofructokinase is greatly affected by intracellular pH. Because the pH optimum of this enzyme is 8.0, the activity of the enzyme and the overall rate of glycolysis tend to increase with increased pH (alkalosis) and decrease with decreased pH (acidosis). Phosphofructokinase may also be activated by the product of the further phosphorylation of fructose-6-phosphate ( 301). Pyruvate kinase is strongly inhibited by its product, ATP, and pyruvate kinase activity may therefore be related to the rate at which ATP is used in the cell's metabolic processes.

**TABLE 8.10. Activity of Glycolytic Enzymes in Erythrocytes of Normal Adults**

| Enzyme                                   | Activity <sup>a</sup> |
|--|-----------------------|
| Hexokinase                               | 1.3                   |
| Phosphoglucose isomerase                 | 61.0                  |
| Phosphofructokinase                      | 9.0                   |
| Aldolase                                 | 3.2                   |
| Triosephosphate isomerase                | 2111.0                |
| Glyceraldehyde-3-phosphate dehydrogenase | 226.0                 |
| Phosphoglycerate kinase                  | 320.0                 |
| Diphosphoglyceromutase                   | 4.8                   |
| Phosphoglyceromutase                     | 25.0                  |
| Enolase                                  | 5.4                   |

|                       |       |
|-----------------------|-------|
| Pyruvate kinase       | 15.0  |
| Lactate dehydrogenase | 200.0 |

<sup>a</sup> Micromoles per minute per gram of hemoglobin at 37° C and at high substrate concentrations.

From Beutler E, Blume KG, Kaplan JC, et al. International Committee for Standardization in Hematology: recommended methods for red cell enzyme analysis. *Br J Haematol* 1977;35:331, with permission.

---

The importance of glycolysis to the red cell is illustrated by the manifestations of inherited disorders, in each of which the activities of one of the glycolytic enzymes is impaired ( [Chapter 33](#)) ( [302](#)). Under such circumstances, the viability of the red cell is reduced, and hemolytic anemia results.

The most important product of the pentose phosphate pathway in erythrocytes is reduced NADPH. The red cell lacks the reactions to use NADPH for energy; instead, NADPH, by serving as a cofactor in the reduction of GSSG, is a major reducing agent in the cell and the ultimate source of protection against oxidative attack. The utilization of NADPH is the main stimulus to the utilization of glucose-6-phosphate by the pathway. Redox agents, such as methylene blue, cysteine, ascorbate, and others, induce an up to 20-fold increase in pentose metabolism, presumably by bringing about oxidation of GSH ( [303](#), [304](#)). This metabolic flexibility allows the red cell to respond to unexpected oxidant challenge.

A second function of the pentose pathway is the conversion of hexoses to pentoses. For the most part, the latter are recycled into the glycolytic pathway; however, D-ribose-5-phosphate may be used for nucleotide synthesis.

## REFERENCES

1. Ponder E. Hemolysis and related phenomena. New York: Grune & Stratton, 1948.
2. Evans E, Fung YC. Improved measurements of erythrocyte geometry. *Microvasc Res* 1972;4:335.
3. Canham PB, Burton AC. Distribution of size and shape in populations of normal human red cells. *Circ Res* 1968;22:405.
4. Price-Jones C. Red blood cell diameters. London: Oxford Medical Publications, 1933.
5. England JM, Down MC. Red cell volume distribution curves and the measurement of anisocytosis. *Lancet* 1974;1:701.
6. Bessman JD, Johnson RK. Erythrocyte volume distribution in normal and abnormal subjects. *Blood* 1975;46:369.
7. Mayhew TM, Mwamengele GL, Self TJ, Travers JP. Stereological studies on red corpuscle size produce values different from those obtained using haematocrit- and model-based methods. *Br J Haematol* 1994;86:355.
8. Bull BS, Brailsford D. Red blood cell shape. In: Agre P, Parker JC, eds. Red blood cell membranes: structure, function, clinical implications. New York: Marcel Dekker Inc, 1989.
9. Lew VL, Raftos JE, Sorette M, et al. Generation of normal human red cell volume, hemoglobin content,

and membrane area distributions by “birth” or regulation? *Blood* 1995;86:334.

10. d'Onofrio G, Chirillo R, Zini G, et al. Simultaneous measurement of reticulocyte and red blood cell indices in healthy subjects and patients with microcytic and macrocytic anemia. *Blood* 1995;85:818.

11. Lenard JG. A note on the shape of the red cell. *Bull Math Biol* 1974;36:55.

12. Schmid-Schonbein H. Erythrocyte rheology and the optimization of mass transport in the microcirculation. *Blood Cells* 1975;1:285.

13. Skalak R, Branemark P-I. Deformation of red blood cells in capillaries. *Science* 1969;164:717.

14. Xue M, Kato Y, Terada N, et al. Morphological study by an “in vivo cryotechnique” of the shape of erythrocytes circulating in large blood vessels. *J Anat* 1998;193[Part 1]:73.

15. Evans EA. Structure and deformation properties of red blood cells: concepts and quantitative methods. *Methods Enzymol* 1989;173:3.

16. Brecher G, Bessis M. Present status of spiculed red cells and their relationship to the discocyte-echinocyte transformation. A critical review. *Blood* 1972;40:333.

17. Nakao M, et al. Effect of inosine and adenine on adenosine triphosphate regeneration and shape transformation in long stored erythrocytes. *Biochim Biophys Acta* 1959;32:564; *Nature* 1960;187:945,954; *Nature* 1961;191:284; *J Biochem (Tokyo)* 1961;49:487; 1960;48:672.

18. White JG. Scanning electron microscopy of erythrocyte deformation: the influence of a calcium ionophore, A2387. *Semin Hematol* 1976;13:121.

19. Bessis M. Red cell shapes. An illustrated classification and its rationale. *Nouv Rev Fr Hematol* 1972;12:721.

20. Weed RI, Bessis M. The discocyte-stomatocyte equilibrium of normal and pathological red cells. *Blood* 1973;41:471.

21. Wong P. A basis of echinocytosis and stomatocytosis in the disc-sphere transformations of the erythrocyte. *J Theor Biol* 1999;196:343.

22. Manno S, Takauwa Y, Mohandas N. Identification of a functional role for lipid asymmetry in biological membranes: phosphatidylserine-skeletal protein interactions modulate membrane stability. *Proc Natl Acad Sci U S A* 2002;99:1943.

23. Chasis JA, Shohet SB. Red cell biochemical anatomy and membrane properties. *Annu Rev Physiol* 1987;39:237.

24. Palek J, Lambert S. Genetics of the red cell membrane skeleton. *Semin Hematol* 1990;27:290.

25. Hoefner DM, Blank ME, Davis BM, Diedrich DF. Band 3 antagonists, p-azidobenzylphlorizin and DIDS, mediate erythrocyte shape and flexibility changes as characterized by digital image morphometry and microfiltration. *J Membr Biol* 1994;141:91.

26. Heidi M, Van Dort DW, Knowles JA, et al. Analysis of integral membrane protein contributions to the deformability and stability of the human erythrocyte membrane. *J Biol Chem* 2001;276:46968.

27. Jay AWL. Geometry of the human erythrocyte. I. Effect of albumin on cell geometry. *Biophys J* 1975;15:205.

28. Gorter E, Grendel F. On bimolecular layers of lipoids on the chromocytes of the blood. *J Exp Med* 1925;41:439.

29. Danielli JF, Davson H. A contribution to the theory of permeability of thin films. *J Cell Physiol* 1935;5:483,495; *J Cell Physiol* 1936;7:393.

30. Danielli JF. The bilayer hypothesis of membrane structure. *Hosp Pract* Jan 1973.
31. Stockenius W, Engelman DM. Current models for the structure of biological membranes. *J Cell Biol* 1969;42:613.
32. Singer SJ, Nicholson GL. The fluid mosaic model of the structure of cell membranes. *Science* 1972;175:720; *Annu Rev Biochem* 1974;43:805.
33. Bennett V. Spectrin-based membrane skeleton: a multipotential adaptor between plasma membrane and cytoplasm. *Physiol Rev* 1990;70:1029.
34. deVetten MP, Agre P. The Rh polypeptide is a major fatty acid-acylated erythrocyte membrane protein. *J Biol Chem* 1988;263:18,193.
35. Telen MJ. Phosphatidylinositol-linked red blood cell membrane proteins and blood group antigens. *Immunohematology* 1991;7:65.
36. Baker RF. Ultrastructure of the red blood cell. *Fed Proc* 1967;26:1785.
37. Robertson JD. The ultrastructure of biological membranes. *Arch Intern Med* 1972;129:202.
38. Hillier J, Hoffman JF. On the ultrastructure of the plasma membrane as determined by the electron microscope. *J Cell Physiol* 1953;42:203.
39. Weinstein RS, McNutt NS. Ultrastructure of red cell membranes. *Semin Hematol* 1970;7:259.
40. Terada N, Fujii Y, Ohno S. Three-dimensional ultrastructure of in situ membrane skeletons in human erythrocytes by quick-freezing and deep-etching method. *Histol Histopathol* 1996;11:787.
41. Dodge JT, et al. The preparation and chemical characteristics of hemoglobin-free ghosts of human erythrocytes. *Arch Biochem Biophys* 1963;100:119.
42. Steck TL. The organization of proteins in the human red blood cell membrane. *J Cell Biol* 1974;62:1.
43. Sweeley CC, Dawson G. Lipids of the erythrocyte. In: Jamieson GA, Greenwalt TJ, eds. *Red cell membrane*. Philadelphia: JB Lippincott Co, 1969.
44. Cooper RA. Lipids of human red cell membrane: normal composition and variability in disease. *Semin Hematol* 1970;7:296.
45. Schwartz RS, et al. Plasma membrane phospholipid organization in human erythrocytes. *Curr Top Hematol* 1985;5:63.
46. Van Deenen LLM, De Gier J. Chemical composition of lipids in red cells of various animal species. In: Bishop C, Surgenor DM, eds. *The red blood cell*. New York: Academic Press, 1964.
47. Ways P, Hanahan DJ. Characterization and quantification of red cell lipids in normal man. *J Lipid Res* 1964;5:318.
48. Neerhout RC. Erythrocyte lipids in childhood. *Pediatr Res* 1972;6:736.
49. Bretscher MS. Membrane structure: some general principles. *Science* 1978;181:623.
50. Rothman JE, Lenard J. Membrane asymmetry. *Science* 1977;195:743.
51. Cogan U, Schachter D. Asymmetry of lipid dynamics in human erythrocyte membranes studied with impermeant fluorophores. *Biochemistry* 1981;20:6396.
52. Fisher KA. Analysis of membrane halves: cholesterol. *Proc Natl Acad Sci U S A* 1976;73:173.
53. Haest CWM, Deuticke B. Possible relationship between membrane proteins and phospholipid



- asymmetry in the human erythrocyte membrane. *Biochim Biophys Acta* 1976;436:353.
54. Haest CWM, et al. Spectrin as a stabilizer of the phospholipid asymmetry in the human erythrocyte membrane. *Biochim Biophys Acta* 1978;509:21.
  55. Cooper RA. Abnormalities of cell-membrane fluidity in the pathogenesis of disease. *N Engl J Med* 1977;297:371.
  56. Dodge JT, Phillips GB. Composition of phospholipids and of phospholipid fatty acids and aldehydes in human red cell. *J Lipid Res* 1967;8:667.
  57. Shohet SB. Hemolysis and changes in erythrocyte membrane lipids. *N Engl J Med* 1972;286:577,638.
  58. Nelson GJ. Composition of neutral lipids from erythrocytes of common mammals. *J Lipid Res* 1967;8:374.
  59. Bull BS, Brailsford JD. The biconcavity of the red cell: an analysis of several hypotheses. *Blood* 1973;41:833.
  60. Cooper RA. Influence of increased membrane cholesterol on membrane fluidity and cell function in human red blood cells. *J Cell Biochem* 1978;8:413.
  61. Tishler RB, Carlson FD. A study of the dynamic properties of the human red blood cell membrane using quasi-elastic light-scattering spectroscopy. *Biophys J* 1993;65:2586.
  62. Glomset JA. The plasma lecithin: cholesterol acyltransferase reaction. *J Lipid Res* 1968;9:155.
  63. Norum KR, et al. Familial lecithin-cholesterol acyltransferase deficiency. *Scand J Clin Lab Invest* 1967;20:231; 1968;21:327.
  64. Cooper RA, Jandl JH. Bile salts and cholesterol in the pathogenesis of target cells in obstructive jaundice. *J Clin Invest* 1968;47:809.
  65. Tarlov AR, Mulder E. Phospholipid metabolism in rat erythrocytes: quantitative studies of lecithin biosynthesis. *Blood* 1967;30:853.
  66. Shohet SB, et al. Hereditary hemolytic anemia associated with abnormal lipids. *Blood* 1971;38:445.
  67. Farquhar JW, Ahrens J Jr. Effects of dietary fats on human erythrocyte fatty acid patterns. *J Clin Invest* 1963;42:675.
  68. Sutherland WH, Shilton ME, Nye ER, et al. Urban/rural differences in red blood cell fatty acid composition, plasma lipids and diet in Melanesian Fijians. *Eur J Clin Nutr* 1995;49:233.
  69. Fairbanks G, et al. Electrophoretic analysis of the major polypeptides of the human erythrocyte membrane. *Biochemistry* 1971;10:2606.
  70. Towbin H, Staehelin T, Gordon J. Electrophoretic transfer of proteins from polyacrylamide gels to nitrocellulose sheets: procedure and some applications. *Proc Natl Acad Sci U S A* 1979;76:4350.
  71. Neville DM, Glossmann H. Plasma membrane subunit composition. *J Biol Chem* 1971;246:6335.
  72. Anstee DJ, et al. Abnormal blood-group-Ss-active sialoglycoproteins in the membrane of Miltenberger class III, IV and V human erythrocytes. *Biochem J* 1979;183:193.
  73. Dahr W. Immunochemistry of sialoglycoproteins in human red blood cell membranes. In: Vengelen-Tyler V, Judd WJ, eds. *Recent advances in blood group biochemistry*. Arlington, VA: American Association of Blood Banks, 1986.
  74. Dahr W, et al. Immunochemical aspects of the MNSs blood group system. *J Immunogenet* 1975;2:87.
  75. Furthmayr H. Glycophorins A, B, C: a family of sialoglycoproteins. Isolation and preliminary

characterization of trypsin-derived peptides. *J Cell Biochem* 1978;9:79.

76. Anstee DJ. The nature and abundance of human red cell surface glycoproteins. *J Immunogenet* 1990;17:219.
77. Tomita M, et al. Primary structure of human erythrocyte glycophorin A. Isolation and characterization of peptides and complete amino acid sequence. *Biochemistry* 1978;17:4756.
78. Rahuel C, et al. Characterization of cDNA clones for human glycophorin A. Use for gene localization and for analysis of normal and glycophorin A deficient (Finnish type) genomic DNA. *Eur J Biochem* 1988;172:147.
79. Kudo S, Fukuda M. Structural organization of glycophorin A and B genes: glycophorin B gene evolved by homologous recombination at Alu repeat sequences. *Proc Natl Acad Sci U S A* 1989;86:4619.
80. Vignal A, et al. Molecular analysis of glycophorin A and B gene structure and expression in homozygous Miltenberger class V (MiV) human erythrocytes. *Eur J Biochem* 1989;184:337.
81. Anderson RA, Lovrien RE. Glycophorin is linked by band 4.1 protein to the human erythrocyte membrane skeleton. *Nature* 1984;307:655.
82. Chasis JA, et al. Signal transduction by glycophorin A: role of extracellular and cytoplasmic domains in a modulatable process. *J Cell Biol* 1988;107:1351.
83. Groves JD, Tanner MJA. The effects of glycophorin A on the expression of the human red cell anion transporter (band 3) in *Xenopus* oocytes. *J Membr Biol* 1994;140:81.
84. Bruce LJ, Groves JD, Okubo Y, et al. Altered band 3 structure and function in glycophorin A- and B-deficient (Mk Mk) red blood cells. *Blood* 1994;84:916.
85. Lux SE, et al. Cloning and characterization of band 3, the human erythrocyte anion-exchange protein (AE1). *Proc Natl Acad Sci U S A* 1989;86:9089.
86. Tanner MJ, et al. The complete amino acid sequence of the human erythrocyte membrane anion-transport protein deduced from the DNA sequence. *Biochem J* 1988;256:703.
87. Beckmann R, Smythe JS, Anstee DJ, Tanner MJ. Functional cell surface expression of band 3, the human red blood cell anion exchange protein (AE1), in K562 erythroleukemia cells: band 3 enhances the cell surface reactivity of Rh antigens. *Blood* 1998;92:4428.
88. Beckmann R, Smythe JS, Anstee DJ, Tanner MJ. Coexpression of band 3 mutants and Rh polypeptides: differential effects of band 3 on the expression of the Rh complex containing D polypeptide and the Rh complex containing CcEe polypeptide. *Blood* 2001;97:2496.
89. Pawloski JR, Hess DT, Stamler JS. Export by red blood cells of nitric oxide bioactivity. *Nature* 2001;409:622.
90. Palek J, Jarolim P. Clinical expression and laboratory detection of red cell membrane protein mutations. *Semin Hematol* 1993;30:249.
91. Issitt PD. Null red blood cell phenotypes: associated biological changes. *Transfus Med Rev* 1993;7:139.
92. Cherif-Zahar B, et al. Molecular cloning and protein structure of a human blood group Rh polypeptide. *Proc Natl Acad Sci U S A* 1990;87:6243.
93. Smythe JS, Avent ND, Judson PA, et al. Expression of RHD and RHCE gene products using retroviral transduction of K562 cells establishes the molecular basis of Rh blood group antigens. *Blood* 1996;87:2968.
94. Cartron JP. Defining the Rh blood group antigens. *Biochemistry and molecular genetics. Blood Rev* 1994;8:199.
95. Cherifzahar B, Raynal V, Gane P, et al. Candidate gene acting as a suppressor of the Rh locus in most

cases of Rh-deficiency. *Nat Genet* 1996;12:168.

96. Marini AM, Matassi G, Raynal V, et al. The human Rhesus-associated RhAG protein and a kidney homologue promote ammonium transport in yeast [see comments]. *Nat Genet* 2000;26:341.

97. Westhoff CM, Ferreri-Jacobia M, Mak DO, Foskett JK. Identification of the erythrocyte Rh blood group glycoprotein as a mammalian ammonium transporter. *J Biol Chem* 2002;277:12499.

98. Soupene E, King N, Feild E, et al. Rhesus expression in a green alga is regulated by CO<sub>2</sub>. *Proc Natl Acad Sci U S A* 2002;99:7769.

99. Hartwig JH. Actin-binding proteins 1—spectrin superfamily protein profile. *Protein Profile* 1995;2:703.

100. Beck KA, Nelson WJ. The spectrin-based membrane skeleton as a membrane protein-sorting machine. *Am J Physiol Cell Physiol* 1996;39:C1263.

101. Huebner K, et al. The alpha-spectrin gene is on chromosome 1 in mouse and man. *Proc Natl Acad Sci U S A* 1985;82:3790.

102. Prchal JT, et al. Isolation and characterization of cDNA clones for human erythrocyte beta spectrin. *Proc Natl Acad Sci U S A* 1987;84:7468.

103. Winkelmann JC, et al. Molecular cloning of the cDNA for human beta spectrin. *Blood* 1988;72:328.

104. Schafer DA, Cooper JA. Control of actin assembly at filament ends. *Annu Rev Cell Dev Biol* 1995;11:497.

105. Conboy JG. Structure, function, and molecular genetics of erythroid membrane skeletal protein 4.1 in normal and abnormal red blood cells. *Semin Hematol* 1993;30:58.

106. Lambert S, Bennett V. From anemia to cerebellar dysfunction. A review of the ankyrin gene family. *Eur J Biochem* 1993;211:1.

107. Delaunay J. Genetic disorders of the red cell membranes. *FEBS Lett* 1995;369:34.

108. Liu SC, Derick LH, Palek J. Dependence of the permanent deformation of red blood cell membranes on spectrin dimer-tetramer equilibrium: implication for permanent membrane deformation of irreversibly sickled cells. *Blood* 1993;81:522.

109. Advani R, Sorenson S, Shinar E, et al. Characterization and comparison of the red blood cell membrane damage in severe human alpha- and beta-thalassemia. *Blood* 1992;79:1058.

110. Mathai JC, Mori S, Smith BL, et al. Functional analysis of aquaporin-1 deficient red cells. The Colton-null phenotype. *J Biol Chem* 1996;271:1309.

111. Agre P, Preston GM, Smith BL, et al. Aquaporin CHIP: the archetypal molecular water channel. *Am J Physiol* 1993;265:F463.

112. Tanner MJ. Molecular and cellular biology of the erythrocyte anion exchanger (AE1). *Semin Hematol* 1993;30:34.

113. Mueckler M, Caruso C, Baldwin SA, et al. Sequence and structure of a human glucose transporter. *Science* 1985;229:941.

114. Baly DL, Horuk R. The biology and biochemistry of the glucose transporter. *Biochim Biophys Acta* 1988;947:571.

115. Elbrink J, Bihler I. Membrane transport: its relation to cellular metabolic rates. *Science* 1975;188:1177.

116. Klepper J, Willemsen M, Verrips A, et al. Autosomal dominant transmission of GLUT1 deficiency. *Hum Mol Genet* 2001;10:63.

117. Orringer EP, Parker JC. Ion and water movements in red blood cells. *Prog Hematol* 1973;8:1.
118. Kaplan JH. Active transport of sodium and potassium. In: Agre P, Parker JC, eds. *Red blood cell membranes: structure, function, clinical implications*. New York: Marcel Dekker Inc, 1989.
119. Hoffman JF, et al. The Na:K pump in red cells is electrogenic. *Fed Proc* 1979;38:2440.
120. Proverbio F, Hoffman JF. Membrane compartmentalized ATP and its preferential use by the Na,K-ATPase of human red cell ghosts. *J Gen Physiol* 1977;69:605.
121. Jorgenson PL. Mechanism of the Na<sup>+</sup>, K<sup>+</sup> pump. Protein structure and conformation of the pure (Na<sup>+</sup>, K<sup>+</sup>)-ATPase. *Biochim Biophys Acta* 1982;694:27.
122. Mercer RW, et al. Rat-brain Na,K-ATPase beta-chain gene: primary structure, tissue-specific expression, and amplification in ouabain-resistant HeLa C<sup>+</sup> cells. *Mol Cell Biol* 1986;6:3884.
123. Hardwicke PMD, Freytag JW. A proteolipid associated with Na, K-ATPase is not essential for ATPase activity. *Biochem Biophys Res Commun* 1982;102:250.
124. Kawakami K, et al. Primary structure of the alpha-subunit of human Na,K-ATPase deduced from cDNA sequence. *J Biochem* 1986;100:389.
125. Kawakami K, et al. Molecular cloning and sequence analysis of human Na,K-ATPase beta-subunit. *Nucleic Acids Res* 1986;14:2883.
126. Brahm J. Urea permeability of human red cells. *J Gen Physiol* 1983;82:1.
127. Olives B, Neau P, Bailly P, et al. Cloning and functional expression of a urea transporter from human bone marrow cells. *J Biol Chem* 1994;269:31649.
128. Olives B, Martial S, Mattei MG, et al. Molecular characterization of a new urea transporter in the human kidney. *FEBS Lett* 1996;386:156.
129. Schrier SL. Human erythrocyte membrane enzymes: current status and clinical correlates. *Blood* 1977;50:227.
130. Chow F-L, et al. The acetylcholinesterase defect in paroxysmal nocturnal hemoglobinuria: evidence that the enzyme is absent from the cell membrane. *Blood* 1985;66:940.
131. Rosse WF. Phosphatidylinositol-linked proteins and paroxysmal nocturnal hemoglobinuria. *Blood* 1990;75:1595.
132. Telen MJ. Erythrocyte blood group antigens: polymorphisms of functionally important molecules. *Semin Hematol* 1996;33:302.
133. Mallozzi C, Di Stasi AM, Minetti M. Free radicals induce reversible membrane-cytoplasm translocation of glyceraldehyde-3-phosphate dehydrogenase in human erythrocytes. *Arch Biochem Biophys* 1995;321:345.
134. Plut D, et al. Evidence for the participation of cytosolic protein kinase in membrane protein phosphorylation in intact erythrocytes. *Eur J Biochem* 1978;82:333.
135. Ralston GB. Spectrin-actin interactions. In: Harris JR, ed. *Blood cell biochemistry 1. Erythroid cells*. New York: Plenum Press, 1990.
136. Mercer RW, et al. Na,K-ATPase structure. In: Agre P, Parker JC, eds. *Red blood cell membranes: structure, function, clinical implications*. New York: Marcel Dekker Inc, 1989.
137. Minetti G, Low P. Erythrocyte signal transduction pathways and their possible functions. *Curr Opin Hematol* 1997;4:116.

138. Sager G. Receptor binding sites for beta-adrenergic ligands on human erythrocytes. *Biochem Pharmacol* 1982;31:99.
139. Sager G, Jacobsen S. Effect of plasma on human erythrocyte beta-adrenergic receptors. *Biochem Pharmacol* 1985;34:3767.
140. Hines PC, Zen Q, Burney SN, et al. Novel epinephrine and cyclic AMP-mediated activation of B-CAM/LU-dependent sickle (SS) RBC adhesion. *Blood* 2003 ( *in press*).
141. Hardison RC. A brief history of hemoglobins: plant, animal, protist, and bacteria. *Proc Natl Acad Sci U S A* 1996;93:5675.
142. Braunitzer G, et al. Der homologe Chemische aufbau der Peptidketten in Human hamoglobin. *A Z Physiol Chem* 1960;320:170.
143. Goodman M. Decoding the pattern of protein evolution. *Prog Biophys Mol Biol* 1981;37:105.
144. Hill RL, Buettner-Janusch J. Evolution of hemoglobin. *Fed Proc* 1964;23:1236.
145. Deisseroth A, Nienhuis A, Turner P, et al. Localization of the human  $\alpha$ -globin structural gene to chromosome 16 in somatic cell hybrids by molecular hybridization assay. *Cell* 1977;12:205.
146. Deisseroth A, Nienhuis A, Lawrence J, et al. Chromosome localization of the human  $\beta$  globin gene on human chromosome 11 in somatic cell hybrids. *Proc Natl Acad Sci U S A* 1978;75:1456.
147. Huehns ER, Beaven GH. Developmental changes in human hemoglobins. *Clin Dev Med* 1971;37:175.
148. Fritsch EF, Lawn RM, Maniatic T. Molecular cloning and characterization of the human  $\beta$ -like globin gene cluster. *Cell* 1980;19:959.
149. Huehns ER, et al. Human embryonic hemoglobins. *Nature* 1964;201:1095.
150. Kamuzora H, Lehmann H. Human embryonic hemoglobins including a comparison by homology of the human  $\gamma$  and  $\alpha$  chains. *Nature* 1975;256:511.
151. Huehns ER, Farooqi AM. Oxygen dissociation properties of human embryonic red cells. *Nature* 1975;254:335.
152. Weatherall DJ, Pembrey ME, Pritchard J. Fetal hemoglobin. *Clin Hematol* 1974;3:467.
153. Bunn HF, Jandl JH. Control of hemoglobin function within the red cell. *N Engl J Med* 1970;282:1414.
154. Schroeder WA, et al. Evidence for multiple structural genes for  $\gamma$ -chain of human fetal hemoglobin. *Proc Natl Acad Sci U S A* 1968;60:537.
155. Ricco G, Mazza V. Significance of a new type of human fetal hemoglobin carrying a replacement isoleucine-threonine at position 75 (E19) of the gamma chain. *Hum Genet* 1976;32:305.
156. Schroeder WA, et al. Further studies on the frequency and significance for the T $\gamma$ -chain of human fetal hemoglobin. *J Clin Invest* 1979;63:269.
157. Alter BP. The G $\gamma$ :A $\gamma$  composition of fetal hemoglobin in fetuses and newborns. *Blood* 1979;54:1158.
158. Jensen M, et al. The developmental change in the G $\gamma$  and A $\gamma$  globin proportions in hemoglobin F. *Eur J Pediatr* 1982;138:311.
159. Allen DW, Wyman J, Smith CA. The oxygen equilibrium of foetal and adult human hemoglobin. *J Biol Chem* 1953;203:81.
160. Tyuma I, Shimizu K. Different response to organic phosphates of human fetal and adult hemoglobins.

Arch Biochem Biophys 1969;129:404.

161. Poyart C, Bursaux E, Guesnon P, Teisseire B. Chloride binding and the Bohr effect of human fetal erythrocytes and Hb FII solutions. *Pflugers Arch* 1978;37:169.
162. Bard H. The postnatal decline of hemoglobin F synthesis in normal full-term infants. *J Clin Invest* 1975;55:395.
163. Dover GJ, Boyer SH, Charache S, Heintzelman K. Individual variation in the production and survival of F-cells in sickle cell disease. *N Engl J Med* 1978;299:1428.
164. Ley TJ, Nienhuis AW. Induction of hemoglobin F synthesis in patients with beta thalassemia. *Annu Rev Med* 1985;36:485.
165. De Rosa MC, Sanna MT, Messina I, et al. Glycated human hemoglobin (HbA1c): functional characteristics and molecular modeling studies. *Biophys Chem* 1998;72:323.
166. Schneck AG, Schroeder WA. The relation between the minor components of whole human adult hemoglobin as isolated by chromatography and starch block electrophoresis. *J Am Chem Soc* 1961;83:1472.
167. McDonald MJ, et al. Glycosylated minor components of human adult hemoglobin. *J Biol Chem* 1978;253:2327.
168. Spicer KM, et al. Synthesis of hemoglobin A1c and related minor hemoglobins by erythrocytes. *J Clin Invest* 1979;64:40.
169. Bunn HF, et al. Further identification of the nature and linkage of the carbohydrate in hemoglobin. *J Clin Invest* 1976;57:1652.
170. Al-Abed Y, VanPatten S, Li H, et al. Characterization of a novel hemoglobin-glutathione adduct that is elevated in diabetic patients. *Mol Med* 2001;7:619.
171. Fitzgibbons JF, et al. Red cell age-related changes of hemoglobins Aia+b and A1c in normal and diabetic subjects. *J Clin Invest* 1976;58:820.
172. Abraham EC, Cameron B, Abraham A, Stallings M. Glycosylated hemoglobins in heterozygotes and homozygotes for hemoglobin C with or without diabetes. *J Lab Clin Med* 1984;104:602.
173. Bernstein RE. Nonenzymatically glycosylated proteins. *Adv Clin Chem* 1987;26:1.
174. Lawrence AM, Abaira C. New modalities in diabetes treatment. *Am J Med* 1988;85:153.
175. Salemans TH, et al. The value of HbA1 and fructosamine in predicting impaired glucose tolerance—an alternative to OGTT to detect diabetes mellitus or gestational diabetes. *Ann Clin Biochem* 1987;24:447.
176. Bry L, Chen PC, Sacks DB. Effects of hemoglobin variants and chemically modified derivatives on assays for glycohemoglobin. *Clin Chem* 2001;47:153.
177. International Hemoglobin Information Center. IHIC variants list. *Hemoglobin* 1989;13:223.
178. Schmidt RM, Rucknagel DL, Necheles TF. Comparison of methodologies for thalassemia screening by Hb A2 quantitation. *J Lab Clin Med* 1975;86:873.
179. Steinbert MH, Adams JG 3rd. Hemoglobin A2: origin, evolution, and aftermath. *Blood* 1991;78:2165.
180. Huisman THJ, Schroeder WA, Brodie AN, et al. Microchromatography of hemoglobins. III. A simplified method for the determination of hemoglobin A2. *J Lab Clin Med* 1975;86:700.
181. Bollekens JA, Forget BG. Delta beta thalassemia and hereditary persistence of fetal hemoglobin. *Hematol Oncol Clin North Am* 1991;5:399.
182. Pembrey ME, McWade P, Weatherall DJ. Reliable routine measurement of small amounts of foetal

haemoglobin by alkalai denaturation. *J Clin Pathol* 1972;25:738.

183. Bunn HF. Subunit assembly of hemoglobin: an important determinant of hematologic phenotype. *Blood* 1987;69:1.
184. Chernoff AL. A method for the quantitative determination of HgbA2. *Ann N Y Acad Sci* 1964;119:557.
185. Neerhout NC, et al. Quantitative determination of hemoglobin A2 with the use of disc electrophoresis. *J Lab Clin Med* 1966;67:314.
186. Rozman RS, et al. Rapid measurement of hemoglobin A2 by means of cellulose acetate membrane electrophoresis. *J Lab Clin Med* 1963;62:692.
187. Robinson AR, et al. A new technique for differentiation of hemoglobin. *J Lab Clin Med* 1957;50:745.
188. Boyer SH, Belding TK, Margolet L, Nouyes AN. Fetal hemoglobin restriction to a few erythrocytes (F cells) in normal human adults. *Science* 1975;188:361.
189. Zago MA, Wood WG, Clegg JB, et al. Genetic control of F cells in human adults. *Blood* 1979;53:977.
190. Kleihaure E, Braun H, Betke K. Demonstration von fetalem Hamoglobin in den Erythrozyten eines Blutausstrichs. *Klin Wochenschr* 1957;35:637.
191. Lloyd-Evans P, Guest AR, Austin EB, Scott ML. Use of a phycoerythrin-conjugated anti-glycophorin A monoclonal antibody as a double label to improve the accuracy of FMH quantification by flow cytometry. *Transfus Med* 1999;9:155.
192. Bunn HF, Forget BG. Hemoglobin: molecular, genetic and clinical aspects. Philadelphia: WB Saunders, 1986.
193. Lehmann H, Carrell RW. Variations in the structure of human hemoglobin. *Br Med Bull* 1969;25:14.
194. Bolton W, Perutz MF. Three dimensional fourier synthesis of horse deoxyhemoglobin at 2.8 Angstrom units resolution. *Nature* 1970;228:551.
195. Shaanan B. The structure of human oxyhaemoglobin at 2.1 A resolution. *J Mol Biol* 1983;171:31.
196. Hrakl Z, Vodrazka Z. A study of the conformation of human globin in solution by optical methods. *Biochim Biophys Acta* 1967;133:527.
197. deCastro CM, Lee M, Devlin B, et al. A novel  $\beta$ -globin mutation,  $\beta$ Durham-N.C. [ $\beta$ 114 Leu<sup>?</sup>Pro], detected by PCR-SSCP, produces a dominant thalassemia-like phenotype. *Blood* 1994;83:1109.
198. Perutz MF, Kilmartin JV, Nagai K, et al. Influence of globin structures on the state of the heme. Ferrous low spin derivatives. *Biochemistry* 1976;15:378.
199. Baldwin J, Chothia C. Haemoglobin: the structural changes related to ligand binding and its allosteric mechanism. *J Mol Biol* 1979;129:175.
200. Chance MR, Parkhurst LJ, Powers LS, Chance B. Movement of Fe with respect to the heme plane in the R-T transition of carp hemoglobin. An extended x-ray absorption fine-structure study. *J Biol Chem* 1986;261:5689.
201. Kurlekar N, Mehta BC. Hemoglobin A2 levels in iron-deficiency anemia. *Isr J Med Res* 1981;73:77.
202. Forget BG, Cavallesco C, Benz EJ Jr, et al. Studies of globin chain synthesis and globin mRNA content in a patient homozygous for hemoglobin Lepore. *Hemoglobin* 1978;2:117.
203. Shaeffer JR, McDonald MJ, Bunn HF. Assembly of normal and abnormal human hemoglobins. *Trends Biochem Sci* 1981;6:158.
204. Shaeffer JR, Kingston RE, McDonald MJ, Bunn HF. Electrostatic interactions in the assembly of



human hemoglobin. *Nature* 1983;306:498.

205. Embury SH, Dozy AM, Miller J, et al. Concurrent sickle-cell anemia and alpha-thalassemia. Effect on severity of anemia. *N Engl J Med* 1982;306:270.

206. Steinberg MH. Case report: effects of iron deficiency and the -88 C>T mutation on HbA2 levels in beta-thalassemia. *Am J Med Sci* 1993;305:312.

207. Barcroft J. The respiratory function of the blood. Part II. Haemoglobin. London: Cambridge University Press, 1928.

208. Humpeler E, Amor H. Sex differences in the oxygen affinity of hemoglobin. *Pflugers Arch* 1973;343:151.

209. Astrup P. Red-cell pH and oxygen affinity of hemoglobin. *N Engl J Med* 1970;283:202.

210. Riggs A. Functional properties of hemoglobins. *Physiol Rev* 1965;45:619.

211. Benesch R, Benesch RE. The effect of organic phosphates from the human erythrocyte on the allosteric properties of hemoglobin. *Biochem Biophys Res Commun* 1967;26:162.

212. Brewer GJ, Eaton JW. Erythrocyte metabolism: interaction with oxygen transport. *Science* 1971;171:1205.

213. Marschner JP, Seidlitz T, Rietbrock N. Effect of 2,3-diphosphoglycerate on O<sub>2</sub>-dissociation kinetics of hemoglobin and glycosylated hemoglobin using the stopped flow technique and an improved in vitro method for hemoglobin glycosylation. *Int J Clin Pharmacol Ther* 1994;32:116.

214. Chanutin A, Curnish RR. Effect of organic and inorganic phosphates on the oxygen equilibrium of human erythrocytes. *Arch Biochem Biophys* 1967;121:96.

215. Haggarty NW, et al. The complete amino acid sequence of human erythrocyte diphosphoglycerate mutase. *EMBO J* 1983;2:1213.

216. Reynolds CH. Activation of human erythrocyte 2,3-bisphosphoglycerate phosphatase at physiologic concentrations of substrate. *Arch Biochem Biophys* 1986;250:106.

217. Rosa R, Calvin MC. Comparative effects of two sulfhydryl reagents on the activities of a multifunctional red cell enzyme: bisphosphoglycerate mutase. *Biochem Biophys Res Commun* 1988;153:945.

218. Rose ZB. The enzymology of 2,3-bisphosphoglycerate. *Adv Enzymol* 1980;51:211.

219. Yu KT, et al. 2,3-diphosphoglycerate phosphatase/synthase: a potential target for elevating the diphosphoglycerate level in human red cells. *J Pharmacol Exp Ther* 1990;252:192.

220. Salhany JM, et al. The rate of deoxygenation of red blood cells. Effect of intracellular 2,3-diphosphoglycerate and pH. *FEBS Lett* 1971;16:257.

221. Bunn HF, et al. Hemoglobin function in stored blood. *J Clin Invest* 1969;48:311.

222. Oski FA, et al. The in vitro restoration of red cell 2,3-diphosphoglycerate levels in banked blood. *Blood* 1971;37:52.

223. Tinmouth A, Chin-Yee I. The clinical consequences of the red cell storage lesion. *Transfus Med Rev* 2001;15:91.

224. Lenfant C, et al. Effect of altitude on oxygen binding by hemoglobin and on organic phosphate levels. *J Clin Invest* 1968;47:2652.

225. Edwards UJ, Canon B. Oxygen transport during erythropoietic response to moderate blood loss. *N Engl J Med* 1972;287:115.

226. Torrance J, et al. Intraerythrocytic adaptation to anemia. *N Engl J Med* 1970;283:165.
227. Oski FA, et al. Exercise with anemia. *Ann Intern Med* 1971;74:44.
228. Perutz MF. Stereochemistry of cooperative effects in haemoglobin. *Nature* 1970;288:726.
229. Ackers GK. The energetics of ligand-linked subunit assembly in hemoglobin required a third allosteric structure. *Biophys Chem* 1990;37:371.
230. Daugherty MA, et al. Identification of the intermediate allosteric species in human hemoglobin reveals a molecular code for cooperative switching. *Proc Natl Acad Sci U S A* 1991;88:1110.
231. Rorth M. Hemoglobin interactions and red cell metabolism. *Ser Haematol* 1972;5:1.
232. Surgenor DM. Transport of oxygen and carbon dioxide. In: Bishop C, Surgenor DM, eds. *The red blood cell*. New York: Academic Press, 1964.
233. Arnone A. X-ray studies of the interaction of CO<sub>2</sub> with human deoxyhemoglobin. *Nature* 1974;247:143.
234. Boyer SH, et al. Developmental changes in human erythrocyte carbonic anhydrase levels: coordinate expression with adult hemoglobin. *Dev Biol* 1983;97:250.
235. Brady HJ, et al. Expression of the human carbonic anhydrase I gene is activated late in fetal erythroid development and regulated by stage-specific trans-acting factors. *Br J Haematol* 1990;76:135.
236. Barlow JH, et al. Human carbonic anhydrase I cDNA. *Nucleic Acids Res* 1987;15:2386.
237. Lloyd J, et al. Nucleotide sequence and derived amino acid sequence of a cDNA encoding human muscle carbonic anhydrase. *Gene* 1986;41:233.
238. Venta PJ, et al. Polymorphic gene for human carbonic anhydrase II: a molecular disease marker located on chromosome 8. *Proc Natl Acad Sci U S A* 1983;80:4437.
239. Behravan G, et al. Fine tuning of the catalytic properties of carbonic anhydrase. Studies of a Thr300-His variant of human isoenzyme II. *Eur J Biochem* 1990;190:351.
240. Tashian RE, et al. Inherited variants of human red cell carbonic anhydrases. *Hemoglobin* 1980;4:635.
241. Kiso Y, Yoshida K, Kaise K, et al. Erythrocyte carbonic anhydrase-I concentrations in patients with Graves' disease and subacute thyroiditis reflect integrated thyroid hormone levels over the previous few months. *J Clin Endocrinol Metab* 1991;72:515.
242. Sly WS, et al. Carbonic anhydrase II deficiency in 12 families with the autosomal recessive syndrome of osteopetrosis with renal tubular acidosis and cerebral calcification. *N Engl J Med* 1985;313:139.
243. Sly WS, et al. Carbonic anhydrase II deficiency identified as the primary defect in the autosomal recessive syndrome of osteopetrosis with renal tubular acidosis and cerebral calcification. *Proc Natl Acad Sci U S A* 1983;80:2752.
244. Carter ND, et al. Red cells genetically deficient in carbonic anhydrase II have elevated levels of a carbonic anhydrase indistinguishable from muscle CA III. *Ann N Y Acad Sci* 1984;429:284.
245. Lee TS. End-tidal partial pressure of carbon dioxide does not accurately reflect PaCO<sub>2</sub> in rabbits treated with acetazolamide during anaesthesia. *Br J Anaesth* 1994;73:225.
246. Discussion. In: Rorth M, Astrup P, eds. *Oxygen affinity of hemoglobin and red cell acid base status*. New York: Academic Press, 1972.
247. Lancaster JR Jr. Simulation of the diffusion and reaction of endogenously produced nitric oxide.

Proc Natl Acad Sci U S A 1994;91:8137.

248. Jia L, Bonaventura J, Stamler JS. S-nitrosohaemoglobin: a dynamic activity of blood involved in vascular control. *Nature* 1996;380:221.
249. Gow AJ, Luchsinger BP, Pawloski JR, et al. The oxyhemoglobin reaction of nitric oxide. *Proc Natl Acad Sci U S A* 1999;96:9027.
250. Gow AJ, Stamler JS. Reactions between nitric oxide and haemoglobin under physiological conditions. *Nature* 1998;391:169.
251. Pawloski JR, Hess DT, Stamler JS. Export by red blood cells of nitric oxide bioactivity. *Nature* 2001;409:622.
252. Hsieh H-S, Jaffe ER. The metabolism of methemoglobin in human erythrocytes. In: Surgenor DM, ed. *The red blood cell*, ed 2. New York: Academic Press, 1975.
253. Rachmilewitz EA. Denaturation of the normal and abnormal hemoglobin molecule. *Semin Hematol* 1974;11:441.
254. Berzofsky JA, et al. Sulfheme proteins: optical and magnetic properties of sulfmyoglobin and its derivatives. *J Biol Chem* 1971;246:3367.
255. Morell DB, et al. The structure of the chromophore of sulphmyoglobin. *Biochim Biophys Acta* 1967;136:121.
256. Berzofsky JA, et al. Sulfheme proteins. IV. The stoichiometry of sulfur incorporation and the isolation of sulfhemin, the prosthetic group of sulfmyoglobin. *J Biol Chem* 1972;247:3783.
257. Sass MD, et al. TPNH-methemoglobin reductase deficiency. A new red cell enzyme defect. *J Lab Clin Med* 1967;70:760.
258. Mansouri A. Methemoglobin reduction under near physiological conditions. *Biochem Med* 1989;42:43.
259. Gibson QH. The reduction of methaemoglobin in red blood cells and studies on the cause of idiopathic methaemoglobinemia. *Biochem J* 1948;42:13.
260. Bull PC, et al. Cloning and chromosomal mapping of human cytochrome b5 reductase (DIA1). *Ann Hum Genet* 1988;52:263.
261. Yubisui T, et al. Molecular cloning of cDNAs of human liver and placenta NADH-cytochrome b5 reductase. *Proc Natl Acad Sci U S A* 1987;84:3609.
262. Hultquist DE, et al. Catalysis of methaemoglobin reduction by erythrocyte cytochrome b5 and cytochrome b5 reductase. *Nature* 1971;229:252.
263. Hegesh E, et al. Congenital methemoglobinemia with a deficiency of cytochrome b5. *N Engl J Med* 1986;314:757.
264. Miyata M, et al. Isolation and characterization of human liver cytochrome b5 cDNA. *Pharmacol Res* 1989;21:513.
265. Bloom GE, Zarkowsky HS. Heterogeneity of the enzymatic defect in congenital methemoglobinemia. *N Engl J Med* 1969;281:919.
266. Carrell RW, et al. Activated oxygen and hemolysis. *Br J Haematol* 1975;30:259.
267. Fridovich I. Oxygen radicals, hydrogen peroxide and oxygen toxicity. In: Pryor WA, ed. *Free radicals in biology*, vol. I. New York: Academic Press, 1976.
268. Fridovich I. Superoxide dismutases. *Annu Rev Biochem* 1975;44:147.
269. Misra HP, Fridovich I. The oxidation of phenylhydrazine: superoxide and mechanism. *Biochemistry*

1976;15:681.

270. Lynch RE, et al. Inhibition of superoxide dismutase of methemoglobin formation from oxyhemoglobin. *J Biol Chem* 1976;251:1015; *Biochemistry* 1977;16:4563.

271. Sutton HC, et al. The rate of reaction of superoxide radical iron with oxyhemoglobin and methemoglobin. *Biochem J* 1976;155:503; 1976;155:493.

272. Lynch RE, Fridovich I. Lysis of red cell vesicles exposed to superoxide anion. *Blood* 1977;50[Suppl 1]:81.

273. Jabusch JR, et al. Some sulfhydryl properties and primary structure of human erythrocyte superoxide dismutase. *Biochemistry* 1980;19:2310.

274. Cohen G, Hochstein P. Glutathione peroxidase. *Biochemistry* 1963;2:1420.

275. Hill AS Jr, et al. The role of nonhemoglobin proteins and reduced glutathione in the protection of hemoglobin from oxidation in vitro. *J Clin Invest* 1964;43:17.

276. Ganther HE, et al. Studies on selenium in glutathione peroxidase. *Fed Proc* 1974;33:694(abst).

277. Chada S, et al. Isolation and chromosomal localization of the human glutathione peroxidase gene. *Genomics* 1990;6:268.

278. McBride OW, et al. Gene for selenium-dependent glutathione peroxidase maps to human chromosomes 3, 21, and X. *Biofactors* 1988;1:285.

279. Necheles TF, et al. Erythrocyte glutathione-peroxidase deficiency. *Br J Haematol* 1970;19:605.

280. Tudhope GR. Red cell catalase in health and in disease, with reference to the enzyme activity in anaemia. *Clin Sci* 1967;33:165.

281. Jacobs HS, et al. Oxidative hemolysis and erythrocyte metabolism in acatalasia. *J Clin Invest* 1965;44:1187.

282. Aebi HE, Wyss SR. Acatalasemia. In: Stanbury JB, et al., eds. *The metabolic basis of inherited disease*. New York: McGraw-Hill, 1978.

283. Agar NS, et al. Erythrocyte catalase. A somatic oxidant defense. *J Clin Invest* 1986;77:319.

284. Ohno H, et al. Physical training and fasting erythrocyte activities of free radical scavenging enzyme systems in sedentary men. *Eur J Appl Physiol* 1988;57:173.

285. Schroeder WT, Saunders GF. Localization of the human catalase and apolipoprotein A-1 genes to chromosome 11. *Cytogenet Cell Genet* 1987;44:231.

286. Aviram I, Shaklai N. The association of human erythrocyte catalase with the cell membrane. *Arch Biochem Biophys* 1981;212:329.

287. Kirkman HN, Gaetani GF. Catalase: a tetrameric enzyme with four tightly bound molecules of NADPH. *Proc Natl Acad Sci U S A* 1984;81:4343.

288. Minnich V, et al. Glutathione biosynthesis in human erythrocytes. *J Clin Invest* 1971;50:507.

289. Srivastava SK, Beutler E. The transport of oxidized glutathione from human erythrocytes. *J Biol Chem* 1969;244:9.

290. Srivastava SK, Beutler E. The enzymatic cleavage of glutathione-hemoglobin preparations by glutathione reductase. *Biochem J* 1970;119:353.

291. Krauth-Siegel RL, et al. Glutathione reductase from human erythrocytes. The sequences of the

NADPH domain and of the interface domain. *Eur J Biochem* 1982;121:259.

292. Untucht-Grau R, et al. Glutathione reductase from human erythrocytes: amino acid sequence of the structurally known FAD-binding domain. *Eur J Biochem* 1981;120:407.

293. Tutic M, et al. Cloning and sequencing of mammalian glutathione reductase cDNA. *Eur J Biochem* 1990;188:523.

294. Beutler E. Glutathione reductase: stimulation in normal subjects by riboflavin supplementation. *Science* 1969;165:613.

295. Beutler E. Effect of flavin compounds on glutathione reductase activity. *J Clin Invest* 1969;48:1957.

296. Koutras GA, et al. Effect of sodium chromate on erythrocyte glutathione reductase. *J Clin Invest* 1964;43:323.

297. Valentine WN, Paglia DE. Syndromes with increased red cell glutathione (GSH). *Hemoglobin* 1980;4:799.

298. Moses SW, et al. Glycogen metabolism in the normal red blood cell. *Blood* 1972;40:836; 1974;44:275.

299. Murphy JR. Erythrocyte metabolism. *J Lab Clin Med* 1960;55:281,286.

300. Schuster R, et al. Interrelations between glycolysis and the hexose monophosphate shunt in erythrocytes as studied on the basis of a mathematical model. *Biosystems* 1988;22:19.

301. Tanaka KR, Zerez CR. Red cell enzymopathies of the glycolytic pathway. *Semin Hematol* 1990;27:165.

302. Fujii S, et al. Fructose-6-phosphate, 2-kinase activity in human erythrocytes. *Blood* 1987;70:1211.

303. Davidson WD, Tanaka KR. Factors affecting pentose phosphate pathway activity in human red cells. *Br J Haematol* 1972;23:371.

304. Szeinberg A, Marks PA. Substances stimulating glucose catabolism by the oxidative reactions of the pentose phosphate pathway in human erythrocytes. *J Clin Invest* 1961;40:914.

2004 Lippincott Williams & Wilkins  
John P. Greer, John Foerster, John N. Lukens  
George M. Rodgers, Frixos Paraskevas, Bertil Glader  
Wintrobe's Clinical Hematology

METHODS FOR ESTIMATING ERYTHROCYTE LIFESPANCohort MethodsRandom Labeling MethodsERYTHROCYTE AGINGErythrocyte EnzymesCalcium BalanceMembrane Carbohydrates and Surface ChargeOxidative InjuryAutologous Antibodies to Membrane AntigensMECHANISMS AND SITES OF RED CELL DESTRUCTIONExtravascular HemolysisIntravascular HemolysisFATE OF INTRAVASCULAR HEMOGLOBINHaptoglobinHemoglobin and the KidneyPlasma Heme, Hemopexin, and MethemalbuminEXTRAVASCULAR HEMOGLOBIN DEGRADATIONFormation of BilirubinBilirubin TransportHepatic Bilirubin MetabolismIntestinal Bile Pigment MetabolismAlternate Pathways of Heme and Bilirubin CatabolismLaboratory Evaluation of Hemoglobin Catabolism and Bile PigmentsACKNOWLEDGMENTREFERENCES

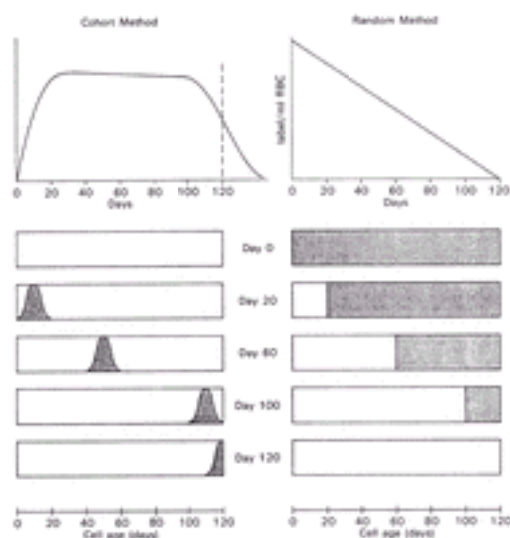
The mature erythrocyte lacks the organelles that make protein synthesis possible, and, thus, it is incapable of self-repair. Its lifespan is finite and is shortened further when the cell's environment becomes hostile or when the cell's ability to cope with damaging extracellular influences becomes impaired. Excessive destruction of red cells plays a major role in hemolytic diseases. This chapter focuses on the following issues: How long do normal red cells live? Why do red blood cells (RBCs) die? Where do RBCs die? What are the biochemical changes associated with red cell death?

## METHODS FOR ESTIMATING ERYTHROCYTE LIFESPAN

Valid measurements of erythrocyte survival in the intact animal became possible in 1919 when Ashby devised the differential agglutination technique (<sup>1</sup>). Since then, other less cumbersome methods have been introduced. Studies with these techniques have demonstrated that, after a finite lifespan, the erythrocyte becomes nonviable and disappears from the circulation. In humans, this lifespan averages approximately 120 days. In other mammals, values range from 40 days in mice to 225 days in the llama (<sup>2</sup>). Still longer survivals, 600 to 1400 days, are observed in poikilotherms with low metabolic rates, such as toads and turtles (<sup>3</sup>).

There are a number of direct methods for measuring erythrocyte lifespan (<sup>2, 4</sup>). *Cohort*

*methods* depend on the incorporation of an isotopically labeled substance into a group (“cohort”) of newly formed cells. If exposure to the label is brief and there is no reuse of label, the tagged cells will be of very nearly the same age. In contrast, *random-labeling methods* use tracers that bind with all cells in the circulation regardless of age. The patterns of time-dependent change in circulating red cell label produced by these two procedures are quite different ( Fig. 9.1). Cohort labels result in a pattern characterized by a plateau, the length of which is a measure of erythrocyte lifespan. In contrast, random labels begin to disappear from the circulation immediately, and erythrocyte lifespan is related to the time when all label has vanished, the so-called extinction time. In the past, these procedures helped define normal and abnormal RBC survival in various anemias.



**Figure 9.1.** Comparison of idealized patterns produced by cohort and random methods of labeling circulating erythrocytes. These curves are constructed on the assumptions that no elution of label occurs and that all erythrocyte destruction is senescent. Bars below the main graphs indicate distribution of labeled cells ( *shaded areas*) by cell age. These labeled cells can be thought of as being forced to the right by a piston made of newly produced, unlabeled cells. RBC, red blood cells. (Modified from Berlin NI, et al. Life span of the red blood cell. *Physiol Rev* 1959;39:577.)

## Cohort Methods

The ideal cohort label would produce labeling in the shortest possible time, would label the erythrocyte and no other cells or proteins, would not injure the labeled cell or alter its survival, would remain with the cell throughout its life, would not be reused, would present no risks to the recipient, would be easily assayed, and would not be excessively expensive. Some of the isotopes used throughout the years include  $^{59}\text{Fe}$  ( [5](#) ) and glycine tagged with  $^{15}\text{N}$ ,  $^{14}\text{C}$ , or  $^3\text{H}$  ( [2](#) ). These are incorporated into hemoglobin (Hb) when it is synthesized by the erythrocyte precursors and remain with the cell throughout its lifespan. To determine the erythrocyte lifespan with cohort labels, assays must be performed for over 120 days if the red cell lifespan is normal. Of the various cohort labels,  $^{59}\text{Fe}$  is reasonably safe and relatively easy to assay.

## Random-Labeling Methods

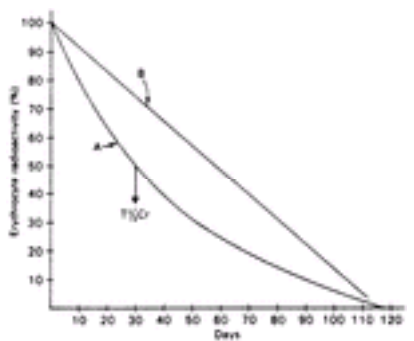
Random-labeling methods have proved to be much more useful than cohort methods for



both clinical and research applications because accurate information is made available in a relatively short time. The time at which half of the label has disappeared from the circulation ( $t_{1/2}$ ) is recorded. When there is neither a significant degree of random destruction nor elution of label, the shape of the disappearance curve is linear, and the mean erythrocyte lifespan is equal to twice the value for  $t_{1/2}$ . Random methods include those based on the Ashby differential agglutination technique as well as those in which cells are labeled with isotopes, the most common of which is  $^{51}\text{Cr}$ .

The Ashby method is of historical interest. This procedure uses the transfusion of compatible but immunologically identifiable blood (e.g., group O cells into a group A, B, or AB recipient) (1, 6). At appropriate intervals, the donor red cells are enumerated after agglutination or hemolysis (7) of the recipient's cells by appropriate antisera. When properly performed, the differential agglutination technique yields accurate results. The observed disappearance curves are linear in normal human subjects, and deviation from linearity indicates random destruction. Inability to measure the survival of a subject's cells in his or her own circulation, as well as the hazards of transfusion and the exacting requirements of technique, obviously limited the usefulness of this method.

Radioactive chromium was introduced as a red cell label in 1950 and was used in survival studies *in vivo* shortly thereafter (8, 9). Anionic (hexavalent) chromium in the form of the chromate ion ( $^{51}\text{CrO}_4^{-2}$ ) can penetrate the red cell membrane. Once inside the cell, it is converted to the trivalent cation ( $\text{Cr}^{+3}$ ) and, in this form, becomes firmly, but not irreversibly, bound to Hb. The chromium attaches to the  $\beta$ -chains of Hb A and, to a lesser extent, to the  $\gamma$ -chains of Hb F (10). The principal disadvantage of the chromium label is that it is slowly eluted from the cell. The rate of elution in normal subjects was found to be 0.57 to 1.28%/day and averaged 0.93%/day (8). An assumed rate of 1%/day is often used for analysis of chromium survival curves. The disappearance of  $^{51}\text{Cr}$  from the circulation thus reflects not only the red cell lifespan, but also the elution rate; as a consequence, the chromium disappearance curve is nonlinear. However, if the data are plotted on a semilogarithmic scale, or if appropriate correction factors (11) are applied, the pattern approximates a straight line (Fig. 9.2). From such a plot, the disappearance half-life ( $t_{1/2} \text{Cr}$ ) may be derived. The chromium elution rate depends in part on the techniques used in the labeling procedure (12). Consequently, reported average normal values for  $t_{1/2} \text{Cr}$  have varied widely from 25 to 33 days.



**Figure 9.2.**  $^{51}\text{Cr}$  erythrocyte survival curve in a normal subject before (A) and after (B) correction for elution (see text). Half of the radioactivity is gone at 30 days ( $T_{1/2}\text{Cr}$ ), but the radioactivity does not disappear completely until 115 days, the so-called extinction time.

Red cell survival studies are infrequently done nowadays, but, if performed, the chromium method is used more than any of the other available methods. Because it emits a high-energy  $\gamma$ -ray, radioassay is comparatively easy and requires little sample preparation. Also, radioactivity monitored over the body surface can be used to determine the principal sites of destruction ([13](#)). Because labeling usually is performed *ex vivo*, cross-transfusion studies also are possible; thus, survival of a patient's cells in a normal recipient or of normal cells in a patient can be evaluated by this method. Previously, these procedures yielded much information regarding cell survival in various hemolytic anemias, helping to define intrinsic versus extrinsic hemolytic disorders. Safety considerations nowadays do not allow for similar studies.

Diisopropylfluorophosphate labeled with  $^{32}\text{P}$  (DF  $^{32}\text{P}$ ) reacts with esterases, especially cholinesterase, and becomes firmly bound to the cell ([14](#)). DF  $^{32}\text{P}$  labels leukocytes and platelets as well as erythrocytes. In contrast to chromium, little DF  $^{32}\text{P}$  is eluted after the first 24 to 48 hours, and none is eluted after 10 days. As a result, the normal disappearance curve is nearly linear, and many complexities of interpretation are avoided ([15](#), [16](#)). For these reasons, DF  $^{32}\text{P}$  is a highly satisfactory label for determining lifespan. However, sample preparation is somewhat complicated, surface counting is not possible, and it is no longer commercially available ([17](#)).

The lifespan of the normal human erythrocyte as measured by the various procedures described above is essentially the same, namely, 117 (110 to 135) days by the Ashby method, 113 (108 to 120) days when the  $^{51}\text{Cr}$  label is used, 118 (109 to 127) days with  $^{15}\text{N}$ -glycine, and 124 days with DF  $^{32}\text{P}$ . Thus, it appears that approximately 0.83% of the circulating red cells are replaced each day.

## ERYTHROCYTE AGING

Once the erythrocyte has lost its nucleus and ribosomes, it can no longer synthesize protein. With the loss of its mitochondria, it is dependent on anaerobic glycolysis to provide energy. In humans, it must then survive 4 months and hundreds of miles of hazardous travel with very limited equipment with which to maintain itself. Nevertheless, it does retain significant repair capacity. In addition to its ability to sustain effective levels of adenosine triphosphate (ATP), the reduced form of nicotinamide adenine dinucleotide, and nicotinamide adenine dinucleotide phosphate (NADPH) and to maintain its ionic composition, it can also reduce methemoglobin and oxidized glutathione, synthesize glutathione, and reseal its membrane if a portion of it is lost. Despite these and other capabilities, the cell ultimately is unable to sustain its existence ([18](#), [19](#) and [20](#)).

In attempting to identify the changes that occur in the erythrocyte as it ages, the typical approach has been to separate young and old red cells, to measure a chemical or physical feature of the old cells, and to ascribe the observed difference to the effect of cell age. Further, it has been common to assume that the observed change believed to be due to age continues to worsen and ultimately causes the death of the erythrocyte. The most commonly used method for separating young and old cells makes use of the observation that erythrocyte density increases as a function of age ([21](#), [22](#), [23](#), [24](#) and [25](#)). Although this change occurs with considerable consistency ([22](#), [26](#)), some mixture of young and old cells has almost always been demonstrated in each density fraction ([27](#), [28](#), [29](#), [30](#) and [31](#)), and, thus, the different compartments represent mostly "young" or mostly "old" cells. Sensitivity to osmotic lysis is another property that increases with age; however, cell fractions separated on the basis of this property are also not uniform with respect to age

([32](#), [33](#)). Separation of red cells by age has also been proposed on the basis of surface charge ([34](#), [35](#)) or cell size ([36](#), [37](#)). Other approaches have been based on examining surviving RBCs in animals or patients with suppressed erythropoiesis ([38](#), [39](#) and [40](#)) or after a cohort of cells labeled with biotin ([41](#), [42](#)). These latter methods may avoid the problems inherent in the methods based on density separation.

Various hypotheses have been proposed to explain red cell death, and these include (a) changes in red cell enzymes with age, (b) alterations in calcium balance, (c) changes in membrane carbohydrates and surface charge, (d) oxidative injury, and (e) development of autologous antibodies to membrane antigens. The following sections summarize the data on which various hypotheses have been based. In addition to the abnormalities cited in these sections, many other changes have been observed in aging cells ([Table 9.1](#)). Whether any of these abnormalities is of physiologic significance is not known.

**TABLE 9.1. Erythrocyte Changes Associated with Aging** [a](#)

|   |   |
|---|---|
| Changes in physical characteristics   | Changes in glycolysis   |
| Increased density ( <a href="#">22</a> , <a href="#">289</a> )                                | Decreased overall rate of glycolysis ( <a href="#">298</a> , <a href="#">312</a> )  |
| Decreased deformability ( <a href="#">290</a> , <a href="#">291</a> )                         | Decreased ATP ( <a href="#">76</a> , <a href="#">313</a> )  |
| Increased osmotic and mechanical fragility ( <a href="#">116</a> , <a href="#">292</a> )      | Decreased 2,3-diphosphoglycerate ( <a href="#">76</a> , <a href="#">294</a> , <a href="#">298</a> )   |
| Decreased cell size ( <a href="#">36</a> , <a href="#">76</a> , <a href="#">292</a> )         | Decreased hexokinase ( <a href="#">43</a> , <a href="#">44</a> , <a href="#">51</a> , <a href="#">313</a> , <a href="#">314</a> , <a href="#">315</a> and <a href="#">316</a> ) |
| Changes in hemoglobin   | Decreased glucose phosphate isomerase ( <a href="#">44</a> , <a href="#">317</a> )  |
| Increased methemoglobin ( <a href="#">293</a> )   | Decreased phosphofructokinase ( <a href="#">44</a> , <a href="#">318</a> , <a href="#">319</a> )  |
| Increased hemoglobin-oxygen affinity ( <a href="#">294</a> , <a href="#">295</a> )            | Decreased aldolase ( <a href="#">44</a> , <a href="#">51</a> , <a href="#">313</a> )  |
| Increased glycosylated hemoglobin ( <a href="#">296</a> , <a href="#">297</a> )               | Decreased triosephosphate isomerase ( <a href="#">44</a> )  |
| Changes in cellular constituents  | Decreased glyceraldehyde-3-phosphate dehydrogenase ( <a href="#">44</a> )   |
| Decreased K <sup>-</sup> ( <a href="#">76</a> , <a href="#">298</a> , <a href="#">299</a> )   | Decreased phosphoglycerate kinase ( <a href="#">44</a> , <a href="#">320</a> )  |
| Increased Na <sup>-</sup> ( <a href="#">76</a> , <a href="#">298</a> , <a href="#">299</a> )  | Decreased 3-phosphoglycerate mutase ( <a href="#">44</a> )  |
| Increased Ca <sup>2-</sup> ( <a href="#">70</a> , <a href="#">300</a> )                       | Decreased enolase ( <a href="#">44</a> )  |
| Changes in the membrane   | Decreased pyruvate kinase ( <a href="#">44</a> , <a href="#">51</a> , <a href="#">312</a> , <a href="#">315</a> , <a href="#">318</a> )   |
| Decreased lipid content ( <a href="#">301</a> , <a href="#">302</a> and <a href="#">303</a> ) | Decreased lactate dehydrogenase ( <a href="#">44</a> )  |
| Decreased surface area ( <a href="#">290</a> , <a href="#">301</a> )                          | Changes in glutathione metabolism   |
| Decreased negative charge ( <a href="#">75</a> , <a href="#">304</a> , <a href="#">305</a> )  | Decreased reduced glutathione ( <a href="#">324</a> , <a href="#">325</a> )   |
| Decreased membrane glycoproteins ( <a href="#">76</a> , <a href="#">306</a> )                 | Decreased glutathione reductase ( <a href="#">326</a> )   |
| Decreased (Ca <sup>2-</sup> -Mg <sup>2-</sup> )-ATPase activity ( <a href="#">307</a> )       | Decreased glutathione peroxidase ( <a href="#">86</a> )   |

Decreased protein 4.1b ( 308)

Decreased sialic acid residues ( 73, 74, 75 and 76)

Increased membrane-bound hemichromes ( 87)

Increased lipid peroxidation ( 90)

Increased membrane protein polymers ( 309)

Increased spectrin-hemoglobin aggregates ( 93)

Increased denatured hemoglobin-band 3 copolymers ( 310)

Increased protein 4.1a ( 308)

Decreased Na-K-ATPase ( 330)

Increased  $\alpha$ -galactosyl residues ( 99)

Increased phosphatidylserine ( 108)

Altered blood group antigens ( 311)

Development of antigenic band 3 ( 72)

Changes in the hexose monophosphate shunt pathway

Decreased glucose-6-phosphate dehydrogenase ( 43, 51, 116, 313, 321, 322)

Decreased 6-phosphogluconate dehydrogenase ( 116, 313, 322, 323)

Decreased transketolase ( 322)

Decreased glutathione-S-transferase ( 325)

Changes in purine and pyrimidine nucleotide metabolism

Decreased purine nucleoside phosphorylase ( 320)

Decreased adenylate kinase ( 320)

Decreased pyrimidine 5' nucleotidase ( 38, 51, 315)

Miscellaneous enzyme changes

Decreased catalase ( 327, 328)

Decreased aminophospholipid translocase ( 329)

Decreased protein kinase C ( 53)

Decreased acetylcholinesterase ( 316, 331)

Decreased thiopurine methyltransferase ( 332)

Decreased S-adenosylhomocysteine hydrolase ( 333)

Decreased glyoxalase ( 288)

ATP, adenosine triphosphate.

<sup>a</sup> Many of these differences compare very young erythrocytes (reticulocytes; less dense cells) and older red cells (fewer reticulocytes; more dense cells). In some cases, particularly with enzyme changes, it is not clear whether the differences reflect changes between reticulocytes and most other red blood cells or whether the differences are a reflection of normal mature red blood cell aging *in vivo* (see text for details).

---

## Erythrocyte Enzymes

The activities of erythrocyte enzymes have been measured in cells separated by age on the basis of cell density, osmotic lysis, or avidin-biotin affinity ( 41, 43, 44 ). The activities of a number of enzymes have been reported to decline with the age of the erythrocyte, including all of the glycolytic enzymes ( Table 9.1 ). Red cell senescence and destruction may thus depend on this lost metabolic potential ( 45, 46, 47 and 48 ). However, the assumptions on which these studies are based have been criticized ( 49 ). It is recognized that the activities of certain age-dependent enzymes, such as glucose-6-phosphate dehydrogenase, hexokinase, aldolase, and pyruvate kinase, are greatly increased in red cells of individuals with hemolytic anemia. It also is agreed that the metabolic activity of reticulocytes decreases during their short maturation. However, it is less clear that the

decrease continues during the erythrocytes' subsequent lifespan or that metabolic failure is the cause of red cell senescence and death. It has been pointed out that, if enzyme activity were lost rapidly during the first few days of the red cell's life but remained essentially stable thereafter, contamination of samples of old cells with progressively smaller numbers of reticulocytes would result in gradually decreasing enzyme activity in those samples ( 49 ). Studies using methods in which contamination of older cells with reticulocytes is less likely to occur have not consistently confirmed the loss of activities of these enzymes with age ( 38 , 41 , 50 , 51 and 52 ). In one particularly interesting study in transient erythroblastopenia of childhood, a disorder characterized by an older population of red cells at diagnosis ( Chapter 45 ), there was no difference in enzyme activity of affected patients or control erythrocytes, thus suggesting there is minimal loss of enzyme activity beyond the first days of red cell life ( 38 ). However, there are other studies to support the notion that the activity of some enzymes decline after reticulocyte maturation, in particular, the activity of several membrane protein kinases ( 53 ). Impaired phosphorylation of erythrocyte skeletal proteins or of a variety of substrates as a consequence of this lost kinase activity might render the red cell more susceptible to destruction.

## Calcium Balance

Senescence of erythrocytes has been ascribed to a change in calcium balance resulting in an increasing concentration of calcium in older red cells, a change that might reduce erythrocyte deformability. It has been proposed that a major consequence of ATP depletion in aging cells is decreased activity of membrane-bound  $(Ca^{2+}-Mg^{2+})-ATPase$  and, therefore, calcium accumulation. This loss of calcium pump activity with age has been demonstrated in inside-out vesicles prepared from density-separated erythrocytes ( 54 , 55 ). Alternatively, loss of pump activity might occur despite adequate ATP concentrations as a result of destruction of the enzyme by the calcium-activated protease calpain or by increased activity of an ATPase inhibitor ( 56 ). Increased cell calcium would, in turn, result in potassium loss, dehydration, increased cell density, increased viscosity, and diminished cell deformability ( 57 ). Others have proposed that calcium-activated transglutaminases can cross-link membrane or skeletal protein in senescent cells ( 58 , 59 ). Data to support any of the above assumptions are not entirely convincing. ATP depletion may not occur during erythrocyte aging. A decrease in  $(Ca^{2+}-Mg^{2+})-ATPase$  activity in denser, and thus potentially older, red cells has been demonstrated ( 56 , 60 ), but normal activity has also been reported ( 61 ), and, once again, the doubtful reliability of the density gradient separation method makes the significance of these observations uncertain. The presence of aggregates of polymerized polypeptides, as might arise from transglutaminase activity, has been disputed ( 62 ). Furthermore, the capacity of high-density red cells to extrude calcium after calcium loading was not different from that of low-density cells ( 63 ), and survival of transfused calcium-loaded cells was normal ( 64 ). More central to the hypothesis is the concentration of cell calcium. Measurements of the concentration of erythrocyte calcium have yielded inconsistent results ( 65 , 66 , 67 , 68 and 69 ). Studies with fluorine nuclear magnetic resonance to measure calcium in cells separated using the density gradient system demonstrate a clearly greater concentration in the most dense, ostensibly the oldest cell fraction, than in the least dense fraction ( 70 ). The hypothesis that ATP depletion, calcium accumulation, and diminished cell deformability bring about red cell senescence and death is an attractive one but remains without reliable corroboration.

## Membrane Carbohydrates and Surface Charge

It has been proposed that a diminished negative charge on the erythrocyte membrane would significantly reduce the repulsive interaction between red cells and tissue macrophages and thus facilitate red cell phagocytosis. Specifically, it has been shown that sialic acid, the principal source of membrane negative charge, is lost from membranes of high-density red cells, and the total surface negative charge is reduced. Desialylation of red cells decreases their lifespan *in vivo* ( [71](#) ) and increases phagocytosis by autologous macrophages *in vitro* ( [72](#), [73](#) ). It has been proposed that desialylation of membrane glycophorin occurs as the red cell ages and creates a “senescence factor glycopeptide” that is the signal for sequestration of moribund red cells ( [74](#) ). However, electrophoretic mobility of high- and low-density cells is not different ( [35](#), [75](#) ), and the difference in charge and sialic acid content is explainable by a loss of membrane surface area in the high-density cells ( [76](#), [77](#) ). Moreover, when red cells are desialylated and then reinfused, they do not behave as do high-density (and thus potentially aged) cells: Both are sequestered, but desialylated cells are sequestered in the liver rather than in the spleen ( [23](#) ); high-density cells are permanently removed from the circulation, but desialylated cells are only temporarily sequestered ( [78](#), [79](#) ). In addition, erythrocytes from individuals with recessively inherited deficiencies of red cell sialoglycoproteins survive normally ( [80](#) ). It would seem that, if destruction of aging red cells is dependent on loss of sialic acid and of charge, the relationship is not a simple one.

## Oxidative Injury

The role of the erythrocyte as an oxygen-carrying device repeatedly exposes it to the risk of oxidative injury ( [81](#), [82](#) ). In addition, intermediate products of oxidative denaturation of Hb, the hemichromes ( [83](#) ), interact with superoxide and hydrogen peroxide to generate hydroxyl radicals ( [84](#) ) and thus create another source of potential damage to the cell. Increased amounts of methemoglobin ( [85](#) ), hemichromes ( [86](#) ), and denatured Hb (Heinz bodies) ( [86](#), [87](#) ), decreased membrane-free sulfhydryl groups, and increased thiobarbituric acid-reactive substances ( [88](#), [89](#) ), an indicator of lipid peroxidation, all have been reported as evidence of oxidation damage in high-density red cells.

Further evidence is inferred from similarities between aged cells and those exposed to oxidants *in vitro*. In red cells incubated with H<sub>2</sub>O<sub>2</sub> or with an end product of fatty acid peroxidation, malonyldialdehyde, polypeptide polymers are found that may result from cross-linking of the cytoskeletal protein, spectrin ( [90](#) ). Treatment of red cells with H<sub>2</sub>O<sub>2</sub> or with the oxidant acetylphenylhydrazine induces the formation of membrane-bound, covalently cross-linked spectrin and  $\alpha$ -globin chains of Hb that result from oxidative damage to Hb rather than to lipids ( [91](#), [92](#), [93](#) and [94](#) ). This oxidant-induced polymerization of spectrin results in decreased cellular deformability and increased adherence to and phagocytosis by monocytes ( [92](#), [95](#) ). Similar abnormalities have been found in high-density red cells ( [92](#) ), but not all investigators have observed a change in the oxidative state of membrane proteins with age using the density gradient method ( [96](#) ), and no abnormalities of spectrin could be found in old red cells separated by methods other than the density gradient method ( [29](#), [62](#), [97](#) ).

The cytoplasmic domain of cytoskeletal band 3, a transmembrane anion transport protein (see [Chapter 8](#) ), provides a high-affinity site for hemichrome binding to the membrane in red cells exposed to oxidants ( [98](#) ). This interaction results in the formation of clusters of



band 3 molecules in the membrane but apparently does not alter their molecular structure ( [98](#) ). The normally occurring distance between band 3 molecules is too great to be bridged by a single immunoglobulin (Ig) G molecule, but this aggregation of band 3 molecules provides a site to which an autologous anti-band 3 antibody might bind (see [Autologous Antibodies to Membrane Antigens](#) ).

## Autologous Antibodies to Membrane Antigens

Antibodies that bind to the membranes of some erythrocytes are present in the serum of normal humans. Two different IgG antibodies have been identified, one of which apparently binds to an altered form of band 3 protein ( [72](#) ) and the other to a Galal-3 galactosyl-containing glycolipid ( [99](#) ). It has been proposed that binding of one or both of these autologous antibodies provides a senescence signal that is responsible for directing the phagocytosis of aged cells, presumably by recognition of the Fc portion of the bound antibody by the Fc receptor of the macrophage.

The apparent anti-band 3 antibody has been demonstrated in a variety of mammals ( [72](#), [100](#), [101](#) and [102](#) ), but the amount is small. It is possible that during the aging process, modification of band 3 occurs, perhaps by clustering of band 3 molecules as a consequence of oxidative injury ( [98](#) ). The antibody binds to high-density but not to low-density red cells ( [72](#), [102](#) ). In dogs with biotin-labeled erythrocytes ( [103](#) ), it binds to old but not young erythrocytes. However, the number of IgG molecules per biotinylated red cell does not increase with increasing age of the cell ( [104](#) ). *In vitro*, the antibody promotes phagocytosis ( [72](#) ), but an effect on survival *in vivo* has not been shown.

Despite the large literature on the characteristics of the anti-band 3 antibody, there is little evidence of physiologic importance. *In vitro* sequestration of red cells is not inhibited by inhibitors of the Fc receptor, but it is by  $\beta$ -galactosides, suggesting that erythrophagocytosis is mediated by a lectinlike receptor on macrophages ( [73](#), [105](#), [106](#) ). An increase in clearance of anti-band 3-treated guinea pig erythrocytes has been reported, but the increase is minimal ( [107](#) ). Erythrocyte lifespan in mice with severe combined immunodeficiency disease is normal, despite the absence of anti-band 3 antibody in the animals ( [108](#) ). In humans with mutations in band 3, none has been found in whom alterations in anti-band 3 binding sites resulted in prolonged erythrocyte survival ( [109](#) ).

The anti- $\alpha$ -galactosyl IgG is a polyclonal, monospecific antibody interacting specifically with oligosaccharides with the structure Galal-3 $\beta$ 1-4GlcNAc-R, a structure that is not normally expressed in humans, apes, or old world monkeys but is expressed in new world monkeys, nonprimate mammals, and in the bacterial lipopolysaccharides of *Escherichia coli* and *Klebsiella* ( [99](#) ). The antibody is present only in those species, like humans, that do not normally express the Galal-3 Gal epitope. Anti-Gal binds to high-density but not to low-density red cells. Galal-3 galactosyl is exposed on human red cells after their treatment with proteases, such as might occur after repeated exposure of cells to macrophages in the spleen ( [99](#) ). Anti-Gal is present in human plasma at 500 times the concentration of anti-band 3 ( [99](#) ). However, the physiologic significance of this antibody is unclear. Its absence from most mammals indicates that it is not a factor in the senescence of red cells in those species. If it plays a role in the destruction of aging red cells in humans, it is unlikely to be the exclusive mechanism.

The mechanism of red cell senescence is not clear. There is presently no marker by which aged red cells can be unequivocally identified. It may be that human erythrocyte senescence and destruction result from a combination of the many interesting



abnormalities described in the preceding paragraphs or from some as yet unrecognized phenomenon.

## MECHANISMS AND SITES OF RED CELL DESTRUCTION

When the erythrocyte reaches the end of its sojourn, it disappears from the circulation. However, as discussed above, the change in the cell that makes it no longer viable is not known. Much of what is believed to be true is based on inference or on observations made in individuals with hemolytic anemia. Under normal conditions, approximately 80 to 90% of normal erythrocyte destruction occurs without release of Hb into plasma ([110](#), [111](#)). Because of this fact, the major part of the destructive process is presumed to be *extravascular*, probably within macrophages of the spleen and, to a lesser extent, in the liver and bone marrow. Only 10 to 20% of normal destruction occurs *intravascularly*, and this mode of destruction has special characteristics.

### Extravascular Hemolysis

It has long been assumed that erythrophagocytosis is the primary mode of extravascular destruction of senescent red cells in normal subjects ([112](#)). This is supported by two fundamental observations. First, the heme oxygenase system responsible for Hb degradation is located primarily in the phagocytic cells of the spleen, liver, and bone marrow and also in hepatocytes (see discussion below). Second, the iron derived from heme degradation is largely stored within the macrophage. Thus, it seems probable that Hb degradation and, hence, red cell destruction normally take place within these phagocytes. This clearly is true when red cell destruction is greater than normal, as in many types of hemolytic anemia. Likewise, when red cells are damaged *in vitro* and then reinfused, they are mostly removed from the circulation by the fixed macrophages of the spleen and liver ([113](#)). Also, as discussed above, old red cells bind autologous IgG antibodies, and, *in vitro*, these antibody-coated RBCs bind to macrophage Fc receptors, leading to erythrophagocytosis ([72](#), [99](#)).

The relative importance of the spleen and liver in erythrocyte destruction is influenced by the degree of cell damage ([113](#)). Severe degrees of damage lead to destruction in all macrophage-containing organs, but especially in the liver because of its relatively great blood flow. The spleen, in contrast, is apparently more sensitive to cell injury and cells only minimally damaged are preferentially removed by that organ ([114](#)). It is probable that effete red cells are destroyed primarily in the spleen; however, if this organ is removed from normal subjects, macrophages in other organs, especially the liver, rapidly assume this function, and there is no increase in cell survival ([115](#)).

### Intravascular Hemolysis

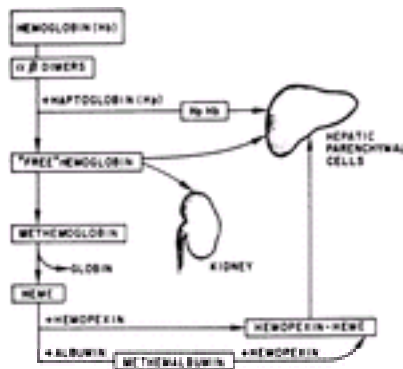
Analysis of haptoglobin (Hp) kinetics in normal human subjects demonstrates that 10 to 20% of erythrocyte destruction occurs intravascularly ([110](#), [111](#)). The mechanisms by which intravascular red cell destruction can occur are osmotic lysis and red cell fragmentation. Susceptibility to osmotic lysis increases with increasing red cell age ([37](#), [116](#), [117](#)). However, it is unlikely that osmotic lysis has any significant role in normal red cell destruction because there is no site within the vascular compartment where the plasma is sufficiently hypotonic to bring lysis about. *Fragmentation* is defined as the loss of a portion of the erythrocyte membrane, often, but not always, accompanied by loss of cellular contents, including Hb. Fragmentation is the characteristic mode of cell destruction in the “microangiopathic” hemolytic anemias ([Chapter 38](#)). In these disorders, large red cell fragments are present in the circulating blood. They appear on

blood smears as small, misshapen, often triangular or helmet-shaped structures (*schistocytes* or *schizocytes*). Fragmentation of red cells usually is a result of erythrocyte interactions with altered endothelium, fibrin deposition, and increased shear stresses.

Fragmented cells can be produced in a variety of ways *in vitro* ( [118](#), [119](#), [120](#), [121](#), [122](#) and [123](#) ). After a portion of the cell is lost, the membrane is capable of self-repair. Fragmentation also occurs within the spleen when the reticulocyte is pitted of red cell inclusions such as residual organelles and hemosiderin granules. To what extent this accounts for the small fraction of intravascular destruction seen in normal erythrocyte aging is not known.

## FATE OF INTRAVASCULAR HEMOGLOBIN

Special features characterize those situations in which red cells are destroyed within the circulation rather than within macrophages. This occurs to a small extent with normal red cell aging, but it is increased significantly in certain hemolytic anemias. When intravascular breakdown of red cells happens, Hb is discharged directly into the circulation, from which it is removed by several mechanisms ( [Fig. 9.3](#)).



**Figure 9.3.** Pathways for the disposal of hemoglobin in plasma. Hemoglobin freely dissociates into  $\alpha\beta$  dimers. These are bound by haptoglobin with subsequent removal of the hemoglobin-haptoglobin complex by hepatic parenchymal cells. Hemoglobin in excess of the haptoglobin-binding capacity circulates as the unbound (free) protein. In this form, it is partially removed by hepatic cells, but it may also follow two other pathways: It may be excreted by the kidney or oxidized to methemoglobin, from which heme is easily dissociated. Heme is initially bound to hemopexin, which transports it to the hepatic parenchymal cell. Heme may also be bound nonspecifically by albumin, forming methemalbumin. This complex probably transfers its heme to hemopexin as the latter becomes available.

## Haptoglobin

At low rates of release of Hb into plasma, all of the Hb is found to be attached to Hp ( [111](#), [124](#), [125](#), [126](#), [127](#), [128](#) and [129](#) ). Because its concentration increases in a variety of inflammatory diseases, an increased Hp level is recognized as a nonspecific sign of disease with much the same significance as an accelerated sedimentation rate. The role of Hp as a Hb-binding protein and as the principal factor affecting the apparent “renal threshold” for Hb was described by Laurell ( [130](#) ).

Haptoglobins are a family of  $\alpha_2$ -glycoproteins that bind Hb. The tetrameric molecule resembles that of certain Igs in that it has two light ( $\alpha$ ) chains and two heavy ( $\beta$ ) chains

linked in humans by disulfide bonds ( [131](#) ). Hp is synthesized as a single polypeptide chain that is cleaved posttranslationally within the endoplasmic reticulum to generate its  $\alpha$  and  $\beta$  subunits ( [132](#) , [133](#) ). Transcriptional activity of the Hp gene is promoted by interleukin-1, interleukin-6, and glucocorticoids as a part of the acute-phase response to systemic inflammation and related physiologic disturbances ( [134](#) , [135](#) , [136](#) , [137](#) and [138](#) ), explaining why Hp levels are increased with inflammation. By electrophoresis of serum, several different Hp bands have been demonstrated. Most of the variations are due to differences in the  $\alpha$ -chains. The observed pattern reflects the genetic constitution of the individual ( [139](#) ). The structural gene for Hp has been localized to the long arm of chromosome 16 (16q22) ( [140](#) , [141](#) and [142](#) ). There are three common alleles in humans. Two of these, designated *Hp*<sup>1F</sup> and *Hp*<sup>1S</sup>, code for electrophoretically distinguishable fast (F) and slow (S) migrating classes of  $\alpha$ -chains.

Early methods for the clinical determination of Hp concentration were based on the hemoglobin binding capacity of the plasma. Measured in this way, the normal range was 0.4 to 2.0 g Hb/L ( [110](#) ). Nowadays, most clinical laboratories measure Hp directly by radial immunodiffusion or immunonephelometric methods, and phenotyping can be performed using monoclonal antibodies and immunoblotting ( [143](#) , [144](#) ). Normal concentrations differ substantially with technique; ranges such as 0.5 to 1.6 g/L ( [145](#) ) are representative, but each clinical laboratory should establish its own reference values. The concentration is also influenced by age. Hp levels are very low in newborns, but levels are measurable by approximately 3 months of age and increase gradually throughout childhood ( [146](#) ). Decreased Hp concentrations also may be observed in disorders associated with hemolytic anemia, ineffective erythropoiesis, liver disease and hereditary ahaptoglobinemia and with pregnancy and estrogen therapy. Increased concentrations may be present in any of those diseases in which concentrations of acute-phase reactants are increased, such as infections and malignancies.

Haptoglobin and Hb bind within the vascular compartment in an essentially irreversible, noncovalent complex. Hp binds  $\alpha\beta$  Hb dimers. Thus, dissociation of tetrameric Hb is the necessary rate-limiting step in the reaction ( [147](#) ). Hp will complex with oxy-, met-, cyanmet- and carbon monoxyhemoglobin ( [148](#) ) but not with deoxyhemoglobin ( [147](#) ), Hb H (Hb $\beta_4$ ), Hb Bart's (Hb ?<sub>4</sub>) ( [149](#) ), or myoglobin ( [150](#) ). Heme-free globin is bound, but heme is not ( [151](#) ).

Haptoglobin is synthesized in the parenchymal cells of the liver ( [150](#) , [152](#) ). When not bound to Hb, it leaves the plasma with a half-disappearance time of 3.5 to 5.0 days ( [111](#) , [126](#) , [153](#) ). The Hp-Hb complex leaves much more rapidly, with a half-disappearance time of 9 to 30 minutes. Approximately 50 to 80% of the Hp turnover in the normal subject is accounted for by the rapid pathway ( [111](#) , [126](#) ). From the kinetics of Hb turnover, it can be calculated that some 10 to 20% of normal erythrocyte destruction occurs intravascularly and uses the Hp system ( [110](#) , [111](#) ). In hemolytic anemias characterized by intravascular hemolysis, catabolism of Hp is so rapid that it essentially disappears from the plasma, a change that is not accompanied by a compensatory increase in Hp synthesis. Hypohaptoglobinemia also occurs in hemolytic states associated with predominantly extravascular hemolysis ( [154](#) , [155](#) ). The explanation for this observation is not established, but it has been suggested that some Hb may be regurgitated from macrophages when the rate of phagocytosis of erythrocytes or erythrocyte fragments reaches a maximum ( [110](#) ).

Catabolism of the Hp-Hb complex occurs in the hepatic parenchymal cell ( [153](#) , [156](#) ). Internalization of the Hp-Hb complex by the hepatocyte is mediated by a receptor

specific for the complex ( [157](#) ). The heme moiety is then detached from globin-Hp and apparently bound to another carrier protein before conversion to biliverdin. The globin-Hp complex is thereafter degraded. Hp is not returned to the plasma.

## Hemoglobin and the Kidney

The Hb-Hp complex is too large (molecular weight, approximately 150 kd) to pass into the glomerular filtrate. Thus, the level of circulating haptoglobin is the most important determinant of the apparent renal threshold ( [130](#) ). When Hp is saturated, free (unbound) Hb circulates briefly in plasma. The hepatic parenchymal cell is responsible for the removal of some of the free Hb from plasma ( [153](#) ). In addition, Hb dissociates into  $\alpha\beta$  dimers, which, having a molecular weight of approximately 32 kd, readily pass through the glomerulus ( [158](#) ). There is a low (less than 0.6 g/L) renal threshold for free Hb present after Hp saturation that is related to renal tubular reabsorption ( [159](#) ). If this tubular reabsorption capacity is exceeded, Hb appears in the urine. Thus, renal handling of Hb is similar to that of glucose, urate, and certain other substances ( [158](#) ).

Hemoglobinuria, when it is of considerable magnitude, can cause precipitation of heme pigment as casts in the distal tubules, proximal tubule cell necrosis, and acute renal failure. The mechanism is disputed, but several theories have been proposed: (a) that Hb or Hb products are directly toxic to proximal tubule cells; (b) that precipitation of Hb results in tubular obstruction and renal failure; and (c) that direct renal injury by Hb does not occur, but instead, products of intravascular hemolysis result in hypotension and other systemic and local vascular events, and these lead to renal failure ( [160](#) , [161](#) , [162](#) and [163](#) ).

Within the tubular epithelial cell, Hb iron is rapidly extracted and stored in the cell as ferritin and hemosiderin ( [158](#) ). Some of the tubular epithelial iron may be reused for Hb synthesis, but its mobilization for this purpose occurs only at a very slow rate. When iron-laden tubular cells are sloughed into the urine, the urine iron concentration increases, and both ferritin and hemosiderin may be detected ( [163](#) ). Clinically, hemosiderinuria is usually detected by the Prussian blue stain of the urinary sediment ( [164](#) ). Detectable hemosiderin usually does not appear in the urine for 48 hours after a specific episode of hemoglobinuria ( [163](#) ) and may persist for more than a week ( [160](#) ). In chronic intravascular hemolysis, such as occurs in red cell fragmentation associated with abnormal prosthetic heart valves, hemosiderinuria is continuous ( [165](#) ) and can result in iron deficiency.

## Plasma Heme, Hemopexin, and Methemalbumin

**HEME** Free Hb in plasma is readily oxidized to methemoglobin. The latter dissociates easily and nonenzymatically into heme and globin ( [166](#) ). Free heme is highly insoluble at physiologic pH. However, hemopexin and albumin are able to bind heme and maintain it in a soluble form. Heme is removed from these proteins by hepatocytes.

**HEMOPEXIN** Hemopexin is a  $\beta$ 1-glycoprotein, consisting of a single polypeptide chain and containing 20% carbohydrate, with a molecular weight of approximately 70 kd ( [165](#) ). It binds heme with the highest known affinity of any heme-binding protein and plays an important role in receptor-mediated hepatocyte heme uptake. The human gene encoding hemopexin has been localized to the region p15.4-p15.5 of chromosome 11 and is thus at the same site as the  $\beta$  globin gene cluster, genes that also code for polypeptides that share the property of binding heme ( [167](#) , [168](#) , [169](#) and [170](#) ). Hemopexin is synthesized in the

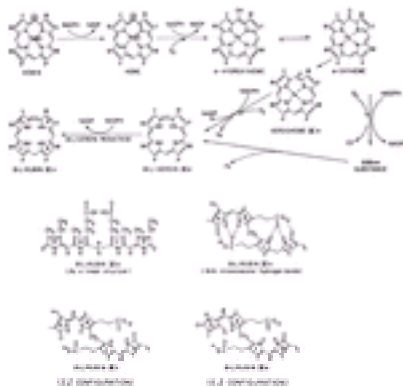
liver ( 171 ) and is found in the plasma in a concentration of 40 to 150 mg/dl. Each hemopexin molecule avidly binds one molecule of heme ( $K_d \sim 10^{-13}$  M). It also binds other porphyrins and bilirubin but with less avidity ( 172 , 173 ). Binding is through the heme iron to two histidine residues of hemopexin ( 172 , 174 , 175 , 176 , 177 , 178 and 179 ). The half-life of hemopexin in normal subjects is approximately 7 days ( 180 ), whereas the heme-hemopexin complex is removed from the circulation with a half-disappearance time of 7 to 8 hours ( 165 ). Hepatocyte uptake of the heme-hemopexin complex is presumably by receptor-mediated endocytosis ( 181 , 182 ). After endocytosis, the heme-hemopexin complex dissociates, and the released hemopexin is returned to the plasma as an intact protein ( 176 , 181 , 183 , 184 ). Transport of heme within the cytoplasm occurs by means of an intrinsic heme-binding membrane protein ( 180 , 181 ), and iron is rapidly released by heme oxygenase. Plasma hemopexin values may be reduced after intravascular hemolysis because of increased hemopexin catabolism ( 180 ). The depletion is less pronounced than is true of Hp, and low values imply a relatively severe degree of hemolysis. Hemopexin, like Hp, is an acute-phase reactant, and plasma levels rise with an inflammatory stimulus ( 185 ).

**METHEMALBUMIN** Each mole of human albumin can bind several moles of heme to form methemalbumin ( 186 ). The disappearance of methemalbumin from the circulation is kinetically complex ( 187 ). Heme added to human serum is initially associated primarily with albumin, presumably because the molar concentration of albumin is considerably greater than that of hemopexin ( 172 , 188 ).

## EXTRAVASCULAR HEMOGLOBIN DEGRADATION

### Formation of Bilirubin

Within 30 minutes of injection of either Hb or nonviable red cells, there is an increased concentration of bilirubin in both plasma and bile, as well as an increase in carbon monoxide (CO) production. The last component, derived from the  $\alpha$ -methene carbon of heme ( 188 ), is exhaled from the lungs. These substances represent the products of heme degradation by a ternary enzyme complex that is composed of heme oxygenase, NADPH-cytochrome *c* (P-450) reductase, and biliverdin reductase ( 189 ). Almost all endogenously derived CO comes from this source ( 188 , 190 ). In most mammals, the heme oxygenase reaction is coupled with a second step in which biliverdin IXa is reduced to bilirubin IXa ( Fig. 9.4).



**Figure 9.4.** Formation of bilirubin IXa from heme. The initial reactions are catalyzed by microsomal heme oxygenase and require nicotinamide adenine dinucleotide phosphate

(NADPH) as a cofactor. The reaction has a high specificity for the  $\alpha$ -methene bridge, and  $\alpha$ -oxyheme is a probable intermediate that is oxidized by molecular oxygen to biliverdin. In mammals, biliverdin is converted to bilirubin by biliverdin reductase. At bottom, alternative methods of representing the structure of bilirubin. The intramolecular hydrogen bonding that occurs with the Z,Z configuration is less extensive in the geometric isomers designated E,Z, and E,E (not shown); hence, the latter are more soluble in water. NADP, nicotinamide adenine dinucleotide phosphate.

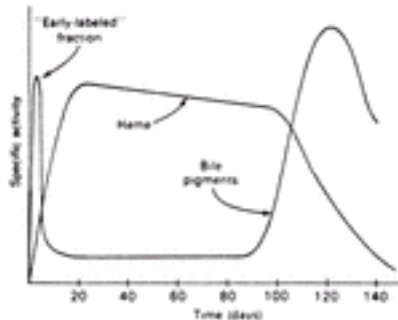
Heme oxygenase activity is present in all tissues in which it has been measured (191). Heme is the preferred substrate, but methemoglobin, methemalbumin, and isolated  $\alpha$ - and  $\beta$ -Hb chains also serve as substrates; there is little or no activity against Hb, myoglobin, or intact Hb-Hp or heme-hemopexin complexes (192). The enzyme is inducible by its substrates (190, 193), and increased heme oxygenase activity is observed in the spleen and liver during hemolytic anemia (192, 193 and 194), in the liver after splenectomy (192), and in renal tubule cells in association with hemoglobinuria (158, 194). The enzyme also is induced by metals, hormones, various drugs, organic compounds, fever, starvation, and stress (195, 196, 197, 198, 199 and 200). On the other hand, there also are agents that inhibit heme oxygenase activity (201); the most studied of these is tin-protoporphyrin (202). This substance acts as a competitive inhibitor of heme oxygenase; thus, its administration results in a marked decrease in the enzyme activity (203). The effect of tin-protoporphyrin is to inhibit the degradation of heme and, hence, the formation of bilirubin (197, 204, 205 and 206). Therefore, it may be useful in the treatment of hyperbilirubinemia states, such as those seen in newborn infants (207, 208, 209 and 210).

The process of heme degradation is a series of autocatalytic oxidations, catalyzed by heme oxygenase, with the reaction intermediates serving as cofactors (211) (Fig. 9.4). Overall, the oxidation of heme uses oxygen and NADPH, with the equimolar production of biliverdin, iron, and CO (212). In mammals, the heme oxygenase reaction is coupled with a second step in which biliverdin is converted to bilirubin. This reaction is brought about by an enzyme, biliverdin reductase, present in most tissues, that catalyzes the reduction of the central methene bridge of biliverdin. In birds, amphibians, and reptiles, biliverdin represents the principal end product of Hb degradation. Mammals have developed bilirubin as the end product, a change with important biologic consequences. Bilirubin is highly lipophilic and virtually insoluble in water, it is toxic to the developing brain, and it requires conjugation to make biliary excretion efficient (213). However, because of its lipophilicity, it can cross the placenta from fetus to mother with greater facility, and, thus, the fetus can use the mother's excretory mechanisms.

If isotopically labeled glycine is administered to a normal person, the label is incorporated into the porphyrin ring and ultimately makes its appearance in bilirubin (214) (Fig. 9.5). Most of the label appears approximately 120 days after administration of the isotope and, therefore, is presumed to be derived from the destruction of senescent red cells; however, a substantial fraction of the pigment is labeled within several days and, hence, is often referred to as the "early-labeled" bilirubin. The original studies estimated that approximately 10 to 20% of bilirubin was early-labeled (214). However, other studies suggest that an even greater fraction, approximately 25% (214, 215), of bilirubin is derived from heme proteins that turn over much more rapidly than Hb. This fraction is made up of at least two components (216). The first, normally the larger one, is labeled maximally at 24 hours and is of hepatic origin, chiefly from the heme of cytochrome P-450 but also from other hemoproteins (215). The second is labeled maximally at approximately 3 to 4 days and is a by-product of erythropoiesis (216). An isotopic label from administered



aminolevulinic acid, to which erythroid cells are relatively impermeable, appears primarily in the hepatic fraction, whereas that from glycine appears in both ( 216 ). The erythropoietic component is probably the product of “ineffective erythropoiesis” and results from the intramedullary destruction of defective red cells. In illnesses associated with exaggerated ineffective erythropoiesis, such as thalassemia or pernicious anemia, there is a marked increase in the early-labeled bilirubin fraction.



**Figure 9.5.** The incorporation of isotopically labeled glycine into heme and bile pigments. Most of the bilirubin labeling occurs at approximately 120 days, at the time of destruction of senescent red cells. Approximately 25% of bilirubin, however, is labeled within the first several days and is therefore called the “early-labeled” fraction.

## Bilirubin Transport

After being released from the sites of heme catabolism, bilirubin appears in the plasma. The normal concentration of plasma bilirubin is less than 1.0 mg/dl. At equilibrium, the concentration is directly related to bilirubin production and inversely related to hepatic clearance ( 217 , 218 ).

The structure of the bilirubin IX<sub>a</sub> molecule is asymmetrical, and several isomeric forms exist depending on the orientation of the outer pyrrole rings (rings A and D) in relation to the inner pyrrole rings (rings B and C) ( Fig. 9.4 ) ( 219 ). In the naturally occurring configuration, all pyrrole rings are similarly rotated, representing the Z,Z or trans configuration. If either of the outer rings is rotated, the E,Z or Z,E geometric isomers are formed. Photoisomerization of the naturally occurring Z,Z configuration of bilirubin forms the photoisomers of the E,Z and E,E configurations in which intramolecular hydrogen bonding is less extensive. Thus, the E,Z and E,E isomers are more soluble and can be excreted without conjugation ( 219 , 220 and 221 ); this is the basis for using phototherapy to prevent neurotoxicity in newborns with hyperbilirubinemia ( 219 , 220 ).

Bilirubin is normally present in plasma in several forms ( 222 , 223 ). Although unconjugated bilirubin is essentially insoluble in water, it combines reversibly with albumin in neutral or alkaline solution. At normal plasma albumin concentrations, the theoretical bilirubin-binding capacity is of the order of 70 mg/dl, of which half is tightly bound. These values are reduced by a decrease in plasma albumin concentration or by the presence of one of many organic, anionic substances that compete for albumin-binding sites, such as heme, fatty acids, sulfonamides, and salicylates ( 224 ). When the binding capacity is exceeded, bilirubin diffuses into the tissues. The tendency of bilirubin to bind to tissues, such as brain, may be due to complex formation with cell membrane polar groups, such as

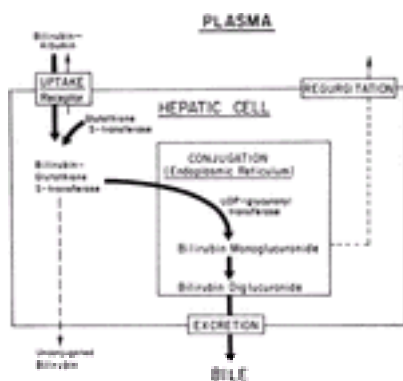


phosphatidylcholine ( [221](#) ).

In normal adults, less than 5% of measurable bilirubin is of the conjugated form ( [225](#), [226](#) ), but, under certain pathologic circumstances, the proportion of conjugated bilirubin is greater. This relatively soluble bilirubin derivative may also be bound to albumin. Most is less tightly bound than the unconjugated form, but a portion is covalently and irreversibly bound ( [227](#) ). That portion of esterified bilirubin that is reversibly bound to albumin is ultrafilterable. In contrast to the other forms of bilirubin present in the plasma, this complex enters the glomerular filtrate, is not reabsorbed in the tubules, and is excreted in the urine.

## Hepatic Bilirubin Metabolism

The processing of bilirubin by the liver is one aspect of a general mechanism whereby plasma protein-bound, organic anions are metabolized and excreted. In addition to bilirubin, other anionic substances follow the same pathways, especially certain dyes (e.g., cholecystographic agents), drugs (e.g., salicylates), steroids, and thyroxine. The process of hepatic bilirubin metabolism may be divided into three distinct phases: uptake, conjugation, and excretion ( [228](#) ) ( [Fig. 9.6](#) ). All three phases must be operative if bilirubin is to be excreted at a normal rate; however, in the normal person, the excretion step is the slowest and is, therefore, the rate-limiting step.



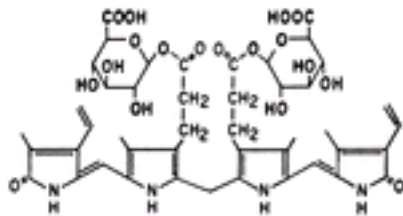
**Figure 9.6.** Normal and abnormal pathways of bilirubin excretion by the hepatic cell. The normal pathways ( *solid arrows* ) include uptake and conjugation of bilirubin and excretion of the conjugated derivative. Abnormal pathways ( *dashed arrows* ) include regurgitation of bilirubin glucuronide into plasma and excretion of unconjugated bilirubin into bile. UDP, uridine diphosphate.

Within the hepatic sinusoids, the albumin-bilirubin complex dissociates, and bilirubin, but not albumin, passes into the hepatocyte. The entry of bilirubin into the hepatocyte takes place via a bidirectional energy-dependent process ( [229](#), [230](#), [231](#), [232](#), [233](#), [234](#), [235](#) and [236](#) ). Conjugated bilirubin uses this mechanism as well ( [233](#), [236](#), [237](#) ). The bidirectional movement of bilirubin is extensive, with 40% of pigment extracted by hepatocytes in a single pass refluxing back into the plasma without change ( [238](#) ). In addition, a part of the bilirubin formed within the liver cell from degradation of hepatic heme, such as cytochrome P-450, refluxes into the plasma in the unconjugated form ( [239](#) ).

Within the hepatocyte, unconjugated bilirubin is bound by one or more of a group of cytosolic enzymes, the glutathione S-transferases, also referred to as *ligandin* or *Y*

*protein* ( [240](#), [241](#), [242](#) and [243](#) ). Glutathione S-transferase probably has no direct role in the uptake of bilirubin ( [244](#) ) but may diminish its reflux back to the plasma ( [240](#) ). It is not known if glutathione S-transferase plays a role in the transport of bilirubin or bilirubin glucuronides within the cell or possibly may serve to regulate the delivery of bilirubin to sites of metabolism within the cell ( [238](#) ).

Within the liver cell, bilirubin is conjugated with glucuronic acid to form bilirubin diglucuronide ( [Fig. 9.7](#) ). In normal human bile, 80% of the bilirubin is present as the diglucuronide; the two monoglucuronide isomers comprise most of the remainder in approximately equal amounts ( [245](#) ). In humans, small amounts of conjugates of glucose and xylose are also present ( [246](#) ). Bilirubin diglucuronide and other conjugated bilirubins are considerably more water-soluble than unconjugated bilirubin, in part because the carbohydrate moieties prevent intramolecular hydrogen bonding. The increased solubility makes biliary excretion of the pigment possible. Little or no unconjugated bilirubin is found in bile, and, if conjugation is seriously impaired, bile bilirubin content is low.



**Figure 9.7.** Bilirubin diglucuronide. The two glucuronic acid molecules are emphasized by bold type.

The conjugation reaction is catalyzed by uridine diphosphate-glucuronyl transferase (UGT). Glucuronic acid, a derivative of glucose, is transferred from uridine diphosphate-glucuronic acid to esterify one of the propionyl carboxyl groups of bilirubin, forming bilirubin monoglucuronide. The biologic advantage provided by forming the diglucuronide is not clear, because the monoglucuronide can be readily excreted into the bile and, in fact, is the major biliary pigment in many mammals ( [246](#) ).

Hepatocyte UGT exists in several isoforms, catalyzing the glucuronidation of a variety of substrates, such as steroid hormones, and a variety of carcinogens and drugs. Bilirubin serves as the substrate for two of these isoforms (B-UGT 1 and B-UGT 2) ( [247](#) ), but only B-UGT 1 is quantitatively significant in humans ( [248](#) ). This enzyme is capable of transferring glucose and xylose, as well as glucuronic acid ( [249](#) ). The availability of uridine diphosphate-glucuronic acid is an important factor regulating the activity of hepatocyte B-UGT 1 ( [250](#), [251](#) ). B-UGT activity is also modulated by a variety of drugs, such as phenobarbital, and hormones, such as cortisol and thyroxine ( [252](#) ).

In hepatocellular disease or biliary obstruction, some conjugated bilirubin may be “regurgitated” into the plasma. In addition, a small portion of conjugated bilirubin within the hepatocyte is deconjugated, and the unconjugated bilirubin, in part, refluxes into the plasma ( [239](#) ). These pathways, in part, explain the increase of both fractions of bilirubin in patients with cholestatic liver disease. In other clinical situations, hyperbilirubinemia is mainly due to an increase in unconjugated bilirubin. The most common of these is hemolytic disease, in which Hb catabolism and, therefore, bilirubin production are increased. However, there also are several inherited disorders in which unconjugated

hyperbilirubinemia occurs because of impaired capacity for bilirubin conjugation.

Decreased ability to conjugate bilirubin is the common feature of three hereditary disorders that differ from one another primarily in the severity of the conjugation impairment. In Crigler–Najjar syndrome, type I, severe unconjugated hyperbilirubinemia is present from birth, and kernicterus is common. In Crigler–Najjar syndrome, type II, less severe jaundice occurs, and, in Gilbert syndrome, the jaundice is quite mild, often not obvious clinically ( [253](#), [254](#) ). These disorders are recessively transmitted, and most patients are therefore homozygous for the mutant gene, although, occasionally, heterozygotes are minimally jaundiced. Mutations in the gene for B-UGT 1 occur in all three diseases. In the two Crigler–Najjar syndromes, the mutation most often involves exon 1, the exon that confers substrate specificity to the enzyme, resulting in a structurally abnormal protein. In Crigler–Najjar syndrome, type I, and in the Gunn rat, an animal model of this disease, the gene product is entirely nonfunctional, whereas in type II, activity of the product is variably reduced ( [248](#), [255](#), [256](#), [257](#), [258](#) and [259](#) ). In Gilbert syndrome, the mutation in some patients has been shown to affect the promoter sequence of exon 1 ( [257](#) ). Gilbert syndrome is very common, occurring in as much as 10% of the general population, but both Crigler–Najjar syndromes are quite rare. In Crigler–Najjar syndrome, type I, tin–protoporphyrin may be effective in reducing the bilirubin concentration. Liver transplantation provides a more permanent benefit. No treatment is generally necessary for the other two disorders. However, it is now recognized that the magnitude of hyperbilirubinemia seen in children with different chronic hemolytic states is influenced by the simultaneous inheritance of the gene for Gilbert disease ( [210](#), [260](#) ). In infants with hereditary spherocytosis who also are homozygous for the mutation responsible for Gilbert syndrome, hyperbilirubinemia almost always requires phototherapy ( [260](#) ). It also is believed that the variable degree of hyperbilirubinemia in glucose–6–phosphate dehydrogenase–deficient neonates reflects the presence or absence of the variant form of uridine–diphosphoglucuronosyl–transferase responsible for Gilbert syndrome ( [210](#) ). In infants known to be glucose–6–phosphate dehydrogenase–deficient, prevention of severe hyperbilirubinemia by administration of a single intramuscular dose of tin–mesoporphyrin, an inhibitor of heme oxygenase, has been demonstrated to be highly effective and safe ( [261](#) ).

Excretion of conjugated bilirubin from the hepatic cell into the bile canaliculus proceeds against a 40:1 gradient when concentration in the bile is compared with that in plasma ( [262](#) ). From animal studies, it has been demonstrated that excretion of bilirubin from hepatocytes is mediated by an ATP–dependent transport system, a canalicular multispecific organic anion transporter in the apical or canalicular membrane of hepatocytes ( [263](#) ). The ATP–dependent carrier system is at least partially shared by a variety of organic anions ( [264](#), [265](#) ). This is normally the rate–limiting step in overall hepatic bilirubin transport. The Dubin–Johnson syndrome ( [266](#), [267](#) ) is a disorder transmitted by autosomal–recessive inheritance and characterized by mild conjugated hyperbilirubinemia and impaired biliary secretion of non–bile–acid organic anions. Bilirubin uptake and conjugation are normal. This defect is similar to that of the TR–rat in which the ATP–dependent transport system is absent ( [265](#) ). Dubin–Johnson syndrome is now believed to be due to mutations in the canalicular multispecific organic anion transporter gene ( [268](#), [269](#) ).

### **Intestinal Bile Pigment Metabolism**

Bilirubin diglucuronide is excreted into the duodenum with other constituents of bile ( [270](#) ). There is little or no intestinal absorption of the conjugated pigment, although unconjugated bilirubin is readily absorbed. Bilirubin diglucuronide probably remains in the

conjugated form during its transit through the small intestine. However, during intestinal stasis and in newborns, increased deconjugation of bilirubin occurs and intestinal absorption takes place. This enterohepatic circulation of bilirubin may contribute to the severity of jaundice associated with the physiologic hyperbilirubinemia of the newborn (271).

When bilirubin diglucuronide reaches the terminal ileum and colon, it is hydrolyzed by bacterial  $\beta$ -glucuronidases (Fig. 9.8). The two methene bridges and usually the two vinyl groups are then reduced by bacterial flora to form a series of colorless tetrapyrroles called *urobilinogens* (272). Because urobilinogen formation is accomplished by bacteria, it does not occur in newborns or in germ-free animals (272), and it may be markedly affected by administration of broad-spectrum antibiotics (272). The urobilinogens are easily dehydrogenated across the two middle rings to form the orange-yellow pigments, urobilins, that contribute to the color of feces.



**Figure 9.8.** Bile pigment metabolism in the gut. These reactions are carried out by bacteria. d-Urobilinogen, mesobilirubinogen, and stercobilinogen are members of the urobilinogen group, which is characterized structurally by saturation of the carbon bridges connecting the pyrrole rings. The urobilins are derived from urobilinogens by oxidation and have one or more double bonds in the connecting carbon bridge. (From Lester R, Troxler RF. Recent advances in bile pigment metabolism. *Gastroenterology* 1969;56:143–169, with permission.)

Approximately 10 to 20% of the urobilinogen formed in the gut is reabsorbed, and the remainder is lost with the feces. The reabsorbed fraction is efficiently excreted by the normal liver without being conjugated (270). This sequence of events is referred to as the *enterohepatic recirculation of urobilinogen*. A portion of the reabsorbed pigment may also be excreted into the urine. Urobilinogen is filtered by the glomerulus, secreted by the renal tubule, and reabsorbed. If the liver's capacity to excrete urobilinogen is impaired, a disproportionate amount appears in the urine.

Also found in the colon is a group of poorly characterized dipyrroles known as *mesobilifuscins*. These brown pigments are partly responsible for the color of normal feces (273). Most of these dipyrroles do not appear to be derived from the degradation of bilirubin; instead, they probably are anabolic by-products of heme synthesis (274). However, in conditions associated with Heinz bodies, excessive amounts of such dipyrroles are excreted in the urine. These are believed to be derived from the heme freed from globin when the Heinz body forms. Furthermore, a dipyrrole is formed from the photodegradation of bilirubin (275), as discussed in the section [Alternate Pathways of Heme and Bilirubin Catabolism](#).

### Alternate Pathways of Heme and Bilirubin Catabolism

Several lines of evidence suggest that some heme may be degraded by pathways other than those previously described. On a stoichiometric basis, it can be calculated that 35 mg of bilirubin should be produced from degradation of 1 g of Hb. However, recovery of fecal urobilinogen is substantially less than expected, suggesting that as much as 20 to 40% of heme may be degraded by some other pathway ( [275](#) ). Only minimal amounts of unconjugated bilirubin are excreted in the urine. Excretion of conjugated bilirubin is substantial despite complete biliary obstruction. In rats with biliary fistulas, only 60 to 80% of administered radioactive Hb or heme is recovered in bilirubin; a portion of the remainder is found in nonbilirubin fractions of bile ( [276](#) , [277](#) ). Radioactive bilirubin in patients and rats with prolonged complete biliary obstruction gradually disappears via an unidentified route ( [277](#) ). Furthermore, in severe, inherited defects of bilirubin conjugation, such as those found in the Gunn rat and in human infants with Crigler–Najjar syndrome, the alternate pathways appear to be increased ( [278](#) ).

One explanation for these observations is that bilirubin is converted by a series of light–stimulated reactions to a variety of water–soluble derivatives, including hydroxyrubins, bilichrysin, and a dipyrrole ( [275](#) ). These light–induced products, which are colorless and do not react with diazo reagents, have been found in the bile of the Gunn rat. A microsomal P448–dependent monooxygenase may contribute to these alternate pathways because inducers of this enzyme increase the turnover of bilirubin in the Gunn rat and reduce the plasma bilirubin concentration ( [279](#) , [280](#) ). In addition, a mitochondrial bilirubin oxygenase has been identified that *in vitro* degrades bilirubin to a variety of products ( [279](#) ).

Photodegradation of bilirubin, such as described above, has been applied to the treatment of unconjugated hyperbilirubinemia in infants ( [Chapter 36](#) ) ( [219](#) , [220](#) , [275](#) , [280](#) ). Exposure to light brings about increased bilirubin excretion and a decrease in the serum bilirubin concentration to nontoxic levels. The photodegradation products are excreted promptly in the bile and may cause the stool to turn to a green or darker brown color. No toxicity of these products has been demonstrated.

### Laboratory Evaluation of Hemoglobin Catabolism and Bile Pigments

The serum bilirubin concentration is an important marker of the rate of bilirubin production and of hepatobiliary function. Traditionally, it has been measured by the van den Bergh test described in 1916 ( [281](#) ). It is based on Ehrlich’s observation that a mixture of sulfanilic acid, hydrochloric acid, and sodium nitrite (diazo reagent) yields a reddish–violet color with a maximum absorption at a wavelength of 450 nm when added to plasma or other solutions containing bilirubin. This reaction remains the basis for most automated clinical measurements of bilirubin ( [282](#) ). The color may appear and reach its maximum intensity at once ( *direct reaction* ). A direct reaction is obtained with bilirubin in bile and in the plasma and urine from patients with obstructive jaundice. The direct–reacting bilirubin approximately corresponds to conjugated bilirubin. The bilirubin in plasma of patients with hemolytic disease does not react directly with the diazo reagent but requires addition of an accelerator such as alcohol ( *indirect reaction* ). Indirect–reacting bilirubin corresponds to unconjugated bilirubin.

The measurement of fecal urobilinogen excretion over several days is a crude test previously used to quantify heme breakdown, but this is rarely used nowadays. More precise measurements of heme catabolism can be determined from measuring endogenous bilirubin production or generation of CO. As discussed previously, the principal catabolic products of heme are iron, CO, and bilirubin. There are no other

significant endogenous sources of the last two compounds; thus, the breakdown of one mole of heme yields precisely one mole of CO and one mole of bilirubin.

The rate of bilirubin production can be calculated from the kinetics of plasma bilirubin disappearance ( [238](#) ). A tracer dose of  $^3\text{H}$ - or  $^{14}\text{C}$ -bilirubin is injected intravenously, the bilirubin pool size is measured, and serial determinations of plasma unconjugated radioactive bilirubin are made over a 24- to 48-hour period. The disappearance curve is complex and requires computer analysis ( [238](#) ). Generally higher rates of bilirubin production are observed in hemolytic states, and the data are expressed in terms of erythrocyte lifespan ( [238](#) ). However, the method is not suited for routine use in view of the difficulty in obtaining adequately labeled bilirubin.

It has been recognized for years that blood carboxyhemoglobin levels are increased in hemolytic disease ( [283](#), [284](#) and [285](#) ); but precise interpretation of such static measurements is complicated by exogenous exposure to CO and by variations in CO excretion. In contrast, the endogenous rate of CO production can be measured by a rebreathing method that circumvents these problems ( [188](#) ). The subject breathes into a closed system from which CO<sub>2</sub> is absorbed and to which O<sub>2</sub> is added. CO excretion is thereby prevented, and the blood level of carboxyhemoglobin increases. Endogenous CO production is calculated from the rate of increase over a 2-hour period and from the body CO dilution. With this method, the rate of CO production has been found to be increased several-fold from normal in patients with a variety of hemolytic anemias ( [188](#) ) and similarly elevated in conditions associated with ineffective erythropoiesis ( [284](#) ). For newborn infants with increased jaundice, it is important to know whether the hyperbilirubinemia is a consequence of accelerated red cell breakdown or due to some other cause. For this purpose, a noninvasive instrument to measure exhaled CO now is commercially available and appears to be a reliable marker of increased Hb breakdown ( [286](#), [287](#) ).

## ACKNOWLEDGMENT

The author wishes to acknowledge Andrew Diess, MD, for the excellent previous chapter on Destruction of Erythrocytes, which served as a template for the current chapter in this eleventh edition of *Wintrobe's Clinical Hematology*.

## REFERENCES

1. Ashby W. The determination of the length of life of transfused blood corpuscles in man. *J Exp Med* 1919;29:267-282.
2. Berlin N. Life span of red blood cell. *Physiol Rev* 1959;39:577-616.
3. Altland P, Brace KC. Red cell life span in the turtle and toad. *Am J Physiol* 1962;203:1188-1190.
4. Bentley SA, Collins ML, Miller DT. Interpretation of red cell survival data for in vivo compatibility testing: a normal value study. *Br J Haematol* 1987;67:241-244.
5. Ricketts C, Cavill I, Napier JA. The measurement of red cell lifespan using  $^{59}\text{Fe}$ . *Br J Haematol* 1977;37:403-408.
6. DeGowin E, Ellis JA, Sheets RF, et al. Studies with inagglutinable erythrocyte counts. *J Clin Invest* 1954;33:163-178.
7. Hurley T, Weisman R Jr. The determination of the survival of transfused red cells by a method of



differential hemolysis. *J Clin Invest* 1954;33:835-843.

8. Ebaugh FJ, Emerson CP, Ross JF. The use of radioactive chromium 51 as an erythrocyte tagging agent for the determination of red cell survival in vivo. *J Clin Invest* 1953;32:1260-1276.

9. Nagel RL, Gibson QH. The binding of hemoglobin to haptoglobin and its relation to subunit dissociation of hemoglobin. *J Biol Chem* 1971;246:69-73.

10. Pearson HA. The binding of Cr 51 to hemoglobin. II. In vivo elution rates of CR 51 from Hb CC, Hb CS, and placental red cells. *Blood* 1966;28:563-568.

11. Recommended methods for radioisotope red cell survival studies. *Blood* 1971;38:378-386.

12. Mollison P, Veall N. The use of the isotope <sup>51</sup>Cr as a label for red cells. *Br J Haematol* 1955;1:62-74.

13. Recommended methods for surface counting to determine sites of red cell destruction. *Br J Haematol* 1975;30:249-254.

14. Cline M, Berlin NI. Red blood cell life span using DF <sup>32</sup>P as a cohort label. *Blood* 1962;19:715-723.

15. Eernisse J, Van Rood JJ. Erythrocyte-survival time determinations with the aid for DF <sup>32</sup>P. *Br J Haematol* 1961;7:382-404.

16. Garby L. Analysis of red cell survival curves in clinical practice and the use of Di-iso-propylfluoraphosphonate DF <sup>32</sup>P as a label for red cells in man. *Br J Haematol* 1962;8:15-27.

17. Mayer K, Freeman JE. Techniques for measuring red cell, platelet, and WBC survival. *Crit Rev Clin Lab Sci* 1986;23:201-217.

18. Clark MR, Shohet SB. Red cell senescence. *Clin Haematol* 1985;14:223-257.

19. Clark MR. Senescence of red blood cells: progress and problems. *Physiol Rev* 1988;68:503-554.

20. Bartosz G. Erythrocyte aging: physical and chemical membrane changes. *Gerontology* 1991;37:33-67.

21. Bennett GD, Kay MM. Homeostatic removal of senescent murine erythrocytes by splenic macrophages. *Exp Hematol* 1981;9:297-307.

22. Piomelli S, Lurinsky G, Wasserman LR. The mechanism of red cell aging. I. Relationship between cell age and specific gravity evaluated by ultracentrifugation in a discontinuous density gradient. *J Lab Clin Med* 1967;69:659-674.

23. Smedsrod B, Aminoff D. Use of <sup>75</sup>Se-labeled methionine to study the sequestration of senescent red blood cells. *Am J Hematol* 1985;18:31-40.

24. Lutz HU, et al. Density separation of human red blood cells on self forming Percoll gradients: correlation with cell age. *Biochim Biophys Acta* 1992;1116:1-10.

25. Walter H, et al. Differential effect of pH on the density and volume of rat reticulocytes and erythrocytes. Relevance to their fractionation by centrifugation. *Cell Biophys* 1990;16:139-148.

26. Piomelli S, Seaman C. Mechanism of red blood cell aging: relationship of cell density and cell age. *Am J Hematol* 1993;42:46-52.

27. Luthra MG, Friedman JM, Sears DA. Studies of density fractions of normal human erythrocytes labeled with iron-59 in vivo. *J Lab Clin Med* 1979;94:879-896.

28. Morrison M, et al. Does cell density correlate with red cell age? *Biomed Biochim Acta* 1983;42:S107-S111.

29. Mueller TJ, et al. Membrane skeletal alterations during in vivo mouse red cell aging. Increase in the



band 4.1a:4.1b ratio. *J Clin Invest* 1987;79:492–499.

30. Lew VL, et al. Generation of normal human red cell volume, hemoglobin content, and membrane area distributions by “birth” or regulation? *Blood* 1995;86:334–341.
31. Dale GL, Norenberg SL. Density fractionation of erythrocytes by Percoll/hypaque results in only a slight enrichment for aged cells. *Biochim Biophys Acta* 1990;1036:183–187.
32. Clark MR, Mohandas N, Shoet SB. Osmotic gradient ektacytometry: comprehensive characterization of red cell volume and surface maintenance. *Blood* 1983;61:899–910.
33. Rifkind JM, Araki K, Hadley EC. The relationship between the osmotic fragility of human erythrocytes and cell age. *Arch Biochem Biophys* 1983;222:582–589.
34. Brooks DE, Seaman GV, Walter H. Detection of differences in surface-charge-associated properties of cells by partition in two-polymer aqueous phase systems. *Nat New Biol* 1971;234:61–62.
35. Bartosz G, Guclu J, Soudain P. Erythrocyte behavior in free-flow electrophoresis is independent of erythrocyte age. *Mech Ageing Dev* 1993;72:97–103.
36. Thompson CB, et al. A method for the separation of erythrocytes on the basis of size using counterflow centrifugation. *Am J Hematol* 1984;17:177–183.
37. van der Vegt SG, et al. Counterflow centrifugation of red cell populations: a cell age related separation technique. *Br J Haematol* 1985;61:393–403.
38. Beutler E, Hartman G. Age-related red cell enzymes in children with transient erythroblastopenia of childhood and with hemolytic anemia. *Pediatr Res* 1985;19:44–47.
39. Ganzoni AM, Oakes R, Hillman RS. Red cell aging in vitro. *J Clin Invest* 1971;50:1373–1378.
40. Linderkamp O, et al. Age dependency of red blood cell deformability and density: studies in transient erythroblastopenia of childhood. *Br J Haematol* 1993;83:125–129.
41. Suzuki T, Dale GL. Biotinylated erythrocytes: in vivo survival and in vitro recovery. *Blood* 1987;70:791–795.
42. Dale GL, et al. Characterization of senescent red cells from the rabbit. *Adv Exp Med Biol* 1991;307:93–103.
43. Jansen G, et al. Glycolytic activity in human red cell populations separated by a combination of density and counterflow centrifugation. Evidence for an improved separation of red cells according to age. *Scand J Haematol* 1986;37:189–195.
44. Seaman C, Wyss S, Piomelli S. The decline in energetic metabolism with aging of the erythrocyte and its relationship to cell death. *Am J Hematol* 1980;8:31–42.
45. Corash L, et al. Selective isolation of young erythrocytes for transfusion support of thalassemia major patients. *Blood* 1981;57:599–606.
46. Graziano JH, et al. A simple technique for preparation of young red cells for transfusion from ordinary blood units. *Blood* 1982;59:865–868.
47. Piomelli S, et al. Separation of younger red cells with improved survival in vivo: an approach to chronic transfusion therapy. *Proc Natl Acad Sci U S A* 1978;75:3474–3478.
48. Piomelli S, Seaman C, Corash L. How do red cell enzymes age? Hypothesis and facts. *Br J Haematol* 1986;64:407–409.
49. Beutler E. How do red cell enzymes age? A new perspective. *Br J Haematol* 1985;61:377–384.
50. Zimran A, Torem S, Beutler E. The in vivo ageing of red cell enzymes: direct evidence of biphasic

decay from polycythaemic rabbits with reticulocytosis. *Br J Haematol* 1988;69:67–70.

51. Zimran A, et al. In vivo aging of red cell enzymes: study of biotinylated red blood cells in rabbits. *Am J Hematol* 1990;33:249–254.

52. Thorburn DR, Beutler E. The loss of enzyme activity from erythroid cells during maturation. *Adv Exp Med Biol* 1991;307:15–27.

53. Jindal HK, et al. Specific loss of protein kinase activities in senescent erythrocytes. *Blood* 1996;88:1479–1487.

54. Seidler NW, Swislocki NI. Ca<sup>2+</sup> transport activities of inside-out vesicles prepared from density-separated erythrocytes from rat and human. *Mol Cell Biochem* 1991;105:159–169.

55. Samaja M, et al. Red cell aging and active calcium transport. *Exp Gerontol* 1990;25:279–286.

56. Samaja M, et al. The effect of in vitro and in vivo cellular aging on the active calcium transport in human inside-out red cell membrane vesicles. *Biochem Biophys Res Commun* 1989;159:432–438.

57. Gardos G. The function of calcium in the potassium permeability of human erythrocytes. *Biochim Biophys Acta* 1958;30:653–654.

58. Anderson DR, Davis JL, Carraway KL. Calcium-promoted changes of the human erythrocyte membrane. Involvement of spectrin, transglutaminase, and a membrane-bound protease. *J Biol Chem* 1977;252:6617–6623.

59. Lorand L, et al. Degradation of transmembrane proteins in Ca<sup>2+</sup>-enriched human erythrocytes. An immunochemical study. *J Biol Chem* 1983;258:5300–5305.

60. Hanahan DJ, Ekholm JE. The expression of optimum ATPase activities in human erythrocytes. A comparison of different lytic procedures. *Arch Biochem Biophys* 1978;187:170–179.

61. Schmidt W, Boning D, Braumann KM. Red cell age effects on metabolism and oxygen affinity in humans. *Respir Physiol* 1987;68:215–225.

62. Suzuki T, Dale GL. Membrane proteins in senescent erythrocytes. *Biochem J* 1989;257:37–41.

63. Clark MR. Calcium extrusion by high-density human red blood cells. *Blood Cells* 1988;14:119–137.

64. Bookchin RM, Roth EF Jr, Lew VL. Near-normal circulatory survival of rabbit red cells exposed to high levels of Ca and ionophore in vitro. *Blood* 1985;66:220–223.

65. Cala PM, Mandel LJ, Murphy E. Volume regulation by Amphiuma red blood cells: cytosolic free Ca and alkali metal-H exchange. *Am J Physiol* 1986;250:C423–C429.

66. Lew VL, et al. Physiological (Ca<sup>2+</sup>)<sub>i</sub> level and pump-leak turnover in intact red cells measured using an incorporated Ca chelator. *Nature* 1982;298:478–481.

67. Murphy E, et al. Nuclear magnetic resonance measurement of cytosolic free calcium levels in human red blood cells. *Am J Physiol* 1986;251:C496–C504.

68. Yoshida M, et al. Ca content of human erythrocytes. What is the true value? *Cell Calcium* 1986;7:169–174.

69. Romero PJ, Romero EA, Winkler MD. Ionic calcium content of light dense human red cells separated by Percoll density gradients. *Biochim Biophys Acta* 1997;1323:23–28.

70. Aiken NR, Satterlee JD, Galey WR. Measurement of intracellular Ca<sup>2+</sup> in young and old human erythrocytes using <sup>19</sup>F-NMR spectroscopy. *Biochim Biophys Acta* 1992;1136:155–160.

71. Durocher JR, Payne RC, Conrad ME. Role of sialic acid in erythrocyte survival. *Blood* 1975;45:11–20.

72. Kay MM. Mechanism of removal of senescent cells by human macrophages in situ. *Proc Natl Acad Sci*

U S A 1975;72:3521–3525.

73. Bratosin D, et al. Flow cytofluorimetric analysis of young and senescent human erythrocytes probed with lectins. Evidence that sialic acids control their life span. *Glycoconj J* 1995;12:258–267.
74. Aminoff D. The role of sialoglycoconjugates in the aging and sequestration of red cells from circulation. *Blood Cells* 1988;14:229–257.
75. Seamon G, Knox RJ, Word FJ, et al. Red cell aging. I. Surface charge density and sialic acid content of density fractionated human erythrocytes. *Blood* 1977;50:1001–1011.
76. Cohen NS, et al. Biochemical characterization of density-separated human erythrocytes. *Biochim Biophys Acta* 1976;419:229–242.
77. Kamber E, Poyiagi A, Deliconstantinos G. Modifications in the activities of membrane-bound enzymes during in vivo ageing of human and rabbit erythrocytes. *Comp Biochem Physiol B* 1984;77:95–99.
78. Balduini CL, et al. Behaviour of young and old desialylated rabbit erythrocytes in vivo. *Hoppe Seylers Z Physiol Chem* 1978;359:1573–1577.
79. Pfannschmidt G, Schauer R. The role of membrane sialyl and galactosyl residues in regulation of the life-time of rabbit erythrocytes. *Hoppe Seylers Z Physiol Chem* 1980;361:1683–1695.
80. Parker JC, Berkowitz LR. Physiologically instructive genetic variants involving the human red cell membrane. *Physiol Rev* 1983;63:261–313.
81. Shapiro S, Pilar T, Gershon H. Exposure to complement-bearing immune complexes enhances the in vitro sequestration of erythrocytes from young but not elderly donors. *Clin Exp Immunol* 1993;91:301–307.
82. Chiu D, Lubin B. Oxidative hemoglobin denaturation and RBC destruction: the effect of heme on red cell membranes. *Semin Hematol* 1989;26:128–135.
83. Hebbel RP, Eaton JW. Pathobiology of heme interaction with the erythrocyte membrane. *Semin Hematol* 1989;26:136–149.
84. Peisach J, Blumberg WE, Rachmilewitz EA. The demonstration of ferrihemochrome intermediates in Heinz body formation following the reduction of oxyhemoglobin A by acetylphenylhydrazine. *Biochim Biophys Acta* 1975;393:404–418.
85. Hebbel RP, et al. Spontaneous oxygen radical generation by sickle erythrocytes. *J Clin Invest* 1982;70:1253–1259.
86. Imanishi H, et al. Glutathione metabolism in red cell aging. *Mech Ageing Dev* 1985;32:57–62.
87. Campwala HQ, Desforges JF. Membrane-bound hemichrome in density-separated cohorts of normal (AA) and sickled (SS) cells. *J Lab Clin Med* 1982;99:25–28.
88. Brovelli A, et al. Membrane processes during 'in vivo' aging of human erythrocytes. *Biomed Biochim Acta* 1983;42:S122–S126.
89. Nakai T, Imanishi H, Takino T. Separation of human red cells by ultracentrifugation in a discontinuous density gradient and relationship between cell age and lipid peroxidation. *Nippon Ketsueki Gakkai Zasshi* 1984;47:1230–1234.
90. Ando K, Beppu M, Kikugawa K. Evidence for accumulation of lipid hydro-peroxides during the aging of human red blood cells in the circulation. *Biol Pharm Bull* 1995;18:659–663.
91. Jain SK. The accumulation of malonyldialdehyde, a product of fatty acid peroxidation, can disturb aminophospholipid organization in the membrane bilayer of human erythrocytes. *J Biol Chem* 1984;259:3391–3394.
92. Arduini A, et al. Mechanism of spectrin degradation induced by phenylhydrazine in intact human

erythrocytes. *Biochim Biophys Acta* 1989;979:1-6.

93. Snyder LM, et al. Irreversible spectrin-haemoglobin crosslinking in vivo: a marker for red cell senescence. *Br J Haematol* 1983;53:379-384.

94. McKenney J, et al. Decreased in vivo survival of hydrogen peroxide-damaged baboon red blood cells. *Blood* 1990;76:206-211.

95. Seppi C, et al. Evidence for membrane protein oxidation during in vivo aging of human erythrocytes. *Mech Ageing Dev* 1991;57:247-258.

96. Sambrano GR, Parthasarathy S, Steinberg D. Recognition of oxidatively damaged erythrocytes by a macrophage receptor with specificity for oxidized low density lipoprotein. *Proc Natl Acad Sci U S A* 1994;91:3265-3269.

97. Piccinini G, et al. Oxidation state of glutathione and membrane proteins in human red cells of different age. *Mech Ageing Dev* 1995;78:15-26.

98. Signorini C, et al. Iron release, membrane protein oxidation and erythrocyte ageing. *FEBS Lett* 1995;362:165-170.

99. Schluter K, Drenckhahn D. Co-clustering of denatured hemoglobin with band 3: its role in binding of autoantibodies against band 3 to abnormal and aged erythrocytes. *Proc Natl Acad Sci U S A* 1986;83:6137-6141.

100. Galili U, et al. A unique natural human IgG antibody with anti-alpha-galactosyl specificity. *J Exp Med* 1984;160:1519-1531.

101. Bartosz G, Soszynski M, Wasilewski A. Aging of the erythrocyte. XII. Protein composition of the membrane. *Mech Ageing Dev* 1982;19:45-52.

102. Glass GA, Gershon H, Gershon D. The effect of donor and cell age on several characteristics of rat erythrocytes. *Exp Hematol* 1983;11:987-995.

103. Christian JA, et al. Senescence of canine biotinylated erythrocytes: increased autologous immunoglobulin binding occurs on erythrocytes aged in vivo for 104 to 110 days. *Blood* 1993;82:3469-3473.

104. Dale GL, Daniels RB. Quantitation of immunoglobulin associated with senescent erythrocytes from the rabbit. *Blood* 1991;77:1096-1099.

105. Sheiban E, Gershon H. Recognition and sequestration of young and old erythrocytes from young and elderly human donors: in vitro studies. *J Lab Clin Med* 1993;121:493-501.

106. Shapiro S, Kohn D, Gershon H. A role for complement as the major opsonin in the sequestration of erythrocytes from elderly and young donors. *Br J Haematol* 1993;83:648-654.

107. Giger U, et al. Naturally occurring human anti-band 3 autoantibodies accelerate clearance of erythrocytes in guinea pigs. *Blood* 1995;85:1920-1928.

108. Connor J, Pak CC, Schroit AJ. Exposure of phosphatidylserine in the outer leaflet of human red blood cells. Relationship to cell density, cell age, and clearance by mononuclear cells. *J Biol Chem* 1994;269:2399-2404.

109. Kay MM. Senescent cell antigen, band 3, and band 3 mutations in cellular aging. *Biomed Biochim Acta* 1990;49:S212-S217.

110. Giblett ER. Recent advances in haptoglobin and transferrin genetics. *Bibl Haematol* 1968;29:10-20.

111. Noyes WD, Garby L. Rate of haptoglobin in synthesis in normal man. Determinations by the return to normal levels following hemoglobin infusion. *Scand J Clin Lab Invest* 1967;20:33-38.

112. Rifkind RA. Destruction of injured red cells in vivo. *Am J Med* 1966;41:711-723.

113. Rosse WF, Dourmashkin R, Humphrey JH. Immune lysis of normal human and paroxysmal nocturnal hemoglobinuria (PNH) red blood cells. 3. The membrane defects caused by complement lysis. *J Exp Med* 1966;123:969–984.
114. Cooper RA, Shattil SJ. Mechanisms of hemolysis—the minimal red-cell defect. *N Engl J Med* 1971;285:1514–1520.
115. Singer K, Weisz L. The life cycle of the erythrocyte after splenectomy and the problems of splenic hemolysis and target cell formation. *Am J Med Sci* 1945;210:301–323.
116. Marks P, Johnson AB. Relationship between the age of human erythrocytes and their osmotic resistance: a basis for separating young and old erythrocytes. *J Clin Invest* 1958;37:1542–1548.
117. Hoffman J, Eden M, Barr JS Jr, et al. The hemolytic volume of human erythrocytes. *J Cell Comp Physiol* 1958;51:405–414.
118. Rous P, Robertson OH. The normal fate of erythrocytes. *J Exp Med* 1917;25:661–664.
119. Bull BS, et al. Microangiopathic haemolytic anaemia: mechanisms of red-cell fragmentation: in vitro studies. *Br J Haematol* 1968;14:643–652.
120. Ham T, Shen SC, Fleming EM, et al. Studies on the destruction of red blood cells. *Blood* 1948;3:373–409.
121. LaCelle P. Alteration of membrane deformability in hemolytic anemias. *Semin Hematol* 1970;7:355–371.
122. Rand R, Burton AC. Mechanical properties of the red cell membrane. *Biophys J* 1964;4:115–135.
123. Weed RI. Disorders of red cell membrane: history and perspectives. *Semin Hematol* 1970;7:249–258.
124. Bowman BH, Kurosky A. Haptoglobin: the evolutionary product of duplication, unequal crossing over, and point mutation. *Adv Hum Genet* 1982;12:189–261, 453–454.
125. Bowman BH, et al. Haptoglobin. *Methods Enzymol* 1988;163:452–474.
126. Javid J. Human haptoglobins. *Curr Top Hematol* 1978;1:151–192.
127. Javid J. Human serum haptoglobins: a brief review. *Semin Hematol* 1967;4:35–52.
128. Kirk RL. The haptoglobin groups in man. *Monogr Hum Genet* 1968;4:1–77.
129. Maeda N, Smithies O. The evolution of multigene families: human haptoglobin genes. *Annu Rev Genet* 1986;20:81–108.
130. Laurell C, Nyman M. Studies on the serum haptoglobin level in hemoglobinemia and its influence on renal excretion of hemoglobin. *Blood* 1957;12:493–506.
131. Mominoki K, et al. Haptoglobin in Carnivora: a unique molecular structure in bear, cat and dog haptoglobins. *Comp Biochem Physiol B Biochem Mol Biol* 1995;110:785–789.
132. Raugei G, et al. Sequence of human haptoglobin cDNA: evidence that the alpha and beta subunits are coded by the same mRNA. *Nucleic Acids Res* 1983;11:5811–5819.
133. Wassler M, Fries E. Proteolytic cleavage of haptoglobin occurs in a subcompartment of the endoplasmic reticulum: evidence from membrane fusion in vitro. *J Cell Biol* 1993;123:285–291.
134. Sevaljevic LJ, et al. Acute phase-dependent changes in the binding of rat liver nucleoproteins to the cytokine response element of the rat haptoglobin gene. *Int J Biochem Cell Biol* 1995;27:185–194.
135. Baumann H, et al. Distinct regulation of the interleukin-1 and interleukin-6 response elements of the

rat haptoglobin gene in rat and human hepatoma cells. *Mol Cell Biol* 1990;10:5967–5976.

136. Hanasaki K, Powell LD, Varki A. Binding of human plasma sialoglycoproteins by the B cell-specific lectin CD22. Selective recognition of immunoglobulin M and haptoglobin. *J Biol Chem* 1995;270:7543–7550.
137. Pajovic S, et al. Species-specific changes in regulatory elements of mouse haptoglobin genes. *J Biol Chem* 1994;269:2215–2224.
138. Marinkovic S, Baumann H. Structure, hormonal regulation, and identification of the interleukin-6- and dexamethasone-responsive element of the rat haptoglobin gene. *Mol Cell Biol* 1990;10:1573–1583.
139. Smithies O, Connell GE, Dixon GH. Inheritance of Haptoglobin subtypes. *Am J Hum Genet* 1962;14:14–21.
140. Povey S, et al. Assignment of the human locus determining phosphoglycolate phosphatase (PGP) to chromosome 16. *Ann Hum Genet* 1980;43:241–248.
141. Robson EB, et al. Probable assignment of the alpha locus of haptoglobin to chromosome 16 in man. *Nature* 1969;223:1163–1165.
142. Simmers RN, Stupans I, Sutherland GR. Localization of the human haptoglobin genes distal to the fragile site at 16q22 using in situ hybridization. *Cytogenet Cell Genet* 1986;41:38–41.
143. Cox KJ, Thomas AS. The application of immunoblotting to the phenotyping of haptoglobin. *J Forensic Sci* 1992;37:1652–1655.
144. Viedma JA, de la Iglesia A, Navarro A. Immunoturbidimetry of haptoglobin and transferrin in the EPOS 5060 analyzer. *Clin Chem* 1987;33:1257.
145. van Rijn HJ, et al. Is the turbidimetric immunoassay of haptoglobin phenotype-dependent? *Clin Biochem* 1987;20:245–248.
146. Salmi TT. Haptoglobin levels in the plasma of newborn infants with special reference to infections. *Acta Paediatr Scand Suppl* 1973;241:1–55.
147. Chiancone E, et al. Studies on the reaction of haptoglobin with haemoglobin and haemoglobin chains. I. Stoichiometry and affinity. *J Mol Biol* 1968;34:347–356.
148. Jayle M, Moretti J. Haptoglobin: biochemical, genetic and physiopathologic aspects. *Prog Hematol* 1962;3:342–359.
149. Nagel R, Ranney HM. Haptoglobin binding capacity of certain abnormal hemoglobins. *Science* 1964;144:1014–1015.
150. Alper CJP, Birtch AG, et al. Haptoglobin synthesis. *J Clin Invest* 1965;44:574–581.
151. McCormick DJ, Atassi MZ. Hemoglobin binding with haptoglobin: delineation of the haptoglobin binding site on the alpha-chain of human hemoglobin. *J Protein Chem* 1990;9:735–742.
152. Wada T, et al. Studies on haptoglobin synthesis in reticuloendothelial tissues. *J Reticuloendothel Soc* 1970;8:195–207.
153. Bissell DM, Hammaker L, Schmid R. Hemoglobin and erythrocyte catabolism in rat liver: the separate roles of parenchymal and sinusoidal cells. *Blood* 1972;40:812–822.
154. Brus I, Lewis SM. The haptoglobin content of serum in haemolytic anaemias. *Br J Haematol* 1959;5:348–355.
155. Hershko C, Cook JD, Finch CA. Storage iron kinetics. II. The uptake of hemoglobin iron by hepatic parenchymal cells. *J Lab Clin Med* 1972;80:624–634.
156. Kino K, et al. Hemoglobin-haptoglobin receptor in rat liver plasma membrane. *J Biol Chem*

1980;255:9616–9620.

157. Higa Y, et al. Catabolism of globin–haptoglobin in liver cells after intravenous administration of hemoglobin–haptoglobin to rats. *J Biol Chem* 1981;256:12322–12328.

158. Bunn HF, Jandl JH. The renal handling of hemoglobin. II. Catabolism. *J Exp Med* 1969;129:925–934.

159. Lathem W. The renal excretion of hemoglobin: regulatory mechanisms and the differential excretion of free and protein–bound hemoglobin. *J Clin Invest* 1959;38:652–658.

160. Zager RA, Gamelin LM. Pathogenetic mechanisms in experimental hemoglobinuric acute renal failure. *Am J Physiol* 1989;256:F446–F455.

161. Feola M, et al. Nephrotoxicity of hemoglobin solutions. *Biomater Artif Cells Artif Organs* 1990;18:233–249.

162. Cheng TS, et al. Effect of lysine on hemolysis–induced kidney damage. *J Lab Clin Med* 1992;119:496–502.

163. Sears DA, et al. Urinary iron excretion and renal metabolism of hemoglobin in hemolytic diseases. *Blood* 1966;28:708–725.

164. Marsh GW, Lewis SM. Cardiac haemolytic anaemia. *Semin Hematol* 1969;6:133–149.

165. Muller–Eberhard U. Hemopexin. *N Engl J Med* 1970;283:1090–1094.

166. Bunn HF, Jandl JH. Exchange of heme among hemoglobins and between hemoglobin and albumin. *J Biol Chem* 1968;243:465–475.

167. Altruda F, et al. The primary structure of human hemopexin deduced from cDNA sequence: evidence for internal, repeating homology. *Nucleic Acids Res* 1985;13:3841–3859.

168. Law ML, et al. The hemopexin gene maps to the same location as the beta–globin gene cluster on human chromosome 11. *Genomics* 1988;3:48–52.

169. Naylor SL, et al. Hemopexin is localized to human chromosome 11. *Somat Cell Mol Genet* 1987;13:355–358.

170. Thorbecke GJ, et al. Sites of formation of the serum proteins transferrin and hemopexin. *J Clin Invest* 1973;52:725–731.

171. Morgan WT, et al. Transfer of heme from heme–albumin to hemopexin. *Biochim Biophys Acta* 1976;444:435–445.

172. Seery VL, Muller–Eberhard U. Binding of porphyrins to rabbit hemopexin and albumin. *J Biol Chem* 1973;248:3796–3800.

173. Cox MC, et al. MCD, EPR and NMR spectroscopic studies of rabbit hemopexin and its heme binding domain. *Biochim Biophys Acta* 1995;1253:215–223.

174. Faber HR, et al. 1.8 Å crystal structure of the C–terminal domain of rabbit serum haemopexin. *Structure* 1995;3:551–559.

175. Morgan WT, et al. Identification of the histidine residues of hemopexin that coordinate with heme–iron and of a receptor–binding region. *J Biol Chem* 1993;268:6256–6262.

176. Wu ML, Morgan WT. Characterization of hemopexin and its interaction with heme by differential scanning calorimetry and circular dichroism. *Biochemistry* 1993;32:7216–7222.

177. Muster P, et al. Further characterization of structural determinants of rabbit hemopexin function. *J Protein Chem* 1991;10:123–128.

178. Balla G, et al. Exposure of endothelial cells to free heme potentiates damage mediated by



- granulocytes and toxic oxygen species. *Lab Invest* 1991;64:648-655.
179. Wochner RD, et al. Hemopexin metabolism in sickle-cell disease, porphyrias and control subjects—effects of heme injection. *N Engl J Med* 1974;290:822-826.
180. Smith A, Morgan WT. Haem transport to the liver by haemopexin. Receptor-mediated uptake with recycling of the protein. *Biochem J* 1979;182:47-54.
181. Smith A, Hunt RC. Hemopexin joins transferrin as representative members of a distinct class of receptor-mediated endocytic transport systems. *Eur J Cell Biol* 1990;53:234-245.
182. Wu ML, Morgan WT. Conformational analysis of hemopexin by Fourier-transform infrared and circular dichroism spectroscopy. *Proteins* 1994;20:185-190.
183. Potter D, et al. In vivo fate of hemopexin and heme-hemopexin complexes in the rat. *Arch Biochem Biophys* 1993;300:98-104.
184. Sinclair PR, et al. Effect of serum proteins on haem uptake and metabolism in primary cultures of liver cells. *Biochem J* 1988;256:159-165.
185. Carmel N, Gross J. Hemopexin metabolism in mice with transplantable tumors. *Isr J Med Sci* 1977;13:1182-1190.
186. Sears DA. Disposal of plasma heme in normal man and patients with intravascular hemolysis. *J Clin Invest* 1970;49:5-14.
187. Liem HH, Muller-Eberhard U. Do heme and bilirubin have identical binding sites on the albumin molecule? *Biochem Biophys Res Commun* 1971;42:634-639.
188. Coburn RF, Williams WJ, Kahn SB. Endogenous carbon monoxide production in patients with hemolytic anemia. *J Clin Invest* 1966;45:460-468.
189. Lundh B, Cavallin-Stahl E, Mercke. Heme catabolism, carbon monoxide production and red cell survival in anemia. *Acta Med Scand* 1975;197:161-171.
190. Tenhunen R, Marver HS, Schmid R. The enzymatic conversion of hemoglobin to bilirubin. *Trans Assoc Am Physicians* 1969;82:363-371.
191. Schacter BA. Heme catabolism by heme oxygenase: physiology, regulation, and mechanism of action. *Semin Hematol* 1988;25:349-369.
192. Sassa S, et al. Heme biosynthesis and drug metabolism in mice with hereditary hemolytic anemia. Heme oxygenase induction as an adaptive response for maintaining cytochrome P-450 in chronic hemolysis. *J Biol Chem* 1979;254:729-735.
193. Shibahara S. Regulation of heme oxygenase gene expression. *Semin Hematol* 1988;25:370-376.
194. Pimstone NR, et al. Inducible heme oxygenase in the kidney: a model for the homeostatic control of hemoglobin catabolism. *J Clin Invest* 1971;50:2042-2050.
195. Maines MD, Ibrahim NG, Kappas A. Solubilization and partial purification of heme oxygenase from rat liver. *J Biol Chem* 1977;252:5900-5903.
196. Mitani K, et al. The role of inorganic metals and metalloporphyrins in the induction of haem oxygenase and heat-shock protein 70 in human hepatoma cells. *Biochem J* 1993;290:819-825.
197. Kappas A, et al. Direct comparison of Sn-mesoporphyrin, an inhibitor of bilirubin production, and phototherapy in controlling hyperbilirubinemia in term and near-term newborns. *Pediatrics* 1995;95:468-474.
198. Rizzardini M, et al. Mechanisms of endotoxin-induced haem oxygenase mRNA accumulation in mouse liver: synergism by glutathione depletion and protection by N-acetylcysteine. *Biochem J* 1994;304:477-483.
199. Rizzardini M, et al. Cytokine induction of haem oxygenase mRNA in mouse liver. *Interleukin 1*

transcriptionally activates the haem oxygenase gene. *Biochem J* 1993;290:343–347.

200. Mitani K, et al. Heat shock induction of heme oxygenase mRNA in human Hep 3B hepatoma cells. *Biochem Biophys Res Commun* 1989;165:437–441.

201. Drummond GS. Control of heme catabolism by Sn–protoporphyrin. *Semin Hematol* 1989;26:24–26.

202. Sardana MK, Kappas A. Dual control mechanism for heme oxygenase: tin(IV)–protoporphyrin potently inhibits enzyme activity while markedly increasing content of enzyme protein in liver. *Proc Natl Acad Sci U S A* 1987;84:2464–2468.

203. Berglund L, et al. Sn–protoporphyrin lowers serum bilirubin levels, decreases biliary bilirubin output, enhances biliary heme excretion and potently inhibits hepatic heme oxygenase activity in normal human subjects. *Hepatology* 1988;8:625–631.

204. Maines MD, Trakshel GM. Differential regulation of heme oxygenase isozymes by Sn– and Zn–protoporphyrins: possible relevance to suppression of hyperbilirubinemia. *Biochim Biophys Acta* 1992;1131:166–174.

205. Vreman HJ, Ekstrand BC, Stevenson DK. Selection of metalloporphyrin heme oxygenase inhibitors based on potency and photoreactivity. *Pediatr Res* 1993;33:195–200.

206. Kappas A, et al. Sn–protoporphyrin use in the management of hyperbilirubinemia in term newborns with direct Coombs–positive ABO incompatibility. *Pediatrics* 1988;81:485–497.

207. Valaes T, et al. Control of jaundice in preterm newborns by an inhibitor of bilirubin production: studies with tin–mesoporphyrin. *Pediatrics* 1994;93:1–11.

208. Boni RE, et al. Tin–mesoporphyrin inhibits heme oxygenase activity and heme–iron absorption in the intestine. *Pharmacology* 1993;47:318–329.

209. Maines MD, Trakshel GM, Kutty RK. Characterization of two constitutive forms of rat liver microsomal heme oxygenase. Only one molecular species of the enzyme is inducible. *J Biol Chem* 1986;261:411–419.

210. Kaplan M, Algur N, Hammerman C. Onset of jaundice in glucose–6–phosphate dehydrogenase–deficient neonates. *Pediatrics* 2001;108:956–959.

211. Sunderman FW Jr. Metal induction of heme oxygenase. *Ann N Y Acad Sci* 1987;514:65–80.

212. Noguchi M, Yoshida T, Kikuchi G. A stoichiometric study of heme degradation catalyzed by the reconstituted heme oxygenase system with special consideration of the production of hydrogen peroxide during the reaction. *J Biochem (Tokyo)* 1983;93:1027–1036.

213. Brown SB, King RF. The mechanism of haem catabolism. Bilirubin formation in living rats by (18O) oxygen labelling. *Biochem J* 1978;170:297–311.

214. Berk PD, et al. A new approach to quantitation of the various sources of bilirubin in man. *J Lab Clin Med* 1976;87:767–780.

215. Barrett PV, Cline MJ, Berlin NI. The association of the urobilin “early peak” and erythropoiesis in man. *J Clin Invest* 1966;45:1657–1667.

216. Robinson SH. Formation of bilirubin from erythroid and nonerythroid sources. *Semin Hematol* 1972;9:43–53.

217. Bloomer JR, et al. Interpretation of plasma bilirubin levels based on studies with radioactive bilirubin. *JAMA* 1971;218:216–220.

218. McDonagh AF, Lightner DA. Phototherapy and the photobiology of bilirubin. *Semin Liver Dis* 1988;8:272–283.

219. Itoh S, Onishi S. Kinetic study of the photochemical changes of (ZZ)–bilirubin IX alpha bound to

human serum albumin. Demonstration of (EZ)-bilirubin IX alpha as an intermediate in photochemical changes from (ZZ)-bilirubin IX alpha to (EZ)-cyclobilirubin IX alpha. *Biochem J* 1985;226:251-258.

220. Bonnett R, Ioannou S. Phototherapy and the chemistry of bilirubin. *Mol Aspects Med* 1987;9:457-471.

221. Gordon ER, Seligson D, Flye MW. Serum bilirubin pigments covalently linked to albumin. *Arch Pathol Lab Med* 1996;120:648-653.

222. Dumas BT, Wu TW. The measurement of bilirubin fractions in serum. *Crit Rev Clin Lab Sci* 1991;28:415-445.

223. Jacobsen J. Binding of bilirubin to human serum albumin—determination of the dissociation constants. *FEBS Lett* 1969;5:112-114.

224. Mustafa MG, King TE. Binding of bilirubin with lipid. A possible mechanism of its toxic reactions in mitochondria. *J Biol Chem* 1970;245:1084-1089.

225. Rosenthal P, Pincus M, Fink D. Sex- and age-related differences in bilirubin concentrations in serum. *Clin Chem* 1984;30:1380-1382.

226. Muraca M, Fevery J, Blanckaert N. Analytic aspects and clinical interpretation of serum bilirubins. *Semin Liver Dis* 1988;8:137-147.

227. Reed RG, et al. Non-resolving jaundice: bilirubin covalently attached to serum albumin circulates with the same metabolic half-life as albumin. *Clin Chem* 1988;34:1992-1994.

228. Berk PD, et al. Studies of bilirubin kinetics in normal adults. *J Clin Invest* 1969;48:2176-2190.

229. Jacobsen C. Lysine residue 240 of human serum albumin is involved in high-affinity binding of bilirubin. *Biochem J* 1978;171:453-459.

230. Berk PD, Stremmel W. Hepatocellular uptake of organic anions. *Prog Liver Dis* 1986;8:125-144.

231. Farrell GC, Gollan JL, Schmid R. Efflux of bilirubin into plasma following hepatic degradation of exogenous heme. *Proc Soc Exp Biol Med* 1980;163:504-509.

232. Gollan JL, Schmid R. Bilirubin update: formation, transport, and metabolism. *Prog Liver Dis* 1982;7:261-283.

233. Scharschmidt BF, Waggoner JG, Berk PD. Hepatic organic anion uptake in the rat. *J Clin Invest* 1975;56:1280-1292.

234. Sorrentino D, Berk PD. Mechanistic aspects of hepatic bilirubin uptake. *Semin Liver Dis* 1988;8:119-136.

235. Tiribelli C, Lunazzi GC, Sottocasa GL. Mechanisms of hepatic uptake of organic anions. *Clin Sci (Lond)* 1986;71:1-8.

236. Shupeck M, et al. Studies of the kinetics of purified conjugated bilirubin-3H in the rat. *Am J Gastroenterol* 1978;70:259-264.

237. Gollan J, et al. Bilirubin kinetics in intact rats and isolated perfused liver. Evidence for hepatic deconjugation of bilirubin glucuronides. *J Clin Invest* 1981;67:1003-1015.

238. Zucker SD, Goessling W, Gollan JL. Kinetics of bilirubin transfer between serum albumin and membrane vesicles. Insight into the mechanism of organic anion delivery to the hepatocyte plasma membrane. *J Biol Chem* 1995;270:1074-1081.

239. Zucker SD, et al. Membrane lipid composition and vesicle size modulate bilirubin intermembrane transfer. Evidence for membrane-directed trafficking of bilirubin in the hepatocyte. *J Biol Chem* 1994;269:19262-19270.

240. Mannervik B, Danielson UH. Glutathione transferases—structure and catalytic activity. *CRC Crit Rev*

Biochem 1988;23:283–337.

241. Pickett CB, Lu AY. Glutathione S-transferases: gene structure, regulation, and biological function. *Annu Rev Biochem* 1989;58:743–764.
242. Wolkoff AW, et al. Hepatic accumulation and intracellular binding of conjugated bilirubin. *J Clin Invest* 1978;61:142–149.
243. Raymond GD, Galambos JT. Hepatic storage and excretion of bilirubin in man. *Am J Gastroenterol* 1971;55:135–144.
244. Boyer TD. The glutathione S-transferases: an update. *Hepatology* 1989;9:486–496.
245. Frydman RB, et al. Interconversion of the molecular forms of biliverdin reductase from rat liver. *Biochim Biophys Acta* 1983;759:257–263.
246. Fevery J, et al. Comparison in different species of biliary bilirubin-IX alpha conjugates with the activities of hepatic and renal bilirubin-IX alpha-uridine diphosphate glycosyltransferases. *Biochem J* 1977;164:737–746.
247. Bosma PJ, et al. Bilirubin UDP-glucuronosyltransferase 1 is the only relevant bilirubin glucuronidating isoform in man. *J Biol Chem* 1994;269:17960–17964.
248. Crawford JM, et al. Hepatic microsomal bilirubin UDP-glucuronosyltransferase. The kinetics of bilirubin mono- and diglucuronide synthesis. *J Biol Chem* 1992;267:16943–16950.
249. Roy Chowdhury J, et al. Isolation and characterization of multiple forms of rat liver UDP-glucuronate glucuronosyltransferase. *Biochem J* 1986;233:827–837.
250. Crawford JM, Hauser SC, Gollan JL. Formation, hepatic metabolism, and transport of bile pigments: a status report. *Semin Liver Dis* 1988;8:105–118.
251. Dills RL, Howell SR, Klaassen CD. Hepatic UDP-glucose and UDP-glucuronic acid synthesis rates in rats during a reduced energy state. *Drug Metab Dispos* 1987;15:281–288.
252. Jansen PL, Oude Elferink RP. Hereditary hyperbilirubinemias: a molecular and mechanistic approach. *Semin Liver Dis* 1988;8:168–178.
253. Labrune P, et al. Genetic heterogeneity of Crigler-Najjar syndrome type I: a study of 14 cases. *Hum Genet* 1994;94:693–697.
254. Seppen J, et al. Discrimination between Crigler-Najjar type I and II by expression of mutant bilirubin uridine diphosphate-glucuronosyltransferase. *J Clin Invest* 1994;94:2385–2391.
255. Aono S, et al. Identification of defect in the genes for bilirubin UDP-glucuronosyl-transferase in a patient with Crigler-Najjar syndrome type II. *Biochem Biophys Res Commun* 1993;197:1239–1244.
256. Bosma PJ, et al. A mutation in bilirubin uridine 5' [**Comp: prime**]-diphosphate-glucuronosyltransferase isoform 1 causing Crigler-Najjar syndrome type II. *Gastroenterology* 1993;105:216–220.
257. Ritter JK, et al. A phenylalanine codon deletion at the UGT1 gene complex locus of a Crigler-Najjar type I patient generates a pH-sensitive bilirubin UDP-glucuronosyltransferase. *J Biol Chem* 1993;268:23573–23579.
258. Bosma PJ, et al. The genetic basis of the reduced expression of bilirubin UDP-glucuronosyltransferase 1 in Gilbert's syndrome. *N Engl J Med* 1995;333:1171–1175.
259. Crawford JM, et al. Hepatic disposition and biliary excretion of bilirubin and bilirubin glucuronides in intact rats. Differential processing of pigments derived from intra- and extrahepatic sources. *J Clin Invest* 1987;79:1172–1180.
260. Iolascon A, et al. UGT1 promoter polymorphism accounts for increased neonatal appearance of

hereditary spherocytosis. *Blood* 1998;91:1093.

261. Kappas A, et al. Sn-Mesoporphyrin interdiction of severe hyperbilirubinemia in Jehovah's Witness newborns as an alternative to exchange transfusion. *Pediatrics* 2001;108:1374-1377.

262. Nishida T, et al. Two distinct mechanisms for bilirubin glucuronide transport by rat bile canalicular membrane vesicles. Demonstration of defective ATP-dependent transport in rats (TR-) with inherited conjugated hyperbilirubinemia. *J Clin Invest* 1992;90:2130-2135.

263. Kitamura T, et al. Defective ATP-dependent bile canalicular transport of organic anions in mutant (TR-) rats with conjugated hyperbilirubinemia. *Proc Natl Acad Sci U S A* 1990;87:3557-3561.

264. Oude Elferink RP, et al. Hepatobiliary secretion of organic compounds; molecular mechanisms of membrane transport. *Biochim Biophys Acta* 1995;1241:215-268.

265. Forker EL. Mechanisms of hepatic bile formation. *Annu Rev Physiol* 1977;39:323-347.

266. Wolkoff AW, Cohen LE, Arias IM. Inheritance of the Dubin-Johnson syndrome. *N Engl J Med* 1973;288:113-117.

267. Dubin I, Johnson F. Chronic idiopathic jaundice with unidentified pigment in liver cells: new clinico-pathologic entity with report of 12 cases. *Medicine* 1954;33:155-197.

268. Toh S, et al. Genomic structure of the canalicular multispecific organic anion-transporter gene (MRP2/cMOAT) and mutations in the ATP-binding-cassette region in Dubin-Johnson syndrome. *Am J Hum Genet* 1999;64:739-746.

269. Wada M, et al. Mutations in the canalicular multispecific organic anion transporter (cMOAT) gene, a novel ABC transporter, in patients with hyperbilirubinemia II/Dubin-Johnson syndrome. *Hum Mol Genet* 1998;7:203-207.

270. Elder G, Gray CH, Nicholson DC. Bile pigment fate in gastrointestinal tract. *Semin Hematol* 1972;9:71-89.

271. Polard R, Odell GB. Physiologic jaundice: the enterohepatic circulation of bilirubin. *N Engl J Med* 1971;284:1-6.

272. Gustaffson B, Lanke LS. Bilirubin and urobilins in germ free, exgerm free and conventional rats. *J Exp Med* 1960;112:975-981.

273. Ostrow JD. Mechanisms of bilirubin photodegradation. *Semin Hematol* 1972;9:113-125.

274. Arias IM. Hepatic aspects of bilirubin metabolism. *Annu Rev Med* 1966;17:257-274.

275. Watson CJ. The continuing challenge of hemoglobin and bile pigment metabolism. *Ann Intern Med* 1965;63:931-944.

276. Landaw SA, Callahan EW Jr, Schmid R. Catabolism of heme in vivo: comparison of the simultaneous production of bilirubin and carbon monoxide. *J Clin Invest* 1970;49:914-925.

277. Cameron JL, et al. Metabolism and excretion of bilirubin-C14 in experimental obstructive jaundice. *Ann Surg* 1966;163:330-338.

278. Kotal P, Fevery J. Urobilinogen-i is a major derivative of bilirubin in bile of homozygous Gunn rats. *Biochem J* 1990;268:181-185.

279. Cardenas-Vasquez R, Yokosuka O, Billing BJ. Enzymic oxidation of unconjugated bilirubin by rat liver. *Biochem J* 1986;236:625-633.

280. Lucey JF. Neonatal phototherapy: uses, problems, and questions. *Semin Hematol* 1972;9:127-135.

281. Dumas BT, et al. Standardization in bilirubin assays: evaluation of selected methods and stability of

- bilirubin solutions. *Clin Chem* 1973;19:984–993.
282. Fevery J, et al. Plasma bilirubin pigments in health and disease. *Mol Aspects Med* 1987;9:391–404.
283. Engstedt L. Earlier investigations on the formation of carbon monoxide in man. *Acta Med Scand* 1957;[Suppl 332]:9–18.
284. White P, et al. Carbon monoxide production associated with ineffective erythropoiesis. *J Clin Invest* 1967;46:1986–1998.
285. Necheles TF, Rai US, Valaes T. The role of haemolysis in neonatal hyperbilirubinaemia as reflected in carboxyhaemoglobin levels. *Acta Paediatr Scand* 1976;65:361–367.
286. Stevenson DK, Vreman HJ. Carbon monoxide and bilirubin production in neonates. *Pediatrics* 1997;100:252–254.
287. Smith DW, et al. Use of noninvasive tests to predict significant jaundice in full-term infants: preliminary studies. *Pediatrics* 1985;75:278–280.
288. McLellan AC, Thornalley PJ. Glyoxalase activity in human red blood cells fractionated by age. *Mech Ageing Dev* 1989;48:63–71.
289. Danon D, Marikovsky Y. Determination of density distribution of red cell population. *J Lab Clin Med* 1964;64:668–674.
290. Linderkamp O, Meiselman HJ. Geometric, osmotic, and membrane mechanical properties of density-separated human red cells. *Blood* 1982;59:1121–1127.
291. Evans EA, La Celle PL. Intrinsic material properties of the erythrocyte membrane indicated by mechanical analysis of deformation. *Blood* 1975;45:29–43.
292. Hoffman J. On the relationship of certain erythrocyte characteristics to their physiological age. *J Cell Comp Physiol* 1958;51:415–423.
293. Keitt AS, Smith TW, Jandl JH. Red-cell “pseudomosaicism” in congenital methemoglobinemia. *N Engl J Med* 1966;275:399–405.
294. Haidas S, Labie D, Kaplan JC. 2,3-Diphosphoglycerate content and oxygen affinity as a function of red cell age in normal individuals. *Blood* 1971;38:463–467.
295. Edwards MJ, Rigas DA. Electrolyte-labile increase of oxygen affinity during in vivo aging of hemoglobin. *J Clin Invest* 1967;46:1579–1588.
296. Elseweidy MM, Fadel HE, Abraham EC. Glycosylated and acetylated hemoglobins in relation to gestational age and red cell age. *Hemoglobin* 1984;8:363–372.
297. Elseweidy MM, Stallings M, Abraham EC. Changes in glycosylated hemoglobins with red cell aging in normal and diabetic subjects and in newborn infants of normal and diabetic mothers. *J Lab Clin Med* 1983;102:628–636.
298. Bernstein R. Alterations in metabolic energetics and cation transport during aging of red cells. *J Clin Invest* 1959;38:1572–1586.
299. Pranker T. The aging of red cells. *J Physiol* 1958;143:325–331.
300. Shiga T, et al. Cell age-dependent changes in deformability and calcium accumulation of human erythrocytes. *Biochim Biophys Acta* 1985;814:289–299.
301. van Gastel C, et al. Some lipid characteristics of normal red blood cells of different age. *Br J Haematol* 1965;11:193–199.
302. Westerman M, Pierce L, Jensen W. Erythrocyte lipids: a comparison of young and normal old

populations. *J Lab Clin Med* 1963;62:394–400.

303. Winterbourn CC, Batt RD. Lipid composition of human red cells of different ages. *Biochim Biophys Acta* 1970;202:1–8.

304. Walter H, Selby FW. Counter–current distribution of red blood cells of slightly different ages. *Biochim Biophys Acta* 1966;112:146–153.

305. Yaari A. Mobility of human red blood cells of different age groups in an electric field. *Blood* 1969;33:159–163.

306. Beeley JG, Blackie R, Baxter A. Glycoprotein and glycolipid changes in aged erythrocytes (proceedings). *Biochem Soc Trans* 1977;5:1725–1726.

307. Vincenzi FF, Hinds TR. Decreased Ca pump ATPase activity associated with increased density in human red blood cells. *Blood Cells* 1988;14:139–159.

308. Inaba M, et al. Deamidation of human erythrocyte protein 4.1: possible role in aging. *Blood* 1992;79:3355–3361.

309. Jain SK, Hochstein P. Polymerization of membrane components in aging red blood cells. *Biochem Biophys Res Commun* 1980;92:247–254.

310. Low PS, et al. The role of hemoglobin denaturation and band 3 clustering in red blood cell aging. *Science* 1985;227:531–533.

311. Shinozuka T, et al. Number and distribution density of ABH and MN antigen sites on young and old human erythrocyte surfaces. *Life Sci* 1988;43:683–689.

312. Chapman RG, Schaumburg L. Glycolysis and glycolytic enzyme activity of aging red cells in man. Changes in hexokinase, aldolase, glyceraldehyde–3–phosphate dehydrogenase, pyruvate kinase and glutamic–oxalacetic transaminase. *Br J Haematol* 1967;13:665–678.

313. Brok F, et al. Enzyme activities in human red blood cells of different age groups. *Isr J Med Sci* 1966;2:291–296.

314. Fornaini G, Magnani M, Fazi A, et al. Regulatory properties of human erythrocyte hexokinase during cell aging. *Arch Biochem Biophys* 1985;239:352–358.

315. Haram S, et al. The mechanism of decline of age–dependent enzymes in the red blood cell. *Enzyme* 1991;45:47–53.

316. Shimizu Y, Suzuki M. The relationship between red cell aging and enzyme activities in experimental animals. *Comp Biochem Physiol B* 1991;99:313–316.

317. Fazi A, et al. Cell age dependent decay of human erythrocytes glucose–6–phosphate isomerase. *Biochim Biophys Acta* 1989;998:286–291.

318. Jimeno P, et al. Changes in glycolytic enzyme activities in aging erythrocytes fractionated by counter–current distribution in aqueous polymer two–phase systems. *Biochem J* 1991;279:237–243.

319. Eppes R, McNamara JV, Powell RD, et al. Activity of phosphofructokinase in human erythrocytes; relationship to cell age. *J Clin Invest* 1966;45:1005a.

320. Kadlubowski M, Agutter PS. Changes in the activities of some membrane–associated enzymes during in vivo ageing of the normal human erythrocyte. *Br J Haematol* 1977;37:111–125.

321. Nehal M, Azam M, Baquer NZ. Changes in the levels of catecholamines, hexokinase and glucose 6–phosphate dehydrogenase in red cell aging. *Biochem Int* 1990;22:517–522.

322. Bonsignore A, et al. Relationship between age and enzymatic activities in human erythrocytes from normal and fava bean–sensitive subjects. *J Clin Invest* 1964;43:834–842.



323. Gordillo E, Machado A. Implication of lysine residues in the loss of 6-phosphogluconate dehydrogenase activity in aging human erythrocytes. *Mech Ageing Dev* 1991;59:291-297.
324. Gershon H, Gershon D. Altered enzyme function and premature sequestration of erythrocytes in aged individuals. *Blood Cells* 1988;14:93-101.
325. Fazi A, et al. Cell age dependent decay of human erythrocytes glutathione S-transferase. *Mech Ageing Dev* 1991;58:255-266.
326. Abraham EC, Taylor JF, Lang CA. Influence of mouse age and erythrocyte age on glutathione metabolism. *Biochem J* 1978;174:819-825.
327. Allison A, Burn GP. Enzyme activity as a function of age in the human erythrocyte. *Br J Haematol* 1955;1:291-303.
328. Gupta BL, et al. Ageing erythrocytes and alloxan diabetes. I. A possible role of catalase, GSH, GSSG, and GSH-enzymes in decreasing defence system. *Biochem Mol Biol Int* 1993;31:669-676.
329. Herrmann A, Devaux PF. Alteration of the aminophospholipid translocase activity during in vivo and artificial aging of human erythrocytes. *Biochim Biophys Acta* 1990;1027:41-46.
330. Blostein R, Grafova E. Decrease in Na(+)-K(+)-ATPase associated with maturation of sheep reticulocytes. *Am J Physiol* 1990;259:C241-C250.
331. Prall YG, Gambhir KK, Ampy FR. Acetylcholinesterase: an enzymatic marker of human red blood cell aging. *Life Sci* 1998;63:177-184.
332. Lennard L, Chew TS, Lilleyman JS. Human thiopurine methyltransferase activity varies with red blood cell age. *Br J Clin Pharmacol* 2001;52:539-546.
333. Bozzi A, et al. S-adenosylhomocysteine hydrolase and adenosine deaminase activities in human red cell ageing. *Clin Chim Acta* 1990;189:81-86.

2004 Lippincott Williams & Wilkins  
John P. Greer, John Foerster, John N. Lukens  
George M. Rodgers, Frixos Paraskevas, Bertil Glader  
Wintrobe's Clinical Hematology

SUBCELLULAR STRUCTURE OF NEUTROPHILS.Azurophilic Granules.Specific Granules.Tertiary Granules.Secretory Vesicles.Plasma Membrane.Cytoskeletal Matrix.Neutrophil Lipids.Lipid RaftsCytoplasmic Lipid Bodies.Cytosol.Nucleus.MORPHOLOGY OF NEUTROPHILS AND PRECURSORS.DEVELOPMENT OF NEUTROPHILS AND THEIR PRECURSORS.Myeloblast.Differentiation from Lymphoblasts and Other Blasts.Neutrophil Promyelocytes and Myelocytes.Neutrophil Granule Development.Neutrophil Metamyelocytes.Band Neutrophils.Polymorphonuclear Neutrophils.Neutrophil Heterogeneity.Neutrophil Antigens.EOSINOPHILS.BASOPHILS AND MAST CELLS.MACROPOLYCYTES.GENETIC SEX AS INDICATED BY LEUKOCYTES.DIFFERENTIATION OF VARIOUS TYPES OF CELLS.DIFFERENTIAL CELL COUNTING AND NORMAL VALUES FOR LEUKOCYTES.NEUTROPHIL KINETICS.Neutrophil Kinetics in the Adult.Neutrophil Kinetics in the Fetus and Newborn.PHYSIOLOGIC VARIATION IN LEUKOCYTES.CONTROL MECHANISMS REGULATING NEUTROPHIL PRODUCTION.Growth Factors.NEUTROPHIL FUNCTION.History.Chemotactic Factor Receptors.Signaling.Neutrophil-Endothelial Adhesion.Neutrophil Aggregation.Chemotaxis.Phagocytosis.Granule Release.Bacterial Killing and Digestion.Oxygen-Dependent Antimicrobial Systems.Oxygen-Independent Antimicrobial Systems.Digestion.Infections That Exhibit Tropism for Neutrophils.Secretory Functions of the Neutrophil.Activation of Proteases by Oxygen Metabolites.

## REFERENCES

Three types of granulocytes are readily identified in peripheral blood smears. Neutrophils are so named because of their neutral staining with Wright stain, whereas eosinophils avidly stain with the dye eosin, and basophils have readily identified large dark-staining granules with Wright stain. Neutrophils play a critical role in host defense by phagocytizing and digesting microorganisms, and inappropriate activation of neutrophils may result in damage to normal host tissues. In the resting uninfected host, the production and elimination of neutrophils are balanced, resulting in a fairly constant concentration of neutrophils in peripheral blood. When an infection occurs, chemotactic agents are generated that result in migration of neutrophils to the site of the infection and activation of neutrophil defensive functions. This effect is often associated with an increased production and release of neutrophils from the bone marrow. This chapter reviews the structure, morphology, production, distribution and kinetics, and functions of neutrophils. This chapter is written in several sections, and the first part of each section contains more general information for students, whereas the second part contains greater detail.

## SUBCELLULAR STRUCTURE OF NEUTROPHILS

Mature neutrophils contain several types of granules and other subcellular organelles. To better understand the functions of neutrophils, many studies have been performed to identify and characterize the molecular composition of the various subcellular compartments of neutrophils. Two techniques are commonly used for this purpose: immunoelectron microscopy and subcellular fractionation. Most recent subcellular fractionation studies used the technique of nitrogen cavitation to disrupt the neutrophils. In this technique, cells are equilibrated with nitrogen at high pressure and then released into a pressure of one atmosphere. The rapid decrease in extracellular pressure results in disruption of the cells by the formation of nitrogen gas within the cell. The disrupted cells are then fractionated by density gradient centrifugation (1). Many types of subcellular organelles and structures are present in neutrophils, as seen by electron microscopy (EM). Four well-defined types of granules have been defined in neutrophils: primary granules, secondary granules, tertiary granules, and secretory vesicles. Some of the known constituents of these granules are indicated in Table 10.1.

TABLE 10.1. Contents of Human Neutrophil Granules

| Azurophil (Primary) Granules | Specific (Secondary) Granules                   | Gelatinase (Tertiary) Granules <sup>a</sup>     | Secretory Vesicles                              |
|------------------------------|---|---|---|
| Membrane<br>CD63             | Membrane<br>CD15 antigens                       | Membrane<br>Mac-1 (CD11b)                       | Membrane<br>Alkaline phosphatase                |
| CD66c                        | CD66a   | FMLP receptor                                   | Cytochrome <i>b</i> <sub>558</sub> <sup>b</sup> |
| CD68                         | CD66b   | Diacylglycerol deacylating enzyme               | Mac-1 (CD11b)                                   |
| Matrix                       | Cytochrome <i>b</i> <sub>558</sub> <sup>b</sup> | Cytochrome <i>b</i> <sub>558</sub> <sup>b</sup> | u-PA receptor                                   |
| Lysozyme                     | FMLP receptor                                   | Laminin receptor                                | FMLP receptor                                   |

|  |  |                         |   |
|--|--|-------------------------|---|
| Defensins                                    | Fibronectin receptor                       | Matrix                  | CD10, CD13, CD45                                    |
| Elastase                                     | G-protein $\alpha$ -subunit                | Gelatinase <sup>a</sup> | CD16  |
| Cathepsin G                                  | Laminin receptor                           | Acetyltransferase       | DAF   |
| Proteinase 3                                 | MAC-1 (CD11b)                              | Lysozyme                | CR1 (CD35)  |
| Esterase N                                   | NB 1 antigen                               |                         | Matrix  |
| $\alpha_1$ -Antitrypsin                      | Rap 1, Rap 2                               |                         | Plasma proteins (including tetranectin and albumin) |
| $\alpha$ -Mannosidase                        | Thrombospondin receptor                    |                         |   |
| Azurocidin                                   | Tumor necrosis factor receptor             |                         | pro-u-PA/u-PA                                       |
| Bactericidal permeability-increasing protein | Vitronectin receptor                       |                         |   |
|  | u-PA receptor                              |                         |   |
| $\beta$ -Glycerophosphatase                  | Matrix                                     |                         |   |
| $\beta$ -Glucuronidase                       | Apolactoferrin                             |                         |   |
| $\beta$ -Galactosidase                       | Lysozyme                                   |                         |   |
| $\beta$ -Glucosaminidase                     | $\beta_2$ -microglobulin                   |                         |   |
| $\alpha$ -Fucosidase                         | Collagenase                                |                         |   |
| Cathepsin B                                  | Gelatinase <sup>a</sup>                    |                         |   |
| Cathepsin D                                  | Histaminase                                |                         |   |
| Acid mucopolysaccharide                      | Heparinase                                 |                         |   |
| Heparin binding protein                      | pro-u-PA                                   |                         |   |
| <i>N</i> -acetyl- $\beta$ -glucosaminidase   | Vitamin B <sub>12</sub> -binding protein   |                         |   |
| Sialidase                                    | Sialidase                                  |                         |   |
| Ubiquitin protein                            | Protein kinase C inhibitor                 |                         |   |
|  | hCAP-18                                    |                         |   |
|  | SGP28                                      |                         |   |
|  | Neutrophil gelatinase-associated lipocalin |                         |   |

DAF, decay accelerating factor; FMLP, f-met-leu-phe; u-PA, urokinase-type plasminogen activator.

<sup>a</sup> Gelatinase is present in only a subset of specific granules; most is present in gelatinase granules.

<sup>b</sup> Cytochrome *b*<sup>558</sup> is also called *b*<sup>245</sup>.

Adapted from references [2](#), [3](#), [4](#), [5](#), [6](#), [7](#), [8](#), [9](#), [10](#), [11](#), [12](#), [13](#) and [14](#).

---

## Azurophilic Granules

The azurophilic, or primary, granules are formed during the promyelocytic stage and in general contain many antimicrobial compounds. These granules fuse with phagocytic

vesicles, resulting in the delivery of their contents to the ingested organism. Among the azurophilic granule contents is myeloperoxidase (MPO), a protein that catalyzes the production of hypochlorite ( $\text{OCI}^-$ ) from chloride and hydrogen peroxide produced by the oxidative burst. MPO constitutes approximately 5% of the dry weight of the neutrophil ( [15](#) ) and imparts the greenish coloration to pus. Defensins, a group of cationic proteins that kill a variety of bacteria, fungi, and viruses ( [16](#), [17](#) and [18](#) ), also constitute approximately 5% of total neutrophil protein ( [19](#) ). Other components of azurophilic granules include lysozyme, which degrades bacterial peptidoglycans ( [20](#) ), bactericidal permeability-increasing protein, which has antibacterial activity against certain gram-negative bacteria ( [21](#), [22](#), [23](#), [24](#) and [25](#) ), azurocidin, which has antibacterial as well as antifungal activity against *Candida albicans* ( [26](#), [27](#) ), and the serine proteinases elastase, cathepsin G, proteinase 3, esterase N, and others ( [28](#), [29](#), [30](#) and [31](#) ). The granule membrane itself contains a large amount of CD66c ( [32](#), [33](#) ) and CD63 antigens ( [34](#) ). Heterogeneity among azurophil granules is likely ( [2](#) ).

### Specific Granules

Although some specific (also called *secondary*) granules, like azurophilic granules, fuse with phagocytic vesicles, it is believed that these granules are largely for release into the extracellular space. The known contents of these granules are also indicated in [Table 10.1](#) and include apolactoferrin, the major specific granule protein, vitamin B<sub>12</sub>-binding protein, plasminogen activator, and collagenase. Lysozyme and some gelatinase are also present in specific granules. Release of specific granule contents may modify the inflammatory process. For example, collagenase may degrade collagen, thus augmenting movement through collagen and participating in tissue remodeling. Apolactoferrin, by binding iron, may have an antibacterial effect by preventing bacteria from obtaining necessary iron for growth ( [35](#) ). Iron binding by apolactoferrin may also modify hydroxyl radical formation and cell adhesion ( [36](#), [37](#), [38](#) and [39](#) ). Specific granules also contain a number of membrane-bound molecules that are also expressed on the cell surface. This includes CD11, CD18, CD66a, CD66b, NB-1, f-met-leu-phe (FMLP) receptors, C5a receptors, and cytochrome *b*<sub>558</sub>. When cells are stimulated, the surface expression of many of these membrane proteins is increased, and some of the up-regulated molecules may be derived from specific granules. The importance of the specific granules in neutrophil function is shown in patients who lack specific granules; these patients are susceptible to repeated skin and respiratory infections and have defective neutrophil chemotaxis and adhesion.

### Tertiary Granules

Tertiary, or gelatinase, granules, which cosediment with specific granules in some subcellular fractionation techniques, were initially identified as gelatinase-containing granules ( [40](#) ). Like specific granules, tertiary granules also contain many membrane proteins that are up-regulated to the cell surface with stimulation ( [10](#) ). The relative contribution of tertiary granules and specific granules to up-regulation of membrane proteins is not clear.

### Secretory Vesicles

Secretory vesicles, which largely distribute in the plasma membrane fraction using subcellular fractionation techniques, have also been described. Complement receptor (CR) 1, recognized by CD35 monoclonal antibodies, has been found exclusively in the light membrane fractions containing secretory vesicles and plasma membranes using

subcellular fractionation techniques ( [12](#) ). The observation that CR1 can be readily up-regulated to the neutrophil surface with weak stimulation demonstrates that secretory vesicles provide an intracellular reservoir from which membrane proteins can be recruited to the cell surface. CR3 (HMac-1), recognized by CD11b antibodies and present in both secretory vesicles and specific granules, is also up-regulated to the cell surface with weak stimulation. In contrast to CR1, a more marked up-regulation of CR3 is observed with more potent stimulation, demonstrating that specific granules can also serve as an intracellular reservoir from which membrane proteins can be up-regulated to the cell surface ( [12](#) ). By EM, the secretory vesicles appear as smooth-surfaced vesicles. A defining feature of secretory vesicles is their rapid and complete translocation to the surface membrane with weak stimulation ( [12](#) ). These secretory vesicles also contain alkaline phosphatase, cytochrome *b*<sub>558</sub>, and FMLP receptors. Secretory vesicles can be up-regulated to the cell surface in the absence of extracellular calcium, in contrast to specific and gelatinase granules, which require extracellular calcium for release ( [12](#) ). The secretory vesicles appear to be formed by a process of endocytosis and contain albumin.

### Plasma Membrane

Many constituents of the neutrophil plasma membrane have been defined. These include membrane channels, adhesive proteins, receptors for various ligands, ion pumps, and ectoenzymes. In the last 15 years, there has been an explosion of information about membrane proteins, identified largely by monoclonal antibodies. Many of these cell-surface molecules probably play a role in regulating the neutrophil response. For example, aminopeptidase N (CD13) can inactivate interleukin (IL)-8, eliminating its chemotactic activity ( [41](#) ), and neutrophil endopeptidase (CD10) can inactivate the chemotactic peptide FMLP ( [42](#) ). Studies with CD66 monoclonal antibodies suggest a role for CD66a, b, c, and d in activating neutrophils ( [43](#) ), and some CD45 antibodies, which recognize a transmembrane protein with tyrosine phosphatase activity in its cytoplasmic domain, inhibit neutrophil chemotaxis ( [44](#) ). Some of the various clusters of differentiation (CD) expressed on neutrophils are shown in [Table 10.2](#). The components of the membrane are not uniformly distributed. Studies have indicated the presence of differentiated domains in the membrane called *rafts*, which are described in the section [Lipid Rafts](#).

**TABLE 10.2. Some CD Antigens Expressed on Neutrophils**

| CD    | CD Antigen  |
|-------|---|
| CD10  | Common acute lymphoid leukemia antigen, neutral endopeptidase |
| CD11a | Leukocyte factor antigen-1                                    |
| CD11b | Mac-1   |
| CD11c | p150, 95  |
| CD13  | Aminopeptidase N  |
| CD15  | Le <sup>x</sup> (Ga1B1?4G1cNAc(Fuca1?3)B1?3Ga1B1? 4G1cNAc?R)  |
| CD15s | sLe <sup>x</sup>  |
| CD16  | FcRIII  |
| CDw17 | LacCer  |
| CD18  | β <sub>2</sub> integrin                                       |
| CD24  | Glycosyl phosphatidylinositol-linked protein                  |
| CD31  | Platelet endothelial cell adhesion molecule-1                 |
| CD32  | FcRII   |

CD43 Leukosialin, sialophorin  
 CD44 Pgp-1  
 CD45 Leukocyte common antigen (a protein tyrosine phosphatase)  
 CD50 Intercellular adhesion molecule-3  
 CD53 Tetraspan molecule  
 CD55 Decay accelerating factor  
 CD62L L-selectin  
 CD63 Tetraspan family member  
 CD64 FcRI  
 CD65 Ga1B1?4G1cNAcB1?3Ga1B1?G1cNAc(Fuca1?3)?R  
 CD65s Sialylated CD65  
 CD66a Biliary glycoprotein  
 CD66b CGM6  
 CD66c NCA  
 CD66d CGM1  
 CD82 Tetraspan family member  
 CD88 C5a receptor  
 CD95 Fas, APO-1  
 CD114 Granulocyte colony-stimulating factor receptor  
 CD156 ADAM-8 (a disintegrin and metalloprotease domain)  
 CD157 Bifunctional ectoenzyme (adenosine diphosphate ribosylase)  
 NOTE: When used to describe the antigen, the term *CD antigen* should be used.

---

## Cytoskeletal Matrix

Like many other cells, neutrophils contain a complex cytoskeleton. Alterations in the distribution of cytoskeletal elements may be important in chemotaxis, phagocytosis, and exocytosis. Many protein components of this cytoskeleton have been identified, including actin, actin-binding protein,  $\alpha$ -actinin, gelsolin, profilin, myosin, tubulin, and tropomyosin. Actin accounts for approximately 10% of neutrophil protein ([45](#)). The reader is referred to other reviews for a more detailed description of the role of the cytoskeleton in neutrophil function ([46](#)).

## Neutrophil Lipids

Although most studies of neutrophil structure have concentrated on proteins, lipids and carbohydrates also serve important functions. Lipids account for approximately 5% of neutrophils by weight ([47](#), [48](#)), of which approximately 35% is phospholipid ([49](#)). Phosphatidylcholine and phosphatidylethanolamine account for approximately 75% of the phospholipid in intact neutrophils ([49](#)). Subcellular distribution studies reveal that plasma membranes and secretory vesicles contain approximately 50% of the cellular phospholipid. Most of the phosphatidylinositol and phosphatidylcholine are present in plasma membrane and secretory granules, whereas a large part of the phosphatidylethanolamine is found in the specific granules ([49](#)). Among the phospholipids, the phosphoinositides are important as sources of inositol 1,4,5-triphosphate (IP<sub>3</sub>) (a signal transduction molecule that results in calcium release) and diacylglycerol [which activates protein kinase C (PKC)]. The occurrence of arachidonic acid in phospholipids, especially phosphatidylcholine, is important as a precursor for the production of leukotrienes, prostaglandins,



thromboxanes, and lipoxins ( 50, 51 ). Cholesterol and triglycerides constitute most of the nonphospholipid neutrophil lipid. Glycolipids, which include both neutral glycosphingolipids and gangliosides, constitute the remaining neutrophil lipids. The study of glycolipids is complex, and the glycolipid composition of neutrophils is not well understood. Glycolipids are important because their carbohydrate components contain many neutrophil differentiation antigens with a multitude of potential functions. The major neutrophil glycolipid is lactosylceramide (LacCer: Gal $\beta$ 1 ? 4Glc $\beta$ 1 ? 1Cer) ( 52, 53 and 54 ) and is recognized by CDw17 monoclonal antibodies. Interestingly, the surface expression of LacCer decreases after neutrophil stimulation. More than 75% of neutrophil LacCer is found in intracellular granules ( 53, 55 ). It has been hypothesized that most LacCer in the granule membranes is found in the outer leaflet and may contribute to the ability of these membranes to form the highly convex surfaces necessary to form these submicron particles ( 51 ). Approximately 75% of the five major glycosphingolipids are located intracellularly ( 55 ). Studies of the subcellular distribution of glycosphingolipids in neutrophils have found no differences among the plasma membrane, primary granules, or secondary granules in the relative amounts of these five glycosphingolipids ( 55 ).

## Lipid Rafts

Studies have demonstrated the existence of large noncovalent detergent-resistant complexes in cell extracts that contain important signaling molecules, including protein kinases and many glycosyl-phosphatidylinositol-linked membrane proteins capable of transmitting signals ( 56, 57, 58 and 59 ). These complexes have been termed *lipid rafts* or *large detergent-resistant complexes*. It is postulated that these complexes or rafts reflect the existence of specific membrane microdomains that have a particular lipid composition, and that these clusters of molecules may be important in transmembrane signaling by proteins in the complex. Rafts or detergent-resistant complexes have been observed in neutrophils (60; Draber P, Draberova L, Skubitz K. *Personal communication*, 2001). There is evidence that in neutrophils proteins may enter these rafts when they are translocated to the cell surface. For example, it appears that CD63 and CD11b/CD18 are not present in detergent-resistant complexes when they are intracellular, but they enter such complexes after translocation to the cell surface ( 60 ).

## Cytoplasmic Lipid Bodies

Cytoplasmic lipid bodies, non-membrane-bound cytoplasmic inclusions, have been described in neutrophils ( 54 ). In inflammation, the number of cytoplasmic lipid bodies in neutrophils increases ( 62 ). These lipid bodies may provide nonmembrane stores of esterified arachidonate. In addition, some signaling proteins, including phosphatidylinositide-3-kinase, are localized to these lipid bodies ( 63 ), although the exact role of these lipid bodies in cell function is unclear ( 63, 64 ).

## Cytosol

Although neutrophil cytoplasm contains many components common to all cells, it is interesting to note that approximately 45% of neutrophil cytosolic protein appears to be attributable to migration inhibitory factor-related proteins (MRPs), MRP-8 and MRP-14 ( 65 ). MRP-8 and MRP-14 are members of the S100 family of calcium binding proteins and form homo- and heterodimers. MRP-14 has been variously called *p14*, *L1 heavy chain*, and *calgranulin b*, and MRP-8 is also known as *p $\delta$* , *L1 light chain*, *calgranulin a*, and *cystic fibrosis antigen* ( 66, 67, 68, 69 and 70 ). Although the role of these proteins in neutrophil function is unclear, the quantity of MRP-8 and MRP-14 associated with neutrophil plasma

membranes has been reported to increase after stimulation ( [65](#) ). MRP-14 can inhibit macrophage activation ( [71](#) ). Annexin I or lipocortin I comprises approximately 3% of cytosolic protein ( [72](#) ). Annexin I is partially regulated by glucocorticoids and appears to be a mediator of the antiinflammatory effects of glucocorticoids ( [72](#) ).

One other notable cytoplasmic constituent is glycogen. Because neutrophils are sometimes required to function in hypoxic conditions, as in an abscess, they are very capable of obtaining energy by glycolysis. The presence of large intracellular glycogen stores gives them the additional ability to function in areas of low extracellular glucose.

## Nucleus

In the past, it has been felt that neutrophils, as end-stage cells, undergo little RNA or protein synthesis. More recently, it has been demonstrated that mature neutrophils can synthesize both RNA and protein ( [73](#) , [74](#) and [75](#) ).

## MORPHOLOGY OF NEUTROPHILS AND PRECURSORS

Evidence for the replenishment of marrow and blood cells from a stem cell compartment is described in [Chapter 8](#). Neither multipotent hematopoietic stem cells nor more committed progenitors are readily identified morphologically by traditional methods, and reliable EM criteria for distinguishing myeloblasts from monoblasts or lymphoblasts are also lacking ( [76](#) , [77](#) , [78](#) , [79](#) and [80](#) ), although pronormoblasts often can be differentiated by the presence of ferritin on the cell surface or in coated vesicles ( [76](#) ). Only the more mature forms of each hematopoietic cell series can be reliably distinguished from one another. In the following pages, the cells identifiable as neutrophils and their precursors are described; other aspects of the eosinophil and basophil systems are considered in [Chapter 14](#) and [Chapter 15](#).

Neutrophilic, eosinophilic, and basophilic granulocytes are thought to follow similar patterns of proliferation, differentiation, maturation, and storage in the bone marrow and delivery to the blood. The details of these processes are best documented for neutrophils. In the first three morphologic stages, the myeloblast, promyelocyte, and myelocyte cells are capable of replication, as shown by their uptake of tritiated thymidine (  $^3\text{H-TdR}$  ) and the presence of mitoses; in later stages, cells cannot divide but continue to differentiate. The morphologic boundaries of each cell compartment were defined many years ago and were based on criteria such as cell size, ratio of size of nucleus to cytoplasm, fineness of nuclear chromatin, nuclear shape, the presence or absence of nucleoli, the presence and type of cytoplasmic granules, and the cytoplasmic color of stained cells ( [Table 10.3](#) ).

**TABLE 10.3. Morphologic Characteristics of Leukocytes (Wright Stain)**

| Type of Cell | Size (μm) | Nucleus              |               |                      |                    |
|--------------|-----------|----------------------|---------------|----------------------|--------------------|
|              |           | Position             | Shape         | Color                | Chromatin          |
| Granulocytes |           |                      |               |                      |                    |
| Myeloblast   | 10–18     | Eccentric or central | Round or oval | Light reddish purple | Very fine meshwork |

|                              |       |                      |                                    |                      |   |
|------------------------------|-------|----------------------|------------------------------------|----------------------|---|
| Promyelocyte                 | 12-20 | Eccentric or central | Round or oval                      | Light reddish purple | Very fine meshwork                                  |
| Myelocyte                    | 12-18 | Eccentric            | Oval or slightly indented          | Reddish purple       | Fine but becomes gradually coarser                  |
| Metamyelocyte                | 10-18 | Central or eccentric | Thick horseshoe or indented        | Light purplish blue  | Basi- and oxychromatin clearly distinguished        |
| Juvenile or band form        | 10-16 | Central or eccentric | Band shape of uniform thickness    | Light purplish blue  | Basi- and oxychromatin clearly distinguished        |
| Polymorphonuclear neutrophil | 10-15 | Central or eccentric | 2-5 or more distinct lobes         | Deep purplish blue   | Rather coarse                                       |
| Polymorphonuclear eosinophil | 10-15 | Central or eccentric | 2-3 lobes                          | Purplish blue        | Coarse  |
| Polymorphonuclear basophil   | 10-15 | Central              | 2-3 lobes                          | Purplish blue        | Coarse, overlaid with granules                      |
| Lymphocytes                  |       |                      |                                    |                      |   |
| Lymphoblasts                 | 10-18 | Eccentric or central | Round or oval                      | Light reddish purple | Moderately coarse particles, stippled               |
| Mature lymphocyte            | 7-18  | Eccentric            | Round or slightly indented         | Deep purplish blue   | Large masses of moderate or large size, or pyknotic |
| Monocyte/macrophage          |       |                      |                                    |                      |   |
| Promonocyte                  | 12-20 | Eccentric or central | Round or oval, moderately indented | Pale bluish violet   | Fine reticulated, skeinlike or lacy                 |
| Monocyte                     | 12-20 | Eccentric or central | Round, oval, notched, or horseshoe | Pale bluish violet   | Fine reticulated, skeinlike or lacy                 |
| Macrophage                   | 15-80 | Central              | Elongated, indented, or oval       | Pale bluish violet   | Spongy  |

| Nucleus          |          |                 | Cytoplasm   |                        |  |
|------------------|----------|-----------------|-------------|------------------------|--|
| Nuclear Membrane | Nucleoli | Relative Amount | Color       | Perinuclear Clear Zone | Granules   |
| Very fine        | 2-5      | Scanty          | Blue        | None                   | None   |
| Fine             | 2-5      | Moderate        | Blue        | None                   | Primary (azurophilic, eosinophilic, or basophilic)           |
| Indistinct       | Rare     | Moderate        | Bluish pink | None                   | Primary plus, in neutrophils, secondary or specific granules |
| Present          | None     | Plentiful       | Pink        | None                   | Neutrophilic, eosinophilic, or basophilic                    |

|              |      |                     |   |                              |  |
|--------------|------|---------------------|---|------------------------------|--|
| Present      | None | Plentiful           | Pink  | None                         | Neutrophilic, eosinophilic, or basophilic                |
| Present      | None | Plentiful           | Faint pink                                  | None                         | Fine, pink, or violet pink                               |
| Present      | None | Plentiful           | Pink  | None                         | Large, coarse, uniform in size, crimson red, numerous    |
| Present      | None | Plentiful           | Faint pink                                  | None                         | Large, coarse, uniform, bluish black                     |
| Fairly dense | 1-2  | Scanty              | Clear blue                                  | Present                      | None   |
| Dense        | None | Scanty or plentiful | Sky blue, deep blue, or even very pale pink | Present if cytoplasm is dark | None or few azurophilic                                  |
| Present      | 1-2  | Moderate            | Grayish or cloudy blue                      | None                         | Few, fine, lilac, or reddish                             |
| Present      | None | Abundant            | Grayish or cloudy blue                      | None                         | Abundant, fine, lilac, or reddish blue                   |
| Distinct     | None | Usually abundant    | Opaque sky blue                             | None                         | Numerous, moderately coarse azure granules, and vacuoles |

---

Because changes in nuclear chromatin and cell size occur during each cell replication cycle and the formation of granules and other cytoplasmic changes occur gradually during the stages of cell development, morphologic definitions are necessarily arbitrary and do not always conform to significant biochemical or physiologic changes. Classifying a cell in one category or another often is difficult because it is actually in transition between the two. Nevertheless, it is useful to separate the cell lines into morphologic compartments and to define normal limits of cell distribution therein because gross changes from these patterns indicate disease.

## DEVELOPMENT OF NEUTROPHILS AND THEIR PRECURSORS

Neutrophil development is summarized in [Figure 10.1](#).



**Figure 10.1.** Appearance of granules during neutrophil maturation. Myeloblasts are undifferentiated cells with a large oval nucleus, large nucleoli, and cytoplasm lacking granules. They originate from a precursor pool of stem cells. Subsequently, there are two stages—the promyelocyte and the myelocyte—each of which produces a distinct type of secretory granule: azurophilic ( *dark granules*) are produced only during the promyelocyte stage; specific granules ( *light granules*) are produced during the myelocyte stage. The metamyelocyte and band forms are nonproliferating stages that develop into the mature polymorphonuclear neutrophil characterized by a multilobulated nucleus and cytoplasm containing primarily glycogen and granules. Both nonspecific azurophilic granules and specific granules persist throughout these later stages. (Modified from Bainton DF, et al. The development of neutrophilic PMN leukocytes in human bone marrow: origin and content of azurophil and specific granules. J Exp Med 1971;134:907.)

Cell division is limited to myeloblasts, promyelocytes, and myelocytes, with later developmental stages undergoing differentiation but no further cell division. The myeloblast contains few granules and is derived from more primitive cells as described in [Chapter 8](#). As the cell differentiates to the promyelocyte stage, development of primary or azurophil granule formation becomes evident. This granule contains MPO, an enzyme whose activity is a classic marker of myeloid differentiation. Azurophil granule production ceases at the end of the promyelocyte stage, coincident with the loss of peroxidase activity from the rough endoplasmic reticulum. Secondary granule, or specific granule, formation begins as the neutrophil enters the myelocyte stage. The peroxidase-negative specific granules are smaller (approximately 200-nm diameter) than the azurophil granules (approximately 500-nm diameter) and are near the limit of resolution by light microscopy. The specific granules impart a pinkish ground-glass background color to neutrophils in Wright-stained smears. Because azurophil granule formation ceases in the promyelocyte stage and the subsequent myelocyte form is still capable of cell division, the density of azurophil granules is lower in differentiation stages past the promyelocyte. The result is that mature neutrophils contain approximately two specific granules for every azurophil granule. With maturation, the azurophil granules, which generate reddish-purple staining in the promyelocytes, lose this metachromasia as they leave the myelocyte stage. This alteration in staining properties is thought to be caused by an increase in acid mucosubstances, which complex with basic proteins already present in the azurophil granules ( [81](#)). Thus, in the mature neutrophil, the azurophil granules appear as light blue-violet granules on Wright-stained smears. The azurophil granules are readily demonstrated by peroxidase staining with light microscopy.

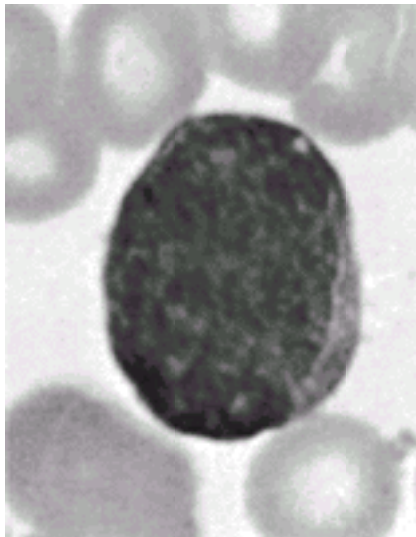
Data concerning antigenic differences between granulocytes and monocytes and their stages of maturation are developing rapidly. Much of this information has been developed using monoclonal antibodies. Such monoclonal antibodies have been analyzed in a series of international workshops in which antibodies are grouped into clusters of differentiation (CD). Although technically only antibodies are assigned CD specificity, in many publications the use of the CD terminology is often used to describe the antigen as well. It must be kept in mind that, because epitopes recognized by monoclonal antibodies are small, many epitopes may be present on an individual molecule, and antibodies may recognize several closely related epitopes, the use of CD nomenclature to characterize

molecules recognized by antibodies of a particular CD may lead to confusion or incorrect conclusions. Some of the CD antigens expressed on neutrophils defined in the Fifth International Workshop and Conference on Human Leukocyte Differentiation Antigens are shown in [Table 10.2](#). Immunogold and enzyme-linked immunologic methods ([82](#)) permit simultaneous morphologic and immunologic examination of individual cells.

## Myeloblast

The word *myeloblast* describes an immature cell, typically found in the bone marrow and not in the blood. This cell can divide and give rise to promyelocytes, which in turn give rise to myelocytes. On the basis of the findings from marrow culture and transplant studies, the neutrophil and macrophage lines share a common stem cell, colony-forming unit granulocyte-monocyte (CFU-GM) ([83](#), [84](#), [85](#) and [86](#)).

The myeloblast ([Fig. 10.2](#)) has a large nucleus, is round or slightly oval, and has a small amount of cytoplasm. In preparations treated with Wright stain ([Table 10.3](#)), the nuclear membrane is smooth and even in outline and is exceedingly thin, with no condensation of chromatin near its inner surface, as noted in lymphoblasts. The chromatin shows an even, diffuse distribution with no aggregation into larger masses, although some condensation may be noted about the nucleoli. The chromatin may appear in the form of fine strands, thus giving the nucleus a sievelike appearance; alternatively, it may have the form of fine dustlike granules, producing a uniform stippled effect. Generally, the myeloblast contains two to five pale, sky-blue nucleoli. The cytoplasm is basophilic (blue), and usually, although not invariably, no clear zone is evident about the nucleus. Sometimes, the cytoplasm is reticular, spongy, or foamy. By definition, no granules are present in the cytoplasm. Leukemic myeloblasts that contain no perceptible granules often are identified by special stains that demonstrate the presence of MPO or esterase, thus providing early evidence of differentiation ([87](#)).



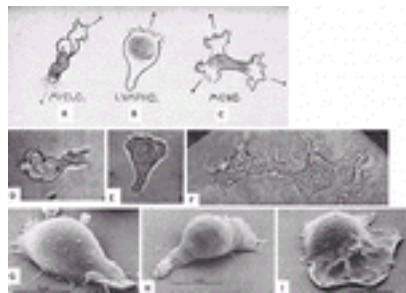
**Figure 10.2.** Myeloblast ( $\times 1000$ , Wright stain). See [Color Plate](#).

EM reveals similar findings ([88](#), [89](#)). The nuclear membrane is thin and indistinct with minimal or no chromatin condensation. The numerous particles of ribonucleoprotein in the cytoplasm produce deep blue basophilia in stained preparations. Mitochondria are abundant but small, and the endoplasmic reticulum is flat and appears infrequently. The

Golgi apparatus is indistinct, and no cytoplasmic granules are present. EM studies of myeloblasts show peroxidase activity in the rough endoplasmic reticulum and Golgi.

Some authors classify what may be slightly more mature cells with several rather large, angular, irregular, and dark-staining azurophilic cytoplasmic granules as myeloblasts. A simpler approach, however, is to include such forms in the promyelocyte stage, thus making the separation between the two cell types clear-cut. The EM classification of myeloid cells, which is based primarily on stages of granule formation, also places cells with beginning granule formation in the promyelocyte category ([80](#), [90](#)).

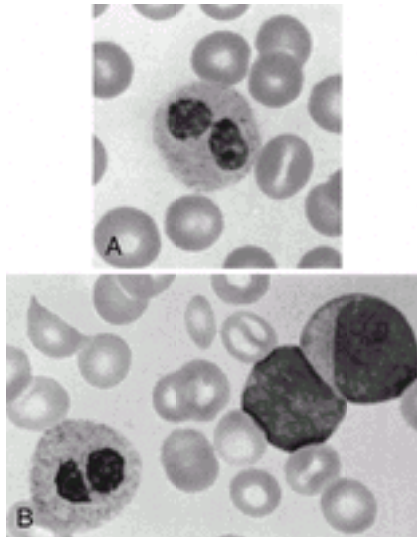
In wet films, myeloblasts appear immobile with thin, tenacious borders. The cytoplasm is hazy and usually contains no stainable substance other than mitochondria, which are diffusely scattered throughout the cytoplasm and stain brilliant blue-green with Janus green. The failure of myeloblasts to move in supravitral preparations is probably related to the nature of the preparation itself rather than to the cells' immobility. In motion picture studies of hanging-drop preparations ([Fig. 10.3](#)), myeloblasts manifest a characteristic snaillike movement ([91](#), [92](#)).



**Figure 10.3.** Diagrams (A, B, C), photographs (D, E, F), and scanning electron micrographs (G, H, I) of living, moving, unstained blasts. The photographs are of cells enlarged ( $\times 1000$ ) from negatives of motion picture films of tissue cultures. **A:** Wormlike shape of myeloblast (myelo.) in motion. **B:** Hand-mirror shape of lymphoblast (lympho.) in motion. **C:** Shape of monocyte (mono.) (histiocyte) in motion. **D:** Myeloblast from the blood of a patient with acute myeloblastic leukemia. **E:** Lymphoblast from the blood of a patient with acute lymphoblastic leukemia. **F:** Two monocytes from normal blood. **G:** Human leukemic myeloblast. **H:** Human leukemic lymphoblast. **I:** Human leukemic monoblast. (Photographs used with permission from Rich AR, et al. The differentiation of myeloblasts from lymphoblasts by their manner of locomotion. Bull Johns Hopkins Hosp 1939;65:291; and electron micrographs used with permission from Senda N. The movement of leucocytes. J Clin Electron Microsc 1974;7:3.)

Because they are in the process of growth and division, myeloblasts vary considerably in size from 10 to 20  $\mu\text{m}$  in diameter. Particularly in patients with acute leukemia, the nucleus may show several wide and deep indentations, suggesting lobulation. Such myeloblasts [see Rieder cells ([93](#))] suggest more rapid maturation on the part of the nucleus than of the cytoplasm (asynchronism of Di Guglielmo). Also in association with leukemia, Auer bodies are evident in the cytoplasm of cells that otherwise look like myeloblasts ([Fig. 10.4A](#), [Fig. 10.4B](#)).



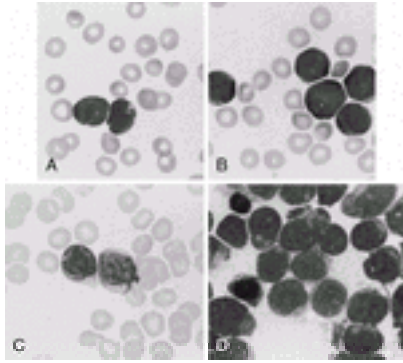


**Figure 10.4. A, B:** Pseudo-Pelger-Huët cells, the latter from the blood of a patient with acute myeloblastic leukemia ( $\times 1000$ , Wright stain). See [Color Plate](#).

Rieder cells, in which the nucleus is polymorphous or highly differentiated yet the cytoplasm is immature, are not a specific cell type but probably represent asynchrony of nuclear and cytoplasmic differentiation in monocytes, lymphocytes, myeloblasts, leukoblasts, or reticuloendothelial monocytoïd cells ([94](#)).

### Differentiation from Lymphoblasts and Other Blasts

With the usual Romanowsky stains and light microscopy, distinguishing among the leukoblasts (myeloblasts, lymphoblasts, and monoblasts) and even pronormoblasts is extremely difficult if cells showing beginning maturational changes (granule formation or hemoglobin synthesis) are excluded from the blast category ([80](#), [88](#)). In the lymphoblast, the nuclear membrane is more dense than that of the myeloblast, and the chromatin is more coarse and may show some aggregation. [Figure 10.5](#) shows representative acute lymphoblastic leukemia cells ([Fig. 10.5A](#), [Fig. 10.5B](#)) and acute myeloid leukemia cells ([Fig. 10.5C](#), [Fig. 10.5D](#)). Lymphoblasts generally have only one or two nucleoli, and their membrane usually is distinct. The mitochondria are short and plumper than those of myeloblasts and often assume a position close to the nucleus. The monoblast is described as showing characteristics similar to those of the mature monocyte, such as fine chromatin, pale nucleus, and ground-glass cytoplasm with a fine, irregular border. In many instances, the identification of blast cells is greatly aided by the company they keep (the more mature and more easily recognized cells about them in sections or in the same blood smear). With the myeloblast, the demonstration of associated promyelocytes, which show azure granulation in Wright or similar stains, is presumptive evidence for this cell's identification. Special stains to detect enzymes, such as peroxidase or esterase, in the blast cytoplasm before lysosomal granules appear may at times be useful in identification, especially in the classification of leukemia ([87](#), [95](#)).

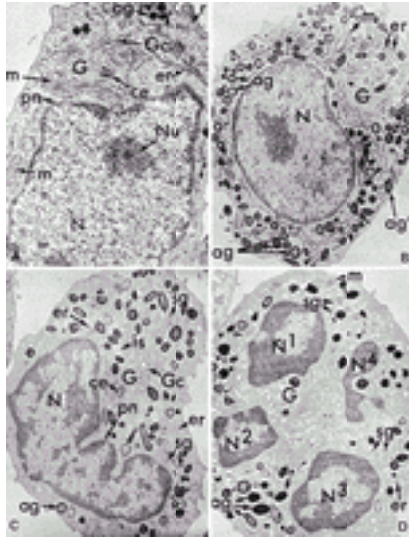


**Figure 10.5.** A: L1 lymphoblastic leukemia, blood. B: L2 lymphoblastic leukemia, blood. C: Acute leukemia, M1 blood ( $\times 1500$ ). D: Acute leukemia, M1 marrow ( $\times 1500$ ). See [Color Plate](#).

### Neutrophil Promyelocytes and Myelocytes

The developmental stages in the granulocyte series and some of their morphologic variations are shown in [Figure 10.1](#). In the past, the several stages beyond the myeloblast were differentiated primarily on the basis of the number and type of granules. Now, EM histochemical and biochemical findings demonstrate that the azurophilic or primary granules first appear at the promyelocyte stage and can be identified on fine structural study as characteristic of the neutrophil, eosinophil, or basophil series ([80](#), [88](#), [90](#), [96](#), [97](#)). They do not transform into specific granules but persist throughout the remainder of the maturation sequence and are seen in all subsequent stages, including the polymorphonuclear forms ([Fig. 10.1](#)) ([90](#), [97](#), [98](#)).

The neutrophil promyelocyte is somewhat larger on average than the myeloblast. In both light and EM preparations, it has a round or oval nucleus in which the nuclear chromatin is diffusely distributed, as in the myeloblast; in later stages, slight chromatin condensation is discerned around the nuclear membrane. Nucleoli are present, but as the cell develops, they become less prominent. Compared with the myeloblast, the endoplasmic reticulum in EM preparations is more prominent and takes on a dilated, vesicular appearance. The azurophilic, primary granules appear and accumulate in increasing numbers during this stage, but the specific or secondary granules are not yet present ([Fig. 10.6](#)) ([80](#), [89](#), [90](#), [96](#), [98](#)). In early promyelocytes, the few granules present may be difficult to see by using light microscopy; they often lie over the nucleus and are evident only on examination at several focal planes.



**Figure 10.6.** Early and late promyelocytes, a myelocyte, and a polymorphonuclear neutrophil (PMN) viewed by electron microscopy. (Courtesy of Bainton D, University of California, San Francisco.) **A:** Early neutrophilic promyelocyte (reacted for peroxidase, 10,500). The nucleus (*N*) with its prominent nucleolus (*Nu*) occupies the bulk of this immature cell. The surrounding cytoplasm contains a few azurophil granules (*ag*), a large Golgi complex (*G*), Golgi cisternae (*Gc*), several mitochondria (*m*), scanty rough endoplasmic reticulum (*er*), and many free polysomes (*r*). A centriole (*ce*) is present in the Golgi region. All of the azurophil granules (*ag*) appear dense because they are strongly reactive for peroxidase. The secretory apparatus [i.e., the perinuclear cisterna (*pn*), rough endoplasmic reticulum (*er*), and Golgi cisternae (*Gc*)] are also reactive although less so than the granules. Specimen was fixed in glutaraldehyde for 16 hours at 4° C, incubated in the peroxidase medium of Graham and Karnovsky for 1 hour at 22° C, postfixed in osmium tetroxide, treated in block with uranyl acetate, dehydrated in ethanol, infiltrated with propylene oxide, and embedded in Araldite. Section stained for 1 minute with lead citrate. **B:** Late neutrophilic promyelocyte (reacted for peroxidase, 7000). This cell is the largest (15 μm) of the neutrophilic series. It has a sizable, slightly indented nucleus (*N*), a prominent Golgi region (*G*), and cytoplasm packed with peroxidase-positive azurophil granules (*ag*). Note the two general shapes of the azurophil granules: spherical (*ag*) and ellipsoid (*ag*). Most are spherical, with a homogeneous matrix, but a few ellipsoid forms containing crystalloids also are present. Many of the spherical forms (*ag*) have a dense periphery and a lighter core, presumably because of incomplete penetration of substrate into the compact centers of mature granules. Peroxidase reaction product is visible (under higher magnification) in less concentrated form within all compartments of the secretory apparatus (endoplasmic reticulum, perinuclear cisterna, and Golgi cisternae). No reaction product is seen in the cytoplasmic matrix, mitochondria, or nucleus. Specimen was fixed in glutaraldehyde for 10 minutes at 4° C and subsequently processed exactly as was the specimen in **A**. **C:** Neutrophilic myelocyte (reacted for peroxidase, 9000). At this stage, the cell is smaller (10 μm) than the promyelocyte, the nucleus is more indented, and the cytoplasm contains two different types of granules: large, peroxidase-positive azurophils (*ag*) and the generally smaller, specific granules (*sg*), which do not stain for peroxidase. A number of immature specific granules (*is*), which are larger, less compact, and more irregular in contour than mature granules, are seen in the Golgi region (*G*). Note that peroxidase reaction product is present only in azurophil granules and is not seen in the rough endoplasmic reticulum (*er*), perinuclear cisterna (*pn*), and Golgi cisternae (*Gc*), in keeping with the fact that azurophil production has ceased, and only peroxidase-negative specific granules are produced during the myelocyte stage. **D:** Mature PMN (reacted for peroxidase, 10,500). The cytoplasm is filled with granules; the smaller peroxidase-negative specific granules (*sg*) are more numerous, the azurophils (*ag*) having been reduced in number by cell divisions after the promyelocyte stage. Some small, irregularly shaped azurophil granule variants are also present (*unlabeled arrow*). The nucleus is condensed and lobulated (

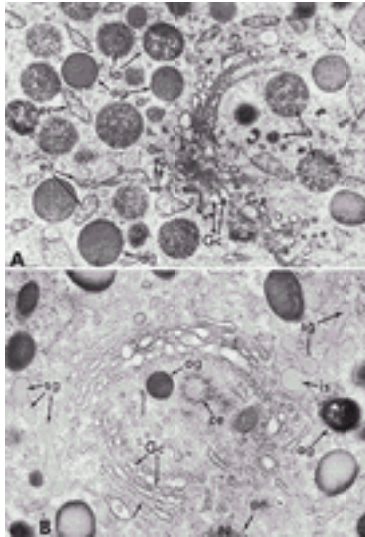
*N1-N4*), the Golgi region ( *G* ) is small and lacks forming granules, the endoplasmic reticulum ( *er* ) is scanty, and mitochondria ( *m* ) are few. Note that the cytoplasm of this cell has a rather ragged, moth-eaten appearance because the glycogen, which is normally present, has been extracted in this preparation by staining in block with uranyl acetate.

Like the myeloblast, the promyelocyte is immobile in flat slide and cover glass preparations; only in the last stage is slight locomotion evident. Even then, the streaming of granules so characteristic of mature granulocytes is lacking ( [99](#) ). For this reason, the cytoplasm has been thought to be in the form of a gel; the increased resistance of the cytoplasm of immature myeloid cells to changes in shape has been proposed as a factor in retention of these cells in the bone marrow ( [100](#), [101](#) ). In hanging-drop preparations, however, promyelocytes are actively mobile.

The *neutrophilic myelocyte* may be defined as the stage in which specific (secondary) granules appear in the cytoplasm and the cell consequently can be identified as belonging to the neutrophilic series when stained and observed to have a pinkish ground-glass background color with the light microscope. As mentioned above, earlier identification of a cell that will become neutrophilic can be made by EM examination of the azurophilic, or primary, granules ( [88](#) ). The nucleus of the neutrophilic myelocyte usually is eccentric and round or oval; one side may appear flattened. The nuclear chromatin is somewhat coarse, and nucleoli are small and often not visible, although they are seen clearly with the electron microscope ( [96](#) ). Primary granules persist in myelocytes, but formation of new primary granules is limited to the promyelocyte, and each succeeding cell division leads to a decrease in their number in the daughter population ( [Fig. 10.1](#) ) ( [90](#), [98](#), [99](#) ). The secondary granules of the neutrophil series are smaller than the primary granules; in the rabbit, cat, and human, they are formed in increasing numbers on the convex surface and lateral borders of the somewhat less prominent Golgi apparatus ( [90](#), [96](#), [98](#) ). The amount of granular endoplasmic reticulum is lower in the myelocyte than in earlier forms, so the cytoplasmic basophilia decreases and disappears. The mitochondria remain small and are few.

### Neutrophil Granule Development

Studies in the rabbit, cat, and human suggest that the primary granules are packaged and released from the inner, concave surface of the Golgi apparatus ( [Fig. 10.7A](#) )—in contrast to the specific or secondary granules of the myelocyte and later granulocyte stages that appear to be formed and released from the outer, convex surface ( [90](#), [96](#), [97](#) and [98](#) ). Studies of membranes from rabbit azurophil and specific granules, although demonstrating similar ultrastructure, have shown them to be distinct and different in cholesterol-phospholipid ratios and protein components ( [102](#) ). This finding not only appears to confirm different sites of granule formation, but also may provide a basis for differences in interaction with endocytic vacuoles. In the mature neutrophil, a ratio of secondary to primary granules of approximately 9:1 is seen in the rabbit ( [103](#) ) and 2 or 3:1 in humans ( [90](#), [104](#) ).



**Figure 10.7.** Granule formation in neutrophil precursors viewed by electron microscopy. (Courtesy of Bainton D, University of California, San Francisco.) **A:** Golgi region of a neutrophilic promyelocyte reacted for peroxidase ( $\times 40,000$ ). At this stage, the peroxidase reaction product is present within the rough endoplasmic reticulum (*er*), the clusters of smooth vesicles (*ve*) at the periphery of the Golgi cisternae (*Gc*), in the Golgi cisternae, and in the immature (*ia*) and mature (*ag*) azurophilic granules. The immature granules are larger and less compact than the uniformly dense mature granules. **B:** Golgi region of a neutrophilic myelocyte reacted for peroxidase ( $\times 40,000$ ). Peroxidase-reactive material is seen in the primary or azurophilic granules (*ag*) but not in the specific (secondary) granules (*sg*). At this stage (myelocyte), no peroxidase reaction product is seen in the endoplasmic reticulum, Golgi cisternae (*Gc*), or newly formed, immature specific granules (*is*). The stacked Golgi cisternae are oriented around the centriole (*ce*), and the outer cisternae (*unlabeled arrow*) contain material of intermediate density that is similar to the content of the specific granules, suggesting that the specific granules arise from the convex face of the Golgi complex as in the rabbit. *pn*, perinuclear cisternae.

The mature primary granules of human neutrophils usually contain central crystalloids when lightly stained ([97](#)). They apparently bind neutral red dye and thus are seen easily as neutral red bodies in supravital preparations ([105](#)). These membrane-bound lysosomes contain enzymes and other substances ([Table 10.1](#)) ([80](#), [90](#), [106](#), [107](#)). Acid phosphatase activity varies considerably, as reported in different studies and in different species ([96](#), [97](#), [108](#), [109](#)). This may be because of inadequacies of the histochemical assays or perhaps is related to species variations ([80](#)). Peroxidase has been associated with primary granules by histochemical, cytochemical, and biochemical methods and is considered a marker enzyme for primary granules in mammals ([80](#), [110](#)). Sulfated mucosubstance presumably accounts for the azurophilic staining of the primary granules; the uptake of radiosulfate by early-stage neutrophils may be the result of incorporation into this substance ([111](#), [112](#)).

The secondary granules of the neutrophil were thought in the past to be characterized by their content of alkaline phosphatase and lack of acid phosphatase ([80](#), [90](#), [113](#)); they lack peroxidase and sulfated mucosaccharide or contain a minimal amount ([80](#)). Alkaline phosphatase was found in blood and exudate neutrophils by many workers, but considerable variation exists between species ([80](#), [96](#), [106](#), [108](#)) and in certain pathologic states ([114](#)). Results of histochemical ([80](#), [90](#), [108](#), [115](#)) and biochemical ([113](#), [116](#)) studies suggested that this enzyme was located in the secondary granules of neutrophils in



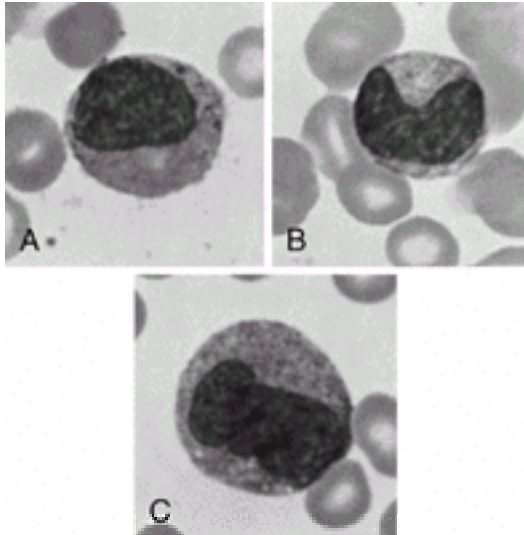
humans and rabbits, perhaps bound to the inner membrane ( [104](#) , [117](#) ). However, subsequent studies demonstrated that alkaline phosphatase is localized in a previously unrecognized organelle, the secretory vesicle ( [Table 10.1](#) ) ( [118](#) ). Lysozyme is present in human neutrophil secondary granules ( [119](#) ), as well as in primary granules; approximately two-thirds of this antibacterial basic protein is in the secondary granule ( [86](#) , [116](#) ). The standard marker enzymes for specific granules are lactoferrin ( [110](#) ) and B<sub>12</sub>-binding protein ( [120](#) ).

A third type of granule, the tertiary granule, also known as the *gelatinase granule* ( [Table 10.1](#) ) ( [97](#) , [121](#) ), is synthesized mainly during the band and segmented neutrophil stages ( [97](#) , [122](#) , [123](#) ).

### Neutrophil Metamyelocytes

The metamyelocyte is characterized by a clearly indented or horseshoe-shaped nucleus without nucleoli (even by EM examination), and the nuclear chromatin is moderately dense, with considerable clumping evident along the nuclear membrane. The cytoplasm is filled with primary, secondary, and tertiary ( [85](#) , [111](#) ) granules, but the secondary granules predominate. The endoplasmic reticulum is sparse, as are polysomes, thus signifying the virtual completion of protein synthesis.

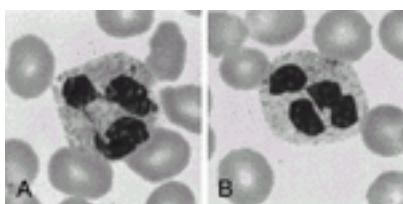
The boundary between the myelocyte and metamyelocyte compartments is best defined physiologically by the fact that myelocytes synthesize DNA, take up <sup>3</sup>H-TdR into their nuclear chromatin, divide, and are actively involved in protein synthesis, as evidenced by the presence of nucleoli, abundant endoplasmic reticulum, and polysomes. Before such techniques became available, differentiation between myelocytes and metamyelocytes was defined mainly in terms of nuclear shape. This characteristic now is recognized as a poor criterion because it has been shown in time-lapse microcinematographic studies of human neutrophils that myelocyte nuclei may assume a markedly indented shape and may subsequently revert to an oval configuration and enter mitosis ( [88](#) ). Consequently, in classifying cells at this stage, the observer should pay particular attention to evidence in the nucleus and cytoplasm that protein synthesis has decreased or stopped. This determination is made on the basis of the fact that the nuclear chromatin is coarse and clumped and that the cytoplasm is faint pink and is essentially the color of the mature cell in stained preparations. These features also are helpful in differentiating metamyelocytes ( [Fig. 10.8A](#), [Fig. 10.8B](#) ) from monocytes ( [Fig. 10.8C](#); see also [Fig. 16.3](#) ) because in monocytes, nuclear chromatin remains fine, and evidence of protein synthesis persists. Ameboid movement is apparent in metamyelocytes, even in cover glass slide preparations, and it is at this stage that directional migration can regularly be demonstrated ( [124](#) ).



**Figure 10.8.** A: Late myelocyte or early metamyelocyte. B: Metamyelocyte. C: Monocyte ( $\times 1000$ , Wright stain). See [Color Plate](#).

### Band Neutrophils

The band stage is characterized by further condensation of nuclear chromatin and transformation of nuclear shapes into sausage or band configurations that have approximately uniform diameters throughout their length ( [Fig. 10.1](#)). Subsequently, one or more constrictions begin to develop and progress until the nucleus is divided into two or more lobes connected by filamentous strands of heterochromatin, the polymorphonuclear stage. A difference of opinion exists concerning the differentiation of the juvenile (band) and polymorphonuclear stages. Some workers require a clearly visible filamentous strand between lobes ( [Fig. 10.9A](#), [Fig. 10.9B](#)) before classifying a cell as a polymorphonuclear form; anything less clear-cut, whether because of overlapping of nuclear lobes or incomplete constriction, is classified as a band form ( [125](#), [126](#)). Other investigators regard a constriction greater than one-half or two-thirds of the nuclear breadth as adequate evidence of lobulation and classify such cells as polymorphonuclear ( [127](#), [128](#)) or use slightly different criteria ( [129](#)). Still others avoid the issue entirely. Because no clear difference has been shown between band and segmented stages other than nuclear shape and a slightly earlier appearance of  $^3\text{H-TdR}$  in the band forms, the distinction becomes arbitrary. However, a clear and easily recognizable separation is needed if one wishes to count nuclear lobes for diagnostic purposes, as in the early detection of folic acid deficiency ( [130](#)) or in assessing marrow release of young forms into the blood ( [131](#)). For such purposes, we have chosen the clear separation of nuclear lobes as the criterion for inclusion in the polymorphonuclear category ( [126](#)). Cells without this complete formation of distinct lobes (usually connected by a filamentous strand) are classified as band forms.



**Figure 10.9.** A, B: Polymorphonuclear neutrophils. See [Color Plate](#).



## Polymorphonuclear Neutrophils

In the polymorphonuclear stage, the nucleus in Wright-stained preparations is a deep, purplish color and contains coarse, condensed chromatin. The lobes are joined by thin filaments of chromatin, although the filaments may not be easily visible if the lobes are partially superimposed. Careful examination by focusing through several planes may facilitate identification. The cytoplasm is faint pink and contains fine, specific granules that sometimes give only a ground-glass appearance. The azurophilic or primary granules have usually lost their dark-staining characteristics by this stage but can be seen with EM. With this technique, the granules exhibit considerable variation in density, presumably a reflection of variation in enzyme content, and they maintain a minimum distance of 100 nm from the cell membrane (132). Large masses of glycogen become evident for the first time in mature neutrophils; this finding may contribute to their capacity for anaerobic metabolism.

The mechanism and purpose of nuclear lobulation are the subject of much speculation. Perhaps it enhances cell deformability and movement through vessel walls and into sites of inflammation, or perhaps nuclear segmentation results from nucleolar emptying and has no function (133). In studies of the nuclear protein matrix at different stages of neutrophil maturation, researchers found no significant changes other than collapse and an increased binding of DNA as the cell matures (134). Thus, the mechanism and purpose of nuclear segmentation remain unclear.

Arneth believed that nuclear lobulation continues as the cell ages and that granulocytes with three or four lobes are more mature than those with only two (135). This statement may be true in the sense that once nuclear constriction begins, the completion of lobulation may continue for some time; during this interval, the cell may be delivered to the blood and thus completion of lobulation may occur in the blood (or in cultures). However, the number of lobes a neutrophil develops appears to be determined in the band stage (or earlier), and the time of appearance of neutrophils in the blood after pulse labeling with  $^3\text{H-TdR}$  is unrelated to the number of nuclear lobes (136).

In wet films, marked amoeboid activity of polymorphonuclear neutrophils at physiologic temperatures is characteristic (137). In supravital stained films, the (specific) granules appear yellowish pink and are refractile; in addition, occasional larger, nonrefractile, deep red vacuoles may be seen.

“Senile” polymorphonuclear leukocytes that are no longer motile and fail to take up the neutral red stain have been identified in *in vitro* preparations (138). They are seen in small numbers in the blood, in which their survival time is short (139).

## Neutrophil Heterogeneity

In the past, polymorphonuclear neutrophils were thought to be a homogeneous population of end-stage cells incapable of protein synthesis and of essentially uniform size, granule content, and functional capability. Sabin first suggested potential heterogeneity among neutrophils when she reported that myelocytes were less motile than more mature neutrophils (138). A range of rates of motility among neutrophils from a single individual has been observed (140, 141), and Harvath and Leonard suggest the existence of two neutrophil populations based on chemotaxis (142). Subsequently, several monoclonal antibodies were described that recognize subpopulations of neutrophils, including one that

appears to recognize the classic NB1 neutrophil antigen and one that recognizes an activation epitope on CD11/CD18 ( [143](#), [144](#) and [145](#) ). Another antibody, 31D8, appears to recognize a neutrophil subset that is more responsive to FMLP as determined by chemotaxis and respiratory burst activity ( [143](#) ). Neonates have a larger percentage of neutrophils that express low levels of 31D8 antigen ( [146](#) ). It has been reported that CR2 (CD21), the receptor for C3d, is present on immature neutrophils but not mature blood neutrophils ( [147](#), [148](#) ). One report found that neutrophils from patients with localized juvenile periodontitis express CD21 (CR2) on their surface, whereas normal neutrophils do not ( [149](#) ).

Some studies of these different populations of polymorphonuclear neutrophils have been interpreted as reflecting maturation or environmental influences ( [150](#) ), in some cases possibly reflecting intravascular exposure to stimuli ( [151](#), [152](#) ). The clinical significance of neutrophil subpopulations is unclear.

### Neutrophil Antigens

Neutrophil antigens have been identified by the use of both monoclonal antibodies and patient sera using classic blood banking techniques. Some neutrophil antigens defined by monoclonal antibodies are shown in [Table 10.2](#). Neutrophil antigens relevant to blood banking and immune neutropenia are discussed more fully in [Chapter 26](#). The proteins bearing two clinically relevant neutrophil antigens (NA and NB) have been identified. The NA1 and NA2 alleles, originally described by Lalezari et al., are present on the glycosyl phosphatidylinositol-linked receptor Fc $\gamma$ RIIIB ( [153](#), [154](#) ). The NB1 antigen, also originally described by Lalezari et al. ( [155](#) ), is present on a glycosyl phosphatidylinositol-linked 58- to 64-kd protein of unknown function ( [156](#), [157](#) and [158](#) ).

### EOSINOPHILS

Eosinophils (see [Fig. 14.1](#)) exhibit the same maturation phenomena as neutrophils, with the exception that only one type of granule is recognized ( [80](#), [88](#) ). In humans, these homogeneous granules appear to be formed throughout all the subsequent stages of maturation. Their contents are first seen as flocculent material in Golgi saccules, then in small vacuoles that condense to form the large homogeneous, dense granules. Subsequently, crystalloids develop, and the granules acquire an angular shape; the angular configuration predominates in the mature polynuclear forms ( [121](#) ). It is unusual to find more than two lobes in mature eosinophils, and the lobes are larger than those seen in neutrophils. The presence of eosinophils with more than two nuclear lobes suggests cell activation, as occurs in parasitic diseases. Eosinophilic granules are considerably larger than neutrophilic granules, appear somewhat refractile under the light microscope, and stain a bright yellowish red with Wright stain ( [99](#) ).

Human eosinophil granules contain eosinophil peroxidase ( [103](#) ), a heme protein that is distinct from neutrophil MPO ( [159](#), [160](#) ); several cationic proteins, including eosinophil cationic protein ( [161](#), [162](#) ); and eosinophil major basic protein (MBP). MBP constitutes a major proportion of total granule protein and damages several parasites such as schistosomes, *Trich-inella spiralis* larvae, and trypanosomes as well as many types of mammalian cells, including respiratory epithelium ( [162](#) ). The granules also contain eosinophil-derived neurotoxin, the functions of which are less well understood ( [162](#) ). In some disease states, evidence for the involvement of eosinophils has been reported by the detection of MBP or erythropoietin at the site of pathology ( [163](#), [164](#) ). Of the mature

granulocytes, eosinophils display the most intense staining with peroxidase; the intensity of staining appears to be related to their basic protein content. Eosinophils are discussed more fully in [Chapter 14](#).

## BASOPHILS AND MAST CELLS

Basophils play an important role in allergic reactions. They express a unique surface antigen profile ( [165](#) ) and contain a variety of vasoactive and immunomodulatory chemicals that are released on activation. Basophils are distinguished by their large, coarse, purplish–black granules (see [Fig. 15.2A](#)) that usually fill the cytoplasm and often obscure the nucleus. The granules are water soluble and thus may be dissolved in the process of staining and washing; the cells may then appear vacuolated with only a few or no basophilic granules remaining. On EM examination, a similar variation is noted in the appearance of the basophilic granules, possibly reflecting variable extraction of granule contents during preparative procedures ( [80](#) , [166](#) , [167](#) ).

The primary basophil granule is formed during the early cell stages and is bounded by a 75–nm membrane that is identical to the cell membrane and to membranes bounding coated vesicles and multivesicular bodies ( [168](#) ). These primary granules are peroxidase positive ( [102](#) , [104](#) ) and contain large amounts of heparin and histamine ( [104](#) , [132](#) , [169](#) ) (sulfated acid mucosubstance), features that are probably responsible for the affinity of the granules for basic dyes. These granules also contain the slow–reacting substance of anaphylaxis, kallikrein, an eosinophil chemotactic factor, and a platelet–activating factor ( [170](#) ). Charcot–Leyden crystals are also seen with both phase microscopy and EM; MBP is found in basophils as well as in eosinophils ( [84](#) , [168](#) ). A second, smaller granule that is bounded by a 5–nm membrane identical to that in the endoplasmic reticulum, Golgi apparatus, and mitochondria has also been described ( [168](#) ). These granules are peroxidase negative ( [102](#) ).

Similar but somewhat larger cells found in the tissues are mast cells. Mast cells normally do not circulate in the blood, however, and probably mature locally in the tissues from mitotically active precursors ( [171](#) ). Although these cells resemble basophils in their metachromasia, acid nature, and content of histamine and heparin, they contain hydrolytic enzymes, 5–hydroxy–tryptamine ( [169](#) ), and serotonin ( [104](#) , [172](#) ), which basophils do not. Also, the ultrastructure of their granules is different in humans and guinea pigs ( [172](#) ). Basophils are discussed more fully in [Chapter 15](#).

## MACROPOLYCYTES

*Macropolycyte* is the name applied to giant polymorphonuclear neutrophils with a diameter greater than 16  $\mu\text{m}$  and with 6 to 14 nuclear lobes ( [173](#) ). Such cells are seen only occasionally in healthy subjects (1.3%), but they are found in approximately 5% of people with infections of various types or with intoxications, usually in association with a neutrophilic leukocytosis and myelocytes in the blood ( [173](#) ). Macropolycytes are commonly seen in association with folic acid or vitamin B<sub>12</sub> deficiency, as well as in patients recovering from the pancytopenia that attends treatment with cytotoxic agents, especially hydroxyurea.

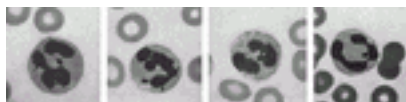
Some authors describe cells with hypersegmented nuclei but of a normal size and call them *polycytes* ( [125](#) ) or *polylobocytes* ( [129](#) ); similar cells with complex nuclei but without hypersegmentation are called *propolycytes* ( [125](#) ). The latter forms are seen in

approximately 10% of patients recovering from leukocytosis with a marked shift to the left and appear in increasing numbers when anticoagulated blood is allowed to stand *in vitro* ( [125](#), [174](#) ).

The mechanism of macropolycyte formation is unknown, but one suggestion is that the skipping of one of the usual cell divisions that occurs during maturation results in a hypersegmented cell ( [175](#) ).

## GENETIC SEX AS INDICATED BY LEUKOCYTES

Only one X chromosome is essential to the normal activity of a cell; the other in the normal XX female remains unextended and thus is visible as a chromatin body. Sex chromatin (Barr) bodies are present in 80 to 90% of the somatic cells of the normal female subject. The sex chromatin body of the neutrophil of females is a small mass, usually adjacent to the nuclear membrane, that stains deeply with hematoxylin, Feulgen reagent, and thionine and is approximately 0.7 to 1.2  $\mu\text{m}$  in diameter. It takes the form of a drumstick projecting from one of the nuclear lobes of approximately 2 to 3% (extreme range, 1 to 17%) of the segmented neutrophils in the blood ( [176](#) ). They are well-defined, solid, round projections of chromatin connected to a lobe by a single, fine chromatin strand ( [Fig. 10.10](#) ). They must be distinguished from small-clubbed or racket-structured, nonspecific nodules that may be smaller or larger as well as irregular in shape or lacking in chromatin, as well as from small (minor) lobes attached to the rest of the nucleus by two strands. Confirmation of the X chromosome in the drumstick has been provided by *in situ* hybridization ( [177](#) ). Sessile nodules are equally gender specific but are more difficult to recognize ( [166](#) ). Drumsticks are not found in normal male subjects ( [178](#) ).



**Figure 10.10.** Granulocytes and sex chromatin patterns. Two cells on the left show the characteristic drumsticks found in the female subjects. The thin strand of chromatin joining the head to a nuclear lobe can be seen clearly. In the two cells on the right, small clubs, such as may be seen in male subjects, should not be confused with drumsticks (Wright stain,  $\times 1300$ ).

The number of chromatin bodies seen in a cell is one less than the number of X chromosomes present. With the increased numbers of X chromosomes found in certain disorders of human development, the number of Barr bodies and drumsticks increases, and isochromosomes formed by duplication of the long arms of the X chromosome give rise to larger drumsticks than are found in the normal female subject ( [179](#) ). Drumsticks or sessile nodules are seen in chromatin-positive male patients with Klinefelter syndrome and are absent in chromatin-negative female patients with Turner syndrome. Eosinophils and probably basophils also have drumsticks. Drumsticks may be difficult to find in the presence of a marked shift to the left. Drumstick counts are reportedly low in the leukocytes of patients with chronic myelocytic leukemia, paralleling the low leukocyte alkaline phosphatase and catalase concentrations ( [180](#) ). Double drumsticks ( [178](#) ) or a sessile nodule plus a drumstick in the same neutrophil are rare ( [181](#) ).

## DIFFERENTIATION OF VARIOUS TYPES OF CELLS

Monocytes are described in detail in [Chapter 16](#); lymphocytes and plasma cells are described in . The morphologic characteristics of the various leukocytes are summarized in [Table 10.3](#) and [Table 10.4](#) to facilitate comparison. Nucleated forms of the erythrocyte series are easily distinguished from most of the leukocytes by their lack of cytoplasmic granules. In Romanowsky–stained films, confusion arises only in the immature (blast) stage. Even then, the more granular and clumped nuclear chromatin may help to identify the pronormoblasts. Polychromatophilic normoblasts at times may be confused with plasma cells or lymphocytes. In the polychromatophilic normoblast, however, the nucleus is more centrally placed than that of the plasma cell or lymphocyte, the cytoplasm is blue–pink, and the cell border may be irregular. The mature lymphocyte is characterized by coarse, clumped chromatin in a nucleus that is eccentrically placed in sparse cytoplasm; a few granules also may be present. Deep blue cytoplasm in a cell with an eccentric nucleus containing coarse, clumped chromatin is the hallmark of the plasma cell.

| Type of cell | Size (µm) | Nucleus              | Type of granules | Stain      | Stain | Stain | Stain |
|--------------|-----------|----------------------|------------------|------------|-------|-------|-------|
| Neutrophil   | 10–12     | Spherical with lobes | None             | Basophilic | None  | None  | None  |
| Eosinophil   | 10–12     | Spherical            | None             | Basophilic | None  | None  | None  |
| Lymphocyte   | 10–12     | Spherical            | None             | Basophilic | None  | None  | None  |
| Monocyte     | 10–12     | Spherical            | None             | Basophilic | None  | None  | None  |
| Platelet     | 2–4       | None                 | None             | Basophilic | None  | None  | None  |
| Normoblast   | 10–12     | Spherical            | None             | Basophilic | None  | None  | None  |
| Plasma cell  | 10–12     | Eccentric            | None             | Basophilic | None  | None  | None  |

**TABLE 10.4. Morphologic Characteristics of Leukocytes (Supravital Stain)**

The nucleated cells of the red cell series are nonmotile; in wet films, they have a rounded, distinct border with homogeneous, nongranular yellowish cytoplasm. The nucleus is round or oval and is centrally placed. The chromatin arrangement gives the nucleus a vesicular appearance; in early forms, one or two large nucleoli are present. In supravital stained preparations, no neutral red bodies are seen, but many coarse, rod–shaped, and coccoid mitochondria are scattered diffusely in the cytoplasm.

Students will find it valuable, when learning to identify the various cells of the blood and bone marrow, to seek each of the morphologic criteria listed in [Table 10.3](#) and [Table 10.4](#) in systematic fashion. By doing so, they will acquire the habit of seeing all that they are viewing and, in time, learn to identify cells because of a number of characteristics perceived unconsciously. The actual identification of cells regarding which some doubt remains can be made only by weighing the evidence for and against each type being considered. One fact to keep in mind is that practically no characteristic of a cell is entirely specific. Thus, a perinuclear clear zone is sometimes seen in cells other than plasma cells, and a rosette of neutral red bodies has been observed in many types of blood and connective tissue cells other than monocytes.

## DIFFERENTIAL CELL COUNTING AND NORMAL VALUES FOR LEUKOCYTES

*Differential cell counting* is the enumeration and classification of the leukocytes seen on the blood smear. The usual procedure is to count at least 100 consecutive leukocytes in an area of good cell distribution. A uniformly thin smear of blood on a cover glass is the best preparation for such examination.

Distributional errors are reduced as more cells are counted. Confidence tables or curves

can be used to estimate the probable error of a differential count when various numbers of cells are counted. [Table 10.5](#) shows 95% confidence limits. Clearly, as more cells of a given type are counted and as the total number of cells enumerated increases, the accuracy of the differential count is greater. Thus, if 200 cells are counted, and a frequency of 70% is found for a given cell type, the true value can be expected to lie between 63.5 and 76.5% for 95% of such counts. If a subsequent 200-cell differential count gives a figure of 80% for that cell type, the difference is probably real, whereas if only 100 cells have been counted, the difference would probably not be significant. Even so, when dealing with cells present only in small numbers (such as eosinophils or basophils in the usual smear), the values obtained from the differential count provide only a gross estimate of cell frequency. For more accurate enumeration of these cell types, absolute counting methods have been developed.

**TABLE 10.5. 95% Confidence Limits for Differential Leukocyte Counts**

| Percentage (%) of Given Cell Type | 100 Cells Counted | 200 Cells Counted |
|-----------------------------------|-------------------|-------------------|
| 0                                 | 0.0–3.0           | 0.0–1.5           |
| 1                                 | 0.5–4.7           | 0.2–3.1           |
| 2                                 | 0.4–6.3           | 0.7–4.6           |
| 3                                 | 0.8–7.7           | 1.3–5.9           |
| 4                                 | 1.4–9.1           | 2.0–7.2           |
| 5                                 | 2.0–10.5          | 2.7–8.5           |
| 10                                | 4.0–16.0          | 5.8–14.2          |
| 20                                | 12.0–28.0         | 14.3–25.7         |
| 30                                | 20.8–39.2         | 23.5–36.5         |
| 40                                | 30.2–49.8         | 33.1–46.9         |
| 50                                | 40.0–60.0         | 42.9–57.1         |
| 60                                | 50.2–69.8         | 53.1–66.9         |
| 70                                | 60.8–79.2         | 63.5–76.5         |
| 80                                | 72.0–88.0         | 74.3–85.7         |
| 90                                | 84.0–96.0         | 85.8–94.2         |

NOTE: For percentages of 5 or less, the limits were derived by assuming a Poisson rather than a binomial distribution. (From Cartwright GE. Diagnostic laboratory hematology. New York: Grune & Stratton, 1968, with permission.)

From the total leukocyte count and the differential count, the absolute concentration of each leukocyte type can be calculated. The accuracy of the result depends on the validity of the total leukocyte count and the differential count. With automatic cell counters, the major component of error now lies in the differential count.

Normal values for absolute leukocyte concentrations obtained by using a Coulter counter and differential counts are shown in [Table 10.6](#). Similar values have been reported with the use of other methods ([182](#)). Some variation is evident in values obtained in different population groups and appears to depend on age, sex, pregnancy, time of day, activity level, and other factors ([183](#)). Racial variation has been reported, especially in Ethiopian Jews ([184](#)) and black Africans, who have significantly lower neutrophil and monocyte counts ([185](#)). Lower counts are less evident in black Americans ([126](#)) and in Africans



eating a Western diet ( [183](#) ).

**TABLE 10.6. Normal Blood Leukocyte Concentrations (95% Confidence Limits)**

| Subjects (Age)                        | Sex      | No. | Time of Day (h)        | WBC         | Neutrophils | Lymphocytes | Monocytes | Eosinophils |
|---------------------------------------|----------|-----|------------------------|-------------|-------------|-------------|-----------|-------------|
| Neonates (day 4)                      |          | 53  | Variable, 96 h of life |             | 1981-7553   | 2200-7100   | 421-2022  | 200-1900    |
| Infants (9-12 mo)                     |          |     |                        |             |             |             |           |             |
| White                                 |          | 50  |                        | 5400-24,200 | 1062-10,890 | 2178-11,718 |           |             |
| Black                                 |          | 50  |                        | 4100-14,300 | 121-6732    | 900-11,400  |           |             |
| European adults (median age, 25 yr)   | M        | 72  | 0930-1130              | 3487-9206   | 1539-5641   |             |           |             |
|                                       |          | 26  | 1430-1630              | 3722-9828   | 1775-6508   |             |           |             |
|                                       | F        | 70  | 0930-1130              | 3839-10,135 | 1861-6821   | 1158-3460   | 221-843   | 25-590      |
|                                       |          | 29  | 1430-1630              | 4450-11,750 | 2137-7836   |             |           |             |
| European adults (age, 54-65 yr)       | M        | 85  | 0900-1530              | 3956-9592   | 2075-6557   | 962-3784    | 59-658    |             |
|                                       | F        | 76  | 0900-1530              | 3423-8258   | 1833-5476   | 776-3455    | 59-732    |             |
| Pregnant Europeans (third trimester)  | F        | 50  | 0930-1630              | 5915-13,962 | 3656-10,769 | 1023-3128   | 349-1140  | 22-330      |
| American white adults (age, 16-44 yr) |          | 226 | a.m. or early p.m.     | 4550-10,100 | 2050-6800   | 1500-4000   | 220-950   | 30-860      |
| Black American adults (age, 16-49 yr) | M        | 65  | a.m. or early p.m.     | 3600-10,200 | 1300-7400   | 1450-3750   | 210-1050  | 30-720      |
| Black African adults (age, 20-45 yr)  | M        | 250 | 0900-1200              | 2587-9075   | 775-4131    | 1012-3876   | 62-688    | 47-3371     |
|                                       | Mostly M | 109 |                        | 3363-8977   |             |             |           |             |

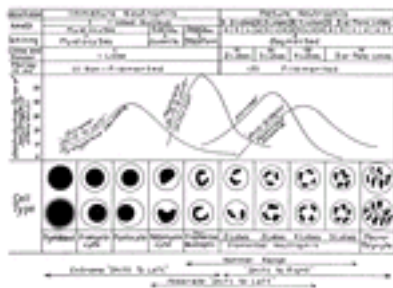
WBC, white blood cell.

NOTE: Values obtained by using a Coulter counter and differential counts of at least 200 cells (except in expressed in cells 10<sup>9</sup>/L.



The absolute leukocyte concentration provides a more accurate picture than the differential count because each leukocyte type is a separate cell system with its own functions, control mechanisms, and responses to disease processes; for example, a patient with chronic lymphocytic leukemia whose total leukocyte count is  $100 \times 10^9$  cells/L, 7% of which are neutrophils and 93% are lymphocytes, does not have granulocytopenia. With a blood neutrophil concentration of  $7.0 \times 10^9$  cells/L, the problem is lymphocytosis.

Various systems for differential counting have been used ( [Fig. 10.11](#) ) ( [186](#) ). Arneth, for example, painstakingly recorded and tabulated from left to right the number of neutrophilic leukocytes with 1, 2, 3, etc. lobes and made other subdivisions ( [135](#) ). The term *shift to the left* is derived from this practice and indicates an increase in the proportion of cells with only one or few lobes, whereas *shift to the right* represents an increase in the proportion of multisegmented forms.



**Figure 10.11.** Several classifications of neutrophils. Note that all the classifications agree on a common dividing line between mature and immature cells. The Schilling classification further subdivides only the immature cells. The Cooke and Ponder and the Arneth classifications further subdivide only the more mature cells. (From Haden RL. Qualitative changes in neutrophilic leukocytes. *Am J Clin Pathol* 1935;5:354, with permission.)

From a clinical viewpoint, it is useful to determine whether young forms of neutrophils (band forms and younger) are increased and whether the proportion of multinucleated forms is increased. An increase of younger forms (band cells, metamyelocytes, and myelocytes) (*shift to the left*) suggests increased release of young neutrophils from the bone marrow, which is seen in association with acute infections ( [131](#) ) and inflammation. If a *shift to the right* is suspected, a neutrophil lobe count may be useful. This process involves counting the total number of nuclear lobes in 100 or 200 neutrophils, calculating the average lobe number/neutrophil, and comparing the results with normal values. The chief difficulty associated with this count is clear definition of what constitutes a separate lobe (see section [Band Neutrophils](#) earlier in chapter). If complete separation of nuclear lobes with or without a connecting filament is the definition used, the normal mean neutrophil lobe count is 2.04, with 95% of normal values falling between 1.66 and 2.42. An increase in mean neutrophil lobe count suggests vitamin B<sub>12</sub> or folic acid deficiency, congenital hypersegmentation of neutrophils, or renal disease ( [130](#) ). A ratio of five-lobed to four-lobed polymorphonuclear cells that is greater than 0.17 is said to be associated more regularly with B<sub>12</sub> deficiency than is an increase in mean nuclear lobe count ( [128](#) ).

Alterations in the total number of leukocytes and in their relative proportions are significant as measures of the reactions of the body to noxious agents. The reactions of leukocytes in association with certain diseases are discussed later in this book, as is the

presence of abnormal inclusions, such as toxic granulation, Döhle bodies, and various inherited abnormalities in leukocyte morphology.

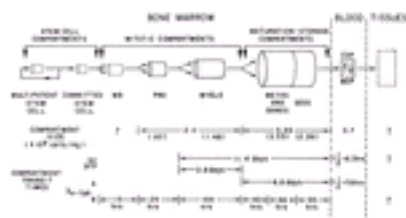
An additional type of differential cell count in common use is the histochemical, semiquantitative estimate of the leukocyte alkaline phosphatase content of neutrophils (see [Chapter 2](#)) ([114](#)).

## NEUTROPHIL KINETICS

The importance of leukocytes in the defense of the organism is well known. Basic to their roles are cell multiplication, maturation, storage, and delivery to the tissues and sites of infection or cell damage. These processes are called *leukocyte kinetics* and are different for each leukocyte type. To simplify the discussion, each type of leukocyte is considered as a separate system, but these systems constantly interact and complement one another in the defense of the body.

### Neutrophil Kinetics in the Adult

In [Chapter 8](#), the process of mitotic cell division, the cell generation cycle, and the origin of neutrophils and other cell types from a multipotent hematopoietic stem cell were discussed. The multipotent hematopoietic stem cell is thought to produce a committed stem cell from which the myeloblast and monoblast are formed ([83](#)); from them, the neutrophilic and monocytic series are derived. The production, kinetics, and lifespan of the neutrophil have been the subject of a number of reviews ([187](#), [188](#), [189](#), [190](#), [191](#), [192](#), [193](#), [194](#), [195](#), [196](#), [197](#), [198](#), [199](#), [200](#) and [201](#)). A model of these processes in adult humans is shown in [Figure 10.12](#). The neutrophil system appears to be incompletely developed in premature babies and in early neonatal life; this topic is discussed in the section [Neutrophil Kinetics in the Fetus and Newborn](#) later in the chapter.



**Figure 10.12.** Model of the production and kinetics of neutrophils in humans. The marrow ([158](#)) and blood compartments ([145](#)) are drawn to show their relative sizes. In the lower one-third of the figure, the compartment transit times as derived from diisopropylfluorophosphate (DF <sup>32</sup>P) studies ([136](#), [145](#)) and from tritiated thymidine (<sup>3</sup>H-TdR) studies ([149](#), [158](#)) are compared. CGP, circulating granulocyte pool; MB, myeloblast; MGP, marginal granulocyte pool; myelo, myelocyte; pro, promyelocyte.

| Cytoplasm       |       |                      |               |              |                          |
|-----------------|-------|----------------------|---------------|--------------|--------------------------|
| Relative Amount | Color | Neutral Red Vacuoles | Mitochondria  |              | Evidence of Phagocytosis |
|                 |       |                      | Shape or Size | Distribution |                          |
|                 |       |                      |               |              |                          |

|  |                           |   |                              |                                       |   |
|--|---------------------------|---|------------------------------|---------------------------------------|---|
| Scanty                                       | Slightly yellow           | None  | Spherical                    | Numerous, diffuse                     | None  |
| Moderate                                     | Gray                      | Refractile, bright red: A = 3-10; B = 30-100; C = full amount | Spherical                    | Diffuse                               | None  |
| Plentiful                                    | Gray                      | Beginning streaming   | Spherical                    | Few                                   | Slight to moderate for bacteria, debris, etc. |
| Plentiful                                    |                           | Yellowish-pink, tiny, refractile                              | Spherical                    | Few                                   | Slight  |
| Clear ecto- and endoplasm except in basophil | Homogeneous and clear     | Bright yellow, large, oval, refractile                        |                              |                                       | Slight  |
|  |                           | Deep maroon, nonrefractile, all streaming                     |                              |                                       |   |
| Scanty                                       | Yellow                    | None  | Short plump rods             | Numerous, especially close to nucleus | None  |
| More   | Grayish yellow            | None or many  | Short plump rods             | Numerous, especially at one side      | None  |
| Usually plentiful                            | Gray                      | Any distribution<br>None or many                              | Short plump rods             | 10-20                                 | None  |
| Usually scanty                               | Colorless                 | Any distribution<br>None or many                              | Smaller                      | 0-10                                  | None  |
|  |                           | Any distribution  |                              |                                       |   |
| Scanty                                       | Slightly yellow and muddy | None, or very fine in centrosphere                            | Fine spheres or slender rods | Numerous                              | None  |
| Moderate                                     | Colorless and muddy       | Numerous, small   | Fine, dustlike               | Moderate number                       | Uncommon                                      |
| Abundant                                     | Colorless and muddy       | Very numerous, vary in size, occasionally rosette             | Fine, dustlike               | Few                                   | Moderate                                      |
| Usually abundant                             | Colorless                 | Often many, but vary in number, size, and color               | Delicate filaments           | Few or none                           | Usually for particles or whole cells          |

---

**MITOTIC AND MATURATION COMPARTMENTS** Neutrophil production in normal adult humans appears to take place only in the bone marrow. The life cycle of the neutrophil can be divided conveniently into bone marrow, blood, and tissue phases. The assumption

is that cells move through the system in an orderly manner as if in a pipeline; this view is supported by the progressive movement of isotopic tracers ( [112](#), [198](#), [202](#), [203](#) ) and azurophilic granules ( [80](#), [90](#), [98](#) ) through the system. The myeloblast, promyelocyte, and myelocyte are capable of cell division, as judged by direct observation in cultures ( [88](#) ) and by their ability to incorporate  $^3\text{H-TdR}$  into their nuclear DNA ( [204](#) ). These forms, therefore, constitute the mitotic compartment ( [Fig. 10.12](#) ). Simultaneously, they undergo differentiation, as evidenced by the appearance of azurophilic and specific granules in their cytoplasm. The more mature forms of the neutrophil series (metamyelocyte, band, and polymorphonuclear neutrophil) are usually considered incapable of cell division (except perhaps in unusual circumstances) ( [205](#) ) and do not incorporate  $^3\text{H-TdR}$  into their nuclei, but they do exhibit continuing maturational changes and thus constitute the maturation compartment. From the maturation compartment, cells flow into the blood and are distributed in two sites: the circulating blood granulocyte pool (CGP) and the marginal granulocyte pool (MGP). Cells in these two pools are in constant equilibrium. Eventually, the cells move through vessel walls to enter the tissues. The exact nature of the MGP is not clear. In the past, it was felt to represent transient adhesion to and rolling along the surface of endothelial cells, primarily in postcapillary venules. However, subsequent studies of a patient with leukocyte adhesion deficiency-2 (LAD-2) demonstrated the presence of a marginating pool ( [206](#) ), although the MGP in this patient with LAD-2 was reduced. Patients with LAD-2 lack the ligands for the selectins CD62P and CD62E and have a marked decrease in neutrophil rolling in postcapillary venules. Normally, the MGP is approximately equal in size to the CGP. Studies of this patient suggested that approximately 20% of neutrophils are in a selectin-independent MGP and approximately 30% are in a selectin-dependent MGP ( [206](#) ). Surprisingly, this patient's neutrophils had a shorter than normal half-life in the circulation with an increased turnover rate. The inability of CD18 or CD62L antibodies to shift neutrophils from the MGP to the CGP also suggests that the transient adhesion to endothelial cells manifest as rolling does not account for the MGP ( [207](#), [208](#) ). In this model, cell production can be estimated either by assessing the production rate in the mitotic compartment or by measuring cell flow through subsequent stages, such as the blood. Accuracy of these measurements is facilitated if the system is studied in the steady state when compartment sizes are constant and cell flow reflects net production and destruction ( [194](#) ). If one assumes a steady state in a scheme such as that shown in [Figure 10.7](#), the flow of cells out of any pool (  $K_{\text{out}}$  ) is equal to the flow of cells into that pool (  $K_{\text{in}}$  ) plus any cells produced in the pool (  $K_b$  ); thus,

$$K_{\text{out}} = K_{\text{in}} + K_b \quad (1)$$

Clearly, in pools other than those in the mitotic compartment,  $K_b$  is 0, and measurements of cell flow (  $K_{\text{in}}$  or  $K_{\text{out}}$  ) equal effective cell production, provided no cell death occurs within the pool.

**Production in the Mitotic Compartment** Because myeloblasts, promyelocytes, and myelocytes constitute approximately 0.9%, 3.3%, and 12.7% of the marrow cells, respectively, it has been assumed that the system has four or five divisions ( [200](#) ). From a review of blood neutrophil radioactivity curves obtained after diisopropylfluorophosphate (DF  $^{32}\text{P}$ ) injection into humans, investigators raised the possibility of at least three divisions at the myelocyte stage ( [200](#) ). Another suggestion generated from marrow differential counts was that only four or five divisions occur in the entire neutrophil proliferation scheme ( [200](#) ). This supposition agreed with results from experiments in dogs ( [209](#) ) and with data from model studies ( [210](#) ). In contrast, studies of myeloid islands in the rat thymus provided evidence for seven divisions during granulocytopoiesis: one in the myeloblast stage, two in the promyelocyte stage, three in the myelocyte stage, and a final one in the metamyelocyte stage ( [133](#), [211](#) ). Calculations made from mitotic index (MI) data ( [192](#), [212](#), [213](#) and [214](#) ) provide estimates of cell generation time (  $t_g$  ) and pool turnover

time.  $M$  ( [212](#), [215](#), [216](#) ) is defined as

$$MI = N_m / N \quad (2)$$

in which MI is the mitotic index for any morphologic cell pool,  $N_m$  is the number of mitoses in that pool, and  $N$  is the total number of cells in the pool. MI can also be expressed as the ratio of the time spent in mitosis (  $t_m$  ) to the cell generation time (  $t_g$  ):

$$MI = t_m / t_g \quad (3)$$

By combining both definitions,

$$MI = N_m / N = t_m / t_g \quad (4)$$

By providing determined values for MI and mitotic time (  $t_m$  ) in the last equation, the generation time (  $t_g$  ) for a particular cell pool can be approximated. From  $t_g$  and the pool size (  $N$  ), the birth rate,  $K_b$ , can be obtained if all cells in the pool are in cycle because each mitosis gives rise to one new cell:

$$K_b = N / t_g \quad (5)$$

In effect, the cell birth rate is equal to the number of mitoses occurring/unit time (  $t$  ), or

$$K_b = N_m / t \quad (6)$$

Although the concept is simple, several problems arise ( [214](#), [217](#) ). A major problem is that the morphologic boundaries of most cell pools are not clearly delineated in terms of the cell cycle ( [217](#) ). For example, to calculate cell production in the myelocyte pool, it must be assumed that all myelocytes are destined to divide; that is, no cells are recognized as myelocytes that are not going to divide again. Because the daughter cells of the last myelocyte mitosis almost certainly do not suddenly become metamyelocytes on completion of division,  $N$  in the preceding equation will be erroneously large, and thus estimates of  $t_g$  will be erroneously long. If the fraction of nonmitotic cells in the myelocyte population were known, the calculations could be corrected for this error, as has been attempted ( [190](#) ). A second major problem is the fact that values for the MI have varied considerably ( [212](#), [214](#), [215](#), [218](#), [219](#), [220](#) and [221](#) ). In addition, a considerable diurnal variation exists in the MI in humans, as well as in animals ( [214](#), [221](#), [222](#) and [223](#) ). Finally, to calculate the absolute neutrophil production rate (in cells/unit of time), the size of the marrow mitotic compartment must be known. Methods for measuring the sizes of marrow myeloid pools have been developed ( [224](#), [225](#), [226](#) and [227](#) ) (see section [Size of Marrow Compartments and Their Morphologic Subdivisions](#) later in chapter), but to date no one has measured these sizes and MI in the same animal at the same time and then calculated neutrophil production rate. Nevertheless, values for the MI for each of the neutrophil precursors capable of mitosis have been determined ( [214](#), [215](#) ), and within the assumptions inherent in such calculations ( [217](#) ), neutrophil production has been estimated ( [196](#), [213](#) ). Similar calculations of neutrophil production can be made from  $^3\text{H-TdR}$ -labeling index data. After flash labeling with  $^3\text{H-TdR}$ , autoradiographs of the bone marrow are obtained, and the proportion of nucleated cells that have incorporated the label into their nuclei is determined ( [191](#), [197](#) ). This labeling index (LI) represents the ratio of labeled cells,  $*N$ , or cells in DNA synthesis (  $N_s$  ) to total cells (  $N$  ) of a defined morphologic type:

$$LI = *N / N = N_s / N \quad (7)$$

The LI can also be defined in terms of DNA synthesis time (  $t_s$  ) and the cell generation time (  $t_g$  ), because  $^3\text{H-TdR}$  is taken into the cell only during the period of DNA synthesis; thus,

$$LI = t_s / t_g \quad (8)$$

By combining both definitions,

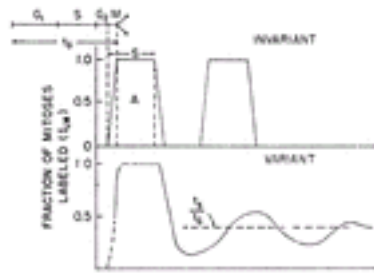
$$LI = N_s/N = t_g/t_s \quad (9)$$

and from determined values for LI and  $t_g$ , the generation time and turnover of a given cell population can be estimated. As with MI data, birth rate is a function of the population turnover time, which can be approximated from the generation time or time spent in various phases of the cell cycle:

$$K_b = N/t_g = N_s/t_s \quad (10)$$

Some of the same problems arise with the  $^3\text{H-TdR}$  LI that are encountered in the use of the MI ( [217](#), [228](#) ). In addition, the use of labeled compounds raises questions of label reuse ( [229](#), [230](#) ) or elution ( [228](#) ) and perturbation of the cell population by the compound ( [188](#), [209](#), [231](#), [232](#) and [233](#) ) or by its radioactivity ( [228](#), [234](#), [235](#) ). The LI reported for humans is myeloblast, 0.85; promyelocyte, 0.65; and myelocyte, 0.33 ( [191](#) ). Somewhat different values have been reported in dogs ( [197](#) ) and rats ( [215](#) ). By using the LI for humans and a value for  $t_s$  of 5 hours (based on studies in dogs) and by determining relative compartment sizes for each cell type from the bone marrow differential count, the relative birth rates (  $K_b$  ) of cells have been calculated ( [190](#), [215](#) ). Some authors have found good agreement between neutrophil production as calculated from the MI and the LI ( [215](#) ), but considerable discrepancy has been reported by other authors ( [190](#) ). This difference may result from the fact that the MI values obtained were low, the studies were done in different subjects at different times, and too small a value for  $t_s$  was used in the calculations. The turnover time of a labeled compartment and neutrophil production rate also may be estimated by measuring the grain count halving time ( [202](#) ). The generation time is derived only if each cell in a given class divides and if no label feeds into the compartment from a labeled precursor class or as a result of label reuse ( [236](#) ). If any of these criteria are not met, the half-time for grain count decrease is longer than the true value, and the estimate of generation time is only a maximal value. Additional disadvantages of this method are that at least several bone marrow samples distributed throughout several half-times are needed and that grain counting is extraordinarily tedious and subject to considerable error. Nevertheless, estimates of compartment turnover time have been made with this method by using  $^3\text{H-TdR}$  ( [202](#) ) and radiosulfate ( [121](#) ). After flash labeling with  $^3\text{H-TdR}$ , the cohort of cells labeled during DNA synthesis may be followed as it subsequently enters mitosis, and the time course of labeled mitoses can be recorded ( [236](#), [237](#) ). Theoretically, such curves should permit measurement of the post-DNA synthesis gap (G2), mitotic time (  $t_m$  ), DNA synthesis time (  $t_s$  ), cell generation time (  $t_g$  ), and pre-DNA synthesis gap (G1) (see [Chapter 8](#) and [Fig. 10.13](#) ). In actual practice, biologic variation rounds off the percentage of labeled mitosis curves, and rapid damping of the waves of cells passing through mitosis ( [Fig. 10.13](#) ) renders such measurements less precise than ideal. However, estimates of myeloid DNA synthesis time obtained with this method are approximately 11 to 13 hours in humans ( [236](#), [237](#) ) and are in good agreement with estimates made in gastrointestinal mucosal cells. From the level of the damped plateau reached after a few hours, the ratio of  $t_s$  to  $t_g$  can be obtained ( [Fig. 10.8](#) ), and the generation time can then be calculated. If the generation time and compartment transit time are presumed to be the same or if the proportion of cells in a compartment that is actively proliferating is known, the neutrophil production rate can be calculated.





**Figure 10.13.** The percentage of labeled mitoses in the course of cell generation. At top of the diagram is the theoretical configuration that would be seen if cells flowed through the proliferation cycle with no variation. The effects of moderate variation in time spent in the several cycle phases on the percent labeled mitosis curve are shown at the bottom.  $G_1$  is the pre-DNA synthesis resting phase (*gap*),  $S$  is the DNA synthetic period,  $G_2$  is the post-DNA synthesis gap, and  $M$  is mitosis.  $t_S$  is the time spent in  $S$ , and  $t_G$  is the duration of the entire generative cycle. (From Cronkite EP, the Brookhaven National Laboratory, and the National Cancer Institute. Kinetics of granulocytopoiesis. Natl Cancer Inst Monogr 30, Human Tumor Cell Kinetics 1969;51, with permission.)

**Neutrophil Production as Measured by Cell Flow in Other Compartments** Another method for approximating neutrophil production involves following the appearance of  $^3\text{H-TdR}$ -labeled cells in the metamyelocyte compartment. Because metamyelocytes do not divide or take up  $^3\text{H-TdR}$ , the appearance of labeled cells in this compartment should reflect the flow of cells into it from the myelocyte compartment; in the steady state, this influx of cells should also reflect the turnover of the metamyelocyte compartment and thus cell production. Approximately 3 hours pass after the injection of  $^3\text{H-TdR}$  before label appears in metamyelocytes both in dogs ([197](#)) and in humans ([236](#)); this time interval is the minimum time for myelocytes taking up the label to pass through  $G_2$  and mitosis and become metamyelocytes. After this lag, the rate of labeled cell inflow into the metamyelocyte compartment is approximately 3 to 5%/hour in both species. In the dog, cell inflow into the metamyelocyte compartment measured in this fashion is less than 50% of that calculated from LI data ([197](#)), suggesting the existence of a major component of ineffective granulocytopoiesis, a myelocyte sink, in the normal animal. However, similar calculations in humans do not confirm the findings of such studies ([190](#)). The resolution of this enigma requires the simultaneous measurement of cell production by using several methods in the same animal at the same time. In a similar manner, the marrow production of neutrophils has been estimated from the size of the postmitotic maturation-storage compartment and the compartment turnover time ([224](#), [225](#), [238](#)). The compartment size is calculated from the marrow neutrophil to erythroid (NE) ratio (determined in marrow sections) and the mean normal marrow normoblast pool size (calculated by multiplying the ratio of subjects' erythroid iron turnover value over the mean normal value for this determination by the mean normal erythroblast population) ([225](#)). The compartment transit time is estimated by injecting  $^3\text{H-TdR}$  and noting the time required for labeled neutrophils to appear in the blood. By this method, marrow neutrophil production in humans has been calculated to be  $0.85 \times 10^9$  cells/kg/day in the normal steady state. Neutrophil production also can be approximated by measuring the flow of cells through the blood, the blood granulocyte turnover rate (GTR). DF  $^{32}\text{P}$  binds irreversibly with a number of esterase enzymes and has been shown to label neutrophils primarily ([239](#), [240](#)). By means of this agent, a subject's own cells can be labeled, and the total blood granulocyte pool (TBGP) and the rate of disappearance of labeled neutrophils from the blood can be determined ([195](#)). Similar measurements can be made by transfusing  $^3\text{H-TdR}$ -labeled cells from a suitable donor ([225](#)). Because neutrophils leave the blood in a random manner (exponential disappearance curve), the GTR is calculated as follows



from the TBGP and the  $t_{1/2}$ :

$$GTR = 0.693/t_{1/2} \text{ TBGP (11)}$$

in which 0.693 is the natural logarithm of 2 and  $t_{1/2}$  is the blood neutrophil half-disappearance time. An important point to keep in mind is that all of these methods assume that the system is in a steady state during the entire course of the measurements. If neutrophil death in the marrow is not significant, the blood GTR equals total neutrophil production. If neutrophil death in the bone marrow is significant, the blood GTR measures effective neutrophil production, and the difference between this determination and total neutrophil production is ineffective granulocytogenesis. Measurements of neutrophil production by compartment turnover methods have given values ranging from 62 to  $400 \times 10^7$  neutrophils/kg/day in humans (Table 10.7) (225, 241) and 150 to  $560 \times 10^7$  neutrophils/kg/day in dogs (225, 238, 242).

TABLE 10.7. Blood Neutrophil Kinetic Parameters in Normal Humans

| Parameter <sup>a</sup>                                       | Diisopropylfluoro-<br>phosphate (Autologous) <sup>a</sup> |            | Tritiated<br>Thymidine<br>(Isologous) <sup>b</sup> |         |
|--|---|------------|--|---------|
|  | Mean  | 95% Limits | Mean   | Range   |
| Total blood granulocyte pool (cells $\times 10^7$ /kg)       | 61  | 27-128     | 40   | 30-48   |
| Circulating blood granulocyte pool (cells $\times 10^7$ /kg) | 31  | 13-49      | 22   | 15-29   |
| Marginated granulocyte pool (cells $\times 10^7$ /kg)        | 29  | 8-115      | 17   | 12-26   |
| Half-life (hr)   | 6.3   | 4-10       | 7.6  | 5.4-9.6 |
| Granulocyte turnover rate (cells $\times 10^7$ /kg/day)      | 160   | 62-400     | 87   | 69-100  |

<sup>a</sup> Based on data from 71 normal subjects whose own blood was labeled *in vitro* and reinfused; see reference 241.

<sup>b</sup> Based on five subjects transfused with cells labeled in compatible donors; see Dancey JT, et al. Neutrophil kinetics in man. *J Clin Invest* 1976;58:705.

Of the methods for assessing neutrophil production just described, only the measurement of blood neutrophil turnover rate with DF  $^{32}\text{P}$  or  $^3\text{H-TdR}$  can be performed easily enough to be of use in studying groups of patients in a clinical setting, and even this is possible in only a few research centers.

**Size of Marrow Compartments and Their Morphologic Subdivisions** In all of the procedures described, with the exception of DF  $^{32}\text{P}$  and  $^3\text{H-TdR}$  blood kinetic measurements, the number of marrow myeloid cells under study must be known to calculate neutrophil production. In the absence of such data, only calculations of relative cell production are possible (190). Direct measurements of the volume and cellularity of the marrow (isolation of skeleton and cell counting or bone biopsy and radioactivity measurement) have been made in dogs (225), rats (243), mice (244), and guinea pigs (245, 246). Several methods for estimating marrow myeloid mass have been devised, but probably the best data are those derived by using marrow NE ratios and measurement of marrow erythroblast mass by the iron dilution technique as originally suggested by Suit (

247). In early studies by Donohue et al. (226, 227), marrow erythroblast radioactivity and NE ratios were counted in marrow suspension smears. Corrections were made for incomplete iron localization in the erythron and for an estimated 30% cell destruction that occurred in preparing the marrow suspensions. In later studies by Harker (248), the NE ratios and radioactivity measurements were made on marrow sections in the hope of avoiding the problem of possible cell destruction. Values for marrow erythroid mass were somewhat lower than those reported by Donohue et al. (226, 227), but they agreed with results obtained when no correction for cell destruction was made. By using marrow sections and the  $^{59}\text{Fe}$  isotope dilution technique, investigators have directly determined the marrow myeloid mass in the dog (225). In humans, however, direct measurement of the marrow normoblast mass has not been feasible in normal subjects, so marrow normoblast mass was estimated from erythron iron turnover values (225, 249). The mean values obtained in 13 normal subjects are presented in Figure 10.12.

**Transit Time through the Nondividing Maturation Pool** After injection of a pulse label of  $^3\text{H}$ -TdR or radiophosphate, a delay of several days occurs before labeled segmented neutrophils appear in the blood. This interval represents the minimum time from DNA synthesis in the last myelocyte generative cycle until the cell has matured into a segmented neutrophil (or band form) and is released into the blood. In patients in a normal steady state, this minimum transit time or emergence time was between 96 and 144 hours (250, 251); in patients with infection, it was as short as 48 hours. Emergence time in dogs is 2 to 3 days (252); in the rat, it is 36 to 42 hours (136). The mean value for myelocyte-to-blood transit time after DNA labeling (defined as the time from  $^3\text{H}$ -TdR or radiophosphate injection to the peak of the blood granulocyte radioactivity curve) was 6 to 9 days in hematologically normal convalescent patients and 7.2 days in eight normal subjects (224). In contrast, studies in which DF  $^{32}\text{P}$  was injected intravenously into normal volunteers (prisoners) led to the conclusion that the mean promyelocyte to blood transit time was 11.4 days, with a myelocyte compartment transit time of 2.9 days (189, 200)—in other words, an 8.5-day myelocyte-to-blood transit time. Results of studies involving the simultaneous use of  $^3\text{H}$ -TdR and DF  $^{32}\text{P}$  in the same subjects suggest that the discrepancies reflect differences between normal ambulatory subjects and hematologically normal convalescent patients (253). In dogs, the average myelocyte-to-blood transit time was 5 days, as measured with both  $^3\text{H}$ -TdR and DF  $^{32}\text{P}$  (253).

**Neutrophil Release from Marrow into Blood** After  $^3\text{H}$ -TdR injection and at the time of first seeing label in band and segmented neutrophils in the bone marrow, some labeled cells are also seen in the blood (190). Authors have suggested that the release of band or segmented neutrophils from the marrow does not follow a strict pipeline or first-in-first-out sequence (190, 250). However, it is not clear whether these observations reflected variance around a mean transit time (200, 252, 254) or random release of mature neutrophils from the marrow (250). Findings in dogs strongly favor the mean transit time concept rather than random release (252). In fact, because the ratio of band to segmented cells is much higher in marrow than in blood, selective release of segmented cells must occur. The mechanisms controlling the release of marrow cells into the blood are only partially understood. Endotoxin disturbs the relationship between marrow sinus endothelial cells and the adventitial (reticular) cells (255, 256), which usually cover approximately 60% of the extraluminal sinusoid surface (257). Endotoxin induces a reticular cell movement away from the endothelium, thus facilitating hematopoietic cell contact with and migration between the endothelial cells (255, 257). Findings of *in vitro* studies of factors influencing marrow granulocyte migration through membranes demonstrate that pore diameter, morphologic age of cells, and the presence of a chemical attractant may be important in marrow cell release (258). Thus, immature granulocytes

(myeloblasts and promyelocytes) could not penetrate membranes with pores smaller than 8  $\mu\text{m}$  and were not responsive to chemoattractants. Mature granulocytes (band and segmented) could penetrate membranes with pores as small as 1  $\mu\text{m}$ , and egress was accelerated by increasing pore size and by use of a chemoattractant. Myelocytes and metamyelocytes exhibited intermediate activity. Integrins and immunoglobulin (Ig) superfamily members appear to play an important role in the organization of the bone marrow microenvironment, and stem cell factor alters the avidity of a  $\alpha_4\beta_1$  and a  $\alpha_5\beta_1$  integrins on hematopoietic cell lines for their ligands ( [259](#) ). A number of mediators of neutrophil release from the bone marrow have been identified, including tumor necrosis factor (TNF)- $\alpha$ , TNF- $\beta$ , granulocyte colony-stimulating factor (G-CSF), granulocyte-macrophage colony-stimulating factor (GM-CSF), IL-8, and C5a ( [206](#) , [260](#) , [261](#) ).

## KINETICS IN THE BLOOD

***Diisopropylfluorophosphate Studies*** With the development of the DF  $^{32}\text{P}$  labeling technique, in which neutrophils are labeled *in vitro* with DF  $^{32}\text{P}$  and returned to the donor, two pools of neutrophils in the blood have been demonstrated: a CGP and an MGP ( [195](#) , [262](#) , [263](#) ). In normal humans, neutrophils in these two pools are in constant equilibrium, and the pools are of approximately equal size ( [Table 10.7](#) ). The CGP is calculated from the blood leukocyte count and the blood volume. The TBGP is measured by the dilution of DF  $^{32}\text{P}$ -labeled neutrophils after their reinjection ( [262](#) ). MGP is the difference between the TBGP and the CGP. Brief exercise or epinephrine injection increases the size of the CGP by approximately 50%, but the TBGP is unchanged; the neutrophilia produced reflects a demargination of cells that lasts only a few minutes ( [262](#) ). The location of at least some of the marginated cells is thought to be along the walls of small blood vessels, primarily postcapillary venules, in many body tissues where neutrophils roll along the vessel wall in loose contact with the endothelial cell surface ( [264](#) ). The distribution of cells in the CGP and MGP can be altered by other means. For example, transient neutropenia was noted 90 minutes after endotoxin injection, but the TBGP was not significantly increased; thus, essentially a shift from CGP to MGP occurred. At the end of 5 hours, the TBGP increased significantly as a result of an outpouring of cells from the bone marrow, and the CGP and MGP were of approximately equal size ( [263](#) ). The administration of steroids also produced an increase in the size of the TBGP, in part for the same reason but also because of decreased outflow into the tissues ( [265](#) ). A rapid transient increase in the marginating pool has been observed during hemodialysis when cuprophane membranes are used ( [266](#) , [267](#) ). Activation of the complement system by contact with the dialyzer membrane was found to produce inflammatory mediators (C5a being a major contributor) that stimulated an increase in neutrophil margination manifest both by an increase in rolling along small vessel endothelium and by the formation of homotypic aggregates of neutrophils with sludging in small vessels ( [268](#) , [269](#) , [270](#) , [271](#) and [272](#) ). This neutrophil margination was transient, being maximal by approximately 15 minutes and resolving by 1 hour of dialysis. After the return of DF  $^{32}\text{P}$ -labeled neutrophils to their donor, the disappearance of labeled cells from the blood follows a single exponential curve with a half-disappearance time (  $t_2$  ) of approximately 7 hours in most normal subjects ( [189](#) , [195](#) , [224](#) , [273](#) , [274](#) , [275](#) and [276](#) ). This finding implies that neutrophils are destroyed or leave the blood randomly rather than according to their age (senescence), as is the case for erythrocytes and platelets ( [195](#) ). Support for this theory is found in the fact that  $^3\text{H}$ -TdR-labeled neutrophils appear in the blood and in saliva almost simultaneously ( [139](#) ). Studies involving leukapheresis ( [277](#) ) and other experiments ( [278](#) ) reveal that neutrophils that have crossed the endothelial barrier between blood and tissues probably do not reenter the circulation, at least not in significant numbers. The number of neutrophils that pass through the blood each day has been estimated at 62 to 400  $\times 10^7$  cells/kg/day ( [Table 10.7](#) )—that is, the GTR. In 1964, it was proposed that neutrophils became

senescent and developed pyknotic nuclear lobes over time, this process truncating the exponential curve of disappearance of DF  $^{32}\text{P}$ -labeled neutrophils (139). Although this concept seemed plausible, no truncation of DF  $^{32}\text{P}$  curves has been noted. Similar blood kinetic results have been obtained with the use of  $^3\text{H}$ -TdR and autoradiographic techniques (279). More recent studies describe the occurrence of apoptosis in neutrophils, and this may be an important mechanism of senescence in some circumstances. Neutrophils undergo apoptosis in tissue culture (approximately 50% of cells in 24 hours); this process is accompanied by a fall in intracellular pH (280, 281 and 282). The addition of G-CSF, GM-CSF, or IL-1 delays but does not prevent this process (280, 283). Macrophages phagocytose senescent (apoptotic) neutrophils (as observed more than a century ago), and this is probably one fate of the short-lived blood neutrophil (281, 282, 284, 285, 286 and 287). Interestingly, glucocorticoids inhibit neutrophil apoptosis (288), but they induce it in susceptible lymphocytes. Fas (CD95) is expressed on neutrophils and is capable of inducing apoptosis as it does in other susceptible cells (288, 289).

**$^{51}\text{Cr}$  Studies** Leukocytes can also be labeled *in vitro* with radiochromate ( $^{51}\text{CrO}_4$ ) and then returned to the body (290, 291 and 292). Unlike DF  $^{32}\text{P}$ , which labels primarily granulocytes (238, 240, 279), leukocyte types other than neutrophils are heavily labeled by the  $^{51}\text{Cr}$  technique (251, 290, 292, 293, 294 and 295). Under some circumstances (such as chronic lymphocytic leukemia), this capacity is advantageous because the distribution and turnover of leukocytes other than neutrophils can be followed (290, 293, 295, 296). In addition,  $^{51}\text{Cr}$  is a  $\gamma$ -emitting isotope, so external counting techniques may detect sites of sequestration or destruction. Results of studies of the infusion of autologous, radiochromate-labeled leukocytes into hematologically normal subjects are more variable than those using the DF  $^{32}\text{P}$  method. The proportion of cells recovered in the blood is sometimes less than that associated with DF  $^{32}\text{P}$ -labeled neutrophils (292), and complex curves are often noted (296). Furthermore, there is no general agreement on  $t_{1/2}$  values; most investigators report values similar to those obtained with DF  $^{32}\text{P}$  (251, 290, 292, 293, 297), but values two to three times longer have been described (298, 299). Several factors may explain these differences, but a major one is probably  $^{51}\text{Cr}$  labels of multiple cell populations. No significant organ sequestration of labeled leukocytes has been detected in normal subjects (292).

**$^{111}\text{In}$  Studies** After the evaluation of a variety of other radioactive agents for labeling leukocytes *in vitro* (300),  $^{111}\text{In}$  chelated with 8-hydroxyquinoline (oxine) was thought to be promising for evaluating the *in vivo* localization of abscesses. The  $^{111}\text{In}$ -oxine complex labels blood cells effectively (95% uptake in 15 minutes) and exhibits minimal elution (<1% released in 2 hours) (301). This label is nonspecific, however, in that it binds to all cell types; thus, cell separation and purification are necessary before labeling occurs (302). Nevertheless, the labeling of autologous neutrophils (or leukocyte suspensions containing mostly neutrophils) and their reinjection is sometimes useful in localizing abscesses in humans although much of the radioactivity initially localizes in the lungs and subsequently appears in the spleen and liver (301).

**MIGRATION INTO TISSUES AND SITES OF DESTRUCTION** At a local site of tissue damage or infection, adherence of neutrophils to the endothelial cells of the vessel wall and their subsequent migration into the tissues can be seen within minutes. After initial adherence, neutrophils project microscopically visible pseudopods between the endothelial cells and force a passage between them (303, 304). This directed movement, chemotaxis, is induced by the binding of a variety of chemoattractant molecules, such as n-formyl peptides (e.g., FMLP), a cleavage product of the fifth component of complement (C5a),

leukotriene B<sub>4</sub> and platelet-activating factor, to specific membrane receptors. Further migration is then delayed by the basement membrane and periendothelial cells, and the neutrophils may move parallel to, but beneath, the endothelium until a passage into the surrounding connective tissue is found. Once neutrophils leave the blood, they do not return in significant numbers ( 278 , 305 ). The sites into which neutrophils normally disappear are poorly understood. Labeled blood neutrophils are found in saliva ( 136 ), but loss into saliva may reflect subclinical infections, because few if any cells are found in the salivary ducts ( 306 ); the rate at which granulocytes enter the oral cavity has been correlated with the degree of gingivitis ( 307 ). Some cells do penetrate the oral mucosa in healthy subjects, presumably as a result of diapedesis ( 306 ). Loss of leukocytes in the urine also has been demonstrated in normal subjects ( 308 ). Leukocyte loss increases significantly in association with pyelonephritis ( 309 ). In addition, arteriovenous catheterization studies in dogs ( 310 ) and in humans ( 311 ) provide evidence that suggests leukocytes also are removed in the lungs, liver, and spleen. Significant numbers may be lost into the gastrointestinal tract. No quantitative data concerning the rate of loss through these various organs are available. Interestingly, bone marrow and blood leukocyte counts were essentially the same in germ-free and normal mice, suggesting that loss via subclinical infections at the various body surfaces is not a major factor in neutrophil turnover ( 312 , 313 ). Neutrophil function can also be regulated by the neuroendocrine axis. For example, glucocorticoids can regulate neutrophil function, at least partly through annexin I or lipocortin I ( 72 ). Opiates have been reported to alter many immune functions, including neutrophil functions such as the respiratory burst, in many species ( 314 ). MRP-14, a prominent component of neutrophils, can inhibit the function of activated macrophages and, possibly by this mechanism, can decrease inflammatory pain ( 71 ).

### Neutrophil Kinetics in the Fetus and Newborn

The fetus exists in a sterile environment and, unlike the adult, does not require antibacterial defenses. However, if the systems ensuring adequate neutrophil production, storage, delivery to tissues, phagocytosis, and bacterial killing are not intact at birth, extrauterine existence is seriously compromised. Maturation of the neutrophil system is not complete in the midgestation fetus, and even the neonate delivered at term has a neutrophil system that in several respects is quantitatively and qualitatively immature. Therefore, one might anticipate that newborns, particularly those delivered prematurely, would be at significant risk for serious bacterial infection, and many studies reveal a strong correlation between prematurity and serious bacterial infection ( 315 , 316 , 317 , 318 , 319 and 320 ). Of all the risk factors for bacterial infection analyzed by the national collaborative study on neonatal infection, premature birth showed the strongest correlation ( 321 ). In addition, babies delivered at term experience a higher incidence of bacterial infection than do older children or adults ( 321 , 322 ) and, when infected, often display poor resolution of infection despite antibiotic therapy.

Newborn infants, particularly if premature, display many other deficiencies in antibacterial defense, such as low levels of IgG antibody, complement components, fibronectin, and lymphokine production ( 323 ), but only maturational differences in neutrophil kinetics are discussed here. Realizing that the neutrophil system of a fetus is underdeveloped and in a state of maturation, a difference in neutrophil pool sizes and kinetics in this group from those in adults can be expected. In addition, rapid somatic growth in the fetus and newborn places added demands, unique to the neonate, on neutrophil production ( 324 ); cells are needed not only for ongoing antibacterial defense, but also for a rapidly



increasing body mass.

The investigation of neutrophil kinetics during fetal and neonatal life in humans has been hampered by lack of applicability of the techniques used for such studies in adults. For instance, DF  $^{32}\text{P}$  and  $^3\text{H}$ -TdR blood kinetic measurements have not been used in babies because of the radiation exposure and the large volumes of blood required. Nevertheless, the results of clinical studies, coupled with extensive investigation in developing animals, illustrate several developmental differences.

**GRANULOCYTE-MACROPHAGE PROGENITOR CELLS** CFU-GM has been isolated from the livers of aborted 5- to 6-week human fetuses ( [325](#) ). Although early fetal CFU-GM produced colonies of mature neutrophils *in vitro*, no mature neutrophils could be located in the liver, marrow, or blood of the 5- to 6-week fetuses from which this CFU-GM was obtained ( [325](#) ). In separate studies, mature neutrophils were not detected in the human fetus until approximately 15 to 16 weeks' gestation ( [326](#), [327](#), [328](#) and [329](#) ), at least 10 weeks after the first appearance of CFU-GM. The concentration of CFU-GM in blood is higher in the fetus and newborn than in adults: 20 to 300 CFU-GM/ml of venous blood in adults and approximately 2000 CFU-GM/ml in term neonates ( [330](#), [331](#), [332](#), [333](#), [334](#), [335](#), [336](#) and [337](#) ). Even higher venous blood concentrations are found in prematurely delivered infants ( [331](#), [336](#) ), with the highest values noted in the most premature subjects ( [331](#) ). The total body pool of CFU-GM has not been measured in human neonates; in rats, the number of CFU-GM/g body weight is small in the fetus ( $0.5 \pm 0.1 \times 10^3$  CFU-GM/g) and increases to adult levels ( $10.5 \pm 0.2 \times 10^3$ /g) at 4 weeks of age ( [338](#) ). The proliferative rate of CFU-GM during human gestation, assessed by thymidine suicide, is rapid in the second trimester ( [331](#) ). Whereas CFU-GM in venous blood of adults displays a thymidine suicide rate ranging from 0 to 7% ( [331](#), [339](#), [340](#) and [341](#) ), rates of 45% have been observed in term neonates, and rates of 75% were noted in prematurely born neonates ( [331](#) ). Similarly, in fetal and neonatal rats ( [246](#) ) and mice ( [340](#) ), the CFU-GM proliferative rate is high and appears to be near maximal at birth, even in the noninfected state ( [342](#), [343](#) ). Unlike in adult animals, no further increase in CFU-GM number ( [344](#) ) or CFU-GM proliferative rate ( [342](#) ) has been detected during either sublethal or lethal bacterial infection, suggesting that the system operates at capacity. It has been suggested that the inability to accelerate neutrophil production above baseline might handicap neonates by limiting their neutrophil supply during a bacterial infection.

**NEUTROPHIL STORAGE POOL** In the fetus, as in the adult, mature neutrophils are stored within the skeletal marrow but also are found in the liver and spleen ( [344](#) ). Techniques that measure the size of the neutrophil storage pool, such as radioisotopic iron labeling, with subsequent liver, spleen, and bone marrow biopsy, have not been applied to normal human neonates. In fetal and neonatal animals, however, the liver and spleen, as well as the long bones, can be removed, and the neutrophils within them can be quantified. Such studies in rats show that the neutrophil storage pool is considerably smaller in prematurely delivered animals ( $1.0$  to  $1.3 \times 10^6$  cells/g body weight) than in term ( $1.3$  to  $2.5 \times 10^6$  cells/g) and adult animals ( $4.5$  to  $7.5 \times 10^6$ /g) ( [345](#) ). During experimental bacterial sepsis in neonatal dogs and rats, the size of the neutrophil storage pool has been serially quantified. Experiments performed with a variety of organisms ( [344](#), [346](#), [347](#), [348](#), [349](#), [350](#), [351](#) and [352](#) ) demonstrate depletion of the storage pool and neutropenia before death. Similarly, in human neonates with lethal bacterial sepsis, neutropenia and depletion of the neutrophil storage pool, as assessed by bone marrow aspiration, are nearly universal findings ( [328](#), [350](#), [353](#), [354](#) ).

**RELEASE FROM STORAGE POOL INTO BLOOD** Within 1 hour of inoculating adult animals with as few as  $10^4$  type III group B streptococci/g body weight, an accelerated

rate of egress of neutrophils from the storage pool into the blood can be detected ( 353 ). In contrast, when newborn animals were given the same or a larger inoculum of  $10^6$  organisms/g, a 4-hour delay occurred before this acceleration in neutrophil storage pool release was observed ( 353 ). This delay between bacterial inoculation and accelerated release of marrow neutrophils may be a significant physiologic disadvantage, which permits prolific initial bacterial multiplication. In other studies, this delay in release of marrow neutrophils was completely corrected by prior administration of type-specific antibody directed toward the organism with which the animal was inoculated ( 347 , 353 ). Some cytokines (e.g., IL-8) readily induce neutrophil release from the marrow ( 261 ).

**ALTERATIONS IN MIGRATION INTO TISSUES AND SITES OF DESTRUCTION IN NEONATES** In many studies, investigators have demonstrated defective neutrophil chemotaxis in neonates. In early investigations, Eitzman and Smith, using the Rebeck skin window technique, demonstrated that a preponderance of eosinophils, not neutrophils, were attracted to the abraded dermis of neonates ( 355 ). Using the same technique, Bullock et al. demonstrated that neutrophils in neonates remained at the site of abrasion longer than they did in adults ( 356 ). Using the Boyden chamber method, neutrophils from newborns were found to be less responsive than adult neutrophils in chemotaxis ( 357 ). In addition, factors generated from neonatal serum attracted neutrophils less well than did factors from adult serum. Diminished chemotaxis of cord blood neutrophils was also demonstrated, with reduction to approximately 80% of levels observed with adult neutrophils ( 358 , 359 and 360 ). Using a different *in vitro* technique for quantification of neutrophil movement (agarose gel), newborn neutrophil chemotaxis was found to be reduced to approximately 20 to 27% of that seen with adult neutrophils ( 361 ). In prematurely delivered neonates, neutrophil chemotaxis was even more defective ( 362 ), and the defect persists for a considerable time after birth. A further reduction in chemotaxis of neutrophils from ill neonates compared to healthy neonates ( 363 ) and decreased chemotaxis in preterm neonates with bacterial sepsis followed by a return to normal neonatal values (approximately 20% of adult values) with resolution of the infection ( 364 ) have been reported. Neutrophil migration has also been investigated *in vivo* in neonatal and adult animals. One technique involved surgical implantation of a sterile polyvinyl sponge disc, standardized for body weight, into rats. At various intervals, the sponges were removed, and neutrophils that had migrated into them were chemically quantified. Concurrent with sponge removal, the long bones (and the liver and spleen in neonates) were also removed, and the size of the total body neutrophil storage pool was determined ( 349 ). By comparison with control animals, only approximately 9% of the neutrophils released from the storage pool in neonates could be accounted for in the sponge. In contrast, approximately 60% of the neutrophils released from the marrow in adults migrated to the sponge, indicating more efficient neutrophil migration in the adult. Another study found that the accumulation of neutrophils in the peritoneal cavity of rats after intraperitoneal inoculation with various chemical attractants was impaired in neonates ( 365 ). The mechanism responsible for deficient neutrophil chemotaxis in neonates is only partly known. By measuring the pressure needed to aspirate neutrophils into a glass pipette, Miller determined that the neonatal neutrophil was more rigid and less deformable than the adult neutrophil, a characteristic that may be detrimental to movement of neutrophils through tissues ( 366 ). In addition, neutrophils from human neonates irreversibly aggregated after activation by C5a, whereas after exposure to the same stimulus, adult neutrophils aggregated and then deaggregated ( 268 , 269 , 270 and 271 , 367 ). Irreversible aggregation of neonatal neutrophils has also been seen in response to activation by FMLP ( 368 ). If irreversible neutrophil aggregation occurs *in vivo* in neonates, then independent neutrophil mobility would probably be impaired. A deficiency in the redistribution of cell-surface adhesion sites, factors related to impaired migration, and impairment of neutrophil adhesiveness has also been reported ( 369 , 370 ) and would impair neutrophil function *in vivo*. Response to complement-derived peptides was also impaired,



as shown in the response of cord blood neutrophils to endotoxin-activated serum ( 371 ). Concanavalin A capping ( 372 ), phytohemagglutinin-induced aggregation ( 373 ), and C5a-induced chemotaxis ( 358 ), as well as FMLP-induced membrane potential change ( 374 ), are reduced in the neonatal neutrophil. No difference in calcium uptake in FMLP-stimulated neutrophils was noted between human neonates and adults, but reduction in calcium uptake by resting neonatal neutrophils was significant ( 375 ). Diminished orientation of neonatal neutrophils after exposure to a chemotactic gradient was noted, and a significant decrease both in the number of microtubules/cell and in the assembly of microtubules was observed ( 376 ).

## PHYSIOLOGIC VARIATION IN LEUKOCYTES

The changes in blood leukocyte concentration that occur with growth and development are shown in [Appendix A](#). By the age of 4 to 8 years, the blood differential cell count approaches that seen in the adult. Normal values are presented in [Table 10.6](#). Metamyelocytes or myelocytes are not often seen on routine examination of the blood smear, but a few such cells can be found in normal blood after a careful search or, more readily, by examination of buffy coat smears (3.6/3000 granulocytes) ( 377 ); atypical mononuclear forms and megakaryocyte fragments containing nuclei are also seen in such smears. Whether a significant difference exists in leukocyte concentration between the sexes or with advancing years has been debated ( 183 , 378 , 379 , 380 and 381 ). Racial variations were reported in black Africans, with lower neutrophil and monocyte counts and higher eosinophil counts; however, these differences were not as evident in Africans eating a Western diet ( 382 ) or in black Americans ( 126 , 183 ).

Although leukocyte concentration is maintained within definite limits in normal humans, fluctuations occur during a single day and from day to day. The suggestion that a characteristic hourly rhythm occurs has not been confirmed ( 383 , 384 ), nor has the occurrence of a digestive leukocytosis been established ( 385 ). Light influences the diurnal variation of neutrophils ( 223 , 386 ). Under conditions of complete physical and mental relaxation, a basal level of  $5.0$  to  $7.0 \times 10^9$  cells/L is usual ( 387 ). Ordinary activity may be associated with a moderate increase, and a somewhat higher level is common in the afternoon. Under all these conditions, however, the leukocyte count tends to remain within the normal range ( [Table 10.6](#) ).

Conclusive demonstration of the effects of climate or season on the leukocyte count is lacking. Some authors claim that meteorologically conditioned fluctuations occur ( 388 ). Heat and intense solar radiation are said to cause leukocytosis ( 389 ). Prolonged residence in Antarctica has been reported to cause leukopenia ( 390 ). Artificially induced heat, sunlight, and ultraviolet light have been reported to cause lymphocytosis ( 391 ). Acute anoxia, both anoxic and anemic, causes neutrophilic leukocytosis ( 392 ) that does not develop in adrenalectomized rats. In the first few days after a subject has arrived at a high altitude, some leukocytosis, accompanied by lymphopenia and eosinopenia, has been observed, followed quickly by slight lymphocytosis and eosinophilia ( 393 ).

Marked leukocytosis regularly occurs with strenuous exercise. Counts as high as  $22.0 \times 10^9$ /L have been recorded for a runner after an 11-second 100-yard dash, and  $35.0 \times 10^9$ /L has been recorded after completing a quarter-mile run in less than 1 minute ( 387 ). The increment of cells usually consists of segmented neutrophils, but lymphocytosis may be prominent as well. Such leukocytosis recedes to normal in less than 1 hour and, in the neutrophil series, is related to a shift of cells from marginal sites (MGP) to the circulation

(CGP) (shift leukocytosis) ( [261](#), [262](#) ). This leukocytosis occurs in the absence of the spleen, suggesting that the spleen is not a major site of cell margination. Leukocyte counts higher than  $20.0 \times 10^9/L$ , mainly neutrophils, are regularly recorded for runners who complete a 26-mile marathon in 2.5 to 3.0 hours; whether a shift to the left, suggesting mobilization of marrow neutrophils, occurs in this circumstance is debatable ( [387](#) ). Postmarathon leukocytosis subsides slowly over a number of hours and probably reflects a redistribution of granulocytes in the blood, combined with mobilization of cells from the marrow with an increase in TBGP size. The magnitude of the leukocytosis associated with exercise appears to depend primarily on the intensity of the activity rather than on its duration ( [394](#) ).

Convulsive seizures, from whatever cause, are associated with an increase in leukocyte count similar to that noted after violent exercise. Electrically induced convulsions are followed by a reduction in eosinophil and lymphocyte number and an increase in neutrophil number, findings consistent with the effects of adrenal hormone secretion ( [395](#) ). Epinephrine injection produces leukocytosis, the nature and duration of which appear to vary with the mode of administration. Intramuscular injection causes leukocytosis in two phases ( [396](#), [397](#) ). In the first phase, maximal at 17 minutes, the number of neutrophils, lymphocytes, and eosinophils increases and then returns toward normal over several hours. This pattern almost certainly represents a shift leukocytosis. In the second phase, the number of neutrophils rises again at approximately 4 hours, although the number of lymphocytes and eosinophils remains at or below preinjection levels ( [397](#) ); this phase may reflect an adrenal steroid effect and consists of an absolute neutrophilia. After intravenous injection, leukocytosis peaking at 5 to 10 minutes and of total duration of less than 20 minutes occurs and has been shown to be purely shift neutrophilia ( [262](#), [263](#) ). The leukocytosis that follows subcutaneous injection is more variable.

During attacks of paroxysmal tachycardia, leukocytosis with cell counts of  $13.0$  to  $22.0 \times 10^9$  cells/L has been reported ( [398](#) ). Pain, nausea and vomiting, and anxiety may cause leukocytosis in the absence of infection ( [399](#) ). The paucity of band forms and metamyelocytes indicates that the neutrophilia results from the redistribution of the cells between the marginal and circulating pools.

Ether anesthesia produces leukocytosis, probably because of emotional and reflex reactions, as well as struggling during the stage of excitement. Narcosis with barbital compounds usually reduces the leukocyte count.

During the ovulatory period, eosinopenia and a slight rise in the number of leukocytes, as well as increased 17-hydroxycorticosteroid levels, have been reported ( [400](#), [401](#) ). Slight leukocytosis occurs during pregnancy, and neutrophilia increases as term approaches ( [183](#), [400](#) ). The onset of labor is accompanied by neutrophilic leukocytosis, which sometimes is pronounced ( $34.0 \times 10^9/L$ ). This state continues for 1 day after delivery, receding to normal only after 4 or 5 days. These changes are accompanied by a reduction in the number of circulating eosinophils ( [400](#) ).

Many of the physiologic variations in leukocytes that have been described can be explained as manifestations of stimulation of the adrenal cortex. The administration of cortisone or hydrocortisone results in increased blood levels of 17-hydroxycortico-steroids that peak at 1 hour ( [402](#) ) and are associated with neutrophilia ( [403](#) ). Eosinopenia and lymphopenia follow, become maximal at 4 to 8 hours, and are proportional to the quantity of hormone administered. Neutrophilia was less constant than

the depression in eosinophil and lymphocyte numbers but is probably caused by a steroid hormone-mediated decreased efflux of neutrophils from the blood and increased cell release from the bone marrow ( 263 , 265 ). Just as exercise can raise the circulating neutrophil count, intense exercise has also been reported to induce neutrophil activation as determined by studies of cell-surface antigen expression ( 404 ). In contrast, ultraviolet B radiation, at doses similar to those naturally received, inhibits neutrophil phagocytosis and adhesion, although the practical significance of these observations is unknown ( 405 ).

## CONTROL MECHANISMS REGULATING NEUTROPHIL PRODUCTION

It is evident that a true steady state of neutrophil kinetics exists only for brief periods. Shifts of cells between marginal and circulating sites may occur without changes in blood neutrophil turnover ( 263 ), but any change in TBGP size must result from changes in cell inflow or egress. Studies involving leukapheresis have shown that a normal animal replenishes a depleted TBGP by mobilizing cells from the marrow granulocyte reserves ( 277 ). This increase in neutrophil concentration and TBGP size, like that seen with most bacterial infections or after endotoxin or steroid administration, must be triggered by some signal, and some means of stimulating cell production must be available to replenish depleted marrow reserves, whatever the etiology.

The nature of these control mechanisms is not well understood, but several control points exist: recruitment of pluripotent stem cells and their induction into committed stem cells, stimulation (and perhaps inhibition) of stem cell and myeloid proliferative cell growth, and selective release of cells from the marrow.

Blood cell development is discussed in [Chapter 3](#) and is only briefly discussed here. Pluripotent stem cells are mostly in the  $G_0$  state and must be induced into actively proliferating committed stem cells. Hematopoietic cell growth and development are usually restricted to certain tissues (e.g., bone marrow in adult humans and bone marrow and spleen in mice). Because cell differentiation is influenced by organ microenvironment (e.g., erythropoiesis is favored in mouse spleen, but granulocytopoiesis is favored in the bone marrow), the concept of local control of pluripotent stem cell induction was developed (the hematopoietic microenvironment) ( 406 ). The importance of the hematopoietic microenvironment is exemplified by the anemia of Steel mice, which results from a defective hematopoietic microenvironment ( 406 ). The defect in Steel mice involves the granulocyte system as well as erythropoiesis ( 407 ) and results from a diminished ability of organ stroma in the bone marrow and spleen to induce committed stem cells from pluripotent stem cells ( 408 ). The demonstration that the Steel (Sl) gene product, deficient in Steel mice, is a growth factor (stem cell factor or stem cell colony-stimulating factor) that binds to a receptor coded by the c-kit protooncogene (or white-spotting locus, W) has provided a molecular basis for understanding the hematopoietic abnormalities in mice with genetic defects in the Steel or W genes ( 259 , 409 ).

As judged from suspension cultures, at least three cell types (giant fat cells, epithelial cells, and phagocytic mononuclear cells) provide the microenvironment needed for multipotent stem cell proliferation ( 410 ). Presumably, these stromal cells produce sufficient concentrations of hematopoietic cell growth factors locally to promote multipotent stem cell proliferation and renewal when required ( 411 ).

### Growth Factors

A large number of growth factors or colony-stimulating factors have been identified that

regulate neutrophil production in the bone marrow, as described in [Chapter 8](#). Two of these, G-CSF and GM-CSF, are in clinical use. Exogenous administration of G-CSF expands the granulocyte mitotic pool and also decreases the bone marrow transit time of the postmitotic cells without changing the blood neutrophil half-life ([412](#)). These factors not only speed the recovery of neutrophil counts after chemotherapy and may decrease associated infectious complications ([413](#), [414](#), [415](#), [416](#) and [417](#)), but also have effects on mature neutrophils. For example, G-CSF transiently increases CD11b expression ([414](#), [418](#), [419](#)) and the affinity of CD62L (L-selectin) for its ligand and then causes CD62L surface expression to decrease ([420](#)). G-CSF also primes neutrophils for subsequent superoxide production in response to FMLP ([421](#), [422](#), [423](#) and [424](#)). Intravenous administration of G-CSF can result in an immediate transient neutropenia ([425](#), [426](#)) similar to the transient increase in the MGP seen with hemodialysis. Evidence of neutrophil degranulation *in vivo* after administration of G-CSF has also been observed ([427](#)). A number of other cytokines among this rapidly expanding class can also activate or prime neutrophils, including TNF- $\alpha$ , IL-6, IL-1, and IL-8 ([428](#), [429](#), [430](#) and [431](#)).

In addition to locally produced stimulators of colony-forming unit stem cell proliferation ([432](#)), inhibitors of proliferation have also been described ([433](#), [434](#)). Lactoferrin (present in the secondary or specific neutrophil granule) binds to specific receptors on some monocyte-macrophages and suppresses release of GM-CSF (and other cytokines), thus inhibiting colony formation. Transferrin also exhibits colony suppression activity, possibly through inhibition of GM-CSF production by T lymphocytes ([435](#)). Soluble forms of receptors for cytokines may also regulate the response of bone marrow progenitors to growth factors ([436](#)). Neural mechanisms controlling hematopoietic cell proliferation and release have also been suggested ([437](#)).

Another control point in the system is the selective release of granulocytes from the marrow. In studies of perfused rat hind limbs, the release of neutrophils from the marrow into the blood ([438](#)) increased with an increase in perfusion flow rate or with a low leukocyte content of the perfusate ([439](#)). Serum or plasma from animals or humans made neutropenic by endotoxin, vinblastine, or nitrogen mustard also induced neutrophilia ([440](#), [441](#), [442](#) and [443](#)). The activity was present during the period of neutropenia and rising neutrophil concentration—but not before or after this period. This neutrophilia-inducing activity was qualitatively dissimilar from that noted after endotoxin, epinephrine, or cortisone administration and acted by causing release of marrow cells. The results of these studies suggest that an endogenously produced humoral factor causes neutrophil release from the marrow ([440](#)). Several factors that stimulate neutrophil release from the bone marrow have been identified, including G-CSF, GM-CSF, C5a, TNF- $\alpha$ , TNF- $\beta$ , IL-8, and, possibly, a cleavage product of the third component of complement ([206](#), [260](#), [261](#)). Studies in rabbits have found that IL-8 induces neutrophil release from the bone marrow without altering the transit time through the mitotic and postmitotic marrow pools ([261](#)).

Thus, evidence exists that several factors, including cell nuclear and cytoplasmic deformability, cell motility, affinity of cell adhesion molecules for ligands, blood flow, and others are important in the control of marrow cell release ([100](#), [101](#), [259](#), [444](#)).

## NEUTROPHIL FUNCTION

The major role of neutrophils is to protect the host against infectious agents. To accomplish this task, the neutrophil must first sense infection, migrate to the site of the

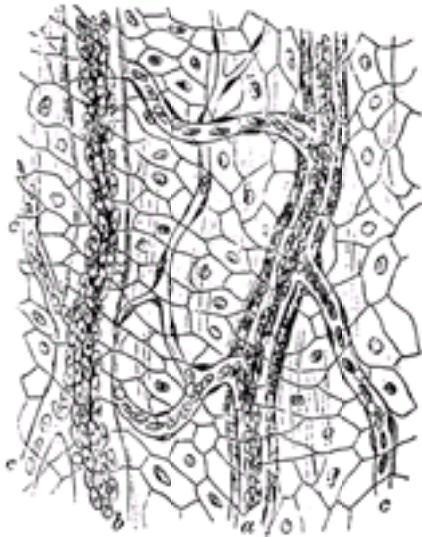
infecting organism, and then destroy the infectious agents. Although neutrophils can sense a stimulus in suspension, they can migrate only when in contact with a surface. Thus, although in some cases neutrophils in blood may respond to a stimulus by adhering to other blood cells or foreign bodies, such as bacteria or biomaterials, the usual first step of the neutrophil after sensing an inflammatory stimulus is to adhere more strongly to the blood vessel wall. Usually, this occurs in a postcapillary venule. After adhesion to the endothelial surface, the neutrophil follows a gradient of chemotactic factors to the site of infection and interacts with the organisms. Finally, when the neutrophil reaches the infecting organism, it must destroy it. This destruction is generally accomplished by phagocytosis of the agent followed by release of granules into the phagocytic vesicle, followed by killing of the organism. The mechanisms by which these phenomena occur are very complex and not completely understood.

## History

Antibacterial properties of blood were described by British surgeon John Hunter at the time of the Revolutionary War. He observed that the cellular (buffy coat) component of blood could retard the “spoilage” of blood ([445](#)); we now would recognize these effects as reflecting the antibacterial properties of leukocytes.

The response to infection by neutrophils in the microvasculature was elegantly described in *An American Text-Book of Surgery* in 1892 ([287](#)). This description remains instructive and is summarized here. At one time, the inflammatory cells at sites of infection were thought to be caused by proliferation of connective tissue cells. After the observations of von Recklinghausen that many of these cells were capable of locomotion (and called “ameboid cells from their resemblance to the amoeba”), Cohnheim identified the cells in the inflamed tissue as leukocytes ([287](#)). Microscopic examination of a frog’s mesentery or tongue reveals “an arteriole with its rapid pulsating current of blood, and near by a small vein in which the blood flows with a more steady movement. The red blood-corpuscles occupy the axis of the blood vessel, and the few white corpuscles which are seen float in the more sluggish stream of plasma which occupies the borders of the lumen and appears as a transparent layer” ([Fig. 10.14](#)). Induction of inflammation by the application of a caustic agent leads to hyperemia. “The rapidity of the flow of blood is greatly increased and a greater amount of blood is observed in the part. The lumen of the artery is greater than before, and the column of red corpuscles is much broader, and fills a comparatively greater portion of the lumen of the vessel. The capillaries are now quite distinctly seen, and are crowded with blood-corpuscles” ([Fig. 10.15](#)). This is followed by





**Figure 10.14.** Diagram of normal vessels and bloodstream: *a*, artery; *b*, vein; *c*, capillary. (From Keen WW, White JW, eds. An American textbook of surgery. Philadelphia: WB Saunders, 1892;11, with permission.)



**Figure 10.15.** Diagram of dilation of the vessels in inflammation: *a*, artery; *b*, vein; *c*, capillary. (From Keen WW, White JW, eds. An American textbook of surgery. Philadelphia: WB Saunders, 1892;11, with permission.)

a slowing of the current which soon becomes much more sluggish than in the normal state. This is first noticed in the capillaries, and soon after in the veins. The pulsation, however, continues in the arteries. As a result of this diminution of speed the column of blood-corpuscles becomes broader and almost completely fills the interior of the vessels. In the veins a great accumulation of white corpuscles takes place on the interior of the walls... Finally, they are so greatly increased in numbers that the entire wall of the vessel appears to be lined with leukocytes. The white corpuscles also accumulate in the capillaries, but not to the same extent [ [Fig. 10.16](#) ].



**Figure 10.16.** Diagram of stasis of blood and diapedesis of white corpuscles in inflammation: *a*, artery; *b*, vein; *c*, capillary. (From Keen WW, White JW, eds. An American textbook of surgery. Philadelphia: WB Saunders, 1892;12, with permission.)

The margination of the neutrophils is shown schematically in [Figure 10.17](#) (platelets or “blood-plaques” are also shown).



**Figure 10.17.** Blood plaques or third corpuscles (*a*). Red corpuscles (*b*). White corpuscles (*c*). (From Keen WW, White JW, eds. An American textbook of surgery. Philadelphia: WB Saunders, 1892;14, with permission.)

Beginning concurrently with the slowing of the blood-stream, is the emigration of the leukocytes from the interior of the veins. Many leukocytes, by a change of shape, send out little prolongations of protoplasm into the substance of the wall, and slight protuberances are soon seen projecting from its outer surface. These enlarge, and we now see the corpuscles presenting an hour-glass appearance. The portions within the vessel soon follow those without, and the leukocytes escape from all contact with the vessel. Many corpuscles appear to follow one another through the same point in the wall [ [Fig. 10.18](#)].



**Figure 10.18.** Diagram of stages of the migration of a single white blood corpuscle through the wall of a vein in 1 hour and 50 minutes (mesentery of the frog). (From Keen WW, White JW, eds. An American textbook of surgery. Philadelphia: WB Saunders, 1892;13, with



permission.)

Migration takes place to a limited extent also from the capillary vessels, but no such process is observed in the walls of the arteries. These same actions of neutrophils, as well as the formation of neutrophil–neutrophil aggregates with infections in rabbit ear veins, were videotaped by W.B. Wood in the 1960s. Using fluorescein–labeled neutrophils, Hammerschmidt et al. later demonstrated that injection of C5a reproduced the increase in neutrophil margination and aggregation in rat mesentery ( [446](#) ).

Early views of neutrophil function at the site of inflammation included a role in the repair process. Later, their ability to phagocytose was recognized. Metchnikoff advanced the theory known as

phagocytosis, according to which the cells of the inflamed part, in virtue of their ability to consume foreign substances, attack and destroy the invading bacteria [ [Fig. 10.19](#) ]. These cells are called phagocytes (from the Greek, “to eat,” and, “a cell”). If they are able to destroy the bacteria, the system is protected from the invading organisms. The leukocytes are called micro–phagocytes (or microphages), and the larger cells developed from the fixed connective–tissue cells are called the macro–phagocytes (or macrophages) ( [287](#) ).



**Figure 10.19.** Diagram of a phagocyte destroying a bacillus. The cell is shown at three different times ( **a**, **b**, and **c** ). (From Keen WW, White JW, eds. An American textbook of surgery. Philadelphia: WB Saunders, 1892;16, with permission.)

## Chemotactic Factor Receptors

The initial step of the neutrophil response to infection is the detection of an appropriate signal. The interaction of bacteria with blood components, especially antibodies and the complement system, results in the formation of various chemotactic factors. In some instances, the bacteria directly release factors that are chemotactic for neutrophils. The interaction of bacteria or their products with other host cells may also result in the formation of chemotactic factors. Neutrophils express specific receptors on their cell surface for a variety of chemotactic factors. These receptors include those for n–formylated peptides such as n–formyl–met–leu–phe (FMLP), C5a, leukotriene B<sub>4</sub>, and platelet–activating factor. The initial activation of the neutrophil occurs when soluble chemotactic factors bind their receptors on the neutrophil surface. As with the interaction of antibodies and haptens, the association kinetics for these receptor–ligand interactions are very rapid. Typically, sufficient receptor–ligand interaction to initiate neutrophil activation occurs within seconds.

## Signaling

Many chemotactic factor receptors appear to be coupled to guanine nucleotide binding

proteins (G proteins) ( 447 ). The role of G proteins in neutrophil signal transduction is supported by a variety of studies, including classic studies using pertussis toxin. Pertussis toxin adenosine diphosphate-ribosylates certain G proteins and inhibits neutrophil responses to a number of stimuli, including FMLP. In contrast, some neutrophil responses, such as phorbol ester-induced secretion, are not inhibited by pertussis toxin. Although the details of signal transduction in neutrophils are not fully elucidated, it appears that the G proteins associated with chemotactic factor receptors are important in receptor activation of phospholipase C, which then hydrolyzes phosphatidylinositol bisphosphate (PIP<sub>2</sub>), resulting in the generation of two second messengers, IP<sub>3</sub> and 1,2-diacylglycerol (DAG). Experiments suggest that IP<sub>3</sub> binds to specific receptors on intracellular membranes, resulting in the release of calcium from intracellular stores, which is rapidly augmented by an influx of extracellular calcium. Thus, shortly after receptor-ligand binding, the intracellular calcium rapidly rises from a resting level of approximately 0.1 mmol/L to approximately 1 mmol/L ( 448 , 449 and 450 ). This rise in free intracellular calcium is transient and returns to baseline in approximately 1 to 3 minutes.

It appears that the initial rise in intracellular calcium caused by the release of intracellular calcium stores plays a critical part in the alteration of membrane permeability to allow the influx of extracellular calcium. To some extent, variations in intracellular calcium transients may direct specific cellular functions in that specific granule release occurs at very low (submicromolar) free calcium concentrations, whereas in studies using permeabilized cells, higher (micromolar) levels of free calcium result in release of both specific and azurophil granules ( 451 , 452 and 453 ). Although the extracellular calcium influx is critical for many neutrophil responses, it is not critical for all, as degranulation is not blocked by ethyleneglycol-bis (2 aminoethyl) tetraacetic acid ( 454 ). Similarly, phagocytosis of particles opsonized with C3bi can occur without apparent intracellular calcium transients ( 455 ).

Protein phosphorylation is an important mechanism of the regulation of protein function, and a number of studies suggest its role in neutrophil activation. phorbol myristate acetate, which activates a number of neutrophil functions, binds to PKC and results in its activation. Although Phorbol myristate acetate is not present in neutrophils, DAG, released when phospholipase C hydrolyses PIP<sub>2</sub>, also binds and activates PKC. Because calcium is also important in PKC activation and IP<sub>3</sub> increases intracellular calcium, the hydrolysis of PIP<sub>2</sub> to IP<sub>3</sub> and DAG may contribute to PKC activation via both DAG and IP<sub>3</sub>. Interestingly, the specific granules have been reported to contain a PKC inhibitor, thus providing a possible mechanism to down-regulate PKC-mediated responses ( 456 ).

Although this model explains many observations, it has become clear that signal transduction in neutrophils is far more complex, with both Ca<sup>2+</sup> and PKC-independent pathways. Tyrosine phosphorylation has been found to play a critical role in signal transduction from various chemotactic factor receptors. Multiple neutrophil proteins are rapidly phosphorylated after activation, including Src family kinases; the Lyn kinase is activated by chemotaxins, increasing its ability to phosphorylate substrates. Serine and threonine kinases also appear to be involved in signaling, and some are activated by FMLP. In addition, phosphatidylinositol 3-kinase is also activated by chemotaxins. Phosphatidylinositol 3-kinase catalyzes the phosphorylation of PIP<sub>2</sub> to PIP<sub>3</sub>. Phosphatidylinositol 3-kinase binds some phosphotyrosine residues via the SH2 domain on one of its subunits. Protein tyrosine phosphatases probably also play a role, as the transmembrane protein phosphatase CD45 has been implicated as a regulator of neutrophil function ( 44 , 457 ). Chemotactic factors have also been found to activate phospholipase A<sub>2</sub> and phospholipase D. Finally, the importance of low-molecular-weight guanosine triphosphatases (LMWG) is also being recognized. Knowledge of signal

transduction is rapidly advancing, and the reader is referred to a review ( 461, 462 ) and the current literature.

Physiologic soluble inhibitors of neutrophil function have also been identified. For example, adenosine inhibits neutrophil aggregation, adhesion, chemotaxis, and superoxide production ( 463, 464 and 465 ). These inhibitory effects appear to act via A<sub>2</sub> receptors without preventing the transient rise in intracellular Ca<sup>2+</sup> ( 463, 464 and 465 ).

**NEUTROPHIL PRIMING** “Priming” is an important concept in neutrophil signaling. Signaling in neutrophils is complex and can be initiated by many different stimuli that may share downstream signaling pathways. When neutrophils are exposed to an appropriate low level of a stimulus, they can be primed to a condition such that they display a much more prominent response to a second stimulus than they would if they had not been primed ( 466 ). This phenomenon may be involved in many physiologic neutrophil responses *in vivo*.

### Neutrophil–Endothelial Adhesion

Both neutrophils and endothelial cells express a variety of adhesive molecules on their cell surface, and the expression and activity of these molecules in many cases can be regulated by stimuli. Some of the known adhesion molecules of neutrophils and endothelial cells are indicated in Table 10.8. Approximately one–half of the circulating neutrophils exist in the so–called marginating pool, some of which can be seen microscopically to be rolling along the endothelial surface, maintaining a loose intermittent contact with endothelial cells. The importance of hemodynamic forces, especially of red cells, in directing leukocytes outward from the flowing blood toward the endothelium was described many years ago and subsequently confirmed ( 287, 467, 468 and 469 ). An attractive model of neutrophil–endothelial cell adhesion has been proposed by Springer, which accounts well for the known data ( 470 ). In this model, selectin molecules on the cell surface are responsible for neutrophil rolling along the vessel wall. This loose adhesion brings the neutrophil in close proximity to the endothelial cell, where chemoattractants can be released or displayed on the cell surface. The interaction of these chemoattractants with neutrophil receptors results in signal transmission and the activation of integrin molecules. These integrins can then bind their ligands on the endothelial cell surface, resulting in a marked increase in adhesion to the endothelial cell and cessation of rolling. After this, the cells sense further chemoattractant gradients and migrate into the tissue.

**TABLE 10.8. Neutrophil–Endothelial Cell Adhesion Proteins**

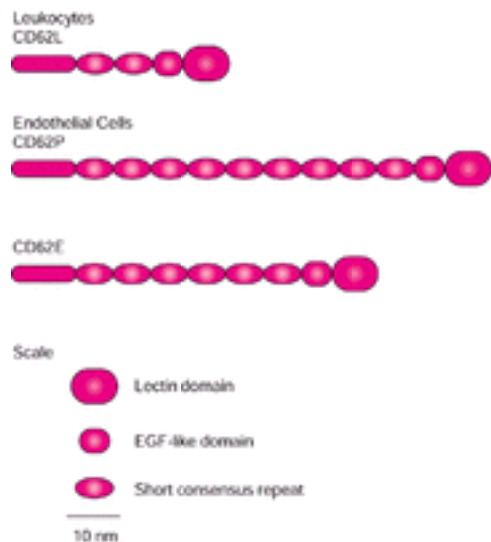
| Neutrophil Integrin           |  | Ligand   |
|-------------------------------|--|--|
| a <sub>1</sub> β <sub>1</sub> | Leukocyte factor antigen–1, CD11a/CD18 | ICAM–1 (CD54)<br>ICAM–2 (CD102)<br>ICAM–3 (CD50) |
| a <sub>M</sub> β <sub>2</sub> | HMac–1, CD11b/CD18                     | ICAM–1, iC3b, fibrinogen,<br>factor X            |
| a <sub>χ</sub> β <sub>2</sub> | p150, 95, CD11c/CD18                   | iC3b, fibrinogen                                 |
| Neutrophil Selectins          |  | Ligand   |

L-selectin CD62L, leukocyte adhesion molecule-1, Mel-14 Sialylated carbohydrates related to sLe<sup>x</sup> (CD15s) and sLe<sup>a</sup>

| Endothelial Selectins   |                        | Ligand   |
|---|------------------------|--|
| E-selectin CD62E, ELAM-1  |                        | Sialylated carbohydrates                                 |
| P-selectin CD62P, granule membrane protein-140, platelet activation-dependent granule-external membrane protein |                        | Sialylated carbohydrates including PSGL-1 on neutrophils |
| Endothelial Ig Family   |                        | Ligand   |
| CD54  | ICAM-1                 | CD11a/CD18<br>CD11b/CD18                                 |
| CD102   | ICAM-2                 | CD11a/CD18   |
| CD31  | PECAM-1                | CD31/a <sub>v</sub> β <sub>3</sub> ?                     |
| Neutrophil Ig Family  |                        | Ligand   |
| CD31  | PECAM-1                | CD31/a <sub>v</sub> β <sub>3</sub> ?                     |
| CD50  | ICAM-3                 | CD11a/CD18   |
| CD66a   | (Biliary glycoprotein) | CD66a, CD66c, CD66e                                      |
| CD66b   | (CGM6)                 | CD66c  |
| CD66c   | (NCA 50/90)            | CD66a, CD66b, CD66c, CD66e                               |

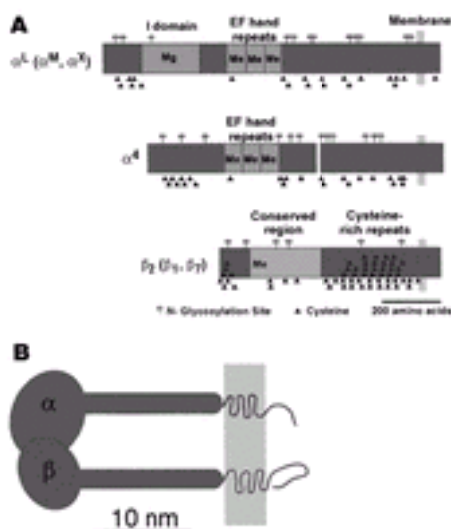
ELAM, endothelial leukocyte adhesion molecule; Ig, immunoglobulin; ICAM, intercellular adhesion molecule; PECAM, platelet endothelial cell adhesion molecule; PSGL, P-selectin glycoprotein ligand.

**SELECTINS** Three selectins have been identified that each have an N-terminal domain that is homologous to Ca<sup>2+</sup>-dependent lectins ( [Fig. 10.20](#)). L-selectin (CD62L, LAM-1, LECAM-1) is expressed on the neutrophil surface. The ligand for L-selectin is the glycoprotein known as *Gly-CAM-1* (glycosylation-dependent cell adhesion molecule-1). Endothelial cells express both E-selectin (CD62E, endothelial-leukocyte adhesion molecule-1) and P-selectin (CD62P, granule membrane protein-140, platelet activation-dependent granule-external membrane protein). E-selectin and P-selectin both recognize Lewis<sup>x</sup>-related sialylated carbohydrates. Expression of E-selectin on the endothelial cell surface can be induced with stimuli such as IL-1 and TNF but requires protein synthesis. In contrast, P-selectin (CD62P) is found in both the Weibel-Palade granules of endothelial cells and the platelet α-granule. Thus, stimulation of endothelial cells with the appropriate stimulus, such as thrombin or histamine, can result in a rapid mobilization of CD62P (P-selectin) to the endothelial cell surface.



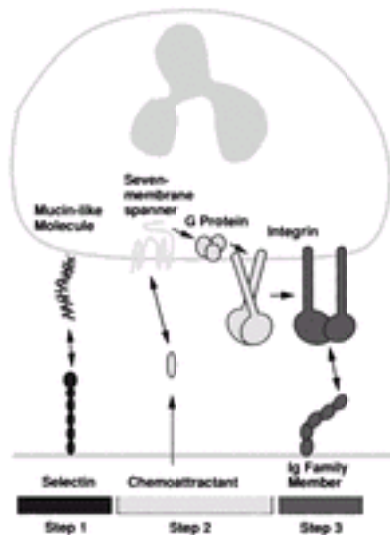
**Figure 10.20.** Schematic representation of selectins. The selectins are shown to scale, based on electron micrographs of P-selectin, and estimates of the sizes of the short consensus repeats, the epidermal growth factor (EGF) repeat, and the lectinlike *N*-terminal domain are given. (From Springer T. Traffic signals for lymphocyte recirculation and leukocyte emigration: the multistep paradigm. *Cell* 1994;76:301–314, with permission.)

**INTEGRINS** Integrins are noncovalently associated heterodimers of  $\alpha$  and  $\beta$  subunits, each of which has characteristic structural motifs ( [Fig. 10.21](#) and [Fig. 10.22](#)). The major integrins of neutrophils are the  $\beta_2$  integrins made up of a  $\alpha_L\beta_2$  (leukocyte factor antigen-1, CD11a/CD18), a  $\alpha_M\beta_2$  (HMac-1, CD11b/CD18), and a  $\alpha_X\beta_2$  (p150,95, CD11c/CD18). Intercellular adhesion molecule (ICAM)-1 (CD54) expressed on the endothelial cell surface is a ligand for both CD11a/CD18 and CD11b/CD18. Other Ig superfamily members are probably also involved in neutrophil-endothelial cell adhesion, including platelet endothelial cell adhesion molecule-1 (CD31), ICAM-3 (CD50) (expressed on the neutrophil but not the endothelial cell), and the CD66 family of neutrophil activation antigens.



**Figure 10.21.** Integrins that bind endothelial ligands. **A:** Schematics of representative integrin  $\alpha$  and  $\beta$  subunits. The structures of a  $\alpha_L$  and  $\beta_2$  integrin subunits are shown as representative of a  $\alpha_M$  and a  $\alpha_X$  or  $\beta_1$  and  $\beta_7$ , respectively; cysteines are identical, whereas glycosylation sites vary but are sparse in the I domain and E hand repeats. The EF hand repeats are divalent metal-binding motifs that may bind  $\text{Ca}^{2+}$  or  $\text{Mg}^{2+}$  (labeled *Me*). A

binding site for  $Mg^{2+}$  and  $Mn^{2+}$  but not  $Ca^{2+}$  has been identified in the I domain. The  $\alpha_4$  integrin subunit has a posttranslational proteolytic cleavage site. A putative divalent cation-binding site has been defined in the conserved domain of the integrin  $\beta_3$  subunit and is shown for  $\beta_2$ . **B:** Scale model of an integrin, based on electron micrographs of the integrins gpIIb/IIIa and very late antigen-5 ( $\alpha_5\beta_1$ ). (From Springer T. Traffic signals for lymphocyte recirculation and leukocyte emigration: the multistep paradigm. Cell 1994;76:301–314, with permission.)



**Figure 10.22.** Three sequential steps provide the traffic signals that regulate leukocyte localization in the vasculature. Selectin molecules that bind carbohydrate ligands, often displayed on mucinlike molecules, are responsible for the initial tethering of a flowing leukocyte to the vessel wall and for labile, rolling adhesions. Tethering brings leukocytes into proximity with chemoattractants that are displayed on or released from the endothelial lining of the vessel wall. Chemoattractants bind to receptors that span the membrane seven times on the surface of leukocytes. These couple to G proteins, which transduce signals that activate integrin adhesiveness. The integrins can then bind to immunoglobulin (Ig) superfamily members on the endothelium, increasing adhesiveness and resulting in arrest of the rolling leukocyte. Following directional cues from chemoattractants and using integrins for traction, leukocytes then cross the endothelial lining of the blood vessel and enter the tissue. (From Springer T. Traffic signals for lymphocyte recirculation and leukocyte emigration: the multistep paradigm. Cell 1994;76:301–314, with permission.)

**SEQUENCE OF NEUTROPHIL-ENDOTHELIAL CELL ADHESION** In the Springer model, selectins are responsible for the initial rolling of the neutrophil along the endothelial cell. The association and disassociation constants of selectins for their ligands are very rapid, and stimulation of neutrophils can result in a rapid increase in L-selectin affinity for its ligand, resulting in tethering of a flowing cell and rolling within a millisecond ([470](#), [471](#)). This increase in affinity is transient, and, in fact, by 5 minutes after stimulation, much of the CD62L is shed from the neutrophil surface. The close interaction of the neutrophil with the endothelial cell surface, mediated by the selectins, allows the neutrophils to sense chemoattractants released from or displayed on the endothelial surface. These chemoattractants bind to specific receptors on the neutrophil surface, many of which span the membrane seven times, are coupled with G proteins, and result in transduction of signals that activate integrin adhesive activity ([Fig. 10.22](#)). Some of the known chemoattractants for neutrophils are listed in [Table 10.9](#). Many tissue-derived chemotactic factors form a protein family termed *chemokines*. These proteins have four conserved cysteines that form two disulfide bonds. The chemokine family is composed of



CXC and CC chemokines. The CXC chemokines have their first two cysteines separated by a single amino acid and stimulate neutrophils, whereas the CC chemokines do not. Among the classically described chemoattractants are the n-formyl peptides. These chemoattractants were initially identified by studies of the observation that supernatants of bacterial cultures were chemotactic for neutrophils. Subsequent studies identified a number of n-formyl peptides with chemotactic activity, and it was hypothesized that the presence of such a receptor would provide a preimmune receptor for the neutrophil to sense bacterial infections because bacterial protein synthesis begins with n-formyl methionine, whereas mammalian protein synthesis does not. Interestingly, mammalian mitochondria do synthesize n-formyl methionyl peptides, and these may in some cases also result in neutrophil activation. Another classic chemoattractant is C5a, a cleavage fragment of the fifth component of complement.

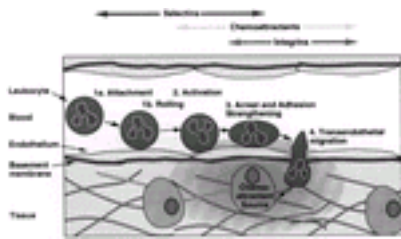
**TABLE 10.9. Neutrophil Chemoattractants**

| Chemoattractant  | Source   |
|--|--|
| <b>Classic chemoattractants</b>  |  |
| N-formyl peptides  | Bacterial (? mitochondrial) protein synthesis                  |
| C5a  | Complement activation  |
| Leukotriene B <sub>4</sub>   | Arachidonic acid metabolism                                    |
| Platelet-activating factor   | Phosphatidylcholine metabolism                                 |
| <b>C-X-C chemokines</b>  |  |
| Interleukin-8 (NAP-1)  | Multiple cells including T cells, monocytes, endothelial cells |
| β-Thromboglobulin (NAP-2/CTAP)   | Degradation of platelet α-granule protein                      |
| gro-α (MGSA)   | Multiple cells including endothelial cells, monocytes          |
| ENA-78   | Epithelial cells   |
| Modified from Springer T. Traffic signals for lymphocyte recirculation and leukocyte emigration: the multistep paradigm. <i>Cell</i> 1994;76:301-314, with permission. NAP, neutrophil-activating protein. |  |

Integrins form a family of adhesive molecules whose affinity for ligand can be rapidly regulated. Stimulation of neutrophils with n-formyl peptides or C5a results in rapid up-regulation of CD11b/CD18 expression on the neutrophil surface. This increase in expression is caused by fusion of secretory vesicles with the cell membrane. With strong stimulation, it is possible that secondary granule fusion contributes as well. However, mere translocation to the cell surface with an increase in cell-surface expression of CD11/CD18 is not sufficient for an increase in adhesiveness. Similarly, studies of cytoplasts have demonstrated that alterations in β<sub>2</sub> integrin-mediated cell adhesion can be manifest without a change in surface expression of CD11b/CD18. Data suggest that alterations in CD11b/CD18-mediated cell adhesiveness are the result of a conformational change of the integrin, causing an alteration in ligand binding. Studies show that, after activation of neutrophils by chemoattractants, approximately 10% of the surface CD11b/CD18 molecules express an activation epitope recognized by a monoclonal antibody (<sup>145</sup>). As shown in [Table 10.8](#), several Ig superfamily members are expressed on endothelial cells and are ligands for leukocyte integrins. Mac-1 (CD11b/CD18) binds to a specific site in the third Ig domain of ICAM-1. Leukocyte factor antigen-1 (CD11a/CD18) binds to the N-terminal domains of both ICAM-1 and ICAM-2. Thus, the model for neutrophil adhesion and transmigration through vessel walls can be depicted as in [Figure 10.22](#) and [Figure 10.23](#). The initial rolling of neutrophils along the vessel wall is mediated by selectins (L-selectin, E-selectin, and P-selectin), and their expression and affinity for ligand can be regulated by inflammatory stimuli. At sites of inflammation, leukocyte rolling



along the vessel wall is increased, and cells may become more closely apposed to the vessel wall, allowing better interaction with chemoattractants released from or presented on the surface of the endothelial cells. Interactions of these chemoattractants with the neutrophil then result in activation of integrin affinity for its ligand, with a resultant firm adhesion of the neutrophil to the endothelial cell surface. Subsequent migration of the neutrophil through the endothelial cell proceeds along the gradient of chemotactic agent. The presence of multiple adhesion molecules and ligands on both the neutrophil and the endothelial cell, which may vary among endothelial cells in different environments, coupled with the array of chemoattractant agents that may be released locally, provides potentially high specificity for localizing the interaction of a particular type of cell within a particular endothelial environment, based on the large number of combinatorial adhesive molecule–ligand pair combinations available (470).



**Figure 10.23.** The three-step area code model. Selectins, chemoattractants, and integrins act in sequence with some overlap. (From Springer T. Traffic signals for lymphocyte recirculation and leukocyte emigration: the multistep paradigm. *Cell* 1994;76:301–314, with permission.)

This model is supported by elegant studies demonstrating that at physiologic shear stress, neutrophils form rolling adhesions on phospholipid bilayers containing P-selectin but not on those containing ICAM-1. Chemoattractants result in integrin-mediated adhesion to bilayers containing ICAM-1 under static conditions but not under shear conditions. In contrast, neutrophils rolling on bilayers containing both P-selectin and ICAM-1 respond to chemoattractants by spreading and becoming firmly adherent via an integrin-ICAM-1 interaction. Chemoattractants do not increase adhesion or rolling on bilayers containing P-selectin alone (470).

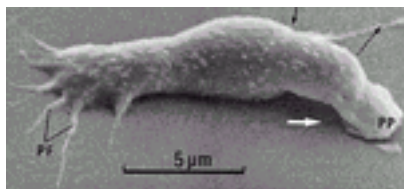
### Neutrophil Aggregation

The increase in polymorphonuclear neutrophil adhesion after stimulation is manifest not only by increased adhesion to endothelial cells, but also by neutrophil–neutrophil and neutrophil–platelet adhesion. Although the *in vivo* formation of neutrophil aggregates was clearly visualized by W.B. Wood in a rabbit ear model of inflammation in the 1960s, the possibility of neutrophil homotypic aggregation was considered novel when formally demonstrated by Craddock et al. (268, 269). Craddock’s observations stemmed from earlier descriptions of the phenomenon of hemodialysis neutropenia (266, 267). The initiation of hemodialysis, using cuprophane membranes, is followed by a rapid fall in the circulating neutrophil count caused by a transient sequestration of neutrophils in the lung, with a return to the circulation by 1 hour (266, 267). Craddock demonstrated that neutrophils undergo homotypic aggregation in response to plasma that had been exposed to cuprophane, largely because of generation of C5a by complement activation (268, 269, 271, 272). Aggregation was also induced by other neutrophil stimuli. Further studies demonstrated that the transient nature of hemodialysis neutropenia was caused by desensitization of neutrophils to the continued infusion of stimulus from the hemodialysis machine, thus demonstrating *in vivo* the phenomenon of desensitization (270). This phenomenon, in some clinical situations (e.g., viral infections), may result in neutrophil dysfunction as described later in this book. Subsequent studies have suggested that neutrophil aggregation and sludging, with resultant organ damage or dysfunction, may play

a role in a variety of pathologic processes including adult respiratory distress syndrome and reperfusion injury.

## Chemotaxis

The work of von Recklinghausen and Conheim described amoebalike movement of leukocytes more than a century ago (287). The neutrophil moves on a surface through a gradient of chemotactic agent by advancing a projection called a *lamellipodium* or *pseudopodium*. Chemotaxis begins with the protrusion of a pseudopodium or lamellipodium at the front of the cell. This occurs where the submembranous actin filament network (the cortex) becomes less filamentous. As the cell moves, the pseudopodium ruffles rapidly. Part of the pseudopodium adheres to the underlying surface, and the contents of the cell move forward into the pseudopodium, making the pseudopodium less prominent. This cycle is then repeated with the protrusion of another pseudopodium. Chemotaxis occurs by repetitions of this process, although often the process is so well coordinated as to appear as a continuous gliding motion. The mechanism of these cell movements has been reviewed (46) and appears to involve alterations in the polymerization state of actin, regulated by several proteins, including actin binding protein, gelsolin, and others, as well as adenosine triphosphate-dependent contraction of the actin network mediated by myosin. Local contraction of the cytoskeleton could move intracellular components forward into an area where the cortical gel has weakened because of shortening of actin filaments beneath the surface of the advancing pseudopodium. Characteristic contraction waves have been observed in human leukocytes and likened to those seen in amoebae and earthworms (Fig. 10.24) (472). In leukocytes, the contraction wave appears to originate in the superficial layer of the submembranous organelle-excluding region called the *cortex*, producing a concave area, and the anterior part of the cell stretches or is propelled forward as a pseudopodium (472).



**Figure 10.24.** Scanning electron micrograph of a moving neutrophil. The contraction wave is observed as a concave (black solid arrow) and a convex (black dashed arrow) area. The advancing pseudopodium (PP) is seen being pushed out in the direction of movement (white arrow). Pseudoflagellae (PF) are seen in the rear of the cell. (From Senda N, et al. The mechanism of the movement of leucocytes. *Exp Cell Res* 1975;91:393, with permission.)

Interestingly, mice that express no gelsolin can breed in captivity and have a prolonged bleeding time and abnormal neutrophil chemotaxis (46). Thus, gelsolin is important in neutrophil chemotaxis, but other proteins can compensate to some extent in its absence. The increase in free calcium that alters the cytoskeleton by activating gelsolin, and thereby decreasing filamentous actin with a resultant decrease in viscosity, may play a role in locomotion; in addition, the transient dissolution of the submembranous cytoskeletal network may allow closer contact of intracellular granules with the plasma membrane, facilitating granule fusion and release. Some granule release occurs with chemotaxis.

Although the mobility of neutrophils and their concentration in inflammatory lesions were

appreciated in early experiments, the development of a two-compartment chamber separated by a leukocyte-permeable membrane has permitted quantitation of chemotaxis *in vitro* and facilitated the investigation of chemotactic factors ( 473 , 474 ). Such studies revealed that neutrophils show directional migration under the influence of chemotactic agents, but a concentration gradient is needed for migration to occur. Even in the absence of a gradient, however, in the presence of a chemotactic factor, random migration is enhanced, and localization, or trapping, of the phagocytes occurs.

## Phagocytosis

Metchnikoff played an important role in describing the phenomenon of phagocytosis ( Fig. 10.25 ). When a neutrophil meets a particle, it envelops it with pseudopodia, which fuse around it, forming a phagosome that rapidly fuses with azurophilic and specific granules. *Endocytosis* is the process by which material is taken into a cell enclosed within pieces of plasma membrane and, therefore, never occurring free within the cytoplasm of the cell ( 475 ). Endocytosis is further divided into pinocytosis (drinking by cells) and phagocytosis (eating by cells). Phagocytosis is usually visible by light microscopy, whereas pinocytosis is not, involving ingestion of small particles, such as macromolecules. Both processes proceed through invagination of the cell membrane and the formation of vesicles or vacuoles (phagosomes).



**Figure 10.25.** Diagram of endocytosis; both phagocytosis of immunoglobulin-coated bacteria and pinocytosis are shown. The fusion of a primary lysosome and a specific granule with the phagosome to form the digestive vacuole, the subsequent degradation of the bacteria leading to the formation of a residual body, and the expulsion of indigestible components are also depicted.

Neutrophils and macrophages are motile and thus are free to migrate into sites of inflammation. Once in the area of inflammation, they come in contact with the foreign material, engulf it, and subject it to the microbicidal and digestive enzymes they contain. This sequence was appreciated by Metchnikoff in the 1880s ( 476 ) when he observed the migration of phagocytes into areas of tissue damage in sponges and lower animals. How phagocytes distinguish foreign particles and damaged autologous cells from normal self-components remains unclear, but this capacity is critical to effective phagocytic function.

## Granule Release

Neutrophils contain four well-defined types of intracellular granules: azurophilic, specific, and gelatinase granules and secretory vesicles. The azurophilic granules contain many antibacterial compounds, and it appears that the fusion of these granules with phagocytic vesicles is important in bacterial killing. Azurophilic granules also contain compounds, such as elastase, that may alter locomotion by hydrolyzing certain extracellular matrix components. The specific granules are more readily released from the cell, suggesting an

important function in the extracellular milieu. For example, specific granules contain products that activate the complement cascade (477). Collagenase may be important in hydrolyzing extracellular matrix proteins and facilitating locomotion. Apolactoferrin, which binds iron, may exert an antibacterial effect by depriving bacteria of iron, altering hydroxyl radical formation, and altering cell adhesion (36, 37). The tertiary granules contain gelatinase in addition to other components, and, like collagenase, this enzyme may play a role in extracellular matrix remodeling during locomotion. Finally, both tertiary granules and the secretory vesicles contain membrane proteins that can be rapidly up-regulated to the cell surface and may play a role in alterations of the functional use of these surface proteins after stimulation. Membrane components of secondary granules are also up-regulated during granule release and may play a role in regulating the expression of these membrane proteins on the cell surface. The specific granules are more readily released than the azurophilic granules, and their secretion, therefore, must be regulated somewhat differently.

### Bacterial Killing and Digestion

Bacterial killing by neutrophils can be ascribed to two general and often synergistic mechanisms: oxidative and nonoxidative. Bacterial killing in the phagosome is augmented by the generation of superoxide. Activated neutrophils produce superoxide via a multicomponent nicotinamide adenine dinucleotide phosphate (NADPH)-dependent oxidase that is activated by neutrophil stimulation. In resting cells, the oxidase components are found in both the plasma membrane and intracellular stores. After stimulation, intracellular components are translocated to the plasma membrane and activated, producing  $O_2^-$ . Subsequent reactions result in the formation of  $H_2O_2$  and hypochlorous acid (HOCl), which increase bacterial killing. Small amounts of other species (such as singlet oxygen and hydroxyl radical) may also form but are probably of little import in bacterial killing.

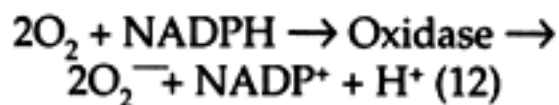
Bacterial killing decreases under anaerobic conditions, whereas phagocytosis does not, so the respiratory burst is important to bactericidal activity. Furthermore, because chronic granulomatous disease is one of the most severe clinical disorders characterized by a defect in bacterial killing, and the defect in this disorder is an inability to develop all of the reactions associated with the respiratory burst, the oxygen-dependent mechanisms appear to be of major importance in bacterial killing (478, 479). However, other bactericidal mechanisms not requiring oxygen also operate within phagocytes (Table 10.10).

**TABLE 10.10. Antimicrobial Systems of the Neutrophil**

|  |
|--|
| Oxygen dependent                             |
| Myeloperoxidase mediated                     |
| Myeloperoxidase independent                  |
| $H_2O_2$                                     |
| Superoxide                                   |
| Oxygen independent                           |
| Acid   |
| Lysozyme                                     |
| Lactoferrin                                  |
| Defensins                                    |
| Bactericidal permeability-increasing protein |
| Cationic granule proteins                    |

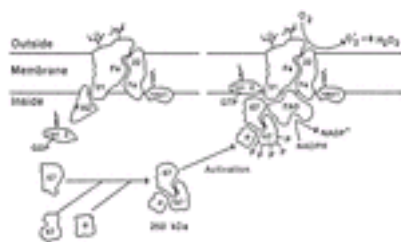
## Oxygen-Dependent Antimicrobial Systems

Neutrophil activation is accompanied by a prominent increase in O<sub>2</sub> use called the *oxidative burst*. The respiratory burst or oxidative burst is a series of metabolic events that take place when phagocytes are appropriately stimulated, resulting in an increase in oxygen consumption, the production of superoxide (O<sub>2</sub><sup>-</sup>), the production of H<sub>2</sub>O<sub>2</sub>, and an increase in glucose oxidation via the hexose monophosphate shunt (478, 480, 481). Most of the oxidative burst is caused by activation of an NADPH oxidase that catalyzes the one electron reduction of oxygen to superoxide, using the electron donor NADPH (478, 482):



Activation of the hexose monophosphate shunt occurs because of the increased NADP<sup>+</sup> produced.

The NADPH oxidase exists in a latent state consisting of both membrane and cytosolic components. Activation involves multiple steps, including assembly and translocation to the resting membrane-bound oxidase complex (consisting of at least three proteins including gp91<sup>phox</sup>, p22<sup>phox</sup>, and Rap 1) of at least two cytosolic components (p47<sup>phox</sup> and p67<sup>phox</sup>) (the term *phox* indicates that the protein is a component of the phagocyte oxidase), phosphorylation of p47<sup>phox</sup>, and translocation of a cytosolic G protein (Rac 1/2) to the membrane-bound oxidase complex (481) (Fig. 10.26). The activated oxidase is readily detected by nitroblue tetrazolium or cytochrome reduction or the production of chemiluminescence; several mechanisms by which this series of oxygen-dependent reactions may kill bacteria have been postulated (Table 10.10).



**Figure 10.26.** Hypothetical model of nicotinamide adenine dinucleotide phosphate (NADPH) oxidase activation. Current knowledge of the oxidase suggests that, in its dormant state (left side of figure), it is composed of both membrane-bound and cytosolic components. The former include the gp91-*phox* and p22-*phox* subunits of cytochrome *b*<sub>558</sub> (and, possibly, rap 1). Evidence suggests that the flavin adenine dinucleotide (FAD) redox center is bound to gp91-*phox*, but because this has not been conclusively established, the FAD is shown bound to a distinct oxidase subunit in the membrane. The cytosolic components include p47-*phox* and p67-*phox*, which appear to exist in a preformed complex of 260 kd. This complex probably contains at least one other additional component (as yet undetermined) labeled in this model as *a*. The low-molecular-mass guanosine triphosphate (GTP)-binding protein, rac 2, is also present in the cytosol in its inactive state [with (guanosine diphosphate) GDP bound], presumably

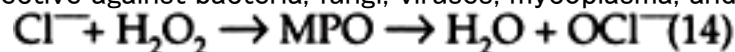
complexed with a GDP dissociation inhibitor (not shown) that serves to keep rac 2 in its inactive state. On stimulation, the p47-/p67- *phox* complex translocates to the membrane. This process may be under the control of the active (GTP-bound) form of rac 2 and further regulated by phosphorylation of p47- *phox*. In its active state, the FAD redox center accepts electrons from NADPH and passes them to molecular oxygen via the heme groups in cytochromes b<sub>558</sub>. Two heme groups are believed to be present in each cytochrome b<sub>558</sub> heterodimer. (From Curnutte JT. Chronic granulomatous disease: the solving of a clinic riddle at the molecular level. Clin Immunol Immunopathol 1993;67:S2-S15, with permission.)

Although O<sub>2</sub> has some antibacterial activity, most O<sub>2</sub> is rapidly converted to H<sub>2</sub>O<sub>2</sub> by dismutation, either spontaneously or catalytically by superoxide dismutase:

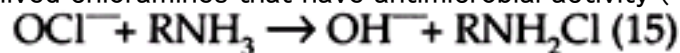


Of the microbicidal oxidants generated by the respiratory burst, O<sub>2</sub> and H<sub>2</sub>O<sub>2</sub> are not potent microbicides; rather, they function as starting materials to generate more potent oxidizing radicals, such as oxidized halogens and oxidizing radicals (478).

**MYELOPEROXIDASE-MEDIATED OXYGEN-DEPENDENT BACTERIAL KILLING WITH OXIDIZED HALOGENS** MPO is present in high concentration in the azurophilic or primary granules of neutrophils and is released into the phagosome during granule-phagosome fusion. MPO, together with H<sub>2</sub>O<sub>2</sub> generated during phagocytosis (483, 484) and an oxidizable cofactor such as halide (e.g., Cl or Br), forms oxidized halogens that are potent antimicrobials effective against bacteria, fungi, viruses, mycoplasma, and tumor cells (479):



The combination of MPO, halide, and H<sub>2</sub>O<sub>2</sub> is efficient in killing bacteria at H<sub>2</sub>O<sub>2</sub> concentrations as low as 10 μm, whereas H<sub>2</sub>O<sub>2</sub> in the absence of MPO requires 0.5 mmol/L or greater levels to produce similar killing (478). Thus, H<sub>2</sub>O<sub>2</sub> alone is a weak antimicrobial. Several mechanisms that have been proposed to explain bacterial killing by this system include halogenation of the bacterial cell wall, oxidation of various bacterial components, the decarboxylation of bacterial wall amino acids (478, 479), and the generation of long-lived chloramines that have antimicrobial activity (478, 485):



There is some evidence that reactive nitrogen intermediates may also be produced (486, 487). Regardless of the mechanisms of killing, the fact that azide inhibition of MPO greatly decreases the microbicidal activity of normal leukocytes provides strong evidence for the importance of this system (483). In patients with MPO deficiency (which is often quantitative rather than qualitative), the activity of other antimicrobial systems is increased, thus partially compensating for the MPO deficiency (483). This finding may explain the increased susceptibility to infection in only approximately 20% of MPO-deficient patients (488).

**MYELOPEROXIDASE-INDEPENDENT (BUT OXYGEN RADICAL-DEPENDENT) BACTERIAL KILLING** This antimicrobial system is important because cells with no detectable MPO activity retain antibacterial actions that require oxygen; in fact, bacterial killing in MPO-deficient cells is associated with greater oxygen consumption than in normal cells (479).

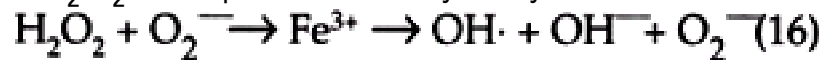
**HYDROGEN PEROXIDE** As mentioned, H<sub>2</sub>O<sub>2</sub> at high concentrations (>0.5 mmol/L) has antimicrobial activity in the absence of MPO (489). Some organisms are more sensitive



than others to H<sub>2</sub>O<sub>2</sub>, and this sensitivity may depend in part on their ability to degrade it (i.e., catalase or peroxidase content). Certain substances such as iodide or ascorbic acid may enhance the bactericidal action of H<sub>2</sub>O<sub>2</sub> or render organisms more sensitive to still other killing mechanisms, such as lysozyme (479).

**SUPEROXIDE ANION** After the discovery that O<sub>2</sub><sup>-</sup> was generated in phagocytes, some authors postulated that O<sub>2</sub><sup>-</sup> itself might be microbicidal. The microbicidal activity of O<sub>2</sub><sup>-</sup> appears to be weak, however, when compared to that of the H<sub>2</sub>O<sub>2</sub> formed from it, especially if MPO is present. Superoxide by itself has minimal bactericidal activity (478, 479).

**HYDROXYL RADICALS** Human neutrophils and monocytes generate OH· radicals, but the role of this highly reactive compound in microbial killing is unclear (478, 479). OH· production from H<sub>2</sub>O<sub>2</sub> and superoxide is catalyzed by iron in the Haber-Weiss reaction:



**SINGLET OXYGEN** Singlet oxygen (<sup>1</sup>O<sub>2</sub>) is a highly reactive form of oxygen that is capable of attacking compounds containing double bonds. However, significant amounts of singlet oxygen are unlikely to form, so its role in bacterial killing is probably not significant (488).

**NITRIC OXIDE** Nitric oxide may interact with neutrophil-derived oxidants to yield other relevant oxidant species. Nitric oxide (NO·) reacts with superoxide (O<sub>2</sub><sup>-</sup>) to form the potent oxidant peroxynitrate (ONOO<sup>-</sup>). Nitrite (NO<sub>2</sub><sup>-</sup>), a major end product of nitric oxide metabolism, has been found to interact with hypochlorous acid (HOCl) or MPO, or both, to form nitrylchloride (NO<sub>2</sub>Cl) and thus promotes tyrosine nitration (490, 491).

Activated neutrophils can convert NO<sub>2</sub><sup>-</sup> to NO<sub>2</sub>Cl and NO<sub>2</sub>· through an MPO-dependent pathway and inactivate endothelial angiotensin-converting enzyme (490). Thus, neutrophil conversion of NO<sub>2</sub><sup>-</sup> to nitrating and chlorinating species may play important physiologic roles. In this regard, nitric oxide synthase has been found in neutrophil primary granules (492), and NO· production by neutrophils has been observed (491).

## Oxygen-Independent Antimicrobial Systems

Because an anaerobic environment does not abolish antimicrobial activity, other mechanisms must be operative, and several have been identified, including the effects of acid, lysozyme, lactoferrin, defensins, cationic proteins, and neutral proteases. The delivery of the wide array of antibacterial compounds to the phagosome by fusion with azurophilic and specific granules generally results in bacterial killing caused by the direct actions of the granule contents. In addition, these effects are potentiated by the acidification of the phagosome, caused partly by the granule contents themselves, as well as active translocation of H<sup>+</sup> ions into the phagosome by ion pumps. The effectiveness of these mechanisms in the absence of superoxide production is demonstrated by both bacterial killing in anaerobic environments and killing by cells from patients with chronic granulomatous disease, in which catalase-positive organisms have an advantage over catalase-negative species. Nonoxidative killing is of obvious importance in hypoxic environments such as an abscess.

**ACID** After particle ingestion, the intraphagosomal pH has been reported to decrease to between 3.0 and 6.5 (493, 494 and 495). Some organisms, such as pneumococci, are sensitive to an acid pH, whereas others tolerate acid environments without damage. In addition, the acid environment may enhance the effect of lysosomal hydrolytic enzymes,



most of which have optimal activity at acid pH.

**LYSOZYME** This low-molecular-weight (14,500-d) basic protein is present in both primary and secondary neutrophil granules and is capable of hydrolyzing the cell wall of certain bacteria. Most organisms are resistant to the direct action of lysozyme ( 479 ), although they may become sensitive to its action after exposure to antibody and complement or to H<sub>2</sub>O<sub>2</sub> and ascorbic acid ( 479 ). Usually, bacterial death appears to precede the action of lysozyme, so its action may be mostly digestive. The leukocytes of Guernsey and Hereford cattle contain no lysozyme but kill organisms normally ( 496 ).

**LACTOFERRIN** This microbiostatic protein (molecular weight of 77,000 d) is found in the specific granules of rabbit heterophils ( 497 ) and in human neutrophils ( 498 ) as well as in many secretions (e.g., milk and mucus) and exudates ( 499 ). It inhibits bacterial growth by binding the essential nutrient iron (two atoms/molecule), and, in contrast to transferrin, this property is maintained at the low pH values encountered in exudates. A synergistic relationship between lactoferrin and other antimicrobial systems may exist, and lactoferrin may be bactericidal for some organisms ( 500 ).

**DEFENSINS** Prominent among the cationic neutrophil granule proteins are the defensins. These small microbicidal peptides kill a variety of bacteria, fungi, and viruses ( 16 , 17 and 18 , 501 ). Defensins appear to exert their effects by forming voltage-dependent ion channels. They are present in a very high concentration compared to other stored antibacterial peptides (approximately 5% of total neutrophil weight).

**BACTERICIDAL PERMEABILITY-INCREASING PROTEIN** Bactericidal permeability-increasing protein has antibacterial activity against certain gram-negative bacteria ( 21 , 22 , 23 , 24 and 25 ). It also has the property of neutralizing the toxic effects of endotoxin.

**OTHER GRANULE PROTEINS** Leukocyte granules from humans, rabbits, guinea pigs, and chickens contain several other basic proteins that migrate toward the cathode on electrophoresis in agarose and exhibit antimicrobial activity ( 21 , 498 ). These proteins differ from species to species ( 21 , 498 ), and their relative importance as antimicrobial agents probably also varies. For example, because chicken leukocytes lack MPO, the cationic proteins presumably are of greatest importance in that species. In rabbit heterophils ( 502 ) and chicken ( 503 ) and human ( 16 , 17 and 18 ) polymorphs, the cationic proteins are located in the primary granules and are delivered into the phagosome, where they coat the bacteria and are presumed to kill them ( 21 , 498 ). Other antibacterial granule components include azurocidin ( 26 , 27 ) and the serine proteinases elastase, cathepsin G, and proteinase 3 ( 28 , 29 , 30 and 31 , 504 ).

## Digestion

Digestion of bacteria is demonstrated both by changes in the morphologic appearance of organisms after phagocytosis and by the release of labeled fragments of bacteria into the surrounding medium ( 504 , 505 ). Digestion is thought to result from the action of the acid hydrolytic enzymes released into the phagosome from the primary lysosome. Metabolic blocking agents, such as iodoacetate, cyanide, and arsenite, which inhibit glycolysis and respiration, have no effect on digestion once the bacteria are within the cell ( 507 ). Some bacteria ingested by neutrophils (e.g., certain pneumococci) may be killed and digested slowly, the undigested material remaining as myelin or residual bodies.

**UNSUCCESSFUL INGESTION, KILLING, OR DIGESTION** Phagocytosis and bacterial killing are not always completed successfully. Some organisms (e.g., certain virulent staphylococci) may survive and multiply within neutrophils and appear to kill them, thus overcoming the defense mechanism ( 508 ). Still other materials ingested by neutrophils, such as the uric acid crystals of gout or the hydroxyapatite crystals of pseudogout, may

cause breakdown of the phagosome wall and release the hydrolytic enzymes into the cell sap ( 509 ). This action may be fatal to the cell, which then lyses and releases its enzymes into the surrounding tissues, where they cause tissue damage and secondary inflammation. In certain streptococcal and other infections, bacterial exotoxins (e.g., streptolysin) are released and damage the phagosomal membrane, thus killing the cell in a similar manner ( 510 ); the infecting organism is freed in the process. Also, certain vitamins (vitamin A) and drugs, when incorporated into phagosomal membranes, render the membranes fragile and readily susceptible to rupture, thereby leading to inflammation ( 509 ).

### Infections That Exhibit Tropism for Neutrophils

Granulocytic ehrlichiosis is a human pathogen ( 511, 512, 513 and 514 ). The *Ehrlichia* are obligate intracellular bacteria related to rickettsia. Human granulocytic ehrlichiosis is an acute febrile illness accompanied by severe myalgias and headaches, usually occurring within 2 weeks of contact with ixodid ticks. Common laboratory findings include leukopenia, thrombocytopenia, and increased transaminases. Although most patients respond promptly to doxycycline, death occurs in approximately 5% of reported cases, and complications such as pneumonia, renal failure, and central nervous system damage have been reported. Characteristic intracytoplasmic inclusions in neutrophils (morulae) are not always seen or recognized. Human granulocytic ehrlichiosis is closely related to two veterinary pathogens infecting granulocytes, *Ehrlichia equi* and *Ehrlichia phagocytophila*, which affect horses and ruminants, respectively.

### Secretory Functions of the Neutrophil

In addition to the fact that the contents of the neutrophil are released passively as a result of cell lysis, a variety of substances probably are actively secreted by leukocytes *in vitro*. Most of these substances have been shown to originate from the granule (including secretory vesicle) fraction. Specific granule contents (lactoferrin, B<sub>12</sub>-binding protein, or both) are released before primary granule contents, and tertiary granules and secretory vesicles are secreted even more rapidly and completely, providing evidence for a differential secretion of granule contents ( 515 ). Because some of these substances are present in plasma normally and the concentration increases in patients with diseases involving the neutrophil system ( 516, 517 and 518 ), some authors suggest that neutrophils may serve a secretory function as well as a phagocytic role *in vivo* ( 519, 520 ).

Two modes of enzyme release or exocytosis are released into phagocytic vacuoles (including release outside the cell during phagocytosis but before the phagosome is sealed off from the exterior of the cell or release during attempted phagocytosis that cannot be completed because of particle size) ( 515 ), and granule content release also occurs that is not associated with phagocytosis—that is, true secretion ( 515 ).

Two well-studied released granule proteins are the B<sub>12</sub>-binding proteins or transcobalamins. Granulocytes contain and actively release B<sub>12</sub>-binding protein ( 519, 521 ). This protein was thought to be a storage protein and is a poor source of metabolically available vitamin ( 522 ). It appears that transcobalamin III is derived from granulocytes; it is unsaturated with B<sub>12</sub> ( 523 ). Markedly elevated transcobalamin I levels are seen in cases of chronic myelocytic leukemia and myeloid metaplasia; low values occur in patients with chronic leukopenia and aplastic anemia ( 522 ), and good correlation with blood granulocyte

pool size has been reported ( [516](#) ).

Lysozyme is present in primary, secondary, and tertiary granules and is also present in monocytes, serum, and tears and other secretions ( [518](#) , [524](#) ). Increased concentrations in serum and urine are found in association with monocytic and myeloblastic leukemias ( [517](#) , [524](#) ). Although it was proposed that serum lysozyme may provide a measure of GTR ( [525](#) ), lysozyme is present in several cell types, and the GTR does not correlate with serum lysozyme levels in neutropenic patients. In addition, the plasma kinetics of lysozyme do not mirror the kinetics of other neutrophil granule proteins or short-term alterations in the number of circulating neutrophils (in contrast to the kinetics of lactoferrin and gelatinase) ( [518](#) ).

Stimulated neutrophils also synthesize and release a variety of cytokines that may regulate the inflammatory response. For example, neutrophils stimulated with lipopolysaccharides synthesize IL-1, TNF- $\alpha$ , and IL-1 receptor antagonist ( [526](#) ), whereas GM-CSF induces synthesis of TNF- $\alpha$  and IL-6 ( [527](#) , [528](#) ).

### Activation of Proteases by Oxygen Metabolites

Reactive oxygen metabolites may also contribute to the physiologic effects of activated neutrophils by activating latent enzyme activities of granule proteases such as collagenase ( [529](#) ). The significance of this process for bacterial killing is unclear but is relevant to other pathophysiologic processes.

## REFERENCES

1. Borregaard N, Heiple JM, Simons ER, Clark RA. Subcellular localization of the b-cytochrome component of the human neutrophil microbicidal oxidase: translocation during activation. *J Cell Biol* 1983;97:52-61.
2. Oren A, Taylor JMG. The subcellular localization of defensins and myeloperoxidase in human neutrophils: immunocytochemical evidence of azurophil granule heterogeneity. *J Lab Clin Med* 1995;125:340-347.
3. Borregaard N, Lollike K, Kjeldsen L, et al. Human neutrophil granules and secretory vesicles. *Eur J Haematol* 1993;51:187-198.
4. Ducker TP, Skubitz KM. Subcellular localization of CD66, CD67, and NCA in human neutrophils. *J Leukoc Biol* 1992;52:11-16.
5. Kjeldsen L, Bainton DF, Sengelov H, Borregaard N. Identification of neutrophil gelatinase-associated lipocalin as a novel matrix protein of specific granules in human neutrophils. *Blood* 1994;83:799-807.
6. Plesner T, Ploug M, Ellis V, et al. The receptor for urokinase-type plasminogen activator and urokinase is translocated from two distinct intracellular compartments to the plasma membrane on stimulation of human neutrophils. *Blood* 1994;83:808-815.
7. de Haas M, Vosseveld PJM, von dem Borne AEGK, Roos D. Fc $\gamma$  receptors of phagocytes. *J Lab Clin Med* 1995;126:330-341.
8. Borregaard N, Christensen L, Bjerrum OW, et al. Identification of a highly mobilizable subset of human neutrophil intracellular vesicles that contains tetranectin and latent alkaline phosphatase. *J Clin Invest* 1990;85:408-416.
9. Kuroki M, Matsuo Y, Kinugasa T, Matsuoka Y. Three different NCA species, CGM6/CD67, NCA-95, and NCA-90, are comprised in the major 90 to 100-kDa band of granulocyte NCA detectable upon

SDS-polyacrylamide gel electrophoresis. *Biochem Biophys Res Commun* 1992;182:501-506.

10. Kjeldsen L, Sengelov H, Lollike K, et al. Isolation and characterization of gelatinase granules from human neutrophils. *Blood* 1994;83:1640-1649.
11. Kjeldsen L, Bainton DF, Sengelov H, Borregaard N. Identification of neutrophil gelatinase-associated lipocalin as a novel matrix protein of specific granules in human neutrophils. *Blood* 1994;83:799-807.
12. Sengelov H, Kjeldsen L, Kroeze W, et al. Secretory vesicles are the intracellular reservoir of complement receptor 1 in human neutrophils. *J Immunol* 1994;153:804-810.
13. Lacal P, Pulido R, Sanchez-Madrid F, Mollinedo F. Intracellular location of T200 and Mo1 glycoproteins in human neutrophils. *J Biol Chem* 1988;263:9946-9951.
14. Borregaard N, Cowland JB. Granules of the human neutrophilic polymorphonuclear leukocyte. *Blood* 1997;89:3503-3521.
15. Schultz J, Kaminker K. Myeloperoxidase of the leukocyte of normal human blood. I. Content and localization. *Arch Biochem* 1962;96:465-467.
16. Ganz T, Lehrer RI. Defensins. *Pharmacol Ther* 1995;66:191-205.
17. Martin E, Ganz T, Lehrer RI. Defensins and other endogenous peptide antibiotics of vertebrates. *J Leuk Biol* 1995;58:128-136.
18. Levy O, Ooi CE, Elsbach P, et al. Antibacterial proteins of granulocytes differ in interaction with endotoxin. Comparison of bactericidal/permeability-increasing protein, p15s, and defensins. *J Immunol* 1995;154:5403-5410.
19. Lehrer RI, Ganz T, Selsted ME. Phagocytic defects. I. Abnormalities outside of the respiratory burst. Oxygen-independent bactericidal systems. Mechanisms and disorders. *Hematol Oncol Clin North Am* 1988;2:159-169.
20. Arnheim N, Inouye M, Law L, Laudin A. Chemical studies on the enzymatic specificity of goose egg white lysozyme. *J Biol Chem* 1973;248:233-236.
21. Spitznagel JK. Antibiotic proteins of human neutrophils. *J Clin Invest* 1990;86:1381-1386.
22. Elsbach P, Weiss J. Prospects for use of recombinant BPI in the treatment of gram-negative bacterial infections. *Infect Agents Dis* 1995;4:102-109.
23. Elsbach P, Weiss J, Doerfler M. The bactericidal/permeability increasing protein of neutrophils is a potent antibacterial and anti-endotoxin agent *in vitro* and *in vivo*. *Prog Clin Biol Res* 1994;388:41-51.
24. Shafer WM, Martin LE, Spitznagel JK. Cationic antimicrobial proteins isolated from human neutrophil granulocytes in the presence of diisopropyl fluorophosphate. *Infect Immun* 1984;45:29-35.
25. Wasiluk KR, Skubitz KM, Gray BH. Comparison of granule proteins for human polymorphonuclear leukocytes with are bactericidal toward *Pseudomonas aeruginosa*. *Infect Immun* 1991;59:4193-4200.
26. Campanelli D, Detmers PA, Nathan CF, Gabay JE. Azurocidin and a homologous serine protease from neutrophils. Differential antimicrobial and proteolytic properties. *J Clin Invest* 1990;85:904-915.
27. Gabay JE, Scott RW, Campanelli D, et al. Antibiotic proteins of human polymorphonuclear leukocytes. *Proc Natl Acad Sci U S A* 1989;86:5610-5614.
28. Baggiolini M, Dewald B. The neutrophil. *Int Arch Allergy Appl Immunol* 1985;76:13-20.
29. Henson PM, Johnson RM, Jr. Tissue injury in inflammation. *J Clin Invest* 1987;79:669-674.
30. Kao RC, Wehner NG, Skubitz KM, et al. Proteinase 3: a distinct polymorphonuclear leukocyte protease which produced emphysema. *J Clin Invest* 1988;82:1963-1973.

31. Tanaka T, Minematsu Y, Reilly CF, et al. Human leukocyte cathepsin G. Subsite mapping with 4-nitroanilides, chemical modification, and effect of possible cofactors. *Biochemistry* 1985;24:2040-2047.
32. Kuroki M, Yamanaka T, Matsuo Y, et al. Immunochemical analysis of carcinoembryonic antigen (CEA)-related antigens differentially localized in intracellular granule of human neutrophils. *Immun Invest* 1995;24:829-843.
33. Skubitz KM, Campbell KD, Iida J, Skubitz APN. CD63 associates with tyrosine kinase activity and CD11/CD18, and transmits an activation signal in neutrophils. *J Immunol* 1996;157:3617-3626.
34. Kuijpers TW, Tool ATJ, van der Schoot EC, et al. Membrane surface antigen expression on neutrophils: a reappraisal of the use of surface markers for neutrophils activation. *Blood* 1991;78:1105-1111.
35. Oram JD, Reiter B. Inhibition of bacteria by lactoferrin and other iron-chelating agents. *Biochim Biophys Acta* 1968;170:351-365.
36. Oseas R, Yang HH, Baehner RL, Boxer LA. Lactoferrin: a promoter of polymorphonuclear leukocyte adhesiveness. *Blood* 1981;57:939-945.
37. Boxer LA, Haak RA, Yang HH, et al. Membrane-bound lactoferrin alters the surface properties of polymorphonuclear leukocytes. *J Clin Invest* 1982;70:1049-1057.
38. Halliwell B, Gutteridge JMC. Oxygen free radicals and iron in relation to biology and medicine: some problems and concepts. *Arch Biochem Biophys* 1986;246:501-514.
39. Aruoma OI, Halliwell B. Superoxide-dependent and ascorbate-dependent formation of hydroxyl radicals from hydrogen peroxide in the presence of iron: are lactoferrin and transferrin promoters of hydroxyl-radical generation? *Biochem J* 1987;241:273-278.
40. Dewald B, Bretz U, Baggiolini M. Release of gelatinase from a novel secretory compartment of human neutrophils. *J Clin Invest* 1982;70:518-525.
41. Kanayama N, Kajiwara Y, Goto J, et al. Inactivation of interleukin-8 by aminopeptidase N (CD13). *Blood* 1995;57:129-134.
42. Painter RG, Dukes R, Sullivan J, et al. Function of neutral endopeptidase on the cell membrane of human neutrophils. *J Biol Chem* 1988;263:9456-9461.
43. Skubitz KM, Campbell KD, Skubitz APN. CD66a, CD66b, CD66c, and CD66d each independently stimulate neutrophils. *J Leuk Biol* 1996;60:106-117.
44. Harvath L, Balke JA, Christiansen NP, et al. Selected antibodies to leucocyte common antigen (CD45) inhibit human neutrophil chemotaxis. *J Immunol* 1991;146:949-957.
45. Southwick FS, Stossel TP. Contractile proteins in leukocyte function. *Semin Hematol* 1983;20:305-321.
46. Stossel TP. The machinery of blood cell movements. *Blood* 1994;367-379.
47. Gottfried EL. Lipids of human leukocytes: relation to cell type. *J Lipid Res* 1967;8:321-327.
48. Gottfried EL. Lipid patterns of leukocytes in health and disease. *Semin Hematol* 1972;9:241-250.
49. Bjerrum OW, Nielsen H, Borregaard N. Quantitative analysis of phospholipids and demonstration of plasmalogen in human neutrophil subcellular fractions by high-performance liquid chromatography. *Scand J Clin Lab Invest* 1989;49:613-622.
50. Samuelsson B, Dahlen SE, Lindgren JA, et al. Leukotrienes and lipoxins: structures, biosynthesis and biological effects. *Science* 1987;237:1171-1176.
51. Samuelsson B, Goldyne M, Granstrom E, et al. Prostaglandins and thromboxanes. *Annu Rev Biochem*

1978;47:997–1029.

52. Symington FW. CDw17: a neutrophil glycolipid antigen regulated by activation. *J Immunol* 1989;8:2784–2790.
53. Symington FW, Murray WA, Bearman SI, Hakomori SI. Intracellular localization of lactosylceramide, the major human neutrophil glycosphingolipid. *J Biol Chem* 1987;262:11356–11363.
54. Kiguchi K, Henning–Chubb CB, Huberman E. Glycosphingolipid patterns of peripheral blood lymphocytes, monocytes, and granulocytes are cell specific. *J Biochem* 1990;107:8–14.
55. Kniep B, Skubitz KM. “Subcellular localization of glycosphingolipids in human neutrophils.” *J Leukoc Biol* 1998;63(1):83–88.
56. Cinek T, Horejsi V. “The nature of large noncovalent complexes containing glycosyl–phosphatidylinositol–anchored membrane glycoproteins and protein tyrosine kinases.” *J Immunol* 1992;149(7):2262–2270.
57. Surviladze Z, Draberova L, et al. “Functional heterogeneity of Thy–1 membrane microdomains in rat basophilic leukemia cells.” *Eur J Immunol* 1998;28(6):1847–1858.
58. Brown DA, Rose JK. “Sorting of GPI–anchored proteins to glycolipid–enriched membrane subdomains during transport to the apical cell surface.” *Cell* 1992;68(3):533–544.
59. Stefanova I, Horejsi V, et al. “GPI–anchored cell–surface molecules complexed to protein tyrosine kinases.” *Science* 1991;254(5034):1016–1019.
60. Skubitz KM, Campbell KD, et al. “CD63 associates with CD11/CD18 in large detergent–resistant complexes after translocation to the cell surface in human neutrophils.” *FEBS Lett* 2000;469(1):52–56.
61. Reference deleted.
62. Bozza PT, Payne JL, et al. “Mechanisms of platelet–activating factor–induced lipid body formation: requisite roles for 5–lipoxygenase and de novo protein synthesis in the compartmentalization of neutrophil lipids.” *J Exp Med* 1996;183(4):1515–1525.
63. Yu W, Cassara J, et al. “Phosphatidylinositide 3–kinase localizes to cytoplasmic lipid bodies in human polymorphonuclear leukocytes and other myeloid–derived cells.” *Blood* 2000;95(3):1078–1085.
64. Weller PF, Ryeom SW, Picard ST, et al. Cytoplasmic lipid bodies of neutrophils: formation induced by cis–unsaturated fatty acids and mediated by protein kinase C. *J Cell Biol* 1991;113:137–146.
65. Lemarchand P, Vaglio M, Mauel J, Markert M. Translocation of a small cytosolic calcium–binding protein (MRP–8) to plasma membrane correlates with human neutrophil activation. *J Biol Chem* 1992;267:19379–19382.
66. Odink K, Cerletti N, Bruggen J, et al. Two calcium–binding proteins in infiltrate macrophages of rheumatoid arthritis. *Nature* 1987;330:80–82.
67. Hogg N, Allen C, Edgeworth J. Monoclonal antibody 5.5 reacts with p8, 14, a myeloid molecule associated with some vascular endothelium. *Eur J Immunol* 1989;19:1053–1061.
68. Dale I, Fagerhol MK, Naesgaard I. Purification and partial characterization of a highly immunogenic human leukocyte protein, the L1 antigen. *Eur J Biochem* 1983;134:1–6.
69. Wilkinson MM, Busuttill A, Hayward C, et al. Expression pattern of two related cystic fibrosis–associated calcium–binding proteins in normal and abnormal tissues. *J Cell Sci* 1988;91:221–230.
70. Dorin JR, Novak M, Hill RE, et al. A clue to the basic defect in cystic fibrosis from cloning the CF antigen gene. *Nature* 1987;326:614–617.
71. Giorgi R, Pagano RL, et al. “Antinociceptive effect of the calcium–binding protein MRP–14 and the

- role played by neutrophils on the control of inflammatory pain." J Leukoc Biol 1998;64(2):214-220.
72. Perretti M, Wheller SK, et al. "Modulation of cellular annexin I in human leukocytes infiltrating DTH skin reactions." J Leukoc Biol 1999;65(5):583-589.
73. Ezekowitz RAB, Orkin SH, Newburger PE. Recombinant interferon gamma augments phagocyte superoxide production and X-chronic granulomatous disease gene expression in X-linked variant chronic granulomatous disease. J Clin Invest 1987;80:1009-1016.
74. LaFleur M, Beaulieu AD, Kreis C, Poubelle P. Fibronectin gene expression in polymorphonuclear leukocytes. Accumulation of mRNA in inflammatory cells. J Biol Chem 1987;262:2111-2115.
75. Woodman RC, Curnutte JT, Babior BM. Evidence that *de novo* protein synthesis participates in a time-dependent augmentation of the chemotactic peptide-induced respiratory burst in neutrophils. Effects of recombinant human colony stimulating factors and dihydrocytochalasin B. J Free Radicals Biol Med 1988;5:355-361.
76. Breton-Gorius J, Reyes F. Ultrastructure of human bone marrow cell maturation. Int Rev Cytol 1976;46:251.
77. Orlic D, et al. An ultrastructural study of erythropoietin-induced red cell formation in mouse spleen. J Ultrastruct Res 1965;13:516.
78. Rifkind RA, et al. An ultrastructural study of early morphogenetic events during the establishment of fetal hepatic erythropoiesis. J Cell Biol 1969;40:343.
79. Tooze J, Davies HG. Light- and electron-microscope studies on the spleen of the newt *Triturus cristatus*: the fine structure of erythropoietic cells. J Cell Sci 1967;2:617.
80. Wetzel BK. The fine structure and cytochemistry of developing granulocytes, with special reference to the rabbit. In: Gordon AS, ed. Regulation of hematopoiesis, vol II. White cell and platelet production. New York: Appleton-Century-Crofts, 1970.
81. Hardin JH, Spicer SS. Ultrastructural localization of dialyzed iron-reactive mucosubstance in rabbit heterophils, basophils, and eosinophils. J Cell Biol 1971;48:368-386.
82. Erber WN, et al. Immunocytochemical labeling of haematological samples using monoclonal antibodies. Hamatol Bluttransfus 1985;29:180.
83. Dao C, et al. Eosinophil and neutrophil colony-forming cells in culture. Blood 1977;50:833.
84. Denburg JA, et al. Heterogeneity of human peripheral blood eosinophil-type colonies: evidence for a common basophil-eosinophil progenitor. Blood 1985;66:312.
85. Ogawa M, et al. Renewal and commitment to differentiation of hemopoietic stem cells (an interpretive review). Blood 1983;61:823.
86. Quesenberry P, Levitt L. Hematopoietic stem cells. N Engl J Med 1979;301:755, 819, 868.
87. Hayhoe FGJ, Quaglino D. Haematological cytochemistry. Edinburgh: Churchill Livingstone, 1980.
88. Boll I, Kuhn A. Granulocytogenesis in human bone marrow cultures studied by means of cinematography. Blood 1965;26:449.
89. Capone RJ, et al. Electron microscope studies on normal human myeloid elements. Blood 1964;23:300.
90. Bainton DF, et al. The development of neutrophilic PMN leukocytes in human bone marrow: origin and content of azurophil and specific granules. J Exp Med 1971;134:907.
91. Rich AR, et al. The differentiation of myeloblasts from lymphoblasts by their manner of locomotion. Bull Johns Hopkins Hosp 1939;65:291.



92. Senda N. The movement of leucocytes. *J Clin Electron Microsc* 1974;7:3.
93. Downey H. The myeloblast. In: Cowdry EV, ed. *Special cytology*, 2nd ed. New York: Paul B Hoeber, 1932.
94. Jordan HE. Comparative hematology. In: Downey H, ed. *Handbook of hematology II*. New York: Paul B Hoeber, 1938.
95. Gralnick HR, et al. Classification of acute leukemia. *Ann Intern Med* 1977;87:740.
96. Ackerman GA. Ultrastructure and cytochemistry of the developing neutrophil. *Lab Invest* 1968;19:290.
97. Scott RE, Horn RG. Ultrastructural aspects of neutrophil granulocyte development in humans. *Lab Invest* 1970;23:202.
98. Bainton DF, Farquhar MG. Origin of granules in polymorphonuclear leukocytes: two types derived from opposite faces of the Golgi complex. *J Cell Biol* 1966;28:277.
99. Ackerman GA, Bellios NC. A study of the morphology of the living cells of blood and bone marrow in vital films with the phase contrast microscope. I. Normal blood and bone marrow. *Blood* 1955;10:3.
100. Lichtman MA. Cellular deformability during maturation of the myeloblast: possible role in marrow egress. *N Engl J Med* 1970;283:943.
101. Lichtman MA, Weed RI. Alteration of the cell periphery during granulocyte maturation: relationship to cell function. *Blood* 1972;39:301.
102. Nachman R, et al. Studies on isolated membranes of azurophil and specific granules from rabbit polymorphonuclear leukocytes. *J Cell Biol* 1972;54:133.
103. West BC, et al. Isolation and partial characterization of human eosinophil granules. *Am J Pathol* 1975;81:575.
104. Bainton DF, et al. Primary lysosomes of blood leukocytes. In: Dingle JT, Dean RT, eds. *Lysosomes in biology and pathology*, vol 5. New York: Elsevier, 1976:3. (Frontiers of Biology series, vol 45).
105. Ackerman GA. Histochemical differentiation during neutrophil development and maturation. *Ann N Y Acad Sci* 1964;113:537.
106. Baggiolini M. The neutrophil. In: Weissmann G, ed. *The cell biology of inflammation*. New York: Elsevier, 1980.
107. Dewald B, et al. Subcellular localization and heterogeneity of neutral proteases in neutrophilic polymorphonuclear leukocytes. *J Exp Med* 1975;141:709.
108. Bainton DF, Farquhar MG. Difference in enzyme content of azurophil and specific granules of polymorphonuclear leukocytes. *J Cell Biol* 1968;39:299.
109. Farquhar MG, et al. Cytochemical localization of acid phosphatase activity in granule fractions from rabbit polymorphonuclear leukocytes. *J Cell Biol* 1972;54:141.
110. Cramer E, et al. Ultrastructural localization of lactoferrin and myeloperoxidase in human neutrophils by immunogold. *Blood* 1985;65:423.
111. Lajtha LG, et al. Uptake of S35 sulphate by human bone marrow cells *in vitro*. *Br J Cancer* 1953;7:401.
112. Vodopick HA, et al. An evaluation of radiosulfate as a granulocyte label in the dog. *J Lab Clin Med* 1966;68:47.
113. Zeya HI, Spitznagel JK. Cationic protein-bearing granules of polymorphonuclear leukocytes:

separation from enzyme-rich granules. *Science* 1969;163:1069.

114. Kaplow LS. Cytochemistry of leukocyte alkaline phosphatase. *Am J Clin Pathol* 1963;39:439.
115. Wetzel BK, et al. Fine structural localization of acid and alkaline phosphatase in cells of rabbit blood and bone marrow. *J Histochem Cytochem* 1967;15:311.
116. Baggiolini M, et al. Resolution of granules from rabbit heterophil leukocytes into distinct populations by zonal sedimentation. *J Cell Biol* 1969;40:529.
117. Bretz U, Baggiolini M. Association of alkaline phosphatase of rabbit polymorphonuclear leukocytes with the membrane of the specific granules. *J Cell Biol* 1973;59:696.
118. Rustin GJS, et al. Studies on the subcellular localization of human neutrophil alkaline phosphatase. *J Cell Sci* 1979;36:401.
119. Hirschhorn R, Weissmann G. Isolation and properties of human leukocyte lysosomes *in vitro*. *Proc Soc Exp Biol Med* 1965;119:36.
120. Dewald B, et al. Release of gelatinase from a novel secretory compartment of human neutrophils. *J Clin Invest* 1982;70:518.
121. Watanabe I, et al. Method for electron microscopic studies of circulating human leukocytes and observations on their fine structure. *J Ultrastruct Res* 1967;20:366.
122. Payne DN, Ackerman GA. Ultrastructural autoradiographic study of the uptake and intracellular localization of <sup>35</sup>S-sulfate by developing human neutrophils. *Blood* 1977;50:841.
123. Borregaard N, Sehested M, Nielsen BS, et al. Biosynthesis of granule proteins in normal human bone marrow cells. Gelatinase is a marker of terminal neutrophil differentiation. *Blood* 1995;85:812-817.
124. Wilkinson PC. The locomotion of leucocytes: definitions and descriptions. In: *Chemotaxis and inflammation*, 2nd ed. New York: Churchill Livingstone, 1982.
125. Ponder E, Mineola LI. The polycyte. *J Lab Clin Med* 1942;27:866.
126. Orfanakis NG, et al. Normal blood leukocyte concentration values. *Am J Clin Pathol* 1970;54:647.
127. Cartwright GE. *Diagnostic laboratory hematology*. New York: Grune & Stratton, 1968.
128. Edwin E. The segmentation of polymorphonuclear neutrophils. *Acta Med Scand* 1967;182:401.
129. Osgood EE, Ashworth CM. *An atlas of hematology*. San Francisco: JW Stacey, 1937.
130. Herbert V. *Megaloblastic anemias: mechanisms and management*. Chicago: Year Book, 1965.
131. Marsh JC, et al. Neutrophil kinetics in acute infection. *J Clin Invest* 1967;46:1943.
132. Zucker-Franklin D. Electron microscopic studies of human granulocytes: structural variations related to function. *Semin Hematol* 1968;5:109.
133. Sin YM, Sainte-Marie G. Granulocytopoiesis in the rat thymus. I. Description of the cells of the neutrophilic and eosinophilic series. *Br J Haematol* 1965;11:613.
134. Eastment CE, et al. The role of the nuclear protein matrix during development of rabbit granulocytes. *Blood* 1981;57:747.
135. Arneht J. *Die Neutrophilen wiessen Blutkörperchen bei Infections-Krankheiten*. Jena: Germany Fischer, 1904.
136. Fliedner TM, et al. Das Studium der Proliferationsdynamik der Myelopoese unter Verwendung der

Einzellautoradiographie. Folia Haematol (Leipz) 1961;6:210.

137. Lewis WH. On the locomotion of the polymorphonuclear neutrophils of the rat in autoplasm cultures. Bull Johns Hopkins Hosp 1934;55:273.
138. Sabin FR. Studies of living human blood cells. Bull Johns Hopkins Hosp 1923;34:277-288.
139. Fliedner TM, et al. Granulocytopoiesis. I. Senescence and random loss of neutrophilic granulocytes in human beings. Blood 1964;24:402.
140. McCutcheon M. Studies on the locomotion of leukocytes I. The normal rate of locomotion of human neutrophilic leukocytes *in vitro*. Am J Physiol 1923;66:180-195.
141. Howard TH. Quantitation of the locomotive behavior of polymorphonuclear leukocytes in clot preparation. Blood 1982;59:946-951.
142. Harvath L, Leonard EJ. Two neutrophil populations in human blood with different chemotactic activities: separation and chemoattractant binding. Infect Immun 1982;36:443-551.
143. Seligman B, Malech HL, Melnich DA, Gallin JI. An antibody binding to human neutrophils demonstrates antigenic heterogeneity detected early in myeloid maturation which correlates with functional heterogeneity of mature neutrophils. J Immunol 1985;135:2647-2653.
144. Clement LT, Lehmyer JE, Garland GL. Identification of neutrophil subpopulations with monoclonal antibodies. Blood 1983;61:326-332.
145. Diamond MS, Springer TA. A subpopulation of Mac-1 (CD11b/ CD18) molecules mediates neutrophil adhesion to ICAM-1 and fibrinogen. J Cell Biol 1993;120:545-556.
146. Krause PJ, Malech HL, Kristie J, et al. Polymorphonuclear leukocyte heterogeneity in neonates and adults. Blood 1986;68:200-204.
147. Ross GD. Structure and function of membrane complement receptors. Fed Proc 1982;41:3089-3093.
148. Ross GD, Jarowsky CI, Rabellino EM, Winchester RJ. The sequential appearance of Ia-like antigens and two different complement receptors during the maturation of human neutrophils. J Exp Med 1978;147:730-744.
149. Genco RJ, van Dyke TE, Levine MJ, et al. Molecular factors influencing neutrophil defects in periodontal disease J. Dent Res 1986;64:1377-1391.
150. Berkow RL, Baehner RL. Volume-dependent human blood polymorphonuclear leukocyte heterogeneity demonstrated with counterflow centrifugal elutriation. Blood 1985;65:71.
151. Gallin JI. Human neutrophil heterogeneity exists, but is it meaningful? Blood 1984;63:977.
152. Scott CS, et al. C3b receptor-negative peripheral blood neutrophils. Scand J Haematol 1984;32:183.
153. Lalezari P, Nussbaum M, Gelman S, Spaet TH. Neonatal neutropenia due to maternal isoimmunization. Blood 1960;15:236-243.
154. Huizinga TWJ, Kleijer M, Tetteroo PAT, et al. Biallelic neutrophil NA-antigen system is associated with a polymorphism on the phospho-inositol-linked Fc $\gamma$ -receptor III (CD16). Blood 1990;75:213-217.
155. Lalezari P, Murphy GB, Allen FH. NB1, a new neutrophil antigen involved in the pathogenesis of neonatal neutropenia. J Clin Invest 1971;50:1108-1115.
156. Stroncek DF, Skubitz KM, McCullough JJ. Biochemical characterization of the neutrophil-specific antigen NB1. Blood 1990;75:744-755.
157. Skubitz KM, Stroncek DF, Sun B. The neutrophil-specific antigen NB1 is anchored via a glycosyl-phosphatidylinositol linkage. J Leukoc Biol 1991;49:163-171.

158. Goldschmeding R, van Dalen CM, Faber N, et al. Further characterization of the NB1 antigen as a variably expressed 56–62 kD GPI-linked glycoprotein of plasma membranes and specific granules of neutrophils. *Br J Haematol* 1992;81:336–345.
159. Olsson I, et al. Purification of eosinophil peroxidase and studies of biosynthesis and processing in human marrow cells. *Blood* 1985;66:1143.
160. Bujak JS, Root RK. The role of peroxidase in the bactericidal activity of human blood eosinophils. *Blood* 1974;43:727.
161. Olsson I, et al. Arginine-rich cationic proteins of human eosinophil granules. Comparison of the constituents of eosinophilic and neutrophilic leukocytes. *Lab Invest* 1977;36:493.
162. Ackerman SJ, et al. Distinctive cationic proteins of the human eosinophil granule: major basic protein, eosinophil cationic protein, and eosinophil-derived neurotoxin. *J Immunol* 1983;131:2977.
163. Ward JC, Gitlin JB, Garry DJ, et al. Epidermolysis bullosa acquisita induced by GM-CSF: a role for eosinophils in treatment-related toxicity. *Br J Haematol* 1992;81:27–32.
164. DeMello DE, Liapis H, Jureidina S, et al. Cardiac localization of eosinophil-granule major basic protein in acute necrotizing myocarditis. *N Engl J Med* 1990;323:1542–1545.
165. Fureder W, Agis H, Sperr WR, et al. The surface membrane antigen phenotype of human blood basophils. *Allergy* 1994;49:861–865.
166. Zucker-Franklin D. Electron microscopic studies of human basophils. *Blood* 1967;29:878.
167. Hastie R. The antigen-induced degranulation of basophil leukocytes from atopic subjects, studied by phase-contrast microscopy. *Clin Exp Immunol* 1971;8:45.
168. Hastie R. A study of the ultrastructure of human basophil leukocytes. *Lab Invest* 1974;31:223.
169. Ackerman GA. Cytochemical properties of the blood basophilic granulocyte. *Ann N Y Acad Sci* 1963;103:376.
170. Hastie R, et al. The antigen-induced degranulation of basophil leukocytes from atopic subjects studied by electron microscopy. *Lab Invest* 1977;36:173.
171. Galli SJ, et al. Basophils and mast cells: morphologic insights into their biology, secretory patterns and functions. *Prog Allergy* 1984;34:1.
172. Bainton DF, et al. Formation and structure of specific granules in basophilic leukocytes of the guinea pig. *Lab Invest* 1969;21:65.
173. Kennedy WP, MacKay I. The macropolycyte in health and disease in Iraq. *J Pathol* 1937;44:701.
174. Oria J, Yoneda S. Variation of the form and structure of the nucleus in the various types of plurisegmented neutrophils. In: Dameshek W, Taylor FHL, eds. *George R Minot symposium of hematology*. New York: Grune & Stratton, 1949.
175. Weicker H. A quantitative model of granulopoiesis. *Schweiz Med Wochenschr* 1956;86:1459.
176. Davidson WM, Smith DR. A morphological sex difference in the polymorphonuclear neutrophil leukocytes. *BMJ* 1954;2:6.
177. Hochstenbach PF, Scheres JM, Hustinx TW, Wieringa B. Demonstration of X chromatin in drumstick-like nuclear appendages of leukocytes by in situ hybridization on blood smears. *Histochemistry* 1986;84:383–386.
178. Maclean N, Edin MB. The drumsticks of polymorphonuclear leucocytes in sex-chromosome abnormalities. *Lancet* 1962;1:1154.

179. Davidson WM. Sexing the blood leucocytes in abnormalities of the sex chromosomes. *Minerva Peditr* 1965;17:585.
180. Tomonaga M, et al. Leukocyte drumsticks in chronic granulocytic leukemia and related disorders. *Blood* 1961;18:581.
181. Davidson WM, Winn S. The relationship between the sex nodule and the sex chromosomes. In: Davidson WM, Smith DR, eds. *Human chromosomal abnormalities*. London: Staples Press, 1961.
182. Simmons A, et al. Normal laboratory values for differential white cell counts established by normal and automated cytochemical methods (Hemalog D-TM). *J Clin Pathol* 1974;27:55-58.
183. Bain BJ, England JM. Normal haematological values: sex difference in neutrophil count. *BMJ* 1975;1:306.
184. Berrebi A, et al. Leukopenia in Ethiopian Jews. *N Engl J Med* 1987;316:549.
185. Shaper AG, Lewis P. Genetic neutropenia in people of African origin. *Lancet* 1971;2:1021.
186. Haden RL. Qualitative changes in neutrophilic leukocytes. *Am J Clin Pathol* 1935;5:354; also in *Principles of hematology*. Philadelphia: Lea & Febiger, 1939.
187. Athens JW. Neutrophilic granulocyte kinetics and granulocytopoiesis. In: Gordon AS, ed. *Regulation of hematopoiesis*. New York: Appleton-Century-Crofts, 1970.
188. Boggs DR. The kinetics of neutrophilic leukocytes in health and in disease. *Semin Hematol* 1967;4:359.
189. Cartwright GE, et al. The kinetics of granulopoiesis in normal man. *Blood* 1964;24:780.
190. Cronkite EP. Enigmas underlying the study of hemopoietic cell proliferation. *Fed Proc* 1964;23:649.
191. Cronkite EP, Fliedner TM. Granulocytopoiesis. *N Engl J Med* 1964;270:1347-1403.
192. Cronkite EP, Vincent PC. Granulocytopoiesis. In: Stohlman F, Jr., ed. *Hemopoietic cellular proliferation*. New York: Grune & Stratton, 1970.
193. Cronkite EP, Vincent PC. Granulocytopoiesis. *Ser Haematol* 1969;2:3.
194. LoBue J. Analysis of normal granulocyte production and release. In: Gordon AS, ed. *Regulation of hematopoiesis, vol II*. New York: Appleton-Century-Crofts, 1970.
195. Mauer AM, et al. Leukokinetic studies. II. A method for labeling granulocytes *in vitro* with radioactive diisopropylfluorophosphate (DFP32). *J Clin Invest* 1960;39:1481.
196. Patt HM. A consideration of myeloid-erythroid balance in man. *Blood* 1957;12:777.
197. Patt HM, Maloney MA. An evaluation of granulocytopoiesis. In: Lamerton LF, Fry RJM, eds. *Cell proliferation*. Philadelphia: FA Davis, 1963.
198. Patt HM, Maloney MA. Kinetics of neutrophil balance. In: Stohlman F, Jr., ed. *The kinetics of cellular proliferation*. New York: Grune & Stratton, 1959.
199. Perry S, et al. Physiology of the granulocyte. *JAMA* 1968;203:937.
200. Warner HR, Athens JW. An analysis of granulocyte kinetics in blood and bone marrow. *Ann N Y Acad Sci* 1964;113:523.
201. Wilbur DW. The neutrophil system. Lawrence Radiation Laboratory Report, Springfield, Virginia: National Bureau of Standards, US Department of Commerce, 1966.

202. Cronkite EP, et al. The use of tritiated thymidine in the study of haemopoietic cell proliferation. In: Wolstenholme GEW, O'Connor M, eds. Ciba foundation symposium on haemopoiesis. London: J & A Churchill, 1960.
203. Maloney MA, Patt HM. Neutrophil life cycle with tritiated thymidine. *Proc Soc Exp Biol Med* 1958;98:801.
204. Bond VP, et al. Proliferative potentials of bone marrow and blood cells studied by *in vitro* uptake of 3H-thymidine. *Acta Haematol (Basel)* 1959;21:1.
205. Lord BI. Cellular proliferation in normal and continuously irradiated rat bone marrow studied by repeated labeling with tritiated thymidine. *Br J Haematol* 1965;11:130.
206. Price TH, Ochs HD, Gershoni-Baruch R, et al. *In vivo* neutrophil and lymphocyte functions studies in a patient with leukocyte adhesion deficiency type II. *Blood* 1994;84:1635-1639.
207. Jagels MA, Chambers JD, Arfors KE, Hugli TE. C5a- and tumor necrosis factor- $\alpha$ -induced leukocytosis occurs independently of  $\beta_2$  integrins and L-selectin: differential effects on neutrophil adhesion molecule expression *in vivo*. *Blood* 1995;85:2900-2909.
208. Jagels MA, Hugli TE. Neutrophil chemotactic factors promote leukocytosis, a common mechanism for cellular recruitment from bone marrow. *J Immunol* 1992;148:1119-1128.
209. Patt HM, Maloney MA. A model of granulocyte kinetics. *Ann N Y Acad Sci* 1964;113:515.
210. Lajtha LG, et al. Kinetics of a bone-marrow stem-cell population. *Ann N Y Acad Sci* 1964;113:742.
211. Sin YM, Sainte-Marie G. Granulocytopoiesis in the rat thymus. II. Pattern for granulocyte formation based on cell counts in granulocytopoietic islands. *Br J Haematol* 1965;2:624.
212. Fliedner TM, et al. The mitotic index of human bone marrow in healthy individuals and irradiated human beings. *Acta Haematol (Basel)* 1959;22:65.
213. Killmann S, et al. Mitotic indices of human bone marrow cells. III. Duration of some phases of erythrocytic and granulocytic proliferation computed from mitotic indices. *Blood* 1964;24:267.
214. Killmann S, et al. Mitotic indices of human bone marrow cells. I. Number and cytologic distribution of mitoses. *Blood* 1962;19:743.
215. Lala PK, et al. A comparison of two markers of cell proliferation in bone marrow. *Acta Haematol (Basel)* 1964;31:1.
216. Leblond CP, Walker BF. Renewal of cell populations. *Physiol Rev* 1956;36:255.
217. Killmann S, et al. Mitotic indices of human bone marrow cells. II. The use of mitotic indices for estimation of time parameters of proliferation in serially connected multiplicative cellular compartments. *Blood* 1963;21:141.
218. Cronkite EP, et al. Anatomic and physiologic facts and hypotheses about hemopoietic proliferating systems. In: Stohman F, Jr., ed. *The kinetics of cellular proliferation*. New York: Grune & Stratton, 1959.
219. Dacie JV, White JC. Erythropoiesis with particular reference to its study by biopsy of human bone marrow: a review. *J Clin Pathol* 1949;2:1.
220. Japa J. A study of the mitotic activity of normal human bone marrow. *Br J Exp Pathol* 1942;23:272.
221. Mauer AM. Diurnal variation of proliferative activity in the human bone marrow. *Blood* 1965;26:1.
222. Golobova MT. Changes in mitotic activity in rats in relation to the time of day and night. *Bull Exp Biol Med Trans* 1958;46:1143.

223. Haus E, Nicolau GY, Lakatua D, Sackett-Lundeen L. Reference values for chronopharmacology. *Ann Rev Chronopharmacol* 1988;4:333-351.
224. Dancy JT, et al. Neutrophil kinetics in man. *J Clin Invest* 1976;58:705.
225. Deubelbeiss KA, et al. Marrow erythroid and neutrophil cellularity in the dog. *J Clin Invest* 1975;55:825.
226. Donohue DM, et al. Quantitative measurement of hematopoietic cells of the marrow. *J Clin Invest* 1958;37:1564.
227. Donohue DM, et al. Quantitative measurement of the erythrocytic and granulocytic cells of the marrow and blood. *J Clin Invest* 1958;37:1571.
228. Cronkite EP, et al. The use of tritiated thymidine in the study of DNA synthesis and cell turnover in hemopoietic tissues. *Lab Invest* 1959;3:263.
229. Feinendegen LE, et al. Physiological thymidine reutilization in rat bone marrow. *Proc Soc Exp Biol Med* 1966;122:448.
230. Feinendegen LE, et al. RNA turnover in normal rat bone marrow. *Ann N Y Acad Sci* 1964;113:727.
231. Friedkin M. Speculations on the significance of thymidylic acid synthesis in the regulation of cellular proliferation. In: Stohman F, Jr., ed. *The kinetics of cellular proliferation*. New York: Grune & Stratton, 1959.
232. Greulich RC, et al. Stimulation of mitosis in adult mice by administration of thymidine. *Proc Natl Acad Sci U S A* 1961;47:743.
233. Hiatt HH, Bojarski TB. Stimulation of thymidylate kinase activity in rat tissues by thymidine administration. *Biochem Biophys Res Commun* 1960;2:35.
234. Hughes WL, et al. Discussion of radiation effects of cellular labels. In: Stohman F, Jr., ed. *The kinetics of cellular proliferation*. New York: Grune & Stratton, 1959.
235. Samuels LD, et al. Tritiated thymidine toxicity in mammalian systems. *Atompraxis* 1964;18:144.
236. Cronkite EP. Kinetics of granulocytopoiesis. *Natl Cancer Inst Monogr* 30, Human Tumor Cell Kinetics, 1969.
237. Stryckmans P, et al. DNA synthesis time of erythropoietic and granulopoietic cells in human beings. *Nature* 1966;211:717.
238. Deubelbeiss KA, et al. Neutrophil kinetics in the dog. *J Clin Invest* 1975;55:833.
239. Brubaker LH, Evans WH. Separation of granulocytes, monocytes, lymphocytes, erythrocytes, and platelets from human blood and relative tagging with diisopropylfluorophosphate (DFP). *J Lab Clin Med* 1969;73:1036.
240. Kurth D, et al. Leukokinetic studies. V. Uptake of tritiated diisopropylfluorophosphate by leukocytes. *Proc Soc Exp Biol Med* 1964;140:422.
241. Bishop CR, et al. Leukokinetic studies. XIV. Blood neutrophil kinetics in chronic, steady-state neutropenia. *J Clin Invest* 1971;50:1678.
242. Raab SO, et al. Granulokinetics in normal dogs. *Am J Physiol* 1964;206:83.
243. Kindred JE. A quantitative study of the hemopoietic organs of young adult albino rats. *Am J Anat* 1942;71:297.
244. Papayannopoulou T, Finch CA. On the *in vivo* action of erythropoietin: a quantitative analysis. *J Clin*



Invest 1972;51:1179.

245. Hudson G. Bone marrow volume in guinea-pigs. *J Anat* 1958;92:150.
246. Hudson G, et al. Cell-populations in the bone marrow of the normal guinea pig. *Acta Anat (Basel)* 1963;52:234.
247. Suit HD. A technique for estimating bone marrow cellularity *in vivo* using <sup>59</sup>Fe. *J Clin Pathol* 1957;10:267.
248. Harker LA. Megakaryocyte quantitation. *J Clin Invest* 1968;47:452.
249. Finch CA, et al. Kinetics of the formed elements of human blood. *Blood* 1977;50:699.
250. Fliedner TM, et al. Granulocytopoiesis. II. Emergence and pattern of labeling of neutrophilic granulocytes in humans. *Blood* 1964;24:683.
251. Perry S, et al. Rates of appearance and disappearance of white blood cells in normal and in various disease states. *J Lab Clin Med* 1958;51:501.
252. Maloney MA, Patt HM. Granulocyte transit from bone marrow to blood. *Blood* 1968;31:195.
253. Bishop CR, Athens JW. Studies of granulocytopoiesis in abnormal conditions. In: Stohman F, Jr., ed. Hemopoietic cellular proliferation. New York: Grune & Stratton, 1970.
254. Boggs DR, et al. Leukokinetic studies. IX. Experimental evaluation of a model of granulopoiesis. *J Clin Invest* 1965;44:642.
255. Weiss L. The hematopoietic microenvironment of the bone marrow: an ultrastructural study of the stroma in normal and eosinophilic rats. *Anat Rec* 1976;186:161.
256. Weiss L. Transmural cellular passage in vascular sinuses of rat bone marrow. *Blood* 1970;36:189.
257. Leblond PF, et al. Scanning electron microscopy of erythropoietin-stimulated bone marrow. *Blood Cells* 1975;1:639.
258. Giordano GF, Lichtman MA. Marrow cell egress. The central interaction of barrier pore size and cell maturation. *J Clin Invest* 1973;52:1154.
259. Kovich NL, Lin N, Yednock T, et al. Stem cell factor modulates avidity of a  $\alpha_4\beta_1$  and a  $\alpha_5\beta_1$  integrins expressed on hematopoietic cell lines. *Blood* 1995;85:159-167.
260. Rother K. Leucocyte mobilizing factor: a new biological activity derived from the third component of complement. *Eur J Immunol* 1972;2:550.
261. Terashima T, English D, et al. "Release of polymorphonuclear leukocytes from the bone marrow by interleukin-8." *Blood* 1998;92(3):1062-1069.
262. Athens JW, et al. Leukokinetic studies. III. The distribution of granulocytes in the blood of normal subjects. *J Clin Invest* 1961;40:159.
263. Athens JW, et al. Leukokinetic studies. IV. The total blood, circulating and marginal granulocyte pools and the granulocyte turnover rate in normal subjects. *J Clin Invest* 1961;40:989.
264. Vejlens G. The distribution of leucocytes in the vascular system. *Acta Pathol Microbiol Immunol Scand [Suppl]* 1938;33:1.
265. Bishop CR, et al. Leukokinetic studies. XIII. A non-steady state kinetic evaluation of the mechanism of cortisol-induced granulocytosis. *J Clin Invest* 1968;47:249.
266. Toren M, Goffinet JA, Kaplow LS. Pulmonary bed sequestration of neutrophils during hemodialysis.

Blood 1970;36:337–340.

267. Brubaker LH, Nolph KD. Mechanisms of recovery from neutropenia induced by hemodialysis. *Blood* 1971;38:623–631.
268. Craddock PR, Fehr J, Dalmaso AP, et al. Hemodialysis leukopenia: pulmonary vascular leukostasis resulting from complement activation by dialyzer cellophane membranes. *J Clin Invest* 1977;59:879–888.
269. Craddock PR, Hammerschmidt DE, White JG, et al. Complement (C5a)-induced granulocyte aggregation *in vitro*. A possible mechanism of complement-mediated leukostasis and leukopenia. *J Clin Invest* 1977;60:260–264.
270. Skubitz KM, Craddock PR. Reversal of hemodialysis granulocytopenia and pulmonary leukostasis. *J Clin Invest* 1981;67:1383–1391.
271. Craddock PR, Fehr J, Brigham KL, et al. Complement and leukocyte-mediated pulmonary dysfunction in hemodialysis. *N Engl J Med* 1977;769–774.
272. Hammerschmidt DE, Weaver LJ, Hudson LD, et al. Association of complement activation and elevated plasma-C5a with adult respiratory distress syndrome. Pathophysiological relevance and possible prognostic value. *Lancet* 1980;1:947–949.
273. Alexanian R, Donohue DM. Neutrophilic granulocyte kinetics in normal man. *J Appl Psychol* 1965;20:803.
274. Athens JW, et al. Leukokinetic studies. X. Blood granulocyte kinetics in chronic myelocytic leukemia. *J Clin Invest* 1965;44:765.
275. Athens JW, et al. Leukokinetic studies. XI. Blood granulocyte kinetics in polycythemia vera, infection, and myelofibrosis. *J Clin Invest* 1965;44:778.
276. Galbraith PR, et al. Patterns of granulocyte kinetics in health, infection and in carcinoma. *Blood* 1965;25:683.
277. Craddock CG, et al. Evaluation of marrow granulocytic reserves in normal and disease states. *Blood* 1960;15:849; *Am J Med* 1960;28:711; In: Stohlman F, Jr., ed. *The kinetics of cellular proliferation*. New York: Grune & Stratton, 1959; *Blood* 1959;14:50; *Ser Haematol* 1965;1:13.
278. Mauer AM, et al. An analysis of leukocyte radioactivity curves obtained with radioactive diisopropylfluorophosphate (DFP32). In: Stohlman F, Jr., ed. *The kinetics of cellular proliferation*. New York: Grune & Stratton, 1959.
279. Meuret G, et al. Neutrophil kinetics in man. Studies using autotransfusion of 3H-DFP labeled blood cells and autoradiography. *Blut* 1972;26:97.
280. Gottlieb RA, Giesing HA, Zhu JY, et al. Cell acidification in apoptosis. G-CSF delays programmed cell death in neutrophils by upregulating the vacuolar H<sup>+</sup>-ATPase. *Proc Natl Acad Sci U S A* 1995;92:5965–5968.
281. Squier MK, Sehnert AJ, et al. “Apoptosis in leukocytes.” *J Leukoc Biol* 1995;57(1):2–10.
282. Moulding DA, Quayle JA, et al. “Mcl-1 expression in human neutrophils: regulation by cytokines and correlation with cell survival.” *Blood* 1998;92(7):2495–2502.
283. Gottlieb RA, Giesing HA, Engler RL, Babior BM. The acid deoxyribonuclease of neutrophils: a possible participant in apoptosis-associated genome destruction. *Blood* 1995;86:2414–2418.
284. Savill JS, Wyllie AH, Henson JE, et al. Macrophage; phagocytosis of aging neutrophils in inflammation. *J Clin Invest* 1989;83:865–875.
285. Savill JS, Henson PM, Haslett C. Phagocytosis of aged human neutrophils by macrophages is mediated by a novel “charge-sensitive” recognition mechanism. *J Clin Invest* 1989;84:1518–1527.

286. Savill J, Dransfield I, Hogg N, Haslett C. Vitronectin receptor-mediated phagocytosis of cells undergoing apoptosis. *Nature* 1990;343:170-173.
287. Inflammation. In: Keen WW, White JW, eds. *An American text-book of surgery*. Philadelphia: WB Saunders, 1892:10-25.
288. Liles WC, Dale DC, Klebanoff SJ. Glucocorticoids inhibit apoptosis of human neutrophils. *Blood* 1995;86:3181-3188.
289. Iwai K, Miyawaki T, Takizawa T, et al. Differential expression of bcl-2 and susceptibility to anti-fas-mediated cell death in peripheral blood lymphocytes, monocytes, and neutrophils. *Blood* 1994;84:1201-1208.
290. Duvall CP, Perry S. The use of 51-chromium in the study of leukocyte kinetics in chronic myelocytic leukemia. *J Lab Clin Med* 1968;71:614.
291. McCall MS, et al. The tagging of leukemic leukocytes with radioactive chromium and measurement of the *in vivo* cell survival. *J Lab Clin Med* 1955;45:717.
292. McMillan R, Scott JL. Leukocyte labeling with <sup>51</sup>chromium. I. Technic and results in normal subjects. *Blood* 1968;32:738.
293. Davidson JG, et al. The kinetics of radiochromate-labeled normal and leukemic lymphocytes. *Clin Res* 1969;17:150.
294. Eyre HJ, et al. Relative labeling of leukocytes, erythrocytes and platelets in human blood by <sup>51</sup>chromium. *Blood* 1970;36:250.
295. McMillan R, et al. Radiochromate leukokinetics in chronic myelocytic leukemia (CML). *Abstr XII Cong Intl Soc Hematol*, 1968.
296. Scott JL, et al. Leukocyte labeling with <sup>51</sup>chromium. IV. The kinetics of chronic lymphocytic leukemic lymphocytes. *Blood* 1973;41:155.
297. Spivak JL, Perry S. Evaluation of <sup>51</sup>Cr as a leucocyte label. *Br J Haematol* 1973;25:321.
298. Vincent PC. The measurement of granulocyte kinetics. *Br J Haematol* 1977;36:1.
299. Dresch C, et al. Kinetic studies of <sup>51</sup>Cr and DF32P-labelled granulocytes. *Br J Haematol* 1975;29:67.
300. McAfee JG, Thaker ML. Survey of radioactive agents for *in vitro* labeling of phagocytic leukocytes. I & II. *J Nucl Med* 1976;17:480-488.
301. Thakur ML, et al. Indium-111-labeled autologous leukocytes in man. *J Nucl Med* 1977;18:1014-1021.
302. Goodwin DA. Cell labeling with oxine chelates of radioactive metal ions. *J Nucl Med* 1978;19:557.
303. Florey HW, Grant LH. Leucocyte migration from small blood vessels stimulated with ultraviolet light: an electron-microscope study. *J Pathol* 1961;82:13.
304. Marchesi VT, Florey HW. Electron micrographic observations on the emigration of leukocytes. *Q J Exp Physiol* 1960;458:343.
305. Boggs DR, et al. Leukokinetic studies. VIII. A search for an extramedullary tissue pool of neutrophilic granulocytes. *Proc Soc Exp Biol Med* 1964;115: 792.
306. Isaacs R, Danielian AC. A study of the white blood corpuscles appearing in the saliva and their relation to those in the blood. *Am J Med Sci* 1927;174: 70.
307. Klinkhamer JM. Quantitative evaluation of gingivitis and periodontal disease. I. The progranulocytic

migratory rate. *Periodontics* 1968;6:297.

308. Addis T. The number of formed elements in the urinary sediment of normal individuals. *J Clin Invest* 1926;2:409.
309. Garnett ES. Observation on the kinetics of urinary granulocytic excretion. *Clin Sci* 1965;28:157.
310. Ambrus CM, Ambrus JL. Regulation of the leukocyte level. *Ann N Y Acad Sci* 1959;77:445.
311. Bierman HR, et al. The pulmonary circulation as a source of leukocytes and platelets in man. *Science* 1951;114:276.
312. Boggs DR, et al. Granulocytopoiesis in germfree mice. *Proc Soc Exp Biol Med* 1967;125:325.
313. Fliedner TM, et al. Über die Umsatzkinetik der Leukocyten bei keimfreien Mäusen. *Schweiz Med Wochenschr* 1966;96:1236.
314. Chadzinska M, Kolaczowska E, et al. "Morphine modulation of peritoneal inflammation in Atlantic salmon and CB6 mice." *J Leukoc Biol* 1999;65(5):590–596.
315. Crosson FJ, et al. Neonatal sepsis at the Johns Hopkins Hospital, 1969–1975: bacterial isolates and clinical correlates. *Johns Hopkins Med J* 1977;140:37.
316. Eickhoff TC, et al. Neonatal sepsis and other infections due to group B streptococci. *N Engl J Med* 1964;271:1221.
317. Freedman RM, et al. A half century of neonatal sepsis at Yale: 1928–1978. *Am J Dis Child* 1981;135:140.
318. McCracken GH, Jr., Shinefield HR. Changes in the pattern of neonatal septicemia and meningitis. *Am J Dis Child* 1966;112:33.
319. Overall JC, Jr. Neonatal bacterial meningitis. *J Pediatr* 1970;76:499.
320. Ziai M, Haggerty RJ. Neonatal meningitis. *N Engl J Med* 1958;259:314.
321. Niswander KR, Gordon M. The women and their pregnancies. The collaborative perinatal study of the National Institute of Neurological Diseases and Stroke. Department of Health, Education and Welfare Publication No(NIH) 73–379. Washington, DC: US Government Printing Office, 1972.
322. Klein JO, March SM. Bacterial sepsis and meningitis. In: Remington JS, Klein JO, eds. *Infectious diseases of the fetus and newborn infant*. Philadelphia: WB Saunders, 1983.
323. Cates KL, Rowe JC, Ballow M. The premature infant as a compromised host. *Curr Probl Pediatr* 1983;13:1.
324. Lubchenco LO, et al. Intrauterine growth as estimated from liveborn birthweight data at 24 to 42 weeks of gestation. *Pediatrics* 1963;32:793.
325. Barak Y, et al. Granulocyte–macrophage colonies in culture of human fetal liver cells: morphologic and ultrastructural analysis of proliferation and differentiation. *Exp Hematol* 1980;8:837.
326. Kelemen E, Calvo W, Fliedner TM. Intravascular hemopoietic cells. In: *Atlas of human hematopoietic development*. Berlin: Springer–Verlag, 1979.
327. Thomas UB, Yoffey JM. Human fetal haematopoiesis. I. The cellular composition of foetal blood. *Br J Haematol* 1962;8:290.
328. Wheeler JG, et al. Neutrophil storage pool depletion in septic, neutropenic neonates. *Pediatr Infect Dis* 1984;3:407.
329. Ijima H, et al. Predominance of macrophage–colony formation in human cord blood. *Exp Hematol*

1982;10:324.

330. Chervenick PA, Boggs DR. *In vitro* growth of granulocytic and mononuclear cell colonies from blood of normal individuals. *Blood* 1971;37:131.
331. Christensen RD, et al. Granulocyte-macrophage progenitor cells in term and preterm neonates. *J Pediatr* 1986;109:1047.
332. Issaragrisil S. Correlation between hematopoietic progenitors and erythroblasts in cord blood. *Am J Clin Pathol* 1983;80:865.
333. Knudtzon S. *In vitro* growth of granulocytic colonies from circulating cells in human cord blood. *Blood* 1974;43:375.
334. Kurnick JE, Robinson WA. Colony growth of human peripheral white blood cells *in vitro*. *Blood* 1971;37:136.
335. McCredie KB, Hersh EM, Freireich EJ. Cells capable of colony formation in the peripheral blood of man. *Science* 1971;171:293.
336. Prindull G, Gabriel M, Prindull B. Circulating myelopoietic stem cells (CFUc). *Blut* 1981;43:109.
337. Prindull G, Prindull B, Meulen N. Haematopoietic stem cells (CFUc) in human cord blood. *Acta Paediatr Scand* 1978;129:413.
338. Christensen RD, Rothstein G. Pre- and postnatal development of granulocytic stem cells in the rat. *Pediatr Res* 1984;18:599.
339. Greenberg PF, Schrier SL. Granulopoiesis in neutropenic disorders. *Blood* 1973;41:753.
340. Richard KA, et al. Studies on the proliferative capacity of the *in vitro* colony-forming cell in human bone marrow. *Aust N Z J Med* 1973;3:361.
341. Tebbi K, et al. A comparison of granulopoiesis in culture from blood and marrow cells of nonleukemic individuals and patients with acute leukemia. *Blood* 1976;48:235.
342. Christensen RD, et al. Granulocytic stem cell (CFUc) proliferation in experimental group B streptococcal sepsis. *Pediatr Res* 1983;17:278.
343. Metcalf D. Hemopoietic colonies, recent results. In: *Cancer research*. New York: Springer-Verlag New York, 1977.
344. Christensen RD, et al. Blood and marrow neutrophils during experimental group B streptococcal infection: quantification of the stem cell, proliferative, storage and circulating pools. *Pediatr Res* 1982;16:549.
345. Erdman SH, et al. The supply and release of storage neutrophils; a development study. *Biol Neonate* 1982;41:132.
346. Christensen RD, et al. Circulating and storage neutrophil changes in experimental type II group B streptococcal sepsis. *Pediatr Res* 1980;14:806.
347. Christiansen RD. Treatment of experimental group B streptococcal infection with hybridoma antibody. *Pediatr Res* 1984;18:1093.
348. Christensen RD. The effect of hybridoma antibody administration upon neutrophil kinetics during experimental type III streptococcal sepsis. *Pediatr Res* 1983;17:795.
349. Christensen RD, Rothstein G. Efficiency of neutrophil migration in the neonate. *Pediatr Res* 1980;14:1147.
350. Christensen RD, et al. Granulocyte transfusion in septic canine neonates. *Pediatr Res* 1982;16:57.

351. Christensen RD, et al. The leukocyte left shift in clinical and experimental neonatal sepsis. *J Pediatr* 1981;98:101.
352. Harper TE, et al. Neonatal meningitis: measurement of neutrophil kinetics and evaluation of experimental treatments. *Pediatr Res* 1986;20:397.
353. Christensen RD, et al. Fatal early onset group B streptococcal sepsis with normal leukocyte counts. *Pediatr Infect Dis* 1985;4:242.
354. Zeligs BJ, et al. Age-dependent susceptibility of neonatal rats to group B streptococcal type III infection: correlation of severity of infection and response of myeloid pools. *Infect Immun* 1982;37:255.
355. Eitzman DV, Smith RT. The nonspecific inflammatory cycle in the neonatal infant. *Am J Dis Child* 1959;97:326.
356. Bullock JD, et al. Inflammatory response in the neonate re-examined. *Pediatrics* 1969;44:58.
357. Miller ME. Chemotactic function in the human neonate: humoral and cellular aspects. *Pediatr Res* 1971;5:487.
358. Boher A, Zeligs BJ, Bellanti JA. Chemotactic responses of various differentiations stages of neutrophils from human cord and adult blood. *Infect Immun* 1982;35:922.
359. Pahwa SG, et al. Cellular and humoral components of monocyte and neutrophil chemotaxis in cord blood. *Pediatr Res* 1977;11:677.
360. Tono-Oka T, et al. Characteristics of impaired chemotactic function in cord blood leukocytes. *Pediatr Res* 1979;13:148.
361. Klein RB, et al. Decreased mononuclear and polymorphonuclear chemotaxis in human newborns, infants, and young children. *Pediatrics* 1977;60:467.
362. Sacchi F, et al. Different maturation of neutrophil chemotaxis in term and preterm newborn infants. *J Pediatr* 1982;101:272.
363. Krause PJ, et al. Polymorphonuclear leukocyte adherence and chemotaxis in stressed and healthy neonates. *Pediatr Res* 1986;20:296.
364. Laurenti F, et al. Neutrophil chemotaxis in preterm infants with infections. *J Pediatr* 1980;96:468.
365. Schuit KE, Homisch L. Inefficient *in vivo* neutrophil migration in neonatal rats. *J Leukocyte Biol* 1984;35:583.
366. Miller ME. Pathology of chemotaxis and random mobility. *Semin Hematol* 1975;12:59.
367. Mease AD, Burgess DP, Thomas FJ. Irreversible neutrophil aggregation: a mechanism of decreased newborn neutrophil chemotactic response. *Am J Pathol* 1981;104:98.
368. Olson TA, et al. Newborn polymorphonuclear leukocyte aggregation: a study of physical properties and ultrastructure using chemotactic peptides. *Pediatr Res* 1983;17:993.
369. Strauss RG, Snyder EL. Chemotactic peptide binding by intact neutrophils from human neonates. *Pediatr Res* 1984;18:63.
370. Anderson DC, Hughes BJ, Smith CW. Abnormal mobility of neonatal polymorphonuclear leukocytes: relation to impaired redistribution of surface adhesion sites by chemotactic factor or colchicine. *J Clin Invest* 1981;68:863.
371. Stark B, Kahane I. Cord blood polymorphonuclear leukocyte chemotaxis: differential response to formyl peptide and endotoxin-activated serum. *Isr J Med Sci* 1983;19:34.
372. Kimura GM, et al. Reduced concanavalin A capping of neonatal polymorphonuclear leukocytes

(PMNs). *Pediatr Res* 1981;15:1271.

373. Mease AD, et al. Decreased phytohemagglutinin-induced aggregation and C5a-induced chemotaxis of human newborn neutrophils. *Pediatr Res* 1980;14:142.

374. Sacchi F, Hill HR. Defective membrane potential changes in neutrophils from human neonates. *J Exp Med* 1984;160:1247.

375. Strauss RG, Snyder EL. Uptake of extracellular calcium by neonatal neutrophils. *J Leukocyte Biol* 1985;37:423.

376. Anderson DC, et al. Impaired motility of neonatal PMN leukocytes: relationship to abnormalities of cell orientation and assembly of microtubules in chemotactic gradients. *J Leukocyte Biol* 1984;36:1.

377. Efrati P, Rozenszajn L. The morphology of buffy coat in normal human adults. *Blood* 1960;16:1012.

378. Allan RN, Alexander MK. A sex difference in the leucocyte count. *J Clin Pathol* 1968;21:691.

379. Gabbert WR, et al. The effect of age on the leukocyte count. *Geriatrics* 1947;2:96.

380. Olbrich O. Blood changes in the aged. *Edinburgh Med J* 1947;54:306.

381. Sturgis CC, Bethell FH. Quantitative and qualitative variations in normal leukocytes. *Physiol Rev* 1943;23:279; *Med Scand* 1958;160:99.

382. Ezeilo G. Non-genetic neutropenia in Africans. *Lancet* 1972;2:1003.

383. Casey AE. The diurnal levels of blood leukocytes in the normal rabbit. *Proc Soc Exp Biol Med* 1940;45:863.

384. Kennon BR, et al. A study of the white blood cell picture in six young men. *Am J Physiol* 1937;118:690.

385. Wachholder K, et al. Änderungen des weissen Blutbildes nach Nahrungsaufnahme. Alimentäre Leukopenie und alimentäre Leukocytose. *Pflugers Arch* 1949;251:459.

386. Sharp GWG. The effect of light on diurnal leucocyte variation. *J Endocrinol* 1960;21:213.

387. Garrey WE, Bryan WR. Variations in white blood cell counts. *Physiol Rev* 1935;15:597.

388. Petersen WF, Berg M. Meteorological influences on leukocytic partition. *Proc Soc Exp Biol Med* 1933;30:832.

389. Kennedy WP, MacKay L. The normal leucocyte picture in a hot climate. *J Physiol* 1936;87:336.

390. Muchmore HG, et al. Neutropenia in healthy men at the south polar plateau. *Arch Intern Med* 1970;125:646.

391. Forwell GD. The response of the leukocyte count in man to environmental heat and to exercise. *J Physiol* 1954;124:66.

392. Cress CH, et al. The effect of anoxic and anemic anoxia on the leukocyte count. *Am J Physiol* 1943;140:299.

393. Verzar F. Die Zahl der Lymphocyten und eosinophilen Leukocyten in 1800 und 3450 m Höhe. *Schweiz Med Wochenschr* 1952;82:324.

394. Farris EJ. The blood picture of athletes as affected by intercollegiate sports. *Am J Anat* 1943;72:223.

395. Altschule MD, et al. Changes in leukocytes of the blood in man after electrically induced convulsions. *Arch Neurol* 1949;62:624.



396. Gabrilove JL, et al. The effect of the parenteral injection of epinephrine on leukocyte counts in normal subjects and in patients with Addison's disease. *Blood* 1949;4:646.
397. Samuels AJ. Primary and secondary leucocyte changes following the intramuscular injection of epinephrine hydrochloride. *J Clin Invest* 1951;30:941.
398. Levine SA, Golden R. Some observations on paroxysmal rapid heart action with special reference to roentgen-ray measurements of the heart in and out of attacks. *Arch Intern Med* 1922;29:836.
399. Milhorat AT, et al. Leukocytosis during various emotional states. *Arch Neurol Psych* 1942;47:779.
400. Davis ME, Hult BE. Changes in circulating eosinophils in women during the menstrual cycle and reproduction. *J Clin Endocrinol* 1949;9:714.
401. Pepper H, Lindsay S. Levels of eosinophils, platelets, leukocytes and 17-hydroxycorticosteroids during normal menstrual cycle. *Proc Soc Exp Biol Med* 1960;104:145.
402. Nelson DH, et al. Blood levels of 17-hydroxycorticosteroids following the administration of adrenal steroids and their relation to levels of circulating leukocytes. *J Clin Invest* 1952;31:843.
403. John TJ. Leukocytosis during steroid therapy. *Am J Dis Child* 1966;111:68.
404. Gray AB, Telford RD, et al. "Granulocyte activation induced by intense interval running." *J Leukoc Biol* 1993;53(5):591-597.
405. Leino L, Saarinen K, et al. "Systemic suppression of human peripheral blood phagocytic leukocytes after whole-body UVB irradiation." *J Leukoc Biol* 1999;65(5):573-582.
406. Trentin JJ. Determination of bone marrow stem cell differentiation by stromal hemopoietic inductive microenvironments (HIM). *Am J Pathol* 1971;65:621.
407. Cline MJ, et al. Organ interactions in the regulation of hematopoiesis: *in vitro* interactions of bone, thymus, and spleen with bone marrow stem cells in normal, S1/S1d and W/Wv mice. *J Cell Physiol* 1977;90:105.
408. Wolf NS. Dissecting the hematopoietic microenvironment. Stem cell lodgment and commitment, and the proliferation and differentiation of erythropoietic descendants in the S1/S1d mouse. *Cell Tissue Kinet* 1974;7:89; Reversibility of hematopoietic stem cell direction (not "commitment") as influenced by the microenvironment. *Blood Cells* 1978;4:37.
409. Witte ON. Steel locus defines new multipotent growth factor. *Cell* 1990;63:5.
410. Dexter TM, et al. Conditions controlling the proliferation of haemopoietic stem cells *in vitro*. *J Cell Physiol* 1977;91:335.
411. Dexter TM, et al. Self-renewal of haemopoietic stem cells: the roles of the environment, of growth factors and of the src oncogene. *Haematol Blood Transfus* 1985;29:363.
412. Price TH, Chatta GS, et al. "Effect of recombinant granulocyte colony-stimulating factor on neutrophil kinetics in normal young and elderly humans." *Blood* 1996;88(1):335-340.
413. Demetri GD, Griffin JD. Granulocyte colony-stimulating factor and its receptor. *Blood* 1991;78:2791-2808.
414. Gabrilove J. The development of granulocyte colony-stimulating factor in its various clinical applications. *Blood* 1992;80:1382-1385.
415. Metcalf D. The molecular biology and functions of the granulocyte-macrophage colony-stimulating factors. *Blood* 1986;67:257-267.
416. Rowe JM, Andersen JW, Mazza JJ, et al. A randomized placebo-controlled phase III study of granulocyte-macrophage colony-stimulating factor in adult patients (55 to 70 years of age) with acute

myelogenous leukemia: a study of the Eastern Cooperative Oncology Group (E1490). *Blood* 1995;86:457-462.

417. Bunn P, Crowley J, Kelly K, et al. Chemoradiotherapy with or without granulocyte-macrophage colony-stimulating factor in the treatment of limited-stage small-cell lung cancer: a prospective phase III randomized study of the southwest oncology group. *J Clin Oncol* 1995;13:1632-1641.

418. Yuo A, Kitagawa S, Osaka A. Recombinant human granulocyte colony-stimulating factor as an activator of human granulocytes: potentiation of responses triggered by receptor mediate agonists and stimulation of C3bi receptor expression and adherence. *Blood* 1990;74:2114-2149.

419. Yong KL, Linch DC. Differential effects of granulocyte- and granulocyte-macrophage colony-stimulating factors (G- and GM-CSF) on neutrophil adhesion *in vitro* and *in vivo*. *Eur J Haematol* 1992;49:251-259.

420. Spertini O, Kansas GS, Munro JM, et al. Regulation of leukocyte migration by activation of the leukocyte adhesion molecule-1 (LAM-1) selectin. *Nature* 1991;349:691-694.

421. Ohsaka A, Kitagawa S, Sakamoto S, et al. *In vivo* activation of human neutrophil functions by administration of recombinant human granulocyte colony stimulating factor in patients with malignant lymphoma. *Blood* 1989;74:2743-2748.

422. Avalos B, Gassos JC, Hedvat C, et al. Human granulocyte colony-stimulating factor: biologic activities and receptor characterization on hematopoietic cells and small cell lung cancer cell lines. *Blood* 1990;75:851-857.

423. Balazovich KJ, Almeida HI, Boxer LA. Recombinant human G-CSF and GM-CSF prime human neutrophils for superoxide production through different signal transduction mechanisms. *J Lab Clin Med* 1991;118:576-584.

424. Khwaja A, Carver JE, Linch DC. Interactions of granulocyte-macrophage colony-stimulating factor (CSF), granulocyte CSF, and tumor necrosis factor  $\alpha$  in the priming of the neutrophil respiratory burst. *Blood* 1992;79:745-753.

425. Morstyn G, Souza LM, Keech J, et al. Effect of granulocyte colony-stimulating factor on neutropenia induced by cytotoxic chemotherapy. *Lancet* 1988;1:667-672.

426. Lindemann A, Herrmann F, Oster F, et al. Hematologic effects of recombinant granulocyte colony-stimulating factor in patients with malignancy. *Blood* 1989;74:2644-2651.

427. de Haas M, Kerst JM, van der Schoot CE, et al. Granulocyte colony-stimulating factor administration to healthy volunteers: analysis of the immediate activating effects on circulating neutrophils. *Blood* 1994;84:3885-3894.

428. Berkow RL, Wang D, Larrick JW, et al. Enhancement of neutrophil superoxide production by preincubation with recombinant human tumor necrosis factor. *J Immunol* 1987;139:3783-3791.

429. Borish L, Rosenbaum R, Albury L, Clark S. Activation of neutrophils by recombinant IL-6. *Cell Immunol* 1989;121:280-289.

430. Sullivan GW, Carper HT, Sullivan JA, et al. Both recombinant interleukin-1 (beta) and purified human monocyte interleukin-1 prime human neutrophils for increased oxidative activity and promote neutrophils spreading. *J Leukoc Biol* 1989;45:389-395.

431. Yuo A, Kitagawa S, Kasahara T, et al. Stimulation and priming of human neutrophils by interleukin-8: cooperation with tumor necrosis factor and colony-stimulating factors. *Blood* 1991;78:2708-2714.

432. Lord BI, et al. A stimulator of stem cell proliferation in regenerating bone marrow. *Biomedicine* 1977;27:223.

433. Broxmeyer HE, et al. Cell-free granulocyte colony inhibiting activity derived from human polymorphonuclear neutrophils. *Exp Hematol* 1977;5:87; *Science* 1978;199:552.

434. Oshita AK, et al. cGMP stimulation of stem cell proliferation. *Blood* 1977;49:585.
435. Broxmeyer HE, Lu L. Control of myelopoietic growth factor production. In: Hematopoietic stem cell physiology. New York: Alan R. Liss, 1985.
436. Heaney ML, Golde DW. Soluble cytokine receptors. *Blood* 1996;87:847-857.
437. Flidner TM, et al. Morphologic and cytokinetic aspects of bone marrow stroma. In: Stohlman F, Jr., ed. Hemopoietic cellular proliferation. New York: Grune & Stratton, 1970.
438. Katz R, et al. Studies of the purification of the leukocytosis-inducing factor (LIF). *J Reticuloendothel Soc* 1966;3:103.
439. Dornfest BS, et al. Mechanisms of leukocyte production and release. II. Factors influencing release from isolated perfused rat legs. *J Lab Clin Med* 1962;60:777.
440. Boggs DR, et al. Mechanisms controlling homeostasis of neutrophilic leukocytes. *Haematol Lat* 1967;10:43.
441. Boggs DR, et al. Neutrophilia-induced activity in plasma of dogs recovering from drug-induced myelotoxicity. *Am J Physiol* 1966;211:51.
442. Handler ES, et al. Mechanisms of leukocyte production and release. V. Studies on the leukocytosis-inducing factor in the plasma of rats treated with typhoid-paratyphoid vaccine. *J Lab Clin Med* 1966;67:398.
443. Boggs DR, et al. Neutrophil releasing activity in plasma of normal human subjects injected with endotoxin. *Proc Soc Exp Biol Med* 1968;127:689.
444. Lichtman MA, et al. The regulation of the release of granulocytes from normal marrow. In: Greenwelt TJ, Jamieson GA, eds. The granulocyte: function and clinical utilization. New York: Alan R. Liss, 1977.
445. Hunter J. A treatise on the blood, inflammation and gun-shot wounds. Nicol, London, 1774.
446. Hammerschmidt DE, Harris PD, Wayland H, et al. Complement-induced granulocyte aggregation *in vivo*. *Am J Pathol* 1981;102:146-150.
447. Gerard NP, Gerard C. The chemotactic receptor for human C5a anaphylatoxin. *Nature* 1991;349:614-617.
448. von Tscharner V, Deranleau DA, Baggiolini M. Calcium fluxes and calcium buffering in human neutrophils. *J Biol Chem* 1986;261:10163-10168.
449. Krause KH, Lew PD. Subcellular distribution of Ca<sup>2+</sup> pumping sites in human neutrophils. *J Clin Invest* 1987;80:107-116.
450. Theler JM, Lew DP, Jaconi ME, et al. Intracellular pattern of cytosolic Ca<sup>2+</sup> changes during adhesion and multiple phagocytosis in human neutrophils. Dynamics of intracellular Ca<sup>2+</sup> stores. *Blood* 1995;85:2194-2201.
451. Barrowman MM, Cockcroft S, Gomperts BD. Differential control of azurophilic and specific granule exocytosis in Sendai-virus-permeabilized rabbit neutrophils. *J Physiol* 1987;383:115.
452. Lew PD, Monod A, Waldvogel FA, et al. Quantitative analysis of the cyto-solic free calcium deficiency of exocytosis from three subcellular compartments in intact human neutrophils. *J Cell Biol* 1986;102:2197.
453. Smolen JE, Stoehr SJ, Boxer LA. Human neutrophils permeabilized with digitonin respond with lysosomal enzyme release when exposed to micromolar levels of free calcium. *Biochem Biophys Acta* 1986;886:1-17.

454. Smolen JE, Korchak HM, Weissmann G. The roles of extracellular and intracellular calcium in lysosomal enzyme release and superoxidized anion generation by human polymorphonuclear leukocytes. *Biochim Biophys Acta* 1981;677:512.
455. Lew PD, Andersson T, Hed J, et al.  $Ca^{2+}$ -dependent and  $Ca^{2+}$ -independent phagocytosis in human neutrophils. *Nature* 1985;315:509.
456. Balazovich KJ, Smolen JE, Boxer LA. Endogenous inhibitor of protein kinase C: association with human peripheral blood neutrophils but not with specific granule-deficient neutrophils or cytoplasts. *J Immunol* 1986;137: 1665.
457. Cui Y, Harvey K, Akard L, et al. Regulation of neutrophil responses by phosphotyrosine phosphatase. *J Immunol* 1994;152:5420-5428.
458. Reference deleted.
459. Reference deleted.
460. Reference deleted.
461. Bokoch GM. Chemoattractant signaling and leukocyte activation. *Blood* 1995;86:1649-1660.
462. Lowell CA, Berton G. "Integrin signal transduction in myeloid leukocytes." *J Leukoc Biol* 1999;65(3):313-320.
463. Cronstein BN, Levin RI, Belanoff J, et al. Adenosine: an endogenous inhibitor of neutrophil-mediated injury to endothelial cells. *J Clin Invest* 1986;78:760-770.
464. Cronstein BN, Levin RI, Philips M, et al. Neutrophil adherence to endothelium is enhanced via adenosine A1-receptors and inhibited by adenosine A2-receptors. *J Immunol* 1992;148:2201-2206.
465. Skubitz KM, Wickham NW, Hammerschmidt DE. Endogenous and exogenous adenosine inhibit granulocyte aggregation without altering the associated rise in intracellular calcium concentration. *Blood* 1988;72:29-33.
466. Condliffe AM, Chilvers ER, et al. "Priming differentially regulates neutrophil adhesion molecule expression/function." *Immunology* 1996;89(1):105-111.
467. Blixt A, Johnson P, Braide M, Bagge U. Microscopic studies on the influence of erythrocyte concentration on the post-junctional radial distribution of leukocytes at small venular bifurcations. *Int J Microcirc Clin Exp* 1985;4:141-156.
468. Schmid-Schonbein GW, Usami S, Skalak R, Chien S. The interaction of leukocytes and erythrocytes in capillary and postcapillary vessels. *Microvasc Res* 1980;19:45-70.
469. Metchnikoff E. In: *Lectures on the comparative pathology of inflammation*. New York: Dover Publications, 1968:135-137.
470. Springer TA. Traffic signals for lymphocyte recirculation and leukocyte emigration: the multistep paradigm. *Cell* 1994;76:301-314.
471. Alon R, Hammer DA, Springer TA. Lifetime of the P-selectin-carbohydrate bond and its response to tensile force in hydrodynamic flow. *Nature* 1995;374:539-542.
472. Senda N, et al. The mechanism of the movement of leucocytes. *Exp Cell Res* 1975;91:393.
473. Boyden SV. The chemotactic effect of mixtures of antibody and antigen on polymorphonuclear leucocytes. *J Exp Med* 1962;115:453.
474. Baum J, et al. A simplified method for the measurement of chemotaxis of polymorphonuclear

leukocytes from human blood. *J Lab Clin Med* 1971;77:501.

475. de Duve C, Wattiaux R. Functions of lysosomes. *Annu Rev Physiol* 1966;28:435.

476. Metchnikoff E. Sur la lutte des cellules de l'organisme contre l'invasion des microbes. *Ann Inst Pasteur Microbiol* 1887;1:321.

477. Wright DG, Gallin JI. A functional differentiation of human neutrophil granules: generation of C5a by a specific (secondary) granule product and inactivation of C5a by azurophil (primary) granule products. *J Immunol* 1977;119:1068-1076.

478. Babior BM. The respiratory burst of phagocytes. *J Clin Invest* 1984;73:599.

479. Klebanoff SJ. Antimicrobial mechanisms in neutrophilic polymorphonuclear leukocytes. *Semin Hematol* 1975;12:117; In: Bellanti JA, Dayton DH, eds. *The phagocytic cell in host resistance*. New York: Raven Press, 1975.

480. Hampton MB, Kettle AJ, et al. "Inside the neutrophil phagosome: oxidants, myeloperoxidase, and bacterial killing." *Blood* 1998;92(9):3007-3017.

481. DeLeo FR, Quinn MT. "Assembly of the phagocyte NADPH oxidase: molecular interaction of oxidase proteins." *J Leukoc Biol* 1996;60(6):677-691.

482. Curnette JT. Chronic granulomatous disease: the solving of a clinic riddle at the molecular level. *Clin Immunol Immunopathol* 1993;67:S2-S15.

483. Klebanoff SJ. Myeloperoxidase: contribution to the microbicidal activity of intact leukocytes. *Science* 1970;169:1095.

484. Klebanoff SJ, White LR. Iodination defect in the leukocytes of a patient with chronic granulomatous disease of childhood. *N Engl J Med* 1969;280:460.

485. Test ST, Lampert MB, Ossanna PJ, et al. Generation of nitrogen-chlorine oxidants by human phagocytes. *J Clin Invest* 1984;74:1341-1349.

486. Malawista SE, Montgomery RR, Van Blaricom G. Evidence for reactive nitrogen intermediates in killing of staphylococci by human neutrophil cytoplasts. A new microbicidal pathway for polymorphonuclear leukocytes. *J Clin Invest* 1992;90:631-636.

487. Maly FE, Schurer-Maly CC. How and why cells make superoxide: the "phagocytic" NADPH oxidase. *NIPS* 1995;10:233-238.

488. Lehrer RI, Cline MJ. Leukocyte myeloperoxidase deficiency and disseminated candidiasis. *J Clin Invest* 1969;48:1478.

489. Babior BM. Oxidants from phagocytes: agents of defense and destruction. *Blood* 1984;64:959.

490. Eiserich JP, Hristova M, et al. "Formation of nitric oxide-derived inflammatory oxidants by myeloperoxidase in neutrophils." *Nature* 1998;391(6665):393-397.

491. Nath J, Powledge A. "Modulation of human neutrophil inflammatory responses by nitric oxide: studies in unprimed and LPS-primed cells." *J Leukoc Biol* 1997;62(6):805-816.

492. Evans TJ, Buttery LD, et al. "Cytokine-treated human neutrophils contain inducible nitric oxide synthase that produces nitration of ingested bacteria." *Proc Natl Acad Sci U S A* 1996;93(18):9553-9558.

493. Jensen MS, Bainton DF. Temporal changes in pH within the phagocytic vacuole of the polymorphonuclear neutrophilic leukocyte. *J Cell Biol* 1973;56:379.

494. Mandell GL. Intraphagosomal pH of human polymorphonuclear neutrophils. *Proc Soc Exp Biol Med* 1970;134:447.

495. Rous PJ. On the mobilization of acid material within cells. *J Exp Med* 1925;41:399.
496. Padgett GA, Hirsch JG. Lysozyme: its absence in tears and leukocytes of cattle. *Aust J Exp Biol Med Sci* 1967;45:569.
497. Baggilioni M, et al. Association of lactoferrin with specific granules in rabbit heterophil leukocytes. *J Exp Med* 1970;131:559.
498. Spitznagel JK. Nonoxidative antimicrobial reactions of leukocytes. In: Snyderman R, ed. *Contemporary topics in immunobiology*, vol 14. New York: Plenum Publishing, 1984.
499. Masson PL, et al. Lactoferrin, an iron-binding protein in neutrophilic leukocytes. *J Exp Med* 1969;130:643.
500. Arnold RR, et al. A bactericidal effect for human lactoferrin. *Science* 1977;197:263.
501. Martin E, Ganz T, et al. "Defensins and other endogenous peptide antibiotics of vertebrates." *J Leukoc Biol* 1995;58(2):128-136.
502. Baggilioni M, et al. Further biochemical and morphological studies of granule fractions from rabbit heterophil leukocytes. *J Cell Biol* 1970;45:586.
503. Brewer DB. Electron microscopy of phagocytosis of staphylococci. *J Pathol* 1963;86:299.
504. Owen CA, Campbell EJ. "The cell biology of leukocyte-mediated proteolysis." *J Leukoc Biol* 1999;65(2):137-150.
505. Ayoub EM, Wannamaker LW. The fate of group A streptococci following phagocytosis. *J Immunol* 1967;99:1099.
506. Reference deleted.
507. Cohn ZA. The fate of bacteria within phagocytic cells. I. *J Exp Med* 1963;117:27.
508. Rogers DE, Tompsett R. The survival of staphylococci within human leukocytes. *J Exp Med* 1952;95:209.
509. Weissman G. Effect on lysosomes of drugs useful in connective tissue disease. In: Campbell PN, ed. *Interaction of drugs and subcellular components in animal cells*. London: J & A Churchill, 1968.
510. Zucker-Franklin D. Electron microscope study of the degranulation of polymorphonuclear leukocytes following treatment with streptolysin. *Am J Pathol* 1965;47:419.
511. Chen SM, Dummler JS, Bakken JS, et al. Identification of a granulocytotropic Ehrlichia species as the etiologic agent of human disease. *J Clin Microbiol* 1994;32:589-595.
512. Bakken JS, Dummler JS, Chen SM, et al. Human granulocytic ehrlichiosis in the upper Midwest United States: a new species emerging? *JAMA* 1994;272:212-218.
513. Bakken JS, Kreuth J, Wilson-Nordskog C, et al. Clinical and laboratory characteristics of human granulocytic ehrlichiosis. *JAMA* 1996;275:199-205.
514. Goodman JL, Nelson C, Vitale B, et al. Direct cultivation of the causative agent of human granulocytic ehrlichiosis. *N Engl J Med* 1996;334:209-215.
515. Baggilioni M, Dewald B. Exocytosis by neutrophils. In: Snyderman R, ed. *Contemporary topics in immunobiology*, vol 14. New York: Plenum Publishing, 1984.
516. Chikkappa G, et al. Correlation between various blood white cell pools and the serum B<sub>12</sub>-binding capacities. *Blood* 1971;37:142.

517. Wiernik P, Sepick AA. Clinical significance of serum and urinary muramidase activity in leukemia and other hematologic malignancies. *Am J Med* 1969;46:330.
518. Lollike K, Kjeldsen L, Sengelov H, Borregaard N. Lysozyme in human neutrophils and plasma. A parameter of myelopoietic activity. *Leukemia* 1995;9:159–164.
519. Corcino J, et al. Release of vitamin B<sub>12</sub>-binding proteins by human leukocytes *in vitro*. *J Clin Invest* 1970;49:2250.
520. Stormorhen H. The release reaction of secretion. *Scand J Haematol [Suppl]* 1969;9:1.
521. Simons K, Weber T. The vitamin B<sub>12</sub>-binding protein in human leukocytes. *Biochim Biophys Acta* 1966;117:201.
522. Herbert V. Diagnostic and prognostic values of measurement of serum vitamin B<sub>12</sub>-binding proteins. *Blood* 1968;32:305.
523. Allen RH. Human vitamin B<sub>12</sub> transport proteins. *Prog Hematol* 1975;9:57.
524. Osserman EF, Lawlor DF. Serum and urinary lysozyme in monocytic and monomyelocytic leukemia. *J Exp Med* 1966;124:921.
525. Fink ME, Finch SC. Serum neuramidase and granulocyte turnover. *Proc Soc Exp Biol Med* 1968;127:365.
526. Lord PC, Wilmoth LM, Mizel SB, McCall CE. Expression on interleukin 1 alpha and beta genes by human blood polymorphonuclear leukocytes. *J Clin Invest* 1991;87:1312–1321.
527. Lindemann A, Riedel D, Oster W, et al. Granulocyte–macrophage colony stimulating factor induces cytokine secretion by human polymorphonuclear leukocytes. *J Clin Invest* 1989;83:1308–1312.
528. Melani C, Mattia GF, Silvani A, et al. Interleukin–6 expression in human neutrophil and eosinophil peripheral blood granulocytes. *Blood* 1993;81:2744–2749.
529. Weiss SJ. Tissue destruction by neutrophils. *N Engl J Med* 1989;320:365–376.

2004 Lippincott Williams & Wilkins  
John P. Greer, John Foerster, John N. Lukens  
George M. Rodgers, Frixos Paraskevas, Bertil Glader  
Wintrobe's Clinical Hematology

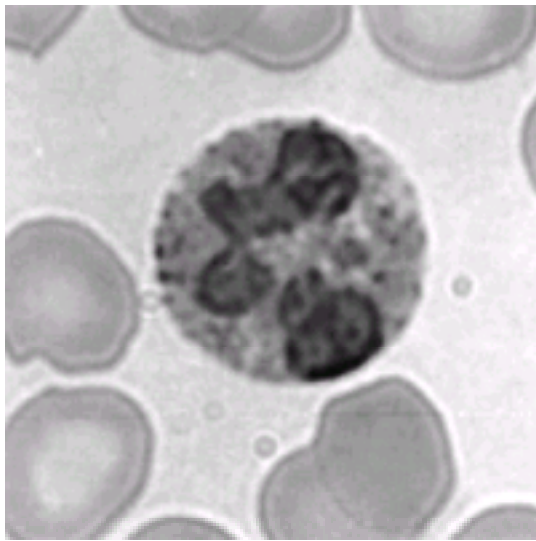


EOSINOPHIL DIFFERENTIATIONInterleukin-5 Receptor SignalingEosinophil Production and Survival in Peripheral TissueEOSINOPHIL HETEROGENEITYEOSINOPHIL TISSUE ACCUMULATIONTethering and RollingAdhesionTransmigration and ChemotaxisEOSINOPHIL MEDIATORSMembrane-Derived MediatorsGranule-Derived ProteinsEosinophil-Derived CytokinesRespiratory BurstDegranulation MechanismsEosinophils and Allergic DiseaseEosinophils and AsthmaThe Eosinophil ControversyEosinophils and Atopic DermatitisEosinophils and Gastrointestinal DiseasePulmonary Infiltrates with EosinophiliaEosinophilia and Toxic ResponsesEosinophilia Associated with Neoplastic and Myeloproliferative DiseaseEosinophilia with Other Neoplastic DiseaseIatrogenic EosinophiliaEosinophils and the Human Immunodeficiency VirusEffector Role of the Eosinophil in Worm InfectionsCONCLUSIONSREFERENCES

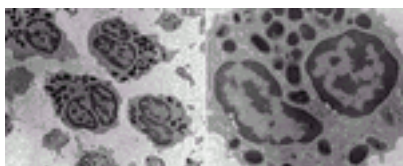
The eosinophil was first described for its characteristic intracytoplasmic granules that exhibit a high affinity for eosin, a negatively charged dye. Although rare in healthy individuals, the eosinophil is prominent in peripheral blood and tissue in association with various disease conditions including allergy ( [1](#), [2](#), and [3](#) ), inflammatory responses against metazoan helminthic parasites ( [4](#), [5](#) ), and certain skin and malignant conditions. The eosinophil has received special attention for its potential pathophysiologic role in the manifestation of allergic diseases such as asthma, rhinitis, eczema, and Crohn's disease. Disorders of the respiratory tract, particularly allergic asthma and rhinitis, exhibit a strong correlation with the number as well as activation status of infiltrating tissue eosinophils. Similarly, many disorders of the gastrointestinal system exhibit prominent eosinophilic inflammation in the mucosa. The presence of eosinophils in the airway and gut mucosa has been associated with both allergic [immunoglobulin (Ig) E-dependent] and nonallergic (IgE-independent) manifestations of disease. Although clinically these conditions have been characterized as either allergic or nonallergic, it appears that the mechanisms underlying recruitment and activation of eosinophils in both types of disease are similar. In spite of extensive efforts to characterize this enigmatic leukocyte, the immunologic role of the eosinophil in disease and its importance in the pathogenesis of asthma remain unclear. However, there is increasing evidence that the eosinophil is a major effector cell

in many types of allergic and nonallergic inflammation, as well as in parasitic disease.

*Eosinophils* are mobile, terminally differentiated granulocytes that arise principally from the bone marrow (<sup>6</sup>). They are approximately 8  $\mu\text{m}$  in diameter, and their nuclei are usually bilobed, although three or more lobes are also often observed. The eosinophil is characterized by its large crystalloid granules, also known as *secondary* or *specific granules*, as shown in light microscopy by their bright red staining properties with acidic dyes such as eosin (Fig. 11.1). As apparent in electron micrographs, the crystalloid granules contain electron-dense crystalline cores surrounded by an electron-lucent granule matrix (Fig. 11.2). Eosinophils contain up to four other granule types: primary granules, small granules, lipid bodies, and small secretory vesicles. *Crystalloid granules* are membrane-bound and contain a number of highly cationic basic proteins (see section [Granule-Derived Proteins](#)). The latter have been implicated in the tissue damage observed in asthma and other similar allergic conditions. Allergen and parasite-induced eosinophilia have been shown to be T-cell-dependent and are mediated by soluble factors (cytokines) released from sensitized lymphocytes (<sup>7</sup>). Recent advances in human eosinophil research have also indicated that eosinophil infiltration into the tissue in allergic-type responses and asthma is regulated by a series of biologic events, which includes a complex interplay between immunologic and inflammatory mechanisms including cytokines and chemokines (<sup>8</sup>, <sup>9</sup>).



**Figure 11.1.** Photomicrograph of a peripheral blood eosinophil stained with May-Grünwald-Giemsa. See [Color Plate](#).



**Figure 11.2.** Electron photomicrographs of peripheral blood eosinophils from buffy coat. Original magnification 7655  $\times$  and 22,000  $\times$  courtesy of Dr. G. E. Quinonez, Department of Pathology, University of Manitoba.

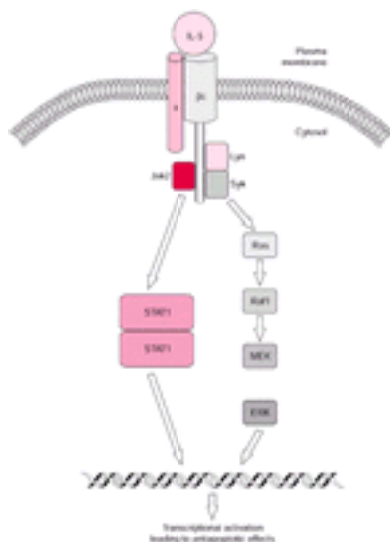
## EOSINOPHIL DIFFERENTIATION

Peripheral blood and tissue eosinophils are derived by hemopoiesis from CD34<sup>+</sup> myelocytic progenitors found in the bone marrow and in inflamed tissues. Eosinophils make up approximately 3% of the bone marrow from healthy individuals, of which 37% are fully differentiated, and the remainder are promyelocytes/myelocytes and metamyelocytes (6, 10). The appearance of newly matured cells in the blood occurs approximately 2.5 days from the time of the last mitotic division (6). The turnover of eosinophils is approximately  $2.2 \times 10^8$  cells per kg per day, and the bone marrow possesses the largest end-differentiated eosinophil reservoir in the healthy body (9 to  $14 \times 10^8$  cells per kg) (11). Progenitors differentiate on exposure to a network of cytokines and chemokines to become committed to the eosinophil/basophil (Eo/B) lineage (12). Eosinophils are more closely related to basophils than neutrophils and monocytes due to lineage differentiation at this stage (13). In addition, eosinophils retain elements of expression of basophil/mast cell-specific high-affinity Fcε receptor (α subunit) (14), whereas basophils continue expression of low concentrations of eosinophil major basic protein (MBP) (15). Cytokines and chemokines are soluble immunoregulatory factors generated under appropriate stimulation from T cells in the bone marrow. The three key cytokines that are critical for stimulation of bone marrow production of eosinophils are interleukin (IL)-3, IL-5, and granulocyte-macrophage colony-stimulating factor (GM-CSF) (16, 17). These three cytokines are also produced by CD4<sup>+</sup> and CD8<sup>+</sup> T lymphocytes from peripheral blood as well as inflamed tissues (18). In bone marrow samples, committed eosinophil precursors can be recognized by their expression of the IL-5 receptor (IL-5R) and the C-C chemokine receptor, CCR3, in addition to CD34 (19). It is now well recognized that IL-5 is a key cytokine in terminal differentiation of eosinophils (20), and expression of IL-5R on the progenitor cell is one of the first signs of commitment to the eosinophil lineage. The expression of IL-5R is almost exclusively limited to eosinophil progenitors and mature peripheral blood eosinophils, with some expression on basophils but not neutrophils or monocytes. This selectivity in receptor distribution indicates that IL-5 acts primarily as an eosinophilopoietic cytokine.

### Interleukin-5 Receptor Signaling

The IL-5R consists of two subunits: an α subunit of 60 to 80 kd and a common β<sub>c</sub> subunit of between 120 and 140 kd, which is shared with IL-3R and GM-CSF receptor. IL-5 interacts with its α subunit specifically but at a lower affinity than the β<sub>c</sub> subunit (40). IL-5 stimulation through the β<sub>c</sub> subunit leads to phosphorylation of the tyrosine kinases Jak (Janus kinase) 2, Lyn, and Syk. Whereas Jak2 signals through the nuclear translocation factor STAT (signal transducer and activator of transcription)-1, Lyn and Syk signal through the mitogenic Ras-Raf1-mitogen activated protein kinase kinase-extracellular signal regulated kinase pathway (Fig. 11.3). Tyrosine phosphorylation enhances the expression of the antiapoptotic protein Bcl-x<sub>L</sub> in eosinophils and decreases translocation of the proapoptotic signaling molecule Bax, resulting in decreased activation of apoptotic signaling through the caspase family (41, 42). GM-CSF prolongs the survival of eosinophils bound to tissue sites via α<sub>4</sub> integrin for up to 2 weeks (34) and has also been shown to inhibit eosinophil apoptosis similarly to IL-5. This has resulted in several groups proposing that inhibition of IL-5 with anti-IL-5 antibody therapy results in the complete loss of eosinophils from the body, thus preventing the manifestation of allergic symptoms (see section [The Eosinophil Controversy](#)). The obligatory role of IL-5 in the differentiation of the eosinophil has been confirmed by numerous studies on transgenic

mice in which the expression of the gene for IL-5 caused marked eosinophilia and increased numbers of eosinophil precursors in their bone marrow ( [21](#), [22](#) ). Interestingly, eosinophil differentiation in this transgenic model appeared to be completely independent of IL-3 and GM-CSF, suggesting that IL-5 alone may be sufficient to generate an eosinophilia from stem cell precursors. However, although IL-5 gene-deficient mice exhibit almost no eosinophils in their blood, a small pool of apparently IL-5-independent eosinophils persists in the mucosal tissues of these animals. Additional eosinophilopoietic factors may assist in inducing the differentiation of Eo/B progenitors in the bone marrow, including IL-4, IL-6, IL-11, IL-12, stem cell factor, and others ( [23](#) ). C-C chemokines, named for their adjacent cysteine residues in the C-terminus amino acid sequence as distinct from the CXC chemokines, include eotaxin and RANTES ( *r*egulated on *a*ctivation, *n*ormal *T*-cell expressed and secreted), which have also been shown to be important in the development of eosinophils ( [24](#) ). Overall, at the level of the bone marrow, the early development of Eo/B progenitors is driven by IL-3 and GM-CSF, among other factors, whereas at later stages, IL-5 regulates the terminal differentiation of eosinophils. Eotaxin may facilitate the efflux of fully mature eosinophils into the peripheral circulation.



**Figure 11.3.** Signaling pathway leading from binding of interleukin-5 (IL-5) to its receptor in the membrane to transcriptional activation in the cell nucleus via the Ras-Raf1-MEK-ERK pathway. The  $\beta$  subunit of the receptor is also able to activate the Jak2-STAT-1 (Janus kinase 2- signal transducer and activator of transcription pathway-1). Transcriptional activation is proposed to generate antiapoptotic effects in eosinophils.

The half-life of eosinophils in the circulation is approximately 18 hours with a mean blood transit time of 26 hours ( [25](#) ), although this is extended in eosinophilic conditions, possibly due to the elevation of systemic eosinophil-activating cytokines that promote eosinophil survival. Based on a study of 740 medical students, the normal range of blood eosinophils was shown to average between 0.0 to  $0.5 \times 10^9/L$ , with counts ranging from 0.015 to  $0.65 \times 10^9/L$  ( [26](#) ). Circulating eosinophil counts exhibit diurnal variation in humans, in which the lowest and highest levels are seen in the morning and evening, respectively, often exhibiting more than 40% variation within a day ( [27](#), [28](#) ). Mild eosinophilia is generally considered to be  $0.5$  to  $1.5 \times 10^9/L$ , moderate eosinophilia is  $1.5$  to  $5.0 \times 10^9/L$ , and marked eosinophilia is greater than  $5.0 \times 10^9/L$ . Allergy is commonly associated with eosinophilia in the mild range, whereas parasitic infestation is often characterized by a

marked eosinophilia.

Eosinophils are predominantly tissue cells, and their major target organs for homing include the gastrointestinal tract, the lungs, and the skin. Once they enter target tissues, eosinophils do not return to the blood circulation. Tissue eosinophil numbers can remain high in tissues even when peripheral numbers are low, suggesting that their survival is enhanced on extravasation. Curiously, pathogen-free laboratory animals have no eosinophils in their blood, whereas tissue eosinophils are difficult to find, suggesting that the appearance of eosinophils may be disease related ( [10](#) ).

### Eosinophil Production and Survival in Peripheral Tissue

Eosinophil development and maturation may also occur *in situ* in peripheral (extramedullary) sites outside of the bone marrow. In this case, Eo/B precursors are released into the bloodstream directly from the bone marrow to circulate to sites where they specifically transmigrate in response to locally produced cytokines and chemokines. This may provide an alternative mechanism for the persistence or accumulation of tissue eosinophils. Like neutrophils, eosinophils are end-stage cells, which, in culture, rapidly undergo cell death by either apoptosis or necrosis. However, eosinophil-active cytokines, such as IL-3, IL-5, and GM-CSF, as well as interferon (IFN)- $\gamma$ , prolong eosinophil survival in culture for up to 2 weeks ( [29](#), [30](#) and [31](#) ). They also enhance receptor expression as well as cell function including cytotoxicity against metazoan targets and mediator release. Activated eosinophils can generate a number of cytokines themselves *in vitro*. This may lead to autocrine prolongation of eosinophil maturation and survival in tissues ( [32](#) ). Local tissue types such as endothelial cells, fibroblasts, and epithelial cells may also contribute to the production of IL-5 and GM-CSF for *in situ* eosinophil maturation and differentiation in airway or gut mucosa.

Extracellular matrix proteins have been shown to modulate eosinophil response to physiologic soluble stimuli ( [33](#) ). Eosinophils adhere specifically to fibronectin ( [34](#) ), an abundant extracellular matrix protein; very late antigen (VLA)-4, a known receptor for fibronectin ( [35](#) ), was involved in mediating eosinophil-fibronectin interactions ( [34](#) ). Similarly, VLA-6 expressed on eosinophils was shown to interact with the connective tissue protein laminin.

IL-5 delays eosinophil apoptosis and promotes eosinophil priming and activation ( [36](#) ). IL-5 production by airway CD4<sup>+</sup> T cells may be directly stimulated by eosinophils in a paracrine manner to enhance survival of tissue eosinophils ( [37](#) ). Eosinophil progenitors in nasal explants from atopic patients have been shown to survive and develop into fully mature eosinophils *ex vivo* using similar mechanisms ( [38](#) ). Allergen challenge of these explants, as well as lung explants of Brown-Norway rats, was shown to evoke a rapid (6-hour) accumulation of MBP-positive cells after allergen challenge ( [39](#) ). This was shown to be dependent on IL-5 production within the explant—a key cytokine in eosinophil survival. Thus, the growth, maturation, and prolongation of survival of eosinophils in extramedullary tissues may occur in sites other than the bone marrow.

### EOSINOPHIL HETEROGENEITY

Human peripheral blood eosinophils exhibit marked heterogeneity based on their physical, morphologic, and functional properties. There are three different populations of eosinophils that can be characterized based on their intrinsic buoyant density and responsiveness to stimuli. These are the normodense, hypodense, and primed eosinophils, which can be described in both normal and eosinophilic subjects. Each of these

populations responds differently to stimuli, which may be related to their stage of maturation. In addition, they may derive from distinct pools of eosinophils that are genetically regulated. The majority of blood eosinophils (>90%) from normal individuals are normodense, which separate out from other leukocytes in the lower interfaces of Percoll or metrizamide discontinuous density gradients. Hypodense eosinophils can be seen in a proportion of eosinophils from individuals with a raised eosinophil count that exhibit lower density than eosinophils from normal subjects, resulting in a spread of eosinophil populations in the gradient, with contaminating mononuclear cell bands ( 43 ). Morphologically, hypodense eosinophils appear vacuolated, contain more lipid bodies, express less MBP, and possess smaller crystalloid granules that appear to be slightly more lucent and take up less cell volume, although these are of equal numbers to normodense eosinophils ( 44 ). They also exhibit a greater cell volume than normodense eosinophils ( 45 ). The mechanism for this heterogeneity is not clear. The presence of low-density (or hypodense) eosinophils appears to be a nonspecific phenomenon that occurs in any eosinophilic condition including parasitosis, asthma, allergic rhinitis, idiopathic hypereosinophilic syndrome, and certain malignancies. It was originally thought that the numbers of hypodense cells correlated with the degree of eosinophilia, although this has not been consistently observed ( 43 , 46 , 47 , 48 and 49 ). Thus, the mechanisms governing the production of hypodense eosinophils are likely to be distinct from those that control eosinopoiesis.

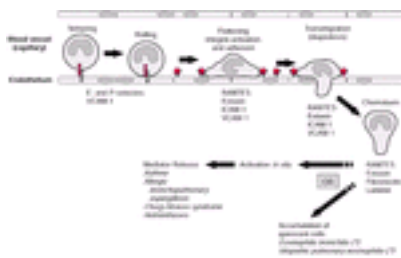
Functionally, hypodense eosinophils appear to be more activated because they exhibit elevated oxygen consumption ( 43 ) and increased cytotoxicity toward helminthic targets ( 46 ) and release more leukotriene C<sub>4</sub> (LTC<sub>4</sub>) after physiologic stimulation ( 50 ). Activation of eosinophils *in vitro* with inflammatory mediators such as platelet-activating factor (PAF), as well as long-term culture with cytokines (e.g., IL-3, IL-5, and GM-CSF), has been associated with a decrease in eosinophil density ( 29 , 51 ). Two possible explanations may account for the enhanced responsiveness of hypodense eosinophils. The first is that hypodense eosinophils frequently comigrate to the same density as neutrophils in metrizamide or Percoll gradients, thus making it difficult to separate these two cell types. Neutrophils could, therefore, enhance the responsiveness of eosinophils through cell-cell interaction. For example, total LTC<sub>4</sub> produced by a mixture of eosinophils and neutrophils was found to be greater than the amount produced by either cell type alone ( 52 ). However, other studies assessing the possibility of neutrophils enhancing eosinophil responsiveness have been negative ( 53 , 54 and 55 ). Second, hypodense eosinophils have been shown to express a greater number of receptors for IgG, IgE, CD44, complement, and the p55 subunit of the IL-2 receptor when compared with normodense cells ( 43 , 56 , 57 and 58 ), which may explain their enhanced responsiveness to stimuli. However, the surface expression of numerous other receptors does not differ between normodense and hypodense eosinophils, with some populations (e.g., CD18) even showing decreased expression in hypodense cells ( 59 ). Furthermore, normodense eosinophils from patients with an eosinophilia have enhanced effector function compared with eosinophils from normal individuals. It is possible, therefore, that the formation of low-density eosinophils results from the migration of normodense eosinophils from the bone marrow to the circulation, whereupon they become activated by elevated systemic factors. Another scenario may be that the association between hypodensity and activation is coincidental, with the less dense cells being immature.

## EOSINOPHIL TISSUE ACCUMULATION

Eosinophils migrate to the lungs and the gastrointestinal tract during their normal development ( 60 , 61 ) and, possibly, in response to environmental factors as part of a role in innate defense against parasites. The mechanisms involved in the selective tissue



recruitment of eosinophils across the vascular endothelium and into tissues in allergic reactions occur sequentially in four well-defined steps. These include (a) the *tethering* of the eosinophil to the luminal surface of the vascular endothelium during normal transport through the blood vessel, (b) the *rolling* of the eosinophil along the luminal surface of the activated endothelium in a reversible manner, (c) firm *adhesion* of the eosinophil to endothelial cells, and (d) *transmigration* of the eosinophil through the endothelium into target tissues ( Fig. 11.4). A further, less understood step in eosinophil trafficking in the tissues is the *in situ* differentiation of circulating committed Eo/B precursors. Most migration through endothelium occurs at postcapillary venules. Each of these steps is controlled by a complex network of chemotactic factors and adhesion molecules that collectively direct the movement of the eosinophil into the tissues. For eosinophils, selectins and  $\alpha_4$  integrins are thought to be important in tethering and rolling, whereas  $\alpha_4$  and  $\beta_2$  (CD18) integrins mediate firm adhesion. The transmigration step is believed to be primarily regulated by  $\beta_2$  integrins as well as C-C chemokines such as eotaxin. Cytokines and chemokines are elaborated by surrounding tissues to modulate the transmigration of eosinophils into tissues. Many of these mechanisms appear to be controlled at the level of the T-cell response to antigen (allergen)-presenting cells and the subsequent release of cytokines and chemokines, which, in turn, regulate the activity of eosinophils.



**Figure 11.4.** Eosinophil tethering, rolling, adhesion, transmigration, and chemotaxis in response to inflammatory signals in tissues. During chemotaxis, eosinophils may either become activated in response to local inflammation and release mediators, as in asthma and other related conditions, or accumulate in tissues in the apparent absence of mediator release. ICAM-1, intercellular adhesion molecule; RANTES, regulated on activation, normal T-cell expressed and secreted; VCAM-1, vascular cell adhesion molecule-1.

## Tethering and Rolling

Our knowledge of the mechanisms involved in eosinophil interactions with the endothelium extends primarily from *in vitro* assays of leukocyte adhesion to cultured human umbilical vein endothelial cells (HUVECs) both in stable and under flow conditions. Antibodies specific for adhesion molecules have been applied in this system and have identified critical regulatory molecules required for adhesion and transmigration of eosinophils. Tethering and rolling of eosinophils on HUVECs under flow conditions are regulated by selectins [L-selectin (CD62L)] expressed on the eosinophil surface interacting with E- and P-selectins (CD62E and CD62P, respectively) on endothelial cells (62). Selectins are characterized by a lectin-binding domain that is involved in the initial anchoring of inflammatory cells to the venular endothelium. This interaction is enhanced after the release of inflammatory mediators from these cells as well as neighboring tissues. Once tethered, eosinophils roll until they become stimulated by a chemoattractant stimulus (indicating local inflammation), which induces activation of  $\alpha_4$  integrin receptors on the leukocyte. In addition, rolling appears to facilitate the subsequent adherence and transmigration of eosinophils into tissues. Eosinophils also express P-selectin



glycoprotein ligand-1 and the integrins  $\alpha_4\beta_1$  (VLA-4) and  $\alpha_4\beta_7$ , which are involved in cell rolling (62). Eosinophil integrins bind to target sites in the endothelium, primarily intercellular adhesion molecule (ICAM)-1 (CD54) and vascular cell adhesion molecule (VCAM)-1 (CD106) through their Mac-1 ( $\alpha\beta_2$  integrin, also known as CR3 or CD11b/CD18) and VLA-4 ( $\alpha_4\beta_1$  integrin) receptors, respectively. The constitutive expression of VLA-4 ( $\alpha_4\beta_1$  integrin) is limited to a small number of leukocytes, including eosinophils, monocytes, basophils, and T cells, suggesting that regulated expression of its ligand, VCAM-1, on endothelial cells may be important in selective recruitment of these cells (63).

## Adhesion

The firm adhesion of eosinophils involves the interaction of  $\alpha_4$  and  $\beta_2$  integrins with the endothelial layer. Specifically, eosinophils adhere to tumor necrosis factor (TNF)- $\alpha$ , IL-1 $\beta$ , and lipopolysaccharide-activated HUVECs through CR3/ICAM-1 and VLA-4/VCAM-1 interactions (63, 64, 65, 66 and 67). Other adhesion molecules that may contribute to this process are leukocyte function-associated antigen-1, VLA-6 ( $\alpha_4\beta_1$ ), a  $\alpha_4\beta_7$  integrin, p150,95, and CD11d. Eosinophils exhibit differential binding properties through VCAM-1 and ICAM-1, which are dependent on their activation status. Freshly prepared unstimulated eosinophils preferentially bind to endothelial VCAM-1 via VLA-4 ( $\alpha_4\beta_1$ ) rather than  $\beta_2$  to ICAM-1 (24, 24, 68). Once activated, eosinophil preference for VCAM-1 shifts to that of endothelial ICAM-1 via  $\beta_2$  integrins (24, 69, 70 and 71). During extravasation (diapedesis) into tissues, the eosinophil becomes progressively more activated on contact with extracellular matrix proteins and other stimulated cells. Tissue eosinophils from an antigen challenge model express increased CD11, CD69, and ICAM-1 (72). Eosinophil binding in tissues switches to ICAM-1 and the connecting segment-1 region of tissue fibronectin (62, 69, 73). The change in the activation status is also confirmed by the changes in the expression of cell-surface molecules seen as the eosinophil goes through tissue. Eosinophils recovered from bronchoalveolar lavage (BAL) express increased ICAM-1, Mac-1, CD69, and decreased L-selectin, suggesting an activated state (42).

Cytokines such as IL-4 and IL-13 have been shown to up-regulate eosinophil adhesion, primarily through up-regulation of VCAM-1 on endothelial cells (74, 75). The effects of IL-4 and IL-13 are mediated through Jak3 and the nuclear transcription factor STAT-6 (76, 77). Interestingly, a decrease in tissue eosinophilia has been observed in allergen-challenged STAT-6<sup>-/-</sup> mice, in spite of high levels of VCAM-1 expression (77). This difference was thought to be due to decreased expression of CCR3 in eosinophils, which is directly controlled by STAT-6 (78). Results from STAT-6<sup>-/-</sup> mice would suggest that IL-4 and IL-13 also have a role in the induction of CCR3 on eosinophils and T cells. These findings underline the importance of cytokine and chemokine cross-talk in the generation of blood eosinophilia and tissue diapedesis.

The switch to ICAM-1-mediated adhesion and transmigration may be associated with facilitation of eosinophil entrance into the tissue. Increased  $\beta_1$  expression (VCAM associated) has been shown to slow eosinophil migration compared with ICAM-1/ $\beta_2$  (79). It is important to note that anti-VLA-4 antibodies may not prevent eosinophil migration into tissue if ICAM-1 or P-selectin sites are the first targets for activated eosinophils (62).

IL-5 also up-regulates eosinophil, but not neutrophil, adhesion to unstimulated endothelium, offering a selective pathway of eosinophil adhesion ( [64](#) ). IL-5 has been shown to activate transendothelial migration of eosinophils through ICAM-1 via decreased  $\beta_1$  and increased  $\beta_2$  integrin expression ( [80](#) ). Similarly, stimulation of eosinophil CCR3 with a chemo-kine such as eotaxin, which can be released from endothelial cells, also increases  $\beta_2$  integrin expression, resulting in preferential binding to ICAM-1 ( [81](#) ). Thus, numerous cytokines and chemokines have been shown to enhance eosinophil adhesion to endothelium.

Complement proteins are also important in eosinophilic trafficking in tissues. Complement-mediated inflammation, as seen with parasite infection, is associated with the release of C3a and C5a. Whereas C3a increases binding of eosinophil to endothelium but does not increase migration, C5a increases both adhesion and migration ( [82](#) ). VCAM-1 and ICAM-1 are involved in complement-mediated binding and migration of eosinophils, as this process is blocked by the application of anti- $\alpha_4$  and  $-\beta_2$  antibodies. These findings illustrate the importance of adhesion molecules VCAM-1 and ICAM-1 in the complement-mediated pathway of anaphylaxis and host defense.

Other more general inflammatory cytokines, such as IL-1 and TNF, are also released by inflamed tissues and have significant effects on eosinophil migration ( [62](#) ). Messages encoding both IL-1 and TNF are increased in the airways of symptomatic as opposed to nonsymptomatic asthmatics ( [83](#) ), and IL-1 is increased in tissues from sites of cutaneous allergy ( [84](#) ). Antibodies to IL-1 have been shown to decrease the expression of VCAM-1 and ICAM-1 in endothelial cells ( [85](#) ). Mice deficient in IL-1 expression (IL-1<sup>-/-</sup>) have decreased eosinophil rolling, adhesion, and transmigration ( [86](#) ). TNF has also been shown to increase expression of endothelial ICAM-1, VCAM-1, P-selectin, and E-selectin, causing increased eosinophil rolling and adhesion ( [87](#), [88](#) and [89](#) ). In addition, TNF<sup>-/-</sup> mice show decreased eosinophil adhesion and migration into tissue, similar to IL-1<sup>-/-</sup> mice ( [90](#) ). These factors may have important roles in allergic asthma in which preferential accumulation of eosinophils is a feature of atopic (IgE-dependent) inflammatory conditions.

Eosinophils move through the endothelium by extending lamellipodia, thus leading to lamellar motion ( [62](#) ). Changes in the binding affinity for adhesion molecules and extracellular matrix proteins are thought to contribute to cell movement on a substratum. A gradient in binding affinity of eosinophil VLA-4 to fibronectin has been demonstrated ( [91](#) ), in which increased adherence at the leading edge of the cell is followed by deadherence at the rear of the cell, allowing the cell to move on. Cytokines and chemokines also influence the binding of eosinophils to tissue surfaces, such as GM-CSF, which increases the binding affinity of VLA-4 to VCAM-1 or connecting segment-1 ( [92](#) ), and eotaxin, which stimulates the reverse reaction ( [81](#) ). In addition, eotaxin may induce cytoskeletal changes via mitogen-activated protein kinases ( [62](#) ). Other chemokines or chemotactic factors, such as RANTES, monocyte chemoattractant protein (MCP)-3, and C5a, may also alter  $\beta_1$  integrin affinity ( [69](#), [93](#) ). The balance of these factors determines the rate of eosinophil migration.

### Transmigration and Chemotaxis

Once eosinophils adhere to vascular endothelium, they commence diapedesis, whereby

they emerge out of the capillaries and traverse the adjacent connective tissue en route to the focus of the inflammatory response. Although cytokines (e.g., IL-3, IL-5, and GM-CSF) are essential for the development and proliferation of eosinophils, they are likely to play an immunomodulatory role in priming eosinophils for better chemotactic responses to target tissue sites. The most potent eosinophil chemoattractants include PAF, leukotriene D<sub>4</sub>, C5a, IL-2, and C-C chemokines such as eotaxin and RANTES (94, 95). C-C chemokines appear to be essential for inducing the specific migration of eosinophils to inflamed sites. Several distinct families of chemokines have been identified, and the CCR3-binding family in particular plays a crucial role in generating tissue eosinophilia due to the nearly exclusive expression of CCR3 in eosinophils (24). This family of chemokines consists of eotaxin (1, 2 and 3); RANTES; MCP-2, -3, and -5; and macrophage inhibitory protein (MIP)-1a. Chemokines binding CCR3 may be selective for granulocytes such as eosinophils and basophils, as neutrophils do not express this receptor. Eotaxin is the only chemokine specific to eosinophils, making it a key member of the CCR3 family (94, 96). CCR3 chemokines are produced by endothelial cells, epithelial cells, T cells, macrophages, fibroblasts, and eosinophils, among other tissue sources (32, 97).

Basal expression of eotaxin in the gut is elevated compared with other tissues in the normal animal (98). During allergen-induced eosinophilia, eotaxin expression is further increased within tissues (99). Some synergism exists between IL-5 and eotaxin, as IL-5 stimulation enhances the eosinophil response to eotaxin both *in vitro* and *in vivo* (100, 101). To define the specific role of eotaxin in inflammation, eotaxin gene knock-out (Eo<sup>-/-</sup>) mice have been deployed (60, 102). These mice produce IL-5 normally and, thus, continue to develop blood eosinophilia similar to their wild-type heterozygotes. However, Eo<sup>-/-</sup> mice do not develop tissue eosinophilia. Thus, the primary role of CCR3 appears to be involved in the homing of circulating eosinophils to target tissues expressing eotaxin.

Additional chemokines of the CCR3 family have been shown to exert important effects in situations in which eotaxin may not be necessarily essential to the response (62, 103). Each chemokine appears to have a unique role in the timing and location of tissue eosinophilia. Peripheral blood levels and cultured mononuclear cells from patients with allergic dermatitis produce increased levels of RANTES, MCP-1, and MIP-1a compared with nonallergic controls (104). Similar to eotaxin, IL-5-stimulated eosinophils have an increased affinity for RANTES. However, unlike eotaxin, RANTES was specifically associated with exacerbations of eosinophilic bronchitis, thought to be provoked by viral infection. Infections with respiratory syncytial virus leading to eosinophilia have been correlated with increased RANTES, MCP-1, and MIP-1a expression (105, 106). Children with asthma have large increases in eosinophil-associated MBP, RANTES, and MIP-1a in their nasal secretions during naturally acquired viral infections (107). Therefore, the apparently broader range of effects of RANTES, MIP-1a, and MCP-1 may also increase the range of eosinophil activity in disease, even though all of these bind specifically to CCR3 on eosinophils.

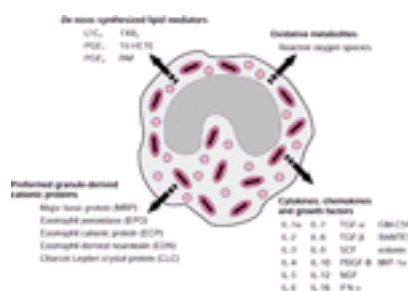
Other factors are also produced in mucosal tissues that are moderately or strongly chemotactic for eosinophils. These include bacterial products [e.g., endotoxin and the tripeptide f-Met-Leu-Phe (fMLP)], the anaphylatoxin complement factor, C5a, opsonized particles [which exert their effect via complement (CR1, CR3) and FcγRII receptors], and other cytokines (IL-4, IL-8, and, possibly, IL-13). In addition, the lipid-derived mediators leukotriene B<sub>4</sub> (LTB<sub>4</sub>) and PAF, which are elevated in allergic responses and induce eosinophil respiratory burst and degranulation at higher doses (23, 33, 108, 109), are also eosinophilotactic. Eosinophil cytokines IL-3, IL-5, and GM-CSF are able to enhance the

chemotactic ability of each of these factors. Although PAF antagonists are not sufficient at preventing eosinophilic inflammation in allergy, treatment of allergic individuals with leukotriene modifiers has been effective at reducing eosinophil numbers and inhibiting eosinophil activation ( [110](#) ).

Eosinophils also express a range of receptors for Igs that may contribute to chemotactic and activation responses in tissues. These include receptors for IgA, IgD, IgE, IgG, and IgM, which may possess up to three chains (α, β, and γ). Some controversy has surrounded the existence of the high-affinity receptor for IgE (FcεRI) on eosinophils. Recent studies have shown that the α subunit of FcεRI in eosinophils is expressed intracellularly rather than on the cell surface in resting cells, which may be mobilized to the surface and released during activation ( [111](#), [112](#) ). Interestingly, although murine FcεRI contains α, β, and γ subunits, the human homolog lacks the β subunit, suggesting that this subunit is redundant in signaling in cells expressing FcεRI. Eosinophils express an IgE-binding protein, galectin-3 (Mac-2/e-binding protein), as well as the low-affinity FcεRII (CD23), which may have contributed to apparent high-affinity binding for IgE in earlier studies. Cross-linking of Ig receptors on eosinophils has been shown to be highly effective at inducing respiratory burst and eosinophil-derived neurotoxin (EDN) degranulation in eosinophils, with a hierarchy of effectiveness in degranulation demonstrated to be in the order of secretory IgA = IgA > IgG &gt; IgE ( [113](#) ). Eosinophil cytokines such as IL-3, IL-5, and GM-CSF were demonstrated to enhance this process ( [114](#) ). IgA, particularly the secretory isoform, is an important mucosal antibody involved in supporting the body's first line of defense. Thus, the sensitivity of the eosinophil to IgA is in agreement with its proposed role in protection against invasive organisms in mucosal tissues.

## EOSINOPHIL MEDIATORS

The eosinophil is considered to be both a factory and a store for a large array of mediators that are released on activation and are thought to be important in various inflammatory reactions associated with this cell ( [Fig. 11.5](#) ).



**Figure 11.5.** Mediators released by activated eosinophils. *De novo*-synthesized lipid mediators and oxidative metabolites are elaborated directly from cell membrane or lipid bodies after enzyme activation, whereas granule-derived cationic proteins and cytokines, chemokines, and growth factors are released after granule-plasma membrane fusion during degranulation. GM-CSF, granulocyte-macrophage colony-stimulating factor; 15-HETE, 15-hydroxyeicosatetraenoic acid; IFN, interferon; IL, interleukin; LTC<sub>4</sub>, leukotriene C<sub>4</sub>; MIP, macrophage inhibitory protein; NGF, nerve growth factor; PAF, platelet-activating factor; PDGF, platelet-derived growth factor; PG, prostaglandin; RANTES, regulated on activation, normal T-cell expressed and secreted; SCF, stem cell factor; TGF, transforming growth factor; TXB, thromboxane B.

## Membrane-Derived Mediators

Eosinophils produce a wide variety of lipid-derived mediators that have profound biologic activity. The more important products are eicosanoids, which include leukotrienes (especially LTC<sub>4</sub>), prostaglandins (PGs) (especially PGE<sub>2</sub>), thromboxane, and lipoxins (especially lipoxin A<sub>4</sub>), as well as PAF. The main substrate for these mediators is arachidonic acid (AA), which is specifically liberated from membrane phospholipids possessing this fatty acid at the *sn*-2 position by phospholipase A<sub>2</sub> (PLA<sub>2</sub>) during receptor stimulation. Of the nine known families of PLA<sub>2</sub>, two families are expressed in eosinophils: the type IIA and type IV enzymes, commonly known as *secretory* (s) and *cytosolic* (c) PLA<sub>2</sub>, respectively ( [115](#), [116](#)). These enzymes are distinguished by their distribution, size, and sensitivity to Ca<sup>2+</sup>. Thus, granule-stored sPLA<sub>2</sub> (13 to 15 kd) requires millimolar amounts of Ca<sup>2+</sup> for activity, whereas cytosolically localized cPLA<sub>2</sub> (85 kd) is catalytically active in the presence of micromolar amounts of Ca<sup>2+</sup>. Interestingly, eosinophils express 20- to 100-fold higher levels of sPLA<sub>2</sub> in their granules than other circulating leukocytes, suggesting a functional role in inflammatory processes involving eosinophil degranulation.

Eosinophils are a rich source of LTC<sub>4</sub> (5S-hydroxy-6R, S-glutathionyl-7,9- *trans*-11,14- *cis*-eicosatetraenoic acid) ( [117](#), [118](#)). Stimulation with the calcium ionophore A23187 generates up to 40 ng per 10<sup>6</sup> cells of LTC<sub>4</sub> from normal-density eosinophils, whereas light-density eosinophils elaborate 70 ng per 10<sup>6</sup> cells. Eosinophils produce negligible amounts (6 ng per 10<sup>6</sup> cells) of LTB<sub>4</sub> (5S-12R-dihydroxy-6,14- *cis*-8,10- *trans*-eicosatetraenoic acid) compared with up to 200 ng per 10<sup>6</sup> cells from neutrophils. LTC<sub>4</sub> generation by human eosinophils was also observed after stimulation with both opsonized zymosan and via an FcγRII-dependent mechanism using Sepharose beads coated with IgG ( [50](#)). Release was maximal at 45 minutes, greater in hypodense eosinophils than in normal-density eosinophils, and enhanced by fMLP. The production of LTC<sub>4</sub> is critically dependent on the activation of 5-lipoxygenase, an enzyme that resides in the euchromatin region of the nucleus that translocates to the nuclear membrane on cell activation, where it activates an 18-kd protein called FLAP (5-lipoxygenase-activating protein) ( [119](#)). The substrate for 5-lipoxygenase is AA, which may be released from membrane phospholipids by PLA<sub>2</sub>. The first product of this enzyme is the intermediary compound 5-HPETE (5-hydroperoxyeicosatetraenoic acid), which is transformed into the unstable epoxide LTA<sub>4</sub>. At this point, human eosinophils predominantly generate LTC<sub>4</sub> through the action of LTC<sub>4</sub> synthetase ( [117](#), [118](#)). Eosinophils are particularly rich in LTC<sub>4</sub> synthetase and account for 70% of all LTC<sub>4</sub> synthetase-positive cells in the airway mucosa of normal and asthmatic individuals ( [120](#)). LTC<sub>4</sub> is generated intracellularly in human eosinophils stimulated with the calcium ionophore A23187. LTC<sub>4</sub> is later exported from the cell in a regulated manner ( [121](#)).

The production of 15-HETE (15-hydroxyeicosatetraenoic acid) via the 15-lipoxygenase pathway occurs in activated eosinophils. 15-Lipoxygenase may be distinguished from 5-lipoxygenase in that it can modify a larger pool of fatty acid substrates than the latter enzyme and oxygenates fatty acids that are esterified in phospholipids. Substrates include AA, linoleic acid, polyenoic acids, and more complex lipids, such as lipoproteins. Eosinophils are capable of generating 100 to 300 times more 15-HETE than neutrophils, endothelial cells, and fibroblasts ( [122](#)), and eosinophils also account for 85% of cells



positive for 15-lipoxygenase in the airway submucosa of normal and asthmatic subjects, which was elevated in asthmatic airways ( [123](#) ).

Eosinophils generate large amounts of PAF after stimulation with calcium ionophore, opsonized zymosan, or IgG-coated Sepharose beads ( [124](#), [125](#), [126](#) and [127](#) ). PAF (1-*O*-alkyl-2-acetyl-*sn*-glycerol-3-phosphocholine) is a potent phospholipid mediator that causes leukocyte activation. For instance, eosinophils elaborated 25 ng per 10<sup>6</sup> cells of PAF after stimulation with calcium ionophore and up to 2 ng per 10<sup>6</sup> cells after IgG stimulation. Much of the PAF remained cell associated, possibly acting as an intracellular messenger or alternatively binding to PAF receptors on eosinophils (thus acting as an autocrine agent). Interestingly, stimulation of eosinophils with fMLP did not augment PAF release, and hypodense eosinophils from patients with a marked eosinophilia released less PAF than normal eosinophils. [<sup>3</sup>H]PAF added to hypodense eosinophils was more rapidly incorporated into the phospholipid pool than [<sup>3</sup>H]PAF with normal-density cells ( [126](#) ). This suggested that hypodense eosinophils were metabolizing the exogenous PAF at a greater rate than normodense cells and may explain why stimulation with fMLP did not result in an increased amount of PAF generation. As with leukotriene synthesis, eosinophil-derived release of PAF was maximal at 45 minutes. Regulated PAF production is controlled by the release of biologically inactive lyso-PAF from membrane phospholipids by PLA<sub>2</sub>, which is later acetylated to form PAF by an acetyltransferase ( [125](#) ).

The cyclooxygenase pathway is prominent in eosinophils as well, and eosinophils are capable of producing PGE<sub>1</sub> and PGE<sub>2</sub>, as well as thromboxane B<sub>2</sub> from cyclooxygenase acting on free AA. In studies with guinea pig eosinophils, thromboxane B<sub>2</sub> and PGE<sub>2</sub> were shown to be generated after PAF or A23187 stimulation ( [128](#), [129](#) ).

Many of the enzymes associated with membrane-derived mediator release from eosinophils, including cyclooxygenase and 5-lipoxygenase, are found stored in association with lipid bodies ( [Table 11.1](#) ) ( [130](#), [131](#) and [132](#) ).

**TABLE 11.1. Content of Human Eosinophil Granules and Secretory Vesicles**

| Crystalloid Granules      | Primary Granules                             | Small Granules           | Lipid Bodies     | Secretory Vesicles        |
|---------------------------|--|--------------------------|------------------|---------------------------|
| Core                      |  |                          |                  |                           |
| Catalase                  |  |                          |                  |                           |
| Cathepsin D               |  |                          |                  |                           |
| Enoyl-CoA-hydrolase       |  |                          |                  |                           |
| β-Glucuronidase           |  |                          |                  |                           |
| Major basic protein       |  |                          |                  |                           |
| Matrix                    |  |                          |                  |                           |
| Acid β-glycerophosphatase |  | Elastase                 | Esterase         |                           |
| Acid phosphatase          | Charcot-Leyden crystal protein (galectin-10) | Acid phosphatase         | Arachidonic acid | Plasma proteins [albumin] |
| Acyl-CoA oxidase          |  | Arylsulfatase B (active) | Cyclooxygenase   |                           |

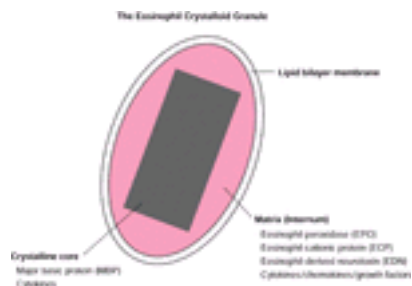
|   |                             |   |
|---|-----------------------------|---|
| Arylsulfatase B (inactive)                      | Catalase                    | Eosinophil peroxidase                                 |
| Bactericidal/permeability-increasing protein    | Eosinophil cationic protein | 5-Lipoxygenase  |
| Catalase  |                             | 15-Lipoxygenase                                       |
| Cathepsin D                                     |                             | Leukotriene C <sub>4</sub> synthase                   |
| Collagenase                                     |                             |   |
| Elastase  |                             |   |
| Enoyl-CoA-hydrolase (also in core)              |                             |   |
| Eosinophil cationic protein                     |                             |   |
| Eosinophil-derived neurotoxin                   |                             |   |
| Eosinophil peroxidase                           |                             |   |
| Flavin adenine dinucleotide                     |                             |   |
| β-Glucuronidase                                 |                             |   |
| β-Hexosaminidase                                |                             |   |
| 3-Ketoacyl-CoA thiolase                         |                             |   |
| Lysozyme  |                             |   |
| Major basic protein                             |                             |   |
| Nonspecific esterases                           |                             |   |
| Phospholipase A <sub>2</sub> (type II)          |                             |   |
| Membrane  |                             |   |
| CD63  |                             | Cytochrome <i>b</i> <sub>558</sub> [p22 <i>phox</i> ] |
| V-type H <sup>+</sup> -adenosine triphosphatase |                             | Vesicle-associated membrane protein-2                 |
| CoA, coenzyme A.                                |                             |   |

## Granule-Derived Proteins

Eosinophils contain at least five different populations of phospholipid bilayer membrane-bound granules.

**Crystalloid granules** These specialized and unique granules measure between 0.5 and 0.8 μm in diameter, contain crystalline electron-dense cores (internum) surrounded by an electron-lucent matrix, and can take up acidic dyes avidly due to their cationic nature (2, 133). They are mainly present in mature eosinophils, although coreless granules have been observed in immature eosinophils. These granules contain the bulk of highly charged cationic proteins present in eosinophils, including MBP, eosinophil peroxidase (EPO), eosinophil cationic protein (ECP), and EDN. There are approximately 200 crystalloid granules in each cell. The core is predominantly comprised of crystallized MBP ( Fig. 11.6).





**Figure 11.6.** Structure of the eosinophil crystalloid granule. This membrane-bound organelle is a major site of storage of eosinophil cationic granule proteins as well as a number of cytokines, chemokines, and growth factors.

**Primary granules** These coreless granules are enriched with Charcot–Leyden crystal (CLC) protein and are present in immature as well as mature eosinophils. Some authors refer to immature crystalloid granules as *primary granules in eosinophil promyelocytes*. These measure between 0.1 and 0.5  $\mu\text{m}$  in diameter and are less abundant than crystalloid granules.

**Small granules** These granules are also free of cores and contain acid phosphatase, arylsulfatase B, catalase, and cytochrome *b* 558.

**Lipid bodies** There are approximately five lipid bodies per mature eosinophil, the number of which increases in certain eosinophilic disorders, especially in idiopathic hypereosinophilia. Lipid bodies are enriched in AA esterified into glycerophospholipids.

**Secretory vesicles** Eosinophils are densely packed with small secretory vesicles in their cytoplasm. These vesicles appear as dumbbell-shaped structures in cross sections and contain albumin, suggesting an endocytotic origin. These structures are also known as *microgranules* or *tubulovesicular structures*. Eosinophil MBP (13.8 kd) is an arginine-rich 117-amino acid protein that constitutes a significant proportion of total cell protein in human eosinophils (5 to 10 pg per cell). MBP was originally named for its abundance in guinea pig eosinophils, which contain as much as 250 pg per cell, making up 50% of the total cellular protein (134). The high isoelectric point of MBP (10.9) cannot be measured accurately due to the extremely basic nature of the protein (135). MBP has been shown to be cytotoxic to airway tissues, including bronchial epithelial cells and pneumocytes. Thus, MBP may be at least partly responsible for tissue damage associated with eosinophil infiltration into the bronchial mucosa in asthma (2). Indeed, airway sections from patients with status asthmaticus exhibit intense MBP-specific immunofluorescence, suggesting that infiltrated eosinophils were fully activated, undergoing extracellular secretion of their contents of MBP (136). The effects of MBP, in the absence of opsonization, on target cells such as parasites is thought to result from increased membrane permeability through surface charge interactions leading to perturbation of the lipid bilayer (137). MBP is synthesized during the promyelocytic stage of eosinophil development, characterized by the presence of message encoding this protein, in a neutral prepro-form that is later processed to form pro-MBP, which is subsequently transported to the immature crystalloid granule and cleaved to form MBP (138, 139). Mature MBP undergoes condensation from the periphery of immature crystalloid granules to the internum, where it develops a crystalline core as its concentration is increased (139, 140). Once eosinophils have reached full maturity, MBP is no longer synthesized, and messenger RNA encoding MBP disappears from the cell (139, 141). MBP acts on other inflammatory cells, including neutrophils and eosinophils, to induce degranulation and lipid mediator release (142, 143). Other eosinophil basic proteins include EPO, ECP, and EDN, which reside in the matrix compartment of the crystalloid granule. EPO is a highly basic [isoelectric point (pI) of 10.9] heme-containing protein composed of two subunits: a heavy chain of 50 to 57 kd and a light chain of 11 to 15 kd. EPO is a haloperoxidase with 68% sequence identity to neutrophil myeloperoxidase, suggesting that a peroxidase multigene family may have developed through gene duplication (135, 144). Eosinophils store

approximately 15 pg per cell of EPO, which is important in catalyzing the peroxidative oxidation of halides and pseudohalides, leading to the formation of bactericidal hypohalous acids, particularly hypobromous acid, in reaction with superoxide generated during respiratory burst ( [145](#), [146](#) and [147](#) ). The molecular mass of ECP is between 16 and 21 kd, with approximately 15 pg per cell expressed in human eosinophils. The pI of ECP (10.8) is identical to that of MBP due to a similar arginine-rich sequence. Early studies have demonstrated that ECP, a member of a subfamily of RNase (ribonuclease) A multigenes that possesses intrinsic RNase activity, is bactericidal, promotes degranulation of mast cells, and is toxic to helminthic parasites on its own ( [148](#), [149](#) ). The mechanism of action of ECP is thought to involve the formation of pores or channels in the target membrane, which is apparently not dependent on its reversible RNase activity ( [150](#) ). ECP is perhaps most well known for its ability to elicit the Gordon phenomenon when it was injected into the cranial ventricles of rabbits, causing the destruction of Purkinje cells and leading to spongiform changes in the cerebellum, pons, and spinal cord ( [151](#), [152](#) ). EDN, another member of the RNase A multigene family, of 18.5 kd with approximately 100-fold higher RNase activity than ECP, is less basic than MBP or ECP with a pI of 8.9 due to a relatively smaller number of arginine residues in its sequence. ECP and EDN share a remarkable sequence homology of 70% at the amino acid level for the pre-form of both proteins, suggesting that evolutionarily, these proteins are derived from the same gene ( [153](#), [154](#) ). Eosinophils express approximately 10 pg per cell of EDN, but there is marked variation between individuals. EDN similarly induces the Gordon phenomenon when injected intracranially in laboratory animals ( [151](#), [152](#) ). Messenger RNA encoding EPO, ECP, and EDN has been detected in mature eosinophils, suggesting that eosinophils have the capacity to continue to synthesize these proteins in their end-differentiated state ( [141](#) ). Recent findings have suggested that the gene family expressing ECP and EDN has one of the highest rates of mutation in the primate genome, ranking with those of Igs, T-cell receptors, and major histocompatibility complex classes ( [154](#) ). These genes effectively comprise a superfamily of RNases expressed in the mammalian genome. Such an extreme rate of mutation suggests that the evolutionary constraints acting on the ECP/EDN superfamily have promoted the acquisition of a specialized antiviral activity. This may be inferred from the high mutation rates of other genes commonly associated with host protection against viral infection. Whether ECP or EDN possess any antiviral activity has yet to be demonstrated, although some studies have indicated that EDN and EPO may be potent antiviral factors in respiratory infections ( [155](#) ). The CLC protein (17.4 kd) is produced in eosinophils at very high levels (accounting for 10% of the total cellular protein), although its functional role is still obscure. CLC is a hydrophobic protein with strong sequence homology to the carbohydrate-binding galectin family of proteins and has been designated *galectin-1C* ( [156](#) ). CLC is released in large quantities in the tissues in eosinophilic disorders, resulting in the formation of distinct, needle-shaped structures that are colorless and measure 20 to 40  $\mu\text{m}$  in length and 2 to 4  $\mu\text{m}$  across. CLCs are abundant in the sputum and feces of patients with severe respiratory and gastrointestinal eosinophilia, which were first observed by Charcot and Robin in 1853. A list of these and other granule proteins synthesized and stored in eosinophils is presented in [Table 11.1](#) and published elsewhere ( [23](#), [157](#), [158](#) ).

## Eosinophil-Derived Cytokines

Human eosinophils have been shown to produce up to 29 different cytokines, chemokines, and growth factors ( [Table 11.2](#) ) with the potential to regulate various immune responses. These cytokines have been identified in eosinophils by detecting mRNA or protein (or both) using reverse transcriptase-polymerase chain reaction, *in situ* hybridization, and immunocytochemical staining ( [159](#), [160](#) and [161](#) ). In addition, picogram amounts of cytokines, chemokines, and growth factors were measured in supernatants of stimulated eosinophils

([160](#), [162](#)). These cytokines are likely to act in an autocrine, paracrine, or juxtacrine manner, thereby regulating local inflammatory events. Studies have demonstrated that the production of eosinophil-activating cytokines (e.g., IL-3 and GM-CSF) by eosinophils may be important in prolonging the survival of these cells by a putative autocrine loop ([34](#), [160](#)). For instance, the adherence of highly purified eosinophils to the extracellular matrix protein fibronectin resulted in prolonging the survival of these cells in the absence of exogenous cytokines ([34](#)). Fibronectin-induced eosinophil was inhibitable by antibodies against fibronectin and VLA-4 and up-regulated by picogram amounts of IL-3 and GM-CSF derived from eosinophils ([34](#)). Observations on eosinophil cytokine release have been mainly studied *in vitro*, but a few have been confirmed *in vivo* ([163](#), [164](#), [165](#) and [166](#)).

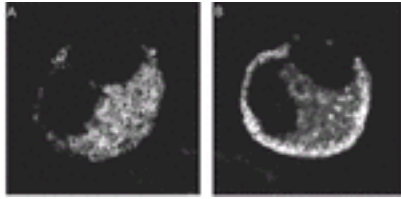
**TABLE 11.2. Cytokines, Chemokines, and Growth Factors Produced by Human Eosinophils**

| Cytokine                      | Product         | Stored Protein in Resting Cells (per 10 <sup>6</sup> cells) | Intracellular Site of Storage       |
|-------------------------------|-----------------|---|-------------------------------------|
| <b>Interleukins</b>           |                 |   |                                     |
| Interleukin-1a                | mRNA<br>protein | —   | —                                   |
| Interleukin-2                 | mRNA<br>protein | 6 ± 2 pg  | Crystalloid granules (core)         |
| Interleukin-3                 | mRNA<br>protein | —   | —                                   |
| Interleukin-4                 | mRNA<br>protein | ~75 ± 20 pg   | Crystalloid granules (core)         |
| Interleukin-5                 | mRNA<br>protein | —   | Crystalloid granules (core/matrix?) |
| Interleukin-6                 | mRNA<br>protein | 25 ± 6 pg   | Crystalloid granules (matrix)       |
| Interleukin-9                 | mRNA<br>protein | —   | —                                   |
| Interleukin-10                | mRNA<br>protein | ~25 pg  | —                                   |
| Interleukin-11                | mRNA<br>protein | —   | —                                   |
| Interleukin-12                | mRNA<br>protein | —   | —                                   |
| Interleukin-13                | mRNA<br>protein | —   | —                                   |
| Interleukin-16                | mRNA<br>protein | 1.6 ± 0.8 ng  | —                                   |
| Leukemia inhibitory factor    | mRNA<br>protein | —   | —                                   |
| <b>Interferons and others</b> |                 |   |                                     |
| Interferon-?                  | mRNA<br>protein | —   | —                                   |
| Tumor necrosis factor         | mRNA<br>protein | —   | Crystalloid granules (matrix)       |

|  |         |               |  |
|--|---------|---------------|--|
| Granulocyte-macrophage colony-stimulating factor             | mRNA    | 15.1 ± 0.3 pg | Crystalloid granules (core)                                |
| Chemokines   | protein |               |  |
| Eotaxin  | mRNA    | 19 ± 4 pg     | Crystalloid granules                                       |
|  | protein |               |  |
| Interleukin-8  | mRNA    | <3 pg         | Cytoplasmic  |
|  | protein |               |  |
| Macrophage inflammatory protein-1a                           | mRNA    | —             | —  |
|  | protein |               |  |
| MCP-1  | Protein | —             | —  |
| MCP-3  | mRNA    | —             | —  |
| MCP-4  | mRNA    | —             | —  |
| RANTES   | mRNA    | 72 ± 15 pg    | Crystalloid granules (matrix) and small secretory vesicles |
|  | protein |               |  |
| Growth factors   |         |               |  |
| Heparin-binding epidermal growth factor-like binding protein | mRNA    | —             | —  |
|  | protein |               |  |
| Nerve growth factor  | mRNA    | 4 ± 2 pg      | —  |
|  | protein |               |  |
| Platelet-derived growth factor B-chain                       | mRNA    | —             | —  |
|  | protein |               |  |
| Stem cell factor   | mRNA    | —             | Membrane, cytoplasm  |
|  | protein |               |  |
| TGF-α  | mRNA    | 22 ± 6 pg     | Crystalloid granules (matrix) and small secretory vesicles |
|  | protein |               |  |
| TGF-β1   | mRNA    | —             | —  |
|  | protein |               |  |

MCP, monocyte chemoattractant protein; mRNA, messenger RNA; RANTES, regulated on activation, normal T-cell expressed and secreted; TGF, transforming growth factor.

A major distinction in cytokine production between eosinophils and T cells is that the former store their cytokines intracellularly as preformed mediators. Although many eosinophil-derived cytokines are elaborated at lower concentrations than other leukocytes, eosinophils possess the ability to release these cytokines immediately (within minutes) after stimulation. Stored cytokines include IL-2, IL-4, IL-5, IL-6, IL-10, IL-13, IL-16, GM-CSF, TNF, eotaxin, IL-8, RANTES, nerve growth factor, and TGF-α. Studies using immunogold electron microscopic analysis or confocal laser-scanning microscopy coupled with double immunofluorescence labeling have indicated that several of these cytokines are found in close association with either the crystalline core or matrix of the crystalloid-specific granules of the cell ( [Table 11.2](#)) ( [161](#), [167](#), [168](#), [169](#), [170](#), [171](#) and [172](#)). For example, RANTES was found to be associated predominantly with the matrix compartment of the crystalloid granule in eosinophils ( [Fig. 11.7](#)).



**Figure 11.7.** Translocation of the chemokine RANTES (regulated on activation, normal T-cell expressed and secreted) in human eosinophils activated by interferon- $\gamma$  *in vitro*. Immunoreactivities for RANTES (green fluorescence) and eosinophil major basic protein (MBP) (red fluorescence) are shown in control (A) and IFN- $\gamma$ -stimulated (10 minutes, 500 U/ml) (B) cells. The yellow color (B) resulted from co-localization of green and red immunofluorescence stains. Note that immunoreactivity for MBP remained associated with the cores of the crystalloid granules in both cells, whereas the green label for RANTES translocated toward the cell membrane. RANTES was proposed to be released from eosinophils by piecemeal degranulation. See [Color Plate](#). (Experimental conditions described in Lacy P, Mahmudi-Azer S, Bablitz B, et al. Rapid mobilization of intracellularly stored RANTES in response to interferon-gamma in human eosinophils. *Blood* 1999;94:23-32.)

Developing eosinophils possess the ability to express cytokine message and protein at early stages of maturation. Eosinophils generated from semisolid culture of cord blood-derived CD34<sup>+</sup> cells in the presence of IL-3 and IL-5 were shown to express IL-5 and GM-CSF mRNA after 10 days of culture ([173](#)). Freshly purified CD34<sup>+</sup> cells expressed IL-4 and RANTES mRNA but not IL-4 and RANTES protein. On day 23 of culture, IL-4 and RANTES immunofluorescence were found localized to the matrix of MBP<sup>+</sup> crystalloid granules ([174](#)). In addition, IL-6 protein expression was found in cells after day 16 of culture ([140](#)).

Another site of storage of cytokines and chemokines is within the small secretory vesicle. At least two such proteins were shown to be associated with these vesicles—namely, RANTES and TGF- $\alpha$  immunolabeling ([161](#)). These organelles ([175](#)) belong to the same group of secretory vesicles identified by electron microscopy analysis as tubulovesicular structures. RANTES-positive vesicles are highly sensitive to stimulation by IFN- $\gamma$  and are rapidly mobilized (within 10 minutes of stimulation) to secrete RANTES extracellularly ([161](#), [176](#)). Crystalloid granules, which also contain RANTES within their matrix compartment, were found to release this chemokine more slowly in response to IFN- $\gamma$  (1 hour), whereas the majority of MBP remained associated with the core of these granules. These observations suggest that eosinophils have the ability to “shuttle” RANTES from the crystalloid granules to the cell exterior and may provide an important *in vitro* model for eosinophil piecemeal degranulation (PMD) (see section [Degranulation Mechanisms](#)).

The bioactivity of cytokines from eosinophils has also been explored to determine the potential physiologic effects of these factors. Studies have shown that IL-2, IL-4, IL-12, IL-16, GM-CSF, RANTES, and TGF- $\beta$  derived from eosinophils are capable of exerting bioactive effects on bystander cells using *in vitro* assays ([32](#), [158](#)). For example, the release of IL-4 from eosinophils was thought to be important in driving the initiation of a T helper cell 2 (Th2)-type response in *Schistosoma mansoni* infection in mice. IL-2 and IFN- $\gamma$  from CD28-stimulated eosinophils were shown to stimulate proliferation in an IL-2-dependent cell line and major histocompatibility complex class II expression on Colo 205 cells, respectively ([177](#)). These studies have demonstrated that eosinophil-derived cytokines and chemokines have the ability to regulate responses, at least at the level of local inflammatory responses.

Generally speaking, eosinophils produce significantly smaller amounts of cytokines than T cells, B cells, and other cells in the immune system. However, in eosinophilic inflammation, eosinophils outnumber T cells in the tissues by as much as 100-fold. As such, the magnitude of the presence of eosinophils may be a determining factor in regulating immune responses at a local level. The release of eosinophil cytokines often takes place within a much shorter period than T-cell-released cytokines (which may be several hours), as eosinophil-derived cytokines are stored as preformed mediators in crystalloid granules that may be secreted in response to stimuli in a matter of minutes. The implications of eosinophil cytokine production are extensive, such as in the case of IL-4, which may be released from eosinophils to direct Th2 cell differentiation in local lymph nodes. In support of this possibility, eosinophils have been shown to traffic to paratracheal draining lymph nodes (in a mouse model of asthma), where they were demonstrated to function as antigen-presenting cells expressing major histocompatibility complex class II and costimulatory CD80 and CD86 to stimulate CD4<sup>+</sup> T cells ( [178](#) ). During intimate cell-cell contact, the production of IL-4 and IL-13 is not required in abundance to effect important immunomodulatory events, such as enhanced switching of T cells to the Th2 phenotype and increased IgE synthesis, both of which are hallmarks of allergic disorders ( [179](#), [180](#) ).

The recognition of the capacity of the eosinophil to synthesize and release these cytokines has introduced a new paradigm shift toward understanding the potential of the eosinophil as an effector cell in allergic inflammation. However, the full capacity of the eosinophil to elaborate cytokines, the precise microenvironment requirements for such synthesis, and the intracellular pattern of production and storage remain to be the subject of intensive investigation.

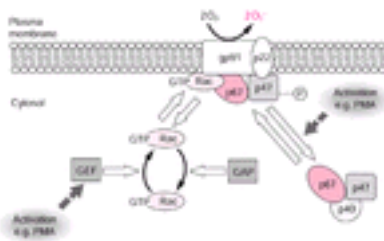
## Respiratory Burst

Eosinophils undergo respiratory burst concurrently with the release of other mediators during cell activation. *Respiratory burst* is defined as the increase in cell metabolism (measured by the elevated activity of the hexose monophosphate shunt) and oxygen consumption, coupled with the release of reactive oxygen species (ROS). Many stimuli are capable of inducing respiratory burst in eosinophils, including LTB<sub>4</sub>, PAF, fMLP, C5a, opsonized particles, and RANTES ( [23](#) ). The principal product of respiratory burst is superoxide (O<sub>2</sub><sup>-</sup>), a potent oxidant with a highly reactive electron in its outer valence, possessing relatively weak intrinsic microbicidal activity. The function of O<sub>2</sub><sup>-</sup> is thought to reside in its ability to dismutate into more reactive ROS, including hydrogen peroxide (H<sub>2</sub>O<sub>2</sub>) and the hydroxyl radical (OH<sup>-</sup>). The reaction of ROS with granule EPO also leads to the formation of hypohalous acids (hypobromous acid) on reaction with EPO produced after eosinophil degranulation. The formation of ROS subsequent to O<sub>2</sub><sup>-</sup> generation is dependent on the presence of a number of catalysts, such as superoxide dismutase, which accelerates the formation of H<sub>2</sub>O<sub>2</sub>, and the ferrous ion, which induces OH<sup>-</sup> production from H<sub>2</sub>O<sub>2</sub>. O<sub>2</sub><sup>-</sup> is also able to react with nitric oxide (NO) produced from nitric oxide synthase (NOS) enzymes (e.g., iNOS, eNOS) to form the highly reactive peroxynitrite (ONOO<sup>-</sup>), which has been shown to modify tyrosine residues and alter cell function.

The regulated burst of O<sub>2</sub><sup>-</sup> production is largely mediated through the activation of a membrane-associated enzyme complex: the nicotinamide adenine dinucleotide phosphate (NADPH) oxidase ( [Fig. 11.8](#) ). This enzyme complex is crucial for maintenance of host



defense as it mediates the destruction of ROS-sensitive organisms. In addition, overactivation of the NADPH oxidase is likely to be cytotoxic to tissues and has been implicated in the pathogenesis of many eosinophil-related disorders including allergic asthma (181). Interestingly, eosinophils possess the ability to generate up to tenfold more superoxide than other phagocytes, including neutrophils, in which the mechanisms associated with NADPH oxidase activation have been studied in greater detail (182). The ability of eosinophils to release more  $O_2^-$  is thought to be the result of higher levels of expression of the protein components that make up the NADPH oxidase complex (183, 184, 185, 186 and 187).



**Figure 11.8.** Assembly and activation of the nicotinamide adenine dinucleotide phosphate (NADPH) oxidase complex during respiratory burst. This complex is essential for the inducible release of superoxide for microbicidal reactions and is also present in neutrophils. During cell activation, the guanosine triphosphatase (GTPase) Rac, normally bound to guanosine diphosphate (GDP) in the resting cell, is activated by a guanine exchange factor (GEF) to bind to GTP. This results in translocation of Rac-GTP to the cell membrane, where other cytosolic proteins (p67 *phox* and p47 *phox*) have also translocated, to bind to the two subunits of cytochrome *b*<sub>558</sub> (gp91 *phox* and p22 *phox*). After the assembly of the oxidase, electrons are transferred from NADPH in the cytosol via flavin adenine dinucleotide (a cofactor) to oxygen molecules to form the highly reactive oxygen intermediate superoxide. Assembly of this complex is reversed by GTPase-activating protein (GAP), which hydrolyzes GTP on Rac to GDP, and by dissociation of the *phox* subunits. PMA, phorbol myristate acetate (a phorbol ester commonly used to activate respiratory burst in granulocytes).

NADPH oxidase is a complex of at least five subunits: two (p22 *phox* and gp91 *phox*) reside in the membrane as part of the cytochrome *b*<sub>558</sub> protein. The other three (p67 *phox*, p47 *phox*, and p40 *phox*) remain in the cytosol in resting states (182) but assemble to form a complex and to be translocated to the membrane after a phagocytic stimulus. Rac1 or Rac2 is complexed with the guanine dissociation inhibitor RhoGDI. Rac1 and Rac2 are monomeric guanine triphosphatases (GTPases), which exhibit 92% homology in their amino acid sequence, and are functionally interchangeable in their ability to activate NADPH oxidase, although they differ in their tissue distribution. Another potential modulator of the oxidase is the monomeric GTPase Rap1a, although its precise role is unknown. Thus, whereas Rac1 is ubiquitously expressed throughout the body, neutrophils, eosinophils, and other blood cells predominantly express Rac2, which is mainly expressed in hemopoietic tissues (188, 189 and 190). The five minimal components of the NADPH oxidase complex were determined using cell-free assays (191), although several other proteins, such as p40 *phox* and Rap1a, may be involved in fine-tuning the activity of the oxidase (192).

The pathway leading from receptor stimulation to activation of the oxidase is still poorly understood and appears to exhibit species differences. For example, phorbol esters, such



as phorbol myristate acetate, are commonly used as highly potent artificial stimuli to activate respiratory burst in eosinophils in experimental conditions. Phorbol esters are classically known for their ability to directly activate protein kinase C (PKC) ( [193](#), [194](#) and [195](#) ). However, the use of pharmacologic inhibitors of PKC has generated paradoxical results in that PKC inhibitors only partially inhibit agonist-induced H<sub>2</sub>O<sub>2</sub> release in guinea pig eosinophils ( [194](#), [196](#) ). In human eosinophils, PKC inhibitors actually augment the rate of oxygen consumption in response to opsonized particles ( [197](#) ). These findings suggest that PKC is not critical for agonist-induced respiratory burst in eosinophils, although stimulation of PKC appears to be able to induce superoxide release on its own.

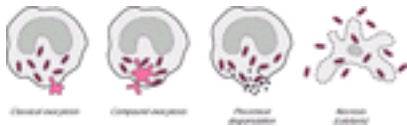
Taken together, eosinophils generate substantial amounts of O<sub>2</sub><sup>-</sup> as part of their role in host defense, and the mechanisms associated with the release of this toxic mediator are under investigation. The release of O<sub>2</sub><sup>-</sup> from eosinophils is likely to be a crucial component of the pathophysiologic processes underlying eosinophilic inflammation in mucosal tissues.

## Degranulation Mechanisms

*Degranulation* is defined as the exocytotic fusion of granules with the plasma membrane during receptor-mediated secretion. During exocytosis, the outer leaflet of the lipid bilayer membrane surrounding the granule encounters the inner leaflet of the plasma membrane, a process known as *docking*. The docking step is hypothesized to be regulated by intracellular membrane-associated proteins that act as receptors directing the specificity of granule targeting. After docking, the granule and plasma membrane fuse together and form a reversible structure called the *fusion pore*, which is also thought to be regulated by similar, or the same, membrane-associated proteins regulating granule docking. Depending on the intensity of the stimulus, the fusion pore may either retreat, leading to reseparation of the granule from the plasma membrane, or expand and allow complete integration of the granule membrane into the plasma membrane as a continuous sheet. The inner leaflet of the granule membrane becomes outwardly exposed, and the granule contents are subsequently expelled to the exterior of the cell ( [198](#) ).

There are four main forms of eosinophil granule release that have been observed *in vitro* and *in vivo* ( [Fig. 11.9](#) ). The first is the classic sequential release of single crystalloid granules, which was the original hypothesis suggested for a predominant route of degranulation in eosinophils. This type of release is typically seen *in vitro* and can be elegantly demonstrated electrophysiologically using patch-clamp procedures that measure changes in membrane capacitance, which are directly proportional to increases in the surface area of the cell membrane. During the sequential release of individual crystalloid granules, a stepwise increment in capacitance may be observed as their membranes fuse with that of the cell membrane ( [199](#), [200](#) and [201](#) ). The second mode of granule release is compound exocytosis, also demonstrated by patch-clamp analysis in which sudden, very large increments in cell membrane capacitance were measured that can be divided into discrete numbers of granules ( [202](#) ). Ultrastructural studies of guinea pig eosinophils have also demonstrated evidence for compound exocytosis ( [203](#) ) similar to that observed in rat eosinophils adhering to the outer surface of opsonized parasitic larvae ( [202](#), [204](#) ). Additional evidence for compound exocytosis was suggested in eosinophils stimulated with a cocktail of IL-3, IL-5, and GM-CSF, which were observed to fuse their granules after activation as determined by immunofluorescence for CD63, a marker for crystalloid granules ( [205](#) ). The third manner in which eosinophils degranulate is by PMD. PMD was first characterized by Dvorak and colleagues for the appearance of numerous small vesicles in the cytoplasm coupled with the apparent loss of crystalloid granule core and

matrix components, creating a “mottled” appearance in electron microscopy analysis ( [206](#) ). This was thought to be due to small vesicles budding off from the larger secondary granules and moving to the plasma membrane for fusion, thereby causing gradual emptying of the crystalloid granules to the outside of the cell. PMD was the most commonly observed pattern of degranulation seen *in situ* in biopsy samples from the upper airways of allergic individuals ( [207](#) ) and is likely to be physiologically the most important mechanism for eosinophil mediator release in allergic disease. An *in vitro* model for PMD has been established using IFN- $\gamma$ -stimulated eosinophils, in which a piecemeal manner of RANTES release was detected by a combination of confocal laser-scanning microscopy, immunogold labeling, and subcellular fractionation ( [161](#) ). Airway tissue eosinophils not undergoing PMD appeared necrotic, which is a fourth pattern of granule release termed *cytolysis* ( [208](#) ). This type of release has been previously observed to occur after prolonged *in vitro* stimulation of human eosinophils with the calcium ionophore A23187 ( [209](#) ) and appears to be a physiologically relevant granule release event.

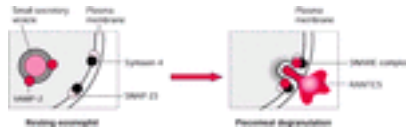


**Figure 11.9.** Four putative physiologic modes of eosinophil degranulation. The most common observed forms of degranulation in allergic disease are piecemeal degranulation and necrosis (cytolysis). Parasitic and fungal diseases typically exhibit eosinophils undergoing compound exocytosis.

The mechanisms associated with classic exocytosis, compound exocytosis, and PMD, but not cytolysis, are thought to require specific intracellular membrane-associated proteins acting as receptors for granule docking and fusion. These proteins include a family of molecules known as *SNAREs* [an acronym for *SNAP* (soluble NSF attachment protein) receptors]. The paradigm associated with SNARE molecule function predicts that these proteins are essential for exocytosis. SNAREs were originally described in neuronal tissues and were found to group themselves into two distinct locations: the granule-associated SNAREs (the so-called vesicular SNAREs, or v-SNAREs) and the plasma membrane-associated SNAREs (target SNAREs, or t-SNAREs) ( [210](#) ). For a functional SNARE complex to form, allowing the granule to dock with the plasma membrane, one v-SNARE binds to two t-SNARE molecules. In neuronal cells, a commonly observed v-SNARE is vesicle-associated membrane protein (VAMP)-1 or its isoform VAMP-2. In these cells, the t-SNAREs associating with VAMP-2 that were originally described were synaptosome-associated protein of 25 kd (SNAP-25) and syntaxin-1A. These three molecules form a stable detergent-resistant four-helix coiled-coil bundle, which may be regulated by protein phosphorylation. The precise mechanisms regulating SNARE binding and activation are not yet known.

Nonneuronal cells also express SNAREs, although some isoforms have been identified with high sequence homology to the neuronal SNAREs. Up to three SNAP-25 isoforms and approximately 16 syntaxin-1 isoforms have been characterized based on detection of homologous SNARE motif messenger RNA sequences. Interestingly, most nonneuronal secretory cells appear to require SNAP-23 and syntaxin-3, syntaxin-4, or syntaxin-6 ( [211](#) , [212](#) and [213](#) ) for control of exocytosis. Eosinophils have been shown to express the v-SNARE VAMP-2 in their small secretory vesicles containing RANTES but not their crystalloid granules ( [214](#) ). The t-SNARE isoforms syntaxin-4 and SNAP-23 are expressed in the cell membrane of eosinophils, and these have the potential to act as cognate

membrane-binding partners for VAMP-2 during PMD ( [215](#) ). The SNARE molecules identified in eosinophils are proposed to regulate docking of RANTES-containing small secretory vesicles during PMD ( [Fig. 11.10](#) ).



**Figure 11.10.** Schematic model for molecular regulation of granule-plasma membrane fusion proposed to occur in piecemeal degranulation in eosinophils. In this model, the v-SNARE (SNAP receptor) vesicle-associated membrane protein (VAMP)-2 is expressed on small secretory vesicles that store RANTES (regulated on activation, normal T-cell expressed and secreted) as a preformed mediator; t-SNAREs, SNAP-23, and syntaxin-4 reside on the inside of the plasma membrane. After cell activation, v- and t-SNAREs bind together to form a SNARE complex, resulting in fusion and release of vesicular contents, including RANTES. (See [Lacy P, Logan MR, Bablitz B, et al. Fusion protein vesicle-associated membrane protein 2 is implicated in IFN-gamma-induced piecemeal degranulation in human eosinophils from atopic individuals. J Allergy Clin Immunol 2001;107:671-678](#); and [Logan MR, Lacy P, Bablitz B, et al. Expression of eosinophil target SNAREs as potential cognate receptors for vesicle-associated membrane protein-2 in exocytosis. J Allergy Clin Immunol 2002;109:299-306](#).)

Mechanisms associated with granule release in eosinophils are critical for effector function of eosinophils. Without degranulation and mediator secretion, the eosinophil is a relatively inert cell and does not affect the surrounding tissues, as seen in cases of idiopathic pulmonary eosinophilia and eosinophilic pneumonia. In these conditions, eosinophil numbers are increased in the capillaries and tissues of the lung, but no cellular or structural damage is evident, probably because of the lack of eosinophil degranulation. In contrast, asthmatic patients show profound eosinophilia in the airways combined with significant tissue destruction, suggesting that, in addition to eosinophilic infiltration, their undergoing degranulation may contribute to mucosal damage in the airways and related symptoms of asthma.

## Eosinophils and Allergic Disease

The association between eosinophils and allergic disease has been known for many years. Eosinophils are a feature of allergic and nonallergic asthma, and large numbers of eosinophils ( [216](#) ) and eosinophil granule products are commonly found in and around the bronchi in patients who have died of asthma ( [136](#) ).

## Eosinophils and Asthma

A correlation between the degree of bronchial hyperresponsiveness (a cardinal clinical feature of asthma) and peripheral blood eosinophilia has been observed in subjects who exhibited a dual response after allergen challenge ( [27](#), [217](#) ). Eosinophils in the airways may be assessed using bronchial biopsy or BAL or, more recently, by the use of sputum, a noninvasive technique that may be of clinical value ( [218](#), [219](#) ). The use of fiberoptic bronchoscopy in obtaining bronchial samples in the past decade has helped in acquiring a better appreciation of eosinophil involvement in asthma ( [220](#) ). A consistent finding in asthmatic airways was the presence of increased numbers of activated eosinophils, which correlated broadly with the severity of disease as reflected in symptoms, bronchial

hyperreactivity, and lung function ( [221](#) ).

Even in mild disease, there is a significant increase in number of eosinophils in the airways of patients, and these eosinophils are activated, as evidenced by the presence of the early activation marker CD69 in tissue eosinophils ( [222](#) ). This marker was also present in eosinophils from BAL fluid in patients with mild asthma ( [222](#) ). Challenge with allergen ( [223](#) , [224](#) ) or low-molecular-weight occupational compounds such as toluene diisocyanate ( [225](#) ) has been associated with eosinophilia. In *intrinsic asthma*, defined as nonatopic asthma lacking a dependency on IgE-mediated immune responses, similar increases in airway eosinophils have been noted when there is no clear involvement of allergy ( [221](#) , [225](#) ).

Challenge of the airways with allergen induces local airway inflammation characterized by influx of both neutrophils and eosinophils. In the late phase of the response, eosinophils are the predominant feature ( [217](#) , [224](#) ). A transient peripheral blood eosinophilia may also occur after these challenges ( [217](#) ). Increases in ECP-positive eosinophils were observed in both intrinsic and extrinsic asthma and correlated with the degree of airway responsiveness and asthma symptom scores ( [221](#) ). Data from this study also demonstrated up-regulation of CD4<sup>+</sup> T-cell activation in both intrinsic and extrinsic asthma.

Although eosinophils are closely associated with the pathogenesis of allergic diseases, the evidence that this reflects a cause-and-effect relationship is still largely circumstantial. Inhibition of the migration of eosinophils into the airways of allergen-challenged nonhuman primates has been achieved by the use of monoclonal antibodies against the adhesion molecule ICAM-1, which also inhibited the development of airway hyperresponsiveness ( [226](#) ). A number of studies showed that although there was an increased number of eosinophils in the peripheral blood, BAL and bronchial biopsies in asthmatics, as well as a significant increase in the level of eosinophilia with increasing clinical severity, there did not appear to be a direct linear correlation between the degree of bronchial hyperresponsiveness and that of eosinophilic inflammation in asthmatics ( [227](#) , [228](#) ). This suggests that other factors, independent of airway inflammation, may control the degree of airway hyperresponsiveness.

## The Eosinophil Controversy

Early studies on eosinophil function in the immune response suggested that eosinophils played an immunoprotective role in allergy. For example, eosinophils produce histaminase, which was thought to act by down-regulating mast cell-mediated early phase responses to allergen ( [229](#) ). However, reports emerging in the latter part of the twentieth century suggested that eosinophils may have a destructive role in allergy and asthma, based on the discovery of intensely stained deposits of eosinophil MBP in the airways of individuals who died from fatal asthma ( [136](#) ). Nevertheless, significant correlations between numbers of activated airway eosinophils (and their released products) and disease severity have been provided in a large body of literature ( [2](#) , [3](#) ). More recent studies have thrown this concept into doubt, including animal models of asthma (IL-5 gene knock-outs and anti-IL-5-treated mice) and clinical trials using anti-IL-5, IL-12, and IFN- $\gamma$ . In particular, a small clinical trial using a humanized mouse monoclonal anti-IL-5 in patients with mild atopic asthma was reported ( [230](#) ). This treatment has significant therapeutic potential and was predicted to reduce eosinophil numbers in the blood and, consequently, reverse asthmatic symptoms in these patients, based on the hypothesis that eosinophils are principal effector cells in asthma. Anti-IL-5 treatment in animal models of airway hyperresponsiveness was shown to reduce eosinophil numbers and reverse airway

hyperresponsiveness ( [231](#) ). As expected, a single intravenous injection of anti-IL-5 induced a profound reduction in peripheral blood eosinophils in patients for up to 16 weeks. However, in spite of the loss of eosinophils from the circulation, bronchial hyperresponsiveness to histamine persisted in these patients for up to 6 weeks after treatment. Based on these findings, the authors questioned the role of the eosinophil in the late-phase asthmatic response and bronchial hyperresponsiveness. This proposal was reinforced by findings from mouse models of asthma, some of which indicated that the eosinophil may be redundant in mechanisms associated with the development of airway hyperresponsiveness. However, these studies have been contradicted by the findings of other laboratories. It appears that the design of the study is crucial in influencing the outcomes, as discussed below for animal models.

**MOUSE MODELS OF AIRWAY HYPERRESPONSIVENESS** Animal models of asthma have used IL-5 <sup>-/-</sup> mice to determine the contribution of eosinophils to the pathogenesis of airway inflammation induced by allergens. One such report showed that airway hyperresponsiveness was not affected in allergen-sensitized and -challenged IL-5 <sup>-/-</sup> mice, although blood eosinophil numbers were significantly diminished ( [232](#) ). Studies using anti-IL-5 injections in mice generated similar observations ( [233](#), [234](#) ). In another allergen challenge model, increased blood and tissue IL-5 levels were evident in wild-type mice ( [235](#) ). These levels correlated with both blood and tissue eosinophilia and airway hyperresponsiveness. In the same study, IL-5 <sup>-/-</sup> mice neither mounted a blood or tissue eosinophil response after allergen challenge nor developed airway hyperresponsiveness ( [235](#) ). Restoring IL-5 expression in these animals via vaccinia virus encoding IL-5 reconstituted blood and tissue eosinophilia with an associated development of airway hyperresponsiveness. In an inducible model of T-cell-specific transgenic expression of IL-5, mice produced severe skin lesions, gastrointestinal dysfunction, splenic enlargement, and airway hyperresponsiveness similar to symptoms associated with human eosinophilic disorders ( [236](#) ), supporting a crucial role for the eosinophil in tissue damage associated with allergy. The roles of IL-5 and eosinophilia in these mouse models are still in question. Airway hyperresponsiveness may still persist in animals despite treatment with an antibody to IL-5 and depletion of blood eosinophils, depending on the protocol used for sensitization and challenge. Thus, airway hyperresponsiveness may persist during allergen challenge even though blood eosinophilia is lost. The answer to this dilemma may be in the persistence of tissue eosinophils even during IL-5 depletion. Although IL-5 is important in the differentiation and proliferation of eosinophils in the bone marrow, once they arrive in peripheral mucosal tissues, they may switch to an IL-5-independent mechanism of activation and, possibly, recruitment, due to the strong down-regulatory effects of IL-5 on eosinophil IL-5R expression. The possibility of persistence of IL-5-dependent tissue eosinophils has been implicated in results from eotaxin gene-deficient (Eo <sup>-/-</sup>) mice. Despite developing blood eosinophilia, Eo <sup>-/-</sup> mice do not generate tissue eosinophilia ( [37](#) ) with its associated eosinophil-mediated tissue damage after allergen challenge ( [237](#) ). However, in double-knock-out mice, in which IL-5 and eotaxin expression is deficient (IL-5 <sup>-/-</sup>/Eo <sup>-/-</sup>), both blood and tissue eosinophilia were eradicated, and airway hyperresponsiveness was significantly decreased during allergen challenge ( [237a](#) ). These studies indicate that there are distinct roles for eotaxin and IL-5 in eosinophil maturation, proliferation, and homing to target tissues. Thus, although IL-5 is critical for the maturation and proliferation of eosinophils in the bone marrow, eotaxin may be equally essential for movement and maintenance of eosinophilia in the tissues. Therefore, a key event in eosinophil-mediated inflammation leading to airway hyperresponsiveness may lie in the persistence of activated eosinophils in the tissue. However, the appropriateness of the mouse as an animal model for investigating airway hyperresponsiveness has been brought into question. A major limitation of mouse models is that murine eosinophils seem to lack the ability to degranulate *in vivo* or *in vitro* in



response to any known eosinophil-specific agonists. As mentioned earlier, eosinophil degranulation appears to be a vital component of the symptoms associated with allergic airway disease, and the use of mice may be counterproductive in providing clues relating to a better understanding of the role of the eosinophil in airway hyperresponsiveness. In support of this suggestion, knocking out eosinophil MBP or EPO was shown to have little effect on the development of airway hyperresponsiveness after allergen challenge in murine studies ( [238](#) ). In conclusion, these findings have important implications for the treatment of asthmatic patients with anti-IL-5, such that IL-5 depletion may not be sufficient to clear the airways of a persistent population of IL-5-independent, activated tissue eosinophils. Further studies are essential for determining the precise role of the eosinophil in contributing to mucosal inflammatory events in allergy.

## Eosinophils and Atopic Dermatitis

Increased numbers of activated eosinophils are also observed in studies of allergen-challenged nasal and cutaneous tissue in atopic subjects ( [220](#) ). Atopic dermatitis is classically associated with peripheral eosinophilia. Local cutaneous infiltrate with eosinophils is common, and, typically, activated EG2<sup>+</sup> eosinophils are apparent ( [239](#) ). Atopic dermatitis and other cutaneous lesions, such as urticaria, are often associated with deposition of eosinophil products such as the eosinophil granule MBP ( [240](#) , [241](#) ). Cytokines associated with the Th2 lymphocyte, including IL-5, are present at the site of allergen-induced, late-phase cutaneous reactions in allergic individuals ( [242](#) ). Treatment with IFN- $\gamma$  improves atopic dermatitis, but discontinuation of treatment allows for recurrence of the disease. Recent data provide supportive evidence for the importance of eosinophils in atopic dermatitis. Tissue eosinophilia and superficial deposition of eosinophilic granule proteins including EG1, EG2, MBP, and EPO are universally found in skin biopsies of atopic dermatitis. The activated eosinophil appears to be critical to the development and maintenance of chronic atopic dermatitis ( [243](#) ).

## Eosinophils and Gastrointestinal Disease

Eosinophils have been associated with inflammation of the gastrointestinal tract including eosinophilic esophagitis, eosinophilic gastroenteritis, and eosinophilic colitis (reviewed in reference [244](#)). Etiopathic eosinophilic esophagitis is a selective inflammatory esophageal disorder in which T cells, IL-5, eosinophils, and, possibly, IgE-mediated mechanisms may be involved ( [245](#) ). Allergy may play a role in this process, and, in some patients, potentially causative foods may be defined with the use of skin prick testing and patch testing ( [246](#) ). However, treatment with dietary restriction has not been overly successful for the management of eosinophilic esophagitis in children, whereas treatment with orally inhaled fluticasone has been shown to relieve mucosal inflammation and symptoms ( [247](#) ).

Eosinophilic gastroenteritis is also associated with peripheral blood eosinophilia. Infants with bloody diarrhea may have a form of allergic proctocolitis associated with cow's milk allergy, although this may also occur in infants fed soy formula or even those receiving breast milk ( [248](#) , [249](#) ). Either a change in the infant's diet to casein hydrolysate or a change in the maternal diet with avoidance of dairy products usually results in resolution of symptoms ( [249](#) ).

## Pulmonary Infiltrates with Eosinophilia

The complex of pulmonary infiltrates and peripheral blood eosinophilia (PIE syndrome) is found in a number of illnesses, including such syndromes as the classic transient

pulmonary eosinophilic infiltrate (Löffler's) syndrome, allergic angiitis and granulomatosis (Churg–Strauss syndrome), hypersensitivity vasculitis, and allergic bronchopulmonary aspergillosis (ABPA) (reviewed in reference 250). Schatz and co-workers ( 251 ) classified PIE syndromes based primarily on pulmonary infiltrates with the presence of peripheral blood eosinophilia. The above syndromes are classically associated with both pulmonary infiltrates and peripheral blood eosinophilia. In addition, drug reactions, hypereosinophilic syndrome (see section [Eosinophilia Associated with Neoplastic and Myeloproliferative Disease](#)), and parasitic infestation may be associated with a PIE syndrome.

The term *Löffler's syndrome* is seldom used at present because most of these patients are found to have some evidence of parasitic infestation, drug reaction, or even ABPA ( 252 ). ABPA is also often seen in patients previously diagnosed with asthma, which has become resistant to treatment. This is usually associated with marked eosinophilia. ABPA is characterized by a picture of asthma, positive skin test to aspergillus, and aspergillus–precipitating antibodies. Proximal bronchiectasis may also be seen ( 252 ). Churg–Strauss syndrome is a vasculitic disorder associated with eosinophilia, systemic vasculitis, and an asthmalike picture in which the appearance of asthma may precede the vasculitis by some years ( 250 ). Both ABPA and Churg–Strauss syndrome may be diagnosed as severe poorly controlled asthma; unfortunately, both have the potential for fatal outcome. The presence of marked eosinophilia in a patient with poorly controlled asthma must be considered an indicator of underlying vasculitic disease. On rare occasions, parasitic infestation of the lungs can occur (tropical eosinophilia). This also is associated with marked eosinophilia and pulmonary infiltrates. Often, infiltrates are nodular, and consolidation may also be observed, particularly with a subsegmental distribution ( 251 ). Appropriate treatment for the underlying parasitic infiltration is associated with a good prognosis.

### **Eosinophilia and Toxic Responses**

A toxic oil syndrome, characterized by eosinophilia, pneumonitis, and loss of muscle bulk and strength, occurred in Spain in 1981. This epidemic resulted in the death of 277 people and the hospitalization of 12,656 and affected more than 20,000 people ( 253 ). Studies revealed a relationship between the illness and illegally sold cooking oil. The toxic response appeared to be the result of a contaminant (possibly aniline and anilide–oil complexes) in the mixture of vegetable and animal fats.

In 1989, an epidemic of eosinophilia–myalgia syndrome occurred in the United States secondary to the ingestion of L–tryptophan ( 254 , 255 ). This syndrome was subsequently shown to be due to ingestion of a novel form of tryptophan present in one specific manufacturer's product ( 255 ). Recent studies have demonstrated that L–tryptophan–supplemented guinea pigs have altered eotaxin regulation ( 256 ). The authors hypothesize that tryptophan metabolism could affect chemokine levels by several mechanisms leading to hypereosinophilic disorders in susceptible individuals.

Both syndromes were associated with marked eosinophilia. Whereas the acute phase of the toxic oil syndrome was associated with respiratory distress, the chronic phase resembled the eosinophilia–myalgia syndrome with moderate to marked eosinophilia, severe myalgia, fatigue, cough, rash, headache, and continued shortness of breath.

### **Eosinophilia Associated with Neoplastic and Myeloproliferative Disease**

*Idiopathic hypereosinophilic syndrome* is a rare condition characterized by extremely high peripheral blood eosinophil counts and is more commonly seen in males (9:1) ( 257 ). The



etiology is unknown. Patients have eosinophilia that may progress to extremely high levels (often  $>50 \times 10^9$  per L). This is differentiated from eosinophilic leukemia by the absence of blast cells. There is multiple organ involvement with a progressive and, almost always, fatal course, with death often occurring as a result of cardiac dysfunction. Central nervous system damage is also common. In the past, treatment with high doses of corticosteroids and cytotoxic agents has not usually been successful. Treatment with cytokines, such as IFN- $\alpha$  and anti-IL-5, may hold more hope for these patients ( [257](#), [258](#) ).

### Eosinophilia with Other Neoplastic Disease

Eosinophilia is present in patients with eosinophilic leukemia and may also be associated with lymphoid malignancies and bronchogenic carcinoma. Eosinophilia associated with these malignancies is thought to be related to excess production of IL-5 and, possibly, other cytokines by the tumor cells. Studies in Hodgkin's disease have shown presence of mRNA coding for IL expressed in Reed-Sternberg cells ( [259](#) ). Eosinophilia associated with neoplasia may actually predate the diagnosis of the malignancy ( [260](#) ).

### Iatrogenic Eosinophilia

Treatment for a variety of diseases may be associated with eosinophilia. For example, treatment of malignancies with IL-2 induces eosinophilia in most patients during the course of treatment ( [261](#) ). Similarly, infusion of GM-CSF may induce eosinophilia. For example, eosinophilia occurs frequently with reactions to trimethoprim-sulfamethoxazole ( [262](#), [263](#) ) but may occur with reactions to a wide variety of drugs including other antibiotics (e.g., penicillin, tetracycline, nitrofurantoin).

After transplantation, allograft rejection induces eosinophilia in most patients ( [264](#) ). There is substantial evidence for the role of eosinophil granule MBP as an effector for tissue damage during acute allograft reaction ( [265](#) ).

### Eosinophils and the Human Immunodeficiency Virus

Eosinophilia is commonly seen in patients with acquired immunodeficiency syndrome. Eosinophilia in human immunodeficiency virus-infected individuals may relate to intercurrent parasitic infestation or to a characteristic reaction to trimethoprim-sulfamethoxazole treatment for *Pneumocystis carinii* infection ( [263](#) ). However, there are some data to suggest that human immunodeficiency virus may actually use the eosinophil as an important reservoir *in vivo* ( [266](#) ).

### Effector Role of the Eosinophil in Worm Infections

There is a strong apparent relationship between parasitic infection and eosinophilia. Infection with helminths is the most common cause of moderate to marked eosinophilia. The relationship between peripheral blood eosinophilia and tissue-invading helminths has been recognized for many years. In particular, studies in the late 1970s demonstrated that eosinophils had the capacity to kill parasitic targets and led to the concept that eosinophils were immunoprotective ( [181](#) ).

As in allergic inflammation, the precise role of eosinophils in the immunopathologic changes associated with helminth infections remains ill understood and rather controversial. Increases in the number of tissue and peripheral blood eosinophils, together

with elevations in the levels of total and parasitic-specific IgE and mastocytosis, have been considered for a long time to be hallmarks of infection with parasitic worms (4), especially during their tissue migratory phases. Much has been published about the inimical role this cell may play in protection against helminths, but there is equally important evidence to suggest that their presence may be a reflection of their participation in the pathology of the disease rather than immunity to the parasitic metazoa (267). The original observation of Basten and Beeson (7) that helminth-associated eosinophilia is T-cell-dependent was an important turning point in our current understanding of eosinophil-mediated inflammation in worm infections. The identification and subsequent cloning of GM-CSF, IL-3, and, particularly, IL-5 helped to explain the T-cell control of eosinophilic response, both in terms of eosinophilopoiesis and differentiation as well as priming and activation of the mature cell. The question, however, remains as to why there is a selective increase of eosinophils and what their function is, both locally and systematically, in infected subjects.

**IN VITRO AND MURINE PARASITIC HELMINTH STUDIES** Much has been published on the helminthocidal effects of human, primate, and rodent eosinophils against metazoan targets coated with IgG, IgA, IgE, or complement components. In this context, a number of parasitic targets have been studied including schistosomula of *Schistosoma mansoni*, newborn larvae of *Trichinella spiralis*, larvae of *Nippostrongylus brasiliensis*, *Fasciola hepatica*, and others (133, 268). Eosinophils adhere readily to appropriately coated larvae and undergo exocytosis, which results in the deposition of the basic and cytotoxic granule-associated proteins. On their own, these preformed products of eosinophils (including MBP, ECP, and EPO) have potent helminthocidal properties at low molar concentrations (133). The exogenous addition of a number of chemotactic agents, such as LTB<sub>4</sub>, PAF, fMLP (269, 270), and cytokines, such as GM-CSF, IL-3, TNF- $\alpha$ , and IL-5 (271), to eosinophil preparations enhances their cytotoxic capacity against parasitic larvae. In addition to killing worm larvae, eosinophils that adhere to schistosomula via IgG, IgE, or complement generate substantial amounts of membrane phospholipid-derived mediators, especially LTC<sub>4</sub> (272). More recent studies have shown that in IL-5<sup>-/-</sup> mice, skin implants containing parasites did not eliminate larval forms of the organisms (273). The mechanism underlying larval expulsion was shown to be dependent on eosinophils as well as IgM, and the results suggested that the function of eosinophil granule proteins might be associated with disrupting parasitic larvae to allow processing by antigen-presenting cells, including the eosinophil itself.

**HELMINTHIASES IN HUMANS AND NONHUMAN PRIMATES** The precise regulatory and functional roles of eosinophils in human helminthiases during the well-documented inflammatory reaction require urgent and extensive attention. In general, no clear evidence exists of direct contact between eosinophils and adult worms, although accumulation of eosinophils about helminthic parasites has been described. Eosinophil-rich granulomas surrounding dead fragments of skin-invading larvae of the skin-invading nematode *Strongyloides ratt* have been described in hyperimmune rats after challenge (274). Eosinophils were also found in close contact with the surface tegument of schistosomula of *Schistosoma haematobium* in the cutaneous tissue of immune monkeys, associated with the presence of large number of dead larvae in eosinophil-rich sites (269). Similar observations were made in other host-parasite systems (133). Using appropriate antibodies, eosinophil-derived toxic proteins such as MBP have been identified on filarial worm targets *in vivo* (270), and levels of blood ECP are elevated in patients with filariasis, which may suggest the activation and degranulation of eosinophils (271).

## CONCLUSIONS

The eosinophil is an enigmatic and fascinating cell that has intrigued biomedical scientists for more than a century. The precise function of this cell in allergic inflammation and asthma remains a matter of debate and requires further study in appropriately designed research projects. However, it is important to recognize that no single cell type, whether the eosinophil, T cell, mast cell, neutrophil, or other lung cell, is on its own responsible for all aspects of the immunopathology and clinical sequelae of airway inflammation in asthma and related diseases. In recognition of this fact, the attention currently focused on the eosinophil is warranted and timely. This relates partially to the overwhelming evidence in favor of a potential effector role of the eosinophil in parasitic helminthic and allergic diseases, including asthma. Although the mechanisms of eosinophilia in association with allergic disease are not yet fully understood, they seem likely to be controlled at the level of the T-cell response to antigen and the subsequent elaboration of cytokines, which exert both direct and indirect effect on these inflammatory cells. The profile of cytokines generated in allergic reactions, such as the allergen-induced late-phase response in the skin, nose, and lungs, appears to conform to a Th2 profile because mRNA expression of IL-4 and IL-5, but not IFN- $\gamma$  or IL-2, are expressed or up-regulated during these reactions. The release of IL-5 by Th2-type T cells after stimulation with allergen may, therefore, be responsible for the eosinophilia of allergic disease. Thus, a complex network of T cells, eosinophils, and other inflammatory cells as well as their cytokine products may participate in a cascade of events that leads to specific accumulation of eosinophils in sites of allergic inflammation and asthma. Whether tissue damage, a feature of these disease conditions, is the consequence of the activation and exocytosis of these infiltrating cytotoxic cells and the release of their highly basic protein products is yet to be demonstrated unequivocally.

## REFERENCES

1. Gleich GJ, Adolphson CR, Leiferman KM. The biology of the eosinophilic leukocyte. *Annu Rev Med* 1993;44:85-101.
2. Wardlaw AJ, Moqbel R, Kay AB. Eosinophils: biology and role in disease. *Adv Immunol* 1995;60:151-266.
3. Wardlaw AJ, Moqbel R, Kay AB. Eosinophils and the allergic inflammatory response. In: Kay AB, ed. *Allergy and allergic diseases*. Oxford: Blackwell Science, 1997:171-197.
4. Kay AB, Moqbel R, Durham SR, et al. Leucocyte activation initiated by IgE-dependent mechanisms in relation to helminthic parasitic disease and clinical models of asthma. *Int Arch Allergy Appl Immunol* 1985;77: 69-72.
5. Wardlaw AJ, Moqbel R. The eosinophil in allergic and helminth-related inflammatory responses. In: Moqbel R, ed. *Allergy and immunity to helminths. Common mechanisms or divergent pathways?* London: Taylor & Francis, 1992:154-186.
6. Spry CJF. *Eosinophils. A comprehensive review and guide to the scientific and medical literature*. Oxford: Oxford University Press, 1988:1-484.
7. Basten A, Beeson PB. Mechanism of eosinophilia. II. Role of the lymphocyte. *J Exp Med* 1970;131:1288-1305.
8. Kay AB. Asthma and inflammation. *J Allergy Clin Immunol* 1991;87:893-910.
9. Corrigan CJ, Kay AB. T cells and eosinophils in the pathogenesis of asthma. *Immunol Today* 1992;13:501-507.
10. Spry CJ. The natural history of eosinophils. In: Smith H, Cook RM, eds. *Immunopharmacology of eosinophils*. London: Academic Press, 1993:241-243.
11. Walle AJ, Parwaresch MR. Estimation of effective eosinopoiesis and bone marrow eosinophil reserve

capacity in normal man. *Cell Tissue Kinet* 1979;12:249–255.

12. Denburg JA, Sehmi R, Saito H, et al. Systemic aspects of allergic disease: bone marrow responses. *J Allergy Clin Immunol* 2000;106:S242–S246.

13. Inman MD, Sehmi R, O'Byrne P, Denburg JA. The role of the bone marrow in allergic disease. In: Denburg JA, ed. *Allergy and allergic diseases: the new mechanisms and therapeutics*. Totowa: Humana Press, 1998:85–102.

14. Dombrowicz D, Woerly G, Capron M. IgE receptors on human eosinophils. *Chem Immunol* 2000;76:63–76.

15. Ackerman SJ, Kephart GM, Habermann TM, et al. Localization of eosinophil granule major basic protein in human basophils. *J Exp Med* 1983;158:946–961.

16. Denburg JA. Bone marrow in atopy and asthma: hematopoietic mechanisms in allergic inflammation. *Immunol Today* 1999;20:111–113.

17. Foster PS. Allergic networks regulating eosinophilia. *Am J Respir Cell Mol Biol* 1999;21:451–454.

18. Hamelmann E, Gelfand EW. IL-5-induced airway eosinophilia—the key to asthma? *Immunol Rev* 2001;179:182–191.

19. Sutherland DR, Stewart AK, Keating A. CD34 antigen: molecular features and potential clinical applications. *Stem Cells* 1993;11:50–57.

20. Clutterbuck EJ, Hirst EM, Sanderson CJ. Human interleukin-5 (IL-5) regulates the production of eosinophils in human bone marrow cultures: comparison and interaction with IL-1, IL-3, IL-6, and GM-CSF. *Blood* 1989;73:1504–1512.

21. Dent LA, Strath M, Mellor AL, et al. Eosinophilia in transgenic mice expressing interleukin-5. *J Exp Med* 1990;172:1425–1431.

22. Tominaga A, Takaki S, Koyama N, et al. Transgenic mice expressing a B cell growth and differentiation factor gene (interleukin-5) develop eosinophilia and autoantibody production. *J Exp Med* 1991;173:429–437.

23. Giembycz MA, Lindsay MA. Pharmacology of the eosinophil. *Pharmacol Rev* 1999;51:213–339.

24. Bochner BS, Schleimer RP. Mast cells, basophils, and eosinophils: distinct but overlapping pathways for recruitment. *Immunol Rev* 2001;179:5–15.

25. Steinbach KH, Schick P, Trepel F, et al. Estimation of kinetic parameters of neutrophilic, eosinophilic, and basophilic granulocytes in human blood. *Blut* 1979;39:27–38.

26. Krause JR, Boggs DR. Search for eosinopenia in hospitalized patients with normal blood leukocyte concentration. *Am J Hematol* 1987;24:55–63.

27. Horn BR, Robin ED, Theodore J, Van Kessel A. Total eosinophil counts in the management of bronchial asthma. *N Engl J Med* 1975;292:1152–1155.

28. Winkel P, Statland BE, Saunders AM, et al. Within-day physiologic variation of leukocyte types in healthy subjects as assayed by two automated leukocyte differential analyzers. *Am J Clin Pathol* 1981;75:693–700.

29. Rothenberg ME, Owen WF Jr, Silberstein DS, et al. Eosinophils cocultured with endothelial cells have increased survival and functional properties. *Science* 1987;237:645–647.

30. Rothenberg ME, Owen WF Jr, Silberstein DS, et al. Human eosinophils have prolonged survival, enhanced functional properties, and become hypodense when exposed to human interleukin-3. *J Clin Invest* 1988;81:1986–1992.

31. Silberstein DS, Austen KF, Owen WF Jr. Hemopoietins for eosinophils. Glycoprotein hormones that regulate the development of inflammation in eosinophilia-associated disease. *Hematol Oncol Clin North Am*

1989;3:511–533.

32. Lacy P, Moqbel R. Eosinophil cytokines. *Chem Immunol* 2000;76:134–155.
33. Dri P, Cramer R, Spessotto P, et al. Eosinophil activation on biologic surfaces. Production of  $O_2^-$  in response to physiologic soluble stimuli is differentially modulated by extracellular matrix components and endothelial cells. *J Immunol* 1991;147:613–620.
34. Anwar AR, Moqbel R, Walsh GM, et al. Adhesion to fibronectin prolongs eosinophil survival. *J Exp Med* 1993;177:839–843.
35. Mould AP, Wheldon LA, Komoriya A, et al. Affinity chromatographic isolation of the melanoma adhesion receptor for the IIICS region of fibronectin and its identification as the integrin alpha 4 beta 1. *J Biol Chem* 1990;265: 4020–4024.
36. Simon HU, Yousefi S, Schranz C, et al. Direct demonstration of delayed eosinophil apoptosis as a mechanism causing tissue eosinophilia. *J Immunol* 1997;158:3902–3908.
37. Foster PS, Mould AW, Yang M, et al. Elemental signals regulating eosinophil accumulation in the lung. *Immunol Rev* 2001;179:173–181.
38. Cameron L, Christodoulouopoulos P, Lavigne F, et al. Evidence for local eosinophil differentiation within allergic nasal mucosa: inhibition with soluble IL-5 receptor. *J Immunol* 2000;164:1538–1545.
39. Eidelman DH, Minshall E, Dandurand RJ, et al. Evidence for major basic protein immunoreactivity and interleukin-5 gene activation during the late phase response in explanted airways. *Am J Respir Cell Mol Biol* 1996;15:582–589.
40. Miyajima A, Kitamura T, Harada N, et al. Cytokine receptors and signal transduction. *Annu Rev Immunol* 1992;10:295–331.
41. Pazdrak K, Olszewska-Pazdrak B, Stafford S, et al. Lyn, Jak2, and Raf-1 kinases are critical for the antiapoptotic effect of interleukin-5, whereas only Raf-1 kinase is essential for eosinophil activation and degranulation. *J Exp Med* 1998;188:421–429.
42. Wardlaw AJ, Brightling C, Green R, et al. Eosinophils in asthma and other allergic diseases. *Br Med Bull* 2000;56:985–1003.
43. Winqvist I, Olofsson T, Olsson I, et al. Altered density, metabolism and surface receptors of eosinophils in eosinophilia. *Immunology* 1982;47:531–539.
44. Peters MS, Gleich GJ, Dunnette SL, Fukuda T. Ultrastructural study of eosinophils from patients with the hypereosinophilic syndrome: a morphological basis of hypodense eosinophils. *Blood* 1988;71:780–785.
45. Caulfield JP, Hein A, Rothenberg ME, et al. A morphometric study of normodense and hypodense human eosinophils that are derived *in vivo* and *in vitro*. *Am J Pathol* 1990;137:27–41.
46. Prin L, Capron M, Tonnel AB, et al. Heterogeneity of human peripheral blood eosinophils: variability in cell density and cytotoxic ability in relation to the level and the origin of hypereosinophilia. *Int Arch Allergy Appl Immunol* 1983;72:336–346.
47. Prin L, Charon J, Capron M, et al. Heterogeneity of human eosinophils. II. Variability of respiratory burst activity related to cell density. *Clin Exp Immunol* 1984;57:735–742.
48. Fukuda T, Dunnette SL, Reed CE, et al. Increased numbers of hypodense eosinophils in the blood of patients with bronchial asthma. *Am Rev Respir Dis* 1985;132:981–985.
49. Klopogge E, de Leeuw AJ, de Monchy JG, et al. Hypodense eosinophilic granulocytes in normal individuals and patients with asthma: generation of hypodense cell populations *in vitro*. *J Allergy Clin Immunol* 1989;83:393–400.
50. Shaw RJ, Walsh GM, Cromwell O, et al. Activated human eosinophils generate SRS-A leukotrienes

following IgG-dependent stimulation. *Nature* 1985;316:150-152.

51. Owen WF Jr, Rothenberg ME, Silberstein DS, et al. Regulation of human eosinophil viability, density, and function by granulocyte/macrophage colony-stimulating factor in the presence of 3T3 fibroblasts. *J Exp Med* 1987;166:129-141.
52. Klopogge E, de Leeuw AJ, de Monchy JG, et al. Cellular communication in leukotriene C4 production between eosinophils and neutrophils. *Int Arch Allergy Appl Immunol* 1989;90:20-23.
53. Kajita T, Yui Y, Mita H, et al. Release of leukotriene C4 from human eosinophils and its relation to the cell density. *Int Arch Allergy Appl Immunol* 1985;78:406-410.
54. Bach MK, Brashler JR, Sanders ME, Bienkowski MJ. Pitfalls in the quantitative estimation of the secretion of granule proteins by eosinophils. *J Immunol Methods* 1991;142:243-250.
55. Hodges MK, Weller PF, Gerard NP, et al. Heterogeneity of leukotriene C4 production by eosinophils from asthmatic and from normal subjects. *Am Rev Respir Dis* 1988;138:799-804.
56. Capron M, Kusnierz JP, Prin L, et al. Cytophilic IgE on human blood and tissue eosinophils: detection by flow microfluorometry. *J Immunol* 1985;134:3013-3018.
57. Rand TH, Silberstein DS, Kornfeld H, Weller PF. Human eosinophils express functional interleukin 2 receptors. *J Clin Invest* 1991;88:825-832.
58. Matsumoto K, Appiah-Pippim J, Schleimer RP, et al. CD44 and CD69 represent different types of cell-surface activation markers for human eosinophils. *Am J Respir Cell Mol Biol* 1998;18:860-866.
59. Hartnell A, Moqbel R, Walsh GM, et al. Fc $\gamma$  and CD11/CD18 receptor expression on normal density and low density human eosinophils. *Immunology* 1990;69:264-270.
60. Mishra A, Hogan SP, Lee JJ, et al. Fundamental signals that regulate eosinophil homing to the gastrointestinal tract. *J Clin Invest* 1999;103:1719-1727.
61. Rothenberg ME, Mishra A, Brandt EB, Hogan SP. Gastrointestinal eosinophils. *Immunol Rev* 2001;179:139-155.
62. Broide D, Sriramarao P. Eosinophil trafficking to sites of allergic inflammation. *Immunol Rev* 2001;179:163-172.
63. Bochner BS, Luscinskas FW, Gimbrone MA Jr, et al. Adhesion of human basophils, eosinophils, and neutrophils to interleukin 1-activated human vascular endothelial cells: contributions of endothelial cell adhesion molecules. *J Exp Med* 1991;173:1553-1557.
64. Walsh GM, Hartnell A, Moqbel R, et al. Receptor expression and functional status of cultured human eosinophils derived from umbilical cord blood mononuclear cells. *Blood* 1990;76:105-111.
65. Walsh GM, Mermoud JJ, Hartnell A, et al. Human eosinophil, but not neutrophil, adherence to IL-1-stimulated human umbilical vascular endothelial cells is  $\alpha$ 4 $\beta$ 1 (very late antigen-4) dependent. *J Immunol* 1991;146:3419-3423.
66. Dobrina A, Menegazzi R, Carlos TM, et al. Mechanisms of eosinophil adherence to cultured vascular endothelial cells. Eosinophils bind to the cytokine-induced ligand vascular cell adhesion molecule-1 via the very late activation antigen-4 integrin receptor. *J Clin Invest* 1991;88:20-26.
67. Weller PF, Rand TH, Goelz SE, et al. Human eosinophil adherence to vascular endothelium mediated by binding to vascular cell adhesion molecule 1 and endothelial leukocyte adhesion molecule 1. *Proc Natl Acad Sci U S A* 1991;88:7430-7433.
68. Matsumoto K, Sterbinsky SA, Bickel CA, et al. Regulation of  $\alpha$ 4 integrin-mediated adhesion of human eosinophils to fibronectin and vascular cell adhesion molecule-1. *J Allergy Clin Immunol* 1997;99:648-656.
69. Weber C, Katayama J, Springer TA. Differential regulation of  $\beta$ 1 and  $\beta$ 2 integrin avidity by

chemoattractants in eosinophils. Proc Natl Acad Sci U S A 1996;93:10939–10944.

70. Ebisawa M, Bochner BS, Georas SN, Schleimer RP. Eosinophil transendothelial migration induced by cytokines. I. Role of endothelial and eosinophil adhesion molecules in IL-1 $\beta$ -induced transendothelial migration. J Immunol 1992;149:4021–4028.

71. Shahabuddin S, Ponath P, Schleimer RP. Migration of eosinophils across endothelial cell monolayers: interactions among IL-5, endothelial-activating cytokines, and C-C chemokines. J Immunol 2000;164:3847–3854.

72. Georas SN, Liu MC, Newman W, et al. Altered adhesion molecule expression and endothelial cell activation accompany the recruitment of human granulocytes to the lung after segmental antigen challenge. Am J Respir Cell Mol Biol 1992;7:261–269.

73. Rothenberg ME, MacLean JA, Pearlman E, et al. Targeted disruption of the chemokine eotaxin partially reduces antigen-induced tissue eosinophilia. J Exp Med 1997;185:785–790.

74. Schleimer RP, Sterbinsky SA, Kaiser J, et al. IL-4 induces adherence of human eosinophils and basophils but not neutrophils to endothelium. Association with expression of VCAM-1. J Immunol 1992;148:1086–1092.

75. Bochner BS, Klunk DA, Sterbinsky SA, et al. IL-13 selectively induces vascular cell adhesion molecule-1 expression in human endothelial cells. J Immunol 1995;154:799–803.

76. Kuperman D, Schofield B, Wills-Karp M, Grusby MJ. Signal transducer and activator of transcription factor 6 (STAT6)-deficient mice are protected from antigen-induced airway hyperresponsiveness and mucus production. J Exp Med 1998;187:939–948.

77. Akimoto T, Numata F, Tamura M, et al. Abrogation of bronchial eosinophilic inflammation and airway hyperreactivity in signal transducers and activators of transcription (STAT)6-deficient mice. J Exp Med 1998;187:1537–1542.

78. Matsukura S, Stellato C, Georas SN, et al. Interleukin-13 upregulates eotaxin expression in airway epithelial cells by a STAT6-dependent mechanism. Am J Respir Cell Mol Biol 2001;24:755–761.

79. Kuijpers TW, Mul EP, Blom M, et al. Freezing adhesion molecules in a state of high-avidity binding blocks eosinophil migration. J Exp Med 1993;178:279–284.

80. Werfel SJ, Yednock TA, Matsumoto K, et al. Functional regulation of  $\beta$ 1 integrins on human eosinophils by divalent cations and cytokines. Am J Respir Cell Mol Biol 1996;14:44–52.

81. Tachimoto H, Burdick MM, Hudson SA, et al. CCR3-active chemokines promote rapid detachment of eosinophils from VCAM-1 *in vitro*. J Immunol 2000;165:2748–2754.

82. DiScipio RG, Daffern PJ, Jagels MA, et al. A comparison of C3a and C5a-mediated stable adhesion of rolling eosinophils in postcapillary venules and transendothelial migration *in vitro* and *in vivo*. J Immunol 1999;162:1127–1136.

83. Broide DH, Lotz M, Cuomo AJ, et al. Cytokines in symptomatic asthma airways. J Allergy Clin Immunol 1992;89:958–967.

84. Bochner BS, Charlesworth EN, Lichtenstein LM, et al. Interleukin-1 is released at sites of human cutaneous allergic reactions. J Allergy Clin Immunol 1990;86:830–839.

85. Hirata N, Kohroggi H, Iwagoe H, et al. Allergen exposure induces the expression of endothelial adhesion molecules in passively sensitized human bronchus: time course and the role of cytokines. Am J Respir Cell Mol Biol 1998;18:12–20.

86. Broide DH, Campbell K, Gifford T, Sriramarao P. Inhibition of eosinophilic inflammation in allergen-challenged, IL-1 receptor type 1-deficient mice is associated with reduced eosinophil rolling and adhesion on vascular endothelium. Blood 2000;95:263–269.

87. Walsh LJ, Trinchieri G, Waldorf HA, et al. Human dermal mast cells contain and release tumor necrosis factor  $\alpha$ , which induces endothelial leukocyte adhesion molecule 1. Proc Natl Acad Sci U S A



1991;88:4220-4224.

88. Mackay F, Loetscher H, Stueber D, et al. Tumor necrosis factor  $\alpha$  (TNF- $\alpha$ )-induced cell adhesion to human endothelial cells is under dominant control of one TNF receptor type, TNF-R55. *J Exp Med* 1993;177:1277-1286.
89. Neumann B, Machleidt T, Lifka A, et al. Crucial role of 55-kilodalton TNF receptor in TNF-induced adhesion molecule expression and leukocyte organ infiltration. *J Immunol* 1996;156:1587-1593.
90. Broide DH, Stachnick G, Castaneda D, et al. Inhibition of eosinophilic inflammation in allergen-challenged TNF receptor p55/p75- and TNF receptor p55-deficient mice. *Am J Respir Cell Mol Biol* 2001;24:304-311.
91. Masumoto A, Hemler ME. Multiple activation states of VLA-4. Mechanistic differences between adhesion to CS1/fibronectin and to vascular cell adhesion molecule-1. *J Biol Chem* 1993;268:228-234.
92. Sung KL, Li Y, Elices M, et al. Granulocyte-macrophage colony-stimulating factor regulates the functional adhesive state of very late antigen-4 expressed by eosinophils. *J Immunol* 1997;158:919-927.
93. Kitayama J, Mackay CR, Ponath PD, et al. The C-C chemokine receptor CCR3 participates in stimulation of eosinophil arrest on inflammatory endothelium in shear flow. *J Clin Invest* 1998;101:2017-2024.
94. Jose PJ, Griffiths-Johnson DA, Collins PD, et al. Eotaxin: a potent eosinophil chemoattractant cytokine detected in a guinea pig model of allergic airways inflammation. *J Exp Med* 1994;179:881-887.
95. Alam R, Stafford S, Forsythe P, et al. RANTES is a chemotactic and activating factor for human eosinophils. *J Immunol* 1993;150:3442-3448.
96. Rothenberg ME. Eotaxin. An essential mediator of eosinophil trafficking into mucosal tissues. *Am J Respir Cell Mol Biol* 1999;21:291-295.
97. Schall TJ. Biology of the RANTES/SIS cytokine family. *Cytokine* 1991;3:165-183.
98. Zimmermann N, Hogan SP, Mishra A, et al. Murine eotaxin-2: a constitutive eosinophil chemokine induced by allergen challenge and IL-4 overexpression. *J Immunol* 2000;165:5839-5846.
99. Rothenberg ME, Luster AD, Lilly CM, et al. Constitutive and allergen-induced expression of eotaxin mRNA in the guinea pig lung. *J Exp Med* 1995;181:1211-1216.
100. Collins PD, Marleau S, Griffiths-Johnson DA, et al. Cooperation between interleukin-5 and the chemokine eotaxin to induce eosinophil accumulation *in vivo*. *J Exp Med* 1995;182:1169-1174.
101. Mould AW, Ramsay AJ, Matthaei KI, et al. The effect of IL-5 and eotaxin expression in the lung on eosinophil trafficking and degranulation and the induction of bronchial hyperreactivity. *J Immunol* 2000;164:2142-2150.
102. Matthews AN, Friend DS, Zimmermann N, et al. Eotaxin is required for the baseline level of tissue eosinophils. *Proc Natl Acad Sci U S A* 1998;95:6273-6278.
103. Gonzalo JA, Lloyd CM, Wen D, et al. The coordinated action of CC chemokines in the lung orchestrates allergic inflammation and airway hyperresponsiveness. *J Exp Med* 1998;188:157-167.
104. Kaburagi Y, Shimada Y, Nagaoka T, et al. Enhanced production of CC-chemokines (RANTES, MCP-1, MIP-1a, MIP-1B, and eotaxin) in patients with atopic dermatitis. *Arch Dermatol Res* 2001;293:350-355.
105. Noah TL, Becker S. Chemokines in nasal secretions of normal adults experimentally infected with respiratory syncytial virus. *Clin Immunol* 2000;97:43-49.
106. Harrison AM, Bonville CA, Rosenberg HF, et al. Respiratory syncytial virus-induced chemokine expression in the lower airways: eosinophil recruitment and degranulation. *Am J Respir Crit Care Med* 1999;159:1918-1924.

107. Teran LM, Seminario MC, Shute JK, et al. RANTES, macrophage-inhibitory protein 1a, and the eosinophil product major basic protein are released into upper respiratory secretions during virus-induced asthma exacerbations in children. *J Infect Dis* 1999;179:677-681.
108. Palmblad J, Gyllenhammar H, Lindgren JA, et al. Effects of leukotrienes and f-Met-Leu-Phe on oxidative metabolism of neutrophils and eosinophils. *J Immunol* 1984;132:3041-3045.
109. Kroegel C, Yukawa T, Dent G, et al. Stimulation of degranulation from human eosinophils by platelet-activating factor. *J Immunol* 1989;142:3518-3526.
110. Moqbel R. Leukotriene receptor antagonists in the treatment of asthma: implications for eosinophilic inflammation. *Can Respir J* 1999;6:453-457.
111. Kita H, Kaneko M, Bartemes KR, et al. Does IgE bind to and activate eosinophils from patients with allergy? *J Immunol* 1999;162:6901-6911.
112. Seminario MC, Saini SS, MacGlashan DW Jr, Bochner BS. Intracellular expression and release of Fc epsilon RI alpha by human eosinophils. *J Immunol* 1999;162:6893-6900.
113. Abu-Ghazaleh RI, Fujisawa T, Mestecky J, et al. IgA-induced eosinophil degranulation. *J Immunol* 1989;142:2393-2400.
114. Kita H, Abu-Ghazaleh RI, Gleich GJ, Abraham RT. Regulation of Ig-induced eosinophil degranulation by adenosine 3',5'-cyclic monophosphate. *J Immunol* 1991;146:2712-2718.
115. Zhu X, Munoz NM, Rubio N, et al. Quantitation of the cytosolic phospholipase A2 (type IV) in isolated human peripheral blood eosinophils by sandwich-ELISA. *J Immunol Methods* 1996;199:119-126.
116. Blom M, Tool AT, Wever PC, et al. Human eosinophils express, relative to other circulating leukocytes, large amounts of secretory 14-kD phospholipase A2. *Blood* 1998;91:3037-3043.
117. Weller PF, Lee CW, Foster DW, et al. Generation and metabolism of 5-lipoxygenase pathway leukotrienes by human eosinophils: predominant production of leukotriene C4. *Proc Natl Acad Sci U S A* 1983;80:7626-7630.
118. Shaw RJ, Cromwell O, Kay AB. Preferential generation of leukotriene C4 by human eosinophils. *Clin Exp Immunol* 1984;56:716-722.
119. Cowburn AS, Holgate ST, Sampson AP. IL-5 increases expression of 5-lipoxygenase-activating protein and translocates 5-lipoxygenase to the nucleus in human blood eosinophils. *J Immunol* 1999;163:456-465.
120. Cowburn AS, Sladek K, Soja J, et al. Overexpression of leukotriene C4 synthase in bronchial biopsies from patients with aspirin-intolerant asthma. *J Clin Invest* 1998;101:834-846.
121. Lam BK, Owen WF Jr, Austen KF, et al. The identification of a distinct export step following the biosynthesis of leukotriene C4 by human eosinophils. *J Biol Chem* 1989;264:12885-12889.
122. Holtzman MJ, Pentland A, Baenziger NL, Hansbrough JR. Heterogeneity of cellular expression of arachidonate 15-lipoxygenase: implications for biological activity. *Biochim Biophys Acta* 1989;1003:204-208.
123. Bradding P, Redington AE, Djukanovic R, et al. 15-Lipoxygenase immunoreactivity in normal and in asthmatic airways. *Am J Respir Crit Care Med* 1995;151:1201-1204.
124. Henderson WR, Harley JB, Fauci AS. Arachidonic acid metabolism in normal and hypereosinophilic syndrome human eosinophils: generation of leukotrienes B4, C4, D4 and 15-lipoxygenase products. *Immunology* 1984;51: 679-686.
125. Lee T, Lenihan DJ, Malone B, et al. Increased biosynthesis of platelet-activating factor in activated human eosinophils. *J Biol Chem* 1984;259:5526-5530.
126. Cromwell O, Wardlaw AJ, Champion A, et al. IgG-dependent generation of platelet-activating factor

by normal and low density human eosinophils. *J Immunol* 1990;145:3862–3868.

127. Burke LA, Crea AE, Wilkinson JR, et al. Comparison of the generation of platelet-activating factor and leukotriene C4 in human eosinophils stimulated by unopsonized zymosan and by the calcium ionophore A23187: the effects of nedocromil sodium. *J Allergy Clin Immunol* 1990;85:26–35.

128. Sun FF, Czuk CI, Taylor BM. Arachidonic acid metabolism in guinea pig eosinophils: synthesis of thromboxane B2 and leukotriene B4 in response to soluble or particulate activators. *J Leukoc Biol* 1989;46:152–160.

129. Giembycz MA, Kroegel C, Barnes PJ. Platelet activating factor stimulates cyclo-oxygenase activity in guinea pig eosinophils. Concerted biosynthesis of thromboxane A2 and E-series prostaglandins. *J Immunol* 1990;144:3489–3497.

130. Dvorak AM, Morgan E, Schleimer RP, et al. Ultrastructural immunogold localization of prostaglandin endoperoxide synthase (cyclooxygenase) to non-membrane-bound cytoplasmic lipid bodies in human lung mast cells, alveolar macrophages, type II pneumocytes, and neutrophils. *J Histochem Cytochem* 1992;40:759–769.

131. Bozza PT, Yu W, Penrose JF, et al. Eosinophil lipid bodies: specific, inducible intracellular sites for enhanced eicosanoid formation. *J Exp Med* 1997;186:909–920.

132. Bozza PT, Yu W, Cassara J, Weller PF. Pathways for eosinophil lipid body induction: differing signal transduction in cells from normal and hypereosinophilic subjects. *J Leukoc Biol* 1998;64:563–569.

133. Gleich GJ, Adolphson CR. The eosinophilic leukocyte: structure and function. *Adv Immunol* 1986;39:177–253.

134. Gleich GJ, Loegering DA, Maldonado JE. Identification of a major basic protein in guinea pig eosinophil granules. *J Exp Med* 1973;137:1459–1471.

135. Hamann KJ, Barker RL, Ten RM, Gleich GJ. The molecular biology of eosinophil granule proteins. *Int Arch Allergy Appl Immunol* 1991;94:202–209.

136. Filley WV, Holley KE, Kephart GM, Gleich GJ. Identification by immunofluorescence of eosinophil granule major basic protein in lung tissues of patients with bronchial asthma. *Lancet* 1982;2:11–16.

137. Wasmoen TL, Bell MP, Loegering DA, et al. Biochemical and amino acid sequence analysis of human eosinophil granule major basic protein. *J Biol Chem* 1988;263:12559–12563.

138. Popken-Harris P, McGrogan M, Loegering DA, et al. Expression, purification, and characterization of the recombinant proform of eosinophil granule major basic protein. *J Immunol* 1995;155:1472–1480.

139. Popken-Harris P, Checkel J, Loegering D, et al. Regulation and processing of a precursor form of eosinophil granule major basic protein (ProMBP) in differentiating eosinophils. *Blood* 1998;92:623–631.

140. Mahmudi-Azer S, Velazquez JR, Lacy P, et al. Immunofluorescence analysis of cytokine and granule protein expression during eosinophil maturation from cord blood-derived CD34 progenitors. *J Allergy Clin Immunol* 2000;105:1178–1184.

141. Shalit M, Sekhsaria S, Mauhorter S, et al. Early commitment to the eosinophil lineage by cultured human peripheral blood CD34+ cells: messenger RNA analysis. *J Allergy Clin Immunol* 1996;98:344–354.

142. Moy JN, Gleich GJ, Thomas LL. Noncytotoxic activation of neutrophils by eosinophil granule major basic protein. Effect on superoxide anion generation and lysosomal enzyme release. *J Immunol* 1990;145:2626–2632.

143. Kita H, Abu-Ghazaleh RI, Sur S, Gleich GJ. Eosinophil major basic protein induces degranulation and IL-8 production by human eosinophils. *J Immunol* 1995;154:4749–4758.

144. Ten RM, Pease LR, McKean DJ, et al. Molecular cloning of the human eosinophil peroxidase. Evidence for the existence of a peroxidase multigene family. *J Exp Med* 1989;169:1757–1769.

145. Weiss SJ, Test ST, Eckmann CM, et al. Brominating oxidants generated by human eosinophils.

Science 1986;234:200–203.

146. Mayeno AN, Curran AJ, Roberts RL, Foote CS. Eosinophils preferentially use bromide to generate halogenating agents. *J Biol Chem* 1989;264:5660–5668.
147. Thomas EL, Bozeman PM, Jefferson MM, King CC. Oxidation of bromide by the human leukocyte enzymes myeloperoxidase and eosinophil peroxidase. Formation of bromamines. *J Biol Chem* 1995;270:2906–2913.
148. Gleich GJ, Loegering DA, Bell MP, et al. Biochemical and functional similarities between human eosinophil-derived neurotoxin and eosinophil cationic protein: homology with ribonuclease. *Proc Natl Acad Sci U S A* 1986;83:3146–3150.
149. Lehrer RI, Szklarek D, Barton A, et al. Antibacterial properties of eosinophil major basic protein and eosinophil cationic protein. *J Immunol* 1989;142: 4428–4434.
150. Young JD, Peterson CG, Venge P, Cohn ZA. Mechanism of membrane damage mediated by human eosinophil cationic protein. *Nature* 1986;321:613–616.
151. Durack DT, Sumi SM, Klebanoff SJ. Neurotoxicity of human eosinophils. *Proc Natl Acad Sci U S A* 1979;76:1443–1447.
152. Fredens K, Dahl R, Venge P. The Gordon phenomenon induced by the eosinophil cationic protein and eosinophil protein X. *J Allergy Clin Immunol* 1982;70:361–366.
153. Hamann KJ, Ten RM, Loegering DA, et al. Structure and chromosome localization of the human eosinophil-derived neurotoxin and eosinophil cationic protein genes: evidence for intronless coding sequences in the ribonuclease gene superfamily. *Genomics* 1990;7:535–546.
154. Rosenberg HF, Dyer KD, Tiffany HL, Gonzalez M. Rapid evolution of a unique family of primate ribonuclease genes. *Nat Genet* 1995;10:219–223.
155. Rosenberg HF, Domachowske JB. Eosinophils, eosinophil ribonucleases, and their role in host defense against respiratory virus pathogens. *J Leukoc Biol* 2001;70:691–698.
156. Ackerman SJ, Liu L, Kwatia MA, et al. Charcot-Leyden crystal protein (galectin-10) is not a dual function galectin with lysophospholipase activity but binds a lysophospholipase inhibitor in a novel structural fashion. *J Biol Chem* 2002;277:14859–14868.
157. Hamann KJ, Douglas I, Moqbel R. Eosinophil mediators. In: Busse WW, Holgate ST, eds. *Asthma and rhinitis*. Oxford: Blackwell Science, 2000:394–428.
158. Lacy P, Moqbel R. Immune effector functions of eosinophils in allergic airway inflammation. *Curr Opin Allergy Clin Immunol* 2001;1:79–84.
159. Moqbel R, Hamid Q, Ying S, et al. Expression of mRNA and immunoreactivity for the granulocyte/macrophage colony-stimulating factor in activated human eosinophils. *J Exp Med* 1991;174:749–752.
160. Kita H, Ohnishi T, Okubo Y, et al. Granulocyte/macrophage colony-stimulating factor and interleukin-3 release from human peripheral blood eosinophils and neutrophils. *J Exp Med* 1991;174:745–748.
161. Lacy P, Mahmudi-Azer S, Bablitz B, et al. Rapid mobilization of intracellularly stored RANTES in response to interferon- $\gamma$  in human eosinophils. *Blood* 1999;94:23–32.
162. Hamid Q, Barkans J, Meng Q, et al. Human eosinophils synthesize and secrete interleukin-6, *in vitro*. *Blood* 1992;80:1496–1501.
163. Wong DT, Weller PF, Galli SJ, et al. Human eosinophils express transforming growth factor  $\alpha$ . *J Exp Med* 1990;172:673–681.
164. Wong DT, Elovic A, Matossian K, et al. Eosinophils from patients with blood eosinophilia express

transforming growth factor  $\beta$ 1. *Blood* 1991;78:2702–2707.

165. Desreumaux P, Janin A, Colombel JF, et al. Interleukin-5 messenger RNA expression by eosinophils in the intestinal mucosa of patients with coeliac disease. *J Exp Med* 1992;175:293–296.

166. Broide DH, Paine MM, Firestein GS. Eosinophils express interleukin-5 and granulocyte macrophage-colony-stimulating factor mRNA at sites of allergic inflammation in asthmatics. *J Clin Invest* 1992;90:1414–1424.

167. Beil WJ, Weller PF, Tzizik DM, et al. Ultrastructural immunogold localization of tumor necrosis factor- $\alpha$  to the matrix compartment of eosinophil secondary granules in patients with idiopathic hypereosinophilic syndrome. *J Histochem Cytochem* 1993;41:1611–1615.

168. Dubucquoi S, Desreumaux P, Janin A, et al. Interleukin-5 synthesis by eosinophils: association with granules and immunoglobulin-dependent secretion. *J Exp Med* 1994;179:703–708.

169. Levi-Schaffer F, Lacy P, Severs NJ, et al. Association of granulocyte-macrophage colony-stimulating factor with the crystalloid granules of human eosinophils. *Blood* 1995;85:2579–2586.

170. Moqbel R, Ying S, Barkans J, et al. Identification of messenger RNA for IL-4 in human eosinophils with granule localization and release of the translated product. *J Immunol* 1995;155:4939–4947.

171. Levi-Schaffer F, Barkans J, Newman TM, et al. Identification of interleukin-2 in human peripheral blood eosinophils. *Immunology* 1996;87:155–161.

172. Lacy P, Levi-Schaffer F, Mahmudi-Azer S, et al. Intracellular localization of interleukin-6 in eosinophils from atopic asthmatics and effects of interferon  $\gamma$ . *Blood* 1998;91:2508–2516.

173. Gauvreau GM, O'Byrne PM, Moqbel R, et al. Enhanced expression of GM-CSF in differentiating eosinophils of atopic and atopic asthmatic subjects. *Am J Respir Cell Mol Biol* 1998;19:55–62.

174. Velazquez JR, Lacy P, Mahmudi-Azer S, et al. Interleukin-4 and RANTES expression in maturing eosinophils derived from human cord blood CD34<sup>+</sup> progenitors. *Immunology* 2000;101:419–425.

175. Egesten A, Calafat J, Knol EF, et al. Subcellular localization of transforming growth factor- $\alpha$  in human eosinophil granulocytes. *Blood* 1996;87:3910–3918.

176. Bandeira-Melo C, Gillard G, Ghiran I, Weller PF. EliCell: a gel-phase dual antibody capture and detection assay to measure cytokine release from eosinophils. *J Immunol Methods* 2000;244:105–115.

177. Woerly G, Roger N, Loiseau S, et al. Expression of CD28 and CD86 by human eosinophils and role in the secretion of type 1 cytokines (interleukin-2 and interferon  $\gamma$ ): inhibition by immunoglobulin a complexes. *J Exp Med* 1999;190:487–495.

178. Shi HZ, Humbles A, Gerard C, et al. Lymph node trafficking and antigen presentation by endobronchial eosinophils. *J Clin Invest* 2000;105:945–953.

179. Corrigan CJ. T cells in asthma. In: Holgate ST, Busse WW, eds. *Inflammatory mechanisms in asthma*. New York: Marcel Dekker Inc, 1998:343–359.

180. Wills-Karp M, Luyimbazi J, Xu X, et al. Interleukin-13: central mediator of allergic asthma. *Science* 1998;282:2258–2261.

181. Butterworth AE, Thorne KJ. Eosinophils and parasitic diseases. In: Smith H, Cook RM, eds. *Immunopharmacology of eosinophils*. London: Academic Press, 1993:119–150.

182. DeLeo FR, Quinn MT. Assembly of the phagocyte NADPH oxidase: molecular interaction of oxidase proteins. *J Leukoc Biol* 1996;60:677–691.

183. Bolscher BG, Koenderman L, Tool AT, et al. NADPH:O<sub>2</sub> oxidoreductase of human eosinophils in the cell-free system. *FEBS Lett* 1990;268:269–273.

184. Someya A, Nagaoka I, Iwabuchi K, Yamashita T. Comparison of  $O_2^-$ -producing activity of guinea-pig eosinophils and neutrophils in a cell-free system. *Comp Biochem Physiol B* 1991;100:25-30.
185. Yagisawa M, Yuo A, Yonemaru M, et al. Superoxide release and NADPH oxidase components in mature human phagocytes: correlation between functional capacity and amount of functional proteins. *Biochem Biophys Res Commun* 1996;228:510-516.
186. DeChatelet LR, Shirley PS, McPhail LC, et al. Oxidative metabolism of the human eosinophil. *Blood* 1977;50:525-535.
187. Yazdanbakhsh M, Eckmann CM, De Boer M, Roos D. Purification of eosinophils from normal human blood, preparation of eosinoplasts and characterization of their functional response to various stimuli. *Immunology* 1987;60:123-129.
188. Didsbury J, Weber RF, Bokoch GM, et al. Rac, a novel ras-related family of proteins that are botulinum toxin substrates. *J Biol Chem* 1989;264:16378-16382.
189. Heyworth PG, Bohl BP, Bokoch GM, Curnutte JT. Rac translocates independently of the neutrophil NADPH oxidase components p47 *phox* and p67 *phox*. Evidence for its interaction with flavocytochrome b558. *J Biol Chem* 1994;269:30749-30752.
190. Lacy P, Mahmudi-Azer S, Bablitz B, et al. Expression and translocation of Rac2 in eosinophils during superoxide generation. *Immunology* 1999;98:244-252.
191. Abo A, Boyhan A, West I, et al. Reconstitution of neutrophil NADPH oxidase activity in the cell-free system by four components: p67- *phox*, p47- *phox*, p21 <sup>rac1</sup>, and cytochrome *b*-245. *J Biol Chem* 1992;267:16767-16770.
192. Bokoch GM, Knaus UG. The role of small GTP-binding proteins in leukocyte function. *Curr Opin Immunol* 1994;6:98-105.
193. Petreccia DC, Nauseef WM, Clark RA. Respiratory burst of normal human eosinophils. *J Leukoc Biol* 1987;41:283-288.
194. Perkins RS, Lindsay MA, Barnes PJ, Giembycz MA. Early signalling events implicated in leukotriene B<sub>4</sub>-induced activation of the NADPH oxidase in eosinophils: role of Ca<sup>2+</sup>, protein kinase C and phospholipases C and D. *Biochem J* 1995;310:795-806.
195. Mellor H, Parker PJ. The extended protein kinase C superfamily. *Biochem J* 1998;332(Pt 2):281-292.
196. Rabe KF, Giembycz MA, Dent G, Barnes PJ. Activation of guinea pig eosinophil respiratory burst by leukotriene B<sub>4</sub>: role of protein kinase C. *Fundam Clin Pharmacol* 1992;6:353-358.
197. van der BT, Kok PT, Blom M, et al. Transient exposure of human eosinophils to the protein kinase C inhibitors CGP39-360, CGP41-251, and CGP44-800 leads to priming of the respiratory burst induced by opsonized particles. *J Leukoc Biol* 1993;54:552-557.
198. Moqbel R, Lacy P. Exocytotic events in eosinophils and mast cells. *Clin Exp Allergy* 1999;29:1017-1022.
199. Lindau M, Nusse O, Bennett J, Cromwell O. The membrane fusion events in degranulating guinea pig eosinophils. *J Cell Sci* 1993;104:203-210.
200. Hartmann J, Scepek S, Lindau M. Regulation of granule size in human and horse eosinophils by number of fusion events among unit granules. *J Physiol* 1995;483:201-209.
201. Scepek S, Lindau M. Exocytotic competence and intergranular fusion in cord blood-derived eosinophils during differentiation. *Blood* 1997;89:510-517.
202. Scepek S, Moqbel R, Lindau M. Compound exocytosis and cumulative degranulation by eosinophils and its role in parasitic killing. *Parasitol Today* 1994;10:276-278.

203. Newman TM, Tian M, Gomperts BD. Ultrastructural characterization of tannic acid-arrested degranulation of permeabilized guinea pig eosinophils stimulated with GTP- $\gamma$ -S. *Eur J Cell Biol* 1996;70:209-220.
204. McLaren DJ, Mackenzie CD, Ramalho-Pinto FJ. Ultrastructural observations on the *in vitro* interaction between rat eosinophils and some parasitic helminths (*Schistosoma mansoni*, *Trichinella spiralis* and *Nippostrongylus brasiliensis*). *Clin Exp Immunol* 1977;30:105-118.
205. Mahmudi-Azer S, Downey GP, Moqbel R. Translocation of the tetraspanin CD63 in association with human eosinophil mediator release. *Blood* 2002;99:4039-4047.
206. Dvorak AM, Furitsu T, Letourneau L, et al. Mature eosinophils stimulated to develop in human cord blood mononuclear cell cultures supplemented with recombinant human interleukin-5. Part I. Piecemeal degranulation of specific granules and distribution of Charcot-Leyden crystal protein. *Am J Pathol* 1991;138:69-82.
207. Erjefalt JS, Andersson M, Greiff L, et al. Cytolysis and piecemeal degranulation as distinct modes of activation of airway mucosal eosinophils. *J Allergy Clin Immunol* 1998;102:286-294.
208. Persson CG, Erjefalt JS. Eosinophil lysis and free granules: an *in vivo* paradigm for cell activation and drug development. *Trends Pharmacol Sci* 1997;18:117-123.
209. Fukuda T, Ackerman SJ, Reed CE, et al. Calcium ionophore A23187 calcium-dependent cytolytic degranulation in human eosinophils. *J Immunol* 1985;135:1349-1356.
210. Söllner T, Whiteheart SW, Brunner M, et al. SNAP receptors implicated in vesicle targeting and fusion. *Nature* 1993;362:318-324.
211. Brumell JH, Volchuk A, Sengelov H, et al. Subcellular distribution of docking/fusion proteins in neutrophils, secretory cells with multiple exocytic compartments. *J Immunol* 1995;155:5750-5759.
212. Ravichandran V, Chawla A, Roche PA. Identification of a novel syntaxin- and synaptobrevin/VAMP-binding protein, SNAP-23, expressed in non-neuronal tissues. *J Biol Chem* 1996;271:13300-13303.
213. Guo Z, Turner C, Castle D. Relocation of the t-SNARE SNAP-23 from lamellipodia-like cell surface projections regulates compound exocytosis in mast cells. *Cell* 1998;94:537-548.
214. Lacy P, Logan MR, Bablitz B, Moqbel R. Fusion protein vesicle-associated membrane protein 2 is implicated in IFN- $\gamma$ -induced piecemeal degranulation in human eosinophils from atopic individuals. *J Allergy Clin Immunol* 2001;107:671-678.
215. Logan MR, Lacy P, Bablitz B, Moqbel R. Expression of eosinophil target SNAREs as potential cognate receptors for vesicle-associated membrane protein-2 in exocytosis. *J Allergy Clin Immunol* 2002;109:299-306.
216. Dunnill MS. The pathology of asthma with special reference to changes in the bronchial mucosa. *J Clin Pathol* 1960;13:27-33.
217. Durham SR, Kay AB. Eosinophils, bronchial hyperreactivity late-phase asthmatic reactions. *Clin Allergy* 1985;15:411-418.
218. Gibson PG, Dolovich J, Denburg JA, et al. Sputum cell counts in airway disease: a useful sampling technique. *Agents Actions Suppl* 1990;30:161-172.
219. Pizzichini E, Pizzichini MM, Efthimiadis A, et al. Indices of airway inflammation in induced sputum: reproducibility and validity of cell and fluid-phase measurements. *Am J Respir Crit Care Med* 1996;154:308-317.
220. Wardlaw AJ. Eosinophils in the 1990s: new perspectives on their role in health and disease. *Postgrad Med J* 1994;70:536-552.
221. Bentley AM, Menz G, Storz C, et al. Identification of T lymphocytes, macrophages, and activated



- eosinophils in the bronchial mucosa in intrinsic asthma. Relationship to symptoms and bronchial responsiveness. *Am Rev Respir Dis* 1992;146:500–506.
222. Hartnell A, Robinson DS, Kay AB, Wardlaw AJ. CD69 is expressed by human eosinophils activated *in vivo* in asthma and *in vitro* by cytokines. *Immunology* 1993;80:281–286.
223. Metzger WJ, Zavala D, Richerson HB, et al. Local allergen challenge and bronchoalveolar lavage of allergic asthmatic lungs. Description of the model and local airway inflammation. *Am Rev Respir Dis* 1987;135:433–440.
224. Montefort S, Gratziau C, Goulding D, et al. Bronchial biopsy evidence for leukocyte infiltration and upregulation of leukocyte–endothelial cell adhesion molecules 6 hours after local allergen challenge of sensitized asthmatic airways. *J Clin Invest* 1994;93:1411–1421.
225. Fabbri LM, Boschetto P, Zocca E, et al. Bronchoalveolar neutrophilia during late asthmatic reactions induced by toluene diisocyanate. *Am Rev Respir Dis* 1987;136:36–42.
226. Wegner CD, Gundel RH, Reilly P, et al. Intercellular adhesion molecule–1 (ICAM–1) in the pathogenesis of asthma. *Science* 1990;247:456–459.
227. Wardlaw AJ, Dunnette S, Gleich GJ, et al. Eosinophils and mast cells in bronchoalveolar lavage in subjects with mild asthma. Relationship to bronchial hyperreactivity. *Am Rev Respir Dis* 1988;137:62–69.
228. Bousquet J, Chanez P, Lacoste JY, et al. Eosinophilic inflammation in asthma. *N Engl J Med* 1990;323:1033–1039.
229. Zeiger RS, Colten HR. Histaminase release from human eosinophils. *J Immunol* 1977;118:540–543.
230. Leckie MJ, ten Brinke A, Khan J, et al. Effects of an interleukin–5 blocking monoclonal antibody on eosinophils, airway hyper–responsiveness, and the late asthmatic response. *Lancet* 2000;356:2144–2148.
231. Egan RW, Athwahl D, Chou CC, et al. Pulmonary biology of anti–interleukin–5 antibodies. *Mem Inst Oswaldo Cruz* 1997;92[Suppl 2]:69–73.
232. Hogan SP, Matthaei KI, Young JM, et al. A novel T cell–regulated mechanism modulating allergen–induced airways hyperreactivity in BALB/c mice independently of IL–4 and IL–5. *J Immunol* 1998;161:1501–1509.
233. Nagai H, Yamaguchi S, Inagaki N, et al. Effect of anti–IL–5 monoclonal antibody on allergic bronchial eosinophilia and airway hyperresponsiveness in mice. *Life Sci* 1993;53:L243–L247.
234. Corry DB, Folkesson HG, Warnock ML, et al. Interleukin 4, but not interleukin–5 or eosinophils, is required in a murine model of acute airway hyperreactivity. *J Exp Med* 1996;183:109–117.
235. Hogan SP, Koskinen A, Matthaei KI, et al. Interleukin–5–producing CD4<sup>+</sup> T cells play a pivotal role in aeroallergen–induced eosinophilia, bronchial hyperreactivity, and lung damage in mice. *Am J Respir Crit Care Med* 1998;157:210–218.
236. Lee NA, McGarry MP, Larson KA, et al. Expression of IL–5 in thymocytes/T cells leads to the development of a massive eosinophilia, extramedullary eosin–ophilopoiesis, and unique histopathologies. *J Immunol* 1997;158:1332–1344.
237. Hogan SP, Mishra A, Brandt EB, et al. A pathological function for eotaxin and eosinophils in eosinophilic gastrointestinal inflammation. *Nat Immunol* 2001;2:353–360.
- 237a. Mattes J, Yang M, Mahalingam S, et al. Intrinsic defect in T cell production of interleukin (IL)–13 in the absence of both IL–5 and eotaxin precludes the development of eosinophilia and airways in experimental asthma. *J Exp Med* 2002;195:1433–1444.
238. Lee NA, Gelfand EW, Lee JJ. Pulmonary T cells and eosinophils: coconspirators or independent triggers of allergic respiratory pathology? *J Allergy Clin Immunol* 2001;107:945–957.
239. Frew AJ, Kay AB. The relationship between infiltrating CD4<sup>+</sup> lymphocytes, activated eosinophils, and

the magnitude of the allergen-induced late phase cutaneous reaction in man. *J Immunol* 1988;141:4158-4164.

240. Peters MS, Schroeter AL, Kephart GM, Gleich GJ. Localization of the eosinophil granule major basic protein in chronic urticaria. *J Invest Dermatol* 1983;81:39-43.

241. Peters MS, Winkelmann RK, Greaves MW, et al. Extracellular deposition of eosinophil granule major basic protein in pressure urticaria. *J Am Acad Dermatol* 1986;16:513-517.

242. Kay AB, Ying S, Varney V, et al. Messenger RNA expression of the cytokine gene cluster, interleukin-3, IL-4, IL-5, and granulocyte-macrophage colony-stimulating factor in allergen-induced late-phase cutaneous reactions in atopic subjects. *J Exp Med* 1991;173:775-8.

243. Kiehl P, Falkenberg K, Vogelbruch M, Kapp A. Tissue eosinophilia in acute and chronic atopic dermatitis: a morphometric approach using quantitative image analysis of immunostaining. *Br J Dermatol* 2001;145:720-729.

244. Rothenberg ME, Mishra A, Brandt EB, Hogan SP. Gastrointestinal eosinophils in health and disease. *Adv Immunol* 2001;78:291-329.

245. Straumann A, Bauer M, Fischer B, et al. Idiopathic eosinophilic esophagitis is associated with a Th2-type allergic inflammatory response. *J Allergy Clin Immunol* 2001;108:954-961.

246. Sperget JM, Beausoleil JL, Mascarenhas M, Liacouras CA. The use of skin prick tests and patch tests to identify causative foods in eosinophilic esophagitis. *J Allergy Clin Immunol* 2002;109:363-368.

247. Teitelbaum JE, Fox VL, Twarog FJ, et al. Eosinophilic esophagitis in children: immunopathological analysis and response to fluticasone propionate. *Gastroenterology* 2002;122:1216-1225.

248. Perisic VN, Filitovic D, Kokai G. Allergic colitis with rectal bleeding in an exclusively breastfed neonate. *Acta Paediatr Scand* 1988;77:163-164.

249. Powell GK. Milk and soy induced enterocolitis of infancy: clinical features and standardization of challenge. *J Pediatr* 1978;93:553-560.

250. Leavitt RY, Fauci AS. Pulmonary vasculitis. *Am Rev Respir Dis* 1986;134:149-166.

251. Schatz M, Wasserman S, Paterson R. The eosinophil and the lung. *Arch Intern Med* 1982;142:1515-1519.

252. Greenberger PA. Allergic bronchopulmonary aspergillosis. *J Allergy Clin Immunol* 1984;74:645-653.

253. Rigau-Perez JG, Perez-Alvarez L, Duenas-Castro S, et al. Epidemiologic investigation of an oil-associated pneumonic paralytic eosinophilic syndrome in Spain. *Am J Epidemiol* 1984;119:250-260.

254. Kamb ML, Murphy JJ, Jones JL, et al. Eosinophilia-myalgia syndrome in L-tryptophan-exposed patients. *J Am Med Assoc* 1992;267:77-82.

255. Mayeno AN, Lin F, Foote CS, et al. Characterization of 'peak E,' a novel amino acid associated with eosinophilia-myalgia syndrome. *Science* 1990; 250:1707-1708.

256. Stahl JL, Cook EB, Pariza MA, et al. Effect of L-tryptophan supplementation on eosinophils and eotaxin in guinea pigs. *Exp Biol Med (Maywood)* 2001;226:177-184.

257. Spry CJF. The idiopathic hypereosinophilic syndrome. In: Makino S, Fukuda T, eds. *Eosinophils: biological and clinical aspects*. Boca Raton: CRC Press, 1993:403-420.

258. Smit AJ, Van Essen LH, de Vries EGE. Successful long-term control of idiopathic hypereosinophilic syndrome with etoposide. *Cancer* 1991;67:2826-2827.

259. Samoszuk M, Hansen L. Detection of interleukin-5 messenger RNA in Reed-Sternberg cells of Hodgkin's disease with eosinophilia. *Blood* 1990;75:13-16.

260. Samoszuk M, Ramzi E, Cooper DL. Interleukin-5 in RNA in three T-cell lymphomas with eosinophilia. *Am J Hematol* 1993;42:402.
261. Silverstein DS, Schoof DD, Rodrick ML, et al. Activation of eosinophils in cancer patients treated with interleukin-2 and interleukin-2-generated LAK cells. *J Immunol* 1989;142:2162-2167.
262. Berg PA, Daniel PT. Co-trimoxazole induced hepatic injury—an analysis of cases with hypersensitivity-like reactions. *Infection* 1987;15:S259-264.
263. White MV, Hadad ZH, Brunner E, Sainz C. Desensitization to trimethoprim sulfamethoxazole in patients with acquired immune deficiency syndrome and *Pneumocystis carinii* pneumonia. *Ann Allergy* 1989;62:177-179.
264. Shalev O, Rubinger D, Barlatzky Y, et al. Eosinophilia associated with acute allograft kidney rejection. *Nephron* 1982;31:182-183.
265. Ten RM, Gleich GJ, Holley KE, et al. Eosinophil granule major basic protein in acute renal allograft rejection. *Transplantation* 1989;47:959-963.
266. Freedman AR, Gibson FM, Fleming SC, et al. Human immunodeficiency virus infection of eosinophils in bone marrow cultures. *J Exp Med* 1991;174:1661-1664.
267. Finkelman FD, Pearce EJ, Urban JF Jr, Sher A. Regulation and biological function of helminth-induced cytokine responses. *Immunol Today* 1991;12:A62-A66.
268. Butterworth AE. Cell-mediated damage to helminths. *Adv Parasitol* 1984;23:143-235.
269. Hsu SY, Hsu HF, Penick GD, et al. Immunoglobulin E, mast cells, and eosinophils in the skin of rhesus monkeys immunized with x-irradiated cercariae of *Schistosoma japonicum*. *Int Arch Allergy Appl Immunol* 1979;59:383-393.
270. Kephart GM, Gleich GJ, Connor DH, et al. Deposition of eosinophil granule major basic protein onto microfilariae of *Onchocerca volvulus* in the skin of patients treated with diethylcarbamazine. *Lab Invest* 1984;50:51-61.
271. Spry CJ. Alterations in blood eosinophil morphology, binding capacity for complexed IgG and kinetics in patients with tropical (filarial) eosinophilia. *Parasite Immunol* 1981;3:1-11.
272. Moqbel R, Walsh GM, Nagakura T, et al. The effect of platelet-activating factor on IgE binding to, and IgE-dependent biological properties of, human eosinophils. *Immunology* 1990;70:251-257.
273. Herbert DR, Lee JJ, Lee NA, et al. Role of IL-5 in innate and adaptive immunity to larval *Strongyloides stercoralis* in mice. *J Immunol* 2000;165:4544-4551.
274. Moqbel R. Histopathological changes following primary, secondary and repeated infections of rats with *Strongyloides ratti*, with special reference to tissue eosinophils. *Parasite Immunol* 1980;2:11-27.

2004 Lippincott Williams & Wilkins  
John P. Greer, John Foerster, John N. Lukens  
George M. Rodgers, Frixos Paraskevas, Bertil Glader  
Wintrobe's Clinical Hematology

## Basophilic Leukocytes: Mast Cells and Basophils

### GENERAL MORPHOLOGY, DEGRANULATION, AND RECOVERY

#### Degranulation

#### Recovery

### ONTOGENY AND DEVELOPMENTAL BIOLOGY OF MAST CELLS AND BASOPHILS

#### Mast Cell Growth and Differentiation

#### Mast Cell Progenitors

#### Basophil Growth and Differentiation

#### Basophil Differentiation-Inducing Cytokines

#### Clinical Relevance of Basophil and Mast Cell Differentiation

### CHARACTERISTICS OF MAST CELLS AND BASOPHILS

#### Surface Phenotype

#### Mediators

#### Activation of Mast Cells and Basophils

#### Inhibition of Basophil and Mast Cell Activation

### BASOPHIL AND MAST CELL FUNCTIONS

#### Inflammatory Injury and Host Defenses

#### Containment of Injury, Initiation of Repair, Remodeling, and Normal Function

#### Dynamic Equilibrium and Homeostasis

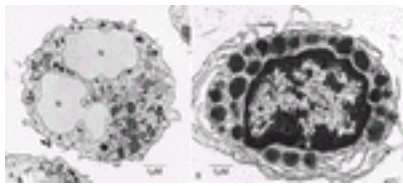
### REFERENCES

In his 1965 tome, Hans Selye (<sup>1</sup>) reviewed the literature on two populations of basophilic leucocytes, namely, mast cells and basophils. These cells have many similarities, but also exhibit several intriguing differences. Despite an ever-expanding scientific literature, we do not understand the precise nature of their relationship or the integration of factors that determine if one, the other, or both are present and active in inflammatory disorders such as allergic inflammation. More recently, there have been several reviews that document advances made in our understanding of these cells, their development, contents, biosynthetic activities, activation, and functions (<sup>2</sup>, <sup>3</sup>, <sup>4</sup>, <sup>5</sup>, <sup>6</sup>, <sup>7</sup>, <sup>8</sup>, <sup>9</sup>, <sup>10</sup>, <sup>11</sup> and <sup>12</sup>).

Mast cells and basophils contain electron-dense cytoplasmic granules and stain metachromatically with selected basic dyes. They produce numerous inflammatory mediators, many, such as histamine, that are common to both cells, and others that are cell-specific. Both cells express a tetrameric isoform of the high affinity receptor for immunoglobulin (Ig) E with one  $\alpha$ -, one  $\beta$ - and two  $\gamma$ -chains ( $\alpha\beta\gamma_2$ ), whereas human monocytes, dendritic cells, and Langerhans cells express a trimeric isoform ( $\alpha\gamma_2$ ) of the receptor (<sup>13</sup>). When this high-affinity IgE receptor is cross-linked by sensitizing allergen or by anti-IgE antibodies, both mast cells and basophils can be activated, mediator synthesis and secretion induced, and their gene expression altered. Through such mechanisms, mast cells and basophils are prominent players in allergic inflammation and other immune and inflammatory events.

In a thoughtful review, Galli et al. (<sup>2</sup>) provided concise descriptions for mast cells and

basophils. Basophils ( [Fig. 12.1A](#)) ( [14](#)) are



**Figure 12.1. A:** Human basophils are round and have irregular, short surface projections, cytoplasmic secretory granules, and aggregates of cytoplasmic glycogen. N, nucleus. (Reproduced from Dvorak AM, Warner JA, Fox P, et al. Recovery of human basophils after FMLP-stimulated secretion. *Clin Exp Allergy* 1996;26:281–294, with permission.) **B:** Human skin mast cell with monolobed nucleus with partially condensed chromatin, numerous cytoplasmic granules containing crystalline structures, and regularly distributed, narrow, thin surface projections. (Reproduced from Dvorak AM. Human mast cells. In: Beck F, Hild W, Kriz W, et al., eds. *Advances in anatomy, embryology and cell biology*. Leicester: Springer-Verlag, 1989, with permission.)

cells with the kinetics and natural history of granulocytes that mature in bone marrow, circulate in the blood, and retain certain characteristic ultrastructural features, even after migrating into the tissues during inflammatory or immunologic processes. The ultrastructure of mature basophils varies according to species but generally includes electron-dense cytoplasmic granules, prominent aggregates of cytoplasmic glycogen, and short, blunt, irregularly distributed plasma membrane processes. There is no convincing evidence that mature basophils, whether in the circulation or in the tissues, retain mitotic capability, or that basophils metamorphose into mast cells upon entering the tissues.

Mast cells ( [Fig. 12.1B](#)) ( [15](#)):

ordinarily mature outside of the bone marrow or circulation, generally in the connective tissues or serous cavities. Cells in this lineage(s), wherever distributed, apparently retain at least limited or latent proliferative capacity... immature and mature granules of mast cells and basophils differ distinctively in ultrastructure. Mast cells also differ from basophils in lacking electron-dense aggregates of cytoplasmic glycogen, and in having a plasma membrane surface with uniformly distributed, thin, elongate folds and processes. Mast cell nuclei may appear bilobed in an individual photomicrograph, but they generally lack the pattern of peripherally condensed nuclear chromatin characteristic of basophils and other granulocytes.

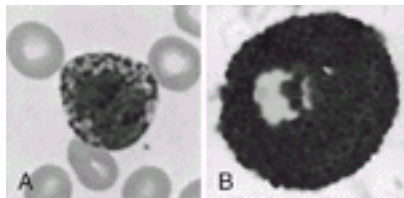
These descriptions have withstood the test of time well and represent our current understanding of basophils and mast cells. In many ways, the original statement by Ehrlich in 1879 ( [1](#)) that basophils were “blood mast cells,” and the corollary, that mast cells are tissue basophils, while incorrect from a developmental standpoint, is still of some value in thinking about the nature of these two cell types. The striking inverse relationship between the numbers of circulating basophils and the numbers of tissue mast cells has been used for decades to infer similarities in function ( [1](#)).

In this chapter, we provide an overview of the developmental biology of the two cell types,

including knowledge about their progenitors and growth factors involved in lineage commitment, differentiation, and maturation. Programmed cell death and factors influencing survival have been increasingly well recognized as important components in the regulation of inflammation and myeloproliferative disorders. Mature basophils and mast cells differ markedly in their surface phenotype, stored mediators, and in the synthesis of new mediators after activation. Factors that activate and regulate the functions of mast cells and basophils also show fascinating similarities and differences. Last, from this background, we provide a conceptual overview of the functions of mast cells and basophils in allergic disease and in other inflammatory and noninflammatory clinical settings. There is much to be learned about the developmental biology and cellular and molecular controls of their phenotypes and functions. As we progress early in the 21st century and in exciting new developments in biology and medicine, we are optimistic that our exponential learning curve for basophils and mast cells will continue and lead to effective strategies to manipulate the complexities of these cells for the betterment of those suffering from allergic and other diseases.

## GENERAL MORPHOLOGY, DEGRANULATION, AND RECOVERY

Histochemical staining of blood smears or cytocentrifuge preparations of enriched basophils or mast cells with Wright–Giemsa or May–Grünwald stains, shows many similarities in these cell types ( [Fig. 12.2](#)). The cytoplasm of the cells is generally pink, the nucleus is purplish or blue, and the cytoplasmic granules are dark blue to purple or even blackish. Basophils in peripheral blood or tissues range in size from 10 to 15  $\mu\text{m}$ , whereas mast cells in tissue sites may appear irregular in shape and up to 20  $\mu\text{m}$  in a long dimension. Dvorak has published extensively on the morphology of normal mast cells and basophils, as well as on the changes associated with degranulation and recovery of these cells following their activation by different stimuli. The reader is encouraged to review her work, which is only briefly summarized here ( [16](#), [17](#)).



**Figure 12.2. A:** Human peripheral blood basophil stained with Wright. (From Lee G, Bithell T, Foerster J, et al., eds. *Wintrobe's clinical hematology*, 9th ed. Philadelphia: Lea & Febiger, 1993, with permission.) **B:** Rat peritoneal mast cell stained with May–Grunwald Giemsa. See [Color Plate](#).

Ultrastructural analyses demonstrate many similarities between mast cells and basophils, but also identify some differences ( [Fig. 12.1A](#) and [Fig. 12.1B](#)). In the blood, basophils are round, whereas in the tissues they can appear in various shapes. Mast cells can appear to be round, oval, or elongate–spindle shaped in the tissues. The surface of basophils exhibits blunt processes of variable shape and size, whereas mast cells often possess long, fingerlike processes that extend from the surface. The nucleus of mast cells can be round or lobed, whereas that of the basophil is generally multilobed. Nucleoli are often not apparent or are absent from normal mast cells and basophils. Basophils have an abundance of condensed chromatin positioned at the periphery of the nucleus, whereas mast cells have little condensed chromatin.

The cytoplasm of normal mature mast cells has few mitochondria and a relatively

inconspicuous Golgi apparatus; ribosomes, rough endoplasmic reticulum, and aggregates of glycogen are rare. In normal basophils, mitochondria and aggregates of glycogen are more abundant than in mast cells, but as with mast cells, Golgi apparatus, ribosomes, and rough endoplasmic reticulum are rare in normal basophils. The most prominent cytoplasmic elements in both cell types are the membrane-bound, electron-dense granules.

Basophils generally possess fewer granules than mast cells, and the granules exhibit a more homogeneous morphology than those of mast cells. Basophil granules are often homogeneously electron-dense, although dense particles may be interspersed with membrane aggregates and whorls. Charcot-Leyden crystals can be formed in basophils as well. Mast cell granules may be homogeneously electron-dense, or may exhibit electron-dense particles, membrane or complex scroll-like patterns, highly organized crystalline structures, or combinations of these. The relationship of these different granule patterns to the tissue site, phase in development, or mediator content is not clear, although it has been proposed that major histocompatibility complex class II-positive vesicles of 60 to 80 nm, called *exosomes*, released by mast cells after activation arise from these structures within the granules ([18](#)). Interestingly, Dvorak has reported that mast cell granules, in addition to storing mediators, are also sites of RNA metabolism and protein synthetic activity ([19](#)). Additionally, basophils contain numerous electron-lucent vesicles of 50 to 70 nm that often contain contents similar to granules. These may be associated with a form of mediator exocytosis (see [Degranulation](#)).

In addition to these membrane-bound granules, mast cells and basophils also contain rounded, non-membrane-bound, electron-dense structures called *lipid bodies*, rich stores of arachidonic acid. Lipid bodies appear to increase in number associated with cell activation and are thought to be derived from membrane catabolism and the rapid synthesis of lipid mediators, such as the cyclooxygenase and lipoxygenase derivatives of arachidonic acid.

## Degranulation

Mast cells and basophils appear to undergo distinct types of mediator secretion from granule stores, depending on the stimuli involved in their activation ([16](#), [17](#)). Anaphylactic degranulation occurs after stimulation through the IgE receptor or after other stimuli, such as fragments of the complement cascade. Anaphylactic degranulation can be extensive, involving the majority of the granules, or it can be more restricted. The numbers of granules involved appears to correlate with the proportion of the total cellular histamine that is released. By contrast, in numerous inflammatory reactions where mast cell and basophil infiltration can occur, such as in cutaneous delayed hypersensitivity, a less explosive form of mediator secretion, called piecemeal degranulation or secretion can occur.

In anaphylactic degranulation in mast cells, the granules rapidly exhibit signs of swelling, then demonstrate membrane fusion with adjacent granules, interconnecting chains and channels form that ultimately fuse with the plasma membrane, creating pores or larger openings where granule contents or larger granule structures can be seen outside the cell. Prominent cytoplasmic filaments can be seen close to the granules, and actin complexes can be seen outside the cell in association with granules or their contents. The process is generally similar for basophils. Electron-dense granules appear to evolve into electron-lucent vacuoles, many of which communicate to other vacuoles and to the cell surface through pores within 5 to 10 minutes. In addition, apparently intact granules can be seen outside the cell. This anaphylactic degranulation does not lead to major cell death, but as outlined later in the chapter, the cells can recover and be able to



degranulate again.

Piecemeal secretion also occurs in mast cells, basophils, and eosinophils ( [20](#) ) and is the most prevalent morphologic expression of mast cell and basophil secretion in nonallergy inflammatory conditions in human biopsy material. This form of mediator secretion can also demonstrate a continuum in its extent, presumably depending on the magnitude or nature of the activation stimulus. It is postulated that exocytotic vesicles containing granule contents bud off the granules, move to the cell surface, fuse with the plasma membrane, and discharge their contents to the extracellular space. This form of mediator secretion is believed to be associated with secretion of only selected mediators, not the entire contents of the granules, and there is increasing evidence for such selectivity. As with anaphylactic degranulation, piecemeal secretion is associated with the ability of mast cells to recover and to function again.

## Recovery

Dvorak ( [16](#) ) has summarized the evidence for the ability of mast cells and basophils to recover and regranulate after activation. In the process of recovery, mast cells and basophils appear to be able to conserve membrane and other components and exhibit several morphologic changes that demonstrate the cells can resynthesize granule and other components, for example, extensive rough endoplasmic reticulum, elaborate Golgi apparatus, microtubules, and new granules. This recovery appears to occur within 1 to 2 days, but may involve longer times. Whether death by necrosis or apoptosis is a feature of mast cell or basophil activation in some conditions remains to be carefully evaluated.

## ONTOGENY AND DEVELOPMENTAL BIOLOGY OF MAST CELLS AND BASOPHILS

The tissue mast cell and the blood basophil are probably not, under normal conditions, derived directly from a common progenitor in any species. However, recent evidence from a variety of observations of leukemic cell lines and clinical conditions has revived the notion of lineage pathways that may be shared by basophils and mast cells, basophils and eosinophils, and basophils and megakaryocytes ( [21](#), [22](#) and [23](#) ). Phylogenetically, there appears to be an inverse relationship between the presence of basophils and mast cells ( [1](#) ). Whereas mast cell growth and differentiation has, until now, been relatively better understood in rodents than in human systems and basophil production more fully worked out in the human, major advances in understanding human mast cell growth and differentiation have come about by application of knowledge from rodent models. An exponential growth in knowledge of human basophil and mast cell ontogeny has ensued, including identification and the developmental biology of the specific mast cell hemopoietin, stem cell factor (SCF), and its receptor, *c-kit*. Using definition by flow cytometry and culture with recombinant cytokines, the lineage pathways of basophils and mast cells have been investigated, including analysis of signal transduction and specific transcriptional regulation of basophil and mast cell differentiation in hemopoietic stem cells.

### Mast Cell Growth and Differentiation

In rodents and humans, mast cells can be grown *in vitro* from lineage-committed, unipotent, or multipotent progenitors. Although interleukin-3 (IL-3) is known to contribute to murine mast cell and basophil development ( [24](#) ), it is unable to induce human mast cell differentiation from cultures of human cord blood or fetal liver; however, IL-3 can promote human basophil development ( [25](#) ). A “novel” growth factor was thus postulated

for human mast cells, shown to be fibroblast-derived, and identified in both rodents and primates as SCF or c-kit ligand ( [26](#), [27](#) and [28](#) ). In general, human mast cell differentiation *in vitro* is not influenced directly by cytokines that promote mast cell development in rodents, such as IL-4, IL-9, IL-10, or eotaxin ( [29](#) ), but almost uniquely by SCF ( [25](#), [27](#) ), with cofactor effects by IL-3 ( [26](#), [27](#) ), IL-6 ( [30](#) ), thrombopoietin ( [31](#), [32](#) ), and nerve growth factor (NGF) ( [33](#), [34](#) ). SCF is produced by murine and human fibroblasts, epithelial cells, endothelial cells, and tumor cell lines ( [35](#) ), and must bind to an intact c-kit receptor to effect differentiation. Mutations in c-kit can result in mast cell deficiency *in vivo* and *in vitro* (loss-of-function) or, alternately, in autonomous mast cell growth (gain-of-function) ( [35](#), [36](#), [37](#) and [38](#) ). IL-3 by itself, in addition to rodent mast cell differentiation-inducing activity, is a differentiation and activation factor for human and primate basophils ( [39](#), [40](#) and [41](#) ). Because it does not bind to human mast cells, its supportive role in human mast cell differentiation may be due to its ability to induce SCF-responsive progenitors into cycle ( [42](#) ). [Table 12.1](#) lists cytokines, growth factors, transcription factors, and signaling molecules that regulate primate/human and rodent mast cell differentiation ( [43](#), [44](#), [45](#), [46](#), [47](#), [48](#), [49](#), [50](#) and [51](#) ).

**TABLE 12.1. Regulation of Mast Cell Growth and Differentiation**

| Rodent (reference)   | Primate/Human (reference)  |
|--|--|
| Cytokines/growth factors   |  |
| Stem cell factor/c-kit (gain-of-function mutation) ( <a href="#">48</a> )    | Stem cell factor/c-kit (gain-of-function mutation) ( <a href="#">38</a> , <a href="#">43</a> ) |
| IL-3   | [IL-3]   |
| IL-4 <sup>a</sup>  | [IL-6]   |
| IL-9 <sup>a</sup>  | [IL-4]   |
| IL-10 <sup>a</sup>   | Nerve growth factor ( <a href="#">33</a> )   |
| [IL-13]  | [TPO] ( <a href="#">31</a> , <a href="#">32</a> )  |
| [Eotaxin] ( <a href="#">29</a> )   |  |
| Basic fibroblast growth factor ( <a href="#">44</a> )                        |  |
| [Nerve growth factor] <sup>a</sup>   |  |
| Transcription factors/signaling molecules                                    |  |
| GATA-2   | Granulocyte-macrophage colony-stimulating factor <i>negative</i> ( <a href="#">47</a> )        |
| Gab-2 ( <a href="#">45</a> )   | Retinoic acid <i>negative</i> ( <a href="#">50</a> )   |
| Lyn ( <a href="#">46</a> )   | Interferon- $\alpha$ and - $\gamma$ <i>negative</i> ( <a href="#">51</a> )                     |
| v-erb  |  |
| flk2/flt3 <i>negative</i> ( <a href="#">49</a> )                             |  |
| Tumor growth factor- $\beta$ <i>negative</i>                                 |  |
| IL, interleukin; negative, down-regulator.                                   |  |
| NOTE: Entries in brackets are cofactors, rather than playing a primary role. |  |
| <sup>a</sup> Role in phenotype switching.                                    |  |

## Mast Cell Progenitors

Studies of protease content of human mast cells, identifying tryptase-containing (MC<sub>T</sub>) and tryptase/chymase-containing mast cells (MC<sub>TC</sub>) subpopulations (see below) have been used to infer lineage commitments of mast cell subtypes: for example, studies of bowel biopsies from patients with T-cell or combined immunodeficiency (52) and *in vitro* examination of fetal liver-derived MC<sub>T</sub> and MC<sub>TC</sub> (26). In rodents and humans, mast cell differentiation proceeds from an immature CD34<sup>+</sup>, CD38<sup>+</sup>, CD13<sup>+</sup>, c-kit<sup>+</sup>, FcεRI<sup>-</sup>, FcγRII/III<sup>+</sup> progenitor into mucosal or serosal phenotypes, as characterized by serine protease content primarily under the stimulation of SCF and other cytokines (27, 53, 54, 55, 56 and 57) (Fig. 12.3). In human SCF-stimulated cord blood of fetal liver cultures, both MC<sub>T</sub> and MC<sub>TC</sub> phenotypes are found; likewise, various phenotypes of murine mast cells, characterized according to serine protease content, are present in IL-3 and SCF-stimulated bone marrow cultures. Various cytokines can regulate these phenotypic changes, which may not necessarily occur in any linear order, but rather exhibit switching and “trans-differentiation” (58, 59 and 60), reflecting stochastic processes in progenitor differentiation. Primitive cord blood CD34<sup>+</sup>, c-kit<sup>-</sup> progenitors may respond quite differently to hemopoietic cytokines than more mature FcεRI<sup>+</sup>, c-kit<sup>+</sup> cells (61, 62). Thus, tissue-dependent stages of progenitor commitment may ultimately predict, in the presence of SCF, differences in mast cell differentiation and phenotype *in vitro* (27). Mast cell progenitors can be identified in blood, bone marrow, and tissues, especially in relation to mast cell-inducing stimuli, such as viruses or nematodes (52, 56, 57, 63, 64 and 65).



**Figure 12.3.** Mast cell (MC) and basophil (B) ontogeny. An orderly sequence of differentiation is depicted, beginning with a primitive CD34<sup>+</sup>, FcεRI<sup>-</sup>, c-kit<sup>-</sup> hemopoietic stem cell (HSC), and proceeding through various stages of commitment to either mast cell or basophil/eosinophil (E) lineages. In reality, the differentiation process is stochastic, and multiple cytokines binding to their receptors permit specific, end-stage differentiation to proceed. GM-CSFR, granulocyte-macrophage colony-stimulating factor receptor; IL, interleukin; Meg, megakaryocyte.

Leukemic cell lines with basophilic phenotype have also been used to study basophil and mast cell progenitors and immunophenotypic markers of lineage commitment (65, 66, 67, 68, 69, 70 and 71). These are reviewed later in the chapter for mature basophils and mast cells. A model of HL-60 basophilic differentiation (66), for example, has identified unexpected phenotypic profiles of maturing basophils and possibly mast cells, including CD15 (Lewis X) down-regulation, CD35 (CR1) up-regulation and transient expression of c-kit. Similar concepts of combined basophil/mast cell commitment in leukemic cells have been raised from studies of KU812, HMC-1 and other cell lines (67, 71, 72 and 73). Although these findings may represent aberrant pathways activated during malignant

transformation, the recent identification of a novel antigenic marker of mast cells, basophils, and their progenitors ( [21](#), [74](#) ), and the presence in peripheral blood of basophilic cells, which express mast cell proteases ( [23](#) ), has revived earlier postulates ( [75](#), [76](#) ) that these two cell types indeed share some lineage characteristics in humans.

## Basophil Growth and Differentiation

Most of what is known of basophilopoiesis is derived from human systems, because basophils are readily identifiable in the circulation in humans. In addition, pure or mixed basophil colonies in semisolid cultures can be identified ( [75](#), [77](#), [78](#) ), thus defining a basophil (–eosinophil) progenitor (termed *colony forming unit–basophili* or *colony forming unit –basophil/eosinophili*). These colony forming unit–basophils can be derived from normal, atopic ( [77](#), [79](#) ), or leukemic human specimens ( [76](#), [77](#), [79](#), [80](#) ), the latter including blood of patients with chronic myeloid leukemia (CML) or related myeloproliferative disorders, acute myeloid leukemia, and systemic mastocytosis. The phenotype and lineage commitment of the basophil progenitor, including more recent notions of lineage sharing with mast cells and/or megakaryocytes ( [21](#), [22](#) ), is depicted in [Figure 12.3](#).

## Basophil Differentiation–Inducing Cytokines

Although no single cytokine has been shown to be a specific basophilopoietin, IL–3 is the main cytokine involved in human basophil growth and differentiation ( [39](#) ); granulocyte macrophage–colony stimulating factor (GM–CSF) ( [66](#), [75](#), [77](#), [78](#) ), IL–4 ( [14](#), [81](#) ), IL–5 ( [14](#), [80](#) ), and SCF ( [35](#), [53](#) ) may also play roles. IL–5, interestingly, promotes both eosinophil and basophil differentiation ( [14](#), [80](#) ), because it acts on a common basophil–eosinophil progenitor ( [Fig. 12.3](#) ) ( [81](#) ). Retinoic acid (RA) may influence granulocyte progenitors to a neutrophilic as opposed to basophilic–eosinophilic pathway, as well as down–regulate human mast cell differentiation ( [82](#) ); conversely, a mutation in the RA receptor allows for expression of basophil differentiation ( [83](#) ). Studies on basophil crisis in CML and the *in vitro* suppressive effects of RA on basophil–eosinophil differentiation in these and normal cultures support this notion ( [69](#), [84](#) ).

Other factors that modulate basophil–eosinophil or mast cell differentiation include tumor growth factor– $\beta$  (TGF– $\beta$ ) ( [85](#) ), which can suppress eosinophil and enhance basophil differentiation in the presence of IL–3; the bcr–abl gene, which presents in CML as the Philadelphia chromosome or t(9;22) translocation ( [86](#) ); NGF, which can induce basophil colony growth in humans and mast cell phenotype switch in rodents ( [34](#) ); the oncogene v–erb, which in the rodent is associated with the development of lethal mastocytosis as a result of co–stimulation of mast cell growth by epidermal growth factors and SCF ( [87](#), [88](#) ); and platelet–activating factor (PAF), which may synergize with other cytokines to induce basophil and eosinophil differentiation ( [89](#) ). *In vivo* in primates, parenteral IL–3 and GM–CSF administration leads to basophilia and eosinophilia, along with an egress from the marrow of granulocyte, and specifically, basophil/eosinophil progenitors ( [40](#) ); this is in contrast to SCF–induction of mastocytosis *in vivo* in human skin ( [90](#) ).

[Table 12.2](#) lists the cytokines involved in basophil growth and differentiation ( [81](#) ).

Although IL–3 and SCF represent the primary mast cell growth factors in mouse and rat ( [35](#), [91](#) ), IL–3 is a basophil, but not a mast cell; differentiation factor in the human and SCF has little known effect on basophil differentiation ( [35](#), [39](#) ). Together with GM–CSF, NGF can co–stimulate human basophil differentiation ( [34](#) ). IL–4 has minimal activity on human

basophil differentiation ( 25 , 81 ) even though IL-4 can down-regulate c-kit expression ( 35 ). GM-CSF and IL-5 are prominent basophilopoietins, as well as basophil-activation factors, both *in vitro* and *in vivo* in several species ( 25 , 66 , 75 , 77 , 79 , 81 , 92 , 93 ). Microenvironmental stimuli, including various cytokines such as IL-3, IL-6, SCF, GM-CSF, TGF-β, and tumor necrosis factor (TNF), may regulate the ultimate phenotypic direction and lineage commitment of human basophils and mast cell subtypes ( 81 , 94 ); these include negative regulatory effects documented for TGF-β ( 85 , 95 ), IL-4 ( 96 ), interferon-γ (IFN-γ) ( 85 , 97 ), and GM-CSF ( 47 ). Contrasts between the murine and human systems, in terms of which factors stimulate basophil or mast cell growth and differentiation or regulate phenotypic switching, must be recognized in any analysis of basophil and mast cell lineages.

**TABLE 12.2. Cytokines and Other Factors Involved in Basophil Growth and Differentiation**

| Cytokine   | Effect  |
|--|---|
| Granulocyte-macrophage colony-stimulating factor | Basophil growth and differentiation; promotes <i>in vivo</i> basophilia and increases in circulating colony-forming unit-basophil/eosinophil (primates); basophil activation/survival; down-regulates human mast cell differentiation |
| IL-3   | Human basophil growth and differentiation; basophil activation/survival; promotes <i>in vivo</i> basophilia (in primates); mast cell differentiating activity in rodents  |
| IL-5   | Primarily eosinophil, but also basophil growth and differentiation; basophil and eosinophil activation/survival   |
| Tumor growth factor-β                            | Suppresses human eosinophil and enhances basophil differentiation in the presence of IL-3; suppresses rodent IL-3-dependent mast cell proliferation   |
| bcr-abl  | Involved in basophil/mast cell/megakaryocytic lineage expression in human myeloid leukemias   |
| Nerve growth factor                              | Induces mast cell hyperplasia (rodents), human mast cell line (HMC-1) and basophil-eosinophil differentiation <i>in vitro</i>   |
| IL, interleukin.                                 |   |

### Clinical Relevance of Basophil and Mast Cell Differentiation

**ALLERGY AND ALLERGIC DISEASE** The clinical relevance of basophil-eosinophil or basophil-mast or mast cell progenitor fluctuations in the blood of patients with a variety of allergic disorders, especially those with allergic rhinitis, nasal polyposis, and asthma, but also in subjects with atopic dermatitis and drug allergies, has been documented ( 31 , 98 , 99 and 100 ). The numbers of these progenitors in the peripheral blood are higher out of allergy season, and decreased during seasonal allergen exposure ( 100 , 101 and 102 ), with recovery towards normal after the season. Likewise, selective increases occur in circulating basophil progenitors in patients with allergic asthma in response to allergen inhalation challenge ( 100 , 103 ), including up-regulation of cytokine (IL-3, IL-5, and GM-CSF) as well as chemokine (CCR1, -CCR3 and CXCR4) receptors on CD34<sup>+</sup> cells

from bone marrow ( [104](#), [105](#) ). In transient leukemias occurring in Down syndrome (trisomy 21), as well as in related megakaryoblastic leukemia, there is basophilic differentiation (which could include mast cells) from leukemic cell progenitors ( [106](#) ). Because there are increased numbers of mast cells as well as basophils in various hematologic malignancies ( [107](#) ), the relationship between leukemic processes and basophil or mast cell lineage commitment is underscored. One of the reasons for this may be aberrant stimulation of basophil or mast cell lineage development by certain transcription factors that also regulate erythroid and megakaryocytic lineages; these include GATA-1 through 3 ( [108](#), [109](#) and [110](#) ), with GATA-2 having been shown, using knockout mice and transfection to be primarily involved in basophil/mast cell lineage commitment ( [111](#), [112](#) ), and GATA-3 in Th2 cell switching, the latter supportive of basophil, eosinophil, and mast cell differentiation. Embryonic stem cells or CD34<sup>+</sup> progenitors transfected with GATA genes express varying degrees of erythroid/megakaryocytic and basophil/mast cell commitment ( [108](#), [109](#) and [110](#) ). Factors such as Gab-2, an adaptor protein ( [45](#) ); the signaling molecule Lyn ( [46](#) ); or the flt3 ligand for tyrosine kinase receptor appear to play secondary roles to c-kit and its ligand in signal transduction and subsequent transcription factor regulation of basophil and mast cell differentiation ( [113](#) ). Several other hemopoietic malignancies also exhibit basophil and mast cell lineage dysregulation, including CML/myeloproliferative disorders and systemic mastocytosis. In mast cell proliferative diseases (systemic mastocytosis and urticaria pigmentosa), proliferation of tissue mast cells is common; although mature mast cells appear only rarely in the blood (termed *mast cell leukemia*), higher numbers of both basophil and mast cell progenitors can be documented ( [56](#), [75](#), [114](#) ). These observations emphasize the atypicality of hemopoietic malignancies with regard to clear-cut distinctions between basophil and mast cell lineages ( [68](#) ). Gain-of-function mutations in both juxtamembrane and intracellular domains of c-kit provide an explanation for many adult mast cell proliferative diseases (either associated with hemopoietic malignancy or not), though such mutations are rarely found in the pediatric form of limited, skin-associated mastocytosis termed *urticaria pigmentosa* ( [37](#), [38](#), [43](#), [44](#) ). The presence of basophilia or basophil crisis heralding terminal blast crisis in CML has long been known ( [114](#) ) and bcr-abl (see above) may play a role in basophil/mast cell lineage expression during this phase ( [69](#) ). Hyperhistaminemia in CML and myeloproliferative disorders is related to increased numbers of turnover of basophils (and, possibly, mast cells) ( [65](#), [76](#) ); indeed, blood basophilia and basophil progenitor increases are poor prognostic indicators in CML ( [76](#), [114](#) ). Such phenomena may relate to specific chromosomal abnormalities in atypical forms of leukemia associated with basophilia or eosinophilia ( [68](#), [69](#), [115](#), [116](#) and [117](#) ), for example, inversion of chromosome 16 (inv 16) associated with atypical eosinophils with basophilic granulation ( [115](#) ); t(6;9) chromosomal translocation associated with basophilia and leukemia ( [116](#) ); trisomy 21 ( [106](#) ); and, in several translocations associated with increased numbers of basophils in patients with acute promyelocytic and other leukemias, such as t(15;17), del(5)(q31q35) and t(9;14) ( [116](#), [118](#) ). Basophils and/or mast cells, sometimes concurrently, can be derived from leukemic clones ( [119](#) ); analysis of leukemic cell lines derived from such patients reveals cells of mixed basophil-mast cell lineage ( [30](#), [65](#), [71](#), [72](#), [76](#), [120](#) ). However, the precise relationship between specific chromosomal aberrations and basophil or mast cell differentiation *in vivo* has not yet been clarified. The biologic significance of increased numbers of mast cells in a variety of hemopoietic and lymphatic malignancies, as well as in refractory anemias ( [107](#) ), may be related to acquisition in the leukemic clone of concomitant c-kit mutations ( [43](#) ); see above. Apart from c-kit/SCF, whether other cytokines are involved in malignant basophil or mast cell proliferation *in vivo* is not known; for example, whether dysregulated cytokine genes such as IL-3, IL-4, IL-5, and GM-CSF in 5q leukemias ( [121](#), [122](#) ) are responsible for CML basophil crisis is unclear. Overproduction of a cytokine at local tissue sites may



induce cell proliferation; this is supported by recent experiments on SCF-induced mast cell and melanocyte hyperplasia *in vivo* in humans ( [90](#), [123](#) ), and in studies on the mast cell-promoting effects of basic fibroblast growth factor ( [44](#) ).

## CHARACTERISTICS OF MAST CELLS AND BASOPHILS

### Surface Phenotype

With the widespread use of monoclonal antibodies to identify surface markers on cells, a wealth of information is available about the surface phenotype of mast cells and basophils. This includes information about Ig receptors, complement components, cytokine receptors, adhesion molecules, and other molecules with or without CD nomenclature. Many authors have contributed to a comprehensive characterization of these markers on human mast cells and basophils and the mast cell and basophil-like cell lines, HMC-1 and KU812 respectively ( [124](#), [125](#), [126](#) and [127](#) ). One prominent difference is that mature mast cells express CD117 or c-kit, the receptor for SCF ( [Table 12.3](#) ), whereas mature basophils do not. As outlined above, SCF is an important factor in mast cell development and given that in addition to mast cell progenitors, mature mast cells also express its receptor, CD117, it is not surprising that SCF affects the activation of mediator secretion by mature mast cells.

**TABLE 12.3. Selected Surface Phenotypic Markers of Human Mast Cells and Basophils**

| Marker             | Cell Type  |           |
|--------------------|------------|-----------|
|                    | Mast Cells | Basophils |
| Fc receptors       |            |           |
| FcεRI (αβγ2)       | +          | +         |
| FcεRII (CD23)      | -          | -         |
| FcγRI (CD64)       | +          | -         |
| FcγRII (CD32)      |            |           |
| A                  | +          | +         |
| B                  | +          | +         |
| FcγRIII (CD16)     | +          | -         |
| Integrins          |            |           |
| CD11a/18 (αLβ2)    | -          | +         |
| CD11b/18 (αMβ2)    | -          | +         |
| CD11c/18 (αXβ2)    | -          | +         |
| Cytokine receptors |            |           |
| IL-2R (CD25)       | -          | +         |
| c-kit (CD117)      | -          | -         |
| IL-3Ra (CD123)     | ±          | +         |
| IL-3/5/GMRB        | -          | +         |
| Other              |            |           |
| 2D7 antigen        | -          | +         |
| HLA-DR             | +          | Inducible |

IL, interleukin; +, yes; ±, some mast cell populations respond, some do not; -, no.



Another potentially important difference between mast cells and basophils is in their expression of Fc receptors. Mast cells and basophils both express high-affinity receptors for IgE (13), but to date, the only receptor for IgG that has been identified on basophils is Fc $\gamma$ RII (CD32), whereas mast cells can express CD16, CD32, and CD64 (127). Further investigation of Fc $\gamma$  receptors on human mast cells and basophils will be important, because different receptors such as Fc $\gamma$ RIIA and B and Fc $\gamma$ RIII have been shown to play distinct roles in mediator secretion and phagocytosis or endocytosis (128). Mice deficient in Fc $\gamma$ RII are highly sensitive to IgG-triggered mast cell degranulation through Fc $\gamma$ RIII and exhibit enhanced passive cutaneous anaphylaxis and elevated Ig levels in response to both thymus-dependent and thymus-independent antigens (129). It has been postulated that Fc $\gamma$ RIIB down-regulates Fc $\epsilon$ RI signaling and is important in the regulation of mast cell and basophil activities (7, 10, 130).

Another intriguing difference between mast cells and basophils lies in their expression of selected integrin molecules (Table 12.3). Human basophils, but not mast cells, express CD11a/18, CD11b/18 and CD11c/18, which have as their complementary ligands ICAM-1/2, C3bi, and fibrinogen respectively. The latter are expressed on endothelial cells and appear to be involved in the migration of basophils into the tissues during inflammation. By contrast, mature mast cells and basophils express a repertoire of adhesion molecules designed to interact with the extracellular matrix components. The ligation of these surface molecules plays a significant role in cell recruitment and activation, and in the future these interactions may be targets for strategies to modulate allergic or other diseases (131).

## Mediators

Mast cells and basophils are storehouses of inflammatory mediators that can be released by IgE-mediated and other stimuli (Table 12.4). Mediators such as histamine, PAF, and arachidonic acid metabolites have been extensively studied and are considered to be important in the pathogenesis of inflammatory diseases such as asthma (132). A major distinction between the two cell types (i.e., mast cells and basophils) lies in the proteinases that are abundant in mast cells in humans (133) or other species (134, 135 and 136). Proteinases are excellent markers of mast cell heterogeneity. In humans, two major populations have been identified based on their proteinase content, namely, MC $\gamma$  and MC $\delta$ .

**TABLE 12.4. Selected Mediators of Human Mast Cells and Basophils**

| Marker                       | Cell Type  |                      |
|------------------------------|--|----------------------|
|                              | Mast Cells   | Basophils            |
| Histamine                    | +  | +                    |
| Platelet activating factor   | +  | +                    |
| Nitric oxide                 | +  | Not known            |
| Proteoglycans                | Heparin, chondroitin sulfates                                  | Chondroitin sulfates |
| Arachidonic acid metabolites | LTB $_4$ , LTC $_4$ , PGD $_2$ , PGE $_2$ , thromboxane A $_2$ | LTB $_4$ , LTC $_4$  |

|             |  |
|-------------|--|
| Proteinases | Tryptase, chymase, carboxypeptidase A, cathepsin G-like  |
| Cytokines   | IL-1, -2, -3, -4, -5, -6, -8, -10, -11, -13, -16, TNF, LT, IL-4, IL-13, NGF, TGF $\beta$ , GM-CSF, RANTES, MCP1 I-309, MIP-1a, MIP-1a-1B, FGF, lymphotactin, PDGF-AB, VEGF, BDNF |

FGF, fibroblast growth factor; GM-CSF, granulocyte-macrophage colony-stimulating factor; IL, interleukin; LT, leukotriene; MCP, macrophage chemotactic protein; MIP, macrophage inflammatory protein; NGF, nerve growth factor; PDGF, platelet-derived growth factor; PGD<sub>2</sub>, prostaglandin D<sub>2</sub>; PGE<sub>2</sub>, prostaglandin E<sub>2</sub>; RANTES, regulated upon activation, normal T-cell expressed and secreted; TGF, tumor growth factor; TNF, tumor necrosis factor; VEGF, vascular endothelial growth factor.

NOTE: Mediators selected from more comprehensive lists published by others and recent updates (e.g., 4,6,12,132,137-141).

---

Perhaps the most exciting research on the mediators of mast cells and basophils has focused on the cytokines that these cells produce ( [Table 12.4](#) ) ( [4](#), [6](#), [137](#), [137](#), [138](#), [139](#), [140](#), [141](#), [142](#) and [143](#) ). Since initial observations in the late 1980s, research in this field has expanded rapidly and one must be careful in making generalizations. There is literature on cytokine expression in cells freshly isolated from *in vivo* sites, but many studies have used primary cell cultures or long-term cell lines, and the relevance of this work to cytokine expression *in vivo* must be viewed cautiously. Additionally, several species have been studied, and often the cytokines have only been identified by the expression of mRNA as assessed by the sensitive technique of reverse transcriptase-polymerase chain reaction. However, cytokine protein levels have been defined in numerous studies as well, and the amounts secreted by mast cells and/or basophils range from small to relatively large quantities. For example, basophils produce large quantities of IL-4 and IL-13 (100s of pg/10<sup>6</sup> cells). The cytokine repertoire of mast cells includes a broad spectrum representing those associated with both Th1 and Th2 phenotypes. It may be that in a given population of mast cells, cytokines are differentially expressed in individual cells or at different times, or that individual mast cells truly express several functionally distinct cytokines. In the latter case, one would speculate that there are rigorous control mechanisms regulating production, secretion, and functions of individual cytokines.

### Activation of Mast Cells and Basophils

Much has been written about factors that activate basophils and mast cells, and it is clear that for many of the stimuli that have been studied, it is difficult to make generalizations. Much of the literature involves cells from rodents or guinea pigs and not all the factors that activate mast cells or basophils from these species also activate human cells ( [144](#) ). Furthermore, in addition to species differences, marked heterogeneity exists among mast cell populations from different tissue sites within a single species ( [4](#), [12](#), [145](#) ). Another important consideration is that there are stimulus-specific differences in the mediators released when basophils or mast cells are activated, that is, activation is not an all-or-none phenomenon.

Human basophils and mast cells can be activated by cross-linkage of Fc receptors for IgE or IgG with sensitizing allergens or with antibodies to the receptors or to their Ig ligands ( [Table 12.5](#) ). Such cross-linkage initiates a complex cascade of biochemical signaling events in the cells ( [6](#), [7](#), [11](#) ) and results in the release of several stored and newly synthesized mediators. A number of other stimuli, including anaphylatoxins C3a and C5a, certain lectins, and the bacterial product formyl methionyl leucyl phenylalanine activate

basophils and/or mast cells. Interestingly, with the unexplained exceptions of polyarginine, polycationic substances such as compound 48/80 and numerous basic polypeptides, including a spectrum of neuropeptides, activate human skin mast cells, but not human mast cells from other sites or human basophils ( 144 ).

**TABLE 12.5. Factors That Activate Mediator Secretion from Human Basophils and Mast Cells**

| Stimulation  | Mast Cells        |  | Basophils |
|--|-------------------|--|-----------|
| FcεR and FcγR cross-linkage                                      | +                 | +  |           |
| Compound 48/80   | SMC only          | -  |           |
| Basic polypeptides <sup>a</sup> (includes several neuropeptides) | SMC only          | -  |           |
| Polyarginine   | ±                 | +  |           |
| Anaphylatoxins (C3a, C5a)  | +                 | +  |           |
| FMLP   | -                 | +  |           |
| Lectins (e.g., Concanavalin A)                                   | +                 | +  |           |
| Interleukins/chemokines (CC)/Histamine releasing factors (HRF)   | MIP-1a, IL-1, SCF | IL-1 and -3, GM-CSF, MCP-1 and -3, MIP-1a, RANTES, CCL-7, IL-8, HrHRF, CTAPIII/NAP-2 |           |

CTAP, connective tissue activating peptide; GM-CSF, granulocyte-macrophage colony-stimulating factor; IL, interleukin, MCP, macrophage chemotactic protein; MIP, macrophage inflammatory protein; NAP, neutrophil activating peptide; RANTES, regulated upon activation, normal T-cell expressed and secreted; SCF, stem cell factor; SMC, human skin mast cells; +, yes; ±, some mast cell populations respond, some do not; -, no.

<sup>a</sup> Includes adrenocorticotrophic hormone, melitin, substance P, vasoactive intestinal polypeptide, neurotensin, bradykinin, etc.

Presently, the working model to explain these observations ( 144 ) proposes that human skin and rat peritoneal mast cells possess a nonspecific binding site for these polycationic secretagogues, including neuropeptides such as substance P, that involves the direct activation of Gi-like G-protein, initiating cell activation. Neurogenic vasodilatation produced by an axonal reflex in human skin appears to involve mast cell activation by neuropeptides released from primary afferent nerves ( 144 ). Similar mast cell-dependent neurogenic inflammation has been described in other sites, such as the respiratory ( 146 ) and gastrointestinal tract ( 147 ), and appears to be important in at least some inflammatory and infectious diseases. Most recently, Janiszewski et al. ( 148 ) provided strong evidence that this neurogenic mast cell activation can occur at physiologic doses of substance P, rather than only at pharmacologic doses as has been shown previously for mast cell activation *in vitro* ( 149 ).

In recent years, there has been great interest in observations that basophils and mast cells can be activated by several interleukins, chemokines, and histamine releasing factors ( Table 12.5 ) ( 4 , 6 , 150 , 151 ). However, the significance of these pathways of basophil and mast cell activation *in vivo* in health or disease is becoming increasingly clear, particularly in chronic allergic diseases. The CC chemokines appear to be important in basophil, but there is less information about mast cell activation, whereas SCF is a specific stimulus for

mast cells, acting through the receptor CD117 ( 25 , 35 ). Most recently, Redegeld and colleagues made the intriguing observation that highly purified Ig light chain can sensitize mast cells for antigen-specific activation ( 152 ), providing a molecular mechanism for earlier observations of antigen-specific, but nonantibody-mediated, mast cell activation ( 153 ). Currently, it is not clear how a light chain confers antigen specificity, although the authors reported light chain binding to the mast cell surface. Additional research on the role of such stimuli for mast cells and/or basophils will shed light on the pathogenesis of inflammatory diseases.

### Inhibition of Basophil and Mast Cell Activation

Several antiallergic and antiinflammatory drugs inhibit the release of histamine from human basophils and/or mast cells ( Table 12.6 ) ( 154 , 155 and 156 ). Although such drugs are valuable in the treatment of a variety of inflammatory diseases, their actions are multiple and varied, and it is impossible to define precisely their mode of action. In turn, it is difficult to attribute to one cell type or another an unequivocal role in these inflammatory diseases. Furthermore, given the heterogeneity of mast cells in different tissue sites, and perhaps even at different times during the evolution of an inflammatory insult, (e.g., initial injury, repair phase, chronicity, or remodeling phase), different agents may vary in the nature or extent of their modulatory effects on basophils and mast cells.

**TABLE 12.6. Inhibition of Histamine Secretion from Human Basophils and Mast Cells**

| Drug                                   | Basophils | Mast Cells                    |
|--|-----------|-------------------------------|
| Sodium cromoglycate/nedocromil sodium  | –         | ? (lung); – (skin)            |
| β <sub>2</sub> agonists                | ?         | ?                             |
| Methylxanthines                        | ?         | ?                             |
| Cetirizine (H <sub>1</sub> antagonist) | ?         | ?                             |
| Sulfasalazine or metabolites           | ?         | ?                             |
| Corticosteroids                        | ?         | – (short term); ? (long term) |
| Cyclosporine A/FK506                   | ?         | ?                             |

?, decreased; –, negative.

Given the plethora of functions of cytokines in immune and inflammatory responses, it is not surprising that they have become a focal point to study the modulation of allergic and other inflammatory events. Furthermore, despite some notable exceptions, the postulate that distinct profiles of cytokines (Th1 and Th2) orchestrate these responses ( 157 ) has stimulated a flurry of studies of cytokine regulation of mast cell functions. Selected cytokines modulate mast cell activation and mediator secretion ( Table 12.7 ) and as would be predicted, the Th1-associated cytokine IFN-γ and the related IFN-α/β, inhibit histamine, serotonin, and TNF secretion by mast cells ( 158 , 159 and 160 ). Interestingly, the effects of IFN-γ on mast cell mediator secretion are dependent on exogenous or endogenous nitric oxide ( 161 , 162 ). TGF-β<sub>1</sub> also inhibits histamine and TNF production by rat mast cells ( 163 ). Furthermore, IL-10, often associated with Th2 responses, inhibits TNF and IL-6 production by mast cells ( 164 , 165 and 166 ), but enhances their antigen-induced secretion of histamine ( 166 ). This information, taken together with evidence that histamine, serotonin, and prostaglandin E<sub>2</sub> ( 167 , 168 , 169 and 170 ) also

modulate mediator secretion, suggests that several basophil and mast cell mediators may have autocrine regulatory roles in inflammation.

**TABLE 12.7. Inhibition of Basophil and Mast Cell Activation by Cytokines and Other Factors**

| Factor   | Basophils      | Mast Cells   |
|--|----------------|--|
| Cytokines  |                |  |
| IFN- $\gamma$ , - $\alpha$ / $\beta$                                 | ?<br>Histamine | ? TNF, serotonin, histamine, adhesion                  |
| IL-10  | ?<br>Histamine | ? TNF, IL-6, IFN- $\gamma$                             |
| TGF- $\beta$   | ?              | -/? histamine<br>?TNF, histamine                       |
| Histamine [H <sub>2</sub> and H <sub>3</sub> (mast cells) receptors] | ?<br>Histamine | ? Histamine and TNF                                    |
| Prostaglandin <sub>2</sub>   | ?              | ? Histamine, platelet-activating factor, TNF<br>? IL-6 |

IFN, interferon; IL, interleukin; TGF, tumor growth factor; TNF, tumor necrosis factor;  $\gamma$ , decreased;  $\alpha$ , increased.

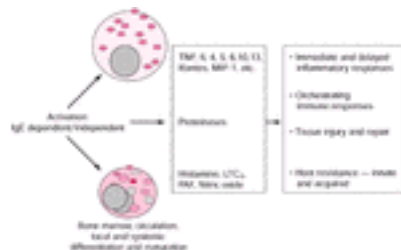
## BASOPHIL AND MAST CELL FUNCTIONS

### Inflammatory Injury and Host Defenses

Investigations of the functions of basophils and mast cells have focused on their roles in allergic and other inflammatory disorders. The highly visible symptoms of IgE-mediated allergic reactions and life-threatening anaphylaxis have directed scientific priorities in studies of basophilic leucocytes. In turn, we have learned a great deal about some aspects of these cells, notably about their activation, inflammatory mediators, and regulation. Numerous drugs are available that inhibit many of their functions, and a wealth of novel approaches are on the horizon that will attempt to exploit endogenous pathways employed by cytokines to regulate allergic and other inflammatory responses ( [163](#), [164](#), [165](#) and [166](#) ). Nevertheless, several challenges remain, including perhaps the most obvious question, why do both basophils and mast cells exist, and what functions distinguish them?

Both basophils and mast cells are central players in allergic inflammation. They share high-affinity receptors for IgE and produce several mediators in common, each with a wealth of potential in the initiation of inflammatory cascades and in the complex cellular and molecular networks involved in injury and repair ( [Fig. 12.4](#) ). In the early phase of the allergic responses, it appears to be critically important that there is a pool of circulating mature basophils, and also a large tissue repository of mast cells. However, basophils and mast cells are not restricted to these sites, as under certain circumstances a large influx of basophils can occur into local tissues [e.g., cutaneous basophilic hypersensitivity ( [171](#) ) and asthma ( [172](#), [173](#) )], and the numbers of mast cell progenitors in the circulation can be increased ( [81](#) ). Cutaneous basophilic hypersensitivity reactions can often be dissociated

in time or in mediator content from allergic inflammation, and also from classic delayed type hypersensitivity; such reactions appear to involve both a T cell–dependent phase in basophil recruitment, as well as a phase that can involve IgE and IgG antibodies that interact with antigens to activate the cells in the tissues ([81](#)).



**Figure 12.4.** Mast cells and basophils in injury and host defense. Summary of the activation of mast cells and basophils, the mediators they produce, and the spectrum of their actions in host defenses and tissue injury. Ig, immunoglobulin; IL, interleukin; LTC, leukotriene C; PAF, platelet–activating factor; TNF, tumor necrosis factor.

The roles of basophils and mast cells in allergic inflammation also differ by some of the stimuli that appear to be important for the activation of each cell type. Some mast cell populations respond to a number of basic secretagogues, including several neuropeptides. Moreover, given the close anatomic association between mast cells and nerves ([174](#)) and abundant evidence for their functional interdependence, it is likely that as a component of allergic and other inflammatory reactions, mast cell–dependent neurogenic pathways are important. There is much less evidence to suggest that neurogenic inflammation is a major pathway in basophil–mediated reactions. However, CC chemokines appear to be important in basophil activation ([Table 12.5](#)).

Because initial reports of the role of mast cells in innate antimicrobial immunity ([175](#), [176](#)) and in the possible role of toll–like receptors, there has been great interest in expression and function of these receptors on mast cells ([9](#), [177](#), [178](#)) and basophils ([6](#), [179](#)). The mechanisms by which engagement of such receptors on mast cells and/or basophils induce cell activation and mediator secretion will be particularly enlightening with regard to their functions. Undoubtedly, the spectrum of mediators produced by these pathways of mast cell and basophil activation will differ from that following IgE–mediated activation in allergic reactions, and will help elucidate the different roles of these two cell types in host defenses and homeostasis.

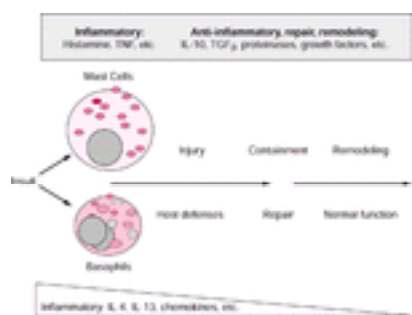
The mediators that are produced by the two types of basophilic leucocytes are another obvious source of similarities and distinctions in their functions. Several mediators are shared (e.g., histamine, LTC<sub>4</sub>, PAF, and others), whereas the cytokine and proteinase profiles of the two cell types are distinct. Although the differences in proteinase content likely hold clues to the functional distinctions between the cell types, we are just beginning to identify some of the substrate specificities of mast cell proteinases or of their functions ([180](#), [181](#)). It is intriguing that an inhibitor of mast cell–specific tryptase has promising bronchodilatory and antiinflammatory effects in a model of allergic asthma ([182](#), [183](#)). Perhaps such drugs will help distinguish between the roles of mast cells and basophils in allergic inflammation. Differences in the cytokine profiles of mast cells and basophils, for example, TNF in mast cells and IL–4 and IL–13 in basophils, may help uncover the unique aspects of the functions of these two cells. These functions could include alterations in the cytokine profiles in the microenvironment that influence the



development of particular local immune and inflammatory responses ( [184](#) ).

### Containment of Injury, Initiation of Repair, Remodeling, and Normal Function

After the initial insult and injury, the inflammatory response elaborates mediators and pathways that minimize the extent of the tissue damage and begin repair processes. Mast cell and basophil mediators are involved in these phases of the response ( [Fig. 12.5](#) ). Histamine, arachidonic acid metabolites, and several cytokines, particularly IL-1, IL-6, IL-10, TNF, and TGF- $\beta$  have several effects on endothelial, epithelial, mesenchymal, and inflammatory cells. Such effects include influences on epithelial integrity and function, regulation of blood flow and vascular permeability, tissue edema, fibroblast proliferation, and biochemical phenotype, etc. Unfortunately, these aspects of the functions of basophils and mast cells are poorly known. The relationship between mast cell activation and fibroblasts and angiogenesis in models of tissue repair and remodeling has been studied ( [185](#) , [186](#) ), and it is obvious that the pathways involved are multifactorial. As experimental models are developed to address these questions, we will begin to understand the role of mast cells and basophils in this “containment and repair phase” of inflammatory injury.



**Figure 12.5.** Model of activities of mast cells and basophils in the sequential responses of tissue injury, containment, repair, and remodeling. IL, interleukin; TGF $\beta$ , tumor growth factor- $\beta$ ; TNF, tumor necrosis factor.

Once the site of injury is contained and repair processes have begun, mast cells and perhaps basophils are likely to be involved in the remodeling of the tissues and the return to normal function. The numerous proteinases of mast cells have distinct substrate specificities and among their functions must be restructuring of the connective tissue, extracellular matrix in the local environment ( [187](#) , [188](#) ). Cytokines, such as TGF- $\beta$ , IL-1, and IL-6, that influence the activities of fibroblasts are likely to be important candidates for this remodeling phase in the responses to injury. Given the lifespan and normal distribution of mast cells and basophils, an attractive hypothesis is that in this simplified model of tissue injury, containment, and remodeling, basophils play a particularly important role in the injury phase, but that their importance in the latter phases is minimal. By contrast, mast cells are undoubtedly important in the injury phase, but also in the containment and remodeling phases. Given the plasticity of mast cell phenotype, it may be that there is a general pattern of expression of functionally linked clusters of mast cell genes that in a carefully orchestrated manner facilitate the evolving roles of local mast cell populations in the phases of injury, containment, and repair.

### Dynamic Equilibrium and Homeostasis

In addition to the evolving mast cell phenotype in the sequence of injury, repair, and



remodeling, some phenotypes of mast cells are involved in normal tissue homeostasis. Neurogenic and endocrine activation of mast cells occurs at subtle physiologic, rather than pharmacologic, levels of activity ( [189](#), [190](#) ). This aspect of mast cell function is not well understood, but there is a wide and fascinating literature on these cells in such diverse processes as sexual behavior, implantation, parturition, neuroendocrine signaling (e.g., thyroid and adrenal function), hypothalamic–pituitary–adrenal axis, gastric acid secretion, metabolism of bone, central nervous system functions, and myelopoiesis. Furthermore, given the prominent anatomic association between mast cells and the vasculature, and the effects of mast cell products on blood flow, permeability, and leucocyte adhesion and diapedesis in inflammation ( [191](#) ), it is widely held that one normal physiologic role of mast cells is in the dynamic regulation of tissue perfusion and the chemical and cellular composition of extravascular spaces. To date, little direct evidence exists that basophils exhibit similar functions, although given that they produce several potent mediators known to have such effects, it is possible that they exhibit such effects outside of acute inflammatory injury. However, it is the mast cell literature that suggests these cells are prominent in these more physiologic activities, whereas the basophil appears to be a rapid, circulating response that can be recruited to sites of injury.

It is an exciting time to be involved in biomedical research on basophilic leucocytes. The tools available to ask critically important questions are constantly improving ( [6](#), [132](#) ) and as a result our conceptual overview of function is improving and our ability to use this knowledge to treat allergic and other inflammatory conditions or myeloproliferation disorders is improving. The next several years promise to hold exciting advances in the field.

## REFERENCES

1. Selye H. The mast cells. Washington: Butterworth–Heinemann, 1965.
2. Galli SJ, Dvorak AM, Dvorak HF. Basophils and mast cells: morphologic insights into their biology, secretory patterns, and function. *Prog Allergy* 1984;34:1–141.
3. Födinger M, Mannhalter C. Molecular genetics and development of mast cells: implications for molecular medicine. *Mol Med Today* 1997;3:131–137.
4. Metcalfe DD, Baram D, Mekori Y. Mast cells. *Physiol Rev* 1997;77:1033–1079.
5. Mécheri S, David B. Unraveling the mast cell dilemma: culprit or victim of its generosity? *Immunol Today* 1997;18:212–215.
6. Falcone FH, Haas H, Gibbs BF. The human basophil: a new appreciation of its role in immune responses. *Blood* 2000;96:4028–4038.
7. Ott VL, Cambier JC. Molecular mechanisms in allergy and clinical immunology. *J Allergy Clin Immunol* 2000;106:429–440.
8. Kawakami T, Galli SJ. Regulation of mast–cell and basophil function and survival by IgE. *Nat Rev Immunol* 2002;2:773–786.
9. Féger F, Varadaradjalou S, Gao Z, et al. The role of mast cells in host defense and their subversion by bacterial pathogens. *Trends Immunol* 2002;23:151–158.
10. Katz HR. Inhibitory receptors and allergy. *Curr Opin Immunol* 2002;14:698–704.
11. Rivera J, Cordero JR, Furumoto Y, et al. Macromolecular protein signaling complexes and mast cell responses: a view of the organization of IgE–dependent mast cell signaling. *Mol Immunol* 2002;38:1253–1258.
12. Stenton GR, Befus AD. Intestinal mast cells. In: Challacombe SJ, Brostoff J, eds. Food allergy and

intolerance, 2nd ed. London: Harcourt Brace & Company Ltd., 2002;85–102.

13. Kinet JP. The high-affinity IgE receptor (FcεRI): from physiology to pathology. *Annu Rev Immunol* 1999;17:931–972.
14. Dvorak AM, Warner JA, Fox P, et al. Recovery of human basophils after fMLP-stimulated secretion. *Clin Exp Allergy*, 1996;26:281–294.
15. Dvorak AM. Human mast cells. In: Beck F, Hild W, Kriz W, et al., eds. *Advances in anatomy, embryology and cell biology*. Leicester: Springer-Verlag, 1989.
16. Dvorak AM. Basophil and mast cell degranulation and recovery. In: Harris JR, ed. *Blood cell biochemistry*. New York, London: Plenum Publishing, 1991.
17. Dvorak AM. Ultrastructural analysis of human mast cells and basophils. *Human basophils and mast cells: biological aspects*. *Chem Immunol* 1995;61:1–33.
18. Raposo G, Tenza D, Mecheri S, et al. Accumulation of major histocompatibility complex class II molecules in mast cell secretory granules and their release upon degranulation. *Mol Biol Cell* 1997;8:2361–2645.
19. Dvorak AM, Morgan ES, Lichtenstein LM, et al. RNA is closely associated with human mast cell secretory granules, suggesting a role(s) for granules in synthetic processes. *J Histochem Cytochem* 2000;48:1–12.
20. Moqbel R, Lacy P. Exocytotic events in eosinophils and mast cells. *Clin Exp Allergy* 1999;29:1017–1022.
21. Arock M, Schneider E, Boissan M, et al. Differentiation of human basophils: an overview of recent advances and pending questions. *J Leukoc Biol* 2002;71:557–564.
22. Dy M, Pacilio M, Arnould A, et al. Modulation of histidine decarboxylase activity and cytokine synthesis in human leukemic cell lines: relationship with basophilic and/or megakaryocytic differentiation. *Exp Hematol* 1999;27:1295–1305.
23. Li L, Li Y, Reddel SW, et al. Identification of basophilic cells that express mast cell granule proteases in the peripheral blood of asthma, allergy, and drug-reactive patients. *J Immunol* 1998;161:5079–5086.
24. Lantz CS, Boesiger J, Song CH, et al. Role for interleukin-3 in mast-cell and basophil development and in immunity to parasites. *Nature* 1998;392:90–93.
25. Saito H, Hatake K, Dvorak AM, et al. Selective differentiation and proliferation of hematopoietic cells induced by recombinant human interleukins. *Proc Natl Acad Sci U S A* 1988;85:2288–2292.
26. Irani AM, Nilsson G, Miettinen U, et al. Recombinant human stem cell factor stimulates differentiation of mast cells from dispersed human fetal liver cells. *Blood* 1992;80:3009–3021.
27. Valent P, Spanblochl E, Sperr WR, et al. Induction of differentiation of human mast cells from bone marrow and peripheral blood mononuclear cells by recombinant human stem cell factor/kit-ligand in long-term culture. *Blood* 1992;80:2237–2245.
28. Mitsui H, Furitsu T, Dvorak AM, et al. Development of human mast cells from umbilical cord blood cells by recombinant human and murine c-kit ligand. *Proc Natl Acad Sci U S A* 1993;90:735–739.
29. Quackenbush EJ, Wershil BK, Aguirre V, et al. Eotaxin modulates myelopoiesis and mast cell development from embryonic hematopoietic progenitors. *Blood* 1998;92:1887–1897.
30. Saito H, Ebisawa M, Sakaguchi N, et al. Characterization of cord-blood-derived human mast cells cultured in the presence of Steel factor and interleukin-6. *Int Arch Allergy Immunol* 1995;107:63–65.
31. Mwamtemi HH, Koike K, Kinoshita T, et al. An increase in circulating mast cell colony-forming cells in asthma. *J Immunol* 2001;166:4672–4677.

32. Sawai N, Koike K, Mwanemtemi HH, et al. Thrombopoietin augments stem cell factor-dependent growth of human mast cells from bone marrow multipotential haemopoietic progenitors. *Blood* 1999;93:3703-3712.
33. Welker P, Grabbe J, Gibbs B, et al. Nerve growth factor- $\beta$  induces mast-cell marker expression during in vitro culture of human umbilical cord blood cells. *Immunology* 2000;99:418-426.
34. Matsuda H, Coughlin MD, Bienenstock J, et al. Nerve growth factor promotes human haemopoietic colony growth and differentiation. *Proc Natl Acad Sci U S A* 1988;85:6508-6512.
35. Galli SJ, Zsebo KM, Geissler EN. The kit ligand, stem cell factor. *Adv Immunol* 1994;55:1-96.
36. Piao X, Bernstein A. A point mutation in the catalytic domain of c-kit induces growth factor independence, tumorigenicity, and differentiation of mast cells. *Blood* 1996;87:3117-3123.
37. Kitamura Y, Morii E, Jippo T, et al. Regulation of mast cell phenotype by MITF. *Int Arch Allergy Immunol* 2002;127:106-109.
38. Féger F, Dumas AR, Leriche L, et al. Kit and c-kit mutations in mastocytosis: a short overview with special reference to novel molecular and diagnostic concepts. *Int Arch Allergy Immunol* 2002;127:110-114.
39. Valent P, Schmidt G, Besemer J, et al. Interleukin-3 is a differentiation factor for human basophils. *Blood* 1989;73:1763-1769.
40. Donohue RE, Seehra J, Metzger M, et al. Human IL-3 and GM-CSF act synergistically in stimulating hematopoiesis in primates. *Science* 1988;241:1820-1823.
41. Bischoff SC, Krieger M, Brunner T, et al. RANTES and related chemokines activate human basophil granulocytes through different G protein-coupled receptors. *Eur J Immunol* 1993;23:761-767.
42. Metcalfe D. Hematopoietic regulators: redundancy or subtlety? *Blood* 1993;82:3515-3519.
43. Beghini A, Cairolì R, Morra E, et al. *In vivo* differentiation of mast cells from acute myeloid leukemia blasts carrying a novel activating ligand-independent c-kit mutation. *Blood Cells Mol Dis* 1998;24:262-270.
44. Li CY, Baek JY. Mastocytosis and fibrosis: role of cytokines. *Int Arch Allergy Immunol* 2002;127:123-126.
45. Nishida K, Wang L, Morii E, et al. Requirement of Gab2 for mast cell development and KitL/c-Kit signaling. *Blood* 2002;99:1866-1869.
46. O'Laughlin-Bunner B, Radosevic N, Taylor ML, et al. Lyn is required for normal stem cell factor-induced proliferation and chemotaxis of primary hematopoietic cells. *Blood* 2001;98:343-350.
47. Du Z, Li Y, Xia H, et al. Recombinant human granulocyte-macrophage colony-stimulating factor (CSF), but not recombinant human granulocyte CSF, down-regulates the recombinant human stem cell factor-dependent differentiation of human fetal liver-derived mast cells. *J Immunol* 1997;159:838-845.
48. Kitamura Y, Tsujimura T, Jippo T, et al. Regulation of development, survival and neoplastic growth of mast cells through the c-kit receptor. *Int Arch Allergy Immunol* 1995;107:54-56.
49. Pharr PN, Hofbauer A. Loss of flk-2/flt3 expression during commitment of multipotent mouse hematopoietic progenitor cells to the mast cell lineage. *Exp Hematol* 1997;25:620-628.
50. Kinoshita T, Koike K, Mwanemtemi H, et al. Retinoic acid is a negative regulator for the differentiation of cord blood-derived human mast cell progenitors. *Blood* 2000;95:2821-2828.
51. Kirshenbaum AS, Worobec AS, Davis TA, et al. Inhibition of human mast cell growth and differentiation by interferon gamma-1b. *Exp Hematol* 1998;26:245-251.
52. Irani AM, Craig SS, DeBlois G, et al. Deficiency of the tryptase-positive, chymase-negative mast cell type in gastrointestinal mucosa of patients with defective T lymphocyte function. *J Immunol*

1987;138:4381-4386.

53. Kirshenbaum AS, Goff JP, Dreskin SC, et al. IL-3-dependent growth of basophil-like and mast-like cells from human bone marrow. *J Immunol* 1989;142:2424-2429.
54. Gurish MF, Ghildyal N, McNeil HP, et al. Differential expression of secretory granule proteases in mouse mast cells exposed to interleukin 3 and c-kit ligand. *J Exp Med* 1992;175:1003-1012.
55. Lantz CS, Huff TF. Murine KIT<sup>+</sup> lineage-bone marrow progenitors express Fc $\epsilon$ RII but do not express FcRI until mast cell granule formation. *J Immunol* 1995;154:355-362.
56. Rottem M, Okada T, Goff JP, et al. Mast cells cultured from the peripheral blood of normal donors and patients with mastocytosis originate from a CD34<sup>+</sup>/Fc epsilon RI<sup>-</sup> cell population. *Blood* 1994;84:2489-2496.
57. Rodewald HR, Dessing M, Dvorak AM, et al. Identification of a committed precursor for the mast cell lineage. *Science* 1996;271:818-822.
58. Nakano T, Sonoda T, Hayashi C, et al. Fate of bone marrow-derived cultured mast cells after intracutaneous intraperitoneal and intravenous transfer into genetically mast cell-deficient W/W<sup>v</sup> mice. Evidence that cultured mast cells can give rise to both connective tissue type and mucosal mast cells. *J Exp Med* 1985;162:1025-1043.
59. Reynolds DS, Serafin WE, Faller DV, et al. Immortalization of murine connective tissue-type mast cells at multiple stages of their differentiation by coculture of splenocytes with fibroblasts that produce Kirsten sarcoma virus. *J Biol Chem* 1988;263:12783-12791.
60. Tsai M, Shih LS, Newlands GFJ, et al. The rat c-kit ligand, stem cell factor, induces the development of connective tissue-type and mucosal mast cells in vivo. Analysis by anatomical distribution, histochemistry, and protease phenotype. *J Exp Med* 1991;174:125-131.
61. Rottem M, Barbieri S, Kinet JP, Metcalfe DD. Kinetics of the appearance of FcRI-bearing cells in interleukin-3-dependent mouse bone marrow cultures: correlation with histamine content and mast cell maturation. *Blood* 1992;79:972-980.
62. Mayani H, Dragowska W, Landsdorp PM. Characterization of functionally distinct subpopulations of CD34<sup>+</sup> cord blood cells in serum-free long-term cultures supplemented with hematopoietic cytokines. *Blood* 1993;82:2664-2672.
63. Sorden SD, Castleman WL. Virus-induced increases in bronchiolar mast cells in brown Norway rats are associated with both local mast cell proliferation and increases in blood mast cell precursors. *Lab Invest* 1995;73:197-204.
64. Denburg JA, Befus AD, Bienenstock J. Growth and differentiation in vitro of mast cells from mesenteric lymph nodes of *Nippostrongylus brasiliensis*-infected rats. *Immunology* 1980;41:195-202.
65. Valent P, Spanblochl E, Bankl HC, et al. Kit ligand/mast cell growth factor-independent differentiation of mast cells in myelodysplasia and chronic myeloid leukemic blast crisis. *Blood* 1994;84:4322-4332.
66. Hutt-Taylor SR, Harnish D, Richardson M, et al. Sodium butyrate and a T lymphocyte cell line-derived differentiation factor induce basophilic differentiation of the human promyelocytic leukemia cell line HL-60. *Blood* 1988;71:209-215.
67. Butterfield JH, Weiler D, Dewald G, Gleich GJ. Establishment of an immature mast cell line from a patient with mast cell leukemia. *Leuk Res* 1988;12:345-355.
68. Shimizu N, Kita K, Masuya M, et al. Cellular characteristics of chronic myelocytic leukemia basophilic crisis cells: phenotype, responsiveness to and receptor gene expression for various kinds of growth factors and cytokines. *Exp Hematol* 1993;21:119-125.
69. Tallman MS, Hakimian D, Snower D, et al. Basophilic differentiation in acute promyelocytic leukemia. *Leukemia* 1993;7:521-526.
70. Agis H, Willheim M, Sperr WR, et al. Monocytes do not make mast cells when cultured in the presence of SCF. Characterization of the circulating mast cell progenitor as a c-kit<sup>+</sup>, CD34<sup>+</sup>, Ly<sup>-</sup>, CD14<sup>-</sup>, CD17<sup>-</sup>,

colony-forming cell. *J Immunol* 1993;151:4221-4227.

71. Blom T, Nilsson G, Sundstrom C, et al. Characterization of a human basophil-like cell line (LAMA-84). *Scand J Immunol* 1996;44:54-61.

72. Nilsson G, Blom T, Kusche-Gullberg M, et al. Phenotypic characterization of the human mast-cell line HMC-1. *Scand J Immunol* 1994;39:489-498.

73. Samorapoompichit P, Kiener HP, Schernthaner GH, et al. Detection of tryptase in cytoplasmic granules of basophils in patients with chronic myeloid leukemia and other myeloid neoplasms. *Blood* 2001;98:2580-2583.

74. Buhning HJ, Simmons PJ, Pudney M, et al. The monoclonal antibody 97A6 defines a novel surface antigen expressed on human basophils and their multipotent and unipotent progenitors. *Blood* 1999;94:2343-2356.

75. Denburg JA, Richardson M, Telizyn S, et al. Basophil/mast cell precursors in human peripheral blood. *Blood* 1983;61:775-780.

76. Denburg JA, Wilson WEC, Bienenstock J. Basophil production in myeloproliferative disorders: increases during acute blastic transformation of chronic myeloid leukemia. *Blood* 1982;60:113-120.

77. Denburg JA, Telizyn S, Messner H, et al. Heterogeneity of human peripheral blood eosinophil-type colonies: evidence for a common basophil-eosinophil progenitor. *Blood* 1985;66:312-318.

78. Leary AG, Ogawa M. Identification of pure and mixed basophil colonies in culture of human peripheral blood and marrow cells. *Blood* 1984;64:78-83.

79. Otsuka H, Dolovich J, Richardson M, et al. Metachromatic cell progenitors and specific growth and differentiation factors in human nasal mucosa and polyps. *Am Rev Respir Dis* 1987;136:710-717.

80. Denburg JA, Silver JE, Abrams JS. Interleukin-5 is a human basophilopoietin: induction of histamine content and basophilic differentiation of HL-60 cells and of peripheral blood basophil-eosinophil progenitors. *Blood* 1991;77:1462-1468.

81. Denburg JA. Basophil and mast cell lineages in vitro and in vivo. *Blood* 1992;79:846-860.

82. Kinoshita T, Sawai N, Hidaka E, et al. Interleukin-6 directly modulates stem cell factor-dependent development of human mast cells derived from CD34<sup>+</sup> cord blood cells. *Blood* 1999;94:496-508.

83. Tsai S, Collins SJ. A dominant negative retinoic acid receptor blocks neutrophil differentiation at the promyelocyte stage. *Proc Natl Acad Sci U S A* 1993;90:7153-7157.

84. Leber B, Denburg JA. Retinoic acid modulation of induced basophil differentiation. *Allergy* 1997;52:1201-1206.

85. Sillaber C, Geissler K, Scherrer R, et al. Type beta transforming growth factors promote interleukin-3 (IL-3)-dependent differentiation of human basophils but inhibits IL-3-dependent differentiation of human eosinophils. *Blood* 1992;80:634-641.

86. Elefanty AG, Cory S. bcr-abl-Induced cell lines can switch from mast cell to erythroid or myeloid differentiation in vitro. *Blood* 1992;79:1271-1281.

87. von Ruden T, Stingl L, Ullrich A, et al. Rescue of W-associated mast cell defects in W/W<sup>v</sup> bone marrow cells by ectopic expression of normal and mutant epidermal growth factor receptors. *Blood* 1993;82:1463-1470.

88. von Ruden T, Kandels S, Radaszkiewicz T, et al. Development of a lethal mast cell disease in mice reconstituted with bone marrow cells expressing the v-erbB oncogene. *Blood* 1992;79:3145-3158.

89. Saito H, Hayakawa T, Mita H, et al. PAF-induced eosinophilic and basophilic differentiation in human hematopoietic precursor cells. *J Lipid Mediat* 1992;5:135-137.

90. Costa JJ, Demetri GD, Harrist TJ, et al. Recombinant human stem cell factor (kit ligand) promotes human mast cell and melanocyte hyperplasia and functional activation *in vivo*. *J Exp Med* 1996;183:2681–2686.
91. Ihle JN, Keller J, Oroszlan S, et al. Biological properties of homogeneous interleukin 3. I. Demonstration of WEHI-3 growth factor activity, mast cell growth factor activity, P cell-stimulating factor activity, colony-stimulating factor activity, and histamine-producing cell stimulating factor activity. *J Immunol* 1983;131:282–287.
92. Sanderson CJ, Warren DJ, Strath M. Identification of a lymphokine that stimulates eosinophil differentiation *in vitro*. Its relationship to interleukin 3, and functional properties of eosinophils produced in culture. *J Exp Med* 1985;162:60–74.
93. Plaetinck G, Van der Heyden J, Tavernier J, et al. Characterization of interleukin 5 receptors on eosinophilic sublines from human promyelocytic leukemia (HL-60) cells. *J Exp Med* 1990;172:683–691.
94. Denburg JA, Finotto S, Marshall JS, et al. Mast cells, stromal cells and inflammation. In: Kaliner MA, Metcalfe DD, eds. *The mast cell in health and disease*. New York: Marcel Dekker, 1993:743–761.
95. Broide DH, Wasserman SI, Alvaro-Garcia J, et al. Transforming growth factor- $\beta$ 1 selectively inhibits IL-3-dependent mast cell proliferation without affecting mast cell function or differentiation. *J Immunol* 1989;143:1591–1597.
96. Sillaber C, Strobl H, Bevec D, et al. IL-4 regulates c-kit proto-oncogene product expression in human mast and myeloid progenitor cells. *J Immunol* 1991;147:4224–4228.
97. Takagi M, Koike K, Nakahata T. Antiproliferative effect of IFN- $\gamma$  on proliferation of mouse connective tissue-type mast cells. *J Immunol* 1990;145:1880–1884.
98. Li Y, Li L, Wadley R, et al. Mast cells/basophils in the peripheral blood of allergic individuals who are HIV-1 susceptible due to their surface expression of CD4 and the chemokine receptors CCR3, CCR5, and CXCR4. *Blood* 2001;97:3484–3490.
99. Nomura I, Katsunuma T, Matsumoto K, et al. Human mast cell progenitors in peripheral blood from atopic subjects with high IgE levels. *Clin Exp Allergy* 2001;31:1424–1431.
100. Denburg JA, Telizyn S, Belda A, et al. Increased numbers of circulating basophil progenitors in atopic patients. *J Allergy Clin Immunol* 1985;76:466–472.
101. Otsuka H, Dolovich J, Befus AD, et al. Peripheral blood basophils, basophil progenitors, and nasal metachromatic cells in allergic rhinitis. *Am Rev Respir Dis* 1986;133:757–762.
102. Otsuka H, Dolovich J, Richardson M, et al. Metachromatic cell progenitors and specific growth and differentiation factors in human nasal mucosa and polyps. *Am Rev Respir Dis* 1987;136:710–717.
103. Gibson PG, Manning PJ, O'Byrne PM, et al. Allergen-induced asthmatic responses: relationship between increases in airway responsiveness and increases in circulating eosinophils, basophils, and their progenitors. *Am Rev Respir Dis* 1991;143:331–335.
104. Sehmi R, Wood LJ, Watson R, et al. Allergen-induced increases in IL-5 receptor  $\alpha$ -subunit expression on bone marrow-derived CD34<sup>+</sup> cells from asthmatic subjects. A novel marker of progenitor cell commitment toward eosinophilic differentiation. *J Clin Invest* 1997;100:2466–2475.
105. Sehmi R, O'Byrne PM, Dorman S, et al. Upregulation of eotaxin receptor, CCR3, on bone marrow CD34<sup>+</sup> progenitor cells following allergen-inhalation challenge in asthmatic subjects: a mechanism of progenitor cell egress from the bone marrow during allergic inflammation. *J Allergy Clin Immunol* 2001;107:S324.
106. Suda T, Suda J, Miura Y, et al. Clonal analysis of basophil differentiation in bone marrow cultures from a Down's syndrome patient with megakaryoblastic leukemia. *Blood* 1985;66:1278–1283.
107. Prokocimer M, Polliack A. Increased bone marrow mast cells in preleukemic syndromes, acute

leukemia, and lymphoproliferative disorders. *Am J Clin Pathol* 1981;75:34–38.

108. Martin DIK, Zon LI, Mutter G, et al. Expression of an erythroid transcription factor in megakaryocytic and mast cell lineages. *Nature* 1990;344:444–447.

109. Green AR, Lints T, Visvader J, et al. SCL is coexpressed with GATA-1 in hemopoietic cells but is also expressed in developing brain. *Oncogene* 1992;7:653–660.

110. Visvader JE, Elefanty AG, Strasser A, et al. GATA-1 but not SCL induces megakaryocytic differentiation in an early myeloid line. *EMBO J* 1992;11:4557–4564.

111. Jippo T, Mizuno H, Xu Z, et al. Abundant expression of transcription factor GATA-2 in proliferating but not in differentiated mast cells in tissues of mice: demonstration by in situ hybridization. *Blood* 1996;87:993–998

112. Tsai FY, Orkin SH. Transcription factor GATA-2 is required for proliferation/survival of early hematopoietic cells and mast cell formation, but not for erythroid and myeloid terminal differentiation. *Blood* 1997;89:3636–3643.

113. Lyman SD, Brasel K, Rousseau AM, et al. The flt3 ligand: a hematopoietic stem cell factor whose activities are distinct from steel factor. *Stem Cells* 1994;12[Suppl 1]:99–110.

114. Soler J, O'Brien M, deCastro JT, et al. Blast crisis of chronic granulocytic leukemia with mast cell and basophil precursors. *Am J Clin Pathol* 1985;83:254–259.

115. Le Beau MM, Larson RA, Bitter MA, et al. Association of an inversion of chromosome 16 with abnormal marrow eosinophils in acute myelomonocytic leukemia: a unique cytogenetic–clinicopathological association. *N Engl J Med* 1983;309:630–636.

116. Gotoh H, Murakami S, Oku N, et al. Translocations t(15;17) and t(9;14)(q34;q22) in a case of acute promyelocytic leukemia with increased number of basophils. *Cancer Genet Cytogenet* 1988;36:103–107.

117. Pearson MG, Vardiman JW, Le Beau MM, et al. Increased numbers of marrow basophils may be associated with a t(6;9) in ANLL. *Am J Hematol* 1985;18:393–403.

118. Yamagata T, Miwa A, Eguchi M, et al. Transformation into acute basophilic leukaemia in a patient with myelodysplastic syndrome. *Br J Haematol* 1995;89:650–652.

119. Bodger MP, Morris CM, Kennedy MA, et al. Basophils (Bsp-1+) derive from the leukemic clone in human myeloid leukemias involving the chromosome breakpoint 9q34. *Blood* 1989;73:777–781.

120. Nilsson G, Carlsson M, Jones I, et al. TNF- $\alpha$  and IL-6 induce differentiation in the human basophilic leukaemia cell line KU812. *Immunology* 1994;81:73–78.

121. Le Beau MM, Lemons RS, Espinosa R III, et al. Interleukin-4 and interleukin-5 map to human chromosome 5 in a region encoding growth factors and receptors and are deleted in myeloid leukemias with a del(5q). *Blood* 1989;73:647–650.

122. van Leeuwen BH, Martinson ME, Webb GC, et al. Molecular organization of the cytokine gene cluster, involving the human IL-3, IL-4, IL-5 and GM-CSF genes, on human chromosome 5. *Blood* 1989;73:1142–1148.

123. Longley BJ, Jr., Morganroth GS, Tyrrell L, et al. Altered metabolism of mast-cell growth factor (c-*kit* ligand) in cutaneous mastocytosis. *N Engl J Med* 1993;328:1302–1307.

124. Agis H, Fureder W, Bankl HC, et al. Comparative immunophenotypic analysis of human mast cells, blood basophils and monocytes. *Immunology* 1996;87:535–543.

125. Ghannadan M, Hauswirth AW, Scherthaner GH, et al. Detection of novel CD antigens on the surface of human mast cells and basophils. *Int Arch Allergy Immunol* 2002;127:299–307.

126. Toba K, Koike T, Shibata A, et al. Novel technique for the direct flow cytofluorometric analysis of human basophils in unseparated blood and bone marrow, and the characterization of phenotype and



peroxidase of human basophils. *Cytometry* 1999;35:249–259.

127. Tkaczyk C, Metcalfe DD, Gilfillan AM. Fc $\gamma$ RI and other Fc receptors on human mast cells. Alternative paradigms for the regulation of mast-cell activation. *ACI International* 2002;14:109–116.

128. McKenzie SE and Schreiber AD. Fc gamma receptors in phagocytes. *Curr Opin Hematol* 1998;5:16–21.

129. Takai T, Ono M, Hikida M, et al. Augmented humoral and anaphylactic responses in Fc RII-deficient mice. *Nature* 1996;379:346–349.

130. Kepley CL, Cambier JC, Morel PA, et al. Negative regulation of Fcepsilon RI signaling by FcgammaRII costimulation in human blood basophils. *J Allergy Clin Immunol* 2000;106:337–348.

131. Bianchine PJ, Metcalfe DD. Adhesion molecules and their relevance in understanding the biology of the mast cell. In: Kitamura Y, Yamamoto S, Galli SJ, et al., eds. *Biological and molecular aspects of mast cell and basophil differentiation and function*. New York: Raven Press, 1995:139–147.

132. Williams CMM, Galli SJ. The diverse potential effector and immunoregulatory roles of mast cells in allergic disease. *J Allergy Clin Immunol* 2000;105:847–859.

133. Irani AMA, Schwartz LB. Neutral proteases as indicators of human mast cell heterogeneity. In: Schwartz LB, ed. *Neutral proteases of mast cells*. Basel: Karger, 1990:146–162.

134. Miller HR, Pemberton AD. Tissue-specific expression of mast cell granule serine proteinases and their role in inflammation in the lung and gut. *Immunology* 2002;105:375–390.

135. Lutzelschwab C, Pejler G, Aveskogh M, et al. Secretory granule proteases in rat mast cells. Cloning of 10 different serine proteases and a carboxypeptidase A from various rat mast cell populations. *J Exp Med* 1997;185:13–29.

136. Huang C, Sali A, Stevens RL. Regulation and function of mast cell proteases in inflammation. *J Clin Immunol* 1998;18:169–183.

137. Oliveira SH, Lukacs NW. Stem cell factor and IgE-stimulated murine mast cells produce chemokines (CCL2, CCL17, CCL22) and express chemokine receptors. *Inflamm Res* 2001;3:168–174.

138. Wakahara S, Fujii Y, Nakao T, et al. Gene expression profiles for Fc epsilon RI, cytokines and chemokines upon Fc epsilon RI activation in human cultured mast cells derived from peripheral blood. *Cytokine* 2001;16:143–152.

139. Skaper SD, Pollock M, Facci L. Mast cells differentially express and release active high molecular weight neurotrophins. *Brain Res Mol Brain Res* 2001;97:177–185.

140. Sayama K, Diehn M, Matsuda K, et al. Transcriptional response of human mast cells stimulated via the Fc $\epsilon$ RI and identification of mast cells as a source of IL-11. *BMC Immunol* 2002;3:1–5.

141. Nakajima T, Inagaki N, Tanaka H, et al. Marked increase in CC chemokine gene expression in both human and mouse mast cell transcriptomes following Fcepsilon receptor I cross-linking: an interspecies comparison. *Blood* 2002;100:3861–3868.

142. King CA, Anderson R, Marshall JS. Dengue virus selectively induces human mast cell chemokine production. *J Virol* 2002;76:8408–8419.

143. Hosoda M, Yamaya M, Suzuki T, et al. Effects of rhinovirus infection on histamine and cytokine production by cell lines from human mast cells and basophils. *J Immunol* 2002;169:1482–1491.

144. Foreman J. Non-immunological stimuli of mast cells and basophil leucocytes. In: Foreman J, ed. *Immunopharmacology of mast cells and basophils*. London: Academic Press, 1993:57–69.

145. Forsythe P, Ennis M. Clinical consequences of mast cell heterogeneity. *Inflamm Res* 2000;49:147–154.

146. Barnes PJ, Belvisi MG, Rogers DF. Modulation of neurogenic inflammation: novel approaches to inflammatory disease. *Trends Pharmacol Sci* 1990;11:185–189.
147. Pothoulakis C, Castagliuolo I, LaMont JT. Nerves and intestinal mast cells modulate responses to enterotoxins. *News Physiol Sci* 1998;13:58–63.
148. Janiszewski J, Bienenstock J, Blennerhassett MG. Picomolar doses of substance P trigger electrical responses in mast cells without degranulation. *Am J Physiol* 1994;267:C138–C145.
149. Shanahan F, Denburg J, Fox J, et al. Mast cell heterogeneity: effects of neuroenteric peptides on histamine release. *J Immunol* 1985;135:1331–1337.
150. Alam R, Grant JA. The chemokines and the histamine-releasing factors: modulation of function of basophils, mast cells and eosinophils. In: Marone G, ed. *Human basophils and mast cells: biological aspects*. Basel: Karger, 1995:72–87.
151. MacDonald SM, Rafnar T, Langdon J, et al. Molecular identification of an IgE-dependent histamine-releasing factor. *Science* 1995;269:688–690.
152. Redegeld F, van der Heijden MW, Kool M, et al. Immunoglobulin-free light chains elicit immediate hypersensitivity-like responses. *Nat Med* 2002;8:694–701.
153. Askenase PW, Rosenstein RW, Ptak W. T cells produce an antigen-binding factor with in vivo activity analogous to IgE antibody. *J Exp Med* 1983;157:862–873.
154. Okayama Y, Church MK. Drugs modifying the responses of mast cells and basophils. In: Foreman J, ed. *Immunopharmacology of mast cells and basophils*. London: Academic Press, 1993:139–152.
155. Marone G, Spadaro G, Genovese A. Pharmacological modulation of human mast cell and basophil secretion *in vitro* and *in vivo*. In: Kitamura Y, Yamamoto S, Galli SJ, et al., eds. *Biological and molecular aspects of mast cell and basophil differentiation and function*. New York: Raven Press, 1995:193–210.
156. Fox CC, Moore WC, Lichtenstein LM. Modulation of mediator release from human intestinal mast cells by sulfasalazine and 5-aminosalicylic acid. *Dig Dis Sci* 1991;36:179–184.
157. Mosmann TR, Sad S. The expanding universe of T-cell subsets: Th1, Th2 and more. *Immunol Today* 1996;17:103–148.
158. Swieter M, Ghali WA, Rimmer C, et al. Interferon- $\alpha\beta$  inhibits IgE-dependent histamine release from rat mast cells. *Immunology* 1988;66:606–610.
159. Coleman JW, Buckley MG, Holliday MR, et al. Interferon-gamma inhibits serotonin release from mouse peritoneal mast cells. *Eur J Immunol* 1991;21:2559–2564.
160. Bissonnette EY, Befus AD. Inhibition of mast cell-mediated cytotoxicity by IFN- $\alpha/\beta$  and  $-\gamma$ . *J Immunol* 1990;145:3385–3390.
161. Forsythe P, Gilchrist M, Kulka M, et al. Mast cells and nitric oxide: control of production, mechanisms of response. *Int Immunopharmacol* 2001;1:1525–1541.
162. Coleman JW. Nitric oxide: a regulator of mast cell activation and mast cell-mediated inflammation. *Clin Exp Immunol* 2002;129:4–10.
163. Bissonnette EY, Enciso A, Befus AD. TGF- $\beta_1$  inhibits the release of histamine and tumor necrosis factor- $\alpha$  from mast cells through an autocrine pathway. *Am J Respir Cell Mol Biol* 1997;16:275–282.
164. Arock M, Zuany-Amorim C, Singer M, et al. Interleukin-10 inhibits cytokine generation from mast cells. *Eur J Immunol* 1996;26:166–170.
165. Marshall JS, Leal-Berumen I, Nielsen L, et al. Interleukin (IL)-10 inhibits long-term IL-6 production but not preformed mediator release from rat peritoneal mast cells. *J Clin Invest* 1996;97:1122–1128.

166. Lin TJ, Befus AD. Differential regulation of mast cell function by interleukin-10 and stem cell factor. *J Immunol* 1997;159:4015-4023.
167. Lichtenstein LM, Gillespie E. The effects of the H<sub>1</sub> and H<sub>2</sub> antihistamines on "allergic" histamine release and its inhibition by histamine. *J Pharmacol Exp Ther* 1975;192:441-450.
168. Bissonnette EY. Histamine inhibits TNF- $\alpha$  release by mast cells through H<sub>2</sub> and H<sub>3</sub> receptors. *Am J Respir Cell Mol Biol* 1996;14:620-626.
169. Hogaboam CM, Bissonnette EY, Chin BC, et al. Prostaglandins inhibit inflammatory mediator release from rat mast cells. *Gastroenterology* 1993;104:122-129.
170. Leal-Berumen I, O'Byrne P, Gupta A, et al. Prostanoid enhancement of interleukin-6 production by rat peritoneal mast cells. *J Immunol* 1995;155:4759-4767.
171. Dvorak AM, Dvorak HF. Cutaneous basophil hypersensitivity—a twenty-year perspective, 1970 to 1990. In: Foreman J, ed. *Immunopharmacology of mast cells and basophils*. London: Academic Press, 1993:139-152.
172. Guo CB, Liu MC, Galli SJ, et al. Identification of IgE-bearing cells in the late-phase response to antigen in the lung as basophils. *Am J Respir Cell Mol Biol* 1994;10:384-390.
173. Schroeder JT, Lichtenstein LM, Roche EM, et al. IL-4 production by human basophils found in the lung following segmental allergen challenge. *J Allergy Clin Immunol* 2001;107:265-271.
174. van der Kleij HPM, Blennerhassett M, Bienenstock J. Nerve-mast cell interactions: partnership in health and disease. *Autonomic Neuroscience Series, Volume 15, 2003 (in press)*.
175. Echtenacher B, Männel DN, Hültner L. Critical protective role of mast cells in a model of acute septic peritonitis. *Nature* 1996;381:75-77.
176. Malaviya R, Ikeda T, Ross E, et al. Mast cell modulation of neutrophil influx and bacterial clearance at sites of infection through TNF- $\alpha$ . *Nature* 1996;381:77-80.
177. Supajatura V, Ushio H, Nakao A, et al. Protective roles of mast cells against enterobacterial infection are mediated by toll-like receptor 4. *J Immunol* 2001;167:2250-2256.
178. McCurdy JD, Lin TJ, Marshall JS. Toll-like receptor 4-mediated activation of murine mast cells. *J Leukoc Biol* 2001;70:977-984.
179. Sabroe I, Jones EC, Usher LR, et al. Toll-like receptor (TLR)2 and TLR4 in human peripheral blood granulocytes: a critical role for monocytes in leukocyte lipopolysaccharide responses. *J Immunol* 2002;168:4701-4710.
180. Huang C, De Sanctis GT, O'Brien PJ, et al. Evaluation of the substrate specificity of human mast cell tryptase beta I and demonstration of its importance in bacterial infections of the lung. *J Biol Chem* 2001;276:26276-26284.
181. Karlson U, Pejler G, Fröman, et al. Rat mast cell protease 4 is a  $\beta$ -chymase with unusually stringent substrate recognition profile. *J Biol Chem* 2002;277:18579-18585.
182. Clark JM, Abraham WM, Fishman CF, et al. Tryptase inhibitors block allergen-induced airway and inflammatory responses in allergic sheep. *Am J Respir Crit Care Med* 1995;152:2076-2083.
183. Oh SW, Pae CI, Lee DK, et al. Tryptase inhibition blocks airway inflammation in a mouse asthma model. *J Immunol* 2002;168:1992-2000.
184. Romagnani S. Induction of TH<sub>1</sub> and TH<sub>2</sub> responses: a key role for the "natural" immune response? *Immunol Today* 1992;13:379-381.
185. Garbuzenko E, Nagler A, Pickholtz D, et al. Human mast cells stimulate fibroblast proliferation, collagen synthesis and lattice contraction: a direct role for mast cells in skin fibrosis. *Clin Exp Allergy*

2002;32:237–246.

186. Norrby K. Mast cells and angiogenesis. *APMIS* 2002;110:355–371.

187. Gruber BL, Schwartz LB. The mast cell as an effector of connective tissue degradation: a study of matrix susceptibility to human mast cells. *Biochem Biophys Res Commun* 1990;171:1272–1278.

188. Lohi J, Harvima I, Keski-Oja J. Pericellular substrates of human mast cell tryptase: 72,000 dalton gelatinase and fibronectin. *J Cell Biochem* 1992;50:337–349.

189. Befus D. Reciprocal interactions between mast cells and the endocrine system. In: Freier S, ed. *The neuroendocrine-immune network*. Boca Raton: CRC Press, 1990:39–52.

190. Silver R, Silverman AJ, Vitkovic L, Lederhendler II. Mast cells in the brain: evidence and functional significance. *Trends Neurosci* 1996;19:25–31.

191. Gaboury JP, Niu XF, Kubes P. Nitric oxide inhibits numerous features of mast cell-induced inflammation. *Circulation* 1996;93:318–326.

2004 Lippincott Williams & Wilkins  
John P. Greer, John Foerster, John N. Lukens  
George M. Rodgers, Frixos Paraskevas, Bertil Glader  
Wintrobe's Clinical Hematology

HistoryPhylogeny and OntogenyMORPHOLOGYMonoblastsPromonocytesMonocytesMacrophagesMONONUCLEAR PHAGOCYTE PRODUCTION AND KINETICSBone Marrow KineticsMonocyte Kinetics in BloodTissue Macrophage KineticsCHARACTERISTICS AND DISTRIBUTION OF TISSUE MACROPHAGESLung MacrophagesSplenic MacrophagesBowel MacrophagesSkin Macrophages (Langerhans Cells)Liver Macrophages (Kupffer Cells)Brain Macrophages (Microglial Cells)Peritoneal MacrophagesRenal MacrophagesMilk MacrophagesReproductive Tract MacrophagesBone Macrophages (Osteoclasts)Granuloma MacrophagesSynovial MacrophagesMONONUCLEAR PHAGOCYTE ANTIGENS AND RECEPTORSHLACD4 and Chemokine Receptors (Human Immunodeficiency Virus 1 "Receptors")Fc ReceptorsComplement Receptors $\alpha$ 2-Macroglobulin ReceptorsGlycoprotein ReceptorsTransferrin and Lactoferrin ReceptorsLipoprotein ReceptorsCytokine, Interleukin, and Growth Factor ReceptorsIntegrinsChemotactic Peptide ReceptorsCoagulation Factor ReceptorsHormone ReceptorsMicrobial Component ReceptorsENDOCYTOSIS/PHAGOCYTOSISCHEMOTAXISPRODUCTS OF MONONUCLEAR PHAGOCYTESEnzymesReactive Oxygen SpeciesReactive Nitrogen SpeciesBioactive LipidsPeroxisome Proliferator-Activated Receptor-?Cytokines and Growth FactorsIMMUNOREGULATORY FUNCTIONS

ANTIMICROBIAL AND ANTITUMOR EFFECTS.  
 MONONUCLEAR PHAGOCYTES AND APOPTOSIS.  
 ERYTHROCYTE DESTRUCTION AND IRON METABOLISM.  
 REFERENCES.

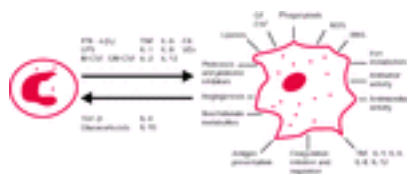
The *mononuclear phagocyte system*, also known as the *reticuloendothelial system*, is composed of monocytes, macrophages, and their precursor cells (1). The cells composing this system (Table 13.1) possess common origins, morphologies, and functions, and they arise in the bone marrow from progenitors committed to mononuclear phagocyte production. Monocytes are released into the blood and, after a short time in the circulation, migrate into different tissues, either randomly or specifically in response to chemotactic stimuli. In the tissues, they differentiate in response to soluble stimuli to become tissue macrophages with characteristic morphologic and functional qualities. This process of differentiation (the acquisition of different, more specialized functions) has been termed *activation*. Figure 13.1 depicts the bidirectional, factor-influenced modulation of function (“classic activation”) of a monocyte or macrophage.

**TABLE 13.1. Cells of the Mononuclear Phagocyte System**

---

|   |
|---|
| Bone marrow   |
| Monoblast   |
| Promonocyte   |
| Monocyte  |
| Blood   |
| Monocyte  |
| Tissue  |
| Bone macrophage (osteoclast)  |
| Bowel macrophage  |
| Brain macrophage (microglial cell)                                      |
| Liver macrophage (Kupffer cell)   |
| Lung macrophage (interstitial and alveolar)                             |
| Lymph node macrophage   |
| Milk macrophage   |
| Renal macrophage  |
| Reproductive tract macrophage (testicular, ovarian, uterine, oviductal) |
| Serosal macrophage (peritoneal and pleural)                             |
| Skin macrophage (Langerhans cell)                                       |
| Spleen macrophage   |
| Synovial macrophage (type A cell)                                       |

---



**Figure 13.1.** Modulation of mononuclear phagocyte function (“classic activation” of macrophages). Monocytes and macrophages can produce and elaborate many different bioactive products, and their function can be modulated by different substances. The figure depicts the reversible “activation” and “deactivation” mediated by these

substances. CK, chemokine; CSF, colony-stimulating factor; GF, growth factor; GM-CSF, granulocyte macrophage CSF; IFN, interferon; IL, interleukin; LPS, lipopolysaccharide; M-CSF, macrophage CSF; RNS, reactive nitrogen species; ROS, reactive oxygen species; TGF, tumor growth factor; TNF, tumor necrosis factor; VD<sub>3</sub>, vitamin D<sub>3</sub>.

Cells of the mononuclear phagocyte system are phylogenetically very primitive. No animals can live without them. They participate in a wide variety of important functions in the body, including removal of dead, senescent, foreign, or altered cells or foreign particles, regulation of the function of other cells, processing and presentation of antigens in immune reactions, participation in various inflammatory reactions, and destruction of microbes and tumor cells.

## History

Ilya Metchnikov studied amoeboid cells of invertebrate animals. He believed that these mobile cells, which were capable of ingesting solid particles, could serve in the defense of the organism against “noxious intruders.” In an experiment using the transparent starfish larva, he observed the cells migrating to and aggregating around a rose thorn introduced into the tissue (2, 3). He coined the term *macrophage* for these phagocytic connective tissue cells (as opposed to the more common *granular leukocytes* or *microphages*). Based on his subsequent observations on phagocytosis in invertebrates and the prior observations of Cohnheim regarding the migration of leukocytes through vessel walls (4), he stated in 1882 that “Diapedesis and accumulation of white corpuscles in inflammatory diseases must be regarded as modes of defense of the organism against microorganisms, the leukocytes in this struggle devouring and destroying the parasites” (5).

In the late 1800s, Ehrlich introduced techniques for staining blood cells; these allowed a more exact identification of the white corpuscles. Using several different dyes, he divided the blood cells into lymphocytes, large mononuclear cells, large mononuclear cells with indented nuclei, and polymorphous nucleated cells with neutrophilic, acidophilic, or basophilic granules (6). The “large mononuclear cells with indented nuclei” were later called *monocytes* (3).

The term *reticuloendothelial system* was first used by Aschoff in 1924 to designate cells that have the ability to remove and store injected carbon particles or the dye neutral red from the blood and lymph (7). *Reticulo* refers to the property of forming reticular or lattice networks in various organs, and *endothelia* refers to the location of most of the phagocytic cells identified in these early studies. The microscopic techniques at that time could not discern that the vascular linings in organs such as the spleen, liver, and lymph nodes were composed of endothelial cells (essentially nonphagocytic cells) as well as phagocytic cells (macrophages). Modern methods permit the distinction to be made, and, thus, the term *reticuloendothelial system* for the body’s system of monocytes and macrophages is a misnomer. During the early investigations, different components of the system were named descriptively, depending on their location, the nature of material engulfed by the cells, and the diseases affecting the cells, as well as their relationship to other structures. For example, macrophages of the tissues were called “histiocytes,” and the histiocytes of loose connective tissue were referred to as “resting wandering cells” or “amoeboid wandering cells” depending on their observed motility in the tissues, whereas the highly vacuolated histiocytes were called “rhagio-crine cells” because of their supposed secretory activity. The histiocytes of the omentum were named “clasmatocytes” because of the cytoplasmic budding, which was interpreted by Ranvier as an indication that the cells served a nutritive function. The “littoral cells” were those histiocytes adjacent to the bloodstream (e.g., the Kupffer cells of the liver or the splenic



macrophages) ( [8](#) ). In the early 1900s, several investigators demonstrated that blood monocytes, after long-term culture *in vitro*, developed into cells that were similar in appearance to tissue macrophages, inflammatory epithelioid cells, and multinucleated giant cells ( [9](#) , [10](#) and [11](#) ). Using meticulous observations with supravital dyes through the transparent rabbit ear, Ebert and Florey showed that blood monocytes emigrated into the tissue *in vivo* and changed into cells with the appearance of inflammatory tissue macrophages ( [12](#) ).

In the 1950s and 1960s, work by George Mackaness and colleagues helped define mechanisms by which macrophages become activated to control the growth of intracellular organisms ( [13](#) ). In the 1960s through the 1990s, Zanvil Cohn and co-workers defined many aspects of the cell biology of mononuclear phagocytes ( [14](#) ). John Hibbs, Carl Nathan, and colleagues in the 1970s through the 1990s further defined the processes of macrophage activation and the importance of nitric oxide (NO) as a macrophage effector molecule for antimicrobial and antitumor action ( [15](#) ). Studies beginning in the 1970s by Seymour Klebanoff, Bernard Babior, John Curnutte, and colleagues helped to clarify mechanisms of oxidative microbial killing and molecularly define the phagocyte oxidase ( [16](#) , [17](#) and [18](#) ). Donald Metcalf, Richard Stanley, and co-workers in the 1970s through the 1990s did detailed studies of hematopoiesis and growth factors, demonstrating basic mechanisms of hematopoiesis/monocytopoiesis, the clinical uses of colony-stimulating factors (CSFs), and the actions of macrophage CSF (M-CSF) in monocytopoiesis and mononuclear phagocyte function and embryogenesis ( [19](#) , [20](#) ). Molecular characterization of leukocyte receptors and ligands by a variety of investigators in the 1980s and 1990s gave new insights into mononuclear phagocyte interactions with other cells (e.g., lymphocytes and endothelium), microorganisms, and tumor cells ( [21](#) ). In the 1990s, gene transfer or gene disruption techniques ( [22](#) , [23](#) ) provided new tools for the analysis of mononuclear phagocyte and cytokine biology. In the late 1990s and early 2000s, researchers identified mammalian analogs of the *Drosophila* Toll receptor, cloned the mammalian Toll-like receptor 4 (TLR4), identified TLR4 as the receptor for lipopolysaccharide (LPS) and the membrane transducer for LPS signaling in mononuclear phagocytes and other cells, and identified other TLRs as receptors for other microbial components ( [24](#) , [25](#) ). The complex interplay of novel cytokines and receptors [osteoprotegerin (OPG), OPG ligand (OPGL), and receptor activator of nuclear factor- $\kappa$ B (NF- $\kappa$ B)] controlling osteoclast formation and differentiation was defined ( [26](#) ). Researchers further established the arginine/inducible NO synthase type 2 (NOS2)/arginase pathway as a regulator of cell growth and toxicity, apoptosis, inflammation, and host resistance to tumors and microbes ( [27](#) , [28](#) , [29](#) , [30](#) , [31](#) and [32](#) ). And finally, further particulars of the paths of macrophage activation (classic and alternative) are being dissected ( [33](#) , [34](#) ).

## Phylogeny and Ontogeny

Phylogenetically, mononuclear phagocytes are primitive cells. Invertebrates have phagocytic mononuclear cells that are known by various names (e.g., *coelomocytes*, *amoebocytes*, *hemocytes*) and are morphologically and functionally similar to the mononuclear phagocytes of mammals ( [35](#) ). These or comparable phagocytes are present in all the phyla of the animal kingdom (metazoan or higher). Whereas lymphocytes first appear in the cyclostome hagfish (vertebrate), immunoglobulins (Ig) and complement (C') appear still later in evolution. Amoebocytes serve various functions in these primitive animals. First, they are important in nutrition. Different particles and microbes are digested and transported by the amoebocytes, and the digested products are used by the host ( [36](#) ). Second, amoebocytes serve as scavengers by surrounding and

ingesting/digesting apoptotic, dead, or dying tissue. This is especially important in the physiologic process of metamorphosis in insects and amphibians ( [2](#), [35](#), [37](#) ), as well as in encapsulating and walling off foreign material ( [35](#), [38](#), [39](#) and [40](#) ). Third, amoebocytes play an important role in protecting the animal against infections and, possibly, cancer. For example, cells of the earthworm, crayfish, starfish, oyster, cockroach, and sponge recognize bacteria as foreign and phagocytize and destroy them ( [35](#), [40](#), [41](#) ). Cells from crayfish also can kill mammalian tumor cells *in vitro* by a nonspecific, nonphagocytic process comparable to that of mammalian macrophages ( [42](#) ). Invertebrates have soluble “recognition factors” that function as primitive opsonins for particles ( [35](#), [42](#) ); these may have been forerunners of the Ig and C’ systems. As in mammalian macrophages, products from bacteria appear to be specifically chemotactic for amoebocytes ( [43](#) ). Phagocytes mediate the rejection of foreign tissue grafts ( [35](#), [44](#) ). Thus, phagocytes from evolutionarily primitive animals function very effectively in protecting the host in the absence of B or T lymphocytes, Ig, or C’. With evolution and the acquisition of lymphocytes, Ig, and C’, phagocytes developed receptors for these ligands, and their nutritive function decreased, but the important functions of phagocytosis, endocytosis, encapsulation, and recognition of foreign substances, remained.

During ontogeny, pluripotent hemopoietic stem cells sequentially occupy the embryonic yolk sac, fetal liver, spleen, and adult bone marrow. Hematopoietic stem cells are derived from ventral mesodermal tissue. Stem cells migrate from the yolk sac and colonize receptive intraembryonic hemopoietic organs, where they can then respond to stimuli for differentiation along certain cellular pathways ( [45](#) ). The embryonic macrophages play important roles in tissue metamorphosis by scavenging dying and dead cells and, possibly, by mediating the destruction of cells in areas of tissue remodeling ( [2](#), [37](#) ). Mononuclear phagocytes may also regulate embryonic growth by the secretion of various mitogens or growth factors ( [46](#), [47](#) ).

Before day 9 in the mouse embryo, no cells identifiable as mononuclear phagocytes are seen anywhere (including the yolk sac), even though the yolk sac contains cells capable of forming macrophage colonies in appropriate assays ( [48](#) ). After day 10, glass-adherent macrophages with Fc receptors (FcRs) are seen in the yolk sac. After 12 days of gestation, mononuclear phagocytes are found in the liver and then in other tissues ( [48](#) ). In fetal rats, macrophages with phagocytic capability can be detected in inflammatory lesions as early as 16 days. Work in transparent zebrafish embryos has shown that macrophages appear as early as erythroid cells, originating from the ventrolateral mesoderm ( [49](#) ). The macrophages migrate to the yolk sac, differentiate, and then join the blood or invade the head region. These macrophages can phagocytose apoptotic cells and also ingest and kill injected bacteria. In zebrafish hematopoiesis, macrophages appear to use a rapid differentiation pathway that goes from early hematopoietic cells directly to relatively mature, functional macrophages without use of the monocyte as an intermediary cell ( [49](#) ).

The macrophage inflammatory response is seen at earlier times in gestation than the neutrophil response ( [50](#) ). Research in transparent zebrafish has shown that infection of the embryo with mycobacteria at a stage before lymphocyte development results in macrophage aggregates with hallmarks of granuloma ( [51](#) ). At birth, mononuclear phagocyte function is not fully developed. Neonates are highly susceptible to infections by viruses and intracellular pathogenic bacteria and have a poorly developed inflammatory response. Studies in mice show that the abnormalities relate to abnormal immune response-related antigen expression that results in poor antigen presentation, macrophage-mediated cytotoxicity, and interleukin (IL)-1 production. These defects can

be bypassed by treatment of macrophages with lymphokines ( [52](#), [53](#) ). Prostaglandins of the E series and  $\alpha$ -fetoprotein suppress the expression of major histocompatibility complex (MHC) class II antigen on macrophages; these substances may play a role in the low expression of MHC class II antigen in neonatal macrophages. The uptake and degradation of opsonized bacteria and the phagocytosis of C'-coated erythrocytes are normal in neonatal macrophages ( [52](#), [53](#) ).

## MORPHOLOGY

### Monoblasts

The monoblast normally is found only in the bone marrow. This cell is difficult to identify with certainty ( [54](#) ). However, the ability of single cells grown in agar culture to produce mixed granulocyte-macrophage or pure macrophage colonies suggests that there is a common precursor that develops into neutrophil (microphage) or macrophage cells ( [55](#), [56](#) ). The monoblast is defined by its ability to form mature colonies of mononuclear phagocytes in *in vitro* cultures. It is nonmotile, nonadherent to glass or plastic, and measures approximately 14  $\mu\text{m}$  in diameter. It is characterized by deeply basophilic cytoplasm, a large nucleus with little indentation, fine stringy chromatin, and one or two large nucleoli. Numerous fine, spherical, or slender rodlike mitochondria can be seen in supravital stained cells, but neutral red-containing vacuoles are absent or only a few very fine bodies are seen. These are presumably pinocytotic vesicles. On electron microscopic examination, aggregated ribosomes and scattered strips of endoplasmic reticulum are seen in the cytoplasm, but the Golgi apparatus is small ( [57](#) ). Distinguishing the monoblast from the myeloblast on morphologic grounds is difficult and probably impossible even when using the electron microscope.

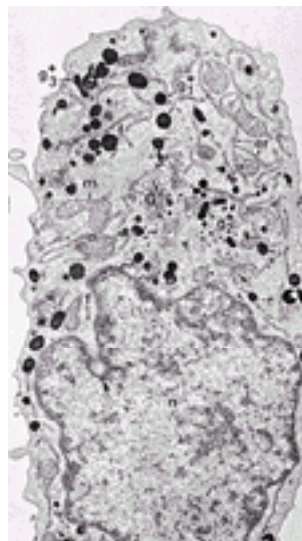
### Promonocytes

The human promonocyte, essentially the earliest cell clearly recognizable morphologically in this lineage, is 11 to 13  $\mu\text{m}$  in diameter and has a high nuclear to cytoplasmic ratio ( [54](#), [58](#), [59](#) ). The nucleus is indented with fine chromatin and may contain a nucleolus. The cytoplasm has considerable basophilia on Wright stain, and the cells stain for nonspecific esterase, peroxidase, and lysozyme ( [Table 13.2](#) ). These cells can phagocytize opsonized bacteria and IgG-coated erythrocytes but not IgM C'-coated erythrocytes. There is active pinocytosis as determined by uptake of dextran sulfate. A high proportion of these cells can incorporate tritiated thymidine, indicating that they are actively synthesizing DNA ( [54](#), [60](#) ). On electron microscopy, rough endoplasmic reticulum (RER) is well developed, and free polyribosomes are scattered throughout the cytoplasm ( [61](#) ) ( [Fig. 13.2](#) ). The Golgi apparatus is well developed, and granules of varying size and shape surround it, together with small vesicles that seem to arise from the Golgi cisternae. The RER, Golgi cisternae, and the early granules contain peroxidase, aryl sulfatase, and acid phosphatase ( [62](#) ). Numerous bundles of filaments are present in the cytoplasm around the nucleus, a feature of value in identifying these cells as monocytes ( [61](#), [62](#), [63](#) and [64](#) ). The cytoplasmic membrane of the promonocyte exhibits various processes and projections that presumably are related to its property of motility and active endocytosis ( [61](#), [62](#) ). The promonocyte is distinguishable from the promyelocyte by the fact that promonocytes contain fewer and smaller granules, and their granules lack crystalloids; the cytoplasm characteristically contains bundles of filaments, and the nuclei are quite irregular and deeply indented ( [61](#), [62](#), [63](#) and [64](#) ).

**TABLE 13.2. Characteristics of Human Mononuclear Phagocytes**

|                           | Bone Marrow |          | Blood    |          |         |       | Tissue        |       |
|---------------------------|-------------|----------|----------|----------|---------|-------|---------------|-------|
|                           | Promonocyte | Monocyte | Monocyte | Alveolar | Splenic | Bowel | Skin          | Liver |
| Diameter (µm)             | 10–13       | 9–11     | 10–12    | 15–50    | 17–50   | NR    | 10–40         | NR    |
| Nuclear/cytoplasmic ratio | >1          | ~1       | ~1       | <1       | <1      | <1    | <1            | <1    |
| Nucleus shape             | Round       | Indented | Indented | Var      | Var     | Var   | Conv          | Var   |
| Granules                  | Rare        | Few      | Many     | Many     | Many    | Many  | Many; Birbeck | Many  |
| Labeling index (%)        | 79.0        | NR       | 0.1      | NR       | NR      | NR    | Low           | 3.0   |
| Lysozyme                  | ±           | +        | +        | +        | +       | +     | +             | +     |
| Peroxidase                | +           | +        | +        | 0        | ±       | 0     | 0             | 0     |
| Nonspecific esterase      | +           | +        | ++       | +++      | ++      | ++    | ++            | ++    |
| Adherence                 | No          | Yes      | Yes      | Yes      | Yes     | Yes   | Yes           | Yes   |
| Fc receptor               | +           | +        | +        | +        | +       | +     | +             | +     |
| Complement receptor       | +           | +        | +        | +        | +       | +     | +             | +     |
| HLA-DR                    | +           | +        | +        | +        | +       | +     | +++           | +     |

Conv, convoluted; NR, not reported; Var, variable.  
 NOTE: Degree of positivity is indicated by 0 to +++.

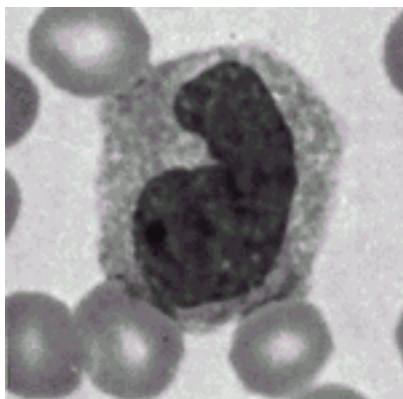


**Figure 13.2.** Electron micrograph of a promonocyte from human bone marrow stained for peroxidase. The nucleus (*n*), situated at one end of the cell, exhibits an irregular outline and deep indentations. The cytoplasm contains a number of cytoplasmic organelles. Peroxidase reactivity is demonstrable throughout the rough endoplasmic reticulum (*er*), Golgi complex (*G*), and all cytoplasmic granules (*g + 1*, *g + 2*, *g + 3*). Apparently, all granules mature from the earliest forms, which are spherical and dense (*g + 1*) with a homogeneous matrix, to more condensed and elongated forms (*g + 2*) and then to dumbbell forms (*g + 3*). The Golgi complex (*G*) is composed of several stacks of cisternae and occupies a large area adjacent to the nucleus. Bundles of filaments (*f*) are prominent in the cytoplasm and are believed to be useful in characterizing the cell as a monocyte

form. Several mitochondria (*m*) are also seen.  $\times 18,000$ . (From Nichols BA, Bainton DF. Differentiation of human monocytes in bone marrow and blood. *Lab Invest* 1973;29:27, with permission.)

## Monocytes

Monocytes are 10 to 11  $\mu\text{m}$  in diameter, being generally smaller than promonocytes but larger than other mature leukocytes. Monocytes seen in the bone marrow and the peripheral blood vary considerably in size and shape, but the “typical” monocyte is usually easily distinguishable from other leukocytes. The nucleus is large and oval or indented and centrally placed. By light microscopy, nucleoli usually are not seen. The nuclear chromatin is delicate, and the membrane is thin. The cytoplasm is abundant, gray or light blue-gray in Wright-stained preparations, and contains numerous fine, clear, or lilac vacuoles ( [Fig. 13.3](#)). The granules resemble fine dust and give the bluish cytoplasm a ground-glass appearance. In certain circumstances (e.g., bacteremia) or with heavy staining, the granules appear more prominent. The delicate chromatin and the bluish color of the cytoplasm in the monocyte are most helpful in differentiating these cells from metamyelocytes or band forms of neutrophils. Granules in monocytes contain peroxidase but are much smaller than those found in neutrophils ( [62](#), [64](#), [65](#) ).



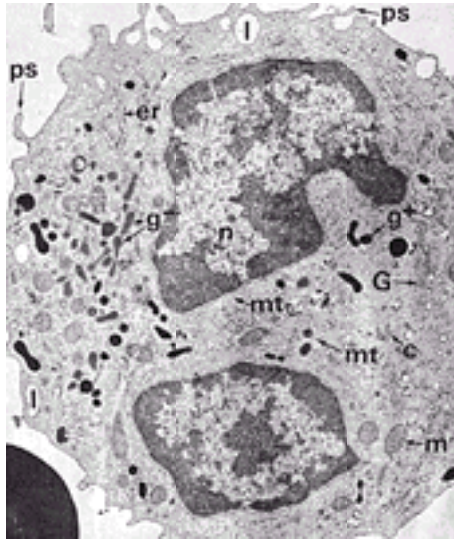
**Figure 13.3.** Monocyte  $\times 1000$  (approximately). Wright stain. See [Color Plate](#).

The cells attach avidly to plastic (polystyrene) or glass, are motile in their adherent state, and spread and project thin processes within 1 to 3 hours ( [9](#), [10](#) and [11](#), [66](#), [67](#) ). On phase microscopy, phase-dense granules, which correspond to lysosomes, can be seen in the cytoplasm. The lysosomes are excluded from the actin-rich thin border area of cortical cytoplasm (hyaloplasm). Cell motion is ameboid in nature; large, filmy, irregular pseudopods extend slowly from the delicate cytoplasm as the cell moves randomly. In response to chemotactic signals, the movement is directed, and the cell assumes a delta shape with the slender, pointed edge trailing ( [66](#) ).

Electron microscopy shows that the mature monocyte contains a horseshoe-shaped nucleus, with dense, granular peripheral chromatin surrounding extensive, light-staining central nucleoplasm ( [Fig. 13.4](#)). Nucleoli have been observed in as many as 50% of blood monocytes ( [62](#), [64](#) ). The mitochondria are spherical or elongated and are usually located in the periphery of the abundant cytoplasm. The Golgi apparatus is well developed, and small vesicles are especially numerous in this region but may be found throughout the



cytoplasm.

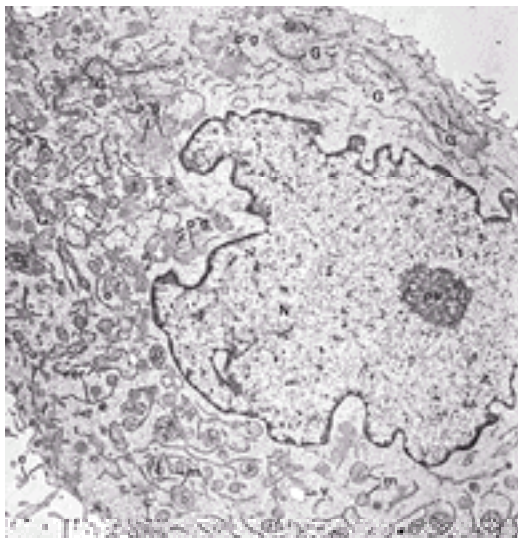


**Figure 13.4.** Electron micrograph of a normal human blood monocyte examined for peroxidase. In the nucleus ( *n* ), the chromatin is more condensed than in earlier forms, is mainly peripheral in distribution, and is interrupted at the nuclear pores. The voluminous cytoplasm ( *c* ) contains a full complement of organelles associated with protein synthesis and export of secretory granules. Peroxidase is present in only some of the granules ( *g*<sup>+</sup> ), but others ( *g*<sup>-</sup> ), as well as the endoplasmic reticulum ( *er* ) and Golgi complex ( *G* ), now lack the reaction product. At this stage, the two kinds of granules are approximately equal in number and similar in size and shape, ranging from 90 to 450 nm in length and from spherical or rodlike to dumbbell in shape. Microtubules ( *mt* ) radiate from the cell center, where a centriole can be seen adjacent to the Golgi complex ( *G* ). The moderately abundant endoplasmic reticulum has a more peripheral distribution than in the promonocyte, and modest numbers of mitochondria ( *m* ) are present. Numerous pseudopodia ( *ps* ) extend from the cell surface. The peripheral lacunae ( *l* ) represent tangential sectioning through surface irregularities. × 16,200. (From Nichols BA, Bainton DF. Differentiation of human monocytes in bone marrow and blood. *Lab Invest* 1973;29:27, with permission.)

At the monocyte stage, peroxidase production ceases, and the RER and Golgi complex no longer contain the enzyme, but peroxidase is present in storage granules ( [63](#) ). A second population of granules is produced that contains no peroxidase ( [63](#), [64](#), [68](#) ). In normal human monocytes, peroxidase activity can be detected in the Golgi area and in the RER after adherence to plastic or glass for 2 to 18 hours. Patients with hereditary deficiency of neutrophil peroxidase have monocytes that lack the enzyme in their storage granules ( [68](#) ); however, after adherence and *in vitro* culture, peroxidase activity appears as it does in normal monocytes, suggesting that the peroxidase stored in monocyte granules and the peroxidase that appears in the RER and Golgi after adherence are two distinct proteins ( [68](#) ). The peroxidase of the RER and Golgi is inhibited by aminotriazole and sodium azide, whereas that of the granules is not ( [64](#) ). Cytochemical staining at the light and electron microscope levels has demonstrated many other enzymes, including acid phosphatase, sodium fluoride-resistant nonspecific esterase (alpha naphthyl butyrate or acetate esterase), naphthylaminidase, lysozyme, beta glucuronidase, 5' nucleotidase, galactosidases, and numerous other hydrolases and proteases ( [69](#), [70](#), [71](#), [72](#) and [73](#) ).

## Macrophages

Macrophages represent the tissue component of the mononuclear phagocyte system. This is a very heterogeneous group of cells with many different phenotypes. In general, they are believed to arise from emigrated blood monocytes and apparently differentiate in response to local conditions and factors (1). Macrophages are large, actively phagocytic cells measuring 15 to 80  $\mu\text{m}$  in diameter. Their shape is irregular, and their motility comparable to that of blood monocytes. Bleblike and filiform pseudopods are seen frequently. The cytoplasm is abundant. The nucleus is egg-shaped or may be indented or elongated. When stained with Wright stain, the chromatin appears “spongy,” and the nuclear membrane is distinct. The cytoplasm is sky-blue and contains coarse, azure granules and vacuoles. Electron microscopy of macrophages shows a spectrum of cell types ranging from those comparable to monocytes to much larger cells with more cytoplasm and more vacuolization and granulation (Fig. 13.5). Peroxidase is seen in the RER and Golgi but, in contradistinction to monocytes, is absent in the granules (64, 68). Some “intermediate” cells are seen in which peroxidase is present in the RER, Golgi, and granules; these may be monocytes that have recently emigrated into the tissues (74).



**Figure 13.5.** Electron micrograph of a peroxidase-negative human macrophage that developed after 14 days in liquid culture. The eccentric nucleus ( *N* ) contains a distinct nucleolus ( *nu* ) and the cytoplasm is filled with many organelles [i.e., mitochondria ( *m* ), rough endoplasmic reticulum ( *rer* ), a large Golgi complex ( *G* ), and numerous small vesicles or vacuoles ( *v* )]. No peroxidase can be detected at this late stage of maturation. In addition to the occasional clear vacuoles ( *v* ) are many inclusions, which are peroxidase-negative granules ( *p-g* ). Their content is unknown.  $\times 14,500$ . *e*, filipodium. (From Bainton D, Golde DW. Differentiation of macrophages from normal human bone marrow in liquid culture. *J Clin Invest* 1978;61:1555, with permission.)

## MONONUCLEAR PHAGOCYTE PRODUCTION AND KINETICS

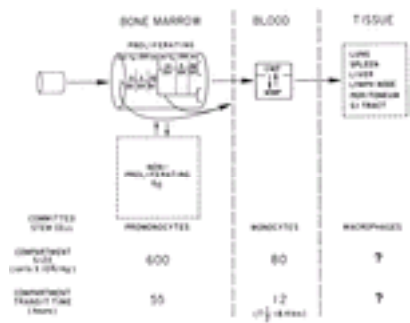
### Bone Marrow Kinetics

The major site of production of mononuclear phagocytes is the bone marrow. Primitive stem cells become committed to the mononuclear phagocyte lineage in a stochastic



fashion and then, under the influence of growth factors and cytokines, differentiate into monocytes. Myeloid cell growth is controlled by different glycoprotein growth factors that can cause the development *in vitro* of colonies composed of granulocytes only (G-CSF), macrophages only (M-CSF), both granulocytes and macrophages (GM-CSF), or granulocytes, macrophages, normoblasts, megakaryocytes, mast cells, and stem cells (MULTI-CSF or IL-3) ( [55](#), [75](#) ). The macrophage growth factors cause both proliferation and differentiation of primitive hematopoietic cells to monoblasts, promonocytes, and mature monocytes. They work through specific, high-affinity cell-surface receptors that initiate the cell proliferation ( [55](#), [76](#), [77](#) ). Receptors for M-CSF are restricted to cells of the mononuclear phagocyte system and are species specific. Mouse mononuclear phagocytes bind M-CSF specifically with high affinity (saturation at  $>2 \times 10^{10}/L$ ) ( [77](#) ). Blood monocytes have approximately 3000 receptors per cell, and the larger alveolar macrophages have up to 16,000 receptors per cell. Of bone marrow cells, approximately 4.0% have receptors (determined by autoradiographic studies), whereas 2.0% of spleen cells, 8.0% of blood cells, 21.0% of peritoneal cells, 0.4% of lymph node cells, and 12.0% of alveolar cells can specifically bind the M-CSF and form macrophage colonies *in vitro* in response to M-CSF ( [77](#) ). The receptor for the mononuclear phagocyte growth factor, M-CSF, is closely related to the c- *fms* protooncogene product ( [78](#), [79](#) ). The transcription factor PU.1 is necessary for the M-CSF-dependent proliferation of mononuclear phagocytes ( [80](#) ). Mononuclear phagocyte development during fetal and neonatal life is dependent on M-CSF ( [81](#) ). The critical importance of M-CSF in the development of mononuclear phagocytes is underscored by the absence of abnormalities in mononuclear phagocytes in mice lacking GM-CSF (those with targeted disruption of the GM-CSF gene) ( [82](#), [83](#) ).

Studies of human mononuclear phagocytopoiesis have shown that 3% of bone marrow cells are promonocytes ( [84](#) ). When marrow cells were incubated *in vitro* with  $^3\text{HTdR}$ , one group of investigators showed that approximately 79% of the promonocytes were labeled ( [65](#) ), whereas another group showed that 12% were labeled ( [84](#), [85](#) ). Double-labeling studies (  $^3\text{HTdR}$  and  $^{14}\text{CTdR}$  ), as well as serial  $^3\text{HTdR}$  injections, indicated a DNA synthesis time of approximately 10 hours and a generation time of 29 hours for promonocytes. When  $^3\text{HTdR}$  was injected into normal subjects and the subsequent appearance of labeled monocytes in the blood was monitored, a lag period of only 5 to 7 hours was noted, thus demonstrating the absence of a significant storage compartment. Subsequently, several waves of labeled cells appeared, reflecting the flow into the blood of cells labeled during promonocyte proliferation in the marrow ( [85](#) ). From studies of the time course of labeled monocytes in the blood after the intravenous injection of  $^3\text{HTdR}$ , the transit time through the marrow proliferation pool was estimated to be 54 hours ( [85](#) ). This is approximately twice the promonocyte generation time of 29 hours and suggests that there are, on the average, two catenated promonocyte generations in the bone marrow of normal humans ( [Fig. 13.6](#) ). The size of the marrow promonocyte pool in normal humans has been calculated from data on total marrow cellularity to be approximately  $60 \times 10^6$  cells per kg of body weight. From these data, the labeling index of 12%, and DNA synthesis time of 10 hours, a production rate of  $7 \times 10^6$  cells per kg per hour can be calculated ( $60 \times 10^6 \times 0.12/10$  hours) ( [85](#) ). Other workers have demonstrated comparable values using different techniques ( [54](#), [65](#) ). Similar numbers of cells are turning over through the blood as determined from blood monocyte kinetic measurements ( [86](#) ).



**Figure 13.6.** Model of the production and kinetics of the monocyte–macrophage system in humans. The marrow and blood compartments are drawn to show their relative sizes. The compartment transit times are derived from  $^3\text{HTdR}$  and  $^3\text{H-DFP}$  labeling studies. A small number of young cells may enter the blood from the  $G_1$  phases of the promonocyte cell cycle (*curved arrows*). The box outlined by dashed lines indicates a large compartment of marrow promonocytes in the resting or  $G_0$  stage (see text).  $G_i$ , cell generation time with the subcompartments  $G_1$  (pre-DNA synthesis gap), S (DNA synthesis period), and  $G_2$  (post-DNA synthesis gap); CMP, circulating monocyte pool; GI, gastrointestinal; MMP, marginal monocyte pool;  $T_{1/2}$ , half-life.

### Monocyte Kinetics in Blood

Blood monocytes are a population of recently formed young cells on their way from the bone marrow to their ultimate sites of activity in the tissues; therefore, monocyte production can be calculated from the turnover of blood monocytes. Blood monocyte kinetics have been evaluated in humans by *in vivo* and *in vitro* labeling of autologous blood with tritiated diisopropyl fluorophosphate, reinjecting the labeled cells, and measuring the proportion of labeled cells present at later times by autoradiographic techniques ([85](#), [86](#)). These studies have shown the marginal monocyte pool to be approximately three and one-half times the size of the circulating pool. Blood monocytes left the vascular system in an exponential manner with a half-life of 4.5 to 10.0 hours (mean of 8.4 hours) ([85](#), [86](#)). This 8.4-hour half-life is shorter than the 71.0 hours calculated from experiments using *in vivo* labeling with  $^3\text{HTdR}$  ([87](#)). From the blood pool size and the half-life value, the blood monocyte turnover rate was calculated to be approximately  $7 \times 10^6/\text{kg}/\text{hour}$  ([85](#)).

Alterations in monocyte kinetics have been measured after the acute or chronic administration of adrenal glucocorticoids to humans ([88](#)) and mice ([89](#)). Profound monocytopenia develops promptly in both species, and its duration and degree depend on the amount, solubility, and route of steroid administration. In humans, the cellularity of induced exudates is decreased by steroid administration ([88](#)). In mice, the number of cells harvested from the peritoneum is only moderately decreased (approximately 30%), but the flow of  $^3\text{HTdR}$ -labeled monocytes from the blood into the peritoneum in response to an inflammatory stimulus is markedly reduced. The mechanism of the sudden monocytopenia is not fully understood, nor is it clear whether the reduced cellularity at the site of inflammation merely reflects the monocytopenia, is the result of other steroid effects on the monocytes or the vascular wall, or is due to yet other factors. In septicemia, monocytopoiesis is enhanced in the marrow, and the blood monocyte turnover rate is increased in humans ([85](#)). Administration of recombinant G-CSF, GM-CSF, or IL-3 to humans amplified bone marrow production of mononuclear phagocytes and release of monocytic cells into the blood ([90](#)). The peripheral half-life of blood monocytes in subjects receiving the growth factors was reduced ([90](#)). G-CSF administration to normal people in preparation for blood stem cell harvesting caused an eightfold increase in

neutrophil and monocyte counts and a slight decrease in platelet counts (91). The effects of recombinant growth factors on tissue macrophage numbers and function are not known.

## Tissue Macrophage Kinetics

Tissue macrophages arise primarily from emigrated blood monocytes that differentiate into macrophages. Chimera studies in experimental animals have shown that marked donor marrow or blood monocytes (radioactive label, abnormal or opposite sex chromosome marker, unique enzyme, or distinctive morphologic marker) eventually are found in tissues as macrophages. This has been shown in the case of peritoneal macrophages (92, 93, 94 and 95), liver Kupffer cells (96, 97 and 98), alveolar macrophages (99, 100, 101 and 102), osteoclasts (103), type-A synovial cells (104), and inflammatory tissue macrophages (105). Studies in humans after bone marrow or liver transplants from opposite sex donors have given evidence for the bone marrow or blood origin of liver Kupffer cells (106) and alveolar macrophages (107). Animals receiving total body irradiation with shielding of a small portion of bone marrow followed by *in vivo* <sup>3</sup>HTdR injection have near-normal levels of labeled (bone marrow-derived) peritoneal (60), Kupffer (96), and alveolar macrophages (108), suggesting that these tissue macrophages are derived from the bone marrow. Furthermore, glucocorticosteroids, which inhibit the egress of blood monocytes into tissues but not the <sup>3</sup>HTdR incorporation into mononuclear phagocyte precursors (89), decrease the labeling indices of peritoneal, Kupffer, and alveolar macrophages to near zero (65, 96, 108). However, most studies in experimental animals and in humans have shown a detectable, albeit small, <sup>3</sup>HTdR-labeling index in peritoneal, alveolar, Kupffer, and wound macrophages (54, 65, 96, 108, 109 and 110). Some have contended that local proliferation of tissue macrophages plays an important physiologic role in the maintenance of macrophage numbers there. For example, in mice made severely monocytopenic by the injection of strontium-89 (which localizes in bone marrow and dramatically reduces marrow mononuclear phagocyte production), the levels of peritoneal macrophages remain stable for months with <sup>3</sup>HTdR-labeling indices of 3 to 5% in the tissue macrophages (110, 111 and 112). Local proliferation of tissue macrophages in physiologic conditions contributes to tissue macrophage renewal, but the precise extent of this is unknown.

Studies in mice have attempted to define the kinetics of tissue macrophages. Pulse labeling with <sup>3</sup>HTdR has given information on blood half-lives, the numbers of macrophages in the various compartments, and the number of monocytes that enter the tissues per unit of time for peritoneum, liver, and lung (65, 96, 108) (Fig. 13.7). Approximately 8% of the blood monocytes go to the peritoneal cavity, and there are approximately  $1 \text{ to } 3 \times 10^6$  resident peritoneal macrophages per mouse. The turnover rate for peritoneal macrophages is low (approximately 0.1% per hour), giving a turnover time of approximately 41 days. There are approximately  $0.9 \times 10^6$  Kupffer cells per liver in the mouse (96), and the calculated mean turnover time is 21 days. Approximately one-half of the labeled blood monocytes migrate to the liver, where they reside as Kupffer cells. Approximately 15% of labeled blood monocytes migrate into the lung. The total mouse lung macrophage population is approximately  $2 \times 10^6$  (108); of these, 93% are in alveoli and 7% are found in the interstitium. The calculated mean turnover time for lung macrophages is approximately 27 days. Data for other tissue mononuclear phagocytes are not available.



**Figure 13.7.** Distribution of mouse monocytes that leave the peripheral blood. In the various organs, the monocytes become macrophages. (From van Furth R, et al. Characteristics, origin, and kinetics of human and murine mononuclear phagocytes. In: van Furth R, ed. Mononuclear phagocytes. Functional aspects. The Hague: Martinus Nijhoff, 1980, with permission.)

To maintain a steady number of tissue macrophages in the face of the noted steady influx of monocytes into the tissues, the tissue macrophages must have a steady local death rate, a steady efflux from the tissues, or both. Some alveolar macrophages are removed by the mucociliary pathway and are expectorated or swallowed ( [108](#), [113](#), [114](#) ). There is evidence that interstitial lung macrophages migrate to lymph nodes via the lymphatics ( [115](#), [116](#) ), where they may die. Macrophages from the small intestine and liver migrate to regional lymph nodes ( [117](#), [118](#) ). Macrophages in granulomas (epithelioid cells and multinucleated giant cells) die *in situ* ( [119](#) ). There is no good evidence that tissue macrophages ever reenter the blood. However, when researchers injected fluorescent spheres into the subcutaneous tissue of mice, the spheres were phagocytized by exuded monocytes and then migrated to draining lymph nodes where they had characteristics of dendritic cells (DC) ( [120](#) ). In monocyte-deficient osteopetrotic mice, the appearance of the labeled cells in lymph nodes was reduced by more than 85%. These data indicate that tissue macrophages can leave one tissue (subcutaneous tissue) and enter another (lymph node), where they may differentiate into another cell type (DC) ( [120](#) ).

## CHARACTERISTICS AND DISTRIBUTION OF TISSUE MACROPHAGES

Cells of the mononuclear phagocyte system are widely distributed throughout the body ( [Table 13.1](#) ). The cells in the various tissues are quite heterogeneous, differing in numerous parameters. Because of the broad distribution and the difficulty of isolating those deeply embedded in some tissues, it has been difficult to quantitate the numbers in different compartments and the total number in the body. Studies using a monoclonal antibody that recognizes a specific mononuclear phagocyte antigen (F4/80) have provided some data ( [121](#) ). The macrophage antigen was found in a wide variety of tissues; the organs with the highest total F4/80 antigen content were the bowel, liver, bone marrow, spleen, lymph nodes, and kidney ( [121](#) ). Although levels of F4/80 may vary with the “activation” state of macrophages, these studies are helpful in assessing macrophage content.

### Lung Macrophages

The interstitial and alveolar macrophages constitute the lung macrophage pool, with approximately 7% being interstitial ( [108](#) ). Interstitial cells are likely the immediate antecedents of the free alveolar macrophages ( [122](#), [123](#) ). Pulmonary macrophages are essential components of the respiratory defense system, and, because of their accessibility, alveolar macrophages have been studied most extensively. Alveolar macrophages are 15 to 50  $\mu\text{m}$  in diameter. Their appearance and structure depend on the age of the cell and the nature and quantity of the material that has been endocytized. In

Giemsa- or Wright-stained preparations, their cytoplasm is gray or light blue and contains numerous cytoplasmic granules. The nuclear to cytoplasmic ratio is approximately 1:3. Nucleoli are sometimes seen. There is abundant smooth endoplasmic reticulum and RER. A variable number are extremely vacuolated or "foamy." Phagosomes may contain dust particles, bacteria, erythrocytes, and cellular debris. Some of the inclusions contain surfactant, the phospholipid synthesized by alveolar type II cells that is important in the maintenance of normal lung function. The normal alveolar macrophage removes and degrades surfactant material ( [124](#) ). It does not contain hemoglobin (Hb), and only trace amounts of iron are present. However, in situations of pulmonary hemorrhage (occult or overt), large quantities of Hb and iron in the form of hemosiderin can be found in the cells ( [124](#) ). They contain  $\alpha$ -naphthyl butyrate esterase (nonspecific esterase), lysozyme, and acid phosphatase and stain positively with the periodic acid-Schiff (PAS) stain. There is little or no peroxidase activity in alveolar macrophages, but they do contain catalase. They have receptors for the Fc fragment of IgG and C' (C3b) ( [125](#) , [126](#) and [127](#) ). Ultrastructurally, the nuclei of alveolar macrophages are polymorphous and frequently have an eccentrically placed nucleus with a nucleolus ( [124](#) , [128](#) ). Multinucleated cells are rarely seen. There are numerous membrane-bound cytoplasmic vesicles or primary lysosomes that contain various enzymes typical of lysosomes, including cathepsins, lysozyme,  $\beta$ -glucuronidase, aminopeptidase,  $\beta$ -galactosidase, aryl sulfatase, acid ribonuclease, and phospholipases ( [124](#) , [129](#) , [130](#) ).

Alveolar macrophages exist at the tissue-air interphase, where they encounter inhaled pollutants and microorganisms. They exist in an environment with a high partial pressure of oxygen as compared to the other mononuclear phagocytes of the body. As a consequence, alveolar macrophages have metabolic properties different from macrophages in other sites. Their basal glucose consumption and respiratory rate are greater than those of all other phagocytes studied ( [131](#) ). However, unlike phagocytes from other sites, they have a poor respiratory burst and little increase in hexose monophosphate shunt activity in response to soluble stimuli or phagocytosis ( [131](#) ). Rat alveolar macrophages have high levels of cytochrome oxidase and low levels of the glycolytic pathway enzymes pyruvate kinase and phosphofructokinase when compared to peritoneal macrophages. This particular enzyme phenotype in alveolar macrophages can be changed to that of peritoneal macrophages by incubating the cells in relatively anaerobic conditions *in vitro* ( [132](#) ).

Alveolar macrophages contain and secrete numerous enzymes typical of mononuclear phagocytes. Elastase and collagenase may have a role in the production of tissue destruction and the evolution of emphysema ( [133](#) ), especially in people with a  $\alpha_1$ -antitrypsin (a  $\alpha_1$ -antiprotease) deficiency. In addition to the various proteases, alveolar macrophages have been noted to contain the protease inhibitor  $\alpha_1$ -antiprotease ( [134](#) , [135](#) ). The elastolytic enzyme activity of alveolar macrophages (possibly a cathepsin B) is poorly inhibited by the natural protease inhibitors of serum, whereas that of neutrophils is well inhibited ( [136](#) ). This suggests that macrophages of the lung may be more important in elastin degradation than neutrophils.

Numerous environmental agents can alter alveolar macrophage function ( [137](#) ). Cigarette smoke is one of the most important toxins to which alveolar macrophages are exposed and contains many materials in the particulate and vapor phases. Smokers have increased numbers of alveolar macrophages ( [124](#) , [138](#) ), and cells from smokers show several abnormalities. They are slightly larger in diameter than those from nonsmokers and contain variable numbers of inclusions ( [124](#) , [139](#) ), such as electron dense areas, lipid vacuoles, and "needlelike" and "fiberlike" structures. The needlelike structures may



represent ingested kaolinite or aluminum silicate from the cigarettes ( [140](#) ). Cells from smokers spread more on glass and have more lamellipodia and filipodia than those of nonsmokers ( [124](#) ). The smokers' cells contain higher levels of elastase and lysosomal enzymes, and these enzymes are released more completely from smokers' cells either spontaneously or in response to cigarette smoke ( [124](#) ). These enzymes are important in the pathogenesis of pulmonary emphysema. Alveolar macrophages from smokers also have impaired synthesis of RNA and protein ( [141](#) ), increased glucose utilization ( [142](#) ), increased hydrogen peroxide production, increased hexose monophosphate shunt activity, and reduced levels of glutathione peroxidase ( [124](#) ). *In vitro* cigarette smoke exposure in high amounts impairs various functions of macrophages ( [124](#) ). Also, alveolar macrophages contain the enzyme aryl hydrocarbon hydroxylase, and it is increased in macrophages from smokers ( [125](#) , [143](#) ). This enzyme transforms carcinogenic, polycyclic aromatic hydrocarbons into less dangerous hydrophilic compounds. There may be a relationship between the inducibility of this enzyme and the susceptibility to lung cancer ( [144](#) ).

Pulmonary macrophages are important in specific immunologic reactions because of their processing of inhaled antigens and interactions with lymphocytes ( [124](#) ). Alveolar macrophages can produce IL-1 ( [145](#) ), interferon (IFN)- $\alpha$  and - $\gamma$  ( [146](#) , [147](#) ), chemotactic substances ( [148](#) ), and CSFs ( [149](#) ). IL-1, with its multiple effects, may be important in many different physiologic and pathologic conditions in the lungs ( [47](#) ). IL-1 is a mitogen for fibroblasts. Alveolar macrophages interacting with silica or asbestos have been noted to contain or secrete a factor(s) that enhances fibroblast proliferation and collagen synthesis ( [150](#) , [151](#) and [152](#) ), suggesting that IL-1 may play a role in the fibrosis seen in humans with silicosis and asbestosis. Chemokines produced by macrophages may also be important in the pathogenesis of fibrotic lung disease ( [153](#) ).

### **Splenic Macrophages**

Splenic macrophages are present both in the red and the white pulp ( [121](#) ). The red pulp is composed almost exclusively of macrophages involved in the phagocytosis and destruction of blood cells. Although the precise routes and dynamics of cellular movement within and through the spleen are not fully understood, red pulp macrophages apparently emigrate there through the fenestrations of the basement membranes of the splenic sinuses and, occasionally, can be seen extending their pseudopods through these fenestrations, possibly interacting with blood elements ( [154](#) ). The red pulp has the densest concentration of the macrophage antigen F4/80 found in the mouse ( [155](#) ). In the white pulp, the macrophages are much less frequent and are found in the germinal centers, where, occasionally, they are seen phagocytizing lymphocytes ( [156](#) ). White pulp macrophages are presumably involved in antigen processing and generation of the immune response. Splenic macrophages measure 17 to 50  $\mu\text{m}$  in diameter and contain more RER and Golgi zone than blood monocytes ( [156](#) ). Red pulp macrophages contain numerous inclusions, including phagocytized erythrocytes, neutrophils, eosinophils, and platelets ( [154](#) , [157](#) ). In hemolytic anemias and immune thrombocytopenias, an increased amount of phagocytized debris is present; occasionally, the macrophages appear as "sea-blue histiocytes" with the endocytized cellular membranes converted to ceroid ( [158](#) ). Splenic macrophages have receptors for the Fc portion of IgG and for C' ( [159](#) , [160](#) ), express antigens typical of other mononuclear phagocytes at other sites ( [155](#) , [160](#) ), and contain ferritin and hemosiderin ( [154](#) ).

## Bowel Macrophages

Using immunohistochemical techniques, researchers demonstrated numerous macrophages bearing the macrophage-specific antigen F4/80 in the lamina propria throughout the gastrointestinal tract ( [161](#) ). Many of the labeled cells are spread along the base of the epithelial cells, apparently underlying the basement membrane. In the small intestine, the macrophages extend to the epithelium of the crypts. Some of the macrophage antigen-positive cells are associated with capillaries or with numerous lymphocytes and plasma cells in the lamina propria ( [161](#) ). The cortical areas of the gut-associated lymphoid areas contain very few of the antigen-positive macrophages ( [155](#) ). There are very few of the macrophages in the Peyer patches, but there are macrophages in the dome epithelium of the Peyer patch ( [155](#), [162](#) ).

In addition to immunohistochemical means of detection, bowel macrophages are recognizable by observing ingestion of carbon particles, PAS staining, and cytochemical stains for acid phosphatase. By electron microscopy, bowel macrophages are often located adjacent to blood vessels or in close association with plasma cells in the lamina propria. They have large lysosomes, phagosomes, and electron-dense inclusions ( [163](#) ). Mitoses are rarely seen ( [162](#) ).

The role of intestinal macrophages in physiologic and pathologic conditions is not fully understood. Gut-associated macrophages probably play a role in the development of an immune response to absorbed antigens, in suppressing immune responses, or in developing immune tolerance ( [162](#) ). The cells may be important in phagocytizing bacteria and cell debris. Sequestration of waste material in macrophages and then shedding these macrophages into the intestinal lumen may serve as a mechanism for eliminating accumulated or dead intestinal wall material ( [162](#) ). Likewise, iron-laden macrophages are shed from the villi into the gut lumen in patients with iron overload ( [164](#), [165](#) ). In the obligate sanguivore vampire bat, the bowel apparently plays a large role in the elimination of excess body iron; iron-laden macrophages migrate there and desquamate into the stool ( [166](#) ). We do not know if this excretory system for iron is important in humans.

Intestinal macrophages are involved in diseases affecting the bowel. Various investigators have postulated that macrophage-secreted proteases [including acid hydrolases, elastases, and collagenases ( [69](#), [167](#) )] may injure the bowel in conditions such as Crohn disease in humans and in experimentally induced cecal inflammation in guinea pigs ( [162](#), [168](#) ). In inflammatory bowel disease, there is an increase in the mucosal macrophage population derived from circulating monocytes. These macrophages contribute to inflammation by secreting cytokines such as IL-1, IL-6, IL-8, IL-12, IL-18, and tumor necrosis factor (TNF) ( [169](#) ). They also generate reactive oxygen and nitrogen species, molecules with proinflammatory properties. Elevated bowel lumen NO and increased expression of NOS2 have been noted with various inflammatory bowel disorders ( [170](#) ). These include celiac disease ( [171](#), [172](#) and [173](#) ), ulcerative colitis ( [174](#) ), and inflammatory bowel disease ( [175](#) ). IL-10 generally serves as a deactivator of macrophage function, and mice with genetically disrupted IL-10 gene have overactive bowel macrophages and an inflammation of the bowel comparable to that seen in humans with inflammatory bowel disease ( [176](#) ). Lysozyme, an enzyme found in highest concentrations in macrophages, is elevated in stool and intestinal mucus in humans with bowel inflammation ( [177](#) ). Serum lysozyme is elevated in patients with Crohn disease ( [178](#) ) and in other types of inflammatory bowel disease ( [179](#) ). Granulomas seen in Crohn disease and in intestinal



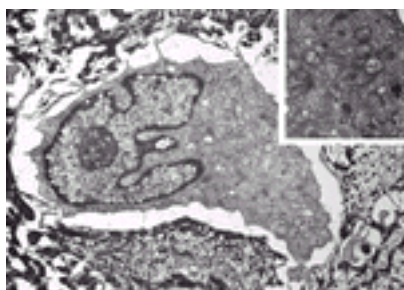
tuberculosis are composed of monocytes/macrophages, together with lymphocytes and plasma cells ( [180](#), [181](#) and [182](#) ). Fibrosis, which accompanies these disorders, may be caused, in part, by proliferation of local fibroblasts stimulated by macrophage-derived fibroblast growth factors, such as IL-1 ( [47](#) ).

Using epidemiologic and linkage studies, a susceptibility locus for inflammatory bowel disease has mapped to chromosome 16. Mutations in a gene at this location (Nod2) have been discovered in patients with Crohn disease. Nod2, a monocyte/macrophage-specific protein ( [185](#) ), is involved in activation of NF- $\kappa$ B and regulation of apoptosis. Subjects with variant Nod2 have a dramatically increased likelihood of developing Crohn disease (but not ulcerative colitis) ( [183](#), [184](#) ).

Whipple disease, a multisystem disease caused by an infection with an unusual and fastidious microorganism, is characterized by an accumulation of epithelioid macrophages in various organs, prominently including the bowel wall ( [186](#) ). The macrophages contain PAS-positive material. The causative organism, *Tropheryma whippelii*, has been identified by polymerase chain reaction studies of nucleic acid from involved tissues ( [187](#), [188](#) ). The organism is very difficult to culture *in vitro*, but by incubating blood mononuclear cells with the monocyte “deactivating” cytokine IL-4, researchers are able to grow *T. whippelii* in blood monocytes in tissue culture ( [189](#), [190](#) ). The organism can also be grown *in vitro* in fibroblasts under certain conditions. Practical laboratory diagnosis is based on identifying typical PAS-positive macrophages in affected tissues and demonstration of *T. whippelii* nucleic acid in blood leukocytes or affected tissues using polymerase chain reaction amplification and possibly by use of specific tests using antiorganism antibody or *in situ* hybridization using specific nucleic acid probes ( [190](#), [191](#) ).

### Skin Macrophages (Langerhans Cells)

The mononuclear phagocytes of the skin are called *Langerhans cells* ( [192](#) ). Not easily seen in routine stains, these cells must be stained with metal salts such as gold chloride, with cytochemical stains, or with immunohistochemical stains ( [192](#), [193](#) and [194](#) ). Langerhans cells have a relatively clear cytoplasm, a lobulated nucleus without organelles characteristic of keratinocytes and melanocytes, and a unique cytoplasmic granule, the *Birbeck granule* ( [192](#), [195](#) ) ( [Fig. 13.8](#) ). The tennis racket-shaped granules are seen only by electron microscopy and may measure 0.8 to 2.0  $\mu$ m in length. The origin and function of these granules are unknown.



**Figure 13.8.** Electron micrograph of a Langerhans cell from the skin of a normal human. The cell displays a lobulated nucleus and numerous cytoplasmic Langerhans (“Birbeck”) granules. The inset shows a higher power view of several of the granules.  $\times 25,000$ . (Photograph courtesy of Dr. John Shelburne.)

Langerhans cells make up 3 to 8% of the epidermal cells ( [196](#) ). They are of bone marrow origin ( [197](#) ) but can proliferate locally as well ( [198](#) ). Reticular dysgenesis is a rare inherited immunodeficiency characterized by lack of blood monocytes and neutrophils and low lymphocyte numbers (despite normal erythrocyte and platelet counts). These patients have normal skin macrophages but absent Langerhans cells ( [199](#) ). After bone marrow transplant therapy, the Langerhans cells return. Langerhans cells have receptors for the Fc portion of IgG and for C3 ( [200](#) , [201](#) ) and express the MHC class II antigens [immune-associated (Ia) in mice and HLA-DR in humans] ( [192](#) , [202](#) ). The cells express a macrophage-related antigen recognized by monoclonal antibody F4/80 ( [161](#) ) and the CD1a antigen ( [203](#) ). CD1a is not expressed on normal blood monocytes, but it is found on intrathymic thymocytes. Langerhans cells contain no peroxidase, but adenosine triphosphatase activity is present. They adhere to glass and have some pinocytotic and phagocytic activity but much less than macrophages from other areas ( [192](#) ).

The primary function of Langerhans cells is to serve as antigen-presenting cells ( [204](#) ). In this respect, they are closely related to the marginal zone macrophages, the follicular DC, the medullary macrophages, and interdigitating cells of the T-cell areas of lymph nodes ( [192](#) , [204](#) ). There is a strong correlation between the expression of MHC class II antigen and the ability to serve as an accessory cell. Langerhans cells synthesize and express large amounts of MHC class II antigen and are seen in apposition to lymphocytes at sites of allergic contact dermatitis, suggesting an important role in contact (delayed) hypersensitivity ( [205](#) , [206](#) ). Langerhans cells can also acquire antigen in the skin and carry it to regional lymph nodes, where they are sometimes seen as “veiled” cells ( [192](#) ). Langerhans cells are probably also involved in rejection of skin allografts, and there is some evidence that they aid in the differentiation (keratinization) of epidermal cells by an unknown mechanism ( [207](#) ).

Langerhans cells are involved in various disease states. As discussed above, they participate in allergic contact dermatitis reactions. In histiocytosis X (or so-called Langerhans cell granuloma), there is an accumulation of these cells in various areas of the body ( [208](#) ). Histologically, this does not appear to be a malignant condition ( [209](#) , [210](#) ). The cells in this condition have the Birbeck granules, express Fc and C3 receptors, and have more phagocytic capability than normal Langerhans cells ( [208](#) ).

### **Liver Macrophages (Kupffer Cells)**

A large portion of the body's mononuclear phagocytes resides in the liver ( [96](#) , [121](#) ). Liver macrophages (or Kupffer cells) are the phagocytes of the liver sinusoidal walls ( [211](#) ). They lie on the endothelial cells or are embedded in the endothelial lining and may extend into the Disse space. Kupffer cells are also in close contact with other liver cells, including fat-storing cells and pit cells, as well as reticulin fibers. By scanning electron microscopy, they have microvilli and occasional lamellipodia. The cells have slightly irregular oval nuclei, small mitochondria, and numerous endocytic vacuoles. They contain “wormlike structures,” apparently unique internal structures consisting of internalized membrane with a thick coat of membrane material ( [212](#) , [213](#) ). By transmission electron microscopy, the external membrane has a thick, fuzzy coat. Kupffer cells contain peroxidase in the endoplasmic reticulum, whereas liver endothelial cells contain no peroxidase ( [211](#) ).

Kupffer cells play important roles in liver injury and in various disorders ( [214](#) ). In their

critical position along the sinusoidal wall, they phagocytize different bloodborne particles. These include injected experimental particles such as carbon and latex, liposomes, bacteria ( [215](#) ), parasites ( [216](#) ), viruses ( [217](#) ), and altered or opsonized erythrocytes ( [157](#) , [218](#) ). They efficiently remove portal blood bacteria that come from the gut ( [215](#) ). Furthermore, they are important in clearing endotoxin from the blood passing through the liver ( [219](#) ). Kupffer cells can produce IL-1, TNF, arachidonic acid catabolites, reactive oxygen species (ROS), and reactive nitrogen species and alter the functions of hepatocytes ( [214](#) , [220](#) ). These alterations range from subtle Kupffer cell-mediated changes to marked hepatocyte injury. Kupffer cells can regulate hepatocyte general protein and fibrinogen synthesis ( [221](#) ) and cytochrome P-450 drug transformation reactions ( [222](#) ). Bacteria and endotoxin cause an increase in the membrane microvilli and an increase in the levels of certain lysosomal enzymes ( [213](#) ). Kupffer cells may play a role in eliminating fibrin and fibrin degradation products from blood; in disseminated intravascular coagulation, this capability is depressed ( [223](#) ).

Phagocytosis by the macrophages in the liver is mediated by Kupffer cell Fc or CRs ( [159](#) , [224](#) , [225](#) and [226](#) ). Antibody opsonization of various particles dramatically enhances their removal from the circulation by these liver cells ( [211](#) ). The Kupffer cells recognize erythrocytes that have been injured or aged *in vitro* ( [218](#) ) or that have been treated with neuraminidase ( [227](#) ). The cells have receptors for *N*-acetylglucosamine ( [228](#) ). Plasma fibronectin also acts as a particle opsonin recognized by Kupffer cells ( [229](#) ). Murine Kupffer cells synthesize and secrete fibronectin, C' factor B, and apolipoprotein E ( [230](#) ). They also display MHC class II antigen and the macrophage antigen F4/80, but they lack the Mac-1 antigen ( [230](#) ).

Kupffer cells can serve as accessory cells in presenting antigens to and stimulating DNA synthesis in T lymphocytes ( [231](#) , [232](#) ). This interaction, like that involving macrophages from other sites, is genetically restricted ( [232](#) ). Kupffer cells from normal animals are cytostatic for tumor cells ( [233](#) ), and those from animals injected with *Corynebacterium parvum* are cytolytic for tumor cells ( [234](#) ). In mice, unlike peritoneal macrophages, Kupffer cells produce hydrogen peroxide very poorly in response to phagocytosis or soluble stimuli ( [230](#) ). IFN- $\gamma$ , which enhances capacity for peroxide production in peritoneal macrophages and blood monocytes, has no such effect on Kupffer cells ( [230](#) ). Kupffer cells are not very effective in *in vitro* killing of *Toxoplasma gondii* trophozoites and *Leishmania donovani* promastigotes and amastigotes, and IFN- $\gamma$  does not enhance this cytotoxicity ( [230](#) ). IFN- $\gamma$  does, however, increase the expression of MHC class II antigen in murine Kupffer cells. In experimental sublethal infection of mice with *Listeria monocytogenes*, there is an influx of immigrant macrophages into the liver ( [230](#) ). These newly immigrated liver macrophages, unlike the Kupffer cells, are able to produce substantial amounts of peroxide and display significant antimicrobial effect ( [230](#) ).

Kupffer cells, like hepatocytes, can produce large amounts of NO, and this can have profound effects on hepatocyte function and liver homeostasis in general ( [220](#) ). NO is responsible for many Kupffer cell-mediated effects on hepatocytes. These include alteration of hepatocyte total protein synthesis, decreased glycolysis, decreased glyceraldehyde-3-phosphate dehydrogenase activity, increased cellular cyclic guanosine monophosphate content, decreased cytochrome P-450 activity, decreased mitochondrial respiration, and tumor cell cytostasis. In microbial sepsis and endotoxemia, there is an increase in hepatic production of IL-1 and TNF, as well as an increase in NO production. Although the NO likely mediates the vasodilation and hypotension and has the potential

for toxic effects on hepatocytes, experiments in sepsis models using mice have shown that inhibition of NO production by administration of L-arginine analogs causes an accentuation of hepatic necrosis ( [220](#), [235](#) ). Part of this accentuated toxicity may be caused by worsening of thrombosis and coagulative necrosis.

### Brain Macrophages (Microglial Cells)

Investigators in the early 1900s noted special-appearing cells in brain prepared by silver impregnation staining methods ( [236](#) ). These cells have been called *microglial cells*, *gitter cells*, and *rod cells* ( [237](#) ). Although early workers postulated that these microglial cells were a type of brain macrophage ( [236](#), [237](#) and [238](#) ), only recently have studies given unambiguous evidence of this ( [239](#), [240](#) ). Using immunohistochemical techniques, researchers have shown that cells with the typical appearance of microglial cells display the macrophage-specific antigen F4/80, the FcR for IgG1/IgG2b, and the myelomonocytic antigen Mac-1 ( [240](#) ). In the adult mouse, there are two distinct populations of brain cells bearing the macrophage antigens. Round monocyte-like cells with short processes associated with the choroid plexus, ventricles, and leptomeninges measure approximately 10  $\mu\text{m}$  in diameter. More typical microglial cells have little cytoplasm but long processes. The body of the latter cell measures approximately 5 to 7  $\mu\text{m}$  in diameter, and the processes extend up to 40  $\mu\text{m}$  from the body ( [240](#) ). Most of the microglial cells are in the gray matter. By electron microscopy, the nucleus is irregularly shaped with unevenly distributed nuclear chromatin. The cytoplasm has elongated cisternae of endoplasmic reticulum, and the long processes themselves contain few organelles. Mitochondria are present in moderate numbers. Lysosomes, endocytic vacuoles, and internalized lipid material are seen in the cells. The cells can internalize erythrocytes and carbon particles, and they contain nonspecific esterase. With injury or inflammation, there is a dramatic increase in the number of microglial cells ( [237](#), [241](#) ).

Information from experiments using chimera and labeled monocytes strongly suggests that microglial cells are derived from circulating blood monocytes ( [237](#), [242](#), [243](#) ). Dying neurons likely act as a chemotactic stimulus for monocytes to migrate into the area and differentiate into microglial cells ( [239](#), [240](#) ). In developing mouse retina, degenerating neurons can be observed, and macrophages migrate from the blood vessels overlying the developing retina, phagocytize the dying neurons, and then develop into F4/80+ microglial cells ( [239](#) ). In the brain gray matter, the microglial cells are seen in highest concentrations around vessels and around degenerating, pyknotic cells ( [237](#), [240](#) ). During development in the mouse, macrophages invade the brain and can be followed through a series of transitional forms as they differentiate to become microglial cells. Apparently, the programmed neuronal cell death that accompanies brain maturation acts as a stimulus to attract monocytes ( [240](#) ).

Brain macrophages are frequently infected with human immunodeficiency virus 1 (HIV-1) in subjects with HIV-1 infection or acquired immunodeficiency syndrome. Infected blood monocytes can emigrate into the brain carrying HIV-1 with them and then differentiate and reside in the central nervous system. This "Trojan horse" introduction of the virus is apparently the primary method of infection ( [244](#) ). Also, brain macrophages and microglial cells express the HIV-1 receptors/co-receptors CD4, chemokine receptor 3 (CCR3), CCR5, and CXCR4. Products of infected macrophages may directly injure and kill neurons; candidate neurotoxins from macrophages include NO, platelet-activating factor, kynurenine metabolites, and proinflammatory cytokines ( [244](#) ).

The function of brain mononuclear phagocytes is not fully known. They phagocytize dying

neurons and their processes, debris, and foreign material ( [237](#), [238](#) ). Although no experimental evidence has been presented, they probably also play a role in the induction of immune responses, in mediating antimicrobial and antitumor effects, and possibly in modulating neuronal cell function. Brain macrophages may function to prevent excessive inflammatory responses by controlling T-lymphocyte responses through the inhibition of T-lymphocyte proliferation and, in some cases, by inducing T-lymphocyte anergy ( [245](#) ).

## Peritoneal Macrophages

Much of the work with mononuclear phagocytes in experimental animals has been done with peritoneal macrophages because they can be conveniently obtained in adequate numbers and cultured. Peritoneal macrophages differ morphologically from their precursor blood monocytes. They measure 15 to 45  $\mu\text{m}$  in diameter, adhere avidly to glass or plastic substrates, and frequently manifest vacuolated cytoplasm. Human studies have primarily used cells from women undergoing elective laparoscopy or laparotomy ( [246](#), [247](#), [248](#), [249](#) and [250](#) ), patients with indwelling catheters immediately after operative placement or patients undergoing chronic dialysis with indwelling peritoneal catheters ( [251](#), [252](#) ), or patients with benign or malignant ascites ( [251](#) ). The cell population from normal women is composed of 85 to 95% macrophages; the remainder are lymphocytes ( [246](#), [247](#) and [248](#) ). The macrophages are heterogeneous, with some resembling blood monocytes morphologically, but most looking more like tissue macrophages ( [246](#) ). There are approximately  $2$  to  $5 \times 10^6$  peritoneal macrophages in a normal woman ( [247](#), [248](#) and [249](#) ). The number varies during the menstrual cycle, with the highest numbers near the time of menstruation; retrograde menstruation may cause this increase ( [248](#) ). Women with endometriosis have increased numbers of peritoneal macrophages ( [247](#), [248](#) and [249](#), [253](#) ). These peritoneal macrophages in endometriosis are activated as judged by a number of parameters, including increased expression of NOS2 and increased ability to produce NO ( [254](#) ).

Peritoneal macrophages are peroxidase negative, have Fc and C' receptors (CRs), and are heterogeneous with respect to cytochemistry and phagocytic ability ( [247](#), [250](#), [252](#), [255](#) ). Hydrogen peroxide and superoxide production in response to phorbol myristate acetate is comparable to that of blood monocytes ( [256](#) ). Peritoneal macrophages are capable of killing tumor cells and bacteria ( [251](#), [252](#), [256](#) ), and, in general, are more effective in killing tumor cells than are blood monocytes ( [256](#) ). The number of peritoneal macrophages in patients with acute inflammatory peritonitis or with malignant ascites is elevated ( [251](#) ). However, the functional capabilities in comparison to resident normal peritoneal macrophages are not known.

## Renal Macrophages

Although inconspicuous on routine hematoxylin- and eosin-stained sections, kidneys contain a large number of macrophages ( [121](#), [257](#) ). They are of bone marrow origin, are phagocytic, bear Fc and CRs, express MHC class II antigen, stain positively for nonspecific esterase, and adhere to plastic or glass substrate. The highest concentration of macrophages is in the medullary interstitial cell population, where they cover much of the outer surfaces of the collecting tubules ( [155](#) ). Macrophages are also seen in close proximity to the macula densa and afferent and efferent arterioles of the glomerular capillary bed, as well as around Bowman capsule ( [155](#) ). The glomerular mesangium of normal animals usually does not contain cells typical of mononuclear phagocytes ( [258](#), [259](#) ).



).

In conditions of glomerular injury, however, there is an influx of monocytes into the glomerulus. This is especially prominent in disorders characterized by crescent formation, in which macrophages constitute up to 50% of the cells in the crescent ( [260](#) ). IL-1, TNF, and IL-6 may contribute to the inflammation noted in glomerulonephritis ( [260](#) ). IL-1 secreted by the mononuclear phagocytes may play a role in the glomerular cell proliferation seen in these disorders ( [47](#), [261](#), [262](#) ). Mice that develop a spontaneous disease similar to human systemic lupus erythematosus overexpress NOS2 and overproduce NO. Blocking the NOS *in vivo* with an L-arginine analog prevents development of arthritis and nephritis ( [263](#) ). In humans with lupus nephritis or IgA nephropathy, there is an increased expression of NOS2 that correlates with the severity of disease ( [264](#) ).

### Milk Macrophages

There are a large number of mononuclear phagocytes in human colostrum and milk, and these macrophages can be transferred from mother to nursing baby. There are from 0.2 to  $21.0 \times 10^6$  cells/ml milk ( [265](#), [266](#) ). Approximately 40% of milk leukocytes are nonspecific esterase-positive macrophages capable of adhering to plastic or glass substrate ( [265](#) ). These cells have Fc and CRs, are able to mediate cytostasis and cytolysis of tumor cells ( [265](#), [266](#) and [267](#) ), and can phagocytize and kill bacteria ( [268](#) ). They can also modulate the mitogenic activity of lymphocytes ( [269](#) ). Breast milk macrophages (unlike blood monocytes) spontaneously produce GM-CSF in *in vitro* culture and differentiate to DC after treatment with IL-4 alone ( [270](#) ). Milk macrophages express high levels of CD86, CD40, and HLA-DR, but they do not express CD1a, a molecule characteristic of DC. CD83, a molecule usually found in DC, is expressed by milk macrophages but not by blood monocytes ( [270](#) ). Also, unlike blood monocytes, milk macrophages express the molecule “DC-specific intracellular adhesion molecule-3-grabbing nonintegrin” (DC-SIGN). DC-SIGN is generally a DC-specific lectin that mediates interactions with a variety of particles, including HIV-1 ( [270](#) ). DC-SIGN expression in milk macrophages could be important in the vertical transmission of HIV-1.

### Reproductive Tract Macrophages

The testis contains large numbers throughout the interstitium ( [271](#), [272](#) ). The cells adhere to glass or plastic, bear Fc and CRs, and express MHC class II antigen and nonspecific esterase activity. Testicular macrophages display F4/80, CD11b, CD11c, CD13, CD14, and CD68. The cells can produce cytokines typical of mononuclear phagocytes (e.g., IL-1 and TNF). Also, they phagocytize sperm in the seminiferous tubules and vas deferens ( [273](#) ) and are believed to be important in eliminating unejaculated, dying sperm ( [273](#), [274](#) ). They can phagocytize bacteria ( [275](#) ), participate in the destruction and elimination of invading organisms ( [276](#) ), and participate in the formation of “sperm granulomas” seen occasionally in men who have had vasectomies ( [277](#) ). Because of their location and the presence of MHC class II antigen on their surfaces, some have speculated that testicular macrophages are important in the induction of immunity against antigens (including sperm antigens) ( [277](#) ). In a group of men with infertility of various causes, testicular macrophages were more prominent in the tubular wall and tubular lumen (compared to those with other types of infertility and to fertile men), and in those with germ cell arrest and Sertoli only causation, the numbers of macrophages were increased in number by twofold ( [278](#) ). This suggests that the testicular macrophages may adversely affect fertility

in certain situations. Macrophage function can be modified by sex hormones, and macrophages can modulate sex hormone production ( [275](#), [279](#), [280](#) ). Apparently, macrophages can synthesize testosterone ( [280](#) ). Testicular macrophages express the HIV-1 receptors CD4, CCR5, and CXCR4 (but not CCR3) ( [281](#) ). This indicates that these macrophages can be infected with HIV-1 and possibly play a role in HIV-1 transmission.

The ovary contains macrophages that phagocytize degenerating luteal cells during normal estrus, postpartum luteolysis, and follicle atresia ( [271](#), [282](#) ). These mononuclear phagocytes have the usual characteristics of tissue macrophages—FcRs, ability to ingest latex spheres, tight adherence to plastic substrate, and nonspecific esterase activity ( [282](#) ). Macrophages isolated from mouse corpora lutea enhance progesterone production by ovarian cells. It is likely that intraovarian macrophages play a role in maintaining progesterone secretion by luteal cells *in vivo* ( [282](#) ).

The number of macrophages in the body of the uterus is increased immediately after insemination ( [283](#) ), in the presence of intrauterine contraceptive devices ( [284](#), [285](#) and [286](#) ), and during pregnancy ( [287](#), [288](#) ). Intrauterine devices are seen to be coated with macrophages, and these inflammatory macrophages may play a part in damaging the gametes or zygote and preventing implantation ( [284](#), [285](#) and [286](#) ). Uterine macrophages are frequently seen phagocytizing sperm ( [283](#) ). In mice, macrophages constitute 10 and 22% of uterine cells from normal and pregnant mice, respectively ( [288](#) ). These macrophages represent a large part of the uterine decidua during pregnancy (up to 10 to 20% of the total number of uterine cells). A large proportion of uterine macrophages in pregnancy are MHC class II antigen- or CD54-positive, suggesting that they may be activated in some fashion ( [288](#), [289](#) ). Uterine macrophages (many expressing NOS2) increase as pregnancy progresses, but there is a decline in endometrial macrophage numbers at least 1 day before onset of parturition ( [289](#), [290](#) ). Because NOS2-derived NO exerts a relaxing effect on uterine smooth muscle and promotes uterine quiescence, some have suggested that the decrease in macrophages just before delivery results in a decrease in this general inhibitory effect on uterine contractility ( [289](#) ). Decidual macrophages produce NO; NO elaborated by activated decidual macrophages may be an effector molecule in mediating early embryo loss in spontaneous abortion ( [291](#) ).

Oviducts contain a few typical macrophages that, based on analysis of women with oviducts blocked either proximally or distally, arise from migration of peritoneal macrophages through the fimbrial openings ( [292](#) ). The number of macrophages in these sites reflects the number in the peritoneum. Oviductal macrophages may interfere with fertilization by injuring or phagocytizing normal or antibody-opsonized sperm ( [249](#), [292](#), [293](#) ).

Mice with a genetically disrupted M-CSF gene have reduced fertility ( [294](#) ). Homozygous M-CSF<sup>-/-</sup> mice have markedly reduced numbers of testicular and ovarian macrophages that accompany their reduced fertility. Males have reduced numbers of sperm and decreased libido, and females have extended estrous cycles and poor ovulation rates. However, the major reproduction defect appears to be a defective feedback regulation of the hypothalamic-pituitary-gonadal axis, suggesting that defects in brain macrophages (microglial cells) contribute to the problem. Also, it is likely that there is abnormal macrophage-influenced function of steroidogenic cells, such as Leydig cells in males and corpus luteal cells in females ( [294](#) ).



## Bone Macrophages (Osteoclasts)

*Osteoclasts* are specialized multinucleated cells found in bone that mediate bone resorption ( [295](#), [296](#) and [297](#)). They form from circulating hematopoietic cells of bone marrow origin ( [295](#), [298](#)). Because of their morphologic similarity to inflammatory multinucleated giant cells, investigators have postulated that they are formed from emigrated blood monocytes ( [103](#), [295](#), [296](#), [298](#)). Blood monocytes and peritoneal macrophages can degrade bone *in vitro* ( [299](#), [300](#)). In murine systems, bone-degrading ability relates to the degree of macrophage multinuclearity ( [299](#)). In osteopetrosis, there is an inability to produce M-CSF with a resultant defect in osteoclast function ( [20](#), [301](#), [302](#) and [303](#)). Some studies have provided evidence that osteoclasts may be derived from a hematopoietic cell that is different from monocytes/macrophages ( [304](#)). Osteoclasts, but not mononuclear phagocytes, respond to calcitonin ( [305](#)), isolated osteoclasts do not express most antigens characteristic of mononuclear phagocytes ( [306](#)), osteoclasts do not have the macrophage antigen F4/80 ( [298](#)), and monoclonal antiosteoclast antibodies do not react with mononuclear phagocytes ( [307](#)). Nevertheless, it is likely that the osteoclast represents a highly differentiated mononuclear phagocyte that simply differs in these respects.

Osteoclasts lack certain antigens usually noted on macrophages (e.g., Fc and C3 receptors), but they express high levels of tartrate-resistant acid phosphatase, the vitronectin receptor, and calcitonin receptors ( [26](#)). Several factors have been discovered that enhance osteoclast formation *in vitro*. These include 1,25 dihydroxyvitamin D<sub>3</sub>, prostaglandin E<sub>2</sub>, IL-1, IL-11, TNF, and glucocorticoids. These factors work through induction of OPGL (identical to TNF-related activation-induced cytokine) in osteoblasts. OPGL, in turn, binds to the receptor activator of NF- $\kappa$ B on osteoclast precursors, and, in the presence of M-CSF, the osteoclast precursors develop into mature osteoclasts. OPG is a soluble decoy receptor for OPGL that serves to inhibit osteoclast formation and differentiation ( [26](#), [308](#)). Tumor growth factor (TGF)- $\beta$  increases the proportion of precursors that become osteoclasts, and it is an essential co-stimulator of osteoclast formation. Research using mice with disruption of various genes has been very helpful in understanding the control of osteoclast formation and function and bone resorption. Mice with disruptions of M-CSF, C-src, C-fos, NF- $\kappa$ B, OPGL, and receptor activator of NF- $\kappa$ B have osteopetrosis, whereas those with disrupted OPG have osteoporosis ( [26](#)).

## Granuloma Macrophages

A *granuloma* is defined as “...a compact, organized collection of mononuclear phagocytes (macrophages or epithelioid cells), which may or may not be accompanied by accessory features such as necrosis or the infiltration of other inflammatory leukocytes” ( [309](#)). Granulomas are characteristic of host responses to many different living and nonliving agents ( [119](#), [310](#), [311](#)). In general, they form as reactions to particulate or indigestible agents that persist in tissues for long periods of time. Cells of granulomas serve both protective and destructive functions for the host. They protect by killing microbial agents and, possibly, tumor cells, by processing antigen, and by interacting with lymphocytes. But they also cause destruction and fibrosis of adjacent normal tissues ( [119](#), [309](#), [312](#)). Multinucleated giant macrophages are prominent features of these granulomas. Multinucleated macrophages form by a process of cellular fusion of uninuclear monocytes or macrophages ( [119](#), [311](#), [313](#)). Cytokines, growth factors, and dihydroxyvitamin D<sub>3</sub>, as well as fusion proteins of viruses (including HIV-1) are important in inducing this fusion

process ( [119](#), [311](#), [313](#), [314](#) ). IFN- $\gamma$ , IL-3, IL-4, and GM-CSF can induce the fusion of monocytes or macrophages to form cells *in vitro* resembling those seen in human granulomas ( [313](#), [315](#), [316](#), [317](#), [318](#) and [319](#) ). TNF may be important in these *in vitro* processes ( [320](#) ).

Granulomatous inflammation *in vivo* is characterized by heterogeneous responses controlled by inciting antigens and different cytokines, with Th1-type (e.g., IL-2 and IFN- $\gamma$ ) or Th2-type cytokines (e.g., IL-4 and IL-10) influencing patterns of responses. The specific cytokines involved in granulomatous inflammation vary with the inciting organisms/antigens. IFN- $\gamma$ , IL-1, and TNF generally serve to enhance granulomatous inflammation associated with mycobacteria (Th1 type), whereas in those associated with schistosomiasis, IL-4 and IL-10 enhance granulomatous inflammation (Th2 type) ( [320](#), [321](#), [322](#) and [323](#) ). In studies of mice with either Th1- (induced with mycobacterial purified protein derivative on plastic beads) or Th2- (induced with *Schistosoma mansoni* egg antigens on plastic beads) antigens, there are differing patterns of chemokine responses ( [324](#) ). Of 24 different chemokines analyzed, there were characteristic profiles for Th1- and Th2-type responses that appeared to be controlled by certain cytokines. NOS2 is noted in induced granulomas, indicating that NO may play a role in the inflammation ( [325](#), [326](#) ), and NOS2-derived NO regulates the size, quantity, and quality of granulomas in *Mycobacterium avium*-infected mice ( [327](#) ).

There is increased expression of osteopontin in granulomas, and osteopontin is absolutely required for granuloma formation ( [328](#), [329](#) ). Osteopontin is a secreted soluble cytokine that influences migration of mononuclear phagocytes and T lymphocytes. Osteopontin deficiency in mice is associated with impaired resistance to herpes simplex virus, *Listeria monocytogenes*, and mycobacterial infection ( [328](#), [329](#) ), and relatively low-level osteopontin in tissues in humans is associated with poorly formed granulomas, lack of multinucleated giant cells in granuloma, and impaired resistance to infection with *Mycobacterium bovis* (bacillus Calmette-Guérin) ( [329](#), [330](#) ). Secreted lymphotoxin (LT- $\alpha$ 3; also known as TNF- $\beta$ ) is also required for granuloma formation and for control of mycobacterial infection, whereas membrane-bound LT- $\beta$  does not ( [331](#) ). Although LT- $\beta$  is required for lymph node formation, absence of LT- $\beta$  does not in itself modify granuloma formation. Lung inflammatory lesions that develop in LT- $\alpha$ -deficient mice show absence of macrophages and multinucleated giant cells and increased numbers of neutrophils. Generally, however, LT- $\alpha$ -deficient mice have normal T-cell and macrophage function ( [331](#) ). In transparent zebrafish, infection of the embryo with mycobacteria at a stage before lymphocyte development results in macrophage aggregates with hallmarks of granuloma ( [51](#) ). These studies indicate that granuloma formation is possible in the context of “innate” immunity.

The functions of multinucleated macrophages are not precisely known. They differ from mononuclear phagocytes in several ways—namely, diminished ability to phagocytize particles and to reduce nitroblue tetrazolium, diminished expression of 5' nucleotidase, and reduced expression of various mononuclear phagocyte antigens ( [310](#), [332](#) ). Fusing macrophages express a unique surface molecule that may be involved in the fusion process ( [333](#) ). Multinucleated macrophages can also kill tumor cells ( [334](#), [335](#) ). The lifespan of multinucleated macrophages is believed to be shorter than that of other tissue macrophages ( [119](#) ).

## Synovial Macrophages

Synovial type A cells are macrophages. These cells are phagocytic, have FcRs, express

MHC class II antigen and nonspecific esterase activity, are of bone marrow origin, and look like mononuclear phagocytes on light and electron microscopy ( 104 ). In inflammatory arthritides such as rheumatoid arthritis (RA), there are increased numbers of synovial tissue macrophages ( 336 ), and the numbers of synovial macrophages correlate well with the degree of articular destruction ( 337 ). Macrophages play a critical role in the initiation and propagation of arthritis; they participate in antigen presentation, regulation of T- and B-lymphocyte activity, secretion of proteases, production of proinflammatory cytokines and arachidonic acid derivatives, and generation of reactive oxygen and nitrogen species ( 336 ). Humans with RA have accelerated generation of mononuclear phagocytes by bone marrow cells ( 338 ). Elimination of macrophages in rat models of arthritis ameliorates the arthritis ( 339 ). Evidence points toward proteases ( 336 ), ROS ( 340 ), and reactive species such as NO and peroxynitrite ( 263 , 341 , 342 ) as the most important macrophage-derived effector molecules in arthritis.

## MONONUCLEAR PHAGOCYTE ANTIGENS AND RECEPTORS

The plasma membrane is a dynamic structure in a constant state of change. The mouse macrophage, through endocytosis, completely internalizes the equivalent of its entire surface membrane area every 33 minutes ( 343 ). Accompanying this and other kinds of endocytosis, various surface membrane components are internalized and diminished in activity. These include 5' nucleotidase (CD73) ( 344 ) and the antigen F4/80 ( 345 ). This probably accounts for the reduced levels in activated macrophage cells that possess enhanced rates of endocytosis ( 346 ). The membrane lipids of macrophages influence membrane fluidity and can be altered by environmental conditions. For example, membrane cholesterol and phospholipids change after phagocytosis ( 347 ), and membrane fatty acid composition changes after incubation in medium with high levels of saturated fatty acids ( 348 ); these changes can alter the activities of the macrophages.

### HLA

Several mononuclear phagocyte antigens have been identified with monoclonal antibodies ( 349 , 350 ). Antibodies against these antigens are of use in precisely identifying, separating, and isolating mononuclear phagocytes *in vitro*, in typing leukemias, and, potentially, in treating disorders such as transplant rejection, hemolytic anemias, immune thrombocytopenias, and malignancies of mononuclear phagocytes. Many of the antibodies recognize determinants expressed on other cell types, especially other myeloid cells, but some of the antibodies recognize antigens found only on mononuclear phagocytes. Many antigens on the surface of macrophages have been characterized. Antigens of the major histocompatibility complex are expressed by mononuclear phagocytes [class I or HLA-A, B, and C ( 351 ) as well as class II or HLA-D ( 352 , 353 )]. The expression of these antigens can be modulated by various factors, such as IFN- $\gamma$  ( 352 ). Some monoclonal antibodies discriminate between different classes of mononuclear phagocytes—for example, between normal mouse macrophages and those activated for tumor cell killing ( 354 , 355 ), between human mononuclear phagocytes isolated from different anatomic sites ( 356 , 357 and 358 ), between freshly isolated human blood monocytes and monocytes cultured for several days ( 356 , 358 ), and among different “subsets” of mononuclear phagocytes ( 359 ).

### CD4 and Chemokine Receptors (Human Immunodeficiency Virus 1 “Receptors”)

The mononuclear phagocyte interacts with the environment through its receptors. Some ligands, such as glucocorticoids, diffuse through the membrane to interact with

intracellular receptors, but most bind to plasma membrane receptors. Once a ligand binds to its receptor, the macrophage reacts in some way (e.g., by altering gene expression, inducing secretion, or changing shape). [Table 13.3](#) lists some of the mononuclear phagocyte receptors. Although once believed to be exclusively a lymphocyte antigen, the CD4 (T4) molecule is also expressed on mononuclear phagocytes. CD4 is necessary for infection of these cells with HIV-1 ([360](#)). HIV-1 infection of lymphocytes leads to rapid death of the infected cells, but HIV-1-infected monocytes and macrophages persist in *in vitro* culture and *in vivo*, frequently forming multinucleated giant cells (syncytia) and serving as reservoirs for the virus ([360](#), [361](#)). Different strains of HIV-1 preferentially infect different hematopoietic cells; these are broadly divided into *lymphocytotropic* (LCT) and *monocytotropic* (MCT) viruses. LCT strains infect normal T lymphocytes and T-cell line cells (but not mononuclear phagocytes), whereas MCT strains infect normal mononuclear phagocytes and normal T lymphocytes but not cell line cells ([361](#)). MCT strains are preferentially transmitted in new infections, despite an evolution of viruses to LCT from MCT strains over the course of infection in individuals ([362](#), [363](#) and [364](#)). For LCT strains of HIV-1, the seven transmembrane-spanning receptor *fusin* is required (in addition to CD4) for fusion of bound virus and productive infection ([365](#)). For MCT strains (and primary HIV-1 isolates), a different seven transmembrane-spanning receptor, *CCR5*, serves as the major co-receptor for infection and cofactor for fusion ([366](#), [367](#)). This molecule also serves as a receptor for regulated upon activation, normal T-cell expressed and secreted, macrophage inflammatory protein (MIP)-1a and MIP-1B; these beta chemokines can inhibit HIV-1 infection of cells ([368](#)). Some people resist infection with HIV-1 despite repeated challenges. It appears that these individuals are resistant because they have a defect in CCR5 that renders their cells noninfectable by primary strains of HIV-1 ([369](#), [370](#)). Furthermore, infected individuals who are heterozygotic for the mutant CCR5 have a slow progression of disease and prolonged life after infection ([371](#)). Approximately 1% and 10 to 15% of western Europeans are homozygotic and heterozygotic for the mutant gene, respectively, whereas very few (essentially zero) Africans have the mutation ([371](#)). DC, unique cells differentiated from monocytes, display the DC-SIGN (CD209) antigen. DC-SIGN, which can also be expressed by some macrophages, is a C-type lectin that serves as antigen receptor, recognizing pathogens through carbohydrates ([372](#)). It regulates DC trafficking, and it also binds HIV-1 and protects it in early endosomes, allowing HIV-1 transport by DC to lymphoid tissues where it enhances infection of permissive target cells ([372](#)). DC-SIGN also serves as the receptor for *Mycobacterium tuberculosis* on DC, using lipoarabinomannan as the ligand for binding ([373](#), [374](#)).

**TABLE 13.3. Mononuclear Phagocyte Receptors**

| Ig Fc receptors           | IL, cytokine, and growth factor receptors |
|---------------------------|---|
| IgG receptor              | IL-1 receptor (CD121)                     |
| FcγRI receptor (CD64)     | IL-3 receptor (CD123)                     |
| FcγRII receptor (CD32)    | IL-4 receptor (CD124)                     |
| FcγRIIA receptor          | IL-5 receptor (CD125)                     |
| FcγRIIB receptor          | IL-6 receptor a (CD126)                   |
| FcγRIIC receptor          | IL-10 receptor (CDw210)                   |
| FcγRIII receptor (CD16)   | IL-12 receptor (CD212)                    |
| FcγRIIIA receptor (CD16a) | IL-13 receptor (CD213)                    |
| FcγRIIIB receptor (CD16b) | Macrophage CSF receptor (CD115)           |
| IgE receptor              |   |

|  |  |
|--|--|
| FcεRI receptor   | IFN-γ receptor (CD119)   |
| FcεRII receptor (CD23)   | IFN-α receptor (CD118)   |
| FcεRIIA receptor   | TNFRs  |
| FcεRIIB receptor   | p55 (TNFR1; CD120a)  |
| IgA receptor   | p75 (TNFR2; CD120b)  |
| FcαR receptor (CD89)   | Granulocyte CSF receptor (CD114)   |
| CRs  | Macrophage CSF receptor (CD115)  |
| CR1 (CD35)   | Granulocyte-macrophage CSF receptor (CD116)                                      |
| CR3 (CD11b/CD18)   | Tumor growth factor-β receptor (endoglin;<br>CD105)                              |
| α <sub>2</sub> -Macroglobulin receptor (CD91)  | Chemotactic factor receptors   |
| Mannose receptor (mannose-binding<br>protein; CD206)   | Chemotactic peptide receptor (e.g.,<br>formyl-methionine-leucine-phenyl-alanine) |
| Dendritic cell-specific intercellular<br>adhesion molecule-3-grabbing<br>nonintegrin (CD209)   |  |
|  | Chemokine receptors (CXCR4, chemokine<br>receptor 5)                             |
| Transferrin receptor   | C5a receptor (CD88)  |
| Lactoferrin receptor   | Fibronectin receptors  |
| Urokinase plasminogen activator<br>receptor (CD87)   | Hormone receptors  |
| Microbial component receptors  | 1,25 dihydroxyvitamin D <sub>3</sub> receptor                                    |
| LPS/LPS-binding protein receptor<br>(CD14)   | Glucocorticoid receptor  |
| TLRs   | Insulin receptor   |
| TLR2 (receptor for bacterial<br>lipoprotein, peptidoglycan,<br>lipoarabinomannan, zymosan)   | Prostaglandin receptor   |
| TLR3 (receptor for<br>double-stranded RNA and<br>polyinosine/polycytosine)   | Glucagon receptor  |
| TLR4 (receptor for bacterial LPS)  | Thyrotropin receptor   |
| TLR5 (receptor for bacterial<br>flagellin)   | Somatomedin receptor   |
| TLR6 (with TLR2, receptor for<br>mycoplasma lipoprotein)   | Testosterone receptor  |
| TLR9 (receptor for<br>CpG-containing DNA)  | Estrogen receptor  |
| Scavenger receptors (A-F)  | Nicotinic acetylcholine receptor   |
| Lipoprotein receptors  | Poliovirus receptor (CD155)  |
| LDL-R  | Hyaluronan receptor (CD44)   |
| Modified LDL-R   |  |
| “Remnant receptor”   |  |
| CpG DNA, Microbial DNA with a large content of unmethylated cytosines adjacent to<br>guanosines; CR, complement receptor; CSF, colony-stimulating factor; IFN, interferon; Ig,<br>immunoglobulin; IL, interleukin; LDL-R, low-density lipoprotein receptor; LPS,<br>lipopolysaccharide; TLR, Toll-like receptor; TNFR, tumor necrosis factor receptor. |  |

---

## Fc Receptors

Mononuclear phagocytes react with Igs through the FcR. All FcRs are integral membrane proteins in the Ig superfamily, except for Fc $\gamma$ RIIIB, which is linked to the membrane by a glycosylphosphatidylinositol (GPI) anchor. The receptors interact with the Fc portions of Igs. Ig interaction with cells through FcRs results in many responses, ranging from effector functions such as antibody-dependent cytotoxicity, particle phagocytosis, enzyme secretion, and reactive oxygen and nitrogen species generation ( [375](#), [376](#), [377](#) and [378](#) ). The best-characterized FcRs are those for IgG and IgE (Fc $\gamma$ R and Fc $\epsilon$ R, respectively). Fc $\gamma$ RI (CD64) is the high-affinity FcR for IgG; it is expressed on numerous leukocytes, including neutrophils, monocytes, and macrophages. IFN- $\gamma$  can enhance Fc $\gamma$ RI expression on mononuclear phagocytes by more than 20-fold. Fc $\gamma$ RII (CD32) is found on essentially all cells that bear Fc $\gamma$ Rs except natural killer cells. Fc $\gamma$ RII binds IgG with low affinity, and, unlike Fc $\gamma$ RI, it does not bind monomeric IgG. Fc $\gamma$ RII is encoded by a minimum of three related genes, and isoforms of Fc $\gamma$ RIIB are formed by alternative splicing. Fc $\gamma$ RIIB is expressed by mononuclear phagocytes, lymphocytes, and some primitive hematopoietic cells but not by natural killer cells or neutrophils. Fc $\gamma$ RIIA and IIC are preferentially expressed in neutrophils, and IIB is expressed in lymphocytes; monocytes express all three. Fc $\gamma$ RIII (CD16) is seen only in mononuclear phagocytes, natural killer cells, and myeloid precursor cells. Fc $\gamma$ RIIIB noted in neutrophils is not an integral membrane protein; it is linked by the GPI anchor and is absent in patients with paroxysmal nocturnal hemoglobinuria. Fc $\gamma$ R-IIIA is a conventional integral membrane protein with an intracytoplasmic tail. Fc $\gamma$ RIIIA is able to mediate antibody-dependent cell-mediated cytotoxicity and phagocytosis, whereas Fc $\gamma$ RIIIB is not.

Fc $\epsilon$ RI, the high-affinity FcR for IgE, is present only on mast cells and basophils; it is involved in allergic reactions. Fc $\epsilon$ RII (CD23), the low-affinity receptor, is present on B and T lymphocytes, mononuclear phagocytes, and eosinophils. This receptor does not belong to the Ig superfamily of receptors. It is somewhat homologous to the receptor for asialoglycoprotein. Fc $\epsilon$ RIIA is found in resting B cells, whereas Fc $\epsilon$ RIIB is noted in activated B cells, mononuclear phagocytes, and eosinophils, especially after stimulation with IL-4. Engaging Fc $\epsilon$ RII on mononuclear phagocytes induces a variety of cellular changes, many of which relate to the induction of NO synthesis ( [378](#) ).

IgA receptors (FcaR; CD89) have been detected on monocytes, polymorphonuclear neutrophils, and eosinophils and on phagocytic cells at mucosal sites ( [379](#) ). These receptors bind both secretory and serum forms of IgA and require the Ca<sup>2+</sup> region of the IgA molecule for ligand recognition. Monocytes and polymorphonuclear neutrophils modulate their expression of the FcaR on treatment with cytokines, such as GM-CSF, and LPS. Purified FcaRs appear as heavily glycosylated molecules with an average molecular weight of 60 kd, dropping to 32 and 36 kd on treatment with  $\Lambda$ -glycanase. Ligation of FcaRs on phagocytic cells by multivalent IgA complexes induces a variety of responses, including superoxide generation, release of inflammatory mediators, phagocytosis, and killing of various pathogenic microorganisms. Thus, the apparent role of these receptors is to amplify the protective effects of the IgA antibody, a function of potential importance to mucosal defense ( [379](#) ).

## Complement Receptors

Mononuclear phagocytes have different types of CRs ( [380](#), [381](#) ). CR1 (CD35) binds C3b/C4b and is found primarily on erythrocytes but also on monocytes and neutrophils. The receptor is a 200-kd transmembrane glycoprotein. Expression of CR1 on human



mononuclear phagocytes can be increased by treatment of the cells with agents such as chemotactic peptides, lymphokines, and fibronectin. *CR2* (CD21), the receptor for C3d, g and the Epstein–Barr virus, is not found on mononuclear phagocytes. *CR3* (CD11b/CD18, Mac-1) binds C3bi. It is found on mononuclear phagocytes as well as on neutrophils ( [380](#), [381](#) ). *CR3* exists as a dimer (one  $\alpha$ -chain CD18 and one  $\beta$ -chain CD11b) in the membrane. The  $\alpha$ -chains are shared by the antigens recognized by antibodies LFA-1, Mac-1/Mo1, and p150,95, whereas the  $\beta$ -chains are distinct for each antigen ( [382](#) ). *CR3* appears to function as an adherence protein, and cells lacking these antigens (and *CR3*) show defective adherence, phagocytosis of C3bi-coated particles, and depressed production of ROS ( [383](#), [384](#) and [385](#) ). When normal human monocytes bind particles to their *CR1* or *CR3*, these particles are generally not ingested. However, cultured blood monocytes as well as freshly isolated human peritoneal macrophages both bind and ingest these particles ( [250](#), [380](#) ). In addition to binding C3bi, *CR3* also binds intercellular adhesion molecule-1 (ICAM-1, CD54). Certain patients with recurrent bacterial infections whose monocytes, granulocytes, and null cells lack these antigens have been described ( [383](#), [384](#) and [385](#) ). Cells from these patients manifest reduced phagocyte adherence to glass or plastic, phagocytosis of C3bi-coated particles, and reduced production of ROS with phagocytosis of zymosan.

C5a anaphylatoxin, the amino-terminal fragment of C5 produced after the enzymatic cleavage, causes a variety of effects on mononuclear phagocytes, most notably chemotaxis ( [386](#) ). C5a receptors (CD88) are members of the superfamily of G-protein-coupled receptors characterized by unique motifs, including seven membrane-spanning hydrophobic domains. These receptors are closely related to receptors for chemotactic (fMLP) peptides ( [386](#), [387](#) ). C5a and fMLP receptors are expressed on both neutrophils and mononuclear phagocytes.

### **$\alpha_2$ -Macroglobulin Receptors**

Mononuclear phagocytes have specific receptors for  $\alpha_2$ -macroglobulin (A $_2$ M) (CD91) that has been modified by interacting with proteases or certain ligands ( [388](#), [389](#) ). A $_2$ M is synthesized by many different cells, including mononuclear phagocytes, hepatocytes, and fibroblasts. A $_2$ M serves not only as a broad-spectrum protease inhibitor, but it also binds numerous growth factors, cytokines, hormones, antigens, and microbial proteins, including IL-1, leukemia inhibitory factor, TNF, IL-6, TGF- $\beta$ , IFN- $\gamma$ , streptococcal cell wall proteins, and modified lipoproteins ( [389](#), [390](#) ). *Modified A $_2$ M* [A $_2$ M that has interacted with protease or ligand (A $_2$ M\*)] binds to mononuclear phagocyte A $_2$ M\* receptors and initiates cellular changes. Expression of the receptor can be modulated by several factors, including IFN- $\gamma$ , endotoxin, and M-CSF. A $_2$ M\* binding is accompanied by receptor-mediated internalization and modulation of cell function ( [388](#), [389](#) ). Antigen bound to A $_2$ M is apparently targeted to mononuclear phagocytes for subsequent antigen presentation to lymphocytes and enhanced immune responses ( [389](#) ). A $_2$ M\* may either antagonize or enhance cellular responses to bound growth factors and cytokines by blocking growth factor/cytokine receptor binding or by enhancing cellular uptake and processing of the ligand.

### **Glycoprotein Receptors**

Macrophages also have specific receptors for glycoproteins with mannose, fucose, or *N*-acetylglucosamine terminal groups ( [391](#) ). These proteins are bound and internalized by the phagocytes, and the receptors are probably recycled to the surface. This system may represent a mechanism for clearing escaped or excess glycoprotein hydrolases in the



macrophage's environment. Macrophages from mice with chronic infection with bacillus Calmette-Guérin (so-called activated macrophages) have reduced numbers of receptors for these glycoproteins, whereas receptors for other ligands such as A<sub>2</sub>M are not altered (392). The mannose-binding protein (CD206) can serve as a primitive opsonin for various microbes (33).

### Transferrin and Lactoferrin Receptors

The mononuclear phagocyte diferric transferrin receptor (TfR) (CD71) plays a role in the transport of iron into the cell (393). Diferric transferrin binds to a specific membrane receptor and is internalized from a coated pit into an acid uncoated vesicle; at the acid pH of the vesicle, iron dissociates from the transferrin protein. Then the apotransferrin dissociates from the receptor, and the receptor is available for another round of ligand binding (394). The number of TfRs per cell is reduced in mouse macrophages activated *in vivo* or *in vitro* (395, 396). Mononuclear phagocytes also have specific cellular receptors for lactoferrin (397). In episodes of acute endotoxemia or bacteremia, apolactoferrin is released from the specific granules by the action of IL-1. This apolactoferrin, after competing for and binding iron, is internalized by the mononuclear phagocyte receptors, thus possibly contributing to the hyposideremia seen in these conditions (47, 397, 398). Transferrin also binds to the low-density lipoprotein (LDL) receptor-related protein (390).

### Lipoprotein Receptors

Mononuclear phagocyte lipoprotein receptors control the entry of these proteins and their associated lipids into the cells (399). Subendothelial vascular mononuclear phagocytes accumulate lipoproteins and cholesteryl esters and form "foam cells," thus contributing to the generation of the atherosclerotic plaque (400, 401). Certain receptors for LDL and modified lipoproteins ("macrophage scavenger receptors" or MSR) are important in this accumulation (390). The LDL receptor recognizes apolipoproteins B-100 and E, which are constituents of LDL, very LDL, intermediate-density lipoprotein, and catabolized chylomicrons (chylomicron remnants). Mouse peritoneal macrophages have very few receptors for LDL, but they do have many MSR (400, 402). Human blood monocytes have both LDL receptor and MSR, and, in the course of *in vitro* culture of monocytes, there is a dramatic increase of MSR (400, 402, 403, 404, 405 and 406). Modified LDL with its cholesteryl esters binds to the MSR and is internalized into the lysosomal compartment where an acid lipase produces free cholesterol. This cholesterol is reesterified to cholesteryl esters, which are stored in the cytoplasm as lipid droplets. Unlike the LDL receptor, the levels of acetyl-LDL receptors are not regulated by the cellular level of cholesterol or cholesteryl esters, so the process can proceed unchecked and result in engorgement of the macrophages with lipid (400). Patients with homozygous familial hypercholesterolemia who lack the receptors for LDL have normal numbers of acetyl-LDL receptors (400). Modified LDL can bind to a variety of mononuclear phagocyte receptors; these include (a) MSR (CD204), (b) Fc $\gamma$ RIIB2, (c) CD36 (thrombospondin), and (d) CD68 (macrosialin), a lysosomal-associated membrane protein ("lamp") of macrophages (390).

Mononuclear phagocyte scavenger receptors (SRs) are a group of proteins that bind chemically or oxidatively modified lipoproteins, polyanions, and apoptotic cells (407, 408). There are at least six classes of SR (classes A through F). SR-AI and SR-AII bind acetylated and oxidized LDL, polyanions, and apoptotic cells. SR-B includes CD36 and SR-BI. CD36 binds acetylated and oxidized LDL, phosphatidyl serine, and apoptotic cells. CD36 interacts with the vitronectin receptor in binding apoptotic cells. CD36 is a phagocytic receptor. SR-BI is a receptor for high-density lipoprotein, the lipoprotein that

can remove cholesterol from cells. SR-CI binds acetylated LDL and polyanions. The class D SR macrophage scavenger receptor (CD68) binds oxidized LDL, the class E SR LOX-1 binds oxidized LDL and polyanions, and the class F SR binds acetylated and oxidized LDL and polyanions. Humans with CD36 deficiency have reduced myocardial fatty uptake and an increased incidence of hypertrophic cardiomyopathy ( [408](#) ).

Expression of the SR can be regulated by various factors, including LPS, M-CSF, TGF- $\beta$ , IFN- $\gamma$ , retinoic acid, glucocorticoids, and vitamin D<sub>3</sub>. M-CSF stimulates SR expression, and *in vivo* M-CSF lowers cholesterol levels. Based on the large variety of ligands for these receptors, SR appears to play a role in several physiologic and pathologic processes [e.g., atherosclerosis, cell adhesion, host defense and innate immunity, cell interactions involving adhesion molecules, inflammatory responses to microbes (namely, bacterial LPS and lipoteichoic acid), and inanimate particulates (i.e., asbestos)] ( [390](#) , [408](#) , [409](#) ).

Cholesteryl esters are removed from mononuclear phagocytes only after deesterification with the production of free cholesterol ( [400](#) ), which is then removed by a high-density lipoprotein. Mononuclear phagocytes produce and secrete apoprotein E in the form of phospholipid discs. These particles, along with cholesteryl ester formed by the action of lecithin-cholesterol acyl transferase, are assembled extracellularly into a large spherical particle containing a core of cholesteryl esters and a coat containing apoproteins A-I and E ( [400](#) , [403](#) ). This particle may be high-density lipoprotein-c, which transports the cholesterol to the liver, where it is metabolized.

The LDL receptor-related protein (also called the *remnant receptor*) binds chylomicrons and very LDL that have been modified by hydrolases (e.g., lipoprotein lipase) and by association and disassociation with apolipoproteins ( [390](#) ). Receptors for these “remnants” are expressed on hepatocytes and Kupffer cells. LDL receptor-related protein has a C-terminal cytoplasmic portion, a single transmembrane domain, and an extracellular domain that is similar to that of the LDL receptor. The receptor mediates the endocytosis of apolipoprotein E-containing, remnantlike lipoproteins, lipoprotein lipase, chylomicron remnants, lactoferrin, A2M-ligand complexes, plasminogen activator-plasminogen activator inhibitor-1 complexes, and certain toxic ligands such as *Pseudomonas* exotoxin A and, possibly, bacterial LPS. LDL receptor-related protein expression is decreased by treatment of cells with IFN- $\gamma$ , LPS, or prostaglandin E<sub>2</sub>, and is increased by M-CSF.

### Cytokine, Interleukin, and Growth Factor Receptors

Mononuclear phagocytes express members of the TNF receptor (TNFR) family. This is a family of receptors that includes the p55 (TNFR1; CD120a) and p75 (TNFR2; CD120b) components of the TNFR, CD40, CD27, CD30, and CD95 (Fas) ( [410](#) ). These receptors are type I membrane proteins containing homologous extracellular domains, with cytoplasmic domains of variable length without significant sequence homology. Ligands for these proteins are all type II membrane molecules, with extracellular carboxy-terminal regions and intracellular amino-termini. Binding of ligand to receptor can induce cellular growth, differentiation, or apoptotic death. In the case of TNFR1 and Fas, engaging the receptor with TNF- $\alpha/\beta$  or Fas ligand, respectively, induces apoptotic death of the cell by activating a complex pathway leading to fragmentation of DNA by endonucleases, nuclear dissolution, and nonnecrotic death ( [411](#) ). This apoptotic cell death occurs in a variety of cell types under physiologic (“programmed cell death”) and pathologic conditions. It serves as an important means of immunologic cell selection of lymphocytes during development (negative selection or clonal deletion of immature T cells), tissue remodeling during embryogenesis and inflammation, and cell-mediated cytotoxicity. MRL- *lpr/lpr* mice have no or very little Fas (CD95) due to a retrotransposon insertion in the gene, resulting

in aberrant splicing and premature termination of transcription; they have defective apoptosis with consequent massive lymphadenopathy and autoimmune disease comparable to humans with RA and systemic lupus erythematosus. Mice with the *g/a* defect have a point mutation in the gene for Fas–ligand, defective apoptosis, lymphadenopathy, and autoimmunity ( [412](#) , [413](#) ). Humans with CD95 defects, impaired apoptosis, and aspects of autoimmunity have been identified ( [414](#) , [415](#) ).

Mouse macrophages and human monocytes have high–affinity specific receptors for IFN– $\gamma$  (CD119) ( [416](#) , [417](#) ). The effects of IFN– $\gamma$  in modulating the activities of mononuclear phagocytes apparently are mediated through these receptors. IFN– $\gamma$  serves as a “macrophage–activating factor” in mouse ( [418](#) ) and human ( [313](#) , [419](#) , [420](#) and [421](#) ) mononuclear phagocytes. Individuals with mutations in IFN– $\gamma$  receptor chains are susceptible to severe infections with bacillus Calmette–Guérin, nontuberculous mycobacteria, *Listeria*, and *Salmonella* ( [422](#) , [423](#) ). Monocytes also have receptors for IFN– $\alpha$  (CD118) ( [424](#) ). IFN– $\alpha$  administered *in vivo* or used *in vitro* with isolated cells can activate monocytes for expression of NOS2 and for NO production ( [425](#) ). Macrophages have IL–12 receptors (CD212), and genetic deficiencies of these receptors predispose to severe infections with poorly virulent mycobacteria and *Salmonella* ( [426](#) ).

## Integrins

As noted earlier, mouse mononuclear phagocytes have receptors for M–CSF (CD115), the specific growth factor for the mononuclear phagocyte lineage ( [55](#) , [77](#) , [427](#) ). Mononuclear phagocytes also express integrin receptors. The integrins are a family of widely expressed cell–surface adhesion receptors. Integrins are  $\alpha\beta$  heterodimers, including the leukocyte–specific  $\beta 2$  integrin LFA–2 (CD11a/CD18), Mac–1 (CR3, CD11b/CD18), and p150, p95 (CD11c/CD18) ( [428](#) ). Ligands for the various integrins include collagen, laminin, fibronectin, vascular cell adhesion molecule–1, vitronectin, ICAM–1 and –2, fibrinogen, factor X, and C3bi. In addition to mediating adhesion, binding to integrins can cause transmission of signals into cells and modulate aspects of cellular function, including migration, proliferation, and differentiation ( [428](#) ).

## Chemotactic Peptide Receptors

Mononuclear phagocytes have specific high–affinity receptors for synthetic chemotactic peptides ( [429](#) , [430](#) ), such as *N*–formyl–norleucine–leucine–phenylalanine–norleucine–tyrosine–lysine and *N*–formyl–methionine–leucine–phenylalanine. The chemotactic peptide (“fMLP”) receptor is a member of the seven transmembrane–spanning, G–protein–linked receptor family ( [387](#) ). There is sequence and structural similarity of the fMLP receptor to the C5a receptor, and the responses of neutrophils and mononuclear phagocytes (the major cell types expressing these receptors) are likewise quite similar ( [386](#) , [387](#) ). These peptides induce not only directed movement (chemotaxis) of the cells but also lysosomal enzyme release and ROS production.

## Coagulation Factor Receptors

Mononuclear phagocytes are capable of synthesizing coagulation factors (see below), and they also display coagulation factor receptors ( [431](#) , [432](#) ). Coagulation processes and activated coagulation factors are important mediators of blood coagulation and anticoagulation, and they also play roles in cell mito–genesis, inflammation, atherogenesis, tissue remodeling, cell adherence, and chemotaxis. Monocytes and macrophages have

well-characterized receptors for factor VII/VIIa [tissue factor (TF)], fibrinogen (CD11b/CD18 and CD11c/CD18), factor X (CD11b/CD18), factor Xa (membrane-bound factor V and an “effector cell protease receptor type 1”), thrombin (the thrombin protease-activated receptor), and urokinase-type plasminogen activator (CD87). TF is a membrane lipoprotein that initiates the extrinsic pathway of coagulation on mononuclear phagocytes and endothelial cells (433). TF acts as a high-affinity receptor and cofactor for factor VII/VIIa. Monocyte expression of TF is increased by treatment with LPS, TNF, immune complexes, and lymphocyte products (433, 434). The thrombin receptor is G-protein-linked seven transmembrane segment receptor expressed on several cell types, including mononuclear phagocytes (435). Thrombin cleavage of the extracellular part of the receptor exposes a tethered ligand that mediates functional changes in the receptor-bearing cell. The urokinase-type plasminogen activator receptor (CD87) is identical to the monocyte differentiation antigen Mo3 (436). It localizes urokinase-type plasminogen activator on the membrane and contributes to cell-mediated fibrinolysis, plays a role in tissue remodeling and cell invasiveness through tissues, and modulates cell adhesiveness. The receptor is a GPI-linked membrane protein. Its expression is increased by treatment of cells with IFN- $\gamma$  and TNF.

### Hormone Receptors

The effects of several different hormones (e.g., insulin, glucagon, thyrotropin, somatomedin, prostaglandins of the E series, dexamethasone, dihydroalprenolol, 1,25 dihydroxyvitamin D<sub>3</sub>, and sex hormones) on mononuclear phagocytes are probably mediated by specific cellular receptors (275, 279, 437, 438). Monocytes and macrophages display receptors for a variety of other cytokines and growth factors, as noted in [Table 13.3](#).

### Microbial Component Receptors

Mononuclear phagocytes respond to picomolar to nanomolar amounts of microbial components in complex ways. TLRs are central to the mediation of these effects and key to the innate immune system in animals (25, 439). The Toll protein was originally identified in *Drosophila* (the fruit fly) as an essential determinant of dorsoventral polarity in embryogenesis, and it was subsequently shown that a family of Toll proteins and related proteins were important in antifungal and antimicrobial immunity in the flies (25). The cytoplasmic portion of the IL-1 receptor has homology to *Drosophila* Toll. In vertebrates, the TLRs are a family of proteins (TLR1 through TLR10) ([Table 13.4](#)). Members of the TLR family are involved in the recognition of pathogen-associated molecular patterns, with various TLRs binding recognized microbial components. TLR2 binds bacterial peptidoglycan, LPS-associated protein, and bacterial laminoarabinomannan. TLR2 also cooperates with TLR6 to bind and mediate the effects of *Mycoplasma* lipoprotein. Mice with disrupted TLR2 have impaired production of TNF, IL-6, and NO in response to several gram-positive cell walls (likely the peptidoglycan component). TLR2 may also interact with *Porphyromonas gingivalis* and *Leptospira interrogans*, two unique LPSs. TLR2 also reacts with the GPI membrane components of *Trypanosoma cruzi*.

**TABLE 13.4. Toll-Like Receptors (TLRs)**

| TLR  | Ligand  |
|------|---|
| TLR2 | Peptidoglycan, LPS-associated lipoprotein, laminoarabinomannan, zymosan, <i>Mycoplasma</i> lipoprotein (in association with TLR6) |

TLR3 Double-stranded RNA, polyinosine/polycytosine

TLR4 LPS

TLR5 Flagellin

TLR6 *Mycoplasma* lipoprotein (in association with TLR2)

TLR9 CpG-DNA

CpG DNA, microbial DNA with a large content of unmethylated cytosines adjacent to guanosines; LPS, lipopolysaccharide.

Adapted from Takeuchi O, Akira S. Genetic approaches to the study of toll-like receptor function. *Microbes Infect* 2002;4:887; and Medzhitov R, Janeway CJ. Advances in immunology: innate immunity. *N Engl J Med* 2000;343:338.

---

Investigators noted in the mid-1900s that mice of the inbred strains C<sub>3</sub>H/HeJ and C57Bl/10ScCr were unresponsive to LPS from gram-negative bacteria *in vivo*, and that LPS did not activate macrophages and B cells of these mice *in vitro*. Researchers cloned the mouse TLR4 gene and discovered that this LPS insensitivity is caused by mutations in the TLR4 gene in these strains—a point mutation in the cytoplasmic domain of TLR4 in C<sub>3</sub>H/HeJ mice and a TLR4 null mutation in C57Bl/10ScCr mice ( [24](#), [440](#), [441](#) ).

Subsequently, investigators have demonstrated TLR4 mutations in humans who were unresponsive to inhaled LPS ( [442](#) ). TLR4 is expressed by mononuclear phagocytes, cardiomyocytes, airway epithelium, endothelial cells, smooth muscle cells, and, to a small extent, in other cells. People with TLR4 mutations appear to be at increased risk for infection with gram-negative organisms and for septic shock ( [443](#) ), but they have decreased risk of atherosclerosis ( [444](#) ). This protection from atherosclerosis may be due to diminished inflammatory responses to certain microbes (e.g., *Chlamydia pneumoniae*) believed to be important in the pathogenesis of atherosclerosis ( [444](#) ). Levels of TLR4, MD2, and MyD88 are increased in human mononuclear phagocytes by IFN- $\gamma$  treatment, and these increases correlate with increased responsiveness to LPS ( [445](#) ).

TLR3 is the receptor for double-stranded RNA and polyinosine/polycytosine, and TLR5 serves as the receptor for flagellin, the major protein of bacterial flagella. Microbial DNA is a potent immunostimulant and inducer of inflammation, and it is a potent adjuvant in vaccines ( [446](#), [447](#) and [448](#) ). Microbial DNA (unlike DNA from vertebrates) has a large content of unmethylated cytosines adjacent to guanosines (CpG DNA). TLR9 is the receptor for CpG DNA, and it mediates the cellular effects of this immunostimulant ( [449](#), [450](#) ). Mice with a disrupted gene for TLR9 have absent or diminished responses to CpG DNA.

Signaling through the TLR/IL-1R pathways proceeds through several common signaling pathways leading to the nuclear translocation of NF- $\kappa$ B and activation of various kinases. For example, LPS binds a plasma protein (LPS-binding protein), which, in turn, can bind in a specific manner with membrane or soluble CD14 ( [451](#), [452](#) ). Also, LPS alone (or the LPS/LPS-binding protein complex) binds to TLR4, which is complexed with protein MD2. Signal transduction starts with the adapter protein MyD88 interacting with the TLR/IL-1R cytoplasmic tail and recruitment of the IL-1R-associated kinase. Activated IL-1R-associated kinase then binds and activates TNFR-associated factor 6, which, in turn, stimulates the I $\kappa$ B kinase and MAP kinase. This leads to nuclear translocation of NF- $\kappa$ B and transcription of proinflammatory cytokines and growth factors ( [25](#) ). MyD88 is absolutely critical to this complex pathway that mediates responses through TLR2, TLR4, TLR9, and the IL-1R pathways ( [25](#), [453](#) ). MyD88-deficient mice lack cellular responses to



LPS, peptidoglycan, CpG DNA, IL-1, and IL-18.

## ENDOCYTOSIS/PHAGOCYTOSIS

Mononuclear phagocytes internalize substances by either *pinocytosis* (the uptake of solutes) or *phagocytosis* (the uptake of particulates). Pinocytosis can proceed by receptor-mediated processes (discussed above) or by receptor-independent processes. In general, most of the internalized vesicles fuse with lysosomes, and the contents of the vacuoles are processed in the lysosome ( 454 ). Parts of the lysosome/vesicle membrane bud off and return to the plasma membrane, thus recycling the originally internalized membrane and providing a mechanism for maintaining membrane surface area without requiring new membrane synthesis ( 454 , 455 ).

Particles are phagocytized either through opsonins (e.g., Ig, C', or fibronectin) or by ill-defined, opsonin-independent mechanisms ( 456 ). Polystyrene (latex) spheres and aldehyde-fixed erythrocytes are examples of particles avidly phagocytized by mononuclear phagocytes without the need for opsonins. Surface hydrophobicity, charge, or both may be determinants of this nonspecific uptake, but the precise processes involved are not known. When particles such as erythrocytes are opsonized with IgG, mouse macrophages or human monocytes bind and phagocytize them, but if they are opsonized with C3b or C3bi, macrophages or monocytes bind the particles but do not internalize them ( 380 ). However, activated mouse macrophages, cultured human monocytes, or fresh human peritoneal macrophages can bind and internalize C'-coated particles ( 250 , 380 ). For an IgG-opsonized particle to be phagocytized, it must have IgG ligands surrounding it circumferentially. Otherwise, the macrophage membrane extends only as far as the IgG without totally internalizing the particle. This "zipper" concept of opsonized particle phagocytosis requires that the opsonins be in continuous approximation in a density great enough to encircle the entire surface of the particle ( 457 , 458 ).

## CHEMOTAXIS

Mononuclear phagocytes, like neutrophils, exhibit general movement (chemokinesis) as well as directed movement (chemotaxis) in response to various factors ( 66 , 429 , 459 ). Movement of monocytes and macrophages to and within sites of inflammation and tissue injury is influenced by chemotactic factors. Substances derived from plasma, cells, bacteria, and connective tissue proteins can serve as chemotactic factors. These include C5a ( 460 ), fibronectin fragments ( 461 ), elastin fragments ( 462 ), collagen fragments ( 463 ), *N*-formylated oligopeptides ( 429 , 430 ), the chemokines ( 464 , 465 ), and a variety of proteins derived from normal and malignant cells ( 459 , 466 , 467 ). The mononuclear phagocyte recognizes the chemotactic factor through a receptor, senses the direction of the concentration gradient of the factor, and then transduces this information into the cell and regulates intracellular effector mechanisms. The transduction mechanism may involve protein kinase C and the phosphatidylinositol cycle with generation of the second messengers 1,2-diacylglycerol and inositol 1,4,5-triphosphate ( 468 , 469 ). In addition to their chemotactic effects, many of the chemotactic factors cause mononuclear phagocyte membrane depolarization and ion flux, cellular aggregation, and lysosomal enzyme and ROS secretion ( 429 , 459 ).

C5a is a potent chemotactic factor for mononuclear phagocytes ( 459 ). This C' fragment is released after C' activation by antigen-antibody complexes, endotoxin, or cell-derived proteases. Cell-derived chemotactic factors may play an important role *in vivo*. These can

come, for example, from antigen-stimulated lymphocytes ( 467 ), platelets ( 470 ), or tumor cells ( 466 ). Neoplasms are also known to elaborate peptides that selectively inhibit mononuclear phagocyte chemotaxis *in vitro* and macrophage accumulation *in vivo* ( 471 ). This factor, derived from various murine and human cell tumor cell lines and human malignant effusions, is chemically and antigenically related to the immunosuppressive retroviral protein P15E ( 472 ).

The cytoskeletal apparatus of the mononuclear phagocyte is responsible for membrane ruffling, pseudopod formation, and cellular locomotion ( 473 ). Local intracellular variations of calcium concentration modulate the gel/sol states of the cytoskeletal filaments on which myosin contracts. Actin is the main constituent of microfilaments, and it is the most abundant protein of macrophages ( 474 ). Acumentin ( 475 ) and gelsolin ( 476 ) retard globular actin from polymerizing. But when intracellular calcium falls, globular actin is converted to filament actin. Filament actin is then strengthened by cross-linking by actin-binding protein ( 477 ). Macrophage myosin, a magnesium adenosine triphosphatase, serves to contract actin ( 474 ). Mononuclear phagocyte microtubule function is necessary for normal chemotaxis, but phagocytosis is altered little by microtubule-disrupting agents ( 478 ).

## PRODUCTS OF MONONUCLEAR PHAGOCYTES

Mononuclear phagocytes are capable of producing many substances that can influence the host. Some of these substances are secreted constitutively, not requiring any particular stimulus to initiate the secretion. However, secretion of most macrophage products is influenced by stimuli acting on the cell. In general, the secretory capacity of macrophages parallels their state of activation and correlates well with their ability to mediate bactericidal and tumoricidal activities. Some of the products can act on the phagocytes themselves, thus providing the possibility for autoregulation of cell function. [Table 13.5](#) lists some of the secretory products of mononuclear phagocytes.

**TABLE 13.5. Products of Mononuclear Phagocytes**

|   |                               |
|---|-------------------------------|
| Enzymes   | Angiogenesis factors          |
| Acid hydrolases   | Binding proteins              |
| Angiotensin-converting enzyme                               | Transferrin                   |
| Arginase  | Transcobalamin II             |
| Catalase  | Fibronectin                   |
| Heme oxygenase  | Apolipoprotein E              |
| Lipoprotein lipase  | Bioactive lipids              |
| Lysozyme  | Arachidonate derivatives      |
| Reduced nicotinamide adenine dinucleotide phosphate oxidase | Hydroxyeicosatetraenoic acids |
| Neutral proteases   | Leukotrienes B, C, D, and E   |
| Plasminogen activator                                       | Prostacyclin                  |
| Elastase  | Prostaglandin E <sub>2</sub>  |
| Collagenase   | Prostaglandin F <sub>2a</sub> |
| Nitric oxide synthase type 2                                | Thromboxane B <sub>2</sub>    |
| Nonspecific esterase  | Platelet-activating factor    |
| Peroxidase  | Chemotactic factors           |



|                                   |                                      |
|-----------------------------------|--------------------------------------|
| Phospholipase A <sub>2</sub>      | Cytokines/growth factors             |
| Superoxide dismutase              | Erythropoietin                       |
| Complement factors                | Fibroblast growth factor             |
| C1, C4, C2, C3, C5                | IFN- $\alpha$                        |
| Factors B, D, I, H                | IFN-?                                |
| Properdin                         | IL-1                                 |
| Coagulation factors               | IL-3                                 |
| XIII, X, IX, VII, V, II           | IL-6                                 |
| Thrombomodulin                    | IL-8                                 |
| Thromboplastin (tissue factor)    | IL-10                                |
| Reactive oxygen species           | IL-12                                |
| Hydrogen peroxide                 | Macrophage colony-stimulating factor |
| Hydroxyl radical                  | Platelet-derived growth factor       |
| Singlet oxygen                    | Tumor necrosis factor                |
| Superoxide anion                  |                                      |
| Reactive nitrogen species         |                                      |
| Nitric oxide                      |                                      |
| Peroxynitrite                     |                                      |
| IFN, interferon; IL, interleukin. |                                      |

---

## Enzymes

*Lysozyme* (also called *muramidase*) is a 14-kd protein secreted from mononuclear phagocytes in a steady, constitutive manner. It is a major secretory product, composing up to 2.5% of cellular protein produced per day (479). Mononuclear phagocytes contain and secrete more lysozyme than do neutrophils. This enzyme is able to lyse bacteria (especially gram-positive organisms) that contain a certain glucosidic linkage. Animals or patients with an increased mononuclear phagocyte mass or with monocytic or myelomonocytic leukemia have high levels of plasma, urine lysozyme, or both (480). This sometimes leads to tubular dysfunction, excess loss of potassium, and refractory hypokalemia (481).

The *neutral proteases*, including plasminogen activator, collagenase, and elastase, are enzymes that are active at neutral pH and can degrade connective tissue components. Plasminogen activator secretion from macrophages is enhanced if the cells have been activated to a certain state and if they are phagocytizing particles (482). However, endotoxin, a stimulus known to produce highly activated or tumoricidal macrophages, dramatically reduces plasminogen activator secretion (483). Plasminogen activator not only generates plasmin from plasminogen, but it also cleaves C1, C3, and activated Hageman factor. As noted earlier, elastase and collagenase secreted by alveolar macrophages may play a role in the genesis of emphysema (133). Elastase can degrade a large number of substrates other than elastin, including a  $\gamma$ -antiprotease (484), Ig (485), proteoglycans, fibronectin, fibrin, and fibrinogen (486, 487 and 488). These neutral proteases may be used by the mononuclear phagocytes to degrade components of the extracellular matrix as they migrate through the tissues.

A large number of acid hydrolases are present in macrophage lysosomes. The content of

these enzymes is increased as mononuclear phagocytes are stimulated by microbial products, lymphokines, phagocytosis, and *in vitro* culture ( 69, 72, 489 ). The secretion of these enzymes can be stimulated by phagocytosis, by engaging Fc or CRs, or after treatment with lymphokines ( 489 ). In certain instances of tissue inflammation with low tissue pH ( 490 ), the acid hydrolases may be able to act on tissue components. Potential substrates include basement membranes, cartilage, collagen, C' components, proteoglycans, and Ig ( 489 ).

Mononuclear phagocytes synthesize all of the C' factors of the classic and the alternative pathways except C6–9 ( 489, 491 ). Some of these factors can be acted on by various proteases to form products that can alter the function of macrophages. These include Bb, C3b, and C3a ( 491 ). Factor Bb inhibits macrophage migration and promotes macrophage spreading ( 492 ). C3a and C3b modulate macrophage production of arachidonic acid metabolism ( 493 ). IFN- $\gamma$  increases factor B and C2 production and decreases C3 production, whereas IFN- $\alpha$  has little or no effect.

Mononuclear phagocytes produce several coagulation factors. These include those enhancing coagulation [the membrane-bound TF (procoagulant) activity that binds and activates factor VII ( 433 ), as well as factor XIII, which cross-links fibrin ( 494, 495 )] and those inhibiting coagulation [plasminogen activator ( 482, 483 ) and different protease inhibitors]. The procoagulant activity of macrophages and monocytes is dramatically enhanced by endotoxin or antigen-antibody complexes ( 496, 497 ). Mononuclear phagocyte-associated procoagulant/anticoagulant activities are important in atherogenesis, inflammation, cellular growth control, tissue remodeling, cell migration, and invasiveness. Much of the fibrin deposition seen in delayed hypersensitivity reactions and in tumors likely results from mononuclear phagocyte-derived procoagulants ( 498, 499 ). In inflammatory lesions such as those seen in RA, macrophages express a variety of procoagulant and anticoagulant molecules ( 500, 501 ). Mononuclear phagocyte-associated procoagulants play important roles in the disseminated intravascular coagulation seen in malignancy and infection and in the prothrombotic state noted in association with malignancy ( 502 ).

Among the protease inhibitors, A2M is very important because it affects many of the proteases, including plasminogen activator, plasmin, elastase, kallikrein, and thrombin ( 503 ). Mononuclear phagocytes synthesize and secrete this protein ( 487, 504 ), as well as a  $\alpha_1$ -antiprotease ( 134, 135, 505 ). As noted earlier, mononuclear phagocytes have receptors for A2M-protease complex, and this complex can modulate the function of these cells ( 506, 507 and 508 ).

## Reactive Oxygen Species

As mononuclear phagocytes ingest particles or as they are stimulated with certain surface active agents, they exhibit a respiratory burst, much like that seen in neutrophils ( 18 ). Oxygen is consumed at an increased rate, the hexose monophosphate shunt is stimulated, reduced glutathione and reduced nicotinamide adenine dinucleotide phosphate (NADPH) are generated, and oxygen is reduced to superoxide anion by an oxidase. This oxidase requires NADPH, a flavoprotein, cytochrome b245, and ubiquinone ( 17 ). The superoxide anion dismutates to hydrogen peroxide, and some hydroxyl radical may also form in the presence of iron ( 509 ). Some peroxide diffuses out of the cell, whereas some is changed to water and oxygen by the action of catalase. In addition to phagocytic stimuli

and surface active agents (e.g., arachidonic acid or phorbol myristate acetate), antigen-antibody complexes, C5a, ionophores, fatty acids, and lectins can also trigger the mononuclear phagocyte respiratory burst ( [510](#) ). If mononuclear phagocytes have been activated by *in vivo* infection or by *in vitro* treatment with lymphokines such as IFN- $\gamma$ , their ability to secrete ROS is greatly enhanced ( [313](#), [420](#), [421](#), [510](#) ). These oxygen species have the ability to lyse nucleated and nonnucleated cells, to inactivate certain enzymes, and to alter lipids, nucleic acids, and proteins ( [511](#) ). The reduced oxygen species are also important in the metabolism of arachidonic acid products.

The enzyme complex NADPH oxidase in neutrophils and mononuclear phagocytes consists of membrane components (cytochrome b558, p22-Phox, the guanosine triphosphate-binding protein Rac2, and flavin adenine dinucleotide) and cytoplasmic components (p47-Phox and gp91-Phox) ( [16](#) ). Humans with chronic granulomatous disease (CGD) have a defect in one of these subunits, rendering their phagocytes unable to generate ROS. Abnormalities in gp91-Phox are the most common. CGD from a gp91-Phox defect is an X-linked disease, with male hemizygotes expressing the full defect, whereas CGD patients with defects in the other subunits are autosomal recessive. Mouse models of CGD created by genetically disrupting expression of gp91-Phox ( [512](#) ) or p47-Phox ( [513](#) ) are useful in analyzing CGD and in developing new treatments for the disease. Hydrogen peroxide formed from  $O_2^-$  can be used by certain peroxidases or converted to oxygen and water by catalase. Superoxide and peroxide may be toxic in themselves, or they may interact with NO and metals to form more toxic species such as peroxynitrite or hydroxyl radicals (see below).

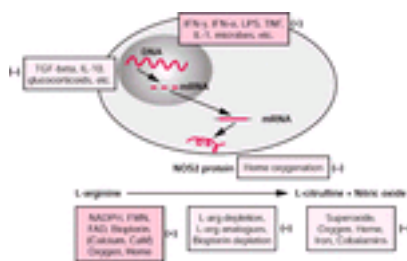
## Reactive Nitrogen Species

The simple gas NO has multiple important physiologic and pathologic functions ( [514](#), [515](#) ). These include roles in (to mention only a few) host resistance to tumors and microbes, regulation of blood pressure and vascular tone, neurotransmission, learning, neurotoxicity, carcinogenesis, and control of cellular growth and differentiation ( [514](#), [515](#), [516](#), [517](#) and [518](#) ). In the presence of oxygen, NO rapidly (within seconds) is converted to nitrite and nitrate, substances that are generally not bioactive ( [519](#) ). NO binds with high affinity to iron in heme groups of proteins such as Hb, myoglobin, and guanylyl cyclase; Hb and myoglobin are very effective quenchers of NO action. NO also nitrosylates the Hb globin  $\beta$ -chain cysteine at position 93 ( [520](#) ). This S-nitrosohemoglobin can subsequently release NO and participate in a cycle of NO/oxygen loading/unloading that is somewhat comparable to that of oxygen/carbon dioxide in the respiratory cycle ( [520](#), [521](#) ).

NO also reacts with  $O_2^-$ , and superoxide dismutase prolongs NO life by eliminating  $O_2^-$ . On reacting with  $O_2^-$ , NO may generate peroxynitrite (OONO-), a very toxic/reactive molecule that is a very important final effector toxic molecule when one thinks of NO toxicity in oxygenated systems ( [515](#) ). Peroxynitrite reacts with protein and nonprotein sulfhydryls, DNA, and membrane phospholipids. Peroxynitrite also nitrates free and protein-associated tyrosines (and other phenolics) via the metal-catalyzed formation of the nitronium ion to form nitrotyrosine. Nitration of proteins modifies their functions, and nitrated proteins serve as relatively long-lived markers (a "track") of NO and peroxynitrite action in tissues ( [515](#), [522](#) ). Tyrosine nitration has been associated with inflammatory disorders ( [515](#), [522](#), [523](#) ).

There are three forms of the enzyme NOS encoded by three different genes. Neural NOS (nNOS or NOS1) and endothelial cell NOS (eNOS or NOS3) are constitutive enzymes,

demonstrating low level, constant transcription of messenger RNA (mRNA). The enzymatic expressions of NOS1 and NOS3 are modulated by regulation of cytoplasmic calcium levels, with agents inducing increases in calcium (e.g., calcium ionophores or ligands such as acetylcholine) with subsequent binding to calmodulin and activation of the enzyme. Inducible NOS (iNOS or NOS2) can be regulated at multiple levels, but induction of mRNA transcription by agents such as cytokines or LPS appears to be of major importance ( 524 ) ( Fig. 13.9 ). Although NOS2 was described initially in mononuclear phagocytes, it is also found in synoviocytes, chondrocytes, endothelial cells, smooth muscle cells, hepatocytes, and others ( 514 , 518 , 525 , 526 and 527 ). NOS3 is myristoylated and membrane-bound; although NOS1 and NOS2 are not myristoylated, they can exist in membrane-bound and cytoplasmic forms. In the mouse macrophage NOS2 promoter, there are two functionally important areas upstream of the 5' end of the gene, which contain consensus sequences for several known DNA-binding proteins ( 524 ). The human NOS2 promoter differs from that in the mouse, extending at least 26 kb upstream from the transcription start site ( 528 ).



**Figure 13.9.** Factors inhibiting or enhancing expression of nitric oxide (NO) synthase type 2 (iNOS or NOS2) and production of NO. The transcription of NOS2 messenger RNA (mRNA) can be enhanced ( + ) or diminished ( - ) by various cytokines/growth factors and bacterial products. The enzyme NOS converts L-arginine (l-arg) to nitric oxide and L-citrulline, and it requires reduced nicotinamide adenine dinucleotide phosphate (NADPH), biopterin, flavin mononucleotide (FMN), FAD, oxygen, and heme for activity. Depletion of L-arginine or biopterin diminishes activity. L-arginine analogs, such as Ng-mono-methyl-L-arginine, block enzyme activity. NO can inhibit NOS activity by oxidizing the enzyme's heme group. Superoxide and oxygen rapidly diminish NO activity by oxidizing it. Iron, heme, and cobalamins can blunt NO's activity by binding NO to their iron or cobalt. CaM, calmodulin; IFN, interferon; IL, interleukin; LPS, lipopolysaccharide; TGF, tumor growth factor; TNF, tumor necrosis factor.

Regulation of NOS2 can occur at multiple steps ( 524 ), including mRNA transcription, mRNA stability, mRNA translation, and mRNA level (precise mechanisms not known). At the protein level, NOS may be regulated by calmodulin binding, dimer formation (the functional enzyme exists as a dimer), substrate (L-arginine) depletion, substrate recycling (L-citrulline to L-arginine), tetrahydrobiopterin availability, end product inhibition (NO interaction with NOS heme), phosphorylation, and subcellular localization. Important NOS cofactors include FAD, flavin mononucleotide, NADPH, tetrahydrobiopterin, and calmodulin-calcium. For NOS2, calmodulin is tightly bound to protein, making it relatively resistant to inhibition by calcium chelators. Activities of NOS can be influenced by tetrahydrobiopterin levels, and cytokines/LPS can enhance tetrahydrobiopterin production ( 529 , 530 ). Heme is a critical component of NOS; NO can act as a feedback inhibitor of NOS activity by binding to the iron in heme ( 531 , 532 ). At the protein level, NOS may be regulated in many ways: calmodulin binding, dimer formation (the functional enzyme exists as a dimer), substrate (L-arginine) depletion, substrate recycling (L-citrulline to L-arginine), tetrahydrobiopterin availability, end product inhibition (NO

interaction with NOS heme), phosphorylation, and subcellular localization.

Although many have shown high-level NO production by murine macrophages, there has been some difficulty in showing that human mononuclear phagocytes produce NO *in vitro*. However, recent studies have clearly documented that human mononuclear phagocytes from patients with a variety of illnesses express high levels of NOS2 and produce NO *in vitro* and *in vivo* ( [533](#), [534](#) ). Some researchers have seen NOS2 antigen in human alveolar macrophages ( [535](#), [536](#) and [537](#) ). Cancer patients treated with IL-2 overproduce NO via an NOS mechanism ( [538](#) ). Blood mononuclear cells from RA patients express higher levels of NOS2 than do those from normal individuals, and the cells are more responsive to IFN- $\gamma$  and endotoxin stimulation for NO production *in vitro*, indicating that their cells are activated for NOS expression and NO production *in vivo* ( [342](#) ). Tanzanian children spontaneously express NOS2 antigen in their blood mononuclear cells, and this is increased in those with mild or asymptomatic malaria and markedly decreased in those with cerebral malaria ( [539](#) ). Patients with hepatitis C infection receiving IFN- $\alpha$  treatment *in vivo* have monocytes that express high levels of NOS2 mRNA and antigen and have high-level NOS enzyme activity ( [425](#) ). Also, IFN- $\alpha$  activates normal blood monocytes *in vitro* for NOS2 expression and NO production ( [425](#) ). Finally, as noted above, peritoneal macrophages from women with endometriosis and infertility spontaneously express NOS2 antigen and produce NO *in vivo* and *in vitro*, and they are more responsive to IFN- $\alpha$  or IFN- $\gamma$  and LPS *in vitro* ( [254](#) ).

NOS2 expression is controlled primarily by levels of mRNA transcription. Human NOS2 promoter polymorphisms have been identified that are associated with resistance to infection and NOS2 expression/NO production. The G-954C (a G to C change at 954 bases upstream from the transcription site) polymorphism is associated with protection from severe malaria in Gabonese children ( [540](#) ), and mononuclear cells from those with the G-954C genotype express more NOS activity and produce more NO *in vitro* ( [541](#) ). The polymorphic pentanucleotide repeat CCTTT (approximately 7 to 20 repeats) is at approximately position -2500 in the NOS2 promoter. Gambian children with high numbers of repeats were found to have more severe malaria and to be more likely to die from malaria ( [542](#) ). Other researchers discovered the C-1173T NOS2 promoter polymorphism, which was very significantly associated with protection from severe malaria in Tanzanian children (primarily cerebral malaria) and severe malaria in Kenyan children (primarily severe malaria anemia) ( [543](#) ). Those with the C-1173T polymorphism had increased levels of NO *in vivo*, suggesting that the polymorphism was functional. C-1173T was noted only in Africans, and its protective effects against malaria disease were independent of any other NOS2 polymorphism ( [543](#) ).

## Bioactive Lipids

Bioactive lipids produced by mononuclear phagocytes are important in inflammatory processes. The secretion of these products can be triggered by engagement of the FcRs, phagocytosis of particles, and treatment with phorbol diesters or ionophores ( [544](#) ). Much of the macrophage fatty acid is arachidonic acid, and a great deal of this can be mobilized and used in the synthesis of both cyclooxygenase (COX) and lipoxygenase products. The ability of mononuclear phagocytes to produce these bioactive lipids is dramatically influenced by the activation state of the cells. Prostaglandins of the E series can depress the ability of mononuclear phagocytes to produce CSF ( [544](#), [545](#) ) and cause decay in the tumoricidal ability of macrophages ( [546](#) ). Leukotriene B, a potent chemotactic factor ( [547](#) ), and leukotriene C, an important mediator in anaphylaxis ( [548](#) ), are produced by mononuclear phagocytes. Human blood monocytes produce as much thromboxane and as



many leukotrienes as platelets and more than neutrophils ( 544 , 549 ). There is a complex interplay between NOS2 and COX2 and between NO and prostaglandin production ( 550 ). Macrophage-derived NO and prostaglandin E<sub>2</sub> may modulate the activities of COX2 and NOS2, respectively, and thus determine levels of prostaglandin and NO produced ( 550 ).

### Peroxisome Proliferator-Activated Receptor-?

Cyclopentenone prostaglandins [e.g., 15-deoxy-<sup>12,14</sup> PGJ<sub>2</sub> (15d-PGJ<sub>2</sub>)] are metabolites of PGD<sub>2</sub>; they act as physiologic agonist ligands for peroxisome proliferator-activated receptor-? (PPAR-?) ( 551 ). PPARs are members of the nuclear hormone receptor superfamily of ligand-activated transcriptional factors that includes receptors for steroids, thyroid hormone, vitamin D, and retinoic acid ( 552 ). PPAR binds to the peroxisome proliferator response element as a heterodimer with the retinoic acid receptor. PPAR- $\alpha$  is expressed in liver, heart, kidney, muscle, brown adipose tissue, and gut. PPAR- $\beta$  is expressed widely, but its function is unknown. PPAR- $\gamma$  is expressed in adipose tissue and leukocytes.

PPAR- $\alpha$  and PPAR- $\beta$  both play important roles in inflammation ( 553 , 554 ). The natural prostaglandin 15d-PGJ<sub>2</sub> and the antidiabetic thiazolidinediones are ligands for PPAR- $\beta$ , whereas hypolipidemic fibrates (e.g., clofibrate) and eicosanoids, such as leukotriene B<sub>4</sub> and 8 (S)-hydroxyeicosatetraenoic acid, are synthetic and natural ligands for PPAR- $\alpha$ . Leukotriene B<sub>4</sub> activates oxidative degradation of fatty acids and their derivatives and regulates the degradation of leukotriene B<sub>4</sub>, and thus, perhaps, prolongs the duration of inflammation ( 554 ). Mice with PPAR- $\alpha$  gene disruption have a prolonged response to inflammatory stimuli ( 554 ). PPAR- $\beta$  with its ligands modulates transcription of genes that regulate lipid metabolism and expression of genes involved in inflammation ( 551 ). In leukocytes, PPAR- $\beta$  is expressed mainly in mononuclear phagocytes. With activation, PPAR- $\beta$  expression is increased ( 551 , 555 , 556 ). PPAR- $\beta$  is highly expressed in thioglycollate-induced mouse peritoneal macrophages, in atheromatous plaque macrophages, and in macrophages treated with LPS, GM-CSF, M-CSF, or phorbol myristate acetate ( 556 , 557 ). Natural ligands include 15d-PGJ<sub>2</sub> and components of oxidized LDLs (e.g., 13-hydroxyoctadecadienoic acid). The antidiabetic thiazolidinedione drugs and the nonsteroidal antiinflammatory drugs aspirin and indomethacin also serve as ligands ( 558 , 559 ). In macrophages, the PPAR- $\beta$ -ligand system increases CD36 expression but decreases expression of several factors including gelatinase-B, IL-1, IL-6, and TNF ( 555 , 556 ). Treatment of macrophages with IL-4 enhances expression of 12/15-lipoxygenase, and its products 13-hydroxyoctadecadienoic acid and 15-hydroxyeicosatetraenoic acid act as ligands for PPAR- $\beta$  ( 560 ). This system is involved in the IL-4-dependent transcription of the CD36 gene in mouse and human macrophages. Furthermore, activation of the PPAR- $\beta$  pathway inhibits mouse and human osteoclast differentiation, blocking the effects of M-CSF- and OPGL-induced osteoclast formation and activity ( 561 ).

PPAR- $\beta$  ligands reduce NOS2 expression; this has been shown in mononuclear phagocytes and mesangial cells. In mesangial cells from autoimmune MRL- *lpr/lpr* mice [animals in which spontaneous NOS2 overexpression and NO overproduction are critical for disease pathogenesis ( 263 )], there is a relative deficiency of 15d-PGJ<sub>2</sub> ( 562 ). Researchers postulated that this lack of a “deactivator” contributed to the heightened activation and increased NOS2. Others showed that PPAR- $\beta$  agonists inhibited induction of NOS2 by cytokines that were accompanied by an increase in heme oxygenase-1

expression ( 563 ). Zinc deuteroporphyrin, an inhibitor of heme oxygenase-1 expression, partially blunted the agonist-induced decrease in NOS2. They found no consistent effects of 15d-PGJ<sub>2</sub> on COX2. The agonist 15d-PGJ<sub>2</sub> reduces LPS-induced COX2 expression in human monocytelike U937 cells ( 564 ). It is possible that there is feedback control of COX2 expression through PPAR-?. The effects of PPAR-? agonists on COX2 expression have not been examined methodically in mononuclear phagocytes from normal humans or from those with inflammation (e.g., RA). Activation of PPAR-? by 15d-PGJ<sub>2</sub> or BRL49653 (and, to a lesser extent, by activation of PPAR- $\alpha$  by Wy13,643) induces apoptosis of human monocyte-derived macrophages *in vitro* ( 565 ). The apoptotic effects are greatest in cells treated with TNF/IFN-? and the PPAR-? agonists. Treatment with PPAR-? agonists is accompanied by inhibition of the transcriptional activity of the NF-?B p65/RelA subunit. Regulation of gene expression by PPAR-? is mediated, in part, by antagonizing the activities of activating protein-1, signal transducer and activator of transcription-1, and NF-?B ( 555 , 566 ). Also, PPAR-? directly interacts with certain specific response elements as a heterodimer with retinoid X receptor ( 552 ).

The PPAR-? agonists 15d-PGJ<sub>2</sub> and troglitazone induce human RA synoviocyte apoptosis *in vitro* ( 567 ). In human RA synovium, there is increased PPAR-? expression, primarily in the synovial lining macrophages, with some expression in fibroblasts and endothelial cells. Intraperitoneal administration of 15d-PGJ<sub>2</sub> (and, to some extent, troglitazone) suppresses adjuvant-induced arthritis and pannus formation in rats ( 567 ).

## Cytokines and Growth Factors

Mononuclear phagocytes secrete factors that promote cellular proliferation and regulate the activities of other cells. IL-1 is a mononuclear phagocyte product that has many different activities ( 47 ). It can stimulate proliferation of T and B lymphocytes; cause hyperthermia by action through hypothalamic cells; alter synovial cell synthesis of prostaglandins, collagenase, and plasminogen activator; enhance fibroblast proliferation; enhance catabolic activities in muscle; cause specific granule release from neutrophils; and cause hepatocyte synthesis of acute phase reactants ( 47 ).

Mononuclear phagocytes are important in angiogenesis ( 568 ). Macrophage-derived factors modify extracellular matrix by releasing degrading enzymes, by synthesizing extracellular matrix components, and by releasing monokines that influence the extracellular matrix. Mononuclear phagocytes also produce factors that induce proliferation of endothelial cells (basic fibroblast growth factor, G- and GM-CSF, TGF- $\alpha$ , insulinlike growth factor-I, platelet-derived growth factor, vascular endothelial growth factor, IL-8, and substance P). Furthermore, mononuclear phagocytes can produce substances that inhibit angiogenesis (e.g., monocyte-derived endothelial cell inhibitory factor, macrophage-derived endothelial cell inhibitor, thrombospondin 1, IFN- $\alpha$ , and IFN-?) ( 568 ). Mononuclear phagocytes produce M-CSF ( 55 ) and erythropoietin ( 569 ).

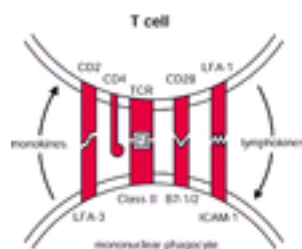
Macrophages, after stimulation with endotoxin, can secrete TNF (also called *cachectin*), a 17-kd protein that has multiple activities, including the stasis and lysis of various tumor cells, suppression of lipoprotein lipase, synthesis of lipogenic enzymes in fibroblasts/adipocytes, and the induction of insulin resistance in fibroblasts/adipocytes ( 570 , 571 and 572 ). This factor may contribute to cachexia in animals with chronic infections and cancer and to death from endotoxin administration in mice ( 573 , 574 , 575 and 576 ). TNF and its close relative lymphotoxin- $\alpha$  are members of a family of ligands that bind to either a 55-kd or a 75-kd receptor ( 573 ). The 55-kd receptor generally mediates apoptosis of



cells, whereas the 75-kd receptor mediates the proliferative and metabolic responses. Several factors are secreted by mononuclear phagocytes that inhibit the proliferation of normal and malignant cells. These include arginase ( [577](#) ), thymidine ( [578](#) ), IFN- $\alpha$  and IFN- $\gamma$  ( [146](#) , [147](#) ), ROS, reactive nitrogen species, and TNF.

## IMMUNOREGULATORY FUNCTIONS

Mononuclear phagocytes, and the morphologically similar but clearly distinct DC, act as antigen-presenting (“accessory”) cells working to promote B- and T-lymphocyte viability, proliferation, and lymphokine secretion ( [351](#) , [353](#) ). As mentioned above, they secrete IL-1, which enhances T- and B-lymphocyte proliferation ( [47](#) , [204](#) , [579](#) ). Antigens are processed by mononuclear phagocytes before they are presented to T cells. Antigens are degraded to peptide fragments, which are then presented via either class I or class II MHC molecules, with class I molecules being involved with endogenously generated antigens and class II with exogenous antigens. Antigen peptides generated endogenously in the cytoplasm (e.g., those generated from an intracellular infection such as influenza virus) by the actions of the proteasome are actively transported across the RER and presented at the mononuclear phagocyte membrane in association with the class I MHC molecule. This antigen is then presented to CD4 T lymphocytes for the generation of sensitized, cytotoxic lymphocytes. Exogenous protein antigens presented at the membrane of mononuclear phagocytes are endocytosed and processed in a lysosomal compartment. Class II  $\alpha$ - and  $\beta$ -chains associate with invariant (Ii) chains and progress through the endoplasmic reticulum. Exogenous antigen peptide fragment then complexes with the  $\alpha\beta$ -chains in an acidic endosome with dissociation of Ii from the complex. The antigen-class II  $\alpha\beta$  complex is then transported to the cell membrane, where antigen can be presented to responding cells in the context of MHC class II molecule. Antigen-presenting cells must physically interact with responding lymphocytes. The process of MHC class I or II-associated-antigen presentation to the T-cell receptor complex is facilitated by certain receptor–ligand couplings between mononuclear phagocytes and responding T lymphocytes ( [Fig. 13.10](#) ). These pairs include CD2 with LFA-3, LFA-1 with ICAM-1 or -2, and CD28 with B7-1 (CD80) or B7-2 (CD86). Lymphokines and monokines elaborated by the interacting cells influence expression of these accessory molecules and act as co-stimulatory molecules for activation of lymphocytes. CD8 and CD4 have a low affinity for binding to MHC class I and II molecules, respectively, and they likely contribute to the interactions.



**Figure 13.10.** Mononuclear phagocyte antigen presentation enhancement by mononuclear phagocyte–lymphocyte interactions involving certain receptor–ligand pairings. The major histocompatibility complex class II antigen presentation to the lymphocyte T-cell receptor complex is facilitated by interactions of cell adhesion molecules with their respective receptors/ligands. Levels of expression of the receptors/ligands are modulated by monokines/lymphokines elaborated by the mononuclear phagocytes/lymphocytes. Ag, antigen; ICAM, intercellular adhesion molecule; LFA, lymphocyte function-associated; TCR, T-cell receptor complex.

## ANTIMICROBIAL AND ANTITUMOR EFFECTS

Experimental animals that harbor chronic infections due to intracellular microorganisms have enhanced resistance to infection with antigenically unrelated microbes and parasites and to the growth of tumor cells. Mononuclear phagocytes mediate this resistance ( [13](#), [580](#), [581](#) and [582](#) ). Macrophages from these animals show enhanced ability to cause stasis and lysis of such microbes and tumor cells *in vitro* and are termed *activated macrophages*. Although activities for antimicrobial and antitumor effects generally parallel each other, these functions sometimes diverge ( [583](#) ). Mononuclear phagocytes in their unactivated state can serve as reservoirs for a latent, persistent infection with organisms such as mycobacteria, fungi, protozoa, viruses, and certain bacteria. However, once activated, macrophages inhibit replication and kill most of these organisms. These antimicrobial effects are believed to be mediated by NO and ROS ( [15](#), [584](#), [585](#) and [586](#) ). Lymphokines, especially IFN- $\gamma$ , enhance antimicrobial effects; these parallel the enhanced ability to produce NO and hydrogen peroxide. Differentiated macrophages do not possess appreciable peroxidase, with the result that the peroxidase/halide/peroxide complex [which is so potent in producing hypochlorous acid in neutrophils ( [18](#) )] is not always operative in mononuclear phagocytes. Oxygen-independent mechanisms, such as lysozyme, cationic proteins, defensins ( [587](#) ), lysosomal enzymes and acid pH, IFN, and iron sequestration, can play a role in mononuclear phagocyte-mediated antimicrobial effects ( [511](#), [588](#), [589](#) ). Monocytes and macrophages from patients with CGD are unable to produce superoxide and hydrogen peroxide, yet these cells have nearly normal antitumor effects ( [590](#) ). Microorganisms can evade the effects of mononuclear phagocytes by different mechanisms. Examples include the inhibition of phagosome-lysosome fusion by mycobacteria and *Chlamydia* ( [591](#), [592](#) ) and rupture of the phagosome membrane with spilling of *T. cruzi* into the cytoplasm ( [593](#) ).

Both NAPH oxidase-derived superoxide and NOS2-derived NO play critical roles in the antimicrobial activities *in vivo*. Using mice with disruptions of NOS2 or the gp91 subunit of NAPH oxidase (Phox) (either the respective single “knock-outs” or a double NOS2/Phox “knock-out”), investigators have determined that mice with disrupted NOS2 or Phox are highly susceptible to infection and death with *Salmonella typhimurium*, and those with the double disruption are more susceptible ( [585](#), [586](#) ). Despite impaired resistance in both NOS2- and Phox-disrupted mice, the kinetics of bacterial replication were markedly different in the two groups, with Phox-disrupted mice having dramatic proliferation of *S. typhimurium* in the first few hours, whereas NOS2-disrupted mice had a slower accumulation of the microbes. Thus, Phox (and superoxide, hydrogen peroxide, and, perhaps, peroxy-nitrite) appears to be most important in the first few hours of infection, whereas NOS2 (and NO and NO-related molecules) had a more sustained effect that lasted for several days ( [585](#), [586](#) ). Mice with NOS2 disruption are also extremely susceptible to infection and death from mycobacterial tuberculosis infection ( [594](#) ). Studying *L. donovani* in comparable mice, researchers noted that both mice with disruption of NOS2 and those with disrupted Phox have increased susceptibility to infection during the early stage of liver infection ( [595](#) ). After this early phase, infection was controlled in the Phox-disrupted mice, but it was unrestrained in mice with NOS2 disruption. Granulomas developed in both types of mice ( [595](#) ).

Genetic defects in Phox (CGD) have been noted in humans, but comparable human NOS2 mutants with associated immunodeficiency have not been noted. In addition to the direct antimicrobial effects of NO, NO can serve to dampen or prevent manifestations of disease in those infected with microbes. For example, children with the C-1173T NOS2

promoter polymorphism have increased NO production and are protected from severe disease and death from infection with *Plasmodium falciparum* ( 543 ). However, despite this protection, those with the polymorphism do not have reduced levels of malaria parasitemia ( 543 ). The “antidisease” effect of NO is likely related to an NO-mediated decrease in TNF production ( 596 ) and an NO-mediated decrease in endothelial cell adhesion molecule expression (and, thus, a decrease in adherence of parasitized erythrocytes to endothelium cells) ( 597 ).

The antitumor effects of mononuclear phagocytes are potent and complex. Macrophages activated for antitumor activity are immunologically nonspecific in that they act on tumor cells irrespective of species or antigenic makeup, but they are selective in that tumor cells are affected whereas normal cells are relatively spared ( 581 ). This cytotoxic activity generally requires macrophage-target cell contact, and supernatants do not mediate the damage. Tumor cell cytotoxicity consists of both cytostasis and cytolysis. It is unlikely that ROS are the primary mediators of tumor cell cytotoxicity. Spontaneous tumor cell killing by mouse or human mononuclear phagocytes is unaffected by anaerobiosis and quenchers or by scavengers of ROS ( 590 , 598 ), and monocytes from patients with CGD (those unable to produce peroxide and superoxide) kill target cells normally ( 590 , 599 ). The cytostatic effects are mediated, at least in part, by inhibition of mitochondrial respiration with resultant inhibition of DNA synthesis ( 600 , 601 ). The cytotoxic effect is accompanied by a loss of tumor cell iron ( 602 ). Potential mediators of the cytotoxic effect include ROS ( 603 ), thymidine ( 578 ), arginase ( 577 ), a cytolytic protease ( 604 ), TNF ( 573 , 605 ), and NO ( 606 ). Cytotoxic activated macrophages synthesize NO (frequently measured as its oxidation products nitrite and nitrate). NO is a mediator of activated macrophage-induced tumor cytotoxicity; it causes inhibition of tumor cell DNA synthesis, induction of iron release from tumor cells, inhibition of tumor cell mitochondrial respiration, inhibition of ribonucleotide reductase, and induction of apoptosis ( 514 , 601 , 602 , 606 , 607 , 608 and 609 ).

The process of mononuclear phagocyte activation can result in cells with various phenotypes. For the sake of precision, most designate the function for which the cells are activated (e.g., “activated for increased ability to kill microbes” or “activated for increased expression of arginase”). Activation is generally a graded process in which cells can be modulated to different states in which they display different functional abilities ( 33 , 34 , 581 , 610 , 611 and 612 ). *Classic macrophage activation* was originally described as the process by which the cells are activated to a state of increased ability to inhibit the growth of or to kill microbes or tumor cells ( Fig. 13.1 ). In animals with chronic infection, lymphocytes sensitized to microbial antigens secrete lymphokines that chronically act on mononuclear phagocytes ( 13 , 581 ). *In vitro*, macrophages are activated by multiple signals in a sequential fashion. Cells are primed for function by the action of soluble activating factors. IFN- $\gamma$  serves as one of these potent factors ( 416 , 418 , 419 , 420 and 421 ). Once primed in this manner, macrophages show several different functional and antigenic changes, but they are, in general, not tumoricidal. However, these macrophages can be triggered to kill by different bacterial products such as endotoxin, porin, and muramyl dipeptide in very low amounts ( 581 , 610 , 612 , 613 and 614 ). This system of sequential, stepwise classic activation has been demonstrated with experimental animal and human cells ( 581 , 610 , 613 ). IFN- $\gamma$ , TNF, and LPS are prototype classic activators. Classically activated macrophages generally have increased production of NO, superoxide, TNF, IL-1, IL-12, IL-6, MIP-1a, and macrophage chemotactic protein-1, and they display lower levels of the mannose receptor ( 33 , 34 ) ( Table 13.6 ). Classically activated macrophages have markedly enhanced antimicrobial activity.

**TABLE 13.6. Activated Macrophages**

|                       | Classic   | Alternative  | Type II  |
|-----------------------|---|--|--|
| Activators            | IFN- $\gamma$ , TNF, LPS  | IL-4, IL-13, glucocorticoids                           | IFN- $\gamma$ , TNF, LPS with Fc receptor ligation |
| Markers               | ? MHC-II, CD86; ? mannose receptor  | ? Mannose receptor; ? scavenger receptor; ? FIZZ1, Ym1 | ? MHC-II, CD86                                     |
| Cytokine production   | ? TNF, IL-12, IL-1, IL-6  | ? IL-1 receptor antagonist; ? IL-10, CD23              | ? IL-10, TNF, IL-6                                 |
| Chemokine production  | IP-10, macrophage inflammatory protein-1a, macrophage chemotactic protein-1 | Alternative macrophage-activation-associated-1         | —  |
| NOS2/Nitric oxide     | ????  | ??? or none  | ??? or none  |
| Arginase              | None  | ????   | —  |
| Microbicidal activity | ????  | None   | —  |

IFN, interferon; IL, interleukin; LPS, lipopolysaccharide; MHC-II, major histocompatibility complex class II antigen; TNF, tumor necrosis factor; ?, increased;  $\gamma$ , decreased.  
Adapted from references [33](#), [34](#), [610](#), and [612](#).

IL-4, IL-13, and glucocorticoids are the prototype activators for the *alternative activation of macrophages* ([33](#), [34](#)). Alternatively activated macrophages produce high levels of arginase (and, thus, consume arginine and limit NO production because of substrate depletion) and high levels of IL-1 receptor antagonist and IL-10, display increased levels of the mannose receptor and the SR, and kill microbes poorly. They also display the unique transcription factors FIZZ1 and Ym1, whereas classically activated macrophages do not ([615](#)). They have little or no increase in MHC class II antigen, and they are poor at presenting antigen to T cells. However, they have increased fibronectin and extracellular matrix synthesis. Increased polyamine synthesis as a result of arginase activity leads to increased cell growth, collagen formation, and tissue repair.

Ligation of FcRs of macrophages (e.g., with IgG immune complexes) coupled with signaling through TLR (e.g., with LPS) or with CD40 or CD44 results in perhaps a third variety of activated cells, *type II activated macrophages* ([34](#)). These cells are similar to classically activated macrophages but produce high levels of IL-10 and do not have high levels of arginase. In general, they inhibit inflammation, probably as a result of the high IL-10 production. Whereas classically activated macrophages stimulate T cells to produce IFN- $\gamma$  (Th1 response, likely as a result of IL-12), type II activated macrophages induce T lymphocytes to produce IL-4 (Th2 response, likely in response to IL-10) and cause Ig class switching by B lymphocytes.

A variety of factors and actions can cause *macrophage deactivation*. It is important to define *activation* when assessing these processes. The cytokines IL-10 and TGF- $\beta$  “deactivate” macrophages by decreasing MHC II expression, NOS2 expression, NO production, COX2 expression, and prostaglandin production. As noted above, IL-4

diminishes NOS2 expression and NO production, but it also increases arginase expression, and IL-4-treated macrophages, although “deactivated” for some functions, are activated for others. Also, IL-4 increases macrophage CD23 (the low-affinity IgE receptor), and engagement of CD23 by IgE increases macrophage NOS2 expression and NO production (378). As noted above, PPAR- $\alpha$  agonists reduce monocyte and macrophage production of TNF and NO (551). Phagocytosis of apoptotic cells decreases activity of macrophages, generally by enhancing production of IL-10 and TGF- $\beta$ .

## MONONUCLEAR PHAGOCYTES AND APOPTOSIS

*Apoptosis* (programmed cell death) is a natural, active process that can be envisioned as a way to rid the body of effete cells, excess cells, or cells that are potentially dangerous (616) (Fig. 13.11). The process can begin with either the cell death receptor pathway (initiated by a variety of ligands through TNF receptors and CD95) or the mitochondrial pathway [initiated by a variety of signals such as x-irradiation, ultraviolet irradiation, chemotherapy drugs, and p53 (DNA damage)] (616). Both paths lead to a cascadelike activation of a series of cysteine-aspartate proteases (caspases), with resultant apoptosis and cell death. In the cell death receptor pathway, for example, CD95 ligand binds to CD95 and induces receptor clustering. This clustering recruits, via the Fas-associated death domain protein, multiple procaspase 8 molecules, and the resulting high concentrations of the caspase zymogens causes caspase 8 activation. Caspase 8 then activates procaspase 3 to active caspase 3, the final common caspase in the cascade. The mitochondrial pathway is activated by exogenous insults, as noted above, and also by internal signals such as DNA damage. These signals cause release of mitochondrial cytochrome *c* and the adapter protein Apaf-1. These two molecules associate with procaspase 9 to form the apoptosome with activation of procaspase 9 and subsequently procaspase 3, with resultant active caspase 3 and apoptosis. Caspase substrates include procaspases but also an inhibitor of DNase (ICAD), nuclear lamins, and a member of the p21-activated kinase family (PAK2). These caspase actions (and likely others) result in apoptosis and death of cells. The Bcl-2 family of proteins are important apoptosis regulators that act mainly at the mitochondrion membrane. Bcl-2 blocks apoptosis by inhibiting release of cytochrome *c* and Apaf-1 from the mitochondrion, whereas proapoptotic members of the Bcl-2 family (e.g., Bax) enhance release. Caspase 3 activity is inhibited by the inhibitor of apoptosis protein, and this, in turn, can be blocked by the second mitochondria-derived activator of caspases or the direct IAP-binding protein with low isoelectric point (DIABLO). The complexity and redundancy of the regulatory factors for this pathway underscore its importance and potency. In addition to protein inhibitors of caspases, NO inhibits all members of the caspase family by nitrosylating the active-site cysteine (617, 618). Also, NO enhances Bcl-2 expression and, thus, reduces apoptosis (619). On the other hand, high levels of NO delivered exogenously to cells from NO donors or by adjacent NO-producing cells induce apoptosis and cell death (620, 621).





**Figure 13.11.** Apoptosis pathways. Apoptosis (programmed cell death) can be initiated through the cell death receptor pathway [via ligands for tumor necrosis factor–related receptors (TNF–Rs)] or through the mitochondrion pathway (via exogenous insults such as chemotherapy drugs or irradiation). Both paths lead to activation of cysteine–aspartate proteinases (caspases) with resultant apoptosis and cell death. In the cell death receptor pathway, a TNF–R (e.g., CD95 or TNF–R1) is engaged by ligand; the receptors cluster and recruit numerous procaspase 8 molecules via the Fas–associated death domain (FADD) protein. Caspase (Casp) 8 is then generated, and this activates caspase 3 zymogen to active caspase 3. In the mitochondrion pathway, an external signal, such as a drug or irradiation, modifies the mitochondrion membrane’s permeability, resulting in release of cytochrome *c* (Cyt C) and the apoptosis–activating factor–1 (Apaf–1). These two molecules associate with procaspase 9 to form the apoptosome with activation of procaspase 9 and then subsequently procaspase 3, with resultant active caspase 3 and apoptosis. Inhibitors of apoptosis include Bcl–2, which inhibits Cyt C release from mitochondria, inhibitor of apoptosis protein (IAP), which blocks caspase 3 activity, and nitric oxide (NO), which inhibits caspases by nitrosylating the active site cysteine. IAP activity can be blocked by the second–mitochondria–derived activator of caspases (Smac). NO synthase (NOS) inhibitors, which reduce NO production, or NO quenchers, which block biologic activity of NO, reduce the NO inhibition of caspases and eventually enhance apoptosis. NO can also enhance production of Bcl–2 ( *dashed line*). L–arg, L–arginine; *uv*, ultraviolet irradiation; XRT, x–ray therapy.

Several microbes can cause apoptosis of macrophages ( [622](#) ), and macrophage–mediated cellular cytotoxicity for tumor target cells is mediated, at least in part, by apoptosis ( [623](#) ). As noted above, macrophages play a critical role in cell destruction and tissue remodeling in embryonic development and in physiologic destruction and elimination of effete cells ( [624](#) ). These processes are, in the main, apoptotic in nature. Macrophages are also critically important for the removal of apoptotic cells from tissues ( [625](#) , [626](#) ). This removal of apoptotic cells is apparently important to reduce the release of toxic cell debris in the local environment and to diminish any proinflammatory effects of the debris. In addition to this physical removal, phagocytosis of apoptotic cells by macrophages increases production of the antiinflammatory substances IL–10, TGF– $\beta$ , and prostaglandin E<sub>2</sub>, and it decreases production of the proinflammatory substances TNF, IL–1, IL–8, GM–CSF, NO, leukotriene C<sub>4</sub>, and thromboxane B<sub>2</sub>, thus further diminishing inflammation ( [625](#) , [626](#) ). Phagocytosis of necrotic (as opposed to apoptotic) cells by macrophages generally results in production of proinflammatory mediators and a decrease in antiinflammatory mediators.

Phosphatidyl serine exposed on the outer leaflet of apoptotic cells is the primary recognition signal used by macrophages to initiate phagocytosis and other apoptotic surface molecules such as sugars on proteins and lipids, oxidized LDL–like proteins, ICAM–3, and a C1q–binding site ( [625](#) , [626](#) ). A macrophage phosphatidyl serine–receptor is central to the process, but other molecules also play important roles. These include certain lectins, the C1q–receptor, CR3, CR4, the vitronectin receptor, CD14, and SRs

(SRA, CD36, CD68, and LOX-1) ( [625](#), [626](#) ).

## ERYTHROCYTE DESTRUCTION AND IRON METABOLISM

Mononuclear phagocytes in different sites (especially the spleen and liver) are important in removing altered or senescent cells such as erythrocytes ( [157](#), [627](#) ), neutrophils ( [628](#) ), and platelets ( [158](#), [629](#) ). The mechanism by which these senescent cells are recognized is poorly understood. It is possible that aged erythrocytes are opsonized by an Ig that reacts with band 3 of the erythrocyte membrane ( [630](#) ) or that desialylation that accompanies aging renders erythrocytes recognizable as altered ( [227](#) ). Macrophages process a large amount of erythrocytes and Hb daily. Once erythrocytes are internalized into macrophage phagosomes, their membrane is lysed, Hb is oxidized to methemoglobin, heme and globin dissociate, and globin is degraded to amino acids. The heme is degraded by the heme oxygenase complex to carbon monoxide, biliverdin, and iron. Ferrous iron is transported intracellularly by an iron-adenosine triphosphatase ( [631](#) ). Iron is transferred to the membrane, where ceruloplasmin oxidizes iron for transfer to transferrin. Ferroportin 1 may play an important role in exporting iron from mononuclear phagocytes in a fashion comparable to that in the placenta and in the enterocyte ( [632](#) ). Depending on iron needs, iron may be stored in ferritin within the mononuclear phagocyte ( [633](#), [634](#) ). Ferritin (or hemosiderin) iron can be retrieved later through a “labile” iron pool to be made available to transferrin and used for Hb or heme protein synthesis. Mononuclear phagocytes normally serve as important storage sites for body iron. Their antimicrobial and antitumor effects can be inhibited by iron overload ( [588](#), [598](#) ). SCLC11A1 (formerly called *natural resistance macrophage-associated protein 1*) is a divalent ion transporter that plays a role in macrophage iron transport and sequestration. Defects in this gene determine susceptibility to infection with intracellular organisms in mice and humans ( [635](#), [636](#) and [637](#) ).

NO regulates the RNA-binding protein *iron response element-binding protein* (IRE-BP) ( [638](#), [639](#) ). IRE-BP is a cytoplasmic protein that binds to the 5' untranslated region of ferritin mRNA and erythroid aminolevulinic acid synthase mRNA and to the 3' untranslated region of the TfR mRNA. Binding to these respective regions decreases ferritin and aminolevulinic acid synthase mRNA translation (resulting in lower levels of ferritin and aminolevulinic acid synthase) and stabilizes TfR mRNA (resulting in higher levels of TfR). IRE-BP is cytoplasmic aconitase, an iron-sulfur cluster protein. NO reacts with the iron in aconitase and inhibits its enzymatic function. When NO reacts with IRE-BP, iron is displaced from the iron-sulfur cluster, decreasing aconitase enzyme activity and increasing IRE-BP binding to appropriate mRNAs. NO produced by mouse Mac can modify IRE-BP activity and influence ferritin synthesis ( [640](#), [641](#) ). An arginine analog that inhibits NO synthesis prevents IFN- $\gamma$ - and LPS-induced activation of IRE-BP and IRE-BP binding to the appropriate mRNAs. This is important as a clue to understanding certain abnormalities in iron metabolism noted in inflammatory states and in the anemia noted in patients with chronic inflammation (the “anemia of chronic disease”). NO produced in association with inflammation may modify iron metabolism and cause disorders in heme, TfR, ferritin synthesis, and erythrocyte production by mechanisms involving IRE-BP.

## REFERENCES

1. van Furth R. Cells of the mononuclear phagocyte system. Nomenclature in terms of sites and conditions. In: van Furth R, ed. Mononuclear phagocytes. Functional aspects. The Hague: Martinus Nijhoff; 1980.
2. Metchnikov I. Immunity in infective diseases. In: Starling FA, Starling EH, eds. Comparative pathology of



inflammation. New York: Dover, 1968.

3. Papperheim A, Ferrata A. Über die verschiedenen lymphoiden zellformen des normalen und pathologischen blutes mit speziellen berucksichtigung der grossen monocuclearen des normalbutes und ihrer beziehund zu lymphozyten und myeloischen lymphoidzellen am meerschweinchen demonstriert. *Folia Haematol (Leipz)* 1910;10:78.
4. Cohnheim J. Neue untersuchungen uber die entzuendung. In: Berlin: Hirschwald, 1873.
5. Craddock CG. Defenses of the body: the initiators of defense, the ready reserves, and the scavengers. In: Wintrobe MM, ed. *Blood, pure and eloquent*. New York: McGraw-Hill, 1980.
6. Ehrlich P. Methodologische beitrage zur physiologie und pathologie der verschisdenen formen der leukocyten. *Z Klin Med* 1880;1:553.
7. Aschoff L. Lecture on pathology. In: New York: Paul Hoeber, 1924.
8. Maximow AA. The macrophages or histiocytes. In: Cowdry EV, ed. *Special cytology. The form and functions of the cell in health and disease*. New York: Hafner, 1932.
9. Goldstein MN, McCormick T. Cytochemical studies during the differentiation of normal human monocytes *in vitro*. *Am J Pathol* 1957;33:737.
10. Lewis MR. The formation of macrophages, epithelioid cells and giant cells from leucocytes in incubated blood. *Am J Pathol* 1925;1:91.
11. Lewis WH. The formation of giant cells in tissue cultures and their similarity to those in tuberculous lesions. *Am Rev Respir Dis* 1927;15:616.
12. Ebert RH, Florey HW. The extravascular development of the monocyte observed *in vivo*. *Br J Exp Pathol* 1939;20:342.
13. Mackaness GB. Cellular resistance to infection. *J Exp Med* 1962;116:381.
14. Steinman RM, Moberg CL. Zanvil Alexander Cohn 1926–1993. *J Exp Med* 1994;179:1.
15. Nathan CF, Hibbs JB Jr. Role of nitric oxide synthesis in macrophage antimicrobial activity. *Curr Opin Immunol* 1991;3:65.
16. Forehand JR, Nauseef WM, Curnutte JT, et al. Inherited disorders of phagocyte killing. In: Scrivner CR, Beaudet AL, Sly WS, eds. *The metabolic basis of molecular and inherited diseases*. New York: McGraw-Hill, 1995:3995.
17. Babior BM. The respiratory burst of phagocytes. *J Clin Invest* 1984;73:599.
18. Klebanoff SJ. Oxygen metabolism and the toxic properties of phagocytes. *Ann Intern Med* 1980;93:480.
19. Metcalf D. The granulocyte–macrophage regulators—reappraisal by gene inactivation [review]. *Exp Hematol* 1995;23:569.
20. Stanley ER, Berg KL, Einstein DB, et al. The biology and action of colony stimulating factor–1. *Stem Cells* 1994;12:15.
21. Springer TA. Traffic signals for lymphocyte recirculation and leukocyte emigration: the multistep paradigm. *Cell* 1994;76:301.
22. Majzoub JA, Muglia LJ. Knockout mice. *N Engl J Med* 1996;334:904.
23. Viney JL. Transgenic and gene knockout mice in cancer research. *Cancer Metastasis Rev* 1995;14:77.

24. Beutler B. Tlr4: central component of the sole mammalian lps sensor. *Curr Opin Immunol* 2000;12:20.
25. Takeuchi O, Akira S. Genetic approaches to the study of toll-like receptor function. *Microbes Infect* 2002;4:887.
26. Chambers TJ. Regulation of the differentiation and function of osteoclasts. *J Pathol* 2000;192:4.
27. Bogdan CT, Rollingshoff M, Diefenbach A. The role of nitric oxide in innate immunity [review]. *Immunol Rev* 2000;173:17.
28. Hibbs JB. Infection and nitric oxide. *J Infect Dis* 2002;185:S9.
29. Luiking YC, Deutz NE. Isotopic investigation of nitric oxide metabolism in disease. *Curr Opin Clin Nutr Metab Care* 2003;6:103.
30. Mills CD. Macrophage arginine metabolism to ornithine/urea or nitric oxide/citrulline: a life or death issue. *Crit Rev Immunol* 2001;21:399.
31. Moncada S. Nitric oxide: discovery and impact on clinical medicine [review]. *J R Soc Med* 1999;92:164.
32. Kim YM, Bombeck CA, Billiar TR. Nitric oxide as a bifunctional regulator of apoptosis [review]. *Circulation Res* 1999;84:253.
33. Gordon S. Alternative activation of macrophages. *Nat Rev Immunol* 2003;3:23.
34. Mosser DM. The many faces of macrophage activation. *J Leukoc Biol* 2003;73:209.
35. Jenkin CR. Factors involved in the recognition of foreign material by phagocytic cells from invertebrates. In: Marchalonis JJ, ed. *Comparative immunology*. New York: John Wiley and Sons, 1976.
36. Yonge CM. Evolution of and adaptation in the digestive system of the metazoa. *Biol Rev* 1937;12:87.
37. Saunders JWJ. Death in embryonic systems. *Science* 1966;154:604.
38. Lackie AM. Cellular recognition of foreign-ness in two insect species, the American cockroach and desert locust. *Immunology* 1979;36:909.
39. Levin J, Bang FB. A bacterial disease of *Limulus polyphemus*. *Bull Johns Hopkins Hosp* 1956;98:325.
40. Tyson CJ, Jenkin CR. Phagocytosis of bacteria in vitro by haemocytes from the crayfish (*Parachaeraps bicarinatus*). *Aust J Exp Biol Med Sci* 1974;52:341.
41. Bertheussen K. Endocytosis by echinoid phagocytes in vitro. I. Recognition of foreign matter. *Dev Comp Immunol* 1981;5:241.
42. Tyson CJ, Jenkin CR. The cytotoxic effect of haemocytes from the crayfish (*Parachaeraps bicarinatus*) on tumour cells of vertebrates. *Aust J Exp Biol Med Sci* 1974;52:915.
43. Howland KH, Cheng TC. Identification of bacterial chemoattractants for oyster (*Crassostrea virginica*) hemocytes. *J Invertebr Pathol* 1982;39:123.
44. Cooper EL. Transplantation immunity in annelids. I. Rejection of xenografts exchanged between *Lumbricus terrestris* and *Eisenia foetida*. *Transplantation* 1968;6:322.
45. Zon LI. Developmental biology of hematopoiesis. *Blood* 1995;86:2876.
46. Baserga R. Tissue growth factors. In: Baserga R, ed. *Tissue growth factors*. New York: Springer-Verlag New York, 1981.
47. Dinarello CA. Biologic basis for interleukin-1 in disease [review]. *Blood* 1996;87:2095.

48. Cline M. Ontogeny of mononuclear phagocytes. In: van Furth R, ed. *Mononuclear phagocytes in immunity, infection and pathology*. Oxford: Blackwell Science, 1975.
49. Herbomel P, Thisse B, Thisse C. Ontogeny and behaviour of early macrophages in the zebrafish embryo. *Development* 1999;126:3735.
50. Gruber B, Esterly JR. Ontogeny of the inflammatory response in the fetal rat. *Biol Neonate* 1980;37:158.
51. Davis JM, Clay H, Lewis JL, et al. Real-time visualization of mycobacterium-macrophage interactions leading to initiation of granuloma formation in zebrafish embryos. *Immunity* 2002;17:693.
52. Lu CY. Ontogeny of murine macrophages: functions related to antigen presentation. *Infect Immun* 1982;36:169.
53. Lu CY. Macrophage ontogeny: implications for host defense, T-lymphocyte differentiation, and the acquisition of self-tolerance. *Clin Immunol Immunopath* 1985;5:253.
54. Van Furth R, Raeburn JA, Van Zwet TL. Characteristics of human mononuclear phagocytes. *Blood* 1979;54:485.
55. Metcalf D. The granulocyte-macrophage colony-stimulating factors. *Science* 1985;229:16.
56. Virolainen M, Defendi V. Ability of hematopoietic spleen colonies to form macrophages in vitro. *Nature* 1968;217:1069.
57. Fedorko ME, Hirsch JG. Structure of monocytes and macrophages. *Semin Hematol* 1970;7:109.
58. Van Furth R, Diesselhoff-Den Dulk MM. The kinetics of promonocytes and monocytes in the bone marrow. *J Exp Med* 1970;132:813.
59. Hirsch JG, Fedorko ME. Ultrastructure of human leukocytes. *J Cell Biol* 1968;36:615.
60. Van Furth R, Cohn ZA. The origin and kinetics of mononuclear phagocytes. *J Exp Med* 1968;128:415.
61. Breton-Gorius J, Reyes F. Ultrastructure of human bone marrow cell maturation. *Int Rev Cytol* 1976;46:251.
62. Bainton DF, Nichols BA. Differentiation of monocytes. Origin, nature, and fate of their azurophil granules. *J Cell Biol* 1971;50:498.
63. Bainton DF, Golde DW. Differentiation of macrophages from normal human bone marrow in liquid culture. *J Clin Invest* 1978;61:1555.
64. Nichols BA, Bainton DF. Differentiation of human monocytes in bone marrow and blood. *Lab Invest* 1973;29:27.
65. van Furth R, Diesselhoff-Den Dulk MM, Raeburn JA, et al. Characteristics, origin and kinetics of human and murine mononuclear phagocytes. In: van Furth R, ed. *Mononuclear phagocytes. Functional aspects*. The Hague: Martinus Nijhoff, 1980:279.
66. Wilkinson PC. The locomotion of leucocytes: definitions and descriptions. In: *Chemotaxis and inflammation*. Edinburgh: Churchill Livingstone, 1982.
67. Zuckerman KH, Ackerman SK, Douglas SD. Long-term human peripheral blood monocyte cultures: establishment, metabolism and morphology of primary human monocyte-macrophage cell cultures. *Immunology* 1979;38:401.
68. Bainton DF. Changes in peroxidase distribution within organelles of blood monocytes and peritoneal macrophages after surface adherence in vitro and in vivo. In: van Furth R, ed. *Mononuclear phagocytes. Functional aspects*. The Hague: Martinus Nijhoff, 1980.

69. Bagglioni M. Lysosomal hydrolases. In: Reichard SM, Filkins JP, eds. The reticuloendothelial system. A comprehensive treatise. New York: Plenum Publishing, 1985.
70. Bozdech MJ, Bainton DF. Identification of alpha-naphthyl butyrate esterase as a plasma membrane ectoenzyme of monocytes and as a discrete intracellular membrane-bounded organelle in lymphocytes. *J Exp Med* 1981;153:182.
71. Braunsteiner H, Schmalz F. Cytochemistry of monocytes and macrophages. In: van Furth R, ed. Mononuclear phagocytes. Philadelphia: FA Davis Co, 1970.
72. Davies P, Bonney RJ. Secretory products of mononuclear phagocytes: a brief review. *J Reticuloendothel Soc* 1979;26:37.
73. Li CY, Lam KW, Yam LT. Esterases in human leukocytes. *J Histochem Cytochem* 1973;21:1.
74. Deimann W. Endogenous peroxidase activity in mononuclear phagocytes. *Prog Histochem Cytochem* 1984;15:1.
75. Metcalf D. Control of granulocytes and macrophages: molecular, cellular, and clinical aspects. *Science* 1991;254:529.
76. Nicola NA, Vadas M. Hemopoietic colony-stimulating factors. *Immunol Today* 1984;5:76.
77. Byrne PV, Guilbert LJ, Stanley ER. Distribution of cells bearing receptors for a colony-stimulating factor (CSF-1) in murine tissues. *J Cell Biol* 1982;91:848.
78. Sherr CJ, Rettenmier RW, Sacca R, et al. The c-fms proto-oncogene product is related to the receptor for the mononuclear phagocyte growth factor, CSF-1. *Cell* 1985;41:665.
79. Sherr CJ. Colony stimulating factor-1 receptor. *Blood* 1990;75:1.
80. Celada A, Borrás FE, Soler C, et al. The transcription factor pu.1 is involved in macrophage proliferation. *J Exp Med* 1996;184:61.
81. Cecchini MG, Dominguez MG, Mocci S, et al. Role of colony stimulating factor-1 in the establishment and regulation of tissue macrophages during postnatal development of the mouse. *Development* 1994;120:1357.
82. Dranoff G, Crawford AD, Sadelain M, et al. Involvement of granulocyte-macrophage colony stimulating factor in pulmonary homeostasis. *Science* 1994;264:713.
83. Stanley E, Lieschke GJ, Grail D, et al. Granulocyte/macrophage colony-stimulating factor-deficient mice show no major perturbation of hematopoiesis but develop a characteristic pulmonary pathology. *Proc Natl Acad Sci U S A* 1994;91:5592.
84. Meuret G, Hoffman G. Monocyte kinetic studies in normal and disease states. *Br J Haematol* 1973;24:275.
85. Meuret G, Batara E, Furste HO. Monocytopoiesis in normal man: pool size, proliferation activity and DNA synthesis time of promonocytes. *Acta Haematol (Basel)* 1975;54:261.
86. Meuret G, Bemmert J, Hoffman G. Kinetics of human monocytopoiesis. *Blood* 1974;44:801.
87. Whitelaw DM. Observations on human monocyte kinetics after pulse labeling. *Cell Tissue Kinet* 1972;5:311.
88. Boggs DR, Athens JW, Cartwright GE, et al. The effect of adrenal glucocorticosteroids upon the cellular composition of inflammatory exudates. *Am J Pathol* 1964;44:763.
89. Thompson J, Van Furth R. The effect of glucocorticosteroids on the kinetics of mononuclear phagocytes. *J Exp Med* 1970;131:429.

90. Lord BI. Myeloid cell kinetics in response to haemopoietic growth factors. *Baillieres Clin Haematol* 1992;5:533.
91. Anderlini P, Przepiorka D, Seong D, et al. Clinical toxicity and laboratory effects of granulocyte-colony-stimulating factor (filgrastim) mobilization and blood stem cell apheresis from normal donors, and analysis of charges for the procedures. *Transfusion* 1996;36:590.
92. Balner H. Identification of peritoneal macrophages in mouse radiation chimeras. *Transplantation* 1963;1:217.
93. Goodman JW. The origin of peritoneal fluid cells. *Blood* 1964;23:18.
94. Haller O, Arnheiter H, Lindemann J. Natural genetically determined resistance toward influenza virus in hemopoietic mouse chimeras. Role of mononuclear phagocytes. *J Exp Med* 1979;150:117.
95. Virolainen M. Hematopoietic origin of macrophages as studied by chromosome markers in mice. *J Exp Med* 1968;127:943.
96. Crofton RW, Diesselhoff-den Dulk MM, van Furth R. The origin and kinetics of the Kupffer cells in the normal steady state. *J Exp Med* 1978;148:1.
97. Howard JG. The origin and immunological significance of Kupffer cells. In: van Furth R, ed. *Mononuclear phagocytes*. Oxford: Blackwell Science, 1970.
98. Shand FL, Bell EB. Studies on the distribution of macrophages derived from rat bone marrow cells in xenogeneic radiation chimeras. *Immunology* 1972;22:549.
99. Brunstetter M, Hardie JA, Schiff R, et al. The origin of pulmonary alveolar macrophages. *Arch Intern Med* 1971;127:1064.
100. Godleski JG, Brain JD. The origin of alveolar macrophages in mouse radiation chimeras. *J Exp Med* 1972;136:630.
101. Johnson KJ, Ward PA, Stiker G, et al. A study of the origin of pulmonary macrophages using the Chediak-Higashi marker. *Am J Pathol* 1980;101:365.
102. Pinkett MO, Cowdrey CM, Nowell PC. Mixed hematopoietic and pulmonary origin of "alveolar macrophages" as demonstrated by chromosome markers. *Am J Pathol* 1966;48:859.
103. Underwood JCE. From where comes the osteoclast? *J Pathol* 1984;144:225.
104. Edwards JCW. The origin of type a synovial lining cells. *Immunobiology* 1982;161:227.
105. Volkman A, Gowans JL. The origin of macrophages from the bone marrow in the rat. *Br J Exp Pathol* 1965;46:62.
106. Gale RP, Sparkes RS, Golde DW. Bone marrow origin of hepatic macrophages (Kupffer cells) in humans. *Science* 1978;201:937.
107. Thomas ED, Ramberg RE, Sale GE, et al. Direct evidence for a bone marrow origin of the alveolar macrophage in man. *Science* 1976;192:1016.
108. Blusse van Oud Albas A, van Furth R. Origin, kinetics, and characteristics of pulmonary macrophages in the normal steady state. *J Exp Med* 1979;149:1504.
109. Volkman A. Disparity in origin of mononuclear phagocyte populations. *J Reticuloendothel Soc* 1976;19:249.
110. Volkman A, Chang NC, Straubach PH, et al. Differential effects of chronic monocyte depletion on macrophage populations. *Lab Invest* 1983;49:291.
111. Volkman A, Chang NCA, Straubach PH, et al. Maintenance of resident macrophage populations in

monocyte-depleted mice. In: Volkman A, ed. Mononuclear phagocyte biology. New York: Marcel Dekker Inc, 1985.

112. Sawyer RT, Strausbach PH, Volkman A. Resident macrophage proliferation in mice depleted of blood monocytes by strontium-89. *Lab Invest* 1982;46:165.

113. Brain JD. Free cells in the lungs. *Arch Intern Med* 1970;126:477.

114. Spritzer AA, Watson JA, Aule JA, et al. Pulmonary macrophage clearance. The hourly rates of transfer of pulmonary macrophages to the oropharynx of the rat. *Arch Environ Health* 1968;17:726.

115. Lauwerijns JM, Baert JH. Alveolar clearance and the role of pulmonary lymphatics. *Am Rev Respir Dis* 1977;115:625.

116. Sorokin SP, Brain JD. Pathways of clearance in mouse lungs exposed to iron oxide aerosols. *Anat Rec* 1975;181:581.

117. MacPherson GG, Steer HW. The origin and properties of peripheral lymph mononuclear phagocytes. In: van Furth R, ed. Mononuclear phagocytes. Functional aspects. The Hague: Martinus Nijhoff, 1980.

118. Smith JB, McIntosh GH, Bede M. The traffic of cells through tissues: a study of peripheral lymph in sheep. *J Anat* 1970;107:87.

119. Papadimitriou JM. Macrophage fusion in vivo and in vitro: a review. In: Poste G, Nicolson GL, eds. Membrane fusion. New York: Elsevier North-Holland, 1978.

120. Randolph GJ, Inaba K, Robbani DF, et al. Differentiation of phagocytic monocytes into lymph node dendritic cells in vivo. *Immunity* 1999;11:753.

121. Lee SH, Starkey PM, Gordon S. Quantitative analysis of total macrophage content in adult mouse tissues. *Immunochemical studies with monoclonal antibody f4/80. J Exp Med* 1985;161:475.

122. Adamson IYR, Bowden DH. Role of monocytes and interstitial cells in the generation of alveolar macrophages. II. Kinetic studies after carbon loading. *Lab Invest* 1980;42:518.

123. Bowden DH, Adamson IYR. Role of monocytes and interstitial cells in the generation of alveolar macrophages. I. Kinetic studies of normal mice. *Lab Invest* 1980;42:511.

124. Hocking WG, Golde DW. The pulmonary-alveolar macrophage. *N Engl J Med* 1979;301:580.

125. Daughaday CC, Douglas SD. Membrane receptors on rabbit and human pulmonary alveolar macrophages. *J Reticuloendothel Soc* 1976;19:37.

126. Reynolds HY, Atkinson JP, Newball HH, et al. Receptors for immunoglobulin and complement on human alveolar macrophages. *J Immunol* 1975;114:1813.

127. Shurin SB, Stossel TP. Complement (C3)-activated phagocytosis by lung macrophages. *J Immunol* 1978;120:1305.

128. Cohen AB, Cline MJ. The human alveolar macrophage. Isolation, cultivation in vitro, and studies of morphologic and functional characteristics. *J Clin Invest* 1971;50:1390.

129. Franson RC, Waite M. Lysosomal phospholipases a1 and a2 of normal and bacillus Calmette Guerin-induced alveolar macrophages. *J Cell Biol* 1973;56:621.

130. Nichols BA. Normal rabbit alveolar macrophages. II. Their primary and secondary lysosomes as revealed by electron microscopy and cytochemistry. *J Exp Med* 1976;144:920.

131. Oren R, Farnhom AE, Saito K, et al. Metabolic patterns in three types of phagocytizing cells. *J Cell Biol* 1963;17:487.

132. Simon LM, Robin ED, Phillips JR, et al. Enzymatic basis for bioenergetic differences of alveolar

versus peritoneal macrophages and enzyme regulation by molecular O<sub>2</sub>. *J Clin Invest* 1977;59:443.

133. Johanson WGJ, Pierce AK. Effects of elastase, collagenase, and papain on structure and function of rat lungs in vitro. *J Clin Invest* 1972;51:288.

134. Cohen AB. Interrelationships between the human alveolar macrophage and alpha-1-antitrypsin. *J Clin Invest* 1973;52:2793.

135. Blondin J, Rosenberg R, Janoff A. An inhibitor in human lung macrophages active against human neutrophil elastase. *Am Rev Respir Dis* 1972;106:477.

136. Chapman HA Jr, Stone OL. Comparison of live human neutrophil and alveolar macrophage elastolytic activity in vitro. Relative resistance of macrophage elastolytic activity to serum and alveolar proteinase inhibitors. *J Clin Invest* 1984;74:1693.

137. Dannenberg AM Jr. Influence of environmental factors on the respiratory tract. Summary and perspectives. *J Reticuloendothel Soc* 1977;22:273.

138. Niewoehner DE, Kleinerman J, Rice DB. Pathologic changes in the peripheral airways of young cigarette smokers. *N Engl J Med* 1974;291:755.

139. Harris JO, Swenson EW, Johnson JE III. Human alveolar macrophages. Comparison of phagocytic ability, glucose utilization, and ultrastructure in smokers and nonsmokers. *J Clin Invest* 1970;49:2086.

140. Brody AR, Craighead JE. Cytoplasmic inclusions in pulmonary macrophages of cigarette smokers. *Lab Invest* 1975;32:125.

141. Holt PG, Keast D. Acute effects of cigarette smoke on murine macrophages. *Arch Environ Health* 1973;26:300.

142. Low RB. Protein biosynthesis by the pulmonary alveolar macrophage: conditions of assay and the effects of cigarette smoke extracts. *Am Rev Respir Dis* 1974;110:466.

143. Cantrell E, Busbee D, Warr G, et al. Induction of aryl hydrocarbon hydroxylase in human lymphocytes and pulmonary alveolar macrophages—a comparison. *Life Sci* 1973;13:1649.

144. Paigen B, Gurtoo HL, Minowada J, et al. Questionable relation of aryl hydrocarbon hydroxylase to lung-cancer risk. *N Engl J Med* 1977;297:346.

145. Hunninghake GW. Release of interleukin-1 by alveolar macrophages of patients with active pulmonary sarcoidosis. *Am Rev Respir Dis* 1984;129:569.

146. Acton JD, Myrvik QN. Production of interferon by alveolar macrophages. *J Bacteriol* 1966;91:2300.

147. Robinson BWS, McLemore TL, Crystal RG. Gamma interferon is spontaneously released by alveolar macrophages and lung T lymphocytes in patients with pulmonary sarcoidosis. *J Clin Invest* 1985;75:1488.

148. Kazmierowski JA, Gallin JI, Reynolds HY. Mechanism for the inflammatory response in primate lungs. Demonstration and partial characterization of an alveolar macrophage-derived chemotactic factor with preferential activity for polymorphonuclear leukocytes. *J Clin Invest* 1977;59:273.

149. Golde DW, Finley TN, Cline MJ. Production of colony-stimulating factor by human macrophages. *Lancet* 1972;2:1397.

150. Bowden DH, Adamson IYR. Pulmonary macrophages. In: Carr I, Daems WT, eds. *The reticuloendothelial system. A comprehensive treatise, Vol. 1.* New York: Plenum Publishing, 1980.

151. Burrell R, Anderson M. The induction of fibrogenesis by silica-treated alveolar macrophages. *Environ Res* 1973;6:389.

152. Heppleston AG, Styles JA. Activity of a macrophage factor in collagen formation by silica. *Nature* 1967;214:521.



153. Smith RE, Strieter RM, Zhang K, et al. A role for c-c chemokines in fibrotic lung disease. *J Leukoc Biol* 1995;57:782.
154. Simon GT. Splenic macrophages. In: Carr I, Daems WT, eds. *The reticuloendothelial system. A comprehensive treatise*, Vol 1. New York: Plenum Publishing, 1980.
155. Hume DA, Robinson AP, Macpherson GG, et al. The mononuclear phagocyte system of the mouse defined by immunohistochemical localization of antigen f4/80. Relationship between macrophages, Langerhans cells, reticular cells and dendritic cells in lymphoid and hematopoietic organs. *J Exp Med* 1983;158:1522.
156. Wennberg E, Weiss L. Splenic erythroclasia: an electron microscopic study of hemoglobin h disease. *Blood* 1968;31:778.
157. Rous P. Destruction of the red blood corpuscle in health and disease. *Physiol Rev* 1923;3:75.
158. Saltzstein SL. Phospholipid accumulation in histiocytes of splenic pulp associated with thrombocytopenic purpura. *Blood* 1961;18:73.
159. Huber H, Douglas SD, Fudenberg HH. The IgG receptor: an immunologic marker for the characterization of mononuclear cells. *Immunology* 1969;17:7.
160. van Voorhis WC, Witmer MD, Steinman RM. The phenotype of dendritic cells and macrophages. *Fed Proc* 1983;42:3114.
161. Hume DA, Perry VH, Gordon S. The mononuclear phagocyte system of the mouse defined by immunohistochemical localisation of antigen f4/80: macrophages associated with epithelia. *Anat Rec* 1984;210:503.
162. LeFevre ME, Hammer R, Joel DD. Macrophages of the mammalian small intestine: a review. *J Reticuloendothel Soc* 1979;26:553.
163. Palay SL, Karlin LJ. An electron microscopical study of the intestinal villus. *J Biophys Biochem Cytol* 1959;5:363.
164. Astaldi G, Meardi G, Lising T. The iron content of jejunal mucosa obtained by Crosby's biopsy in hemochromatosis and hemosiderosis. *Blood* 1966;28:70.
165. Crosby WH. The control of iron balance by the intestinal mucosa. *Blood* 1963;22:4441.
166. Morton D, Wimsatt WA. Distribution of iron in the gastro-intestinal tract of the common vampire bat: evidence for macrophage-linked iron clearance. *Anat Rec* 1980;198:183.
167. Unanue ER. Secretory functions of mononuclear phagocytes. *Am J Pathol* 1976;83:396.
168. MacDonald TT, Murch SH. Aetiology and pathogenesis of chronic inflammatory bowel disease. *Baillieres Clin Gastroenterol* 1994;8:1.
169. Mahida YR. The key role of macrophages in the immunopathogenesis of inflammatory bowel disease [review]. *Inflamm Bowel Dis* 2000;6:21.
170. Weinberg JB. Nitric oxide production and nitric oxide synthase type 2 expression by human mononuclear phagocytes: a review. *Mol Med* 1998;4:557.
171. Everts B, Stotzer PO, Olsson M, et al. Increased luminal nitric oxide concentrations in the small intestine of patients with coeliac disease. *Eur J Clin Invest* 1999;29:692.
172. van Straaten EA, Koster-Kamphuis L, Bovee-Oudenhoven IM, et al. Increased urinary nitric oxide oxidation products in children with active coeliac disease. *Acta Paediatr* 1999;88:528.
173. ter Steege J, Burman W, Arends JW, et al. Presence of inducible nitric oxide synthase,

nitrotyrosine, CD68, and CD14 in the small intestine in celiac disease. *Lab Invest* 1997;77:29.

174. Ikeda I, Kasajima T, Ishiyama S, et al. Distribution of inducible nitric oxide synthase in ulcerative colitis. *Am J Gastroenterol* 1997;92:1339.

175. Singer II, Kawka DW, Scott S, et al. Expression of inducible nitric oxide synthase and nitrotyrosine in colonic epithelium in inflammatory bowel disease. *Gastroenterology* 1996;111:871.

176. Leach MW, Davidson NJ, Fort MM, et al. The role of IL-10 in inflammatory bowel disease: "of mice and men" [review]. *Toxicol Pathol* 1999;27:123.

177. Klockars M, Reitano S, Reitano JJ, et al. Immunohistochemical identification of lysozyme in intestinal lesions in ulcerative colitis and Crohn's disease. *Gut* 1977;18:377.

178. Falchuk KR, Perrotto JL, Isselbacher KJ. Serum lysozyme in Crohn's disease and ulcerative colitis. *N Engl J Med* 1975;292:395.

179. Nugent FW, Mallari R, George H, et al. Serum lysozyme in inflammatory bowel disease. *Gastroenterology* 1976;70:1014.

180. Janowitz HD. Crohn's disease. In: Berk JE, ed. *Gastroenterology*. Philadelphia: WB Saunders, 1985.

181. Achord JL. Chronic inflammatory bowel disease. In: *Chronic inflammatory bowel disease*. New York: Medcom Press, 1974.

182. Tanner AR, Arthur MJ, Wright R. Macrophage activation, chronic inflammation and gastrointestinal disease. *Gut* 1984;25:760.

183. Hugot JP, Chamaillard M, Zouali H, et al. Association of nod2 leucine-rich repeat variants with susceptibility to Crohn's disease. *Nature* 2001;411:599.

184. Ogura Y, Bonen DK, Inohara N, et al. A frameshift mutation in nod2 associated with susceptibility to Crohn's disease. *Nature* 2001;411:603.

185. Ogura Y, Inohara N, Benito A, et al. Nod2, a nod1/apaf-1 family member that is restricted to monocytes and activates NF- $\kappa$ B. *J Biol Chem* 2001;276:4812.

186. Comer GM, Brandt LJ, Abissi CJ. Whipple's disease: a review. *Am J Gastroenterol* 1983;78:107.

187. Relman DA, Schmidt TM, MacDermott RP, et al. Identification of the uncultured bacillus of Whipple's disease [see comments]. *N Engl J Med* 1992;327:293.

188. Wilson KH, Blichington R, Frothingham R, et al. Phylogeny of the Whipple's-disease-associated bacterium. *Lancet* 1991;338:474.

189. Schoedon G, Goldenberger D, Forrer R, et al. Deactivation of macrophages with interleukin-4 is the key to the isolation of *Tropheryma whippelii*. *J Infect Dis* 1997;176:672.

190. Marth T, Raoult D. Whipple's disease. *Lancet* 2003;361:239.

191. Dutly F, Altwegg M. Whipple's disease and "*Tropheryma whippelii*." *Clin Microbiol Rev* 2001;14:561.

192. Silberberg-Sinakin I, Thorbecke GJ. The Langerhans cell. In: Carr I, Daems WT, eds. *The reticuloendothelial system. A comprehensive treatise*, Vol. 1. New York: Plenum Publishing, 1980.

193. Langerhans P. Uber die nerven der menschlichen haut. *Virchows Arch [Cell Pathol]* 1868;44:325.

194. Friedman PS. The immunobiology of the Langerhans cells. *Immunol Today* 1981;2:124.

195. Birbeck MS, Breathnach AS, Everall JD. An electron microscopic study of basal melanocytes and high level clear cells (Langerhans cells) in vitiligo. *J Invest Dermatol* 1961;37:51.

196. Katz SI, Tamaki K, Sachs D. Langerhans cells are derived from cells originating in bone marrow. *Nature* 1979;282:324.
197. Frélinger JG, Hood L, Hill S, et al. Mouse epidermal Ia molecules have a bone marrow origin. *Nature* 1979;282:321.
198. Giacometti L, Montagna W. Langerhans cells. Uptake of tritiated thymidine. *Science* 1967;157:439.
199. Emile JF, Geissmann F, Martin OD, et al. Langerhans cell deficiency in reticular dysgenesis. *Blood* 2000;96:58.
200. Stingl G, Wolf-Schreiner E, Pichler WJ, et al. Epidermal Langerhans cells bear Fc and C3 receptors. *Nature* 1977;268:245.
201. Stingl G, Katz SI, Shevach EM, et al. Detection of Ia antigens on Langerhans cells in guinea pig skin. *J Immunol* 1978;120:570.
202. Tamaki K, Stingl G, Gullino M, et al. Ia antigens in mouse skin are predominantly expressed on Langerhans cells. *J Immunol* 1979;123:784.
203. Fithian E, Kung P, Goldstein G, et al. Reactivity of Langerhans cells with hybridoma antibody. *Proc Natl Acad Sci U S A* 1981;78:2541.
204. Roitt I, Brostoff J, Male D. Immunology. In: Roitt I, Brostoff J, Male D, eds. *Immunology*, 4th ed. London: Mosby, 1996.
205. Silberberg I. Apposition of mononuclear cells to Langerhans cells in contact allergic reactions. An ultrastructural study. *Acta Derm Venereol* 1973;53:1.
206. Toews GB, Bergstresser PR, Streilein JW, et al. Epidermal Langerhans cell density determines whether contact hypersensitivity or unresponsiveness follows skin painting with dnfb. *J Immunol* 1980;124:445.
207. Potten CS, Allen TD. A model implicating the Langerhans cell in keratinocyte proliferation control. *Differentiation* 1976;5:443.
208. Cline MJ. Histiocytes and histiocytosis. *Blood* 1994;84:2840.
209. Lieberman PH. Langerhans cell (eosinophilic) granulomatosis. *J Invest Dermatol* 1980;75:71.
210. Nezelof C, Basset F, Rouseau MF. Histiocytosis x. Histogenetic arguments for a Langerhans cell origin. *Biomedicine* 1973;18:365.
211. Seljelid R. Properties of Kupffer cells. In: van Furth R, ed. *Mononuclear phagocytes. Functional aspects*. The Hague: Martinus Nijhoff, 1980.
212. Toro I, Ruzsa P, Rohlich P. Ultrastructure of early phagocytic stages in sinus endothelial and Kupffer cells of the liver. *Exp Cell Res* 1962;26:601.
213. Wisse E. On the fine structure and function of rat liver Kupffer cells. In: Carr I, Daems WT, eds. *The reticuloendothelial system. A comprehensive treatise, Vol. 1*. New York: Plenum Publishing, 1980.
214. Winwood PJ, Arthur MJ. Kupffer cells: their activation and role in animal models of liver injury and human liver disease. *Semin Liver Dis* 1993;13:50.
215. Benacerraf B, Sebstylen, Schlossman S. A quantitative study of the kinetics of blood clearance of <sup>32</sup>p-labelled *Escherichia coli* and staphylococci by the reticuloendothelial system. *J Exp Med* 1959;110:27.
216. Meis JF, Verhave JP, Jap PH, et al. An ultrastructural study of the role of Kupffer cells in the process of infection by *Plasmodium berghei* sporozoites in rats. *Parasitology* 1983;86:231.

217. Brunner KT, Hurez D, McCluskey RT, et al. Blood clearance of p<sup>32</sup>-labelled vesicular stomatitis and Newcastle disease viruses by the reticuloendothelial system in mice. *J Immunol* 1960;85:99.
218. Rifkind RA. Destruction of injured red cells in vivo. *Am J Med* 1966;41:711.
219. Noyes HE, McInturf CR, Blahuta GI. Studies on the distribution of *E. coli* endotoxin in mice. *Proc Soc Exp Biol Med* 1959;100:65.
220. Harbrecht BG, Billiar TR. The role of nitric oxide in Kupffer cell-hepatocyte interactions. *Shock* 1995;3:79.
221. Sanders KD, Fuller GM. Kupffer cell regulation of fibrinogen synthesis in hepatocytes. *Thromb Res* 1983;32:133.
222. Peterson TC, Renton KW. Depression of cytochrome p-450-dependent drug biotransformation in hepatocytes after the activation of the reticuloendothelial system by dextran sulfate. *J Pharmacol Exp Ther* 1984;229:229.
223. Emeis JJ, Lindeman J. Rat liver macrophages will not phagocytose fibrin during disseminated intravascular coagulation. *Hemostasis* 1976;5:193.
224. Lepay DA, Nathan CF, Steinman RM, et al. Murine Kupffer cells. Mononuclear phagocytes deficient in the generation of reactive oxygen intermediates. *J Exp Med* 1985;161:1079.
225. Schreiber AD, Frank MM. Role of antibody and complement in the immune clearance and destruction of erythrocyte. I. In vivo effects of IgG and IgM complement-fixing sites. *J Clin Invest* 1972;51:575.
226. Schreiber AD, Frank MM. Role of antibody and complement in the immune clearance and destruction of erythrocytes. II. Molecular nature of IgG and IgM complement-fixing sites and effects of their interaction with serum. *J Clin Invest* 1972;51:583.
227. Aminoff D, Bruegge WF, Bell WC, et al. Role of sialic acid in survival of erythrocytes in the circulation: interaction of neuraminidase-treated and untreated erythrocytes with spleen and liver at the cellular level. *Proc Natl Acad Sci U S A* 1977;74:1521.
228. Steer C. Kupffer cells and glycoproteins: does a recognition phenomenon exist? *Bull Kupffer Cell Found* 1978;1:26.
229. Blumenstock F, Saba TM, Weber P, et al. Purification and biochemical characterization of a macrophage stimulating alpha-2-globulin opsonic protein. *J Reticuloendothel Soc* 1976;19:157.
230. Lepay DA, Steinman RM, Nathan CF, et al. Liver macrophages in murine listeriosis. Cell-mediated immunity is correlated with an influx of macrophages capable of generating reactive oxygen intermediates. *J Exp Med* 1985;161:1503.
231. Rogoff TM, Combes B, Lipsky PE. Functional capabilities of guinea pig Kupffer cells. *Gastroenterology* 1977;72A:161.
232. Rogoff TM, LoSpalluto J, Lipsky PE. Antigen handling by isolated guinea pig Kupffer cells. *Fed Proc* 1978;37:1469.
233. Keller F, Wild M-T, Kirn A. In vitro cytostatic properties of unactivated rat Kupffer cells. *J Leukoc Biol* 1984;35:467.
234. Cohen SA, Salazar D, von Muenchhausen W, et al. Natural antitumor defense system of the murine liver. *J Leukoc Biol* 1985;37:559.
235. Billiar TR, Curran RD, Harbrecht BG, et al. Modulation of nitrogen oxide synthesis in vivo: Ng-monomethyl-L-arginine inhibits endotoxin-induced nitrate/nitrite biosynthesis while promoting hepatic damage. *J Leukoc Biol* 1990;48:565.
236. Hortega PDR. Microglia (facsimile of 1932 ed). In: Penfield W, ed. *Cytology and cellular pathology in*

the nervous system, Vol. 2. New York: Hafner, 1965.

237. Baldwin F. Microglia and brain macrophages. In: Carr I, Daems WT, eds. The reticuloendothelial system. A comprehensive treatise, Vol. 1. New York: Plenum Publishing, 1980.
238. Oehmichen M. Monocytic origin of microglia cells. In: van Furth R, ed. Mononuclear phagocytes. Immunity, infection and pathology. Oxford: Blackwell Scientific, 1975.
239. Hume DA, Perry VH, Gordon S. Immunohistochemical localization of a macrophage-specific antigen in developing mouse retina: phagocytosis of dying neurons and differentiation of microglial cells to form a regular array in the plexiform layers. *J Cell Biol* 1983;97:253.
240. Perry VH, Hume DA, Gordon D. Immunohistochemical localization of macrophages and microglia in the adult and developing mouse brain. *Neuroscience* 1985;15:313.
241. Gehrmann J, Matsumoto Y, Kreutzberg GW. Microglia—intrinsic immune effector cell of the brain [review]. *Brain Res Rev* 1995;20:269.
242. Ling EA, Penny D, Leblond CP. Use of carbon labelling to demonstrate the role of blood monocytes as precursors of the “ameboid cells” present in the corpus callosum of postnatal rats. *J Comp Neurol* 1980;193:631.
243. Oehmichen M. Are resting and/or reactive microglia macrophages? *Immunobiology* 1982;161:246.
244. Zink W, Ryan L, Gendelman HE. Macrophage-virus interactions. In: Burke B, Lewis CE, eds. *Macrophages in the central nervous system*. New York: Oxford Medical Publications, 2002.
245. Matyszak MK, Lawson LJ, Perry VH, et al. Stromal macrophages of the choroid plexus situated at an interface between the brain and peripheral immune system constitutively express major histocompatibility class ii antigens. *J Neuroimmunol* 1992;40:173.
246. Becker S, Halme J, Haskill S. Heterogeneity of human peritoneal macrophages: cytochemical and flow cytometric studies. *J Reticuloendothel Soc* 1983;33:127.
247. Haney AF, Muscato JJ, Weinberg JB. Peritoneal fluid cell populations in infertility patients. *Fertil Steril* 1981;35:696.
248. Halme J, Becker S, Wing R. Accentuated cyclic activation of peritoneal macrophages in patients with endometriosis. *Am J Obstet Gynecol* 1984;148:85.
249. Muscato JJ, Haney AF, Weinberg JB. Sperm phagocytosis by human peritoneal macrophages: a possible cause of infertility in endometriosis. *Am J Obstet Gynecol* 1982;144:503.
250. Newman SL, Becker S, Halme J. Phagocytosis by receptors for C3b (CR1), iC3b (CR3), and IgG (Fc) on human peritoneal macrophages. *J Leukoc Biol* 1985;38:267.
251. Mantovani A, Polentarutti N, Peri G, et al. Cytotoxicity of peripheral blood monocytes and tumor-associated macrophages in patients with ascites and tumor-associated macrophages in patients with ascites ovarian tumors. *J Natl Cancer Inst* 1980;64:1307.
252. Ganguly R, Milutinovich J, Lazzell V, et al. Studies of human peritoneal cells: a normal saline lavage technique for the isolation and characterization of cells from peritoneal dialysis patients. *J Reticuloendothel Soc* 1980;27:303.
253. Olive DL, Weinberg JB, Haney AF. Peritoneal macrophages and infertility: the association between cell number and pelvic pathology. *Fertil Steril* 1985;44:772.
254. Osborn BH, Haney AF, Misukonis MA, et al. Inducible nitric oxide synthase expression by peritoneal macrophages in endometriosis-associated infertility. *Fertil Steril* 2002;77:46.
255. Kurlander RJ, Haney AJ, Gartrell J. Human peritoneal macrophages possess two populations of IgG Fc receptors. *Cell Immunol* 1984;86:479.

256. Weinberg JB, Haney AF. Spontaneous tumor cell killing by human blood monocytes and human peritoneal macrophages: lack of alteration by endotoxin or quenchers of reactive oxygen species. *J Natl Cancer Inst* 1983;70:1005.
257. Hume DA, Gordon S. Mononuclear phagocyte system of the mouse defined by immunohistochemical localization of antigen f4/80. Identification of resident macrophages in renal medullary and cortical interstitium and the juxtaglomerular complex. *J Exp Med* 1983;157:1704.
258. Alpers CE, Beckstead JH. Monocyte/macrophage derived cells in normal and transplanted human kidneys. *Clin Immunol Immunopath* 1985;36:129.
259. Schreiner GF, Cotran RS, Unanue ER. Macrophages and cellular immunity in experimental glomerulonephritis. *Springer Semin Immunopathol* 1982;5:251.
260. Main IW, Nikolic-Paterson DJ, Atkins RC. T cells and macrophages and their role in renal injury. *Semin Nephrol* 1992;12:395.
261. Lovett DH, Ryan JL, Sterzel RB. A thymocyte-activating factor derived from glomerular mesangial cells. *J Immunol* 1983;130:1796.
262. Martin B, Gimbrone MA, Unanue ER, et al. Stimulation of non-lymphoid mesenchymal cell proliferation by a macrophage-derived growth factor. *J Immunol* 1981;126:1510.
263. Weinberg JB, Granger DL, Pisetsky DS, et al. The role of nitric oxide in the pathogenesis of spontaneous murine autoimmune disease: increased nitric oxide production and nitric oxide synthase expression in mrl-lpr/lpr mice, and reduction of spontaneous glomerulonephritis and arthritis by orally administered Ng-monomethyl-L-arginine. *J Exp Med* 1994;179:651.
264. Furusu A, Miyazaki M, Abe K, et al. Expression of endothelial and inducible nitric oxide synthase in human glomerulonephritis. *Kidney Int* 1998;53:1760.
265. Balkwill FR, Hogg N. Characterization of human breast milk macrophages cytostatic for human cell lines. *J Immunol* 1979;123:1451.
266. Pitt J. The milk mononuclear phagocyte. *Pediatrics* 1979;64[suppl]:745.
267. Mantovani A, Bar Shavit Z, Peri G, et al. Natural cytotoxicity on tumour cells of human macrophages obtained from diverse anatomical sites. *Clin Exp Immunol* 1980;39:776.
268. Robinson JE, Harvey BAM, Soothill JF. Phagocytes and killing of bacteria and yeast by human milk cells after opsonization in aqueous phase of milk. *Br Med J* 1978;1:1443.
269. Parmley MJ, Beer AE, Billingham RE. In vitro studies on the T-lymphocyte population of human milk. *J Exp Med* 1976;144:358.
270. Ichikawa M, Sugita M, Takahashi M, et al. Breast milk macrophages spontaneously produce granulocyte-macrophage colony-stimulating factor and differentiate into dendritic cells in the presence of exogenous interleukin-4 alone. *Immunology* 2003;108:189.
271. Hume DA, Halpin D, Charlton H, et al. The mononuclear phagocyte system of the mouse defined by immunohistochemical localization of antigen f4/80: macrophages of endocrine organs. *Proc Natl Acad Sci U S A* 1984;81:4174.
272. Hutson JC. Testicular macrophages. *Int Rev Cytol* 1994;149:99.
273. Tjioe DY, Steinberger E. Spermiphages in human testes. *Fertil Steril* 1967;18:807.
274. Holstein A-F. Spermatophagy in the seminiferous tubules and excurrent ducts of the testis in rhesus monkey and in man. *Andrologia* 1978;10:331.
275. Yee JB, Hutson JC. Testicular macrophages: isolation, characterization and hormonal

responsiveness. *Biol Reprod* 1983;29:1319.

276. Sell S, Baker-Zander S, Powell HC. Experimental syphilitic orchitis in rabbits: ultrastructural appearance of *treponema pallidum* during phagocytosis and dissolution by macrophages in vivo. *Lab Invest* 1982;46:355.

277. Hancock RJT. Immune response to sperm. *Oxf Rev Reprod Biol* 1981;3:182.

278. Frungieri MB, Calandra RS, Lustig L, et al. Number, distribution pattern, and identification of macrophages in the testes of infertile men. *Fertil Steril* 2002;78:298.

279. Miller L, Hunt JS. Sex steroid hormones and macrophage function [review]. *Life Sci* 1996;59:1.

280. Milewich L, Chen GT, Lyons C, et al. Metabolism of androstenedione by guinea pig peritoneal macrophages: synthesis of testosterone and 5 alpha-reduced metabolites. *J Steroid Biochem* 1982;17:61.

281. Habasque C, Aubry F, Jegou B, et al. Study of the HIV-1 receptors CD4, CXCR4, CCR5 and CCR3 in the human and rat testis. *Mol Hum Reprod* 2002;8:419.

282. Kirsch TM, Friedman AC, Vogel RL, et al. Macrophages in corpora lutea of mice: characterization and effects on steroid secretion. *Biol Reprod* 1981;25:629.

283. Moyer DL, Rimdusit S, Mishell DRJ. Sperm distribution and degradation in the female reproductive tract. *Obstet Gynecol* 1970;35:831.

284. Myatt L, Bray MA, Gordon D, et al. Macrophages on intrauterine contraceptive devices produce prostaglandins. *Nature* 1975;257:227.

285. Sagioglu N, Sagioglu E. The cytology of intrauterine contraceptive devices. *Acta Cytol (Baltimore)* 1970;14:58.

286. Sheppard BL, Bonnar J. Scanning and transmission electron microscopy of material adherent to intrauterine contraceptive devices. *Br J Obstet Gynecol* 1980;87:155.

287. Hunt JS. Immunologically relevant cells in the uterus. *Biol Reprod* 1994;50:461.

288. Hunt JS, Manning LS, Mitchell D, et al. Localization and characterization of macrophages in murine uterus. *J Leukoc Biol* 1985;38:255.

289. Mackler AM, Green LM, McMillan PJ, et al. Distribution and activation of uterine mononuclear phagocytes in peripartum endometrium and myometrium of the mouse. *Biol Reprod* 2000;62:1193.

290. Mackler AM, Iezza G, Akin MR, et al. Macrophage trafficking in the uterus and cervix precedes parturition in the mouse. *Biol Reprod* 1999;61:879.

291. Haddad EK, Duclos AJ, Baines MG. Early embryo loss is associated with local production of nitric oxide by decidual mononuclear cells. *J Exp Med* 1995;182:1143.

292. Haney AF, Misukonis MA, Weinberg JB. Macrophages and infertility: oviductal macrophages as potential mediators of infertility. *Fertil Steril* 1983;39:310.

293. London SN, Haney AF, Weinberg JB. Macrophages and infertility: enhancement of human macrophage-mediated sperm killing by antisperm antibodies. *Fertil Steril* 1985;43:274.

294. Cohen PE, Nishimura K, Zhu LY, et al. Macrophages: important accessory cells for reproductive function. *J Leukoc Biol* 1999;66:765.

295. Bonucci E. New knowledge on the origin, function, and fate of osteoclasts. *Clin Orthop* 1981;158:252.

296. Mundy GR. Monocyte-macrophage system and bone resorption. *Lab Invest* 1983;49:119.



297. Hall TJ, Chambers TJ. Molecular aspects of osteoclast function. *Inflamm Res* 1996;45:1.
298. Hume DA, Loutit JF, Gordon S. The mononuclear phagocyte system of the mouse defined by immunohistochemical localization of antigen f4/80: macrophages of bone and associated connective tissue. *J Cell Sci* 1984;66:189.
299. Fallon MD, Teitelbaum SL, Kahn AJ. Multinucleation enhances macrophage-mediated bone resorption. *Lab Invest* 1983;49:159.
300. Teitelbaum SL, Kahn AJ. Mononuclear phagocytes, osteoclasts and bone resorption. *Miner Electrolyte Metab* 1980;3:2.
301. Wiktor JW, Bartocci A, Ferrante AWJ, et al. Total absence of colony-stimulating factor 1 in the macrophage-deficient osteopetrotic (op/op) mouse. *Proc Natl Acad Sci U S A* 1990;87:4828.
302. Witmer-Pack MD, Hughes DA, Schuler G, et al. Identification of macrophages and dendritic cells in the osteopetrotic (op/op) mouse. *J Cell Sci* 1993;104:1021.
303. Marks SCJ, Seifert MF. The development and structure of osteoclasts in osteopetrosis. In: Butler WT, ed. *The chemistry and biology of mineralized tissues*. Birmingham: Ebsco Media, 1984.
304. Loutit JF, Nisbet NW. The origin of the osteoclast. *Immunobiology* 1982;161:193.
305. Chambers TJ, Magnus CJ. Calcitonin alters behaviour of isolated osteoclasts. *J Pathol* 1982;136:27.
306. Horton MA, Lewis D, McNulty K, et al. Human fetal osteoclasts fail to express macrophage antigens. *Br J Exp Pathol* 1985;66:103.
307. Horton MA, Pringle JAS, Chambers TJ. Identification of human osteoclasts with monoclonal antibodies. *N Engl J Med* 1985;312:923.
308. Yasuda H, Shima N, Nakagawa N, et al. A novel molecular mechanism modulating osteoclast differentiation and function. *Bone* 1999;25:109.
309. Adams DO. The biology of the granuloma. In: Ioachim HL, ed. *Pathology of granulomas*. New York: Raven Press, 1983.
310. Papadimitriou JM, Cornelisse CJ. Mononuclear radiographic study of DNA synthesis in macrophages and multinucleate foreign body giant cells. *J Reticuloendothel Soc* 1975;18:260.
311. Postlethwaite AE, Jackson BK, Beachey EH, et al. Formation of multinucleated giant cells from human monocyte precursors: mediation by a soluble protein from antigen- and mitogen-stimulated lymphocytes. *J Exp Med* 1982;155:168.
312. Dunn MA. Fibrosis in granulomas. In: Borsos DL, Yoshida T, eds. *Basic and clinical aspects of granulomatous disease*. New York: Elsevier/North Holland Biomedical Press, 1980.
313. Weinberg JB, Hobbs MM, Misukonis MA. Recombinant human gamma-interferon induces human monocyte polykaryon formation. *Proc Natl Acad Sci U S A* 1984;81:4554.
314. Levy JA. Pathogenesis of human immunodeficiency virus infection. *Microbiol Rev* 1993;57:183.
315. Abe E, Miyaura C, Tanaka H, et al. Dihydroxyvitamin D<sub>3</sub> promotes fusion of mouse alveolar macrophages both by a direct mechanism and by a spleen cell-mediated indirect mechanism. *Proc Natl Acad Sci U S A* 1983;80:5583.
316. Abe E, Ishimi Y, Jin CH, et al. Granulocyte-macrophage colony-stimulating factor is a major macrophage fusion factor present in conditioned medium of concanavalin A-stimulated spleen cell cultures. *J Immunol* 1991;147:1810.
317. Enelow RI, Sullivan GW, Carper HT, et al. Induction of multinucleated giant cell formation from in vitro culture of human monocytes interleukin-3 and interferon-gamma comparison with other stimulating factors.

Am J Respir Cell Mol Biol 1992;6:57.

318. McInnes A, Rennick D. Interleukin 4 induces cultured monocytes/macrophages to form giant multinucleated cells. *J Exp Med* 1988;167:598.
319. Takashima T, Ohnishi K, Tsuyuguchi I, et al. Differential regulation of formation of multinucleated giant cells from concanavalin a-stimulated human blood monocytes by IFN-g and IL-4. *J Immunol* 1993;150:3002.
320. Kindler V, Sappino A-P, Grau GE, et al. The inducing role of tumor necrosis factor in the development of bactericidal granulomas during bcg infection. *Cell* 1989;56:731.
321. Chensue SW, Warmington KS, Ruth J, et al. Cross-regulatory role of interferon-gamma (IFN-gamma), IL-4 and IL-10 in schistosome egg granuloma formation: in vivo regulation of Th activity and inflammation. *Clin Exp Immunol* 1994;98:395.
322. Chensue SW, Warmington KS, Ruth JH, et al. Cytokine function during mycobacterial and schistosomal antigen-induced pulmonary granuloma formation. Local and regional participation of IFN-gamma, IL-10, and TNF. *J Immunol* 1995;154:5969.
323. Wynn TA, Cheever AW. Cytokine regulation of granuloma formation in schistosomiasis. *Curr Opin Immunol* 1995;7:505.
324. Qiu B, Frait KA, Reich F, et al. Chemokine expression dynamics in mycobacterial (type-1) and schistosomal (type-2) antigen-elicited pulmonary granuloma formation. *Am J Pathol* 2001;158:1503.
325. Tsuji M, Dimov VB, Yoshida T. In vivo expression of monokine and inducible nitric oxide synthase in experimentally induced pulmonary granulomatous inflammation—evidence for sequential production of interleukin-1, inducible nitric oxide synthase, and tumor necrosis factor. *Am J Pathol* 1995;147:1001.
326. Facchetti F, Vermi W, Fiorentini S, et al. Expression of inducible nitric oxide synthase in human granulomas and histiocytic reactions. *Am J Pathol* 1999;154:145.
327. Ehlers S, Kutsch S, Benini J, et al. Nos2-derived nitric oxide regulates the size, quantity and quality of granuloma formation in mycobacterium avium-infected mice without affecting bacterial loads. *Immunology* 1999;98:313.
328. Ashkar S, Weber GF, Panoutsakopoulou V, et al. Eta-1 (osteopontin): an early component of type-1 (cell-mediated) immunity. *Science* 2000;287:860.
329. O'Regan AW, Hayden JM, Body S, et al. Abnormal pulmonary granuloma formation in osteopontin-deficient mice. *Am J Respir Crit Care Med* 2001;164:2243.
330. Nau GJ, Chupp GL, Emile JF, et al. Osteopontin expression correlates with clinical outcome in patients with mycobacterial infection. *Am J Pathol* 2000;157:37.
331. Roach DR, Briscoe H, Saunders B, et al. Secreted lymphotoxin-alpha is essential for the control of an intracellular bacterial infection. *J Exp Med* 2001;193:239.
332. Weinberg JB, Hobbs MM, Misukonis MA. Phenotypic characterization of gamma interferon-induced human monocyte polykaryons. *Blood* 1985;66:1241.
333. Saginario C, Qian H-Y, Vignery A. Identification of an inducible surface molecule specific to fusing macrophages. *Proc Natl Acad Sci U S A* 1995;92:12210.
334. Poste G. The tumoricidal properties of inflammatory tissue macrophages and multinucleate giant cells. *Am J Pathol* 1979;96:595.
335. Weinberg JB. Macrophage polykaryon formation in vitro by peritoneal cells from mice given injections of sodium periodate. *Am J Pathol* 1983;110:182.
336. Harris ED Jr. Rheumatoid arthritis. Pathophysiology and implications for therapy. *New Engl J Med*

1990;322:1277.

337. Mulherin D, Fitzgerald O, Bresnihan B. Synovial tissue macrophage populations and articular damage in rheumatoid arthritis. *Arthritis Rheum* 1996;39:115.
338. Hirohata S, Yanagida T, Itoh K, et al. Accelerated generation of CD14<sup>+</sup> monocyte-lineage cells from the bone marrow of rheumatoid arthritis patients. *Arthritis Rheum* 1996;39:836.
339. Kinne RW, Schmidt-Weber CB, Hoppe R, et al. Long-term amelioration of rat adjuvant arthritis following systemic elimination of macrophages by clodronate-containing liposomes. *Arthritis Rheum* 1995;38:1777.
340. Greenwald RA. Oxygen radicals, inflammation, and arthritis: pathophysiological considerations and implications for treatment. *Semin Arthritis Rheum* 1991;20:219.
341. Sakurai H, Kohsaka H, Liu MF, et al. Nitric oxide production and inducible nitric oxide synthase expression in inflammatory arthritides. *J Clin Invest* 1995;96:2357.
342. St Clair EW, Wilkinson WE, Lang T, et al. Increased expression of blood mononuclear cell nitric oxide synthase type 2 in rheumatoid arthritis patients. *J Exp Med* 1996;184:1173.
343. Steinman RM, Brodie SE, Cohn ZA. Membrane flow during pinocytosis: a stereologic analysis. *J Cell Biol* 1976;68:665.
344. Edelson PJ, Cohn ZA. 5' Nucleotidase activity of mouse peritoneal macrophages. II. Cellular distribution and effects of endocytosis. *J Exp Med* 1976;144:1596.
345. Esekowitz RAB, Austyn J, Stahl PD, et al. Surface properties of bacillus Calmette-Guerin-activated mouse macrophages. Reduced expression of mannose-specific endocytosis, Fc receptors, and antigen f4/80 accompanies induction of Ia. *J Exp Med* 1981;154:60.
346. Edelson PJ, Zweibel R, Cohn ZA. The pinocytic rate of activated macrophages. *J Exp Med* 1975;147:1150.
347. Mahoney EM, Hamill AI, Scott WA, et al. Response of endocytosis to altered fatty acyl composition of macrophage lipids. *Proc Natl Acad Sci U S A* 1977;74:4895.
348. Werb Z. Macrophage membrane synthesis. In: van Furth R, ed. *Mononuclear phagocytes in immunity, infection and pathology*. Oxford: Blackwell Scientific, 1975.
349. Todd RF III, Schlossman S. Utilization of monoclonal antibodies in the characterization of monocyte-macrophage differentiation antigens. In: Bellanti JA, Herscovitz HB, eds. *The reticuloendothelial system. A comprehensive treatise*. New York: Plenum Publishing, 1984.
350. Leenen PJ, de Bruijn MF, Voerman JS, et al. Markers of mouse macrophage development detected by monoclonal antibodies. *J Immunol Methods* 1994;174:5.
351. Shreffler DC, David CS. The H-2 major histocompatibility complex and the immune response gene region: genetic variation, function and organization. *Adv Immunol* 1975;20:125.
352. Koeffler HP, Ranyard J, Yelton L, et al. Gamma-interferon induces expression of the HLA-D antigens on normal and leukemic human myeloid cells. *Proc Natl Acad Sci U S A* 1984;81:4080.
353. Unanue ER. The regulatory role of macrophages in antigenic stimulation. II. Symbiotic relationship between lymphocytes and macrophages. *Adv Immunol* 1981;31:1.
354. Koestler TP, Rieman D, Muirhead K, et al. Identification and characterization of a monoclonal antibody to an antigen expressed on activated macrophages. *Proc Natl Acad Sci U S A* 1984;81:4505.
355. Taniyama T, Watanabe T. Establishment of hybridoma secreting a monoclonal antibody specific for activated tumoricidal macrophages. *J Exp Med* 1982;156:1286.
356. Andreesen R, Bross KJ, Osterholz J, et al. Human macrophage maturation and heterogeneity:

- analysis with a newly generated set of monoclonal antibodies to differentiation antigens. *Blood* 1986;67:1257.
357. Biondi A, Rossing TH, Bennet J, et al. Surface membrane heterogeneity among human mononuclear phagocytes. *J Immunol* 1984;132:1237.
358. Zwadlo G, Brocker EB, van Bassewitz DB, et al. A monoclonal antibody to a differentiation antigen present on mature human macrophages and absent from monocytes. *J Immunol* 1985;134:1487.
359. Ziegler-Heitbrock HW, Fingerle G, Strobel M, et al. The novel subset of CD14+/CD16+ blood monocytes exhibits features of tissue macrophages. *Eur J Immunol* 1993;23:2053.
360. Stevenson M, Gendelman HE. Cellular and viral determinants that regulate HIV-1 infection in macrophages. *J Leukoc Biol* 1994;56:278.
361. Weinberg JB. Human immunodeficiency virus type 1 and hematopoietic cells: mechanisms of infection and effects on cellular function. *Current Opin Hematol* 1993;1:138.
362. Schuitemaker H, Kootstra NA, de Goede RE, et al. Monocytotropic human immunodeficiency virus type 1 (HIV-1) variants detectable in all stages of HIV-1 infection lack T-cell line tropism and syncytium-inducing ability in primary T-cell culture. *J Virol* 1991;65:356.
363. Schuitemaker H, Koot M, Kootstra NA, et al. Biological phenotype of human immunodeficiency virus type 1 clones at different stages of infection: progression of disease is associated with a shift from monocytotropic to T-cell-tropic populations. *J Virol* 1992;66:1354.
364. Schuitemaker H. Macrophage-tropic HIV-1 variants: initiators of infection and aids pathogenesis? *J Leukoc Biol* 1994;56:218.
365. Feng Y, Broder CC, Kennedy PE, et al. HIV-1 entry cofactor—functional cDNA cloning of a seven-transmembrane, G protein-coupled receptor. *Science* 1996;272:872.
366. Alkhatib G, Combadiere C, Broder CC, et al. CC CKR5: A RANTES, MIP-1alpha, MIP-1beta receptor as a fusion cofactor for macrophage-tropic HIV-1. *Science* 1996;272:1955.
367. Deng HK, Liu R, Ellmeier W, et al. Identification of a major co-receptor for primary isolates of HIV-1. *Nature* 1996;381:661.
368. Cocchi F, DeVico AL, Garzino-Demo A, et al. Identification of RANTES, MIP-1 alpha, and MIP-1 beta as the major HIV-suppressive factors produced by CD8+ T cells. *Science* 1995;270:1811.
369. Liu R, Paxton WA, Choe S, et al. Homozygous defect in HIV-1 coreceptor accounts for resistance of some multiply exposed individuals to HIV-1 infection. *Cell* 1996;86:367.
370. Samson M, Libert F, Doranz BJ, et al. Resistance to HIV-1 infection in Caucasian individuals bearing mutant alleles of the CCR-5 chemokine receptor gene [see comments]. *Nature* 1996;382:722.
371. Dean M, Carrington M, Winkler C, et al. Genetic restriction of HIV-1 infection and progression to aids by a deletion allele of the CKR5 structural gene. *Science* 1996;273:1856.
372. Geijtenbeek TB, Engering A, Van Kooyk Y. Dc-sign, a c-type lectin on dendritic cells that unveils many aspects of dendritic cell biology. *J Leukoc Biol* 2002;71:921.
373. Geijtenbeek TB, Van Vliet SJ, Koppel EA, et al. Mycobacteria target dc-sign to suppress dendritic cell function. *J Exp Med* 2003;197:7.
374. Tailleux L, Schwartz O, Herrmann JL, et al. Dc-sign is the major mycobacterium tuberculosis receptor on human dendritic cells. *J Exp Med* 2003;197:121.
375. Ravetch JV, Kinet JP. Fc receptors. *Ann Rev Immunol* 1991;9:457.
376. Bonney RJ, Narun P, Davies P, et al. Antigen-antibody complexes stimulate the synthesis and

- release of prostaglandins by mouse peritoneal macrophages. *Prostaglandins* 1979;18:605.
377. Mulligan MS, Hevel JM, Marletta MA, et al. Tissue injury caused by deposition of immune complexes is L-arginine dependent. *Proc Natl Acad Sci U S A* 1991;88:6338.
378. Paul-Eugene N, Mossalayi D, Sarfati M, et al. Evidence for a role of Fc epsilon RII/CD23 in the IL-4-induced nitric oxide production by normal human mononuclear phagocytes. *Cell Immunol* 1995;163:314.
379. Shen L. Receptors for IgA on phagocytic cells. *Immunol Res* 1992;11:273.
380. Ross GD, Atkinson JP. Complement receptor structure and function. *Immunol Today* 1985;6:115.
381. Krych M, Atkinson JP, Holers VM. Complement receptors. *Curr Opin Immunol* 1992;4:8.
382. Sanchez-Madrid F, Nagy JA, Robbins E, et al. A human leukocyte differentiation antigen family with distinct alpha-subunits and a common beta-subunit: the lymphocyte function-associated antigen (LFA-1), the C3bi complement receptor (okm1/mac-1), and the p150,95 molecule. *J Exp Med* 1983;159:1785.
383. Arnaout MA, Spits H, Terhorst C, et al. Deficiency of a leukocyte surface glycoprotein (LFA-1) in two patients with mo1 deficiency. Effects of cell activation on mo1/LFA-1 surface expression in normal and deficient leukocytes. *J Clin Invest* 1984;74:1291.
384. Beatty PG, Ochs HD, Harlan JM, et al. Absence of monoclonal-antibody-defined protein complex in boy with abnormal leucocyte function. *Lancet* 1984;1:535.
385. Springer TA, Thompson WS, Miller LJ, et al. Inherited deficiency of the mac-1, LFA-1, p150,95 glycoprotein family and its molecular basis. *J Exp Med* 1984;160:1901.
386. Gerard C, Gerard NP. C5a anaphylatoxin and its seven transmembrane-segment receptor. *Ann Rev Immunol* 1994;12:775.
387. Gerard C, Gerard NP. The pro-inflammatory seven-transmembrane segment receptors of the leukocyte. *Curr Opin Immunol* 1994;6:140.
388. Gonias SL, LaMarre J, Crookston KP, et al. Alpha 2-macroglobulin and alpha 2-macroglobulin receptor/LRP. A growth regulatory axis. *Ann N Y Acad Sci* 1994;737:273.
389. Chu CT, Pizzo SV. Alpha-2-macroglobulin, complement, and biologic defense: antigens, growth factors, microbial proteases, and receptor ligation. *Am J Pathol* 1994;71:792.
390. Krieger M. Structures and functions of multiligand lipoprotein receptors: macrophage scavenger receptors and LDL receptor-related protein (LRP). *Ann Rev Biochem* 1994;63:601.
391. Stahl PD, Rodman JS, Miller MJ, et al. Evidence for receptor-mediated binding of glycoproteins, glycoconjugates and lysosomal glycosidases by alveolar macrophages. *Proc Natl Acad Sci U S A* 1978;75:1399.
392. Imber MJ, Pizzo SV, Johnson WJ, et al. Selective diminution of the binding of mannose by murine macrophages in the late stages of activation. *J Biol Chem* 1982;257:5129.
393. Wyllie JC. Transferrin uptake by rabbit alveolar macrophages in vitro. *Br J Haematol* 1977;37:17.
394. Hanover JA, Dickson RB. Transferrin: receptor-mediated endocytosis and iron delivery. In: Pastan I, Willingham MC, eds. *Endocytosis*. New York: Plenum Publishing, 1985.
395. Hamilton TA, Gray PW, Adams DO. Expression of the transferrin receptor on murine peritoneal macrophages is modulated by in vitro treatment with interferon gamma. *Cell Immunol* 1984;89:478.
396. Hamilton TA, Weiel JE, Adams DO. Expression of the transferrin receptor in murine peritoneal macrophages is modulated in the different stages of activation. *J Immunol* 1984;132:2285.
397. van Snick JL, Masson PL. The binding of human lactoferrin to mouse peritoneal cells. *J Exp Med*

1976;144:1568.

398. van Snick JL, Masson PL, Heremans JF. The involvement of lactoferrin in the hyposideremia of acute inflammation. *J Exp Med* 1974;140:1068.

399. Tabas I. Cholesterol and phospholipid metabolism in macrophages. *Biochim Biophys Acta* 2000;1529:164.

400. Brown MS, Goldstein JL. Lipoprotein metabolism in the macrophage: implications for cholesterol deposition in atherosclerosis. *Ann Rev Biochem* 1983;52:223.

401. Fowler S, Shio H, Haley NJ. Characterization of lipid-laden aortic cells from cholesterol-fed rabbits. IV. Investigation of macrophage-like properties of aortic cell populations. *Lab Invest* 1979;41:372.

402. Goldstein JL, Ho YK, Brown MS, et al. Cholesteryl-ester accumulation in macrophages resulting from receptor-mediated uptake and degradation of hypercholesterolemic canine beta-very low density lipoproteins. *J Biol Chem* 1980;255:1839.

403. Brown MS, Basu SK, Falck JR, et al. The scavenger cell pathway for lipoprotein degradation: specificity of the binding site that mediates the uptake of negatively charged LDL by macrophages. *J Supramolec Struct* 1980;13:67.

404. Freeman MW. Macrophage scavenger receptors. *Curr Opin Lipidol* 1994;5:143.

405. Hughes DA, Fraser IP, Gordon S. Murine macrophage scavenger receptor: adhesion function and expression. *Immunol Lett* 1994;43:7.

406. Hughes DA, Fraser IP, Gordon S. Murine macrophage scavenger receptor: in vivo expression and function as receptor for macrophage adhesion in lymphoid and non-lymphoid organs. *Eur J Immunol* 1995;25:466.

407. Platt N, Dasilva RP, Gordon S. Recognizing death—the phagocytosis of apoptotic cells. *Trends Cell Biol* 1998;8:365.

408. de Villiers WJS, Smart EJ. Macrophage scavenger receptors and foam cell formation. *J Leukoc Biol* 1999;66:740.

409. Platt N, da Silva RP, Gordon S. Class a scavenger receptors and the phagocytosis of apoptotic cells. *Biochem Soc Trans* 1998;26:639.

410. Smith CA, Farrah T, Goodwin RG. The TNF receptor superfamily of cellular and viral proteins: activation, costimulation, and death. *Cell* 1994;76:959.

411. Cleveland JL, Ihle JN. Contenders in FASL/TNF death signaling. *Cell* 1995;81:479.

412. Hang L, Theofilopoulos AN, Dixon FJ. A spontaneous rheumatoid arthritis-like disease in mrl-l mice. *J Exp Med* 1982;155:1690.

413. Singer GG, Carrera AC, Marshak-Rothstein A, et al. Apoptosis, Fas and systemic autoimmunity: the MRL-LPR/LPR model. *Curr Opin Immunol* 1994;6:913.

414. Fisher GH, Rosenberg FJ, Straus SE, et al. Dominant interfering Fas gene mutations impair apoptosis in a human autoimmune lymphoproliferative syndrome. *Cell* 1995;81:935.

415. Ledeist F, Emile JF, Rieuxlaucat F, et al. Clinical, immunological, and pathological consequences of Fas-deficient conditions. *Lancet* 1996;348:719.

416. Celada A, Gray P, Rinderknecht E, et al. Evidence for a gamma-interferon receptor that regulates macrophage tumoricidal activity. *J Exp Med* 1984;160:55.

417. Finbloom DS, Hoover DL, Wahl LM. The characteristics of binding of human recombinant interferon-gamma to its receptor on human monocytes and human monocyte-like cell lines. *J Immunol*

1985;135:300.

418. Pace JL, Russell SW, Torres BA, et al. Recombinant mouse gamma interferon induces the priming step in macrophage activation for tumor cell killing. *J Immunol* 1983;130:2011.
419. Le I, Prensley W, Yip YK, et al. Activation of human monocyte cytotoxicity by natural and recombinant immune interferon. *J Immunol* 1983;131:2831.
420. Murray HW, Rubin BY, Rothermel CD. Killing of intracellular *leishmania donovani* by lymphokine-stimulated human mononuclear phagocytes. Evidence that interferon-gamma is the activating lymphokine. *J Clin Invest* 1983;72:1506.
421. Nathan CF, Murray HW, Wiebe ME, et al. Identification of interferon-gamma as the lymphokine that activates human macrophage oxidative metabolism and antimicrobial activity. *J Exp Med* 1983;158:670.
422. Jouanguy E, Altare F, Lamhamedi S, et al. Interferon-gamma-receptor deficiency in an infant with fatal bacille Calmette-Guerin infection. *N Engl J Med* 1996;335:1956.
423. Doffinger R, Jouanguy E, Dupuis S, et al. Partial interferon-gamma receptor signaling chain deficiency in a patient with bacille Calmette-Guerin and *Mycobacterium abscessus* infection. *J Infect Dis* 2000;181:379.
424. Brassard DL, Grace MJ, Bordens RW. Interferon-alpha as an immunotherapeutic protein. *J Leukoc Biol* 2002;71:565.
425. Sharara AI, Perkins DJ, Misukonis MA, et al. Interferon (IFN)-alpha activation of human blood mononuclear cells in vitro and in vivo for nitric oxide synthase (NOS) type 2 mRNA and protein expression-possible relationship of induced NOS2 to the anti-hepatitis C effects of IFN-alpha in vivo. *J Exp Med* 1997;186:1495.
426. Altare F, Lammas D, Revy P, et al. Inherited interleukin 12 deficiency in a child with bacille Calmette-Guerin and *Salmonella enteritidis* disseminated infection. *J Clin Invest* 1998;102:2035.
427. Tushinski FJ, Oliver IT, Guilbert LJ, et al. Survival of mononuclear phagocytes depends on a lineage-specific growth factor that the differentiated cells selectively destroy. *Cell* 1982;28:71.
428. Hynes RO. Integrins: versatility, modulation, and signaling in cell adhesion. *Cell* 1992;69:11.
429. Nidel JE, Cuatrecasas P. Formyl peptide chemotactic receptors of leukocytes and macrophages. *Curr Top Cell Regul* 1980;17:137.
430. Weinberg JB, Muscato JJ, Nidel JE. Monocyte chemotactic peptide receptor. Functional characteristics and ligand-induced regulation. *J Clin Invest* 1981;68:621.
431. Altieri DC. Proteases and protease receptors in modulation of leukocyte effector functions. *J Leukoc Biol* 1995;58:120.
432. Altieri DC. Coagulation assembly on leukocytes in transmembrane signaling and cell adhesion. *Blood* 1993;81:569.
433. Edgington TS, Mackman N, Brand K, et al. The structural biology of expression and function of tissue factor. *Thromb Haemost* 1991;66:67.
434. Conkling PR, Greenberg CS, Weinberg JB. Tumor necrosis factor induces tissue factor-like activity in human leukemia cell line u937 and peripheral blood monocytes. *Blood* 1988;72:128.
435. Vu T-KH, Hung DT, Wheaton VI, et al. Molecular cloning of a functional thrombin receptor reveals a novel proteolytic mechanism of receptor activation. *Cell* 1991;64:1057.
436. Min HY, Semnani R, Mizukami IF, et al. cDNA for Mo3, a monocyte activation antigen, encodes the human receptor for urokinase plasminogen activator. *J Immunol* 1992;148:3636.
437. Provvedine DM, Tsoukas CD, Deftos LF, et al. 1,25 dihydroxyvitamin D<sub>3</sub> receptors in human



leukocytes. *Science* 1983;221:1181.

438. Werb Z. Hormone receptors and hormonal regulation of macrophage physiological functions. In: van Furth R, ed. *Mononuclear phagocytes. Functional aspects.* The Hague: Martinus Nijhoff, 1980.
439. Medzhitov R, Janeway CJ. Advances in immunology: innate immunity. *N Engl J Med* 2000;343:338.
440. Beutler B. Tlr4 as the mammalian endotoxin sensor. *Curr Top Microbiol Immunol* 2002;270:109.
441. Poltorak A, He X, Smirnova I, et al. Defective LPS signaling in c3h/vej and c57bl/10scsr mice: mutations in TLR4 gene. *Science* 1998;282:2085.
442. Arbour NC, Lorenz E, Schutte BC, et al. TLR4 mutations are associated with endotoxin hyporesponsiveness in humans. *Nat Genet* 2000;25:187.
443. Lorenz E, Mira JP, Frees KL, et al. Relevance of mutations in the TLR4 receptor in patients with gram-negative septic shock. *Arch Intern Med* 2002;162:1028.
444. Kiechl S, Lorenz E, Reindl M, et al. Toll-like receptor 4 polymorphisms and atherogenesis. *N Engl J Med* 2002;347:185.
445. Kuijpers TW, Harlan JM. Monocyte-endothelial interactions: insights and questions [review]. *J Lab Clin Med* 1993;122:641.
446. Krieg AM. Immune effects and mechanisms of action of CpG motifs. *Vaccine* 2000;19:618.
447. Pisetsky DS. Immunostimulatory DNA: a clear and present danger? *Nat Med* 1997;3:829.
448. Ghosh DK, Misukonis MA, Reich C, et al. Host response to infection: the role of CpG DNA in induction of cyclooxygenase 2 and nitric oxide synthase 2 in murine macrophages. *Infect Immun* 2001;69:7703.
449. Bauer S, Kirschning CJ, Hacker H, et al. Human TLR9 confers responsiveness to bacterial DNA via species-specific CpG motif recognition. *Proc Natl Acad Sci U S A* 2001;98:9237.
450. Chuang TH, Lee J, Kline L, et al. Toll-like receptor 9 mediates CpG-DNA signaling. *J Leukoc Biol* 2002;71:538.
451. Ulevitch RJ. Recognition of bacterial endotoxins by receptor-dependent mechanisms. *Adv Immunol* 1993;53:267.
452. Ziegler-Heitbrock HWL, Ulevitch RJ. CD14: cell surface receptor and differentiation. *Immunol Today* 1993;14:121.
453. Takeuchi O, Akira S. MyD88 as a bottle neck in Toll/IL-1 signaling. *Curr Top Microbiol Immunol* 2002;270:155.
454. Muller WA, Steinman RM, Cohn ZA. Membrane flow during endocytosis. In: van Furth R, ed. *Mononuclear phagocytes. Functional aspects.* The Hague: Martinus Nijhoff, 1980.
455. Rabinovich M. Phagocytic recognition. In: van Furth R, ed. *Mononuclear phagocytes.* Oxford: Blackwell Scientific, 1970.
456. Brown EJ. Phagocytosis. *Bioessays* 1995;17:109.
457. Griffin FM Jr, Griffin JA, Leider JE, et al. Studies on the mechanism of phagocytosis. I. Requirements for circumferential attachment of particle-bound ligands to specific receptors on the macrophage plasma membrane. *J Exp Med* 1975;142:1263.
458. Griffin FM Jr, Griffin JA, Silverstein SC. Studies on the mechanism of phagocytosis. II. The interaction of macrophages with anti-immunoglobulin IgG-coated bone marrow-derived lymphocytes. *J Exp Med* 1976;144:788.

459. Snyderman R, Goetzl E. Molecular and cellular mechanisms of leucocyte chemotaxis. *Science* 1981;213:830.
460. Chenoweth DE, Goodman MG, Weigle WO. Demonstration of a specific receptor for human C5a anaphylatoxin on murine macrophages. *J Exp Med* 1982;156:68.
461. Norris DA, Clark RA, Swigart LM, et al. Fibronectin fragment(s) are chemotactic for human peripheral blood monocytes. *J Immunol* 1982;129:1612.
462. Hunninghake GM, Davidson JM, Rennard S, et al. Elastin fragments attract macrophage precursors to diseased sites in pulmonary emphysema. *Science* 1981;212:925.
463. Postletwaite AE, Kang AH. Collagen- and collagen peptide-induced chemotaxis of human blood monocytes. *J Exp Med* 1976;143:1299.
464. Baggiolini M, DeWold B, Moser B. Interleukin-8 and related chemotactic cytokines—CXC and CC chemokines. *Adv Immunol* 1994;55:97.
465. Schall TJ, Bacon KB. Chemokines, leukocyte trafficking, and inflammation. *Curr Opin Immunol* 1994;6:865.
466. Bottazzi B, Polentarutti N, Balsari A, et al. Chemotactic activity for mononuclear phagocytes of culture supernatants from murine and human tumor cells: evidence for a role in the regulation of the macrophage content of neoplastic tissues. *Int J Cancer* 1983;31:55.
467. Postlethwaite AE, Arnold E, Snyderman R. Characterization of chemotactic activity produced in vivo by a cell-mediated immune reaction in the guinea pig. *J Immunol* 1975;114:274.
468. Snyderman R, Pike MC. Chemoattractant receptors on phagocytic cells. *Ann Rev Immunol* 1984;2:257.
469. Berridge MJ, Irvine RF. Inositol triphosphate, a novel second messenger in cellular signal transduction. *Nature* 1984;312:315.
470. Deuel TF, Senior RM, Chang D, et al. Platelet factor 4 is chemotactic for neutrophils and monocytes. *Proc Natl Acad Sci U S A* 1981;78:4584.
471. Snyderman R, Pike MC. An inhibitor of macrophage chemotaxis produced by neoplasms. *Science* 1976;192:370.
472. Cianciolo G, Lostrom M, Tam M, et al. Murine malignant cells synthesize a 19,000-dalton protein that is physicochemically and antigenically related to the immunosuppressive retroviral protein, p15e. *J Exp Med* 1983;158:885.
473. Stossel TP. The machinery of blood cell movements. *Blood* 1994;84:367.
474. Hartwig JH, Stossel TP. Macrophages: their use in elucidation of the cytoskeletal roles of actin. *Methods Cell Biol* 1982;25:201.
475. Southwick FS, Hartwig JH. Acumentin, a protein in macrophages which caps the pointed end of actin filaments. *Nature* 1982;297:303.
476. Yin HL, Hartwig JH, Maruyama K, et al. Ca<sup>2+</sup> control of actin filament length. Effects of macrophage gelsolin on actin polymerization. *J Biol Chem* 1978;253:8988.
477. Brotschi EA, Hartwig JH, Stossel TP. The gelation of actin by actin-binding protein. *J Biol Chem* 1978;253:8988.
478. Bhisey AN, Freed JJ. Altered movement of endosomes in colchicine-treated cultured macrophages. *Exp Cell Res* 1971;64:430.
479. Gordon S, Todd J, Cohn ZA. In vitro synthesis and secretion of lysozyme by mononuclear

phagocytes. *J Exp Med* 1974;139:1228.

480. Zucker S, Hanes DJ, Vogler WR, et al. Plasma muramidase: a study of methods and clinical applications. *J Lab Clin Med* 1970;75:83.

481. Pickering TG, Catovsky D. Hypokalemia and raised lysozyme levels in acute leukemia. *Q J Med* 1973;42:677.

482. Unkeless JC, Gordon SC, Reich E. Secretion of plasminogen activator by stimulated macrophages. *J Exp Med* 1974;139:834.

483. Chapman HA Jr, Vavrin Z, Hibbs JB Jr. Macrophage fibrinolytic activity: identification of two pathways of plasmin formation by intact cells and of a plasminogen activator inhibitor. *Cell* 1982;28:653.

484. Banda MJ, Clark EJ, Werb Z. Limited proteolysis by macrophage elastase inactivates human alpha-1-protease inhibitor. *J Exp Med* 1980;152:1563.

485. Banda MJ, Clark EJ, Werb Z. Selective proteolysis of immunoglobulins by mouse macrophage elastase. *J Exp Med* 1983;157:1184.

486. Jones PA, Werb Z. Degradation of connective tissue matrices by macrophages. II. Influence of the matrix composition on proteolysis of glycoproteins, elastin, and collagen by macrophages in culture. *J Exp Med* 1980;152:1527.

487. Werb Z, Banda MJ, Jones PA. Degradation of connective tissue matrices by macrophages. I. Proteolysis of elastin, glycoproteins, and collagen by proteinases isolated from macrophages. *J Exp Med* 1980;152:1340.

488. Werb Z, Bainton DF, Jones PA. Degradation of connective tissue matrices by macrophages. III. Morphological and biochemical studies on extracellular, pericellular, and intracellular events in matrix proteolysis by macrophages in culture. *J Exp Med* 1980;152:1537.

489. Takemura R, Werb Z. Secretory products of macrophages and their physiological functions. *Am J Physiol* 1984;246:C1.

490. Light RW, MacGregor MI, Ball WC, et al. Diagnostic significance of pleural fluid pH and pCO<sub>2</sub>. *Chest* 1973;64:591.

491. Brade V, Bentley C. Synthesis and release of complement components by macrophages. In: van Furth R, ed. *Mononuclear phagocytes. Functional aspects*. The Hague: Martinus Nijhoff, 1980.

492. Bianco C, Gotze O, Cohn ZA. Complement, coagulation, and mononuclear phagocytes. In: van Furth R, ed. *Mononuclear phagocytes. Functional aspects*. The Hague: Martinus Nijhoff, 1980.

493. Rutherford B, Schenkein HA. C3 cleavage products stimulate release of prostaglandins by human mononuclear phagocytes in vitro. *J Immunol* 1983;130:874.

494. Henriksson P, Becker S, Lynch G, et al. Identification of intracellular factor XIII in human monocytes and macrophages. *J Clin Invest* 1985;76:528.

495. Weisberg LJ, Shiu DT, Conkling PR, et al. Identification of normal human peripheral blood monocytes and liver as sites of synthesis of coagulation factor XIII alpha-chain. *Blood* 1988;70:579.

496. Schwartz BS, Levy GA, Fair DS, et al. Murine lymphoid procoagulant activity induced by bacterial lipopolysaccharide and immune complexes in a monocyte prothrombinase. *J Exp Med* 1982;155:1464.

497. Rickles FR, Levin J, Hardin JA, et al. Tissue factor generation by human mononuclear cells: effects of endotoxin and dissociation of tissue factor generation from mitogenic response. *J Lab Clin Med* 1977;89:792.

498. Hogg N. Human monocytes have prothrombin cleaving activity. *Clin Exp Immunol* 1983;53:725.

499. Hopper KE, Geczy CL, Davies WA. A mechanism of migration inhibition in delayed-type

- hypersensitivity reactions. I. Fibrin deposition on the surface of elicited peritoneal macrophages in vivo. *J Immunol* 1981;126:1052.
500. Weinberg JB, Pippen AM, Greenberg CS. Extravascular fibrin formation and dissolution in synovial tissue of patients with osteoarthritis and rheumatoid arthritis. *Arthritis Rheum* 1991;34:996.
501. Edwards RL, Ewan VA, Rickles FR. Macrophage procoagulants, fibrin deposition, and the inflammatory response. In: Phillips SM, Escobar MR, eds. *The reticuloendothelial system*, Vol. 9. New York: Plenum Publishing, 1986:233.
502. Edwards RL, Rickles FR. The role of leukocytes in the activation of blood coagulation. *Semin Hematol* 1992;29:202.
503. Barret AL, Starkey PM. The interaction of alpha-2-macroglobulin with proteinases. Characteristics and specificity of the reaction and an hypothesis concerning its molecular mechanism. *Biochem J* 1973;133:709.
504. Hovi T, Moshe D, Vaheiri A. Cultured human monocytes synthesize and secrete alpha-2-macroglobulin. *J Exp Med* 1977;145:1580.
505. Boldt DH, Chan SK, Keaton K. Cell surface alpha-1-protease inhibitor on human peripheral mononuclear cells in culture. *J Immunol* 1982;129:1830.
506. Kaplan J, Nielsen ML. Analysis of macrophage surface receptors. II. Internalization of alpha-macroglobulin-protease complexes by rabbit alveolar macrophages. *J Biol Chem* 1979;154:7329.
507. Kaplan J, Nielsen ML. Analysis of macrophage surface receptors. I. Binding of alpha-macroglobulin-protease complexes to rabbit alveolar macrophages. *J Biol Chem* 1979;154:7323.
508. Hoffman M, Feldman SR, Pizzo SV. Alpha-2-macroglobulin "fast" forms inhibit superoxide production by activated macrophages. *Biochim Biophys Acta* 1983;760:421.
509. Weiss SJ, King GW, LoBuglio AF. Evidence for hydroxyl radical generation by human monocytes. *J Clin Invest* 1977;60:370.
510. Nathan CF. Secretion of oxygen intermediates: role in effector functions of activated macrophages. *Fed Proc* 1982;41:2206.
511. Nathan CF, Cohn ZA. Cellular components of inflammation: monocytes and macrophages. In: Kelley WN, Harris EDJ, Ruddy S, eds. *Textbook of rheumatology*. Philadelphia: WB Saunders, 1985.
512. Pollock JD, Williams DA, Gifford MA, et al. Mouse model of x-linked chronic granulomatous disease, an inherited defect in phagocyte superoxide production. *Nat Genet* 1995;9:202.
513. Jackson SH, Gallin JI, Holland SM. The p47(phox) mouse knock-out model of chronic granulomatous disease. *J Exp Med* 1995;182:751.
514. Nathan C. Nitric oxide as a secretory product of mammalian cells. *FASEB J* 1992;6:3051.
515. Beckman JS, Crow JP. Pathological implications of nitric oxide, superoxide and peroxynitrite formation [review]. *Biochem Soc Trans* 1993;21:330.
516. Magrinat G, Mason SN, Shami PJ, et al. Nitric oxide modulation of human leukemia cell differentiation and gene expression. *Blood* 1992;80:1880.
517. Punjabi CJ, Laskin DL, Heck DE, et al. Production of nitric oxide by murine bone marrow cells. Inverse correlation with cellular proliferation. *J Immunol* 1992;149:2179.
518. Moncada S, Higgs A. The L-arginine-nitric oxide pathway. *N Engl J Med* 1993;329:2002.
519. Stamler JS, Singel DJ, Loscalzo J. Biochemistry of nitric oxide and its redox-activated forms [review]. *Science* 1992;258:1898.

520. Jia L, Bonaventura C, Bonaventura J, et al. S-nitrosohaemoglobin: a dynamic activity of blood involved in vascular control. *Nature* 1996;380:221.
521. McMahon TJ, Moon RE, Lusching BP, et al. Nitric oxide in the human respiratory cycle. *Nat Med* 2002;8:711.
522. Haddad IY, Pataki G, Hu P, et al. Quantitation of nitrotyrosine levels in lung sections of patients and animals with acute lung injury. *J Clin Invest* 1994;94:2407.
523. Kooy NW, Royall JA, Ye YZ, et al. Evidence for in vivo peroxynitrite production in human acute lung injury. *Am J Respir Crit Care Med* 1995;151:1250.
524. Nathan C, Xie Q-W. Regulation of biosynthesis of nitric oxide. *J Biol Chem* 1994;269:13725.
525. Palmer RM, Hickery MS, Charles IG, et al. Induction of nitric oxide synthase in human chondrocytes. *Biochem Biophys Res Commun* 1993;193:398.
526. Charles IG, Palmer RMJ, Hickery MS, et al. Cloning, characterization, and expression of a cDNA encoding an inducible nitric oxide synthase from the human chondrocyte. *Proc Natl Acad Sci U S A* 1993;90:11419.
527. Stefanovic-Racic M, Stadler J, Georgescu HI, et al. Nitric oxide synthesis and its regulation by rabbit synoviocytes. *J Rheumatol* 1994;21:1892.
528. Geller DA, Billiar TR. Molecular biology of nitric oxide synthases [review]. *Cancer Metastasis Rev* 1998;17:7.
529. Gross SS, Levi R. Tetrahydrobiopterin synthesis. An absolute requirement for cytokine-induced nitric oxide generation by vascular smooth muscle. *J Biol Chem* 1992;267:25722.
530. Rosenkranz-Weiss P, Sessa WC, Milstien S, et al. Regulation of nitric oxide synthesis by proinflammatory cytokines in human umbilical vein endothelial cells: elevations in tetrahydrobiopterin levels enhance endothelial nitric oxide synthase specific activity. *J Clin Invest* 1994;93:2236.
531. Assreuy J, Cunha FQ, Liew FY, et al. Feedback inhibition of nitric oxide synthase activity by nitric oxide. *Br J Pharmacol* 1993;108:833.
532. Rogers NE, Ignarro LJ. Constitutive nitric oxide synthase from cerebellum is reversibly inhibited by nitric oxide formed from L-arginine. *Biochem Biophys Res Commun* 1992;189:242.
533. Weinberg JB, Misukonis MA, Shami PJ, et al. Human mononuclear phagocyte inducible nitric oxide synthase (iNOS). Analysis of iNOS mRNA, iNOS protein, biopterin, and nitric oxide production by blood monocytes and peritoneal macrophages. *Blood* 1995;86:1184.
534. Weinberg JB. Nitric oxide production and nitric oxide synthase type 2 expression by human mononuclear phagocytes—a review [review]. *Molec Med* 1998;4:557.
535. Nicholson S, Bonecinalmeida MDG, Silva LE Jr, et al. Inducible nitric oxide synthase in pulmonary alveolar macrophages from patients with tuberculosis. *J Exp Med* 1996;183:2293.
536. Kobzik L, Bredt DS, Lowenstein CJ, et al. Nitric oxide synthase in human and rat lung: immunocytochemical and histochemical localization. *Am J Respir Cell Mol Biol* 1993;9:371.
537. Tracey WR, Xue C, Klinghofer V, et al. Immunochemical detection of inducible NO synthase in human lung. *Am J Physiol* 1994;266:L722.
538. Hibbs JB Jr, Westenfelder C, Taintor R, et al. Evidence for cytokine-inducible nitric oxide synthesis from L-arginine in patients receiving interleukin-2 therapy [published erratum appears in *J Clin Invest* 1992;90:295]. *J Clin Invest* 1992;89:867.
539. Anstey NM, Weinberg JB, Hassanali M, et al. Nitric oxide in Tanzanian children with malaria. Inverse relationship between malaria severity and nitric oxide production/nitric oxide synthase type 2 expression. *J*

Exp Med 1996;184:557.

540. Kun JFJ, Mordmuller B, Lell B, et al. Polymorphism in promoter region of inducible nitric oxide synthase gene and protection against malaria. *Lancet* 1998;351:265.
541. Kun JF, Mordmuller B, Perkins DJ, et al. Nitric oxide synthase 2 (Iambarene) (g-954c), increased nitric oxide production, and protection against malaria. *J Infect Dis* 2001;184:330.
542. Burgner D, Xu W, Rockett K, et al. Inducible nitric oxide synthase polymorphism and fatal cerebral malaria. *Lancet* 1998;352:1193.
543. Hobbs MR, Udhayakumar V, Levesque MC, et al. A new Nos2 promoter polymorphism associated with increased nitric oxide production and protection from severe malaria in Tanzanian and Kenyan children. *Lancet* 2002;360:1468.
544. Schultz RM. The role of macrophage-derived arachidonic acid oxygenation products in the modulation of macrophage and lymphocyte function. In: Hadden JW, Szentivanyi A, eds. *The reticuloendothelial system*. New York: Plenum Publishing, 1985.
545. Kurland JI, Broxmeyer HE, Pelus LM, et al. Role of monocyte-macrophage-derived colony-stimulating factor and prostaglandin E in the positive and negative feedback control of myeloid stem cell proliferation. *Blood* 1978;52:388.
546. Taffet SM, Russel SW. Macrophage-mediated tumor cell killing: regulation of expression of cytolytic activity by prostaglandin E. *J Immunol* 1981;126:424.
547. Goetzl EJ, Pickett WC. Novel structural determinants of the human neutrophil chemotactic activity of leukotriene B. *J Exp Med* 1981;153:482.
548. Samuelsson B. Mediators of immediate hypersensitivity reactions and inflammation. *Science* 1983;220:568.
549. Pawlowski NA, Kaplan G, Hannill AL, et al. Arachidonic acid metabolism by human monocytes. Studies with platelet-depleted cultures. *J Exp Med* 1983;158:393.
550. Weinberg JB. Nitric oxide synthase 2 and cyclooxygenase 2 interactions in inflammation. *Immunol Res* 2000;22:319.
551. Ricote M, Huang JT, Welch JS, et al. The peroxisome proliferator-activated receptor gamma (PPAR gamma) as a regulator of monocyte/macrophage function. *J Leukoc Biol* 1999;66:733.
552. Mangelsdorf DJ, Evans RM. The RXR heterodimers and orphan receptors. *Cell* 1995;83:841.
553. Serhan CN. Inflammation. Signalling the fat controller. *Nature* 1996;384:23.
554. Devchand PR, Keller H, Peters JM, et al. The PPARalpha-leukotriene B4 pathway to inflammation control. *Nature* 1996;384:39.
555. Ricote M, Li AC, Willson TM, et al. The peroxisome proliferator-activated receptor-gamma is a negative regulator of macrophage activation. *Nature* 1998;391:79.
556. Jiang CY, Ting AT, Seed B. PPAR-gamma agonists inhibit production of monocyte inflammatory cytokines. *Nature* 1998;391:82.
557. Ricote M, Huang J, Fajas L, et al. Expression of the peroxisome proliferator-activated receptor gamma (PPAR-gamma) in human atherosclerosis and regulation in macrophages by colony stimulating factors and oxidized low density lipoprotein. *Proc Natl Acad Sci U S A* 1998;95:7614.
558. Forman BM, Chen J, Evans RM. Hypolipidemic drugs, polyunsaturated fatty acids, and eicosanoids are ligands for peroxisome proliferator-activated receptors alpha and delta. *Proc Natl Acad Sci U S A* 1997;94:4312.
559. Lehmann JM, Lenhard JM, Oliver BB, et al. Peroxisome proliferator-activated receptors alpha and

gamma are activated by indomethacin and other non-steroidal anti-inflammatory drugs. *J Biol Chem* 1997;272:3406.

560. Huang JT, Welch JS, Ricote M, et al. Interleukin-4-dependent production of PPAR-gamma ligands in macrophages by 12/15-lipoxygenase. *Nature* 1999;400:378.

561. Mbalaviele G, Abu-Amer Y, Meng A, et al. Activation of peroxisome proliferator-activated receptor-gamma pathway inhibits osteoclast differentiation. *J Biol Chem* 2000;275:14388.

562. Reilly CM, Oates JC, Cook JA, et al. Inhibition of mesangial cell nitric oxide in mrl/lpr mice by prostaglandin j(2) and proliferator activation receptor-gamma agonists. *J Immunol* 2000;164:1498.

563. Colville-Nash PR, Qureshi SS, Willis D, et al. Inhibition of inducible nitric oxide synthase by peroxisome proliferator-activated receptor agonists: correlation with induction of heme oxygenase 1. *J Immunol* 1998;161:978.

564. Inoue H, Tanabe T, Umesono K. Feedback control of cyclooxygenase-2 expression through PPAR gamma. *J Biol Chem* 2000;275:28028.

565. Chinetti G, Griglio S, Antonucci M, et al. Activation of proliferator-activated receptors alpha and gamma induces apoptosis of human monocyte-derived macrophages. *J Biol Chem* 1998;273:25573.

566. Straus DS, Pascual G, Li M, et al. 15-deoxy-delta(12,14)-prostaglandin j(2) inhibits multiple steps in the NF-kappa b signaling pathway. *Proc Natl Acad Sci U S A* 2000;97:4844.

567. Kawahito Y, Kondo M, Tsubouchi Y, et al. 15-deoxy-delta(12,14)-pgj(2) induces synoviocyte apoptosis and suppresses adjuvant-induced arthritis in rats. *J Clin Invest* 2000;106:189.

568. Sunderkotter C, Steinbrink K, Goebeler M, et al. Macrophages and angiogenesis. *J Leukoc Biol* 1994;55:410.

569. Kurland JI, Meyers PA, Moore MAS. Synthesis and release of erythroid colony- and burst-potentiating activities by purified populations of murine peritoneal macrophages. *J Exp Med* 1980;151:838.

570. Pekala PH, Kawakami M, Vine W, et al. Studies of insulin resistance in adipocytes induced by macrophage mediator. *J Exp Med* 1983;157:1360.

571. Pekala PH, Kawakami M, Angus CW, et al. Selective inhibition of synthesis of enzymes for de novo fatty acid biosynthesis by an endotoxin-induced mediator from exudate cells. *Proc Natl Acad Sci U S A* 1983;80:2743.

572. Torti FM, Dieckmann B, Beutler B, et al. A macrophage factor inhibits adipocyte gene expression: an in vitro model of cachexia. *Science* 1985;229:867.

573. Bazzoni F, Beutler B. The tumor necrosis factor ligand and receptor families. *New Engl J Med* 1996;334:1717.

574. Cerami A, Beutler B. The role of cachectin/TNF in endotoxic shock and cachexia. *Immunol Today* 1988;9:28.

575. Beutler B, Milsark IW, Cerami AC. Passive immunization against cachectin/tumor necrosis factor protects mice from lethal effect of endotoxin. *Science* 1985;229:869.

576. Tracey KJ, Beutler B, Lowry SF, et al. Shock and tissue injury induced by recombinant human cachectin. *Science* 1986;234:470.

577. Kung JT. Suppression of in vitro cytotoxic response by macrophages due to induce arginase. *J Exp Med* 1977;146:665.

578. Stadecker MJ, Calderon J, Karnovsky ML, et al. Synthesis and release of thymidine by macrophages. *J Immunol* 1977;119:1738.



579. Brodsky FM, Guagliardi LE. The cell biology of antigen processing and presentation. *Ann Rev Immunol* 1991;9:707.
580. Hibbs JB Jr, Lambert LH Jr, Remington JS. Possible role of macrophage mediated nonspecific cytotoxicity in tumour resistance. *Nat New Biol* 1972;235:48.
581. Hibbs JB Jr, Chapman HA Jr, Weinberg JB. The macrophage as an antineoplastic surveillance cell: biological perspectives. *J Reticuloendothel Soc* 1978;24:549.
582. Nathan CF, Murray HW, Cohn ZA. The macrophage as an effector cell. *N Engl J Med* 1980;303:622.
583. Campbell PA, Czuprynski CJ, Cook JL. Differential expression of macrophage effector functions: bactericidal versus tumoricidal activities. *J Leukoc Biol* 1984;36:293.
584. Degroote MA, Fang FC. No inhibitions. Antimicrobial properties of nitric oxide. *Clin Infect Dis* 1995;21:S162.
585. Mastroeni P, Vazquez-Torres A, Fang FC, et al. Antimicrobial actions of the NADPH phagocyte oxidase and inducible nitric oxide synthase in experimental salmonellosis. II. Effects on microbial proliferation and host survival in vivo. *J Exp Med* 2000;192:237.
586. Vazquez-Torres A, Jones-Carson J, Mastroeni P, et al. Antimicrobial actions of the NADPH phagocyte oxidase and inducible nitric oxide synthase in experimental salmonellosis. I. Effects on microbial killing by activated peritoneal macrophages in vitro. *J Exp Med* 2000;192:227.
587. Hiemstra PS, van Furth R. Antimicrobial mechanisms: antimicrobial polypeptides of mononuclear phagocytes. *Immunol Ser* 1994;60:197.
588. Weinberg ED. A defense against infection and neoplasia. *Physiol Rev* 1984;64:65.
589. Murray HW, Byrne GI, Hothermel CD, et al. Lymphokine enhances oxygen-independent activity against intracellular pathogens. *J Exp Med* 1983;158:234.
590. Chen AR, Koren HS. Impaired oxidative burst does not affect human monocyte tumoricidal activity. *J Immunol* 1985;134:1909.
591. Draper P, D'Arcy Hart P. Phagosomes, lysosomes, and mycobacteria: cellular and microbial aspects. In: van Furth R, ed. *Mononuclear phagocytes in immunity, infection, and pathology*. Oxford: Blackwell Scientific, 1975.
592. Eissenberg LG, Wyrick PB. Inhibition of phagolysosome fusion is localized to *Chlamydia psittaci*-laden vacuoles. *Infect Immun* 1981;32:889.
593. Nogueira N, Crone ZA. *Trypanosoma cruzi*: in vitro induction of macrophage microbicidal activity. *J Exp Med* 1978;148:288.
594. MacMicking JD, North RJ, LaCourse R, et al. Identification of nitric oxide synthase as a protective locus against tuberculosis. *Proc Natl Acad Sci U S A* 1997;94:5243.
595. Murray HW, Nathan CF. Macrophage microbicidal mechanisms in vivo: reactive nitrogen versus oxygen intermediates in the killing of intracellular visceral leishmania donovani. *J Exp Med* 1999;189:741.
596. Florquin S, Amraoui Z, Dubois C, et al. The protective role of endogenously synthesized nitric oxide in staphylococcal enterotoxin b-induced shock in mice. *J Exp Med* 1994;180:1153.
597. De Caterina R, Libby P, Peng HB, et al. Nitric oxide decreases cytokine-induced endothelial activation. Nitric oxide selectively reduces endothelial expression of adhesion molecules and proinflammatory cytokines. *J Clin Invest* 1995;96:60.
598. Weinberg JB, Hibbs JB Jr. Endocytosis of red blood cells or haemoglobin by activated macrophages inhibits their tumoricidal effect. *Nature* 1977;269:245.

599. Koller CA, LoBuglio AF. Monocyte-mediated antibody-dependent cell-mediated cytotoxicity: the role of the metabolic burst. *Blood* 1981;58:293.
600. Granger DL, Taintor RR, Cook JL, et al. Injury of neoplastic cells by murine macrophages leads to inhibition of mitochondrial respiration. *J Clin Invest* 1980;65:357.
601. Granger DL, Lehninger AL. Sites of inhibition of mitochondrial electron transport in macrophage-injured neoplastic cells. *J Cell Biol* 1982;95:527.
602. Hibbs JB Jr, Taintor RR, Vavrin Z. Iron depletion: possible cause of tumor cell cytotoxicity induced by activated macrophages. *Biochem Biophys Res Commun* 1984;123:716.
603. Nathan CF, Brukner LH, Silverstein SC, et al. Extracellular cytolysis by activated macrophages and granulocytes. I. Pharmacologic triggering of effector cells and the release of hydrogen peroxide. *J Exp Med* 1979;149:84.
604. Adams DO, Johnson WJ, Marino PA. Mechanisms of target recognition and destruction in macrophage-mediated tumor cytotoxicity. *Fed Proc* 1982;41:2212.
605. Old LJ. Tumor necrosis factor (TNF). *Science* 1985;230:630.
606. Hibbs JB Jr, Taintor RR, Vavrin Z, et al. Nitric oxide: a cytotoxic activated macrophage effector molecule [published erratum appears in *Biochem Biophys Res Commun* 1989;158:624]. *Biochem Biophys Res Commun* 1988;157:87.
607. Kwon NS, Stuehr DJ, Nathan CF. Inhibition of tumor cell ribonucleotide reductase by macrophage-derived nitric oxide. *J Exp Med* 1991;174:761.
608. Drapier JC, Hibbs JB Jr. Murine cytotoxic activated macrophages inhibit aconitase in tumor cells. Inhibition involves the iron-sulfur prosthetic group and is reversible. *J Clin Invest* 1986;78:790.
609. Albina JE, Cui S, Mateo RB, et al. Nitric oxide-mediated apoptosis in murine peritoneal macrophages. *J Immunol* 1993;150:5080.
610. Adams DO, Hamilton TA. The cell biology of macrophage activation. *Ann Rev Immunol* 1984;2:283.
611. Russell SW, Doe WF, McIntosh AT. Functional characterization of a stable, noncytotoxic stage of macrophage activation in tumors. *J Exp Med* 1977;146:1511.
612. Weinberg JB, Chapman HA Jr, Hibbs JB Jr. Characterization of the effects of endotoxin on macrophage tumor cell killing. *J Immunol* 1978;121:72.
613. Kleinerman ES, Schroit AJ, Fogler WE, et al. Tumoricidal activity of human monocytes activated in vitro by free and liposome encapsulated human lymphokines. *J Clin Invest* 1983;72:304.
614. Weinberg JB, Ribi E, Wheat RW. Enhancement of macrophage-mediated tumor cell killing by bacterial outer membrane proteins (porins). *Infect Immun* 1983;42:219.
615. Raes G, De Baetselier P, Noel W, et al. Differential expression of *fizz1* and *ym1* in alternatively versus classically activated macrophages. *J Leukoc Biol* 2002;71:597.
616. Hengartner MO. The biochemistry of apoptosis. *Nature* 2000;407:770.
617. Li J, Billiar TR, Talanian RV, et al. Nitric oxide reversibly inhibits seven members of the caspase family via *s*-nitrosylation. *Biochem Biophys Res Commun* 1997;240:419.
618. Kim YM, Talanian RV, Billiar TR. Nitric oxide inhibits apoptosis by preventing increases in caspase-3-like activity via two distinct mechanisms. *J Biol Chem* 1997;272:31138.
619. Genaro AM, Hortelano S, Alvarez A, et al. Splenic B lymphocyte programmed cell death is prevented by nitric oxide release through mechanisms involving sustained Bcl-2 levels. *J Clin Invest* 1995;95:1884.

620. Albina JE, Reichner JS. Role of nitric oxide in mediation of macrophage cytotoxicity and apoptosis [review]. *Cancer Metastasis Rev* 1998;17:39.
621. Brune B, von Knethen A, Sandau KB. Nitric oxide (NO): an effector of apoptosis [review]. *Cell Death Differ* 1999;6:969.
622. Hilbi H, Zychlinsky A, Sansonetti PJ. Macrophage apoptosis in microbial infections. *Parasitology* 1997;115:S79.
623. Aliprantis AO, Diezroux G, Mulder LCF, et al. Do macrophages kill through apoptosis [review]? *Immunol Today* 1996;17:573.
624. Meier P, Finch A, Evan G. Apoptosis in development. *Nature* 2000;407:796.
625. Geske FJ, Monks J, Lehman L, et al. The role of the macrophage in apoptosis: hunter, gatherer, and regulator. *Int J Hematol* 2002;76:16.
626. Savill J. Apoptosis in resolution of inflammation. *Kidney Blood Press Res* 2000;23:173.
627. LoBuglio AF, Cotran RS, Jandl JH. Red cells coated with immunoglobulin G: binding and sphering by mononuclear cell in man. *Science* 1967;158:1582.
628. Newman SL, Henson JE, Henson PM. Phagocytosis of senescent neutrophils by human monocyte-derived macrophages and rabbit inflammatory macrophages. *J Exp Med* 1982;154:430.
629. Court WS, Christenson AK, Sacks RW, et al. Human monocyte interaction with antibody-coated platelets. I. General characteristics. *Am J Hematol* 1984;17:225.
630. Kay MMB. Senescent cell antigen is immunologically related to band 3. *Proc Natl Acad Sci U S A* 1983;80:1631.
631. Baranano DE, Wolosker H, Bae BI, et al. A mammalian iron ATPase induced by iron. *J Biol Chem* 2000;275:15166.
632. Donovan A, Brownlie A, Zhou Y, et al. Positional cloning of zebrafish ferroportin1 identifies a conserved vertebrate iron exporter. *Nature* 2000;403:776.
633. Crichton RR. Iron uptake and utilization by mammalian cells. II. Intracellular iron utilization. *Trends Biochem Sci* 1984;9:283.
634. Octave J-N, Schneider Y-J, Trouet A, et al. Iron uptake and utilization by mammalian cells. I. Cellular uptake of transferrin and iron. *Trends Biochem Sci* 1983;8:217.
635. Barton CH, Biggs TE, Baker ST, et al. NRAMP1: a link between intracellular iron transport and innate resistance to intracellular pathogens. *J Leukoc Biol* 1999;66:757.
636. Bellamy R, Ruwende C, Corrah T, et al. Variations in the NRAMP1 gene and susceptibility to tuberculosis in West Africans. *N Engl J Med* 1998;338:640.
637. Gruenheid S, Gros P. Genetic susceptibility to intracellular infections: NRAMP1, macrophage function and divalent cations transport [review]. *Curr Opin Microbiol* 2000;3:43.
638. Klausner RD, Rouault TA, Harford JB. Regulating the fate of mRNA: the control of cellular iron metabolism. *Cell* 1993;72:19.
639. Hentze MW, Kuhn LC. Molecular control of vertebrate iron metabolism: mRNA-based regulatory circuits operated by iron, nitric oxide, and oxidative stress. *Proc Natl Acad Sci U S A* 1996;93:8175.
640. Weiss G, Goossen B, Doppler W, et al. Translational regulation via iron-responsive elements by the nitric oxide/NO-synthase pathway. *EMBO J* 1993;12:3651.
641. Drapier JC, Hirling H, Wietzerbin J, et al. Biosynthesis of nitric oxide activates iron regulatory factor

in macrophages. EMBO J 1993;12:3643.

2004 Lippincott Williams & Wilkins  
John P. Greer, John Foerster, John N. Lukens  
George M. Rodgers, Frixos Paraskevas, Bertil Glader  
Wintrobe's Clinical Hematology

ATTACHMENT: ROLE OF OPSONINSFc? ReceptorsComplement ReceptorsINGESTIONSignal Transduction by Phagocytic ReceptorsEnclosure of the Phagocytic VacuoleACTIN AND PARTNERS: AN INCREDIBLE MACHINEActivation of Arp2/3 by Wiskott-Aldrich Syndrome ProteinActin Polymerization in PhagocytosisActin-Binding ProteinsREGULATORY MECHANISMS: DOWNSTREAM PATHWAYSCalciumProtein Kinase C FamilyPhosphoinositide KinasesGuanosine TriphosphatasesEzrin, Radixin, and Moesin FamilyDIGESTIONMicrobicidal MechanismsNicotinamide Adenine Dinucleotide Phosphate Reduced OxidaseDefects of Oxidative MetabolismPHAGOCYTOSIS OF APOPTOTIC CELLSPHAGOCYTOSIS OF SENESCENT ERYTHROCYTESASSESSMENT OF PHAGOCYTIC FUNCTIONNitroblue TetrazoliumFlow CytometryChemiluminescenceREFERENCES

The discovery of phagocytosis by Elie Metchnikoff marks the birth of immunology (<sup>1</sup>). As with many other great ideas in the history of science, its origin and evolution can be traced to questions totally unrelated to the subsequent demonstration that phagocytosis plays a major role in defense against intruders in multicellular organisms. Metchnikoff was a zoologist with research in embryology. His early research was concerned with the identification of primordial embryologic structures and functions that could link them to the evolution of species; in other words, he was searching for a link between ontogeny and phylogeny. Digestion was considered one of the most ancient functions—it existed even in unicellular organisms and was also detected among cells of primitive embryologic layers.

These early investigations led to the observations that mobile cells of the primitive digestive tract of the starfish larvae were engulfing foreign material, such as carmine droplets, that Metchnikoff introduced into the larvae. Because carmine had no nutritive value, as he later described the moment, “a new thought suddenly flashed across my brain. It struck me that similar cells might serve in the defense of the organism against intruders.” The now famous Messina experiment provided proof for his new idea. He introduced thorns from his Christmas tangerine tree to starfish larvae, and, after anxiously waiting all night for his results, he observed the next morning that several mobile cells surrounded the thorns. This experiment was followed by observations that, if the spores of the *Monospora bicuspidata* that had entered the body of *Daphnia* were

quickly engulfed by wandering cells, *Daphnia* survived; otherwise, the organism died. These results led him to believe that the function of the ameboid cells was important in the defense against infection. The word *phagocytosis* was suggested to him by Dr. Claus, a professor of zoology at Vienna, defining the function of “devouring cells” (from the Greek *phago*, eat).

In multicellular organisms, the cells that are involved in phagocytosis have been called *professional phagocytes* by Rabinovitch. Most widely recognized phagocytes, are the polymorphonuclear leukocytes and the mononuclear phagocytes (monocytes and macrophages). A number of mechanisms have been identified by which extracellular material gains entry into the cell ( <sup>2</sup> ). The term *endocytosis* is used to characterize the uptake of macromolecules in solution, and it can be subdivided into *clathrin-mediated endocytosis*, *non-clathrin-mediated endocytosis*, and *macropinocytosis* ( <sup>3</sup> ).

Clathrin-mediated endocytosis is the best characterized ( <sup>4</sup> ). Clathrin consists of three heavy and three light chains (triskelions) forming lattices of hexagons and pentagons. In addition to clathrin, the endocytic vesicles are also coated with adaptors such as adaptor protein 2, can assemble into empty coats or cages, and produce lattice-coated vesicles. The formation of the endocytic vesicle is regulated by a guanosine triphosphatase (GTPase), dynamin. Clathrin-mediated endocytosis is used by certain macromolecules with well-defined receptors present in the clathrin-coated pit or vesicle in the cell membrane, such as receptors for transferrin, low-density lipoprotein, and epidermal growth factor. Non-clathrin-mediated endocytosis is carried out by caveolae and non-clathrin-coated vesicles. Macropinocytosis is a form of endocytosis that results in the formation of large vesicles, usually at the leading edge of the cell membrane where ruffling occurs. It is used by antigen-presenting cells to capture antigen for presentation in the context of major histocompatibility molecules. These various forms of endocytosis involve uptake of fluids, a process that was known as *pinocytosis* (from the Greek *pino*, drink). Phagocytosis is endocytosis of large particles (<1  $\mu\text{m}$ ). Phagocytosis differs from pinocytosis not only in terms of the size of the material to be ingested but also in its temperature dependence (it does not occur below 18° C) and its requirement of an intact cytoskeletal system.

It is helpful to consider the morphologic aspects of phagocytosis in three stages: (a) attachment and opsonization, (b) ingestion, and (c) digestion.

## ATTACHMENT: ROLE OF OPSONINS

Attachment of foreign particles on the phagocytic surface is facilitated greatly by substances known as *opsonins*, discovered by Almroth Wright and immortalized in *The Doctor's Dilemma* by George Bernard Shaw. The best-known opsonins are immunoglobulin (Ig) G antibodies, complement components (or their activation products), and certain oligosaccharides terminating in mannose or galactose.

The various opsonins bind to the surface of the phagocyte by specific receptors: Fc receptors (FcRs) for the IgG (Fc?R), complement receptors (CRs) for complement components, and the mannose receptor for the mannose-terminating oligosaccharides.

### Fc? Receptors

There are three Fc?Rs: Fc?RI (CD64), Fc?RII (CD32), and Fc?RIII (CD16). Their genes have been mapped on chromosome 1 at q21-23. Many isoforms exist; some are encoded by distinct genes, whereas others are generated as a result of alternative splicing ( <sup>5</sup>, <sup>6</sup> and <sup>7</sup> ). Eight genes have been identified so far, three for Fc?RI (A, B, and C), three for Fc?RII (A, B, and C), and two for Fc?RIII (A and B). All FcRs have a ligand-binding

polypeptide chain known as a  $\alpha$ -chain, and, in some, the  $\alpha$ -chain is associated with homodimers of the  $\beta$ -chain or heterodimers of the  $\beta$ - and  $\gamma$ -chains (discussed later). The  $\alpha$ -chain belongs to the Ig superfamily with conserved extracellular regions, which contain two (Fc $\gamma$ RII and Fc $\gamma$ RIII) or three (Fc $\gamma$ RI) Ig domains. Their cytoplasmic regions are distinct, suggesting that they may be involved in different functions.

One important characteristic feature of their cytoplasmic region is the presence of conserved tyrosine (Y)-containing sequences YXXL (where X is any amino acid and L is leucine) known as *ITAM* (immunoreceptor tyrosine-based activation motif), which is found in components of B-cell and T-cell receptors. The ITAM motif consists of two YXXL sequences separated by nonconserved amino acids and, in its full-length form, contains up to 25 residues (8). This sequence plays a central role in signal transduction of several receptors of the cells of the immune system.

Understanding the role of Fc $\gamma$ R in phagocytosis became possible with transfection of the appropriate gene in a cell line (COS-1) from monkey kidney, which lacks Fc $\gamma$ Rs but has the intracellular machinery required for phagocytosis (9).

The Fc $\gamma$ RI (CD64) is found on monocytes and macrophages and binds monomeric IgG with high affinity ( $K_a = 5 \times 10^8$  mol/L). When present alone, it does not mediate phagocytosis, although it binds IgG-coated sheep erythrocytes. The binding site of the IgG is located in the NH<sub>2</sub> terminal region of the CH<sub>2</sub> domain of the IgG. IgG1 and IgG3 subclasses bind with higher affinity than IgG4 and IgG2. The  $\alpha$ -chain of Fc $\gamma$ RI lacks the ITAM motif and can mediate phagocytosis even when it totally lacks its cytoplasmic region, provided that it is associated with the  $\beta$ -chain that contains ITAM motifs (10). On monocyte and macrophage cell lines, the Fc $\gamma$ RI is associated with the  $\beta$ -chain (11, 12).

The Fc $\gamma$ RII (CD32) is a low-affinity receptor and does not bind monomeric IgG. Its expression on neutrophils is low (10,000 to 40,000 per cell) and shows subclass specificity for IgG dimers (IgG3 > IgG1 = IgG2 &gt; IgG4). The CH<sub>2</sub> and CH<sub>3</sub> domains of the IgG may be involved in the binding. Fc $\gamma$ RIIA is expressed on neutrophils, monocytes, and macrophages, whereas the Fc $\gamma$ RIIB is expressed only on B lymphocytes (13, 14). The Fc $\gamma$ RIIA isoform contains two YXXL sequences (i.e., one complete ITAM) and effectively induces phagocytosis, whereas the Fc $\gamma$ RIIB contains only a single cytoplasmic YXXL sequence and does not induce a phagocytic signal unless a second YXXL sequence is inserted by transfection (15). The position of the two sequences and the number of amino acids separating them play a role in phagocytosis.

The Fc $\gamma$ RIIIA (CD16) is also a low-affinity receptor and consists of an  $\alpha$ -chain (the ligand binding) and a homodimer of  $\beta$ -chains or a heterodimer of  $\beta$  and  $\gamma$  subunits (16, 17). The  $\beta$  subunit is important not only for the induction of the phagocytic signal but also for the surface expression of Fc $\gamma$ RIII. The Fc $\gamma$ RIIIB is found on neutrophils and is anchored to the outer leaflet of the plasma membrane by a glycosylphosphatidylinositol group, whereas the Fc $\gamma$ RIIIA is a transmembrane protein with a cytoplasmic domain and is expressed on natural killer cells (18). The most critical difference between the two Fc $\gamma$ RIII proteins is located in amino acid 203, where a serine in Fc $\gamma$ RIIIB determines the glycosylphosphatidylinositol anchor, whereas a phenylalanine in the Fc $\gamma$ RIIIA directs for the transmembrane form.

The expression of Fc $\gamma$ R can be constitutive or inducible by cytokines. The resting neutrophils do not express Fc $\gamma$ RI but express between 10,000 and 40,000 copies of Fc $\gamma$ RII



and 100,000 to 300,000 copies of Fc $\gamma$ RIII ( [19](#)).

Soluble forms have been demonstrated for all three Fc $\gamma$ Rs, which are generated by several mechanisms. Serum contains high levels of Fc $\gamma$ RIIB, probably released from polymorphonuclear cells by serine protease activity ( [20](#)). Other mechanisms involve alternative splicing (Fc $\gamma$ RIIA) or stop codons (Fc $\gamma$ RI). It becomes apparent that Fc $\gamma$ Rs in general exert a wide range of biologic functions within the network of immunologic regulation and function ( [21](#), [22](#)). The expression of the various forms of Fc $\gamma$ R and their functions are summarized in [Table 14.1](#) and [Table 14.2](#), respectively.

**TABLE 14.1. Fc $\gamma$  Receptor (Fc $\gamma$ R) Expression**

|                  | Mf | Monocytes | Neutrophils | Natural Killer Cells | B Cells | T Cells |
|------------------|----|-----------|-------------|----------------------|---------|---------|
| Fc $\gamma$ RI   | +  | +         | +           | –                    | –       | –       |
| Fc $\gamma$ RIIA | +  | +         | +           | –                    | –       | –       |
| Fc $\gamma$ RIIB | +  | +         | –           | –                    | +       | –       |
| Fc $\gamma$ RIIC | +  | +         | +           | –                    | –       | –       |
| Fc $\gamma$ RIIA | +  | +         | –           | +                    | –       | +       |
| Fc $\gamma$ RIIB | –  | –         | +           | –                    | –       | –       |

+, receptor expressed on cell; –, receptor is not expressed on cell.

**TABLE 14.2. Fc $\gamma$  Receptor (Fc $\gamma$ R) Function**

|                  | Phagocytosis O <sub>2</sub> ADCC |     |     | Tumor Necrosis Factor- $\alpha$ |
|------------------|----------------------------------|-----|-----|---------------------------------|
| Fc $\gamma$ RI   | +                                | +   | +   | +                               |
| Fc $\gamma$ RII  | +                                | +   | +   | +                               |
| Fc $\gamma$ RIIA | +                                | +   | +   | +                               |
| Fc $\gamma$ RIIB | -/+                              | -/+ | -/+ | ?                               |

ADCC, antibody-dependent cell cytotoxicity; +, receptor performs this function; -/+, receptor sometimes performs this function.

### Complement Receptors

Certain complement components and their activation-induced fragments bind to receptors present on phagocytes and enhance phagocytosis. The best studied are the C3b receptor (CR1; CD35), the C3d receptor (CR2; CD21), and the receptor for the inactive fragments of C3b, that is, iC3b (CR3; CD11b and CR4; CD11c). Under certain conditions, some of them mediate ingestion of complement-coated particles. Opsonization by C3 is necessary for phagocytosis to occur, but C3 by itself does not induce ingestion. Marked synergy, however, exists between C3 and IgG in inducing phagocytosis. C3b- or C3d-coated red cells enhance phagocytosis of IgG-coated red cells by 20-fold ( [23](#)). However, CRs can promote both attachment and ingestion in macrophages activated under the influence of T-cell-derived lymphokines ( [24](#), [25](#)), shown to be macrophage colony-stimulating factor and interleukin (IL)-4 ( [26](#)). The ability of C3b receptors to

promote phagocytosis relates to their capacity to be redistributed on the surface of the phagocyte, and lymphokines may do precisely this ( [27](#) ). This lateral mobility of the CRs may permit their engagement to the intracellular machinery that is involved in engulfment. Actually, this mobility of the FcR and CR on the cell membrane can be induced by soluble ( [28](#) ) or immobilized immune complexes ( [29](#) ), and, when it becomes extensive, it leads to impairment of the ability of phagocytes to ingest IgG-coated particles.

A receptor for C1q also mediates enhanced phagocytosis ( [30](#) ). Three cell-surface C1q-binding proteins have been identified. Two of them (60 kd and 126 kd) bind to the “collagenlike” region of C1q (cC1qR) and the third one (33 kd) binds to the globular heads of C1q (gC1qR). The 60-kd cC1qR is structurally related to the Ca-binding protein, calreticulin ( [31](#) ), and binds also to mannose-binding lectin and pulmonary surfactant protein A ( [32](#) ), all of which enhance phagocytosis ( [33](#) ). Mannose-binding lectin and pulmonary surfactant protein A have a primary structure similar to C1q. They have collagenous and globular domains.

The mannose-binding lectin, more commonly known as the *mannose receptor*, is a C-type lectin expressed by macrophages and dendritic cells ( [34](#) ) and is involved in uptake of mycobacteria and other pathogens as a result of binding to lipoglycan, lipoarabinomannan ( [35](#), [36](#) ). Phagocytosed pathogens are directed to the endocytic pathway, and the lipoarabinomannan antigens associated with these pathogens are presented to T cells in the context of CD1b molecules ( [37](#) ) (see [Chapter 2](#) and [Chapter 18](#) ). This is a link between innate and adaptive immunity.

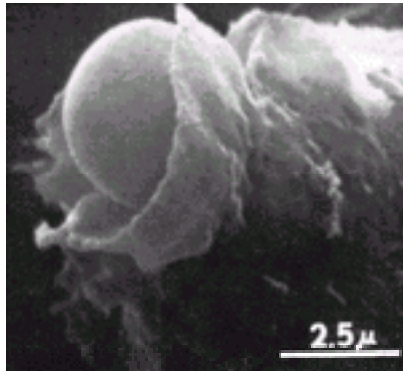
Macrophages also express high-affinity receptors for lipopolysaccharides, the lipopolysaccharide receptor (CD14) ( [38](#) ) (see [Chapter 2](#) ). This receptor enhances ingestion of gram-negative bacteria ( [39](#) ) and triggers release of cytokines, especially tumor necrosis factor- $\alpha$ .

Opsonization of pathogens (coated with antibody or complement) markedly facilitates attachment and subsequent ingestion and is particularly important for encapsulated bacteria, such as pneumococci, that resist phagocytosis. Capsules are usually very hydrophilic and prevent the approach of the phagocyte. Opsonization with antibody and complement combined results in bacterial clearance by several logs more than without opsonization or opsonization with either opsonin alone. It is interesting that the subclasses of IgG that bind strongly to the Fc $\gamma$ R also fix complement well. Nonencapsulated bacteria can be ingested without opsonization through receptors that bind latex particles, zymosan, and others.

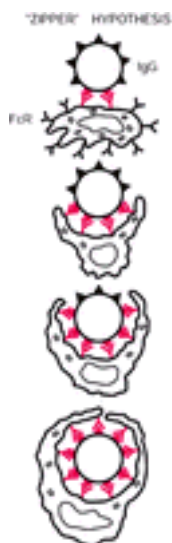
## INGESTION

After attachment, the phagocyte extends pseudopodia that encircle the particle and eventually enclose it within a vesicle known as a *phagosome*. Phagocytosis stimulated by one particle does not induce ingestion of other particles attached to the same phagocyte that by themselves would not be phagocytosed ( [40](#) ). In other words, the response of the membrane to the phagocytic stimulus is segmental, not generalized. This segmental response engages the receptors of the phagocyte with the respective ligand on the particle. Successive ligand-receptor engagements lead to the extension of broad lamellipodia of the phagocytic membrane over the particle, forming a phagocytic cup ( [Fig. 14.1](#) ). Eventually, the advancing ends of the lamellipodia fuse and enclose the particle within the phagosome. This sequential and circumferential ligand-receptor interaction has been called the *zipper hypothesis of phagocytosis* ( [41](#) ) ( [Fig. 14.2](#) ). The validity of the

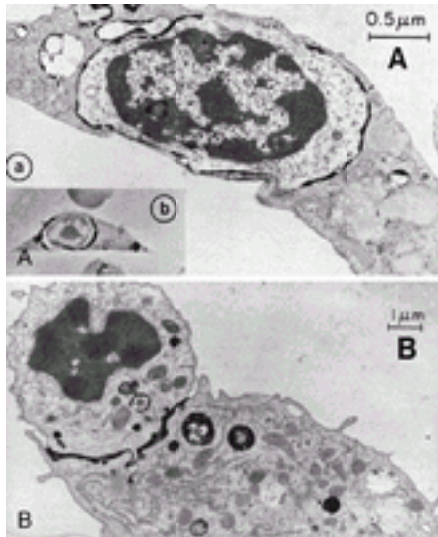
zipper mechanism is shown by the inability of macrophages to phagocytose lymphocytes when their surface Ig is capped by anti-Ig antibodies. Lymphocytes treated with anti-Ig antibodies can be phagocytosed if their entire surface is coated with the anti-Ig antibody (42) ( Fig. 14.3). However, if capping of surface Ig is allowed to take place (i.e., the surface Ig and anti-Ig complexes have moved to one pole of the cell), the phagocyte is firmly attached to the cap, but pseudopodia do not extend to the remaining surface of the cell.



**Figure 14.1.** Phagocytosis of a red blood cell. Scanning electron micrograph of phagocytosis of an immunoglobulin G-coated red blood cell. Lamellipodia extending from the macrophage over the red cell form a “cup” that engulfs the red cell. (From Kay MM. Hodgkin’s disease: a war between T-lymphocytes and transformed macrophages? *Recent Results Cancer Res* 1976;56:111–121, with permission.)



**Figure 14.2.** The “zipper” mechanism of phagocytosis. A phagocyte establishes contact with an immunoglobulin G (IgG)–opsonized particle through interaction of the Fc $\gamma$  receptor (Fc $\gamma$ R) of the phagocyte with the IgG opsonin. Signals generated by this interaction lead to actin polymerization and the formation of pseudopodia. New contacts between the Fc $\gamma$ R on the advancing pseudopodia and the IgG opsonin lead to further advancement of the pseudopodia and additional contacts resulting in progressive encircling of the opsonized particle and the formation of the phagosome. This stepwise binding of the ligands (opsonins) to their respective receptors is known as the *zipper mechanism of phagocytosis*. Partially opsonized particles are not ingested (see Fig. 14.3).

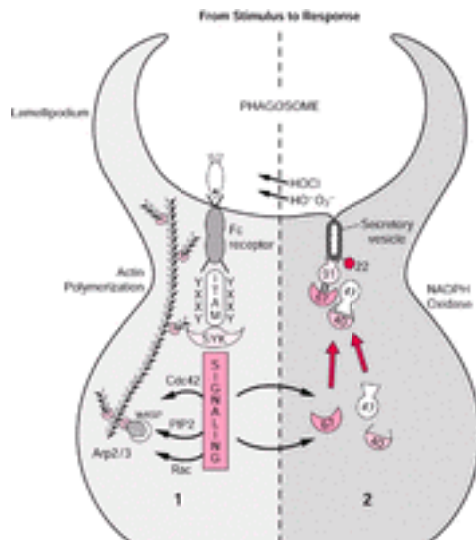


**Figure 14.3.** Phagocytosis of opsonized and partially opsonized lymphocytes. **A:** Mouse lymphocytes were treated with immunoglobulin (Ig) G rabbit anti-mouse Ig followed by sheep IgG anti-rabbit-F(ab')<sub>2</sub> antibody. The peroxidase reaction shows that these lymphocytes have surface Ig distributed around the entire surface of the cell. As shown by electron microscopy (a) and phase microscopy (b), these lymphocytes are phagocytosed by the macrophages. **B:** Lymphocytes were first allowed to cap their surface Ig and then were treated with the sheep anti-rabbit-F(ab')<sub>2</sub> antibody. The macrophage is attached to the lymphocyte only in the area of the cap, whereas pseudopodia are unable to extend beyond the cap over the lymphocyte surface that has lost the Ig-anti-Ig complexes. Peroxidase-labeled antibodies are seen in vacuoles (asterisks) and tubular invaginations of the membrane (arrows). (From Griffin FM Jr, Griffin JA, Silverstein SC. Studies on the mechanism of phagocytosis. II. The interaction of macrophages with anti-immunoglobulin IgG-coated bone marrow-derived lymphocytes. *J Exp Med* 1976;144:788, with permission.)

### Signal Transduction by Phagocytic Receptors

Six members of the Src family have been identified in phagocytes: Fgr, Fyn, Hck, Lyn, Ycs, and Src. Some of these are associated with specific receptors. These kinases are important for the early phosphorylation events after Fc $\gamma$ R engagement (43). There is a high degree of redundancy among these kinases because significant interference of phagocytosis requires inactivation of several members (44).

On stimulation with IgG-coated particles, these kinases are activated and are redistributed to actin-rich phagocytic caps (Fig. 14.4, part 1). The ITAMs of the FcRs are phosphorylated by Src kinases and become docking sites for Syk kinase, which has a critical role in phagocytosis because Syk<sup>-/-</sup> macrophages cannot internalize IgG-opsonized particles (45).



**Figure 14.4.** From stimulus to response: signaling pathways in phagocytosis. A particle opsonized by immunoglobulin G binds to Fc $\gamma$  receptor (stimulus). Two types of responses are triggered by the stimulus: response 1 (1), formation of the phagosome through actin polymerization and extension of pseudopodia, which ingest the particle; and response 2 (2), the respiratory burst through activation of nicotinamide adenine dinucleotide phosphate (NADPH) oxidase. Response 1 involves SYK and other kinases (phosphatidylinositol 3-kinase, and so forth), generating a second wave of downstream signaling molecules (e.g., phosphoinositides, activation of guanosine triphosphatases, and so forth), which focus on the Wiskott-Aldrich syndrome protein (WASP), a master activator that links the process to actin polymerization through Arp2/3 (see text for details). Response 2 consists of the assembly of the NADPH oxidase in the membrane of the forming phagosome from several individual proteins present in the membrane or translocated from the cytosol (see text for details). Response 1 will enclose the invader within the phagosome, to be killed by response 2 and eventually withdrawn in the interior of the cell to be disintegrated in the endosomes and lysosomes. Arp2/3, actin-related proteins 2 and 3; ITAM, immunoreceptor tyrosine-based activation motif; PIP2, phosphatidylinositol 4,5-bisphosphate.

Several molecules have been implicated in downstream signaling, such as protein kinase C (PKC), phospholipase A<sub>2</sub>, phospholipase C, phosphatidylinositol 3-kinase (PI3K), GTPases of the Rho family, and so forth.

Ca<sup>2+</sup> concentration increases around the phagocytic cup, but its role remains controversial. The increase seems to be due to Ca<sup>2+</sup> release from the phagosome into the cytosol (46). Ca<sup>2+</sup> is important for triggering actin depolymerization through gelsolin activation. Ca<sup>2+</sup> mobilization is independent of inositol 1,4,5-triphosphate in neutrophils, indicating that the increase of Ca<sup>2+</sup> around the forming phagosome does not come from intracellular stores.

Phospholipase C (47) and PI3K (48) have also been shown to have a role in phagocytosis in different cells. The main role of PI3K in neutrophils and macrophages appears to be regulation of membrane extension during pseudopod formation, mediated by myosin X (49). PI3K acts both directly at the level of pseudopod extension and for extracellular signal-regulated kinase activation, which stimulates phospholipase A<sub>2</sub> for arachidonic acid release. Arachidonic acid acts as a second messenger to regulate

phagocytosis.

Rac and Cdc42 regulate actin assembly and internalization of Fc $\gamma$ R-coated particles ( [50](#), [51](#) ). The Wiskott–Aldrich syndrome protein (WASP) directly binds Cdc42 and Rac and is recruited to the phagocytic cup ( [52](#), [53](#) ) (see below).

The signaling for inhibition of phagocytosis is regulated through inhibitory receptors, which express immunoreceptor tyrosine-based inhibitory motifs. Ligation of inhibitory receptors results in phosphorylation of the ITIMs by Src kinases, which become docking sites for protein tyrosine phosphatases SHP-1 and SHP-2. The phosphatases dephosphorylate activating receptors, blocking downstream signaling, and the activation is arrested ( [54](#) ). The inhibitory receptor, Fc $\gamma$ RIIB, recruits the inositol phosphatases SHIP-1 and SHIP-2, which act on PI(3,4,5)P<sub>3</sub> (PIP<sub>3</sub>) and break it down to PI(3,4)P<sub>2</sub> (PIP<sub>2</sub>), thus arresting the downstream signaling of PI3K. Recruitment of SHIP-phosphatases is determined by the amino acid in the Y+2 position within the immunoreceptor tyrosine-based inhibitory motifs ( [55](#) ) and by inadequate phosphorylation level ( [56](#) ). Overexpression of SHIP in macrophages results in inhibition of Fc $\gamma$ RIIB-mediated phagocytosis ( [57](#) ), and co-ligation of Fc $\gamma$ RIIA and Fc $\gamma$ RIIB reduces phagocytosis in monocytes ( [58](#) ).

### Enclosure of the Phagocytic Vacuole

It is believed that the receptor interaction is solely sufficient to trigger phagocytosis. However, mechanical parameters of the target particle can affect the outcome. When presented with particles of identical chemical properties but of different rigidity, macrophages show a preference to engulf rigid objects ( [59](#) ). Constitutively active Rac1 stimulates phagocytosis of soft particles.

Internalization of the engulfed particle requires actin reorganization and membrane fusion. However, macrophages are able to ingest a number of particles with a total surface larger than the cell itself without net loss of surface, and even with surface gains ( [60](#) ). Phagocytes must, therefore, supply new membrane from sources within the cell to be able to meet the needs for the enclosure of the phagosome ( [61](#) ). Membranous pieces are supplied from an endosomal compartment recruited by phospholipase A<sub>2</sub> ( [62](#) ). Focal exocytosis at sites of phagocytosis is necessary along with actin rearrangements to induce proper pseudopodial extension. Focal addition of endomembranes is now considered a partner to cytoskeletal actin rearrangements for several cellular processes [i.e., phagocytosis (extension of lamellipodia), cell spreading, and chemotaxis] ( [63](#) ). Actin reorganization and membrane insertions by exocytosis are regulated by different mechanisms. Inhibition of PI3K plays no role in actin polymerization, yet it blocks completion of the phagosome, indicative of mechanisms other than rearrangements of actin cytoskeleton ( [48](#), [64](#) ). The detection of endosomal markers on the plasma membrane during phagocytosis is accepted as evidence of membrane insertions during phagosome formation ( [65](#) ).

Most intracellular fusion events are determined by a specific protein machinery, which includes soluble factors, such as the N-ethylmaleimide-sensitive factor (NSF) and the soluble NSF-attachment protein, SNAP, as well as membrane complexes such as SNAP-attachment protein receptor, SNARE. NSF is an adenosine triphosphatase (ATPase) important for SNARE function. The membranes to be fused need to bear specific SNAREs, known as *vesicle* or *v-SNAREs* and *target* or *t-SNAREs*. Particular v- and t-SNAREs dictate the specificity of intracellular molecular fusion events ( [66](#) ). Inactivation of two SNARE proteins, VAMP2 and VAMP3, reduces efficiency of



phagocytosis. Exocytosis of endosomal membranes is a focal event and occurs at the sites of phagocytosis.

Another group of GTPases, the Rabs, contribute to vesicle exocytosis and interact with SNARE proteins ( [67](#) ).

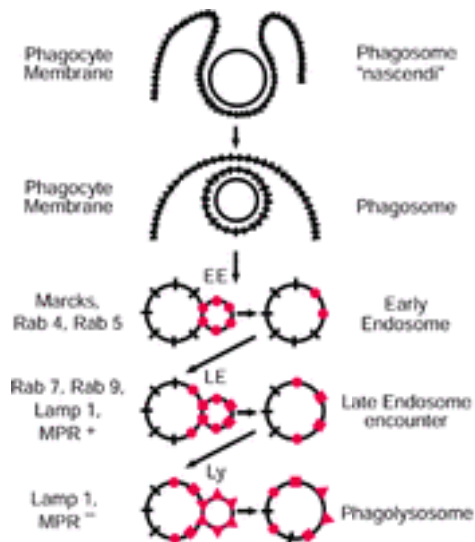
Two other proteins, dynamin2 and amphiphysin II<sub>m</sub>, which are associated with endocytic vesicles, also participate in phagocytosis ( [68](#), [69](#) ). Dynamin2 is a GTPase and, through its SH<sub>3</sub> (Src homology 3) domain, interacts with amphiphysin II<sub>m</sub> recruited to clathrin-coated pits. It also contributes to pseudopod extension.

Once the phagosome is formed, it is pulled to the interior of the cell by actin filaments and myosins. There are several myosin isoforms ( [70](#) ), which are localized around phagosomes in macrophages, and their ATPase activity moves the phagosome along actin filaments. As the phagosome is internalized, it matures. Maturation implies changes of the composition of its membrane. During maturation, the phagosomes progressively acquire a variety of proteins that are characteristic of endosomes and lysosomes ( [71](#), [72](#) and [73](#) ), whereas other proteins acquired during invagination are recycled back to the plasma membrane.

Early in the maturation process, an ATPase acidifies the phagosomal vacuole. The exact mechanism of the maturation process is not clear. According to one view, the “kiss and run” model ( [74](#) ), phagosomes and endosomes do not coalesce, but membrane components and luminal contents are exchanged by momentary fusion followed by fission. Multiple fusion and fission events change the composition of their membrane and content. Others believe that early and late endosomes and lysosomes simply exchange components by means of carrier vesicles ( [3](#) ).

Phagosomes move toward the cell interior with the help of microtubules, and, during this journey, they have multiple contacts with endocytic organelles with which they fuse ( [Fig. 14.5](#) ). Eventually, their membrane is remodeled and comes to resemble a lysosomal membrane. This change is characterized by loss of small GTPases and acquisition of lamp proteins. The Rab family of proteins consists of ras-like GTP-binding proteins that serve as key regulators in endocytic trafficking. Rab proteins may, therefore, be used as markers for the endosomal vesicles. Rab5 is present on early endosome, whereas Rab7 is a late endosome-specific marker. The Rab5 member of the family, which is detected in the phagosome and normally regulates fusion of early endosomes, suggests that the phagosome fuses at an early stage with endocytic vesicles. The evidence is certainly more convincing that the phagosome fuses later with late endosomes and eventually transforms to terminal lysosomes.





**Figure 14.5.** The journey of the phagosome along the endocytic pathway to the cell interior. The membrane of the phagosome in the process of being born (phagosome nascendi) has the same composition as the cell membrane and contains the phagocytosed particle. The intracellular movement of the phagosome and other endocytic vesicles involves the microtubules. During this journey, the membrane composition of the phagosome changes as it bounces and partially fuses with other endocytic vesicles such as the early (EE) and late (LE) endosomes. Eventually, the altered phagosome fuses with lysosomal vesicles, which are in a dynamic, continuous exchange cycle with the LEs. The fusion between endocytic vesicles is regulated by the Rab family of guanosine triphosphate-binding proteins. Some of them are highly restricted to a certain stage in the endosomal pathway, such as Rab 4 and Rab 5 in the EEs and Rab 7 and Rab 9 in the LEs. The Rab proteins are not present on the lysosome. At the stage of LE and later, other proteins, such as the lysosomal associated membrane proteins (Lamp), are characteristic markers of these vesicles. Marcks, myristoylated alanine-rich C-kinase substrate; MPR, mannose-6-phosphate receptor.

The relationship of late endosome to lysosome is dynamic. Molecules (i.e., receptors) that will be recycled are sorted out in the early endosome and are directed back to the membrane through the recycling vesicles, whereas other endocytosed material is delivered by carrier vesicles to late endosomes. The late endosomes are of lighter density than lysosomes, and although lysosomes eventually contain all internalized substances, they probably fuse with late endosomes on more than one occasion, indicating that an equilibrium likely exists between late endosomes and lysosomes.

Rab9 functions in the transport of mannose-6-phosphate receptors (MPRs) between late endosome and the trans-Golgi network. There are two distinct MPRs, one 275 kd and a second 46 kd. The former binds mannose independently of divalent cations and has been called *cation-independent MPR*. It also binds insulinlike growth factor II. The latter requires divalent cations for optimal ligand binding and is referred to as *cation-dependent MPR*. MPRs cycle between Golgi, endosomes, and plasma membranes. Cation-independent MPR is present in one or more endosomes but is undetectable in lysosomes. The cation-dependent MPR is also found in endosomes that contain the cation-independent MPR. This suggests that the lysosomal enzymes that are transported by the MPRs are delivered to the acidic endosomal compartment rather than to lysosomes, and the MPRs are then recycled back to the Golgi, plasma membrane, or both.

## ACTIN AND PARTNERS: AN INCREDIBLE MACHINE

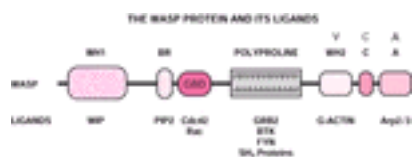
Extension of pseudopods and locomotion of cells is achieved by the assembly of actin filaments and their branching to form networks.

Actin is an ATP-binding protein that exists as a globular monomer (G-actin) and as polymerized filaments (F-actin). In electron micrographs, actin filaments have a characteristic arrowhead appearance with a pointed end and a barbed end. The barbed end has a higher affinity for actin monomers than the pointed end.

Each actin monomer has a bound ATP, which, after polymerization, is hydrolyzed to adenosine diphosphate (ADP), releasing inorganic phosphate. Monomers released from polymerized actin carry ADP, and, to polymerize again, ADP must be exchanged with ATP because ATP-actin has a higher affinity for the barbed ends of F-actin.

The assembly of actin filaments is a highly complex process and, at the beginning, must involve reactions between actin monomers *de novo*, but later, when a filament is formed, monomers are added to the filaments for extension or branching. This process is called *nucleation*, which refers to “initiation of new actin filaments by assembly from monomers” (75). *Elongation*, on the other hand, is the addition of new monomers to barbed ends of the filament (Fig. 14.4, part 1). Recently, the protein complex Arp2/3 has been shown to be the universal actin nucleation and organizer machine, conserved across the species (76, 77). Arp2/3 consists of seven subunits, two actin-related proteins (Arp), Arp 2 and Arp 3, and five other proteins (ARPC1 through 5). The crystal structure of Arp2/3 has recently been solved (78). The Arp2/3 complex is a flat ellipsoid with dimensions 150 Å long, 140 Å wide, and 70 to 100 Å thick. The overall shape is in the form of a C-shaped clamp formed by the ARPC2 and ARPC4 subunits, while the Arp2 and Arp3 sit in the center. The other ARPC subunits reinforce and decorate the edges of the clamp. Activation of Arp2/3 complex by the WASP family of proteins brings Arp2 into proximity with Arp3 for nucleation (see below).

Purified Arp2/3 has little activity (79) and requires activation by nucleation-promoting factors. Nucleation-promoting factors are members of the WASP family of proteins. WASP has a modular structure consisting of several structurally and functionally distinct domains (Fig. 14.6). At the C-terminal of the protein is the VCA region, consisting of three domains: W or V (verprolin homology), C (cofilin homology or central or “connecting”), and A (acidic). W is also known as WH<sub>2</sub> (WASP homology 2 domain), and VCA is referred to as WA. WH<sub>2</sub> binds monomeric actin, competing with profilin and thymosin-β<sub>4</sub>.



**Figure 14.6.** The structure of the Wiskott–Aldrich syndrome protein (WASP) and its ligands. WASP consists of several domains that mediate different functions (see text for details). Arp2/3, actin-related proteins 2 and 3; BR, basic region; GBD, guanosine triphosphatase-binding domain; PIP<sub>2</sub>, phosphatidylinositol 4,5-bisphosphate; SH<sub>3</sub>, Src homology 3; VCA, verprolin homology, cofilin homology, acidic domains; WH<sub>1</sub>, WASP homology domain 1; WH<sub>2</sub>, WASP homology domain 2; WIP, WASP-interacting protein.

The A and C domains bind to the Arp2/3 complex, whereas the N-terminal to WA (VCA) polyproline region (P), rich in ProXXPro motifs (X = any amino acid), binds SH<sub>3</sub> domain-containing proteins (i.e., Grb2, Fyn, BTK).

The P region also binds the actin-binding protein, profilin, and the Cdc-42-interacting protein-4, which may connect WASP with the microtubules.

Farther to the center of WASP is the GTPase-binding domain (GBD), target for the small GTPases, Cdc42 and Rac. It is followed by a short lysine-rich basic region, which may be the actual binding site of PIP<sub>2</sub> ([80](#), [81](#)). The N-terminal domain, WH<sub>1</sub>, binds WIP (WASP-interacting protein), a member of the proline-rich actin-binding family of proteins. WIP has been implicated in regulation of actin cytoskeleton. It contains a WH<sub>2</sub> actin monomer-binding domain, a profilin-binding domain, and a WASP-binding domain in its carboxy terminus. It regulates N-WASP-mediated polymerization and filopodium formation and stabilizes actin filaments. N-WASP has two WH<sub>2</sub> domains, and Scar (suppressor of G-protein-coupled cyclic AMP receptor), also known as WAVE (WASP family verpoin-homologous proteins), lacks GBD and WH<sub>1</sub> domains. In conclusion, the C and A domains contribute to the binding of the Arp2/3 complex but not the WH<sub>2</sub> domain. The binding sites for actin and for the Arp2/3 complex are close together or even overlap.

### Activation of Arp2/3 by Wiskott-Aldrich Syndrome Protein

The crucial role of WASPs depends on their C-terminal WA (VCA) region, which binds and activates the Arp2/3 complex. WA binds simultaneously to G-actin and to Arp2/3 complex, with the actin filament enhancing the affinity of WASP for the Arp2/3 complex. The WASP dissociates rapidly from the complex after nucleation ([82](#)).

WASP mediates the “presentation” of G-actin to Arp2/3 followed by its activation. As shown by constructs containing individual domains of the VCA region, the A domain confers high-affinity binding to Arp2/3 but not activation, whereas the V domain is indispensable for activation and, at the same time, enhances G-actin binding ([83](#)). Thus, the V, C, and A domains act cooperatively in Arp2/3-mediated function for actin polymerization ([84](#), [85](#)).

The ARPC2 and ARPC1 subunits anchor the complex to the side of the “mother” filament at a 70-degree angle. WASPs stabilize the conformation by linking ARPC1 and ARPC3 subunits.

Activity of WASPs is markedly enhanced by GTP-Cdc42, PIP<sub>2</sub>, and GRB2. Each of these factors individually has a weak effect, and it is likely that their action is additive or even synergistic ([86](#), [87](#)). For example, GTP-Cdc42 is unable to activate WASP by itself, but it augments PIP<sub>2</sub> stimulation. Electron micrographs show that the Arp2/3 complex contacts three successive subunits of the “mother” filament, and the Arp2/3 form the first two subunits of the branching or “daughter” filament ([88](#)).

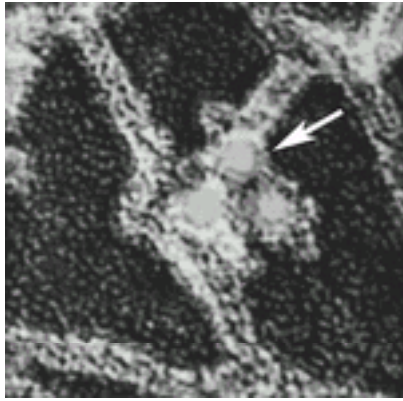
### Actin Polymerization in Phagocytosis

Nucleation could take place either on the side of a filament (“branching nucleation”) ([88](#), [89](#) and [90](#)) or at its barbed ends ([91](#)). Strong evidence by a variety of techniques ([92](#), [93](#) and [94](#)) shows that a complex network of F-actin grows like a tree, with branches always

extending from the sides of a filament ( [Fig. 14.7](#)). As shown in [Figure 14.8](#), gold-labeled Arp2/3 binds to the side of a preexisting branch or mother filament ( [88](#)). Elongation of the daughter filaments then takes place by the addition of new actin monomers with their pointed ends fitting to the barbed ends of the previous units ( [Fig. 14.7](#)). Thus, the branches of the advancing actin network push forward by their free barbed ends. This model of actin polymerization is also supported by the fact that Arp2/3 initiates nucleation even from mother filaments that have their barbed ends capped ( [95](#)). Finally, the protein cortactin, which binds only to the sides of the F-actin filaments, mediates nucleation by Arp2/3 complex ( [96](#)). Cortactin has an *N*-terminal acidic domain and five to six repeats in the central part of the molecule, which have the F-actin binding site ( [97](#)). Cortactin acts as a mediator between WASP and the Arp2/3 complex. They both bind simultaneously to the complex and synergistically contribute to Arp2/3 activation, despite the fact that they compete for a common binding site on Arp2/3 ( [98](#)). Cortactin binds to the Arp3 subunit of the complex and mediates the binding of the complex to F-actin, whereas WASP activates the complex. Cortactin thus promotes and stabilizes the formation of new daughter actin filaments ( [99](#)).



**Figure 14.7.** Organization of actin polymerization. Actin-branching polymerization by actin-related proteins 2 and 3 (Arp2/3). Arp2/3 binds to the sides of preexisting (“mother”) filaments and adds new G-actin monomers by side branching. The “push” of the actin filaments comes from the barbed ends of the new elongated “daughter” filaments.



**Figure 14.8.** Localization of the actin-related proteins 2 and 3 (Arp2/3) complex at branching points of actin filaments. Electron micrographs of actin filaments. The Arp2/3 complex is localized at the branching points (arrow). The complex was identified by a specific antibody, the binding of which was detected by a secondary gold-conjugated antiimmunoglobulin antibody. (From Svitkina TM, Borisy GG. Arp2/3 complex and actin depolymerizing factor/cofilin in dendritic organization and treadmilling of actin filament array in lamellipodia. *J Cell Biol* 1999;145:1009–1026, with permission.)

WASP is subject to autoinhibition and exists in an inactive form. The “inactive conformation” results from an intramolecular interaction between the hydrophobic core of GBD and the C-terminal WA effector domain, which brings the occlusion of the WASP WA domain. Binding of GTP-Cdc42 to GBD disrupts the hydrophobic core, an action enhanced by PIP<sub>2</sub>. Change in the conformation “opens” the C-terminal VCA domain for binding of the Arp2/3 complex ( [86](#), [100](#) ).

The leading edge of a moving phagocyte is known as the *lamellipodium*. It extends forward and seems to pull the rest of the cell body along with it. Pseudopodia project from the lamellipodium and attach closely to the particle to be ingested. The lamellipodium and pseudopodia contain no cytoplasmic organelles and, as a result, have a glassy appearance ( [Fig. 14.9](#) ). Both, however, are rich in actin filaments. Actin constitutes 10% of the total protein in macrophages and is present in two forms, G-actin (globular or monomeric) and F-actin (filamentous or polymeric).



**Figure 14.9.** Phagocytosis of yeast particles by polymorphonuclear leukocytes. A human

neutrophil extends long pseudopodia that encircle two yeast particles. HE, hyaline ectoplasm. [From Stossel TP. Phagocytosis (second of three parts). *N Engl J Med* 1974;290:744, with permission.]

Actin polymerization during phagocytosis has been well documented ( [101](#), [102](#) ), as has the role of the WASP family of proteins in the mechanism of polymerization through activation of the Arp2/3 complex ( [103](#), [104](#) and [105](#) ). Monocytes and macrophages from patients with Wiskott–Aldrich syndrome (WAS) have reduced capacity for phagocytosis ( [106](#) ). WAS is a rare X-linked, recessive immunodeficiency disease. Patients suffer from recurrent pyogenic and opportunistic infections, eczema, and thrombocytopenia with small platelets. WAS is due to a wide spectrum of gene mutations that result in the expression of no WASP or a truncated protein lacking the crucial C-terminal VCA or WA region. In an X-linked thrombocytopenia form or attenuated WAS, the WASP gene has missense mutations in the N-terminal region ( [107](#) ). Finally, an X-linked neutropenia form or myelodysplasia has been detected as a result of mutations of part of the gene encoding the GBD domain. Mice with targeted disruption of the GBD domain share some of the features (i.e., lack of T-cell activation) but not others ( [108](#) ).

Fragments of Arp2/3 containing the WA domain almost completely inhibit phagocytosis, a finding emphasizing the importance of Arp2/3 in the process ( [109](#) ). The Arp2/3 complex, WASP, and N-WASP localize to the surface of phagosomes during Fc $\gamma$ R- and CR3-mediated phagocytosis ( [106](#), [109](#) ).

An intriguing function of actin polymerization is related to the movement of various endosomal vesicles. Actin polymerization propels them to their destinations by a “rocketing” mechanism ( [110](#) ). The Arp2/3 complex and N-WASP are localized to the surface of moving endosomes and lysosomes and to the surface of motile macropinosomes ( [111](#), [112](#) ). A similar function of actin polymerization has been demonstrated with the motility of intracellular pathogens ( [113](#) ). Such pathogens are associated with actin “comet tails,” which contain many of the components of lamellipodia. Structurally, however, the filaments in lamellipodia are branched as a result of dendritic nucleation, whereas the “comet tails” are short, randomly oriented filaments with some dendritic nucleation ( [114](#) ). Thus, it is evident that actin polymerization and dendritic nucleation with an expanding F-actin network provide all the mechanical force necessary for “pushing” lamellipodia around the particle and completing the enclosure of the phagosome ( [115](#) ).

## Actin-Binding Proteins

**PROFILIN AND COFILIN** Profilin and thymosin- $\beta_4$  bind monomeric actin and modify its properties for polymerization. Thymosin- $\beta_4$  is a peptide of 43 residues that competes with profilin (125 to 139 residues) for binding to actin ( [116](#) ). Thymosin- $\beta_4$  binds more strongly to ATP-actin and is a sequestering protein. Profilin has a higher affinity for ATP-actin monomers than for the barbed ends of actin in filaments because its binding site is buried in the filament structure. As a result, profilin maintains a pool of free ATP-actin ready for filament elongation. In cells with both proteins, profilin serves as a carrier between the thymosin- $\beta_4$ -actin pool and the barbed ends of actin filaments ( [117](#) ). At least two F-actin pools exist in vertebrate cells, one relatively stable, which is often associated with tropomyosin (an actin filament-binding protein with an  $\alpha$ -helical coiled-coil structure), and one more dynamic, usually found in the leading edge of motile cells. Recently, it has been shown that the proteins that regulate the high turnover of



F-actin filaments belong to the family of ADF-cofilin (ADF, actin depolymerizing factor; cofilin, forming *cofilamentous* structure with actin) (118, 119). There are approximately 30 members in the family with conserved actin-binding regions. A second homologous region outside the actin-binding site suggests that they bind to another protein (120). ADF and cofilin are usually cytoplasmic proteins, but, under stress, they accumulate in the nucleus accompanied by actin, which forms actin rods (118). Nuclear localization, which is mediated by a specific sequence, has been detected in many types of cells as inclusion bodies that frequently have a fibrillar or lattice appearance. Actin and cofilin have been detected in these inclusions. The three-dimensional structure of yeast cofilin shows that it consists of a  $\beta$  sheet with four strands surrounded by four  $\alpha$ -helices. This structure has been called the *ADF-homology domain*. The ADF-homology domain shares similarities with the gelsolin family. Gelsolin has six repeats of this domain (121). Cofilin interacts with actin through its N-terminal region (122), an interaction inhibited by PIP<sub>2</sub>. The structure of the cofilin-actin filament complex shows that cofilin makes contacts on the outside of the filament with both the pointed and barbed ends (123). In general, ADF/cofilin binds to the actin-ADP subunits of the F-actin filament, increasing the off-rate from the pointed end and thus depolymerizing F-actin and severing actin filaments (118); in doing so, it increases the number of barbed ends. When actin monomers dissociate from the pointed ends of the filament, they have ADP nucleotide, and, to be reused, ADP must be exchanged with ATP. However, ADF/cofilin prevents the exchange, limiting the reuse of actin monomers released from filaments (124). Profilin, on the other hand, strongly increases the nucleotide exchange, even in the presence of ADF/cofilin (125), and it appears that profilin and ADF/cofilin regulate recycling of actin-ADP and F-actin filament turnover based on their opposite effects on nucleotide exchange. Filament turnover is rapid during extension of pseudopods and cell movement. Lamellipodia move up to 1  $\mu$ m per second (370 subunits per second). The mechanisms that regulate the high rate of depolymerization, and of severing when it is required, are not well understood. Polymerization or filament extension requires free barbed ends, which can be generated by various mechanisms such as uncapping and severing.

**GELSOLIN** Gelsolin is the most abundant protein that caps filament ends, and it regulates cytoskeleton remodeling in response to Ca<sup>2+</sup> and PIP<sub>2</sub> binding (126). Severing is the breaking of noncovalent bonds between two actin molecules within a filament. After severing, gelsolin remains attached to the barbed ends of the filament as a cap (capping). Gelsolin is the most effective severing protein identified to date (127). Through actin cytoskeleton reorganization, it plays a role in cell motility, phagocytosis, chemotaxis, and wound healing (128). Animals of mixed-strain background that are deficient in gelsolin have no gross pathology, but inbred strains are not viable at perinatal stages (129). Gelsolin consists of six structurally similar domains (G<sub>1</sub> through G<sub>6</sub>), evolved by gene duplications from one prototypical domain (125). Significant structural similarities exist between the domains in each triplex (G<sub>1</sub> through G<sub>3</sub> and G<sub>4</sub> through G<sub>6</sub>). The actin-binding site is masked and is revealed in response to Ca<sup>2+</sup> increase, which releases contacts between domains and exposes actin-binding sites in G<sub>2</sub>, G<sub>1</sub>, and G<sub>4</sub> domains. There are up to eight Ca<sup>2+</sup>-binding sites of two types. Type 1 sites are shared between gelsolin and actin and govern the strength of interactions between them. Type 2 sites have the potential for causing movement between the domains. The structure of the gelsolin-F-actin complex has been solved and provides insights into the mechanism of severing (130, 131). Ca<sup>2+</sup> activation triggers binding of G<sub>2</sub> to F-actin, and this brings the G<sub>1</sub> into a position to disrupt actin-actin interaction. The second disruption needed to sever the monomer is contributed by G<sub>6</sub>, which brings G<sub>4</sub> domain for a pincer action with G<sub>1</sub> to remove the actin monomer. There are at least two G-actin-binding sites in domains 1, 2, and 4 and one PIP<sub>2</sub>-binding site in domain 2. Lowering Ca<sup>2+</sup> concentration



may not induce gelsolin uncapping after severing. PIP<sub>2</sub> is the only known agent that inhibits gelsolin severing and dissociates gelsolin from actin *in vitro* (132). In platelets, removal of gelsolin contributes to actin polymerization (133) and to filament growth. Severing is the major mechanism for generating free barbed ends in platelets (134), and the thrombin receptor-activating peptide stimulates Arp2/3 activation for all actin-dependent morphologic changes (135).

## REGULATORY MECHANISMS: DOWNSTREAM PATHWAYS

### Calcium

One of the first signals observed in response to FcγR activation of phagocytosis is the increase of cytosolic Ca<sup>2+</sup> (136). The role of Ca<sup>2+</sup> in FcR-mediated phagocytosis remains controversial, but, for CR3-mediated phagocytosis in neutrophils, it plays no role. In macrophages, neither phagocytosis nor phagosome-lysosome fusion is Ca<sup>2+</sup>-dependent (137). Ca<sup>2+</sup>, however, is important in some aspects of actin network reorganization and in the function of gelsolin.

### Protein Kinase C Family

These serine/threonine kinases are activated by the phospholipase product diacylglycerol, as well as by Ca<sup>2+</sup>. Members of the family have been identified in the phagosome (PKC-α, -β, -γ, and -δ) during FcγR-mediated phagocytosis, and pleckstrin, a major substrate for PKC phosphorylation, is recruited in macrophage phagosomes (138). Other substrates for PKC are the proteins MARCKS (*myristoylated alanine-rich C-kinase substrate*), which mediate cross-linking of actin filaments. In mice deficient in MARCKS, however, the FcγR- and C3-mediated phagocytosis is normal (139), indicating that simple localization around the phagosome is not necessarily indicative of functional participation.

### Phosphoinositide Kinases

Phosphoinositides bind to pleckstrin homology domains, which are detected in well over 100 different proteins. The majority of these proteins are found in membranes and have been implicated in a variety of membrane functions (140, 141).

Phosphoinositides are major regulators of various aspects of the phagocytic process (142, 143) and are produced from the function of PI3K. PI3K, however, is not localized in the phagosome (144) as a result of displacement by its own product, PIP<sub>3</sub> (145). PI3K is activated by FcγRs and is required for phagocytosis by macrophages—not in the initial stages of phagosome formation but mainly for its closure (146), when actin reorganization is important. Different sizes of particles seem to require different handling by the phagocytic machinery. Among the PI3K classes, PI3K class I is involved for phagocytosis of particles larger than 3 μm but not for their subsequent maturation (147). In contrast, PI3K class III (which forms PIP<sub>3</sub>) is needed for phagosome maturation (147, 148). PIP<sub>2</sub> is an important regulator of WASPs and of gelsolin (see above).

### Guanosine Triphosphatases

Small GTP-binding proteins are key regulators of actin cytoskeleton (149, 150). Assembly

of actin beneath an opsonized particle requires the small GTPases, Cdc42, and Rac1, which control the cytoskeletal rearrangements during particle uptake ( [102](#), [151](#), [152](#) ). Cdc42 and Rac1 control different steps in the phagocytic process (i.e., pseudopod formation for Cdc42 and phagosome closure for Rac1) ( [152](#) ). In contrast, actin polymerization mediated by CR3 depends on the activity of Rho A, whereas Cdc42 and Rac1 are not involved ( [153](#) ). GTPases act on WASP family members, which activate the Arp2/3 complex ( [154](#) ). GTP-Cdc42 and PIP<sub>2</sub> act on the inactive form of WASP as a result of autoinhibition and restore its active conformation ( [155](#), [156](#) and [157](#) ). The transient PIP<sub>2</sub> accumulation at the phagocytic cups is part of the activation signal for WASP, together with Cdc42 recruitment. Rac1 stimulates gelsolin dissociation, thus preventing depolymerization of filaments and promoting the closure of the phagosome ( [158](#) ).

### Ezrin, Radixin, and Moesin Family

The gap between cytoskeleton and membrane may be filled, in some systems, by a family of three proteins, ezrin, radixin, and moesin, known as the *ERM family* ( [159](#) ). These proteins act as linkers between plasma membrane and actin ( [160](#) ). Their *N*-terminal binds to some membrane proteins, such as CD44, and their *C*-terminal binds to actin. This intermolecular cross-linking requires activation, which is probably mediated by the Rho protein. Normally, the ERM proteins have a head-to-tail association that is released after activation ( [161](#), [162](#) ).

The cytoskeleton is linked to the extracellular matrix through integrins ( [163](#) ) and interacts with talin, which is a cytosolic protein recruited under the particle attachment at F-actin sites during FcR-mediated phagocytosis ( [164](#) ).

## DIGESTION

### Microbicidal Mechanisms

Microbicidal mechanisms used by the phagocytes can be divided into (a) oxygen-independent and (b) oxygen-dependent mechanisms. Oxygen-dependent mechanisms may be subdivided into (a) myeloperoxidase (MPO)-mediated (halide radicals-generated) and (b) MPO-independent.

**OXYGEN-INDEPENDENT MECHANISMS** Detailed description of neutrophil and macrophage granule content and their role in digestion of phagocytosed material is provided in Chapters 10 and 13, respectively. The neutrophil primary or azurophilic granules contain several bacteriocidal proteins (i.e., lysozyme, lactoferrin, cathepsin G, and elastase) and small peptides known as *defensins* ( [165](#) ). Defensins are peptides of 29 to 35 amino acids, including six invariant cysteines forming intramolecular disulfide bonds, which stabilize the cyclic structure of the peptide with a triple-stranded  $\beta$ -sheet configuration. They kill microorganisms and mammalian cells, even those resistant to tumor necrosis factor- $\alpha$ , by inserting themselves into the cell membrane, which they permeabilize. The mechanism of insertion involves interaction with negatively charged molecules, probably membrane lipids. The secondary (or specific) granules contain lysozyme, collagenase, and so forth. Lysozyme is a cationic enzyme that hydrolyzes glycosidic bonds and has bacteriocidal properties for some bacteria.

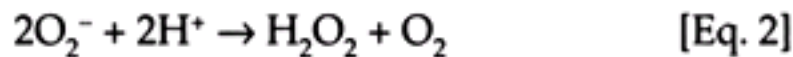
**OXYGEN-DEPENDENT MICROBICIDAL ACTIVITY** During particle ingestion, phagocytes show a two- to threefold increase in O<sub>2</sub> consumption, which is insensitive to cyanide, a two- to tenfold increase of glucose oxidation via the hexose monophosphate shunt, and the generation of hydrogen peroxide. This combination of metabolic activities came to be

known as *respiratory burst* ( [166](#), [167](#) ) ( [Fig. 14.4](#), part 2). Respiratory burst was actually discovered in 1933 ( [168](#), [169](#) ).

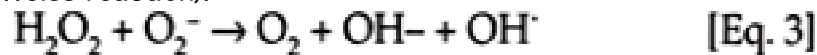
***Myeloperoxidase-Independent Systems*** The burst of respiratory activity results from the activation of an enzyme known as *nicotinamide adenine dinucleotide phosphate (NADPH) oxidase*, a key enzyme present only in professional phagocytes and in much smaller quantities in B cells. When oxygen accepts one electron, it is reduced to superoxide anion,  $O_2^-$ , according to the reaction shown in Equation 1.



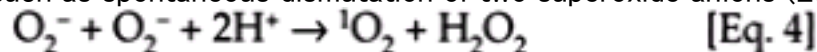
where  $NADP^+$  is the oxidized form of nicotinamide adenine dinucleotide phosphate.  $H_2O_2$  is produced by oxidation-reduction of two superoxide radicals ( $O_2^-$ ), a reaction known as dismutation, catalyzed by the enzyme superoxide dismutase according to the reaction shown in Equation 2.



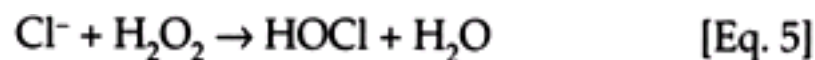
Alternatively,  $H_2O_2$  can be produced by reduction of  $O_2$  by the transfer of two electrons catalyzed by the NADPH oxidase. It is possible, however, in conditions in which  $H_2O_2$  is detected in the absence of detectable  $O_2^-$ , that the superoxide may not be diffusing out of the space of the enzyme ( [169](#), [170](#) and [171](#) ). Superoxide and  $H_2O_2$  are not used by the phagocyte for bacterial killing because  $H_2O_2$  is weakly microbicidal and superoxide is innocuous. They are, however, used as intermediates to produce oxidizing radicals or in reaction with halides to generate hypochlorous acid (HOCl) or hypochlorite mediated by MPO ( [171](#) ). Other  $O_2$  radicals are generated by interaction of  $O_2^-$  and  $H_2O_2$  such as the hydroxyl radical ( $OH^{\cdot}$ ). This reaction is slow and may not take place directly but through the catalytic action of trace metals such as iron (Equation 3, known as the *Haber-Weiss reaction*).



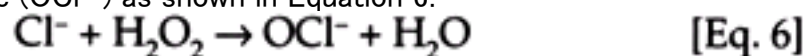
Singlet oxygen ( $^1O_2$ ) is another  $O_2$  intermediate that is generated as a result of the shifting of one of the two unpaired electrons to another orbit of energy and a change in its direction of spin.  $^1O_2$  dissipates its excess energy quickly by thermal decay or light emission [like chemiluminescence (CL)], and it can be produced by a number of mechanisms such as spontaneous dismutation of two superoxide anions (Equation 4).



***Myeloperoxidase-Dependent Oxidants*** The MPO system produces potent antimicrobial reactive oxygen radicals effective against bacteria, fungi, viruses, and mycoplasma. MPOs are enzymes that catalyze the oxidation of a number of substances termed *hydrogen or electron donors*. The components of the system are MPO,  $H_2O_2$ , and halide. The products of the reactions are also toxic to tissues and cells of the host.  $H_2O_2$  reacts with a halide, a reaction mediated by MPO that is present in the primary or azurophilic granules of the neutrophils and in the lysosomes of the juvenile monocytes but is not present in macrophages. This reaction generates hypochlorous acid as shown in Equation 5

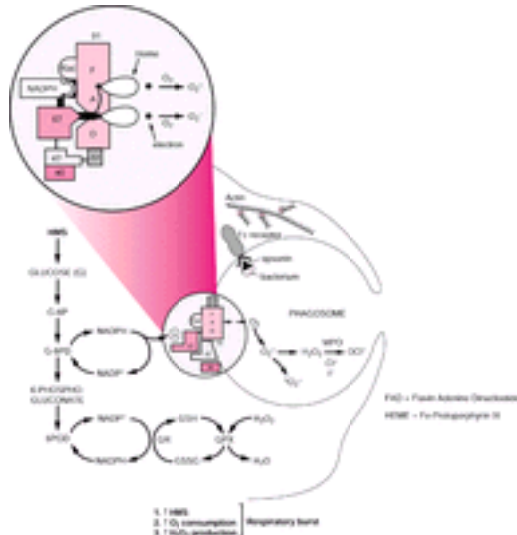


or hypochlorite ( $OCl^-$ ) as shown in Equation 6.



HOCl attacks the phagocytosed microorganisms and causes damage to their cell membranes. Of the halides, chlorine is present in leukocytes at a high concentration, but iodine is considerably more effective on a molar basis. The halide oxidants are quickly detoxified by reacting with low-molecular-weight amines to yield chloramines (i.e.,

taurine), present in high concentrations in neutrophils. The acceleration of the hexose monophosphate shunt is a result of the production of  $\text{NADP}^+$  and the regeneration of NADPH by the action of glucose-6-phosphate dehydrogenase ( Fig. 14.10). However,  $\text{NADP}^+$  increases also from the glutathione (GSH) peroxidase/GSH reductase system, which reduces  $\text{H}_2\text{O}_2$  to  $\text{H}_2\text{O}$  (as shown in Equations 7 and 8).



**Figure 14.10.** The production of oxygen radicals. The nicotinamide adenine dinucleotide phosphate reduced (NADPH) oxidase is assembled from five subunits (two localized on the membrane of a secretory vesicle and three residing within the cytoplasm). The assembly is powered by signals emanating from the triggering of the Fc receptor. Phosphorylation of p47<sup>phox</sup> in the cytoplasm may be an early event that triggers translocation of all three cytosolic subunits to join the other two on the membrane. The hexose monophosphate shunt (HMS) provides NADPH, which binds to p67<sup>phox</sup> associated with p47<sup>phox</sup> to the gp91<sup>phox</sup> of the membrane flavocytochrome b<sub>558</sub>. Within p67<sup>phox</sup> is the "activation" domain of the oxidase, which mediates the transport of electrons to flavin adenine dinucleotide (FAD) of gp91<sup>phox</sup>, then on to hemes ( 208 , 209 , 210 and 211 ), and finally to O<sub>2</sub> generating superoxide and H<sub>2</sub>O<sub>2</sub>. G6P, glucose-6-phosphate; G-6PD, glucose-6-phosphate dehydrogenase; GPX, glutathione peroxidase; GR, glutathione reductase; GSH, glutathione; GSSG, oxidized glutathione; Heme, Fe-protoporphyrin IX; MPO, myeloperoxidase; NADP<sup>+</sup>, oxidized form of nicotinamide adenine dinucleotide phosphate; 6PGD, 6-phosphogluconate dehydrogenase.



where GSSG is oxidized GSH. NADPH is regenerated through the metabolism of the glucose ( 172 ). Not only microorganisms but also the phagocyte and surrounding tissues are susceptible to damage ( 173 ). Phagocytes apply different mechanisms to detoxify the oxidant radicals, such as the superoxide dismutase (converts O<sub>2</sub><sup>-</sup> to H<sub>2</sub>O<sub>2</sub>), catalase (converts H<sub>2</sub>O<sub>2</sub> to H<sub>2</sub>O), GSH reductase (converts H<sub>2</sub>O<sub>2</sub> to H<sub>2</sub>O), amines (convert HOCl to chloramines), and so forth. The oxidants have been implicated in the pathogenesis of a number of clinical conditions such as chronic lung disease. The NADPH oxidase is the enzyme that catalyzes the generation of O<sub>2</sub>-derived oxidants during phagocytosis or on stimulation by a variety of substances such as phorbol myristate acetate, N-formylated oligopeptides of bacterial origin that are secreted or released from dead organisms, complement-derived anaphylatoxin C5a, and IL-8. The activity of the

enzyme depends on a number of components, which are brought together immediately after stimulation. The active enzyme is associated exclusively with the plasma membrane.

## Nicotinamide Adenine Dinucleotide Phosphate Reduced Oxidase

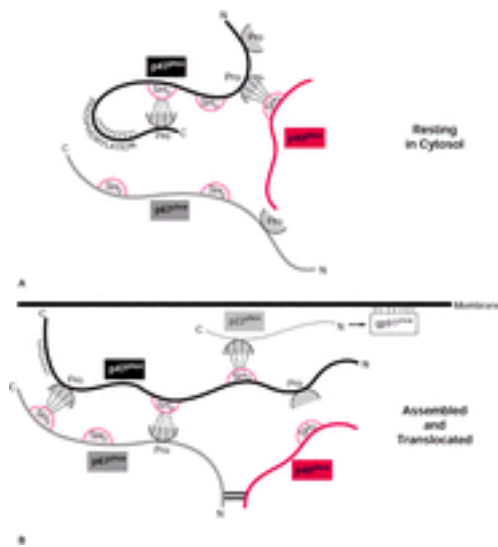
NADPH oxidase is the enzyme that generates  $O_2$  radicals from molecular  $O_2$  (174). NADPH oxidase consists of five subunits that, in the resting state, are separated between the membrane (two) and the cytosol (three). The leukocyte oxidase is the prototype of oxidases found in a variety of cells. The neutrophil NADPH oxidase is also detected in B lymphocytes.

### STRUCTURE

**Membrane Components: Cytochrome *b* 558** Two of the subunits of the oxidase, gp91<sup>phox</sup> and p22<sup>phox</sup> (phox: *phagocytic oxidase*), are located in the membranes of secretory vesicles and specific granules and form a heterodimer known as *cytochrome b* 558 (Fig. 14.10). The heterodimer contains two heme prosthetic “groups,” both residing within the gp91<sup>phox</sup> (175) subunit, one of them within its hydrophobic NH<sub>2</sub> terminal region (176, 177), coordinated by histidine residues (178). The carboxy terminal of gp91<sup>phox</sup> has flavin- and NADPH-binding sites, homologous to the ferredoxin-NADPH<sup>+</sup> reductase of the flavoenzyme family (179, 180). In almost all patients with mutations in *b* 558, the neutrophils lack both subunits regardless of which subunit is affected by the mutation (181). Expression of one subunit affects the expression of the other. In patients deficient in p22<sup>phox</sup>, the fully glycosylated gp91<sup>phox</sup> subunit is not detected, but only a partially processed precursor (65 kd) with high mannose carbohydrate side chains (182). Expression of the mature gp91<sup>phox</sup> polypeptide with fully processed oligosaccharide side chains was restored, however, by expression of a recombinant p22<sup>phox</sup>. Inhibition of heme biosynthesis results in decrease of *b* 558 expression with marked decrease of p22<sup>phox</sup> and of mature gp91<sup>phox</sup> (183), indicating that the heme prosthetic groups contribute to the assembly and stability of the heterodimer. The gene for p22<sup>phox</sup> (or a subunit) is located on chromosome 16q24. The protein has 195 amino acids with hydrophobic helices in the *N*-terminal half of the molecule that could serve as membrane-spanning regions (184). There are five potential glycosylation sites (185). The gene for gp91<sup>phox</sup> is located on chromosome X p21.1. The protein contains 570 amino acids with four or five transmembrane helices and five potential glycosylation sites in the *N*-terminal region. Mutations of this gene account for the most common forms of chronic granulomatous disease (CGD). There are three cytosolic components, p67<sup>phox</sup>, p47<sup>phox</sup>, and p40<sup>phox</sup>. The gene for p67<sup>phox</sup> is located on chromosome 1q25. The protein has 526 amino acids and two SH<sub>3</sub> domains, which are present in Src tyrosine kinases and other signaling molecules. They mediate protein-protein interactions by binding to proline-rich sequences (186), which are detected in all cytosolic components. The p47<sup>phox</sup> has two SH<sub>3</sub> domains and three proline-rich sequences. In the resting state, the *C*-terminal proline-rich sequence interacts with one of its own SH<sub>3</sub> domains and the second from the *N*-terminus proline-rich sequence interacts with the SH<sub>3</sub> domain of p40<sup>phox</sup> (Fig. 14.11A). This interaction between its own domains is considered a possible reason for the inability of resting p47<sup>phox</sup> to bind cytochrome *b* 558. On activation, the *C*-terminal proline-rich sequence interacts with an SH<sub>3</sub> domain of p67<sup>phox</sup>, which is important for their translocation to the membrane. The *C*-terminal region contains six to eight putative



phosphorylation sites.



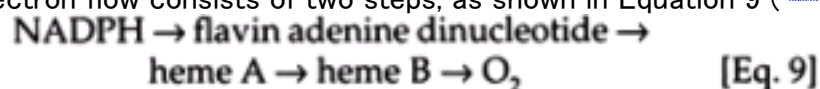
**Figure 14.11.** Interactions between the cytosolic components of nicotinamide adenine dinucleotide phosphate (NADPH) oxidase. All three components, p40<sup>phox</sup>, p47<sup>phox</sup>, and p67<sup>phox</sup>, contain Src homology 3 (SH<sub>3</sub>; found in signaling molecules), and p47<sup>phox</sup> and p67<sup>phox</sup>, in addition, have proline-rich sequences. These domains mediate protein-protein interactions involved in the association of the cytosolic components, which then are translocated to the membrane for the assembly of the NADPH oxidase.

Another domain recently discovered in NADPH oxidase subunits is called *phox homology domain* or *PX*. PX is a 125- to 140-amino acid module, which is found in proteins involved in membrane targeting and trafficking, cytoskeletal organization, and protein sorting ([187](#)). It is the hallmark domain of the members of the protein-sorting nexin family ([188](#)) but is also found in phospholipases D<sub>1</sub> and D<sub>2</sub> and the protein kinase CISK, implicated in IL-3-dependent cell survival. Localization on vesicular compartments is strictly PX-dependent. PX domain contains basic and hydrophobic residues and binds phosphoinositides. The p47<sup>phox</sup> pleckstrin homology domain binds strongly PI(3,4)P<sub>2</sub> and weakly PI(3,5)P<sub>2</sub> and PI(3,4,5)P<sub>3</sub> ([189](#)). The binding site for phosphoinositides is contributed by β-strands and a pair of α-helices linked by a loop. Basic clusters and hydrophobic residues contribute to the binding, and two of the basic residues crucial for binding are conserved. Mutation of one of them, Arg42Gln, results in an autosomal-recessive form of CGD. These findings provide a rational explanation for the impaired respiratory burst in mice deficient in the p110? (class IB PI3K), which are unable to produce phosphoinositides ([190](#)). The p40<sup>phox</sup> subunit is a protein of 339 amino acids. It contains one SH<sub>3</sub> domain and one PX domain, which binds PI(3)P and targets localization of p40<sup>phox</sup> on endosomal membranes. Localization is abolished as a result of inhibition of PI3K function on the mutation R57Q, which interferes with PI(3)P binding ([191](#)).

#### ASSEMBLY AND ACTIVATION OF NICOTINAMIDE ADENINE DINUCLEOTIDE

**PHOSPHATE OXIDASE** Multiple phosphorylations of p47<sup>phox</sup> are critical for the assembly and translocation of the cytosolic subunits because they regulate a number of steps in the process. Phosphorylations are mediated by protein kinase A on C-terminal serines. Some of the serines, such as Ser379, are more important than others ([192](#)). Mutations Ser379Ala, Ser359Ala, and Ser370Ala result in loss of oxidase activity as well as block of phosphorylation of the remaining serines. Phosphorylation of Ser303/304 increases oxygen radical production, but the mechanism is not clear ([193](#)). In general,

phosphorylation seems to increase binding of p67<sup>phox</sup> to *b*<sub>558</sub> (194). A very important consequence of p47<sup>phox</sup> phosphorylations is the opening of the phosphoinositide-binding pocket on the PX domain (195). The PX domain has been shown to mediate targeting of p47<sup>phox</sup> and p40<sup>phox</sup> to endosomal membranes (188, 196, 197 and 198). However, the “pocket” that binds the phospholipids is “closed” as a result of intramolecular interactions (195). Phosphorylations (Ser303/304/328/359) seem to change the molecular conformation and “open” the pocket. One may envision the sequence of events regulated by phosphorylations of p47<sup>phox</sup> as follows: conformational changes of p47<sup>phox</sup>, “opening” of the pocket for phosphoinositide binding, targeting of the subunits to endosomes, facilitation of p67<sup>phox</sup> binding to *b*<sub>558</sub>, and increase of O<sub>2</sub> radical production. The assembly and translocation require interactions between all three cytosolic components. One interaction involves p47<sup>phox</sup> (C-terminal proline-rich sequence) and p67<sup>phox</sup> (C-terminal SH<sub>3</sub> domain) and a second interaction involves the SH<sub>3</sub> domain of p47<sup>phox</sup> and proline sequences of p67<sup>phox</sup> (199, 200 and 201) (Fig. 14.11B). Deletion of both SH<sub>3</sub> domains of p67<sup>phox</sup> abolishes its membrane binding. The adaptor protein p40<sup>phox</sup> also participates in the assembly through direct binding to p67<sup>phox</sup>, which is linked to p47<sup>phox</sup> (202). p47<sup>phox</sup> is critical for the translocation of the cytosolic subunits, whereas the other subunits follow as a result of their interactions with p47<sup>phox</sup>. p47<sup>phox</sup> binds to p22<sup>phox</sup> through one of the two SH<sub>3</sub> domains, which are expressed in tandem in the middle of p40<sup>phox</sup>. The N-terminal SH<sub>3</sub> domain binds to a proline-rich sequence in the C-terminus of p22<sup>phox</sup> (Fig. 14.11B). This interaction is essential for oxidase activity. However, the SH<sub>3</sub> domain of p47<sup>phox</sup> is masked in the resting state by an interaction with an Arg/Lys domain in the C-terminus. Phosphorylation of serines within the Arg/Lys domain unmasks the N-terminal SH<sub>3</sub> domain of p47<sup>phox</sup> and allows binding to the C-terminal p22<sup>phox</sup> proline-rich sequence (203). Another cytosolic component that regulates NADPH oxidase activity is Rac, which exists in two isoforms, Rac1 and Rac2. Both are low-molecular-weight GTP-binding proteins. On activation of neutrophils, Rac2 becomes associated with the cell membrane. The translocation is independent of the other cytosolic subunits. There are two functional regions in Rac: the “effector” region and the “insert” region (204). The C-terminus anchors Rac to the membrane, whereas the effector region binds to p67<sup>phox</sup>, and the insert region binds to *b*<sub>558</sub> (205). Rac2 regulates oxidase activity (206) as a result of interaction directly with *b*<sub>558</sub> and participation in the electron transfer (207). The NADPH oxidase has an “activation domain,” which is localized on p67<sup>phox</sup> (208) and is essential for the generation of superoxide (209). In the assembled NADPH oxidase on the membrane, the important component is *b*<sub>558</sub>. Its p91<sup>phox</sup> subunit is the catalytic moiety that transfers the electrons from NADPH to O<sub>2</sub>, whereas the other components are regulatory. The pathway of electron flow consists of two steps, as shown in Equation 9 (208).



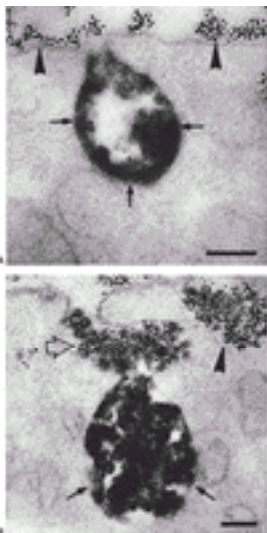
The *b*<sub>558</sub> shows no activity unless the cytosolic subunits and Rac assemble in the membrane in a 1:1:1 ratio with *b*<sub>558</sub>. The p47<sup>phox</sup> is essential for translocation and provides binding sites for the other components as well as enhancing p67<sup>phox</sup> affinity (210). A protein complex constructed by genetically engineered fusion of p47<sup>phox</sup> and p67



$\text{p}67^{\text{phox}}$  tested *in vitro* efficiently reconstituted the NADPH oxidase in terms of activity and stability (211). The fusion protein, tested in a cell-free system, had eightfold higher efficiency and produced a higher activity than the individual proteins. Rac binds to both  $b_{558}$  and  $\text{p}67^{\text{phox}}$  as an adaptor protein, but it is also required for electron transport. The activation domain of the NADPH oxidase is located within  $\text{p}67^{\text{phox}}$  (i.e., sequence 199 to 210, which mediates the electron transfer from NADPH to flavin adenine dinucleotide) (208). A single mutation of residue 204 completely eliminates NADPH oxidase activity without affecting the interactions of the components of the oxidase. The activation domain does not influence NADPH binding. In the second step, electrons are transferred to the hemes and then on to  $\text{O}_2$  for superoxide formation. Rac is required for both steps of the electron transfer.

#### LOCALIZATION OF NICOTINAMIDE ADENINE DINUCLEOTIDE PHOSPHATE OXIDASE

The original assembly and activation of the NADPH oxidase are carried out within intracellular vesicles and not on the plasma membrane. Human neutrophils contain a unique population of slender, rod-shaped vesicles that contain alkaline phosphatase (212). Neutrophil stimulation up-regulates these vesicles, which fuse to form tubular structures and eventually reach the cell membrane. Flavoprotein  $b_{558}$  is associated with these vesicles, which are known as *secretory vesicles* (213). Using cytochemical markers for alkaline phosphatase to identify these vesicles and cationized native ferritin as a marker for plasma membrane, it was clearly shown that superoxide (identified by a diamino benzidine cytochemical reaction) was first released within the secretory vesicles of the neutrophil (214) (Fig. 14.12). In human neutrophils undergoing phagocytosis, most of the oxygen radicals are detected in these vesicles, which then, by a process of exocytosis, reach the plasma membrane. The plasma membrane remains devoid of free radical production. These findings provide an explanation for the lag period of the release of oxygen radicals after stimulation. Components of NADPH oxidase and Rac were detected by immunolabeling in punctate clusters of  $0.03$  to  $0.10 \mu\text{m}^2$  on the cytoplasmic side of the membrane on neutrophils attached on glass surfaces (215). However, the process of adherence may have altered the distribution of the oxidase components, whereas in the previous study (214), the neutrophils were in suspension.



**Figure 14.12.** Localization of nicotinamide adenine dinucleotide phosphate oxidase. The NADPH oxidase is first assembled on the membrane of secretory vesicles of neutrophils, which then migrate and fuse with the cell membrane. **A:** The oxidant-positive vesicles (arrows) are separate from ferritin (small dark dots), identifying the cell surface (arrowheads). **B:** An oxidant-producing vesicle (dark arrows) opens to the cell surface (arrowheads) coated with cationic ferritin (dots, wide arrow). (Courtesy of Professor

Harumichi Seguchi, Department of Anatomy and Cell Biology, Kuchi Medical Center, Kohasu, Okoh-cho, Nankoku, Kochi Japan; Kobayashi T, Robinson JM, Seguchi H. Identification of intracellular sites of superoxide production in stimulated neutrophils. *J Cell Sci* 1998;111:81-91, with permission.)

## Defects of Oxidative Metabolism

**CHRONIC GRANULOMATOUS DISEASE** CGD is a rare inherited disorder caused by defective NADPH oxidase that affects approximately 1 in 500,000 individuals. The main manifestations of the disease consist of infections of the lungs, gastrointestinal tract, and skin. In the majority of cases, the manifestations of the disease appear during the first year of life. Infections are caused by a variety of microorganisms such as bacteria and fungi. Some of the main pathogens contain catalase, the enzyme that converts the  $H_2O_2$  to  $H_2O$ , and, as a result, it cannot be used by the phagocytes for the formation of oxidants (216). Microbicidal mechanisms other than the oxidants (lysosomal enzymes and peptides) are not as effective, and, as a result, patients develop complications caused by chronic inflammatory stimulation, such as granulomatous obstruction of the esophagus and ileocolitis with diarrhea (217, 218). Early studies of the function of leukocytes *in vitro* from patients with CGD revealed that there is no respiratory burst on stimulation, suggesting that the defect is associated with the NADPH oxidase (218, 219). The breakthrough in our understanding of the genetics of inheritance of CGD and the nature of NADPH oxidase came with the development of a cell-free system for activating the oxidase (220). It was shown in this system that both the membranes and the cytosol are needed for oxidase activity (221, 222). With this system, it was found that some patients have a defect associated with the membranes, whereas others have a defect associated with the cytosol. Furthermore, it was established that patients with X-linked CGD were characterized by a membrane defect and absence of cytochrome  $b_{558}$ . Autosomal inheritance, on the other hand, was associated with normal levels of  $b_{558}$  and a defect in the cytosol, which later was shown to have absence of  $p47^{phox}$  or  $p67^{phox}$ . Analysis of a large number of patients and kindreds has shown that the majority of the patients (70%) have mutations affecting  $gp91^{phox}$  or  $p22^{phox}$  (222, 223). Those with mutations affecting  $gp91^{phox}$  show X-linked inheritance, and those with mutations affecting  $p22^{phox}$  show autosomal inheritance. A great variety of mutations have been identified with  $gp91^{phox}$ , including single nucleotide insertions or deletions, creating frameshifts or premature stop codons, and deletions of part or all of an exon (224). The X-linked CGD is highly heterogeneous. Mutations of the CYBB gene usually lead to lack of  $gp91^{phox}$  expression and absence of NADPH oxidase activity (known as  $X91^{\circ} CGD$ ). In others, the  $gp91^{phox}$  protein is normally expressed but totally lacks oxidase activity (known as  $X91^+ CGD$ ), and, finally, in another group of patients,  $gp91^{phox}$  protein is decreased and oxidase activity is proportionally diminished ( $X91-CGD$ ). An interesting  $X91^+$  patient with an Arg54Ser mutation had a defect in the electron transport from flavin adenine dinucleotide to heme, but the translocation of  $p47^{phox}$  to  $p67^{phox}$  was normal (225). In another patient, neutrophils, monocytes, and B cells had no oxidase activity, but eosinophils had normal activity (226). This patient probably had a mutation in a regulatory element of the CYBB gene directing the transcription to various cells. These experiments of nature have provided us with considerable information about the structure, the assembly, and the function of this very important enzyme, the NADPH oxidase. A patient has been reported with a mutation of Rac2, having deficiency in phagocytosis. The mutation (Asp57Asn) was negative-dominant and was associated with reduced production of superoxide and decreased cell movement (227). The mutant protein was unable to bind GTP. Only a small

number of mutations of p47<sup>phox</sup> and p67<sup>phox</sup> have been reported. Deficiency of p47<sup>phox</sup> or p67<sup>phox</sup> is seen in 33% and 5% of all CGD cases, respectively. Infections in patients with CGD are treated aggressively with antibiotics and, more recently, with interferon- $\gamma$ , which stimulates phagocyte activation ( [228](#) ).

#### **DEFICIENCY OF GLUTATHIONE REDUCTASE AND GLUTATHIONE SYNTHETASE**

Deficiencies of GSH reductase and synthetase have been described. The patients have impaired neutrophil function but are not prone to bacterial infections. These enzymes are components of the GSH cycle, so that they convert H<sub>2</sub>O<sub>2</sub> to H<sub>2</sub>O in the presence of reduced GSH, which is converted to GSSG. The GSSG regenerates reduced GSH in the presence of NADPH.

#### **DEFECTS IN GRANULE PROTEINS**

**Myeloperoxidase** MPO is an important enzyme present in the azurophilic granules of neutrophils and in the lysosomes of monocytes. It generates oxidants from H<sub>2</sub>O<sub>2</sub> and halides. The mature enzyme is a 150-kd heterodimer composed of two heavy and two light chains. It is synthesized primarily during the promyelocytic stage of myeloid differentiation. Hereditary MPO deficiency is a benign abnormality that does not result in clinical illness despite the fact that MPO-deficient neutrophils exhibit a delayed bacterial and fungal killing *in vitro* ( [229](#) ). MPO-messenger RNA transcripts are detected in neutrophils from patients, suggesting that deficiency of the enzyme is caused by some posttranslational defect. Because only neutrophils and monocytes have MPO, other cells (macrophages) may provide defense. It is also possible that the MPO-independent mechanisms are sufficient for protection ( [230](#) ).

**Lactoferrin** Lactoferrin is present in the specific or secondary granules and is a member of the transferrin gene family. It is found in secretions such as tears, milk, saliva, and pancreatic secretions. It has antimicrobial activity through iron chelation and regulates neutrophil adhesiveness. Some individuals have deficiency of the contents of specific granules. These patients are prone to recurrent bacterial and fungal infections of the skin and deep tissues. They are also deficient in defensins, a component of the primary granules.

### **PHAGOCYTOSIS OF APOPTOTIC CELLS**

Macrophages discriminate between viable and apoptotic cells. Uptake of apoptotic cells is noninflammatory, although certain receptors recognizing apoptotic cells are critical for innate immunity. The same receptors engulfing microbial organisms, however, trigger an inflammatory response. Receptors contributing to uptake of apoptotic cells are scavenger receptors class A and class B, receptors for oxidized low-density lipoprotein, integrins, and so forth ( [231](#), [232](#), [233](#) and [234](#) ). Scavenger receptors class A and B are multiligand and multifunctional receptors. Class A scavenger receptors have been implicated for recognition of apoptotic thymocytes and activated platelets ( [232](#) ). The cells undergoing apoptosis lose phospholipid asymmetry and expose phosphatidyl serine (PS). This change is required for recognition and engulfment ( [235](#) ). Normally, phospholipid asymmetry is maintained by the activity of an amino phospholipid translocase, a Mg<sup>2+</sup>-dependent ATPase. However, viable macrophages were shown to express PS constitutively on their surface. Annexin V, a PS-specific binding protein, inhibited phagocytosis of apoptotic cells but not of other particles ( [236](#) ). The antiinflammatory effect in the clearance of apoptotic cells is an active process due to the release of transforming growth factor- $\beta$ , IL-10, and prostaglandin E<sub>2</sub> ( [233](#), [237](#) ).

WASP is recruited to the phagocytic cup and plays an important and nonredundant role in clearance of apoptotic cells ( [238](#) ). Cdc42, which activates WASP, also contributes in this process ( [239](#) ). Defective clearance of apoptotic cells may explain the susceptibility of WAS patients to autoimmune disease because aggregation of lipids on apoptotic cell

membranes and their inefficient removal have been linked to development of autoantibody production ( [240](#) ) and autoimmune disorders ( [241](#) ).

A flow cytometric method for measuring phagocytosis of apoptotic cells has been developed ( [242](#) ). It has the advantages of assessment of large numbers of cells and high sample throughput and can distinguish bound from internalized apoptotic cells. Apoptotic cells are labeled with 5-chloromethylfluorescein diacetate.

## PHAGOCYTOSIS OF SENESCENT ERYTHROCYTES

Several processes have been implicated as causes of senescence of red blood cells (RBCs), such as loss of carbohydrates by desialylation, modification of natural components such as band 3, and glycophorin and phospholipid asymmetry with the appearance on the surface of PS ( [243](#) , [244](#) and [245](#) ). There are several reports regarding the nature of the antigen that triggers removal of the RBC as it approaches the end of its lifespan. The nature of a senescent epitope is not yet clear, but all major classes of organic matter have been implicated for the primary signal (i.e., proteins, carbohydrates, and lipids). Senescence is considered by some to be the unmasking of amino acid sequences by proteolysis or rearrangement due to clustering or oligomerization of band-3 protein ( [246](#) , [247](#) and [248](#) ). Others, however, have shown that the senescent antigen is not present on the polypeptide of band 3 but on a glycan ( [249](#) ). Strong evidence supports that  $\beta$ -galactosyl residues stimulate IgG autoantibodies and phagocytosis of aging RBCs ( [249](#) ). Presence of PS on the cell surface directly correlates with the propensity of RBCs to bind to monocytes and be rapidly cleared in the spleen ( [250](#) , [251](#) ).

A flow cytometric method has been developed for an accurate measurement of erythrophagocytosis ( [252](#) ).

## ASSESSMENT OF PHAGOCYTTIC FUNCTION

### Nitroblue Tetrazolium

The standard method of laboratory testing for phagocytosis is the reduction of a colorless substance known as *nitroblue tetrazolium* to a blue-black formazan-insoluble deposit within the neutrophils. This indicates the presence of an activated respiratory burst oxidase. In normal persons, less than 10% of blood neutrophils are nitroblue tetrazolium-positive, whereas in patients with bacterial infections, more than 10% of neutrophils are nitroblue tetrazolium-positive.

### Flow Cytometry

Phagocytic function can be assessed by flow cytometry, which has the advantage over other methods because of the smaller number of cells and fewer preparative procedures required. One useful method uses fluorescein heat-killed *Candida albicans*. After phagocytosis, ethidium bromide is added. Because the ethidium bromide (red color) does not penetrate viable cells, only the external organisms stain red, whereas those phagocytosed stain green (fluorescein) ( [253](#) ).

Flow cytometry can also be used to measure oxidative mechanisms. The most useful method is the measurement of intracellular  $H_2O_2$  by the dichlorofluorescein (DCFH) diacetate probe ( [254](#) , [255](#) ). The DCFH diacetate dye is incorporated into the lipid regions

of the cell, where the acetate side chains are cleaved by hydrolytic enzymes to the nonfluorescence molecule, 2'-7', DCFH, which becomes trapped within the cell. On cell activation, the RBO generates superoxide anion, which is further reduced to H<sub>2</sub>O<sub>2</sub>. In the presence of H<sub>2</sub>O<sub>2</sub>, peroxidases oxidize the DCFH to 2'-7', dichlorofluorescein, which fluoresces at 530 nm (the same emission as fluorescein thioisocyanate). The green fluorescence produced is proportional to the amount of H<sub>2</sub>O<sub>2</sub> generated. It is possible to determine the intracellular H<sub>2</sub>O<sub>2</sub> produced ( [254](#) ).

## Chemiluminescence

Some of the reactive oxygen intermediates generated during phagocytosis exist for a short period of time in a higher energy state but release this energy in the form of light known as *CL* ( [256](#) ), which can be quantified ( [257](#) ).

CL can be amplified by the use of bystander molecules called *chemiluminescent probes*, which react with the O<sub>2</sub> radicals to produce excited products in high yield. The intensity of CL is directly proportional to the functional capacity of the phagocytes. The two most commonly used probes are luminol (5-amino-2,3, dihydro-1,4, phthalazinedione) and lucigenin (10,10-dimethyl-9,9-biacridinium dinitrate), and the most commonly used stimulus is zymosan (yeast particles).

CL is proportional to phagocytic activity as long as the CL probes and the stimulus are not rate-limiting. Contamination by erythrocytes reduces CL because the extinction coefficient of hemoglobin is in the blue region of the visible region and light is absorbed.

## REFERENCES

1. Chernyak L, Tauber AI. The birth of immunology: Metchnikoff, the embryologist. *Cell Immunol* 1988;117:218-233.
2. Robinson MS, Watts C, Zerial M. Membrane dynamics in endocytosis. *Cell* 1996;84:13-21.
3. Mukherjee S, Ghosh RN, Maxfield FR. Endocytosis. *Physiol Rev* 1997;77:759-803.
4. Scales SJ, Gomez M, Kreis TE. Coat proteins regulating membrane traffic. *Int Rev Cytol* 2000;195:67-144.
5. Indik ZK, Park JG, Hunter S, Schreiber AD. The molecular dissection of Fc $\gamma$  receptor mediated phagocytosis. *Blood* 1995;86:4389-4399.
6. van de Winkel JG, Capel PJ. Human IgG Fc receptor heterogeneity: molecular aspects and clinical implications. *Immunol Today* 1993;14:215-221.
7. Ravetch JV, Kinet JP. Fc receptors. *Annu Rev Immunol* 1991;9:457-492.
8. Cambier JC. New nomenclature for the Reth motif (or ARH1/TAM/ARAM/YXXL). *Immunol Today* 1995;16:110.
9. Indik ZK, Kelly C, Chien P, et al. Human Fc $\gamma$ RII, in the absence of other Fc $\gamma$  receptors, mediates a phagocytic signal. *J Clin Invest* 1991;88:1766-1771.
10. Indik ZK, Hunter S, Huang MM, et al. The high affinity Fc $\gamma$  receptor (CD64) induces phagocytosis in the absence of its cytoplasmic domain: the  $\gamma$  subunit of Fc $\gamma$ RIIIA imparts phagocytic function to Fc $\gamma$ RI. *Exp Hematol* 1994;22:599-606.
11. Ernst LK, Duchemin AM, Anderson CL. Association of the high-affinity receptor for IgG (Fc $\gamma$ RI) with

the  $\alpha$  subunit of the IgE receptor. *Proc Natl Acad Sci U S A* 1993;90:6023–6027.

12. Masuda M, Roos D. Association of all three types of Fc $\gamma$ R (CD64, CD32, and CD16) with a  $\beta$ -chain homodimer in cultured human monocytes. *J Immunol* 1993;151:7188–7195.

13. Brooks DG, Qiu WQ, Luster AD, Ravetch JV. Structure and expression of human IgG Fc $\gamma$ RII (CD32). Functional heterogeneity is encoded by the alternatively spliced products of multiple genes. *J Exp Med* 1989;170:1369–1385.

14. Cassel DL, Keller MA, Surrey S, et al. Differential expression of Fc $\gamma$ RIIA, Fc $\gamma$ RIIB and Fc $\gamma$ RIIC in hematopoietic cells: analysis of transcripts. *Mol Immunol* 1993;30:451–460.

15. Indik ZK, Pan XQ, Huang MM, et al. Insertion of cytoplasmic tyrosine sequences into the nonphagocytic receptor Fc $\gamma$ RIIB establishes phagocytic function. *Blood* 1994;83:2072–2080.

16. Letourneur O, Kennedy IC, Brini AT, et al. Characterization of the family of dimers associated with Fc receptors (Fc $\gamma$ RI and Fc $\gamma$ RIII). *J Immunol* 1991;147:2652–2656.

17. Wirthmueller U, Kurosaki T, Murakami MS, Ravetch JV. Signal transduction by Fc $\gamma$ RIII (CD16) is mediated through the  $\alpha$  chain. *J Exp Med* 1992;175:1381–1390.

18. Ravetch JV, Perussia B. Alternative membrane forms of Fc $\gamma$ RIII (CD16) on human natural killer cells and neutrophils. Cell type-specific expression of two genes that differ in single nucleotide substitutions. *J Exp Med* 1989;170:481–497.

19. Huizinga TW, Kerst M, Nuyens JH, et al. Binding characteristics of dimeric IgG subclass complexes to human neutrophils. *J Immunol* 1989;142:2359–2364.

20. Huizinga TW, de Haas M, Kleijer M, et al. Soluble Fc gamma receptor III in human plasma originates from release by neutrophils. *J Clin Invest* 1990;86:416–423.

21. Fridman WH, Teillaud JL, Amigorena S, et al. The isotypic circuit: immunoglobulins, Fc receptors and immunoglobulin binding factors. *Int Rev Immunol* 1987;2:221–240.

22. Daeron M. Fc receptor biology. *Annu Rev Immunol* 1997;15:203–234.

23. Ehlenberger AG, Nussenzweig V. The role of membrane receptors for C3b and C3d in phagocytosis. *J Exp Med* 1977;145:357–371.

24. Griffin JA, Griffin FM Jr. Augmentation of macrophage complement receptor function in vitro. I. Characterization of the cellular interactions required for the generation of a T-lymphocyte product that enhances macrophage complement receptor function. *J Exp Med* 1979;150:653–675.

25. Griffin FM Jr, Griffin JA. Augmentation of macrophage complement receptor function in vitro. II. Characterization of the effects of a unique lymphokine upon the phagocytic capabilities of macrophages. *J Immunol* 1980;125:844–849.

26. Sampson LL, Heuser J, Brown EJ. Cytokine regulation of complement receptor-mediated ingestion by mouse peritoneal macrophages. M-CSF and IL-4 activate phagocytosis by a common mechanism requiring autostimulation by IFN- $\beta$ . *J Immunol* 1991;146:1005–1013.

27. Griffin FM Jr, Mullinax PJ. Augmentation of macrophage complement receptor function in vitro. III. C3b receptors that promote phagocytosis migrate within the plane of the macrophage plasma membrane. *J Exp Med* 1981;154:291–305.

28. Griffin FM Jr. Effects of soluble immune complexes on Fc receptor- and C3b receptor-mediated phagocytosis by macrophages. *J Exp Med* 1980;152:905–919.

29. Michl J, Pieczonka MM, Unkeless JC, et al. Fc receptor modulation in mononuclear phagocytes maintained on immobilized immune complexes occurs by diffusion of the receptor molecule. *J Exp Med* 1983;157:2121–2139.

30. Nepomuceno RR, Henschen-Edman AH, Burgess WH, Tenner AJ. cDNA cloning and primary structure analysis of C1qR(P), the human C1q/MBL/SPA receptor that mediates enhanced phagocytosis in vitro.

Immunity 1997;6:119–129.

31. Malhotra R, Willis AC, Jensenius JC, et al. Structure and homology of human C1q receptor (collectin receptor). *Immunology* 1993;78:341–348.
32. Malhotra R, Thiel S, Reid KB, Sim RB. Human leukocyte C1q receptor binds other soluble proteins with collagen domains. *J Exp Med* 1990;172:955–959.
33. Tenner AJ, Robinson SL, Ezekowitz RA. Mannose binding protein (MBP) enhances mononuclear phagocyte function via a receptor that contains the 126,000 M(r) component of the C1q receptor. *Immunity* 1995;3:485–493.
34. Ezekowitz RA, Sastry K, Bailly P, Warner A. Molecular characterization of the human macrophage mannose receptor: demonstration of multiple carbohydrate recognition-like domains and phagocytosis of yeasts in Cos-1 cells. *J Exp Med* 1990;172:1785–1794.
35. Schlesinger LS, Hull SR, Kaufman TM. Binding of the terminal mannosyl units of lipoarabinomannan from a virulent strain of *Mycobacterium tuberculosis* to human macrophages. *J Immunol* 1994;152:4070–4079.
36. Cross CE, Bancroft GJ. Ingestion of acapsular *Cryptococcus neoformans* occurs via mannose and  $\beta$ -glucan receptors, resulting in cytokine production and increased phagocytosis of the encapsulated form. *Infect Immun* 1995;63:2604–2611.
37. Prigozy TI, Sieling PA, Clemens D, et al. The mannose receptor delivers lipoglycan antigens to endosomes for presentation to T cells by CD1b molecules. *Immunity* 1997;6:187–197.
38. Wright SD, Ramos RA, Tobias PS, et al. CD14, a receptor for complexes of lipopolysaccharide (LPS) and LPS binding protein. *Science* 1990;249:1431–1433.
39. Wright SD, Tobias PS, Ulevitch RJ, Ramos RA. Lipopolysaccharide (LPS) binding protein opsonizes LPS-bearing particles for recognition by a novel receptor on macrophages. *J Exp Med* 1989;170:1231–1241.
40. Griffin FM Jr, Silverstein SC. Segmental response of the macrophage plasma membrane to a phagocytic stimulus. *J Exp Med* 1974;139:323–336.
41. Griffin FM Jr, Griffin JA, Leider JE, Silverstein SC. Studies on the mechanism of phagocytosis. I. Requirements for circumferential attachment of particle-bound ligands to specific receptors on the macrophage plasma membrane. *J Exp Med* 1975;142:1263–1282.
42. Griffin FM Jr, Griffin JA, Silverstein SC. Studies on the mechanism of phagocytosis. II. The interaction of macrophages with anti-immunoglobulin IgG-coated bone marrow-derived lymphocytes. *J Exp Med* 1976;144:788–809.
43. Korade-Mirnic Z, Corey SJ. Src kinase-mediated signaling in leukocytes. *J Leukoc Biol* 2000;68:603–613.
44. Garcia-Garcia E, Rosales C. Signal transduction during Fc receptor-mediated phagocytosis. *J Leukoc Biol* 2002;72:1092–1108.
45. Crowley MT, Costello PS, Fitzer-Atlas CJ, et al. A critical role for Syk in signal transduction and phagocytosis mediated by Fc $\gamma$  receptors on macrophages. *J Exp Med* 1997;186:1027–1039.
46. Lundqvist-Gustafsson H, Gustafsson M, Dahlgren C. Dynamic Ca<sup>2+</sup> changes in neutrophil phagosomes. A source for intracellular Ca<sup>2+</sup> during phagolysosome formation. *Cell Calcium* 2000;27:353–362.
47. Boelho RJ, Teruel M, Diekman R, et al. Localized biphasic changes in phosphatidyl-4,5-bisphosphate at sites of phagocytosis. *J Cell Biol* 2000;151:1353–1368.
48. Cox D, Tseng Cc, Bjekic C, Greenberg S. A requirement for phosphatidylinositol 3-kinase on pseudopod extension. *J Biol Chem* 1999;274:1240–1247.



49. Cox D, Berg JS, Cammer M, et al. Myosin X is a downstream effector of PI(3)K during phagocytosis. *Nat Cell Biol* 2002;4:469–477.
50. Cox D, Chang P, Zhang D, et al. Requirement for both Rac1 and Cdc42 in membrane ruffling and phagocytosis in leukocytes. *J Exp Med* 1997;186:1487–1489.
51. Caron E, Hall A. Identification of two distinct mechanisms of phagocytosis controlled by different Rho GTPases. *Science* 1998;282:1717–1721.
52. Lorenzi R, Brickell PM, Katz DR, et al. Wiskott–Aldrich syndrome protein is necessary for efficient IgG-mediated phagocytosis. *Blood* 2000;95:293–294.
53. Leverrier Y, Lorenzi R, Blundell MP, et al. Cutting edge: the Wiskott–Aldrich syndrome protein is required for efficient phagocytosis of apoptotic cells. *J Immunol* 2001;166:4831–4834.
54. Long EO. Regulation of immune responses through inhibitory receptors. *Annu Rev Immunol* 1999;17:875–904.
55. Bruhns P, Vely F, Malbec O, et al. Molecular basis of the recruitment of the SH<sub>2</sub> domain-containing inositol 5-phosphatases SHIP-1 and SHIP-2 by Fc $\gamma$ RIIB. *J Biol Chem* 2000;275:37357–37364.
56. Lesourne R, Bruhns P, Fridman WH, Daeron M. Insufficient phosphorylation prevents Fc $\gamma$ RIIB from recruiting the SH<sub>2</sub> domain-containing protein tyrosine phosphatase SHP-1. *J Biol Chem* 2001;276:6327–6336.
57. Cox D, Dale BM, Kashiwada M, et al. A regulatory role for Src homology 2 domain-containing inositol 5'-phosphatase (SHIP) in phagocytosis mediated by Fc $\gamma$  receptors and complement receptor 3 (aMB2; CD11b/CD18). *J Exp Med* 2001;193:61–72.
58. Trindandapani S, Siefker K, Teilland JL, et al. Regulated expression and inhibitory function of Fc $\gamma$ RIIB in human monocytic cells. *J Biol Chem* 2002; 277:5082–5089.
59. Holevinsky KO, Nelson DJ. Membrane capacitance changes associated with particle uptake during phagocytosis in macrophages. *Biophys J* 1998;75:2577–2586.
60. Beningo KA, Wang Y-L. Fc receptor-mediated phagocytosis is regulated by mechanical properties of the target. *J Cell Sci* 2002;115:849–856.
61. Greenberg S. Modular components of phagocytosis. *J Leukoc Biol* 1999;66:712–715.
62. Lennartz MR, Yuen AF, Masi SM, et al. Phospholipase A2 inhibition results in sequestration of plasma membrane into electron lucent vesicles during IgG-mediated phagocytosis. *J Cell Sci* 1997;110:2041–2052.
63. Booth JW, Trimble WS, Grinstein S. Membrane dynamics in phagocytosis. *Semin Immunol* 2001;13:357–364.
64. Araki N, Johnson MT, Swanson JA. A role of phosphoinositide-3 kinase in the completion of macropinocytosis and phagocytosis by macrophages. *J Cell Biol* 1996;135:1249–1260.
65. Cox D, Lee DJ, Dale BM, et al. A Rab 11-containing rapidly recycling compartment in macrophages that promotes phagocytosis. *Proc Natl Acad Sci U S A* 2000;97:680–685.
66. McNew JA, Parlati F, Fukuda R, et al. Compartmental specificity of cellular membrane fusion encoded in SNARE proteins. *Nature* 2000;407:153–159.
67. Zerial M, McBride H. Rab proteins as membrane organizers. *Nat Rev Mol Cell Biol* 2001;2:107–117.
68. Gold ES, Underhill DM, Morrisette NS, et al. Dynamin 2 is required for phagocytosis in macrophages. *J Exp Med* 1999;190:1849–1856.
69. Gold ES, Morrisette NS, Underhill DM, et al. Amphiphysin II $\alpha$ , a novel amphiphysin II isoform is

required for macrophage phagocytosis. *Immunity* 2001;12:285–292.

70. Berg JS, Powell BC, Cheney RE. A millennial myosin census. *Mol Biol Cell* 2001;12:780–784.
71. Pitt A, Mayorga LS, Stahl PD, Schwartz AL. Alterations in the protein composition of maturing phagosomes. *J Clin Invest* 1992;90:1978–1983.
72. Ward DM, Perou CM, Lloyd M, Kaplan J. “Synchronized” endocytosis and extracellular sorting in alveolar macrophages: the early sorting endosome is a transient organelle. *J Cell Biol* 1995;129:1229–1240.
73. Gotthardt D, Warnatz HJ, Henschel O, et al. High resolution dissection of phagosome maturation reveals distinct membrane trafficking phases. *Mol Biol Cell* 2002;13:3508–3520.
74. Desjardins M, Huber LA, Parton R, Griffiths G. Biogenesis of phagosomes proceeds through a sequential series of interactions with the endocytic apparatus. *J Cell Biol* 1994;124:677–688.
75. Pollard TD, Blanchoin L, Mullins RD. Molecular mechanisms controlling actin filament dynamics in non-muscle cells. *Annu Rev Biophys Biomol Struct* 2000;29:545–576.
76. Welch MD, Mullins RD. Cellular control of actin nucleation. *Annu Rev Cell Dev Biol* 2002;18:247–288.
77. Higgs HN, Pollard TD. Regulation of actin filament network formation through Arp2/3 complex: activation by a diverse array of proteins. *Annu Rev Biochem* 2001;70:649–675.
78. Robinson RC, Turbedsky K, Kaiser DA, et al. Crystal structure of Arp2/3 complex. *Science* 2001;294:1679–1684.
79. Mullins RD, Heuser JA, Pollard TD. The interaction of Arp2/3 complex with actin: nucleation, high-affinity pointed end capping, and formation of branching network filaments. *Proc Natl Acad Sci U S A* 1998;95:6181–6186.
80. Higgs HN, Pollard TD. Activation by Cdc42 and PIP<sub>2</sub> of Wiskott–Aldrich syndrome protein (WASP) stimulates actin nucleation of Arp2/3 complex. *J Cell Biol* 2000;150:1311–1320.
81. Rohatgi R, Ho HY, Kirschner MW. Mechanism of N–WASP activation by Cdc42 and phosphatidylinositol–4,5–biphosphate. *J Cell Biol* 2000;150:1299–1310.
82. Marchand JB, Kaiser DA, Pollard TD, Higgs HN. Interaction of WASP/Scar proteins with actin and vertebrate Arp2/3 complex. *Nat Cell Biol* 2001;3:76–82.
83. Hüfer K, Higgs HN, Pollard TD, et al. The verpulin-like central (VC) regions of Wiskott–Aldrich syndrome protein induces Arp2/3 complex-dependent actin nucleation. *J Biol Chem* 2001;276:35761–35767.
84. Weaver AM, Young ME, Lee W–L, Cooper JA. Integration of signals to the Arp2/3 complex. *Curr Opin Cell Biol* 2003;15:23–30.
85. Thrasher AJ. WASp in immune-system organization and function. *Nat Rev Immunol* 2002;2:635–646.
86. Prehoda KE, Scott JA, Mullins RD, Lim WA. Integration of multiple signals through cooperative regulation of the N–WASP–Arp2/3 complex. *Science* 2000;290:801–806.
87. Rohatgi R, Nollau P, Ho HY, et al. Nck and phosphatidylinositol–4,5–biphosphate synergistically activate actin polymerization through the N–WASP–Arp2/3 pathway. *J Biol Chem* 2001;276:26448–26452.
88. Svitkina TM, Borisy GG. Arp2/3 complex and actin depolymerizing factor/cofilin in dendritic organization and treadmilling of actin filament array in lamellipodia. *J Cell Biol* 1999;145:1009–1026.
89. Machesky LM, Mullens RD, Higgs HN, et al. Scar, a WASP-related protein, activates nucleation of actin filaments by the Arp2/3 complex. *Proc Natl Acad Sci U S A* 1999;96:3739–3744.
90. Pollard TD, Blanchoin L, Mullins RD. Molecular mechanisms controlling actin filament dynamics in

non-muscle cells. *Annu Rev Biophys Biomol Struct* 2000;29:545–576.

91. Pantaloni D, Boujemaa R, Didry D, et al. The Arp2/3 complex branches filament barbed ends: functional antagonism with capping proteins. *Nat Cell Biol* 2000;2:385–391.
92. Blanchoin L, Amann KJ, Higgs HN, et al. Direct observation of dendritic actin filament networks nucleated by Arp2/3 complex and WASP/Scar proteins. *Nature* 2000;404:1007–1011.
93. Amann KJ, Pollard TD. Direct real-time observation of actin filament branching mediated by Arp2/3 complex using total internal reflection fluorescence microscopy. *Proc Natl Acad Sci U S A* 2001;98:15009–15013.
94. Ichetovkin I, Grant W, Condeelis J. Cofilin produces newly polymerized actin filaments that are preferred for dendritic nucleation by the Arp2/3 complex. *Curr Biol* 2002;12:79–84.
95. Amann KJ, Pollard TD. The Arp2/3 complex nucleates actin filament branches from the sides of pre-existing filaments. *Nat Cell Biol* 2001;3:306–310.
96. Uruno T, Liu J, Zhang P, et al. Activation of Arp2/3 complex-mediated actin polymerization by cortactin. *Nat Cell Biol* 2001;3:259–266.
97. Weaver AM, Karginov AV, Kinley AW, et al. Cortactin promotes and stabilizes Arp2/3-induced actin filament network formation. *Curr Biol* 2001;11:370–374.
98. Weaver AM, Heuser JE, Karginov AV, et al. Interaction of cortactin and N-WASP with Arp2/3 complex. *Curr Biol* 2002;12:1270–1278.
99. Higgs HN. Actin nucleation: cortactin caught in the act. *Curr Biol* 2002;12:R593–R595.
100. Kim AS, Kakalis LT, Abdul-Manan N, et al. Autoinhibition and activation mechanisms of the Wiskott–Aldrich syndrome protein. *Nature* 2000;404:151–158.
101. May RC, Machesky LM. Phagocytosis and the actin cytoskeleton. *J Cell Sci* 2001;114:1061–1077.
102. Castellano F, Chavrier P, Caron E. Actin dynamics during phagocytosis. *Semin Immunol* 2001;13:347–355.
103. Snapper SB, Rosen FS. The Wiskott–Aldrich syndrome protein (WASP). Roles in signaling and cytoskeletal organization. *Annu Rev Immunol* 1999;17:905–929.
104. Machesky LM, Insall RH. Scar1 and the related Wiskott–Aldrich syndrome protein, WASP, regulate the actin cytoskeleton through the Arp2/3 complex. *Curr Biol* 1998;8:1347–1356.
105. Castellano F, Le Clainche C, Patin D, et al. A WASP–VASP complex regulates actin polymerization at the plasma membrane. *EMBO J* 2001;20:5603–5614.
106. Lorenzi R, Bricell PM, Katz DR, et al. Wiskott–Aldrich syndrome protein is necessary for efficient IgG mediated phagocytosis. *Blood* 2000;95:2943–2946.
107. Natarangelo LD. Missense mutations of the WASP gene cause intermittent X-linked thrombocytopenia. *Blood* 2002;99:2268–2269.
108. Snapper SB, Rosen FS, Mizoguchi E, et al. Wiskott–Aldrich syndrome protein-deficient mice reveal a role for WASP in T but not B cell activation. *Immunity* 1998;9:81–90.
109. May RC, Caron E, Hall A, Machesky LM. Involvement of Arp2/3 complex in phagocytosis mediated by Fc gamma R or CR3. *Nat Cell Biol* 2000;2:246–248.
110. Taunton J. Actin filament nucleation by endosomes, lysosomes, and secretory vesicles. *Curr Opin Cell Biol* 2001;13:85–91.
111. Taunton J, Rowning BA, Coughlin ML, et al. Actin-dependent propulsion of endosomes and

lysosomes by recruitment of N-WASP. *J Cell Biol* 2000;148:519–530.

112. Merrifield CJ, Moss SE, Ballestrem C, et al. Endocytic vesicles more at the tips of actin tails in cultured mast cells. *Nat Cell Biol* 1999;1:72–74.
113. Dramsi S, Cossart P. Intracellular pathogens and the actin cytoskeleton. *Annu Rev Cell Dev Biol* 1998;14:137–166.
114. Cameron LA, Svitkina TM, Vignjevic D, et al. Dendritic organization of actin comet tails. *Curr Biol* 2001;11:130–135.
115. Borisy GG, Svitkina TM. Actin machinery: pushing the envelope. *Curr Opin Cell Biol* 2000;12:104–112.
116. Nachmias VT. Small actin-binding proteins: the  $\beta$ -thymosin family. *Curr Biol* 1993;5:56–62.
117. Pantaloni D, Carlier MF. How profilin promotes actin filaments assembly in the presence of thymosin- $\beta$ 4. *Cell* 1993;75:1007–1014.
118. Bamburg JR. Proteins of the ADF/cofilin family: essential regulators of actin dynamics. *Annu Rev Cell Dev Biol* 1999;15:185–230.
119. Carlier M-F, Ressad F, Pantaloni D. Control of actin dynamics in cell motility. Role of ADF/cofilin. *J Biol Chem* 1999;274:33827–33830.
120. Lappalainen P, Fedorov EV, Fedorov AA, et al. Essential functions and actin-binding surfaces of yeast cofilin by systematic mutagenesis. *EMBO J* 1997;16:5520–5530.
121. Puius YA, Mahoney NM, Almo SC. The modular structure of actin-regulatory proteins. *Curr Opin Cell Biol* 1998;10:23–24.
122. Kusano K, Abe H, Obinata T. Detection of a sequence involved in actin-binding and phosphoinositide-binding in the N-terminal side of cofilin. *Mol Cell Biochem* 1999;190:133–141.
123. McGough A, Pope B, Chiu W, Weeds AG. Cofilin changes the twist of F-actin: implications for actin filament dynamics and cellular function. *J Cell Biol* 1997;138:771–781.
124. Teubner A, Wagner A. Kinetic evidence for a readily exchangeable nucleotide at the terminal subunit of the barbed ends of actin filaments. *Biochemistry* 1998;37:7532–7538.
125. Didry D, Carlier M-F, Pantaloni D. Synergy between actin depolymerizing factor/cofilin and profilin in increasing actin filament turnover. *J Biol Chem* 1998;273:25602–25611.
126. Sun HQ, Yamamoto M, Mejillano M, Yin HL. Gelsolin, a multifunctional actin regulatory protein. *J Biol Chem* 1999;274:33179–33182.
127. Selden LA, Kinosian HJ, Newman J, et al. Severing of F-actin by the amino-terminal half of gelsolin suggests internal cooperativity in gelsolin. *Biophys J* 1998;75:3092–3100.
128. Southwick FS. Gelsolin and ADF/cofilin enhance the actin dynamics of motile cells. *Proc Natl Acad Sci U S A* 2000;97:6936–6938.
129. Kwiatkowski DJ. Functions of gelsolin: motility, signaling, apoptosis, cancer. *Curr Opin Cell Biol* 1999;11:103–108.
130. Choe H, Burtnick LD, Mejillano M, et al. The calcium activation of gelsolin: insights from the 3Å structure of the G<sub>4</sub>-G<sub>6</sub>/actin complex. *J Mol Biol* 2002;324:691–702.
131. Dawson JF, Sablin EP, Spudich JA, Fletterick RJ. Structure of an F-actin trimer disrupted by gelsolin and implications for the mechanism of severing. *J Biol Chem* 2003;278:1229–1238.
132. Jammey PA, Iida K, Yin HL, Stossel TP. Polyphosphoinositide micelles and polyphosphoinositide-containing vesicles dissociate endogenous gelsolin-actin complexes and promote actin assembly from the fast-growing end of actin filaments blocked by gelsolin. *J Biol Chem*

1987;262:12228–12236.

133. Hartwig JH, Bokoch GM, Carpenter CL, et al. Thrombin receptor ligation and activated Rac uncap actin filament barbed ends through phosphoinositide synthesis in permeabilized human platelets. *Cell* 1995;82:643–653.
134. Barkalow K, Witke W, Kwiatkowski DJ, Hartwig JH. Coordinated regulation of platelet actin filament barbed ends by gelsolin and capping protein. *J Cell Biol* 1996;134:389–399.
135. Li Z, Kim ES, Bearer EL. Arp2/3 complex is required for actin polymerization during platelet shape change. *Blood* 2002;99:4466–4474.
136. Young JD, Ko SS, Cohn ZA. The increase of intracellular free calcium associated with IgG gamma 2b/gamma 1 Fc receptor–ligand interactions: role in phagocytosis. *Proc Natl Acad Sci U S A* 1984;81:530–534.
137. Zimmerli S, Majeed M, Gustavsson M, et al. Phagosome–lysosome fusion is a calcium–independent event in macrophages. *J Cell Biol* 1996;132:49–61.
138. Brumell JH, Howard JC, Craig K, et al. Expression of the protein kinase C substrate pleckstrin in macrophages: association with phagosomal membranes. *J Immunol* 1999;163:3388–3395.
139. Carballo E, Pitterle DM, Stumpo DJ, et al. Phagocytic and macropinocytic activity in MARCKS–deficient macrophages and fibroblasts. *Am J Physiol* 1999;277:C163–C173.
140. Czech MP. PIP<sub>2</sub> and PIP<sub>3</sub>: complex roles at the cell surface. *Cell* 2000;100:603–606.
141. Vanhaesebroeck B, Leever SJ, Ahmadi K, et al. Synthesis and function of 3–phosphatidylinositol lipids. *Annu Rev Biochem* 2001;70:535–602.
142. Gillooly DJ, Simonsen A, Stenmark H. Phosphoinositides and phagocytosis. *J Cell Biol* 2001;155:15–18.
143. Martin TF. Phosphoinositide lipids as signaling molecules: common themes for signal transduction, cytoskeletal regulation, and membrane trafficking. *Annu Rev Cell Dev Biol* 1998;14:231–264.
144. Strzelecka A, Pyrzynska B, Kwiatkowska K, Sobota A. Syk kinase, tyrosine phosphorylated proteins and actin filaments accumulate at forming phagosomes during Fc gamma–receptor–mediated phagocytosis. *Cell Motil Cytoskeleton* 1997;38:287–296.
145. Kwiatkowska K, Sobota A. Signaling pathways in phagocytosis. *Bioessays* 1999;21:422–431.
146. Cox T, Tseng CC, Bjekic G, Greenberg S. A requirement for phosphatidylinositol 3–kinases in pseudopod extension. *J Biol Chem* 1999;274:1240–1247.
147. Vieira OV, Botelho RJ, Rameh J, et al. Distinct roles of class I and III phosphatidylinositol 3–kinases in phagosome formation and maturation. *J Cell Biol* 2001;155:19–26.
148. Fratti RA, Backer JM, Reenberg J, et al. Role of phosphatidylinositol 3–kinase and Rab5 effectors in phagosome biogenesis and mycobacterial phagosome maturation arrest. *J Cell Biol* 2001;154:631–644.
149. Hall A. Rho GTPases and the actin cytoskeleton. *Science* 1998;279:509–514.
150. Tapon N, Hall A. Rho, Rac and Cdc42 GTPases regulate the organization of the actin cytoskeleton. *Curr Opin Cell Biol* 1997;9:86–92.
151. Cox D, Chang P, Zhang Q, et al. Requirements for both rac1 and Cdc42 in membrane ruffling and phagocytosis in leukocytes. *J Exp Med* 1997;186: 1487–1494.
152. Massol P, Montcourrier P, Guillemot JC, Chavrier P. Fc receptor–mediated phagocytosis required CDC42 and Rac1. *EMBO J* 1998;17:6219–6229.
153. Caron E, Hall A. Identification of two distinct mechanisms of phagocytosis controlled by different

Rho GTPases. *Science* 1995;282:1717–1721.

154. Machesky LM, Insall RH. Scar1 and the related Wiskott–Aldrich syndrome protein, WASP, regulate the actin cytoskeleton through the Arp2/3 complex. *Curr Biol* 1998;8:1347–1356.

155. Higgs HN, Pollard TD. Activation by Cdc42 and PIP(2) of Wiskott–Aldrich syndrome protein (WASp) stimulates actin nucleation by Arp2/3 complex. *J Cell Biol* 2000;150:1311–1320.

156. Rohatgi R, Ho H–Y, Kirschner MW. Mechanisms of N–WASP activation by CDC42 and phosphatidylinositol 4,5–biphosphate. *J Cell Biol* 2000;150:1299–1310.

157. Kim AS, Kahalis LT, Abdul–Manan N, et al. Autoinhibition and activation mechanisms of the Wiskott–Aldrich syndrome protein. *Nature* 2000;404:151–158.

158. Arcaro A. The small GTP–binding protein Rac promotes dissociation of gelsolin from actin filaments in neutrophils. *J Biol Chem* 1998;273:805–813.

159. Tsukita S, Yonemura S. ERM (ezrin/radixin/moesin) family: from cytoskeleton to signal transduction. *Curr Opin Cell Biol* 1997;9:70–75.

160. Arpin M, Algrain M, Louvard D. Membrane–actin microfilament connections: an increasing diversity of players related to band 4.1. *Curr Opin Cell Biol* 1994;6:136–141.

161. Gary R, Bretscher A. Heterotypic and homotypic associations between ezrin and moesin, two putative membrane–cytoskeletal linking proteins. *Proc Natl Acad Sci U S A* 1993;90:10846–10850.

162. Gary R, Bretscher A. Ezrin self–association involves binding of an N–terminal domain to a normally masked C–terminal domain that includes the F–actin binding site. *Mol Biol Cell* 1995;6:1061–1075.

163. Burridge K, Fath K, Kelly T, et al. Focal adhesions: transmembrane junctions between the extracellular matrix and the cytoskeleton. *Annu Rev Cell Biol* 1988;4:487–525.

164. Greenberg S, Burridge K, Silverstein SC. Co–localization of F–actin and talin during Fc receptor–mediated phagocytosis in mouse macrophages. *J Exp Med* 1990;172:1853–1856.

165. Lehrer RI, Lichtenstein AK, Ganz T. Defensins: antimicrobial and cytotoxic peptides of mammalian cells. *Annu Rev Immunol* 1993;11:105–128.

166. Sbarra AJ, Karnovsky ML. The biochemical basis of phagocytosis. I. Metabolic changes during the ingestion of particles by polymorphonuclear leukocytes. *J Biol Chem* 1959;234:1355–1362.

167. Babior BM, Kipnes RS, Curnutte JT. Biological defense mechanisms. The production by leukocytes of superoxide, a potential bactericidal agent. *J Clin Invest* 1973;52:741–744.

168. Baldrige CW, Gerard RW. The extra respiration of phagocytosis. *Am J Physiol* 1933;103:235–236.

169. Babior BM. The respiratory burst of phagocytes. *J Clin Invest* 1984;73:599–601.

170. Klebanoff SJ. Oxygen metabolism and the toxic properties of phagocytes. *Ann Intern Med* 1980;93:480–489.

171. Klebanoff SJ. Antimicrobial mechanisms in neutrophilic polymorphonuclear leukocytes. *Semin Hematol* 1975;12:117–142.

172. Babior BM. Oxidants from phagocytes: agents of defense and destruction. *Blood* 1984;64:959–966.

173. Fantone JC, Ward PA. Role of oxygen–derived free radicals and metabolites in leukocyte–dependent inflammatory reactions. *Am J Pathol* 1982;107:397–418.

174. Babior BM. NADPH oxidase: an update. *Blood* 1999;93:1464–1476.

175. Yu L, Quinn MT, Cross AR, Dinauer MC. Gp91–phox is the heme binding subunit of the

superoxide-generating NADPH oxidase. *Proc Natl Acad Sci U S A* 1998;95:7993–7998.

176. Quinn MT, Mullen JL, Jesaitis AJ. A human neutrophil cytochrome b contains multiple hemes. Evidence for heme associated with both subunits. *J Biol Chem* 1992;267:7303–7309.

177. Finegold A, Shatwell K, Segal A, et al. Intramembrane bis-heme motif for transmembrane electron transport conserved in a yeast iron reductase and the human NADPH oxidase. *J Biol Chem* 1996;271:31021–31024.

178. Hurst JK, Loehr TM, Curnutte JT, Rosen H. Resonance raman and electron paramagnetic resonance structural investigations of neutrophil cytochrome b<sub>558</sub>. *J Biol Chem* 1991;266:1627–1634.

179. Segal AW, West I, Wientjes F, et al. Cytochrome b-245 is a flavocytochrome containing FAD and the NADPH-binding site of the microbicidal oxidase of phagocytes. *Biochem J* 1992;284:781–788.

180. Rotrosen D, Yeung CL, Leto TL, et al. Cytochrome b<sub>558</sub>. The flavin-binding component of the phagocyte NADPH oxidase. *Science* 1992;256:1459–1462.

181. Parkos CA, Dinauer MC, Jesaitis A, et al. Absence of both the 91 KD and 22 KD subunits of human neutrophil cytochrome b in two genetic forms of chronic granulomatous disease. *Blood* 1989;73:1416–1420.

182. Porter C, Parkar M, Verhoeven A, et al. p22-phox-deficient chronic granulomatous disease: reconstitution by retrovirus-mediated expression and identification of a biosynthetic intermediate of gp91-phox. *Blood* 1994;84:2767–2775.

183. Yu L, Zhen L, Dinauer MC. Biosynthesis of the phagocyte NADPH oxidase cytochrome b<sub>558</sub>. Role of heme incorporation and heterodimer formation in maturation and stability of gp91<sup>phox</sup> and p22<sup>phox</sup> subunits. *J Biol Chem* 1997;272:27288–27294.

184. Parkos CA, Dinauer MC, Walker LE, et al. Primary structure and unique expression of the 22 kilodalton light chain of human neutrophil cytochrome b. *Proc Natl Acad Sci U S A* 1988;85:3319–3323.

185. Dinauer MC, Orkin SH, Brown R, et al. The glycoprotein encoded by the X-linked chronic granulomatous disease locus is a component of the neutrophil cytochrome b complex. *Nature* 1987;327:717–720.

186. Leto TL, Adams AG, de Mendez I. Assembly of the phagocyte NADPH oxidase: binding of Src homology 3 (SH<sub>3</sub>) domains to proline-rich targets. *Proc Natl Acad Sci U S A* 1994;91:10650–10654.

187. Penting CP. Novel domains in NADPH oxidase subunits, sorting nexins and PtdIns 3-kinases: binding partners of SH<sub>3</sub> domains? *Protein Sci* 1996;5:2353–2357.

188. Cheever ML, Sato TK, de Beer T, et al. Phox domain interaction with PtdIns(3)P targets the Vam7 t-SNARE to vacuole membranes. *Nat Cell Biol* 2001;3:613–618.

189. Kanai F, Liu H, Field SJ, et al. The PX domains of p47<sup>phox</sup> and p40<sup>phox</sup> phagosome formation and maturation bind to lipid products of PI(3)K. *Nat Cell Biol* 2001;3:675–678.

190. Hirsch E, Katanaev VL, Garlanda C, et al. Central role for G protein-coupled phosphoinositide 3-kinase gamma in inflammation. *Science* 2000;287:1049–1053.

191. Ellson CD, Gobert-Gosse S, Anderson KE, et al. PtdIns(3)P regulates the neutrophil oxidase complex by binding to the P domain of p40<sup>phox</sup>. *Nat Cell Biol* 2001;3:679–682.

192. Foust LP, El Benna J, Babior BM, et al. The phosphorylation targets of p47<sup>phox</sup>, a subunit on the respiratory burst oxidase. Functions of the individual target serines as evaluated by site-directed mutagenesis. *J Clin Invest* 1995;96:1499–1505.

193. Inanami O, Johnson JL, McAdara JK, et al. Activation of the leukocyte NADPH oxidase by phorbol ester requires the phosphorylation of p47<sup>phox</sup> on serine 303 and 304. *J Biol Chem* 1998;273:9539–9543.



194. Dang PM-C, Cross AR, Quinn MT, Babior BM. Assembly of the neutrophil respiratory burst oxidase: a direct interaction between p67<sup>phox</sup> and cytochrome b<sub>558</sub> II. *Proc Natl Acad Sci U S A* 2002;99:4262–4265.
195. Karathanassis D, Stahelin RV, Bravo J, et al. Binding of the PX domain of p47<sup>phox</sup> to phosphatidylinositol 3,4-bisphosphate and phosphatidic acid is masked by an intramolecular interaction. *EMBO J* 2002;21:5057–5068.
196. Zhan Y, Virbasius JV, Song X, et al. The p40<sup>phox</sup> and p47<sup>phox</sup> PX domains of NADPH oxidase target cell membranes via direct and indirect recruitment by phosphoinositides. *J Biol Chem* 2002;277:4512–4518.
197. Ellson CD, Andrews S, Stephens LR, Hawkins PT. The PX domains: a new phosphoinositide-binding module. *J Cell Sci* 2002;115:1099–1105.
198. Ago T, Takeya R, Hiroaki H, et al. The PX domain as a novel phosphoinositide-binding molecule. *Biochem Biophys Res Commun* 2001;287:733–738.
199. McPhail LC. SH<sub>3</sub>-dependent assembly of the phagocyte NADPH oxidase. *J Exp Med* 1994;180:2011–2015.
200. Finan P, Shimizu Y, Gout I, et al. An SH<sub>3</sub> domain and proline-rich sequence mediate an interaction between two components of the phagocyte NADPH oxidase complex. *J Biol Chem* 1994;269:13752–13755.
201. de Mendez I, Garrett MC, Adams AG, Leto TL. Role of p67<sup>phox</sup> SH<sub>3</sub> domain in assembly of the NADPH oxidase system. *J Biol Chem* 1994;269:16326–16332.
202. Kuribayashi F, Nuno H, Wakamatsu K, et al. The adaptor protein p40<sup>phox</sup> as a positive regulator of the superoxide-producing phagocyte oxidase. *EMBO J* 2002;21:6312–6320.
203. Huang J, Kleinberg ME. Activation of the phagocyte NADPH oxidase protein p47<sup>phox</sup>. Phosphorylation controls SH<sub>3</sub> domain dependent binding to p22<sup>phox</sup>. *J Biol Chem* 1999;274:19731–19737.
204. Freeman JL, Abo A, Lambeth JD. Rac “insert region” is a novel effector region that is implicated in that activation of NADPH oxidase, but not PAK65. *J Biol Chem* 1996;271:19794–19801.
205. Nisimoto Y, Freeman JLR, Motalebi SA, et al. Rac binding to p67<sup>phox</sup>. Structural basis for interactions of the Rac1 effector region and insert region with components of the respiratory burst oxidase. *J Biol Chem* 1997;272:18834–18841.
206. Kim C, Dinauer MC. Rac2, an essential regulator of neutrophil nicotinamide adenine dinucleotide phosphate oxidase activation in response to specific signaling pathways. *J Immunol* 2001;166:1223–1232.
207. Diebold BA, Bokoch GM. Molecular basis for Rac2 regulation of phagocyte NADPH oxidase. *Nat Immun* 2002;2:211–215.
208. Nisimoto Y, Motalebi S, Han C-H, Lambeth J. The p67<sup>phox</sup> activation domain regulates electron transport flow from NADPH to flavin in flavocytochrome b<sub>558</sub>. *J Biol Chem* 1999;274:22999–23055.
209. Han C-H, Freeman JLR, Lee T, et al. Regulation of the neutrophil respiratory burst oxidase. Identification of an activation domain in p67<sup>phox</sup>. *J Biol Chem* 1998;273:16663–16668.
210. De Leo FR, Ulman KV, Davis AR, et al. Assembly of the human neutrophil NADPH oxidase involves binding of p67<sup>phox</sup> and flavocytochrome b to a common functional domain in p47<sup>phox</sup>. *J Biol Chem* 1996;271:17013–17020.
211. Ebisu K, Nagasawa T, Watanabe K, et al. Fused p47<sup>phox</sup> and p67<sup>phox</sup> truncations efficiently reconstitute NADPH oxidase and higher activity and stability than the individual components. *J Biol Chem*

2001;276:24498–24505.

212. Kobayashi T, Robinson JM. A novel intracellular compartment with unusual secretory properties in human neutrophil. *J Cell Biol* 1991;113:743–756.

213. Calafat J, Kuijpers TW, Janssen H, et al. Evidence of small intracellular vesicles in human blood phagocytes containing cytochrome b<sub>558</sub> and the adhesion molecules CD11b/CD18. *Blood* 1993;81:3122–3129.

214. Kobayashi T, Robinson JM, Seguchi H. Identification of intracellular sites of superoxide production in stimulated neutrophils. *J Cell Sci* 1998;111:81–91.

215. Wientjes FB, Segal AW, Harting JH. Immunoelectron microscopy shows a clustered distribution of NADPH oxidase components in the human neutrophil plasma membrane. *J Leukoc Biol* 1997;61:303–312.

216. Mandell GL, Hook EW. Leukocyte bactericidal activity in chronic granulomatous disease: correlation of bacterial hydrogen peroxide production and susceptibility to intracellular killing. *J Bacteriol* 1969;100:531–532.

217. Odell EW, Segal AW. Killing of pathogens associated with chronic granulomatous disease by the non-oxidative microbicidal mechanisms of human neutrophils. *J Med Microbiol* 1991;34:129–135.

218. Baehner RL, Nathan DG. Leukocyte oxidase: defective activity in chronic granulomatous disease. *Science* 1967;155:835–836.

219. Quie PG, White JG, Holmes B, Good RA. In vitro bactericidal capacity of human polymorphonuclear leukocytes: diminished activity in chronic granulomatous disease of childhood. *J Clin Invest* 1967;46:668–679.

220. Curnutte JT, Kuver R, Scott PJ. Activation of neutrophil NADPH oxidase in a cell-free system. Partial purification of components and characterization of the activation process. *J Biol Chem* 1987;262:5563–5569.

221. Babior BM, Kuver R, Curnutte JT. Kinetics of activation of the respiratory burst oxidase in a fully soluble system from human neutrophils. *J Biol Chem* 1988;263:1713–1718.

222. Casimir C, Chetty M, Bohler MC, et al. Identification of the defective NADPH-oxidase component in chronic granulomatous disease: a study of 57 European families. *Eur J Clin Invest* 1992;22:403–406.

223. Curnutte JT. Chronic granulomatous disease: the solving of a clinical riddle at the molecular level. *Clin Immunol Immunopathol* 1993;67:S2–S15.

224. Roos D, de Boer M, Kuribayashi F, et al. Mutations in the X-linked and autosomal recessive forms of chronic granulomatous disease. *Blood* 1996;87:1663–1681.

225. Cross AR, Heyworth PG, Rae J, Curnutte JT. A variant X-linked chronic granulomatous disease patient (X91<sup>+</sup>) with partially functional cytochrome b. *J Biol Chem* 1995;270:81–94.

226. Kuribayashi F, Kumatori A, Suzuki S, et al. Human peripheral eosinophils have a specific mechanism to express gp91<sup>phox</sup>, the large subunit of cytochrome b<sub>558-1</sub>. *Biochem Biophys Res Commun* 1995;209:146–152.

227. Williams DA, Tao W, Yang F, et al. Dominant negative mutation of the hematopoietic-specific Rho GTPase, Rac2, is associated with a human phagocyte immunodeficiency. *Blood* 2000;96:1646–1654.

228. The International Chronic Granulomatous Disease Cooperative Study Group. A controlled trial of interferon gamma to prevent infection in chronic granulomatous disease. *N Engl J Med* 1991;324:509–516.

229. Lomax KJ, Malech HL, Gallin JI. The molecular biology of selected phagocyte defects. *Blood Rev* 1989;3:94–104.

230. Hampton MB, Kettle AJ, Winterbourn CC. Inside the neutrophil phagosome: oxidants,

myeloperoxidase and bacterial killing. *Blood* 1998;92:3007–3017.

231. Fadok VA, Bratton DL, Frasch SC, Warner ML. The role of phosphatidylserine in recognition of apoptotic cells by phagocytes [see comments]. *Cell Death Differ* 1998;5:551–562.

232. Platt N, da Silva RP, Gordon S. Recognizing death: the phagocytosis of apoptotic cells. *Trends Cell Biol* 1998;8:365–372.

233. Fadok VA, Chimini G. The phagocytosis of apoptotic cells. *Semin Immunol* 2001;13:365–372.

234. Fadok VA, Bratton DL, Henson PM. Phagocyte receptors for apoptotic cells: recognition, uptake, and consequences. *J Clin Invest* 2001;108:957–962.

235. Fadok VA, de Cathelineau A, Daleke DL, et al. Loss of phospholipid asymmetry and surface exposure of phosphatidylserine is required for phagocytosis of apoptotic cells by macrophages and fibroblasts. *J Biol Chem* 2001;276:1071–1077.

236. Callahan MK, Williamson P, Schlegel RA. Surface expression of phosphatidylserine on macrophages is required for phagocytosis of apoptotic thymocytes. *Cell Death Differ* 2000;7:645–653.

237. Henson PM, Bratton DL, Fadok VA. The phosphatidylserine receptor: a crucial molecular switch? *Nat Rev Mol Cell Biol* 2001;2:627–633.

238. Leverrier Y, Lorenzi R, Blundell MP, et al. Cutting edge: the Wiskott–Aldrich syndrome protein is required for efficient phagocytosis of apoptotic cells. *J Immunol* 2001;166:4831–4834.

239. Leverrier Y, Ridley AJ. Requirement for Rho GTPases and PI–3 kinases during apoptotic cell phagocytosis by macrophages. *Curr Biol* 2001;11:195–199.

240. Casciola–Rosen L, Rosen A, Petri M, Schlissel M. Surface blebs on apoptotic cells are sites of enhanced procoagulant activity: implications for coagulation events and antigenic spread in systemic lupus erythematosus. *Proc Natl Acad Sci U S A* 1996;93:1624–1629.

241. Hermann M. Impaired phagocytosis of apoptotic cell material by monocytes–derived macrophages from patients with systemic lupus erythematosus. *Arthritis Rheum* 1998;41:1241–1250.

242. Jersmann HPA, Ross KA, Vivers S, et al. Phagocytosis of apoptotic cells by human macrophages: analysis by multiparameter flow cytometry. *Cytometry* 2003;51A:7–15.

243. Bratosin D, Mazurier J, Tissier JP, et al. Cellular and molecular mechanisms of senescent erythrocyte phagocytosis by macrophages. A review. *Biochimie* 1998;80:173–195.

244. Lutz HU. Red cell clearance (a review). *Biomed Biochem Acta* 1987;46:65–71.

245. Danon D, Marikorsky Y. The aging of the red cell. A multifactor process. *Blood Cells* 1988;14:7–15.

246. Kay MMB. Localization of senescent antigen on band 3. *Proc Natl Acad Sci U S A* 1984;81:5753–5757.

247. Kay MM, Bosman GJ, Johnson GJ, Beth AH. Band 3 polymers and aggregates and hemoglobin precipitates in red cell aging. *Blood Cells* 1988;14:275–295.

248. Turrini F, Arese P, Yuan J, Low PS. Clustering of integral membrane proteins of the human erythrocyte membrane stimulates autologous IgG binding complement deposition and phagocytosis. *J Biol Chem* 1991;266:23611–23617.

249. Ando K, Kikugawa K, Beppu M. Binding of an anti–Band 3 autoantibody to sialylated poly–N–acetyllactosaminyl sugar chains of band 3 glycoprotein on polyvinylidene difluoride membrane and sepharose gel: further evidence for anti–band 3 autoantibody binding to the sugar chains of oxidized and senescent erythrocytes. *J Biochem* 1996;119:639–647.

250. Henrich CJ, Aminoff D. Isolation and characterization of a glycopeptide from human senescent

erythrocytes. *Carbohydr Res* 1983;120:55–66.

251. Allen TM, Williamson P, Schlegel RA. Phosphatidylserine as a determinant of reticuloendothelial recognition of liposome models of the erythrocyte surface. *Proc Natl Acad Sci U S A* 1988;85:8067–8071.

252. Bratosin D, Mazurier J, Slomianny C, et al. Molecular mechanisms of erythrophagocytosis: flow cytometric quantitation of in vitro erythrocyte phagocytosis by macrophages. *Cytometry* 1997;30:269–274.

253. Robinson JP, Carter WO. Flow cytometric analysis of granulocytes. In: Bauer KDA, Duque RE, Shankey TV, eds. *Clinical flow cytometry. Principles and application*. Baltimore: Williams & Wilkins, 1993:405–433.

254. Seeds MC, Bass DA. Measurements of granulocytes oxidative metabolism. In: Laerum ODL, Bjernes R, eds. *Flow cytometry in hematology*. San Diego: Academic Press, 1992:131–152.

255. Lehman AK, Sörnes S, Haltensen A. Phagocytosis: measurement by flow cytometry. *J Immunol Methods* 2000;243:229–242.

256. Cheson BD, Christensen RL, Sperling R, et al. The origin of the chemiluminescence of phagocytosing granulocytes. *J Clin Invest* 1976;58:789–796.

257. Allen RC, Stjernholm RL, Steele RH. Evidence for the generation of an electronic excitation state(s) in human polymorphonuclear leukocytes and its participation in bactericidal activity. *Biochem Biophys Res Commun* 1972;47:679–684.

2004 Lippincott Williams & Wilkins  
John P. Greer, John Foerster, John N. Lukens  
George M. Rodgers, Frixos Paraskevas, Bertil Glader  
Wintrobe's Clinical Hematology

LYMPHOCYTESMORPHOLOGY OF LYMPHOCYTESLight MicroscopyTransmission Electron MicroscopyScanning Electron MicroscopyLYMPHOCYTE LOCOMOTIONIN VITRO BLAST TRANSFORMATIONPLASMA CELLSLYMPHOID ORGANSPrimary Lymphoid OrgansSecondary Lymphoid OrgansLYMPHOCYTE HOMING AND RECIRCULATIONHoming to Secondary Lymphoid OrgansDendritic Cell MigrationSpecial Homing PathwaysSignificance of Lymphocyte Homing and RecirculationREFERENCES**LYMPHOCYTES**

In the early part of the twentieth century, the main debate about the nature and function of the lymphocyte centered around its relationship to cells of the connective tissue and other inflammatory exudate cells. Lymphocytes were considered capable of transforming into granulocytes, monocytes, macrophages, fibroblasts, and other cells. Marschalko (<sup>1</sup>), Downey (<sup>2</sup>), Maximow (<sup>3</sup>), and Bloom (<sup>4</sup>) all believed that lymphocytes also gave rise to plasma cells. Scientific evidence for these assumptions was lacking, however, and in 1936, Rich said, “the complete ignorance of the function of this cell is one of the most humiliating and disgraceful gaps in all medical knowledge” (<sup>5</sup>). The first conclusive evidence that antibodies were formed within lymph nodes (LNs) was presented in 1935 by McMaster and Hudack (<sup>6</sup>), but it took another decade to prove conclusively that lymphoid cells within LNs were the cells that contained antibody (<sup>7</sup>, <sup>8</sup>). This discovery tipped the balance in favor of the lymphocytic theory of antibody production (<sup>9</sup>). In parallel with these studies, the classic work of Fagraeus (<sup>10</sup>) brought strong indirect evidence of the relationship of plasma cells to antibody production, and the conclusive demonstration by Coons et al. of the presence of antibodies within plasma cells by means of the new and powerful immunofluorescence technique is a landmark in the long debate on the origin of antibodies and the function of plasma cells (<sup>11</sup>, <sup>12</sup>). The only remaining question concerning whether plasma cells arise from lymphocytes was answered 10 years later by the elegant studies of Harris et al. in which they demonstrated indisputably the gradual change of a lymphocyte to an antibody-forming plasma cell by means of ultrastructural studies (<sup>13</sup>, <sup>14</sup> and <sup>15</sup>). At the same time, Nowell dispelled the myth that small lymphocytes are end-stage cells incapable of proliferating and taking on new functions (<sup>16</sup>).

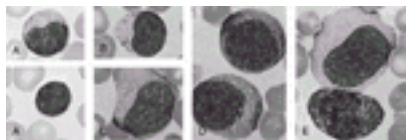
The lymphocytes consist of heterogeneous populations of cells that differ greatly from each other in terms of origin, life-span, preferred areas of settlement within the lymphoid

organs, surface structure, and function. Although some morphologic characteristics, such as size, granularity, and nucleocytoplasmic ratio, distinguish lymphocyte populations from each other, they provide no clues to their lineage and function. The most important, precise, and quantitative method in use in clinical laboratories is based on the identification of certain glycoproteins displayed on the membrane of lymphocytes and collectively called *markers*. Two remarkable discoveries have helped in the dissemination of routine application of marker analysis in clinical medicine: the development of monoclonal antibodies and the invention of flow cytometry (see [Chapter 3](#)).

## MORPHOLOGY OF LYMPHOCYTES

### Light Microscopy

Most lymphocytes in the blood are small (10  $\mu\text{m}$  or smaller), although larger forms are common ( [Fig. 15.1A](#)). Some of these large lymphocytes are known as *large granular lymphocytes* because they contain azurophilic granules in their cytoplasm ( [Fig. 15.1B](#)) ( [17](#), [18](#)). Often, the distribution of lymphocyte diameters does not yield the commonly described three peaks of small, medium, and large lymphocytes because the dimensions of the cells vary according to the method of preparation ( [19](#)). In blood smears stained with Romanovsky dyes, the nucleus is deep purplish blue, usually round or slightly indented and composed of dense aggregates of chromatin. Nucleoli are not visible with ordinary techniques, although a nucleolus may be seen in wet smears and histologic sections. The cytoplasm forms a narrow rim in small lymphocytes, but it may be abundant in larger cells. The cytoplasm is moderately basophilic and usually is devoid of granules, but larger cells may contain several bright reddish violet (azurophilic) granules that differ from the granules of myeloid cells in that they do not give the oxidase or peroxidase reaction.



**Figure 15.1.** Morphologic heterogeneity of human peripheral blood lymphocytes. **A:** Giemsa-stained blood smears: small and large lymphocytes. **B:** Large granular lymphocyte with azurophilic granules. **C:** Atypical lymphocyte. **D:** Lymphocytes resembling plasma cells (plasmacytoid) from the blood of a patient with viral pneumonia. **E:** One atypical lymphocyte and one plasmacytoid lymphocyte from peripheral blood. See [Color Plate](#).

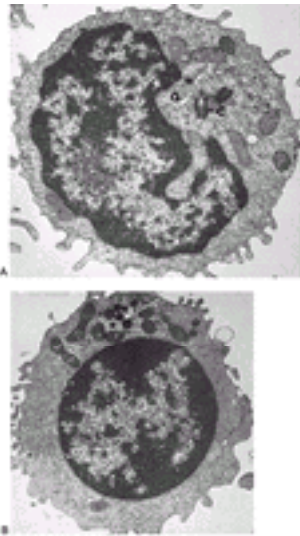
By phase contrast microscopic analysis, a well-defined centrosome can be observed. This area of the cytoplasm is adjacent to the nucleus, and because it is somewhat rigid, it may cause an indentation in the nucleus.

Often, transitional forms between lymphocytes and plasma cells are seen in the blood of patients with viral infections ( [Fig. 15.1C](#), [Fig. 15.1D](#), [Fig. 15.1E](#) and [Fig. 15.1E](#)). These cells are variously known as *lymphocytoid plasma cells* or *plasmacytoid lymphocytes*. They obviously represent morphologic stages of differentiation of antigenically stimulated lymphocytes.

### Transmission Electron Microscopy

The small lymphocyte (6 to 9  $\mu\text{m}$  in size) reveals a smooth, bilaminar cytoplasmic membrane that contains only a few microvilli, except in the area of the uropod of motile

cells ( Fig. 15.2) ( 20, 21, 22, 23 and 24). Occasional blebs, consisting of membrane-bound cytoplasm, are seen on the cell surface and may well be artifacts. The scanty cytoplasm of small lymphocytes shows a remarkable absence of organelles. The Golgi apparatus is small and usually is found near the nuclear notch. One or two centrioles are often seen in the appropriate plane of section. No organized endoplasmic reticulum is observed, although careful scrutiny may reveal one or two profiles. Many free ribosomes and occasional ribosome clusters are evident. Typical mitochondria are common, but lysosomes containing enzymes characteristic of these organelles are sparse. Dense bodies of unknown significance may also be seen occasionally. The cytoskeleton consists of occasional microtubules in the cytoplasm and microfilaments located adjacent to the cell membrane.



**Figure 15.2.** Ultrastructure of normal peripheral blood lymphocytes. **A:** A typical resting lymphocyte. The nucleus contains primarily heterochromatin in aggregates along the nuclear membrane. The nucleolus in lymphocytes is usually small. In the cytoplasm, the ribosomes are dispersed, but occasionally, a few short strands of rough endoplasmic reticulum are visible. The mitochondria are well developed and the centrioles ( *C*), longitudinally sectioned in this illustration, show evidence that the cell is ready to enter mitosis on triggering. The Golgi apparatus ( *G*) is small (  $\times 24,000$ ). **B:** This lymphocyte contains granules ( *arrow*) and is likely to correspond to the large granular lymphocyte variety. The cytoplasm is abundant and filled with ribosomes with a few strands of endoplasmic reticulum (  $\times 12,000$ ). (From Zucker-Franklin D, Greaves MF, Grossi CF. Atlas of blood cells, 2nd ed. Philadelphia: Lea & Febiger, 1988, with permission.)

The nucleus is enveloped by a double membrane that fuses at the site of nuclear pores. Abundant dense heterochromatin forms aggregates close to the membrane and less often within the body of the nucleus. These aggregates are separated by interchromatinic spaces containing chromatin, small bits of aggregated chromatin, ribosome-like particles, and fibrils. A nucleolus usually is seen. The medium lymphocyte is larger (6 to 8  $\mu\text{m}$ ) because of an increase in the amount of cytoplasm. The nucleus contains chromatin that is looser, is distributed in small blocks, and adheres only in part to the nuclear membrane. The Golgi apparatus is more developed than in the small lymphocyte. The cytoplasm also contains numerous polyribosomes and a few strands of endoplasmic reticulum, mostly parallel with the nuclear membrane.

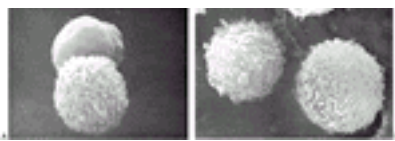
Lymphoblasts usually are larger cells (8 to 12  $\mu\text{m}$ ) with loose nuclear chromatin and a giant nucleolus that has a reticulated appearance. It occupies as much as one-third of the



nuclear area. The cytoplasm contains many polyribosomes, but cisternae of endoplasmic reticulum are scarce. Lymphocytes carry the normal diploid number of 44 autosomes and two sex chromosomes.

### Scanning Electron Microscopy

It was suggested originally that human peripheral blood lymphocytes could be separated into two broad categories on the basis of findings of scanning electron microscopy, depending on their cell-surface morphology ( [25](#), [26](#) ). One population had a fairly smooth surface, whereas the other was described as hairy, being covered by numerous microvilli ( [Fig. 15.3](#) ). The former was considered to correspond to thymus-derived (or T) lymphocyte, whereas the latter was thought to represent bone marrow-derived (or B) lymphocyte. Results of subsequent studies demonstrated that the surface features of lymphocytes depend on the methods used for preparation of the cells as well as the functional state of the cells ( [27](#), [28](#) ). Thus, lymphocytes stimulated by various mitogens have villi independent of their origin. In addition, both T and B lymphocytes have microvilli while in circulation and especially when they pass through the venules of LNs characterized by high endothelial cells ( [29](#) ). On the other hand, all lymphocytes have a smooth surface when they reach their respective home microenvironment ( [30](#) ). Therefore, the smooth cell surface likely is associated with resting lymphocytes, whereas the appearance of microvilli is triggered by environmental stimuli that interact with cell-surface receptors. These newly formed microvilli may help lymphocytes to interact with target substrates.



**Figure 15.3.** Heterogeneity of human lymphocytes by scanning electron microscope. **A:** A smooth and a villous lymphocyte, thought to correspond to that of T and B lymphocytes, respectively. The appearance of the lymphocytes, however, depends on the method of preparation; both lymphocytes are smooth when they rest in their microenvironments ( $\times 14,500$ ). **B:** Two villous cells in a preparation depleted of T cells ( $\times 14,500$ ). (From Zucker-Franklin D, Greaves MF, Grossi CF. Atlas of blood cells, 2nd ed. Philadelphia: Lea & Febiger, 1988, with permission.)

### LYMPHOCYTE LOCOMOTION

Lymphocyte locomotion ( [31](#) ) was described vividly by Lewis ( [32](#) ), who observed that the cell first extends a pseudopod separated from the rest of the cell by a groove that encircles the cell body. Eventually, as the groove deepens, the nucleus is pushed forward through the constriction ring, giving rise to the classic shape of the motile lymphocyte, resembling a hand mirror or pear. The advancing front is occupied by the nucleus, which is separated by a deep constriction from the rest of the cytoplasm that trails behind, forming the handle of the mirror. The cytoplasmic tail is called the *uropod* (from Greek *ura*, “tail,” and *pod*, “foot”) ( [Fig. 15.4](#) ) ( [33](#) ). It is studded with microvilli and microspikes, which vary in width from 12.5 to 200 nm and to as much as 0.8  $\mu\text{m}$  in length. The motile lymphocyte moves with an average speed of 20  $\mu\text{m}/\text{minute}$ . In general, motility increases with the state of cell activation as lymphoblasts demonstrate greater locomotion than small lymphocytes. It could therefore be stated that locomotion is enhanced by stimuli inducing blast transformation ( [34](#) ). The uropod not only is associated with locomotion but

also serves as a site for a variety of interactions with lymphocytes, macrophages, and other cells ( [35](#) ). In mixed lymphocyte cultures, lymphocytes may approach macrophages and then turn around to establish contacts with them through their uropods. The locomotion of lymphocytes around macrophages has been called *peripolesis* ( [36](#) ) to distinguish it from *emperipolesis* (“inside roundabout wandering”), which describes the penetration of malignant cells by lymphocytes ( [37](#) ). T lymphocytes also adhere to macrophages by means of uropods, forming clusters or rosettes ( [38](#) , [39](#) ). A stable cluster forms only when macrophages and lymphocytes are exposed to antigen. The T lymphocytes within clusters are stimulated into proliferative activity. In general, uropod formation is a morphologic expression of lymphocyte activation as measured by DNA synthesis ( [34](#) , [40](#) ).



**Figure 15.4.** Lymphocyte locomotion. The lymphocyte assumes the characteristic hand-mirror configuration. The nucleus occupies the front, and part of the cytoplasm forms a tail or uropod ( *Ur* ), which displays an elaborate pattern of microspikes ( *Ms* ). A small pseudopod ( *Ps* ) on the side contains only ribosomes. (From Rosenstreich DI, et al. The uropod-bearing lymphocyte of the guinea pig. Evidence for thymic origin. *J Exp Med* 1972;135:1037, with permission.)

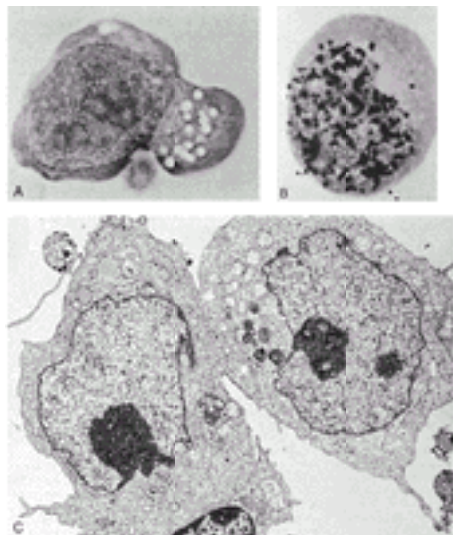
The locomotion of lymphocytes is strikingly different from that of other cells. Lymphocytes move forward in a steady manner, maintaining the hand-mirror shape, whereas myeloblasts express a wriggling wormlike locomotion, and the cells of the monocytic series change shape and direction continuously ( [41](#) ).

Although it was suggested that uropod formation is a characteristic of T lymphocytes ( [34](#) ), B lymphocytes also form uropods after stimulation with antiimmunoglobulin antibodies ( [42](#) ). In this case, the uropod forms after capping of the surface immunoglobulin (Ig) is completed; the cap ultimately is found over the uropod, where it is endocytosed. The uropod also has been known to serve as a site for endocytosis of foreign substances ( [40](#) ). Ultrastructurally, the uropod contains practically all of the cytoplasmic organelles, including the Golgi apparatus, mitochondria, microfilaments, and microtubules.

## ***IN VITRO* BLAST TRANSFORMATION**

In addition to specific antigens, lymphocytes also can be activated in a nonspecific manner by substances known collectively as *mitogens*. The activation of lymphocytes by nonspecific mitogens is known as *blast transformation*. The term *mitogen* generally refers to all substances capable of inducing cell division by mitosis. The mitogens used most commonly are lectins of plant origin that bind to carbohydrates. Some of these lectins have specificity for either T or B lymphocytes, whereas others stimulate both. The mitogen studies conclusively demonstrated that the two types of lymphocytes differentiate along different pathways. The B lymphocyte becomes a plasma cell with rich endoplasmic reticulum, whereas the T lymphocyte has a different blast morphology, rich in cytoplasmic organelles, something that had not been clearly demonstrated at that time. Thus, phytohemagglutinin (PHA), derived from the red kidney bean *Phaseolus vulgaris*, activates T lymphocytes, and pokeweed mitogen (PWM), derived from the roots of *Phytolacca americana*, triggers Ig secretion from B cells in the presence of T cells. Activation of lymphocytes by mitogens requires binding of mitogen to appropriate receptors, which is an obligatory step in the process of lymphocyte activation (43). Cross-linking and receptor redistribution ensue. Certain properties of the ligand, such as its valency, and its physical state, such as its solubility, play important roles in determining the selective response of one or the other lymphocyte populations. For example, concanavalin A in soluble form stimulates only T lymphocytes; when immobilized on plastic surfaces, it also activates B cells (44).

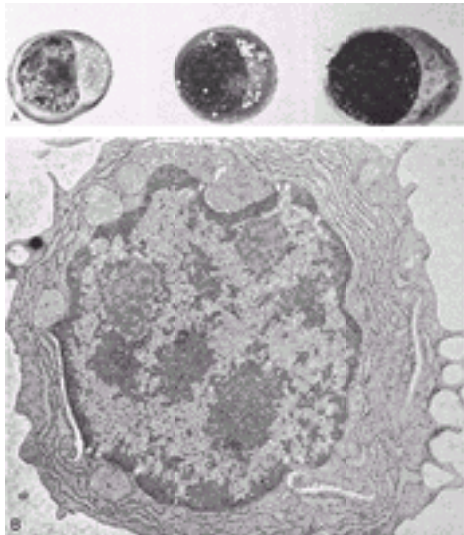
Lymphocytes transformed by PHA are large (10 to 20  $\mu\text{m}$ ), with dark blue cytoplasm resulting from an increase in the RNA content (Fig. 15.5A) (45, 46). Frequent mitotic figures are first seen at 40 hours and peak at 72 hours. By autoradiographic analysis, thymidine grains are concentrated over the nucleus (Fig. 15.5B). The nucleus enlarges and becomes leptochromatic. Changes in the nucleoli are seen early and consist of an increase in the size and concentration of the granules in the granular zone and later in the intranucleolar chromatin (Fig. 15.5C). Striking cytoplasmic changes include an overall increase in the amount of cytoplasm, increased numbers of ribosomal clusters, and an enlarged Golgi complex.



**Figure 15.5.** Phytohemagglutinin (PHA)–stimulated lymphocytes. **A:** Characteristic blast, 72 hours after PHA stimulation. Note prominent nucleoli and vacuolization of the cytoplasm. **B:** A blast cell incorporating  $^3\text{H}$ –thymidine 48 hours after PHA stimulation. **C:** Ultrastructure of the blasts is characterized by thinly distributed chromatin in the nucleus (contrast to resting lymphocyte depicted in Fig. 15.2) and a large prominent nucleolus (

*dark area*) ( $\times 3600$ ). ( **A** and **B** from Yoffey JM, et al. Morphological studies in the culture of human lymphocytes with phytohaemagglutinin. *Br J Haematol* 1965;11:488, with permission.)

Human peripheral blood lymphocytes transformed with PHA acquire a highly elaborate vacuolar system consisting of endocytic vesicles, multivesicular structures, and dense bodies ( [47](#) ). The various components of the vacuolar system have their origin in the endocytic vesicles and are involved in uptake, transport, storage, and digestion of endocytosed material. This intense lysosomal vesicle formation constitutes a striking feature of PHA stimulation and correlates with enhanced endocytic activity ( [48](#) ). Transformation by PWM peaks at 72 hours and involves 50 to 60% of the lymphocytes. Three types of cells have been identified in culture: nontransformed small lymphocytes, blasts morphologically similar to plasmablasts, and immature plasmacytes ( [Fig. 15.6](#) ) ( [49](#), [50](#) ). The latter have an eccentric nucleus with clumped chromatin. The Golgi complex is well developed, and the endoplasmic reticulum is well organized. These changes provide morphologic evidence of Ig synthesis stimulated by PWM.

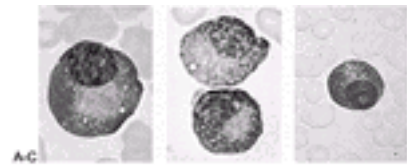


**Figure 15.6.** Plasmacytic differentiation of lymphocytes stimulated by pokeweed mitogen (PWM). **A:** Three large plasmablast type of cells 72 hours after PWM stimulation. (From Chessin LN, et al. Studies on human peripheral blood lymphocytes in vitro. II. Morphological and biochemical studies on the transformation of lymphocytes by pokeweed mitogen. *J Exp Med* 1966;124:873, with permission.) **B:** A cell with well-developed endoplasmic reticulum in the peripheral blood of a child 24 days after ingestion of pokeberries ( $\times 12,000$ ). (From Barker BE, et al. Ultrastructural properties of pokeweed-stimulated leukocytes in vivo and in vitro. In: Rieke WO, ed. *Proceedings of the 3rd Annual Leukemia Culture Conference*. New York: Appleton-Century-Crofts, 1969, with permission.)

## PLASMA CELLS

Plasma cells are progeny of lymphocytes, although originally they were considered to constitute a separate and independent cell line. Morphologically, they are differentiated easily from other cell types ( [Fig. 15.7A](#) ). The cells are spherical or ellipsoid and range from 5 to 30  $\mu\text{m}$  in size. The cytoplasm is abundant, always is basophilic, and usually is deep blue; it may have a granular character. Plasma cells have a well-defined perinuclear

clear zone that contains the Golgi apparatus. In supravitaly prepared films, the cytoplasm of plasma cells is deep yellowish gray. The nucleus is small in relation to the cell size; it is round or oval, eccentrically placed, and contains dense masses of chromatin, often arranged in a wheel-spoke fashion (Radkern).



**Figure 15.7.** Plasma cells. **A:** Normal plasma cell. **B:** Plasmacytes with vacuoles from the bone marrow of a patient with infection and arthritis. **C:** Needle type of inclusions in plasma cell. See [Color Plate](#). ( **C** used by permission of the American Society of Hematology Slide Bank, 3rd ed, 1990.)

With use of the electron microscope ( [Fig. 15.8A](#)), the surface membrane and the nucleus appear to be similar to those of the lymphocyte. The cytoplasm of the plasma cell is characterized by a well-developed rough endoplasmic reticulum that fills most of the cytoplasmic space, except in the area of the perinuclear clear zone containing the Golgi apparatus. The endoplasmic reticulum consists of lamellae arranged in various patterns, usually in parallel convolutions. The inner surfaces of the lamellae are smooth and form the walls of spaces (cisternae) that are filled with amorphous products of varying density. The outer aspects of the lamellae are rough because of attached ribosomes. A few mitochondria may be seen.



**Figure 15.8.** Electron micrographs of a plasma cell and an intermediate form. **A:** Typical plasma cell has cytoplasm filled with endoplasmic reticulum (  $\times 6000$ ). **B:** A lymphocytoid-plasma cell with scant amounts of cytoplasm filled with endoplasmic reticulum and a few mitochondria ( *m*) (9900). N, nucleus. (From Maldonado JE, et al. “Intermediate” cell types and mixed cell proliferation in multiple myeloma: electron microscopic observations. *Blood* 1966;27:212, with permission.)

The above-described electron microscopic appearance of plasma cells is the most typical. Often, however, intermediate forms are found ( [14](#)). Thus, some cells may resemble small lymphocytes morphologically but may contain an unusually well-developed rough endoplasmic reticulum ( [Fig. 15.8B](#)). Such intermediate cells ( [Fig. 15.1C](#), [Fig. 15.1D](#), and [Fig. 15.1E](#)) are common in the blood of patients with plasma cell dyscrasias ( [51](#)) and of those with immunologic diseases characterized by hypergammaglobulinemia ( [51](#)). Similar cells have been encountered in the blood of patients with viral infections (Turk cells) ( [20](#)), including infectious mononucleosis, as well as in the blood of apparently healthy individuals ( [23](#)). Alternatively, immature plasma cells may have an appearance more akin to that of PHA-transformed cells; the nucleus is large and leptochromatic and the cytoplasm contains a rather simple endoplasmic reticulum, but many ribosomes and



polyribosomes are present. Thus, it is often difficult to draw sharp cytologic dividing lines. Other plasma cells may contain vacuoles or needle-type inclusions in the cytoplasm ( [Fig. 15.7B](#), [Fig. 15.7C](#)). The molecular and genomic aspects of plasma cell differentiation are discussed in [Chapter 16](#).

## LYMPHOID ORGANS

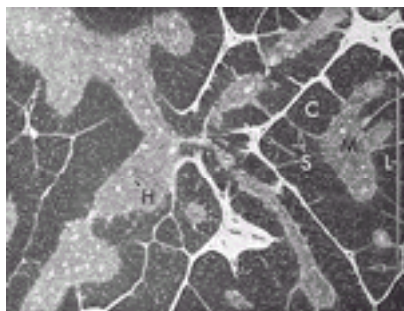
The tissue aggregates of the immune system are separated into primary and secondary lymphoid organs. In humans, the primary lymphoid organs are the bone marrow and the thymus. The secondary lymphoid organs are the spleen, LNs, the Peyer patches (PPs) of the gut, and the Waldeyer ring (tonsils and adenoids). This division provides an anatomic basis for two fundamental stages of lymphocyte differentiation: the antigen-independent stage and the antigen-dependent stage. The primary lymphoid organs develop before the secondary organs in ontogeny and provide the proper microenvironment for antigen-independent differentiation of lymphocytes from immature precursors. At the end of this early stage of lymphocyte differentiation, immunocompetent lymphocytes are released and home to specific areas of the secondary lymphoid organs. The secondary lymphoid organs provide an optimal microenvironment for attracting antigen-specific lymphocytes, directing the terminal stages of lymphocyte differentiation and distributing the fully differentiated effector cells or their products to other parts of the body. The following section is a description of the architecture of the lymphoid organs as it pertains to the function of the immune system ( [52](#)).

### Primary Lymphoid Organs

**BONE MARROW** A detailed account of the histologic features and function of bone marrow is given in [Chapter 6](#). This chapter briefly concentrates on the contribution of bone marrow in lymphopoiesis as a “primary lymphoid organ.” The bone marrow is the major hematopoietic organ in humans and supports differentiation of all blood cells ( [53](#), [54](#) and [55](#)). In some cases, such differentiation is not always complete. T lymphocytes and monocytes, for example, reach their final stages of maturation in locations outside the bone marrow. The bone marrow is divided into two histologically distinct compartments: an extravascular compartment, which is the site of hematopoiesis, and a vascular compartment, composed of wide venous blood vessels known as *sinuses*. These vessels receive blood from the nutrient artery and the periosteal capillary network. The sinuses are radially disposed in the bone marrow and eventually open into larger, centrally located sinuses that exit through the same foramina used by the nutrient arteries. The walls of the venous sinuses consist of an endothelial layer, a basement membrane, and the adventitia. The endothelial cells are flat, with tapering ends, and contain the usual organelles. They contain lysosomes and therefore are endowed with endocytic activity. The adventitial cells have broad sheetlike processes that form a reticulum, the interstices of which are occupied by the hematopoietic cells. Volume changes in the body and the processes of the adventitial cells affect the volume of the hematopoietic space. Under some circumstances, the adventitial cells become swollen because of an increased fat content, and the gross appearance of the marrow turns from red to yellow. In conditions of increased demand on the hematopoietic process, the fatty adventitial cells decrease in size, allowing an expansion of the hematopoietic compartment. The adventitial cells are related to the reticular cells found in the splenic cords and are therefore called *adventitial reticular cells*. The hematopoietic compartment displays a specific cellular arrangement of hematopoietic cells. For example, the megakaryocytes lie close to the adventitial cells and deliver platelets directly into the sinuses through apertures in the sinus walls. Erythrocytes are produced near the sinuses, forming erythroblastic islets. Granulocytopoiesis takes place at a distance from the sinus wall in a diffuse pattern or sometimes in distinct clusters or sheets. Available evidence obtained through labeling techniques suggests that new lymphocytes are formed at the periphery of the bone

marrow and move toward the center in a centripetal fashion. In mice given  $^3\text{H}$ -thymidine, the largest number of labeled cells and cells with the highest number of grains indicating the highest rate of DNA synthesis are found near the periphery when the marrow is examined 1 hour after injection of the label ( 56 ). Later, labeled cells are detected in all regions. However, RAG1 transcribing cells were identified scattered throughout the marrow, even in mice homozygous for RAG/GFP, in which progression beyond the prolymphocyte stage is blocked ( 57 ). The lymphocyte progenitors are enriched in a prolymphocyte population  $\text{Lin}^- \text{c-kit}^{\text{lo}}$ , which can be separated from RAG1/GFP knock-out mice. They contain progenitors for B cells, which are  $\text{CD122}^-$  [interleukin (IL)-2 $\beta$ ] and for natural killer (NK) cells, which are  $\text{CD122}^+$ , and under defined culture conditions can mature toward B or NK lineage. B-cell differentiation can be blocked in the presence of  $\beta$ -estradiol. Stem cells, or early lymphoid progenitors, or prolymphocytes populate the thymus under certain conditions. The labeling index of lymphocytes within the sinuses is intermediate between those of the whole bone marrow and those in the peripheral blood, suggesting that newly synthesized lymphocytes are discharged into the circulation. Identifiable lymphocytes are found singly or in small groups near the sinusoidal walls, with some of them in transit through the wall of the sinus ( 58 ). B lymphocytes acquire membrane Ig while located extravascularly. B lymphocytes are not stored in the bone marrow except for brief periods before their release into the circulation. Histologically, no lymphoid follicles are distinguishable in the normal bone marrow. Mature cells pass into the lumen of sinuses. The bone marrow resembles the red pulp of the spleen with its vascular sinuses and a reticular meshwork formed by the adventitial cells or the cordal reticular cells, respectively. It differs in that the bone marrow circulation is closed; the circulation of the red pulp is at least partially open, with no endothelial continuity between the arteries and the veins.

**THYMUS** The thymus is a lymphoepithelial organ situated in the superior mediastinum ( 59 , 60 and 61 ). It consists of two lobes that are divided into lobules that form the basic anatomic units of the thymus. The thymus is covered by a fibrous capsule from which fibrous bands (trabeculae) penetrate the parenchyma, dividing it into lobules. Histologically, the lobules have two distinct regions ( Fig. 15.9): the peripheral region, which is called the *cortex* and is divided into the outermost or subcapsular cortex and the inner or deep cortex, and the central region, which is called the *medulla*. In hematoxylin-eosin-stained sections, the cortex appears dark blue to purple because of the predominance of lymphocytes (80 to 85%), whereas the medulla appears eosinophilic because of the predominance of the epithelial cells. These anatomic divisions correspond to functionally distinct microenvironments that support specific phases of thymocyte differentiation. The subcapsular or superficial cortex contains large, actively dividing blasts with many mitotic figures. The deep cortex is composed principally of nondividing, small thymocytes, and the medulla contains predominantly medium-sized thymocytes. The relationships between the thymocytes in each compartment and the mechanisms underlying thymocyte differentiation are discussed in detail in [Chapter 17](#).



**Figure 15.9.** Histology of thymus shows lobules ( *L* ) consisting of cortex ( *C* ) and medulla ( *M* ). *H*, Hassall corpuscles; *S*, septa (trabeculae).

**Ontogeny** The human thymus develops from the third branchial pouch on each side, and,

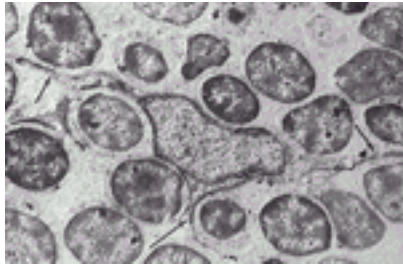


at the 10-mm embryo stage, it consists of a cylindrical prolongation that extends caudally. By the 35-mm stage, the part closest to the mediastinum is separated from its connection to the pharynx and lies free in the mediastinum. Although evidence suggests that endoderm from the third pharyngeal pouch and ectoderm from the third pharyngeal cleft provide epithelial elements to the thymic anlage, the extent of the contribution from each layer is the subject of some controversy. Initially, the thymic anlage is hollow (cervical vesicle), but in the mouse, the cavity disappears by day 13 of gestation, and the epithelial rudiments become solid. However, small ductular or cystic structures are recognizable during thymic involution in immune deficiencies and in certain thymomas that are thought to reproduce early ontogenetic stages (62). Polycystic structures are the histologic hallmark of the thymus of the nude mouse (62) and the nude rat (63), animals that lack normal T lymphocyte differentiation and constitute the definitive model of immune deficiency. Normally, the original tubular epithelial structures, one on each side, descend into the anterior superior mediastinum where they fuse, forming the mature organ with two lobes. At this stage, the thymus is triangular, with the base resting on the pericardium and the apex pointing toward the neck. The first step in thymic development is the formation of the lymphoid thymic anlage, which originates from epithelial cells from the third pharyngeal pouch (64). The genes important at this stage are Pax9 (pharyngeal endoderm) and Hox-a3 (pharyngeal endodermal mesenchyme) (65, 66). Targeted mutations of Hox-a3 (Hox1.5) gene results in athymic embryos with other craniofacial abnormalities (67). Once the anlage is formed, the function of the whn (winged helix nude) gene is required (68, 69). The whn gene encodes a nuclear protein, Whn, which is a transcription factor of the forked/winged/helix family. It contains a DNA binding domain and a strongly acidic transcriptional activation domain, which is functionally indispensable. Mutations affect the DNA binding domain or the C-terminal transcriptional activation domain and are associated with athymia and hairlessness because the gene regulates the keratinization of hair. Mesenchyme of neural crest origin also plays an important role in thymic development (70). It migrates into the thymus early in development, surrounding the epithelial rudiments, and is closely associated with the developing thymocytes. It forms the connective tissue capsule and trabecular septa that penetrate the parenchyma, dividing it into lobules (70). It is also likely that it provides extracellular matrix into the cortex and medulla, such as hyaluran, collagen, and fibronectin, which may be important for the presentation of growth factors to the thymocytes (71). This part of mesenchymal development occurs after the lymphocytic invasion. The undifferentiated epithelial cells are large, with dispersed chromatin, short, blunt cytoplasmic processes, and sparse tonofilaments. As the cell matures, the amount of cytoplasm decreases, and long dendritic processes form. By day 14 in the mouse, tonofilaments and desmosomes develop (72), which permit tight junctions between adjacent cells and the formation of the epithelial framework, within the interstices of which T lymphocyte differentiation takes place. Around day 11 to 13 in mice, the epithelium is colonized by basophilic blast cells that originate outside of the thymus and give rise to the lymphocytic population. Migrating lymphoid progenitors initiate a symbiotic relationship with the epithelial cells and contribute to the organization of the thymic microenvironments. Whereas prothymocytes (i.e., immature cells) regulate induction of the cortical microenvironment (73), mature TCR<sup>+</sup> thymocytes organize thymic medullary epithelial cells (74, 75). E-cadherin plays an important role at this stage because it mediates the interactions that shape the architecturally distinct cortical and medullary thymic microenvironments (76). In mice, blocking the homophilic E-cadherin interactions interferes with differentiation into these two distinct epithelial phenotypes and blocks early thymocyte differentiation (i.e., progression from the double negative to the double positive stage). E-cadherin is strongly expressed on epithelial cells as well as on the double negative (CD4<sup>-</sup> CD8<sup>-</sup>) thymocytes in mice, suggesting its participation in the interaction between these two cell types. However, in human thymus, homophilic interactions cannot occur because E-cadherin is not expressed in thymocytes but is detected on epithelial cells. CD103 (a E $\beta$  7 integrin),

the ligand for E-cadherin, is expressed on a subpopulation of double negative (CD4<sup>-</sup> CD8<sup>-</sup>) and single positive CD8<sup>+</sup> thymocytes. Therefore, heterotypic interactions enhance thymocyte proliferation in the human thymus ( [77](#), [78](#) ). The thymic anlage is permeated by blood vessels, which also contribute to a well-organized medullary epithelial compartment, even in the absence of CD3<sup>+</sup> mature thymocytes (i.e., in Rag-2<sup>-/-</sup> mice. These animals develop a hypoplastic thymus (due to lack of mature T cells), but the medullary epithelium is otherwise well organized. Addition of keratinocyte growth factor, a member of the fibroblast growth factor family secreted from mesenchymal cells, results in the expansion of the epithelial medullary compartment in the Rag2<sup>-/-</sup> mice ( [79](#) ). The relB gene encoding a subunit of the nuclear factor- $\kappa$ B complex is critical in coordinating several aspects of the development and organization of medullary epithelial cells and dendritic cells (DCs). Overexpression of CD40L on thymocytes disrupts the thymic architecture and the epithelial differentiation, with loss of cortical epithelial cells, expansion of the medullary compartment, and infiltration of the capsule with a mixture of CD3<sup>+</sup> cells, B cells, and macrophages ( [80](#) ). These findings point out that regulation of normal development of thymus is a highly complex process, delicately regulated by multiple cellular interactions and soluble factors released as a result of these interactions. The medullary epithelium is quite heterogeneous and expresses several molecules, which are considered tissue specific, such as parathyroid hormone, thyroglobulin, insulin, C-reactive protein, and even structures with features of respiratory epithelium and others, which phenotypically and structurally resemble thyroid follicles. This may represent “promiscuous” gene expression or a “mosaic” of epithelial differentiation ( [81](#) ). Nevertheless, it is highly intriguing, and it may form the basis for the establishment of self-tolerance. This view is supported by the demonstration that the gene *aire*, which is defective in autoimmune-polyendocrinopathy-candidiasis-ectodermal dystrophy, is expressed by medullary thymic endothelial cells ( [82](#) ). Expression of *aire* is regulated by rel-B signaling. Indisputable evidence from experiments involving interspecies grafting leaves little doubt that the lymphoid elements of the thymus are always derived from the recipient of the endodermal pharyngeal graft and therefore did not arise from the graft. Furthermore, the migration of the lymphoid stem cells into the epithelial rudiment takes place in waves of stem cells entering the rudiment only at certain periods during which the epithelium is receptive. This receptivity apparently is determined by chemoattractants released from the epithelial cells ( [83](#) ).

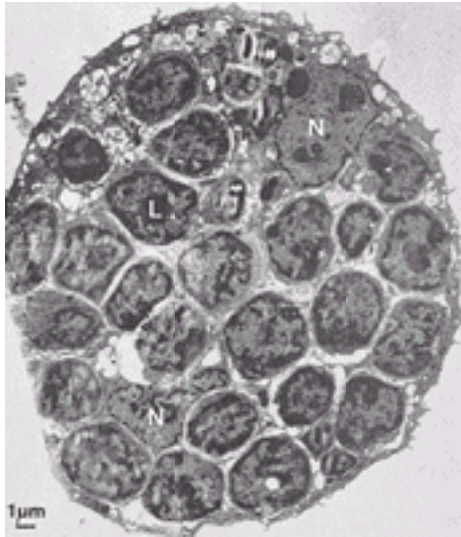
### **Nonlymphoid Cellular Elements**

**Epithelial Cells** Ultrastructurally, the epithelial cells are phenotypically highly heterogeneous, probably reflecting their divergent origins (see [Chapter 17](#)) ( [84](#), [85](#) and [86](#) ). In the past, the epithelial cells have been referred to by a variety of designations, such as *reticular*, *syncytial*, *epithelioia*, and *squamoid*. The epithelial cells in the cortex have cytoplasmic processes as long as 25  $\mu$ m that are now known as *dendritic epithelial cells* ( [Fig. 15.10](#) ). The characteristic features that distinguish them from other cells in the thymic parenchyma are the presence of tonofilaments and desmosomes. The tonofilaments are filamentous structures approximately 3.0 nm in diameter and 0.1 to 3.0  $\mu$ m in length. They often form bundles and are located close to the nucleus. Desmosomes are detected at the junctions of the dendritic processes of adjacent epithelial cells ( [59](#), [84](#) ). Their oval nuclei have evenly distributed chromatin and prominent nucleoli. The epithelial cells joined by desmosomes form a continuous meshwork that surrounds the trabeculae, the blood vessels, and the inner surface of the capsule. Between the epithelial sheath and the supporting scaffolding of the trabeculae and blood vessels is a continuous basement membrane distinct from the basement membrane of the capillaries. The epithelial meshwork thus separates cavernous spaces filled with thymocytes.



**Figure 15.10.** Ultrastructure of the thymus. An epithelial DC at center ( *E*) extends long cytoplasmic processes ( *arrows*). Note the intimate contact between the epithelial cell and the surrounding thymocytes (4400). (From Bloodworth JMB Jr, et al. Ultrastructure of the human thymus, thymic tumors, and myasthenia gravis. *Pathol Annu* 1975;10:329, with permission.)

Dendritic epithelial cells are found predominantly in the cortex, and because they do not have secretory granules, they probably do not participate in the secretion of thymic hormones. They guide thymocyte differentiation through cellular interactions taking place on their surface. Such interactions are regulated by products of genes of the major histocompatibility complex. Indeed, the presence on epithelial cells of class I and II molecules in mice ( [87](#)) and humans ( [88](#)) has been demonstrated. The distribution of class II antigens is typically dendritic in the cortex, but it is confluent in the medulla ( [89](#)). The class II antigens are of higher density than the class I antigens in cortical epithelial cells, but they are of the same high density in the medullary epithelium. Using immunohistochemical techniques and electron microscopy, investigators have shown that these molecules are of epithelial origin because they are located on cells containing desmosomes and tonofilaments ( [90](#), [91](#)). Class II antigens are first detected on fetal epithelial cells on day 14 of gestation in the mouse ( [92](#)), approximately 2 to 3 days after the arrival of lymphoid stem cells. It is intriguing that nude mice, animals absolutely deficient of mature T lymphocytes, have a total lack of class II antigens in the thymic rudiment. The thymocyte–epithelial cell interaction in the outer cortex results in the formation of lymphoepithelial complexes known as *nurse cells* ( [Fig. 15.11](#)) ( [93](#)). These complexes are composed of large clusters of lymphocytes surrounded by cell membrane and appear to reside within the cell body of an epithelial cell. Their significance in T–cell differentiation is discussed in [Chapter 17](#). The epithelial cells of the medulla do not have long dendritic processes and are known as *epithelioic* or *spatulate epithelia* cells. They are more pleomorphic and contain dark granular inclusions that may have secretory functions. Another variety of epithelial cells, known as *squamoia*, is found exclusively in the medulla ( [84](#)). These cells probably give rise to Hassall corpuscles and contain dense bundles of tonofilaments and masses of keratohyalin.



**Figure 15.11.** A typical large nurse cell containing many thymocytes ( *L* ) and two epithelial nuclei ( *N* ). Between the internalized thymocytes are cytoplasmic vesicles and tonofilaments. Some nurse cells contain thymocytes in mitosis. (From Wekerle H, et al. Thymic nurse cells. Lympho–epithelial cell complexes in murine thymuses: morphological and serological characterization. *J Exp Med* 1980;151:925, with permission.)

The Hassall corpuscles are solid or cystic, and their origin is highly disputed. In 1906, Hammar suggested that Hassall corpuscles arise as solid structures through the tight apposition of as many as 20 to 50 epithelial cells in a concentric fashion. Degenerative changes in the centrally located cells produce the cystic forms. The cavity of the cystic forms of these corpuscles is lined with epithelial cells with villous projections, and sometimes it is filled with debris and degenerated cells. In some solid corpuscles, keratinization is prominent and is similar to that of the skin. Monoclonal antibodies specific for high–molecular–weight keratins that react with terminally differentiated epithelial cells of the skin also bind to Hassall corpuscles ( [60](#), [94](#) ). Epithelial cells of the deep cortex are phenotypically different from those in the medulla ( [95](#), [96](#) ), which undergo terminal keratinocyte differentiation ( [97](#) ). Schambacher ( [97a](#) ) suggested that the lining cells of small ductules give rise to the solid forms as a result of proliferative activity. Whatever their origin, their function remains unknown. Some authors suggest that Hassall corpuscles function as the graveyard of thymocytes ( [98](#), [99](#) ) or that they represent remnants of the medullary duct epithelium.

**Macrophages** Macrophages are found throughout the thymus: among thymocytes, in capsular and septal connective tissues, and in the perivascular space. Some macrophages are surrounded by thymocytes and form rosette–like structures. Thymic macrophages direct thymocyte maturation. Others contain debris and lymphocytes in various stages of degeneration and appear to be involved in the disposal of many thymocytes dying within the thymus. Macrophages are more prominent in involuted thymuses after stress or steroid hormone treatment, rendering the histologic picture of a starry sky. Lymphocyte phagocytosis is found in the germinal center (GC), a site that also is characterized by high proliferative activity.

**Interdigitating Dendritic Cells** A third population of nonlymphoid cells in the medulla is known as *interdigitating* DCs (IDCs). These cells are of bone marrow origin and belong to the newly recognized family of IDCs present in the T–cell–dependent areas of the peripheral lymphoid organs. They contain an irregularly shaped nucleus and clear cytoplasm, but they lack the Birbeck granules characteristic of Langerhans cells (LCs). In interspecies avian grafting experiments, investigators showed that the interdigitating cells enter the thymus with the first lymphoid stem cell wave and continuously thereafter ( [100](#) ). In the mouse, the DCs are CD8a<sup>+</sup>, derived from a common precursor with T cells ( [101](#) ). The thymic DCs are lymphoid related [i.e., granulocyte–macrophage colony–stimulating

factor is not required for their development (in contrast to the myeloid DCs), and they need functional Ikaros transcription factors for their maturation] ([102](#)). In humans, pluripotent stem cells, which leave the bone marrow to migrate to the thymus, have the potential to develop into T cells and DCs ([103](#)).

**Myoid Cells** Myoid cells contain numerous intracytoplasmic filaments arranged in a haphazard fashion and are seen in many lower vertebrates. Their presence in human fetal thymuses has been documented, but their identification in postnatal thymuses remains controversial. One suggestion is that myoid cells originate from mesenchymal or epithelial cells. The latter seems likely because of their attachment to epithelial cells by desmosomes.

**Lymphoid Cells** Lymphoid cells constitute 80 to 85% of the cortical and 15% of the medullary cells. The outer cortex lymphocytes are large blast cells with dark blue cytoplasm that proliferate actively. They are the immediate descendants of bone marrow-derived prothymocytes, which enter the thymus and migrate to the subcapsular cortex. As they mature, they move into the deeper cortex, which is occupied by small nondividing thymocytes. The medullary thymocytes are of medium size and are considered emigrant cells, although this fact has not been proven conclusively. The differentiation and the relationship between subcapsular, deep cortical, and medullary thymocytes are discussed in [Chapter 17](#).

**Thymic Vasculature: Blood–Thymus Barrier** The thymic anlage initially is avascular. Vessels penetrate the thymus at approximately 12 to 14 weeks of gestation. The thymic arteries, which are branches of the inferior thyroid, internal mammary, and pericardial phrenic arteries, enter the thymus from the surrounding tissues, pass down to the medulla, and branch into arterioles that penetrate into the deep cortex. Capillaries that arise from the arterioles run toward the subcapsular cortex, where they anastomose and turn inward toward the medulla, eventually forming venules ([104](#), [105](#), [106](#), [107](#), and [108](#)). This arrangement may serve as a countercurrent exchange mechanism to reduce the concentrations of substances present in the blood of the centrifugal capillaries ([109](#)). The vessels are ensheathed with epithelial cells and connective tissue that is continuous with the capsule. Histologically, therefore, a number of layers can be distinguished from the lumen of the blood vessels outward: endothelium; the vascular basement membrane; a mesenchymal perivascular connective tissue space occupied by collagen fibers, fibroblasts, some macrophages, and other cells; an epithelial basement membrane; and the epithelial cell syncytium. These layers constitute the blood–thymus barrier. The mesenchymal interstitial space is probably formed in the early stages of development when the thymic epithelial cells envelop the blood vessels. This space is considered extraparenchymal. The tightness of the barrier has been tested with particulate and protein tracers. It is tight in the cortex, mainly because of the impermeability of the endothelial junctions. Traces of protein transported by plasmalemmal vesicles of the endothelial cells and released on the parenchymal front are removed rapidly by the macrophages along the vessels in the interstitial space and thereby are prevented from coming into contact with the thymocytes. The barrier is incomplete in the medulla, however, especially along the site of thymocyte migration through the wall of venules ([107](#)). The fact that antigens can be detected in the thymus indicates that the “barrier” has leaks ([110](#)). Nevertheless, experimental tracers never reach the cortical parenchyma. This arrangement of the vasculature and epithelial sheaths separates the thymus into the intraparenchymal compartment, composed of the lymphoepithelial complex, and the extraparenchymal compartment, composed of the blood vessels and the surrounding interstitial space.

**Involution** Beginning at puberty, the thymus undergoes a gradual process of involution, characterized by loss of the cortical lymphocytes and atrophy of epithelial cells and their replacement by fat originating from mesenchymal cells present in the connective tissues along the vasculature and capsule. More than 50% of the thymus is replaced by adipose tissue by the age of 40 to 45 years, but the fat is still contained in the extraparenchymal compartment, separated from the remaining lymphoepithelial complex by the epithelial basement membrane and the sheet of epithelial cells. The speed of age-related involution



may be influenced by stress and other factors. In contrast to the chronic involution occurring as a result of aging, the thymus undergoes acute involution as a result of stress. This involution is mediated by adrenal corticosteroids ( [111](#), [112](#) and [113](#)). Injections of glucocorticoids eliminates as much as 75% of the thymocytes within 2 to 3 days. The changes affect both the cortex and the medulla but are more pronounced in the cortex. Most of the cortical thymocytes are cortisone sensitive, whereas the medullary thymocytes are cortisone resistant. After acute stress, the lymphocytes undergo pyknotic changes, fragmentation of the nuclei, and a decrease in size; eventually, they are phagocytosed by macrophages. Recovery takes place within 8 to 10 days and is marked by an early increase in mitotic activity in the subcapsular cortex.

### ***Pathology of the Human Thymus***

***Myasthenia Gravis*** The thymus from patients with myasthenia gravis typically shows histologic changes characterized by the development of follicles with GCs composed of B cells typical of reactive peripheral lymphoid organs ( [84](#), [114](#), [115](#), [116](#) and [117](#)). They are located outside the epithelial basement membrane, predominantly in the medulla, and are surrounded by many Hassall corpuscles. Many plasma cells are easily discernible ( [118](#)). In some cases, an increase in the number of medullary epithelial cells containing thymic hormones is noted ( [119](#)). The cause of these histopathologic lesions is unknown. Antibodies against the acetylcholine receptor in the neuromuscular junction play an important role in the pathogenesis of myasthenia gravis ( [120](#)), and it is intriguing that the receptor, or a structurally similar antigen, has been detected on thymic cells ( [121](#), [122](#)). Antibodies from patients with myasthenia gravis react with striations of myoid cells from animal and human thymuses in culture and muscle cells expressing acetylcholine receptors ( [123](#), [124](#)). Approximately 10 to 15% of patients with myasthenia gravis have thymomas, but these histologic changes are not characteristic of myasthenia gravis in that they have been observed in patients with other diseases, such as endocrinopathies (Addison disease and thyrotoxicosis) and autoimmune diseases (such as systemic lupus erythematosus). Similar lesions have been identified in thymuses from patients with multiple sclerosis ( [125](#)). A well-documented fact is that the thymus and the brain share some antigens, such as the Thy-1 antigen (CD90).

***Dysplasia*** The thymus of patients with severe combined immunodeficiency disease is characterized by scant lymphocytes with reduced numbers of epithelial cells.

***Thymomas*** Tumors of the thymus are epithelial or lymphocytic, or they contain a mixture of both cellular elements ( [84](#), [126](#)). In some cases, ductal and glandular structures are detected, mixed with other epithelial cells. These cases are thought to imitate the early ontogenetic stages of the thymic anlage and support the view of the double origin of the thymic epithelium. Thymic lymphomas that appear as mediastinal masses are associated with T-cell acute lymphatic leukemia in children ( [127](#)). The cells of these tumors bear the phenotype of cortical thymocytes in the early stages of their development.

## **Secondary Lymphoid Organs**

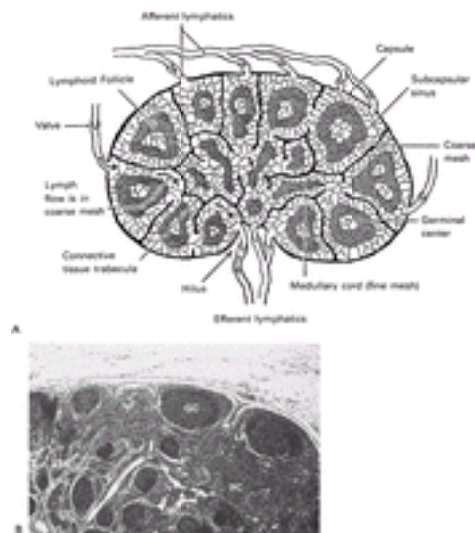
### **LYMPH NODES**

***Ontogeny*** The ontogeny of the secondary lymphoid organs, LN, PPs, and spleen, is highly complex ( [128](#), [129](#)). The fundamental concepts of lymphoid organ neogenesis were generated approximately 100 years ago ( [130](#)). But only now are they verified by the identification of the genes, their products, and the cells that orchestrate the building of the “homes” where the mature T and B lymphocytes, out of the primary lymphoid organs, will be homing to. The first stage in the development of the LN and PP is the budding from large vessels of lymph sacs, which are then penetrated by connective tissue and lymphatic vessels. These vessels interconnect with other vessels, forming a network ( [130](#)). These original observations have been verified by the identification of the genes and the determination of the time of their expression during embryogenesis. The Prox-1 gene is expressed on lymphatic endothelial cells and is required for budding and sprouting of the

lymphatic endothelium ( [131](#) ). Sabin ( [130](#) ) observed that one spot of budding to generate a lymph sac occurs in the anterior cardinal veins of the neck. This lymph sac gives rise to the lymphatics of the neck, thorax, heart, lungs, and forelegs. In the same location, the expression of the Prox-1 gene was identified. Lymphotoxin (LT) is essential for the formation of LN and PP, as shown in  $LT\alpha^{-/-}$  mice in which there is a profound defect in the formation of LN, complete absence of PP, and grossly disturbed splenic microarchitecture. The membrane form of LT is the active signaling molecule in LN and PP biogenesis ( [132](#) ).  $LT\alpha$  forms heterotrimers with  $LT\beta$  ( $LT\alpha_1\beta_2$ ) and exists as a membrane-bound form on the cell surface.  $LT\alpha_1\beta_2$  does not bind to either of the two tumor necrosis factor (TNF) receptors but to its own receptor, the LT- $\beta$  receptor (LTBR) ( [133](#) ). After completion of the connective tissue structure, the first cells to colonize the LN in mice express the phenotype  $CD4^+ CD45^+$  ( [134](#) ). These cells are not T cells because they are  $TCR^-$  and  $CD3^-$  but express  $LT\alpha_1\beta_2$ . They cannot differentiate to either T or B lymphocytes but stimulated by IL-2, they can differentiate towards NK cells and with a combination of other cytokines give rise to antigen-presenting cells ( [134](#) ). The precursors of these cells are IL-7R positive and reside in the liver ( [135](#) ). The generation of the  $CD45^+ CD4^+ CD3^-$  cells, from the liver precursors, requires the function of the ROR $\gamma$  gene ( [136](#) ). Another gene that has also been implicated in the generation of the  $CD45^+ CD4^+ CD3^-$  is Id2.  $Id2^{-/-}$  mice lack all LN and PP but have normal spleen ( [137](#) ). Id2 gene is a negative regulator (i.e., its product blocks the helix-loop-helix proteins and thus allows differentiation of the  $CD4^+ CD3^-$  cells). Finally, the development of all LN (but not of the PP) depends on the TRANCE/TRANCE-R signaling. TRANCE (or RANK-L, OPG-L) is a member of the TNF family of cytokines, and mice deficient in TRANCE have absent LN and a serious defect in bone development due to the absence of osteoclasts ( [138](#) ). The TRANCE $^{-/-}$  (RANK) mice also show a complete absence of LN but normal PP ( [139](#) ). Mutation of another gene "aly" (alymphoplasia) results in complete absence of LN and PP and lack of well-defined lymphoid follicles in the spleen ( [140](#) ). Development of B-cell-rich lymphoid follicles requires the function of the B lymphocyte chemoattractant (BLC) or CXCL13 and its receptor CXCR5, which stimulates homing of B lymphocytes to the follicles. BLC induces up-regulation of a  $\beta_2$  LT, which promotes follicular DC development and BLC expression, establishing a positive feedback loop ( [141](#) ). Colonization of the paracortical areas by T cells is regulated by another system of chemokine and its receptor (see [Lymphocyte Homing and Recirculation](#)).

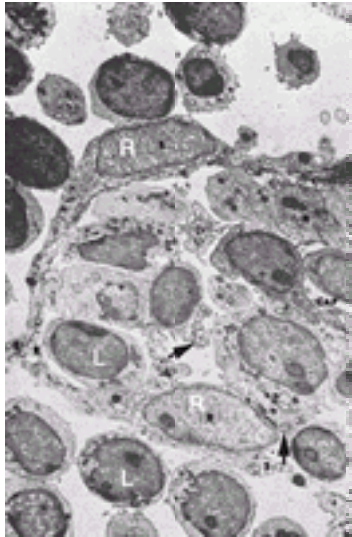
**Structure** The LNs are ovoid structures ranging in size from a few millimeters to more than a centimeter ( [142](#), [143](#) and [144](#) ). They are particularly common at the base of extremities, in the retroperitoneum and the mediastinum, and along blood vessels. LNs are surrounded by a fibrous capsule from which trabeculae penetrate the parenchyma, forming a fibrous supporting meshwork. Blood vessels enter and leave LNs through the hilum. Histologically, two regions can be distinguished: a peripheral cortex and a central medulla. The cortex is subdivided into the superficial cortex, located immediately beneath the capsule, and the deep cortex or paracortex, which is located toward the center of the node ( [Fig. 15.12](#) ). To gain a clear understanding of LN function, it is useful to regard LNs as consisting of the reticulum and the cellular compartment.



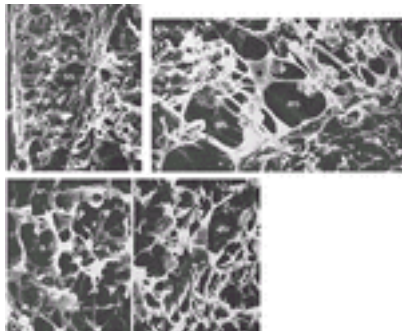


**Figure 15.12.** Lymph node. **A:** Drawing of a lymph node. **B:** Cross section of a normal lymph node. GC, germinal centers; LF, lymphocytic follicles; MC, medullary cords; PC, paracortical lymphoid areas. See [Color Plate](#).

**Lymph Node Reticulum** The basic framework of the LN is composed of trabeculae made of bundles of collagen and a few elastic fibers ([145](#), [146](#)). This fibrous reticulum is argyrophilic when silver impregnation techniques are applied, forming a closely knit spongelike framework, with the fibers branching frequently and anastomosing freely with each other. The fibers penetrate dense lymphatic tissue and also surround the sinuses. They are ensheathed by two kinds of cells ([Fig. 15.13](#)). On the side that borders the dense lymphoid tissue, the fibrous reticulum is covered by thin, elongated cells that have been identified as fibroblasts or fibroblastic reticulum cells. They have large nuclei and endoplasmic reticulum in their cytoplasm. Cytoplasmic processes join similar processes of adjacent cells and form a continuous cellular sheath (cellular reticulum), which separates the fibrous reticulum from the dense lymphoid tissue. On the side bordering the sinuses, the fibers are covered by flat cells containing multiple vesicles. These are the littoral or endothelial cells lining the sinuses. The littoral cells have no basement membrane. Fibers sometimes cross the sinuses and are covered by endothelial cells ([Fig. 15.14](#)). They divide the lumen into smaller interconnecting compartments. These trabeculae not only provide mechanical support for the sinuses but also slow the flow of the lymph, enhancing the opportunities for phagocytosis by macrophages present along their course or lining the sinus walls. The sinuses originate from a foramen on the inner wall of the subcapsular sinus where afferent lymphatics terminate. The outer wall of the subcapsular sinuses are formed by the capsule of the LN. The sinuses follow the fibrous trabeculae through the LN parenchyma. Viewed from this perspective, the reticulum divides the LN into two distinct spaces. One consists of conventional vascular channels, the sinuses, which are sparsely occupied by cells and have a rapid rate of flow. This compartment of the LN facilitates lymphocyte traffic. The other division may be regarded as vascular spaces with unique characteristics: they are lined by fibroblasts, are tightly packed with lymphocytes and other cells, and have slow rates of flow. Immune responses take place in this compartment through cellular interactions. Both of these spaces communicate through pores in the inner wall of the subcapsular sinus.



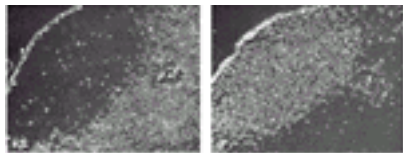
**Figure 15.13.** Ultrastructure of a lymph node. The area in the center and to the right is occupied by dense lymphoid tissue with many lymphoid cells. It is separated from the sinus ( *upper area, left, and below*) by flat endothelial cells lining the sinus ( *s*), bulky reticular cells ( *R*) bordering the dense lymphoid tissue, and collagenous fibers ( *c*) between the two cellular layers. Arrows indicate collagenous fibers traversing the dense lymphoid tissue. Cap, blood capillary. (From Clark SL Jr. The reticulum of lymph nodes in mice studied with the electron microscope. *Am J Anat* 1962;110:217, with permission.)



**Figure 15.14.** Ultrastructure of a lymph node. **A:** Subcapsular sinus ( *SS*) traversed by trabeculae ( *arrows*) stretches between the capsule ( *Cs*) and the parenchyma ( *LF*) (  $\times 600$ ). **B:** Medullary sinus ( *MS*) with medullary cord ( *MC*) and a meshwork of trabeculae ( *asterisk*). (  $\times 1900$ ). **C:** Lymphoid parenchyma and the meshwork of trabeculae ( *arrows*) separating intercommunicating cavernous spaces normally occupied by lymphocytes ( *Ly*). ( *left*,  $\times 1100$ ; *right*,  $\times 1600$ ). BV, blood vessel. (From Luk SC, et al. The architecture of the normal lymph node and hemolymph node. A scanning and transmission electron microscopic study. *Lab Invest* 1973;29:258, with permission.)

**Cellular Compartments** The most abundant type of cell in the LN is the lymphocyte. In the region beneath the capsule, known as the *cortex*, the lymphocytes are arranged in clusters known as *follicles*. If the follicle is composed of uniform small lymphocytes, it is a primary follicle; if it contains pale, lightly stained, blastlike cells with a euchromatic nucleus at its center, it is a secondary follicle. The central zone of the secondary follicle is called a *germinal center* (GC). The GC is the hallmark of antigenic stimulation. In the secondary follicles, the lymphocytes that surround the GC constitute the mantle or crescent. These cells were so named by Flemming in 1885 because he considered them “breeding grounds for the generation of lymphocytes” ( [147](#)). Later, Hellman called them “reaction centers,” important in the induction of immunity ( [148](#)). In the areas between the follicles, lymphocytes are distributed diffusely (diffuse cortex). The region that separates

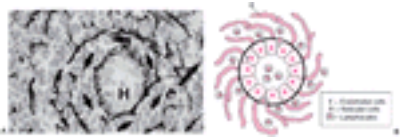
the cortex from the medulla is the deep cortex or paracortex and contains tightly packed lymphocytes. The histologic arrangement of lymphocytes in the LN corresponds to distinct functions performed by separate classes of lymphocytes ( [Fig. 15.15](#)). The follicles are occupied by B lymphocytes and represent the sites of intense activity during humoral (antibody) responses (see [Chapter 16](#)). Two types of lymphoid cells are present in the GC: the centroblasts (noncleaved), which are large and activated B lymphocytes, and the centrocytes (cleaved), which are small and are derived from the centroblasts. The centroblasts are located at the bottom of the GC (dark zone), and the centrocytes are located at the upper part (apical zone). The role of the GC in the maturation of the antibody response is discussed in [Chapter 16](#). A subpopulation of centroblasts expresses a phenotype characteristic of Burkitt cells ( [149](#)). GCs also contain a subset of T cells ( [150](#) ), which are CD4<sup>+</sup>, CD45RO<sup>+</sup>, and CD57<sup>+</sup> ( [151](#) ), and belong to the Th2 subset. These T cells are important in initiating T–B cell interactions for antibody formation. A large number of B lymphocytes not selected for antibody synthesis (or generation of memory cells) die by apoptosis and are disposed of by phagocytic macrophages known as *tingible body macrophages*.



**Figure 15.15.** B- and T-cell-dependent areas of the lymph node. Frozen section of a mouse lymph node was examined by immunofluorescence with an antiimmunoglobulin antiserum (**A**) or an antiserum to T cells (**B**). **A:** Only the follicle fluoresces (B-cell-dependent area). **B:** The paracortex fluoresces brightly (T-cell-dependent area), whereas the follicle remains dark except for a few scattered fluorescent T cells. These are CD4<sup>+</sup> helper T cells, which migrate to the germinal center because they express the chemokine receptor CXCR5 and are attracted to its ligand, BCA-1 chemokine released from cells in the follicle (see [Lymphocyte Homing and Recirculation](#)). (From Weissman IL, et al. The lymphoid system. Its normal architecture and the potential for understanding the system through the study of lymphoproliferative diseases. *Hum Pathol* 1978;9:25, with permission.)

The mantle of the follicle is composed of small lymphocytes that morphologically appear identical. However, they are functionally and phenotypically heterogeneous. A small number are small lymphocytes not yet antigenically stimulated that have arrived from the bone marrow, are immunologically competent, and express both IgM and IgD ( [152](#) ). The majority are small, recirculating, and indistinguishable from the previous set but may have responded to T-independent antigens. A third population are memory B cells, which are long lived and recirculating, and express IgG or IgA. Some of the B lymphocytes of the mantle are CD5<sup>+</sup>. The relationship of this lymphocyte to CD5<sup>-</sup> B cells is discussed in [Chapter 16](#). The paracortex and diffuse cortex constitute the T-cell compartments that undergo histologic changes during cell-mediated immunity. Sometimes in the paracortex, nodules consisting of IDCs and T cells are formed after an immune response ( [153](#), [154](#) ). Cross sections of paracortex stained with special stains show a set of concentric rings, which form barriers or walls separating vascular spaces in between, where the lymph flows ( [Fig. 15.16](#)). This structure constitutes the paracortical cord ( [155](#) ) with its center in the high endothelial venule (HEV) (see description later in this section). Lymphocytes exit the HEV through an interendothelial route and emerge into the perivenular channels (PVCs) ( [156](#) ), which is the space between the abluminal side of the endothelium and the surrounding pericytes. These channels are bounded by pericytes or fibroblastic reticular cells (FRCs). FRCs circumscribe the HEV with at least two layers of overlapping cells. Flow of lymphocytes through PVCs is rate limiting because the PVC around the HEV is extremely narrow, and lymphocytes must distend the channel to flow through it. On emergence from PVCs, the lymphocytes enter a space packed densely with cells, known

as the *corridor*. The wall of the corridor is a network of FRCs. Corridors are wide and can accommodate two lymphocytes side by side. Their walls are reticular fibers consisting of collagen, which are enclosed by FRCs. The FRCs leave a tiny space surrounding the fibers, which is called the *conduit*. The corridors allow cellular interactions. Slowly moving T cells sample antigens on stationary DCs, “shaking hands much like the receiving line at a wedding” ( [156](#) ). The conduit, on the other hand, is a specialized system where fluid carries soluble factors important for the immune functions of the lymphocytes. The corridor space, where flow is slow, is separated from the sinuses, where flow is fast, by the reticular fibers and the endothelium of the sinuses.



**Figure 15.16.** Cross section of a paracortical cord showing the corridor, outlined by reticular fibers stained by Gomori stain. **A:** The corridor encircles the high endothelial venule in the center ( *H* ). **B:** The drawing represents an “idealized” cross section of panel **A**. See [Color Plate](#). (Courtesy of Drs. Gretz, Anderson, and Shaw. From Gretz JE, Anderson AO, Shaw S. Cords, channels, corridors, and conduits: critical architectural elements facilitating cell interactions in the lymph node cortex. *Immunol Rev* 1997; 156:11–24, with permission.)

In the medulla, the cells are arranged in cords (medullary cords) composed of lymphocytes, macrophages, and plasma cells.

**Other Cells: Dendritic Cells** The functions of lymphocytes are predicated on their interactions with other cells, such as macrophages and DCs. Macrophages are found in large numbers in the walls of the sinuses and in the dense lymphoid regions. They phagocytose and rapidly remove foreign substances. Within minutes after injection, foreign substances are found in the phagolysosomes of medullary macrophages. Macrophages therefore contribute in an important way to the filtering functions of LNs as they capture and destroy infectious agents. In the process of phagocytosing foreign material, macrophages process antigen for presentation to lymphocytes, especially the T lymphocytes. Antigen presentation, however, is mediated by other non-phagocytic professional antigen-presenting cells, generally known as *dendritic cells* (DCs) ( [157](#) ). Their name vividly describes their morphology, with long arborizing cytoplasmic processes or dendrites (from the Greek *dendron*: tree), extending from the cell body for long distances. Within the LN, there are two distinct populations of DCs: one resides in the follicles, known as a *follicular DC* or *FDC*, and the second in the paracortex, known as *interdigitating DC* or *IDC*. Their origins, functions, and cellular associations are distinct. FDCs are autochthonous, whereas IDCs are immigrants that arrive from remote parts of the body using the routes of the lymphatic vessels. FDCs are found in the follicles and have an irregularly shaped nucleus with long, beaded cytoplasmic processes. They are not phagocytic and retain antigen for prolonged periods. The FDCs capture immune complexes and function as arbiters of life and death for emerging centrocytes based on high or low affinity, respectively, of their receptor for antigen (see [Chapter 16](#)). They also have been implicated in the generation of memory lymphocytes, the maintenance of antibody production with the formation of plasma cells. Two types of FDCs have been described, one with filiform and one with beaded dendrites ( [158](#) ). The FDCs interact with B lymphocytes through adhesion molecules such as intercellular adhesion molecule-1 (ICAM-1) (CD54) and vascular cell adhesion molecule-1 (VCAM-1) (CD106), which interact with the ligands LFA-1 (CD11a/CD18 or a  $\alpha\beta_2$  integrin) and VLA-4 (CD49d), respectively, on the surface of the B cells ( [159](#) ). The FDC network may be disrupted in angioimmunoblastic lymphadenopathy, acquired immunodeficiency syndrome, and Hodgkin disease ( [160](#), [161](#) ). Electron microscopic studies of the primary follicles detected reticulum cells, with little or no evidence of phagocytic activity, making contacts with neighboring cells by very tight adhesions or desmosomes ( [162](#) ). These “reticulum cells” are stellate in



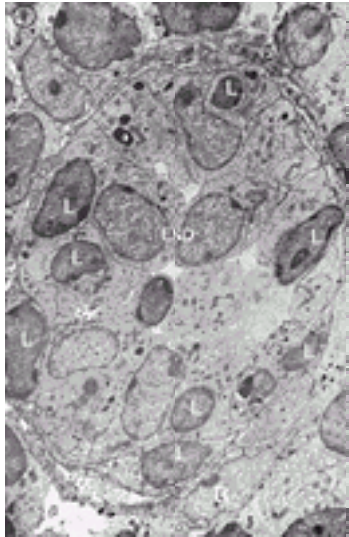
shape, have long cytoplasmic processes, and are probably of mesenchymal origin. GC FDCs probably derive from the primary follicle reticulum cells. Dendritic reticulum cells do not ensheath collagenous fibers and therefore are distinct from the fibroblastic reticulum cells that form and ensheath the collagenous fibers. The IDCs are located in the paracortex ( [163](#) ). They extend numerous cytoplasmic processes that surround T cells. The IDC is not phagocytic but carries antigen from the periphery to present it to T cells in the paracortex of the LNs. Tight junctions between IDCs and T lymphocytes have been detected by electron microscopy and become particularly prominent after stimulation with antigens that elicit strong cell-mediated immunity. Their cytoplasm is electron lucent and contains lysosomelike vesicles and tubular structures extending to the periphery of the cell. The IDCs are S100<sup>+</sup> and CD1a<sup>+</sup>. The paracortical T-cell nodules consist of T cells, large numbers of IDCs, and endothelial venules, and may be the *in vivo* equivalent of the clusters formed *in vitro* between T cells and antigen-presenting cells. Therefore, they are important in the generation of antigen-specific T lymphocytes. T-cell nodules are detected next to B-cell follicles, forming the “composite nodules.” Prominent T-cell nodules are detected in dermatopathic lymphadenitis where large numbers of LCs migrate from the areas of inflamed skin. Similar changes are also seen in regional LNs draining areas of T-cell lymphomas involving the skin. Mechanisms and routes of migration of IDCs are discussed in the section [Dendritic Cell Migration](#).

### **Vasculature**

**Ontogeny** Growth factors of the vascular endothelial growth factor (VEGF) family control lymphangiogenesis. They activate VEGF-specific receptors of which VEGFR-3 (Flt4) has been implicated in the regulation of lymphatic development and lymphangiogenesis. VEGF-C and VEGF-D are important in lymphangiogenesis. Both are processed after synthesis and form mature dimers of the VEGF domain. Both bind with high affinity to VEGFR-2 and VEGFR-3 expressed on endothelial cells. VEGFR-3 is a receptor tyrosine kinase with seven extracellular Ig-like domains and cytoplasmic tyrosine kinase domain ( [164](#), [165](#) and [166](#) ).

**Lymphatic Vessels** Afferent lymphatics pierce the capsule and empty into subcapsular sinuses ( [167](#) ). Cortical sinuses originate from the subcapsular sinus and often run along the trabeculae and through the cortex to the medulla, where they become medullary sinuses. Eventually, the sinuses give rise to the efferent lymphatic vessels that leave the LN at the hilum.

**Blood Vessels** The artery enters the LN at the hilum, gives rise to arterioles that reach the cortex along the trabeculae, and finally split into a rich network of capillaries. The capillaries empty into venules that extend from the cortex to the medullary cords and eventually exit from the hilum as veins. The venules linked most immediately to the capillaries possess unique endothelial cells that are tall and cuboidal and therefore contrast with the endothelial linings of other venules that usually are low or flat. The HEVs ( [Fig. 15.17](#) and [Fig. 15.18](#) ) are the sites at which lymphocytes migrate from the blood circulation into the lymphatic circulation ( [168](#) ). The high endothelial cells have abundant cytoplasm, and their luminal surface is covered by a 1.5-nm-thick coat composed of filamentous and granular material. This coat may signal passing lymphocytes to cross the HEV wall ( [169](#) ). On the basis of the content of their polyribosomes, two types of cells are distinguished by electron microscopy; one is lighter and one darker ( [170](#) ), and the latter is also intensely pyroninophilic. The cytoplasm also contains numerous microtubules that radiate from the centriole, as well as multiple dense bodies that probably are related to lysosomes but also may function as storage sites for glycoproteins used in the formation of the cell coat. One striking morphologic feature is the large Golgi complex with myriad vesicles, a characteristic associated more commonly with actively secreting cells than with endothelial cells ( [169](#) ). Indeed, these cells secrete chemokines, which direct transendothelial migration of lymphocytes in HEV (see section [Lymphocyte Homing and Recirculation](#)).



**Figure 15.17.** A postcapillary venule is practically occluded by the tall endothelial cells (*End*). Some lymphocytes (*L*) are crossing the wall of the high endothelial venule and enter the lymph node. The wall is surrounded by reticular cells (*R*) ( $\times 4500$ ). (From Clark SJL Jr. The reticulum of lymph nodes in mice studied with the electron microscope. *Am J Anat* 1962;110:217, with permission.)



**Figure 15.18.** Lymphocytes crossing the high endothelial venule (HEV). Lymphocyte migration is shown in successive stages (1–4). After attachment to the luminal surface of an endothelial cell (1), the lymphocytes insinuate between endothelial cells (2) and cross the basement membrane (3) and a sheath of reticular cells (RC) surrounding the HEV (4). The endothelial cells are attached to the neighboring cells by junctional complexes and to the perivascular sheaths by foot processes (FF). (From Anderson AO, Anderson ND. Lymphocyte emigration from high endothelial venules in rat lymph nodes. *Immunology* 1976;31:455, with permission.)

The bulky nucleus protrudes into the lumen and contains a well-developed reticulated nucleolus ([143](#)), characteristics of a metabolically highly active cell. Acid hydrolase activity and nonspecific esterases that are not present in other endothelia have been detected in these cells, as well as a peculiar ability to shift to anaerobic metabolism. The height of the endothelial cells and their metabolic activity are influenced by the number of circulating T lymphocytes. Neonatal thymectomy and chronic thoracic duct drainage ([171](#), [172](#)) in mice and rats result in flattening of the endothelium, loss of pyroninophilia, and absence of lymphocytes migrating through the HEV wall. Infusion of lymphocytes into these animals reconstitutes the normal morphologic appearance of HEV. In congenitally athymic (nude) mice ([173](#)) and rats ([174](#), [175](#)), the endothelium of HEVs is flat. Some evidence also has implicated the macrophages as playing a regulatory role in determining the morphology and metabolic activity of the endothelial cells ([176](#)). The HEVs are surrounded by layers of sheaths that derive from cytoplasmic plates of reticular cells

linked to the fibrous reticulum of the LN ( [167](#) ). These sheaths may regulate the passage of lymphocytes to the LN while limiting fluid leakage and providing vascular support ( [Fig. 15.16B](#) ). When Marchesi and Gowans ( [177](#) ) originally identified the HEVs as the site for lymphocyte migration, they thought that lymphocytes cross the HEV wall by penetrating the cytoplasm of the high endothelial cells. This crossing is now recognized as an artifact because all lymphocytes that appeared on electron microscopic sections to be surrounded by endothelial cells were in fact outside of these cells when evaluated with tracer studies. Thus, the lymphocytes migrate across the HEV wall by insinuating themselves between endothelial cells ( [178](#) , [179](#) ). The interactions of lymphocytes and the HEV during homing and recirculation are described in the section [Transendothelial Migration](#).

**Morphologic Changes during the Immune Response** Antigens enter the LN via the afferent lymphatics that empty into the subcapsular sinus. Antigen then percolates in the sinuses through the parenchyma and is eventually found in two areas of the LN. In the medulla, it is localized within the lysosomes of macrophages ( [180](#) , [181](#) ), whereas in the cortex, it is associated with the membranes of FDC ( [180](#) , [182](#) ). Antibody facilitates this follicular localization. During a humoral response, intense proliferative activity is observed in the center of the follicles 1 to 2 days after immunization. By 72 hours, large pyroninophilic cells are seen in the GCs of draining LNs ( [183](#) ). These cells have been given various names, such as *immunoblasts*, a term introduced originally by Dameshek ( [184](#) ). They also have been known as *germinoblasts* ( [185](#) ). To avoid confusion with gonadal cells, however, they were renamed *centroblasts*. This blast is a large cell (larger than 10  $\mu\text{m}$ ) and has a nucleus with loose chromatin and a giant reticulated nucleolus that may occupy as much as one-half of the nuclear area. The Golgi apparatus is moderately developed and contains many free polyribosomes but only few cisternae of endoplasmic reticulum. As the endoplasmic reticulum becomes more abundant, these cells are known as *plasmablasts* ( [186](#) ). At this stage, their nucleus possesses clumps of heterochromatin and a moderate-sized nucleolus. Free polyribosomes are still present, and the cisternae of the endoplasmic reticulum do not fill the cytoplasm entirely. By day 5, an increase is noted in the number of tingible body macrophages that give the GCs the appearance of a starry sky. Tingible body macrophages (Körper of Flemming) are macrophages that have phagocytosed nuclear debris of lymphocytes (the graveyard theory) ( [187](#) ). Because of their intense basophilic cytoplasm, the immunoblasts (or centroblasts) demarcate a histologic area known as the *dark zone* (also known as the *basal* or *lower zone* because it is located in the area of the GC that is toward the interior of the LN) ( [188](#) ). As they become more mature (immunocytes, centrocytes), they occupy the light zone (also called the *upper zone* because it is located above the dark zone toward the capsule). Small numbers of plasma cells are detected in the GCs. Kinetic studies with  $^3\text{H}$ -thymidine provided evidence of the origin of centrocytes from the centroblasts and the dissemination of the activated cells beyond the confines of the GC ( [189](#) ). Some GC blasts contain antibody ( [190](#) ). Little doubt remains that the GC blasts originate from B lymphocytes. They display a unique phenotype characterized by lack of membrane IgD. The formation of GCs depends on the presence of T lymphocytes ( [191](#) ). The significance of the GC reaction is discussed in [Chapter 16](#). They are the source of plasma cells ( [192](#) ), seen in the medullary cords by day 3 or 4 after immunization. In addition, they give rise to memory cells ( [193](#) ). For antigens that stimulate strong cell-mediated immunity, the proliferative activity and increase in the pyroninophilic blast cells are noted in the paracortex, which is the T-cell-dependent area.

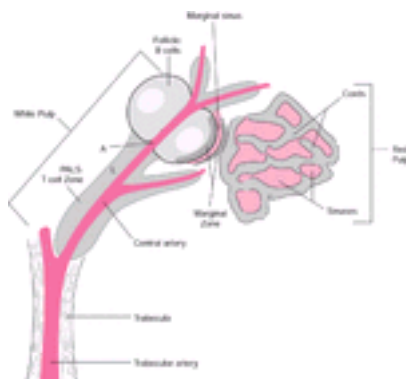
**Functions** LNs should be viewed as dynamic structures, the cells of which are constantly on the move. The functions of LNs can be considered in two broad categories. As an efficient mechanical filter, the LN includes an exquisite arrangement of the reticular meshwork and the sinuses with strategically located master phagocytic cells, the macrophages. If the filtration function fails to control infectious agents, the LNs become new foci for spread of disease. The LNs also constitute important sites of immune



functions that depend on complex interactions between lymphocytes and other cells. To this effect, LNs provide a suitable microenvironment, which includes the HEVs that permit lymphocytes to enter (home) and recirculate; stromal cells that direct lymphocytes to distinct domains, such as the IDC of the paracortex that attract T lymphocytes and present them antigens; and the FDC in the follicles that interact with B cells. LNs thus are important sites for the generation of effector mechanisms, including antibodies and T-cell-mediated immune responses. Both responses are exported from LNs and are carried to remote sites to control infections.

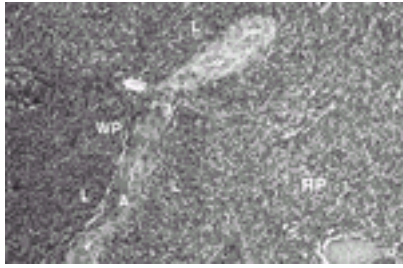
**SPLEEN** The orphan homeobox gene 11 (Hox11) controls the expression of the spleen ( [194](#) ). Knock-out mice (Hox<sup>-/-</sup>) lack the spleen but otherwise appear normal. No defects in other secondary lymphoid organs or bone marrow and thymus have been detected. Although the spleen is considered a secondary lymphoid organ, it serves several other functions unrelated to the immune system. The spleen affects all blood cells throughout their life-span ( [195](#) ). It provides the microenvironment for the final differentiation of reticulocytes, platelets, and monocytes; it removes aged or deformed red blood cells; and it is a reservoir for erythrocytes and granulocytes.

**Structure** The spleen is covered by a connective tissue capsule that is several millimeters thick ( [142](#) , [143](#) , [196](#) , [197](#) ). The human spleen contains only a few muscle cells and thus is not capable of marked contractions. The internal surface of the capsule is the point of origin for an extensive network of trabeculae several millimeters in each dimension that divides the organ into communicating compartments. The appearance is spongelike, with the spaces containing the parenchyma or pulp tissue. The capsule is indented on the medial surface where the blood vessels, lymphatics, and nerves enter and leave. Sections of the spleen stained with hematoxylin and eosin reveal two kinds of parenchyma: one is stained dark blue to purple because of the predominance of small lymphocytes (the white pulp) and the second is red because of the predominance of blood-filled sinuses (the red pulp) ( [Fig. 15.19](#) ).



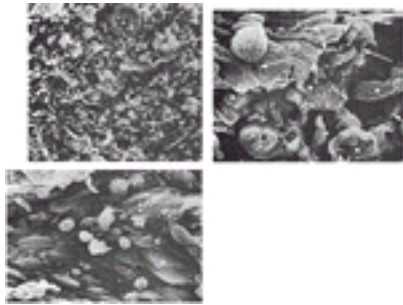
**Figure 15.19.** Drawing of the splenic structure and circulation. PALS, periarteriolar lymphatic sheath.

**White Pulp** The white pulp is the main lymphatic tissue of the spleen and surrounds the blood vessels ( [Fig. 15.19](#) and [Fig. 15.20](#) ). The splenic artery branches into trabecular arteries that follow the trabeculae and in turn give off branches that leave the trabeculae. These structures are now called *central arteries* because of their central position in the white pulp ( [Fig. 15.20](#) ). They are muscular vessels that can alter blood flow by their contraction and relaxation. The white pulp is composed of the supporting reticulum, the free cells, and the blood vessels.



**Figure 15.20.** Section of the [spleen](#). White pulp ( *WF*): lymphocytes ( *L*) packed around an arteriole ( *A*). Red pulp ( *RP*) surrounds the white pulp and consists mainly of sinuses, the cords, and cordal spaces. See [Color Plate](#).

The reticulum is a scaffolding made of reticular fibers produced by reticular cells. The reticulum cells are spindle shaped with conspicuous microfilaments in their cytoplasm and prominent endoplasmic reticulum. The nucleus contains finely dispersed chromatin. This reticulum provides support for the free cells and the blood vessels. It runs circumferentially around the central artery and becomes particularly pronounced in the periphery of the white pulp, where the reticular cells extend sheets of membranes concentrically ( [198](#) , [199](#) ) ( [Fig. 15.21A](#)).



**Figure 15.21.** Ultrastructure of the spleen by scanning electron microscope. **A:** Periarteriolar lymphatic sheath with a central artery ( *A*). Tightly packed lymphocytes lie between fibers and reticular cells ( *arrows*) that run circumferentially around the artery. **B:** Lumen of a sinus at upper left has elongated endothelial lining cells. The cord below contains bulky reticular cells ( *asterisks*) and fibers ( *white arrows*). Some erythrocytes ( *E*) are visible in the cordal spaces. The large cell in the lumen of the sinus is probably a macrophage with several thin cytoplasmic strands ( *arrow*). The beaded black lines identify at the cut edge of the sinus its adventitial layer (terminal bead) and its endothelial layer (subterminal bead). **C:** Lumen of a sinus that bifurcates to the right. The elongated endothelial cells are in close apposition without any visible gaps. (From Weiss L. A scanning electron microscopic study of the spleen. *Blood* 1974;43:665, with permission.)

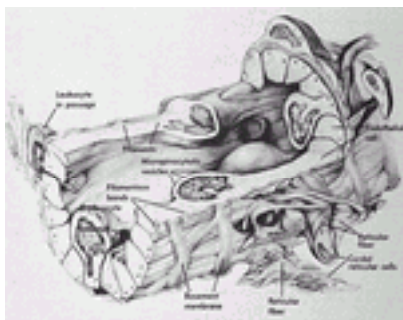
The central artery gives off secondary branches that radiate through the white pulp with different destinations. Some vessels terminate before they reach the edges of the white pulp, and some go beyond and terminate in the marginal zone (MZ) or extend even further into the red pulp. In the human spleen, some branches curve back from the red pulp and form a delicate network around lymphatic follicles located at the periphery of the white pulp. The predominant cell type of the white pulp is the lymphocyte, which occupies the interstices of the spongelike meshwork of the reticulum, forming two histologically distinct arrangements. Immediately surrounding the central artery, lymphocytes are tightly packed in a diffuse sheath that follows the central artery much like a cellular cylinder, eventually becoming thinner as the artery divides into small arterioles. This diffuse lymphocytic collection is known as the *periarteriolar lymphatic sheath* or *PALS* ( [Fig. 15.20](#) and [Fig. 15.21A](#)). The PALS is divided into the central and peripheral areas. The central area immediately surrounding the artery is occupied by tightly packed T lymphocytes. The stroma in this area contains the interdigitating cells seen also in the T-dependent area (paracortex) of the LN ( [200](#) , [201](#) ). T lymphocytes usually are found in intimate contact with

the interdigitating cells. The periphery of PALS lacks the interdigitating cells and contains B and T lymphocytes. Lymphocyte collections in the form of follicles are seen in this region, some of them containing blastlike cells at their center that form the GC (secondary follicle). The small lymphocytes that surround the GCs constitute the mantle that separates the GC from the MZ. These GCs, like their counterparts in the LN, can be divided histologically into a dark zone occupied by large pyroninophilic blasts with high mitotic activity and a light zone with more mature cells. The light zone, which faces the MZ, has an abundance of the characteristic FDCs that also are present in the nodules of the LN. They are large cells with unusually shaped nuclei that are poor in heterochromatin, and the cytoplasmic extensions are thin sheets rather than dendrites. The FDCs are not phagocytic but retain foreign substances on their membranes for long periods. In experiments conducted with animals, it was shown that their numbers increase after immunization. No FDC can be located in the central section of PALS. Their presence in the mantle of the nodules facing the MZ places them in a strategic location to capture foreign substances entering the spleen. Findings of studies involving animals reveal that antigens are localized first in the MZ and then cross the marginal sinus to lodge in the mantle of the nodules, forming a crescentic cap. The nodules of the peripheral section of PALS constitute the B-dependent regions of the spleen. The segregation of the two major lymphocyte populations into distinct settlements within the secondary lymphoid organs seems to be determined by the nature of their underlying neighbors.

**Marginal Zone** The MZ is the part of the parenchyma that lies between the white and red pulps ( Fig. 15.19 and Fig. 15.20). This area of the spleen is important because it comes in contact with large quantities of circulating blood. Many arterial vessels terminate in this region, some of them in funnel-shaped orifices that empty their contents into the interstices of the marginal zone. Unlike the red pulp, the MZ has no sinuses. In rodents, a marginal sinus separates the MZ from the white pulp, but the human spleen lacks a marginal sinus. Some authors suggest that the marginal sinus may be functionally equivalent to the postcapillary venule and, in rodents, the site at which lymphocytes enter the splenic parenchyma. The lymphocytes entering the marginal sinus have multiple microvilli with which they establish contacts with reticular cells as they find their way toward their microenvironments. Once they reach their destination, the microvilli disappear. However, the marginal sinus does not have the tall endothelial cells that direct traffic in the LNs. Some authors speculate that this function is performed by splenic macrophages located in the marginal sinus. These cells have distinct phagocytic and morphologic properties that distinguish them from macrophages in other locations of the spleen, including the ability to bind lymphocytes ( 202). Splenic processing of blood cells begins in the MZ.

**Marginal Zone Lymphocytes: Functions and Malignancies** The nature and function of the MZ B cell is not well understood. In human spleen, the MZ contains clusters of B cells and macrophages in the vicinity of the periphery of the white pulp. Morphologically, phenotypically, and genotypically, these cells differ from naïve B cells. They are large with pale cytoplasm and irregular nucleus. They are IgD<sup>-</sup>, CD5<sup>-</sup>, CD10<sup>-</sup>, and CD23<sup>-</sup>, and have mutated their Ig-V genes ( 203, 204). MZ B cells are memory cells, but constitute a heterogeneous population in response to antigens and V<sub>H</sub> gene rearrangements. In terms of response to antigens, there are three types, those responding to T-cell-dependent antigens ( 205), and those responding to T-independent antigens, which are of two types: type 1 [i.e., lipopolysaccharides ( 205)], or type 2 [i.e., bacterial capsular polysaccharides ( 203)]. B-cell neoplasms involving a cell with strikingly similar morphologic, phenotypic, and cytogenetic characteristics have been reported to have different anatomic localizations (splenic, nodal, and extranodal) and clinical presentations ( 206, 207). Variations detected by mutational analysis were considered as evidence that these lymphomas originate from different subsets of marginal cells ( 208). Furthermore, the evidence that mucosal-associated lymphomas preferentially disseminate to the spleen was considered as evidence of the relationship of these cells to the splenic MZ cell ( 209).

**Red Pulp** On a histologic section, the red pulp consists of sinuses, which give the pulp its color, and cords ( [210](#), [211](#) ). The cords are composed of a meshwork of reticular fibers and cells. The reticular cells are large and extend membranous processes into the interstices ( [Fig. 15.19](#), [Fig. 15.20](#), and [Fig. 15.21](#) ) that contact those of adjacent cells, forming cavernous spaces. The large reticular cell sheets have microfilaments that endow them with the capacity to retract and extend, thus determining the available space and regulating blood flow. These cordal spaces receive blood directly from the arterial vessels. The central artery gives off many branches and terminates in slender, straight, nonanastomosing arterioles that enter the cords of the red pulp, not the sinuses. Some of the arterioles divide into arterial capillaries that are enveloped by a sheath of phagocytic cells. These sheaths were called *ellipsoids*, but now are called *periarterial macrophage sheaths*. In the human spleen, the periarterial macrophage sheath is not well developed. As well as functioning as a major source of phagocytic cells, the periarterial macrophage sheath also may regulate blood flow. The cords have been considered to represent a unique vascular space, the flow through which is regulated by the cordal reticular cells. In addition, removal of old or damaged red cells take place in the cords. The red pulp sinuses are 35 to 40  $\mu\text{m}$  in diameter and are tortuous vascular channels lined with an endothelium consisting of elongated, tapered cells arranged with their long axes parallel to that of the vessel ( [Fig. 15.21B](#), [Fig. 15.21C](#) ). The endothelial cells have three distinctive morphologic features: (a) micropinocytotic vesicles, (b) loosely organized cytoplasmic filaments, and (c) tightly organized filaments along the basal side, which provide the cell with rigidity and contractility. Slitlike gaps between the endothelial cells allow the penetration of blood cells from the cordal spaces into the lumen. The slits never exceed 0.2 to 0.5  $\mu\text{m}$  in width. The intraendothelial filaments run parallel to the slits and restrict their opening ( [212](#) ). They arch between adjacent ring components of the basement membrane. Although normal red blood cells are flexible and capable of passing through the slits, the presence of rigid inclusions, such as Heinz bodies, interferes with their passage. The basement membrane is not continuous but consists of a network of reticular fibers that resemble a roll of chicken wire. Fibers running circumferentially (annular fibers) are thick and are joined by thinner fibers that run longitudinally ( [Fig. 15.22](#) ). The network is connected to the reticulum of the cords. Some reticular cells are in close contact with the wall of the sinuses. Through the fenestrations of this network, blood cells pass from the cords to the sinuses. Adventitial cells cover the sinus wall from the cordal side. They contribute to blood flow regulation by covering or exposing the interendothelial slits.



**Figure 15.22.** A human splenic sinus. The elongated lining cells run parallel to axis of the sinus. The vessel is supported by cordal reticular cells and fibers and a fenestrated basement membrane consisting of heavy fibrous strands running circumferentially and lighter longitudinal strands. Thus, the circular bands, like the hoops of a barrel, hold the endothelial cells (staves of the barrel) tightly. (From Weiss L. The spleen. In: Weiss L, ed. Cell and tissue biology. Baltimore: Urban and Schwarzenberg, 1988, with permission.)

The splenic circulation has been the subject of debate. According to some investigators, the circulation is closed, with endothelial continuity from the arteries to the sinuses and veins. Others believe the circulation is open—that the arteries empty their blood into the MZ and red pulp cords and the blood percolates through the cavernous spaces of the cords and finally crosses the wall of the sinuses through the interendothelial slits.

According to this view, the circulation is anatomically open but is functionally closed. This question has not been resolved, but it is likely that both types of pathways exist. In keeping with this last hypothesis is the finding that the largest amount of blood passes through the spleen as rapidly as it does through other organs, whereas a smaller portion of blood has a considerably slower rate of flow.

**Morphologic Changes during the Immune Response** Within 24 hours of antigenic stimulation, an accumulation of polymorphonuclear leukocytes is detected in the red pulp (186). Large pyroninophilic blast cells are first seen 3 to 4 days later in the PALS. They then migrate toward the periphery as they mature to plasma cells. They eventually reach the cords of the red pulp and are found even within the sinuses. GCs are well developed by the end of the first week. When viewed by electron microscopy, the most immature blasts have a large nucleus, a prominent nucleolus, and an increase in the number of ribosomes, but no organized endoplasmic reticulum is evident. These blasts are known as *immunoblasts*. When they develop dilated endoplasmic reticulum, they are known as *plasmablasts*. Proplasmacytes are the next stage of maturation. These cells have abundant endoplasmic reticulum and a few remaining free ribosomes, findings that differentiate this stage of development from mature plasma cells.

**Immunologic Significance of the Spleen** The two most important immunologic functions of the spleen are phagocytosis and the development of the effector mechanisms of humoral and cell-mediated immunity (213). The labyrinthine structure of the spleen is ideal for the effective removal of invading microorganisms by phagocytes that come to reside in the spaces of the reticulum. Phagocytosis is facilitated by the coating of bacteria with complement, antibody, or both. Although the phagocytic function of the spleen is well recognized, its contribution to humoral or cell-mediated immunity in humans has generated considerable controversy (214, 215). Originally, it was reported that children who underwent splenectomy for congenital hemolytic anemia had an increased incidence of overwhelming, fatal infections (216). Not all subsequent studies, however, yielded results that confirmed these findings. Splenectomy for hematologic disorders apparently has far more serious consequences than splenectomy for trauma. The incidence of overwhelming sepsis in the former cases is 24.8% as compared to a 1.45% incidence for the latter group (217). The contribution of the spleen to humoral responses in laboratory animals has been known for a long time (218). In humans, the loss of the spleen also compromises the immune system and its ability to form antibody (219, 220). Even impaired antibody synthesis by peripheral blood lymphocytes has been detected in postsplenectomy patients (221). In spleenless Hox<sup>-/-</sup> mice, there is no major defect in antiviral immunity except for some delay in antibody response by 1 to 2 days (222).

## LYMPHOCYTE HOMING AND RECIRCULATION

### Homing to Secondary Lymphoid Organs

Migration of leukocytes across the vascular endothelium is a complex, multistep process and involves different types of endothelia for different leukocytes, as well as a variety of adhesion molecules (223, 224, 225, 226 and 227).

When B and T lymphocytes finish their maturation in the bone marrow and thymus, respectively (primary lymphoid organs), they are still naïve—that is, they have not yet encountered antigenic stimulation. The migration patterns of naïve lymphocytes differ from those of the activated (or memory) lymphocytes. Naïve lymphocytes enter the secondary lymphoid organs and settle in specific (T dependent and T independent) compartments (homing). Subsequently, they use the blood and lymphatic circulation as traffic routes and migrate between secondary lymphoid organs without any specific preference (recirculation). Antigen-activated or memory lymphocytes migrate specifically to sites where they have encountered antigen. Thus, memory T lymphocytes tend to



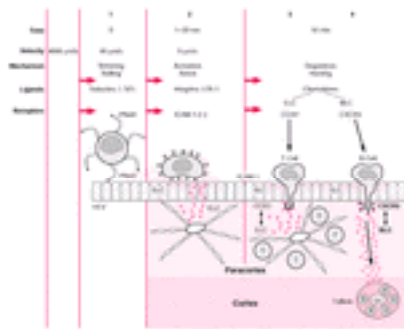
accumulate in extranodal tissues where they have previously been antigenically stimulated. These lymphoid accumulations are sometimes called *tertiary lymphoid tissues* and are associated with epithelial surfaces such as the gut, respiratory tree, and sites of inflammation in skin and synovium. In some of these accumulations, however, there are also small numbers of naïve lymphocytes.

If antigen is drained to regional LNs, it triggers accumulation of antigen-specific memory T lymphocytes to these nodes. In general, two fundamentally distinct routes of entry of lymphocytes to the LN can be distinguished. The first is by crossing of the HEV, which is primarily followed by the naïve lymphocytes, and the second is by the afferent lymphatics after the lymphocytes have entered tissue spaces by crossing flat endothelium. The second route is followed by the activated T lymphocytes ( [228](#), [229](#) and [230](#) ).

Homing of lymphocytes to secondary lymphoid organs takes place through the HEVs, which are abundant in T-cell-dependent areas of the LN, but are used as entry sites for both T and B lymphocytes ( [230](#) ). In the spleen, homing takes place through blood sinusoids in the MZ. HEVs are also found in other extranodal locations, such as PP, tonsils, adenoids of the pharynx, appendix, and other lymphocyte aggregates of the stomach and small intestine.

The best HEV marker currently available is a carbohydrate epitope recognized by the monoclonal antibody MECA-79 ( [231](#), [232](#) ).

Crossing of HEV by lymphocytes involves three steps, which have been defined for interactions of all leukocytes with endothelia: (a) tethering and rolling, (b) integrin activation and arrest or tight adhesion, and (c) transendothelial migration ( [Fig. 15.23](#) ).



**Figure 15.23.** Homing of T and B lymphocytes to peripheral lymph nodes. 1. Rolling: Lymphocytes entering the high endothelial venule ( HEV ) slow down as a result of interaction of the L-selectin ( *L-SEL* ) (lymphocytes) with its ligand the peripheral node addressin ( *PNa<sub>a</sub>* ) on endothelial cells. 2. Arrest: Secondary lymphoid tissue chemokine ( *SLC* ) chemokine, constitutively produced by HEV cells, activates integrin  $\alpha_L \beta_2$  (CD11a/CD18) and tightly adheres lymphocyte to the endothelial surface. 3. Diapedesis: *SLC* (produced by HEV cells) and Epstein-Barr virus-induced molecule 1 ligand chemokine ( *ELC* ) (produced by dendritic cells and transcytosed to the surface) act on appropriate receptors (CCR7) and attract T (stronger) and B (weaker) cells that insinuate themselves through the endothelial cells. 4. Home settling: Entering the node, T cells settle in the paracortex (ELC production), while B cells and a few antigenically experienced CD4<sup>+</sup> T cells move on, being attracted by another chemokine, B lymphocyte chemoattractant ( *BLC* ) (or *BCA-1* ), acting on both of them, expressing the receptor CXCR5 to settle in the follicles. Gc, germinal center; ICAM, intercellular adhesion molecule; INT, integrin.

**TETHERING AND ROLLING** Tethering is the establishment of loose and transient contacts between the lymphocyte and the endothelial cell. This adhesion is weak, and the shear forces of blood flow result in the rolling of the lymphocyte along the endothelium. Tethering to and rolling along the vascular endothelium, in this case HEV, is mediated by L-selectin (CD62L, previously known as *LECAM-1*, *MEL14*, and *LAM-1*) on lymphocytes and its counterreceptors on HEV cells. For L-selectin to mediate rolling, it must be located on the tips of the microvilli ( [233](#), [234](#) ). The L-selectin mediates the primary adhesion (rolling) on HEVs of peripheral LN. However, for homing of naive lymphocytes to the secondary lymphoid organs of the gut (PP), L-selectin requires the cooperation of the integrin,  $\alpha_4\beta_7$ , which is not required for peripheral LN homing. This integrin is important for activated T lymphocytes that lack L-selectin expression ( [235](#) ). The importance of L-selectin for lymphocyte adhesion to HEV was shown with blocking antibodies ( [236](#) ) and by gene knockout, which decreases the lymphocyte migration to LN by 99% ( [237](#) ). Rolling by L-selectin requires linkage to cytoskeletal proteins such as  $\alpha$ -actinin, vinculin, and talin through its 11 carboxy terminal amino acids ( [238](#) ). Rolling enables leukocytes to reduce speed and thus be able to sense chemoattractants in order to activate firm adhesion. The tether bond dissociation increases exponentially as shear stress increases, but this is compensated for with an increase in the number of selectin-ligand bonds between the lymphocyte and the endothelial cell, while at the same time, the bonds are clustered and collectively resist breaking more efficiently than individually. At higher shear, the average lifetime of rolling tethers is much longer as a result of elongation of microvillous tethers. This type of kinetics stabilizes leukocyte rolling over a wide range of shear forces ( [239](#) ). It is accepted that a ligand for L-selectin needs to carry three critical structural elements: sialic acid, fucose, and sulfate. Monoclonal antibodies specific for sialyl 6-sulfo LewisX oligosaccharide stain HEV and almost completely inhibit binding of L-selectin to human HEV. Cotransfection of complementary DNAs for 6-sulfotransferase and  $\alpha1\beta3$  fucosyl transferase VII (Fuc-TVII) generates significant L-selectin binding. L-selectin, however, prefers that this ligand is sulfate at carbohydrate-6 ( [240](#) ). Antigens that carry L-selectin-binding saccharides are known as *vascular addressins*. One is known as *glycosylation cell adhesion molecule 1* or *GlyCAM1*, and is a secreted protein not found on the cell membrane, which argues against a direct function as a cell adhesion molecule. In mice deficient in the GlyCAM1 gene, lymphocyte trafficking still occurs. A second antigen is CD34, detected on endothelial cells throughout the vasculature, therefore not HEV specific. Furthermore, disruption of CD34 gene does not abolish trafficking through HEV. At the present time, the nature of the macromolecule that carries the epitope detected by the monoclonal antibody MECA79, which defines an HEV-specific carbohydrate epitope, remains elusive and is known as *peripheral node addressin*, or *PNa* ( [241](#), [242](#) ). Biochemical and genetic evidence infers that, for the synthesis of sulfated glycan moieties, sulfation precedes the 2 $\beta$ 3 sialylation, which in turn would be followed by  $\alpha1\beta3$  fucosylation, required for an L-selectin ligand. With targeted deletion of FucT-VII locus, which encodes an  $\alpha1\beta3$  fucosyltransferase expressed in HEV, there is an 80 to 90% reduction of short-term lymphocyte homing. And yet, some other work suggested that although sulfate on the epitope is required for L-selectin binding, neither sialic acid ( [243](#) ) nor fucose ( [244](#) ) are directly involved in the binding.

**INTEGRIN ACTIVATION AND ARREST** In preparation for transendothelial migration, lymphocytes need to adhere firmly on the endothelial cells. Arrest is achieved by activation of LFA-1 ( $\alpha_L\beta_2$ ) integrin, which interacts with ICAM-1 or ICAM-2 ( [245](#) ). On resting lymphocytes, LFA-1 exists in an inactive form but within less than 1 second, it is activated by chemokines constitutively expressed on lymphoid tissues ("lymphoid chemokines") ( [246](#), [247](#) ), such as secondary lymphoid tissue chemokine (SLC, or CCL21) ( [248](#), [249](#) ) and Epstein-Barr virus-induced molecule 1 ligand chemokine (ELC, or CCL19), also called *macrophage inflammatory protein-3 $\beta$*  (MIP-3 $\beta$ ) ( [250](#) ). SLC induces arrest of naive T cells to ICAM-1 ( [251](#) ) with sixfold higher efficiency for naive than memory T cells



([252](#)). The arrest is pertussis toxin sensitive, implying that the signaling mechanism is mediated through G-proteins. The ELC shares the same binding specificity with SLC, but its role is less obvious. ELC transcripts are restricted to nonendothelial cells in the perivascular area of paracortex ([253](#)). However, it is brought to the luminal surface of the HEV by transcytosis and is able to participate in LFA-1 activation and arrest of the lymphocytes through the same receptor CCR7 as SLC ([254](#)).

**TRANSENDOTHELIAL MIGRATION** SLC induces strong chemotaxis for T cells and to a lesser extent on B cells ([248](#)). Entry of lymphocytes to the secondary lymphoid organs, especially T cells, requires the expression of CCR7, the high-affinity receptor for its ligand SLC. SLC is very important for entry of T cells into secondary lymphoid organs, as shown in mice with the *plt* mutation (paucity of LN T cells). These mice lack SLC, cannot enter through HEV, and the structure of the paracortical areas is severely disorganized.

SLC gene in mice is located on chromosome 4 ([255](#)), which corresponds to human chromosome 9p13, where SLC is located. Furthermore, T cells lacking the SLC receptor (CCR7) have a markedly reduced ability to enter LNs and PPs. In CCR7-deficient mice, B-cell homing into secondary lymphoid organs is not disturbed. The arrest of B cells on HEV takes place in the absence of SLC, indicating that other chemotactic activities regulate entry of B cells into secondary LNs. Stroma cell-derived factor 1 (SDF-1) is recognized by the CXCR4 receptor, expressed on resting T and B cells. This chemokine/receptor system may also contribute to lymphocyte entry into LNs. However, this interaction is not important for T cells as CXCR4-deficient mice have normal T-cell areas. The redundancy of the mechanisms for B-cell homing explains the normal B-cell homing in *plt* mice, as well as on SDF-1 and CXCR4-deficient mice. Transgenic mice that do not produce SLC on the normal anatomic locations but have expression directed to pancreas under the control of the insulin promoter II, have collections of CD4<sup>+</sup> and CD8<sup>+</sup> cells near the center of the islets and only a few scattered B cells surrounding them ([256](#)). In older mice, these clusters in the islets develop stromal reticulum, seen in LNs and vascular endothelium with morphology of HEV. B cell follicular-like clusters without GCs merge with the T-cell areas. This study clearly demonstrates the important role of SLC in LN neogenesis. Once naïve lymphocytes have crossed the HEV, chemokines direct the lymphocytes for compartmental homing (i.e., T lymphocytes to the paracortex and B lymphocytes to the follicles). SLC is expressed not only on HEV, but also by stromal cells within the T-cell areas of LNs, spleen, and PPs. A second ligand for CCR7 is ELC, which is also expressed in T-cell areas. ELC is made by macrophages and the DCs of the paracortex. *In vitro* SLC and ELC attract T cells effectively, but B cells only weakly. In conclusion ([Fig. 15.23](#)), T cells cross HEV by the SLC and ELC chemokines and their receptor CCR7. ELC attracts them to the paracortical areas. B cells cross the HEV by more than one chemokine/receptor system. However, once inside the LN, they are attracted to the follicles by chemokine BLC (CXCL13) or BCA-1 (B-cell-attracting chemokine 1, CXCL13), which binds to the receptor BLR1 (Burkitt lymphoma receptor 1) or CXCR5. The CXCR5 is expressed by mature as well as activated B cells and in addition by CD4<sup>+</sup>-activated T cells. Antigen-activated CD4<sup>+</sup> T cells down-regulate CCR7 (receptor for SLC and ELC) and up-regulate CXCR5. Therefore, this CD4<sup>+</sup> T-cell subset, in contrast to naïve T cells that stay in the paracortex, travels with B cells to the follicles. This explains the early fluorescent antibody results, which detected small numbers of scattered T cells within the GC ([Fig. 15.15A](#)). They induce strong antibody responses in culture with B cells ([257](#)). CXCR5-deficient mice show defective follicular localization of B cells. BLC is expressed constitutively by FDC in lymphoid follicles of LNs and other secondary lymphoid organs. BLC-deficient mice show severe defects in the development of secondary lymphoid organs. Histologically, B cells do not appear organized in follicles but form a ring around the T-cell areas ([258](#)). The importance of BLC for organization of B cells into follicles was shown by the ectopic expression of BLC in pancreatic islets. Only B lymphocytes accumulate in these sites ([259](#)). Organization of primary follicles requires the network of FDCs, which in turn depends on LT  $\alpha_1\beta_2$  and

TNF expressed on B cells. BLC, for its action, is strongly dependent on these cytokines ( [260](#) ). In conclusion, for proper formation of follicles and localization of B lymphocytes, two ligand–receptor systems are mandatory: the TNF/LT $\alpha$   $\beta$   $\beta$  ligand and its receptor LTBR, and the BLC ligand and its receptor CXCR5.

**SIGNALING IN LYMPHOCYTE HOMING** The Ras–homologous A protein (Rho A), a guanosine triphosphate–binding protein, is involved in the intracellular signaling for the integrin activation pathway ( [261](#), [262](#) ). The mechanism of coupling to the Ras/Map kinase cascade is not yet well defined. Activation of Ras leads to stimulation of a cascade of protein kinases that ultimately phosphorylate and activate mitogen–activated protein kinase. Mitogen–activated protein kinase is linked to several cellular functions such as regulation of transcription factors and cytoskeleton. Phospholipase C $\beta$  activation results in the production of inositol triphosphate and diacylglycerol. Inositol triphosphate is important in mobilizing Ca<sup>2+</sup> from intracellular sources, whereas diacylglycerol is important in the activation of protein kinase C. PI3–K is also activated in response to chemokine stimulation, which links further downstream with phospholipase D activation, actin rearrangements, and vesicular trafficking ( [263](#) ). Transendothelial migration occurs rapidly, and the lymphocyte reaches the basement membrane within minutes. The cell moves toward the cell–cell junctions. Adhesive contacts with the endothelium are modulated so that the cell is not immobilized. Modulation may involve decrease of activation signals. A substance secreted by the HEV cells called *hevin* has been isolated and shown to be homologous to the extracellular matrix adhesion modulator known as *secreted protein acidic and rich cysteine* or *SPARC* ( [264](#) ). It may be a factor modulating lymphocyte transendothelial migration.

### Dendritic Cell Migration

The traffic of DCs is regulated by cytokines (IL–1, TNF– $\alpha$ ), chemokines, and  $\beta$ –defensins. Immature DCs, regardless of their origin, express the chemokine receptor 6 (CCR6), which binds the chemokine MIP–3 $\alpha$  (CCL20) ( [265](#) ). In the case of LCs ( [266](#) ), it directs them to the skin, where the ligand from CCR6 (i.e., MIP–3 $\alpha$ ) is constitutively expressed by keratinocytes, which provide the homing signals for the positioning of LCs to the suprabasal layer of epidermis.  $\beta$ –defensins produced by mucosal membranes after microbial infection bind to CCR6 and thus attract immature DCs to submucosal areas ( [267](#) ).

LCs are connected physically with keratinocytes through homotypic interactions mediated by E–cadherin. Inflammatory or allergic stimuli down–regulate E–cadherin, resulting in “maturation” and detachment of LCs ( [268](#) ). CD40–CD40 ligand may also play a role for their emigration ( [269](#) ). Detached LCs downregulate CCR6 and up–regulate another chemokine receptor, CCR7, which allows the now mobile LCs to move toward the lymphatic vessels in response to its ligand, SLC ( [270](#) ). The barrier to their migration, imposed by the basement membrane of the skin (collagen IV), is brought down through the matrix metalloproteinase–9, released by LCs with specificity to collagen IV ( [271](#) ). LCs cross the abluminal side of the lymphatic vessels, probably with the involvement of P–glycoprotein, and eventually enter LNs. In the lymphatic vessels, they are known morphologically as *veiled cells* on the basis of their morphology [i.e., large lamellipodia (veils), which, like sails, propel them forward]. They enter the LN from the afferent lymphatic vessel into the subcapsular sinus to reach the T–cell areas, attracted by SLC and MIP–3 $\beta$  (or ELC), both of them ligands of CCR7 receptor ( [272](#) ). In the T–cell areas, they are known as *interdigitating DCs* or *IDCs*, as their elaborate long cytoplasmic processes interdigitate between T cells. IDCs present to T–cell antigens they have captured in the periphery, initiating an immune response (see [Chapter 18](#)).

## Special Homing Pathways

**SKIN HOMING** Memory lymphocytes tend to return to the type of tissue where they have encountered the antigen ( [273](#) ). Lymphocytes that entered the afferent lymphatics from the skin have a distinct phenotype ( [274](#) ). T lymphocytes localized in the skin express a marker called *cutaneous lymphocyte-associated antigen* (CLA), which binds to E-selectin ( [275](#), [276](#) ). E-selectin is induced on dermal endothelial cells in delayed type of hypersensitivity and in chronically inflamed skin ( [277](#) ). Other molecules also mediate strong adhesion of memory T cells to skin, such as  $\alpha_4\beta_1$  (VLA-4) interacting with VCAM-1, and the integrin  $\alpha_3\beta_1$  with the extracellular matrix component epiligrin ( [278](#) ). However, T lymphocytes may penetrate the epidermis using E-cadherin.

**HOMING TO THE GUT** Lymphoid cells in the gut are found in three areas: as well-organized collections known as *Peyer patches* or *PPs*, which are secondary lymphoid organs; in the lamina propria underlying the intestinal epithelium; and after penetration of the basement membrane interspersed between epithelial cells—that is, the intraepithelial lymphocytes (IELs). Naïve lymphocytes home to PPs, whereas memory cells home to extralymphoid sites—that is, the intestinal lamina propria as a result of variations in the expression of highly specialized homing receptors. The HEV of the PPs is weak for ligand of L-selectin and MAdCAM-1<sup>hi</sup>, whereas the naïve lymphocytes are L-selectin<sup>+</sup> and  $\alpha_4\beta_7$ <sup>lo-med</sup>. Therefore, neither set of molecules alone is capable of mediating tethering and rolling to initiate integrin activation, but cooperation between the two sets of molecules allows naïve lymphocytes to enter the PPs. The endothelium of the lamina propria is negative for L-selectin ligand, but strong for MAdCAM-1 expression. Naïve lymphocytes are unable to use L-selectin and, being weak in  $\alpha_4\beta_7$  expression, they cannot initiate rolling and are blocked from entering the lamina propria. On the other hand, memory lymphocytes, although they lack L-selectin (and as a result cannot enter PPs), have strong  $\alpha_4\beta_7$  expression and are able to initiate rolling and enter the lamina propria. Some of the lymphocytes are able to penetrate the basement membrane of the intestinal epithelium and settle between enterocytes to become IELs. IELs interact with intestinal epithelium through an integrin known as the *human mucosal lymphocyte* molecule ( [279](#) ), now shown to be the  $\alpha_E\beta_7$  integrin ( [280](#), [281](#) ).  $\alpha_E\beta_7$  is expressed in approximately 2 to 6% of blood T cells, which are a memory subset and are CLA1<sup>-</sup> and L-selectin<sup>-</sup> ( [282](#) ). The  $\alpha_E\beta_7$  integrin is induced by transforming growth factor- $\beta$  ( [283](#) ). The same cytokine also is known to trigger class switch of IgM<sup>+</sup> B cells to IgA, which is the predominant Ig class produced by the gut lymphocytes. It is of interest that MAdCAM-1, a gut mucosal addressin, contains an IgA-like domain ( [284](#) ).

**HOMING TO INFLAMMATORY SITES** Lymphocytes are known to accumulate in sites of chronic inflammation and tissues with active autoimmune mechanisms. The phenotype of these lymphocytes indicates that they are activated, and therefore antigenically stimulated ( [273](#) ). Cytokines produced from macrophages, such as IFN- $\gamma$  and TNF- $\alpha$ , regulate lymphocyte traffic to inflammatory sites. Accumulation of lymphocytes at chronic inflammation sites involves several adhesion molecules such as LFA-1 and  $\alpha_4$  integrins, as well as E-selectin and VCAM-1. Chemoattractants, such as macrophage inflammatory protein 1 $\beta$  (MIP-1 $\beta$ ) enhance binding of CD8<sup>+</sup> T cells ( [285](#) ), whereas RANTES attracts selectively memory T cells ( [286](#) ). The monocyte chemoattractant protein 1 (MCP-1) is a major lymphocyte chemoattractant (in addition to its strong activity on monocytes) ( [245](#) ); this explains the mixed composition of cellular infiltrates, rich in lymphocytes and monocytes, in sites of chronic and autoimmune inflammatory reactions. MCP-1 is present in abundance in areas of antigenic challenge and autoimmune diseases ( [287](#) ). The data suggest that C-C chemokines provide the triggering signal for the integrin-dependent

tight adhesion of lymphocytes to endothelia for emigration to inflammatory sites. **HOMING TO OTHER SITES** Hemopoietic progenitors in bone marrow transplantation use the  $\alpha_4\beta_1$ -VCAM-1 set to home to bone marrow ( [288](#)). Interaction of P-selectin with its ligand, P-selectin-dependent ligand (PSGL-1), is also implicated ( [289](#)). Lymphocyte homing to tonsils is mediated by L-selectin and CD34 ( [290](#)), whereas the attachment of lymphocytes to brain microvasculature is mediated by the sulfoglucuronosyl paragloboside, a ligand for L-selectin ( [291](#)).

### Significance of Lymphocyte Homing and Recirculation

It is estimated that as many as  $5 \times 10^6$  lymphocytes/second leave the blood and cross HEVs in the body. The process of rolling and sticking to the HEV takes only 1 to 20 seconds and the transendothelial passage approximately 10 minutes ( [292](#)). From *in situ* microscopic observations of PPs, the velocity of the lymphocyte before contact with HEV is approximately 4000  $\mu\text{m}/\text{second}$ , and rolling effectively reduces this to approximately 40  $\mu\text{m}/\text{second}$  ( [293](#)). Thus, rolling increases the chances for firm adhesion, but at the same time the cell may escape if proper triggering for activation of integrin mechanisms fails to be initiated. Triggering mechanisms involve G-protein-linked chemoattractant receptors and their ligands, and they can bring about integrin activation within 1 to 3 seconds after contact for tight adhesion.

Homing and recirculation are not random, but the result of active interactions determined by the phenotypes of the HEV cells and the lymphocytes. Homing to specific microenvironments of the secondary lymphoid organs is developmentally determined (i.e., T dependent vs. T independent), and carried out under the guidance of chemokines and their receptors, and the cellular composition of the microenvironments (i.e., IDCs vs. FDCs) ( [293](#)). When lymphocytes are antigenically stimulated, the pattern of migration, known as *recirculation*, is modified as a result of this experience. Antigenically specific lymphocytes are directed to particular tissues so that they may influence more effectively the intensity of the immune response. This ultimately is the significance of lymphocyte recirculation as reflected in the difference between naïve lymphocytes and the lymphocytes that become antigenically experienced. Homing and recirculation are forms of lymphocyte differentiation. These, like many other aspects of their differentiation (i.e., IgM vs. IgG production or Th0 vs. Th1 or Th2 cytokine pattern secretion), are refined in the periphery in response to antigenic stimulation so that they best meet the environmental challenges for the protection of the body. Immune responses within the secondary microenvironments ( [294](#), [295](#)) as well as “tertiary” microenvironments (i.e., the areas of disease and inflammation) are all under the control of the chemokines ( [296](#)). Knowledge of the mechanisms of chemokine regulation will allow the development of therapeutic strategies to control inflammatory diseases ( [296](#)).

### REFERENCES

1. Marschalko T von. Ueber die sogenannten plasmazellen; ein beitrag zur kenntniss der herkunft der entzündlichen infiltrationszellen. Arch Derm Syph 1895;30:241.
2. Downey H. The origin and structure of the plasma cells of normal vertebrates, especially of the cold blooded vertebrates, and the eosinophils of the lung of Amblystoma. Folia Haematol 1911;11:275.
3. Maximow A. Untersuchungen über blut und bindegewebe. VIII. Die zytologischen eigenschaften der fibroblasten, reticulumzellen und lymphozyten des lymphoiden gewebes ausserhalb des organismus ihre genetischen wechselbeziehungen und prospektiven entwicklungspotenzen. Arch Mikroskop Anat 1923;97:283.

4. Bloom W. Relationships between lymphocytes, monocytes and plasma cells. *Folia Haematol (Leipz)* 1928;37:63.
5. Rich AR. Inflammation in resistance to infection. *Arch Pathol* 1936;22:228–254.
6. McMaster PD, Hudack SS. The formation of agglutinins within lymph nodes. *J Exp Med* 1935;61:783–805.
7. Dougherty TF, Chase JH, White A. The demonstration of antibodies in lymphocytes. *Proc Soc Exp Biol Med* 1944;57:295–298.
8. Harris TN, Grimm E, Mertens E, Ehrich WE. The role of the lymphocyte in antibody formation. *J Exp Med* 1945;81:73–83.
9. Ehrich WE, Harris TN. The site of antibody formation. *Science* 1945;101:28–31.
10. Fagraeus A. Antibody production in relation to the development of plasma cells. In vivo and in vitro experiments. *Acta Med Scand* 1948;204[Suppl]:1–122.
11. Coons AH, Leduc EH, Conolly JM. Studies on antibody production. I. A method for the histochemical demonstration of specific antibody and its application to a study of the hyperimmune rabbit. *J Exp Med* 1955;102:49–61.
12. Leduc EH, Coons AH, Conolly JM. Studies on antibody production. II. The primary and secondary responses in the popliteal lymph node of the rabbit. *J Exp Med* 1955;102:61–82.
13. Gudat FG, Harris TN, Harris S, Hummeller K. Studies on antibody producing cells. I. Ultrastructure of 19s and 7s antibody-producing cells. *J Exp Med* 1970;132:448–474.
14. Harris TN, Hummeller K, Harris S. Electron microscopic observations on antibody producing lymph node cells. *J Exp Med* 1966;123:161–172.
15. Hummeller K, Harris TN, Tomasini N, et al. Electron microscopic observations on antibody producing cells in lymph and blood. *J Exp Med* 1966;124:255–262.
16. Nowell PC. Phytohemagglutinin: an initiator of mitosis in cultures of normal leukocytes. *Cancer Res* 1960;20:462–466.
17. Bessis M. *Living blood cells and their ultrastructure*. New York: Springer-Verlag, 1973.
18. Grossi CE, Greaves MF. Normal lymphocytes. In: Zucker-Franklin D, ed. *Atlas of blood cells. Function and pathology*, 2nd ed. Philadelphia: Lea & Febiger, 1988.
19. Gowans JL, McGregor DD. The immunological activities of lymphocytes. *Prog Allergy* 1965;9:1–78.
20. Bessis M, Thiery JP. Electron microscopy of human white blood cells and their stem cells. *Int Rev Cytol* 1961;12:199–241.
21. Mandel TE. The ultrastructure of mammalian lymphocytes and their progeny. In: Marchalonis JL, ed. *The lymphocyte: structure and function*. New York: Marcel Dekker, 1977.
22. Olah I, Rohlich P, Toro I. *Ultrastructure of lymphoid organs. An electron microscopic atlas*. Philadelphia: Lippincott, 1975.
23. Zucker-Franklin D. The ultrastructure of lymphocytes. *Semin Hematol* 1969;6:4–27.
24. Zucker-Franklin D. The ultrastructure of cells in human thoracic duct lymph. *J Ultrastruct Res* 1963;9:325–339.
25. Polliack A, Hammerling U, Lampen N, de Harven E. Surface morphology of murine B and T

- lymphocytes: a comparative study by scanning electron microscopy. *Eur J Immunol* 1975;5:32-39.
26. Polliack A, Lampen N, Clarkson BD, et al. Identification of human B and T lymphocytes by scanning electron microscopy. *J Exp Med* 1973;138:607-624.
  27. Alexander EL, Wetzel B. Human lymphocytes: similarity of B and T surface morphology. *Science* 1975;188:732-734.
  28. Dwyer JM. Identifying and enumerating human T and B lymphocytes: a review of techniques, problems, and progress in clinical studies. *Prog Allergy* 1976;21:178-260.
  29. van Ewijk W. Immunoelectron-microscopic characterization of lymphoid microenvironments in the lymph node and thymus. *Ciba Found Symp* 1980;71:21-37.
  30. van Ewijk W, Brons NH, Rozing J. Scanning electron microscopy of homing and recirculating lymphocyte populations. *Cell Immunol* 1975;19:245-261.
  31. Parrot DMV, Wilkinson PC. Lymphocyte locomotion and migration. *Prog Allergy* 1981;28:193-284.
  32. Lewis WH. Locomotion of lymphocytes. *Bull Johns Hopkins Hosp* 1931;49:29-36.
  33. McFarland W, Heilman DH, Moorhead JE. Functional anatomy of the lymphocyte in immunological reactions in vitro. *J Exp Med* 1966;124:851-858.
  34. Rosenstreich DL, Shevach E, Green I, Rosenthal AS. The uropod-bearing lymphocyte of the guinea pig. Evidence for thymic origin. *J Exp Med* 1972;135:1037-1048.
  35. McFarland W, Schechter GP. The lymphocyte in immunological reactions in vitro: ultrastructural studies. *Blood* 1970;35:683-688.
  36. Sharp JA, Burwell RG. Interaction ("peripoleis") of macrophages and lymphocytes after skin homografting or challenge with soluble antigens. *Nature* 1960;188:474-475.
  37. Humble JG, Jayne WH, Pulvertaft RJV. Biological interaction between lymphocytes and other cells. *Br J Haematol* 1956;2:283-294.
  38. Nielsen MH, Jensen H, Braendstrup O, Werdelin O. Macrophage-lymphocyte clusters in the immune response to soluble protein antigen in vitro. II. Ultrastructure of clusters formed during the early response. *J Exp Med* 1974;140:1260-1272.
  39. Werdelin O, Braendstrup O, Petersen E. Macrophage-lymphocyte clusters in the immune response to soluble protein antigen in vitro. I. Roles of lymphocytes and macrophages in cluster formation. *J Exp Med* 1974;140:1245-1259.
  40. Biberfeld P. Uropod formation in phytohaemagglutinin (PHA) stimulated lymphocytes. *Exp Cell Res* 1971;66:433-445.
  41. Rich AR, Wintrobe MM, Lewis MR. The differentiation of myeloblasts from lymphoblasts by their manner of locomotion. A motion picture study of the cells of normal bone marrow and lymph nodes, and of leukemic blood. *Bull Johns Hopkins Hosp* 1939;65:291-309.
  42. Schreiner GF, Unanue ER. Membrane and cytoplasmic changes in B lymphocytes induced by ligand-surface immunoglobulin interaction. *Adv Immunol* 1976;24:37-165.
  43. Greaves M, Janossy G. Elicitation of selective T and B lymphocyte responses by cell surface binding ligands. *Transplant Rev* 1972;11:87-130.
  44. Andersson J, Sjoberg O, Möller G. Mitogens as probes for immunocyte activation and cellular cooperation. *Transplant Rev* 1972;11:131-177.
  45. Douglas SD. Electron microscopic and functional aspects of human lymphocyte response to mitogens. *Transplant Rev* 1972;11:39-59.

46. Douglas SD. Human lymphocyte growth in vitro: morphologic, biochemical, and immunologic significance. *Int Rev Exp Pathol* 1971;10:41–114.
47. Biberfeld P. Endocytosis and lysosome formation in blood lymphocytes transformed by phytohemagglutinin. *J Ultrastruct Res* 1971;37:41–68.
48. Biberfeld P. Morphogenesis in blood lymphocytes stimulated with phytohemagglutinin (PHA). A light and electron microscopic study. *Acta Pathol Microbiol Scand (A)* 1971;223[Suppl 223]:1–70.
49. Chessin LN, Borjeson J, Welsch PD, et al. Studies on human peripheral blood lymphocytes in vitro. II. Morphological and biochemical studies on the transformation of lymphocytes by pokeweed mitogen. *J Exp Med* 1966;124:873–884.
50. Douglas SD, Hoffman PF, Borjeson J, Chessin LN. Studies on human peripheral blood lymphocytes in vitro. III. Fine structural features of lymphocyte transformation by pokeweed mitogen. *J Immunol* 1967;98:17–30.
51. Zucker–Franklin D. Structural features of cells associated with the paraproteinemias. *Semin Hematol* 1964;1:165.
52. Osmond DG. The ontogeny and organization of the lymphoid system. *J Invest Dermatol* 1985;85[1 Suppl]:2S–9S.
53. Weiss L. Bone marrow. In: Weiss L, ed. *Cell and tissue biology*. Baltimore: Urban and Schwarzenberg, 1988.
54. Weiss L. Haemopoiesis in mammalian bone marrow. *Ciba Found Symp* 1981;84:5–21.
55. Weiss L. The haemopoietic microenvironment of bone marrow: an ultrastructural study of the interactions of blood cells, stroma and blood vessels. *Ciba Found Symp* 1980;71:3–19.
56. Osmond DG, Fahlman MT, Fulop GM, Rahal DM. Regulation and localization of lymphocyte production in the bone marrow. *Ciba Found Symp* 1981;84:68–86.
57. Hirose J, Kouro T, Igarashi H, Yokota T, et al. A developing picture of lymphopoiesis in bone marrow. *Immunol Rev* 2002;189:28–40.
58. Osmond DG. Population dynamics of bone marrow B lymphocytes. *Immunol Rev* 1986;93:103–124.
59. Bearman RM, Levine GD, Bensch KG. The ultrastructure of the normal human thymus: a study of 36 cases. *Anat Rec* 1978;190:755–781.
60. Haynes BF. The human thymic microenvironment. *Adv Immunol* 1984;36:87.
61. Weiss L. The thymus. In: Weiss L, ed. *Cell and tissue biology*. Baltimore: Urban and Schwarzenberg, 1988.
62. Owen JJT, Jordan RK, Raff MC. The development of the thymus in the nude mouse. *Eur J Immunol* 1975;5:653–655.
63. Vos JG, Berkvens JM, Kruijt BC. The athymic nude rat. I. Morphology of the lymphoid and endocrine organs. *Clin Immunol Immunopathol* 1980;15:213–228.
64. Anderson G, Moore NC, Owen JJT, Jenkinson EJ. Cellular interactions in thymocyte development. *Ann Rev Immunol* 1996;14:73–99.
65. Manley NR, Capecchi M. The role of Hoxa3 in mouse thymus and thyroid development. *Development* 1995;121:1989–2003.
66. Peters H, Neubüser A, Kratochwil P, Balling R. Pax9–deficient mice lack pharyngeal pouch derivatives and teeth and exhibit craniofacial and limb abnormalities. *Genes Dev* 1998;12:2735–2747.



67. Chisaka O, Capecchi MR. Regionally restricted developmental defects resulting from targeted disruption of the mouse homeobox gene *hox-1.5*. *Nature* 1991;350:473-479.
68. Nehls M, Pfeifer D, Schorpp M, Hedrich H, et al. New member of the winged-helix protein family disrupted in mouse and rat nude mutations. *Nature* 1994;372:103-107.
69. Schuddekopf K, Schorpp M, Boehm T. The whn transcription factor encoded by the nude locus contains an evolutionarily conserved and functionally indispensable activation domain. *Proc Natl Acad Sci U S A* 1996;93:9661-9664.
70. Le Lièvre CS, Le Douarin NM. Mesenchymal derivatives of the neural crest: analysis of chimaeric quail and chicken embryos. *J Embryol Exp Morphol* 1975;34:125-154.
71. Patel DD, Hale LP, Whichard LP, et al. Expression of CD44 molecules and CD44 ligands during human thymic fetal development: expression of CD44 isoforms is developmentally regulated. *Int Immunol* 1995;7:277-286.
72. Mandel T. Differentiation of epithelial cells in the mouse thymus. *Z Zellforsch Mikrosk Anat* 1970;106:498-515.
73. Hollander GA, Wong B, Nichogiannopoulou A, et al. Developmental control point in induction of thymic cortex regulated by a subpopulation of prothymocytes. *Nature* 1995;373:350-353.
74. Ritter MA, Boyd RL. Development in the thymus: it takes two to tango. *Immunol Today* 1993;14:462-469.
75. Surh CD, Ernst B, Sprent J. Growth of epithelial cells in the thymic medulla is under the control of the mature T cells. *J Exp Med* 1992;176:611-616.
76. Muller KM, Leudecker CJ, Udey MC, Farr AG. Involvement of E-cadherin in thymus organogenesis and thymocyte maturation. *Immunity* 1997;6:257-264.
77. Kutlesa S, Wessels JT, Speiser A, et al. E-cadherin-mediated interactions of thymic epithelial cells with CD103<sup>+</sup> thymocytes lead to enhanced thymocyte cell proliferation. *J Cell Sci* 2002;115:4505-4515.
78. Anderson M, Anderson SK, Farr AG. Thymic vasculature: organizer of the medullary epithelial compartment? *Int Immunol* 2000;12:1105-1110.
79. Erickson M, Morkowski S, Lehar S, et al. Regulation of thymic epithelium by keratinocyte growth factor. *Blood* 2002;100:3269-3278.
80. Dunn RJ, Leudecker CJ, Haugen HS, et al. Thymic overexpression of CD40 ligand disrupts normal thymic epithelial organization. *J Histochem Cytochem* 1997;45:129-147.
81. Farr AG, Dooley JL, Erickson M. Organization of thymic medullary epithelial heterogeneity: implications for mechanisms of epithelial differentiation. *Immunol Rev* 2002;189:20-27.
82. Bjorses P, Aaltonen J, Horelli-Kuitunen N, et al. APECED: a new clue to autoimmunity. *Hum Mol Genet* 1998;7:1547-1553.
83. Le Douarin NM, Dieterlen-Lievre F, Oliver PB. Ontogeny of primary lymphoid organs and lymphoid stem cells. *Am J Anat* 1984;170:261-299.
84. Bloodworth JMB, Jr., Hirachuka H, Hickey RC, Wu J. Ultrastructure of the human thymus, thymic tumors, and myasthenia gravis. *Pathol Annu* 1975;10:329-391.
85. Boyd RL, Tucek CL, Godfrey DI, et al. The thymic microenvironment. *Immunol Today* 1993;14:445-459.
86. van Ewijk W. T-cell differentiation is influenced by thymic microenvironments. *Annu Rev Immunol* 1991;9:591-615.
87. Rouse RV, Weissman IL. Microanatomy of the thymus: its relationship to T cell differentiation. *Ciba*

Found Symp 1981;84:161–177.

88. Janossy G, Thomas JA, Goldstein G, Bollum FJ. The human thymic microenvironments. *Ciba Found Symp* 1981;84:193–214.

89. van Ewijk W. Immunohistology of lymphoid and non-lymphoid cells in the thymus in relation to T lymphocyte differentiation. *Am J Anat* 1984;170:311–330.

90. Jenkinson EJ. Expression and function of major histocompatibility complex antigens in the developing thymus: studies on normal and nude mice. *Ciba Found Symp* 1981;84:178–192.

91. Jenkinson EJ, van Ewijk W, Owen JJ. Major histocompatibility complex antigen expression on the epithelium of the developing thymus in normal and “nude” mice. *J Exp Med* 1981;153:280–292.

92. Jenkinson EJ, Owen JJ, Aspinall R. Lymphocyte differentiation and major histocompatibility complex antigen expression in the embryonic thymus. *Nature* 1980;284:177–179.

93. Wekerle H, Ketelsen UP, Ernst M. Thymic nurse cells. Lymphoepithelial cell complexes in murine thymuses: morphological and serological characterization. *J Exp Med* 1980;151:925–944.

94. Lobach DF, Scarce RM, Haynes BF. The human thymic microenvironment: phenotypic characterization of Hassall’s bodies with the use of monoclonal antibodies. *J Immunol* 1985;134:250–257.

95. Haynes BF, Scarce RM, Lobach DF, Hensley LL. Phenotypic characterization and ontogeny of mesodermal-derived and endocrine epithelial components of the human thymic microenvironment. *J Exp Med* 1984;159:1149–1168.

96. Laster AJ, Itoh T, Palker TJ, Haynes BF. The human thymic microenvironment: thymic epithelium contains specific keratins associated with early and late stages of epidermal keratinocyte maturation. *Differentiation* 1986;31:67–77.

97. Lobach DF, Haynes BF. Ontogeny of the human thymus during fetal development. *J Clin Immunol* 1987;7:81–97.

97a. Schier KJ. The thymus according to Schambacher: medullary ducts and reticular epithelium of thymus and thymomas. *Cancer* 1981;48:1183–1199.

98. Pinkel D. Ultrastructure of human fetal thymus. *Am J Dis Child* 1968;115:222–238.

99. Siegler R. The morphology of the thymus and their relation to leukemia. In: Good RA, ed. *The thymus in immunobiology*. New York: Harper & Row, 1964.

100. Oliver PD, Le Douarin NM. Avian thymic accessory cells. *J Immunol* 1984;132:1748–1755.

101. Wu L, Li CL, Shortman K. Thymic dendritic cell precursors: relationship to the T lymphocyte lineage and phenotype of the dendritic cell progeny. *J Exp Med* 1996;184:903–911.

102. Shortman K, Vremec D, Corcoran LM, Georgopoulos K, et al. The linkage between T-cell and dendritic cell development in the mouse thymus. *Immunol Rev* 1998;165:39–46.

103. Spits H, Blom B, Jaleco AC, Weijerk, et al. Early stages in the development of human T, natural killer and thymic dendritic cells. *Immunol Rev* 1998;165:75–86.

104. Bearman RM, Bensch KG, Levine GD. The normal human thymic vasculature: an ultrastructural study. *Anat Rec* 1975;183:485–497.

105. Clark SL, Jr. The penetration of proteins and colloidal materials into the thymus from the bloodstream. In: *Wistar Inst Symp Monogr* 1964;2:9–32.

106. Hwang WS, Ho TY, Luk SC, Simon GT. Ultrastructure of the rat thymus. A transmission, scanning electron microscope, and morphometric study. *Lab Invest* 1974;31:473–487.

107. Raviola E, Karnovsky MJ. Evidence of a blood-thymus barrier using electron-opaque tracers. *J Exp*

Med 1972;136:466–498.

108. Weiss L. Electron microscopic observations on the vascular barrier in the cortex of the thymus of the mouse. *Anat Rec* 1963;145:413–437.
109. Clark SL, Jr. The intrathymic environment. *Contemp Top Immunobiol* 1973;2:77–99.
110. Nienwenhuis P, Stet RJ, Wagenaar JP, et al. The transcapsular route: a new way for (self-) antigens to bypass the blood–thymus barrier? *Immunol Today* 1988;9:372–375.
111. Cowan WK, Sorenson GD. Electron microscopic observations of acute thymic involution produced by hydrocortisone. *Lab Invest* 1964;13:353.
112. Fisher ER. Pathology of the thymus and its relation to human disease. In: Good RA, ed. *The thymus in immunobiology: structure, function and role in disease*. New York: Hoeber, 1964.
113. Gad P, Clark SL, Jr. Involution and regeneration of the thymus in mice, induced by bacterial endotoxin and studied by quantitative histology and electron microscopy. *Am J Anat* 1968;122:573–605.
114. Christensson B, Matel G, Biberfeld P. Immunological studies on human thymus. Occurrence and distribution of immunoglobulins and immunological receptors in myasthenia gravis and control patients. *Acta Med Scand* 1980;208:161–168.
115. Drachman DB. Myasthenia gravis. *N Engl J Med* 1978;298:136–142.
116. Pizzighella S, Riviera AP, Tridente G. Thymic involvement in myasthenia gravis. Study by immunofluorescent and immunoperoxidase staining. *J Neuroimmunol* 1983;4:117–127.
117. Tridente G. Immunopathology of the human thymus. *Semin Hematol* 1985;22:56–67.
118. Goldstein G, Abbot A, Mackay IR. An electron–microscope study of the human thymus: normal appearances and the findings in myasthenia gravis and systemic lupus erythematosus. *J Pathol Bacteriol* 1968;95:211–215.
119. Dalakas MC, Engel WK, McClure, et al. Immunocytochemical localization of thymosin–a1 in thymic epithelial cells of normal and myasthenia gravis patients and in thymic cultures. *J Neurol Sci* 1981;50:239–247.
120. Lindstrom J. Autoimmune response to acetylcholine receptors in myasthenia gravis and its animal model. *Adv Immunol* 1979;27:1–50.
121. Engel WK, et al. Thymic epithelial cell contains acetylcholine receptor. *Lancet* 1977;1:1310.
122. Fuchs S, Schmidt–Hopfeld I, Tridente G, Tarrab–Hazdai R. Thymic lymphocytes bear a surface antigen which cross–reacts with acetylcholine receptor. *Nature* 1980;287:162–164.
123. Kao I, Drachman DB. Thymic muscle cell bear acetylcholine receptors: possible relation to myasthenia gravis. *Science* 1977;195:74–75.
124. Wekerle H, et al. Striated muscle fibers differentiate in monolayer cultures of adult thymus reticulum. *Nature* 1975;256:493.
125. Trotter JL, Ferguson TF, Garvey WF. Studies on the thymus from patients with multiple sclerosis and myasthenia gravis. *J Neuroimmunol* 1982;3:99–111.
126. Levine GD, Rosai J. Thymic hyperplasia and neoplasia: a review of current concepts. *Hum Pathol* 1978;9:495–515.
127. Smith JL, Clein GP, Barker CR, Collins RD. Characterization of malignant mediastinal lymphoid neoplasm (Sternberg sarcoma) as thymic in origin. *Lancet* 1973;1:74–77.
128. Fu YX, Chaplin DD. Development and maturation of secondary lymphoid tissues. *Ann Rev Immunol*

1999;17:399–433.

129. Cupedo T, Kraal G, Megius RE. The role of CD45<sup>+</sup> CD4<sup>+</sup> CD3<sup>-</sup> cells in the lymphoid organ development. *Immunol Rev* 2002;189:41–50.

130. Sabin FR. The lymphatic system in human embryos, with a consideration of the morphology of the system as a whole. *Am J Anat* 1909;9:43–91.

131. Wigle JT, Harvey N, Detman M, et al. An essential role for Prox1 in the induction of the lymphatic endothelial cell phenotype. *EMBO J* 2002;21: 1505–1513.

132. De Togne P, Goelner J, Ruddle NH, et al. Abnormal development of peripheral lymphoid organs in mice deficient in lymphotoxin. *Science* 1994;264:703–707.

133. Ware CF, Van Arsdale TL, Crow PD, Browning JL. The ligands and receptors of the lymphotoxin system. *Curr Top Microbiol Immunol* 1995;198:175–218.

134. Mebius RE, Rennert P, Weissman IL. Developing lymph nodes collect CD4<sup>+</sup> CD3<sup>-</sup> LTB<sup>+</sup> cells that can differentiate to APC, NK cells, and follicular cells but not to T or B cells. *Immunity* 1997;7:493–504.

135. Mebius RE, Miyamoto I, Christensen J, et al. The fetal liver counterpart of adult common lymphoid progenitors gives rise to all lymphoid lineages, CD45<sup>+</sup> CD4<sup>+</sup> CD3<sup>-</sup> cells, as well as macrophages. *J Immunol* 2001;166:6593–6601.

136. Kurebayashi S, Ueda E, Sakaue M, et al. Retinoid-related orphan receptor gamma (ROR gamma) is essential for lymphoid organogenesis and controls apoptosis during thymopoiesis. *Proc Natl Acad Sci U S A* 2000;97:10132–10137.

137. Yokota Y, Mansow A, Mori S, et al. Development of peripheral lymphoid organs and natural killer cells depends on the helix–loop–helix inhibitor Id2. *Nature* 1999;397:702–706.

138. Kim D, Mebius RE, MacMicking JD, et al. Regulation of peripheral lymph node genesis by the tumor necrosis factor family member TRANCE. *J Exp Med* 2000;192:1467–1478.

139. Dougall WC, Glaccum A, Charrier K, et al. RANK is essential for osteoclast and lymph node development. *Genes Dev* 1999;13:2412–2424.

140. Miyawaki S, Nakamura Y, Suzuka H, et al. A new mutation, aly, that induces a generalized lack of lymph nodes accompanied by immunodeficiency in mice. *Eur J Immunol* 1994;24:429–434.

141. Ansel KM, Ngo VN, Hyman PL, et al. A chemokine-driven positive feedback loop organizes lymphoid follicles. *Nature* 2000;406:309–314.

142. Movat HZ, Fernando NVP. The fine structure of the lymphoid tissue. *Exp Mol Pathol* 1964;3:546–568.

143. Olah I, Rohlich P, Toro I. Ultrastructure of lymphoid organs. An electron microscopic atlas. Philadelphia: JB Lippincott, 1975.

144. Weiss L. Lymphatic vessels and lymph nodes. In: Weiss L, ed. Cell and tissue biology. Baltimore: Urban and Schwarzenberg, 1988.

145. Clark SL, Jr. The reticulum of lymph nodes in mice studied with the electron microscope. *Am J Anat* 1962;110:217–257.

146. Luk SC, Nopajaroonsri C, Simon GT. The architecture of the normal lymph node and hemolymph node. A scanning and transmission electron microscopic study. *Lab Invest* 1973;29:258–265.

147. Flemming W. Studien über regeneration der Gewebe. I. Die zellvermehrung in den lymphdrüsen and verwandten organen und ihr einfluss auf deren bau. *Arch Mikrosk Anat* 1884;24:50.

148. Hellman T. Studien über das lymphoide gewebe. Die bedeutung der sekundärfollikel. *Beitrage Pathol*

Anat Allgem Pathol 1921;68:333.

149. Gregory CD, Tursz T, Edwards CF, et al. Identification of a subset of normal B cells with a Burkitt's lymphoma (BL)-like phenotype. *J Immunol* 1987;139:313-318.

150. Rouse RV, Ledbetter JA, Weissman IL. Mouse lymph node germinal centers contain a selected subset of T cells—the helper phenotype. *J Immunol* 1982;128:2243-2246.

151. Bowen MB, Butch AW, Parvin CA, et al. Germinal center T cells are distinct helper-inducer T cells. *Hum Immunol* 1991;31:67-75.

152. Kincade PW. Formation of B lymphocytes in fetal and adult life. *Adv Immunol* 1981;31:177-245.

153. van den Oord JJ, De Wolf-Peeters C, Desmet VJ, et al. Nodular alteration of the paracortical areas. An in situ immunohistochemical analysis of primary, secondary, and tertiary T-nodules. *Am J Pathol* 1985;120:55-66.

154. Inaba K, Witmer MD, Steinman RM. Clustering of dendritic cells, hyper T lymphocytes, and histocompatible B cells during primary antibody responses in vitro. *J Exp Med* 1984;160:858-876.

155. Kelly RH. Functional anatomy of lymph nodes: the paracortical cords. *Int Arch Allergy Appl Immunol* 1975;48:836-849.

156. Gretz JE, Anderson AO, Shaw S. Cords, channels, corridors and conduits: critical architectural elements facilitating cell interactions in the lymph node cortex. *Immunol Rev* 1997;156:11-24.

157. Tew JG, Phipps RP. Immune functions of dendritic type cells. In: Bellanti JA, Herscovitz HB, eds. *The reticuloendothelial system. A comprehensive treatise, vol 6.* New York: Plenum Press, 1984.

158. Szakal AK, Kosco MH, Tew JG. Microanatomy of lymphoid tissue during humoral immune responses: structure function relationships. *Annu Rev Immunol* 1989;7:91-109.

159. Freedman AS, Munro JM, Rice GE, et al. Adhesion of human B cells to germinal centers in vitro involves VLA-4 and ICAM-1. *Science* 1990;249:1030-1033.

160. Janossy G, Pinching AJ, Bofil M, et al. An immunohistological approach to persistent lymphadenopathy and its relevance to AIDS. *Clin Exp Immunol* 1985;59:257-266.

161. Alavaikko MJ, Hansmann ML, Nebendahl C, et al. Follicular dendritic cells in Hodgkin's disease. *Am J Clin Pathol* 1991;95:194-200.

162. Cyster JG, Ansel KM, Eklund EH, Hyman PL. Follicular stromal cells and lymphocyte homing to follicles. *Immunol Rev* 2000;176:181-193.

163. Veldman JE, Kaiserling E. Interdigitating cells. In: Carr I, Daems WT, eds. *The reticuloendothelial system. A comprehensive treatise, vol 1.* New York: Plenum Press, 1980.

164. Achen MG, Stacker SA. The vascular endothelial growth factor family: proteins which guide the development of the vasculature. *Int J Exp Pathol* 1998;79:255-265.

165. Oh SJ, Jeltsch MM, Birkenhäger R, et al. VEGF and VEGF-C: specific induction of angiogenesis and lymphangiogenesis in the differentiated avian chorioallantoic membrane. *Dev Biol* 1997;188:96-109.

166. Lymboussaki A, Partanen TA, Olofsson B, et al. Expression of the vascular endothelial growth factor C receptor VEGFR-3 in lymphatic endothelium in skin and vascular tumors. *Am J Pathol* 1998;153:395-403.

167. Anderson AO, Anderson ND. Studies on the structure and permeability of the microvasculature in normal rat lymph nodes. *Am J Pathol* 1975;80:387-418.

168. Gowans JL, Knight EJ. The route of recirculation of lymphocytes in the rat. *Proc Roy Soc (Biol)* 1964;159:257.

169. Wenk EJ, Orlic D, Reith EJ, Rhodin JA. The ultrastructure of mouse lymph node venules and the

passage of lymphocytes across their walls. *J Ultrastruct Res* 1974;47:214-241.

170. Anderson ND, Anderson AO, Wyllie RG. Specialized structure and metabolic activities of high endothelial venules in rat lymphatic tissues. *Immunology* 1976;31:455-473.

171. Goldschneider I, McGregor DD. Migration of lymphocytes and thymocytes in the rat. I. The route of migration from blood to spleen and lymph nodes. *J Exp Med* 1968;127:155-168.

172. Parrot DMV, De Sousa MAB, East J. Thymus-dependent areas in the lymphoid organs of neonatally thymectomized mice. *J Exp Med* 1966;123:191-204.

173. DeSousa MAB, Parrot DMV, Pantelouris EM. The lymphoid tissues in mice with congenital aplasia of the thymus. *Clin Exp Immunol* 1969;4:637-644.

174. Brooks CG, Webb PJ, Robbins RA, et al. Studies on the immunobiology of rnu/rnu "nude" rats with congenital aplasia of the thymus. *Eur J Immunol* 1980;10:58-65.

175. Fossum S, Smith ME, Bell EB, Ford WL. The architecture of rat lymph nodes. III. The lymph nodes and lymph-borne cells of the congenitally athymic nude rat (rnu). *Scand J Immunol* 1980;12:421-432.

176. Hendriks HR, Eestermans IL. Disappearance and reappearance of high endothelial venules and immigrating lymphocytes in lymph nodes deprived of afferent lymphatic vessels: a possible regulatory role of macrophages in lymphocyte migration. *Eur J Immunol* 1983;13:663-669.

177. Marchesi VT, Gowans JL. The migration of lymphocytes through the endothelium of venules in lymph nodes: an electron microscope study. *Proc R Soc (Biol)* 1964;159:283-290.

178. Anderson AO, Anderson ND. Lymphocyte emigration from high endothelial venules in rat lymph nodes. *Immunology* 1976;31:731-748.

179. Schoefl GI. The migration of lymphocytes across the vascular endothelium in lymphoid tissue. A reexamination. *J Exp Med* 1972;136:568-588.

180. Nossal GJV, Ada GL. Antigen, lymphoid cells and the immune response. New York: Academic Press, 1971.

181. Nossal GJV, Abbot A, Mitchell J. Antigen in immunity. XIV. Electron microscopic radioautographic studies of antigen capture in the lymph node medulla. *J Exp Med* 1968;127:263-276.

182. Nossal GJV, Abbot A, Mitchell J, Lummus Z. Antigen in immunity. XV. Ultrastructural features of antigen capture in primary and secondary lymphoid follicles. *J Exp Med* 1968;127:277-290.

183. Stein H, Gerdes J, Mason DY. The normal and malignant germinal center. *Clin Haematol* 1982;11:531-559.

184. Dameshek W. "Immunoblasts" and immunocytes. An attempt at a functional nomenclature. *Blood* 1963;21:243-245.

185. Lennert K, Caesar R, Muller HK. Electron microscopic studies of germinal centers in man. In: Cottier H, ed. Germinal centers in immune responses. New York: Springer-Verlag, 1967:49-59.

186. Movat HZ, Fernando NVP. The fine structure of the lymphoid tissue during antibody formation. *Exp Mol Pathol* 1965;4:155-188.

187. Swartzendruber DC, Congdon CC. Electron microscope observations on tingible body macrophages in mouse spleen. *J Cell Biol* 1963;19:641-646.

188. Mori M, Ishi Y, Onoé T. Studies on the germinal center. I. Ultrastructural study of germinal centers in human lymph nodes with correspondence to the zonal differentiation. *J Reticuloendothel Soc* 1969;6:140-157.

189. Hanna MG, Jr. An autoradiographic study of the germinal center in spleen white pulp during early

intervals of the immune response. *Lab Invest* 1964;13:95–104.

190. Kojima M, Imai Y. Genesis and function of germinal center. *Gann Monogr Cancer Res* 1973;15:1–24.
191. Jacobson EB, Caporale LH, Thorbecke GJ. Effect of thymus cell injections on germinal center formation in lymphoid tissues in nude (thymusless) mice. *Cell Immunol* 1974;13:416–430.
192. Nossal GJV, Makela O. Autoradiographic studies on the immune response. I. The kinetics of plasma cell proliferation. *J Exp Med* 1962;115:209–230.
193. Thorbecke GJ, et al. The production of memory cells by the white pulp of the spleen in rabbits. In: Cottier H, ed. *Germinal centers in immune response*. New York: Springer-Verlag, 1967.
194. Roberts CWM, Shutter JR, Korsmeyer SJ. Hox11 controls the genesis of the spleen. *Nature* 1994;368:747–749.
195. Lewis SM. The spleen—mysteries solved and unresolved. *Clin Haematol* 1983;12:363–373.
196. MacPherson AIS, Richmond J, Stuart AE. *The spleen*. Springfield: Charles C Thomas, 1973.
197. Weiss L. The spleen. In: Weiss L, ed. *Cell and tissue biology*. Baltimore: Urban and Schwarzenberg, 1988.
198. Weiss L. A scanning electron microscopic study of the spleen. *Blood* 1974;43:665–691.
199. Weiss L. The structure of the normal spleen. *Semin Haematol* 1965;2:205–228.
200. Veerman AJP. On the interdigitating cells in the thymus-dependent area of the rat spleen: a relation between the mononuclear phagocytic system and T lymphocytes. *Cell Tissue Res* 1974;148:247–441.
201. Veerman AJP, van Ewijk W. White pulp compartments in the spleen and rats and mice. A light and electron microscopic study of lymphoid and non-lymphoid cell types in T- and B-areas. *Cell Tissue Res* 1975;156:417–441.
202. Lyons AB, Parish CR. Are murine marginal-zone macrophages the splenic white pulp analog of high endothelial venules? *Eur J Immunol* 1995;25:3165–3172.
203. Spencer J, Perry ME, Dunn-Walters DK. Human marginal-zone B cells. *Immunol Today* 1998;19:421–426.
204. Tierens A, Delabie J, Michiels L, et al. Marginal-zone B cells in the human lymph nodes and spleen show somatic hypermutations and display clonal expansion. *Blood* 1999;93:226–234.
205. MacLennan ICM, Liu YJ. Marginal zone B cells respond to both polysaccharide antigens and protein antigens. *Res Immunol* 1991;142:436.
206. Dierlamm J, Pittaluga S, Wlodarska I, et al. Marginal zone B cell lymphomas of different sites share similar cytogenetic and morphologic features. *Blood* 1996;87:299–307.
207. Berger F, Felman P, Thieblemont C, et al. Non-MALT marginal B cell lymphomas: a description of clinical presentation and outcome in 124 patients. *Blood* 2000;95:1950–1956.
208. Tierens A, Delabie J, Pittaluga S, et al. Mutational analysis of the rearranged immunoglobulin heavy chain genes of marginal zone cell lymphomas indicates an origin from different marginal zone B lymphocyte subsets. *Blood* 1998;91:2381–2386.
209. Du MQ, Peng HZ, Degan A, et al. Preferential dissemination of B cell gastric mucosa-associated lymphoid tissue (MALT) lymphoma to the splenic marginal zone. *Blood* 1997;90:4071–4077.
210. Chen LT, Weiss L. Electron microscopy of the red pulp of human spleen. *Am J Anat* 1972;134:425–457.



211. Weiss L. The red pulp of the spleen: structural basis of blood flow. *Clin Haematol* 1983;12:375–393.
212. Chen LT, Weiss L. The role of the sinus wall in the passage of erythrocytes through the spleen. *Blood* 1973;41:529–537.
213. Lockwood CM. Immunological functions of the spleen. *Clin Haematol* 1983;12:449–465.
214. Bohnsack JF, Brown EJ. The role of the spleen in resistance to infection. *Annu Rev Med* 1986;37:49–59.
215. Dickerman JD. Bacterial infection and the asplenic host: a review. *J Trauma* 1976;16:662–668.
216. King HK, Schumaker HB. Splenic studies. I. Susceptibility to infection after splenectomy in infancy. *Ann Surg* 1952;136:239.
217. Singer DB. Postsplenectomy sepsis. *Perspect Pediatr Pathol* 1973;1:285–311.
218. Rowley DA. The effect of splenectomy on the formation of circulating antibody in the adult male albino rat. *J Immunol* 1950;64:289–295.
219. Hosea SW, Berch CG, Brown EJ, et al. Impaired immune response of splenectomized patients to polyvalent pneumococcal vaccine. *Lancet* 1981;1:804–807.
220. Sullivan JL, Och HD, Schiffman G, et al. Immune response after splenectomy. *Lancet* 1978;1:178–181.
221. Drew PA, et al. Alterations in immunoglobulin synthesis by peripheral blood mononuclear cells from splenectomized patients with and without splenic regrowth. *J Immunol* 1984;132:191.
222. Karrer U, Althage A, Odermatt B, et al. On the key role of secondary lymphoid organs in antiviral immune responses studied in antiviral immune responses studied in alymphoplastic (aly/aly) and spleenless (Hox11<sup>-/-</sup>) mutant mice. *J Exp Med* 1997;185:2157–2170.
223. Carlos TM, Harlan JM. Leukocyte–endothelial adhesion molecules. *Blood* 1994;84:2068–2101.
224. Imhof BA, Dunon D. Leukocyte migration and adhesion. *Adv Immunol* 1995;58:345–416.
225. Girard JP, Springer TA. High endothelial venules (HEVs): specialized endothelium for lymphocyte migration. *Immunol Today* 1995;16:449–457.
226. Dunon D, Piali L, Imhof BA. To stick or not to stick: the new leukocyte homing paradigm. *Curr Opin Cell Biol* 1996;8:714–723.
227. Butcher EC, Picker LJ. Lymphocyte homing and homeostasis. *Science* 1996;272:60–66.
228. Picker LJ, Butcher EC. Physiological and molecular mechanisms of lymphocyte homing. *Annu Rev Immunol* 1992;10:561–591.
229. Mackay CR, Marston WL, Dudler L. Naive and memory T cells show distinct pathways of lymphocyte recirculation. *J Exp Med* 1990;171:801–817.
230. Westermann J, Blaschke V, Zimmermann G, et al. Random entry of circulating lymphocyte subsets into peripheral lymph nodes and Peyer’s patches: no evidence in vivo of a tissue–specific migration of B and T lymphocytes at the level of high endothelial venules. *Eur J Immunol* 1992;22:2219–2223.
231. Streeter PR, Rouse BT, Butcher EC. Immunohistologic and functional characterization of a vascular addressin involved in lymphocyte homing into peripheral lymph nodes. *J Cell Biol* 1988;107:1853–1862.
232. Berg EL, Robinson MK, Warnock RA, Butcher EC. The human peripheral lymph node vascular addressin is a ligand for LECAM–1, the peripheral lymph node homing receptor. *J Cell Biol*

1991;114:343–349.

233. von Andrian UH, Hasslen SR, Nelson RD, et al. A central role for microvillous receptor presentation in leukocyte adhesion under flow. *Cell* 1995;82: 989–999.

234. Berlin C, Bargatze RF, Campbell JJ, et al.  $\alpha_4$  Integrins mediate lymphocyte attachment and rolling under physiologic flow. *Cell* 1995;80:413–422.

235. Bargatze RF, Jutila MA, Butcher EC. Distinct roles of L-selectin and integrins  $\alpha_4\beta_7$  and LFA-1 in lymphocyte homing to Peyer's patch-HEV in situ: the multistep model confirmed and refined. *Immunity* 1995;3:99–108.

236. Hamann A, Andrew DP, Jablonski-Westrich D, et al. Role of  $\alpha_4$ -integrins in lymphocyte homing to mucosal tissues in vivo. *J Immunol* 1994;152:3282–3293.

237. Arbonés ML, Ord DC, Ley K, et al. Lymphocyte homing and leukocyte rolling and migration are impaired in L-selectin-deficient mice. *Immunity* 1994;1:247–260.

238. Pavalko FM, Walker DM, Graham L, et al. The cytoplasmic domain of L-selectin interacts with cytoskeletal proteins via  $\alpha$ -actinin: receptor positioning in microvilli does not require interaction with  $\alpha$ -actinin. *J Cell Biol* 1995;129:1155–1164.

239. Chen S, Springer TA. An automatic braking system that stabilizes leukocyte rolling by an increase in selectin bond number with shear. *J Cell Biol* 1999;144:185–200.

240. Kanamori A, Kojima N, Uchimura K, et al. Distinct sulfation requirements of selectins disclosed using cells that support rolling mediated by all three selectins under shear flow. L-selectin prefers carbohydrate 6-sulfation to tyrosine sulfation, whereas P-selectin does not. *J Biol Chem* 2002;277:32578–32586.

241. Vestweber D, Blanks JE. Mechanisms that regulate the function of the selectins and their ligands. *Physiol Rev* 1999;79:181–213.

242. Lowe JB. Glycosylation in the control of selectin counter-receptor structure and function. *Immunol Rev* 2002;186:19–36.

243. Hemmerich S, Butcher EC, Rosen SD. Sulfation-dependent recognition of high endothelial venules (HEV)-ligands by L-selectin and MECA 79, an adhesion-blocking monoclonal antibody. *J Exp Med* 1994;180:2219–2226.

244. Maly P, Thall AD, Petryniak CE, et al. The  $\alpha$ -(1,3) fucosyltransferase Fuc-TVII controls leukocyte trafficking through an essential role in L-, E- and P-selectin ligand biosynthesis. *Cell* 1996;86:643–653.

245. Warnock RA, Askari S, Butcher EC, von Adrian U. Molecular mechanisms of lymphocyte homing to peripheral lymph nodes. *J Exp Med* 1998;187:205–216.

246. Butcher EC, Picker LJ. Lymphocyte homing and homeostasis. *Science* 1996;272:60–66.

247. Ebneth K, Kaldjian EP, Anderson AO, Shaw W. Orchestrated information transfer underlying leukocyte endothelial interactions. *Annu Rev Immunol* 1996;14:155–177.

248. Gunn MD, Tangemann K, Tam C, et al. A chemokine expressed in lymphoid high endothelial venules promotes the adhesion and chemotaxis of naïve T lymphocytes. *Proc Natl Acad Sci U S A* 1998;95:258–263.

249. Nagira M, Imai T, Yoshida R, et al. A lymphocyte-specific CC chemokine, secondary lymphoid tissue chemokine (SLC), is a highly efficient chemoattractant for B cells and activated T cells. *Eur J Immunol* 1998;28:1516–1523.

250. Campbell JJ, Butcher EC. Chemokines in tissue-specific and microenvironment-specific lymphocyte homing. *Curr Opin Immunol* 2000;12:336–341.

251. Campbell JJ, Hendrick J, Zlotnic A, et al. Chemokines and the arrest of lymphocytes under flow

conditions. *Science* 1998;279:381–384.

252. Tangemann K, Gunn MD, Giblin P, Rosen SD. A high endothelial cell-derived chemokine induces rapid, efficient, and subset-selective arrest of rolling T lymphocytes on a reconstituted endothelial substrate. *J Immunol* 1998;161:6330–6337.

253. Ngo VN, Tang HL, Cyster JG. Epstein-Barr virus-induced molecule 1 ligand chemokine is expressed by dendritic cells in lymphoid tissues and strongly attracts naïve T cells and activated B cells. *J Exp Med* 1998;188:373–386.

254. Backevold ES, Yamanaka T, Palframan RT, et al. The CCR7 ligand ELC (CCL19) is transcytosed in high endothelial venules and mediate T cell recruitment. *J Exp Med* 2001;193:1105–1111.

255. Nakano H, Mori S, Yonekawa H, et al. A novel mutant gene involved in T-lymphocyte-specific homing into peripheral lymphoid organs on mouse chromosome 4. *Blood* 1998;91:2886–2895.

256. Fan L, Reilly CR, Luo Y, et al. Cutting edge: ectopic expression of the chemokine TCA4/SLC is sufficient to trigger lymphoid neogenesis. *J Immunol* 2000;164:3955–3959.

257. Schaerli P, Willmann K, Lang AB, et al. CXC chemokine receptor 5 expression defines follicular homing T cells with B cell helper function. *J Exp Med* 2000;192:1553–1562.

258. Ansel KM, Ngo VN, Hyman PL, et al. A chemokine-driven positive feedback loop organizes lymphoid follicles. *Nature* 2000;406:309–314.

259. Luther SA, Lopez T, Bai W, et al. BCL expression in pancreatic islets causes B cell recruitment and lymphotoxin-dependent lymphoid neogenesis. *Immunity* 2000;12:471–481.

260. Ngo VN, Korner H, Gunn MD, et al. Lymphotoxin alpha/beta and tumor necrosis factor are required for stromal cell expression of homing chemokines in B and T cell areas of the spleen. *J Exp Med* 1999;189:403–412.

261. Laudanna C, Campbell JJ, Butcher EC. Role of Rho in chemoattractant-activated leukocyte adhesion through integrins. *Science* 1996;271:981–983.

262. Zhang Z, Vuori K, Wang H, et al. Integrin activation by R-ras. *Cell* 1996;85:61–69.

263. Sotsios Y, Ward SG. Phosphoinositide kinase: a key biochemical signal for cell migration in response to chemokines. *Immunol Rev* 2000;177:217–235.

264. Girard JP, Springer TA. Cloning from purified high endothelial venule cells of hevin, a close relative of the antiadhesive extracellular matrix protein SPARC. *Immunity* 1995;2:113–123.

265. Dieu MC, Vanbervliet B, Vicari A, et al. Selective recruitment of immature and mature dendritic cells by distinct chemokines expressed in different anatomic sites. *J Exp Med* 1998;188:373–386.

266. Romani N, Ratzinger G, Pfaller K, et al. Migration of dendritic cells into lymphatics. The Langerhans cell example: routes, regulation, and relevance. *Int Rev Cytol* 2001;207:237–270.

267. Cook DN, Prosser DM, Foster R, et al. CCR6 mediates dendritic cell localization, lymphocyte homeostasis, and immune responses in mucosal tissue. *Immunity* 2000;12:495–503.

268. Schwarzenberger K, Udey MC. Contact allergens and epidermal pro-inflammatory cytokines modulate Langerhans cell E-cadherin expression in situ. *J Invest Dermatol* 1996;106:553–558.

269. Moodycliffe AM, Schreedhar V, Ullrich SE, et al. CD40-CD40 ligand interactions in vivo regulate migration of antigen bearing dendritic cells from the skin to draining lymph nodes. *J Exp Med* 2000;191:2011–2020.

270. Kellerman SA, Hudak S, Oldham ER, et al. The CC chemokine receptor-7 ligands 6C kine and macrophage inflammatory protein-3  $\beta$  are potent chemoattractants for in vitro- and in vivo-derived dendritic cells. *J Immunol* 1999;162:3859–3864.

271. Kobayashi Y, Matsumoto M, Kotani M, Makino T. Possible involvement of matrix metalloproteinase-9 in Langerhans cell migration and maturation. *J Immunol* 1999;163:5989-5993.
272. Cyster JG. Chemokines and the homing of dendritic cells to the T cell areas of lymphoid organs. *J Exp Med* 1999;189:447-450.
273. Mackay CR. Migration pathways and immunologic memory among T lymphocytes. *Semin Immunol* 1992;4:51-58.
274. Mackay CR, Marston WL, Dudler L, et al. Tissue-specific migration pathways by phenotypically distinct subpopulations of memory T cells. *Eur J Immunol* 1992;22:887-895.
275. Berg EL, Yoshino T, Rott LS, et al. The cutaneous lymphocyte antigen is a skin lymphocyte homing receptor for the vascular lectin endothelial cell-leukocyte adhesion molecule 1. *J Exp Med* 1991;174:1461-1466.
276. Picker LJ, Kishimoto TK, Smith CW, et al. ELAM-1 is an adhesion molecule for skin-homing T cells. *Nature* 1991;349:796-799.
277. Cotran RS, Gimbrone MA, Jr., Bevilacqua MP, et al. Induction and detection of a human endothelial activation antigen in vivo. *J Exp Med* 1986;164:661-666.
278. Wayner EA, Gil SG, Murphy GF, et al. Epiligrin, a component of epithelial basement membranes, is an adhesive ligand for a  $\beta_1$  positive T lymphocytes. *J Cell Biol* 1993;121:1141-1152.
279. Cerf-Bensussan N, Jarry A, Brousse N, et al. A monoclonal antibody (HML-1) defining a novel membrane molecule present on human intestinal lymphocytes. *Eur J Immunol* 1987;17:1279-1285.
280. Cerf-Bensussan N, Bègue B, Gagnon J, Meo T. The human intraepithelial lymphocyte marker HML-1 is an integrin consisting of a  $\beta_7$  subunit associated with a distinctive  $\alpha$  chain. *Eur J Immunol* 1992;22:273-277.
281. Cepek KL, Parker CM, Madara JL, Brenner MB. Integrin  $\alpha\beta_7$  mediates adhesion of T lymphocytes to epithelial cells. *J Immunol* 1993;150:3459-3470.
282. Picker LJ, Terstappen LW, Rott LS, et al. Differential expression of homing-associated adhesion molecules by T cell subsets in man. *J Immunol* 1990;145:3247-3255.
283. Parker CM, Cepek KL, Russell GJ, et al. A family of  $\beta_7$  integrins on human mucosal lymphocytes. *Proc Natl Acad Sci U S A* 1992;89:1924-1928.
284. Briskin MJ, McEvoy LM, Butcher EC. MAdCAM-1 has homology to immunoglobulin and mucin-like adhesion receptors and to IgA1. *Nature* 1993;363:461-464.
285. Tanaka Y, Adams DH, Hubscher S, et al. T-cell adhesion induced by proteoglycan-immobilized cytokine MIP-1 $\beta$ . *Nature* 1993;361:79-82.
286. Schall TJ, Bacon K, Toy KJ, Goeddel DV. Selective attraction of monocytes and T lymphocytes of the memory phenotype by cytokine RANTES. *Nature* 1990;347:669-671.
287. Miller MD, Krangel MS. Biology and biochemistry of the chemokines: a family of chemotactic and inflammatory cytokines. *Crit Rev Immunol* 1992;12:17-46.
288. Papayannopoulou T, Craddock C, Nakamoto B, et al. The VLA4/VCAM-1 adhesion pathway defines contrasting mechanisms of lodgment of transplanted murine hemopoietic progenitors between bone marrow and spleen. *Proc Natl Acad Sci U S A* 1995;92:9647-9651.
289. Zannettino AC, Berndt MC, Butcher C, et al. Primitive human hematopoietic progenitors adhere to P-selectin (CD62P). *Blood* 1995;85:3466-3477.
290. Puri KD, Finger EB, Gaudernack G, Springer TA. Sialomucin CD34 is the major L-selectin ligand in

human tonsil high endothelial venules. *J Cell Biol* 1995;131:261–270.

291. Kanda T, Yamawaki M, Ariga T, Yu RK. Interleukin 1 $\beta$  up-regulates the expression of sulfoglucuronosyl paragloboside, a ligand for L-selectin, in brain microvascular endothelial cells. *Proc Natl Acad Sci U S A* 1995;92:7897–7901.

292. Smith ME, Ford WL. The recirculating lymphocyte pool of the rat: a systemic description of the migratory behavior of recirculating lymphocytes. *Immunology* 1983;49:83–94.

293. Förster R, Schubel A, Breitfeld D, et al. CCR7 coordinates the primary immune response by establishing functional microenvironments in secondary lymphoid organs. *Cell* 1999;99:23–33.

294. Butcher EC, Williams M, Youngman K, et al. Lymphocyte trafficking and regional immunity. *Adv Immunol* 1999;72:209–253.

295. Shaniel C, Rolinck AG, Melchers F. Attractions and migrations of lymphoid cells in the organization of humoral immune responses. *Adv Immunol* 2001;78:111–168.

296. Gerard C, Rollins BJ. Chemokines and disease. *Nat Immunol* 2001;2:108–115.

2004 Lippincott Williams & Wilkins  
John P. Greer, John Foerster, John N. Lukens  
George M. Rodgers, Frixos Paraskevas, Bertil Glader  
Wintrobe's Clinical Hematology

ONTOGENYStem Cell to Progenitor B (Pro-B) CellPro-B Cell to Immunoglobulin+ B CellIMMUNOGLOBULIN GENESVH-D-JH GENESVH GenesD GenesJH GenesV(D)J RecombinationRAG-1 AND RAG-2 PROTEINSHUMAN LIGHT CHAIN GENE LOCIHEAVY AND LIGHT CHAINS GETTING TOGETHERREGULATION OF V(D)J RECOMBINATIONV GENE REPERTOIREPATHOLOGY OF V(D)J RECOMBINATION: IMMUNE DEFICIENCIESSEVERE COMBINED IMMUNODEFICIENCY MUTATIONV(D)J RECOMBINATION DEFECTS: DNA CLEAVAGEOMENN SYNDROME (OMIM NO: 603554)V(D)J RECOMBINATION DEFECTS: DNA REPAIRATAXIA TELANGIECTASIA (OMIM NO: 208900)NIJMGEN BREAKAGE SYNDROME (OMIM NO: 251260)BLOOM SYNDROME (OMIM NO: 210800)DEFECTS IN LIGASESXERODERMA PIGMENTOSUM (OMIM NO: 278700)GENETIC DEFECTS OF EARLY B-CELL DEVELOPMENTCell Signaling during B-Cell DevelopmentSignaling DefectsDefects of ?5Defects of Immunoglobulin a (CD79a)Defects of  $\mu$ -Heavy ChainDefects of B-Cell Linker ProteinBRUTON AGAMMAGLOBULINEMIA (OMIM NO: 300300)PHENOTYPIC CHANGES IN THE EARLY STAGES OF B-CELL DEVELOPMENTMATURE B LYMPHOCYTESSURFACE IMMUNOGLOBULINB-CELL ANTIGEN RECEPTOR COMPLEX: STRUCTURE AND SIGNALINGB-Cell Receptor StructureB-Cell Receptor and Lipid RaftsB-Cell Receptor SignalingADAPTER MOLECULES: SIGNALING PLASTICITY AND DIVERSITYB-CELL SIGNALING THROUGH ACCESSORY STRUCTURESINTERLEUKIN-4INTERLEUKIN-5INTERLEUKIN-6CD40POLYCLONAL ACTIVATIONMORPHOLOGIC CHANGES ASSOCIATED WITH B-CELL DIFFERENTIATIONPlasma CellB-Cell Differentiation: Plasma CellsMolecular and Ultrastructural Aspects of Immunoglobulin BiosynthesisGlobal Gene View of B-Cell Activation and DifferentiationB-Cell SubpopulationsREFERENCES**ONTOGENY**

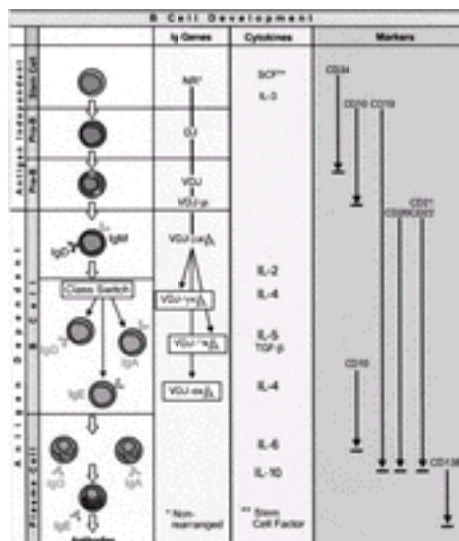
Pluripotential stem cells give rise to all hematopoietic lineages, including B and T

lymphocytes. These cells undergo asymmetric division; as a result, one daughter cell follows a pathway of differentiation, whereas the other remains a self-renewing stem cell. These stem cells differentiate into various lineages depending on their interaction with the appropriate stromal cells as well as growth and differentiation factors. Stem cell differentiation is guided by the type of stromal elements to which the stem cells are exposed. Stem cells placed into the thymic microenvironment develop into T cells, whereas those in contact with bone marrow-derived stromal cells develop into B lymphocytes or myeloid cells. B-cell development and differentiation can be divided into two broad periods: the first period, from stem cell to immature immunoglobulin (Ig) M<sup>+</sup> B cell, is antigen independent; the second period, from immature B cell to plasma cell, is antigen dependent. The first period can be further subdivided into two stages: from stem cell to *progenitor B (pro-B)* cell, and from pro-B cell to immature Ig<sup>+</sup> B cell.

B-cell differentiation has been studied in animals and humans on cells obtained from different stages of development (embryonic vs. adult) as well as cells from patients with lymphoproliferative disorders, which, by some, are considered “frozen windows” of normal differentiation. This approach, however, is not accepted by all because some evidence suggests the existence of some degree of asynchronous maturation in acute leukemias, with phenotypes not found normally (1).

### Stem Cell to Progenitor B (Pro-B) Cell

See [Figure 16.1](#).



**Figure 16.1.** B-cell differentiation. The first stage of B-cell development takes place in the bone marrow. B-cell progenitors stimulated by direct contacts with cells of bone marrow stroma and the cytokines secreted by them differentiate by initiating rearrangements of their immunoglobulin (Ig) genes and the expression of lineage-specific antigens. This stage of differentiation is antigen-independent, and the emerging B lymphocytes develop their antigen-specific repertoire (VDJ recombinations). The second stage of their development takes place in the secondary lymphoid organs under the influence of antigenic stimulation and the interaction with several types of cells, such as dendritic cells, T cells, and the cytokines secreted by them. During this stage, depending on the nature of signals, B cells generate plasma cells or memory cells. Antibodies of various classes are synthesized and secreted (class switch), while their affinity for antigen is increased. This is achieved by a process of “hypermutation,” which introduces new bases to DNA sequences not existing in the germ line. The backbone of differentiation



over the entire pathway is the Ig gene rearrangements. Because they occur randomly, the cells in both stages are subject to selection, which secures survival of cells possessing the appropriate V(D)J configuration. IL, interleukin; TGF, transforming growth factor. (From Paraskevas F. B lymphocytes. In: Israels L, Israels E, eds. Mechanisms in hematology. With permission from Core Health Services, Inc.)

**TRANSCRIPTIONAL REGULATION** Hematopoiesis is a highly complex process coordinated by several genes that orchestrate through their products multiple cell interactions and the release of growth and differentiation factors (2). During this process, more than eight specific cell lineages arise from pluripotent stem cells. Their differentiation is guided through a well-defined hierarchical sequence to mature functional cells (3). Lymphopoiesis, during fetal life, takes place in the yolk sac and liver but, after birth, like the rest of definitive hematopoiesis, takes place in the bone marrow (4). “Master” genes regulate differentiation of lineages through transcription factors, which activate target genes, progressively narrowing their differentiation potential to specific lineages (3). Several genes coordinate the various stages of lymphocytic development (5). The transcription factor PU.1 of the Ets family is identical to the Spi-1/Sfp1 protooncogene expressed mainly in monocytes, macrophages, and B lymphocytes. Lack of PU.1 gene function in mice affects the development of B lymphocytes, monocytes, and neutrophils, and the animals die before birth (6). Myeloid and lymphoid lineages come from a common progenitor, but it is difficult to define precisely the point of commitment for lymphocytic differentiation. Mice mutant for PU.1 have no evidence of initiation of lymphopoiesis [i.e., no B220<sup>+</sup> cells (marker specific for B cells) in the liver and no transcripts of Igh, *recombination activating gene* (RAG)-1, or RAG-2 genes]. Normal development of lymphopoiesis depends on the Ikaros family of transcription factors, which selectively regulate lymphocytic development. *Ikaros* is a zinc finger factor expressed in B and T cells at different stages of differentiation (except plasma cells) (7). Ikaros generates eight protein isoforms by alternative splicing, and some of them bind through an N-terminal zinc finger motif to DNA sequences that contain GGGA core motifs (8, 9). *Ikaros*<sup>-/-</sup> mice have a complete block of B-cell differentiation (10), with lack of pro-B and precursor B cells (pre-B cells) in fetal liver or bone marrow. Ikaros is localized in the nucleus of most primitive hematopoietic stem cell subsets, particularly at two stages: (a) in long-term self-renewing stem cells and (b) in non-self-renewing multipotent progenitors able to differentiate into lymphoid-committed progenitors (11). The isoforms detected in hematopoietic stem cells differ from those detected in lymphoid progenitors, but all of them share two C-terminal zinc fingers that mediate their self-association, forming multiple heteromeric complexes. Other members of the Ikaros family (i.e., Aiolos and Helios) encode transcription factors that form multimeric complexes with Ikaros (12). The Ikaros gene is required not only for early stages of lymphocytic differentiation but also for late stages, especially in T-cell maturation (13). Another important gene for lymphoid development is Pax5. Multiple isoforms are generated by alternative splicing, and one of them is the B-lineage-specific activator protein (BSAP) (14). BSAP activity is detected in all stages of B-cell development except plasma cells. A complementary DNA (cDNA) of BSAP encodes an N-terminal-paired domain, an octapeptide conserved among Pax genes, and a partial homeodomain. The paired domain is necessary for DNA binding. The target genes for BSAP are CD19 (15), VpreB1, and *?*5 (16) and several intronic sites of C<sub>H</sub> gene. In the bone marrow of homozygous mutant mice, the B220<sup>+</sup> IgM<sup>+</sup> cells are selectively reduced to less than 1% of normal, and development of B1 and B2 lineages is severely compromised. Pax5 is needed for VDJ heavy chain Ig gene rearrangements, and the precise block is after the first DJ<sub>H</sub> rearrangement (17). As a result, Pax5 mutation does not block recombinase induction per se and allows a significant pro-B-cell population to be formed. The target for BSAP is the adaptor protein BLNK (B-cell linker protein) (SLP-65), which acts as scaffolding in linking Syk tyrosine kinase with

downstream signaling proteins [i.e., PLC $\gamma$  2, Bruton tyrosine kinase (Btk), and so forth] ( 18 ). BSAP regulates the BLNK gene by binding to its proximal promoter region. BLNK expression is a checkpoint in the pro-B to pre-B transition and mediates the constitutive signaling of the pre-B-cell receptor (pre-BCR) in cell proliferation, growth factor responsiveness, and V(D)J recombination. BSAP also diverts differentiation of a common myeloid/lymphoid progenitor to lymphocytic differentiation as a result of its ability to suppress the response of the progenitor to myeloid growth factors ( 19 ). This was shown by expression of BSAP ectopically in stem cells. The E2A gene is highly important for lymphocytic differentiation. The E2A gene encodes two proteins—E12 and E47 of the basic helix-loop-helix family—by differential splicing. The proteins encoded by E2A bind to DNA as a homodimer, uniquely in B cells ( 20, 21 ), and are essential for coordination of Ig gene rearrangements ( 22 ); therefore, in their absence, B-cell differentiation is blocked before entrance into the pro-B-cell stage. The basic region mediates DNA binding, whereas the HLH domain is required for protein dimerization. The target genes for E12 are the early B-cell factor (EBF) and Pax5 ( 23 ). E12 acts on a progenitor cell directing differentiation along B lineage while blocking myeloid differentiation. The EBF is a transcription factor essential for early B-lymphocyte development in regulation of the expression of Iga (mb-1) and Ig $\beta$  (B29) co-receptors. The EBF-deficient mice lack Iga and Ig $\beta$  transcripts in pro-B cells ( 24 ), and isolated human EBF factor has been shown to bind to Iga and Ig $\beta$  promoters ( 25 ). Combined E2A and EBF mutations arrest B-cell development at a stage earlier than that of Pax5, because recombinase expression is blocked, and there is no expression of pre-BCR genes,  $\lambda$ 5, and VpreB and, consequently, no formation of the pre-BCR ( 26, 27 ). The three transcription factors Pax5, E2A, and EBF form a cross-regulatory network. E2A is essential for Pax5 expression and normal expression of EBF. On the other hand, EBF is needed for Pax5 expression, as well as the expression of the E47 product of the E2A gene, which is the most potent for B-cell regulation. Collectively, gene targets of the Ikaros, E2A, PU.1, EBF, and Pax5 transcription factors, regulate stages of B-cell differentiation before the expression of Ig genes. Lately, it has been shown that the E2A gene plays a central role in some aspects of B lymphopoiesis in subsequent stages ( 28 ). In mice, E2A proteins are required for the interleukin (IL)-7-dependent expansion of pro-B cells and their progression to the pre-B-cell stage and, even later, for the regulation of rearrangements of the Ig $\gamma$  genes and heavy chain isotype switching.

**CELL INTERACTIONS IN EARLY B-CELL DEVELOPMENT** Study of B-cell differentiation has become feasible with the development of long-term bone marrow culture techniques ( 29 ). This approach has helped to define the cells that are essential for the development of B cells and the factors that support B-cell growth and differentiation. It has been understood that the bone marrow stroma makes a critical contribution to hematopoietic differentiation. The term *stroma* (Greek for *mattress*) is used in a collective sense to include a variety of cells, such as adventitial reticular cells, adipocytes, fibroblasts, and endothelial cells of the sinuses ( 30, 31 ). The stroma also includes extracellular matrix, composed of various fibrous proteins, glycoproteins (gps), and heparan sulfate, effective in binding cytokines. Granulocyte-macrophage colony-stimulating factor can bind to marrow stromal glycosaminoglycans and be presented to hematopoietic stem cells. Stromal cells have been isolated from adult bone marrow ( 32 ) or fetal bone marrow after removal of adherent cells (i.e., macrophages, endothelial cells). These cells have the morphology of an adventitial/reticular/fibroblast cell, which expresses several adhesion molecules ( 33, 34 ). They support, in cultures, differentiation of fetal bone marrow cells (CD34<sup>+</sup>, CD19<sup>-</sup>) ( 35 ) toward B-cell lineage (i.e., with loss of CD34 and acquisition of CD19 and the VpreB protein). Several adhesion molecules have been implicated in the mediation of interaction between B-cell progenitors and stromal cells; critical among them are vascular cell adhesion molecule-1 (VCAM-1) on stromal cells and very late antigen-4 (VLA-4) on B-cell progenitors ( 34, 36 ),

37 and 38). CD34 is expressed not only on stem cells (39), but also on stromal cell precursors (40) and endothelial cells (41, 42), thus mediating their interactions with its counter-receptor, L-selectin (43), expressed on progenitor cells. Among cytokines that could mediate growth and differentiation of lymphocytes in the bone marrow, IL-7 attracted attention because it was shown in experiments in mice that it plays a critical role in B-cell development (44, 45 and 46). For human lymphocytes, however, although IL-7 transduces signals, it is not essential for B-cell differentiation (47). One might expect that deficiency of IL-7 or IL-7R should block B-cell differentiation in mice at the same stage. This, however, is not the case, because IL-7R deficiency blocks differentiation at a point of differentiation just before the pro-B cell, when the DJ<sub>H</sub> recombination has not yet taken place and the cell has the CD19<sup>-</sup>B220<sup>+</sup> phenotype. IL-7 deficiency acts a step later, that is, between the pro-B and the pre-B cell (48). B220 is a murine B-cell-specific marker, which is one of the CD45R isoforms. In mice lacking IL-7R, the recombination process comes to a halt, because the IL-7R normally targets V<sub>H</sub> segments to the recombinase complex; furthermore, Pax5, which normally stimulates recombination, is silenced (49). Although the block of IL-7 deficiency is after the pro-B cells, these cells have certain abnormalities, such as failure to up-regulate terminal deoxynucleotidyl transferase (TdT) and the high-affinity IL-7R α-chain (50). The net result of IL-7 deficiency is the lack of expression of μ-chain and the pre-BCR-events that normally promote the advancement from pro-B-cell to pre-B-cell stage. The stimulation of proliferation and μ-chain expression follows distinct signaling pathways, because mutation Y449F in the cytoplasmic region of IL-7Ra abrogates proliferation induced by IL-7, but it does not block μ-chain expression (51). A cytokine isolated from thymic stroma, thymic stroma lymphopoietin (TSLP), binds to the IL-7Ra receptor, and it is likely that, in the absence of IL-7, thymic stroma lymphopoietin binds to IL-7R and promotes continuation of B-cell differentiation in the absence of IL-7, with development of IgM<sup>+</sup> B cells from IgM<sup>-</sup> precursors (52). Support for the experiments, which demonstrated the lack of an essential role for IL-7 in human B-cell development, was also provided from one of nature's experiments. The human X-linked severe combined immunodeficiency (X-SCID) is due to mutations of the γc-chain, a common subunit for several cytokine receptors (i.e., IL-2, IL-4, IL-7, IL-9, and IL-15). Patients with X-linked SCID lack T and natural killer (NK) cells but have normal or even elevated B cells (53). Likewise, patients with mutations of the IL-7Ra chain have normal numbers of B cells (54). Although IL-7 is not essential for human B-cell development, it nevertheless exerts some changes in gene expression, especially in concert with other growth factors or stromal cells (55). It synergizes with flt-3 ligand and induces strong expansion of fetal B cells *in vitro* (56). Furthermore, IL-7R has been detected on human B-cell progenitors, which lack expression of CD19 and have a pro-B-cell phenotype as well as clonogenic capacity (57). These cells are also CD34<sup>+</sup>, have messenger RNAs (mRNAs) for Igβ, RAG-1, and Pax5, and are TdT<sup>+</sup>. In addition, IL-7Ra<sup>-</sup>/CD19<sup>-</sup>/CD34<sup>+</sup> cells do not differentiate in short-term cultures into pro-B cells. Therefore, IL-7Ra expression defines an entry into a stage characterized by up-regulation of multiple B lymphoid-associated markers. A number of reports have shown that B lymphocytes arise from progenitors common to B cells and myeloid cells (58, 59). Single adult human CD34<sup>+</sup>/Lin<sup>-</sup>/CD38<sup>-</sup> cells in culture over a murine fetal liver adherent cell line (AFT024) supplied with IL-7, flt-3 ligand, and IL-3 differentiate into B cells, NK cells, myeloid cells, and dendritic cells (58). Another pluripotent stem cell isolated from cord blood with the CD34<sup>+</sup>/CD38<sup>-</sup>/CD7<sup>+</sup> phenotype differentiates *in vitro* into B cells, NK cells, and dendritic cells but is devoid of myeloid or erythroid potential (59). Because of variation in the external microenvironments used in all these reports, it is difficult to define the pathway for B-lineage commitment, from early multilineage progenitors, to the pro-B-cell stage, which expresses D<sub>H</sub> Ig gene

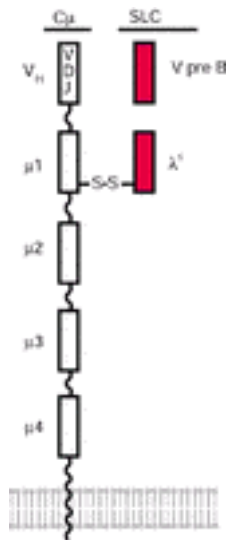
rearrangement. Expression of the CXCR4 chemokine receptor has been detected in CD34<sup>+</sup> hematopoietic progenitors ( [60](#) ), and a cell committed to B-cell development was positive for the chemokine receptor CXCR4 (being the fourth chemokine receptor to be cloned) ( [61](#) ). The ligand for CXCR4 is the stromal cell-derived factor-1/pre-B-cell growth-stimulating factor (SDF-1/PBSF) ( [62](#) ). CXCR4, also known as *fusin*, together with CCR5, acts as a co-receptor for human immunodeficiency virus (HIV) to infect host cells, and SDF-1 blocks the entry of HIV to T cells ( [61](#) ). CD34<sup>+</sup>, CXCR4<sup>-</sup> bone marrow cells can generate myeloid and lymphoid progenitors, but the CD34<sup>+</sup>, CXCR4<sup>+</sup> cells, although they lack myeloid, erythroid, megakaryocytic, and mixed colony-forming potential, give rise to B- and T-lymphoid progenitors ( [61](#) ). CXCR4 is expressed earlier than IL-7R and TdT; therefore, it defines a B-lineage-committed progenitor better and more accurately than other commonly used markers.

### Pro-B Cell to Immunoglobulin + B Cell

Molecular definition of the stages of early B-cell development started with the demonstration of cells that display in the cytoplasm  $\mu$ H-chains without L-chains and no mature IgM molecules on the cell surface. These cells were called *pre-B cells* ( [63](#) ). Further definition followed two different avenues: phenotypic markers or Ig gene rearrangement status ( [64](#) ). Single cell polymerase chain reaction analysis allowed, however, the stages of B-cell development to be ordered better by the sequence of the Ig gene rearrangements than by phenotype.

Ig gene rearrangements are the most important indication of B-lineage commitment and the transition from stem cells to the pro-B-cell stage ( [Fig. 16.1](#) ). With the continuation of Ig gene rearrangements, the pro-B cell becomes a pre-B cell, which, sometimes, is divided into pre-BI and pre-BII stages. When the Ig gene rearrangements reach their final stage and IgM is expressed on the cell surface, differentiation reaches the end of the first period (i.e., the immature B lymphocyte). During the pro-B-cell and pre-B-cell stages, three sets of genes prepare for the expression of the complete Ig molecule on the B-cell surface. One set includes RAG-1 and RAG-2, the second set the *surrogate light chain* (SLC) genes, composed of the products of the two genes VpreB and  $\lambda 5$ , and the third set consists of the genes CD79a (mb1) and CD79b (B29). Their products, Iga and Ig $\beta$ , respectively, form the co-receptor, which supports the expression of IgM on the surface of the B cell. Throughout these stages, the expression of IgM, as well as B-cell-receptor repertoire and allelic exclusion (i.e., expression of only one of the two alleles), become possible.

Rearrangements of the Ig genes start with the joining of a D to J<sub>H</sub> segment in the pro-B cells. Pro-B cells proliferate in contact with stromal elements and express the SLC linked to a gp30 protein, which is sometimes referred to as *surrogate heavy chain*, to form the pro-B-cell receptor ( [65](#), [66](#) and [67](#) ). Expression of SLC is easily detected on mouse ( [68](#) ) but more difficult to detect on human pro-B cells ( [66](#), [67](#) ). The SLC consists of two non-covalently associated proteins, VpreB and  $\lambda 5$  ( [Fig. 16.2](#) ), encoded by genes located on chromosome 22, where the  $\lambda$ -chain genes are also located ( [69](#), [70](#) ). There is only one VpreB gene in humans.



**Figure 16.2.** The hypothetical structure of the pre-B cell receptor. The pre-B cell receptor is composed of the  $\mu$  chain and a surrogate light chain that consists of two components, the  $\lambda^5$  and the VpreB. The  $\mu$  chain is linked by disulfide bond to the  $\lambda^5$  component, whereas the VpreB is non-covalently attached. It is not yet clear whether surrogate light chain can be expressed on the surface without  $\mu$  chain.

VpreB and  $\lambda^5$  have several unusual features that distinguish them from conventional light chains. Both have atypical sequences that target them to the endoplasmic reticulum (ER) (71). The VpreB is composed of 102 amino acids with homology to a conventional V domain. However, the conventional V domain has a total of nine  $\beta$  strands, including a sequence encoded by a J segment. VpreB has no sequence similar to the J segment and is shorter by one strand—the  $\beta_7$  strand. The C-terminal portion of VpreB has no homology to any other known protein. The N-terminal end of the  $\lambda^5$  protein is unique with only marginal sequence homologies to conventional domains. The C-terminal end of  $\lambda^5$  has an Ig-like fold, homologous to the conventional  $\lambda$ -chain C domain. This is followed by a sequence with marginal homology to the Ig structures and an extra  $\beta$  strand homologous to the J region of the conventional V $\lambda$  domains. The unique regions of the VpreB and  $\lambda^5$ -chains do not contribute to the assembly of the SLC, which is mediated by the extra  $\beta_7$  strand of  $\lambda^5$ , because deletion of this strand abolishes formation of SLC (71). The unique region of the  $\lambda^5$ -chain, however, acts as an intramolecular chaperon by preventing the folding of the protein when it is expressed in the absence of VpreB. This extra  $\beta$  strand complements the missing VpreB  $\beta$  strand. Thus, it appears that the Ig domains in each protein split between the two of them the control of the folding and the assembly of SLC (71). The assembled SLC associates with the  $\mu$ -chain to form the pre-BCR. In the meantime, the C<sub>H1</sub> domain of the  $\mu$ H-chain is protected from improper folding by the hsp70 protein BiP, which retains the  $\mu$ H-chain in the ER (72). Protection from improper folding of C<sub>H1</sub> is taken over by the C $\lambda^5$  protein as long as it is associated with the VpreB as SLC (73). SLC escorts the  $\mu$ H-chain to the surface of the cell. However, not all  $\mu$ H-chains can pair with the SLC because some V segments have structural features that prevent their association. At this point, the RAG-1, RAG, and TdT genes are turned off, securing allelic exclusion (74).

In the pre-BCR, the  $\lambda^5$ -chain represents the equivalent of the C domain of the conventional L-chain of BCR, a reasonable assumption considering that  $\lambda^5$  has 85% homology with the C $\lambda$  domain. The VpreB, on the other hand, is the equivalent to the V<sub>L</sub>



domain ( [75](#) ).

SLC is linked to  $\mu$  H-chain through the first constant domain (C $\mu$ 1) by a disulfide bond ( [76](#) ). The role of the SLC in the formation of the pre-BCR is dual. The C domain of  $\gamma$ 5 protein interacts with C $\mu$ 1 (which was bound by BiP). The second interaction involves VpreB (and part of  $\gamma$ 5) with the V $\mu$  domain of the  $\mu$  H-chain ( [77](#) ). This interaction is likely to be the first step in the selection of the B-cell repertoire ( [76](#) ). The pre-BCR in contact with unknown ligand on stromal cells induces asymmetric divisions of pre-B cells ( [78](#) ). One of the two cells retains contact with stroma and continues to divide (large pre-BI cell), whereas the second cell loses contact and differentiates to pre-BII-cell stage (small cells).

With the pre-B cell ceasing to divide, the rearrangement machinery is turned on again. L-chain genes start to rearrange; if the rearrangement is productive, an L-chain is synthesized to form a complete IgM molecule, expressed on the cell surface. This marks the transition to the immature B-cell stage. The strong proliferative capacity of the pre-B cells was analyzed in Pax5<sup>-/-</sup> mice. Pre-B cells from these animals have an extensive renewal capacity, multipotency, and ability to reconstitute recipient animals with lymphoid and myeloid lineages ( [79](#) ). Signaling is transmitted by the I $\alpha$ /I $\beta$  partners of the pre-BCR, which is linked to several protein tyrosine kinases [i.e., Syk, lyn, BLNK, and phosphoinositide 3-kinase (PI3K)] ( [80](#) ). Ligand binding causes aggregation of the pre-BCR, resulting in endocytosis of pre-BCR, loss of cell-surface expression, and accumulation of pre-BCR within membrane lipid microdomains.

From its location in lipid rafts, the pre-BCR initiates signaling, which achieves two important outcomes for the subsequent fate of the differentiating B cell: (a) it activates MAP kinases to block apoptosis usually triggered by the engagement of CD24 ( [81](#) ); and (b) it down-regulates RAG-1/RAG-2 expression to turn V(D)J recombination off so that the second  $\mu$ H allele closes ( [75](#) ) and allelic exclusion is accomplished ( [82](#) ).

The RAG-1/RAG-2 proteins are still expressed at the active proliferating pre-BI stage but are silenced during the quiescent pre-BII stage. Because the cell has achieved its objectives (i.e., survival and allelic exclusion), it reactivates the V(D)J recombination machinery to allow rearrangements of the conventional  $\gamma$ / $\delta$ -chains, to be able to form the complete IgM molecule, and to enter the immature B-cell stage.

The nontranscribed allele is in close association with heterochromatin and the transcription factor Ikaros, both markers of transcriptionally silent genes ( [83](#) , [84](#) ). The importance of pre-BCR signaling for progression from pro-B-cell to pre-B-cell stages and beyond is emphasized by deficiencies of any component of the pre-BCR or downstream signaling molecules that block developmental progression of B cells at the pro-B or pre-B stage ( [85](#) ). Targeting the genes for VpreB ( [86](#) ),  $\gamma$ 5 ( [87](#) ), or the exons of the  $\mu$ -chain ( [88](#) ) blocks B-cell differentiation at the pro-B- to pre-B-cell stage in mice, although the VpreB expression in  $\gamma$ 5-deficient mice is normal ( [89](#) ). An 11-year-old boy with  $\gamma$ 5 deficiency had virtually no B cells and was agammaglobulinemic ( [90](#) ).

The proteins of the SLC are not detected on the surface or in the cytoplasm of the majority of B cells in the bone marrow or circulation, except in a subpopulation of self-reactive B cells found in germinal centers ( [91](#) ) and circulation ( [92](#) ). VpreB<sup>+</sup> B cells with RAG mRNA have also been described in normal human tonsils and the joints of patients with rheumatoid arthritis ( [93](#) , [94](#) ). It seems that SLC is perhaps produced

intermittently during B-cell differentiation.

In conclusion, the pre-BCR plays a major role in the expansion of pre-B cells, allelic exclusion, and repertoire selection.

## IMMUNOGLOBULIN GENES

Among the first successes of recombinant DNA investigation was the characterization of the Ig genes. They exist in three loci—one each for the heavy,  $\mu$ -, and  $\delta$ -chains. For human Ig, these loci are located on chromosomes 14 ( [95](#) ), 2 ( [96](#) ), and 22 ( [97](#), [98](#) ), respectively. Separate genes encode the V and C domains of the Ig molecule. The human heavy chain genes are not completely linked. The  $C_{\mu}$  gene is closest to the V-D-J segments. At the 3' end of the H-chain locus, there are two copies of a  $\mu$ - $\mu$ -e-a unit ( [Fig. 16.3](#) ). One of the duplicated e sequences is a pseudogene ( $\mu$ e) in which the  $C_{H1}$  and  $C_{H2}$  domains have been deleted. The genome contains a third closely homologous e-related sequence: a “processed” pseudogene found on chromosome 9. These kinds of pseudogenes probably are products of a reverse transcription from RNA and then are inserted at locations in the genome unrelated to the original locus.



**Figure 16.3.** Human immunoglobulin heavy chain gene locus. The heavy chain gene locus contains the  $\mu$  and  $\delta$  genes close to the  $J_H$  genes, whereas the remaining heavy chain genes are further downstream in two clusters from duplications. See text.

A  $\mu$ -related pseudogene lacking the switch region is present between the two  $\mu$ - $\mu$ -e-a duplications. The recombination events occur in a region on the 5' side of the  $C_H$  coding sequences. This region contains repetitive DNA sequences and has been known as the *switch region* (S) or *sequence*. Within the switch regions occur the recombination breakpoints during isotype switch (see [Chapter 18](#)). Usually, the stimuli for switch recombination, like IL-4 and CD40, promote transcription across the S regions to produce switch junctions, one of which is retained in the chromosome and the other is found in a circular DNA (see [Chapter 18](#)).

## $V_H$ -D- $J_H$ GENES

The heavy chain of the IgM molecule is encoded by four sets of DNA: *variable* ( $V_H$ ), *diversity* ( $D_H$ ), *joining* ( $J_H$ ), and the *constant* ( $C_{\mu}$ ) genes.

### $V_H$ Genes

A  $V_H$  gene encodes the first 95 or 96 amino acids of a V domain. The exact number of  $V_H$  genes is not known but is estimated to be 100 to 200. From the available  $V_H$  genes, only a portion of them are functional, and an even smaller portion is available for rearrangement ( [99](#), [100](#) ). The  $V_H$  genes constitute seven families based on their homology at the DNA level and are known as  $V_{H I}$  to  $V_{H VII}$ . The number of members in each family varies, the smallest being  $V_{H IV}$ - $V_{H VI}$ . Most  $V_H$  genes are polymorphic, but the degree of variation varies, usually being small ( [101](#) ). The  $V_H$  segment encodes the hydrophobic leader sequence, the three framework regions, and the two



*complementarity-determining regions (CDR)*. Diversity varies among the families.

## D Genes

The term *D gene* or *segment* was proposed to indicate the “diversity” of an antibody at positions after amino acid 99 to the beginning of the J segment ( [102](#)). This sequence spans the third CDR. The D segments are located in chromosome band 14q32, with the major locus between V<sub>H</sub> and J<sub>H</sub> loci and several D segments interspersed within the V<sub>H</sub> segments. The segments are sandwiched between signal sequences (see below).

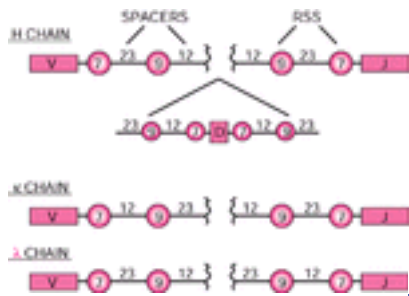
The CDR3 is encoded by the 3' end of the V<sub>H</sub> segment, the D gene segment, and the D–J<sub>H</sub> junctional area. There are approximately 30 D segments grouped in seven families. The D segment spans approximately 70 kb. Each segment has a promoter on its 5' end and allows initiation of transcription when Ig genes at the pre-B-cell stage start rearrangements. The first rearrangement produces a DJ<sub>H</sub> complex, which, together with the  $\mu$  gene, encodes a protein known as *D $\mu$  protein*.

## J<sub>H</sub> Genes

There are six functional J<sub>H</sub> genes and three pseudogenes. The J<sub>H</sub> gene encodes the 3' end of CDR3 and the fourth framework region.

## V(D)J Recombination

**FORMATION OF CODING AND SIGNAL JOINTS** Immediately next to the V, D, and J genes are conserved sequences of seven nucleotides (heptamers), which are attached to the 3' side of the V segments, the 5' side of the J segments, and both sides of the D segments ( [Fig. 16.4](#)). The heptamer is followed by 12 or 23 nonconserved base pairs (bp) (spacers) followed by another sequence of nine bp (nonamer), which may diverge from the consensus sequence. This noncoding sequence is known as *recombination signal sequence* (RSS) and, in its consensus form, is as follows: 5'–coding sequence–CACAGTG–12 or 23 spacer–ACAAAACC–3'. The 12–bp spacer corresponds to one turn of the DNA a helix, whereas the 23–bp spacer corresponds to two turns. This way, the recombining segments are juxtaposed on the same side of the DNA helix, so that they can be recognized by the enzymes of the recombination machinery ( [103](#), [104](#) and [105](#)). Joining of the various segments is limited between an RSS with a 12–bp spacer and one with 23 bp ( [106](#)) (the 12/23 rule). Recombination follows strictly the 12/23 rule of spacers, which prevents inappropriate recombination (i.e., a V<sub>H</sub> segment joining directly to a J<sub>H</sub> segment, as both of them have a 23 spacer between their heptamers and nonamers) ( [106](#)). The pattern of the RSS at each locus is uniform. For example, in the Ig locus, all V<sub>k</sub> segments have next to their heptamers a 12–bp spacer, whereas all J<sub>k</sub> segments have a 23–bp spacer. This prevents accidental joining of two V<sub>k</sub> or J<sub>k</sub> segments. The RSSs are the only sequences that are required for recombination, whereas the coding sequences (V, D, or J) can be replaced by other DNA, and joining still occurs if the 12/23 rule is satisfied.



**Figure 16.4.** Recombination signal sequences ( *RSS*) and heptamer/nonamer spacing sequences. The coding sequences of the immunoglobulin genes are flanked by a 7-nucleotide sequence (heptamer), which is followed by either 12 or 23 nucleotides, which in turn are followed by a 9-nucleotide sequence (nonamer) and again by a 23- or 12-nucleotide spacer. This order allows rearrangements only between a segment in which the 7/9 sequences are separated by a 12mer spacer and another segment in which they are separated by a 23mer spacer. This is known as the *12/23 rule*.

During recombination, two new structures are formed: the joining of the coding sequences ( *coding joint*), which is imprecise, and the joining of the RSS ( *signal joint*), which is precise. The V(D)J recombination ( [Fig. 16.5](#)) is mediated by two enzymes known as *RAG proteins*. RAG-1 and RAG-2 are not related to other proteins, and RAG-2 has no known relatives. Their expression is normally limited to immature B and T cells and continues after the expression of surface antigen receptor but then ceases when the receptor is cross-linked. Deficiency of RAG proteins in mice ( [107](#), [108](#)) or humans ( [109](#)) results in SCID.



**Figure 16.5.** V(D)J recombination. Shown in this figure is the recombination of two hypothetical segments, D27 and J5. The recombination begins with recombination activating gene-1 (RAG-1) and RAG-2 recognizing the heptamers and monomers (see text) ( **Panel 1**). They cut out one strand at the junction between the heptamer and the coding sequence. The other strand is severed by a nucleophile attack from the cut end ( **Panel 2**). The two blunt ends of the heptamers form the signal joint ( **Panel 3**), while a hairpin seals the cut coding ends ( **Panel 4**). Hairpin is nicked open either by the RAG proteins or by a ubiquitous DNA double strand repair complex ( **Panels 5 and 6**). The opening is usually asymmetric and creates “overhangs,” with the nucleotides at the end of the “overhang” being complementary as they derive from the complementary opposite strand. These are known as “palindromic” ( *P*) nucleotides ( **Panels 5 and 6**) (from the Greek *palindromicos*, meaning moving forward and backward in succession). The double DNA strand breaks of the coding joint receive nucleotides from the function of TdT (non-germ-line nucleotides) known as *N-nucleotides* ( **Panel 7**). Improperly paired nucleotides are removed ( **Panel 8**), and the coding joint is completed with the addition of missing nucleotides ( **Panel 9**). The P and N nucleotides added to the coding joint constitute the junctional diversity. (From Paraskevas F. The immunoglobulin molecule. In: Israels L, Israels E, eds. Mechanisms in hematology. With permission from Core Health Services, Inc.)

The RAG-1/RAG-2 proteins, as a tetramer, initiate the V(D)J recombination, which proceeds in three steps ( [110](#), [111](#), [112](#) and [113](#) ). The RAG-1 binds to the nonamer, which acts as an “anchoring” platform while the heptamer stabilizes the complex in the presence of RAG-2. The recognition by RAG proteins of the RSS is assisted by sequence-nonspecific DNA bending proteins, HMG1/2 (high motility group), which enhance binding and cleavage ( [114](#) ). Originally, it was postulated that HMG proteins “bend” the DNA to bring heptamer and nonamer closer together for binding. However, RAG itself also is able to bend the DNA (approximately 60 degrees); thus, HMG proteins probably maintain this position, functioning like a clamp ( [115](#) ). HMG proteins do not bind specific DNA sequences but recognize unusual structures like DNA bends. During the first step of V(D)J recombination, the RSSs are recognized by the recombinase and are brought in juxtaposition, forming the synaptic complex or paired complex. In the second step, the “recombinase” nicks the phosphoester bond between the last nucleotide of the coding sequence and the first nucleotide of the RSS ( [Fig. 16.5](#), panel 1). The precise mechanism of the hydrolysis of the phosphate ester bond is not known. The nicking reaction requires the physiologic divalent cation  $Mg^{2+}$ . Cleavage leaves blunt phosphorylated signal ends and hairpin sealed coding ends ( [Fig. 16.5](#), panels 2 and 3). The hairpin in the coding ends is formed between the 3'-OH of the top strand and the central phosphor atom of the phosphate group on the lower strand. Formation of the hairpin requires significant bending of one or both DNA strands ( [Fig. 16.5](#), panel 4). In the third step, the hairpin must be nicked open, so that the two coding ends form the coding joint. Opening of the hairpin may be done by a DNA repair complex ( [116](#) ) or RAG proteins themselves ( [117](#) ). Because nicking may not be exactly in the center of the hairpin, the opening creates an overhang in one strand formed by the nucleotides from the other strand ( [Fig. 16.5](#), panels 5 and 6). These are known as *P-nucleotides* and are coming from the opposite or complementary end of the hairpin or palindrome [from the Greek *palindromic*, meaning movement forward and backward successively (i.e., the piston of an engine)] ( [118](#) ). As a result, they have an inverse complementary relationship with the adjacent coding end. Most of the coding ends detected in normal lymphoid precursors have 3' overhangs ( [119](#) ). TdT adds nucleotides known as *N-nucleotides* (non-germ line) to the strand with the missing nucleotides ( [Fig. 16.5](#), panels 7 and 8). Disruption of TdT drastically lowers junctional insertions. In fetal and neonatal periods, the N insertions are low or absent as a result of the developmental regulation of TdT. TdT knock-out mice are not significantly immunodeficient, but their repertoire, even as adults, is similar to that of normal newborn mice, which lack N-nucleotides ( [120](#) ). The alterations in the coding joint as a result of P- and N-nucleotides are the basis for “*junctional diversity*” ( [Fig. 16.5](#), panel 9). The RAG proteins continue to be bound to the signal and coding ends in a four-end complex, known as *cleaved signal complex*, at least while the coding ends are still processed. The repair of the DNA cleavage involves the machinery for double-strand break repair ( [121](#), [122](#) and [123](#) ). A DNA-dependent protein kinase (DNA-PK) (Ku86, Ku70 complex), XRCC4, and DNA ligase 4 (Lig4) are essential for efficient V(D)J recombination and double-strand break repair. Mice with defects in this complex normally join signal sequences but not coding segments ( [124](#) ). The DNA-PK consists of a catalytic subunit (DNA-PK<sub>CS</sub>) and a DNA-binding component called *Ku*, which is a heterodimer of 70-kd and 86-kd polypeptides. The kinase activity is activated when *Ku* binds to altered DNA structures such as double-stranded breaks, nicks, and hairpin loops ( [125](#) ). Once activated, the kinase phosphorylates a number of proteins, including p53, Ku, Lsp90, transcription factors, and so forth. In Ku86-deficient mice, the V(D)J recombination is arrested after the cleavage step. Ku86 probably disassembles DNA-protein complexes containing broken ends to allow further processing ( [126](#) ). The RSSs are highly conserved among vertebrates from sharks to humans. In the RSS, the three heptamer nucleotides closest to the recombination site are the most important, whereas mutations at other heptamer positions still allow recombination. RSS variations may influence the use of gene segments. For example, the RSSs of mouse Ig? are closer to the consensus sequence

than those of Ig $\gamma$ ?; this possibly explains the greater use of Ig $\gamma$ ? than Ig $\delta$ ? chains in mouse Igs.

**DNA DOUBLE-STRAND BREAK REPAIR** At the end of the recombination, the coding segments remain in the chromosome, and the signal joint forms a circular DNA ( [123](#) ). The RSS joint is assumed to be lost from the cells, converted to reactive, broken DNA, to be disposed of in the next cell division: This is known as *deletional recombination*. However, the existence of inverted segments of DNA in these loci indicates that, sometimes, signal joints are retained in the chromosome: This is known as *inversional recombination*. This mechanism restores chromosomal integrity ( [127](#) ). The fate of the signal joint has taken an unexpected direction as a result of findings indicating that the RAG proteins may be able to perform genetic transposition (i.e., act as transposases) ( [128](#), [129](#) and [130](#) ). As the name indicates, *transposases* transpose or insert pieces of DNA in a new location. The transposase MuA of the bacterio-phage Mu is the best characterized of these types of enzymes ( [131](#) ). It consists of a tetramer in which two of the subunits nick the two ends of the Mu genome and the other two catalyze the transfer of the ends into the target DNA. These reactions are important in the transmission of drug resistance among bacteria and integration of retroviruses, like HIV and so forth, into the genome. In fact, the MuA active site exhibits a striking similarity to the HIV integrase. It is interesting that the RAG-1/2 also act as a tetramer in V(D)J recombination. RAG-1/2 resembles the HIV integrase responsible for inserting DNA copies of the viral genome into the cellular chromosomes. Notable differences, however, exist in the nick cleavage mechanisms between the two ( [132](#), [133](#) ). As a result of these recent insights into the nature of V(D)J recombination and the function of RAG-1/2, the question of the fate of the signal joint becomes very important. Signal joints have been found to be cleaved quite efficiently ( [134](#) ). *In vitro* experiments showed that transposition is targeted not to a particular DNA sequence, but to structural features, such as hairpins, inverted repeats, supercoiling of DNA forming cruciform structures, and generally distorted DNA structures ( [135](#), [136](#) ). Active transposition events are detrimental to the host due to the mutagenic potential of genomic rearrangements. *In vitro* experiments demonstrating transposition were performed with only the core part of RAG-1/2; it is conceivable that other parts of the molecule exert an inhibitory effect on this potential function of RAG-1/2. Although the *in vitro* experimental evidence suggests that there is a bias toward transposition, there is no evidence that this occurs *in vivo*, as it severely compromises genomic stability in the lymphocytes. On the other hand, lymphoid malignancies are associated with chromosomal translocations, many of which involve the Ig on T-cell receptor (TCR) loci and potentially may be mediated by the V(D)J recombinase ( [137](#) ). Cleavage of DNA is always potentially dangerous. Although the recombinase function is essential for the integrity and normal function of the immune system, it is, at the same time, perilous. The genes essential for double-strand repairs encode the DNA-PK and its “associates” and the Ku autoantigen, a DNA end-binding protein ( [138](#) ) (see above). Mutations in this system result in the accumulation of V(D)J-specific double-strand breaks, indicating a defective repair mechanism, which causes SCID ( [139](#), [140](#) ). Loss of function of the ATM gene, a relative to DNA-PK, results in ataxia telangiectasia (AT) in humans ( [141](#) ). A new gene has recently been added to those already known that regulate double-strand DNA break (DSB) repairs. It has been named *Artemis* ( [142](#) ) after the Greek goddess who was the protector of small children and animals ( [143](#) ). It belongs to the superfamily of metallo- $\beta$ -lactamase enzymes and is associated with the DNA-PK complex ( [144](#) ). It is involved in the nonhomologous end-joining pathway, a DNA repair process used by eukaryotic cells ( [145](#), [146](#) ), as well as in the repair of broken DNA ends from the V(D)J recombinase activity. The repair requires that the hairpin in the coding joint is opened by the DNA-PK-Artemis protein complex ( [144](#), [147](#) ). In such a complex, Artemis acquires endonuclease activity, which does not possess by itself ( [148](#) ). Artemis has been shown to be mutated in patients with SCID expressing radiosensitivity ( [142](#) ). Patients with hypomorphic mutations in Artemis have

not only immunodeficiency, but also predisposition to lymphoma ( [147](#) ).

## RAG-1 AND RAG-2 PROTEINS

Both RAG proteins are required for V(D)J recombination because lack of function of either one leads to SCID ( [148](#), [149](#) ). A region that retains the recombinase activity is known as *core* and has been used for studies *in vitro*. For RAG-1, the core is located in the sequence 384–1008 of a total of 1040 and for RAG-2 in amino acids 1–383 of 527. The core of RAG-2 contains six repeats, each consisting of an antiparallel  $\beta$  sheet formed by four  $\beta$  strands. The repeats are arranged in a circular formation like blades of a propeller ( [149](#) ), a structure known to mediate protein–protein interactions. The C-terminal quarter of RAG-2 consists of a plant homeodomain fold, which is found in proteins with chromatin-binding properties ( [150](#) ).

Mutational analysis of the RAG proteins has provided some clues of structure–function relations. The catalytic properties of the proteins have similarities with members of the retroviral integrase superfamily ( [137](#) ) and require divalent metal ions for their function—a requirement characteristic of some nucleases, the function of which depends on acidic amino acids. Indeed, in RAG-1, several acidic amino acids are critical for both nicking and hairpin formation, without affecting the DNA binding ( [151](#) ). For RAG-1, the N-terminus is important for activity ( [152](#) ), and the binding of RAG-1 directly to DNA is supported by basic residues of RAG-2 ( [153](#) ). Deletion of the C-terminal region of RAG-2 results in the reduction of the number of B and T cells ( [154](#) ). The plant homeodomain of RAG-2 regulates differential access to sites of recombination, and although dispensable for the D/J<sub>H</sub> recombination, it is essential for the V<sub>H</sub>/DJ<sub>H</sub> step ( [155](#) ).

## HUMAN LIGHT CHAIN GENE LOCI

The two light chain isotypes,  $\kappa$  and  $\lambda$ , comprise approximately 60% and 40% of all Igs, respectively. They consist of a V domain and a C domain of approximately 107 residues in length. The V domain is encoded by the V and J segments, the former encoding the first 95 to 96 residues and the latter encoding the remaining 12 to 13. There is a single C $\kappa$  gene, and there are several C $\lambda$  genes.

The  $\kappa$  locus contains approximately 76 V $\kappa$  segments grouped into six families and five J $\kappa$  segments but no D segments.

The  $\lambda$  locus contains ten families of V $\lambda$  segments, a high number of pseudogenes, and several C $\lambda$  genes, each preceded by a single J $\lambda$  segment.

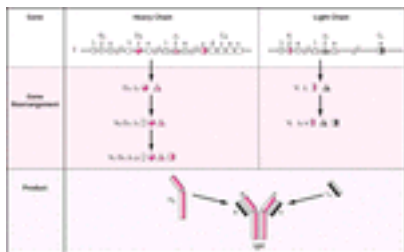
## HEAVY AND LIGHT CHAINS GETTING TOGETHER

One of the consequences of the imprecision of the V(D)J recombination is a change in the reading frame at the junction between the two gene segments. When the segments join out of phase so that the triplet reading frame for translation is not preserved, the rearrangement results in V(D)J combinations with numerous stop codons that interrupt the translation. Such recombination events are known as *nonproductive rearrangements*. When gene segments are joined in phase, the reading frame is maintained, and the rearrangement is productive. If the junction lies within a codon, the resulting amino acid is encoded by nucleotides from both gene segments involved. The identity of the amino acid depends on the exact position of the joint and on the sequences of the individual gene segments. It is estimated that only one in three recombination attempts are productive,



but the imprecision in the joints between variable gene segments increases their diversity by at least 100-fold.

The Ig gene rearrangements occur in an ordered fashion. They show preference for using certain gene segments, result in allelic exclusion, and follow a certain sequence in the order of rearrangement of the various loci. This indicates that there are regulatory mechanisms underlying the process of rearrangement. The IgH heavy chain gene is rearranged first and results in the formation of a complete V gene from three individual segment clusters. One of the D segments joins one of the J<sub>H</sub> segments, but the D to J<sub>H</sub> rearrangement does not take place exclusively in B cells because it has also been found sometimes in T cells. In the next step, which is regulated by the D $\mu$  protein, a V segment joins the DJ<sub>H</sub> complex. D $\mu$  protein is encoded by the DJ<sub>H</sub> complex and the  $\mu$ -heavy chain constant gene—that is, it is a  $\mu$ -chain lacking a V<sub>H</sub> segment. D $\mu$  protein can be expressed on the membrane of the cell with an SLC. Expression of D $\mu$  protein prevents further V<sub>H</sub> to DJ<sub>H</sub> rearrangement, or rearrangements are diverted to another pathway such as  $\lambda$ -chain rearrangements, which are accelerated. Productive, complete  $\mu$ -chain rearrangement inhibits further rearrangements in the opposite allele (allelic exclusion) (156). Completion of the  $\mu$ -chain rearrangement is followed by rearrangements of the  $\lambda$ -chain, and if both  $\lambda$  alleles fail to rearrange productively, the  $\lambda$ -chain gene is rearranged last (Fig. 16.6). However, this hierarchical order of Ig gene rearrangements has been challenged because examination of B cells at different stages of early development showed that the heavy and light chain genes rearrange independently (157). At the end of its early developmental stage, the B cell emerges with the expression on its surface of a unique antigen receptor consisting of IgM accompanied by two accessory molecules, Iga and Ig $\beta$  (158).



**Figure 16.6.** Heavy immunoglobulin (Ig) M chain–kappa light chain rearrangement. With the completion of the V(D)J recombination of the  $\mu$  chain and the formation of a complete  $\mu$ H chain, the L $\kappa$  chain rearranges, and, if successful, it forms the complete IgM $\kappa$  molecule. If both  $\lambda$  alleles rearrange unsuccessfully, the  $\lambda$  gene rearranges. If successful, an IgM $\lambda$  molecule is formed. If both  $\lambda$  genes cannot rearrange successfully, the cell dies by apoptosis. (From Paraskevas F. The immunoglobulin molecule. In: Israels L, Israels E, eds. Mechanisms in hematology. With permission from Core Health Services, Inc.)

## REGULATION OF V(D)J RECOMBINATION

For the recombinase to initiate rearrangements, the gene must be accessible—that is, the locus must be able to act as a template for the recombinase. In cells competent to rearrange, it was found that J $\kappa$  and V<sub>H</sub> genes have already been transcribed, but these RNAs (called *germ-line* or *sterile transcripts*) are incapable of encoding the protein. There is correlation between transcription and gene rearrangement. Several possibilities may exist to explain this finding. Because inactive genes are not accessible to the recombinase, it is possible that the altered structure of the chromatin allows the recombinase to recognize the RSSs. Alternately, enhancers establish altered chromatin

regions where both the recombinase and the transcription machinery have access ( [161](#) ). This is known as the *accessibility hypothesis* ( [104](#) , [159](#) , [160](#) and [161](#) ).

Enhancers play an important role, but promoters and silencers also function in gene accessibility. The Ig heavy chain enhancer ( $E_H$ ) is located within the intron between the  $J_H$  segments and the  $C_H$  gene and is associated with matrix attachment regions. Targeted mutations of  $E_H$  have resulted in a dramatic decrease in  $J_H$  recombination ( [162](#) , [163](#) ). There are three additional enhancers within the Ig heavy chain locus, and one of them (DQ52) seems to compete more efficiently for conferring accessibility to the  $J_H$  region. Interaction between DQ52 and  $E_H$  is likely responsible for the ordered rearrangement (i.e., D to  $J_H$  followed by  $V_H$  to  $DJ_H$ ) ( [164](#) ). The  $\kappa$ -light chain intronic enhancer is only active in mature B cells and plasmacytomas, and its stage restriction is dictated by a single motif that binds the transcription factor nuclear factor- $\kappa$ B (NF- $\kappa$ B) ( [165](#) ). NF- $\kappa$ B recognizes a 10-bp motif termed  $\kappa$ B, which is crucial for  $\kappa$ -light chain intronic enhancer activity. NF- $\kappa$ B consists of two subunits with the smaller one containing the DNA-binding function.

Other enhancers lie in the vicinity of the  $C_H$  gene, two others in the  $\lambda$  locus. The one between  $J\lambda$  and  $C\lambda$  genes becomes trans-criptionally active during pre-B- to B-cell transition ( [166](#) ). The mechanism by which promoters regulate accessibility is not known. The matrix attachment regions are regions rich in AT, bind nuclear matrix, and demarcate regions of chromatin that undergo base unpairing and other regions that mediate binding of topoisomerase II. This regional division of chromatin may also be regulated from a distance by *trans*-acting factors, which bind to specific motifs within the enhancer and promoter elements. For example, disruption of E2A and EBF transcription factors results in block of B-cell development at a stage before Ig heavy chain gene rearrangements. Despite the promiscuity and redundancy of regulatory elements, transcription is still tissue lineage and stage specific.

## V GENE REPERTOIRE

Certain aspects of the study of the Ig V gene repertoire and the Ig gene rearrangement have found wide applications in clinical medicine ( [167](#) ). The total number of V genes defines the available repertoire. However, not all genes are equally expressed; as a result, the expressed repertoire is usually biased because some V genes are expressed in significantly higher frequency than would be expected if all had an equal chance for rearrangement. This biased expression affects all gene segments—V, D, and J. For example, the  $J_H4$  segment (one of the existing six), on the basis of equal opportunity with the other five segments, should be detected in 17% of B cells, yet it is found in 32% of B clones from fetal liver ( [168](#) ) and in 42% of pre-B-cell acute lymphocytic leukemia (ALL) ( [169](#) ). The bias of the expressed repertoire shows striking association with certain diseases. For example, a member of the  $V_H4$  family,  $V_H4-21$ , is found in cold agglutinins ( [170](#) ). Preferential expression of certain  $V_H$  segments is also detected in ALL clones. In ALL, the frequency of N-nucleotide additions differs in children younger than 3 years of age (12.5%), as compared with children with ALL older than 3 years of age (89%) ( [171](#) ). Because in fetal B lymphocytes the frequency of N-nucleotide additions is low, it is suggested that the transforming event in the younger age group probably occurred during fetal life.

In chronic lymphocytic leukemia (CLL), the use of V genes is also restricted; the same is true in non-Hodgkin lymphomas. It is interesting that in certain cases of follicular lymphoma, the V genes have not only undergone somatic mutations, but also continue to



do so during the course of the disease, suggesting that the malignant clone is responsive to an antigen ( [172](#), [173](#) ). Somatic mutations have also been detected in multiple myeloma as expected, because the malignancy derives from an advanced stage of differentiation of B cells ( [174](#) ).

Defects in V(D)J recombination have been identified with human diseases ( [175](#) ). For example, loss of RAG-1/RAG-2 function results in SCID. In certain autosomal-recessive diseases, hypersensitivity to DNA-damaging agents results in chromosomal breaks and rearrangements with an increased incidence for development of leukemia and other malignancies. They have been classified as DNA repair disorders and include AT, Fanconi anemia, xeroderma pigmentosum, and Bloom syndrome. V(D)J recombination with artificial substrates is normal in these patients.

In mice, an autosomal-recessive mutation, the SCID mutation, results in absence of B and T cells as a result of impairment of the V(D)J recombination. Both lymphoid and nonlymphoid SCID cells are hypersensitive to killing by ionizing radiation because of a DNA double-strand base repair defect. It is rather important that a human gene on chromosome 8q11 has been identified that restores V(D)J recombination, double-strand base repairs, and normal resistance to irradiation in SCID cells ( [176](#), [177](#) ). The DNA binding protein, DNA-PK, is a strong candidate for the defect in SCID mice ( [178](#), [179](#) ) (see [V\(D\)J Recombination Defects: DNA Repair](#) ). This protein binds to DNA termini to prevent nucleotide loss through exonucleases, and it is assumed that it regulates the activities of DNA repair and recombination.

## **PATHOLOGY OF V(D)J RECOMBINATION: IMMUNE DEFICIENCIES**

One of the widest applications related to V(D)J recombination is in regards to the diagnosis of lymphoproliferative diseases. Identification of gene organization of Ig and TCR has been one of the most sensitive methods to identify lineage and clonality of neoplasms. Application of molecular genetics enables the identification of unique markers of rearranged genes. These applications explore not only normally rearranged genes, but also detect translocations involving Ig or TCR genes and provide major insights into the cause of the malignant transformation. The diagnostic applications of V(D)J recombination are widely covered in other chapters of this book and are beyond the scope of this brief summary.

V(D)J recombination is absolutely necessary for immune diversity and survival. However, this objective can only be achieved through DSBs that threaten genomic stability. The complexity of the recombinase function is matched by complex DNA repair machinery. Disorders related to V(D)J recombination may be considered in two categories: those related to the first step (cleavage) and those related to the second step (cleavage repair).

## **SEVERE COMBINED IMMUNODEFICIENCY MUTATION**

An experiment of nature in mice has revealed the two fundamental processes operating in V(D)J recombination (i.e., DSBs with gene rearrangements followed by DNA repair).

Bosma reported the SCID mutation in mice ( [180](#) ). It is associated with severe combined immune deficiency, lack of mature lymphocytes, and agammaglobulinemia. Productive rearrangements occur only at a low level, and coding joints are absent, whereas signal joints are normal. SCID T cells have long P-nucleotide sequences and accumulate hairpins at the TCR $\alpha$  coding ends. In addition to the lack of rearrangements, there is an inability to repair damage from irradiation. The SCID mutation is located on mouse chromosome 16; however, human chromosome 8 can complement both mouse SCID

defects. This indicates that the SCID defect for humans is in chromosome 8. However, human chromosome 8 is not associated with any known immunodeficiency or DNA repair diseases. The gene for DNA polymerase 8 is in chromosome 8p11–12.

## V(D)J RECOMBINATION DEFECTS: DNA CLEAVAGE

Two types of RAG–1 and RAG–2 gene inactivations have been identified in mice. The first type results in inactivation of the recombinase so that V(D)J recombinations cannot be initiated ( [107](#), [108](#)). The mice have no mature T and B lymphocytes, but there is an increase of immature lymphocytes in the lymphoid organs. The second type of mutation consists of a single conservative amino acid substitution in both proteins. It does not affect the initiation of V(D)J recombination but severely impairs the coding and signal joint formation ( [181](#), [182](#)). The mutant enzymes are defective in hairpin opening *in vitro* and the formation of the coding joint *in vivo*. This evidence indicates that the RAG proteins, in addition to their cleavage function, are important for the formation of the joints; therefore, they must remain associated with the postcleavage complex to achieve opening of the hairpin.

No human syndrome has yet been identified comparable to the mouse SCID mutation. In humans, approximately 20% of SCID patients lack both T and B lymphocytes and have normal NK cell counts ( [183](#)). Some of these patients have RAG–1 or RAG–2 gene mutations ( [184](#)); others are characterized by an increased radiosensitivity of their bone marrow cells and fibroblasts (RS–SCID) ( [185](#)).

The predicted RAG–2 structure consists of two globular domains separated by a hinge of approximately 60 amino acids. The largest domain (350 residues) includes the previously described core region of RAG–2, which is enzymatically active. This domain forms a  $\beta$  propeller with six blades arranged in a circle from a center. Each blade is a  $\beta$  sheet consisting of four  $\beta$  strands. The  $\beta$ -propeller fold (present in some integrins and other proteins) is known to mediate protein–protein interactions. Six out of seven mutations described today in humans are clustered on one side of the propeller in regions exposed to the solvent ( [186](#)). This side is involved in RAG–1–RAG–2 interactions, which are absolutely critical for functional activity. Two of these mutants (C41W and M285R) have been found to reduce the interaction between RAG–1 and RAG–2 *in vitro*, and no DNA binding activity of the complex was detected ( [187](#)). This is consistent with the hypothesis that RAG–2 stabilizes the RAG–1/RAG–2 complex ( [188](#)).

## OMENN SYNDROME (OMIM NO: 603554)

*Omenn syndrome* is an inherited disorder characterized by absence of circulating B cells and infiltration of the skin and intestine by activated oligoclonal T lymphocytes (HLA–D<sup>+</sup>). There is eosinophilia and elevated serum IgE ( [189](#), [190](#)). The patient has diffuse erythrodermia, hepatosplenomegaly, protracted diarrhea, and failure to thrive. The activated T cells secrete Th2 types of cytokines ( [191](#), [192](#)), highly restricted in their TCR repertoire ( [193](#)). They infiltrate skin, gut, liver, and spleen, causing a graft–versus–host–like disease ( [194](#)).

Inherited mutations in RAG–1 and RAG–2 genes have been reported ( [195](#), [196](#)) in a series of 20 patients with Omenn syndrome resulting in partial V(D)J recombinase activity ( [197](#)). Because similar mutations have been detected in patients with T/B SCID, it has been suggested that an additional factor exists in Omenn syndrome to account for the different

clinical picture, such as an autoantigen or an external antigen that drives T-cell activation. In an interesting mutation in a 5-week-old girl with Omenn-like SCID, the RAG-1 gene had a deletion of a nucleotide (631 delT) ([196](#)); as a result, the N-terminal region of RAG-1 protein was deleted by a premature stop codon. The patient had a high number of T cells with almost a polyclonal TCR gene rearrangement, but there were no B cells and hardly detectable Ig gene rearrangements. The truncated RAG-1 protein apparently could still support TCR but not Ig gene rearrangements. This suggests that the N-terminus of RAG-1 is specifically involved in Ig V(D)J rearrangements.

## V(D)J RECOMBINATION DEFECTS: DNA REPAIR

A DSB is one of the most significant lesions that threaten cell integrity. The cells have developed exquisite repair machinery to maintain genomic stability. Immune diversity, another function vital to the survival of an organism, has to cross the dangerous path of DSBs ([198](#)). The body uses the DSB machinery to repair the “damage” caused by the recombinase ([199](#)). The major mechanism for repair of DNA DSBs in mammalian cells is nonhomologous end-joining, a process that rejoins breaks with the use of little or no homology. Five proteins operate in nonhomologous end-joining; three of them form the DNA-PK complex (Ku70, Ku80, and DNA PK), the XRCC4, and the DNA ligase IV ([200](#)). The Ku protein is an autoantigen that induces autoantibodies in patients with scleroderma, polymyositis, or systemic lupus erythematosus. Two proteins, Ku70 and Ku82, form a stable heterodimer, which binds DNA ends irrespective of sequence composition. The heterodimer forms a complex with a third component—the DNA-PK. DNA-PK complex phosphorylates many DNA binding proteins, including transcription factors c-Jun and p53. However, the most efficiently phosphorylated substrates are those bound close to DSBs, including the Ku components of the DNA-PK complex. It appears that the main function of the DNP-PK complex is the regulation of the nonhomologous end-joining process. Mice defective in Ku proteins have SCID ([126](#), [201](#), [202](#)); in general, defects in the DSB repair machinery are associated with immunodeficiencies ([203](#)).

## ATAXIA TELANGIECTASIA (OMIM NO: 208900)

AT is an autosomal-recessive disorder characterized by immunodeficiency, progressive cerebellar ataxia, oculocutaneous telangiectasias, clinical radiosensitivity, chromosomal instability, and elevated risk for development of lymphoid malignancies ([204](#)). Immunodeficiency affects both T and B cells, and there is a decrease of serum IgA. The AT cells display  $\gamma$ -irradiation sensitivity and cell cycle checkpoint control (i.e., inability to arrest at the G<sub>1</sub>-S- and S-phase checkpoints and, at the time of irradiation, an impaired G<sub>2</sub>-M arrest). AT cells also have a DNA repair defect ([205](#)). They can rejoin DNA BSB efficiently, but the defect is localized on a protein member of the PI3K family of kinases with serine threonine protein kinase activity ([206](#)), which phosphorylates a number of proteins involved in mechanisms of damage repair (i.e., p53 and Chk1) ([207](#), [208](#)). The majority of patients have frameshift mutations, which inactivate the gene.

## NIJMGEN BREAKAGE SYNDROME (OMIM NO: 251260)

*Nijmegen breakage syndrome* is a rare autosomal disorder with clinical features overlapping with those of AT. The patients have defective humoral and cellular immunity, radiosensitivity, chromosomal instability, and predisposition to cancer ([209](#)). The patients have recurrent bacterial sinopulmonary infections, hypogammaglobulinemia, and impaired antibody responses to antigens. The cells from the patients have defects at some

checkpoints of the cell cycle ( [210](#) ). The defective protein is nibrin or p95 (NBS1), which shows homology with the protein Xrs2, involved in DNA repair response in yeast.

## BLOOM SYNDROME (OMIM NO: 210900)

*Bloom syndrome* is a rare autosomal-recessive disorder with immunodeficiency, genomic instability, and predisposition to cancer. It presents with a variable clinical picture—respiratory infections, chronic lung disease, and low IgM levels. Affected individuals show sun sensitivity in the face and infertility ( [211](#) ).

## DEFECTS IN LIGASES

There are multiple DNA ligases in higher organisms. A point mutational change in DNA ligase I, which does not abolish the activity of the enzyme, was found in an individual who experienced recurrent sinopulmonary infections leading to bronchiectasis ( [212](#) ).

## XERODERMA PIGMENTOSUM (OMIM NO: 278700)

*Xeroderma pigmentosum* is a rare disorder associated with sun sensitivity, high risk of cutaneous malignancy in sun-exposed areas, and immunodeficiency in some of the patients ( [213](#) ). Some aspects of immunosuppression associated with xeroderma pigmentosum are due to defects in the DNA repair machinery. The patients have impaired NK-cell cytotoxicity.

## GENETIC DEFECTS OF EARLY B-CELL DEVELOPMENT

### Cell Signaling during B-Cell Development

After the  $V_H$  to  $DJ_H$  rearrangement of the H-chain gene, the cytoplasmic  $\mu$ -chain pairs with the SLC and traffics to the cell surface in association with the signal transducing chains Iga and Ig $\beta$  to form the pre-B-cell complex. Signaling for the transition from pre-B cells to Ig<sup>+</sup> B cells requires the *immunoreceptor tyrosine-based activation motif (ITAM)* motifs of the cytoplasmic domains of the Iga and Ig $\beta$  chains because inactivation of ITAMs by mutation blocks the transition to Ig<sup>+</sup> B cells ( [214](#), [215](#) ). Deficiency of Ig $\beta$  chain by gene targeting abolishes formation of the Iga/Ig $\beta$  dimer and blocks assembly of the SLC. As a result, differentiation of B cell is arrested at the pro-B-cell stage ( [216](#) ).

Interactions of pro-B and pre-B cells with stromal elements are necessary for progression through the early stages of B-cell development, but a ligand for the pre-BCR has not yet been identified, and it is conceivable that the receptor may be signaling constitutively. It is apparent that the presence of ITAM motifs and the concentration of signaling molecules around them are the critical factors in determining progression through the early stages of B-cell development. Pro-B cells are able to become pre-B cells in the absence of the  $\mu_H$ -chain as long as the Iga/Ig $\beta$  chains are aggregated and thus can recruit sufficient numbers of signaling molecules around their ITAMs ( [217](#) ). Furthermore, signaling by other molecules unrelated to pre-BCR, such as Epstein-Barr virus (EBV) latent protein 2A (LMP2A), can drive pro-B- to pre-B-cell transition. LMP2A constitutively possesses its own signaling activity in nontransformed cells ( [218](#) ). It is a protein spanning the membrane 12 times, with ITAM motifs in its cytoplasmic region. Phosphorylation of these motifs recruits Syk and Src kinases and thus bypasses the normal checkpoints of B-cell development. Surface Ig (sIg)-negative B cells with latent

EBV infection are released in the periphery to colonize peripheral lymphoid organs.

Of all the signaling molecules assembled around the cytoplasmic tails of the pre-BCR complex, the Syk kinase is important for the pro-B- to pre-B-cell transition ( [219](#) ). The ITAMs of I $\alpha$  and I $\beta$  chains act as docking sites for Syk kinase and trigger its activation ( [220](#) ). An important function for signaling is provided by the adaptor protein BLNK, which acts as a scaffolding to link Btk (and other molecules) to downstream signaling molecules. In BLNK <sup>-/-</sup> mice, the transition from pro-B- to pre-B-cell stage is blocked ( [221](#) , [222](#) ), and a similar defect has been detected in a patient with deficiency of BLNK and block of B-cell development ( [223](#) ). The arrest of B-cell development is more severe in the Syk- than BLNK-deficient mice. It is likely that the Syk kinase uses other signaling pathways bypassing BLNK.

### Signaling Defects

Failure of B-cell development may result from defects in signaling through the pre-BCR. These experiments of nature have helped in delineating the molecular mechanisms of early B-cell development ( [85](#) ). Immune deficiencies due to arrest of B-cell development are usually associated clinically with recurrent bacterial infections, laboratory findings of markedly reduced numbers of B cells, and hypogammaglobulinemia. Of all the patients, 85% have mutations in Btk, whereas the remaining 15% constitute a heterogeneous group with defects of various signaling molecules.

### Defects of $\mu$ 5

The SLC is formed from two components: the VpreB and the  $\mu$ 5. In humans, there is one VpreB gene and three  $\mu$ 5 genes ( [224](#) ). A boy with mutations in both alleles of the gene  $\mu$ 5/14-1 has been described with recurrent infections, hypogammaglobulinemia, and lack of B cells detected in early age. The patient had three base pair changes in a single allele and alterations within exon 3. Changes in codons 131 and 140 were silent whereas that in codon 142 resulted in the replacement of proline, which in this place is highly conserved, to leucine (P142L) ( [90](#) ). The boy at 9 years of age had 0.1% CD19<sup>+</sup> cells in the blood, but these cells were of the mature phenotype. In contrast to this patient, mice deficient in  $\mu$ 5 have a leaky block at the pro-B-cell stage and still maintain 10 to 20% of the B cells.

### Defects of Immunoglobulin a (CD79a)

While screening several patients with defects of B-cell development, one 2-year-old girl was identified with an A to G substitution in the splice acceptor site preceding exon 3 of I $\alpha$  ( [225](#) ), resulting in I $\alpha$  transcripts that were aberrant, because most of them had no exon 3. The patient showed failure to thrive, had diarrhea in the first month of life, and, later, had bronchitis and neutropenia. She had severe hypogammaglobulinemia and absent B cells. The block of B-cell development was at the pro-B-cell stage.

### Defects of $\mu$ -Heavy Chain

Defects in  $\mu$ H have been associated with agammaglobulinemia in individuals from two families. The defects consist of a large deletion of a 75- to 100-kb segment, including D, JH, and  $\mu$  genes, or a base pair substitution in the alternative splice site, with inhibition of the synthesis of the membrane form of Ig ( [226](#) ).  $\mu$ H mutations with agammaglobulinemia should be distinguished from the X-linked agammaglobulinemia, because the disease from  $\mu$ H mutations can occur in females. Another report described a female patient with a



cytosine insertion at the beginning of the CH1 exon of the  $\mu$  gene, which resulted in premature codon and absence of the  $\mu$ H-chain ( [227](#) ).

### Defects of B-Cell Linker Protein

The gene for human BLNK is located on the long arm of chromosome 10, at 10q23.22. BLNK is an adapter protein, which, after phosphorylation by Syk, recruits several signaling molecules (i.e., PLC $\gamma$ , Vav, Cbl, and Btk). A 20-year-old man with absent B cells and hypogammaglobulinemia was found to have two bp alterations: One of them did not change the amino acid (proline), but the second one, which was an A to T substitution, affected the +3 position of the splice donor site for intron 1 approximately 20 bp downstream from the first alteration. The second defect resulted in a marked decrease in BLNK transcripts and the protein ( [223](#) ). The patient had recurrent infections, undetectable serum Ig, and at the age of 20 years, less than 0.01% of CD19<sup>+</sup> cells in the blood. Mice with BLNK deficiency have only a leaky block of B-cell differentiation at pro-B cell stage.

In general, mutations of  $\gamma 5$  or BLNK cause a more profound block of B-cell differentiation in the human as compared to the mouse ( [228](#) ).

### BRUTON AGAMMAGLOBULINEMIA (OMIM NO: 300300)

In 1952, Bruton described a male child with hypogammaglobulinemia and early onset of bacterial infections ( [229](#) ) later found to be inherited in an X-linked pattern and became known as *X-linked agammaglobulinemia* ( [230](#) ). The constellation of findings consists of very low serum Ig levels (i.e., for IgG, approximately 10% of the normal control), no antibody production after immunization, markedly decreased B cells (0.3% of normal levels) ( [231](#) ), and no germinal centers, the hallmark of antibody production, in the lymph nodes. The genetic defect is located in the midportion of the long arm of the X chromosome (i.e., Xq22) ( [232](#) ). There are several variants of the disease in relation to immunologic function and clinical heterogeneity ( [233](#) ). The product of this gene was identified as a Src protein tyrosine kinase (PTK) that was called *Bruton tyrosine kinase* or *Btk* ( [234](#), [235](#) ). More than 400 mutations have been characterized to date ( [236](#) ).

Btk is a member of the Btk/Tec family of PTKs, which includes Btk, Tec, Itk, Rlk, and Bmx ( [237](#) ). In the C-terminal end, Btk contains the catalytic (SH<sub>1</sub>) domain. Next lies the SH<sub>2</sub> domain, which associates with phosphorylated tyrosines. It is followed by one SH<sub>3</sub> domain, which binds proline-rich sequences in protein-protein interactions. Next to the SH<sub>3</sub> is a Tec homology (TH) domain, which contains the Zn<sup>2+</sup> binding Btk motif and a proline-rich stretch. At the N-terminus is the pleckstrin homology (PH) domain, which binds with high-affinity phosphatidylinositol-3,4,5-triphosphate (PIP<sub>3</sub>) and is responsible for the translocation of Btk to the membrane. Btk and Tec kinases lack the unique N-terminal myristylated SH<sub>4</sub> region, which is carried by other Src kinases. Btk occupies a central position in BCR signaling and regulation of lineage development, and is linked to multiple downstream signaling pathways through BLNK [also known as *SH<sub>2</sub> domain-containing leukocyte protein (SLP)-65*]. BLNK functions as a scaffolding protein and binds to the SH<sub>2</sub> domain of Btk ( [238](#) ). It connects Syk to Btk and links Btk to downstream signaling molecules, like PLC $\gamma$ <sub>2</sub>, a linkage essential for Ca<sup>2+</sup> signals ( [239](#) ). Btk also associates with Wiskott-Aldrich syndrome protein via the SH<sub>3</sub> domain; this is the reason that in XLA patients with defective Btk, the collagen-induced tyrosine

phosphorylation of Wiskott–Aldrich syndrome protein in platelets is reduced ( [240](#) ). Different regions of Btk are critical for Btk activation and signal transduction [i.e., the PH domain binds to Ca<sup>2+</sup>-dependent (α, βI, βII) and Ca<sup>2+</sup>-independent isoforms of protein kinase C (PKC) (ε and ζ) in mouse B cells ( [241](#) ), to IP<sub>3</sub> ( [242](#) ), and to heterotrimeric G proteins ( [243](#) )]. Sequential phosphorylations of regulatory tyrosines by the BCR-associated Src kinases activate Btk, such as the phosphorylation of Tyr551 in the kinase domain or Tyr 223 in the SH<sub>3</sub> domain ( [244](#) , [245](#) , [246](#) and [247](#) ).

In Src kinases, negative regulation is mediated by the Tyr527 in their C-terminal region, but Btk has no equivalent residue, and it is likely that such a function is mediated by the recently identified inhibitor of Btk (IBtk). IBtk binds to the PH domain and down-regulates Btk function, such as Ca<sup>2+</sup> mobilization and NF-κB activation ( [248](#) ).

It appears that Btk is a bi-directional regulator with the capacity to deliver survival or apoptotic signals depending on the expression of surface receptors and the stage of the cell differentiation ( [249](#) , [250](#) ). The molecular mechanism of Btk function in XLA is still not quite clear. Mutations of Btk gene include deletions, insertions, or substitutions ( [251](#) ) and produce variable degrees of immunodeficiency, whether in the kinase domain ( [235](#) ) or in other domains.

Evidence from the bone marrow of XLA patients shows that there is an expansion of pro-B cells, whereas the numbers of more mature B cells are negligible ( [252](#) ). Based on the expression of VpreB, the pre-BI cells are SLC positive, and a number of them are large in size and cycling, whereas the pre-BII cells are negative. It appears that Btk blocks normal B-cell maturation at a point just before that stage (i.e., it interferes with the transition of pro-B cells to pre-BI stage) ( [252](#) ). Some patients express an inactive form of Btk and have a more severe form of XLA than those expressing no Btk molecule ( [253](#) ).

## PHENOTYPIC CHANGES IN THE EARLY STAGES OF B-CELL DEVELOPMENT

The study of phenotypes of B-cell precursors in normal adult bone marrow is hampered by the relative paucity of these cells. Therefore, some investigators have resorted to the study of leukemias under the assumption that they accurately reflect normal B-cell development. Because aberrant phenotypes in acute leukemias have been identified, suggesting asynchronous antigen expression, the validity of the results from such an approach has been challenged ( [1](#) , [254](#) ). Normal adult bone marrow ( [255](#) ) or fetal bone marrow and fetal liver ( [256](#) , [257](#) ) have been used as a source of B-cell precursors in cultures *in vitro* or after injection in SCID mice. B lymphocytes derive from cells expressing high levels of CD34 ( [258](#) , [259](#) ).

Phenotypically, B-cell development can be separated into three stages: (a) precursor B cell (which includes pro-B cells and pre-B cells), (b) immature B cells, and (c) mature B cells ( [Fig. 16.1](#) ). Markers defining the first stage are CD19, and, occasionally, some other “promiscuous” markers, such as CD2 or CD7, are detected, but probably the best marker is the detection of the SLC by a monoclonal antibody, a hallmark of a B cell, progressing through the progenitor stages. Entrance into the immature B-cell stage is defined by the surface expression of IgM, with antisera not only for μ chains but also for light chains ? or ?. This indicates that the μ chain is associated with a light chain and not with the SLC, suggesting that the Ig gene rearrangements are complete. The immature B-cell stage is



characterized by expression of only IgM without IgD. Functionally, this is important because the former phenotype defines a cell vulnerable to tolerogenic stimuli indicative of its “immaturity.” At this stage, the cell expresses other markers, such as CD10 and CD24, at high density. The mature B-cell stage is simply identified by coexpression of IgD as well as other markers such as CD20, CD21, and CD22.

Another useful phenotypic marker for precursor B cells is the nuclear enzyme TdT ( [260](#) ). Tdt is a DNA polymerase catalyzing the elongation of polynucleotide chains without template ( [261](#) ) and adds N-nucleotides at the DNA cleavage site during V(D)J recombination. CD24 is expressed at a very early stage, and it is present at a much higher density as compared with the mature sIg<sup>+</sup> B lymphocyte ( [262](#) ). CD2 expression has been detected on biphenotypic ALL cells and also on their normal counterparts in human fetal hematopoietic tissues ( [263](#) , [264](#) ). Whether they represent common T and B lineage progenitors remains to be seen. Pre-B cells have been detected during fetal life first in the liver (by 8 weeks) and later in the bone marrow (by 12 weeks) ( [265](#) , [266](#) ). In the liver, they are mixed among other myeloid cells next to liver parenchyma in extrasinusoidal areas ( [267](#) ).

The small pre-B cell is the immediate precursor of the immature B cells and starts to express sIgM by the end of the first trimester. In adults, pre-B cells are present in the bone marrow, where they constitute 0 to 7% of the nucleated cells and only rarely are noted in the peripheral lymphoid organs.

During the last phase of pre-B cell, CD34 and TdT disappear, CD10 is down-regulated, and the cell expresses first CD22 and later CD20. Before its appearance on the cell surface, CD22 is detected in the cytoplasm very early during development. It is identical to the surface CD22 and is B-lineage restricted ( [268](#) ). The receptors for Fc are not present on pre-B cells but receptors for C3b have been detected in some large pre-B cells and in approximately 40% of the small pre-B cells ( [269](#) ).

## MATURE B LYMPHOCYTES

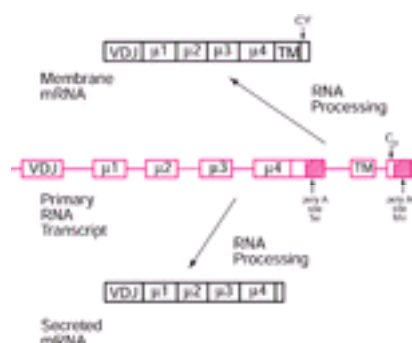
The hallmark of maturing B lymphocytes is the appearance of sIg, and the first one expressed is IgM. During fetal life, the IgM<sup>+</sup> cells (which are mostly CD5<sup>+</sup>) populate the lymph nodes and settle in the primary lymphoid follicles after 16 to 20 weeks of gestation. By 13 weeks, most of the B cells are IgM<sup>+</sup>IgD<sup>+</sup>, and later IgG or IgA is added. This triple phenotype of fetal B cells persists until birth but is converted to the adult single phenotype during the first few months of life. In adult life, cells expressing IgG or IgA are mostly IgM<sup>-</sup> and IgD<sup>-</sup>. By 10 weeks of age, practically all B cells in the spleen are IgM<sup>+</sup>IgD<sup>+</sup>, whereas in the bone marrow only 30 to 40% coexpress the two isotypes. Maturation of B lymphocytes is associated with a change in the density of the two isotypes from IgM<sup>high</sup>IgD<sup>-</sup> to IgM<sup>high</sup>IgD<sup>low</sup> and finally to IgM<sup>low</sup>IgD<sup>high</sup>. New markers appear on B lymphocytes with the expression of IgM ( [Fig. 16.1](#) ). CD21 is present in more than 90% of resting B lymphocytes and is the same as the C3d/EBV receptor. With activation, CD21 and CD22 are lost, and, concomitantly, CD23 is expressed. CD23 is up-regulated by IL-4 ( [270](#) ) and the EBV nuclear antigen-2 (EBNA-2) ( [271](#) ) and is down-regulated by interferon-γ. CD24 expression decreases with B-cell maturation, and, in combination with the expression of CD45, it can be used to determine stages of B-cell maturation relevant to B-cell neoplasias ( [272](#) ). CD45 expression also varies with B-cell maturation. Its expression is low on the most immature precursors in the bone marrow, is up-regulated as normal B-cell differentiation progresses, and then declines at the

terminal stages of differentiation as plasma cells become negative for CD45 ( [273](#) ).

Probably the most important application of the phenotypic changes occurring during B-cell differentiation is in B-cell malignancies because it is widely accepted that B-cell leukemias/lymphomas correspond to distinct stages of differentiation. An attempt to incorporate immunophenotypes (and genetic techniques) into the traditional morphologic features has resulted in a revised classification with well-defined disease entities ( [274](#) ) and more recently in the revised World Health Organization classification ( [275](#) ).

## SURFACE IMMUNOGLOBULIN

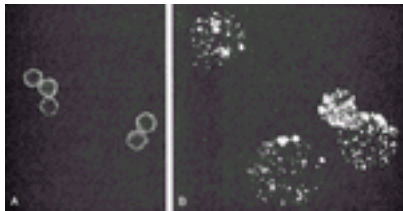
sIg serves as the receptor for antigen on B lymphocytes. It is identified most commonly with the use of fluorochrome-conjugated anti-Ig antisera. The first Ig to appear on the membrane of B lymphocytes is IgM. In contrast to the secreted pentameric form, the membrane IgM (mIgM) is composed of only one subunit (8S) containing two H and two L chains. The second isotype to appear is IgD, which is present either as a complete four-chain molecule or as a half molecule. The ratio of secretory to mIg increases with maturation from resting B cells to plasma cells. The transmembrane and secreted forms are encoded by the same gene. There are two transcription termination of polyadenylation sites: One is 3' to the last constant chain exon, and the second is 3' to the second transmembrane exon ( [Fig. 16.7](#) ). Termination at the first site results in loss of transmembrane exons and production of the secreted form, whereas polyadenylation at the second site produces the membrane form.



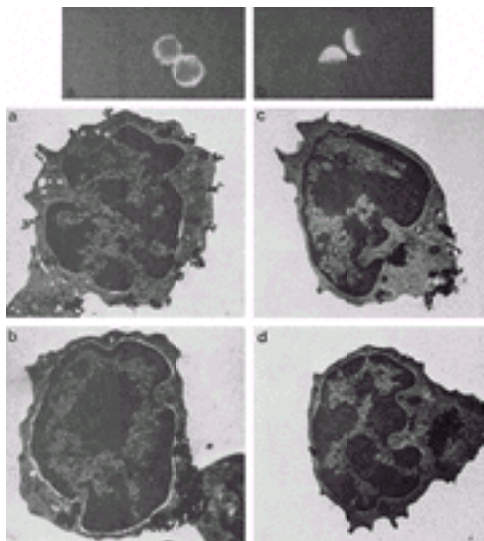
**Figure 16.7.** Expression of membrane versus secreted immunoglobulin (Ig) depends on alternative processing of the primary RNA transcript. There are two polyadenylation ( *poly A* ) sites, one for secreted ( *Se* ) and one for the membrane ( *Me* ) forms. C $\mu_1$ –C $\mu_4$  are the exons of IgM. Cy, cytoplasmic region; mRNA, messenger RNA; TM, transmembrane region.

Between 50,000 and 100,000 molecules of Ig are found on each B lymphocyte. This number is an average, because the density of sIg varies among individual B cells ( [276](#) ). The mIg is distributed throughout the membrane in small clusters, including the microvilli ( [277](#), [278](#) ). In human B lymphocytes, the clusters are separated from each other by a few thousand Ångstroms of bare membrane, indicating restriction in the free distribution of mIg. In the mouse, the clusters are interconnected by strands composed of a few molecules, forming a lacy, continuous network. When examined at 4° C in the fluorescent microscope with fluorescein conjugated anti-Ig antibodies, the mIg appears distributed as a ring, but an increase in the temperature to 37° C prompts the formation of clusters (patching) that move rapidly toward one pole of the cell, forming a cap ( [279](#) ) ( [Fig. 16.8](#) and [Fig. 16.9](#) ). Shortly after the formation of the cap, changes in cell shape occur accompanied by cell movement. The cell pushes out a projection located opposite to the

cap that corresponds to membrane ruffles noted on scanning electron microscopic analysis ( <sup>280</sup> ) ( Fig. 16.10). After the formation of the cap, a constriction under the cap encircles the cell, and the cell takes the shape of a hand mirror, with the cap occupying the area of the uropod with numerous microvilli. A dense band of microfilaments is noted under the constriction that separates the cell into the uropod containing the cap and the area opposite the cap containing the cell organelles and the nucleus. The uropod is well formed after the cap is completed.

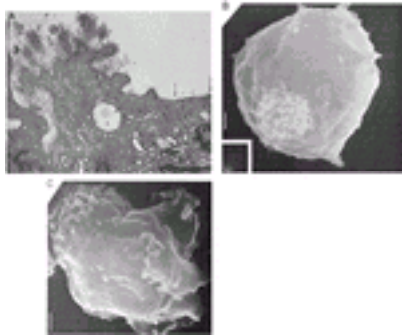


**Figure 16.8.** Demonstration of surface immunoglobulin (Ig) by immunofluorescence on B lymphocytes. Viable normal B lymphocytes treated with anti-IgM antiserum at 4° C present a staining pattern of a uniform ring around the periphery of the cell (A) or discrete patches uniformly dispersed over the cell surface (B). (From Zucker-Franklin D, Greaves MF, Grossi CF. Atlas of blood cells, 2nd ed. Philadelphia: Lea & Febiger, 1988, with permission.)



**Figure 16.9.** Redistribution of surface immunoglobulin (Ig). **A:** Mouse B lymphocytes treated with fluorescein-conjugated anti-mouse Ig antibody. **a:** Surface Ig is uniformly distributed around the cell (ring pattern). This pattern is seen only if the cell is kept at 0° C. **b:** Warming the cell to room temperature causes redistribution of the Ig so that it occupies only one pole (cap pattern). (From Taylor RB, et al. Redistribution and pinocytosis of lymphocyte surface immunoglobulin molecules induced by anti-immunoglobulin antibody. *Nature* 1971;233:225, with permission. Copyright ©1971 Macmillan Magazines Limited.) **B:** Mouse B lymphocytes treated with rabbit anti-mouse Ig-conjugated with iodine-125 were examined by high resolution radioautography. **a:** At the ultrastructural level, Ig is distributed around the entire surface of the cell, if it is maintained at 4° C. **b:** Surface Ig accumulates to one of the poles of the cell (uropod), forming a cap when it is warmed at 37° C. **c** and **d:** The cap is eventually endocytosed. (From Unanue ER, Perkins WD, Karnovsky MJ. Ligand-induced movement of lymphocyte membrane macromolecules. I. Analysis by immunofluorescence and ultrastructural radioautography. *J Exp Med* 1972;136:885-906. Reproduced by copyright permission of

the Rockefeller University Press.)



**Figure 16.10.** Ultrastructure of a cap. **A:** Anti-immunoglobulin (Ig) labeled with hemocyanin in mouse spleen B lymphocyte is heavily concentrated in the uropod around short microvilli. Some of the capped Ig has been endocytosed (*E*). The label in the cap is densely packed, whereas the adjacent areas are clear of label (arrows). (From Karnovsky MJ, Unanue ER, Leventhal M. Ligand-induced movement of lymphocyte membrane macromolecules. II. Mapping of surface moieties. *J Exp Med* 1972;136:907–930. Reproduced by copyright permission of the Rockefeller University Press.) **B:** A cell with a tightly packed cap with smooth surface in the remaining body. **C:** The cap is separated by a constriction from the rest of the body, which shows intense membrane ruffling. G, Golgi apparatus. (**B** and **C** from Karnovsky MJ, Unanue E. Cell surface changes in capping studied by correlated fluorescence and scanning electron microscopy. *Lab Invest* 1978;39:554–564, with permission.)

Although patches are observed at 4° C, capping can take place only at temperatures above 20° C and preferably at 37° C ([281](#), [282](#)). The formation of patches is a passive phenomenon resulting from the aggregation of small complexes on the plane of the membrane. Capping requires energy provided by the respiratory chain and glycolysis. In most human B lymphocytes, capping does not take place because the Ig clusters on the surface of the cells are widely separated from each other. As a result, cross-linking is not possible because cell motility can be blocked without any effect on Ig capping ([281](#)), and capping in many B cells is already complete before any amoeboid movement is noticed.

Colchicine, which disrupts microtubules, has no effect on capping, and only a slight effect is noted with cytochalasin B, which disrupts the microfilaments. The combination of these drugs, however, inhibits mIg capping profoundly. Calcium, which plays an important role in contractile systems, is also critically involved in mIg capping ([281](#), [282](#), [283](#)), probably through calmodulin, which is found under the caps ([284](#)).

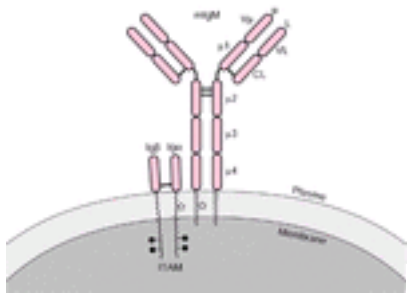
During the process of capping, mIg becomes physically associated with the cytoskeleton, and after treatment with nonionic detergents, it remains bound to the insoluble cytoskeleton. After binding of the anti-Ig antibody, two constituents of microfilaments, myosin as well as actin, are redistributed and are found in the uropod under the caps.

The fate of the complexes in the cap has been studied morphologically using autoradiography, electron microscopy, and measurements of radioactivity. The bulk of the complexes is internalized (endocytosed) in the presence of adequate antibody. Endocytosed material is catabolized within the lysosomes, and small fragments are released into the culture medium. With the completion of endocytosis, the B lymphocyte

remains free of mIg until it is resynthesized to the original level by 24 hours.

## B-CELL ANTIGEN RECEPTOR COMPLEX: STRUCTURE AND SIGNALING

The sIg of B lymphocytes forms a complex with several components assembled into two structurally and functionally distinct modules: an antigen recognition module (sIg), and a signal transducer module (a heterodimer of two polypeptide chains  $I\alpha/\beta$ ) (Fig. 16.11) (285, 286, 287 and 288). sIg provides the specificity for antigen recognition through its antigen-binding sites. However, the cytoplasmic tails of the two heavy chains of mIgM consist of three amino acids and therefore are not suitable in signal transduction. Two other polypeptide chains known as  $I\alpha$ , containing a 61-residue cytoplasmic tail, and  $I\beta$ , with a 48-residue tail, are associated with mIgM. The genes encoding for these proteins are known as *mb-1* and *B-29*, respectively. In their cytoplasmic tails, these proteins carry a sequence motif of six conserved and precisely distributed amino acids (tyrosines and negatively charged amino acids) over a sequence of 26 residues. This motif has been termed *immunoreceptor tyrosine-based activation motif* or *ITAM* (289). ITAMs have been found in  $\alpha$ ,  $\beta$ ,  $\epsilon$ ,  $\delta$ , and  $\gamma$  chains of CD3 and Fc receptors.



**Figure 16.11.** The B-cell receptor (BCR). The surface immunoglobulin (Ig) (two heavy and two light chains) constitute the antigen-specific component of BCR, which is associated noncovalently with a heterodimer consisting of two chains  $I\alpha$  and  $I\beta$ . This heterodimer constitutes the signal transduction component. The  $I\alpha$  chain associates with the H chains through ionic interactions. ITAM, immunoreceptor tyrosine-based activation motif; mIgM, membrane immunoglobulin M.

The transmembrane region of  $C\mu$  is required for binding to  $I\alpha/I\beta$  heterodimer, and it is one of the highly conserved portions of the Ig molecule between species and isotypes. The conserved amino acids are not all hydrophobic but contain several hydrophilic residues. This amphipathic nature indicates again that mIg forms complexes with other proteins.

The genes *mb-1* and *B-29* are active only in B lineage and are expressed even before the assembly of the V gene. In myeloma cells, only the *B-29* is expressed but not the *mb-1*, and that prevents expression of Ig in plasma cells. For surface expression of Ig, the complete assembly of the Ig with  $I\alpha/I\beta$  heterodimers is required. This explains the lack of detection of mIg on plasma cells (290). Transfection of plasma cells with the *mb-1* gene results in expression of sIg (291). A patch of polar amino acids within the transmembrane region of  $C\mu$  signals retention of IgM within the ER until the  $I\alpha/I\beta$  heterodimer associates with IgM for transportation to the cell surface.

B-cell activation leads to proliferation (i.e., clonal expansion) and differentiation (i.e., generation of plasma cells for antibody secretion). Signaling for both processes is initiated



on the surface of a naïve B cell when antigen binds and cross-links specific receptors (i.e., sIgM). The signal is transmitted to the cell interior by co-receptors and then propagated via complex signaling pathways to the nucleus. A well-orchestrated sequence of events leads to cell enlargement (“blast”), progression from G<sub>0</sub> to G<sub>1</sub> phase of the cell cycle, and incorporation of H<sub>3</sub>-thymidine [i.e., proliferation (clonal expansion)]. The same signals activate other genes, resulting in protein synthesis and formation of antibodies (differentiation).

## B-Cell Receptor Structure

After the synthesis of IgM is completed, it becomes associated with Iga and Igβ to reach the cell membrane. Iga and Igβ are encoded by the genes mb-1 and B-29, respectively ( [292](#) ). The B-29 gene is expressed throughout the life of the B cells, whereas mb-1 is turned off in plasma cells. All Ig isotypes need to associate with the Iga/Igβ heterodimer for their expression on the cell membrane and for their function. Analysis of the transmembrane regions of the heavy chains of mouse Igs shows that 11 out of 13 conserved amino acids lie on one side of the transmembrane α-helix, suggesting that this side interacts with transmembrane regions of other proteins. Because only Iga has polar residues on both sides of the transmembrane α-helix, it was assumed that Iga forms contacts with transmembrane regions on both sides ( [285](#) ). These considerations formed the basis for a model of the B-cell receptor complex in which the IgM component is in the center with one Iga/Igβ heterodimer on each side ( [293](#) ). Based, however, on new evidence, this model has been challenged. It is believed that each IgM molecule is associated with only one Iga/Igβ heterodimer ( [Fig. 16.11](#) ) ( [294](#) ). If this model is correct, the question remains whether both chains are linked to IgM, or only Iga binds to both heavy chains, and Iga-BCR forms oligomers with additional molecules of the same isotype. In the arrangement of the components of the oligomers, in the resting state of B cell, one side of the transmembrane helix of the Ig associates with the Iga while the other with a similar Ig isotype.

## B-Cell Receptor and Lipid Rafts

The oligomers continuously deliver signals at a low level needed to maintain the B cell alive. Ligand binding changes the orientation of the BCR molecules so that their ITAMs become more accessible to phosphorylation that causes *signal spreading* restricted to BCRs of the same isotype ( [294](#) ). Signal spreading indicates that the oligomeric receptors form arrays in which the receptors are in close proximity ( [295](#) ). These early events of BCR reorganization provide a mechanism for detecting low concentrations of antigens, thus increasing the threshold of activation.

Cross-linking of BCR by multivalent antigen leads to a series of morphologic and molecular events that are interrelated (i.e., BCR aggregation and loading to “lipid rafts,” signaling, internalization of BCR, and antigen presentation).

In the resting state, BCRs “float” on the cell membrane as monomers, but at the time of “signal spreading,” they form oligomers and gather in specialized membrane microdomain referred to as *lipid rafts*. Cross-linking with antigen enhances the transfer of BCRs to lipid rafts ( [295](#) , [296](#) , [297](#) and [298](#) ), but the pre-BCRs are constitutively located on lipid rafts ( [299](#) ). Lipid rafts are areas of the membrane enriched in cholesterol and glycosphingolipids with saturated fatty acid side chains consisting of GM1 gangliosides. They are resistant to solubilization in nonionic detergents at low temperatures. Most of the proteins are excluded from the lipid rafts, except proteins modified by saturated fatty acids. Such proteins include acylated Src kinases and the α subunits of trimeric G proteins. Lipid rafts

facilitate BCR signaling by co-localizing signaling molecules, but also by excluding molecules that inhibit BCR signaling such as CD22. Furthermore, in anergic or tolerized B cells, the BCR is unable to enter lipid rafts, indicating that inclusion of BCR within these microdomains is an absolute requirement for initiation of signaling (300). Similarly, localization of BCR within the rafts occurs only in mature, but not immature, B cells (301). The translocation of the BCR into lipid rafts is independent of any signaling initiated by the receptor and does not require actin cytoskeleton polymerization or the Iga/IgB complex (302). Lipid rafts facilitate not only activation, but also apoptosis, because cross-linking of CD24, a glycosylphosphatidylinositol-anchored protein that is down-regulated during B-cell differentiation, induces apoptosis via a lipid raft signaling system (303). CD24 cross-linking brings some BCR within the lipid rafts activating Lyn kinase.

B cells are not only antibody-producing cells after BCR-mediated differentiation, but in addition are antigen-processing and -presenting cells. With this function, they can attract antigen-specific T cells to receive T-cell help (304). Lipid rafts mediate also this function of B cells, diverting the antigen captured by B cells to the endocytic pathway for further processing (305). From evidence cited above, it appears that the association of immune receptors with rafts is regulated and is part of the mechanism that determines the fate of BCR signaling during development and antigen-driven differentiation. As indicated above, in immature or anergic cells, BCRs have no access to lipid rafts, but the of the CD21/CD19 complex co-receptor, which markedly enhances BCR activation, significantly stabilizes the residence of BCR within rafts and thus prolongs B-cell activation (306). The FcγRII, which acts as an inhibitor of B-cell activation, on the other hand, destabilizes BCR-raft association (307).

After translocation of BCR (or other immune receptors) into lipid rafts, the rafts appear to form clusters [i.e., clustered rafts (295)] increasing the range of their diameter from hundreds of nanometers to micrometers. Clustering results from receptor cross-linking between rafts and eventually linking rafts with linker proteins such as LAT (linker of activation of T cells) in T cells. In addition, cytosolic proteins that have been associated with cytoplasmic domains of receptors residing within a raft may also contribute to the bridging of individual lipid rafts to form larger conglomerates. Cytoskeletal components are also linked to activated receptors and their reorganization bridges clustered rafts.

Continuation of raft clustering eventually leads to the formation of the “synapse,” a highly ordered membrane structure in which immune receptors, signaling molecules, and cell adhesion molecules are clustered (308). Synapse formation is a highly organized structure with a cluster of immune receptors in the center ringed by adhesion molecules and several signaling molecules and cytoskeletal components on the cytoplasmic side. The formation of the synapse was first identified on T cells, but it has now been identified also on B cells (309). The B-cell synapse is associated with antigen capturing for processing, and when antigen is captured by other antigen-presenting cells, such as dendritic cells, they trigger the formation of the synapse on B cells. During this close encounter between the dendritic cell with synapse formation, the B cells sample and gather antigen for internalization and processing.

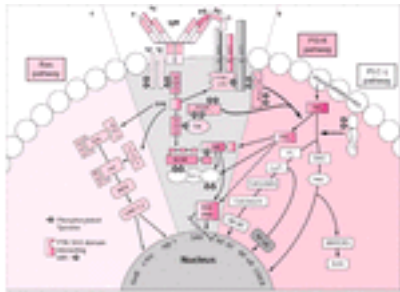
The mechanisms of internalization have been discussed earlier with the Ig redistribution after anti-Ig binding (see [Surface Immunoglobulin](#)). Lipid rafts are the middle point between signaling and internalization, and these two events are interrelated (310) because signaling regulates the BCR internalization (311). Cells with deficiency of expression of Src kinases, which normally initiate B-cell signaling, fail to internalize the receptor (312), and the targeting of antigen to the major histocompatibility complex class II peptide-loading



compartment is also disrupted ( [313](#) ). Internalization of BCR occurs when clathrin is associated with rafts and is tyrosine phosphorylated after BCR cross-linking ( [314](#) ). When lipid rafts are disrupted either by expression of LMP2A protein of EBV or reagents that sequester cholesterol, internalization does not occur ( [312](#), [314](#) ).

## B-Cell Receptor Signaling

The most important structural elements of signaling molecules for the initiation of B-cell activation and differentiation is the ITAM motifs of the I $\alpha$ /I $\beta$  heterodimer and the PTKs associated with the complex ( [Fig. 16.12](#) ). The ITAM is characterized by a sequence of 26 amino acids D/E-X<sub>7</sub>-D/E-X<sub>2</sub>-YXXL/I-X<sub>6</sub>(<sup>7</sup>)-YXXL/I, with six of them being conserved (X = any amino acid). Critical for signaling are the two tyrosines (Y), and one or both of them are phosphorylated when the BCR is engaged by antigen.



**Figure 16.12.** B-cell activation. Signal transduction initiated by the engagement of the B-cell receptor (BCR) is a highly complex process. For a better understanding, it is divided arbitrarily into three main signaling pathways: (a) initiation: with the assembly by adapter proteins such as BLNK ( *B*-cell *i* *n*ker protein), Cbl, and others of signaling protein tyrosine kinase ( *PTK*) complexes such as Src (Lyn, Fyn), Syk, and Btk; (b) inositol phosphatides generation by the activation of PI3K and PLC- $\beta$ ; (c) the ras/Erk pathway assembled by adapter proteins Grb, Shc, and Sos. These pathways carry the signals downstream to other signaling molecules Akt, calcineurin, and Erk/1,2 and to activation of transcription factors nuclear factor- $\kappa$ B (NF- $\kappa$ B), NF-AT, CREB, c-fos, etc. (From Paraskevas F. B lymphocytes. In: Israels L, Israels E, eds. Mechanisms in hematology. With permission from Core Health Services, Inc.)

BCR signaling is a highly complex process ( [315](#), [316](#) and [317](#) ), but for the sake of understanding, the interactions are divided somewhat arbitrarily into three major pathways: (a) initial interactions, (b) phosphoinositide pathways, and (c) the ras pathway.

**INITIATION PATHWAY** BCR has no intrinsic PTK activity but uses several distinct families of cytoplasmic PTKs. Three distinct types of PTKs are activated on BCR engagement: (a) the Src-PTKs (Lyn, Blk, and Fyn), (b) Syk, and (c) Btk ( [315](#) ). Activation of Lyn is one of the earliest events in BCR-induced signaling, which is constitutively acylated and as a result localizes in the cell membrane. It is responsible for the initial phosphorylation of the ITAMs of I $\alpha$  and I $\beta$ . The kinase activity of Lyn is regulated by phosphorylation of a carboxyterminal regulatory tyrosine by the kinase Csk ( [318](#) ) and dephosphorylation by the phosphatase CD45 ( [319](#) ). Lyn has one SH<sub>3</sub> domain on its N-terminus, followed by one SH<sub>2</sub> domain and the kinase domain in the C-terminus. The SH<sub>2</sub> domains bind phosphorylated tyrosines, whereas the SH<sub>3</sub> domains bind proline-rich sequences. BCR engagement triggers dephosphorylation of Tyr508 by the CD45

phosphatase, whereas Ty394 within the catalytic domain is rapidly phosphorylated. Syk kinase is recruited to the phosphorylated ITAMs of Ig $\alpha$  and Ig $\beta$ , and is phosphorylated by Lyn or by an autophosphorylation mechanism (320). Activation of Syk is a critical event in BCR signaling and for recruitment of BLNK, or SLP-65, a linker protein with a major scaffolding function connecting several downstream signaling molecules (321). BLNK assembles macromolecular complexes that include PLC $\gamma$ , Vav, and Btk and additional linker proteins Grb2 and Nck (322, 323). Phosphorylation in five tyrosine residues of BLNK is required for coordination of the assembly of multimolecular complexes. Btk belongs to the TEC family of kinases and differs in several aspects from the Src kinases [i.e., it is not myristoylated, does not contain a negative regulatory phosphorylation site in the C-terminus, and has a pleckstrin homology domain (PH) in the N-terminus]. Btk function is regulated by phosphorylation of the Tyr551, which is essential for Btk participation in signal transduction (324). Btk also interacts with phosphatidylinositol-3,4,5-triphosphate (PIP $_3$ ), an interaction required for recruitment of Btk to the cell membrane (325). Because PIP $_3$  is generated from activated PI3 kinase, Btk is targeted to the membrane after PI3 kinase activation, where it could be phosphorylated by Lyn or Syk.

**GENERATION OF PHOSPHOINOSITIDES** Hydrolysis of inositol-containing phospholipids is mediated by the lipid metabolizing enzymes PLC $\gamma$  and PI3K. There are several pathways leading to activation of PLC $\gamma$  in B cells (326). BLNK associated with PLC $\gamma$  $_2$  (which is the main isoform in B cells) brings it in an appropriate position for activation by Syk kinase. On the other hand, Btk also contributes to PLC $\gamma$  $_2$  activation because B cells from XLA patients show a profound reduction of IP $_3$  production on BCR engagement (327). PIP $_3$ , the product of PI3 kinase activation, binds to the PH domain of PLC $\gamma$  $_2$ , thus providing another pathway for PLC $\gamma$  $_2$  activation. PLC $\gamma$  $_2$  activation leads to hydrolysis of phospholipids, generating IP $_3$  and DAG (diacylglycerol). IP $_3$  binds to appropriate receptors on the ER, leading to Ca $^{2+}$  release from internal stores. PI3 kinase is activated by at least two pathways. A prominent substrate for tyrosine phosphorylation is the product of the oncogene c-cbl. BCR engagement phosphorylates p12-cbl, which is then associated with the 85-kd component of PI3 kinase (328). A second pathway is through the CD19/CD21 co-receptor complex (329, 330). BCR stimulation phosphorylates the two YXXM motifs of CD19, which then bind the SH $_2$  domain of the p85 regulatory subunit of PI3 kinase. Enhanced phosphorylation occurs when the CD19/CD21 complex binds C3d fragments. Furthermore, the proline-rich region of the p85 subunit binds to SH $_3$  domains of Lyn and Fyn, further enhancing PI3K activation. Ca $^{2+}$  binds to calmodulin and promotes calmodulin-dependent protein kinase activation and calcineurin, a serine-threonine-specific protein phosphatase. Calcineurin directly dephosphorylates the NFAT family of transcription factors (331, 332). DAG, one of the two second messengers produced by PLC $\gamma$  $_2$  activation, activates PKC. One target of PKC on B cells is MARCKS, a protein that regulates actin reorganization. Ca $^{2+}$  elevation also activates a number of other transcription factors, such as NF- $\kappa$ B and ATF-2. Phospho-inositides generated by PI3K bind to Akt/PKB kinase, an evolutionarily conserved kinase across species (333). Akt is the product of an oncogene transduced by the acute transforming retrovirus (Akt-8). The viral and cellular oncogenes encode a serine-threonine protein kinase consisting of a C-terminal kinase domain and an N-terminal PH domain. Mutations of the PH domain blocks Akt activation by growth factors or phosphoinositides. Akt activation is also mediated by the serine/threonine kinase PDK1, which is stimulated by PIP $_3$  (not PIP $_2$ ) and phosphorylates Akt on Thr308. Akt inhibits glycogen synthase kinase 3 (GSK3), which destabilizes Myc and cyclin D, both required for cell cycle progression. A combination of various Akt activation effects play a role for its transforming and oncogenic potential. Some of its multiple effects include transcriptional regulation of gene expression, inhibition of apoptosis, cell cycle regulation, insulin-induced

metabolic signals, endocytosis, etc.

**RAS PATHWAY** BCR cross-linking leads to an increase of the guanosine triphosphate (GTP)-bound ras and its accumulation in the membrane under BCR. Ras is a guanine nucleotide-binding protein, which cycles between a guanosine diphosphate (GDP)-bound (inactive) and a GTP-bound (active) state. The proteins of the Ras family are protooncogenes, which, on mutation, accumulate in the GTP-bound state in human tumors. On activation of B lymphocytes, Ras is rapidly converted to the GTP-bound state. The cycle between GDP and GTP binding is controlled by guanine nucleotide exchange factors (GEFs) that promote the transition from a GDP- to a GTP-bound state. This is reversed by guanosine triphosphatase (GTPase)-activating proteins, which stimulate GTPase activity of Ras and result in hydrolysis of GTP to GDP. The balance between GEFs and GTPase-activating proteins regulates Ras activity ( [334](#) ). The most likely pathway of ras activation is through the adapter protein Shc, which is phosphorylated after BCR engagement. Shc binds to a second adapter protein Grb-2, which in turn binds to Sos, a nucleotide exchange factor. This multimolecular complex is associated with the membrane ( [335](#) , [336](#) ). A guanine nucleotide exchanger protein, Vav, with selectivity for Ras, is recruited to the phosphorylated Tyr341 and Tyr345 of Syk through its SH<sub>2</sub> domain and is, subsequently, phosphorylated in B cells ( [337](#) ). Vav is a GEF in the Rho family for GTPases. These Ras-like proteins are molecular switches that are active in the GTP-bound state and can promote site-specific actin polymerization to create alterations in plasma membrane structures such as filopodia and lamellipodia. Vav has a DbpA homology domain, which has the GEF activity, a PH domain (binds phosphoinositides), and SH<sub>2</sub> domain, and two SH<sub>3</sub> domains. The PH domain of Vav uses PIP<sub>3</sub> for recruitment to the cell membrane. Vav may also be recruited to the membrane by binding to Tyr391 of CD19. A negative regulator of the ras pathway is Cbl, which competes for the binding to Sos. Cbl ( *casitas B-lineage lymphoma* ) is the cellular homolog of v-Cbl, part of the transforming gene of the Cas-NS1 retrovirus, a murine virus, capable of causing pre-B cell lymphomas. It contains a proline-rich region (residues 481 to 688), a leucine zipper motif (residues 855 to C-terminus), and multiple potential SH<sub>2</sub> binding motifs. It binds to PTKs such as Fyn, ZAP-70, and Btk, to the adapter molecule Grb2, and to PI3K ( [338](#) ). In B-cell signaling, Cbl binds to BLNK through its SH<sub>2</sub> domain and inhibits association of PLC- $\gamma$  phosphorylation ( [339](#) ). Binding of Sos and Cbl to Grb-2 is mutually exclusive because the proline-rich domains of these proteins compete for the same SH<sub>3</sub> domain of Grb2. A group of signal transduction pathways is characterized by successive phosphorylations of serine/threonine kinases. This group consists of a mitogen-activated protein kinase (MAPK), a MAPK kinase (MAPKK), and a MAPKK kinase (MAPKKK). Ras-GTP phosphorylates Raf-1, which is the MAPKKK of this cascade. Raf-1 phosphorylates and activates MEK1 and MEK2, which in turn phosphorylates ERK1 and ERK2. Phosphorylated ERKs form dimers and are translocated to the nucleus where they phosphorylate transcription factors c-fos and Jun members of the Ets family.

## ADAPTER MOLECULES: SIGNALING PLASTICITY AND DIVERSITY

Adapter proteins possess domains mediating protein-protein or protein-lipid interactions, but have no enzymatic activity. Two groups of adapter proteins can be identified: transmembrane adapter proteins and cytosolic adapter proteins (CAPs). In general, adapter proteins assemble multimolecular signaling complexes and direct their formation to specific cellular locations ( [340](#) , [341](#) , [342](#) , [343](#) and [344](#) ). At the initial stages of B-cell activation, Lyn, Syk, and Btk kinases are activated. A transmembrane adapter protein, PAG ( *phosphoprotein associated with glycosphingolipid-enriched microdomains* ), links Lyn to the kinase that phosphorylates the C-terminal tyrosine for Lyn activation. The CAP adapter protein BLNK (SLP-65) connects Btk to Syk and brings PLC- $\gamma$  on the lipid rafts. There are inhibitors for adapter proteins, such as IBtk, which binds to the pleckstrin domain of Btk and negatively regulates its activation. BLNK is directly

associated with Iga/IgB co-receptors connecting several important molecules to BCR for the initial stage of signaling. BLNK is indispensable for LMP2A (latent membrane protein), a constitutively activated EBV protein in infected B cells. LMP2A signaling can substitute for the signaling of BCR and maintains survival of EBV infected B cells, leading to infectious mononucleosis or Burkitt lymphoma. The CAP BLNK is clearly required for the translocation of PLC $\gamma$  2 from the cytosol to the plasma membrane and its subsequent activation. BLNK is critical for assembling the signaling complex for Ca<sup>2+</sup> increase.

## B-CELL SIGNALING THROUGH ACCESSORY STRUCTURES

Many other cell-surface molecules participate in B-cell signaling. The co-receptor complex CD19/CD21 activates the CD19-associated PTKs, which induce phosphorylation of tyrosine residues on CD19 motifs ( 345 ). These then become potential SH $\gamma$  2 binding sites for PI3 kinase, which generates phosphoinositides. Recruitment of PI3K to CD19 requires phosphorylation of Tyr484 and Tyr515. Activation of PI3K generates PIP $\gamma$  3, which functions to localize Btk to the plasma membrane where it is phosphorylated and activated by Src and Syk kinases. BCR activation of Btk is dependent on CD19 expression, whereas activation of Lyn and Syk is not ( 346 ). PLC activation generates DAG, which activates PKC, and 1,4,5-triphosphate, which increases cellular Ca<sup>2+</sup> ( 345 ). CD22 is associated with BCR, which on engagement phosphorylates some of the six tyrosines of CD22. This in turn leads to recruitment of SHP-1 via its SH $\gamma$  2 domain to CD22 ( 347 ). CD22 contains ITAMs and four immunoreceptor tyrosine-based inhibition motifs (ITIMs) in the cytoplasmic region. PI3K and PLC- $\gamma$  1 associate with CD22 through the YXXM motif recognized by the N-terminal SH $\gamma$  2 domain of the p85 subunit of PI3K, whereas the protein tyrosine phosphatase SHP1 binds to ITIMs. As a result of multiple ITIMs, CD22 is probably a negative regulator of B-cell activation. (For more details, see CD22 in [Chapter 2](#).)

## INTERLEUKIN-4

Although several cytokines act on B cells, the action of IL-4 was first demonstrated on B lymphocytes, and on these cells IL-4 evokes the strongest reactions. IL-4 binds to a transmembrane receptor and results in cross-linking with another protein termed *common gamma chain* ( $\gamma$ c), which is shared by other cytokines ( 348 , 349 , and 350 ). Mutations in  $\gamma$ c chain results in X-linked SCID, an inherited disease with profound suppression of cell-mediated and humoral immunity ( 351 , 352 ). IL-4 binding induces phosphorylation of a substrate of 170 kd designated as 4PS, which is unique because no other cytokine except IL-13 binding phosphorylates a similar substrate. However, insulin and insulin growth factor-1 result also in 4PS phosphorylation. 4PS is structurally similar to insulin receptor substrate-1 (IRS-1). The gene for 4PS has been cloned and is called *IRS-2*. IRS-1/2 contains more than 20 potential tyrosine phosphorylation sites and 30 potential threonine/serine phosphorylation sites. The tyrosine phosphorylation sites bind with high affinity to cellular proteins possessing SH $\gamma$  2 domains and thus act as docking sites for several signal-transducing proteins such as PI3 kinase and growth factor receptor-bound protein 2 (Grb2). Mutational analysis has mapped a region of the IL-4R between amino acids 437 and 557, which is important for IRS-1 phosphorylation and therefore signal transduction ( 353 ). This region contains a single tyrosine, is shared by the IL-4 receptor (IL-4R) and the insulin receptor, and is known as *IAR motif*.

Although the insulin receptor and IL-4R have many similarities, they have an important difference. The insulin receptor is a receptor tyrosine kinase, whereas the IL-4R and  $\gamma$ c are not, but are associated with non-receptor PTKs. Association of IL-4R and  $\gamma$ c

activates kinases associated with IL-4R, which then phosphorylates the tyrosine in the I4R motif. This allows 4PS to bind to the IL-4R and be phosphorylated by the kinases associated with the IL-4R. The phosphorylated motif I4R interacts with the PTB domain of IRS1/2. PTB domains are found in adapter proteins, such as Shc, and bind phosphopeptides. IRS1/2 becomes phosphorylated as a result of interaction with IL-4Ra receptor and binds to the p85 subunit of PI3K, which as an adapter links IRS1/2 to the catalytic subunit p110. PI3K is activated as a result of conformational changes, acts on phosphatidylinositol of the cell membrane, and transfers phosphate groups from adenosine triphosphate to the D<sub>3</sub> position of inositol-generating PIP<sub>3</sub> and phosphatidylinositol 3,4-bisphosphate. The phosphoinositides act on downstream kinases (i.e., PKC and Akt) that make important contributions to cell survival. Activation of the IRS1/2 signaling proteins is associated with activation of the ras/MAPK pathway (see [Ras Pathway](#)).

IL-4R is also associated with the Janus kinases (or JAKs) ([354](#), [355](#)). The  $\alpha$  chain binds to JAK1, whereas the  $\gamma$  chain binds to JAK3. The receptors bind to these kinases through their membrane proximal domains, which are known as box 1 and box 2 motifs and have some similarity among cytokine receptors.

The sequence between residues 557 and 657 of the  $\alpha$  chain (known as the *gene regulation domain*) is critical for expression of IL-4 responsive genes. It contains three conserved Tyr residues (Y575, Y603, and Y631), which can potentially be phosphorylated and thus be able to associate with SH<sub>2</sub> domains. IL-4 utilizes the STAT-6 member of the transcription factor family known as *STATs* (signal transducers and activators of transcription) ([356](#)). IL-4-responsive genes include class II HLA, CD23, germ-line Ige and  $\gamma$ <sub>1</sub> chains and IL-4Ra chain ([357](#)).

Engagement of IL-4R results in the activation of JAK1 and JAK3, which phosphorylate tyrosines of the cytoplasmic region of the receptor. STAT-6 binds through its SH<sub>2</sub> domains to the phosphorylated tyrosines and becomes itself phosphorylated at its C-terminus by the activated JAK kinases. The phosphorylated STAT-6 dimerizes and binds to promoters of the IL-4-responsive genes ([358](#)). (See [Chapter 18](#) for more on IL-4.)

## INTERLEUKIN-5

The  $\alpha$  chain of IL-5R is a type I membrane protein of 415 amino acids, its extracellular region comprising three sets of fibronectin type III domains, whereas the intracellular domain does not contain sequences of tyrosine kinase but shows homology with a part of the actin-binding domain of  $\beta$ -spectrin ([359](#)). It also has a region rich in prolines conserved among receptors of other cytokines (e.g., IL-3, granulocyte-macrophage colony-stimulating factor receptor or CD116; see [Chapter 2](#)).

A second  $\beta$  chain is important for signal transduction, but it does not contribute to IL-5 binding. A membrane proximal region contains a conserved box 1/box 2 motif that is responsible for the interaction with JAK2, and the distal domain is responsible for the activation of the ras-related pathways. IL-5 signaling increases Btk activity.

## INTERLEUKIN-6

IL-6 is a pleiotropic cytokine that, among many other functions, is involved in terminal differentiation of B cells ([360](#), [361](#) and [362](#)). The extracellular region of the IL-6R consists of one constant region domain of the Ig superfamily and two fibronectin type III domains,



which have four conserved cysteine residues and a motif containing two tryptophans and two serines. This motif is located in a groove between the two fibronectin domains. The intracellular domain is short and is not involved in signal transduction. Associated with the IL-6R is a protein known as *gp130*, which dimerizes when IL-6 binds to the IL-6R. The gp130 protein is shared by other cytokine receptors and initiates signal transduction. Homodimerization of gp130 induces activation of JAK kinases, which are associated with the membrane proximal region of gp130, known also as *box 1*. This leads into phosphorylation of a tyrosine in the distal part of gp130 (box 3), resulting in binding through an SH<sub>2</sub> domain of the transcription factor STAT-3, previously known as *acute phase response factor* or *APRF*. JAK kinases activate STAT-3 by phosphorylation.

Another nuclear target for gp130 signaling is the transcription factor NF-IL-6 with a leucine zipper motif. This factor is inducible in hepatocytes and monocytes by IL-6 and other cytokines and mediates the expression of IL-6-inducible genes. NF-IL-6 has a consensus sequence for MAP kinase, suggesting that it is activated through this pathway, which is ras-dependent. (For further details, see [Chapter 18](#).)

## CD40

CD40 is a member of the tumor necrosis factor receptor family, which interacts with its ligand, CD154, expressed on T cells. [See CD40 and CD40 Ligand (CD154) Interactions in [Chapter 18](#).] Signal transduction by CD40 is mediated by certain proteins that bind to its cytoplasmic region and are known as *TRAFs* (tumor necrosis factor receptor activation factor). (See [Chapter 2](#), CD40.) Engagement of CD40 by its ligand activates the Src kinases Lyn and Fyn and Btk. Signaling follows the Ras pathway via the nucleotide exchanging factor SOS, leading to JNK and ERK activation ([350](#)). The functional outcome of CD40 depends on the state of activation of B cells and the intensity of stimulation. On naïve B cells, it induces proliferation and Ig production, but on memory cells, it induces apoptosis. CD40 activation induces homotypic adhesion of B cells mediated by CD54 (intercellular adhesion molecule-1)-CD11/CD18 (LFA-1), or CD23-CD21. The functional outcomes depend on the type of TRAFs that are associated with CD40. For example, trimers of TRAF-2 mediate apoptosis, whereas trimers of TRAF-6 or TRAF-5 mediate proliferation ([363](#)). Germinal center formation and Ig class switch are hallmarks of T-cell-dependent responses, and TRAF-6 plays a role in class switch (see [Chapter 18](#)).

## POLYCLONAL ACTIVATION

Certain substances can activate B lymphocytes independent of their antigenic specificity. The response to these substances involves all B-cell clones, and, for this reason, these substances became known as *polyclonal B-cell activators* (PBAs).

PBAs are primarily microbial cell constituents such as lipopolysaccharide (LPS), purified protein derivative, staphylococcal protein A, streptolysin O, pneumococcal polysaccharide III, a water-soluble antigen from *Nocardia*, and EBV ([364](#)). Other PBAs often used are dextrans, polyvinyl pyrrolidone, and the extract of a poisonous plant, *Phytolacca americana*, pokeweed mitogen. PBAs can be separated into two categories on the basis of their need for T cells; some, such as pokeweed mitogen, are T-cell-dependent, whereas others, such as EBV, are T-cell-independent. An optimal number of macrophages (accessory cells) is also necessary for the function of some PBAs, but in large numbers, they exert a suppressive effect.

PBAs can be categorized also on the basis of their effect on B lymphocytes. Some PBAs promote B-cell proliferation only, whereas others, in addition, stimulate Ig secretion.

There are species and organ differences in the response of B lymphocytes to PBAs.

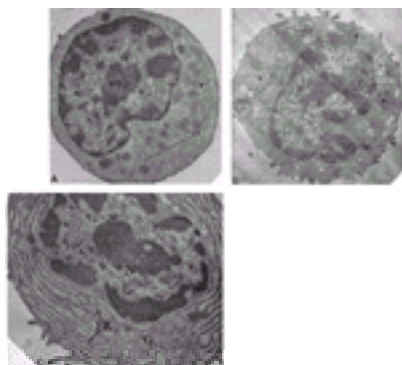
In studies involving the use of PBAs, the T to B cell ratio is critical in Ig secretion ( 364 ).

For several years, LPS has been used experimentally as PBA, but only recently was its receptor shown to be the CD14 molecule ( 365 ). LPS binding to CD14 is enhanced in the presence of a plasma protein, LPS-binding protein ( 366 ). CD14 is primarily expressed on monocytes and granulocytes. Its structure, function, and role in human disease has been reviewed ( 367 ). (See more in Chapter 2, CD14.)

## MORPHOLOGIC CHANGES ASSOCIATED WITH B-CELL DIFFERENTIATION

### Plasma Cell

Elegant studies of morphologic differentiation in immunized animals at the ultrastructural level were performed by Harris et al., who isolated individual cells involved in antibody synthesis ( 368 ) ( Fig. 16.13 ). These authors showed that antibody production is detected while the cell still retains a “lymphocytic” morphology and contains no ER. These cells can be differentiated from inactive lymphocytes by the abundance of free polyribosomes and a large nucleolus. A spectrum of cells actively secreting antibody can be ranked according to the size and development of their ER ( 369 , 370 , 371 , 372 and 373 ). During early differentiation, the ER is scarce and unorganized. Later, the lamellae increase in length and become parallel until they fill the entire cytoplasm and give rise to its onion-skin appearance. The Golgi apparatus increases concomitantly. No dividing line exists that distinguishes the cells that make IgM from those that make IgG antibody, although a preponderance of IgM producers with lymphocytic morphology and of IgG producers with plasmacytic morphology is noted ( 369 , 374 ).



**Figure 16.13.** Morphology of antibody production. Terminal B-cell differentiation (antigen-dependent) is characterized morphologically by the gradual increase of the amount of cytoplasm and, concomitantly, the appearance of strands and eventually well-organized endoplasmic reticulum. **A:** An antibody-producing lymphoid cell with sparse endoplasmic reticulum (*ER*). (From Harris TN, Hummeler K, Harris S. Electron microscopic observations on antibody-producing lymph node cells. *J Exp Med* 1966;123:161–172, with permission.) **B:** Endoplasmic reticulum (*ERVS*, is slightly distended, containing amorphous material. (From Hummeler K, Harris TN, Tomassini N, et al. Electron microscopic observations on antibody-producing cells in lymph and blood. *J Exp Med* 1966;124:255–262, with permission.) **C:** Mature plasma cell displaying well-organized ER and distinct Golgi apparatus (*G*). (From Gudat FG, Harris TN, Harris S, Hummeler K.



Studies on antibody-producing cells. I. Ultrastructure of 19S and 7S antibody-producing cells. J Exp Med 1970;132:448–474, with permission.) M, mitochondrion; N, nucleus; NOS, nucleolus; NU, nucleus. (Figures A, B, and C, reproduced from J Exp Med, as cited, by copyright permission of the Rockefeller University Press.)

The term *plasma cell* was first used by Waldeyer in 1875 ( [375](#) ). His description, however, included several types of cells, and in 1881, Unna ( [376](#) ) redefined the cells as he observed them in a case of lupus, emphasizing the characteristic basophilia of the cytoplasm (“granuloplasm”). In a subsequent report ( [377](#) ) containing pictures of methyl green- and pyronin-stained cells, several cells are identified easily as characteristic plasma cells. In 1895, Marschalko took issue with Unna’s description and emphasized that the appearance of the nucleus with its characteristic arrangement of angular chromatin blocks and its eccentric position within the cell are to be used as stringent criteria for the identification of plasma cells ( [378](#) ). The characteristic nuclear morphology was given the name *radkern* by Pappenheim. Early analytic reviews of plasma cells were provided by Downey ( [379](#) ) and later by Michels ( [380](#) ). In those early years, whether the plasma cell was a normal constituent of tissues was the subject of considerable debate. Its origin was disputed, but several prominent investigators believed that it originated from lymphocytes.

The modern period of plasma cell study was introduced in 1937 by the clinical observations of Bing and Plum, who noted the close association of hyperglobulinemia and the presence of plasma cells ( [381](#) ). Subsequent studies in hyperimmunized rabbits were carried out by Bjornboe and Gormsen ( [382](#) ), who demonstrated that antibody production correlated with massive plasma cell proliferation in the spleen. In his doctoral thesis, Fagraeus ( [383](#) ) left little doubt about the importance of plasma cells in antibody formation. Differences among animals in their capacity to produce antibody could be related to differences in the number of plasma cells, particularly immature plasma cells. Fagraeus thought that mature plasma cells had “passed the stage of their greatest functional intensity.”

Indisputable evidence in favor of antibody production by plasma cells was provided by Coons, who introduced the powerful technique of immunofluorescence to immunology ( [384](#) , [385](#) ). Plasma cells containing antibody were detected in the red pulp of the spleen, the medullary cords of the lymph nodes, and focal granulomata of immunized animals. Excellent detailed descriptions of the morphology and ultrastructure of plasma cells have been published ( [386](#) , [387](#) , [388](#) and [389](#) ).

The plasma cell is round or oval with an eccentrically located nucleus and chromatin arranged in pyramidal blocks against the nuclear membrane, giving the characteristic “cartwheel” appearance ( [Fig. 16.14](#) ). The cytoplasm is intensely basophilic because of the high content of ribonucleoprotein. Certain plasma cells stain red to violaceous rather than blue and are known as *flaming plasma cells*, a name coined by Undritz. This coloration is attributed to the accumulation within the ER cisternae of Ig with a high carbohydrate content. Electron microscopic studies revealed that the nucleus is surrounded by a double membrane. The outer membrane is covered with ribonucleoprotein particles and is continuous with the cytoplasmic ER. The Golgi is well developed and consists of vesicles and tubules. The centrosome lies next to the nucleus surrounded by the Golgi apparatus. Several microtubules radiate from the centriole. Many prominent mitochondria are scattered between the ER lamellae. A striking ultrastructural feature of the plasma cell is the rich and well-organized ER. It consists of membranes studded on one side by ribosomal particles and arranged in parallel arrays. In the mature plasma cell, the ER fills the entire cytoplasm. The cisternae are sometimes distended with

erial, giving rise to cytoplasmic inclusions known as *Russell* es are composed of Ig ( [390](#), [391](#) ), although sometimes Ig . One suggestion is that these inclusions are not made from Ig is condensed to such a degree that it cannot be netimes are detected within the nucleus (intranuclear umstances, the plasma cell contains large quantities of a stends the cell and stains gray or sometimes red as in the ed *thesaurocytes* ( [393](#) ), reveal, under electron microscopic ternae ( [394](#) ) ( [Fig. 16.15](#) ). The flaming cell likely represents cyte in terms of storage of synthesized Ig ( [395](#), [396](#) ). Two these forms are the result of disturbances in the secretion as, the cells often are similar to thesaurocytes ( [397](#), [398](#) and [400](#) ). Mott cells, which are considered plasma cells with an result from a complete or partial block in the secretion on of ER cisternae ( [401](#) ).

Normal. **B, C:** Plasmacytes with vacuoles from the bone tion and arthritis. See [Color Plate 15.7](#).

**Figure 16.15.** Unusual forms of plasma cells. Under certain circumstances related to immunoglobulin (Ig) secretion, the cisternae of endoplasmic reticulum are distended as a result of the accumulation of Ig. Plasma cells with accumulation of a homogeneous material that sometimes stains pink or red on Giemsa preparations (thesaurocytes). **A, B:**

Giemsa stain of bone marrow from two patients with IgA myeloma. Cell in **A** is bright red; that in **B** stains bluish-gray. **C, D:** Ultrastructure of thesaurocytes with different degrees of distention of the cisternae of the endoplasmic reticulum. (From Bessis M, et al. Étude comparée du plasmacytome et du syndrome de Waldenstrom. *Nouv Rev Fr Hematol* 1963;3:159, with permission.)

The most immature plasma cell is the plasmablast. It has a nucleus with evenly dispersed chromatin and a large nucleolus. The ER is sparse, and the cytoplasm is filled with clusters of polyribosomes. As the cell matures, the chromatin forms clumps, and the ER becomes more abundant and well organized. As typical lymphocytes mature into plasma cells, they pass through intermediate stages. These cells are evident in the blood of patients who have plasma cell dyscrasias or immunologic diseases characterized by hypergammaglobulinemia. Similar cells sometimes are encountered in the blood of patients with viral infections (Turk cells), including infectious mononucleosis. The intermediate forms have blue cytoplasm with abundant ER, but not as much as that seen in mature plasma cells. Some intermediate forms resemble the less mature transformed lymphocytes with simple ER and many ribosomes and polyribosomes.

### **B-Cell Differentiation: Plasma Cells**

Plasma cells down-regulate a large number of cell-surface molecules, such as BCR, Major Histocompatibility Complex class II, CD19, and CD20. Plasma cells express the cell-surface molecule Syndecan-1 (CD138) and, strongly, CD38. Differentiation of plasma cells requires the transcription factor Blimp-1, which is a transcriptional repressor ( [402](#) ). Blimp-1 represses c-myc transcription, which explains cessation of cell cycle in plasma cells, as well as represses Pax5, which is required for lineage commitment of B-cell development and for isotype switching in germinal centers. Down-regulation of Pax5 is necessary for development of antibody-producing cells because it represses XBP-1, J chain, and Ig heavy chain gene transcription ( [403](#) ). Blimp-1 promotes plasmacytic differentiation by extinguishing expression of genes important for BCR signaling, germinal center function, and proliferation, but allows expression of XBP-1 ( [389](#) ). XBP-1 is the only transcription factor required specifically for terminal differentiation of B lymphocytes to plasma cells ( [404](#) ). XBP-1 (X-box-binding protein) is a basic-region leucine zipper protein essential for the growth of hepatocytes and has been implicated in the proliferation of malignant plasma cells ( [405](#) ).

A small subpopulation of germinal center cells in the light zone express Blimp-1, which functions upstream from XBP-1 ( [406](#) ). These cells have survived the selection and are probably destined to become plasma cells. Blimp-1 represses BCL-6, a germinal center-restricted transcriptional repressor required for germinal center function. A negative feedback loop operates in the germinal centers between Blimp-1 and BCL-6. When BCL-6 is expressed, Blimp-1 expression and plasma cell differentiation are blocked. However, Blimp-1 activation represses BCL-6, and plasmacytic differentiation is irreversible. (See also [Chapter 18](#).)

### **Molecular and Ultrastructural Aspects of Immunoglobulin Biosynthesis**

Knowledge regarding the biosynthesis, assembly, and secretion of Ig has been derived from studies involving normal lymphoid organs, mouse plasmacytomas, human tumors, and cell-free systems ( [407](#), [408](#) ). The bulk of Ig is made on membrane-bound ribosomes.

Heavy (H) and light (L) chains are synthesized separately, the H chain on large 270S to 300S polyribosomes composed of 16 to 20 subunits, the L chains on smaller 190S to

200S polyribosomes composed of 7 to 8 subunits. The size of these polysomes is such as to suggest synthesis of each chain as a single unit. Under normal conditions, L chains may be synthesized in slight excess.

After separate synthesis of H and L chains, intramolecular folding and assembly of the individual chains begins on nascent proteins, but the assembly is completed primarily after the release of polypeptide chains from the ribosomes into the cisternae of the ER. Depending on the Ig class, the assembly begins with the formation of the H-L half molecules, two of which then combine to form a complete Ig monomer. Alternately, two H chains combine to form H<sub>2</sub> followed by H<sub>2</sub>L, suggesting that the final H<sub>2</sub>L<sub>2</sub> structure may be reached by several pathways ( 407, 408 ). Assembly of H chains is restricted between chains of the same class so that dimers between different H chain isotypes are not formed in cells expressing both. In most instances, polymeric Ig, such as IgM (19S) and IgA (9S, 11S, 13S), are assembled intracellularly from their constituent subunits, but results of a few studies suggest that assembly occurs at the time of secretion or extracellularly ( 409 ).

The attachment of core oligosaccharides to the N glycosylation acceptor site begins on the ribosome, but glycosylation is completed in the Golgi apparatus where the polypeptides are transported from the ER ( 410 ). The Golgi apparatus is also the site of final processing of the carbohydrate ( 411 ) and where the molecule is attached to membrane and then packaged into vesicles for secretion or incorporation into the plasma membrane ( 411 ). This mechanism of secretion is a form of reverse pinocytosis. Disruption of the traffic of the vesicles containing Ig inhibits Ig secretion.

The carbohydrate moiety may facilitate the secretion of Ig by the cell, although this effect depends on the Ig class and the amount of Ig synthesized. For some classes, such as IgM, Ig secretion is blocked when glycosylation is inhibited. H chains that have not assembled with L chains form complexes with an H-chain-binding protein (BiP) ( 412, 413 ). BiP prevents transportation of H chains to the Golgi complex until they become associated with the L chains that displace BiP. The presence of such complexes provides an explanation for the lack of secretion of  $\mu$  chains in pre-B cells when L chains are not available. In contrast to the normal situation, free H chains are secreted in association with certain lymphomas such as H-chain disease ( 414, 415 ). In these disorders, the H chains have a large deletion involving the CH1 domain ( 416 ). This deletion explains how these mutant chains can be secreted in that complexes with BiP can be formed only through the CH1 domain ( 417, 418 ).

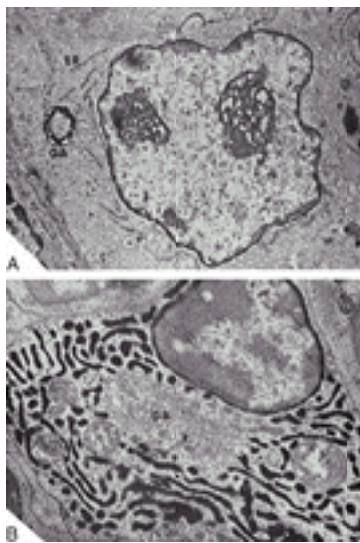
Although the synthesis of L chains and H chains takes only 30 and 60 seconds, respectively, the addition of carbohydrates and the process of secretion take at least 30 minutes. An adult synthesizes approximately 2.3 g of Ig daily ( 419, 420 ).

Most Ig-synthesizing cells contain one type of H chain and one type of L chain ( 421, 422 ), but a few cells (usually less than 1%) contain more than one type of H chain, usually  $\mu$  and  $\gamma$ .

The ultrastructural aspects of Ig and antibody formation have been elucidated through elegant studies by Avrameas et al., who used immunoenzyme techniques ( 423, 424, 425, 426, 427 and 428 ).

Antibody first appears in the perinuclear cisternae ( 426 ) and eventually is detected in the rest of the ER ( 426, 429 ) ( Fig. 16.16 ). Activation of the ER cisternae is gradual, because

not all of them within the same cell contain antibody at any one moment ([426](#)). Antibody is found in association with the ribosomes of ER and is not detected outside the ER cisternae. In most immature blasts with a sparse or nonexistent ER, antibody is present in the cytoplasm, presumably synthesized on polyribosomal clusters. Not only the intracellular distribution but also the rate of synthesis increases with time, and Ig, in some cases, distends the cisternae, forming large spheric masses reminiscent of Russell bodies. Not all plasma cells contain antibody during the primary response. In the first 2 to 3 days after immunization, most of the plasma cells contain Ig that has no antibody activity ([430](#), [431](#)). Antibody-containing plasma cells appear later in the response. In neoplastic myeloma cells, Ig also is located within the ER cisternae ([432](#)). Not all cisternae are active in Ig synthesis within the same cell. Throughout plasmacytic differentiation, the Golgi apparatus always contains antibody.



**Figure 16.16.** Ultrastructural localization of antibody. **A:** An immature plasma cell demonstrates antibody primarily in the perinuclear area. Antibody is also detected in the few strands of endoplasmic reticulum (*ER*, *arrows*, and the Golgi (*GA*) apparatus. **B:** Plasma cell with well-developed endoplasmic reticulum filled with antibody. Both cells were isolated from rabbits immunized with peroxidase. For the intracellular localization of the antiperoxidase antibody, the cells were treated with peroxidase before incubation with diaminobenzidine. (From Leduc EH, Avrameas S, Bouteille M. Ultrastructural localization of antibody in differentiating plasma cells. *J Exp Med* 1968;127:109–118. Reproduced by copyright permission of the Rockefeller University Press.)

### Global Gene View of B-Cell Activation and Differentiation

The history of the lymphocyte as discussed in the previous section (Plasma Cells) evolved during the entire length of the twentieth century through four distinct stages: (a) microscopic morphology (late 1800 to 1940); (b) ultrastructural morphology (linking lymphocyte to plasma cell and antibody production) (1940 to 1960); (c) distinction of lymphocytic lineages, T and B [first by functional assays, middle 1960s, and then by cell-surface markers after the Nobel prize-winning discovery of monoclonal antibodies (1975) by Köhler and Milstein] ([433](#)) (immunophenotypic period); and (d) molecular genetics, ushered in by a second Nobel prize-winning discovery by Tonegawa ([106](#)).

The Ig gene is assembled from multiple gene segments, and every B cell is characterized

by its own unique rearrangement [see [V\(D\)J Recombination](#)] maintained throughout its life and is transferred to all the members of its progeny when it forms a clone of antibody-producing cells, with idiotypes characteristic of the parent B cell.

Malignancies arise from one cell, therefore are monoclonal, and inherit this unique Ig rearrangement. However, in any normal cell, other genes are activated in support of its function, but it has not been possible to identify these genes, because it was not known what to look for.

The new technology of “gene profiling” enables identification of the genes that are activated and, very likely, characteristic of each stage in the life of the B cell. This technology has already been applied on normal B cells to characterize their genetic profile at various functional states. It is hoped that gene profiling will promote the understanding of genes individually or in groups expressed in each stage and identify the functional stage of the malignant transformation. Most of the work on genes in the past was done by the identification of the role of changes in individual genes, one at a time, with correlation of these changes to the function in question. This has been compared to “examining a few pixels” in an attempt to “understand a movie” ([434](#)).

Gene profiling inspects activation and gene transcription of hundreds or thousands of genes, providing a global “genomic” view. In contrast to gene sequencing (“structural genomics”), gene profiling is considered a new field of “functional genomics.”

Several methods were developed in the 1990s to examine expression of genes on a large scale. One that applies serial analysis of gene expression (SAGE) uses gene-specific 14-bp sequence tags for enumeration of genes expressed in a cell ([435](#)). In the new methods, DNA fragments from individual genes are placed on a solid support in an ordered array. Total cellular mRNA isolated from cells is used to generate by reverse transcription cDNA probes, which are tagged by a radioactive or fluorescent probe. The cDNA probes are then applied to the arrays for hybridization with the DNA on the array. The hybridization results are quantitated by phosphorimagers for radioactive probes or a scanning confocal microscope for fluorescent probes. In one commonly used microarray system, oligonucleotides are produced by *in situ* synthesis in a technique called *photolithography* and are hybridized by fluorescent cDNA probes ([436](#), [437](#)). In another technique, PCR products from cDNA clones are spotted onto coated glass slides ([438](#), [439](#)). In this technique, two cDNA probes from different samples, labeled with different fluorochromes (usually Cy3 or Cy5), are applied on the microarray simultaneously for hybridization. The expression for each gene is evaluated by the ratio of the fluorescence, and interpretation of data uses algorithms. Various analytical tools are available, and no single tool is better than others. Their use may well depend on the experimental design and the questions asked ([440](#), [441](#)).

One approach uses hierarchical clustering ([442](#)). This algorithm begins by clustering pairs of genes with most similar pattern of expression, eventually building larger and larger clusters. Clustering may be unsupervised (i.e., the arrangement of gene expression follows predefined parameters built in the algorithm). In supervised clustering, the investigator introduces other parameters such as clinical data. Several algorithms have been designed for data analysis, and more than one may be necessary for the analysis.

Three B-cell functional states were evaluated in an experimental model: naïve B cells, B cells activated *in vitro* by a foreign antigen (hen egg lysozyme, HEL), and B cells tolerant against self. In this case, B cells were obtained from transgenic mice (i.e., expressing HEL from birth); therefore, the B cells have developed tolerance against HEL as for any other



natural self-antigen ( [443](#), [444](#) ).

The results show that the naïve or resting state is maintained by several inhibitory genes, whereas activation is associated with loss of expression of some of the inhibitory genes rather than induction of genes that regulate entry into the cell cycle. B cells tolerant to “self” are characterized by increasing expression of more inhibitory genes at the same time that they maintain the expression of the basal inhibitory gene profile.

Some other data reveal that the gene profile of *in vitro* activated B cells differs from that of germinal center B cells where they are activated by T cells ( [434](#) ). Germinal center B cells actually differ from naïve B cells in the expression of hundreds of genes ( [445](#) ). The function of signaling molecules has been studied by inactivation of the appropriate gene, but this approach does not provide the total picture. Repercussions from changes in the expression of other genes cannot be heard. An attempt was made to provide an answer to this question from the effect of reduction of the function of PI3K or Btk to other genes. Reduced function of PI3K or Btk significantly affected 5% of BCR-dependent gene expression ( [446](#) ). The data also suggested that PI3K acts through Btk in regulating genes critical for determining entry into the cell cycle.

By hierarchical clustering, it has been possible to identify groups of genes characteristic of a lineage or a specific stage of differentiation or proliferation (i.e., germinal center B cell). Each group of genes defines a “signature” of a cell type or of a function, etc.

Plasma cells, which represent the end stage of B-cell differentiation, were found to have 1476 known genes, which were differently expressed as compared to B cells ( [447](#) ). A number of factors characteristic of terminal differentiation (i.e., related to RNA polymerase I) were down-regulated, while a number of transcription factors were maintained (e.g., AP-1, NFAT, and NF- $\kappa$ B). Two genes for factors associated with neuronal cell positioning, reeling and neuropilin-1, were unexpectedly expressed. Their role in plasma cell life remains to be determined.

A large body of data has already been collected in the short period since this technology was developed for large-scale application. The early findings in B-cell malignancies hold a number of unexpected results ( [448](#) ). Diffuse large B-cell lymphomas (DLBCLs) have been shown to have two different gene profiles ( [448](#) ). In one group of patients, the cells had a germinal center gene profile, whereas in the second group, the lymphoma cells showed a profile of mitogenically activated B cell. These two groups also differ in several other genes. DLBCL with the germinal center B-cell profile has retained the hypermutation machinery, but not the second group, resembling mitogenically activated B cells ( [449](#) ). Germinal center B-like DLBCL also closely resembles follicular lymphoma ( [450](#) ). On the basis of sharing some gene expressions with a small population of B cells within the germinal center as well as with plasma cells, it has been suggested that the activated B-like DLBCL may arise from a cell in its transition of becoming a plasma cell.

Another important finding so far is the possibility that B-CLL, which, phenotypically, has been separated into two groups on the basis of CD38 expression, may actually be one “genomic” disease with two variants ( [451](#) ). A small number of less than 30 genes may, however, be able to distinguish cases with IgV mutated versus unmutated profiles ( [452](#) ). Furthermore, the gene profiles have indicated that in the majority of cases, the cells are related to memory B cells rather than naïve B cells or B cells of any other category. This may not be unexpected, because the somatic hypermutation machinery is active in CLL and could play a role in intraclonal diversification development ( [453](#) ). Microarray gene profiling has been used to identify B-CLL cases with cells resistant to apoptosis after



DNA damage. Thirteen of 16 genes were found specific for resistant B-CLL cells ( [454](#) ). A study of mantle cell lymphoma also detected resistance to apoptosis gene profiling. The FADD gene, a key gene associated with Fas mediated apoptosis, was down-regulated tenfold in this lymphoma ( [455](#) ).

In multiple myeloma, the profiling suggests a classification into four subgroups ( [456](#) , [457](#) ). Group 1 patients (MM1) have a gene profile similar to MGUs, whereas the patients in MM4 group have poor prognosis with a gene profile similar to myeloma cell lines. Numerous unaccounted genes with “unknown” function have been detected so that only 10% of all these genes have matched entries in the database Expressed Sequence Tags ( [458](#) ).

The origin of Hodgkin and Reed-Sternberg (HRS) cells have remained elusive, and, recently, strong evidence has been presented that in most cases with this disease, the cell is of B-lineage origin and only rarely originates from a T cell ( [459](#) ). Identification of gene profiling demonstrated that the HRS cell expresses a distinct gene profile irrespective of its B- or T-cell derivation. The gene profile is similar to that of EBV-transformed B cell or cell lines from large cell lymphomas with features of *in vitro*-activated B cells ( [460](#) ). Among the genes specifically identified in HRS are a cluster of genes for transcription factors (i.e., GATA-3, ABF-1, EAR3, and Nrf3). Down-regulation of several genes that are active in B cells were identified. Several of these genes are positively regulated by the transcription factor Pax5 [see [Stem Cell to Progenitor B \(Pro-B\) Cell](#)]. However, the Pax5 gene is still expressed in HRS cells, and, therefore, the loss of B-cell specific gene expression remains unknown ( [461](#) ).

Btk mutations influence the expression of other genes in EBV-transformed cell lines, and, in the absence of functional Btk, 11 genes were identified that were induced more than 1.9-fold ( [462](#) ).

Microarray gene profiling has been applied to develop a molecular predictor of survival after chemotherapy for DLBCL. The study used 17 genes to construct a predictor of overall survival ( [463](#) ). Four gene groups were identified and clustered within individual signatures. The proliferation signature was the best predictor for adverse outcome. Signatures identifying good prognosis were the lymph node signature, encoding extracellular matrix, and the connective tissue growth factor, which promotes fibrosis and synthesis of extracellular matrix. Some of these genes are linked to histologic or other lymph node reactions, known already for their favorable prognosis. For example, the lymph node signature is associated with expression of genes also expressed in macrophages and NK cells, presumed to indicate a cellular antitumor response. The other favorable signature is the major histocompatibility complex class II gene expression.

## B-Cell Subpopulations

A subpopulation of B cells can be detected on the basis of expression of the CD5 antigen ordinarily present on T cells. The CD5 antigen (formerly T1 or Leu1) is a 67,000-d gp detected on all normal T cells ( [464](#) , [465](#) ), on a small subpopulation of normal B cells ( [466](#) ), and on all cells from patients with CLL ( [467](#) , [468](#) and [469](#) ). The CD5 B cells possess unique properties. They are phenotypically identical to CD5<sup>-</sup> B cells ( [470](#) ), but they are larger; in mice, they have ten times more mIgM with  $\alpha$  chains, which is expressed only rarely in mice. The CD5<sup>+</sup> B cells are present in high numbers in fetal and neonatal life (50% of all IgM<sup>+</sup> B cells), but they progressively diminish in number after birth and are present in small numbers in secondary lymphoid organs in adult life ( [471](#) , [472](#) and [473](#) ). At birth, most

of the B cells in cord blood are CD5<sup>+</sup> ( [472](#) ), but they constitute less than 10 to 30% of B cells in adult spleen, lymph nodes, and peripheral blood. Their proliferative capacity is high, and as a result they give rise spontaneously to cell lines that demonstrate c-myc amplification ( [474](#) ). The CD5 binds to CD72.

Presently, there are two views regarding the origin of the CD5<sup>+</sup> subpopulation. According to one of them, the CD5<sup>+</sup> cells (also known as *B1a*) belong to a lineage of B cells distinct from the conventional B lymphocytes (CD5<sup>-</sup>) ( [475](#), [476](#) and [477](#) ). The CD5<sup>+</sup> (B-1) cells develop early in ontogeny and, in the adult, predominate in peritoneal and pleural cavities and are self-replenished—that is, they do not arise from undifferentiated progenitors. Progenitors of CD5<sup>+</sup> cells are present in fetal liver and omentum but not adult bone marrow, whereas conventional B-cell progenitors are present in fetal liver and adult bone marrow. According to the second hypothesis, the B-1 cells derive from conventional B cells ( [478](#), [479](#) ), based on *in vitro* evidence of stimulation of conventional B cells with anti-IgM antibodies and IL-6, which generated the B-1 phenotype ( [480](#) ). B-1 cells may have different antibody repertoires (e.g., have few N-region insertions in their rearranged V genes), and the V<sub>H</sub> repertoire is biased toward V gene families proximal to J<sub>H</sub>, whereas in adult B cells it is more randomized.

Perhaps the most controversial aspect is the production of autoantibodies. In NZB mice, a strain well known for autoimmune phenomena, the CD5<sup>+</sup> B cells are increased in number and spontaneously secrete IgM autoantibodies ( [473](#), [474](#), [475](#), [476](#), [477](#), [478](#), [479](#), [480](#) and [481](#) ). Increased numbers of CD5<sup>+</sup> B cells are found in patients with rheumatoid arthritis ( [482](#) ), Sjögren syndrome ( [483](#) ), and progressive systemic sclerosis ( [484](#) ) but not in patients with systemic lupus erythematosus ( [485](#) ). Numbers of CD5<sup>+</sup> B cells are also increased after bone marrow transplantation ( [486](#) ). In 95% of patients with B-cell CLL, the leukemic cells express the CD5 antigen ( [467](#), [468](#), [487](#) ), which is also detected on cells from other B-cell lymphomas. The CD5<sup>+</sup> B cells from normal subjects ( [488](#) ) or from patients with CLL ( [489](#) ) produce autoantibodies, such as cold agglutinins, antibodies against cytoskeletal elements, and rheumatoid factor, but according to another view, these Ig are not autoantibodies but are polyreactive or natural antibodies with specificities against some self-antigens, such as the Fc fragment of IgG, DNA, and thyroglobulin ( [488](#) ). The CD5<sup>+</sup> B-cell subpopulation may therefore play an important role in the development of B-cell repertoire related to natural immunity, which develops in the absence of an encounter with exogenous antigens ( [490](#) ). Certain V genes are selectively expressed in CD5<sup>+</sup> B cells, and those are not changed by somatic hypermutation normally observed in CD5<sup>-</sup> B cells responding to exogenous antigens ( [490](#) ).

The marginal zone B lymphocytes share many phenotypic characteristics with B-1 cells and, like them, develop in response to T-independent type 2 antigens. The B-2 repertoire is selected by self-antigen and therefore tends to be autoreactive. Selection into B-1a population is favored during fetal life because TdT is not expressed during this period; therefore the repertoire is limited in its specificity range. This dangerous repertoire is kept under control by the CD5-mediated negative signaling, thus preventing inappropriate activation. On the other hand, this repertoire is useful because the B-1 cell specificities are directed against several pathogens and are important in mucosal immunity ( [491](#) ).

## REFERENCES

1. Hurwitz CA, Loken MR, Graham ML, et al. Asynchronous antigen expression in B lineage acute lymphoblastic leukemia. *Blood* 1988;72:299–307.
2. Metcalf D. Hematopoietic regulators: redundancy or subtlety? *Blood* 1993;82:3515–3523.
3. Orkin SH. Diversification of haematopoietic stem cells to specific lineages. *Nat Rev Genet* 2000;1:57–64.
4. Shivdasani RA, Orkin SH. The transcriptional control of hematopoiesis. *Blood* 1996;87:4025–4039.
5. Opstelten D. B lymphocyte development and transcription regulation in vivo. *Adv Immunol* 1996;63:197–268.
6. Scott EW, Simon MC, Anastasi J, et al. Requirement of transcription factor PU.1 in the development of multiple hematopoietic lineages. *Science* 1994;265:1573–1577.
7. Georgopoulos K, Moore D, Derfler B. Ikaros, an early lymphoid restricted transcription factor, a putative mediator for T cell commitment. *Science* 1992;258:808–812.
8. Molnar A, Georgopoulos K. The Ikaros gene encodes a family of functionally diverse zinc finger DNA binding proteins. *Mol Cell Biol* 1994;14:785–794.
9. Molnar A, Wu P, Largerspada D, et al. The Ikaros gene encodes a family of lymphocyte restricted zinc finger DNA binding proteins, highly conserved in human and mouse. *J Immunol* 1996;156:585–592.
10. Georgopoulos K, Bigby M, Wong J–H, et al. The Ikaros gene is required for the development of all lymphoid lineages. *Cell* 1994;79:143–156.
11. Klug CA, Morrison SJ, Masek M, et al. Hematopoietic stem cells and lymphoid progenitors express different Ikaros isoforms, and Ikaros is localized to heterochromatin in immature lymphocytes. *Proc Natl Acad Sci U S A* 1998;95:657–662.
12. Kelley CM, Ikeda T, Korpally J, et al. Helios, a novel dimerization partner of Ikaros, expressed in the earliest hematopoietic progenitors. *Curr Biol* 1998;8:508–515.
13. Winandy S, Wu P, Georgopoulos K. A dominant mutation of the Ikaros gene leads to rapid development of leukemia and lymphoma. *Cell* 1995;83:289–299.
14. Barberis A, Widenhorn K, Vitelli L, et al. A novel B–cell–lineage–specific transcription factor present in early but not late stages of differentiation. *Genes Dev* 1990;4:849–859.
15. Kozmik Z, Wong S, Dorfler P, et al. The promoter of the CD19 gene is a target for the B–cell–specific transcription factor BSAP. *Mol Cell Biol* 1992;12:2662–2672.
16. Okabe T, Watanabe T, Kudo A. A pre–B and B cell–specific DNA binding protein, EBB–1, which binds to the promoter of the VpreB1 gene. *Eur J Immunol* 1992;22:37–43.
17. Nutt SL, Urbanek P, Rolink A, et al. Essential functions of Pax5 (BSAP) in pro–B cell development: difference between fetal and adult B lymphopoiesis and reduced V–to–DJ recombination at the IgH locus. *Genes Dev* 1997;11:476–491.
18. Schebesta M, Pfeffer PL, Businger M. Control of pre–BCR signaling by Pax5–dependent activation of the BLNK gene. *Immunity* 2000;17:473–485.
19. Chiang MY, Monroe JG. BSAP/Pax5A expression blocks survival and expansion of early myeloid cells implicating its involvement in maintaining commitment to the B–lymphocyte lineage. *Blood* 1999;94:3621–3632.
20. Zhuang Y, Soriano P, Weintraub H. The helix–loop–helix gene E2A is required for B cell formation. *Cell* 1994;79:875–884.
21. Markus M, Benezra R. Two isoforms of protein disulfide isomerase after the dimerization status of

- E2A proteins by a redox mechanism. *J Biol Chem* 1999;274:1040–1049.
22. Bain G, Romanow WJ, Albers K, et al. Positive and negative regulation of V(D)J recombination by the E2A proteins. *J Exp Med* 1999;189:289–300.
  23. Kee BL, Murre C. Induction of early B cell factor (EBF) and multiple lineage genes by the basic helix–loop–helix transcription factor E12. *J Exp Med* 1998;188:699–713.
  24. Kerblad P, Rosberg M, Leanderson T, et al. The B29 (immunoglobulin beta–chain) gene is a genetic target for early B–cell factor. *Mol Cell Biol* 1999;19:392–401.
  25. Gisler R, Jacobsen SEW, Sigvardsson M. Cloning of human early B–cell factor and identification of target genes suggest a conserved role in B–cell development in man and mouse. *Blood* 2000;96:1457–1464.
  26. Baker SJ, Reddy EP. B cell differentiation: role of E2A and Pax5/BSAP transcription factors. *Oncogene* 1995;11:413–426.
  27. Lin H, Grosschedl R. Failure of B cell differentiation in mice lacking the transcription factor EBF. *Nature* 1995;376:263–267.
  28. Kee BL, Quong MW, Durre C. E2A proteins: essential regulators at multiple stages of B–cell development. *Immunol Rev* 2000;175:138–149.
  29. Whitlock CA, Witte ON. Long–term culture of B lymphocytes and their precursors from murine bone marrow. *Proc Natl Acad Sci U S A* 1982;79:3608–3612.
  30. Kincade PW, Lee G, Pietrangeli CE, et al. Cells and molecules that regulate B lymphopoiesis in bone marrow. *Annu Rev Immunol* 1989;7:111–143.
  31. Dorshkind K. Regulation of hemopoiesis by bone marrow stromal cells and their products. *Annu Rev Immunol* 1990;8:111–137.
  32. Moreau I, Duvert V, Caux C, et al. Myofibroblastic stromal cells isolated from human bone marrow induce the proliferation of both early myeloid and B–lymphoid cells. *Blood* 1993;82:2396–2405.
  33. Pribyl JAR, Shah N, Dittel BN, et al. Methods of purification and growth of human B cell precursors in bone marrow stromal cell–dependent cultures. In: Lefkovits I, ed. *The immunology methods manual*. New York Academic Press, 1997:902–923.
  34. Dittel BN, McCarthy JB, Wayner EA, et al. Regulation of human B–cell precursor adhesion to bone marrow stromal cells by cytokines that exert opposing effects on the expression of vascular cell adhesion molecule–1 (VCAM–1). *Blood* 1993;81:2272–2282.
  35. Pribyl JAR, Le Bien TW. Interleukin 7 independent development of human B cells. *Proc Natl Acad Sci U S A* 1996;93:10348–10353.
  36. Miyake K, Weissman IL, Greenberger JS, et al. Evidence for a role of the integrin VLA–4 in lympho–hemopoiesis. *J Exp Med* 1991;173:599–607.
  37. Miyake K, Medina K, Ishihara K, et al. VCAM–like adhesion molecule on murine bone marrow stromal cells mediates binding of lymphocyte precursors in culture. *J Cell Biol* 1991;114:557–565.
  38. Ryan DH, Nuceie BL, Abboud CN, et al. Vascular cell adhesion molecule–1 and the integrin VLA–4 mediate adhesion of human B–cell precursors to cultured bone marrow adherent cells. *J Clin Invest* 1991;88:995–1004.
  39. Simmons DL, Satherthwaite AB, Tenen DG, et al. Molecular cloning of a cDNA encoding CD34, a sialomucin of human hematopoietic stem cells. *J Immunol* 1992;148:267–271.
  40. Simmons PJ, Toroh–Storb B. CD34 expression by stromal precursors in normal human adult bone marrow. *Blood* 1991;78:2848–2853.
  41. Fina L, Molgaard HV, Robertson D, et al. Expression of the CD34 gene in vascular endothelial cells.

Blood 1990;75:2417–2426.

42. Lin G, Finger E, Gutierrez-Ramos JC. Expression of CD34 in endothelial cells, hematopoietic progenitors and nervous cells in fetal and adult mouse tissue. *Eur J Immunol* 1995;25:1508–1516.
43. Baumhueter S, Dybdal N, Kyle C, et al. Global vascular expression of murine CD34, a sialomucin-like endothelial ligand for L-selectin. *Blood* 1994;84:2554–2565.
44. von Freeden-Jeffrey U, Vieira P, Lucian LA, et al. Lymphopenia in interleukin (IL)-7 gene-deleted mice identified IL-7 as a non-redundant cytokine. *J Exp Med* 1995;181:1519–1526.
45. Namen AE, Schmierer AE, March CJ, et al. B cell precursor growth-promoting activity: purification and characterization of a growth factor active on lymphocyte precursors. *J Exp Med* 1988;167:988–1002.
46. Grabstein KH, Waldschmidt TJ, Finkelman FD, et al. Inhibition of murine B and T lymphopoiesis in vivo by an anti-interleukin 7 monoclonal antibody. *J Exp Med* 1993;178:264–275.
47. Le Bien TW. Fates of human B-cell precursors. *Blood* 2000;96:9–23.
48. Peschan JJ, Morissey PJ, Grabstein KH, et al. Early lymphocyte expansion is severely impaired in interleukin 7 receptor-deficient mice. *J Exp Med* 1994;180:1955–1960.
49. Corcoran AE, Riddell A, Krooshoop D, et al. Impaired immunoglobulin gene rearrangement in mice lacking the IL-7 receptor. *Nature* 1998;391:904–907.
50. Wei C, Zeff R, Goldschneider I. Murine pro-B cells require IL-7 and its receptor complex to up-regulate IL-7Ra, terminal deoxynucleotidyltransferase, and *cμ* expression. *J Immunol* 2000;164:1961–1970.
51. Corcoran AE, Smart FM, Cowling RJ, et al. The interleukin-7 receptor alpha chain transmits distinct signals for proliferation and differentiation during B lymphopoiesis. *EMBO J* 1996;15:1924–1932.
52. Levin SD, Koelling RM, Friend SL, et al. Thymic stromal lymphopoietin: a cytokine that promotes the development of IgM<sup>+</sup> B cells in vitro and signals via a novel mechanism. *J Immunol* 1999;162:677–683.
53. Noguchi M, Yi H, Rosenblatt HM, et al. Interleukin-2 receptor  $\gamma$  chain mutation results in X-linked severe combined immunodeficiency in humans. *Cell* 1993;73:147–157.
54. Puel A, Ziegler SF, Buckley RH, et al. Defective IL7R expression in T-B+NK<sup>+</sup> severe combined immunodeficiency. *Nat Genet* 1998;20:394–397.
55. Dittel BN, Le Bien TW. The growth response to IL-7 during normal B cell ontogeny is restricted to B-lineage cells expressing CD34. *J Immunol* 1995;154:58–67.
56. Namikawa R, Muench MO, de Vries JE, et al. The FLK2/FLT3 ligand synergizes with interleukin-7 in promoting stromal cell-independent expansion and differentiation of human fetal pro-B cells in vitro. *Blood* 1996;87:1881–1890.
57. Ryan DH, Nuccie BL, Ritterman I, et al. Expression of interleukin-7 receptor by lineage-negative human bone marrow progenitors with enhanced lymphoid proliferative potential and B-lineage differentiation capacity. *Blood* 1997;89:929–940.
58. Hao Q-L, Zhu J, Price MA, et al. Identification of a novel human multilymphoid progenitor in cord blood. *Blood* 2001;97:3683–3690.
59. Reynaud D, Lefort N, Manie E, et al. In vitro identification of human pro-B cells which give rise to macrophages, natural killer and T cells. *Blood* 2003 (*in press*).
60. Deichmann MR, Kronenwett R, Haas R. Expression of the human immunodeficiency viruses type-1, coreceptors CXCR4 (fusin, LESTR) and CKR-5 in CD34<sup>+</sup> hematopoietic progenitor cells. *Blood* 1997;89:3522–3528.
61. Ishii T, Nishihara M, Ma F, Ebihara Y, et al. Expression of stromal cell-derived factor-1/pre-B cell

growth-stimulating factor receptor, CXC chemokine receptor 4, on CD34<sup>+</sup> human bone marrow cells is a phenotypic alteration for committed lymphoid progenitors. *J Immunol* 1999;163:3612–3620.

62. Bleul CC, Farzan M, Choe H, et al. The lymphocyte chemoattractant SDF-1 is a ligand for LESTR/fusin and blocks HIV-1 entry. *Nature* 1996;382:829–833.

63. Raff MC, Megson M, Owen JJT, et al. Early production of intracellular IgM by B-lymphocyte precursors in the mouse. *Nature* 1976;259:224–226.

64. Osmond DG, Rolink A, Melchers F. Murine B lymphopoiesis: towards a unified model. *Immunol Today* 1998;19:65–68.

65. Meffre E, Fougereau M, Argenson JN, et al. Cell surface expression of surrogate light chain ( $\psi$ L) in the absence of  $\mu$  on human pro-B cell lines and normal pro-B cells. *Eur J Immunol* 1996;26:2172–2180.

66. Sanz E, de la Hera A. A novel anti-VpreB antibody identifies immunoglobulin surrogate receptors on the surface of human pre-B cells. *J Exp Med* 1996;183:2693–2698.

67. Lemmers B, Gauthier L, Guelpa-Fonlupt V, et al. The human ( $\psi$ L<sup>+</sup> $\mu$ <sup>-</sup>) pro-B complex: cell surface expression and biochemical structure of a putative transducing receptor. *Blood* 1999;93:4336–4346.

68. Karasuyama H, Rolink A, Shinkai Y, et al. The expression of VpreB lambda 5 surrogate light chain in early bone marrow precursor B cells of normal and B-cell deficient mutant mice. *Cell* 1994;77:133–143.

69. Mattei MG, Fumoux F, Roeckel N, et al. The human pre-B specific  $\psi$ -like cluster is located in the 22q11.2–22q12.3 region distal to the IgC $\gamma$  locus. *Genomics* 1991;9:544–546.

70. Karasuyama H, Rolink A, Melchers F. Surrogate light chain in B cell development. *Adv Immunol* 1996;63:1–41.

71. Minegishi Y, Hendershot LM, Conley ME. Novel mechanisms control the folding and assembly of  $\psi$ 5/14.1 and VpreB to produce an intact surrogate light chain. *Proc Natl Acad Sci U S A* 1999;96:3041–3046.

72. Hendershot LM, Kearney JF. A role for human heavy chain binding protein in the developmental regulation of immunoglobulin transport. *Mol Immunol* 1998;25:585–595.

73. Melchers F. Fct for life in the immune system? Surrogate L chain tests H chains that test L chains. *Proc Natl Acad Sci U S A* 1999;96:2571–2573.

74. Grawunder U, Leu TM, Schatz DG, et al. Down-regulation of RAG1 and RAG2 gene expression in pre-B cells after functional immunoglobulin heavy chain rearrangement. *Immunity* 1995;3:601–608.

75. Burrows PD, Stephan RP, Wang Y-H, et al. The transient expression of pre-B receptors governs B cell development. *Semin Immunol* 2002;14:343–349.

76. Karasuyama H, Rolink A, Melchers F. Surrogate light chain in B cell development. *Adv Immunol* 1996;61:1–41.

77. Gauthier L, Lemmers B, Guelpa-Fonlupt V, et al.  $\mu$ -Surrogate light chain, physicochemical interactions of the human pre-B cell receptor: implications for V<sub>H</sub> repertoire selection and cell signaling at the pre-B cell stage. *J Immunol* 1999;162:41–50.

78. Bradl H, Jack HM. Surrogate light chain-mediated interaction of a soluble pre-B cell receptor with adherent cell lines. *J Immunol* 2001;167:6403–6411.

79. Shaniel C, Gottar M, Roosnek E, et al. Extensive in vivo self-renewal, long term reconstitution capacity, and hematopoietic multipotency of Pax5-deficient precursor B-cell clones. *Blood* 2000;99:2760–2766.

80. Guo B, Kato RM, Garcia-Lloret M, et al. Engagement of the human pre-B cell receptor generates a lipid raft-dependent calcium signaling complex. *Immunity* 2000;13:243–253.

81. Taguchi T, Kiyokawa N, Mimori K, et al. Pre-B cell antigen receptor-mediated signal inhibits CD24-induced apoptosis in human pre-B cells. *J Immunol* 2003;170:252-260.
82. Melchers F, ten Boekel E, Yamagami T, et al. The roles of pre-B and B cell receptors in the stepwise allelic exclusion of mouse IgH and L chain gene loci. *Semin Immunol* 1999;11:307-317.
83. Skok J, Brown K, Azura V, et al. Nonequivalent nuclear location of immunoglobulin alleles in B lymphocytes. *Nat Immunol* 2001;2:848-854.
84. Sabbattini P, Lundgren M, Georgiou A, et al. Binding of Ikaros to the  $\gamma 5$  promoter silences transcription through a mechanism that does not require heterochromatin formation. *EMBO J* 2001;20:2812-2822.
85. Conley ME, Rohrer J, Rapalus L, et al. Defects in early B-cell development: comparing the consequences of abnormalities in pre-B cell signaling in the human and the mouse. *Immunol Rev* 2000;178:75-90.
86. Mundt C, Licence S, Shimizu T, et al. Loss of precursor B cell expansion but not allelic exclusion in VpreB1/VpreB2 double-deficient mice. *J Exp Med* 2001;193:435-445.
87. Kitamura D, Kudo A, Shaal S, et al. A critical role of  $\gamma 5$  protein in B cell development. *Cell* 1992;69:823-831.
88. Kitamura D, Roes J, Kuhn R, et al. A B cell-deficient mouse by targeted disruption of the membrane exon of the immunoglobulin  $\mu$  chain gene. *Nature* 1991;350:423-426.
89. Stephan RP, Elgavish E, Karasuyama H, et al. Analysis of VpreB expression during B lineage differentiation in  $\gamma 5$ -deficient mice. *J Immunol* 2001;167:3734-3739.
90. Minegishi Y, Coustan-Smith E, Wang YH, et al. Mutations in the human lambda 5/14.1 gene result in B cell deficiency and agammaglobulinemia. *J Exp Med* 1998;187:71-77.
91. Wang Y-H, Namura J, Faye-Peteren OM, et al. Surrogate light chain production during B cell differentiation: differential intracellular versus cell surface expression. *J Immunol* 1998;161:1132-1139.
92. Meffre E, Chiorazzi M, Nussenzweig MC. Circulating human B cells display a unique antibody repertoire. *J Immunol* 2001;167:2151-2156.
93. Meffre E, Papavasiliou F, Cohen P, et al. Antigen receptor engagement turns off the V(D)J recombination machinery in human tonsil B cells. *J Exp Med* 1998;188:765-772.
94. Meffre E, Davis E, Schiff C, et al. Circulating human B cells that express surrogate light chains and edited receptors. *Nat Immunol* 2000;1:207-213.
95. Kirsch IR, Morton CC, Nakahara K, et al. Human immunoglobulin heavy chain genes map to a region of translocations in malignant B lymphocytes. *Science* 1982;216:301-303.
96. Malcolm S, Barton P, Murphy C, et al. Localization of human immunoglobulin  $\lambda$  light chain variable region genes to the short arm of chromosome 2 by in situ hybridization. *Proc Natl Acad Sci U S A* 1982;79:4957-4961.
97. Erikson J, Martinis J, Croce CM. Assignment of the genes for human  $\lambda$  immunoglobulin chains to chromosome 22. *Nature* 1981;294:173-175.
98. McBride OW, Hieter PA, Hollis GF, et al. Chromosomal location of human kappa and lambda immunoglobulin light chain constant region genes. *J Exp Med* 1982;155:1480-1490.
99. Tomlison IM, Walter G, Marks ID, et al. The repertoire of human germline VH sequences reveals about fifty groups of V<sub>H</sub> segments with different hypervariable loops. *J Mol Biol* 1992;227:776-798.
100. Matsuda F, Shin EK, Nagaoka H, et al. Structure and physical map of 64 variable segments in the 3'



- 0.8-megabase region of the human immunoglobulin heavy-chain locus. *Nat Genet* 1993;3:88–94.
101. Pascual V, Capra JD. Human immunoglobulin heavy-chain variable region genes: organization, polymorphism, and expression. *Adv Immunol* 1991;49:1–74.
102. Schilling J, Clevinger B, Davie JM, et al. Amino acid sequence of homogeneous antibodies to dextran and DNA rearrangements in heavy-chain V-region gene segments. *Nature* 1980;283:35–40.
103. Schatz DG, Oettinger MA, Schlissel MS. V(D)J recombination: molecular biology and regulation. *Annu Rev Immunol* 1992;10:359–383.
104. Sleckman BP, Gorman JR, Alt FW. Accessibility control of antigen-receptor variable-region gene assembly: role of cis-acting elements. *Annu Rev Immunol* 1996;14:459–481.
105. Gellert M. Recent advances in understanding V(D)J recombination. *Adv Immunol* 1997;64:39–64.
106. Tonegawa S. Somatic generation of antibody diversity. *Nature* 1983;302:575–581.
107. Mombaerts P, Iacomini J, Johnson RS, et al. RAG1-deficient mice have no mature B and T lymphocytes. *Cell* 1992;68:869–877.
108. Shinkai Y, Ruthven G, Lam K-P, et al. RAG2-deficient mice lack mature lymphocytes owing to inability to initiate V(D)J rearrangement. *Cell* 1992;68:855–867.
109. Schwarz K, Gauss GH, Ludwig L. RAG mutations in human B cell-negative SCID. *Science* 1996;274:97–99.
110. Bailin T, Mo X, Sadofsky MJ. A RAG1 and RAG2 tetramer complex is active in cleavage in V(D)J recombination. *Mol Cell Biol* 1999;19:4664–4671.
111. Eastman QM, Leu TMJ, Schatz DG. Initiation of V(D)J recombination in vitro obeying the 12/23 rule. *Nature* 1996;380:85–88.
112. Hiom K, Geller M. Assembly of a 12/23 paired signal complex: a critical control point in V(D)J recombination. *Mol Cell* 1998;1:1011–1019.
113. Hiom K, Gellert M. A stable RAG1–RAG2–DNA complex that is active in V(D)J recombination. *Cell* 1997;88:65–72.
114. van Gent DC, Hiom K, Paull TT, et al. Stimulation of V(D)J cleavage by high mobility group proteins. *EMBO J* 1997;16:2665–2670.
115. Fugmann SD, Lee AI, Shockett PE, et al. The RAG proteins and V(D)J recombination: complexes, ends, and transposition. *Annu Rev Immunol* 2000;18:495–527.
116. Paull TT, Gellert M. Nbs1 potentiates ATP-driven DNA unwinding and endonuclease cleavage by the Mre11/Rad 50 complex. *Genes Dev* 1999;13:276–288.
117. Besmer E, Mansilla-Soto J, Cassard S, et al. Hairpin coding and opening is mediated by RAG1 and RAG2 proteins. *Mol Cell* 1998;2:817–828.
118. Lewis SM. The mechanism of V(D)J joining: lessons from molecular immunological and comparative analysis. *Adv Immunol* 1994;56:27–150.
119. Livak F, Schatz DG. Identification of V(D)J recombination coding end intermediates in normal thymocytes. *J Mol Biol* 1997;267:1–9.
120. Gilfillan S, Dietrich A, Lemeur M, et al. Mice lacking TdT: mature animals with an immature lymphocyte repertoire. *Science* 1993;261:1175–1178.
121. Taccioli GE, Jackson SP. Menage a trois—double strand break repair, V(D)J recombination and DNA-PK. *Bioessays* 1995;17:949–957.

122. Roth DB, Lindahl T, Gellert M. Repair and recombination—how to make ends meet. *Curr Biol* 1995;5:496–499.
123. Roth DG, Nakajima PB, Menetski JP, et al. V(D)J recombination in mouse thymocytes: double-strand breaks near T cell receptor delta rearrangement signals. *Cell* 1992;69:41–53.
124. Lieber MR, Hesse JE, Lewis S, et al. The defect in murine severe combined immune deficiency: joining of signal sequences but not coding segments in FCJ recombination. *Cell* 1998;55:7–16.
125. Gottlieb TM, Jackson SP. The DNA-dependent protein kinase: requirement for DNA ends and association with Ku antigen. *Cell* 1993;72:131–142.
126. Zhu C, Bogue MA, Lim D-S, et al. Ku86-deficient mice exhibit severe combined immunodeficiency and defective processing of V(D)J recombination intermediates. *Cell* 1996;86:379–389.
127. Zachau HG. The immunoglobulin kappa locus or what has been learned from looking closely at one-tenth of a percent of the human genome. *Gene* 1993;135:167–173.
128. Schatz DG. V(D)J recombination moves in vitro. *Semin Immunol* 1997;9:149–159.
129. Agrawal A, Eastman QM, Schatz DG. Transposition mediated by Rag1 and Rag2 and its implications for the evolution of the immune system. *Nature* 1998;394:744–751.
130. Hiom K, Melek M, Gellert M. DNA transposition by the RAG1 and RAG2 proteins: a possible source of oncogenic translocations. *Cell* 1998;94:463–470.
131. Rice D, Mizurechi K. Structure of the bacteriophage Mu transposase core: a common structural motif for DNA transposition and retroviral insertion. *Cell* 1995;82:209–220.
132. Rice P, Craigie R, Davies DR. Retroviral integrases and their cousins. *Curr Opin Struct Biol* 1996;6:76–83.
133. Gellert M. V(D)J recombination: RAG proteins repair factors and regulation. *Annu Rev Biochem* 2002;71:101–132.
134. Neiditch MB, Lee GS, Huye LE, et al. The V(D)J recombinase efficiently cleaves and transposes signal joints. *Mol Cell* 2002;9:871–878.
135. Neiditch MB, Lee GS, Landree MA, et al. The RAG transposase can capture and commit to target DNA before or after donor cleavage. *Mol Cell Biol* 2001;21:4302–4312.
136. Lee GS, Neiditch MB, Sinden RR, et al. Targeted transposition by the V(D)J recombinase. *Mol Cell Biol* 2002;22:2068–2077.
137. Roth DB, Craig NL. VDJ recombination: a transposase goes to work. *Cell* 1998;94:411–414.
138. Snider V, Chu G. The end-joining reaction in V(D)J recombination. *Semin Immunol* 1997;9:189–197.
139. Kirchgessner CU, Patil CK, Evans JW, et al. DNA-dependent kinase (p350) as a candidate gene for the murine SCID defect. *Science* 1995;267:1178–1182.
140. Peterson SR, Kurimasa A, Oshimura M, et al. Loss of catalytic subunit of the DNA dependent protein kinase in DNA double-strand break repair mutant mammalian cells. *Proc Natl Acad Sci U S A* 1995;92:3171–3174.
141. Danka JS, Guidos CJ. Essential and perilous: V(D)J recombination and DNA damage checkpoints in lymphocyte precursors. *Semin Immunol* 1997;9:199–206.
142. Moshous D, Callebaut I, de Chasseval R, et al. Artemis, a novel DNA double strand break repair/V(D)J recombination protein mutated in human severe combined immune deficiency. *Cell* 2001;105:177–186.

143. Brandt VL, Roth DB. Artemis: guarding small children and, now, the genome. *J Clin Invest* 2003;111:315–316.
144. Ma Y, Pannicke U, Schwartz K, et al. Hairpin opening and overhang processing by an Artemis/DNA-dependent protein kinase complex in non-homologous end joining and V(D)J recombination. *Cell* 2002;108:781–794.
145. Lieber MR. The biochemistry and biological significance of non-homologous DNA end joining: an essential repair process in multicellular eukaryotes. *Genes Cells* 1999;4:77–85.
146. Chu G. Double strand break repair. *J Biol Chem* 1997;272:24097–24100.
147. Moshous D, Pannetier C, de Chasseval R, et al. Partial T and B lymphocyte immunodeficiency and predisposition to lymphoma in patients with hypomorphic mutations in Artemis. *J Clin Invest* 2003;111:381–387.
148. Schlissel MS. Does Artemis end the hunt for hairpin-opening activity in V(D)J recombination? *Cell* 2002;109:1–4.
149. Callebut I, Mornon JP. The V(D)J recombination activating protein RAG2 consists of six-bladed propeller and a PHD finger-like domain, as revealed by sequence analysis. *Cell Mol Life Sci* 1998;54:880–891.
150. Aravind L, Koonin EV. Gleaning non-trivial structural-functional and evolutionary information about proteins by iterative database searches. *J Mol Biol* 199;187:1023–1040.
151. Landree MA, Wibbenmeyer JA, Roth DB. Mutational analysis of RAG1 and RAG2 identifies three catalytic amino acids in RAG1 critical for both cleavage steps and V(D)J recombination. *Genes Develop* 1999;13:3059–3069.
152. McMahan CJ, Difilippantonio MJ, Rao N, et al. A basic motif in the N-terminal region of RAG1 enhances V(D)J recombination activity. *Mol Cell Biol* 1997;17:4544–4552.
153. Fugmann SD, Schatz DG. Identification of basic residues in RAG2 critical for DNA binding by the RAG1–RAG2 complex. *Mol Cell* 2001;8:899–910.
154. Akamatsu Y, Monroe R, Dudley DD, et al. Deletion of the RAG2 C terminus leads to impaired lymphoid development in mice. *Proc Natl Acad Sci U S A* 2003;100:1209–1214.
155. Kirch SA, Rathbun GA, Oettinger MA. Dual role of RAG2 in V(D)J recombination: catalysis and regulation of ordered Ig gene assembly. *EMBO J* 1998;17:4881–4886.
156. Kilamura D, Rajewsky K. Targeted disruption of  $\mu$  chain membrane exon causes loss of heavy-chain allelic exclusion. *Nature* 1992;356:154–156.
157. Ehlich A, Schaal S, Gu H, et al. Immunoglobulin heavy and light chain genes rearrange independently at early stages of B cell development. *Cell* 1993;72:695–704.
158. Reth M, Hombach J, Wienands J, et al. The B-cell antigen receptor complex. *Immunol Today* 1991;12:196–201.
159. Alt FW, Blackwell TK, Yancopoulos GD. Development of the primary repertoire. *Science* 1987;238:1079–1087.
160. Alt FW, Oltz EM, Young F, et al. VDJ recombination. *Immunol Today* 1992;13:306–314.
161. Schlissel MS, Stanhope-Baker P. Accessibility and the developmental regulation of V(D)J recombination. *Semin Immunol* 1997;9:161–170.
162. Chen J, Young F, Bottaro A, et al. Mutations of the intronic IgH enhancer and its flanking sequences differentially affect accessibility of the J  $\mu$  locus. *EMBO J* 1993;12:4635–4645.

163. Serve M, Eablitzky F. V(D)J recombination in B cells is impaired but not blocked by targeted deletion of the immunoglobulin heavy chain intron enhancer. *EMBO J* 1993;12:2321–2327.
164. Kottman AH, Zevnik B, Welte M, et al. A second promoter and enhancer element within the immunoglobulin heavy chain locus. *Eur J Immunol* 1994;24:817–821.
165. Staudt LN, Lenardo MJ. Immunoglobulin gene transcription. *Annu Rev Immunol* 1991;9:373–398.
166. Atchison ML, Perry RP. The role of the  $\gamma$  enhancer and its binding factor NF- $\kappa$ B in the developmental regulation of  $\gamma$  gene transcription. *Cell* 1987;48:121–128.
167. Stewart AK, Schwartz RS. Immunoglobulin V regions and the B cell. *Blood* 1994;83:1717–1730.
168. Schroeder HW Jr, Wang JY. Preferential utilization of conserved immunoglobulin heavy chain variable gene segments during human fetal life. *Proc Natl Acad Sci U S A* 1990;87:6146–6150.
169. Wasserman R, Ito Y, Galili N, et al. The pattern of joining (JH) gene usage in the human IgH chain is established predominantly at the B precursor cell stage. *J Immunol* 1992;149:511–516.
170. Pascual V, Victor K, Spellerberg M, et al. V<sub>H</sub> restriction among human cold agglutinins. The VH4–21 gene segment is required to encode anti-I and anti-I specificities. *J Immunol* 1992;149:2337–2344.
171. Wasserman R, Galili N, Ito Y, et al. Predominance of fetal type DJH joining in young children with B precursor lymphoblastic leukemia as evidence of an in utero transforming event. *J Exp Med* 1992;176:1577–1581.
172. Friedman DF, Cho EA, Goldman J, et al. The role of clonal selection in the pathogenesis of an autoreactive human B cell lymphoma. *J Exp Med* 1991;174:525–537.
173. Zelenetz AD, Chen TT, Levy R. Clonal expansion in follicular lymphoma occurs subsequent to antigenic selection. *J Exp Med* 1992;176:1137–1148.
174. Bakkus MH, Heirman C, Van Riet I, et al. Evidence that multiple myeloma Ig heavy chain VDJ genes contain somatic mutations but show no intraclonal variation. *Blood* 1992;80:2326–2335.
175. Schwarz K, Bartram CR. V(D)J recombination pathology. *Adv Immunol* 1996;61:285–326.
176. Banga SS, Hall KT, Sandhu AK, et al. Complementation of V(D)J recombination defect and x-ray sensitivity of SCID mouse cells by human chromosome 8. *Mutat Res* 1994;315:239–247.
177. Komatsu K, Kubota N, Gallo M, et al. The SCID factor on human chromosome 8 restores V(D)J recombination in addition to double-strand break repair. *Cancer Res* 1995;55:1774–1779.
178. Blunt T, Finnie NJ, Taccioli GE, et al. Defective DNA-dependent protein kinase activity is linked to V(D)J recombination and DNA repair defects associated with the murine SCID mutation. *Cell* 1995;80:813–823.
179. Peterson SR, Kurimasa A, Oshimura M, et al. Loss of the catalytic subunit of the DNA-dependent protein kinase in DNA double-strand-break-repair mutant mammalian cells. *Proc Natl Acad Sci U S A* 1995;92:3171–3174.
180. Bosma GC, Custer RP, Bosma MJ. A severe combined immunodeficiency mutation in the mouse. *Nature* 1983;301:527–530.
181. Schultz HY, Landree MA, Qiu J-X, et al. Joining-deficient RAG1 mutants block V(D)J recombination in vivo and hairpin opening in vitro. *Mol Cell* 2001;7:65–75.
182. Qiu J, Kale SB, Schultz HY, et al. Separation of function mutants reveal critical roles for RAG2 in both cleavage and joining steps of V(D)J recombination. *Mol Cell* 2001;7:77–87.
183. Fisher A, Cavazzana-Calvo M, De Saint Basile G, et al. Naturally occurring primary deficiencies of

the immune system. *Annu Rev Immunol* 1997;15:93–124.

184. Schwarz K, Gauss GH, Ludwig L, et al. RAG mutations in human B cell-negative SCID. *Science* 1996;274:97–99.
185. Nicolas N, Moshous D, Papadopoulo D, et al. A human severe combined immunodeficiency (SCID) condition with increased sensitivity to ionizing radiation and impaired V(D)J rearrangements defines a new DNA recombination/repair deficiency. *J Exp Med* 1998;188:627–634.
186. Corneo B, Moshous D, Callebaut I, et al. Three dimensional clustering of human RAG2 gene mutations in severe combined immune deficiency. *J Biol Chem* 2000;275:12672–12675.
187. Villa A, Santagata S, Bozzi F, et al. Partial V(D)J recombination activity leads to Omenn syndrome. *Cell* 1998;93:885–896.
188. Mo X, Bailin T, Sadofsky MJ. RAG1 and RAG2 cooperate in specific binding to the recombination signal sequence in vitro. *J Biol Chem* 1999;274:7025–7031.
189. Ommen GS. Familial reticuloendotheliosis with eosinophilia. *N Engl J Med* 1965;273:427.
190. De Saint-Basila G, Le Deist F, De Villartay JP, et al. Restricted heterogeneity of T lymphocytes in combined immunodeficiency with hypereosinophilia (Omenn's syndrome). *J Clin Invest* 1991;87:1352–1359.
191. Schandene L, Ferster A, Mascart-Lemone F, et al. T helper 2-like cells and therapeutic effects of interferon gamma in combined immunodeficiency with hypereosinophilia (Omenn's syndrome). *Eur J Immunol* 1993;23:56–60.
192. Melamed I, Cohen A, Roifman CM. Expansion of CD3<sup>+</sup>CD4<sup>-</sup>CD8<sup>-</sup> T cell population expressing high levels of IL-5 in Omenn's syndrome. *Clin Exp Immunol* 1994;95:14–21.
193. Rieux-Laucat F, Bahadoran P, Brousse N, et al. Highly restricted human T-cell repertoire beta (TCRB) chain diversity in peripheral blood and tissue-infiltrating lymphocytes in Omenn's syndrome (severe combined immunodeficiency with hypereosinophilia). *J Clin Invest* 1998;102:312–321.
194. Wirt DP, Brooks EG, Vaidya S, et al. Novel T-lymphocyte population in combined immunodeficiency with features of graft versus host disease. *N Engl J Med* 1989;321:370–374.
195. Wada T, Takei K, Kudo M, et al. Characterization of immune function and analysis of RAG gene mutation in Omenn syndrome and related disorders. *Clin Exp Immunol* 2000;119:148–155.
196. Noordzig JG, Verkaik NS, Hartwig NG, et al. N-terminal truncated human RAG1 protein can direct T cell receptor but not immunoglobulin gene arrangements. *Blood* 2000;96:203–209.
197. Corneo B, Moshous D, Güngör T, et al. Identical mutations in RAG1 or RAG2 genes leading to defective V(D)J recombinase activity can cause either T-B-severe combined immune deficiency or Omenn syndrome. *Blood* 2001;97:2772–2776.
198. Jeggo PA, Concannon P. Immune deficiency and genomic stability: opposite goals but similar paths. *J Photochem Photobiol* 2001;65:88–96.
199. Weaver DT. V(D)J recombination and double-strand break repair. *Adv Immunol* 1995;58:29–85.
200. Jeggo PA. DNA breakage and repair. *Adv Genetics* 1998;38:185–218.
201. Blunt T, Finnie NJ, Taccioli GE, et al. Defective DNA-dependent protein kinase activity is linked to V(D)J recombination and DNA repair defects associated with murine SCID mutation. *Cell* 1995;80:813–823.
202. Nussenzweig MC, Li GC. Requirement for Ku80 in growth and immunoglobulin V(D)J recombination. *Nature* 1996;382:551–555.
203. Gennery AR, Cant AJ, Jeggo PA, et al. Immunodeficiency associated with DNA repair defects. *Clin Exp Immunol* 2000;121:1–7.

204. Gatti R, Boder E, Vinters HV, et al. Ataxia–telangiectasia: an interdisciplinary approach to pathogenesis. *Medicine* 1991;70:99–117.
205. Jeggo PA, Carr AM, Lehmann AR. Splitting the ATM: distinct repair and checkpoint defects in ataxia–telangiectasia. *Trends Genet* 1998;14:312–316.
206. Savitsky K, Bar–Shira A, Gilad S, et al. A single ataxia telangiectasia gene with a product similar to PI–3 kinase. *Science* 1995;268:1749–1753.
207. Khanna KK, Keating KE, Kozlov S, et al. ATM associates with and phosphorylates p53: mapping the region of interaction. *Nat Genet* 1998;20:398–400.
208. Matsuoka S, Huang M, Elledge SJ. Linkage at ATM to cell cycle regulation by the Chk2 protein kinase. *Science* 1998;282:1893–1897.
209. van der Burgt I, Chrzanowska KH, Smeets D, et al. Nijmegen breakage syndrome. *J Med Genet* 1996;33:153–156.
210. Yamazaki V, Wegner RD, Kirchgessner CU. Characterization of cell cycle checkpoint responses after ionizing radiation in Nijmegen breakage syndrome cells. *Cancer Res* 1998;58:2316–2322.
211. German J. Bloom syndrome: a Mendelian prototype of somatic mutational disease. *Medicine* 1993;72:393–406.
212. Tomkinson AE, Mackey ZB. Structure and function of mammalian DNA ligases. *Mutat Res* 1998;407:1–9.
213. Caspari AA, Fleisher TA, Kraemer KH. Impaired interferon production and natural killer cell activation in patients with the skin cancer prone disorder, xeroderma pigmentosum. *J Clin Invest* 1993;92:1135–1142.
214. Papavasiliou F, Jankovic M, Suh H, et al. The cytoplasmic domains of the immunoglobulin Iga and Igb can independently induce the precursor B cell transition and allelic exclusion. *J Exp Med* 1995;182:1389–1394.
215. The Y–M, Neuberger MS. The immunoglobulin Iga and Igb cytoplasmic domains are independently sufficient to signal B cell maturation and activation in transgenic mice. *J Exp Med* 1997;185:1753–1758.
216. Kurosaki T. Functional dissection of BCR signaling pathways. *Curr Opin Immunol* 2000;12:276–281.
217. Nagata K, Nakamura T, Kitamura F, et al. The Iga/Igb heterodimer on  $\mu$ -negative pro–B cells is competent for transducing signals to induce early B cell differentiation. *Immunity* 1997;7:559–570.
218. Caldwell RG, Wilson JB, Anderson SJ, et al. Epstein–Barr virus LMP2A drives B cell development and survival in the absence of normal B cell receptor signals. *Immunity* 1998;9:405–411.
219. Cheng AM, Rowley B, Pao W, et al. Syk tyrosine kinase required for mouse viability and B cell development. *Nature* 1995;378:303–306.
220. Kurosaki T. Genetic analysis of B cell receptor signaling. *Annu Rev Immunol* 1999;17:555–592.
221. Jumaa H, Wollscheid B, Mitterer M, et al. Abnormal development and function of B lymphocytes in mice deficient for the signaling adaptor protein SLP–65. *Immunity* 1999;11:547–554.
222. Pappu R, Cheng AM, Li B, et al. Requirement for B cell linker protein (BLNK) in B cell development. *Science* 1999;286:1949–1954.
223. Minegishi Y, Rohrer J, Coustan–Smith E, et al. An essential role for BLNK in human B cell development. *Science* 1999;286:1954–1957.
224. Chang H, Dmitrovsky E, Hieter PA, et al. Identification of three new Ig lambda–like genes in man. *J Exp Med* 1986;163:425–435.

225. Minegishi Y, Coustan-Smith E, Rapalus L, et al. Mutations in Iga (CD79a) result in a complete block of B-cell development. *J Clin Invest* 1999;104:1115-1121.
226. Yel L, Minegishi Y, Coustan-Smith E, et al. Mutations in the mu heavy chain in patients with agammaglobulinemia. *N Engl J Med* 1996;335:1486-1493.
227. Schiff C, Lemmers B, Deville A, et al. Autosomal primary immunodeficiencies affecting human bone marrow B-cell differentiation. *Immunol Rev* 2000;178:91-98.
228. Xu S, Tan JE, Wong EP, et al. B cell development and activation defects resulting in xid-like immunodeficiency in BLNK/SLP-65-deficient mice. *Int Immunol* 2000;12:397-404.
229. Bruton OC. Agammaglobulinemia. *Pediatrics* 1952;9:722.
230. Janeway CA, Apt L, Gitlin D. Agammaglobulinemia. *Trans Assoc Am Physicians* 1953;66:200.
231. Siegal FP, Pernis B, Kunkel HG. Lymphocytes in human immunodeficiency states: a study of membrane-associated immunoglobulins. *Eur J Immunol* 1971;1:482.
232. Parolini O, Hejtmancik JF, Allen RC, et al. Linkage analysis and physical mapping near the gene for X-linked agammaglobulinemia at Xq22. *Genomics* 1993;15:342-349.
233. Conley ME, Parolini O, Rohrer J, et al. X-linked agammaglobulinemia: new approaches to old questions based on the identification of the defective gene. *Immunol Rev* 1994;138:5-21.
234. Tsukada S, Saffran DC, Rawlings DJ, et al. Deficient expression of a B cell cytoplasmic tyrosine kinase in human X-linked agammaglobulinemia. *Cell* 1993;72:279-290.
235. Vetrie D, Verechovsky I, Sideras P, et al. The gene involved in X-linked agammaglobulinemia is a member of the src family of protein-tyrosine kinases. *Nature* 1993;361:226-233.
236. Conley ME, Mathias D, Treadaway J, et al. Mutations of Btk in patients with presumed X-linked agammaglobulinemia. *Am J Hum Genet* 1998;62:1034-1043.
237. Desiderio S. Role of Btk in B cell development and signaling. *Curr Opin Immunol* 1997;9:534-540.
238. Tsukada S, Baba Y, Watanabe D. Btk and BLNK in B cell development. *Adv Immunol* 2001;77:123-162.
239. Kurosaki T, Tsukada S, et al. BLNK: connecting Syk and Btk to calcium signals. *Immunity* 2000;12:1-5.
240. Gross BS, Wilde JI, Quek L, et al. Regulation and function of WASp in platelets by the collagen receptor, glycoprotein VI. *Blood* 1999;94:4166-4176.
241. Yao L, Kawakami Y, Kawakami T. The pleckstrin homology domain of Bruton tyrosine kinase interacts with protein kinase C. *Proc Natl Acad Sci U S A* 1994;91:9175-9179.
242. Salim K, Bottomley MJ, Querfurth E, et al. Distinct specificity of the recognition of phosphoinositides by the pleckstrin homology domains of dynamin and Bruton's tyrosine kinase. *EMBO J* 1996;15:6241-6250.
243. Jiang Y, Ma W, Wan Y, et al. The G protein Ga12 stimulates Bruton's tyrosine kinase and a rasGAP through a conserved PH/BM domain. *Nature* 1998;395:808-813.
244. Park H, Wahl MI, Afar DE, et al. Regulation of Btk function by a major autophosphorylation site within the SH<sub>3</sub> domain. *Immunity* 1996;4:515-525.
245. Kurosaki T, Kurosaki M. Transphosphorylation of Bruton's tyrosine kinase on tyrosine 551 is critical for B cell antigen receptor function. *J Biol Chem* 1997;272:15595-15598.
246. Sutterthwaite AB, Li Z, Witte ON. Btk function in B cell development and response. *Semin Immunol*



1998;10:309–316.

247. Wahl MI, Fluckiger A–C, Kato RM, et al. Phosphorylation of two regulatory tyrosine residues in the activation of Bruton's tyrosine kinase via alternative receptors. *Proc Natl Acad Sci U S A* 1997;94:11526–11533.
248. Liu W, Quinto I, Chen X, et al. Direct inhibition of Bruton's tyrosine kinase by IBtk, a Btk binding protein. *Nat Immunol* 2001;2:939–946.
249. Uckun FM. Bruton's tyrosine kinase (BTK) as a dual-function regulator of apoptosis. *Biochem Pharmacol* 1998;56:683–691.
250. Islam TC, Smith CIE. The cellular phenotype conditions Btk for cell survival or apoptosis signaling. *Immunol Rev* 2000;178:49–63.
251. Vihinen M, Brandeau O, Branden LJ, et al. BTK base, mutation database for X-linked agammaglobulinemia (XLA). *Nucleic Acids Res* 1998;26:242–247.
252. Nomura K, Kanegane H, Karasuyama, et al. Genetic defect in human X-linked agammaglobulinemia impedes a maturational evolution of pro-B cells and into a later stage of pre-B cells in the B cell differentiation pathway. *Blood* 2000;96:610–617.
253. Rawlings DJ, Witte ON. Bruton's tyrosine kinase is a key regulator of B-cell development. *Immunol Rev* 1994;138:105–119.
254. Ross CW, Stoolman LM, Schuitzer B, et al. Immunophenotypic aberrancy in adult acute lymphoblastic leukemia. *Am J Clin Pathol* 1990;94:590–599.
255. Loken MR, Shah VO, Dattilio KL, et al. Flow cytometric analysis of human bone marrow. II. Normal B lymphocyte development. *Blood* 1987;70:1316–1324.
256. Ryan D, Kossover S, Mitchell S, et al. Subpopulations of common acute lymphoblastic leukemia antigen-positive lymphoid cells in normal bone marrow identified by hematopoietic differentiation antigens. *Blood* 1986;68:417–425.
257. Uckun FM, Ledbetter JA. Immunobiologic differences between normal and leukemic human B-cell precursors. *Proc Natl Acad Sci U S A* 1988;85:8603–8607.
258. DiGiusto D, Chen S, Combs J, et al. Human fetal bone marrow early progenitors for T, B, and myeloid cells are found exclusively in the population expressing high levels of CD34. *Blood* 1994;84:421–432.
259. Pontvert-Delucq S, Breton-Gorius J, Schmitt C, et al. Characterization and functional analysis of adult human bone marrow cell subsets in relation to B-lymphoid development. *Blood* 1993;82:417–429.
260. Janossy G, Bollum FJ, Bradstock KF, et al. Terminal transferase-positive human bone marrow cells exhibit the antigenic phenotype of common acute lymphoblastic leukemia. *J Immunol* 1979;123:1525–1529.
261. Bollum FJ. Terminal deoxynucleotidyl transferase as a hematopoietic cell marker. *Blood* 1979;54:1203–1215.
262. Duperray C, Boiron JM, Boucheix C, et al. The CD24 antigen discriminates between pre-B and B cells in human bone marrow. *J Immunol* 1990;145:3678–3683.
263. Uckun FM. Regulation of human B-cell ontogeny. *Blood* 1990;76:1908–1923.
264. Uckun FM, Muraguchi A, Ledbetter JA, et al. Biphenotypic leukemic lymphocyte precursors in CD2<sup>+</sup>CD19<sup>+</sup> acute lymphoblastic leukemia and their putative normal counterparts in human fetal hematopoietic tissues. *Blood* 1989;73:1000–1015.
265. Hokland P, Rosenthal P, Griffin JD, et al. Purification and characterization of fetal hematopoietic cells that express the common acute lymphoblastic leukemia antigen (CALLA). *J Exp Med* 1983;157:114–129.

266. Gathings WE, Lawton AR, Cooper MD. Immunofluorescent studies of the development of pre-B cells, B lymphocytes and immunoglobulin isotype diversity in humans. *Eur J Immunol* 1977;7:804-810.
267. Kamps WA, Cooper MD. Microenvironmental studies of pre-B and B cell development in human and mouse fetuses. *J Immunol* 1982;129:526-531.
268. Boue DR, LeBien TW. Expression and structure of CD22 in acute leukemia. *Blood* 1988;71:1480-1486.
269. Tedder TF, Fearon DT, Bartland GL, et al. Expression of C3b receptors on human B cells and myelomonocytic cells but not natural killer cells. *J Immunol* 1983;130:1668-1673.
270. Defrance T, Aubry JP, Rousset F, et al. Human recombinant interleukin 4 induces Fc epsilon receptors (CD23) on normal human B lymphocytes. *J Exp Med* 1987;165:1459-1467.
271. Wang F, Gregory CD, Rowe M, et al. Epstein-Barr virus nuclear antigen 2 specifically induces expression of the B-cell activation antigen CD23. *Proc Natl Acad Sci U S A* 1987;84:3452-3456.
272. Lavabre-Bertrand T, Duperray C, Brunet C, et al. Quantification of CD24 and CD45 antigens in parallel allows a precise determination of B-cell maturation stages: relevance for the study of B-cell neoplasias. *Leukemia* 1994;8: 402-408.
273. Caldwell CW, Patterson WP. Relationship between CD45 antigen expression and putative stages of differentiation in B-cell malignancies. *Am J Hematol* 1991;36:111-115.
274. Harris NL, Jaffe ES, Stein H, et al. A revised European-American classification of lymphoid neoplasms: a proposal from the International Lymphoma Study Group. *Blood* 1994;84:1361-1392.
275. Jaffe ES, Harris NL, Stein H, et al., eds. WHO classification of tumors. Pathology and genetics of tumors of haematopoietic and lymphoid tissues. Lyon, France: IARC Press, 2001.
276. Scher I, Sharrow SO, Wistar R Jr, et al. B-lymphocyte heterogeneity: ontogenetic development and organ distribution of B-lymphocyte populations defined by their density of surface immunoglobulin. *J Exp Med* 1976;144:494-506.
277. de Petris S, Raff MC. Distribution of immunoglobulin on the surface of mouse lymphoid cells as determined by immunoferritin electron microscopy. Antibody-induced, temperature-dependent redistribution and its implications for membrane structure. *Eur J Immunol* 1972;2:523-535.
278. Lejonc RJ, Gourdin MF, Mannoni P, et al. The surface morphology of human B lymphocytes as revealed by immunoelectron microscopy. *J Exp Med* 1975;141:392-410.
279. Taylor RB, et al. Redistribution and pinocytosis of lymphocyte surface immunoglobulin molecules induced by anti-immunoglobulin antibody. *Nature* 1971;233:225.
280. Karnovsky MJ, Unanue ER. Cell surface changes in capping studied by correlated fluorescence and scanning electron microscopy. *Lab Invest* 1978;39:554-564.
281. Schreiner GF, Unanue ER. Membrane and cytoplasmic changes in B lymphocytes induced by ligand-surface immunoglobulin interaction. *Adv Immunol* 1976;24:37-165.
282. Unanue ER, Karnovsky MJ. Redistribution and fate of Ig complexes on the surface of B lymphocytes: functional implications and mechanisms. *Transplant Rev* 1973;14:184-210.
283. Braun J, Unanue ER. B lymphocyte biology studied with anti-Ig antibodies. *Immunol Rev* 1980;52:3-28.
284. Nelson GA, Andrews ML, Karnovsky MJ. Participation of calmodulin in immunoglobulin capping. *J Cell Biol* 1982;95:771-780.
285. Reth M. Antigen receptors on B lymphocytes. *Annu Rev Immunol* 1992;10:97-121.

286. Cambier JC, Bedzyk W, Campbell K, et al. The B-cell antigen receptor: structure and function of primary, secondary, tertiary and quaternary components. *Immunol Rev* 1993;132:85-106.
287. van Noesel CJ, van Lier RA. Architecture of the human B-cell antigen receptors. *Blood* 1993;82:363-373.
288. Pleiman CM, D'ambrosio D, Cambier JC. The B-cell antigen receptor complex: structure and signal transduction. *Immunol Today* 1994;15:393-399.
289. Cambier JC. Antigen and Fc receptor signaling. The awesome power of the immunoreceptor tyrosine-based activation motif (ITAM). *J Immunol* 1995;155:3281-3285.
290. Paraskevas F, Lee S-T, Israels LG. Absence of  $\gamma$ -globulin receptors on mouse plasmacytoma cells. *Nature* 1970;227:395-396.
291. Hombach J, Tsubata T, Leclercq L, et al. Molecular components of the B cell antigen receptor complex of class IgD differ partly from those of IgM. *Nature* 1990;343:760-762.
292. Hombach J, Lottspeich F, Reth M. Identification of the genes encoding the IgM- $\alpha$  and Ig- $\beta$  components of the IgM antigen receptor complex by amino-terminal sequencing. *Eur J Immunol* 1990;20:2796-2799.
293. Schamel WWA, Reth A. Monomeric and oligomeric complexes of the B cell antigen receptor. *Immunity* 2000;13:5-14.
294. Matsuuchi L, Gold MR. New views of BCR structure and organization. *Curr Opin Immunol* 2001;13:270-277.
295. Simons K, Toomre D. Lipid rafts and signal transduction. *Nat Rev Mol Cell Biol* 2000;1:31-39.
296. Aman MJ, Ravichandran KS. A requirement for lipid rafts in B cell receptor induced Ca<sup>2+</sup> flux. *Curr Biol* 2000;10:293-396.
297. Cheng PC, Dykstra ML, Mitchell RN, et al. A role for lipid rafts in B cell antigen receptor signaling and antigen targeting. *J Exp Med* 1999;190:1549-1560.
298. Aman MJ, Ravichandran KS. A requirement for lipid rafts in B cell receptor induced Ca<sup>2+</sup> flux. *Curr Biol* 2000;10:393-396.
299. Guo B, Kato RM, Garcia-Lioret M, et al. Engagement of the human pre-B cell receptor generates a lipid raft-dependent calcium-signaling complex. *Immunity* 2000;13:243-253.
300. Weintraub BC, Jun JE, Bishop AC, et al. Entry of B cell receptor into signaling domains is exhibited in tolerant B cells. *J Exp Med* 2000;191:1443-1448.
301. Chung JB, Boumeister MA, Monroe JG. Cutting edge: differential sequestration of plasma membrane-associated B cell antigen receptor in mature and immature B cells into glycosphingolipid-enriched domains. *J Immunol* 2001; 166:736-740.
302. Cheng PC, Brown BK, Song W, et al. Translocation of the B cell antigen receptor into lipid rafts reveals a novel step in signaling. *J Immunol* 2001;166:3693-3701.
303. Suzuki T, Kiyokawa K, Taguchi T, et al. CD24 induces apoptosis in human B cells via the glycolipid-enriched membrane domains/rafts-mediated signaling system. *J Immunol* 2001;166:5567-5577.
304. Germain RN. MHC-dependent antigen processing and peptide presentation: providing ligands for T lymphocyte activation. *Cell* 1994;76:287-299.
305. Cheng PC, Dykstra ML, Mitchell RN, et al. A role for lipid rafts in B cell antigen receptor signaling and antigen targeting. *J Exp Med* 1999;190:1549-1560.
306. Cherukuri A, Cheng PC, Sohn HW, et al. The CD19/CD21 complex functions to prolong B cell antigen

receptor signaling from lipid rafts. *Immunity* 2001;14:169–179.

307. Dykstra M, Cherukuri A, Pierce SK. Rafts and synapses in the spatial organization of immune cell signaling cascades. *J Leuk Biol* 2001;70:699–707.

308. Bromley SK, Burack WR, Johnson KG, et al. The immunological synapse. *Annu Rev Immunol* 2001;19:375–396.

309. Batista FD, Iber D, Neuberger MS. B cells acquire antigen from target cells after synapse formation. *Nature* 2001;411:489–494.

310. Di Fiore PP, De Camilli P. Endocytosis and signaling: an inseparable partnership. *Cell* 2001;106:1–4.

311. Pierce SK. Lipid rafts and B-cell activation. *Nat Rev Immunol* 2002;2:96–105.

312. Dykstra ML, Longnecker R, Pierce SK. Epstein–Barr virus coopts lipid rafts to block signaling and antigen transport functions of BCR. *Immunity* 2001;14:57–67.

313. Wagle NM, Cheng P, Kim J, et al. B-lymphocyte signaling receptors and the control of class II antigen processing. *Curr Top Microbiol Immunol* 2000;245:101–126.

314. Stoddart A, Dykstra ML, Brown BK, et al. Lipid rafts unite signaling cascades with clathrin to regulate BCR internalization. *Immunity* 2002;17:451–462.

315. De Franco AL. The complexity of signaling pathways activated by the BCR. *Curr Opin Immunol* 1997;9:296–308.

316. Reth M, Wienands J. Initiation and processing of signals from the B cell antigen receptor. *Annu Rev Immunol* 1997;15:453–479.

317. Kurosaki T. Genetic analysis of B cell antigen receptor signaling. *Annu Rev Immunol* 1999;17:555–592.

318. Hata AH, Sabe H, Kurosaki T, et al. Functional analysis of Csk in signal transduction through the B-cell antigen receptor. *Mol Cell Biol* 1994;14:7306–7313.

319. Yanagi S, Sugawara H, Kurosaki M, et al. CD45 modulates phosphorylation of both autophosphorylation and negative regulatory tyrosines of Lyn in B cells. *J Biol Chem* 1996;271:30487–30492.

320. Kurosaki T, Takata M, Yamanashi Y, et al. Syk activation by the Src family tyrosine kinase in B cell receptor signaling. *J Exp Med* 1994;179:1725.

321. Chiu CW, Dalton M, Ishiai M, et al. BLNK: molecular scaffolding through cis-mediated organization of signaling proteins. *EMBO J* 2002;21:6472–6521.

322. Fu C, Turck C, Kurosaki T, et al. BLNK: a central linker protein in B cell activation. *Immunity* 1998;9:93–103.

323. Yablonski D, Weiss A. Mechanisms of signaling by the hematopoietic-specific adaptor proteins, SLP-76 and LAT and their B cell counterpart BLNK/SLP65. *Adv Immunol* 2001;79:93–128.

324. Kurosaki T, Kurosaki M. Transphosphorylation of Btk on tyrosine 551 is critical for B cell antigen receptor function. *J Biol Chem* 1997;272:15595–15598.

325. Li Z, Wahl MI, Equinea A, et al. Phosphatidylinositol 3-kinase activates Bruton's tyrosine kinase in concert with Src family of kinases. *Proc Natl Acad Sci U S A* 1997;94:13820–13825.

326. Falasca M, Logan SK, Lehto VP, et al. Activation of phospholipase C? by PI-3 kinase-induced PH domain-mediated membrane targeting. *EMBO J* 1998;17:414–422.

327. Fluckiger A-C, Li Z, Kato RM, et al. Btk/Tec kinases regulate sustained increases in intracellular Ca

- <sup>2+</sup> following B-cell receptor activation. *EMBO J* 1998;17:1973–1985.
328. Kim TJ, Kim Y-T, Pillai S. Association of activation phosphatidylinositol 3-kinase with p129<sup>cbl</sup> in antigen receptor-ligated B cells. *J Immunol* 1995;270:27504–27509.
329. Tuveson DA, Carter RH, Soltoff SP, et al. CD19 of B cells as a surrogate kinase insert region to bind phosphatidylinositol 3-kinase. *Science* 1993;260:986–989.
330. Marshall AJ, Niro H, Yun TJ, et al. Regulation of B-cell activation and differentiation by the phosphatidylinositol 3-kinase and phospholipase C? pathways. *Immunol Rev* 2000;176:30–46.
331. Rao A, Luo C, Hogan PG. Transcription factors of the NFAT family: regulation and function. *Annu Rev Immunol* 1997;15:707–747.
332. Dolmetsch RE, Lewis RS, Goodnow CC, et al. Differential activation of transcription factors induced by Ca<sup>2+</sup> response amplitude and duration. *Nature* 1997;386:855–858.
333. Chan TO, Rittenhouse SE, Tsichlis PN. ATK/PKB and other D3 phospho-inositide-regulated kinases: kinase activation by phosphoinositide-dependent phosphorylation. *Annu Rev Biochem* 1999;68:965–1044.
334. Genot E, Cantrell DA. Ras regulation and function in lymphocytes. *Curr Opin Immunol* 2000;12:289–294.
335. Harmer SL, de Franco AL. Shc contains two Grb<sup>2</sup> binding sites needed for efficient formation of complexes with SOS in B lymphocytes. *Mol Cell Biol* 1997;17:4087–4095.
336. Lankester AC, van Schijndel GM, Rood PM, et al. B cell antigen receptor cross-linking induces tyrosine phosphorylation and membrane translocation of a multimeric Shc complex that is augmented by CD19 co-ligation. *Eur J Immunol* 1994;24:2818–2825.
337. Deckert M, Tartare-Deckert S, Couture C, et al. Functional and physical interactions of Syk family kinases with the Vav protooncogene product. *Immunity* 1996;5:591–604.
338. Deckert M, Elly C, Altman A, et al. Coordinated regulation of the tyrosine phosphorylation of Cbl by Fyn and Syk tyrosine kinases. *J Biol Chem* 1998;273:8867–8874.
339. Yasuda T, Maeda A, Kurosaki M, et al. Cbl suppresses B cell receptor-mediated phospholipase C (PLC)- $\gamma_2$  binding. *J Exp Med* 2000;191:641–650.
340. Leo A, Schraven B. Adapters in lymphocyte signaling. *Curr Opin Immunol* 2001;13:307–316.
341. Campbell KS. Signal transduction from the B-cell antigen-receptor. *Curr Opin Immunol* 1999;11:256–264.
342. Kelle ME, Chan AC. Regulation of B-cell function by linker proteins. *Curr Opin Immunol* 2000;12:267–275.
343. Kurosaki T. Regulation of B-cell signal transduction by adapter proteins. *Nat Rev Immunol* 2002;2:354–363.
344. Leo A, Wienands J, Baier G, et al. Adapters in lymphocyte signaling. *J Clin Invest* 2002;109:301–309.
345. Tedder TF, Zhou L-J, Engel P. The CD19/CD21 signal transduction complex of B lymphocytes. *Immunol Today* 1994;15:437–442.
346. Buhl AM, Cambier JC. Phosphorylation of CD19 Y484 and Y515 and linked activation of phosphatidylinositol 3-kinase are required for B cell antigen receptor-mediated activation of Bruton's tyrosine kinase. *J Immunol* 1999;162:4438–4446.
347. Tedder TF, Tuscano J, Sato S, et al. CD22, a B lymphocyte-specific adhesion molecule that regulates antigen receptor signaling. *Annu Rev Immunol* 1997;15:481–504.

348. Nelms K, Keegan AD, Zamorano J, et al. The IL-4 receptor: signaling mechanisms and biological functions. *Annu Rev Immunol* 1999;17:701-738.
349. Keegan AD, Nelms K, Wang LM, et al. Interleukin 4 receptor: signaling mechanisms. *Immunol Today* 1994;15:423-432.
350. Russell SM, Keegan AD, Harada N, et al. Interleukin-2 receptor gamma chain: a functional component of the interleukin-4 receptor. *Science* 1993;262:1880-1883.
351. Leonard WJ, Shores EW, Love PE. Role of the common cytokine receptor-? chain in cytokine signaling and lymphoid development. *Immunol Rev* 1994;137:97-114.
352. Voss SD, Hong R, Sondel PM. Severe combined immunodeficiency, interleukin-2 (IL-2), and the IL-2 receptor: experiments of nature continue to point the way. *Blood* 1994;83:626-635.
353. Keegan AD, Nelms K, White M, et al. An IL-4 receptor region containing an insulin receptor motif is important for IL-4-mediated IRS-1 phosphorylation and cell growth. *Cell* 1994;76:811-820.
354. Ihle JN, Witthuhn BA, Quelle FW, et al. Signaling through the hematopoietic cytokine receptors. *Annu Rev Immunol* 1995;13:369-398.
355. Schindler C, Darnell JE Jr. Transcriptional responses to polypeptide ligands: the JAK-STAT pathway. *Annu Rev Biochem* 1995;64:621-651.
356. Shuai K, Stark GR, Kerr IM, et al. A single phosphotyrosine residue of Stat91 required for gene activation by interferon. *Science* 1993;261:1744-1746.
357. Shinioda K, van Deursen J, Sangster MY, et al. Lack of IL-4 induced Th2 response and IgE class switching in mice with disrupted Stat-6 gene. *Nature* 1996;380:630-633.
358. Nakanishi K, Yoshida N, Kishimoto T, et al. Essential role of Stat-6 in IL-4 signaling. *Nature* 1996;380:627-630.
359. Takatsu K, Takaki S, Hitoshi Y. Interleukin-5 and its receptor system: implications in the immune system and inflammation. *Adv Immunol* 1994;57:145-190.
360. Akira S, Taga T, Kishimoto T. Interleukin-6 in biology and medicine. *Adv Immunol* 1993;54:1-78.
361. Kishimoto T, Akira S, Narazaki M, et al. Interleukin-6 family of cytokines and gp130. *Blood* 1995;86:1243-1254.
362. Akira S, Yoshida K, Tanaka T, et al. Targeted disruption of the IL-6 related genes: gp130 and NF-IL-6. *Immunol Rev* 1995;148:221-253.
363. Grammer AC, Lipsky PE. CD40-mediated regulation of immune responses by TRAF-dependent and TRAF-independent signaling mechanisms. *Adv Immunol* 2001;76:61-178.
364. Waldmann TA, Broder S. Polyclonal B-cell activators in the study of the regulation of immunoglobulin synthesis in the human system. *Adv Immunol* 1982;32:1-63.
365. Wright SD, Ramos RA, Tobias PS, et al. CD14, a receptor for complexes of lipopolysaccharide (LPS) and LPS binding protein. *Science* 1990;249:1431-1433.
366. Schumann RR, Leong SR, Flaggs GW, et al. Structure and function of lipopolysaccharide binding protein. *Science* 1990;249:1429-1431.
367. Ulevitch RJ. Recognition of bacterial endotoxins by receptor-dependent mechanisms. *Adv Immunol* 1993;53:267-289.
368. Gudat FG, Harris TN, Harris S, et al. Studies on antibody-producing cells. III. Identification of young

- plaque-forming cells by thymidine-<sup>3</sup>H labeling. *J Exp Med* 1971;134:1155-1169.
369. Gudat FG, Harris TN, Harris S, et al. Studies on antibody-producing cells. II. Appearance of <sup>3</sup>H-thymidine-labeled rosette-forming cells. *J Exp Med* 1971;133:305-320.
370. Gudat FG, Harris TN, Harris S, et al. Studies on antibody-producing cells. I. Ultrastructure of 19S and 7S antibody-producing cells. *J Exp Med* 1970;132:448-474.
371. Harris TN, Hummeler K, Harris S. Electron microscopic observations on antibody-producing lymph node cells. *J Exp Med* 1966;123:161-172.
372. Hummeler K, Harris TN, Tomassini N, et al. Electron microscopic observations on antibody-producing cells in lymph and blood. *J Exp Med* 1966;124:255-262.
373. Bosman C, Feldman JD, Pick E. Heterogeneity of antibody-forming cells. An electron microscopic analysis. *J Exp Med* 1969;129:1029-1044.
374. Bosman C, Feldman JD. The proportion and structure of cells forming antibody, ?G and ?M immunoglobulins, and ?G and ?M antibodies. *Cell Immunol* 1970;1:31-50.
375. Waldeyer W. Ueber bindegewebezellen. *Arch Mikroskop Anat* 1875;11:176.
376. Unna PG. Ueber plasmazellen insbesondere bei lupus. *Monatsschr Prakt Dermatol* 1881;12:296.
377. Unna PG. Die herkunft der plasmazellen. *Virchows Arch Pathol Anat Physiol Klin Med* 1913;214:320.
378. v. Marschalko T. ber die sogenannten plasmazellen, ein beitrage zur kenntniss der herkunft der entzündlichen infiltrationszellen. *Arch Derma Syph* 1895;30:241.
379. Downey H. The origin and structure of the plasma cells of normal vertebrates, especially of the cold blooded vertebrates, and the eosinophils of the lung of *Amblystoma*. *Folia Haematol (Frankf)* 1911;11:275.
380. Michels N. The plasma cell. *Arch Pathol* 1931;11:775.
381. Bing J, Plum P. Serum proteins in leucopenia. *Acta Med Scand* 1937;92:415.
382. Bjorneboe M, Gormsen H. Experimental studies on the role of plasma cells as antibody producers. *Acta Pathol Microbiol Scand* 1943;20:649.
383. Fagraeus A. Antibody production in relation to the development of plasma cells. In vivo and in vitro experiments. *Acta Med Scand (Suppl)* 1948;204:1.
384. Coons AH, et al. Studies on antibody production. I. A method for the histochemical demonstration of specific antibody and its application to a study of the hyperimmune rabbit. *J Exp Med* 1955;102:49.
385. Leduc EH, et al. Studies on antibody production. II. The primary and secondary responses in the popliteal lymph node of the rabbit. *J Exp Med* 1955;102:61.
386. Bessis M. *Living blood cells and their ultrastructure*. New York: Springer, 1973.
387. Movat HZ, Fernando NVP. The fine structure of connective tissue. II. The plasma cell. *Exp Mol Pathol* 1962;1:535.
388. Murphy MJ, Hay JB, Morris B, et al. Ultrastructural analysis of antibody synthesis in cells from lymph and lymph nodes. *Am J Pathol* 1972;66:25-42.
389. Olah I, Rohlich P, Toro I. *Ultrastructure of lymphoid organs. An electron microscopic atlas*. Philadelphia: JB Lippincott, 1975.
390. Blom J, Mansa B, Wilk A. A study of Russell bodies in human monoclonal plasma cells by means of immunofluorescence and electron microscopy. *Acta Pathol Microbiol Scand [A]* 1976;84:335-349.



391. Matthews JB. The immunoglobulin nature of Russell bodies. *Br J Exp Pathol* 1983;64:331–335.
392. Hsu SM, Hsu PL, McMillan PN, et al. Russell bodies: a light and electron microscopic immunoperoxidase study. *Am J Clin Pathol* 1982;77:26–31.
393. Paraskevas F, Heremans J, Waldenström J. Cytology and electrophoretic pattern in  $\gamma_1A(\beta_2A)$  myeloma. *Acta Med Scand* 1961;170:575–589.
394. Bessis M, et al. Etude comparee du plasmocytome et du syndrome de Waldenstrom. *Nouv Rev Fr Hematol* 1963;3:159.
395. Maldonado JE, Brown AL Jr, Bayrd ED, et al. Ultrastructure of the myeloma cell. *Cancer* 1966;19:1613–1627.
396. Maldonado JE, Bayrd ED, Brown AL Jr. The flaming cell in multiple myeloma. A light and electron microscopy study. *Am J Clin Pathol* 1965;44:605–612.
397. Azar HA, Zaino EC, Pham TD, et al. “Nonsecretory” plasma cell myeloma: observations on seven cases with electron microscopic studies. *Am J Clin Pathol* 1972;58:618–629.
398. Mabry RJ, Shelburne J, Cohen HJ. In vitro kinetics of immunoglobulin synthesis and secretion by nonsecretory human myeloma cells. *Blood* 1977;50:1031–1038.
399. Nilsson K, Killander D, Killander J, et al. Short-term tissue culture of two nonsecretory human myelomas. A morphological and functional study. *Scand J Immunol* 1976;5:819–828.
400. Forssman O, Nilsson G. A case of myeloma with flaming plasma cells but no significant M-compound in serum or urine. *Acta Med Scand* 1967;181:33–36.
401. Alanen A, Pira U, Lassila O, et al. Mott cells are plasma cells defective in immunoglobulin secretion. *Eur J Immunol* 1985;15:235–242.
402. Shaffer AL, Lin K-I, Kuo TC, et al. Blimp-1 orchestrates plasma cell differentiation by extinguishing the mature B cell gene expression program. *Immunity* 2002;17:51–62.
403. Lin KI, Angelin-Duclos C, Kuo TC, et al. Blimp-1-dependent repression of Pax5 is required for differentiation of B cells to IgM secreting plasma cells. *Mol Cell Biol* 2002;22:4771–4780.
404. Reinold AM, Iwakoshi NN, Manis J, et al. Plasma cell differentiation requires the transcription factor XBP-1. *Nature* 2001;412:300–307.
405. Wan XY, et al. Identification of c-myc promoter-binding protein and X-box binding protein 1 as interleukin-6 target genes in human multiple myeloma cells. *Int J Oncol* 1999;15:173–178.
406. Angelin-Duclos C, Cattoretti G, Lin K-I, et al. Commitment of B lymphocytes to a plasma cell fate is associated with Blimp-1 expression in vivo. *J Immunol* 2000;165:5462–5471.
407. Baumal R, Scharff MD. Synthesis, assembly and secretion of mouse immunoglobulin. *Transplant Rev* 1973;14:163–183.
408. Buxbaum JN. The biosynthesis, assembly, and secretion of immunoglobulins. *Semin Hematol* 1973;10:33–52.
409. Parkhouse RM. Assembly and secretion of immunoglobulin M (IgM) by plasma cells and lymphocytes. *Transplant Rev* 1973;14:131–144.
410. Schenkein I, Uhr JW. Immunoglobulin synthesis and secretion. I. Biosynthetic studies of the addition of the carbohydrate moieties. *J Cell Biol* 1970;46:42–51.
411. Vitetta ES, Uhr JW. Synthesis, transport, dynamics and fate of cell surface Ig and alloantigens in

murine lymphocytes. *Transplant Rev* 1973;14:50–75.

412. Bole DG, Hendershot LM, Kearney JF. Posttranslational association of immunoglobulin heavy chain binding protein with nascent heavy chains in nonsecreting and secreting hybridomas. *J Cell Biol* 1986;102:1558–1566.

413. Haas IG, Wabl M. Immunoglobulin heavy chain binding protein. *Nature* 1983;306:387–389.

414. Franklin EC, et al. Heavy chain disease. A new disorder of serum  $\gamma$ -globulins. Report of the first case. *Am J Med* 1964;37:332.

415. Seligmann M, Mihaesco E, Preud'homme JL, et al. Heavy chain diseases: current findings and concepts. *Immunol Rev* 1979;48:145–167.

416. Franklin EC, Frangione B. The molecular defect in a protein (CRA) found in gamma-1 heavy chain disease, and its genetic implications. *Proc Natl Acad Sci U S A* 1971;68:187–191.

417. Hendershot L, Bole D, Kohler G, et al. Assembly and secretion of heavy chains that do not associate posttranslationally with immunoglobulin heavy chain-binding protein. *J Cell Biol* 1987;104:761–767.

418. Hendershot L, Bole D, Kearney JF. The role of immunoglobulin heavy chain binding protein in immunoglobulin transport. *Immunol Today* 1987;8:11.

419. Solomon A, et al. Metabolism of normal 6.6S  $\gamma$ -globulin in normal subjects and in patients with macroglobulinemia and multiple myeloma. *J Lab Clin Med* 1963;62:1.

420. Waldmann TA, Strober W. Metabolism of immunoglobulins. *Prog Allergy* 1969;13:1–110.

421. Bernier GM, Cebra JJ. Frequency distribution of  $\alpha$ ,  $\beta$ ,  $\gamma$  and  $\delta$  polypeptide chains in human lymphoid tissues. *J Immunol* 1965;95:246–253.

422. Chiappino G, Pernis B. Demonstration with immunofluorescence of 19S macroglobulins and 7S gamma globulins in different cells of the human spleen. *Pathol Microbiol* 1964;27:8.

423. Avrameas S, Bouteille M. Ultrastructural localization of antibody by antigen label with peroxidase. *Exp Cell Res* 1968;53:166–176.

424. Avrameas S, Leduc EH. Detection of simultaneous antibody synthesis in plasma cells and specialized lymphocytes in rabbit lymph nodes. *J Exp Med* 1970;131:1137–1168.

425. Leduc EH, Scott GB, Avrameas S. Ultrastructural localization of intracellular immune globulins in plasma cells and lymphoblasts by enzyme-labeled antibodies. *J Histochem Cytochem* 1969;17:211–224.

426. Leduc EH, Avrameas A, Bouteille M. Ultrastructural localization of antibody in differentiating plasma cells. *J Exp Med* 1968;127:109–118.

427. Miller HR, Avrameas S, Ternynck T. Intracellular distribution of antibody in immunocytes responding to primary challenge with horseradish peroxidase. *Am J Pathol* 1973;71:239–260.

428. Miller HR, Avrameas S, Ternynck T. Intracellular distribution of antibody in immunocytes responding to secondary challenge with horseradish peroxidase. *Am J Pathol* 1973;71:261–278.

429. De Petris S, et al. Localization of antibodies in plasma cells by electron microscopy. *J Exp Med* 1963;117:849.

430. Antoine JC, Avrameas S. Correlations between immunoglobulin- and antibody-synthesizing cells during primary and secondary immune responses of rats immunized with peroxidase. *Immunology* 1976;30:537–547.

431. Bernard J, Jeannesson P, Thiernesse N, et al. Subpopulations of Ig-secreting cells induced by peroxidase immunization: discrimination according to antibody storage and secretion. *Immunology* 1979;36:719–727.

432. Rifkind R, et al. The intracellular distribution of gamma globulin in a mouse plasma cell tumor (x5563) as revealed by fluorescence and electron microscopy. *J Exp Med* 1962;116:423.
433. Köhler G, Milstein C. Continuous cultures of fused cells secreting antibody of predefined specificity. *Nature* 1975;256:495-497.
434. Staudt LM, Brown PO. Genomic views of the immune system. *Annu Rev Immunol* 2000;18:829-859.
435. Velculescu VE, Zhang L, Vogelstein B, et al. Serial analysis of gene expression. *Science* 1995;270:484-487.
436. Pease AC, Solas D, Sullivan EJ, et al. Light-generated oligonucleotide arrays for rapid DNA sequence analysis. *Proc Natl Acad Sci U S A* 1994;91:5022-5026.
437. Lockhart DJ, Dong H, Byrne MC, et al. Expression monitoring by hybridization to high-density oligonucleotide arrays. *Nat Biotechnol* 1996;14:1675-1680.
438. Cheung VG, Morley M, Aguilar F, et al. Making and reading microarrays. *Nat Genet* 1999;21(Suppl 1):15-19.
439. Hedge P, Qi R, Abernathy K, et al. A concise guide to cDNA microarray analysis. *Biotechniques* 2000;29:548-562.
440. Ermolaeva O, Rastogi M, Pruitt KD, et al. Data management and analysis for gene expression arrays. *Nat Genet* 1998;20:19-23.
441. Sherlock G. Analysis of large-scale gene expression data. *Curr Opin Immunol* 2000;12:201-205.
442. Eisen MB, Spellman PT, Brown PO, et al. Cluster analysis and display of genome-wide expression patterns. *Proc Natl Acad Sci U S A* 1998;95:14863-14868.
443. Glynne R, Ghandour G, Rayner J, et al. B-lymphocytes quiescence tolerance and activation as viewed by global gene expression profiling on microarrays. *Immunol Rev* 2000;176:216-246.
444. Glynne RJ, Watson SR. The immune system and gene expression microarrays: new answers to old questions. *J Pathol* 2001;195:20-30.
445. Ma C, Staudt LM. Molecular definition of the germinal center stage of B-cell differentiation. *Philos Trans R Soc Lond B Biol Sci* 2001;356:83-89.
446. Fruman DA, Ferl GZ, An SS, et al. Phosphoinositide 3-kinase and Bruton's tyrosine kinase regulate overlapping sets of genes in B lymphocytes. *Proc Natl Acad Sci U S A* 2002;99:359-364.
447. Underhill GH, George D, Bremer EG, et al. Gene expression profiling reveals a highly specialized genetic program of plasma cells. *Blood* 2003 (*in press*).
448. Staudt LM. Gene expression profiling of lymphoid malignancies. *Annu Rev Med* 2002;53:303-318.
449. Lossos IS, Alizadeh AA, Eisen MB, et al. Ongoing immunoglobulin somatic mutation in germinal center B cell-like but not in activated B cell-like diffuse large cell lymphomas. *Proc Natl Acad Sci U S A* 2000;97:10209-10213.
450. Alizadeh AA, Eisen MB, Davis RE, et al. Distinct types of diffuse large B-cell lymphoma identified by gene expression profiling. *Nature* 2000;403:503-511.
451. Rosenwald A, Alizadeh AA, Widhopf GF, et al. Relation of gene expression phenotype in B-cell chronic lymphocytic leukemia. *J Exp Med* (*in press*).
452. Klein U, Tu Y, Stolovitzky GA, et al. Gene expression profiling of B cell chronic lymphocytic leukemia reveals a homogeneous phenotype related to memory B cells. *J Exp Med* 2001;194:1625-1638.
453. Gurrieri C, McGuire P, Zan H, et al. Chronic lymphocytic leukemia B cells can undergo somatic

hypermutation and intracлонаl immunoglobulin V<sub>H</sub>DJ<sub>H</sub> gene diversification. *J Exp Med* 2002;196:629–639.

454. Vallat L, Magdelenat H, Merle-Beral H, et al. The resistance of B-CLL cells to DNA damage-induced apoptosis defined by DNA microarrays. *Blood* 2003 (*in press*).

455. Hofmann W-K, de Vos S, Tsukasaki K, et al. Altered apoptosis pathways in mantle cell lymphoma detected by oligonucleotide microarray. *Blood* 2001;98:787–794.

456. Zhan F, Hardin J, Kordsmeier B, et al. Global gene expression profiling of multiple myeloma, monoclonal gammopathy of undetermined significance, and normal bone marrow plasma cells. *Blood* 2002;99:1745–1757.

457. Zhan F, Tian E, Bremm K, et al. Gene expression profiling of human plasma cell differentiation and classification of late-stage B-cell development. *Blood* 2003;101:1128–1140.

458. Claudio JO, Masih-Khan E, Tang E, et al. A molecular compendium of genes expressed in multiple myeloma. *Blood* 2002;100:2175–2186.

459. Küppers R, Rajewsky K. The origin of Hodgkin and Reed/Sternberg cells in Hodgkin's disease. *Annu Rev Immunol* 1998;16:471–493.

460. Küppers R, Klein U, Schwering I, et al. Identification of Hodgkin and Reed-Sternberg cell-specific genes by gene expression profiling. *J Clin Invest* 2003;111:529–537.

461. Schwering I, Bräuninger A, Klein U, et al. Loss of the B-lineage-specific gene expression program in Hodgkin and Reed-Sternberg cells of Hodgkin lymphoma. *Blood* 2003;101 (*in press*).

462. Islam TC, Lindvall J, Wennborg A, et al. Expression profiling in transformed human B cells: influence of Btk mutations and comparison to B cell lymphomas using filter and oligonucleotides. *Eur J Immunol* 2002;32:982–993.

463. Rosenwald A, Wright G, Chan WC, et al. The use of molecular profiling to predict survival after chemotherapy for diffuse large-B-cell lymphoma. *N Engl J Med* 2002;346:1937–1947.

464. Ledbetter JA, Evans RL, Lipinski M, et al. Evolutionary conservation of surface molecules that distinguish T lymphocyte helper/inducer and cytotoxic/suppressor subpopulations in mouse and man. *J Exp Med* 1981;153:310–323.

465. Ledbetter JA, Rouse RV, Micklem HS, et al. T cell subsets defined by expression of Lyt-1,2,3 and Thy-1 antigens. Two-parameter immunofluorescence and cytotoxicity analysis with monoclonal antibodies modifies current views. *J Exp Med* 1980;152:280–295.

466. Caligaris-Caplo F, Gobbi M, Bofill M, et al. Infrequent normal B lymphocytes express features of B-chronic lymphocytic leukemia. *J Exp Med* 1982;155:623–628.

467. Boumsell L, Coppin H, Pham D, et al. An antigen shared by a human T cell subset and B cell chronic lymphocytic leukemic cells. Distribution on normal and malignant lymphoid cells. *J Exp Med* 1980;152:229–234.

468. Martin PJ, Hansen JA, Siadak AW, et al. Monoclonal antibodies recognizing normal human T lymphocytes and malignant human B lymphocytes: a comparative study. *J Immunol* 1981;127:1920–1923.

469. Royston I, Majda JA, Baird SM, et al. Human T cell antigens defined by monoclonal antibodies: the 65,000-dalton antigen of T cells (T65) is also found on chronic lymphocytic leukemia cells bearing surface immunoglobulin. *J Immunol* 1980;125:725–731.

470. Gadol N, Ault KA. Phenotypic and functional characterization of human Leu1 (CD5) B cells. *Immunol Rev* 1986;93:23–34.

471. Antin JH, Emerson SG, Martin P, et al. Leu-1+ (CD5+) B cells. A major lymphoid subpopulation in human fetal spleen: phenotypic and functional studies. *J Immunol* 1986;136:505–510.

472. Hardy RR, Hayakawa K. Development and physiology of Ly-1B and its human homolog, Leu-1 B.

Immunol Rev 1986;93:53–79.

473. Hayakawa K, Hardy RR. Development and function of B-1 cells. *Curr Opin Immunol* 2000;12:346–353.
474. Herzenberg LA, Stall AM, Lalor PA, et al. The Ly-1 B cell lineage. *Immunol Rev* 1986;93:81–102.
475. Braun J, Citri Y, Baltimore D, et al. B-Ly1 cells: immortal Ly-1<sup>+</sup> B lymphocyte cell lines spontaneously arising in murine splenic cultures. *Immunol Rev* 1986;93:5–21.
476. Herzenberg LA, Kantor AB. B-cell lineages exist in the mouse. *Immunol Today* 1993;14:79–83.
477. Kantor AB, Herzenberg LA. Origin of murine B cell lineages. *Annu Rev Immunol* 1993;11:501–538.
478. Hardy RR, Hayakawa K. CD5 B cells, a fetal B cell lineage. *Adv Immunol* 1994;55:297–339.
479. Haughton G, Arnold LW, Whitmore AC, et al. B-1 cells are made, not born. *Immunol Today* 1993;14:84–87.
480. Wortis HH. Surface markers, heavy chain sequences and B cell lineages. *Int Rev Immunol* 1992;8:235–246.
481. Rabin E, Cong YZ, Wortis HH. Loss of CD23 is a consequence of B-cell activation. Implications for the analysis of B-cell lineages. *Ann N Y Acad Sci* 1992;651:130–142.
482. Hayakawa K, Hardy RR, Honda M, et al. Ly-1 B cells: functionally distinct lymphocytes that secrete IgM autoantibodies. *Proc Natl Acad Sci U S A* 1984;81:2494–2498.
483. Plater-Zyberk C, Maini RN, Lam K, et al. A rheumatoid arthritis B cell subset expresses a phenotype similar to that in chronic lymphocytic leukemia. *Arthritis Rheum* 1985;28:971–976.
484. Dauphinee M, Tovar Z, Talal N. B cells expressing CD5 are increased in Sjögren's syndrome. *Arthritis Rheum* 1988;31:642–647.
485. Hardy RR, Hayakawa K, Shimizu M, et al. Rheumatoid factor secretion from human Leu-1<sup>+</sup> B cells. *Science* 1987;236:81–83.
486. Kipps TJ. The CD5 B cell. *Adv Immunol* 1989;47:117–185.
487. Ault KA, Antin JH, Ginsburg D, et al. Phenotype of recovering lymphoid cell populations after marrow transplantation. *J Exp Med* 1985;161:1483–1502.
488. Caligaris-Cappio F, Janossy G. Surface markers in chronic lymphoid leukemias of B cell type. *Semin Hematol* 1985;22:1–12.
489. Casali P, Notkins AL. Probing the human B-cell repertoire with EBV: polyreactive antibodies and CD5<sup>+</sup> B lymphocytes. *Annu Rev Immunol* 1989;7:513–535.
490. Sthoeger ZM, Wakai M, Tse DB, et al. Production of autoantibodies by CD5-expressing B lymphocytes from patients with chronic lymphocytic leukemia. *J Exp Med* 1989;169:255–268.
491. Berland R, Wortis HH. Origins and functions of B-1 cells with notes on the role of CD5. *Annu Rev Immunol* 2002;20:253–300.

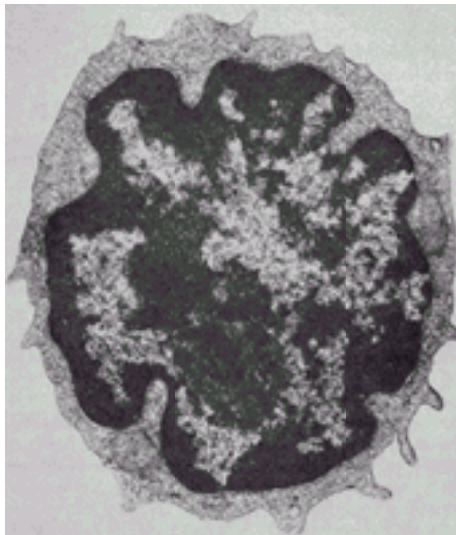
2004 Lippincott Williams & Wilkins  
John P. Greer, John Foerster, John N. Lukens  
George M. Rodgers, Frixos Paraskevas, Bertil Glader  
Wintrobe's Clinical Hematology

**MORPHOLOGY****ONTOGENY OF THE THYMIC MICROENVIRONMENT****T-CELL PROGENITORS****NOTCH AND T-CELL COMMITMENT****PHENOTYPIC DIFFERENTIATION****T-RECEPTOR GENES****T Cell- $\alpha\beta$  versus T Cell- $\gamma\delta$  and the Pre-T-Cell Receptor****CD4/CD8 Lineage Commitment****Positive and Negative Selection****Cells and Molecules in the Selection of Thymocytes** **$\alpha/\beta$  T-CELL RECEPTOR COMPLEX****Ligand-Binding Component:  $\alpha\beta$  and Peptide-Major Histocompatibility Complex Interaction****Co-Receptors in Peptide-Major Histocompatibility Complex Interaction****Signal-Transducing Component of T-Cell Receptor Complex****Co-Receptors to T-Cell Receptor: CD4 and CD8****T-CELL ACTIVATION****Topology of Immune Recognition****The Gathering Storm: Lipid Rafts and the Immunologic Synapse****Immunologic Synapse in Three Stages****T-Cell Receptor Signaling****T-Cell Activation and the Cytoskeleton****Regulation of T-Cell Activation: Co-Stimulation and Inhibition****CD4 T-CELL DIFFERENTIATION****Stage I: Transcriptional Regulation****Stage II: Maturation of Th1/Th2 Cells****CD8 T-CELL DIFFERENTIATION****GENOMIC VIEW OF TYPE 1 AND TYPE 2 DIFFERENTIATION****TH1 AND TH2 PARADIGM: STRONG DEFENSE SYSTEM****CD8 T LYMPHOCYTES****Activation of Cytotoxic T Lymphocytes****Granule Contents****Mechanism of Target Cell Lysis****Functions Mediated by Lymphocyte Toxicity****How Many Roads Lead to Death?****Regulatory T Cells** **$\gamma\delta$  T CELLS** **$\gamma\delta$  T-Cell Repertoire** **$\gamma\delta$  T-Cell Receptor Structure and Antigen Recognition** **$\gamma\delta$  T-Cell Function****NATURAL KILLER CELLS****Morphology, Cytochemistry, and Surface Markers****Ontogeny of Natural Killer Cells****Natural Killer Cell Receptors****Natural Cytotoxicity****Natural Resistance****Regulation of Adaptive Immunity****Natural Killer Cells and Malignancies****Natural Killer Cells and Bone Marrow Stem Cells****Natural Killer Cells and Bone Marrow Transplantation****Regulation of Hematopoiesis****Natural Killer Cell Proliferations****NATURAL KILLER T CELLS**

## MORPHOLOGY

The T lymphocyte, under routine staining procedures (Giemsa or Wright), is 5 to 8  $\mu\text{m}$  in diameter, with a high nucleocytoplasmic ratio. The nucleus is purple with densely packed chromatin, and the cytoplasm forms a narrow light-blue rim.

By transmission electron microscopy, the nucleus shows shallow indentations with dense heterochromatin along the nuclear membrane and euchromatin occupying most of the remaining nuclear surface. One or two nucleoli are visible ( [Fig. 17.1](#)). The cytoplasm shows a few organelles, such as mitochondria and a small Golgi apparatus. By scanning electron microscopy, T lymphocytes show either smooth surface or only small numbers of microvilli, depending on the method of preparation as well as the state of activation ( [1](#), [2](#) ).



**Figure 17.1.** Ultrastructure of T cells. The normal T cell has a small rim of cytoplasm with only a few organelles. Nucleus shows dense heterochromatin. (From Zucker-Franklin D, Greaves MF, Grossi CE. Atlas of blood cells, 2nd ed. Philadelphia: Lea & Febiger, 1988, with permission.)

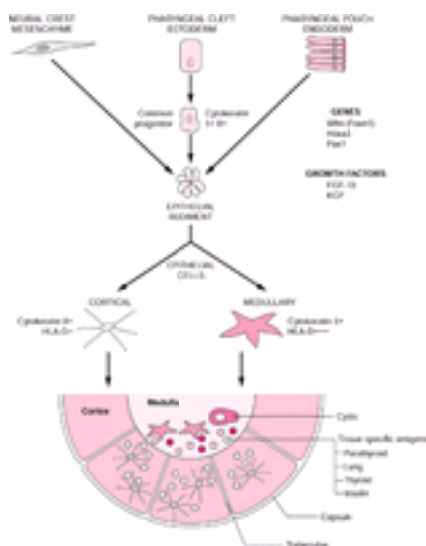
Some T lymphocytes present in normal subjects are characterized by a highly indented nucleus and are known as *cerebriform mononuclear cells* ( [3](#) ). These cells are not detected in T lymphocyte-depleted fractions and constitute approximately 3 to 4% of the unfractionated T lymphocytes. They possess scanty cytoplasm, and the degree of their nuclear indentation is expressed as a nuclear contour index (nuclear perimeter/area) ( [4](#) ). Their structural similarity to the cells present in cutaneous T-cell lymphomas suggests that they represent the normal equivalent of Sézary cells, which are derived from T lymphocytes.

## ONTOGENY OF THE THYMIC MICROENVIRONMENT

The ontogeny of thymus and its structure are discussed in [Chapter 15](#).



The thymic anlage develops from epithelial structures of the third branchial complex (<sup>5</sup>). However, the exact embryonic origins (i.e., ectodermal vs. endodermal or both) are still controversial. Most investigators believe that the medullary and cortical epithelia arise from the third pharyngeal cleft (ectoderm) and the third pharyngeal pouch (endoderm), which express the Pax1 gene (Fig. 17.2). Neural crest cells (Hoxa3-positive) invade the epithelial cluster to form the thymic rudiment. Several studies support the view that the cortical and medullary epithelia originate from a common precursor, and, in the early stages, the epithelium coexpresses markers that are later segregated to the cortical or medullary compartments. After completion of thymic organogenesis, the cortical epithelia are cytokeratin 8<sup>+</sup>, whereas medullary epithelia are cytokeratin 5<sup>+</sup> (<sup>6</sup>), except for a small subpopulation in the corticomedullary junction, which is cytokeratin 5<sup>+</sup>/8<sup>+</sup> (<sup>6</sup>). Furthermore, neoplastic human thymomas often express both cortical and medullary epithelial markers (<sup>7</sup>).



**Figure 17.2.** Morphogenesis of thymus. Elements from the third pharyngeal cleft form the epithelial rudiment, joined by mesenchymal cells from the neural crest. The common epithelial progenitor differentiates into cortical and medullary epithelium under the influence of the mesenchyme. The presence of endodermal cysts and tissue-specific “antigens” and “organoids” suggests some contribution from the endoderm. FGF, fibroblast growth factor; KGF, keratinocyte growth factor.

The best evidence of the origin of thymic epithelia from a common progenitor is the identification by monoclonal antibodies of a cell that, on differentiation *in vivo*, generates the full thymic microenvironment (<sup>8, 9</sup>). The monoclonal antibody, MTS24, detects a glycoprotein with mucinlike characteristics and a peptide backbone (<sup>8</sup>). The antigen is detected during the early embryonic stages in the anterior endodermal epithelium, pharyngeal endoderm, and a portion of intermediate mesoderm, which develops the urogenital epithelium. The MTS24<sup>+</sup> cells are major histocompatibility complex (MHC) class II positive and express cytokeratin 5 and cytokeratin 8, which are markers of the medullary and cortical epithelium, respectively. Highly purified MTS24 cells, inserted under the kidney capsule, are able to develop into a complete thymus and, furthermore, provide the complete milieu necessary for T-cell development.

Because primordial epithelial cells normally need the cooperation of mesenchymal cells for thymus organogenesis ( [10](#) ), it is conceivable that, in the case of the ectopically placed MTS24 cells, this is provided by comparable cellular elements from the kidney capsule. The MTS24 antibody completely blocks T-cell development in fetal thymic organ cultures, supporting the conclusion that the molecule recognized by the MTS24 antibody regulates normal epithelial function.

During this early stage in the development of the thymus, the cell interactions are regulated by a number of transcription factors, such as *Hoxa3* and *Pax1*, which initiate the formation of the thymic primordium in mice ( [11](#), [12](#) ). An important step in our understanding of the genetic control of thymic development came from the study of the “nude” mouse and the cloning of the gene that confers the nude phenotype, designated *whn* for *winged helix nude* ( [13](#) ), and more recently renamed *Foxn1*. The *Foxn1* gene encodes a transcription factor with a DNA-binding domain of the forkhead/winged helix class. The defect responsible for the nude phenotype is a single base pair deletion in the third exon of the *Foxn1* gene. It results in hair loss, the arrest of the thymic epithelial cell expansion, and inability to attract the hematopoietic precursors into the epithelial rudiment ( [14](#), [15](#) ). Formation of the epithelial primordium is not affected by the loss of *whn* function, but subsequent differentiation of the primitive epithelial precursors into subcapsular, cortical, and medullary epithelial cells is arrested ( [16](#) ), and the epithelial rudiment becomes cystic.

In normal development, the epithelial rudiment is invaded by mesenchymal cells from the neural crest ( [17](#) ), which stimulate epithelial progenitor differentiation into cortical and medullary subpopulations ( [18](#), [19](#), [20](#) and [21](#) ). These mesenchymal-epithelial interactions are mediated by growth factors and their receptors, such as the fibroblast growth factor 10 (FGF10) and its specific receptor, FGFR2IIIb, on thymic epithelial cells. Deficiency of either the factor or the receptor results in severe thymic hypoplasia ( [22](#), [23](#) ). When immature lymphoid cells begin to arrive in the thymic rudiment, another wave of cellular interactions takes place between the developing lymphoid cells and the stromal epithelial cells. This second stage of thymic development establishes thymic microenvironments conducive to thymocyte differentiation and repertoire selection.

Further differentiation and maturation are under the regulation of interactions with thymocytes. Experiments in animals and experiments of nature in humans (disease processes), have clearly shown the symbiotic relationship between epithelial cells and lymphocytes. Prothymocytes regulate differentiation of cortical epithelial cells ( [24](#) ), whereas mature thymocytes organize the medullary microenvironment ( [25](#), [26](#) and [27](#) ). The pharmacologic action of cyclosporine A blocks thymocyte maturation at the double-positive (DP) stage (i.e., CD4<sup>+</sup>CD8<sup>+</sup>) ( [28](#) ). As a result, the histologic architecture of cortex and the cortical thymocytes remain intact, whereas the medulla is depleted of epithelial cells and mature thymocytes. The evidence cited above indicates that the thymocytes contribute to the development and survival of the epithelial cells in their respective anatomic compartments.

The epithelial cells in the cortex and medulla differ by ultrastructure, by immunophenotype, and by functional characteristics. Ultrastructurally, three subsets have been detected on the basis of cytoplasmic processes, secretory organelles, and desmosome connections ( [29](#) ). Type I cells, located in the cortex, have stellate cytoplasmic processes and make contact with their neighbors, forming a syncytium. Type II cells are found in the medulla, are voluminous with many secretory intracellular vesicles, and have short cytoplasmic processes. Type III cells are rare, may contain vacuoles

(pseudocysts), and are located in the medulla.

By immunophenotype, six clusters of thymic epithelial staining (CTES) have been identified. Ultrastructurally, type 1 epithelium (CTES II) ( [30](#) ) produces thymic hormones. Type 2 (pale), type 3 (intermediate electron lucency), and type 4 (dark with oval nuclei) are in the cortex proper (CTES III). These cells extend fine cytoplasmic processes, establishing contacts with neighboring cells, and are connected by desmosomes forming a syncytium, the interstices of which are filled with thymocytes. Some tend to engulf up to 20 to 40 thymocytes in a lymphoepithelial cluster, known as *nurse cells*, detected in human thymus ( [31](#) , [32](#) ) (see [Chapter 15, Fig. 15.11](#)). The internalized thymocytes are located within caveolae lined by plasma membranes. The lack of penetration by certain dyes indicates that the nurse cells are not an artefact, are completely sealed from the rest of the thymus, and may play a role in T-cell selection. Their formation is not dependent on interactions of T-cell receptors (TCRs) with MHC because they are present in knock-out mice deprived of TCR- $\alpha\beta$  ( [33](#) ).

A better understanding of the thymocyte-epithelial cell interdependence for survival came from experiments with a variety of TCR-transgenic mice ( [34](#) ). The final organization of the cortical and medullary epithelium depends on interactions of the TCR on the thymocytes with ligands on stromal cells. Thymocytes expressing a transgenic TCR that triggers strong positive selection, resulting only in maturation of CD4<sup>+</sup>8<sup>-</sup> T cells, lose the normal reticular pattern of cortical epithelial cells, and the epithelium in the medulla forms small scattered groups of cells surrounded by macrophages and dendritic cells ( [35](#) ).

Several other transgenic models demonstrated that maintenance of a balance between positive selection, negative selection, and nonselection is necessary to preserve normal compartmentalization and architectural integrity of the thymic epithelia ( [36](#) , [37](#) ). It is the diversity of signals emanating from these physiologic processes within the thymus during thymocyte maturation that are critical for the maintenance of epithelial organization. These signals are generated from the endogenously rearranged TCRs, which regulate positive and negative selection.

In addition to thymocytes, the thymic vasculature is also an important epithelial organizer ( [38](#) ). In RAG2<sup>-/-</sup> mice, the medullary epithelium forms cuffs around intermediate-sized vessels, particularly the postcapillary venules. This anatomic arrangement may have important functional implications. The medullary epithelial cells have been linked to negative selection and tolerance induction ( [39](#) , [40](#) and [41](#) ) and are therefore strategically located around the postcapillary venules where the concentration of autoantigens would be high. The possible functional importance of this peculiar anatomic arrangement of the medullary epithelium is also suggested from the detection of several molecules and structures considered to be tissue specific within the medulla (i.e., parathyroid hormone, thyroglobulin, insulin, and even organized epithelial “organoids” with ultrastructural features of respiratory epithelium and thyroid follicles) ( [42](#) ). The ectopic location of these molecules and structures is supported by the detection of the expression of the appropriate genes ( [42](#) ). It has also been postulated that, because these “ectopic” tissues within the medulla have their origin from primordial endoderm, the precursors of the epithelial cells in the medulla also may arise from pharyngeal endoderm. Further support of this view comes from the histologic appearance of medulla in athymic mice, in which further differentiation of these cells fails and the epithelium remains in the primordial condition of endodermal cysts.

Whereas epithelial development depends on FGF, its functional integrity is maintained by other growth factors contributed by the mesenchyme. The keratinocyte growth factor

(KGF), a member of the FGF family, is a paracrine growth factor produced by mesenchymal cells. It acts on epithelial cells that express a splice variant of FGF (i.e., FGFR2IIIb). In fetal thymic organ cultures, exogenous KGF expands the medullary epithelium, and in RAG<sup>-/-</sup> animals deprived of thymocytes, which normally produce KGF, the administration of KGF restores the normal medullary epithelial architecture (43).

The architectural integrity of the thymus is maintained throughout life, but eventually, thymus atrophies with age (44). Changes in signals between epithelial cells and thymocytes may determine thymic involution (45). Stat3 has been identified as an important signaling molecule between epithelial and mesenchymal cells in the thymic microenvironment (46). Stat3 gene disruption in mice results in severe thymic atrophy and enhanced susceptibility of the thymus to environmental stress, such as glucocorticoids or  $\gamma$ -irradiation.

The extracellular matrix (ECM) is the second important component of thymic stroma after the cells (47). It consists of multiple collagens, reticulin fibers, glycosaminoglycans, and glycoproteins, including laminin and fibronectin. Heterotrimeric laminin molecules consist of at least 15 naturally occurring isoforms, which are formed by five  $\alpha$ , three  $\beta$ , and three  $\gamma$  subunits. In the human thymus, laminin with  $\alpha_2$ -chains (LN-2/4) or  $\alpha_5$ -chains (LN-10/11) are detected in the subcapsular epithelium and blood vessels (48). The CD4<sup>-</sup>/CD8<sup>-</sup> (double negative) thymocytes are located in the subcapsular area by strong attachment to LN-10/11 through their  $\alpha_6\beta_1$  integrin. The CD4<sup>+</sup>/CD8<sup>+</sup> (DP) thymocytes, however, lose their capacity to adhere to LN-10/11 and move down to the cortex. Another laminin receptor,  $\alpha_6\beta_4$ , is also strongly expressed in CD4<sup>-</sup>/CD8<sup>-</sup> thymocytes in postnatal life (49).

These thymocyte-stroma interactions facilitate intrathymic migration and regulate positioning of the developing thymocytes to appropriate microenvironments during differentiation. The ECM proteins support the growth of thymocytes and epithelial cells and facilitate cell-cell interaction, especially migration of thymocytes in and out of nurse cells. Receptors for ECM proteins are highest in the double-negative precursors but gradually decrease with maturation.

## T-CELL PROGENITORS

There are differences between embryonic and adult thymocyte development. The T-cell progenitors in fetal life derive from the liver, whereas in adult life, they come from the bone marrow. The difference in stem cell origin has implications in subsequent lymphoid development, apparently as a result of precommitment or restriction of developmental options at the level of stem cell (50). For example, fetal liver stem cells in a fetal thymic microenvironment generate  $\gamma/\delta$  T cells expressing the V $\gamma$ 3 gene, whereas adult stem cells have lost this property (51). Another difference is related to the expression of the terminal deoxynucleotidyl transferase (TdT) enzyme in adult but not in embryo cells. TdT introduces N-nucleotides during the antigen receptor gene rearrangements and thus is responsible for an additional level of diversity, known as *junctional diversity*. Thus, fetal lymphoid cells have an “immature repertoire” (52).

Human thymus becomes fully differentiated by approximately the fifteenth week of gestation (i.e., approximately 7 to 8 weeks after colonization of the thymic rudiment). These early migrants contribute to the development of the thymic microenvironment. Cells with the CD34<sup>+</sup>/CD38<sup>weak</sup>/CD90<sup>+</sup> phenotype contain T-cell progenitors when

they grow in fetal thymic organ cultures. In human adult bone marrow, CD34<sup>+</sup>/CD38<sup>-</sup>HLADR<sup>+</sup> stem cells have the potential to differentiate toward lymphoid and myeloid lineages (53). These cells are CD45RA<sup>+</sup>, lack Thy1 (CD90) antigen, and may represent an intermediate oligopotent stem cell with T-cell-reconstituting ability (54). By phenotype, there are three subpopulations in the bone marrow, which can differentiate to T cells in the thymus: CD34<sup>+</sup>/CD2<sup>+</sup>, CD34<sup>+</sup>/CD7<sup>+</sup>, and CD34<sup>+</sup>/CD2<sup>+</sup>/CD7<sup>+</sup>, and all three are negative for CD3/CD4/CD8 (55). It has been suggested that T-lineage commitment takes place in the bone marrow and that these cells carry the distinct phenotype CD34<sup>+</sup>, CD7<sup>+</sup>, CD2<sup>+</sup>, CD5<sup>+</sup>, and LECAM-1<sup>high</sup> (56). Bone marrow T-lineage-committed cells, however, can differentiate into nonlymphoid lineages (i.e., myeloid/erythroid) by cytokines from thymic epithelial cells, (57), and precursors from fetal liver are still “pluripotential” as thymic microenvironment is permissive for development of cells of other lineages than T lineage (58, 59). These cells form granulocyte-macrophage colony-forming units but have lost the multilineage hematopoietic potential present on the most primitive stem cells (54). The CD45RA (a high molecular isoform of CD45) is not present in primitive progenitors that initiate long-term cultures (60) but is found on more committed bone marrow progenitors and on subsets of mature T cells. It is expressed in the early stages of intrathymic development and remains until T cells become mature (61). Bone marrow progenitors arriving in the thymus respond to interleukin (IL)-7 secreted from stromal cells and change to a CD34<sup>+</sup> and strongly CD7<sup>+</sup> phenotype, the first fully committed T-lineage cells with loss of the potential for myeloid differentiation (62).

Because the cells arriving in the thymus are multipotent or at least oligopotent but the cells coming out of the thymus are exclusively T lymphocytes, the question to be answered is about the nature of the signal(s) that determine T-lineage commitment.

## NOTCH AND T-CELL COMMITMENT

Signaling through the Notch receptor is a key factor for T-cell commitment (63, 64, 65 and 66). Notch plays a pivotal role in determining T/B-lineage choice, and signaling through Notch drives commitment of lymphoid precursors to T lineage (67, 68 and 69). Notch belongs to a family of conserved proteins that function as cell-surface receptors and direct regulators of gene transcription (70). It was first isolated as a gene involved in chromosomal translocations with the TCR-β gene in a subset of cases of human T-cell acute lymphoblastic leukemia (71). The extracellular domain of Notch contains a variable number of tandem epidermal growth factor-like repeats and three Lin/Notch repeats, which function for ligand binding and Notch activation (72). The intracellular region contains six Cdc10/ankyrin repeats characteristic of protein-protein interactions and essential for signal transduction. The Notch protein initially is synthesized as a single-polypeptide chain, but, as a result of proteolytic processing, it is split into two parts. The extracellular region is separated and forms a noncovalent heterodimer with the remaining portion consisting of the transmembrane and the cytoplasmic regions.

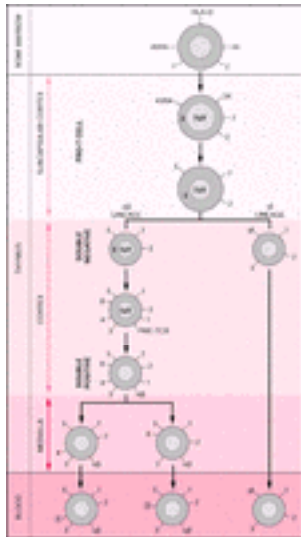
Ligands for Notch are Delta, Serrate, and several other molecules corresponding to these two classes. In general, those homologous to Delta are referred to as *Delta*, and those homologous to Serrate are called *Serrate* or *Jagged* (72). These ligands are transmembrane proteins with an extracellular domain with a variable number of epidermal growth factor-like repeats and the unique domain for this family, the DSL (*Delta/ Serrate Lag-2*) domain, which mediates binding to Notch and activation. Which of the two groups of ligands is important for T-lineage commitment remains controversial (73). In cells of

the immune system, there are two Notch receptors, Notch 1 and Notch 2, and four signals ( [74](#) ). The pleiotropic signaling by Notch regulates differentiation, proliferation, and cell death, but it is not yet clear which function most precisely determines cell fate and ultimately directs T-cell commitment ( [75](#), [76](#) ). With Notch inactivation, the double-negative T cells diminish in the thymus, whereas B-cell precursors increase, probably from a more efficient production of B cells within the thymus ( [77](#) ). On the other hand, transgenic expression of Notch in the bone marrow permits the accumulation of CD4<sup>+</sup>/CD8<sup>+</sup> T cells. Notch 1's functional role seems to be in developmental specification, driving T-cell precursors at the expense of B-cell precursors and perhaps directing the choice of a common precursor between these two fates. A role of Notch 1 in subsequent stages of T-cell differentiation (i.e., lineage commitment and positive vs. negative selection) is still questionable.

## PHENOTYPIC DIFFERENTIATION

The first migrants to the thymus settle to the subcapsular cortex and are large, dividing pluripotential cells, CD34<sup>+</sup>/CD45RA<sup>+</sup>, with the TCR genes in the germ-line configuration ( [56](#), [78](#), [79](#), [80](#), [81](#), [82](#) and [83](#) ). CD2 and CD7 expression may precede arrival in the thymus ( [Fig. 17.3](#) ). Potentially, they are able to differentiate to other lineages, such as natural killer (NK) cells, dendritic cells, and monocytes. The CD34<sup>+</sup> cells then coexpress other markers such as CD38 and CD71 (transferrin receptor) associated with proliferating cells, and a portion of them are CD10<sup>+</sup>. Shortly after they acquire CD1a, they up-regulate CD4 followed first by CD8a and then CD8 $\beta$ . The majority of the CD34<sup>+</sup> cells at this stage are negative for CD3, CD4, and CD8 (triple negative, or TN), but a small subpopulation expresses low levels of CD4 (CD3/CD4<sup>low</sup>/CD8) ( [84](#) ). This population may be an intermediate between the TN thymocytes and the main cortical population that are positive for both CD4 and CD8 (DP). Researchers have detected other intermediate phenotypes such as CD3/CD4<sup>+</sup>/CD8a<sup>+</sup> $\beta$ <sup>-</sup> ( [85](#) ). These intermediates may indicate that, in the progression from TN to DP, acquisition of the CD4 and CD8 is not synchronous. In mice, intermediates have also been detected that are CD4<sup>-</sup>/CD8<sup>+</sup> ( [86](#) ) or CD4<sup>+</sup>/CD8<sup>-</sup> ( [87](#) ). Expression of CD1 begins while the cell is still TN. CD1 is absent from the most immature and most mature thymocytes and peripheral T cells. In conclusion, progression from TN to DP is characterized by several intermediate stages, expressing in sequence CD1, CD4, and finally CD8 and CD3 before they acquire the typical phenotype of the cortical thymocyte [i.e., CD3<sup>+</sup>/CD4<sup>+</sup>/CD8<sup>+</sup>/CD1<sup>+</sup> (DP)] ( [79](#) ).





**Figure 17.3.** T-cell differentiation in the thymus. Progenitor cells from bone marrow are first detected in the subcapsular cortex expressing the CD7 and CD2 on the cell surface and CD3 in the cytoplasm. At this stage, rearrangements of the T-cell receptor (TCR) genes and a gene encoding the pre-Ta protein form the pre-TCR. The pre-TCR controls the separation of the two T-cell lineages,  $\gamma/\delta$  and  $\alpha/\beta$ . The  $\alpha/\beta$  cells eventually contribute to the majority of T cells within the thymus and in the periphery. On the basis of expression of the CD4 and CD8 markers, thymocytes are divided into four subpopulations: absence of both markers (double negatives), presence of both on the same cell (double positives), and expression of each marker on separate cells. See text for details. TdT, terminal deoxynucleotidyl transferase.

In the process of differentiation, CD34 is progressively lost while the intensity of CD7 decreases. Myeloid and NK cells have been detected in various *in vitro* systems arising from thymocytes ( [57](#), [88](#), [89](#) ), and the thymic microenvironment is able to support myeloid differentiation ( [58](#) ). However, others could not detect myeloid differentiation from CD34<sup>+</sup>/CD7<sup>+</sup> thymocytes in response to myeloid growth factors, whereas bone marrow cells with the same phenotype contained myeloid clonogenic cells ( [82](#) ).

During the early stages of T-cell development, there are a series of control points in the progression from the earliest precursors to the DP stage. The control points depend on the thymic microenvironment and have been well characterized in the mouse ( [90](#) ). In orderly sequence, these control points are the expression of  $\alpha$ -chain of IL-2, onset of TCR- $\beta$  and  $\gamma$ -gene rearrangements, branching of the TCR- $\gamma/\delta$  lineage, expression of a dimeric form of TCR- $\beta$ -chain, and, finally, expression of CD4, CD8, and the TCR- $\alpha/\beta$ . At the stage of DP, the cells are subject to positive selection. If the TCR and CD8 engage a class I peptide complex, the CD4 is down-regulated. The opposite happens for a CD4 class II-restricted cell that down-regulates CD8. The final maturation is gradual and slow and may involve additional changes for the development of the single-positive mature T lymphocytes.

Interactions between stromal cells and the thymocytes are mediated by direct communication (adhesion molecules) and mediators (cytokines and thymic hormones). Adherence of thymocytes to epithelial cells is mediated by CD2 and the lymphocyte function molecule-3 (LFA-3, CD58) ( [91](#) ), intercellular adhesion molecule (ICAM), and LFA-1 ( [92](#) ). Blocking the receptors for fibronectin (FN), very late antigen-5 (VLA-5), and very late antigen-6 (VLA-6), which are expressed on immature thymocytes, inhibits their differentiation ( [47](#), [48](#) ). Epithelial cells also express several receptors for ECM.



Evidence of direct cellular communication between various thymic cells was provided by the demonstration of the existence of gap junctions formed by connexin 43 between two epithelial cells or between epithelial cells and thymocytes ( 93 ).

Of the cytokines that have been implicated in T-cell differentiation, IL-7 is essential ( 94 ). It is produced constitutively by epithelial cells, and it induces proliferation of TN thymocytes ( 95 ) or maintains their viability ( 96 ). CD34<sup>+</sup> thymocytes cultured with IL-7 start to express CD8 and CD4 but remain CD3 and TCR negative, indicating that other stimuli from stromal cells are essential for generating CD3<sup>+</sup>/CD4<sup>+</sup>/CD8<sup>+</sup> cells. IL-7 also induces TCR-β gene rearrangements ( 97 ). Mice genetically deficient in IL-7 receptor have a profound reduction of T and B lymphocytes, and thymocyte development is blocked at a very early stage before the induction of CD25 and TCR-β gene rearrangements ( 98 ). IL-7 function is potentiated by stem cell factor ( 82 ).

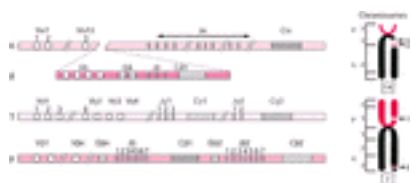
Other cytokines, such as IL-1, IL-2, and IL-4, have also been shown to play some role in thymocyte differentiation ( 94 ). Thymic hormones are produced by epithelial cells and can induce *in vitro* functions associated with mature T cells, such as helper cells in antibody production. Some of the hormones have been isolated in pure form (i.e., the thymosins, a family of peptides present in thymic extracts; thymulin, a peptide of nine amino acids with homology to thymosins; and thymopoietin, which induces expression of T-cell markers in bone marrow cells).

The thymus is continuously colonized by hematopoietic progenitors that have the genes for the TCR in germ-line configuration. In an adult mouse, approximately 100 to 1000 such progenitors enter the thymus daily, and it takes approximately 3 weeks to undergo complete differentiation to mature functional and self-tolerant T cells.

The biologic processes within the thymus are highly complex, but for a better understanding, we divide them, somewhat arbitrarily, into three areas: (a) lineage determination (i.e., TCR-αβ vs. TCR-γδ), (b) separation of the two main T-cell subsets (i.e., CD4 vs. CD8), (c) selection for survival of those cells with a TCR able to recognize foreign antigens (positive selection) and elimination of those possessing autoreactive configurations (negative selection). Understanding of these events will be facilitated by a prior description of the genes encoding the TCRs.

## T-RECEPTOR GENES

Knowledge of the structure and patterns of expression of the various TCR genes is essential to our understanding of antigen recognition by T cells ( 99 ). The TCR gene, “a needle in the haystack,” was isolated by the technique of subtractive hybridization ( 100 ). Four human and murine TCR genes have been identified: α ( 101 ), β ( 102 ), γ, and δ ( 103 , 104 ) ( Fig. 17.4 ).



**Figure 17.4.** Organization of the genes for human T-cell receptor chains (see text for details). (Adapted from Kronenberg M, Siu G, Hood LE, Shastri N. The molecular genetics

of the T-cell antigen receptor and T-cell antigen recognition. *Annu Rev Immunol* 1986;4:529–591; and Raulet DH. The structure, function, and molecular genetics of the T-cell receptor. *Annu Rev Immunol* 1989;7:175–207.)

The human  $\alpha$  gene is located on chromosome 14 (bands q11–12) (105), as are the immunoglobulin (Ig) genes (band q32). Rearrangement involving the region of the chromosome containing the  $\alpha$  genes has been detected in patients with T-cell malignancies (106, 107). The  $\delta$  gene is located on chromosome 14 within the  $\alpha$  gene (see below) (108). The  $\beta$  and  $\gamma$  genes are located on chromosome 7 (109, 110). Translocations and inversions of chromosomes 14 and 7 are often seen in association with ataxia telangiectasia, probably involving fragile sites that normally are used during the TCR gene rearrangements.

All TCR genes display an overall organization similar to that of the Ig genes. They are composed of variable (V) and constant (C) genes. The V gene is made of three segments (V, J, and D) in the  $\beta$  and  $\gamma$  genes, but only two segments (V and J) in the  $\alpha$  and  $\delta$  genes (99, 104). Each V-gene family is divided into subfamilies, like the Ig V genes, on the basis of sequence similarity (more than 75%).

In humans, the TCR genes group consists of one  $C\alpha$  gene (111), two  $C\beta$  genes (112), two  $C\gamma$  genes (104), and one  $C\delta$  gene (104). With the exception of  $C\delta$ , which is composed of three exons, all of the genes have four exons. The  $\delta$  locus is located between the  $C\alpha$  and  $J\alpha$  gene segments. Diversity in the TCR genes is generated through rearrangements with each of the V and J segments and D in the case of  $\beta$  and  $\gamma$ , forming the complete V gene. The TCR genes, however, contain a large number of J segments as compared to the Ig genes.

Associated with the  $C\alpha$  gene are approximately 50  $V\alpha$  and 61  $J\alpha$  segments that spread over 100 kb of DNA. The  $\beta$ -chain gene complex spans around 600 kb (113) and incorporates 57  $V\beta$  segments. Each of the two  $C\beta$  genes possesses a set of  $J\beta$  segments and one  $D\beta$  segment. The  $V\beta$  segments are all located upstream from the two clusters of  $C\beta$  genes. During rearrangements when a  $V\beta$  segment forms a  $VDJ$  complex, the transcript is committed to use the same  $C\beta$  segment genes. The  $\delta$  gene locus contains two  $C\delta$  genes, each associated with its own set of  $J\delta$  segments. There are approximately 14  $V\delta$  segments, all located upstream separately from the two  $C\delta$ - $J\delta$  clusters. The  $C\delta$  gene complex lies between the V and J segments of the  $\alpha$  gene complex. There are eight  $V\delta$ , three  $D\delta$ , and three  $J\delta$  segments.

Like the Ig genes, the TCR gene segments are flanked by heptamer-spacer-nonamer sequences, which serve as recognition sites for the recombinase, the enzyme that initiates recombination of the segments. The same RAGs 1 and 2 (RAG1 and RAG2) regulate the V(D)J recombinations for both T and B cells. But RAG1/RAG2 act in a lineage-specific manner (i.e., Ig genes are assembled only in B cells and TCR genes only in T cells). The recombinations are also developmentally regulated. For T cells, the  $\beta$  genes are recombined before a  $\delta$  gene; as for B cells, the IgH is recombined before IgL. These differences are explained by differential accessibility of V genes during development. Mutations of either one of these genes in mice result in complete arrest of maturation of both B- and T-cell lineages (114, 115). The mechanism of V(D)J recombination has been described in detail in [Chapter 16](#).

The mechanisms generating diversity are combinatorial associations of different V, D, and J segments and combinatorial pairing of TCR proteins. However, in contrast to the Ig genes, fewer V segments are available to the TCR genes. The diversity of the TCR is

mainly junctional (i.e., a result of additions of nucleotides at the DNA cleavage site). Additions that depend on template are known as *P nucleotides*, and random additions are called *N nucleotides added by Td1* (see details in [Chapter 16](#)). Td1 is not expressed during fetal life, and, in Td1 knock-out mice, the T-cell repertoire is of fetal type (i.e., less diverse). Td1 is expressed only in immature lymphocytes and is responsible for the transition from fetal to adult repertoire by contributing enormously to the lymphocyte antigen receptor repertoire. A striking difference between Ig and TCR is the lack of somatic hypermutations, which is very important in generating high-affinity antibodies in the germinal centers ([Chapter 18](#)). Assembly of V genes of  $\beta$ ,  $\delta$ , and  $\alpha$  genes occurs during the DN stage. If the  $\delta$  rearrangement is successful, the cell becomes a T- $\delta$  cell. If the  $\beta$ -chain rearranges successfully, it forms a heterodimer with the pre-Ta-chain and differentiates along the T- $\alpha\beta$  lineage entering the DP phenotypic stage.

TCR gene rearrangements occur in two discrete stages of thymocyte development. The first occurs during the DN stage with the  $\delta$  gene rearranging first, followed by the  $\beta$  and  $\alpha$  genes. The  $\alpha$  gene rearranges during the DP stage. During the  $\beta$  gene rearrangement, a DB segment joins a JB segment, and, as with the Ig gene rearrangement, a VB joins the DBJB complex. If the rearrangement is not productive, the cell may have one more chance at rearranging a second CB cluster, as there are two CB genes each with its own D and J segments.

### T Cell- $\alpha\beta$ versus T Cell- $\delta$ and the Pre-T-Cell Receptor

At this point, the decision needs to be made in choosing a TCR- $\delta$  versus a TCR- $\alpha\beta$  lineage by any one of three proposed models. According to one model, each lineage starts from a separate precursor (*stochastic or independent*). A second model proposes that there is a common precursor for both lineages (*instructive*). The third model (*competitive*) postulates that rearrangements for the genes of the respective lineages start concurrently and that those finishing successfully first determine the fate of the cell. Evidence appears to support a variant of the stochastic model ([114](#)). Whatever the mechanism, it is agreed that the TCR- $\delta$  gene rearrangement occurs in thymocytes that can adopt either the  $\delta$  or  $\alpha\beta$  fates, whereas during the DP stage, activation of the TCR- $\alpha$  gene rearrangement seals the fate of the T cell for the  $\alpha\beta$  lineage.

Determination of lineage is regulated by transcription factors that act on promoters and enhancers and make appropriate genes accessible to the recombinase ([115](#), [116](#)). Another regulatory mechanism involves the pre-TCR. At this stage of T-cell development, the  $\beta$ -chain forms a heterodimer with another protein, referred to as *pre-Ta* (pTa), and the complex is referred to as *pre-TCR* ([117](#)). The pTa is a 33-kd type I transmembrane protein of the Ig superfamily. It consists of a single Ig-like domain. Two cysteines form the intrachain disulfide bond, whereas a third cysteine just above the transmembrane region forms the disulfide bridge with the TCR- $\beta$  chain ([118](#)). The human pTa gene is located on the short arm of chromosome 6, in the vicinity of the HLA locus. The pTa-chain is not essential for CD3 expression.

The pre-TCR has a major role in TCR- $\alpha\beta$  versus TCR- $\delta$  commitment. It generates large numbers of CD4<sup>+</sup>/CD8<sup>+</sup> T cells with productive TCR- $\beta$  rearrangements and directs these cells to the TCR- $\alpha\beta$  lineage ([119](#)).

The cells that have undergone rearrangements of the  $\beta$ ,  $\delta$ , and  $\alpha$  are diverted by the pre-TCR into the  $\alpha\beta$  lineage before they assemble a complete  $\delta$  TCR. The pre-TCR stimulation induces expansion of the cells that have rearranged the  $\beta$  gene, followed by extensive rearrangements of the  $\alpha$  locus. The  $\alpha$ -gene rearrangements excise the  $\delta$  gene,

which is located within the  $\alpha$  locus, and further  $\gamma$ d T-cell differentiation is blocked.

In mice deficient in pTa expression, pre-TCR is not formed, and  $\alpha\beta$ -TCR cells are markedly reduced. These data support the instructive mechanism in the generation of the  $\alpha\beta$  and  $\gamma$ d T cells.

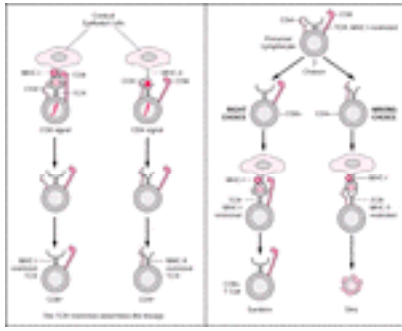
The selection for TCR- $\beta$  is initiated at a stage phenotypically characterized by expression of CD4<sup>+</sup>/CD8a<sup>+</sup> $\beta$ <sup>-</sup> (120). The productive V $\beta$  gene rearrangement in one allele prevents rearrangements of the second allele, a process called *allelic exclusion* that is regulated by the pre-TCR. Signaling by the pre-TCR requires the CD3 chains  $\gamma$ ,  $\epsilon$ ,  $\zeta$ , and  $\eta$ , and the Lck kinase (121), with the CD3- $\epsilon$  and  $\zeta$  chains especially indispensable for the pre-TCR function. Other functions mediated by pre-TCR signaling are cell survival and phenotypic changes. Pre-TCR promotes thymocyte survival, whereas signaling by TCR induces apoptosis (122, 123). Because pre-TCR is expressed on DN T cells, the antiapoptotic function of pre-TCR is crucial for their survival and differentiation of DN T cells into the DP stage when the TCR is needed for positive or negative selection.

Both receptors follow initially similar signaling pathways, such as tyrosine phosphorylation and so forth, but in the apoptotic pathway, they diverge at the level of Fas ligand (FasL) induction, which requires induction of Nur77 and nuclear factor of activated T cells (NFAT) transcription factors. These factors can be induced only by the TCR- $\alpha\beta$  and not by the pre-TCR. No ligand has yet been detected for the pre-TCR. However, the pTa possesses a palmitoyl moiety that spontaneously targets the pTa chain to the cell membrane (lipid rafts) (124). This may offset the requirements for a ligand because the pre-TCR from such a location is able to signal constitutively. Signaling through pre-TCR results in expression of certain transcription factors required for the differentiation of precursors to  $\alpha\beta$ -T cells, frequently referred to as  $\beta$  *selection*. Some of these factors are the E-proteins of the basic helix-loop-helix transcription activators required for expression of CD4, TCR- $\alpha$  and TCR- $\beta$  chains, and so forth (125).

### CD4/CD8 Lineage Commitment

The DP thymocyte (CD4<sup>+</sup>/CD8<sup>+</sup>) differentiates to two phenotypically and functionally distinct lineages of  $\alpha\beta$  T cells: CD4<sup>+</sup> and CD8<sup>+</sup>. The TCR of the CD4<sup>+</sup> cells interacts with peptides bound to class II MHC molecules, whereas the TCR of the CD8<sup>+</sup> cells recognizes peptide-class I MHC complexes. The CD4 and CD8 proteins are not clonally distributed and are known as *co-receptors* because they corecognize the same ligands as the TCR (126). The mechanism by which the separation of the lineages from DP thymocytes is achieved remains unresolved (127, 128).

According to one theory, known as *instructive*, thymocytes carrying an MHC class I-restricted TCR differentiate to CD8<sup>+</sup> lineage, whereas engagement of TCR with class II MHC induces commitment to CD4 (129) (Fig. 17.5). An alternative model, known as *stochastic*, accepts that the DP thymocytes are already committed randomly to a lineage; they make a choice that is unrelated to the MHC specificity of their TCR (129). Data collected from a variety of approaches do not agree with any particular mechanism in lineage commitment. Mice with a class I-specific TCR transgene support predominantly CD8 differentiation, whereas the class II-specific TCR transgene directs DP thymocytes to CD4 lineage (130). According to the instructive model, the CD4 or CD8 transduces differentiation-specific signals, but no lineage-specific signals have ever been identified.



**Figure 17.5.** CD4<sup>+</sup>/CD8<sup>+</sup> lineage commitment. Two mechanisms have been suggested for CD4/CD8 lineage commitment. According to the instructive model (A), the major histocompatibility complex (MHC) restriction of the T-cell receptor (TCR) determines the lineage commitment (i.e., a cell with an MHC I-restricted TCR becomes CD8<sup>+</sup>, whereas if the TCR is class II restricted, it becomes CD4<sup>+</sup>). The stochastic model (B) accepts that the double-positive thymocyte is already precommitted randomly to the lineage.

Other data indicate that the cytoplasmic region of CD4 directs CD4 lineage commitment (131). A chimeric construct, for example, made of the cytoplasmic region of CD4 and the extracellular and transmembrane region of CD8a, supported the development of cells with the CD4<sup>+</sup>/CD8a<sup>-</sup> phenotype with a class I-restricted TCR (132). CD4 is preferentially associated with its cytoplasmic tail with the tyrosine kinase Lck. Therefore, CD4 is likely to deliver stronger signals than the coengagement of TCR and CD8 (133, 134).

The *strength of signal model* suggests that strong signals induce CD4 differentiation, whereas weak signals (by the CD8a cytoplasmic tail) induce CD8. Another aspect of signaling that was evaluated was the duration of signals as an important parameter. Accordingly, TCR of a DP thymocyte initiates down-regulation of CD8 and produces a CD4<sup>+</sup>/CD8<sup>-</sup> intermediate cell. At this stage, the duration of signaling determines the final outcome. That is, short signaling produces CD8<sup>+</sup> T cells, whereas persistence of signaling in the CD4<sup>+</sup>/CD8<sup>-</sup> intermediate cell causes CD4<sup>+</sup> differentiation (135).

Variation of Lck function seems to be the single most important parameter in CD4/CD8 lineage decision. Constitutively active Lck promotes CD4 differentiation, even in the presence of class I MHC-restricted TCR. When, on the other hand, Lck is catalytically inactive, all thymocytes, including those with class II MHC-restricted TCR, become CD8<sup>+</sup> (136, 137). In the absence of Lck, cross-linking of CD3 induces CD8 differentiation (138). The Lck-dependent regulation of lineage commitment is not only phenotypic but also functional, because the class II MHC-restricted CD8<sup>+</sup> cells behave as killer cells, whereas the class I-restricted CD4<sup>+</sup> cells up-regulate CD40 ligand, a function characteristic of helper T cells (136). Signaling initiating from Lck is channelled through the Ras-Erk pathway (139).

The various experimental approaches used in these studies make it clear that the signals required for CD4 differentiation are promiscuous, which is believed to indicate that CD4 differentiation is a default pathway (140).

The multiplicity of the models entertained and the ambiguity of some of the results are

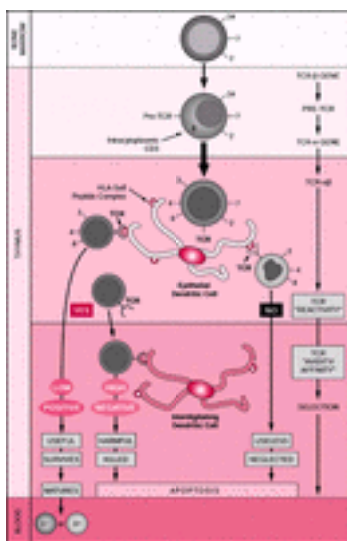
also a testimony that the precise mechanism of T-cell lineage commitment remains still elusive and certainly complex ( 128 , 141 ).

In summary, Lck is a key regulator, but other signals originating from the TCR in the absence of a co-receptor or in the absence of a significant recruitment of Lck provide sufficient Src activity for a response. Such signals depend on the nature of the peptides involved in positive versus negative selection, which is linked to lineage selection ( 138 ). Although the prevailing opinion accepts that lineage commitment and the selection of thymocytes with useful TCRs are linked, some of the models proposed point to the opposite ( 142 ).

### Positive and Negative Selection

The random nature of rearrangements of TCR genes generates specificities directed not only against foreign antigens but also against self-antigens. Self-reactive T cells are harmful if they have the opportunity of exiting the thymus. Mechanisms have therefore been developed that allow the thymus to “select the useful, neglect the useless and destroy the harmful” ( 143 ). The decision on which pathway each cell will ultimately follow is made by the TCR. The time for selection appears to begin at the DP stage when the TCR is expressed at low levels ( 144 , 145 , 146 and 147 ). The TCR of the thymocytes recognizes self-peptides presented by the MHC molecules. The nature of the criteria used by the TCR for directing individual DP thymocytes to three different fates has been, and still is, one of the most challenging questions in immunology.

It has been widely accepted that the options for each DP thymocyte are determined by some fine qualities and properties of the TCR and MHC-peptide (pMHC) ligand interaction. If the affinity of interaction is “weak,” the cell is positively selected, and if the binding is of high affinity, the cell is negatively selected ( 148 ). The term *avidity*, however, incorporates the affinity of the individual TCR, the level of occupancy of all TCRs, and, therefore, the receptor-ligand densities. Low avidity, therefore, triggers positive selection, and high avidity triggers negative selection ( Fig. 17.6 ).



**Figure 17.6.** T-cell repertoire selection. Functional T-cell differentiation and repertoire development can be distinguished in three steps. In the first step, the CD4<sup>-</sup>/CD8<sup>-</sup> or double-negative thymocyte initiates rearrangements of the T-cell receptor (TCR)-β gene



and forms the pre-TCR by associating the  $\beta$ -chain with another protein, called *pre- $\gamma$* . The pre-TCR controls the transition from the double-negative step to the double-positive step (coexpression of CD4 and CD8). The transition is characterized by rearrangements of the TCR- $\alpha$  gene and expression of the  $\alpha\beta$  TCR complex, as well as expression of the CD4 and CD8 co-receptors. The second critical step is the separation of thymocytes with a TCR reacting with a self-peptide-major histocompatibility complex (MHC) presented by cortical epithelial cells from those with a nonreactive TCR. The latter are ignored and die by apoptosis, whereas the former are subject to selection. In the third critical step, the thymocytes are selected for either survival (positive selection) or deletion (negative selection). The TCR complex controls this step, and thymocytes with high affinity for the self-peptide-MHC complex are killed by apoptosis because they probably contain the autoreactive clones. Thymocytes with low-affinity TCRs survive and further differentiate to the CD4<sup>+</sup> or CD8<sup>+</sup> T cells (single positives). Positive and negative selections are mediated by different cells: positive by cortical epithelial cells and negative by interdigitating dendritic cells (bone marrow derived). (From Paraskevas F. T lymphocytes. In: Israels LG, Israels ED, eds. Mechanisms in hematology. Core Health Services, Inc., 2001, with permission.)

Another proposal suggests that engagement of TCR with the ligand induces two distinct types of activation (*qualitative mode*). The positively selecting ligand induces one type of mechanism, whereas the negatively selecting ligand activates by both mechanisms ([149](#), [150](#) and [151](#)). In another version of the same theme, instead of *quality* of signal, we consider *quantity* or *intensity* of signaling. Positive selection represents a specialized or partial activation, whereas full activation (like that of a mature T cell) is lethal for that thymocyte. Cells with TCRs that cannot bind with sufficient avidity are neglected and die by apoptosis.

When the cell is positively selected, the expression of recombination-activating genes (RAG), which encode the proteins for V(D)J recombination, and the PT $\alpha$  gene are turned off, and the CD4 and CD8 are partially down-regulated. As the cell at this stage moves from the cortex to the medulla, one of the co-receptors is reexpressed and the cell lineage is defined ([139](#), [152](#)).

Just as for lineage differentiation, signaling for positive and negative selection largely depends on Lck, and in the absence of Lck, both selection mechanisms are compromised ([153](#)). Lck interacts with the co-receptors CD4 and CD8 through two cysteines in the cytoplasmic region of each co-receptor and two cysteines in Lck ([154](#)).

The binding of TCR to the ligand induces phosphorylation of the three immunoreceptor tyrosine-based activation motifs (ITAMs) of the  $\zeta$ -chain and the single ITAM in each of the CD3  $\epsilon$ -,  $\eta$ -, and  $\theta$ -chains. The  $\zeta$ -chain is constitutively associated in thymocytes with the ZAP-70 kinase, suggesting that a low level of activation takes place continuously ([155](#)). Receptor clustering from greater ligand engagement results in further phosphorylation and Lck involvement.

ZAP-70 is indispensable for positive and negative selection because both processes are abrogated in ZAP-70-deficient mice ([156](#)). The Src-like adaptor protein (SLAP) down-regulates the TCR expression during the DP stage of development and rescues T-cell development in the absence of ZAP-70. Overall, SLAP acts as a negative regulator and probably “marks” activated receptors for retention and degradation ([157](#)). The main downstream signaling pathway for positive selection is the Ras/map kinase (MAPK) cascade ([158](#)). TCR signaling alone is not sufficient to induce selection for survival or



death ( [159](#) ). CD2 expression exerts a strong influence on TCR repertoire. In the absence of CD2, the thymocytes with high affinity for peptide–MHC escape negative selection ( [160](#) ). CD2 also influences pre–TCR function in the usage of Va genes, which is substantially altered in CD2–deficient mice.

The co–stimulatory interaction of CD40/CD40L is a master regulator of negative selection, usually acting in the regulation of the ligands of other co–stimulatory molecules, such as CD80 and CD86 ( [161](#) ). CD40 may also induce other co–stimuli required for thymocyte deletion, such as CD54 (ICAM–1), FasL, or tumor necrosis factor (TNF) ( [162](#) , [163](#) and [164](#) ). These molecules could regulate negative selection separately or in combination with CD5 and CD28. The CD28 co–stimulatory molecule engaged with TCR signals thymocytes to undergo apoptosis or maturation, depending on the intensity of co–stimulation ( [165](#) ).

Stimulation of maturation of DP thymocytes follows activation of the extracellular signal–regulated kinase (ERK)/MAPK pathway and up–regulation of the antiapoptotic protein Bcl–2. Apoptosis is triggered with the expression of the Nur77 family of transcription factors and occurs only if TCR engagement is accompanied by co–stimulation. Ca<sup>2+</sup> fluxes in mature T lymphocytes regulate proliferation, differentiation, and survival. Some of the functions of Ca<sup>2+</sup> are mediated by the Ca<sup>2+</sup>–dependent phosphatase calcineurin. The function of calcineurin is disrupted by cyclosporin A and FK506. Both of these substances form complexes with cellular proteins, termed *immunophilins*, that bind and sequester calcineurin. Cyclosporin A and FK506 block the initial steps of positive selection ( [166](#) , [167](#) ). On the other hand, intracellular chelators reduce deletion ( [168](#) ), which suggests that interference of Ca<sup>2+</sup> fluxes and function exerts several effects on the selection process.

All signaling pathways end up targeting regulation of transcription factors, and various studies have examined the roles of NFAT and nuclear factor– $\kappa$ B (NF– $\kappa$ B), but only members of the Nur77 family have been clearly shown to be involved in the process of selection, with a major role in apoptosis of massive numbers of thymocytes ( [169](#) ). It has been estimated that 90 to 95% of thymocytes die inside the thymus, and the appearance of very large numbers of dead cells on histologic sections is the reason that histopathologists called the thymus the “graveyard” of T cells.

The timing of positive versus negative selection has been difficult to define. Negative selection was believed to occur relatively late because the TCR affinity increases with time, and it is the high affinity of TCR that triggers negative selection ( [148](#) ). However, with the progression of maturation, lineage commitment also takes place, and data have shown that CD4 or CD8 expression may not be an obligate requirement for negative selection and that negative selection can occur at the DP stage ( [170](#) ). Other evidence, however, suggests that negative selection occurs only after cells have been positively selected ( [171](#) ). It is probably difficult to pinpoint precisely the stage for negative selection because removal of autoreactive cells requires stringent criteria, which may be satisfied only in connection with not only the maturational stage but also with distinct microenvironmental conditions and special stromal cells.

## Cells and Molecules in the Selection of Thymocytes

The approach taken for identification of the cells that govern positive and negative selection was the construction of radiation–resistant chimeras. Hematopoietic components of the thymic stroma are radiosensitive, whereas the epithelial components

are radioresistant. These differences allowed the construction of chimeric thymuses (i.e., thymuses composed of epithelial and hematopoietic elements with a different MHC background). These experiments indicated that the thymic cortical epithelium is responsible for positive selection ( [172](#), [173](#), [174](#) and [175](#) ). The hematopoietic stromal cells, on the other hand, are potent inducers of negative selection ( [151](#), [176](#) ). Other data make the separation between distinct cell types for each of the two selection processes less sharp ( [177](#) ). Because the cortical epithelial cells have weak MHC expression and the developing DP thymocytes at that stage have low TCR expression, the interactions are only of low avidity, which is required by positive but not by negative selection. Similarly, the hematopoietic cells in the corticomedullary junction express MHC molecules at higher density, and the T cells have up-regulated their TCRs. As a result, the interactions in this anatomic location are appropriate for negative selection.

The mobility of the developing thymocyte from cortex to the medulla during this period accommodates the functional needs of these two processes by discrete microenvironmental regions. By experiments *in vitro*, it has been concluded that different cell types may mediate positive and negative selection, but conditions may not be the same in unmanipulated thymuses.

In conclusion, the anatomic constraints rather than the functional capacities of various cells could explain the observation that positive selection occurs predominantly on cortical epithelial cells and negative selection on medullary hematopoietic stromal cells.

The ligands for positive and negative selection are self-peptides bound to MHC molecules ( [177a](#), [178](#) ). A thymocyte bearing a TCR specific for class I-peptide complex is positively selected if the peptide it carries is in a low concentration and is killed if the peptide concentration is high ( [179](#), [180](#) ). However, the weak interactions required for positive selection and the strong interactions operating in negative selection can also be provided by the half-life of the pMHC complex (i.e., short half-life for positive and long half-life for negative selection).

The original question of affinity versus concentration was better answered with manipulation of the pMHC. Positive selection is driven by peptides with varying affinities; however, by increasing the concentration of the peptide, even low-affinity ligands can positively select ( [181](#) ).

Another important question regarding selection in the thymus relates to the specificity of the ligands and the selected TCRs. The T lymphocytes exiting the thymus express a highly diverse repertoire of specificities to effectively respond to the universe of microbial peptides ( [182](#) ). It is, however, unlikely that the positive selection of every CD8<sup>+</sup> T cell relies on the recognition of a unique self-peptide during thymic development. This is because the diversity of self-peptides expressed on thymic stromal cells would not be sufficiently large to select a repertoire of T cells that can respond to all existing foreign peptides. Therefore, it has been argued that the recognition of self-peptides in positive selection must be relatively degenerate. In other words, a single pMHC can trigger the positive selection of multiple thymocytes ( [183](#) ); therefore, the peptide recognition during positive selection is cross-reactive ( [184](#) ). This apparent degeneracy of the peptide binding to TCR is the result of a significant contribution to the binding by the MHC molecule. It is well known that an unusually large number of T cells (approximately 1%) react against allogeneic MHC ( [185](#) ). Therefore, the MHC contributes to the specificity of the selected TCRs ( [186](#) ).

Other parameters of a pMHC complex, such as the conformation ( [187](#) ) and the

concentration ( [188](#) ) of the peptide, contribute to the repertoire selection. Despite the evidence that each pMHC complex selects more than one TCR, the large diversity of the fully developed T-cell repertoire depends on a large number of pMHC ( [189](#) ) as well as on the quantity and quality of the stromal cells ( [190](#) ). Peptide diversity during the selection seems to have a greater effect on negative than on positive selection. In thymus organ cultures, the epithelial (positive selection) and bone marrow dendritic cells (negative selection) could be regulated. In testing with a diverse array of peptides, the addition of 1% of dendritic cells reduced the number of CD4<sup>+</sup> T cells selected by 80% compared to that of the controls in the absence of dendritic cells. Thus, the quantity and quality of the selecting stromal cells have a significant impact on the selected repertoire by multiple peptides ( [190](#) ).

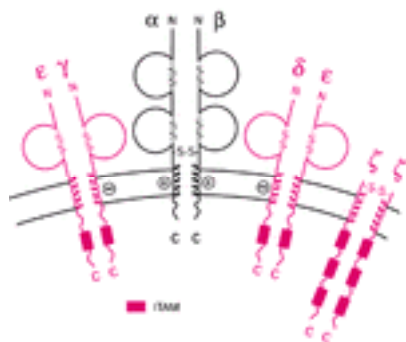
At the end of the selection process, mature T lymphocytes exit the thymus and home to the secondary lymphoid organs (see [Chapter 15](#)). There are two types of TCR- $\alpha\beta$  T cells, the CD4<sup>+</sup> (T helper cell) and the CD8<sup>+</sup> (cytotoxic T cell), and one TCR- $\gamma\delta$  cell.

## $\alpha/\beta$ T-CELL RECEPTOR COMPLEX

The TCR complex is composed of two components: One component is unique in each T cell and is involved in antigen recognition (ligand binding), and the second component is the same in all T cells and is involved in signal transduction leading to T-cell activation ( [191](#), [192](#) and [193](#) ).

### Ligand-Binding Component: $\alpha\beta$ and Peptide-Major Histocompatibility Complex Interaction

The  $\alpha\beta$  receptor is formed by two chains,  $\alpha$  and  $\beta$  ( [Fig. 17.7](#) ). Each chain consists of a constant domain, C $\alpha$  and C $\beta$ , and a variable domain, V $\alpha$  and V $\beta$ . The V $\alpha$  domain is encoded by two genes, V $\alpha$  and J $\alpha$ , and is homologous to the V domain of the Ig heavy chain. The V $\beta$  domain is formed by three polypeptides, V $\beta$ , D, and J $\beta$ . The constant domains correspond to the IgC-domains, but there are certain differences. The C $\alpha$ -C $\beta$  interface is highly polar, whereas that of C<sub>L</sub>-C<sub>H1</sub> is hydrophobic. C $\beta$  has a large loop, which extends out to the side of the domain. It has been proposed that it may interact with the co-receptors. The C $\alpha$  domain has several structural deviations from the C-type Ig domain.



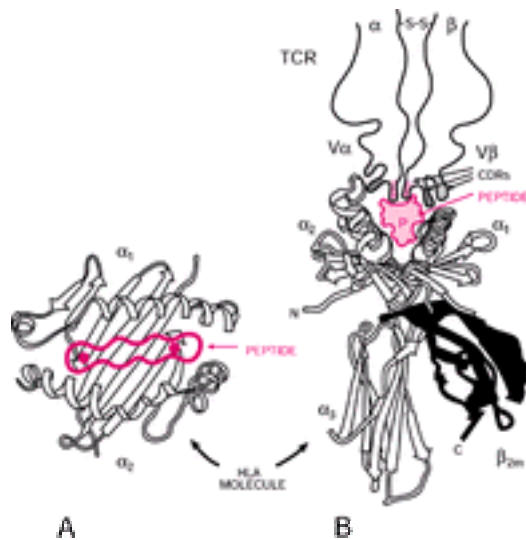
**Figure 17.7.** T-cell receptor complex. The T-cell receptor complex consists of two components: ligand binding (antigen recognition) and signal transduction. The antigen recognition component consists of two polypeptide chains,  $\alpha$  and  $\beta$ . Because of their short intracytoplasmic tails, they cannot link themselves to the signal transduction

cascade. The signal transduction component consists of the CD3 proteins:  $\zeta$ ,  $\eta$ , and  $\epsilon$ , members of the immunoglobulin superfamily, and two other proteins forming either a homodimer (two  $\xi$  proteins) or a heterodimer ( $\xi$ - $\xi$ ). The  $\zeta$ -,  $\eta$ -, and  $\epsilon$ -chains have one immunoreceptor tyrosine-based activation motif each, and the  $\xi$ -chain has three. See text for details.

The V domains are highly similar to the V domains of an antibody molecule. They contribute to the formation of the TCR-combining site, which is made up of hypervariable loops or complementarity-determining regions (CDRs) 1, 2, and 3 from the  $\alpha$ - and  $\beta$ -chains and another loop termed *HV4*, which exhibits some hypervariability. The CDR1 and CDR2 are formed by the V segments, which are less polymorphic in the TCR than in Ig because fewer V segments are available for TCR, whereas the CDR3 is polymorphic as a result of the larger number of J segments available for  $\beta$ -chain contributing to CDR3.

The loops of  $V\beta$  that form the expected antigen-binding site of the TCR are similarly placed as in the Ig V region. The chains are linked by a disulfide bond, and the heterodimer is anchored to the cell membrane by the transmembrane region, ending in the cytoplasm by a short (three- to five-amino acid) cytoplasmic tail. Crystallization of the TCR shows that it resembles the Fab fragment of the Ig molecule ( [193](#) ). However, the TCR- $\alpha\beta$  is extensively glycosylated with up to seven N-linked sites distributed between the  $\alpha$ - and  $\beta$ -chains. The combining site is usually flat, similar to antiprotein antibodies and consistent with the TCR's function of binding to the generally flat, undulating surface of the pMHC ( [194](#) ). The diversity of the CDR3s is much higher, implying that the function of CDR3s is in peptide discrimination, whereas CDRs 1 and 2 interact with more conserved structural elements of the MHC. The TCRs contain many more J segments and thus are able to increase V-J $\alpha$  and V-D-J $\beta$  junctional diversity in the CDR3s ( [195](#) ). The residues of the TCR that contact the pMHC are always in the apices of the CDRs (i.e., for CDR1 $\alpha$ , residues 27 to 30; for CDR2 $\alpha$ , residues 50 to 52; for CDR1 $\beta$ , residues 27 to 30; and for CDR2 $\beta$ , residues 52 and 53).

The TCR interacts with peptides bound to MHC molecules ( [Fig. 17.8](#) ). The aminoterminal domains,  $a_1$  and  $a_2$  of the MHC class I heavy chain, form the binding site for the peptide. The site consists of a floor of eight strands of antiparallel  $\beta$ -pleated sheets, which support two  $\alpha$  helices, one contributed by the  $a_1$  domain and the other by the  $a_2$  domain aligned in an antiparallel orientation. The floor of the groove is supported by two Ig domains from below; one is the  $a_3$  domain of the heavy chain and the other the  $\beta_2$ -microglobulin. This arrangement forms a groove, on the floor of which lies the peptide from an antigen to be presented to the TCR. Some of the residues of the peptide are exposed above the groove and interact directly with the TCR, whereas others point to the floor of the groove. Depressions in the floor of the groove, known as *pockets A through F*, interact with some side-chains of the bound peptide ( [196](#) ).



**Figure 17.8.** T-cell receptor (TCR) interaction with HLA/peptide complex.

Crystallographic studies of the HLA class I molecule have shown that the two variable domains ( $\alpha_1$  and  $\alpha_2$ ) form a groove that binds the peptide that is released as a result of antigen processing. The peptide groove is formed by the helices of the  $\alpha_1$  and  $\alpha_2$  domains (A). Binding of the peptide is mediated through anchor amino acids near both ends of the peptide (in A). The TCR binds to both the major histocompatibility complex molecule and the peptide. The complementarity-determining region (CDR) 3 of both the  $\alpha$ - and  $\beta$ -chains interacts with amino acids of the peptide, whereas the CDR1 and CDR2 interact with the major histocompatibility complex molecule (B).

For HLA-B27, the side-chain of the C-terminal of the bound peptide sits deep in the F-pocket, whereas the N-terminal forms strong hydrogen bonds with the hydroxyl groups of conserved amino acids at the end of the groove (197). (For details of interaction with the pMHC, see Chapter 18.)

For crystallization of TCR-pMHC, the peptide was attached covalently through a linker to the amino terminus of the  $\beta$ -chain of an MHC class II molecule (198) or covalently connected to the amino terminus of the  $\beta$ -chain of the TCR (199) and thus tethered to the MHC groove. Such approaches provided stable complexes of HLA-DR1 and HLA-DR4 that permitted their crystallization. TCR extracellular domains were produced in *Escherichia coli*. Several TCR-pMHC have been analyzed to clarify the contributions of Va for the buried surface area (i.e., the interface between TCR and the pMHC). The buried surface area varies extensively (1239 Å<sup>2</sup> to 1931 Å<sup>2</sup>). The contribution of Va is on the average 57% and that of the Vb 43%, but individual chain contributions vary between complexes (200). The overall orientation of the TCR over the pMHC is diagonal (201, 202) rather than orthogonal (203). It is more likely that the TCR twists over the MHC molecule by approximately 35 degrees and varies also in its roll (range, 19 degrees) and tilt (range, 30 degrees) (204, 205).

The interactions that position the TCR in a diagonal orientation also place the CDR1 and CDR2 loops over the  $\alpha_1/\alpha_2$  or  $\alpha_1/\beta_1$  helices for the MHC class I and class II molecules, respectively. The Va domain is critical in setting up these orientations and the read-out of the peptide sequence. Thus, the CDR1 and CDR2 interactions of Va are conservative (192) and provide the basic affinity of the TCR, whereas the CDR3 loop is positioned to primarily contact the peptide in the peptide-binding groove and the Vb interaction is more variable in the C-terminal half of the peptide. The contribution of the individual CDR loops

to the interaction varies. CDRs 1 $\beta$  and 2 $\beta$  actually contribute little or nothing to the interaction in those studied. In general, the CDR3 loops are centrally located and usually dominate the interactions ( [200](#) ).

The contributions of the peptide to the interactions with the TCR also vary. Usually, approximately two to five side-chains of the peptide make direct contact with the TCR. These contact points, known as *hot spots*, are peptide residues that bulge out of the groove, and this bulging is more prominent in MHC class I and is sometimes profound ( [206](#) ). Such extensive bulges need to be accommodated in the TCR-MHC interface. Ridges in the MHC molecule sometimes force the peptides to bulge high out of the groove, and these residues of the peptide provide intimate contact with the TCR ( [207](#), [208](#) ). For MHC class I, the hot spots are predominantly residues P<sub>5</sub>, P<sub>7</sub>, and P<sub>8</sub> for nonamer peptides and P<sub>4</sub>, P<sub>6</sub>, and P<sub>7</sub> for octamer peptides. In MHC class II-TCR interactions, the contributions of the side-chains of the peptide are more uniformly dispersed (P<sub>1</sub>, P<sub>2</sub>, P<sub>3</sub>, P<sub>5</sub>, P<sub>8</sub>), and the peptides are slightly deeper in the MHC binding groove ( [206](#) ).

No single contact dominates the TCR-pMHC interactions, as is often observed in the antigen-antibody interactions. A small number of amino acids dominate the energy landscape in antigen-antibody interaction, as shown by somatic mutations that result in higher affinity binding ( [209](#) ).

In the case of TCR, any change of the affinity or even prolongation of interaction, which may happen in the thymus during selection, results in negative selection. Based on these considerations, it appears likely that the CDR1 and CDR2 loops interacting with the helices of the MHC are responsible for positive selection, whereas the CDR3 loops probably play a more important role in negative selection. As an extension of these considerations in delineating the roles of V region loops of the TCR, the CDR1 and CDR2 loops provide the basic affinity in the interaction, whereas the CDR3 provides the specificity ( [200](#) ). The residues of the peptide that protrude highest from the groove provide the basis for discrimination of peptide and for altering affinity or half-life of the TCR-pMHC interaction.

An important point that came out of these crystallographic studies is the role of the water that fills the TCR-pMHC interfaces. This water provides additional complementarity by filling the cavities in the interface, and some of these molecules mediate contact between TCR and pMHC ( [210](#), [211](#) ).

Overall, the consistent feature of TCR-pMHC interaction is that the peptide contributes a smaller portion of the binding interface (21 to 34%) and a smaller proportion of contacts (26 to 47%) than the MHC. The central positions of the peptide play the critical role, and those define the peptides as agonists, partial agonists, and antagonists ( [212](#), [213](#) ). The binding of TCR to the pMHC results in T-cell activation. Usually, there is a broad correlation between affinity, half-life, and the functional outcomes ( [214](#), [215](#) ). Mutational analysis of the role of the centrally located residues indicates that in some systems, the biologic activity increases ( [216](#) ), yet in others, the peptide is converted from an agonist to an antagonist ( [217](#) ); nevertheless, the affinities of the pMHC for TCR change only marginally.

Contacts on certain hot spots are very sensitive in changing the functional read-out but are not based on changes in the affinity of binding or half-life differences in the TCR-pMHC complexes ( [218](#) ). It has been argued that affinities usually have been measured in isolated TCR-pMHC complexes, and true affinity measurements may require



the presence of co-receptors and signaling components and need to be measured with cellular assays ( [217](#) ).

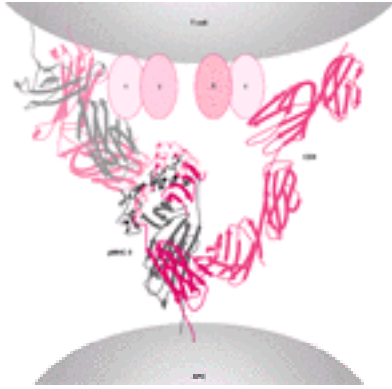
Because changes in the TCR-pMHC complementarity interface are important for triggering biologic reactions, the conformational changes that have been observed in the TCR-complex crystal structures have been considered for initiation of signaling, but their role is not clear ( [219](#) ). Conformational changes contribute to an increase in the binding of a number of other peptides (i.e., an expansion of the repertoire) ( [220](#) ).

### Co-Receptors in Peptide-Major Histocompatibility Complex Interaction

The TCR is not alone in its interaction with the pMHC but is associated with co-receptors (i.e., CD4, CD8, and the CD3  $\zeta$ -,  $\eta$ -,  $\epsilon$ -, and  $\gamma$ -chains, together with the  $\alpha\beta$  heterodimer, form the TCR complex. The CD4 or CD8 acts as assistant to the TCRs of the helper or cytotoxic function of the cells, respectively. Therefore, they have been known as *co-receptors* ( [126](#), [221](#) ). In the current model, the CD4 binds to the same MHC II as the TCR of the CD4<sup>+</sup> T cell, and similarly, the CD8 binds to the same MHC I as the TCR of the CD8<sup>+</sup> T cell. The binding of the co-receptors occurs with another site of the MHC molecule than that involved in the TCR binding. The TCR binds to pMHC surface at an angle between 45 and 80 degrees relative to the axis of the two  $\alpha$  helices of MHC ( [222](#) ), which excludes the possibility for direct association of the co-receptors with the TCR that binds the same pMHC. One possibility is that the co-receptors could be linked with TCR in the cytoplasm through signaling molecules (i.e., ZAP-70 and Lck) ( [223](#), [224](#) ). Another possibility is that the co-receptor associated with a TCR binds to a different pMHC to which a second TCR binds, forming a *pseudodimer* ( [225](#) ).

The CD8 acts as a dimer that includes either two  $\alpha$ -chains or one  $\alpha$ - and one  $\beta$ -chain, whereas CD4 is a monomer with four Ig-like domains (see [Chapter 2](#)). Both CD8 chains consist of an Ig-like V domain and a long mucinlike stalk. The Ig-like domain binds to the  $\alpha_3$  domain of MHC ( [226](#) ), forming also some hydrogen bonds with the  $\alpha_2$  domain and the  $\beta_{2M}$ -chain, away from the peptide interface. In CD4, only the fourth Ig-like domain binds directly to pMHC. The ternary complex (TCR-pMHC-CD4/CD8) within the T cell-antigen-presenting cell (APC) interface of the immunologic synapse has a V shape ( [227](#) ) ( [Fig. 17.9](#) ). Although the CD8a stalk is longer than the CD8 $\beta$ -chain, even in its full extension, it reaches only 50 to 60 Å, which is not long enough to traverse the distance of approximately 100 Å to the TCR-pMHC complex. As a result, the TCR-pMHC has to tilt for the CD8 to reach the MHC. The stalk of the CD8-chains is heavily glycosylated, and changes in glycosylation (which occurs after T-cell activation) result in a decrease of binding to MHC ( [228](#) ).





**Figure 17.9.** T-cell receptor (TCR)–major histocompatibility complex (MHC)–co-receptors interaction. The CD4 and CD8 are co-receptors of the TCR [i.e., “assistants” in the interaction of TCR with peptide–MHC complex (pMHC)]. In this function, the  $N$ -terminal domain of CD4 (D1) makes contact with the  $\alpha_2$  and  $\beta_2$  domains of MHC II. In the CD8, the CD8a subunit of the CD8a $\beta$  heterodimer contributes the binding energy, interacting with both the  $\alpha_2$  and  $\alpha_3$  domains of pMHC I, and CD8 $\beta$  binds only to  $\alpha_3$ . Therefore, both co-receptors recognize different sites of MHC from the TCR. The length of each receptor is not long enough to reach the MHC binding site, traversing alongside the TCR–MHC complex. It is proposed that TCR–MHC has to tilt for the co-receptor to reach the MHC, forming a V-shaped ternary complex. The CD3 components of the TCR ( $\zeta$ ,  $\eta$ , e) probably are located inside the V-shaped structure. APC, T cell–antigen-presenting cell. (Courtesy of Dr. G.F. Gao.)

The co-receptors enhance TCR signaling by strengthening the stability of the TCR–pMHC complex ( [229](#), [230](#) ). The V-shaped ternary complex accepts that the co-receptors bind to the same pMHC as the TCR ( [227](#) ), whereas the CD3 components probably lie inside the “open angle” of the V-shaped structure ( [Fig. 17.9](#) ). Such an arrangement makes possible the association of signaling molecules, such as ZAP–70, Lck, and Src kinases, with CD4 and CD8. With this topologic model, direct interaction of the co-receptors with TCR is not likely as was previously indicated ( [231](#) ).

The CD2 binds to CD58 (LFA–3) in humans and to CD48 in rats. Interaction is based on electrostatic complementarity, with the CD2 surface heavily populated by basic residues, whereas the CD58 is acidic. The interactions span approximately 134 Å—very similar to that of TCR–pMHC. Therefore, the CD2/CD58 interaction in the contact zone between T cell and the APC would facilitate the scanning of pMHC by TCR ( [232](#) ). CD2 lowers thresholds for TCR triggering *in vitro* and T-cell activation *in vivo* ( [233](#) ).

CD28 and CTLA–4 (CD152) are type I membrane proteins consisting of one moderately to heavily glycosylated V Ig-like domain. They are expressed as disulfide-linked homodimers. Their counterreceptors B7–1 (CD80) and B7–2 (CD86) consist of two Ig-like domains, a membrane-proximal C2 type, and a membrane-distal V-type. B7–2 binds CD28 more effectively than CTLA–4 and, as a result, enhances co-stimulatory effects when CD28 and CTLA–4 are coexpressed.

In contrast, B7–1 binds preferentially CTLA–4, and its inhibitory effect would not be affected in the presence of CD28. Delayed expression of B7–1 on APCs appears to be timed to enhance the inhibitory function of CTLA–4. The CTLA–4 periodic arrays of crystal lattices enhance the avidity of interaction, whereas the CD28/B7–2 interaction does not have this potential. As a result, during an immune response, the CD28/B7–2-activating complexes are 10,000-fold less stable than the inhibitory

complexes formed later by CTLA-4/B7-1 ( [234](#) ).

### Signal-Transducing Component of T-Cell Receptor Complex

The TCR- $\alpha\beta$  is accompanied by five other polypeptide chains, collectively known as *CD3 proteins*:  $\zeta$ ,  $\eta$ ,  $\epsilon$ ,  $\delta$ , and  $\gamma$ . They form disulfide-linked heterodimers  $\delta\epsilon$ ,  $\eta\zeta$ , or a homodimer,  $\gamma\gamma$  ( [235](#), [236](#) ) ( [Fig. 17.7](#) ). The  $\zeta$ ,  $\eta$ , and  $\epsilon$  proteins show a significant degree of similarity to one another. The  $\zeta$ ,  $\eta$ , and  $\epsilon$  proteins consist of an Ig-like domain similar to the C domain with an intra-chain disulfide bond. The extracellular region of the  $\zeta$ -chain is only nine amino acids long and contains the only cysteine of the molecule, which forms the disulfide bond with the other chain or with an  $\eta$ -chain. In the transmembrane region, the  $\zeta$ ,  $\eta$ , and  $\epsilon$  proteins have a negatively charged amino acid complementary to a positively charged amino acid of the transmembrane region of the TCR- $\alpha\beta$  chains. The cytoplasmic regions of  $\zeta$ -,  $\eta$ -, and  $\epsilon$ -chains are long, ranging from 40 to 80 amino acids, whereas that of the  $\delta$ -chain is even longer with 113 amino acids. The  $\gamma$ -chain is a splice variant of the  $\delta$ -chain and, as a heterodimer with the  $\delta$ -chain, exists only in a small number of T cells.

The CD3 proteins have a dual mission in the function of the TCR: escort the receptor to the cell membrane and mediate the signals generated by the TCR-pMHC complex. The complex is assembled in the endoplasmic reticulum, transported to the Golgi apparatus, and then transferred to the plasma membrane. The amount of the  $\zeta$ -chain is rate limiting because it is synthesized at only 10% of the level of the other chains. This results in the degradation of a vast majority of the newly synthesized  $\alpha$ ,  $\beta$ , or CD3 components within 4 hours of their synthesis ( [237](#) ). The remaining undegraded chains are long-lived and form complete TCR-CD3 complexes with the limiting  $\zeta$ -chain. The TCR-CD3 complex lacking the  $\zeta$ -chain migrates through the endoplasmic reticulum and Golgi intact and then is transported to the lysosomes where it is degraded. A lysosome-targeting motif has been identified in the  $\zeta$ - and  $\delta$ -chains and consists of a dileucine-based motif (DKQTLL) and tyrosine-based motif ( [238](#) ) in the carboxyterminal region. In the completed complex, the TCR  $\alpha$ -chain pairs with CD3  $\zeta$ - and  $\epsilon$ -chains, and the TCR  $\beta$ -chain pairs with CD3  $\delta$  and  $\epsilon$ . The  $\zeta$ -chain joins the TCR and the CD3 chains in the last stage of the assembly. The topology of the TCR-CD3 complex is shown in [Figure 17.6](#). Two TCR  $\alpha\beta$  heterodimers are associated with one each of  $\delta\epsilon$  and  $\eta\zeta$  heterodimers and one  $\gamma\gamma$  homodimer. The signal transduction function of the CD3 proteins is based on the presence of one ITAM in each of the  $\zeta$ ,  $\eta$ , and  $\epsilon$  proteins and three in the  $\delta$ -chain. An ITAM consists of two YXXY/L sequences separated by six to eight amino acids (in the one letter code for amino acids: Y, tyrosine; L, leucine; and X, any amino acid) ( [239](#) ).

Phosphorylation of the tyrosines turns the ITAM motifs into docking sites for protein tyrosine kinases, which bind to the ITAM through their SH<sub>2</sub> domain (see below). An important protein tyrosine kinase in T-cell activation, the ZAP-70, is recruited to the  $\zeta$ -chain ITAM motifs. The multiplicity of ITAM motifs in the cytoplasmic tails of the CD3 proteins results in signal amplification and increases the sensitivity of the TCR to ligand stimulation. Triplication of a single ITAM motif significantly enhances Ca<sup>2+</sup> mobilization, association with ZAP-70, and transcriptional activity in the NFAT complex involved in IL-2 gene regulation ( [240](#) ). Cross-linking of a single isolated ITAM results in approximately threefold induction in NFAT-regulated activity, and cross-linking of a triplicated motif results in approximately eightfold increase in NFAT-regulated activity (i.e., comparable to the intact  $\zeta$ -chain).

### Co-Receptors to T-Cell Receptor: CD4 and CD8

**CD4** CD4 is the characteristic marker of  $\alpha\beta$  T cells with helper activity and cytokine

secretion. The molecule consists of four Ig-like domains, with domains D1 and D3 similar to a V domain, and D2 and D4 similar to C domains (C-2 type) with patches of sequences similar to V domain. In D1 and D3, the nine  $\beta$  strands form two  $\beta$  sheets (ABED and GFCC'?). The D1 shares all the features conserved and characteristic of the V antibody domain. In the D3, the intersheet disulfide bond as well as the salt bridge are absent. As a result, the two sheets move apart and "slide" relative to each other. D2 also has no intersheet disulfide bond. The domains are linearly arranged, forming a rod with limited flexibility between the domains ( [241](#), [242](#) ). The binding of CD4 to MHC II molecules and to HIVgp120-envelop protein was studied by mutational analysis. The binding is mediated by a sequence of two  $\beta$  strands, C'C', within the D1 domain that form a ridge (residues 35 to 46) ( [243](#) ). Phe43 within this sequence is critical for binding to gp120, as well as for CD4 co-receptor function ( [244](#) ) because it provides the major binding energy, whereas the surrounding charged amino acids facilitate specificity ( [245](#) ). Crystal structure of the D1/D2 domains from CD4 complexed with class II molecule shows that the CD4 N-terminal V domain is directed and reaching into the two membrane-proximal domains of MHC II molecule ( [246](#) ). Both TCR and CD4 are tilted rather than oriented vertically, forming a V-shaped CD4-pMHCII-TCR ternary complex ( [Fig. 17.9](#) ). In this complex, the antigen-binding groove of pMHC II is no longer parallel to the cell surface but makes an approximately 45-degree angle with the membrane. However, despite the V shape of the ternary complex, the membrane-proximal domains of each of the components are all roughly vertical, including domain 4 of CD4 and the  $\alpha_2$  and  $\beta_2$  domains of pMHC II as well as the C $\beta$  domain of TCR. Only the C $\alpha$  domain of TCR hangs almost parallel above the membrane with its lengthy stalk bridging the space. The extracellular fragment of CD4 crystallizes as a dimer associated via the D4 domains ( [247](#) ). Oligomers of CD4 have been extracted from isolated lymphocytes ( [248](#) ). The CD4 dimers are associated with superdimers or dimers of dimers of the MHC II molecules ( [249](#) ). Each CD4 molecule interacts with one dimer of MHC II. Amino acid substitutions in the faces of the MHC II molecules that participate in the formation of the superdimers block activation of CD4<sup>+</sup> T cells, implying that superdimer formation is a prerequisite for T-cell activation ( [249](#) ). Stable binding to MHC II requires oligomerization of CD4, and this is facilitated by the D3/D4 domains. Collectively, data gathered from a variety of approaches suggest that CD4 oligomerizes once it binds to one MHC II molecule, forming tetramers or even larger oligomers and cross-linked lattices ( [250](#) ). In this process, CD4 oligomerization is influenced not only by MHC II but also by the TCR. When CD4 and TCR co-localize to interact with the same pMHC II molecule, the CD4 brings p56<sup>lck</sup>, which is associated with its short cytoplasmic tail, to the site of immune recognition. This may constitute one of the main contributions of CD4 to TCR signaling ( [251](#) ).

**CD8** CD8 consists of an Ig-like ectodomain, a membrane-proximal stalk (or hinge) region, a transmembrane region, and a cytoplasmic region. The Ig-like domain is involved in the binding to MHC, as shown by crystallographic evidence ( [252](#) ) and mutational analysis ( [253](#) ). The CDR loops of the A and B strands of the CD8 $\alpha\alpha$  molecule contact the  $\alpha_2$ ,  $\alpha_3$ , and  $\beta_2$ M domains of MHC I ( [254](#) ). The  $\beta$  subunit of the CD8 interacts only with the  $\alpha_3$  domain, whereas the  $\alpha$  subunit interacts with the  $\alpha_2$  and  $\alpha_3$  domains ( [255](#) ). In these interactions, the  $\alpha_3$  domain is shifted to better accommodate the CD8 binding ( [256](#) ). Multiple contacts between the co-receptor and MHC I promote the functional contributions of the co-receptor to T-cell activation ( [257](#) ). CD8 enhances cytotoxic T lymphocyte (CTL) activation by enhancing the stability of interaction between the APC and the T cell ( [258](#) ). In addition, the  $\alpha$ -chain of the CD8 is associated with the p56<sup>lck</sup>, which is brought closer to the ZAP-70 kinase associated with the TCR, a role that has also been assigned to the CD4 co-receptor. The contributions, therefore, of both co-receptors in ligand recognition and enhancement of TCR signaling are multiple and involve facilitation of TCR clustering, stabilization of the TCR-pMHC complex, and

promotion of signaling by bringing together signaling molecules attached separately on the cytoplasmic tails of the TCR and co-receptors ( [259](#) ). The availability of pMHC tetramers has encouraged studies on the function of CD4 and CD8 co-receptors in TCR binding to pMHC. The CD4 is critical for signal transduction with pMHC tetramers ( [260](#) , [261](#) and [262](#) ), but the CD8 co-receptor also contributes to the initial phase of interaction (binding), the duration of interaction (stability), and the delivery of signal transduction ( [263](#) , [264](#) ). The final result of CD8 function depends on the epitope of CD8 involved in the interactions, which are more pronounced with low-affinity ligands ( [264](#) ). Blockade of CD8 $\beta$  may affect TCR-CD8 rather than CD8-MHC interaction. The CD8 $\beta$  is more efficient than CD8 $\alpha$  at association with the TCR ( [265](#) ). An important new function of the co-receptors in TCR-mediated activation is the demonstration that CD4 and CD8 associate with LAT (linker for activation of T cells), a 36- to 38-kd membrane-associated adaptor protein that plays a central role in TCR signaling ( [266](#) , [267](#) ). As a result of LAT association with surface co-receptors and the coengagement of the TCR with the co-receptors, LAT is phosphorylated and recruits downstream signaling molecules ( [268](#) ). In conclusion, the contribution of the co-receptors in TCR signaling results from (a) the physical approximation of the Lck, which is associated with the co-receptors; (b) phosphorylation of the ITAMs of the CD3 chains of TCR; (c) recruitment of ZAP-70; and (d) phosphorylation of LAT, also associated with the co-receptors. Individual TCR molecules are probably associated with either Lck or with LAT ( [268](#) ).

## T-CELL ACTIVATION

### Topology of Immune Recognition

The  $\alpha\beta$ -TCR recognizes short peptides (i.e., eight to ten residues long) for class I-restricted TCRs or 13 to 25 amino acids for class II-restricted TCRs. However, only approximately nine amino acids contact the TCR. The peptide is held by the MHC molecule embedded in a groove formed by the  $\alpha_1$ - $\alpha_2$  domains of MHC I or by the  $\alpha_1$ - $\beta_1$  domains of the MHC II (see [Chapter 18](#)). Interaction of TCRs initiates signal transduction leading to transcription of genes encoding cytokines in CD4<sup>+</sup> T cells or assembling and mobilizing the lytic machinery in CD8<sup>+</sup> T cells for killing cells infected by viruses, transformed to a malignant state, or being “strangers,” such as in transplanted tissues. The crystal structure of  $\alpha\beta$ -TCR has been solved and, for several of them, in complex with their cognate pMHC ligand ( [257](#) , [269](#) , [270](#) , [271](#) , [272](#) and [273](#) ). The data support the docking model of the TCR ligand interaction, in which the TCR approaches the peptide held on an MHC platform. In this model, the Va domain of the TCR is closest to the N-terminal residues of the peptide, whereas the V $\beta$  domain of the TCR is closest to the C-terminal end of the peptide. In this orientation, the TCR V $\beta$  domain contacts the MHC I  $\alpha_1$  domain, whereas the TCR Va domain interacts with the  $\alpha_2$  of MHC I. The TCR orientation relative to the long axis of the MHC platform varies between 45 and 80 degrees (i.e., the angle formed between a line passing through the centers of the Va and V $\beta$  domains of the TCR and a second line defined by the peptide on the MHC platform) ( [274](#) ). The peptides in all MHC I structures have their N- and C-termini anchored into two fixed pockets approximately 20 Å apart in the MHC I platform. Longer peptides usually bulge in the center. In MHC II, the peptides assume an extended conformation, and the middle portion is smooth and concaves away from the TCR. Residues 1 and 5 of the peptide (p-1, p-5) in MHC II point toward the TCR and are critical in TCR recognition. The co-receptors bind to the same pMHC ligand as the TCR, but the binding of the co-receptor is independent of the TCR binding and is severalfold weaker ( [251](#) , [275](#) ).

The TCR, the pMHC, and the co-receptor form a ternary complex that assumes a V

shape with the pMHC II at the apex and the TCR and CD4 as the two arms.

Overall, the data from crystallized complexes of TCR with pMHC suggest that TCR docking on the MHC platform involves residues that are conserved within the CDR1 and CDR2 of the TCR and provide basal level of stabilizing energy in the formation of the complex ( [276](#) ). Variations within the CDR3a and CDR3b loops affect the way the TCRs footprint on the pMHC surface.

### The Gathering Storm: Lipid Rafts and the Immunologic Synapse

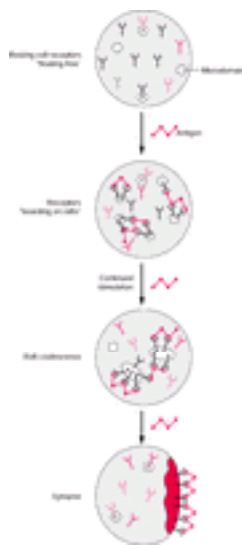
A model for T-cell activation proposes that a naïve or resting T cell needs to cross several stages to achieve full activation ( [277](#) ). During the first stage, which lasts a few seconds, contacts need to be established by adhesion molecules that overcome charge repulsions between cells. In the next stage, active cytoskeletal rearrangements bring together accessory molecules and the TCR and concomitantly exclude unligated molecules, such as CD45 (a protein tyrosine phosphatase) as well as CD43. CD43 is a highly glycosylated protein with strong repulsive forces forming a thick glycocalyx “cloud” approximately 45 nm thick around the cells. Because the distance spanned by the TCR–MHC complex is a mere 15 nm, for TCR to sample the pMHC ligand, clearing the area of contact between TCR and MHC from the interfering tall molecules, like CD43 and CD45, is mandatory. This takes minutes. Finally, the fundamental signaling units of several signaling molecules are “loaded” on a lipid raft, sustained by the cytoskeleton. This takes hours.

*Lipid rafts* are evolutionarily conserved structures that gather receptors involved in signaling in various cell types ( [278](#), [279](#), [280](#) and [281](#) ). The lipid rafts are defined as cholesterol-dependent microdomains resistant to solubilization in nonionic detergents at low temperatures ( [282](#) ). The lipids contained within the cellular plasma membrane include glycerophospholipids, glycosphingolipids, and sterols. Rafts consist of sphingolipids and cholesterol, which can move through the more liquid-disordered phase of the membrane containing glycerophospholipids ( [283](#) ). Because of their lipid consistency, lipid rafts have also been referred to as *glycosphingolipid-enriched membrane microdomains* or *GEMs*. Lipid rafts are anchored by filamentous actin, and actin polymerization causes their coalescence. Phosphatidylinositol-( [4](#), [5](#) ) biphosphate (PIP<sub>2</sub>) activates proteins involved in actin-membrane interactions, such as binding of the ezrin-radixin-moesin family to CD44, a protein broadly expressed on detergent-resistant membranes. Detergent-resistant membranes are presumed to be isolated rafts. PIP<sub>2</sub> activates actin nucleation and polymerization of raft domains. Raft size is poorly understood because they cannot be visualized by light microscopy without clustering ( [284](#) ). In resting T cells, the TCR and GM1 are homogeneously distributed. Cross-linking, however, produces large enough aggregates to be visualized using epifluorescence microscopy. Fluorescence resonance energy transfer is sensitive to distances in the order of a few nanometers. Because fluorescence resonance energy transfer was detected between glycosylphosphatidylinositol (GPI)-anchored transferrin receptors interacting with natural ligands, it was concluded that rafts exist but that they are smaller than 70 nm in diameter ( [284](#) ). Others could not find microdomains enriched in GPI-anchored proteins or GM1. Some MHC II molecules loaded with a select set of peptides are detected on microdomains made up of tetraspan proteins, such as CD9, CD63, CD81, or CD82 ( [282](#) ). These tetraspan microdomains are recognized by CDw78 antibody (mAb FN1), which originally was believed to recognize an epitope of HLA-class II molecules.

A central feature of lipid rafts is that they allow for the lateral segregation of proteins within the plasma membrane. This provides a mechanism for compartmentalization of



signaling components within the membrane, concentrating certain components in lipid rafts and excluding others ( [Fig. 17.10](#)). Proteins with GPI linkage, such as CD14, CD16, CD48, and CD58, are associated with the outer leaflet of lipid rafts. Cytoplasmic proteins, on the other hand, associate with the inner leaflet of lipid rafts through acylation. Most of the Src signaling proteins are acylated and raft associated. The vast majority of transmembrane proteins are excluded from rafts constitutively and cannot be induced to partition into rafts on cross-linking.



**Figure 17.10.** Rafts: elementary units of the immunologic synapse? In the resting state, the multichain immune recognition receptors (MIRR) (i.e., T-cell receptor, B-cell receptor, and so forth) “float” free on the lipid membrane, or transiently, some may get on board on certain membrane “microdomains,” also known as “lipid rafts.” Interaction with a multivalent ligand aggregates several receptors that accumulate within the rafts, forming multimolecular clusters. On prolonged exposure to the ligand, the MIRR clusters result in raft coalescence with the formation of a large aggregate, the immunologic synapse. Cytoskeletal reorganization from multichain immune recognition receptor and chemokine signaling promotes immunologic synapse formation. (Adapted from a model proposed by Dykstra M, et al. Location is everything: lipid rafts and immune cell signaling. *Annu Rev Immunol* 2003;21:457–481.)

Some proteins important in T-cell activation, such as LAT, CD4, and CD8, reside on rafts. Other proteins reside constitutively outside of the rafts but, when activated, become translocated to rafts. The multichain immune recognition receptor family is an example ( [285](#), [286](#) ). Translocation into rafts after ligand binding appears to be immediate, occurring within seconds of engagement of the receptors, and is selective. For example, CD45,  $\alpha 4$  integrin, and IL-1 receptor are excluded from rafts and do not translocate into rafts, even on cross-linking ( [287](#), [288](#) ). The transmembrane domains of the receptors appear to have a significant influence on translocation, as exchange or mutation of the transmembrane regions alters the translocation properties of the receptors. Translocation of the receptor into the lipid rafts does not need actin reorganization. However, stable residency into the rafts depends on interaction with actin cytoskeleton.

The constitutive presence of receptors in rafts may be related to their role in cell survival. For example, the pre-TCR is constitutively associated with rafts and, with its signaling, instructs lineage commitment. TCR/CD28 is excluded from rafts in immature

thymocytes, and signaling leads to apoptosis ( [289](#) ).

In addition to their role in signaling, lipid rafts serve as platforms for B–cell receptors (BCRs) to transport bound antigen for processing and presentation. The internalization of BCR with captured antigen is initiated from rafts.

Retention of receptors in rafts is a mechanism for augmentation of cell activation. The CD19/CD21 complex is excluded from rafts, but its colligation with BCR by antigen–antibody–complement complexes causes translocation of BCR and CD19/CD21 complex into rafts, where the complex prolongs the retention of BCR within the rafts ( [290](#) ).

T–cell activation causes rearrangement of the actin cytoskeleton and polarization of the cell toward the site of activation, such as the APC. This polarization is reflected by reorientation of the microtubule–organizing center toward the APC ( [291](#), [292](#) ). The TCR is clustered together with associated molecules (CD4, CD8, CD2, CD28, and so forth), a process known as *capping*. Capping depends on actin reorganization regulated by phosphoinositides, which activate Vav [a guanosine diphosphate–guanosine triphosphate (GTP) exchange factor] and the Wiskott–Aldrich syndrome protein (WASp). In patients with Wiskott–Aldrich syndrome, WASp is lacking or markedly reduced, and they have defects in actin polymerization, capping, and antigen–induced proliferative responses ( [293](#) ). WASp regulates the Arp2/3 complex, which mediates actin branching and polymerization (see [Chapter 14](#)).

PIP<sub>3</sub> is a strong activator of Vav, which is targeted to detergent–resistant membranes after TCR activation. In Vav–deficient mice, the capping is severely disrupted, and T–cell proliferation is reduced. Raft aggregation is disrupted by the negative regulator of T–cell activation, Cbl (Casitas B–cell lymphoma–b), which is a molecular adaptor and part of the ubiquitin ligation machinery involved in the degradation of phosphorylated proteins. Cbl inhibits TCR clustering and sustained tyrosine phosphorylation. In Cbl–deficient mice, TCR/CD3 stimulation alone can activate receptor clustering without the need for CD28 co–stimulation ( [294](#) ).

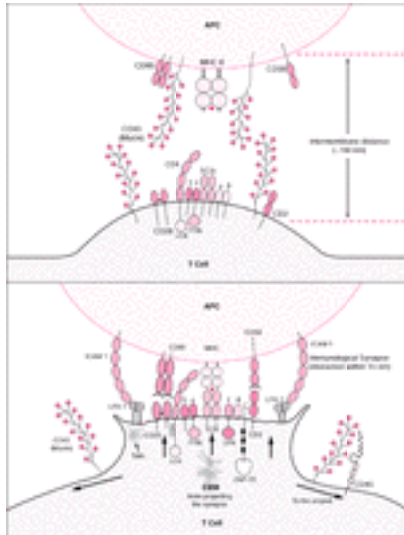
### Immunologic Synapse in Three Stages

The TCR interactions with pMHC take place in an intercellular junction between the T cell and the APC. In this junction, signal 1 (TCR) and signal 2 (co–stimulation) are processed. This interface reveals a dramatic reorganization of signaling components, forming what is called the *immunologic synapse* (IS), a term borrowed from Sherrington’s turn–of–the–century definition of the interconnections of neurons as synapses (from the Greek *synapsis*, meaning joining, linking, connecting) ( [294a](#) ). The IS relays information across the cell junction in both directions ( [295](#) ).

The IS is organized into two major compartments: the central supramolecular activation cluster ( *cSMAC* ), enriched in TCRs and CD28, and the peripheral supramolecular activation cluster ( *pSMAC* ), which contains the LFA–1 molecule and talin ( [296](#) ) ( [Fig. 17.11](#) ). On the side of the APC, correspondingly, the cSMAC contains the pMHC and CD80 (ligand for CD28) and the pSMAC contains the ICAM–1 (counter–receptor for LFA–1) and CD58, ligand for CD2. The IS develops over a period of minutes after interactions of the T cell and the APC. Formation of the synapse depends on an intact cytoskeleton ( [297](#) ). T–cell activation is accompanied by a dynamic reorganization of cortical actin with increase of filamentous actin. These cytoskeletal changes are accompanied by progressive morphologic changes of the T cells, which first become



round, followed by spreading of the cell ( [298](#) ). In the absence of antigen, the T cell maintains its motility, continues to crawl around the APC, and may even leave for another partner. Some receptors on the APC may convey a “danger signal” for the T cell to pay particular attention and explore the APC in search of antigen ( [299](#) ).



**Figure 17.11.** The structure of the immunologic synapse. The immunologic synapse is formed between T cell and an antigen-presenting cell (APC) (in the case of CD4<sup>+</sup> T cell) or with a target cell (in the case of CD8<sup>+</sup> T cell). Immunologic synapse formation is a multistep process. A thick glycocalyx on both cells, made predominantly from the mucin molecule CD43, comes in conflict with the approaching T cell and APC. This distance (50 to 100 nm) is too long for the T-cell receptor (TCR)–peptide–major histocompatibility complex (MHC), which interacts at 15 nm. The integrin lymphocyte function molecule (LFA)–1 and its counterreceptor, intercellular adhesion molecule (ICAM), which interact at 40 nm, may bring the cells for an initial contact. More important, chemokine signaling that activates heterotrimeric G–proteins activates myosin II, and the cortical cytoskeleton collapses, disanchoring CD43 by the ERM (ezrin/radixin/moesin) adaptor proteins. With loss of the cell rigidity, a new F–actin network creates a pseudopod that propels the leading edge of the T cell toward the APC. This approach at an intercellular distance of 15 nm prevents CD43 reentry in the central area of T cell–APC contact. Concomitantly, talin (a large cytoskeletal protein with attachment to integrins) maintains LFA–1 immobilized in a ring around the central part of the synapse. Although LFA–1/ICAM–1 interacts initially at a distance of 40 nm (extended LFA–1 form), after activation, it assumes a bent form (high affinity) that brings the cell membranes closer (“ratchet”–like effect). Multiple other adhesion molecules of low affinity, such as between CD2 and CD58, contribute to the alignment of the two cell surfaces at 15–nm distance, allowing the TCR to sample the small numbers of peptide–MHC (“proofreading”). The final mature immunologic synapse (“bull’s eye”) consists of a central supramolecular activation cluster and the peripheral integrin–rich zone. (Dustin ML, et al. The immunological synapse and the actin cytoskeleton: molecular hardware for T cell signaling. *Nat Immunol* 2000;1:23–29; and Delon J, et al. Imaging of T–cell interactions with antigen presenting cells in culture and in intact lymphoid tissue. *Immunol Rev* 2002;189:51–63.)

In the *first stage*, the contact is antigen independent and is mediated by CD28 on the T cell with CD80/CD86 on the APC, which are more abundant ( $>10^4$ ) than the pMHC (approximately 100 to 200). The CD28 affinity for CD80 is at least two orders of magnitude above that determined for the TCR–pMHC interaction. These interactions of

CD28 preceding the TCR encounters are actually contrary to the original definition of the co-stimulatory function of CD28, believed to parallel or even follow TCR signaling.

The *second stage* of IS formation is antigen dependent. The T cell extends large cytoplasmic, pulsatile protrusions toward the APC ( [300](#), [301](#) ). Tyrosine phosphorylated Vav-1 and tyrosine phosphorylated SLP-76 assemble with the p21-activated kinase (Pak) via the adaptor protein Nck ( [302](#), [303](#) and [304](#) ).

The T cell/APC complex is stabilized in the *third stage*, which is regulated by increases of intracellular  $\text{Ca}^{2+}$ . By the end of the third phase, SMAC is in place with all the receptors and the signaling molecules, held together with clusters of GEMs (lipid rafts) on the surface and an elaborate cytoskeleton scaffolding underneath.

The kinetics of the IS from its early beginnings are coordinated and organized by the cytoskeleton ( [297](#) ). The TCR-pMHC can only interact at a distance of 15 nm, which is significantly below the thick glycocalyxes of the two cells that separate their membranes by a 50- to 100-nm distance. Adhesion molecules, such as L-selectin, located on the tip of microvilli, may very well initiate the T-cell-APC interaction, until LFA-1, lying on flat surfaces of the membrane, is released from its inhibitory state by activating signals delivered by chemokines.

These signals also result in the formation of myosin II thick filaments, which disrupt and pull the thick network of polymerized actin away. In this clearing, new actin polymerization pushes forward new filopodia and lamellipodia (i.e., the cell becomes motile). Now that the T cell is polarized, the long interfering molecules of the glycocalyx, such as CD43 and CD45, are pulled to the rear end, or *uropoa*, of the cell.

In the meantime, activated high-affinity LFA-1 released from inhibition stabilizes the contact area between the cells, moving laterally and forming strong bonds with ICAM-1 across the cell junction ( [305](#) ). In the membrane clearing created and stabilized by LFA-1 adhesion, the TCRs sample MHC on the APC surface for complementary peptides. It has been noted that paradoxically, a large cluster of TCRs has been pulled to the rear of the cell but, through the mediation of myosin II, are brought to the front, reinforcing the frontal cluster ( [306](#) ). Nascent IS is further stabilized by TCR links with the cytoskeleton. These links are mediated by some of the components of CD3 (i.e.,  $\gamma$ -chain), which, through its phosphorylated ITAMs, induces actin polymerization ( [291](#) ).

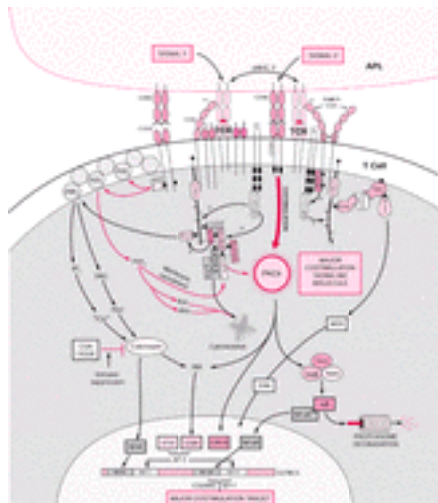
If pMHCs are present on the APC surface, the T cell stops moving ( [301](#), [307](#) ). The central area of T cell closest to APC includes the bulk of the TCRs, which are surrounded by the further away integrins ( [296](#), [308](#) ).

The final arrangement defines the *mature IS* or the *bull's eye* ( [296](#) ) (i.e., the cSMAC, a central area 1 to 3  $\mu\text{m}$  in diameter that contains TCR, CD28, and CD2, surrounded by pSMAC, an adhesion ring that contains the LFA-1 and talin). Formation of mature IS with APCs (instead of artificial lipid bilayers) shows that the TCR signaling precedes the completion of the mature IS ( [309](#) ). Bull's eye IS also has been observed with  $\text{CD8}^+$  T cells during recognition and killing of target cells ( [310](#) ). Granule secretion occurs after the microtubule organizing center (MTOC) polarization in cSMAC, where membrane fusion occurs. Cellular functions between T cells and the target cells have been demonstrated by transmission and scanning electron microscopy several years ago. These junctions are followed by disruption and blebbing of the target cell membrane ( [311](#), [312](#) ).

Synapses with dendritic cells are formed even in the absence of antigen or MHC ( [313](#), [314](#) ). Encounters with dendritic cells are relatively short as compared to B cells ( [315](#) ). This may be due to chemokine secretion by dendritic cells, which stimulate T-cell migration. There also seems to be other differences between dendritic cells and B cells, such as the length of time of the encounter, which is short for dendritic cells but longer for B cells. The role of the dendritic cell in the formation of IS is active with full involvement of its cytoskeleton, whereas the B cell remains passive and the T cell makes the major contribution ( [316](#) ). The functional consequences of the formation of a mature IS are believed to be primarily related to polarized secretion ( [317](#), [318](#) ) and signaling ( [319](#) ). IS may help to retain secreted substances close to the targeted cell. Although this is true for the synapses formed by killer lymphocytes such as CD8<sup>+</sup> cytotoxic T cell or the NK cell, it may not apply to the CD4<sup>+</sup> T cell, which uses the APC to pull the trigger for its activation. In this case, the IS concentrates crucial molecules, such as CD28, that provide co-stimulatory signals and enhance TCR-mediated signaling ( [320](#), [321](#) ).

### T-Cell Receptor Signaling

Two models have been proposed for sustained T-cell signaling: (a) *serial engagement* (migration), when the T cell migrates from one APC to the next and thus renews its signaling capacity ( [315](#) ); and (b) signaling based on *formation of IS*. Both models achieve similar results but require different molecular mechanisms. The mature IS forms a specialized mode of signaling and enables T cells to remain responsive to antigen while still with the initial APC. For a better understanding of the complexities of signaling, we organize it into three phases: (a) initiation, (b) generation of phosphoinositides, and (c) the Ras pathway ( [Fig. 17.12](#), [Table 17.1](#) ).



**Figure 17.12.** T-cell activation. T cells are activated by two signals: Signal 1 is delivered by the T-cell receptor (TCR) interacting with peptide-major histocompatibility complex (pMHC), and signal 2, or co-stimulatory signal, by CD28 interacting with CD80/CD86. A number of adaptor proteins (i.e., proteins acting as scaffolding) assemble a supramolecular signaling complex. Foremost among them are LAT (linker for activated T cells) and SLP-76 (SH<sub>2</sub>-domain-containing leukocyte-specific phosphoprotein of 76 kd). LAT expression is limited to T cells, natural killer (NK) cells, platelets, and mast cells and is not expressed on B cells or monocytes. LAT is a membrane adaptor protein as compared to

SLP-76, which is cytoplasmic. Engagement of TCR activates Lck, which is associated with the co-receptor (CD4 or CD8). Lck phosphorylates ZAP-70 ( $\zeta$ -chain-associated protein). ZAP-70 in turn phosphorylates LAT, which at this point makes the transition between proximal and downstream signaling events initiated by TCR. LAT is also associated with the co-receptor, competing in the binding with Lck. LAT and Lck are linked to individual co-receptors, rather than both of them being linked to the same molecule. LAT as an adaptor protein is a scaffolding that is associated with several downstream molecules: Phospholipase (PLC)- $\gamma$  generates phosphoinositides and increases  $Ca^{2+}$ , which activate protein kinase C (PKC) and calcineurin respectively. Another cluster is formed with Gads (Grb-related protein), SLP-76, Vav, and so forth that regulates the cytoskeleton together with the  $PIP_3$  product of phosphoinositide-3-kinase (PI3K). The other signaling pathway linked to LAT is through the Ras activation, linking to the activation of MAPK/ERK kinase (MEK) and extracellular signal-regulated kinase (ERK). A central position in T-cell signaling is occupied by the novel PKC isoform, PKC $\zeta$ , which is selectively expressed in T lymphocytes and is recruited to the immunologic synapse. It induces essential activation signals for interleukin-2 synthesis in cooperation with calcineurin. It is a master inducer of NF $\kappa$ B activation and its translocation to the nucleus. PI3K associated with CD28 generates  $PIP_3$  that recruits Vav and PKC $\zeta$  to the membrane. APC, antigen-presenting cell; DAG, diacylglycerol; SLPP, serum lipophosphoprotein. (Important information from Bosselut R, et al. Association of the adaptor molecule LAT with CD4 and CD8 co-receptors identifies a new co-receptor function in T cell receptor signal transduction. *J Exp Med* 1999;190:1517–1525; Myung PS, et al. Adapter proteins in lymphocyte antigen-receptor signaling. *Curr Opin Immunol* 2000;12:256–266; Koretzky GA, et al. *Nat Rev Immunol* 2001;169:6261–6268; and Cantrell DA. T-cell antigen receptor signal transduction. *Immunology* 2002;105:369–374.)

**TABLE 17.1. T-Cell Receptor- $\alpha\beta$  Activation Machinery**

| Receptors/Ligands  | Antigen Recognition | Signal Transduction | Adhesion | Ligand/Counterreceptors                               |
|--------------------|---------------------|---------------------|----------|---|
| $\alpha/\beta$     | +                   | -                   | -        | Major histocompatibility peptide complex <sup>a</sup> |
| $e/\zeta-e/\zeta$  | -                   | +                   | -        | -   |
| $\zeta/\zeta$      | -                   | +                   | -        | -   |
| CD4                | -                   | +                   | -        | HLA Class II  |
| CD8                | -                   | +                   | -        | HLA Class I   |
| CD2                | -                   | +                   | +        | CD58 (LFA-3)  |
| CD28/CTLA-4        | -                   | +                   | -        | CD80/CD86   |
| CD40L              | -                   | +                   | -        | CD40  |
| CD11a/CD18 (LFA-1) | -                   | +                   | +        | CD54 (intercellular adhesion molecule-1)              |

LFA, lymphocyte function molecule.

<sup>a</sup> See text for details.

**INITIATION PHASE** Signaling is initiated by activation of Lck, which is regulated by two tyrosines: Tyr 394 in the activation loop and Tyr 505 in the C-terminus. Lck is kept inactive or “closed” by two intramolecular bonds: One is between Tyr 505, which is phosphorylated by the C-terminal Src, Csk, and binds to the SH<sub>2</sub> domain of Lck; a second bond is formed between the SH<sub>3</sub> domain of Lck and a sequence connecting the SH<sub>2</sub> and the kinase domains. For activation of Lck, the Tyr 505 needs to be

dephosphorylated by CD45, a protein tyrosine phosphatase ( [322](#) ), whereas Tyr 394 is autophosphorylated and activates the kinase domain. The large-size CD45 isoforms are excluded from the IS ( [323](#) , [324](#) ), but some move back to cSMAC adjacent to the TCRs ( [325](#) ). Lck, recruited by CD4, is maintained in the activated state by CD28 ( [321](#) ) and phosphorylates the ITAMs of the  $\zeta$ -chain of TCR in a sequential and ordered manner, establishing thresholds of T-cell activation ( [326](#) ). This mechanism determines whether a sufficient number of tyrosines are phosphorylated for full activation and supports the kinetic proofreading model of T-cell activation, which examines the relationship between kinetics of TCR-ligand interaction and intensities of T-cell activation ( [327](#) , [328](#) , [329](#) and [330](#) ). ZAP-70 is recruited to the phosphorylated ITAMs of the  $\zeta$ -chain and in turn activates the adaptor protein LAT, which then is localized in the rafts. LAT has a short extracellular and long intracellular region and possesses a central position in T-cell activation because it assembles other adaptor molecules and signaling proteins. There are two groups of adaptor proteins: transmembrane adaptor proteins and cytosolic adaptor proteins ( [331](#) ). LAT (a transmembrane adaptor protein) is located in the rafts and is phosphorylated by ZAP-70. As a result, it recruits PLC- $\zeta$ 1, phosphoinositide 3-kinase (PI3K), IL-2-inducible T-cell kinase (Itk), adaptor proteins Grb2 and Gads, and, indirectly, Vav and SLP-76 ( [332](#) , [333](#) and [334](#) ). SLP-76 is a cytosolic adaptor protein that has three protein-binding motifs and plays an essential role in signaling pathways required for IL-2 secretion ( [335](#) ). It is expressed on thymocytes, T cells, mast cells, NK cells, and platelets. Through Gads, it binds indirectly to LAT after TCR ligation. So LAT and SLP-76 function as mutually dependent intermolecular scaffolds, together recruiting crucial signaling regulators to sites of raft aggregation. In mice deficient in SLP-76 (or LAT), thymocyte development is arrested at the stage at which the TCR  $\beta$ -chain is coupled to the pre-Ta-chain. SLP-76 recruits Itk to lipid rafts and allows for optimal phosphorylation of PLC- $\zeta$ 1, which also associates with ZAP-70.

**PHOSPHOINOSITIDE METABOLISM** Phosphoinositides are produced by the action of PLC- $\zeta$ 1 and PI3K. PLC- $\zeta$ 1 binds to LAT and is activated as a result of phosphorylation of multiple tyrosines by ZAP-70. PLC- $\zeta$ 1 hydrolyzes inositol phospholipids generating diacylglycerol and inositol ( [1](#) , [4](#) , [5](#) )-triphosphate (IP<sub>3</sub>). Diacylglycerol contributes to activation of protein kinase C (PKC), whereas IP<sub>3</sub> increases Ca<sup>2+</sup> released from intracellular sources. There are multiple isoforms of PKC serine kinases, which are regulated by Ca<sup>2+</sup>, diacylglycerol, phospholipids, the classic PKC ( $\alpha$ ,  $\beta$ ,  $\gamma$ ), and the novel PKC ( $\delta$ ,  $\epsilon$ ,  $\zeta$ , and  $\eta$ ) ( [336](#) ). PKC $\zeta$  is recruited to the plasma membrane and is the only isoform detected in cSMAC together with TCR ( [337](#) ). PKC $\zeta$ 's targets are nuclear factor- $\kappa$ B activation, IL-2 production, regulation of integrin function, and control of cytoskeleton through association with Vav. Both Ca<sup>2+</sup> and PKC synergize in the increase in transcriptional activity of NFAT. Ca<sup>2+</sup> acts through calcineurin, a calmodulin-dependent phosphatase that contributes to induction or function of NFAT. The immunosuppressive drugs cyclosporin A and FK506, bound to their binding protein, immunophilin, inhibit Ca<sup>2+</sup>-mediated signaling of T lymphocytes by sequestering cytosolic calcineurin. This is the mechanism of inhibition of IL-2 secretion. The PI3K produces phosphatidylinositol 3,4,5-triphosphate (PI-3,4,5-P<sub>3</sub>), which acts as a second messenger. It binds to proteins that contain a pleckstrin homology domain and recruits them to the inner leaflet of the cell membrane ( [338](#) ). PI3K overall is involved in survival and cytoskeletal signaling processes and is essential for adhesion signals. Important targets for PI3K products are the GTPases, Rac and Rho, stimulated by GEF (guanine nucleotide exchange) proteins promoting transition from the inactive guanosine diphosphate-bound state to the active GTP-bound conformation. Rac and Rho regulate several functions in the life of the T cell, and during T-cell activation, they regulate cytoskeletal rearrangements. The PI-3,4,5-P<sub>2</sub> product of PI3K is converted to PI-3,4-P<sub>2</sub> by the phosphatidylinositol-5 phosphatase (SHIP). This product binds to the pleckstrin homology



domain of the protein kinase B or Akt. Akt moves to the nucleus, where it acts on several substrates regulating cell survival, NF- $\kappa$ B activation, metabolism, and energy generation ( [339](#) ). It also regulates transcription factors (i.e., NFAT and the Forkhead family), promoting cell survival and progression through the cell cycle. All signals from PI3K products are eventually terminated by the inositol phosphatase SHIP.

**RAS PATHWAY** The adaptor protein Grb2 is a bifunctional molecule having an SH<sub>2</sub> domain with which it binds to phosphorylated tyrosines of LAT, whereas its SH<sub>3</sub> domain binds other proteins that have proline-rich sequences. These proteins are cytosolic, but through association with LAT, they are translocated to the membrane ( [333](#) ). Grb2 functions in many cells and associates with a large number of proteins ( [340](#) ). In T cells, it is associated with the proline-rich domain of SOS, the mammalian homolog of the *Drosophila* “son of Sevenless” protein. SOS is a critical activator of the small G protein Ras ( [341](#) ). Grb2-SOS binding is mediated by another small linker protein, Shc. Cbl, an inhibitor of activation, also binds to Grb2. The Ras pathway activates Erk kinase and MAPK. MAPK pathway may induce integrin activation, and, in reverse, the integrin may induce MAPK pathway through PI3K. There are other bidirectional signaling pathways that, in general, send signals to the nucleus and activate membrane molecules by a feedback pathway.

## T-Cell Activation and the Cytoskeleton

The cytoskeleton plays an important role in IS formation and T-cell activation. T cells polarize toward their target, focusing the signaling on the secretory apparatus at the APC or target cell. Cytochalasin D, which disrupts the cytoskeleton assembly, blocks T-cell activation. Actin dynamics are controlled by a biphasic model at the IS. TCR engagement initiates actin solubilization through changes in the phosphorylation of ezrin, radixin, and moesin that allow certain molecules to move away from the points of contact with APC ( [342](#) ). With the formation of new actin filaments, LFA-1 is anchored and stabilizes the adhesion between T cell and APC ( [343](#) ). Polarization of the MTOC requires TCR and involves members of the Rho family of GTPases Cdc42, Rac, and Rho.

Disruption of the Rho family members perturbs survival of T cells, proliferation, differentiation, migration, and effector functions ( [298](#) , [344](#) ). Cdc42, like all members of the Rho family of GTPases, functions as a binary switch regulated by nucleotide binding. When Cdc42 binds GTP, it is converted from the inactive to the active form and binds effector molecules with high affinity. One of its important substrates is WASp (see [Chapter 14](#) ). Mutations of the WASp gene are responsible for the clinical manifestations of Wiskott-Aldrich syndrome (i.e., thrombocytopenia, eczema, and recurrent infections). T cells from Wiskott-Aldrich syndrome patients lack microvilli and have abnormal cell shape. Mutants with inactive Cdc42 prevent efficient conjugation of T cells with APC. In contrast, T cells with constitutively active Cdc42 mutants form extensive filopodia rich in F-actin, which interfere with the formation of IS because Cdc42 accumulates in the T-APC contact area. Activation of WASp is achieved by a complex formed by SLP-76 adaptor protein, Vav, and Nck (phosphorylated by ZAP-70). In this trimolecular complex, SLP-76 binds Vav, which converts Cdc42-guanosine diphosphate to the GTP form. Cdc42-GTP binds to the GTPase binding domain domain of WASp. At the same time, the Nck binds by its SH<sub>3</sub> domain to the polyproline sequence of WASp. These interactions release WASp from its autoinhibitory state and enable it to activate the Arp2/3 complex for actin-branching polymerization ( [345](#) , [346](#) , [347](#) and [348](#) ) (see [Chapter 14](#) ). Other studies suggest that WASp may not be the critical or even the sole regulator of actin polymerization, but other molecules, such as its homolog N-WASp, are involved. However, mice with a WASp deficient in the VCA domain have defects in T-cell development ( [349](#) ).

A significant contribution to the T-cell interaction with the APC is made by the ERM cytoskeletal proteins (i.e., ezrin-radixin-moesin) (350). These proteins act as linkers between cortical actin and plasma membrane, connecting the F-actin to cytoplasmic tails of several transmembrane proteins (i.e., ICAMs, CD43, Fas, and so forth). In the resting T cell, the plasma membrane is rigid because of the thick actin network kept by phosphorylated moesin. With TCR engagement, moesin is dephosphorylated, the actin network “thaws,” and the proteins linked to the cytoskeleton are freed to move. The tall ones, CD43, are “squeezed” out of the narrow junction between T cell and APC (351). At the same time, new F-actin networks create pseudopod extensions for contact with the APC. Moesin in the back of the cell is rephosphorylated and keeps the excluded molecules actively out of the IS. CD43, and other molecules that are excluded to the uropod, form a cluster called *distal pole complex*. This cluster may not be simply a negative contributor to T-cell activation by collecting tall molecules interfering in the formation of the IS, but it has its own signaling mechanism in some aspects of T-cell activation, such as cytokine secretion (352).

### Regulation of T-Cell Activation: Co-Stimulation and Inhibition

T-cell activation depends on signals delivered by the TCR engaged with pMHC. However, additional signaling is needed, and this function is known as *co-stimulation*. Co-stimulatory signals are delivered to the T cell through the CD28 molecule reacting with ligands (counter-receptors) on APCs [i.e., CD80 (B7-1) and CD86 (B7-2)]. These receptors do not act independently but modify the responses mediated by TCR. The CD28 consists of one Ig-like domain of V-type, whereas the two ligands contain two Ig domains, one V-type and one C-type. CD28 is constitutively expressed on T cells (all CD4<sup>+</sup> and approximately 50% of CD8<sup>+</sup>). Another receptor, the CTLA-4 (CD152) shares approximately 30% identity with CD28; it is not detected in naïve T cells but is induced after T-cell activation.

Both CD28 and CTLA-4 share the same ligands. In co-stimulation, the critical event is up-regulation of the B7 molecules on the surface of the APCs (353). The major role of CD28 function is to stimulate cell cycle progression and prevent apoptosis. It also enhances production of various cytokines, such as IL-1, IL-2, IL-4, IL-5, and interferon (IFN)- $\gamma$ , and plays a fundamental role in Th1-Th2 differentiation. CD28/B7 interactions also play a critical role in B-cell stimulation. The importance of CD28/B7 interaction was established in transplantation. The importance of the CD28/B7 costimulation pathway was established with studies in transplantation in mice in which blockade of the pathway by CTLA4-Ig prolonged cardiac graft survival and prevented development of vascular lesions associated with chronic rejection (353a). Mice deficient in CD28 or in both B7-1 and B7-2 are resistant in the development of experimental allergic encephalomyelitis (353b).

Another co-stimulatory receptor homologous to CD28 and CTLA-4, termed *ICOS* (inducible co-stimulator), is a disulfide-linked homodimer (354). ICOS lacks the extracellular motif present in CD28, which is implicated in binding with the B7 molecules. It is an inducible molecule expressed in activated, but not resting, T cells. ICOS augments T-cell proliferative responses and cytokine secretion, particularly IL-10 (355). The ligand for ICOS (ICOS-L or B7h) is a B7-like molecule expressed constitutively on B cells and macrophages. Co-stimulation by ICOS promotes germinal center reaction and isotype switching. ICOS and CD28 regulate Th2 responses, but whereas CD28 is critical in the priming stage to induce Th2 differentiation, ICOS plays a role in regulating Th2 effector functions (356). Activation of the ICOS pathway of co-stimulation initiates acute and chronic graft rejection, which indicates that the ICOS co-stimulatory pathway also

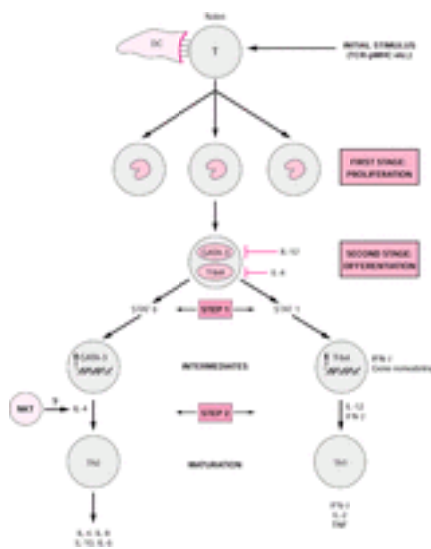


regulates Th1 responses ( 357 ).

## CD4 T-CELL DIFFERENTIATION

Activated naïve CD4<sup>+</sup> helper T cells (Th), in response to signals from TCR engagement with pMHC, proliferate and differentiate into cytokine-secreting effector cells, which have been distinguished into two major categories ( 358 ). Th1 cells produce primarily IFN- $\gamma$ , IL-2, and TNF- $\beta$ , whereas Th2 cells secrete IL-4, IL-5, IL-6, IL-10, and IL-13. Both types of cells produce IL-3, TNF- $\alpha$ , and granulocyte-macrophage colony-stimulating factor. Once the initial stimulus from TCR is received, the cells proliferate in response to the autocrine growth factor IL-2. At this stage, they are called pT helper cells (pTh) because they have not yet differentiated enough to secrete cytokines. Both Th1 and Th2 cells derive from a single precursor, and several factors regulate their differentiation ( 359 , 360 and 361 ). The Th1 cells induce predominantly inflammatory immune reactions and control intracellular bacterial infections (cellular immunity). They are also associated with some autoimmune diseases. The Th2 cells provide defense against extracellular pathogens, regulating the humoral antibody-mediated immune response. They are also the mediators of allergic reactions.

Th1 versus Th2 differentiation takes place in two stages. During the first stage, the activation signals delivered by TCR precondition the naïve T cell for one or the other pathway of differentiation. In the second stage, final development of effector cells is dependent on IL-12 or IL-4 ( Fig. 17.13 ).



**Figure 17.13.** CD4<sup>+</sup> T-cell differentiation. After their differentiation in the thymus into the two main lineages, CD4<sup>+</sup> and CD8<sup>+</sup>, the CD4<sup>+</sup> or Th cells differentiate further in the peripheral lymphatic organs into effector cells with distinct patterns of cytokine secretion. The initial stimulus is delivered by the T-cell receptor (TCR) and results in the proliferation of the naïve T cell. These activated T cells (pTh) have only a limited potential of interleukin (IL)-2 secretion, and they acquire the propensity to respond to additional signals for further differentiation. Primary stimuli via the TCR (dose of antigen, intensity and duration of TCR triggering) influence downstream signaling (Ca<sup>2+</sup>, protein kinase C, map kinase, and so forth) that regulates transcription factor expression. Expression of GATA-3 leads to Th2, whereas T-bet leads to Th1 differentiation. In the second stage, exposure to cytokines [i.e., IL-4 or IL-12/interferon (IFN)- $\gamma$ ] drives the

final steps of differentiation to the Th1 or Th2 pattern of cytokine secretion. NKT, natural killer T cell; TNF, tumor necrosis factor. (Adapted from Noble A. Review article: molecular signals and genetic reprogramming in peripheral T-cell differentiation. *Immunology* 2000;101:289–299; Murphy KM, et al. The lineage decisions of helper T cells. *Nat Rev Immunol* 2002;2:933–944; and Diehl S, et al. The two faces of IL-6 on Th1/Th2 differentiation. *Mol Immunol* 2002;39:531–536.)

## Stage I: Transcriptional Regulation

In the early stages of Th cell differentiation, TCR stimulation activates a number of downstream signaling pathways. Differential signaling of MAPKs, PKC, and calcineurin preconditions Th cells toward one or the other pathway in the absence of cytokines from the environment ( [362](#) ). A number of parameters related to antigenic stimulation and co-stimulation influence the final outcome. Low doses of antigen or low affinity of binding favors Th2 development, whereas large doses of antigen or high affinity of binding support predominantly Th1 differentiation. Co-stimulatory signals modulate the outcome. CD28 ligation favors Th2 development, perhaps by enhancing IL-4 production ( [363](#) ) or by direct activation of signal transducer and activator of transcription 6 (STAT-6) ( [364](#) ).

The CD40/CD40L interactions selectively induce Th1 cells, but this is the result of the production of IL-12 from APCs ( [365](#) ). During the early stage of Th activation, key genetic and epigenetic events take place that lead to accessibility and activation of specific genes. Expression of certain transcription factors is critical in the early regulation of differentiation ( [366](#) , [367](#) ).

**TH1 REGULATION** The most prominent factor for Th1 differentiation is IL-12. In naïve T cells, the IL-12 receptor is not functional but is induced by IFN- $\alpha/\beta$ . Binding of IL-12 to its receptor induces phosphorylation of Janus kinases Jak2 and Tyk2, which phosphorylate STAT-4. STAT-4 translocates to the nucleus and activates target genes. The GTPase, Rac 2, which is selectively expressed on Th1 cells, activates the IFN- $\gamma$  promoter via NF- $\kappa$ B and MAPK ( [368](#) ). During the early Th1 polarizing signaling, the key transcription factor for Th1 development is T-bet (for *T-box* expressed in *T* cells) induced in naïve T cells ( [369](#) , [370](#) ). T-bet transactivates IFN- $\gamma$  promoter, induces chromatin remodeling of the gene that encodes INF- $\gamma$  ( [371](#) ), and induces expression of the  $\beta_2$  subunit of IL-12 receptor ( [370](#) ). The importance of T-bet in Th1 differentiation is underscored by the susceptibility of T-bet knock-out mice to challenge with *Leishmania major* ( [372](#) ) and their predisposition to allergic disease.

**TH2 REGULATION** The key transcription factor for Th2 differentiation is GATA-3 ( [366](#) ), induced in the early stages under Th2 polarizing signaling. STAT-6 activation enhances expression of GATA-3. GATA-3 induces expression of another Th2-specific factor, c-maf. C-maf is a basic region/leucine-zipper transcription factor that binds to and transactivates the IL-4 promoter ( [373](#) , [374](#) ).

**EPIGENETIC MODIFICATION OF CYTOKINE GENES** Detailed description of these early events is beyond the scope of this brief review. The reader is referred to reviews of the topic ( [366](#) , [375](#) ). Transcriptionally inactive gene loci have a condensed chromatin with DNA tightly packed around the nucleosomes. For gene transcription, “open” chromatin is associated with acetylated histones and hypomethylation of DNA. Accessibility of IL-4 and IFN- $\gamma$  genes is initiated promptly after TCR and CD28 activation, but for sustained transcription, STAT-6 or STAT-4 signaling and induction, GATA-3 and T-bet are required. Within the first few days of Th1 and Th2 differentiation, signs of accessibility of the cytokine gene loci are observed in Th-activated cells. These signs are hypersensitivity to DNAase I and DNA demethylation.

## Stage II: Maturation of Th1/Th2 Cells

In the second stage, IL-12 and IL-4 play a major role in the maturation of Th1 and Th2 cells, respectively. IL-12 and IL-18 act synergistically to produce IFN- $\gamma$  from terminally differentiating Th1 cells. IL-23 is composed of the p40 subunit of IL-12 paired with the IL-23  $\alpha$ -chain related to one of the chains of IL-12. It binds to IL-12  $\beta$ -chain but interacts with its own IL-23R. It activates STAT-4 and may act during the induction of Th1 and the production of IFN- $\gamma$  in cooperation with IL-18.

The IL-27 is produced by APCs and induces proliferation of naïve T cells. It acts together with IL-12 in promoting IFN- $\gamma$  production and is the ligand for the T-cell cytokine receptor in the early development of Th1 cells ( [376](#) ). Th2 maturation is promoted by IL-21, which is produced from Th2 cells, and specifically inhibits IFN- $\gamma$  production and decreases responsiveness of T cells to IL-12, thus amplifying Th2 development ( [377](#) ).

IL-6 is produced by several types of cells, especially APCs. It activates NFAT, leading to production of IL-4, which promotes Th2 differentiation. However, IL-6 also inhibits Th1 development because it up-regulates the suppression of cytokine signaling (SOCS) 1. SOCS, also known as *STAT-induced STAT inhibitor*, belongs to a family of regulators of cytokine production. SOCS1 inhibits IFN- $\gamma$  production and the development of Th1 cells. Thus, IL-6 plays a dual role in Th1/Th2 differentiation through induction of IL-4 and SOCS-1 ( [378](#) ). IL-10 has also been reported to promote Th2 differentiation, but its main effect is in suppressing Th1 cells.

Another cytokine with double regulatory function is IL-18. IL-18 is produced from macrophages and synergizes with IL-12 for IFN- $\gamma$  production from NK cells and T cells. In collaboration with IL-2, it promotes Th1 differentiation in activated T cells ( [379](#) ). Overproduction of both cytokines induces severe inflammatory disorders. In addition to its function as Th1 inducer and as proinflammatory cytokine, under certain experimental conditions, IL-18 stimulates Th2 cell differentiation, increase of IgE, and allergic manifestations ( [380](#) ). The role of dendritic cells in humans is not clear as the production of cytokines varies depending on signals received from T cells.

## CD8 T-CELL DIFFERENTIATION

CD8<sup>+</sup> T cells produce primarily type 1 cytokines because CD8<sup>+</sup> T cells have no requirement for STAT-4 signaling via IL-12 to develop into Tc1 effectors. The Tc1/Tc2 regulation is mediated by transforming growth factor (TGF)- $\beta$  with IL-4 promoting Tc1 development and cytotoxicity in the presence of TGF- $\beta$  ( [382](#) ). There is some kind of cross-regulation between CD4<sup>+</sup> and CD8<sup>+</sup> T cells. CD8<sup>+</sup> T cells produce relatively high levels of IFN- $\gamma$  and, as a result, enhance Th1 immunity. On the other hand, Th2 cell-derived IL-4 stimulates development of Tc2 cells in allergic states.

Another Th cell that secretes high levels of TGF- $\beta$  together with varying amounts of IL-4 and IL-10 is known as *Th3* and is associated with a suppressor function. Secretion of these cytokines by Th3 cells requires antigenic stimulation before they function as active suppressor cells ( [381](#) ). Another suppressor T cell, known as *T regulatory-1* (Tr1) produces high levels of IL-10 and IL-5. (For regulatory T cells, see below.)

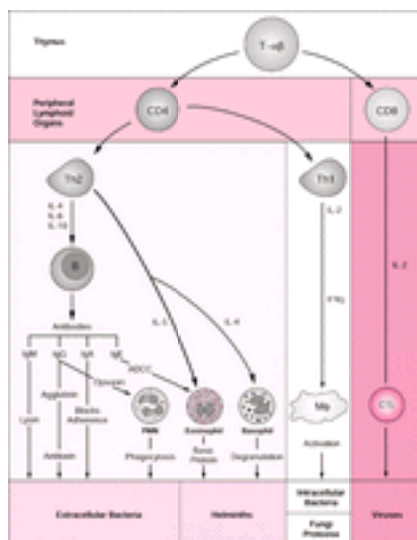
## GENOMIC VIEW OF TYPE 1 AND TYPE 2 DIFFERENTIATION

Application of the new technology of gene expression by gene microarrays on polarized type 1 and type 2 CD4 and CD8 T cells identified similarities in the broad pattern of gene expression in both CD4 and CD8 T cells for type 1 and type 2 polarization, but differences were also identified between the two lineages (383). Large numbers of apoptosis-related genes were expressed, particularly in Th1 cells, which correlates with the propensity of these cells to undergo activation-induced cell death (384). A large number of cytokine and growth factor genes are preferentially expressed by either type 1 or type 2 cells. Th2 cells resemble Tc2 cells in their cytokine gene profile. Differences are also noted in genes involved in synthesis of cell migration molecules, such as CCR1, CXCR4, and  $\beta_7$  integrin in Th2 cells and  $\alpha_4$  integrin in Th1 cells. This is something that should be expected because the two Th populations home to different locations (385).

## TH1 AND TH2 PARADIGM: STRONG DEFENSE SYSTEM

The adaptive immune system evolved to recognize, discriminate, and memorize foreign antigens and pathogens. It has developed specialized cells that are able to capture anything that manages to cross into the body's interior and present it to lymphocytes possessing specific receptors.

The “supreme commander” in this system is the T lymphocyte that regulates all defense operations. It became clear in recent years that T lymphocytes constitute a diversified population. One of them (CD4<sup>+</sup>, Th2) activates the B cells for antibody production, and a second (CD4<sup>+</sup>, Th1) activates macrophages for cell-mediated immunity. The first provides defense against extracellular and helminthic infections. The second acts against intracellular bacterial infections, fungi, and protozoa (Fig. 17.14).



**Figure 17.14.** Th1 and Th2 cells and effector mechanisms against pathogens. See text for details. ADCC, antibody-dependent cell-mediated cytotoxicity; CTL, cytotoxic T lymphocyte; IFN, interferon; Ig, immunoglobulin; IL, interleukin; PMN, polymorphonuclear cells. (From Paraskevas F. T lymphocytes. In: Israels LG, Israels ED, eds. Mechanisms in hematology. Core Health Services Inc., 2001, with permission.)

Th1 cells coordinate the activation of macrophages and constitute the most important

cellular defense mechanism against intracellular pathogens. Macrophage activation is mediated by IFN- $\gamma$ , the principal cytokine produced by Th1 cells. Macrophages activated by IFN- $\gamma$  rapidly kill susceptible intracellular bacteria. They produce TNF- $\alpha$ , which synergizes with IFN- $\gamma$ . IFN- $\gamma$  has been used successfully as adjunct to chemotherapy in the treatment of leprosy, tuberculosis, and atypical mycobacteriosis. In induction of Th1 immunity, IL-12 is rapidly produced by infected macrophages, which activates NK cells and stimulates production of IFN- $\gamma$ , which subsequently induces Th1 differentiation. However, overproduction of IL-12, by a positive feedback mechanism triggered by IFN- $\gamma$ , results in inflammatory responses. IL-12 production is inhibited by IL-10.

There is compelling evidence that the Th1 cells have an essential role in protection during mycobacterial infection ( 386 ). Mice deficient in IL-4, a major Th2 cytokine, have a normal response to *Mycobacterium tuberculosis*, whereas increased production of IL-4 correlates with disease progression ( 387 ). Mice infected acutely with *M. tuberculosis* are protected by adoptive transfer of Th1 cells with a tenfold reduction in bacterial counts, whereas recipients of Th2 cells suffer from weight loss and lung fibrosis ( 388 ).

Leishmanial disease currently affects some 12 million people in 88 countries. The annual incidence is approximately two million new cases. Experimental studies have clearly documented that Th1 response is associated with restriction of the disease and cure, whereas a Th2 response is associated with progressive systemic disease. Balb/c mice are susceptible to leishmania infection because they are unable to generate a Th1 response, whereas C57Bl/6 mice are resistant to the infection as a result of strong Th1 response. In Balb/c mice, the draining lymph nodes show elevated transcripts for IL-4 but not for IFN- $\gamma$  ( 389 ).

The most critical unifying effect able to induce resistance has been the successful attenuation of IL-4 expression in the draining lymph node of infected susceptible animals during the first 24 hours of infection. The extent of IL-12 responsiveness is also a critical determinant for the development of a curative immune response because it induces a Th1 response ( 390 ).

Another example of the importance of a balanced Th1/Th2 response is related to the allergic inflammation ( 391 ). The pathophysiologic mechanisms of asthma seem to be based on dysregulation of the Th1/Th2 balanced response with a preponderance of Th2 cytokines. Asthma affects 8 to 10% of the population in the United States and is the leading cause of hospitalization among children younger than 15 years of age, causing an exorbitant financial burden on society. Th2-dominant responses stimulate antibody-mediated responses, activate mast cells, and elicit tissue eosinophilia (i.e., the predominant response in the asthmatic airway) ( 392 ). IL-13 is one of the Th2 cytokines, and overexpression of IL-13 in transgenic mice induces an inflammatory response with an infiltrate rich in eosinophils and macrophages. Furthermore, it causes airway fibrosis, mucous metaplasia, and airway hyperresponsiveness ( 393 ). It is likely that asthma is the result of a dysregulated mucosal immune system and pathologic T-cell response in genetically susceptible individuals ( 394 ).

## CD8 T LYMPHOCYTES

The CD8<sup>+</sup> T lymphocyte is one of the two professional cytotoxic lymphocytes, the other being the NK cell. The CD8<sup>+</sup> T lymphocytes, also known as CTL, differ from NK cells in the basic mechanism of target recognition. CTL expresses an  $\alpha\beta$ -TCR, recognizing processed peptides presented by MHC class I molecules (pMHC), whereas the NK cell cytotoxicity is regulated by the C-lectin type of NK cell receptors (CD94) or members of

the killer cell Ig-like receptors (KIRs), which recognize class I HLA allotypes rather than pMHC ( 395 ).

Two fundamentally different groups of methods of evaluation of target cell lysis have been developed: One evaluates disruption of cell membrane and release of tracers incorporated into the target, and the other evaluates DNA fragmentation resulting from apoptotic nuclear damage. In the first category, the most widely used method has been the release of radioactive chromium,  $^{51}\text{Cr}$ , preloaded into the target ( 396 ). More sensitive techniques using fluorescent impermeant dyes have been developed. DNA fragments released from the nuclei are harvested, and a “ladder” pattern is identified ( 397 ). Direct comparisons of the cytotoxic potency of different cell populations cannot be made by these methods because the target cell death is not linearly related to the cytotoxic input. Usually, the number of cytotoxic cells required to achieve a given level of target cell lysis is expressed in lytic units, which are inversely related to the effector cell number.

### Activation of Cytotoxic T Lymphocytes

For the CTL to become an active effector, the precursor cell must be stimulated by antigen to undergo proliferation and differentiation ( 398 ). The activation or priming results from the interaction of the naïve  $\text{CD8}^+$  T cell with professional APCs. As a result of priming, they form secretory granules, to which the killing machinery is delivered (i.e., perforin, granzymes, and FasL) ( 399 , 400 ). Before activation, granules are not always visible. The granule by electron microscopy is 0.5 to 1.0  $\mu$  in diameter and is heterogeneous in its structure ( 401 ). The core is homogeneous, is sometimes surrounded by double membranes, and contains the perforin enclosed by a thin membrane ( 402 ). Multiple small vesicles surround the core toward the periphery of the granule. Depending on the preponderance of these two components, granules have been distinguished as type I (dominated by the cores) or type II (with dominant multivesicular component but no cores). Other granules are intermediate between types I and II. The granules are similar to late endosomes and have the properties of two usually separate organelles: those of the secretory type and those of the lysosomes ( 403 ). Similarities with lysosomes include the acidic pH, the mannose-6-phosphate receptor (MPR), and the lysosomal marker, lysosome-associated membrane protein. Endocytic components carrying CD3/TCR, CD8, and MHC molecules reach the perforin-containing granule and are displayed in the outer leaflet of the membrane.

### Granule Contents

**PERFORIN (CYTOLYSIN)** *Perforin* is a 65- to 75-kd glycoprotein with patchy homology to C9 complement component. It is synthesized as an inactive precursor, which is cleaved to yield a 60-kd active form ( 404 ). The protein consists of two regions: One has homology to complement proteins ( $\text{C}_6$  to  $\text{C}_9$ ), and the other is a C2 domain related to  $\text{Ca}^{2+}$ -binding proteins ( 405 ). The C-terminal portion is cleaved by proteolytic enzymes activating the C2 domains for phospholipid binding ( 406 ). The N-terminal is involved in interaction with the membrane and polymerization. However, the central portion contains four membrane-spanning domains, potentially capable of forming amphipathic  $\alpha$  helices of  $\beta$  sheets. At the carboxy terminal, a short peptide (pro-piece with a bulky glycan attached) is removed, and the remaining perforin monomer undergoes conformational changes in the presence of  $\text{Ca}^{2+}$ , inserting itself in the membrane. Interaction with other perforin monomers forms the polyperforin pores ( 407 , 408 and 409 ). At least three to four monomers are needed to form a functional channel, whereas 10 to 20 aggregated monomers are needed to produce a pore visible by electron microscopy.



**GRANULYSIN** Granulysin is a member of the saposin ( [410](#), [411](#) ) family of lipid-binding proteins, related functionally to defensins and other bacterial peptides, but is structurally different. It is active against gram-positive and gram-negative bacteria, fungi, and parasites. It disrupts artificial liposomes, damages mitochondria, and activates caspase 9 to induce apoptosis. It probably plays an important role in innate and acquired antimicrobial defenses. It kills extracellular *M. tuberculosis* and decreases their viability inside the cell ( [412](#) ).

**GRANZYMES** Granzymes are serine proteases of the chymotrypsin family ( [413](#), [414](#) ). The crystal structure of granzyme B has been solved, and its structural similarity with chymotrypsin has been verified ( [415](#) ). On the basis of the gene structure, proteolytic specificity, and biologic function, these enzymes are divided into three subfamilies. They are produced as proenzymes, with an acidic inactivating peptide. During their transport through the endoplasmic reticulum and Golgi apparatus, they are processed so that they are targeted to the secretory pathway. The activation peptide is removed by dipeptidyl peptidase I (DPPI), and a sequence motif interacts with proteoglycan in the granule to maintain proper conformation for activation. Granzyme B has a unique specificity among mammalian serine proteases in that it requires aspartic acid as P1 amino acid (i.e., the cleavage leaves a carboxy-terminal aspartic acid). Granzymes are highly positively charged proteins at neutral pH and form complexes with proteoglycans in the granule and extracellularly with polyanionic components.

**CALRETICULIN** Calreticulin is a  $\text{Ca}^{2+}$  storage protein and carries a sequence that retains it in the endoplasmic reticulum. It co-localizes with perforin and is released together with perforin, which binds to the P-domain of calreticulin. Calreticulin functions as a chaperone protein for perforin and protects the CTL during biogenesis of the granules ( [416](#) ). Fragments of individual calreticulin domains used in lytic assays showed that the  $\text{Ca}^{2+}$ -binding C-domain, which does not bind perforin, has the strongest capacity for inhibitory activity ( [417](#) ). However, lysis is independent of calreticulin's ability to sequester  $\text{Ca}^{2+}$ . It is suggested that calreticulin stabilizes membranes and thus prevents polyperforin pore formation.

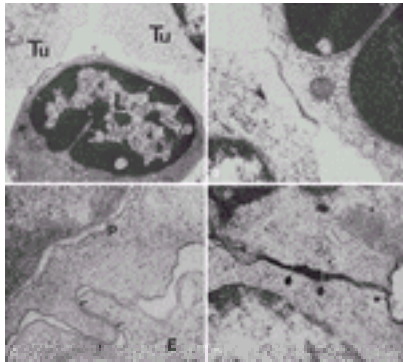
**OTHER COMPONENTS** Chondroitin sulfate proteoglycans are negatively charged and are exocytosed during target lysis. They probably regulate delivery of the positively charged granzymes ( [418](#) ). The multivesicular domain of the granule is rich in MPR, which is normally absent in mature lysosomes but present in early endosomes. The dipeptidyl peptidase (cathepsin C) is a lysosomal cysteine protease responsible for posttranslational processing in the generation of activated myeloid and lymphoid granule serine proteases.

## Mechanism of Target Cell Lysis

**SECRETORY SYNAPSE** As we have seen with the CD4 T lymphocyte, recognition of the antigenic determinants by TCR is associated with the formation of the IS. In the synapse, the SMAC is organized by TCR and adhesion molecules. CTL also forms a synapse with the target cells, and within the synapse, there is a defined secretory domain ( [419](#) ). LFA-1 and talin form an outer ring of adhesion proteins with a distinct secretory domain in the center and separate from the cluster of the TCR and signaling molecules ( [420](#) ). Electron microscopy shows granules on the point of degranulation. The CTL acquires the hand mirror configuration during movement, with the nucleus leading in front and cytoplasmic organelles trailing behind. The Golgi is apposed tightly to the membrane at the point of contact, and organelles appear to be "streaming" toward the contact site. Confocal microscopy shows that the granules initially cluster just behind the MTOC and then go around the MTOC to reach the secretory domain. Intimate interdigitations are visible over a large area, but a thin extracellular space separates the two cells that are held together by gap junctions ( [421](#) ) ( [Fig. 17.15](#) ). Gap junctions exist normally between cells in various tissues and probably serve the function of cellular communication. The nucleus moves



away, and the granules take up position next to the area of adherence with the target.

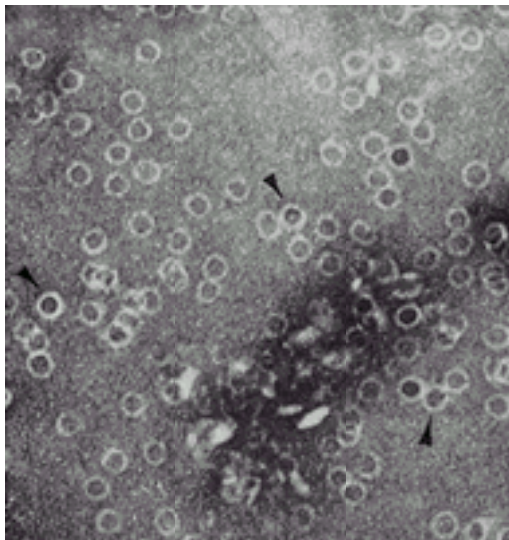


**Figure 17.15.** Interaction between a cytotoxic T cell and its target. **A–C:** Cytotoxic T cell attaches to its target over broad areas of the cell membrane. The formation of the conjugate involves interdigitations of microvilli between the two cells. **D:** Lanthanum nitrate fills the gap between cytotoxic T lymphocyte and its target and reveals junctions (arrows) that stretch between the two cells. The function of these junctions remains unknown. **E,** EL-4 tumor cell; **L,** lymphocyte; **P,** peritoneal exudate cell (i.e., cytotoxic T cell); **Tu,** tumor. ( **A,B,** and **D** from Grimm E, Price Z, Bonavida B. Studies on the induction and expression of T cell-mediated immunity. VIII. Effector-target junctions and target cell membrane disruption during cytolysis. *Cell Immunol* 1979;46:77–99; **C** from Kalina M, Berke G. Contact regions of cytotoxic T lymphocyte-target cell conjugates. *Cell Immunol* 1976;25:41–51, with permission.)

Confocal microscopy identifies regions of the secretory synapse where granules are secreted between Ick and talin or CD11a ( [Fig. 17.11](#)). The granules stream around the nucleus along microtubules and accumulate behind the MTOC and the Golgi apparatus. Then they move around the Golgi and reach the synapse, where secretion occurs between the adhesion ring and the signaling domain. They fuse with the membrane within 4 minutes after contact with the target ( [422](#)). This fusion marks the beginning of the  $\text{Ca}^{2+}$ -dependent second stage characterized by striking intracellular changes. The most remarkable of these changes is the reorientation of the MTOC, which, together with the Golgi, takes a position facing the area of contact with the target ( [423](#), [424](#) and [425](#)). The  $\text{Ca}^{2+}$  requirements for lysis may also be due to the  $\text{Ca}^{2+}$  dependency of the MTOC reorientation that is a prerequisite for CTL killing ( [426](#)). Granules attach to and then move along microtubules toward the MTOC and finally are secreted at the MTOC. Disruption of microtubules by certain drugs severely impairs killing ( [425](#)). For the last stage of granule secretion, a GTP-binding protein, Rab27a, is critical for moving the granules from the MTOC to the synapse ( [427](#)). In a rare autosomal-recessive disease known as *Griscelli syndrome*, Rab27 is defective. These patients have albinism because melanocytes require Rab27a to secrete melanosomes. WASp, which activates the Arp2/3 complex for actin polymerization, is also required for cytotoxicity ( [428](#)). Lymphocyte-mediated killing can be confined to two pathways: the perforin-granzyme-mediated and the Fas-mediated pathways ( [429](#)). Independent of the importance of the contribution of each pathway in target cell lysis, the fact is that lysis absolutely requires exocytosis of granules and their contents. Exocytosis requires signaling from PI3K and ERK. The importance of exocytosis is emphasized by markedly decreased cytotoxicity of CTLs and NK cells in Griscelli syndrome and the ashen mouse. The ashen mice have a profound decrease of cytotoxicity, even though they have normal FasL expression and FasL cytotoxicity ( [430](#)). Patients with Griscelli syndrome and the ashen mouse have a loss of function mutation in the RAB27A gene that abrogates the expression of Rab27a GTPase (one of approximately 50 GTPases). Rab27a affects the functions of the dense granules of platelets, melanosomes of melanocytes, and secretory lysosomes of CTLs. In platelets,

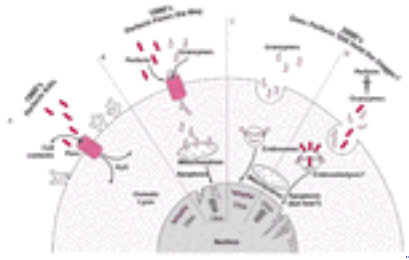
Rab27a regulates secretion only of the dense granules. Increase of  $\text{Ca}^{2+}$  is critical for cytotoxicity, which results from extracellular sources, because it does not occur if extracellular  $\text{Ca}^{2+}$  is removed ( 431 ).

**ROLE OF PERFORIN** *Perforin* was the name given to a protein within the granules that perforates the cell membrane and opens pores, which originally were believed to be the cause of lysis and cell death. The C-terminal domain of perforin is the  $\text{Ca}^{2+}$ -binding site that initiates the insertion of the molecule into cell membrane ( 406 ). The insertion is mediated by exposure of several aspartate residues after cleavage of the C-terminus to yield a 60-kd active form. These residues are presumed to become approximated in three dimensions and bind  $\text{Ca}^{2+}$ , and the molecule becomes highly reactive for lipids from exposure of amphipathic domains. Some data suggest that perforin actually is inserted into the lipid bilayer with the help of a receptor. NK cells release a lysolipid, the platelet-activating factor, which binds to its receptor and forms a bridge between the platelet-activating factor receptor and perforin ( 432 ). At 37° C, perforin inserts into the membrane, and approximately 20 perforin monomers form a tubular structure (16 nm wide) with a torus in the upper ring ( 433 ), similar to that formed by the C9 component of complement ( Fig. 17.16). Purified perforin causes cell lysis but not the DNA fragmentation and condensation associated with apoptosis, which is a hallmark of target cell lysis by CTLs ( 434 ). Furthermore, nuclear changes occur before cell membrane damage ( 435 ).



**Figure 17.16.** Lesions (arrows) inflicted on its target by cytotoxic T lymphocytes. Cytotoxic T lymphocytes form punched-out lesions on the membrane of the target similar to those formed by complement. (From Dennert G, Podack ER. Cytolysis by H-2-specific T killer cells. Assembly of tubular complexes on target membranes. *J Exp Med* 1983;157:1483-1495, with permission.)

Target cell death requires combined action of perforin and granule-associated granzymes. However, mice deficient in perforin suffer more serious consequences of lack of or diminished cytolytic functions ( 436 ) as compared to mice deficient in granzymes A and B ( 437 ). It has been assumed that granzymes enter passively through perforin pores ( Fig. 17.17). Large pores that allow passive diffusion of the granzymes are formed only with large concentrations of perforin. The pore size formed by small concentrations of perforin does not permit diffusion of proteins larger than 8 kd. However, even under these conditions, granzymes (32 to 65 kd) have access to the cytosol, although evidently not by direct diffusion through perforin pores. A lysin from *Listeria monocytogenes* also permits granzyme access to cytosol even in the absence of any measurable plasma membrane damage ( 438 ).

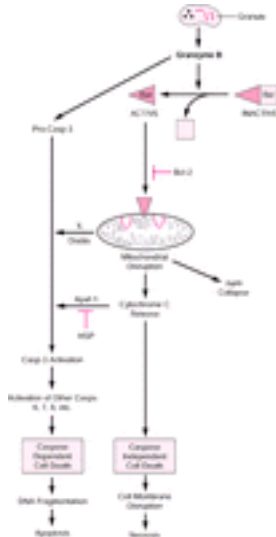


**Figure 17.17.** What is the role of perforin in cell lysis? The perforin lesion used to be considered the cause of cell death by osmotic lysis (as with complement) ( *A* ). When the granzymes were implicated in the cause of cell death by the apoptotic pathway, it was believed that the pores of perforin allow the entrance of the granzymes into the cell ( *B* ). Granzymes, however, can still enter the cell without perforin, but by themselves, they cannot cause cell death ( *C* ). Because granzymes enter the cell by endocytosis and are within endocytic vesicles, it is argued that perforin is needed to release them in the cytosol by punching holes in the vesicles (endosomolytic mechanism) ( *D* ). At this point, it is known that cytotoxic T lymphocytes kill their targets, and for this function, they need at least two of the contents of the granules: the granzymes and the perforin. The exact mechanism, however, is still strongly debated.

The entrance of granzyme B into the cell at low perforin concentrations is suggested to occur, probably as a result of endocytosis (“facilitated access” hypothesis). Perforin endocytosed together with granzyme disrupts the endocytic pathway and releases granzyme for delivery to the nucleus. Support for this interpretation comes from the observation that brefeldin, which interferes with redistribution of proteins out of the endosomal system, inhibited perforin-induced release of granzyme B, blocked its translocation to the nucleus, and inhibited cell death ( [438](#) ). Granzyme B is therefore able to enter into the interior of the cell autonomously in the absence of perforin. However, apoptotic death does not occur unless perforin is added ( [439](#) ). Granzyme binds to MPR when it is trafficking within the cell at the time of synthesis but also on the surface of the target cell ( [440](#) ). However, MPR is not critical for transportation of granzyme B within the target cell because cells lacking MPR are still subject to apoptosis by granzyme B, which enters the cell by constitutive fluid-phase micropinocytosis ( [441](#) , [442](#) ) or some other, probably specific, receptor. Endocytosis follows the binding to the receptor, and the granzyme B is detected first within Rab5-positive endocytic vesicles and subsequently in Rab5-negative, novel endocytic compartments that are not identifiable by any of the known endocytic markers ( [443](#) ). The granzyme B is released to the cytoplasm by a second signal provided by perforin or replication-deficient adenovirus (Ad2). From the cytoplasm, the granzyme B reaches the nucleus, initiating the apoptotic pathway. The localization in the nucleus occurs before the nuclear events of apoptosis, suggesting that nuclear translocation of the granzyme B transmits an apoptotic signal that is communicated to the nucleus ( [444](#) ).

**ROLE OF GRANZYMES** Independent of the role played by each of the constituents of the granules, it is absolutely clear that *exocytosis* is crucial for target cell death. In T cells, the granules are synthesized when the cells receive activation signals, whereas in NK cells, the granules are preformed. At least four granzymes are present ubiquitously in human cytotoxic cells (i.e., A, G, H, and K). After their synthesis, the granzymes undergo posttranslational modifications and, as a result, assume an active conformation. First, the signal peptide is removed and, subsequently, a short propeptide, which for granzymes A and B is DPPI ( [445](#) ). Subsequently, they are glycosylated and then sorted by the MPR in the Golgi apparatus on the way to the granules ( [446](#) ). Granzyme B is a serine protease originally defined as an *aspase* because it cleaves after aspartic acid in the P1 position and is the only granzyme with the preference for proteolytic cleavage after aspartate residues. In this respect, it has a specificity similar to caspases and has an extended substrate specificity with nine amino acids making contact with the substrate. The first

substrate of biologic significance of granzyme B was found to be a member of the caspase family (447). Cleavage of target-cell caspases (448) results in the activation of the cellular apoptotic cascade (Fig. 17.18). Granzyme B activates apoptosis by two distinct pathways [i.e., by directly cleaving its substrates, caspase 3 or caspase 8 (449), and by a caspase-independent pathway through mitochondria]. Mitochondria have a central role in the execution of apoptosis, involving disruption of electron transport and energy metabolism, production of reactive oxygen radicals, and the release of apoptotic proteins, such as cytochrome *c* (450, 451).



**Figure 17.18.** Cytotoxic T lymphocyte killing of target cells. The cytotoxic T lymphocyte killing of its targets is mediated by both the granzyme(s) (Gr), especially GrB, and the perforin, and because both of them share the same intracellular residence (i.e., the granule), the killing mechanism is known as the *granule exocytosis mechanism*. GrB activates caspase (Casp)–3, either directly or, most likely, *in vivo* by cleavage of the proapoptotic member of the Bcl2 family, Bid. The active Bid acts on the mitochondrion and causes opening of the permeability transition (PT) pore of the inner mitochondrial membrane that causes (or is the result of) the collapse of the  $\Delta\Psi_m$  (mitochondrial transmembrane potential).  $\Delta\Psi_m$  normally results from the asymmetric distribution of protons and other ions on both sides of the inner mitochondrial membrane. It is essential for normal mitochondrial function.  $\Delta\Psi_m$  disruption occurs before cells exhibit nuclear DNA fragmentation or aberrant exposure of phosphatidyl serine on the outer cell membrane; therefore, it constitutes probably the earliest common event of the apoptotic cascade. Mitochondrial disruption activates a factor not yet well identified (X) and contributes to amplification of activation of Casp–3 and other Casps subsequently (Casp–6, –7, –8, –9, –10). The factor X may be Diablo [direct inhibitor of apoptosis proteins–binding protein], which facilitates processing of Casps through inhibition of inhibitor of apoptosis proteins. The Bid pathway of Casp–3 activation provides a greater lethal threshold of amplification of activation of Casps than the direct GrB activation. In addition to the Casp–dependent pathway (apoptosis), disruption of mitochondria by GrB–activated Bid leads to cell death by necrosis. HSP, heat–shock protein. [Kroemer G, et al. Mitochondrial control of apoptosis. *Immunol Today* 1997;18:44–51; Heibein JA, et al. Granzyme B–induced loss of mitochondrial inner membrane potential ( $\Delta\Psi_m$ ) and cytochrome *c* release are caspase independent. *J Immunol* 1999;163:4683–4693; Sutton VR, et al. Initiation of apoptosis by granzyme B requires direct cleavage of bid, but not direct granzyme B–mediated caspase activation. *J Exp Med* 2000;192:1403–1413; and Barry M, et al. Cytotoxic T lymphocytes: all roads lead to death. *Nat Rev Immunol* 2002;2:401–409.]

Mitochondrial factors enhance the extramitochondrial caspase activation. Bcl2 can rescue cells from granzyme B–mediated cell death, specifically blocking the pathways that operate directly through mitochondrial perturbations. Bcl2 suppresses the mitochondrial



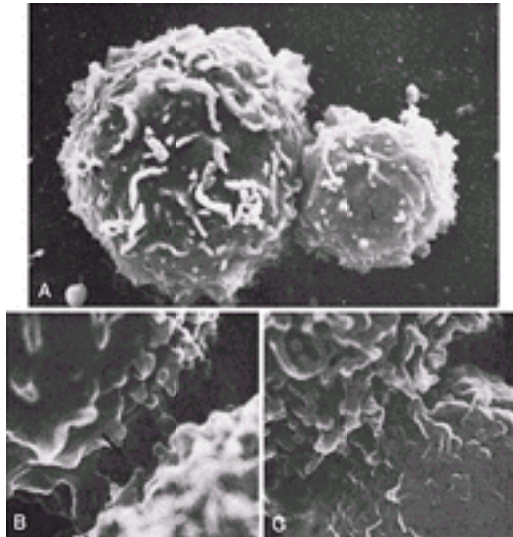
pathway because it prevents loss of mitochondrial membrane depolarization and inhibits the release of cytochrome *c* and apoptosis-inducing factor into the cytosol ( 452 ). The mitochondrial apoptotic pathway is triggered by direct cleavage of Bid ( 453 ), which results in the translocation of tBid to mitochondria, where it interacts with its receptors, Bax and Bak, to cause cytochrome *c* release. Cytochrome *c* then activates the apoptosome, which activates caspase 9 and ultimately caspase 3 ( 454 ). Bcl2 apparently blocks granzyme B-induced apoptosis by acting at an upstream point of the granzyme B pathway (i.e., blocking the translocation of the granzyme to the nucleus) ( 455 ).

**Granzyme A** Granzyme A is a tryptase and induces caspase-independent cell death. It concentrates in the nucleus of the targeted cells and degrades histone H1 into small fragments ( 456 ). Histone H1 plays a critical role in chromatin hypercondensation, which protects genomic DNA from endonuclease digestion. Histone digestion provides a mechanism for unfolding compacted chromatin and facilitating endogenous DNAase access to DNA during T-cell granule-mediated apoptosis. Another target for granzyme A is protein HMG2 ( *high-mobility group protein 2*). HMG2 is a nonhistone protein that binds to the internucleosomal linker region of DNA and to core histones and is involved in critical steps in DNA replication and transcription. It binds preferentially to distorted DNA and unwinds damaged DNA for its repair. It facilitates the assembly of higher-order nucleoprotein structures by bending and looping DNA or by stabilizing underwound DNA. Granzyme A cleaves HMG2 protein and thus opens up chromatin and blocks the *de novo* transcription required for cellular repair responses. Opening up chromatin probably contributes to the observed synergy of granzyme A with granzyme B in the induction of oligonucleosomal DNA fragmentation during CTL lysis ( 457 ). Both granzyme A and B directly cleave lamin B ( 458 ), a member of the lamin family of proteins that maintain the integrity of the nuclear envelope. Granzyme A, bound to proteoglycans, has been detected in the blood of patients with viral diseases and rheumatoid arthritis ( 459 ). In complexes with proteoglycans, it is protected against inactivation by protease inhibitors (a<sub>2</sub>-macroglobulin and so forth). However, its role in the blood in these conditions remains unknown. The entry of granzyme A into the nucleus requires the signal from perforin, and once inside the nucleus, it binds to insoluble factors because it does not leak out, even after the nuclear membrane is permeabilized ( 460 ).

**DEATH RECEPTOR PATHWAY** Cytotoxic lymphocytes use two pathways for killing their targets: the exocytosis pathway (perforin-granzyme) and a death receptor pathway. Although there are multiple receptors on the cell surface that can initiate an apoptotic cascade, they converge at one point downstream to a common final pathway. The point of confluence is the adaptor molecule FADD ( *Fas-associated death domain*). These alternate apoptotic pathways may be considered as the FADD pathway ( 461 ). The pathways that converge to FADD are initiated by Fas (CD95), the most physiologically important receptor in the family of TNF receptors. FADD binds and recruits caspase 8, which stands at the apex of the cascade of all caspases ( 462 ) and forms the DISC ( *death-inducing signaling complex*) ( 463 ). Caspase 8 may target the mitochondria through Bid or caspase 3, depending on the cell type ( 464 , 465 ). In the FADD pathway, the FasL is not stored even in activated cells, and as a result, it requires the induction of a new ligand after TCR stimulation, which requires 1 to 2 hours after stimulation. The half-life of the ligand is long (2 to 3 hours), and the CTL can kill innocent bystanders (as long as they express the appropriate receptor, Fas) without the need for TCR signaling ( 466 ). In this respect, the FADD pathway is much more promiscuous than the perforin pathway. The death receptor pathway is important for CD4<sup>+</sup> Th1 cells ( 467 ).

**MEMBRANE MORPHOLOGY OF TARGET CELL LYSIS** In the early stages of cell death induced by CTL, plasma membrane components are translocated to intracellular membrane structures, including nuclear envelope and mitochondria. Membrane-bound perforin and the granzymes are internalized at the same time, and it is postulated that, subsequently, perforin releases the granzymes to the cytosol by an endosomolytic action for activation of the caspase pathway ( [Fig. 17.17](#) and [Fig. 17.18](#)). In the early stage, the

target does not undergo extensive permeabilization during perforin-dependent CTL lysis. The first detectable change in the target cell-surface morphology consists of the formation of small dilatations of the surface microvilli, forming small vesicles that eventually expand into large blebs even before  $^{51}\text{Cr}$  release can be detected. Some of the detached vesicles attach to neighboring CTLs, suggesting that they carry some target-specific antigens on their surface ( [Fig. 17.19](#)).



**Figure 17.19.** Cytotoxic T lymphocyte–target cell interaction. **A–C:** Scanning electron microscopy of the formation of the killer cell synapses. Intimate contact is established between the microvilli of the two cells. Compare with the electron microscopic view in [Figure 17.15](#). ( **B,C** from Kalina M, Berke G. Contact regions of cytotoxic T lymphocyte–target cell conjugates. *Cell Immunol* 1976;25:41–51; and **A** from Grimm E, Price Z, Bonavida B. Studies on the induction and expression of T cell-mediated immunity. VIII. Effector–target junctions and target cell membrane disruption during cytolysis. *Cell Immunol* 1979;46:77–99, with permission.)

## Functions Mediated by Lymphocyte Toxicity

**DEFICIENCIES OF GRANULE CONTENTS** Virus-specific cytotoxic  $\text{CD8}^+$  T cells are induced on infection against many viruses ( [Fig. 17.14](#)). Lysis of an infected cell may occur in the eclipse phase before any infectious virus has been produced, and CTLs kill virus-infected cells before new viral antigens can be detected on the surface with antibodies ( [468](#)). Fas deficiency has no effect on the role of viral clearance, but elimination of both Fas and perforin leads to uncontrolled infection ( [469](#)). Normal mice easily survive a high inoculum ( $10^6$  PFU) of the ectomelia virus, a murine-specific poxvirus. However, perforin-deficient mice succumb with a dose as small as 10 PFU. Perforin deficiency in mice is associated with increased susceptibility to a variety of infections by viruses, protozoa (plasmodium, *Trypanosoma cruzi*), and bacteria (i.e., mycobacteria, salmonella, chlamydia, *Listeria*, and so forth) ( [470](#)). Defense involves not only cytolytic mechanisms but also cytokines (i.e.,  $\text{IFN-}\gamma$ , TNF, and so forth), as well as microbicidal molecules. In the experimental model of lymphocytic choriomeningitis virus infection in mice, a nonlytic viral infection, perforin-dependent cytotoxicity is crucial in the control of the acute stage ( [471](#)). During the chronic stage of this infection, perforin down-regulates  $\text{CD8}^+$  T-cell expansion and prevents immunopathology ( [472](#)). In perforin-deficient mice, however, the lack of this immunoregulatory control results in expansion of  $\text{CD8}^+$ -activated T cells, with approximately 50% of the animals dying within

2 to 4 weeks as a result of the immunopathologic damage from uncontrollable CD8<sup>+</sup> proliferation and activation. Infusion of normal CD8<sup>+</sup> T cells fully reverses pathology and the associated mortality. This example clearly differentiates between defense and immunopathology, which normally is averted from an “exocytosis”-mediated mechanism of regulation of CD8<sup>+</sup> cytolytic cells. In another model involving the *lpr/lpr* mice, which are deficient in the Fas receptor, deficiency of perforin markedly accelerates the spontaneous lymphoproliferative disease, which normally occurs at a slower pace in these mice. This evidence also supports the notion that perforin plays a role in immune regulation, prevention of immunopathology, and autoimmunity. Recently, a homozygous loss of function defect in the human perforin gene has been detected that is associated with several clinical manifestations, mainly due to uncontrolled T-cell and macrophage activation with overproduction of inflammatory cytokines. The syndrome is known as *familial hemophagocytic lymphohistiocytosis* (FHL) (473). The disease is mapped in chromosome 10q21–22 (i.e., the location of the perforin gene). Overall, the incidence of the mutation is approximately 20% in all FHL patients. For the development of FHL syndrome, a viral infection or a defect of an additional pathway that controls lymphocyte homeostasis is required. Perforin-deficient mice, for reasons unknown at the present time, do not develop symptomatology similar to human FHL. Mice deficient in granzyme B lose the ability to induce DNA fragmentation, even though perforin causes membrane damage. Deficiency of both granzymes A and B causes susceptibility to ectromelia infection (474), although cytotoxic lymphocytes with the same deficiency and inability to cause DNA fragmentation are still able to exert a potent antitumor effect (475). DPPI, also known as *cathepsin c*, is a lysosomal cysteine protease expressed in most tissues, and in CTLs, it is found in the secretory compartment. It belongs to the papain superfamily of proteases and shares similarities to lysosomal cysteine proteases cathepsins B, H, and L. Granzymes A and B become enzymatically active only after cleavage of the N-terminal dipeptide by DPPI and are stored in the lysosomal granules in the active form along with perforin. DPPI knock-out mice resemble the perforin-deficient mice: Both fail to cause apoptosis. DPPI deficiency results in failure to activate the granzymes, whereas perforin deficiency fails to deliver the granzymes into target cells (476, 477). Deficiency of DPPI has been detected in humans with Papillon-Lefèvre syndrome, which is characterized by keratosis palmoplantaris with perio-dontopathia (478). There is premature tooth loss due to periodontal disease and thickening of the skin.

**GRAFT-VERSUS-HOST AND GRAFT-VERSUS-LEUKEMIA REACTIONS** Lymphocyte cytotoxicity has been implicated in graft-versus-host disease after allogeneic bone marrow transplantation, with contribution to the pathogenesis by both the perforin and Fas pathways (479, 480 and 481). It is agreed that cytotoxic lymphocytes contribute to the development of the disease, but there is no agreement about the underlying mechanism. The graft-versus-leukemia effect, however, seems to be mediated predominantly by the perforin pathway.

**GRANZYME INHIBITORS** An important characteristic of the function of cytotoxic cells is that they avoid successfully the damaging effect of the lethal weapons they deliver to kill their targets. As a matter of fact, the CTLs, after a successful hit, disengage and are directed against another target. Some recent observations provided a molecular explanation for their protection from “suicide.” The effector cells contain a potent inhibitor of granzyme B, known as *proteinase inhibitor 5* (482, 483). The inhibitor is a serpin, is found in both the cytoplasm and the nucleus, and forms tight complexes with granzyme B but does not inhibit most of the caspases. Serpins are a large family of intracellular and extracellular protease inhibitors. Many viruses encode serpins that block caspases, the enzymes of apoptosis. Inhibitors of granzyme B can be encoded by several viruses. Best described is the poxvirus-encoded cytokine response modifier A (CrmA). Overexpression of CrmA in target cells inhibits CTL-mediated killing, but predominantly through a Fas-mediated pathway. CrmA inhibits granzyme B and several caspases. With several of the steps of CTL cytotoxicity now understood, therapeutic interventions are possible for several of the steps of lymphocyte cytotoxicity in a number of human



conditions.

## How Many Roads Lead to Death?

Despite the wealth of information on the mechanism of this important pathway, there are several areas that are not well understood. Perforin has an indispensable role in the delivery of granzyme B, but certainly not simply as a pore-forming molecule. Granzymes, on the other hand, induce the nuclear changes affecting the DNA (i.e., by apoptosis), but even if they enter the cell in the absence of perforin, they cannot be translocated to the nucleus without perforin (484). The mechanism of granzyme delivery by perforin is not clear. It has been postulated that intracellular delivery of granzymes is through an endosomolytic mechanism (485). Translocation of a fluorescent probe from the target cell membrane to interior membranes, including the nuclear envelope and mitochondria, is supportive of this prediction (486).

The relationship of the roles of perforin and granzymes in cytotoxicity was examined in the *gld/gld* mice, which have a FasL deficiency and therefore cannot have Fas-mediated cytotoxicity. The additional deficiency of granzyme B in *gld/gld* mice (i.e., mice with the phenotype GrB *gld/gld*) leads to CTLs with residual cytotoxicity, which can only be perforin dependent. This can be concluded also from the fact that perforin<sup>-/-</sup> *gld/gld* CTLs have no residual cytotoxicity (487). It is reasonable to conclude that the cytotoxicity, which is independent of granzyme B, is normally accounted for partially by a Fas pathway and partially by a second perforin-dependent mechanism. Finally, inhibitors of caspases block the Fas death pathway, but in CTL granule exocytosis, the target cell lysis is not detectably blocked, although the accompanying apoptotic nuclear damage is efficiently blocked. Thus, caspase inhibitors prevent the hallmark phenotype of apoptosis without affecting cell death, as evidenced by lysis (488). At this point, not all the roads used by the CTL that may lead to cell death have been fully explored.

## Regulatory T Cells

During the 1970s, CD8<sup>+</sup> cells were separated into two functional groups, with one being cytotoxic and another having a distinct function of regulating ongoing immune responses or inducing tolerance to autoantigens. These *suppressor T cells* were defined by the ability of T cells from animals tolerant to an antigen to suppress the immune response to the same antigen (489). Suppressor cells could be distinguished by cell-surface markers from helper T cells, as both could be induced after immunization (490). Molecular biologists could not identify genes that could encode the plethora of suppressive factors that could only be demonstrated functionally in supernates of suppressor cells or clones (491).

The field of suppressor cells was broadly dismissed (492). For a period of time, the role of “suppression” in immune regulation was attributed to the balance between Th1 and Th2 cells. Th2 cells, for example, regulate Th1 responses by exerting a suppressive effect on Th1 differentiation by their cytokines, a phenomenon called *immune deviation*.

More recently, the notion of suppressor cells has been revived, and their existence has been demonstrated (493, 494), but in their resurrection, they have been given a new name: *regulatory T cells*.

Regulatory T cells (Tr1) develop in the thymus, maintain homeostatic equilibrium of immunity and tolerance, and are able to control destructive autoimmunity specific to

different tissue antigens. The nonobese mouse is a strain genetically susceptible to development of spontaneous insulinitis; the incidence of diabetes between 3 to 5 months of age correlates with progressive loss of Tr1 cells as the disease progresses ( [495](#), [496](#) ).

Another strain of mice develops an inflammatory bowel disease that has several similarities to human Crohn disease and ulcerative colitis. In this model, inflammatory disease of the bowel develops in response to intestinal pathogens and depends on the accumulation of activated dendritic cells ( [497](#) ). However, the Tr1 cells impede the ability of dendritic cells to induce a sustained inflammatory response. IL-10 and TGF- $\beta$  produced by Tr1 inhibit intestinal inflammation and T-helper cell responses, type 1 or type 2 ( [498](#) ).

The presence of Tr1 cells has been demonstrated in severe combined immunodeficiency disease (SCID) patients successfully transplanted with mismatched hematopoietic stem cells ( [499](#) ), as well as in recipients of kidney or liver allografts ( [500](#) ), indicating that the Tr1 cells regulate transplantation tolerance. Oral tolerance is a long-recognized mechanism of tolerance, induced by partially degraded dietary antigens presented to the gut-associated lymphoid tissues ( [501](#) ). Regulatory cells induced by this method secrete TGF- $\beta$  and have been called *Th3 regulatory cells* ( [502](#) ). These cytokines can be induced by high doses of antigen, given by mouth, in a number of experimental autoimmune diseases and also in patients with multiple sclerosis after oral administration of myelin proteins ( [503](#) ).

In patients with the helminthic infection by fluke *Onchoercia volvulus*, strong inflammatory responses, and thus damage to the patient, are suppressed by TGF- $\beta$  and IL-10 cytokines produced by Th3 regulatory cells and not by a shift from Th1 and Th2 responses ( [504](#) ). The same cytokines have also been associated with remissions of chronic idiopathic purpura ( [505](#) ).

Although the emphasis of immunosuppressive mechanisms by Tr cells has been placed on the secretion of the immunosuppressive cytokines TGF- $\beta$  and IL-10, Tr cells activated by their TCR ( [506](#) ) suppress immune responses by killing Th cells by apoptosis ( [507](#), [508](#) ) or by blocking up-regulation of co-stimulatory molecules (CD80, CD86, CD54, CD58) ( [509](#) ) or inhibiting their transcription by NF- $\kappa$ B and the CD40/CD40L pathways ( [510](#) ).

The source of Tr is the thymus, which, like other developing thymocytes, is submitted to the scrutiny of selection processes for its specificity. The criteria of their positive selection appear unorthodox because they are based on high-avidity interactions involving a limited peptide repertoire ( [511](#) ). High-avidity interactions between the TCRs of developing thymocytes and their ligands on the thymic stroma mediate negative selection of autoreactive cells.

Another functional deviation from the normal pathways is that the CD8<sup>+</sup> Tr cells recognize antigen in the context of class II molecules. Such CD8<sup>+</sup> T cells have been isolated from leprosy patients ( [512](#) ). Their specificity is very unusual considering that the co-receptor for the TCR is CD8. Recently, important insights into the mechanisms of autoimmunity by CD8<sup>+</sup> Tr were realized through studies on the control of experimental allergic encephalomyelitis, which is considered to be an instructive model for the human demyelinating disease multiple sclerosis, as both share similar pathology and the same functional abnormalities. The pathogenic effector cells in the mouse model are CD4<sup>+</sup> (Te), which recognize an immunodominant N-terminal peptide of the myelin basic protein,

and their TCR uses the VB8.2-J $\beta$ 2.7 gene segments. Two regulatory cells have been identified, one CD4<sup>+</sup> and the other CD8<sup>+</sup>. Activation of the CD4<sup>+</sup> Tr cell recruits and activates the CD8<sup>+</sup> Tr, the ultimate effector of regulation (508), but secretion of IFN- $\gamma$  by the CD4<sup>+</sup> Tr is necessary. The most interesting aspects in this multicellular complex of regulation of autoimmunity are the specificities of the TCRs of the CD4<sup>+</sup> and CD8<sup>+</sup> Tr cells (513). The TCR of the CD4<sup>+</sup> Tr recognizes a peptide from the framework 3 region of the VB8.2 TCR of the pathogenic CD4<sup>+</sup> Te. The TCR of the CD8<sup>+</sup> Tr recognizes a peptide from the CDR of the VB8.2 TCR of the same pathogenic CD4<sup>+</sup>VB8.2 cells. The net result of these interactions is the elimination of the pathogenic T cell with amelioration of the disease.

T lymphocytes with diverse functions (i.e., helper as well as pathogenic inflammatory) develop concurrently during an immune response, and as a result of differential expression of chemokine receptors, they are diverted by different migratory pathways to separate sites (514). It is therefore highly important that Tr induction is a component of the same response to regulate the function of potentially pathogenic T cells. The rapid explosion of research on suppressor T cells since their resurrection is an indication of their significance in protection from immunopathology as well as for regulation of the immune responses (515, 516).

## Regulatory T CELLS

### Regulatory T-Cell Repertoire

Commitment to the Regulatory T-cell lineage takes place in the thymus, and the operating mechanisms have been discussed earlier in this chapter. (See [Regulatory T Cell- \$\alpha\beta\$  versus Regulatory T Cell- \$\gamma\delta\$  and the Pre-T-cell Receptor.](#))

Rearrangements of the human  $\alpha$  and  $\beta$  loci appear to occur in a developmentally ordered fashion (517). Initially, the Regulatory TCR repertoire is small because rearrangements involve a small number of V segments, and the junctional diversity is limited.

In human embryos between 8.5 to 15.0 weeks of gestation, the most common V fragments are V $\beta$ 2 joined to D $\beta$ 3 and V $\beta$ 1-8 or V $\beta$ 9 with J $\beta$ 1. These cells are referred to as the *V $\beta$ 2 cells*. Rearrangements after birth at approximately 4 to 6 months of age involve joining other  $\beta$  segments such as V $\beta$ 1 to D $\beta$ 1 and D $\beta$ 2 and the V $\beta$ 1 family with the J $\beta$ 2 cluster. Postnatally, in the thymus, the V $\beta$ 2 subset represents 15% and the V $\beta$ 1 85% of the  $\beta$  cells, and these proportions remain relatively constant throughout adult life (518). However, in the blood, the V $\beta$ 2 subset increases with age from 25% in cord blood to more than 70% in adult blood, whereas the V $\beta$ 1 subset decreased from 50% in cord blood to less than 30% in adult blood (519).

Although intrinsic or genetic factors generate subsets of  $\beta$  T cells, extrinsic or environmental factors act further to shape and select specific clones. An enormous selective pressure is exerted on the development of  $\beta$  T cells throughout life to produce populations of cells that express antigen receptors that are encoded by specific gene segments. The predominance in adult human blood of the V $\beta$ 2 to V $\beta$ 9 population is explained by such antigen-mediated expansion (518). These expansions create oligoclonal populations due to selection pressures from environmental microbes and certain edible plants. In contrast to the V $\beta$ 2/V $\beta$ 2 (V $\beta$ 2 is the same as V $\beta$ 9) T cells that are a major circulating population, the V $\beta$ 1 cells account for the vast majority of the  $\beta$  T cells in

tissues such as intestine and spleen ( [520](#) ).

## γδ T-Cell Receptor Structure and Antigen Recognition

Antigen recognition by the γδ TCR resembles recognition by antibodies ( [521](#) ). The V and C domains are organized into “Ig folds” (i.e., approximately seven β strands packed face to face in two antiparallel β sheets, constrained by intradomain disulfide bonding). The V regions are subdivided into framework and hypervariable regions, which have three CDRs. The orientations of V<sub>γ</sub> and V<sub>δ</sub> are similar to the relative orientations between the V domains in the Fab Ig fragment or the αβ TCR. However, the CDR3 of V<sub>γ</sub> is diverse in length and composition (8 to 21 amino acids), a range similar only to the IgH (3 to 25). Furthermore, the CDR3 loops of the γδ TCR protrude above the rest of the molecule and create clefts between them, which strikingly distinguishes them from the equivalent loops of the αβ TCR, which are flat and bind to pMHC, and from the antibodies that bind large proteins ( [522](#) ).

In general, the γδ TCR is broadly conserved but with unique structural features. Antigen recognition by γδ TCRs is fundamentally different from that of αβ TCRs. Antigens are not required to be processed and there is no MHC restriction; as a result, the γδ TCR is allowed to recognize a wide array of antigens ( [521](#), [522](#), [523](#) and [524](#) ). The antigens recognized are those with a wide distribution that are constitutively expressed by host cells and by microbial pathogens and those that are inducibly expressed or might be restricted to certain cell types. Examples of the former category are nonprotein substances such as pyrophosphates and alkylamines that are found in bacteria, plant, or animal cells ( [525](#), [526](#) and [527](#) ), and bacterial and mammalian homologs of heat-shock protein 60 kd (HSP-60) ( [528](#) ).

Human peripheral blood V<sub>γ</sub>2V<sub>δ</sub>2 cells are present in large numbers in lepromatous lesions reactive with monoalkyl compounds of mycobacterial cell walls. The most potent compound is monoethylphosphate, which stimulates cytotoxic activity of these cells. The phosphate group is very important in the recognition of this substance by the γδ TCR. Several other phosphorylated compounds could be shown to have reactivity with the γδ TCR. Alkylamines, such as isobutylamine and so forth, derived from plant food products or from bacteria also stimulate V<sub>γ</sub>9V<sub>δ</sub>2<sup>+</sup> T cells ( [527](#) ).

A third class of antigens (i.e., the aminobiphosphonates) that are used to inhibit osteoclastic bone resorption, particularly in cancer patients, can also stimulate V<sub>γ</sub>9V<sub>δ</sub>2 cells ( [529](#) ). Antigens recognized by γδ TCR are also found in other infectious agents (i.e., *Listeria*, *Plasmodium* *coccidia*, and so forth). V<sub>γ</sub>9<sup>+</sup> T cells also respond to superantigens, such as staphylococcal enterotoxin A ( [530](#) ). Superantigens interact with the MHC class II molecules and TCRs in a way distinct from that of normal peptide antigens. They bind independently to MHC class II and to TCRs. They interact with the V<sub>β</sub> domain of the TCR outside of the CDRs and with the outer faces of the MHC molecule, outside the peptide-binding groove.

The functional γδ TCR exists as a complex with the CD3 polypeptide chains. Some mucosal γδ T cells interact with MHC-encoded proteins, MICA and MICB ( [531](#) ).

Recognition is through the activating NKG2D C-type lectin receptor ( [532](#) ), but the contribution of the γδ TCR is not clear. MICA and MICB class I molecules identify stressed cells and have a very restricted pattern of expression, primarily limited to intestine. MICA and MICB do not present peptides because the peptide-binding groove is of limited size ( [533](#) ) (see [Chapter 18](#)). These molecules may function in innate immunity

as important targets for V $\gamma$ 1<sup>+</sup> cells for elimination of stressed cells ( 520 ). Some V $\gamma$ 1<sup>+</sup> cells recognize the nonpolymorphic CD1c member of the CD1 family of molecules, expressed on APCs, that presents lipid and glycolipid foreign antigens to T cells ( 534 ). These  $\gamma$ d cells activated in response to CD1c produce IFN- $\gamma$  and direct  $\alpha\beta$  T cells to Th1 differentiation. Furthermore, they are cytotoxic and express granulysin, and they could lyse infected dendritic cells via the perforin pathway and kill released bacteria by granulysin. Therefore, their role is significant in host defense before antigen-specific T cells have differentiated ( 535 ).

Direct recognition of CD1c may represent a bridge between innate and adaptive immunity in a similar fashion to recognition of CD1d by murine and human NK<sup>+</sup> $\alpha\beta$  T cells ( 536 ), which polarize T cells to a Th2 phenotype. The CD1c-restricted  $\gamma$ d T cells promote the maturation of myeloid-derived dendritic cells, which, at the immature stage, express high levels of CD1a, b, and c antigens. When these dendritic cells mature, they are able to present antigens to CD4<sup>+</sup> T cells. This function of  $\gamma$ d T cells is important because they rapidly provide mature dendritic cells early during microbial invasion and, at the same time, secrete IL-12 to drive T-cell polarization to the Th1 type ( 537 ).

### $\gamma$ d T-Cell Function

The recognition of antigens by the  $\gamma$ d TCR is more akin to that of antibodies rather than the  $\alpha\beta$  TCR. It does not need antigen processing by APC and presentation by MHC. The available crystal structure of human V $\gamma$ 9/V $\gamma$ 2 shows that the functional similarities are, as expected, based on structural similarities with the heavy as well as the light chains of Igs, as discussed earlier.

Subsets of  $\gamma$ d T cells are characterized by the expression of distinct sets of V $\gamma$  genes, the V $\gamma$ 1 and V $\gamma$ 2. They are believed to represent separate lineages with different developmental pathways ( 538 ) and different tissue distribution. Most of the  $\gamma$ d T cells with intraepithelial localization (i.e., nasal mucosal, small intestine, and colon) are V $\gamma$ 1, whereas the V $\gamma$ 2 are detected in the peripheral blood, where they constitute approximately 5% of all T cells.

In general, the function of the  $\gamma$ d T cells in infectious diseases includes an immediate response to invasion by pathogens and a long-term regulation of the inflammatory response. The V $\gamma$ 9/V $\gamma$ 2 T cells release proinflammatory chemokines ( 539 ), and provide protection against mycobacteria by directly killing infected macrophages ( 540 ) and extracellular bacteria by granulysin with the help of perforin ( 541 ). The  $\gamma$ d T cells represent the largest population of mycobacteria-reactive T cells in the blood of humans, and more than 85% of them are V $\gamma$ 9/V $\gamma$ 2 and proliferate vigorously in response to the infection.

Persistent chronic disease correlates with a decline and eventual disappearance of mycobacteria-reactive  $\gamma$ d T cells ( 542 ). This loss is due to Fas-FasL-mediated apoptotic death as a result of activation-induced cell death from chronic stimulation by mycobacterial antigens. After clearance of the mycobacteria at a late stage of the disease, the  $\gamma$ d T cells contribute to the resolution of the response and prevention of chronic inflammatory disease by directly killing activated macrophages ( 543 ). This may be facilitated by the expression of CCR5, the receptor for the chemokine RANTES (MIP-1 $\alpha$ ) produced by macrophages ( 545 ).  $\gamma$ d T cells participate in responses against several other infectious agents ( 524 ). The evidence of a role of  $\gamma$ d cells against cancer is still

circumstantial ( [544](#) ).

A role of  $\gamma\delta$  T cells in autoimmune disease has been demonstrated in some experimental models. As has been discussed earlier, their mucosal localization places the  $\gamma\delta$  T cells in a unique position for defense against infectious agents, but also in induction of mucosal tolerance. Induction of oral tolerance is a very old observation ( [546](#) ). Antigens given by mouth induce specific systemic unresponsiveness, an observation that has been documented repeatedly in animals and humans.

Nonobese diabetic mice develop spontaneous insulinitis and diabetes, a disease that shares a number of immunologic and pathogenetic features with human type I diabetes. Conformationally intact but biologically inactive insulin administered in these animals intranasally induces immunoregulatory  $\gamma\delta$  T cells, which secrete IL-10, accounting for the antidiabetic suppressor effect ( [547](#) ).

$\gamma\delta$  T cells accumulate in the synovium of patients with rheumatoid arthritis ( [548](#) ). In an animal model of collagen-induced arthritis, the role of  $\gamma\delta$  T cells is controversial; whether  $\gamma\delta$  T cells promote or reduce exacerbation of inflammation may depend on the stage of the disease (early or late, respectively) ( [549](#) ). The evidence so far for the role of  $\gamma\delta$  T cells in defense, immune regulation, and surveillance as a result of their broad reactivity places this cell in a critical position as a “sentinel” between innate and adaptive immunity ( [550](#) ). This function is supported by its receptors, which share broad structural features of the Ig domains.

## NATURAL KILLER CELLS

NK cells were originally described on a functional basis according to their capability of killing certain tumor cells of hematopoietic origin in the absence of prior stimulation. Subsequently, they were identified by monoclonal antibodies as a discrete population of cytolytic lymphocytes and were implicated in several activities *in vivo*, such as activity against tumor cells, resistance to viral infections, and regulation of hematopoiesis ( [551](#) , [552](#) and [553](#) ).

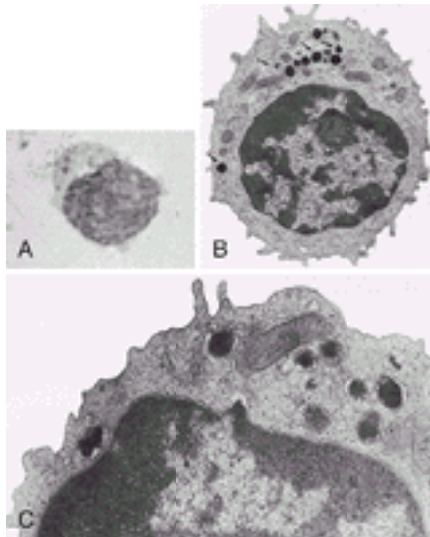
NK cells are a heterogeneous population with respect to phenotype and target specificity. Although the majority of the  $CD56^+$  NK cells are  $CD3^-$ , small numbers of  $CD45^+/CD3^+$  cells have been detected, and large granular lymphocyte (LGL) leukemias with the same phenotype have been reported ( [554](#) ).

### Morphology, Cytochemistry, and Surface Markers

LGLs are large cells with pale blue cytoplasm and a high cytoplasmic to nuclear ratio. Their main histologic feature is the presence of azurophilic granules ( [555](#) ). These cells constitute 2 to 6% of the peripheral white cells and approximately 10 to 15% of the peripheral blood lymphocytes. They are larger than the typical lymphocytes (10 to 12  $\mu\text{m}$ ) with a larger amount of cytoplasm that contains peroxidase-negative granules ( [Fig. 17.20](#) ). The  $\alpha$ -naphthyl acetate esterase distribution is similar to that found in monocytes, with a diffuse membrane-associated pattern in the cytoplasm, and is different from the dotlike pattern of T lymphocytes. LGLs do not adhere to surfaces and have no phagocytic activity. Ultrastructurally, they are heterogeneous in terms of size and the density of the granule matrix ( [556](#) ). The granules are located next to the Golgi apparatus, which also contains several smooth membranes and coated vesicles. The Golgi apparatus apparently is involved in the packaging of the granule contents. The granules have an electron-dense



center surrounded by a layer of lesser opacity. Like the granules of CTL, the NK-cell granules contain perforin and granzymes, which are both important for their cytotoxic function ( 557 ). The granules may be present in various forms, such as smooth or coated, depending on the stage of cell activation.



**Figure 17.20.** Natural killer cell morphology and ultrastructure. **A:** Natural killer cell is characterized by large amounts of pale blue cytoplasm and the presence of azurophilic granules. **B:** By electron microscopy, the granules in the cytoplasm appear heterogeneous in terms of size and density ( *arrows*). A few scattered mitochondria are present. **C:** The granule consists of an electron-dense center that contains the perforin and may be enclosed by a thin membrane. Surrounding the core is a layer of lesser opacity containing the granzymes. The granules of the cytotoxic cells are probably derived from two separate organelles—those of secretory granules and those of lysosomes—and are sometimes called *granulosomes*. (From Zucker-Franklin D, Greaves MF, Grossi CE. Atlas of blood cells, 2nd ed. Philadelphia: Lea & Febiger, 1988, with permission.)

LGLs are phenotypically and functionally heterogeneous (i.e.,  $CD56^{+}/CD3^{-}/CD8^{-}$ ), and the majority of them are  $CD16^{+}$  (approximately 80 to 90%); others are  $CD57^{+}/CD3^{+}/CD8^{+}TCR-\alpha/B^{+}$ . Both populations are cytolytic, but the  $CD57^{+}$  cells are T (or NK-like) cells that are non-MHC restricted. The  $CD56^{+}$  population is sometimes known as *NK-LGL*, whereas the  $CD57^{+}$  population is known as *T-LGL*. Both populations are  $CD2^{+}$  and  $CD7^{+}$ . The separation of the two cell types is not absolute, and we often detect an intermediate cell population that is  $CD56^{+}/CD57^{+}$ . The relationship of these cells to those expressing only one of the two markers is not known. Clonal diseases have been described from both the NK-LGL and T-LGL lineages, with distinct clinical syndromes.

### Ontogeny of Natural Killer Cells

**PHENOTYPIC STUDIES** The presence on NK cells of some markers ( $CD2$ ,  $CD7$ ) characteristic of T cells raised the question of common ontogenetic origins between these two lymphocytes. However, interference with T-cell development, as in athymic or SCID mice ( 558 ) or in mice with targeted disruptions of *RAG*, has no impact on NK-cell development. It is conceivable that the two lineages derive from a common progenitor



with separation of their developmental pathways. Some evidence for a common T/NK precursor has been obtained ( 559 , 560 ) and relates to expression of cytoplasmic CD3 $\epsilon$ ,  $\delta$ , and  $\epsilon$ . Cytoplasmic expression of CD3 $\epsilon$ ,  $\delta$ , and  $\epsilon$  proteins has been detected in fetal NK cells ( 561 , 562 ), and overexpression of CD3 $\epsilon$  blocks T/NK-cell development without affecting other hematopoietic lineages, including B lymphocytes ( 563 ). Progenitors of NK cells have been identified in the thymus based on the expression of CD56 within the TN thymocyte population ( 564 ), and a common T/NK-cell precursor was detected among the CD34<sup>+</sup> TN population ( 565 ). The common progenitor has a CD45/CD5 phenotype and becomes an NK-committed cell with loss of the capacity for T-cell differentiation with the expression of CD56. The common precursor is present among TN thymocytes that are CD34<sup>+</sup> and become CD34<sup>-</sup> as the cell is committed to NK lineage. NK-cell differentiation requires a combination of stem cell factor, IL-7, and IL-2 in the presence of a stromal feeder layer. Precursors of NK cells have also been identified in fetal thymuses of mice ( 566 ). These cells express CD16 and can differentiate into DP (CD4<sup>+</sup>/CD8<sup>+</sup>) thymocytes if they remain in contact with the thymic stroma or into NK cells if they are removed from the thymic microenvironment. This again supports the notion that the thymus is not essential for NK-cell development. The common T- and NK-cell progenitor in fetal mouse thymus is CD117<sup>+</sup>/CD44<sup>+</sup>/CD25<sup>-</sup>/NK1.1<sup>+</sup> and shows commitment to NK lineage with loss of CD117 expression ( 567 ). The overall scheme of differentiation in fetal mouse thymus suggests that multipotent precursors entering the thymus first lose B-lymphoid potential as they up-regulate NK1.1 and commit to a T/NK lineage. Then CD25 is up-regulated while CD117 is down-regulated, and cells commit to T- and NK-cell lineages, respectively. Bone marrow is also an important location of NK-cell progenitors. They are CD34<sup>+</sup>/CD7<sup>+</sup> and differentiate to mature NK cells either in the presence ( 568 ) or absence of stromal cells ( 569 , 570 and 571 ). The progenitors express CD34 and CD7 but are CD33<sup>-</sup>, and cytokines such as stem cell factor, IL-2, and IL-7 are essential, especially at the early stage of their differentiation. Depending on the conditions of culture, other cytokines, such as IL-7 and IL-3, are needed. Cytolytic activity against NK-cell targets is detected at the time of CD56 expression. Mature NK cells can be stimulated by IL-2 for further enhancement of cytotoxic activity, increase of cytotoxic granule content, expression of adhesion molecules, and acquisition of properties attributed to lymphokine-activated killer cells. Other cytokines, such as IL-7 and IL-12, have similar effects, albeit to a lesser degree than IL-2. For example, IL-12 potentiates suboptimal concentrations of IL-2 ( 572 ). The common lymphocyte precursor in the bone marrow with the CD34<sup>+</sup>/CD10<sup>+</sup>/CD45RA<sup>+</sup> phenotype is able to develop into NK cells *in vitro* ( 573 ). Uncommitted hematopoietic progenitors are CD34<sup>+</sup>/CD38<sup>-</sup>, but up-regulation of CD38 indicates enrichment of cells committed to a particular hematopoietic lineage. CD34<sup>+</sup>/CD38<sup>2+</sup> progenitors in fetal thymus develop into T cells, but CD34<sup>+</sup>/CD38<sup>2+</sup> progenitors in fetal liver have no T-cell precursor activity. This population has no TCR- $\alpha$  rearrangements and no pre-TCR  $\alpha$  chain expression and develops *in vitro* into NK cells through an intermediate stage of CD3<sup>-</sup>/NKRP-1<sup>+</sup>/CD34<sup>-</sup>/CD56<sup>-</sup> ( 574 , 575 ). A similar NKRD-1<sup>+</sup>/CD56<sup>-</sup> population has been detected in cord blood and develops into mature CD56<sup>+</sup> NK cells in the presence of IL-12 ( 576 ).

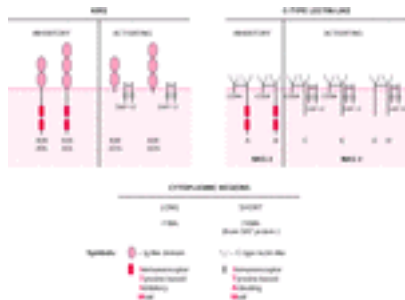
**FUNCTIONAL STUDIES AND DIFFERENTIATION** The cytokine environment regulates NK-cell maturation for the two distinct human NK-cell populations, one IFN- $\gamma$ - and a second IL-13-producing. IL-4 regulates the size of the IL-13 population primarily by inducing their proliferation, whereas IL-12 has minimal effects on the proliferation of IFN- $\gamma$ <sup>+</sup> NK cells. Cells with the CD161<sup>+</sup>(NKRP-1)/CD56<sup>-</sup> phenotype produce IL-13 but do not produce IFN- $\gamma$  and have no perforin-mediated cytotoxicity ( 577 ). CD161 is encoded by the NK-gene complex, which includes CD69 and CD94. The CD161<sup>+</sup>CD56<sup>-</sup>, IL-13-producing cells differentiate to phenotypically mature IFN- $\gamma$ -producing cells in the

presence of IL-12 and feeder cells. As cells mature, they pass through an intermediate stage of IL-13<sup>+</sup>/IFN- $\gamma$ <sup>+</sup> NK cells and eventually acquire the mature irreversible phenotype IFN- $\gamma$ <sup>+</sup>/IL-13<sup>-</sup>/CD56<sup>+</sup> (578). The molecular defect of X-linked severe combined immunodeficiency conclusively demonstrated that cytokines are critical for T- and NK-cell development (579, 580). These X-SCID patients present with a severe block of T- and NK-cell development, whereas normal or even elevated numbers of B cells are present. The cause of the disease is the lack of the common  $\gamma$ -chain shared by several interleukin receptors (i.e., IL-2, IL-4, IL-7, IL-9, and IL-15). The most important among these interleukins is IL-7, which promotes development of human thymocytes (and, in the mouse, B lymphocytes also). Deficiency of Jak-3, a tyrosine kinase associated with the  $\gamma$ -chain, also blocks NK-cell development (581). Other data suggest a critical role for IL-15 (582, 583). Of the transcription factors, the Ikaros family is required for trans-cryptonal regulation of NK-cell development (584, 585).

### Natural Killer Cell Receptors

NK cells are one of the important cellular components of innate immunity, with the mission to defend the body immediately against pathogens or in the early stages of tumor development. As a consequence, the recognition molecules or receptors of the NK cells are displayed on the cell surface without the need of assembly (i.e., rearrangements from multiple DNA segments after the antigenic encounter) (586, 587, 588 and 589). Another important difference from other receptors such as BCRs or TCRs is that NK receptors do not directly recognize pathogens or their products but the quantitative change of MHC molecules induced as a result of the infection. In humans, three distinct families of genes have been defined that encode for receptors of HLA class I molecules. One family belongs to the Ig superfamily and are called *killer Ig-like receptors* (KIRs). The second family is structurally Ig-like, named *Ig-like transcripts* (ILTs). Ig-like transcripts are expressed mainly on B, T, and myeloid cells, but some members are also present on NK cells. They are also called *LIRs* for *leukocyte Ig-like receptors*. The third family consists of *C-type lectin receptors*. C-type lectins are a superfamily with homologous modular carbohydrate-recognition domains (CRD) that bind carbohydrates in a Ca<sup>2+</sup>-dependent manner. The proteins of this family of NK receptors form group V (outside of a total of seven groups) of the c-type of lectins superfamily (590). The C-type lectin receptors, however, have structural differences from the other (more than 200) members of the superfamily, and it has been proposed that it be renamed as a new family of *C-type lectin-like NK-receptor domains* (CLTD) (591).

**IMMUNOGLOBULIN-LIKE RECEPTORS: THE KIRS AND LIRS** The KIRs have two or three Ig-like domains and hence are designated *KIR2D* or *KIR3D receptors*, respectively (592) (Fig. 17.21 and Table 17.2). The cytoplasmic domains of the KIRs can be either long (L) or short (S), corresponding to their function, either inhibitory or activating, respectively. The inhibitory receptors contain one or two immunoreceptor tyrosine-based inhibitory motifs, or ITIMs, (I/V/L/S)-X-Y-XX-(L/V) (where  $\lambda$  denotes any amino acid) (593). When tyrosine (Y) is phosphorylated, it recruits and activates SHP-1 phosphatase, leading to inhibition of signaling. Activating receptors do not signal directly but must associate noncovalently (via a salt bridge linking the transmembrane regions) with other signaling adaptor molecules that have ITAMs in their cytoplasmic domain (consensus sequence, -Y-X-X-L-X<sub>6-8</sub>-YXXL/I) (594). NK cells express three ITAM-bearing transmembrane proteins:  $\gamma$ , Fc $\epsilon$ RI $\gamma$ , and DAP12. The first two are present as homodimers or heterodimers, whereas DAP12 is exclusively a disulfide homodimer. (The KIRs are known under the CD designation CD158a-m and CD158z. See Table 17.2 and Chapter 2 for details.)



**Figure 17.21.** Natural killer (NK)-cell receptors. The NK-cell receptors in humans structurally belong to two different families: One family has immunoglobulin (Ig) domains in the extracellular region and are known as *killer Ig receptors* (KIRs) and the other family has a C-type lectin-like domain. The C-type lectin domain recognizes oligosaccharides (and sometimes polypeptides), but the binding is directly mediated by  $\text{Ca}^{2+}$ , hence the term *C-type lectin*. However, the NK-cell receptors with the C-type fold lack the  $\text{Ca}^{2+}$ -ligating elements and thus have been termed *C-type lectin-like*. (See Kogelberg H, Feizi T. New structural insights into lectin-type proteins of the immune system. *Curr Opin Struct Biol* 2001;11:635–643.) The NK-cell receptors in both families are functionally divided into *inhibitory* and *activating*. The labyrinthine jargon of the NK-cell receptors becomes simpler with the acquaintance of some rules: The inhibitory KIRs have either two or three Ig domains in the extracellular region (i.e., 2D or 3D) and a long or short cytoplasmic tail (i.e., 2DL or 2DS and 3DL or 3DS). Those with long cytoplasmic tails are inhibitory, whereas those with short tails are activating. Thus, the receptor KIR 2DL is an inhibitory receptor with two Ig domains, whereas the receptor KIR 3DS is an activating receptor with three Ig domains. (See more details in text and in [Table 17.2](#).)

**TABLE 17.2. Natural Killer Cell Receptors and CD Designation**

| A           | KIRs       | B     | LIRs/ILTs   |
|-------------|------------|-------|-------------|
| CD158a      | KIR2DL1    | CD85a | LIR3 (ILT5) |
| CD158 b1/b2 | KIR2DL2/L3 | CD85b | ILT8        |
| CD158c      | KIR2DS6    | CD85c | LIR8        |
| CD158d      | KIR2DL4    | CD85d | LIR2 (ILT4) |
| CD158 e1/e2 | KIR3DL1/S1 | CD85e | LIR4 (ILT6) |
| CD158f      | KIR2DL5    | CD85f | ILT11       |
| CD158g      | KIR2DS5    | CD85g | ILT7        |
| CD158h      | KIR2DS1    | CD85h | LIR7 (ILT1) |
| CD158i      | KIR2DS4    | CD85i | LIR6        |
| CD158j      | KIR2DS2    | CD85j | LIR1 (ILT2) |
| CD158k      | KIR3DL2    | CD85k | LIR5 (ILT3) |
| CD158z      | KIR3DL7    | CD85l | ILT9        |
|             |            | CD85m | ILT10       |

NOTE: See also [Figure 17.20](#) for structural classification. (Designations were assigned during the seventh HLADA Workshop, Harrogate, UK, June 2000.)

ILT, immunoglobulin-like transcript; KIR, killer cell immunoglobulin-like receptor; LIR, leukocyte immunoglobulin-like receptor.

From Mason D. CD Antigens 2001. *Immunology* 2001;103:401–406, with permission.

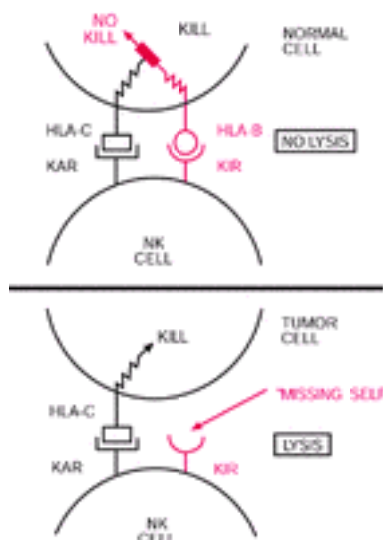
A fundamental difference between recognition by KIRs and TCRs is that the KIRs recognize more than one MHC allele. They do this by recognizing conserved residues

within the polymorphic regions of MHC, whereas TCR recognizes the polymorphic residues. In addition, KIRs display a precise specificity for a particular MHC allotype. This is achieved by variations in single amino acids of KIR molecules ( [595](#) ). The ligands for KIRs are alleles of all three MHC class I molecules, HLA-A, HLA-B, and HLA-C, which can confer protection from lysis by NK cells. Generally, KIR3D receptors recognize HLA-A and -B, whereas KIR2D receptors recognize HLA-C alleles. A number of techniques have been used to study the binding and specificity of the receptors. No other molecule is necessary for binding except the HLA alleles ( [596](#) , [597](#) and [598](#) ). Crystal structures of some KIR receptors with their ligands have been solved. The KIR2DL2 in complex with HLA-Cw3 and peptide shows that KIR binds in nearly orthogonal orientation across the  $\alpha 1$  and  $\alpha 2$  helices of HLA-Cw3. It contacts positions 7 and 8 of the peptide, but most contacts are between the KIR and conserved HLA-C residues ( [599](#) ). Allotypic specificity is determined by the interaction between Lys44 of KIR2DL2 and Asn80 of the HLA-Cw3. In general, the peptides play a minimal role in the interaction, a point that strikingly distinguishes TCR-MHC from the KIR-MHC interactions ( [600](#) ). LIR-1 is a member of the LIR family (LIR-1 to LIR-8) expressed on monocytes, B cells, dendritic cells, and some NK cells. LIRs have two to four extracellular Ig-like domains and ITIMs in the cytoplasmic region; therefore, engagement with MHC molecules protects target cells from lysis. The first aminoterminal domain of LIR-1 binds to the nonpolymorphic  $\alpha 3$  domain of MHC I, an interaction that is more similar to that of CD4 with the MHC-II than to that of KIRs. LIR-1 also recognizes the human cytomegalovirus protein UL18, which has a structure similar to MHC-I and associates even with  $\beta 2$ -microglobulin and host peptides. LIR-1 binds to this human cytomegalovirus protein with an affinity that is more than 1000-fold higher than the host MHC-I. This mechanism illustrates an example of viral subversion of host defenses and protection of infected cells from lysis ( [601](#) ) because the binding of LIR-1 to UL18 sends an inhibitory signal.

**C-TYPE LECTIN-LIKE RECEPTORS** The members of the C-type lectin-like receptor family are either homodimers (the large murine family Ly49A-W, CD69, and NKR-P1) or heterodimers, which consist of an invariant chain CD94 and a second subunit from the NKG2 family members A, B, C, and E ( [602](#) ). The function of the heterodimeric proteins depends on the cytoplasmic regions of the variant chains [i.e., whether long (NKG2A,B) or short (NKG2C,E), corresponding to inhibitory or activating functions, respectively]. The inhibitory subunits have one pair of ITIMs in the cytoplasmic region, whereas the activating subunits associate with the ITAM-containing adaptor molecule DAP12. The NKG2D protein forms a homodimer (does not pair with CD94) and is an activating receptor. Each subunit is composed of an extracellular C-type lectin-like domain known also as *NK-receptor domain* or *NKD*. The NKD, however, binds proteins and not carbohydrates, which are the ligands for the classical C-type lectins, and furthermore, their structure differs from the classical C-type lectins ( [603](#) ). C-type lectin-like NK-receptor domains include other important molecules of innate immunity, macrophage mannose receptor, collectins (i.e., pulmonary surfactants), and so forth. The ligands for CD94/NKG2 proteins are the nonclassical HLA-E molecule, which binds peptides from the leader sequence of the HLA-A, -B, -C, and -G molecules ( [604](#) , [605](#) ). Expression of HLA-E depends on the presence of the signal peptides, thus providing a safe strategy for NK cells to monitor the presence of polymorphic HLA molecules ( [606](#) ) because absence of HLA-E would indicate absence of some of the HLA-A, B, or -C. HLA-E is also capable of binding signal sequence of heat shock protein (HSP)-60. HSP-60 is present in all living cellular organisms ( [607](#) ) and serves as a mitochondrial chaperone. HSP-60 levels are increased in response to stress stimuli (i.e., temperature increase, nutrient deprivation, exposure to toxic chemicals, inflammation, and so forth). HSP-60 protects these cells from harmful stimuli, but at the same time, the HLA-E/HSP-60 peptide is not recognized by the inhibitory receptor, CD94/NKG2A, and these cells are eliminated by NK-cell activation ( [608](#) ). The ligands for the NKG2D receptor are the MHC class I-related molecules MICA and MICB, which are up-regulated in virally infected cells and many

tumors (609, 610). They are minimally expressed in normal tissues but up-regulated in stressed cells (611). MICA is composed of two structural domains: one in the form of a platform formed by a  $\alpha_1/\alpha_2$  and the second in the form of a C-type Ig-like  $\alpha_3$  domain (612). The NKG2D receptor binds orthogonally to the MICA platform in a way similar to the docking of TCR on pMHC (see above) (613). For signaling, it uses the adaptor protein DAP10, which has no ITAMs but contains the sequence YXXM that recruits the p85 subunit of PI3 kinase and is thus less susceptible to the SHP-1-coupled receptors (609). Another family of ligands for NKG2D is made up of proteins that bind the UL16 cytomegalovirus protein, known as *UL16-binding proteins* (ULBP) (614, 615). The UL16-binding proteins possess a  $\alpha_1$  and a  $\alpha_2$  domains but differ from MIC and MHC-I in lacking the  $\alpha_3$  domain, and they are GPI-anchored proteins without  $\beta_2M$  protein. Binding to NKG2D receptor has been demonstrated by blocking of ULBP binding by anti-NKG2D antibodies (616).

**CONCLUSION** The major breakthrough in the regulation of NK cell function came with the formulation of the “missing self” hypothesis (617, 618, 619 and 620) (Fig. 17.22). The hypothesis states that NK cells can recognize and selectively lyse targets that fail to express self-MHC-I antigens. The validity of the hypothesis has been demonstrated in multiple *in vivo* and *in vitro* systems as summarized (619). The basic premise is that when appropriate MHC-I molecules are expressed, the lysis of target is inhibited, but when the target is deficient in MHC-I expression, the target is lysed. Specific inhibitory receptors engaged with normal MHC-I molecules prevent activating receptors to kill the target. Cells that have lost a normal MHC-I expression (“missing self”) (i.e., tumors or infected cells) are unable to deliver an inhibitory signal to NK cells and become susceptible to lysis. Cells susceptible to lysis by NK cells as a result of deficiency of MHC-I molecules could be protected by transfection of MHC-I alleles. This experiment provided formal demonstration of the validity of the missing self hypothesis. The NK cell displays two functionally distinct receptors: inhibitory and activating. They are also structurally divided into the Ig-like receptors and the C-type lectin-like receptors (621, 622). The human lectinlike receptor gene complex is on chromosome 12p13.1, and the genes for the Ig-like receptors are in chromosome 19q13.4.



**Figure 17.22.** Natural killer (NK)-cell cytotoxicity: the missing self. NK-cell cytotoxicity is a delicate balance between activating receptors and inhibitory receptors. Both (whether of the immunoglobulin SF or C-type lectin) have HLA class I specificity, although some receptors recognize non-major histocompatibility complex molecules. The presence of activating receptors against normal cells causes no problem as long as the NK cells possess at least one inhibitory receptor, the signal of which is always dominant. However, with alterations of the structure of a class I molecule or complete loss of the molecule,



the binding of the inhibitory receptor is abolished and the activating signal remains unopposed. This is the essence of the missing self hypothesis. KAR, killer-activating receptors; KIR, killer Ig receptors. (Kärre K. How to recognize a foreign submarine. *Immunol Rev* 1997;155:5–9.)

The effector functions of the NK cell receptors are controlled by the transmembrane and cytoplasmic regions. The inhibitory receptors have ITIMs in their cytoplasmic tails and recruit SHP-1 phosphatase. Activating receptors have a short cytoplasmic region, but for signaling, they borrow the function of ITAMs by associating with adaptor molecules like DAP-12. Association is mediated by a positively charged residue of the receptor and an oppositely charged (i.e., aspartate) residue of the adaptor (623). Further research into the regulation of NK-cell function by the NK receptors is expected to expose new initiatives for investigating tumor immunosurveillance (624) and autoimmunity (625). In hematology specifically, the manipulation of receptor-ligand interactions may help in allogeneic bone marrow transplantation to prevent leukemia relapse and graft-versus-host disease (626, 627, 628 and 629).

### Natural Cytotoxicity

The cytotoxic mechanism of NK cells is similar to that of CD8<sup>+</sup> T cells.

### Natural Resistance

NK cells are one of the main effectors of innate immunity. Their role against viral infections has been well documented (630). NK cells selectively lyse virally infected cells but spare noninfected cells. The mechanism of natural resistance against viral infections may involve direct lysis of the infected cells or production of TNF- $\alpha$ , which stimulates NK-cell activity. A patient with selective deficiency of NK cells has been described who had life-threatening viral infections (631). NK cells also play a role against certain intracellular parasites, such as *Toxoplasma gondii*. Production of TNF- $\alpha$  and IL-12 activates NK cells for production of IFN- $\gamma$ , which is important for macrophage activation in the defense against intracellular parasites (632).

### Regulation of Adaptive Immunity

NK cells enhance responses of B and T cells during the early stages of an immune response. As a result of stimulation by IL-12, produced by macrophages in response to infectious agents, NK cells produce large amounts of IFN- $\gamma$  (633). IFN- $\gamma$  acts on macrophages and enhances their antigen-presenting function by increasing expression of class II antigens. IFN- $\gamma$  is important in directing T-cell differentiation to Th1 cytokine responses. Induction of predominantly Th1 responses leads to enhancement of cell-mediated immunity. Finally, IFN- $\gamma$  activates macrophages, enhancing their microbicidal function.

### Natural Killer Cells and Malignancies

NK cells provide surveillance against tumor cells and virus-infected cells. Circumstantial evidence consistent with the role of NK cells in surveillance against tumors includes the higher incidence of lymphoproliferative diseases in patients with Chédiak-Higashi syndrome, who have profound deficits in NK activity. In patients with X-linked lymphoproliferative disease, NK activity is deficient as well (634), and the same is true for people with high familial incidence of cancer (635). Similarly, beige mice have a defect of

NK cells and a high incidence of lymphoproliferative diseases. On the other hand, nude mice that are T cell-deficient but have normal NK activity do not have increased susceptibility to tumor development. Certain carcinogenic substances have been shown to suppress NK-cell activity. Long-term studies of NK-cell activity in patients with solid tumors revealed a positive correlation between NK-cell activity and survival time without metastasis ( [636](#) ). Decrease of NK-cell activity has been detected in patients with malignant lymphoma, in patients before relapse of leukemia, and also in women with breast cancer and metastasis to regional lymph nodes but not in those without involvement of lymph nodes.

### Natural Killer Cells and Bone Marrow Stem Cells

When mice from inbred strains are crossed, the F1 progeny can accept organ grafts from either parent. Acceptance of the organ grafts results from the fact that the F1 animals express codominantly the class I antigens from both parents, and therefore, the F1 T cells recognize them as self. In contrast to organ grafts, however, the F1 mice reject bone marrow stem cells from either parent ( [637](#) , [638](#) ). This is known as *hybrid resistance* and is mediated by NK cells but not T cells.

Bone marrow stem-cell rejection is based on another set of antigens known as *hematopoietic histocompatibility* (Hh) antigens, which are inherited in a recessive pattern. The nature of Hh antigens and the mechanism of rejection of bone marrow stem cells in hybrid resistance are not well understood. NK cells may recognize the Hh antigens, or the lack of an MHC class I antigen on the donor cells may also play a role (missing self).

### Natural Killer Cells and Bone Marrow Transplantation

NK cells engraft quickly after bone marrow transplantation and constitute the majority of the peripheral blood lymphocytes during the first few weeks after transplantation ( [639](#) , [640](#) ). In approximately one-third of the patients after autologous or allogeneic bone marrow transplantation, a normally minor NK subpopulation (CD56<sup>+</sup>/CD16<sup>-</sup>) was markedly expanded (up to 40% of peripheral blood lymphocytes) ( [641](#) ). This population may represent a different stage of differentiation from the major CD56<sup>+</sup>/CD16<sup>+</sup> population.

In human bone marrow transplantation, NK activity may help in graft take by controlling viral infections, eliminating leukemic cells, or stimulating hematopoiesis ( [635](#) ).

### Regulation of Hematopoiesis

Existing evidence suggests that NK cells exert both inhibitory and stimulatory effects on hemopoietic progenitors. These effects are mediated predominantly by the release of cytokines from NK cells rather than by cytotoxicity.

Strong evidence exists that an increase in the number of LGLs is associated with anemia or granulocytopenia. NK cells inhibit *in vitro* granulocytopenia in the granulocyte-macrophage colony-forming cell assay ( [642](#) ). NK cells also exert a promoting effect on hematopoiesis, however, and the net effect may actually depend on the stage of maturation of the progenitor cells ( [643](#) ).

In some patients with neutropenia, there is an increase of NK-like cells in the bone marrow but not in the peripheral blood. These cells can be identified only by



immunophenotyping ( [644](#) ).

## Natural Killer Cell Proliferations

Expansions of LGLs can be either transient or persistent. The former are reactive, whereas the latter can be either reactive or clonal. Markers for clonal expansions of LGLs are not available in practice. Diagnosis of LGL expansions can be made by morphology and then confirmed by phenotype. Most patients have a chronic elevation of LGLs without other signs of malignancy, and their clinical course is not progressive, even without treatment. In many cases, an associated disease (such as rheumatoid arthritis, hepatitis, or malignancy) has been observed. Artificially, a level of 2000/ $\mu$ l of LGLs in the peripheral blood, which is five to seven times the normal value (250 to 450/ $\mu$ l), is believed to represent a lymphoproliferative disease of LGL if it persists for longer than 3 months ( [645](#) ). Some of the most common clinical presentations are fever, infections, neutropenia, anemia, and thrombocytopenia. Mortality was associated with moderately elevated counts of LGLs (2000 to 3000/ $\mu$ l) and very high counts (more than 7000/ $\mu$ l), which indicates that LGL proliferations are, in general, highly heterogeneous.

The clonality of LGL proliferations cannot be demonstrated by immunophenotype. However, cytogenetic abnormalities have been detected ( [646](#), [647](#) ), and in LGL cases that are CD57<sup>+</sup> (and therefore express TCRs), rearrangements of TCR- $\beta$  genes are detected in most of the cases ( [648](#) ). Because these cases are also associated with widespread involvement of several organs, such as the spleen, liver, and bone marrow, the term *LGL leukemia* has been proposed ( [646](#) ).

In some studies, the predominant phenotype of the LGL is CD57<sup>+</sup> (HNK-1<sup>+</sup>) CD3<sup>+</sup>, and these patients often have rheumatoid arthritis, neutropenia, and splenomegaly; a combination resembling Felty syndrome ( [649](#) ). Anemia and thrombocytopenia are not uncommon, and serologically, rheumatoid factor, antinuclear antibodies, hypergammaglobulinemia, and immune complexes are detectable.

Two major subtypes have been distinguished in terms of clinical presentation and the phenotype of the cells ( [650](#), [651](#) and [652](#) ). The LGL in type A, also known as *T-LGL*, are CD57<sup>+</sup>/CD3<sup>+</sup>/CD8<sup>+</sup>/CD2<sup>+</sup>, and those in type B, also known as *NK-LGL*, are CD56<sup>+</sup>/CD3<sup>+</sup>/CD8<sup>+</sup>/CD2<sup>+</sup>. Patients with T-LGL often have neutropenia (84%), rheumatoid arthritis, and autoantibodies. However, these clinical and serologic findings in patients with T-LGL (CD57<sup>+</sup>) could not be confirmed in other studies ( [653](#) ). The patients had clonal proliferations, as shown by TCR gene rearrangements, and the pathognomonic finding is neutropenia with an otherwise indolent course. NK-LGL leukemias are observed in younger patients and run an aggressive course ( [654](#) ). The most characteristic clinical presentation is hepatosplenomegaly and involvement of the gastrointestinal system with ascites. The course of the disease is acute, and often the patients die within 1 to 2 months after diagnosis.

## NATURAL KILLER T CELLS

Natural killer T (NKT) cells have been identified as a novel lymphocyte lineage, which, in humans, express the cell-surface marker CD161 (NKR-PIA) (see [Chapter 2](#)), that is structurally related to several other proteins encoded by the NK-gene complex, including CD94, NKG2, CD69, and, in the mouse, Ly49 ( [655](#) ). These cells are specific for aGalCer presented by CD1d ( [656](#) ). They express V regions that are homologous to those that are

expressed by mouse Va14i T cells and have a rearrangement of Va24 to Ja15, which forms the CDR3a that is highly similar to Va14i of mice.

The NKT cells in mice are characterized by the NK1.1 marker and undergo rearrangements involving Va14 and Ja18 (formerly Ja281) segments that always have a glycine residue at position 93. This generates an invariant Va14 receptor (Va14iTCR), which is used only by the NKT cells but not by T cells. The expression of an invariant TCR suggests that the selection is mediated by a monomorphic rather than polymorphic MHC molecule (657). Using CD1d/a-GalCer tetramers (see Chapter 3 for details on this technique), Va14i<sup>+</sup> cells could not be detected in athymic mice, indicating that maturation and selection of NKT cells take place in the thymus (658) and represent a separate T-cell lineage. In a striking difference from the selection of mainstream T cells (i.e., by thymus epithelial cells), the NKT cells are selected by DP CD4<sup>+</sup>/CD8<sup>+</sup> thymocytes expressing CD1d (659). After selection, the Va14i precursor population is exported and acquires the NKT phenotype in the periphery (660). The distribution of the Va14i T cells in the periphery is unique. In mice, they migrate to the liver and from there to sites of inflammation responding to stimuli, such as chemokines and glycolipids.

The cells have a surface phenotype characteristic of recently activated or memory T cells, even when the cells are obtained from cord blood (661) or from germ-free mice (662). This is consistent with the postulated autoreactivity of the NKT cells *in vivo* and their peripheral expansion in the presence of autologous ligands, presented by CD1d.

Inhibitory receptors prevent unchecked autoreactivity for CD1d (663). The role for these NK receptors in directing the distribution and function of NKT cells in the body remains to be seen.

### Natural Killer T-Cell Function

The cells with Va14 (in mice) or Va24 (in humans) TCR play a critical role in immune responses. Va14 cells are important for regulation of immune responses, inhibition of tumor development, and protection from autoimmune disease development. These cells have a cytolytic function (664) and rapidly induce cytokines after stimulation (665). In response to these cytokines, they recruit and activate other cells (i.e., NK cells, T cells, B cells, and macrophages).

In humans, CD4<sup>+</sup>Va24i cells preferably produce IL-4, which is believed to regulate Th1/Th2 differentiation (666, 667), but the Th1 versus Th2 polarization is more complex and depends on additional factors such as the number of antigenic stimulations with a shift to Th2 after multiple challenges (668, 669).

Shift to Th2 cytokine secretion prevents the development of type I diabetes in mice with genetic predisposition (670), as well as allergic encephalomyelitis in another strain susceptible to the development of this disease (671). In experimental autoimmune diseases that develop spontaneously, there is a direct correlation between the development of the disease and the decline of Va14 cells (672).

Selective reduction of Va24 cells has also been shown in patients with systemic sclerosis (673), systemic lupus erythematosus, rheumatoid arthritis (674), and type I diabetes (675).

NKT cells have been implicated in the prevention and metastasis of tumors in mice ( [676](#)). However, tumor suppression is regulated by more than one subset of NKT cells secreting IL-13 ( [677](#)). Ultraviolet irradiation induces immunosuppression and skin cancer, and the suppression can be transferred by CD1-restricted NKT cells, which act as suppressor cells ( [678](#)). Others have also found that NKT cells are not critical in the IL-12-mediated rejection of tumors ( [679](#)), and it appears that the conflicting results in the literature about the role of NKT in tumor responses are due to complex factors, including the types of tumors and their microenvironment, and other cells interacting with NKT cells and, not least, with the functionally different subsets of NKT cells ( [680](#)). NKT cells have been implicated in protective immunity against several pathogens [i.e., mycobacteria ( [681](#)) and malaria parasites ( [682](#))].

In conclusion, NKT cells are phenotypically and functionally heterogeneous, endowed with cytolytic and cytokine secretion functions. They regulate several functions in the immune response that are related to host defenses against infections, autoimmunity, and tumor immunity. Their function seems to depend on their “age,” state of activation, regional microenvironments, and, of course, interaction with other cells. They have been called “nonconformist” and “unconventional” and probably for good reason, because they are suited to get involved in such a great variety of homeostatic disequilibrium conditions of the host.

## REFERENCES

1. Pollack A, Lampen N, Clarkson BD, et al. Identification of human B and T lymphocytes by scanning electron microscopy. *J Exp Med* 1973;138:607–624.
2. Pollack A, Hammerling U, Lampen N, et al. Surface morphology of murine B and T lymphocytes: a comparative study by scanning electron microscopy. *Eur J Immunol* 1975;5:32–39.
3. van der Loo EM, Gnossen J, Meijer CJ. Morphological aspects of T cell subpopulations in human blood: characterization of the cerebriform mononuclear cells in healthy individuals. *Clin Exp Immunol* 1981;43:506–516.
4. Meijer CJ, van der Loo EM, van Vloten WA, et al. Early diagnosis of mycosis fungoides and Sezary's syndrome by morphometric analysis of lymphoid cells in the skin. *Cancer* 1980;45:2864–2871.
5. Cordier AC, Haumont SM. Development of thymus, parathyroids, and ultimobranchial bodies in NMRI and nude mice. *Am J Anat* 1980;157:227–263.
6. Klug DB, Carter C, Drouot E, et al. Interdependence of cortical thymic epithelial cell differentiation on T-lineage commitment. *Proc Natl Acad Sci U S A* 1998;95:11822–11827.
7. Schleup M, Wilcox N, Ritter MA, et al. Myasthenia gravis thymus: clinical, histological and culture correlations. *J Autoimmun* 1988;1:445–467.
8. Gill J, Malin M, Hollander GA, et al. Generation of complete thymic microenvironment by MTS24+ thymic epithelial cells. *Nat Immunol* 2002;3:635–642.
9. Bennett AR, Farley A, Blair NF, et al. Identification and characterization of thymic epithelial progenitor cells. *Immunity* 2002;16:803–814.
10. Suniara RK, Jenkinson EJ, Owen JJ. An essential role for thymic mesenchyme in early T cell development. *J Exp Med* 2000;191:1051–1056.
11. Manley NR, Cappechi MR. The role of Hoxa-3 in mouse thymus and thyroid development.

Development 1995;121:1989–2003.

12. Su DM, Manley NR. *Hoxa3* and *Pax1* transcription factors regulate the ability of fetal thymic epithelial cells to promote thymocyte development. *J Immunol* 2000;164:5753–5760.
13. Nehls M, Pfeifer D, Schorp PM, et al. New member of the winged-helix protein family disrupted in mouse and rat nude mutations. *Nature* 1994;372:103–107.
14. Itoi M, Kawamoto H, Katsura Y, et al. Two distinct steps of immigration of hematopoietic progenitors into the early thymus anlage. *Int Immunol* 2001;13:1203–1211.
15. Blackburn CC, Augustine CL, Li R, et al. The *nu* gene acts cell-autonomously and is required for differentiation of thymic epithelial progenitors. *Proc Natl Acad Sci U S A* 1996;93:5742–5746.
16. Nehls M, Kyewski B, Messerle M, et al. Two genetically separable steps in the differentiation of thymic epithelium. *Science* 1996;272:886–889.
17. Bockman DE, Kirby ML. Dependence of thymus development on derivatives of neural crest. *Science* 1984;223:498–500.
18. Anderson G, Jenkinson EJ. Lymphostromal interactions in thymic development and function. *Nat Rev Immunol* 2001;1:31–40.
19. Manley NR. Thymus organogenesis and molecular mechanisms of thymic epithelial cell differentiation. *Semin Immunol* 2000;12:421–428.
20. Blackburn CC, Manley NR, Palmer DB, et al. One for all and all for one: thymic epithelial stem cells and regeneration. *Trends Immunol* 2002;23:391–395.
21. Bennett AR, Farley A, Blaer NF, et al. Identification and characterization of thymic epithelial progenitor cells. *Immunity* 2002;16:803–814.
22. Ohuchi H, Hori Y, Yamasaki M, et al. FGF10 acts as a major ligand for FGF receptor 2IIIb in mouse multi-organ development. *Biochem Biophys Res Commun* 2000;277:643–649.
23. Revest JM, Suniara RK, Kerr K, et al. Development of the thymus requires signaling through the fibroblast growth factor receptor  $\alpha 2$ -IIIb. *J Immunol* 2001;167:1954–1961.
24. Hollander CA, Wong B, Nichogiannopoulou A, et al. Developmental control point in induction of thymic cortex regulated by a subpopulation of prothymocytes. *Nature* 1995;373:350–353.
25. Van Ewijk W, Shores EW, Singer A. Crosstalk in the mouse thymus. *Immunol Today* 1994;16:214–217.
26. Ritter MA, Boyd RL. Development in the thymus: it takes two to tango. *Immunol Today* 1993;14:462–469.
27. Suhr CD, Ernst B, Sprent J. Growth of epithelial cells in the thymic medulla is under the control of the mature T cells. *J Exp Med* 1992;176:611–616.
28. Jenkins MK, Schwarz R, Pardoll DM. Effects of cyclosporin A on T cell development and clonal deletion. *Science* 1988;241:1655–1658.
29. Van Ewijk W. T-cell differentiation is influenced by thymic microenvironments. *Annu Rev Immunol* 1991;9:591–615.
30. Boyd RL, Tucek CL, Godfrey DI, et al. The thymic microenvironment. *Immunol Today* 1993;14:445–459.
31. van Vliet E, Melis M, van Ewijk W. Immunohistology of thymic nurse cells. *Cell Immunol* 1984;87:101–109.
32. Kyewski BA. Thymic nurse cells possible sites of T cell selection. *Immunol Today* 1986;7:374–379.
33. Mombaerts P, Clarke AR, Rudnicki MA, et al. Mutations in T-cell antigen receptor genes  $\alpha$  and  $\beta$  block

thymocyte development at different stages. *Nature* 1992;360:225–231.

34. Goverman J, Brabb T, Huseby ES, et al. TCR signaling regulates thymic organization: lessons from TCR–transgenic mice. *Immunol Today* 1997;18:204–208.

35. Brabb T, Huseby ES, Morgan TM, et al. Thymic stromal organization is regulated by the specificity of T cell receptor/major histocompatibility complex interactions. *Eur J Immunol* 1997;27:136–146.

36. Matechak EO, Kileen N, Hedrick SM, et al. MHC class II–specific T cells can develop in the CD8 lineage when CD4 is absent. *Immunity* 1996;4:337–347.

37. Hogquist KA, Jameson SC, Heath WR, et al. T cell receptor antagonist peptides induce positive selection. *Cell* 1994;76:17–27.

38. Anderson M, Anderson SK, Farr AG. Thymic vasculature: organizer of the medullary epithelial compartment? *Intern Immunol* 2000;12:1105–1110.

39. Schonrich G, Momburg F, Hammerling GJ, et al. Anergy induced by thymic medullary epithelium. *Eur J Immunol* 1992;22:1687–1691.

40. Hoffmann MW, Allison J, Miller JF. Tolerance induction by thymic medullary epithelium. *Proc Natl Acad Sci U S A* 1992;89:2526–2530.

41. Klein L, Klein T, Ruther U, et al. CD4 T cell tolerance to human C reactive protein, an inducible serum protein is mediated by medullary thymic epithelium. *J Exp Med* 1998;188:5–16.

42. Farr AG, Dooley JL, Erickson M. Organization of thymic medullary epithelial heterogeneity: implications for mechanisms of epithelial differentiation. *Immunol Rev* 2002;189:20–27.

43. Erickson M, Morkowski S, Lehar S, et al. Regulation of thymic epithelium by keratinocyte growth factor. *Blood* 2002;100:3269–3278.

44. Mackall CL, Gress RE. Thymic aging and T cell regeneration. *Immunol Rev* 1997;160:91–102.

45. Mackall CL, Punt JA, Morgan P, et al. Thymic function in young/old chimeras: substantial thymic regenerative capacity despite irreversible age–associated thymic involution. *Eur J Immunol* 1998;28:1886–1893.

46. Sano S, Takahuma Y, Sugawara T, et al. Stat3 in thymic epithelial cells is essential for postnatal maintenance of thymic architecture and thymocyte survival. *Immunity* 2001;15:261–273.

47. Savino W, Villa–Verde DM, Lannes–Vieira J. Extracellular matrix proteins in intrathymic T–cell migration and differentiation? *Immunol Today* 1993;14:158–161.

48. Kutlesa A, Siler U, Speiser A, et al. Developmentally regulated interactions of human thymocytes with different laminin isoforms. *Immunology* 2002;105:407–418.

49. Wadsworth S, Halverson MJ, Coligan JE. Developmentally regulated expression of the  $\beta_4$  integrin on immature mouse thymocytes. *J Immunol* 1992;149:421–428.

50. Shortman K, Wu L. Early T lymphocyte progenitors. *Annu Rev Immunol* 1996;14:29–47.

51. Ikuta K, Uchida N, Friedman J, et al. Lymphocyte development from stem cells. *Annu Rev Immunol* 1992;10:759–783.

52. Komori T, Okada A, Stewart V, et al. Lack of N regions in antigen receptor variable region genes of TdT–deficient lymphocytes. *Sciences* 1993;261:1171–1175.

53. Huang S, Terstappen LWMM. Lymphoid and myeloid differentiation of single human CD34+HLA–DR+CD38<sup>–</sup> hematopoietic stem cells. *Blood* 1994;83:1515–1526.

54. Galy AHM, Cen D, Travis M, et al. Delineation of T–progenitor cell activity within the CD34+

compartment of adult bone marrow. *Blood* 1995;85:270–278.

55. Tjønnefjord GE, Veiby OP, Steen R, et al. T lymphocyte differentiation in vitro from adult human pre-thymic CD34<sup>+</sup> bone marrow cells. *J Exp Med* 1993;177:1531–1539.

56. Terstappen LWMM, Huang S, Picker LJ. Flow cytometric assessment of human T-cell differentiation in thymus and bone marrow. *Blood* 1992;79:666–677.

57. Kurtzberg J, Denning SM, Nycum LM, et al. Immature human thymocytes can be driven to differentiate into non-lymphoid lineages by cytokines from thymic epithelial cells. *Proc Natl Acad Sci U S A* 1989;86:7575–7579.

58. Barcena A, Galy AHM, Punnenen J, et al. Lymphoid and myeloid differentiation of fetal liver CD34<sup>+</sup> lineage<sup>-</sup> cells in human thymic organ culture. *J Exp Med* 1994;180:123–132.

59. Spits H, Lanier L, Phillips JH. Development of human T and natural killer cells. *Blood* 1995;85:2654–2670.

60. Lansdorp PM, Dragowska W. Long-term erythropoiesis from constant numbers of CD34<sup>+</sup> cells in serum-free cultures initiated with highly purified progenitor cells from human bone marrow. *J Exp Med* 1992;175:1501–1509.

61. Deans JP, Wilkins JA, Caixia S, et al. Prolonged expression of high molecular mass CD45RA isoform during the differentiation of human progenitor thymocytes to CD3<sup>+</sup> cells in vitro. *J Immunol* 1991;147:4060–4068.

62. Schmitt C, Ktorza S, Sarun S, et al. CD34-expressing human thymocyte precursors proliferate in response to interleukin-7 but have lost myeloid differentiation potential. *Blood* 1993;82:3675–3685.

63. Harman BC, Jenkinson EJ, Anderson G. Entry into the thymic microenvironment triggers Notch activation in the earliest migrant t cell progenitors. *J Immunol* 2003;170:1299–1303.

64. Anderson G, Pongracz J, Parnell S, et al. Notch ligand-bearing thymic epithelial cells initiate and sustain Notch signaling in thymocytes independently of T cell receptor signaling. *Eur J Immunol* 2001;31:3349–3354.

65. Deftos ML, Bevan MJ. Notch signaling in T cell development. *Curr Opin Immunol* 2000;12:166–172.

66. Deftos ML, He Y-W, Ojala EW, et al. Correlating Notch signaling and thymocyte maturation. *Immunity* 1998;9:777–786.

67. Pui JC, Allman D, Xu L, et al. Notch 1 expression in early lymphopoiesis influences B versus T lineage determination. *Immunity* 1999;11:299–308.

68. Radtke FA, Wilson A, Stark G, et al. Deficient T cell fate specification in mice with an induced inactivation of Notch-1. *Immunity* 1999;10:547–558.

69. Koch U, Lacombe TA, Holland D, et al. Subversion of the T/B lineage decision in the thymus by lunatic fringe-mediated inhibition of Notch-1. *Immunity* 2001;15:225–236.

70. Milner LA, Bigas A. Notch as a mediator of cell fate determination in hematopoiesis: evidence and speculation. *Blood* 1999;93:2431–2448.

71. Ellisen LW, Bird J, West DC, et al. TAN-1 the human homolog of the *Drosophila* notch gene is broken by chromosomal translocations in T lymphoblastic neoplasms. *Cell* 1991;66:649–661.

72. Rebay I, Fleming RJ, Rehon RG, et al. Specific EGF repeats of Notch mediate interactions with Delta and Serrate: implications for Notch as a multifunctional receptor. *Cell* 1991;67:687–699.

73. Jaleco AC, Neves H, Hooijberg E, et al. Differential effects of Notch ligands Delta-1 and Jagged-1 in human lymphoid differentiation. *J Exp Med* 2001;194:991–1002.

74. Artavanis-Tsakonas S, Rand MD, Lake RJ. Notch signaling: cell fate control and signal integration in

development. *Science* 1999;284:770–776.

75. Robey E. Regulation of T cell fate by notch. *Annu Rev Immunol* 1999;17:283–295.

76. Osborne B, Miele L. Notch and the immune system. *Immunity* 1999;11:653–663.

77. Wilson A, MacDonald HR, Radtke F. Notch–1 deficient common lymphoid precursors adopt a B cell fate in the thymus. *J Exp Med* 2001;194:1003–1012.

78. Moore TA, Zlotnik A. T–cell lineage commitment and cytokine responses of thymic progenitors. *Blood* 1995;86:1850–1860.

79. Galy A, Verma S, Barcena A, et al. Precursors of CD3+CD4+CD8+ cells in the human thymus are defined by the expression of CD34. Delineation of early events in human thymic development. *J Exp Med* 1993;178:391–401.

80. Adkins B, Mueller C, Okada CY, et al. Early events in T–cell maturation. *Annu Rev Immunol* 1987;5:325–365.

81. Fowlkes BJ, Pardoll, DM. Molecular and cellular events of T cell development. *Adv Immunol* 1989;44:207–264.

82. Schmitt C, Ktorza S, Sarun S, et al. CD34–expressing human thymocyte precursors proliferate in response to interleukin–7 but have lost myeloid differentiation potential. *Blood* 1993;82:3675–3685.

83. Schmitt C, Ktorza, Sarun S, et al. CD34–positive early stages of human T–cell differentiation. *Leuk Lymphoma* 1995;17:43–50.

84. Kraft DL, Weissman IL, Waller EK. Differentiation of CD3<sup>–</sup>CD4<sup>–</sup>CD8<sup>–</sup> human fetal thymocytes in vivo: characterization of a CD3<sup>–</sup>CD4<sup>–</sup>CD8<sup>–</sup> intermediate. *J Exp Med* 1993;178:265–277.

85. Hori T, Cupp J, Wrighton N, et al. Identification of a novel human thymocyte subset with a phenotype of CD3<sup>–</sup>CD4<sup>+</sup>CD8a<sup>+</sup>B<sup>–</sup>. Possible progeny of the CD3<sup>–</sup>CD4<sup>–</sup>CD8<sup>–</sup> subset. *J Immunol* 1991;146:4078–4084.

86. Guedos CJ, Weissman IL, Adkins B. Intrathymic maturation of murine T lymphocytes from CD8<sup>+</sup> precursors. *Proc Natl Acad Sci U S A* 1989;86:7542–7546.

87. Chervenak R, Dempsey D, Saloff R, et al. The expression of CD4 by T cell precursors resident in both the thymus and the bone marrow. *J Immunol* 1993;151:4486–4493.

88. Marquez C, Trigueros C, Fernandez E, et al. The development of T and non–T cell lineages from CD34<sup>+</sup> human thymic precursors can be traced by the differential expression of CD44. *J Exp Med* 1995;181:475–483.

89. Sanchez MJ, Spits H, Lanier LL, et al. Human natural killer cell committed thymocytes and their relation to the T cell lineage. *J Exp Med* 1993;178:1857–1866.

90. Godfrey DI, Zlotnik A. Control points in early T–cell development. *Immunol Today* 1993;14:547–553.

91. Volger LW, Tuck DT, Springer TA. Thymocyte binding to human thymic epithelial cells is inhibited by monoclonal antibodies to CD2 and LFA–3 antigens. *J Immunol* 1987;138:358–363.

92. Singer KH, Le PI, Denning SM, et al. The role of adhesion molecules in epithelial–T–cell interactions in thymus and skin. *J Invest Dermatol* 1990;94:85S–90S.

93. Alves LA, Campos de Carvalho AC, Cirne Lima EQ, et al. Functional gap junctions in thymic epithelial cells are formed by connexin 43. *Eur J Immunol* 1995;25:431–437.

94. Carding SR, Hayday AC, Bottomly K. Cytokines in T–cell development. *Immunol Today* 1991;12:239–245.

95. Groh V, Fabbi M, Strominger JL. Maturation or differentiation of human thymocyte precursors in



vitro? Proc Natl Acad Sci U S A 1990;87:5973–5977.

96. Suda T, Zlotnik A. IL-7 maintains the T cell precursor potential of CD3<sup>-</sup>CD4<sup>-</sup>CD8<sup>-</sup> thymocytes. *J Immunol* 1991;146:3068–3073.
97. Muegge K, Vila MP, Durum SK. Interleukin-7: a cofactor for V(D)J rearrangement of the T cell receptor  $\beta$  gene. *Science* 1993;261:93–95.
98. Perschon JJ, Morrissey PJ, Grabstein KH, et al. Early lymphocyte expansion is severely impaired in interleukin 7 receptor deficient mice. *J Exp Med* 1994;180:1955–1960.
99. Kronenberg M, Siu G, Hood LE, et al. The molecular genetics of the T-cell antigen receptor and T-cell antigen recognition. *Annu Rev Immunol* 1986;4:529–591.
100. Davis MM, Chien YH, Gascoigne NR, et al. A murine T cell receptor gene complex: isolation, structure and rearrangement. *Immunol Rev* 1984;81:235–258.
101. Yoshikai Y, Clark SP, Taylor S, et al. Organization and sequences of the variable, joining and constant region genes of the human T-cell receptor  $\alpha$ -chain. *Nature* 1985;316:837–840.
102. Davis MM. Molecular genetics of the T cell-receptor beta chain. *Annu Rev Immunol* 1985;3:537–560.
103. Brenner MB, Strominger JL, Krangel MS. The  $\delta$  T cell receptor. *Adv Immunol* 1988;43:133–192.
104. Raulet DH. The structure, function, and molecular genetics of the  $\delta$  T cell receptor. *Annu Rev Immunol* 1989;7:175–207.
105. Caccia N, Bruns GA, Kirsch IR, et al. T cell receptor  $\alpha$  chain genes are located on chromosome 14 at 14q11–14q12 in humans. *J Exp Med* 1985;161:1255–1260.
106. Hecht F, Morgan R, Hecht BK, et al. Common region on chromosome 14 in T-cell leukemia and lymphoma. *Science* 1984;226:1445–1447.
107. Williams DL, Look AT, Melvin SL, et al. New chromosomal translocations correlate with specific immunophenotypes of childhood acute lymphoblastic leukemia. *Cell* 1984;36:101–109.
108. Griesser H, Champagne E, Tkachuk D, et al. The human T cell receptor  $\alpha$ - $\delta$  locus: a physical map of the variable, joining and constant region genes. *Eur J Immunol* 1998;18:641–644.
109. Isobe M, Erikson J, Emanuel BS, et al. Location of gene for  $\beta$  subunit of human T-cell receptor at band 7q35, a region prone to rearrangements in T cells. *Science* 1985;228:580–582.
110. Le Beau MM, Diaz MO, Rowley JD, et al. Chromosomal localization of the human T cell receptor  $\beta$ -chain genes. *Cell* 1985;41:335.
111. Hayday AC, Diamond DJ, Tanigawa G, et al. Unusual organization and diversity of T-cell receptor  $\alpha$ -chain genes. *Nature* 1985;316:828–832.
112. Sims JE, Tunnacliffe A, Smith WJ, et al. Complexity of human T-cell antigen receptor  $\beta$ -chain constant- and variable-region genes. *Nature* 1984;312:541–545.
113. Caccia N, Kronenberg M, Saxe D, et al. The T cell receptor beta chain genes are located on chromosome 6 in mice and chromosome 7 in humans. *Cell* 1984;37:1091–1099.
114. MacDonald AW, Wilson A. The role of the T-cell receptor (TCR) in  $\alpha\beta/\delta$  lineage commitment: clues from intracellular TCR staining. *Immunol Rev* 1998;165:87–94.
115. Krangel MS, Hernandez-Munain C, Lauzirica P, et al. Developmental regulation of V(D)J recombination at the TCR $\alpha/\delta$  locus. *Immunol Rev* 1998;165:131–147.
116. Sleckman BP, Bassing CH, Barden CG, et al. Accessibility control of variable region gene assembly

during T-cell development. *Immunol Rev* 1998;165:121–130.

117. Groettrup M, Ungewiss K, Azogui O, et al. A novel disulfide-linked heterodimer on pre-T cells consists of the T cell receptor  $\beta$  chain and a 33 kd glycoprotein. *Cell* 1993;75:283–294.

118. von Boehmer H, Fehling HJ. Structure and function of the pre-T cell receptor. *Annu Rev Immunol* 1997;15:433–452.

119. von Boehmer H, Aifantis I, Azogui O, et al. Crucial function of the pre-T-cell receptor (TCR) in TCR $\beta$  selection, TCR $\beta$  allelic exclusion and  $\alpha\beta$  versus  $\gamma\delta$  lineage commitment. *Immunol Rev* 1998;165:111–119.

120. Blom B, Verschuren MCM, Heemskerk MHM, et al. TCR gene rearrangements and expression of the pre-T cell receptor complex during human T-cell differentiation. *Blood* 1999;93:3033–3043.

121. von Boehmer H, Aifantis I, Feinberg J, et al. Pleiotropic changes controlled by the pre-T-cell receptor. *Curr Opin Immunol* 1999;11:135–142.

122. Steff A-M, Trop S, Maira M, et al. Opposite ability of pre-TCR and  $\alpha\beta$  TCR to induce apoptosis. *J Immunol* 2001;166:5044–5050.

123. Murga C, Barber DF. Molecular mechanisms of pre-T cell receptor-induced survival. *J Biol Chem* 2002;277:39156–39162.

124. Saint-Ruf C, Panigada M, Azogui O, et al. Different initiation of pre-TCR and  $\gamma\delta$ TCR signaling. *Nature* 2000;406:524–527.

125. Michie AM, Zuniga-Pflucker JC. Regulation of thymocyte differentiation: pre-TCR signals and  $\beta$ -selection. *Semin Immunol* 2002;14:311–323.

126. Janeway CA Jr. The T cell receptor as a multicomponent signaling machine: CD4/CD8 coreceptors and CD45 in T cell activation. *Annu Rev Immunol* 1992;10:645–674.

127. Singer A, Bosselut R, Bhandoola A. Signals involved in CD4/CD8 lineage commitment: current concepts and potential mechanisms. *Semin Immunol* 1999;11:273–281.

128. Germain RN. T-cell development and the CD4–CD8 lineage decision. *Nat Rev Immunol* 2002;2:309–322.

129. von Boehmer H. The selection of the  $\alpha\beta$  heterodimeric T cell receptor for antigen. *Immunol Today* 1986;7:333–336.

130. Robey EA, Fowlkes BJ, Gordon J, et al. Thymic selection in CD8 transgenic mice supports an instructive model for commitment to a CD4 or CD8 lineage. *Cell* 1991;64:99–107.

131. Seong RH, Chamberlain JW, Parnes JR. Signal to T-cell differentiation to a CD4 cell lineage is delivered by CD4 transmembrane regions and/or cytoplasmic tail. *Nature* 1992;356:718–720.

132. Itano A, Salmon P, Kioussis D, et al. The cytoplasmic domain of CD4 promotes the development of CD4 lineage T cells. *J Exp Med* 1996;183:731–741.

133. Veillette A, Bookman M, Horak E, et al. The CD4 and CD8 T cell surface antigens are associated with the internal membrane tyrosine-protein kinase p56<sup>lck</sup>. *Cell* 1988;55:301–308.

134. Wiest D, Yuan L, Jefferson J, et al. Regulation of T cell receptor expression in immature CD4<sup>+</sup>CD8<sup>+</sup> thymocytes by p56lck tyrosine kinase: basis for differential signaling by CD4 and CD8 in immature thymocytes expressing both coreceptor molecules. *J Exp Med* 1993;178:1701–1712.

135. Bosselut R, Fergenbaum L, Sharrow SO, et al. Strength of signaling by CD4 and CD8 coreceptor tails determines the number but not the lineage direction of positively selected thymocytes. *Immunity* 2001;14:483–494.

136. Hernandez-Hoyos G, Sohn SJ, Rothenberg EV, et al. Lck activity controls CD4/CD8 T cell lineage

commitment. *Immunity* 2000;12:313–322.

137. Sohn SJ, Forbush KA, Pan XC, et al. Activated p56<sup>lck</sup> directs maturation of both CD4 and CD8 single positive thymocytes. *Blood* 2001;166:2209–2217.

138. Basson MA, Bommhardt U, Mee PJ, et al. Molecular requirements for lineage commitment in the thymus—antibody-mediated receptor engagement reveal a central role for Lck in lineage decisions. *Immunol Rev* 1998;165:181–195.

139. Bommhardt U, Basson MA, Krummrei U, et al. Activation of the extracellular signal-related kinase/mitogen-activated protein kinase pathway discriminates CD4 versus CD8 lineage commitment in the thymus. *J Immunol* 1999;163:715–722.

140. Cibotti R, Punt JA, Dash KS, et al. Surface molecules that drive T cell development in vitro in the absence of thymic epithelium and in the absence of lineage-specific signals. *Immunity* 1997;6:245–255.

141. Chan S, Correia-Neves M, Benoist C, et al. CD4/CD8 lineage commitment: matching fate with competence. *Immunol Rev* 1998;165:195–207.

142. Keefe R, Dave V, Allman D, et al. Regulation of lineage commitment distinct from positive selection. *Science* 1999;286:1149–1153.

143. von Boehmer H, The HS, Kisielow P. The thymus selects the useful, neglects the useless and destroys the harmful. *Immunol Today* 1989;10:57–61.

144. Bevan MJ. In thymic selection, peptide diversity gives and takes away. *Immunity* 1997;7:175–178.

145. Amsen D, Kruisbeek AM. Thymocyte selection: not by TCR alone. *Immunol Rev* 1998;165:209–229.

146. Anderson G, Hare KJ, Jenkinson EJ. Positive selection of thymocytes: the long and winding road. *Immunol Today* 1999;20:463–468.

147. Jameson S, Hogquist KA, Bevan MJ. Positive selection of thymocytes. *Annu Rev Immunol* 1995;13:93–126.

148. Sprent J, Webb SR. Function and specificity of T cell subsets in the mouse. *Adv Immunol* 1987;41:39–133.

149. Mannie MD. A unified model for T cell antigen recognition and thymic selection of the T cell repertoire. *J Theor Biol* 1991;151:169–192.

150. Janeway CA Jr, Dianzani U, Portoles P, et al. Cross linking and conformational change in T-cell receptors: role in activation and in repertoire selection. *Cold Spring Harb Symp Quant Biol* 1989;54(2):657–666.

151. Fowlkes BJ, Pardoll DM. Molecular and cellular events of T cell development. *Adv Immunol* 1989;44:207–264.

152. Jamieson SC, Bevan MJ. T cell selection. *Curr Opin Immunol* 1998;10:214–219.

153. Trobridge PA, Forbush KA, Levin SD. Positive and negative selection of thymocytes depends on Lck interaction with the CD4 and CD8 coreceptors. *J Immunol* 2001;166:809–818.

154. Turner JM, Brodsky MH, Irving BA, et al. Interaction of the unique N-terminal region of the tyrosine kinase p56<sup>lck</sup> with the cytoplasmic domains of CD4 and CD8 is mediated by cysteine motifs. *Cell* 1990;60:755.

155. Van Oers NSC, Kileen N, Weiss A. ZAP-70 is constitutively associated with tyrosine phosphorylated TCR in murine thymocytes and lymph node T cells. *Immunity* 1994;1:675–685.

156. Negishi I, Motoyama N, Nakayama K, et al. Essential role for ZAP-70 in both positive and negative selection. *Nature* 1995;376:435–438.

157. Sosinowski T, Kileen N, Weiss N. The Src-like adaptor protein downregulates the T cell receptor on CD4+CD8+ thymocytes and regulates positive selection. *Immunity* 2001;15:457-466.
158. Alberola-Ila J, Hernandez-Hojos G. The Ras/MAPK cascade and the control of positive selection. *Immunol Rev* 2003;191:79-96.
159. Page DM, Kane LP, Allison JP, et al. Two signals are required for negative selection of CD4<sup>+</sup>CD8<sup>+</sup> thymocytes. *J Immunol* 1993;151:1868-1880.
160. Sasada T, Reinherz EL. A critical role for CD2 in both thymic selection events and mature T cell function. *J Immunol* 2001;166:2394-2403.
161. Li R, Page DM. Requirement for a complex array of costimulators in the negative selection of autoreactive thymocytes in vivo. *J Immunol* 2001;166:6050-6057.
162. Dautigny N, Le Campion A, Lucas B. Timing and casting for actors of thymic negative selection. *J Immunol* 1999;162:1294-1302.
163. Page DM. Cutting edge: thymic selection and autoreactivity are regulated by multiple coreceptors involved in T cell activation. *J Immunol* 1999;163:3577-3581.
164. Kishimoto H, Sprent J. Several different cell surface molecules control negative selection of medullary thymocytes. *J Exp Med* 1999;190:65-74.
165. McKean DJ, Huntoon CJ, Bell MP, et al. Maturation versus death of developing double-positive thymocytes reflects competing effects on Bcl-2 expression and can be regulated by the intensity of CD28 costimulation. *J Immunol* 2001;166:3468-3475.
166. Wang CR, Hashimoto K, Kubo S, et al. T cell receptor-mediated signaling events in CD4+CD8+ thymocytes undergoing thymic selection: requirement of calcineurin activation for thymic positive selection but not negative selection. *J Exp Med* 1995;181:927-941.
167. Urdahl KB, Pardoll DM, Jenkins MK. Cyclosporin A inhibits positive selection and delays negative selection in  $\alpha\beta$  TCR transgenic mice. *J Immunol* 1994;152:2853-2862.
168. Kane LP, Hedrick SM. A role for calcium influx in setting the threshold for CD3<sup>+</sup>CD8<sup>+</sup> thymocyte negative selection. *J Immunol* 1996;156:4594-4601.
169. Zhou T, Cheng J, Yang P, et al. Inhibition of Nur77/Nurr1 leads to inefficient clonal deletion of self-reactive T cells. *J Exp Med* 1996;183:1879-1892.
170. Fowlkes BJ, Schwartz RA, Pardoll DM. Deletion of self reactive thymocytes occurs at a CD4<sup>+</sup>CD8<sup>+</sup> precursor stage. *Nature* 1988;334:620-623.
171. Guidos CJ, Danska JS, Fathman CG, et al. T cell receptor mediated negative selection occurs after commitment to the CD4 or CD8 lineages. *J Exp Med* 1990;172:835-845.
172. van Ewijk W, Ron Y, Monaco J, et al. Compartmentalization of MHC class II gene expression in transgenic mice. *Cell* 1988;53:357-370.
173. Benoist C, Mathis D. Positive selection of the T cell repertoire: where and when does it occur? *Cell* 1989;58:1027-1033.
174. Bill J, Palmer E. Positive selection of CD4<sup>+</sup> T cell mediated by MHC class II-bearing stromal cell in the thymic cortex. *Nature* 1989;341:649-651.
175. Cosgrove D, Chan SH, Waltzinger C, et al. The thymic compartment responsible for positive selection of CD4<sup>+</sup> T cells. *Int Immunol* 1992;4:707-710.
176. Sprent J, Lo D, Gao E-K, et al. T cell selection in the thymus. *Immunol Rev* 1988;101:173-190.

177. Robey E, Fowlkes BJ. Selective events in T cell development. *Annu Rev Immunol* 1994;12:675–705.
- 177a. Bevan MJ. In a radiation chimaera host H<sub>2</sub> antigen determine the immune responsiveness of donor cytotoxic cells. *Nature* 1977;269:417–418.
178. Zinkernagel RM, Callahan GN, Althage A, et al. On the thymus in the differentiation of “H<sub>2</sub> self-recognition” by T cells: evidence for dual recognition. *J Exp Med* 1978;147:882–896.
179. Hogquist KA, Jameson CS, Heath WR, et al. T cell receptor antagonist peptides induce positive selection. *Cell* 1994;76:17–27.
180. Sebзда E, Wallace VA, Mayer J, et al. Positive and negative thymocyte selection induced by different concentrations of a single peptide. *Science* 1994;263:1615–1618.
181. Liu C-P, Crawford F, Marrack P, et al. T cell positive selection by a high density, low affinity ligand. *Proc Natl Acad Sci U S A* 1998;95:4522–4526.
182. Ashton-Rickhardt PG. The role of peptide in the positive selection of CD8<sup>+</sup> T cells in the thymus. *Thymus* 1993;22:111–115.
183. Ignatowicz L, Rees W, Pacholczyk R, et al. T cells can be activated by peptides that are unrelated in sequence to their selecting peptide. *Immunity* 1997;7:179–186.
184. Hu Q, Bazemore-Walker CR, Girao C, et al. Specific recognition of thymic self-peptides induces the positive selection of cytotoxic T lymphocytes. *Immunity* 1997;7:221–231.
185. Hunt DF, Michel H, Dickinson TA, et al. Peptides presented to the immune system by the murine class II major histocompatibility complex molecule I-A<sup>d</sup>. *Science* 1992;256:1817–1820.
186. Ignatowicz L, Kappler J, Marrack P. The repertoire of T cells shaped by a single MHC/peptide ligand. *Cell* 1996;86:521–529.
187. Barton GM, Beers C, de Roos P, et al. Positive selection of self-MHC-reactive T cells by individual peptide-MHC class II complexes. *Proc Natl Acad Sci U S A* 2002;99:6937–6942.
188. Lee D-S, Ahn C, Ernst B, et al. Thymic selection by a single MHC/peptide ligand: autoreactive T cells are low affinity cells. *Immunity* 1999;10:83–92.
189. Surh CD, Lee D-S, Fung-Leung W-P, et al. Thymic selection by a single MHC/peptide ligand produces a semidiverse repertoire of CD4<sup>+</sup> T cells. *Immunity* 1997;7:209–219.
190. Anderson G, Partington KM, Jenkinson EJ. Differential effects of peptide diversity and stromal cell type in positive and negative selection in the thymus. *J Immunol* 1998;161:6599–6603.
191. Bentley GA, Mariuzza RA. The structure of the T cell antigen receptor. *Annu Rev Immunol* 1996;14:563–590.
192. Garcia KC, Teyton L, Wilson IA. Structural basis of T cell recognition. *Annu Rev Immunol* 1999;17:369–397.
193. Fields BA, Mariuzza RA. Structure and function of the T-cell receptor: insights from x-ray crystallography. *Immunol Today* 1996;17:330–336.
194. Madden D. The three-dimensional structure of peptide-MHC complexes. *Annu Rev Immunol* 1995;13:587–622.
195. Davis MM, Bjorkman PJ. T-cell antigen receptor genes and T-cell recognition. *Nature* 1988;334:395–402.
196. Bjorkman PJ, Saper MA, Samraoui B, et al. Structure of the human class I histocompatibility antigen

HLA-A<sub>2</sub>. Nature 1987;329:506–512.

197. Madden D, Gorga J, Strominger J, et al. The structure of HLA-B27 reveals nonamer self-peptides bound in an extended conformation. Nature 1991;353:321–325.
198. Kozono H, White J, Clements J, et al. Production of soluble MHC class II proteins with covalently bound single peptides. Nature 1994;369:151–154.
199. Hennecke J, Carfi A, Wiley DC. Structure of a covalently stabilized complex of a human  $\alpha\beta$  T-cell receptor, influenza HA peptide and MHC class II molecules, HLA-DR1. EMBO J 2000;19:5611–5624.
200. Rudolph MG, Wilson IA. The specificity of TCR/pMHC interaction. Curr Opin Immunol 2002;14:52–65.
201. Garcia KC, Degano M, Stanfield RL, et al. An  $\alpha\beta$  T cell receptor structure at 2.5 Å and its orientation in the TCR-MHC complex. Science 1996;274:209–210.
202. Garboczi DN, Ghosh P, Utz U, et al. Structure of the complex between human T-cell receptor, viral peptide and HLA-A<sub>2</sub>. Nature 1996;384:134–141.
203. Reinherz EL, Tan K, Tang L, et al. The crystal structure of a T cell receptor in complex with peptide and MHC class II. Science 1999;286:1913–1921.
204. Ding YH, Smith KJ, Garboczi DN, et al. Two human T cell receptors bind in a similar diagonal mode to the HLA-A<sub>2</sub>/Tax peptide complex using different TCR amino acids. Immunity 1998;8:403–411.
205. Teng MK, Smolyar A, Tu AG, et al. Identification of a common docking topology with substantial variation among different TCR-peptide-MHC complexes. Curr Biol 1998;8:409–412.
206. Speir JA, Stevens J, Joly E, et al. Two different highly exposed, bulged structures for an unusually long peptide bound to rat MHC class I TR1-A<sup>a</sup>. Immunity 2001;4:81–92.
207. Young AC, Zhang W, Sacchettini JC, et al. The three dimensional structure of H-2D<sup>b</sup> at 2.4 Å resolution: implications for antigen-determinant selection. Cell 1994;76:39–50.
208. Speir JA, Garcia KC, Brunmark A, et al. Structural basis of 2C TCR allorecognition of H-2L<sup>d</sup> peptide complexes. Immunity 1998;8:553–562.
209. Braden BC, Goldman ER, Marinzza RA, et al. Anatomy of an antibody molecule: structure, kinetics, thermodynamics and mutational studies of the antilysozyme antibody D1.3. Immunol Rev 1998;163:45–57.
210. Reiser JB, Darnault C, Guimezanes A, et al. Crystal structure of a T cell receptor bound to an allogeneic MHC molecule. Nat Immunol 2000;1:291–297.
211. Hennecke J, Wiley DC. Structure of a complex of the human  $\alpha\beta$ -T cell receptor HA1.7, influenza HA peptide, and MHC class II cross-restriction and alloreactivity. J Exp Med 2002;195:571–581.
212. Kersh GJ, Allen PM. Essential flexibility in the T cell recognition of antigen. Nature 1996;380:495–498.
213. Sloan-Lancaster J, Allen PM. Altered peptide ligand-induced partial T cell activation: molecular mechanisms and role in T cell biology. Annu Rev Immunol 1996;14:1–27.
214. Davis MM, Boniface JJ, Reich Z, et al. Ligand recognition by alpha beta T cell receptors. Annu Rev Immunol 1998;16:523–544.
215. Manning TC, Kranz DM. Binding energetics of T cell receptors: correlation with immunological consequences. Immunol Today 1999;20:417–422.
216. Udaka K, Wiesmuller KH, Kienle S, et al. Self-MHC restricted peptides recognized by an alloreactive T lymphocyte clone. J Immunol 1996;157:670–678.
217. Sykulev Y, Vugmeyster Y, Brunmark A, et al. Peptide antagonism and T cell receptor interactions

with peptide MHC complexes. *Immunity* 1998;9:475–483.

218. Kersh GJ, Kersh EN, Fremont DH, et al. High- and low-potency ligands with similar affinities for the TCR: the importance of kinetics in TCR signaling. *Immunity* 1998;9:817–826.

219. Garcia KC. Molecular interactions between extracellular components of the T-cell receptor signaling complex. *Immunol Rev* 1999;172:73–85.

220. Garcia KC, Degano M, Pease LR, et al. Structural basis of plasticity in T cell receptor recognition of a self peptide–MHC antigen. *Science* 1998;279:1166–1172.

221. Beyers AD, Spruyt LL, Williams AF. Molecular associations between the T lymphocyte antigen receptor complex and the surface antigens CD2, CD4 or CD8 and CD5. *Proc Natl Acad Sci U S A* 1992;89:2945–2949.

222. Hennecke J, Wiley DC. T cell receptor–MHC interactions up close. *Cell* 2001;104:1–4.

223. Thome M, Duplay P, Guttinger M, et al. Syk and ZAP–70 mediate recruitment of p56lck/CD4 to the activated T cell receptor/CD3/zeta complex. *J Exp Med* 1995;181:1997–2006.

224. Thome M, Germain V, Di Santo JP, et al. The p56lck SH2 domain mediates recruitment of CD8/p56lck to the activated T cell receptor/CD3/zeta complex. *Eur J Immunol* 1996;26:2093–2100.

225. Irvine DJ, Purbhoo MA, Krogsgaard M, et al. Direct observation of a single ligand recognition by T cells. *Nature* 2002;419:845–849.

226. Gao GF, Jacobsen BK. Molecular interactions of coreceptor CD8 and MHC class I: the molecular basis for functional coordination with the T–cell receptor. *Immunol Today* 2000;21:630–636.

227. Gao GF, Rao Z, Bell JI. Molecular coordination of  $\alpha\beta$  T–cell receptors and coreceptors CD8 and CD4 in their recognition of peptide–MHC ligands. *Trends Immunol* 2002;23:408–413.

228. Moody AM, Chui D, Reche PA, et al. Developmentally regulated glycosylation of the CD8 alpha beta coreceptor stalk modulates ligand binding. *Cell* 2001;107:501–512.

229. Zamoyska R. The CD8 coreceptor revisited: one chain good, two chains better. *Immunity* 1994;1:243–246.

230. van der Merwe PA, Davis SJ. Molecular interactions mediating T cell antigen recognition. *Annu Rev Immunol* 2003;21:659–684.

231. Vignali DA, Vignali KM. Profound enhancement of T cell activation mediated by the interaction between the TCR and the D3 domain of CD4. *J Immunol* 1999;162:1431–1439.

232. van der Merwe PA, McNamee PN, Davies EA, et al. Topology of the CD2–CD48 cell adhesion molecule complex: implications for antigen recognition by T cells. *Curr Biol* 1995;5:74–84.

233. Bachmann MF, Barner M, Kopf M. CD2 sets quantitative thresholds in T cell activation. *J Exp Med* 1999;190:1383–1392.

234. Collins AV, Brodie DW, Gilbert RJC, et al. The interaction properties of costimulatory molecules revisited. *Immunity* 2002;17:201–210.

235. Clevers H, Larcon B, Wileman T, et al. The T cell receptor/CD3 complex: a dynamic protein ensemble. *Annu Rev Immunol* 1998;16:629–662.

236. Chan AC, Desdi DM, Weiss A. The role of protein tyrosine kinases and protein tyrosine phosphatases in T cell antigen receptor signal transduction. *Annu Rev Immunol* 1994;12:555–592.

237. Minami Y, Weisman AM, Samelson LE, et al. Building a multichain receptor: synthesis, degradation, and assembly of the T–cell antigen receptor. *Proc Natl Acad Sci U S A* 1987;84:2688–2692.

238. Letourneur F, Klausner RD. A novel di-leucine motif and a tyrosine based motif independently



mediate lysosomal targeting and endocytosis of CD3 chains. *Cell* 1992;69:1143–1157.

239. Cambier JC. Antigen and Fc receptor signaling. The awesome power of the immunoreceptor tyrosine based activation motif (ITAM). *J Immunol* 1995;155:3281–3285.

240. Irving BA, Chan AC, Weiss A. Functional characterization of a signal transducing motif present in the T cell antigen receptor  $\zeta$  chain. *J Exp Med* 1993;177:1093–1103.

241. Lange G, Lewis SJ, Murshudov GN, et al. Crystal structure of an extracellular fragment of the rat CD4 receptor containing domains 3 and 4. *Structure* 1994;2:469–481.

242. Brady RL, Barclay AN. The structure of CD4. *Curr Top Microb Immunol* 1996;205:1–18.

243. König R, Clury S, Germain RN. The structural basis of CD4–MHC class II interactions: coreceptor contributions to T cell receptor antigen recognition and oligomerization–dependent signal transduction. *Curr Top Microbiol Immunol* 1996;205:19–46.

244. Tachibana M, Siddiqi MA, Ikegami Y, Eshima K, et al. Coreceptor function of mutant human CD4 molecule without affinity to gp120 of human immunodeficiency virus. *J Biol Chem* 2000;275:20288–20294.

245. Wang J–H, Reinherz EL. Structural basis of cell–cell interactions in the immune system. *Curr Opin Struct Biol* 2000;10:656–661.

246. Wang J–H, Meijers R, Xiong Y, et al. Crystal structure of the human CD4 N–terminal two–domain fragment complexed to a class II MHC molecule. *Proc Natl Acad Sci U S A* 2001;98:10799–10804.

247. Lynch GW, Sloane AJ, Raso V, et al. Direct evidence of native CD4 oligomers in lymphoid and monocytoid cells. *Eur J Immunol* 1999;29:2590–2602.

248. Cherry RJ, Wilson KM, Triantafilou K, et al. Detection of dimers of dimers of human leukocyte antigen (HLA)–DR on the surface of living cells by single–particle fluorescence imaging. *J Cell Biol* 1998;140:71–79.

249. Lindstedt R, Monk N, Lombardi G, et al. Amino acid substitutions in the putative MHC class II “dimer of dimers” interface inhibit CD4+ T cell activation. *J Immunol* 2001;166:800–808.

250. Sakihama T, Smolyar A, Reinherz EL. Molecular recognition of antigen involves lattice formation between CD4, MHC class II and TCR molecules. *Immunol Today* 1995;16:581–587.

251. Xiong Y, Kern P, Chang H–C, et al. T cell receptor binding to a pMHCII ligand is kinetically distinct from and independent of CD4. *J Biol Chem* 2001;276:5659–5667.

252. Gao GF, Tormo J, Gerth UC, et al. Crystal structure of the complex between human CD8 alpha and HLA–A2. *Nature* 1997;387:630–634.

253. Connolly JM, Hansen TH, Ingold AL, et al. Recognition by CD8 on cytotoxic T lymphocytes is ablated by several substitutions in the same class I molecule. *Proc Natl Acad Sci U S A* 1990;87:2137–2141.

254. Gibling PA, Leahy DJ, Mennone J, et al. The role of charge and multiple faces of the CD8–alpha/alpha homodimer in binding to major histocompatibility complex class I molecules—support for a bivalent model. *Proc Natl Acad Sci U S A* 1994;91:1716–1720.

255. Devine L, Sun JR, Barr MR, et al. Orientation of the Ig domains of the CD8 alpha beta relative to MHC class I. *J Immunol* 1999;162:846–851.

256. Gao GF, Jokobsen BK. Molecular interactions of coreceptor CD8 and MHC class I: the molecular basis for functional coordination with T–cell receptor. *Immunol Today* 2000;21:630–636.

257. Garboczi DN, Ghosh P, Utz U, et al. Structure of the complex between human T–cell receptor, viral peptide, and HLA–A2. *Nature* 1996;384:134–141.

258. Sun J, Leahy DJ, Kavathas PB. Interaction between CD8 and major histocompatibility complex (MHC) class I mediated by multiple contact surfaces that include a  $\alpha_2$  and a  $\alpha_3$  domains of MHC class I. *J Exp*

Med 1995;182: 1275–1280.

259. König R. Interactions between MHC molecules and co-receptors of the TCR. *Curr Opin Immunol* 2002;14:75–83.
260. Hamad AR, O'Herrin SM, Lebowitz MS, et al. Potent T cell activation with dimeric peptide–major histocompatibility complex class II ligand: the role of CD4 coreceptor. *J Exp Med* 1998;188:1633–1640.
261. Crawford F, Kozono H, White J, et al. Detection of antigen-specific T cells with multivalent soluble class II MHC covalent peptide complexes. *Immunity* 1998;8:675–682.
262. Boniface JJ, Rabinowitz JD, Wulfig C, et al. Initiation of signal transduction through the T cell receptor requires the multivalent engagement of peptide/MHC ligand. *Immunity* 1998;9:459–466.
263. Campanelli R, Palernio B, Garbelli S, et al. Human CD8 co-receptor is strictly involved in MHC–peptide tetramer–TCR binding and T cell activation. *Intern Immunol* 2002;14:39–44.
264. Daniels MA, Jameson SC. Critical role for CD8 in T cell receptor binding and activation by peptide/major histocompatibility complex multimers. *J Exp Med* 2000;191:335–345.
265. Kwan Lim GE, McNeill L, Whitley K, et al. Co-capping studies reveal CD8/TCR interactions after capping CD8 beta polypeptides and intracellular associations of CD8 with p56(lck). *Eur J Immunol* 1998;28:745–754.
266. Zhang W, Sloan–Lancaster J, Kitchen J, et al. LAT: the ZAP–70 tyrosine kinase substrate that links T cell receptor to cellular activation. *Cell* 1998;92:83–92.
267. Finco TS, Kadlecsek T, Zhang W, et al. LAS is required for TCR–mediated activation of PLC– $\gamma$ 1 and the Ras pathway. *Immunity* 1998;9:617–626.
268. Bosselut R, Zhang, Ashe JM, et al. Association of the adaptor molecule LAT with CD4 and CD8 coreceptors identifies a new coreceptor function in T cell receptor signal transduction. *J Exp Med* 1999;190:1517–1525.
269. Garcia KC, Degano M, Stanfield RL, et al. An  $\alpha\beta$  T cell receptor structure at 2.5 Å and its orientation in the TCR–MHC complex. *Science* 1996;274:209–219.
270. Ding YH, Smith KJ, Garboczi DN, et al. Two human T cell receptors bind in a similar diagonal mode to the HLA–A2/Tax peptide complex using different TCR amino acids. *Immunity* 1998;8:403–411.
271. Teng MK, Smolyar A, Tse AG, et al. Identification of a common docking topology with substantial variation among different TCR–peptide–MHC complexes. *Curr Biol* 1998;8:409–412.
272. Reinherz EL, Tan K, Tang L, et al. The crystal structure of a T cell receptor in complex with peptide and MHC class II. *Science* 1999;286:1913–1921.
273. Hennecke J, Carfi A, Wiley DC. Structure of a covalently stabilized complex of a human  $\alpha\beta$  T cell receptor, influenza HA peptide and MHC class II molecule, HLA–DR1. *EMBO J* 2000;19:5611–5624.
274. Wang J–H, Reinherz EL. Structural basis of T cell recognition of peptides bound to MHC molecules. *Mol Immunol* 2001;38:1039–1049.
275. Wyer JR, Wilcox BE, Gao GF, et al. T cell receptor and co-receptor CD8 $\alpha\alpha$  bind peptide–MHC independently and with distinct kinetics. *Immunity* 1999;10:219–225.
276. Mazza G, Housset D, Piras C, et al. Glimpses at the recognition of peptide–MHC complexes by T cell antigen receptors. *Immunol Rev* 1998;163:187–196.
277. Shaw AS, Dustin ML. Making T cell receptor go the distance: a topological view of T cell activation. *Immunity* 1997;6:361–369.
278. Simons K, Toomre D. Lipid rafts and signal transduction. *Nat Rev Mol Cell Biol* 2000;1:31–41.

279. Cherukuri A, Dykstra ML, Pierce SK. Floating the raft hypothesis: lipid rafts play a role in immature cell activation. *Immunity* 2001;14:657–660.
280. Langlet C, Bernard A–M, Drevot P, et al. Membrane rafts and signaling by the multichain immune recognition receptors. *Curr Opin Immunol* 2000;12:250–255.
281. Brown DA, London E. Structure and function of sphingolipid– and cholesterol–rich membrane rafts. *J Biol Chem* 2000;275:17221–17224.
282. Brown DA, London E. Functions of lipid rafts in biological membranes. *Annu Rev Cell Dev Biol* 1998;14:111–136.
283. Morley SCP, Bierer BE. The actin cytoskeleton, membrane lipid microdomains and T cell signal transduction. *Adv Immunol* 2001;77:1–43.
284. Varma R, Mayer S. GPI–anchored proteins are organized in submicron domains at the cell surface. *Nature* 1998;394:798–801.
285. Vogt AB, Spindeldreher S, Kropshofer H. Clustering MHC–peptide complexes prior to their engagement in the immunological synapse: lipid raft and tetraspan microdomains. *Immunol Rev* 2002;189:136–151.
286. Dykstra M, Cherukuri A, Sohn HW, et al. Location is everything: lipid rafts and immune cell signaling. *Annu Rev Immunol* 2003;21:457–481.
287. Cheng PC, Cherukuri A, Dykstra ML, et al. Floating the raft hypothesis: the roles of lipid rafts in B cell antigen receptor function. *Semin Immunol* 2001;13:107–114.
288. Janes PW, Ley SC, Magee AI, et al. The role of lipid rafts in T cell antigen receptor (TCR) signaling. *Semin Immunol* 2000;12:23–34.
289. Cherukuri A, Dykstra M, Pierce SK. Floating the raft hypothesis: lipid rafts play a role in immune cell activation. *Immunity* 2001;14:657–660.
290. Cherukuri A, Cheng PC, Sohn HW, et al. The CD19/CD21 complex functions to prolong B cell antigen receptor signaling from lipid rafts. *Immunity* 2001;14:169–179.
291. Lowin–Kropf B, Shapiro VS, Weiss A. Cytoskeletal polarization of T cells is regulated by an immunoreceptor tyrosine–based activation motif–dependent mechanism. *J Cell Biol* 1998;140:861–871.
292. Harder T. Raft membrane domains and immunoreceptor functions. *Adv Immunol* 2001;77:45–92.
293. Snapper SB, Rosen FS. The Wiskott–Aldrich syndrome protein (WASP): roles in signaling and cytoskeletal organization. *Annu Rev Immunol* 1999;17:905–929.
294. Chiang YJ, Kole HK, Brown K, et al. Bcl–b regulates the CD28 dependence of T cell activation. *Nature* 2000;403:216–220.
- 294a. Sherrington CS. *The integrative action of the nervous system*. London, 1906.
295. Bromley S, Burack WR, Johnson KG, et al. The immunological synapse. *Annu Rev Immunol* 2001;19:375–396.
296. Monks CR, Freiberg BA, Kupfer H, et al. Three dimensional segregation of supramolecular activation clusters in T cells. *Nature* 1998;395:82–86.
297. Dustin ML, Cooper JA. The immunological synapse and the actin cytoskeleton: molecular hardware for T cell signaling. *Nat Immunol* 2000;1:23–29.
298. Acuto O, Cantrell D. T cell activation and the cytoskeleton. *Annu Rev Immunol* 2000;18:165–184.

299. Matzinger P. An innate sense of danger. *Semin Immunol* 1998;10:399–415.
300. Donnadieu E, Bismuth G, Trautman A. Antigen recognition by helper T cells elicits a sequence of distinct changes of their shape and intracellular calcium. *Curr Biol* 1994;4:584–595.
301. Negulescu PA, Krasieva TB, Khan A, et al. Polarity of T cell shape, motility and sensitivity to antigen. *Immunity* 1996;4:421–430.
302. Tuosto L, Michel F, Acuto O. p95vav associates with tyrosine phosphorylated SLP–76 in antigen stimulated T cells. *J Exp Med* 1996;184:1161–1166.
303. Wu J, Motbo DG, Koretzky GA, et al. Vav and SLP–76 interact and functionally cooperate in IL–2 gene activation. *Immunity* 1996;4:593–602.
304. Wardenburg JP, Pappu R, Bu JY, et al. Regulation of PAK activation and the cell cytoskeleton by the linker protein SLP–76. *Immunity* 1998;9:607–616.
305. Sedwik CE, Morgan MM, Jusino L, et al. TCR, LFA–1 and CD28 play unique and complementary roles in signaling T cell cytoskeletal reorganization. *J Immunol* 1999;162:1367–1375.
306. Wüfling C, Davis MM. A receptor/cytoskeletal movement triggered by costimulation during T cell activation. *Science* 1998;282:2266–2269.
307. Dustin M, Bromely SK, Kan Z, et al. Antigen receptor engagement delivers a stop signal to migrating T lymphocytes. *Proc Natl Acad Sci U S A* 1997;94:3909–3913.
308. Grakoui A, Bromley SK, Sumen C, et al. The immunological synapse: a molecular machine controlling T cell activation. *Science* 1999;285:221–227.
309. Lee KH, Holderf AD, Dristin ML, et al. T cell receptor signaling precedes immunological synapse formation. *Science* 2002;295:1539–1542.
310. Stinchcombe JC, Bossi G, Booth S, et al. The immunological synapse of CTL contains a secretory domain and membrane bridges. *Immunity* 2001;15:751–761.
311. Liepins A, Foanes RB, Lifter J, et al. Ultrastructural changes during T–lymphocyte–mediated cytolysis. *Cell Immunol* 1997;28:109–124.
312. Grimm E, Price Z, Bonavida B. Studies on the induction and expression of T cell–mediated immunity VIII. Effector–target junctions and target cell membrane disruption during cytolysis. *Cell Immunol* 1979;46:77–99.
313. Revy P, Sospedra M, Barbour B, et al. Functional antigen independent synapses formed between T cells and dendritic cells. *Nat Immunol* 2001;2:925–931.
314. Kondo T, Cortese I, Markovic–Plese S, et al. Dendritic cells signal T cells in the absence of exogenous antigen. *Nat Immunol* 2001;2:932–938.
315. Gunzer M, Schafer A, Borgmann S, et al. Antigen presentation in extracellular matrix: interactions of T cells with dendritic cells are dynamic, short lived, and sequential. *Immunity* 2000;13:323–332.
316. Wüfling C, Sjaastad MD, Davis MM. Visualizing the dynamics of T cell activation: intracellular adhesion molecule 1 migrates readily to the T cell/B cell interface and acts to sustain calcium levels. *Proc Natl Acad Sci U S A* 1998;95:6302–6307.
317. Davis SJ, van der Merwe PA. The immunological synapse: required for T cell receptor signaling or directing effector function. *Curr Biol* 2001;11:R289–R290.
318. van der Merwe PA, Davis SJ. Immunology. The immunological synapse—a multitasking system. *Science* 2002;295:1479–1480.
319. van der Merwe PA. Formation and function of the immunological synapse. *Curr Opin Immunol*

2002;14:293–298.

320. Bromley SK, Iaboni A, Davis SJ, et al. The immunological synapse and CD28–CD80 interactions. *Nat Immunol* 2001;2:1159–1166.

321. Holdorf AD, Lee KH, Burack WR, et al. Regulation of Lck activity by CD4 and CD28 in the immunological synapse. *Nat Immunol* 2002;3:259–264.

322. Mustelin T, Coggeshall KM, Altman A. Rapid activation of T cell tyrosine protein kinase pp56<sup>lck</sup> by the CD45 phosphotyrosine phosphatase. *Proc Natl Acad Sci U S A* 1989;86:6302–6306.

323. van der Merwe PA, Davis SJ, Shaw AS, et al. Cytoskeletal polarization and redistribution of cell surface molecules during T cell antigen recognition. *Semin Immunol* 2000;12:5–21.

324. Leupen O, Zaru R, Laroche T, et al. Exclusion of CD45 from T cell receptor signaling area in antigen-stimulated T lymphocytes. *Curr Biol* 2000;10:277–280.

325. Johnson KG, Bromley SK, Dustin ML, et al. A supramolecular basis for CD45 regulation during T cell activation. *Proc Natl Acad Sci U S A* 2000;97:10138–10143.

326. Kersh EN, Shaw AS, Allen PM. Fidelity of T cell activation through multistep T cell receptor ? phosphorylation. *Science* 1998;281:572–575.

327. Kersh GJ, Allen PM. Essential flexibility in the T-cell recognition of antigen. *Nature* 1996;380:495–498.

328. McKeethan TW. Kinetic proofreading in T cell receptor signal transduction. *Proc Natl Acad Sci U S A* 1995;92:5042–5046.

329. Rabinowitz JD, Beeson C, Lyons DS, et al. Kinetic discrimination in T cell activation. *Proc Natl Acad Sci U S A* 1996;93:1401–1405.

330. Lanzavecchia A, Iezzi G, Viola A. From TCR engagement to T cell activation: a kinetic view of T cell behavior. *Cell* 1999;96:1–4.

331. Leo A, Wienandz, Baier G, et al. Adapters in lymphocyte signaling. *J Clin Invest* 2002;109:301–309.

332. Zhang W, Sloan-Lancaster J, Kitchen J, et al. LAT: the ZAP-70 tyrosine kinase substrate that links T cell receptor to cellular activation. *Cell* 1998;92:83–92.

333. Samelson LE. Signal transduction mediated by the T cell antigen receptor: the role of adapter proteins. *Annu Rev Immunol* 2002;20:371–394.

334. Sims TN, Dustin ML. The immunological synapse. *Immunol Rev* 2002;186:100–117.

335. Koretzky GA, Myung PS. Positive and negative regulation of T cell activation by adaptor proteins. *Nat Rev Immunol* 2001;1:95–107.

336. Meller H, Parker PJ. The extended protein kinase C superfamily. *Biochem J* 1998;332:281–292.

337. Isakov N, Altman A. Protein kinase C (?) in T cell activation. *Annu Rev Immunol* 2002;20:761–794.

338. Cantrell DA. T cell antigen receptor signal transduction. *Immunology* 2002;105:369–374.

339. Jones RG, Parsons M, Bonnard M, et al. Protein kinase B regulates T lymphocyte survival nuclear factor kappa B activation and Bcl-X (L) levels in vivo. *J Exp Med* 2000;191:1721–1734.

340. Karetzky GA. The role of Grb2-associated proteins in T-cell activation. *Immunol Today* 1997;18:401–406.

341. Egan SE, Gidding BW, Brooks MW, et al. Association of SOS Ras exchange protein with Grb2 is

- implicated in tyrosine kinase signal transduction and transformation. *Nature* 1993;363:45–51.
342. Delon J, Kaibuchi K, Germain RN. Exclusion of CD43 from the immunological synapse is mediated by phosphorylation-regulated relocation of cytoskeletal adaptor moesin. *Immunity* 2001;15:691–701.
343. Cannon JL, Burkhardt JK. The regulation of actin remodeling during T-cell-APC conjugate formation. *Immunol Rev* 2002;186:90–99.
344. Henning S, Cleverly S. Small GTPases in lymphocyte biology: Rho proteins take center stage. *Immunol Res* 1999;20:29–42.
345. Abdul-Manan N, Aghazadeh B, Liu GA, et al. Structure of Cdc42 in complex with the GTPase-binding domain of the “Wiskott-Aldrich syndrome” protein. *Nature* 1999;399:379–383.
346. Higgs HN, Pollard TD. Activation by Cdc 42 and PIP(2) of Wiskott-Aldrich syndrome protein (WASp) stimulates actin nucleation by Arp2/3 complex. *J Cell Biol* 2000;150:1311–1320.
347. Prehoda KE, Scott JA, Dyche Mullins R, et al. Integration of multiple signals through cooperative regulation of N-WASP-Arp2/3 complex. *Science* 2000;290:801–806.
348. Thrasher AJ. WASp in immune system organization and function. *Nat Rev Immunol* 2002;2:635–646.
349. Zhang J, Shi F, Badour K, et al. WASp verpolin homology, cofilin homology, and acidic region domain-mediated actin polymerization is required for T cell development. *Proc Natl Acad Sci U S A* 2002;99:2240–2245.
350. Das V, Nal B, Roumier A, et al. Membrane-cytoskeleton interactions during the formation of the immunological synapse and subsequent T-cell activation. *Immunol Rev* 2002;189:123–135.
351. Delon J, Stoll S, Germain RN. Imaging of T-cell interactions with antigen presenting cells in culture and in intact lymphoid tissue. *Immunol Rev* 2000;189:51–63.
352. Cullinan P, Sperling AI, Burkhardt JK. The distal pole complex: a novel membrane domain distal to the immunological synapse. *Immunol Rev* 2002;189:111–122.
353. Lenschow DJ, Walunas TL, Bluestone JA. CD28/B7 system of T cell costimulation. *Annu Rev Immunol* 1996;14:233–258.
- 353a. Larsen CP, Elwood ET, Alexander DZ, et al. Long-term acceptance of skin and cardiac allografts after blocking CD40 and CD28 pathways. *Nature* 1996;381:434–438.
- 353b. Chang TT, Jabs C, Sobel RA, et al. Studies in B7-deficient mice reveal a critical role for B7 Costimulation in both induction and effector phases of experimental autoimmune encephalomyelitis. *J Exp Medicine* 1999;190:733–740.
354. Beier KC, Hutloff A, Dittrich AM, et al. Induction, binding specificity and function of human ICOS. *Eur J Immunol* 2000;30:3707–3717.
355. Carreno BM, Collins M. The B7 family of ligands and its receptors: new pathways for costimulation and inhibition of immune response. *Annu Rev Immunol* 2002;20:29–53.
356. Gonzalo JA, Tian J, Delaney T, et al. ICOS is critical for T helper cell-mediated lung mucosal inflammatory responses. *Nat Immunol* 2001;2:597–604.
357. Özkaynak E, Gao W, Shemmeri N, et al. Importance of ICOS-B7RP-1 costimulation in acute and chronic allograft rejection. *Nat Immunol* 2001;2:591–596.
358. Mosmann TR, Cherwinski H, Bond MW, et al. Two types of murine helper T cell clones. I. Definition according to profiles of lymphokine activities and secreted proteins. *J Immunol* 1986;136:2348–2357.
359. Constant SL, Bottomly K. Induction of Th1 and Th2 CD4<sup>+</sup> T cell responses: the alternative responses. *Annu Rev Immunol* 1997;15:297–322.

360. Noble A. Molecular signals and genetic programming in peripheral T-cell differentiation. *Immunology* 2000;101:289-299.
361. Murphy KM, Reiner SL. The lineage decisions of helper T cells. *Nat Rev Immunol* 2002;2:933-944.
362. Noble A, Thomas MJ, Kemeny DM. Early Th1/Th2 cell polarization in the absence of IL-4 and IL-12: T cell receptor signaling regulates the response to cytokines in CD4 and CD8 T cells. *Eur J Immunol* 2001;31:2227-2235.
363. Rugilson IC, Sperling AI, Fields PE, et al. CD28 costimulation promotes the production of Th2 cytokines. *J Immunol* 1997;158:658-665.
364. Oki S, Otsuki N, Kohsaka T, et al. STAT-6 activation and Th2 cell proliferation driven by CD28 signals. *Eur J Immunol* 2000;30:1416-1424.
365. Howland KC, Ausubel LJ, London CA, et al. The roles of CD28 and CD40 ligand in T cell activation and tolerance. *J Immunol* 2000;164:4465-4470.
366. Löhning M, Richter A, Radbruch A. Cytokine memory of T helper thymocytes. *Adv Immunol* 2002;80:115-181.
367. Ho I, Glimcher LH. Transcription: tantalizing times for T cells. *Cell* 2002;109:S109-S120.
368. Li B, Yu H, Zheng W, et al. Role of guanosine triphosphate Rac2 in T helper 1 cell differentiation. *Science* 2000;288:2219-2222.
369. Szabo SJ, Kim ST, Costa GL, et al. A novel transcription factor, T-bet, directs Th1 lineage commitment. *Cell* 2000;100:655-669.
370. Afkarian M, Sedy J, Yang J, et al. T-bet is a STAT-1-induced regulator of IL-12R expression in naïve CD4+ T cells. *Nat Immunol* 2002;3:549-557.
371. Mullen AC, High FA, Hutchins AS, et al. Role of T-bet in commitment of TH1 cells before IL-12 dependent selection. *Science* 2001;292:1907-1910.
372. Szabo SJ, Sullivan BM, Stemmann C, et al. Distinct effects of T-bet in TH1 lineage commitment and IFN- $\gamma$  production in CD4 and CD8 T cells. *Science* 2002;295:338-342.
373. Ho IC, Hodge MR, Rooney JW, et al. The proto-oncogene c-maf is responsible for tissue-specific expression of interleukin-4. *Cell* 1996;85:973-983.
374. Kim JI, Ho IC, Grusby MJ, et al. The transcription factor c-Maf controls the production of interleukin-4 but not other Th2 cytokines. *Immunity* 1999;10:745-751.
375. Arni O, Rao A. T cell differentiation: a mechanistic view. *Curr Opin Immunol* 2000;12:654-659.
376. Chen Q, Ghilardi N, Wang H, et al. Development of Th1-type of immune responses requires the type I cytokine receptor TCCR. *Nature* 2000;407:916-920.
377. Wurster AL, Rogers VL, Satoskar AR, et al. Interleukin-21 is a T helper (Th) cell 2 cytokine that specifically inhibits differentiation of naïve Th cells into interferon  $\gamma$ -producing Th1 cells. *J Exp Med* 2002;196:969-977.
378. Diehl S, Rincon M. The two faces of IL-6 on Th1/Th2 differentiation. *Mol Immunol* 2002;39:531-536.
379. Nakanishi K, Yoshimoto T, Tsutsui H, et al. Interleukin-18 regulates both Th1 and Th2 responses. *Annu Rev Immunol* 2001;19:423-474.
380. Yoshimoto T, Mizutani H, Tsutsui H, et al. IL-18 induction of IgE: dependence on CD4+ T cells, IL-4 and STAT-6. *Nat Immunol* 2000;1:132-137.
381. Seddon B, Mason D. Peripheral antoantigen induces regulatory T cells that prevent autoimmunity. *J*



Exp Med 1999;189:877–882.

382. Erard F, Garcia-Sanz JA, Moriggl R, et al. Presence or absence of TGF- $\beta$  determines IL-4-induced generation of type 1 or type 2, CD8 T cell subsets. *J Immunol* 1999;162:209–214.
383. Chtanova T, Kemp RA, Sutherland APR, et al. Gene microarrays reveal extensive differential gene expression in both type 1 and type 2 cells. *J Immunol* 2001;167:3057–3063.
384. Rogge L, Bianchi E, Biffi M, et al. Transcript imaging of the development of human T helper cells using oligonucleotide arrays. *Nat Genet* 2000;25:96–101.
385. Sallusto F, Mackay CR, Lanzavecchia A. The role of chemokine receptors in primary, effector, and memory immune responses. *Annu Rev Immunol* 2000;18:593–620.
386. Altare F, Durandy A, Lammas D, et al. Impairment of mycobacterial immunity in human interleukin-12 receptor deficiency. *Science* 1998;280:1432–1435.
387. van Crevel R, Caryadi E, Preyers F, et al. Increased production of interleukin 4 by CD4<sup>+</sup> and CD8<sup>+</sup> T cells from patients with tuberculosis is related to the presence of pulmonary cavities. *J Infect Dis* 2000;181:1194–1197.
388. Wangoo A, Sparer T, Brown IN, et al. Contribution of Th1 and Th2 cells to protection and pathology in experimental models of granulomatous lung disease. *J Immunol* 2001;166:3432–3439.
389. Lolbach W, Laskay T. The host response to Leishmania infection. *Adv Immunol* 2000;74:275–317.
390. Romani L, Pucceti P, Bistoni F. Interleukin-12 in infectious diseases. *Clin Microbiol Rev* 1997;10:611–636.
391. Wills-Karp M. Immunologic basis of antigen-induced airway hyperresponsiveness. *Annu Rev Immunol* 1999;17:255–281.
392. Elias JA, Lee CG, Zheung T, et al. New insights into the pathogenesis of asthma. *J Clin Invest* 2003;111:291–297.
393. Zhu Z, Homer RJ, Wang Z, et al. Pulmonary expression of interleukin-13 causes inflammation, mucus hypersecretion, subepithelial fibrosis, physiologic abnormalities and eotaxin production. *J Clin Invest* 1999;103:779–788.
394. Neurath MF, Finotto S, Glimcher LH. The role of Th1/Th2 polarization in mucosal immunity. *Nat Med* 2002;8:567–573.
395. Trowsdale J. Genetic and functional relationships between MHC and NK receptor genes. *Immunity* 2001;15:363–374.
396. Sanderson CJ. The uptake and retention of chromium by cells. *Transplantation* 1976;21:526–529.
397. Matzinger P. The JAM test. A simple assay for DNA fragmentation and cell death. *J Immunol Methods* 1991;145:185–192.
398. Mescher MF. Molecular interactions in the activation of effector and precursor cytotoxic T lymphocytes. *Immunol Rev* 1995;146:179–210.
399. Bossi G, Griffiths GM. Degranulation plays an essential part in regulating cell surface expression of Fas ligand in T cells and natural killer cells. *Nat Med* 1999;5:90–96.
400. Blott EJ, Bossi G, Clark R, et al. Fas ligand is targeted to secretory lysosomes via proline-rich domain in its cytoplasmic tail. *J Cell Sci* 2001;114:2405–2416.
401. Peters PJ, Borst J, Oorschot V, et al. Cytotoxic T lymphocyte granules are secretory lysosomes, containing both perforin and granzymes. *J Exp Med* 1991;173:1099–1109.
402. Tschopp J, Nabholz M. Perforin-mediated target lysis by cytolytic T lymphocytes. *Annu Rev Immunol*

1990;8:279–302.

403. Peters PJ, Geuze HJ, Van der Donk HA, et al. A new model for lethal hit delivery by cytotoxic T lymphocytes. *Immunol Today* 1990;11:28–32.

404. Smith MJ, Kelly JM, Sutton VR, et al. Unlocking the secrets of cytotoxic granule proteins. *J Leuk Biol* 2001;70:18–29.

405. Nalefski EA, Falke JJ. The C2 domain calcium-binding motif: structure and functional diversity. *Protein Sci* 1996;5:2375–2390.

406. Vellner R, Zvelebil MJ, Hopkins J, et al. Perforin is activated by proteolytic cleavage during biosynthesis which reveals a phospholipid-binding C2 domain. *EMBO J* 1997;16:7287–7296.

407. Tschopp J, Schafer S, Masson D, et al. Phosphoryl choline acts as a calcium dependent receptor molecule for lymphocyte perforin. *Nature* 1989;337:272–274.

408. Young JD, Hengartner H, Podack ER, et al. Purification and characterization of a cytolytic pore-forming protein from granules of cloned lymphocytes with natural killer activity. *Cell* 1986;44:849–859.

409. Liu C-C, Walsh CM, Young J D-E. Perforin: structure and function. *Immunol Today* 1995;16:194–201.

410. Pena SV, Hanson DA, Carr BA, et al. Processing, subcellular localization and function of 519 (granulysin), a human late T cell activation molecule with homology to small, lytic, granule proteins. *J Immunol* 1997;158:2680–2688.

411. Krensky AM. Granulysin: a novel antimicrobial peptide of cytolytic T lymphocytes and natural killer cells. *Biochem Pharmacol* 2000;59:317–320.

412. Stenger S, Hanson DA, Teitelbaum R, et al. An antimicrobial activity of cytolytic T cells mediated by granulysin. *Science* 1998;282:121–125.

413. Smyth MJ, O'Connor MD, Trapani JA. Granzymes: a variety of serine protease specificities encoded by genetically distinct subfamilies. *J Leuk Biol* 1996;60:555–562.

414. Trapani JA. Dual mechanisms of apoptosis induction by cytolytic lymphocytes. *Int Rev Cytol* 1997;182:111–192.

415. Waugh SM, Harris JL, Fletterick B, et al. The structure of the pro-apoptotic protease granzyme B reveals the molecular determinants of its specificity. *Nat Struct Biol* 2000;7:762–765.

416. Andrin C, Pinkoski MJ, Burns K, et al. Interaction between a Ca<sup>2+</sup> binding protein calreticulin and perforin, a component of the cytotoxic T-cell granules. *Biochemistry* 1998;37:10386–10394.

417. Fraser SA, Karimi R, Michalak M, et al. Perforin lytic activity is controlled by calreticulin. *J Immunol* 2000;164:4150–4155.

418. Calvin JP, Spaeny-Dekking LH, Wang B, et al. Apoptosis induced by granzyme B-glycosaminoglycan complexes: implications for granule-mediated apoptosis in vivo. *J Immunol* 1999;162:5345–5350.

419. Stinchcombe JC, Bossi G, Booth S, et al. The immunological synapse of CTL contains a secretory domain and membrane bridges. *Immunity* 2001;15:751–761.

420. Bossi G, Trambas C, Booth S, et al. The secretory synapse: the secrets of a serial killer. *Immunol Rev* 2002;189:152–160.

421. Grimm E, Price Z, Bonavida B. Studies on the induction and expression of T cell-mediated immunity. VIII Effector-target junctions and target cell membrane disruption during cytolysis. *Cell Immunol* 1979;46:77–79.

422. Yanelli JR, Sullivan JA, Mandell GL, et al. Reorientation and fusion of cytotoxic T lymphocyte granules after interaction with target cells as determined by high resolution cinemicrography. *J Immunol*

1986;136:377–382.

423. Geiger B, Rosen D, Berke G. Spatial relationships of microtubule-organizing centers and the contact area of cytotoxic T lymphocyte and target cells. *J Cell Biol* 1982;95:137–143.

424. Kupfer A, Singer SJ. Cell biology of cytotoxic and helper T cell functions: immunofluorescence microscopic studies of single cells and cell couples. *Annu Rev Immunol* 1989;7:309–337.

425. Kupfer A, Dennert G. Reorientation of the microtubule-organizing center and the Golgi apparatus in cloned cytotoxic lymphocytes triggered by binding to lysable target cells. *J Immunol* 1984;133:2762–2766.

426. Kupfer A, Dennert G, Singer SJ. The reorientation of the Golgi apparatus and the microtubule-organizing center in the cytotoxic effector cell is a prerequisite in the lysis of bound target cells. *J Mol Cell Immunol* 1985;2:37–49.

427. Menasche G, Pastural E, Feldmann J, et al. Mutations in RAB27A cause Griscelli syndrome associated with haemophagocytic syndrome. *Nat Genet* 2000;25:173–176.

428. Orange JS, Ramesh N, Remold-O'Donnell E, et al. Wiskott-Aldrich syndrome protein is required for NK cell cytotoxicity and colocalizes with actin to NK cell-activating immunologic synapse. *Proc Natl Acad Sci U S A* 2002;99:11351–11356.

429. Kagi D, Ledermann B, Bürke K, et al. Molecular mechanisms of lymphocyte-mediated cytotoxicity and their role in immunological protection and pathogenesis in vivo. *Annu Rev Immunol* 1996;14:207–232.

430. Haddad EK, Uri X, Hammer JA III, et al. Defective granule exocytosis in Rab27a-deficient lymphocytes from Ashen mice. *J Cell Biol* 2001;152:835–842.

431. Gray LS, Grarra JR, Sullivan JA, et al. Spatial and temporal characteristics of the increase in intracellular Ca<sup>2+</sup> induced in cytotoxic T lymphocytes by cellular antigen. *J Immunol* 1988;141:2424–2430.

432. Berthou C, Bourge JF, Zhang Y, et al. Interferon- $\gamma$ -induced membrane PAF-receptor expression confers tumor cell susceptibility to NK perforin-dependent lysis. *Blood* 2000;95:2329–2336.

433. Dourmaskin RR, Deteix P, Simone CB, et al. Electron microscopic demonstration of lesions of target cell membranes associated with antibody-dependent cellular cytotoxicity. *Clin Exp Immunol* 1980;42:554–560.

434. Duke RC, Persecchini PM, Chang S, et al. Purified perforin induces target cell lysis but not DNA fragmentation. *J Exp Med* 1989;170:1451–1456.

435. Shi L, Kam CM, Powers JC, et al. Purification of three cytotoxic lymphocyte granule serine proteases that induce apoptosis through distinct substrate and target cell interactions. *J Exp Med* 1992;176:1521–1529.

436. Bhakdi S, Tranum-Jensen J. Alpha-toxin of staphylococcus aureus. *Microbiol Rev* 1991;55:733–751.

437. Ebnet KM, Hausmann M, Lehmann-Grube F, et al. Granzyme A-deficient mice retain potent cell-mediated cytotoxicity. *EMBO J* 1995;14:4230–4239.

438. Browne KA, Blink E, Sutton VR, et al. Cytosolic delivery of granzyme B by bacterial toxins: evidence that endosomal disruption, in addition to transmembrane pore formation, is an important function of perforin. *Mol Cell Biol* 1999;19:8604–8615.

439. Shi L, Mai S, Israels S, et al. Granzyme B (GraB) autonomously crosses the cell membrane and perforin initiates apoptosis and GraB nuclear localization. *J Exp Med* 1997;185:855–866.

440. Motyka B, Korbitt G, Pinkoski MJ, et al. Mannose-6-phosphate/insulin-like growth factor II receptor is a death receptor for granzyme B during cytotoxic T cell-induced apoptosis. *Cell* 2000;103:491–500.

441. Trapani JA, Sutton VR, Thia KYT, et al. A clathrin/dynamin- and mannose-6-phosphate receptor-independent pathway for granzyme B-induced cell death. *J Cell Biol* 2003;160:223–233.

442. Griffiths GM. Endocytosing the death sentence. *J Cell Biol* 2003;160:155–156.
443. Pinkoski MJ, Hobman M, Heibein JA, et al. Entry and trafficking of granzyme B in target cells during granzyme B–perforin–mediated apoptosis. *Blood* 1998;92:1044–1054.
444. Trapani JA, Jans P, Smyth MJ, et al. Perforin–dependent nuclear entry of granzyme B precedes apoptosis, and is not a consequence of nuclear membrane dysfunction. *Cell Death Differ* 1998;5:488–496.
445. Smyth JA, McGuire MJ, Thia KYT. Expression of recombinant human granzyme B. *J Immunol* 1995;154:6299–6305.
446. Griffiths GM. Protein sorting and secretion during CTL killing. *Semin Immunol* 1997;9:109–115.
447. Darmon AJ, Nicholson DW, Bleakley RC. Activation of apoptotic protease CPP32 by cytotoxic T–cell–derived granzyme B. *Nature* 1995;377:446–448.
448. Andrade F, Roy S, Thornberry N, et al. Granzyme B directly and efficiently cleaves several downstream caspase substrates: implications for CTL–induced apoptosis. *Immunity* 1998;8:451–460.
449. Barry M, Bleakley RC. Cytotoxic T lymphocytes: all roads lead to death. *Nat Rev Immunol* 2002;2:401–409.
450. Heibein JA, Barry M, Motyka B, et al. Granzyme B induced loss of mitochondrial inner membrane potential ( $\Delta\psi_m$ ) and cytochrome c release are caspase independent. *J Immunol* 1999;163:4683–4693.
451. MacDonald G, Shi L, van de Velde C, et al. Mitochondria–dependent and –independent regulation of granzyme B induced apoptosis. *J Exp Med* 1999;189:131–144.
452. Susin SA, Zamzami N, Castedo M, et al. Bcl–2 prevents the release from mitochondria of an apoptogenic protease. *J Exp Med* 1996;184:1331–1334.
453. Sutton VR, Davis JE, Cancilla M, et al. Initiation of apoptosis by granzyme B requires direct cleavage of Bid, but not direct granzyme B–mediated caspase activation. *J Exp Med* 2000;192:1403–1413.
454. Alimonte JB, Shi L, Bajjal PK, et al. Granzyme B induces BID–mediated cytochrome c release and mitochondrial permeability transition. *J Biol Chem* 2001;276:6974–6982.
455. Jans DA, Sutton VR, Jans P, et al. BCL–2 blocks perforin–induced nuclear translocation of granzymes concomitant with protection against the nuclear events of apoptosis. *J Biol Chem* 1999;274:3953–3961.
456. Zhang D, Pasternack MS, Beresford PJ, et al. Induction of rapid histone degradation by the cytotoxic T lymphocyte protease granzyme A. *J Biol Chem* 2001;276:3683–3690.
457. Fan Z, Beresford PJ, Zhang D, et al. HMG2 interacts with the nucleosome assembly protein SET and is a target for the cytotoxic T–lymphocyte protease granzyme A. *Mol Cell Biol* 2002;22:2810–2820.
458. Zhang D, Beresford PJ, Greenberg AH, et al. Granzymes A and B directly cleave lamins and disrupt the nuclear lamina during granule–mediated cytolysis. *Proc Natl Acad Sci U S A* 2001;98:5746–5751.
459. Spaeny EHA, Kamp AM, Froelich CJ, et al. Extracellular granzyme A, complexed to proteoglycans, is protected against inactivation by protease inhibitors. *Blood* 2000;95:1465–1472.
460. Jans DA, Briggs LJ, Jans P, et al. Nuclear targeting of the serine protease granzyme A (fragmentin–1). *J Cell Sci* 1998;111:2645–2654.
461. Russell JH, Ley TJ. Lymphocyte–mediated cytotoxicity. *Annu Rev Immunol* 2002;20:323–370.
462. Juo P, Kuo CJ, Yuan J, et al. Essential requirement for caspase–8/FLICE in the initiation of the Fas–induced apoptotic cascade. *Curr Biol* 1998;8:1001–1008.
463. Kischkel FC, Hillbardt S, Behrman I, et al. Cytotoxicity–dependent APO–1 (Fas/CD95)–associated

proteins form a death-inducing signaling complex (DISC) with the receptor. *EMBO J* 1995;14:5579–5588.

464. Waterhouse NJ, Trapani JA. CTL: Caspases Terminate Life, but that's not the whole story. *Tissue Antigens* 2002;59:175–183.

465. Fesik SW. Insights into programmed cell death through structural biology. *Cell* 2000;103:273–282.

466. Wang R, Rogers AM, Ratliff TL, et al. CD95-dependent bystander lysis caused by CD4<sup>+</sup> T helper 1 effectors. *J Immunol* 1996;157:2961–2968.

467. Ju ST, Cui H, Panka DJ, et al. Participation of target Fas protein in apoptosis pathway induced by CD4<sup>+</sup> Th1 and CD8<sup>+</sup> cytotoxic T cells. *Proc Natl Acad Sci U S A* 1994;91:4185–4189.

468. Zinkernagel RM, Althage A. Antiviral protection by virus-immune cytotoxic T cells: infected target cells are lysed before infectious virus progeny is assembled. *J Exp Med* 1997;145:644–651.

469. Parra B, Lin MD, Stohlman SA, et al. Contributions of Fas–Fas ligand interactions to the pathogenesis of mouse hepatitis virus in the central nervous system. *J Virol* 2000;74:2447–2450.

470. Harty JT, Tvinnereim AR, White DW. CD8<sup>+</sup> T cell effector mechanisms in resistance to infection. *Annu Rev Immunol* 2000;18:275–308.

471. Kügi D, Ledermann B, Bucki K, et al. Cytotoxicity mediated by T cells and antiviral killer cells is greatly impaired in perforin deficient mice. *Nature* 1994;369:31–37.

472. Matlobian M, Suresh M, Glass A, et al. A role for perforin in downregulating T-cell responses during chronic viral infection. *J Virol* 1999;73:2527–2536.

473. Stepp SE, Dufourcq-Lagelouse R, Le Deist F, et al. Perforin gene defects in familial hemophagocytic lymphohistiocytosis. *Science* 1999;286:1957–1959.

474. Müllbacher A, Waring P, Hla RT, et al. Granzymes are the essential downstream effector molecules for the control of primary virus infections by cytolytic leukocytes. *Proc Natl Acad Sci U S A* 1999;96:13940–13955.

475. Davis JE, Smyth MJ, Trapani JA. Granzyme A and B-deficient killer lymphocytes are defective in eliciting DNA fragmentation but retain potent in vivo antitumor capacity. *Eur J Immunol* 2001;31:39–47.

476. Podack ER. How to induce involuntary suicide: the need for dipeptidyl peptidase I. *Proc Natl Acad Sci U S A* 1999;99:8312–8314.

477. Pham CTN, Ley TJ. Dipeptidyl peptidase I is required for the processing and activation of granzymes A and B in vivo. *Proc Natl Acad Sci U S A* 1999;96:8627–8632.

478. Toomes C, Janies J, Wood AJ, et al. Loss-of-function mutation in the cathepsin c gene result in periodontal disease and palmoplantar keratosis. *Nat Genet* 1999;23:421–424.

479. Graubert TA, Di Persio JF, Russel JH, et al. Perforin granzyme-dependent and -independent mechanisms are both important for the development of graft-versus-host disease after murine bone marrow transplantation. *J Clin Invest* 1997;100:904–911.

480. Baker MB, Riley RL, Podack ER, et al. Graft-versus-host disease associated lymphoid hypoplasia and B cell dysfunction is dependent upon donor T cell-mediate Fas–ligand function, but not perforin function. *Proc Natl Acad Sci U S A* 1997;94:1366–1371.

481. Braun MY, Lewin B, French L, et al. Cytotoxic T cell deficient in both functional Fas ligand and perforin show residual cytolytic activity yet lose their capacity to induce lethal acute graft-versus-host disease. *J Exp Med* 1996;183:657–661.

482. Sun J, Bird CH, Sutton V, et al. A cytosolic granzyme B inhibitor related to the viral apoptotic regulator cytokine response modifier A is present in cytotoxic lymphocytes. *J Biol Chem* 1996;271:27802–27809.

483. Bird CH, Sutton VR, Sun J, et al. Selective regulation of apoptosis: the cytotoxic lymphocyte serpin proteinase inhibitor 9 protects against granzyme B-mediated apoptosis without perturbing the Fas cell death pathway. *Mol Cell Biol* 1998;18:6387-6398.
484. Trapani JA, Smyth MJ. Functional significance of the perforin/granzyme cell death pathway. *Nat Rev Immunol* 2002;2:735-747.
485. Froelich CJ, Dixit VM, Yang X. Lymphocyte granule-mediated apoptosis: matters of viral mimicry and deadly proteases. *Immunol Today* 1998;19:30-36.
486. Kawasaki Y, Saito T, Shiota-Someya Y, et al. Cell death-associated translocation of plasma membrane components induced by CTL. *J Immunol* 2000;164:4641-4648.
487. Shestra S, Russel JH, Ley TJ. Mechanism responsible for granzyme B-independent cytotoxicity. *Blood* 1997;89:4085-4091.
488. Henkart PA, Williams MS, Zacharchuk CM, et al. Do CTL kill target cells by inducing apoptosis? *Semin Immunol* 1997;9:135-144.
489. Gershon RK, Kondo K. Infectious immunological tolerance. *Immunology* 1971;21:903-914.
490. Cantor H Shin FW, Boyse EA. Separation of helper T cells from suppressor cells expressing different Ly components. II Activation by antigen: after immunization, antigen specific suppressor and helper activities are mediated by distinct T-cell subclasses. *J Exp Med* 1976;143:1381-1390.
491. Dorf ME, Benacerraf B. Suppressor cells and immunoregulation. *Annu Rev Immunol* 1984;2:127-157.
492. Möller G. Do suppressor T cells exist? *Scand J Immunol* 1988;27:247-250.
493. Shevach EM. Regulatory T cells in autoimmunity. *Annu Rev Immunol* 2000;18:423-449.
494. Shevach EM. CD4+CD25+ suppressor cells: more questions than answers. *Nat Rev Immunol* 2002;2:389-400.
495. Bach JF, Chatenoud L. Tolerance to islet autoantigens and type I diabetes. *Annu Rev Immunol* 2001;19:131-161.
496. Chatenoud L, Solomon B, Bluestone JA. Suppressor T cells—they're back and critical for regulation of autoimmunity. *Immunol Rev* 2001;182:149-163.
497. Singh B, Read S, Asseman C, et al. Control of intestinal inflammation by regulatory T cells. *Immunol Rev* 2001;182:190-200.
498. Roncarolo MG, Bacchetta R, Bordignon C, et al. Type 1 T regulatory cells. *Immunol Rev* 2001;182:68-79.
499. Bacchetta R, Bigler M, Touraine JL, et al. High levels of interleukin-10 production in vivo are associated with tolerance in SCID patients transplanted with HLA mismatched hematopoietic stem cells. *J Exp Med* 1994;179:493-502.
500. Van Buskirk AM, Burlingham WJ, Jankowska-Gan E, et al. Human allograft acceptance is associated with immune regulation. *J Clin Invest* 2000;106:145-155.
501. Faria AM, Weiner HL. Oral tolerance: mechanisms and therapeutic applications. *Adv Immunol* 1999;73:153-264.
502. Weiner HL. Induction and mechanism of action of transforming growth factor- $\beta$ -secreting Th3 regulatory cells. *Immunol Rev* 2001;187:207-214.
503. Fukaura H, Kent SC, Pietrusewicz MJ, et al. Induction of circulating myelin basic protein and proteolipid protein-specific transforming growth factor- $\beta$ <sub>1</sub>-secreting Th3 T-cells by oral administration of

myelin in multiple sclerosis patients. *J Clin Invest* 1996;98:70–77.

504. Doetze A, Satoguina J, Burchard G, et al. Antigen-specific cellular hyporesponsiveness in a chronic human helminth infection is mediated by Th3/Tr1 type cytokines IL-10 and transforming growth factor- $\beta$  but not by Th1 to Th2 shift. *Int Immunol* 2000;12:623–630.

505. Andersson PO, Stockelberg D, Jacobson S, et al. A transforming growth factor  $\beta_1$ -mediated bystander immune suppression could be associated with remission of chronic idiopathic thrombocytopenic purpura. *Ann Hematol* 2000;79:507–513.

506. Kumar V, Sercarz E. An integrative model of regulation centered on recognition of TCR peptide/MHC complexes. *Immunol Rev* 2001;182:113–121.

507. Shevach EM, McHugh RS, Piccirillo CA, et al. Control of T-cell activation by CD4<sup>+</sup> CD25<sup>+</sup> suppressor T cells. *Immunol Rev* 2001;182:58–67.

508. Madakamtil LT, Maricic I, Sercarz E, et al. Regulatory T cells control autoimmunity in vivo by inducing apoptotic depletion of activated pathogenic lymphocytes. *J Immunol* 2003;170:2985–2992.

509. Cortesini R, Le Maout J, Ciubaturiu R, et al. CD8<sup>+</sup>CD28<sup>-</sup> T suppressor cells and the induction of antigen-specific antigen-presenting cell mediated suppression of Th reactivity. *Immunol Rev* 2001;182:201–206.

510. Li J, Liu Z, Jiang S, et al. T suppressor lymphocytes inhibit NF- $\kappa$ B-mediated transcription of CD86 gene in APC. *J Immunol* 1999;163:6386–6392.

511. Annacker O, Pimenta-Araujo R, Burlen-Defranoux O, et al. On the ontogeny and physiology of regulatory T cells. *Immunol Rev* 2001;182:5–17.

512. Salgame P, Convit J, Bloom BR. Immunological suppression by human CD8<sup>+</sup> T cells is receptor dependent and HLA-DQ restricted. *Proc Natl Acad Sci U S A* 1991;88:2598–2602.

513. Steinman L. Multiple sclerosis: a coordinated immunological attack against myelin in the central nervous system. *Cell* 1996;85:299–302.

514. Campbell DJ, Kim CH, Bretcher EC. Separable effector T cell populations specialized for B cell help or tissue inflammation. *Nat Immunol* 2001;2:876–881.

515. Vikmanovic-Stejic M, Thomas MJ, Noble A, et al. Specificity restriction and effector mechanisms of immunoregulatory CD8<sup>+</sup> T cells. *Immunology* 2001;102:115–122.

516. Maloy KJ, Powrie F. Regulatory T cells in the control of immune pathology. *Nat Immunol* 2001;2:816–822.

517. McVay LD, Cardig SR, Bottomly K, et al. Regulated expression and structure of T cell receptor gamma delta transcript in human thymic ontogeny. *EMBO J* 1991;10:83–88.

518. Parker CM, Groh V, Band H, et al. Evidence for extrathymic changes in the T cell receptor  $\gamma/\delta$  repertoire. *J Exp Med* 1990;171:1597–1612.

519. Bottino C, Tambussi G, Ferrini S, et al. Two subsets of human T lymphocytes expressing  $\gamma/\delta$  antigen receptor are identifiable by monoclonal antibodies directed to two distinct molecular forms of the receptor. *J Exp Med* 1988;168:491–505.

520. Falini B, Flenghi S, Pileri P, et al. Distribution of T cells bearing different forms of the T cells receptor  $\gamma/\delta$  in normal and pathological human tissues. *J Immunol* 1989;143:2480–2488.

521. Hayday AC.  $\gamma/\delta$  cells: a right time and a right place for a conserved third way protection. *Annu Rev Immunol* 2000;18:975–1026.

522. Allison TJ, Garboczi DN. Structure of  $\gamma/\delta$  T cell receptors and their recognition on non-peptide



antigens. *Mol Immunol* 2001;38:1051–1061.

523. Carding SR, Egan PJ.  $\gamma\delta$  T cells: functional plasticity and heterogeneity. *Nat Rev Immunol* 2002;2:336–345.

524. Born W, Cody C, Jones–Carson J, et al. Immunoregulatory functions of  $\gamma\delta$  T cells. *Adv Immunol* 1999;71:77–144.

525. Constant P, Davodeau F, Peyrat MA, et al. Stimulation of human gamma delta T cells by non-peptide mycobacterial ligands. *Science* 1994;264:267–270.

526. Tanaka Y, Morita CT, Tanaka Y, et al. Natural and synthetic non-peptide ligands for human  $\gamma\delta$  T cells. *Nature* 1995;375:155–158.

527. Buckowski JF, Monita CT, Brenner MB. Human  $\gamma\delta$  T cells recognize alkyl-amines derived from microbes, edible plants, tea: implications for innate immunity. *Immunity* 1999;11:57–65.

528. O'Brien RL, Fu Y, Cranfill R, et al. Heat-shock protein Hsp-60-reactive  $\gamma\delta$  cells: a large, diversified T-lymphocyte subset with highly focused specificity. *Proc Natl Acad Sci U S A* 1992;89:4348–4352.

529. Fleisch H. Biphosphonates. Pharmacology and use in the treatment of tumor-induced hypercalcemic and metastatic bone disease. *Drugs* 1991;42:919–944.

530. Morita CT, Li H, Lamphear JG, et al. Superantigen recognition by  $\gamma\delta$  T cells: SEA recognition site for human V $\gamma$ 2 T cell receptors. *Immunity* 2001;14:331–344.

531. Groh V, Steinle A, Bauer S, et al. Recognition of stress-induced MHC molecules by intestinal epithelial  $\gamma\delta$  T cells. *Science* 1998;279:1737–1740.

532. Bauer S, Groh V, Wu J, et al. Activation of NK cells and T cells by NKG2D, a receptor for stress-induced MICA. *Science* 1999;285:727–729.

533. Li P, Willie ST, Bauer S, et al. Crystal structure of the MHC class I homolog MIC-A, a  $\gamma\delta$  T cell ligand. *Immunity* 1999;10:557–584.

534. Beckman EM, Melian A, Behar SM, et al. CD1c restricted responses of mycobacteria-specific T cells. Evidence for antigen presentation by a second member of the human CD1 family. *J Immunol* 1996;157:2795–2803.

535. Spada FM, Grant EP, Peters PJ, et al. Self-recognition of CD1 by  $\gamma\delta$  T cells: implications for innate immunity. *J Exp Med* 2000;191:937–948.

536. Exley M, Garcia J, Balk SP, et al. Requirements for CD1d recognition by human invariant Va24 CD4<sup>+</sup>CD8<sup>−</sup> T cells. *J Exp Med* 1997;186:109–120.

537. Leslie DS, Vincent MS, Spada FM, et al. CD1-mediated  $\gamma\delta$  T cell maturation of dendritic cells. *J Exp Med* 2002;196:1575–1584.

538. De Rosa SC, Mitra DK, Watanabe N, et al. V $\gamma$ 1 and V $\gamma$ 2  $\gamma\delta$  T cells express distinct surface markers and might be developmentally distinct lineages. *J Leukoc Biol* 2001;70:518–526.

539. Cipriani B, Borsellino G, Poccia F, et al. Activation of C-C  $\beta$ -chemokines in human peripheral blood  $\gamma\delta$  T cells by isopentenyl pyrophosphate and regulation by cytokines. *Blood* 2000;95:39–47.

540. Dieli F, Troye-Blomberg M, Ivanyi J, et al. V $\gamma$ 9/V $\gamma$ 2 T lymphocytes reduce viability of intracellular *Mycobacterium tuberculosis*. *Eur J Immunol* 2000;30:1512–1519.

541. Dieli F, Troye-Blomberg M, Ivanyi J, et al. Granulysin-dependent killing of intracellular and extracellular *Mycobacterium tuberculosis* by V $\gamma$ 9/V $\gamma$ 2 T lymphocytes. *J Infect Dis* 2001;184:1082–1085.

542. Li B, Bassiri H, Rossman MD, et al. Involvement of Fas/Fas-ligand pathway of activation-induced cell death of mycobacteria-reactive human  $\gamma\delta$  T cells: a mechanism for the loss of  $\gamma\delta$  T cells in patients

with pulmonary tuberculosis. *J Immunol* 1998;161:1558–1567.

543. Carding SR, Egan PJ. The importance of  $\gamma\delta$  T cells in the resolution of pathogen-induced inflammatory immune responses. *Immunol Rev* 2000;173:98–108.

544. Ferrarini M, Ferrero E, Dagna L, et al. Human  $\gamma\delta$  T cells: a non-redundant system in the immune-surveillance against cancer. *Trends Immunol* 2002;23:14–18.

545. Glatzel A, Wesch D, Schiemann F, et al. Patterns of chemokine receptor expression on peripheral blood  $\gamma\delta$  T lymphocytes: strong expression of CCR5 is a selective feature of V $\alpha$ 2/V $\alpha$ 9  $\gamma\delta$  T cells. *J Immunol* 2002;168:4920–4929.

546. Wells H. Studies on the chemistry of anaphylaxis III. Experiments with isolated proteins, especially those of the hen's egg. *J Infections* 1911;9:147–151.

547. Hänninen A, Harrison LC.  $\gamma\delta$  T cells as mediators of mucosal tolerance: the autoimmune diabetes model. *Immunol Rev* 2000;173:109–119.

548. Holoshitz J. Activation of  $\gamma\delta$  T cells by mycobacterial antigens in rheumatoid arthritis. *Microbes Infect* 1999;1:197–202.

549. Peteman GM, Spencer G, Sperling AI, et al. Role of  $\gamma\delta$  T cells in murine collagen-induced arthritis. *J Immunol* 1993;151:6546–6558.

550. De Libero G. Sentinel function of broadly reactive human  $\gamma\delta$  T cells. *Immunol Today* 1997;18:22–26.

551. Herberman RB, Ortaldo JR. Natural killer cells: their roles in defenses against disease. *Science* 1981;214:24–30.

552. Trinchieri G. Biology of natural killer cells. *Adv Immunol* 1989;47:187–376.

553. Robertson MJ, Ritz J. Biology and clinical relevance of human natural killer cells. *Blood* 1990;76:2421–2438.

554. Gentile TC, Uner AH, Hutchison RE, et al. CD3<sup>+</sup>, CD56<sup>+</sup> aggressive variant of large granular lymphocyte leukemia. *Blood* 1994;84:2315–2321.

555. Timonen T, Saksela E, Ranki A, et al. Fractionation, morphological, and functional characterization of effector cells responsible for human natural killer activity against cell line targets. *Cell Immunol* 1979;48:133–148.

556. Grossi CE, Cadoni A, Zicca A, et al. Large granular lymphocytes in human peripheral blood: ultrastructural and cytochemical characterization of the granules. *Blood* 1982;59:277–283.

557. Caulfield JP, Hein A, Schmidt RE, et al. Ultrastructural evidence that the granules of human natural killer cell clones store membrane in a nonbilayer phase. *Am J Pathol* 1987;127:305–316.

558. Garni-Wagner BA, Witte PL, Tutt MM, et al. Natural killer cells in the thymus. Studies in mice with severe combined immune deficiency. *J Immunol* 1990;144:796–803.

559. Lanier LL, Spits H, Phillips JH. The developmental relationship between NK cells and T cells. *Immunol Today* 1992;13:392–395.

560. Spits H, Lanier LL, Phillips JH. Development of human T and natural killer cells. *Blood* 1995;85:2654–2670.

561. Phillips JH, Hori T, Nagler A, et al. Ontogeny of human natural killer (NK) cells: fetal NK cells mediate cytolytic function and express cytoplasmic CD3e,  $\gamma$  proteins. *J Exp Med* 1992;175:1055–1066.

562. Lanier LL, Chang C, Spits H, et al. Expression of cytoplasmic CD3e proteins in activated human adult natural killer (NK) cells and CD3 $\gamma$ ,  $\delta$ , e complexes in fetal NK cells. Implications for the relationship of NK and T lymphocytes. *J Immunol* 1992;187:1876–1880.

563. Wang B, Biron C, She J, et al. A block in both early T lymphocyte and natural killer cell development in transgenic mice with high-copy numbers of the human CD3 gene. *Proc Natl Acad Sci U S A* 1994;91:9402–9406.
564. Sánchez MJ, Spits H, Lanier LL, et al. Human natural killer cell committed thymocytes and their relation to the T cell lineage. *J Exp Med* 1993;178:1857–1866.
565. Sánchez MJ, Muench MO, Roncarolo MG, et al. Identification of a common T/natural killer cell progenitor in human fetal thymus. *J Exp Med* 1994;180:569–576.
566. Rodewald HR, Moingeon P, Lucich JL, et al. A population of early fetal thymocytes expressing Fc $\gamma$ RII/III contains precursors of T lymphocytes and natural killer cells. *Cell* 1992;69:139–150.
567. Carlyle JR, Zuniga-Pflucker JC. Lineage commitment and differentiation in the fetal mouse. *Immunol Rev* 1998;165:63–74.
568. Miller JS, Alley KA, McGlave P. Differentiation of natural killer (NK) cells from human primitive marrow progenitors in a stroma-based long-term culture system: identification of a CD34<sup>+</sup>7<sup>+</sup> NK progenitor. *Blood* 1994;83:2594–2601.
569. Lotzová E, Savary CA, Champlin RE. Genesis of human oncolytic natural killer cells from primitive CD34<sup>+</sup>CD33<sup>-</sup> bone marrow progenitors. *J Immunol* 1993;150:5263–5269.
570. Silva MR, Hoffman R, Srour EF, et al. Generation of human natural killer cells from immature progenitors does not require marrow stromal cells. *Blood* 1994;84:841–846.
571. Shibuya A, Nagayoshi K, Nakamura K, et al. Lymphokine requirement for the generation of natural killer cells from CD34<sup>+</sup> hematopoietic progenitor cells. *Blood* 1995;85:3538–3546.
572. Naune B, Espevik T. Immunoregulatory effects of cytokines on natural killer cells. *Scand J Immunol* 1994;40:128–134.
573. Galy A, Travis M, Cen D, et al. Human T, B, natural killer, and dendritic cells arise from a common bone marrow progenitor subset. *Immunity* 1995;3:459–473.
574. Jaleco AC, Blom B, Res P, et al. Fetal liver contains committed NK progenitors of CD34<sup>+</sup> cells into T cells. *J Immunol* 1997;159:694–702.
575. Spits H, Blom B, Jaleco AC, et al. Early stages in the development of human T, natural killer and thymic dendritic cells. *Immunol Rev* 1998;165:75–86.
576. Bennett IM, Zatssepina O, Zanai L, et al. Definition of a natural killer NKRP-1A/CD56<sup>-</sup>/CD16<sup>-</sup> functionally immature human NK cell subset that differentiates in vitro in the presence of interleukin 12. *J Exp Med* 1996;184:1845–1856.
577. Zamai L, Ahmad M, Bennett IM, et al. Natural killer (NK) cell-mediated cytotoxicity: differential use of TRAIL and Fas ligand by immature and mature primary human NK cells. *J Exp Med* 1998;188:2375–2380.
578. Loza MJ, Perussia B. Final steps in natural killer cell maturation: a model for type 1–type 2 differentiation? *Nat Immunol* 2001;2:917–924.
579. Voss SD, Hong R, Sondel PM. Severe combined immunodeficiency, interleukin 2 (IL-2) and IL-2 receptor: experiments of nature continue to point the way. *Blood* 1994;83:626–635.
580. Di Santo JP, Colucci F, Guy-Grand D. Natural killer and T cells of innate and adaptive immunity: lymphoid compartments with different requirements for common  $\gamma$  chain-dependent cytokines. *Immunol Rev* 1998;165:29–38.
581. Park SY, Saijo K, Takahashi T, et al. Developmental defects of lymphoid cells in Jak3 kinase-deficient mice. *Immunity* 1995;3:771–782.

582. Mrozek E, Anderson Pk, Caligiuri MA. Role of interleukin-15 in the development of human CD56<sup>+</sup> natural killer cells from CD34<sup>+</sup> hematopoietic progenitor cells. *Blood* 1996;87:2632-2640.
583. Prizanov IJ, Bennett M, Kumar V. IL-15 can substitute for the bone marrow microenvironment in the differentiation of natural killer cells. *J Immunol* 1996;157:4282-4285.
584. Wang J-H, Nichogiannopoulou A, Wu L, et al. Selective defects in the development of the fetal and adult lymphoid system in mice with an Ikaros null mutation. *Immunity* 1996;5:537-549.
585. Williams NS, Klem J, Puzanov IJ, et al. Natural killer cell differentiation: insights from knockout and transgenic mouse models and in vitro systems. *Immunol Rev* 1998;165:47-61.
586. Natarajan K, Dimasi N, Wang J, et al. Structure and function of natural killer cell receptors: multiple molecular solutions to self, nonself discrimination. *Annu Rev Immunol* 2002;20:853-885.
587. Long E. Regulation of immune responses through inhibitory receptors. *Annu Rev Immunol* 1999;17:875-904.
588. Lanier LL. NK cell receptors. *Annu Rev Immunol* 1998;16:359-393.
589. Sawicki MW, Dimasi N, Natarajan K, et al. Structural basis of MHC class I recognition by natural killer cell receptors. *Immunol Rev* 2001;181:52-65.
590. Drickamer K. Ca<sup>2+</sup>-dependent carbohydrate-recognition domains in animal proteins. *Curr Opin Struct Biol* 1993;3:393-400.
591. Weiss WI, Taylor ME, Drickamer K. The C-type lectin superfamily. *Immunol Rev* 1998;163:19-34.
592. André P, Biassoni R, Colonna M, et al. New nomenclature for MHC receptors. *Nat Immunol* 2001;2:661.
593. Billadeau DD, Leibson PJ. ITAMs versus ITIMs: striking a balance during cell regulation. *J Clin Invest* 2002;109:161-168.
594. Lanier LL. On guard-activating NK cell receptors. *Nat Immunol* 2001;2:23-27.
595. Boyington JC, Brooks AG, Sun PD. Structure of the killer cell immunoglobulin-like receptors and their recognition of the class I MHC molecules. *Immunol Rev* 2001;181:66-78.
596. Wagtmann N, Rajagopalan S, Winter CC, et al. Killer cell inhibitory receptors specific for HLA-C and HLA-B identified by direct binding and by functional transfer. *Immunity* 1995;3:801-809.
597. Fan QR, Garboczi DN, Winter CC, et al. Direct binding of a soluble natural killer cell inhibitory receptor to a soluble human leukocyte antigen-Cw4 class I major histocompatibility complex molecule. *Proc Natl Acad Sci U S A* 1996;93:7178-7183.
598. Mandelboim O, Reyburn HT, Sheu EG, et al. The binding site of NK receptors on HLA-C molecules. *Immunity* 1997;6:341-350.
599. Boyington JC, Motyka SA, Schuck P, et al. Crystal structure of an NK cell immunoglobulin-like receptor in complex with its class I MHC ligand. *Nature* 2000;405:537-552.
600. Fan QR, Long EO, Wiley DC. Crystal structure of the human natural killer cell inhibitory receptor KIR2DL1-HLA-Cw4 complex. *Nat Immunol* 2001;2:452-460.
601. Chapman TL, Heikeman AP, Bjorkman PJ. The inhibitory receptor LIR-1 uses a common binding interaction to recognize class I MHC molecules and the viral homolog ?L18. *Immunity* 1999;11:603-613.
602. Lopez-Bodet M, Perez-Villar JJ, Carretero M, et al. Structure and function of the CD94 C-type lectin receptor complex involved in recognition of HLA class I molecules. *Immunol Rev* 1997;155:165-174.

603. Boyington JC, Riaz AN, Patamewenu A, et al. Structure of CD94 reveals a novel C-type lectin fold: implications for the NK cell-associated CD94/NKG2 receptors. *Immunity* 1999;10:75–82.
604. Borrego F, Ulbrecht M, Weiss EH, et al. Recognition of human histocompatibility leukocyte antigen (HLA)-E complexed with HLA class I signal sequence-derived peptides by CD94/NKG2 confers protection from natural killer cell-mediated lysis. *J Exp Med* 1998;187:813–818.
605. Brand VM, Allan DS, O'Callaghan CA, et al. HLA-E binds to natural killer cell receptors C94/NKG2A, B, and C. *Nature* 1998;391:795–799.
606. Brand VM, Allan DSJ, Wilson D, et al. TAP- and tapasin-dependent HLA-E surface expression correlates with the binding of an MHC class I leader peptide. *Curr Biol* 1997;8:1–10.
607. Michaëlsson J, Teixeira de Matos C, Achour A, et al. A signal peptide derived from hsp60 binds HLA-E and interferes with CD94/NKG2a recognition. *J Exp Med* 2002;196:1403–1414.
608. Long EO, Rajagopalan S. Stress signals activate natural killer cells. *J Exp Med* 2002;196:1399–1402.
609. Wu J, Song Y, Bakker AB, et al. An activating immunoreceptor complex formed by NKG2D and DAP10. *Science* 1999;285:730–732.
610. Bauer S, Groh V, Wu J, et al. Activation of NK cells and T cells by NKG2D, a receptor for stress inducible MICA. *Science* 1999;285:727–729.
611. Groh V, Steinle A, Bauer S, et al. Recognition of stress-induced MHC molecules by intestinal epithelial gamma delta T cells. *Science* 1998;279:1737–1740.
612. Li P, Morris DL, Williox BE, et al. Complex structure of the activating immunoreceptor NKG2D and its MHC class I-like ligand MICA. *Nat Immunol* 2001;2:443–451.
613. Li P, Willie ST, Bauer S, et al. Crystal structure of the MHC class I homolog MIC-A, a gamma delta T cell ligand. *Immunity* 1999;10:577–584.
614. Radaev S, Rostro B, Brooks AG, et al. Conformational plasticity revealed by the cocrystal structure of NKG2D and its class I MHC-like ligand ULBP3. *Immunity* 2001;15:1039–1049.
615. Cosman D, Mullberg J, Sutherland CL. ULPs, novel MHC class I-related molecules bind to CMV glycoprotein UL16 and stimulate NK cytotoxicity through the NKG2D receptor. *Immunity* 2001;14:123–133.
616. Sutherland CL, Chalupny NJ, Cosman D. The UL16-binding proteins, a novel family of MHC class I-related ligands for NKG2D, activate natural killer cell functions. *Immunol Rev* 2001;181:185–192.
617. Kärre K, Ljunggren HG, Piontek G, et al. Selective rejection of H-2-deficient lymphoma variants suggests alternative immune defense strategy. *Nature* 1986;319:675–678.
618. Ljunggren HG, Karre K. In search of the missing self. MHC molecules and NK cell recognition. *Immunol Today* 1990;11:237–244.
619. NK Cells. MHC class I antigens and missing self. *Immunol Rev* 1997;115.
620. Karre K. How to recognize a foreign submarine. *Immunol Rev* 1997;155:5–9.
621. Borrego F, Kabat J, Kim DK, et al. Structure and function of major histocompatibility complex (MHC) class I specific receptors expressed on human natural killer (NK) cells. *Mol Immunol* 2002;38:637–660.
622. Moretta L, Biassoni R, Bottino C, et al. Human NK cells and their receptors. *Microbes Infect* 2002;4:1539–1544.
623. Campbell KS, Colonna M. DAP12: a key accessory protein for relaying signals by natural killer cell receptors. *Int J Biochem Cell Biol* 1999;31:631–636.
624. Smyth MJ, Godfrey DI, Trapani JA. A fresh look at tumor immunosurveillance and immunotherapy.

Nat Immunol 2001;2:293–299.

625. Yen JH, Moore BE, Nakajima T, et al. MHC class I-recognizing receptors are disease risk genes in rheumatoid arthritis. *J Exp Med* 2001;193:1–10.
626. Farag SS, Fehninger TA, Ruggeri L, et al. Natural killer cell receptors: new biology and insights into the graft-versus-leukemia effect. *Blood* 2002;100:1935–1947.
627. Murphy WJ, Koh CY, Raziudolin A, et al. Immunobiology of natural killer cells and bone marrow transplantation: merging of basic and preclinical studies. *Immunol Rev* 2001;181:279–289.
628. Ruggeri L, Capanni M, Casucci M. Role of natural killer cell alloreactivity in HLA-mismatched hematopoietic stem cell transplantation. *Blood* 1999;94:333–339.
629. Ruggeri L, Capanni M, Urbani E. Effectiveness of donor natural killer cell alloreactivity in mismatched hematopoietic transplants. *Science* 2002;295:2097–3100.
630. See DM, Khemka P, Sahl L, et al. The role of natural killer cells in viral infections. *Scand J Immunol* 1997;46:217–224.
631. Biron CA, Byron KS, Sullivan JL. Severe herpes virus infections in an adolescent without natural killer cells. *N Engl J Med* 1989;320:1731–1735.
632. Gazzinelli RT, Hieny S, Wynn TA, et al. Interleukin 12 is required for the T-lymphocyte-independent induction of interferon gamma by an intracellular parasite and induces resistance in T-cell-deficient hosts. *Proc Natl Acad Sci U S A* 1993;90:6115–6119.
633. Trinchieri G. Interleukin-12: a proinflammatory cytokine with immunoregulatory functions that bridge innate resistance and antigen-specific adaptive immunity. *Annu Rev Immunol* 1995;13:251–276.
634. Sullivan JL, Byron KS, Brewster FE, et al. Deficient natural killer cell activity in X-linked lymphoproliferative syndrome. *Science* 1980;210:543–545.
635. Strayer DR, Carter WA, Mayberry SD, et al. Low natural cytotoxicity of peripheral blood mononuclear cells in individuals with high familial incidences of cancer. *Cancer Res* 1984;44:370–374.
636. Whiteside TL, Herberman RB. The role of natural killer cells in human disease. *Clin Immunol Immunopathol* 1989;53:1–23.
637. Yu YY, Kumar V, Bennett M. Murine natural killer cells and marrow graft rejection. *Annu Rev Immunol* 1992;10:189–213.
638. Cudkovicz G, Hochman PS. Do natural killer cells engage in regulated reactions against self to ensure homeostasis? *Immunol Rev* 1979;44:13–41.
639. Ault KA, Antin JH, Ginsburg D, et al. Phenotype of recovering lymphoid cell populations after marrow transplantation. *J Exp Med* 1985;161:1483–1502.
640. Reittie JE, Gottlieb D, Heslop HE, et al. Endogenously generated activated killer cells circulate after autologous and allogeneic marrow transplantation but not after chemotherapy. *Blood* 1989;73:1351–1358.
641. Jacobs R, Stoll M, Stratmann G, et al. CD16CD56<sup>+</sup> natural killer cells after bone marrow transplantation. *Blood* 1992;79:3239–3244.
642. Hansson M, Beran M, Andersson B, et al. Inhibition of in vitro granulopoiesis by autologous allogeneic human NK cells. *J Immunol* 1982;129:126–132.
643. Matera L, Santoli D, Garbarino G, et al. Modulation of in vitro myelopoiesis by LGL: different effects on early and late progenitor cells. *J Immunol* 1986;136:1260–1265.
644. Picker LJ, Furst A, Robingson SH, et al. Immunoarchitecture of the bone marrow in neutropenia: increased HNK-1<sup>+</sup> cells define a subset of neutropenic patients. *Am J Hematol* 1987;25:29–41.

645. Pandolfi F, Loughran TP Jr, Starkebaum G, et al. Clinical course and prognosis of the lymphoproliferative disease of granular lymphocytes. A multicenter study. *Cancer* 1990;65:341–348.
646. Loughran TP Jr, Kadin ME, Starkebaum G, et al. Leukemia of large granular lymphocytes: association with clonal chromosomal abnormalities and autoimmune neutropenia, thrombocytopenia, and haemolytic anemia. *Ann Intern Med* 1985;102:169–175.
647. McKenna RW, Arther DC, Gajl-Peczalska KJ, et al. Granulated T cell lymphocytosis with neutropenia: malignant or benign chronic lymphoproliferative disorder? *Blood* 1985;66:259–266.
648. Rambaldi A, Pelicci PG, Allavena P, et al. T cell receptor  $\beta$  chain gene rearrangements in lymphoproliferative disorders of large granular lymphocytes/natural killer cells. *J Exp Med* 1985;162:2156–2161.
649. Loughran TP Jr, Starkebaum G. Large granular lymphocyte leukemia. Report of 38 cases and review of the literature. *Medicine* 1987;66:397–405.
650. Chan WC, Link S, Mawle A, et al. Heterogeneity of large granule lymphocyte proliferations: delineation of two major subtypes. *Blood* 1986;68:1142–1153.
651. Scott CS, Richards SJ. Classification of large granular lymphocyte (LGL) and NK-associated (NKa) disorders. *Blood Rev* 1992;6:220–233.
652. Loughran TP Jr. Clonal diseases of large granular lymphocytes. *Blood* 1993;82:1–14.
653. Sun T, Brody J, Koduru P, et al. Study of the major phenotype of large granular T-cell lymphoproliferative disorder. *Am J Clin Pathol* 1992;98:516–521.
654. Imamura N, Kusunoki Y, Kawa-Ha K, et al. Aggressive natural killer cell leukaemia/lymphoma: report of four cases and review of the literature. Possible existence of a new clinical entity originating from the third lineage of lymphoid cells. *Br J Haematol* 1990;75:49–59.
655. Gumperz JE, Parham P. The enigma of the natural killer cell. *Nature* 1995;378:245–248.
656. Brossay L, Chioda M, Burdin N, et al. CD1d-mediated recognition of an  $\alpha$ -galactosylceramide by natural killer T cells is highly conserved through mammalian evolution. *J Exp Med* 1998;188:1521–1528.
657. Taniguchi M, Harada M, Kojo S, et al. The regulatory role of Va14 NKT cells in innate and acquired immune response. *Annu Rev Immunol* 2003;21:483–513.
658. MacDonald HR. CD1d-glycolipid tetramers: a new toll to monitor natural killer T cells in health and disease. *J Exp Med* 2000;192:F15–F19.
659. Coles MC, Raulet DH. NK1.1<sup>+</sup> T cells in the liver arise in the thymus and are selected by interactions with class I molecules on CD4<sup>+</sup>CD8<sup>+</sup> cells. *J Immunol* 2000;164:2412–2418.
660. Kronenberg M, Gapin L. The unconventional lifestyle of NKT cells. *Nat Rev Immunol* 2002;2:557–568.
661. van der Vliet HJJ, Nishi N, de Gruijl TD, et al. Human natural killer T cells acquire a memory-activated phenotype before birth. *Blood* 2000;95:2440–2442.
662. Dark SH, Banlagha K, Lee D, et al. Unaltered phenotype, tissue distribution and function of Va14<sup>+</sup> NKT cells in germ-free mice. *Eur J Immunol* 2000;30:620–625.
663. Ikarashi Y, Mikami R, Bendelac A, et al. Dendritic-cell maturation overrules H-2D-mediated natural killer T (NKT)-cell inhibition. Critical role for B7 in CD1d-dependent NKT-cell interferon- $\gamma$  production. *J Exp Med* 2001;194:1179–1186.
664. Kawano T, Nakayama T, Kamada M, et al. Antitumor cytotoxicity mediated by ligand-activated human Va24 NKT cells. *Cancer Res* 1999;59:5102–5105.



665. Godfrey DI, Hammond KJ, Poulton LD, et al. NKT cells: facts, functions, and fallacies. *Immunol Today* 2000;221:573–583.
666. Gumperz JE, Miyake S, Yamamura T, et al. Functionally distinct subsets of CD1d-restricted NKT cells revealed by CD1d tetramer staining. *J Exp Med* 2002;195:625–636.
667. Lee PT, Banlagha K, Teyton L, et al. Distinct functional lineages of human Va24 natural killer T cells. *J Exp Med* 2002;195:637–641.
668. Burden N, Brossay L, Kronenberg M. Immunization with  $\alpha$ -galactosyl ceramide polarized CD1-reactive NKT cells towards Th2 cytokine synthesis. *Eur J Immunol* 1999;29:2014–2225.
669. Singh N, Hong S, Scherer DC, et al. Cutting edge: activation of NKT cells by CD1d and  $\alpha$ -galactosylceramide directs conventional T cells to the acquisition of a Th2 phenotype. *J Immunol* 1999;163:2373–2377.
670. Hong S, Wilson MT, Serizawa I, et al. The natural killer T cell ligand  $\alpha$ -galactosylceramide prevents autoimmune diabetes in non-obese diabetic mice. *Nat Med* 2001;7:1052–1056.
671. Singh AK, Wilson MT, Hong S, et al. Natural killer T cell activation protects mice against experimental autoimmune encephalomyelitis. *J Exp Med* 2001;194:1801–1811.
672. Mieza MA, Itoh T, Cui JQ, et al. Selective reduction of Va14<sup>+</sup> NKT cells associated with disease development in autoimmune-prone mice. *J Immunol* 1996;156:4035–4040.
673. Sumida T, Sakamoto A, Murata H, et al. Selective reduction of T cells bearing invariant Va24JaQ antigen receptor in patients with systemic sclerosis. *J Exp Med* 1995;182:1163–1168.
674. Kojo S, Adachi Y, Keeno H, et al. Dysfunction of T cell receptor AV24AJ18<sup>+</sup>, BV21<sup>+</sup> double negative regulatory natural killer T cells in autoimmune diseases. *Arthritis Rheum* 2001;44:1127–1138.
675. Wilson SB, Kent SC, Horton HF, et al. Multiple differences in gene expression in regulatory Va24JaQ T cells from identical twins discordant for type I diabetes. *Proc Natl Acad Sci U S A* 2002;97:7411–7416.
676. Smyth MJ, Crowe NV, Hayakawa Y, et al. NKT cells—conductors of tumor immunity? *Curr Opin Immunol* 2002;14:165–171.
677. Terabe M, Matsui S, Noben-Trauth N, et al. NKT cell-mediated repression of tumor immunosurveillance by IL-13 and the IL-4R-STAT6 pathway. *Nat Immunol* 2000;1:515–520.
678. Moodycliffe AM, Clydesdale C, Ullrich SE. Immune suppression and skin cancer development: regulation by NKT cells. *Nat Immunol* 2000;1:521–525.
679. Park S-H, Kyin T, Bendelac A, et al. The contribution of NKT cells, NK cells, and other  $\gamma$ -chain-dependent non-T, non-B cells to IL-12 mediated rejection of tumors. *J Immunol* 2003;170:1197–1201.
680. Smyth MJ, Godfrey DI. NKT cells and tumor immunity—a double-edged sword. *Nat Immunol* 2000;1:459–460.
681. Gansert JL, Kiessler V, Engele M, et al. Human NKT cells express granulysin and exhibit antimycobacterial activity. *J Immunol* 2003;170:3154–3161.
682. Gonzalez-Aseguinolaza G, de Oliveira C, Tomaska M.  $\alpha$ -galactosylceramide activated Va14 natural killer T cells mediate protection against murine malaria. *Proc Natl Acad Sci U S A* 2000;97:8461–8466.

2004 Lippincott Williams & Wilkins  
John P. Greer, John Foerster, John N. Lukens  
George M. Rodgers, Frixos Paraskevas, Bertil Glader  
Wintrobe's Clinical Hematology

MAJOR HISTOCOMPATIBILITY COMPLEXClass I RegionClass II RegionClass III RegionMAJOR HISTOCOMPATIBILITY COMPLEX MOLECULES: CLASSICALClass I MoleculesClass II MoleculesMAJOR HISTOCOMPATIBILITY COMPLEX MOLECULES: NONCLASSICALClass I: HLA-E, HLA-F, and HLA-GClass II: HLA-DM and HLA-DOMajor Histocompatibility Complex Class I Chain-Related Genes and ProteinsCD1 System: Genes and ProteinsUL-16 Binding Proteins: The Latest Member of the Major Histocompatibility Complex FamilyORIGINS OF MAJOR HISTOCOMPATIBILITY COMPLEXANTIGEN PROCESSING AND PRESENTATIONAntigen-Presenting CellsProcessing Antigens for Class I PresentationProcessing Antigen for Class II PresentationAntigen Presentation by CD1DENDRITIC CELLSMigration of Dendritic CellsDendritic Cell FunctionsDendritic Cells in Human DiseaseLangerhans CellsVeiled CellsInterdigitating Dendritic CellsFollicular Dendritic CellsGEOGRAPHY OF T-B CELL INTERACTIONSGERMINAL CENTER REACTIONB Cells in Germinal Centers: Struggle for SurvivalSurvival of the FittestLong Live the BAFFled Germinal Center B CellFollicular T Helper and Germinal Center B CellsCD40 and CD40 Ligand (CD154) InteractionsIMMUNOGLOBULIN CLASS SWITCHSOMATIC HYPERMUTATIONMechanism of HypermutationGENOMIC VIEW OF GERMINAL CENTER REACTIONPOSTGERMINAL CENTER DIFFERENTIATIONMemory B CellsPlasma CellsHYPER-IG M SYNDROME (HIGM): GENETIC DEFECTS OF CLASS-SWITCH RECOMBINATIONCYTOKINES IN B-CELL DIFFERENTIATIONJaks and Signal Transducers and Activators of TranscriptionInterleukin-2 and Interleukin-2 ReceptorX-Linked Severe Combined ImmunodeficiencyInterleukin-4 and Interleukin-4 ReceptorInterleukin-5 and Interleukin-5 ReceptorInterleukin-6 and Interleukin-6 ReceptorInterleukin-6 in T-B Cell Interaction and MyelomaInterleukin-10 and Interleukin-10 Receptor

## IMMUNOGLOBULIN STRUCTURE

[Primary Structure: One Polypeptide from Two Genes](#)

[Secondary Structure: Immunoglobulin Fold](#)

[Tertiary Structure: Immunoglobulin Domain](#)

[Quaternary Structure: Immunoglobulin Monomer](#)

[Carbohydrate Moiety](#)

[Enzymatic Fragments](#)

[Combining Site](#)

[Idiotypes and Allotypes](#)

## IMMUNOGLOBULIN FUNCTION

[Immunoglobulin G](#)

[Immunoglobulin A](#)

[Immunoglobulin M](#)

[Immunoglobulin D](#)

[Immunoglobulin E](#)

[J Chain](#)

## COMPLEMENT

[Classical Pathway](#)

[Alternative Pathway](#)

[Lectin Complement Pathway](#)

[Membrane Attack Complex](#)

## REGULATION OF COMPLEMENT ACTIVATION

[Control of the Initiation Step](#)

[Regulators on Cell Surfaces](#)

[Regulators in Body Fluids](#)

[Control of the Membrane Attack Complex Assembly](#)

[Control of Deposited MAC: CD59](#)

[Conclusion](#)

## ANAPHYLATOXINS

### COMPLEMENT COMPONENT DEFICIENCIES

[C1 Esterase Inhibitor: Hereditary Angioneurotic Edema](#)

[Deficiency of Other Early Complement Components](#)

[Paroxysmal Nocturnal Hemoglobinuria: Decay-Accelerating Factor \(CD55\) or Clustering \(CD59\) Deficiencies, or Both](#)

[Deficiencies of Terminal Complement Components](#)

## COMPLEMENT SYSTEM: FROM SEA URCHINS TO HOMO SAPIENS SAPIENS

### REFERENCES

## MAJOR HISTOCOMPATIBILITY COMPLEX

The function of the immune system is under genetic control (<sup>1</sup>). Immunogenetic studies and molecular genetic techniques have helped to elucidate the mechanisms by which genes regulate immune functions.

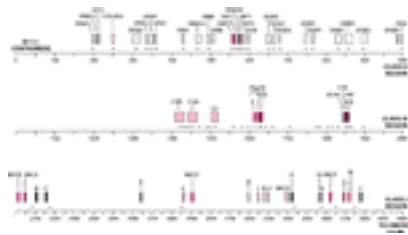
The genes that regulate immune functions are found in a chromosomal region known as the *major histocompatibility complex (MHC)*. This general term is applied to a group of loci that contain genes encoding the structure of molecules involved in transplantation reactions, thus the word *histocompatibility*. The designation *major* indicates that this locus is the most important of many defining histocompatibility.

The antigens that are defined by the MHC have been given specific names in different species, for example, human leukocyte antigens (HLA) in humans and histocompatibility-2 or H-2 in the mouse.

The HLA complex extends over approximately 4000 kilobases (kb) on the short arm of chromosome 6, precisely 6p21-3; the H-2 complex is located on chromosome 17 and occupies a segment that is halfway between the centromere and the telomere. Approximately 180 genes have been located within the HLA region, and the number increases constantly with the increase in the sensitivity and sophistication of techniques

of molecular biology.

The complex is divided into three regions: (a) The class I region occupies the most distal (telomeric) end of the short arm of the chromosome and spans approximately 1.8 megabases (Mb); (b) the class II region (approximately 1 Mb) occupies the most centromeric end of the chromosome; and (c) the class III region is between the other two regions ( [2](#) ) ( [Fig. 18.1](#) ).



**Figure 18.1.** The human major histocompatibility complex contains genes that are grouped in three regions. Closest to the centromere is the class II region, followed by the class III region, and finally the class I region. Within the class II region are proteasome genes and TAP-1 and TAP-2 genes. The class II genes are located from the centromere in the order DP, DQ, and DR. The class III region contains genes of the complement system heat shock protein 70, tumor necrosis factor- $\alpha$ , and tumor necrosis factor- $\beta$ . The class I region contains the genes for the  $\alpha$ -chain of the HLA-A, HLA-B, and HLA-C molecules and the genes that encode the newly discovered class Ib molecules, such as HLA-E, HLA-F, HLA-G, HLA-H. (Useful information was found in Campbell RD, Trowsdale J. Map of the human MHC. *Immunol Today* 1993;14:349–352; Beck S, et al. Complete sequence and gene map of a human major histocompatibility complex. The MHC sequencing consortium. *Nature* 1999;401:921–923; and Poster produced by the MHC sequencing consortium. The complete sequence of human major histocompatibility complex. *Nature* 1999;401. Text hyperlink: [Supplementary information.](#))

### Class I Region

Of the polymorphic class I genes, HLA-A, HLA-B, and HLA-C, HLA-B is the most centromeric, and HLA-A is the most telomeric, with HLA-C in between and closest to HLA-B. There are several nonclassical class I or Ib genes that include HLA-E, HLA-F, HLA-G, HLA-H, HLA-I, HLA-J, HLA-K, and HLA-L, as well as several pseudogenes and gene fragments ( [2](#) , [3](#) , [4](#) and [5](#) ). Pseudogenes give products that do not associate with  $\beta_2$  microglobulin ( $\beta_2m$ ), probably as a result of deleterious mutations, and the gene fragments are not expressed, because the genes are severely disrupted.

The human MHC class I region spans 1.8 Mb from the MICB gene to the HLA-F gene at the telomeric end of the HLA region. There are 118 genes (73 known and 45 new genes) with one gene for every 15.2 kb. The G+C content on the average is 45.8% ( [6](#) ). It contains three classical HLA class I genes, HLA-A, HLA-B, and HLA-C; three nonclassical class I genes, HLA-E, HLA-F, and HLA-G; and two of the nonclassical MHC class I chain-related (MIC) genes MICA and MICB. The class I region also contains 50 non-HLA genes.

Many diseases (e.g., Behçet syndrome, ankylosing spondylitis, ulcerative colitis, Takayasu arteritis, Hashimoto thyroiditis) are associated with a particular class I allele. The large-scale genomic sequencing has greatly facilitated the clarification of gene organization and the identification, as well as mapping, of the disease-susceptible genes (

7).

A total of 758 microsatellite repeats have been identified, consisting of two, three, four, or five nucleotides. They can be used as markers for mapping the exact location of the disease that is associated with the HLA genes.

Class I genes are composed of eight coding sequences or exons that are separated by noncoding sequences or introns (8). The eight exons correspond to the domains of the protein. The first exon encodes the hydrophobic N-terminal precursor or leader sequence; the second, third, and fourth exons encode the three extracellular domains. The fifth exon encodes the hydrophobic transmembrane segment and the basic residues that act as an anchor. The sixth and seventh exons are small, coding for the cytoplasmic domain of the molecule. The second and third exons are the most polymorphic, whereas the fourth exon is the most conserved (9).

### Class II Region

The human class II molecules were defined originally by mixed lymphocyte cultures, and because participation of the products of class I, HLA-A, HLA-B, and HLA-C was excluded, the region for the new genes was called *D*. Later, serologic reagents obtained from multiparous women defined specificities related to HLA-D (DR). The D region is located on the centromeric (left) side of the HLA-B. Three subregions are recognized, DP, DQ, and DR, in a telomeric direction. The class II region has a 40% G+C content and has only one gene for every 25 kb, much lower in density than the class I (15.2/kb) or class III (14.3/kb).

Recombinant DNA technology has helped to reveal the three basic subregions, each with its own  $\alpha$  and  $\beta$  genes. The  $\alpha$  gene is composed of five exons: (a) the signal sequence; (b) the  $\alpha_1$  domain, (c) the  $\alpha_2$  domain, (d) the transmembrane region and cytoplasmic tail, and (e) an untranslated 3' region. The  $\beta$  gene consists of six exons.

By comparison with murine class II genes, considerable gene expansion has apparently taken place in the evolution of human MHC—that is, many more  $\alpha$  and  $\beta$  genes are in the human class II region (10). The DR molecule is homologous to the murine E molecule, and the human DQ molecule is homologous to the murine A molecule.

The genes encoding the  $\alpha$ - and  $\beta$ -chains of a class II molecule are designated as A and B, respectively. The DR contains one A gene, three B genes, and pseudogenes (11). The  $\alpha$ -chain can associate with two different  $\beta$ -chains to give two different molecules. In the DQ and DP subregions, only one set of genes (A and B) is expressed, and the genes in the other set are pseudogenes. Not all class II molecules that are encoded by these genes are polymorphic. For example, the DR $\alpha$  chain is not polymorphic, and the DP $\alpha$  shows only limited polymorphism.

Within the class II region, several genes encode proteins that are related to antigen processing. Two of them, LMP-2 and LMP-7 (large multifunctional protease), are subunits of the proteasome that cleaves peptides from antigens that are present in the cytoplasm to be transported and loaded on class I molecules (12).

Close to these genes are also the TAP-1 and TAP-2 genes (transporters associated with antigen presentation), which encode the proteins that transport the peptides from cytosol across the endoplasmic reticulum (ER) membrane to be loaded on class I (13, 14). The DR subregion has several haplotypes. In general, this subregion has multiple DRB genes and

pseudogenes, which arise from duplication or recombination events, or both. The DR $\alpha$  gene is the most telomeric of all class II genes.

The DQ subregion has two pairs of DQ genes, but one of them is nonfunctional. The DP also has two pairs of genes, but only one is expressed, and the others are pseudogenes.

Within the class II region are the genes for the nonclassical molecules DMA and DMB which are distantly related to classical loci (approximately 30% amino acid identity) and must have duplicated from them at an early stage. There are no polymorphic variations in humans in the DM gene. The DN and DO genes, like DM, may play a role in peptide editing (15).

Other genes in the class II region are antigen-processing genes. They constitute a cluster of four genes. Two of them, TAP-1 and TAP-2, are adenosine triphosphate (ATP)-binding cassette (ABC) transporters (for structure and function, see the section [Antigen Processing and Presentation](#)). The proteasome genes, LMP-2 and LMP-7, are both members of the catalytic subunit of proteasome (see the section [Antigen Processing and Presentation](#)).

### **Class III Region**

The class III genes encode proteins that do not participate in antigen presentation, such as the genes of certain components of the classical and alternative complement pathways (C4, C2, and B), as well as the genes of tumor necrosis factor (TNF)- $\alpha$  and TNF- $\beta$ , HSP-70, and the 21-hydroxylase-producing gene. Telomeric to the class III region is a group of genes that encode the proteins that are involved in inflammation or infection. One cluster consists of genes that encode the TNF- $\alpha$ , TNF- $\beta$  (LTA), and LTB cytokines, and several other genes, such as B144, which is expressed only on monocytes and macrophages; the I $\beta$ -like gene, which is related to I $\beta$ , which is a regulator protein for nuclear factor- $\kappa$ B (NF- $\kappa$ B). It has been proposed that this region should be named the *class IV region*. (16).

The genes of class I and class II regions are present in multiple alleles or, in other words, alternate forms that are defined by distinct DNA sequences. The combination of all HLA-I and HLA-II alleles is known as the *haplotype*. Because the HLA genes are expressed codominantly, each individual therefore inherits two haplotypes. Each class I locus has several alleles, and, according to an adopted nomenclature, each allele is defined by its locus, an asterisk, and a four-digit number. The number that defines the allele relates to the serologically defined antigen that is detected on a molecule that is synthesized by the allele (first two digits) and allows discrimination between closely related alleles (last two digits). For example, the B27 locus has at least seven identifiable alleles, which are defined as HLA-B\*2701 through HLA-B\*2707.

The HLA antigens are serologically recognized epitopes on molecules that are synthesized by the alleles; for example, the B27 determinant is present on all seven different products of the seven B27 alleles.

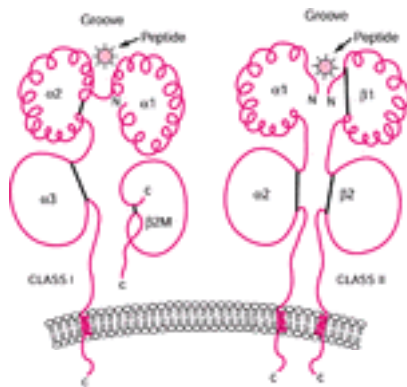
## **MAJOR HISTOCOMPATIBILITY COMPLEX MOLECULES: CLASSICAL**

### **Class I Molecules**

Class I molecules include those that are traditionally detected by serologic reagents that are encoded by the MHC genes HLA-A, HLA-B, and HLA-C. More recently, another group of molecules that are structurally homologous to the class I molecules (44 to 82%)

has been detected. These molecules are known as *class Ib* (<sup>17</sup>) to distinguish them from the classical class I molecules that are now sometimes called *class Ia*. Some of the class Ib molecules are encoded by MHC-linked genes, such as HLA-E, HLA-F, and HLA-G, whereas others, such as CD1, the low-affinity immunoglobulin (Ig) G Fc receptor of murine neonatal intestine, the zinc- $\alpha_2$  globulin, and certain CTMV genes, are encoded by non-MHC genes. In our discussion, the traditional molecules are identified as *class I*, and the new members are identified as *class Ib*.

The class I molecule is a heterodimer that consists of an H chain or an  $\alpha$ -chain (44 kd) and a noncovalently associated light (L) chain (12 kd) that is known as  $\beta_2 m$  (<sup>18</sup>) ( [Fig. 18.2](#)). The  $\beta_2 m$  gene is not linked to MHC and is located on chromosome 15.



**Figure 18.2.** Structure of class I and class II major histocompatibility complex molecules. The class I molecule is a heterodimer of a heavy chain or  $\alpha$ -chain and a noncovalently associated light chain,  $\beta_2$  microglobulin ( $\beta_2 m$ ). The  $\alpha$ -chain consists of three domains: the N-terminal  $\alpha_1$ , followed by  $\alpha_2$  and an immunoglobulin-like  $\alpha_3$  domain. The  $\alpha_1$  and  $\alpha_2$  domains are polymorphic and form a groove, which accepts a peptide from foreign antigens to be presented to T cells (see the chapter text). The membrane proximal domain is nonpolymorphic. The  $\beta_2 m$  protein is homologous to the  $C_{H3}$  immunoglobulin domain. It is located underneath the  $\alpha_1$  domain. The class II molecule is a heterodimer of two chains,  $\alpha$  and  $\beta$ . Each consists of an N-terminal polymorphic domain that forms the peptide groove. The membrane proximal domains are nonpolymorphic.

The  $\alpha$ -chain is divided into three extracellular domains,  $\alpha_1$ ,  $\alpha_2$ , and  $\alpha_3$ . Except for the domain that is most distal to the membrane ( $\alpha_1$ ), the other two consist of a loop that is formed by a disulfide bond. The transmembrane portion consists of hydrophobic residues and terminates in five amino acids, including three arginines (Args) and one lysine (Lys) that anchor the molecule to the membrane. There is extensive homology between human and mouse MHC molecules (70 to 75%). Variability within the products of allelic genes of the MHC is much greater than it is between the products of other allelic eukaryotic genes, which usually differ only by one amino acid. The variable residues are clustered in seven sequences (<sup>19</sup>), three of which are in the  $\alpha_1$  domain and four of which are in the  $\alpha_2$  domain. The  $\alpha_3$  domain is highly conserved. Amino acids 223, 227, and 229 in the  $\alpha_3$  domain are critical for interaction with CD8 (<sup>20</sup>). The extensive antigenic polymorphism that is identified in class I molecules is the result of a combination of many variable positions, each one of which has a low degree of variability.

The H chain is glycosylated in the Golgi apparatus, with the carbohydrate moiety



consisting of neutral sugars, galactosamine, and sialic acid.

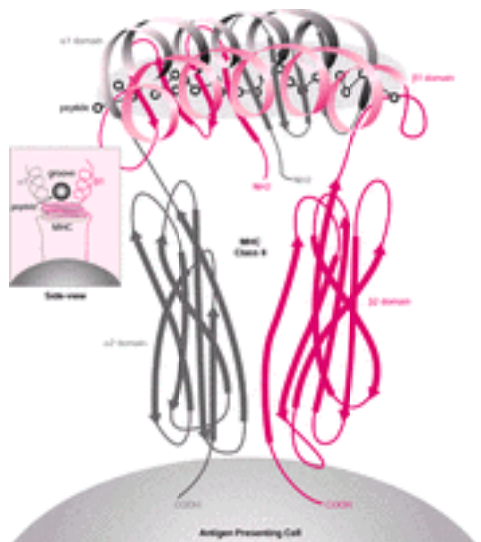
The L chain,  $\beta_2m$ , was first isolated from human urine and migrates in the  $\beta_2$  region by electrophoresis. The structure of  $\beta_2m$  is highly conserved, consisting of one Ig domain with one disulfide bond. It has a high degree of homology between species and minimal allelic variation. It is homologous to the  $C_{\mu 3}$  domain of human Ig and to the  $a_3$  domain of the class I molecule to which it is associated noncovalently.

The L chain plays an important role in the transport of the  $\alpha$ -chain, because cells that are derived from patients with Burkitt lymphoma, who are unable to synthesize the  $\beta_2m$ , do not express HLA antigens. On the basis of results from *in vitro* biosynthetic studies, it appears that the  $\alpha$ -chain is associated with  $\beta_2m$  within minutes after its completion. All three extracellular domains of the  $\alpha$ -chain are in contact with  $\beta_2m$  (21). The majority of these features have been conserved in the class I-b molecules.

$\beta_2m$  is present on all cells, and small amounts are shed into body fluids. Because of its low molecular weight, it is filtered out rapidly by the glomeruli, but it is reabsorbed from the kidney tubules and then catabolized. In patients with kidney diseases in whom tubular function is impaired, increased amounts of  $\beta_2m$  are detected in the urine. It is also found in increased quantities in the serum and in other fluids from individuals with certain malignancies, such as lymphomas and myelomas.

The most significant homology exists between the  $a_3$  domain and the constant Ig region.

The crystallographic structure of HLA class I markedly helped the understanding of the function of the molecule (22).  $\beta_2m$  and the  $a_3$  domain form the base that supports the  $a_1$  and  $a_2$  domains. Each of the  $a_1$  and  $a_2$  domains consist of four antiparallel  $\beta$  strands and one  $\alpha$  helix. This structure is similar to that of the class II molecule shown in [Figure 18.3](#). Seeing them from the top, the way the T-cell receptor (TCR) does, the juxtaposition of the two domains isolates a longitudinal *cavity*, which is commonly known as *the groove*, which is 30 Å long and 12 Å wide in the middle. Its floor consists of the  $\beta$  pleated sheets of the  $a_1$  and  $a_2$  domains (“intramolecular dimer”), and the sidewalls are two  $\alpha$  helices, one each from the  $a_1$  and  $a_2$  domains. The MHC I groove tapers at both ends to a width of approximately 5 Å and then is blocked completely by bulky amino acid side chains (Tyr84, Trp167), which are conserved in virtually all class I MHCs (21). It is lined by a series of pockets (A to F), which are sites of interaction with the peptide.



**Figure 18.3.** Drawing of a major histocompatibility complex (MHC) class II molecule–peptide complex. The MCH class II molecule forms a groove with walls that are made by a helices from the  $\alpha_1$  and  $\beta_1$  domains and a floor by  $\beta$  pleated sheets that is formed by antiparallel  $\beta$  strands from each chain. The peptide is usually long (15 to 25 residues) and projects out of both ends, which are not closed (as with MHC class I molecules).

The polymorphism of the class I molecule is particularly concentrated in the groove ([23](#)), and yet certain residues are strongly conserved among virtually all class I molecules. These residues surround, on the left and right ends of the groove, the first and last pockets (A and F), which bind the N-terminus and C-terminus of the peptide, respectively. The other pockets line the central portion of the groove and are also involved in peptide binding ([24](#)). Many of the MHC side chains that contribute to the formation of the pockets are polymorphic, and, as a result, the architecture of the pockets varies among the class I molecules. In some molecules, a bulky side chain may block a pocket that is open in another molecule. In other molecules, a smaller polymorphic amino acid may extend the size of the pocket ([25](#)). The binding pocket for the C-terminal peptide side chain appears to be the most universal of the primary class I side pockets. This may explain the fact that there are sequence restrictions on the final residue of the peptides ([26](#)). A given groove can bind hundreds or even thousands of different peptides, which are identical or homologous at only a few side chain positions ([26](#), [27](#)). Side chains from the MHC residues protrude into the groove from the  $\alpha$  helices and the  $\beta$  sheet and form an irregular surface along the length of the groove, so that side pockets extend out from the main cavity ([28](#)).

A class I molecule usually accommodates within the groove peptides that are nine amino acids long and that bind with an affinity that is 100- to 1000-fold higher than longer or shorter peptides. The binding of the peptides is mediated by certain amino acids that are known as *anchor residues* (sequence-dependent binding). The set of anchor residues that bind to a certain MHC molecule is known as a *sequence motif*. It allows the identification of peptides within a complex immunogen that are likely to bind to class I MHC. Hydrogen bonds between the peptide and conserved MHC I side chains provide stability to the peptide binding, which is sequence independent ([29](#)). A prominent kink or arch is found approximately one-third of the way from the N-terminus that lifts the peptide up, away from the main floor.

The arch that is formed by the peptide contributes to the antigenic specificity of the

complex, despite the fact that 73 to 83% of the peptide surface is buried by the MHC in the complex. A number of side chains that do not affect the binding of the peptide to the MHC contribute strikingly to the TCR binding (flag side chains) ( [30](#), [31](#) ). Antigenic specificity is provided not only by the flag side chains, but also by the conformational flexibility of the peptide. Peptides that differ in length are usually accommodated by buckling at the center of the cleft, and even peptides of the same length adopt strikingly different conformations ( [32](#) ).

In many different peptides, the flag side chains are prominently exposed at the surface of the complex and provide TCR with a direct access to the antigenic identity of the bound peptide ( [30](#) ). The upward-pointing orientation of flag side chains, such as P1 and P4, is conserved in many different HLA-A2-peptide complexes. Some peptides are sandwiched between the MHC and the TCR and make contact with both molecules.

In conclusion, the requirements to satisfy the vast and exquisite specificity of the TCR are provided by the peptide-MHC complex, which is formed with only a small number of nonvariable MHC molecules. To the peptide-MHC complex formation, the peptide binding is contributed by sequence-dependent binding and is supplemented by sequence-independent interactions of the primary anchor side chains in specific MHC pockets. These interactions, although constraining the conformation of class I-bound peptides at both ends, leave the center relatively free to adopt a conformation that optimizes the secondary anchor and other interactions with the MHC molecule. The MHC molecule is a remarkable tool with which evolution has achieved so much by so little.

## Class II Molecules

The second group of MHC genes, the class II genes, encode glycoproteins that regulate cell interactions in the immune response. The genes reside in the D region of the MHC in humans and in the I region of the MHC in the mouse. The class II proteins are also referred to as *Ia antigens* (immune response antigens). They are not as widely distributed as the class I molecules. They are found in high concentrations on B lymphocytes and on a subpopulation of macrophages, as well as on dendritic cells (DCs). On T cells, small quantities are detectable under conditions that are associated with T-cell activation *in vitro* ( [33](#) ) or during the course of certain diseases ( [34](#) ). However, human T cells may acquire Ia antigens from other cells ( [35](#) ), and, with murine T lymphocytes, Ia antigens are passively acquired from macrophages ( [36](#) ). A variety of cell types respond to interferon (IFN)- $\gamma$  and express Ia antigens, including vascular endothelial cells ( [37](#) ), melanoma cells ( [38](#) ), and brain astrocytes.

The human class II molecule is a heterodimer of two noncovalently linked proteins, an  $\alpha$ -chain (34 kd) and a  $\beta$ -chain (29 kd) ( [39](#) ). Each chain can be divided into four domains, two of which form the extracellular region in each chain, and the third and fourth correspond to the transmembrane segment and the intracellular part of the chain, respectively. With the exception of the  $\alpha_1$  domain, the other three domains ( $\alpha_2$ ,  $\beta_1$ , and  $\beta_2$ ) are loops that are formed by disulfide bonds. The two domains that are most proximal to the cell membrane ( $\alpha_2$  and  $\beta_2$ ) are homologous to the Ig constant domain. All  $\alpha$ -chains and  $\beta$ -chains in humans are homologous, sharing between 60 and 70% of their respective amino acid sequences. Between different loci, the amino acid differences are distributed randomly in the  $\beta$ -chains ( [40](#) ). The human DR, DQ, and DP  $\beta$ -chains and DQ  $\alpha$ -chains are polymorphic, and only the DR  $\alpha$ -chains and DP  $\alpha$ -chains seem to be invariant.

The assembly and expression of class II molecules involves a third chain that is known as

*invariant I* (CD74) ( [41](#) ), which is encoded by a gene on chromosome 5. Complementary DNA clones have been isolated, and the amino acid sequence indicates that the I chain is a type II transmembrane protein—that is, the N-terminal is inside the cell. When synthesized in the absence of MHC class II molecules, the invariant chain exists as a trimer or even as a hexamer ( [42](#) ). The complex of the I chain with the class II  $\alpha$ - and  $\beta$ -chains is a nonamer that consists of a core of three I chains, each one associated with an  $\alpha$  and  $\beta$  class II dimer ( [43](#) ).

The mechanism of binding the I chain to the  $\alpha/\beta$  dimer is not completely known. However, a peptide from the N-terminal two-thirds of the I chain, which is known as *class II-associated invariant chain peptide (CLIP)*, inhibits the binding of the antigenic peptides to the class II molecule ( [44](#) ). The assembly of the class II-invariant chain complex occurs in the ER. Class II  $\alpha/\beta$  dimers that are formed in the absence of the invariant chain are poorly expressed on the cell surface and remain in the ER, as they cannot maintain their normal folded structure. In the assembly of multimeric proteins, certain ER-associated proteins stabilize the partially folded subunits, thus preventing aggregation. These proteins are known as *chaperons* ( [45](#), [46](#) ). HLA-DR chains bind during their synthesis to ER resident proteins GRP94 and ERp72 but, in the absence of the I chain, remain bound to these ER chaperons for prolonged periods of time ( [47](#) ) (see the details for the I chain: CD74, [Chapter 2](#)).

Another ER resident protein that associates with class II chains is calnexin ( [48](#) ). The class II molecule is transported to the Golgi apparatus and enters the endosomal-lysosomal system, where it is loaded with an antigenic peptide on its way to cell surface expression ( [49](#) ) (see [Processing Antigen for Class II Presentation](#)).

The polymorphism of the class II molecule is localized in the  $\alpha_1$  and  $\beta_1$  domains. HLA-DR, HLA-DQ, and HLA-DP have three hypervariable regions in their  $\beta_1$  domains, whereas the  $\alpha_1$  domain of HLA-DQ has only one hypervariable region ( [50](#) ). The CD4 molecule interacts with amino acids 134 to 148 of the  $\beta_2$  domain ( [51](#), [52](#) ).

The crystallographic structure of the HLA-DR1 molecule reveals similarities with the structure of the HLA class I molecule ( [53](#), [54](#) ). The  $\alpha_1$  and  $\beta_1$  domains form the peptide-binding groove ( [Fig. 18.3](#) ). As with the class I molecule, the floor is the  $\beta$  pleated sheet, and the walls are the  $\alpha$  helices from the  $\alpha$  and  $\beta$  chains. The first two hypervariable regions are found on the floor, whereas the third hypervariable region is on the  $\alpha$  helix of the  $\beta$  chain. The class II groove can accommodate longer peptides (10 to 25 residues), because, in contrast to the class I groove, it is open on both ends ( [55](#) ). Long peptides, which range from 15 to 25 residues, can bind in an extended conformation, projecting out of both ends of the groove. This contrasts with class I peptide binding, in which mostly nonamers bind with extended, but kinked, conformations, and the N- and C-termini of the peptides are bound to groove pockets. In class I molecules, the residues at the end of the groove are conserved, imposing a tight binding for the peptides, but, in the class II molecules, conserved residues are located at different intervals along the groove, making the peptide-binding side chain independent. Even the strictest pocket in class II accommodates a variety of hydrophobic and aromatic side chains. The peptides in class II bind through the central region, and their N- and C-terminal ends protrude from the open ends of the groove ( [54](#) ). The reasons for these differences between class I and class II are not known.

The evidence from the crystallographic studies indicates that the class II molecules exist as tetramers on the cell surface ( [53](#), [56](#) ). The TCR may also exist as a dimer of dimers on

the T-cell surface ( [57](#) ). Therefore, the geometry of the TCR–MHC peptide interaction places the complementarity–determining region (CDR) 3 loops of the Va and VB chains of TCR in contact correspondingly with the N- and C-terminal ends of the peptide, whereas the CDR1 and CDR2 loops are in contact with the  $\beta_1$  and  $\alpha_1$  domains. Dimerization of soluble class I molecules that are loaded with a specific peptide is also required for T-cell activation ( [58](#) ). Ligand-induced dimerization of receptors is a general feature for cell activation and involves most of the known receptors.

## MAJOR HISTOCOMPATIBILITY COMPLEX MOLECULES: NONCLASSICAL

### Class I: HLA-E, HLA-F, and HLA-G

The nonclassical class I HLA molecules are HLA-E, HLA-F, and HLA-G. These molecules are also known as *class Ib*, to distinguish them from class Ia (HLA-A, HLA-B, and HLA-C). They constitute one group of the class Ib molecules, the other being the CD1 molecules, a non-MHC linked group with genes that are located in chromosome 1. The nonclassical class I HLA molecules show limited polymorphism, and their tissue expression is low, but they play a significant role as molecules of antigen recognition ( [59](#) ). They all form heterodimers with  $\beta_2m$ . They have conserved the key residues that interact with CD8.

**HLA-E** The structure of HLA-E is similar that of to class Ia molecules ( [60](#) ). The sites for  $\beta_2$  and CD8 interaction are conserved. The size of the HLA-E groove is structurally similar to that of the classical molecules, but it is highly hydrophobic to accommodate the leader peptides, which are profoundly hydrophobic. Changes in crucial positions within the groove with certain residues determine the peptide preference, such as tryptophan (Trp) at position 97 instead of Asn or Arg in class Ia molecules and phenylalanine at position 116, so that the C-terminal half of the peptide can interact. Peptides occupy all the pockets in HLA-E, and these interactions keep the peptide tightly bound with some additional help from hydrogen bonds along the length of the groove. The secure fastening of the peptides reinforces the favorable selection of a specific peptide ( [60a](#) ). HLA-E binds nonamer peptides from the leader peptides of most but not all class Ia alleles, which facilitate the expression of the molecule on the cell surface ( [61](#) ). Peptides with alterations in any position of the canonical peptide drastically reduce the binding and, as a result, the HLA-E expression. The leader peptides of class Ia HLA molecules enter the cytosol after they are cleaved from the coding sequence and are then transported to the inside of the ER by the TAP transporter, to be loaded on to HLA-E ( [62](#) ). Detection of HLA-E on the cell surface of CD56<sup>+</sup>CD16<sup>+</sup> natural killer (NK) cells can be achieved accurately with HLA-E tetramers ( [63](#) ) (further information regarding HLA-tetramers can be found in [Chapter 3](#)). The tetramers react with the CD94/NKG2A receptors, and HLA-E is a major ligand for this inhibitory receptor on NK cells ( [64](#) ) ( [Chapter 17](#) ). Recognition of HLA-E by this receptor inhibits activation of NK cells and thus protects cells from being killed by the cytotoxic NK cells ( [65](#) ). Because HLA-E is expressed with the leader peptides of MHC class I molecules, its presence on the cell surface sends signals to surveilling NK cells that there is no “missing self,” that is, an absence of MHC class I molecules, and thus protects cells from being killed by NK cells. Rare CD8<sup>+</sup> T cells have been detected that bind HLA-E directly through the TCR ( [66](#) ). Subversion of the protective mechanism that is conferred by HLA-E has been demonstrated with the cytomegalovirus (CTMV). The leader peptide of the CTMV glycoprotein gpUL40 is the same as the class Ia leader peptides, and, as a result, it binds to HLA-E ( [67](#) ). Although CTMV down-regulates MHC class I expression on infected cells, thus rendering them susceptible to lysis by NK cells (“missing self,” [Chapter 17](#)), it concomitantly



up-regulates HLA-E, thus inhibiting lysis. This mechanism represents an escape route for CMTV. Another example of subversion of HLA-E function is the binding of heat shock protein (HSP)-60 signal peptide (68). HSP-60 is present in all normal cells and in eukaryotic cells. It serves as a mitochondrial chaperon. Stress stimuli, such as heat, nutrient deprivation, toxic chemicals, and inflammation, up-regulate HSP-60. Binding of the HSP-60 signal peptide to HLA-E results in loss of its recognition by the CD94/NKG2A receptor and renders stressed cells susceptible to NK cell lysis.

**HLA-F** The structure of HLA-F is not known in great detail, but some predictions have been made based on the known structure of HLA-E and the sequence analysis of HLA-F (59). HLA-F tetramers stain monocytes and bind to Ig-like transcript (ILT)-2 and ILT-4 (63, 69). ILT molecules, also known as *leukocyte Ig-like receptors*, are structurally and functionally related. They recognize HLA class I allotypes, rather than individual peptide-MHC complexes, and are expressed on monocytes, macrophages, and DCs. HLA-F is retained intracellularly, empty, but reaches cell surface after acquisition of its ligand (70).

**HLA-G** HLA-G shows limited polymorphism, restricted tissue distribution, and low levels of expression and therefore belongs to the nonclassical MHC molecules. In the HLA-G gene, all of the regulatory elements of HLA class I genes are missing, thus suggesting that its expression and distribution is uniquely regulated (71). HLA-G is expressed strongly in extravillous cytotrophoblast, endothelial cells of fetal vessels, and in other tissues, such as the thymus. It is not detected in syncytiotrophoblast. Messenger RNA (mRNA) of HLA-G is detected in peripheral blood T and B cells, keratinocytes, fetal liver, and other cells (72). Tetrameric complexes of HLA-G bind to monocytes, especially the CD16<sup>+</sup> subpopulation, and react with ILT-2 and ILT-4 receptors, but they do not bind T, B, or NK cells (63, 73). The HLA-G gene transcribes six different transcriptional isoforms, membrane bound and soluble forms (72). The complete transmembrane isoform HLA-G1 consists of three extracellular domains, whereas isoforms HLA-G2, HLA-G3, and HLA-G4 have one or two domains. HLA-G1 and HLA-G2 exist in soluble form. The HLA-G molecule binds peptides that have primary anchors in positions 2, 3, and 9. The peptide-binding pocket residues determine the specificity of the molecule. The isoforms HLA-G2 and HLA-G3 lack the  $\alpha_2$  domain and, as a result, do not bind peptides. They also do not bind the CD8 molecule and are therefore unable to present peptides. The HLA-G molecule has an antigen-presenting potential, but, because of the limited diversity of the peptides and its low polymorphism, the function of the molecule is rather restricted. However, it may still be sufficient, considering the limited species of viruses that infect the placenta (72). Other than antigen-presenting functions, HLA-G may be more important for its role during pregnancy. HLA-G exerts inhibitory functions by several mechanisms. First, it directly binds to CD94/NKG2A, which is an inhibitory receptor (74, 75, 76 and 77); second, it binds to receptor KIR2DL4 on all NK cells that inhibit lysis of cells that express HLA-G (78); third, the leader peptide of HLA-G binds to HLA-E, which interacts with the inhibitory receptor CD94/NKG2A. These inhibitory mechanisms are important for the protection of the fetus, because HLA-G is strongly expressed in the placenta.

## Class II: HLA-DM and HLA-DO

**HLA-DM** There are two nonclassical class II proteins with their genes within the class II region. For HLA-DM, there are two genes, DMA and DMB, on the centromeric site of TAP and LMP genes. DMA and DMB encode the  $\alpha$ - and  $\beta$ -chains of the DM molecule (79), which is detected in all class II expressing cells and is up-regulated by IFN- $\gamma$ , together with classical class II molecules. Class II molecules associate with the invariant (Ii) chain after they enter the ER and form nonameric complexes ( $\alpha\beta I_i$ )<sub>3</sub>. Through the CLIP, the Ii chain prevents class II molecules from binding peptides within the ER (see details in the

following discussion). The heterodimer DM is formed in the ER, and, by the time class II molecules pass through the endosomal system on the way to the cell surface, the DM protein has already arrived there by a multivesicular system that is known as the *MHC class II compartment (MIIC)*. It is retained in MIIC by a tyrosine (Tyr)-based targeting motif (YTPL) that is located in the cytoplasmic tail of the  $\beta$ -chain. DM transiently binds directly to the HLA class II-CLIP complex (<sup>80</sup>) and induces the release of CLIP, whereas DM remains associated with the class II molecule until the peptide to be loaded has been found and is safely in place within the groove (<sup>81</sup>). DM rescues empty HLA-II molecules from denaturation and loss of their peptide-binding capacity. Both HLA-II and DM are in an "acidic" environment, and conformational changes of both molecules seem to facilitate their interaction (<sup>82</sup>). Another important function of the DM molecule after the removal of CLIP and maintenance of an intact three-dimensional structure of the class II molecule is the *editing* of peptide loading. *Editing* implies a selection, from a variety of available peptides, of a *good* peptide, which is defined by the stability of its interactions within the groove (<sup>83</sup>). Intrinsic stability is determined by multiple hydrogen bonds between the peptide backbone and the conserved residues of the binding groove and by the anchor side chains and the specificity pockets (<sup>84</sup>). The mechanism of the ultimate release of DM from HLA-II is not clear. It appears that DM binds more stably to an empty HLA-II than to one that contains a peptide (<sup>85</sup>).

**HLA-DO** The genes that encode the  $\alpha$ - and  $\beta$ -chains of the DO molecule are similar to the class II genes. The DO proteins have a more restricted distribution and are detected in B cells, DCs, a melanoma cell line, and cortical and medullary epithelial cells in the thymus (<sup>86</sup>). On completion of its synthesis, DO associates with DM, and the tetramer is transported mainly to lysosomes in which most of it is localized (<sup>87</sup>, <sup>88</sup>). The lysosomes that contain DO also contain class II molecules. Loading of peptides to class II is slower in the presence of DMDO tetramers, thus suggesting that DO is a negative regulator of DM function (<sup>89</sup>), and overexpression of DO results in accumulation of MHC class II-CLIP complexes at the cell surface. The regulation of peptide presentation by DO limits only one of the mechanisms of antigen uptake—that is, by free fluid phase—whereas membrane Ig-mediated uptake is augmented (<sup>90</sup>).

## Major Histocompatibility Complex Class I Chain-Related Genes and Proteins

A distinct family of genes, the last and final to be detected within the MHC class I region, is known as *MIC* (<sup>91</sup>). *MICC*, *MICD*, and *MICE* are in close proximity to HLA-E, HLA-A, and HLA-F, respectively. *MICE* and *MICG* are between HLA-G and HLA-F, and *MICF* is centromeric to HLA-G. *MICC*, *MICE*, *MICF*, and *MICG* are pseudogenes. *MICA* and *MICB* are unusually large genes (11 to 13 kb) compared to an average of 3.5 kb for HLA-A to HLA-G genes. However, their overall genomic structure parallels those of the other MHC genes and of the Ig superfamily genes in general, in which distinct functional domains are encoded by separate exons. The crystal structure of *MICA* shows that the molecule has a general configuration of a class I molecule—that is, a membrane that is proximal to the Ig-like C-type domain—with the  $\alpha_3$  domain and the two  $\alpha_1$  and  $\alpha_2$  distal domains forming together an eight-stranded antiparallel  $\beta$  pleated sheet that is bordered at the edges by two  $\alpha$  helices (<sup>92</sup>). The groove is less spacious than that of class Ia molecules—10 Å within the first four  $\beta$  strands and 7 Å across the second four  $\beta$  strands (compared to >18 Å of classical MHC I and 14.4 Å for CD1). This agrees with the inability to detect *MICA*-associated peptides previously (<sup>93</sup>). The most striking finding is that the groove is oriented down toward the membrane (<sup>94</sup>), so that the whole molecule appears like a wilting flower (<sup>95</sup>).

Another major difference from other MHC molecules is the lack of  $\beta_2m$  binding due to



restructuring of the interface of binding, which ablates the interaction ( [92](#)).

The surprising findings about the structure of these proteins were matched by equally surprising findings about their function. The MIC proteins are recognized by the  $\gamma\delta$  T cell, especially the V $\delta$ 1 cell, but not by the  $\alpha\beta$  T cells ( [93](#), [96](#)).

In addition, MICA is the ligand for NKG2D activating receptor of NK and  $\gamma\delta$  T cells, triggering cytolytic responses against epithelial tumors that express MICA ( [97](#)). NKG2D is the most common NK cell receptor that is known, but it may require a synergistic action by a TCR ( [98](#)).

The polymorphic residues are concentrated in the  $\alpha_2$  domain ( [92](#)), which apparently is reoriented after binding with the ligand NKG2D ( [99](#)). This ligand-induced repositioning of the MICA molecule brings the  $\alpha_1$ - $\alpha_2$  platform with the same polymorphic residues in contact with the NKG2D receptor. This receptor-induced conformational change is probably facilitated by the coil of the  $\alpha_1$  to  $\alpha_3$  domains.

A number of disease associations have been detected with MIC alleles, such as ankylosing spondylitis, Behçet syndrome, psoriasis vulgaris, and Kawasaki disease.

In summary, the MICA and MICB polymorphic HLA-like molecules present several unresolved enigmas. Their distribution is relatively restricted to epithelial and endothelial tissues (not on T or B cells), and their expression is associated with some form of stress ( [100](#), [101](#)). In spite of their polymorphism, they are recognized by  $\gamma\delta$  T cells in a genetically unrestricted manner. Their groove under normal conditions is unavailable for binding owing to their disorganized structure. However, conformational changes are induced on interaction with a receptor. New surprises await further research into their structure and function.

### CD1 System: Genes and Proteins

One of the first monoclonal antibodies, which was made after the discovery of hybridoma technology by Milstein et al. ( [102](#)), was specific for a protein that later was given the first number, CD1, when the CD nomenclature was introduced at the First International Workshop on Human Leukocyte Differentiation Antigens, which was held in Paris in 1982.

The CD1 family consists of four proteins, CD1a, CD1b, CD1c, and CD1d, which are encoded by genes CD1A, CD1B, CD1C, CD1D, and a fifth gene, CD1E, which is not transcribed. The genes are located on chromosome 1q22-23, and the proteins that they encode have significant homology to MHC class I and II proteins. They are divided into group 1, which contains CD1a, CD1b, CD1c, and CD1e, and group 2, which contains CD1d.

Group 1 genes do not exist in mice and rats. This is interpreted as an indication that pathogens that usually select and maintain genes with a defense function are not pathogens anymore for these species. CD1 molecules represent an ancient family of antigen-presenting molecules. The fact that CD1 molecules are homologous to the MHC molecules suggests that both evolved from a common ancestor with the subsequent diversification into the two main CD1 lineages or groups. CD1 consists of three extracellular domains,  $\alpha_1$ ,  $\alpha_2$ , and  $\alpha_3$ . The  $\alpha_1$  domain has minimal, if any, homology to MHC I, whereas with the other two, homology is approximately 35%, which is still far below the average of 70% between different class I proteins.

All CD1 proteins are transmembrane and associate with  $\beta_2m$ .  $\beta_2m$  is necessary for folding and membrane expression ( [103](#) ). The crystal structure of mouse CD1d1 shows a remarkable similarity in overall shape to MHC class I proteins ( [104](#) ). The  $\alpha_1$  and  $\alpha_2$  domains form a groove with  $\beta$  pleated sheets. The groove is different from that of the MHC molecules, with three channels, A, C and F', and a distinct tunnel, which is designated T'.

Another difference between CD1 and MHC is that the CD1 groove is formed by hydrophobic residues, so it is unlikely to form hydrogen bonds with the peptide. It is also closed at both ends and is covered for much of its length.

A complex of CD1b with ligands has been crystallized, and its structure has been solved ( [105](#) ). The total volume of the groove ( $220 \text{ \AA}^3$ ) is filled with hydrocarbons. Two alkyl groups are necessary for stable ligand binding, and the four interconnected channels are occupied by the alkyl groups. Mycobacterial mycolates, which play a crucial role for the survival of mycobacteria in the intracellular environment, have been the first characterized ligands for CD1b ( [106](#) ) and are large molecules. Lipids with three alkyl groups, such as triacylglycerols that are found in atherosclerotic plaques, are presented by CD1, are expressed on macrophages of the atherosclerotic lesions, and activate T cells ( [107](#), [108](#) ). The role of this mechanism in the formation and evolution of such lesions remains to be determined.

### **UL-16 Binding Proteins: The Latest Member of the Major Histocompatibility Complex Family**

The UL-16 binding proteins (ULBPs) are novel class I-related surface proteins. Their identification was based on their ability to bind the UL-16 glycoprotein of the human CTMV ( [109](#) ). The ULBP family has three members, ULBP-1, ULBP-2, and ULBP-3. The ULBP genes are located on chromosome 6q25 and not within the MHC complex. However, sequence alignments show clearly that the ULBPs belong to the MHC class I family. The ULBP proteins are glycosyl phosphatidyl inositol (GPI)-linked, do not have the  $\alpha_3$  domain of class I MHC, and do not associate with  $\beta_2m$ . Expression of ULBPs or the MICs on target cells confers susceptibility to NK cell killing. The ULBP transduces signals that override the negative signal that is generated by an inhibitory receptor. ULBP messages are expressed by a variety of cells, tissues, and tumors. The ULBPs are ligands for the homodimeric NKG2D C-type lectin receptor ( [110](#), [111](#) ), which is expressed not only on NK cells, but also on T cells and activated macrophages ( [112](#), [113](#) ). The cytoplasmic domain of NKG2D is short, and, as a result, signaling is delivered by the DAP-10 adaptor protein that is associated with NKG2D ( [Chapter 17](#) ). DAP-10 binds to the p85 subunit of phosphoinositide 3-kinase (PI3K) and adaptor Grb2, transmitting downstream signals from NKG2D through Janus kinase 2 and Akt activation pathways ( [111](#) ). NKG2D delivers co-stimulatory signals to T cells ( [114](#) ), stimulates proliferation, and induces increased production of cytokines and other activation-associated molecules ( [110](#) ). UL-16 mediates an additional evasive function of the human CTMV by inhibiting MICB expression, because it binds directly to MICB, causing its intracellular retention ( [115](#) ).

## **ORIGINS OF MAJOR HISTOCOMPATIBILITY COMPLEX**

The human MHC is close to 4 Mb long with approximately 180 to 200 genes, which traditionally have been divided to three regions—starting from the centromere to

telomere, class II, class III, and class I. During evolution, genetic events, such as insertions, duplications, deletions, inversions, conversions, and translocations, have introduced modifications, but the conserved genes have escaped identification with ancestral chromosomal regions. Genes that arose within a species by duplication are termed *paralogous genes*, and the chromosomal segment that contains the duplicated genes is termed the *paralogous region*. In the late 1990s, it was realized that three other chromosomes, 1, 9, and 19, have genes that are organized in the same manner as MHC ([116](#), [117](#)).

Some genes, such as NOTCH and PBX, are represented in all four chromosomal paralogous regions, whereas others are only represented in two or three. Two hypotheses have been proposed for the explanation of these observations: (a) All four paralogous regions arose from large-scale chromosomal duplication ([118](#), [119](#)), and (b) the paralogous regions arose from independent duplications of genes, which were brought into proximity by selective forces (the *functional clustering* hypothesis) ([120](#)). It is possible that chromosomal duplication may have played a primary role, and functional clustering may only have played a minor one.

The hypothesis proposes that the “block duplication” that generated the four paralogous regions had taken place before the emergence of jawed vertebrates. Because all vertebrates have four paralogous regions, the duplication from one ancestral region must have occurred twice. It is postulated that the first occurred before the emergence of jawless fishes, which have two paralogous groups, and the second occurred before the emergence of jawed vertebrates. In the vertebrates, the gene order within each region is poorly conserved, probably as a result of structural rearrangements over the past 500 million years since the second duplication. The hypothesis of “block duplication” draws severe criticism from others who have data from phylogenetic analyses of individual gene families that are considered to be inconsistent with “block duplication” ([121](#)). Comparison between class I and class II genes between mouse and man shows that, although the genes of class II subregions in the mouse, A and E, are orthologous to the corresponding human class II subregions DQ and DR, the class I genes between human (primate) and mouse (rodent) are not orthologous.

Class Ia genes cluster with class Ib genes but have risen independently by gene duplication from classical genes.

Furthermore, the polymorphism of MHC molecules is localized within the peptide-binding region. Within this region, the number of nonsynonymous nucleotide substitutions (amino acid altering) far exceed the synonymous, whereas the opposite is true with the rest of the molecule. Because the synonymous substitutions are almost neutral, it becomes evident that polymorphism is supported by a form of natural selection, which favors peptide-binding region diversity. Other genomic evidence from the *Xenopus laevis* (frog) indicates that, in this amphibian, there are class I, II, and III genes, which are linked ([122](#)). Similarly, in cartilaginous fish (sharks), the most primitive organisms with MHC, the gene structures and sequence variations are impressively similar to humans. Sharks also share with humans the MHC class I and class II linkage ([123](#)) that is common to all amphibian, bird, and mammalian species ([124](#)). The proposed primordial MHC (proto-MHC) consists of the linkage group class I-LMP-2-LMP-7-TAP-2-RING-3-RXR-class I and several genes that are involved in the preparation of class I presentation, that is, LMP-2 and LMP-7 (for proteasome) and TAP-2 for peptide transporter. It is likely that, with further genomic sequencing analyses and phylogenetic tree analyses, the nature and composition of proto-MHC will be determined.

For many years, the HLA haplotype has been considered to be the most important

genetic marker of susceptibility to many diseases. It has been found that the strongest disease associations are with alleles at multiple loci rather than with individual alleles. The expression of alleles from multiple loci has been called the *ancestral haplotype (AH)*. AHs are conserved genomic sequences that are separated by recombination hotspots. For example, the 8.1 AHs (A1, CW7, B8, CHAQ0, DR3, and DQ2) are associated with multiple immunologic diseases (125, 126). No single gene predisposes to all diseases, but different regions of 8.1 AH are associated with diseases, such as insulin-dependent diabetes, systemic lupus erythematosus (SLE), gluten sensitive enteropathy, dermatitis herpetiformis, common variable immunodeficiency, IgA deficiency. The AH 8.1 is also associated with rapid loss of CD4<sup>+</sup> T cells and impaired survival after human immunodeficiency virus (HIV) infection. The precise immunologic mechanisms that give rise to such diverse diseases are not completely known. It affects the balance of cytokines with low interleukin (IL)-2 and IFN- $\gamma$  and normal IL-4 production, with a bias toward T helper cell (T<sub>H</sub>) 2-type of immune responses.

## ANTIGEN PROCESSING AND PRESENTATION

### Antigen-Presenting Cells

The development of humoral and cell-mediated immunity depends on complex cellular interactions that involve lymphocytes and nonlymphoid cells. Activation of lymphocytes by antigen requires its processing and presentation by another cell that is commonly known as an *antigen-presenting cell (APC)* (Table 18.1). Macrophages promptly capture foreign substances, and antigen processing and presentation was first demonstrated. Other APCs are the DCs (see [Dendritic Cells](#)) and B lymphocytes.

TABLE 18.1. Antigen-Presenting Cells

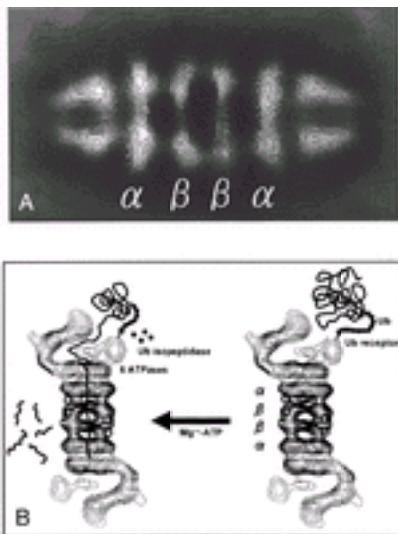
|   | B Cell  | Macrophage  | Dendritic Cell   |
|---|---|---|--|
| Antigen uptake                              | +++<br>Surface immunoglobulin (antigen specific)            | +++<br>Phagocytosis   | +++  |
| Major histocompatibility complex expression | Constitutive  | Inducible   | Constitutive   |
| Co-stimulatory activity                     | +++ to ++++   | - to +++  | ++++   |
| Antigen presented                           | Inducible<br>- to +++<br>Toxins                             | Inducible<br>- to +++<br>Extracellular and vesicular bacteria | Constitutive<br>++++<br>Viruses                                |
| Location                                    | Viruses<br>Bacteria<br>Lymphoid tissues<br>Peripheral blood | Wide body distribution  | Viruses<br>"Allergens?"<br>Wide body distribution<br>Epithelia |

+++ , strong; +++++, very strong; -, negative.

From Janeway CA Jr, Travers P. Immunobiology. The immune system in health and disease, 1st ed. New York: Garland, 1994, with permission.

## Processing Antigens for Class I Presentation

Antigen processing begins in the cytoplasm with an ATP-dependent, proteolytic machine that is known as a *proteasome*, which is highly conserved, from yeast to mammals ([127](#), [128](#), [129](#), [130](#) and [131](#)). Most of the MHC class I presented peptides are generated outside the endosomes and lysosomes, and energy that is supplied by ATP is required. The proteolytic subunit of the proteasome is a large cylindrical structure of 20S, which is arranged in four stacked rings. Based on structural analysis, the 20S proteasome is composed of two types of sequences,  $\alpha$  and  $\beta$ . The central two rings of the 20S proteasome is composed of seven distinct, but homologous,  $\beta$  subunits, which surround a central chamber at which proteolysis occurs ([Fig. 18.4](#)). The other two outer rings are made of  $\alpha$  subunits, which form openings from which substrates enter and leave. Isolated subunits have no proteolytic activity, therefore the subunits must assume a precise conformation in the  $\beta$  ring to be active. It has been determined that the proteolytic mechanism depends on the hydroxyl group of the N-terminal threonine (Thr) of the  $\beta$  subunits. This mechanism of proteolysis by the proteasome is distinct from any other known protease. The function of the  $\alpha$  subunits may be related to the formation of a scaffolding for the self-assembly of the  $\beta$  rings ([132](#)), as well as the facilitation of the entry of the substrates.



**Figure 18.4.** The proteasome. **A:** Photograph of the 26S proteasome, which consists of a central unit (20S proteasome) that is composed of seven  $\alpha$  and seven  $\beta$  subunits that are arranged in four rings in the order of  $\alpha\beta\beta\alpha$ . The central unit performs the catalytic functions. On each side of the central cylinder, there is a regulatory unit. **B:** Proteins to be degraded are first coupled to ubiquitin (Ub), which binds to an appropriate receptor in the regulatory unit that directs the protein to the central canal (“digestive tract”) of the proteasome. ATP, adenosine triphosphate. (From Tanaka K, Tanahashi N, Tsurumi C, et al. Proteasomes and antigen processing. *Adv Immunol* 1997;64:1–38, with permission.)

The 20S (650 kd) proteasome is capped on each side by a 19S (700 kd) regulatory complex ([129](#), [131](#)) to form the 26S (2000 kd) proteasome with proteolytic activity. Each 19S cap contains approximately 20 distinct subunits. It has been known as *PA700 proteasome activator*, because, in the presence of ATP, it associates with the 20S particle and stimulates peptidase activity. In the absence of P700, the 20S particle cannot

degrade ubiquitinated proteins. At least six of the P700 subunits are putative ATPases and account for the ATP requirements in proteasome-mediated proteolysis. The 26S proteasome has a dumbbell shape, with the 20S proteasome as a cylinder in the center and the two PA700 V-shaped subunits attached on each end. IFN- $\gamma$  induces expression of three  $\beta$ -type subunits, two of them encoded by genes, LMP-2 and LMP-7, within the class II region, and a third one, MECL-1, which is encoded outside the MHC (133). IFN- $\gamma$  also down-regulates three of the normally constitutively expressed subunits. The net result of IFN- $\gamma$  stimulation is the exchange of three constitutive  $\beta$  subunits by those that are IFN- $\gamma$  inducible and that are incorporated into the 20S proteasome (134). This function of IFN- $\gamma$  changes the activity of the immunoproteasome.

Another regulatory complex, PA28 (11S), a 200-kd conical structure, also forms a cap at either end of the 20S proteasome (135). It stimulates multiple peptidase activities with faster kinetics. PA28 consists of two components,  $\alpha$  and  $\beta$ , which are structurally related to the Ki antigen, a nuclear antigen that is detected by autoantibodies in patients with SLE. Ki antigen is now renamed PA28 $\beta$ . The PA28 at the two ends of the 20S proteasome consist of a heterohexameric complex with alternating  $\alpha$  and  $\beta$  subunits. PA28 proteasome is not involved in the initial cleavage of proteins but rather degradation of polypeptides of intermediate size. It is thought to work after the initial action of the 26S proteasome.

How, from a long polypeptide or a protein, the specific peptide that precisely fits to the groove of the MHC is generated is a tantalizing question. These *specific* peptides are *embedde*d within the polypeptide chain, and, to be extracted, two precise cuts are needed, one at the N-terminal (start) and one at the C-terminal (end). The importance of proteasomes for the generation of MHC class I-restricted peptides is widely recognized (136, 137 and 138). Antigen processing in the cytoplasm does not generate exactly the final product in one step. The view that proteasome makes the C-terminal cut is favored by several studies (139, 140). According to this view, the proteasome releases intermediates with a precisely cut C-terminal end but with an extended N-terminal end. Proteasome cleaves peptides on the carboxyl side of basic and hydrophobic residues of substrates. This specificity satisfies an important requirement for the binding of peptide to the MHC class I groove, that is, basic and hydrophobic residues normally serve in anchoring the peptide in the groove. In addition, the C-terminally cut peptides are also more efficiently transported by the TAP transporter.

N-terminal trimming is necessary to produce the antigenic peptide and may occur probably by aminopeptidases in the ER (141). It is estimated that the 26S proteasome generates an antigenic peptide from an intact protein with an efficiency of one peptide for every 20 molecules that are degraded (142). The peptides generated are 3 to 22 residues long, but only 20% are in the range that is favored for high affinity binding (eight to ten residues) (143). Crystal structure of proteasome has revealed that the distance between active Thr residues of adjacent  $\beta$  subunits is approximately 28 Å. This distance determines the length of the generated peptides (144).

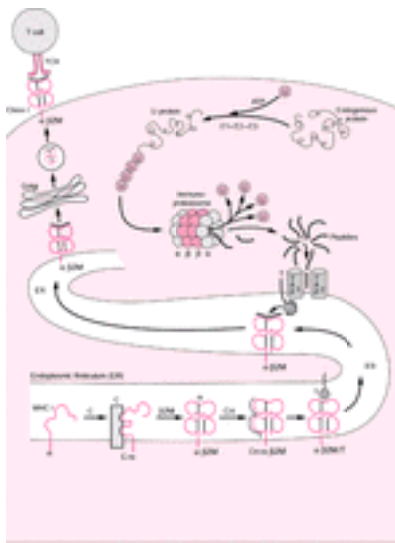
The ubiquitin proteolytic pathway has a crucial role in the degradation of short-lived and regulatory proteins that are important in a variety of cellular processes. Proteolytic cleavage by the proteasome requires the conjugation of the substrate by ubiquitin (145). The ubiquitin (8.5 kd) is one of the most conserved proteins in evolution and is activated to a high-energy thioester bond at its C-terminal by an activating enzyme, E1. After activation, one of several E2 enzymes (ubiquitin-carrier proteins) transfers ubiquitin to an E3 protein (ubiquitin-protein ligase) to which the substrate protein is specifically bound. This E3 protein covalently attaches ubiquitin to the substrate at which it binds to epsilon



NH<sub>2</sub> groups of an internal Lys residue. This step is repeated until a polyubiquitin chain is formed, which serves as a recognition marker to the 26S proteasome. After degradation, ubiquitin molecules are released to participate in another cycle of proteolysis.

The proteasome exhibits three distinct peptidase activities that are associated with  $\beta$  subunits. One is *chymotrypsin-like* because it hydrolyses peptides after a large hydrophobic residue, a second is *trypsin-like* because it cleaves after basic residues, and a third hydrolyzes after acidic residues. Occupancy of the chymotryptic site by a peptide substrate allosterically activates cleavages by the postacidic site, which in turn inhibits the chymotryptic site. By these cycles of activation–inhibition, the proteins are cleaved in pieces and are propagated for further fragmentation by other active sites.

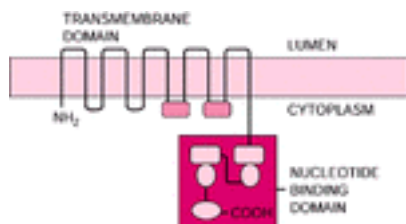
**PEPTIDE TRANSPORT** Peptides that are generated by the proteasome must be transported across the ER membrane to meet the MHC class I molecules at which they are synthesized ( Fig. 18.5 ) ( 146 , 147 ). The first indication that peptides are actively transported to the interior of the ER came from the study of mutant cell lines that had low MHC class I expression and could not present antigen, although their capacity to synthesize the molecules was intact. In the absence of peptides, the class I molecule cannot maintain its quaternary structure, folds up, and is incapable of moving along the constitutive pathway to the cell surface. Two genes have been identified within the MHC complex that encode the transporters of cytosolic peptides ( 148 , 149 and 150 ). They are called *transporters associated with antigen presentation (TAPs)*. Transfection of these genes to the mutant lines that were mentioned previously corrected their defect in antigen presentation. Profound defects in MHC class I restricted antigen presentation were detected in humans lacking TAP-2 ( 151 ) and in mutant mice lacking TAP-1 ( 152 ).



**Figure 18.5.** Processing and presentation for major histocompatibility complex (MHC) class I. Peptides (approximately eight to ten amino acids long) are generated by proteolysis of endogenous proteins by a multisubunit protein-degradative machine that is known as a *proteasome*. The protein to be degraded is first ubiquitinated. Ubiquitin (U) is attached by a covalent bond to the e-NH<sub>2</sub> group of a lysine residue by an enzyme complex. The peptides are carried across the membrane of the endoplasmic reticulum (ER) by the transporter associated with antigen presentation (TAP) to be loaded on the groove of MHC class I molecules. The nascent  $\alpha$ -chain of MHC retains its proper conformation by calnexin (C) and after the addition of the  $\beta_2$  microglobulin ( $\beta_2m$ ) chain by calreticulin (Crt). When the peptide passes inside the ER and lands on the MHC groove, with the help of tapasin (T), calreticulin is relieved from its chaperon duties, because the peptide stabilizes the MHC conformation. ATP, adenosine triphosphate; TCR, T-cell receptor.



The TAP proteins are members of the ABC family that is found in prokaryotes and eukaryotes ( [153](#) ). In mammals, the ABC proteins are grouped into four subfamilies: the P-glycoproteins, the cystic fibrosis transmembrane conductance regulators, the peroxisomal membrane proteins (PMP), and the TAP proteins. From the genomic structure of the human TAP-1 and TAP-2 genes, it is predicted that the TAP-1 protein has ten transmembrane-spanning segments ( [Fig. 18.6](#) ). The sixth segment is joined to the seventh and the eighth is joined to the ninth by hydrophilic cytoplasmic segments ( [146](#) ). The nucleotide-binding domain (NBD), which is located in the cytoplasm, is large and consists of several modules. Two are involved in nucleotide binding (Walker motifs), and three others are hydrophilic. The direction of transport varies. Some members transport their substrates away from the NBD (such as P-glycoprotein), and others transport their substrates toward the NBD. The TAP proteins are functional only as heterodimers ( [154](#) ) and are located in the ER and the *cis*-Golgi ( [155](#) ). In addition to the ATP-binding site ( [156](#) ), a peptide-binding site is formed by both subunits ( [157](#) ). Peptide binding is ATP independent, but its transport is ATP dependent ( [158](#) , [159](#) ). It is of interest that peptides with 7 to 12 residues and a C-terminus are more efficiently transported, and those are precisely the requirements for optimal binding by the class I MHC molecule ( [159](#) , [160](#) ). Because peptides are usually rapidly degraded in the cytoplasm, it is suggested that they may be carried from the proteasome to the TAP proteins by chaperon proteins, such as those of the HSP-70 family. Genes that encode such proteins have been found in the MHC region ( [161](#) ). Peptide binding to TAP precedes its translocation across the ER membrane. TAP could act as a peptide channel if binding activates TAP and permits the diffusion of peptides across the membrane. Most data, however, are consistent with the transporter function, that is, binding that is followed by translocation. ATP binding releases the peptide as a result of conformational changes of the NBD.



**Figure 18.6.** The transporter associated with antigen processing (TAP). This model for TAP-1 protein is predicted from the structure of the gene. The exons of the gene probably encode structural units (modules), which correspond to distinct functional domains of the protein. Thus, TAP-1 consists of ten transmembrane segments that form the transmembrane domain (N-terminus) and a large nucleotide-binding domain (NBD) (C-terminus) that is localized within the cytoplasm. The NBD consists of several modules (two of them bind adenosine triphosphate, Walker motifs, *crosshatchea*) and three hydrophilic segments (*open rectangles and open circle*). The TAP proteins form a functional unit only as heterodimers (TAP-1 and TAP-2). (From Elliott T. Transporter associated with antigen processing. *Adv Immunol* 1997;65:47-109, with permission.)

An important question that is related to class I antigen presentation is the mechanism by which viral proteins or tumor antigens, which are synthesized within the ER, are targeted to the cytosol to be handled by the processing machinery. There is an *ER retrograde* pathway that transports proteins from the ER to the cytosol ( [162](#) ). Until these proteins are assembled and folded properly, they are retained within the ER by calnexin or calreticulin. Misfolded or aberrant proteins are released for proteasomal degradation ( [163](#) ). However, the ER possesses proteolytic activity, that is, aminopeptidases that may also process N-terminally extended precursors of antigenic peptides for loading to MHC class I molecules.

**ASSEMBLY AND LOADING OF CLASS I MOLECULES** The size restriction for peptides

to bind to class I molecules is eight to ten residues. The restriction is imposed by the structure of the MHC class I groove, which is closed at the two ends. The class I  $\alpha$  chain and  $\beta_2m$  are synthesized on membrane-associated ribosomes and are inserted cotranslationally into the ER through a specialized structure that is known as the *translocator*. *N*-glycosylation takes place in the ER during the translocation process. HLA-A, HLA-B, and HLA-C have a single *N*-glycosylation site. The ER chaperon, BiP, a HSP-70 homolog, interacts with proteins during this stage and, through ATP regulation, provides the energy that is required for the movement of the protein through the ER membrane. BiP binds with free HLA heavy (H) chains. Calnexin is the most important chaperon and binds to newly synthesized free class I  $\alpha$  chain (164, 165) but not to the heterodimer (Fig. 18.5). *Calnexin* is a transmembrane lectin and binds to *N*-linked glycans that bear a single glucose after removal by glycosidases of the extra glucose residues. How calnexin facilitates folding is not known, but the glucose is removed by a glycosidase II and calnexin is released. If the MHC class I molecule has not achieved its proper folding, a second glycosylation cycle follows with another attempt at refolding. Removal of calnexin permits the MHC class I molecule to leave the ER. Another chaperon that has been detected by some studies is calreticulin, which is a soluble homolog of calnexin. The TAP heterodimeric proteins transport the cytosolic peptides that are generated by the proteasome across the ER membrane. They bind to MHC class I molecules through an additional component that is called *tapasin* (TAP-associated glycoprotein) (166). Tapasin is a transmembrane glycoprotein that has an ER retention signal in the cytoplasmic region. The gene that encodes tapasin is in the centromeric end of the human MHC region. Tapasin probably forms a bridge between TAP and MHC class I molecules (167) (Fig. 18.5). However, tapasin also stabilizes class I molecules in the absence of peptides by occupying the groove, a function that is performed by the  $\beta_2m$  chain in class II MHC molecules. In addition, tapasin is involved in peptide loading (168) and also influences the peptide selection (169). An additional molecule that associates with MHC class I molecules at the assembly stage is ERp57, an enzyme that ensures the correct formation of intrachain and interchain disulfide bonds (170). ERp57 is a thiol-dependent reductase and a cysteine (Cys) protease. As a protease, it may play a role in the trimming of peptides, because it remains attached to the complex until the time of the peptide loading. The order and kinetics of the assembly of the various components of the loading complex is as follows (171, 172): H chain  $\beta_2m$  heterodimers can be recovered within 4 minutes after translation, and the peptide joins 2 minutes later. Shortly after the synthesis of the H chain, one disulfide bond forms in the  $\alpha_2$  domain, and a second forms in the  $\alpha_3$  domain. Disulfide bond formation is necessary for  $\beta_2m$  binding and peptide loading. The  $\beta_2m$  is required for physical support of the peptide-binding groove. Calnexin may be bound to a nascent H chain, but calnexin dissociates as  $\beta_2m$  binds to the H chain, and calreticulin is taken up by the heterodimer. The other one-half of the complex is being assembled in the meantime, that is, TAP forms a complex with tapasin, and both are joined by calnexin and ERp57. When the two halves of the final complex join together, calnexin dissociates, and the final loading complex is complete. Loading of the peptide at this point releases the MHC class I- $\beta_2m$  heterodimer for the secretory pathway to reach the cell membrane.

### PRESENTATION OF EXOGENOUS ANTIGEN BY MAJOR HISTOCOMPATIBILITY COMPLEX CLASS I MOLECULES

The class I MHC system evolved to identify cells that bear peptides that derive mostly from infectious agents. The vast majority of peptides that are presented by MHC I derive from proteins that are synthesized by the cell's own ribosomes. The proteins or polypeptides that generate these peptides are referred to as *endogenous*, whereas peptides that derive from proteins or microorganisms that are phagocytosed are termed *exogenous*. It has been widely accepted that endogenous antigens trigger a CD8<sup>+</sup> class I restricted response, whereas exogenous antigens activate CD4<sup>+</sup> class II restricted cells. However, several examples over the years have detected class I restricted CD8<sup>+</sup> T-cell responses with dead phagocytosed viruses, bacteria,

transplants, dead cells, and others, which were handled by the immune system as exogenous antigens and were targeted to the endocytic system ( [173](#) ). This has been known as *cross-priming*, which was originally described in mice that were immunized with cells that expressed minor histocompatibility antigens ( [174](#) ). Today, it is also known as *cross presentation*. Several examples exist for CD8<sup>+</sup> responses that are induced with dead viruses ( [175](#) ) or purified proteins ( [176](#) ). Hepatitis B surface antigen, given by the exogenous route and submitted to efficient endolysosomal processing, can lead to peptide loaded MHC class I molecules ( [177](#) ). An interesting example of cross presentation is the uptake by APCs of antigens that are chaperoned by HSP ( [178](#) ). HSPs are highly conserved peptide-binding molecules that control the folding of proteins and prevent their aggregation. HSP-70 that is complexed with a variety of synthetic peptides is taken up by APCs and elicits CD8<sup>+</sup> T-cell class I restricted antitumor cytolytic responses ( [179](#) ). The HSP-peptide complexes are internalized by a receptor-mediated mechanism and are subsequently processed by a proteasome-dependent TAP-dependent mechanism or through the endosomal route ( [180](#) ). This is a highly efficient mechanism whereby antigens that follow an exogenous route induce strong CD8<sup>+</sup> responses against tumors ( [181](#) ) or viruses ( [182](#) ). Peptides that are introduced into the cytosol induce a strong class I restricted response only if they are chaperoned by HSP but not alone ( [183](#) ). Receptors for HSP have been detected on CD11b<sup>+</sup> cells ( [184](#) ), and, recently, the receptor was identified to be the CD91 protein for all HSPs ( [185](#) ) (see [Chapter 2](#)). CD91 is a receptor for a  $\gamma$ -macroglobulin and, with calreticulin, binds and stimulates uptake of apoptotic cells ( [186](#) ); together, they act as receptors for the collectin family, and, through them, organ clearance is regulated to enhance removal of apoptotic cells and cell debris ( [187](#) ). It is postulated that HSP-peptide complexes that are given by the exogenous route might be used in the future to elicit protective immunity against cancer on viruses ( [188](#) ). Although macrophages, DCs, and B cells have been reported to be able to mediate cross presentation, the evidence collectively suggests that the most important cell is a DC. Interactions between CD4 and CD8 T cells that interact with the same APC are apparently needed ( [189](#) ). Cross-priming is involved, predominantly in response to virus infection, cancer cells, and histoincompatible tissues. Although cross-priming is associated with an immune response, depending on the nature of the antigen (e.g., normal healthy cellular antigens), cross presentation leads to the opposite of the immune response—cross-tolerance.

## Processing Antigen for Class II Presentation

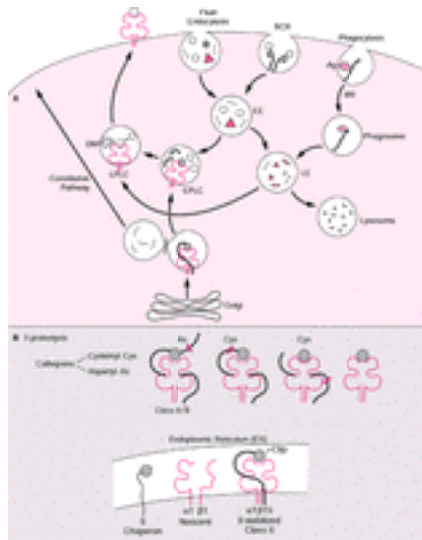
### BIOSYNTHESIS OF MAJOR HISTOCOMPATIBILITY COMPLEX CLASS II MOLECULES

Expression of class II MHC molecules is restricted mainly to certain cell types, such as macrophages, DCs, and B lymphocytes. However, MHC class II molecules can be induced in other cells by IFN- $\gamma$ . Regulation of MHC class II molecule expression occurs at the level of transcription. Many factors that regulate their expression are DNA binding and are ubiquitously expressed ( [190](#) ). An important mediator is the MHC class II *trans*-activator molecule (CIITA) that is not a direct DNA-binding molecule and is detected in cells that express class II, constitutively or after induction with IFN- $\gamma$ . CIITA also regulates the expression of the Ii chain and HLA-DM molecules. The MHC class II molecules and Ii chain are cotranslationally inserted into the membrane of the ER through a signal peptide. Once in the ER, the Ii forms trimers through the association of its luminal sequence, followed by association with MHC II, forming nonamers ( [191](#) ). Ii is a type II membrane protein (NH<sub>2</sub>-terminus at the cytosolic face of ER) and is associated rapidly with three MHC class II molecules ( [192](#) ), which are added sequentially. A central region of the Ii, which is termed *CLIF*, occupies the peptide-binding region of MHC class II. The MHC

class II-Ii association conceals a motif that retains Ii into the ER, and, as a result, the nonamer complex moves to the Golgi apparatus (193). Leucine (Leu) signals in Ii bind the AP-1 and AP-2 adaptors (194), but more than one sorting mechanism probably exists, depending on the cell type. The MHC class II-Ii complexes are targeted to late endosomes (195, 196), possibly with an intermediate stopover, on the cell membrane or on the early endosome. Permanent localization in the early endosomes (by exchanging the cytoplasmic tail of Ii with that of transferrin receptor) blocks class II presentation, indicating that late endosomes or lysosomes provide the appropriate milieu for class II presentation (197).

### GENERATION OF ANTIGENIC PEPTIDES FOR CLASS II MAJOR

**HISTOCOMPATIBILITY COMPLEX PRESENTATION** Proteolytic breakdown of exogenous antigen in the endocytic pathway is essential for peptide loading. Specific uptake involves endocytosis and phagocytosis, mediated by various receptors in different cells, such as the B-cell receptor (BCR) in B cells, mannose receptors and Fc receptors in macrophages. The mannose receptor recognizes patterns of carbohydrates on the surface of the cell wall of infectious agents, and this increases dramatically the efficiency of class II-mediated presentation by DCs (Fig. 18.7).



**Figure 18.7.** Processing and presentation for major histocompatibility complex (MHC) class II. Pathogens or their products are captured by phagocytic or dendritic cells and are carried to the interior of the cell enclosed within endocytic vesicles. **A:** Endocytosis may be mediated through receptors, such as the mannose receptor (MR) or a B-cell receptor (BCR), such as antigen (Ag)-specific immunoglobulin, or may be simply carried along with fluid. Depending on the method of entrance, they end up within typical phagosomes or early endosomes (EEs). The endocytic pathway is relatively complex, which is reflected in changes of their composition and pH. There is a dramatic morphologic change from a simple vesicle to multilamellar and multivesicular compartments that are known as *MHC class II compartments*. The endocytosed material is targeted to early peptide loading compartment (EPLC) and late peptide loading compartment (LPLC), vesicles with class II MHC. Their conformation and groove are maintained by the invariant (Ii) chain in EPLC and HLA-DM in LPLC. The MHC class II molecule is synthesized in the endoplasmic reticulum (ER) and its conformation is stabilized by the chaperon protein Ii chain. A region of Ii that is termed *class II-associated invariant chain peptide (CLIP)*, occupies the groove and prevents the collapse of MHC class II molecules. MHC class II molecules and Ii exist as nonamers. The complex moves out of the ER, passes through the Golgi apparatus, and reaches the EPLC, where the Ii chain is proteolytically destroyed, but CLIP still remains in the groove. Exchange of CLIP with the antigenic peptide is catalyzed by the nonclassical HLA-DM protein. In the last step of this long and tortuous path, the MHC class II-peptide complex is delivered to the plasma membrane by the EPLC vesicle, where it interacts

with the appropriate T-cell receptor on CD4<sup>+</sup> T cells. **B:** Proteolysis of the Ii chain is mediated by cathepsins, which cleave at a cysteine or aspartic acid residue. LE, late endosome.

The endocytic route that is taken by endocytosed foreign material consists of a complex network of compartments that vary in morphology, physiochemical properties, and content. Three major regions, however, can be distinguished: the early endosomes with slightly acidic pH are barely proteolytic; the late endosomes are more acidic and contain some components that are classically used as markers of lysosomal compartments, LAMP-1 and LAMP-2 and the lysosomes that have a low pH and are rich in hydrolytic enzymes. This route is intersected by another route that originates in the *trans*-Golgi network (TGN). This route is taken by molecules that come out of the ER, and, depending on specific signals such as dileucine or mannose-6-phosphate, they follow the secretory pathway on the way to the cell membrane or secretion. Foreign antigens that enter the endocytic pathway are subject to gradual proteolysis, which may generate peptides that are suitable for receptive MHC class II molecules ( [198](#) ). Antigens follow different routes in the endocytic pathway, and antigen processing is different ( [199](#) ). “Exit tracks” from the endocytic pathway join the constitutive secretory pathway for reaching the membrane. Proteolytic activities along the endocytic pathway are acquired progressively. Acidification is an important factor for protein unfolding, and, as the pH decreases progressively, it influences several steps in the processing of incoming antigens and in peptide loading, such as protease activity, MHC class II molecule aggregation, peptide receptivity, and function of chaperones HLA-DM and HLA-DO. Antigen processing is primarily carried out by proteases, and most of the lysosomal proteases are known as *cathepsins*. The final peptide that is suitable for loading on to MHC class II molecules is prepared by the action of the protease alone or with the assistance of the MHC molecule. A *protease-guided* initial step breaks down large proteins into smaller polypeptide chains, which may partially be accessible to MHC class II molecules. At this point *MHC class II-guided* processing allows the protease to trim down unnecessary protrusions outside the binding site ( [200](#) ). Several proteases exist within the endocytic system, endoproteases and exoproteases, and some cooperation between them is anticipated ( [201](#) ). It appears that the first key protease is a Cys endopeptidase that cleaves after Asn residues ( [202](#) ). Once this enzyme takes the first step, other enzymes complete the digestion for the generation of peptides.

#### PEPTIDE LOADING ON THE MAJOR HISTOCOMPATIBILITY COMPLEX II MOLECULE

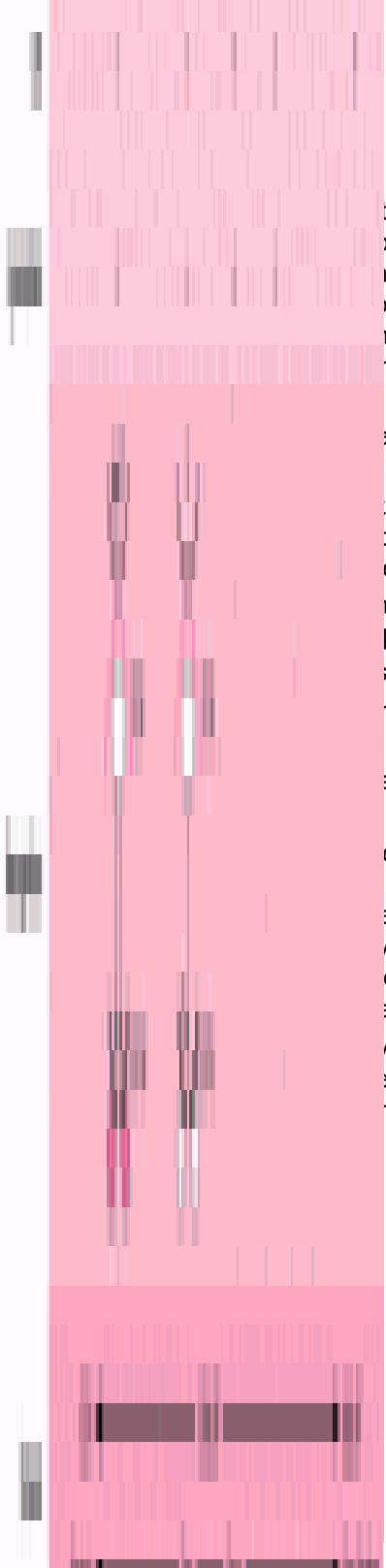
As indicated in the section [Class II Molecules](#), the MHC class II molecule arrives in the endocytic system as a nonamer with the Ii chain. The CLIP region of Ii is inserted in the peptide-binding groove and prevents interaction with ER-resident proteins or other proteins on the way to the endosomes. CLIP also keeps the MHC class II molecule stable until the time of peptide loading. The precise location of the peptide loading within the endocytic system has been debated for a long time. Electron microscopic studies demonstrate that the MHC class II molecule is found throughout the endosomal pathway, including mannose-6-phosphate-positive late endosomes and in late endosomes and lysosomes, a compartment that is rich in MHC II but negative for the mannose-6-phosphate receptor, which is known as *MIIC*. This compartment consists of vesicles 200 to 300 nm in diameter with heterogeneous morphology, such as multivesicular, multilamellar, tubulovesicular. Various functional stages of MIICs are distinguished on the basis of the Ii detection, for example, in some of them, the intact Ii chain is detected; in others, only the amino-terminal region is detected; and, in others, the Ii chain is absent. Loss of the Ii chain is associated with a change from multivesicular to multilamellar MIIC ( [203](#) ). Another endocytic compartment, which is known as the *CIIV* (for class II vesicles), from a B-cell line is similar to MIIC. Both are considered the site for peptide loading ( [204](#) ). The MIIC compartment is set aside from the remaining endosomal vesicles, and several endocytic markers are absent. These vesicles receive newly synthesized MHC class II molecules by virtue of the targeting motif of the Ii chain. Once they arrive, the Ii targeting motif is removed (C-terminal region), and the MHC II-Ii



complex is retained within the MIIC for prolonged periods of time ( 205 ). The MHC class II compartment is particularly abundant in DCs, which are the professional APCs. The first step in the peptide loading is the digestion of the Ii chain in the MHC class II-Ii chain nonamer complex ( Fig. 18.7 ). The carboxyterminal region of Ii is cleaved by a protease that releases an MHC class II-Ii trimer ( 206 ). Ii degradation occurs in an orchestrated fashion until only the CLIP remains attached to the MHC class II molecule. Proteolysis proceeds in two stages, and, for proteolysis of the second intermediate, different cathepsins are used in different APCs. Of the lysosomal enzymes, cathepsin S plays an essential role in the degradation of Ii in B cells and DCs, and its absence has major consequences for the onset of humoral immune responses ( 201 ). Cathepsin L, on the other hand, is expressed on thymic epithelial cells ( 207 ). Removal of CLIP from the peptide binding groove and subsequent loading with antigenic peptide is catalyzed by the nonclassical class II HLA-DM, which binds directly to MHC class II-CLIP complex ( 79 ), near the N-terminus of MHC class II ( 208 ). It is thought that the DM induces a transitional “open” state to the MHC class II groove that releases CLIP. This occurs by disruption of a few H-bonds between MHC class II and CLIP ( 209 ). It is intriguing that HLA-DM does not interact with MHC class II that is associated with intact Ii chain. The HLA-DO molecule is a negative regulator of HLA-DM, and, when it is overexpressed, it results in an accumulation of MHC-CLIP complexes. MHC class II-peptide complexes are transported to the cell surface by vesicles, the movement of which depends on the cytoskeletal elements. MIIC transport is microtubule dependent ( 210 ). Microtubules are assembled from  $\alpha\beta$  tubulin heterodimers in the microtubule organizing center and extend toward the periphery. A large family of motor proteins, which are known as *kinesins*, mediate transport of vesicles of the secretory pathway, cytotoxic granules, lysosomes, etc. On microtubules, kinesin transports vesicles towards the plus (+) end of the microtubule (the end away from the microtubule organizing center, towards the cell periphery). Another group of proteins, dynein, creates motion towards the negative (-) end of the microtubule ( 211 ). Thus, dynein is important to keep vesicles around the nucleus, because inhibition of its function shuttles all the vesicles to the cell membrane. How and when the vesicular movement is regulated is unknown. In monocytes, IL-10 triggers positioning of MIIC in the cell, but, in B cells, the BCR performs this function. The signal for kinesin to transport the mature MIIC—that is, the MIIC that is loaded with the peptide—to the cell surface is unknown. It is also intriguing that only MHC class II-peptide complexes are detected on the cell surface but not the other contents of the MIIC vesicle.

## Antigen Presentation by CD1

CD1 was first identified in human cortical thymocytes but later was detected on other cells, such as on antigen-presenting DCs, and CD1a is expressed on Langerhans cell (LC), a specialized DC in the epidermis ( 212 ). CD1c is detected on a subset of peripheral blood B cells and B cells of the marginal zone, and CD1d is expressed in intestinal epithelia and in a wide variety of hematopoietic cells. The members of the CD1 family are antigen-presenting molecules, and, after their synthesis, they must first reach an appropriate vesicular compartment for peptide loading on the way to the cell surface. There are striking differences in the intra-cellular distribution of the CD1 isoforms ( 213 , 214 ). CD1a is found mainly on the cell surface but also in early endosomes ( 215 , 216 ) and in LCs that are present in the Birbeck granules. Together with CD1d, CD1b accumulates in the late endosomes and lysosomes, whereas CD1c is found in the early endosomes (transferrin receptor positive). The ratio between surface expression and intracellular concentration also varies between the isoforms. The differential expression of the isoforms is regulated by a Tyr-based motif in the intracellular region that is present in all isoforms except CD1a ( 217 , 218 ). This sequence, YXXZ (Y represents Tyr; X represents any amino acid; and Z represents an amino acid with bulky side chains), interacts with a



targeting signals for adaptor proteins AP-1–AP-4 (219). AP-2 is positioned in the plasma membrane from TGN to the endosomal–lysosomal system, whereas AP-2 is positioned in the plasma membrane, where it directs proteins to clathrin-coated pits that enter the endocytic pathway. The AP-3 is implicated in the sorting of proteins to lysosomes and lysosomes. The AP proteins determine the final destination of the CD1 molecules, but the binding to a specific AP member is determined by signals that surround the Tyr-based motif (220). The YXXZ motif is found in proteins that target to endosomal and lysosomal compartments, because mutations in this sequence inhibit presentation of mycobacterial antigens. Although the YXXZ motif predicts the final destination, it does not always get followed. The CD1d first follows a direct route from the TGN, through the YXXØ motif (Ø represents phenylalanine), it is rapidly internalized and is directed to the MIIC compartment (Mantelinguo et al., 2001), which is closely associated with lysosomes and may represent a fusion product of these compartments. CD1d is associated with the invariant chain, which is processed in this compartment independently of the Tyr-based motif (221). The invariant chain is degraded by cathepsin S to allow loading of the CD1d and to facilitate antigen presentation (222, 223).

Antigens presented by CD1 molecules are lipids and glycolipids (Fig. 18.8). Long-chain, branched, free fatty acids and constitute the thick outer layer of the mycobacterial cell wall. It confers resistance to mycobacteria. They contain approximately 80 carbon atoms and are required for mycobacterial survival. In addition to mycolic acid, arabinomannan (LAM) and lipomannan are large molecules composed of many sugar residues and are presented also by CD1 molecules (224). Other antigens presented include phosphatidylinositol mannosides and glycosylated monomycolate.

**Figure 18.8.** Microbial glycolipid presentation to T cells. The CD1 molecule, an orphan family of major histocompatibility complex (MHC)-like molecules, presents long carbon-chain glycolipids from mycobacteria and other similar pathogens, to natural killer T cells (NKT), T-cell receptor (TCR)- $\delta$ , and TCR- $\alpha\beta$  cells, linking innate and adaptive immunity. The CD1 molecules are expressed in various compartments of the endocytic system, providing a broad surveying mechanism for the detection of intracellular mycobacterial infections. Localization of CD1 molecules depends on endosomal targeting sequences for loading of glycolipids. The glycolipids in general consist of a hydrophilic head of carbohydrate molecules and one or two lipid tails. The head interacts with the TCR, whereas the lipid tails are accommodated within the large groove of the CD1 molecules, penetrating into two deep pockets. Ag, antigen;  $\alpha$ -Glc,  $\alpha$ -galactosylceramide; GMM, glucose monomycolate; H-1 PIP, hexosyl-1-phosphoisoprenoid; LAM, lipoarabinomannan; M- $\beta$ 1-PhDo, mannosyl- $\beta$ 1-phosphodolichols.



The first identification of the CD1 role in the presentation of glycolipids was on a double negative T-cell line that was isolated after repeated stimulations with crude *Mycobacterium tuberculosis* antigen ( [225](#) ). Only later was it found that the presentation requires the loading of mycobacterial antigens in acidified late endosomes and lysosomes. Mycobacteria are taken up by phagocytosis and reside within nonacidified phagosomes (due to a paucity in the vacuolar H<sup>+</sup> ATPase). Therefore, they are restricted in their capacity to fuse with late endosomes and lysosomes ( [226](#) ). The macrophage mannose receptor that has been implicated in glycolipid uptake by APC ( [227](#) ) is absent from mycobacterial phagosomes.

The mechanism of distribution of various mycobacterial antigens to the subcellular compartments is not well understood. LAM has been found in late endosomes and lysosomes, either by being released from the phagosome or after uptake from the extracellular environment by the mannose receptor ( [227](#) ). Nevertheless, mycobacterial antigens are distributed throughout the endocytic system after their release from the phagosome ( [228](#) , [229](#) ). Antigens that are released from phagocytosed mycobacteria reach various compartments of the endocytic lysosomal system, where all CD1 isoforms, that is, CD1a, CD1b, and CD1c, gain access to mycobacterial glycolipids at these different sites ( [Fig. 18.8](#) ). CD1a and CD1c sample the antigens in phagosomes that are arrested in the early endosomal stage, whereas CD1b samples antigens in phagosomes that are arrested in the late mature phagolysosome stage ( [112](#) ). The CD1 molecule binds the lipid antigens by accommodating the first two lipid tails within the hydrophobic groove, whereas the hydrophilic caps (sugars) are exposed to the solvent and directly contact the TCR ( [230](#) ). The buried surface of the groove, as determined from crystallographic studies, is 1400 Å<sup>2</sup>, which could optimally accommodate a lipid with 32 carbons in length. However, some of the antigens that are presented by CD1 are 44 carbons long, and the mycolic acids are 80 carbons long. Presentation of large lipids takes hours (trafficking to late endosomes), whereas the same antigens with shorter chains are presented rapidly but inefficiently from the cell membrane ( [231](#) ). DCs specialize in the presentation of lipids with long alkyl chains, whereas nonprofessional APCs present preferentially short-chain glycolipids. The acidic environment of the late endosomes and lysosomes is an important factor in the interaction of the large lipid antigens with the groove. The properties of the CD1b protein are dramatically altered in an acidic pH to facilitate the interaction with its ligands. There is a reversible unfolding of the α-helical portions of CD1 in an acidic pH, which permits the direct binding of the hydrophobic portions of the molecule, thus burying the alkyl chains ( [232](#) , [233](#) ). The depth, enclosed nature, and hydrophobicity of the interior of the CD1 groove is well adapted to carry out antigen presentation of lipids and amphipathic glycolipids, for which the hydrophobic component is sequestered within the groove, whereas the carbohydrates are left outside to interact with the TCR.

The structure of glycolipids is altered by APC. Terminal glycosyl residues are removed from certain glycolipids, resulting in the exposure of epitopes that are reactive with TCR ( [234](#) ). Glycosylation also generates new antigens, as is the case of glycosylation of mycolic acids during mycobacterial infections, with the use of glucose from the host and a mycobacterial enzyme ( [235](#) ). Glycolipid processing generates a large variety of lipid ligands for presentation by CD1 proteins ( [236](#) ).

In addition to bacterial glycolipids (i.e., LAM) and glucose monomycolate, CD1b molecules recognize self-glycosphingolipids, such as GM1 ganglioside ( [237](#) ). Several of these gangliosides can bind to CD1b, and, in striking contrast to bacterial glycolipids, the

self-glycolipids bind on the cell surface without the need of the late endosome and lysosome acidified environment ( [238](#) ). Five or more oligosaccharide groups are required to stimulate TCR recognition with a large component of the ligand that is exposed. Apparently, these gangliosides act as blockers to prevent harmful autoreactivity. The number of these autoreactive T cells increases in multiple sclerosis ( [237](#) ).

**CD1 SYSTEM IN MICROBIAL IMMUNITY** The protective value of CD1-mediated immunity is currently under intensive investigation ( [239](#), [240](#) and [241](#) ). The CD1<sup>+</sup> cells correlate with the level of immunity to *Mycobacterium leprae* and are present in the lesion tenfold more abundantly in the tuberculoid form (immunologically responsive) than they are in the lepromatous form (immunologically unresponsive). Low numbers of CD1<sup>+</sup> cells correlate with low granulocyte-macrophage colony-stimulating factor (GM-CSF) levels and high IL-10 levels, which inhibits GM-CSF secretion. GM-CSF is a key differentiating factor for mature CD83<sup>+</sup> DCs ( [232](#), [242](#) ). CD1-restricted T cells contribute to intracellular bacterial infections, such as *M. tuberculosis*, based on high levels of IFN- $\gamma$  secretion and strong cytolytic activity. The CD1 isoforms survey broadly the endocytic system over pathways that are distinct from those of MHC class I and MHC class II molecules, and, furthermore, they are restricted to presentation of an important class of antigens, lipids, which are not covered by the MHC molecules. Among them, CD1c is particularly important, because it is expressed on LCs (in the absence of CD1b) and B cells (without CD1a or CD1b) ( [243](#) ).

## DENDRITIC CELLS

DCs, as their name indicates, are characterized by their long and elaborate cytoplasmic branching processes (the Greek word *dendron* means *tree*). The adaptive immune system under evolutionary pressures developed cells with exquisite specific receptors, for sensing components of pathogens, to generate molecular and cellular effector mechanisms for their elimination. Sensing of the pathogens or their products requires their breakdown (processing) and presentation by cells of the innate immunity. Foremost among the APCs are the DCs ( [244](#), [245](#) and [246](#) ). DCs are a highly heterogeneous group that resides in most peripheral tissues at sites at which the body interfaces with the environment (i.e., skin, intestine, respiratory mucosal). Although DCs, like other hematopoietic cells, ultimately derive from bone marrow progenitors, partially differentiated precursors are outside the bone marrow, such as peripheral blood, cord blood, and thymus. Such progenitors that are exposed *in vivo* to bacterial or inflammatory products, cytokines, etc., differentiate to more mature cells with DC morphology and function. This large plasticity of DC development has created confusing and sometimes contradictory results. Basically, there are two lines of differentiation from stem cells, one along *myeloia* lineage and another along *lymphoia* lineage; thus, the generation of two prevailing terms: *myeloid DC* and *lymphoid DC*. DC precursors circulate in the peripheral blood with a monocytic phenotype CD14<sup>+</sup>CD11c<sup>+</sup>CD13<sup>+</sup>. These cells, cultured *in vivo* in the presence of GM-CSF and IL-4, give rise to the DCs that are considered as *myeloid DCs*. However, the same precursors that are cultured with fibroblasts differentiate to macrophages ( [247](#) ). IL-6 that is released from fibroblast in contact with the monocytic precursors up-regulates the macrophage colony-stimulating factor receptors. This switches differentiation to macrophages, by an autocrine mechanism, based on the secreted macrophage colony-stimulating factor. Progenitors from cord blood that are considered lymphoid with the potential to differentiate to NK cells could give rise *in vitro* to phenotypically and functionally potent DCs under the stimulation with various cytokines ( [248](#) ). *In vitro* studies may not represent the normal *in vivo* pathways of differentiation but, nevertheless, provide evidence that, *in vivo* also, partially differentiated cells of different lineages may choose a DC differentiation pathway when they are exposed to appropriate conditions. The stimuli for DC differentiation vary widely, from

inflammatory microbial products ( [249](#)) to simply crossing endothelial barriers ( [250](#)). DCs that develop within the thymus are CD8<sup>+</sup> and considered to be of lymphoid origin. However, it is documented that even myeloid DCs can also express CD8, therefore CD8 expression does not define lineage origin ( [251](#), [252](#)). Origin from lymphoid precursors was suggested by a unique DC that is known as a *plasmacytoid T cell* or *plasmacytoid monocyte*. These cells have a typical plasma cell-like morphology; lack expression of myeloid markers; and are CD11c<sup>-</sup>, CXCR3<sup>+</sup>, and L-selectin (CD62L)<sup>+</sup>. DCs are heterogeneous with respect to their phenotype, anatomic distribution, and function.

Functionally, DCs have been distinguished into two groups, DC1 and DC2; the former derives from myeloid monocytes (pre-DC1), and the second derives from a plasmacytoid DC precursor (pre-DC2) ( [253](#)). This separation correlates with functional differentiation. Myeloid DCs from monocytes that are activated by the CD40 ligand (CD40L) produce large amounts of IL-12 and induce preferentially T<sub>H</sub>1 development. Lymphoid DC2s from plasmacytoid precursors produce lower amounts of IL-12 and preferentially induce T<sub>H</sub>2 development ( [254](#), [255](#)). Another study, however, reached opposite conclusions ( [256](#)), suggesting that the two DCs represent two separate evolutionary traits. The pre-DC1s express the toll-like receptor (TLR)-2 and TLR-4, and preDC2s express TLR-7 and TLR-9 ( [257](#)).

Pre-DC1s are strongly positive for mannose receptor and rapidly produce large amounts of proinflammatory cytokines, such as TNF- $\alpha$ , IL-6, and IL-12, in response to ligands of TLR-2—bacterial glycoproteins. Pre-DC2s produce IFN- $\gamma$  in response to ligands of TLR-9—bacterial DNA ( [258](#)). The origin, response to stimuli, and pathways of differentiation of DCs vary greatly, depending on conditions that are still poorly understood.

The precursors of DCs from bone marrow progenitors move to the periphery as *immature* DCs and take position at crucial sites of potential entry of pathogens. Once they capture antigens and are exposed to stimuli, they *mature* and migrate to regional lymphoid organs to present antigens and to activate the adaptive immune responses by presenting antigens that are brought from the periphery. DCs are the professional APCs in immunity.

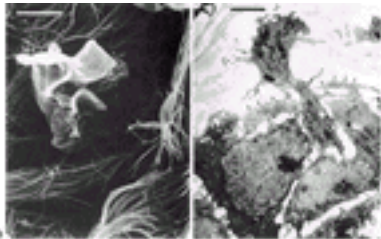
### Migration of Dendritic Cells

DCs are cells that are continuously on the move from the moment they come out of the bone marrow to settle in various organs and tissues as immature DCs. In these locations, they are easily exposed to antigens and invading pathogens, and, now as mature, activated DCs, they migrate to the lymphoid organs. Each of these pathways is orchestrated by distinct sets of molecules and receptors, foremost among them being the chemo-kines and their receptors.

Circulating monocytes and immature DCs express receptors for inflammatory chemokines (CXCR-1, CCR-1, CCR-2, and CCR-5), as well as receptors for bacterial and complement chemoattractants (receptor for *N*-formyl-methionyl-leucyl-phenylalanine-R and C5a-R) ( [259](#)), and, in response to such mediators, they develop into DCs ( [260](#)). The crossing of the blood wall by DC precursors is mediated by a DC-specific adhesion molecule that is known as *DC-specific intercellular adhesion molecule (ICAM)-3 grabbing nonintegrin (DC-SIGN, or CD209)*. DC-SIGN is a novel cell surface C-type lectin that is expressed on DCs, binds ICAM-3, and mediates interactions between DCs and T cells ( [261](#)). The extracellular region of DC-SIGN has a C-terminal, C-type carbohydrate recognition domain, particularly for mannose. DC-SIGN interacts with ICAM-2 on the endothelial cells and establishes shear-resistant contacts with blood vessel walls for the

transmigration of the DCs ( [262](#) ). The DC–SIGN–ICAM–2 interaction is involved in the bloodborne DC precursor exit into peripheral tissues and in tissue mature DC to peripheral lymphoid tissues. In the skin and epithelia of lung, intestine, etc., immature DCs are exposed to stimuli that trigger their maturation, such as cytokines (TNF- $\alpha$ , IL-1) and microbial products [e.g., lipopolysaccharide (LPS)].

The mature DCs change to a new phenotype (MHC II  $^{+++}$ , co-stimulatory and adhesion molecules positive) and acquire new migratory capacity. As a result, they migrate to the T-cell areas of the regional lymph nodes. DCs first down-regulate CCR-1 and CCR-5 [receptors for macrophage inflammatory protein (MIP)-1 $\alpha$  and MIP-1 $\beta$ ] up-regulate CCR-7 and become responsive to secondary lymphoid tissue chemokine (SLC) and Epstein-Barr virus-induced molecule 1 ligand chemokine (ELC), the ligands for CCR-7 ( [263](#), [264](#) ). Maturing DCs first move from their interstitial location to afferent lymphatic capillaries, where SLC is secreted from the endothelial cells and is carried to draining lymph nodes. The migratory pathways of the LCs, the DCs of the epidermis, provide a vivid example of the exquisite regulation of DC migration ( [Fig. 18.9](#) ) ( [265](#) ).



**Figure 18.9.** Migration of dendritic cells. **A:** A Langerhans cell that is migrating through the labyrinthine space of the dermis, guided by chemo-kine signals that are received by its chemokine receptors. **B:** The Langerhans cell penetrates into the dermis through a hole ( *between the two groups of arrows* ) in the basement membrane ( *asterisk* ). (From Romani, et al. *Inter Rev Cytol* 2001;207:237–270, with permission.)

The LC precursors, CD11  $^{+}$  and CD1a  $^{+}$  ( [266](#) ), are recruited into dermis, depending on the selectin expression of the dermal blood vessels ( [267](#) ). These cells express the CCR-6 receptor, which binds the inflammatory chemokine MIP-3 $\alpha$  (CCL-20) that is produced by keratinocytes of the epidermis ( [268](#), [269](#) ). The LCs remain in the suprabasal layer, physically connected to neighboring keratinocytes by homotypic interactions that are mediated by E-cadherin that is expressed by keratinocytes and LCs. Concomitantly, the CCR-6 is down-regulated, and the CCR-7 is up-regulated, which allows the LCs to move toward the lymphatic vessels in response to SLC. The basement membrane of the skin, however, stands as a barrier to their migration. LCs penetrate the lamina densa, which consists of type IV collagen and is digested by the matrix metalloproteinase of LCs. They cross the dermis and reach the abluminal side of the vessels. Entry into the lymphatic vessel is poorly understood, but P-glycoprotein may be involved.

LCs are carried by the lymph and acquire morphology that is known as a *veiled cell*, as a result of their broad sail-like membranous sheets. Entering the lymph node, they settle in the T-dependent areas in response to SLC (CCL-21) and ELC (MIP-3 $\beta$ , CCL-19), ligands for the CCR-7 receptor. SLC is produced by the endothelial cells of the high endothelial venule ( [Chapter 15](#) ), and ELC is produced by DCs or other cells in the paracortex ( [270](#) ). The LCs that settle in the paracortex are known as *interdigitating DCs (IDCs)*.

Accumulation of DCs around tumors follows the same mechanisms that fully depend on the interaction between chemokines that are released by tumors and the appropriate receptors on DCs ( [271](#) ).

## Dendritic Cell Functions

DCs are best known for their efficient antigen presentation function. They capture antigens and pathogens, which they internalize and process for antigen presentation. DCs use a variety of receptors to take in antigens, such as receptors for Fc and complement, macrophage-scavenger receptors, mannose receptors, and DEC-205. However, of all the receptors that the DCs use to endocytose pathogens, the best studied is the DC-SIGN receptor that binds to HIV ( [272](#) ). HIV is not endocytosed by the DC, but the DC-SIGN binds to gp120 envelope glycoprotein, and the DC transfers the HIV to the lymphoid organs, where it enhances infection of T cells that express CD4 and chemokine co-receptors. DCs are efficient APCs for the class II restricted pathway, but endocytosed antigens can also be diverted to the class I-restricted pathway. This is known as *cross-priming* or *cross presentation* (see the section [Presentation of Exogenous Antigen by Major Histocompatibility Complex Class I Molecules](#)). Immature DCs are crucial for this mechanism of presentation.

Interaction with pathogens by immature DCs not only prepares naïve T cells for priming, but also activates immature DCs for maturation. This is mediated by signaling receptors, such as the toll-like receptors (TLRs) of innate immunity (i.e., TLR-2 that is involved in response to gram-positive bacterial components or TLR-4 that interacts with LPS in response to gram-negative bacteria). An interesting example of the diversity of responses to a single bacterial protein by immature DCs is the bacterial cell wall protein OmpA (from *Klebsiella pneumoniae*). This protein triggers maturation signaling of immature DCs through the TLR-2 receptor, endocytosis via receptor-dependent mechanism, and cross-priming antigen specific CD8<sup>+</sup> T cells (in the absence of CD4<sup>+</sup> T-cell help) ( [273](#) ).

DCs, however, are not simply antigen-delivering cells for lymphocytes. They play a key role in the maintenance of T and B lymphocyte pools in the absence of exogenous antigen.

For T cells, this function depends on the high density of MHC class II molecules ( [274](#) ). It is postulated that the MHC class II molecules display self-peptides, and the interaction generates and transmits signals that are sufficient for the survival of T cells and could be traced from the cell surface to the nucleus (increase of IL-12R  $\beta_2$ -chain and IFN- $\gamma$  mRNA). Contact between DCs and naïve T cells in the absence of antigen is established by the interaction of DC-SIGN (DCs) and the ICAM-3 (T cells) ( [261](#) ). This strong interaction allows the establishment of interactions with other adhesion molecules to form the immunologic synapse. These synapses are antigen independent and induce local Tyr phosphorylation, small Ca<sup>2+</sup> responses, and long-term survival ( [275](#) ).

DCs can regulate differentiation of naïve B cells. In the initiation of the antibody response, a three-cell interaction takes place between T, B, and D cells with various combinations of cell surface-expressed molecules. This gives time to B cells to process and present peptide through its class II MHC molecules, for a cognate T and B cell interaction ( [276](#) ). DCs directly modulate growth and differentiation of B cells and enhance 30- to 300-fold IgG and IgA secretion, whereas, in response to IL-2, they produce large amounts of IgM ( [277](#) ). IL-2 is a key cytokine that is produced early after DC stimulation



by maturation signals ( [278](#) ).

## Dendritic Cells in Human Disease

DCs accumulate in the joints of rheumatoid arthritis and within psoriatic plaques, which express high levels of CD1b and CD1c, and are active stimulators of autologous T-cell proliferation. In contact allergy, hapten-modified proteins are processed by LCs that migrate to draining lymph nodes and initiate immune responses. A similar pathway is taken by DCs in the respiratory airways that capture and process inhaled antigens in asthma. The DCs are significantly higher in asthmatics. Targeting DCs may be an important new therapeutic approach for asthma.

In human parasitic infections, immature DCs can phagocytose the organism and restrain parasite replication in dermal infiltrates.

The role of DCs as potentiators and initiators of antiviral immune responses is well documented, especially in stimulating recall of cytotoxic T-lymphocyte responses. Nevertheless, viruses still survive within DCs and subvert the immune response by down-regulation of MHC class I molecule expression, induction of immunosuppressive cytokines (IL-10), or down-regulation of immunostimulatory cytokines (IL-12). In the pathogenesis of HIV disease, the DC-SIGN acts as a dendritic-specific HIV-1 binding protein that does not need a co-receptor and promotes binding and transmission of HIV-1 to T cells rather than entry to DCs. The virus is retained in an infectious state but is not allowed to enter the DC. DC-SIGN literally presents HIV to T cells in a nonprocessed infectious form. Various carcinomas display a heavy infiltrate of DCs with high MHC class II molecule expression that is associated with better prognosis. DCs have been used in trials in cancer therapy. Prospects for future successful DC immunotherapy are promising ( [279](#) ). T-cell immunity can be induced, even in patients with advanced stage IV melanoma by vaccination with antigen-pulsed mature monocyte-derived DCs ( [280](#) ). When the DCs are loaded with MHC class II molecule-binding melanoma peptides, strong tumor-specific T<sub>H</sub>1 responses were elicited.

In a large body of literature regarding animal models, DCs that were loaded with tumor-associated antigens were able to induce antitumor immunity ( [281](#) ). Measurements of CD8<sup>+</sup> T cells by using MHC tetramers ( [Chapter 3](#) ) help quantify antigen-specific responses ( [282](#) ).

## Langerhans Cells

LCs were first observed in the epidermis by Langerhans and can be identified only by means of special stains, making use of the affinity of the cell for heavy metal ions or the uptake by the cell of L-dopa, dopamine, and noradrenaline ( [283](#) ). The demonstration of a formalin-resistant and sulfhydryl-dependent ATPase is a reliable and specific technique for identifying LC. Their ultrastructure was described first by Birbeck et al. ( [284](#) ), who also described a characteristic granule that bears his name.

LCs constitute 3 to 8% of all cells in the epidermis and are present in all parts of the skin, esophagus, and cervix; they are not found in the cornea, trachea, stomach, or bladder. In humans, the number of LCs per unit of skin varies between 40,000 and 100,000/cm<sup>2</sup>. Their precursors originate in the bone marrow, and, in the mature stage, they are located in the suprabasal layers of the skin, within the epidermis, where they can be distinguished from keratinocytes on the basis of absent desmosomes and tonofilaments and from

melanocytes by the absence of melanosomes.

The long dendritic processes form a continuous network. The nucleus is irregular and lobulated. The cytoplasm is clear and contains microfilaments and multivesicular bodies, as well as the unique Birbeck granule, which is rod shaped with periodic striations, giving it the appearance of a zipper. LCs are present in the dermal lymphatics, the marginal sinus, and the paracortex of draining lymph nodes, which suggests that these cells are mobile (see the previous discussion).

Mature LCs express a granule-associated antigen, E-cadherin ( [285](#) ), and HLA-D antigens. Ultraviolet irradiation depletes the skin of LCs and blocks the induction of contact sensitivity.

### Veiled Cells

*Veiled cells* are present in the afferent lymph and resemble LCs ( [286](#) ). Their name derives from the possession of long, actively moving processes or veils that are approximately 100 nm thick. The veils do not contain organelles, and their movement must therefore be generated at a distance. Their nucleus is highly convoluted, and the cytoplasm contains bundles of microfilaments. Only approximately 4% of veiled cells contain a Birbeck granule, but all possess a large vacuole under the cell surface. They elicit a strongly positive response when they are tested for ATPase, and they resemble LC in the content of other enzymes. They are not actively phagocytic, but they possess Fc receptors.

After contact sensitization, Langerhans-like cells appear in the dermal lymphatics, and an increase in the number of veiled cells in the lymph that drain the area is noted. Once in the lymph node, most veiled cells localize in the T-cell-dependent areas, where they may function as interdigitating cells. Some veiled cells enhance the response of T lymphocytes to mitogens. Their function possibly consists of transporting antigens into the paracortical area, where they present them to T lymphocytes. Thus, a cellular chain for antigen transport exists in which more than one cell type takes part. Starting from the floor of the subcapsular sinus, antigen is localized first in cells that have the appearance of LCs, but, in deeper regions of the cortex, a second cell with morphologic characteristics of veiled cells has been identified ( [287](#) ). These two cells are similar to the cells that are known to migrate from skin areas to the paracortex ( [288](#) ).

### Interdigitating Dendritic Cells

The T-cell-dependent areas of the lymphoid organs contain substantial numbers of DCs that are known as *IDCs* ( [286](#) ). They have a clear cytoplasm and an irregularly shaped nucleus and extend long dendritic processes to contact T cells. They express MHC class II antigens but do not express receptors for the Fc fragment of Ig and complement. IDCs are positive for CD83 and the S100b protein (cytoplasm). The name usually is reserved to describe cells that lack Birbeck granules.

Many common features are shared by IDCs and DCs from other compartments (e.g., skin and splenic white pulp). This led to the view that a single DC system exists in which the peripheral non-lymphoid organs' DCs migrate to the T-cell-dependent areas and become IDCs ( [289](#) ). This has been shown by labeling DCs that are isolated from the spleen of mice and injecting them into footpads. The labeled cells migrated to the periarteriolar sheath of the spleen or paracortex of the lymph node ( [290](#) ). DCs from the skin that is painted with hapten migrate within 24 hours to the lymph nodes ( [291](#) ).

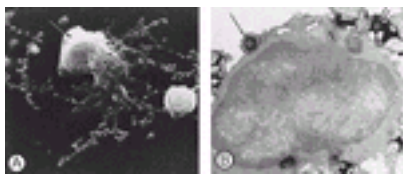


Similarly, *Leishmania* parasites that are injected into the skin are found within IDCs in the T-cell areas of the lymph nodes, probably as a result of uptake of the parasites by skin DCs that migrated to the lymph nodes to become IDCs ( [292](#) ). In patients with skin allergies, one finds Birbeck granules in some IDCs of local lymph nodes. Also, the T-cell areas stain strongly for CD12, a marker that is expressed on LCs. This evidence supports the notion that LCs migrate from areas of the skin to the T-cell areas of regional lymph nodes. Transportation of antigen from the periphery to lymph nodes is not only characteristic of the skin DC but is also a function that is performed by intestinal DCs and other DCs in the periphery.

### Follicular Dendritic Cells

Follicular dendritic cells (FDCs) are found in the follicles and germinal centers (GCs) of lymph nodes and were identified by a distinct dendritic pattern of antigen localization in the follicles ( [293](#) ). Antigen trapping in the follicles requires antibody with an intact Fc fragment and complement. The antigen that is so trapped persists for long periods, in contrast to the antigen that is captured by the medullary macrophages. Cytologically, the FDCs have an irregular nucleus, a narrow rim of cytoplasm, and filiform dendrites, giving the cell the sunburstlike pattern ( [294](#) ). On their surface, they express Fc and C3 receptors and MHC class II antigens.

Electron microscopic studies identified two FDC types: FDC with filiform dendrites, which mature to an FDC with beaded dendrites ( [295](#) ). After secondary immunization, FDCs form spherical particles that are called *iccosomes* (immune complex-coated body) ( [Fig. 18.10](#) ). The iccosomes are formed through interactions of two FDC types. One cell binds immune complexes, and the second cell with beaded dendrites binds to the areas of the complexes. Thus, the *bead* becomes coated with the complexes and the cytoplasmic membrane of the first FDC that carries the complexes. At this stage, the bead is filled with immune complexes and is subsequently detached as iccosomes that are dispersed among the cells of a developing GC. This process constitutes what is called the *alternative antigen presentation pathway* ( [295](#) ) to distinguish it from the more conventional antigen capture and presentation.



**Figure 18.10.** Follicular dendritic cell and iccosomes. **A:** Scanning electron micrograph that illustrates a follicular dendritic cell ( *arrow* ) with beaded dendrites. Each dendrite contains several iccosomes. **B:** Transmission electron micrograph of a lymphocyte from the germinal center with two iccosomes in contact with its surface ( *arrows* ). (From Szakal AK, Kosco MH, Tew JG. A novel in vivo follicular dendritic cell-dependent iccosome-mediated mechanism for delivery of antigen to antigen-processing cells. *J Immunol* 1988;140: 341–353, with permission.)

Antigen complexes are poor immunogens because they deliver a down-regulatory signal to the B cell that is related to the phosphorylation of the immune receptor Tyr-based inhibitory motif on the B-cell Fc receptor ( [296](#) ). However, the FDC strongly expresses FcR, and it is conceivable that, as FDC binds to complexes, it limits the available Fc on

the complexes for binding to the FcR on B cells. FDC also delivers co-stimulatory signals to B cells, probably through complement-derived fragments, C3dg and C3d, which are associated with the FDC-bound complexes. Complement fragments bind on B cells to complement receptor 2 (CR2, CD21), which is a member of the CD19/CD21/TAPA-1 complex, a co-receptor of the B-cell antigen receptor ( [Chapter 16](#)) ( [297](#) ). Thus, the FDC-associated complexes co-ligate the antigen BCR and the CD19/CD21/TAPA-1 co-receptor, providing two signals for B-cell stimulation.

The CD21 exists in two isoforms, one long and one short. FDCs express selectively the long isoform of CD21, whereas the short molecule is expressed by B cells. CD21 on FDC most likely participates in binding of complexes. The FDC-dependent B-cell stimulation is enhanced by IL-2.

FDC traps and retains large numbers of retroviral particles ( [298](#) ), which markedly alter the function of FDC and the anatomy of the follicle. Infected FDC brings the virus and CD4<sup>+</sup> T cells together, promoting their infectivity. The antigen presentation function of FDC is lost, and, eventually, the cells are destroyed.

There are two views on the origin of FDCs: One proposes a hematopoietic origin, whereas the other proposes a mesenchymal-fibroblast origin. FDCs have a fibroblastic morphology and express certain molecules, such as vimentin and desmin, which are found in mesenchymal tissues. FDCs are also found in areas of chronic inflammation ( [299](#) ). As of today, there is no convincing evidence for either theory. For the time being, FDCs continue to be defined as the cells in the follicles of lymphoid organs that have the property to trap complexes of Ig and antigen. The reticulum cells within the GCs were thought to be different from those in the mantle, but, by ultrastructural studies, DCs in GCs and those of the mantle zone (or primary follicles) are considered to be of the same family ( [300](#) ).

## GEOGRAPHY OF T-B CELL INTERACTIONS

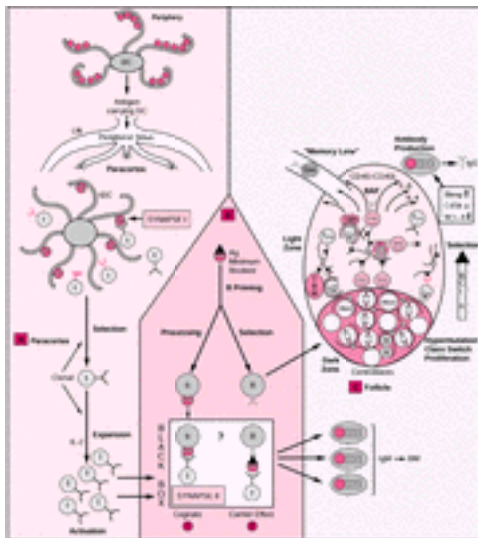
Immune responses are regulated by the dose and the localization of antigen ( [301](#) ). Furthermore, for T and B lymphocytes that need to collaborate, recognition of antigen by their antigen receptors is not sufficient to activate them, but a second signal (co-stimulation) is required. T lymphocytes are in the paracortical areas, and the most abundant APCs in the paracortex are the IDCs.

The complexity of the mechanisms that are involved in activation of naïve T cells *in vivo* was elucidated with TCR transgenic T cells ( [302](#) ). When antigen is injected in the absence of an adjuvant, T-cell activation does not take place or is too small in intensity and short in duration and therefore is nonproductive. *Nature's adjuvants* are the DCs, which are interspersed in the tissues behind the physical barriers of the body. In these locations, DCs are immature but nevertheless are still phagocytic and are able to capture pathogens or their products. Under these conditions and further possible stimulation by inflammatory cyto-kines, DCs transform into mature DCs, and although they may have lost their phagocytic capacity, they have acquired two new important properties. First, they change their chemokine receptors to migrate to the T-cell areas of the draining lymph nodes. In addition, they acquire co-stimulatory molecules (CD80 and CD86), adhesion molecules (CD48 and CD58), and class II MHC molecules that are loaded with peptides from newly internalized antigens are expressed on the cell membrane. In addition to these molecular immunologic changes, morphologic signs of their activated state become apparent, with long cytoplasmic dendrites reaching out between T cells. This morphologic appearance contributed to their name as *IDCs*. Inflammatory cytokines, such as TNF- $\alpha$ , that are

released from activated macrophages contribute to the activation of DCs ( [303](#), [304](#) and [305](#) ) and up-regulate CD40 expression on DCs ( [306](#) ), which further promotes interaction with CD40L<sup>+</sup> T cells ( [307](#) ).

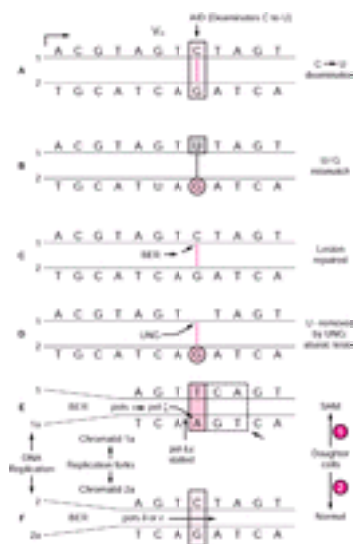
Activated DCs lead to significant immune responses, whereas immature DCs can be tolerogenic, as is shown with healthy human volunteers. Immature DCs inhibit CD8<sup>+</sup> T-cell immunity to viral peptide-specific IL-10-producing T cells ( [308](#) ). In contrast, mature DCs (triggered by a mixture of macrophage products, such as IL-1 $\beta$ , IL-6, TNF- $\alpha$ , and prostaglandin E<sub>2</sub>) induce functionally superior CD8<sup>+</sup> T cells and polarize CD4 T cells toward IFN- $\gamma$  production.

Maturation stimuli direct co-stimulatory molecules and MHC class II-peptide complexes to membrane microdomains (“lipid rafts”), where they are able to interact more efficiently with the CD28 and TCR as the DCs and T cells form the immunologic synapse ( [Chapter 17](#) ) ( [309](#), [310](#) ). This is the *first cognate interaction*, which takes place between DCs and T cells in the paracortical area and results in full activation of T cells ( [Fig. 18.11](#) ). Co-stimulatory signaling amplifies the TCR signaling to as much as 100-fold, as T cells respond to lower doses of antigen (approximately 100-fold lower dose). The co-stimulatory pathway up-regulates bcl-x<sub>L</sub> and prevents Fas-mediated apoptosis of newly activated T cells ( [311](#) ). Co-stimulation enhances production of IL-2 from activated T cells and induces expansion of antigen-specific T cells.



**Figure 18.11.** Chance and necessity: the germinal center reaction. Antigen (Ag) captured in the periphery by dendritic cells (DCs) is brought to the regional lymph nodes to be presented to naïve T cells (t) (synapse I). Clonally selected naïve T cells become activated by interleukin (IL)-2 (T). They up-regulate the CXCR5 receptor, respond to BLC chemokine that is secreted from follicular cells, and move toward or even inside of the follicle ( [Chapter 15](#) ). In the border between the paracortex and the mantle of the follicle, they interact with B cells. The interactions are not yet well characterized *in vivo*. Some B cells process antigen and may present it to T cells that are selected by DCs (synapse II) ( [1](#) ). B cells may have been selected by the same antigen but for a different epitope. B and T cells may bind to the same immunogen but on different epitopes (“carrier effect”) (synapse II) ( [2](#) ). Synapse II promotes differentiation of plasma cells that secrete immunoglobulin (Ig) M. B cells move inside the follicle to the pole that is adjacent to the T-cell zone (dark zone) and begin intensive proliferation. They are Ig negative and

are called *centroblasts*. B cells undergo mutations in the V gene at a high rate (somatic hypermutation) ( Fig. 18.14), and they change their IgM to another Ig class (class switch) ( Fig. 18.13). When proliferation subsides, centroblasts move to the center of the germinal center—that is, the light zone—and are known as *centrocytes* (Ig positive). Their B-cell receptor (BCR) is submitted to the scrutiny of antigen-antibody complexes on dendrites of DCs of the densely populated light zone. In most centrocytes, somatic hypermutations have decreased or destroyed the affinity of their BCR and enter the pathway for apoptosis. Their corpses are removed by macrophages that are known as *tingible body macrophages* (TBM). If the affinity is increased, they are given the green light for survival and growth (BAFF, IL-6, IL-4, CD40-CD40L). Surviving cells have higher affinity than their predecessors ( *affinity maturation*). They receive signals from germinal center DCs or follicular T helper cells (T<sub>FH</sub>). Depending on the instructions that are received, some centrocytes go down the memory lane, whereas others become plasma cells. Two genes are most influential in the regulation of germinal center reaction: B-cell lymphoma 6 (BCL-6) in the early phase represses all genes that regulate the second state; the B-lymphocyte-induced maturation protein-1 (Blimp-1) is released from repression when BCL-6 is down-regulated by high-affinity BCR signals. Blimp-1 regulates plasma cell differentiation. b, naïve B cell; B, primed, antigen-specific B cell; BAF, B-cell activating factor of the TNF family; BM, bone marrow; CIITA, major histocompatibility complex class II *trans*-activator molecule; IDC, interdigitating dendritic cell.



**Figure 18.14.** Somatic hypermutation. The immunoglobulin M of B cells that leave the bone marrow is of low affinity and has been selected before exposure to antigen. The need to improve the affinity is satisfied by another round of B-cell receptor diversification in the germinal centers, after exposure to antigen. In the dark zone of the germinal centers, mutations are introduced in the V gene at a rate of one million times faster than natural mutations; thus, it is called *somatic hypermutation* (SHM) (see the chapter text for details). During SHM, double-strand breaks occur in the DNA, as well as rapid gene transcription. Furthermore, for SHM, the immunoglobulin gene promoter is essential, as is an enzyme, activation-induced deaminase (AID). AID removes the NH<sub>2</sub> group of deoxycytosine (dC) (A), forming deoxyuracil (dU) (B). The change generates a dU/deoxyguanosine (dG) mismatch (B). The lesion may be repaired by the base excision repair (BER) (C), and mutation is prevented. However, dU may be removed by another enzyme, uracil-DNA glycosylase (UNG). In this case, the DNA strand remains in one spot that is unoccupied by any base (abasic lesion) (D). High-fidelity DNA polymerases (pols) (i.e.,  $\alpha$  or  $\epsilon$ ) are stalled at the abasic lesions, and a promiscuous error-prone pol (i.e.,  $\delta$  or  $\zeta$ ) takes over. It usually places a deoxyalanine (dA) on the sister chromatid, opposite to the abasic lesion (E). The positioning of thymidine (T) opposite dA repairs the lesion, but

pol continues over the lesion (“translesional pols”), altering the bases downstream. This generates a cluster of mutations that are close to the dU excision. As a result, one of the daughter cells is normal (F), whereas the other (with the abasic lesion) has mutational changes (E). V<sub>H</sub> variable region of the heavy chain.

The factors that drive these two processes are the levels of MHC class II-peptide complexes and, therefore, the TCR stimulation and the intensity of co-stimulation; both are related to the stability of the synapse ( 312, 313 and 314 ). Recurrent and sustained exposures to antigen and to polarizing cytokines are essential for differentiation of CD4<sup>+</sup> T cells ( 315 ). Early withdrawal of antigenic stimulation arrests differentiation, even in the continued presence of cytokines. For T<sub>H</sub>1 differentiation, prolonged signaling is required to induce appropriate epigenetic modifications to maintain high levels of T-bet expression ( Chapter 17, see the section on T<sub>H</sub>1 and T<sub>H</sub>2 differentiation).

An important aspect of T-cell differentiation involves antigen selection of a TCR-restricted repertoire ( 316 ). This was clearly shown in the immune response against pigeon cytochrome C, in which the specificity is determined by the CDR3 of the TCR α-chain. Out of eight preferred CDR3 features that are rapidly selected early during the response, only one (TCR-α93 glutamic acid) existed to any significant extent before immunization. This TCR restriction and clonal dominance is antigen driven and is propagated by expansion of one or a few clones from the postthymic repertoire.

This selective T-cell expansion for effector and memory function takes place in the T-cell zone, before the GC reaction. Inflammatory cytokines, particularly IL-1 or TNF-α, also mediate some of these effects through CD28 co-stimulation by up-regulating expression of CD80 and CD86 on DCs.

After the peak of clonal expansion, the number of antigen-specific T cells falls owing to cell death, which may occur via Fas-dependent or activation-induced cell death ( 316 ). For the antibody response to continue, T and B cells, which are specific for different epitopes of the same antigen, must move from their separate locations to meet. Of the surviving activated T cells, most of them move out of the lymph node as memory T cells, but a small portion migrates to the edges of the paracortex next to the follicle, while B cells also move to the same location ( 317, 318 ). Chemokines and their receptors are the main regulators of primary immune responses, setting the stage for the main players, as well as orchestrating their performance. CCR-7 is the most important to organize the appropriate microenvironment to make the initial interaction possible ( 319 ). As multiple cells contribute to an immune response, change in the chemokine receptor program regulates the second stage in the cell interactions for antibody synthesis. CCR-7 is the receptor for chemokines SLC (6Ckine, exodus2, CCL-21) and ELC (MIP-3β, exodus3, CCL-19). SLC is secreted by the cells of high endothelial venules and mediates the crossing of T cells to the lymph nodes. ELC is secreted by stromal cells of the paracortex and attracts naïve T cells to settle within the T-cell areas ( Chapter 15 ). DCs in the peripheral tissues up-regulate CCR-7 expression as part of their maturation and are guided to the paracortical areas. The CXCR-5 is the receptor for chemokine BLC (CXCL-13), which is secreted by stromal cells in the follicles and attracts B cells that cross the high endothelial venules to settle in the follicular area. Activated CD4<sup>+</sup> T cells up-regulate CXCR-5 and migrate toward and into the follicles ( 320, 321, 322, 323 and 324 ). Whether the T-cell-B-cell interaction takes place on the paracortical side ( 318 ) or the follicular side ( 317 ) of the T-cell-B-cell border is not clear. The fact is that the two cells physically interact ( *second cognate interaction* ), forming a synapse by adhesion molecules and supported by co-stimulatory molecules, including the inducible co-stimulator (ICOS) on

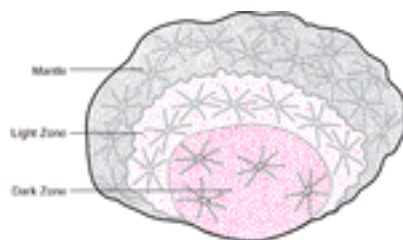


activated T cells and its counterreceptor B7-h on B cells ( [325](#) ).

## GERMINAL CENTER REACTION

Interaction of B cells with activated T cells initiates their proliferation and migration into the area within the primary follicle, which is now called the *secondary follicle*. Some of the activated B cells differentiate at the edge of the T-cell zone into plasma cells, secreting IgM and migrating to the medullary cords and on to the bone marrow. Plasma cell differentiation in this area could also be induced in a T-cell-independent way, especially from antigens that are known as *T-cell-independent antigens*. The IgM antibody is part of the early phase of antibody production ( [326](#) ). The remaining antigen-specific B cells are recruited within the follicle and rapidly expand to form the *GCs* ( [327](#), [328](#) and [329](#) ). The GCs are oligoclonal, and, with a cell cycle time of the dividing B cells of approximately 6 hours, the number of accumulating blasts within 3 days is in the order of  $1$  to  $1.5 \times 10^4$ . During this exponential growth, the small recirculating B cells are excluded and are pushed aside to form the familiar *mantle* that surrounds the GC. By the time the B blasts finish their exponential growth, they have filled the FDC network that is close to the T-cell zone, which is known as the *dark zone*, and the B blasts are known as *centroblasts*.

Centroblasts are  $Ig^-$  and give rise to nondividing  $Ig^+$  cells, which are known as *centrocytes*, which occupy the center of the follicle or the *light zone*. Light zone has been divided into an *apical* (FDC  $CD23^{2+}$ ) and a *basal* component (FDC  $CD23^-$ ) ( [Fig. 18.12](#) ).



**Figure 18.12.** The germinal center. Dark zone: centroblasts in cell cycle. Light zone: strong expression of CD23 on dense follicular dendritic cell (FDC) network. Mantle: loose FDC network.

Several important events for the life of B cells take place in the GCs: *clonal expansion*, *somatic hypermutation (SHM)*, resulting in affinity maturation, *Ig class switch*, and generation of *memory B cells* and *plasma cells*.

B cells express the CXCR-5 receptor for chemokine BCL and BCA-1 (CXCL-13), which is secreted constitutively by cells within the DC network and is home to the follicular area. Furthermore, the DC-specific chemokine DC-CK1 (CCL-18, also known as *PARC*) attracts preferably  $CD38^-$  mantle zone B cells toward the FDC and may well provide the initiation signal for the formation of GCs ( [330](#) ). Responsiveness to the BCA-1 chemokine is also shown by a subpopulation of memory  $CD4^+$  T cells that express the CXCR-5 receptor for the BCA-1 chemo-kine and, as a result, are attracted to the follicles. They are known as *follicular T helper cells* ( $T_{FH}$ ) ( [321](#), [322](#) and [323](#) ). The expression of CXCR-5 is transient and occurs before T-cell proliferation during T-cell activation.

DC-CK1 (CCL18), a chemoattractant for B cells and  $CD4RA^+$  T cells, contributes to the multicellular interactions between DCs, T cells, and B cells in the initiation of humoral

response. The FDCs are strongly positive for CD21 and CD23 and form a dense network in the light zone. In the dark zone, they are weakly positive for CD21 and negative for CD23, and they form a light network. The FDCs express the long isoform of CD21, which is the only specific marker for human FDCs, whereas the B cells express only the short isoform. FDCs trap immune complexes and present antigen to B cells, although the B cells can undergo somatic mutation and memory cell formation, even in the absence of complexes ( [331](#) ), probably by other signals that are received from FDCs, which support B cells in the immune response in several ways. Engagement of CD21 in the BCR by complement in the antigen-antibody complexes augments the stimulation that is delivered by FDCs ( [332](#) ). Furthermore, engagement of the Fc $\gamma$ RIIB on DCs diverts binding of the complexes from the same receptor on B cells. Fc $\gamma$ RIIB is an inhibitory receptor, and, thus, by trapping the complexes, the FDCs protect B cells from inhibition ( [332](#) ), although mRNA for Fc $\gamma$ RIIB could not be detected in B cells ( [333](#) ).

There is cross talk between FDC progenitors and B cells, because B-cell signals contribute to FDC maturation and network development. LT- $\alpha$ , LT- $\beta$ , TNF- $\alpha$  from B cells and TNFR-1 expression by some non-bone marrow derived cells lead to FDC cluster formation in the lymphoid organs ( [334](#) ).

Because FDCs have no phagocytic activity and do not synthesize MHC class II molecules, they are unable to present peptides that are complexed with MHC after processing of internalized antigens. However, there are two other ways that FDCs perform their antigen-presenting function. Cytochemically, antigen has been detected on FDCs along filiform or beaded dendrites. The beads, like pearls on a string, are particles that contain immune complexes, which are called *icosomes* (immune complex coated body), which are usually detected in the early phase of the formation of the GCs ( [295](#) ). Complement in the complexes binds to CD21 on FDC (a member of the CD19/CD21/CD81 co-receptor complex), which delivers a crucial signal that dramatically augments the stimulation that is delivered by the binding of antigen to BCR. FDCs have no phagocytic activity and do not synthesize MHC class II molecules and therefore are unable to process antigen for presentation ( [335](#) ). MHC class II, however, has been detected on the surface of FDCs in the form of microvesicles that contain MHC class II molecules and other antigen that are foreign to the FDC ( [336](#) ). These vesicles are exosomes that are enriched in MHC class II molecules and members of the tetraspan family (i.e., CD37, CD53, CD63, CD81, and CD82) ( [Chapter 2](#) ). The exosomes derive from multivesicular endosomes that are released by B cells with specificity for attachment to DCs and the ability to stimulate CD4<sup>+</sup> T cells ( [337](#), [338](#) ). This is an interesting example of cell communication, antigen processing, and presentation for T-cell activation. FDCs therefore have a dual mission for B-cell response within the GCs: antigen processing and presentation to B cells and promotion of B-cell differentiation and isotype switching ( [339](#), [340](#) ).

In addition to FDCs, T cells have a critical role in the GC formation, primarily for the late stages of GC reaction and not during the initial development ( [341](#), [342](#) ). GCs that are induced in the absence of T cells are of short duration, and the V genes of the antibodies do not undergo hypermutation. The GCs abort dramatically at the time when T cells normally select the high affinity B cells ( [341](#) ). The demise of the GCs at this point is a fail-safe mechanism to prevent autoreactive B cells from escaping in the periphery with development of autoimmunity.

In the dark zone, lymphocytes are densely packed, and only fine FDC processes penetrate this area. The FDCs in the dark zone are CD23<sup>-</sup> and only weakly CD21<sup>+</sup>. The centroblasts are in rapid cell cycle and do not increase in number but give rise to a progeny of *centrocytes* that are nondividing and express surface Ig. Centrocytes are



located in the light zone and are CD21 strongly positive and CD23 moderately to strongly positive. In this stage of the evolution of the GC, the B cell is selected for survival or death, based on the affinity of the antigen receptor as the cell emerges from changes that are induced to the receptor by hypermutation (see the following discussion).

## B Cells in Germinal Centers: Struggle for Survival

Proliferation of B cells in the GCs is stimulated by antigen, but different mechanisms regulate the proliferation in the two GC zones, dark versus light. The paucity of T cells in the dark zone suggests that this early, expansive B-cell phase is supported by strong stimulatory signals from complement-containing immune complexes, FDC-B-cell cognate interactions, and soluble factors from FDCs ( 343 ). In the light zone, T<sub>FH</sub> cells play a more important role, and, although the density of FDCs is much higher, some FDCs are inhibitory for B-cell activation. GCs after primary immunization develop within 4 to 6 days, and centroblasts in the dark zone continue to maintain a high output of centrocytes for 7 to 14 days ( 344 ). The centroblasts undergo SHM that results in antigen receptor diversification.

The decision between life or death, a process known as *selection*, takes place within the light zone as the B cell emerges from the dark zone. The mechanism of selection is not yet clear, but antigen that is trapped on FDCs is used to “test” the affinity of the BCR of the centrocytes. A key determinant for selection is the CDR3, which has a major contribution to diversity and affinity of the receptor. Structurally identical receptors are handled differently if variations in CDR3 exist between them, and such variations drive the selection process ( 345 ). The vast majority of these random mutations is deleterious to antigen binding and destroys or diminishes the affinity of the BCR that existed when the antigen-specific B blast entered the dark zone from the paracortex-follicular border. These cells are negatively selected and are diverted to apoptosis.

Other cells have acquired autoreactivity, and these cells receive no signals from FDCs and therefore die from “neglect” ( 346 ). Of the cells in which BCR expresses reactivity with antigen, some emerge from the mutational process with high affinity, and only those are positively selected to achieve *affinity maturation*. Affinity maturation was discovered 35 years ago ( 347 , 348 and 349 ) and remained poorly understood until somatic diversification of BCR genes in the GCs was demonstrated ( 350 ). Affinity maturation signifies the increase of the affinity of antibodies between those that are produced early after primary immunization (low affinity) and those that are produced 2 weeks after immunization or better after secondary immunization (high affinity). Affinity maturation is associated with somatic diversification that occurs during hypermutation. As shown from studies in mice, the D and J regions of the H chain (16 amino acids long) of the antibodies that are synthesized 7 days after immunization have no residue changes that could be attributed to mutations. However, in the 14 days, antibodies carry somatic mutations that have caused an increase in the affinity ( 351 , 352 ). Positive selection of these high affinity antibodies constitutes affinity maturation.

## Survival of the Fittest

One of the puzzling phenomena that is related to the life of B cells after their release from the bone marrow is the fact that approximately 70% of them do not reach maturation and die. B-cell survival and maturation relies on the delivery of signals, most importantly through BCR, and survival depends on a mechanism of positive selection ( 353 ). The immature B cells that leave the bone marrow undergo a progressive maturation process that takes the cell through three stages, which are known as *transitional stage type 1*

(*T1*, *type 2 (T2)*, and *type 3 (T3)*) ( [354](#), [355](#)). T1 cells are IgM<sup>hi</sup>, IgD<sup>-</sup>, CD23<sup>-</sup>, and CD21<sup>lo</sup>, and T2 cells are IgM<sup>hi</sup>, IgD<sup>hi</sup>, CD23<sup>+</sup>, and CD21<sup>hi</sup> ( [356](#)).

Although the location and mechanism by which this huge number of B cells perish has not been identified, it is possible that a prime location is the light zone in which the mechanism of cell death is by apoptosis as a result of a BCR that is incapacitated by hypermutation.

B cells require and receive multiple signals from different cells and molecules for survival. The cognate interaction between FDCs and B cells provides signals through antigen presentation (albeit weak), as well as through several receptor–ligand pair interactions, such as ICAM–lymphocyte function–associated antigen–1, vascular cell adhesion molecule–1–very late antigen–4, and CD23–CD21 ( [357](#)).

In addition, DC stimulates B–cell proliferation and Ig synthesis, which are mediated by the CD137–ligand system ( [358](#)). CD137 is a member of the TNF receptor family that is expressed by FDCs and stimulates the CD137 ligand–expressing B cells by reverse signaling.

### Long Live the BAFFed Germinal Center B Cell

An important, recently described B–cell survival factor that is known as the *B–cell activation factor member of the TNF family (BAFF)*, promotes maturation of B cells and prolongs their survival and, under certain conditions, B–cell growth ( [359](#), [360](#) and [361](#)). BAFF is also known as *B–lymphocyte stimulator*, *TNF and apoptosis ligand–related leukocyte–expressed ligand 1* ( [362](#)), or *TNF homolog that activates apoptosis, NF– $\kappa$ B, and c–Jun NH<sub>2</sub>–terminal kinase* ( [363](#)). BAFF forms a trimerlike TNF, as other members of the family, but its unique feature is the presence of two Mg<sup>2+</sup> ions. The gene for BAFF is located in human chromosome 13q34, a location that is frequently involved in translocations in Burkitt lymphoma. BAFF exists as a membrane–bound form and as a soluble form. It is closely related (approximately a 50% similarity) to another TNF family member, a proliferation–inducing ligand (APRIL). Both BAFF and APRIL bind to two receptors, B–cell maturation antigen (BCMA) and transmembrane activator and calcium modulator and cyclophilin ligand interactor (TACI) with high affinity, but preferences by the ligands have been detected ( [364](#)), with BAFF being associated more often with TACI and APRIL than with BCMA ( [365](#)). A third receptor, which is called *BAFF–R*, binds selectively BAFF and not APRIL. BCMA, TACI, and BAFF–R are located on human chromosomes 16p13.1, 17p.11.2, and 22q13.2, respectively.

Structural analysis of the three receptors and the phenotypes of mice that are deficient in each one have shown that BAFF transmits the survival signal to transitional cells through the BAFF–R and not through BCMA or TACI ( [366](#)). All three receptors are devoid of death domains, and BAFF–R is devoid of TNF receptor–associated factor (TRAF) binding domains. TRAFs are adaptor proteins that mediate transmission of downstream signaling in the activation of NF– $\kappa$ B and mitogen–activated protein kinase (MAPK) pathways. BCMA, however, activates NF– $\kappa$ B through binding of TRAF–5 or TRAF–6 but not TRAF–2 ( [367](#)).

Action of NF– $\kappa$ B is associated with strong antiapoptotic function that regulates the end stages of B–cell maturation, Ig class switching, GC organization, and other processes ( [368](#)). In the absence of the TRAF binding domain, BAFF–R uses the C–terminal sequence for survival signaling. Replacement of the last C–terminal amino acids results in loss of

BAFF-R function and of peripheral blood B cells in mice (strain A/WySn) ( [369](#) ).

The mechanism of action of BAFF is not stimulation of B-cell proliferation but promotion of survival, probably by increasing BCL2 expression ( [370](#) ). Loss of signaling by NF- $\kappa$ B blocks up-regulation of BCL2. Mice that are deficient in c-Rel and Rel A, which are members of the NF- $\kappa$ B family of transcription factors, have a block of B-cell maturation and are similar to mice that lack BAFF or BAFF-R. BCL2 expression rescues these mice from B-cell deficiency ( [371](#) ). BAFF acts on the T2 transitional stage of B-cell maturation and on marginal-zone B lymphocytes. In mice that are transgenic for BAFF, the T2 and marginal-zone compartments of B cells are enlarged. The effect of BAFF on various transitional stages of B cells is regulated by different downstream mediators, mainly, however, by up-regulation of the antiapoptotic genes A1 and bcl-x<sub>L</sub> in marginal zone cells. The net result is a proportional increase in the survival of the cells that traverse each stage ( [372](#) ).

An important consequence of protracted action of BAFF is the development of autoimmunity as a result of excessive survival of T2 B cells. The levels of BAFF in the sera of patients with SLE, rheumatoid arthritis, and Sjögren syndrome are elevated ( [373](#) , [374](#) ). In some of these patients, the BAFF and APRIL have been found in the serum in the form of active heterotri-mers ( [375](#) ). The pathogenetic relationship between these two members of the TNF family and the levels of various autoantibodies was shown by the fact that their levels were correlated with titers of the autoantibodies in Sjögren syndrome, such as the levels of Ig, rheumatoid factor, and anti-skin-sensitizing antibody ( [376](#) ).

Chronic infection may lead to sustained release of BAFF and emergence of autoreactivity. BAFF therefore appears to be critically involved in certain antibody-mediated autoimmune diseases. Most studies have concentrated on the roles of BAFF and APRIL on B cells. However, APRIL also acts on T-cell survival by a mechanism that involves up-regulation of BCL2 ( [377](#) ) and BAFF; although it does not appear to deliver a typical survival signal, it acts nevertheless on T-cell co-stimulation ( [378](#) ).

APRIL is up-regulated in many tumors (colon, prostatic carcinoma) and promotes tumor growth ( [379](#) ), but a soluble form of BCMA and TACI counteracts the action of APRIL and inhibits tumor growth ( [380](#) ). The enhancement by APRIL of tumor growth may be due to up-regulation of BCL2 or signals that are delivered by inflammatory cells in the neighborhood of the growing tumors by cells, such as monocytes (which express APRIL), that provide optimal conditions for growth of some tumors, such as Burkitt lymphoma ( [381](#) ).

The tumor promoter function of APRIL contrasts to functions of many other TNF-related ligands. The difference in the level of expression of APRIL between normal and neoplastic cells is dramatic. Because adenocarcinoma cells lack any detectable expression of BCMA or TACI, it is likely that another APRIL receptor exists in these tumors. Because BAFF and APRIL promote the survival of B cells and the development of autoimmunity, the inflammatory milieu of an autoimmune reaction supplies paracrine signals for the development of malignancies on an autoimmune background ( [365](#) ), a connection that was identified clinically many years ago ( [382](#) ).

## Follicular T Helper and Germinal Center B Cells

The CD4<sup>+</sup>CD45RO<sup>+</sup> recently activated T cells in the blood cross into the lymph nodes, and, because they have down-regulated CCR-7 and have acquired instead the CXCR-5 receptor, they respond to the call from DCs in the GCs—that is, to chemokine CXCL-13 (BLC and BCA-1) ( [321](#) ). In the GCs, they become known as *T<sub>FH</sub> cells*. In this location, T<sub>FH</sub> cells express high levels of CD40L, a co-stimulatory molecule that is required for B-cell activation and Ig class switch, as well as for the induction of ICOS. CD28 is required for naïve T cells to differentiate into effector GC T cells and for subsequent primary antibody response. Secondary B-cell responses and continuous B-cell activation depend on the CD28 homolog, ICOS—that is, T-cell help is delivered for B cells in an orderly sequence of interactions ( [383](#) ). The importance of ICOS for sustained B-cell proliferation is reflected in the ICOS deficient mice that have no GCs after secondary immunizations.

Memory T<sub>H</sub> cells, after repeated antigenic challenges, emerge with restricted V-region genes and preferred CDRs that confer peptide specificity ( [384](#) ). The memory T cell acquires a functional potential of cytokine secretion early in the primary response, but the delivery of these functions is highly regulated and complex.

T-cell memory is an “operational property of the whole animal or immune system” ( [385](#) ), and, under this broad definition, the requirements for its maintenance and the delivery of specialized functions, although precisely regulated, depend on complex microenvironmental influences.

B-cell proliferation and differentiation is down-regulated by cytotoxic T lymphocyte-associated protein-4 (CTLA-4), a negative regulator for B-cell proliferation. CTLA-4 is sequestered in a late or post-Golgi endosomal compartment and is available for rapid delivery to the cell surface, where it interacts with B7 ligands ( [385](#) ). Interaction with B7 causes phosphorylation of one of the Tyr-containing sequences of CTLA-4 that binds the SRC homology 2 (SH2) domain of the Syp phosphatase. Syp dephosphorylates signaling molecules in the vicinity of TCR, dampening or inhibiting completely the TCR signaling pathway ( [386](#) ).

### **CD40 and CD40 Ligand (CD154) Interactions**

CD40 and CD40L (CD154) are members of the TNF superfamily and play a crucial role in T-dependent and T-independent humoral immune responses. The CD40 gene is localized in chromosome 20q11-13.2. CD40 is homologous to TNF receptor, and CD40L is homologous to TNF. [For details of the structure and expression of CD40 and CD154 (CD40L), see [Chapter 2](#)].

CD40 is expressed on DCs and B cells, and CD154 is expressed on T cells. The CD40-CD154 interaction is critical for T-cell activation and development of the T<sub>H1</sub> and T<sub>H2</sub> responses ( [387](#), [388](#), [389](#) and [390](#) ). The extracellular region contains four Cys-rich domains, and the intracellular region contains distinct sites for binding the adaptor proteins, TRAF-1, TRAF-2, TRAF-3, TRAF-5, and TRAF-6 and a separate site for direct binding of Jak-3 (the Janus family of protein Tyr kinases).

CD40 engagement delivers signals along two broad pathways: TRAF dependent and TRAF independent. TRAFs are adaptor proteins that link the receptor to signaling molecules and mediate specific biological responses. The specific functional outcomes of CD40 engagement extend to a huge territory of cell biology in general and of B cells specifically,

such as clonal expansion, activation, chemokine and cytokine secretion and responsiveness, Ig production, and Ig class switch. The reader is referred to the reviews that were cited previously.

The functions that are induced by CD40 engagement are the result of activation of several transcription factors, more importantly NF- $\kappa$ B, AP-1, and c-AMP response element. Ligation of CD40 on B cells results in proliferation or apoptosis, depending on the differentiation state of the B cell, particularly by linking to different TRAF adaptor molecules. For example, in murine B cells, multimers of TRAF-2 mediate apoptosis, whereas TRAF-3, TRAF-5, or TRAF-6 stimulates proliferation. CD40 induces homotypic adhesion between B cells through expression of lymphocyte function-associated antigen-1-ICAM-1, or CD23-CD21. The same molecules can also mediate interactions between B cells and T cells or DCs.

Important contributions of CD40-CD154 interactions in humoral immunity are the regulation of APC functions, GC formation, Ig synthesis, and Ig class switch ( [391](#), [392](#) ). A central role in several of these functions of CD40 is played by the duration of expression of the ligand of CD40 by the T cells ( [393](#) ). Some memory T cells have preformed CD154 that can be rapidly expressed on the surface after T-cell activation ( [394](#) ).

Expression of CD154 for a limited time allows B cells to terminally differentiate and secrete antibody. T<sub>H</sub>1-differentiated cells express CD154 for longer than 3 days and suppress antibody production, whereas activated T<sub>H</sub>2 memory cells express CD154 for less than 12 hours and allow antibody to be produced ( [393](#) ). Expression of CD154 on T cells is reciprocally regulated by cytokines; although IL-12 sustains CD154 expression, IL-4 represses CD154 expression. These findings provide an explanation for a controversy in the past: whether CD40 engagement promotes ( [395](#) ) or inhibits ( [396](#) ) B-cell differentiation and Ig secretion. It is clear now that prolonged engagement of CD40 inhibits secretion of Ig ( [396](#) ).

Multimers of TRAF-3 and TRAF-5 mediate the signals for T-dependent humoral responses.

Signaling events from CD40 engagement without TRAF involvement are still unclear. CD40 ligation leads to phosphorylation of several protein Tyr kinases, such as Lyn, Blk, Btk, and Syk. Jak-3 binds directly to CD40, but the role of signaling by this pathway remains controversial. Btk leads to expression of CD80 and CD86 after CD40 ligation.

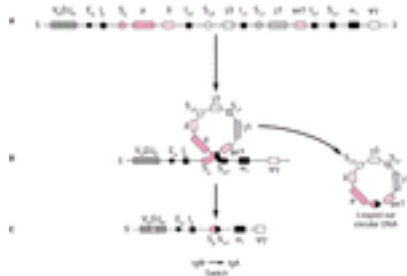
In general, signaling through TRAFs seems to be more important for the CD40-mediated functions.

## IMMUNOGLOBULIN CLASS SWITCH

*Class or isotype switch* refers to the change of the H chain of the antibody molecule, by the constant domains of another H chain class. When the antibody changes to another Ig class, it still retains the entire L chain and the V domains of the H chain. In other words, the antibody retains the same specificity for antigen but changes all effector functions that are determined by the H chain domains, such as complement fixation, and phagocytosis ( [397](#) ). The change involves a recombination of H chain genes that results in deletion of DNA. It is called *switch recombination*, as it occurs between the *switch (S) regions*. Class switch affects all Ig classes except IgD, which has no S region of its own and is coexpressed with IgM by termination of transcription and RNA processing. Switch recombination occurs in mature B cells after exposure to antigen, T dependent or



independent; simply by T-cell signals alone in the absence of antigen (i.e., CD40 and CD40L); or by cytokines. Before switch recombination, RNA transcripts of germline genes of the constant region of the H chain ( $C_H$ ) are detected from the same isotype at which switching takes place. Transcription initiates within the promoter of the intronic (I) exon, proceeds through the S region, and terminates in the 3' end of the  $C_H$  gene, at the poly (A) site of secreted or membrane  $C_H$  gene (398) (Fig. 18.13).



**Figure 18.13.** Class switch recombination (CSR). In CSR, the surface immunoglobulin (Ig) M of the B cells is replaced by an Ig of another class. The IgM gene, which is located in the variable region of the heavy chain ( $V_H$ ) proximal end of the constant region of the light chain ( $C_H$ ) gene cluster (A) is replaced in that position by a gene of another class. In the 5' side of each  $C_H$  gene is the S region (switch) (A), followed by a specific intronic (I) promoter, which regulates cytokine-induced transcription of the target gene. The intronic enhancer ( $E_\mu$ ) makes  $S_\mu$  accessible for recombination with other downstream S regions (“accessibility model”). Beyond accessibility, an enzyme that is known as *activation-induced deaminase* (AID, (Fig. 18.14) is involved in CSR. The contribution of AID is not yet clarified, but AID deficiency in mice blocks completely CSR, although germinal center reaction is still intact. The S region of the new Ig gene is brought in juxtaposition to  $S_\mu$ , and the intervening sequence is looped out (B). The new  $C_H$  is brought in next to the  $V_H$  (C). The new Ig has the same specificity ( $V_H$ ) but possesses different biological functions that are dictated by the  $C_H$ .

A unique sequence 5' to each I exon determines the selectivity of the switch recombination, acting as the site for binding of a series of regulatory proteins that are expressed after activation. The I region targets class switching to specific S regions that initiate transcription (399), and an intact I region is required for recombination. The factors that initiate recombination confer accessibility of the switch *recombinase* to the  $C_H$  locus (accessibility model) (397). Basically, what *accessibility* means is that the gene that undergoes switching must be transcriptionally active and therefore accessible. Although accessibility allows transcription, which is targeted to a specific S region to be initiated, it is not the only operating mechanism in class-switch recombination (CSR) (400).

Understanding CSR took an unexpected turn with the discovery that CSR and SHM are mediated by the same or similar mechanisms (401, 402). An enzyme that is known as *activation-induced cytidine deaminase* (AID, is an RNA-editing enzyme that is induced after cell activation (403, 404 and 405). RNA editing is a posttranslational modification of RNA. The type of editing that occurs in mammalian cells involves deamination of a base that converts it to another base (e.g., cytidine to uridine or adenosine to inosine). Usually, the editing enzyme is associated with other proteins, forming an editing complex or editosome. AID is structurally similar to the RNA-editing enzyme, APOBEC-1, which deaminates deoxycytidine. APOBEC-1 is involved in editing of the mRNA for

apolipoprotein-B, generating a new mRNA that encodes a protein, which is an essential component of chylomicron. B-cell activation is important for the induction of CSR recombinase and the selection of the target S region. Both of these events are absolute requirements for CSR.

Activation of the B cell usually occurs through BCR or CD40/CD40L or a cytokine. CSR has always been considered highly dependent of CD40L, and IgG, IgA, and IgE production is severely impaired in the X-linked hyper-IgM (HIGM) syndrome (see the section [Hyper-Immunoglobulin M Syndrome](#)). The CSR activation through CD40/CD40L is T-cell dependent, because CD40 signaling depends on its ligation by the CD40L that is expressed on T cells. Viral glycoproteins and bacterial LPSs can stimulate IgG and IgA production in the absence of CD40L-expressing T cells. A more physiologic T-independent CSR is induced by DCs through BlyS and APRIL ([406](#)).

A cytokine that selects a specific S region as a target activates the I promoter located 5' to the S region of that isotype and induces the germline transcripts that contain the I and C<sub>H</sub> exons. The S region is removed by splicing, leaving the 5'-I<sub>H</sub>C<sub>H</sub>-3' germline RNA. Each cytokine selects a specific I promoter.

Cytokines direct switching for certain Ig classes; IL-4 specifically directs switching to IgG4 and IgE, whereas IFN- $\gamma$  antagonizes some of the effects of IL-4 on germline transcription. TGF- $\beta$  increases IgA transcripts followed by IgA switching.

Upstream (i.e., 5') of the I exons are sequences that are considered as sites of action of cytokines, which generate DNAase hypersensitive sites to be used for germline transcription.

For example, IL-4, which is a switch factor for IgE, binds to the IL-4 receptor and activates the Jak kinases. The Jak kinases induce the signal transducer and activator of transcription (STAT)-6, which binds to IL-4 responsive elements that are found upstream of the IgE gene and switch on IgE transcription.

The S regions that are used for CSR consist of tandemly repetitive units with many palindromic, that is, inverted, repeats. S regions are essential for CSR and in all isotypes have similar sequences that are recognized by the CS recombinase. These sequences form stem-loop structures when the DNA is single stranded. Therefore, CS recombinase may recognize the secondary structure of the S region DNA rather than the primary sequence. In this respect, it differs from V(D)J recombinase, which targets consensus heptamer and nonamer sequences around the V, D, and J segments. In CSR, the germline transcripts and AID are not sufficient to induce class switch, as was originally thought ([407](#)), but *trans*-acting factors may play a role ([400](#), [408](#)). These *trans*-acting factors are thought to act as docking proteins that recruit AID to the S regions ([409](#), [410](#) and [411](#)).

The initial event in CSR is a double strand, blunt, or staggered break that produces 3' or 5' overhangs. If, for example, the class switch is between the IgM constant gene and IgA-1 constant gene ([Fig. 18.3](#)), CSR brings the IgA heavy chain gene ([1](#)) close to the V (V<sub>H</sub>DJ<sub>H</sub>) gene. Thus, after the IgM/IgA class switch the IgA antibody has the same specificity as the IgM. The intervening DNA sequence between the S $\mu$  and S $\alpha$  regions forms a circular structure that is looped out ([402](#)). The circular DNA that is looped out includes the I promoter of the target S region, which is driven by specific cytokine stimulation before the CSR. This I promoter is still active in the looped-out DNA and directs production of transcripts, termed *circular transcripts*, which depend on the expression of AID. Circular transcripts may be used as a hallmark of active CSR ([411](#)) and



were detected in the majority of patients (14 out of 20) with CLL. This indicates that some cells of the clone are able to differentiate *in vivo* along the pathway that induces CSR ( 412 ) by stimuli provided from bystander immune cells. The double-strand break (DSB) repair machinery is recruited to repair the DNA breaks. Since the S regions are heterogeneous in nature, the joining of the DNA is completed by the nonhomologous end-joining (NHEJ) system. Mutations in the NHEJ system inhibit class switch ( 413 ).

NHEJ is a process that rejoins DNA breaks with the use of little or no homology. There are five proteins that operate in NHEJ: Ku70, KU86, and DNA-dependent protein kinase (DNA-PK). DNA-PK consists of a catalytic subunit (DNA-PK<sub>CS</sub>) and a DNA-binding component that is called *Ku*, itself a heterodimer of 70- and 80-kd polypeptides. The protein kinase activity of DNA-PK is activated when Ku binds to altered DNA structures, such as DSB, nicks, or hairpin loops ( 414 ). Mice that are deficient in Ku80 exhibit severe combined immunodeficiency (SCID) and defective processing of V(D)J recombination intermediates. DNA-PK is a member of PI3K family of kinases.

The discovery of the mechanism of CSR is a major advance in our understanding of the complexity of mechanisms that are used by the immune system in the diversification of genetic information to meet the needs and challenges by pathogens ( 402 , 415 , 416 ), and it is even more intriguing that the same machinery that is used for CSR is also used for a second diversification mechanism that takes place also in the GCs, SHM ( 401 , 402 , 417 ).

## SOMATIC HYPERMUTATION

The first diversification of genetic information in B lymphocytes takes place in the bone marrow during B-cell development. It involves the building of a BCR by random selection of a few DNA segments that are joined by V(D)J recombination. The assembly of these segments constitutes the *combinatorial diversity* (CD). CD is enhanced further by the addition during the repair of the cut ends of the DNA of palindromic and nongermline nucleotides that generate another level of diversity, the *junctional diversity*. (See [Chapter 16, Figure 16.5](#).)

When the IgM<sup>+</sup> B lymphocyte moves out of the bone marrow to the real world of the secondary lymphoid organs, it finds itself not well prepared to meet the existing challenges. It further diversifies its BCR during the evolution of the immune response within the GCs by two additional mechanisms: antibody CSR and SHM. Both of these pathways of diversification use similar mechanisms, with a prominent role played by an enzyme, which is known as *AID*, that functions as a deaminase and is induced after cell activation. Under conditions of stimulation of murine splenic B lymphocytes (e.g., LPS or IL-4, which do not induce SHM), large numbers of mutations were detected in the 3' subregion of the S<sub>μ</sub> region ( 417 ). The S<sub>μ</sub> mutations are independent of the CSR, because they are detected in the S<sub>μ</sub> of switched and unswitched alleles. These mutational changes of S<sub>μ</sub> have been considered similar to the mutations that are introduced by SHM during B-cell activation in the GCs ( 418 ). Comparison of the amino acid sequence of L chains from mouse myeloma proteins, with the sequence of the same gene from bone marrow B cells (germline) confirmed that the amino acid differences have occurred as a result of mutations ( 419 ). SHM is the mechanism by which the affinity of antibodies increases after antigen stimulation, a phenomenon that was discovered in the late 1960s and has been known as *affinity maturation* ( 348 ).

The mutations are largely confined to the V domains ( 420 , 421 ) and occur in the framework regions, as well as the hypervariable regions. They also tend to occur on some

residues (hot spots) more often than on others. Hot spots of SHM overlap with the CDRs, which directly contact the antigen. However, the SHM mechanism does not seem to target a specific sequence, because SHM has even been detected in other molecules, such as the BCL6 gene ( [422](#) ), Iga, and Igβ genes ( [423](#) ) and CD95 ( [424](#) ), or even in completely artificial sequences that are inserted into an Ig $\gamma$  transgene ( [425](#) ). Comparison of the mutability of triplets shows that some are more often targeted than others. For each of the triplets, one can calculate an expected ratio of replacement (R) to silent (S) mutations. For example, in triplets that encode glycine (Gly), six of the nine possible nucleotide substitutions result in an amino acid replacement mutation that gives an R:S value of 2 (6/3). In the case of histidine, eight out of nine possible substitutions generate an amino acid exchange, and the ratio is 8 (8:1). Evolution has selected for CDRs in which the codon usage leads to a high ratio of R:S mutations. Those are mutations that are likely to affect the antibody-binding site, and the R:S value in the CDR is used as a marker for affinity maturation.

The process of SHM occurs during the period in which the B cell undergoes a high rate of divisions (approximately one every 6 hours); this period is observed in the dark zone of GCs and is also linked to transcription, with which it is positively correlated ( [426](#) ). GCs have been considered the centers of hypermutation ( [427](#) ), although in lymphotoxin- $\alpha$ -deficient mice that lack GCs, mutations can still be induced with strong antigenic stimulations ( [428](#) ). The nature of the signals that are necessary for SHM is not well understood. CD40/CD40L interaction is important for the development of GCs and for proliferative activity, both of which are requirements for SHM. Under conditions *in vitro* that allow SHM to take place, three signals have been identified to be required: signals from anti-Ig, anti-CD40, and anti-CD38 ( [429](#) ).

With the use of several phenotypic markers, the B lymphocytes have been separated into different groups that represent different stages of B-cell differentiation. The majority of the B cells in humans expresses IgM (as much as 90%) and can be distinguished into IgM<sup>+</sup>/IgD<sup>+</sup>, IgM<sup>+</sup>/IgD<sup>-</sup>, and IgM<sup>-</sup>/IgD<sup>-</sup> groups.

The IgM<sup>+</sup>/IgD<sup>+</sup> do not carry mutations, except for a subpopulation that expresses CD27 ( [430](#) ). IgM<sup>+</sup>/IgD<sup>+</sup> B cells are newly released from bone marrow and are considered still antigenically inexperienced. The two other groups IgM<sup>+</sup>/IgD<sup>-</sup> and IgM<sup>-</sup>/IgD<sup>-</sup> have mutations and therefore belong to their postGC lymphocytes ( [431](#) ).

## Mechanism of Hypermutation

The hypermutation domain—that is, the region in which mutations occur—spans 1.5 to 2.0 kb downstream of the Ig promoter ( [Fig. 18.14](#) ). The frequency of the mutations increases in the 5'– to 3'–direction, peaks over the V(D)J recombination site, and then decreases toward the J–C junction. The 5' boundary near the promoter is sharp, but the 3' boundary near the enhancer region is less well defined. The I enhancer is the only sequence in the Ig gene cluster that is irreplaceable and must be in the correct orientation. The need of the enhancer provides the explanation of the strong correlation of SHM with the transcription process. The mutation rate is  $10^{-3}$  to  $10^{-4}$  base pairs per generation, that is, six orders of magnitude higher than the spontaneous mutations ( [432](#) ). The mutations are usually point mutations, but insertions, deletions, or duplications also occur ( [431](#), [433](#) ). Although mutations are limited within the boundaries of 1.5 to 2.0 kb, they tend to exhibit a characteristic nucleotide substitution preference, which affects not only the primary sequence, but also secondary structures, such as hairpin loops, which are encoded by palindromic motifs. In spite of these preferences, the sequence of the V gene itself does

not initiate the mutation, because artificial substrates hypermutate successfully ( 434 ).

Two steps have been considered important for SHM: (a) *DNA cleavage*, which results in DSBs, and (b) *DSB repair*, which is done by an error-prone mechanism ( 435 ). It is recognized that (a) DSBs occur in hypermutating sequences (hot spots), (b) they are coupled to transcription, (c) they depend on the presence of the Ig enhancer, and (d) they correlate with the appearance of nearby mutations ( 436 , 437 ). The DSBs are restricted to cells that have completed or almost completed DNA replication and need to be repaired before the end of cell division. In eukaryotes, there are two DNA repair mechanisms: homologous and NHEJ, each of which is used in distinct phases of the cell cycle. The NHEJ is used in G<sub>1</sub> to S phase, and the homologous recombination is used in late S to G<sub>2</sub> phase.

In V(D)J recombination, the DNA breaks occur in the G<sub>1</sub> phase and are repaired by the NHEJ that is activated in the same period of the cell cycle. SHM occurs during the G<sub>2</sub> phase ( 438 ), when a sister chromatid is present, and homologous recombination is active, whereas NHEJ occurs in the absence of such a template. The precise phase of the cell cycle for introduction of mutations, however, is not yet agreed on, because they have also been detected during the G<sub>1</sub> phase ( 439 ). For SHM, the AID is necessary, because AID deficiency impairs SHM. The relationship of AID to the DSBs is not clear, and AID probably makes no contribution to their generation ( 440 ), because, according to some evidence, AID acts after their occurrence ( 436 ). Furthermore, DSBs occur with the same frequency in rearranged and germline genes, and yet SHM is preferentially attracted to the rearranged genes ( 441 ), which suggests that DSBs do not express any functional affinity for AID attraction. AID has landed on the stage of SHM only recently, evokes considerable wonder, and attracts massive attention. AID's activity is well understood, but its role in SHM remains elusive ( 442 ).

Another approach in search for answers for the SHM mechanism concentrates on polymerases ( 443 ). Most mutations in SHM are point mutations, but deletions, insertions, or duplications of DNA segments are also common. These changes are recognized as the signature for a DNA polymerase (pol) and are considered as strong evidence against an SHM mechanism that invokes a base-modifying enzyme or chemical DNA modification. Based on these arguments, the SHM could be the result of a DNA polymerase with poor discriminatory capacity for bases. Such a polymerase could be one of the Y family of DNA polymerases—pol  $\eta$ , pol  $\theta$ , pol  $\iota$ , pol  $\kappa$  ( 444 )—that are specialized for bypassing DNA lesions (translesional polymerases). Some of these polymerases have been implicated in SHM ( 445 , 446 , 447 and 448 ).

Pol  $\eta$  is significantly error prone when it copies normal DNA and makes, on the average, several more mistakes than a stringent polymerase ( 448 ). Patients with a null mutation of pol  $\eta$  present a variant form of xeroderma pigmentosum with a propensity for skin malignancies ( 449 ). These sloppy polymerases have the capacity to bypass a DNA lesion, which may otherwise bring the DNA replication to a halt and the cell to its death. However, during the replication of normal DNA, they are notoriously unfaithful in the selection of bases.

Where does AID fit into this scenario? AID may function in signaling processes or in editing key molecules in B-cell differentiation in the GCs (see the section [Hyper-Ig M Syndrome](#)), at the mRNA level or by direct alteration of the target V gene, at the level of the RNA transcript. However, some recent results point out another pathway that is

opened to AID in CSR and SHM. AID, as mentioned earlier, is a deaminase that converts deoxycytosine (dC) to deoxyuracil (dU) ( [Fig. 18.14A](#), [Fig. 18.14B](#)). This conversion takes place during transcription of target genes and affects only the nontemplate DNA strand that is exposed as single-stranded DNA during the elongation reaction. This evidence supports once more the direct relationship of transcription and mutations that are linked by the deamination function of AID ( [450](#)). As a result of this function, AID creates a dU/deoxyguanosine (dG) mismatch or lesion in the DNA, which needs to be repaired. A major mechanism in the resolution of the lesion is excision of the uracil, which can be accomplished by several enzymes, one of them being a *uracil-DNA glycosylase* (*UNG*, ( [451](#))). UNG is the major DNA glycosylase in the mouse that processes programmed dU/dG lesions in the Ig genes ( [452](#)). If the dU that is created by AID is removed by UNG, an *abasic site* (AP) is generated ( [Fig. 18.14D](#)). If the base excision repair mechanism (BER) arrives first, ahead of the replication fork, a nick or a gap is created, which is filled quickly by the high-fidelity pol  $\delta$  or pol  $\epsilon$ , and no mutations take place. However, if the replication fork wins the race to the lesion, the high-fidelity polymerases are stalled ( [Fig. 18.14E](#)), and an error-prone polymerase, such as pol  $\eta$ , pol  $\theta$ , and pol  $\iota$ , places a base across from the AP site. If the polymerase continues its error-prone function, it introduces many more errors, that is, mutations ( [453](#)). In mice that are deficient for UNG, the class switch is markedly impaired. This indicates that the AP that is created from removal of dU by the UNG is essential for CSR. The generation of double DNA breaks follows through interference with BER assembly by the CSR machinery.

Our understanding of the mechanisms of CSR and SHM has made some spectacular strides in the recent past. The AID appears to be important for somatic diversification of Ig genes, but the question still remains whether AID can unite all gene changes, such as SHP, CSR, and gene conversion ( [454](#)), or if AID needs more than one other aid ( [455](#)). To this point, it is interesting that AID deaminates dC on single-stranded DNA, but it requires the action of RNAse ( [456](#)). As of today, this is the latest aid that comes to AID's help.

## GENOMIC VIEW OF GERMINAL CENTER REACTION

The study of the GC reaction by conventional, morphologic, and functional methods has provided a clear picture of the central position of the GC in the differentiation of B cells and the function of humoral immunity. Microarray technology carries our understanding to the last frontier ( [457](#)), the genes that are involved in initiation and evolution of the reaction. Findings by this approach confirm what is known—that the naïve, antigenically inexperienced, B cell does not divide and does not make Ig but is poised to respond to antigen. Indeed, naïve B cells express genes that are inhibitory of proliferation (*WAF-1*), as well as growth expression (*BIN1* and *BOK1*) genes. They also express mRNA for early response genes (*c-Jun* and *ERF-2*) and cyclins D1 and D2 that function during the transition from G<sub>1</sub> to S phase.

The change from naïve B cell to centroblast is as striking at the gene level as it is with the techniques that have been used so far. The centroblast expresses the vast majority of proliferation-associated genes, as well as those that regulate the cell cycle and mitosis. One of the unexpected results was the lack of expression of *c-myc* protooncogene, which is known to be associated with cell proliferation. Genes that regulate apoptosis are up-regulated, whereas antiapoptotic genes (*Bcl2*) are down-regulated. Studies of gene expression do not detect significant differences between centrocytes and centroblasts, although these two populations have distinct functional characteristics. It is suggested that one of the two populations may be heterogeneous. The light zone contains detectable subpopulations by phenotype or by the expression of transcription factors.

In general, the global gene profile of naïve B cells is that of suppression, actively maintained by notable inhibitors of signal transduction ( [458](#) ). However, the GC B cell is characterized by a proliferation signature, which includes activation of genes that participate in various stages of cell cycle, such as cyclin, cyclin-dependent kinase (cdk), and CDC2, which drive cells through the G2 and M phases. Additionally, other genes that organize the mitotic spindle are also activated ( [459](#) ). Somewhat atypical is the lack of c-myc expression, a gene known for its proliferative function. Lack of c-myc expression ( [457](#) ) is reflected by the down-regulation of sets of genes involved in energy metabolism that are transcriptionally regulated by c-myc.

The lack of c-myc function may be due to the expression of the human homolog to the mouse Mad 3 gene, which forms dimers with c-myc and thus blocks its function as a transcriptional activator.

The GC B cells are thus poised to undergo apoptosis, which takes place extensively in the light zone, after hypermutation. Well-known antiapoptotic genes, such as Bcl-2 and Bcl-X<sub>L</sub>, which are targeted by the NF- $\kappa$ B transcription factor are poorly expressed. Not only antiapoptotic genes are suppressed, but expression of proapoptotic genes, such as BIK (member of the Bcl-2 family), constitute part of the GC B-cell signature.

The BCL6 gene is highly expressed during the GC reaction that promotes the differentiation within GCs but is down-regulated during plasmacytic differentiation ( [460](#) ). Mice that are deficient in BCL6 fail to develop GCs, and are deficient in affinity maturation with a reduction in antibody responses. BCL6 represses CD40L-induced and NF- $\kappa$ B-dependent gene transcription of B7-1, a co-stimulatory molecule that is essential for T-cell-B-cell interactions ( [461](#) ). Mice that are deficient in BCL6 not only cannot develop GCs, but their memory B cells also have no V<sub>H</sub> mutations ( [462](#) ). Because BCL6 appears to be a major promoter of GC reaction, the question that is raised is what are the signals that oppose BCL6 signaling and bring GC reaction to a halt? The BCR signaling opposes BCL6 transcription ( [463](#) ), probably directing BCL6 degradation by proteasomes as a result of its phosphorylation by MAPKs ( [464](#), [465](#) ). The hypermutated high-affinity BCRs interact in the light zone with antigen, and the signals that are generated are sufficiently strong to phosphorylate BCL6, leading to its degradation and bringing GC reaction to a halt. Important molecules that have been kept suppressed, such as B-lymphocyte-induced maturation protein (Blimp) 1, initiate plasma cell differentiation (see the following discussion). With BCL6 degradation, Blimp, a major plasma cell differentiation factor, is up-regulated and completes the end stage of the GC reaction.

## POSTGERMINAL CENTER DIFFERENTIATION

After somatic diversification in the dark zone, the centroblast moves into the light zone as a centrocyte-expressing surface Ig that has undergone SHM. The centrocytes are submitted to the selection procedure by antigen that is carried on the dendrites of the dense FDC network in the light zone. The majority of centrocytes are destined to die, because the mutational changes are detrimental to their affinity and avidity. Loss or diminished binding to antigen leads to programmed cell death, and those dead centrocytes are rapidly removed by macrophages, which are now called *tingible body macrophages*. Some of the centrocytes may be recycled, once more, through the dark zone for further clonal expansion, diversification, and selection.

This recycling provides, once more, the opportunity for reaching the highest affinity peak. In the light zone, the selection process separates the *fittest* B cells (high affinity) for



survival and the *unfit* (poor or no affinity) for death (negative selection). Positive and negative selection may work in concert, so that, among the positively selected high-affinity B cells, those with autoreactivity are deleted ( 466 ) by apoptosis, because overexpression of Bcl2 in B cells allows the survival of autoreactive B cells ( 467 ). The products of several genes participate in the regulation of the selection processes. The protein tyrosine kinase Lyn plays a rate-limiting role in BCR triggering through phosphorylation of CD22, an inhibitory molecule that recruits SHP-1 to the BCR-CD22 complex ( 468 ). The transcription factor Aiolos maintains B cells at low reactivity levels, because, in mice that are deficient in Aiolos, there is increase of serum Igs, autoantibody production, and the development of B-cell lymphomas ( 469 ).

CD21 appears necessary for the survival of GC B cells with high-affinity BCRs. CD21 is a complement receptor (CR2) and, as a component of the CD19/CD21/CD81 co-receptor, mediates the binding of complement-containing immune complexes to B cells and provides a survival signal for B cells ( 470 ). The CD19/CD21 co-receptor is a major regulator of B-cell function in humoral immunity, for fine tuning of signals that are received by the BCR ( 471 ). Simultaneous ligation of BCR and the CD19-CD21 complex (i.e., with antigen-antibody-complement complexes) lowers significantly the threshold of antigen that is required to trigger B-cell activation by antigen alone through the BCR. (See [Chapter 16, Fig. 16.12](#))

The centrocyte that has been positively selected is poised for commitment to one of the two pathways of differentiation: memory B cell or plasma cell, depending on whether the normally delivered signals are properly received.

## Memory B Cells

Centrocytes can be diverted to the memory B-cell pool by positive signals or by the lack of negative signals. The CD40/CD40L interaction or IL-4 stimulation ( 472 ) belongs to the first category. The apoptotic pathway that normally deletes centrocytes belongs to the second category. Apoptosis normally deletes centrocytes that have emerged from the dark zone with nonfunctional or low-affinity receptors. Interference, therefore, with the apoptotic pathway blocks negative selection and results in accumulation of heavily mutated B cells that bring forward a “bad” memory of the primary response. Thus, overexpression of Bcl2, an antiapoptotic protein, interferes with negative selection and diverts centrocytes to the memory pool ( 473 ). Similarly, the lymphoproliferative mutation that incapacitates the Fas receptor results in accumulation of heavily mutated B cells ( 474 ). These changes disrupt the anatomic organization of lymphatic organs with the development of autoimmune lympho-proliferative disease.

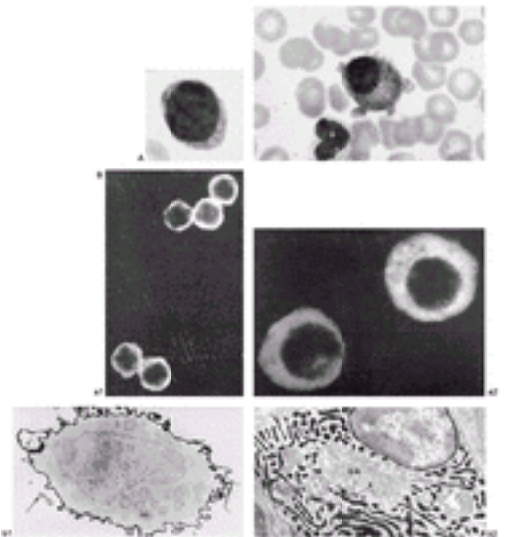
Memory B cells are long lived and do not secrete antibody until they are challenged again. In such a secondary antigenic challenge, they respond to much smaller doses of antigen, expand clonally, and produce seven to ten times more antibody than the antigen-inexperienced B cells ( 475 ). Memory B cells have undergone an Ig class switch, and expression of Ig classes can be used for their classification, as well as for the classification of other markers, such as CD27 ( 476 ) or CD148 ( 477 ).

The mechanism that maintains the memory B-cell pool is unknown. Antigen is not required to keep them alive, and, according to a hypothesis that has some appeal, B-cell memory (and, for that matter, T-cell memory also) is maintained by idiotypic-antiidiotypic interactions between B cells ( 478 ). Such interactions take place between B cells that have been antigenically stimulated, therefore their BCR carries distinct *idiotypes* that are specific for this clone. These idiotypes are structures (protein sequences) within the

antigen binding site that are specific for this particular BCR. Other B cells that respond to these idiotypes express a BCR with antiidiotypic properties. Interaction between idiotypic cells (memory cells for the primary antigen) and antiidiotypic B cells, according to this hypothesis, stimulates enough proliferative activity to maintain the B-cell memory pool. Such interactions may also link and maintain T-cell memory within a pan-lymphocyte idiotypic-antiidiotypic web.

## Plasma Cells

The purpose of the B cell's life is to make antibodies after it reaches maturity, a stage of differentiation that is characterized morphologically by the development of an elaborate ER and functionally by the synthesis of Ig that is released extracellularly. Since the detection and description of the plasma cell by Marshalko and Unna ([Chapter 16](#)), clinicians and scientists have become quite familiar with the morphology, ultrastructure, and physiology of the plasma cell. The new techniques of molecular biology and genomics identify the genes that bring about this spectacular morphologic and functional transformation ([Fig. 18.15](#)).



**Figure 18.15.** Lymphocytes and plasma cells. Morphologic and functional differences between lymphocyte and plasma cells. **A:** Morphology: routine staining. **B:** Immunoglobulin production and expression: B-cell surface versus plasma cell intracellular immunoglobulin. **a:** Fluorescence. **b:** High-resolution autoradiography. GA, Golgi apparatus; Mi, mitochondrion.

The earliest signs of the plasma-cell differentiation are detected within the GCs when the positively selected centrocytes choose one of the two pathways that are available to them. A small number of centrocytes express a partial plasma cell phenotype, CD138 (syndecan-1); the transcription factor Blimp-1; and down-regulation of BLC6 and Pax5 ([479](#) and [480](#)). These precursors exit the GCs and migrate to the bone marrow, where they develop into plasma cells, secreting high-affinity antibodies. They are probably the same cells that are detected on bone marrow smears ([481](#)), surviving with signals that are delivered by marrow stromal cells ([482](#)), and are able to secrete antibody in the absence of antigen for several months ([483](#)). These postGC plasma cells should be distinguished from preGC plasma cells secreting IgM antibody, that are generated in the early stage of



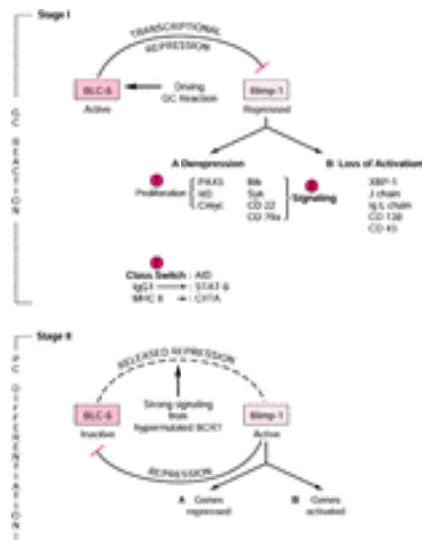
the primary response.

IL-6 is particularly effective in driving high-affinity B lymphocytes to plasma-cell differentiation ( [484](#), [485](#)). Before the acquisition by B cells of plasma-cell characteristics, the cell loses expression of MHC class II molecules, CD19, CD20, CD22, and CD45 ( [486](#)) and up-regulates CD38 (the highest density of all stages during B-cell development) and CD138 (or syndecan-1) ( [487](#)). CD38 is a transmembrane type II protein (i.e., NH<sub>2</sub> terminal intracellular), which is the *ectoenzyme* nicotinamide adenine dinucleotide (NAD<sup>+</sup>), converting NAD<sup>+</sup> to adenosine diphosphate ribose (glycohydrolase activity) ( [Chapter 2](#), CD38). CD138 binds to hepatocyte growth factor, which is produced by mesenchymal cells and stimulates myeloma cell growth ( [Chapter 2](#), CD138). Among transcription factors, Pax5 is down-regulated, whereas Blimp-1 is up-regulated ( [479](#)).

The BCL6 protooncogene exerts a negative effect on plasma-cell differentiation, because it suppresses genes that are critical in the promotion of their differentiation. BCL6 is a pox virus zinc finger (POZ)/zinc finger (ZF) protein, which contains six Krüppel-type ZF motifs at the C-terminal end and a POZ motif at the N-terminal. Therefore, it belongs to the POZ domain and Krüppel-like family (POK) of proteins ( [488](#)).

The ZF proteins contain cysteines and histidines that are spaced at regular intervals with a zinc atom that is coordinated between two cysteines and two histidines. ZF proteins are folded in nine loops, with an invariant Leu and a Tyr or Phe that is located in each loop and is important for the DNA binding. The zinc binds to the consensus core sequence TTCCT (A/C) GAA that is found in several BCL6 target genes, but it also mediates protein-protein interactions, notably with class II histone deacetylases (HDACs), c-Jun transcription factor, etc. The POZ domain is a protein-protein interaction motif that is conserved in evolution and is found in many transcription factors, oncogenic proteins, ion channel proteins, etc. POZ proteins are involved in critical cellular processes, such as development, oncogenesis, apoptosis, and transcription. The most common property of the POZ domain is repression of transcription, based on its ability to recruit the HDAC.

Histone acetylation is mediated by a histone acetyltransferase complex. Acetylation destabilizes the nucleosomal structure by neutralizing the positively charged Lys residues of the N-terminal tail domain of core histone and increases the accessibility of DNA to transcriptional regulatory proteins ( [489](#), [490](#)). Therefore, acetylation plays an important role in the regulation of gene expression and DNA replications and repair. Deacetylation has the opposite effect. There are two classes of enzymes that deacetylate histones: Class I (HDAC-1, HDAC-2, HDAC-3, and HDAC-8) is detected in yeasts and similar organisms, and class II (HDAC-4, HDAC-5, HDAC-6, HDAC-7, HDAC-9, and HDAC-10) is detected in vertebrates. BCL6 recruits class II HDAC-4, HDAC-5, and HDAC-7, forming complexes through the N-terminal POZ domain and C-terminal ZF region ( [491](#)). BCL6, lacking four of the six ZF proteins, loses entirely its ability to recruit the HDACs. It is likely that this interaction exerts the transcriptional repression of BCL6 ( [492](#)). Several genes are targets for BCL6, such as CD40, IL-4, Blimp-1, B7-1, and cyclin D2 ( [Fig. 18.16](#)). Point mutations of ZF indicate that ZF-3, ZF-4, ZF-5, and ZF-6 abolish DNA binding and the ability of BCL6 to bind to its cognate cis element ( [488](#)). BCL6 represses genes that are activated by STAT-6 or NF- $\kappa$ B ( [493](#)), thus regulating IL-4 signaling and IgE production. BCL6 competes with STAT-6 for the same DNA-binding sites and thus inhibits specific STAT-6-dependent gene transcription. BCL6<sup>-/-</sup> mice have dysregulation of IgE production and develop type T<sub>H</sub>2 inflammation of the heart and lungs ( [460](#), [493](#)).



**Figure 18.16.** Gene regulation of germinal center (GC) reaction. Several genes by their expression or their repression contribute to the molecular and cellular processes that take place within the GCs. More than any others, two genes virtually conduct the GC orchestra: B-cell lymphoma 6 (BCL-6) and B-lymphocyte-induced maturation protein-1 (Blimp-1). BCL-6 is a repressor gene that is identified in diffuse large B-cell lymphomas. It represses several genes and, importantly, Blimp-1 (stage I). As a result, BCL-6 releases from repression all genes that are normally repressed by Blimp-1 (A). The net result is “activation” of genes for proliferation (1), class switch (2), somatic hypermutation, and signaling B-cell molecules (3). BCL-6 is down-regulated, probably by strong signals that are delivered by hypermutated high-affinity B-cell receptors (BCRs) (stage II). Loss of BCL-6 function releases Blimp-1 from repression. Genes that are active during the first stage I are now repressed, whereas genes that are important for plasma cell (PC) differentiation are activated, such as XBP-1 and immunoglobulin L chain. Thus, the GC reaction and the generation of antibodies are finely tuned, basically by a repressor loop between the two master genes BCL-6 and Blimp-1. AID, activation-induced deaminase; CIITA, major histocompatibility complex class II *trans*-activator molecule; MHC II, major histocompatibility complex class II; STAT, signal transducer and activator of transcription.

Suppression of STAT-3 by BCL6 blocks plasma-cell differentiation through inhibition of Blimp-1 (494) ( Fig. 18.16). This function of BCL6 is, at least partially, critical in the role of BCL6 in B-cell differentiation—the block of terminal plasma-cell differentiation to maintain proliferation and hypermutation for affinity maturation (i.e., maintenance of GC reaction). BCL6’s function is curtailed by signals from high-affinity BCRs that are initiated from interactions with antigen in the light zone. If BCL6 function achieves constitutive independence through chromosomal translocations, it may lead to B-cell lymphomas. When BCL6 is down-regulated, it releases suppression of Blimp-1, a transcriptional repressor that is important for plasma-cell differentiation (389). The genes that are repressed by Blimp are shown in Fig. 18.6. Several of the biologic characteristics of plasma cells are explained by the repressor function of Blimp-1. Blimp-1 represses c-myc and inhibits proliferation (495) and also represses the Pax5 gene, releasing XBP-1 from Pax repression, which is needed for plasma cell formation (496). Blimp-1 also releases Pax5-mediated inhibition of H-chain (497) and J-chain (498) synthesis.

Plasma cells have lost the antigen-presenting function of their parent B cells. This is due to loss of MHC class II expression as a result of repression of the gene that encodes the

CIITA, which is required for MHC II expression in B cells ( [499](#) ).

Blimp-1 is the master regulator of genes of the plasma-cell differentiation program. Genes that are regulated by Blimp are direct targets or are regulated by other Blimp-1 target genes. The basic function of Blimp-1 is repression of transcription, which is active or passive. Factors that act as passive repressors interfere with transcriptional activators by competing with their binding site on the promoter or by binding directly to the activation domain of the activator. In active repression, the repressors interact directly with the components of the transcription machinery or recruit co-repressors, such as the HDACs. *Blimp-1 is an active repressor* that is associated directly with HDACs and carries them to the promoters it binds ( [500](#) ). HDACs bring alterations in the chromatin structure, which underlines the basic mechanism of Blimp-1 function. Another co-repressor for Blimp-1 is a complex of the Groucho family proteins ( [501](#) ).

## **HYPER-IG M SYNDROME (HIGM): GENETIC DEFECTS OF CLASS-SWITCH RECOMBINATION**

The cognate interaction between CD40L (CD154), which is expressed on activated T cells, and CD40, which is constitutively expressed on B cells, is required for terminal B-cell differentiation. Signaling through CD40 leads to B-cell proliferation, rescue of B cells from apoptosis, SHM, CSR, and GC reaction. Mutations of CD40L result in the X-linked syndrome that is characterized by the lack of GCs in the lymphoid organs and the inability of B cells to undergo CSR, and IgG, IgA, IgE are absent or markedly decreased ( [502](#), [503](#) and [504](#) ). Men who are affected with HIGM syndrome are susceptible to bacterial infections, but also experience *Pneumocystis carinii* pneumonia and *Cryptosporidium* intestinal infections, which are usually observed in T-cell deficiencies ( [505](#) ). Lack of interaction between T cells and macrophages leads to defective macrophage activation, which is probably the basis for opportunistic infections ( [506](#), [507](#) and [508](#) ). This syndrome was the first to be described and is known as *HIGM1 syndrome*. Some patients with HIGM1 syndrome have a few IgM<sup>+</sup>/IgD<sup>+</sup> B cells that express CD27, a memory B-cell marker, and have SHM. The B cell from these patients indicates that SHM may follow more than one pathway. HIGM1 is due to mutations in the gene that encodes CD40L ( [509](#) ).

Carriers of HIGM1 are considered to be asymptomatic, because expression of CD40L, even in only a small fraction of T cells, is sufficient for effective immunity. A female carrier has been described with HIGM1 syndrome as a result of extreme lyonization of the normal X chromosome ( [510](#) ). This patient was the sister of a boy who was affected with HIGM1 syndrome, and only 5% of T cells were CD40L<sup>+</sup>.

A second HIGM syndrome with autosomal-recessive inheritance (HIGM2) has normal CD40L but does not undergo CSR *in vitro* in the presence of CD40 agonists ( [511](#), [512](#) ). CD40 gene sequence and CD40 expression are normal. The defect of HIGM2 is linked to chromosome 12p13, where the AID gene also maps. Mutations of the AID have been identified. These patients lack CSR and SHM and have lymph node hyperplasia with giant GCs ( [513](#) ). The cells in these GCs are proliferating B cells that coexpress IgM, IgD, and CD38, a phenotype that was previously described as characteristic of the GC founder-cell subset ( [514](#) ). Some mutations are predicted to lead to truncated forms of AID by generating stop codons; other missense mutations are localized within the putative cytidine deaminase catalytic region of the protein. The phenotype of HIGM2 is similar to the phenotype of mice with deficiency of AID ( [515](#) ).

In a group of 13 patients with HIGM syndrome and normal CD40L, all patients had AID mutations, five of them with a missense mutation of Arg112 His, which indicates that Arg112 is the hot spot of mutations ( [516](#) ). Levels of IgG, IgA, and IgE were undetectable, and SHM was impaired, which shows that AID is indispensable in CSR and SHM.

Another group of 14 patients of French–Canadian descent from Quebec, Canada, had a C-to-T transition in codon 112, resulting in the substitution of Arg with Cys. These patients inherited the genetic defect from a common founder ( [517](#) ).

In contrast to HIGM1 syndrome, patients with HIGM2 have bacterial, but not opportunistic, infections.

Mutations of the AID gene do not account for all cases of autosomal–recessive HIGM syndrome. Mutations in the CD40 gene, which lead to lack of CD40 expression, cause an autosomal–recessive form of immunodeficiency with HIGM, which is characterized by lack of CSR, impaired memory B lymphocytes, formation, and defective SHM (HIGM3) ( [518](#) ). One patient was detected at 4 months of age with severe respiratory distress because of *P. carinii* infection. The other two patients experienced recurrent respiratory infections early in life.

## CYTOKINES IN B-CELL DIFFERENTIATION

The structure and function of the main cytokines that are involved in B-cell differentiation and their receptors are briefly described here. Some of the cytokines have similar structural features and have been divided into two groups, type I and type II.

Type I cytokines consist of four  $\alpha$  helices (A, B, C, and D) that are connected by long loops. If the molecule is viewed in the direction from the NH<sub>2</sub> to the COOH terminal, the orientation of the A and B helices is up, and the orientation of the C and D helices is down (i.e., up–up–down–down). Depending on the length of the helix, they are distinguished as short chain or long chain. Cytokines with short chains include IL–2, IL–3, IL–4, IL–5, IL–7, IL–9, IL–13, IL–15, and SCF, and those with long chains include erythropoietin, thrombopoietin, IL–6, IL–11, leukemia inhibitory factor, and oncostatin. Only the short–chain cytokines have  $\beta$ –sheet structures in the AB and CD loops. There are intrachain disulfide bonds to maintain the overall tertiary structure, but the number varies, for example, IL–2 has one disulfide bond and IL–4 has three. The sequences in helices A and D are the most conserved in evolution, and these helices make contacts with the receptors. The receptors of the cytokines that are discussed here have a characteristic *cytokine-binding domain* (CBD) that consists of two fibronectin type III (FnIII) domains. The N–terminal contains four conserved cysteines that form two disulfide bonds and the membrane proximal conserved sequence WSXWS [Trp–Ser–X–Trp–Ser, where X is any amino acid]. The cytokine receptors use several signaling pathways. Briefly described here is the Jak–STAT pathway, which mediates most of the cytokine effects.

The biological properties of the interleukins described here are listed in [Table 18.2](#).

**TABLE 18.2. Biologic Activities of Cytokines**

---

Effects On:

---

| Cytokine Produced |                  | B Cells  | T Cells        | Macrophages |
|-------------------|------------------|--|----------------|-------------|
| IL-2              | T <sub>H</sub> 1 | Growth   | Growth         | —           |
| IL-4              | T <sub>H</sub> 2 | Growth<br>? Major histocompatibility complex<br>Activation<br>? Immunoglobulin E | Growth         | Activation  |
| IL-5              | T <sub>H</sub> 2 | Differentiation<br>? Immunoglobulin A  | —              | —           |
| IL-6              | T <sub>H</sub> 2 | Growth<br>Differentiation  | Co-stimulation | —           |

IL, interleukin; T<sub>H</sub>, T helper cell, ?, increased.

### Jaks and Signal Transducers and Activators of Transcription

The Janus family of kinases, which is known as *Jak* (*just another kinase*), has been given the name of the Roman god, *Janus*, the god of gates and doorways and the god of all beginnings and endings, who had two faces. Jaks also have two tandem domains, a kinase, and a pseudokinase (519, 520). Each molecule consists of seven homology domains, which are termed *Jak homology (JH) domains*. JH1 is the catalytic domain and has the features of a Tyr kinase domain, whereas the N-terminal binds to cytokine receptors. Mutation of the conserved Lys in subdomain II that binds ATP abrogates kinase activity. Jaks are apparently interdependent in their function, because they form homo- or heterodimers with other members of the family when the receptors with which they associate form homo- or heterodimers. Certain domains are used as cytokine receptor-specific binding sites. For example, Jak-1 uses JH7 and JH6 for binding to IL-2RB and IL-4Ra, but the binding to IFN $\alpha$ BL and IL-10Ra requires another domain (521). The Jak-3 kinase is rapidly phosphorylated by IL-2 and binds to the  $\gamma$ c chain through the JH6 and JH7 domains, whereas the Jak-1 associates with the  $\beta$  chain.

STATs are latent cytosolic transcription factors with an acronym that accurately reflects the speed of their activation and the urgency of their biological function, in agreement with the STAT (at once) order for immediate action in clinical medicine and emergency rooms. There are seven known mammalian STAT proteins that were conserved in evolution from primitive eukaryotes to humans (522). The important structural features of STATs are the SH2 (Src homology 2) domain and the DNA-binding domain (523). The SH2 domain is used to bind to phosphorylated Tyr and is used for their dimerization. After phosphorylation of their single Tyr (Y-P), they form homodimers or heterodimers, based on the interaction of the Y-P with the SH2 domain of another molecule of a similar or different STAT. Dimerization unmasks a nuclear localization signal that permits STATs to enter the nucleus and bind to DNA (523). STATs must take six steps for the full expression of their function: (a) bind to Y-P, (b) become phosphorylated themselves, (c) dimerize, (d) translocate to the nucleus, (e) bind to DNA, and (f) participate in gene transcription. STATs bind to Y-P of cytokine receptors or Y-P of a STAT that is already bound to the receptor or directly to a Jak.

The DNA binding domain in the C-terminal in some STATs contains a Ser whose phosphorylation is important for transcriptional activity.

Jaks and STATs constitute an important signaling pathway for cytokines. All IFNs and

cytokines activate one or more STATs. Because there are more cytokines than STATs, it is not possible for each cytokine to have its own STAT. However, cytokines form groups that share the same STATs. For some STATs that are activated by many cytokines (STAT-3, STAT-5a, and STAT-5b), their unique actions cannot be mediated by STATs alone, but with a combination of other transcription factors.

In addition to transcription regulation, some STATs recruit other signaling components. STAT-4 and STAT-5 are two of the most important STATs in the STAT pathway, primarily because of their role in T<sub>H</sub> cell differentiation. STAT-3 and STAT-1 have a primary role in the function of IL-5 and IFN- $\gamma$ , respectively, in defense against infectious agents ( 524 ).

### Interleukin-2 and Interleukin-2 Receptor

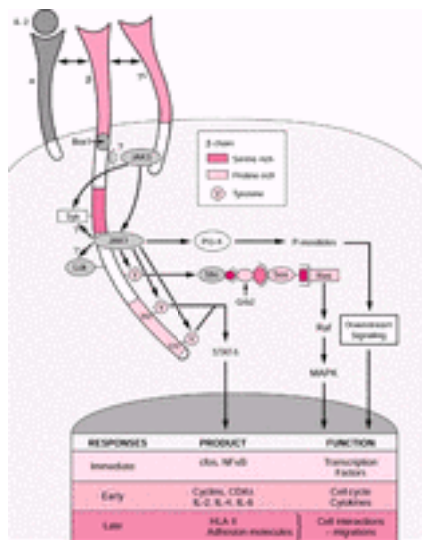
IL-2 and IL-2R were the first to be isolated, and, although IL-2 was originally thought to be only a T-cell growth factor, subsequent studies demonstrated that it acted on several types of cells, including B cells and NK cells ( 525 ). IL-2 belongs to the short-chain four- $\alpha$ -helical bundles. IL-2R consists of a complex of three polypeptide chains: the IL-2R $\alpha$ , IL-2R $\beta$ , and  $\gamma$ c (common) chains. The  $\gamma$ c chain is shared by receptors of several ILs, such as IL-4, IL-7, IL-9, and IL-15.

IL-2R $\alpha$  binds IL-2 with low affinity [dissociation constant ( $K_D$ ) =  $10^{-8}$ ], whereas, in association with IL-2R $\beta$ , it forms an intermediate affinity complex ( $K_D$  =  $10^{-9}$ ), and all three subunits form the high-affinity receptor ( $K_D$  =  $10^{-11}$ ). The IL-2R $\beta$  subunit has two pairs of conserved cysteines that are close to the N-terminal end and the sequence WSXWS in the membrane-proximal end of the extracellular region, which is characteristic of type I cytokine receptors.

The intracellular region has the Box1, Ser (S), acidic (A), and proline (H)-rich regions. The extracellular region of the  $\gamma$ c chain has an N-terminal domain with two pairs of cysteines, and the second membrane-proximal domain contains the highly conserved WSXWS motif. The  $\alpha$  and  $\beta$  subunits are expressed only on lymphocytes, but, after activation, they are also expressed on macrophages. The  $\gamma$ c chain is detected in several other hematopoietic cells ( 526 ).

The contributions of each of the three chains to IL-2 binding are not quite clear. The  $\alpha$ -chain is necessary to form, with the other two chains, the high-affinity IL-2R while the  $\gamma$ c chain contributes three loops from the extracellular region (including two of the cysteines) to the IL-2 and IL-7 binding ( 527 ). IL-2 expresses lectin properties and binds to the  $\beta$ -chain in a Ca<sup>2+</sup> independent manner to oligomannosidic *N*-glycans (five to six mannose residues) ( 528 ). It is proposed that by this mechanism IL-2 links the  $\beta$ -chain of IL-2R with CD23 ( 528 ). The  $\beta$  and  $\gamma$ c chains are certainly the signal-transducing components of the IL-2R. Signaling through the IL-2R follows several paths to the nucleus ( Fig. 18.17 ). One pathway is the Ras-MAPK cascade that is initiated by the phosphorylation of the Shc adaptor protein ( 525 ). A second is the PI3K activation, and a third one is through the Jak-STATs.





**Figure 18.17.** Interleukin (IL)-2 signaling. The IL-2 receptor complex consists of three polypeptide chains:  $\alpha$ ,  $\beta$ , and  $\gamma$ . High-affinity binding of IL-2 requires all three chains. The  $\beta$ -chain is associated with Jak 1 kinase, Src kinases (e.g., Lck), and Syk. Jak 1 phosphorylates tyrosines of the C-terminal region of the  $\beta$ -chain, which become docking sites for signal transducer and activator of transcription 5 (STAT-5). One of them links to the adaptor protein Shc, which connects to the Ras pathway and mitogen-activated protein kinase (MAPK) activation. Jak 1 also connects with phosphoinositide 3-kinase (PI3K) and the downstream signaling that is mediated by phosphoinositides. Jak-3 is associated with the  $\gamma$ -chain and probably with  $\beta$ -chain. It probably activates Jak 1 and Syk. IL-2 and IL-2R signaling induces multiple and prolonged T-cell responses, such as immediate responses, transcription factors that activate genes for cell cycle, and cytokine release. Later induction of integrins supports T-cell migration and interactions with other cells. IL-2 was the first cytokine to be discovered and retains a commanding role in the regulation of several aspects in T-cell life. NF- $\kappa$ B, nuclear factor- $\kappa$ B.

The A region of the  $\beta$ -chain is associated with members of the Src family and PI3K (529). The H region mediates activation of the Jak family of Tyr kinases that activate STATs (529). The most membrane-proximal Tyr (Y) 338 is involved in the phosphorylation of the adaptor protein, Shc, which is linked to the Ras pathway. The two membrane-distal Tyr Y322 and Y510 associate the  $\beta$ -chain with the Jak-1 kinase (530), which interacts with the PI3K. This pathway leads to maximal T-cell proliferation (531). IL-2 and several others are associated with the Jak-STAT signal transduction pathway. The Jak-3 kinase is rapidly activated by IL-2, and, through the JH7 and JH6 domains, it binds to the  $\gamma$  chain (532), whereas Jak-1 is associated with the  $\beta$ -chain (533).

Understanding the mechanism of T-cell progression through the cell cycle has been advanced by the discovery of rapamycin, a potent immunosuppressant (525). Rapamycin is a macrocyclic lactone that is derived from the filamentous bacterium *Streptomyces hygroscopicus* (534) and has structural similarities to another powerful immunosuppressant, FK506, or tacrolimus. Both substances bind to a family of intracellular receptors, FK506-binding proteins (FKBPs), which are peptidyl-prolyl isomerases, that is, they catalyze the *cis-trans* interconversion of peptide bonds that contain proline. The complexes of FK506 and FKBP in T cells inhibit calcineurin, a  $\text{Ca}^{2+}$ -regulated Ser-Thr phosphatase, which plays a crucial role for the activation of gene transcription by IL-2. However, the rapamycin-FKBP complexes do not bind to calcineurin but to another protein that is called *target of rapamycin (TOR)* (535). This protein is expressed in *Saccharomyces cerevisiae*, and provides resistance to the potent antifungal action of



rapamycin.

The protein TOR is apparently needed for the transition of T cells from G<sub>1</sub> to S phase. Transition of the cell from G<sub>1</sub> to S phase is regulated by G<sub>1</sub> cyclins and their associated cdks ( [536](#) ), which assure the orderly progression from G<sub>1</sub> to S phase. IL-2 stimulates the synthesis of three cyclins, D<sub>2</sub>, E, and A ( [537](#) ). These cyclins form complexes with cdks, which sequentially (D<sub>2</sub>-complexes followed by E-complexes and then A-complexes) lead the cell from G to S phase. Rapamycin affects the assembly and function of all three cyclin-cdk complexes. The D<sub>2</sub>-complexes function by phosphorylating their substrate, the retinoblastoma protein, which normally is phosphorylated at a low level and restricts the G<sub>1</sub>-to-S transition. The function of cyclin-cdk complexes is regulated by another set of proteins that are called *kinase inhibitory proteins (KIPs)* ( [538](#) ), which bind and inhibit the kinase activities of the cyclin-cdk complexes. The IL-2R delivers a signal for KIP down-regulation, whereas rapamycin prevents the IL-2-induced reduction of KIP.

The TOR protein regulates the p70<sup>56K</sup> protein, which is present in mammalian cells, and, as a protein kinase, phosphorylates various intracellular substrates that are involved in protein synthesis and cell cycle control. T-cell activation by antigen induces within the first 30 minutes a number of transcription factors (e.g., c-fos, NF-AT, and NF-?B) (immediate response). These factors in turn activate the transcription of cytokine genes, such as IL-2, IFN-?, IL-4, and IL-5 (early response).

IL-2 stimulates T-cell clonal expansion and dictates proliferation of antigen-selected T cells. Antigenic stimulation induces IL-2R's expression and secretion of IL-2 and other cytokines ( [526](#) ). Cross-linking of surface Ig leads to IL-2R expression on B cells and responsiveness to IL-2. IL-2 stimulates proliferation of B cells and Ig secretion and mediates the switch from the membrane form to the secretory form of the  $\mu$  chain, allowing formation of pentameric IgM molecules. Therefore, IL-2 is critical for primary immune responses that are characterized by the production of IgM antibodies. IL-2 stimulates secretion of other cytokines, such as IL-4, IL-5, and IFN-?, preparing the stage for isotype switch and the maturation of the antibody response. Antigen activation of T cells initiates a series of waves of gene activation that is coordinated by TCR signaling and IL-2 secretion, with the expansion of the role of T-cell cytokines in B-cell proliferation, antibody secretion, affinity maturation, and class switch (late response).

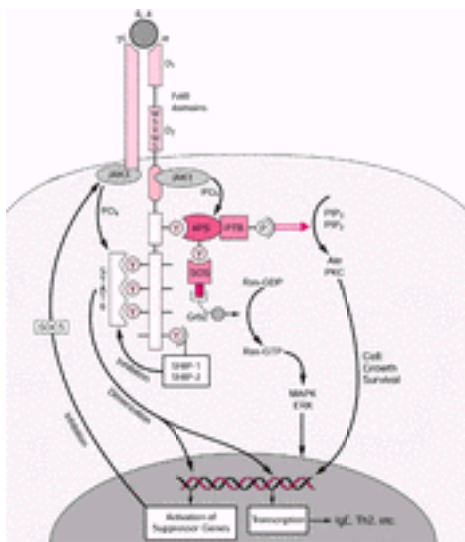
### X-Linked Severe Combined Immunodeficiency

The  $\gamma$ c chain gene of the IL-2R is located in chromosome Xq13, which is also the locus for X-linked SCID. X-linked SCID patients are phenotypically identical—T<sup>-</sup>, B<sup>+</sup>, and NK<sup>-</sup> ( [539](#) ). From a large group of patients with SCID,  $\gamma$ c deficiency accounts for 42%, and Jak-3 deficiency accounts for approximately 6% of the cases ( [540](#) ). This form of SCID is associated with severe T-cell defects in T-cell development and lack of peripheral T and NK cells. Patients have severe persistent infections of the upper respiratory and gastrointestinal tracts by CTMV, fungal, and bacterial pathogens. Patients require bone marrow transplantation to survive. B-cell levels are normal or elevated in the T<sup>-</sup>, B<sup>+</sup>, and NK<sup>-</sup> SCID cases. With the exception of two large deletions, the  $\gamma$ c mutations are missense mutations that involve one or a few nucleotides. Five mutational hot spots have been identified in exons that encode part of the extracellular domain ( [541](#) ). In patients with autosomal SCID, a single amino acid substitution Y100C in the JH7 domain of Jak-3 prevents the interaction of Jak-3 with the receptor ( [542](#) ).

## Interleukin-4 and Interleukin-4 Receptor

The IL-4 is one of the small four-helix bundle cytokines with four  $\alpha$  helices, A, C, B, and D, two end-to-end long loops, and a short  $\beta$  sheet that is packed against the B and D helices (543). It has a biological activity that is species specific, in spite of the fact that the main binding residues are conserved.

IL-4 is a pleiotropic cytokine that is produced by CD4<sup>+</sup> T<sub>H</sub>2 cells, NKT cells,  $\gamma\delta$  T cells, basophils, and mast cells, and it is essential for T<sub>H</sub>2 differentiation (Chapter 17). IL-4 binds with high affinity to the IL-4Ra, and this complex recruits the  $\gamma$ c chain (Fig. 18.18). IL-4 binding induces a conformational change in the receptor, forming a structural mosaic in the binding interface. The interacting residues are grouped into three clusters (544), with the first two clusters consisting of a nucleus of polar groups that are surrounded by hydrophobic side chains. They have been compared to the avocado fruit in which a nucleus is enveloped by an oily shell. The first cluster is around Glu9, and the second cluster is around Arg88 of IL-4 and Asp72 of the IL-4Ra.



**Figure 18.18.** Interleukin (IL)-4 signaling. IL-4 binds to a receptor, which consists of two chains,  $\alpha$  and  $\gamma$ c. The  $\alpha$  receptor has two extracellular fibronectin III domains (Fn) (D1 and D2), with features of a cytokine receptor homology domain, which is seen in type I cytokine receptors. D2 is characterized by the WSXWS motif (amino acid letter code: W is tryptophan, S is serine, and X is any amino acid) that is implicated in folding and transport of the receptor. The binding of IL-4 to the  $\alpha$ -chain is mediated by three discrete clusters. Two of them are known as *avocado clusters* because they consist of a central core of polar groups that is surrounded by a hydrophobic (*oily*) shell. The third cluster is dominated by electrostatic interactions and stabilizes the complex. The  $\alpha$ -chain associates with Jak-1 and the  $\gamma$ c chain with Jak-3. Distinct domains of the cytoplasmic tail of the  $\alpha$ -chain mediate the multiplicity of IL-4 function. A unique feature in the IL-4Ra  $\alpha$ -chain is its association with a protein that is known as *IL-4 phosphotyrosine substrate (4PS)*, which links to phosphoinositide 3-kinase (PI3K) and downstream signaling for cell growth and survival. 4PS also connects to the Ras pathway for mitogen-activated protein kinase (MAPK) activation. 4PS binds to a unique sequence of IL-4Ra that is shared by the insulin receptor. In the insulin receptor, this motif binds a protein-linking signaling pathway, which is known as *insulin receptor substrate 1 (IRS-1)*. 4PS of the IL-4Ra is homologous to IRS-1 and has been called *IRS-2*. Jak-3 phosphorylates tyrosines of the

$\alpha$ -chain that are used by signal transducer and activator of transcription 6 (STAT-6) for binding. This phosphorylation is regulated by SHIP phosphatases, which are associated with the C-terminal part of the  $\alpha$ -chain. STAT-6 induces the suppressor proteins, suppressors of cytokine signaling (SOCSs), which inhibit Jak-3 activation. GTP, guanosine triphosphate; PTB, phosphotyrosine binding domain.

The third cluster steers and accelerates the binding of the IL-4 with the receptor (544). The first and second clusters show cooperativity and additive properties, which reinforce the binding to higher affinity (545). IL-4R consists of a complex of two proteins, IL-4Ra and the  $\gamma$ c-chain. The IL-4Ra has two FnIII domains. The N-terminal (D1) has the conserved disulfide bonds of an Ig fold, whereas the second domain (D2) has no disulfide bonds; both have unique structural features (546). A membrane-proximal WSXWS domain maintains the favorable conformation for cytokine binding. The cytoplasmic region has the box 1 motif (proline rich) and an acidic region that is adjacent to box 1 that interacts with Src Tyr kinases. Ligand binding causes heterodimerization of the  $\alpha$ - and  $\gamma$ c-chains and activation of Jak-1, Jak-2, and Jak-3 kinases (547), the first two associating with IL-4Ra and the last associating with  $\gamma$ c.

Activation of Tyr kinases that are associated with the IL-4R leads to phosphorylation of the five tyrosines of the cytoplasmic region of IL-4Ra (543), which function as docking sites for Src kinases.

The functions of IL-4Ra are mediated by distinct domains in the cytoplasmic region. The first, most membrane-proximal domain contains the Y497 (Y1), which interacts with the IL-4 phosphotyrosine substrate (4PS), a 180-kd protein related to insulin receptor substrate 1 (IRS-1) that is phosphorylated and generates proliferative signals (548). Interestingly, 4PS was found to be homologous to a cytoplasmic protein, which is used as a substrate for the insulin receptor. Insulin binding to the insulin receptor results in a rapid autophosphorylation of the receptor, which is a receptor protein kinase. The receptor subsequently phosphorylates cytoplasmic substrates that link to downstream signaling pathways. One such major substrate of the insulin receptor is the IRS-1. 4PS, which is homologous to IRS-1, has been called *IRS-2* (549). IRS-1 and -2 bind to the sequence [ <sup>488</sup>PL-(X) 4 NPXYXSXSD <sup>502</sup> ] around Y497 of the IL-4R, which is highly homologous to a sequence in the cytoplasmic regions of the insulin receptor, and of the insulin growth factor-1 receptor, both of which activate IRS-1 and -2. This sequence is critical for transducing signals through insulin receptor and IL-4Ra and was termed the *insulin IL-4 receptor* or *I4R motif* ( Fig. 18.18 ). The IRS-2 has a phosphotyrosine-binding domain, which binds to the I4R motif of the IL-4Ra and insulin receptor. IRS-1 and -2 become phosphorylated when they bind to phosphorylated IL-4Ra and act as a docking site for several SH2 domain-containing signaling molecules. Among such signaling molecules are the PI3K that generates phosphoinositides, which in turn activate Akt and protein kinase C (PKC), which are important in cell growth and survival.

The adaptor protein Shc binds to phosphorylated IL-4Ra chain and links through Grb2 to Ras pathway activation. STAT-6 is the primary STAT that is activated by IL-4 stimulation, leading to expression of IL-4 responsive genes. STAT-6 plays an important role in IL-4-induced responses, and, for IL-4 signaling to be maintained, STAT-6 undergoes continuous cycling (550). When STAT-6 is deactivated in the nucleus, it is exported back to the cytoplasm, where it becomes available for another cycle of phosphorylation and reactivation. STAT-6 (together with STAT-4) is the most important STAT in the immune response to sepsis, mainly because of its role in T<sub>H</sub> differentiation.

STAT-6 is essential for T<sub>H</sub>2 differentiation on activation by IL-4.

The phosphorylated C-terminal *immunoreceptor tyrosine-based inhibitory motif* (ITIM) of the IL-4Ra acts as docking site for SHP-1 and SHP-2 phosphotyrosine phosphatases. The former is expressed primarily in hematopoietic tissues, whereas the latter is expressed in several other tissues. Another phosphatase, SHIP, regulates the PI3K signaling pathways.

The Jak-STAT pathway is also subject to regulation by a family of newly discovered suppressor proteins that are termed *suppressors of cytokine signaling* (SOCSs) (551). There are four members in the SOCS family: SOCS-1, SOCS-2, SOCS-3, and CIS (cytokine-inducible SH2-containing protein). The SOCS proteins have an SH2 domain in the center, an N-terminal variable region, and a region of homology at the C-terminus, which is termed the *SOCS box*, with a unique sequence and an unknown function. Five families (20 members) have been identified with a sequence that is homologous to the SOCS box, but the rest of their structure is different (552). SOCS proteins are not constitutively present in the cells but are induced only after cytokine stimulation. The mechanism of their action is different among the members of the family. SOCS-1 binds to the catalytic domain of Jak-2 kinase, whereas CIS competes with signaling molecules, such as STATs, for binding to STAT binding sites (553). SOCS-1 and SOCS-3 inhibit IL-4-dependent STAT-6 activation by binding to Jak-1 (554, 555).

IL-4 activates the Ras-MAPK pathway through interaction of IRS-2 with the Grb2 protein. The Ras pathway, and other small guanosine triphosphatases (GTPases) that are related to Ras, is regulated by the Ras GTPase activating protein, which activates the GTPase activity of Ras. Down-regulation of Ras is controlled by a molecule that is termed *interleukin-four receptor interacting protein* (FRIP), which binds to the I4R motif of IL-4Ra and, through Ras GTPase activating protein (Ras GAP), inactivates the Ras GTP active form.

**FUNCTIONS OF INTERLEUKIN-4 IN T-CELL-B-CELL INTERACTIONS** IL-4 plays a central role in differentiation of naïve T cells to T<sub>H</sub>2 cells capable of producing IL-4, IL-5, IL-10, and IL-13 (Chapter 17). Thus, IL-4, through T<sub>H</sub>2 differentiation, controls humoral immunity. IL-4 increases MHC class II expression in B cells, DCs, and macrophages, thus enhancing their class II antigen presentation, and up-regulates the CD23 expression of B cells. IL-4 promotes activation and viability of B cells. A major role of IL-4 in B-cell function is in class switch, as it induces the switch to IgG1, IgG3, IgG4, and, most importantly, IgE. In this respect, it plays a major role in allergic reactions and protection against helminthic infestations. The mechanism of promotion of CSR by IL-4 is through up-regulation of AID (556). AID is required for CSR and hypermutation (see [Immunoglobulin Class Switch](#)). CD45 has recently been defined as a Janus phosphatase (556a). It negatively regulates IgE CSR in human B cells through inhibition of IL-4-induced (plus anti-CD40) IgE germline transcription.

### Interleukin-5 and Interleukin-5 Receptor

IL-5 was originally described as a T-cell replacing factor or B-cell growth factor 2. It affects the terminal differentiation of B cells and is a single polypeptide of a total of 134 amino acids with a molecular weight of 30 to 40 kd (557). Its tertiary structure reveals two domains with a cytokine fold (four  $\alpha$  helices and two  $\beta$  sheets), as is seen in GM-CSF, IL-2, and IL-4. The IL-5 gene is found on chromosome 5.

The IL-5 receptor is expressed on B cells, eosinophils, and certain cell lines. It consists of

an  $\alpha$ - and  $\beta$ -chain. The  $\beta_c$ -chain is shared by GM-CSF and IL-3 receptors and is functionally analogous to other common chains that are shared by several cytokines, such as the gp130 of the IL-6 family and the common  $\gamma$ -chain of the IL-2 receptor family. The  $\beta_c$ -chain consists of 880 amino acids with four extracellular domains that are related to the FnIII domains, a single region, and the intracellular region (558). The four extracellular domains consist of seven  $\beta$  strands (A through G), which form two cytokine receptor modules. The membrane-proximal module contains the recognition contact sites for the  $\alpha$ -chain (559). The membrane-proximal cytoplasmic region shows similarities to the sequences of box 1 and box 2 of other receptors and serves for recruitment of members of the family of Jaks. The cytoplasmic region also contains several Tyr residues that are phosphorylated after cytokine binding. Binding of the cytokine induces dimerization of the receptor through free Cys that is present in the  $\alpha$  subunit and in the first domain of the  $\beta_c$ -chain. The disulfide bonds that are formed involve the  $\alpha$ -chain of one receptor with the  $\beta_c$ -chain of the second receptor and vice versa. Dimerization is essential for the Tyr phosphorylation of the receptors. Because the  $\beta_c$ -chain is shared by different cytokines, there are sites that are specific for shared interactions.

Detailed studies of the function of IL-5 on mouse B cells have concluded that IL-5 stimulates production of IgM, IgG1, and IgA. IL-5 acts on surface IgA<sup>+</sup> B cells to induce IgA production; therefore, it acts on B cells that are committed to IgA secretion. IL-5 synergizes with IL-4 in augmenting IgM secretion of human B cells and with IL-2 for IgG, IgG, and IgA secretion. The effects of IL-5 are detected on activated B lymphocytes.

IL-5 plays a unique role in the production, activation, and localization of eosinophils (560), which are seen in patients with asthma and helminthic infestations. IL-5 is detected in some patients with severe exacerbations of asthma (561), and it is conceivable that exacerbations are associated with activation of T cells that secrete IL-5. Local expression of IL-5 was detected by *in situ* hybridization in mucosal bronchial biopsies, which was correlated with the number of infiltrating eosinophils (562). Patients who are infected with the filarial parasite *Loa loa* produce high levels of IL-5 (563).

### Interleukin-6 and Interleukin-6 Receptor

IL-6 is a cytokine with pleiotropic activities produced by a great variety of cells (Table 18.3) that plays a central role in immunity and inflammation. IL-6 induces (a) terminal differentiation and Ig secretion of B cells; (b) growth promotion of B cells, plasma cells, and myeloma cells; (c) support of colony formation by stem cells; (d) induction of acute phase response (APR) proteins; (e) differentiation and activation of T cells and macrophages; and (f) neural differentiation. It is also involved in the pathology of several diseases, such as rheumatoid arthritis, proliferative glomerulonephritis, and multiple myeloma. At least 11 different activities are known, with an equal number of acronyms; these turned out to be mediated by the same molecule, which was called *IL-6*. IL-6 is a member of a family of structurally and functionally related cytokines, which includes IL-11, leukemia inhibitory factor (LIF), oncostatin M (OSM), ciliary neurotrophic factor (CNTF), and cardiotrophin-1 (CT-1). Redundancy of function is a result of the sharing of the signal-transducing component of gp130.

**TABLE 18.3. Interleukin-6 Production**

| Producing Cell | Inducer                       |
|----------------|-------------------------------|
| B cells        | IL-4, IL-1, and TNF- $\alpha$ |



|                   |  |
|-------------------|--|
| T cells           | Phytohemagglutinin and tissue plasminogen activator  |
| Macrophages       | IL-6, interferon- $\gamma$ , granulocyte-macrophage colony-stimulating factor, IL-1, and LPS |
| Endothelial cells | LPS, interferon- $\gamma$ , IL-1, IL-4, and TNF- $\alpha$                                    |
| Fibroblasts       | IL-1, TNF- $\alpha$ , and LPS  |
| Keratinocytes     | IL-1, IL-4, and phorbol myristate acetate  |
| Osteoblasts       | IL-1, TNF- $\alpha$ , and LPS  |
| Kupffer cells     | IL-1, TNF- $\alpha$ , and LPS  |

IL, interleukin; LPS, lipopolysaccharide; TNF, tumor necrosis factor.

---

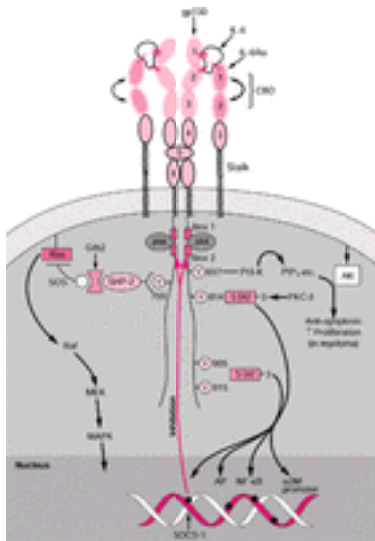
IL-6 is a glycoprotein that belongs to the long-chain, four- $\alpha$ -helical bundle of cytokines ( [564](#), [565](#) and [566](#) ) and binds to the IL-6R-gp130 complex (see the following discussion) but, in addition, has the intriguing property of a lectin that interacts with a trisaccharide (HNK-1 or CD57) ( [567](#) ) ( [Chapter 2](#), CD57). CD57 is a sulfated trisaccharide that is carried by *N*-glycans, that is, complex polysaccharides. It has been identified in the nervous system as a major target of peripheral neuropathies in patients with lymphomas.

IL-6R consists of an extracellular region with one Ig-like domain (C2-type) and two FnIII domains, which form the *cytokine-binding domain* (CBD), which is characteristic of the class I cytokine receptors. The first FnIII domain has two disulfide bonds, whereas the second has the sequence WSXWS ( [568](#) ). IL-6 binds to the IL-6R-gp130 complex by three contact sites. Site one is located in the loop that connects helices A and B of the IL-6 and interacts with the D2 domain of IL-6R. Site two is located at the C-terminal of helix D of IL-6, and interacts with the D2 domain of gp130 ( [569](#) ). A third site interacts with the N-terminal Ig-like domain (D1) of gp130. gp130 is the signal transduction component of the IL-6-gp130 complex, because the cytoplasmic region of IL-6R is short ( [570](#), [571](#) and [572](#) ).

The gp130 protein has an extracellular region that consists of six domains. D2 and D3 have the features that are characteristic of the cytokine-binding domain of class I cytokine receptors. D1 is an Ig-like domain, whereas D4 to D6 are FnIII domains. IL-6 induces the formation of a hexamer that consists of two molecules each of IL-6, IL-6R, and gp130. The crystal structure of gp130 shows that the uncomplexed receptor assumes an L-shaped quaternary structure with limited flexibility ( [573](#) ). gp130 associates with other cytokines, such as OSM, LIF, and CNTF. The crystal structure shows that there is little domain reorientation of the ligand-binding domains, indicating that the overall structure is adaptable to bind multiple cytokines ( [573](#) ). The gp130 protein also has an *N*-glycan that carries the HNK-1 epitope ( [574](#) ), which interacts with IL-6. The lectin activity of the IL-6 is necessary for the initial signal transduction ( [574](#) ).

Binding of IL-6 to the IL-6R-gp130 complex triggers signal transduction, which follows two pathways: the Src protein tyrosine kinases and the Jaks ( [575](#) ) ( [Fig. 18.19](#) ). Activated Jaks phosphorylate several Tyr (Y) residues of the gp130 cytoplasmic region, which then become docking sites for signaling molecules that possess SH2 domains ( [575a](#) and [575c](#) ). The second membrane proximal Y recruits the SHP-2 phosphatase, leading to the activation of MAPK. Activation of the Src kinase, Hck, phosphorylates adaptor molecules that link to the Grb2, SOS, Ras pathway to MAPK activation ( [576](#) ). This pathway mediates proliferative signaling and, at the same time, through activation of SHP-2 phosphatase (

577), dephosphorylates Pyk2 and blocks dexamethasone-induced apoptosis of myeloma cells ( 578).



**Figure 18.19.** Interleukin (IL)-6 and IL-6 receptor (IL-6R) signaling. The IL-6 binds first to IL-6Ra (site I). This binary complex forms a composite site that is termed *site II*, which interacts with the cytokine binding domain (CBD) of gp130 (which includes domains D2 and D3), forming a trimolecular complex. Recruitment of site III on the immunoglobulin-like activation domain (IGD) (i.e., D1 of the gp130) results in the formation of higher-order activation complexes (i.e., a hexamer), which is fully active (gene transcription). High-affinity binding to the N-terminal domains of gp130 (D1 to D3) is not sufficient for receptor activation. The membrane proximal (D4 to D6) domains of gp130 are necessary for activation, as they facilitate appropriate spacing (especially D5) of the cytoplasmic components of gp130. gp130 is the signaling component of the complex and recruits Jak-1 and Jak-2 kinases, with Jak-1 having an essential role. Jaks bind to box 1 and box 2 of the membrane proximal cytoplasmic regions. The N-terminal domain of Jaks comprises a 4.1-ezrin-radixin-moesin domain, which is crucial to link Jak with the receptor. Proteins 4.1 is a large family of proteins that link the membrane of the cell with the cytoskeleton. Jaks phosphorylate tyrosines (Y), which then act as docking sites for signal transducer and activator of transcription (STAT) 3 factors. On dimerization, STAT-3 is translocated to the nucleus, binding to DNA through its DNA-binding domain. STAT-3 is phosphorylated on serines by PKC- $\zeta$  kinase. Phosphoinositide 3-kinase (PI3-K) is recruited on phosphorylated tyrosine 657. The other important signaling pathway involves activation of SHP-2 phosphatase, which interacts with Grb2-SOS adaptor proteins and leads to Ras activation and the ERK1/2-mitogen-activated protein kinase (MAPK) cascade. STAT binding sites are in close proximity with binding sites of other transcription factors. MEK, mitogen-activated extracellular signal-regulated kinase; PIP, phosphatidylinositol phosphate. [Important information obtained: Heinrich PC, et al. *Biochem J*. 2003 (*in press*); Heinrich PC, et al. *Biochem J* 1998;334:297-314; Chow D-C, et al. *Science* 2001;291:2150-2155; Cole AR, Hall NE, Trentlein HR, Edde JS, et al. Disulfide bond structure and *N*-gly-cosylation sites of the extracellular domain of the human interleukin-6 receptor. *J Biol Chem* 1999;274:7207-7215; Kurth I, Horsten U, Pflanz S, et al. Importance of the membrane-proximal extracellular domains for activation of the signal transducer glycoprotein 130. *J Immunol* 2000;164:273-282; and Kurth I, Horsten U, Pflanz S, et al. Activation of the signal transducer glycoprotein 130 by both IL-6 and IL-11 requires two distinct binding epitopes. *J Immunol* 1999;162: 1480-1487.]

Any of the four most distal Tyr residues mediate STAT-3 activation. The STAT-3



structure is similar to that of other STATs: an N-terminal tetramerization domain, a central DNA-binding domain, a conserved SH2 domain (that binds to the cytokine receptor or another STAT molecule for dimerization), followed by a conserved Y and a C-terminal transactivation domain. STAT-3 is the major STAT in IL-6 signaling (579). IL-6 signaling is down-regulated by SOCS-1 (see the previous discussion), which is induced via activation of STAT-3 (580). Another mechanism of IL-6R down-regulation involves endocytosis of gp130, after IL-6 binding. It is mediated by a dileucine motif after phosphorylation of a Ser residue in the cytoplasmic tail of the gp130 protein (581) (Fig. 18.19).

### Interleukin-6 in T-B Cell Interaction and Myeloma

On T cells, IL-6 acts as an activation, growth, and differentiation factor. It can replace co-stimulatory signals from APCs to stimulate IL-2 secretion and T-cell proliferation (Table 18.4).

**TABLE 18.4. Interleukin-6 Functions**

| Target                    | Function  |
|---------------------------|---|
| B cells                   | Production of IgM, IgG, IgA<br>Growth of plasma cells   |
| T cells                   | Activation<br>Growth<br>Differentiation   |
| Hematopoietic progenitors | Induce progression from G <sub>0</sub> to G <sub>1</sub> phase<br>Enhance survival<br>Stimulate proliferation<br>Enhance megakaryopoiesis<br>Macrophage differentiation |
| Hepatocytes               | Acute phase protein synthesis   |
| Skin                      | Stimulates proliferation of keratinocytes   |
| Blood vessels             | Increase permeability   |
| Neuronal cells            | Proliferation of astrocytes<br>Survival of cholinergic neurons  |
| Ig, immunoglobulin.       |   |

IL-6 is the most important growth factor for B cells (normal and malignant). It is a potent stimulator of terminal B-cell differentiation and antibody formation (582).

The role of IL-6 in multiple myeloma has been extensively studied (583). It is involved in proliferation of plasmablasts and differentiation into mature plasma cells, acting by an autocrine or paracrine mechanism. In addition to its proliferative activity, it blocks the apoptotic pathway (see the previous discussion). The gp130 protein is activated sometimes in the absence of direct ligand binding, i.e. independent of IL-6R and IL-6. IFN- $\alpha$  induces tyrosine phosphorylation of gp130 in myeloma cell lines that are responsive to IL-6 (584). The question is raised of whether receptor cross-talk may be a common theme in the biology of multiple myeloma. The human herpesvirus 8 (HHV-8) is associated

with all forms of Kaposi sarcoma (KS) as well as primary effusion lymphoma. It is found in the lymph nodes of a high proportion of patients with multicentric Castleman disease, a polyclonal plasmacytosis that is characterized by hyperplastic lymphadenopathy ( [585](#), [586](#) and [587](#) ). IL-6 is present at elevated levels in KS and multicentric Castleman disease lesions, and IL-6 promotes the growth of KS cells in culture. HHV-8 encodes a homolog of human IL-6 that is known as *viral IL-6* (*vIL-6*), which acts as a mitogenic factor and induces intracellular signaling that is generally the same as IL-6. vIL-6 induces receptor dimerization and forms complexes with IL-6R and gp130 ( [588](#), [589](#) ). Signaling by vIL-6 may be dependent or independent of the IL-6Ra.

One of the most striking responses to injury and inflammation is the *acute phase response* ( *APR* ). APR consists of alterations in several serum proteins that are known as *acute phase proteins* (*APPs*), which are synthesized mainly by the liver. The response involves more than 1000-fold increases in C-reactive protein (CRP) and serum amyloid A (SAA) and moderate increases in fibrinogen,  $\alpha$ -1 antitrypsin, complement factor B, and others. The biosynthesis of these proteins takes place in the liver and is regulated by a factor that was known as *hepatocytes stimulating factor* (HSF), which later was shown to be IL-6. Several other cytokines, such as IL-1, TNF- $\alpha$ , IL-11, and TGF- $\beta$ , are also capable of inducing APP from the liver. In addition to induction of APP, other systemic responses are associated with APR, such as fever and release of ACTH. These responses are also mediated through IL-6.

IL-6 has multiple other effects, such as bone remodeling, proliferation of keratinocytes, increase of endothelial cell permeability, and proliferation of astrocytes.

### Interleukin-10 and Interleukin-10 Receptor

The search for a product of T<sub>H</sub>2 cells that would inhibit proliferation, effector function, and even development of T<sub>H</sub>1 cells resulted in the discovery of a factor that inhibited cytokine synthesis. This cytokine synthesis inhibitory factor (CSIF) was called *IL-10*. It is produced by T<sub>H</sub>2 clones and inhibits the synthesis of IFN- $\gamma$  from the T<sub>H</sub>1 clones ( [590](#) ).

The primary structure of the IL-10 was determined from a complementary DNA that was isolated from T<sub>H</sub>2 cells ( [591](#) ). It has four  $\alpha$ -helices and is expressed as a noncovalent dimer ( [592](#), [593](#) ). The IL-10 gene is located on chromosome 1. It expresses strong homology to an open reading frame in the Epstein-Barr virus genome, GCRF1 ( [591](#) ). This gene may represent an ancestral captured cellular cytokine gene and is designated *viral IL-10* (*vIL-10*).

In addition to T cells, IL-10 is produced by macrophages in response to LPS, by B cells, especially after Epstein-Barr virus transformation ( [594](#) ) and by keratinocytes, especially after exposure to ultraviolet light.

IL-10 stimulates strongly proliferation of B cells, especially after cross-linking of CD40 by anti-CD40 antibody ( [595](#) ), and this effect is synergistically enhanced by IL-4. IL-10 induces B-cell differentiation that is activated by anti-CD40 antibodies, with the production of large amounts of IgM, IgG, and IgA antibodies. This activity is antagonized by IL-4 but is enhanced by TGF- $\beta$ , especially for IgA secretion ( [596](#) ). In general, the effects of IL-4 and IL-10 on proliferation and differentiation of B cells account for much of the noncontact help that is provided during T-cell-B-cell interactions in antibody responses. As a suppressor cytokine of T-cell proliferation and cytokine response, IL-10 plays an important role in tolerating exogenous antigens, especially in immunotherapy of

allergy ( 597 ). It selectively inhibits the CD28-mediated co-stimulatory pathway and, as a result, inhibits T-cell responses that are initiated by engagement of a small number of TCR, a situation that is critically dependent on CD28 co-stimulation. Blocking of CD28 co-stimulation depends on inhibition of CD28 tyrosine phosphorylation, which is the initial step in co-stimulation by CD28. IL-10 regulates cyclooxygenase-2 expression and reduces production of prostaglandins that act directly on cyclooxygenase-2 expression or through regulation of inflammatory cytokines ( 598 ).

## IMMUNOGLOBULIN STRUCTURE

Antibodies are Igs that are produced by B cells in response to foreign antigens; therefore, they have the property of binding specifically to the antigen that triggered their production. Igs constitute the fraction of plasma proteins, originally defined as  $\gamma$ -globulins, because they were located behind the  $\alpha$ - and  $\beta$ -globulins, as a result of their slow electrophoretic mobility. When it was shown that these  $\gamma$ -globulins are products of cells of the immune system, they were given the name *immunoglobulins*.

Antibodies have two fundamental properties for defense against pathogens: They bind specifically to the antigen that is responsible for their induction by one part of their molecule and then dispose the captured antigen with the cooperation of other molecules (complement) or cells (phagocytes) of the immune system.

### Primary Structure: One Polypeptide from Two Genes

One of the most revolutionary hypotheses in the recent history of molecular biology was proposed for the structure of the antibody molecule: The Ig molecule is encoded by two different sets of genes ( 599 ). The C-terminal region is encoded by one gene that is selected from a small group of genes, whereas the N-terminal region is encoded by two or three genes that are selected from a large number (hundreds) of genes. The Ig molecule consists of two short or light (L) chains and two long or heavy (H) chains, which are held together by disulfide bonds.

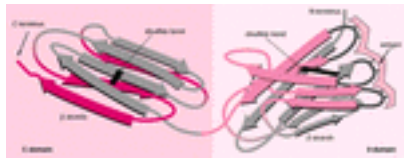
The two L chains are of equal length, each consisting of 214 amino acids. The H chains vary in length; the shortest is the  $\delta$ -chain, which is made of 446 amino acids, and the longest is the  $\mu$ -chain, which is made of 567 amino acids. A striking feature of the primary structure of H and L chains is the considerable variation at the N-terminal end of the chains as compared to a significant degree of homology at the C-terminal end. The former region is known as the *variable* or *V region*, and the latter as the *constant* or *C region*. In L chains, the V region of the light chain ( $V_L$ ) constitutes one-half of the chain (amino acids 1 to 107), and the remaining part of the chain is the constant ( $C_L$ ) region of the light chain. The L chains are encoded by a V and a J gene (N-terminal one-half) and a C gene (C-terminal one-half). For L chains, the V gene contributes amino acids 1 to 95, and the J gene contributes the remaining 13 amino acids. The V region of the H chains is encoded by three genes,  $V_H$ ,  $J_H$ , and D ( Chapter 16 ). For the  $V_H$  region, the  $V_H$  gene encodes amino acids 1 to 94, and the remaining amino acids are encoded by the  $D_H$  and  $J_H$  genes. The rest of the chain is divided into three constant regions,  $C_{H1}$ ,  $C_{H2}$ , and  $C_{H3}$ , for IgG, IgA, and IgD, and four constant regions for IgM and IgE.

Within the V regions are three short stretches of amino acid sequences that show extreme variability and are therefore known as *hypervariable regions*. Hypervariable regions contain amino acids that are in contact with the antigen, and, in the primary structure of the molecule, these regions are separated by long stretches of less variable amino acid sequences. However, these hypervariable regions are in close proximity to

each other when the molecule assumes its functional tertiary structure. Amino acid sequences that are not part of the hypervariable regions form the *framework regions* and constitute 80% of the V region.

### Secondary Structure: Immunoglobulin Fold

Results from crystallographic studies confirm that the Ig polypeptide chain is folded back and forth on itself in opposite directions (antiparallel), forming a sheet, which is known as the  $\beta$  *pleated sheet*, and is arranged as a sandwich (or  $\beta$  barrel), with a hydrophobic center. This is known as the *Ig fold* ( [Fig. 18.20](#)). Each strand bends in a hairpin fashion when it changes direction. Almost all bends contain a Gly that is highly conserved.



**Figure 18.20.** Tertiary structure of a light chain that depicts the variable (V) and constant (C) domains. Each domain is composed of two sheets that are formed by strands of polypeptide chains that possess the basic  $\beta$  pleated structure. In each sheet, the strands run in alternating directions (antiparallel). The strands are shown as broad arrows, pointing in an N-terminal to C-terminal direction. The strands that belong to the same sheet are blank or hatched. Stretches of polypeptide chains that connect the strands form loops. Three of these loops in the V domain include the complementarity-determining regions (CDR), which are involved in antigen binding. The strands are identified by letters, A to G, starting from the N-terminal end. The V domain contains two additional strands C' and C? (which are not shown in the diagram as broad arrows). Interactions between the  $V_L$  and  $V_H$  sheets contribute to the formation of a cylindrical V module that contains the antigen combining site. The black bars represent the disulfide bonds.

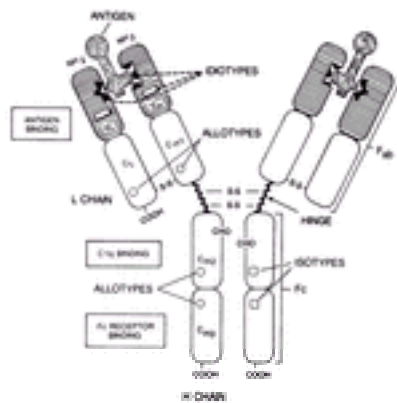
### Tertiary Structure: Immunoglobulin Domain

The intrachain disulfide bonds divide each chain into globular structures of approximately 100 to 110 amino acids that are known as *domains*. The IgG molecule has four V-region domains, one  $C_L$  per L chain and three  $C_H$  per H chain. Considerable homology exists between the V domains and between all C domains. The degree of homology suggests that domains originated from one primordial gene and evolved independently rather than as a group comprising a single H chain. Each Fab fragment (see the following discussion) has four domains: the  $V_L$  and  $V_H$  interact to form the V module, and the  $C_L$  and  $C_{H1}$  interact to form the C module. Each domain is made of two  $\beta$  pleated sheets (x and y), one consisting of three, the other of four, antiparallel strands that are labeled A through G. In each of the two V domains, there are two additional strands that are called C' and C?. The sheets are held together by one invariant disulfide bond and by interactions between the strands A-B-E and D for the C modules and C-C-F and G for the V module. The hypervariable regions correspond to the hairpin loops that link the strands as they turn around to run in the opposite direction, which are called *complementarity determining regions CDRs* ( [Fig. 18.20](#)). Each V domain has three CDRs for a total of six in the V module. They are known in sequence order along the polypeptide chain as L1, L2, and L3 for the  $V_L$  domain, and H1, H2, and H3 for the  $V_H$  domain. The length of each CDR varies considerably, both as a function of usage of the V gene, mainly affecting CDR-1 and -2, and as a consequence of junctional diversity—that is, additions of amino acids during V(D)J recombination that affect the CDR3 ( [Chapter 16](#)). All six CDRs contribute

to the formation of each combining site. Because of their positioning in the free end of the V module, they are endowed with some mobility, which may be important for binding with the antigen. In the Fab fragment, they form a cavity that is 15 Å long, 6 Å wide, and 6 Å deep. The strands correspond to conserved sequences that are known as *framework (FR) sequences*. Each V domain has four conserved FR sequences, FR1 through FR4. The Ig fold is not unique to the Ig molecule but is also found in other molecules, such as the  $\alpha$ - $\beta$  and  $\gamma$ - $\delta$  T-cell receptors; the class I and II MHC molecules; the CD2, CD3, CD4, and CD8; and the  $\beta_2m$ , which represents a free domain. Several other proteins have Ig-like domains that form the Ig superfamily.

### Quaternary Structure: Immunoglobulin Monomer

The Ig molecule consists of four polypeptide chains, which are held together by disulfide bonds and noncovalent interactions ( [600](#) ) ( [Fig. 18.21](#) ). Two of the chains have a molecular weight of 53 kd (IgG) or 75 kd (IgM) and are known as *H chains*. The other two chains have a molecular weight of 22.5 kd and are known as *L chains*. The former determine the major Ig class of the molecule: IgG, IgM, IgA, IgD, and IgE. The respective H chains are designated by the Greek letters:  $\gamma$  (IgG),  $\mu$  (IgM),  $\alpha$  (IgA),  $\delta$  (IgD), and  $\epsilon$  (IgE). Within each class are subclasses: four for IgG ( [1](#), [2](#), [3](#), and [4](#) ), two for IgM, and two for IgA. The H chains are distinguished by isotypes to identify antigenic determinants that are shared by all individuals of a given species. Humans have ten loci for constant region genes and, therefore, 10 isotypes that correspond to the total number of what otherwise are known as subclasses:  $\mu_1$ ,  $\mu_2$ ,  $\gamma_1$ ,  $\gamma_2$ ,  $\gamma_3$ ,  $\gamma_4$ ,  $\alpha_1$ ,  $\alpha_2$ , and  $\epsilon$ . There are only two types of L chains, kappa ( $\kappa$ ) and lambda ( $\lambda$ ). The L chains of the  $\lambda$ -type exist in four isotypes ( $\lambda_1$ ,  $\lambda_2$ ,  $\lambda_3$ , and  $\lambda_4$ ). Any given Ig molecule has two  $\lambda$ -chains or two  $\kappa$ -chains but never one of each type. The  $\lambda$  to  $\kappa$  ratio varies between species: In humans, it is 70:30, whereas in the mouse, it is 95:5.



**Figure 18.21.** Basic arrangement of the polypeptide chains, the enzymatic fragments, and their domain structure of the immunoglobulin G molecule. Locations for structures that are defined as idiotypes, allotypes, and isotypes are shown, as well as the position of the carbohydrate (CHO). Various domains are shown on the left side.

The hinge region is located between  $C_{H2}$  and  $C_{H3}$  and is rich in proline residues. Cysteines form the interheavy chain disulfide bonds. Because of its unique amino acid sequence, this region does not fold well and thus becomes susceptible to enzymatic attack. The hinge region also affects the flexibility of the molecule and other properties, such as complement binding. IgM and IgE have no hinge region but instead have an extra

C domain.

Disulfide bonds are important because they maintain the association of the four chains and divide the Ig molecule into functional domains. The H and L chains are held together by interchain disulfide bonds. Each L chain is attached to the H chain by one disulfide bond, with the exception of human IgA2, which contains no disulfide bond between H and L chains. The disulfide bond is formed between C-terminal cysteine of the  $\gamma$ -chain or the penultimate cysteine in the  $\mu$ -chain and the cysteine that is closest to the middle of the H chain.

The two half-molecules are held together by interchain disulfide bonds between the two H chains. The number of these bonds varies between classes: the IgG1 molecule has two, whereas IgG3 possesses 15. Disulfide bonds exist within each chain (intra-chain). All L chains have two bonds, and all  $\gamma$ - and  $\alpha$ -chains have four bonds;  $\mu$ -,  $\delta$ -, and  $\epsilon$ -chains have five bonds. Because the cysteines that form the intrachain bonds are separated by 40, or even 70, amino acids, the bond can be formed only if the two cysteines are brought into apposition by looping the intervening sequence. The regularity of the distribution of the intrachain disulfide bonds formed the basis of the domain hypothesis, in which the Ig molecule is separated into distinct functional regions ( [601](#) ).

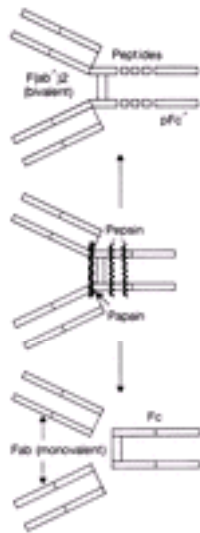
### Carbohydrate Moiety

Carbohydrate chains are of variable length and shape. The number of these chains varies between isotypes: two in IgG molecules, ten in IgM molecules, 16 in IgA molecules, and 12 in IgE molecules. The carbohydrate chains are attached to the C<sub>H2</sub> domain, forming a bond between the first carbon of asparagines and the sugar *N*-acetylglucosamine (GlcNAc). Procedures that interfere with the glycosylation of the  $\alpha$ - and  $\epsilon$ -chains prevent the secretion of IgA and IgE molecules.

### Enzymatic Fragments

Treatment of the Ig molecule with papain generates three fragments. Two of these fragments are identical; each contains one antigen-binding site and thus are known as *Fab* (fragment antigen-binding) ( [602](#) ). The third piece, which is known as *Fc* (fragment crystallizable), mediates fixation of Ig molecules to skin and other cells (macrophages and lymphocytes), fixes complement, and mediates transport of the Ig molecule across the placenta. Digestion of the Ig molecule with pepsin yields one large piece, with a molecular weight of 100 kd. This divalent fragment, which is known as *F(ab)*<sub>2</sub>, consists of two *Fab* fragments, each capable of binding antigen. The *Fc* fragment is digested by pepsin into small peptides ( [Fig. 18.22](#) ).





**Figure 18.22.** Proteolytic fragmentation of the immunoglobulin G molecule by papain and pepsin. Papain hydrolyzes the molecule to the N-terminal side of the interchain disulfide bonds and releases three fragments of approximately equal size, two Fab and one Fc. Pepsin acts on the C-terminal side of the disulfide bonds and forms one large divalent fragment [F(ab')<sub>2</sub>]; the Fc is fragmented to small peptides and one larger fragment that is known as pFc.

## Combining Site

The antigen-combining site is located near the tip of the two arms on the Y-shaped Ig molecule ( [603](#), [604](#) ). The size of the combining site was determined initially by Kabat by using antidextran antibodies that reacted with oligosaccharides of different lengths. Maximal inhibition of the binding was obtained with an oligosaccharide that consisted of six isomaltohexose molecules. The structure of the combining site has also been studied by means of affinity labeling. With this technique, the hapten is linked to a chemical group that interacts with the amino acids that are closest to those that form the combining site. This method helped demonstrate that H and L chains participate in the formation of the combining site. The antigen-binding V module may be viewed as a stable, packed FR structure with six superimposed flexible CDRs. Molecular biologists have now constructed hybrid genes that combine FR and CDR from different Igs. On transfection to lymphoid cell lines, these genes produced antibodies with the specificity of the CDR donor ( [605](#) ).

## Idiotypes and Allotypes

Antibodies and myeloma proteins possess determinants that are characteristic for each antibody or myeloma protein and are known as *individually specific antigenic determinants* or *idiotypes*. Idiotypes can be detected by means of antisera. Some antiidiotypic antibodies detect determinants that are restricted to a single Ig (individual, or private, IdI), and other antibodies detect determinants that are present in antibodies or myeloma proteins other than those that are used for immunization (public, or cross-reactive, IdX). Idiotypic determinants, which are known as *idiotopes*, have also been classified according to their location in relation to the combining site: α-idiotopes are located outside of the combining site; β-idiotopes are close to the site, so that the binding of the antiidiotypic antibody interferes with the binding of the antigen; and ?-idiotopes are formed by the site itself ( [606](#) ).

In addition to CDR, the idiotope-determining region (IDR) can be defined not on the basis



of amino acid sequence variability, but as a surface-variable structure that is complementary to a structure on the V region of another Ig molecule. Although all CDRs are also IDRs, the partial overlap between these two kinds of regions suggests that IDRs outnumber CDRs (606). IDRs, therefore, are functionally involved in antigen recognition, as well as in recognizing and being recognized by other Ig molecules. This functional attribute of IDR is central to the network theory of immune regulation of Jerne (607, 608).

Allotypes are allelic variants of Ig polypeptide chains that segregate in mendelian fashion in outbred populations. Allotypes that vary by one or a few amino acids are simple allotypes, whereas those that are characterized by greater differences are complex allotypes. In humans, Ig allotypes have been well characterized for all subclasses of the IgG (?) H chains (Gm allotypes), for IgA (a) H chains (Am allotypes), and for the ?-chains (Km allotypes). The current nomenclature contains the class and subclass of the allotype (G1m, G2m, G3m, and G4m) as well as the specific allotype number in parentheses, for example, G3m(5) (609). Some allotypes are conformational and only become reactive with antibody when the allotype-carrying chain is associated with another chain. Km allotypes are detected only when their K chain is linked to an H chain. The Km allotypes, Km(1), Km(1,2), and Km(3), result from amino acid substitutions at positions 153 and 191 in C?. These two positions are in close apposition within the C? domain and form the Km determinant, which appears to be on the surface of the domain and is therefore capable of inducing antibodies. The isotypic markers of C? (known as *Oz* and *KERN*) also are close to those positions. The H chain allotypes of different H chain isotypes are inherited together as a group, which is sometimes referred to as a *haplotype*.

## IMMUNOGLOBULIN FUNCTION

### Immunoglobulin G

IgG is the major Ig in humans and constitutes approximately three-fourths of the total Ig (Table 18.5). The serum concentration varies from 8 to 16 g/L in adults, but the intravascular pool accounts for less than one-half the total body IgG; approximately 55% is found widely distributed within the extravascular space. The total body content is in excess of 1 g/kg of body weight. IgG molecules have a half-life of 21 days and therefore have the longest lifespan.

TABLE 18.5. Properties of Immunoglobulins

| Properties                       | IgM      | IgG  | IgA        | IgD  | IgE  |
|----------------------------------|----------|------|------------|------|------|
| Subclasses                       | 2        | 4    | 2          | —    | —    |
| Molecular weight (kd)            | 950      | 150  | 150 to 300 | 185  | 190  |
| Heavy chain                      | $\mu$    | ?    | a          | ?    | e    |
| Light chain                      | ?, ?     | ?, ? | ?, ?       | ?, ? | ?, ? |
| Percent carbohydrates            | 10 to 12 | 4    | 10         | 12   | 12   |
| Survival (t <sub>1/2</sub> days) | 5        | 21   | 6          | 3    | 2    |
| Complement fixation              |          |      |            |      |      |
| Classical                        | +++      | +    | —          | —    | —    |
| Alternative                      | —        | —    | +          | +    | +    |
| Cross placenta                   | —        | +    | —          | —    | —    |
| External secretions              | +        | +    | +++        | —    | +    |
| Cytophilic for:                  |          |      |            |      |      |

|                           |     |      |     |              |
|---------------------------|-----|------|-----|--------------|
| Macrophages               | ±   | +++  | -   | -            |
| Mast cells                | -   | ±    | -   | +++          |
| Serum concentration (g/L) | 1.5 | 11.0 | 2.4 | 0.03 < 0.005 |
| Percent of total Ig       | 5   | 80   | 15  | -            |

Ig, immunoglobulin; +, weak; +++, strong; -, negative; ±, borderline.

The four isotypic subclasses of IgG molecules are distributed as follows: IgG1, 66%; IgG2, 23%; IgG3, 7%; and IgG4, 4%. These antigenic differences are the result of variations in amino acid sequences of the carboxy-terminal parts of the  $\gamma$ -chains. All four types of molecules are found in any given normal serum, but individual molecules contain only a single type of  $\gamma$ -chain. The IgG subclasses carry numbers of disulfide bonds that are arranged in different ways. The hinge region is also strikingly different among the subclasses; it is long in IgG3. The length of the hinge region is important for certain functions of the Fc fragment.

**BIOLOGIC PROPERTIES** Most of the antibodies that are found in secondary antibody responses to antigen are IgGs. IgG is selectively transferred across the placenta, thereby giving a measure of protection to the newborn (610) (Table. 18.5). Some biologic properties of IgG proteins, and particularly those that are mediated by the Fc fragment, are distinctly subclass specific. IgG1 and IgG3 react most readily with C1q, the first component of complement, and therefore activate complement most efficiently. IgG2 is less reactive, and intact IgG4 proteins are completely unreactive. The binding of Fc to macrophage and granulocyte Fc receptors is most efficient with IgG1 and IgG3, and this reaction is important in the process of opsonization. Anti-Ig antibodies (rheumatoid factors) react most readily with IgG1, IgG2, and IgG4 proteins and not at all with IgG3 proteins (611). IgG3, on the other hand, has a tendency to aggregate (612), a property that probably is also responsible for the affinity of the molecule for C1q. Aggregation of IgG3 may lead to clinically significant hyperviscosity states, especially in patients with IgG3 myeloma. In addition, IgG3 is selectively retained in the sera of some patients who have generalized hypogammaglobulinemia (613). Some antibody activities are subclass specific. Thus anti-Rh antibodies are usually IgG1 or IgG3; anti-factor VIII antibodies are often restricted to IgG4, and other antibodies, such as antidextran and antilevan, have been found to be IgG2.

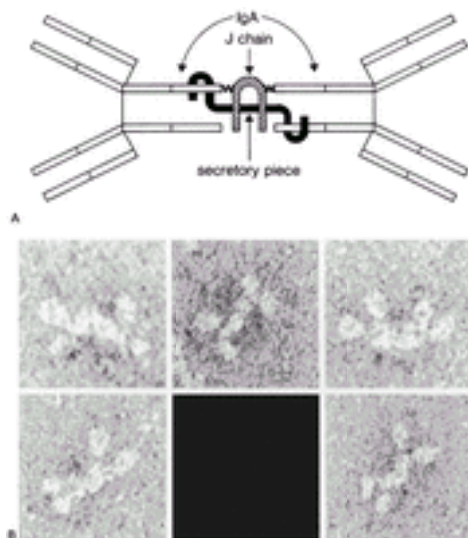
## Immunoglobulin A

The IgA class of antibodies can be divided into two separate systems of Ig (614, 615). One system, IgA1, provides IgA antibodies for the circulation and the internal secretions, such as the aqueous humor of the eye, the cerebrospinal fluid, and the synovial, amniotic, pleural, and peritoneal fluids. These IgA antibodies probably are synthesized by nonmucosal lymphoid tissues. The other system, IgA2, is found in external secretions, such as saliva, tears, bile, and colostrum, as well as secretions of the respiratory tract, the gastrointestinal tract, the seminal vesicles, the cervix, and the urinary tract. The IgA of external secretions is, for the most part, not derived from the blood but is produced locally by plasma cells that are situated in proximity to the epithelial mucosa. It is the predominant Ig in external secretions, although smaller amounts of IgM and IgG also may be found.

In the serum, 85% of IgA molecules are monomers, with a molecular weight of 170 kd and a sedimentation coefficient of 7S; 9S, 11S, and 13S polymers make up the remainder. Approximately 1% is secretory IgA; this percentage increases in association with a variety of mucosal inflammatory diseases. The serum concentration of IgA is in the range of 2 to

3 g/L, with a half-life of 6 days. Monomeric IgA is composed of two H (α) and two L chains. The α-chains of IgA1 and IgA2 subclasses are strikingly different in the hinge region. Certain bacterial proteases cleave IgA1, but not IgA2, into Fab and Fc fragments. These IgA1 proteases are exquisitely specific. In the IgA2 subclass, the H and L chains are not held together by a disulfide bond.

Secretory IgA (sIgA) is a large molecule with a molecular weight of 390 to 400 kd. It consists of two IgA molecules forming a dimer and two additional non-Ig components, which are known as the *J chain* and the *secretory component* (SC) (616, 617). The J chain joins two IgA molecules through a disulfide bond to form a dimer, whereas the SC is the extracellular part of the polymeric Ig receptor (pIgR), which remains attached to IgA after trans-epithelial crossing (Fig. 18.23) (618). The epithelial cells in the glands and basolateral crypts of the gastrointestinal and upper respiratory tracts produce the full-length (100 kd) pIgR located in the nonserosal surface of the epithelial cells. It consists of five V-type Ig-like domains in the extracellular region, a transmembrane, and a 103 amino-acid intracellular region. Binding of polymeric IgA (pIgA) to the first extracellular domain of the pIgR is followed by endocytosis and transcytosis across the epithelial cell (619). The initial step is through clathrin-coated pits and requires two cytoplasmic tyrosines of pIgR and phosphorylation of serine 726. The endocytosed complex is delivered first to Rab+ basolateral early endosomes (BEEs) and then on to Rab17+ common recycling endosome (CRE). In this compartment, the complex is sorted and directed to the apical plasma membrane (619).



**Figure 18.23. A:** Dimer of immunoglobulin A (IgA). The J chain is linked through disulfide bonds with the  $C_{\alpha 3}$  domains of the monomers. The secretory piece attaches through disulfide bonds to the Fc fragments of the monomers. **B:** IgA dimers. (Courtesy of Dr. K. H. Roux.)

The IgA dimer is released on the luminal side of the epithelial cell, with the extracellular portion of the pIgR (i.e., the SC), still attached, forming the secretory IgA (sIgA) (620, 621). During transcytosis, disulfide bonds form between pIgR and pIgA. The J chain is essential for the transport of IgA, and expression of the J chain by plasma cells is particularly critical for the overall function of sIgA in mucosal surfaces (622). A disulfide bond between the J chain and the IgA monomer is sufficient for IgA dimerization. IgA polymers are also formed that retain high affinity for free SC. The SC protects the IgA from

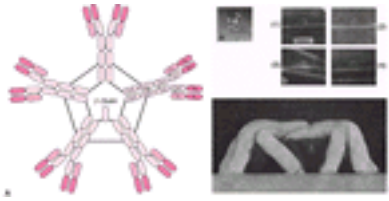
intracellular digestion by proteolytic enzymes. The SC is more efficient than IgR in providing protection because, as a result of its carbohydrates, it is able to anchor the sIgA to mucus within infected areas, in contrast to the random distribution of pIgR. Furthermore, pIgR can be used by some bacteria (e.g., *Streptococcus pneumoniae*) to gain access to the transcytosis pathway. The IgA transport system is unique in that, in contrast to other pathways, it does not lead to degradation of its ligand, the IgA molecule. The IgA and the asialo glycoprotein transport of hepatocytes occupy the same compartment inside the cell, yet each follows distinct pathways subsequently.

**BIOLOGIC PROPERTIES** Although IgA is incapable of fixing complement or acting as an opsonin, the secretory IgA molecule, together with complement and lysozyme, is capable of killing *Escherichia coli*. Secretory IgA does not activate complement by the classic pathway, but chemically aggregated IgA (not 11S IgA) has been shown to have activity in the alternate complement pathway. Like other Igs, secretory IgA is capable of blocking bacterial adherence to mucosal surfaces, thereby preventing colonization. It may also act as a blocking antibody to reaginic reactions on mucosal surfaces and may prevent the absorption of antigenic molecules from the lumen of the gut. Surprisingly, most IgA-deficient individuals appear to be fairly healthy and not overly susceptible to upper respiratory tract infections. IgA antibodies against intrinsic factor have been reported in the gastric secretion of patients with pernicious anemia. It has been proposed that IgA may serve as a carrier of antigens from the blood to the mucosal sites, providing an explanation of how antigens find their way into external secretions through the SC transport system. This antigen clearance function of IgA has been substantiated. Perhaps the mucosal synthesis of IgA makes it particularly suitable for removal of dietary and microbial antigens that are absorbed from the gut. More recently, receptors for the Fc portion of IgA were identified on peripheral and alveolar macrophages, lymphocytes, and neutrophils (623). Through such receptors, IgA participates in antibody-dependent cell-mediated cytotoxicity reactions.

## Immunoglobulin M

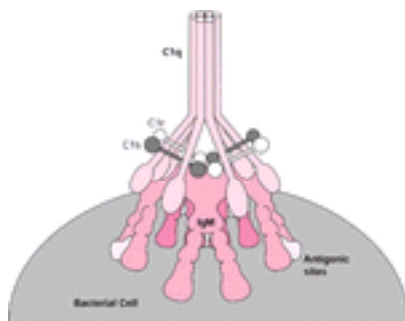
IgM antibodies are proteins with a molecular weight of 850 kd that sediment predominantly at 18S to 19S but also at 22S, 26S, and 35S (Table 18.5). Because of their size, IgM molecules are referred to as *macroglobulins*. Their rate of synthesis is only one-twentieth of that of IgG, whereas their fractional catabolic rate is two to three times that of IgG, which accounts for the relatively short survival (half-life of 5 days) and low serum levels (0.8 to 3.0 g/L) of IgM.

IgM macromolecules are composed of five identical subunits that are called *IgM monomers*, each of which consists of two  $\mu$  (H) chains and two L chains (Fig. 18.24A). The L chains may be  $\lambda$  or  $\kappa$  and are identical to those of other Ig. The H chains, on the other hand, have some unique structural features. Whereas human  $\lambda$ -chains vary in length from 446 to 450 amino acid residues,  $\mu$ -chains contain in excess of 500 residues and have a correspondingly higher molecular weight of approximately 70 kd. In addition,  $\mu$ -chains appear to consist of a variable region and four constant regions, in contrast to the three constant regions of  $\lambda$ -chains. Similar to  $\lambda$ -chains, however, each region (constant and variable) contains a loop of approximately 60 amino acids with an internal disulfide bridge that is flanked on either side by approximately 20 amino acids. Carbohydrates account for 10.7% of the molecule by weight and are distributed over five sites within the constant region: one within the Fd region, one in the hinge region, two within Fc, and one near the COOH terminus. They affect the conformation and other properties of the molecule but do not contribute directly to antibody specificity. Two subclasses of IgM (IgM1, IgM2) have been identified on the basis of antigenic differences within the  $\mu$ -chain.



**Figure 18.24. A:** Immunoglobulin M (IgM) pentameric molecule. The IgM molecule is composed of five subunits that are held together through disulfide bonds. In the polymerization of the subunits, the J chain is involved. (From Roitt IM, Brostoff J, Male DK. Immunology, 2nd ed. St. Louis: Mosby, 1989, with permission.) **B:** By electron microscopy, the IgM molecule appears star shaped (a). When it is bound to antigen, such as the flagellum of *Salmonella*, it assumes the crab or staple form (b: 1–4), a model of which is shown in c. (From Feinstein A, Munn EA. Conformation of the free and antigen-bound IgM antibody molecules. Nature 1969;224:1307–1309, with permission.)

In the intact IgM molecule, five monomers are assembled in a star-shaped configuration, with the carboxy-terminal (Fc pieces) being joined at the center through disulfide bonds, whereas the antigen-binding sites (Fab pieces) extend toward the periphery. The molecule appears to have a great deal of rotational freedom, and, although bound to particulate antigen, it may take on the appearance of a staple or a spider (Fig. 18.24B), with its legs (Fab pieces) extending toward the plane of the antigen (a cell surface) and its body consisting of closely linked Fc fragments that protrude from the center, thus making it ideally suited for complement fixation (Fig. 18.25).



**Figure 18.25.** Immunoglobulin M (IgM)–C1 esterase interaction. On the surface of pathogens, IgM assumes the staple (as seen sideways) or crab conformation. While the Fabs touch the surface of a pathogen, or immune complexes deposited on tissues, the Fc fragments form a plateau on which C1q finds space to touch down with the heads of the arms. The C1r–C1s tetramer weaves between the arms as a necklace. Recognition of patterns by C1q creates a conformational shake up, which is transmitted to the catalytic domains of C1r, which is activated. In turn, C1r activates the C1s, which performs the esterase functions of the whole complex, C1 esterase.

Because the IgM molecule consists of five subunits, each with two antigen-combining sites, there are ten combining sites per IgM pentamer. A single J chain has been found attached to the IgM pentamer by disulfide bridges. IgM monomers do not have J chains.

**BIOLOGIC PROPERTIES** Macroglobulins are restricted mostly to the intravascular pool. Little if any IgM crosses the placental barrier, and the amount that is present at birth is almost entirely of fetal origin. Detectable levels of IgM may be synthesized by the human fetus by as early as the twentieth week of gestation, but high levels of IgM at birth usually are indicative of intrauterine sepsis (624). On cell surfaces, a single molecule of IgM



readily fixes complement, whereas antibody doublets are required for fixation of complement by IgG. IgG is efficient at 4° C and 37° C, however, whereas IgM is inefficient at the lower temperature. Binding of C1q to IgM has been assigned to both C $\mu$ 3 and C $\mu$ 4 domains. Mutations that involve a single amino acid in the C $\mu$ 3 domain abolishes complement fixation ( [625](#) ). Specific macrophage receptor sites for the Fc region of IgM have been described in animal systems. Such receptors may play a critical role in the process of phagocytosis of immune complexes. IgM antibodies are the first to be produced in a primary immune response, to be replaced subsequently by IgG antibodies. However, certain types of antibody responses remain mostly IgM, including those against LPS and the heterophil (Forssman) antigens. Wassermann antibodies, isohemagglutinins, cold agglutinins, and antibodies to the O antigens of gram-negative bacteria are usually IgM.

**IMMUNOGLOBULIN M MONOMER** IgM monomer (7S IgM) is the predominant Ig on the B-cell surface. Naturally occurring 7S to 8S IgM monomers also have been identified in normal sera, and higher concentrations of monomers occur in association with various diseases, including SLE, Waldenström macroglobulinemia and other hypergammaglobulinemic states, congenital rubella, and immune deficiency disorders, such as ataxia telangiectasia and dysgammaglobulinemia. In some instances, IgM monomers possess antibody activity against blood group substances or cell nuclei (antinuclear factors). IgM monomers may be related to more primitive Ig and appear to be synthesized as such, rather than to represent an *in vivo* or *in vitro* breakdown product of IgM.

## Immunoglobulin D

IgD is found in low concentration in normal serum (3 to 400 mg/L) ( [626](#) ). It consists of two H (?) chains and two L (? or ?) chains, has a molecular weight of 180 kd, and sediments at 7S. It appears to be catabolized rapidly (half-life of 2.8 days), is confined largely to the intravascular space, and does not cross the placental barrier. The IgD has three constant region domains and an unusual hinge region, which is strikingly different from the hinge regions of other Ig. It is longer than the  $\gamma$ 1,  $\gamma$ 2, and  $\alpha$ 2 hinges and has a highly charged C-terminal one-half. Its unusual structure makes it extremely susceptible to proteolytic cleavage. IgD is a major surface Ig of peripheral blood lymphocytes.

IgD plays an important role as antigen receptor in B-cell activation. It is expressed during certain periods of B-cell differentiation. IgD may function as an antigen receptor that is capable of triggering antibody production, whereas binding of antigen to IgM leads to tolerance. Both receptors, however, are capable of inducing proliferation and differentiation of B lymphocytes.

## Immunoglobulin E

Reaginic antibodies, which mediate acute and sometimes life-threatening allergic reactions in atopic patients, belong to this distinct class of Igs ( [627](#) ). IgE molecules also have 2 H (e) chains and 2 L chains. They have a molecular weight of 200 kd and a sedimentation coefficient of 8.2S, and they contain 12% carbohydrate. The e-chains are approximately the same size as the  $\mu$ -chains, with four constant region domains totaling approximately 550 amino acids. Each molecule has 15 half-cysteines, eight of which form intrachain disulfide bonds within the four constant domains. The formation of two interchain H-H bonds between two noncomplementary regions, that is, between Ce1 and Ce2 and between Ce2 and Ce3, is unique to e-chains. Carbohydrates are found throughout the chains. All six oligosaccharide units are N-linked to Asn. The survival of IgE molecules in the serum is shorter than that of any other Ig (half-life of 2.4 days), and their serum concentration is in the range of 0.1 to 0.7 mg/L, with a mean of 0.3 mg/L. Higher concentrations may be found in the sera of patients who have asthma, hay fever, eczema, Wiskott-Aldrich syndrome, and helminthic infestations. IgE-forming plasma cells

are found most commonly in the respiratory, gastric, and intestinal mucosa and in the regional lymph nodes, but a few are noted in the spleen and in other lymph nodes. Thus, IgE, like IgA, is classified as a secretory Ig.

**BIOLOGIC PROPERTIES** IgE antibodies are capable of sensitizing basophils and mast cells. The Fc portion of the IgE molecule fits into specific receptor sites on the cell surface. When bivalent or multivalent antigens bind at least two adjacent IgE molecules, the mast cell or basophil is triggered to degranulate, thereby releasing vasoactive substances, especially histamine and slow-reacting substance of anaphylaxis, which are responsible for such clinical manifestations as wheal and flare reactions, bronchospasm, small vessel dilation, and shock. Reduction of the disulfide bonds destroys the ability of the molecule to bind to the Fc receptor, and heating of the IgE at 56° C inactivates its cytotoxic activity. This inactivation is associated with loss of antigenic determinants in the Ce3 and Ce4 domains, suggesting that these regions are important for binding to the receptor.

### J Chain

The J (joining) chain has been detected in association with polymeric forms of serum and secretory IgA, as well as with the IgM pentamer ( 617, 628 ). This chain has a molecular weight of 15 kd. It is attached to IgA or IgM polymers by disulfide linkages. It is not detectable by antisera while the polymers are in their native state, but it becomes readily accessible if the polymers are dissociated. In contrast to the secretory piece, J chains are produced by plasma cells and appear to play a key role in the process of polymerization of Ig, serving as a clasp or zipper to fasten the last two monomeric components of a polymeric Ig together.

The complete amino acid sequence has been inferred from cloned genomic DNA. The chain is larger than previously determined, containing 137 amino acids. Many cysteine residues are scattered throughout the molecule. Of the 137 amino acids in mouse and human J chains, 106 are identical (77%). This characteristic, plus the fact that the C-terminal regions of the  $\mu$ - and  $\alpha$ -chains are also conserved, suggests that the polymerization of Ig molecules has been conserved in evolution, probably because they confer advantages in defense mechanisms in that they aggregate complex pathogens more effectively.

## COMPLEMENT

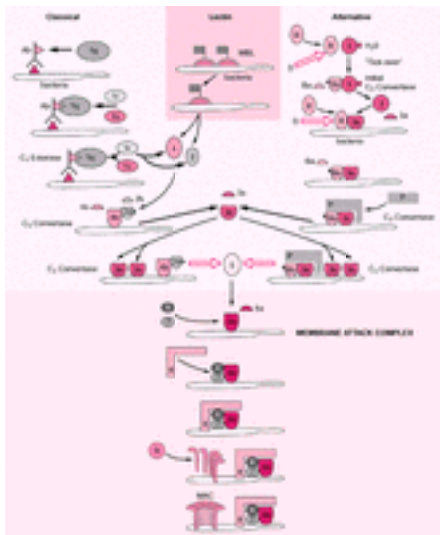
In the late nineteenth century, studies showed that serum contains a substance that is capable of lysing bacteria. Jules Bordet proved that this substance was present in fresh serum and lost activity when it was heated to 56° C. The name *complement* was suggested by Paul Ehrlich and J. Morgenroth, because it was thought to complete the activity of the antibodies from which it could be distinguished by its distinct properties. Complement activity has been measured ever since its discovery by the release of hemoglobin from antibody-sensitized sheep erythrocytes. It is now recognized that complement represents a multimolecular system. It is activated by three different pathways, the classical, the alternative, and the lectin, with the final lytic or effector function being carried out by a common pathway. This final common pathway leads to the formation of the *membrane attack complex (MAC)*.

### Classical Pathway

The classical pathway is initiated by two functional units: the recognition unit, which consists of three proteins, C1q, C1r, and C1s, and the activation unit, which consists of



C2, C3, and C4 ( [629](#), [630](#) ) ( [Fig. 18.26](#) ). The MAC is activated by the classical pathway by the generation of three complex enzymes with proteolytic activity, the formation of which requires the association of two or more proteins ( [631](#) ). Not all Ig classes are capable of binding to C1q; IgG1 and IgG 3 bind readily, whereas IgG4 does not bind at all. Complement binding to the IgG subclasses is determined by the flexibility of the hinge that prevents steric interference between Fab and C1q binding. IgG3, with the longest hinge region, is the most efficient of all IgG subclasses. Exposure of the C1q binding site of IgM molecules is optimal when the molecule assumes the staple configuration as it binds to the antigen ( [Fig. 18.25](#) ). This site is hidden in the native form of IgM by the closeness of the subunits. IgM has the strongest binding ability because one C1q molecule that is bound to one IgM antibody is capable of lysing an erythrocyte, whereas two IgG molecules in close proximity are required to achieve the same effect. Ig antibodies that are bound to independent epitopes can activate the complement cascade in this way. Depending on the epitope density, activation occurs when at least 800 IgG molecules bind to the cell. For this reason, IgM antibodies are considerably more efficient lysins.

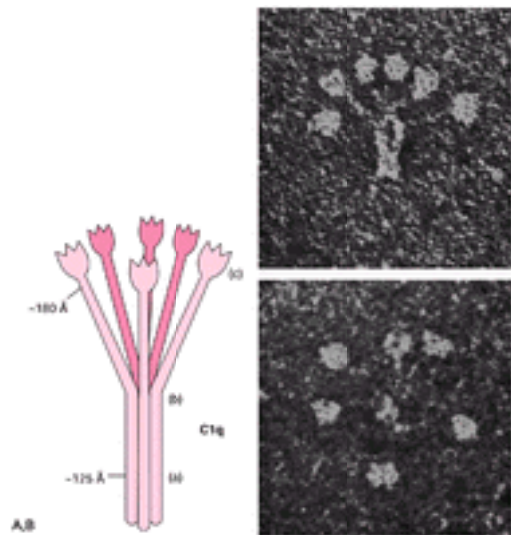


**Figure 18.26.** The complement (C) pathways. The hemolytic function of the C is activated by three pathways, which converge to the same final common pathway (see the chapter text for details). The classical pathway uses C1q as the recognition molecule, which generates sequentially three enzymatic functions: C1 esterase, C3 convertase, and C5 convertase. The alternative pathway initiates activation by a “tick over” mechanism in the absence of antibody and again generates similar enzymatic functions as the classical pathway. The lectin pathway is triggered by a receptor, mannose-binding lectin (MBL), which, through carbohydrate binding, activates the MBL-associated serine protease (MASP) esterases. A MASP cleaves C4 and C2, generating the same C3 convertase as the classical pathway, which it joins at this point. All pathways converge to the same membrane attack complex (MAC) pathway, which they initiate by cleaving C5.

**STEP 1: C1 ESTERASE (C1S)** C1 esterase is a complex that is assembled from three proteins: C1q (recognition subunit), C1r, and C1s (catalytic complex) ( [632](#) ).

**C1q: Recognition Unit of C1s** All activators of the complement cascade recognize the C1q, which consists of a total of 18 polypeptide chains, six of each of the three different types, A, B, and C ( [633](#), [634](#) and [635](#) ). All polypeptide chains are equal in length, and each is comprised of a short N-terminal region that is involved in the formation of A–B and C–C interchain disulfide bonds. It is followed by collagenlike sequences, which consist of repeating triplets X–Y–Gly, a collagenlike motif (X is often a proline; Y is usually

hydroxyproline or hydroxylysine). These sequences are not found in human serum proteins but are present in collagen fibrils. At the beginning, three heterotrimers (each consisting of A, B, and C polypeptide chains) associate, forming a stalk. Due to interruption of the collagen sequence, the triplets dissociate into radiating six arms ( Fig. 18.27A). At the C-terminal end, each arm ends in a globular head, which consists of heterotrimers of protein domains that are known as *C1q modules* ( 636). When viewed by electron microscopy, the C1q resembles a bouquet of flowers ( Fig. 18.27B).



**Figure 18.27. A:** C1q molecule. Each of the six subunits is made of three polypeptide chains that form a triple helical strand. The N-terminal ends have a collagenlike structure and are packed together, forming a central stalk (*a*); halfway, they bend and separate from each other (*b*), to end at the C-terminal end in a globular domain (*c*), that binds to the immunoglobulin. **B:** Electron micrographs of the C1q molecule (**upper**) and bird's eye view (**lower**). (From Knobel H, Villiger W, Isliker H. Chemical analysis and electron microscopy studies of human C1q prepared by different methods. *Eur J Immunol* 1975;5:78–82.)

### **Modules of the C1**

**gC1q Module** Most of the C1 activators, such as immune complexes,  $\beta$ -amyloid fibrils, and HIV, are recognized by the globular heads of C1q ( 637). Each head is composed of trimers of the gC1q domain, which is detected not only in C1q but also in type VIII and type X collagens and several other proteins ( 633). The gC1q modules bear structural features that are seen in members of the TNF family ( 638).

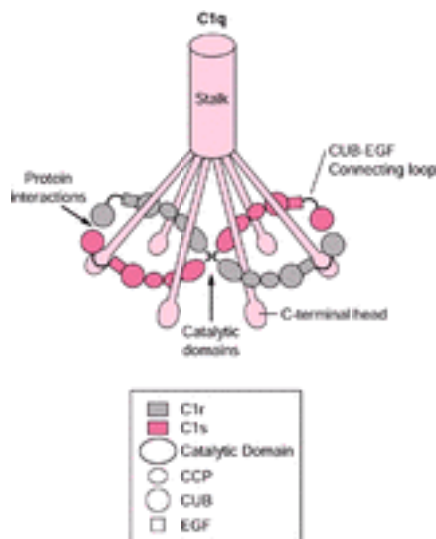
**CUB Module: C1r–C1s Uegf Bone Morphogenetic Protein–1 Module** The acronym CUB was given from the detection of this module for the first time in the sea urchin protein, Uegf, and the human bone morphogenetic protein–1. The CUB modules of C1r and C1s surround the single epidermal growth factor (EGF) module and a pair of complement control protein (CCP) modules. CUB modules are detected in proteins that are involved in developmental processes. They contain four cysteine residues, forming two disulfide bonds, except the N-terminal CUB module of C1r and C1s, which has only two cysteines.

**EGF-Module: Epidermal Growth Factor-Like** EGF-like modules are detected in diverse proteins that are involved in processes such as blood coagulation and cell adhesion. They have six cysteines that form three disulfide bonds. In C1r and C1s, the EGF module has characteristic consensus sequences with residues Asp and Asn that are hydroxylated and are involved in  $\text{Ca}^{2+}$  binding.

**CCP Module** The complement control protein (CCP) module is detected in complement receptors and other CCPs. Their consensus sequence consists of aromatic and hydrophobic residues and four cysteines. The crystal structure has been solved and shows six  $\beta$  strands around a hydrophobic core ( 639). The modules are ellipsoidal with the  $\beta$  strands aligned along their long axis with N- and C-termini at opposite ends.

**Serum Protease Domain** The target bonds in the substrates for cleavage by the C1 esterase have one Arg residue. Indicative of its trypsinlike enzymatic specificity is the Asp residue that is found close to the substrate binding site. Arginyl bonds, such as Arg–isoleucine (Ile), are the targets in the autoactivation of C1r and in the activation of C1s by C1r. Arg–containing bonds are also cleaved in C4 and C2 by the active C1s. C1s esterase activity is expressed only by the multimolecular complex, which is a tetramer that is formed by two C1r and two C1s. Therefore, the enzymatic activity depends on protein–protein interactions between the four components of the esterase, which are facilitated by  $\text{Ca}^{2+}$  (640).  $\text{Ca}^{2+}$  brings together one CUB and one EGF module to form a compact structure (641). During the formation of the tetramer, interactions are flexible to allow a single C1r to cleave the neighboring and the distant C1s (642).

**C1r and C1s** The C1r and C1s are single polypeptide chains of approximately 85 kd, with a Ser protease activity. In the proenzyme form, they are single glycoproteins, which are activated by cleavage of a single Arg–Ile bond, forming a two–chain active enzyme. They are composed of two CUB modules (643), an EGF–like module, two CCP modules, and a C–terminal chymotrypsin–like Ser protease domain (Fig. 18.28).



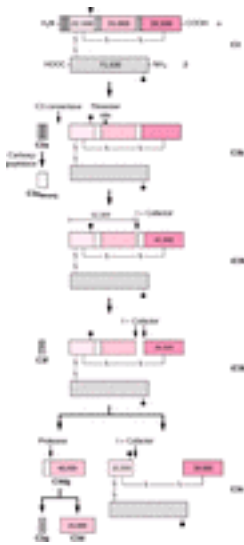
**Figure 18.28.** C1 esterase assembly. The C1 esterase is a complex that consists of one C1q molecule (recognition component) and a tetramer of two C1r and two C1s. The tetramer in isolation assumes a linear form: C1s–C1r–C1r–C1s. It weaves among the arms of the C1q in a necklacelike way and assumes a figure eight. This arrangement allows access of the catalytic domain of the C1 in the zymogen form, to be in contact with the active catalytic domain of C1r for C1s to be activated. Both C1rs have access to both C1s. The flexibility of the tetramer allows changes in their relative position, so that the active C1s sites have access to C4 and C2 for their cleavage and formation of the C4a–C2b C3 convertase. The CUB and EGF modules of C1r are connected by a flexible loop and form a high–affinity  $\text{Ca}^{2+}$  binding site that is involved in the interaction with C1s. The CUB–EGF pair interacts with the C1q arm. When the heads of C1q interact with a pattern of sites on the surface of a target, a conformational stress that is transmitted through the arms of C1q triggers the C1r catalytic domain and results in its activation. CCP, complement control protein.

**Assembly of C1 Esterase** The first enzymatic activity of the C cascade is assembled from five components, one C1q, two C1r, and two C1s (Fig. 18.28). The C1r–C1s tetramer, in isolation, is a linear structure, with the C–terminal domains responsible for the catalytic function and the N–terminal involved in the  $\text{Ca}^{2+}$ –dependent protein interactions. In the linear form, the two C1r catalytic domains are in the center, whereas those of the C1s are at the two ends. In the assembly of the C1 esterase, which is the first enzymatic activity of the classical complement cascade, the linear tetramer assumes a compact

figure-eight conformation. In this configuration, all four catalytic domains of C1r and C1s are brought in juxtaposition under the cone that is formed by the arms of the C1q. The protein interaction domains are located outside the arms of C1q (644, 645 and 646). Activation of C1 esterase occurs on recognition by the globular heads of C1q of pattern target sites (e.g., antibody bound to pathogen surfaces and immune complexes). This binding generates transient conformational changes, which activate C1r by disrupting the C1r homodimer. Activated C1r in turn breaks an Arg-Ile bond, activating C1s (640). These transient “earthquakes” do not bring the collapse of the elaborate C1 esterase edifice, because C1r and C1s are associated tightly to the C1q collagen arms by the CUB-EGF modules that were discussed previously. C1s is a highly specific enzyme, but, within the mechanical constraints that are imposed by the superstructure of the whole assembly, it requires some degree of freedom of mobility for its interaction with the substrate. These requirements are provided by the CCP modules, especially CCP-2, which is linked by a flexible hinge to the CCP-1 module. This allows CCP-2 to act as a handle and a spacer, to amplify the shift that is required for the serine protease domain (639, 646).

**C1q Binding Proteins** In addition to its function in C activation, C1q binds to other proteins that are sometimes called *receptors*, mediating other C1q functions (647, 648). There are two types of surface proteins that bind to C1q. One binds to the collagenous portion of C1q (cC1q receptor), and the other binds to the globular heads (gC1q receptor). Some of these proteins are transmembrane, whereas others are intracellular, such as calreticulin (cC1qR) and the gC1q-binding protein (gC1qR). The C1q structure bears similarity to the proteins of the collectin family, which includes the mannose-binding lectin (MBL), the pulmonary surfactant protein A, and conglutinin. However, the collectins are C-type lectins and bind carbohydrates, whereas the heads of C1q recognize protein patterns on immune complexes. The term *C1qR* has been used loosely, sometimes without hard evidence that the receptor triggers cell signaling that leads to some cellular functions (648). The gC1qR is expressed on myeloid cells (649) and microglial cells (650), in which it mediates chemotaxis and phagocytosis, and in platelets (651), modulating their function in injured vascular sites. Calreticulin is a  $\text{Ca}^{2+}$ -binding protein that is located primarily in the ER of most nucleated cells. It has been found that calreticulin binds C1q and therefore qualifies as cC1qR, but the significance of this interaction remains elusive.

**STEP 2: C4 AND C2 COMPLEX: C3 CONVERTASE** C3 convertase is formed by the interaction of two fragments from the C4 and C2 components of complement. Complement component 4 circulates in the blood as a disulfide-linked heterotrimer that consists of  $\alpha$ - (93 kd),  $\beta$ - (75 kd), and  $\gamma$ -chains (33 kd). C3 and C5 components share a similar structure considered to be evolutionarily derived from one ancestral gene. The C3 and C4 components share an *internal thioester bond*, which is formed between a cysteine and a glutamine, which are two residues apart (652). **C4** is synthesized as a single polypeptide chain but is later hydrolyzed, giving rise to the three constituent chains. C1s activates C4 by splitting the  $\alpha$ -chain, releasing the C4a fragment from the N-terminal end of the chain. The thioester bond, which is normally hidden in the C4b fragment, is exposed, reacts with  $\text{NH}_2$  or OH group of the surrounding molecules (Fig. 18.29), and deposits C4b on the surface of potential targets for C attack.



**Figure 18.29.** C3 degradation. The C3 component not only contributes to the classical pathway in the formation of the C5 convertase, but also, as a result of fragmentation, provides parts of its molecule for other important functions. For example, C3a serves as an anaphylatoxin, C3b serves as a ligand for the CR1 receptor (CD35), C3d serves as a ligand for CR2 receptor (CD21), iC3b serves as a ligand for CR3 receptor (lymphocyte function-associated antigen-1 integrin, CD11b/CD18) and for CD11c/CD18 integrin. (Courtesy of Dr. J.D. Lambris. From Sahu A, et al. *Immunol Rev* 2001;180:35–48, with permission.)

**C2** is a single-chain protein of approximately 100 to 110 kd, with a distinct structure that consists of three globular regions: three N-terminal CCP domains, a single von Willebrand factor (vWF) domain in the center, and a serine protease domain in the C-terminus ([653](#)). CCP modules are highly compact structures, folding independently into a  $\beta$  barrel (e.g., two interacting antiparallel  $\beta$  sheets) which form an ellipsoid structure. Loops that connect the  $\beta$ -strands protrude out of the module and may function as the ligand binding sites. The vWF type A module consists of five parallel  $\beta$  strands and a short antiparallel strand that form a central twisted core, which is surrounded by seven amphipathic  $\alpha$  helices ([654](#)). Cleavage of C2 by C1s occurs in the N-terminal region of the vWF domain, which results in the generation of two fragments, a larger (70-kd) C2a, consisting of most of vWF and SP domains, and a smaller (30-kd) C2b fragment (CCP-1, CCP-2, and CCP-3). Fragmentation of C2 exposes a C4b-binding site that is located on the C2b fragment, which interacts with C4b. C4b-C2a complex formation depends on  $Mg^{2+}$  ions, which are coordinated by residues in the metal ion-binding MIDAS (metal ion-dependent adhesion site) motif of the vWF modules, which is also present in several integrins ([Chapter 2](#), CD61). By electron microscopy, the C2a fragment appears as a two-lobed structure that links the C4b and C3b fragments in the final C5 convertase (see the following discussion). The C4b-C2a complex is a Ser esterase with an esterolytic activity and with the C3 as the natural substrate ([655](#)).

### STEP 3: C3B-C4B-C2A COMPLEX: C5 CONVERTASE

**C3 Component** The C3 component of complement is the most abundant in the serum (1.2 mg/ml) and occupies the most critical position in all three C cascades. The prevailing hypothesis is that a gene that was common for all three components, C3, C4, and C5, originated from an ancestral  $\alpha_2$ -macroglobulin gene. Subsequent duplication formed the C4 and C3-C5 genes, and a second duplication formed separate C3 and C5 genes. C3 is comprised of an  $\alpha$ -chain (110 kd) and a  $\beta$ -chain (75 kd), which are connected covalently by a single disulfide bond. It is synthesized as a single protein and is modified

posttranslationally by a furinlike enzyme, which removes a sequence of four arginines ([656](#)). Another disulfide bond within the  $\alpha$ -chain connects the N- and C-terminals ([Fig. 18.29](#)). C3 convertase cleaves the  $\alpha$ -chain at a site that is close to the N-terminus, generating



two fragments: a small C3a (9 kd) and a large C3b (176 kd). The C3b consists of the remaining  $\alpha$ -chain, which is linked by the disulfide bond to the intact  $\beta$ -chain. Cleavage of the  $\alpha$ -chain of C3 by the C3 convertase exposes the thioester bond, which, in the intact molecule, is well protected within a pocket in the  $\alpha$ -chain with a half-life of 231 hours. In the metastable C3b fragment, the bond is exposed with a half-life of 60 microseconds. These differences strikingly express the extraordinary reactivity of the thioester bond for certain groups on the cell surfaces. The thioester bond participates in a chemical transacylation reaction that results in the attachment of C3b on OH or NH<sub>2</sub> groups on cell surfaces, complex carbohydrates, or immune complexes that are within a radius of 600 Å from the point at which it was generated. Attachment of C3b is not discriminatory between self and nonself surfaces but is regulated by CCPs (see the following discussion). The selection, however, of the OH groups on the sites of binding is quite restricted (657). C3b expresses multiple sites for binding to other complement proteins, which determine its fate. C3b is deposited on and around the C4b-C2a complex, binding through the thioester bond. The deposition produces an enzyme with a change in the specificity from C3 to C5, generating the C5 convertase (658). C3b is also deposited on other previously deposited C3b molecules, forming C3b-C3b dimers. The C3b-C4b and C3b-C3b form high-affinity binding sites for C5, and, probably, the role of these dimers is to hold the substrate in a rigid position for efficient cleavage of C5. It also appears that the C3b-C3b-IgG complexes function as better precursors of convertases than monomeric C3b.

**C3 Fragmentation** C3 is fragmented by several enzymes that generate a variety of functionally active fragments (Fig. 18.29). The activation of C3 by the C3 convertase cleaves the peptide bond between residues 726 and 727 (Arg-Ser) and generates a small C3a (9 kd) and a large C3b (176 kd) fragments. C3a is the N-terminal of the  $\alpha$ -chain that functions as anaphylatoxin. C3b consists of the remaining  $\alpha$ -chain ( $\alpha'$ ) and the entire  $\beta$ -chain, which are linked by the disulfide bond. C3b is inactivated by further proteolysis by factor I and one of the cofactors. The first cleavage occurs between residues 1281 to 1282 of the  $\alpha'$ -chain and generates the inactivated C3b or iC3b<sub>2</sub>, which is the ligand for CD11b-CD18 integrin (Chapter 2). A second cleavage by factor I separates a small fragment C3f (2 kd) from the  $\alpha'$ -chain and yields another inactivated C3b or iC3b<sub>2</sub>. Factor I, with CR1 or factor H as cofactors, cleaves once more the  $\alpha$ -chain at residues 932 and 933, to yield C3dg and C3c. The C3dg fragment is a ligand for CD21 (CR2), a component of the co-receptor complex CD19-CD21-CD81 on B cells (Chapter 16). C3dg is cleaved by a protease into C3g and C3d fragments.

### Alternative Pathway

The alternative complement pathway represents an important natural defense mechanism that is independent of the immune response (Fig. 18.26). Activation of the alternative pathway involves three components: C3, B factor, and D factor. Polysaccharides (zymosan), bacterial products, aggregated human IgA, cobra venom factor, and many other substances are activators of the alternative C cascade. The mechanisms that initiate this pathway have been the subject of much debate. The enzyme that cleaves C3 contains C3b as one of its components, which is the product of a previous C3 cleavage. The origin of the first C3b becomes a puzzling problem. Normally, the C3 continuously generates a low level of a functionally C3b-like form by a "tick-over" mechanism. The mechanism for the "tick-over" is not a proteolytic process, but involves the spontaneous hydrolysis of the thioester bond by H<sub>2</sub>O and the formation of a metastable C3 (H<sub>2</sub>O). The hydrolysis occurs *in vitro* at 37° C at a rate of 0.005% per minute (659). The C3 (H<sub>2</sub>O) is an uncleaved C3 molecule and yet has the conformation and function of a C3b in the presence of Mg<sup>2+</sup>, which provides a site for binding of the B factor.

**FACTOR B** Factor B (90 kd) has a similar structure to C2: It consists of three CCP modules, a vWF type A module, and a serine protease domain that are all connected by

short amino acid sequences. By electron microscopy, it appears as a three-lobed structure, presumably with each module corresponding to one of the lobes.

**FACTOR D** Factor D is a Ser protease with only one known substrate, factor B. The single Arg<sup>233</sup>-Lys<sup>234</sup> bond of factor B becomes susceptible to the enzymatic activity of factor D only when it forms a Mg<sup>2+</sup>-dependent complex with C3b. It is the only enzyme in blood that is able to catalyze this reaction and is therefore absolutely required for alternative pathway activation. The concentration of factor D in the blood is  $1.8 \pm 0.4$  µg/ml, the lowest of any complement protein, which makes factor D the limiting factor in the activation of the alternative pathway. It is a single-chain protein (24 kd) and is structurally similar to pancreatic serine proteases. It circulates in blood in a zymogen or profactor form ( [660](#) ) converted to the mature enzyme as a result of conformational changes. However, this first step generates a “resting” enzyme because of an inhibitory sequence loop, which prevents its activation. The active enzyme conformation is induced after binding to the substrate in a second step. Factor D has a structure that is similar to other members of the serine proteases: The polypeptide chain is folded into two antiparallel β barrels. Each barrel consists of six β strands with the same topology in all members ( [661](#) ). Efficient catalysis requires three amino acids, Asp<sup>102</sup>, His<sup>57</sup>, and Ser<sup>195</sup>, forming the *catalytic triad*, and the positioning of the three residues is crucial for the synergistic action that is required for hydrolysis of the target bond. In the bottom of the substrate specificity pocket is an Asp residue, which places factor D in the category of the trypsin subfamily of serine proteases and cleaves an Arg-Lys bond of its single natural substrate, factor B.

**PROPERDIN** Properdin is one of six plasma glycoproteins, which collectively comprise the alternative pathway of complement. It was first described by Pillemer et al. ( [662](#) ) as a novel plasma protein that activated complement in the absence of immune complexes. Properdin consists of a single chain (53 kd), which by electron microscopy appears as a rodlike structure that forms cyclic dimers, trimers, and tetramers in a ratio of 26:54:20 ( [663](#) ). The monomer consists of an N-terminal region of no known homology, followed by six thrombospondin type 1 repeats (TSRs) of approximately 60 amino acids ( [664](#) ). Repeats of this type have first been identified in the cell adhesion molecule thrombospondin and in a variety of other proteins, including thrombospondin types 1 and 2, C6 through C9, and the circumsporozoite protein of malaria parasites ( [665](#) ). Removal of TSR-5 prevents binding to C3b and sulfatide, whereas, with the removal of TSR-4, properdin is unable to stabilize the C3b-Bb complex but is still able to bind C3b and sulfatide ( [666](#), [667](#) ), while it exists only as a monomer or a dimer. Absence of TSR-3 does not have an impact on any of the functions of properdin, including the formation of the polymers. TSR-5 is important for polymer formation, because, in its absence, no cyclic polymers are detected. Properdin, like thrombospondin, binds sulphated glycoconjugates and sulfatide with especially high affinity when it is activated ( [668](#) ). Properdin significantly contributes to linking innate and adaptive immunity. It is synthesized by endothelial cells, especially under turbulent blood flow conditions ( [669](#) ), and mRNA has been detected in neutrophils, monocytes, and T cells. In response to chemoattractants C5a or IL-8, neutrophils discharge their properdin content promptly, as well as C3 and factor B, which they store within their granules. Factor D is supplied locally by blood, which completes the list of the components that are essential for activation of the alternative pathway. T cells and monocytes participate in the process, because they also secrete properdin, factor B, and C3. Activation-produced fragments C3d and iC3b are essential B-cell activation factors ( [670](#) ), thus linking with the adaptive immune system.

**ACTIVATION OF THE ALTERNATIVE COMPLEMENT PATHWAY** In the presence of Mg<sup>2+</sup>, C3 (H<sub>2</sub>O) (also referred to as iC3) binds factor B, which is cleaved by factor D into a large Bb and a small Ba fragment ( [Fig. 18.26](#) ). The Bb forms a complex with the iC3, which is termed the *initial C3 convertase*. Although the iC3-Bb complex is destroyed on host surfaces by factor H and factor I (see the following discussion), C3b fragments that



are deposited on foreign surfaces associate with factor B in the presence of  $Mg^{2+}$ . The C3b-B complex activates factor D, which cleaves factor B into Bb and Ba fragments. The distinction between activator and nonactivator surfaces is not clear. An activator surface is one that allows binding of factor B to C3b in preference of factor H (see the following discussion), thus activating the alternative pathway. The opposite is true for nonactivators. Nonactivators can be converted to activators by removing sialic acid. A widely used activator is cobra venom factor, which binds to factor B and forms a stable C3 convertase. The factor is functionally analogous to C3b but is related structurally to C3c. It is used to deplete serum of C3 in a variety of experimental situations and is resistant to inactivation by factors H and I. The C3b-Bb is stabilized by the serum protein properdin, which amplifies the cleavage and deposition of more C3b molecules ( [671](#), [672](#) ) to form the *C5 convertase*. The serine protease activity of the C3b-Bb complex, which is located in the Bb component, accelerates deposition of C3b fragments (C3b amplification), a unique feature of the alternative pathway, on and around the C3b-Bb complex. Some will form C3b-C3b dimers, which have a high affinity for C5 (self-amplified C5 convertase) ( [672](#) ) and switch cleavage from C3 to C5, thus initiating the formation of the cytolytic C5b-9 complex. As the activation continues, at the outer ring of this circle, monomeric C3bs form more C3 convertases with factor B, which in turn deposits a new crop of C3bs, forming a new generation of C3b-C3b dimers, that is, C5 convertases. These cycles of successive outward deposition of C3 and C5 convertase activities continues until all surfaces are covered or the supply of individual components is exhausted.

### Lectin Complement Pathway

The lectin pathway is an important humoral mechanism of innate immunity. It is activated by pattern recognition receptors, such as mannose binding lectin (MBL), which interacts with carbohydrates ( [673](#) ) ( [Fig. 18.26](#) ).

MBL is a member of the *collectin* family, which includes the lung surfactant proteins, SP-A and SP-D, and a protein that is localized in the hepatic cell cytosol, CL-L1. Collectins are composed of a C-terminal lectin domain (carbohydrate recognition domain) and a neck region that connects to the collagenlike region, followed by a short cross-linking region that contains two to three cysteines. The neck region forms an  $\alpha$ -helical coiled-coil structure, which initiates the formation of a trimer. In blood, MBL is found as multimers (i.e., dimers to hexamers). MBL is a C-type lectin, as it requires  $Ca^{2+}$  for binding to a carbohydrate ligand.

Associated with MBL are four serine proteases that are known as *MBL-associated serine proteases (MASPs)*: MASP-1, MASP-2, MASP-3 ( [674](#), [675](#) ), and sMAP or MAP-19, a truncated form of MASP-2. MASP-2 and sMAP are encoded by a single gene, but two different mRNAs are generated by alternative splicing ( [676](#) ). All MASP proteases have a modular structure that is identical to C1r-C1s: a CUB domain, an EGF-like domain, a second CUB domain, two CCP domains, and a serine protease domain. The serine protease domain is homologous to the chymotrypsinogen family. An Asp residue in the substrate specificity pocket indicates trypsinlike substrate specificity. MASP's association with MBL is mediated by the CUB-EGF domain and is  $Ca^{2+}$  dependent ( [676](#) ). The MASP proteases are activated when MBL binds to conserved pathogen-associated sugar arrays that form molecular patterns, which are shared by broad classes of pathogens ( [677](#) ).

When MASP is activated, it cleaves C4 and C2, and the C4b fragment binds covalently to the microbial surface or the lectin itself and becomes the focus for C2 binding and

activation. The remaining cascade is identical to that of the classical pathway ( [Fig. 18.26](#) ).

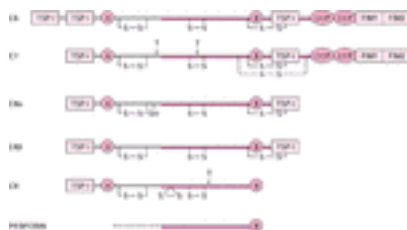
MBL binds mannose–acetyl glucosamine or GlcNAc, which are also ligands for other types of GlcNAc–binding lectins, which are termed *ficolins* and are present in the serum. Ficolins contain collagenlike and fibrinogen–like domains. They bind to GlcNAc through the fibrinogen–like domain. They are associated with MASPs and sMAP and have the capacity to activate the lectin complement pathway ( [678](#) ). In the serum, there are two types of ficolins, which are named L–ficolin and H–ficolin (Hakata antigen) ( [679](#) , [680](#) ).

The recognition that is mediated by MBL and ficolins in complement activation is detected as far back in evolution as the ascidians, our closest invertebrate relatives. It indicates that the complement pathway has been important in innate immunity since before the evolution of adaptive immune systems in jawed vertebrates.

### Membrane Attack Complex

**C5** C5 (191 kd) consists of two polypeptide chains,  $\alpha$  (115 kd) and  $\beta$  (75 kd). C5 convertase selectively cleaves an Arg–Leu bond ( [74](#) and [75](#) ) of the  $\alpha$ –chain, generating C5a, a potent leukocyte chemotactic peptide that consists of 74 amino acids and has considerable structural homology with C3a and C4a, the other two anaphylatoxins. The remaining larger fragment, C5b, in its nascent state, constitutes the nucleus for the MAC. It possesses a metastable binding site with specificity for C6. By electron microscopy, C5 has the shape of a heart or of an ellipse, but the heart–shaped form is related to the elliptical type by rotation ( [681](#) ). The binding sites for C6 and C7 are located in the  $\alpha$ –chain of C5b. Interaction with C5b involves the C–terminal of C6, specifically the C6c fragment that consists of two factor I modules (FIMs).

**C6** C6 is a single polypeptide chain (104 kd) ( [682](#) ), which, by trypsin digestion, can be separated into an N–terminal region (C6a) with some homology to C8 and C9 and a C–terminal region (C6b) with homology to factor H and factor I. Several disulfide bonds separate discrete segments of C6, which is structurally homologous to a variety of other proteins. Overall, the primary sequence is a “patchwork” with several modules that are involved in protein–protein interactions ( [Fig. 18.30](#) ). Starting from the N–terminus, there are several domains: two tandem thrombospondins type 1 (TSP–1s), a class A low–density lipoprotein receptor (LDLR), an extended central segment that is referred to as the membrane attack complex perforin (MACPF) domain with homology to perforin, an EGF, a third TSP–1, two CCPs, and two FIMs, which are related to those in the H chain of the complement control factor I ( [683](#) ). The FIMs are specific C5–binding modules, and yet they are not absolutely necessary, probably because other hydrophobic interactions also contribute to the C5 and C6 interactions. As devices that facilitate C5 and C6 interactions, FIMs make a greater contribution to the classical pathway in which C5b density is not as high as it is in the alternative pathway, because fewer C5bs are formed in the classical pathway, and C5b half–life is shorter ( [684](#) ).



**Figure 18.30.** Structural organization of the C6 through C9 complement components. The last five complement components (C6 to C9) are structurally and genetically related proteins and form the membrane attack complex family. They all have a similar modular structure. In the middle of each molecule is a sequence–designated membrane attack

complex perforin to emphasize its similarity with perforin. Membrane attack complex perforin is the portion of the molecule that is inserted in the membrane to form the pore. C8 $\gamma$  is the sixth component, which is not modular and differs structurally from the others. It is considered that the perforin gene gave rise first to the C9 gene, which evolved in retrograde, followed by the appearance of the genes for the other proteins. The modules in the C6 and C7, which are not shared by C8 and C9 [i.e., complement control protein (CCP) and factor I module (FIM)] are used to interact with C5. A, low-density lipoprotein receptor class A; B, low-density lipoprotein receptor class B (or epidermal growth factor precursor module); TSP-1, thrombospondin 1.

The secondary structure of C6 is a mixture of a helices and  $\beta$  sheets. The  $\alpha$  helices reside in MACPF, which is free of disulfide bonds. By transmission electron microscopy, C6 appears like a sickle.

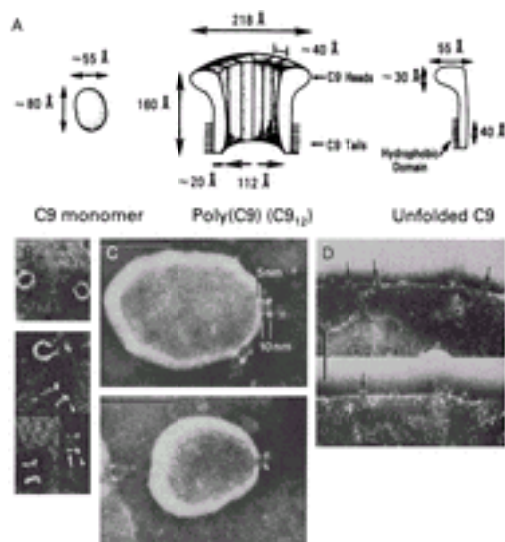
**C7** C7 is a single polypeptide (97 kd), which, like C6, is a mosaic of several modules that are found in other proteins. Starting from the N-terminal, C7 has one TSP-1, one LDLR type A (LDLR-A), a second TSP-1, two CCPs, and two FIMs. Its secondary structure is high in  $\beta$  sheets (38%), and, by electron microscopy, it appears as a flexible elongated molecule ( $151 \times 59 \times 43 \text{ \AA}$ ) (685). The three components C5-C6-C7 in a fluid phase form rosettes as a consequence of radial aggregation. However, the complexes on a phospholipid area insert themselves, anchoring by the stalk, while the Cys-rich segments fasten the complex for the assembly of the MAC. The C5b-7 complex does not traverse the phospholipid membrane and does not cause lysis. The long, flexible stalk of C7 provides greater surface area for interaction within the membrane.

**C8** The C8 component consists of three chains:  $\alpha$  (64 kd),  $\beta$  (64 kd), and  $\gamma$  (22 kd), all being encoded by separate genes. The C8 $\alpha$  and C8 $\gamma$  are linked by a single disulfide bond, and the C8 $\alpha$ -C8 $\beta$  $\gamma$  heterodimer is associated noncovalently with C8 $\beta$  through a binding site on the C8  $\alpha$ -chain (686). The  $\alpha$ -chain interacts with C9, directs the insertion into the membrane of the first C9 in the formation of MAC, and interacts with lipids, thus becoming accessible to MAC formation. Importantly, together with the membrane protein CD59, they inhibit MAC formation in homologous cells and protect them from lysis. The C8  $\beta$ -chain has three binding sites for C8 $\alpha$ , the C5b-7 complex, and membrane lipids. For binding of C8 $\beta$  to the C8 $\alpha$ - $\gamma$  complex, the N-terminal TSP-1, LDLR-A, and the MACPF segment are most important, and, furthermore, they mediate the incorporation of C8 into the MAC (687). The C8  $\alpha$ - and  $\beta$ -chains are structurally related and are members of the MAC family, whereas the C8  $\gamma$ -chain is a member of the lipocalin family, which is unrelated to the MAC family (688). The lipocalins are widely distributed proteins that are involved in the transport of small lipophilic substances, such as retinol and pheromones, but C8 does not bind retinol (689). They all share the same folding pattern, which is known as the *lipocalin fold*. Strikingly, C8 $\gamma$  is the only protein from a different family among the 35 proteins of the complement system. Furthermore, C8 $\gamma$  is not absolutely required for the expression of C8 activity by the  $\alpha$ - and  $\beta$ -chains; however, it enhances their function (690). The crystal structure of C8 $\gamma$  has been solved and confirms its lipocalin fold and, furthermore, identifies its structural relationship to the neutrophil gelatinase, a protein that is released from the granules of activated neutrophils (691). Overall, it forms a calyx with a distinct large hydrophobic cavity at the base of the calyx for ligand binding.

**C9** Complement component C9 is a single polypeptide chain (71 kd), which has a modular structure that is similar to that of the other members of the MAC family: an N-terminal TSP-1; an LDLR-A; the extended central sequence MACPF, which is homologous to perforin (692); and an EGF module in the C-terminal end. C9 is endowed with the capacity to polymerize spontaneously in a circular fashion and to create tubules.

**MEMBRANE ATTACK COMPLEX FORMATION** The C5b-7 complex binds to the cell membrane, and, although it inflicts no harm to the cell, it marks it for subsequent assault by C8 (Fig. 18.26). The C5b-8 complex appears foliaceous by electron microscopy, with branched structures radiating from the central pedicle (693), but, on smaller phospholipid

vesicles, C5b-8 monomers appear as long rodlike structures that are 250 Å wide (694). The C8  $\alpha$ -chain mediates binding and self-polymerization of C9 to form MAC (695). The N-terminal TSP-1 and LDLR-A modules are the principal binding sites for C9 with the cooperative function of MACPF domain. MACs are heterogeneous in size, probably as a result of their composition, and the number of the C9 subunits may vary from 1 to 18, whereas all other components contribute only one molecule (696). The final molecular weight of the MAC therefore varies between 66 and 1850 kd. The average C9 binding capacity per C8 molecule is 15.4 molecules. C9 polymerizes spontaneously, but the C5b-8-induced rate of C9 polymerization is 10,000-fold greater. Self-associating C9 complexes develop new antigenic determinants that are not present in the monomer. C9 is inserted into the membrane through its C-terminal region, and disulfide bonds stabilize the complex. Electron microscopically, the polymerized C9 appears as a cylinder that extends 120 Å above the cell surface. The extracellular hydrophilic end terminates in an annulus that is 30 Å thick, with an inner diameter of approximately 100 Å (697, 698) (Fig. 18.31). The C5b-8 is attached firmly to the C9 cylinder and actually extends 160 to 180 Å above the annulus. The annulus, which is seen with computer-assisted programs, appears to be made of whorls (699) (Fig. 18.31).



**Figure 18.31. A:** C9 molecule in its monomeric form, folded (**left**) or unfolded (**right**) and in its polymerized form (center) as a tubular structure that is seen on cell membranes. **B:** Poly C9 as ring structures (*top view*, or tubules (*side view*). [Courtesy of Dr. E.R. Podack. From Podack ER, Tschopp J. Polymerization of the ninth component of complement (C9): formation of poly(C9) with a tubular ultrastructure resembling the membrane attack complex of complement. Proc Natl Acad Sci U S A 1982;79:574-578.] **C:** Lipid vesicle with a typical cylinder that is formed from polymerization of C9 (*side view*). The cylinder penetrates the wall and protrudes to the outside, above the surface of the vesicle. **D:** Lesions that are induced by complement on sheep red blood cell membranes clearly show cylindrical structures of the membrane attack complex and its penetration into the membrane (*arrows*). (Courtesy Dr. S. Bhakdi. From Bhakdi S, Tranum-Jensen J. Molecular nature of the complement lesion. Proc Natl Acad Sci U S A 1978;75:5655-5659.)

Because the height of the monomeric C9 is only 80 Å, and the poly C9 cylinder is 160 Å, the C9 must be unfolding and must transform into a rodlike structure. Thus, the formation of the cylinder by polymerization of C9 molecules involves the transformation of a hydrophilic C9 monomer into an amphiphilic C9 polymer. The N-terminal part of C9 does not participate directly in polymerization and is located in the upper rim of the cylinder (699). The MACPF domain traverses across the thickness of the cell membrane, forming the wall of the cylinder. The C-terminal part of C9 returns back up near the rim, indicating that polymerization transforms a straight ellipsoid C9 into U shape (700). C9

aligns with other molecules side by side, like staves of a barrel forming a volutelike structure (i.e., a capital of an Ionian-style Greek column). Not all agree with the cylinder model of MAC. Others suggest that MAC proteins cause a distortion of the phospholipid bilayer, thus creating “leaky patches” ( [701](#) ).

## REGULATION OF COMPLEMENT ACTIVATION

Complement activation is an effective host defense mechanism, but, at the same time, it can inflict serious damage to host tissues. For this reason, it must be effectively regulated to distinguish self from nonself, as well as to limit its activation process in time, so that any damage to the host is limited, and the consumption of important components is restricted. A large number of proteins, known as *complement control proteins*, or *CCPs*, are involved in the regulation of complement activation ( [Table 18.6](#) ). This complex regulatory system is best understood if we consider the stages of complement activation that are regulated or whether CCPs exist in fluids versus cellular surfaces. CCPs exert regulation mainly by accelerating dissociation of the convertases, a function that is known as *decay-accelerating activity (DAA)*, or by acting as cofactors to the serine protease factor I, a function that is known as *cofactor activity (CA)*. Some regulators are able to serve both as decay accelerators and cofactors, such as factor H, C4-binding protein (C4bp), and complement receptor 1 (CD35).

**TABLE 18.6. Regulatory Proteins of Complement**

| Factor                    | Location | Function   |
|---------------------------|----------|--|
| Initiation step           |          |  |
| C1 inhibitor              | Serum    | Inactivates C1r and C1s  |
| Amplification step        |          |  |
| Factor I                  | Serum    | Fragmentation of C3b and C4b   |
| Membrane cofactor protein | Membrane | Cofactor for factor I in degradation of C3b  |
| Decay-accelerating factor | Membrane | Prevents C3 convertase formation   |
| C4 binding protein        | Serum    | Dissociates preformed C3 and C5 convertases<br>Accelerates decay of C4b as cofactor for factor I |
| Factor H                  | Serum    | Impairs uptake of factor B by C3<br>Cofactor for factor I in C3b cleavage                        |
| Complement receptor 1     | Membrane | Promotes cleavage of C3b<br>Impairs uptake of factor B by C3b<br>Displaces Bb from C3b           |
| Properdin                 | Serum    | Stabilizes C3 convertases  |
| Membrane attack           |          |  |
| S protein                 | Serum    | Blocks fluid phase membrane attack complex   |
| CD59                      | Membrane | Blocks membrane attack complex on cells  |

Adapted from Liszewski MK, Farries TC, Lublin DM, et al. Control of the complement system. *Adv Immunol* 1996;61:201–283.

### Control of the Initiation Step

**C1 INHIBITOR** C1 inhibitor (C1 INH) is a heavily glycosylated  $\alpha$ -globulin with a molecular



weight of 105 kd. It is synthesized in the liver and by blood monocytes. Its gene is located on chromosome 11. C1 INH belongs to the superfamily of *serpin proteins* (serine protease inhibitors) (702). The inhibitor possesses a site that is structurally similar to the substrate, and, when a protease binds to this site and cleaves a peptide bond, it forms a covalent bond that results in a stable complex between the inhibitor and the enzyme. C1 INH inhibits activation of the classical and alternative pathways. It binds to C1r and C1s, forming stable complexes that prevent them from acting as an esterase. It also binds to the C1r–C1s complex and causes rapid dissociation of the C1 esterase. In the alternative pathway, it prevents factor B from binding to immobilized C3b. Cleavage of factor B by factor D is markedly inhibited when C3b is incubated with C1 INH (703). A genetically inherited deficiency of C1 INH is manifested by recurrent acute attacks of circumscribed edema. Hereditary angioneurotic edema (HAE) may cause death from laryngeal edema. The mortality rate that is associated with this condition has been reduced with androgen therapy. This disease assumes two forms. In most (85%) cases (type 1 HAE), the inhibitor is present in reduced concentrations, whereas, in the second form (type 2 HAE), it is present in normal concentrations, but it is biologically inactive.

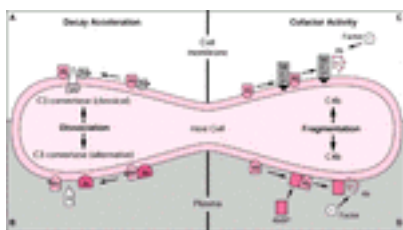
**CONTROL OF C3 AND C5 CONVERTASES** The C3 convertase cleaves C3 to C3b and C3a, whereas the C5 convertase cleaves C5 and initiates the final stage that ends with the formation of MAC. These amplification steps are regulated by seven proteins: three of them are present in the serum (C4BP, factor H, and factor I), and four are cell membrane proteins [MCP, decay–accelerating factor (DAF), CR1, and CR2]. The overall function of these proteins is to prevent formation of the two convertases on self cells. Except for factor I, all other proteins belong to a structurally related family of proteins that is known as the *regulators of complement activation (RCAs, or now complement control proteins (CCPs))*. The genes are clustered on the long arm of chromosome 1q32. A striking structural feature that is common to these proteins is the multiple homologous cysteine–rich domains, which are 60 amino acids in length and are referred to as *CCP repeats* (older name is *short consensus repeats*) (704). The CCP module or repeat has four invariant cysteines, an invariant tryptophan, and highly conserved prolines, glycines, and hydrophobic residues (705). The number of CCP domains varies; thirty are found in CR1, twenty in factor H, and four in CD55. The 60–amino acid unit represents an ancestral domain that gave rise to the complement genes through duplication and splicing with domains from the serine protease gene family. The CCP domains are found in other complement proteins, such as C1r, C1s, C2, and factor B, as well as in noncomplement proteins, such as IL–2 receptor, haptoglobin, and coagulation factor XIII. Each CCP domain has a hydrophobic core that is interlaced with  $\beta$  strands that are connected by protruding loops, which possess a privileged position for interactions with other proteins. The control of the convertases is achieved by two mechanisms: (a) by dissociating the convertase to its individual components (DAA) and (b) by proteolytic degradation of C4b or C3b components as a result of the CA of the RCA proteins that act as cofactors for the serine protease, factor I. Some proteins have DAA and CA activity in the serum (C4BP, factor H) or cell surface (CR1), whereas others possess only one activity for the C4b and C3b components.

## Regulators on Cell Surfaces

**MEMBRANE COFACTOR PROTEIN (CD46)** The extracellular region of membrane cofactor protein (MCP) consists of four CCP domains that contain the binding site for C3b and C4b and a region that is rich in serines, threonines, and prolines. The serine, threonine, and proline region is O–glycosylated and provides protection from proteolysis. A portion of this region may be removed by alternative splicing, which generates two of the four MCP isoforms. Two alternate forms of cytoplasmic regions contribute to the formation of another two MCP isoforms. MCP is present in almost all cells examined, except for the red blood cells. Sites for C3b binding are in CCP–2, CCP–3, and CCP–4 domains. The C3b and C4b binding sites have residues that bind to both complement components as well as others that are specific for each component (706). MCP acts as

cofactor for the serine protease factor I for inactivation of C4b that is deposited on self tissues ( 707 ). MCP in the maternal–fetal interface protects the fetal tissue from attack by the maternal complement. It is found on the inner membrane of the spermatozoa and may play a role in protecting the sperm against C3b deposition. MCP is a receptor for several pathogens. The measles virus binds to an extended surface of MCP that encompasses the area from the top of CCP–1 to the bottom of CCP–2 ( 708 ). The measles virus binding to CD46 is more like that of poliovirus to its receptor: a wider open area that is flexibly hinged between CCP–1 and CCP–2 domains ( 709 ). This leaves the virus still exposed to immune attack. It contrasts with the narrow, recessed binding site or canyon in the case of HIV and rhinoviruses ( 710 ). The M protein of *Streptococcus pyogenes* ( 711 ), which causes serious suppurative skin infections (e.g., cellulitis, necrotizing fasciitis), binds directly to CCP–3 and CCP–4 domains at a site that is distinct from the C3b binding site. MCP mediates adherence of group A streptococci to keratinocytes ( 712 ). Human herpesvirus 6 also uses CD46 as a receptor and binds to CCP–2 and CCP–3 ( 713 ).

**DECAY-ACCELERATING FACTOR (CD55)** DAF contains four CCP domains and is attached to the membrane by a GPI anchor ( 714 ). Its molecular weight is between 70 to 80 kd, depending on its glycosylation. Soluble forms exist in body fluids that may arise from the action of a phospholipase on the membrane form. It is expressed on all hematopoietic cells, endothelial and epithelial cells, and cells of the gastrointestinal, genitourinary, and central nervous systems. Erythrocytes possess approximately 3000 DAF molecules, and, among the lymphoid cells, the NK cells appear deficient in DAF. Neutrophil activation results in enhanced expression of DAF (from 10,000 to 20,000 molecules per cell). It is present in a soluble form in many body fluids, including plasma, tears, saliva, urine, synovial fluid, and cerebrospinal fluid. DAF accelerates the decay of C3 convertase for the classical and alternative pathways but prevents its formation ( 715 ) ( Fig. 18.32 ). Regulation by DAF involves separate sites for the two convertases as well as common sites for both ( 716 ). For the alternative C3 convertase, DAF acts on the type A domain (vWF type A domain) of the Bb component ( 717 ). Classical C3 convertase is regulated by a site that is located in the CCP–2–CCP–3 domain junction, which consists of three consecutive lysines and a hydrophobic patch ( 718 , 719 ). DAF is used as receptor by many pathogens, such as several types of echoviruses, enteroviruses, and *E. coli*. It constitutes a functional component of the LPS receptor complex ( 720 ). CD55 is the ligand (counter–receptor?) of CD97, the prototype of a large seven–span transmembrane family (as many as 2000 members) with variable numbers of EGF domains and sequence homology to the G–protein–coupled peptide hormone receptors ( 721 , 722 and 723 ). CD97 is associated with inflammation and is detected in malignancies.



**Figure 18.32. A,B:** Decay activity on cell surfaces. **A:** Decay–accelerating factor (DAF, CD55) is a GP I anchored protein, which dissociates formed C3 convertase complex, as well as prevents its formation. **B:** Factor H is a serum protein that expresses DA activity by attacking C3 convertases on self surfaces. It binds to the C3b–Bb complex and displaces factor B irreversibly. **C,D:** Cofactor activity. **C:** Membrane cofactor protein (MCP, CD46) is a cell membrane protein, which contains binding sites for C3b and C4b. It acts as cofactor for factor I to cleave both proteins. It is also the measles virus receptor. **D:** The C4b binding protein (C4BP) is a serum protein that acts as a cofactor for factor I for cleaving C4b.



**COMPLEMENT RECEPTOR 1** Receptors for complement components or their breakdown products are expressed on many cells and tissues. They mediate various effector functions listed in [Table 18.7](#). Some of the functions of complement receptors that are related to the regulation of complement activation are briefly reviewed.

**TABLE 18.7. Cellular Distribution and Function of Receptors for Complement Components**

| Receptor | Cell Type                | Functions  |
|----------|--------------------------|--|
| C1q      | Neutrophils              | Respiratory burst                                      |
|          | Monocytes                | —  |
|          | B cells                  | —  |
|          | Null cells               | Enhanced antibody-dependent cell-mediated cytotoxicity |
| CR1      | Macrophages              | Enhanced phagocytosis                                  |
|          | Neutrophils              | Same as macrophages                                    |
|          | B cells                  | —  |
|          | T cells                  | —  |
|          | Red blood cells          | —  |
|          | Eosinophils              | —  |
|          | Epithelial cells: kidney | —  |
|          | CR2                      | B cells  |
| CR3      | Similar to CR1           | Similar to CR1   |
| Factor H | B cells                  | Secretion of factor I                                  |
|          | Monocytes                | Respiratory burst                                      |
|          | Neutrophils              | —  |
| C5a      | Mast cells               | Histamine release                                      |
|          | Neutrophils              | Chemotaxis, increased adhesiveness                     |
|          | Macrophages              | Enhancement of CR1 expression                          |
| C3a/C4a  | Mast cells               | Histamine release                                      |

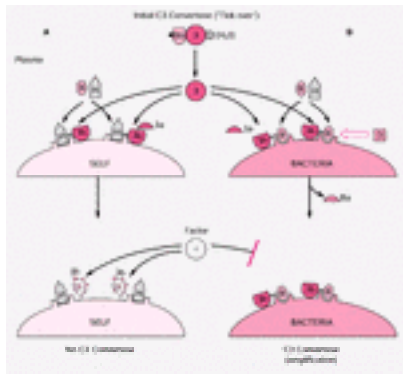
From Fearon DT, Wong WW. Complement ligand-receptor interactions that mediate biological responses. *Annu Rev Immunol* 1983;1:243, with permission.

The complement receptor type one (CR1, C3b/C4b receptor, CD35) was the first to be discovered as the *receptor for immune adherence*, a fundamental event in the initiation of the immune response. It is a polymorphic membrane protein of 190 to 280 kd composed of 2039 residues and present on all peripheral blood cells except platelets, NK cells, and most T cells ([724](#)). CR1 is expressed on kidney podocytes and FDCs. Cell membrane expression of CR1 is up-regulated by chemotactic peptides, such as C5a, endotoxin, and cytokines. Blood cells at resting state express only 5 to 10% of the total cellular CR1 at the plasma membrane, whereas the remaining CR1 is found intra-cellularly. The red blood cells express 100 to 400 receptors per cell, and the leukocytes have 10,000 to 50,000 receptors per cell. However, because the number of red cells is approximately 1000 times more than white cells, they possess more than 85% of the total CR1 that is available in the blood. CR1 contains 30 CCP domains with three sites for C4b binding and two sites for C3b binding ([725](#)). CCP-15 domain is critical for C4b binding and, together with CCP-16 domain, is required for C3b binding ([726](#)). The CCP domains are arranged in larger domains that are known as *long homologous repeats* (LHR), with each one containing seven CCPs. It is likely that this arrangement facilitates the binding of CR1 with clusters of its ligands. There are four allotypes of CR1 (A to D). CR1, one of the most versatile RCAs, possesses DAA and CA, which are restricted to reducing the

complement activity on cells that have absorbed immune complexes. The DAA of CD35 is mediated by CCP-1 to CCP-3 domains for the classical and alternative pathways (727). In the classical pathway, CR1 inhibits the uptake of C2 by C4b as well as displaces C2a from C4b2a C3 convertase and from C4b2a3b C5 convertase. It also promotes the cleavage of C4b to C4c and C4d by factor I and the cleavage of C3b to iC3b (ligand of CR3) and C3dg (ligand of CR2) by factor I. In the alternative pathway, the CR1 impairs uptake of factor B by C3b and displaces Bb from C3bBb C3 convertase. Complexes that are bound to erythrocytes are eliminated in the spleen. Conversion of C3b to fragments leads to binding of the complexes to macrophages and monocytes that possess CR3 or to lymphoid follicular areas in which all three CR are expressed. The CR1 has the capacity to inhibit complement activation on cells and tissues other than those in which it is expressed (extrinsic protection). In contrast, DAF and MCP protect only the cells on which they are expressed (intrinsic protection). CR1 facilitates phagocytosis, one of the first recognized functions. Direct phagocytosis by CR1 in the absence of other ligands does not occur with resting neutrophils or monocytes. However, activation of these cells up-regulates CR1 expression and alters its function, so that phagocytosis of C3b-coated particles may occur. Soluble human CR1 inhibits complement-dependent tissue damage and reduces inflammatory responses.

### Regulators in Body Fluids

**FACTOR H** Factor H is a soluble glycoprotein that is present in blood at concentrations of 0.3 to 0.5 mg/L. It is a single polypeptide chain of 150 kd with a highly elongated shape. It is composed of 1213 amino acids that are assembled in 20 CCP domains. Factor H is synthesized mainly in the liver by hepatocytes and Kupffer cells (728) but also in other extrahepatic sites (myeloblasts). IL-6 is the main cytokine that regulates its synthesis. The main functions of factor H are: (a) binding to the  $\alpha$ -chain of C3b (729), blocking the amplification cycle in the alternative pathway ("tick-over"), and preventing the generation of C3 convertase, C3bBb; (b) binding to the C3bBb enzyme and irreversibly displacing the Bb component (DA activity); and (c) acting as cofactor for factor I and enhancing its affinity for C3b. By these three activities, factor H prevents formation of the C5 convertase and, thus, the generation of MACs by the alternative pathway. Factor H possesses an impressive number of discriminatory functional sites. Its 20 CCP domains and its long and flexible structure allow factor H to scan a large surface area. The affinity of factor H for C3b is affected by the properties of the cell or tissue surface. Carbohydrate-rich polymers that are found on yeast and bacterial cells prevent binding of factor H to C3b, thus enabling the complement activation to react against these pathogens. Removal of sialic acid from sheep erythrocytes prevents binding of factor H to C3b and allows activation of complement. Factor H binds to polyanions, and blocking of this site enhances its affinity for C3b (730). The propensity of factor H to bind on polyanions, such as heparin, on host tissues may function as a protective mechanism against the alternative complement pathway (731). The discriminatory ability of factor H depends on its differential binding to various types of surfaces to which C3b has been initially deposited (Fig. 18.33). The nonactivating surfaces have sialic acid and other negatively charged glycosaminoglycans to which factor H binds through domain CCP-20. The same domain is important for binding within approximately 30 Å from the C3d attachment site, indicating that the binding sites of factor H for polyanion and C3d overlap (732). It is possible that discrimination by factor H occurs by a joint recognition of C3 and polyanions. CCP-11 to CCP-20 domains are important for binding to activator surfaces (733), but the DAA or CA varies among these CCPs, depending on the nature of the surface on which C3b has been deposited (733). It appears that factor H uses different CCP domains, individually or in combinations, for recognition of C3, host, or foreign tissues. CCP-1 to CCP-4 domains are used to bind intact C3b, CCP-6 to CCP-10 domains are used for binding C3c within the C3b, and CCP-16 to CCP-20 domains are used for the C3d part of the C3b (734).

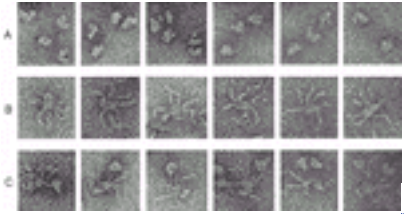


**Figure 18.33.** Self–nonself–discrimination by factor H. **A:** Factor H prevents alternative complement activation by blocking the amplification cycle of the alternative pathway. It enhances its affinity to C3b as a result of binding to certain polyanions (negatively charged glycosaminoglycans) on self surfaces. Binding to C3b invites factor I to fragment C3b (cofactor activity). **B:** On pathogen surfaces, factor B expresses a higher affinity to deposited C3b and, with a lack of appropriate carbohydrate ligand for factor H, forms the alternative C3 convertase.

Recently, single base mutations or base–pair deletions have been demonstrated in sporadic and familial cases of hemolytic uremic syndrome (HUS) ([735](#)). HUS is characterized by microangiopathic hemolytic anemia, thrombocytopenia, and acute renal failure in affected individuals and is classified as diarrheal (D+HUS) or nondiarrheal (D–HUS) and sporadic or familial. A set of 12 missense mutations in the CCP domains between CCP–16 through CCP–20 is associated with HUS. Nine of them are in CCP–20 and are inferred to lead to a functional defect ([736](#)). The positions of these mutations correspond to basic residues that are involved in binding to heparin. It is suggested that these mutations interfere with the normal function of factor H to bind to sulphated glycosaminoglycans and to prevent the activation of the alternative complement pathway. These experiments of nature strongly imply that the host versus foreign discrimination by factor H resides in CCP–20 and is lost by these mutations ([737](#)). Lack of host recognition results in uncontrolled complement activation and, eventually, renal failure. Mice that are deficient in factor H develop membranoproliferative glomerulonephritis as a result of uncontrolled activation of the alternative complement pathway ([738](#)). Factor H is a member of a family that consists of a total of six members. Factor H–like protein 1 (FHL–1), or reconectin, shares the complement regulatory functions with factor H and interacts with heparin. It contains the first seven of 20 CCP domains of factor H and has four unique residues that are attached to the C–terminal end ([739](#)). Both factor H and FLH–1 are synthesized by the same gene, but their transcripts are differentially regulated. They are produced by the liver, monocytes, and neuronal cells. Other members of the family are factor H–related (FHR) proteins 3 and 4 (FHR–3 and FHR–4) ([740](#)). FHR–3 and FHR–4 bind to C3b, particularly the C3d region. They do not express DAA for C3bBb convertase, and CA is detected only weakly ([741](#)).

**C4b–BINDING PROTEIN** The C4b–binding protein (C4BP) is a regulator of the classical complement pathway C3 convertase. C4BP possesses CA and DAA. It consists of eight subunits that radiate from a central core in a spiderlike formation ([Fig. 18.34](#)). The peripheral end of each subunit is capable of binding one C4 molecule. Each of the seven subunits known as a *–chains* has a molecular weight of 75 kd, and the eighth subunit, known as *B–chain*, is 45 kd. They are flexible, 33 nm in length, and are linked together by disulfide bonds near the carboxy termini. In addition to the most common form of C4BP, a7:B1, there are two other minor forms, a7:B0 and a6:B1. The a–chains are composed of 549 amino acids that are divided between eight CCP domains, with 58 residues left in the C–terminus to form the disulfide bond with the other a–chains in the core region. The B–chains have three CCP domains and are attached by a disulfide bond in a similar way to

the  $\alpha$ -chains. The genes for C4BP are within the gene cluster of the other RCA proteins. The C4b-binding site is localized in the CCP-1 and CCP-2 domains of the  $\alpha$ -chain, in a cluster of positively charged amino acids ([742](#)). The same region is also important for binding to heparin, *Bordetella pertussis*, and the M-protein of *S. pyogenes*, *Neisseria gonorrhoeae*, and *E. coli*.



**Figure 18.34.** Electron micrographs of the C4b (A) and the C4b-binding protein (B) that form complexes with C4b (C). (Courtesy of Dr. B. Dahlback. From Dahlback B, Smith CA, Muller-Eberhard HJ. Visualization of human C4b-binding protein and its complexes with vitamin K-dependent protein S and complement protein C4b. Proc Natl Acad Sci U S A 1983;80:3461–3465, with permission.)

C4BP is synthesized in the liver under stimulation of IL-6 and TNF- $\alpha$  ([743](#)) and is present in the blood at a concentration of 0.2 mg/L. The mechanism of control of the classical pathway by C4BP depends on the binding to C4b and the displacement of C2a from the C4b2a convertase (DAA), as well as its function as a cofactor for cleavage of C4b by factor I. Dissociation of C2a from the classical pathway C3 convertase destroys its activity and prevents rebinding of the C2a to C4b. C4BP acts also as cofactor for cleavage of C3b by factor I ([744](#)). Protein S binds with high affinity to the  $\beta$ -chain of C4BP ([745](#)). Protein S of the coagulation pathway is a vitamin K-dependent anticoagulant protein. It acts as the cofactor for activated protein C that inactivates factor Va and is also the direct inhibitor of factor Xa. The concentration of free protein S is determined by the concentration of C4BP, as 50% or more of protein S is bound to C4BP. Protein S that is bound to C4BP is unable to participate in the anticoagulant protein C system. It is critical that the balance between free and C4BP-bound protein S is maintained stable, as lack of free protein S leads to thrombosis. Protein S-bound C4BP is probably localized on negatively charged surfaces that are found in platelets and apoptotic cells. Conditions with elevated C4BP (autoimmune diseases) may be associated with increased clotting tendency as a result of increased binding of protein S to C4BP.

**FACTOR I** Factor I is a serine protease that mediates proteolytic degradation of C3b, iC3b, and C4b only if a cofactor binds to the substrate to promote the binding of the enzyme. These cofactors for C3 and C4 degradation on host cells are MCP ([Fig. 18.32](#)), and, to a lesser extent, CR1, whereas, in plasma, the cofactors are C4BP and factor H ([Fig. 18.32](#) and [Fig. 18.33](#)). Factor I is constitutively active and essential for control of the fluid and cellular complement reactions. Genetic deficiency of factor I leaves the generation of C3 convertases uncontrolled, leading to incapacitation of the complement system as a result of the continuous low level conversion of C3. Fragmentation by factor I of C3 and C4 determines the specificity of their derivatives for CR1, CR2, and CR3. Factor I is a two-chain disulfide linked protein that is synthesized from a single chain precursor. The H chain is 50 kd, and the L chain is 38 kd in molecular mass and has the Ser esterase domain. The H chain is composed of three different types of modules that are derived from different gene superfamilies. One module, which is also found in C6 and C7, is from members of the follistatin family of the extracellular matrix, a second type is a scavenger receptor cysteine-rich module, and the third type are two LDLR-A modules.

The only known substrates for factor I are C3b and C4b. C3b is cleaved at Arg<sup>1303</sup>-Ser<sup>1304</sup> and Arg<sup>1320</sup>-Ser<sup>1321</sup>. For this cleavage, the cofactors are factor H, MCP, and CR1.

C4BP acts as a cofactor for cleavage of C4b and C3b. C4b is cleaved at Arg<sup>1336</sup>-Asn<sup>1337</sup>. In general, for C3b and C4b and all subsequent fragments, factor I acts on the C-terminal side of an Arg.

## Control of the Membrane Attack Complex Assembly

**PROTEIN S** Protein S is identical to vitronectin (serum spreading factor). It is a 75- to 80-kd protein that is synthesized from a single polypeptide chain that is subsequently cleaved to give the mature polypeptide as a single- or double-chain protein. At the NH<sub>2</sub>-terminus, there is a somatomedin B domain (containing eight cysteines) followed by a linear sequence, which contains the RGD sequence that is responsible for the binding of integrins. Two domains of the S protein have homology to hemopexin. The C-terminus is rich in basic residues that mediate the binding of S protein with sulfated polysaccharides. Protein S binds to the metastable C5b-7 complex and prevents the formation of MAC. Because MAC in the process of its formation can be inserted on any cell membrane, the most important function of S protein is the protection of the cells of the body that may be attacked by MAC as innocent bystanders. Protein S acts through its heparin binding site, which prevents the polymerization of C9. The protein S is important in cell matrix interactions, and, through its multiple binding sites, it participates in several other functions of adherence, phagocytosis, the coagulation cascade in which it interacts with thrombin.

**CLUSTERIN (CYTOLYSIS INHIBITOR)** Clusterin is an 80-kd protein composed of two chains (α and β). The gene is located on chromosome 8p21. It is present in a variety of tissues and in the serum at concentrations of 35 to 105 μg/L. It forms complexes with lipoproteins and binds to C7, C8b, and C9, to inhibit MAC formation (746). Clusterin is involved in several other poorly understood functions. It has been found to be up-regulated in injured tissues and in Alzheimer disease, as well as in tissues undergoing apoptosis.

## Control of Deposited MAC: CD59

CD59 is an 18- to 20-kd protein that inhibits MAC formation (747). It has been known by a variety of other names, such as *homologous restriction factor 20* (HRF20), *membrane inhibitor of reactive lysis* (MIRL), and *protectin*. It is a GPI-anchored protein and is widely distributed in human tissues and most body fluids (see the following discussion). CD59 expression is lacking in patients with paroxysmal nocturnal hemoglobinuria (PNH).

## Conclusion

The RCA proteins exert several important functions in the regulation of complement activity: (a) They prevent complement activation in the blood (factor H and C4BP); (b) they interfere with the assembly and function of convertase activity on cell membranes (DAF, MCP), protecting the cells of the body from complement attack; (c) they transport and clear immune complexes (CR1); and (d) they mediate transmembrane and intracellular trafficking (CR1) and transmembrane signaling (CR2).

The CCP units that are characteristic of the members of the proteins of the RCA gene cluster are present also in C1r, C6, C7, factor B, properdin, and noncomplement proteins, such as coagulation factor XIII and IL-2 receptor. The 60-amino acid unit represents an ancestral domain that gave rise to the complement genes through duplication and splicing with domains from the serine protease gene family.

## ANAPHYLATOXINS

Activation of the complement cascade leads to the release of important inflammatory factors that are known as *anaphylatoxins*: the C3a, C4a, and C5a molecules. They induce numerous inflammatory responses and also play a role as immunomodulatory molecules;



therefore, they act as local hormones. Their amino acid sequence varies from 74 to 78 residues. The cysteines are conserved in all anaphylatoxins and form three disulfide bonds that stabilize the conformation and form the core of the molecule. The C-terminus forms the active site, with the C-terminal Arg being essential for function. Under physiologic conditions, the molecule is folded or compact.

C3a and C5a have a high content of a helix in a compact hairpin configuration that is maintained by the three disulfide bonds. The C-terminal end protrudes from this helical core and is considered to be the active site of the molecule that mediates biologic activities. Removal of the last Arg (C5a desArg) results in a loss of spasmogenic activity, but the chemotactic and other neutrophil activation functions are retained (748). The N-terminal region of C5a binds to its high-affinity receptor on neutrophils, which spans the membrane seven times with the N-terminus on the extracellular side (749). It belongs to the rhodopsin family of receptors, the members of which are linked to G proteins. Binding of C5a to its receptor on neutrophils induces a variety of responses, depending on its concentration, such as chemotaxis, granule secretion, up-regulation of adhesion molecules, changes of cytoskeleton, and activation of NADPH (nicotinamide adenine dinucleotide phosphate oxidase). These responses are mediated by G proteins, and the downstream signaling involves activation of phospholipase C, tyrosine kinases, and MAPKs or phosphatidylinositol-3-kinase, which are important for chemotaxis.

All anaphylatoxins are cleaved rapidly in the serum by carboxypeptidase-N, an enzyme that removes the C-terminal Arg that is found on all three anaphylatoxins. The main biologic function of anaphylatoxins is related to their ability to increase vascular permeability. Vascular permeability may be increased by several mechanisms, foremost among which is the release of histamine. Mast-cell degranulation has been observed at the site of anaphylatoxin injection. Generation of prostaglandin E<sub>2</sub> also causes vasodilation. Anaphylatoxins also cause serious lung injury because of their capacity to recruit and sequester circulating leukocytes in the pulmonary circulation and the subsequent release of mediators at the site of sequestration. Finally, production of oxygen- and nitrogen-derived radicals, leukocyte margination, release of granule-associated proteolytic enzymes, capillary leakage, and all components of an inflammatory response are also mediated by anaphylatoxins.

## COMPLEMENT COMPONENT DEFICIENCIES

### C1 Esterase Inhibitor: Hereditary Angioneurotic Edema

HAE is an autosomal-dominant disease that afflicts persons of all races with no sex predominance (750). It manifests as recurrent attacks of intense, massive localized edema without pruritus. The attacks occur in the absence of any identifiable initiating event. Most commonly involved viscera are the respiratory and gastrointestinal systems. Involvement of upper airways may result in severe life-threatening symptoms, including risk of asphyxiation. There are two types of HAE: type 1 (80 to 85% of cases) is caused by decreased production of C1 INH; type 2 (15 to 20%) is caused by a functionally impaired C1 INH. Quantitative and functional analyses of C1 esterase inhibitor and complement components C4 and C1q should be performed in cases that are suspected of HAE.

C1 INH belongs to the same family as a<sub>1</sub>-antitrypsin, and antithrombin IFN- $\gamma$  and IL-6 stimulate its synthesis and release from the liver and monocytes. The main function of C1 INH is prevention of autoactivation of the complement cascade. It also inactivates coagulation factors XIIa, XIIf, and XIId and activated kallikrein. The mechanism of action involves formation of irreversible covalent bonds with the substrates.

It is proposed that, under physiologic conditions, small quantities of factor XII are autoactivated to factor XIIa after contact with certain surfaces. Factor XIIa triggers the contact system, which cleaves prekallikrein to kallikrein, which in turn cleaves kininogen, thus generating excessive release of kinins, especially bradykinin. This pathway normally is blocked by C1 INH, which inhibits factor XIIa. In the absence of the normal control function of C1 INH, not only factor XIIa is not inhibited, but kallikrein also generates plasmin from plasminogen, which in turn activates factor XIIa for more kallikrein and activation of the C1 esterase.

### Deficiency of Other Early Complement Components

Homozygous deficiencies of the early components of the classical pathway are associated with SLE ( [751](#) ), and the severity of the associated disease is greatest with C1q deficiency. C1q deficiency is caused by failure of C1q synthesis or synthesis of a dysfunctional molecule. C4 deficiency is associated with early onset of severe SLE. C2 deficiency is the most common homozygous complement deficiency in whites. C3 deficiency is associated with recurrent pyogenic infections. Deficiency of factor H has been associated with membranoproliferative glomerulonephritis (see the previous discussion).

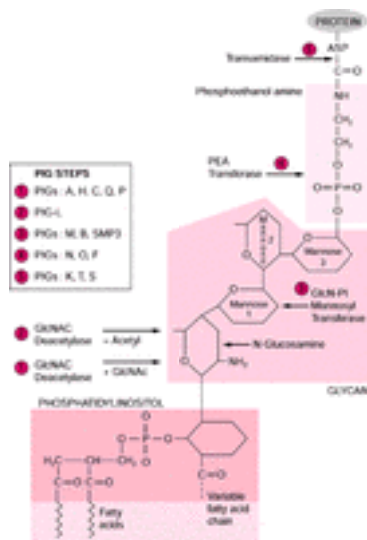
### Paroxysmal Nocturnal Hemoglobinuria: Decay–Accelerating Factor (CD55) or Clustering (CD59) Deficiencies, or Both

PNH is an acquired hematopoietic stem cell disorder, which is manifested by intravascular hemolysis, venous thrombosis, aplastic anemia, myelodysplasia, and leukemia. The defect is the result of somatic mutations that consist of deletions, insertions, or point mutations of the PIG–A [phosphatidyl inositol (PI) glycan complementation class A] gene, which is involved in the synthesis of GPI ( [752](#) , [753](#) ).

The GPI anchor consists of three components: (a) phospho–ethanolamine (PEA), (b) a glycan core (consisting of three mannose molecules and one GlcNAc), and (c) PI.

**GLYCOSYL PHOSPHATIDYL INOSITOL BIOSYNTHESIS** GPI synthesis involves multiple steps and takes place in the ER ( [Fig. 18.35](#) ). In the *first step*, GlcNAc is attached to PI, a common product of cellular metabolism. The transfer of GlcNAc is catalyzed by the GPI–*N*–acetyltransferase, a complex enzyme that is composed of at least six proteins ( [754](#) , [755](#) ). The first gene that has been cloned is PIG–A ( *phosphatidyl inositol glycan class A* ), which is located in the short arm of the X chromosome. The other proteins of the GlcNAc transferase are PIG–H, PIG–C, PIG–Q, PIG–P, and dolichol phosphate mannose (DPM) 2. The PIG–A (GPI–3) component performs the catalytic function of the complex ( [756](#) ). PIG–H (GPI–15) interacts with PIG–A, and PIG–C (GPI–2) forms a scaffolding for the other components to facilitate their interactions. PIG–Q (GPI–1) contributes to the association between PIG–C, PIG–A, and PIG–H, stabilizes the transferase, and blocks its destruction from cellular systems that screen highly hydrophobic proteins.





**Figure 18.35.** Biosynthesis of glycosyl phosphatidyl inositol (GPI). GPI consists of three components: (a) phosphatidyl inositol (PI), (b) glycan (made of one *N*-glucosamine and three mannose molecules), and (c) one phosphoethanolamine (PEA). GPI anchored is synthesized in the endoplasmic reticulum and to proteins, expressing a signal that is encoded in the C-terminal sequence. The signal sequence is cleaved to expose the GPI attachment site (?-site). The first of several steps (1, in GPI biosynthesis attaches *N*-acetyl glucosamine (GlcNAc) to PI, by the enzyme GlcNAc transferase. The acetyl group is removed in the second step (2, by a deacetylase. Subsequently, three mannose (M) molecules are added by different mannose transferases (3, (attachment bonds differ), and, finally, the PEA molecule is attached by a PEA transferase. The attachment of the completed GPI to the protein is mediated by a transamidase complex. The first enzyme, GlcNAc transferase, is a complex of at least five gene products (see the chapter text for details). Phosphatidyl inositol glycan complementation class A (PIG-A) performs the catalytic function of the enzyme, and mutations in this gene result in paroxysmal nocturnal hemoglobinuria.

PIG-P is a small hydrophobic component, which interacts with PIG-A, therefore it is essential for GPI synthesis. Surprisingly, the PIG-P gene is located in the critical region of chromosome 21, which is involved in Down syndrome and is predicted to have a function that is related to malformations of the tongue. DPM-2 is the regulatory subunit of the DPM synthase (DPMS), which supplies mannose for GPI biosynthesis. DPM-2 therefore participates in two enzymatic complexes, the GlcNAc transferase and mannose synthase. The *second step* for GPI synthesis is catalyzed by PIG-L (GPI-12), which has GlcNAc-PI de-*N*-acetylase activity ([757](#)) and removes the acetyl group from GlcNAc. In the *third step*, PI is acylated and this is followed by flipping the intermediate structure to the luminal side of ER by an unknown lipase. In the *fourth step*, three mannose units are added by mannose transferases that are associated with the ER membrane. PIG-M adds the first mannose to the GlcNAc unit, and PIG-B-(GPI-10) attaches the third one. The *fifth step* in GPI synthesis is the addition of PEA by appropriate transferases, PIG-N, PIG-O, PIG-F, and GPI-7. In humans, there is only one PEA, which is added to the third mannose. PIG-O is responsible for such a reaction, and its function is stabilized by PIG-F. PIG-N is involved in the addition of PEA to the first mannose. Once the synthesis of GPI is complete, it is transferred to the protein by a transamidase complex. This complex consists of PIG-K (GPI-8), a small protein that is a protease, and PIG-T (GPI-16), PIG-S (GPI-17), and GPAA-1-GAA-1 proteins ([758](#)). These proteins interact physically with each other, but PIG-T is the most important for the stability of the complex. The protein to have the GPI attached is first processed by removing the N-terminal leader peptide. The protein bound on the luminal side by a C-terminal peptide is translocated to the transamidase complex in the presence of the BiP chaperon. The C-terminal peptide of the protein is removed, and the transamidase complex attaches the

GPI through the ethanolamine head to the newly exposed C-terminal (? site). This C-atom is linked to the amino group of PEA, which is attached to the third mannose by an amide bond.

**PAROXYSMAL NOCTURNAL HEMOGLOBINURIA: IMMUNOPATHOLOGY** The biochemical defect of PNH occurs in the first step of GPI synthesis and results from mutations in the PIG-A gene. Because PIG-A is on the X chromosome, one mutational event is sufficient to cause the disease ( [759](#), [760](#) ). Cell proteins that are anchored by GPI are missing from PNH hematopoietic cells, and some of the clinical manifestations are due to loss of GPI-anchored proteins. Lack of CD55 alone is not responsible for the hemolytic component of the disease, because individuals with the Inab phenotype in which CD55 is absent have only slightly increased sensitivity. CD59, which binds to C3 and prevents binding and subsequent polymerization of C9, accounts for the intravascular hemolysis and, possibly, thrombosis in PNH ( [761](#) ). Diagnosis of PNH has improved with flow cytometry, which uses monoclonal antibodies to detect the proportion of granulocytes and monocytes that lack CD59. This proportion is larger than that of abnormal red cells. Appropriate combinations of CD14, CD16, CD64, and CD66 in a two-parameter analysis, such as CD64 versus CD14, can accurately detect the abnormal leukocytes. In addition to hemolysis, thrombosis is an important manifestation of PNH. The cause of thrombosis is probably due to the release of microparticles from platelets with procoagulant activity, such as particles that are rich in factor Va, factor Xa, and the prothrombinase complex. Endothelial cells are stimulated to express tissue factor and may contribute to thrombosis. Furthermore, the urokinase plasminogen activator receptor (uPAR CD87), a GPI-anchored protein, is absent. Normally, it binds urokinase on the surface of granulocytes and monocytes, converting plasminogen to plasmin-initiating fibrinolysis. Lack of uPAR may therefore promote thrombosis. An important, albeit still unanswered, question is the relationship of PNH to bone marrow aplasia or myelodysplasia and the development of acute myelogenous leukemia. Normal stem cells from patients with PNH show diminished proliferative potential *in vitro* as compared to mutant PNH CD34<sup>+</sup> stem cells ( [762](#) ). The PNH clone with a proliferative advantage expands and dominates over the normal cells. It has been suggested that PNH is expressed only when normal hematopoiesis is impaired and when the PNH clone dominates hematopoiesis. This is supported by some evidence that a tiny proportion of PIG-A<sup>-</sup> progeny exists in normal individuals ( [763](#) ).

### Deficiencies of Terminal Complement Components

Deficiencies of the terminal complement components, such as C7, have been detected in several countries, whereas C6 has been primarily detected in blacks in the United States and in South Africa, and the majority of C9 deficiencies have been found in Japan ( [751](#), [764](#), [765](#), [766](#) and [767](#) ). C6 deficiency has been defined as *quantitatively zero C6* (C6Q0) or subtotal C6 (C6SD), when C6 is structurally abnormal but hemolytically active ( [768](#) ).

Deficiencies are due to single-base deletions or mutations that lead to premature stop codons. In C6 deficiency, there is a tendency for mutations in exon 6 ( [767](#) ) with defects in an area that is adjacent to a sequence that contains seven Gs and a string of six Ts ( [769](#) and [770](#) ). Carboxy terminally truncated C6, which results in a shorter dysmorphic, but functionally active, molecule, has been detected in South African families ( [771](#) ). Complement component C6 deficiency is associated with *Neisseria* infections (meningococci and gonococci) ( [751](#) ), with *N. meningitidis* infection often being recurrent ( [772](#) ).

Infections with serogroup B are the major problem with these patients; these infections

limit the usefulness of the available vaccine, which is not directed against this group. Other infections have also been detected in homozygous C6 deficiency, such as SLE, Still disease, and glomerulosclerosis ( [773](#) ).

## COMPLEMENT SYSTEM: FROM SEA URCHINS TO *HOMO SAPIENS SAPIENS*

The innate immune system antedates the appearance of the RAG genes, an evolutionary hallmark at the dawn of the adaptive immunity. The origins of the complement system can be traced as far back as the echinoderms, because C3 and a factor B-like protein have been identified in sea urchins ( [680](#) , [774](#) , [775](#) ). The ascidians (sea squirts), or tunicates, occupy a crucial intermediary position between invertebrates and vertebrates. Two lectins (that correspond to mammalian MBL), ficolins, two MASPs, a C3, a B factor, and a C3 receptor have been identified in ascidians. These findings indicate that a lectinlike pathway also precedes the development of the classical pathway, which seems to emerge only at the stage of cartilaginous fishes at the same time as the appearance of the adaptive immunity.

### REFERENCES

1. Benacerraf B, Germain RN. The immune response genes of the major histocompatibility complex. *Immunol Rev* 1978;38:70–119.
2. Campbell RD, Trowsdale J. Map of the human MHC. *Immunol Today* 1993;14:349–352.
3. el Kahloun A, Chauvel B, Mauvieux V, et al. Localization of seven new genes around the HLA-A locus. *Hum Mol Genet* 1993;2:55–60.
4. Geraghty DE, Koller BH, Hansen JA, et al. The HLA class I gene family includes at least six genes and twelve pseudogenes and gene fragments. *J Immunol* 1992;149:1934–1946.
5. Geraghty DE, Koller BH, Pei J, et al. Examination of four HLA class I pseudogenes. Common events in the evolution of HLA genes and pseudogenes. *J Immunol* 1992;149:1947–1956.
6. Shiina T, Tamiya G, Oka A, et al. Genome sequencing analysis of the 1.8 Mb entire human MHC class I region. *Immunol Rev* 1999;167:193–199.
7. Shiina T, Tamiya G, Oka A, Takishima N, et al. Molecular dynamics of MHC genesis unraveled by sequence analysis of the 1,796,938-bp HLA class I region. *Proc Natl Acad Sci U S A* 1999;96:13282–13287.
8. Koller BH, Geraghty D, Orr HT, et al. Organization of the human class I major histocompatibility complex genes. *Immunol Res* 1987;6:1–10.
9. Srivastava R, Duceman BW, Biro PA, et al. Molecular organization of the class I genes of human major histocompatibility complex. *Immunol Rev* 1985;84:93–121.
10. Korman AJ, Boss JM, Spies T, et al. Genetic complexity and expression of human class II histocompatibility antigens. *Immunol Rev* 1985;85:45–86.
11. Beck S, Trowsdale J. Sequence organization of the class II region of the human MHC. *Immunol Rev* 1999;167:201–210.
12. Groettrup M, Soza A, Kuckelkorn U, et al. Peptide antigen production by the proteasome: complexity provides efficiency. *Immunol Today* 1996;17:429–435.
13. Trowsdale J, Hanson I, Mockridge I, et al. Sequences encoded in the class II region of the MHC related to the ‘ABC’ superfamily of transporters. *Nature* 1990;348:741–744.

14. Monaco JJ. Genes in the MHC that may affect antigen processing. *Curr Opin Immunol* 1992;4:7073.
15. Kropshofer H, Hammerling GJ, Vogt AB. How HLA-DM edits the MHC class II peptide repertoire: survival of the fittest? *Immunol Today* 1997;18:77-82.
16. Gruen JR, Weissman SM. Evolving views of the major histocompatibility complex. *Blood* 1997;90:4252-4265.
17. Shawar SM, Vyas JM, Rodgers JR, et al. Antigen presentation by major histocompatibility complex class I-b molecules. *Annu Rev Immunol* 1994;12:839-880.
18. Wilson IA, Fremont DH. Structural analysis of MHC class I molecules with bound peptide antigens. *Semin Immunol* 1993;5:75-80.
19. Lopez de Castro JA, Barbosa JA, Krangel MS, et al. Structural analysis of the functional sites of class I HLA antigens. *Immunol Rev* 1985;85:149-168.
20. Salter RD, Benjamin RJ, Wesley PK, et al. A binding site for the T-cell co-receptor CD8 on the  $\alpha 3$  domain of HLA-A2. *Nature* 1990;345:41-46.
21. Saper MA, Bjorkman PJ, Wiley DC. Refined structure of the human histocompatibility antigen HLA-A2 at 2.6 Å resolution. *J Mol Biol* 1991;219:277-319.
22. Bjorkman PJ, Saper MA, Samraoui B, et al. Structure of the human class I histocompatibility antigen, HLA-A2. *Nature* 1987;329:506-512.
23. Hedrick PW, Whittam TS, Parham P. Heterozygosity at individual amino acid sites: extremely high levels for HLA-A and -B genes. *Proc Natl Acad Sci U S A* 1991;88:5897-5901.
24. Madden DR, Gorga JC, Strominger JL, et al. The structure of HLA-B27 reveals nonamer self-peptides bound in an extended conformation. *Nature* 1991;353:321-325.
25. Garrett TPJ, Saper MA, Bjorkman PJ, et al. Specificity pockets for the side chains of peptide antigens in HLA-Aw68. *Nature* 1989;342:692-696.
26. Engelhard VH. Structure of peptides associated with MHC class I molecules. *Curr Opin Immunol* 1994;6:13-23.
27. Rotzschke O, Falk K. Origin, structure and motifs of naturally processed MHC class II ligands. *Curr Opin Immunol* 1994;6:45-51.
28. Young AC, Zhang W, Sacchettini JC, et al. The three-dimensional structure of H-2D<sup>b</sup> at 2.4 Å resolution: implications for antigen-determinant selection. *Cell* 1994;76:39-50.
29. Madden DR. The three-dimensional structure of peptide-MHC complexes. *Annu Rev Immunol* 1995;13:587-622.
30. Madden DR, Gorga JC, Strominger JL, et al. The three-dimensional structure of HLA-B27 at 2.1 Å resolution suggests a general mechanism for tight peptide binding to MHC. *Cell* 1992;70:1035-1048.
31. Bowness P, Allen RL, McMichael AJ. Identification of T cell receptor recognition residues for a viral peptide presented by HLA B27. *Eur J Immunol* 1994;24:2357-2363.
32. Madden DR, Garboczi DN, Wiley DC. The antigenic identity of peptide-MHC complexes: a comparison of the conformations of five viral peptides presented by HLA-A2. *Cell* 1993;75:693-708.
33. Ko HS, Fu SM, Winchester RJ, et al. Ia determinants on stimulated human T lymphocytes. Occurrence on mitogen- and antigen-activated T cells. *J Exp Med* 1979;150:246-255.
34. Yu DT, Winchester RJ, Fu SM, et al. Peripheral blood Ia-positive T cells. Increases in certain diseases

and after immunization. *J Exp Med* 1980;151:91–100.

35. Yu DT, McCune JM, Fu SM, et al. Two types of Ia-positive T cells. Synthesis and exchange of Ia antigens. *J Exp Med* 1980;152:89s–98s.
36. Lee ST, Paraskevas F. Macrophage–T cell interactions. II. The uptake by T cells of fragments bearing Ia determinants released from macrophages. *Cell Immunol* 1979;48:1–14.
37. Pober JS, Gimbrone MA Jr, Cotran RS, et al. Ia expression by vascular endo–thelium is inducible by activated T cells and by human  $\gamma$ -interferon. *J Exp Med* 1983;157:1339–1353.
38. Houghton AN, Thomson TM, Gross D, et al. Surface antigens of melanoma and melanocytes. Specificity of induction of Ia antigens by human  $\gamma$ -interferon. *J Exp Med* 1984;160:255–269.
39. Kappes D, Strominger JL. Human class II major histocompatibility complex genes and proteins. *Annu Rev Biochem* 1988;57:991–1028.
40. Rask L, Gustafsson K, Larhammar D, et al. Generation of class II antigen polymorphism. *Immunol Rev* 1985;84:123–143.
41. Cresswell P, Blum JS, Kelner DN, et al. Biosynthesis and processing of class II histocompatibility antigens. *Crit Rev Immunol* 1987;7:31–53.
42. Marks MS, Blum JS, Cresswell P. Invariant chain trimers are sequestered in the rough endoplasmic reticulum in the absence of association with HLA class II antigens. *J Cell Biol* 1990;111:839–855.
43. Roche PA, Marks MS, Cresswell P. Formation of a nine–subunit complex by HLA class II glycoproteins and the invariant chain. *Nature* 1991;354:392–394.
44. Riberdy JM, Newcomb JR, Surman MJ, et al. HLA–DR molecules from an antigen–processing mutant cell line are associated with invariant chain peptides. *Nature* 1992;360:474–477.
45. Craig EA. Chaperones: helpers along the pathways to protein folding. *Science* 1993;260:1902–1903.
46. Agard DA. To fold or not to fold... *Science* 1993;260:1903–1904.
47. Schaiff WT, Hruska KA Jr, McCourt DW, et al. HLA–DR associates with specific stress proteins and is retained in the endoplasmic reticulum in invariant chain negative cells. *J Exp Med* 1992;176:657–666.
48. Anderson KS, Cresswell P. A role for calnexin (IP90) in the assembly of class II MHC molecules. *EMBO J* 1994;13:675–682.
49. Cresswell P. Assembly, transport, and function of MHC class II molecules. *Annu Rev Immunol* 1994;12:259–293.
50. Marsh SG, Bodmer JG. HLA class II nucleotide sequences, 1992. *Hum Immunol* 1992;35:1–17.
51. Konig R, Huang LY, Germain RN. MHC class II interaction with CD4 mediated by a region analogous to the MHC class I binding site for CD8. *Nature* 1992;356:796–798.
52. Cammarota G, Scheirle A, Takacs B, et al. Identification of a CD4 binding site on the  $\beta_2$  domain of HLA–DR molecules. *Nature* 1992;356:799–801.
53. Brown JH, Jardetzky TS, Gorga JC, et al. Three–dimensional structure of the human class II histocompatibility antigen HLA–DR1. *Nature* 1993;364:33–39.
54. Stern LJ, Brown JH, Jardetzky TS, et al. Crystal structure of the human class II MHC protein HLA–DR1 complexed with an influenza virus peptide. *Nature* 1994;368:215–221.
55. Chicz RM, Urban RG, Lane WS, et al. Predominant naturally processed peptides bound to HLA–DR1 are derived from MHC–related molecules and are heterogeneous in size. *Nature* 1992;358:764–768.

56. Jardetzky TS, Brown JH, Gorga JC, et al. Three-dimensional structure of a human class II histocompatibility molecule complexed with superantigen. *Nature* 1994;368:711-718.
57. Fields BA, Mariuzza RA. Structure and function of the T-cell receptor: insights from X-ray crystallography. *Immunol Today* 1996;17:330-336.
58. Abastado JP, Lone YC, Casrouge A, et al. Dimerization of soluble major histocompatibility complex-peptide complexes is sufficient for activation of T cell hybridoma and induction of unresponsiveness. *J Exp Med* 1995;182:439-447.
59. O'Callaghan CA, Bell JH. Structure and function of human MHC class Ib molecules HLA-E, HLA-F and HLA-G. *Immunol Rev* 1998;163:129-138.
60. O'Callaghan CA, Tormo J, Willcox BE, et al. Structural features impose tight peptide binding specificity in non-classical MHC molecule HLA-E. *Mol Cell* 1998;1:531-541.
- 60a. Miller JD, Weber DA, Ibegbu C, et al. Analysis of HLA-E peptide-binding specificity and contact residues in bound peptide required for recognition by CD94/NKG2. *J Immunol* 2003;171:1369-1375.
61. Braud VM, Jones EY, McMichael AJ. The human major histocompatibility complex class Ib molecule HLA-E binds signal sequence derived peptides with primary anchor residues at positions 2 and 9. *Eur J Immunol* 1997;27:1164-1169.
62. Braud VM, Allan DS, Wilson D, et al. TAP and tapasin-dependent HLA-E surface expression correlates with the binding of an MHC class I leader peptide. *Curr Biol* 1998;8:1-10.
63. Allan DSJ, Lepin EJM, Braud VM, et al. Tetrameric complexes of HLA-E, HLA-F, and HLA-G. *J Immunol Methods* 2002;268:43-50.
64. Lee N, Llano M, Carretero M, et al. HLA-E is a major ligand for the natural killer inhibitory receptor CD94/NKG2A. *Proc Natl Acad Sci U S A* 1998;95:5199-5204.
65. Borrego F, Ulbrecht M, Weiss EH, et al. Recognition of human histocompatibility leukocyte antigen (HLA-E) complexed with HLA class I signal sequence derived peptides by CD94/NKG2 confers protection from natural killer cell-mediated lysis. *J Exp Med* 1998;187:813-818.
66. Garcia P, Llano M, de Heredia AB, et al. Human T cell receptor-mediated recognition of HLA-E. *Eur J Immunol* 2002;32:936-944.
67. Tomasec P, Braud VM, Richards C, et al. Surface expression of HLA-E, an inhibitor of natural killer cells, enhanced by human cytomegalovirus gpUL40. *Science* 2000;287:1031-1033.
68. Michaëlson J, Teixeira de Matos C, Achour A, et al. A signal peptide derived from hsp60 binds HLA-E and interferes with CD94/NKG2A recognition. *J Exp Med* 2002;196:1403-1414.
69. Lepin EJ, Bastin JM, Allan DS, et al. Functional characterization of HLA-F and binding of HLA-F tetramers to ILT2 and ILT4 receptors. *Eur J Immunol* 2000;30:3552.
70. Wainwright SD, Siro PA, Holmes CH. HLA-F is a predominantly empty, intracellular, TAP-associated MHC class Ib protein with a restricted expression pattern. *J Immunol* 2000;164:319-328.
71. Le Bouteiller P, Lenfant F. Antigen-presenting function(s) of the non-classical HLA-E, -F, and -G class I molecules: the beginning of a story. *Res Immunol* 1996;147:301-313.
72. Le Bouteiller P, Blaschitz A. The functionality of HLA-G is emerging. *Immunol Rev* 1999;167:233-244.
73. Allan DSJ, Colonna M, Lanier LL, et al. Tetrameric complexes of human histocompatibility leukocyte antigen (HLA)-G bind to peripheral blood myelomonocytic cells. *J Exp Med* 1999;189:1149-1155.
74. Pende D, Sivori S, Accame L, et al. HLA-G recognition by human natural killer cells. Involvement of CD94 both as inhibitory and as activated receptor complex. *Eur J Immunol* 1997;27:1875-1880.

75. Söderstrom K, Corliss B, Lanier LL, et al. CD94/NKG2 is the predominant inhibitory receptor involved in recognition of HLA-G by decidual and peripheral blood NK cells. *J Immunol* 1997;159:1072-1075.
76. Mandelboim O, Razmany L, Davis DM, et al. Multiple receptors for HLA-G on human natural killer cells. *Proc Natl Acad Sci U S A* 1997;94:14666-14670.
77. Navarro F, Llano M, Bellon T, et al. The ILT2 (LIR1) and CD94/NKG2A NK cell receptors respectively recognize HLA-G1 and HLA-E molecules coexpressed on target cells. *Eur J Immunol* 1999;29:277-283.
78. Rajagopalan S, Long EO. A human compatibility leukocyte antigen (HLA)-G-specific receptor expressed on all natural killer cells. *J Exp Med* 1999;189:1093-1099.
79. Alfonso C, Karlsson L. Nonclassical MHC class II molecules. *Annu Rev Immunol* 2000;18:113-142.
80. Sanderson F, Thomas C, Neefjes J, et al. Association between HLA-DM and HLA-DR in vivo. *Immunity* 1996;4:87-96.
81. Kropshofer H, Hammerling GJ, Vogt AB. The impact of non-classical MHC proteins HLA-DM and HLA-DO on loading of MHC class II molecules. *Immunol Rev* 1999;172:267-278.
82. Ullrich HJ, Döring K, Grüneberg U, et al. Interaction between HLA-DM and HLA-DR involves regions that undergo conformational changes at lysosomal pH. *Proc Natl Acad Sci U S A* 1997;94:13163-13168.
83. Kropshofer H, Vogt AB, Moldenhauer G, et al. Editing of the HLA-DR peptide repertoire by HLA-DM. *EMBO J* 1996;15:6144-6154.
84. Sant AJ, Beeson C, McFarland B, et al. Individual hydrogen bonds play a critical role in MHC class II peptide interactions: implications for the dynamic aspects of class II trafficking and DM-mediated peptide exchange. *Immunol Rev* 1999;172:239-253.
85. Kropshofer H, Arndt SO, Moldenhauer G, et al. HLA-DM acts as a molecular chaperone and rescues empty HLA-DR molecules at lysosomal pH. *Immunity* 1997;6:293-302.
86. Douek DC, Altman DM. HLA-DO is an intracellular class II molecule with distinctive thymic expression. *Int Immunol* 1997;9:335-364.
87. Liljedahl M, Kuwana T, Fung-Leung WP, et al. HLA-DO is a lysosomal resident which requires association with HLA-DM for efficient intracellular transport. *EMBO J* 1996;15:4817-4824.
88. Kropshofer H, Vogt AB, They C, et al. A role for HLA-DO as a co-chaperone of HLA-DM in peptide loading of MHC class II molecules. *EMBO J* 1998;17:2971-2981.
89. Van Ham SM, Tjin EP, Lillemeijer BF, et al. HLA-DO is a negative modulator of HLA-DM-mediated MHC class II peptide loading. *Curr Biol* 1997;7:950-957.
90. Alfonso C, Liljedahl M, Wingvist O, et al. The role of H2-O and HLA-DO in major histocompatibility complex class II-restricted antigen processing and presentation. *Immunol Rev* 1999;172:255-266.
91. Bahram S. MIC genes: from genetics to biology. *Adv Immunol* 2001;76:1-60.
92. Li P, Willie ST, Bauer S, et al. Crystal structure of the MHC class I homolog MIC-A, a gamma delta T cell ligand. *Immunity* 1999;10:577-584.
93. Groh V, Steinle A, Bauer S, et al. Recognition of stress-induced MHC molecules by the intestinal epithelial gamma delta T cells. *Science* 1998;279:1737-1740.
94. Strong RK. Class (I) will come to order-not. *Nat Struct Biol* 2000;7:173-176.
95. Stephens HAF. MICA and MICB genes: can the enigma of their polymorphism be resolved? *Trends Immunol* 2001;22:378-385.
96. Groh V, Rhinehart R, Secrist H, et al. Broad tumor-associated expression and recognition of tumor



derived  $\gamma\delta$  T cells of MICA and MICB. *Proc Natl Acad Sci U S A* 1999;96:6879–6884.

97. Bauer S, Groh V, Wu J, et al. Activation of NK cells and T cells by NKG2D, a receptor for stress-inducible MICA. *Science* 1999;285:727–732.

98. Groh V, Rhinehart R, Randolph-Habecker J, et al. Costimulation of CD8<sup>+</sup>  $\alpha\beta$  T cells by NKG2D via engagement by MIC induced on virus-infected cells. *Nat Immunol* 2001;2:255–260.

99. Li P, Morris DL, Willcox BE, et al. Complex structure of the activating immunoreceptor NKG2D and its MHC class I-like ligand MICA. *Nat Immunol* 2001;2:443–451.

100. Groh V, Bahram S, Bauer S, et al. Cell stress-related human major histocompatibility complex class I gene expressed in gastrointestinal epithelium. *Proc Natl Acad Sci U S A* 1996;93:12445–12450.

101. Zwirner NW, Dole K, Stastny P. Differential surface expression of MICA by endothelial cells, fibroblasts, keratinocytes and monocytes. *Hum Immunol* 1999;60:323–330.

102. McMichael A, Pilch JR, Galfre G, et al. A human thymocyte antigen defined by a hybrid myeloma monoclonal antibody. *Eur J Immunol* 1979;9:205–210.

103. Sugita M, Porcelli SA, Brenner MB. Assembly and retention of CD1b heavy chains in the endoplasmic reticulum. *J Immunol* 1997;159:2358–2365.

104. Zeng Z, Castano AR, Segelke BW, et al. Crystal structure of mouse CD1: an MHC-like fold with a large hydrophobic binding groove. *Science* 1997;277:339–345.

105. Godola SD, Caccai NR, Harlos K, et al. Structure of human CD1b with bound ligands and 2.3 Å, a maze for alkyl chains. *Nat Immunol* 2002;3:721–726.

106. Beckman EM, Porcelli SA, Morita CT, et al. Recognition of a lipid antigen by CD1-restricted  $\alpha\beta$ <sup>+</sup> T cells. *Nature* 1994;372:691–694.

107. Wu R, Giscombe R, Holm G, et al. Induction of human cytotoxic T lymphocytes by oxidized low density lipoproteins. *Scand J Immunol* 1996;43:381–384.

108. Melian A, Geng YJ, Sukhova GK, et al. CD1 expression in human atherosclerosis—a potential mechanism for T cell activation by foam cells. *Am J Pathol* 1999;155:775–786.

109. Cosman D, Mullberg J, Sutherland CL, et al. ULBPs, novel MHC class I related molecules, bind to CMV glycoprotein UL16 and stimulate NK cytotoxicity, through the NKG2D receptor. *Immunity* 2001;14:123–133.

110. Kubin M, Cassiano L, Chalupny J, et al. ULBP1, 3, 3: novel MHC class I-related molecules that bind to human cytomegalovirus glycoprotein UL16, activate NK cells. *Eur J Immunol* 2001;31:1428–1437.

111. Sutherland CL, Chalupny NJ, Schooley K, et al. UL16-binding proteins, novel MHC class I-related proteins, bind to NKG2D and activate multiple signaling pathways in primary NK cells. *J Immunol* 2002;168:671–679.

112. Bauer S, Groh V, Wu J, et al. Activation of NK and T cells by NKG2D, a receptor for stress inducible MICA. *Science* 1999;285:727–729.

113. Diefenbach A, Jamieson AM, Liu SD, et al. Ligands for the murine NKG2D receptor: expression by tumor cells and activation of NK cells and macro-phages. *Nat Immunol* 2000;1:119–126.

114. Groh V, Rhinehart R, Randolph-Habecker J, et al. Costimulation of CD8  $\alpha\beta$  T cells by NKG2D via engagement by MIC induced on virus-infected cells. *Nat Immunol* 2001;2:255–260.

115. Wu J, Chalupny NJ, Manley TJ, et al. Intracellular retention of the MHC class I-related chain B ligand of NKG2D by the human cytomegalovirus UL16 glycoprotein. *J Immunol* 2003;170:4196–4200.

116. Flajnik MF, Kasahara M. Comparative genomics of the MHC: glimpses into the evolution of the

adaptive immune system. *Immunity* 2001;15:351–362.

117. Parham P. Virtual reality in the MHC. *Immunol Rev* 1999;167:5–15.

118. Kasahara M. The chromosomal duplication model of the major histocompatibility complex. *Immunol Rev* 1999;167:17–32.

119. Abi-Rached L, McDermott MF, Pontarotti P. The MHC big bang. *Immunol Rev* 1999;167:33–44.

120. Hughes AL. Phylogenetic tests of the hypothesis of block duplication of homologous genes on human chromosomes 6, 9 and 1. *Mol Biol Evol* 1998;15:854–870.

121. Yeager M, Hughes AL. Evolution of the mammalian MHC: natural selection, recombination and convergent evolution. *Immunol Rev* 1999;167:45–58.

122. Flajnik MF, Ohta Y, Namikawa-Yamada C, et al. Insight into the primordial MHC from studies in ectothermic vertebrates. *Immunol Rev* 1999;167:59–67.

123. Hashimoto K, Okamura K, Yamaguchi H, et al. Conservation and diversification of MHC class I and its related molecules in vertebrates. *Immunol Rev* 1999;167:81–100.

124. Kaufman J, Jacob J, Shaw I, et al. Gene organization determines evolution of function in the chicken MHC. *Immunol Rev* 1999;167:101.

125. Price P, Witt C, Allcock R, et al. The genetic basis for the association of the 8.1 ancestral haplotype (A1, B8, DR3) with multiple immunopathological diseases. *Immunol Rev* 1999;167:257–274.

126. Dawkins R, Leelayuwat C, Goudieri S, Tay G, et al. Genomics of the major histocompatibility complex: haplotypes, duplication, retroviruses and disease. *Immunol Rev* 1999;167:275–304.

127. York IA, Rock KL. Antigen processing and presentation by the class I major histocompatibility complex. *Annu Rev Immunol* 1996;14:369–396.

128. Tanaka K, Tanahashi N, Tsurumi C, et al. Proteasomes and antigen processing. *Adv Immunol* 1997;64:1–38.

129. Coux O, Tanaka K, Goldberg AL. Structure and functions of the 28S and 26S proteasomes. *Annu Rev Biochem* 1996;65:801–847.

130. Shastri N, Schwab S, Serwold T. Producing nature's gene-chips: the generation of peptides for display by MHC class I molecules. *Annu Rev Immunol* 2002;20:463–493.

131. Rock KL, York IA, Saric T, et al. Protein degradation and the generation of MHC class I-presented peptides. *Adv Immunol* 2002;80:1–70.

132. Zwickl P, Kleinz J, Baumeister W. Critical elements in proteasome assembly. *Nat Struct Biol* 1994;1:765–770.

133. Monaco JJ, Nandi D. The genetics of proteasomes and antigen processing. *Annu Rev Genet* 1995;29:729–754.

134. Tanaka K, Kasahara M. The MHC class I ligand-generating system: role of immunoproteasomes and the interferon- $\gamma$ -inducible proteasome activator PA28. *Immunol Rev* 1998;163:161–176.

135. Dubiel W, Pratt G, Ferrel K, et al. Purification of an 11S regulator of the multicatalytic protease. *J Biol Chem* 1992;267:22369–22377.

136. Niedermann G, Geier E, Lucchiari-Hartz M, et al. The specificity of proteasomes: impact on MHC class I processing and presentation of antigens. *Immunol Rev* 1999;72:29–48.

137. Kloetzel P-M. Antigen processing by the proteasome. *Nat Rev Mol Cell Biol* 2001;2:179–187.

138. Rock KL, Gramm C, Rothstein L, et al. Inhibitors of the proteasome block the degradation of most

cell proteins and the generation of peptides presented on MHC class I molecules. *Cell* 1994;78:761–771.

139. Craiu A, Akopian T, Goldberg A, et al. Two distinct proteolytic processes in the generation of a major histocompatibility complex class I-presented peptide. *Proc Natl Acad Sci U S A* 1997;94:10850–10855.

140. Cascio P, Hilton C, Killelev AF, et al. 26S proteasomes and immunoproteasomes produce mainly N-extended versions of an antigenic peptide. *EMBO J* 2000;20:2357–2366.

141. Paz P, Brouwenstijn N, Perry R, et al. Discrete proteolytic intermediates in the MHC class I antigen processing pathway and MHC I-dependent peptide trimming in the ER. *Immunity* 1999;11:241–251.

142. Ben Shahan S, Komlosch A, Nadav E, et al. 26S proteasome-mediated production of an authentic major histocompatibility class I-restricted epitope from an intact protein substrate. *J Biol Chem* 1999;274:2963–2972.

143. Yewdell JW, Bennick JR. Cut and trim: generating MHC class I peptide ligands. *Curr Opin Immunol* 2001;13:13–18.

144. Stock D, Nederlog PM, Seemüller E, et al. Proteasome: from structure to function. *Curr Opin Biotechnol* 1996;7:376–385.

145. Schwartz AL, Ciechanover A. The ubiquitin-proteasome pathway and pathogenesis of human diseases. *Annu Rev Med* 1999;50:57–74.

146. Momburg F, Hämmerling GJ. Generation of TAP-mediated transport of peptides for major histocompatibility complex class I molecules. *Adv Immunol* 1998;68:191–256.

147. Elliot T. Transporter association with antigen processing. *Adv Immunol* 1997;65:47–109.

148. Cerundolo V, Alexander J, Anderson K, et al. Presentation of viral antigen controlled by a gene in the major histocompatibility complex. *Nature* 1990;345:449–452.

149. Monaco JJ. Major histocompatibility complex-linked transport proteins and antigen processing. *Immunol Res* 1992;11:125–132.

150. Townsend A, Trowsdale J. The transporters associated with antigen presentation. *Semin Cell Biol* 1993;4:53–61.

151. de la Salle H, Hanau D, Fricker D, et al. Homozygous human TAP peptide transporter mutation in HLA class I deficiency. *Science* 1994;265:237–241.

152. Van Kaer L, Ashton-Rickardt PG, Ploegh HL, et al. TAP1 mutant mice are deficient in antigen presentation, surface class I molecules, and CD4<sup>+</sup> T cells. *Cell* 1992;71:1205–1214.

153. Higgins CF. ABC transporters: from microorganisms to man. *Annu Rev Cell Biol* 1992;8:67–113.

154. Russ G, Esquivel F, Yewdell JW, et al. Assembly, intracellular localization, and nucleotide binding properties of the human peptide transporters TAP1 and TAP2 expressed by recombinant vaccinia viruses. *J Biol Chem* 1995;270:21312–21318.

155. Kleijmeer MJ, Kelly A, Geuze HJ, et al. Location of MHC-encoded transporters in the endoplasmic reticulum and cis-Golgi. *Nature* 1992;357:342–344.

156. Muller KM, Ebensperger C, Tampe R. Nucleotide binding to the hydrophilic C-terminal domain of the transporter associated with antigen processing (TAP). *J Biol Chem* 1994;269:14032–14037.

157. Androlewicz MJ, Cresswell P. Human transporters associated with antigen processing possess a promiscuous peptide-binding site. *Immunity* 1994;1:7–14.

158. Androlewicz MJ, Anderson KS, Cresswell P. Evidence that transporters associated with antigen processing translocate a major histocompatibility complex class I-binding peptide into the endoplasmic reticulum in an ATP-dependent manner. *Proc Natl Acad Sci U S A* 1993;90:9130–9134.

159. Shepherd JC, Schumacher TN, Ashton-Rickardt PG, et al. TAP1-dependent peptide translocation in vitro is ATP dependent and peptide selective. *Cell* 1993;74:577-584.
160. Schumacher TN, Kantesaria DV, Heemels MT, et al. Peptide length and sequence specificity of the mouse TAP1/TAP2 translocator. *J Exp Med* 1994;179:533-540.
161. Sargent CA, Dunham I, Trowsdale J, Campbell RD. Human major histocompatibility complex contains genes for the major heat shock protein HSP70. *Proc Natl Acad Sci U S A* 1989;86:1968-1972.
162. Wang Y, Chen D, Androlewicz MJ. The role of endoplasmic reticulum-associated protein degradation in MHC class I antigen processing. *Immunol Rev* 1999;172:67-72.
163. Plempner RK, Wolf DH. Retrograde protein translocation: eradication of secretory proteins in health and disease. *Trends Biochem Sci* 1999;24:266-270.
164. Vassilakos A, Cohen-Doyle MF, Peterson PA, et al. The molecular chaperone calnexin facilitates folding and assembly of class I histocompatibility molecules. *EMBO J* 1996;15:1495-1506.
165. Cresswell P, Bangia N, Dick T, et al. The nature of MHC class I peptide loading complex. *Immunol Rev* 1999;172:21-28.
166. Ortmann B, Copeman J, Lehner PJ, et al. A critical role for tapasin in the assembly and function of multimeric MHC class I-TAP complexes. *Science* 1997;277:1306-1309.
167. Sadasivan B, Lehner PJ, Ortmann B, et al. Roles of calreticulin and a novel glycoprotein, tapasin, in the interaction of MHC class I molecules with TAP. *Immunity* 1996;5:103-114.
168. Li S, Paulsson KM, Sjögren H-O, et al. Peptide-bound major histocompatibility complex class I molecules associate with tapasin before dissociation from transporter associated with antigen processing. *J Biol Chem* 1999;274:8649-8654.
169. Peh CA, Burrows SR, Barnden M, et al. HLA-B27-restricted antigen presentation in the absence of tapasin reveals polymorphism in mechanisms of HLA class I peptide loading. *Immunity* 1998;8:531-542.
170. Morrice NA, Powis SJ. A role for the thiol dependent reductase ERp57 in the assembly of MHC class I molecules. *Curr Biol* 1998;8:713-716.
171. Solheim JC. Class I MHC molecules: assembly and antigen presentation. *Immunol Rev* 1999;172:11-19.
172. Diedrich G, Bangia N, Pan M, et al. A role for calnexin in the assembly of the MHC class I loading complex in the endoplasmic reticulum. *J Immunol* 2001;166:1703-1709.
173. Yewdell JW, Norbury CC, Bennink JR. Mechanisms of exogenous antigen presentation by MHC class I molecules in vitro and in vivo: implications for generating CD8<sup>+</sup> T cell responses to infectious agents, tumors, transplants and vaccines. *Adv Immunol* 1999;73:1-77.
174. Bevan MJ. Cross-priming for a secondary cytotoxic response to minor H antigens with H<sub>2</sub> congenic cells which do not cross-react in the cytotoxic assay. *J Exp Med* 1976;143:1283-1288.
175. Schrader JW, Edelman GM. Joint recognition by cytotoxic T cells of inactivated Sendai virus and products of the major histocompatibility complex. *J Exp Med* 1977;145:523-539.
176. Tevethia SS, Flyer DC, Tjian R. Biology of simian virus 40 (SV40) transplantation antigen (TrAg) VI. Mechanism of induction of SV40 transplantation immunity in mice by purified SV40 T antigen (D<sub>2</sub> protein). *Virology* 1980;107:13-23.
177. Reimann J, Shirmbeck R. Alternative pathways for processing exogenous and endogenous antigens that can generate peptides for MHC class I-restricted presentation. *Immunol Rev* 1999;172:131-152.
178. Shrivastava P. Interaction of heat shock proteins with peptides and antigen presenting cells:

- chaperoning of the innate and adaptive immune responses. *Annu Rev Immunol* 2002;20:395–425.
179. Blachere NE, Li Z, Chandawarkar RY, et al. Heat shock protein–peptide complexes, reconstituted in vitro, elicit peptide–specific cytotoxic T lymphocyte response and tumor immunity. *J Exp Med* 1997;186:1315–1322.
180. Castellino F, Boucher PE, Eichelberg K, et al. Receptor–mediated uptake of antigen/heat shock protein class I antigen presentation via two distinct processing pathways. *J Exp Med* 2000;191:1957–1964.
181. Udono H, Levey DL, Srivastava PK. Cellular requirements for tumor–specific immunity elicited by heat shock proteins: tumor rejection antigen gp96 primes CD8<sup>+</sup> T cells in vivo. *Proc Natl Acad Sci U S A* 1994;91:3077–3081.
182. Suto R, Srivastava PK. A mechanism for the specific immunogenicity of heat shock protein–chaperoned peptides. *Science* 1995;269:585–588.
183. Binder RJ, Blachere NE, Srivastava PK. Heat shock protein–chaperone peptides but not free peptides introduced into the cytosol are presented efficiently by major histocompatibility complex I molecules. *J Biol Chem* 2001;276:17163–17171.
184. Binder RJ, Harris ML, Menoret A, et al. Saturation, competition and specificity in interaction of heat shock proteins (hsp) gp96, hsp90 and hsp70 with CD11b<sup>+</sup> cells. *J Immunol* 2000;165:2582–2587.
185. Basu S, Binder RJ, Ramalingam T, et al. CD91 is a common receptor for heat shock proteins gp96, hsp90, hsp70, and calreticulin. *Immunity* 2001;14:303–313.
186. Ogden CA, de Cathelineau A, Hoffmann PR, et al. C1q and mannose binding lectin engagement of cell surface calreticulin and CD91 initiates macropinocytosis and uptake of apoptotic cells. *J Exp Med* 2001;194:781–795.
187. Vancivier RW, Ogden CA, Fadok VA, et al. Role of surfactant proteins A, D and C1q in the clearance of apoptotic cells in vivo and in vitro: calreticulin and CD91 as a common collectin receptor complex. *J Immunol* 2002;169:3978–3986.
188. Srivastava PK, Menoret A, Basu S, et al. Heat shock proteins come of age: primitive functions acquire new roles in an adaptive world. *Immunity* 1998;8:657–665.
189. Heath WR, Carbonne FR. Cross–presentation, dendritic cells, tolerance, and immunity. *Annu Rev Immunol* 2001;19:47–64.
190. Boss JM. Regulation of transcription of MHC class II genes. *Curr Opin Immunol* 1997;9:107–113.
191. Cresswell P. Invariant chain structure and MHC class II function. *Cell* 1996;84:505–507.
192. Cresswell P. Assembly, transport and function of MHC class II molecules. *Annu Rev Immunol* 1994;12:259–293.
193. Schutze MP, Peterson PA, Jackson MR. An N–terminal double–arginine motif maintains type II membrane proteins in the endoplasmic reticulum. *EMBO J* 1994;13:1696–1705.
194. Rodionov DG, Bakke O. Medium chains of adaptor complexes AP–1 and AP–2 recognize leucine–based sorting signals from the invariant chain. *J Biol Chem* 1998;273:6005–6008.
195. Geuze HJ. The role of endosomes and lysosomes in MHC class II functioning. *Immunol Today* 1998;19:282–287.
196. Neefjes J. CIIV, MIIC and other compartments for MHC class II loading. *Eur J Immunol* 1999;29:1421–1425.
197. Bakke O, Nordeng TW. Intracellular traffic to compartments for MHC class II peptide loading: signals for endosomal and polarized sorting. *Immunol Rev* 1999;172:171–187.
198. Villadangos JA. Presentation of antigens by MHC class II molecules: getting the most out of them.

Mol Immunol 2001;38:329–346.

199. Fernandes DM, Vidard L, Rock KL. Characterization of MHC class II-presented peptides generated from an antigen targeted to different endocytic compartments. *Eur J Immunol* 2000;30:2333–2343.
200. Villadangos JA, Ploegh HL. Proteolysis in MHC class II antigen presentation: who's in charge? *Immunity* 2000;12:233–239.
201. Villadangos JA, Bryant RAR, Deussing J, et al. Proteases involved in MHC class II antigen presentation. *Immunol Rev* 1999;172:109–120.
202. Antoniou AN, Blackwood SL, Mazzeo D, et al. Control of antigen presentation by a single protease cleavage site. *Immunity* 2000;12:391–398.
203. Wubbolts R, Neeffjes J. Intracellular transport and peptide loading of MHC class II molecules: regulation by chaperones and motors. *Immunol Rev* 1999;172:189–208.
204. Amigorena S, Drake JR, Webster P, et al. Transient accumulation of new class II MHC molecules in a novel endocytic compartment in B lymphocytes. *Nature* 1994;369:113–120.
205. Pieters J. MHC class II restricted antigen processing and presentation. *Adv Immunol* 2000;75:159–208.
206. Bryant PW, Lennon-Dumenil A-M, Fiebiger E, et al. Proteolysis and antigen presentation by MHC class II molecules. *Adv Immunol* 2002;80:71–114.
207. Nakagawa TY, Reidensky AY. The role of lysosomal proteinases in MHC II-mediated antigen processing and presentation. *Immunol Rev* 1999;172:121–129.
208. Doebele RC, Busch R, Scott HM, et al. Determination of the HLA-DM interaction site on HLA-DR molecules. *Immunity* 2000;13:517–527.
209. Mosyak L, Zaller DM, Wiley DC. The structure of HLA-DM, the peptide exchange catalyst that loads antigen onto class II MHC molecules during antigen presentation. *Immunity* 1998;9:377–383.
210. Matteoni R, Kreis TE. Translocation and clustering of endosomes and lysosomes depends on microtubules. *J Cell Biol* 1998;105:1253–1265.
211. Wubbolts R, Fernandez-Borja M, Jordens I, et al. Opposing motor activities of kinesin and dynein mediate bi-directional transport of MHC class II containing vesicles. *J Cell Sci* 1998;112:785–795.
212. Ito T, Inaba M, Inaba K, et al. A CD1a<sup>+</sup>/CD11c<sup>+</sup> subset of human blood dendritic cells is a direct precursor of Langerhans cells. *J Immunol* 1999;163: 1409–1419.
213. Briken V, Jackman RM, Watts GF, et al. Human CD1b and CD1c isoforms survey different intracellular compartments for the presentation of microbial lipid antigens. *J Exp Med* 2000;192:281–287.
214. Sugita M, Grant EP, van Donselaar E, et al. Separate pathways for antigen presentation by CD1 molecules. *Immunity* 1999;11:743–752.
215. Manolova V, Hirabayashi Y, Mori L, et al. CD1a and CD1b surface expression is independent from de novo synthesized glycosphingolipids. *Eur J Immunol* 2003;33:29–37.
216. Schaible UE, Hagens K, Fischer K, et al. Intersection of group I CD1 molecules and mycobacteria in different intracellular compartments of dendritic cells. *J Immunol* 2000;164:4843–4852.
217. Jackman RM, Stenger S, Lee A, et al. The tyrosine containing cytoplasmic tail of CD1b is essential for its efficient presentation of bacterial antigens. *Immunity* 1998;8:341–351.
218. Chiu YH, Jayawardena J, Weiss A, et al. Distinct subsets of CD1d-restricted T cells recognize self-antigens loaded in different cellular compartments. *J Exp Med* 1999;189:103–110.

219. Robinson MS, Bonifacino JS. Adaptor-related proteins. *Curr Opin Cell Biol* 2001;13:444–453.
220. Bonifacino JS, Dell’Angelica EC. Molecular bases for the recognition of tyrosine-based sorting signals. *J Cell Biol* 1999;145:923–926.
221. Jayawardena-Wolf J, Benlogha K, Chiu Y-H, et al. CD1d endosomal trafficking is independently regulated by an intrinsic CD1d-encoded tyrosine motif and by the invariant chain. *Immunity* 2001;15:897–908.
222. Riese RJ, Shi G-P, Villadangos J, et al. Regulation of CD1 function and NK1-1 T cell selection and maturation by cathepsin S. *Immunity* 2001;15:909–919.
223. Moody DB, Porcelli SA. CD1 trafficking: invariant chain gives a new twist to the tale. *Immunity* 2001;15:861–865.
224. Sugita M, Moody DR, Jackman RM, et al. CD1—a new paradigm for antigen presentation and T cell activation. *Clin Immunol Immunopathol* 1998;87:8–14.
225. Porcelli S, Morita CT, Brenner MB. CD1b restricts the response of human CD4<sup>+</sup>8<sup>+</sup> T lymphocytes to a microbial antigen. *Nature* 1992;360:593–597.
226. Sturgill-Koszyski S, Schlesinger PH, Chakraborty P, et al. Lack of acidification of *Mycobacterium* phagosomes produced by exclusion of the vesicular proton-ATPase. *Science* 1994;263:678.
227. Prigozy TI, Sieling PA, Clemens D, et al. The mannose receptor delivers lipoglycan antigens to endosomes for presentation to T cells by CD1b molecules. *Immunity* 1997;6:187–197.
228. Briken V, Moody DB, Porcelli SA. Diversification of CD1 proteins: sampling the lipid content of different cellular compartment. *Semin Immunol* 2000;12:517–525.
229. Beatty WL, Rhoades ER, Ulrich HJ, et al. Trafficking and release of mycobacterial lipids from infected macrophages. *Traffic* 2000;1:235–247.
230. Moody DB, Besra GS, Wilson IA, et al. The molecular basis of CD1-mediated presentation of lipid antigens. *Immunol Rev* 1999;172:285–296.
231. Moody DB, Briken V, Cheng TY, et al. Lipid length controls antigen entry into endosomal and non-endosomal pathways for CD1b presentation. *Nat Immunol* 2002;3:435–442.
232. Porcelli SA, Modlin RL. The CD1 system: antigen-presenting molecules for T cell recognition of lipids and glycolipids. *Annu Rev Immunol* 1999;17:297–329.
233. Ernst W, Maher J, Cho S, et al. Molecular interaction of CD1b with lipoglycan antigens. *Immunity* 1998;8:331–340.
234. Prigozy TI, Nardenko O, Qasba P, et al. Glycolipid antigen processing for presentation by CD1d molecules. *Science* 2001;291:664–667.
235. Moody DB, Reinhold BB, Reinhold VN, et al. Uptake and processing of glycosylated mycolates for presentation of CD1b-restricted T cells. *Immunol Letters* 1999;65:85–91.
236. Moody DB, Besra GS. Glycolipid targets of CD1-mediated T-cell responses. *Immunology* 2001;104:243–251.
237. Shamshiev A, Donda A, Carena I, et al. Self glycolipids as T cell autoantigens. *Eur J Immunol* 1999;29:1667–1675.
238. Shamshiev A, Donda A, Prigozy TI, et al. The ab T cell response to self-glycolipids shows a novel mechanism of CD1b loading and a requirement to complex oligosaccharides. *Immunity* 2000;13:255–264.
239. Park S-H, Bendelac A. CD1-restricted T-cell responses and microbial infection. *Nature*



2000;406:788–792.

240. Jackman RM, Moody DB, Porcelli SA. Mechanisms of lipid antigen presentation by CD1. *Crit Rev Immunol* 1999;19:49–63.

241. Gumperz JE, Brenner MB. CD1-specific T cells in microbial immunity. *Curr Opin Immunol* 2001;13:471–478.

242. Descher CC, Brenner MB. CD1 antigen presentation and infectious disease. *Contrib Microbiol* 2003;10:164–182.

243. Sugita M, van der Wel N, Rogers RA, et al. CD1c molecules broadly survey the endocytic system. *Proc Nat Acad Sci* 2000;97:8445–8450.

244. Bell D, Young JW, Bancereau J. Dendritic cells. *Adv Immunol* 1999;72:255–324.

245. Bancereau J, Briere F, Coux C, et al. Immunobiology of dendritic cells. *Annu Rev Immunol* 2000;18:767–811.

246. Guermonprez P, Valladeau J, Zitrogel L, et al. Antigen presentation and T cell stimulation by dendritic cells. *Annu Rev Immunol* 2002;20:621–667.

247. Chomar P, Bancereau J, Davoust J, et al. IL-6 switches the differentiation of monocytes from dendritic cells to macrophages. *Nat Immunol* 2000;1:510–514.

248. Canque B, Camus S, Dalloul A, et al. Characterization of dendritic cell differentiation pathways from cord blood, CD34<sup>+</sup>CD7<sup>+</sup>CD45RA<sup>+</sup> hematopoietic progenitor cells. *Blood* 2000;96:3748–3756.

249. Randolph GJ, Inaba K, Robiani DF, et al. Differentiation of phagocytic monocytes into lymph nodes dendritic cells in vivo. *Immunity* 1999;11:753–761.

250. Randolph GJ, Beaulieu S, Lebecque S, et al. Differentiation of monocytes into dendritic cells in a model of transendothelial trafficking. *Science* 1998;282: 480–483.

251. Merad M, Fong L, Bogenberger J, et al. Differentiation of myeloid dendritic cells into CD8a-positive dendritic cells in vivo. *Blood* 2000;96:1865–1872.

252. Traver D, Akashi K, Manz M, et al. Development of CD8a positive dendritic cells from a common myeloid progenitor. *Science* 2000;290:2152–2154.

253. Rissoan M-C, Soumelis V, Kadowaki N, et al. Reciprocal control of T helper cell and dendritic cell differentiation. *Science* 1999;283:1183–1186.

254. Ito T, Amakawa R, Inaba M, et al. Differential regulation of human blood dendritic cell subsets by IFNs. *J Immunol* 2001;166:2961–2969.

255. Arpinati M, Green CL, Heinfeld S, et al. Granulocyte-colony stimulating factor mobilizes T helper 2-inducing dendritic cells. *Blood* 2000;95:2484–2490.

256. Cella M, Fchette F, Lanzavecchia A, et al. Plasmacytoid dendritic cells activated by influenza virus and CD40L drive a potent Th1 polarization. *Nat Immunol* 2000;1:305–310.

257. Liu Y-J, Kanzler H, Coumelis V, et al. Dendritic cell lineage, plasticity and cross-regulation. *Nat Immunol* 2001;2:585–589.

258. Hemmi H, Takeuchi O, Kawai T, et al. Toll-like receptor recognizes bacterial DNA. *Nature* 2000;408:740–745.

259. Sallusto F, Lanzavecchia A. Understanding dendritic cell and T-lymphocyte traffic through the analysis of chemokine receptors. *Immunol Rev* 2000;177:134–140.

260. Randolph GJ, Beaulieu S, Lebecque S, et al. Differentiation of monocytes into dendritic cells in a

model of transendothelial trafficking. *Science* 1998;282:480–483.

261. Geitjtenbeek TBH, Torensma R, van Vliet SJ, et al. Identification of DC-SIGN, a novel dendritic cell-specific ICAM-3 receptor that supports primary immune responses. *Cell* 2000;100:575–585.
262. Geitjtenbeek TBH, Krooshoop DJEB, Bleijis DA, et al. CD-SIGN-ICAM-2 interaction mediates dendritic cell trafficking. *Nat Immunol* 2000;1:353–357.
263. Sozzani S, Allavena P, D'Amico G, et al. Differential regulation of chemo-kine receptors during dendritic cell maturation: a model for their trafficking properties. *J Immunol* 1998;161:1083–1086.
264. Dieu M-C, Vanbervliet B, Vicari A, et al. Selective recruitment of immature and mature dendritic cells by distinct chemokines expressed in different anatomic sites. *J Exp Med* 1998;188:373–386.
265. Romani N, Ratzinger G, Pfaller K, et al. Migration of dendritic cells into lymphatics—the Langerhans cell example: routes, regulation and relevance. *Int Rev Cytol* 2001;207:237–270.
266. Ito T, Inaba M, Inaba K, et al. A CD1a<sup>+</sup>/CD11c<sup>+</sup> subset of human blood dendritic cells is a direct precursor of Langerhans cells. *J Immunol* 1999;163:1409–1419.
267. Robert C, Fuhlbrigge RC, Kieffer JD, et al. Interaction of dendritic cells with skin endothelium: a new perspective on immunosurveillance. *J Exp Med* 1999;189:627–635.
268. Charbonnier AS, Kohrgruber N, Kriehuber E, et al. Macrophage inflammatory protein 3 is involved in the constitutive trafficking of epidermal Langerhans cells. *J Exp Med* 1999;190:1755–1767.
269. Dieu-Nosjean MC, Massacrier C, Homey B, et al. Macrophage inflammatory protein-3 alpha is expressed at inflamed epithelial surfaces, and is the most potent chemokine known in attracting Langerhans cell precursors. *J Exp Med* 2000;192:705–718.
270. Cyster JG. Chemokines and the homing of dendritic cells to the T cell areas of lymphoid organs. *J Exp Med* 1999;189:447–450.
271. Alavena P, Sica A, Vecchi A, et al. The chemokine receptor switch paradigm and dendritic cell migration: its significance in tumor tissues. *Immunol Rev* 2000;177:141–149.
272. Geitjtenbeek TBH, Kwon DS, Torensma R, et al. DC-SIGN, a dendritic cell-specific HN-1-binding protein that enhances trans-infection of T cells. *Cell* 2000;100:587–597.
273. Jeannin P, Rinno T, Goetsch L, et al. OmpA targets dendritic cells, induces their maturation and delivers antigen into MHC class I presentation pathway. *Nat Immunol* 2000;1:502–509.
274. Kondo T, Cortese I, Markovic-Plese S, et al. Dendritic cells signal T cells in the absence of exogenous antigen. *Nat Immunol* 2001;2:932–938.
275. Revy P, Sospedra M, Barbour B, et al. Functional antigen-independent synapses formed between T cells and dendritic cells. *Nat Immunol* 2001;2:925–931.
276. MacPherson G, Kushnir N, Wikes M. Dendritic cells, B cells and the regulation of antibody synthesis. *Immunol Rev* 1999;172:325–334.
277. Dubois B, Vanbervliet B, Fayette J, et al. Dendritic cells enhance growth and differentiation of CD40-activated B lymphocytes. *J Exp Med* 1997;185:941–951.
278. Grannuci F, Vizzardelli C, Pavelka N, et al. Inducible IL-2 production by dendritic cells revealed by global gene expression analysis. *Nat Immunol* 2001;2:882–888.
279. Fong L, Engleman EG. Dendritic cells in cancer immunotherapy. *Annu Rev Immunol* 2000;18:245–273.
280. Thurner B, Haendle I, Röder C, et al. Vaccination with Mage-3A1 peptide-pulsed mature, monocyte-derived dendritic cells expands specific cytotoxic T cells and induces regression of some metastases in advanced stage IV melanoma. *J Exp Med* 1999;190:1669–1678.

281. Gilboa E. The makings of a tumor rejection antigen. *Immunity* 1999;11:263–270.
282. Bancereau J, Schuler-Thurner B, Palucka AK, et al. Dendritic cells as vectors for therapy. *Cell* 2001;106:271–274.
283. Silberberg-Sinakin I, Baer RL, Thorbecke GJ. Langerhans cells: role in contact hypersensitivity and relationship to lymphoid dendritic cells and to macrophages. *Immunol Rev* 1980;53:203–232.
284. Birbeck MS, Breathnach AS, Overall JD. An electron microscope study of basal melanocytes and high-level clear cells (Langerhans cells) in vitiligo. *J Invest Dermatol* 1961;37:51–63.
285. Tang A, Amagai M, Granger LG, et al. Adhesion of epidermal Langerhans cells to keratinocytes mediated by E-cadherin. *Nature* 1993;361:82–85.
286. Balfour BM, Drexhage HA, Kamperdijk EW, et al. Antigen-presenting cells, including Langerhans cells, veiled cells and interdigitating cells. *Ciba Found Symp* 1981;84:281–301.
287. Szakal AK, Kosco MH, Tew JG. A novel in vivo follicular dendritic cell-dependent iccosome-mediated mechanism for delivery of antigen to antigen-processing cells. *J Immunol* 1988;140:341–353.
288. Hoefsmit EC, Duijvestijn AM, Kamperdijk EW. Relation between Langerhans cells, veiled cells, and interdigitating cells. *Immunobiology* 1982;161:255–265.
289. Steinman RM. The dendritic cell system and its role in immunogenicity. *Annu Rev Immunol* 1991;9:271–296.
290. Fossum S. Lymph-borne dendritic leucocytes do not recirculate, but enter the lymph node paracortex to become interdigitating cells. *Scand J Immunol* 1988;27:97–105.
291. van Wilsem EJ, Breve J, Kleijmeer M, et al. Antigen-bearing Langerhans cells in skin draining lymph nodes: phenotype and kinetics of migration. *J Invest Dermatol* 1994;103:217–220.
292. Moll H, Fuchs H, Blank C, Rollinghoff M. Langerhans cells transport *Leishmania major* from the infected skin to the draining lymph node for presentation to antigen-specific T cells. *Eur J Immunol* 1993;23:1595–1601.
293. Mandel TE, Phipps RP, Abbot A, et al. The follicular dendritic cell: long term antigen retention during immunity. *Immunol Rev* 1980;53:29–59.
294. Szakal AK, Gieringer RL, Kosco MH, et al. Isolated follicular dendritic cells: cytochemical antigen localization, Nomarski, SEM, and TEM morphology. *J Immunol* 1985;134:1349–1359.
295. Szakal AK, Kosco MH, Tew JG. Microanatomy of lymphoid tissue during humoral immune responses: structure function relationships. *Annu Rev Immunol* 1989;7:91–109.
296. D'Ambrosio D, Hippen KL, Minskoff SA, et al. Recruitment and activation of PTP1C in negative regulation of antigen receptor signaling by Fc gamma RIIB1. *Science* 1995;268:293–297.
297. Tew JG, Wu J, Qin D, et al. Follicular dendritic cells and presentation of antigen and costimulatory signals to B cells. *Immunol Rev* 1997;156:39–52.
298. Burton GF, Masuda A, Heath SL, et al. Follicular dendritic cells (FDC) in retroviral infection: host/pathogen perspectives. *Immunol Rev* 1997;156:185–197.
299. Lindhout E, van Eijk M, van Pel M, Lindeman J, et al. Fibroblast-like synoviocytes from rheumatoid arthritis patients have intrinsic properties of follicular dendritic cells. *J Immunol* 1999;162:5949–5956.
300. Cyster JG, Ansel KM, Reif K, et al. Follicular stromal cells and lymphocyte homing to follicles. *Immunol Rev* 2000;176:181–193.
301. Zinkernagel RM, Ehl S, Aichele P, et al. Antigen localization regulates immune responses in a dose-

and time-dependent fashion: a geographical view of immune reactivity. *Immunol Rev* 1997;156:199–209.

302. Pape KA, Kearney ER, Khoruts A, et al. Use of adoptive transfer of T-cell-antigen-receptor-transgenic T cells for the study of T-cell activation in vivo. *Immunol Rev* 1997;156:67–78.

303. Cumberbatch M, Kimber I. Tumour necrosis factor- $\alpha$  is required for accumulation of dendritic cells in draining lymph nodes and for optimal contact sensitization. *Immunology* 1995;84:31–35.

304. Roake JA, Rao AS, Morris PJ, et al. Dendritic cell loss from nonlymphoid tissues after systemic administration of lipopolysaccharide, tumor necrosis factor, and interleukin 1. *J Exp Med* 1995;181:2237–2247.

305. De Smedt T, Pajak B, Muraille E, et al. Regulation of dendritic cell numbers and maturation by lipopolysaccharide in vivo. *J Exp Med* 1996;184:1413–1424.

306. McLellan AD, Sorg RV, Williams LA, et al. Human dendritic cells activate T lymphocytes via a CD40:CD40 ligand-dependent pathway. *Eur J Immunol* 1996;26:1204–1210.

307. Lenschow DJ, Walunas TL, Bluestone JA. CD28/B7 system of T cell costimulation. *Annu Rev Immunol* 1996;14:233–258.

308. Dhodapkar MV, Steinman RM, Darsevsky J, et al. Antigen-specific inhibition of effector T cell function in humans after injection of immature dendritic cells. *J Exp Med* 2001;193:233–238.

309. Turley SJ, Inaba K, Garrett WS, et al. Transport of peptide-MHC class II complexes in developing dendritic cells. *Science* 2000;288:522–527.

310. Monks CR, Freiberg BA, Kupfer H, et al. Three-dimensional segregation of supramolecular activation clusters in T cells. *Nature* 1998;395:82–86.

311. Boise LH, Minn AJ, Noel PJ, et al. CD28 costimulation can promote T cell survival by enhancing the expression of Bcl-XL. *Immunity* 1995;3:87–98.

312. Lanzavecchia A, Sallusto F. Dynamics of T lymphocyte responses: intermediates, effectors, and memory cells. *Science* 2000;290:92–97.

313. Lanzavecchia A, Sallusto F. Antigen decoding by T lymphocytes: from synapses to fate determination. *Nat Immunol* 2001;2:487–492.

314. Lanzavecchia A, Sallusto F. Regulation of T cell immunity by dendritic cells. *Cell* 2001;106:263–266.

315. Bejenoff M, Wurtz O, Guerder S. Repeated antigen exposure is necessary for the differentiation, but not the initial proliferation of naïve CD4<sup>+</sup> T cells. *J Immunol* 2002;168:1723–1729.

316. Rafaei Y, Van Parijs L, Abbas AK. Genetic models of abnormal apoptosis in lymphocytes. *Immunol Rev* 1999;169:273–282.

317. Garside P, Ingulli E, Merica RR, et al. Visualization of specific B and T lymphocyte interactions in the lymph node. *Science* 1998;281:96–99.

318. MacLennan ICM, Gulbranson-Judge A, Toellner K-M, et al. The changing preference of T and B cells for partners as T-dependent antibody responses develop. *Immunol Rev* 1997;156:53–66.

319. Förster R, Schubel A, Breitfeld D, Kremmer E, et al. CCR7 coordinates the primary immune response by establishing functional microenvironments in secondary lymphoid organs. *Cell* 1999;99:23–33.

320. Ansel KM, McHeyzer-Williams LJ, Ngo VN, et al. In vivo-activated CD4 T cells upregulate CXC chemokine receptor 5 and reprogram their responses to lymphoid chemokines. *J Exp Med* 1999;190:1123–1134.

321. Breitfeld D, Ohl L, Kremmer E, et al. Follicular B helper T cells express CXC chemokine receptor 5,

- localize to B cell follicles and support immunoglobulin production. *J Exp Med* 2000;192:1545–1551.
322. Schaerli P, Willemann K, Lang AB, et al. CXC chemokine receptor 5 expression defines follicular homing T cells with B cell helper function. *J Exp Med* 2000;192:1553–1562.
323. Moser B, Ebert L. Lymphocyte traffic control by chemokines: follicular B helper T cells. *Immunol Letters* 2003;85:105–112.
324. Jenkins MK, Khoruts A, Ingulli E, et al. In vivo activation of antigen-specific CD4<sup>+</sup> T cells. *Annu Rev Immunol* 2001;19:23–45.
325. Kopf M, Coyle AJ, Schmitz N, et al. Inducible costimulator protein (ICOS) controls T helper cell subset polarization after virus and parasite infection. *J Exp Med* 2000;192:53–62.
326. Baumgarth N. A two-phase model of B cell activation. *Immunol Rev* 2000;176:171–180.
327. Liu Y-J, Johnson GD, Gordon J, MacLennan ICM. Germinal centers in T-cell-dependent antibody responses. *Immunol Today* 1992;13:17–21.
328. Kelsoe G. In situ studies of the germinal center reaction. *Adv Immunol* 1995;60:267–288.
329. McHeyser-Williams LJ, Driver DJ, McHeyser-Williams MG. Germinal center reaction. *Curr Opin Immunol* 2001;8:52–59.
330. Lindhout E, Vissers JLM, Hartgers FC, et al. DC-CK1 is expressed by germinal center dendritic cells and attracts CD38-negative mantle zone B lymphocytes. *J Immunol* 2001;166:3284–3289.
331. Hannum LG, Haberman AM, Anderson SM, et al. Germinal center initiation, variable gene region hypermutation and mutant B cell selection without detectable immune complexes on follicular dendritic cells. *J Exp Med* 2000;192:931–942.
332. Tew JG, Wu J, Fakher M, et al. Follicular dendritic cells: beyond the necessity of T cell help. *Immunol Today* 2001;22:361–367.
333. Macardle PJ, Mardell C, Bailey S, et al. Fc gamma RIIb expression on human germinal center B lymphocytes. *Eur J Immunol* 2002;32:3736–3744.
334. Gonzalez M, Mackay F, Browning JL, et al. The sequential role of lymphotoxin and B cells in the development of splenic follicles. *J Exp Med* 1998;187:997–1007.
335. van Nierop K, de Groot C. Human follicular dendritic cells: function, origin, and development. *Sem Immunol* 2002;14:251–257.
336. Denzer K, van Eijk M, Kleijmeer MJ, et al. Follicular dendritic cells carry MHC class II-expressing microvesicles at their surface. *J Immunol* 2000;165:1259–1265.
337. Escola JM, Kleijmeer MJ, Stoorvogel W, et al. Selective enrichment of tetraspan proteins on the internal vesicles of multivesicular endosomes and on exosomes secreted by human B lymphocytes. *J Biol Chem* 1998;273:20121–20127.
338. Hammond C, Denzin LK, Pan M, et al. The tetraspan protein CD82 is a resident of MHC class II compartments where it associates with HLA-DR, -DM and -DO molecules. *J Immunol* 1998;161:3282–3291.
339. Debois B, Barthélémy C, Durand I, et al. Toward a role of dendritic cells in the germinal center reaction: triggering of B cell proliferation and isotype switching. *J Immunol* 1999;162:3428–3436.
340. Dubois B, Bridon J-M, Fayette J, et al. Dendritic cells directly modulate B cell growth and differentiation. *J Leuk Biol* 1999;66:224–230.
341. Garcia de Vineusa C, Cook CM, Ball J, et al. Germinal centers without T cells. *J Exp Med* 2000;191:485–493.
342. Lentz VM, Manser T. Germinal centers can be induced in the absence of T cells. *J Immunol*

2001;167:15–20.

343. Hollowood K, Goodlad JR. Germinal center cell kinetics. *J Pathol* 1998;185:229–233.

344. Hollowood K, Macartney JC. Cell kinetics of a germinal center reaction—a stathmokinetic study. *Eur J Immunol* 1992;22:261–266.

345. Xu JL, Davis MM. Diversity in the CDR3 region of V(H) is sufficient for most antibody specificities. *Immunity* 2000;13:37–45.

346. Pulendran B, van Driel R, Nossal GJV. Immunological tolerance in germinal centers. *Immunol Today* 1997;18:27–32.

347. Eisen HN, Siskind GW. Variations in affinities of antibodies during the immune response. *Biochemistry* 1964;3:996–1008.

348. Siskind GD, Benacerraf B. Cell selection by antigen in the immune response. *Adv Immunol* 1969;10:1–50.

349. Steiner LA, Eisen HN. Sequential changes in the relative affinity of antibodies synthesized during the immune response. *J Exp Med* 1967;126:1161–1175.

350. Tonegawa S. Somatic generation of antibody diversity. *Nature* 1983;302:575–581.

351. Griffiths GM, Berek C, Kaartinen M, et al. Somatic mutation and the maturation of the immune response. *Nature* 1984;312:271–275.

352. Berek C, Berger A, Apel A. Maturation of the immune response in germinal centers. *Cell* 1991;67:1121–1129.

353. Levine MH, Haberman AM, Sant'Angelo DB, et al. A B-cell receptor-specific selection step governs immature to mature B cell differentiation. *Proc Natl Acad Sci U S A* 2000;97:2743–2748.

354. Carsetti R, Koeler G, Lamers MC. Transitional B cells are the target of negative selection in the B cell compartment. *J Exp Med* 1995;181:2129–2140.

355. Allman D, Lindsley RC, DeMuth W, et al. Resolution of three nonproliferative immature splenic B cell subsets reveals multiple selection points during peripheral B cell maturation. *J Immunol* 2001;167:6834–6840.

356. Loder FB, Mutchler RJ, Ray CJ, et al. B cell development in the spleen takes place in discrete steps and is determined by the quality of B cell receptor-derived signals. *J Exp Med* 1999;190:75–89.

357. Koopman G, Keehnen RMJ, Lindhout E, et al. Adhesion through LFA-1 (CD11a/CD18)–ICAM-1 (CD54) and the VLA-4 (CD49d)–VCAM-1 (CD106) pathways prevents apoptosis of germinal center B cells. *J Immunol* 1994;152: 376–377.

358. Pauly S, Broll K, Wittmann M, et al. CD137 is expressed by follicular dendritic cells and costimulates B lymphocyte activation in germinal centers. *J Leuk Biol* 2002;72:35–42.

359. Mackay F, Schneider P, Rennert P, et al. BAFF and APRIL: a tutorial on B cell survival. *Annu Rev Immunol* 2003;21:231–264.

360. Waldschmidt TJ, Noelle RJ. Long live the mature B cell—a BAFFling mystery resolved. *Science* 2001;293:2012–2014.

361. Schneider P, McKay F, Steiner V, et al. BAFF, a novel ligand of the tumor necrosis factor family, stimulates B cell growth. *J Exp Med* 1999;189:1747–1756.

362. Shu HB, Hu WH, Johnson H. TALL-1 is a novel member of the TNF family that is down-regulated by mitogens. *J Leuk Biol* 1999;65:680–683.

363. Mukhopadhyay A, Ni J, Zhai YF, et al. Identification and characterization of a novel cytokine, THANK,

a TNF homologue that activates apoptosis, nuclear factor  $\kappa$ B and c-Jun NH<sub>2</sub>-terminal kinase. *J Biol Chem* 1999;274: 15978–15981.

364. Marsters SA, Yan M, Pitti RM, et al. Interaction of the TNF homologues Bly and APRIL with the TNF receptor homologues BCMA and TACI. *Curr Biol* 2000;10:785–788.

365. Ware CF. APRIL and BAFF connect autoimmunity and cancer. *J Exp Med* 2000;192:F35–F37.

366. Schiemann B, Gommermann JL, Vora K, et al. An essential role for BAFF in the normal development of B cells through a BCMA-independent pathway. *Science* 2001;293:2111–2114.

367. Shu HB, Johnson H. B cell maturation protein is a receptor for the tumor necrosis factor family member TALL-1. *Proc Nat Assoc Sci USA* 2000;97:9156–9161.

368. Li Q, Verma IM. NF- $\kappa$ B regulation in the immune system. *Nat Rev Immunol* 2002;2:725–734.

369. Thompson JS, Bixler SA, Qian F, et al. BAFF-R, a newly identified TNF receptor that specifically interacts with BAFF. *Science* 2001;293:2108–2111.

370. Batten M, Groom J, Cachero TG, et al. BAFF mediates survival of peripheral immature B lymphocytes. *J Exp Med* 2000;192:1453–1465.

371. Grossman M, O'Reilly LA, Gugasyan R, et al. The anti-apoptotic activities of Rel and Rel A required during B-cell maturation involve the regulation of Bcl2 expression. *EMBO J* 2000;19:6351–6360.

372. Hsu BL, Harless SM, Lindsley RC, et al. Cutting edge: B Lys enables survival of transitional and mature B cells through distinct mediators. *J Immunol* 2002;168:5993–5996.

373. Zhang J, Roschke V, Baker KP, et al. Cutting edge: a role for lymphocyte stimulator in systemic lupus erythematosus. *J Immunol* 2001;166:6–10.

374. Groom J, Kalled SL, Cutler AH, et al. Association of BAFF/BLys overexpression and altered B cell differentiation with Sjögren's syndrome. *J Clin Invest* 2002;109:59–68.

375. Roschke V, Snosnovtseva S, Ward CD, et al. BLys and APRIL from biologically active heterotrimers, that are expressed in patients with systemic immune-based rheumatic diseases. *J Immunol* 2002;169:434–4321.

376. Mariette Y, Roux S, Zhang J, et al. The level of BLys (BAFF) correlates with the titre of autoantibodies in human Sjögren's syndrome. *Ann Rheum Dis* 2003;62:168–171.

377. Stein JV, Lopez-Fraga M, Elustondo FA, et al. APRIL modulates B and T cell immunity. *J Clin Invest* 2002;109:1587–1598.

378. Huard B, Schneider P, Mareri D, et al. T cell costimulation by the TNF ligand BAFF. *J Immunol* 2001;167:6225–6231.

379. Hahne M, Kataoka T, Schröter M, et al. APRIL, a new ligand of the tumor necrosis factor family, stimulates tumor cell growth. *J Exp Med* 1998;188:1185–1190.

380. Rennert P, Schneider P, Cachero TG, et al. A soluble form of B cell maturation antigen, a receptor for the tumor necrosis factor family member APRIL, inhibits tumor cell growth. *J Exp Med* 2000;192:1677–1683.

381. Levens JM, Gordon J, Gregory CD. Microenvironmental factors in the survival of human B-lymphoma cells. *Cell Death Differ* 2000;7:59–69.

382. Goldenberg G, Paraskevas F, Israels LG. The association of rheumatoid arthritis with plasma cell and lymphocytic neoplasms. *Arthr Rheum* 1969;12:569–579.

383. Walker LSK, Wiggett HE, Gaspal FMC, et al. Established T cell-driven germinal center B cell proliferation is independent of CD28 signaling but is tightly regulated through CTLA-4. *J Immunol*



2001;170:91–98.

384. McHeyzer-Williams LJ, Panus JF, Mikszta JA, et al. Evolution of antigen-specific T cell receptors in vivo: pre-immune and antigen-driven selection of preferred complementarity-determining regions 3 (CDR3) motifs. *J Exp Med* 1999;189:1823–1838.
385. Dutton RW, Bradley LM, Swain SL. T cell memory. *Annu Rev Immunol* 1998;16:201–223.
386. Waterhouse P, Marengere LEM, Mittrücker HW, et al. CTLA-4, a negative regulator of T-lymphocyte activation. *Immunol Rev* 1996;153:183–207.
387. Foy TM, Aruffo A, Bajorath J, et al. Immune regulation by CD40 and its ligand GP39. *Annu Rev Immunol* 1996;14:591–617.
388. Grewal IS, Flavell RA. The role of CD40 ligand in costimulation and T-cell activation. *Immunol Rev* 1996;153:85–106.
389. Grewal IS, Flavell RA. CD40 and CD154 in cell-mediated immunity. *Annu Rev Immunol* 1998;16:111–135.
390. Grammer AC, Lipsky PE. CD40-mediated regulation of immune responses by TRAF-dependent and TRAF-independent signaling mechanisms. *Adv Immunol* 2001;76:61–178.
391. Grewal IS, Flavell RA. The CD40 ligand. At the center of the immune universe? *Immunol Res* 1997;16:59–70.
392. Kawabe T, Naka T, Yoshida K, et al. The immune responses in CD40-deficient mice: impaired immunoglobulin class switching and germinal center formation. *Immunity* 1994;1:167–178.
393. Lee BO, Haynes L, Eaton SM, et al. The biological outcome of CD40 signaling is dependent on the duration of CD40 ligand expression: reciprocal regulation by interleukin (IL)-4 and IL-12. *J Exp Med* 2002;196:693–704.
394. Casamayor-Palleja M, Khan M, MacLennan ICM. A subset of CD4<sup>+</sup> memory T cells contains preformed CD40 ligand that is rapidly but transiently expressed on their surface after activation through the T cell receptor complex. *J Exp Med* 1995;181:1293–1301.
395. Grabsteen KH, Maliszewski CR, Shanebeck K, et al. The regulation of T cell-dependent antibody formation in vitro by CD40 ligand and IL-2. *J Immunol* 1993;150:3141–3147.
396. Randall TD, Heath AW, Santo-Argumedo L, et al. Arrest of B lymphocyte terminal differentiation by CD40 signaling: mechanism for lack of antibody-secreting cells in germinal centers. *Immunity* 1998;8:733–742.
397. Stavnezer J. Antibody class switching. *Adv Immunol* 1996;61:79–146.
398. Lutzker S, Alt FW. Structure and expression of germ line immunoglobulin gamma 2b transcripts. *Mol Cell Biol* 1988;8:1849–1852.
399. Lorenz M, Jung S, Radbruch A. Switch transcripts in immunoglobulin class switching. *Science* 1995;267:1825–1828.
400. Snapper CM, Marcu KB, Zelazowski P. The immunoglobulin class switch: beyond accessibility. *Immunity* 1997;6:217–223.
401. Honjo T, Kinoshita K, Muramatsu M. Molecular mechanism of class switch recombination: linkage with somatic hypermutation. *Annu Rev Immunol* 2002;20:165–196.
402. Kinoshita K, Honjo T. Linking class-switch recombination with somatic hypermutation. *Nat Rev Mol Cell Biol* 2001;2:493–503.
403. Muramatsu M, Kinoshita K, Fagarasan S, et al. Class switch recombination and hypermutation require

activation-induced cytidine deaminase (AID), a potential RNA editing enzyme. *Cell* 2000;102:553–563.

404. Muramatsu M, Honjo T. Complex layers of genetic alteration in the generation of antibody diversity. *Trends Immunol* 2001;22:66–68.

405. Muramatsu M, Sankaranand VS, Anant S, et al. Specific expression of activation-induced cytidine deaminase (AID), a novel member of the RNA-editing deaminase family in germinal center B cells. *J Biol Chem* 1999;274:18470–18476.

406. Litinski MB, Nardelli B, Hilbert DM, et al. DCs induce CD40-independent immunoglobulin class switching through Bly S and APRIL. *Nat Immunol* 2002;3:822–829.

407. Manis JP, Tian M, Alt FW. Mechanism and control of class-switch recombination. *Trends Immunol* 2002;23:31–39.

408. Shanmugam A, Shi MJ, Yauch L, et al. Evidence for class-specific factors in immunoglobulin isotype switching. *J Exp Med* 2000;191:1365–1380.

409. Ma L, Wortis H, Kenter AL. Two new isotype specific switching factors detected for Ig class switching. *J Immunol* 2002;168:2835–2846.

410. Starnezer J. Molecular processes that regulate class switching. *Curr Top Microbiol Immunol* 2000;245:127–168.

411. Kinoshita K, Harigai M, Fagarasan S, et al. A hallmark of active class switch recombination: transcripts directed by I promoters on looped-out circular DNAs. *Proc Natl Acad Sci U S A* 2001;98:12620–12623.

412. Cerutti A, Zan H, Kim EC, et al. Ongoing in vivo immunoglobulin class switch DNA recombination in chronic lymphocytic leukemia B cells. *J Immunol* 2002;169:6594–6603.

413. Rolink A, Melchers F, Andersson J. The SCID but not the RAG-2 gene product is required for S- $\mu$ -S-e heavy-chain class switching. *Immunity* 1996;5: 319–330.

414. Jeggo PA. DNA breakage and repair. *Adv Genet* 1998;38:185–218.

415. Kenter AL. Class-switch recombination: after the dawn of AID. *Curr Opin Immunol* 2003;15:190–198.

416. Vercelli D. Novel insights into class switch recombination. *Curr Opin Allergy Clin Immunol* 2002;2:147–151.

417. Nagaoka H, Muramatsu M, Yamamura N, et al. Activation induced deaminase (AID)-directed hypermutation in the immunoglobulin S $\mu$  region: implication of AID involvement in a common step of class switch recombination and somatic hypermutation. *J Exp Med* 2002;195:529–534.

418. Wagner SD, Neuberger MS. Somatic hypermutation of immunoglobulin genes. *Annu Rev Immunol* 1996;14:441–457.

419. Bernard O, Hozumi N, Tonegawa S. Sequences of mouse immunoglobulin light chain gene before and after somatic changes. *Cell* 1978;15:1133–1144.

420. Kim S, Davis M, Sinn E, et al. Antibody diversity: somatic hypermutation of rearranged V $\mu$  genes. *Cell* 1981;27:573–581.

421. Lebeque SG, Gearhart PJ. Boundaries of somatic mutation in rearranged immunoglobulin genes: 5' boundary is near the promoter and 3' boundary is ~ 1 kb from V(D)J gene. *J Exp Med* 1990;172:1717–1727.

422. Peng HZ, Du MQ, Koulis A, et al. Nonimmunoglobulin gene hypermutation in germinal center B cells. *Blood* 1999;93:2167–2172.

423. Gordon MS, Kanegai CM, Doern JR, et al. Somatic hypermutation of the B cell receptor genes B29 (IgB, CD79b) and mb1 (Iga, CD79a). *Proc Nat Assoc Adv Sci U S A* 2003;100:4126–4131.

424. Müschen M, Re D, Jungnickel B, et al. Somatic mutation of the CD95 gene in human B cells as a side-effect of the germinal center reaction. *J Exp Med* 2000;192:1833-1839.
425. Klotz EL, Kackett J Jr, Storb U. Somatic hypermutation of an artificial test substrate within an Ig kappa transgene. *J Immunol* 1998;161:782-790.
426. Bachl J, Carlson C, Gray-Schopfer V, et al. Increased transcription levels induce higher mutation rates in a hypermutating cell line. *J Immunol* 2001;5051-5057.
427. Malennan I. The center of hypermutation. *Nature* 1999;354:352-353.
428. Matsumoto M, Lo SF, Carruthers CJL, et al. Affinity maturation without germinal centers in lymphotoxin-a-deficient mice. *Nature* 1996;382:462-466.
429. Bergthorsdottir S, Gallagher A, Jainandunsing S, et al. Signals that initiate somatic hypermutation of B cells in vitro. *J Immunol* 2001;166:2228-2234.
430. Klein U, Goossens T, Fischer M, et al. Somatic hypermutation in normal and transformed human B cells. *Immunol Rev* 1998;162:261-280.
431. Wilson P, Liu Y-J, Bancereau J, et al. Amino acid insertions and deletions contribute to diversity the human Ig repertoire. *Immunol Rev* 1998;162:143-151.
432. Berek C, Berger A, Apel M. Maturation of the immune response in germinal centers. *Cell* 1991;67:1121-1129.
433. Goossens T, Klein U, Küppers R. Frequent occurrence of deletions and duplications during somatic hypermutation: implications of oncogene translocations and heavy chain disease. *Proc Natl Acad Sci U S A* 1998;95:2463-2468.
434. Neuberger MS, Ehrenstein MR, Klex N, et al. Monitoring and interpreting the intrinsic features of somatic hypermutation. *Immunol Rev* 1998;162:107-116.
435. Brenner S, Milstein C. Origin of antibody variation. *Nature* 1966;211:242-243.
436. Papavasiliou FN, Schatz DC. The activation-induced deaminase functions in a postcleavage step of the somatic hypermutation process. *J Exp Med* 2002;195:1193-1198.
437. Kong Q, Maizels N. DNA breaks in hypermutating immunoglobulin genes: evidence of a break-and-repair pathway of somatic hypermutation. *Genetics* 2001;158:369-378.
438. Papavasiliou FN, Schatz DG. Cell cycle-regulated DNA double-strand breaks in somatic hypermutation of immunoglobulin genes. *Nature* 2000;408:216-221.
439. Faili A, Aoufouchi S, Gueranger Q, et al. AID-dependent somatic hypermutation occurs as a DNA single-strand event in the BL2 cell line. *Nat Immunol* 2002;3:815-821.
440. Bross L, Muramatsu M, Kinoshita K, et al. DNA double-strand breaks: prior to but not sufficient in targeting hypermutations. *J Exp Med* 2002;195:1187-1192.
441. Jacobs H, Bross L. Towards an understanding of somatic hypermutation. *Curr Opin Immunol* 2001;13:208-218.
442. Chua KF, Alt FW, Manis JP. The function of AID in somatic mutation and class switch recombination: upstream or downstream of DNA breaks. *J Exp Med* 2002;195:F37-F41.
443. Weill JC, Bertoci B, Foili A, et al. Ig gene hypermutation: a mechanism is due. *Adv Immunol* 2002;80:183-202.
444. Ohmori H, Friedberg EC, Fuchs RP, et al. The Y family of DNA polymerases. *Mol Cell* 2001;8:7-8.
445. Zeng X, Winter D, Kasmer K, et al. DNA polymerase eta is an A-T mutator in somatic hypermutation

of immunoglobulin variable genes. *Nat Immunol* 2001;2:537–541.

446. Faili A, Aoufouchi S, Flatter E, et al. Induction of somatic hypermutation in immunoglobulin genes is dependent on DNA polymerase  $\iota$ . *Nature* 2002;419:944–947.

447. Diaz M, Verkoczy LK, Flaznik MF, et al. Decreased frequency of somatic hypermutation and impaired affinity maturation but intact germinal center formation in mice expressing antisense RNA to DNA polymerase  $\zeta$ . *J Immunol* 2001;167:327–335.

448. Matsuda T, Bebenek K, Masutani C, et al. Low fidelity DNA synthesis by human DNA polymerase  $\epsilon$ . *Nature* 2000;404:1011–1013.

449. Masutani C, Kusumoto R, Yamada A, et al. The human XPV (xeroderma pigmentosum variant) gene encodes human polymerase  $\epsilon$ . *Nature* 1999;399:700–704.

450. Ramiro AR, Staropoulos P, Jancovic M, et al. Transcription enhances AID-mediated cytidine deamination by exposing single stranded DNA on the nontemplate strand. *Nat Immunol* 2003;4:452–456.

451. Lindahl T, Barnes DE. Repair of endogenous DNA damage. *Cold Spring Harb Symp Quant Biol* 2001;65:127–133.

452. Rada C, Williams GT, Nilsen H, et al. Immunoglobulin isotype switching is inhibited and somatic hypermutation perturbed in UNG-deficient mice. *Curr Biol* 2002;12:1738–1755.

453. Storb U, Stavnezer J. Immunoglobulin genes: generating diversity with AID and UNG. *Curr Biol* 2002;12:R725–R727.

454. Fugmann SD, Schatz DG. One AID to unite them all. *Science* 2002;295:1244–1245.

455. Honjo T. Does AID need another aid? *Nat Immunol* 2002;3:800–801.

456. Bransteitter R, Pham P, Scharff MD, et al. Activation-induced cytidine deaminase deaminates deoxycytidine on single-stranded DNA but requires the action of RNase. *Proc Natl Acad Sci U S A* 2003;100:4102–4107.

457. Klein U, Tu Y, Stolovitzky GA, et al. Transcriptional analysis of the B cell germinal center reaction. *Proc Natl Acad Sci U S A* 2003;100:2639–2644.

458. Glynne R, Ghandour G, Rayner J, et al. B-lymphocyte quiescence, tolerance and activation as viewed by global gene expression profiling on microarrays. *Immunol Rev* 2000;176:216–246.

459. Shaffer AL, Rosenwald A, Hurt EM, et al. Signatures of the immune response. *Immunity* 2001;15:375–385.

460. Schaffer AL, Yu X, He Y, et al. BCL-6 represses genes that function in lymphocyte differentiation, inflammation, and cell cycle control. *Immunity* 2000;13:199–212.

461. Niu H. The protooncogene BCL-6 in normal and malignant B cell development. *Hematol Oncol* 2002;20:155–166.

462. Toyama H, Okada S, Hatano M, et al. Memory B cells without somatic hypermutation are generated from BCL-6-deficient cells. *Immunity* 2002;17:329–339.

463. Allman D, Jain A, Dent A, et al. BCL-6 expression during B-cell activation. *Blood* 1996;87:5257–5268.

464. Moriyama M, Yamochi T, Semba K, et al. BCL-6 is phosphorylated at multiple sites in its serine- and proline-clustered region by mitogen-activated protein kinase (MAPK) in vivo. *Oncogene* 1997;14:2465–2474.

465. Niu H, Ye BH, Dalla-Favera R. Antigen receptor signaling induces MAP-kinase-mediated phosphorylation and degradation of the BCL-6 transcription factor. *Genes Dev* 1998;12:1953–1961.

466. Manser T, Tumas-Brundage KM, Casson LP, et al. The roles of antibody variable region hypermutation and selection in the development of the memory B-cell compartment. *Immunol Rev*

1998;162:182–196.

467. Haude S, Notides E, Manser T. Bcl-2 obstructs negative selection of autoreactive, hypermutated antibody V regions during memory B cell development. *Immunity* 1998;8:189–198.

468. Cornall RG, Cyster JG, Hibbs ML, et al. Polygenic autoimmune tracts: Lyn, CD22, and SHP-1 are limiting elements of a biochemical pathway regulating BCR signaling and selection. *Immunity* 1998;8:497–508.

469. Wong JH, Avitahl N, Carriapa A, et al. Aiolos regulated B cell activation and maturation to effector state. *Immunity* 1998;9:543–553.

470. Fischer MB, Georg S, Shen L, et al. Dependence of germinal center B cells on expression of CD21/CD35 for survival. *Science* 1998;280:582–585.

471. Tedder TF, Inaoki M, Sato S. The CD19–CD21 complex regulates signal transduction thresholds governing humoral immunity and autoimmunity. *Immunity* 1997;6:107–118.

472. Zhang X, Li L, Jung J, Xiang S, et al. The distinct roles of T cell derived cyto-kines and a novel follicular dendritic cell–signaling molecule 8D6 in germinal center B cell differentiation. *J Immunol* 2001;167:49–56.

473. Smith KGC, Light A, O'Reilly LA, et al. bcl-2 transgene expression inhibits apoptosis in the selection of memory B cells and bone marrow antibody–forming cells. *J Exp Med* 2000;191:475–484.

474. Takahashi YT, Ohta H, Takemori T. Fas is required for clonal selection in germinal centers and the subsequent establishment of the memory B cell repertoire. *Immunity* 2001;14:181–192.

475. McHeyzer–Williams MG, Ahmed R. B cell memory and the long–lived plasma cell. *Curr Opin Immunol* 1999;11:172–179.

476. Klein U, Kuppers R, Rajewsky K. Evidence of a large compartment of IgM–expressing memory B cells in humans. *Blood* 1997;89:1288–1298.

477. Tangye SG, Liu YJ, Aversa G, et al. Identification of functional human splenic memory B cells by expression of CD148 and CD27. *J Exp Med* 1998;188:1691–1703.

478. Nayak R, Mitra–Kaushik S, Shaila MS. Perpetuation of immunological memory: a relay hypothesis. *Immunology* 2001;102:387–395.

479. Calame KL, Lin KI, Tunyaplin C. Regulatory mechanisms that determine the development and function of plasma cells. *Annu Rev Immunol* 2003;21:205–230.

480. Angelin–Duclos C, Cattoretti G, Lin KI, et al. Commitment of B lymphocytes to a plasma cell fate is associated with blimp-1 expression in vivo. *J Immunol* 2000;165:5462–5471.

481. O'Conner BP, Cascalho M, Noelle RJ. Short–lived and long–lived bone marrow plasma cells are derived from a novel precursor population. *J Exp Med* 2002;195:737–745.

482. Merville P, Dechanet J, Desmouliere A, et al. Bcl-2<sup>+</sup> tonsillar plasma cells are rescued from apoptosis by bone marrow fibroblasts. *J Exp Med* 1996;183:227–236.

483. Slifka MK, Ahmed R. Long–lived plasma cells: a mechanism for maintaining persistent antibody production. *Curr Opin Immunol* 1998;10:252–258.

484. Kawano MM, Mihara K, Huang N, et al. Differentiation of early plasma cells on bone marrow stromal cells requires interleukin-6 for escaping apoptosis. *Blood* 1995;85:487–494.

485. Smith KG, Light A, Nossal GJ, et al. The extent of affinity maturation differs between the memory and antibody–forming cell compartments in the primary immune response. *EMBO J* 1997;16:2996–3006.

486. Morrison AM, Nutt SL, Thevenin C, et al. Loss– and gain–of–function mutations reveal an important role of BSAP (Pax5) at the start and end of B cell differentiation. *Semin Immunol* 1998;10:133–142.

487. Calame KL. Plasma cells: finding new light at the end of B cell development. *Nat Immunol* 2001;2:1103-1108.
488. Mascle X, Albagli O, Lemerrier C. Point mutations in BCL-6 DNA-binding domain reveal distinct roles for the six zinc fingers. *Biochem Biophys Res Commun* 2003;300:391-396.
489. Strahl BD, Allis CD. The language of covalent histone modifications. *Nature* 2000;403:41-45.
490. Struhl K. Histone acetylation and transcriptional regulatory mechanisms. *Genes Dev* 1998;12:599-606.
491. Lemerrier C, Brocard MP, Puvion-Dutilleul F, et al. Class II histone deacetylases are directly recruited by BCL-6 transcriptional repressor. *J Biol Chem* 2002;277:22045-22052.
492. Lee SC, Battaro A, Insel RA. Activation of terminal B cell differentiation by inhibition of histone deacetylation. *Mol Immunol* 2003;39:923-932.
493. Niu H. The proto-oncogene BCL-6 in normal and malignant B cells development. *Hematol Oncology* 2002;20:155-166.
494. Reljic R, Wagner SD, Peakman LJ, et al. Suppression of signal transducer and activator of transcription 3-dependent B lymphocyte terminal differentiation by BCL-6. *J Exp Med* 2000;192:1841-1847.
495. Lin Y, Wong K, Calame K. Repression of c-myc transcription by Blimp-1, an inducer of terminal B cell differentiation. *Science* 1997;276:596-599.
496. Lin KI, Angelin Duclos C, Kuo T-C, et al. Blimp-1-dependent repression of Pax-5 is required for differentiation of B cells to IgM secreting plasma cells. *Mol Cell Biol* 2002;22:4771-4780.
497. Singh M, Birstein BK. NF-HB (BSAP) is a repressor of the murine immunoglobulin heavy-chain 3' alpha enhancer at early stages of B-cell differentiation. *Mol Cell Biol* 1993;13:3611-3622.
498. Rinkenberger JL, Wallin JJ, Johnson KW, et al. An interleukin-2 signal relieves BSAP (Pax5)-mediated repression of the immunoglobulin J chain gene. *Immunity* 1996;5:377-386.
499. Piskurich JF, Lin KI, Lin Y, et al. BLIMP-1 mediates extinction of major histocompatibility class II transactivator expression in plasma cells. *Nat Immunol* 2000;1:526-532.
500. Yu J, Angelin-Duclos C, Greenwood J, et al. Transcriptional repression of Blimp-1 (PRD1-BF1) involves recruitment of histone deacetylase. *Mol Cell Biol* 2000;20:2592-2603.
501. Ben B, Chee KJ, Kim TH, et al. PRD1-BF1/Blimp-1 repression is mediated by corepressors of the Groucho family of proteins. *Genes Dev* 1999;13:125-137.
502. Alien RC, Armitage RJ, Conley ME, et al. CD40 ligand gene defects responsible for X-linked hyper IgM syndrome. *Science* 1993;259:990-993.
503. Aruffo A, Farrington M, Hollenbaugh D, et al. The CD40 ligand, gp39, is defective in activated T-cells from patients with X-linked hyper-IgM syndrome. *Cell* 1993;72:291-300.
504. Kroczek RA, Graf D, Brugnani D, et al. Defective expression of CD40 ligand on T-cells causes "X-linked immunodeficiency with hyper-IgM (HIGM1)." *Immunol Rev* 1994;138:39-59.
505. Notorangelo LD, Duse M, Ugazio AG. Immunodeficiency with hyper-IgM (HIM). *Immunodeficiency Rev* 1992;3:101-121.
506. Shu U, Kiniwa M, Wu CY, et al. Activated T cells induce interleukin-2 production by monocytes via CD40-CD40 ligand interaction. *Eur J Immunol* 1995;25:1125-1128.
507. Wiley JA, Harmsen AG. CD40 ligand is required for resolution of *Pneumocystis carinii* pneumonia in mice. *J Immunol* 1995;155:3525-3529.

508. Noelle RJ. CD40 and its ligand in host defense. *Immunity* 1996;4:415-419.
509. Weller S, Faili A, Garcia C, et al. CD40-CD40L independent Ig gene hypermutation suggests a second B cell diversification pathway in humans. *Proc Natl Acad Sci U S A* 2001;98:1166-1170.
510. de Saint Basile G, Tabone M-D, Durandy A, et al. CD40 ligand expression deficiency in a female carrier of the X-linked hyper-IgM syndrome as a result of X chromosome lyonization. *Eur J Immunol* 1999;29:367-373.
511. Callard RE, Smith SH, Herbert J, et al. CD40 ligand (CD40L) expression and B cell function in agammaglobulinemia with normal or elevated levels of IgM (HIM). Comparison of X-linked, autosomal recessive and non-X-linked forms of the disease, and obligate carriers. *J Immunol* 1994;153:3295-3306.
512. Conley ME, Larche M, Bonagura VR, et al. Hyper IgM syndrome associated with defective CD40-mediated B cell activation. *J Clin Invest* 1994;94:1404-1409.
513. Revy D, Muto T, Levy Y, et al. Activation-induced cytidine deaminases (AID) deficiency causes the autosomal recessive form of the hyper-IgM syndrome (HIGM2). *Cell* 2000;102:565-575.
514. Durandy A, Honjo T. Human genetic defects in class-switch recombination (hyper-IgM syndromes). *Curr Opin Immunol* 2001;13:543-548.
515. Muramatsu M, Kinoshita K, Faragasan S, et al. Class switch recombination and hypermutation require activation-induced cytidine deaminase (AID), a potential RNA editing enzyme. *Cell* 2000;102:553-563.
516. Zhu Y, Nonoyama S, Morio T, et al. Type two hyper-IgM syndrome caused by mutation in activation-induced cytidine deaminase. *J Med Dent Sci* 2003;50:41-46.
517. Minegishi Y, Lavoie A, Cunningham-Rundles C, et al. Mutations in activation-induced cytidine deaminase in patients with hyper IgM syndrome. *Clin Immunol* 2000;97:203-210.
518. Ferrari S, Giliani S, Insalaco A, et al. Mutations of CD40 gene cause an autosomal recessive form of immunodeficiency with hyper IgM. *Proc Natl Acad Sci U S A* 2001;98:12614-12619.
519. Leonard WL, O'Shea JJ. JAKS and STATS: biological implications. *Annu Rev Immunol* 1998;16:293-322.
520. Kisseleva T, Bhattacharya S, Schroeder-Braunstein, et al. Signaling through the JAK/STAT pathway: recent advances and future challenges. *Gene* 2002;285:1-24.
521. Usacheva A, Kotenko S, Witte MM, et al. Two distinct domains within the N-terminal region of Janus kinase 1 interact with cytokine receptors. *J Immunol* 2002;169:1302-1308.
522. Hoey T, Brusby MJ. STATs as mediators of cytokine-induced responses. *Adv Immunol* 1999;71:145-162.
523. Vinkemeier U, Moarefi I, Darnell JE, et al. Structure of the amino-terminal protein interaction domain of STAT-4. *Science* 1998;279:1048-1052.
524. Scott MJ, Godshall CJ, Cheadle WG. JAKs, STATs, cytokines and sepsis. *Clin Diag Lab Immunol* 2002;9:1153-1159.
525. Karnitz LM, Abraham RT. Interleukin-2 receptor signaling mechanisms. *Adv Immunol* 1996;61:147-197.
526. Sugamura K, Asao H, Kondo M, et al. The interleukin-2 receptor  $\gamma$  chain: its role in the multiple cytokine receptor complexes and T cell development in XSCID. *Annu Rev Immunol* 1996;14:179-205.
527. Olosz F, Malek TR. Three loops of the common  $\gamma$  chain ectodomain required for the binding of interleukin-2 and interleukin-7. *J Biol Chem* 2000;275:30100-30105.
528. Zanetta JP, Alonso C, Michalski JC. Interleukin-2 is a lectin that associates its receptor with the



T-cell receptor complex. *Biochem J* 1996;318:49–53.

529. Fujii H, Ogasawara K, Otsuka H, et al. Functional dissection of the cytoplasmic subregions of the IL-2 receptor  $\beta$  chain in primary lymphocyte populations. *EMBO J* 1998;17:6551–6557.

530. Friedman MC, Migone T-S, Russel SM, et al. Different interleukin 2 receptor  $\beta$  chain tyrosines couple to at least two signaling pathways and synergistically mediate interleukin 2-induced proliferation. *Proc Natl Acad Sci U S A* 1996;93:2077–2082.

531. Migone TS, Rodig S, Cacalano NA, et al. Functional cooperation of the interleukin-2 receptor  $\beta$  chain and Jak1 in phosphatidylinositol 3-kinase recruitment and phosphorylation. *Mol Cell Biol* 1998;18:6416–6422.

532. Chen M, Cheng A, Chen Y-Q, et al. The amino terminus of JAK3 is necessary and sufficient for binding to the common  $\gamma$  chain and confers the ability to transmit interleukin 2-mediated signals. *Proc Natl Acad Sci U S A* 1997;94:6910–6915.

533. Zhu M-L, Berry JA, Russel SM, et al. Delineation of the regions of interleukin-2 (IL-2) receptor  $\beta$  chain important for association of Jak1 and Jak3. *J Biol Chem* 1998;273:10719–10725.

534. Sigal NH, Dumont FJ. Cyclosporin A, FK-506, and rapamycin: pharmacologic probes of lymphocyte signal transduction. *Annu Rev Immunol* 1992;10:519–560.

535. Brown EJ, Albers MW, Shin TB, et al. A mammalian protein targeted by G1-arresting rapamycin-receptor complex. *Nature* 1994;369:756–758.

536. Sherr CJ. G1 phase progression: cycling on cue. *Cell* 1994;79:551–555.

537. Ajchenbaum F, Ando K, DeCaprio JA, et al. Independent regulation of human D-type cyclin gene expression during G1 phase in primary human T lymphocytes. *J Biol Chem* 1993;268:4113–4119.

538. Polyak K, Lee MH, Erdjument-Bromage H, et al. Cloning of p27Kip1, a cyclin-dependent kinase inhibitor and a potential mediator of extracellular antimitogenic signals. *Cell* 1994;78:59–66.

539. Noguchi M, Nakamura Y, Russel SM, et al. Interleukin-2 receptor  $\gamma$  chain: a functional component of the interleukin-7 receptor. *Science* 1993;263:1877–1880.

540. Buckley RH, Schiff RI, Schieff SE, et al. Human severe combined immunodeficiency: genetic, phenotypic, and functional diversity in one hundred eight infants. *J Pediatr* 1997;130:378–387.

541. Cacalano N, Johnston JA. Interleukin-2 signaling and inherited immunodeficiency. *Am J Hum Genet* 1999;65:287–293.

542. Cacalano M, Migone TS, Bazan F, et al. Autosomal SCID caused by a point mutation in the N-terminus of Jak3: mapping of the Jak3-receptor interaction domain. *EMBO J* 1999;18:1549–1558.

543. Mueller TD, Zhang JL, Sebald W, et al. Structure, binding, and antagonists in the IL-4/IL-13 receptor family. *Biochem Biophys Acta* 2002;1592:237–250.

544. Hage T, Sebald W, Reinemer P. Crystal structure of the interleukin-4/receptor  $\alpha$  chain complex reveals a mosaic binding interface. *Cell* 1999;97:271–281.

545. Zhang JL, Simeonowa I, Wang Y, et al. The high-affinity interaction of human IL-4 and the receptor  $\alpha$  chain is constituted by two independent binding clusters. *J Mol Biol* 2002;315:399–407.

546. Bork P, Holm L, Sander C. The immunoglobulin fold. Structural classification, sequence patterns and common core. *J Mol Biol* 1994;242:309–320.

547. Nelms K, Keegan AD, Zamorano J, et al. The IL-4 receptor: signaling mechanisms and biologic functions. *Annu Rev Immunol* 1999;17:701–738.

548. Reichel M, Nelson BH, Greenberg PD, et al. The IL-4 receptor  $\alpha$ -chain cytoplasmic domain is sufficient for activation of JAK-1 and STAT-6 and the induction of IL-4 specific gene expression. *J*

Immunol 1997;158:5860–5867.

549. Sun XJ, Wong LM, Zhang Y, et al. Role of IRS-2 in insulin and cytokine signaling. *Nature* 1995;377:173–177.

550. Andrew RP, Erickson MB, Cunningham CM, et al. Analysis of the life cycle of STAT-6. Continuous cycling of STAT-6 is required for IL-4 signaling. *J Biol Chem* 2002;277:36563–36569.

551. Starr R, Hilton DJ. SOCS: suppressors of cytokine signaling. *Int J Biochem Cell Biol* 1998;30:1081–1085.

552. Hilton DJ, Richardson RT, Alexander WS, et al. Twenty proteins containing a C-terminal SOCS box form five structural classes. *Proc Natl Acad Sci U S A* 1998;95:114–119.

553. Alexander WS, Starr R, Metcalf D, et al. Suppressors of cytokine signaling (SOCS): negative regulators of signal transduction. *J Leuk Biol* 1999;66:588–592.

554. Hague SJ, Harbor PC, Williams BRG. Identification of critical residues required for suppression of cytokine signaling-specific regulation of interleukin-4 signaling. *J Biol Chem* 2000;275:26500–26506.

555. Losman JA, Chen XP, Hilton D, et al. SOCS-1 is a potent inhibitor of IL-4 signal transduction. *J Immunol* 1999;162:3770–3774.

556. Zhou C, Saxon A, Zhang K. Human activation-induced cytidine deaminase is induced by IL-4 and negatively regulated by CD45: implication of CD45 as a Janus kinase phosphatase in antibody diversification. *J Immunol* 2003;170: 1887–1893.

556a. Sasaki JI, Sasaki T, Matsumoto W, et al. CD45 is a JAK phosphatase and negatively regulates cytokine receptor signaling. *Nature* 2001;40:349–354.

557. Takatsu K, Takaki S, Hitoshi Y. Interleukin-5 and its receptor system: implications in the immune system and inflammation. *Adv Immunol* 1994;57:145–190.

558. Bagley CJ, Woodcock JM, Stomski FC, et al. The structural and functional basis of cytokine receptor activation: lessons from the common  $\beta$  subunit of the granulocyte-macrophage colony-stimulating factor, interleukin-3 (IL-3), and IL-5 receptors. *Blood* 1997;89:1471–1482.

559. Woodcock JM, Bagley CJ, Zacharakis B, et al. A single tyrosine residue in the membrane-proximal domain of the granulocyte-macrophage colony-stimulating factor, interleukin (IL)-3, and IL-5 receptor common  $\beta$ -chain is necessary and sufficient for high affinity binding and signaling by all three ligands. *J Biol Chem* 1996;271:25999–26006.

560. Sanderson CJ. Interleukin-5, eosinophils, and disease. *Blood* 1992;79:3101–3109.

561. Corrigan CJ, Haczku A, Gemou-Engesaeth V, et al. CD4 T-lymphocyte activation in asthma is accompanied by increased serum concentrations of interleukin-5. Effect of glucocorticoid therapy. *Am Rev Respir Dis* 1993;147:540–547.

562. Hamid Q, Azzawi M, Ying S, et al. Expression of mRNA for interleukin-5 in mucosal bronchial biopsies from asthma. *J Clin Invest* 1991;87:1541–1546.

563. Limaye AP, Abrams JS, Silver JE, et al. Interleukin-5 and the post treatment eosinophilia in patients with onchocerciasis. *J Clin Invest* 1991;88:1418–1421.

564. Akira S, Taga T, Kishimoto T. Interleukin-6 in biology and medicine. *Adv Immunol* 1993;54:1–78.

565. Bravo J, Heath JH. Receptor recognition by gp130 cytokines. *EMBO J* 2000;19:2399–2411.

566. Somers W, Stahl M, Seehra JS. 1.9 Å crystal structure of interleukin 6: implications for a novel mode of receptor dimerization and signaling. *EMBO J* 1997;16:989–997.

567. Cebo C, Durier V, Lagant P, et al. Function and molecular modeling of the interaction between

- human interleukin 6 and its HNK-1 oligosaccharide ligands. *J Biol Chem* 2002;277:12246-12252.
568. Cole AR, Hall NE, Trentlein HR, et al. Disulfide bond structure and N-glycosylation sites of the extracellular domain of the human interleukin-6 receptor. *J Biol Chem* 1999;274:7207-7215.
569. Özbek S, Gröntzinger J, Krebs B, et al. The membrane proximal cytokine receptor domain of the human interleukin-6 receptor is sufficient for ligand binding but not for gp130 association. *J Biol Chem* 1998;273:21374-21379.
570. Kurth I, Horsten U, Pflanz S, et al. Importance of the membrane-proximal extracellular domains for activation of the signal transducer glycoprotein 130. *J Immunol* 2000;164:273-282.
571. Kalai M, Montero-Julian FA, Grötzinger J, et al. Analysis of the hIL-6/hIL-6-R binding interface at the amino acid level: proposed mechanisms of interaction. *Blood* 1997;89:1319-1333.
572. Kurth I, Horsten U, Pflanz S, et al. Activation of the signal transducer glycoprotein 130 by both IL-6 and IL-11 requires two distinct binding epitopes. *J Immunol* 1999;162:1480-1487.
573. Bravo J, Staunton D, Heath JH, et al. Crystal structure of a cytokine-binding region of gp130. *EMBO J* 1998;17:1665-1674.
574. Cebo C, Vergoten G, Zanetta J-P. Lectin activities of cytokines: functions and putative carbohydrate-recognition domains. *Biochem Biophys Acta* 2002;1572:422-434.
575. Taga T, Kishimoto T. GP130 and the interleukin-6 family of cytokines. *Annu Rev Immunol* 1997;15:797-819.
- 575a. Chow DC, He XL, Snow AL, et al. Structure of an extracellular gp130 cyto-kine receptor signaling complex. *Science* 2001;291:2150-2155.
- 575b. Heinrich PC, Behrmann I, Müller-Newen G, et al. Interleukin-6-type cytokine signaling through the gp130/Jak/STAT pathway. *Biochem J* 1998;334:297-314.
- 575c. Heinrich PC, Behrmann I, Haan S, et al. Principles of IL-6-type cytokine signalling and its regulation. *Biochem J* [serial online] May 29, 2003.
576. Schaeffer M, Schneiderbauer M, Weidler S, et al. Signaling through a novel domain of gp130 mediates cell proliferation and activation of Hck and Erk kinases. *Mol Cell Biol* 2001;21:8068-8081.
577. Adachi M, Fisher EH, Ihle J, et al. Mammalian SH2-containing protein tyrosine phosphatases. *Cell* 1996;85:15.
578. Chouhan D, Hideshima P, Pandey P, et al. RAFTK/PYK2-dependent and independent apoptosis in multiple myeloma cells. *Oncogene* 1999;18:6733-6740.
579. Levy DE, Lee CK. What does Stat-3 do? *J Clin Invest* 2002;109:1143-1148.
580. Narazaki M, Fujimoto M, Matsumoto T, et al. Three distinct domains of SSI-1/SOCS-1/JAB protein required for its suppression of interleukin 6 signaling. *Proc Natl Acad Sci U S A* 1998;95:13130-13134.
581. Gibson RM, Schiemann W, Prichard LB, et al. Phosphorylation of human gp130 at Ser-782 adjacent to the di-leucine internalization motif. Effects on expression and signaling. *J Biol Chem* 2000;275:22574-22582.
582. Kishimoto T, Akira S, Narazaki M, et al. Interleukin-6 family of cytokines and gp130. *Blood* 1995;86:1243-1254.
583. Lauta VM. A review of the cytokine network in multiple myeloma. Diagnostic, prognostic and therapeutic implications. *Cancer* 2003;97:2440-2452.
584. French JD, Walters DK, Jelinek DF. Transactivation of gp130 in myeloma cells. *J Immunol* 2003;170:3717-3723.

585. Castleman B, Iverson L, Menendez VP. Localized mediastinal lymph node hyperplasia resembling thymoma. *Cancer* 1956;9:822–830.
586. Keller AR, Hochholzer L, Castleman B. Hyaline-vascular and plasma-cell types of giant lymph node hyperplasia of the mediastinum and other locations. *Cancer* 1972;29:670–683.
587. Yoshizaki K, Matsuda T, Nishimoto N, et al. Pathogenic significance of interleukin-6 (IL-6/BSF-2) in Castleman's disease. *Blood* 1989;74:1360–1367.
588. Li H, Wang H, Nicholas J. Detection of direct binding of human herpesvirus 8-encoded interleukin-6 (IL-6) to both gp130 and IL-6 receptor (IL-6R) and identification of amino acid residues of vIL-6 important for IL-6R-dependent and -independent signaling. *J Virol* 2001;75:3325–3334.
589. Li H, Nicholas J. Identification of amino acid residues of gp130 signal transducer and gp80 a receptor subunit that are involved in ligand binding and signaling by human herpesvirus 8-encoded interleukin 6. *J Virol* 2002;76:5627–5636.
590. Mosmann TR. Properties and functions of interleukin-10. *Adv Immunol* 1994;56:1–26.
591. Vieira P, de Waal-Malefyt R, Dang MN, et al. Isolation and expression of human cytokine synthesis inhibitory factor cDNA clones: homology to Epstein-Barr virus open reading frame BCRF1. *Proc Natl Acad Sci U S A* 1991;88:1172–1176.
592. Moore KW, O'Garra A, de Waal-Malefyt R, et al. Interleukin-10. *Annu Rev Immunol* 1993;11:165–190.
593. Moore KW, de Waal Malefyt R, Coffman RL, et al. Interleukin-10 and the interleukin-10 receptor. *Annu Rev Immunol* 2001;19:683–765.
594. Burdin N, Peronne C, Banchereau J, et al. Epstein-Barr virus transformation induces B lymphocytes to produce human interleukin 10. *J Exp Med* 1993;177:295–304.
595. Rousset F, Garcia E, Defrance T, et al. Interleukin 10 is a potent growth and differentiation factor for activated human B lymphocytes. *Proc Natl Acad Sci U S A* 1992;89:1890–1893.
596. Defrance T, Vanbervliet B, Briere F, et al. Interleukin 10 and transforming growth factor  $\beta$  cooperate to induce anti-CD40-activated naive human B cells to secrete immunoglobulin A. *J Exp Med* 1992;175:671–682.
597. Akdis CA, Blaser K. Mechanisms of interleukin-10-mediated immune suppression. *Immunology* 2001;103:131–136.
598. Berg DJ, Zhang J, Lauricella DM, et al. IL-10 is a central regulator of cyclooxygenase-2 expression and prostaglandin production. *J Immunol* 2001;166:2674–2680.
599. Dreyer WJ, Bennett JC. The molecular basis of antibody formation: a paradox. *Proc Natl Acad Sci U S A* 1965;54:864–869.
600. Edelman GM, Gall WE. The antibody problem. *Annu Rev Biochem* 1969;38:415–466.
601. Edelman GM, Cunningham BA, Gall WE, et al. The covalent structure of an entire  $\gamma$ G immunoglobulin molecule. *Proc Natl Acad Sci U S A* 1969;63:78–85.
602. Porter RR. The hydrolysis of rabbit  $\gamma$ -globulin and antibodies with crystalline papain. *Biochem J* 1959;73:119.
603. Amit AG, Mariuzza RA, Phillips SE, et al. Three-dimensional structure of an antigen-antibody complex at 2.8 Å resolution. *Science* 1986;233:747–753.
604. Capra JD, Edmundson AB. The antibody combining site. *Sci Am* 1977;236:50–59.
605. Jones PT, Dear PH, Foote J, et al. Replacing the complementarity-determining regions in a human

antibody with those from a mouse. *Nature* 1986;321:522–525.

606. Kieber–Emmons T, Kohler H. Towards a unified theory of immunoglobulin structure–function relations. *Immunol Rev* 1986;90:29–48.
607. Jerne NK. Idiotypic networks and other preconceived ideas. *Immunol Rev* 1984;79:5–24.
608. Jerne NK. Towards a network theory of the immune system. *Ann Immunol (Paris)* 1974;125C:373–389.
609. Review of the notation for the allotypic and related markers of human immunoglobulins. *J Immunol* 1976;117:1056–1058.
610. Morell A, Skvaril F, van Loghem E, et al. Human IgG subclasses in maternal and fetal serum. *Vox Sang* 1971;21:481–492.
611. Natvig JB, Kunkel HG. Human immunoglobulins: classes, subclasses, genetic variants, and idiotypes. *Adv Immunol* 1973;16:1–59.
612. Capra JD, Kunkel HG. Aggregation of  $\gamma$ -G3 proteins: relevance to the hyperviscosity syndrome. *J Clin Invest* 1970;49:610–621.
613. Yount WJ, Seligmann M, Hong R, et al. Imbalances of gamma globulin subgroups and gene defects in patients with primary hypogammaglobulinemia. *J Clin Invest* 1970;49:1957–1966.
614. Mestecky J, McGhee JR. Immunoglobulin A (IgA): molecular and cellular interactions involved in IgA biosynthesis and immune response. *Adv Immunol* 1987;40:153–245.
615. Underdown BJ, Schiff JM. Immunoglobulin A: strategic defense initiative at the mucosal surface. *Annu Rev Immunol* 1986;4:389–417.
616. Tomasi TB Jr. Structure and function of mucosal antibodies. *Annu Rev Med* 1970;21:281–298.
617. Mostov KE. Transendothelial transport of immunoglobulins. *Annu Rev Immunol* 1994;12:63–84.
618. Johansen FE, Braathen R, Brandtzaeg P. Role of the J chain in secretory immunoglobulin formation. *Scand J Immunol* 2000;52:240–248.
619. Rojas R, Apodaca G. Immunoglobulin transport across polarized epithelial cells. *Nat Rev Mol Cell Biol* 2002;3:944–955.
620. Phalipon A, Corthesy B. Novel functions of the polymeric receptor: well beyond transport of immunoglobulins. *Trends Immunol* 2003;24:55–58.
621. Norderhaug IN, Johanssen FE, Schjerven H, et al. Regulation of the formation and external transport of secretory immunoglobulins. *Crit Rev Immunol* 1999;19:481–508.
622. Johansen FN, Braathen R, Brandtzaeg P. The J chain is essential for polymeric Ig receptor–mediated epithelial transport of IgA. *J Immunol* 2001;167:5185–5192.
623. Kaetzel CS. Polymeric Ig receptor: defender of the fort or Trojan Horse? *Current Biol* 2001;11:R35–R38.
624. Stiehm ER, Ammann AJ, Cherry JD. Elevated cord macroglobulins in the diagnosis of intrauterine infections. *N Engl J Med* 1966;275:971–977.
625. Davis AC, Shulman MJ. IgM—molecular requirements for its assembly and function. *Immunol Today* 1989;10:118–122.
626. Rowe DS, Fahey JL. A new class of human immunoglobulins. I. A unique myeloma protein. *J Exp Med* 1965;121:171.

627. Ishizaka K. Human reaginic antibodies. *Annu Rev Med* 1970;21:187–200.
628. Halpern MS, Koshland ME. Novel subunit in secretory IgA. *Nature* 1970;228:1276–1278.
629. Muller–Eberhard HJ. Molecular organization and function of the complement system. *Annu Rev Biochem* 1988;57:321–347.
630. Muller–Eberhard HJ, Schreiber RD. Molecular biology and chemistry of the alternative pathway of complement. *Adv Immunol* 1980;29:1–53.
631. Reid KB, Porter RR. The proteolytic activation systems of complement. *Annu Rev Biochem* 1981;50:433–464.
632. Reid KB, Day AJ. Structure–function relationships of the complement components. *Immunol Today* 1989;10:177–180.
633. Kishore U, Reid KBM. C1q: structure, function, and receptors. *Immunopharmacology* 2000;49:159–170.
634. Arlaud GJ, Gaboriaud C, Thielens NM, et al. Structural biology of C1: dissection of a complex molecular machinery. *Immunol Rev* 2001;180:136–145.
635. Arlaud GJ, Gaboriaud C, Thielens NM, et al. Structural biology of C1 complex of complement unveils the mechanisms of its activation and proteolytic activity. *Mol Immunol* 2002;39:383–394.
636. Reid KBM, Porter RR. Subunit composition and structure of subcomponent C1q of the first component of human complement. *Biochem J* 1976;155:19–23.
637. Tacnet–Delorme P, Chevallier S, Arlaud GJ. Beta amyloid fibrils activate the C1 complex of complement under physiological conditions. Evidence for a binding site for A beta on the C1q globular regions. *J Immunol* 2001;167:6374–6381.
638. Shapiro L, Scherer PE. The crystal structure of a complement–1q family protein suggests an evolutionary link to tumor necrosis factor. *Curr Biol* 1998;8:335–338.
639. Gaboriaud C, Rossi V, Bally V, et al. Crystal structure of the catalytic domain of human complement C1s: a serine protease with a handle. *EMBO J* 2000;19:1755–1765.
640. Budayova–Spano M, Lacroix MB, Thielens NM, et al. The crystal structure of the zymogen catalytic domain of the complement protease C1r reveals that a disruptive mechanical stress is required to trigger activation of the C1 complex. *EMBO J* 2002;21:231–239.
641. Thielens NM, Enrie K, Lacroix M, et al. The N–terminal CUB–epidermal growth factor module pair of human complement C1r binds Ca<sup>2+</sup> with high affinity and mediates Ca<sup>2+</sup>–dependent interaction with C1s. *J Biol Chem* 1999;274:9149–9159.
642. Lörincz Z, Gal P, Dobo J, Czeh S, et al. The cleavage of two C1s subunits by a single active C1r reveals substantial flexibility of the C1s–C1r–C1r–C1s tetramer in the C1 complex. *J Immunol* 2000;165:2048–2051.
643. Bork P, Beckmann G. The CUB domain. A widespread module in developmentally regulated proteins. *J Mol Biol* 1993;231:539–545.
644. Arlaud GJ, Colomb MG, Gagnon J. A functional model of the human C1 complex. *Immunol Today* 1987;8:106–111.
645. Arlaud GJ, Gaboriaud C, Thielens NM, et al. Structural biology of C1. *Biochem Soc Trans* 2002;30:1001–1006.
646. Arlaud GJ, Gaboriaud C, Thielens NM, et al. Structural biology of C1: dissection of a complex molecular machinery. *Immunol Rev* 2001;180:136–145.

647. Eggleton P, Reid KBM, Tenner AJ. C1q—How many functions? How many receptors? *Trends Cell Biol* 1998;8:428–431.
648. Eggleton P, Tenner AJ, Reid KBM. C1q receptors. *Clin Exp Immunol* 2000;120:406–412.
649. Leigh LEA, Ghebrehwet B, Perera TPS, et al. C1q mediated chemotaxis by human neutrophils: involvement of  $\alpha$ C1qR and G-protein signaling mechanisms. *Biochem J* 1998;330:247–254.
650. Webster SD, Park M, Fonseca MI, et al. Structural and functional evidence of microglial expression of C1qR, the C1q receptor that enhances phagocytosis. *J Leukoc Biol* 2000;65:109–116.
651. Peerschke EIB, Ghebrehwet B. Human blood platelet  $\alpha$ C1qR/p33. *Immunol Rev* 2001;180:56–64.
652. Tack BF. The  $\beta$ -Cys- $\gamma$ -Glu thioester bond in human C3, C4, and a  $\gamma$ 2-macro-globulin. *Springer Semin Immunopathol* 1983;6:259–282.
653. Jenkins PV, Pasi KJ, Perkins SJ. Molecular modeling of ligand and mutation sites of the type A domains of human von Willebrand factor and their relevance to von Willebrand's disease. *Blood* 1998;91:2032–2044.
654. Hinselwood J, Perkins SJ. Metal-dependent conformational changes in a recombinant vWF-A domain from human factor B: a solution study by circular dichroism, Fourier transform infrared, and  $^1\text{H}$  NMR spectroscopy. *J Mol Biol* 2000;298:135–147.
655. Arlaud GJ, Volanakin JE, Thielens NM, et al. The atypical serine proteases of the complement system. *Adv Immunol* 1998;69:249–307.
656. Sahu A, Lambris JD. Structure and biology of complement protein C3, a connecting link between innate and acquired immunity. *Immunol Rev* 2001;180:35–48.
657. Sahu A, Kozel TR, Pangburn MK. Specificity of the thioester-containing reactive site of human C3 and its significance to complement activation. *Biochem J* 1994;302:429–436.
658. Pangburn MK, Rawal N. Structure and function of complement C5 convertase enzymes. *Biochem Soc Trans* 2002;30:1006–1010.
659. Pangburn MK, Schreiber RD, Muller-Eberhard HJ. Formation of the initial C3 convertase of the alternative complement pathway. Acquisition of C3b-like activities by spontaneous hydrolysis of the putative thioester in native C3. *J Exp Med* 1981;154:856–867.
660. Jing H, Macon KJ, Moore D, et al. Structural basis of profactor D activation: from a highly flexible zymogen to a novel self-inhibited serine protease, complement factor D. *EMBO J* 1999;18:804–814.
661. Volanakis JE, Narayana SVL. Complement factor D, a novel serine protease. *Protein Sci* 1996;5:553–564.
662. Pillemer L, Blum L, Lepow IH, et al. *Science* 1954;120:279–285.
663. Pangburn MK. Analysis of the natural polymeric forms of human properdin and their functions in complement activation. *J Immunol* 1989;142:202–207.
664. Smith CA, Pangburn MK, Vogel C-W, et al. Molecular architecture of human properdin, a positive regulator of the alternative pathway of complement. *J Biol Chem* 1984;259:4582–4588.
665. Goundis D, Reid KBM. Properdin, the terminal complement components, thrombospondin, and circumsporozoite protein of malaria parasites contain similar sequence motifs. *Nature* 1988;335:82–85.
666. Higgins JMG, Wiedemann H, Timpl R, et al. Characterization of mutant forms of recombinant human properdin lacking single thrombospondin type I repeats. *J Immunol* 1995;155:5777–5785.
667. Perdikoulis MV, Kishore U, Reid KBM. Expression and characterization of the thrombospondin type I



repeats of human properdin. *Biochem Biophys Acta* 2001;1548:265–277.

668. Holt GD, Pangburn MK, Ginsburg V. Properdin binds to sulfatide [Gal(3–SO<sub>4</sub>)B1–1Cer] and has a sequence homology with other proteins that bind sulphated glycoconjugates. *J Biol Chem* 1990;265:2852–2855.

669. Bongrazio M, Pries AR, Zakrewicz A. The endothelium as physiological source of properdin: role of wall shear stress. *Mol Immunol* 2003;39:669–675.

670. Schwaebler WJ, Reid KBM. Does properdin crosslink the cellular and the humoral immune response? *Immunol Today* 1999;20:17–21.

671. Xu Y, Narayana SVL, Volanakis JE. Structural biology of the alternative pathway convertase. *Immunol Rev* 2001;180:123–135.

672. Rawal N, Pangburn MK. Structure/function of C5 convertases of complement. *Int Immunopharmacol* 2001;1:415–422.

673. Petersen SV, Thiel S, Jensenius JC. The mannan-binding lectin pathway of complement activation: biology and disease association. *Mol Immunol* 2001;38:133–149.

674. Dahl MR, Thiel S, Matsushita M, et al. A new mannan-binding lectin associated serine protease, MASP-3, and its association with distinct complexes of the MBL complement activation pathway. *Immunity* 2001;15:1–10.

675. Thielens NM, Cseh S, Thiel S, et al. Interaction properties of human mannan-binding lectin (MBL)-associated serine proteases-1 and -2 MBL-associated serine proteases-1 and -2, MBL-associated protein 19 and MBL. *J Immunol* 2001;166:5068–5077.

676. Stover CM, Thiel S, Thelen M, et al. Two constituents of the initiation complex of the mannan-binding lectin activation pathway of complement are encoded by a single structural gene. *J Immunol* 1999;162:3481–3490.

677. Jack DL, Klein NJ, Turner MW. Mannose-binding lectin: targeting the microbial world for complement attack and opsonophagocytosis. *Immunol Rev* 2001;180:86–99.

678. Matsushita M, Fujita T. Ficolins and the lectin complement pathway. *Immunol Rev* 2001;180:78–85.

679. Matsushita M, Kuraya M, Hamasaki N, et al. Activation of the lectin complement pathway by H-ficolin (Hakata antigen). *J Immunol* 2002;168:3502–3506.

680. Fujita T. Evolution of the lectin-complement pathway and its role in innate immunity. *Nat Rev Immunol* 2002;2:346–353.

681. Di Scipio RG. Formation and structure of the C5b-7 complex of the lytic pathway of complement. *J Biol Chem* 1992;267:17087–17094.

682. Di Scipio RG, Hugli TE. The molecular architecture of human complement C6. *J Biol Chem* 1989;264:16197–16206.

683. Haefliger J-A, Tschopp J, Vial N, Jenne DE. Complete primary structure and functional characterization of the sixth component of the human complement system. *J Biol Chem* 1989;264:18041–18051.

684. Di Scipio RG, Linton SM, Rushmere NK. Function of the factor I modules (FIMs) of human complement component C6. *J Biol Chem* 1999;274:31811–31818.

685. Di Scipio RG, Chakravarti DN, Muller-Eberhard HJ, et al. The structure of human complement component C7 and the C5b-7 complex. *J Biol Chem* 1988;263:549–560.

686. Sodetz JM. Structure and function of C8 in the membrane attack sequence of complement. *Curr Top Microbiol Immunol* 1989;140:19.

687. Musingarimi P, Plumb ME, Sodetz JM. Interaction between the C8 alpha-gamma and C8 beta subunits of human complement C8: role of the C8 beta N-terminal thrombospondin type 1 module and membrane attack complex/perforin domain. *Biochemistry* 2002;41:11255-11260.
688. Schreck SF, Parker C, Plumb ME, et al. Human complement protein C8?. *Biochem Biophys Acta* 2000;1482:199-208.
689. Schreck SF, Plumb ME, Platteborze PL, et al. Expression and characterization of recombinant subunits of human complement component C8: further analysis of the function of C8a and C8?. *J Immunol* 1998;161:311-318.
690. Parker CL, Sodetz JM. Role of the human C8 subunits in complement-mediated bacterial killing: evidence that C8? is not essential. *Mol Immunol* 2002;39:453-458.
691. Ortlund E, Parker CL, Schreck SF, et al. Crystal structure of human complement protein C8 gamma at 1.2 Å resolution reveals a lipocalin fold and a distinct ligand binding site. *Biochemistry* 2002;41:7030-7037.
692. Shinkai Y, Takio K, Okumura K. Homology of perforin to the ninth component of complement (C9). *Nature* 1988;334:525-527.
693. Dourmashkin RR. The structural events associated with the attachment of complement components to cell membranes in reactive lysis. *Immunology* 1978;35:205-212.
694. Tschopp J, Podack ER, Muller-Eberhard HJ. Ultrastructure of the membrane attack complex of complement: detection of the tetramolecular C9 polymerized complex C5b-8. *Proc Natl Acad Sci U S A* 1982;79:7474-7478.
695. Scibek JJ, Plumb ME, Sodetz JM. Binding of human complement C8 to C9: role of the N-terminal modules in the C8 alpha subunit. *Biochemistry* 2002;41:14546-14551.
696. Müller-Eberhardt HJ. Membrane attack complex of complement. *Annu Rev Immunol* 1986;4:503-528.
697. Trantum-Jensen J, Bhakdi S, Bhakdi-Lehnen B, et al. Complement lysis: the ultrastructure and orientation of the C5b-9 complex on target sheep erythrocyte membranes. *Scand J Immunol* 1978;7:45-46.
698. Tschopp J, Podack ER, Muller-Eberhard HJ. Ultrastructure of the membrane attack complex of complement: detection of the tetramolecular C9-polymerizing complex C5b-8. *Proc Natl Acad Sci U S A* 1982;79:7474-7478.
699. Di Scipio RG, Berlin C. The architectural transition of human complement component C9 to poly (C9). *Mol Immunol* 1999;36:575-585.
700. Di Scipio RG. The size, shape, and stability of complement component C9. *Mol Immunol* 1993;30:1097-1106.
701. Esser AF. Big MAC attack: complement proteins cause leaky patches. *Immunol Today* 1991;12:316-318.
702. Davis AE 3rd. C1 inhibitor and hereditary angioneurotic edema. *Annu Rev Immunol* 1988;6:595-628.
703. Juang H, Wagner E, Zhang H, et al. Complement 1 inhibitor is a regulator of the alternative complement pathway. *J Exp Med* 2001;194:1609-1616.
704. Liszewski MK, Farries TC, Lublin DM, et al. Control of the complement system. *Adv Immunol* 1996;61:201-283.
705. Kirkitadze MD, Barlow PN. Structure and flexibility of the multiple domain proteins that regulate complement activation. *Immunol Rev* 2001;180:146-161.
706. Liszewski MK, Leung M, Cui W, et al. Dissecting sites important for complement regulatory activity in

- membrane cofactor protein (MCP;CD46). *J Biol Chem* 2000;275:37692–37701.
707. Barilla-La Barca ML, Liszewski MK, Lambris JD, et al. Role of membrane cofactor protein (CD46) in regulation of C4b and C3b deposited on cells. *J Immunol* 2002;168:6298–6304.
708. Casaanovas JM, Larvie M, Stehle T. Crystal structure of two CD46 domains reveals an extended measles virus-binding surface. *EMBO J* 1999;18:2911–2922.
709. Manchester M, Naniche D, Stehle T. CD46 as a measles receptor: form follows function. *Virology* 2000;274:5–10.
710. Manchester M, Liszewski MK, Atkinson JP, et al. Multiple isoforms of CD46 (membrane cofactor protein) serve as receptors for measles virus. *Proc Natl Acad Sci U S A* 1994;91:2161–2165.
711. Okada N, Liszewski MK, Atkinson JP, et al. Membrane cofactor protein (CD46) is a keratinocyte receptor for the M protein of the group A streptococcus. *Proc Natl Acad Sci U S A* 1995;92:2489–2493.
712. Giannakis E, Jokiranta TS, Ormsy RJ, et al. Identification of the Streptococcal M protein binding site on membrane cofactor protein (CD46). *J Immunol* 2002;168:4585–4592.
713. Greenstone HL, Santoro F, Lusso P, et al. Human herpesvirus 6 and measles virus employ distinct CD46 domains for receptor function. *J Biol Chem* 2002;277:39112–39118.
714. Lublin DM, Atkinson JP. Decay-accelerating factor: biochemistry, molecular biology, and function. *Annu Rev Immunol* 1989;7:35–58.
715. Fujita T, Inoue T, Ogawa K, et al. The mechanism of action of decay-accelerating factor (DAF). DAF inhibits the assembly of C3 convertases by dissociating C2a and Bb. *J Exp Med* 1987;166:1221–1228.
716. Brodbeck WG, Kuttner-Kondo L, Mold C, et al. Structure/function studies of human decay-accelerating factor. *Immunology* 2000;101:104–111.
717. Hourcade DE, Mitchell L, Kuttner-Kondo LA, et al. Decay-accelerating factor (DAF), complement receptor 1 (CR1), and factor H dissociate the complement AP C3 convertase (C3bBb) via sites on the type A domain of Bb. *J Biol Chem* 2002;277:1107–1112.
718. Williams P, Chaudry Y, Goodfellow IG, et al. Mapping CD55 function. The structure of two pathogen-binding domains at 1.7 Å. *J Biol Chem* 2003;278:10691–10696.
719. Uhrinova S, Lin F, Ball G, et al. Solution structure of a functionally active fragment of decay-accelerating factor. *Proc Natl Acad Sci U S A* 2003;100: 4718–4723.
720. Hane H, Ulmer AJ, El-Samalouti VT, et al. Decay-accelerating factor (DAF/CD55) is a functional active element of the LPS receptor complex. *J Endo-toxin Res* 2001;7:227–231.
721. Hamman J, Vogel B, van Schindel GMW, et al. The seven-span transmembrane receptor CD97 has a cellular ligand (CD55, DAF). *J Exp Med* 1996;184:1185–1189.
722. McKnight AJ, Gordon S. The EGF-TM7 family: unusual structures at the leukocyte surface. *J Leuk Biol* 1998;63:271–280.
723. Lea S. Interactions of CD55 with non-complement ligands. *Biochem Soc Trans* 2002;30:1014–1019.
724. Krych-Goldberg M, Atkinson JP. Structure-function relationships of complement receptor type 1. *Immunol Rev* 2001;180:112–122.
725. Krych M, Clemenza L, Howdeshell D, et al. Analysis of the functional domains of complement receptor type 1 (C3b/C4b receptor;CD35) by substitution mutagenesis. *J Biol Chem* 1994;269:13273–13278.
726. Smith BO, Mallin RL, Krych-Goldberg M, et al. Structure of the C3b binding site of CR1 (CD35), the immune adherence receptor. *Cell* 2002;108:769–780.
727. Krych-Goldberg M, Hauhart RE, Subramanian VB, et al. Decay accelerating activity of complement

receptor type 1 (CD35). *J Biol Chem* 1999;274:31160–31168.

728. Schlaf G, Demberg T, Beisel N, et al. Expression and regulation of complement factor H and I in rat and human cells: some critical notes. *Mol Immunol* 2001;38:231–239.

729. DiScipio RG. Ultrastructures and interactions of complement factors H and I. *J Immunol* 1992;149:2592–2599.

730. Meri S, Pangburn MK. Discrimination between activators and nonactivators of the alternative pathway of complement: regulation via a sialic acid/polyanion binding site on factor H. *Proc Natl Acad Sci U S A* 1990;87:3982–3986.

731. Meri S, Pangburn MK. Regulation of alternative pathway complement activation by glycosaminoglycans: specificity of the polyanion binding site on factor H. *Biochem Biophys Res Commun* 1994;198:52–59.

732. Hellwage J, Jokiranta TS, Friese MA, et al. Complement C3b/C3d and cell surface polyanions are recognized by overlapping binding sites on the most carboxy-terminal domain of complement factor H. *J Immunol* 2002;169:6935–6944.

733. Pangburn MK, Pangburn KLW, Koistinen V, et al. Molecular mechanisms of target recognition in an innate immune system: interactions among factor H, C3b, and target in the alternative pathway of human complement. *J Immunol* 2000;164:4742–4751.

734. Jokiranta TS, Hellwage J, Koistinen V, et al. Each of the three binding sites of factor H interacts with a distinct site on C3b. *J Biol Chem* 2000;275:27657–27662.

735. Richards A, Buddles MR, Denne RL, et al. Factor H mutations in hemolytic uremic syndrome cluster in exons 18–20, a domain important for host cell recognition. *Am J Hum Genet* 2001;68:485–490.

736. Perkins SJ, Goodship THJ. Molecular modeling of the C-terminal domains of factor H of human complement: a correlation between haemolytic uraemic syndrome and a predicted heparin binding site. *J Mol Biol* 2002;316:217–224.

737. Pangburn MK. Localization of the host recognition functions of complement factor H at the carboxyl-terminal: implications for hemolytic uremic syndrome. *J Immunol* 2002;169:4702–4706.

738. Pickering MC, Cook HT, Warren J, et al. Uncontrolled C3 activation causes membranoproliferative glomerulonephritis in mice deficient in complement factor H. *Nat Genet* 2002;31:424–428.

739. Zipfel PF, Jokiranta TS, Hellwage J, et al. The factor H protein family. *Immunopharmacology* 1999;42:53–60.

740. Friese MA, Hellwage J, Jokiranta TS, et al. FHL-1/reconectin and factor H: two human complement regulators which are encoded by the same gene are differently expressed and regulated. *Mol Immunol* 1999;36:809–818.

741. Hellwage J, Sakari T, Jokiranta TS, et al. Functional properties of complement factor H-related proteins FHR-3 and FHR-4: binding to the C3d region of C3b and differential regulation by heparin. *FEBS Lett* 1999;462:345–352.

742. Blom AM, Kask L, Dahlbäck B. Structural requirements for the complement regulatory activities of C4BP. *J Biol Chem* 2001;276:27136–27144.

743. Barnum SR, Dahlback B. C4b-binding protein, a regulatory component of the classical pathway of complement, is an acute-phase protein and is elevated in systemic lupus erythematosus. *Complement Inflamm* 1990;7:71–77.

744. Blom AM, Kask L, Dahlbäck B. CCP1–4 of the C4b-binding protein  $\alpha$ -chain are required for factor I mediated cleavage of complement factor C3b. *Mol Immunol* 2003;39:547–556.

745. Nelson RM, Long GL. Solution-phase equilibrium binding interaction of human protein S with C4b-binding protein. *Biochemistry* 1991;30:2384–2390.

746. Tschopp J, Chonn A, Hertig S, et al. Clustering, the human apolipoprotein and complement inhibitor, binds to complement C7, C8B, and the b domain of C9. *J Immunol* 1993;151:2159–2165.
747. Farkas I, Baranyi L, Ishikawa Y, et al. CD59 blocks not only the insertion of C9 into MAC but inhibits ion channel formation by homologous C5b–8 as well as C5b–9. *J Physiol* 2002;539.2:537–545.
748. Frank MM, Fries LF. The role of complement in inflammation and phagocytosis. *Immunol Today* 1991;12:322–326.
749. Gerard C, Gerard NP. C5A anaphylatoxin and its seven transmembrane–segment receptor. *Annu Rev Immunol* 1994;12:775–808.
750. Nzeako UC, Frigas E, Tremaine WJ. Hereditary angioedema. *Arch Intern Med* 2001;161:2417–2429.
751. Morgan PB, Walport MJ. Complement deficiency and disease. *Immunol Today* 1991;12:301–306.
752. Rosse WF, Ware RE. The molecular basis of paroxysmal nocturnal hemoglobinuria. *Blood* 1995;86:3277–3286.
753. Johnson RJ, Hillmen P. Paroxysmal nocturnal haemoglobinuria: nature's gene therapy. *Mol Pathol* 2002;55:145–152.
754. Ikezawa H. Glycosylphosphatidylinositol (GPI)–anchored proteins. *Biol Pharm Bull* 2002;25:409–417.
755. Watanabe R, Inoue N, Westfall B, et al. The first step of glycosylphosphatidylinositol biosynthesis is mediated by a complex of PIG–A, PIG–H, PIG–C and GPI–1. *EMBO J* 1998;17:877–885.
756. Kinoshita T, Inoue N. Dissecting and manipulating the pathway for glycosylphosphatidylinositol–anchor biosynthesis. *Curr Opin Chem Biol* 2000;4: 632–638.
757. Eisenhaber B, Maurer–Stroh S, Novatchkova M, et al. Enzymes and auxiliary factors for GPI lipid anchor biosynthesis and post–translational transfer to proteins. *BioEssays* 2003;25:367–385.
758. Ohishu K, Inoue N, Kinoshita T. PIG–S and PIG–T, essential GPI anchor attachment to proteins, form a complex with GAA1 and GPI8. *EMBO J* 2001;20:4088–4098.
759. Hall C, Richards SJ, Hillmen P. The glycosylphosphatidylinositol anchor and paroxysmal nocturnal haemoglobinuria/aplasia model. *Acta Haematol* 2002;108:219–230.
760. Rosse WF, Ware RE. The molecular basis of paroxysmal nocturnal hemoglobinuria. *Blood* 1995;86:3277–3286.
761. Rosse WF. New insights into paroxysmal nocturnal hemoglobinuria. *Curr Opin Hematol* 2001;8:61–67.
762. Chen R, Nagarajan S, Prince G, et al. Impaired growth and elevated Fcγ receptor expression in PIGA<sup>+</sup> stem cells in primary paroxysmal nocturnal hemoglobinuria. *J Clin Invest* 2000;106:689–696.
763. Young NS, Maciejewski JP. Genetic and environmental effects in paroxysmal nocturnal hemoglobinuria: this little PIG–A goes “Why? Why? Why?” *J Clin Invest* 2000;106:637–641.
764. Orren AT, Würzner PC, Potter BA, et al. Properties of low molecular weight complement component C6 found in human subjects with subtotal C6 deficiency. *Immunology* 1992;75:10–16.
765. Orren A. Molecular mechanisms of complement component C6 deficiency; a hypervariable exon 6 region responsible for three of six reported defects. *Clin Exp Immunol* 2000;119:255–258.
766. Fernie BA, Orren A, Sheehan G, et al. Molecular basis of C7 deficiency. *J Immunol* 1997;159:1019–1026.
767. Orren A, O'Hara AM, Morgan BP, et al. An abnormal but functionally active complement component

- C9 protein found in an Irish family with subtotal C9 deficiency. *Immunology* 2003;108:384–390.
768. Hobart MJ, Fernie BA, Fijen KA, et al. The molecular basis of C6 deficiency in the western Cape, South Africa. *Hum Genet* 1998;103:506–512.
769. Cooper DN, Krawezak M. Gene deletions causing human disease: mechanisms of mutagenesis and the role of the local DNA sequence environment. *Hum Genet* 1991;86:425–441.
770. Zhu Z-B, Atkinson TP, Hovanky KT, et al. High prevalence of complement component C6 deficiency among African-Americans in the south-eastern United States. *Clin Exp Immunol* 2000;119:305–310.
771. Würzner R, Hobart MJ, Fernie BA, et al. Molecular basis of subtotal complement C6 deficiency. A carboxy-terminally truncated but functionally active C6. *J Clin Invest* 1995;95:1877–1883.
772. Orren A, Potter PC, Cooper R, et al. Deficiency of the sixth component of complement and susceptibility to *Neisseria meningitidis* infections. Studies in ten families and five isolated cases. *Immunology* 1987;62:249–253.
773. Dragon-Durey MA, Fremeaux-Bacchi V, Blouin J, et al. Restricted genetic defects underlie human complement C6 deficiency. *Clin Exp Immunol* 2003;132:87–91.
774. Smith LC, Clow LA, Terwilliger DP. The ancestral complement system in sea urchins. *Immunol Rev* 2001;180:16–34.
775. Smith LC, Azumi K, Nonaka M. Complement systems in invertebrates. The ancient alternative and lectin pathways. *Immunopharmacology* 1999;42:107–120.

2004 Lippincott Williams & Wilkins  
John P. Greer, John Foerster, John N. Lukens  
George M. Rodgers, Frixos Paraskevas, Bertil Glader  
Wintrobe's Clinical Hematology

HISTORICAL PERSPECTIVEMEGAKARYOCYTESCellular Basis of MegakaryopoiesisExtrinsic Regulation of MegakaryopoiesisMegakaryocyte Cellular DevelopmentPLATELETSStructural and Functional AnatomyPlatelet PhysiologyPlatelet Biochemistry and MetabolismPlatelet Microparticles, Heterogeneity, and KineticsInteractions beyond Platelets: The Coagulant SystemREFERENCES

The role of platelets in humans is straightforward: “Platelets plug holes in blood vessels.” However, the development of platelets from megakaryocytes and the structure of platelets in the blood are far from simple. This chapter describes first the production of platelets from marrow megakaryocytes and second the anatomy and composition of these unique elements.

## HISTORICAL PERSPECTIVE

Platelets were described by Addison in 1841 as “extremely minute...granules” in clotting blood (<sup>1</sup>) and were termed *platelets* (*blutplättchen*) by Bizzozero, who also observed their adhesive qualities as “increased stickiness...when a vascular wall is damaged” (<sup>2</sup>, <sup>3</sup>). The same elements were identified by microscopic examination of blood smears by Osler and by Hayem in the late nineteenth century (<sup>4</sup>, <sup>5</sup>).

Megakaryocytes have been recognized as rare marrow cells for nearly two centuries, but it was the elegant *camera lucida* studies of Howell in 1890 and his coining of the term *megakaryocyte* that led to their broader appreciation as distinct entities (<sup>6</sup>). In 1906, James Homer Wright put forth the hypothesis that blood platelets are derived from the cytoplasm of megakaryocytes (<sup>7</sup>, <sup>8</sup>), and the basic elements of thrombopoiesis were established.

## MEGAKARYOCYTES

Blood cell production is an enormous and complex task. Platelet production begins in the yolk sac (<sup>9</sup>) and, like the remainder of hematopoiesis, shifts to the fetal liver and then to the marrow at the time of gestation. Based on the adult blood volume (5 l), the number of platelets per  $\mu\text{l}$  of blood ( $\sim 2 \times 10^5$ ), and their circulatory half-life (10 days), it can be calculated that each day an adult human produces  $1 \times 10^{11}$  platelets. The platelet count varies among the healthy population ( $1.5$  to  $3.5 \times 10^5/\mu\text{l}$ ) but remains within a fairly narrow range in any given individual. In times of increased demand, platelet production can



rise tenfold or more. This chapter discusses the biochemical, cell physiologic, and molecular mechanisms underlying the development of megakaryocytes, the complex processes by which they generate thousands of platelets and then undergo programmed cell death (PCD), and the cell biology and biochemistry of platelet function in hemostasis. It is hoped that a thorough understanding of these processes will clarify the underlying mechanisms responsible for their pathologic disruption and aid in better devising strategies to intervene in those conditions associated with reduced, enhanced, or disordered megakaryocyte or platelet function, or both.

## Cellular Basis of Megakaryopoiesis

The basic concepts of a hierarchic organization of stem and progenitor cells leading to mature blood cell production were formulated by Till and McCulloch in the early 1960s, although the concept of a common “mother cell” of all blood elements in the adult dates to Danchakoff in 1916 ( [10](#) ). The capacity to transplant marrow cells and reconstitute all of hematopoiesis in lethally irradiated recipients provided an *in vivo* assay for the hematopoietic stem cell (HSC), but it was not until the development of clonal *in vitro* assays of hematopoietic progenitors that a coherent model of blood cell production emerged. The pioneering work of Pluznik and Sachs ( [11](#) ) and of Bradley and Metcalf ( [12](#) ) provided a convenient method to enumerate and characterize marrow cells committed to various hematopoietic lineages. These investigators independently developed culture conditions that allowed colonies of cells to develop from single progenitors. However, the first hematopoietic colonies were composed of leukocytes; due to the more fastidious conditions required for megakaryopoiesis *in vitro*, the description of clonal megakaryocyte growth did not occur for another decade or more ( [13](#), [14](#), [15](#) and [16](#) ). Recent work using density fractionation, cell sorting, and fluorescent dye exclusion methods has yielded purified populations of stem cells ( [17](#), [18](#), [19](#), [20](#) and [21](#) ), common myeloid ( [22](#) ) and lymphoid ( [23](#) ) progenitors, and lineage-restricted hematopoietic progenitors ( [24](#), [25](#) ); these methods have greatly advanced understanding of the cell and the molecular biology of megakaryocyte development.

Culture conditions that support the proliferation of megakaryocytic progenitors have been described using methylcellulose, agar, or a plasma clot assay. Multiple investigators have demonstrated two colony morphologies that exclusively contain megakaryocytes. The colony-forming unit megakaryocyte (CFU-MK) is a cell that develops into a simple colony containing 3 to 50 mature megakaryocytes ( [13](#), [14](#) and [15](#) ). Larger, more complex colonies that include satellite collections of megakaryocytes and contain up to several hundred cells are derived from the burst-forming unit megakaryocyte (BFU-MK) ( [16](#), [17](#) ). Such lineage-restricted colonies have been described using marrow cells from both human and murine sources. Because of the difference in their proliferative potential and by analogy to erythroid progenitors, BFCU-MK and CFU-MK are thought to represent primitive and mature progenitor cells restricted to the megakaryocyte lineage. Human marrow BFCU-MKs are CD34<sup>+</sup> and HLA-DR<sup>-</sup> and develop into multifocal collections of at least 100 megakaryocytes within approximately 21 days in culture ( [16](#), [17](#), [26](#), [27](#) ). CFU-MK-derived colonies are morphologically simpler, containing as few as three megakaryocytes and developing in 10 to 12 days; their progenitors are CD34<sup>+</sup> but HLA-DR<sup>+</sup> and are rapidly cycling cells as determined by their sensitivity to 5-fluorouracil ( [13](#), [14](#) and [15](#), [28](#), [29](#) ). Recently, the close relationship of the erythroid and megakaryocyte lineages was reinforced by the identification of a mixed erythroid-megakaryocyte progenitor ( [30](#), [31](#), [32](#), [33](#) and [34](#) ). It is unlikely that all CFU-MK and BFCU-MK arise from colony-forming unit erythroid-megakaryocytes, although definitive evidence has not yet been presented. More recently, fractionation methods have been devised that yield

purified populations of CFU-MK for functional and biochemical analysis ( [25](#) ).

## Extrinsic Regulation of Megakaryopoiesis

**IDENTIFICATION AND PURIFICATION OF HUMORAL REGULATORS** Perhaps the greatest debate surrounding the role of growth factors in hematopoiesis is whether they affect the differentiation of hematopoietic stem and progenitor cells or whether they merely allow for the survival of receptor-bearing cells by preventing PCD. Evidence for both views has been presented ( [35](#) , [36](#) and [37](#) ), and it is fair to say that this controversy is far from resolved. Nevertheless, a great deal is now understood about the cyto-kines that affect megakaryocyte development. In the search to identify the primary humoral regulator of thrombopoiesis, several cytokines, first identified using alternate hematopoietic activity assays, were also found to affect megakaryocyte development. Interleukin (IL)-3, granulocyte-macrophage colony-stimulating factor (GM-CSF), and the c-kit ligand (KL) support the proliferation of megakaryocyte progenitors in plasma-containing cultures ( [38](#) , [39](#) , [40](#) , [41](#) and [42](#) ). IL-3 is a 25- to 30-kd protein produced primarily by T lymphocytes ( [43](#) ). The mature human polypeptide contains 133 amino acids, but significant amounts of N-linked carbohydrate modification account for the larger-than-expected relative molecular mass ( $M_r$ ) of the cyto-kine. GM-CSF is an 18- to 30-kd protein also produced by T lymphocytes, but endothelial cells, monocytes, and fibroblasts also produce the protein and, like IL-3, GM-CSF is highly modified with both N-linked and O-linked carbohydrate ( [44](#) ). Although the two polypeptides display essentially no primary sequence homology, their tertiary structures are highly related ( [45](#) , [46](#) ), and the receptors for the two cytokines share a common subunit ( [47](#) ). However, the physiologic relevance of IL-3 and GM-CSF for thrombopoiesis is uncertain because their administration to mice or humans has only minimal effects on platelet production, and the genetic elimination of either cytokine has no impact on megakaryopoiesis, even in combination with the elimination of other thrombopoietic cytokines ( [48](#) , [49](#) ). In contrast to the hematopoietic cytokine family, KL is more closely related to other hematopoietic proteins that use protein tyrosine kinase receptors, such as macrophage colony-stimulating factor and the flt-3 ligand (FL) ( [50](#) ). Nevertheless, KL has been shown to stimulate megakaryocyte colony growth when used in combination with other cytokines ( [42](#) , [51](#) , [52](#) ). Moreover, genetic elimination of *c-kit* reduces megakaryocyte production ( [53](#) ) and the rebound thrombocytosis that occurs after immunosuppressive therapy ( [54](#) , [55](#) ). Kit ligand was first identified using several different biologic assays (in addition to the term *KL*, the cytokine has been dubbed *stem cell factor*, *mast cell growth factor*, and *steel factor*) ( [56](#) , [57](#) , [58](#) and [59](#) ). Most recent studies indicate that the cytokine acts primarily on primitive cells of the hematopoietic, melanogenic, and germ cell systems ( [60](#) , [61](#) , [62](#) , [63](#) , [64](#) and [65](#) ). KL is a dimeric protein composed of two identical non-covalently linked polypeptides; the soluble form monomer contains 165 residues ( [66](#) ), derived by proteolytic cleavage of a membrane-bound form of the molecule ( [67](#) ). The membrane-bound form is actually more active than the soluble cytokine because cell survival and proliferation signals derived from the former are prolonged in receptor-bearing cells ( [68](#) ). Moreover, a naturally occurring mutant allele of the gene ( *S*<sup>a</sup> ), which allows production of the soluble but not the membrane-bound form of KL, results in a phenotype nearly identical to deletion of the entire locus ( [69](#) ). The effects of FL on megakaryocyte formation have also been investigated. This growth factor was initially identified as a ligand for a novel member of the protein tyrosine kinase family of receptors ( [50](#) ). Similar to KL, to which it is most closely related, FL is found in both soluble and membrane-bound forms, is a non-covalently linked dimer, and affects primarily primitive hematopoietic cells ( [50](#) , [70](#) , [71](#) ). Although several studies have shown

that when used alone FL does not support megakaryocyte colony formation, some studies suggest that it works in synergy with other megakaryocyte stimulatory agents to augment the proliferation of CFU-MK in culture ( [72](#) ). Moreover, the administration of FL to mice clearly expands the number of marrow and splenic progenitor cells that can give rise to megakaryocytes *in vitro* ( [73](#) ). However, genetic elimination of FL or its receptor has no platelet phenotype. In the late 1980s and early 1990s, three molecules related by use of a common receptor subunit were characterized that display effects on megakaryocyte production. IL-6, cloned by several groups using multiple assays [hepatocyte growth, myeloma cell growth, immunoglobulin (Ig) secretion, antiviral activity], was also found to enhance megakaryocyte maturation. IL-6 is a 26-kd polypeptide widely produced in response to inflammatory stimuli from T cells, fibroblasts, macrophages, and stromal cells ( [74](#) ). The mature protein is composed of 184 amino acids, contains two disulfide bonds, and displays both N-linked and O-linked carbohydrate modification. Although IL-6 alone does not affect *in vitro* megakaryopoiesis, it augments the number of megakaryocyte colonies obtained in the presence of IL-3 or KL ( [75](#) , [76](#) ). In such culture systems, IL-6 exerts primarily a differentiating effect, as its levels correlate with megakaryocyte size and ploidy in long-term marrow cultures, and its neutralization reduces these parameters ( [77](#) , [78](#) , [79](#) and [80](#) ). The administration of IL-6 to mice, dogs, or humans results in a modest thrombocytosis ( [75](#) , [78](#) , [81](#) , [82](#) , [83](#) and [84](#) ). These findings suggest that IL-6 might contribute to megakaryopoiesis *in vivo*—a conclusion supported by its production by tumor cells in selected cases of paraneoplastic thrombocytosis ( [85](#) , [86](#) , [87](#) , [88](#) and [89](#) ). However, genetic elimination of IL-6 does not significantly affect basal platelet production ( [90](#) ); recent evidence suggests that the cytokine affects platelet production indirectly ( [91](#) ). IL-11 and leukemia inhibitory factor (LIF) also act in synergy with IL-3 or KL to augment megakaryocyte formation. IL-11 is a 23-kd polypeptide initially cloned from a gibbon marrow stromal cell line as an activity that supported the proliferation of an IL-6 responsive myeloma cell line ( [92](#) , [93](#) ). LIF was initially cloned as a human interleukin that induced DA-1 cells to proliferate (hence its alternate name, *HILDA*) or induced leukemic M1 cells to differentiate ( [94](#) , [95](#) ). LIF displays a wide range of activities ( [96](#) ) including effects on the liver (initiates the acute phase response), neurons (induces an adrenergic to cholinergic switch), adipocytes (inhibits lipoprotein lipase), and embryonic cells (maintains pluripotentiality). Like IL-6 and IL-11, LIF enhances megakaryocyte maturation *in vitro* ( [80](#) , [97](#) ). Moreover, IL-6 and IL-11 were also found to augment the effects of IL-3 and KL on the proliferation of primitive hematopoietic cells, suggesting that these cytokines augment megakaryocyte development at multiple levels. Consistent with these *in vitro* findings, the administration of either recombinant IL-11 or LIF to rodents, nonhuman primates, or humans produces a modest thrombocytosis ( [94](#) , [98](#) , [99](#) , [100](#) , [101](#) and [102](#) ). Together, such findings suggested to many that these pleiotropic cytokines might provide the equivalent of the postulated primary regulator of platelet function, thrombopoietin (TPO). However, several investigators argued that neither IL-6 nor IL-11 was TPO ( [103](#) , [104](#) , [105](#) and [106](#) ). Consistent with this opposing view, only approximately 25% of thrombocytopenic children (amegakaryocytic thrombocytopenia, aplastic anemia, immune-mediated thrombocytopenia) displayed elevated levels of IL-11 ( [107](#) ), and IL-11 levels are, for the most part, normal in adult patients with thrombocytopenia secondary to liver failure or after myelosuppressive or myeloablative therapy ( [88](#) , [108](#) , [109](#) ). Moreover, genetic elimination of either LIF or the IL-11 receptor has no obvious effect on thrombopoiesis ( [110](#) , [111](#) ). The term *thrombopoietin* was first coined in 1958 to describe the primary regulator of platelet production ( [112](#) ). Over the following four decades, evidence both for and against its existence as a distinct entity was presented ( [113](#) , [114](#) ). Although not appreciated at the time, a major insight into megakaryocyte biology was provided in 1986 when Françoise Wendling and her colleagues described a murine retrovirus, myeloproliferative leukemia virus, which induced a vast expansion of

hematopoietic cells (115). The responsible viral oncogene was characterized in 1990 (116), and its cellular homolog *c-mpl* was cloned in 1992 (117). Based on the presence of two copies of the hematopoietic cytokine receptor motif, it was immediately apparent that *c-mpl* encoded a growth factor receptor. However, its ligand was not known. Using three distinct strategies, four separate groups were able to clone the cDNA for the corresponding hormone and reported their results in 1994 (118, 119, 120 and 121). The gene for this *c-mpl* ligand was mapped to human chromosome 3q26–28, spans 6 to 8 kb, consists of seven exons, and encodes a predicted 36-kd polypeptide (122, 123 and 124). The recombinant and naturally occurring hormones migrate as 70-kd proteins, indicating substantial posttranslational modification, a conclusion verified by the finding of six sites of N-linked carbohydrate and many sites of O-linked carbohydrate (125). Based on its biologic activities, the *c-mpl* ligand was termed *thrombopoietin* (126). TPO bears striking homology to erythropoietin (EPO), the primary regulator of erythropoiesis, within the amino terminal half of the predicted polypeptide (118, 119, 120 and 121). The two proteins are more closely related than any other two cytokines within the hematopoietic cytokine family, sharing 20% identical amino acids, an additional 25% conservative substitutions, and identical positions of three of the four cysteine residues. However, unlike any of the other cytokines in the family, TPO contains a 181-residue carboxyl terminal extension, which bears homology to no known proteins. Two functions have been assigned to this region: It prolongs the circulatory half-life of the hormone (127), and it aids in secretion of the cytokine from cells that normally synthesize it (128, 129). The biologic activities of TPO are consistent with a primary role in megakaryopoiesis. Incubation of marrow cells from mice, rats, dogs, nonhuman primates, and humans with TPO leads to an impressive stimulation of megakaryocyte growth in both suspension and semisolid culture (52, 118, 126, 130). Compared to cultures initiated with IL-3 or KL, with or without IL-6, IL-11, or LIF, marrow cells grown in TPO contain greater numbers of megakaryocytes, and the cells are larger and more highly polyploid. When administered to animals or humans, TPO stimulates platelet production in a log-linear manner to levels tenfold higher than baseline (120, 126, 127, 131, 132 and 133) without affecting the peripheral blood red or white cell counts. However, perhaps unexpectedly, the number of erythroid and myeloid progenitors and mixed myeloid progenitors in marrow and spleen were also increased in some studies (134, 135), an effect that is especially impressive when the hormone is administered to animals after myelosuppressive therapy (134, 136, 137) and probably due to the synergy (52) between TPO and the other hematopoietic cytokines circulating at high levels in this condition. Clinically, the most important activity of TPO is likely to be its effects on megakaryopoiesis, potentially ameliorating the thrombocytopenia that occurs in natural and iatrogenic states of marrow failure. In this regard, a number of investigators have reported promising results in preclinical trials of the cytokine (136, 137, 138, 139, 140 and 141). More recently, a number of clinical trials have been conducted, with the hormone helpful in many (132, 142, 143, 144 and 145) but not all clinical situations (146, 147 and 148). The biologic effects of TPO *in vitro* and of its administration *in vivo* strongly suggest the hormone plays an important role in hematopoiesis. Based on genetic studies, it is now clear that TPO is the primary regulator of thrombopoiesis. Genetic elimination of *c-mpl* or *tpc* leads to profound thrombocytopenia in mice due to a greatly reduced number of megakaryocyte progenitors and mature megakaryocytes and the reduced polyploidy of the remaining megakaryocytes (123, 149). More recently, a human equivalent of *mpl* deficiency has been identified: congenital amegakaryocytic thrombocytopenia. In more than a dozen cases, the presence of nonsense or missense mutations has been identified that in homozygous or mixed heterozygous inheritance eliminates TPO responsiveness (150, 151 and 152). In addition to the critical roles for TPO revealed by these knock-out studies, the broader range of hematopoietic activities identified in *in vitro* studies of stem and primitive hematopoietic cells (153, 154) was confirmed in genetically engineered mice (155,

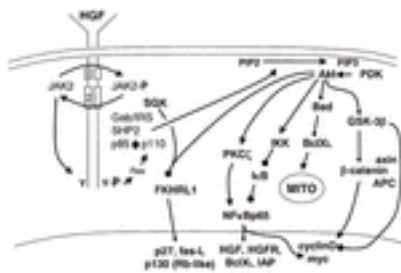


[156](#)) and in patients with congenital amegakaryocytic thrombocytopenia ([157](#)). By contrast, genetic elimination of IL-3, GM-CSF, IL-6, IL-11 receptor, or LIF produces other hematologic phenotypes but has no effect on thrombopoiesis ([111](#), [158](#), [159](#), [160](#) and [161](#)), and mutation of KL reduces platelet production only modestly ([51](#)). The TPO gene displays an unusual 5' untranslated region structure. Unlike the majority of genes that initiate translation of the encoded polypeptide from the first ATG codon present in the mRNA, TPO translation initiates at the eighth ATG codon located within the third exon of a full-length transcript [there are two transcription initiation sites that differ because of alternate splicing of the first exon ([122](#))]. Moreover, the eighth ATG is embedded in the short open reading frame (ORF) of the seventh ATG—a particularly inefficient circumstance for translation initiation ([162](#)). As such, little TPO protein is produced for any given amount of mRNA. Although it is not yet certain whether this molecular arrangement has physiologic consequences (i.e., it can be differentially regulated), it is clear that mutation of the TPO gene in noncoding sequences can lead to enhanced translation efficiency and thrombocytosis. Four cases of familial thrombocytosis have been linked to mutations in the region surrounding the initiation codon. In two families, a single mutation in different nucleotides of the intron 3 splice donor sequence results in alternate splicing of the primary TPO transcript, eliminating the seventh and eighth ATG codons, and in the creation of a new amino terminus by the fusing of the fifth ORF with the TPO coding sequence. This novel TPO mRNA is efficiently translated, resulting in supraphysiologic levels of hormone production and nonclonal expansion of thrombopoiesis ([163](#), [164](#)). In another mutant TPO allele, the deletion of a single nucleotide within the seventh ORF leads to its fusion with the TPO coding sequence and to now-enhanced translation of TPO from the seventh ATG codon ([165](#)). Finally, another mutation within the seventh ORF leads to its premature termination, preventing its interference with translation initiation from the usual eighth initiation codon ([166](#)) and again enhancing TPO production. These diseases of mRNA translation were recently summarized ([167](#)). The induction of acute immune-mediated thrombocytopenia results in a relatively rapid restoration of platelet levels followed by a brief period of rebound thrombocytosis ([114](#), [168](#), [169](#) and [170](#)). In most experimental and natural cases of thrombocytopenia, plasma concentrations of TPO vary inversely with platelet counts, rising to maximal levels within 24 hours of the onset of profound thrombocytopenia ([171](#), [172](#) and [173](#)). Two models have been advanced to explain these findings. In the first, TPO production is constitutive, but its consumption (and, hence, the level remaining in the blood to affect megakaryopoiesis) is determined by the mass of mpl receptors (i.e., platelets and megakaryocytes) accessible to the plasma ([174](#), [175](#)). In this way, states of thrombocytosis result in increased TPO consumption (by the expanded platelet mass of mpl receptors), reducing megakaryopoiesis. Conversely, thrombocytopenia reduces peripheral blood TPO destruction, resulting in elevated blood levels of the hormone that drive megakaryopoiesis and platelet recovery. This model is based on one advanced for the regulation of macrophage colony-stimulating factor levels by monocyte uptake and destruction ([176](#)). The weight of current evidence supports an important role for this mechanism in the regulation of TPO production because the level of hepatic and renal TPO mRNA, the two most prominent tissue sources of specific transcripts, do not vary in states of profound thrombocytopenia or thrombocytosis ([173](#), [177](#)). Moreover, TPO knock-out mice display a gene dosage effect ([118](#)); platelet levels in heterozygous mice are intermediate between the wild-type and nullizygous animals, suggesting that active regulation of the remaining TPO locus does not compensate for the reduced level of mRNA derived from the remaining normal allele, at least for this minimal (60% of normal) thrombocytopenic stimulus. An alternative model suggests that TPO expression is a regulated event; very low platelet levels can induce enhanced mRNA production. Evidence for this model of regulation has been slower to develop. However, two studies argue that TPO mRNA levels are modulated in response to thrombocytopenia, at least in the marrow. By using a semiquantitative assay, McCarty and co-workers found increased TPO-specific mRNA in

the marrow of mice made thrombocytopenic by both immune and myelosuppressive methods ( [177](#) ). These findings were confirmed in more recent studies; TPO was found in marrow stromal cells ( [178](#), [179](#) ), and, using *in situ* hybridization, marrow—but not liver or kidney—TPO mRNA signals were increased in patients with thrombocytopenia ( [178](#) ). In addition, a number of platelet proteins have been shown to modulate TPO production from marrow stromal cells [e.g., CD40 ligand, platelet-derived growth factor, fibroblast growth factor, transforming growth factor (TGF)- $\beta$ , platelet factor (PF) 4, and thrombospondin ( [180](#), [181](#) )], providing additional mechanisms for the regulation of thrombopoiesis. However, the relative importance of TPO gene regulation in the marrow is presently uncertain. The human TPO gene 5' flanking region lacks a TATA box or a CAAT motif and directs transcription initiation at multiple sites over a 50-nucleotide region ( [182](#) ). Reporter gene analysis in a hepatocyte cell line identified an Ets2 transcription factor-binding motif responsible for high-level expression of the gene. The 5' flanking region also includes specificity protein-1-, activator protein-2-, and nuclear factor- $\kappa$ B (NF- $\kappa$ B)-binding sites ( [122](#) ), although the contribution of these transcription factors to TPO gene expression, either under steady-state or stimulated conditions, has not yet been studied. In addition to the positive regulators of megakaryopoiesis, several substances have been shown to down-modulate megakaryocyte development. TGF- $\beta$  is a family of five isoforms, all disulfide-linked homodimers each containing 112 residues ( [183](#) ). TGF- $\beta$ <sub>1</sub> is the predominant type of TGF found in hematopoietic tissues; platelet  $\alpha$ -granules are a particularly rich source of the cytokine. TGFs are, in general, inhibitors of hematopoiesis, particularly of megakaryocyte development ( [184](#), [185](#), [186](#), [187](#) and [188](#) ). The two best understood TGF- $\beta$  growth inhibitory effects are exerted on cell cycle progression. After binding to one of five TGF receptors, two pathways that block cell cycle progression are activated: pRb is hypophosphorylated ( [189](#) ), antagonizing the effects of G<sub>1</sub>-phase cyclin-dependent kinases ( [190](#) ), and the cell cycle inhibitor p27 is up-regulated, again halting cell cycle progression at the level of S phase ( [191](#) ). It should be noted that TGF- $\beta$  is not inhibitory only for megakaryopoiesis; rather, the cytokine appears to reduce hematopoiesis at many levels ( [192](#), [193](#) and [194](#) ). In contrast to these effects of TGF- $\beta$  on cell proliferation, recent evidence has been presented that the cytokine might enhance megakaryocyte differentiation by enhancing expression of the cell cycle inhibitor p15<sup>Ink</sup> ( [195](#) ), an effect that may be due to autocrine production of the cytokine. Additional platelet granule proteins found to inhibit megakaryocyte development include the chemokine PF4 ( [196](#) ) and  $\beta$ -thromboglobulin ( [197](#) ). Whether these cytokines constitute a negative feedback regulatory system (i.e., high platelet counts lead to enhanced TGF- $\beta$ ,  $\beta$ -thromboglobulin, and PF4 release, resulting in inhibition of megakaryocyte development) is uncertain at present. Finally, interferon (IFN)- $\alpha$  inhibits megakaryopoiesis, and its use leads to modest to severe thrombocytopenia in a significant number of patients undergoing therapy for chronic hepatitis ( [198](#), [199](#) ). The mechanisms responsible for the inhibitory effect of IFN- $\alpha$  are several. Some studies suggest a direct inhibitory effect of IFN- $\alpha$  on growth factor-induced proliferation pathways. For example, the cytokine augments double-stranded RNA-activated protein kinase activity, inhibiting translation initiation factor-2 and implicating reduction of the growth factor-induced protein synthesis necessary for cytokine response ( [200](#) ). Other investigators have reported that the functionally similar cytokine IFN- $\beta$  induces expression of the cell cycle inhibitor p27<sup>kip1</sup>, arresting cells in G<sub>0</sub>/G<sub>1</sub> ( [201](#) ). More recently, Wang and colleagues demonstrated that IFN- $\alpha$  induces a suppressor of cytokine signaling-1-based feedback mechanism that cross-reacts and depresses TPO signaling ( [202](#) ) (see the section [Molecular Mechanisms That Translate Cytokine Signaling into Megakaryocyte Survival, Proliferation, and Differentiation](#)). Thus, in addition to the multiple positive mediators of megakaryopoiesis, several cytokines block the process and can lead to thrombocytopenia.

**COMPONENTS OF THE HEMATOPOIETIC MICROENVIRONMENT** It has been estimated that the cellular concentration within the marrow is  $10^9$  per ml; as such, cell–cell and cell–matrix interactions are certain to occur (203). Marrow stromal cells influence hematopoiesis in a number of ways. Marrow cells produce several cytokines that positively or negatively affect megakaryocyte growth (179, 204, 205, 206, 207 and 208) and some that are expressed on their cell surfaces (68, 205). Stromal cells are the origin of a number of extracellular matrix proteins and glycomucins that either directly affect hematopoietic cells or do so indirectly by binding growth factors and presenting them in a functional context (209, 210). They also bear ligands for Notch proteins, cell–surface receptors conserved from *Drosophila* to human, which are critical mediators of cell fate decisions (211, 212). Recent evidence has established important roles for Notch and its ligands Delta and Jagged as mitogenic regulators of primitive and mature hematopoietic progenitor cells (213, 214 and 215). Cell–cell interactions mediated by integrins present on hematopoietic cells and their counter–receptors on stromal cells are also very important for hematopoiesis (216); in addition to bringing hematopoietic cells into close proximity to cells producing soluble or cell–bound cytokines and, hence, raising the local concentration of these growth–promoting proteins, integrin engagement leads to intracellular signaling, usually promoting entry into the cell cycle and the prevention of PCD.

**MOLECULAR MECHANISMS THAT TRANSLATE CYTOKINE SIGNALING INTO MEGAKARYOCYTE SURVIVAL, PROLIFERATION, AND DIFFERENTIATION** Although each of the cytokines and cell–surface proteins that affect megakaryocyte growth and development use entirely distinct receptors, a remarkable overlap of biochemical consequences of receptor engagement has been identified in studies of cytokine signaling. As such, the molecular events triggered by cytokine action are discussed in general, with those that affect specific aspects of megakaryocyte development expanded on in the sections below. Several lines of evidence indicate that tyrosine phosphorylation is vital for cellular responses to hematopoietic growth factors (217, 218 and 219). Nevertheless, the receptors for most hematopoietic cytokines that affect megakaryocytes, including IL–3, IL–6, IL–11, LIF, and TPO, do not display any enzymatic activity. Instead, receptors of this class recruit cytoplasmic Janus kinase (JAK) family tyrosine kinases to a short motif (termed *box1*) adjacent to the transmembrane domain of the receptor (220, 221). Once the receptor is bound by ligand, a conformational change brings the tethered JAK kinases into close juxtaposition (222), resulting in their transphosphorylation (Fig. 19.1). Four JAK kinases have been identified in hematopoietic cells: JAK1, JAK2, JAK3, and TYK2 (220). Of the cytokines that affect megakaryopoiesis, IL–3 activates JAK2 (223); IL–6, IL–11, and LIF activate JAK1, JAK2, and TYK2 (although JAK1 is most important) (224); and TPO leads to JAK2 and TYK2 phosphorylation (225, 226 and 227) (although JAK2 is most important) (228). Moreover, even members of the receptor tyrosine kinase family that affect megakaryopoiesis, such as KL or FL, activate JAK kinases (229, 230).



**Figure 19.1.** A model of growth factor–induced stimulation of cell cycling and cell survival. On binding to its cognate receptor, hematopoietic growth factor (HGF) induces a conformational change in a preexisting dimeric receptor. Such a change brings the cytoplasmic domains of the two receptors into close juxtaposition, allowing interaction of two Janus kinase (JAK) molecules normally tethered to the box 1 (and possibly) box 2



regions of the receptor. This event leads to mutual cross-tyrosine phosphorylation (indicated by -P), kinase activation, and subsequent phosphorylation of tyrosine (Y) residues in the cytoplasmic domain of the receptor. In this particular example, additional substrates for the activated JAK kinase include adapter proteins of the Gab and IRS families, the phosphatase SHP2, and the regulatory subunit (p85) of phosphoinositol 3-kinase (PI3K). Once this multimolecular complex forms, it recruits and activates the kinase domain of PI3K (p110), which then phosphorylates membrane-bound phosphoinositol 4,5 phosphate (PIP2) to form PI 3,4,5 phosphate (PIP3). Proteins containing pleckstrin homology domains including phosphoinositide-dependent kinase (PDK) and the serine/threonine kinase Akt (also termed *protein kinase B*) are then recruited to cell membranes bearing PIP3, thereby allowing PDK to phosphorylate Akt and activate it. The substrates of Akt include (a) Bad, inactivating the proapoptotic molecule [which would otherwise act to sequester and inactivate the mitochondrial (MITO) membrane antiapoptotic molecule BclX<sub>L</sub>]; (b) glycogen synthase kinase (GSK)-3 $\beta$ , which with axin and the product of the adenomatosis polyposis coli (APC) gene product, inhibits the nascent transcription factor  $\beta$ -catenin; (c) inhibitor of  $\tau$ B kinase (IKK), thereby activating it to phosphorylate inhibitor of  $\tau$ B (I $\tau$ B), thereby inactivating it, removing it from nuclear factor- $\tau$ B (NF- $\tau$ B), and allowing the latter to translocate to the nucleus and act as a transcription factor for prosurvival [inhibitor of apoptosis (IAP), BclX<sub>L</sub>, and other HGFs and hematopoietic growth factor receptors (HGFRs)]; (d) protein kinase C (PKC)  $\zeta$ , which also helps to activate NF- $\tau$ B; and (e) the forkhead transcription factor FKHL1, inactivating it, which would otherwise stimulate transcription of cell cycle inhibitors such as p27 and the proapoptotic fas-ligand (fas-L). The serum and glucocorticoid responsive kinase (SGK) also helps to inactivate forkhead transcription factors, although the mechanism of its activation by growth factors is not certain. The activating (with respect to cell cycling and survival) events are depicted as solid arrows; the inhibitory actions as lines ending in solid circles.

Phosphorylation of JAKs leads to their activation, which, in turn, leads to phosphorylation of a number of substrates, including the receptors themselves and reversibly tethered signaling molecules. One of the best studied families of secondary signaling molecules is the signal transducers and activators of transcription (STATs); these latent transcription factors dock at P-Tyr residues of cytokine receptors and are phosphorylated by JAKs, and, once so modified, P-STATs dimerize, translocate to the nucleus, and bind to specific genetic elements altering transcription. Both P-Tyr and P-Ser modifications are required to fully activate STATs ( [231](#) and [232](#) ). Of the cytokines affecting megakaryocyte development, IL-3 and GM-CSF activate STAT5 ( [233](#) ); IL-6, IL-11, and LIF activate STAT3 ( [234](#), [235](#) ); and TPO activates both STAT3 and STAT5 ( [236](#), [237](#), [238](#) and [239](#) ). Among the known targets of the STATs known to play an important role in cell survival and proliferation are BclX<sub>L</sub> and *c-myc* ( [240](#), [241](#), [242](#) and [243](#) ), with STAT1 displaying generally inhibitory effects on cell cycling and STAT3 and STAT5 displaying the opposite ( [244](#) ). Receptor P-Tyr motifs recruit additional signaling intermediates via SRC homology 2 domains, including the p85 regulatory subunit of phosphoinositol (PI) 3-kinase (PI3K), the guanine nucleotide exchange factor Vav, adapter proteins such as Shc and the Gabs, and the phosphatase SHP2, which, once modified by phosphorylation or docking-induced conformational change, induce activation of additional signaling pathways. The recruitment of pleckstrin homology (PH) domain-containing proteins to the inner cell membrane activates many signaling pathways and brings others into close juxtaposition to their substrates or activators, helping to orchestrate many of the biochemical responses to hematopoietic growth factors. PH domain-containing proteins dock to PI 4,5 phosphate (PIP2) and PI 3,4,5 phosphate (PIP3), which are generated in cell membranes by PI3K, a heterodimeric lipid kinase composed of a 110-kd kinase (p110) and an 85-kd (p85) regulatory subunit ( [Fig. 19.1](#) ). PI3K activity is initiated by the engagement of the two SRC homology 2 domains of p85, either by a phosphorylated cytokine receptor [usually in the context of YXXM or YVAC ( [245](#), [246](#) and [247](#) )] or an adapter molecule ( [248](#), [249](#), [250](#), [251](#) and [252](#) ), resulting in conformational changes allowing its recruitment and activation of p110 (

253). Once engaged by membrane-bound receptor or adapter molecule, p110 is brought into proximity of its membrane lipid substrates and its coactivator, membrane-bound activated ras (254). The levels of membrane PI phosphorylation are also under negative regulation by the phosphatases SRC homology 2-containing inositol phosphatase (255, 256 and 257) and PTEN (258, 259). PI3K is activated in response to several cyto-kines that affect thrombopoiesis, including IL-3, GM-CSF, KL, IL-6, and TPO (230, 251, 252, 260, 261, 262, 263, 264 and 265), the blockade of which, in primary megakaryocytes, leads to reduced cell survival and DNA synthesis (266). Of the many proteins activated by PI3K, the Ser/Thr kinase Akt and its activating kinase phosphoinositide-dependent kinase (PDK)-1 (267) have received the most attention. PDK1 activity toward a specific substrate is dictated by the target protein conformation and by its juxtaposition to substrate. PDK1 contains a PH domain and is thus recruited to the cell membrane on PI3K-induced formation of PIP3, bringing PDK substrates with it (268). Once membrane PI phosphates engage the PH domain of a PDK1 substrate (e.g., Akt), a conformational change exposes a phosphorylation site, allowing its phosphorylation and activation by PDK1 (263). Additional substrates for this type of conformational change requirement are protein kinase C  $\alpha$  and p70S6K [which also requires mitogen-activated protein kinase (MAPK) phosphorylation of an autoinhibitory region]. Once Akt is phosphorylated by PDK1, then it likely autophosphorylates on Ser<sup>473</sup> (an activity previously attributed to a putative “PDK2”), leading to full activation of the kinase (269). Perhaps the best known function of Akt is to phosphorylate the proapoptotic protein Bad, resulting in its binding to protein 14-3-3 and destruction, removing its inhibitory effect on Bcl-X<sub>L</sub> (Fig. 19.1) (270, 271 and 272). However, other studies indicate that the phosphorylation of Bad does not always correlate with the prevention of PCD (273, 274), leading one to consider other Akt-mediated antiapoptotic pathways. Akt also affects the activity or abundance of a number of transcription factors linked to cell survival and cell cycling. One such pathway is the lymphocyte enhancer factor-1/ternary complex factor, initially identified downstream of Wnt, an evolutionary conserved signaling molecule involved in processes as diverse as segmentation, control of asymmetric cell divisions, and hematopoietic expansion (275, 276). In response to cytokine receptor signaling, Akt phosphorylates and thereby inactivates glycogen synthase kinase-3 $\beta$ , which, if active, phosphorylates  $\beta$ -catenin, leading to its proteasomal destruction (277, 278) (Fig. 19.1). The net effect of Akt activation is the accumulation of free  $\beta$ -catenin, which translocates to the nucleus converting lymphocyte enhancer factor-1/ternary complex factor from a transcriptional repressor to an activator (279, 280). Among the known genetic targets of the  $\beta$ -catenin/lymphocyte enhancer factor-1/ternary complex factor complex that mediate cell proliferation are *cyclin D*, *p27*, and *c-myc* (281, 282 and 283). Glycogen synthase kinase-3 $\beta$  also has a second, more direct negative effect on the cell cycle: phosphorylating cyclin D1, forcing its association with the nuclear exportin CRM1, and leading to its destruction in the cytoplasm (284); Akt-mediated reduction in glycogen synthase kinase-3 $\beta$  activity thus also enhances nuclear cyclin D levels, driving cell cycling. Another indirect Akt target is NF- $\kappa$ B, a family of dimeric transcription factors sequestered at baseline in the cytoplasm by inhibitor of  $\kappa$ B (I $\kappa$ B) proteins but released to the nucleus on ubiquitin-mediated destruction of the latter. The vital antiapoptotic targets of NF- $\kappa$ B are caspase inhibitors (285, 286 and 287) and members of the bcl family (288, 289 and 290). Akt activates I $\kappa$ B kinase (I $\kappa$ BK), leading to I $\kappa$ B phosphorylation and destruction (Fig. 19.1). In addition, Akt activates ets2 (291), which induces transcription of NF- $\kappa$ B genes (292). The net effect is to increase nuclear NF- $\kappa$ B, leading to survival of hematopoietic cells (293). In addition, a number of stimulatory effects of NF- $\kappa$ B on the cell cycle have been identified, including transcription of *cyclin D* and *c-myc* (294, 295, 296, 297, 298 and 299). MAPKs are approximately 40-kD Ser/Thr kinases that are highly

conserved in all eukaryotic cells from yeast to humans and play a major role in nearly every type of cell. At least six signaling cascades classified as MAPK pathways have been identified ( [300](#), [301](#) ) and have been found to mediate cell proliferation, survival, apoptosis, or differentiation. For instance, MAPK induces proliferation in NIH3T3 cells and differentiation in PC12 cells. At present, three classes of MAPKs have been identified in megakaryocytes: extracellular stimulus response kinase (ERK) 1 and ERK2 (also termed *p44* and *p42*, respectively); c-jun N-terminal kinase; and p38 kinase ( [302](#), [303](#) and [304](#) ). Most receptors that activate MAPKs do so by activating ras. For the hematopoietic cytokine receptors, the adapter molecule Shc is recruited to the tyrosine-phosphorylated receptor cytoplasmic domain, which is then phosphorylated by JAK. P-Shc then recruits the adapter protein Grb2, which activates the guanine nucleotide exchange factor SOS, which then charges ras with guanosine triphosphate (GTP), thereby activating it. Active ras, in turn, leads to the activation of a MAPK kinase kinase, such as Raf-1, which phosphorylates a MAPK kinase, such as MEK1, which then phosphorylates a MAPK, such as ERK1 and ERK2. Because cells contain numerous MAPK kinase kinases and MAPK kinases, the potential for cross-talk between different MAPK pathways is large; this potential is reduced considerably through scaffolding proteins that sequester only the corresponding MAPK kinase kinase, MAPK kinase, and MAPK ( [305](#), [306](#) ). Virtually every cytokine affecting megakaryocytes activates ERK1 and ERK2 ( [230](#), [261](#), [307](#), [308](#) and [309](#) ). Alternate pathways to MAPK activation have also been described in platelets ( [310](#) ), and integrin engagement in fibroblasts affects the cellular localization of ERK1/2, exerting a profound effect on its capacity to signal ( [311](#) ). Blockade of ERK1 and ERK2 has been shown to reduce cell proliferation in c-mpl receptor-bearing cell lines and both cell proliferation and the generation of highly polyploid cells in megakaryocytic progenitors ( [312](#) ) but, curiously, to enhance proliferation of more primitive megakaryocytic progenitors from cord blood ( [313](#) ). The molecular targets of active MAPKs in megakaryocyte progenitors that mediate the effect of ERK1 and ERK2 on cell survival, proliferation, and differentiation are presently a topic of intense research; most studies in other cell systems suggest that ERK affects nuclear transcription factors, such as Elk-1 ( [314](#), [315](#) ), which then modulate activity of the cell cycle machinery. For example, stimulation of ERK1 and ERK2 leads to increased levels of cyclin D in fibroblasts ( [316](#) ), forced overexpression of cyclin D1 increases megakaryocyte polyploidy ( [317](#) ), and blockade of cyclin D3 in megakaryocytes reduces endomitosis ( [318](#) ). MAPKs also act on additional kinases; for example, the serum- and glucocorticoid-responsive kinase is also activated in a MAPK-dependent fashion in response to growth factors ( [319](#) ). Finally, although TPO activates JNK and p38 in mpl-bearing cells, primary megakaryocytes, and platelets ( [320](#), [321](#) ), less is known of their effects on megakaryocyte development. The development of blood cells is dependent on both soluble cytokines and the hematopoietic microenvironment; interaction between hematopoietic cells and their surroundings is dependent on cell-surface  $\beta_1$  integrins. Numerous cytokines have been shown to affect integrin affinity ( [322](#), [323](#), [324](#), [325](#), [326](#), [327](#), [328](#) and [329](#) ). Recent studies have elucidated at least one of the pathways initiated by cytokine binding that affects hematopoietic  $\beta_1$  integrins. On ligand binding, cytokine receptors trigger JAK and STAT activation; one target of the former is the adapter protein CrkL ( [330](#), [331](#) and [332](#) ). One of the targets of CrkL is C3G, a guanine nucleotide exchange factor that activates Rap1, a small G protein known to enhance cell adhesion through  $\beta_1$  integrins ( [333](#) ). As should be clear from the previous discussion, the megakaryocyte and probably all hematopoietic cells use multiple molecular pathways to effect cell survival and proliferation and, although not as well understood, probably also display this seemingly redundant approach to support cellular differentiation. Recent work with the TPO receptor has helped to clarify the nature and teleology behind this seeming redundancy. Phosphorylation of the penultimate tyrosine residue in the cytoplasmic domain of c-Mpl leads to Shc, STAT3, and STAT5 activation (

154, 239). Moreover, MAPK activation is also thought to emanate from the distal half of the receptor (309). Nevertheless, a truncated form of c-Mpl bearing neither of these regions continues to activate STAT5, MAPK, and PI3K in a TPO-dependent manner (239), and introduction of a similarly truncated receptor into the germ line in place of the full-length receptor affords the resultant mice a normal steady-state platelet count throughout life (334). However, these mice do not respond properly to stress; compared to normal mice, platelet recovery after immune-mediated or chemotherapy-induced thrombocytopenia is substantially delayed. Thus, the seeming redundancy in cytokine signaling appears to reflect a capacity of the cell to grade the TPO response into steady-state and emergency thrombopoiesis. A similar conclusion regarding signaling via STAT5 in erythropoiesis has been presented (242). The signaling cascades initiated by IL-3, IL-6, IL-11, and TPO are of limited duration. Multiple mechanisms exist to govern this process. One such mechanism depends on dephosphorylation of cytokine receptors. For example, after IL-3-induced receptor phosphorylation, hematopoietic cell phosphatase (also termed *SHPTP1* or *SHP1*) binds to the  $\beta_c$  subunit and dephosphorylates the IL-3 receptor. Overexpression of the phosphatase is associated with diminished IL-3-induced proliferation (335), strongly suggesting that this mechanism serves to limit ligand-induced signaling. A similar mechanism has been shown to limit EPO-induced signaling; genetic elimination of the region of phosphatase binding leads to congenital erythrocytosis (336). Another mechanism of feedback inhibition of cytokine receptor signaling is mediated by the suppressor of cytokine signaling (SOCS) proteins (337). At present, five members of this STAT-induced family of signaling proteins have been found to inhibit signaling, either by directly blocking JAK kinase function or by competing for binding to phosphotyrosine receptor-signaling sites with secondary signaling mediators. Hence, when a cytokine such as IL-3, IFN, or TPO induces STAT activation, it activates a delayed mechanism that shuts down signaling. This mechanism can also account for receptor cross-talk (i.e., the ability of one cytokine signal to negatively impact another) (201, 338).

## Megakaryocyte Cellular Development

**HEMATOPOIETIC STEM AND COMMON MYELOID PROGENITOR CELLS** The HSC is capable of giving rise to all blood cell lineages. Operationally, the cell is recognized retrospectively by its ability to repopulate all aspects of hematopoiesis after transplantation into myeloablated recipients. Although morphologically indistinguishable from small lymphocytes, hematopoietic stem and primitive progenitor cells express several cell-surface proteins that distinguish them from nonhematopoietic and more mature hematopoietic cells. As thrombopoiesis begins with the HSC, the following section on megakaryocyte development also includes a brief discussion of this cell with an emphasis on those aspects most important for platelet production. Numerous investigators have used monoclonal antibodies to hematopoietic cell-surface proteins to negatively or positively (or both) enrich bone marrow and blood for stem and primitive progenitor cells. However, the function of only a few of the stem cell-surface proteins recognized by these antibodies is known. Others have taken advantage of the capacity of primitive hematopoietic cells to extrude fluorescent organic chemicals or of their buoyant density to obtain purified populations of these scarce marrow cells; most successful stem cell purification strategies use two or three such techniques. The antigenic proteins and glycoproteins (gps) exclusively or predominantly present on mammalian stem cells include (a) CD34, a 90- to 110-kd type I gp that has been postulated to mediate cell adhesion, cell cycle arrest, or both (19, 339, 340); (b) Thy1, also termed *CD90* (341, 342), a heavily glycosylated glycoposphoinositol-linked protein that participates in T-cell adhesion to stromal cells (343), the cross-linking of which affects T-cell proliferation and survival (344, 345), although it is uncertain if this also occurs in HSCs; (c) the c-kit receptor, also termed *CD117* (346), which supports primitive hematopoietic cell survival and



proliferation; (d) murine AA4 ( [20](#) ), a molecule homologous to the human phagocyte C1q complement receptor ( [347](#) ); (e) murine Sca1 ( [341](#) ), the cross-linking of which coactivates T cells in the presence of other mitogens (but there is no evidence that this occurs with HSCs); (f) AC133 ( [348](#) ), a protein of unknown function ( [349](#) ); (g) CD164 ( [350](#) ), a cell-surface sialomucin that is present in several alternately spliced isoforms, which is possibly involved in blood cell homing, trafficking, and recirculation ( [351](#) ); and (h) the TPO receptor c-Mpl ( [130](#), [352](#) ), which is in many ways the most unexpected stem cell-surface molecule because TPO was postulated to be a lineage-specific growth and differentiation factor. Nevertheless, several groups have shown that (a) TPO affects the survival and proliferation of purified HSCs *in vitro* ( [152](#), [153](#) ), (b) essentially all of the repopulating capacity of murine marrow resides in the mpl<sup>+</sup> fraction of cells ( [155](#) ), and (c) genetic elimination of c-mpl leads to an 85% reduction in the number of repopulating stem cells in mice ( [155](#) ) and to aplastic anemia in humans ( [150](#), [151](#) ). Many or most of the surface membrane proteins found on HSCs are also present on cells that have begun to differentiate toward specific lineages, but also present on the latter cells—but not on stem cells—are CD38 and HLA-DR and other markers of lineage-specific maturation, including CD3, CD4, CD5 or CD8 (T cells), CD11b, CD14 or Gr-1 (macrophages and granulocytes), CD10, CD19, CD20 or B220 (B cells), and glycophorin A or Ter119 (erythroid), allowing separation of stem and more mature cells from marrow cells. Because stem cells have active small molecule exporters, manifest clinically as the multidrug resistance phenotype, they actively eliminate many fluorescent molecules such as rhodamine 123 or Hoechst 33342 dyes, allowing selection of stem cells based on the lowest retention of these substances ( [21](#), [353](#), [354](#), [355](#) and [356](#) ). Recent studies have clearly indicated the existence of distinct progenitor cells committed to either the lymphoid lineage [the common lymphoid progenitor is Lin<sup>-</sup>/IL-7R<sup>+</sup>/Thy1<sup>-</sup>/Sca-1<sup>low</sup>/c-kit<sup>low</sup> ( [23](#) )] or the myeloid lineage [the common myeloid progenitor (CMP) is IL-7Ra<sup>-</sup>/Lin<sup>-</sup>/c-kit<sup>+</sup>/Sca-1<sup>-</sup> ( [22](#) )]. One of the primary goals of modern physiology is to provide a molecular understanding of the gene or sets of genes required to orchestrate specific developmental events. Fundamental to this process is an understanding of the proteins present in cells that regulate gene transcription in a lineage-, ontogenic stage-, and maturation phase-specific manner. Several transcription factors have been identified in stem cell populations or have been shown to affect stem cell differentiation into the lymphoid and myeloid lineages. Members of the Hox family of transcription factors likely serve as master regulators of hematopoietic cell fate decisions, based on (a) a similar role in multiple organ systems ( [357](#) ); (b) their lineage- and differentiation-stage-specific expression pattern in hematopoietic cells ( [358](#), [359](#) and [360](#) ); (c) the disruption of their usual level or pattern of expression leads to hematologic expansion or malignancies ( [361](#), [362](#) ); and (d) their elimination ( [363](#), [364](#) and [365](#) ), or elimination of the gene(s) that regulate them ( [366](#), [367](#) ), leads to hematopoietic defects. In addition, members of the extradenticle family of homeodomain-containing proteins have been found to serve as cofactors for Hox proteins, altering their DNA-binding affinities and specificities. Like Hox genes, genetic elimination of some of these cofactor proteins can lead to HSC defects; for example, *Pbx1* null mice display a prominent defect in the generation of CMPs from HSCs ( [368](#) ). The *Ikaros* gene encodes a family of lymphoid-restricted zinc-finger transcription factors related to the *Drosophila hunchback* gene ( [369](#) ). All isoforms of Ikaros contain an identical C-terminal activation domain and two zinc-finger dimerization domains. However, only isoforms 1 to 3 of the six known alternately spliced forms contain at least three of the four N-terminal zinc fingers required for DNA to bind to the consensus DNA core motif GGGA ( [370](#) ). The PU.1 gene is one of approximately 30 members of the Ets family of transcription factors ( [369](#) ) that binds to the purine-rich PU box sequence (5'-GGAA-3'). Genetic inactivation studies of the *Ikaros* and *PU.1* genes have shown that their encoded transcription factors are involved in commitment to the lymphoid lineage; fetal stem cells

in *Ikaros*  $-/-$  mice do not generate any definitive T- or B-lymphocyte precursors (371). However, stem cells can give rise to thymocyte precursors postnatally, but cells that undergo aberrant differentiation into the CD4 lineage and all natural killer cells, most thymic dendritic cells, and some  $\gamma\delta$ T-cell subsets do not develop in adult mice. Thus, *Ikaros* is essential for all of lymphopoiesis early during ontogeny and for several subsets later in life. In a similar fashion, *PU.1*-deficient mice also lack any definitive T- and B-cell precursors in their lymphoid organs at birth (372, 373). However, knock-out mice maintained on antibiotics survived the first 48 hours of life and began to develop normal-appearing T cells 3 to 5 days later. In contrast, mature B cells and macrophages remained undetectable in these older mice, indicating absolute tissue dependence for this lineage. Transcription factors that may be responsible for myeloid commitment include SCL (stem cell leukemia) and GATA-2. The *SCL* gene was first identified at the site of chromosomal rearrangement in a patient with stem cell leukemia and encodes a helix-loop-helix transcription factor that pairs with one of two nuclear partners: LMO1 or LMO2 (374). The protein is present in HSCs, CMPs, and CFU-EMK progenitors (22). Previous studies have shown that SCL is down-regulated in differentiating granulocytic and monocytic progenitor cells (375, 376 and 377) and that forced expression of the gene in three hematopoietic cell lines inhibits cytokine-induced granulocytic and monocytic differentiation (377, 378 and 379). Together, these results suggest that down-modulation of *SCL* expression is required for HSC differentiation. Moreover, KL has been shown to sustain *SCL* expression in primary CD34<sup>+</sup> cells, maintaining them in an undifferentiated state, whereas GM-CSF down-regulates SCL levels and favors granulocyte and monocyte differentiation (380). These studies provide further insights into the vital question of the permissive versus directive role of growth factors in hematopoiesis. The GATA family of transcription factors contains six members that have a highly related DNA-binding domain composed of two evolutionarily conserved zinc fingers (381). GATA-1 and GATA-2 are present in hematopoietic cells; GATA-2 is found in the same cells as SCL, with GATA-1 expression restricted to the latter stages of hematopoietic differentiation. Because genetic elimination of GATA-2 is lethal due to numerous nonhematopoietic defects, and lineage-specific knock-outs have not yet been engineered, the role of GATA-2 in early hematopoiesis is not yet certain. However, like *SCL*, it appears that elimination of *GATA-2* expression is required for hematopoietic cell maturation because its forced expression in primitive cells blocks both their amplification and differentiation (382). As noted above, numerous lines of evidence indicate that HSCs express the c-Mpl receptor; this is most convincingly demonstrated by the ability to sort all repopulating stem cells into the mpl<sup>+</sup> fraction of AA4<sup>+</sup>/Sca<sup>+</sup> cells (155). Several investigators have also shown that the 5' flanking region of the *c-mpl* gene contains a GATA site, that deletion of this site reduces expression of an mpl-reporter construct, and that GATA-1 transactivates the gene in two hematopoietic cell lines (383, 384). However, GATA-1 is not likely to be responsible for expression of *c-mpl* in stem cells because the transcription factor does not appear in hematopoietic cells until they have become DR<sup>+</sup>—an event that occurs after the cells lose their repopulating capacity (385). Instead, it is possible that GATA-2 fulfills this role in stem cells, although there is no evidence yet available establishing that this protein can transactivate the mpl GATA site, which is an important caveat because not all genes regulated by GATA-1 can be activated by GATA-2 (386). It is thus also possible that other regulatory elements drive *c-mpl* expression in stem cells. Along these lines, it has been shown that an ets site is also present in the proximal regulatory region of the *c-mpl* gene, that its alteration reduces expression of a linked reporter gene, and that forced expression of the two ets proteins Ets-1 and Fli-1 leads to enhanced *c-mpl* promoter activity in human erythroleukemia (HEL) line cells (383). The regulation of stem cell survival, proliferation, and differentiation has been difficult to address due to their rarity and the requirement that they be assessed retrospectively using cumbersome transplantation assays. Nevertheless, it is clear that several cytokines exert important effects on HSCs. The pursuit of the cytokines that affect HSCs is of more than pure

physiologic interest, as the availability of the right combination of such proteins could allow expansion of the cells for therapeutic use without sacrificing their pluripotent and self-renewal capacities. Three proteins, KL, FL, and TPO, exert important effects on the number and growth of HSCs both *in vitro* and *in vivo*. The importance of KL to hematopoiesis is easily demonstrated; although nullizygous mice (*S<sub>l</sub>/S<sub>l</sub>*) are embryonic lethal due to a number of developmental defects, the presence of a partially functional allele (*S<sub>l</sub><sup>a</sup>*) allows compound heterozygotes (*S<sub>l</sub>/S<sub>l</sub><sup>a</sup>*) to survive gestation. However, the resultant mice are severely anemic (387) because of diminished numbers of primitive and lineage-committed hematopoietic progenitors in the marrow and spleen (388, 389), best demonstrated by the diminished capacity of marrow cells from mice deficient in *KL* or of the gene for the corresponding *c-kit* receptor to compete with wild-type cells in competitive repopulation transplantation assays (390, 391). In addition to its critical role in hematopoietic ontogeny, treatment of adult mice with a neutralizing c-kit receptor monoclonal antibody also results in severe pancytopenia (392), indicating an important hematopoietic role for the receptor-ligand pair throughout life. By itself, KL is only a weak stimulator of hematopoiesis, primarily inducing the development of mast cells both *in vitro* and *in vivo*. However, in the presence of IL-3, IL-6, IL-11, granulocyte colony-stimulating factor, or TPO, KL exerts profound effects on the generation of hematopoietic progenitor cells of all lineages (151, 152, 393, 394, 395 and 396), pointing to primitive hematopoietic cells as critical targets. The molecular mechanisms of such synergy are beginning to emerge. Recently, a physical association of the c-kit and EPO receptors has been detected after KL stimulation of cells bearing both receptors, an event that is essential for their functional synergy (397, 398). However, despite much progress in understanding the basis for the effects of KL on hematopoietic progenitor cells, the physiologic role of KL on HSC survival and expansion has been more difficult to document. For example, although KL can expand CFU-S manyfold (399) and support the survival of highly enriched populations of stem cells (400), other factors produced by marrow stromal cells can support HSC survival when KL function is eliminated (401). Flt ligand was cloned as the binding partner for a recently identified novel orphan receptor (70), a protein closely related to the receptor for M-CSF (termed *c-fms*) (hence, the term *flt* stands for *fms* like tyrosine kinase). FL was initially derived from T cells (49, 70); subsequent studies indicate that the cytokine is also produced by marrow stromal cells (178, 402). Blood levels of FL are approximately 15 pg/ml in normal animals and humans, levels of which can rise to 2500 pg/ml in response to pancytopenia (403). Interestingly, only pancytopenia, as seen in patients with Fanconi anemia or acquired aplastic anemia, and not individual lineage deficiencies causes an increase in blood FL concentrations, suggesting that the cytokine is a bona fide regulator of stem or primitive hematopoietic cells. Consistent with this hypothesis is competitive repopulation data indicating that stem cells from flt3/flk2 receptor-deficient mice do not effectively reconstitute the hematopoietic system (404). Like KL, FL appears to act on hematopoietic cells only in synergy with other hematopoietic cytokines or hormones (405, 406). Administration of the recombinant protein to animals and humans results in a modest rise in lymphocyte levels, a moderate increase in neutrophils, and a marked increase in monocytes, natural killer cells, and dendritic cells (407, 408). In particular, these antigen-presenting cells seem particularly dependent on FL, as the combination of FL and TGF- $\beta$ <sub>1</sub> can generate dendritic cells from CD34-selected marrow cells in serum-free culture (409). However, it is in combination with TPO that the FL effects on stem cells have been most dramatic; long-term culture-initiating cells, a surrogate marker for the HSC, were reported to expand 10<sup>5</sup>-fold from cord blood CD34<sup>+</sup> cells cultured for 20 weeks in the presence of FL and TPO (410). Multiple lines of evidence indicate that TPO can exert profound effects on the HSC. TPO has been shown to support the survival of candidate HSC populations and acts in synergy with IL-3 and KL to induce these cells into the cell cycle



and increase their output of both primitive and committed hematopoietic progenitor cells of all lineages ( [151](#), [152](#), [411](#) ). Moreover, these *in vitro* effects are reflective of *in vivo* events; administration of TPO to myelosuppressed animals leads to more rapid recovery of all hematopoietic lineages, including primitive cells ( [131](#), [135](#), [139](#), [412](#), [413](#) ), and genetic elimination of TPO or its receptor is associated with reduction of the numbers of marrow hematopoietic stem and progenitor cells of all lineages to 15 to 25% of normal values ( [154](#), [414](#), [415](#) ). In addition, as noted above, TPO acts in synergy with FL to expand primitive hematopoietic cells in suspension culture and, more recently, when used to supplement long-term marrow cultures, the hormone was found to maintain hematopoietic repopulating stem cells for up to 2 months without loss ( [416](#) ), compared to standard long-term cultures in which stem cells are no longer detectable at this time. One of the major advances in experimental hematology has been the capacity to grow hematopoietic cells in long-term culture ( [417](#) ). By allowing a stromal cell and extracellular proteinaceous matrix to form over several weeks in the presence of serum, these long-term cultures are capable of supporting hematopoiesis for months when subsequently recharged with fresh marrow cells. It is presumed that the cell-cell and cell-matrix interactions that develop in such cultures more closely resemble those found *in vivo*, helping to explain the longevity of such cultures and their capacity to maintain the numbers of hematopoietic stem and primitive progenitor cells far longer *ex vivo* than do nonstromal-based cultures. The molecular basis for the improved hematopoietic environment of long-term cultures is thought to rely on stromal cell-surface molecules that promote cell-cell contact, prevent PCD, and regulate growth. *Integrins* are a family of heterodimeric single-pass transmembrane proteins (19  $\alpha$  and 8  $\beta$  subunits form 25 different cell-surface adhesion receptors) characterized by multiple Ig-like extracellular domains that allow two-way communication between a cell and its environment ( [215](#), [418](#), [419](#) ). A large number of cell types require contact for survival; *in vitro*, this is usually manifest as integrin-dependent cell adhesion, either to extracellular matrix protein(s), often through an "RGD" (Arg-Gly-Asp) recognition sequence, or to other cells. In such cultures, disruption of adherence causes a type of apoptosis termed *anoikis*; for example, endothelial cells undergo anoikis on forced detachment *in vitro* due to disruption of multiple integrins ( [420](#), [421](#) ). Integrins can also influence the proliferation of cells by affecting the G<sub>1</sub> to S phase transition of the cell cycle ( [422](#) ). These effects also operate *in vivo*; mice nullizygous for a  $\beta_1$  integrin (a component of the  $\alpha_1\beta_1$  collagen receptor) have a hypoplastic dermis, and the growth of a  $\beta_1^{-/-}$  fibroblasts on collagen is substantially reduced ( [423](#) ). Hematopoietic stem and progenitor cells express multiple integrins, including a  $\beta_1$  [also termed *very late antigen* (VLA) 4], which binds to either vascular cell adhesion molecule-1 (VCAM-1) or fibronectin, and a  $\beta_1$  (VLA5), which binds to distinct regions of fibronectin. The avidity of progenitor cell-integrin interaction can be altered by external effectors; numerous cytokines and chemokines, including KL, IL-1, IL-3, IL-6, GM-CSF, granulocyte colony-stimulating factor, TPO, and stromal cell-derived factor-1, have been shown to enhance integrin-mediated binding ( [322](#), [323](#), [324](#), [325](#), [326](#), [327](#), [328](#), and [329](#) ). Counter-receptors for both integrins, such as VCAM-1 and fibronectin, are highly expressed in the marrow matrix and on marrow stromal cells. It is also clear that integrin-based interactions with the stroma are responsible for homing and retention of stem and primitive progenitor cells in the marrow, as antibodies that interfere with the interaction can mobilize stem and progenitor cells into the peripheral blood ( [424](#) ). However, it is not yet certain whether integrins can influence the survival or growth of stem cells or influence their ultimate developmental fate.

**ERYTHROID-MEGAKARYOCYTIC PROGENITORS** Progenitors for megakaryocytes and erythroid cells display many common features. They share a number of transcription factors [SCL, GATA-1, GATA-2, and nuclear factor-erythroid 2 (NF-E2)], cell-surface molecules (Ter119), and cytokine receptors (for IL-3, KL, EPO, and TPO), and most erythroid and megakaryocytic leukemia cell lines display, or can be induced to display,

features of the alternate lineage (425). Moreover, the cytokines most responsible for erythropoiesis and megakaryopoiesis, EPO and TPO, are the two most closely related proteins in the hematopoietic cytokine family (117, 118 and 119) and display synergy in stimulating the growth of progenitors of both lineages (51, 133, 426, 427). For these and other reasons, it has been postulated that erythropoiesis and megakaryopoiesis might share a common progenitor cell (30, 31)—a hypothesis that is now established (22, 428, 429). Like other primitive hematopoietic cells, bipotent erythroid/megakaryocytic progenitors resemble small lymphocytes but can be distinguished by a specific pattern of cell-surface protein display. Akashi and co-workers have shown that a population of Lin<sup>-</sup>/IL-7Ra<sup>-</sup>/c-kit<sup>+</sup>/Sca-1<sup>-</sup> CMP cells can be further fractionated into CD34<sup>+</sup>/FcγR<sup>+</sup> cells that are committed to the neutrophilic and monocytic lineages and CD34<sup>-</sup>/FcγR<sup>-</sup> cells that give rise only to erythroid and megakaryocytic cells. Cells committed to the megakaryocyte lineage then begin to express CD41 and CD61 (integrins α<sub>IIb</sub> and β<sub>3</sub>), CD42 (gpIb), and gpV. These and other cell-surface markers provide experimental hematologists several strategies to purify committed megakaryocytic progenitors (25, 430). Another useful method to identify megakaryoblasts, at least in studies of rodent megakaryopoiesis, is histochemical staining for acetylcholinesterase (431) and von Willebrand's factor (vWF) (432, 433 and 434). The antigenic profile of megakaryocyte development is illustrated in Table 19.1.

**TABLE 19.1. Antigenic Profile of Developing Megakaryocytes**

|        | Hematopoietic Stem Cell | Common Myeloid Progenitor | Colony-Forming Unit Erythroid-Megakaryocyte | Burst-Forming Unit Megakaryocyte | Colony-Forming Unit Megakaryocyte |
|--------|-------------------------|---------------------------|---|----------------------------------|-----------------------------------|
| CD34   | +++                     | +++                       | -   | -                                | -                                 |
| CD38   | -                       | -                         | -   | -                                | -                                 |
| CD41   | -                       | -                         | ±   | +                                | +                                 |
| CD42   | -                       | -                         | -   | -                                | +                                 |
| HLA-DR | -                       | -                         | -   | -                                | +                                 |
| CD117  | +                       | +                         | +   | +                                | +                                 |

NOTE: + to +++ indicate relative levels of antigen expression.

The molecular basis by which primitive hematopoietic cells give rise to bipotent erythroid/megakaryocytic progenitors or to bipotent granulocyte/monocyte progenitors is a topic of much investigation, as is the question of how these bipotent cells “select” a lineage. Many investigators believe that the stochastic emergence of one or a small set of lineage-specific transcription factors in a cell determines its developmental fate; thus, the molecular mechanisms that lead to the expression of α<sub>IIb</sub> integrin (gpIIb or CD41), the platelet fibrinogen receptor, become critical for the lineage and illustrate the concept. The transcription factors expressed during megakaryocyte development are shown in Table 19.2 (435).

**TABLE 19.2. Transcription Factors Expressed during Megakaryocyte Development**

|        | Hematopoietic Stem Cell | Common Myeloid Progenitor | Colony-Forming Unit Erythroid-Megakaryocyte | Burst-Forming Unit Megakaryocyte | Colony-Forming Unit Megakaryocyte |
|--------|-------------------------|---------------------------|---|----------------------------------|-----------------------------------|
| GATA-2 | +++                     | +++                       | -   | -                                | -                                 |
| Ikaros | +++                     | -                         | -   | -                                | -                                 |

|        |   |    |   |     |     |
|--------|---|----|---|-----|-----|
| GATA-1 | - | +  | - | +++ | +++ |
| C/EBPa | - | ++ | - | -   | -   |
| NF-E2  | - | -  | - | +   | ++  |
| Fli-1  | - | -  | - | +   | ++  |

NOTE: + to +++ indicate relative levels of antigen expression.

In elegant studies using a toxic transgene controlled by its promoter, erythroid and megakaryocytic progenitor cells were shown to express a  $\text{IIb}$  integrin (436). Using mixed erythroid/megakaryocytic cell lines, several *cis*-acting sequences that affect expression of a  $\text{IIb}$  integrin have been identified and include functionally important binding sites for GATA-1, Ets, and SP1 (437, 438 and 439). A very similar profile of *cis*-regulatory elements is found in the promoters for gpIb, gpV, and gpIX, components of the platelet vWF receptor (440, 441 and 442). GATA-1 is present in all erythroid and megakaryocytic cells; SP1 is ubiquitous; and the Ets family transcription factor PU.1 is expressed in erythroid and megakaryocytic cell lines and, at least in one mpl-bearing cell line, is responsive to TPO (443). GATA-1 is an X-linked gene encoding a 50-kd polypeptide that contains two zinc fingers required for DNA binding (444). The importance of GATA-1 for erythroid and megakaryocytic development comes from genetic elimination of the transcription factor; *GATA-1*  $-/-$  mice are embryonic lethal due to a failure of erythropoiesis (445), and megakaryocyte-specific elimination of GATA-1 leads to severe thrombocytopenia due to dysmegakaryopoiesis (446). GATA-1 acts with another protein that affects transcription without binding to DNA: Friend of GATA (FOG) (447). The importance of this interaction to megakaryopoiesis is clear; several different mutations of the site on GATA-1 responsible for FOG binding lead to congenital thrombocytopenia (448, 449 and 450). As noted above, the ets family of transcription factors includes approximately 30 members that bind to a purine box sequence, proteins that interact in both positive and antagonistic ways. For example, PU.1, initially termed *Spi-1* based on its association with spleen focus-forming virus-induced erythroleukemias, blocks erythroid differentiation, although it appears important for megakaryocyte development (443). An important concept developed in recent years may help to explain how transcription factors contribute to lineage commitment; once a lineage-specific transcription factor level rises, positive feedback loops are activated that consolidate the event. For example, should a multipotent hematopoietic progenitor express CCAAT/enhancer-binding protein  $\beta$ , it will differentiate along the eosinophilic lineage, with the transcription factor acting to induce eosinophil-specific markers (e.g., major basic protein) and to down-modulate FOG (451, 452). This latter event is crucial, as forced expression of FOG dedifferentiates cells committed to the eosinophilic lineage into multipotent progenitors (453). A similar paradigm appears to contribute to the erythroid/megakaryocytic versus neutrophilic/monocytic dichotomy; GATA-1 appears to be the integral trigger for the entire erythroid and megakaryocytic developmental program. Like commitment to the eosinophilic lineage, GATA-1 appears to exert a reciprocal feedback inhibition on transcription factors that induce neutrophilic/monocytic differentiation. Once GATA-1 is expressed in stem cell progeny, the EMk differentiation pathway is locked into place as the transcription factor inhibits binding of the primary transcriptional regulator of myeloid differentiation, PU.1, to its myeloid promoter targets (454). In contrast, because PU.1 needs to be down-regulated during erythropoiesis (455), if this transcription factor first predominates in the multipotent progenitor, then its inhibition of GATA-1 *trans*-activator function on erythroid and megakaryocyte-specific genes (456) might commit the cell to the neutrophilic or monocytic lineages. Several investigators have shown that components of the extracellular matrix can affect platelet formation *in vitro* and platelet function *in vivo*. However, despite an impressive array of evidence that integrins can

affect cell survival and proliferation in adherent cells, few have tried to extrapolate these conclusions to hematopoietic cells. Although hematopoietic progenitors are not typically thought of as adherent cells, the high cell density in the marrow and the presence of multiple integrins on the surface of hematopoietic cells, including megakaryocytic progenitors ( [324](#), [457](#), [458](#), [459](#) and [460](#) ), argue that integrin engagement might affect thrombopoiesis. In recent studies, the role of integrins  $\alpha_4\beta_1$  and  $\alpha_5\beta_1$  in erythropoiesis has been deciphered ( [461](#) ). In a similar fashion, Fox and colleagues have determined that fibronectin engagement of a  $\alpha_5\beta_1$  integrin augments megakaryocytic progenitor cell proliferation, whereas binding of a  $\alpha_4\beta_1$  reduces it ( [462](#) ). These two findings not only open a window on the contribution of the marrow microenvironment to hematopoiesis, but also begin to provide a molecular understanding of commitment in the bipotent EMk lineage. The biochemical mechanisms that might mediate direct integrin signaling have been recently reviewed ( [463](#), [464](#) ).

**PROGENITORS COMMITTED TO THE MEGAKARYOCYTIC LINEAGE** Megakaryocytic progenitors are CD34<sup>+</sup>, c-kit<sup>+</sup>, mpl<sup>+</sup>, HLA-DR<sup>+</sup>, and CD41/61<sup>+</sup>. Several cytokines stimulate the proliferation and survival of megakaryocytic progenitor cells, first identified as megakaryocyte colony-stimulating factors. Initial studies of megakaryocyte colony formation used plasma as a source of megakaryocyte colony-stimulating factor. With the cloning of IL-3 in the mid-1980s, the cytokine was shown to stimulate megakaryocyte colony formation ( [37](#), [79](#) ). Likewise, GM-CSF was shown to have similar but less potent effects ( [39](#), [465](#) ). The availability of recombinant KL in the early 1990s revealed that it also stimulated megakaryocyte colony formation when used in conjunction with plasma ( [50](#), [79](#) ). In the 1990s, it was also determined that although incapable of stimulating the growth of megakaryocyte progenitor cells alone, cytokines that function by stimulating the gp130 co-receptor (IL-6, IL-11, LIF) acted in synergy with these other cytokines (IL-3, KL) to augment the number and size of megakaryocyte colonies ( [75](#), [79](#), [91](#), [466](#), [467](#) and [468](#) ). More recently, TPO has been shown to be a potent megakaryocyte colony-stimulating factor, both alone and in synergy with KL, IL-3, and IL-11 and, surprisingly, in synergy with EPO ( [51](#), [125](#), [129](#) ). With the exception of IL-3 and GM-CSF, administration of each of these cytokines has also been shown to promote platelet production *in vivo* ( [81](#), [97](#), [133](#) ). Despite this plethora of cytokines shown to affect megakaryocyte progenitor cells *in vitro* and *in vivo*, genetic elimination of the majority of these molecules does not affect resting or stimulated platelet production; only deficiencies in KL or c-kit [50% reduction ( [48](#) ), which may be due to stem cell and not megakaryocyte progenitor cell deficiency] and TPO and c-Mpl [reduction to 10% of normal ( [469](#) )] lead to thrombocytopenia. The cause of the remaining thrombopoiesis in *tpo* or *c-mpl* nullizygous mice has been searched for but not yet determined ( [48](#), [110](#), [470](#), [471](#) ). In addition to these studies of the growth factors required for the process, important new insights into the transcription factors that drive megakaryopoiesis have been reported. The ets protein Fli-1 is present in megakaryocytic progenitors ( [472](#) ) and seems to play a particularly important role in megakaryocyte development. For example, Fli-1 promotes a megakaryocytic developmental program in the mixed erythroid/megakaryocytic cell line K562 ( [473](#) ); it drives expression of megakaryocyte-specific genes ( [474](#) ); dysmegakaryopoiesis occurs in Fli-1 null embryos ( [472](#) ); patients with thrombocytopenia associated with Jacobsen or Paris-Trousseau syndrome have terminal deletions of 11q, the site of *Fli-1* in humans ( [475](#) ); and forced expression of Fli-1 in pluripotent human hematopoietic cells leads to megakaryocytic differentiation ( [476](#) ) and down-modulation of erythropoiesis via reduction in GATA-1 expression ( [477](#) ). Thus, a basic outline of the genetic details for a stem cell to ultimately commit to the megakaryocytic lineage has emerged. Although future work will undoubtedly fill in many details, it appears that the development of CFU-MK requires a pluripotent stem cell to express *SCL* and *GATA-2* and to avoid *Ikaros* allowing (directing) its development into a CMP; then, it must express *GATA-1* and turn off *PU.1* to become

a CFU-EMK; finally, it must turn on *Fli-1* and turn down (but not turn off) *GATA-1* to emerge as a CFU-MK. Whether TPO or other megakaryopoietic cytokines or components of the marrow microenvironment can influence these events remains an intriguing and critical question for experimental hematologists.

**MEGAKARYOBLAST/STAGE I MEGAKARYOCYTES** A generally accepted terminology has been developed to describe the developmental stages of megakaryocytes, the major criteria being the quality and quantity of the cytoplasm and the size, lobulation, and chromatin pattern of the nucleus. Stage I megakaryocytes account for approximately 20% of all megakaryocyte lineage cells in a normal marrow. They are 6 to 24  $\mu\text{m}$  in diameter and contain a relatively large, minimally indented nucleus with loosely organized chromatin and multiple nucleoli and scant basophilic cytoplasm containing a small Golgi complex, a few mitochondria and  $\alpha$ -granules, and abundant free ribosomes. This early phase of megakaryocyte development is also sometimes termed a *megakaryoblast* and, in rodent megakaryocytes, is characterized by intense staining for acetylcholinesterase. Although the elegant toxigene experiments of Marguerie and colleagues clearly demonstrated that the  $\alpha_{\text{IIb}}\beta_3$  integrin gene must be expressed as early as the EMk progenitor stage (436) and possibly in the CMP, it is not until early stages of megakaryocyte development that the cell-surface protein becomes functionally important.  $\alpha_{\text{IIb}}\beta_3$  integrin is an integral transmembrane protein of two subunits. The  $\alpha$  subunit contains several divalent cation-binding sites and is dependent on  $\mu\text{mol}$  levels of  $\text{Ca}^{2+}$  for proper conformation and dimer formation. Of the two subunits, only the  $\alpha$  subunit is megakaryocyte lineage specific; loss of  $\alpha_{\text{IIb}}\beta_3$  integrin leads to Glanzmann's thrombasthenia due to failure of the defective platelets to engage fibrinogen during aggregation. The two subunits of  $\alpha_{\text{IIb}}\beta_3$  integrin are synthesized in the endoplasmic reticulum and form a  $\text{Ca}^{2+}$ -dependent complex immediately on translation—a step necessary for membrane expression. Subsequently, the  $\alpha$  subunit is cleaved into heavy and light chains and modified with carbohydrate before transfer to the cell-surface, demarcation, and  $\alpha$ -granule membranes (478, 479). Megakaryocytes and platelets contain approximately twice the amount of  $\alpha_{\text{IIb}}\beta_3$  integrin as is present on the cell surface, the granule compartment serving as a mobilizable pool that is exteriorized on platelet activation. The role of the integrin in platelet function is discussed in the section [Major Surface Adhesive Glycoproteins: Glycoprotein Ib and Glycoprotein IIb-IIa](#), but because megakaryocytes do not synthesize but contain fibrinogen in their  $\alpha$ -granules and megakaryocytes from patients with Glanzmann's thrombasthenia do not, it is clear that  $\alpha_{\text{IIb}}\beta_3$  integrin begins to function, at least at the level of fibrinogen binding and uptake, long before platelet formation. The gpIb/IX complex is developmentally expressed only slightly after the appearance of  $\alpha_{\text{IIb}}\beta_3$  integrin (480). Although endothelial cells have been reported to express gpIb (481), its levels are very low; otherwise, gpIb is a megakaryocyte-specific protein that is expressed in the same distribution as  $\alpha_{\text{IIb}}\beta_3$  integrin. gpV is also expressed in complex with gpIb and IX in a 2:2:1 (Ib:IX:V) stoichiometric ratio (482, 483). Because its genetic elimination has little effect on platelet adhesion (484) and, unlike gpIb and gpIX, no mutations of gpV have been associated with Bernard-Soulier syndrome (485), gpV is not required for function of the gpIb/V/IX complex as a vWF receptor. Rather, gpV appears to function as a target of thrombin, possibly playing a role in platelet activation (486, 487). Another feature of stage I megakaryocytes is the initial development of demarcation membranes. Initially described more than 30 years ago (488), what begins as invaginations of the plasma membrane ultimately develops into a highly branched interconnected system of channels that course through the cytoplasm. The use of electron-dense tracers indicated that the demarcation membrane system is in open communication with the extracellular space (488, 489 and 490), and biochemical analysis indicates that the composition of these membranes is very similar to the plasma membrane at each stage of megakaryocyte development. Over the 72 hours it takes for stage III and stage IV cells to develop from stage I megakaryocytes, the demarcation membrane system grows by approximately



25-fold. The purpose of the demarcation membrane system has been disputed for nearly 20 years (491); initially, it was thought to compartmentalize the cytoplasm of the mature megakaryocyte into platelet territories, which ultimately fragment into mature platelets along the cleavage planes so formed, but others believe the demarcation membranes provide the necessary surface membrane required for the evaginations of megakaryocytes known as *proplatelet processes* that form in stage IV megakaryocytes and give rise on fragmentation to mature platelets. Much work is presently focused on this question (492). One of the most characteristic features of megakaryocyte development is endomitosis, DNA replication in the absence of nuclear or cytoplasmic division, which results in megakaryocyte poly-ploidy. Endomitosis begins in megakaryoblasts after the standard cell divisions required to expand the number of immediate megakaryocytic precursor cells and is completed by the end of stage II megakaryocyte development (493, 494). This carefully controlled process (i.e., each cycle of DNA synthesis produces an exact doubling of all the chromosomes) results in cells containing DNA content from 8 to 128 times the normal chromosomal complement in a single, highly lobated nucleus. Although poorly understood for many years, the recent ability to produce a large number of normal megakaryocytes in culture has begun to shed light on this enigmatic process. Endomitosis is not simply the absence of mitosis but rather an aborted mitosis (495). The cell cycle kinetics of endomitotic cells is also unusual, characterized by a short G<sub>1</sub> phase, a normal or modestly prolonged DNA synthesis phase, a short G<sub>2</sub> phase, and a very short endomitosis phase (496). During the latter, megakaryocytic chromosomes condense, the nuclear membrane breaks down, and centromeres form mitotic spindles on which the replicated chromosomes assemble. However, after initial chromosomal separation, individual chromatids fail to complete their normal migration to opposite poles of the cell, the spindle dissociates, and the cell once again enters G<sub>1</sub> phase (495, 497). Attempts at biochemical analysis of this process have come from leukemic cell lines and normal cultured megakaryocytes. The cell cycle is driven in all cells by the progressive activation of a series of serine/threonine kinases, all of which are dependent on cell cycle phase-restricted activating subunits, termed *cyclins* (498, 499). In addition, cell cycle kinase inhibitors, such as p21, p27, and the Ink proteins, or inhibitory phosphorylation of the cyclin-dependent kinases must be overcome. As the major departure from normal cell cycle behavior in megakaryocytes occurs during M phase, an attractive hypothesis to explain endomitosis is a failure to form or activate the M phase cyclin-dependent kinase cyclin B-cdc2 (500). Also termed *mitosis-promoting factor*, cyclin B-cdc2 participates in several aspects of mitosis, including chromosomal condensation, nuclear membrane breakdown, and inhibition of previous phases of the cell cycle. Of some interest, yeast, which carry temperature-sensitive mutations of either cyclin B or cdc2 homologs, undergo an extra round of DNA synthesis when grown at the nonpermissive temperature and then returned to the permissive temperature (501, 502). Working with the bipotent erythroid/megakaryocytic cell line HEL, Long and colleagues found that endomitotic cells contain high levels of cyclin B but lack cdc2 (503). In contrast, MegT cells, derived from the transformation of murine marrow with a temperature-sensitive SV40 large T antigen driven by a megakaryocyte-specific promoter, fail to produce cyclin B during their mitotic phase (504). Additionally, the overexpression of cyclin D coupled with the elimination of cdc2 in F36 cells engineered to express c-mpl leads to polyploidy (505). Thus, each of these cell lines became polyploid by failing to express a functional mitotic kinase during endomitotic development but by different mechanisms. In contrast to these findings, results from normal murine and human megakaryocytes argue for normal mitotic kinase activity during endomitosis. Using TPO to expand marrow cell cultures *in vitro*, two groups have demonstrated the presence of both cyclin B and cdc2 in endomitotic megakaryocytes and their associated kinase activity (495, 506) as well as a normal metaphase checkpoint mechanism (507). Thus, although probably etiologic for polyploidy in leukemic cell lines, studies in normal murine and human marrow cells call into question whether decreased mitosis-promoting factor

(cyclin B-cdc2) is responsible for normal megakaryocyte endomitosis. Rather, recent attention has focused on two aspects of the process: the multipolar spindle that forms in polyploid megakaryocytes and the anaphase/telophase process termed *exit from mitosis*. This latter event encompasses a late anaphase checkpoint, in which a sequestered nucleolar phosphatase, cdc14, must be released to initiate the final stages of anaphase by activating Cdh1, a proteasome activator that triggers the destruction of cyclin B and other proteins required for exit from mitosis ( 508 , 509 , 510 and 511 ). Part of this process is the proper localization of survivin, INCENP (inner centromere protein), and the Aurora kinases at the centromere and midbody of the spindle ( 512 ). Of interest, elimination of survivin or INCENP in organisms as diverse as *Drosophila* and mammals leads to the abrogation of proper cell division and the formation of a cellular syncytium containing a large nuclear mass ( 513 , 514 and 515 ). Of further interest, a megakaryocytic cell line and normal murine megakaryocytes appear to be deficient in one of the Aurora kinases ( 516 , 517 and 518 ). Although such studies are only in their infancy, it appears that the elimination of mechanisms that are normally required to couple DNA synthesis and nuclear and cytoplasmic division can be down-modulated during megakaryocyte development. The promoters for a  $\text{IIb}$  integrin, gpIb, gpIX, and PF4 genes have been the focus of several recent studies and are active at the megakaryoblast stage of development. Most investigators have identified consensus sequences for both GATA-1 and members of the Ets family of transcription factors in the 5' flanking regions of these genes, the deletion of which reduces or eliminates reporter gene expression ( 437 , 474 , 519 , 520 ), at least in mature hematopoietic cells. Another important target of GATA-1 in megakaryocytes appears to be polyphosphate 4-phosphatase (P4P). By subtracting cDNA obtained from GATA-1 knock-down megakaryocytes from that generated from wild-type cells, a clone for P4P was obtained ( 521 ). One of the unexplained features of megakaryocytes in GATA-1 knock-down mice is that instead of the massive cell death seen in GATA-1-deficient erythroid progenitors ( 445 ), the aberrantly developing megakaryocytes in GATA-1 knock-down marrow are highly abundant and proliferate *in vitro* far greater than control cells ( 446 ). P4P catalyzes the hydrolysis of the D-4 position phosphate of PIP2 and PIP3. As these membrane phospholipids are products of PI3K, they play an important role in the proliferative and survival response to megakaryocyte growth factors. When reintroduced into the knock-down mice, P4P diminishes the exuberant growth characteristic of the knock-down cells ( 521 ). These findings are very much akin to the phenotype of cells from PTEN or src homology 2-containing inositol phosphatase (enzymes that hydrolyze the D-3 and D-5 positions of PIP3) knock-out mice. Although potentially a mechanism of proliferative control in megakaryocytes, the precise role of P4P in thrombopoiesis awaits further study. The cytokines responsible for survival and proliferation of megakaryoblasts are thought to include TPO, IL-3, and KL, with the first being the most critical. The proliferation of megakaryocytes is dependent on at least two signaling pathways, PI3K and MAPK, with the latter being particularly important for the generation of polyploid cells ( 522 ), a critical aspect of cells at this stage of development.

**STAGE II MEGAKARYOCYTES** Stage II megakaryocytes contain a lobulated nucleus and more abundant, but less intensely basophilic, cytoplasm. Ultrastructurally, the cytoplasm contains more abundant  $\alpha$ -granules and organelles, and the demarcation membrane system begins to expand at this stage of development. Stage II megakaryocytes measure 14 to 30  $\mu\text{m}$  in diameter, comprise approximately 25% of marrow megakaryocytes, and display ploidy values of 8 to 64 N. Early in megakaryocyte development, the cytoplasm acquires a rich network of microfilaments and microtubules. Toward stage III and IV, these proteins accumulate in the cell periphery, creating an organelle-poor peripheral zone. Biochemically, the megakaryocyte cytoskeleton is composed of actin,  $\alpha$ -actinin, filamin, nonmuscle myosin [including the product of the *MYH9* gene, mutated in several giant platelet thrombocytopenic syndromes ( 523 , 524 )],  $\beta$ 1 tubulin, talin, and several other actin-binding proteins. Like platelets, megakaryocytes can respond to external stimuli by changing shape, transporting organelles around the cytoplasm, and secreting granules.



These functions are dependent on the microfilament and microtubule systems of the cell. In addition, microtubules are believed to be a measuring stick for platelet formation during proplatelet generation in stage IV cells ([492](#)). As discussed in the section [Erythroid–Megakaryocytic Progenitors](#), GATA-1 is vital for committing primitive multipotent progenitors into the erythroid/megakaryocyte pathway. However, the transcription factor is also critical later in megakaryopoiesis for cytoplasmic development. The first convincing evidence that GATA proteins are essential for megakaryocyte development came from studies of the myeloid leukemia cell line 416B. The forced overexpression of *GATA-1*, but not *SCL*, led to partial megakaryocytic differentiation of these cells ([525](#)). More recently, analysis of *GATA-1* knock-down mice revealed that megakaryocytes undergo endomitosis, but cytoplasmic development is severely altered; the scant cytoplasm was deficient in demarcation membranes and platelet-specific granules and contained excess rough endoplasmic reticulum and peripheral clear zones ([446](#)). Thus, although identification of the target genes responsible for this phenotype requires additional study, GATA-1 appears essential for postendomitotic megakaryocyte cytoplasmic maturation. Although more prominent in later stages of megakaryocyte differentiation, platelet-specific  $\alpha$ -granules first begin to form adjacent to the Golgi apparatus as 300- to 500-nm round or oval organelles in stage I and II cells. Three distinct compartments are recognized in  $\alpha$ -granules: (a) a central electron-dense nucleoid containing fibrinogen, PF4,  $\beta$ -thromboglobulin, TGF- $\beta$  1, vitronectin, multimerin, and tissue-type plasminogen activator; (b) a relatively lucent peripheral zone containing tubules and vWF (an arrangement akin to Weibel–Palade bodies found in endothelial cells); and (c) the granule membrane containing many of the critical platelet receptors for cell rolling (P-selectin, also termed *CD62p*), firm adhesion (gpIb/V/IX), and aggregation ( $\alpha$  IIb $\beta$  3 integrin). Proteins present in  $\alpha$ -granules arise from *de novo* megakaryocyte synthesis (e.g., gpIb/V/IX, gpIV,  $\alpha$  IIb $\beta$  3 integrin, vWF, P-selectin,  $\beta$ -thromboglobulin, platelet-derived growth factor), nonspecific pinocytosis of environmental proteins (e.g., albumin and IgG), or cell-surface membrane receptor-mediated uptake from the environment [e.g., fibrinogen ([526](#)), fibronectin, and factor V ([527](#))].

**STAGE III/IV MEGAKARYOCYTES** Continued cytoplasmic maturation characterizes stage III/IV megakaryocyte development—cells that comprise almost one-half of all recognizable members of this lineage in normal marrow. Stage III/IV megakaryocytes are extremely large (40 to 60  $\mu$ m in diameter) and display a low nuclear to cytoplasmic ratio. Cytoplasmic basophilia wanes with development during stage III, the demarcation membrane system is prominent, and the endoplasmic reticulum and Golgi apparatus are disappearing during these final stages of maturation. The nucleus is usually eccentrically placed, and although sometimes appearing as several distinct nuclei in biopsy sections, it remains highly lobulated but single in all stages of megakaryocyte development. Most of the specific characteristics of megakaryocyte membranes have been achieved at this stage of development. Megakaryocyte membrane lipid composition progressively changes through development, achieving approximately four times the content of phospholipids and cholesterol found in immature cells; megakaryocytes contain approximately the same amounts of membrane-neutral lipid and phospholipid as platelets, but relatively more phosphatidylinositol and less phosphatidylserine (PS) and arachidonic acid. One transcription factor that plays an important role in the final stages of megakaryocyte maturation is NF-E2. Initially described as an erythroid-specific, heterodimeric protein belonging to the basic leucine zipper family of transcription factors, NF-E2 is composed of a ubiquitously expressed p18 subunit and a p45 protein present also in megakaryocytes ([528](#), [529](#)). NF-E2 binds to tandem activator protein-1-like motifs, like that seen in the second DNase hypersensitive site of the  $\beta$ -globin locus control region ([528](#)), and is required for  $\beta$ -globin expression ([530](#), [531](#)). However, the genetic elimination of p45 failed to significantly affect erythropoiesis; rather, p45-deficient mice displayed prominent alterations in megakaryocyte development and severe thrombocytopenia ([532](#)). Although interbreeding of heterozygous p45 mice results in live births with the expected mendelian ratios, nullizygous mice die soon after birth of widespread hemorrhage. Examination of the

animals reveals a modest expansion of marrow megakaryocytes but a failure of the cells to produce platelets. Additional studies localized the NF-E2 defect to cytoplasmic maturation. Megakaryocytes from knock-out mice proliferate normally in response to TPO; they become polyploid and express *mpl*, acetylcholinesterase, the megakaryocyte-specific marker 4A5 (thought to be gpV), PF4, and a  $\text{IIIb}\beta_3$  integrin. However, megakaryocytes from the knock-out animals are deficient in platelet granules and demarcation membranes, the regions of megakaryocyte cytoplasm required for platelet formation. Thus, the loss of either GATA-1 or NF-E2 results in a failure of the late aspects of cellular maturation. Of interest, p45 NF-E2 is induced by GATA-1/FOG ( [453](#) ), potentially providing an explanation for the lack of cytoplasmic development in GATA knock-down mice. Nevertheless, identification of the target genes on which these two transcription factors exert their effects on cellular maturation is just now beginning ( [533](#) ). Platelets form by fragmentation of megakaryocyte cytoplasm. It has been estimated that each megakaryocyte gives rise to 1000 to 5000 platelets ( [534](#) , [535](#) and [536](#) ) before the residual nuclear material is engulfed and eliminated by marrow macrophages ( [537](#) ). Stage IV megakaryocytes are wholly engaged in platelet formation. Careful microscopic studies have localized marrow megakaryocytes to the abluminal surface of sinusoidal endothelial cells. Fully mature megakaryocytes develop cytoplasmic processes constricted at platelet-sized intervals that extend through the endothelial barrier into the sinusoidal lumen, where platelets are released ( [538](#) ). It is likely that both integrin-mediated cell-cell interactions and extracellular matrix degradation are required for this process ( [539](#) , [540](#) and [541](#) ). It is also possible that the final stages of megakaryocyte fragmentation occur in the lung, at least for some megakaryocytes. Howell and Donahue reported in 1939 that platelet levels in pulmonary venous blood exceed those found in the pulmonary artery, suggesting platelet production in the lung ( [542](#) ). Whether this represents the migration and fragmentation of intact megakaryocytes in the lung or merely the final size reduction of large fragments of megakaryocyte cytoplasm that are also released into the blood ( [543](#) ) is not clear. Lung megakaryocytes have been characterized by Slater and co-workers, who believe they contribute substantially to blood platelet production ( [544](#) ). However, in our recent preclinical studies of TPO in mice ( [126](#) ), we did not detect any denuded megakaryocyte nuclei in the lungs of mice sacrificed with platelet counts as high as 4 million per  $\text{mm}^3$ . Moreover, cultured megakaryocytes can form functional platelets *in vitro* by generating proplatelets in the absence of endothelial surfaces or the pulmonary circulation (see below). Thus, the role of pulmonary bed platelet production remains controversial. One study found that dog lungs contain 2.5 megakaryocytes per  $\text{cm}^2$  ( [545](#) ); extrapolation of these data would suggest that human lungs contain approximately 6000 megakaryocytes—only enough to account for a small proportion (<0.1%) of daily platelet production. More than 25 years ago, careful marrow morphologic studies demonstrated that marrow megakaryocytes issue long, thin, beaded extensions through the sinusoidal endothelial cells and into the vascular lumen ( [546](#) ). These proplatelet processes are thought to ultimately fragment into platelets, which are then free to leave the marrow space and circulate. Support for this mechanism of platelet formation was bolstered by the development of *in vitro* conditions in which similar structures could form ( [540](#) , [541](#) , [547](#) , [548](#) ). Subsequent studies revealed that integrin and subcellular matrix engagement was required for this process ( [549](#) , [550](#) ) and that the platelets derived from such cultures were functional ( [548](#) ). More recent studies have begun to delve into the molecular basis of proplatelet formation. Although only limited insights have been gained thus far, it is clear that (a) despite the importance of TPO for the generation of fully mature megakaryocytes from which proplatelets arise, elimination of the cytokine during the final stages of platelet formation is not detrimental; (b) external signals for proplatelet formation are probably required for the process to proceed efficiently, a conclusion based on most investigators finding that although proplatelet formation is possible under serum-free conditions, plasma and an integrin ligand-containing substratum (e.g., fibronectin, vitronectin)

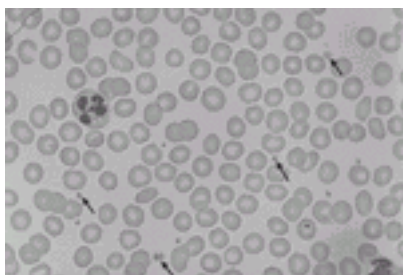
stimulate the process substantially ( [312](#) , [548](#) ); (c) proplatelet formation involves massive reorganization of megakaryocyte cytoskeletal components including actin and tubulin; (d) proplatelet generation is an active, motile process in which the termini of the process branch and issue platelets ( [492](#) ); and (e) activation of protein kinase C is necessary for the process to proceed ( [312](#) ). One report suggests that thrombin/antithrombin III complex with or without high-density lipoprotein particles mediates the favorable effect of plasma on proplatelet formation ( [551](#) ), although older data suggest that prothrombin and its conversion to thrombin by megakaryocytes inhibit the process ( [552](#) ). The size of the individual platelets formed is also of interest; however, little is known about this aspect of platelet formation except that it has been proposed that tubulin acts as a measuring device for the proper site to pinch off platelets from proplatelet processes. It is also clear that the mechanism of platelet formation must be affected in some way by the transcription factor GATA-1, the gpIb/IX complex, the Wiskott-Aldrich syndrome protein, and platelet myosin, as defects in each of these genes lead to unusually large or small platelets ( [448](#) , [449](#) , [485](#) , [524](#) , [553](#) ).

## PLATELETS

Megakaryocytes and megakaryocytopoiesis, described in the section [Megakaryocytes](#), produce the circulating platelet of the blood that is comprised of fragments of megakaryocyte cytoplasm and functions in both normal hemostasis and abnormal thrombosis. This section, Platelets, describes normal platelet structure and function.

### Structural and Functional Anatomy

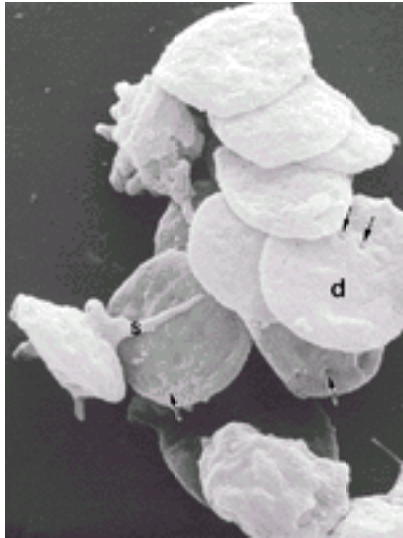
**LIGHT MICROSCOPY** Light microscopy of Wright-stained smears ( [Fig. 19.2](#) ) reveals platelets as small, anucleate (i.e., lacking a nucleus) fragments with occasional reddish granules, measuring approximately 2  $\mu\text{m}$  in diameter with a volume of approximately 8 fl ( [554](#) , [555](#) ) and exhibiting considerable variation in size and shape. Platelets released from the marrow under “conditions of stress” such as thrombocytopenia and termed *stress platelets* are large and often beaded in shape ( [543](#) ), whereas young platelets, recently released from the marrow, are termed *reticulate* in reference to their RNA content and in analogy to young red cell reticulocytes ( [556](#) ).



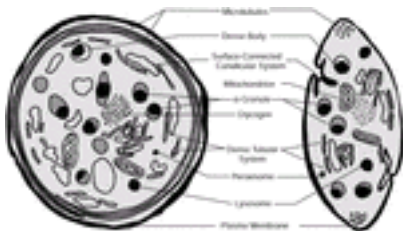
**Figure 19.2.** A human peripheral blood smear stained with Wright-Giemsa. Platelets, indicated by arrows, are interspersed between erythrocytes and a few leukocytes. The pale, grayish-blue cytoplasm contains purple-red granules. Original magnification of 35-mm slide =  $\times 100$ . See [Color Plate](#).

**ELECTRON MICROSCOPY AND SUBCELLULAR FEATURES** Platelets exist in two distinct forms, resting and activated, with the resting state marked by baseline metabolic activity and the activated form resulting from agonist stimulation (i.e., response to thrombin). Because platelets change their structure during the “resting-to-activated” transition, some description of these changes is provided here, and additional information on platelet function and the physiology of activated platelets is given in [Chapter 20](#). By

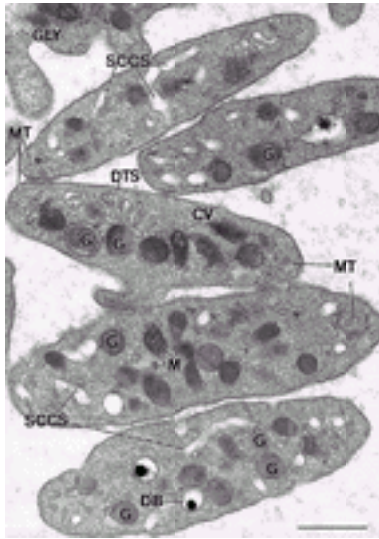
scanning electron microscopy, circulating resting blood platelets appear as flat discs with smooth contours, rare spiny filopodia ( [Fig. 19.3](#)), and random openings of a channel system, the surface-connected canalicular system (SCCS), which invaginates throughout the platelet and is the conduit by which granule contents exocytose after stimulation ( [557](#), [558](#) ). Although the platelet is anucleate, transmission electron microscopy reveals a complex surface and a cytoplasm packed with a number of different subplatelet structures and organelles that are essential to the maintenance of normal hemostasis ( [Fig. 19.4](#) and [Fig. 19.5](#) ). In describing detailed platelet anatomy, most information is derived from transmission electron microscopy, and platelet structure is classified into four general areas: the platelet surface, membranous structures, cytoskeleton (sol-gel zone), and granules. This classification is followed here.



**Figure 19.3.** Scanning electron micrograph of unstimulated human platelets. Most are discoid (d) in shape. Many surface indentations, indicated by arrows, are present; these correspond to openings of the surface-connected canalicular system to the external milieu. Magnification =  $\times 15,000$ . (Data from Stenberg PE, Shuman MA, Levine SP, Bainton DF. Optimal techniques for the immunocytochemical demonstration of  $\beta$ -thromboglobulin, platelet factor 4, and fibrinogen in the alpha granules of unstimulated platelets. *Histochem J* 1984;16:983-1001.)



**Figure 19.4.** Diagram of a human platelet displaying components visible by electron microscopy and cytochemistry. In addition to membranous components (plasma membrane, surface-connected canalicular system, and dense tubular system), mitochondria, microtubules, and glycogen, four types of storage organelles are identified:  $\alpha$ -granules, dense bodies, lysosomes, and microperoxisomes. Whereas the first two can be identified morphologically, microperoxisomes and lysosomes are recognizable only by cytochemical stains. (From Bentfeld-Barker ME, Bainton DF. Identification of primary lysosomes in human megakaryocytes and platelets. *Blood* 1982;59:472-481, with permission.)



**Figure 19.5.** Ultrastructure of unstimulated human platelets. Membranous organelles, including the surface-connected canalicular system (SCCS) and dense tubular system (DTS), and cytoplasmic organelles, including mitochondria (M),  $\alpha$ -granules (G), dense bodies (DB), coated vesicles (CV), and glycogen (GLY), are visualized at the ultrastructural level. Microtubules (MT) are present as cross-sectional and longitudinal profiles at the poles of the discoid platelets. Magnification =  $\times 46,000$ . Bar =  $0.5 \mu\text{m}$ .

## PLATELET SURFACE

**Plasma Membrane** The platelet plasma membrane separates intra- from extracellular regions and, in thin sections, exhibits a typical 20-nm thick trilaminar structure ( [559](#) ) whose overall appearance does not differ from that of other blood cells ( [560](#) ). However, this “unit membrane” of platelets is exceptionally complex in composition, distribution, and function, incorporating a number of gps and lipids into its phospholipid bilayer and integrating a variety of extra- and intraplatelet events such as permeability, agonist stimulation, and platelet adhesion, activation/secretion, and aggregation. In terms of the fine structure of the membrane, freeze-fracture techniques show that intramembranous particles in platelets are concentrated on the outer (external face) leaflet ( [561](#) , [562](#) ), where numerous receptors are located, suggesting that these intramembranous particles might be related to prominent platelet surface receptors such as gpIIb-IIIa ( [562](#) ). The lipid composition of the membrane also warrants comment; it contains a large proportion of total platelet phospholipid, approximately 60% ( [563](#) ), and distributes it in an asymmetric manner, with neutral species located mainly in the outer layer and anionic forms, such as PS, concentrated on the inner side ( [564](#) ). This sequestration of PS, which promotes plasma coagulation by contributing to the prothrombinase complex ( [565](#) ), on the inner side of the membrane may account for the fact that resting platelets are essentially nonreactive in terms of thrombin generation ( [566](#) ). On the other hand, activated platelets make a major contribution to thrombin formation through the interactions of factors Xa and Va and prothrombin—an activity referred to originally as *platelet factor 3*—on their surface ( [566](#) , [567](#) and [568](#) ). Finally, the plasma membrane contains sodium and calcium aden- osine triphosphatase (ATPase) pumps, which are important for maintaining ionic homeostasis ( [569](#) ).

**Glycocalyx** A fuzzy layer of lipids, sugars, and proteins, 15 to 20 nm thick, coats the outside surface of the platelet plasma membrane, including the SCCS, and interacts with both the plasma and the cellular components of the blood and blood vessels. Termed the *platelet glycocalyx* ( [488](#) ), the layer provides a transfer point for plasma proteins such as fibrinogen as they are taken up into secretory granules by endocytosis ( [570](#) ). The glycocalyx contains gps, glycolipids, mucopolysaccharides, and adsorbed plasma proteins (



557, 559) and produces a net negative surface charge mainly due to sialic acid residues on certain proteins such as gpIb (571). This charge is thought to minimize attachment of circulating platelets to each other and to vessels (572). Being rich in the extracellular regions of both adhesive gps and agonist receptors, the glycocalyx is a fundamental participant in all aspects of platelet function.

**PLATELET MEMBRANOUS SYSTEMS** Platelets have features of muscle-related cells in terms of their high content of actin and their contractile response during activation. Similar musclelike qualities are found in the two membranous systems of platelets, the SCCS and the dense tubular system, which resemble transverse tubules and sarcotubules, respectively (560, 573).

**Surface-Connected Canalicular System** The surface-connected canalicular system, also called the *open canalicular system*, is fenestrated and contiguous with the surface plasma membrane (557, 574, 575 and 576), weaving through the entire platelet cytoplasm in a tortuous fashion. The glycocalyx is less prominent in the SCCS as is one major surface gp, the gpIb-IX-V complex, whereas the other major receptor, gpIIb-IIIa, is distributed homogeneously through both the surface and the SCCS (577). The SCCS has several prominent functional roles: first, as an internal reservoir of membrane to facilitate platelet spreading and filopodia formation after adhesion (577); and second, as a storage reservoir for membrane gps, such as gpIIb-IIIa, that increase on the platelet surface after activation (578). The system also provides a route for granule release during the secretory phase of platelet activation (558) and serves as a route of ingress and egress for molecules as they translocate between the plasma and the platelet (574).

**Dense Tubules** Unlike the SCCS, the *dense tubular system* is a closed-channel system consisting of narrow, membrane-limited tubules, approximately 40 to 60 nm in diameter (579). Characteristically, it contains amorphous, moderately electron-dense material resembling cytoplasm within its lumina (579). It is, in fact, residual smooth endoplasmic reticulum from the megakaryocyte (580, 581). Peroxidase (582, 583 and 584), glucose-6-phosphatase (585), acetylcholinesterase (in cat, rat, and mouse but not human platelets or megakaryocytes) (586), adenylate cyclase, and Ca<sup>2+</sup>- and Mg<sup>2+</sup>-activated ATPases (587) have been cytochemically demonstrated in the dense tubular system. This channel system is involved in the regulation of intracellular calcium transport because it has been reported to selectively bind, sequester, and release divalent cations after activation (587). The dense tubular system is also the site of prostaglandin (PG) synthesis in platelets (588, 589).

**PLATELET CYTOSKELETON** Both the shape of platelets and their ability to contract and spread depend on a cytoplasmic framework of monomers, filaments, and tubules that constitute the cytoskeleton (590). The cytoskeleton can direct platelet shape change, send out extracellular extensions, collect and then extrude secretory granules, and affect surface reactivity (Fig. 19.6). These varied functions are performed by three distinct structures: first, the membrane skeleton, which buttresses the inner side of the plasma membrane; second, the mass of actin and intermediate filaments, which fills the cytoplasm (cytoplasmic actin filaments; also termed the *sol-gel zone*); and third, the circumferential microtubule band, which encircles the substance of the platelet to produce the resting disclike form (577, 590). Three different protein filaments/tubules contribute to the overall network: namely, 5- to 6-nm-diameter microfilaments of actin (591, 592), 10- to 12-nm intermediate filaments of desmin and vimentin (593, 594), and 25-nm microtubules composed mainly of tubulin (595, 596 and 597). Together, these filaments, depending on the activation state of the platelet, comprise 30 to 50% of total platelet protein.



**Figure 19.6.** Human platelet cytoskeletons prepared by simultaneous fixation and lysis in Triton X-100 detergent. Single actin filaments, indicated by short arrows, course throughout the platelet cytoplasm. Clusters of filaments, indicated by long arrows, also are present. Note the microtubule coils at the platelet peripheries (*arrowheads*). Magnification =  $\times 30,000$ . (From Boyles J, Fox JEB, Phillips DR, Stenberg PE. Organization of the cytoskeleton in resting, discoid platelets: preservation of actin filaments by a modified fixation that prevents osmium damage. *J Cell Biol* 1985;101:1463–1472, with permission.)

In addition to well-established electron microscopic technologies (quick freeze and deep etch; negative staining) ( [598](#) ), a more recent detergent extraction technique has been widely applied to understand the composition and function of the platelet cytoskeleton ( [599](#) ). Under defined conditions, the nonionic detergent Triton X-100 is added to resting or activated platelets, and the insoluble proteins, sedimenting at  $15,600 \times g$  for 15 minutes, are operationally defined as the *platelet cytoskeleton* or *cytoplasmic actin filaments* ( [590](#) ). The remaining supernate is recentrifuged at  $100 K \times g$  for 1 hour, and the pelleted proteins are termed the *membrane cytoskeleton* because they prove to contain surface-associated molecules such as gpIb ( [600](#) ). Such work has permitted the analysis of a number of physically linked proteins, including structural, signaling, and receptor elements, as they associate with or dissociate from the two cytoskeletal preparations (membrane and cytoplasmic) under varying conditions and with different time courses ( [601](#) , [602](#) ). The literature on the third cytoskeletal structure, the microtubules, has generally remained outside these studies that use Triton X-100 and is discussed later.

**Membrane Skeleton** This structure was first described more than 30 years ago by electron microscopy ( [603](#) , [604](#) ) and then analyzed biochemically through the detergent lysis approach noted in the section [Platelet Cytoskeleton](#) ( [599](#) ). Also termed the *submembrane region/ skeleton/ cytoskeleton*, this is basically a collection of short actin filaments that underpin the plasma membrane and connect surface receptors with the bulk of cytoplasmic actin filaments ( [591](#) ). For example, the membrane skeleton associates with the cytoplasmic domain of the transmembrane gpIb through actin-binding protein (filamin 1) and appears to attach to gpIIb-IIIa also, although the precise linkage to this second major surface gp is not well defined ( [590](#) ). A number of additional associated proteins with a variety of linking and signaling properties, such as spectrin, talin, pp60c-src, and Rho, have been identified ( [Table 19.3](#) ) ( [577](#) , [590](#) ). Such a convergence of interesting molecules makes this structure a focus for studies that seek to understand the role of signal transduction in platelet activation. In addition, the membrane skeleton appears to play a role in platelet spreading after adhesion and in regulating the surface mobility of receptors such as gps Ib and IIb-IIIa ( [577](#) ). Various cytoskeletal molecules are



listed in [Table 19.3](#), divided according to their presence in high- or low-speed fractions of the detergent-extracted skeleton. A brief summary of the properties of the individual proteins is presented along with pertinent references.

**TABLE 19.3. Major Platelet Cytoskeletal Proteins**

| Protein                           | Molecular Weight | Principal Known Function   | References  |
|-----------------------------------|------------------|--|---|
| Actin                             | 42,000           | Major protein constituent of microfilaments; 30% of platelet protein; F-actin binds myosin.    | <a href="#">590</a> , <a href="#">623</a>                       |
| Myosin II                         | 500,000          | Binds actin; phosphorylation of light chains contracts microfilaments; 4% of platelet protein. | <a href="#">590</a> , <a href="#">606</a> , <a href="#">621</a> |
| Talin                             | 235,000          | Interacts with $\alpha$ -actinin, vinculin; 2% of platelet protein.                            | <a href="#">607</a>   |
| Vinculin                          | 130,000          | Interacts with talin; links to actin.  | <a href="#">608</a>   |
| $\alpha$ -Actinin                 | 102,000          | Dimer forms a gel with F-actin; promotes actin polymerization.                                 | <a href="#">590</a>   |
| Actin-binding protein (filamin 1) | 260,000          | Cross-links actin filaments; links membrane skeleton with glycoprotein Ib-IX complex.          | <a href="#">601</a> , <a href="#">609</a>                       |
| Gelsolin                          | 91,000           | Caps and severs actin filaments.   | <a href="#">613</a>   |
| Thymosin $\beta_4$                | 5000             | Binds 1:1 with G-actin monomers and inhibits its polymerization.                               | <a href="#">614</a>   |
| Profilin                          | 15,200           | Binds 1:1 with G-actin and inhibits its polymerization; adds adenosine triphosphate.           | <a href="#">615</a>   |
| Tropomyosin                       | 28,000           | Binds groove on certain F-actins.  | <a href="#">590</a>   |
| Caldesmon                         | 80,000           | Regulates actomyosin ATPase and actin bundling.  | <a href="#">616</a>   |
| Myosin light chain kinase         | 105,000          | Phosphorylates myosin, activates its ATPase, and causes contraction.                           | <a href="#">622</a>   |
| Calmodulin                        | 17,000           | Binds four $\text{Ca}^{2+}$ ; activates myosin light chain kinase.                             | <a href="#">590</a> , <a href="#">622</a>                       |

ATPase, adenosine triphosphatase.

**Cytoplasmic Actin and Intermediate Filaments (The Sol-Gel Zone)** The bulk of the platelet cytoskeleton consists of a large amount of actin ( $M_r = 42,000$ ) that comprises approximately 25% of total platelet protein ([605](#)). Other platelet cytoskeletal proteins, such as tropomyosin and  $\alpha$ -actinin, are present in lower amounts (2 to 5% of total platelet protein) ([606](#), [607](#), [608](#), and [609](#)). The actin exists in soluble, monomeric (G-actin), and filamentous (F-actin) forms and connects to both the membrane skeleton and the microtubules ([577](#)). In resting platelets, approximately 40% of actin is in microfilaments, which are dispersed throughout the cytoplasm and obscured by their small size and the many other subplatelet structures present, such as granules ([610](#)). The intermediate filaments are more stable, resistant structures, rich in vimentin, that appear to bear tension within the cytoplasm ([594](#)). Platelet stimulation results in profound changes in cytoskeletal organization. Morphologically, platelets rapidly lose their discoid shape, become rounded, and extend filopodia ([611](#), [612](#)). With the rise in intracellular calcium, the proportion of F-actin increases rapidly to 60 or 70%; the transition is governed by the actions of gelsolin and the dissociation of the filament-capping protein capZ, coupled with

the subsequent interactions of thymosin  $\beta_4$ , polyphosphoinositides, profilin, and the actin-related protein 2/3 complex ( 612, 613, 614 and 615 ). Actin monomers polymerize onto filaments at platelet peripheries ( 611, 616 ), and bundles of new filaments form to fill developing filopodia ( 617, 618 and 619 ). Phosphorylation of myosin light chain results in binding of myosin to actin ( 620, 621 and 622 ), providing the tension required for granule centralization and retraction of filopodia ( 623 ). Additional proteins, such as talin and surface gpIIb-IIIa, join the developing electron-dense actin filaments, and the structure is remodeled through the action of an associated calcium-dependent protease, calpain ( 624 ). Added to these multiple events is the activation of several Rho family GTPases that mediate different aspects of platelet spreading ( 625 ). The sum of these events in platelet function is critical because the combination of various additions, rearrangements, and remodeling steps underpins shape change and spreading (filopodia and lamellipodia formation) along with platelet secretion and clot retraction ( 590 ).

**Microtubules** A circumferential microtubule band that supports the discoid form of the platelet ( 595, 596 ) is made of two nonidentical subunit proteins ( $\alpha$  and  $\beta$  tubulin) ( 626 ), associated with microtubule-associated proteins ( 627, 628 ). The 25-nm-diameter microtubule coil lies adjacent to, but does not touch, the plasma membrane ( 629 ). By electron microscopy of sectioned platelets, microtubules appear as 8 to 24 tubular profiles at the poles of discoid platelets. Microtubules are present primarily in their polymerized form in unstimulated platelets. Platelet activation results in microtubule disassembly and then reassembly; such alterations in the marginal microtubule bundle result in platelet shape changes ( 629, 630 ). Microtubules may be disorganized in giant platelet disorders ( 626 ).

**PLATELET GRANULES AND ORGANELLES** Normal platelet function appears to require some amplification or accentuation of any given stimulus to obtain an appropriate response. Accordingly, platelets possess secretory granules and mechanisms that serve this purpose by releasing additional stimulatory materials, previously sequestered within the resting platelet, into the environment of a developing hemostatic or thrombotic mass. Two main secretory granules, the  $\alpha$ -granules and the dense bodies, appear to be the main effectors with their highly reactive and readily available contents [i.e., adenosine diphosphate (ADP) and fibrinogen] ( 631 ). Platelet granule secretion begins with a dramatic increase in platelet metabolic activity, set off by a wave of calcium release and marked by increased adenosine triphosphate (ATP) production ( 632, 633 ). ATP generation proceeds with rapid changes in the cytoskeleton with the “bundling” of actin filaments and the development of the “contractile ring” around centralized granules before their extrusion ( 559, 560 ). After platelet stimulation by agonists, granules fuse with the surface membranes and extrude their contents ( 634 ). The actual site of granule membrane fusion, in the SCCS or plasma membrane or both, remains unclear ( 558, 635 ). Internal contraction is required for this extrusion and ultimate discharge into the surrounding medium. Some of the molecular events that govern platelet granule release appear to involve many of the same proteins and processes observed in other systems of membrane docking, fusion, and extrusion ( 636, 637 and 638 ). Furthermore, granule secretion in platelets is a graded process that depends on the number, concentration, and nature of the original stimulus/stimuli, either strong (i.e., thrombin and collagen) or weak (i.e., ADP and epinephrine) ( 639 ).  $\alpha$ -Granules and dense bodies are distinguished morphologically from one another by their electron density as revealed by electron microscopy, whereas lysosomes and microperoxisomes require enzyme cytochemical stains to be visualized ( 640, 641 ). The role of these other platelet granules (lysosomes, peroxisomes) and organelles, such as mitochondria, is less dramatic than those of the  $\alpha$ -granules and dense bodies and is discussed later.

**$\alpha$ -Granules**  $\alpha$ -Granules, numbering approximately 50 per platelet, are the predominant platelet granules with a cross-sectional diameter of approximately 300 nm ( 642 ). They are

approximately spherical in shape with an outer membrane enclosing two distinct intragranular zones that vary in electron density. The larger, electron-dense region is often eccentrically placed and consists of a nucleoid material that is rich in platelet-specific proteins such as  $\beta$ -thromboglobulin (643). The second zone of lower electron density lies in the periphery adjacent to the granule membrane and contains tubular structures with adhesive gps such as vWF and multimerin along with factor V (644, 645 and 646). It has been known for many years that platelets take up material into their cytoplasm from the external milieu (647), and recent work demonstrates that they can incorporate specific plasma proteins into their  $\alpha$ -granules (648, 649). At this point, one can categorize the various  $\alpha$ -granule proteins into different aspects such as origin (megakaryocyte or nonmegakaryocyte), location within the granule, and function (adhesive or mitogenic). The proteins are discussed below in that order and listed in Table 19.4 with references.

**TABLE 19.4. Major Platelet Granular Constituents Secreted with Activation**

| <b><math>\alpha</math>-Granules</b>  |  |                                       |   |                             |
|--|--|---------------------------------------|---|-----------------------------|
| Protein  | Comments   | Amount/ $10^9$<br>Platelets           | Concentration<br>in Platelets<br>>Plasma  | Reference                   |
| <b>Coagulant proteins</b>  |  |                                       |   |                             |
| Fibrinogen   | Critical ligand for aggregation                  | 140 $\mu\text{g}/10^9$<br>platelets   | 3 $\times$ conc.<br>platelets<br>>plasma  | 631                         |
| Factor V   | Critical cofactor for coagulation                | 4 $\mu\text{g}/10^9$<br>platelets     | 30 $\times$ conc.<br>platelets<br>>plasma | 663                         |
| <b>Platelet-specific proteins</b>  |  |                                       |   |                             |
| Platelet factor 4  | Marker for platelet activation                   | 12 $\mu\text{g}/10^9$<br>platelets    | 20 K conc.<br>platelets<br>>plasma        | 654                         |
| $\beta$ -Thromboglobulin   | Marker for activation                            | 10–20 $\mu\text{g}/10^9$<br>platelets | 20 K conc.<br>platelets<br>>plasma        | 655                         |
| <b>Mitogenic and angiogenic factors</b>  |  |                                       |   |                             |
| Platelet-derived growth factor   | Smooth muscle mitogen                            | 30–100 ng/ $10^9$<br>platelets        |   | 680, 683                    |
| Transforming growth factor- $\beta$  | Complex activation pathway; binds thrombospondin |                                       |   | 681                         |
| Vascular endothelial growth factor   | Relatively high concentrations in platelets      |                                       |   | 682                         |
| <b>Adhesive glycoproteins and <math>\alpha</math>-granule membrane-specific proteins</b> |  |                                       |   |                             |
| Thrombospondin   | Multiple complexes                               | 40 $\mu\text{g}/10^9$<br>platelets    | 20 K conc.<br>platelets<br>>plasma        | 656, 657,<br>658 and<br>659 |

|                             |   |                                      |                                |   |
|-----------------------------|---|--------------------------------------|--------------------------------|---|
| von Willebrand factor (vWF) | Role in adhesion  | 0.3 µg/10 <sup>9</sup> platelets     | 100 × conc. platelets > plasma | <a href="#">1030</a> , <a href="#">1031</a> |
| Multimerin                  | Binds factor V; resembles vWF binding factor VIII; has RDG sequence |                                      |                                | <a href="#">646</a>                         |
| P-selectin                  | Mediates platelet-leukocyte binding                                 | 20,000 copies on activated platelets |                                | <a href="#">672</a>                         |

#### Dense Granules

| Constituent            | Comments  | Concentration in Granules (nmol/mg Dense Granule Protein) | Percent (%) Secreted                 | Reference           |
|------------------------|---|---|--------------------------------------|---------------------|
| Adenosine diphosphate  | Highly concentrated; a critical mediator of aggregation | 630   | 95 secreted with platelet activation | <a href="#">631</a> |
| Adenosine triphosphate |   | 440   | 40 released with activation          | <a href="#">688</a> |
| Calcium                |   | 2630  | 70 secreted with activation          |                     |
| Serotonin              |   | 100   | 95 released with activation          |                     |

conc., concentration.

NOTE: A number of additional elements are released or secreted from within the platelet. For example, α-granules also contain the major platelet surface glycoproteins (gps) gpIIb-IIIa and gpIb-IX along with albumin and immunoglobulin G, adhesive glycoproteins (fibronectin, vitronectin), fibrinolytic components (α<sub>2</sub>-antiplasmin, plasminogen activator), and coagulation-related proteins (high-molecular-weight kininogen, α<sub>2</sub>-macroglobulin). In addition, dense granules contain guanosine triphosphate/guanosine diphosphate and high concentrations of pyrophosphate, phosphate, and magnesium, much of which is secreted with activation ([631](#)). A number of additional proteins are present, some released and some retained in the platelet cytosol, such as a subunit of factor XIII, amyloid β-protein precursor, protease nexin I, and tissue factor pathway inhibitor.

Three proteins, β-thromboglobulin, PF4, and thrombospondin, are highly concentrated in α-granules and are synthesized in megakaryocytes. The first two, β-thromboglobulin and PF4, show homology in amino acid sequence and share the additional features of localization in the dense nucleoid of α-granules, heparin-binding properties, and membership in the CXC family of chemokines ([526](#), [576](#), [650](#), [651](#), [652](#) and [653](#)). Together, they constitute approximately 5% of total platelet protein, and because of their platelet specificity (produced solely in megakaryocytes), they can serve as useful markers for platelets in serum or plasma ([654](#), [655](#)). The origins, neutrophil-activating properties, heparin-binding features, structures, and antiangiogenic effects of these small (M<sub>r</sub> = ~10,000) but complex proteins and their relatives have been described ([631](#)). The third member of this group, thrombospondin, first described as thrombin-sensitive protein/endogenous platelet lectin ([656](#), [657](#) and [658](#)), is part of the thrombospondin family of proteins, comprises 20% of the total platelet protein released in response to thrombin, and participates in platelet plug formation ([656](#), [659](#), [660](#)). vWF is synthesized by megakaryocytes and is present in the tubular structures of the α-granule peripheral zone,

similar to its localization within Weibel–Palade bodies of vascular endothelial cells (645, 661). Factor V and multimerin, a factor V/Va-binding protein (646, 662, 663), co-localize with vWF in platelets but not in endothelial cells. Additional coagulant proteins in the  $\alpha$ -granule include fibrinogen, which is incorporated actively from plasma but apparently is not synthesized by megakaryocytes (648, 664), and a plasminogen activator similar to tissue plasminogen activator (665). *In vitro* studies demonstrate that antibodies to gpIIb–IIIa are transported from the plasma membrane into  $\alpha$ -granules (666), and cycling of gpIIb–IIIa between granules and the platelet surface has been described (667). Some data suggest that these movements of the gpIIb–IIIa complex could affect fibrinogen transport into granules (668). The reservoir of gpIIb–IIIa present in  $\alpha$ -granule membranes may contribute significantly to the surface fibrinogen receptors present on activated platelets (669, 670 and 671). Two distinct granule membrane proteins, P-selectin (granule membrane protein–140) and granule membrane protein–33, have been shown to be translocated from the granule membrane to the plasma membrane after platelet activation (672, 673). Finally, a number of additional proteins have been located to the surface of  $\alpha$ -granules alone, including CD9, platelet–endothelial cell adhesion molecule–1 (PECAM–1), Rap 1b, gpIb–IX–V, and osteonectin (674, 675 and 676) (Table 19.4). Small amounts of virtually all plasma proteins, such as albumin, IgG, fibronectin, and  $\beta$ -amyloid protein precursor, may be taken up into the platelet  $\alpha$ -granules (661, 677, 678 and 679). In addition, the presence of several growth factors, including platelet–derived growth factor, TGF- $\beta$ <sub>1</sub>, and vascular endothelial growth factor, in these granules has important implications for the potential mitogenic activity of platelets (680, 681 and 682). For example, activated and aggregating platelets can potentially release these growth stimulants directly onto responsive vascular cells, such as smooth muscle cells, and induce proliferation that can relate to the progression of atherosclerotic vascular lesions (683, 684). The platelets and megakaryocytes of patients with gray platelet syndrome have decreased numbers of  $\alpha$ -granules and reduced levels of some proteins. It is proposed that there is incorrect targeting of  $\alpha$ -granule proteins to the  $\alpha$ -granule in the megakaryocyte in this disease (685, 686).

**Dense Bodies** Dense bodies, numbering approximately five per platelet, are exceptionally electron dense and easily appreciated by electron microscopy due to their distinctive “bull’s eye” appearance (687). With an approximate diameter of 250 nm, these granules contain a large reservoir of ADP, a critical agonist for platelet activation that amplifies the effect of other stimuli (688). In addition to this nonmetabolic pool of ADP, the dense bodies are rich in ATP, pyrophosphate, calcium, and serotonin (5-hydroxytryptamine) with lesser amounts of GTP, guanosine diphosphate, and magnesium (631). The adenine nucleotides are synthesized and segregated by megakaryocytes, whereas serotonin is incorporated into dense granules from the plasma by circulating platelets (689, 690 and 691). There is more ADP than ATP in dense bodies, and both can lead to adenosine monophosphate (AMP). In turn, AMP can be dephosphorylated to adenosine or cyclized to produce cyclic AMP, an inhibitor of the platelet stimulatory response. The dense granule membrane contains P-selectin and granulophysin (692).

**Lysosomes** Lysosomes are small, acidified vesicles, approximately 200 nm in diameter, that are identifiable only with specific cytochemical stains for acid phosphatase and aryl sulfatase (640) or through immunocytochemistry for cathepsin D and lysosome-associated membrane proteins (LAMP–1/LAMP–2; these are expressed on the plasma membrane after activation) (693, 694 and 695). The exact identification of the CD63 antigen and its relationship to the integral lysosomal membrane proteins have proved controversial (696, 697). Lysosomes are the only platelet granules that contain acid hydrolases with pH optima of 3.5 to 5.5, including  $\beta$ -glucuronidase, cathepsins, aryl sulfatase,  $\beta$ -hexosaminidase,  $\beta$ -galactosidase, heparitinase, and  $\beta$ -glycerophosphatase (



631). Lysosomal constituents are released more slowly and incompletely (maximally, 60% of the granules) than  $\alpha$ -granule or dense body components after platelet stimulation, and their release also requires stronger agonists such as thrombin or collagen, suggesting that they may have a greater role in lysis of thrombi than in the immediate hemostatic response ( 698 , 699 ).

#### **Organelles: Microperoxisomes, Coated Vesicles, Mitochondria, and Glycogen**

*Microperoxisomes* are rare, small (90 nm in diameter) granules, demonstrable with alkaline diaminobenzidine due to their catalase activity ( 700 ). The structure may participate in the synthesis of platelet-activating factor, but its ultimate fate within the platelet cytoplasm is unknown ( 701 ). *Coated vesicles* are 70- to 90-nm-diameter platelet organelles, distinguished by their electron-dense bristle coat ( 702 ). The polyhedral surface coat is composed of clathrin, and special staining reveals that the same coat that is in the plasma and SCCS membranes is found on the coated pits and vesicles themselves ( 703 ). Coated pits and vesicles transfer plasma components to platelet granules, and the number of coated vesicles in platelets increases after stimulation with ADP ( 704 ). Mitochondria in platelets are similar, with the exception of their smaller size, to those in other cell types. There are approximately seven per human platelet, and they serve as the site for the actions of the respiratory chain and the citric acid cycle ( 705 ). Glycogen is found in small particles or in masses of closely associated particles, playing an essential role in platelet metabolism ( 706 ).

## **Platelet Physiology**

The physiologic challenge to platelets remains simple: “Plug holes in blood vessels”; this stands in contrast to the complex information on platelet anatomy noted in the section [Structural and Functional Anatomy](#).

**A GLOBAL VIEW** The point of this “global view” is to emphasize a limited number of major current features of platelet physiology. To begin, it is fair to say that the platelet has come a long way from its past as an “inert particle” or possible artifact ( 4 , 707 ) to its present recognition as a remarkable fragment of megakaryocyte cytoplasm, capable of intense, focused activity that produces a tenacious mass at a site of vessel damage or disease ( 708 , 709 ). The clinical relevance of platelets is well illustrated by the widespread use of platelet gpIIb-IIIa antagonists (e.g., abciximab, eptifibatide) during angioplasty ( 710 , 711 ) and by the general acceptance of aspirin as an antiplatelet agent to prevent heart attack and stroke ( 712 , 713 ).

**Inert but Poised Monitor of Vascular Lumen** A new platelet, emerging from the bone marrow, survives for 10 days in the blood; during this time, it makes innumerable circuits through the vasculature and is continually pushed outward by rheologic forces to the interface between moving blood and the immobile vessel wall ( 714 , 715 ). In the absence of agonists, the platelet remains unactivated for its entire lifespan; its surface receptors, signaling pathways, and contractile elements appear unresponsive—perhaps due, in part, to its negative surface charge and exposure to prostacyclin (PGI<sub>2</sub>) in the microvasculature ( 716 ). Similarly, the major intraplatelet metabolic systems are minimally active in such resting platelets: ATP generation, lipid metabolism to generate ATP, and lipid transformations to PGs are absent or minimal. However, to the best of our knowledge, if this same resting platelet encounters a severed blood vessel (i.e., a bleeding time wound) or an atheromatous plaque ( 717 ), it can immediately stop (adhere) at the site and begin to generate a platelet hemostatic or thrombotic mass (plug). The emphasis here is on the dramatic difference between the resting and activated forms of the platelet and the fact that the inert form can circulate for days in the absence of agonists. Conversely, a vessel abnormality or other agonist can set off activation almost instantaneously at essentially any place within the circulation at any time.

**Greater Role in Arteries Than in Veins** Thrombocytopenic patients exhibit mucocutaneous bleeding (skin and mucous membranes), whereas hemophilia patients experience deep visceral bleeding (joints, muscle masses) (718). The distinction is by no means perfect, but it is clinically relevant. Physicians use the difference as a rough, initial approach to understanding causation in a bleeding patient (719). Platelet deposition (primary hemostasis) is more important than fibrin deposition (secondary hemostasis) in stopping bleeding from the small exposed vessels of the skin (petechiae) and mucous membranes (epistaxis, menorrhagia). Apparently, these vessels have an arteriolar or arterial nature. The converse is true in joints (knee, elbow) and muscles (psoas muscle) in which fibrin deposition is more critical, and the bleeding vessels appear to be venous in terms of the hemostatic pathway involved. The same pattern emerges in treating arterial versus venous thrombosis, with antiplatelet agents (aspirin, clopidogrel) being used to prevent coronary and cerebral vascular events (arterial) and anticoagulants (warfarin, heparin) used in deep venous thrombosis (venous) (720, 721). The point emerges that the platelet system has an efficient means (gpIb and vWF) to manage the flow conditions of the arterial circulation, whereas the fibrin system of plasma coagulation does not. As a result, platelets function successfully in arteries and arterioles, whereas fibrin deposition functions less well. Conversely, in the venous system with minimal blood flow, thrombin and fibrin act appropriately under static or low-flow conditions, and platelets have a lesser role.

**Initial, Basic Challenge: Arrest and Anchor a Moving Platelet** Moving platelets in the arterial circulation use their movement to stop their movement (709). This puzzling and unique functional mechanism, termed *shear-dependent platelet adhesion*, is not understood presently at a molecular level, although the structures of the relevant receptor-ligand pair, platelet gpIb-IX-V and plasma vWF, are known in detail (722, 723). Under resting, static conditions, the two components display no affinity for one another, and exogenous stimuli such as ristocetin are required to induce their interaction (724). However, in the presence of rather modest shear forces ( $>6$  dyne per  $\text{cm}^2$ ), the two proteins develop a sufficient binding affinity to arrest and anchor platelets at the lip of a severed blood vessel or to a vascular surface in the high-flow environment of a coronary artery plaque (725). The fundamental question is how shear force, generated by moving blood, affects the receptor or the ligand, or both. To date, a number of possible explanations have been advanced (726). The most often-stated theory is that shear force alters the conformation of vWF once it is bound to the exposed subendothelium of a damaged artery. However, shear could also affect the receptor alone (708).

**Emerging Concept: Surface versus Core of a Platelet Deposit** In 1999, a major insight altered the thinking about arterial platelet adhesion by demonstrating that the addition of platelets to the surface of a growing platelet deposit/thrombus requires the binding of circulating vWF to the gpIb receptor exposed on the surface of immobilized aggregating platelets (727). This sequence of events is markedly different from the older concept that vWF served only to adhere platelets to a nonplatelet surface such as the subendothelium and that thrombus growth was entirely dependent on the fibrinogen-to-integrin (gpIIb-IIIa) linkage, known earlier to be a major mechanism for platelet aggregation in suspended systems (728). The new concept of vWF-to-gpIb interactions as part of thrombus growth has led to current work on the overall structure of a platelet plug in an arterial flow environment (729). The “thrombus surface” differs dramatically from the “thrombus core,” with vWF-gpIb being the dominant surface system and fibrinogen (particularly platelet  $\alpha$ -granule fibrinogen)-gpIIb-IIIa probably being the required intrathrombus strengthening system needed to produce a resilient platelet mass (730).

**Bedrock of Platelet Function: Glycoprotein Ib to Glycoprotein IIb-IIIa Axis** The list of platelet surface receptors, signaling molecules, and secreted granular contents is long. However, the number of critical molecules is much smaller if one focuses on the activities of two platelet-specific genes with unique, specific, and dominant roles: gpIb and gpIIb (731, 732). For example, gpIb and the gpIIb-IIIa receptor are present in high number (i.e.,



~50,000 receptors per platelet), and deficiencies in either one cause severe clinical bleeding syndromes (Bernard–Soulier syndrome and Glanzmann thrombasthenia) (733, 734, 735, 736 and 737). Therefore, these two receptors are central to platelet function and play central roles. Each receptor–ligand pair has a distinct role, separated in time. For example, the gpIb–vWF interactions subserves shear–dependent adhesion, but once the platelet has stopped and anchored itself to the vessel wall or to the platelet deposit, the receptor–ligand interaction switches to an “off” configuration or mode, and if the gpIIb–IIIa–fibrinogen receptor–ligand pair does not act, then the anchored platelet is likely to release and disengage (738, 739).

**Other Essential Elements: One Plasma and One Granule Ligand** Plasma vWF is composed of approximately 100 subunits that form elongated multimers up to 1.0 μm in length, a distance that approaches one–half of the platelet diameter (740, 741). This huge strand of protein has a highly specific and unique role to mediate platelet adhesion to vascular subendothelium under the flow conditions of the arterial circulation (742). Apparently, the extreme length of vWF is needed for arterial platelet adhesion, but an outer limit to vWF length must exist because if it is longer, then thrombotic thrombocytopenic purpura ensues (743, 744). Thrombotic thrombocytopenic purpura results from the absence of the metalloprotease that normally cleaves vWF to an effective but not pathologic length (745). In addition to vWF, α–granule fibrinogen, probably with plasma fibrinogen, is required to link aggregating platelets into a permanent and resilient mass once platelet function is initiated by gpIb and vWF. Plasma fibrinogen alone appears insufficient to give optimal function, so signal transduction is needed within the platelet to activate gpIIb–IIIa once shear–dependent adhesion has occurred. Consequently, α–granule secretion of fibrinogen into the deposit is also exceptionally important for normal platelet mass development (730).

**Summary** The essence of platelet physiology is constant surveillance of the lumens of the arterial circulation, followed by rapid deposition at sites of damage. The initial step of adhesion depends on platelet gpIb and plasma vWF, whose affinity requires shear forces generated by blood flow. The binding of gpIb–vWF is followed by aggregation through the gpIIb–IIIa–fibrinogen system as amplified and reinforced by signal transduction and secretion events that activate gpIIb–IIIa and release α–granule fibrinogen.

**A MOLECULAR PERSPECTIVE** This section classifies the major molecular systems in platelets as (a) surface receptors, (b) signaling elements, (c) molecules that govern shape change and motility, (d) selected granule constituents and members of the membrane fusion system for granule secretion, and (e) inhibitors.

**Surface Membrane Receptors** The surface membrane receptors of platelets are broadly classified here as *adhesive* or *agonist*; in turn, they are somewhat arbitrarily ordered as to potential importance, depending on current knowledge of their number on the platelet surface, the extent of their activity, and their known clinical relevance. They mediate a wide variety of adhesive cellular interactions, often through specific ligand binding, and they function as receptors that can receive signals from outside the platelet, resulting in distinct platelet responses to the external environment. Table 19.5 provides a current summary of these receptors.

**TABLE 19.5. Platelet Surface Glycoprotein (gp) Receptors for Adhesion/Aggregation**

| Receptor | Family Group and/or Name | Ligand | Comment | Molecules/Platelet |
|----------|--------------------------|--------|---------|--------------------|
|----------|--------------------------|--------|---------|--------------------|

Fundamental pairing (many copies; clear role; lack leads to clinical bleeding)

|            |                                |                    |                                |           |
|------------|--------------------------------|--------------------|--------------------------------|-----------|
| gpIb-IX-V  | Leucine rich vWF gp            |                    | Lack: Bernard-Soulier syndrome | 25,000    |
| gpIIb-IIIa | $\alpha_{IIb}\beta_3$ Integrin | Fibrinogen and vWF | Lack: Glanzmann thrombasthenia | 50-80,000 |

Collagen receptors (confusing bleeding, no bleeding, or mild bleeding)

|          |                            |                         |  |        |
|----------|----------------------------|-------------------------|--|--------|
| gpIa-IIa | $\alpha_2\beta_1$ Integrin | Collagen                | Variable reports of bleeding with deficit      | 1000   |
| gpIV     | No family known, CD36      | Collagen/thrombospondin | No bleeding with deficit                       | 20,000 |
| gpVI     | Ig family                  | Collagen                | Role in activation; mild bleeding with deficit | 2000   |

Extracellular matrix receptors (few copies and no known platelet deficiency states)

|                    |                            |             |   |      |
|--------------------|----------------------------|-------------|---|------|
| gpIc-IIa           | $\alpha_5\beta_1$ Integrin | Fibronectin | $\alpha$ -Chain differs from $\alpha_6$               | 1000 |
| gpIc-IIa           | $\alpha_6\beta_1$ Integrin | Laminin     | $\alpha$ -Chain migrates with $\alpha_5$ on PAGE      | 1000 |
| $\alpha_v$ -gpIIIa | $\alpha_v\beta_3$ Integrin | Vitronectin | Same $\beta$ -chain as gpIIb-IIIa, different $\alpha$ | 100  |

Additional surface elements of uncertain significance in hemostasis

|         |                 |         |                                      |      |
|---------|-----------------|---------|--------------------------------------|------|
| PECAM-1 | Ig family, CD31 | Heparin | Uncertain function, perhaps adhesion | 8000 |
|---------|-----------------|---------|--------------------------------------|------|

|                |                     |   |        |
|----------------|---------------------|---|--------|
| Fc $\gamma$ R2 | Ig family,<br>CD32  | Immune<br>complexes; role<br>in immune<br>complex<br>deposits | 1000   |
| CD9            | Tetraspanin,<br>p24 | Unknown role,<br>but abundant<br>surface copies               | 40,000 |

Ig, immunoglobulin; PAGE, polyacrylamide gel electrophoresis; PECAM-1, platelet-endothelial cell adhesion molecule-1; vWF, von Willebrand factor.

NOTE: The group of surface receptors noted above functions in interactions between cells or between cells and immobilized surfaces, and the group differs markedly from the other major class of platelet surface receptors that mediate specific responses to soluble agonists. These latter "agonist receptors" include those for thrombin, adenosine diphosphate, and thromboxane A<sub>2</sub> and, as discussed in the text, generally prove to be G protein-coupled receptors with seven-transmembrane domains.

**Major Surface Adhesive Glycoproteins: Glycoprotein Ib and Glycoprotein IIb-IIIa** The *gpIb-IX-V complex* is a set of four distinct polypeptide chains, although the group is often referred to as simply *gpIb* ( [722](#), [746](#), [747](#) and [748](#) ). Produced from four discrete genes on four different chromosomal sites ( [749](#), [750](#), [751](#) and [752](#) ), the different peptide chains share structural features (e.g., leucine-rich repeats, specific interactions within the surface-expressed complex/system, and common absence in the deficiency state, Bernard-Soulier syndrome) ( [735](#), [753](#), [754](#) ) and form the receptor that mediates the shear-dependent interaction of platelets with vWF ( [755](#), [756](#), [757](#) and [758](#) ). The active site within *gpIb*a binds the vWF ligand within a discrete region, termed the *A1 domain*, a structure that is distinct from the RGD-containing sequence in vWF that interacts with *gpIIb-IIIa* ( [758](#), [759](#) ). Platelet *gpIb-IX-V* also binds thrombin in the same charged region of *gpIb*a located to the COOH-terminal side of the seven leucine-rich repeats ( [760](#) ). The complex also serves as a thrombin receptor (in addition to its thrombin-binding quality) after the cleavage and removal of the *gpV* chain through proteolysis ( [761](#), [762](#) ). Each chain has distinctive features: *gpIb*a, with a large amount of sialic acid-rich O-linked carbohydrate in its macroglycopeptide region, contributes to the negative charge of the plasma membrane ( [571](#), [763](#) ). *gpIb*B has a phosphorylation site and is disulfide bonded to the  $\alpha$ -chain. *gpIX* has a single leucine-rich repeat, as does the  $\beta$ -chain, whereas *gpV* has 15 tandem repeats ( [747](#), [748](#), [764](#) ). *gpIb*a extends into the shear field of the extracellular environment through a variable number of 13-amino acid repeats ( [765](#) ) and also is connected to the platelet cytoskeleton by the interaction of its cytoplasmic domain with actin-binding protein ( [766](#) ). Both the  $\alpha$ - and  $\beta$ -chains interact with a potential signaling element termed  $\gamma$ 14-3-3 ( [767](#), [768](#) ). *gpIb* is present on platelet surfaces in a 2:2:1 ratio with *gpIX* and *gpV*, respectively ( [769](#) ), and patients with Bernard-Soulier syndrome who lack or have deficient levels of *gpIb* and *gpIX* ( [735](#) ) exhibit a bleeding diathesis. *gpIIb-IIIa* is the platelet fibrinogen receptor for aggregation and one of the major surface structures and is present in 50 to 100,000 copies distributed on the surface itself, the SCCS, and the  $\alpha$ -granules ( [732](#) ). As a member of the integrin family of proteins, *gpIIb-IIIa* is a transmembrane heterodimer made up of a two-chain disulfide-linked  $\alpha$  subunit with four divalent cation-binding domains and a disulfide bond-rich  $\beta$  subunit ( [736](#), [737](#), [770](#), [771](#) ). *gpIIb* and *gpIIIa* require Ca<sup>2+</sup> to maintain their heterodimeric complex ( [772](#) ) and undergo a Ca<sup>2+</sup>-dependent conformational change after platelet agonist-induced stimulation that facilitates strong binding to fibrinogen and vWF ( [773](#), [774](#) ). This results in the cross-linking

of gpIIb-IIIa molecules on adjacent platelets and subsequent platelet aggregation ( [775](#), [776](#), [777](#) and [778](#) ). As an integrin, gpIIb-IIIa recognizes the RGD sequence and binds to a variety of related adhesive, RGD-containing ligands, including fibrinogen, fibronectin, vWF, vitronectin, and thrombospondin ( [779](#) ). However, binding affinities vary between ligands, either soluble or immobilized, and the major ligand site on the C-terminus of the fibrinogen  $\alpha$ -chain lacks the RGD sequence ( [777](#), [778](#), [779](#), [780](#) and [781](#) ). Platelets exhibit both inside-out (response to surface agonist) and outside-in (response to ligand binding of IIb-IIIa) signaling that regulates and responds to this dominant receptor activity ( [777](#), [778](#), [779](#), [780](#), [781](#) and [782](#) ). The precise molecular basis for the dramatic variations in ligand affinity and the pathways that signal to or from the receptor have been difficult to define. However, point mutations, detected in Glanzmann's thrombasthenia kindreds, have indicated various functional sites, and progress has been made in identifying activating elements ( [783](#), [784](#), [785](#), [786](#), [787](#), [788](#) and [789](#) ). Recent progress suggests that calcium integrin-binding protein activates the receptor by binding to the cytoplasmic domain of IIb and that the Wiskott-Aldrich syndrome protein may play a role in this stimulatory process ( [790](#), [791](#) and [792](#) ).

**Other Surface Membrane Adhesive Receptors** The *collagen receptors* are a set of three membrane proteins (gpIa-IIa, IV, and VI) that mediate collagen interactions. Early studies suggested a significant functional role for these proteins because suspended collagen is a powerful platelet agonist and activator *in vitro* ( [793](#), [794](#), [795](#) and [796](#) ). However, several issues arise when assessing the importance of these receptors. First, they tend to be present in relatively low density [ $<5000$  per platelet ( [797](#) )]; second, their congenital deficiency states are either rare and found to diminish with age [gpIa-IIa deficiency ( [796](#), [798](#) )] or common and of no clinical significance [i.e., approximately 5% of individuals in some populations lack gpIV and do not bleed ( [799](#) )]; third, they do not function under arterial flow conditions, during which the platelet contribution to hemostasis and thrombosis is most important ( [800](#) ). The proteins themselves are well characterized: gpIa-IIa (a  $\alpha_2\beta_1$  integrin, VLA-2) is an adhesion receptor for collagen whose degree of conformational change with platelet activation is debated ( [796](#), [801](#), [802](#) ); gpIV (CD36, gpIIIb, thrombospondin receptor) binds collagen in addition to other surface elements, such as red blood cells containing malarial parasites, but the significance of its contribution to platelet reactivity with collagen remains unclear ( [803](#), [804](#) ); gpVI (member of the Ig superfamily) appears to play a role in signal transduction through *src* family kinases and may act in concert with the Fc $\gamma$  and gpIa-IIb receptors ( [805](#), [806](#) ). To summarize, available knowledge suggests that these platelet collagen receptors have a modest, perhaps redundant, functional role.

**Caveat** Although not included here, vWF can be classified as part of the collagen and extracellular matrix receptor systems, because vWF binds to collagen and related molecules and, in turn, interacts with platelet gpIb. However, descriptions of the vWF-collagen interaction indicate that vWF is not activated by collagen or other subendothelial/extracellular matrix components ( [807](#), [808](#) ). In the absence of shear force, vWF bound to collagenlike materials does not differ from vWF bound to plastic or other inert surfaces ( [708](#), [807](#), [809](#) ). In the absence of stimulants (shear, ristocetin), no affinity exists between platelet gpIb and these soluble or immobilized forms of vWF. The conformational effect of shear on collagen-bound vWF is debated ( [810](#), [811](#) ). The integrin receptors for specific extracellular matrix components include gpIa-IIa for collagen, as noted above, and additional entities for fibronectin, laminin, and vitronectin. All four are trace integrin surface receptors that are found on a variety of cells, present in 1000 copies per platelet or less, whose contribution to platelet function is uncertain. The fibronectin receptor (gpIc-IIa, a  $\alpha_5\beta_1$ , VLA-5, CD29) appears to function in resting platelets ( [812](#) ). A second, distinct platelet gpIc-IIa receptor (a  $\alpha_6\beta_1$ , VLA-6, CD29) binds laminin in a cation-specific manner (Mg/Mn dependent, Ca independent) ( [813](#) ), whereas

the last member of this group ( $\alpha_v\beta_3$ , CD51/61), present in 100 copies per platelet, uses a  $\beta$ -chain identical to that of the IIb-IIIa receptor but binds selectively to vitronectin (814).

**Additional Receptors Related to Adhesion** PECAM-1 binds to heparinlike molecules and may contribute to platelet-heparin interactions and the interactions of platelets with other cells (815). P-selectin [platelet activation-dependent granule-external membrane protein (PADGEM); granule membrane protein-140] is present on  $\alpha$ -granule membranes, as well as the Weibel-Palade body membranes of endothelial cells (816). Because it is translocated to the platelet plasma membrane after activation, its expression on the platelet surface has been used as an indicator of platelet activation *in vivo*. P-selectin mediates the adhesion of neutrophils and monocytes to activated platelets and endothelial cells and, thus, may serve to localize these cells to sites of injury (816, 817). A quadraspanin of uncertain function, *p24/CD9*, is abundant on platelet membranes and is found on a variety of other cell types as well (818). Other surface receptors found in platelets include the Fc $\gamma$ RIIA, with its capacity to bind immune complexes (819); intercellular adhesion molecule-2, capable of mediating platelet-leukocyte interaction (820); platelet-endothelial cell tetraspan antigen-3 (821) of uncertain function; several C1q complement receptors, potentially involved in platelet activation through the contact system (822); and a second nonintegrin receptor for laminin (823).

**Surface Membrane Agonist Receptors for Thrombin, Adenosine Diphosphate, and Thromboxane A<sub>2</sub>** A broad distinction is drawn between the *adhesive* receptors discussed above and the *agonist* receptors noted here. Three main agonist receptors are emphasized because of two attributes: first, their exceptional ability to activate platelets and their clear connection to plasma coagulation (thrombin receptors); second, their obvious clinical relevance as drug targets with clopidogrel acting upon an ADP receptor and aspirin through the thromboxane A<sub>2</sub> pathway. Most of these receptors prove to be seven-transmembrane, G protein-coupled receptors (GPCRs).

**Platelet Thrombin Receptors: Protease-Activated Forms** Platelets have two general forms of thrombin receptors: the well-known protease-activated receptors (PARs) (824) and the recently reported form that arises when gpV is cleaved from the gpIb-IX-V complex (discussed above) (761). In human platelets, the major PAR for thrombin is the one first described in 1991 and now known as *PAR-1* (825), whereas the functional contribution of the second, *PAR-4*, remains unclear (826). In the mouse, knock-out technology has shown that more than one platelet PAR can be required for normal responsiveness to thrombin (827). The basic physiology of thrombin-mediated cleavage of an N-terminal peptide from the extracellular portion of any individual PAR remains applicable to all of the isoforms, with the newly exposed N-terminus then acting as a “tethered ligand” to activate the system through one of at least three G protein  $\alpha$  subunits:  $G_{aq}$ ,  $G_{a12/13}$ , and  $G_{ai}$  (828, 829 and 830). The irreversible nature of the thrombin cleavage of the PARs is followed by subsequent uncoupling, internalization, and degradation of the receptor within lysosomes (831). One of the remarkable aspects of the platelet PAR system is its exceptional “strong agonist” quality that rapidly sets off irreversible platelet activation and aggregation despite the presence of only 2000 PAR molecules per platelet (832, 833). Also, the PARs appear to be a critical link between the plasma coagulation system of secondary hemostasis that produces thrombin and the platelet arm of hemostasis that depends on the “resting to activated” process induced by agonists (834).

**Platelet Adenosine Diphosphate Receptors** Platelets have a unique relationship with ADP. Not only is the nucleotide a well-known agonist for activation (835), it is also selectively sequestered and stored in dense granules (the nonmetabolic pool) for later use as an amplification system for other agonists (688). One of the three platelet ADP receptors, P2Y<sub>12</sub>, appears to be found only in platelets (836) and provides the target for



clopidogrel and ticlopidine, agents commonly used as antiplatelet agents to prevent heart attacks and strokes ( [721](#) ). Although ADP is generally classified as a “weak agonist” for activation ( [837](#) ), it has the historic distinction of being the first one recognized ( [838](#) ), and it interacts widely and effectively with other agonists, such as thrombin and TxA<sub>2</sub>, to activate platelets ( [839](#), [840](#) ). Purine receptors for ADP are designated as P<sub>2</sub> and then further classified as γ for metabolic paths or as X for ion channels. Platelets prove to have two P<sub>2</sub>Y receptors: P<sub>2</sub>Y<sub>1</sub>, acting through phospholipase Cβ/Gα<sub>q</sub>, and P<sub>2</sub>Y<sub>12</sub>, inhibiting adenylyl cyclase through Gai ( [836](#), [841](#), [842](#), [843](#) and [844](#) ). However, only one P<sub>2</sub>X ion channel species is found in platelets: P<sub>2</sub>X<sub>1</sub>, which is ATP-gated and permits rapid calcium influx from external sites into the cytoplasm ( [843](#), [844](#) and [845](#) ). Together, the ADP effects on platelets also lead to intracellular calcium flux from intracellular stores, separate from P<sub>2</sub>X<sub>1</sub>; this process is accompanied by inositol 1,4,5 phosphate 3 (IP<sub>3</sub>) formation through PIP<sub>2</sub>-selective phospholipase Cβ isoforms and arachidonate release through phospholipase A<sub>2</sub> ( [842](#), [843](#), [846](#), [847](#) and [848](#) ).

**Thromboxane A<sub>2</sub> Receptors** TxA<sub>2</sub> is a PG-like lipid synthesized almost exclusively by platelets (as opposed to endothelial or other cells) ( [849](#), [850](#) ). It is a prototypic hemostatic/thrombotic agent in view of its short-lived, localized nature and its ability to activate platelets while contracting blood vessels ( [851](#) ). The physiology of TxA<sub>2</sub> formation is well known: Arachidonate released from phospholipids by phospholipase A<sub>2</sub> is oxidized by platelet cyclooxygenase-1 and then isomerized to TxA<sub>2</sub>, which, in turn, acts on the TxA<sub>2</sub> receptor(s) ( [852](#) ). The isolated receptor is encoded by a single gene but exists in separate platelet and endothelial forms, presumably due to alternative splicing of the transcript ( [853](#), [854](#) ). The receptor exhibits both higher (induces shape change) and lower (induces aggregation) binding affinities for ligands and depends on ADP release for full activity ( [855](#), [856](#) ).

**Additional Agonist Systems: Epinephrine, Serotonin, Vasopressin, and Platelet-Activating Factor Receptors** The functional *in vivo* significance of these receptors is less well defined—and much less certain—than those noted above. They are all GPCRs, present in 250 copies per platelet or fewer; each has been studied *in vitro*, with epinephrine emerging as the best-known member of the group ( [857](#) ). Epinephrine acts on platelets through the α<sub>2</sub> adrenergic receptor ( [858](#) ), leading to a drop in adenylyl cyclase activity and inducing both first-phase aggregation without shape change and second-phase aggregation through synergy with ADP release ( [857](#), [859](#), [860](#) ). The study of the platelet serotonin receptor, 5HT<sub>2A</sub>, as in the forebrain ( [861](#) ) has generated interest in the concept that serotonin transport and receptors in platelets might correlate with serotonin metabolism in psychiatric disorders ( [862](#) ). However, no firm conclusions have been reached, and serotonin, although stored in dense granules, does not induce platelet aggregation in whole blood ( [863](#) ). The vasopressin V<sub>1</sub>-type receptor is present in fewer than 100 copies per platelet, and physiologic concentrations of the hormone are unlikely to activate platelets directly ( [864](#), [865](#) ). The lipid mediator, platelet activating factor, acts through a specific receptor under specific circumstances (TxA<sub>2</sub> synthesis, ADP release), and the significance of the human pathway remains unclear ( [866](#), [867](#) ).

**Signaling Molecules and Pathways** No attempt is made here to trace specific receptors to specific intracellular GTP-binding elements and then to individual signaling molecules such as a phospholipase C species. The pathways are too complex and interrelated for such a venture to be successful. Rather, major pathways activated during agonist stimulation are simply noted here, and further discussion is provided later in this section concerning cytoskeletal rearrangements. Work on platelet signal transduction has emphasized molecular mechanisms that account for the activation of gpIIb-IIIa for fibrinogen binding, particularly in response to gpIb-based ligand binding and adhesion. However, despite consistent effort, this central and critical linkage(s) remains largely unexplained. Binding of

vWF to platelet gpIb does initiate signaling events and must involve the receptor linkages to  $\beta$ 1-3 and actin-binding protein (868, 869 and 870), but no specific steps that connect gpIb directly with gpIIb-IIIa activation have been definitely defined. The possibility remains that the Ib to IIb-IIIa pathway is basically mechanical and depends on physical connections that are broken by shear forces exerted on IIb-IIIa when platelet movement is stopped through the initial Ib-to-vWF-to-subendothelium relationship. The possibility that such a direct connection exists is supported by the fact that activation of IIb-IIIa is nearly instantaneous after platelet arrest through gpIb. Rapid activation and ligation of IIb-IIIa are required for successful platelet plug formation because the initial, shear-dependent interaction of Ib with vWF is rapidly reversed and lost once the platelet is immobilized and the shear forces, which permitted adhesion, dissipate.

**G Protein-Coupled Receptors** The basic model for platelet agonist signaling involves a GPCR (i.e., for thrombin, ADP, TxA<sub>2</sub>) that binds its ligand and subsequently activates one or more pathways through its heterotrimeric G proteins. Perhaps the best-defined examples are (a) the G<sub>iα</sub> subunit that suppresses adenylate cyclase (this drop in cyclic AMP activates platelets) (871) and (b) the G<sub>qα</sub> subunit that activates the beta isoform of phospholipase C (872). The converse of the G<sub>iα</sub> effect on cyclic AMP is the inhibitory PGI<sub>2</sub> receptor (prostacyclin) that releases the G<sub>sα</sub> subunit to raise cyclic AMP levels and inhibit platelet function (873). The dissociation and function of these α subunits by guanosine diphosphate/GTP exchange, catalyzed by the ligand-bound receptor, are accompanied by the separate activities of the other subunits that function as a βγ dimer to activate PI3 kinase along with phospholipase Cβ(s) (873) and other signaling molecules.

**Phospholipase C and Protein Kinase C Isoforms and Phosphoinositol Hydrolysis** The release of IP<sub>3</sub> from PI 4,5-P<sub>2</sub> is fundamental to platelet activation, because this messenger (IP<sub>3</sub>) leads to the essential early release of calcium, presumably through the IP<sub>3</sub> receptor of the dense tubules, that follows agonist addition (874). PI-specific phospholipase C isoforms, specifically beta1 and beta2, also release diacylglycerol from PIP<sub>2</sub> that, together with released calcium, stimulates the activity of protein kinase C(s) (875, 876 and 877). Although the entire spectrum of protein kinase C substrates remains unclear, one of the main targets is p47 (pleckstrin), which is phosphorylated at several sites and acts in actin reorganization and in PI metabolism (878, 879 and 880).

**Phosphoinositol Metabolism and Phosphoinositol 3-Kinase** Inositol phospholipids, although constituting only a small (<10%) fraction of platelet phospholipids, are intensely active in signaling events and appear to be the focus of synthetic and lipase enzymes that regulate a constellation of substrates and products (874, 881). One of the prominent synthetic enzymes is PI3K, which phosphorylates the different PI species at the 3-position (882). The PI3K enzyme(s) appears to interact with several signaling pathways and may play some central and as yet only partially understood role in platelet activation (883).

**Arachidonate Release and Phospholipase A<sub>2</sub>** Generation of platelet TxA<sub>2</sub> appears to be regulated by the availability of the major substrate arachidonic acid (20:4) (884). Although the exact pathways of arachidonate release have been extensively studied, the current picture suggests that the bulk of the 20:4 substrate comes from the 2-position of phosphatidylcholine and phosphatidylethanolamine (PE) through the actions of one or more of the isoforms of phospholipase A<sub>2</sub> (884, 885).

**Molecular Aspects of Shape Change, Spreading, and Contraction** Recent research provides a major advance in our understanding of how platelets change shape, spread, and contract—namely, insight into small GTP-binding proteins that serve a general initiating role in these events (590, 625, 886). The *Rho* family includes three such platelet proteins that appear to set off separate but related cytoskeletal events: Rac, lamellipodia formation; cdc42, filopodia; and Rho A, focal adhesions and stress fibers (590, 887). A series of proteins translate the initial activation of the *Rho* element to the local, specific end result, including PI3K and related enzymes that produce polyphosphoinositides (PIP<sub>2</sub>)



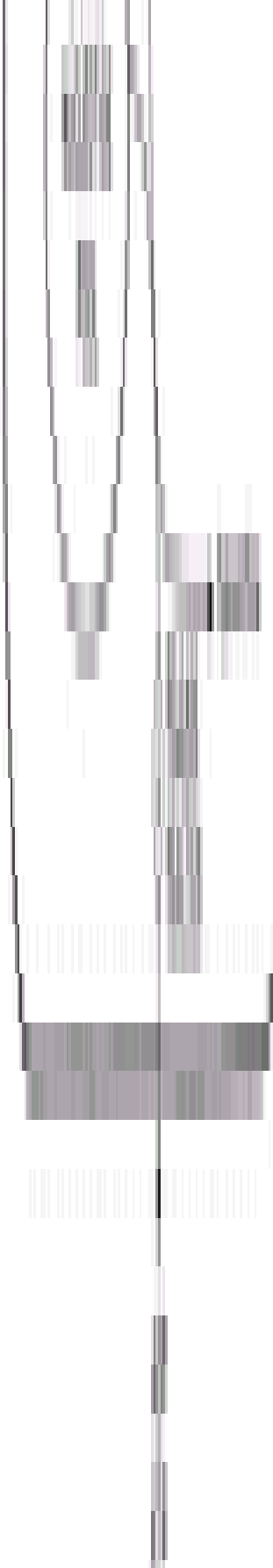
([888](#)); both Wiskott–Aldrich syndrome protein and vasodilator–stimulated phosphoprotein that regulate actin filaments ([889](#), [890](#)); and members of both the serine/threonine (p65PAK family) and tyrosine (pp60 *src* family) kinase families with multiple targets ([891](#), [892](#) and [893](#)). These pathways converge on a later set of messengers that effect the remodeling of actin filaments ([618](#)). This next set of agents uncaps, nucleates, polymerizes, and bundles actin, including gelsolin, profilin, thymosin  $\beta_4$ , vinculin, and zyxin ([613](#), [615](#), [894](#)); a variety of additional modulators such as PIP2, mentioned above; myosin, regulated by myosin light chain kinase; and calpains, calcium–dependent proteases that remodel several substrates ([622](#), [624](#)). Altogether, the welter of interactions, substrates, targets, and end results is daunting, and the mix emphasizes the complex regulation of these events ([590](#)). The overall fact emerges, again, that platelets are actin rich, musclelike fragments, capable of dramatic changes in shape, size, and surface reactivity, that use a host of molecular elements to accomplish the basic goal of plugging vascular holes with an adherent, amorphous, resilient deposit.

### ***Secreted Elements and Molecules Governing Platelet Secretion***

***Diverse Secreted Proteins: With and without Clear–Cut Function*** Platelets contain a number of proteins in their  $\alpha$ –granules that vary widely in their amount and apparent function. For example, the large amount of the small, platelet–specific proteins PF4 and  $\beta$ –thromboglobulin does not correlate directly with any obvious, critical contribution to platelet function ([652](#)). Similarly, megakaryocytes and platelets synthesize and retain a large amount of thrombospondin, but the precise and essential function for this protein remains somewhat unclear ([659](#)). Recent work demonstrates a new role for PF4. Complexed with heparin and bound to surface Fc $\gamma$ RIIA, PF4 provides a target antigen for the antibodies that mediate heparin–induced thrombocytopenia ([895](#)). Conversely, with regard to fibrinogen, platelets do not synthesize it but do appear to take it up and concentrate it within granules for its critical role in developing the core of a platelet deposit through aggregation ([648](#), [649](#)). The role of vWF in platelet function is also well defined, and the protein is both synthesized in megakaryocytes and stored in platelets ([661](#)). However, other adhesive plasma proteins that resemble fibrinogen and vWF, such as vitronectin and fibronectin, are also incorporated into platelet  $\alpha$ –granules, but their contribution to function remains unclear.

***Molecules of Membrane Fusion*** Considerable work has led to a general understanding of membrane fusion in a variety of cells ([896](#), [897](#)), and similar insights are now being applied to understanding fusion events in platelets ([898](#), [899](#) and [900](#)). The challenge is to explain how a granule within a cell or platelet finds a suitable site on the plasma membrane with which to fuse ([896](#), [897](#)). Once fusion occurs, the vesicle or granule contents gain access to the outside milieu, and transport or secretion proceeds. The underlying hypothesis, termed *SNARE* [soluble N–ethylmaleimide sensitive factor (*NSF*) attachment protein receptor], states that vesicles/granules match themselves to a fusion site through the binding of a specific vesicle protein (v–SNARE) to a complex in the site or target (t–SNARE) ([896](#)). In platelets, three separate granules ( $\alpha$ –granules, dense granules, lysosomes) appear to fuse with either the SCSS or the surface plasma membrane, and specific assays that discriminate among these events have led to the identification of molecules of interest ([901](#), [902](#) and [903](#)). The number of relevant proteins and participants (calcium, diacylglycerol) that regulate each fusion event is large, but considerable progress is being made in this promising area.

***Inhibitory Molecules and Pathways*** In considering the native, nondrug inhibitors of platelets, prostacyclin (PGI<sub>2</sub>) has been particularly well studied. This unstable, readily hydrolyzed PG is synthesized by endothelial cells and acts through a specific GPCR present on platelets, termed the *IP receptor*, to stimulate adenylate cyclase and raise platelet cyclic AMP levels ([904](#)). Platelets also respond to the stable PGs (PGE<sub>2</sub>, D<sub>2</sub>, F<sub>2a</sub>) through specific receptors ([905](#)). A second endothelium–derived platelet inhibitor is nitric



ugh a stimulation of guanylate cyclase that raises cyclic [6](#)). Additional mechanisms of platelet inhibition involve an armed *CD39* or *ecto-ADPase*), that cleaves and inactivates [7](#)). Platelet activation can also be dampened by receptor t acts to phosphorylate GPCRs within their cytoplasmic

### abolism

**ND IONIC** The platelet, after considerable investigation, fragment with abundant metabolic capability but minimal ecause it contains only low levels of RNA and lacks a t, the platelet is composed of approximately 60% protein, . Platelet minerals include magnesium, calcium, potassium, ostantial amounts of vitamin B <sub>12</sub>, folic acid, and ascorbic ; of sodium and potassium within the platelet are 39 mEq [0](#)). This gradient against plasma, apparently distributed in rtments, is maintained by an active ion pump, which derives ase of the ouabain-sensitive, Na<sup>+</sup>/K<sup>+</sup>-dependent type ([910](#) :ain a low cytoplasmic Ca<sup>2+</sup> concentration (~100 to 500 port from plasma and promoting active efflux of this ion of calcium are present in platelets: a rapidly turning-over ;odium-calcium antiporter in the plasma membrane and a egulated by calcium, magnesium-ATPase and sequestered [912](#)). Platelets are, therefore, able to transport calcium from st a gradient into the extracellular space or by ular system.

**GENERATION OF ADENOSINE TRIPHOSPHATE** There are ie energy metabolism of the platelet ([Fig. 19.7](#)) and that of active glycolysis and the synthesis and use of large amounts the major mediator of intracellular energy use is an platelet, like muscle, is metabolically adapted to expend y during aggregation, the release reaction, and clot

**Figure 19.7.** Simplified scheme of platelet energy metabolism. Platelet energy is derived from the metabolism of glucose and, to a lesser extent, from the metabolism of fatty acids. Energy is provided in approximately equal amounts by glycolysis and the citric acid cycle. The platelet energy reserve is provided by the metabolic pool of platelet nucleotides that is in a state of continuous turnover. This energy is used for the maintenance of the platelets' structural integrity and in the reactions accompanying the response of platelets to stimuli. The granule-bound storage (nonmetabolic) nucleotide pool is discharged during the release reaction. ADP, adenosine diphosphate; AMP,

adenosine monophosphate; ATP, adenosine triphosphate; IMP, inosine monophosphate. (Adapted from Hirsh J, Doery JCG. Platelet function in health and disease. *Prog Hematol* 1972;7:185–234.)

The major energy source for the platelet is glucose, which is rapidly taken up from the plasma ( [Fig. 19.7](#), Step 1). Under basal conditions, 40 to 50% of the absorbed glucose is used to provide energy for synthetic functions or is converted into glycogen. Electron microscopy reveals prominent masses of glycogen in some platelets. The glycolytic pathway with its regulatory enzymes (phosphorylase, pyruvate kinase, hexokinase, phosphofructokinase, and glyceraldehyde 3-phosphate dehydrogenase) ( [914](#) ), the citric acid cycle, the pentose-phosphate shunt, and the NAD-NADH [nicotinamide adenine dinucleotide-nicotinamide adenine dinucleotide (reduced form)] system are all active in the platelet. Ninety-eight percent of platelet pyruvate is converted to lactate, which leaves the platelet ( [915](#), [916](#) and [917](#) ). In addition to glycolysis, platelets contain enzymes for oxidative phosphorylation and fatty acid oxidation ( [Fig. 19.7](#), Step 2) ( [918](#), [919](#) ). ATP production in platelets is affected greatly by the suspending medium, chelating agents, and *in vitro* manipulation of platelets. In plasma, oxidative ATP production by unstimulated platelets is predominant, and all ATP formed by oxidative phosphorylation may be the product of  $\beta$ -oxidation of fatty acids ( [920](#) ); glycogen turnover, the hexose monophosphate shunt, and the citric acid cycle are virtually inactive ( [917](#) ). Glycolysis is capable of completely compensating for reduced ATP production when oxidative phosphorylation is inhibited. Platelet stimulation by agents that induce aggregation and release is associated with a marked increase in metabolic activity involving glycogenolysis ( [921](#) ) as well as with glycolysis and oxidation to varying degrees ( [914](#), [922](#) ). The total amounts of ATP synthesized by the two pathways are approximately equal because of the greater ATP yield per mole of glucose provided by oxidation ( [915](#), [919](#) ). ATP energy is used in unstimulated platelets to maintain homeostatic levels of  $H^+$ ,  $K^+$ ,  $Na^+$ , and  $Ca^{2+}$  ( [923](#), [924](#) ).

**NUCLEOTIDE METABOLISM AND THE NONMETABOLIC ROLE FOR ADENOSINE DIPHOSPHATE** Adenine nucleotides constitute 90% of free platelet nucleotides and are partitioned into at least two different pools, which undergo minimal interchange ( [Fig. 19.7](#)) ( [925](#) ). The metabolic or cytoplasmic pool makes up 40% of total adenine nucleotides; it is used for the maintenance of various energy-consuming cell functions and is retained during platelet release. In large part made up of ATP, this pool is constantly turning over, as revealed by the rapid incorporation of  $^{14}C$ -adenine and  $^{32}P$ -phosphate into ATP. In unstimulated platelets, the relative concentrations of metabolic AMP, ADP, and ATP are maintained by the enzyme adenylate kinase ( [Fig. 19.7](#), Step 3) ( [926](#), [927](#) ). The storage pool, which is present in the dense bodies, contains approximately two-thirds of the total platelet nucleotides, mainly in the form of ADP and ATP ( [928](#) ). It is metabolically inactive, does not rapidly incorporate exogenous adenine or phosphate, and equilibrates slowly with the metabolic pool ( [929](#) ). Nucleotides in this pool are extruded from the platelet during the release reaction ( [Fig. 19.7](#), Step 4) and cannot be replenished after release. ATP hydrolysis is required for conversion of G-actin to F-actin, and the resultant ADP becomes associated with F-actin; this small percentage of platelet ADP bound to actin constitutes one-third of the nucleotide compartment ( [930](#) ). Perhaps as much as 40% of all ATP produced is used during the process of actin treadmilling ( [931](#) ), and as much as 7% is used in the turnover of the phosphoinositides PIP and PIP<sub>2</sub> ( [932](#) ). The ATP that is broken down to provide energy for the release reaction is not rephosphorylated; rather, it is irreversibly degraded to hypoxanthine ( [Fig. 19.7](#), Step 5), which diffuses out of the cell ( [925](#) ). This reaction also proceeds slowly in stored normal platelets ( [928](#) ). Hypoxanthine in the plasma may be reincorporated slowly into metabolic AMP by the salvage pathway ( [Fig. 19.7](#), Steps 6 and 7) ( [928](#), [933](#) ). The platelet has only a limited capacity for *de novo*

nucleotide synthesis (934). In artificial media, adenine nucleotides are synthesized by the platelet from adenine (Fig. 19.7, Step 9) (927). The physiologic significance of these pathways is unclear, however, because mammalian plasma does not contain adenine or adenosine. An alternative pathway by which platelet nucleotides are formed presumably is the salvage pathway, the means by which exogenous hypoxanthine is slowly incorporated into metabolic AMP (Fig. 19.7, Steps 6 and 7) (928). This nucleotide is formed in the liver, usually is present in the plasma, and may be transported by erythrocytes (927). Platelets also contain guanine nucleotides and uracil and cytosine pyrimidines. The role of cyclic AMP in platelet function has been noted above. Platelet stimulation results in marked activation of ATP-producing pathways (935). The steady-state level of ATP decreases, and hypoxanthine accumulates (935). In addition, a transient but greatly increased uptake of phosphate by platelets occurs (936). Although ATP-requiring processes are activated by platelet stimulation, it is unknown whether or how these are coupled to signal processing in platelets.

**LIPID COMPOSITION AND METABOLISM AND THE GENERATION OF ARACHIDONIC ACID** Phospholipids constitute 80% of total platelet lipid, with neutral lipids and glycolipids comprising the remainder (937). The five major phospholipids identified in human platelets are PC (38% of total phospholipids), PE (27%), sphingomyelin (17%), PS (10%), and PI (5%) (563). Studies of platelet subcellular fractions reveal that 57% of total human platelet phospholipids are present in the plasma membrane (938). Most of the negatively charged phospholipids (i.e., PE, PI, and PS) are contained in the inner leaflet (938, 939 and 940), an asymmetric arrangement that prevents inappropriate coagulation by sequestering the phospholipids that accelerate plasma coagulation (mainly PS) away from the platelet surface. Such an asymmetric arrangement may be maintained by an aminophospholipid translocase or “flipase” in platelet membranes (941, 942) that selectively pumps PS and PE from the outer to inner plasma membrane; choline-bearing phospholipids would accumulate by diffusion in the outer membrane (943). This asymmetry collapses when platelets are activated (944). These same phospholipids (i.e., PS and PE that interact with coagulation proteins) redistribute with platelet activation and are thereby exposed on the surface to function in promoting clot formation (945). The process appears to be controlled by one or more recently described enzymes, termed *scramblases* (946, 947). Almost all platelet fatty acids are esterified in phospholipids, leaving only trace amounts in the free form. Platelet phospholipids are enriched in arachidonate, the precursor of PGs, at their “*sn-2*” position (884, 948). After agonist stimulation, phospholipase A<sub>2</sub> activity rises, probably through phosphorylation of the platelet “type IV” isoform, and arachidonic acid is released from membrane phospholipids, predominantly PC (949, 950 and 951). The combination of phospholipase C and diglyceride lipase may contribute to this PG substrate release (952). After release, arachidonic acid is oxygenated to form the cyclic endoperoxide intermediate, PGH<sub>2</sub>, by cyclooxygenase-1 [the recently crystallized platelet form of the major PG-forming enzyme (953, 954), which leads to TxA<sub>2</sub> formation (884, 948)]. The lipoxygenase pathway accounts for a small proportion of arachidonate metabolism, producing mainly 12-HETE (12-hydroxy-eicosatetraenoic acid) whose functional role remains unclear (955). Neutral lipids, mainly cholesterol, make up approximately 28% of total platelet lipids. Cholesterol is a major constituent of platelet membranes and is also present in the platelet cytoskeleton (956). It is synthesized by megakaryocytes but not by platelets. Finally, neutral glycolipids, gangliosides, and ceramides have been detected in platelets (937).

### Platelet Microparticles, Heterogeneity, and Kinetics

**MICROPARTICLES** The concept of “platelet dust” or microparticles has attracted a good

deal of attention ( [957](#), [958](#) ). These tiny structures are rich in surface PS and can contribute significantly to the acceleration by platelets of plasma coagulation, specifically factor Xa and thrombin generation ( [958](#) ). Apparently formed by calpain- and scramblase-mediated detachment of buds extended from platelet pseudopods ( [959](#), [960](#) ), microparticles can be visualized by electron microscopy ( [961](#) ) and have been found to bind factors Xa, VIII, and Va, along with protein S ( [962](#), [963](#) ). The composition of microparticles varies with the agonist or stimulus (C5b-9, ionophore A23187, thrombin, tissue factor, shear) involved in their formation ( [964](#), [965](#) ), but their physiologic significance seems clear—particularly because platelets from a patient with Scott syndrome, a disorder in which clinical bleeding occurs, exhibit defective microparticle formation and function ( [966](#), [967](#) ).

**PLATELET HETEROGENEITY** Platelets vary in number, size, density, age, and apparent physiologic effectiveness. The normal platelet count varies between 150 to 400,000 per  $\mu$ l, and normal platelet size (mean platelet volume) varies between 7.5 and 10.5 fl. However, perhaps the main point that emerges from the clinical observation is that some patients with severe thrombocytopenia have little or no bleeding, often with morphologically large platelets on blood smears. This type of largely anecdotal information has spawned the idea that some individuals have “hyperfunctional” platelets that compensate for low numbers by their increased effectiveness ( [968](#) ). A literature has developed that supports the idea that young platelets, presumably those recently released from the bone marrow, are larger and more dense, contain more of certain proteins (i.e., PF4), and exhibit some alterations in function as compared to smaller platelets ( [969](#) ). Circulating platelets may, indeed, diminish in size during a normal circulating lifespan by shedding some of their surface components, and this process may reflect hemostatic events that do not result in loss of the entire platelet ( [970](#) ). It is uncertain whether platelets of different sizes and densities originate from different populations of megakaryocytes ( [971](#) ). However, many of the properties of large platelets may reflect unique attributes of platelets recently released from the marrow or proplatelets produced under conditions of accelerated production ( [972](#) ).

### PLATELET DISTRIBUTION AND SURVIVAL KINETICS

**Labeling** Platelets labeled with  $^{51}\text{Cr}$  (chromate) have been used to estimate platelet lifespan in humans at 8 to 12 days ( [973](#) ), and the method has been widely validated ( [974](#) ). Alternatively, and more recently,  $^{111}\text{In}$  (indium) chelated with 8-hydroxyquinoline has been used to label platelets, as have  $^{32}\text{P}$ -labeled diisopropylfluorophosphate,  $^{68}\text{Ga}$  (gallium), and nonisotopic methods using aspirin inhibition of  $\text{TxB}_2$  formation or biotin ( [975](#), [976](#), [977](#), [978](#) and [979](#) ). Platelet labeling is not commonly used at present for clinical evaluations, but all of the published studies give the same approximate values for distribution and survival.

**Distribution** Transfusion of  $^{51}\text{Cr}$ -labeled platelets into normal subjects results in approximately two-thirds remaining in the circulation—in contrast to nearly 100% in splenectomized patients ( [980](#), [981](#) ). In addition, administration of epinephrine, which evacuates platelets from the spleen, increases the peripheral platelet count 30 to 50% ( [981](#) ). Platelet counts in asplenic patients are not affected. Taken together, these data suggest that approximately one-third of the total platelet mass pools in the spleen. Some studies suggest that the splenic pool consists of the youngest, largest platelets ( [982](#) ). The splenic pool exchanges freely with the platelets in the peripheral circulation. The mechanism of splenic sequestration has been hypothesized to result from a longer transit time through the splenic cords (which platelets enter because of their small size) or from binding to the reticular and endothelial cells of the spleen ( [983](#) ). Pathophysiologic states can result in 80 to 90% of platelets being sequestered in the spleen, resulting in thrombocytopenia. Release of platelets from the lungs after intracardiac administration of epinephrine has been reported ( [984](#) ). Also, platelet counts rise after vigorous exercise,



and this rise is not affected by splenectomy ( 985 ). This nonsplenic pool represents approximately 16% of the total platelet mass.

**Lifespan** Platelet lifespan, based on the time required to clear labeled platelets from the circulation, has been estimated to be 8 to 12 days in humans. In steady state, when platelet production equals destruction, platelet turnover has been estimated at  $1.2$  to  $1.5 \times 10^{11}$  cells per day ( 980 , 986 ). Recommendations for estimation of platelet lifespan have been published by the Panel on Diagnostic Application of Radioisotopes in Hematology, International Committee for Standardization in Hematology ( 986 ), and multiple models for analysis of platelet lifespan have been proposed ( 987 ). The sites for platelet removal appear to be the spleen ( 981 ), the liver, and the bone marrow ( 988 ). Evidence that the primary site for platelet removal is the spleen includes data that platelet survival in dogs increases 47% after splenectomy ( 989 ), but studies of the effect of splenectomy on platelet lifespan in humans have produced mixed results ( 988 , 990 ). There is disagreement as to whether platelets are removed from the circulation by a random process or as a result of senescence. Mathematic models, which predict rectilinear platelet survival curves if senescence is the primary component or curvilinear survival curves if random processes predominate ( 991 ), do not aid in the resolution of this controversy because platelet survival curves not only are a composite of mathematic functions, but also vary with the labeling method used.

## Interactions beyond Platelets: The Coagulant System

**PLATELET INTERACTIONS WITH THE PLASMA COAGULATION SYSTEM** The plasma coagulation “cascade” or “waterfall” involves both extrinsic and intrinsic pathways and generates factor Xa and thrombin through the formation of successive calcium-dependent complexes ( 992 ). In turn, such complex development occurs primarily on phospholipid surfaces ( 993 , 994 ); with the discovery that soluble factor Xa bound avidly to FVa on the surface of activated platelets and produced explosive thrombin generation, the idea arose that the surface of activated platelets could be a major site for coagulation reactions ( 566 , 568 , 995 ). A further elaboration of the concept of “platelet-based coagulation” holds that activated platelets may contain a specific protein(s), linked with surface factor Va, and perhaps missing in Scott syndrome, that provides part of the specific binding site for plasma factor Xa and accounts for the dramatic amplification of factor Xa’s ability to generate thrombin ( 967 , 995 ). At this point, the “long-sought-for protein(s)” remains somewhat uncertain ( 568 ) and could even be classified under the rubric of “platelet factor 3,” an operational term for an as yet unclear platelet component that accelerates coagulation ( 996 ). This is, however, an area of active research, and a protein of interest, effector cell protease receptor-1 (EPR-1), has been identified that accounts for part of the factor Xa-binding site. First isolated from leukocytes and endothelium ( 997 , 998 ), EPR-1 alone can bind factor Xa, but it is found associated with FVa on the surface of activated platelets where it forms part of the factor Xa-binding site, confirmed with the use of an anti-EPR-1 monoclonal antibody ( 999 ). In view of the fact noted above that thrombin is generated by platelet-bound factors Va-Xa ( 1000 ), investigators also asked if a similar set of reactions might govern a second and separate set of interactions, involving factor Xa formation through soluble factor IXa interacting first with platelet-bound VIIIa and then cleaving factor X to Xa ( 1001 ). Similar results were obtained, showing that the presence of activated platelets significantly accelerates factor IXa-VIIIa-dependent factor Xa production, which could be termed an *intrinsic generation* of factor Xa because it does not involve tissue factor necessarily and does proceed through factor IX ( 567 , 1001 , 1002 , 1003 , 1004 and 1005 ). However, no platelet protein(s) has been defined that combines with platelet-bound factor VIIIa to form a site for soluble factor IXa ( 568 , 1005 ), and factor VIII, unlike factor V, does not appear to be present within

resting, unactivated platelets ( 568 ). Because the plasma carrier protein for factor VIII, vWF, is synthesized by megakaryocytes, the presence of vWF in platelets does not imply that factor VIII must also be *present within the platelet* ( 1006 , 1007 ). Platelets also may not take up significant amounts of plasma vWF with its bound factor VIII—a clear difference from their active uptake of plasma fibrinogen ( 649 ). This system of *intrinsic* generation of factor Xa through platelet-bound factor VIIIa-IXa can provide factor Xa for the “first” FVa-EPR-1 system described above, but *extrinsic* production of factor Xa would also be expected at any site of cellular damage or injury through the well-known pathway of tissue factor and plasma factor VIIa acting on plasma factor X ( 1008 ). However, such “soluble” or fluid-phase formation of factor Xa may be limited by the plasma inhibitor of the tissue factor pathway termed *tissue factor pathway inhibitor* that binds the complex of factors VIIa and Xa that forms with tissue factor ( 1009 ). The above-described system of factor Xa generation on platelets leads to a subsequent, related question: namely, the origin of the factor IXa that provides its proteolytic effector ( 568 ). Prior work indicates that factor IXa can arise through both the well-known factor XIa-dependent step of the “cascade” and a more recently recognized pathway involving tissue factor-factor VIIa ( 1010 ). The possibility of FXIa involvement has proved to be a fascinating area for investigation and has led to the third aspect of the platelet-coagulation axis concerning both platelet *and* plasma factor XI and the initiation of the intrinsic pathway to form factor IXa ( 1011 ). One of the major obstacles in understanding plasma coagulation has been our inability to explain the contact system and the dichotomy between factor XI, whose deficiency causes bleeding, and the other contact factors (factor XII, high-molecular-weight kininogen, prekallikrein), whose absence does not cause bleeding ( 1012 ). At least a partial explanation has come in the form of a “revised model” for coagulation based on the discovery that thrombin can activate factor XI, particularly on platelet surfaces or in the presence of proteoglycans ( 1013 , 1014 ). In this instance, traces of thrombin, generated through tissue factor from sites of cellular injury, activate plasma factor XI (bound to platelets through the presence of prothrombin itself), which, in turn, activates plasma factor IX and leads to a subsequent dramatic increase in thrombin production ( 1015 , 1016 and 1017 ). Such a sequence of events is favored by the presence of platelets that protect any surface-bound reactants from soluble inhibitors, such as protease nexin II, and conserve any small amount of initial thrombin by linking it to immobilized protein substrates, away from plasma inhibitors ( 1017 ). The data are consistent with the clinical observation that the amount of *platelet* factor XI ( *not plasma* factor XI; platelet FXI is a “splice variant” relative of plasma factor XI, although the precise role of platelet FXI remains uncertain) determines the bleeding severity in deficient patients, and the information explains how factor XI can be activated regardless of other contact factors ( 1018 , 1019 ). This work illustrates that platelets play a multifaceted role in coagulation and emphasizes the fundamental difference between *resting* platelets with no ability to accelerate coagulation [except for prothrombin binding to gpIIb-IIIa on resting platelets ( 1020 )] and agonist-*activated* platelets that are intensely active participants. The question of whether platelet microparticles or whole activated platelets are more relevant/significant in terms of providing the surface for coagulation reactions has been addressed, and whole platelets have been judged to be more relevant ( 1021 ). Each of the three systems described above produces a critical protease (IIa-thrombin, factor Xa, factor IXa), and each one has both unique and shared features. However, many aspects remain unknown such as the modification of the activated platelet surface by scramblase enzymes, the individual role(s) of anionic phospholipids, and the potential contributions of additional proteins that may interact with platelet-expressed Va (besides EPR-1), factors VIIIa or XIa (besides prothrombin). Regardless of the exact mechanisms involved, the binding of any coagulation factor to a high-affinity binding site on the platelet plasma membrane concentrates that factor locally and can orient it with respect to other factors. Also, multiple studies show that platelet surface-bound coagulation proteins are generally protected from their usual plasma



inhibitors ( [1022](#) ). Finally, such binding (i.e., factor Xa to activated platelets) can facilitate the rapid delivery of a potent coagulant and potential agonist to a site of vessel injury where it may be most valuable in hemostasis.

**“PLASMA” COAGULATION FACTORS WITHIN PLATELETS** Three factors (factor V, fibrinogen, and vWF) found in platelet  $\alpha$ -granules appear to be the most significant elements in platelet contribution to coagulation ( [Table 19.6](#) ). Platelets have particularly large amounts of fibrinogen, which they do not synthesize, and lesser amounts of vWF, which they do. The origin of FV appears to be a combination of incorporation from plasma and *de novo* synthesis in megakaryocytes ( [568](#) ).

**TABLE 19.6. Platelet-Associated Coagulation Factors**

| Protein                         | Amount Present   | Subcellular Localization    | Mechanism of Release or Exposure | Proposed Function                             |
|---------------------------------|--|-----------------------------|----------------------------------|---|
| Fibrinogen                      |  |                             |                                  |   |
| Total                           | 5–25 mg/10 <sup>11</sup> platelets <sup>a</sup>        |                             |                                  |   |
| Surface-associated              | 0.3–10.0 mg/10 <sup>11</sup> platelets <sup>b, c</sup> | Adsorbed to platelet        | Not released                     | Platelet aggregation by adenosine diphosphate |
| Intracellular                   | 3–7 mg/10 <sup>11</sup> platelets <sup>a</sup>         | Membrane $\alpha$ -granules | Secretion                        | ?Platelet aggregation by thrombin             |
| Factor V                        | 0.25–0.77 mg/10 <sup>11</sup> platelets <sup>b</sup>   | $\alpha$ -Granules          | Secretion                        | Receptor for factor Xa                        |
| von Willebrand factor           | 10–64 units/10 <sup>11</sup> platelets <sup>c</sup>    | $\alpha$ -Granules          | Secretion                        | Platelet adhesion                             |
| Factor XI                       | 1.2–6.1 units/10 <sup>11</sup> platelets <sup>a</sup>  | Platelet membrane           | Unknown                          | Initiation of intrinsic coagulation           |
| Factor XIII                     | 50% of the total in blood <sup>a</sup>                 | Cytosol                     | Not released                     | $\alpha$ Subunit of factor XIII               |
| High-molecular-weight kininogen | 60 $\mu$ g/10 <sup>11</sup> platelets <sup>d</sup>     | $\alpha$ -Granules          | Secretion                        | ?Contact activation of coagulation            |

<sup>a</sup> Quantitation by bioassay.

<sup>b</sup> Quantitation by radioimmunoassay.

<sup>c</sup> Quantitation by electroimmunodiffusion.

<sup>d</sup> Quantitation by competitive enzyme-linked immunosorbent assay.

The bulk of FV (20% of total factor V in blood) is located in the  $\alpha$ -granules, and the thrombin-activated form, factor Va, is the major secreted platelet phosphoprotein ( [1023](#) ),

[1024](#)). The distinct and critical role of FV in hemostasis is underscored by the findings in two kindreds of factor V Quebec, in which a selective defect in  $\alpha$ -granule factor V (plasma factor V is nearly normal), probably due to excessive granule-based proteolysis, is accompanied by a severe bleeding diathesis ([1025](#), [1026](#)). Platelet fibrinogen, like the plasma form, is a large dimeric protein. However, it constitutes up to 10% of total platelet protein ([1027](#), [1028](#)), and recent evidence shows that, in addition to its well-known role in ADP-induced platelet aggregation, it also appears to be essential for the development of the core region of a developing platelet deposit/thrombus ([1029](#)). Platelet vWF does not currently have a distinct, described role in platelet function, apart from that of the plasma molecule. It is present in relatively large amounts in  $\alpha$ -granules, and after platelet secretion in response to agonists, it interacts with either gpIIb-IIIa or gpIb ([1030](#)). Platelet vWF does consist of large multimers and may play a role in platelet adherence to subendothelium ([1031](#)).

**OTHER PLATELET “COAGULATION” FACTORS** The numerous platelet proteins that participate in plasma coagulation are listed in [Table 19.6](#). Several additional plasma coagulation factors are associated with platelets along with a variety of coagulation inhibitors as noted below. FXIII is contained in the cytosol and is not organelle associated; it is a fully active subunit of plasma factor XIII. FXIII makes up 50% of the total amount of factor XIII activity in blood. It has been suggested that it provides the a subunit for plasma factor XIII ([1032](#)). High-molecular-weight kininogen is present in  $\alpha$ -granules and is secreted and expressed on the platelet plasma membrane after thrombin activation ([1033](#)). The function of platelet high-molecular-weight kininogen is unknown. Platelets contain 2.5% of protein S found in whole blood. This protein is synthesized in megakaryocytes, stored in  $\alpha$ -granules, and released from platelets on thrombin stimulation ([1034](#)). It is thought that secretion and binding of this pool of protein S to the platelet membrane localize activated protein C on the platelet surface, and together these promote the rapid inactivation of coagulation factors Va and VIII on membranes ([1035](#)).

**Protease Inhibitors** All known plasma protease inhibitors ([1036](#)) are also localized to platelet  $\alpha$ -granules. These include a  $1$ -protease inhibitor, a  $2$ -macroglobulin, C1 inhibitor, a  $2$ -antiplasmin, plasminogen activator inhibitor-1, lipoprotein-associated coagulation inhibitor, protease nexin I (thrombin inhibitor), and protease nexin II (factors IXa and XIa inhibitors).

**Clot Retraction** When whole blood is placed in a glass tube and simply left to clot for several hours at ambient temperature, clear serum is expressed from the bulk of the fibrin-red cell mass as platelets exert their global contractile potential ([1037](#)). This ability of platelets to incorporate essentially all the red cells into and to extrude essentially all the serum proteins (except fibrin) and fluid out of the clot has fascinated observers for centuries and led to the inevitable conclusion that this same *in vitro* process might be replicated in the same fashion *in vivo* ([1038](#)). This is a logical but unproved hypothesis. Formal laboratory study of clot retraction indicates that platelet contractile proteins, such as actomyosin, participate as do the major surface receptor and plasma ligand, gpIIb-III and fibrinogen ([1039](#)). However, beyond these broadly based studies, relatively few additional details are available to translate this dramatic laboratory event into a physiologic mechanism. However, with current interest and technology to assess the progress on *ex vivo* systems, such observations may be feasible in the near future.

## REFERENCES

1. Addison W. On the colourless corpuscles and on the molecules and cytoblasts in the blood. London Med Gaz 1841;NS 30:144-152.
2. Bizzozero G. Ueber einer neuen formbestandtheil des blutes und dessen rolle bei der thrombose und der blutgerinnung. Virchows Arch fur pathol Anat und Physiol 1882;90:261-332.

3. De Gaetano G. A new blood corpuscle: an impossible interview with Giulio Bizzozero. *Thromb Haemost* 2001;86:973–979.
4. Osler W, Schaefer EA. Über einige im blute vorhandene bacterienbildende massen. *Centralbl Med Wissensch* 1873;11:577–578.
5. Hayem G. Recherches sur l'évolution des hematies dans le sang de l'homme, et des vertebres. *Arch Physiol (deuxieme serie)* 1878;5:692–734.
6. Howell WH. Observations upon the occurrence, structure, and function of the giant cells of the marrow. *J Morphol* 1890;4:117–130.
7. Wright JH. The origin and nature of the blood plates. *Boston Med Surg J* 1906;23:643–645.
8. Wright JH. The histogenesis of blood platelets. *J Morphol* 1910;21:263–278.
9. Xu MJ, Matsuoka S, Yang FC, et al. Evidence for the presence of murine primitive megakaryocytopoiesis in the early yolk sac. *Blood* 2001;97:2016–2022.
10. Danchakoff V. Origin of the blood cells. Development of the haematopoietic organs and regeneration of the blood cells from the standpoint of the monophyletic school. *Anat Rec* 1916;10:397–414.
11. Pluznik DH, Sachs L. The cloning of normal mast cells in tissue culture. *J Cell Physiol* 1965;66:319–324.
12. Bradley TR, Metcalf D. The growth of mouse bone marrow cells *in vitro*. *Aust J Exp Biol Med Sci* 1966;44:287–299.
13. Metcalf D, MacDonald HR, Odartchenko N, Sordat B. Growth of mouse megakaryocyte colonies *in vitro*. *Proc Natl Acad Sci U S A* 1975;72:1744.
14. McLeod DL, Shreeve MM, Axelrad AA. Induction of megakaryocyte colonies with platelet formation *in vitro*. *Nature* 1976;261:492.
15. Vainchenker W, Bougeut J, Guichard J, Breton-Gorius J. Megakaryocyte colony formation from human bone marrow precursors. *Blood* 1979;53:1023.
16. Long MW, Gragowski LL, Heffner CH, Boxer LA. Phorbol diesters stimulate the development of an early murine progenitor cell. The burst-forming unit-megakaryocyte. *J Clin Invest* 1985;76:431–438.
17. Briddell RA, Brandt JE, Straneva JE, et al. Characterization of the human burst-forming unit-megakaryocyte. *Blood* 1989;74:145–151.
18. Spangrude GJ, Heimfeld S, Weissman IL. Purification and characterization of mouse hematopoietic stem cells. *Science* 1988;241:58–62.
19. Civin CI, Strauss LC, Fackler MJ, et al. Positive stem cell selection—basic science. *Prog Clin Biol Res* 1990;333:387–401.
20. Matthews W, Jordan CT, Wiegand GW, et al. A receptor tyrosine kinase specific to hematopoietic stem and progenitor cell-enriched populations. *Cell* 1991;65:1143–1152.
21. Penn PE, Jiang DZ, Fei RG, et al. Dissecting the hematopoietic microenvironment. IX. Further characterization of murine bone marrow stromal cells. *Blood* 1993;81:1205–1213.
22. Akashi K, Traver D, Miyamoto T, Weissman IL. A clonogenic common myeloid progenitor that gives rise to all myeloid lineages. *Nature* 2000;404:193–197.
23. Kondo M, Weissman IL, Akashi K. Identification of clonogenic common lymphoid progenitors in mouse bone marrow. *Cell* 1997;91:661–672.
24. Muta K, Krantz SB, Bondurant MC, Wickrema A. Distinct roles of erythropoietin, insulin-like growth

- factor I, and stem cell factor in the development of erythroid progenitor cells. *J Clin Invest* 1994;94:34-43.
25. Hodohara K, Fujii N, Yamamoto N, Kaushansky K. Stromal cell derived factor 1 acts synergistically with thrombopoietin to enhance the development of megakaryocytic progenitor cells. *Blood* 2000;95:769-775.
  26. Long MW, Heffner CH, Gragowski LL. *In vitro* differences in responsiveness of early (BFU-Mk) and late (CFU-Mk) murine megakaryocyte progenitor cells. *Prog Clin Biol Res* 1986;215:179-186.
  27. Briddell RA, Hoffman R. Cytokine regulation of the human burst-forming unit-megakaryocyte. *Blood* 1990;76:516-522.
  28. Nakeff A, Daniels-McQueen S. *In vitro* colony assay for a new class of megakaryocyte precursor: colony forming unit megakaryocyte (CFU-M). *Proc Soc Exp Biol Med* 1976;151:587-590.
  29. Mazur EM, Hoffman R, Bruno E. Regulation of human megakaryocytopoiesis. An *in vitro* analysis. *J Clin Invest* 1981;68:733-741.
  30. McDonald TP, Sullivan PS. Megakaryocytic and erythrocytic cell lines share a common precursor cell. *Exp Hematol* 1993;21:1316-1320.
  31. Hunt P. A bipotential megakaryocyte/erythrocyte progenitor cell: the link between erythropoiesis and megakaryopoiesis becomes stronger. *J Lab Clin Med* 1995;125:303-304.
  32. Nicola NA, Johnson GR. The production of committed hematopoietic colony forming cells from multipotent precursor cells *in vitro*. *Blood* 1982;60:1019.
  33. Debili N, Coulombel L, Croisille L, et al. Characterization of a bipotent erythro-megakaryocytic progenitor in human bone marrow. *Blood* 1996;88:1284-1296.
  34. Papayannopoulou T, Brice M, Farrer D, Kaushansky K. Insights into the cellular mechanisms of erythropoietin-thrombopoietin synergy. *Exp Hematol* 1996;24:660-669.
  35. Enver T, Heyworth CM, Dexter TM. Do stem cells play dice? *Blood* 1998;92:348-351.
  36. Metcalf D. Lineage commitment and maturation in hematopoietic cells: the case for extrinsic regulation. *Blood* 1998;92:345-347.
  37. Kondo M, Scherer DC, Miyamoto T, et al. Cell-fate conversion of lymphoid-committed progenitors by instructive actions of cytokines. *Nature* 2000;407:383-386.
  38. Quesenberry PJ, Ihle JN, McGrath E. The effect of interleukin-3 and GM-CSF-2 on megakaryocyte and myeloid clonal colony formation. *Blood* 1985;65:214-217.
  39. Williams N, Sparrow R, Gill K, et al. Murine megakaryocyte colony stimulating factor: its relationship to interleukin-3. *Leuk Res* 1985;9:1487-1496.
  40. Kaushansky K, O'Hara PJ, Berkner K, et al. Genomic cloning, characterization, and multilineage expression of human granulocyte-macrophage colony-stimulating factor. *Proc Natl Acad Sci U S A* 1986;83:3101-3105.
  41. Segal GM, Stueve T, Adamson JW. Analysis of murine megakaryocyte colony size and ploidy: effects of interleukin-3. *J Cell Physiol* 1988;137:537-544.
  42. Briddell RA, Bruno E, Cooper RJ, et al. Effect of *c-kit* ligand on *in vitro* human megakaryocytopoiesis. *Blood* 1991;78:2854-2859.
  43. Yang YC, Ciarletta AB, Temple PA, et al. Human IL-3 (mutli-CSF): identification by expression cloning of a novel hematopoietic growth factor related to murine IL-3. *Cell* 1986;47:3-10.
  44. Wong GG, Witek JS, Temple PA, et al. Human GM-CSF: molecular cloning of the complementary DNA and purification of the natural and recombinant proteins. *Science* 1985;228:810-815.

45. Diederichs K, Boone T, Karplus PA. Novel fold and putative receptor binding site of granulocyte-macrophage colony-stimulating factor. *Science* 1991;254:1779-1782.
46. Feng Y, Klein BK, Vu L, et al. <sup>1</sup>H, <sup>13</sup>C, and <sup>15</sup>N NMR resonance assignments, secondary structure, and backbone topology of a variant of human interleukin-3. *Biochemistry* 1995;34:6540-6551.
47. Lopez AF, Eglinton JM, Gillis D, et al. Reciprocal inhibition of binding between interleukin-3 and granulocyte-macrophage colony-stimulating factor to human eosinophils. *Proc Natl Acad Sci U S A* 1989;86:7022-7026.
48. Chen Q, Solar G, Eaton DL, de Sauvage FJ. IL-3 does not contribute to platelet production in c-Mpl-deficient mice. *Stem Cells* 1998;2[16 Suppl]:31-36.
49. Scott CL, Robb L, Mansfield R, et al. Granulocyte-macrophage colony-stimulating factor is not responsible for residual thrombopoiesis in mpl null mice. *Exp Hematol* 2000;28:1001-1007.
50. Lyman SD, James L, Bos TV, et al. Molecular cloning of a ligand for the flt3/flk2 tyrosine kinase receptor: a proliferative factor for primitive hematopoietic cells. *Cell* 1993;75:1157-1167.
51. Avraham H, Vannier E, Cowley S, et al. Effects of the stem cell factor, c-*kit* ligand, on human megakaryocytic cells. *Blood* 1992;79:365-371.
52. Broudy VC, Lin NL, Kaushansky K. Thrombopoietin (c-*mp*. ligand) acts synergistically with erythropoietin, stem cell factor, and IL-11 to enhance murine megakaryocyte colony growth and increases megakaryocyte ploidy *in vitro*. *Blood* 1995;85:1719-1726.
53. Ebbe S, Phalen E, Stohlman F Jr. Abnormalities of megakaryocytes in S1/S1d mice. *Blood* 1973;42:865-871.
54. Arnold J, Ellis S, Radley JM, Williams N. Compensatory mechanisms in platelet production: the response of S1/S1d mice to 5-fluorouracil. *Exp Hematol* 1991;19:24-28.
55. Hunt P, Zsebo KM, Hokom MM, et al. Evidence that stem cell factor is involved in the rebound thrombocytosis that follows 5-fluorouracil treatment. *Blood* 1992;80:904-911.
56. Flanagan JG, Leder P. The kit ligand: a cell surface molecule altered in steel mutant fibroblasts. *Cell* 1990;63:185-194.
57. Martin FH, Suggs SV, Langley KE, et al. Primary structure and functional expression of rat and human stem cell factor. *Cell* 1990;63:203-210.
58. Huang E, Nocka K, Beier DR, et al. The hematopoietic growth factor KL is encoded by the *S* locus and is the ligand of the *c-kit* receptor, the gene product of the *W* locus. *Cell* 1990;63:225-233.
59. Anderson DM, Lyman SD, Baird A, et al. Molecular cloning of mast cell growth factor, a hemopoietin that is active in both membrane bound and soluble forms. *Cell* 1990;63:235-243.
60. Fleishman RA. From white spots to stem cells: the role of the kit receptor in mammalian development. *Trends Genet* 1993;9:285-290.
61. Morrison-Graham K, Takahashi Y. Steel factor and c-Kit receptor: from mutants to a growth factor system. *Bioessays* 1993;15:77-83.
62. Broudy VC. Stem cell factor and hematopoiesis. *Blood* 1997;90:1345-1364.
63. Sieber-Blum M, Zhang JM. Growth factor action in neural crest cell diversification. *J Anat* 1997;191 (Pt 4):493-499.
64. Rossi P, Sette C, Dolci S, Geremia R. Role of c-kit in mammalian spermatogenesis. *J Endocrinol Invest* 2000;23:609-615.
65. Driancourt MA, Reynaud K, Cortvrint R, Smitz J. Roles of Kit and Kit Ligand in ovarian function. *Rev*

Reprod 2000;5:143–152.

66. Langley KE, Bennett LG, Wypych J, et al. Soluble stem cell factor in human serum. *Blood* 1993;81:656–660.
67. Cheng HJ, Flanagan JG. Transmembrane kit ligand cleavage does not require a signal in the cytoplasmic domain and occurs at a site dependent on spacing from the membrane. *Mol Biol Cell* 1994;5:943–953.
68. Miyazawa K, Williams DA, Gotoh A, et al. Membrane bound steel factor induces more persistent tyrosine kinase activation and longer life span of c-kit gene encoded protein than its soluble form. *Blood* 1995;85:641–649.
69. Flanagan JG, Chan DC, Leder P. Transmembrane form of the kit ligand growth factor is determined by alternative splicing and is missing in the SI<sup>d</sup> mutant. *Cell* 1991;64:1025–1035.
70. Lyman SD, James L, Johnson L, et al. Cloning of the human homologue of the murine flt3 ligand: a growth factor for early hematopoietic progenitor cells. *Blood* 1994;83:2795–2801.
71. Hudak S, Hunte B, Culpepper J, et al. Flt3/flk2 ligand promotes the growth of murine stem cells and the expansion of colony-forming cells and spleen colony-forming units. *Blood* 1995;85:2747–2755.
72. Piacibello W, Garetto L, Sanavio F, et al. The effects of human flt3 ligand on *in vitro* human megakaryocytopoiesis. *Exp Hematol* 1996;24:340–346.
73. Brasel K, McKenna HJ, Morrissey PJ, et al. Hematologic effects of flt3 ligand *in vivo* in mice. *Blood* 1996;88:2004–2012.
74. Kishimoto T. The biology of interleukin-6. *Blood* 1989;74:1–10.
75. Ishibashi T, Kimura H, Shikama Y, et al. Interleukin-6 is a potent thrombopoietic factor *in vivo* in mice. *Blood* 1989;74:1241–1244.
76. Quesenberry PJ, McGrath HE, Williams ME, et al. Multifactor stimulation of megakaryocytopoiesis: effects of interleukin-6. *Exp Hematol* 1991;19:35–44.
77. Kimura H, Ishibashi T, Uchida T, et al. Interleukin-6 is a differentiation factor for human megakaryocytes *in vitro*. *Eur J Immunol* 1990;20:1927–1931.
78. Williams N, De Giorgio T, Banu N, et al. Recombinant interleukin-6 stimulates immature megakaryocytes. *Exp Hematol* 1990;18:69–72.
79. Mei RL, Burstein SA. Megakaryocytic maturation in murine long-term bone marrow culture: role of interleukin-6. *Blood* 1991;78:1438–1447.
80. Debili N, Massé JM, Katz A, et al. Effects of the recombinant hematopoietic growth factors interleukin-3, interleukin-6, stem cell factor, and leukemia inhibitory factor on the megakaryocytic differentiation of CD34<sup>+</sup> cells. *Blood* 1993;82:84–95.
81. Asano S, Okano A, Ozawa K, et al. *In vivo* effects of recombinant human interleukin-6 in primates: stimulated production of platelets. *Blood* 1990;75: 1602–1605.
82. Carrington PA, Hill RJ, Stenberg PE, et al. Multiple *in vivo* effects of interleukin-3 and interleukin-6 on mouse megakaryocytopoiesis. *Blood* 1991;77:34–41.
83. Burstein SA, Downs T, Friese P, et al. Thrombocytosis in normal and sublethally irradiated dogs: response to human interleukin-6. *Blood* 1992;80:420–428.
84. Zeidler C, Kanz L, Hurkuck F, et al. *In vivo* effects of interleukin-6 on thrombopoiesis in healthy and irradiated primates. *Blood* 1992;80:2740–2745.
85. Gastl G, Plante M, Finstad CL, et al. High IL-6 levels in ascitic fluid correlate with reactive

- thrombocytosis in patients with epithelial ovarian cancer. *Br J Haematol* 1993;83:433-441.
86. Blay JY, Favrot M, Rossi JF, Wijidenes J. Role of interleukin-6 in paraneoplastic thrombocytosis. *Blood* 1993;82:2261-2262.
87. Yasumoto S, Imayama S, Hori Y. Increased serum level of interleukin-6 in patients with psoriatic arthritis and thrombocytosis. *J Dermatol* 1995;22:718-722.
88. Heits F, Katschinski DM, Wilmsen U, et al. Serum thrombopoietin and interleukin-6 concentrations in tumour patients and response to chemotherapy-induced thrombocytopenia. *Eur J Haematol* 1997;59:53-58.
89. Wolber EM, Jelkmann W. Interleukin-6 increases thrombopoietin production in human hepatoma cells HepG2 and Hep3B. *J Interferon Cytokine Res* 2000;20:499-506.
90. Bernad A, Kopf M, Kulbacki R, et al. Interleukin-6 is required *in vivo* for the regulation of stem cells and committed progenitors of the hematopoietic system. *Immunity* 1994;1:725-731.
91. Kaser A, Brandacher G, Steurer W, et al. Interleukin-6 stimulates thrombopoiesis through thrombopoietin: role in inflammatory thrombocytosis. *Blood* 2001;98:2720-2725.
92. Paul SR, Bennett F, Calvetti JA, et al. Molecular cloning of a cDNA encoding interleukin-11, a stromal cell-derived lymphopoietic and hematopoietic cytokine. *Proc Natl Acad Sci U S A* 1990;87:7512-7516.
93. Du X, Williams DA. Interleukin-11: review of molecular, cell biology and clinical use. *Blood* 1997;89:3897-3908.
94. Metcalf D, Nicola NA, Gearing DP. Effects of injected leukemia inhibitory factor on hematopoietic and other tissues in mice. *Blood* 1990;76:50-56.
95. Gough NM. Molecular genetics of leukemia inhibitory factor (LIF) and its receptor. *Growth Factors* 1992;7:175-179.
96. Hilton DJ. LIF: lots of interesting functions. *Trends Biochem Sci* 1992;17:72-76.
97. Teramura M, Kobayashi S, Hoshino S, et al. Interleukin-11 enhances human megakaryocytopoiesis *in vitro*. *Blood* 1992;79:327-331.
98. Neben TY, Loebelenz J, Hayes L, et al. Recombinant human interleukin-11 stimulates megakaryocytopoiesis and increases peripheral platelets in normal and splenectomized mice. *Blood* 1993;81:901-908.
99. Yonemura Y, Kawakita M, Masuda T, et al. Effect of recombinant human interleukin-11 on rat megakaryopoiesis and thrombopoiesis *in vivo*: comparative study with interleukin-6. *Br J Haematol* 1993;84:16-23.
100. Hangoc G, Yin T, Cooper S, et al. *In vivo* effects of recombinant interleukin-11 on myelopoiesis in mice. *Blood* 1993;81:965-972.
101. Farese AM, Myers LA, MacVittie TJ. Therapeutic efficacy of recombinant human leukemia inhibitory factor in a primate model of radiation-induced marrow aplasia. *Blood* 1994;84:3675-3678.
102. Gordon MS, McCaskill-Stevens WJ, Battiato LA, et al. A phase I trial of recombinant interleukin-11 (Neumega rhIL-11 growth factor) in women with breast cancer receiving chemotherapy. *Blood* 1996;87:3615-3624.
103. Williams N. Is thrombopoietin interleukin-6? *Exp Hematol* 1991;19:714-718.
104. Straneva JE, van Besien KW, Derigs G, Hoffman R. Is interleukin-6 the physiological regulator of thrombopoiesis? *Exp Hematol* 1992;20:47-50.
105. Hill RJ, Warren MK, Levin J, Gauldie J. Evidence that interleukin-6 does not play a role in the stimulation of platelet production after induction of acute thrombocytopenia. *Blood* 1992;80:346-351.



106. Tsukada J, Misago M, Ogawa R, et al. Synergism between serum factor(s) and erythropoietin in inducing murine megakaryocyte colony formation: the synergistic factor in serum is distinct from interleukin-11 and stem cell factor (c-kit ligand). *Blood* 1993;81:866-867.
107. Cremer M, Schulze H, Linthorst G, et al. Serum levels of thrombopoietin, IL-11, and IL-6 in pediatric thrombocytopenias. *Ann Hematol* 1999;78:401-407.
108. Peck-Radosavljevic M, Zacherl J, Wichlas M, et al. Thrombopoietic cytokines and reversal of thrombocytopenia after liver transplantation. *Eur J Gastroenterol Hepatol* 1999;11:151-156.
109. Weisdorf DJ, DeFor T, Nichol J, et al. Thrombopoietic cytokines in relation to platelet recovery after bone marrow transplantation. *Bone Marrow Transplant* 2000;25:711-715.
110. Escary JL, Perreau J, Dumenil D, et al. Leukaemia inhibitory factor is necessary for maintenance of haematopoietic stem cells and thymocyte stimulation. *Nature* 1993;363:361-364.
111. Nandurkar HH, Robb L, Tarlinton D, et al. Adult mice with targeted mutation of the interleukin-11 receptor (IL11Ra) display normal hematopoiesis. *Blood* 1997;90:2148-2159.
112. Kelemen E, Cserhati I, Tanos B. Demonstration and some properties of human thrombopoietin in thrombocythemic sera. *Acta Haematol (Basel)* 1958;20:350-355.
113. McDonald TP. Thrombopoietin: its biology, purification, and characterization. *Exp Hematol* 1988;16:201-205.
114. Hill RJ, Levin J. Regulators of thrombopoiesis: their biochemistry and physiology. *Blood Cells* 1989;15:141-166.
115. Wendling F, Varlet P, Charon M, Tambourin P. A retrovirus complex inducing an acute myeloproliferative leukemia disorder in mice. *Virology* 1986;149:242-246.
116. Souyri M, Vigon I, Penciolelli JF, et al. A putative truncated cytokine receptor gene transduced by the myeloproliferative leukemia virus immortalizes hematopoietic progenitors. *Cell* 1990;63:1137-1147.
117. Vigon I, Mornon JP, Cocault L, et al. Molecular cloning and characterization of *MPL*, the human homolog of the *v-mpl* oncogene: identification of a member of the hematopoietic growth factor receptor superfamily. *Proc Natl Acad Sci U S A* 1992;89:5640-5644.
118. de Sauvage FJ, Hass PE, Spencer SD, et al. Stimulation of megakaryocytopoiesis and thrombopoiesis by the c-Mpl ligand. *Nature* 1994;369:533-538.
119. Lok S, Kaushansky K, Holly RD, et al. Cloning and expression of murine thrombopoietin cDNA and stimulation of platelet production *in vivo*. *Nature* 1994;369:565-568.
120. Bartley TD, Bogenberger J, Hunt P, et al. Identification and cloning of a megakaryocyte growth and development factor that is a ligand for the cytokine receptor Mpl. *Cell* 1994;77:1117-1124.
121. Sohma Y, Akahori H, Seki N, et al. Molecular cloning and chromosomal localization of the human thrombopoietin gene. *FEBS Lett* 1994;353:57-61.
122. Chang M, McNinch J, Basu R, et al. Cloning and characterization of the human megakaryocyte growth and development factor (MGDF) gene. *J Biol Chem* 1995;270:511-514.
123. Gurney AL, Carver-Moore K, de Sauvage FJ, Moore MW. Thrombocytopenia in *c-mpl*-deficient mice. *Science* 1994;265:1445-1447.
124. Foster DC, Sprecher CA, Grant FJ, et al. Human thrombopoietin: gene structure, cDNA sequence, expression and chromosomal localization. *Proc Natl Acad Sci U S A* 1994;91:13023-13027.
125. Hoffman RC, Andersen H, Walker K, et al. Peptide, disulfide and glycosylation mapping of recombinant human thrombopoietin from Ser1 to Arg246. *Biochemistry* 1996;35:14849-14861.

126. Kaushansky K, Lok S, Holly RD, et al. Promotion of megakaryocyte progenitor expansion and differentiation by the c-Mpl ligand thrombopoietin. *Nature* 1994;369:568–571.
127. Harker LA, Marzec UM, Hunt P, et al. Dose response effects of pegylated human megakaryocyte growth and development factor on platelet production and function in nonhuman primates. *Blood* 1996;88:511–521.
128. Linden HM, Kaushansky K. The glycan domain of thrombopoietin enhances its secretion. *Biochemistry* 2000;39:3044–3051.
129. Muto T, Feese MD, Shimada Y, et al. Functional analysis of the C-terminal region of recombinant human thrombopoietin. *J Biol Chem* 2000;275:12090–12094.
130. Zeigler FC, de Sauvage F, Widmer HR, et al. *In vitro* megakaryocytopoietic and thrombopoietic activity of *c-mpl* ligand (TPO) on purified murine hematopoietic stem cells. *Blood* 1994;84:4045–4052.
131. Basser RL, Rasko JEJ, Clarke K, et al. Thrombopoietic effects of pegylated recombinant human megakaryocyte growth and development factor (PEG-rHuMGDF) in patients with advanced cancer. *Lancet* 1996;348:1279–1281.
132. Vadhan-Raj S, Murray LJ, Bueso-Ramos C, et al. Stimulation of megakaryocyte and platelet production by a single dose of recombinant human thrombopoietin in cancer patients. *Ann Intern Med* 1997;126:673–681.
133. Arnold JT, Daw NC, Stenberg PE, et al. A single injection of pegylated murine megakaryocyte growth and development factor (MGDF) into mice is sufficient to produce a profound stimulation of megakaryocyte frequency, size, and ploidy. *Blood* 1997;89:823–833.
134. Kaushansky K, Broudy VC, Grossmann A, et al. Thrombopoietin expands erythroid progenitors, increases red cell production, and enhances erythroid recovery after myelosuppressive therapy. *J Clin Invest* 1995;96:1683–1687.
135. Farese AM, Hunt P, Boone T, McAvittie TJ. Recombinant human megakaryocyte growth and development factor stimulates thrombocytosis in normal nonhuman primates. *Blood* 1995;86:54–59.
136. Akahori H, Shibuya K, Obuchi M, et al. Effect of recombinant human thrombopoietin in nonhuman primates with chemotherapy-induced thrombocytopenia. *Br J Haematol* 1996;94:722–728.
137. Neelis KJ, Hartong SC, Egeland T, et al. The efficacy of single dose administration of thrombopoietin with coadministration of either granulocyte-macrophage or granulocyte colony-stimulating factor in myelosuppressed rhesus monkeys. *Blood* 1997;90:2565–2573.
138. Hokum MM, Lacey D, Kintsler OB, et al. Pegylated megakaryocyte growth and development factor abrogates the lethal thrombocytopenia associated with carboplatin and irradiation in mice. *Blood* 1995;86:4486–4492.
139. Ulich TR, del Castillo J, Yin S, et al. Megakaryocyte growth and development factor ameliorates carboplatin-induced thrombocytopenia in mice. *Blood* 1995;86:971–976.
140. Grossmann A, Lenox J, Ren HP, et al. Thrombopoietin accelerates platelet, red blood cell and neutrophil recovery in myelosuppressed mice. *Exp Hematol* 1996;24:1238–1246.
141. Molineux G, Hartley CA, McElroy P, et al. Megakaryocyte growth and development factor stimulates enhanced platelet recovery in mice after Bone Marrow Transplantation. *Blood* 1996;88:1509–1514.
142. Fanucchi M, Glaspy J, Crawford J, et al. Effects of polyethylene glycol-conjugated recombinant human megakaryocyte growth and development factor on platelet counts after chemotherapy for lung cancer. *New Engl J Med* 1997;336:404–409.
143. Vadhan-Raj S, Verschraegen CF, Bueso-Ramos C, et al. Recombinant human thrombopoietin attenuates carboplatin-induced severe thrombocytopenia and the need for platelet transfusions in patients with gynecologic cancer. *Ann Intern Med* 2000;132:364–368.

144. Somlo G, Sniecinski I, ter Veer A, et al. Recombinant human thrombopoietin in combination with granulocyte colony-stimulating factor enhances mobilization of peripheral blood progenitor cells, increases peripheral blood platelet concentration, and accelerates hematopoietic recovery following high-dose chemotherapy. *Blood* 1999;93:2798-2806.
145. Basser RL, Underhill C, Davis I, et al. Enhancement of platelet recovery after myelosuppressive chemotherapy by recombinant human megakaryocyte growth and development factor in patients with advanced cancer. *J Clin Oncol* 2000;18:2852-2861.
146. Archimbaud E, Ottmann O, Liu Yin JA, et al. A randomized, double-blind, placebo-controlled study with pegylated recombinant human megakaryocyte growth and development factor (PEG-rHuMGDF) as an adjunct to chemotherapy for adults with de novo acute myeloid leukemia. *Blood* 1999;94:3694-3701.
147. Schiffer CA, Miller K, Larson RA, et al. A double-blind, placebo-controlled trial of pegylated recombinant human megakaryocyte growth and development factor as an adjunct to induction and consolidation therapy for patients with acute myeloid leukemia. *Blood* 2000;95:2530-2535.
148. Bolwell B, Vredenburgh J, Overmoyer B, et al. Phase 1 study of pegylated recombinant human megakaryocyte growth and development factor (PEG-rHuMGDF) in breast cancer patients after autologous peripheral blood progenitor cell transplantation (PBPC). *Bone Marrow Transplant* 2000;26:141-145.
149. de Sauvage FJ, Carver-Moore K, Luoh SM, et al. Physiological regulation of early and late stages of megakaryocytopoiesis by thrombopoietin. *J Exp Med* 1996;183:651-656.
150. Ihara K, Ishii E, Eguchi M, et al. Identification of mutations in the c-mpl gene in congenital amegakaryocytic thrombocytopenia. *Proc Natl Acad Sci U S A* 1999;96:3132-3136.
151. Ballmaier M, Germeshausen M, Schulze H, et al. c-mpl mutations are the cause of congenital amegakaryocytic thrombocytopenia. *Blood* 2001;97:139-146.
152. Van den Oudenrijn S, Bruin M, Folman CC, et al. Mutations in the thrombopoietin receptor, Mpl, in children with congenital amegakaryocytic thrombocytopenia. *Br J Haematol* 2000;110:441-448.
153. Sitnicka E, Lin N, Priestley GV, et al. The effect of thrombopoietin on the proliferation and differentiation of murine hematopoietic stem cells. *Blood* 1996;87:4998-5005.
154. Ku H, Yonemura Y, Kaushansky K, Ogawa M. Thrombopoietin, the ligand for the Mpl receptor, synergizes with steel factor and other early-acting cytokines in supporting proliferation of primitive hematopoietic progenitors of mice. *Blood* 1996;87:4544-4551.
155. Alexander WS, Maurer AB, Novak U, et al. Tyrosine-599 of the c-Mpl receptor is required for Shc phosphorylation and the induction of cellular differentiation. *EMBO J* 1996;16:6531-6540.
156. Solar GP, Kerr WG, Zeigler FC, et al. Role of c-mpl in early hematopoiesis. *Blood* 1998;92:4-10.
157. Kaushansky K. CAMT: new findings, new questions. *Blood* 2001;97:1.
158. Liu F, Wu HY, Wesselschmidt R, et al. Impaired production and increased apoptosis of neutrophils in granulocyte colony-stimulating factor receptor deficient mice. *Immunity* 1996;5:491-501.
159. Mach N, Lantz CS, Galli SJ, et al. Involvement of interleukin-3 in delayed-type hypersensitivity. *Blood* 1998;91:778-783.
160. Owczarek CM, Layton MJ, Robb LG, et al. Molecular basis of the soluble and membrane bound forms of the murine leukemia inhibitory factor alpha chain. Expression in normal, gestating and leukemia inhibitory factor nullizygous mice. *J Biol Chem* 1996;271:5495-5504.
161. Dranoff G, Crawford AD, Sadelain M, et al. Involvement of granulocyte-macrophage colony-stimulating factor in pulmonary homeostasis. *Science* 1994;264:713-716.
162. Morris DR. Cis-acting mRNA structures in gene-specific translational control. In: *mRNA metabolism*

and post-transcriptional gene regulation. New York: Wiley-Liss, 1997:165-180.

163. Wiestner A, Schlemper RJ, van der Maas AP, Skoda RC. An activating splice donor mutation in the thrombopoietin gene causes hereditary thrombocythaemia. *Nat Genet* 1998;18:49-52.

164. Jorgensen MJ, Raskind WH, Wolff JF, et al. Familial thrombocytosis associated with overproduction of thrombopoietin due to a novel splice donor site mutation. *Blood* 1998;92[Suppl 1]:205a.

165. Kondo T, Okabe M, Sanada M, et al. Familial essential thrombocythemia associated with a one base deletion in the 5' untranslated region of the thrombopoietin gene. *Blood* 1998;92:1091-1096.

166. Ghilardi N, Wiestner A, Kikuchi M, et al. Hereditary thrombocythemia in a Japanese family is caused by a novel point mutation in the thrombopoietin gene. *Br J Haematol* 1999;107:310-316.

167. Cazzola M, Skoda RC. Translational pathophysiology: a novel molecular mechanism of human disease. *Blood* 2000;95:3280-3288.

168. Odell TT, McDonald TP, Detwiler TC. Stimulation of platelet production by serum of platelet-depleted rats. *Proc Soc Exp Biol Med* 1961;108:428.

169. De Gabriele G, Penington DG. Regulation of platelet production: thrombopoietin. *Br J Haematol* 1967;13:210-215.

170. McDonald TP. Bioassay for thrombopoietin utilizing mice in rebound thrombocytosis. *Proc Soc Exp Biol Med* 1973;144:1006-1012.

171. Wendling F, Maraskovsky E, Debili N, et al. c-Mpl ligand is a humoral regulator of megakaryocytopoiesis. *Nature* 1994;369:571-574.

172. Nichol J, Hokom M, Hornkohl A, et al. Megakaryocyte growth and development factor: analysis of *in vitro* effects on human megakaryopoiesis and endogenous serum levels during chemotherapy induced thrombocytopenia. *J Clin Invest* 1995;95:2973-2978.

173. Emmons RV, Reid DM, Cohen RL, et al. Human thrombopoietin levels are high when thrombocytopenia is due to megakaryocyte deficiency and low when due to increased platelet destruction. *Blood* 1996;87:4068-4071.

174. Kuter DJ, Rosenberg RD. The reciprocal relationship of thrombopoietin (c-mpl ligand) to changes in the platelet mass during busulfan-induced thrombocytopenia in the rabbit. *Blood* 1995;85:2720-2730.

175. Stoffel R, Wiestner A, Skoda RC. Thrombopoietin in thrombocytopenic mice: evidence against regulation at the mRNA level and for a direct regulatory role of platelets. *Blood* 1996;87:567-573.

176. Bartocci A, Mastrogiannis DS, Migliorati G, et al. Macrophages specifically regulate the concentration of their own growth factor in the circulation. *Proc Natl Acad Sci U S A* 1987;84:6179-6183.

177. McCarty JM, Sprugel KH, Fox NE, et al. Murine thrombopoietin mRNA levels are modulated by platelet count. *Blood* 1995;86:3668-3675.

178. Sungaran R, Markovic B, Chong BH. Localization and regulation of thrombopoietin mRNA expression in human kidney, liver, bone marrow and spleen using *in situ* hybridization. *Blood* 1997;89:101-107.

179. Guerriero A, Worford L, Holland HK, et al. Thrombopoietin is synthesized by bone marrow stromal cells. *Blood* 1997;90:3444-3455.

180. Solanilla A, Dechanet J, El Andaloussi A, et al. CD40-ligand stimulates myelopoiesis by regulating flt3-ligand and thrombopoietin production in bone marrow stromal cells. *Blood* 2000;95:3758-3764.

181. Sungaran R, Chisholm OT, Markovic B, et al. The role of platelet alpha-granular proteins in the regulation of thrombopoietin messenger RNA expression in human bone marrow stromal cells. *Blood* 2000;95:3094-3101.

182. Kamura T, Handa H, Hamasaki N, Kitajima S. Characterization of the human thrombopoietin gene

- promoter. A possible role of an Ets transcription factor, E4TF1/GABP. *J Biol Chem* 1997;272:11361–11368.
183. Daopin S, Piez KA, Ogawa Y, Davies DR. Crystal structure of transforming growth factor- $\beta$ 2: an unusual fold for the superfamily. *Science* 1992;257:369–373.
184. Ishibashi T, Miller SL, Burstein SA. Type beta transforming growth factor is a potent inhibitor of murine megakaryocytopoiesis *in vitro*. *Blood* 1987;69:1737–1741.
185. Kuter DJ, Gminski DM, Rosenberg RD. Transforming growth factor beta inhibits megakaryocyte growth and endomitosis. *Blood* 1992;79:619–626.
186. Han ZC, Bellucci S, Wan HY, et al. New insights into the regulation of megakaryocytopoiesis by haematopoietic and fibroblastic growth factors and transforming growth factor beta 1. *Br J Haematol* 1992;81:1–5.
187. Jackson H, Williams N, Westcott KR, Green R. Differential effects of transforming growth factor- $\beta$ 1 on distinct developmental stages of murine megakaryocytopoiesis. *J Cell Physiol* 1994;161:312–318.
188. Han ZC, Bellucci S, Shen ZX, et al. Glycosaminoglycans enhance megakaryo-cytopoiesis by modifying the activities of hematopoietic growth regulators. *J Cell Physiol* 1996;168:97–104.
189. Laiho M, DeCaprio JA, Ludlow JW, et al. Growth inhibition by TGF- $\beta$  linked to suppression of retinoblastoma protein phosphorylation. *Cell* 1990;62:175–185.
190. Weinberg RA. The retinoblastoma protein and cell cycle control. *Cell* 1995;81:323–330.
191. Polyak K, Kato JY, Solomon MJ, et al. p27Kip1, a cyclin-Cdk inhibitor, links transforming growth factor- $\beta$  and contact inhibition to cell cycle arrest. *Genes Dev* 1994;8:9–22.
192. Ohta M, Greenberger JS, Anklesaria P, et al. Two forms of transforming growth factor- $\beta$  distinguished by multipotential hematopoietic progenitor cells. *Nature* 1987;329:539–541.
193. Keller JR, Mantel C, Sing GK, et al. Transforming growth factor  $\beta$ 1 selectively regulates early murine hematopoietic progenitors and inhibits the growth of IL-3-dependent myeloid leukemia cell lines. *J Exp Med* 1988;168:737–750.
194. Dybedal I, Jacobsen SEW. Transforming growth factor  $\beta$  (TFG- $\beta$ ), a potent inhibitor of erythropoiesis: neutralizing TGF- $\beta$  antibodies show erythropoietin as a potent stimulator of murine burst-forming unit erythroid colony formation in the absence of a burst-promoting activity. *Blood* 1995;86:949–957.
195. Teofili L, Martini M, Di Mario A, et al. Expression of p15Ink4b gene during megakaryocytic differentiation of normal and myelodysplastic hematopoietic progenitors. *Blood* 2001;98:495–497.
196. Gewirtz AM, Calabretta B, Rucinski B, et al. Inhibition of human megakaryo-cytopoiesis *in vitro* by platelet factor 4 (PF4) and a synthetic COOH-terminal PF4 peptide. *J Clin Invest* 1989;83:1477–1486.
197. Abgrall JF, Han ZC, Sensebe L, et al. Inhibitory effect of highly purified human platelet beta-thromboglobulin on *in vitro* human megakaryocyte colony formation. *Exp Hematol* 1991;19:202–205.
198. Fattovich G, Giustina G, Favarato S, Ruol A. A survey of adverse events in 11,241 patients with chronic viral hepatitis treated with alfa interferon. *J Hepatol* 1996;24:38–47.
199. Dusheiko G. Side effects of alpha interferon in chronic hepatitis C. *Hepatology* 1997;26[Suppl 1]:112S–121S.
200. Jaster R, Tschirch E, Bittorf T, Brock J. Interferon- $\alpha$  inhibits proliferation of Ba/F3 cells by interfering with interleukin-3 action. *Cell Signal* 1999;11:769–775.
201. Kuniyasu H, Yasui W, Kitahara K, et al. Growth inhibitory effect of interferon- $\beta$  is associated with the induction of cyclin-dependent kinase inhibitor p27<sup>Kip1</sup> in a human gastric carcinoma cell line. *Cell Growth Differ* 1997;8:47–52.

202. Wang Q, Fox N, Kaushansky K. Interferon- $\alpha$  directly represses megakaryopoiesis by inhibiting TPO-induced signaling through induction of SOCS-1. *Blood* 2000;96:2093-2099.
203. Long MW. Blood cell cytoadhesion molecules. *Exp Hematol* 1992;20:288-301.
204. Kaushansky K, Lin N, Adamson JW. IL-1 stimulates fibroblasts to synthesize granulocyte/macrophage (GM) and granulocyte (G) colony-stimulating factors: a mechanism for the hematopoietic response to inflammation. *J Clin Invest* 1988;81:92-97.
205. Toksoz D, Zsebo KM, Smith KA, et al. Support of human hematopoiesis in long-term bone marrow cultures by murine stromal cells selectively expressing the membrane-bound and secreted forms of the human homolog of the steel gene product, stem cell factor. *Proc Natl Acad Sci U S A* 1992;89:7350-7354.
206. Yang L, Yang YC. Regulation of interleukin (IL)-11 gene expression in IL-1 induced primate bone marrow stromal cells. *J Biol Chem* 1994;269:32732-32739.
207. Linenberger ML, Jacobsen FW, Bennett LG, et al. Stem cell factor production by human marrow stromal fibroblasts. *Exp Hematol* 1995;23:1104.
208. Selleri C, Maciejewski JP, Sato T, Young NS. Interferon- $\gamma$  constitutively expressed in the stromal microenvironment of human marrow cultures mediates potent hematopoietic inhibition. *Blood* 1996;87:4149-4157.
209. Gordon MY, Riley GP, Watt SM, Greaves MF. Compartmentalization of a hematopoietic growth factor (GM-CSF) by glycosaminoglycans in the bone marrow microenvironment. *Nature* 1987;326:403-405.
210. Roberts R, Gallagher J, Spooncer E, et al. Heparan sulphate bound growth factors: a mechanism for stromal cell mediated hemopoiesis. *Nature* 1988;332:376-378.
211. Nye JS, Kopan R. Vertebrate ligands for Notch. *Curr Biol* 1995;5:966-969.
212. Artavanis-Tsakonas S, Matsuno K, Fortini ME. Notch signaling. *Science* 1995;268:225-232.
213. Robey E, Chang D, Itano A, et al. An activated form of Notch influences the choice between CD4 and CD8 T cell lineages. *Cell* 1996;87:483-492.
214. Bigas A, Martin DIK, Milner LA. Notch 1 and Notch 2 inhibit myeloid differentiation in response to different cytokines. *Mol Cell Biol* 1998;18:2324-2333.
215. Karanu FN, Murdoch B, Miyabayashi T, et al. Human homologues of delta-1 and delta-4 function as mitogenic regulators of primitive hematopoietic cells. *Blood* 2001;97:1960-1967.
216. Verfaillie CM. Adhesion receptors as regulators of the hematopoietic process. *Blood* 1998;92:2609-2612.
217. Kanakura Y, Druker B, Cannistra SA, et al. Signal transduction of the human granulocyte-macrophage colony-stimulating factor and interleukin-3 receptors involves tyrosine phosphorylation of a common set of cytoplasmic proteins. *Blood* 1990;76:706-715.
218. Spivak JL, Fisher J, Isaacs MA, Hankins WD. Protein kinases and phosphatases are involved in erythropoietin-mediated signal transduction. *Exp Hematol* 1992;20:500-504.
219. Otani H, Erdos M, Leonard WJ. Tyrosine kinase(s) regulate apoptosis and bcl-2 expression in a growth factor-dependent cell line. *J Biol Chem* 1993;268:22733-22736.
220. Ihle JN, Kerr I. JAKs and STATs in signaling by the cytokine receptor superfamily. *Trends Genet* 1995;11:69-74.
221. Pezet A, Buteau H, Kelly PA, Edery M. The last proline of Box 1 is essential for association with JAK2 and functional activation of the prolactin receptor. *Mol Cell Endocrinol* 1997;129:199-208.
222. Remy I, Wilson IA, Michnick SW. Erythropoietin receptor activation by a ligand induced conformation

change. *Science* 1999;283:990–992.

223. Silvennoinen O, Witthuhn B, Quelle FW, et al. Structure of the murine JAK2 protein tyrosine kinase and its role in IL-3 signal transduction. *Proc Natl Acad Sci U S A* 1993;90:8429–8433.

224. Guschin D, Rogers N, Briscoe J, et al. A major role for the protein tyrosine kinase JAK1 in the JAK/STAT signal transduction pathway in response to interleukin-6. *EMBO J* 1995;14:1421–1429.

225. Drachman J, Griffin JD, Kaushansky K. Stimulation of tyrosine kinase activity by MPL–ligand (thrombopoietin). *J Biol Chem* 1995;270:4979–4982.

226. Miyakawa Y, Oda A, Druker BJ, et al. Recombinant thrombopoietin induces rapid protein tyrosine phosphorylation of Janus kinase 2 and Shc in human blood platelets. *Blood* 1995;86:23–27.

227. Sattler M, Durstin MA, Frank DA, et al. The thrombopoietin receptor c-Mpl activates JAK2 and TYK2 tyrosine kinases. *Exp Hematol* 1995;23:1040–1048.

228. Drachman JG, Millett KM, Kaushansky K. Mpl signal transduction requires functional JAK2, not TYK2. *J Biol Chem* 1999;274:13480–13484.

229. Deberry C, Mou S, Linnekin D. Stat1 associates with c-kit and is activated in response to stem cell factor. *Biochem J* 1997;327(Pt 1):73–80.

230. Linnekin D. Early signaling pathways activated by c-Kit in hematopoietic cells. *Int J Biochem Cell Biol* 1999;31:1053–1074.

231. Wen Z, Zhong Z, Darnell JE. Maximal activation of transcription by STAT1 and STAT3 requires both tyrosine and serine phosphorylation. *Cell* 1995;82:241–250.

232. Decker T, Kovarik P. Serine phosphorylation of STATs. *Oncogene* 2000;19:2628–2637.

233. Azam M, Erdjument–Bromage H, Kreider BL, et al. Interleukin-3 signals through multiple isoforms of Stat5. *EMBO J* 1995;14:1402–1411.

234. Zhong Z, Wen Z, Darnell JE. STAT3: a STAT family member activated by tyrosine phosphorylation in response to epidermal growth factor and interleukin-6. *Science* 1994;264:95–98.

235. Nakajima K, Yamanaka Y, Nakae K, et al. A central role for Stat3 in IL-6–induced regulation of growth and differentiation in M1 leukemia cells. *EMBO J* 1996;15:3651–3658.

236. Bacon CM, Tortolani PJ, Shimosaka A, et al. Thrombopoietin (TPO) induces tyrosine phosphorylation and activation of STAT5 and STAT3. *FEBS Lett* 1995;370:63–68.

237. Pallard C, Gouilleux F, B'enit L, et al. Thrombopoietin activates a STAT5–like factor in hematopoietic cells. *EMBO J* 1995;14:2847–2856.

238. Miyakawa Y, Oda A, Druker BJ, et al. Thrombopoietin induces tyrosine phosphorylation of Stat3 and Stat5 in human blood platelets. *Blood* 1996;87:439–446.

239. Drachman JG, Kaushansky K. Dissecting the thrombopoietin receptor: functional elements of the mpl cytoplasmic domain. *Proc Natl Acad Sci U S A* 1997;94:2350–2355.

240. Lecine P, Algarte M, Rameil P, et al. Elf-1 and Stat5 bind to a critical element in a new enhancer of the human interleukin-2 receptor alpha gene. *Mol Cell Biol* 1996;16:6829–6840.

241. Curiel RE, Lahesmaa R, Subleski J, et al. Identification of a Stat-6–responsive element in the promoter of the human interleukin-4 gene. *Eur J Immunol* 1997;27:1982–1987.

242. Socolovsky M, Fallon AE, Wang S, et al. Fetal anemia and apoptosis of red cell progenitors in Stat5a–/–5b–/– mice: a direct role for Stat5 in Bcl-X(L) induction. *Cell* 1999;98:181–191.

243. Kiuchi N, Nakajima K, Ichiba M, et al. STAT3 is required for the gp130–mediated full activation of the



c-myc gene. *J Exp Med* 1999;189:63–73.

244. Horvath CM. Stat proteins and transcriptional responses to extracellular signals. *Trends Biochem Sci* 2000;25:496–502.

245. Rottapel R, Turck CW, Casteran N, et al. Substrate specificities and identification of a putative binding site for PI3K in the carboxy tail of the murine Flt3 receptor tyrosine kinase. *Oncogene* 1994;9:1755–1765.

246. Damen JE, Cutler RL, Jiao H, et al. Phosphorylation of tyrosine 503 in the erythropoietin receptor (EpR) is essential for binding the P85 subunit of phosphatidylinositol (PI) 3-kinase and for EpR-associated PI 3-kinase activity. *J Biol Chem* 1995;270:23402–23408.

247. Klinghoffer RA, Duckworth B, Valius M, et al. Platelet-derived growth factor-dependent activation of phosphatidylinositol 3-kinase is regulated by receptor binding of SH2-domain-containing proteins which influence Ras activity. *Mol Cell Biol* 1996;16:5905–5914.

248. Rother KI, Imai Y, Caruso M, et al. Evidence that IRS-2 phosphorylation is required for insulin action in hepatocytes. *J Biol Chem* 1998;273:17491–17497.

249. Nishida K, Yoshida Y, Itoh M, et al. Gab-family adapter proteins act downstream of cytokine and growth factor receptors and T- and B-cell antigen receptors. *Blood* 1999;93:1809–1816.

250. Wickrema A, Uddin S, Sharma A, et al. Engagement of Gab1 and Gab2 in erythropoietin signaling. *J Biol Chem* 1999;274:24469–24474.

251. Lecoq-Lafon C, Verdier F, Fichelson S, et al. Erythropoietin induces the tyrosine phosphorylation of GAB1 and its association with SHC, SHP2, SHIP, and phosphatidylinositol 3-kinase. *Blood* 1999;93:2578–2585.

252. Miyakawa Y, Rojnuckarin P, Habib T, Kaushansky K. Thrombopoietin induces PI3K and SHP2 activation through Gab and IRS proteins in BaF3 cells and primary murine megakaryocytes. *J Biol Chem* 2001;276:2494–2502.

253. Rameh LE, Cantley LC. The role of phosphoinositide 3-kinase lipid products in cell function. *J Biol Chem* 1999;274:8347–8350.

254. Rodriguez-Viciana P, Warne PH, Dhand R, et al. Phosphatidylinositol-3-OH kinase as a direct target of Ras. *Nature* 1994;370:527–532.

255. Huber M, Helgason CD, Damen JE, et al. The src homology 2-containing inositol phosphatase (SHIP) is the gatekeeper of mast cell degranulation. *Proc Natl Acad Sci U S A* 1998;95:11330–11335.

256. Aman MJ, Lamkin TD, Okada H, et al. The inositol phosphatase SHIP inhibits Akt/PKB activation in B cells. *J Biol Chem* 1998;273:33922–33928.

257. Liu Q, Sasaki T, Kozieradzki I, et al. SHIP is a negative regulator of growth factor receptor-mediated PKB/Akt activation and myeloid cell survival. *Genes Dev* 1999;13:786–791.

258. Stambolic V, Suzuki A, de la Pompa JL, et al. Negative regulation of PKB/Akt-dependent cell survival by the tumor suppressor PTEN. *Cell* 1998;95:29–39.

259. Cantley LC, Neel BG. New insights into tumor suppression: PTEN suppresses tumor formation by restraining the phosphoinositide 3-kinase/AKT pathway. *Proc Natl Acad Sci U S A* 1999;96:4240–4245.

260. Lev S, Givol D, Yarden Y. Interkinase domain of kit contains the binding site for phosphatidylinositol 3' kinase. *Proc Natl Acad Sci U S A* 1992;89:678–682.

261. Boulton TG, Stahl N, Yancopoulos GD. Ciliary neurotropic factor/leukemia inhibitory factor/interleukin-6/oncostatin M family of cytokines induces tyrosine phosphorylation of a common set of proteins overlapping those induced by other cytokines and growth factors. *J Biol Chem* 1994;269:11648–11655.

262. Craddock BL, Welham MJ. Interleukin-3 induces association of the protein-tyrosine phosphatase

- SHP2 and phosphatidylinositol 3-kinase with a 100-kDa tyrosine-phosphorylated protein in hemopoietic cells. *J Biol Chem* 1997;272:29281-29289.
263. Sattler M, Salgia R, Durstin MA, et al. Thrombopoietin induces activation of phosphatidylinositol-3' kinase pathway and formation of a complex containing p85<sup>P13K</sup> and the protooncprotein p120<sup>GBL</sup>. *J Cell Physiol* 1997;171:28-33.
264. Al-Shami A, Naccache PH. Granulocyte-macrophage colony-stimulating factor-activated signaling pathways in human neutrophils. Involvement of Jak2 in the stimulation of phosphatidylinositol 3-kinase. *J Biol Chem* 1999;274:5333-5338.
265. Majka M, Ratajczak J, Gewirtz AM, Ratajczak MZ. PI-3k-Akt axis inhibits apoptosis in normal human megakaryoblasts and is efficiently activated by thrombopoietin. *Exp Hematol* 2000;28:1492.
266. Geddis A, Kaushansky K. Inhibition of PI3K leads to a block in TPO-induced cell cycling at G1/S in both BaF3/Mpl cells and in primary megakaryocytic progenitors. *Blood* 2000;96[Suppl 1]:539a.
267. Downward J. Mechanisms and consequences of activation of protein kinase B/Akt. *Curr Opin Cell Biol* 1998;10:262-267.
268. Filippa N, Sable CL, Hemmings BA, Van Obberghen E. Effect of phospho-inositide-dependent kinase 1 on protein kinase B translocation and its subsequent activation. *Mol Cell Biol* 2000;20:5712-5721.
269. Toker A, Newton AC. Cellular signaling: pivoting around PDK-1. *Cell* 2000;103:185-188.
270. Zha J, Harada H, Yang E, et al. Serine phosphorylation of death agonist BAD in response to survival factor results in binding to 14-3-3 not BCL-X(L). *Cell* 1996;87:619-628.
271. del Peso L, González-García M, Page C, et al. Interleukin-3-induced phosphorylation of BAD through the protein kinase Akt. *Science* 1997;278:687-689.
272. Datta SR, Dudek H, Tao X, et al. Akt phosphorylation of BAD couples survival signals to the cell-intrinsic death machinery. *Cell* 1997;91:231-241.
273. Scheid MP, Duronio V. Dissociation of cytokine-induced phosphorylation of Bad and activation of PKB/akt: involvement of MEK upstream of Bad phosphorylation. *Proc Natl Acad Sci U S A* 1998;95:7439-7444.
274. Hinton HJ, Welham MJ. Cytokine-induced protein kinase B activation and Bad phosphorylation do not correlate with cell survival of hemopoietic cells. *J Immunol* 1999;162:7002-7009.
275. Wodarz A, Nusse R. Mechanisms of Wnt signaling in development. *Annu Rev Cell Dev Biol* 1998;14:59-88.
276. Van Den Berg DJ, Sharma AK, Bruno E, Hoffman R. Role of members of the Wnt gene family in human hematopoiesis. *Blood* 1998;92:3189-3202.
277. Barth AI, Nathke IS, Nelson WJ. Cadherins, catenins and APC protein: interplay between cytoskeletal complexes and signaling pathways. *Curr Opin Cell Biol* 1997;9:683-690.
278. Papkoff J, Aikawa M. WNT-1 and HGF regulate GSK3 beta activity and beta-catenin signaling in mammary epithelial cells. *Biochem Biophys Res Commun* 1998;247:851-858.
279. Yuan H, Mao J, Li L, Wu D. Suppression of glycogen synthase kinase activity is not sufficient for leukemia enhancer factor-1 activation. *J Biol Chem* 1999;274:30419-30423.
280. Billin AN, Thirlwell H, Ayer DE. Beta-catenin-histone deacetylase interactions regulate the transition of LEF1 from a transcriptional repressor to an activator. *Mol Cell Biol* 2000;20:6882-6890.
281. He TC, Sparks AB, Rago C, et al. Identification of c-MYC as a target of the APC pathway. *Science* 1998;281:1509-1512.
282. Shtutman M, Zhurinsky J, Simcha I, et al. The cyclin D1 gene is a target of the beta-catenin/LEF-1

pathway. *Proc Natl Acad Sci U S A* 1999;96:5522–5527.

283. Gesbert F, Sellers WH, Signoretti S, et al. BCR/ABL regulates expression of the cyclin-dependent kinase inhibitor p27<sup>Kip1</sup> through the phosphatidylinositol 3-kinase/AKT pathway. *J Biol Chem* 2000;275:39223–39230.

284. Alt JR, Cleveland JL, Hannink M, Diehl JA. Phosphorylation-dependent regulation of cyclin D1 nuclear export and cyclin D1-dependent cellular transformation. *Genes Dev* 2000;14:3102–3114.

285. Wu MX, Ao Z, Prasad KVS, et al. IEX-1L, an apoptosis inhibitor involved in NF- $\kappa$ B mediated cell survival. *Science* 1998;281:998–1004.

286. LaCasse EC, Baird S, Korneluk RG, MacKenzie AE. The inhibitors of apoptosis (IAPs) and their emerging role in cancer. *Oncogene* 1998;17:3247–3259.

287. Pahl HL. Activators and target genes of Rel/NF- $\kappa$ B transcription factors. *Oncogene* 1999;18:6853–6866.

288. Hu X, Yee E, Harlan JM, et al. Lipopolysaccharide induces the anti-apoptotic molecules A1 and A20 in microvascular endothelial cells. *Blood* 1998;92:2759–2765.

289. Zong WX, Edelstein LC, Chen C, et al. The prosurvival Bcl-2 homolog Bfl-1/A1 is a direct transcriptional target of NF- $\kappa$ B that blocks TNF $\alpha$ -induced apoptosis. *Genes Dev* 1999;13:382–387.

290. Chen C, Edelstein LC, Gelinas C. The Rel/NF- $\kappa$ B family directly activates expression of the apoptosis inhibitor Bcl-x(L). *Mol Cell Biol* 2000;20:2687–2695.

291. Smith JL, Schaffner AE, Hofmeister JK, et al. ets-2 is a target for an akt (Protein kinase B)/Jun N-terminal kinase signaling pathway in macrophages of motheaten-viable mutant mice. *Mol Cell Biol* 2000;20:8026–8034.

292. Kane LP, Shapiro VS, Stokoe D, Weiss A. Induction of NF- $\kappa$ B by the Akt/PKB kinase. *Curr Biol* 1999;9:601–604.

293. Besancon F, Atfi A, Gespach C, et al. Evidence for a role of NF- $\kappa$ B in the survival of hematopoietic cells mediated by interleukin-3 and the oncogenic TEL/platelet-derived growth factor receptor  $\beta$  fusion protein. *Proc Natl Acad Sci U S A* 1998;95:8081–8086.

294. La Rosa FA, Pierce JW, Sonenshein GE. Differential regulation of the c-myc oncogene promoter by the NF- $\kappa$ B rel family of transcription factors. *Mol Cell Biol* 1994;14:1039–1044.

295. Wang CY, Mayo MW, Korneluk RG, et al. NF- $\kappa$ B antiapoptosis: induction of TRAF1 and TRAF2 and c-IAP1 and c-IAP2 to suppress caspase 8 activation. *Science* 1998;281:1680–1683.

296. Guttridge DC, Albanese C, Reuther JY, et al. NF- $\kappa$ B controls cell growth and differentiation through transcriptional regulation of cyclin D1. *Mol Cell Biol* 1999;19:5785–5799.

297. Hinz M, Krappmann D, Eichten A, et al. NF- $\kappa$ B function in growth control: regulation of cyclin D1 expression and G0/G1-to-S-phase transition. *Mol Cell Biol* 1999;19:2690–2698.

298. Cheng G. NF- $\kappa$ B-mediated up-regulation of Bcl-x and Bfl-1/A1 is required for CD40 survival signaling in B lymphocytes. *Proc Natl Acad Sci U S A* 1999;96:9136–9141.

299. Kanda K, Hu HM, Zhang L, et al. NF- $\kappa$ B activity is required for the deregulation of c-myc expression by the immunoglobulin heavy chain enhancer. *J Biol Chem* 2000;275:32338–32346.

300. Cobb MH, Goldsmith EJ. How MAP kinases are regulated. *J Biol Chem* 1995;270:14843–14846.

301. Robinson MJ, Cobb MH. Mitogen-activated protein kinase pathways. *Curr Opin Cell Biol* 1997;9:180.

302. Kramer RM, Roberts EF, Striffler BA, Johnstone EM. Thrombin induces activation of p38 MAP kinase in human platelets. *J Biol Chem* 1995;270:27395–27398.

303. Nadal F, Levy-Toledano S, Grelac F, et al. Negative regulation of mitogen-activated protein kinase activation by integrin  $\alpha$ IIb $\beta$ 3 in platelets. *J Biol Chem* 1997;272:22381-22384.
304. Barry OP, Kazanietz MG, Pratico D, FitzGerald GA. Arachidonic acid in platelet microparticles up-regulates cyclooxygenase-2-dependent prostaglandin formation via a protein kinase C/mitogen-activated protein kinase-dependent pathway. *J Biol Chem* 1999;274:7545-7556.
305. Schaeffer HJ, Catling AD, Eblin ST, et al. MP1: a MEK binding partner that enhances enzymatic activation of the MAP kinase cascade. *Science* 1998;281: 1668-1671.
306. Whitmarsh AJ, Cavanaugh J, Tournier C, et al. A mammalian scaffold complex that selectively mediates MAP kinase activation. *Science* 1998;281:1671-1674.
307. Okuda K, Sanghera JS, Pelech SL, et al. Granulocyte-macrophage colony-stimulating factor, interleukin-3, and steel factor induce rapid tyrosine phosphorylation of p42 and p44 MAP kinase. *Blood* 1992;79:2880-2887.
308. Yamada M, Komatsu N, Okada K, et al. Thrombopoietin induces tyrosine phosphorylation and activation of mitogen-activated protein kinases in a human thrombopoietin-dependent cell line. *Biochem Biophys Res Commun* 1995;217:230-237.
309. Rouyez MC, Boucheron C, Gisselbrecht S, et al. Control of thrombopoietin-induced megakaryocytic differentiation by the mitogen-activated protein kinase pathway. *Mol Cell Biol* 1997;17:4991-5000.
310. Ezumi Y, Uchiyama T, Takayama H. Thrombopoietin potentiates the protein-kinase-C-mediated activation of mitogen-activated protein kinase/ERK kinases and extracellular signal-regulated kinases in human platelets. *Eur J Biochem* 1998;258:976-985.
311. Aplin AE, Stewart SA, Assoian RK, Juliano RL. Integrin-mediated adhesion regulates ERK nuclear translocation and phosphorylation of Elk-1. *J Cell Biol* 2001;153:273-282.
312. Rojnuckarin P, Kaushansky K. Megakaryocyte proplatelet formation is dependent on PKCa. *Blood* 2001;97:154-161.
313. Fichelson S, Freyssonier JM, Picard F, et al. Megakaryocyte growth and development factor-induced proliferation and differentiation are regulated by the mitogen-activated protein kinase pathway in primitive cord blood hematopoietic progenitors. *Blood* 1999;94:1601-1613.
314. Chen RH, Sarnecki C, Blenis J. Nuclear localization and regulation of erk- and rsk-encoded protein kinases. *Mol Cell Biol* 1992;12:915-927.
315. Marais R, Wynne J, Treisman R. The SRF accessory protein Elk-1 contains a growth factor-regulated transcriptional activation domain. *Cell* 1993;73:381-393.
316. Lavoie JN, L'Allemain G, Brunet A, et al. Cyclin D1 expression is regulated positively by the p42/p44MAPK and negatively by the p38/HOGMAPK pathway. *J Biol Chem* 1996;271:20608-20616.
317. Sun S, Zimmet JM, Toselli P, et al. Overexpression of cyclin D1 moderately increases ploidy in megakaryocytes. *Haematologica* 2001;86:17-23.
318. Zimmet JM, Ladd D, Jackson CW, et al. A role for cyclin D3 in the endomitotic cell cycle. *Mol Cell Biol* 1997;17:7248-7259.
319. Mizuno H, Nishida E. The ERK MAP kinase pathway mediates induction of SGK (serum- and glucocorticoid-inducible kinase) by growth factors. *Genes Cells* 2001;6:261-268.
320. Nagata Y, Nishida E, Todokoro K. Activation of JNK signaling pathway by erythropoietin, thrombopoietin, and interleukin-3. *Blood* 1997;89:2664-2669.
321. Ezumi Y, Nishida E, Uchiyama T, Takayama H. Thrombopoietin potentiates agonist-stimulated activation of p38 mitogen-activated protein kinase in human platelets. *Biochem Biophys Res Commun*

1999;261:58-63.

322. Kovach NL, Lin N, Yednock T, et al. Stem cell factor modulates the avidity of  $\alpha 4\beta 1$  integrins expressed on hematopoietic cell lines. *Blood* 1995;85:159-167.
323. Levesque JP, Leavesley DI, Niutta S, et al. Cytokines increase human hemopoietic cell adhesiveness by activation of very late antigen (VLA)-4 and VLA-5 integrins. *J Exp Med* 1995;181:1805-1815.
324. Zauli G, Bassini A, Vitale M, et al. Thrombopoietin enhances the  $\alpha_{IIb}\beta_3$ -dependent adhesion of megakaryocytic cells to fibrinogen or fibronectin through PI 3 kinase. *Blood* 1997;89:883-895.
325. Takahira H, Gotoh A, Ritchie A, Broxmeyer HE. Steel factor enhances integrin-mediated tyrosine phosphorylation of focal adhesion kinase (pp125FAK) and paxillin. *Blood* 1997;89:1574-1584.
326. Schofield KP, Humphries MJ, de Wynter E, et al. The effect of  $\alpha 4\beta 1$  integrin binding sequences of fibronectin on growth of cells from human hematopoietic progenitors. *Blood* 1998;91:3230-3238.
327. Gotoh A, Ritchie A, Takahira H, Broxmeyer HE. Thrombopoietin and erythropoietin activate inside-out signaling of integrin and enhance adhesion to immobilized fibronectin in human growth-factor-dependent hematopoietic cells. *Ann Hematol* 1997;75:207-213.
328. Peled A, Kollet O, Ponomaryov T, et al. The chemokine SDF-1 activates the integrins LFA-1, VLA-4, and VLA-5 on immature human CD34<sup>+</sup> cells: role in transendothelial/stromal migration and engraftment of NOD/SCID mice. *Blood* 2000;95:3289-3296.
329. Papayannopoulou T. Mechanisms of stem-/progenitor-cell mobilization: the anti-VLA-4 paradigm. *Semin Hematol* 2000;37[1 Suppl 2]:11-18.
330. Oda A, Miyakawa Y, Druker BJ, et al. Crkl is constitutively tyrosine phosphorylated in platelets from chronic myelogenous leukemia patients and inducibly phosphorylated in normal platelets stimulated by thrombopoietin. *Blood* 1996;88:4304.
331. Barber DL, Mason JM, Fukazawa T, et al. Erythropoietin and interleukin-3 activate tyrosine phosphorylation of CBL and association with CRK adaptor proteins. *Blood* 1997;89:3166-3174.
332. Sattler M, Salgia R, Shrikhande G, et al. Steel factor induces tyrosine phosphorylation of CRKL and binding of CRKL to a complex containing c-kit, phosphatidylinositol 3-kinase, and p120(CBL). *J Biol Chem* 1997;272:10248-10253.
333. Arai A, Nosaka Y, Kanda E, et al. Rap1 is activated by erythropoietin or interleukin-3 and is involved in regulation of  $\beta 1$  integrin-mediated hematopoietic cell adhesion. *J Biol Chem* 2001;276:10453-10462.
334. Luoh SM, Stefanich E, Solar G, et al. Role of the distal half of the c-Mpl intracellular domain in control of platelet production by thrombopoietin *in vivo*. *Mol Cell Biol* 2000;20:507-515.
335. Yi T, Mui ALF, Krystal G, Ihle JN. Hematopoietic cell phosphatase associates with the interleukin-3 (IL-3) receptor  $\beta$  chain and down-regulates IL-3-induced tyrosine phosphorylation and mitogenesis. *Mol Cell Biol* 1993;13:7577-7586.
336. Longmore G. Erythropoietin receptor mutations and Olympic glory. *Nat Genet* 1993;4:108-109.
337. Hilton DJ. Negative regulators of cytokine signal transduction. *Cell Mol Life Sci* 1999;55:1568-1577.
338. Begley CG, Nicloa NA. Resolving conflicting signals: cross inhibition of cytokine signaling pathways. *Blood* 1999;93:1443-1447.
339. Krause DS, Fackler MJ, Civin CI, May WS. CD34: structure, biology, and clinical utility. *Blood* 1996;87:1-13.
340. Verfaillie CM. Adhesion receptors as regulators of the hematopoietic process. *Blood* 1998;92:2609-2612.

341. Uchida N, Weissman IL. Searching for hematopoietic stem cells: evidence that Thy-1.1<sup>lo</sup> Lin<sup>-</sup> Sca-1<sup>+</sup> cells are the only stem cells in C57BL/Ka-Thy-1.1 bone marrow. *J Exp Med* 1992;175:175-184.
342. Baum CM, Weissman IL, Tsukamoto AS, et al. Isolation of a candidate human hematopoietic stem-cell population. *Proc Natl Acad Sci U S A* 1992;89:2804-2808.
343. Barda-Saad M, Rozenszajn LA, Ashush H, et al. Adhesion molecules involved in the interactions between early T cells and mesenchymal bone marrow stromal cells. *Exp Hematol* 1999;27:834-844.
344. Fujita N, Kato Y, Naito M, Tsuruo T. A novel anti-Thy-1 (CD90) monoclonal antibody induces apoptosis in mouse malignant T-lymphoma cells in spite of inducing bcl-2 expression. *Int J Cancer* 1996;66:544-550.
345. Schafer H, Bartels T, Hahn G, et al. T-cell-activating monoclonal antibodies, reacting with both leukocytes and erythrocytes, recognize the guinea pig Thy-1 differentiation antigen: characterization and cloning of guinea pig CD90. *Cell Immunol* 1999;197:116-128.
346. Sanchez MJ, Holmes A, Miles C, Dzierzak E. Characterization of the first definitive hematopoietic stem cells in the AGM and liver of the mouse embryo. *Immunity* 1996;5:513-525.
347. Dean YD, McGreal EP, Akatsu H, Gasque P. Molecular and cellular properties of the rat AA4 antigen, a C-type lectin-like receptor with structural homology to thrombomodulin. *J Biol Chem* 2000;275:34382-34392.
348. Miraglia S, Godfrey W, Yin AH, et al. A novel five-transmembrane hematopoietic stem cell antigen: isolation, characterization, and molecular cloning. *Blood* 1997;90:5013-5021.
349. Majka M, Ratajczak J, Machalinski B, et al. Expression, regulation and function of AC133, a putative cell surface marker of primitive human haematopoietic cells. *Folia Histochem Cytobiol* 2000;38:53-63.
350. Watt SM, Bühring HJ, Rappold I, et al. CD164, a novel sialomucin on CD34<sup>+</sup> and erythroid subsets, is located on human chromosome 6q21. *Blood* 1998;92:849-866.
351. Watt SM, Butler LH, Tavian M, et al. Functionally defined CD164 epitopes are expressed on CD34(+) cells throughout ontogeny but display distinct distribution patterns in adult hematopoietic and nonhematopoietic tissues. *Blood* 2000;95:3113-3124.
352. Young JC, Bruno E, Luens KM, et al. Thrombopoietin stimulates megakaryocytopoiesis, myelopoiesis and expansion of CD34<sup>+</sup> progenitor cells from single CD34<sup>+</sup>Thy-1<sup>+</sup>Lin<sup>-</sup> primitive progenitor cells. *Blood* 1996;88:1619-1631.
353. Goodell MA, Brose K, Paradis G, et al. Isolation and functional properties of murine hematopoietic stem cells that are replicating *in vivo*. *J Exp Med* 1996;183:1797-1806.
354. Leemhuis T, Yoder MC, Grigsby S, et al. Isolation of primitive human bone marrow hematopoietic progenitor cells using Hoechst 33342 and Rhodamine 123. *Exp Hematol* 1996;24:1215-1224.
355. Goodell MA, Rosenzweig M, Kim H, et al. Dye efflux studies suggest that hematopoietic stem cells expressing low or undetectable levels of CD34 antigen exist in multiple species. *Nat Med* 1997;3:1337-1345.
356. Bertolini F, Battaglia M, Lanza A, et al. Multilineage long-term engraftment potential of drug-resistant hematopoietic progenitors. *Blood* 1997;90:3027-3036.
357. Botas J. Control of morphogenesis and differentiation by HOM/Hox genes. *Curr Opin Cell Biol* 1993;5:1015-1022.
358. Sauvageau G, Lansdorp PM, Eaves CJ, et al. Differential expression of homeobox genes in functionally distinct CD34<sup>+</sup> subpopulations of human bone marrow cells. *Proc Natl Acad Sci U S A* 1994;91:12223-12227.
359. Magli MC, Largman C, Lawrence HJ. Effects of HOX homeobox genes in blood cell differentiation. *J*

Cell Physiol 1997;173:168–177.

360. Chiba S. Homeobox genes in normal hematopoiesis and leukemogenesis. *Int J Hematol* 1998;68:343–353.
361. Buske C, Humphries RK. Homeobox genes in leukemogenesis. *Int J Hematol* 2000;71:301–308.
362. Buske C, Feuring–Buske M, Antonchuk J, et al. Overexpression of HOXA10 perturbs human lymphomyelopoiesis *in vitro* and *in vivo*. *Blood* 2001;97:2286–2292.
363. Roberts CW, Shutter JR, Korsmeyer SJ. Hox11 controls the genesis of the spleen. *Nature* 1994;368:747–749.
364. Lawrence HJ, Helgason CD, Sauvageau G, et al. Mice bearing a targeted interruption of the homeobox gene HOXA9 have defects in myeloid, erythroid, and lymphoid hematopoiesis. *Blood* 1997;89:1922–1930.
365. Shimamoto T, Tang Y, Naot Y, et al. Hematopoietic progenitor cell abnormalities in Hoxc–8 null mutant mice. *J Exp Zool* 1999;283:186–193.
366. Yu BD, Hess JL, Horning SE, et al. Altered Hox expression and segmental identity in Mll–mutant mice. *Nature* 1995;378:505–558.
367. Yagi H, Deguchi K, Aono A, et al. Growth disturbance in fetal liver hematopoiesis of Mll–mutant mice. *Blood* 1998;92:108–117.
368. DiMartino JF, Selleri L, Traver D, et al. The Hox cofactor and proto–oncogene Pbx1 is required for maintenance of definitive hematopoiesis in the fetal liver. *Blood* 2001;97:618–626.
369. Georgopoulos K. Transcription factors required for lymphoid lineage commitment. *Curr Opin Immunol* 1997;9:222–227.
370. Molnar A, Georgopoulos K. The Ikaros gene encodes a family of functionally diverse zinc finger DNA–binding proteins. *Mol Cell Biol* 1994;14:8292–8303.
371. Wang J, Nichogiannopoulou A, Wu L, et al. Selective defects in the development of the fetal and adult lymphoid system in mice with an Ikaros null mutation. *Immunity* 1996;5:537–549.
372. Scott E, Simon M, Anastasi J, Singh H. Requirement of transcription factor PU.1 in the development of multiple hematopoietic lineages. *Science* 1994;265:1573–1577.
373. McKercher SR, Torbett BE, Anderson KL, et al. Targeted disruption of the *PU.1* gene results in multiple hematopoietic abnormalities. *EMBO J* 1996;15:5647–5658.
374. Begley CG, Aplan PD, Denning SM, et al. The gene SCL is expressed during early hematopoiesis and encodes a differentiation–related DNA–binding motif. *Proc Natl Acad Sci U S A* 1989;86:10128–10132.
375. Labbaye C, Valtieri M, Barberi T, et al. Differential expression and functional role of GATA–2, NF–E2, and GATA–1 in normal adult hematopoiesis. *J Clin Invest* 1995;95:2346–2358.
376. Brady G, Billia F, Knox J, et al. Analysis of gene expression in a complex differentiation hierarchy by global amplification of cDNA from single cells. *Curr Biol* 1995;5:909–922.
377. Hoang T, Paradis E, Brady G, et al. Opposing effects of the basic helix–loop–helix transcription factor SCL on erythroid and monocytic differentiation. *Blood* 1996;87:102–111.
378. Tanigawa T, Elwood N, Metcalf D, et al. The SCL gene product is regulated by and differentially regulates cytokine responses during myeloid leukemic cell differentiation. *Proc Natl Acad Sci U S A* 1993;90:7864–7868.
379. Condorelli GL, Tocci A, Botta R, et al. Ectopic TAL–1/SCL expression in phenotypically normal or leukemic myeloid precursors—proliferative and antiapoptotic effects coupled with a differentiation blockade.



Mol Cell Biol 1997;17:2954–2969.

380. Caceres-Cortes JR, Krosi G, Tessier N, et al. Steel factor sustains SCL expression and the survival of purified CD34<sup>+</sup> bone marrow cells in the absence of detectable cell differentiation. *Stem Cells* 2001;19:59–70.

381. Martin DIK, Tsai SF, Orkin SH. Increased gamma globin gene expression in a non-deletion HPFH mediated by an erythroid specific DNA binding factor. *Nature* 1989;338:435–438.

382. Persons DA, Allay JA, Allay ER, et al. Enforced expression of the GATA-2 transcription factor blocks normal hematopoiesis. *Blood* 1999;93:488–499.

383. Deveaux S, Filipe A, Lemarchandel V, et al. Analysis of the thrombopoietin receptor (MPL) promoter implicates GATA and Ets proteins in the coregulation of megakaryocyte-specific genes. *Blood* 1996;87:4678–4685.

384. Yamaguchi Y, Zon LI, Akerman SJ, et al. Forced GATA-1 expression in the murine myeloid cell line M1: induction of c-Mpl expression and megakaryocytic/erythroid differentiation. *Blood* 1998;91:450–457.

385. Mouthon MA, Bernard O, Mitjavila MT, et al. Expression of tal-1 and GATA-binding proteins during human hematopoiesis. *Blood* 1993;81:647–655.

386. Yamaguchi Y, Ackerman SJ, Minegishi N, et al. Mechanisms of transcription in eosinophils: GATA-1, but not GATA-2, transactivates the promoter of the eosinophil granule major basic protein gene. *Blood* 1998;91:3447–3458.

387. Russell ES. Hereditary anemias of the mouse: a review for geneticists. *Adv Genet* 1979;20:357–459.

388. McCulloch EA, Siminovitch L, Till JE. Spleen-colony formation in anemic mice of genotype WW<sup>V</sup>. *Science* 1964;144:844–846.

389. Lewis JP, O'Grady LF, Bernstein SE, et al. Growth and differentiation of transplanted W/W<sup>v</sup> marrow. *Blood* 1967;30:601–616.

390. Barker JE. *Sl/Sl<sup>a</sup>* hematopoietic progenitors are deficient in situ. *Exp Hematol* 1994;22:174–177.

391. Miller CL, Rebel VI, Helgason CD, et al. Impaired steel factor responsiveness differentially affects the detection and long-term maintenance of fetal liver hematopoietic stem cells *in vivo*. *Blood* 1997;89:1214–1223.

392. Ogawa M, Matsuzaki Y, Nishikawa S, et al. Expression and function of *c-kit* in hemopoietic progenitor cells. *J Exp Med* 1991;174:63–71.

393. Bernstein ID, Andrews RG, Zsebo KM. Recombinant human stem cell factor enhances the formation of colonies by CD34<sup>+</sup> and CD34<sup>+</sup>lin<sup>-</sup> cells, and the generation of colony-forming cell progeny from CD34<sup>+</sup>lin<sup>-</sup> cells cultured with interleukin-3, granulocyte colony-stimulating factor, or granulocyte-macrophage colony-stimulating factor. *Blood* 1991;77:2316–2321.

394. Migliaccio G, Migliaccio AR, Druzin ML, et al. Long-term generation of colony-forming cells in liquid culture of CD34<sup>+</sup> cord blood cells in the presence of recombinant human stem cell factor. *Blood* 1992;79:2620–2627.

395. Brandt J, Briddell RA, Srour EF, et al. Role of *c-kit* ligand in the expansion of human hematopoietic progenitor cells. *Blood* 1992;79:634–641.

396. Ariyama Y, Misawa S, Sonoda Y. Synergistic effects of stem cell factor and interleukin-6 or interleukin-11 on the expansion of murine hematopoietic progenitors in liquid suspension culture. *Stem Cells* 1995;13(4):404–413.

397. Wu H, Klingmüller U, Acurio A, et al. Functional interaction of erythropoietin and stem cell factor receptor is essential for erythroid colony formation. *Proc Natl Acad Sci U S A* 1997;94:1806–1810.

398. Broudy VC, Lin N, Buhning HJ, et al. Analysis of c-kit receptor dimerization by fluorescence

resonance energy transfer. *Blood* 1998;91:898–906.

399. de Vries P, Brasel KA, Eisenman JR, et al. The effect of recombinant mast cell growth factor on purified murine hematopoietic stem cells. *J Exp Med* 1991;173:1205–1211.

400. Li CL, Johnson GR. Stem cell factor enhances the survival but not the self-renewal of murine hematopoietic long-term repopulating cells. *Blood* 1994;84:408–414.

401. Wineman JP, Nishikawa S-I, Müller-Sieburg CE. Maintenance of high levels of pluripotent hematopoietic stem cells *in vitro*: effect of stromal cells and *c-kit*. *Blood* 1993;81:365–372.

402. Lemieux ME, Chappel SM, Miller CL, Eaves CJ. Differential ability of flt3-ligand, interleukin-11, and Steel factor to support the generation of B cell progenitors and myeloid cells from primitive murine fetal liver cells. *Exp Hematol* 1997;25:951–957.

403. Lyman SD, Seaberg M, Hanna R, et al. Plasma/serum levels of flt3 ligand are low in normal individuals and highly elevated in patients with Fanconi anemia and acquired aplastic anemia. *Blood* 1995;86:4091–4096.

404. Mackarehtschian K, Hardin JD, Moore KA, et al. Targeted disruption of the flk2/flt3 gene leads to deficiencies in primitive hematopoietic progenitors. *Immunity* 1995;3:147–161.

405. Muench MO, Roncarolo MG, Menon S, et al. FLK-2/FLT-3 ligand regulates the growth of early myeloid progenitors isolated from human fetal liver. *Blood* 1995;85:963–972.

406. Rasko JE, Metcalf D, Rossner MT, et al. The flt3/flk-2 ligand: receptor distribution and action on murine hemopoietic cell survival and proliferation. *Leukemia* 1995;9:2058–2066.

407. Maraskovsky E, Brasel K, Teepe M, et al. Dramatic increases in the number of functionally mature dendritic cells in Flt3 ligand treated mice: multiple dendritic cell populations identified. *J Exp Med* 1996;184:1953–1962.

408. Maraskovsky E, Daro E, Roux E, et al. *In vivo* generation of human dendritic cell subsets by Flt3 ligand. *Blood* 2000;96:878–884.

409. Strobl H, Bello-Fernandez C, Riedl E, et al. flt3 ligand in cooperation with transforming growth factor-β1 potentiates *in vitro* development of Langerhans-type dendritic cells and allows single-cell dendritic cell cluster formation under serum-free conditions. *Blood* 1997;90:1425–1434.

410. Piacibello W, Sanavio F, Garetto L, et al. Extensive amplification and self-renewal of human primitive hematopoietic stem cells from cord blood. *Blood* 1997;89:2644–2653.

411. Kobayashi M, Laver JH, Kato T, et al. Thrombopoietin supports proliferation of human primitive hematopoietic cells in synergy with steel factor and/or interleukin-3. *Blood* 1996;88:429–436.

412. Farese AM, Hunt P, Grab LB, MacVittie TJ. Combined administration of recombinant human megakaryocyte growth and development factor and granulocyte colony-stimulating factor enhances multi-lineage hematopoietic reconstitution in nonhuman primates after radiation induced marrow aplasia. *J Clin Invest* 1996;97:2145–2151.

413. Kimura S, Roberts AW, Metcalf D, Alexander WS. Hematopoietic stem cell deficiencies in mice lacking c-Mpl, the receptor for thrombopoietin. *Proc Natl Acad Sci U S A* 1998;95:1195–1200.

414. Alexander WS, Roberts AW, Nicola NA, et al. Deficiencies in progenitor cells of multiple hematopoietic lineages and defective megakaryocytopoiesis in mice lacking the thrombopoietin receptor c-Mpl. *Blood* 1996;87:2162–2170.

415. Moore MW, deSavauge FJ. Low levels of erythroid and myeloid progenitors in thrombopoietin- and *c-mpl*-deficient mice. *Blood* 1996;88:803–808.

416. Yagi M, Ritchie KA, Sitnicka E, et al. Sustained ex vivo expansion of hematopoietic stem cells mediated by thrombopoietin. *Proc Natl Acad Sci U S A* 1999;96:8126–8131.

417. Dexter TM. Hemopoiesis in long-term bone marrow cultures. A review. *Acta Haematol*

1979;62:299–305.

418. Hynes RO. Integrins: versatility, modulation and signaling in cell adhesion. *Cell* 1992;69:11–25.

419. Carlos TM, Harlan JM. Leukocyte–endothelial adhesion molecules. *Blood* 1994;84:2068–2101.

420. Fukai F, Mashimo M, Akiyama K, et al. Modulation of apoptotic cell death by extracellular matrix derived proteins and fibronectin–derived antiadhesive peptide. *Exp Cell Res* 1998;242:92–99.

421. Isik FF, Gibran NS, Jang YC, et al. Vitronectin decreases microvascular endothelial cell apoptosis. *J Cell Physiol* 1998;175:149–155.

422. Fang F, Orend G, Watanabe N, et al. Dependence of cyclin E–cdk2 kinase activity on cell anchorage. *Science* 1996;271:499–502.

423. Pozzi A, Wary KK, Gianconti FG, Gardner HA. Integrin alpha1beta1 mediates a unique collagen dependent proliferation pathway *in vivo*. *J Cell Biol* 1998;142:587–594.

424. Papayannopoulou T, Craddock C, Nakamoto B, et al. The VLA4/VCAM–1 adhesion pathway defines contrasting mechanisms of lodgement of transplanted murine hemopoietic progenitors between bone marrow and spleen. *Proc Natl Acad Sci U S A* 1995;92:9647–9651.

425. Long MW, Heffner CH, Williams JL, et al. Regulation of megakaryocyte phenotype in human erythroleukemia cells. *J Clin Invest* 1990;85:1072–1084.

426. Kieran MW, Perkins AC, Orkin SH, Zon LI. Thrombopoietin rescues *in vitro* erythroid colony formation from mouse embryos lacking erythropoietin receptor. *Proc Natl Acad Sci U S A* 1996;93:9126–9131.

427. Birkmann J, Oez S, Smetak M, et al. Effects of recombinant thrombopoietin alone and in combination with erythropoietin and early–acting cytokines on human mobilized purified CD34+ progenitor cells cultured in serum–depleted medium. *Stem Cells* 1997;15:18–32.

428. Papayannopoulou T, Brice M, Farrer D, Kaushansky K. Insights into the cellular mechanisms of erythropoietin–thrombopoietin synergy. *Exp Hematol* 1996;24:660–669.

429. Vannucchi AM, Paoletti F, Linari S, et al. Identification and characterization of a bipotent (erythroid and megakaryocytic) cell precursor from the spleen of phenylhydrazine–treated mice. *Blood* 2000;95:2559–2568.

430. Debili N, Wendling F, Katz A, et al. The Mpl ligand or thrombopoietin or megakaryocyte growth and differentiative factor has both direct proliferative and differentiative activities on human megakaryocyte progenitors. *Blood* 1995;86:2516–2525.

431. Lotem J, Shabo Y, Sachs L. Regulation of megakaryocyte development by interleukin–6. *Blood* 1989;74:1545–1551.

432. Nachman R, Levine R, Jaffe EA. Synthesis of factor VIII antigen by cultured guinea pig megakaryocytes. *J Clin Invest* 1977;60:914–921.

433. Vinci G, Tabilio A, Deschamps JF, et al. Immunological study of *in vitro* maturation of human megakaryocytes. *Br J Haematol* 1984;56:589–605.

434. Sporn LA, Chavin SI, Marder VJ, Wagner DD. Biosynthesis of von Willebrand protein by human megakaryocytes. *J Clin Invest* 1985;76:1102–1106.

435. Traver D, Miyamoto T, Christensen J, et al. Fetal liver myelopoiesis occurs through distinct, prospectively isolatable subsets. *Blood* 2001;98:627–635.

436. Tronik–Le–Roux D, Roullot V, Schweitzer A, et al. Suppression of erythro–megakaryocytopoiesis and the induction of reversible thrombocytopenia in mice transgenic for the thymidine kinase gene targeted by the platelet glycoprotein alpha IIb promoter. *J Exp Med* 1995;181:2141–2151.

437. Lemarchandel V, Ghysadael J, Mignotte V, et al. GATA and Ets cis–acting sequences mediate

megakaryocyte-specific expression. *Mol Cell Biol* 1993;13:668-676.

438. Block KL, Ravid K, Phung QH, Poncz M. Characterization of regulatory elements in the 5' flanking region of the rat *gplIb* gene by studies in primary rat marrow culture system. *Blood* 1994;84:3385-3393.

439. Block KL, Shou Y, Poncz M. An Ets/Sp1 interaction in the 5'-flanking region of the megakaryocyte-specific *alpha IIb* gene appears to stabilize Sp1 binding and is essential for expression of this TATA-less gene. *Blood* 1996;88:2071-2080.

440. Roth GJ, Yagi M, Bastian LS. The platelet glycoprotein Ib-V-IX system: regulation of gene expression. *Stem Cells* 1996;14[Suppl 1]:188-193.

441. Lepage A, Uzan G, Touche N, et al. Functional characterization of the human platelet glycoprotein V gene promoter: a specific marker of late megakaryocytic differentiation. *Blood* 1999;94:3366-3380.

442. Sato N, Kiyokawa N, Taguchi T, et al. Functional conservation of platelet glycoprotein V promoter between mouse and human megakaryocytes. *Exp Hematol* 2000;28:802-814.

443. Doubeikovski A, Uzan G, Doubeikovski Z, et al. Thrombopoietin-induced expression of the glycoprotein IIb gene involves the transcription factor PU.1/Spi-1 in UT7-Mpl cells. *J Biol Chem* 1997;272:24300-24307.

444. Martin DIK, Zon LI, Mutter G, Orkin SH. Expression of an erythroid transcription factor in megakaryocytic and mast cell lineages. *Nature* 1990;344:444-447.

445. Penvy L, Simon MC, Robertson E, et al. Erythroid differentiation in chimeric mice blocked by targeted mutation in the gene for transcription factor GATA-1. *Nature* 1991;349:257-260.

446. Shivdasani RA, Fujiwara Y, McDevitt MA, Orkin SH. A lineage selective knockout establishes the critical role of transcription factor GATA-1 in megakaryocyte growth and platelet development. *EMBO J* 1997;16:3965-3973.

447. Tsang AP, Visvader JE, Turner CA, et al. FOG, a multitype zinc finger protein, acts as a cofactor for transcription factor GATA-1 in erythroid and megakaryocytic differentiation. *Cell* 1997;90:109-119.

448. Nichols KE, Crispino JD, Poncz M, et al. Familial dyserythropoietic anaemia and thrombocytopenia due to an inherited mutation in GATA1. *Nat Genet* 2000;24:266-270.

449. Freson K, Devriendt K, Matthijs G, et al. Platelet characteristics in patients with X-linked macrothrombocytopenia due to a novel GATA-1 mutation. *Blood* 2000;96[Suppl 1]:564a.

450. Drachman JG, Mehaffey MG. X-linked thrombocytopenia due to a novel mutation of GATA-1. *Blood* 2000;96[Suppl 1]:564a.

451. McNagny KM, Sieweke MH, Doderlein G, et al. Regulation of eosinophil-specific gene expression by a C/EBP-Ets complex and GATA-1. *EMBO J* 1998;17:3669-3680.

452. Yamaguchi Y, Nishio H, Kishi K, et al. C/EBP $\beta$  and GATA-1 synergistically regulate activity of the eosinophil granule major basic protein promoter: implication for C/EBP $\beta$  activity in eosinophil gene expression. *Blood* 1999;94:1429-1439.

453. Querfurth E, Schuster M, Kulesa H, et al. Antagonism between C/EBP $\beta$  and FOG in eosinophil lineage commitment of multipotent hematopoietic progenitors. *Genes Dev* 2000;14:2515-2525.

454. Nerlov C, Querfurth E, Kulesa H, Graf T. GATA-1 interacts with the myeloid PU.1 transcription factor and represses PU.1-dependent transcription. *Blood* 2000;95:2543-2551.

455. Fisher RC, Scott EW. Role of PU.1 in hematopoiesis. *Stem Cells* 1998;16:25-37.

456. Zhang P, Behre G, Pan J, et al. Negative cross-talk between hematopoietic regulators: GATA proteins repress PU.1. *Proc Natl Acad Sci U S A* 1999;96:8705-8710.

457. Hagiwara T, Nagasawa T, Nagahisa H, et al. Expression of adhesion molecules on cytoplasmic

processes of human megakaryocytes. *Exp Hematol* 1996;24:690–695.

458. Cui L, Ramsfjell V, Borge OJ, et al. Thrombopoietin promotes adhesion of primitive human hemopoietic cells to fibronectin and vascular cell adhesion molecule-1. *J Immunol* 1997;159:1961–1969.
459. Mossuz P, Schweitzer A, Molla A, Berthier R. Expression and function of receptors for extracellular matrix molecules in the differentiation of human megakaryocytes *in vitro*. *Br J Haematol* 1997;98:819–827.
460. Schick PK, Wojenski CM, He X, et al. Integrins involved in the adhesion of megakaryocytes to fibronectin and fibrinogen. *Blood* 1998;92:2650–2656.
461. Kapur R, Cooper R, Zhang L, Williams DA. Cross-talk between a  $\alpha_4\beta_1/\alpha_5\beta_1$  and c-Kit results in opposing effect on growth and survival of hematopoietic cells via the activation of focal adhesion kinase, mitogen-activated protein kinase, and Akt signaling pathways. *Blood* 2001;97:1975–1981.
462. Fox N, Kaushansky K. Engagement of integrin  $\alpha_4\beta_1$  but not  $\alpha_5\beta_1$  enhances thrombopoietin (TPO)-induced megakaryocyte (MK) growth. *Blood* 2001; 98[Suppl 1]:292a.
463. Gonzalez-Amaro R, Sanchez-Madrid F. Cell adhesion molecules: selectins and integrins. *Crit Rev Immunol* 1999;19:389–429.
464. Levesque JP, Simmons PJ. Cytoskeleton and integrin-mediated adhesion signaling in human CD34+ hemopoietic progenitor cells. *Exp Hematol* 1999;27(4):579–586.
465. Robinson BE, McGrath HE, Quesenberry PJ. Recombinant murine granulocyte macrophage colony stimulating factor has megakaryocyte colony stimulating activity and augments megakaryocyte colony stimulation by interleukin-3. *J Clin Invest* 1987;79:1648–1652.
466. Ikebuchi K, Wong GG, Clark SC, et al. Interleukin-6 enhancement of interleukin-3-dependent proliferation of multipotential hemopoietic progenitors. *Proc Natl Acad Sci U S A* 1987;84:9035–9039.
467. Navarro S, Debili N, LeCouedic JP, et al. Interleukin-6 and its receptor are expressed by human megakaryocytes: *in vitro* effects on proliferation and endoreduplication. *Blood* 1991;77:461–471.
468. Burstein SA, Mei RL, Henthorn J, et al. Leukemia inhibitory factor and interleukin-11 promote maturation of murine and human megakaryocytes *in vitro*. *J Cell Physiol* 1992;153:305–312.
469. de Sauvage FJ, Carver-Moore K, Luoh SM, et al. Physiological regulation of early and late stages of megakaryocytopoiesis by thrombopoietin. *J Exp Med* 1996;183:651–656.
470. Chen Q, Solar G, Eaton DL, de Sauvage FJ. IL-3 does not contribute to platelet production in c-Mpl-deficient mice. *Stem Cells* 1998;[16 Suppl]2:31–36.
471. Gainsford T, Nandurkar H, Metcalf D, et al. The residual megakaryocyte and platelet production in c-Mpl-deficient mice is not dependent on the actions of interleukin-6, interleukin-11, or leukemia inhibitory factor. *Blood* 2000;95:528–534.
472. Spyropoulos DD, Pharr PN, Lavenburg KR, et al. Hemorrhage, impaired hematopoiesis, and lethality in mouse embryos carrying a targeted disruption of the Fli1 transcription factor. *Mol Cell Biol* 2000;20:5643–5652.
473. Kwiatkowski BA, Zielinska-Kwiatkowska AG, Bauer TR Jr, Hickstein DD. The ETS family member Tel antagonizes the Fli-1 phenotype in hematopoietic cells. *Blood Cells Mol Dis* 2000;26:84–90.
474. Bastian LS, Kwiatkowski BA, Breining J, et al. Regulation of the megakaryocyte glycoprotein IX promoter by the oncogenic Ets transcription factor Fli-1. *Blood* 1999;93:2637–2644.
475. Hart A, Melet F, Grossfeld P, et al. Fli-1 is required for murine vascular and megakaryocytic development and is hemizygotously deleted in patients with thrombocytopenia. *Immunity* 2000;13:167–177.
476. Athanasiou M, Clausen PA, Mavrothalassitis GJ, et al. Increased expression of the ETS-related transcription factor FLI-1/ERGB correlates with and can induce the megakaryocytic phenotype. *Cell*

Growth Differ 1996;7:1525–1534.

477. Athanasiou M, Mavrothalassitis G, Sun-Hoffman L, Blair DG. FLI-1 is a suppressor of erythroid differentiation in human hematopoietic cells. *Leukemia* 2000;14:439–445.
478. Duperray A, Berthier R, Chagnon E, et al. Biosynthesis and processing of platelet GPIIb-IIIa in human megakaryocytes. *J Cell Biol* 1987;104:1665–1673.
479. Bennett JS. The molecular biology of platelet membrane proteins. *Semin Hematol* 1990;27:186–204.
480. Debili N, Robin C, Schiavon V, et al. Different expression of CD41 on human lymphoid and myeloid progenitors from adults and neonates. *Blood* 2001;97:2023–2030.
481. Wu G, Essex DW, Meloni FJ, et al. Human endothelial cells in culture and *in vivo* express on their surface all four components of the glycoprotein Ib/IX/V complex. *Blood* 1997;90:2660–2669.
482. Hickey MJ, Hagen FS, Yagi M, Roth GJ. Human platelet glycoprotein V: characterization of the polypeptide and the related Ib-V-IX receptor system of adhesive, leucine-rich glycoproteins. *Proc Natl Acad Sci U S A* 1993;90:8327–8331.
483. Li CQ, Dong JF, Lanza F, et al. Expression of platelet glycoprotein (GP) V in heterologous cells and evidence for its association with GP Ib alpha in forming a GP Ib-IX-V complex on the cell surface. *J Biol Chem* 1995;270:16302–16307.
484. Kahn ML, Diacovo TG, Bainton DF, et al. Glycoprotein V-deficient platelets have undiminished thrombin responsiveness and do not exhibit a Bernard-Soulier phenotype. *Blood* 1999;94:4112–4121.
485. Lopez JA, Andrews RK, Afshar-Kharghan V, Berndt MC. Bernard-Soulier syndrome. *Blood* 1998;91:4397–4418.
486. Ramakrishnan V, DeGuzman F, Bao M, et al. A thrombin receptor function for platelet glycoprotein Ib-IX unmasked by cleavage of glycoprotein V. *Proc Natl Acad Sci U S A* 2001;98:1823–1828.
487. Moog S, Mangin P, Lenain N, et al. Platelet glycoprotein V binds to collagen and participates in platelet adhesion and aggregation. *Blood* 2001;98:1038–1046.
488. Behnke O. An electron microscope study of the megakaryocyte of the rat bone marrow. I. The development of the demarcation membrane system and the platelet surface coat. *J Ultrastruct Res* 1968;24:412–433.
489. Breton-Gorius J, Reyes F. Ultrastructure of human bone marrow cell maturation. *Int Rev Cytol* 1976;46:251–321.
490. Bentfeld-Barker ME, Bainton DF. Ultrastructure of rat megakaryocytes after prolonged thrombocytopenia. *J Ultrastruct Res* 1977;61:201–214.
491. Radley JM, Haller CJ. The demarcation membrane system of the megakaryocyte: a misnomer? *Blood* 1982;60:213–219.
492. Italiano JE Jr, Lecine P, Shivdasani RA, Hartwig JH. Blood platelets are assembled principally at the ends of proplatelet processes produced by differentiated megakaryocytes. *J Cell Biol* 1999;147:1299–1312.
493. Feinendegen LE, Odartchenko N, Cottier H, Bond VP. Kinetics of megakaryocyte proliferation. *Proc Soc Exp Biol Med* 1962;111:177–182.
494. Ebbe S, Stohlman F Jr. Megakaryocytopoiesis in the rat. *Blood* 1965;26:20–35.
495. Vitrat N, Cohen-Solal K, Pique C, et al. Endomitosis of human megakaryocytes are due to abortive mitosis. *Blood* 1998;91:3711–3723.
496. Odell TT, Jackson CW, Reiter RS. Generation cycle of rat megakaryocytes. *Exp Cell Res* 1968;53:321.

497. Rolovic Z. Ploidy value of endoreduplicating human megakaryocytes in immune and hypersplenic thrombocytopenia. In: Bardini MG, Ebbe S, eds. Platelets: production, function, transfusion and storage. New York: Grune & Stratton, 1974:143-155.
498. Nurse P. Ordering S phase and M phase in the cell cycle. *Cell* 1994;79:547-550.
499. Heichman KA, Roberts JM. Rules to replicate by. *Cell* 1994;79:557-562.
500. King RW, Jackson PK, Kirschner MW. Mitosis in transition. *Cell* 1994;79:563-568.
501. Broek D, Bartlett R, Crawford K, Nurse P. Involvement of p34cdc2 in establishing the dependency of S phase on mitosis. *Nature* 1991;349:388-393.
502. Hayles J, Fisher D, Woolard A, Nurse P. Temporal order of S phase and mitosis in fission yeast is determined by the state of the p34 *cdc2*-mitotic B cyclin complex. *Cell* 1994;78:813-822.
503. Datta NS, Williams JL, Caldwell J, et al. Novel alterations in CDK1/CyclinB1 kinase complex formation occur during the acquisition of a polyploid DNA content. *Mol Biol Cell* 1996;7:209-223.
504. Zhang Y, Wang Z, Ravid K. The cell cycle in polyploid megakaryocytes is associated with reduced activity of cyclin B1-dependent *cdc2* kinase. *J Biol Chem* 1996;271:4266-4272.
505. Matsumura I, Tanaka H, Kawasaki A, et al. Increased D-type cyclin expression together with decreased *cdc2* activity confers megakaryocytic differentiation of a human thrombopoietin-dependent hematopoietic cell line. *J Biol Chem* 2000;275:5553-5559.
506. Carow CE, Fox N, Kaushansky K. The kinetics of endomitosis in primary murine megakaryocytes. *J Cell Physiol ( In Press)*.
507. Roy L, Coullin P, Vitrat N, et al. Asymmetrical segregation of chromosomes with a normal metaphase/anaphase checkpoint in polyploid megakaryocytes. *Blood* 2001;97:2238-2247.
508. Gardner RD, Burke DJ. The spindle checkpoint: two transitions, two pathways. *Trends Cell Biol* 2000;10:154-158.
509. Burke DJ. Complexity in the spindle checkpoint. *Curr Opin Genet Dev* 2000;10:26-31.
510. Bardin AJ, Visintin R, Amon A. A mechanism for coupling exit from mitosis to partitioning of the nucleus. *Cell* 2000;102:21-31.
511. Pereira G, Hofken T, Grindlay J, et al. The Bub2p spindle checkpoint links nuclear migration with mitotic exit. *Mol Cell* 2000;6:1-10.
512. Adams RR, Carmena M, Earnshaw WC. Chromosome passengers and the (aurora) ABCs of mitosis. *Trends Cell Biol* 2001;11:49-54.
513. Li F, Ackermann EJ, Bennett CF, et al. Pleiotropic cell-division defects and apoptosis induced by interference with surviving function. *Nat Cell Biol* 1999;1:461-466.
514. Fraser AG, James C, Evan GI, Hengartner MO. *Caenorhabditis elegans* inhibitor of apoptosis protein (IAP) homologue BIR-1 plays a conserved role in cytokinesis. *Curr Biol* 1999;9:292-301.
515. Speliotes EK, Uren A, Vaux D, Horvitz HR. The survivin-like *C. elegans* BIR-1 protein acts with the Aurora-like kinase AIR-2 to affect chromosomes and the spindle midzone. *Mol Cell* 2000;6:211-223.
516. Shindo M, Nakano H, Kuroyanagi H, et al. cDNA cloning, expression, subcellular localization, and chromosomal assignment of mammalian aurora homologues, aurora-related kinase (ARK) 1 and 2. *Biochem Biophys Res Commun* 1998;244:285-292.
517. Katayama H, Ota T, Morita K, et al. Human AIM-1: cDNA cloning and reduced expression during endomitosis in megakaryocyte-lineage cells. *Gene* 1998;224:1-7.



518. Kawasaki A, Matsumura I, Miyagawa J, et al. Downregulation of an AIM-1 kinase couples with megakaryocytic polyploidization of human hematopoietic cells. *J Cell Biol* 2001;152:275-288.
519. Ravid K, Doi T, Beeler DL, et al. Transcriptional regulation of the rat platelet factor 4 gene: interaction between an enhancer/silencer domain of the GATA site. *Mol Cell Biol* 1992;11:6116-6127.
520. Ramachandran B, Surrey S, Schwartz S. Megakaryocyte-specific positive regulatory sequence 5' to the human PF4 gene. *Exp Hematol* 1995;23:49-57.
521. Vyas P, Norris FA, Joseph R, et al. Inositol polyphosphate 4-phosphatase type I regulates cell growth downstream of transcription factor GATA-1. *Proc Natl Acad Sci U S A* 2000;97:13696-13701.
522. Rojnuckarin P, Drachman JG, Kaushansky K. Thrombopoietin-induced activation of the mitogen activated protein kinase pathway in normal megakaryocytes: role in endomitosis. *Blood* 1999;94:1273-1282.
523. May-Hegglin/Fechtner Syndrome Consortium. Mutations in MYH9 result in the May-Hegglin anomaly, and Fechtner and Sebastian syndromes. *Nat Genet* 2000;26:103-105.
524. Kelley MJ, Jawien W, Ortel TL, Korczak JF. Mutation of MYH9, encoding non-muscle myosin heavy chain A, in May-Hegglin anomaly. *Nat Genet* 2000;26:106-108.
525. Visvader JE, Elefanty AG, Strasser A, Adams JM. GATA-1 but not SCL induces megakaryocytic differentiation in an early myeloid cell line. *EMBO J* 1992;11:4557-4564.
526. Harrison P, Savidge GF, Cramer EM. The origin and physiological relevance of alpha-granule adhesive proteins. *Br J Haematol* 1990;74:125-130.
527. Camire RM, Pollak ES, Kaushansky K, Tracy PB. Secretable human platelet-derived factor V originates from the plasma pool. *Blood* 1998;92:3035-3041.
528. Andrews NC, Erdjument-Bromage H, Davidson MB, et al. Erythroid transcription factor NF-E2 is a hematopoietic-specific basic leucine zipper protein. *Nature* 1993;362:722-728.
529. Ney PA, Andrews NC, Jane SM, et al. Purification of the human NF-E2 complex: cDNA cloning of the hematopoietic cell-specific subunit and evidence for an associated partner. *Mol Cell Biol* 1993;13:5604-5612.
530. Bean TL, Ney PA. Multiple regions of p45 NF-E2 are required for beta-globin gene expression in erythroid cells. *Nucleic Acids Res* 1997;25:2509-2515.
531. Versaw WK, Blank V, Andrews NM, Bresnick EH. Mitogen-activated protein kinases enhance long-range activation by the beta-globin locus control region. *Proc Natl Acad Sci U S A* 1998;95:8756-8760.
532. Shivdasani RA, Rosenblatt MF, Zucker-Franklin D, et al. Transcription factor NF-E2 is required for platelet formation independent of the actions of thrombopoietin/MGDF in megakaryocyte development. *Cell* 1995;81:695-704.
533. Deveaux S, Cohen-Kaminsky S, Shivdasani RA, et al. p45 NF-E2 regulates expression of thromboxane synthase in megakaryocytes. *EMBO J* 1997;16:5654-5661.
534. Thiery JP, Bessis M. Mecanisme de la plaquettogenese: etude *in vitro* par la microcinematographie. *Rev Hematol* 1956;11:162.
535. Harker LA, Finch CA. Thrombokinetics in man. *J Clin Invest* 1969;48:963-974.
536. Stenberg PE, Levin J. Mechanisms of platelet production. *Blood Cells* 1989;15:233-247.
537. Radley JM, Haller CJ. Fate of senescent megakaryocytes in the bone marrow. *Br J Haematol* 1983;53:277-287.
538. Tavassoli M, Aoki M. Localization of megakaryocytes in the bone marrow. *Blood Cells* 1989;15:3-14.

539. Leven RM, Yee T. Collagenase production by guinea pig megakaryocytes *in vitro*. *Exp Hematol* 1990;18:743.
540. Tablin F, Castro M, Leven RM. Blood platelet formation *in vitro*. The role of the cytoskeleton in megakaryocyte fragmentation. *J Cell Sci* 1990;97:59–70.
541. Leven RM, Tablin F. Extracellular matrix stimulation of guinea pig megakaryocyte proplatelet formation *in vitro* is mediated by the vitronectin receptor. *Exp Hematol* 1992;20:1316–1322.
542. Howell WH, Donahue DP. The production of blood platelets in the lungs. *J Exp Med* 1939;65:177–204.
543. Tong M, Seth P, Penington DG. Proplatelets and stress platelets. *Blood* 1987;69:522–528.
544. Slater DN, Trowbridge EA, Martin JF. The megakaryocyte in thrombocytopenia: a microscopic study which supports the theory that platelets are produced in the pulmonary circulation. *Thromb Res* 1983;31:163–176.
545. Kaufman KM, Ario R, Pollack S, et al. Origin of pulmonary megakaryocytes. *Blood* 1965;25:767.
546. Becker RP, De Bruyn PPH. The transmural passage of blood cells into myeloid sinusoids and the entry of platelets into the sinusoidal circulation; a scanning electron microscopic investigation. *Am J Anat* 1976;145:183–206.
547. Handagama PJ, Feldman BF, Jain NC, et al. *In vitro* platelet release by rat megakaryocytes: effect of metabolic inhibitors and cytoskeletal disrupting agents. *Am J Vet Res* 1987;48:1142–1146.
548. Choi ES, Nichol JL, Hokom MM, et al. Platelets generated *in vitro* from proplatelet–displaying human megakaryocytes are functional. *Blood* 1995;85:402–413.
549. Hunt P, Hokom MM, Hornkohl A, et al. The effect of the platelet–derived glycosaminoglycan serglycin on *in vitro* proplatelet–like process formation. *Exp Hematol* 1993;21:1295–1304.
550. Leven RM. Differential regulation of integrin mediated proplatelet formation and megakaryocyte spreading. *J Cell Physiol* 1995;163:597–607.
551. Ishida Y, Yano K, Ito T, et al. Purification of proplatelet formation (PPF) stimulating factor: thrombin/antithrombin III complex stimulates PPF of megakaryocytes *in vitro* and platelet production *in vivo*. *Thromb Haemost* 2001;85:349–355.
552. Hunt P, Hokom MM, Wiemann B, et al. Megakaryocyte proplatelet–like process formation *in vitro* is inhibited by serum prothrombin, a process which is blocked by matrix–bound glycosaminoglycans. *Exp Hematol* 1993;21:372–381.
553. Zhu Q, Watanabe C, Liu T, et al. Wiskott–Aldrich syndrome/X–linked thrombocytopenia: WASP gene mutations, protein expression, and phenotype. *Blood* 1997;90:2680–2689.
554. Paulus JM. Platelet size in man. *Blood* 1975;46:321–336.
555. Frojmovic MM, Panjwani R. Geometry of normal mammalian platelets by quantitative microscopic studies. *Biophys J* 1976;16:1071–1089.
556. Robinson MS, Harrison C, Mackie IJ, et al. Reticulated platelets in primary and reactive thrombocytosis. *Br J Haematol* 1998;101:388–395.
557. Behnke O. Electron microscopic observations on the membrane systems of the rat blood platelet. *Anat Rec* 1967;158:121–138.
558. White JG. Electron microscopic studies of platelet secretion. *Prog Hemost Thromb* 1974;2:49–98.
559. White JG, Clawson GC. Overview article: biostructure of blood platelets. *Ultrastruct Pathol* 1980;1:533–558.

560. White JG. Anatomy and structural organization of the platelet. In: Colman RW, Hirsh J, Marder VJ, Salzman EW, eds. Hemostasis and thrombosis. Basic principles and clinical practice, 2nd ed. Philadelphia: JB Lippincott Co, 1987:537-554.
561. Chevalier J, Nurden AT, Thiery JM, et al. Freeze-fracture studies on the plasma membranes of normal human, thrombasthenic and Bernard-Soulier platelets. *J Lab Clin Med* 1979;94:232-245.
562. van Deurs B, Behnke O. Membrane structure of nonactivated and activated blood platelets as revealed by freeze-fracture: evidence for particle redistribution during platelet contraction. *J Cell Biol* 1980;87:209-218.
563. Marcus AJ, Ullman HL, Safier LB. Lipid composition of subcellular particles of human blood platelets. *J Lipid Res* 1969;10:108-120.
564. Bevers EM, Comfurius JP, van Rijn JL, et al. Generation of prothrombin-converting activity and the exposure of phosphatidylserine at the outer surface of platelets. *Eur J Biochem* 1982;122:429-437.
565. Schick PK. The organization of aminophospholipids in human platelet membranes: selective changes induced by thrombin. *J Lab Clin Med* 1978;91:802-811.
566. Miletich JP, Jackson CM, Majerus PW. Properties of the factor Xa binding site on human platelets. *J Biol Chem* 1978;253:6908-6916.
567. Scandura JM, Ahmad S, Walsh PN. A binding site expressed on the surface of activated human platelets is shared by factor X and prothrombin. *Biochemistry* 1996;35:8890-8902.
568. Tracy PB. Role of platelets and leukocytes in coagulation. In: Colman RW, Hirsh J, Marder VJ, et al., eds. Hemostasis and thrombosis. Basic principles and clinical practice, 4th ed. Philadelphia: Lippincott Williams & Wilkins, 2001:575-596.
569. Simons ER, Greenberg-Spersky SM. Transmembrane non-covalent cation gradients. In: Holmsen H, ed. Platelet responses and metabolism, 3rd ed. Boca Raton: CRC Press, 1987:31-49.
570. Handagama P, Shuman MA, Bainton DF. Incorporation of intravenously injected albumin, immunoglobulin G, and fibrinogen in guinea pig megakaryocyte granules. *J Clin Invest* 1989;84:73-82.
571. Grottum KA, Solum NO. Congenital thrombocytopenia with giant platelets: a defect in the platelet membrane. *Br J Haematol* 1968;16:277-285.
572. Collier BS. Biochemical and electrostatic considerations in primary platelet aggregation. *Ann N Y Acad Sci* 1984;416:693-704.
573. White JG. Is the canalicular system the equivalent of the muscle sarcoplasmic reticulum? *Hemostasis* 1975;4:185-191.
574. White JG. A search for the platelet secretory pathway using electron dense tracers. *Am J Pathol* 1970;58:31-49.
575. White JG, Clawson CC. The surface-connected canalicular system of blood platelets—a fenestrated membrane system. *Am J Pathol* 1980;101:353-364.
576. Stenberg PE, Shuman MA, Levine SP, Bainton DF. Redistribution of alpha-granules and their contents in thrombin-stimulated platelets. *J Cell Biol* 1984;98:748-760.
577. Cramer EM. Platelets and megakaryocytes: anatomy and structural organization. In: Colman RW, Hirsh J, Marder VJ, et al., eds. Thrombosis and hemostasis. Basic principles and clinical practice, 4th ed. Philadelphia: Lippincott Williams & Wilkins, 2001:411-428.
578. Kieffer N, Guichard J, Breton-Gorius J. Dynamic redistribution of major surface receptors after contact-induced platelet activation and spreading: an immuno-electron microscopic study. *Am J Pathol* 1992;40:57-73.

579. Behnke O. The morphology of blood platelet systems. *Ser Haematol* 1970;3:3-16.
580. Behnke O. An electron microscope study of the rat megakaryocyte. II. Some aspects of platelet release and microtubules. *J Ultrastruct Res* 1969;26:111-129.
581. Daimon T, Gotoh Y. Cytochemical evidence of the origin of the dense tubular system in the mouse platelet. *Histochemistry* 1982;76:189-196.
582. Breton-Gorius J, Guichard J. Ultrastructural localization of peroxidase activity in human platelets and megakaryocytes. *Am J Pathol* 1972;66:277-286.
583. Breton-Gorius J. The value of cytochemical peroxidase reactions at the ultrastructural level in hematology. *Histochem J* 1980;12:127-137.
584. White JG. Interaction of membrane systems in blood platelets. *Am J Pathol* 1972;66:295-312.
585. Nichols BA, Setzer PY, Bainton DF. Glucose-6-phosphatase as a cytochemical marker of endoplasmic reticulum in human leukocytes and platelets. *J Histochem Cytochem* 1984;32:165-171.
586. Tranum-Jensen J, Behnke O. Acetylcholinesterase in the platelet-megakaryocyte system. II. Structural localization in megakaryocytes of the rat, mouse, and cat. *Eur J Cell Biol* 1981;24:281-286.
587. Cutler L, Rodan G, Feinstein MB. Cytochemical localization of adenylate cyclase and of calcium ion, magnesium ion-activated ATPases in the dense tubular system of human blood platelets. *Biochim Biophys Acta* 1978;542:357-371.
588. Gerrard JM, White JG, Rao GHR, Townsend E. Localization of platelet prostaglandin production in the platelet dense tubular system. *Am J Pathol* 1976;83:283-298.
589. Gerrard JM, White JG, Peterson DA. The platelet dense tubular system: its relationship to prostaglandin synthesis and calcium flux. *Thromb Haemost* 1978;40:224-231.
590. Fox JEB. Platelet cytoskeleton. In: Colman RW, Hirsh J, Marder VJ, et al., eds. *Thrombosis and hemostasis. Basic principles and clinical practice*, 4th ed. Philadelphia: Lippincott Williams & Wilkins, 2001:429-446.
591. Fox JEB, Boyles JK, Reynolds CC, Phillips DR. Actin filament content and organization in unstimulated platelets. *J Cell Biol* 1984;98:1985-1991.
592. White JG. Arrangements of actin filaments in the cytoskeleton of human platelets. *Am J Pathol* 1984;117:207-217.
593. Tablin F, Taube D. Platelet intermediate filaments: detection of a vimentin like protein in human and bovine platelets. *Cell Motil Cytoskeleton* 1987;8:61-67.
594. Muzbek L, Adany R, Glukhova MA, Frid MG. The identification of vimentin in human blood platelets. *Eur J Cell Biol* 1987;43:501-504.
595. Sixma JJ, Molenaar I. Microtubules and microfibrils in human platelets. *Thromb Diath Haemorrh* 1966;16:153-162.
596. Behnke O. Further studies on microtubules. A marginal bundle in human and rat thrombocytes. *J Ultrastruct Res* 1965;13:469-477.
597. Castle AG, Crawford N. Platelet microtubule subunit proteins. *Thromb Haemost* 1979;42:1630-1633.
598. Nakata T, Hirokawa N. Cytoskeletal reorganization of human platelets after stimulation revealed by the quick-freeze deep-etch technique. *J Cell Biol* 1987;105:1771-1780.
599. Fox JEB, Boyles JK, Berndt MC, et al. Identification of a membrane skeleton in platelets. *J Cell Biol* 1988;106:1525-1538.

600. Fox JEB. Linkage of a membrane skeleton to integral membrane glycoproteins in human platelets. Identification of one of the glycoproteins as glycoprotein Ib. *J Clin Invest* 1985;76:1673–1683.
601. Fox JE. Identification of actin-binding protein as the protein linking the membrane skeleton to glycoproteins on platelet plasma membranes. *J Biol Chem* 1985;260:11970–11977.
602. Fox JEB, Lipfert L, Clark EA, et al. On the role of the platelet membrane skeleton in mediating signal transduction. Association of GPIIb-IIIa, pp60c-src, pp62c-yes, and the p21ras GTPase-activating protein with the membrane skeleton. *J Biol Chem* 1993;268:25973–25984.
603. White JG. The submembrane filaments of blood platelets. *Am J Pathol* 1969;56:267–277.
604. Hartwig JH, DeSisto M. The cytoskeleton of the resting human blood platelet: structure of the membrane skeleton and its attachment to actin filaments. *J Cell Biol* 1991;112:407–425.
605. Fox JEB, Reynolds CC, Morrow JS, Phillips DR. Spectrin is associated with membrane-bound actin filaments in platelets and is hydrolyzed by the Ca<sup>2+</sup>-dependent protease during platelet activation. *Blood* 1987;69:537–545.
606. Niederman R, Pollard T. Human platelet myosin. II. *In vitro* assembly and structure of myosin filaments. *J Cell Biol* 1975;67:72–92.
607. O'Halloran T, Beckerle MC, Burridge K. Identification of talin as a major cytoplasmic protein implicated in platelet activation. *Nature* 1985;317:449–451.
608. Koteliensky VE, Gneushev GN, Glukhova MA, et al. Identification and isolation of vinculin from platelets. *FEBS Lett* 1984;165:26–30.
609. Schollmeyer JV, Rao GHR, White JG. An actin-binding protein in human platelets. Interactions with alpha-actinin on gelation of actin and the influence of cytochalasin B. *Am J Pathol* 1978;93:433–446.
610. Nachmias VT. Cytoskeleton of human platelets at rest and after spreading. *J Cell Biol* 1980;86:795–802.
611. Jennings LK, Fox JEB, Edwards HH, Phillips DR. Changes in the cytoskeletal structure of human platelets following thrombin activation. *J Biol Chem* 1981;256:6927–6932.
612. Carlsson L, Markey F, Blikstad I, et al. Reorganization of actin in platelets stimulated by thrombin as measured by the DNase I inhibition assay. *Proc Natl Acad Sci U S A* 1979;76:6376–6380.
613. Lind SE, Janmey PA, Chaponnier C, et al. Reversible binding of actin to gelsolin and profilin in human platelet extracts. *J Cell Biol* 1987;105:833–842.
614. Safer D, Golla R, Nachmias VT. Isolation of a 5-kilodalton actin-sequestering peptide from human blood platelets. *Proc Natl Acad Sci U S A* 1990;87:2536–2540.
615. Carlsson L, Nystrom LE, Sundkvist I, et al. Actin polymerizability is influenced by profilin, a low molecular weight protein in non-muscle cells. *J Mol Biol* 1977;115:465–483.
616. Dingus J, Hwo S, Bryan J. Identification by monoclonal antibodies and characterization of human platelet caldesmon. *J Cell Biol* 1986;102:1748–1757.
617. Casella JF, Flanagan MD, Lin S. Cytochalasin D inhibits actin polymerization of actin filaments formed during platelet shape change. *Nature* 1981;293:302–305.
618. Hartwig JH. Mechanism of actin rearrangements mediating platelet activation. *J Cell Biol* 1992;118:1421–1442.
619. Karlsson R, Lassing I, Hoglund AS, Lindberg U. The organization of microfilaments in spreading platelets: a comparison with fibroblasts and glial cells. *J Cell Physiol* 1984;121:96–113.
620. Fox JEB, Phillips DR. Role of phosphorylation in mediating the association of myosin with the

cytoskeletal structures of human platelets. *J Biol Chem* 1982;257:4120–4126.

621. Nachmias VT, Kavalier J, Jacobowitz S. Reversible association of myosin with the platelet cytoskeleton. *Nature* 1985;313:70–72.

622. Hathaway DR, Adelstein RS. Human platelet myosin light chain kinase requires the calcium-binding protein calmodulin for activity. *Proc Natl Acad Sci U S A* 1979;76:1653–1657.

623. Pollard TD, Fujiwara K, Handin R, Weiss G. Contractile proteins in platelet activation and contraction. *Ann N Y Acad Sci* 1977;283:218–236.

624. Fox JEB, Reynolds CC, Phillips DR. Calcium-dependent proteolysis occurs during platelet activation. *J Biol Chem* 1983;258:9973–9979.

625. Fox JEB. On the role of calpain and Rho proteins in regulating integrin-induced signaling. *Thromb Haemost* 1999;82:391–395.

626. White JG, Sauk JJ. The organization of microtubules and microtubule coils in giant platelet disorders. *Am J Pathol* 1984;116:514–522.

627. Tablin F, Reeber MJ, Nachmias VT. Platelets contain a 210K microtubule-associated protein related to the HeLa cell MAP. *J Cell Sci* 1988;88:317–324.

628. Tablin F, Castro MD. Bovine platelets contain a 280 kD microtubule-associated protein antigenically related to brain MAP 2. *Eur J Cell Biol* 1992;56:415–421.

629. Behnke O, Zelander T. Substructure in negatively stained microtubules of mammalian blood platelets. *Exp Cell Res* 1967;43:236–243.

630. White JG, Krivit W. An ultrastructural basis for the shape changes induced in platelets by chilling. *Blood* 1967;30:625–635.

631. Fukami MH, Holmsen H, Kowalska A, Niewiarowski S. Platelet secretion. In: Colman RW, Hirsh J, Marder VJ, et al., eds. *Hemostasis and thrombosis. Basic principles and clinical practice*, 4th ed. Philadelphia: Lippincott Williams & Wilkins, 2001:561–573.

632. Holmsen H, Kaplan KL, Dangelmaier CA. Differential energy requirements for platelet responses: a simultaneous study of aggregation three secretory processes, arachidonate liberation, phosphatidylinositol turnover and phosphatidate production. *Biochem J* 1984;208:9–21.

633. Verhoeven AJM, Mommersteeg ME, Akkerman JWN. Quantification of energy consumption in platelets during thrombin-induced aggregation and secretion: tight coupling between platelet responses and the increment in energy consumption. *Biochem J* 1984;221:777–786.

634. White JG. Exocytosis of secretory organelles from blood platelets incubated with cationic polypeptides. *Am J Pathol* 1972;69:41–53.

635. Ginsberg MH, Taylor L, Painter RG. The mechanism of thrombin-induced platelet factor 4 secretion. *Blood* 1980;55:661–668.

636. Lemons PP, Chen D, Bernstein AM, et al. Regulated secretion in platelets: identification of elements of the platelet exocytosis machinery. *Blood* 1997;90:1490–1500.

637. Stinchcombe JC, Griffiths GM. Regulated secretion from hemopoietic cells. *J Cell Biol* 1999;147:1–6.

638. Chen D, Lemons PP, Schraw T, Whiteheart WW. Molecular mechanisms of platelet exocytosis: role of SNAP-23 and syntaxin 2 and 4 in lysosome release. *Blood* 2000;96:1782–1788.

639. Packham MA, Guccione MA, Greenberg JP, et al. Release of C14 serotonin during initial platelet changes induced by thrombin, collagen or A23187. *Blood* 1977;50:915–926.

640. Bentfeld-Barker ME, Bainton DF. Identification of primary lysosomes in human megakaryocytes and

platelets. *Blood* 1982;59:472–481.

641. Breton-Gorius J, Guichard J. Two different types of granules in megakaryocytes and platelets as revealed by the diaminobenzidine method. *J Microsc Biol Cell* 1975;3:197–202.

642. Harrison P, Cramer EM. Platelet alpha granules. *Blood Rev* 1993;7:52–65.

643. Holt JC, Niewiarowski S. Biochemistry of alpha granule proteins. *Semin Hematol* 1985;22:151–168.

644. White JG. Tubular elements in platelet granules. *Blood* 1968;32:148–156.

645. Cramer EM, Meyer D, Menn RL, Breton-Gorius J. Eccentric localization of von Willebrand factor in an internal structure of platelet alpha-granule resembling that of Weibel-Palade bodies. *Blood* 1985;66:710–713.

646. Hayward CP, Furmaniak-Kazmierczak E, Cieutat AM, et al. Factor V is complexed with multimerin in resting platelet lysates and colocalizes with multimerin in platelet alpha-granules. *J Biol Chem* 1995;270:19217–19226.

647. Zucker-Franklin D. Endocytosis by human platelets: metabolic and freeze-fracture studies. *J Cell Biol* 1981;91:706–715.

648. Harrison P, Wilbourn B, Debili N, et al. Uptake of plasma fibrinogen into the alpha granules of human megakaryocytes and platelets. *J Clin Invest* 1989;84(4):1320–1324.

649. Handagama PJ, George JN, Shuman MA, et al. Incorporation of a circulating protein into megakaryocyte and platelet granules. *Proc Natl Acad Sci U S A* 1987;84(3):861–865.

650. Sander HJ, Slot JW, Bouma BN, et al. Immunocytochemical localization of fibrinogen, platelet factor 4, and beta thromboglobulin in thin frozen sections of human blood platelets. *J Clin Invest* 1983;72(4):1277–1287.

651. Hegyi E, Nakeff A. Ultrastructural localization of platelet factor 4 in rat megakaryocytes and platelets by gold-labeled antibody detection. *Exp Hematol* 1989;17(3):223–228.

652. Walz A, Dewald B, von Tscherner V, Baggiolini M. Effects of the neutrophil-activating peptide NAP-2, platelet basic protein, connective tissue-activating peptide III and platelet factor 4 on human neutrophils. *J Exp Med* 1989;70:1745–1758.

653. Rollins BJ. Chemokines. *Blood* 1997;90:909–922.

654. Rucinski B, Niewiarowski S, James P, et al. Antiheparin proteins secreted by human platelets: purification and characterization and radioimmunoassay. *Blood* 1979;53:47–58.

655. Kaplan KL, Nossel HL, Drillings M, Lesznik G. Radioimmunoassay of platelet factor 4 and  $\beta$ -thromboglobulin: development and application to studies of platelet release in relation to human platelet factor 4. *Thromb Res* 1977;11:673–681.

656. Baenziger NL, Brodie GN, Majerus PW. A thrombin-sensitive protein of human platelet membranes. *Proc Natl Acad Sci U S A* 1971;68:240–243.

657. Gartner TK, Gerrard JM, White JG, Williams DC. The endogenous lectin of human platelets is an  $\alpha$ -granule component. *Blood* 1981;58:153–157.

658. Jaffe EA, Leung LLK, Nachman RL, et al. Thrombospondin is the endogenous lectin of human platelets. *Nature* 1982;295:246–248.

659. Bornstein P. The thrombospondins: structure and regulation of expression. *FASEB J* 1992;6:3290–3300.

660. Clezardin P, Malaval L, Morei MC, et al. Osteonectin is an alpha granule component involved with thrombospondin in platelet aggregation. *J Bone Miner Res* 1991;260:7502–7509.



661. Wencel-Drake JD, Painter RG, Zimmerman TS, Ginsberg MH. Ultrastructural localization of human platelet thrombospondin, fibrinogen, fibronectin, and von Willebrand factor in frozen thin section. *Blood* 1985;74:929-938.
662. Hayward CPM, Bainton DF, Smith JW, et al. Multimerin is found in the  $\alpha$ -granules of resting platelets and is synthesized by a megakaryocytic cell line. *J Clin Invest* 1993;91:2630-2639.
663. Chiu HC, Schick P, Colman RW. Biosynthesis of coagulation factor V by megakaryocytes. *J Clin Invest* 1985;75:339-348.
664. Camire RM, Kalafatis M, Simioni P, et al. Platelet derived factor Va/Va Leiden cofactor activities are sustained on the surface of activated platelets despite the presence of activated protein C. *Blood* 1998;91:2818-2819.
665. Wang DL, Pan YT, Wang JJ, et al. Demonstration of a functionally active tPA-like plasminogen activator in human platelets. *Thromb Haemost* 1994;71:493-498.
666. Morgenstern E, Ruf A, Patscheke H. Transport of anti-glycoprotein IIb/IIIa-antibodies into the alpha-granules of unstimulated human blood platelets [published erratum appears in *Thromb Haemost* 1992;68:485]. *Thromb Haemost* 1992;67:121-125.
667. Wencel-Drake JD, Frelinger LF, Dieter MG, Lam S-T. Arg-Gly-Asp-dependent occupancy of GPIIb/IIIa by applaggin: evidence for internalization and cycling of a platelet integrin. *Blood* 1993;81:62-66.
668. Harrison P. Platelet alpha granular fibrinogen. *Platelets* 1992;3:1-11.
669. Suzuki H, Nakamura S, Itoh Y, et al. Immunocytochemical evidence for the translocation of  $\alpha$ -granule membrane glycoprotein IIb/IIIa (integrin  $\alpha_{IIb}\beta_3$ ) of human platelets to the surface membrane during the release reaction. *Histochemistry* 1992;97:381-388.
670. Cramer EM, Savidge GF, Vainchenker W, et al. Alpha-granule pool of glycoprotein IIb-IIIa in normal and pathologic platelets and megakaryocytes. *Blood* 1990;75:1220-1227.
671. Wencel-Drake JD, Plow EF, Kunicki TJ, et al. Localization of internal pools of membrane glycoproteins involved in platelet adhesive responses. *Am J Pathol* 1986;124:324-334.
672. Stenberg PE, McEver RP, Shuman MA, et al. A platelet alpha-granule membrane protein (GMP-140) is expressed on the plasma membrane after activation. *J Cell Biol* 1985;101:880-886.
673. Metzelaar MJ, Heijnen HFG, Sixma JJ, Nieuwenhuis HK. Identification of a 33-Kd protein associated with the  $\alpha$ -granule membrane (GMP-33) that is expressed on the surface of activated platelets. *Blood* 1992;79:372-379.
674. Cramer EM, Berger G, Berndt MC. Platelet  $\alpha$ -granule and plasma membrane share two new components: CD9 and PECAM-1. *Blood* 1994;84:1722-1730.
675. Berger G, Masse JM, Cramer EM. Alpha-granule membrane mirrors the platelet plasma membrane and contains the glycoproteins Ib, IX, and V. *Blood* 1996;87:1385-1395.
676. Breton-Gorius J, Clezardin P, Guichard J, et al. Localization of platelet osteonectin at the internal face of the alpha-granule membranes in platelets and megakaryocytes. *Blood* 1992;79:936-941.
677. George JN. Platelet immunoglobulin G: its significance for the evaluation of thrombocytopenia and for understanding the origin of  $\alpha$ -granule proteins. *Blood* 1990;76:859-870.
678. Li QX, Berndt MC, Bush AI, et al. Membrane-associated forms of the BA4 amyloid protein precursor of Alzheimer's disease in human platelet and brain: surface expression on the activated human platelet. *Blood* 1994;84:133-142.
679. Schmaier AH, Dahl LD, Hasan AA, et al. Factor IXa inhibition by protease nexin-2/amyloid beta-protein precursor on phospholipid vesicles and cell membranes. *Biochemistry* 1995;34:1171-1179.

680. Heldin CH, Westermark B. Platelet-derived growth factor: three isoforms and two receptor types. *Trends Genet* 1989;5:108-112.
681. Assoian RK, Komoriya AK, Meyers CA, et al. Transforming growth factor- $\beta$  in human platelets: identification of a major storage site, purification, and characterization. *J Biol Chem* 1983;258:7155-7163.
682. Mohle R, Green D, Moore MA, et al. Constitutive production and thrombin-induced release of vascular endothelial growth factor by human megakaryocytes and platelets. *Proc Natl Acad Sci U S A* 1997;94:663-667.
683. Ross R. The pathogenesis of atherosclerosis. A perspective for the 1990s. *Nature* 1993;362:801-809.
684. Ross R. Atherosclerosis. An inflammatory disease. *New Engl J Med* 1999;340:115-126.
685. Rosa JP, George JN, Bainton DF, et al. Gray platelet syndrome. Demonstration of alpha granule membranes that can fuse with the cell surface. *J Clin Invest* 1987;80:1138-1146.
686. Cramer EM, Vainchenker W, Vinci G, et al. Gray platelet syndrome: immunoelectron microscopic localization of fibrinogen and von Willebrand factor in platelets and megakaryocytes. *Blood* 1985;66:1309-1316.
687. Fukami MH, Salganicoff L. Human platelet storage granules—a review. *Thromb Haemost* 1977;38:963-974.
688. McNicol A, Israels SJ. Platelet dense granules: structure, function and implications for hemostasis. *Thromb Res* 1999;95:1-13.
689. Da Prada M, Pletscher A, Tranzer JP, Knuchel H. Subcellular localization of 5-hydroxytryptamine and histamine in blood platelets. *Nature* 1967;216: 1315-1317.
690. Martin JH, Carson FL, Race GJ. Calcium-containing platelet granules. *J Cell Biol* 1974;60:775-777.
691. White JG. The dense bodies of human platelets: inherent electron opacity of the serotonin storage particles. *Blood* 1969;33:598-606.
692. Israels SJ, Gerrard JM, Jacques YV, et al. Platelet dense granules membranes contain both granulophysin and P-selectin (GMP-140). *Blood* 1992;80:1143-1152.
693. Sixma JJ, Berg Avd, Hasilik A, et al. Immuno-electron microscopical demonstration of lysosomes in human blood platelets and megakaryocytes using anti-cathepsin D. *Blood* 1985;65:1287-1291.
694. Febbraio M, Silverstein RL. Identification and characterization of LAMP-1 as an activation-dependent platelet surface glycoprotein. *J Biol Chem* 1990;265:18531-18537.
695. Silverstein RL, Febbraio M. Identification of lysosome-associated membrane protein-2 as an activation-dependent platelet surface glycoprotein. *Blood* 1992;80:1470-1478.
696. Kannan K, Divers SG, Lurie AA, et al. Cell surface expression of lysosome-associated membrane protein-2 (lamp2) and CD63 as markers of *in vivo* platelet activation in malignancy. *Eur J Haematol* 1995;55:145-151.
697. Crombie R, Silverstein RL. Lysosomal integral membrane protein II binds thrombospondin-1. *J Biol Chem* 1998;273:4855-4862.
698. Holmsen H, Day HJ. The selectivity of the thrombin-induced platelet release reaction: subcellular localization of released and retained constituents. *J Lab Clin Med* 1970;75:840-855.
699. White JG. Platelet secretory granules and associated proteins. *Lab Invest* 1993;68:497-498.
700. de Duve C. Biochemical studies on the occurrence, biogenesis, and life history of mammalian peroxisomes. *J Histochem Cytochem* 1973;21:941-948.

701. Van den BH, de Vet EC, Zomer AS. The role of peroxisomes in ether lipid synthesis. Back to the roots of PAF. *Adv Exp Med Biol* 1996;416:33-41.
702. Behnke O. Degrading and non-degrading pathways in fluid-phase (non-adsorptive) endocytosis in human blood platelets. *J Submicrosc Cytol Pathol* 1992;24:169-178.
703. Morgenstern E. Coated membranes in blood platelets. *Eur J Cell Biol* 1982;26:315-318.
704. Klinger MHF, Kluter H. Immunocytochemical colocalization of adhesive proteins with clathrin in human blood platelets: further evidence for coated vesicle-mediated transport of von Willebrand factor, fibrinogen and fibronectin. *Cell Tissue Res* 1995;279:453-457.
705. Akkerman JWN, Gorter G, Soons H, Holmsen H. Close correlation between platelet responses and adenylate energy charge during transient substrate depletion. *Biochim Biophys Acta* 1983;760:34-42.
706. Holmsen H, Farstad M. Energy metabolism. In: *Platelet responses and metabolism*, vol 2. Boca Raton: CRC Press, 1987:245-282.
707. Schultze M. Ein heizbarer objecttisch und seine verwendung bei unter-suchungen des blutes. *Arch Mikroskop Anat* 1865;1:1-4.
708. Roth GJ. Developing relationships: arterial platelet adhesion, glycoprotein Ib, and leucine-rich glycoproteins. *Blood* 1991;77:5-19.
709. Libby P. Current concepts in the pathogenesis of the acute coronary syndromes. *Circulation* 2001;104:365-372.
710. The EPIC Investigators. Use of a monoclonal antibody directed against the platelet glycoprotein IIb-IIIa receptor in high-risk angioplasty. *New Engl J Med* 1994;330:956-961.
711. Tchong JE, Harrington RA, Kottke P, Marchant K. Multicenter, randomized, double-blind, placebo-controlled trial of the platelet integrin glycoprotein IIb-IIIa blocker integrilin in elective coronary intervention. *Circulation* 1995;91:2151-2157.
712. ISIS-2 Collaborative Group. Randomized trial of intravenous streptokinase, oral aspirin, both or neither among 17,187 cases of suspected acute myocardial infarction: ISIS-2. *Lancet* 1988;2:340-360.
713. Roth GJ, Calverley DC. Aspirin, platelets and thrombosis: theory and practice. *Blood* 1994;83:885-898.
714. Harker LA. The kinetics of platelet production and destruction in man. *Clin Haematol* 1977;6:671-682.
715. Grabowski EF, Friedman LI, Leonard EF. Effects of shear rate on the diffusion and adhesion of blood platelets to a foreign surface. *Ind Eng Chem Fundam* 1972;11:224-232.
716. Weksler BB, Marcus AJ, Jaffe EA. Synthesis of prostaglandin I<sub>2</sub> (prostacyclin) by cultured human and bovine endothelial cells. *Proc Natl Acad Sci U S A* 1977;74:3922-3926.
717. Sixma JJ, Wester J. The hemostatic plug. *Semin Hematol* 1977;14:265-299.
718. Rapaport SI. Preoperative hemostatic evaluation: which tests, if any? *Blood* 1983;61:229-231.
719. Greaves M, Preston FE. Approach to the bleeding patient. In: Colman RW, Hirsh J, Marder VJ, et al., eds. *Hemostasis and thrombosis. Basic principles and clinical practice*, 4th ed. Philadelphia: Lippincott Williams & Wilkins, 2001:783-793.
720. Hyers TM, Agnelli G, Hull RD, et al. Antithrombotic therapy for venous thromboembolic disease. *Chest* 2001;119[Suppl]:176S-193S.
721. Patrono C, Collier B, Dalen JE, et al. Platelet-active drugs. The relationships among dose, effectiveness, and side effects. *Chest* 2001;119[Suppl]:39S-63S.

722. Lopez JA, Chung DW, Fujikawa K, et al. Cloning of the  $\alpha$ -chain of human platelet glycoprotein Ib: a transmembrane protein with homology to leucine-rich  $\alpha 2$  glycoprotein. *Proc Natl Acad Sci U S A* 1987;84:5615–5619.
723. Emsley J, Cruz M, Handin R, Liddington R. Crystal structure of the von Willebrand factor A1 domain and implications for the binding of platelet glycoprotein Ib. *J Biol Chem* 1998;273:10396–10401.
724. Berndt MC, Ward CM, Booth WJ, et al. Identification of aspartic acid 514 through glutamic acid 542 as a glycoprotein Ib-IX complex receptor recognition sequence in von Willebrand factor. Mechanism of modulation of von Willebrand factor by ristocetin and botrocetin. *Biochemistry* 1992;31:11144–11151.
725. Tsuji S, Sugimoto M, Kuwahara M, Miyata S. Role and initiation mechanism of the interaction of glycoprotein Ib with surface-immobilized von Willebrand factor in a solid-phase platelet cohesion process. *Blood* 1996;88:3854–3861.
726. Berndt MC, Shen Y, Dopheide SM, et al. The vascular biology of the glycoprotein Ib-IX-V complex. *Thromb Haemost* 2001;86:178–188.
727. Ruggeri ZM, Dent JA, Saldivar E. Contribution of distinct adhesive interactions to platelet aggregation in blood. *Blood* 1999;94:172–178.
728. Plow EF, Haas TA, Zhang L, et al. Ligand binding to integrins. *J Biol Chem* 2000;275:21785–21788.
729. Sugimoto M, Miyata S. Functional property of von Willebrand factor under flowing blood. *Int J Hematol* 2002;75:19–24.
730. Matusi H, Sugimoto M, Mizuno T, et al. Distinct and concerted functions of von Willebrand factor and fibrinogen in mural thrombosis growth under high shear flow. *Blood* 2002;100:3604–3610.
731. Wicki AN, Clemetson KJ. The glycoprotein Ib complex of human blood platelets. *Eur J Biochem* 1987;163:43–52.
732. Phillips DR, Charo IF, Parise LV, Fitzgerald LA. The platelet membrane glycoprotein IIb-IIIa complex. *Blood* 1988;71:831–843.
733. Du X, Beutler L, Ruan C, et al. Glycoprotein Ib and glycoprotein IX are fully complexed in the intact platelet membrane. *Blood* 1987;69:1524–1531.
734. Wagner CL, Mascelli MA, Neblock DS, et al. Analysis of GPIIb/IIIa receptor number by quantification of 7E3 binding to human platelets. *Blood* 1996;88:907–914.
735. Lopez JA, Andrews RK, Afshar-Kharghan V, Berndt MC. Bernard-Soulier syndrome. *Blood* 1998;91:4397–4409.
736. Poncz M, Eisman R, Heidenreich R. Structure of the platelet membrane glycoprotein IIb. Homology to the alpha subunits of the vitronectin and fibronectin membrane receptors. *J Biol Chem* 1987;262:8476–8483.
737. Fitzgerald LA, Steiner B, Rall SC Jr, et al. Protein sequence of endothelial glycoprotein IIIa derived from a cDNA clone. Identity with platelet glycoprotein IIIa and similarity to “integrin.” *J Biol Chem* 1987;262:3936–3942.
738. Weiss HJ, Turitto VT, Baumgartner HR. Effect of shear rate on platelet interaction with subendothelium in citrated and native blood. I. Shear-dependent decrease of adhesion in von Willebrand's disease and the Bernard-Soulier syndrome. *J Lab Clin Med* 1978;92:750–762.
739. Savage B, Saldivar E, Ruggeri ZM. Initiation of platelet adhesion by arrest onto fibrinogen or translocation on von Willebrand factor. *Cell* 1996;84:289–297.
740. Sadler JE, Shelton-Inloes BB, Sorace JM. Cloning and characterization of two cDNAs coding for human von Willebrand factor. *Proc Natl Acad Sci U S A* 1985;82:6394–6398.
741. Fowler WE, Fretto LJ, Hamilton KK, et al. Substructure of human von Willebrand factor. *J Clin Invest*

1985;76:1491–1500.

742. Sakariassen KS, Bolhuis PA, Sixma JJ. Human blood platelet adhesion to artery subendothelium is mediated by factor VIII–von Willebrand factor bound to subendothelium. *Nature* 1979;279:635–640.
743. Moake JL, Rudy CK, Troll JH. Unusually large plasma factor VIII–von Willebrand factor multimers in chronic relapsing thrombotic thrombocytopenic purpura. *New Engl J Med* 1982;307:1432–1435.
744. Furlan M, Robles R, Galbusera M. Von Willebrand factor–cleaving protease in thrombotic thrombocytopenic purpura and the hemolytic–uremic syndrome. *New Engl J Med* 1998;339:1578–1584.
745. Fujikawa K, Suzuki H, McMullen B, Chung D. Purification of human von Willebrand factor–cleaving protease and its identification as a new member of the metalloproteinase family. *Blood* 2001;98:1662–1666.
746. Lopez JA, Chung DW, Fujikawa K, et al. The  $\alpha$  and  $\beta$  chains of human platelet glycoprotein Ib are both transmembrane proteins containing a leucine–rich amino acid sequence. *Proc Natl Acad Sci U S A* 1988;85:2135–2139.
747. Hickey MJ, Williams SA, Roth GJ. Human platelet glycoprotein IX: an adhesive prototype of leucine–rich glycoproteins with flank–center–flank structures. *Proc Natl Acad Sci U S A* 1989;86:6773–6777.
748. Hickey MJ, Hagen FS, Yagi M, Roth GJ. Human platelet glycoprotein V: characterization of the polypeptide and the related Ib–IX–V receptor system of adhesive, leucine–rich glycoproteins. *Proc Natl Acad Sci U S A* 1993;90:8327–8331.
749. Wenger RH, Kieffer N, Wicki AN, Clemetson KJ. Structure of the human blood platelet membrane glycoprotein Iba gene. *Biochem Biophys Res Commun* 1988;156:389–397.
750. Yagi M, Edelhoff S, Disteche CM, Roth GJ. Structural characterization and chromosomal location of the gene encoding human platelet glycoprotein Ib $\beta$ . *J Biol Chem* 1994;269:17424–17427.
751. Hickey MJ, Roth GJ. Characterization of the gene encoding human platelet glycoprotein IX. *J Biol Chem* 1993;268:3438–3443.
752. Yagi M, Edelhoff S, Disteche CM, Roth GJ. Human platelet glycoproteins V and IX: mapping of two leucine–rich glycoprotein genes to chromosome 3 and analysis of structures. *Biochemistry* 1995;34:16132–16135.
753. Kobe B, Deisenhofer J. A structural basis of the interactions between leucine–rich repeats and protein ligands. *Nature* 1995;374:183–186.
754. Kobe B, Deisenhofer J. The leucine–rich repeat: a versatile binding motif. *Trends Biochem Sci* 1994;19:415–421.
755. Coller BS, Peerschke EI, Lesley E, et al. Studies with a murine monoclonal antibody that abolishes ristocetin–induced binding of von Willebrand factor to platelets: additional evidence in support of GPIb as a platelet receptor for von Willebrand factor. *Blood* 1983;61:99–108.
756. Vicente V, Houghten RA, Ruggeri AM. Identification of a site in the  $\alpha$  chain of platelet glycoprotein Ib that participates in von Willebrand factor binding. *J Biol Chem* 1990;265:274–282.
757. Ward CM, Andrews RK, Smith AI, Berndt MC. Mocarhagin, a novel cobra venom metalloproteinase, cleaves the platelet von Willebrand factor receptor glycoprotein Iba. Identification of the sulfated tyrosine/anionic sequence Tyr 276–Glu 282 of glycoprotein Iba as a binding site for von Willebrand factor and  $\alpha$ –thrombin. *Biochemistry* 1996;35:4929–4938.
758. Andrews RK, Gorman JJ, Booth WJ, et al. Cross–linking of a monomeric 39/34–kDa dispace fragment of von Willebrand factor (Leu–480/Val–481–Gly–718) to the N–terminal region of the  $\alpha$ –chain of membrane glycoprotein Ib on intact platelets with bis (sulfosuccinimidyl) suberate. *Biochemistry* 1989;28:8326–8336.
759. Sugimoto M, Dent J, McClintock R, et al. Analysis of structure–function relationships in the platelet membrane glycoprotein Ib–binding domain of von Willebrand’s factor by expression of deletion mutants. *J*

Biol Chem 1993;268:12185–12192.

760. Jamieson GA, Okumura R. Reduced thrombin binding and aggregation in Bernard–Soulier platelets. *J Clin Invest* 1978;61:861–869.

761. Ramakrishnan V, DeGuzman F, Bao M, et al. A thrombin receptor function for platelet glycoprotein Ib–IX unmasked by cleavage of glycoprotein V. *Proc Natl Acad Sci U S A* 2001;98:1823–1828.

762. Roth GJ. A new “kid” on the platelet thrombin receptor “block”: glycoprotein Ib–IX–V. *Proc Natl Acad Sci U S A* 2001;98:1330–1331.

763. Tsuji T, Tsunehisa S, Watanabe Y, et al. The carbohydrate moiety of human platelet glycoprotein Ib. The structure of the major ser/thr-linked sugar chain. *J Biol Chem* 1983;258:6335–6339.

764. Wardell MR, Reynolds CC, Berndt MC, et al. Platelet glycoprotein Ib $\beta$  is phosphorylated on serine 166 by cyclic AMP–dependent protein kinase. *J Biol Chem* 1989;264:15656–15663.

765. Lopez JA, Ludwig EH, McCarthy BJ. Polymorphism of human glycoprotein Ib $\alpha$  results from a variable number of tandem repeats of a 13 amino acid sequence in the mucin-like macroglycopeptide region: structure–function implications. *J Biol Chem* 1992;267:10055–10062.

766. Andrews RK, Fox JEB. Identification of a region in the cytoplasmic domain of the platelet membrane glycoprotein Ib–IX complex that binds to purified actin–binding protein. *J Biol Chem* 1992;267:18605–18611.

767. Du X, Harris SJ, Tetaz TJ, et al. Association of a phospholipase A2 (14–3–3 protein) with the platelet glycoprotein Ib–IX complex. *J Biol Chem* 1994;269:18287–18291.

768. Calverley DC, Kavanagh TJ, Roth GJ. Human signaling protein 14–3–3 $\eta$  interacts with platelet glycoprotein Ib subunits Ib $\alpha$  and Ib $\beta$ . *Blood* 1998;91:1295–1303.

769. Modderman PW, Admiral LG, Sonnenberg A, von dem Borne AEGK. Glycoproteins V and Ib–IX form a noncovalent complex in the platelet membrane. *J Biol Chem* 1992;267:364–373.

770. McEver RP, Baenziger JU, Majerus PW. Isolation and structural characterization of the polypeptide subunits of membrane glycoprotein IIb–IIIa from human platelets. *Blood* 1982;59:80–88.

771. Hynes RO. Integrins: a family of cell surface receptors. *Cell* 1987;48:549–555.

772. Jennings LK, Phillips DR. Purification of glycoprotein IIb and IIIa from platelet plasma membranes and characterization of a calcium–dependent glycoprotein IIb–IIIa complex. *J Biol Chem* 1982;257:10458–10466.

773. Bennett JS. The platelet–fibrinogen interaction. In: George JN, Nurden AT, Phillips DR, eds. *Platelet membrane glycoproteins*. New York: Plenum Publishing, 1985:193.

774. Plow EF, McEver RP, Collier BS, et al. Related binding mechanisms for fibrinogen, von Willebrand factor and thrombospondin on thrombin–stimulated human platelets. *Blood* 1985;66:724–727.

775. Plow EF, Srouji AH, Meyer D, et al. Evidence that three adhesive proteins interact with a common recognition site on activated platelets. *J Biol Chem* 1984;259:5388–5391.

776. Collier BS, Seligsohn U, West SM, et al. Platelet fibrinogen and vitronectin in Glanzmann thrombasthenia: evidence consistent with specific roles for glycoprotein IIb/IIIa and a  $\alpha$ <sub>v</sub> $\beta$ <sub>3</sub> integrins in platelet protein trafficking. *Blood* 1991;78:2603–2610.

777. Shattil SJ, Hoxie JA, Cunningham M, Brass LF. Changes in the platelet membrane glycoprotein IIb/IIIa complex during platelet activation. *J Biol Chem* 1985;260:11107–11114.

778. Sims PJ, Ginsberg MH, Plow EF, Shattil SJ. Effect of platelet activation on the conformation of the plasma membrane glycoprotein IIb–IIIa complex. *J Biol Chem* 1991;266:7345–7352.

779. Plow EF, Pierschbacher MD, Ruoslahti E, Ginsberg MH. The effect of Arg–Gly–Asp–containing peptides on fibrinogen and von Willebrand factor binding to platelets. *Proc Natl Acad Sci U S A*

1985;82:8057–8061.

780. Kloczewiak M, Timmons S, Lukas TJ, Hawiger J. Platelet receptor recognition site on human fibrinogen. Synthesis and structure–function relationship of peptides corresponding to the carboxy–terminal segment of the gamma chain. *Biochemistry* 1984;23:1767–1774.

781. Farrell DH, Thiagarajan R, Chung DW, Davie EW. Role of fibrinogen  $\alpha$  and  $\beta$  chains in platelet aggregation. *Proc Natl Acad Sci U S A* 1992;89:10729–10732.

782. Smith JW, Ruggeri M, Kunicki TJ, Cheresh DA. Interaction of integrins  $\alpha$ v $\beta$ 3 and glycoprotein IIb–IIIa with fibrinogen. Differential peptide recognition accounts for distinct binding sites. *J Biol Chem* 1990;265:12267–12271.

783. Loftus JC, O'Toole TE, Plow EF, et al. A  $\beta$ 3 integrin mutation abolishes ligand binding and alters divalent cation–dependent conformation. *Science* 1990;249:915–918.

784. Kieffer N, Fitzgerald LA, Wolf D, et al. Adhesive properties of the  $\beta$ 3 integrins. Comparison of GPIIb–IIIa and the vitronectin receptor individually expressed in human melanoma cells. *J Cell Biol* 1991;113:451–459.

785. D'Souza SE, Ginsberg MH, Matsueda GR, Plow EF. A discrete sequence in a platelet integrin is involved in ligand recognition. *Nature* 1991;350: 66–68.

786. Loftus JC, Liddington RC. Cell adhesion in vascular biology: new insights into integrin–ligand interaction. *J Clin Invest* 1997;99:2302–2306.

787. Springer TA. Folding of the N–terminal, ligand–binding region of integrin  $\alpha$ –subunits into a 13–propeller domain. *Proc Natl Acad Sci U S A* 1997;94:65–72.

788. Law DA, Nannizzi–Alaimo L, Phillips DR. Outside–in signal transduction:  $\alpha$ IIb– $\beta$ 3 (GPIIb–IIIa) tyrosine phosphorylation induced by platelet aggregation. *J Biol Chem* 1996;271:10811–10815.

789. Schwartz MA, Schaller MD, Ginsberg MH. Integrins: emerging paradigms of signal transduction. *Annu Rev Cell Biol* 1995;11:549–599.

790. Naik UP, Patel PM, Parise LV. Identification of a novel calcium–binding protein that interacts with the integrin  $\alpha$ IIb cytoplasmic domain. *J Biol Chem* 1997;272:4651–4654.

791. Shattil SJ, Kashiwagi H, Pampori N. Integrin signaling: the platelet paradigm. *Blood* 1998;91:2645–2657.

792. Tsuboi S. Calcium integrin–binding protein activates platelet integrin  $\alpha$ IIb  $\beta$ 3. *J Biol Chem* 2002;277:1919–1923.

793. Santoro SA. Identification of a 160,000 dalton platelet membrane protein that mediates the initial divalent–cation dependent adhesion of platelets to collagen. *Cell* 1986;46:913–922.

794. Staatz WD, Rajpara SM, Wayner EA, et al. The membrane glycoprotein Ia–IIa (VLA–2) complex mediates the  $Mg^{++}$ –dependent adhesion of platelets to collagen. *J Cell Biol* 1989;108:1917–1924.

795. Jung SM, Moroi M. Signal–transducing mechanisms involved in activation of the platelet collagen receptor integrin  $\alpha$ 2 $\beta$ 1. *J Biol Chem* 2000;275:8016–8026.

796. Clemetson KJ, Clemetson JM. Platelet collagen receptors. *Thromb Haemost* 2001;86:189–197.

797. Santoro SA, Rajpara SM, Staatz WD, Woods VL. Isolation and characterization of a platelet surface collagen binding complex related to VLA–2. *Biochem Biophys Res Commun* 1988;153:217–224.

798. Nieuwenhuis HK, Akkerman JW, Houdijk WP, Sixma JJ. Human blood platelets showing no response to collagen fail to express surface glycoprotein Ia. *Nature* 1985;318:470–472.

799. Diaz–Ricart M, Tandon NN, Carretero M, et al. Platelets lacking functional CD36 (glycoprotein IV)



- show reduced adhesion to collagen in flowing whole blood. *Blood* 1993;82:491–496.
800. Savage B, Saldivar E, Ruggeri AM. Initiation of platelet adhesion by arrest onto fibrinogen or translocation on von Willebrand factor. *Cell* 1996;84:289–301.
801. Emsley J, Knight CG, Farndale RW, et al. Structural basis of collagen recognition by integrin  $\alpha 2\beta 1$ . *Cell* 2000;101:47–56.
802. Santoro SA, Walsh JJ, Staatz WD, Baranski KJ. Distinct determinants on collagen support  $\alpha 2\beta 1$  integrin-mediated platelet adhesion and platelet activation. *Cell Regul* 1991;2:905–913.
803. Asch AS, Liu I, Briccetti FM, et al. Analysis of CD36 binding domains. Ligand specificity controlled by dephosphorylation of an ectodomain. *Science* 1993;268:11811–11816.
804. Oquendo P, Hundt E, Lawler J, Seed B. CD36 directly mediates cytoadherence of *Plasmodium falciparum* infected erythrocytes. *Cell* 1995;58:95–103.
805. Gibbins JM, Okuma M, Farndale R, et al. Glycoprotein VI is the collagen receptor in platelets which underlies tyrosine phosphorylation of the Fc receptor  $\gamma$ -chain. *FEBS Lett* 1997;413:255–259.
806. Polgar J, Clemetson JM, Kehrel BE, et al. Platelet activation and signal transduction by convulxin, a C-type lectin from *Crotalus durissus terrificus* (tropical rattlesnake) venom via the  $\alpha 2\beta 1$ /GPVI collagen receptor. *J Biol Chem* 1997;272:13576–13583.
807. Roth GJ, Titani K, Hoyer LW, Hickey MJ. Localization of binding sites within human von Willebrand factor for monomeric type III collagen. *Biochemistry* 1986;25:8357–8361.
808. Pareti FI, Fujimura Y, Dent JA, et al. Isolation and characterization of a collagen binding domain in human von Willebrand factor. *J Biol Chem* 1986;261:15310–15315.
809. Cruz MA, Yuan H, Lee JR, et al. Interaction of the von Willebrand factor (VWF) with collagen. *J Biol Chem* 1995;270:10822–10827.
810. Siedlicki CHA, Lestini BJ, Kottke-Marchant K, et al. Shear-dependent changes in the three-dimensional structure of human von Willebrand factor. *Blood* 1996;88:2939–2950.
811. Novak L, Deckmyn H, Damjanovich S, Harsfalvi J. Shear-dependent morphology of von Willebrand factor bound to immobilized collagen. *Blood* 2001;99:2070–2075.
812. Piotrowicz RS, Orzechowski RP, Nugent DJ, Kunicki TJ. Glycoprotein Ic-IIa functions as an activation-independent fibronectin receptor on human platelets. *J Cell Biol* 1988;106:1359–1368.
813. Sonnenberg A, Modderman PW, Hogervorst F. Laminin receptor on platelets is the integrin VLA-6. *Nature* 1988;336:487–490.
814. Lam SC, Plow EF, D'Souza SE, et al. Isolation and characterization of a platelet membrane protein related to the vitronectin receptor. *J Biol Chem* 1989;264:3742–3748.
815. Albelda SM, Muller WA, Buck CA, Newman PJ. Molecular and cellular properties of PECAM-1 (endoCAM/CD31): a novel vascular cell-cell adhesion molecule. *J Cell Biol* 1991;114:1059–1068.
816. Johnson GI, Cook RG, McEver RP. Cloning of GMP-140, a granule membrane protein of platelets and endothelium: sequence similarity to proteins involved in cell adhesion and inflammation. *Cell* 1989;56:1033–1044.
817. Larsen E, Celi A, Gilbert GE, et al. PADGEM protein: A receptor that mediates the interaction of activated platelets with neutrophils and monocytes. *Cell* 1989;59:305–312.
818. Lanza F, Wolf D, Fox C, et al. cDNA cloning and expression of platelet p24/CD9. Evidence for a new family of multiple membrane spanning proteins. *J Biol Chem* 1991;266:10638–10645.
819. Gratacap MP, Payrastre B, Viala C, et al. Phosphatidylinositol 3,4,5-trisphosphate-dependent stimulation of phospholipase C- $\gamma 2$  is an early key event in Fc  $\gamma$ RIIA-mediated activation of

human platelets. *J Biol Chem* 1998;273:24314–24321.

820. Diacova TG, deFougerolles AR, Bainton DF, Springer TA. A functional integrin ligand on the surface of platelets: intercellular adhesion molecule-2. *J Clin Invest* 1994;94:1243–1249.

821. Sincock PM, Mayrhofer G, Ashman LK. Localization of the transmembrane 4 superfamily (TM4SF) member PETA-3 (CD151) in normal human tissues: comparison with CD9, CD63, and *alpha5 beta1* integrin. *J Histochem Cytochem* 1997;45:515–526.

822. Peerschke EI, Ghebrehiwet B. Platelet receptors for the complement component C1q: implications for hemostasis and thrombosis. *Immunobiology* 1998;199:239–248.

823. Tandon NN, Holland EA, Kralisz U, et al. Interaction of human platelets with laminin and identification of the 67kDa laminin receptor on platelets. *Biochem J* 1991;274:535–544.

824. Coughlin SR. Thrombin signaling and protease-activated receptors. *Nature* 2000;407:258–264.

825. Vu T-KH, Hung DT, Wheaton VI, Coughlin SR. Molecular cloning of a functional thrombin receptor reveals a novel proteolytic mechanism of receptor activation. *Cell* 1991;64:1057–1068.

826. Kahn ML, Zheng YW, Huang W, et al. A dual thrombin receptor system for platelet activation. *Nature* 1998;394:690–694.

827. Ishihara H, Connolly AJ, Zeng D, et al. Protease-activated receptor 3 is a second thrombin receptor in humans. *Nature* 1997;386:502–506.

828. Offermanns S, Toombs CF, Hu YH, Simon MI. Defective platelet activation in G *alpha*(q)-deficient mice. *Nature* 1997;389:183–186.

829. Klages B, Brandt U, Simon MI, et al. Activation of G12/13 results in shape change and rho/rho kinase-mediated myosin light chain phosphorylation in mouse platelets. *J Cell Biol* 1999;144:745–754.

830. Yang J, Wu J, Kowalska MA, et al. Loss of signaling through the G protein, Gz, results in abnormal platelet activation and altered responses to psychoactive drugs. *Proc Natl Acad Sci U S A* 2000;97:9984–9990.

831. Trejo HJ, Coughlin SR. The cytoplasmic tails of protease-activated receptor-1 and substance P receptor specify sorting to lysosomes versus recycling. *J Biol Chem* 1999;274:2216–2224.

832. Holmsen H, Day HJ. The selectivity of the thrombin-induced release reaction. Subcellular localization of released and retained substances. *J Lab Clin Med* 1970;75:840–851.

833. Hung DT, Vu TK, Wheaton VI, et al. Cloned platelet thrombin receptor is necessary for thrombin-induced platelet activation. *J Clin Invest* 1992;89:1350–1358.

834. Colman RW, Clowes AW, George JN, et al. Overview of hemostasis. In: Colman RW, Hirsh J, Marder VJ, et al., eds. *Hemostasis and thrombosis. Basic principles and clinical practice*, 4th ed. Philadelphia: Lippincott Williams & Wilkins, 2001:3–16.

835. Gachet C. ADP receptors of platelets and their inhibition. *Thromb Haemost* 2001;86:222–232.

836. Hollopeter G, Jantzen HM, Vincent D, et al. Identification of the platelet ADP receptor targeted by antithrombotic drugs. *Nature* 2001;409:202–207.

837. Siess W. Molecular mechanisms of platelet activation. *Physiol Rev* 1989;69:58–178.

838. Born GVR. Aggregation of blood platelets by adenosine diphosphate and its reversal. *Nature* 1963;194:27–29.

839. Mahaut-Smith MP, Sage SO, Rink TJ. Rapid ADP evoked currents in human platelets recorded with the nystatin permeabilized patch technique. *J Biol Chem* 1992;267:3060–3065.

840. Haslam RJ. Interactions of the pharmacological receptors of blood platelets with adenylate cyclase.

Ser Haematol 1973;6:333–350.

841. Leon C, Vial C, Cazenave JP, Gachet C. Cloning and sequencing of a human cDNA encoding endothelial P2Y<sub>1</sub> purinoceptor. *Gene* 1996;171:295–297.

842. Daniel JL, Dangelmaier C, Jin J, Kunapuli SP. Molecular basis for ADP-induced platelet activation I: evidence for three distinct ADP receptors on platelets. *J Biol Chem* 1998;273:2024–2029.

843. Jin J, Daniel JL, Kunapuli SP. Molecular basis for ADP-induced platelet activation II. The P2Y<sub>1</sub> receptor mediates ADP-induced intracellular calcium mobilization and shape change in platelets. *J Biol Chem* 1998;273:2030–2037.

844. Ralevic V, Burnstock G. Receptors for purines and pyrimidines. *Pharmacol Rev* 1998;50:413–492.

845. McKenzie AB, Mahaut-Smith MP, Sage SO. Activation of receptor-operated cation channels via P2X<sub>1</sub> not P2T purinoceptors in human platelets. *J Biol Chem* 1996;271:2879–2887.

846. Cooper DMF, Rodbell M. ADP is a potent inhibitor of human platelet plasma membrane adenylate cyclase. *Nature* 1979;282:517–520.

847. Hallam TJ, Rink TJ. Response to adenosine diphosphate in human platelets loaded with the fluorescent calcium indicator Quin 2. *J Physiol* 1985;368:131–150.

848. Macfarlane DE, Gardner S, Lipson C, et al. Malondialdehyde production by platelets during secondary aggregation. *Thromb Haemost* 1977;38:1002–1010.

849. Hamberg M, Samuelsson B. Prostaglandin endoperoxides. Novel transformations of arachidonic acid in human platelets. *Proc Natl Acad Sci U S A* 1974;71:3400–3404.

850. Hammerstrom S, Falardeau P. Resolution of prostaglandin endoperoxide synthase and thromboxane synthase of human platelets. *Proc Natl Acad Sci U S A* 1977;74:3691–3695.

851. Hamberg M, Svensson J, Samuelsson B. Thromboxanes: a new group of biologically active compounds derived from prostaglandin endoperoxides. *Proc Natl Acad Sci U S A* 1975;72:2994–2998.

852. Parise LV, Venton DL, LeBreton GC. Arachidonic acid-induced platelet aggregation is mediated by a thromboxane A<sub>2</sub>/prostaglandin H<sub>2</sub> receptor interaction. *J Pharmacol Exp Ther* 1984;228:240–249.

853. Hirata M, Hayashi Y, Ushikubi F, Narumiya S. Cloning and expression of cDNA for a human thromboxane A<sub>2</sub> receptor. *Nature* 1991;349:617–620.

854. Habib A, FitzGerald GA, Maclouf J. Phosphorylation of the thromboxane receptor  $\alpha$ , the predominant isoform expressed in human platelets. *J Biol Chem* 1999;274:2645–2651.

855. Takahara K, Murray R, FitzGerald GA, FitzGerald DJ. The response to thromboxane A<sub>2</sub> analogues in human platelets. Discrimination of two binding sites linked to distinct effector systems. *J Biol Chem* 1990;265:6836–6843.

856. Pulcinelli FM, Ashby B, Gazzaniga PP, Daniel JL. Protein kinase C activation is not a key step in ADP-mediated exposure of fibrinogen receptors on human platelets. *FEBS Lett* 1995;364:87–98.

857. Banga HS, Simons ER, Brass LF, Rittenhouse SE. Activation of phospholipases A and C in human platelets exposed to epinephrine: role of glycoproteins IIb/IIIa and dual role of epinephrine. *Proc Natl Acad Sci U S A* 1986;83:9197–10001.

858. Regan JW, Nakata H, DeMarinis RM, et al. Purification and characterization of the human platelet  $\alpha$ -2-adrenergic receptor. *J Biol Chem* 1986;261:3894–3899.

859. Haslam RJ, Davidson MM, Fox JE, Lynham JA. Cyclic nucleotides in platelet function. *Thromb Haemost* 1978;40:232–239.

860. Lanza F, Beretz A, Stierle A, et al. Epinephrine potentiates human platelet activation but is not an

aggregating agent. *Am J Physiol* 1988;255:1276–1289.

861. Cook EH, Fletcher KE, Wainwright M, et al. Primary structure of the human platelet serotonin 5-HT<sub>2A</sub> receptor: identity with frontal cortex serotonin 5-HT<sub>2A</sub> receptor. *J Neurochem* 1994;63:465–474.

862. Coccaro EF, Kavoussi RJ, Sheline YI, et al. Impulsive aggression in personality disorder correlates with platelet 5-HT<sub>2A</sub> receptor binding. *Neuropsychopharmacology* 1997;16:211–219.

863. Li N, Wallen NH, Ladjevardi M, Hjemdahl P. Effects of serotonin on platelet activation in whole blood. *Blood Coagul Fibrinolysis* 1997;8:517–522.

864. Haslam RJ, Rosson GM. Aggregation of human blood platelets by vasopressin. *Am J Physiol* 1972;223:958–966.

865. Thibonnier M, Roberts JM. Characterization of human platelet vasopressin receptors. *J Clin Invest* 1985;76:1857–1864.

866. Honda Z, Nakamura I, Miki I. Cloning by functional expression of platelet activating receptor from guinea pig lung. *Science* 1991;349:342–348.

867. Rao AK, Willis J, Hassel B, et al. Platelet-activating factor is a weak platelet agonist: evidence from normal human platelets and platelets with congenital secretion defects. *Am J Hematol* 1984;17:153–160.

868. Kroll MH, Hellums JD, McIntire LV, et al. Platelets and shear stress. *Blood* 1996;88:1525–1541.

869. Cunningham JG, Meyer SC, Fox JEB. The cytoplasmic domain of the alpha subunit of glycoprotein (GP) Ib mediates attachment of the entire GPIb-IX complex to the cytoskeleton and regulates von Willebrand factor-induced changes in cell morphology. *J Biol Chem* 1996;271:11581–11587.

870. Munday AD, Berndt MC, Mitchell CA. Phosphoinositide 3-kinase forms a complex with platelet membrane glycoprotein Ib-IX-V complex and 14-3-3 *zeta*. *Blood* 2000;96:577–584.

871. Williams A, Woolkalis MJ, Poncz M, et al. Identification of the pertussis toxin-sensitive G proteins in platelets, megakaryocytes and HEL cells. *Blood* 1990;76:721–730.

872. Shenker A, Goldsmith P, Unson CG, Spiegel AM. The G protein coupled to the thromboxane A<sub>2</sub> receptor in human platelets is a member of the novel G<sub>q</sub> family. *J Biol Chem* 1991;266:9309–9313.

873. Abrams CS, Brass LF. Platelet signal transduction. In: Colman RW, Hirsh J, Marder VJ, et al., eds. *Hemostasis and thrombosis. Basic principles and clinical practice*, 4th ed. Philadelphia: Lippincott Williams & Wilkins, 2001:542–559.

874. Rittenhouse SE, Sasson JP. Mass changes in myoinositol triphosphate in human platelets stimulated by thrombin. Inhibitory effects of phorbol ester. *J Biol Chem* 1985;260:8657–8660.

875. Kaibuchi K, Takai Y, Sawamura M, et al. Synergistic functions of protein phosphorylation and calcium mobilization in platelet activation. *J Biol Chem* 1983;258:6701–6704.

876. Tarver AP, King WG, Rittenhouse SE. Inositol 1,4,5-trisphosphate and inositol 1,2-cyclic 4,5-trisphosphate in thrombin-stimulated platelets. Rapid formation of inositol 1,3,4-trisphosphate. *J Biol Chem* 1987;262:17268–17271.

877. Imaoka T, Lynham JA, Haslam RJ. Purification and characterization of the 47,000-dalton protein phosphorylated during degranulation of human platelets. *J Biol Chem* 1983;258:11404–11414.

878. Abrams CS, Zhao W, Belmonte E, Brass LF. Protein kinase C regulates pleckstrin by phosphorylation of sites adjacent to the N-terminal pleckstrin homology domain. *J Biol Chem* 1995;270:23317–23321.

879. Harlan JE, Hajduk PJ, Yoon HS, Fesik SW. Pleckstrin homology domains bind to phosphatidylinositol-4,5-bisphosphate. *Nature* 1994;371:168–170.

880. Ma AD, Abrams CS. Pleckstrin induces cytoskeletal reorganization via a Rac-dependent pathway. *J*

Biol Chem 1999;274:28730–28735.

881. Leever SJ, Vanhaesebroeck B, Waterfield MD. Signaling through phospho-inositide 3-kinases. The lipids take centre stage. *Curr Opin Cell Biol* 1999;11:219–232.

882. Hartwig JH, Kung S, Kovacsics T. D3 phosphoinositides and outside-in integrin signaling by glycoprotein IIb-IIIa mediate platelet actin assembly and filopodial extension induced by phorbol 12-myristate 13-acetate. *J Biol Chem* 1996;271:32986–32993.

883. Rittenhouse SE. Phosphoinositide 3-kinase activation and platelet function. *Blood* 1996;88:4401–4416.

884. Roth GJ. Platelet arachidonate metabolism and platelet-activating factor. In: Phillips DR, Shuman MA, eds. *Biochemistry of platelets*. Orlando: Academic Press, 1986:69–113.

885. Borsch-Haubold AG, Kramer RM, Watson SP. Cytosolic phospholipase A2 is phosphorylated in collagen- and thrombin-stimulated human platelets independent of protein kinase C and mitogen-activated protein kinase. *J Biol Chem* 1995;270:25885–25892.

886. Hall A. Small GTP-binding proteins and the regulation of the actin cytoskeleton. *Science* 1998;279:509–514.

887. Nobes CD, Hall A. Rho, rac, and cdc42 GTPase regulate the assembly of multimolecular focal complexes associated with actin stress fibers, lamellipodia, and filopodia. *Cell* 1995;81:53–62.

888. Hartwig JH, Bokoch GM, Carpenter CL, et al. Thrombin receptor ligation and activated Rac uncap actin filament barbed ends through phosphoinositide synthesis in permeabilized human platelets. *Cell* 1995;82:643–653.

889. Remold-O'Donnell E, Rosen FS, Kenney DM. Defects in Wiskott-Aldrich syndrome blood cells. *Blood* 1996;87:2621–2631.

890. Haffner C, Jarchau T, Reinhard M, et al. Molecular cloning, structural analysis and functional expression of the proline-rich focal adhesion and microfilament-associated protein VASP. *EMBO J* 1995;14:471–480.

891. Teo M, Manser E, Lim L. Identification and molecular cloning of a p21cdc42 /rac1-activated serine/threonine kinase that is rapidly activated by thrombin in platelets. *J Biol Chem* 1995;270:26690–26697.

892. Haimovich B, Lipfert L, Brugge JS, Shattil SJ. Tyrosine phosphorylation and cytoskeletal reorganization in platelets are triggered by interaction of integrin receptors with their immobilized ligands. *J Biol Chem* 1993;268:15868–15877.

893. Clark EA, Brugge JS. Redistribution of activated pp60c-src to integrin-dependent cytoskeletal complexes in thrombin-stimulated platelets. *Mol Cell Biol* 1993;13:1863–1971.

894. Goldschmidt-Clermont PJ, Furman MI, Wachsstock D, et al. The control of actin nucleotide exchange by thymosin b4 and profilin. A potential regulatory mechanism for actin polymerization in cells. *Mol Biol Cell* 1992;3:1015–1024.

895. Warkentin TE, Kelton JG. Temporal aspects of heparin-induced thrombocytopenia. *New Engl J Med* 2001;344:1286–1292.

896. Sollner T, Whiteheart SW, Brunner M, et al. SNAP receptors implicated in vesicle targeting and fusion. *Nature* 1993;362:318–324.

897. Martin TFJ. Stages of regulated exocytosis. *Trends Cell Biol* 1997;7:271–276.

898. White JG. Platelet secretory process. *Blood* 1999;93:2422–2425.

899. Lemons PP, Chen D, Bernstein AM, et al. Regulated secretion in platelets: identification of elements

of the platelet exocytosis machinery. *Blood* 1997;90:1490–1500.

900. Furie B, Furie BC, Flaumenhaft R. A journey with platelet P-selectin: the molecular basis of granule secretion, signaling and cell adhesion. *Thromb Haemost* 2001;86:214–221.

901. Bernstein AM, Whiteheart SW. Identification of a cellubrevin/vesicle associated membrane protein 3 homologue in human platelets. *Blood* 1993;93:571–579.

902. Flaumenhaft R, Croce K, Chen E, et al. Proteins of the exo-cytotic core complex mediate platelet alpha-granule secretion: roles of vesicle associated membrane protein, SNAP-23, and syntaxin 4. *J Biol Chem* 1999;274:2492–2501.

903. Chen D, Bernstein AM, Lemons PP, Whiteheart SW. Molecular mechanisms of platelet exocytosis: role of SNAP-23 and syntaxin2 in dense core granule release. *Blood* 2000;95:921–929.

904. Majerus PW. Arachidonate metabolism in vascular disorders. *J Clin Invest* 1983;72:1521–1527.

905. Ashby B, Colman RW, Daniel JL, et al. Platelet stimulatory and inhibitory receptors. In: Colman RW, Hirsh J, Marder VJ et al., eds. *Hemostasis and thrombosis*, 4th ed. Philadelphia: Lippincott Williams & Wilkins, 2001:505–520.

906. Radoski MW, Palmer RM, Moncada S. Modulation of platelet aggregation by an L-arginine-nitric oxide pathway. *Trends Pharmacol Sci* 1991;12:87–101.

907. Marcus AJ, Broekman MJ, Drosopoulos JH. The endothelial cell ecto-ADPase responsible for inhibition of platelet function is CD39. *J Clin Invest* 1997;99:1351–1359.

908. Ferguson SSG, Barak LS, Zhang J, Caron MG. G-protein-coupled receptor regulation: role of G-protein-coupled receptor kinases and arrestins. *Can J Physiol Pharmacol* 1996;74:1095–1110.

909. Weiss HJ, Kelly A, Herbert V. Vitamin B<sub>12</sub> and folate activity in normal human platelets. *Blood* 1968;31:258–262.

910. Cooley MH, Cohen P. Potassium transport in human blood platelets. *J Lab Clin Med* 1967;70:69–79.

911. Brass LF. The effect of Na<sup>+</sup> on Ca<sup>2+</sup> homeostasis in unstimulated platelets. *J Biol Chem* 1984;259:12571–12575.

912. Enouf J, Bredoux R, Bourdeau N, Levy-Toledano S. Two different Ca<sup>2+</sup> transport systems are associated with plasma and intracellular human platelet membranes. *J Biol Chem* 1987;262:9293–9297.

913. Karpatkin S, Charmatz A, Langer RM. Glycogenesis and glycconeogenesis in human platelets. Incorporation of glucose, pyruvate, and citrate into platelet glycogen, glycogen synthetase and fructose-1,6 diphosphatase activity. *J Clin Invest* 1970;49:140–149.

914. Akkerman JWN. Regulation of glycolytic flux in human platelets: relationship between energy produced by glyco(genol)ysis and energy consumption. *Biochim Biophys Acta* 1978;541:241–250.

915. Karpatkin S. Studies on human platelet glycolysis. Effect of glucose, cyanide, insulin, citrate, and agglutination and contraction on platelet glycolysis. *J Clin Invest* 1967;46:409–417.

916. Karpatkin S, Charmatz A. Heterogeneity of human platelets. III. Glycogen metabolism in platelets of different sizes. *Br J Haematol* 1970;19:135–143.

917. Akkerman JWN. Regulation of carbohydrate metabolism in platelets. A review. *Thromb Haemost* 1978;39:712–724.

918. Cohen P, Derksen A, Bosch H. Pathways of fatty acid metabolism in human platelets. *J Clin Invest* 1970;49:128–139.

919. Doery JCG, Hirsh J, Cooper I. Energy metabolism in human platelets: interrelationship between

glycolysis and oxidative metabolism. *Blood* 1970;36:159–168.

920. Holmsen H, Farstad M. Energy metabolism. In: Holmsen H, ed. *Platelet responses and metabolism*, vol 2: receptors and metabolism. Boca Raton: CRC Press, 1987:245–254.

921. Gear ARL, Schneider W. Control of platelet glycogenolysis; activation of phosphorylase kinase by calcium. *Biochim Biophys Acta* 1975;392:111–120.

922. Marcus AJ. Pathways of oxygen utilization by stimulated platelets and leukocytes. *Semin Hematol* 1979;16:188–195.

923. Simons ER, Greenberg–Sepersky SM. Transmembrane monovalent cation gradients. In: Holmsen H, ed. *Platelet responses and metabolism*, vol 3: response metabolism relationships. Boca Raton: CRC Press, 1987:31–50.

924. Dean WL. Structure, function, and subcellular localization of a human platelet  $\text{Ca}^{2+}$ -ATPase. *Cell Calcium* 1989;10:289–297.

925. Holmsen H, Day HJ, Storm E. Adenine nucleotide metabolism of blood platelets. VI. Subcellular localization of nucleotide pools with different functions in the platelet release reaction. *Biochim Biophys Acta* 1969;186:254–266.

926. Karpatkin S, Langer RM. Biochemical energetics of simulated platelet plug formation. Effect of thrombin, adenosine diphosphate, and epinephrine on intra- and extracellular adenine nucleotide kinetics. *J Clin Invest* 1968;47:2158–2168.

927. Holmsen H, Rozenberg MC. Adenine nucleotide metabolism of human blood platelets. III. Adenine phosphoribosyl transferase and nucleotide formation from exogenous adenine. *Biochim Biophys Acta* 1968;157:266–279.

928. Holmsen H, Salganicoff L, Fukami MH. Platelet behaviour and biochemistry. In: Ogston D, Bennett P, eds. *Haemostasis: biochemistry, physiology, and pathology*. London: Wiley–Liss, 1977:239–319.

929. Reimers HJ, Packham MA, Mustard JF. Labeling of the releasable adenine nucleotides of washed human platelets. *Blood* 1977;49:89–99.

930. Holmsen H. Energy metabolism and platelet responses. *Vox Sang* 1981;40:1–7.

931. Daniel JL, Molish IR, Robkin L, Holmsen H. Nucleotide exchange between cytosolic ATP and F-actin-bound ADP may be a major ATP-utilizing process in unstimulated platelets. *Eur J Biochem* 1986;156:677–684.

932. Verhoeven AJM, Tysnes OB, Aarbakke GM, et al. Turnover of the phosphomonoester groups of polyphosphoinositol lipids in unstimulated platelets. *Eur J Biochem* 1987;166:3–9.

933. Rivard GE, McLaren JD, Brunst RF. Incorporation of hypoxanthine into adenine and guanine nucleotides by human platelets. *Biochim Biophys Acta* 1975;381:144–156.

934. Jerushalmy Z, Patya M, Boer P, Sperling O. De novo synthesis of purine nucleotides in human platelets. *Haemostasis* 1980;9:20–27.

935. Akkerman JWN, Verhoeven AJM. Energy metabolism and function. In: Holmsen H, ed. *Platelet responses and metabolism*, vol 3: response–metabolism relationships. Boca Raton: CRC Press, 1987:69–99.

936. Verhoeven AJM, Tysnes OB, Horvli O, et al. Stimulation of phosphate uptake in human platelets by thrombin and collagen. Changes in specific  $^{32}\text{P}$ -labeling of metabolic ATP and polyphosphoinositides. *J Biol Chem* 1987;262:7047–7052.

937. Schick PK. Platelet and megakaryocyte lipids. In: Colman RW, Hirsh J, Marder VJ, et al., eds. *Hemostasis and thrombosis: basic principles and clinical practice*, 4th ed. Philadelphia: Lippincott Williams & Wilkins, 2001:521–534.

938. Perret B, Chap HJ, Douste–Blazy L. Asymmetric distribution of arachidonic acid in the plasma



membrane of human platelets: a determination using purified phospholipases and a rapid method for membrane isolation. *Biochim Biophys Acta* 1979;556:434-446.

939. Schick PK, Kurica KB, Chacko GK. Location of phosphatidylethanolamine and phosphatidylserine in the human platelet plasma membrane. *J Clin Invest* 1976;57:1221-1226.

940. Bevers EM, Comfurius P, Zwaal RF. Changes in membrane phospholipid distribution during platelet activation. *Biochim Biophys Acta* 1983;736:57-66.

941. Comfurius P, Senden JMG, Tilly RHJ, et al. Loss of membrane phospholipid asymmetry in platelets and red cells may be associated with calcium-induced shedding of plasma membrane and inhibition of aminophospholipid translocase. *Biochim Biophys Acta* 1990;1026:153-160.

942. Beleznyay Z, Zachowski A, Devaux PF, et al. ATP-dependent aminophospholipid translocation in erythrocyte vesicles: stoichiometry of transport. *Biochemistry* 1993;32:146-152.

943. Diaz C, Schroit AJ. Role of translocases in the generation of phosphatidylserine asymmetry. *J Membr Biol* 1996;151:1-9.

944. Sims PJ, Wiedmer T. Unraveling the mysteries of phospholipid scrambling. *Thromb Haemost* 2001;86:266-275.

945. Comfurius P, Williamson P, Smeets EF, et al. Reconstitution of phospholipid scramblase activity from human blood platelets. *Biochemistry* 1996;35:7631-7634.

946. Zhou Q, Zhao J, Stout JG, et al. Molecular cloning of human plasma membrane phospholipid scramblase. A protein mediating trans-bilayer movement of plasma membrane phospholipids. *J Biol Chem* 1997;272:18240-18244.

947. Wiedmer T, Zhou QS, Kwok DY, Sims PJ. Identification of three new members of the phospholipid scramblase gene family. *Biochim Biophys Acta* 2000;1467:244-253.

948. Marcus AJ. The role of lipids in platelet function: with particular reference to the arachidonic acid pathway. *J Lipid Res* 1976;9:793-826.

949. Clark JD, Schievella AR, Nalefski EA, Lin LL. Cytosolic phospholipase A2. *J Lipid Mediat Cell Signal* 1995;12:83-117.

950. Riendeau D, Gray J, Weech PK, et al. Arachidonyl trifluoromethyl ketone, a potent inhibitor of 85-kDa phospholipase A2, blocks production of arachidonate and 12-hydroxyicosatetraenoic acid by calcium ionophore-challenged platelets. *J Biol Chem* 1994;269:15619-15624.

951. Dennis EA. The growing phospholipase A2 superfamily of signal transduction enzymes. *Trends Biochem Sci* 1997;22:1-2.

952. Bell RL, Kennerly DA, Standford N, Majerus PW. Diglyceride lipase: a pathway for arachidonate release from human platelets. *Proc Natl Acad Sci U S A* 1979;76:3238-3241.

953. Picot D, Loll PJ, Garavito RM. The x-ray crystal structure of the membrane protein prostaglandin H2 synthase-1. *Nature* 1996;367:243-249.

954. Smith WL, Garavito RM, DeWitt DL. Prostaglandin endoperoxide synthases (cyclo-oxygenases)-1 and -2. *J Biol Chem* 1996;271:33157-33160.

955. Siegel MI, McConnell RT, Porter NA, Cuatrecasas P. Arachidonate metabolism via lipoxygenase and 12L-hydroperoxy-5,8,10,14-icosatetraenoic acid peroxidase sensitive to anti-inflammatory drugs. *Proc Natl Acad Sci U S A* 1980;77:308-312.

956. Schick PK, Tuszyński GP, Woort PWV. Human platelet cytoskeletons: specific content of glycolipids and phospholipids. *Blood* 1983;61:163-166.

957. Wolf P. The nature and significance of platelet products in human plasma. *Br J Haematol*

1967;13:269–288.

958. Barry OP, FitzGerald GA. Mechanisms of cellular activation by platelet microparticles. *Thromb Haemost* 1999;82:794–808.

959. Wiedmer T, Shattil SJ, Cunningham M, Sims PJ. Role of calcium and calpain in complement-induced vesiculation of the platelet plasma membrane and in the exposure of the platelet factor Va receptor. *Biochemistry* 1990;29:623–632.

960. Abrams CS, Ellison N, Budzynski AZ, Shattil SJ. Direct detection of activated platelets and platelet-derived microparticles in humans. *Blood* 1990;75:128–138.

961. George JN, Thoi LL, McManus LM, Reimann TA. Isolation of human platelet membrane microparticles from plasma and serum. *Blood* 1982;60:834–840.

962. Dahlback B, Wiedmer T, Sims PJ. Binding of anticoagulant vitamin K-dependent protein S to platelet-derived microparticles. *Biochemistry* 1992;31:12769–12777.

963. Gilbert GE, Sims PJ, Wiedmer T, et al. Platelet-derived microparticles express high affinity receptors for factor VIII. *J Biol Chem* 1991;266:17261–17268.

964. Sims PJ, Faioni EM, Wiedmer T, Shattil SJ. Complement proteins C5b–9 cause release of membrane vesicles from the platelet surface that are enriched in the membrane receptor for coagulation factor Va and express prothrombinase activity. *J Biol Chem* 1988;263:18205–18212.

965. Thiagarajan P, Tait JF. Collagen-induced exposure of anionic phospholipid in platelets and platelet-derived microparticles. *J Biol Chem* 1991;266:24302–24307.

966. Sims PJ, Wiedmer T, Esmon CT, et al. Assembly of the platelet prothrombinase complex is linked to vesiculation of the platelet plasma membrane. Studies in Scott syndrome: an isolated defect in platelet procoagulant activity. *J Biol Chem* 1989;264:17049–17057.

967. Weiss HJ. Scott syndrome: a disorder of platelet coagulant activity. *Semin Hematol* 1994;31:312–319.

968. McMillan R. Therapy for adults with refractory chronic immune thrombocytopenic purpura. *Ann Intern Med* 1997;126:307–314.

969. Karpatkin S. Heterogeneity of human platelets. VI. Correlation of platelet function with platelet volume. *Blood* 1978;51:307–316.

970. George JN, Lewis PC. Studies on platelet plasma membranes. III. Membrane glycoprotein loss from circulating platelets in rabbits: inhibition by aspirin-dipyridamole and acceleration by thrombin. *J Lab Clin Med* 1978;91:301–306.

971. Penington DG, Streatfield K. Heterogeneity of megakaryocytes and platelets. *Ser Haematol* 1975;8:22–48.

972. Corash L, Mok Y, Levin J, Baker G. Regulation of platelet heterogeneity: effects of thrombocytopenia on platelet volume and density. *Exp Hematol* 1990;18:205–212.

973. Aster RH. The study of platelet kinetics with <sup>51</sup>Cr-labeled platelets. In: Paulus JM, ed. *Platelet kinetics*. Amsterdam: North-Holland, 1971:317–323.

974. Kummer H, Von Muhlenen A, Laissue J. Survival of labeled and non-labeled platelets in the lethally irradiated dog: an evaluation of the <sup>51</sup>Cr-chromium method. *Helv Med Acta* 1969;35:226.

975. Thakur ML, Walsh L, Malech HL, Gottschalk A. Indium-111-labeled human platelets: improved method, efficacy, and evaluation. *J Nucl Med* 1981;22:381–385.

976. Bithell TC, Athens JW, Cartwright GE, Wintrobe MM. Radioactive diisopropyl fluorophosphate as a platelet label: an evaluation of *in vitro* and *in vivo* technics. *Blood* 1967;29:354–372.

977. Welch MJ, Thakur ML, Coleman RE, et al. Gallium-68 labeled red cells and platelets: new agents for

positron tomography. J Nucl Med 1977;18:558-562.

978. Catalano PM, Smith JB, Murphy S. Platelet recovery from aspirin inhibition *in vivo*; differing patterns under various assay conditions. Blood 1981;57:99-105.

979. Heilmann E, Friese P, Anderson S, et al. Biotinylated platelets: a new approach to the measurement of platelet life span. Br J Haematol 1993;85:729-735.

980. Harker LA, Finch CA. Thrombokinetics in man. J Clin Invest 1969;48:963-974.

981. Aster RH. Pooling of platelets in the spleen: role in the pathogenesis of "hypersplenic" thrombocytopenia. J Clin Invest 1966;45:645-657.

982. Shulman NR, Watkins SP Jr, Itscoitz SB, Students AB. Evidence that the spleen retains the youngest and hemostatically most effective platelets. Trans Assoc Am Physicians 1968;81:302-313.

983. Weiss L. A scanning electron microscopic study of the spleen. Blood 1974;43:665-691.

984. Bierman HR, Kelly KH, Cordes FL, et al. The release of leukocytes and platelets from the pulmonary circulation by epinephrine. Blood 1952;7:683.

985. Freedman M, Altszuler N, Karparkin S. Presence of a nonsplenic platelet pool. Blood 1977;50:419-425.

986. Recommended methods for radioisotope platelet survival studies: by the panel on Diagnostic Application of Radioisotopes in Hematology, International Committee for Standardization in Hematology. Blood 1977;50:1137-1144.

987. Lotter MG, Heyns AD, Badenhorst PN, et al. Evaluation of mathematic models to assess platelet kinetics. J Nucl Med 1986;27:1192-1201.

988. Heyns AD, Lotter MG, Badenhorst PN, et al. Kinetics and fate of (111)Indium-oxine labeled blood platelets in asplenic subjects. Thromb Haemost 1980;44:100-104.

989. Dale GL, Wolf RF, Hynes LA, et al. Quantitation of platelet life span in splenectomized dogs. Exp Hematol 1996;24:518-523.

990. Hill-Zobel RL, McCandless B, Kang SA, et al. Organ distribution and fate of human platelets: studies of asplenic and splenomegalic patients. Am J Hematol 1986;23:231-238.

991. Harker LA. Platelet survival time: its measurement and use. Prog Hemost Thromb 1978;4:321-347.

992. Davie EW, Ratnoff OD. Waterfall sequence for intrinsic blood clotting. Science 1964;145:1310-1312.

993. Mann KG, Bopvill EG, Srishnaswamy S. Surface-dependent reactions of the vitamin K-dependent enzyme complexes. Blood 1991;76:1-16.

994. Walsh PN. Platelet coagulant activities and hemostasis: a hypothesis. Blood 1974;43:597-605.

995. Miletich JP, Jackson CM, Majerus PW. Interaction of coagulation factor Xa with human platelets. Proc Natl Acad Sci U S A 1977;74:4033-4036.

996. Hemker HC, Lindhout MJ, Vermeer C. Blood coagulation at phospholipid surfaces. Ann N Y Acad Sci 1977;283:104-110.

997. Altieri DC, Edginton TS. Identification of effector cell protease receptor-1. A leukocyte-distributed receptor for the serine protease factor Xa. J Immunol 1990;145:246-253.

998. Nicholson AC, Nachman RL, Altieri DC, et al. Effector cell protease receptor-1 is a vascular receptor for coagulation factor Xa. J Biol Chem 1996;271: 28407-28413.

999. Bouchard BA, Carcher CS, Thrash BR, et al. Effector cell protease receptor-1, a platelet activation-dependent membrane protein, regulates prothrombinase-catalyzed thrombin generation. J Biol

Chem 1997;272:9244–9251.

1000. Kane WH, Lindhout MJ, Jackson CM, Majerus PW. Factor Va-dependent binding of factor X<sub>a</sub> to human platelets. J Biol Chem 1980;255:1170–1174.

1001. Walsh PN, Camp E, Dende D. Different requirements for intrinsic factor Xa forming activity and platelet factor 3 activity and their relationship to platelet aggregation and secretion. Br J Haematol 1978;40:311–331.

1002. Rosing J, van Rijn JL, Bevers EM, et al. The role of activated human platelets in prothrombin and factor X activation. Blood 1985;65:319–332.

1003. Ahmad SS, Rawala-Sheikh R, Walsh PN. Platelet receptor occupancy with factor IXa promotes factor X activation. J Biol Chem 1989;264:20012–20016.

1004. Saenko EL, Scandella D, Yakhyaev AV, Greco NJ. Activation of factor VIII by thrombin increases its affinity for binding to synthetic phospholipid membranes and activated platelets. J Biol Chem 1998;273:27918–27926.

1005. London F, Ahmad SS, Walsh PN. Annexin V inhibition of factor IXa-catalyzed factor X activation on human platelets and on negatively-charged phospholipid vesicles. Biochemistry 1996;35:16886–16897.

1006. Sporn LA, Chavin SI, Marder VJ, Wagner DD. Biosynthesis of von Willebrand protein by human megakaryocytes. J Clin Invest 1985;76:1102–1106.

1007. Nachman RL, Jaffe EA. Subcellular platelet factor VIII antigen and von Willebrand factor. J Exp Med 1975;141:1101–1113.

1008. Rao LV, Rapaport SI. Activation of factor VII bound to tissue factor: a key early step in the tissue factor pathway of blood coagulation. Proc Natl Acad Sci U S A 1988;85:6687–6691.

1009. Broze GJ Jr. Tissue factor pathway inhibitor and the revised theory of coagulation. Annu Rev Med 1995;46:103–112.

1010. Almus FE, Rao LVM, Rapaport SI. Functional properties of factor VIIa/tissue factor formed with purified tissue factor and with tissue factor expressed on cultured endothelial cells. Thromb Haemost 1989;62:1067–1073.

1011. Walsh PN. Roles of platelets and factor XI in the initiation of blood coagulation by thrombin. Thromb Haemost 2001;86:75–82.

1012. Colman RW. Biologic activities of the contact factors *in vivo*: potentiation of hypotension, inflammation, and fibrinolysis; and inhibition of cell adhesion, angiogenesis, and thrombosis. Thromb Haemost 1999;82:1568–1577.

1013. Gailani D, Broze GJ Jr. Factor XI activation in a revised model of blood coagulation. Science 1991;253:909–912.

1014. Naito K, Fujikawa K. Activation of human blood coagulation factor XI independent of factor XII. Factor XI is activated by thrombin and factor XIa in the presence of negatively charged surfaces. J Biol Chem 1991;266:7353–7358.

1015. Walsh PN, Griffin JH. Contributions of human platelets to the proteolytic activation of blood coagulation factors XII and XI. Blood 1981;57:106–118.

1016. Sinha D, Seaman FS, Walsh PN. Role of calcium ions and the heavy chain of factor XIa in the activation of human coagulation factor IX. Biochemistry 1987;26:3768–3775.

1017. Baglia FA, Badellino KO, Ho DH, et al. A binding site for the kringle II domain of prothrombin in the apple I domain of factor XI. J Biol Chem 2000;275:31954–31962.

1018. Rapaport SI, Proctor RR, Patch MJ, Yettra M. The mode of inheritance of PTA deficiency: evidence

for the existence of a major PTA deficiency and a minor PTA deficiency. *Blood* 1961;18:149–155.

1019. Shirk RA, Konkle BA, Walsh PN. Nonsense mutation in exon V of the factor XI gene does not abolish platelet factor XI expression. *Br J Haematol* 2000;111:91–95.

1020. Byzova TV, Plow EF. Networking in the hemostatic system. Integrin  $\alpha$ IIb $\beta$ 3 binds prothrombin and influences its activation. *J Biol Chem* 1997;272: 27183–27188.

1021. Swords NA, Tracy PB, Mann KG. Intact platelet membranes, not platelet-released microvesicles, support the procoagulant activity of adherent platelets. *Arterioscler Thromb* 1993;13:1613–1621.

1022. Walsh PN, Sinha D, Kueppers F, et al. Regulation of factor XIa activity by platelets and alpha I-protease inhibitor. *J Clin Invest* 1987;80:1578–1586.

1023. Chesney CM, Pifer D, Colman RW. Subcellular localization and secretion of factor V from human platelets. *Proc Natl Acad Sci U S A* 1981;78:5180–5184.

1024. Rand MD, Kalafatis M, Mann KG. Platelet coagulation factor Va: the major secretory phosphoprotein. *Blood* 1994;83:2180–2190.

1025. Tracy PB, Giles AR, Mann KG, et al. Factor V (Quebec): a bleeding diathesis associated with a qualitative platelet factor V deficiency. *J Clin Invest* 1984;74:1221–1228.

1026. Hayward CP, Cramer EM, Kane WH, et al. Studies of a second family with the Quebec platelet disorder: evidence that the degradation of the  $\alpha$ -granule membrane and its soluble contents are not secondary to a defect in targeting proteins to  $\alpha$ -granules. *Blood* 1997;89:1243–1253.

1027. Louache F, Debili N, Cramer E, et al. Fibrinogen is not synthesized by human megakaryocytes. *Blood* 1991;77:311–316.

1028. Nachman RL, Marcus AJ, Zucker-Franklin D. Immunological studies of proteins associated with subcellular fractions of normal human platelets. *J Lab Clin Med* 1967;69:651–668.

1029. Tsuji S, Sugimoto M, Miyata S, et al. Real-time analysis of mural thrombus formation in various platelet aggregation disorders: distinct shear-dependent roles of platelet receptors and adhesive proteins under flow. *Blood* 1999;94:968–975.

1030. Schmaier AH. Platelet forms of plasma proteins: plasma cofactors/substrates and inhibitors contained within platelets. *Semin Hematol* 1985;22: 187–202.

1031. Jenkins CS, Phillips DR, Clemetson KJ, et al. Platelet membrane glycoproteins implicated in ristocetin-induced aggregation. Studies of the proteins on platelets from patients with Bernard-Soulier syndrome and von Willebrand's disease. *J Clin Invest* 1976;57:112–124.

1032. Kappelmayer J, Bacsko B, Birinyi L, et al. Consecutive appearance of coagulation factor XIII subunit A in macrophages, megakaryocytes, and liver cells during early human development. *Blood* 1995;86:2191–2197.

1033. Schmaier AH, Smith RM, Purdon AD, et al. High molecular weight kininogen: localization in unstimulated and activated platelets; and activation by platelet calpain(s). *Blood* 1986;67:119–130.

1034. Schwarz HP, Heeb MJ, Wencel-Drake JD, Griffin JH. Identification and quantitation of protein S in human platelets. *Blood* 1985;66:1452–1455.

1035. Harris KW, Esmon CT. Protein S is required for bovine platelets to support activated protein C binding and activity. *J Biol Chem* 1985;260:2007–2010.

1036. Schmaier AH, Dahl LD, Rozemuller AJM, et al: Protease nexin-2/amyloid  $\beta$  protein precursor. A tight-binding inhibitor of coagulation factor IXa. *J Clin Invest* 1993;92:2540–2545.

1037. Pollard TD, Fujiwara K, Handin R, Weiss G. Contractile proteins in platelet activation and contraction. *Ann N Y Acad Sci* 1977;283:218.

1038. Leistikow EA. Platelet internalization in early thrombogenesis. *Semin Thromb Hemost* 1996;22:289-294.

1039. Rooney MM, Farrell DH, van Hemel BM, et al. The contribution of the three hypothesized integrin-binding sites in fibrinogen to platelet-mediated clot retraction. *Blood* 1998;92:2374-2381.

2004 Lippincott Williams & Wilkins  
John P. Greer, John Foerster, John N. Lukens  
George M. Rodgers, Frixos Paraskevas, Bertil Glader  
Wintrobe's Clinical Hematology

## Platelet Function in Hemostasis and Thrombosis

### PLATELET ADHESION AND ACTIVATION

Platelet Glycoprotein Ib Complex–von Willebrand Factor Interaction and Signaling

Platelet–Collagen Interaction and Signaling

Platelet Thrombin (Protease-Activated) Receptors and Signaling

Platelet Adenosine Diphosphate (Purinergic) Receptors and Signaling

Platelet Activation by Soluble Agonists

Physiologic Inhibition of Platelet Activation

Platelet Secretion

### PLATELET AGGREGATION: $\alpha$ IIb $\beta$ 3 RECEPTOR AND ITS SIGNALING MECHANISMS

Integrin  $\alpha$ IIb $\beta$ 3 Antagonists

### PLATELET RECEPTOR POLYMORPHISMS AND THROMBOTIC RISK

Glycoprotein Ib Complex

$\alpha$ 2B1 Receptor

Platelet Glycoprotein VI

$\alpha$ IIb $\beta$ 3 Receptor

### ROLE OF THE CYTOSKELETON IN PLATELET FUNCTION

### PLATELET–CELL INTERACTIONS

Platelets and Endothelium

Platelets and White Blood Cells

### ROLE OF PLATELETS IN ATHEROTHROMBOSIS

### REFERENCES

## PLATELET ADHESION AND ACTIVATION

Primary hemostasis and arterial thrombosis are the results of a complex series of cell–cell, cell–protein, and protein–protein reactions that involve platelets, leukocytes, subendothelial matrix, and plasma proteins, such as fibrinogen, von Willebrand factor (vWF), and others. The consequences of arterial thrombosis include such events as myocardial infarction (MI), unstable angina, and stroke. These clinicopathologic entities and their associated cellular physiologic mechanisms that are outlined in this chapter collectively account for the largest cause of morbidity and mortality in the Western world.

### Platelet Glycoprotein Ib Complex–von Willebrand Factor Interaction and Signaling

For a long time, it has been recognized that interaction of the platelet glycoprotein (gp) Ib “complex” (including the single–chain polypeptides gpIba, gpIb $\beta$ , gpIX, and gpV) with its primary ligand, vWF, is the receptor–ligand pairing that initiates platelet activation followed by a cascade of events leading to pathologic thrombosis or physiologic hemostasis. A unique aspect of this receptor–ligand interaction is that it requires the presence of high arterial shear rates to take place, thus explaining the predisposition of platelet–rich “white clots” for the arterial circulation over clots found in the venous circulation with its relatively lower shear forces in which clot formation takes place independent of the gpIb complex.

Using a parallel plate flow cytometer, platelet interaction with subendothelial vWF has



been characterized as occurring in a biphasic fashion (1). In this respect, the rate of translocation of platelets from blood to the endothelial surface increased linearly up to wall shear rates of 1500 sec<sup>-1</sup>, whereas the translocation rate remained relatively constant with the wall shear rate between 1500 and 6000 sec<sup>-1</sup>. This ability to mediate translocation or rolling of the platelet on vWF is contingent on the gpIb complex, and mammalian cells expressing either the full complex or a complex lacking the gpV subunit were able to roll onto vWF in a gpIba-chain-dependent manner (2, 3).

It is clear that arterial thrombus formation is contingent on both the presence of high wall shear rates and interaction between the gpIb complex and vWF. Studies involving the endpoint of real-time thrombus formation that involved comparison of both blood from patients with Bernard-Soulier syndrome (that lacks platelet gpIb complex) and severe (type 3) von Willebrand disease versus normal blood led to the conclusion that gpIb and vWF interaction was required for platelet surface interaction at high shear rates [ $>1210$  sec<sup>-1</sup>], whereas normal thrombus formation at lower shear rates [ $<340$  sec<sup>-1</sup>] was possible with blood deficient in either gpIb or vWF (4). In normal blood, thrombus formation was accelerated as shear rate increased, and this served to verify the unique shear flow dependence of this receptor-ligand interaction.

The gpIb complex consists of four transmembrane subunits, each of which is a member of the leucine-rich repeat protein superfamily that participates in cell-matrix interactions throughout nature. Each of the four subunits contains one or more tandem, 24-amino acid leucine-rich repeats flanked by conserved disulfide loop structures at both the N- and C-termini of the repeats (5). gpIba is covalently associated with the gpIb $\beta$ -chain through disulfide linkage of cysteine residues, and both of these chains are noncovalently associated with gpIX in a 1:1 ratio and with gpV in a 2:1 ratio (6, 7 and 8) (Fig. 20.1). The structural aspects of the gpIb complex are examined in greater depth in Chapter 19.



**Figure 20.1.** Glycoprotein (GP) Ib complex. GPIba disulfide linked to GPIb $\beta$  is noncovalently associated with GPIIX and GPV in the ratio of 2:2:2:1. Phosphorylation sites within the cytoplasmic tails of GPIba (Ser 609) and GPIb $\beta$  (Ser 166) are indicated by a circled P. (From Berndt MC, Shen Y, Doppeide SM, et al. The vascular biology of the glycoprotein Ib-IX-V complex. *Thromb Haemost* 2001;86:180, with permission.)

vWF is a large multimeric glycoprotein that circulates in plasma and is also found in platelets and the Weibel-Palade bodies of endothelial cells. Mature vWF is a 2050-amino acid subunit that is disulfide linked into large multimers. It contains three adjacent A domains in the N-proximal half of the peptide that collectively regulate the adhesion of platelets to subendothelial matrix. In this respect, the A<sub>1</sub> and A<sub>3</sub> domains bind to different matrix collagens, whereas the A<sub>1</sub> domain contains the binding site for the gpIb complex (9). The A<sub>1</sub> domain is the primary role player in platelet adhesion because this

part of the molecule is believed to change its conformation in response to immobilization and high shear forces, thus making it a high-affinity ligand for the gpIb complex receptor ( [10](#), [11](#) ). It has also been suggested that shear stresses may induce conformational changes in the gpIb complex that may be important in increasing its affinity for vWF ( [12](#) ).

To further add to the mystery behind the mechanism of shear dependence in gpIb-vWF interaction, *in vitro* activation of vWF and binding to the gpIb complex occur with generally very low affinity without shear, whereas this shear-free binding exhibits high affinity in the presence of the vancomycin-like antibiotic ristocetin and viper venom proteins, such as botrocetin. Interestingly, studies incorporating anti-gpIba and anti-vWF domain A<sub>1</sub> antibodies have suggested that ristocetin and botrocetin each appear to use different receptor and ligand-binding sites to facilitate vWF-gpIb complex interaction ( [13](#), [14](#) and [15](#) ).

The binding interaction between vWF and gpIb appears to involve at least three distinct regions within the N-terminal 282 residues of gpIb. Each of these regions appears to be responsible for either direct binding to vWF or modulating its affinity for the ligand ( [16](#) ). In this respect, one region (His 1 to Glu 282) that includes a cluster between residues Asp 252 and Arg 293 containing sulfated tyrosine residues and important anionic residues appears to be predominantly responsible for vWF-gpIb complex interaction in the presence of botrocetin over ristocetin ( [17](#), [18](#), [19](#) and [20](#) ).

The second region contains the disulfide loop between Cys 209 and Cys 248 along with two naturally occurring mutations (Gly 233 to Val and Met 239 to Val) and two additional mutation sites identified in the laboratory (Asp 235 to Val and Lys 237 to Val) that can individually lead to expression of the pseudo- or platelet-type von Willebrand disease phenotype ( [21](#) ). This disorder is associated with a gain-of-function gpIba on platelets that adheres to vWF in the presence of lower concentrations of ristocetin (0.3 to 0.5 mg/ml) than is required for the wild-type phenotype (1.5 mg/ml). It is analogous to type 2B von Willebrand disease, in which high-molecular-weight vWF multimers are absent from the plasma, and similar gain-of-function mutations have been localized to the Cys 509 to Cys 695 disulfide loop of vWF exon 28.

The third region includes the N-terminal flanking sequence to the leucine-rich repeat (LRG) motifs and the LRGs themselves. Mutations involving single amino acid residues within these LRGs account for some cases of the congenital bleeding disorder Bernard-Soulier syndrome in which the gpIb complex binds poorly or not at all to vWF. Evidence using mammalian Chinese hamster ovary cells expressing loss-of-function proteins and anti-gpIba monoclonal antibodies has suggested that the more N-terminal LRGs may play a more direct role in interaction with vWF ( [22](#) ).

**GLYCOPROTEIN IB COMPLEX INTERACTION WITH THROMBIN** Recent studies have examined the potential role of the gpIb complex in thrombin-mediated platelet activation. The physiologic significance of the interaction of thrombin with the complex has remained relatively controversial. gpIba contains a well-characterized high-affinity binding site for thrombin (see [Chapter 19](#)), and thrombin is also capable of cleaving gpV near the surface to release a soluble fragment ( [23](#) ). Recent studies have suggested that a relationship exists between thrombin binding to the gpIb complex and cleavage of the seven-transmembrane G protein-coupled protease-activated thrombin receptor, protease-activated receptor (PAR)-1 [see the section [Platelet Thrombin \(Protease-Activated\) Receptors and Signaling](#)], and that accelerated coagulation on the surface of a developing thrombus is a downstream consequence of thrombin-gpIb interaction because of enhanced phospholipid exposure ( [24](#), [25](#) ). These studies support a procoagulant role of this thrombin-gpIb pairing. In contrast, studies using gpV-null mice have suggested that the gpV subunit may act as a negative regulator of

thrombin-mediated platelet activation, whereas data from another study suggest that thrombin-gpIb interaction leads to conformational changes in thrombin that reduce its cleavage of fibrinogen ( [26](#), [27](#) ). The phenotype of a gpIba knock-out mouse has been reported and was similar in many ways to human Bernard-Soulier syndrome ( [28](#) ). This mouse was then capable of having the wild-type phenotype restored by a human gpIba transgene. Future use of this mouse model might be helpful toward further elucidation of the physiologic role of platelet gpIb complex interaction with thrombin ( [29](#) ). In the meantime, the current data extend further support for a role for the gpIb complex as a thrombin receptor on platelets, whereas, recent insights notwithstanding, elucidation of the downstream consequences of that interaction with respect to platelet activation and thrombus formation will remain the subject of further investigation. Studies have focused on interaction of the gpIb complex with activated, intact endothelium through ligands other than vWF adherent to subendothelial matrix. These include a study of a reversible association of gpIb with endothelial cell P-selectin, which is examined in more detail in the section [Platelets and Endothelium](#). The interaction of platelet gpIb with the neutrophil adhesion receptor Mac-1 is discussed in the section [Platelets and White Blood Cells](#). One 1999 study has documented the dependence of fibrin-associated platelet procoagulant activity on both the gpIb complex and vWF ( [30](#) ).

**GLYCOPROTEIN IB COMPLEX SIGNALING** When the gpIb complex interacts with its vWF ligand under conditions of elevated shear stress, there is abundant evidence that signaling pathways are activated that lead to (a) elevation of intracellular calcium; (b) activation of protein kinase C (PKC), phosphoinositide 3-kinase (PI3K), and tyrosine kinases such as c-src; and (c) inside-out signaling through the  $\alpha_{IIb}\beta_3$  integrin followed by platelet aggregation ( [16](#) ). Recent attention with respect to downstream events after gpIb receptor occupancy has been directed to the roles of (a) the homodimeric signaling protein 14-3-3, (b) receptor cross-linking, and (c) the immunoreceptor tyrosine-based activation motif (ITAM)-containing proteins Fc $\gamma$  receptor IIA (Fc $\gamma$ RIIA) and Fc receptor (FcR)  $\gamma$ -chain. 14-3-3 $\gamma$  is among the ten isoforms of the 14-3-3 family of proteins that is named according to its electrophoretic gel migration position. Functionally, this family has a wide range of activities, including participating as a DNA damage cell cycle checkpoint protein, regulation of PKC activity, formation of heterotrimers with the signaling kinase Raf and the guanosine triphosphate exchange factor Ras, and so forth ( [31](#), [32](#) and [33](#) ). Binding sites for 14-3-3 have been identified in the cytoplasmic domains of gpIba, gpIb $\beta$ , gpIX, and gpV. In this respect, peptide fragments corresponding to overlapping cytoplasmic sequences of the four subunits demonstrated binding *in vitro*, whereas yeast two-hybrid studies documented *in vivo* interaction between 14-3-3 $\gamma$  and both gpIba and  $\beta$  ( [34](#), [35](#) ). Site-directed mutagenesis and protein binding experiments confirmed the need for phosphorylation of Ser 166 of the 14-3-3 consensus sequence in the gpIb $\beta$  cytoplasmic domain to permit high-affinity 14-3-3 binding ( [35](#), [36](#) ). More recent findings that have evolved in lieu of the above observations include the binding of fibrinogen to mammalian cell-transfected  $\alpha_{IIb}\beta_3$  in response to vWF binding to cotransfected gpIb-IX that was inhibited when the 14-3-3 binding domain was deleted from the gpIb-IX transfectant ( [37](#) ). Also, the lipid kinase PI3K has been found to play a role in this gpIb-IX dependence of  $\alpha_{IIb}\beta_3$  activation through its participation in complex formation with the gpIb complex and 14-3-3 ( [38](#) ). The reason for these associations would be to regulate, in short order, the formation of inositols phosphorylated in the 3-position within the reorganizing cytoskeleton in response to platelet activation (see the section [Role of the Cytoskeleton in Platelet Function](#)) ( [16](#) ). It has been shown that the binding between gpIba and 14-3-3 is disrupted in response to binding of the former to vWF under high shear stress, and this disruption is, in turn, blocked by the prostaglandin (PG), prostacyclin (PGI<sub>2</sub>) ( [36](#) ). Inhibition of platelet activation by PGI<sub>2</sub> works through its interaction with specific G protein-coupled receptors on the platelet surface, resulting in the activation of adenylyl cyclase that induces the formation of cyclic adenosine monophosphate (cAMP). This mediator, in turn,

activates cAMP-dependent kinases [also called *A kinases or protein kinase A (PKA)*], which phosphorylate specific proteins that inhibit platelet activation. Ser 166 of gpIb $\beta$  is phosphorylated by PKA that has itself been activated by PG-driven cAMP. It is, therefore, reasonable to speculate that gpIb $\beta$ -14-3-3 association may be playing a role in maintaining signaling through the gpIb-cytoskeleton complex in a switched-off or resting state and that it is capable of undergoing transition to an activated state when shear-dependent interaction of gpIba with vWF takes place. Many adhesion receptors initiate signaling through cross-linking, and there is evidence to suggest that the gpIb complex may also use this mechanism. gpV subunit surface expression on platelets is roughly half that of the other three subunits (12,000 vs. 25,000 copies per cell). It has also been suggested that two or more gpIba subunits cluster into a complex with the other glycoprotein subunits ([39](#)). The fact that there is one gpV subunit available in this complex for every two of the other subunits, and that both actin-binding protein (ABP; a membrane skeleton protein that associates with gpIba; see later in the chapter) and 14-3-3 exist as dimers, lends support to the concept of a complex consisting of a pair of gpIba-gpIb $\beta$ -gpIX trimers joined noncovalently by a single gpV monomer ([Fig. 20.1](#)). Two 1999 studies interestingly documented association of the gpIb complex with the 14-kd FcR $\gamma$ -chain ([40](#)) and with the 40-kd Fc $\gamma$ RIIA receptor ([41](#)). Both of these proteins contain nonidentical but similar ITAM domain sequences. The FcR $\gamma$ -chain forms a complex with the gpVI monomer and plays an essential role in collagen-mediated platelet activation, as reviewed in the next section. The Fc $\gamma$ RIIA receptor is a member of the immunoglobulin (Ig) superfamily and is without a clearly defined physiologic role in platelets. Occupancy of this receptor by the C-terminal Fc domains of Ig leads to platelet activation, and this is blocked by anti-gpIba antibodies, whereas signaling through vWF is also blocked with anti-Fc $\gamma$ RIIA antibodies ([41](#), [42](#)). Both ITAM-containing receptors can be coimmunoprecipitated with gpIb ([40](#), [42](#)), and both have very similar signaling pathways that involve the tyrosine kinase Syk and phospholipase C (PLC) $\gamma$ 2 ([43](#), [44](#) and [45](#)). Although the physical proximities of these three players have recently become apparent, the nature and significance of any physiologic relationships that exist between the gpIb complex and these two ITAM receptors with respect to vWF-dependent platelet activation is presently unclear.

## Platelet-Collagen Interaction and Signaling

Collagens are very important activators of platelets in the vascular subendothelium and vessel wall, and thus are prime candidates for therapeutic intervention in patients experiencing a pathologic arterial thrombotic event such as MI or stroke. Platelets have two major surface receptors for collagen, the integrin  $\alpha$ <sub>2</sub> $\beta$ <sub>1</sub> and the Ig superfamily member gpVI. The former is considered to be the primary player in platelet adhesion, whereas gpVI is currently believed to play a role in signaling and subsequent platelet activation. In addition to these two surface receptors, the gpIb complex can also be considered an indirect collagen receptor because its subendothelial vWF ligand essentially acts as a bridging molecule between platelets and collagen by fixing itself to the latter that, in turn, acts as scaffolding for the multimers.

The molecular sequence of events by which subendothelial collagen fibrils bind to and activate platelets is presently unknown, and large parts of this area remain controversial and poorly understood ([46](#), [47](#)). Collagen supports platelet adhesion through interaction with the integrin surface receptor  $\alpha$ <sub>2</sub> $\beta$ <sub>1</sub>, although this interaction alone does not support platelet activation ([46](#), [48](#)). Laboratory evidence suggests gpVI and the 14-kd FcR $\gamma$ -chain signaling subunit (FcR $\gamma$ -chain) with which gpVI forms a complex are both required for collagen-mediated platelet adhesion and activation ([43](#), [48](#), [49](#), [50](#), [51](#), [52](#), [53](#), [54](#), [55](#), [56](#), [57](#), [58](#) and [59](#)). In addition to these two players, evidence has recently emerged for the possible

roles of additional platelet surface receptor and is reviewed later in this section.

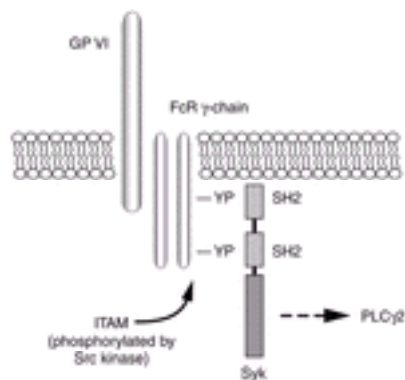
**$\alpha_2\beta_1$  RECEPTOR** The platelet collagen receptor to be first identified and characterized was the integrin  $\alpha_2\beta_1$  receptor, also known as *gpIa/IIa*, and on lymphocytes as *VLA-2* (60). Integrins are a family of  $\alpha$ - $\beta$  heterodimers on the surface of cells that carry out a diverse array of interactions between the cell surface and its environment that ultimately leads to changes in cell behavior in response to the ligand-receptor interaction. In all  $\alpha$  subunits of integrins, seven tandem repeats are localized to the *N*-terminal end and folded into a seven-bladed  $\beta$  propeller structure (61). The  $\alpha_2$  subunit also contains an I domain between the second and third repeats that includes a metal coordination site for  $Mg^{2+}$  that is critical for interaction with collagen (47). Similar domains are found on the  $\beta$  subunit, although less is known about these, and it appears that the interaction of  $\alpha_2\beta_1$  with collagen involves only the I domain of  $\alpha_2$ . The  $\beta_1$  subunit exhibits a cysteine-rich domain containing CGXC sequences that is close to the membrane surface. This region has protein disulfide isomerase activity that is responsible for regulating conformational changes of the  $\beta_1$  subunit (which, in turn, alters  $\alpha_2$  conformation, increasing its avidity for collagen) in response to inside-out signaling through the cytoplasmic domain (62, 67). Thus, the  $\alpha_2\beta_1$  integrin is probably regulated by this endogenous disulfide isomerase activity that rearranges the cysteine-rich domains of  $\beta_1$  and thereby alters the high-affinity state of the I domain on  $\alpha_2$ . In 1991, the so-called two-step, two-site model was proposed by Santoro and colleagues to explain interaction between platelets and collagen (63). The hypothesis speculated that collagen needed to first interact with  $\alpha_2\beta_1$  (adhesion) before it was able to initiate transmission of intracellular signals leading to platelet activation. Since then, much evidence has accumulated that the "second site" responsible for platelet activation is gpVI, as outlined below. For this model to hold true, it is presumed that conformational change in  $\alpha_2\beta_1$  would not be a necessary prerequisite for its ability to adhere to collagen. However, recent data have suggested that when the platelet interacts with other agonists besides collagen, subsequent activation will increase the affinity between  $\alpha_2\beta_1$  and collagen (64, 65). This evidence lends support to  $\alpha_2\beta_1$  undergoing some sort of conformational change after inside-out signaling initiated by some noncollagen agonist that then optimizes its adhesive affinity for subendothelial collagen. To further muddy the waters, it is known that under high shear stress conditions typically present in the arterial circulation, the interaction between platelets and collagen is much reduced if either the gpIb complex or its plasma vWF ligand is absent or blocked. So although  $\alpha_2\beta_1$  and gpVI may be principally responsible for platelet adhesion to collagen followed by activation under low shear or static conditions, the prospect of this receptor pair mediating activation in high shear conditions may not be a tenable one without the brakes first being applied by gpIb complex-subendothelial vWF interaction.

**GLYCOPROTEIN VI RECEPTOR** Although the gpVI receptor was identified on the surface of platelets in 1982, its role in collagen-mediated platelet activation was not appreciated until much later (66). The human and murine genes were recently cloned and characterized, and it was found to be a member of the Ig superfamily (59, 67, 68 and 69). The expression of gpVI in platelets is very closely associated with that of the 14-kd FcR $\gamma$ -chain, which also serves as the signaling subunit for gpVI (70, 71). Expression of gpVI on mouse platelets appears to be dependent on FcR $\gamma$ -chain expression, and the latter has also been found to be critical for collagen-mediated platelet activation (54, 71). gpVI has two Ig C2 loops, and the *N*-terminal loop likely contains the collagen-binding domain (47). It appears that gpVI has a requirement for the quaternary structure of collagen to be in a triple helical conformation for the two to associate (72). Whether gpVI is capable of participating in platelet adhesion to collagen is unclear. If it is, evidence from one study suggests that it may be through activation of  $\alpha_2\beta_1$  (73). Further studies incorporating collagen-related peptides (arranged in triple helical structures with



sequences similar to collagen) and the snake venom convulxin as agonists have been shown to signal by clustering gpVI molecules on the surface (51, 56, 74). However, the idea of gpVI receptor clustering as a platelet activation mechanism applicable to collagen is tempered by consideration of the theoretically much greater distances that would exist between adjacent gpVI binding sites along fibrillar collagen compared with the larger noncovalently linked structures of convulxin in which gpVI binding site distribution is much different (75).

**PLATELET-COLLAGEN SIGNALING** The gpVI signaling pathway has been found to be both essential and sufficient for collagen-mediated platelet activation (76). The gpVI/FcR $\gamma$ -chain complex leads to platelet activation through a pathway that has many aspects in common with signaling by immune receptors, such as the Fc receptor family (of which Fc $\gamma$ RIIA is the lone family member found in platelets) and the B- and T-cell antigen receptors (Fig. 20.2). Much of what we know about gpVI signaling has been based on earlier work related to immune receptor signaling (77, 78).

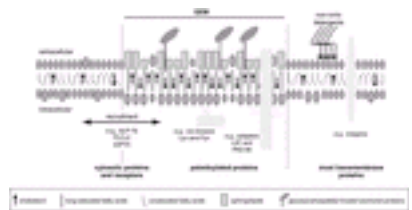


**Figure 20.2.** Collagen activates platelets through the same pathway as an immune receptor. Cross-linking of the glycoprotein (GP) VI/Fc receptor (R)  $\gamma$ -chain leads to tyrosine phosphorylation of the immunoreceptor tyrosine-based activation motif (ITAM) sequence, enabling recruitment of the tyrosine kinase (Syk) through its tandem Src-homology 2 (SH2) domains. This leads to autophosphorylation and subsequent activation of Syk, which in turn leads to tyrosine phosphorylation of phospholipase C $\gamma$ 2 (PLC $\gamma$ 2). A large number of proteins are implicated in the regulation of PLC $\gamma$ 2, as discussed in the text. YP, phosphotyrosine. (From Watson SP. Collagen receptor signalling in platelets and megakaryocytes. *Thromb Haemost* 1999;82:367, with permission.)

Immunoreceptors like the Fc receptors and the FcR $\gamma$ -chain all have the ITAM in common. Tyrosine phosphorylation of the ITAM by Lyn and Fyn of the Src family of tyrosine kinases takes place after activation of gpVI. The phosphorylated Src kinase, in turn, leads to activation of the tyrosine kinase Syk after its autophosphorylation (79). Syk then initiates a downstream signaling cascade involving the membrane linker of activated T cells (LAT) adapter protein that leads to recruitment to the plasma membrane and activation of the cytosolic second messenger-producing enzymes PI3K and PLC $\gamma$ 2. PI3K leads to the generation of PI3,4,5P3 (PIP3), and this, in turn, supports recruitment of a member of the Tec kinase family, Btk, to the membrane along with recruitment of PLC $\gamma$ 2 to the membrane signalosome complex (80). Syk is critical for collagen-mediated platelet activation through the gpVI/FcR $\gamma$ -chain complex, and knock-out mouse studies have shown that absence of this enzyme leads to loss of phosphorylation of LAT, the adapter SLP-76, and PLC $\gamma$ 2 (43, 81, 82). Adapters such as LAT are modular proteins without enzyme activity that support protein-protein interaction. Many adapter proteins appear to participate in the regulation of PLC $\gamma$ 2, including LAT and SLP-76, among others. These proteins appear to come together in T lymphocytes along with PLC $\gamma$ 2 to form a LAT/SLP-76 signalosome that is essential for activation of PLC $\gamma$ 2 (83). SLP-76 is thought to be especially important among adapters in the regulation of PLC $\gamma$ 2. Along with the adapter proteins noted above, PI3K and its associated second messenger pathway

also play a very important role in the regulation of PIC $\beta$ . Using PI3K inhibitors like wortmannin and LY294002, studies have demonstrated significantly reduced PIC $\beta$  activation through gpVI ( [84](#), [85](#) ). These inhibitors have also been shown to block platelet activation through the Fc $\gamma$ RIIA immunoreceptor, and this demonstrates an additional similarity between signaling pathways of this receptor and the Fc $\gamma$ -chain ( [86](#) ). The functional domains of PIC $\beta$  with respect to its translocation to the membrane, the location of its phosphorylation sites, and the downstream signaling consequences of its phosphorylation remain to be determined. This enzyme is known to play a critical role in aggregation and secretion responses to collagen, as demonstrated in PIC $\beta$  knock-out mice and in other studies ( [45](#), [85](#), [87](#) ). The major role of PIC isoforms is concerned with the generation of the second messengers inositol 1,4,5-triphosphate and 1,2-diacylglycerol (DAG) that participate in intracellular calcium homeostasis and activation of PKC, respectively.

**GLYCOLIPID-ENRICHED MEMBRANE DOMAINS (MEMBRANE RAFTS) AND PLATELET-COLLAGEN SIGNALING** Some of the proteins that are key to signaling through immune receptors, such as the platelet Fc $\gamma$ -chain and Fc $\gamma$ RIIA, have recently been recognized to associate within specialized regions of the membrane referred to as *glycolipid-enriched membrane domains* (GEMs), also known as *membrane rafts* ( [88](#) ). GEMs are abundant in cholesterol, sphingolipids, and long-saturated fatty acids along with many of the signaling proteins of ITAM-associated pathways. These domains are attached to the cytoskeleton internally (so cytoskeletal proteins are close to receptor signaling sites), and the extracellular proteins associated with them are glycosyl-phosphatidyl-inositol-anchored proteins ( [Fig. 20.3](#) ). Other cytosol and transmembrane proteins such as LAT, Fyn, and Lyn are attached through palmitoylation of cysteine residues. These proteins and others have been shown to be attracted to GEM sites after membrane receptor activation, although gpVI has also been found in the soluble, non-GEM fractions associated with these experiments.



**Figure 20.3.** Structure of glycolipid-enriched membrane domains (GEMs). Immune receptor signaling is believed to take place in specialized regions of the membrane known as *GEMs*. They are rich in glycoprotein (GP) I-linked extracellular proteins and palmitoylated cytosolic proteins, and many proteins are also excluded from this region. Additional proteins are recruited into GEMs on receptor activation. See text for details. LAT, linker of activated T cells; PLC, phospholipase C. (From Watson SP, Asazuma N, Atkinson B, et al. The role of ITAM- and ITIM-coupled receptors in platelet activation by collagen. *Thromb Haemost* 2001;86:281, with permission.)

The protein composition of GEMs can be studied with the use of nonionic detergents, such as Triton-X-100, and sucrose density gradient isolation of GEM-associated proteins ( [79](#) ). Experiments have demonstrated how proteins associated with collagen signaling, such as Fyn, Lyn, and Syk, are recruited to the GEM fraction after platelet stimulation through the gpVI/Fc $\gamma$ -chain complex that, itself, was also associated with rafts ( [89](#) ). Inhibition of both gpVI-associated platelet aggregation and secretion along with tyrosine phosphorylation of signaling molecules was observed when the cholesterol-depleting agent  $\beta$ -methyl cyclodextrin was incorporated into the experiments of these groups.

### Platelet Thrombin (Protease-Activated) Receptors and Signaling

PARs are G protein-coupled receptors that use a unique mechanism to convert an



extracellular protein cleavage event into an intracellular activation signal. In this case, the ligand is already part of the receptor per se by virtue of the fact that it is represented by the amino acid sequence SFLLRN (residues 42 through 47) and is unmasked as a new amino terminus after thrombin cleaves the peptide bond between Arg 41 and Ser 42. This “tethered ligand” then proceeds to irreversibly dock with the body of its own receptor to effect transmembrane signaling as shown in [Figure 20.4](#).



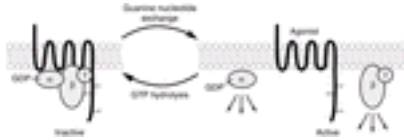
**Figure 20.4.** Protease-activated receptor-1, a typical G protein-coupled receptor. Potential sites are indicated for cleavage by thrombin and cathepsin, *N*-linked glycosylation, and phosphorylation by protein kinases, including protein kinase C (PKC), protein kinase A (PKA), and  $\beta$ -adrenergic receptor kinase (BARK). (From Brass LF. Molecular basis of platelet activation. In: Hoffman R, et al., eds. Hematology: basic principles and practice. New York: Churchill-Livingstone, 2000:1755, with permission.)

Thrombin signaling in platelets is mediated, at least in part, by four members of a family of G protein-coupled PARs (PAR-1, -2, -3, and -4) (see previous section for a discussion of the gpIb complex as a thrombin receptor) ([90](#)). Human platelets express PAR-1 and PAR-4, and activation of either is sufficient to trigger platelet aggregation ([91](#), [92](#)). Mouse platelets express PAR-3 and PAR-4 ([93](#)). PAR-1, -3, and -4 can be activated by thrombin, whereas PAR-2 can be activated by trypsin, tryptase, and coagulation factors VIIa and Xa but not thrombin ([94](#), [95](#), [96](#) and [97](#)). Presumably, other proteases are capable of recognizing the active sites of these receptors and can thus also trigger PAR signaling.

PAR-1 is the prototype family member and was the first to be cloned and characterized in the human and hamster ([91](#), [98](#)). Synthetic peptide that mimics the PAR-1 tethered ligand (SFLLRN) is capable of functioning as an agonist by activating the receptor independent of cleavage of the 41 residue *N*-terminal exodomain.

The mechanism by which G protein-coupled receptors, such as PAR-1, signal through the G proteins is shown in [Figure 20.5](#). PAR-1 is capable of coupling to members of the G12/13, Gq, and Gi/z families and, thus, is connected to a significant number of intracellular signaling pathways. The  $\alpha$  subunits of G12 and G13 are believed to be involved in mediating platelet shape change ([99](#)), and downstream signaling mediators include Rho family members among others. The  $\alpha$  subunit of Gq is needed for platelet secretion and aggregation and participates in activation of PICB that leads to calcium

mobilization and PKC activation ( [100](#), [101](#) ). The  $\alpha$  subunit of  $G_{\alpha z}$  is a  $G_i$  family member that has been speculated to play an epinephrine-like role in human platelets through inhibition of adenylyl cyclase ( [29](#), [102](#) ).



**Figure 20.5.** Signaling through G proteins and G protein-coupled receptors. Agonist binding to the receptor causes the exchange of guanosine triphosphate (GTP) for guanosine diphosphate (GDP) on the guanine nucleotide-binding site of the G protein  $\alpha$  subunit. This causes the dissociation of  $G_{\alpha}$  from  $G_{\beta\gamma}$ , both of which can activate intracellular effectors and ion channels. (From Brass LF. Molecular basis of platelet activation. In: Hoffman R, et al., eds. Hematology: basic principles and practice. New York: Churchill-Livingstone, 2000:1754, with permission.)

The  $\beta\gamma$  subunit counterparts of G proteins involved in PAR-1 signaling are involved in a plethora of activities including activation of protein kinases, channels, and lipid-modifying enzymes, such as PI3K, that provides attachment for multiple signaling protein complexes close to the inner leaflet of the cell membrane ( [103](#), [104](#) and [105](#) ). Thus, this vast network of signaling pathways mediated through several G protein families is in keeping with the pleiotropic roles thrombin has been shown to exhibit in cellular homeostasis that extends beyond platelet activation to include endothelial cells, leukocytes, smooth muscle cells, and T lymphocytes, along with physiologic processes such as tissue injury, inflammation, angiogenesis, and embryonic development ( [29](#) ).

Once it is activated, PAR-1 is subsequently rapidly uncoupled from signaling and internalized into the cell ( [315](#), [316](#) and [317](#) ). It is then transported to lysosomes and degraded ( [106](#), [107](#) and [108](#), [316](#) ). Platelets presumably have no need for a thrombin receptor recycling mechanism, because once activated, they are irreversibly incorporated into blood clots. Conversely, in cell lines with characteristics similar to megakaryocytes, new protein synthesis is needed for recovery of PAR-1 signaling ( [106](#), [316](#) ), and in endothelial cells, it has been demonstrated that sensitivity to thrombin is maintained by delivery of naïve PAR-1 to the cell surface from a preformed intracellular pool ( [106](#) ).

Physiologic differences appear to exist between PAR-1 and PAR-4 on human platelets. When antibodies to the thrombin interaction site of PAR-1 are used, platelet activation is blocked at low, as opposed to high, thrombin concentrations ( [318](#), [319](#) ). Antibodies that blocked PAR-4 alone had no effect on thrombin-mediated platelet activation. If both receptors were blocked, platelet activation was blocked at both low and high thrombin concentrations ( [93](#) ). So it appears that PAR-1 is most efficient at mediating platelet activation at low concentrations of thrombin and that PAR-4 functions in the absence of PAR-1 but only at high thrombin concentrations. Because PAR-1 is capable of mediating platelet activation at low thrombin concentrations, the exact role of PAR-4 in human platelet function is presently speculative. Given the importance of this system with respect to normal hemostasis, PAR-4 may serve as a redundant, back-up receptor to PAR-1, or it may serve as an important receptor for one or more proteases other than thrombin.

## Platelet Adenosine Diphosphate (Purinergic) Receptors and Signaling

Evidence that adenosine diphosphate (ADP) plays an important role in both formation of the platelet plug and the pathogenesis of arterial thrombosis has been accumulating since its initial characterization in 1960 as a factor derived from red blood cells that influences platelet adhesion ( [109](#), [110](#) ). ADP is present in high (molar) concentrations in platelet-dense granules and is released when platelet stimulation takes place with other agonists, such as collagen; thus, ADP serves to further amplify the biochemical and physiologic changes associated with platelet activation and aggregation. Inhibitors of this ADP-associated aggregation include commonly used clinical agents such as clopidogrel and have proven to be very effective antithrombotic drugs ( [111](#), [112](#) ).

Adenine nucleotides interact with P2 receptors that are ubiquitous among different cell types and have been found to regulate a wide range of physiologic processes. They are divided into two groups, the G protein-coupled or “metabotropic” superfamily named *P2Y* and the ligand-gated ion channel or “ionotropic” superfamily termed *P2X* ( [113](#) ). Two G protein-coupled (P2Y) receptors contribute to platelet aggregation. The P2Y1 receptor initiates aggregation through mobilization of calcium stores, and the P2Y12 receptor is coupled to inhibition of adenylyl cyclase and is essential for a full aggregation response to ADP with stabilization of the platelet plug. P2X1 is a third ADP receptor present in platelets, but its exact role remains to be elucidated.

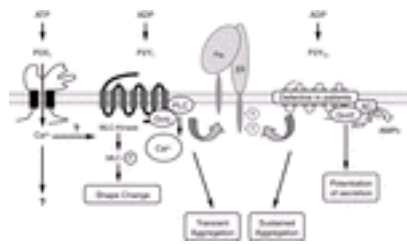
The P2Y1 receptor was first cloned in 1993 from a chick brain complementary DNA library ( [114](#), [115](#) and [116](#) ). Messenger RNA was later found in megakaryocyte-like cell lines, such as HEL and K562, along with human platelets ( [117](#) ). At this point, it was also established by the same group that the purported agonist effects of purified triphosphate nucleotides were, in fact, due to their transformation into diphosphate analogs by the ectonucleotidases present at the cell surface of the platelets and brain capillary endothelial cells being studied ( [117](#), [118](#) ). The P2Y1 receptor has 373 amino acid residues and the prototype structure of a G protein-coupled receptor. It is distributed in various tissues such as heart, blood vessels, testis, and ovary ( [113](#) ).

After the characterization of P2Y1, it became clear that a second platelet ADP receptor had to exist that was responsible for the inhibition of cAMP production by ADP that, in turn, was unaffected by blocking P2Y1 ( [119](#), [120](#), [121](#), [122](#), [123](#) and [124](#) ). The P2Y12 receptor was cloned in 2001 from human and rat platelet complementary DNA libraries using *Xenopus* oocytes ( [125](#) ). The receptor indeed showed the ability to display ADP-mediated inhibition of platelet cAMP formation that was not blocked by P2Y1 antagonists. The receptor has been localized to certain regions of the brain, such as the substantia nigra and thalamus, in addition to platelets ( [125](#) ). It has been suggested that the thienopyridine compound clopidogrel most likely exerts its antithrombotic effect by way of acting on the P2Y12 receptor through a thiol metabolite that can covalently modify its four extracellular cysteine residues ( [126](#) ).

### PLATELET P2Y1 AND P2Y12 RECEPTOR ROLES IN ADENOSINE

**DIPHOSPHATE-MEDIATED ACTIVATION** Inhibition of either of the P2Y1 or P2Y12 receptors is sufficient to block ADP-mediated platelet aggregation, and coactivation of both receptors is therefore necessary, through the G proteins Gq and Gi, respectively, for ADP to activate and aggregate the platelet ( [Fig. 20.6](#) ) ( [127](#) ). A series of studies involving the use of selective P2Y1 and P2Y12 receptor antagonists, a cAMP inhibitor, gene targeting, and Gq and Gi protein agonists that would theoretically activate the two main G protein pathways associated with ADP stimulation (see below) has led to the conclusion

that a signaling event downstream from  $G_i$  is required for the conformational change and subsequent aggregation associated with the  $\alpha_{IIb}\beta_3$  receptor ( [122](#), [124](#), [127](#), [128](#), [129](#), [130](#), [131](#), [132](#) and [133](#) ).



**Figure 20.6.** Current view of the interplay between the platelet P2 receptors. Two G protein-coupled receptors are involved in adenosine diphosphate (ADP)-induced platelet aggregation, P2Y<sub>1</sub> and P2Y<sub>12</sub>. The former is responsible for intracellular calcium mobilization, shape change, and transient aggregation, whereas the latter is coupled to adenylyl cyclase (AC) inhibition and is responsible for amplification of platelet aggregation and potentiation of platelet secretion. Both receptors are required for normal platelet response to ADP. A P2X receptor is also present on platelets and is responsible for rapid calcium influx. It therefore may synergise with the P2Y<sub>1</sub> receptor, although its role in platelet activation is not yet established. AMPc, cyclic adenosine monophosphate; ATP, adenosine triphosphate; MLC, myosin light chain; P, phosphorylated; PLC, phospholipase C; Y, phosphotyrosine. (From Gachet C. ADP receptors of platelets and their inhibition. *Thromb Haemost* 2001;86:227, with permission.)

Studies done with platelets from patients who manifest defective P2Y<sub>12</sub>, along with experiments involving the study of P2Y<sub>1</sub> receptor function in platelet-rich plasma that has high fibrinogen concentrations, have demonstrated that the P2Y<sub>1</sub> receptor has roles in activation and aggregation in addition to shape change and that it is fully capable of mounting an aggregation response that is nonetheless transient in nature ( [122](#), [134](#), [135](#) ). The P2Y<sub>1</sub> receptor is an absolute requirement for ADP-mediated aggregation based on knock-out mouse studies, the demonstration that platelets can become refractory to ADP due to desensitization of the P2Y<sub>1</sub> receptor, and the observation that adrenaline (which activates the G protein  $G_i$  that mediates inhibition of adenylyl cyclase) does not restore aggregation in the presence of P2Y<sub>1</sub> selective antagonists ( [130](#), [131](#), [320](#), [321](#), [322](#) and [323](#) ). Platelet shape change is dependent on two separate G signaling pathways, a Gq-linked release of calcium from internal stores, and a G<sub>12/13</sub> link to activation of Rho kinases and Rho guanine nucleotide exchange factors that activate small G proteins ( [99](#), [136](#), [324](#) ). Although the association of P2Y<sub>1</sub> with the Gq pathway is established, the existence of any relationship between the receptor and the G<sub>12/13</sub> pathway is presently unclear ( [136](#), [137](#) and [138](#) ). The primary role of the P2Y<sub>12</sub> receptor in platelet activation and aggregation is to amplify and complete the aggregation response to ADP as well as to other agonists ( [119](#), [120](#), [121](#), [122](#) and [123](#) ). In the presence of a high ADP concentration, the receptor is also capable of mediating partial platelet aggregation on its own in P2Y<sub>1</sub> and Gq knock-out mice, thus proving that a  $\alpha_{IIb}\beta_3$  conformational change followed by aggregation can actually take place in the absence of calcium mobilization and PKC activation ( [131](#), [137](#) ). In general terms, it appears that P2Y<sub>12</sub> is responsible for acting as an ADP costimulus receptor in the presence of low concentrations of other agonists, such as collagen, thrombin, chemo-kines, or IgG, whereas the P2Y<sub>1</sub> receptor has a specific role early in platelet activation ( [139](#), [140](#) and [141](#) ).

**P2X<sub>1</sub> RECEPTOR** P2X<sub>1</sub> was first discovered in platelets through polymerase chain reaction of transcripts from platelets and megakaryocyte-like cell lines ( [142](#), [143](#), [144](#) and [145](#) ). This third platelet P2 receptor is an adenosine triphosphate-gated ion channel (like all other P2X receptors so far discovered) and is known to mediate rapid and selective

permeability to cations. On platelets, the P2X1 receptor has been shown to mediate fast calcium entry stimulated by ADP ( [146](#) ). P2X1 is a 399-amino acid protein composed of two transmembrane domains, intracellular *N*- and *C*-termini, and an extracellular loop with ten conserved cysteine residues ( [113](#) ). At least three P2X subunits are required to constitute a membrane pore, and these receptors are typically expressed on excitable cells, such as neurons. P2X1 knock-out mice should help to elucidate the physiologic role of these receptors in platelets and have not shown any defects in hemostasis to date ( [147](#) ). Two other studies have likewise been unable to determine any P2X1 role in platelets, although a fourth has suggested a role for the receptor in shape change ( [119](#), [148](#), [149](#) ).

**ADENOSINE DIPHOSPHATE RECEPTOR SIGNALING** ADP is considered a weak agonist by itself compared with collagen or thrombin, for example. Aggregation is typically reversible when stimulated by ADP alone. In addition, low concentrations of ADP serve to amplify the effects of both strong and weaker agonists, the latter including serotonin and adrenaline, among others ( [150](#), [151](#) ). As noted in the preceding paragraphs, ADP signal transduction downstream from the P2Y1 receptor leads to a transient rise in free cytoplasmic calcium due to mobilization from internal stores, and this is followed by secondary store-mediated influx, while a concomitant inhibition of adenylyl cyclase is initiated by ADP stimulation of the P2Y12 receptor. The G protein family member responsible for signaling through P2Y1 to PIC $\beta$  is G<sub>q</sub>, whereas the member responsible for signaling through P2Y12 to inhibit adenylyl cyclase is G<sub>i</sub>. ADP also induces a rapid influx of calcium from the external media through ligand-gated calcium channels ( [152](#), [153](#) ). Although partial platelet aggregation without shape change can be seen in P2Y1 and G<sub>q</sub> knock-out mice in the presence of high ADP concentrations, the fact that aggregation is not seen at lower concentrations suggests that the G<sub>q</sub>-dependent PIC $\beta$  pathway leading to phosphoinositide hydrolysis and PKC activation is necessary to mobilize calcium after ADP stimulation and is essential for full platelet aggregation to take place in response to ADP ( [100](#), [131](#), [137](#), [154](#), [155](#) ). An additional role for ADP in platelets has been proposed in which it is seen as an important cofactor of PI3 kinase activation that is stimulated through the PAR-1 thrombin receptor ( [156](#) ). Similarly, ADP has also been implicated as an important cofactor of platelet activation seen in the settings of experimental cross-linking of the Fc $\gamma$ RIIA immunoreceptor and in patients with heparin-induced thrombocytopenia ( [157](#) ). The latter is a disorder in which platelet activation and often serious thrombotic sequelae take place as a consequence of administration of the anticoagulants heparin or low-molecular-weight heparin. In susceptible patients, an autoantibody is generated by the immune system that is directed to a complex on the platelet membrane formed by the heparin molecule and platelet factor 4. The Fc portion of the autoantibody is then capable of activating the platelet through its interaction with the Fc $\gamma$ RIIA receptor. Activation of PI3K has been shown to be a central player in the above two settings. The same G<sub>i</sub> protein-associated signaling pathway used by platelet ADP receptors has been found to act in a synergistic fashion when it is triggered either through (a) other platelet receptors such as gpVI, or (b) key downstream players triggered by other receptors, such as PIC $\beta$ 2 ( [158](#), [159](#) ). It has been suggested that concomitant signaling through the G proteins and tyrosine kinases of other receptor pathways may potentially be seen as a general mechanism in which ADP contributes to efficient platelet activation and aggregation ( [139](#), [160](#) ).

## Platelet Activation by Soluble Agonists

**$\alpha_2$  ADRENERGIC RECEPTORS AND EPINEPHRINE** There is strong evidence that presently unknown signaling mechanisms appear to be playing effector roles in platelet responses to epinephrine. This molecule is unique among platelet agonists because it is considered by most to be capable of stimulating secretion and aggregation but not cytoskeletal reorganization responsible for shape change. Furthermore, generation of the key signaling enzyme PIC through epinephrine stimulation appears to be dependent on



thromboxane A<sub>2</sub> and can thus be blocked with aspirin ( [161](#) ). It is interesting, however, that epinephrine stimulation in the presence of aspirin is still capable of leading to the conformational change in the α<sub>IIb</sub>β<sub>3</sub> receptor that precedes fibrinogen binding and platelet aggregation ( [162](#), [163](#) ). Similarly, the thrombin inhibitor hirudin has been found to block epinephrine-associated aggregation of washed platelets in one study, suggesting that an element of thrombin costimulation of platelets may be needed to document the effects of epinephrine ( [151](#) ). Platelet responses to epinephrine are mediated through α<sub>2</sub> adrenergic receptors ( [164](#), [165](#) ), and these responses have been found to vary between individuals, with some donors with otherwise normal platelets manifesting delayed or absent responses ( [166](#) ). This delayed-activation phenomenon is similar to that seen in some donors when their platelets are stimulated through the FcγRIIA receptor, and so the explanation may rest with variable adrenergic receptor expression levels, as is the case with the platelet Fc receptor ( [167](#) ).

**ARACHIDONIC ACID, THROMBOXANE A<sub>2</sub>, AND THROMBOXANE RECEPTORS** On platelet stimulation by a number of agonists, arachidonic acid is generated directly by phospholipase A from its membrane phospholipid precursors (PC, PS, and PI) and indirectly by PIC generation of DAG followed by DAG lipase action. Most platelet agonists are believed to activate this process. Three known eicosanoid subsets of biochemical compounds are known to be derived from the formation of arachidonic acid—the prostanoids, leukotrienes, and epoxides. The prostanoids are formed by the cyclooxygenase pathway and include endo-peroxides and thromboxanes along with PGs. The leukotrienes are formed by the lipoxygenase pathway and the epoxides by the cytochrome P-450 epoxygenase pathway. Although all three of these pathways are present in platelets, most of the arachidonic acid ends up being metabolized to thromboxane A<sub>2</sub> ( [168](#) ). Thromboxane A<sub>2</sub> is produced in platelets from arachidonic acid through the generation of PGH<sub>2</sub> by the enzyme cyclooxygenase that is irreversibly inhibited by aspirin through acetylation of a serine residue near its C-terminus ( [169](#), [170](#) ). PGH<sub>2</sub> is the parent compound for both biologically active prostaglandins, such as PGE<sub>2</sub> and PGI<sub>2</sub>, and thromboxane A<sub>2</sub>. The former two compounds act to inhibit platelet activation by generating intracellular cAMP, whereas thromboxane A<sub>2</sub> activates platelets. Although PG and thromboxane pathways can be present in the same cell, platelets primarily synthesize thromboxane, and endothelial cells mainly synthesize PGs such as PGI<sub>2</sub>, which acts as a local vasodilator and thus indirectly opposes platelet activation and vasoconstriction that accompanies hemostasis and thrombus formation ( [170](#) ). Like ADP and epinephrine, thromboxane A<sub>2</sub> is also capable of activating nearby platelets after its release into plasma. It has a very short half-life of 30 seconds before its conversion to the inactive metabolite thromboxane B<sub>2</sub> prevents widespread platelet activation beyond the vicinity of thrombus formation ( [171](#), [172](#) ). Both arachidonic acid and analogs of thromboxane A<sub>2</sub> have been found to activate and aggregate platelets by mediating shape change and phosphorylation of signaling enzymes, such as PICB, PKC, and so forth ( [173](#), [174](#) ). Signaling events associated with stimulation of the thromboxane A<sub>2</sub> receptor (TXR) further downstream from PICB and PKC include activation of p38 mitogen-activated protein kinase and the small heat shock protein hsp27 ( [175](#) ). The TXR is a member of the seven transmembrane G protein-coupled receptor family and has been localized to the plasma membrane. It is postulated to act with a number of G proteins, including the α subunits of Gq, G11, G12, G13, and Gi2 ( [176](#), [177](#), [178](#), [179](#) and [180](#) ). One isoform of the receptor has been cloned from placenta (TXRa) and the other from endothelium (TXRβ). Both are found in platelets and have been found to activate PICB ( [181](#) ). In addition, the α receptor is associated with the activation of adenylate cyclase that leads to generation of cAMP known to inhibit platelet activation, whereas the β receptor inhibits adenylate cyclase activation after its stimulation. Because thromboxane A<sub>2</sub> is a net agonist, the

effects of PICB activation must somehow outweigh those of adenylate cyclase activation, or megakaryocyte and platelet  $\beta$  receptor expression levels may outweigh those of a receptor expression levels ( [181](#) ).

### Physiologic Inhibition of Platelet Activation

One of the many remarkable features of platelets is their ability to remain in a physiologic resting state and resist becoming activated while navigating the heart, arterial and venous circulations, and splenic microcirculation for an average of 10 days. Over this time, platelets can be expected to remain in a quiescent state while they encounter high shear forces, what must be frequent collisions with other circulating cells as well as normal endothelium, and relatively profound turbulence associated with arterial branch points and diseased, yet physically intact arteries and arterioles. Indeed, the pathologic consequences associated with widespread inappropriate platelet activation are life- and limb-threatening when associated with well-characterized clinical disorders, such as thrombotic thrombocytopenic purpura and heparin-induced thrombocytopenia. The mechanisms responsible for maintaining the fine balance of keeping platelets in a resting state until they encounter a genuine need to undergo adhesion, activation, and aggregation at the site of vascular injury are almost as diverse as those responsible for mediating these physiologic phenomena.

Some general mechanisms involved in physiologic inhibition of platelet activation include phenomena such as (a) generation of negative regulating molecules by the platelet (e.g., cAMP), endothelium [e.g., PGI<sub>2</sub>, nitric oxide (NO), heparan sulfate], and at distant sites (e.g., antithrombin); (b) direct contact of circulating platelets with collagen prevented by a barrier of endothelial cells; (c) generation of an ecto-ADPase by endothelial cells that will metabolize ADP secreted from activated platelets and thus is intended to limit further activation; (d) tendency for blood flow to wash away unbound thrombin from the site of platelet plug formation and hence limit the extent of clot formation; (e) brief half-life of certain key platelet activators such as thromboxane A<sub>2</sub>; (f) ability to alter the conformation of a receptor such that it is then able to interact with a specific proaggregatory ligand, as happens with a IIb $\beta$ <sub>3</sub> and plasma fibrinogen; and (g) the ability to inactivate switched-on receptors associated with activation through biochemical modification such as phosphorylation or their removal from the platelet surface.

Biochemical modification leads to receptor desensitization and occurs with G protein-coupled receptors present on the surface of platelets with the notable exception of PAR-1 because thrombin requires an intact N-terminus to activate the receptor ( [182](#) ). Desensitization of G protein-coupled receptors is normally mediated through phosphorylation of serine and threonine residues associated with the cytoplasmic side of the receptor by G protein-coupled receptor kinases ( [183](#) ). The role of phosphorylation of these residues is to uncouple them from their G proteins and then lay the groundwork for internalization of the receptor through the binding of arrestin proteins ( [184](#), [185](#) ). Some of the physiologic and biochemical phenomena related to inhibition of platelet activation are described below.

**INHIBITORY PROSTAGLANDINS** As described earlier in the chapter, PGE<sub>2</sub> and PGI<sub>2</sub>, along with PGE<sub>1</sub>, are examples of PGs generated through the arachidonic acid pathway that play roles with respect to inhibition of platelet activation and aggregation, which are processes mediated in part by other PGs and thromboxanes derived from the same pathway. The inhibitors carry this out through G protein-coupled receptors that regulate adenylyl cyclase-mediated generation of cAMP that in turn activates PKA (or A kinases). PKA then goes on to inhibit other proteins that mediate platelet reactivity through phosphorylation. The receptors of PGs believed to increase cAMP levels in platelets such



as PGI<sub>2</sub> have in the past been described as being coupled to the  $\alpha$  subunits of G<sub>s</sub>, whereas those agents with G protein-coupled receptors that suppress cAMP formation, such as thrombin and epinephrine, are thought to be coupled to G<sub>i</sub> (186). In addition to these considerations, cAMP levels in platelets are also governed by the activity of phosphodiesterase, the enzyme responsible for cAMP breakdown. This enzyme activity is inhibited by drugs such as the weak antiplatelet agent dipyridamole and the bronchodilator theophylline. The targets through which cAMP and PKA reduce platelet reactivity are incompletely understood. As noted earlier in the section [Platelet Glycoprotein Ib Complex-von Willebrand Factor Interaction and Signaling](#), one substrate for PKA is the  $\beta$  subunit of the gpIb complex, and this phosphorylation may, in turn, reduce platelet activation through its increased interaction with the 14-3-3 $\sigma$  protein (35, 36). The 14-3-3 family of proteins exists as homodimers and modulates effector pathways in diverse cell types through interaction with key signaling enzymes (32). Other PKA substrates include ABP, myosin light chain, and several as yet unidentified proteins. There are a number of activation-associated processes in platelets that are affected negatively by increased intracellular cAMP generation. These include limitation of phosphoinositide hydrolysis in platelets, which is believed to occur through blockage of the inositol 1,4,5-triphosphate receptor, and inhibition of the resynthesis of the phosphatidylinositol 4,5-bisphosphate precursor of DAG formation. These events lead to a smaller increase in intracellular calcium levels associated with cell activation (187, 188, 189 and 190).

**PLEKSTRIN AND PROTEIN KINASE C INHIBITION** PKC is an important serine-threonine kinase with protean effector manifestations in platelet signaling. PKC is actually a family of structurally related molecules, and platelets contain at least the  $\alpha$ ,  $\beta$ , and  $\delta$  forms. Once activated, PKC appears to mediate individual roles that, in some respects, may be considered contradictory in nature. These include positive effects like secretion and aggregation, as well as negative effects that can be observed when platelets are incubated with phorbol esters before agonist stimulation. Under these circumstances, the agonist effector-mediated responses are reduced or do not occur, particularly if they are mediated by effectors downstream from phosphoinositide hydrolysis, and this phenomenon may represent a form of negative feedback (191, 192 and 193). This is speculated as possibly being due to a shorter duration of signaling for calcium release (194). Several platelet proteins are known PKC substrates, and these include plekstrin (P47), myosin light chain (P20), ABP, and the  $\alpha$  subunits of the G proteins G<sub>z</sub>, G<sub>12</sub>, and G<sub>13</sub>. The precise role of plekstrin in platelets is unknown, although its first and last 100 residues are homologous with domains in molecules with roles in signal transduction. These so-called plekstrin homology domains are speculated to play roles in protein-protein interactions, and so phosphorylated plekstrin may be playing a role in the negative regulation of PKC. Data from 1995 suggest that phosphorylated plekstrin may be accomplishing negative regulation of PKC through inhibiting phosphoinositide hydrolysis and the activity of the lipid kinase, PI3K (195). Reduced activity of PI3K leads to reduced phosphorylation of PI-4,5-P<sub>2</sub> to PI-3,4,5-P<sub>3</sub>, a molecule that, in turn, is involved in the activation of PKC isoforms (196).

**OTHER INHIBITORY PROCESSES OF PLATELET ACTIVATION** The  $\alpha_{IIb}\beta_3$  receptor on the surface of activated and resting platelets along with the fibrinogen that binds to stimulated platelets expressing the activated form of  $\alpha_{IIb}\beta_3$  have been observed to undergo rapid internalization into megakaryocyte and platelet  $\alpha$ -granules (197, 198). These platelets may not yet be participating in aggregate formation with other platelets. Thus, it has been speculated that this may represent a means by which the platelet not involved in clot formation may actually be able to return to a resting state (199). The *in vivo* evidence supporting this unique platelet inhibitory process is included in a paper describing the transfusion of plasma into an afibrinogenemic patient followed by the demonstration that platelet fibrinogen could be restored faster than new platelets could be produced in the bone marrow (200). NO is generated by endothelial cells and platelets from L-arginine in response to shear stress forces and other platelet agonists, such as

thrombin and ADP. This molecule works to inhibit platelet activation through the cyclic guanosine monophosphate second messenger generated by guanyl cyclase activation. Endothelial NO synthase activity is enhanced during platelet activation, presumably as an additional means for limiting platelet aggregation.

## Platelet Secretion

A detailed description of the biochemical contents of platelet  $\alpha$ - and dense granules along with lysosomal granules is included in [Chapter 19](#) and does not require further elucidation here. The current section describes the physiologic process of platelet secretion under normal circumstances.

The extent of secretion of  $\alpha$ -, dense-, and lysosomal-granule contents is dependent on the strength of the agonist, occurs in association with platelet activation, and is one of the many downstream consequences mediated by the activation and transport to the internal leaflet of the plasma membrane of PKC. Granule contents that are involved in enhancing activation and aggregation of both their own and other platelets in the vicinity include ADP, vWF, fibrinogen, and calcium ions.

The strongest response a platelet can mount to agonist stimulation includes activation, secretion, and aggregation. The granule secretory (release) phase is most readily documented *in vitro* by the “secondary wave” that denotes a second surge of aggregation activity of a fixed number of platelets in response to release of proaggregatory granule contents. These platelets are exposed to an agonist under the controlled, *in vitro* conditions associated with platelet aggregation studies in which clinical defects in primary hemostasis due to either platelet or endothelial perturbations are further characterized. The secondary wave is typically seen best when the agonist is a weaker one, such as epinephrine, or is a relatively lower concentration of a second relatively weak agonist, ADP. These two agonists require both cyclooxygenase activity and a primary wave of aggregation to induce secretion observable at low calcium concentrations, whereas secreted ADP is known to potentiate the platelet-activating capabilities of a number of other agonists ([201](#)).

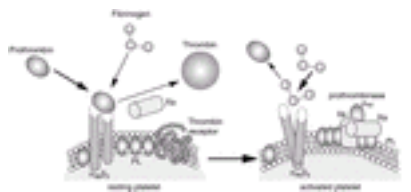
Several studies suggest that the mechanism by which platelet granules (vesicles) fuse with the cell membrane to release their granule contents includes membrane-trafficking events mediated by donor membrane proteins called  $v$ -SNAREs (vesicle SNAP REceptors), which undergo a lock-and-key form of docking with their compatible and specific target membrane proteins called  $t$ -SNAREs ([202](#) [203](#)), followed by exocytotic release of their contents. Simultaneous with the exocytosis of platelet granules, it is apparent that there is also inward (centripetal) movement of other intracellular contents, and this may play a role in transporting proaggregatory proteins away from the membrane surface and thus serve as another counterbalancing mechanism for limiting the extent of thrombus formation. Examples of this phenomenon include the internalization of fibrinogen from the surface of activated platelets, along with gpIIbIIIa receptors from the surface of resting and activated platelets, as noted in the preceding section ([199](#)).

## PLATELET AGGREGATION: $\alpha_{IIb}\beta_3$ RECEPTOR AND ITS SIGNALING MECHANISMS

Platelet aggregation is a complex phenomenon that is the end result of a series of adhesion- and activation-related processes. The molecular mechanisms involved in platelet aggregation continue to be an area of very active research that also periodically reminds us that there is still much to be characterized about this important aspect of platelet function. Well-known essential components of this process include an agonist,

calcium, and the adhesive proteins fibrinogen and vWF. Divalent cations, such as calcium and magnesium, are required for platelet aggregation in trace amounts, and these alter the specificity of the integrin  $\alpha_{IIb}\beta_3$  for its ligands (204). Fibrinogen and vWF play dominant roles in platelet aggregation through binding to  $\alpha_{IIb}\beta_3$  and also by the ability of the former to generate polymerized fibrin as support for the platelets in a thrombus. The multivalent nature of fibrinogen and vWF allows them to cross-link platelets on binding to  $\alpha_{IIb}\beta_3$  on stimulated platelets to initiate platelet aggregation.

Fibrinogen and vWF are not the only ligands for integrin  $\alpha_{IIb}\beta_3$ . It was shown in 2000 that mice deficient in both fibrinogen and vWF form thrombi at nearly normal rates (205). An example of a molecule recently added to the continually evolving list of  $\alpha_{IIb}\beta_3$  ligands is the plasma protein, prothrombin. In 1997, Byzova et al. concluded from their investigations that prothrombin is likely to be a stronger ligand for integrin  $\alpha_{IIb}\beta_3$  when the platelet is in a resting state (206) (Fig. 20.7). The prothrombin bound to  $\alpha_{IIb}\beta_3$  on the resting platelet can be cleaved by nearby factor Xa if the latter is starting to be generated in the vicinity of the receptor. This action leads to release of thrombin from the receptor. The newly generated thrombin may then be available to interact with its G protein-coupled receptors and gpIb complexes on the same and neighboring platelets, resulting in the activation of the platelet and  $\alpha_{IIb}\beta_3$ , which then leads the integrin to favor binding fibrinogen over prothrombin. In addition, platelet transition to an activated state should increase the formation of a prothrombinase complex on the platelet surface, which leads to increased thrombin generation. Activation of prothrombin also then becomes more efficient. This recently characterized set of interactions based on prothrombin and  $\alpha_{IIb}\beta_3$  interaction is illustrative of one of many ways in which positive feedback is able to lead to amplification of the entire process of coagulation. The characterization of these sorts of molecular interactions is important in leading to new targets for antithrombotic therapy and provides a possible explanation for the failure of some current  $\alpha_{IIb}\beta_3$  inhibitors.



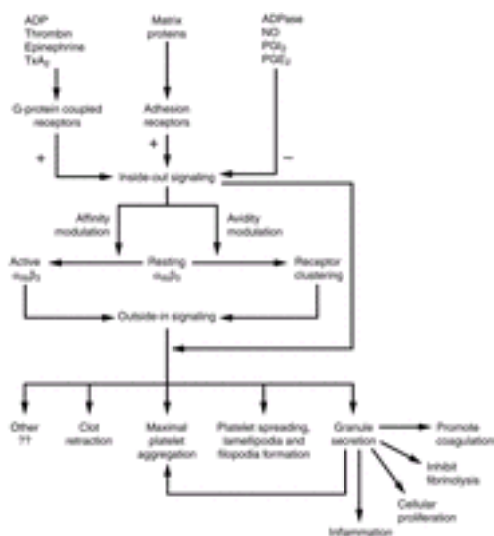
**Figure 20.7.** Model for prothrombin binding and activation on  $\alpha_{IIb}\beta_3$  on platelets. See text for details on the model. PL, anionic phospholipid vesicles rich in phosphatidylserine. (From Plow EF, Cierniewski CS, Xiazho Z, et al.  $\alpha_{IIb}\beta_3$  and its antagonism at the new millenium. *Thromb Haemost* 2001;86:34–40, with permission.)

The molecular basis of integrin signaling that occurs in platelet  $\alpha_{IIb}\beta_3$  is an integral part of thrombus formation and is important in understanding this process. gpIIb and gpIIIa were identified as the abnormality present in patients with Glanzmann thrombasthenia in the 1970s (207, 208). Since that time, they have been extensively studied. They represent the most abundant receptor on the platelet surface. Like all integrin receptors, it is composed of noncovalently linked subunits. Each subunit is encoded by separate genes on the long arm of chromosome 17. Both subunits consist of a large extracellular domain and very short cytoplasmic domains, and together they bind as a heterodimer. Within their combined extracellular domains is the ligand-binding pocket, with surrounding subunit domains conferring its specificity (209). Equally important are their short cytoplasmic domains that are critical for transmembrane signaling. These domains act to anchor the

receptor to the cytoskeletal elements ( [210](#), [211](#) and [212](#) ).

The signaling pathway of the  $\text{gpa}_{\text{IIb}}\beta_3$  is complex and has been extensively studied. The intricacies of this pathway are continually being elucidated. Despite this, the terminal effector molecules affecting its activation remain unknown. Central concepts of the signaling pathway include the ideas of inside-out signaling, which involves the processes termed *affinity* and *avidity modulation* ( [213](#), [214](#) ), and outside-in signaling in which messages are transmitted to the inside of the platelet via the events occurring outside the membrane through a  $\text{IIb}\beta_3$  activation.

These complex pathways were reviewed by Casserly and Topol ( [209](#) ) in 2002 and are summarized in [Figure 20.8](#) from their work. Clearly important to hemostasis and thrombosis is the vessel wall. Normally, the undisturbed endothelium contains nonthrombogenic materials that can neutralize activated coagulation factors, increase blood flow, inhibit platelet aggregation, and modulate fibrinolysis. Substances that inhibit platelet activation released by the endothelium include  $\text{PGI}_2$ , NO, and ADPase. In addition, the platelet itself releases  $\text{PGE}_2$  that acts to prevent its own activation. These molecules act via the  $\text{Gs}$  protein pathway that stimulates protein kinases to modulate various enzymes involved in platelet receptor  $\text{IIb}\beta_3$  activation (see below) ( [215](#) ). They may also act to phosphorylate and inactivate various protein receptor agonists ( [216](#), [217](#) ).



**Figure 20.8.** Schematic illustration of a  $\text{IIb}\beta_3$  receptor regulation via inside-out and outside-in signaling. ADP, adenosine diphosphate; ADPase, adenosine 5'-diphosphatase; NO, nitric oxide;  $\text{PGE}_2$ , prostaglandin E<sub>2</sub>;  $\text{PGI}_2$ , prostacyclin; TxA<sub>2</sub>, thromboxane A<sub>2</sub>. (From Casserly IP, Topol EJ. Glycoprotein IIb/IIIa antagonists—from bench to practice. Cell Mol Life Sci 2002;59:481, with permission.)

Primary platelet agonists such as ADP, thrombin, and matrix proteins collagen and vWF effect platelet aggregation through a process known as *inside-out signaling*. This term denotes an integrin property that involves the binding action of agonists to their receptors, leading to activation of numerous platelet functions, including the conformational change of a  $\text{IIb}\beta_3$  to a high-affinity state, referred to as *affinity modulation*. Ligand binding is initially reversible and later becomes irreversible in nature (

218). Therefore, one of the effects of inside-out signaling on a  $\text{IIb}\beta_3$  is exposure of the fibrinogen-binding site through signal transduction involving the cytoplasmic domains (217, 219). Various regulatory intracellular or transmembrane proteins participate in this process.

Avidity modulation, the less dominant action, acts to cluster the  $\alpha_{\text{IIb}}\beta_3$  heterodimers into oligomers through lateral diffusion (220). These conversions are critical in allowing  $\alpha_{\text{IIb}}\beta_3$  to engage soluble adhesive ligands. These ligands contain the classical integrin recognition sequence RGD, Arg-Gly-Asp, which acts as a bridge between adjacent platelets allowing aggregation to proceed (221). In addition, more  $\alpha_{\text{IIb}}\beta_3$  translocates to the platelet surface membrane from the degranulating  $\alpha$ -granule pool where an additional receptor is stored. These changes facilitate irreversible binding to fibrinogen. An important role for tyrosine kinase- and phosphatase-associated phosphorylation-dephosphorylation in integrin activation exists as assessed by the blockage of fibrinogen binding and platelet aggregation by enzyme inhibitors (222, 223).

After ligand binding occurs, a multitude of intracellular signals are generated that are collectively referred to as *outside-in signaling*. This signaling determines the extent to which platelets will spread on a vascular matrix and how resistant they will be to detachment (224). The signaling occurs during platelet aggregation via further release of granules and adhesion, which is induced by the binding of adhesive proteins to the extracellular domain of  $\beta_3$ . These signals are a determinant of the final clot size.

A short sequence within the cytoplasmic domain of  $\beta_3$ , termed the *ICY* (integrin cytoplasmic tyrosine) *domain*, contains tyrosines that become phosphorylated. The importance of this event is exemplified by studies performed using mice deficient in the ICY domain that result in defective clot retraction and aggregation *in vitro* and bleeding defects *in vivo* (225). The ICY domain tyrosine phosphorylation recruits cytoskeletal myosin, important in clot retraction, and the adapter protein Shc, involved in platelet stimulation. In addition, multiple other proteins become phosphorylated that mediate effector responses, including Grb2, which activates the Ras signaling pathway, in turn activating phospholipase  $A_2$  via mitogen-activated protein kinase effectors. This event generates arachidonic acid metabolites that stabilize platelet-platelet interactions. Once full spreading and aggregation of platelets occurs, usually within several minutes, focal adhesion kinase is phosphorylated (226). The PI3K system is activated once  $\alpha_{\text{IIb}}\beta_3$  is engaged, leading to generation of D3 phosphoinositides (227). These proteins act to prevent the depolymerization of the actin cytoskeleton, with the result that the platelet aggregate is stabilized (228). The end result of this outside-in signaling is a stable platelet clot.

Not only does the  $\alpha_{\text{IIb}}\beta_3$  receptor have important roles with respect to platelet function, but it affects coagulation and the inflammatory process as well. It acts to promote the formation of the prothrombinase complex (229) and mediates the adhesion of leukocytes to the platelet membrane and endothelium (i.e., vascular inflammation) (230, 231, 232 and 233). There have also been reports that it may have a role in cell proliferation (234).

### **Integrin $\alpha_{\text{IIb}}\beta_3$ Antagonists**

Antithrombotic agents that act against the  $\alpha_{\text{IIb}}\beta_3$  receptor are extensive and represent a targeted therapy against the most prevalent platelet surface receptor. They have had a



significant impact on the outcomes of patients with acute coronary syndromes (ACSs) and those requiring percutaneous coronary interventions (PCIs).

Although many anti- $\alpha_{IIb}\beta_3$  agents have been developed, only a small number are currently approved for clinical use. Examples of approved parenteral agents with various mechanisms of action include the chimeric monoclonal antibody abciximab, the synthetic peptide eptifibatide, and the synthetic nonpeptide tirofiban.

In the 1980s, Collier reported on the first mouse monoclonal antibody directed against the  $\alpha_{IIb}\beta_3$  receptor ( [235](#) ), and abciximab was subsequently developed. This antibody binds to a site on the  $\alpha_{IIb}\beta_3$  receptor that is separate from the ligand-binding site and likely acts to sterically hinder ligand access ( [209](#) ). Within minutes of receiving the standard bolus dose, roughly 90% of the  $\alpha_{IIb}\beta_3$  receptors are bound ( [236](#) ). Abciximab then has a slow rate of dissociation that lasts up to 4 hours, and platelet function can be abnormal for up to 7 days after infusion ( [237](#) ).

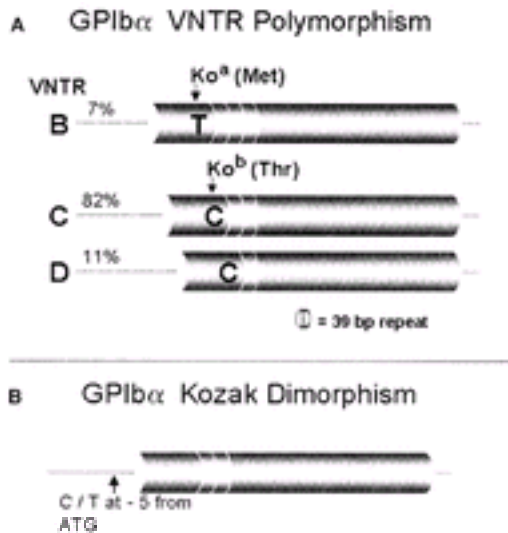
Eptifibatide is a synthetic cyclic heptapeptide that is based on an RGD sequence that blocks all RGD-recognizing integrin receptors. It binds to the ligand-binding pocket of the  $\alpha_{IIb}\beta_3$  receptor such that it blocks its interaction with fibrinogen and vWF. It has a very rapid onset of action and a low affinity leading to quick dissociation. It is approved for use in both the PCI and ACS settings.

Tirofiban is a synthetic nonpeptide tyrosine derivative that mimics the RGD recognition sequence ( [238](#) ). This agent also acts by blocking the ligand-binding region of the  $\alpha_{IIb}\beta_3$  receptor such that it competitively inhibits platelet aggregation. Within minutes, it inhibits platelet aggregation and dissociates from the receptor within seconds. It is approved for use in ACS.

Multiple trials have been conducted to evaluate the efficacy of these and other parenteral  $\alpha_{IIb}\beta_3$  antagonists, and these have been reviewed by Casserly and Topol in 2002 ( [Fig. 20.9](#) ) ( [209](#) ). These trials evaluated the drugs in terms of 30-day postintervention or event episodes of death or nonfatal MIs after PCI or ACS. With over 100,000 patients being evaluated in placebo-controlled trials, the absolute and relative risk reductions in PCI with the use of  $\alpha_{IIb}\beta_3$  inhibitors were 2.9% and 34.0%, respectively. After longer-term follow-up of 1 year, the Evaluation of  $IIb/IIIa$  Platelet Inhibitor for Stenting (EPISTENT) trial demonstrated a significant reduction in mortality after the use of abciximab in PCI. This effect has not been demonstrated with the other mentioned agents, although significantly fewer studies have been performed with them to date. A metaanalysis of the trials performed using tirofiban and eptifibatide in ACS showed no significant difference in mortality with these agents, but did show that there was a significant reduction in endpoints of death/MI, as well as death/MI/revascularization at 48- to 96-hour, 30-day, and 6-month follow-up ( [239](#) ). Less promising results have been seen to date with the oral  $\alpha_{IIb}\beta_3$  inhibitors, and they continue to undergo investigation. One potential advantage of the oral agents may rest with treatment of ischemic complications after PCI and ACS that continue to occur after the period of platelet inhibition produced by intravenous agents. What is clear from all these anti- $\alpha_{IIb}\beta_3$  clinical studies is that there is much more to be learned about the antagonism of  $\alpha_{IIb}\beta_3$ .







**Figure 20.10.** Polymorphisms of the glycoprotein (GP) Iba subunit. **A:** The variable number of tandem repeats (VNTR) polymorphism is characterized by the expression of four (VNTR A, not shown), three (VNTR B), two (VNTR C), or one (VNTR D) copy of a 13-base pair (bp) repeat sequence. Percentages shown are gene frequencies in a typical white population with VNTR A less than 1%. Another dimorphism, the Met/Thr at residue 145, is in linkage disequilibrium with the VNTR polymorphism. Thus, the VNTR A and B alleles express only Met 145, and the VNTR C and D alleles express only Thr 145. **B:** In GPIba, a C/T substitution at a position five nucleotides upstream from the adenine–thymine–guanine (ATG) start codon influences an adjacent Kozak sequence and thus the rate of translation of the messenger RNA transcript by the cell machinery. See text for details. [From Kunicki TJ. The role of platelet collagen receptor (glycoprotein Ia/IIa; integrin  $\alpha_2\beta_1$ ) polymorphisms in thrombotic disease. *Curr Opin Hematol* 2001;8:279, with permission.]

**TABLE 20.1. Studies Showing  $\pm$  Risk Association between Platelet Antigen Polymorphisms and Thrombosis**

| Glycoprotein:      | Integrin Polymorphism |                   |                       |                                   |
|--------------------|-----------------------|-------------------|-----------------------|-----------------------------------|
|                    | gplb <sub>a</sub>     | $\alpha_2\beta_1$ | $\alpha_{IIb}\beta_3$ |                                   |
| Risk Polymorphism: | VNTR A                | Kozak             | Allele 1              |                                   |
|                    |                       |                   | PL A2                 |                                   |
| MI+                | —                     | 325–327           | 330–332               | 267, 337–342                      |
| MI–                | 328                   | 328, 329          | 328, 333–336          | 328, 333, 343–351                 |
| CVD+               | 244, 352              | 353               | 354–356               | —                                 |
| CVD–               | 353                   | 329, 353          | 358                   | 344, 349, 359, 360                |
| CAD+               | 352, 361, 362         | —                 | —                     | 348, 364                          |
| CAD–               | 363                   | 357               | 332, 358              | 340, 341, 343, 344, 347, 360, 365 |

CAD, coronary artery disease; CVD, cerebrovascular disease; MI, myocardial infarction; PL, phospholipid; VNTR, variable number of tandem repeats.  
Adapted and updated from Kunicki TJ. Platelet antigen polymorphisms. In: Schechter GP, Berliner N, Telen MJ, eds. *American Society of Hematology: Education Program Book*. 2000:222–228.

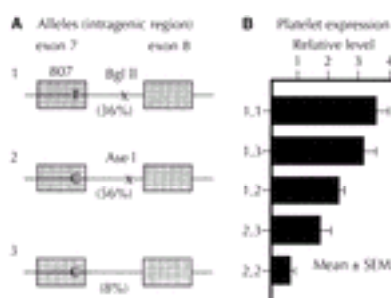
Another polymorphism of the gpIba subunit involves an amino acid substitution at position 145 that switches a threonine for methionine within a leucine-rich motif ( [246](#), [247](#) ). The Thr:Met alleles are present in a ratio of 9:1 in typical white populations, and the Met 145 allele is associated with the VNTR A and B phenotypes ( [248](#) ). This dimorphism is the basis for the human platelet alloantigen-2 antigen system and can participate in platelet transfusion-associated alloantibody formation in multiply transfused patients. It has also been implicated in cardiovascular ( [243](#), [244](#) ) and cerebrovascular ( [244](#), [249](#) ) disease.

A third gpIba polymorphism exists in an upstream region surrounding the translation start site at position -5 from the initiator adenine-thymine-guanine codon and exists as either a T or a C. This is also known as *Kozak sequence dimorphism*. The -5C allele increases the expression of gpIba on the platelet membrane surface by 50% in homozygous individuals ( [250](#), [251](#) ). Most of the data available suggest that this does not lead to a significantly increased risk for cardiovascular or cerebrovascular disease ( [252](#) ).

### $\alpha_2\beta_1$ Receptor

As previously discussed, integrin  $\alpha_2\beta_1$  is a major platelet collagen receptor. It is interesting to note that it has been shown that this receptor's density on the platelet surface correlates with its adhesiveness to type I and type III collagens. The expression level varies up to tenfold between individuals and is linked to specific polymorphisms in the  $\alpha_2$  gene.

A single copy of the  $\alpha_2$  gene exists in the human haplotype and is present on the short arm of chromosome 5 ( [253](#), [254](#) ). Four  $\alpha_2$  alleles have been defined to date. Allele 1 (807T/1648A/2531C) is associated with increased receptor density. Allele 2 (807C/1648G/2531C) and allele 3 (807C/1648A/2531C) are both associated with lower levels of receptor expression. Allele 4 is very rare and is defined by 2531T. It creates the Sit<sup>a</sup> alloantigen. Unique restriction sites can differentiate each allele, as shown in [Figure 20.11](#). In addition to these allelic differences, various groups have also reported two dimorphisms (C-52T and C-92G) within the proximal 5' regulatory region that also contribute to the variable expression of  $\alpha_2\beta_1$  ( [255](#), [256](#), [257](#) and [258](#) ). In this respect, the presence of either the -52T or -92G polymorphism correlate with reduced expression of platelet  $\alpha_2\beta_1$ .



**Figure 20.11.** Integrin  $\alpha_2$  polymorphisms. **A:** Three common  $\alpha_2$  alleles that are distinguished by varying splice sites between exons 7 and 8 and their gene frequencies in a typical white population. **B:** Relative expression levels of  $\alpha_2\beta_1$  as controlled by the inheritance of the three alleles. See text for details. SEM, standard error of mean. [From Kunicki TJ. The role of platelet collagen receptor (glycoprotein Ia/IIa; integrin  $\alpha_2\beta_1$ )

polymorphisms in thrombotic disease. Curr Opin Hematol 2001;8:281, with permission.]

Because the rate of platelet attachment to type I collagen under high shear rate is proportional to the density of the  $\alpha_2\beta_1$  receptors, theoretically, those with allele 1 might be expected to have increased risk of clotting. Overall, the studies investigating a correlation between allele 1 and thrombotic risk have shown equivocal results in MI, a trend suggesting that it is a probable risk factor in cerebrovascular disease and diabetic retinopathy, and a conclusion that it is unlikely to be a risk factor in coronary artery disease or venous thrombosis ( [Table 20.1](#) ).

Most studies have been performed on integrin  $\alpha_2\beta_1$  allele 1 (807T) as a risk factor for MI and warrant discussion. These include case control studies of variable numbers of subjects that have addressed the incidence of MI in patients with coronary artery disease, as well as the occurrence of sudden cardiac death. The study by Santoso et al. ( [259](#) ) is the largest study to date that investigated the relationship between the 807T polymorphism and nonfatal MI in younger patients. The most striking association was with patients younger than 49 years of age who had an MI with the highest odds ratio in the study of 2.61. However, there was no association between allele 1 and the presence of coronary artery disease in this group. This latter observation was verified by Corral et al., in whose study the median age of the patients was 52 years. However, there were no subset evaluations performed specifically for age.

There have been very little data to suggest that alleles 2 through 4 are associated with increased risk of thrombosis. However, Kroll et al. published a large study in 2000 that suggested allele 3 was associated with coronary artery disease, possibly via a qualitative rather than quantitative effect ( [260](#) ).

## Platelet Glycoprotein VI

gpVI is a platelet receptor that, as discussed above, also binds to collagen and induces activation via a pathway that phosphorylates the FcR $\gamma$ -chain ( [43](#) , [52](#) , [54](#) , [70](#) ). gpVI recognizes the Gly-Pro-Hyp (hydroxyproline) sequence on collagen. It has been shown in a small number of volunteers that this receptor expression level varies by fivefold ( [261](#) ) and possibly corresponds to variations in integrin  $\alpha_{IIb}\beta_3$ . However, there is no genetic basis for variation in gpVI expression yet. It may prove to be a useful therapeutic target for patients with ischemic heart disease ( [262](#) ).

## $\alpha_{IIb}\beta_3$ Receptor

Three allelic variants are known within the  $\alpha_{IIb}$  subunit with differences at residue 837 (Val or Met) ( [263](#) ) or 843 (Ile or Ser) ( [264](#) ). The most common variant in the white population is Val 837, Ile 843 (human platelet alloantigen 3a,9a). Eight allelic variants exist within the  $\beta_3$  subunit that vary at six different positions. These include positions 33 (Leu or Pro, human platelet alloantigen 1a or 1b), 40 (Leu or Arg), 62 (Arg or Gln), 143 (Arg or Gln), 407 (Pro or Ala), 489 (Arg or Gln), and 636 (Arg or Cys) ( [265](#) ). The dimorphism at position 40 is serologically indistinguishable. The most frequent dimorphism in the white population is Leu 33, Leu 40, Arg 62, Arg 143, Pro 407, Arg 489, Arg 636 (gene frequency, 0.85) ( [266](#) ). The allele of importance is Pro 33 ( $\beta$ -3PI<sup>A2</sup>; gene frequency, 0.15), which has been implicated as a potential risk factor for coronary thrombosis ( [267](#) ). This allele may confer a lower threshold for agonist-induced platelet responses ( [266](#) ). [Table 20.1](#) summarizes the  $\alpha_{IIb}\beta_3$  polymorphisms and their status as possible risk factors for

thrombosis. None of the platelet receptor polymorphisms has been consistently linked to deep venous thrombosis.

## ROLE OF THE CYTOSKELETON IN PLATELET FUNCTION

Once an agonist has interacted with its platelet membrane receptor and triggered second messenger formation, a key event in platelet activation and subsequent aggregation is the transition of the platelet's shape from the discoid appearance associated with its circulating, resting state to the amorphous, amoebalike appearance with multiple pseudopodial projections that denotes its activation state and readiness to participate in platelet plug formation. The platelet cytoskeleton and its associated signaling proteins are responsible for mediating shape change associated with activation, spreading, secretion, and aggregation. This cytoskeleton is associated with at least 14 different structural proteins that function interdependently as a single unit but can be seen as consisting of three major functional units: (a) a cytoplasmic network consisting mainly of actin, (b) a meshwork of proteins immediately proximal to the cytoplasmic leaflet of the platelet referred to as the *membrane skeleton* (because they contain surface-associated proteins like the gpIb complex), and (c) a microtubule coil that encircles the platelet to contribute to its resting, discoid state. The functional anatomy of these cytoskeletal proteins is described in depth in [Chapter 19](#), and so a relatively brief summary of their role in platelet function is presented in this section.

Transmembrane receptors, such as gpIb and  $\alpha_{IIb}\beta_3$ , appear to participate in anchoring the platelets to extracellular matrix in the arterial subendothelium through their extracellular domains, while their cytoplasmic domains are almost simultaneously associating with membrane skeletal proteins in response. In doing so, these surface receptors are providing sites at which tension can be generated by intracellular contractile elements that subsequently lead to shape change and activation of signaling proteins.

The cytoplasmic network consists of actin filaments and their associated proteins, referred to as *intermediate filaments*. In resting platelets, approximately half of actin is structurally filamentous in nature, and this fraction increases to approximately three-fourths during platelet activation ([268](#)). During this process, the actin filaments are reorganized into longer filaments after their initial breakdown into smaller units. Simultaneously, myosin is phosphorylated by myosin light chain kinase and then associates with F-actin, with the resultant filament then attaching itself to the  $\alpha$  subunit of the gpIb complex through ABP ([269](#), [270](#)). These filaments are also anchored at sites called *focal adhesions*, where the tyrosine kinase Fak becomes activated after platelet stimulation. Focal adhesions assemble around the  $\alpha_{IIb}\beta_3$  integrin on its conformational change (activation) and so play a very important role in signaling pathways associated with platelet activation by drawing together membrane receptors, the cytoskeleton, and signaling phosphoproteins such as members of the Src family, PI3K, and Syk into close physical proximity ([271](#)). Other platelet integrin receptors, such as  $\alpha_2\beta_1$ , also organize focal adhesions after binding to their respective extracellular ligands.

It was noted in the section, Glycoprotein Ib Complex Signaling that phosphorylation of Ser 166 in the cytoplasmic domain of the gpIb complex  $\beta$ -chain has been observed to be mediated by cAMP-associated activation of PKA and that this phosphorylation reduced interaction of gpIb $\beta$  and the signaling molecule, 14-3-3?. The phosphorylation of gpIb $\beta$  has also been demonstrated to have a direct inhibitory effect on actin polymerization ([272](#)) and thus serves as further support that gpIb $\beta$  phosphorylation may be playing a role in maintaining transmembrane signaling in a switched-off or resting state that is capable of

activation when shear-dependent interaction of gpIba with vWF takes place.

The membrane skeleton consists of actin, ABP, talin, vinculin, spectrin, cortactin,  $\alpha$ -actinin, and several membrane glycoproteins, as noted above and in [Table 19.3](#). ABP is a 250-kd elongated dimer that associates with the cytoplasmic domain of the gpIba-chain and acts to link the receptor to actin in the early stages of platelet activation, as noted above. ABP has also been found to coisolate with guanosine triphosphate-binding proteins and also binds to several members of the Ras superfamily of low-molecular-weight guanosine triphosphatases that participate in various aspects of cytoskeletal rearrangement ([273](#), [274](#) and [275](#)). After platelet activation, calpain, the calcium-dependent protease, is activated in aggregating and spreading platelets and cleaves the link between ABP and gpIb. Thus, ABP may be considered a prototype of sorts of membrane skeleton proteins that provides a good example of their important role in terms of interaction with second messengers and other signaling molecules that either may become activated or may act on their substrates after platelet stimulation.

Microtubules have been relatively understudied compared with the above cytoskeletal proteins. Early studies have demonstrated that the submembranous microtubule coil both depolymerizes and repolymerizes in activated platelets, although its organization in resting platelets is unknown ([276](#), [277](#)). The coil consists of a single polymer of tubulin that encircles the platelet periphery and helps to maintain its discoid shape while resting ([278](#)).

## PLATELET-CELL INTERACTIONS

### Platelets and Endothelium

The mechanisms behind platelet interaction with vWF, collagen, and other subendothelial matrix molecules exposed as a result of damaged endothelium have been well studied and described in earlier sections of this chapter. In addition to these platelet-subendothelial interaction paradigms, recent evidence has emerged that circulating, unactivated platelets have the capacity (like neutrophils) to roll on tumor necrosis factor- $\alpha$ -mediated activated endothelium *in vivo* and then reversibly adhere to it in a process that is dependent on endothelial cell expression of P-selectin ([279](#), [280](#), [281](#) and [282](#)). The specific counterreceptor on platelets that P-selectin binds to is unclear and could be the gpIb complex or P-selectin glycoprotein ligand 1, or both ([283](#), [284](#)). These two receptors have structural similarities including similar ligand-binding domains. P-selectin is also expressed on the surface of activated platelets and is an  $\alpha$ -granule component in resting platelets. Along with endothelial P-selectin, it is not surprising that vWF expressed on activated venous endothelium has also been implicated in platelet adhesion and translocation ([285](#)). The precise nature of the relationships between these two endothelial molecules and the platelet gpIb complex, and the role different shear forces may have to play in determining which ligand gpIb may preferentially associate with remain to be determined.

In contrast to these observations, activated platelets have also been demonstrated to adhere to intact endothelial cells in a process dependent on a  $\text{IIb}\beta_3$  bridging that involves endothelial receptors like a  $\sqrt{\beta_3}$  and intercellular adhesion molecule-1 interacting with platelet-bound fibrinogen, fibronectin, and vWF ([286](#), [287](#) and [288](#)). Whether P-selectin expressed on the surface of activated platelets plays any role in their interaction with endothelium is unknown. The fact that P-selectin knock-out mice have been observed to display impaired hemostasis would suggest a potential role in this respect ([289](#)).

## Platelets and White Blood Cells

In addition to the participation of the gpIb complex and P-selectin in the interaction between platelets and intact endothelium described above, these proteins along with the  $\beta_2$  integrin receptor Mac-1 (a  $\mu\beta_2$  or CD11b/CD18) have also been found to participate in interaction between platelets and leukocytes. Platelets contribute to leukocyte rolling and extravasation, which are two well-characterized steps involved in the translocation of the latter cell from the circulation to sites of infection (290). Normally, after interaction of endothelial P-selectin with leukocyte receptors such as P-selectin glycoprotein ligand 1,  $\beta_2$  integrin activation on the leukocyte mediates increased adhesion to endothelium, and that is followed by extravasation.

Neutrophils are also capable of rolling on adherent and activated platelets by interacting with P-selectin expressed on the platelet surface, and they will subsequently display extravasation mediated by activation of Mac-1 (291). The  $\alpha$  subunits of certain integrins, such as Mac-1, have been found to contain “insert” (I) domains, homologous to the  $A_1$  domain of vWF. This observation has taken on added interest since it was shown in 2000 that Mac-1 is capable of binding to the gpIb complex and that this interaction required the I domain of Mac-1 and the leucine-rich repeat region of gpIba (292). Mac-1 knock-out mouse neutrophils were incapable of binding to isolated polypeptide fragments corresponding to the extracellular domain of gpIba (called *glycocalicin*). For this reason and others, the role of Mac-1-gpIb complex interaction could turn out to be important with respect to initiating and propagating inflammation associated with the progression of atherosclerotic, purely thrombotic, or atherothrombotic processes.

## ROLE OF PLATELETS IN ATHEROTHROMBOSIS

Atherosclerosis is the major cause of vascular occlusive disorders such as coronary artery disease, stroke, and peripheral arterial disease. Every year, more than 4 million patients are admitted to hospitals worldwide with ACS, more than 1.5 million of them in the United States (293). Peripheral arterial disease affects up to 12% of the general population and 20% of those older than age 70 years (294). The instability associated with atherosclerotic plaque progression enhances the patients' vulnerability to disruption or ulceration, and this is associated with secondary deep vessel wall injury and thrombus formation (295, 296 and 297). It is clear that platelet activation and aggregation play an integral role in the development of thrombus associated with atherosclerotic plaque based on extensive laboratory and clinical experience.

Angiographic studies have shown that the progression of coronary artery disease is neither linear nor predictable (298). Severe narrowing or total occlusion can often be documented in arterial segments that appeared normal only months earlier at angiographic examination (299, 300). This unpredictable progression is likely caused by plaque disruption and subsequent thrombus formation that changes the plaque geometry (295, 301, 302). Such a rapid change in the plaque may result in thrombotic arterial occlusion with associated ACS.

The interior of intact atherosclerotic plaques is rich in components that are highly thrombogenic (e.g., collagen types I and III, fibrinogen/fibrin, thrombospondin), and the luminal surface is relatively nonthrombogenic. In contrast to these observations, the thrombotic response to plaque disruption is dynamic. In this respect, thrombosis, repeat thrombosis, and thrombolysis along with embolization all occur simultaneously in many



patients with ACS, and this is considered responsible for intermittent flow obstructions ( [303](#) ). The initial flow obstruction is acknowledged as being due to platelet aggregation, but subsequent fibrin stabilization is important to the longevity of the early and fragile platelet thrombus ( [304](#) ). Due to reduced flow caused by the platelet thrombus at the plaque rupture site, a red erythrocyte and fibrin-rich thrombus may form and propagate up and down the artery in both directions ( [303](#) ).

Coronary angioplasty data collected at the time of ACS have shown that transient vasoconstriction often accompanies plaque disruption or fissuring and thrombosis ( [305](#) ). This vasoconstriction occurs with significant wall damage and is dependent on both platelets and thrombin, with the platelet dependence shown to be mediated by serotonin and thromboxane A<sub>2</sub> ( [305](#), [306](#) ). There is also evidence that alteration of the endothelium such as may occur with early atherogenesis (particularly when under the influence of atherosclerosis risk factors) or plaque disruption may cause endothelium to generate more mediators that enhance constriction, such as endothelin-1, and fewer mediators that enhance dilation, such as PGI<sub>2</sub> and NO ( [307](#), [308](#), [309](#) and [310](#) ).

The importance of the role of both arterial wall and systemic inflammation in atherogenesis and its later clinical manifestations, along with the molecular interface between inflammation and thrombosis, have been the subject of much recent attention in the literature ( [311](#), [312](#) ). An increased number of links between thrombosis and inflammatory mediators have been observed in recent years, and new roles for the platelet in inflammation are becoming apparent as a result ( [313](#) ).

As discussed in the previous section, platelets colocalize and directly interact with leukocytes at sites of damaged endothelium that can occur in the setting of hemorrhage, areas of atherosclerotic plaque destabilization, postangioplasty lesions associated with restenosis, and areas of ischemia-reperfusion injury ( [313](#) ). These broadly based settings associated with platelet-leukocyte interactions link hemostatic/thrombotic and inflammatory responses. As described in more detail in the previous section, many of the molecular players mediating leukocyte-endothelium interaction have also been found to play important roles coordinating leukocyte attachment and transmigration across layers of platelets adherent to injured vascular intima ( [292](#), [314](#) ). In addition to this binding of leukocytes to platelets, the binding of platelets to leukocytes influences important white cell effector responses, such as cell activation, signaling associated with integrin activation, chemokine synthesis, and so forth. Thus, it has become clear that inflammation is capable of leading to local thrombosis, and thrombosis is capable of initiating and propagating inflammation. It is likely that progress will continue to be made in the foreseeable future with respect to elucidating the molecular mechanisms linking these fundamental disease processes.

## REFERENCES

1. Savage B, Saldivar E, Ruggeri ZM. Initiation of platelet adhesion by arrest onto fibrinogen or translocation on von Willebrand factor. *Cell* 1996;84:289-297.
2. Fredrickson BJ, Dong JF, McIntire LV, Lopez JA. Shear-dependent rolling on von Willebrand factor of mammalian cells expressing the platelet glycoprotein Ib-IX-V complex. *Blood* 1998;92:3684-3693.
3. Cranmer SL, Ulsemer P, Cooke BM, et al. Glycoprotein (GP) Ib-IX-transfected cells roll on a von Willebrand factor matrix under flow. Importance of the GPIb/actin-binding protein (ABP-280) interaction in maintaining adhesion under high shear. *J Biol Chem* 1999;274:6097-6106.
4. Tsuji S, Sugimoto M, Miyata S, et al. Real-time analysis of mural thrombus formation in various platelet



aggregation disorders: distinct shear-dependent roles of platelet receptors and adhesive proteins under flow. *Blood* 1999;94:968–975.

5. Roth GJ. Developing relationships: arterial platelet adhesion, glycoprotein Ib, and leucine-rich glycoproteins. *Blood* 1991;77:5–19.
6. Berndt MC, Gregory C, Kabral A, et al. Purification and preliminary characterization of the glycoprotein Ib complex in the human platelet membrane. *Eur J Biochem* 1985;151:637–649.
7. Du X, Beutler L, Ruan C, et al. Glycoprotein Ib and glycoprotein IX are fully complexed in the intact platelet membrane. *Blood* 1987;69:1524–1527.
8. Modderman PW, Admiraal LG, Sonnenberg A, von dem Borne AE. Glycoproteins V and Ib-IX form a noncovalent complex in the platelet membrane. *J Biol Chem* 1992;267:364–369.
9. Ruggeri ZM. Structure and function of von Willebrand factor. *Thromb Haemost* 1999;82:576–584.
10. Miyata S, Goto S, Federici AB, et al. Conformational changes in the A1 domain of von Willebrand factor modulating the interaction with platelet glycoprotein Ibalpha. *J Biol Chem* 1996;271:9046–9053.
11. Siedlecki CA, Lestini BJ, Kottke-Marchant KK, et al. Shear-dependent changes in the three-dimensional structure of human von Willebrand factor. *Blood* 1996;88:2939–2950.
12. Peterson DM, Stathopoulos NA, Giorgio TD, et al. Shear-induced platelet aggregation requires von Willebrand factor and platelet membrane glycoproteins Ib and IIb-IIIa. *Blood* 1987;69:625–628.
13. De Luca M, Facey DA, Favalaro EJ, et al. Structure and function of the von Willebrand factor A1 domain: analysis with monoclonal antibodies reveals distinct binding sites involved in recognition of the platelet membrane glycoprotein Ib-IX-V complex and ristocetin-dependent activation. *Blood* 2000;95:164–172.
14. Ward CM, Andrews RK, Smith AI, Berndt MC. Mocarhagin, a novel cobra venom metalloproteinase, cleaves the platelet von Willebrand factor receptor glycoprotein Ibalpha. Identification of the sulfated tyrosine/an-ionic sequence Tyr-276-Glu-282 of glycoprotein Ibalpha as a binding site for von Willebrand factor and alpha-thrombin. *Biochemistry* 1996;35:4929–4938.
15. Nishio K, Fujimura Y, Nishida S, et al. Antiplatelet glycoprotein Ib monoclonal antibody (OP-F1) totally abolishes ristocetin-induced von Willebrand factor binding, but has minimal effect on the botrocetin-induced binding. *Haemostasis* 1991;21:353–359.
16. Berndt MC, Shen Y, Dopheide SM, et al. The vascular biology of the glycoprotein Ib-IX-V complex. *Thromb Haemost* 2001;86:178–188.
17. Ward CM, Andrews RK, Smith AI, Berndt MC. Mocarhagin, a novel cobra venom metalloproteinase, cleaves the platelet von Willebrand factor receptor glycoprotein Ibalpha. Identification of the sulfated tyrosine/an-ionic sequence Tyr-276-Glu-282 of glycoprotein Ibalpha as a binding site for von Willebrand factor and alpha-thrombin. *Biochemistry* 1996;35:4929–4938.
18. Marchese P, Murata M, Mazzucato M, et al. Identification of three tyrosine residues of glycoprotein Ib alpha with distinct roles in von Willebrand factor and alpha-thrombin binding. *J Biol Chem* 1995;270:9571–9578.
19. Dong JF, Hyun W, Lopez JA. Aggregation of mammalian cells expressing the platelet glycoprotein (GP) Ib-IX complex and the requirement for tyrosine sulfation of GP Ib alpha. *Blood* 1995;86:4175–4183.
20. Murata M, Ware J, Ruggeri ZM. Site-directed mutagenesis of a soluble recombinant fragment of platelet glycoprotein Ib alpha demonstrating negatively charged residues involved in von Willebrand factor binding. *J Biol Chem* 1991;266:15474–15480.
21. Miller JL, Cunningham D, Lyle VA, Finch CN. Mutation in the gene encoding the alpha chain of platelet glycoprotein Ib in platelet-type von Willebrand disease. *Proc Natl Acad Sci U S A* 1991;88:4761–4765.
22. Shen Y, Romo GM, Dong JF, et al. Requirement of leucine-rich repeats of glycoprotein (GP) Ibalpha for shear-dependent and static binding of von Willebrand factor to the platelet membrane GP Ib-IX-V

complex. *Blood* 2000;95:903–910.

23. Berndt MC, Phillips DR. Interaction of thrombin with platelets: purification of the thrombin substrate. *Ann N Y Acad Sci* 1981;370:87–95.

24. De Candia E, Hall SW, Rutella S, et al. Binding of thrombin to the Glycoprotein Ib accelerates the hydrolysis of PAR-1 on intact platelets. *J Biol Chem* 2001;276:4692–4698.

25. Dormann D, Clemetson KJ, Kehrel BE. The GPIb thrombin-binding site is essential for thrombin-induced platelet procoagulant activity. *Blood* 2000;96:2469–2478.

26. Ramakrishnan V, DeGuzman F, Bao M, et al. A thrombin receptor function for platelet glycoprotein Ib-IX unmasked by cleavage of glycoprotein V. *Proc Natl Acad Sci U S A* 2001;98:1823–1828.

27. Li CQ, Vindigni A, Sadler JE, Wardell MR. Platelet glycoprotein Ib-alpha binds to thrombin anion-binding exosite II inducing allosteric changes in thrombin's activity. *J Biol Chem* 2001;276:6161–6168.

28. Ware J, Russell S, Ruggeri ZM. Generation and rescue of a murine model of platelet dysfunction: the Bernard-Soulier syndrome. *Proc Natl Acad Sci U S A* 2000;97:2803–2808.

29. Coughlin SR. Protease-activated receptors in vascular biology. *Thromb Haemost* 2001;86:298–307.

30. Beguin S, Kumar R, Keularts I, et al. Fibrin-dependent platelet procoagulant activity requires GPIb receptors and von Willebrand factor. *Blood* 1999;93:564–570.

31. Robinson K, Jones D, Patel Y, et al. Mechanism of inhibition of protein kinase C by 14-3-3 isoforms. *Biochem J* 1994;299:853–861.

32. Muslin AJ, Tanner JW, Allen PM, Shaw AS. Interaction of 14-3-3 with signaling proteins is mediated by the recognition of phosphoserine. *Cell* 1996;84:889–897.

33. Morrison D. 14-3-3: modulators of signaling proteins? *Science* 1994;266:56–57.

34. Andrews RK, Harris SJ, McNally T, Berndt MC. Binding of purified 14-3-3 zeta signaling protein to discrete amino acid sequences within the cytoplasmic domain of the platelet membrane glycoprotein Ib-IX-V complex. *Biochemistry* 1998;37:638–647.

35. Calverley DC, Kavanagh TJ, Roth GJ. Human signaling protein 14-3-3 zeta interacts with platelet glycoprotein Ib subunits Ibalpha and Ibbeta. *Blood* 1998;91:1295–1303.

36. Feng S, Christodoulides N, Resendiz JC, et al. Cytoplasmic domains of GpIbalpha and GpIbbeta regulate 14-3-3zeta binding to GpIb/IX/V. *Blood* 2000;95:551–557.

37. Gu M, Xi X, Englund GD, et al. Analysis of the roles of 14-3-3 in the platelet glycoprotein Ib-IX-mediated activation of integrin alpha(IIb)beta(3) using a reconstituted mammalian cell expression model. *J Cell Biol* 1999;147:1085–1096.

38. Munday AD, Berndt MC, Mitchell CA. Phosphoinositide 3-kinase forms a complex with platelet membrane glycoprotein Ib-IX-V complex and 14-3-3zeta. *Blood* 2000;96:577–584.

39. Lopez JA. The platelet glycoprotein Ib-IX complex. *Blood Coagul Fibrinolysis* 1994;5:97–119.

40. Falati S, Edmead CE, Poole AW. Glycoprotein Ib-V-IX, a receptor for von Willebrand factor, couples physically and functionally to the Fc receptor gamma-chain, Fyn, and Lyn to activate human platelets. *Blood* 1999;94:1648–1656.

41. Torti M, Bertoni A, Canobbio I, et al. Rap1B and Rap2B translocation to the cytoskeleton by von Willebrand factor involves FcgammaII receptor-mediated protein tyrosine phosphorylation. *J Biol Chem* 1999;274:13690–13697.

42. Sullam PM, Hyun WC, Szollosi J, et al. Physical proximity and functional interplay of the glycoprotein Ib-IX-V complex and the Fc receptor FcgammaRIIA on the platelet plasma membrane. *J Biol Chem*

1998;273:5331–5336.

43. Poole A, Gibbins JM, Turner M, et al. The Fc receptor gamma-chain and the tyrosine kinase Syk are essential for activation of mouse platelets by collagen. *EMBO J* 1997;16:2333–2341.
44. Yanaga F, Poole A, Asselin J, et al. Syk interacts with tyrosine-phosphorylated proteins in human platelets activated by collagen and cross-linking of the Fc gamma-IIA receptor. *Biochem J* 1995;311:471–478.
45. Blake RA, Schieven GL, Watson SP. Collagen stimulates tyrosine phosphorylation of phospholipase C-gamma2 but not phospholipase C-gamma1 in human platelets. *FEBS Lett* 1994;353:212–216.
46. Keely PJ, Parise LV. The alpha<sub>2</sub>beta<sub>1</sub> integrin is a necessary co-receptor for collagen-induced activation of Syk and the subsequent phosphorylation of phospholipase Cgamma2 in platelets. *J Biol Chem* 1996;271:26668–26676.
47. Clemetson KJ, Clemetson JM. Platelet collagen receptors. *Thromb Haemost* 2001;86:189–197.
48. Moroi M, Jung SM. Platelet receptors for collagen. *Thromb Haemost* 1997;78:439–444.
49. Ryo R, Yoshida A, Sugano W, et al. Deficiency of P62, a putative collagen receptor, in platelets from a patient with defective collagen-induced platelet aggregation. *Am J Hematol* 1992;39:25–31.
50. Santoro SA, Walsh JJ, Staats WD, Baranski KJ. Distinct determinants on collagen support alpha 2 beta 1 integrin-mediated platelet adhesion and platelet activation. *Cell Regul* 1991;2:905–913.
51. Morton LF, Hargreaves PG, Farndale RW, et al. Integrin alpha 2 beta 1-independent activation of platelets by simple collagen-like peptides: collagen tertiary (triple-helical) and quarternary (polymeric) structures are sufficient alone for alpha 2 beta 1-independent platelet reactivity. *Biochem J* 1995;306:337–344.
52. Gibbins J, Asselin J, Farndale R, et al. Tyrosine phosphorylation of the Fc receptor gamma-chain in collagen-stimulated platelets. *J Biol Chem* 1996;271:18095–18099.
53. Asselin J, Gibbins JM, Achison M, et al. A collagen-like peptide stimulates tyrosine phosphorylation of Syk and phospholipase Cgamma2 in platelets independent of the integrin alpha<sub>2</sub>beta<sub>1</sub>. *Blood* 1997;89:1235–1242.
54. Gibbins JM, Okuma M, Farndale R, et al. Glycoprotein VI is the collagen receptor in platelets which underlies tyrosine phosphorylation of the Fc receptor gamma-chain. *FEBS Lett* 1997;413:255–259.
55. Ichinohe T, Takayama H, Ezumi Y, et al. Cyclic AMP-insensitive activation of c-Src and Syk protein-tyrosine kinases through platelet membrane glycoprotein VI. *J Biol Chem* 1995;270:28029–28036.
56. Polgar J, Clemetson JM, Kehrel BE, et al. Platelet activation and signal transduction by convulxin, a C-type lectin from *Crotalus durissus terrificus* (tropical rattlesnake) venom via the p62/GPVI collagen receptor. *J Biol Chem* 1997;272:13576–13583.
57. Arai M, Yamamoto N, Moroi M, et al. Platelets with 10% of the normal amount of GPVI have an impaired response to collagen that results in a mild bleeding tendency. *Br J Haematol* 1995;89:124–130.
58. Ichinohe T, Takayama H, Ezumi Y, et al. Collagen-stimulated activation of syk but not c-src is severely compromised in human platelets lacking membrane glycoprotein VI. *J Biol Chem* 1997;272:63–68.
59. Clemetson JM, Polgar J, Magnenat E, et al. The platelet collagen receptor glycoprotein VI is a member of the immunoglobulin superfamily closely related to Fc alpha R and the natural killer receptors. *J Biol Chem* 1999;274:29019–29024.
60. Staats WD, Rajpara SM, Wayner EA, et al. The membrane glycoprotein Ia-IIa (VLA-2) complex mediates the Mg<sup>++</sup>-dependent adhesion of platelets to collagen. *J Cell Biol* 1989;108:1917–1924.
61. Springer TA. Folding of the N-terminal, ligand-binding region of integrin alpha-subunits into a beta-propeller domain. *Proc Natl Acad Sci U S A* 1997;94:65–72.

62. Lahav J, Gofer-Dadosh N, Luboshitz J, et al. Protein disulfide isomerase mediates integrin-dependent adhesion. *FEBS Lett* 2000;475:89-92.
63. Santoro SA, Walsh JJ, Staats WD, Baranski KJ. Distinct determinants on collagen support  $\alpha_2\beta_1$  integrin-mediated platelet adhesion and platelet activation. *Cell Regul* 1991;2:905-913.
64. Jung SM, Moroi M. Platelets interact with soluble and insoluble collagens through characteristically different reactions. *J Biol Chem* 1998;273:14827-14837.
65. Jung SM, Moroi M. Signal-transducing mechanisms involved in activation of the platelet collagen receptor integrin  $\alpha_2\beta_1$ . *J Biol Chem* 2000;275:8016-8026.
66. Clemetson KJ, McGregor JL, James E, et al. Characterization of the platelet membrane glycoprotein abnormalities in Bernard-Soulier syndrome and comparison with normal by surface-labeling techniques and high-resolution two-dimensional gel electrophoresis. *J Clin Invest* 1982;70:304-311.
67. Miura Y, Ohnuma M, Jung SM, Moroi M. Cloning and expression of the platelet-specific collagen receptor glycoprotein VI. *Thromb Res* 2000;98:301-309.
68. Jandrot-Perrus M, Busfield S, Lagrue AH, et al. Cloning, characterization, and functional studies of human and mouse glycoprotein VI: a platelet-specific collagen receptor from the immunoglobulin superfamily. *Blood* 2000;96:1798-1807.
69. Ezumi Y, Uchiyama T, Takayama H. Molecular cloning, genomic structure, chromosomal localization, and alternative splice forms of the platelet collagen receptor glycoprotein VI. *Biochem Biophys Res Commun* 2000;277:27-36.
70. Tsuji M, Ezumi Y, Arai M, Takayama H. A novel association of Fc receptor  $\gamma$ -chain with glycoprotein VI and their co-expression as a collagen receptor in human platelets. *J Biol Chem* 1997;272:23528-23531.
71. Nieswandt B, Bergmeier W, Schulte V, et al. Expression and function of the mouse collagen receptor glycoprotein VI is strictly dependent on its association with the FcR $\gamma$  chain. *J Biol Chem* 2000;275:23998-24002.
72. Kehrel B, Wierwille S, Clemetson KJ, et al. Glycoprotein VI is a major collagen receptor for platelet activation: it recognizes the platelet-activating quaternary structure of collagen, whereas CD36, glycoprotein IIb/IIIa, and von Willebrand factor do not. *Blood* 1998;91:491-499.
73. Moroi M, Jung SM, Shinmyozu K, et al. Analysis of platelet adhesion to a collagen-coated surface under flow conditions: the involvement of glycoprotein VI in the platelet adhesion. *Blood* 1996;88:2081-2092.
74. Jandrot-Perrus M, Lagrue AH, Okuma M, Bon C. Adhesion and activation of human platelets induced by convulxin involve glycoprotein VI and integrin  $\alpha_2\beta_1$ . *J Biol Chem* 1997;272:27035-27041.
75. Marlas G, Joseph D, Huet C. Isolation and electron microscope studies of a potent platelet-aggregating glycoprotein from the venom of *Crotalus durissus cascavella*. *Biochimie* 1983;65:405-416.
76. Watson SP. Collagen receptor signalling in platelets and megakaryocytes. *Thromb Haemost* 1999;82:365-376.
77. Myung PS, Boerthe NJ, Koretzky GA. Adapter proteins in lymphocyte antigen-receptor signaling. *Curr Opin Immunol* 2000;12:256-266.
78. Tomlinson MG, Lin J, Weiss A. Lymphocytes with a complex: adapter proteins in antigen signaling. *Immunol Today* 2000;21:584-591.
79. Watson SP, Asazuma N, Atkinson B, et al. The role of ITAM- and ITIM-coupled receptors in platelet activation by collagen. *Thromb Haemost* 2001;86:276-288.
80. Bobe R, Wilde JI, Maschberger P, et al. Phosphatidylinositol 3-kinase-dependent translocation of

phospholipase C $\gamma$ 2 in mouse megakaryocytes is independent of Bruton's tyrosine kinase translocation. *Blood* 2001;97:678-684.

81. Pasquet JM, Gross B, Quek L, et al. LAT is required for tyrosine phosphorylation of phospholipase C $\gamma$ 2 and platelet activation by the collagen receptor GPVI. *Mol Cell Biol* 1999;19:8326-8334.

82. Gross B, Lee JR, Clements JL, et al. Tyrosine phosphorylation of SLP-76 is downstream of Syk following stimulation of the collagen receptor GPVI in platelets. *J Biol Chem* 1999;274:5963-5971.

83. Tomlinson MG, Lin J, Weiss A. Lymphocytes with a complex: adapter proteins in antigen signaling. *Immunol Today* 2000;21:584-591.

84. Falet H, Barkalow KL, Pivniouk VI, et al. Roles of SLP-76, phosphoinositide 3-kinase, and gelsolin in the platelet shape changes initiated by the collagen receptor GPVI/Fc $\gamma$ -chain complex. *Blood* 2000;96:3786-3792.

85. Pasquet JM, Bobe R, Gross B, et al. A collagen-related peptide regulates phospholipase C $\gamma$ 2 via phosphatidylinositol 3-kinase in human platelets. *Biochem J* 1999;342:171-177.

86. Gratacap M-P, Payrastre B, Viala C, et al. Phosphatidylinositol 3,4,5-trisphosphate-dependent stimulation of phospholipase C- $\gamma$ 2 is an early key event in Fc $\gamma$ RIIA-mediated activation of human platelets. *J Biol Chem* 1998;273:24314-24321.

87. Wang D, Feng J, Wen R, et al. Phospholipase C $\gamma$ 2 is essential in the functions of B cell and several Fc receptors. *Immunity* 2000;13:25-35.

88. Langlet C, Bernard AM, Drevot P, He HT. Membrane rafts and signaling by the multichain immune recognition receptors. *Curr Opin Immunol* 2000;12:250-255.

89. Yasuهارu E, Kodama K, Uchiyama T, Takayama H. Constitutive and functional association of the platelet collagen receptor glycoprotein VI-Fc receptor  $\gamma$ -chain complex with membrane rafts. *Blood* 2002;99:3250-3255.

90. Coughlin SR. How the protease thrombin talks to cells. *Proc Natl Acad Sci U S A* 1999;96:11023-11027.

91. Vu T-KH, Hung DT, Wheaton VI, Coughlin SR. Molecular cloning of a functional thrombin receptor reveals a novel proteolytic mechanism of receptor activation. *Cell* 1991;64:1057-1068.

92. Xu WF, Andersen H, Whitmore TE, et al. Cloning and characterization of human protease-activated receptor 4. *Proc Natl Acad Sci U S A* 1998;95:6642-6646.

93. Kahn ML, Nakanishi-Matsui M, Shapiro MJ, et al. Protease-activated receptors 1 and 4 mediate activation of human platelets by thrombin. *J Clin Invest* 1999;103:879-887.

94. Nystedt S, Emilsson K, Wahlestedt C, Sundelin J. Molecular cloning of a potential novel proteinase activated receptor. *Proc Natl Acad Sci U S A* 1994;91:9208-9212.

95. Molino M, Barnathan ES, Numerof R, et al. Interactions of mast cell tryptase with thrombin receptors and PAR-2. *J Biol Chem* 1997;272:4043-4049.

96. Camerer E, Røttingen JA, Iversen JG, Prydz H. Coagulation factors VII and X induce Ca<sup>2+</sup> oscillations in Madin-Darby canine kidney cells only when proteolytically active. *J Biol Chem* 1996;271:29034-29042.

97. Camerer E, Huang W, Coughlin SR. Tissue factor- and Factor X-dependent activation of PAR2 by Factor VIIa. *Proc Natl Acad Sci U S A* 2000;97:5255-5260.

98. Rasmussen UB, Vouret-Craviari V, Jallat S, et al. cDNA cloning and expression of a hamster alpha-thrombin receptor coupled to Ca<sup>2+</sup> mobilization. *FEBS Letts* 1991;288:123-128.

99. Klages B, Brandt U, Simon MI, et al. Activation of G12/G13 results in shape change and rho/rho kinase-mediated myosin light chain phosphorylation in mouse platelets. *J Cell Biol* 1999;144:745-754.

100. Offermanns S, Toombs CF, Hu YH, Simon MI. Defective platelet activation in G $\alpha$ (q)-deficient mice. *Nature* 1997;389:183–186.
101. Taylor S, Chae H, Rhee S-G, Exton J. Activation of the B1 isozyme of phospholipase C by alpha subunits of the Gq class of G proteins. *Nature* 1991;350:516–518.
102. Yang J, Wu J, Kowalska MA, et al. Loss of signaling through the G protein, Gz, results in abnormal platelet activation and altered responses to psychoactive drugs. *Proc Natl Acad Sci U S A* 2000;97:9984–9989.
103. Stoyanov B, Volinia S, Hanck T, et al. Cloning and characterization of a G protein-activated human phosphoinositide-3 kinase. *Science* 1995;269:690–693.
104. Clapham DE, Neer EJ. G protein beta gamma subunits. *Annu Rev Pharmacol Toxicol* 1997;37:167–203.
105. Leervers SJ, Vanhaesebroeck B, Waterfield MD. Signalling through phosphoinositide 3-kinases: the lipids take centre stage. *Curr Opin Cell Biol* 1999;11:219–225.
106. Hein L, Ishii K, Coughlin SR, Kobilka BK. Intracellular targeting and trafficking of thrombin receptors: a novel mechanism for resensitization of a G protein-coupled receptor. *J Biol Chem* 1994;269:27719–27726.
107. Trejo J, Hammes SR, Coughlin SR. Termination of signaling by protease-activated receptor-1 is linked to lysosomal sorting. *Proc Natl Acad Sci U S A* 1998;95:13698–13702.
108. Trejo J, Coughlin SR. The cytoplasmic tails of protease-activated receptor-1 and substance P receptor specify sorting to lysosomes versus recycling. *J Biol Chem* 1999;274:2216–2224.
109. Hellem AJ. The adhesiveness of human blood platelets in vitro. *Scand J Clin Lab Invest* 1960;12:1–117.
110. Gaarder A, Jonsen L, Laland S, et al. Adenosine diphosphate in red cells as a factor in the adhesiveness of human blood platelets. *Nature* 1961;192:531–532.
111. Savi P, Herbert JM. Pharmacology of ticlopidine and clopidogrel. *Haematologica* 2000;85:73–77.
112. Humphries RG. Pharmacology of AR-C69931MX and related compounds: from pharmacological tools to clinical trials. *Haematologica* 2000;85:66–72.
113. Ralevic V, Burnstock G. Receptors for purines and pyrimidines. *Pharmacol Rev* 1998;50:413–492.
114. Webb TE, Simon J, Krishek BJ, et al. Cloning and functional expression of a brain G-protein-coupled ATP receptor. *FEBS Lett* 1993;324:219–223.
115. Léon C, Vial C, Cazenave JP, Gachet C. Cloning and sequencing of a human cDNA encoding endothelial P2Y $_1$  purinoceptor. *Gene* 1996;171:295–297.
116. Ayyanathan K, Webb TE, Sandhu AK, et al. Cloning and chromosomal localization of the human P2Y $_1$  purinoceptor. *Biochem Biophys Res Commun* 1996;218:783–788.
117. Léon C, Hechler B, Vial C, et al. The P2Y $_1$  receptor is an ADP receptor antagonized by ATP and expressed in platelets and megakaryoblastic cells. *FEBS Lett* 1997;403:26–30.
118. Hechler B, Vigne P, Léon C, et al. ATP derivatives are antagonists of the P2Y $_1$  receptor: similarities with the platelet ADP receptor. *Mol Pharmacol* 1998;53:727–733.
119. Daniel JL, Dangelmaier C, Jin J, et al. Molecular basis for ADP-induced platelet activation. I. Evidence for three distinct ADP receptors on human platelets. *J Biol Chem* 1998;273:2024–2029.
120. Geiger J, Honig-Liedl P, Schanzenbacher P, Walter U. Ligand specificity and ticlopidine effects

distinguish three human platelet ADP receptors. *Eur J Pharmacol* 1998;351:235–246.

121. Fagura MS, Dainty IA, McKay GD, et al. P2Y<sub>1</sub>-receptors in human platelets which are pharmacologically distinct from P2Y(ADP)-receptors. *Br J Pharmacol* 1998;124:157–164.

122. Hechler B, Eckly A, Ohlmann P, et al. The P2Y<sub>1</sub> receptor, necessary but not sufficient to support full ADP-induced platelet aggregation, is not the target of the drug clopidogrel. *Br J Haematol* 1998;103:858–866.

123. Jantzen HM, Gousset L, Bhaskar V, et al. Evidence for two distinct G-protein-coupled ADP receptors mediating platelet activation. *Thromb Haemost* 1999;81:111–117.

124. Léon C, Vial C, Gachet C, et al. The P2Y<sub>1</sub> receptor is normal in a patient presenting a severe deficiency of ADP-induced platelet aggregation. *Thromb Haemost* 1999;81:775–781.

125. Hollopeter G, Jantzen HM, Vincent D, et al. Identification of the platelet ADP receptor targeted by antithrombotic drugs. *Nature* 2001;409:202–207.

126. Savi P, Pereillo JM, Uzabiaga MF, et al. Identification and biological activity of the active metabolite of clopidogrel. *Thromb Haemost* 2000;84:891–896.

127. Jin J, Kunapuli SP. Coactivation of two different G protein-coupled receptors is essential for ADP-induced platelet aggregation. *Proc Natl Acad Sci U S A* 1998;95:8070–8074.

128. Jin J, Daniel JL, Kunapuli SP. Molecular basis for ADP-induced platelet activation. II. The P2Y<sub>1</sub> receptor mediates ADP-induced intracellular calcium mobilization and shape change in platelets. *J Biol Chem* 1998;273:2030–2034.

129. Savi P, Beauverger P, Labouret C, et al. Role of P2Y<sub>1</sub> purinoceptor in ADP-induced platelet activation. *FEBS Lett* 1998;422:291–295.

130. Fabre JE, Nguyen M, Latour A, et al. Decreased platelet aggregation, increased bleeding time and resistance to thromboembolism in P2Y<sub>1</sub>-deficient mice. *Nat Med* 1999;5:1199–1202.

131. Léon C, Hechler B, Freund M, et al. Defective platelet aggregation and increased resistance to thromboembolism in purinergic P2Y<sub>1</sub> receptor null mice. *J Clin Invest* 1999;104:1731–1737.

132. Savi P, Pflieger M, Herbert JM. cAMP is not an important messenger for ADP-induced platelet aggregation. *Blood Coagul Fibrinolysis* 1996;7:249–252.

133. Daniel JL, Dangelmaier C, Jin J, et al. Role of intracellular signaling events in ADP-induced platelet aggregation. *Thromb Haemost* 1999;82:1322–1326.

134. Cattaneo M, Lecchi A, Randi AM, et al. Identification of a new congenital defect of platelet function characterized by severe impairment of platelet responses to adenosine diphosphate. *Blood* 1992;80:2787–2796.

135. Nurden P, Savi P, Heilmann E, et al. An inherited bleeding disorder linked to a defective interaction between ADP and its receptor on platelets. *J Clin Invest* 1995;95:1612–1622.

136. Paul BZ, Daniel JL, Kunapuli SP. Platelet shape change is mediated by both calcium-dependent and -independent signalling pathways. *J Biol Chem* 1999;274:28293–28300.

137. Ohlmann P, Eckly A, Freund M, et al. ADP induces partial platelet aggregation without shape change and potentiates collagen-induced aggregation in the absence of Gα<sub>q</sub>. *Blood* 2000;96:2134–2139.

138. Wilde JI, Retzer M, Siess W, Watson SP. ADP-induced shape change: an investigation of the signalling pathways involved and their dependence on the method of platelet preparation. *Platelets* 2000;11:286–295.



139. Gachet C. ADP receptors of platelets and their inhibition. *Thromb Haemost* 2001;86:222–232.
140. Storey RF, Sanderson HM, White AE, et al. The central role of the P2T receptor in amplification of human platelet activation, aggregation, secretion and procoagulant activity. *Br J Haematol* 2000;110:925–934.
141. Jarvis GE, Humphries RG, Roberston MJ, Leff P. ADP can induce aggregation of human platelets via both P2Y<sub>1</sub> and P2T receptors. *Br J Pharmacol* 2000;129:275–282.
142. Vial C, Hechler B, Léon C, et al. Presence of P2X<sub>1</sub> purinoceptors in human platelets and megakaryoblastic cell lines. *Thromb Haemost* 1997;78:1500–1504.
143. Sun B, Li J, Okahara K, Kambayashi J. P2X<sub>1</sub> purinoceptor in human platelets. Molecular cloning and functional characterization after heterologous expression. *J Biol Chem* 1998;273:11544–11547.
144. Scase TJ, Heath MF, Allen JM, et al. Identification of a P2X<sub>1</sub> purinoceptor expressed on human platelets. *Biochem Biophys Res Commun* 1998;242:525–528.
145. Clifford EE, Parker K, Humphreys BD, et al. The P2X<sub>1</sub> receptor, an adenosine triphosphate-gated cation channel, is expressed in human platelets but not in human blood leucocytes. *Blood* 1998;91:3172–3181.
146. MacKenzie A, Mahaut-Smith MP, Sage SO. Activation of receptor-operated cation channels via P2X<sub>1</sub> not P2T purinoceptors in human platelets. *J Biol Chem* 1996;271:2879–2881.
147. Mulryan K, Gitterman DP, Lewis CJ, et al. Reduced vas deferens contraction and male infertility in mice lacking P2X<sub>1</sub> receptors. *Nature* 2000;403:86–89.
148. Takano S, Kimura J, Matsuoka I, Ono T. No requirement of P2X<sub>1</sub> purinoceptors for platelet aggregation. *Eur J Pharmacol* 1999;372:305–309.
149. Rolf MG, Brearley CA, Mahaut-Smith M. Platelet shape change evoked by selective activation of P2X<sub>1</sub> purinoceptors with alpha, beta methylene ATP. *Thromb Haemost* 2001;85:303–308.
150. MacFarlane DE. Agonists and receptors: adenosine diphosphate. In: Holmsen H, ed. *Platelet responses and metabolism*. Boca Raton, FL: CRC Press, 1987:19–36.
151. Lanza F, Beretz A, Stierlé A, et al. Epinephrine potentiates human platelet activation but is not an aggregating agent. *Am J Physiol* 1988;255:H1276–H1288.
152. Sage SO, Rink TJ. Kinetic differences between thrombin induced and ADP induced calcium influx and release from internal stores in fura-2 loaded human platelets. *Biochem Biophys Res Commun* 1986;136:1124–1129.
153. Mahaut-Smith MP, Sage SO, Rink TJ. Rapid ADP evoked currents in human platelets recorded with the nystatin permeabilized patch technique. *J Biol Chem* 1992;267:3060–3065.
154. Yang X, Sun L, Ghosh S, Rao AK. Human platelet signaling defect characterized by impaired production of inositol-1,4,5-triphosphate and phosphatidic acid and diminished pleckstrin phosphorylation: evidence for defective phospholipase C activation. *Blood* 1996;88:1676–1683.
155. Gabbeta J, Yang X, Kowalska MA, et al. Platelet signal transduction defect with G<sub>α</sub> subunit dysfunction and diminished G<sub>αq</sub> in a patient with abnormal platelet responses. *Proc Natl Acad Sci U S A* 1997;94:8750–8755.
156. Trumel C, Payrastre B, Plantavid M, et al. A key role of adenosine diphosphate in the irreversible platelet aggregation induced by the PAR1-activating peptide through the late activation of phosphoinositide 3-kinase. *Blood* 1999;94:4156–4165.
157. Polgar J, Eichler P, Greinacher A, Clemetson KJ. Adenosine diphosphate (ADP) and ADP receptor

play a major role in platelet activation/aggregation induced by sera from heparin-induced thrombocytopenia patients. *Blood* 1998;91:549–554.

158. Nieswandt B, Bergmeier W, Eckly A, et al. Evidence for cross-talk between GPVI and Gi coupled receptors during collagen-induced platelet aggregation. *Blood* 2001;97:3829–3835.

159. Gratacap MP, Hérault JP, Viala C, et al. FcγRIIA requires a Gi-dependent pathway for an efficient stimulation of phosphoinositide 3-kinase, calcium mobilization, and platelet aggregation. *Blood* 2000;96:3439–3446.

160. Payrastre B, Gratacap MP, Trumel C, et al. ADP: an important cofactor of PI 3-kinase activation in human blood platelets. *Haematologica* 2000;85:32–36.

161. Siess W, Weber PC, Lapetina EG. Activation of phospholipase C is dissociated from arachidonate metabolism during platelet shape change induced by thrombin or platelet-activating factor: epinephrine does not induce phospholipase C activation or platelet shape change. *J Biol Chem* 1984;259:8286–8292.

162. Bennett JS, Vilaire G, Burch JW. A role for prostaglandins and thromboxanes in the exposure of platelet fibrinogen receptors. *J Clin Invest* 1981;68:981–987.

163. Peerschke EI. Induction of human platelet fibrinogen receptors by epinephrine in the absence of released ADP. *Blood* 1982;60:71–77.

164. Regan JW, Nakata H, DeMarinis RM, et al. Purification and characterization of the human platelet α<sub>2</sub>-adrenergic receptor. *J Biol Chem* 1986;261:3894–3900.

165. Kobilka BK, Matsui H, Kobilka TS, et al. Cloning sequencing and expression of the gene coding for the platelet α<sub>2</sub>-adrenergic receptor. *Science* 1987;238:650–656.

166. Scrutton MC, Clare KC, Hutton RA, Bruckdorfer KR. Depressed responsiveness to adrenaline in platelets from apparently normal human donors: a familial trait. *Br J Haematol* 1981;49:303–314.

167. Rosenfeld SI, Ryan DH, Looney RJ, et al. Human Fcγ receptors: stable inter-donor variation in quantitative expression on platelets correlates with functional responses. *J Immunol* 1987;138:2869–2873.

168. Smith WL. The eicosanoids and their biochemical mechanisms of action. *Biochem J* 1989;259:315–324.

169. Smith JB, Willis AL. Aspirin selectively inhibits prostaglandin production in human platelets. *Nature* 1971;231:235–237.

170. Roth GJ, Calverley DC. Aspirin, platelets, and thrombosis: theory and practice. *Blood* 1994;83:885–898.

171. FitzGerald GA. Mechanisms of platelet activation: thromboxane A<sub>2</sub> as an amplifying signal for other agonists. *Am J Cardiol* 1991;68:11B–15B.

172. Hamberg M, Svensson J, Samuelsson B. Thromboxanes: a new group of biologically active compounds derived from prostaglandin endoperoxides. *Proc Natl Acad Sci U S A* 1975;72:2994–2998.

173. Gerrard JM, Carroll RC. Stimulation of protein phosphorylation by arachidonic acid and endoperoxide analog. *Prostaglandins* 1981;22:81–94.

174. Pulcinelli FM, Ashby B, Gazzaniga PP, Daniel JL. Protein kinase C activation is not a key step in ADP-mediated exposure of fibrinogen receptors on human platelets. *FEBS Lett* 1995;364:87–90.

175. Saklarvia J, Rawlinson L, Waller RJ, et al. Role for p38 mitogen-activated protein kinase in platelet aggregation caused by collagen or a thromboxane analogue. *J Biol Chem* 1996;271:6586–6589.

176. Knezevic I, Borg C, Le Breton GC. Identification of G<sub>q</sub> as one of the G-proteins which copurify with human platelet thromboxane A<sub>2</sub>/Prostaglandin H<sub>2</sub> receptors. *J Biol Chem* 1993;268:26011–26017.

177. Nakahata N, Miyamoto A, Ohkubo S, et al. Gq/11 communicates the thromboxane A<sub>2</sub> receptors in human astrocytoma cells, rabbit astrocytes and human platelets. *Res Commun Mol Pathol Pharmacol* 1995;87:243–251.
178. Offermanns S, Laugwitz KL, Spicher K, Schultz G. G proteins of the G12 family are activated via thromboxane A<sub>2</sub> and thrombin receptors in human platelets. *Proc Natl Acad Sci U S A* 1994;91:504–508.
179. Allan CJ, Higashiura K, Martin M, et al. Characterization of the cloned HEL cell thromboxane A<sub>2</sub> receptor: evidence that the affinity state can be altered by Ga13 and Gaq. *J Pharmacol Exp Ther* 1996;277:1132–1139.
180. Ushikubi F, Nakamura K, Narumiya S. Functional reconstitution of platelet thromboxane A<sub>2</sub> receptors with Gq and Gi2 in phospholipid vesicles. *Mol Pharmacol* 1994;46:808–816.
181. Hirata T, Ushikubi F, Kakizuka A, et al. Two thromboxane A<sub>2</sub> receptor isoforms in human platelets. Opposite coupling to adenylyl cyclase with different sensitivity to Arg60 to Leu mutation. *J Clin Invest* 1996;97:949–956.
182. Brass LF, Molino M. Protease-activated G protein-coupled receptors on human platelets and endothelial cells. *Thromb Haemost* 1997;78:234–241.
183. Premont RT, Ingles J, Lefkowitz RJ. Protein kinases that phosphorylate activated G protein-coupled receptors. *FASEB J* 1995;9:175–182.
184. Ferguson SS, Barak LS, Zhang J, Caron MG. G-protein-coupled receptor regulation: role of G-protein-coupled receptor kinesis and arrestins. *Can J Physiol Pharmacol* 1996;74:1095–1110.
185. Goodman OB, Krupnick JG, Santini F, et al.  $\beta$ -Arrestin acts as a clathrin adaptor in endocytosis of the  $\beta_2$ -adrenergic receptor. *Nature* 1996;383:447–450.
186. Brass LF. Molecular basis of platelet activation. In: Hoffman R et al., eds. *Hematology: basic principles and practice*. New York: Churchill-Livingstone, 2000:1753–1770.
187. Cavallini L, Coassin M, Borean A, Alexandre A. Prostacyclin and sodium nitroprusside inhibit the activity of the platelet inositol 1,4,5-triphosphate receptor and promote its phosphorylation. *J Biol Chem* 1996;271:5545–5551.
188. Nishimura T, Yamamoto T, Komuro Y, Hara Y. Antiplatelet functions of a stable prostacyclin analog, SM-10906 are exerted by its inhibitory effect on inositol 1,4,5-triphosphate production and cytosolic Ca<sup>2+</sup> increase in rat platelets stimulated by thrombin. *Thromb Res* 1995;79:307–317.
189. Lapetina EG. Incorporation of synthetic 1,2-diacylglycerol into platelet phosphatidylinositol is increased by cyclic AMP. *FEBS Lett* 1986;195:111–114.
190. de Chaffoy de Courcelles D, Roevens P, van Belle H. Agents that elevate platelet cAMP stimulate the formation of phosphatidylinositol 4-phosphate in intact human platelets. *FEBS Lett* 1986;195:115–118.
191. Watson SP, Lapetina EG. 1,2 Diacylglycerol and phorbol ester inhibit agonist-induced formation of inositol phosphates in human platelets: possible implications for negative feedback regulation of inositol phospholipid hydrolysis. *Proc Natl Acad Sci U S A* 1985;82:2623–2626.
192. Zavoico GB, Halenda SP, Sha'afi RI, Feinstein MB. Phorbol myristate acetate inhibits thrombin-stimulated Ca<sup>2+</sup> mobilization and phosphatidylinositol 4,5-bisphosphate hydrolysis in human platelets. *Proc Natl Acad Sci U S A* 1985;82:3859–3862.
193. MacIntyre DE, McHicol A, Drummond AH. Tumour-promoting phorbol esters inhibit agonist-induced phosphatidate formation and Ca<sup>2+</sup> flux in human platelets. *FEBS Lett* 1985;180:160–164.
194. Connolly TM, Lawing WJ Jr, Majerus PW. Protein kinase C phosphorylates human platelet inositol trisphosphate 5'-phosphomonoesterase, increasing the phosphates activity. *Cell* 1986;46:951–958.

195. Abrams CS, Wu H, Zhao W, et al. Pleckstrin inhibits phosphoinositide hydrolysis initiated by G-protein-coupled and growth factor receptors: a role for pleckstrin's PH domains. *J Biol Chem* 1995;270:14485-14492.
196. Nakinishi H, Brewer KA, Exton JH. Activation of the zeta isozyme of protein kinase C by phosphatidylinositol 3,4,5-trisphosphate. *J Biol Chem* 1993;268: 13-16.
197. George JN. Platelet immunoglobulin G: its significance for the evaluation of thrombocytopenia and for understanding the origin of  $\alpha$ -granule proteins. *Blood* 1990;76:859-870.
198. Handagama P, Scarborough RM, Shuman MA, Bainton DF. Endocytosis of fibrinogen into megakaryocyte and platelet  $\alpha$ -granules is mediated by  $\alpha$ IIb $\beta$ 3 (glycoprotein IIb-IIIa). *Blood* 1993;82:135-138.
199. Wencel-Drake JD, Boudignon-Proudhon C, Dieter MG, et al. Internalization of bound fibrinogen modulates platelet aggregation. *Blood* 1996;87:602-612.
200. Harrison P, Wilbourn BR, Cramer EM, et al. The influence of therapeutic blocking of  $\alpha$ IIb $\beta$ 3 on platelet  $\alpha$ -granule fibrinogen. *Br J Haematol* 1992; 82:721-728.
201. Banga HS, Simons ER, Brass LF, Rittenhouse SE. Activation of phospholipases A and C in human platelets exposed to epinephrine: role of glycoproteins IIb/IIIa and dual role of epinephrine. *Proc Natl Acad Sci U S A* 1986;83:9197-9201.
202. Lemons PP, Chen D, Bernstein AM, et al. Regulated secretion in platelets: identification of elements of the platelet exocytosis machinery. *Blood* 1997;90:1490-1500.
203. Bernstein AM, Whiteheart SW. Identification of a cellubrevin/vesicle associated membrane protein 3 homologue in human platelets. *Blood* 1999;93:571-579.
204. Lipfert L, Haimovich B, Schaller MD, et al. Integrin-dependent phosphorylation and activation of the protein tyrosine kinase pp125FAK in platelets. *J Cell Biol* 1992;119:905-912.
205. Ni H, Denis CV, Subbarao S, et al. Persistence of platelet thrombus formation in arterioles of mice lacking both von Willebrand factor and fibrinogen. *J Clin Invest* 2000;106:385-392.
206. Byzova TV, Plow EF. Networking in the hemostatic system. Integrin  $\alpha$ IIb $\beta$ 3 binds prothrombin and influences its activation. *J Biol Chem* 1997;272:27183-27188.
207. Phillips DR, Agin PP. Platelet membrane defects in Glanzmann's thrombasthenia: evidence for decreased amounts of two major glycoproteins. *J Clin Invest* 1977;60:535-545.
208. Nurden AT, Caen JP. An abnormal platelet glycoprotein pattern of three cases of Glanzmann's thrombasthenia. *Br J Haematol* 1974;253:253-260.
209. Casserly IP, Topol EJ. Glycoprotein IIb/IIIa antagonists—from bench to practice. *Cell Mol Life Sci* 2002;59:478-500.
210. Jenkins AL, Nannizzi-Alaimo L, Silver D, et al. Tyrosine phosphorylation of the  $\beta$ 3 cytoplasmic domain mediates integrin-cytoskeletal interactions. *J Biol Chem* 1998;273:13878-13885.
211. Patil S, Jedsadayanmata A, Wencel-Drake JD, et al. Identification of a talin-binding site in the integrin  $\beta$ 3 subunit distinct from the NPLY regulatory motif of post-ligand binding functions: the talin N-terminal head domain interacts with the membrane-proximal region of the  $\beta$ 3 cytoplasmic tail. *J Biol Chem* 1999;274:28575-28583.
212. Calderwood DA, Shattil SJ, Gonsberg MH. Integrins and actin filaments: reciprocal regulation of cell adhesion and signaling. *J Biol Chem* 2000;275:22607-22610.
213. Shattil SJ. Signaling through platelet integrin IIb  $\beta$  3: inside-out, outside-in, and sideways. *Thromb Haemost* 1999;82:318-325.
214. Shattil SJ, Kashiwagi H, Pampori N. Integrin signaling: the platelet paradigm. *Blood*

1998;91:2645–2657.

215. Pigazzi A, Heydrick S, Folli F, et al. Nitric oxide inhibits thrombin receptor-activating peptide-induced phosphoinositide 3-kinase activity in human platelets. *J Biol Chem* 1999;274:14368–14375.

216. Manganello JM, Djellas Y, Borg C, et al. Cyclic AMP-dependent phosphorylation of thromboxane A(2) receptor-associated Galpha(13). *J Biol Chem* 1999;274:28003–28010.

217. Wang GR, Zhu Y, Halushka PV, et al. Mechanism of platelet inhibition by nitric oxide: in vivo phosphorylation of thromboxane receptor by cyclic GMP-dependent protein kinase. *Proc Natl Acad Sci U S A* 1998;95:4888–4893.

218. Peerschke EI. Regulation of platelet aggregation by post-fibrinogen binding events. *Thromb Haemost* 1995;73:862–867.

219. O'Toole TE, Ylanne J, Culley BM. Regulation of integrin affinity states through an NPXY motif in the beta subunit cytoplasmic domain. *J Biol Chem* 1995;270:8553–8558.

220. Bennett JS, Zigmund S, Vilaire G, et al. The platelet cytoskeleton regulates the affinity of the integrin alpha(IIb) beta(3) for fibrinogen. *J Biol Chem* 1999;274:25301–25307.

221. Bennett JS, Vilaire G. Exposure of platelet fibrinogen receptors by ADP and epinephrine. *J Clin Invest* 1979;64:1393–1401.

222. Jackson SP, Schoenwaelder SM, Yuan YP, et al. Non-receptor protein tyrosine kinases and phosphatases in human platelets. *Thromb Haemost* 1996;76:640–650.

223. Lerea KM, Tonks NK, Krebs EG, et al. Vanadate and molybdate increase tyrosine phosphorylation in a 50-kilodalton protein and stimulate secretion in electropermeabilized platelets. *Biochemistry* 1989;28:9286–9292.

224. Savage B, Shattil SJ, Ruggeri ZM. Modulation of platelet function through adhesion receptors. A dual role for glycoprotein IIb-IIIa mediated by fibrinogen and glycoprotein Ib-von Willebrand factor. *J Biol Chem* 1992;267:11300–11306.

225. Phillips DR, Nannizzi-Alaimo L, Srinivasa Prasad KS. B3 Tyrosine phosphorylation in alphaIIb beta3 (platelet membrane GP IIb-IIIa) outside-in integrin signaling. *Thromb Haemost* 2001;80:246–258.

226. Law DA, Phillips DR. Glycoprotein IIb/IIIa in platelet aggregation and acute arterial thrombosis. In: Lincoff AM, Topol EJ, eds. *Platelet glycoprotein IIb/IIIa inhibitors in cardiovascular disease*. Totowa, NJ: Humana Press, 1999:35–66.

227. Downes CP, Currie RA. Lipid signaling. *Curr Biol* 1998;8:R865–R867.

228. Kovacsovics TJ, Bachelot C, Toker A, et al. Phosphoinositide 3-kinase inhibitors spares actin assembly in activating platelets but reverses platelet aggregation. *J Biol Chem* 1995;270:11358–11366.

229. Swords NA, Tracy PB, Mann KG. Intact platelet membranes, not platelet-released microvesicles, support the procoagulant activity of adherent platelets. *Arterioscler Thromb* 1993;13:1613–1622.

230. Henn V, Slupsky JR, Grafe M, et al. CD40 ligand on activated platelets triggers an inflammatory reaction of endothelial cells. *Nature* 1998;391:591–594.

231. Bombeli T, Schwartz BR, Harlan JM. Adhesion of activated platelets to endothelial cells: evidence for a GP-IIb/IIIa-dependent bridging mechanism and novel roles for endothelial intercellular adhesion molecule1 (ICAM-1), alphaV-beta3 integrin, and GPIIb/IIIa. *J Exp Med* 1998;187:329–339.

232. Buttrum SM, Hatton R, Nash GB. Selectin-mediated rolling of neutrophils on immobilized platelets. *Blood* 1993;82:1165–1174.

233. Weber C, Springer TA. Neutrophil accumulation on activated, surface-adherent platelets in flow is mediated by interaction of Mac-1 with fibrinogen bound to alphaIIb beta3 and stimulated by

platelet-activating factor. *J Clin Invest* 1997;100:2085-2093.

234. The ERASER investigators. Acute platelet inhibition with abciximab does not reduce in-stent restenosis (ERASER study). *Circulation* 1999;100:799-806.

235. Coller BS. A new murine monoclonal antibody reports an activation-dependent change in the conformation and/or microenvironment of the platelet glycoprotein IIb/IIIa complex. *J Clin Invest* 1985;76:101-108.

236. Tcheng JE, Ellis SG, George BS, et al. Pharmacodynamics of chimeric glycoprotein IIb/IIIa integrin antiplatelet antibody Fab 7E3 in high-risk coronary angioplasty. *Circulation* 1994;90:1757-1764.

237. Oscende JI, Fuster V, Lev EI, et al. Testing platelet activation with a shear-dependent platelet function test versus aggregation-based tests: relevance for monitoring long-term glycoprotein IIb/IIIa inhibition. *Circulation* 2001;103:1488-1491.

238. Hartman GD, Egbertson MS, Halczenko W, et al. Non-peptide fibrinogen receptor antagonists. Discovery and design of exosite inhibitors. *J Med Chem* 1992;35:4640-4642.

239. Kong DF, Califf RM, Miller DP, et al. Clinical outcomes of therapeutic agents that block the platelet glycoprotein IIb/IIIa integrin in ischemic heart disease. *Circulation* 1998;98:2829-2835.

240. Moroi M, Jung SM, Yoshida N. Genetic polymorphism of platelet glycoprotein Ib. *Blood* 1984;64:622-629.

241. Lopez JA, Ludwig EH, McCarthy BJ. Polymorphism of human glycoprotein Iba results from a variable number of tandem repeats of a 13-amino acid sequence in the mucin-like macroglycopeptide region. *J Biol Chem* 1992;267:10055-10061.

242. Ishida F, Furihata K, Ishida K, et al. The largest variant of platelet glycoprotein Iba has 4 tandem repeats of 13 amino acids in the macroglycopeptide region and a genetic linkage with methionine145. *Blood* 1995;86:1356-1360.

243. Murata M, Matsubara Y, Kawano K, et al. Coronary artery disease and polymorphisms in a receptor mediating shear stress-dependent platelet activation. *Circulation* 1997;96:3281-3286.

244. Gonzalez-Conejero R, Lozano ML, Rivera J, et al. Polymorphisms of platelet membrane glycoprotein Iba associated with arterial thrombotic disease. *Blood* 1998;92:2771-2776.

245. Carter AM, Catto AJ, Bamford JM, et al. Platelet GPIIIa PIA and GP Ib variable number tandem repeat polymorphisms and markers of platelet activation in acute stroke. *Arterioscler Thromb Vasc Biol* 1998;18:1124-1131.

246. Kuijpers RW, Faber NM, Cuypers HT, et al. NH<sub>2</sub>-terminal globular domain of human platelet glycoprotein Iba has a methionine 145/threonine 145 amino acid polymorphism, which is associated with HPA-2 (Ko) alloantigens. *J Clin Invest* 1992;89:381-384.

247. Murata M, Furihata K, Ishida F, et al. Genetic and structural characterization of an amino acid dimorphism in glycoprotein Iba involved in platelet transfusion refractoriness. *Blood* 1992;79:3086-3090.

248. Ishida F, Saji H, Muraya E, et al. Human platelet-specific antigen, Sib<sup>a</sup>, is associated with the molecular weight polymorphism of glycoprotein Iba. *Blood* 1991;78:1722-1729.

249. Sonada A, Murata M, Ito D, et al. Association between platelet glycoprotein Iba genotype and ischemic cerebrovascular disease. *Stroke* 2000;31:493-497.

250. Aramaki KM, Reiner AP. A novel isoform of platelet glycoprotein Iba is prevalent in African Americans. *Am J Hematol* 1999;60:77-79.

251. Kaski S, Kekomaki R, Partanen J. Systematic screening for genetic polymorphism in platelet glycoprotein Iba. *Immunogenetics* 1996;44:170-176.

252. Bussel JB, Kunicki TJ, Michelson AD. Platelets: new understanding of the platelet glycoproteins and

their role in disease. American Society of Hematology Education Book 2000:222–240.

253. Kunicki TJ. The role of platelet collagen receptor (glycoprotein Ia/IIa; integrin  $\alpha_2\beta_1$ ) polymorphisms in thrombotic disease. *Curr Opin Hematol* 2001;8:277–285.

254. Jacquelin B, Rozenshteyn D, Kanaji S, et al. Characterization of inherited differences in transcription of the human integrin  $\alpha_2$  gene. *J Biol Chem* 2001;276(26):23518–23524.

255. Jacquelin B, Tarantino M, Kritzik M, et al. Allele-dependent transcriptional regulation of the human integrin  $\alpha_2$  gene. *Blood* 2001;97:1721–1726.

256. Zutter MM, Santoso SA, Painter AS, et al. The human  $\alpha_2$  integrin gene promoter. Identification of positive and negative regulatory elements important for cell-type and developmentally restricted gene expression. *J Biol Chem* 1994;269:463–469.

257. Zutter MM, Painter AS, Staatz WD, et al. Regulation of  $\alpha_2$  integrin gene expression in cells with megakaryocytic features: a common theme of three necessary elements. *Blood* 1995;86:3006–3014.

258. Zutter MM, Ryan EE, Painter AD. Binding of phosphorylated Sp1 protein to tandem Sp1 binding sites regulates  $\alpha_2$  integrin gene core promoter activity. *Blood* 1997;90:678–689.

259. Santoso S, Kunicki TJ, Kroll H, et al. Association of the platelet glycoprotein IaC807T gene polymorphism with myocardial infarction in younger patients. *Blood* 1999;93:2449–2453.

260. Kroll H, Gardemann A, Fechter A, et al. The impact of the glycoprotein Ia collagen receptor subunit A1648G gene polymorphism on coronary artery disease and acute myocardial infarction. *Thromb Haemost* 2000;83:392–396.

261. Furihata K, Clemetson KJ, Deguchi H, et al. Variation in human platelet GPVI content modulates GPVI-specific prothrombinase activity. *Arterioscler Thromb Vasc Biol* 2001;21:1857–1863.

262. Nieswandt B, Schulte V, Bergmeier W, et al. Long-term antithrombotic protection by in vivo depletion of platelet glycoprotein VI in mice. *J Exp Med* 2001;193:459–470.

263. Noris P, Simsek S, De Bruijne-Admiraal LG, et al. Max<sup>a</sup>, a new low-frequency platelet-specific antigen localized on glycoprotein IIb, is associated with neonatal alloimmune thrombocytopenia. *Blood* 1995;86:1019–1026.

264. Lyman S, Aster RH, Visentin GP, et al. Polymorphism of human platelet membrane glycoprotein IIb associated with the Bak<sup>a</sup>/Bak<sup>b</sup> alloantigen system. *Blood* 1990;75:2343–2348.

265. Newman PJ, Derbes RS, Aster RH. The human platelet alloantigens, PLA1 and PLA2, are associated with a leucine33/proline33 amino acid polymorphism in membrane glycoprotein IIIa, and are distinguishable by DNA typing. *J Clin Invest* 1989;83:1778–1781.

266. Kunicki TJ. Platelet antigen polymorphisms. In: Schechter GP, Berliner N, Telen MJ, eds. American Society of Hematology: Education Program Book. 2000:222–228.

267. Weiss EJ, Bray PF, Tayback M, et al. A polymorphism of a platelet glycoprotein receptor as an inherited risk factor for coronary thrombosis. *N Engl J Med* 1996;334:1090–1094.

268. Carlsson L, Markey F, Blikstad I, et al. Reorganization of actin in platelets stimulated by thrombin as measured by the Dnase I inhibition assay. *Proc Natl Acad Sci U S A* 1979;76:6376–6380.

269. Fox JE. Identification of actin-binding protein as the protein linking the membrane skeleton to glycoproteins on platelet plasma membranes. *J Biol Chem* 1985;260:11970–11977.

270. Ezzell RM, Kenney DM, Egan S, et al. Localization of the domain of actin-binding protein that binds to membrane glycoprotein Ib and actin in human platelets. *J Biol Chem* 1988;263:13303–13309.

271. Bertagnolli ME, Beckerle MC. Regulated membrane-cytoskeleton linkages in platelets. *Ann N Y Acad Sci* 1994;714:88–100.



272. Fox JE, Berndt MC. Cyclic AMP-dependent phosphorylation of glycoprotein Ib inhibits collagen-induced polymerization of actin in platelets. *J Biol Chem* 1989;264:9520-9526.
273. Yada Y, Okano Y, Nozawa Y. Enhancement of GTP gamma S-binding activity by cAMP-dependent phosphorylation of a filamin-like 250 kDa membrane protein in human platelets. *Biochem Biophys Res Commun* 1990;172:256-261.
274. Ueda M, Oho C, Takisawa H, Ogihara S. Interaction of the low-molecular mass guanine-nucleotide-binding protein with the actin-binding protein and its modulation by the cAMP-dependent protein kinase in bovine platelets. *Eur J Biochem* 1992;203:347-352.
275. Ohta Y, Suzuki N, Nakamura S, et al. The small GTPase RalA targets filamin to induce filopodia. *Proc Natl Acad Sci U S A* 1999;96:2122-2128.
276. Escolar G, Sauk J, Bravo ML, et al. Immunogold staining of microtubules in resting and activated platelets. *Am J Hematol* 1987;24:177-188.
277. Nachmias VT. Platelet and megakaryocyte shape change: triggered alterations in the cytoskeleton. *Semin Hematol* 1983;20:261-281.
278. Behnke O. Further studies on microtubules: a marginal bundle in human and rat thrombocytes. *J Ultrastruct Res* 1965;13:469-477.
279. Kansas GS. Selectins and their ligands: current concepts and controversies. *Blood* 1996;88:3259-3287.
280. Frenette PS, Johnson RC, Hynes RO, Wagner DD. Platelets roll on stimulated endothelium in vivo: an interaction mediated by endothelial P-selectin. *Proc Natl Acad Sci U S A* 1995;92:7450-7454.
281. Frenette PS, Moyna C, Hartwell DW, et al. Platelet-endothelial interactions in inflamed mesenteric venules. *Blood* 1998;91:1318-1324.
282. Katayama T, Ikeda Y, Handa M, et al. Immunoneutralization of glycoprotein Ibalpha attenuates endotoxin-induced interactions of platelets and leukocytes with rat venular endothelium in vivo. *Circ Res* 2000;86:1031-1037.
283. Romo GM, Dong JF, Schade AJ, et al. The glycoprotein Ib-IX-V complex is a platelet counterreceptor for P-selectin. *J Exp Med* 1999;190:803-814.
284. Frenette PS, Denis CV, Weiss L, et al. P-selectin glycoprotein ligand 1 (PSGL-1) is expressed on platelets and can mediate platelet-endothelial interactions in vivo. *J Exp Med* 2000;191:1413-1422.
285. Andre P, Denis CV, Ware J, et al. Platelets adhere to and translocate on von Willebrand factor presented by endothelium in stimulated veins. *Blood* 2000;96:3322-3328.
286. Bombeli T, Schwartz BR, Harlan JM. Adhesion of activated platelets to endothelial cells: evidence for a GPIIb/IIIa-dependent bridging mechanism and novel roles for endothelial intercellular adhesion molecule 1 (ICAM-1), alpha5beta3 integrin, and GPIbalpha. *J Exp Med* 1998;187:329-339.
287. D'Souza SE, Byers-Ward VJ, Gardiner EE, et al. Identification of an active sequence within the first immunoglobulin domain of intercellular cell adhesion molecule-1 (ICAM-1) that interacts with fibrinogen. *J Biol Chem* 1996;271:24270-24277.
288. Gardiner EE, D'Souza SE. A mitogenic action for fibrinogen mediated through intercellular adhesion molecule-1. *J Biol Chem* 1997;272:15474-15480.
289. Subramaniam M, Frenette PS, Saffaripour S, et al. Defects in haemostasis in P-selectin-deficient mice. *Blood* 1996;87:1238-1242.
290. Springer TA. Traffic signals for lymphocyte recirculation and leukocyte emigration: the multistep paradigm. *Cell* 1994;76:301-314.

291. Diacovo TG, Roth SJ, Buccola JM, et al. Neutrophil rolling, arrest, and transmigration across activated, surface-adherent platelets via sequential action of P-selectin and the  $\beta_2$ -integrin CD11b/CD18. *Blood* 1996;88:146-157.
292. Simon DI, Chen Z, Xu H, et al. Platelet glycoprotein I $\alpha$  is a counterreceptor for the leukocyte integrin Mac-1 (CD11b/CD18). *J Exp Med* 2000;192:193-204.
293. American Heart Association. 1999 heart and stroke facts. Dallas: American Heart Association, 1999.
294. Criqui MH, Fronek A, Barrett-Connor E, et al. The prevalence of peripheral artery disease in a defined population. *Circulation* 1985;71:510-515.
295. Falk E. Plaque rupture with severe pre-existing stenosis precipitating coronary thrombosis: characteristics of coronary atherosclerotic plaques underlying fatal occlusive thrombi. *Br Heart J* 1983;50:127-134.
296. Davies MJ, Thomas AC. Plaque fissuring: the cause of acute myocardial infarction, sudden ischaemic death, and crescendo angina. *Br Heart J* 1985;53:363-373.
297. Burke AP, Farb A, Malcolm GT, et al. Plaque rupture and sudden death related to exertion in men with coronary artery disease. *JAMA* 1999;281:921-926.
298. Fuster V. Coronary artery disease: a clinical-pathological correlation. In: Fuster V, ed. *Syndromes of atherosclerosis: correlations of clinical imaging and pathology*. Armonk, NY: Futura Publishing Company, 1996:1-15.
299. Ambrose J, Tannenbaum M, Alexopoulos D, et al. Angiographic progression of coronary artery disease and the development of myocardial infarction. *J Am Coll Cardiol* 1988;12:56-62.
300. Little WC, Constantinescu M, Applegate RJ, et al. Can coronary angiography predict the site of a subsequent myocardial infarction in patients with mild-to-moderate coronary artery disease? *Circulation* 1988;78:1157-1166.
301. Davies MJ, Richardson PD, Woolf N, et al. Risk of thrombosis in human atherosclerotic plaques: role of extracellular lipid, macrophages and smooth muscle cell content. *Br Heart J* 1993;69:377-381.
302. Sherman CT, Litvack F, Grundfest W, et al. Coronary angiography in patients with unstable angina pectoris. *N Engl J Med* 1986;315:913-919.
303. Falk E. Coronary thrombosis: pathogenesis and clinical manifestations. *Am J Cardiol* 1991;68[Suppl B]:28B-35B.
304. Falk E. Advanced lesions and acute coronary syndromes: a pathologist's view. In: Fuster V ed. *Syndromes of atherosclerosis: correlations of clinical imaging and pathology*. Armonk, NY: Futura Publishing Company, 1996:81-104.
305. Fuster V. Mechanisms leading to myocardial infarction: insights from studies of vascular biology. *Circulation* 1994;90:2126-2146.
306. Willerson JT, Golino P, Eidt J, et al. Specific platelet mediators and unstable coronary artery lesions: experimental evidence and potential clinical implications. *Circulation* 1989;80:198-205.
307. Egashira K, Inou T, Hirooka Y, et al. Impaired coronary blood flow response to acetylcholine in patients with coronary risk factors and proximal atherosclerotic lesions. *J Clin Invest* 1993;91:29-37.
308. Reddy KG, Nair RN, Sheehan HM, et al. Evidence that selective endothelial dysfunction may occur in the absence of angiographic or ultrasound atherosclerosis in patients with risk factors for atherosclerosis. *J Am Coll Cardiol* 1994;23:833-843.
309. Bogaty P, Hackett D, Davies G, et al. Vasoreactivity of the culprit lesion in unstable angina. *Circulation* 1994;90:5-11.

310. Yanagisawa M, Kurihara H, Kimura S, et al. A novel potent vasoconstrictor peptide produced by vascular endothelial cells. *Nature* 1988;332:411–415.
311. Ross R. Atherosclerosis—an inflammatory disease. *N Engl J Med* 1999;340: 115–126.
312. Libby P, Ridker PM, Maseri A. Inflammation and atherosclerosis. *Circulation* 2002;105:1135–1143.
313. Libby P, Simon DI. Inflammation and thrombosis—the clot thickens. *Circulation* 2001;103:1718–1720.
314. Ostovsky L, King AJ, Bond S, et al. A juxtacrine mechanism for neutrophil adhesion on platelets involves platelet-activating factor and a selectin-dependent activation process. *Blood* 1998;91:3028–3036.
315. Lefkowitz RJ, Pitcher J, Krueger K, Daaka Y. Mechanisms of beta-adrenergic receptor desensitization and resensitization. *Adv Pharmacol* 1998;42:416–420.
316. Hoxie JA, Ahuja M, Belmonte E, et al. Internalization and recycling of activated thrombin receptors. *J Biol Chem* 1993;268:13756–13763.
317. Ishii K, Chen J, Ishii M, et al. Inhibition of thrombin receptor signaling by a G protein-coupled receptor kinase. Functional specificity among G protein-coupled receptor kinases. *J Biol Chem* 1994;269:1125–1130.
318. Hung DT, Vu TK, Wheaton VI, et al. Cloned platelet thrombin receptor is necessary for thrombin-induced platelet activation. *J Clin Invest* 1992;89:1350–1353.
319. Brass LF, Vassallo RJ, Belmonte E, et al. Structure and function of the human platelet thrombin receptor. Studies using monoclonal antibodies directed against a defined domain within the receptor N terminus. *J Biol Chem* 1992;267:13795–13798.
320. Mills DC. ADP receptors on platelets. *Thromb Haemost* 1996;76:835–856.
321. Enjyoji K, Sevigny J, Lin Y, et al. Targeted disruption of cd39/diphosphohydrolase results in disordered hemostasis and thromboregulation. *Nat Med* 1999;5:1010–1017.
322. Baurand A, Eckly A, Bari N, et al. Desensitization of the platelet aggregation response to ADP: differential down-regulation of the P2Y<sub>1</sub> and P2cyc receptors. *Thromb Haemost* 2000;84:484–491.
323. Hechler B, Léon C, Vial C, et al. The P2Y<sub>1</sub> receptor is necessary for ADP-induced platelet aggregation. *Blood* 1998;92:152–159.
324. Bauer M, Retzer M, Wilde JI, et al. Dichotomous regulation of myosin phosphorylation and shape change by Rho-kinase and calcium in intact human platelets. *Blood* 1999;94:1665–1672.
325. Kenny D, Muckian C, Fitzgerald D, et al. Platelet glycoprotein Ib alpha receptor polymorphisms and recurrent ischaemic events in acute coronary syndrome patients. *J Thromb Thrombolysis* 2002;13:13–19.
326. Douglas H, Michaelides K, Gorog D, et al. Platelet membrane glycoprotein Ib alpha gene-5T/C Kvak sequence polymorphism as an independent risk factor for the occurrences of coronary thrombosis. *Heart* 2002;87:70–74.
327. Meisel C, Afshar-Kharghan V, Cascorbi I, et al. Role of Kozak sequence polymorphism of platelet glycoprotein Ibalpha as a risk factor for coronary artery disease and catheter interventions. *J Am Coll Cardiol* 2001;38(4):10237.
328. Rosenberg N, Zivelin A, Chetrit A, et al. Effects of platelet membrane glycoprotein polymorphisms on the risk of myocardial infarction in young males. *Isr Med Assoc J* 2002 Jun;4:411–414.
329. Frank MB, Reiner AP, Schwartz SM, et al. The Kozak sequence polymorphism of platelet glycoprotein Ibalpha and risk of nonfatal myocardial infarction and nonfatal stroke in young women. *Blood* 2001;97:875–879.
330. Roest M, Sixma JJ, Wu YP, et al. Platelet adhesion to collagen in healthy volunteers is influenced by

variation of both alpha(2)beta(1) density and von Willebrand factor. *Blood* 2000;96(4):1433–1437.

331. Moshfegh K, Wuillemin WA, Redondo M, et al. Association of two silent polymorphisms of platelet glycoprotein Ia/IIa receptor with risk of myocardial infarction: a case-control study. *Lancet* 1999;353(9150):351–354.

332. Santoso S, Amrhein J, Hofmann HA, et al. A point mutation Thr(799)Met on the alpha(2) integrin leads to the formation of new human platelet alloantigen Sit(a) and affects collagen-induced aggregation. *Blood* 1999;94(12):4103–4111.

333. Benze G, Heinrich J, Schulte H, et al. Association of the GPIa C807T and GPIIIa PIA1/A2 polymorphisms with premature myocardial infarction in men. *Eur Heart J* 2002;23(4):352–330.

334. Morita H, Kurihara H, Imai Y, et al. Lack of association between the platelet glycoprotein Ia C807T gene polymorphism and myocardial infarction in Japanese. An approach entailing melting curve analysis with specific fluorescent hybridization probes. *Thromb Haemost* 2001;85(2):226–230.

335. Anvari A, Janisiw M, Turel Z, et al. Platelet glycoprotein Ia gene dimorphism alpha2-807 in malignant arrhythmia in coronary artery disease. *Thromb Res* 2000;98(4):281–286.

336. Croft SA, Hampton KK, Daly ME, et al. Kozak sequence polymorphism in the platelet GPIIb/IIIa gene is not associated with risk of myocardial infarction. *Blood* 2000;95(6):2183–2184.

337. Mikkelsen J, Perola M, Laippala P, et al. Glycoprotein IIIa PI(A1/A2) polymorphism and sudden cardiac death. *J Am Coll Cardiol* 2000;36(4):1317–23.

338. Tereshchenko SN, Levchuk NN, Drozdov VN, et al. [Polymorphism of GPIIIa platelet glycoprotein gene PIA1/A2 compared to plasma hemostasis in myocardial infarction patients]. *Ter Arkh* 1999;71(9):66–70.

339. Ardissino D, Mannucci PM, Merlini PA, et al. Prothrombotic genetic risk factors in young survivors of myocardial infarction. *Blood* 1999;94(1):46–51.

340. Anderson JL, King GJ, Blair TL, et al. Associations between a polymorphism in the gene encoding glycoprotein IIIa and myocardial infarction or coronary artery disease. *J Am Coll Cardiol* 1999;33(3):727–733.

341. Zotz RB, Winkelmann BR, Nauck M, et al. Polymorphism of platelet membrane glycoprotein IIIa: human platelet antigen 1b (HPA-1b/PIA2) is an inherited risk factor for premature myocardial infarction in coronary artery disease. *Thromb Haemost* 1998;79(4):731–735.

342. Carter AM, Ossei-Gerning N, Grant PJ. Platelet glycoprotein IIIa PIA polymorphism in young men with myocardial infarction. *Lancet* 1996;348(9025):485–486.

343. Bottiger C, Kastrati A, Koch W, et al. HPA-1 and HPA-3 polymorphisms of the platelet fibrinogen receptor and coronary artery disease and myocardial infarction. *Thromb Haemost* 2000;83(4):559–562.

344. Kekomaki S, Hamalainen L, Kauppinen-Makelin R, et al. Genetic polymorphism of platelet glycoprotein IIIa in patients with acute myocardial infarction and acute ischaemic stroke. *J Cardiovasc Risk* 1999;6(1):13–17.

345. Hooper WC, Lally C, Austin H, et al. The relationship between polymorphisms in the endothelial cell nitric oxide synthase gene and the platelet GPIIIa gene with myocardial infarction and venous thromboembolism in African Americans. *Chest* 1999;116(4):880–886.

346. Scaglione L, Bergerone S, Gaschino G, et al. Lack of relationship between the P1A1/P1A2 polymorphism of platelet glycoprotein IIIa and premature myocardial infarction. *Eur J Clin Invest* 1998;28(5):385–388.

347. Mamotte CD, van Bockxmeer FM, Taylor RR. Pia1/a2 polymorphism of glycoprotein IIIa and risk of coronary artery disease and restenosis following coronary angioplasty. *Am J Cardiol* 1998;82(1):13–16.

348. Gardemann A, Humme J, Stricker J, et al. Association of the platelet glycoprotein IIIa PIA1/A2 gene polymorphism to coronary artery disease but not to nonfatal myocardial infarction in low risk patients.

Thromb Haemost 1998;80(2):214–217.

349. Ridker PM, Hennekens CH, Schmitz C, et al. PIA1/A2 polymorphism of platelet glycoprotein IIIa and risks of myocardial infarction, stroke, and venous thrombosis. *Lancet* 1997;349(9049):385–388.

350. Samani NJ, Lodwick D. Glycoprotein IIIa polymorphism and risk of myocardial infarction. *Cardiovasc Res* 1997;33(3):693–697.

351. Osborn SV, Hampton KK, Smillie D, et al. Platelet glycoprotein IIIa gene polymorphism and myocardial infarction. *Lancet* 1996;348(9037):1309–1310.

352. Sonada A, Murata M, Ito D, et al. Association between platelet glycoprotein Iba genotype and ischemic cerebrovascular disease. *Stroke* 2000;31(2):493–497.

353. Baker RI, Eikelboom J, Lofthouse E, et al. Platelet glycoprotein Iba Kozak polymorphism is associated with an increased risk of ischemic stroke. *Blood* 2001;98(1):36–40.

354. Reiner AP, Kumar PN, Schwartz SM, et al. Genetic variants of platelet glycoprotein receptors and risk of stroke in young women. *Stroke* 2000;31(7): 1628–1633.

355. Sacchi E, Duca F, Franceschi C, et al. Prothrombin gene mutation (G20210A) in healthy Centenarians. *Thromb Haemost* 1999;81(6):990–991.

356. Carlsson LE, Santoso S, Spitzer C, et al. The alpha2 gene coding sequence T807/A873 of the platelet collagen receptor integrin alpha2beta1 might be a genetic risk factor for the development of stroke in younger patients. *Blood* 1999;93(11):3583–3586.

357. Corral J, Lozano ML, Gonzalez–Conejero R, et al. A common polymorphism flanking the ATG initiator codon of GPIb alpha does not affect expression and is not a major risk factor for arterial thrombosis. *Thromb Haemost* 2000;83(1):23–28.

358. Corral J, Gonzalez–Conejero R, Rivera J, et al. Role of the 807 C/T polymorphism of the alpha2 gene in platelet GP Ia collagen receptor expression and function—effect in thromboembolic diseases. *Thromb Haemost* 1999;81(6):951–956.

359. Wagner KR, Giles WH, Johnson CJ, et al. Platelet glycoprotein receptor IIIa polymorphism P1A2 and ischemic stroke risk: the Stroke Prevention in Young Women Study. *Stroke* 1998;29(3):581–585.

360. Corral J, Gonzalez–Conejero R, Lozano ML, et al. Genetic polymorphisms of factor VII are not associated with arterial thrombosis. *Blood Coagul Fibrinolysis* 1998;9(3):267–272.

361. Mikkelsen J, Perola M, Penttila A, et al. Platelet glycoprotein Iba HPA–2 Met/VNTR B haplotype as a genetic predictor of myocardial infarction and sudden cardiac death. *Circulation* 2001 Aug 21;104(8):876–880.

362. Murata M, Kawano K, Matsuvara Y, et al. Genetic polymorphisms and risk of coronary artery disease. *Semin Thromb Hemost* 1998;24(3):245–250.

363. Ito T, Ishida F, Shimodaira S, et al. Polymorphisms of platelet membrane glycoprotein Iba alpha and plasma von Willebrand factor antigen in coronary artery disease. *Int J Hematol* 1999;70(1):47–51.

364. Garcia–Ribes M, Gonzalez–Lamuno D, Hernandez–Estefania R, et al. Polymorphism of the platelet glycoprotein IIIa gene in patients with coronary stenosis. *Thromb Haemost* 1998;79(6):1126–1129.

365. Mikkelsen J, Perola M, Laippala P, et al. Glycoprotein IIIa PI(A) polymorphism associates with progression of coronary artery disease and with myocardial infarction in an autopsy series of middle-aged men who died suddenly. *Arterioscler Thromb Vasc Biol* 1999;19(10):2573–2578.

2004 Lippincott Williams & Wilkins  
John P. Greer, John Foerster, John N. Lukens  
George M. Rodgers, Frixos Paraskevas, Bertil Glader  
Wintrobe's Clinical Hematology

ESSENTIAL FEATURES OF COAGULATIONOVERVIEW OF PROCOAGULANT PATHWAYS: PRIMARY AND ACCESSORY PATHWAYSPROCOAGULANT PROTEINS: ACCESSORY PATHWAY FACTORS AND FACTOR XIFactor XII (Hageman Factor, Contact Factor)Plasma Prekallikrein (Fletcher Factor)High-Molecular-Weight Kininogen (Fitzgerald Factor, Williams Factor)Factor XI (Plasma Thromboplastin Antecedent)PROCOAGULANT PROTEINS: VITAMIN K-DEPENDENT PROTEIN FAMILYGene Structure and ExpressionPosttranslational ProcessingGeneral Structure/Function FeaturesFactor VII (Proconvertin, Convertin)Factor IX (Plasma Thromboplastin Component, Christmas Factor, Hemophilia B Factor)Factor X (Stuart Factor)Factor II (Prothrombin)PROCOAGULANT PROTEINS: PROCOAGULANT COFACTOR PROTEINSTissue Factor (Tissue Thromboplastin, CD142, Coagulation Factor III)Factor VIII (Antihemophilic Factor, Factor VIII:Antigen, Factor VIII:Coagulant)Factor V (Labile Factor)von Willebrand Factor (von Willebrand Factor:Antigen, Ristocetin Cofactor, von Willebrand Factor Ristocetin:Cofactor)PROCOAGULANT PROTEINS: THROMBIN (FACTOR IIA)Roles in CoagulationRoles in AnticoagulationRoles in Tissue Repair and RegenerationThrombin ReceptorsStructure/Function RelationshipsRegulationANTICOAGULANT PROTEINS: DYNAMIC INHIBITORY SYSTEMProtein CProtein SProtein ZThrombomodulinANTICOAGULANT PROTEINS: PROTEINASE INHIBITORS $\alpha$ 2-MacroglobulinTissue Factor Pathway InhibitorANTICOAGULANT PROTEINS: SERINE PROTEASE INHIBITOR SUPERFAMILY (SERPIN)Antithrombin-IIIHeparin Cofactor II (Leuserpin 2) $\alpha$ 1-Proteinase Inhibitor ( $\alpha$ 1-Antitrypsin)C1 Esterase InhibitorProtein C Inhibitor (Plasminogen Activator Inhibitor-3)PROTEINS OF CLOT FORMATIONFactor XIII (Fibrin Stabilizing Factor)Fibrinogen (Factor I) and FibrinPROTEINS OF THE FIBRINOLYTIC SYSTEMPlasminogenPlasminogen ActivatorsINHIBITORS OF THE FIBRINOLYTIC SYSTEMThrombin-Activatable Fibrinolysis Inhibitor

[Plasminogen Activator Inhibitor-1](#)

[Plasminogen Activator Inhibitor-2](#)

[α<sub>2</sub>-Antiplasmin](#)

[PHYSIOLOGIC REGULATION OF FIBRINOLYSIS](#)

[Cellular Regulation of Fibrinolysis](#)

[Urokinase-Type Plasminogen Activator Receptor](#)

[Tissue-Type Plasminogen Activator Receptors](#)

[Role of Platelets in Regulation of Fibrinolysis](#)

[CONCLUSION](#)

[ACKNOWLEDGMENT](#)

[REFERENCES](#)

The processes of blood coagulation and fibrinolysis are the primary defense systems of the vasculature. The opposing forces of fibrin clot formation and dissolution maintain hemostasis and preserve vascular function and integrity. Procoagulant events that culminate in α-thrombin generation and fibrin clot formation protect the vasculature from perforating injury and excessive blood loss. Fibrinolysis removes the fibrin clot, restores blood flow, and initiates mechanisms involved in tissue repair and regeneration.

*Hemostasis*, therefore, refers to multiple discreet processes that center on α-thrombin generation, fibrin clot formation, and fibrin clot dissolution.

Circulating and adherent cells and circulating and cell membrane-associated proteins carry out key roles in the coagulation and fibrinolytic pathways. Hemostasis is not a passive state but is instead actively maintained by the vascular system. Specific cellular and protein interactions are required to maintain an equilibrium state. When the system is perturbed, precise interactions are likewise required to initiate procoagulant events and to promote fibrinolysis and tissue repair. Each individual process that contributes to hemostasis must operate properly, or the entire system is compromised. A balance between the procoagulant, anticoagulant, and fibrinolytic factors is required to prevent uncontrolled bleeding or, conversely, excessive clot formation ([1](#)).

Many of the processes involved in hemostasis are still not well understood. Epidemiologic studies have expanded our knowledge about key factors that determine risk for cardiovascular disease. However, cardiovascular disease is still the primary cause of death in the United States and Western Europe. To more effectively treat and, ultimately, prevent cardiovascular mishaps, we continue to examine the processes that contribute to blood coagulation and fibrinolysis. The current concepts governing the roles of protein components and their structures, functions, and regulation are summarized in the following sections.

## ESSENTIAL FEATURES OF COAGULATION

MacFarlane ([2](#)) and Davie and Ratnoff ([3](#)) provided the first descriptions of the coagulation system in 1964. They proposed a “cascade” or “waterfall” sequence of events in which the reactions occur in a defined series leading to fibrin clot formation. Each reaction shares a similar mechanism in which an inactive zymogen precursor protein is converted to an active enzyme. Generation of the active enzyme requires a multiprotein complex, a surface, and divalent calcium ions ( $\text{Ca}^{2+}$ ). Although some facets of these initial descriptions are still valid, the emerging concept of coagulation and fibrinolysis centers on a complex network of highly interwoven concurrent processes. Procoagulant and fibrinolytic events occur simultaneously with many positive and negative feedback loops regulating the processes. To simplify this intricate mechanism, the reactions that govern hemostasis can be separated into five distinct phases for analysis: *initiation* of coagulation, *propagation* of α-thrombin formation, *termination* of the procoagulant response, *elimination* of the fibrin clot, and tissue *repair* and regeneration.



The reactions involved in these five phases share several key features. The nomenclature used to describe the protein components of the reactions is similar. The enzymes and their zymogen precursors are members of the serine protease family that includes chymotrypsin and trypsin and their respective precursors chymotrypsinogen and trypsinogen. The zymogen and enzyme forms of the coagulation proteases are generally distinguished by an *a* added to the zymogen name to signify the active enzyme. For example, *factor Xa* is the active enzyme, and *factor X* is the corresponding zymogen. Factor II, most commonly referred to as *prothrombin*, is the zymogen that on activation becomes factor IIa or thrombin. Procofactors factor V and factor VIII also share this nomenclature, in which the fully functional cofactor forms are designated *factor Va* and *VIIIa*. Other protein cofactor components that are cell membrane-associated, such as tissue factor and thrombomodulin, have only one form and designation.

The mechanisms of the individual reactions are likewise similar in nature. A complex consisting of a serine protease, cofactor protein, and  $\text{Ca}^{2+}$  assembled on an anionic phospholipid surface activates a zymogen to an enzyme. The prothrombinase complex is the best characterized of these multicomponent catalysts. The prothrombinase complex consists of the enzyme factor Xa, its cofactor, factor Va,  $\text{Ca}^{2+}$ , and an anionic membrane surface. The prothrombinase complex cleaves the zymogen prothrombin to yield the active enzyme a-thrombin. *In vivo*, the phospholipid surface is provided mainly by platelets and, to some extent, by the endothelium and circulating cells such as monocytes.

The essential features of the hemostatic response include speed, amplification, regulation, and localization. The response to injury must be rapid and properly amplified to ensure an adequate address to the injury. Initiation of the procoagulant response occurs when the vascular milieu is perturbed and the antithrombotic nature of the endothelium is shifted to a prothrombotic state. Membrane surface and tissue elements, such as tissue factor, are exposed and set the stage for the subsequent phases of coagulation.

Assembly of the multicomponent procoagulant complexes on the membrane surface triggers the propagation of the coagulation response. The net result of the activities of these complexes (the intrinsic and extrinsic tenase and prothrombinase complexes) is an explosive elevation of the concentration of the enzyme a-thrombin. This rapid burst of a-thrombin is required to sustain the procoagulant response. a-Thrombin activates circulating platelets, the procofactors factors V and VIII, and the zymogens factors VII and XI ( [4](#), [5](#), [6](#), [7](#), [8](#), [9](#), [10](#), [11](#), [12](#) and [13](#) ) and cleaves fibrinogen to yield the fibrin clot. a-Thrombin also activates factor XIII ( [14](#) ), a transglutaminase that cross-links and further stabilizes the fibrin clot. Thrombin-activatable fibrinolysis inhibitor (TAFI), also known as *carboxypeptidase U* ( [15](#) ) or *procarboxypeptidase B* ( [16](#) ), is another zymogen activated in an a-thrombin-dependent fashion ( [17](#) ). The resulting enzyme, TAFIa, protects the fibrin clot from proteolysis and subsequent degradation. The propagation phase thus stems blood loss by providing a stable fibrin clot.

Termination of fibrin clot formation involves constitutive inhibitory processes and a clot-initiated dynamic inhibitory process ( [18](#) ). The termination phase results in inhibition of the procoagulant enzyme complexes either by direct inhibition of the serine protease components or by inactivation of the cofactor proteins. The termination phase serves to limit the coagulation response and prevent excessive clot formation.

Elimination of the resulting clot is a plasmin-dependent process. The enzyme plasmin cleaves the cross-linked fibrin matrix to produce soluble fibrin peptides ( [19](#), [20](#) ). The

mechanism by which plasmin is generated is quite complex and involves several proteins with key roles throughout the hemostatic response.

The solubilization and removal of the fibrin scaffolding of the hemostatic plug are coordinated with processes of tissue repair and regeneration. The extracellular matrix is degraded to allow for cell migration into the damaged area. Cells repopulate the site and re-create the elements necessary to restore the vasculature to its unperturbed state.

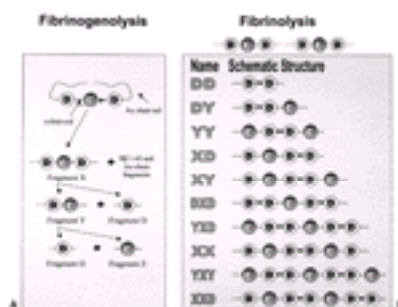
Just as these steps must occur rapidly and in a precise choreographed manner, they must also be localized to the site of injury. Localization presents challenges because the hemostatic response occurs under conditions of flow. Localization is controlled on several levels. Unperturbed endothelial cells actively inhibit coagulation by constitutively synthesizing a variety of anticoagulant proteins and inhibitors and inhibitors of platelet activation. The surface of undamaged cells is also not conducive to the assembly and function of the procoagulant protein complexes. The only surface available for procoagulant complex assembly is therefore the damaged site. Enzyme activity is also limited to the site of injury due to high levels of circulating inhibitors. In addition, the procoagulant enzyme complexes are stabilized and exhibit large increases in catalytic efficiency when interacting with a membrane surface. The membrane surface provides for rapid transfer of intermediate products between complexes as well. Surface-dependent two-dimensional transfer of intermediates between complexes increases the rates of complex assembly and function and, ultimately, provides the burst of  $\alpha$ -thrombin required for clot formation. If the intermediate products dissociated from and reassociated with the membrane, not only would the rates of complex assembly and function be considerably slower, but also the intermediate enzyme products would be exposed to inhibitors and subject to dilution in the circulation. Surface-dependent interactions that channel intermediates between complexes increase catalytic efficiency, sequester enzyme products at the site of injury, and protect enzyme intermediates from inhibition and dilution ( [18](#), [21](#) ). The essential features of the hemostatic response, speed, amplification, regulation and localization, thus ensure that the response is localized to the area of injury, amplified appropriately according to the severity of the injury, and attenuated to allow for subsequent tissue regeneration ( [22](#), [23](#) ).

## OVERVIEW OF PROCOAGULANT PATHWAYS: PRIMARY AND ACCESSORY PATHWAYS

There are two distinct procoagulant pathways. The primary or extrinsic (tissue factor) pathway consists of the intrinsic and extrinsic tenase complexes and the prothrombinase complex ( [Fig. 21.1](#) ). The accessory or intrinsic (contact) pathway is composed of the factor XII-high-molecular-weight kininogen (HMWK)-prekallikrein complex in contact with a negatively charged surface such as glass, dextran sulfate, or kaolin and the factor XIa-HMWK:divalent cation complex in contact with an appropriate cellular membrane. The primary and accessory pathways are initiated by independent routes leading to the activation of factor IX and converge at the intrinsic tenase complex ( [Fig. 21.1](#) ). Regardless of the path chosen, the outcome is the formation of the prothrombinase complex and thrombin generation. Clinical tests differentiate between the two pathways. The activated partial thromboplastin time initiates coagulation through the accessory pathway, whereas the prothrombin time (PT) assay initiates coagulation through the primary pathway ( [24](#), [25](#) and [26](#) ).



**Figure 21.17.** Schematic of the dynamic interaction between the proteins and inhibitors of fibrinolysis. Cross-linked fibrin formation is integrated with fibrin clot dissolution and degradation of its products. The enzymes ( *open circles*), inhibitors ( *hatched circles*), zymogens ( *open boxes*), and complexes ( *large open ovals*) are illustrated in a simplified form to show this multicomponent process. The key proteins involved are plasminogen, plasminogen activators [tissue-type plasminogen activator (tPA), single-chain urokinase-type plasminogen activator (scu-PA), and two-chain urokinase-type plasminogen activator (tcu-PA)], plasminogen activator inhibitor-1 (PAI-1), a  $\alpha_2$ -antiplasmin (a  $\alpha_2$ -AP), and thrombin-activatable fibrinolysis inhibitor (TAFI). t-PA and plasminogen both bind to the fibrin surface where t-PA is an effective catalyst of plasminogen activation. Initially, plasmin proteolysis of fibrin generates new, higher affinity binding sites for plasminogen, setting up an amplifying loop of plasminogen activation. Reinforcing this process, generated plasmin can convert the single-chain form of urokinase, an ineffective catalyst, to its active form, thus increasing the concentration of available plasminogen activation. Opposing these events are antifibrinolytic mechanisms. a  $\alpha_2$ -AP, both soluble and cross-linked to fibrin, forms complexes with plasmin, rendering it inactive. PAI-1 rapidly reacts with both t-PA and two-chain urokinase, reducing the concentration of plasminogen activators. Formation of activated TAFI (TAFIa) results in removal plasmin-generated COOH-terminal lysine residues, thus suppressing the rate of fibrin lysis. Fibrin degradation occurs by cleavage at the D-E-D domains of fibrin polymers by plasmin to yield a variety of polymers as illustrated (see [Fig. 21.16](#)).



**Figure 21.16.** Fibrinogenolysis and fibrinolysis. **A:** Fibrinogen is represented as a trinodular structure (D-E-D domains). Each E-domain and D-domain is separated by a coiled-coil domain. The A $\alpha$ -chain tail is shown as a line. Plasmin digests fibrinogen, yielding various fragments, the largest of which is fragment X. Fragment X contains the two D domains, the E domain, and the  $\alpha$ -helical coiled-coils but lacks the C-termini of the A $\alpha$ -chains and the peptide B $\beta$ -chains. Fragment Y consists of the central E domain connected by the coiled-coil to one of the terminal D domains. Fragment Y can be further degraded by cleavage of the coiled-coil domain to release a second D domain and fragment E. **B:** The domain composition of the monomer units of degraded fibrin is indicated by the circles containing a D or an E. Intermolecular cross-links between the  $\gamma$ -chains are shown as thicker lines connecting the D regions. The structures of the various-sized fragments of cross-linked fibrin monomers resulting from plasmin proteolysis of fibrin are presented.

The designations of primary and accessory pathways are based on clinical evidence of bleeding diseases. Deficiencies of proteins associated with the intrinsic or accessory pathway (factor XII, prekallikrein, and HMWK) do exist but are not associated with abnormal bleeding events, even after surgical challenge ([27](#), [28](#), and [29](#)). However, deficiencies of the protein components of the extrinsic or primary pathway (prothrombin and factors V, VII, VIII, IX, and X) can lead to severe bleeding diatheses ([30](#), [31](#), [32](#), [33](#), [34](#) and [35](#)). Factor XI deficiency may also result in bleeding episodes subsequent to trauma ([36](#), [37](#)). The physiologic role of the accessory pathway is therefore not clearly understood

([38](#)). Factor XI appears to play a more prominent role in coagulation ([39](#)), although this role is most likely unrelated to its activities in the intrinsic pathway. The importance of factor XI is thought to be due to the activation of factor XI to factor XIa by  $\alpha$ -thrombin as part of a positive feedback loop stemming from  $\alpha$ -thrombin generation. Factor XIa then functions in the propagation phase of  $\alpha$ -thrombin generation in association with the primary pathway ([4](#)).

Three proteins, factor XII, prekallikrein, and HMWK, are required for activity of the contact or accessory pathway. Factor XII and prekallikrein are zymogens that are activated to generate serine proteases, and HMWK is a nonenzymatic procofactor. Although these proteins have no defined role in normal hemostasis, the accessory pathway factors are thought to play a key role in disseminated intravascular coagulation (DIC) associated with the systemic inflammatory response syndrome ([40](#), [41](#)). The accessory pathway may also be important in cardiopulmonary bypass due to contact between blood components and synthetic surfaces ([41](#)).

The primary pathway of coagulation, the extrinsic pathway, involves the vitamin K-dependent zymogens and serine proteases, cofactor proteins, and  $\text{Ca}^{2+}$  ions assembled on anionic phospholipid membranes. The complexes display reaction rates  $10^5$  to  $10^6$  times greater than the respective serine proteases alone ([21](#)). The importance of the membrane component in coagulation has been identified by kinetic studies of the prothrombinase complex. In the absence of the membrane surface, the cofactor (factor Va)-enzyme (factor Xa) interaction is relatively weak, with a dissociation constant ( $K_d$ ) of 800 nmol/L ([42](#), [43](#) and [44](#)). The factor Va-lipid interaction ( $K_d = 3$  nmol/L) and factor Xa-lipid interaction ( $K_d = 110$  nmol/L) ([45](#)) show higher affinity. However, all of the components must be present to generate the high-affinity factor Va-factor Xa- $\text{Ca}^{2+}$ -membrane complex, with a  $K_d$  of 1 nmol/L ([46](#)). The fully assembled complex is stabilized through factor Va-factor Xa, factor Va-lipid, and factor Xa-lipid interactions ([11](#), [47](#), [48](#)). The stability of the complex is translated into greater catalytic efficiency as well. The prothrombinase complex converts the zymogen prothrombin to  $\alpha$ -thrombin  $10^5$ -fold faster than a physiologic concentration of factor Xa acting alone ([42](#)).

The three complexes of the primary pathway (extrinsic tenase, intrinsic tenase, and prothrombinase) function in tandem to achieve a rapid burst of  $\alpha$ -thrombin generation. The primary pathway of coagulation is initiated or triggered by the interaction of circulating factor VIIa with its cofactor tissue factor ([49](#), [50](#) and [51](#)). In general, the serine proteases associated with hemostasis circulate in their zymogen or inactive forms; however, low levels of circulating factor VIIa are present in blood ([52](#)). This factor VIIa binds to tissue factor and initiates the procoagulant response. Although low levels of factor VIIa are in continuous circulation, initiation of coagulation is a very specific response. Free factor VIIa is a poor enzyme with virtually no proteolytic activity and does not react with circulating inhibitors in the absence of tissue factor. Tissue factor is an integral membrane protein that is not normally expressed on vascular cell surfaces. Tissue factor is instead constitutively expressed on extravascular cellular surfaces ([53](#), [54](#), [55](#), [56](#), [57](#) and [58](#)) and thus exposed on damage to the endothelial cell layer. Tissue factor is also expressed on peripheral blood cells and endothelial cells stimulated by inflammatory cytokines ([59](#), [60](#)).

On interaction of circulating factor VIIa and injury-exposed tissue factor, the extrinsic tenase complex is formed and initiates coagulation by activating factors IX and X. The



extrinsic tenase also activates additional factor VII. Factor IXa forms a complex with its cofactor, factor VIIIa, to generate the intrinsic tenase complex, and factor Xa combines with factor Va to form the prothrombinase complex. The factor VIIIa–factor IXa complex serves to activate factor X to factor Xa, providing a more robust source of the enzyme component of the prothrombinase complex. Factor Xa associated with a phospholipid surface, in the absence of the cofactor protein factor Va, activates factor VII to factor VIIa, thus providing a positive feedback loop. The rate of factor Xa–phospholipid activation of factor VII is 24–fold higher than the tissue factor–factor VIIa complex ( [61](#) ).

Examination of the roles of the complexes in the primary pathway of coagulation presents a paradox. Because the extrinsic tenase also provides factor Xa, the severe bleeding disorders associated with deficiencies of the intrinsic tenase components factor VIIIa (hemophilia A) and factor IXa (hemophilia B) should not exist. In theory, activation of factor X by the extrinsic tenase could compensate for the lack of factor X activation by the intrinsic tenase in hemophilias A and B. However, this compensatory mechanism only occurs on clinical administration of supraphysiologic concentrations of recombinant factor VIIa. Physiologic levels of factor VIIa are not able to provide sufficient levels of factor Xa to support normal coagulation in the absence of an adequate intrinsic tenase activity.

Although the roles of the intrinsic and extrinsic tenase complexes may appear to be somewhat redundant, closer examination of the complexes provides a clear picture of their respective functions. When factors IX and X are simultaneously presented to the extrinsic tenase to mimic conditions *in vivo*, factor IXa generation is increased, whereas factor Xa generation is suppressed to approximately one–half the level observed when factor X is the only substrate presented ( [62](#), [63](#) ). Factor IX, not factor X, appears to be the preferred substrate of the extrinsic tenase. In addition, factor IXa, the intermediate species in factor IX activation, is generated more rapidly in the presence of factor X. Factor IXa activation to the final product factor IXa occurs at a higher rate than factor IX activation, thereby providing a burst of factor IXa to form the intrinsic tenase complex. The low level of factor Xa generated by the tissue factor–factor VIIa complex most likely functions in the activation of factor IX. A model of extrinsic tenase behavior suggests that factor IX is converted to factor IXa by the extrinsic tenase or factor Xa–phospholipid complex. Factor IXa is then rapidly converted to factor IXa by the extrinsic tenase ( [62](#), [63](#) ). The factor VIIIa–factor IXa complex subsequently activates the major fraction of factor X to factor Xa and provides the enzyme component for the prothrombinase complex. Measurements of second–order rate constants for factor Xa generation by the intrinsic and extrinsic tenase complexes also support this model. The rate of factor Xa generation by the tissue factor–factor VIIa complex is 1/50th the rate of factor Xa generation by the factor VIIIa–factor IXa complex ( [62](#), [63](#) and [64](#) ). Both complexes thus have distinct roles in the procoagulant response.

In summary, the procoagulant response is triggered on factor VIIa interaction with tissue factor exposed, expressed, or both, as a result of vascular perturbation. The extrinsic tenase generates low levels of factors IXa and Xa during the initiation phase of coagulation. Factor Xa–phospholipid complexes also assist in the activation of factor IX. Factor IXa combines with factor VIIIa on the membrane surface, and the intrinsic tenase accelerates factor Xa generation 50–fold over the extrinsic tenase. The burst of factor Xa overcomes circulating levels of factor Xa inhibitors and initiates maximal levels of prothrombinase complex activity. Prothrombinase activity subsequently leads to a burst of a–thrombin generation and propagation of the procoagulant response ( [62](#), [63](#) ).

## PROCOAGULANT PROTEINS: ACCESSORY PATHWAY FACTORS AND FACTOR XI

The procoagulant proteins that make up the intrinsic pathway or accessory pathway consist of factor XII, plasma prekallikrein, HMWK, and factor XI. These proteins are responsible for the contact activation of blood coagulation. The physiologic role of the intrinsic pathway is not clearly understood but does not appear to be essential for hemostasis because individuals deficient in these proteins do not manifest abnormal bleeding. Factor XI appears to play a more prominent role, unrelated to its activities in the intrinsic pathway, in coagulation after activation by thrombin (39). Each of these proteins is described in terms of its gene structure and expression, biochemistry, activation, function, and regulation in regards to hemostasis.

### Factor XII (Hageman Factor, Contact Factor)

*Factor XII*, or *Hageman factor* (HF), is the zymogen precursor of the serine protease factor XIIa. Factor XII is also known as *contact factor* for its role in the initiation of the contact or intrinsic pathway of coagulation on contact with substances such as glass or kaolin. The contact pathway is the basis for the activated partial thromboplastin time clotting assay. Factor XII circulates in plasma at an average concentration of 40 µg/ml (500 nmol/L) (65, 66) (Table 21.1). Increased levels of factor XII are seen in postmenopausal women using estrogen replacement therapy and during pregnancy. Animal studies also demonstrate enhanced expression of factor XII by estrogen and prolactin (67, 68 and 69). Deficiency of factor XII is not associated with bleeding abnormalities; therefore, the precise role of factor XII in hemostasis is unknown at the present time. However, the components of the contact pathway are believed to provide a link between coagulation and inflammation.

TABLE 21.1. Biochemical Properties of Blood Coagulation Proteins

| Protein                         | Molecular Weight (d) | Plasma Concentration |         | Plasma Half-Life (days) | Carbo-hydrate (%) | Clinical Phenotype <sup>a</sup> |   | Functional Classification |
|---------------------------------|----------------------|----------------------|---------|-------------------------|-------------------|---------------------------------|---|---------------------------|
|                                 |                      | (nmol/L)             | (µg/ml) |                         |                   | H                               | T |                           |
| Intrinsic pathway proteins      |                      |                      |         |                         |                   |                                 |   |                           |
| Factor XII                      | 80,000               | 500                  | 40      | 2–3                     | 17                | –                               |   | Protease zymogen          |
| Prekallikrein                   | 85/88,000            | 486                  | 42      |                         | 15                |                                 |   | Protease zymogen          |
| High-molecular-weight kininogen | 120,000              | 670                  | 80      |                         | 42                | –                               |   | Cofactor                  |
| Low-molecular-weight kininogen  | 66,000               | 1300                 | 90      |                         | 30                |                                 |   | Cofactor                  |
| Factor XI                       | 160,000              | 30                   | 5       | 2.5–3.3                 | 5                 | ±                               |   | Protease zymogen          |
| Extrinsic pathway proteins      |                      |                      |         |                         |                   |                                 |   |                           |
| Tissue factor                   | 44,000               |                      |         |                         |                   |                                 |   | Cell-associated cofactor  |
| Factor VII                      | 50,000               | 10                   | 0.5     | 0.25                    | 13                | +                               | ± | VKD protease zymogen      |



|                       |                   |        |      |         |       |   |  |
|-----------------------|-------------------|--------|------|---------|-------|---|--|
| Factor VIIa           | 50,000            |        |      | 0.1     | 13    |   | VKD serine protease                        |
| Factor X              | 59,000            | 170    | 10   | 1.5     | 15    | + | VKD protease zymogen                       |
| Factor Xa             | 48,000            |        |      | 3       |       |   | VKD serine protease                        |
| Factor IX             | 55,000            | 90     | 5    | 1       | 17    | + | VKD protease zymogen                       |
| Factor IXa            | 45,000            |        |      |         |       |   | VKD serine protease                        |
| Factor V              | 330,000           | 20     | 6.6  | 0.5     | 13–25 | + | Soluble procofactor                        |
| B region              | 150,000           |        |      |         | 50    |   |  |
| Factor Va             | 180,000           |        |      |         | 8     |   | Cofactor                                   |
| Factor VIII           | 280,000           | 0.7    | 0.2  | 0.3–0.5 |       | + | Soluble procofactor                        |
| Factor VIIIa          | 170,000           |        |      |         |       |   | Cofactor                                   |
| von Willebrand factor | 255,000 (monomer) | varies | 10   |         | 10–15 | + | Platelet adhesion, carrier for factor VIII |
| Prothrombin           | 72,000            | 1400   | 100  | 2.5     | 8     | + | VKD protease zymogen                       |
| α-Thrombin            | 37,000            |        |      |         | 5     |   | VKD serine protease                        |
| Fibrinogen            | 340,000           | 7400   | 2500 | 3–5     | 3     | + | ± Structural protein, cell adhesion        |
| Aa                    | 66,500            |        |      |         |       |   |  |
| BB                    | 52,000            |        |      |         |       |   |  |
| ?                     | 46,500            |        |      |         |       |   |  |
| Factor XIII           | 320,000           | 93     | 30   | 9–10    |       | + | Transglutaminase zymogen                   |
| A-chain               | 83,200            |        |      |         |       |   |  |
| B-chain               | 79,700            |        |      |         | 5     |   |  |

+, presence of phenotype; -, absence of phenotype; ±, some individuals present with the phenotype and others do not; H, hemorrhagic disease/hemophilia; T, thrombotic disease/thrombophilia; VKD, vitamin K-dependent.

<sup>a</sup> Clinical phenotype: the expression of either H or T phenotype in deficient individuals.

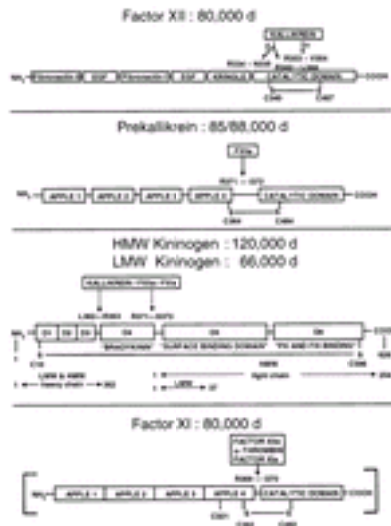
**GENE STRUCTURE AND EXPRESSION** Human factor XII is produced by a single gene located on chromosome 5 q33–qter (70, 71) (Table 21.2). The gene for factor XII spans approximately 12 kilobases (kb) and is comprised of 13 introns and 14 exons (72). The intron/exon gene structure is similar to the gene structures of tissue plasminogen activator (t-PA) and urokinase-type plasminogen activator (u-PA) (72). The promoter does not contain the CAAT or TATA sequences common in other genes, but it does contain two LF-A1 transcription elements characteristic of genes with liver-specific expression. The promoter also contains one estrogen-responsive element (72, 73).

**TABLE 21.2. Molecular Genetics of Blood Coagulation Proteins**

| Protein                         | Molecular Weight (d) | Gene Location: Chromosome | Gene Size (kb) | Gene Organization: Number of Exons | Messenger RNA Size (kb) |
|---------------------------------|----------------------|---------------------------|----------------|------------------------------------|-------------------------|
| Intrinsic pathway proteins      |                      |                           |                |                                    |                         |
| Factor XII                      | 80,000               | 5q33-qter                 | 12             | 14                                 | 2.4                     |
| Prekallikrein                   | 85/88,000            | 4q34-35                   | 30             | 15                                 | 2.4                     |
| High-molecular-weight kininogen | 120,000              | 3q26-qter                 | 27             | 11                                 | 3.5                     |
| Low-molecular-weight kininogen  | 66,000               | 3q26-qter                 |                |                                    |                         |
| Factor XI                       | 160,000              | 4q35                      | 23             | 15                                 | 2.1                     |
| Extrinsic pathway proteins      |                      |                           |                |                                    |                         |
| Tissue factor                   | 44,000               | 1p21-22                   | 12.4           | 6                                  | 2.3                     |
| Factor VII                      | 50,000               | 13q34-qter                | 12.8           | 9                                  | 2.5                     |
| Factor VIIa                     | 50,000               |                           |                |                                    |                         |
| Factor X                        | 59,000               | 13q34-qter                | 27             | 8                                  | 1.5                     |
| Factor Xa                       | 48,000               |                           |                |                                    |                         |
| Factor IX                       | 55,000               | Xq26.3-q27.1              | 33             | 8                                  | 2.8                     |
| Factor IXa                      | 45,000               |                           |                |                                    |                         |
| Factor V                        | 330,000              | 1q21-q25                  | 80             | 25                                 | 6.8                     |
| B region                        | 150,000              |                           |                |                                    |                         |
| Factor Va                       | 180,000              |                           |                |                                    |                         |
| Factor VIII                     | 280,000              | Xq28                      | 186            | 26                                 | 9.0                     |
| Factor VIIIa                    | 170,000              |                           |                |                                    |                         |
| von Willebrand factor (monomer) | 255,000              | 12p-12pter                | 178            | 52                                 | 8.8                     |
| Prothrombin                     | 72,000               | 11p11-q12                 | 21             | 14                                 | 2                       |
| a-Thrombin                      | 37,000               |                           |                |                                    |                         |
| Fibrinogen                      | 340,000              | 4q23-q32                  | 50             |                                    |                         |
| Aa                              | 66,500               |                           | 5.4            | 6                                  | 2.2                     |
| BB                              | 52,000               |                           | 8              | 8                                  | 1.9                     |
| ?                               | 46,500               |                           | 8.5            | 10                                 | 1.6                     |
| Factor XIII                     | 320,000              |                           |                |                                    |                         |
| A-chain                         | 83,200               | 6p24-p25                  | 160            | 15                                 | 3.8                     |
| B-chain                         | 79,700               | 1q31-q32.1                | 28             | 12                                 | 2.3                     |

**BIOCHEMISTRY** Human factor XII is synthesized as a precursor protein with a 19-residue signal peptide. The mature factor XII molecule is a 596-amino acid single-chain  $\beta$ -globulin with a molecular weight of approximately 80 kd ( [74](#), [75](#), [76](#), [77](#) and [78](#) ). It circulates at a concentration of 40  $\mu$ g/ml (500 nmol/L) with a half-life ( $t_{1/2}$ ) of 2 to 3 days ( [Table 21.1](#)). The factor XII molecule is composed of two domains: an NH<sub>2</sub>-terminal heavy chain and a COOH-terminal light chain. The heavy chain contains several domain structures: fibronectin type I and type II domains, two epidermal growth factor (EGF)-like domains, a kringle domain, and a proline-rich region (residues 277-330) ( [Fig. 21.2](#)). The light chain contains the serine protease catalytic domain, a region homologous to the B-chain of the enzyme plasmin. The mature factor XII molecule contains approximately 17% carbohydrate. Glycosylation consists of an O-linked fucose at Thr<sup>90</sup> in the first EGF

domain ( [79](#) ), N-linked carbohydrates at Asn <sup>230</sup> and Asn <sup>414</sup> in the kringle and catalytic domains, respectively, and six O-linked carbohydrates in the proline-rich region ( [80](#) ). The factor XII molecule also contains four zinc ion (Zn <sup>2+</sup> )-binding sites ( [81](#) ). Zn <sup>2+</sup> binding to factor XII likely induces a conformation change that promotes activation of factor XII associated with negatively charged surfaces ( [82](#) , [83](#) and [84](#) ).



**Figure 21.2.** Schematic representation of the accessory pathway (intrinsic) proteins. Factor XII (FXII), prekallikrein (PK), high-molecular-weight (HMW) kininogen, low-molecular-weight (LMW) kininogen, and factor XI (FXI) are shown with their various domains depicted as blocks. Activating proteases are placed in a box above the cleavage sites with the specific amino acid residues of the site shown directly underneath. Key interchain disulfide bonds (S-S) are included. For the kininogens, horizontal arrows indicate the amino acid residues defining heavy and light chain regions of the activated forms of the cofactors. Factor XI is illustrated as a monomer. EGF, epidermal growth factor.

**ACTIVATION** Factor XII undergoes autoactivation on interaction with negatively charged surfaces such as glass, kaolin, dextran sulfate, ellagic acid, celite, or bismuth subgallate ( [85](#) , [86](#) , [87](#) , [88](#) , [89](#) , [90](#) , [91](#) , [92](#) , [93](#) , [94](#) and [95](#) ). This is likely only an artificial *in vitro* event triggered by the artificial surfaces used in studies of the contact pathway. Although factor XII associates with many physiologically relevant anionic surfaces, including negatively charged phospholipids ( [96](#) , [97](#) , [98](#) , [99](#) , [100](#) , [101](#) , [102](#) , [103](#) , [104](#) , [105](#) and [106](#) ), the autoactivation of factor XII induced by these surfaces *in vitro* does not appear to represent the mechanism for factor XII activation *in vivo* ( [107](#) ). Instead, factor XII is most likely activated by a cell membrane-associated proteinase ( [108](#) , [109](#) ). Factor XII, prekallikrein, and HMWK form a complex on anionic phospholipids of the cell membrane, and prekallikrein is cleaved, forming the enzyme kallikrein. Kallikrein then activates factor XII (plasmin activates factor XII as well). Enzymatic activation of factor XII by kallikrein involves a single cleavage at Arg <sup>353</sup>–Val <sup>354</sup> to generate an 80-kd two-chain enzyme, α-factor XIIa (factor XIIa, α-HFa, or HFa), composed of an NH <sub>2</sub>-terminal heavy chain [relative molecular weight (M <sub>r</sub>)= 52,000] and a COOH-terminal light chain (M <sub>r</sub> = 28,000) held together by a disulfide bond (Cys <sup>340</sup>–Cys <sup>467</sup>) ( [Fig. 21.2](#) ). This cleavage is essential for exposure of the active site in factor XIIa ( [110](#) ). Factor XIIa can then bind negatively charged surfaces and activate factor XI and prekallikrein ( [111](#) , [112](#) ). Two secondary cleavages can also occur on factor XII: one outside the disulfide bond (Arg <sup>334</sup>–Asn <sup>335</sup>) and one inside the disulfide loop (Arg <sup>343</sup>–Leu <sup>344</sup>), generating β-factor XIIa (FXII <sub>f</sub>, HF <sub>f</sub>) ( [113](#) , [114](#) , [115](#) and [116](#) ). β-Factor XIIa has

no surface binding capabilities but is able to activate prekallikrein ( [85](#), [117](#), [118](#) ).

**FUNCTION** *Factor XIIa* is a serine protease that activates factor XI and prekallikrein by mechanisms dependent on anionic surfaces and the cofactor HMWK ( [111](#), [119](#) ). Factor XIIa also activates the C1 component of the complement system ( [120](#) ). In addition, factor XIIa down-regulates the Fc receptor on monocytes and macrophages ( [121](#) ), induces release of interleukin (IL)-1 and IL-6 from monocytes and macrophages ( [122](#) ), and stimulates neutrophils ( [123](#) ). Although these roles have no apparent impact on normal coagulation, factor XII/XIIa may be an important link between coagulation and inflammation. Factor XIIa also activates plasminogen to plasmin linking the contact pathway to fibrinolysis ( [124](#) ).

**REGULATION** *C1 inhibitor* is the major inhibitor of both factor XIIa and  $\beta$ -factor XIIa and irreversibly inhibits both enzymes ( [125](#), [126](#), [127](#) and [128](#) ). Antithrombin-III and plasminogen activator inhibitor (PAI)-1 also inhibit factor XIIa ( [129](#), [130](#) and [131](#) ). Endothelial cells and eosinophils are reported to produce proteins that inhibit factor XII activation but not factor XIIa activity ( [132](#), [133](#) and [134](#) ). Amyloid precursor protein likewise is reported to inhibit factor XII activation but not factor XIIa ( [135](#) ).

### Plasma Prekallikrein (Fletcher Factor)

*Plasma prekallikrein*, or *Fletcher factor*, is the zymogen form of the enzyme kallikrein. Prekallikrein circulates in plasma at an average concentration of 42  $\mu\text{g/ml}$  (486 nmol/L) ( [136](#), [137](#) ) ( [Table 21.1](#) ). Approximately 75% circulates in a noncovalent complex with HMWK ( [138](#), [139](#) ), and the remaining 25% circulates as free prekallikrein. Like factor XII, prekallikrein is a component of the intrinsic or accessory pathway and serves as a link between coagulation and inflammation. Prekallikrein is also linked to fibrinolytic events as well. Plasma prekallikrein deficiency is rare and is not associated with hemostatic defects ( [140](#) ).

**GENE STRUCTURE AND EXPRESSION** The human prekallikrein gene is located on chromosome 4q34-35, close to the factor XI gene ( [141](#) ) ( [Table 21.2](#) ). The human plasma prekallikrein gene spans 30 kb and contains 15 exons and 14 introns ( [142](#) ). A total of twelve allelic variants have been identified in the 5' proximal promoter and in 7 of the exons. A common polymorphism (30% of the population) leads to replacement of Asn124Ser in the heavy chain of the apple 2 domain of prekallikrein. Two other polymorphisms in the coding region of the protein, His189Pro in the apple 3 domain of the heavy chain and His183Gln, were identified ( [142](#) ). Prekallikrein and factor XI are highly homologous, and both human factor XI and rat plasma prekallikrein genes are located on chromosome 4, suggesting a gene duplication event from a common ancestor ( [143](#) ). Prekallikrein mRNA has been detected in human kidney, adrenal gland, and placenta, but the liver is considered to be the major site of synthesis ( [144](#), [145](#) ).

**BIOCHEMISTRY** Human plasma prekallikrein is synthesized as a precursor with a 19-amino acid signal peptide. It circulates in plasma at an average concentration of 42  $\mu\text{g/ml}$  (486 nmol/L). The mature form of the protein, appearing as a doublet of 85 and 88 kd when analyzed by sodium dodecyl sulfate-polyacrylamide gel electrophoresis (SDS-PAGE), is a single-chain fast  $\gamma$ -globulin of 619 amino acids ( [124](#), [146](#), [147](#) ) ( [Table 21.1](#) ). Prekallikrein contains 15% carbohydrate with five N-linked sugar moieties ( [144](#) ). Structurally, prekallikrein contains four tandem repeats, called *apple domains*, in the NH<sub>2</sub>-terminal portion of the molecule ( [Fig. 21.2](#) ). Each apple domain consists of 90 to 91 amino acid residues including six to eight cysteines that are disulfide bonded to form the distinct domain structure ( [144](#), [148](#) ). The apple 1 and apple 4 domains mediate the binding

of prekallikrein to HMWK ( [149](#), [150](#) ). The apple domains of prekallikrein are highly homologous to the apple domains of factor XI. Apple domains have only been found in these two proteins, lending support to a gene duplication event from a common ancestor ( [141](#), [151](#) ). The COOH-terminal region of prekallikrein contains the catalytic site.

**ACTIVATION** Prekallikrein is activated by factor XIIa in complex with the cofactor HMWK on an anionic surface ( [Fig. 21.2](#) ). Prekallikrein is also activated by  $\beta$ -factor XII in the absence of a surface ( [152](#) ). The factor XIIa complex or  $\beta$ -factor XII catalyzes the cleavage of the Arg<sup>371</sup>-Ile<sup>372</sup> bond in prekallikrein. This cleavage is also reported to occur in the absence of factor XIIa when prekallikrein is bound to HMWK on the endothelial cell surface ( [108](#) ). The enzyme kallikrein is a two-chain molecule composed of an NH<sub>2</sub>-terminal heavy chain (M<sub>r</sub> = 53,000) containing the four apple domains and a COOH-terminal light chain (M<sub>r</sub> = 36,000 or 33,000) containing the active site ( [124](#), [144](#), [153](#), [154](#) ).

**FUNCTION** Kallikrein is a member of the trypsin family of serine proteases. In the presence of an appropriate anionic surface and the cofactor HMWK, kallikrein activates factor XII to factor XIIa and proteolyzes factor XIIa to  $\beta$ -factor XII. Kallikrein also undergoes autoproteolysis at Lys<sup>140</sup>-Ala<sup>141</sup> to yield  $\beta$ -kallikrein ( [155](#), [156](#) ). Enzyme activity is significantly reduced on conversion of kallikrein to  $\beta$ -kallikrein ( [154](#) ). Kallikrein cleaves HMWK at two sites to generate the vasoactive nonapeptide bradykinin ( [157](#), [158](#) ). Bradykinin is a potent vasodilator and stimulates endothelial cell prostacyclin synthesis, resulting in hypotension ( [159](#), [160](#) ). Kallikrein is also an activator of fibrinolytic zymogens and converts both plasminogen to plasmin and pro-u-PA to u-PA ( [124](#), [161](#), [162](#) ). In addition, kallikrein has been reported to activate neutrophils and stimulate elastase release as part of the hemostatic and inflammatory responses ( [163](#) ).

**REGULATION** C1 inhibitor and a  $\gamma_2$ -macroglobulin are the major inhibitors of kallikrein ( [164](#), [165](#) ). C1 inhibitor forms a 1:1 stoichiometric complex with kallikrein and abolishes its proteolytic and amidolytic activities ( [165](#), [166](#), [167](#) and [168](#) ). a  $\gamma_2$ -Macroglobulin inhibits the ability of kallikrein to generate bradykinin and partially inhibits amidolytic activity ( [166](#) ). C1 inhibitor and a  $\gamma_2$ -macroglobulin each inhibit equivalent amounts of kallikrein in plasma, but C1 inhibitor acts much more rapidly and plays the major role in reducing kallikrein activity ( [169](#) ). Antithrombin-III and antithrombin-III-heparin are slow inhibitors of kallikrein although the antithrombin-III-heparin-HMWK complex is an effective inhibitor ( [170](#), [171](#) and [172](#) ). Protein C inhibitor also inhibits kallikrein ( [173](#), [174](#) and [175](#) ).

### High-Molecular-Weight Kininogen (Fitzgerald Factor, Williams Factor)

HMWK, also known as *Fitzgerald factor* or *Williams factor*, circulates in plasma at an average concentration of 80  $\mu$ g/ml (670 nmol/L) ( [176](#), [177](#) ) ( [Table 21.1](#) ). HMWK acts as a cofactor for the activation of factor XII and prekallikrein and is the precursor of the vasoactive peptide bradykinin. A second form of kininogen, low-molecular-weight kininogen (LMWK), is also found in plasma. LMWK can be cleaved to yield bradykinin but has no procoagulant activity. LMWK circulates at an average concentration of 90  $\mu$ g/ml (1300 nmol/L) ( [178](#) ). Deficiencies of HMW and LMW kininogens are rare and are not associated with bleeding diatheses ( [179](#) ). The major established function of the kininogens is to serve as a source of bradykinin and thereby contribute to a number of vascular events regulated by bradykinin.

**GENE STRUCTURE AND EXPRESSION** The two forms of kininogen, HMW and LMW, are the products of a single gene ( [180](#), [181](#) ) located on chromosome 3q26-qter ( [182](#) ) ( [Table](#)

21.2). The kininogen gene consists of 10 introns and 11 exons and spans 27 kb (181). The gene produces mRNAs for the two different forms of kininogen by alternative splicing (181). HMWK and LMWK share the coding region of the first nine exons and the portion of exon 10 containing the bradykinin sequence and the first 12 amino acids following the COOH-terminal of bradykinin. Exon 10 also codes for a 56-kd light chain unique to HMWK, whereas exon 11 codes for a 4-kd light chain unique to LMWK. Human liver contains mRNAs for both HMW and LMW kininogen (180, 181); only HMWK is expressed and secreted by human umbilical vein endothelial cells (183). Estrogen administration (184) and pregnancy (185) increase HMWK levels. Conversely, progesterone treatment reduces kininogen gene expression and plasma kininogen levels (186).

**BIOCHEMISTRY** Human HMW and LMW kininogens are synthesized as precursor proteins containing 18 amino acid signal peptides. The mature form of HMWK is a 120-kd single-chain  $\alpha$ -globulin of 626 residues, whereas the LMW form is a 66-kd single-chain  $\beta$ -globulin composed of 409 residues (177, 178, 187). Glycosylation at a number of shared sites (Asn<sup>151</sup>, Asn<sup>187</sup>, Asn<sup>276</sup>, and Asn<sup>383</sup>) and sites unique to HMWK (Thr<sup>515</sup>, Thr<sup>521</sup>, Thr<sup>528</sup>, Thr<sup>539</sup>, Thr<sup>553</sup>, Thr<sup>559</sup>, Thr<sup>575</sup>, and Thr<sup>610</sup>) presumably accounts for the substantial increase over the masses predicted from the amino acid compositions (70,000 for HMWK and 46,000 for LMWK). The NH<sub>2</sub>-terminal heavy chains (residues 1 to 362) of the two forms are identical and consist of three consecutive regions designated domains 1, 2, and 3 (D1, D2, and D3) (Fig. 21.2). Domain 1 has a low-affinity Ca<sup>2+</sup>-binding site (188). Domains 2 and 3 share homology with cysteine protease inhibitors (189). Both HMWK and LMWK are potent inhibitors of cysteine proteases such as calpain (176, 190). Domain 3 also contains a cell-binding region (191, 192, 193, 194 and 195) and is reported to inhibit  $\alpha$ -thrombin activity (192, 194, 196) and platelet activation (194, 196). The central domain of both kininogens, domain 4 (D4), is the bradykinin region. Domain 4 also contains a cell-binding region (197) and a region that inhibits  $\alpha$ -thrombin activity (198). The two forms of kininogen have different COOH-terminal light-chain regions. The light chain of LMWK (residues 372 to 409) consists of a single domain, domain 5<sub>L</sub> (D5<sub>L</sub>), with no known function. The light chain of HMWK (residues 372 to 626) is composed of two regions, domain 5<sub>H</sub> (D5<sub>H</sub>) and domain 6<sub>H</sub> (D6<sub>H</sub>). Domain 5<sub>H</sub> contains additional cell-binding regions (191, 193, 195, 199, 200) and mediates HMWK binding to anionic surfaces, heparin and Zn<sup>2+</sup> (170, 171, 201). Domain 6<sub>H</sub> has binding sites for prekallikrein and factor XI (202, 203 and 204).

**ACTIVATION** The major role proposed for the kininogens is the release of bradykinin. Kallikrein, factor XIIa, and factor XIa cleave HMWK to release bradykinin (residues 363 to 371) (Fig. 21.2). Kallikrein also cleaves LMWK to release bradykinin. Bradykinin release from HMWK yields a two-chain protein composed of the heavy chain (D1, D2, and D3) disulfide linked (Cys<sup>10</sup>-Cys<sup>596</sup>) to the light chain (D5<sub>H</sub> and D6<sub>H</sub>). This molecule retains procoagulant activity and binds prekallikrein, factor XI, and anionic surfaces via light-chain interactions (202, 205, 206).

**FUNCTION** HMWK functions as a nonenzymatic cofactor in the contact pathway of coagulation and serves as a precursor of bradykinin. HMWK binds anionic surfaces, prekallikrein, and factor XI, thus enhancing their activation by surface-associated factor XIIa. Although most studies of contact activation make use of artificial surfaces, cell membranes may provide appropriate sites for contact activation *in vivo*. Many cells contain kininogens and express kininogen binding sites (177, 183, 207, 208, 209, 210, 211, 212 and 213). There is some evidence to support cell membrane-associated contact activation. Prekallikrein bound to HMWK on platelets or endothelial cells can result in the generation of kallikrein by a factor XIIa-dependent (108, 162) or -independent mechanism (108). However, factor XI bound to HMWK on the surface of platelets is not activated to factor



XIa ( [214](#) ). The biologic significance of the contact pathway of coagulation is not established. In hemostasis, factor XIa generation most likely occurs by an a–thrombin–dependent pathway, and any factor XIa generated by the contact pathway would not have a measurable impact on coagulation. Bradykinin release as a consequence of these activation events does provide a key vasoactive agent with a variety of roles and directly links the contact pathway to vascular repair processes.

### Factor XI (Plasma Thromboplastin Antecedent)

Factor XI, also known as *plasma thromboplastin antecedent*, circulates as a homodimer at an average concentration of 5 µg/ml (30 nmol/L) ( [215](#) ) in complex with HMWK ( [216](#) ) ( [Table 21.1](#) ). Factor XI is also found in human platelets, and the platelet form accounts for approximately 0.5% of the factor XI antigen in blood ( [217](#) , [218](#) , [219](#) , [220](#) and [221](#) ). Factor XI is the zymogen precursor of the enzyme factor XIa. Unlike the other members of the accessory or contact pathway, factor XIa has an important role in coagulation as part of a positive feedback loop enhancing a–thrombin generation ( [4](#) , [13](#) ). Although rare in the general population (~1 in 100,000 individuals), factor XI deficiency is common in the Ashkenazi (European) Jewish population, with approximately 1 in 200 individuals affected by factor XI deficiency ( [36](#) , [222](#) , [223](#) , [224](#) and [225](#) ). Factor XI deficiency can be associated with severe bleeding tendencies ( [226](#) ) after injury or surgical trauma. Spontaneous hemorrhage is not common. Factor XI deficiency is unusual in that bleeding abnormalities vary considerably and range from a complete absence of symptoms to life–threatening hemorrhage. The severity of the bleeding complications is also not related to the severity of factor XI deficiency. Individuals with mild deficiency may experience severe hemorrhagic events, whereas individuals with severe deficiency may have no abnormal bleeding ( [36](#) , [37](#) , [223](#) , [225](#) , [232](#) , [233](#) , [234](#) and [235](#) ).

**GENE STRUCTURE AND EXPRESSION** The gene for human factor XI is located on chromosome 4q35 and spans 23 kb ( [Table 21.2](#) ). The gene contains 14 introns and 15 exons ( [146](#) , [236](#) ). Although mRNA for human plasma factor XI has been found in liver, pancreas, and kidney ( [237](#) ), the primary site of synthesis is thought to be the liver. Plasma factor XI levels decrease in liver disease, and a patient with no history of factor XI deficiency developed a deficiency subsequent to a liver transplant from a factor XI–deficient donor ( [238](#) ). Platelet factor XI is exclusively synthesized in the megakaryocyte ( [239](#) ). Human platelet factor XI lacks exon 5 and may be an alternative splicing product of the plasma factor XI gene or a product of a gene specific to megakaryocytes ( [239](#) ). There are three major types of genetic mutations associated with factor XI deficiency: (a) intronic point mutations that interrupt exon splicing ( [223](#) , [240](#) ); (b) exonic point mutations that lead to mutations in specific amino acids and result in premature polypeptide termination, disruption of dimerization, or reduced protein secretion ( [223](#) , [240](#) , [241](#) , [242](#) , [243](#) and [244](#) ); and (c) nucleotide deletions that lead to decreased protein synthesis ( [245](#) , [246](#) ). Two specific exonic point mutations account for the majority of the cases of factor XI deficiency in the Ashkenazi Jewish population. An E117X mutation in exon 5 (type II mutation) introduces a stop codon and results in premature polypeptide termination. The type II mutation accounts for approximately 52% of the cases of factor XI deficiency in the Ashkenazi Jewish population. A F283L mutation in exon 9 (type III mutation) that accounts for 36% of the cases is believed to prevent intracellular dimer formation and protein secretion. These mutations are less frequent in the general population ( [222](#) , [223](#) , [240](#) , [244](#) ).

**BIOCHEMISTRY** Human factor XI is found in plasma and in platelets. The two forms of the protein are somewhat different and may have different functions as well. Plasma factor XI accounts for most of the factor XI antigen in the human system and is a



disulfide-linked homodimer ( $M_r = 160,000$ ), with approximately 5% of its mass made up by carbohydrate ( [Table 21.1](#)). Each of the two identical polypeptide chains is synthesized with an 18-amino acid signal peptide. The mature polypeptide chain ( $M_r = 80,000$ ) consists of 607 amino acid residues ( [217](#), [218](#) and [219](#)) and has five potential glycosylation sites, although only Asn<sup>72</sup>, Asn<sup>108</sup>, Asn<sup>432</sup>, and Asn<sup>473</sup> are glycosylated ( [247](#)). Exons 3 to 10 of the plasma factor XI gene encode four NH<sub>2</sub>-terminal tandem sequences termed *apple domains* (apple 1 to apple 4, [Fig. 21.2](#)). The apple domains are homologous to the apple domains in human plasma prekallikrein ( [247](#)). Exons 11 to 15 encode the COOH-terminal catalytic domain. Human platelet factor XI lacks exon 5 and amino acids Ala<sup>91</sup>-Arg<sup>144</sup> in the NH<sub>2</sub>-terminus of the apple 2 domain. The mature platelet polypeptide chain ( $M_r = 55,000$ ) may form a disulfide-linked tetramer of identical subunits ( $M_r = 220,000$ ) or may be disulfide linked to a platelet plasma membrane protein ( [218](#), [232](#), [239](#)). Plasma factor XI circulates in complex with HMWK ( [216](#)). Formation of this complex, mediated by the apple 1 domain of factor XI, is required for factor XI to associate with anionic surfaces ( [249](#)). The apple 1 domain also contains binding sites for  $\alpha$ -thrombin ( [250](#)) and prothrombin ( [235](#)). The apple 2, apple 3, or both, domains mediate the binding of factor IX, the substrate of factor XIa ( [235](#), [251](#), [252](#), [253](#) and [254](#)). In addition to potentially mediating the factor XIa-factor IX interaction, the apple 3 domain contains binding sites for platelets and heparin ( [255](#), [256](#) and [257](#)). The apple 4 domain contains the site (Cys<sup>321</sup>) involved in the dimerization process. Dimerization is required for efficient intracellular processing and protein secretion ( [241](#)). Factor XIIa associates with a region of the apple 4 domain as well ( [258](#)). The COOH-terminal portion of factor XI contains the catalytic domain.

**ACTIVATION** Plasma factor XI is cleaved at an internal Arg<sup>369</sup>-Ile<sup>370</sup> bond to yield a disulfide-linked two-chain activated serine protease ( [Fig. 21.2](#)). The factor XI homodimer yields two disulfide-linked heavy chains containing the apple domains and two light chains containing the active sites ( [259](#), [260](#)). Activation of factor XI can be accomplished by factor XIIa and  $\alpha$ -thrombin and by autoactivation by factor XIa itself. Activation of factor XI by factor XIIa requires HMWK and an anionic surface. However, deficiencies of factor XII and HMWK do not result in bleeding diatheses, whereas factor XI deficiency is associated with hemorrhage. This suggests that factor XIIa-dependent activation of factor XI as part of the contact pathway is not likely to be the primary route of factor XIa generation in hemostasis. The physiologically relevant pathway for factor XI activation in coagulation is believed to involve  $\alpha$ -thrombin ( [4](#), [13](#), [261](#)). Factor XI in complex with HMWK binds to the platelet surface via the apple 3 domain ( [255](#)). The rate of  $\alpha$ -thrombin activation of factor XI on the platelet surface is greater than the rates of platelet-supported factor XIIa activation and factor XIa autoactivation ( [262](#)). Although platelets appear to play a key role in providing the surface for factor XI activation, the precise mechanism of activation of platelet factor XI and its function remain unclear ( [263](#)).

**FUNCTION** Subsequent to activation, factor XIa remains bound to the surface. *Factor XIa* is a trypsinlike serine protease that cleaves and activates factor IX in a Ca<sup>2+</sup>-dependent fashion ( [264](#), [265](#), [266](#) and [267](#)). Factor IXa is the enzyme component of the intrinsic tenase complex that provides the burst of factor Xa for normal coagulation. As part of a positive feedback loop,  $\alpha$ -thrombin activates factor XI. In turn, factor XIa generates factor IXa, leading to the high levels of factor Xa that ensure efficient  $\alpha$ -thrombin generation ( [4](#)).

**REGULATION** Factor XIa is regulated by four serine protease inhibitors or serpins: antithrombin-III, a<sub>1</sub>-protease inhibitor, C1 inhibitor, and a<sub>2</sub>-antiplasmin ( [125](#), [260](#), [268](#), [269](#), [270](#), [271](#), [272](#), [273](#), [274](#), [275](#), [276](#), [277](#) and [278](#)). Factor XIa is also reported to be inhibited by PAI-1 and protein C inhibitor ( [131](#), [280](#)). In addition, platelets secrete several factor XIa

inhibitors ( [281](#), [282](#), [283](#), [284](#) and [285](#) ), including protease nexin-2 (PN2). PN2 is a truncated form of the Alzheimer's  $\beta$ -amyloid protein precursor and contains a Kunitz-type serine protease inhibitor domain. Platelet-bound factor XIa is protected from inactivation by PN2 ( [264](#) ); however, heparin enhances PN2 inactivation of factor XIa. Factor XIa bound to the surface of endothelial cells that secrete heparan sulfate glycosaminoglycans (GAGs) may be readily inactivated by PN2 ( [286](#) ).

## PROCOAGULANT PROTEINS: VITAMIN K-DEPENDENT PROTEIN FAMILY

The first identification/description of vitamin K-dependent proteins was introduced by Henrik Dam and colleagues at the University of Copenhagen in the late 1920s ( [287](#), [288](#), [289](#) and [290](#) ). They demonstrated that chickens fed a lipid-free diet exhibited a hemorrhagic condition. The addition of alfalfa meal or a lipid extract of alfalfa prevented this condition. The active compound, 2-methyl-3-phytyl-1,4-naphthoquinone (phylloquinone), was subsequently isolated from green plants. Further work performed by Doisy and colleagues (Saint Louis, Missouri) ( [291](#) ) in the 1930s showed that vitamin K activity in bacteria is also present as a series of menaquinones, 2-methyl-1,4-naphthoquinones substituted at the 3 position with an unsaturated polyisoprenoid chain. The Nobel prize was awarded to Dam and Doisy in 1941 for their discovery of the fat-soluble vitamin K.

Simultaneously, with the discovery of the vitamin, a naturally occurring antagonist, bishydroxycoumarin (dicumarol), was described. This naturally occurring vitamin K antagonist was identified as a toxic agent in spoiled sweet clover causing hemorrhage in cattle. The increase in clotting time was later identified as a function of decreased PT ( [292](#) ). This led to the synthesis of several oral anticoagulant analogs and coumarin derivatives, including warfarin.

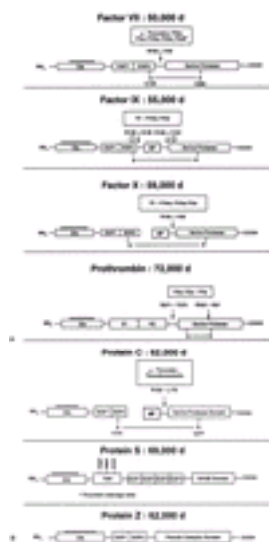
Vitamin K is essential in the biosynthesis of clotting factors. Its role is essential for the activity of these proteins through a mechanism involving the conversion of 9 to 13 NH<sub>2</sub>-terminal glutamic acid residues to  $\gamma$ -carboxy glutamic acid residues (Gla). The enzyme required for this conversion uses a reduced form of vitamin K.

This specific posttranslational modification allows the vitamin K-dependent proteins to interact with Ca<sup>2+</sup> and a membrane surface to exert their effect. The modification was initially identified and characterized in bovine prothrombin ( [293](#), [294](#), [295](#) and [296](#) ). Gla residues were missing or present in decreased amounts in prothrombin isolated from cattle treated with coumarin derivatives. The vitamin K-dependent proteins present in plasma after treatment with anticoagulants lacked biologic activity due to decreased Ca<sup>2+</sup>-dependent phospholipid binding. Therefore, preventing the formation of Gla residues became a basis for anticoagulant therapy.

Recently, two cDNAs were identified that encode proteins with NH<sub>2</sub>-terminal Gla domains ( [297](#) ). Both appear to be integral membrane proteins but bear no other similarity to the other vitamin K-dependent proteins beyond the Gla domain. Mineralized tissues contain two proteins with Gla residues ( [298](#) ). Gla has also been found as a component of the toxin peptides from the marine snail *Conus* ( [299](#), [300](#) and [301](#) ). The biologic activity of the toxins has been found to depend on the Gla residue(s). The identification of Gla in invertebrates suggests that vitamin K has a much wider range of biologic functions than previously thought.

The vitamin K-dependent proteins can be divided into two classes: procoagulant (factors

II, VII, IX, and X; [Fig. 21.3A](#)) and anticoagulant (protein C, protein S, and protein Z; [Fig. 21.3B](#)). The vitamin K–dependent proteins are part of a family of serine proteinases (except for protein S and protein Z) related to the trypsin/chymotrypsin superfamily. Sequence homology exists between the proteins at both the gene and the protein level, possibly due to a common ancestral gene ([302](#), [303](#)). Congenital deficiencies of factors II, VII, IX, and X are associated with bleeding tendencies, whereas protein C and protein S deficiencies are associated with thrombotic tendencies. These proteins are composed of separate domains, each of which is characterized by highly conserved regions that fold, independently from the rest of the molecule, into a characteristic three-dimensional shape. The domains of the vitamin K–dependent proteins are illustrated in [Figure 21.3](#). NH<sub>2</sub>-terminal Gla domains ([9](#), [10](#), [11](#), [12](#) and [13](#)) are followed by either a kringle domain in factor II or an EGF–like domain (EGF) in factor VII, factor IX, factor X, protein C, protein S, and protein Z. Protein S contains a thrombin–sensitive region before the EGF domain. The active site is contained within the serine protease domain for factor II, factor VII, factor IX, factor X, and protein C and becomes functional on specific peptide bond cleavages. Protein S is not a serine protease precursor and instead contains a sex hormone–binding globulin–like domain in the COOH–terminus. Protein Z contains a “pseudo catalytic domain” in the COOH–terminus and does not function as a serine protease enzyme.

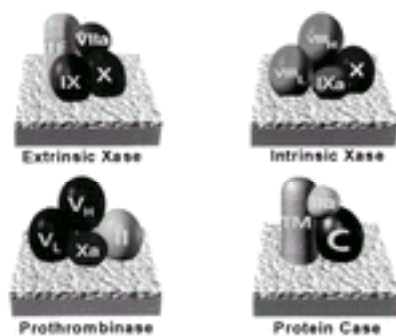


**Figure 21.3.** Schematic representation of the vitamin K–dependent proteins. The building blocks for these proteins include an NH<sub>2</sub>-terminal Gla domain with 9 to 13 Gla residues (Y) followed by either an epidermal growth factor (EGF)–like domain in factor VII (FVII), factor IX (FIX), factor X (FX), protein C, protein S, and protein Z or a kringle (K) domain in prothrombin. Protein S contains a thrombin–sensitive region (TSR) before the EGF domain. Active sites are contained within the serine protease domain. Cleavage sites for the conversion of zymogens to their active forms are designated by arrows; activating proteases are placed in boxes above the arrows. Factor IX, factor X, and protein C are activated by proteolytic removal of an activation peptide (AP). Protein S is not a serine protease precursor and instead contains a sex hormone–binding globulin–like domain (SHGB) in the COOH–terminus. Protein Z also contains a “pseudo catalytic domain” in the COOH–terminus and does not function as a serine protease. For reference, the molecular weight for each zymogen is listed, and disulfide bonds (–S–S–) critical to the integrity of the two–chain zymogens or active forms are presented. **A:** Panel illustrates the procoagulant vitamin K–dependent proteins factor VII, factor IX, factor X, and prothrombin. **B:** Panel illustrates the anticoagulant proteins, protein C, protein S, and protein Z. FSAP, factor VII–activating protease; TF, tissue factor.

The synthesis of these proteins occurs primarily in the liver followed by secretion into circulation. However, recently, a functional prothrombin gene product has been found to be synthesized by human kidney cells ( 304 ). The concentration of circulating zymogens in plasma varies 200-fold from 100 µg/ml for prothrombin to 0.5 µg/ml for factor VII ( Table 21.1 ). Levels present in plasma can be affected by polymorphisms in the promoter or coding region ( 305 , 306 and 307 ) as well as considered a risk factor for ischemic heart disease ( 308 ). Cholesterol and triglyceride levels have also been correlated with plasma concentrations of the vitamin K-dependent proteins ( 309 , 310 and 311 ). Liver function in the synthesis of the clotting factors, dietary intake/adsorption of vitamin K, and drug interactions can affect individuals on anticoagulant therapy ( 312 , 313 ).

Clearance ( $t_{1/2}$ ) of the vitamin K-dependent proteins varies from approximately 6.0 hours for factor VII to 2.5 days for prothrombin ( Table 21.1 ). Once the zymogen is activated to its serine protease form, it is then inactivated by inhibitors and cleared from the blood.

These activated forms of the vitamin K-dependent proteins are key components in the formation of the vitamin K-dependent coagulation complexes: the *extrinsic tenase* (factor VIIa-tissue factor); the *intrinsic tenase* (factor IXa-factor VIIIa); *prothrombinase* (factor Xa-factor Va); and *protein Case* (thrombin-thrombomodulin) ( Fig. 21.4 ). When all the components for each complex are assembled on the appropriate membrane surfaces (e.g., activated platelets, monocytes, blood cells, or endothelium), the specific reactions occur with rates enhanced by  $10^4$ - to  $10^9$ -fold over enzyme-substrate alone ( 21 ) ( Table 21.3 ). A simple calculation can illustrate the importance of the rate enhancements achieved through complex assembly (vitamin K-dependent serine protease-cofactor-membrane- $\text{Ca}^{2+}$ ): If a normal person takes 4 minutes for his or her blood to clot, then in the absence of membrane and cofactor, blood clot formation would take approximately 3.8 years.



**Figure 21.4.** Vitamin K-dependent complexes. Three procoagulant complexes (extrinsic tenase, intrinsic tenase, and prothrombinase) and one anticoagulant complex (protein Case) are illustrated. Each membrane complex consists of a vitamin K-dependent serine protease [factor VIIa (VIIa), factor IXa (IXa), factor Xa (Xa), or thrombin (IIa)] and a soluble or cell-surface-associated cofactor [factor VIIIa (heavy and light chain VIII<sub>H</sub> and VIII<sub>L</sub>), factor Va (heavy and light chain V<sub>H</sub> and V<sub>L</sub>), tissue factor (TF), or thrombomodulin (TM)]. Each serine protease is shown in association with the appropriate cofactor protein and zymogen substrate(s) on the membrane surface. The membrane serves as a scaffold for the coagulation reactants, enhancing the reaction rates by  $10^4$ - to  $10^9$ -fold. When vascular damage or inflammatory cytokine activation occurs, TF becomes exposed to flowing blood carrying low levels of factor VIIa. The formed extrinsic tenase complex activates the circulating serine protease zymogens factors IX and X.

Factor IXa becomes the serine protease for the intrinsic tenase complex, which with its cofactor factor VIIIa, activates factor X to its active protease form factor Xa. Factor Xa formed primarily from the intrinsic tenase combines with its cofactor factor Va to activate II to IIa on the prothrombinase complex. Cofactor regulation occurs when IIa released from the prothrombinase complex binds to endothelial cell surface protein TM to form the protein Case anticoagulant complex. This complex generates activated protein C, which then proteolytically inactivates factors Va and VIIIa. See [Color Plate](#). (From Mann KG. Coagulation explosion. Vermont Business Graphics, 1997, with permission.)

**TABLE 21.3. Rate Enhancement by Vitamin K–Dependent Complexes**

| Complex <sup>a</sup>              | Substrates | Fold Enhancement <sup>b</sup> |
|-----------------------------------|------------|-------------------------------|
| FVIIa/TF/PCPS/Ca <sup>2+</sup>    | FIX        | $>1 \times 10^9$ <sup>c</sup> |
| FVIIa/TF/PCPS/Ca <sup>2+</sup>    | FX         | $3 \times 10^4$               |
| FIXa/FVIIIa/PCPS/Ca <sup>2+</sup> | FX         | $1 \times 10^9$               |
| FXa/FVa/PCPS/Ca <sup>2+</sup>     | FII        | $3 \times 10^5$               |
| FIIa/TM/PCPS/Ca <sup>2+</sup>     | PC         | $1 \times 10^5$               |

F, factor; PC, phosphatidylcholine; PS, phosphatidylserine; TF, tissue factor; TM, thrombomodulin.

<sup>a</sup> Complexes are assembled on membranes composed of PC and PS (3:1 molar ratio PC/PS).

<sup>b</sup> Rate enhancement is derived from the ratio of catalytic efficiency [number of catalytic events per unit time/Michaelis constant ( $k_{cat}/K_m$ )] for the complex to the catalytic efficiency of the free serine protease for a given substrate.

<sup>c</sup> No measurable activation of FIXa by FVIIa without TF and the membrane. The catalytic efficiency of the extrinsic tenase toward FIX is reduced relative to FX.

## Gene Structure and Expression

The family of vitamin K–dependent proteins is mainly synthesized in the liver by hepatocytes. Decreased levels of the vitamin K–dependent proteins are apparent indicators of liver dysfunction ([314](#), [315](#)). Liver transplantation has been shown either to treat vitamin K deficiency ([316](#)) or to bring about vitamin K deficiency ([317](#)). The genes encoding all of the vitamin K–dependent coagulation proteins have been sequenced and are seen in [Table 21.2](#). The difference between the vitamin K–dependent protein genes and most other eukaryotic genes is that the 5′-flanking regions lack TATA boxes. Binding sites for liver–enriched or liver–specific (or both) transcription factors, which are important for hepatic expression of these proteins, are contained within the regulatory region of these genes. A common pentanucleotide motif that occurs in a similar location in the regulatory region of the genes encoding factor VII, factor IX, and factor X may be important in their possible coordinate expression.

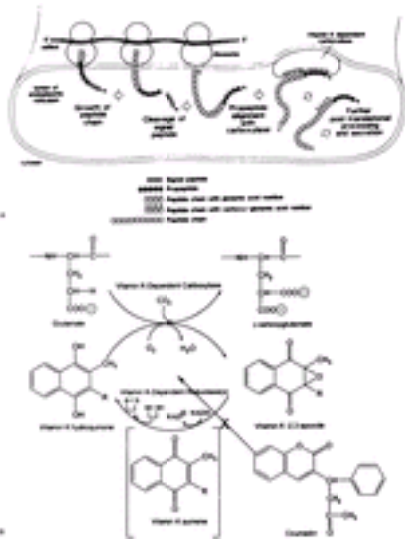
## Posttranslational Processing

The vitamin K–dependent proteins are synthesized in the liver as pre–prozymogens in a process that requires a dietary intake of vitamin K. They are modified posttranslationally



at glutamic acid ( $\gamma$ -carboxylation to form  $\gamma$ -carboxy glutamic acid) ( 294 ) and at aspartic acid and asparagine [ $\beta$ -hydroxylation to form erythro- $\beta$ -hydroxy aspartic acid (Hya) and erythro- $\beta$ -hydroxy asparagine (Hyn)] ( 75 , 318 , 319 ); they are also modified by sulfation at tyrosine residues as well as the addition of sugar moieties (glycosylation) ( 318 , 319 ). This high degree of posttranslational processing is necessary for the biologic activity of the mature vitamin K-dependent proteins.

**PROTEOLYTIC MATURATION** The vitamin K-dependent proteins are synthesized in the liver as a single-chain precursor that contains a pre-pro sequence followed by the polypeptide region. The hydrophobic signal peptide (pre-peptide) gets the protein to the endoplasmic reticulum, the first compartment in the secretory pathway. For the vitamin K-dependent proteins to become mature, the polypeptide is translocated out of the first compartment in the endoplasmic reticulum across the lipid bilayer into the lumen of the endoplasmic reticulum. The signal peptide is then removed by a signal peptidase. The propeptide, which plays a role in docking vitamin K-dependent carboxylase ( 320 ), is removed by an endoprotease. The release of the propeptide coincides with  $\gamma$ -carboxylation (Gla formation) ( 321 ) ( Fig. 21.5A). Removal of an internal di- or tripeptide in single-chain factor X and protein C occurs, which converts them to their mature two-chain zymogen form. Several studies describe the endoprotease that cleaves the propeptide and the internal bonds as furin/paired basic amino acid cleaving enzyme ( 322 , 323 and 324 ).



**Figure 21.5.** Vitamin-K dependent processes. **A:** Schematic representation of the synthesis and posttranslational carboxylation pathway of vitamin K-dependent proteins in the endoplasmic reticulum. (From Bovill EG, Malhotra OP, Mann KG. Mechanisms of vitamin K antagonism. Baillieres Clin Haematol, 1990;3:555–581, with permission.) **B:** The mechanism of  $\gamma$ -carboxy glutamate (Gla) generation by a vitamin K-dependent reaction cycle is illustrated. The regeneration of vitamin K hydroquinone by the vitamin K-dependent reductases is inhibited by anticoagulants, as illustrated by Coumadin.

**CARBOXYLATION AND VITAMIN K-DEPENDENT CARBOXYLASE** The  $\gamma$ -carboxylation reaction is catalyzed by the enzyme  $\gamma$ -glutamyl carboxylase. This enzyme is located in the rough endoplasmic reticulum and requires the reduced form of vitamin K, oxygen and carbon dioxide ( 295 ). The carboxylation mechanism involves proton abstraction of the  $\gamma$ -hydrogen of the glutamate residues near the  $\text{NH}_2$ -terminus of the nascent pre-pro protein ( Fig. 21.5B). The generated carbanion at each glutamic acid residue then reacts with free  $\text{CO}_2$ , forming  $\gamma$ -carboxy glutamic acid. It is this Gla region that mediates the  $\text{Ca}^{2+}$ -dependent binding of the protein to anionic phospholipid surfaces, thereby assuring

close proximity and interaction with other components of the coagulation sequence and with cell receptors for vitamin K-dependent ligands. Without vitamin K, the coagulation protein precursors continue to be synthesized but are not  $\gamma$ -carboxylated. In this form, they are still secreted into plasma but are nonfunctional. The cDNA for the human  $\gamma$ -carboxylase gene was cloned and sequenced by Wu et al. (325). The open reading frame predicts a molecular weight of approximately 87.5 kd. Glycosylation of the carboxylase probably accounts for its decreased mobility on SDS-PAGE (94 kd). Vitamin K-dependent carboxylase has been identified in many cell types (326). This supports the notion that vitamin K has a wide range of biologic functions. The presence of vitamin K is essential to maintain the  $\gamma$ -carboxylation reaction. Vitamin K<sub>1</sub> (phylloquinone) is primarily found in leafy green vegetables and vegetable oils. Additional K activity may be provided by vitamin K<sub>2</sub> (menaquinones) synthesized by intestinal gram-negative bacteria. Synthetic vitamin K<sub>3</sub> (menadione) has no intrinsic activity until it undergoes *in vivo* transformation to the active menaquinone form. These K vitamins are 2-methyl-1,4-naphthoquinones with repeating five-carbon prenyl units at position 3. *In vivo*, vitamin K is recycled in a microsomal oxidation-reduction system for continued use in the  $\gamma$ -carboxylation reaction. To perform the  $\gamma$ -carboxylation reaction, vitamin K has to be present in its reduced hydroquinone form. As the precursor proteins are carboxylated, vitamin K is oxidized to the epoxide. The epoxide in the presence of 2,3-epoxide reductase, using thiols as the reducing agent, yields the quinone form of vitamin K (327). A subsequent nicotinamide adenine dinucleotide phosphate- or nicotinamide adenine dinucleotide-dependent quinone reductase reaction resynthesizes the hydroquinone form. The cycle can thus begin again. One important target for anticoagulant therapy is the process required for the regeneration of reduced hydroquinone vitamin K. Anticoagulants that effectively block this reaction include warfarin (Coumadin), dicumarol, and phenprocoumon (Fig. 21.5B). These oral anticoagulants are structurally similar to the quinone form of vitamin K, thereby targeting the reductase enzyme and inhibiting the reduction to the requisite hydroquinone form. The affinity of the anticoagulants for the reductase enzymes determines the efficacy of the drug (9, 328). In the United States, the most widely used oral anticoagulant warfarin (Coumadin) is also used as rat poison. It acts as a competitive inhibitor of oxidized vitamin K and interferes with its reduction. Without the regeneration of the reduced form of vitamin K, the vitamin K-dependent protein carboxylase is unable to convert glutamate to  $\gamma$ -carboxy glutamate. Thus, these drugs indirectly affect carboxylation and can be overcome with excess vitamin K. The level of competitive inhibition achieved in Coumadin therapy among individuals taking the same dose regimen is variable. Factors affecting the efficacy of treatment include liver function in the synthesis of the clotting factors, enhancement of effect from other medications, and dietary intake/adsorption of vitamin K (329). Therefore, proper monitoring of oral anticoagulant therapy is essential with frequently measured PT and corrected assay sensitivity using the international normalized ratio (330, 331).

**HYDROXYLATION** *Hydroxylation* in the context of vitamin K-dependent proteins refers to the addition of a hydroxyl group (-OH) to aspartic acid and asparagine residues present in the EGF-like domains. The EGF-1 domains of human factors IX, X, protein C, and protein S contain a homologous aspartic acid residue that is hydroxylated to form erythro- $\beta$ -hydroxy aspartic acid (Hya) (75, 332, 333). Protein S also contains asparagine residues in EGF-2 and EGF-4 domains that are hydroxylated to form erythro- $\beta$ -hydroxy asparagine residues (Hyn) (334). This posttranslational modification to Hya and Hyn occurs by a  $\beta$ -hydroxylase enzyme, a 2-oxoglutarate-dependent dioxygenase (318, 319). The mechanism of action involves the recognition of a consensus sequence Cys-X-Asp/Asn-X-X-X-X-Tyr/Phe-X-Cys-X-Cys (334). The reason for this modification to Hya and Hyn is unclear. No effect has been found on the overall fold of the EGF-1 domain, its affinity, or specificity for calcium (335). These modifications also appear to have no relevance on the biologic activity or macromolecular interactions of the vitamin K-dependent proteins (336, 337).



**GLYCOSYLATION** The addition of a carbohydrate moiety as a posttranslational modification to proteins is referred to as *glycosylation*. The vitamin K-dependent proteins contain significant amounts of carbohydrate ( [Table 21.1](#) and [Table 21.4](#)). Carbohydrate adducts on Asn, Ser, and Thr residues are found in key domains of these proteins, including the activation peptide of factor IX and factor X; the EGF domains in factor VII, factor IX, and protein Z; and the kringle domain in prothrombin. In most cases, the purpose of these modifications remains unknown. However, differences in the properties of the carbohydrate variants of protein C have been noted ( [338](#), [339](#) ).

**TABLE 21.4. Human Anticoagulant Proteins and Their Inhibitors: Biochemical Properties**

| Protein                          | Molecular Weight (d) | Plasma Concentration |           | Plasma Half-Life (days)                     | Carbo-hydrate (%) | Clinical Phenotype <sup>a</sup> |   | Protein Family |
|----------------------------------|----------------------|----------------------|-----------|---|-------------------|---------------------------------|---|----------------|
|                                  |                      | (nmol/L)             | (µg/ml)   |   |                   | H                               | T |                |
| Protein C                        | 62,000               | 65                   | 4         | 0.33  | 23                |                                 | + | VKD            |
| Protein S                        | 69,000               | 300                  | 20        | 1.75  | 8                 |                                 | + | VKD            |
| Protein Z                        | 62,000               | 47                   | 2.9       | 2.5   |                   | ±                               |   | VKD            |
| Thrombomodulin                   | 100,000              |                      |           |   |                   |                                 |   |                |
| $\alpha_2$ -Macroglobulin        | 735,000              | 2700–4000            | 2000–3000 | 0.002                                       |                   |                                 |   | Complement     |
| Tissue factor pathway inhibitor  | 40,000               | 1–4                  | 0.1       | $6.4 \times 10^{-4}$ – $1.4 \times 10^{-3}$ |                   |                                 |   | Kunitz         |
| Antithrombin-III                 | 58,000               | 2400                 | 140       | 2.5–3.0                                     | 15                |                                 |   | Serpin         |
| Heparin cofactor II              | 66,000               | 500–1400             | 33–90     | 2.5   | 10                |                                 |   | Serpin         |
| $\alpha_1$ -Proteinase inhibitor | 53,000               | 28,000               | 1500–3500 | 6   | 12                |                                 |   | Serpin         |
| C1 esterase inhibitor            | 104,000              | 962                  | 100       | 0.07  | 35                |                                 |   | Serpin         |
| Protein C inhibitor              | 57,000               | 90                   | 5         | 1   |                   |                                 |   | Serpin         |

+, presence of phenotype; ±, some individuals present with phenotype and others do not; H, hemorrhagic disease/hemophilia; T, thrombotic disease/thrombophilia; VKD, vitamin K-dependent.

<sup>a</sup> Clinical phenotype: the expression of either H or T phenotype in deficient individuals.

### General Structure/Function Features

The vitamin K-dependent proteins, both procoagulant and anticoagulant, share a common protein domain structure. Each has a tripartite design: an NH<sub>2</sub>-terminal γ-carboxy glutamic acid (Gla) domain, a linker region [kringle domains, EGF-like domains (EGF), or a thrombin-sensitive finger region, or all three], and a COOH-terminal domain usually consisting of a serine protease domain (factors II, VII, IX, and X and protein C) ( [Fig. 21.3](#)).

The Gla domain is involved in the Ca<sup>2+</sup> ion-dependent binding of vitamin K-dependent proteins to anionic phospholipid membranes. The number of domains in the linker region is

variable, and, in general, they are involved in protein–protein interactions. The COOH–terminal catalytic domain seen in factors II, VII, IX, and X and protein C is homologous to the pancreatic serine proteases, trypsin, and chymotrypsin. The nonserine protease domain seen in protein S [a cofactor of activated protein C (APC)] is homologous to sex–hormone–binding globulin ( [340](#) ). Protein Z is an enzymatically inactive homolog of factors VII, IX, and X and protein C ( [341](#) ). A separate review of the Gla, EGF, and serine protease domains is presented below.

The importance of each of the domains has been uncovered through studies from natural variants that occur in patients with either familial bleeding (i.e., factor IX deficiency/hemophilia B) or thrombotic disease (i.e., protein C deficiency). The situations that can cause a disease state are either deficiency in the level of protein present [cross–reactive material (CRM) negative] or expressed protein that is present but nonfunctional (CRM+). Defects have diverse causes, including mutations that lead to amino acid substitutions in one or more domains, mutations that introduce stop codons resulting in either no expression or expression of truncated proteins, or defects in posttranslational modifications. In the case of combined vitamin K deficiency, a rare hereditary bleeding disorder ( [342](#) , [343](#) ), two studies have identified a missense mutation in the  $\gamma$ –carboxylase gene that results in a defective  $\gamma$ –glutamyl carboxylase and thus incomplete processing of the vitamin K–dependent proteins ( [344](#) , [345](#) ).

When a hemostatic disorder characterized by a dysfunctional protein (CRM+) is identified, it is through the combination of techniques including protein isolation, *in vitro* studies, and DNA technology that the root of the defect is elucidated. The importance of domains as functional units and of specific amino acid interactions can be uncovered using recombinant DNA technology. Single amino acid substitutions can be introduced into domains or entire domains removed to determine where the intra– and interprotein interactions take place. Structural information through nuclear magnetic resonance spectroscopy and x–ray crystallography provides amino acid assignments and tertiary structure, thus allowing for precise approaches to site–directed mutagenesis studies. The combination of all these techniques results in a map of how the domains are aligned and interact. Further, using computational molecular dynamics can predict conformational changes associated with protein–protein, protein–ligand, and protein–surface interactions. Identifying residues directly involved in binding to membranes, metal ions, or small substrates can lead to new drug therapies.

The first x–ray crystal structure of a vitamin K–dependent protein was obtained by Tulinsky’s laboratory for prothrombin fragment 1 (factor II, residues 1 through 155) in the presence ( [346](#) ) and absence of calcium ( [347](#) , [348](#) ). These results provided information regarding the entire Gla domain, the connector peptide, and kringle 1. In the absence of calcium, only the connector peptide and the kringle can be visualized in the resulting x–ray crystal analysis. Prothrombin is the only vitamin K–dependent protein with a kringle domain. It is likely that organization of the polypeptide chains of the Gla domain is similar for all vitamin K–dependent proteins. To date, several other vitamin K–dependent protein structures have been elucidated ( [349](#) , [350](#) , [351](#) , [352](#) , [353](#) , [354](#) , [355](#) , [356](#) and [357](#) ). Many studies on the individual vitamin K–dependent proteins have been conducted and are detailed under each protein subsection.

All the vitamin K–dependent proteins contain an NH<sub>2</sub>–terminal Gla domain, and only factors II, VII, IX, and X and protein C contain a serine protease domain. Factors IX, X, and VII, protein C, and protein S contain EGF domains. Several recent reviews have been written on vitamin K–dependent proteins ( [358](#) , [359](#) and [360](#) ).

**GLA DOMAIN** The Gla domain constitutes the first approximately 50 residues of the

vitamin K-dependent proteins ( [Fig. 21.3](#)). The negative charge elicited from the string of Gla residues ( [9](#), [10](#), [11](#), [12](#) and [13](#)) contributes to the binding to  $\text{Ca}^{2+}$  and the generation of the conformation required for binding to anionic phospholipid membranes. This surface *in vivo* is supplied by activated platelets or other blood cells in response to vascular damage through exposure of the internal face of their cell membranes where it is phosphatidylserine (PS) rich ( [346](#), [361](#)). *In vitro* systems that attempt to mimic coagulation mainly use natural or synthetic preparations of PS and phosphatidylcholine, often at a 1:3 molar ratio. Studies have shown that PS exposure is crucial for cells to support the membrane-bound enzymatic reactions and that PS is more effective than other equally charged lipids ( [21](#), [362](#), [363](#)). The striking degree of homology among the Gla domains of the vitamin K-dependent clotting factors suggests that the affinity of the calcium-Gla complexes for phospholipids would also be very similar. However, this turns out not to be the case. The dissociation constants for binding to phosphatidylcholine and PS containing vesicles vary, with  $K_d$  values in the range of 50 nmol/L for protein Z and protein S ( [364](#)), 100 to 300 nmol/L for factor X and prothrombin ( [365](#)), 15 nmol/L for protein C ( [364](#)), and 17,000 nmol/L for factor VII ( [364](#), [366](#)). A systematic analysis of the sequence/structural basis for these divergent membrane-binding properties is available ( [358](#), [364](#)). The mode of interaction between the Gla domain-containing coagulation factors and biologic membranes has been difficult to study and is still a subject for debate. Two models of binding have been presented. One involves the bridging of calcium between specific Gla residues and the negative anionic phospholipid membrane components ( [366](#), [367](#)). A second model involves a major hydrophobic contribution to the membrane binding. X-ray crystallographic ( [349](#), [368](#)) and nuclear magnetic resonance studies ( [369](#)) have been conducted to elucidate the conformational changes, in the absence and presence of calcium, that occur on Gla domain binding to a lipid membrane. In the absence of calcium, the negatively charged Gla residues appear exposed to the solution, and the hydrophobic residues of the Gla domain are buried in its interior ( [370](#)). On  $\text{Ca}^{2+}$  binding to the Gla domain, the conformation is altered to expose the hydrophobic residues, making possible their insertion into the lipid membrane. The hydrophobic patch in prothrombin fragment 1 surrounding the first pair of Gla residues was determined to be Phe<sup>4</sup>, Leu<sup>5</sup>, and Val<sup>8</sup>. Site-directed mutagenesis studies of protein C determined these residues (Phe<sup>4</sup>, Leu<sup>5</sup>, and Leu<sup>8</sup>) to be important in membrane interactions ( [371](#), [372](#) and [373](#)). The actual mechanism of membrane binding is still under active investigation.

**EPIDERMAL GROWTH FACTOR DOMAIN** The Gla domain is followed by two tandem EGF domains (EGF-1 and EGF-2) in factor VII, factor IX, factor X, and protein C and four EGF domains (EGF-1 to EGF-4) in protein S ( [374](#)) ( [Fig. 21.3](#)). The first EGF domain (EGF-1) contains the posttranslationally modified amino acid- $\beta$ -hydroxy aspartic acid in the case of factors IX and X, and  $\beta$ -hydroxy asparagine in the case of protein S ( [332](#), [334](#), [375](#), [376](#), [377](#) and [378](#)). An EGF-like domain consists of 40 to 50 amino acids, including six cysteine residues involved in disulfide bond formation. The EGF domains have been evaluated by nuclear magnetic resonance spectroscopy ( [360](#), [379](#), [380](#), [381](#), [382](#) and [383](#)). The EGF-2 domains of factor Xa ( [355](#)) and factor VIIa ( [357](#)) have been evaluated by x-ray crystallography. The EGF-like domains are found widely distributed in extracellular and membrane proteins. Proteins containing these domains are involved in blood coagulation, fibrinolysis, complement activation, and microfibril formation in connective tissue and in signal transduction ( [335](#), [384](#), [385](#)). These domains are similar to the archetypal protein, EGF, which contains nine of these domains and is derived from a membrane-bound precursor. The structure of the EGF-like domains is dominated by  $\beta$  sheets and  $\beta$  turns. Several point mutations in the EGF domain of factor IX have been identified that cause hemophilia B ( [386](#)). Calcium binding sites have been identified in the  $\text{NH}_2$ -terminal EGF-like domains isolated from factors VII, IX, and X and proteins C and Z, with  $K_d$

values ranging from 1 to 5 mM. This Ca<sup>2+</sup>-binding site is functionally important because vitamin K-dependent proteins that have missense mutations in EGF-1 that disrupt the Ca<sup>2+</sup>-binding site have reduced biologic activity. In these proteins, the second EGF domain does not appear to bind calcium. The NH<sub>2</sub>-terminal EGF domain of protein S does not appear to bind Ca<sup>2+</sup>. The function of the EGF domain is still unclear. One hypothesis is that it serves as a spacer. A consistent elongation of the molecules of factors VII, IX, and X and protein C and protein S has been noted. The distance between the membrane binding Gla domain and the serine protease domain is crucial to the placement of the active site in an appropriate position relative to the target peptide bond in its substrate ( [387](#) ). Calcium binding serves a role in the function of these domains. For example, it has been proposed that for appropriate docking of factor VIIa to tissue factor, calcium binding to the EGF domain is required ( [388](#) ). Calcium binding to the EGF domains in non-vitamin K-dependent proteins has been observed in the Notch protein ( [389](#) ) and fibrillin ( [390](#) ).

**SERINE PROTEASE DOMAIN** The serine protease domain accounts for approximately one-half the mass of each protein. Peptide bond cleavage at specific sites converts the vitamin K-dependent zymogens to their active serine protease forms ( [Fig. 21.3](#) ). These enzymes are serine proteases in the same family as trypsin and chymotrypsin. The mechanism of proteolysis by chymotrypsin involves a catalytic triad, composed of Asp<sup>102</sup>, His<sup>57</sup>, and Ser<sup>195</sup> (chymotrypsin numbering). The nucleophilic attack is carried out by the hydroxyl group of Ser<sup>195</sup> with the imidazole ring of His<sup>57</sup> taking up the liberated proton and the carboxylate ion of Asp<sup>102</sup> stabilizing the developing charge. More extensive elements of structure (i.e., calcium, membrane, and cofactor binding sites) are required for interactions of enzymes and substrates in the coagulation process. The serine protease domains of all the Gla-containing factors show a high homology to each other and to trypsin and chymo-trypsin, cleaving almost specifically at arginyl residues. However, unlike trypsin, which shows little specificity beyond the requirement for arginyl or lysyl residues at the cleavage site, the activated coagulation factors have extended substrate specificity pockets where only a small number of amino acid sequences are recognized by each activated factor. Despite the high degree of homology between the protease domains of protein C and factors II, VII, IX, and X, each of these factors has a highly specific function in coagulation. Some of this discrimination may be mediated by surface loops and other domains away from the substrate binding pocket that are not highly homologous.

### Factor VII (Proconvertin, Convertin)

The vitamin K-dependent single-chain zymogen factor VII (M<sub>r</sub> = 50,000), also known as *proconvertin*, circulates in plasma at a concentration of 0.5 µg/ml, or 10 nmol/L ( [391](#), [392](#) ) ( [Table 21.1](#) ). It is synthesized primarily in the liver. The activated two-chain serine protease form, factor VIIa, circulates in plasma at approximately 1% the concentration of its precursor, or 0.1 nmol/L ( [52](#) ). The mechanism for the initial activation of this zymogen is unclear. One recently identified candidate is the factor VII-activating protease (FSAP; see section [Factor VII-Activating Protease](#) ). The function of factor VIIa is to serve as an initiator of the extrinsic pathway of coagulation when bound to its membrane cofactor, tissue factor. Factor VII has the shortest t<sub>1/2</sub> of all the clotting factor zymogens (~3 to 6 hours) ( [393](#) ). Its activated form factor VIIa has a t<sub>1/2</sub> of 2.4 hours ( [394](#), [395](#) ).

Factor VII deficiency is an autosomal-recessive disorder with wide phenotypic and genotypic variability ( [396](#), [397](#), [398](#) and [399](#) ). Its incidence in the general population is approximately 1 in 500,000. In a large French-Canadian kindred, the incidence is approximately 1 in 335 ( [400](#) ). Bleeding phenotypes can range from mild to severe and include bruising, epistaxis, postsurgical hemorrhage, and cerebral hemorrhage. Severe

bleeding is most commonly associated with plasma factor VII levels that are less than 1% (401). Patients have prolonged PTs, and the final diagnosis is established by plasma factor VII coagulant activity (VII:C) using factor VII-deficient plasma and animal thromboplastins, or immunologic quantitation of factor VII antigen, or both (392, 402). Treatment of these individuals includes the use of fresh frozen plasma, prothrombin complex concentrates (403), factor VII concentrates (plasma derived or recombinant) (404), and, recently, liver transplantation (405). Due to its short  $t_{1/2}$  (~3 to 6 hours), therapy with factor VII concentrates is difficult. Recently, the use of recombinant factor VIIa as a safe and effective treatment for factor VII deficiency has been evaluated (406, 407 and 408). During the last decade, supraphysiologic concentrations of recombinant factor VIIa have been used clinically for treatment of patients with hemophilia A or B (factor VIIIa or factor IXa deficiency, respectively) and patients undergoing surgical procedures (409, 410, 411, 412 and 413). Recombinant factor VIIa has been suggested for treatment of almost all bleeding disorders (414). The mechanism of hemostasis by recombinant factor VIIa is not fully understood, although several hypotheses have been proposed (415, 416, 417 and 418).

Studies on the molecular basis for factor VII deficiency have led to the identification of several mutations in the factor VII gene. These mutations have been identified in the splice site (419), the promoter region (420), the EGF domain (421), and numerous single base pair (bp) mutations (422, 423). For more detail, there is a factor VII mutation database available at [europium.csc.mrc.ac.uk](http://europium.csc.mrc.ac.uk) (424). Factor VII deficiency in mice is not lethal at the embryonic stage, but factor VII  $-/-$  neonates die from hemorrhage within the first days after birth (425, 426).

**GENE STRUCTURE AND EXPRESSION** The factor VII gene is located on chromosome 13 band q34-qter, consists of nine exons, and spans 12.8 kb (427, 428 and 429) (Table 21.2). It is located approximately 2.8 kb upstream from the factor X gene. The mRNA encodes a 2.5-kb message (430). Alternative splicing of the factor VII gene yields two gene transcripts. One gene transcript contains eight segments as exons, and the second gene transcript contains nine segments as exons. The additional exon, which is unique among the vitamin K-dependent proteins, is in the pre-pro leader sequence. Factor VII mRNA expression is localized in the liver (431), where its expression is 6% of the factor X mRNA level (432). The 5'-flanking region of the factor VII gene contains binding sites for the liver enriched transcription factor hepatic nuclear factor (HNF)-4 (433). Three potential activation peptide-1 binding sites are also contained in this region.

**BIOCHEMISTRY** Factor VII circulates in plasma (concentration ~10 nmol/L) as a single-chain zymogen of a molecular weight of 50,000 (391, 428, 434, 435). Its 406-amino acid structure consists of an NH<sub>2</sub>-terminal Gla domain containing ten  $\gamma$ -carboxy glutamate residues,  $\beta$ -hydroxy aspartic acid at position 63 (333), an aromatic residue-rich  $\alpha$ -helical region, two EGF domains, and a serine protease domain (Fig. 21.3). The NH<sub>2</sub>-terminus, along with the serine protease domain, is involved in the metal binding properties of the protein and its interaction with its cofactor tissue factor (436, 437 and 438). The COOH-terminus of factor VII is important in its interactions with factor X (439).

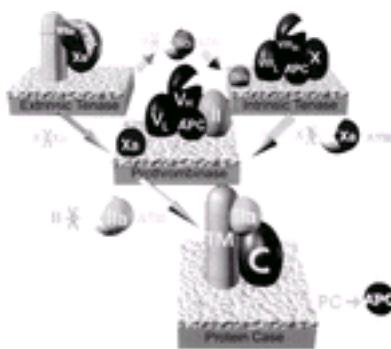
**ACTIVATION** The single-chain zymogen factor VII is activated to its two-chain serine protease form, factor VIIa, through a single peptide bond cleavage between Arg<sup>152</sup>-Ile<sup>153</sup> (Fig. 21.3). The resulting protease consists of an NH<sub>2</sub>-terminal light chain ( $M_r = 20,000$ ) containing the membrane binding Gla domain (ten Gla residues), linked by a single disulfide bond between Cys<sup>135</sup>-Cys<sup>262</sup> to a COOH-terminal heavy chain ( $M_r = 30,000$ ) that contains the catalytic domain. A small amount of activated factor VII (10 to 100 pmol/L) already circulates in the cleaved active two-chain form (440). This small portion of plasma



factor VIIa has very poor catalytic efficiency in the absence of its cofactor, tissue factor (441, 442). The cleavage of factor VII to factor VIIa is catalyzed by several proteases, including  $\alpha$ -thrombin (5), factor IXa (443), factor Xa (5), autoactivation by factor VIIa (444), factor XIIa (445), and FSAP (446).

**FUNCTION** Factor VII is a crucial zymogen in blood coagulation. Factor VII can bind to tissue factor with a subnanomolar  $K_d$  and become activated by a number of proteases. Once converted to its active serine protease form and bound to its cofactor, the integral membrane protein tissue factor, it forms the extrinsic tenase complex (Fig. 21.4). The enzyme complex is so named because it contains a protein, tissue factor, normally extrinsic to the plasma environment. The extrinsic tenase complex (factor VIIa–tissue factor–membrane surface– $\text{Ca}^{2+}$ ) activates a fraction of the circulating vitamin K–dependent zymogens, factors IX and X, to their serine protease forms (45, 228, 447, 448). Thus, it serves to initiate the formation of the intrinsic tenase (factor IXa–factor VIIIa–membrane– $\text{Ca}^{2+}$ ) and the prothrombinase complexes (factor Xa–factor Va–membrane– $\text{Ca}^{2+}$ ). *In vitro* studies have shown that the rate of activation by the extrinsic tenase complex is significantly greater (~100,000–fold) than the rate of substrate (factors IX and X) activation by the enzyme factor VIIa alone (449, 450). Factor Xa bound to a membrane surface can activate additional factor VII in a positive feedback loop (5, 61).

**REGULATION** Free factor VIIa alone, unlike other serine proteases of the coagulation cascade (442), is not readily inhibited by circulating protease inhibitors, including antithrombin–III–heparin complex (451, 452). This is most likely due to its poor catalytic efficiency when not bound to its cofactor tissue factor. However, when factor VIIa is bound to tissue factor, antithrombin–III–heparin exhibits significant inhibition of factor VIIa (453, 454 and 455). Thus, regulation of tissue factor expression is the primary means to control factor VIIa activity. Paradoxically, in normal hemostasis, factor VII (10 nmol/L) is an effective competitor of factor VIIa (0.1 nmol/L) for binding to tissue factor. This competition down–regulates the level of enzymatically active complex (factor VIIa–tissue factor), thus suppressing initiation of the clotting cascade. Once the extrinsic tenase complex (factor VIIa–tissue factor– $\text{Ca}^{2+}$ –membrane) activates factor X to factor Xa, tissue factor pathway inhibitor (TFPI) can form a quaternary complex (factor VIIa–tissue factor–factor Xa–TFPI) with no enzymatic activity (456) (Fig. 21.6).



**Figure 21.6.** Regulation of the procoagulant response. Four vitamin K–dependent complexes are illustrated: the extrinsic tenase, the intrinsic tenase, prothrombinase, and protein C complex. The procoagulant response is regulated by the stoichiometric inhibitors antithrombin–III (ATIII) and tissue factor pathway inhibitor (TFPI). ATIII inhibits thrombin, factor Xa, and factor IXa that are free in solution. TFPI inhibits both factor Xa and the factor VIIa–tissue factor (TF)–factor Xa complex. Activated protein C (APC) generated from the protein C complex [thrombomodulin (TM)–thrombin (IIa)] inactivates FVa and FVIIIa by proteolysis of their heavy chains. PC, protein C. See Color Plate. (From Mann KG. Coagulation explosion. Vermont Business Graphics, 1997, with permission.)

## Factor IX (Plasma Thromboplastin Component, Christmas Factor, Hemophilia B Factor)

The zymogen factor IX is a single-chain vitamin K-dependent procoagulant glycoprotein synthesized in the liver, which has also been referred to as *plasma thromboplastin component*, *Christmas factor*, or *hemophilia B factor*. It circulates in plasma [ $t_{1/2} = 24$  hours (457)] at a mean concentration of 5  $\mu\text{g}/\text{ml}$ , or 90  $\text{nmol}/\text{L}$ , with a relative molecular weight of 55,000 (458) (Table 21.1). In addition, there may be a pool of noncirculating factor IX, which is readily available to the intravascular space, systemically distributed, and sequestered either to the endothelial surface (459) or subendothelial components, specifically collagen IV (460, 461 and 462). High levels of factor IX have been correlated with an increased risk of venous thrombosis (463).

Deficiency of this glycoprotein, known as *hemophilia B*, is considered one of the most common inherited coagulation disorders. The factor IX gene, found on the X chromosome, is a sex-linked recessive bleeding disorder that is found in males. The frequency of this disorder in the general population is approximately 1 in 30,000 males (458, 464). It rarely affects females, but several cases have been identified involving a mutation on the factor IX gene (465, 466). Acquired hemophilia can also occur due to the generation of autoantibodies (467). Many mutations, including large deletions, small deletions, point mutations, and missense mutations, have been identified in factor IX that appear to reduce activity in the presence of normal antigen levels (CRM+) or impair synthesis resulting in reduction of both activity and antigen (CRM-) (468, 469). Several specific cases and studies are noted: X translocation (470), links to factor V Leiden (471), population studies (472, 473, 474 and 475), and factor IX Denver (476). The point mutation called *factor IX Denver* results in a 100-fold decrease in the binding affinity of factor IXa Denver for factor VIIIa ( $K_d = 9.9$   $\text{nmol}/\text{L}$ ) compared to normal factor IXa (476). Mutations in the EGF-1-like domain of factor IX, specifically at Gly<sup>48</sup>, have also been identified in CRM+ individuals with hemophilia B (477). Molecular insights into hemophilia B as well as hemophilia A have been formatted in a recent review with references to accession numbers and locus identification (478).

Hemophiliacs experience prolonged bleeding episodes that can be life threatening and lead to chronic disabilities. The clinical presentation or phenotype is not homogeneous. Severe disease is associated with less than 1% functional factor IX, moderate disease with 1 to 5%, and mild disease with 5 to 25%. Female carriers usually have approximately 20 to 50% functional factor IX. Treatment for hemophilia B as well as hemophilia A involves plasma-derived or recombinant factor IX or factor VIII therapy, respectively (479). One problem with this therapy is the development of inhibitory antibodies. There is a North American Immune Tolerance Registry to study immune tolerance in hemophiliacs (480). An alternative treatment in the last decade has been the use of recombinant factor VIIa at supra-physiologic concentrations (~90  $\mu\text{g}/\text{kg}$ ). These therapies eliminate the immediate danger of bleeding but do not constitute a cure for the patients. The potential for gene-based therapy for the treatment of hemophilia has become a new avenue for investigation (481, 482, 483 and 484). To date, trans-gene therapy has proved successful in animal models, and human trials have been initiated as well (485, 486 and 487).

**GENE STRUCTURE AND EXPRESSION** The gene for factor IX is located on the X chromosome at position q26.3-27.1, near the factor VIII gene (488, 489 and 490). The gene contains eight exons and seven introns and has an overall size of 33 kb (492, 493). Five



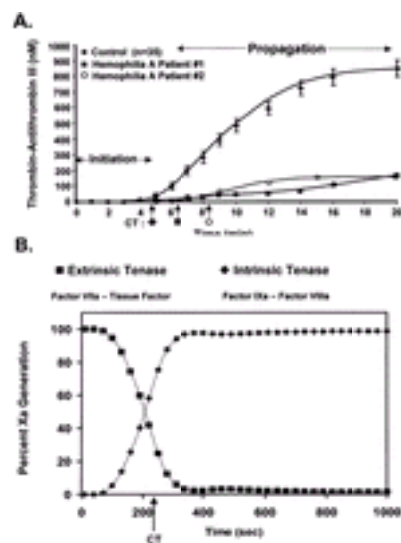
cis-acting elements have been identified in the promoter region of the factor IX gene ( [494](#) , [495](#) ). These include binding sites for transcription factor C/EBP ( [496](#) ), an HNF-1 binding site ( [497](#) ), an HNF-4 binding site ( [498](#) ), and a site for the D-box binding protein ( [499](#) ). Two essential age-regulatory elements, AE5' and AE3', have been identified in the 5' upstream region of the gene encoding factor IX in transgenic mice ( [500](#) ). Together, these elements identify the advancing age-associated increase in factor IX gene expression. Single point mutations in the factor IX promoter region have been correlated with a rare form of hemophilia B termed *hemophilia B Leyden* ( [494](#) , [501](#) , [502](#) ). Hemophilia B Leyden is characterized by an altered developmental expression of blood coagulation factor IX ( [494](#) ). These individuals have increasing levels of factor IX after puberty, or after administration of testosterone, resulting in decreased bleeding instances ( [503](#) , [504](#) ). Studies in mice support the role of androgen receptor binding to the factor IX promoter in regulating the developmental expression of factor IX ( [505](#) ).

**BIOCHEMISTRY** Human factor IX is a member of the vitamin K-dependent protein family and circulates in an inactive single-chain zymogen form at a plasma concentration of 5  $\mu\text{g/ml}$ , or 90 nmol/L, with a relative molecular weight of 55,000 ( [458](#) , [506](#) ) ( [Table 21.1](#) ). Other names for factor IX include *plasma thromboplastin component* and *Christmas factor*. Its structure consists of 415 amino acids that are separated into a Gla domain (12 Gla residues), two tandem EGF domains [EGF-1 (residues 46 to 84) and EGF-2 (residues 85 to 127)], an activation peptide region, and a serine protease domain ( [267](#) , [493](#) , [507](#) ) ( [Fig. 21.3](#) ). Glycosylation in the form of O-linked and N-linked oligosaccharides makes up 17% by weight of the factor IX protein—specifically, O-linked oligosaccharides at Ser<sup>53</sup> and Ser<sup>61</sup> in the EGF-1 domain and O-linked and N-linked oligosaccharides at Asn<sup>157</sup>, Asn<sup>167</sup>, Thr<sup>159</sup>, and Thr<sup>169</sup> in the activation peptide region ( [508](#) , [509](#) , [510](#) and [511](#) ). The Gla domains are crucial for binding to anionic lipid membranes through calcium interactions. The x-ray crystal structure of human factor IX with Ca<sup>2+</sup> has shown that EGF-1 binds a single Ca<sup>2+</sup> with residues Asp<sup>47</sup>, Gly<sup>48</sup>, Gln<sup>50</sup>, Asp<sup>64</sup>, and Asp<sup>65</sup> functioning as the ligands ( [512](#) ). Hydrophobic interactions ( [513](#) ) and a salt bridge (Glu<sup>78</sup>-Arg<sup>94</sup>) ( [514](#) ) between the carboxy end of EGF-1 and EGF-2 have also been identified ( [515](#) ). Ca<sup>2+</sup> binding and hydrophobic interactions lock the domains in a manner that assures biologic activity. Several point mutations in the EGF domain give rise to hemophilia B ( [386](#) ).

**ACTIVATION** Factor IX activation to its serine protease form, factor IXa, is a two-stage process requiring sequential cleavages at Arg<sup>145</sup> and Arg<sup>180</sup>, releasing a 35-residue activation peptide with an approximate molecular weight of 11,000 ( [516](#) , [517](#) ) ( [Fig. 21.3](#) ). Physiologic activators of factor IX are either tissue factor-factor VIIa (extrinsic tenase complex) ( [228](#) , [518](#) ) or factor XIa ( [519](#) , [520](#) ). The first step in activation is the cleavage by its physiologic activators between the Arg<sup>145</sup>-Ala<sup>146</sup> bond, resulting in factor IXa. This cleavage has been shown to be important in its affinity for its cofactor factor VIIIa ( [521](#) ) and has been identified as a molecular defect in factor IX<sub>Chapel Hill</sub> ( [522](#) ). The second step is cleavage between the Arg<sup>180</sup>-Val<sup>181</sup> bond, resulting in factor IX<sub>Chapel Hill</sub>, the active form, also known as *factor IXa*. Both cleavages are required for full biologic activity of factor IXa ( [517](#) ). *In vitro*, factor IX has also been shown to be cleaved by factor Xa at Arg<sup>145</sup> on phospholipid membrane surfaces ( [63](#) ), producing the inactive precursor factor IXa and increasing the overall rate of factor IXa production by tissue factor-factor VIIa. Both cleavage sites, Arg<sup>145</sup> and Arg<sup>180</sup>, have been identified as single point mutations in hemophilia B ( [523](#) ). The x-ray crystal structure of porcine factor IXa has also been solved ( [515](#) ). The active serine protease (M<sub>r</sub> = 45,000) structure is composed of a heavy chain (M<sub>r</sub> = 28,000) and a light chain (M<sub>r</sub> = 17,000) covalently associated through a disulfide

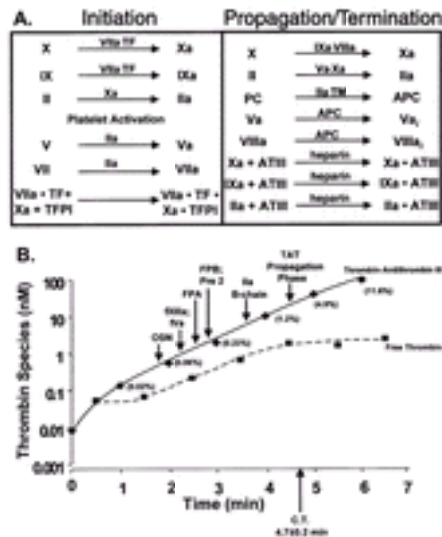
bond. Factor IXa forms the intrinsic tenase complex with its cofactor factor VIIIa,  $\text{Ca}^{2+}$ , and a membrane surface primarily supplied by platelets ( Fig. 21.4). On formation of this complex, factor X is activated to its serine protease form factor Xa. Factor IXa (the enzyme) alone without its cofactor (factor VIIIa) has poor amidolytic and proteolytic activity ( $10^7$ -fold less activity).

**FUNCTION** The main role for factor IXa in blood coagulation is to form the intrinsic tenase complex, which efficiently activates factor X to factor Xa. The complex is so named because the components, including the cofactor, are intrinsic to circulating blood. Tissue factor, the cofactor for the extrinsic tenase complex, is not in contact with circulating blood until the endothelium is damaged. Both complexes activate factor X to factor Xa. The extrinsic tenase complex (factor VIIa-tissue factor- $\text{Ca}^{2+}$ -membrane) catalyzes the initial formation (picomolar amounts) of factor Xa, which ultimately participates in prothrombinase complex assembly and the resulting conversion of prothrombin to thrombin allowing clot formation to occur. The intrinsic tenase complex (factor IXa-factor VIIIa- $\text{Ca}^{2+}$ -membrane) generates the second burst of factor Xa that results in the propagation phase of the activation of prothrombin to thrombin ( Fig. 21.7) ( 524). The intrinsic tenase complex is kinetically more efficient than the extrinsic tenase complex in generating factor Xa. Factor Xa generation by tissue factor-factor VIIa occurs at only 1/50th the rate of factor X activation by the factor IXa-factor VIIIa complex ( 62, 63 and 64). Without the intrinsic complex being formed, as occurs in situations like hemophilia A or B, factor Xa is not generated in levels sufficient to produce the propagation phase of thrombin generation ( Fig. 21.7) ( 418, 525, 526).



**Figure 21.7.** Profiles of thrombin and factor Xa generation. **A:** Time course (x-axis: 0 to 20 minutes) of thrombin-antithrombin-III formation (y-axis: nmol/L thrombin-antithrombin-III complex) during whole blood coagulation initiated with 5-pmol/L tissue factor ( 526). Data represent means plus or minus standard error of the means for 35 individuals; thrombin-antithrombin levels reach maximum levels of 900 nmol/L (?) in this group of normal individuals. Clot time (CT) is shown below with the symbols for each curve. Thrombin generation is divided into two phases: an initiation phase and a propagation phase. When two hemophilia A patients were studied (&scf;, &cir;), CT was delayed, and the propagation phase of thrombin generation was not present ( 418, 525). By not having factor VIIIa present, the intrinsic tenase complex is unable to generate the additional factor Xa that is required for the burst or propagation phase of thrombin generation. **B:** Computer simulation of the time course of factor Xa generation on activation of the factor VIIa-tissue factor pathway ( 524). Factor Xa concentrations are expressed as percent (%) of maximum level achieved for the extrinsic Xase (&scf;, tissue factor-factor VIIa: 100% @ 10 pmol/L) and % of maximum for the intrinsic Xase (? , factor IXa-factor

VIIIa: 100% @ 1 nmol/L). The factor Xa that is initially produced is via the extrinsic tenase complex. After CT, the majority of factor Xa generated is via the intrinsic Xase. The clot time represents the time point in the computer simulation at which calculated thrombin levels are comparable to thrombin levels (~10 nmol/L) measured in clotting whole blood (see Fig. 21.11).



**Figure 21.11.** Initiation, propagation, and termination of thrombin generation and the procoagulant response. **A:** Low levels of thrombin are required to initiate clot formation (initiation phase) and trigger the coagulation cascade response (propagation phase). The enzymes, cofactors, and inhibitors act together to generate a hemostatic response that can be divided into an initiation phase and a propagation/termination phase. During the initiation phase, factors X and IX are converted to their respective serine proteases factor Xa and factor IXa; low levels of thrombin are subsequently generated by factor Xa. This thrombin then can activate platelets and the procofactors factors V and VIII, which stimulate further thrombin generation during the propagation phase. Thrombin generation is attenuated by shutting down the initiation phase by means of the stoichiometric inhibitor of the extrinsic Xase complex, tissue factor pathway inhibitor (TFPI), followed by antithrombin III (ATIII), which directly inhibits thrombin and factors Xa and IXa. **B:** Time course of early thrombin-antithrombin III (TAT) complex formation from whole blood coagulation of 35 individuals is presented: y-axis, TAT [solid line (?)] and free thrombin [dashed line (&sqf;)] concentrations (nmol/L) are shown on a log scale; x-axis, time in minutes (526). Arrows indicate the time and TAT concentration at which each of the indicated events [osteonectin (OSN) release, a marker of platelet activation, factor XIII activation (fXIIIa), fibrinopeptide A (FPA) release, fibrinopeptide B (FPB) release, and prothrombin activation] has entered a phase of rapid activation. The percent of total TAT present at the point of activation is shown in parentheses. APC, activated protein C; C.T., clot time; PC, protein C; TF, tissue factor. (From Brummel KE, Paradis SG, Butenas S, Mann KG. Thrombin functions during tissue factor induced blood coagulation. *Blood* 2002;100:148–152, with permission.)

When the competitive substrates factors IX and X are simultaneously presented to the extrinsic tenase complex, factor IXa generation is increased, whereas factor Xa generation is suppressed (62, 63). This occurs because the factor Xa initially produced cleaves factor IX at Arg<sup>145</sup>, producing factor IXa. Factor IXa is a better substrate for factor VIIa-tissue factor than factor IX; the intermediate is converted to factor IXaβ (factor IXa) by cleavage at Arg<sup>180</sup> by factor VIIa-tissue factor. This cooperative enzymatic action results in factor IX being an improved substrate for the extrinsic tenase complex, whereas factor X activation is suppressed.

**REGULATION** Plasma factor IXa is primarily inhibited by antithrombin-III ( [527](#) ) ( [Fig. 21.6](#) ). *In vitro* experiments conducted on phospholipid vesicles and cell membranes showed that PN2/amyloid  $\beta$ -protein precursor (PN-2/APP) can also inhibit factor IXa ( [528](#) ). Interestingly, an insect salivary protein, Prolixin-S, has been shown to inhibit factor IXa generation and the intrinsic tenase complex formation ( [529](#) ). One strategy to improve existing antithrombotic therapies has been to develop factor IXa inhibitors ( [530](#) )—in particular the use of monoclonal antibodies to target factor IX/factor IXa ( [531](#) , [532](#) ). Currently, problems exist in using direct thrombin inhibitors to regulate thrombin activity. Targeting the end product of an amplifying cascade results in a narrow window of therapeutic dose, which is difficult to achieve in clinical practice ( [533](#) , [534](#) and [535](#) ). The advantages of regulating events upstream (factor IX/factor IXa; the intrinsic tenase complex) as an approach to antithrombotic therapy would be to potentially produce a partial reduction in the magnitude of thrombin formation.

### Factor X (Stuart Factor)

The *zymogen factor X*, or *Stuart factor*, is a vitamin K-dependent glycoprotein that is synthesized in the liver and circulates as a two-chain molecule linked by a disulfide bond ( [518](#) , [536](#) ). It has a molecular weight of 59,000, circulates in plasma at a mean concentration of 10  $\mu\text{g/ml}$  or 170 nmol/L, and has a  $t_{1/2}$  of approximately 1.5 days ( [457](#) , [537](#) , [538](#) ) ( [Table 21.1](#) ). In the Leiden Thrombophilia study, a population-based case control study on venous thrombosis, high levels of factor X alone predicted the risk of thrombosis but were not a risk factor for venous thrombosis when the levels of other vitamin K-dependent proteins were taken into account ( [539](#) ).

Factor X deficiency is a rare autosomal-recessive disorder with varied phenotype and genotype. Homozygous factor X deficiency has an incidence of 1 in 1 million in the general population ( [540](#) ). Whereas heterozygotes are often clinically asymptomatic, the most severely affected homozygous individuals exhibit extensive bleeding early in life. Multiple factor X deficiency cases have been identified, and the gene defects have been elucidated in individuals with bleeding tendencies ( [541](#) , [542](#) , [543](#) , [544](#) , [545](#) , [546](#) and [547](#) ) and in an individual without a bleeding tendency ( [548](#) ). As with most deficiencies, the level of factor X expression is indicative of the bleeding response. When factor X levels are approximately 1%, bleeding can include hemarthrosis, soft tissue hemorrhage, and menorrhagia. With functional levels above 15%, bleeding is infrequent and usually mild. Acquired factor X deficiency is rare and is usually associated with light-chain amyloidosis ( [549](#) , [550](#) and [551](#) ). In amyloidosis, factor X is thought to be adsorbed onto extracellular amyloid fibrils, thereby decreasing the circulating factor X level and increasing bleeding. In these cases, replacement with factor X products is not as effective a therapy for deficiency because it is continuously removed from plasma. Treatment of factor X deficiency can involve the administration of fresh frozen plasma or prothrombin complex concentrates.

The importance of factor X generation is illustrated by transgenic mice with a total deficiency of factor X. Homozygous deficiency (-/-) results in partial embryonic lethality with signs of massive bleeding ( [425](#) , [552](#) ). Those mice that survive to term die within 5 to 20 days from fatal neonatal bleeding. The lethality of factor X knock-out genotype in mice supports the significance of factor X function in hemostasis.

**GENE STRUCTURE AND EXPRESSION** The gene for factor X spans 27 kb, is located on chromosome 13 bands q34-qter, and yields a 1.5-kb mRNA ( [427](#) , [553](#) , [554](#) and [555](#) ) ( [Table 21.2](#) ). The gene for factor X is located near the gene for factor VII. Studies to elucidate

the liver-specific expression of factor X have included the characterization of the human ( 556 ) and murine factor X promoter ( 557 ). Using a hepatoma cell line that expresses factor X, the first 279 bp of the 5'-flanking sequence upstream from the first AUG proved to be sufficient to confer maximal promoter activity ( 556 ). From mutagenesis studies, two protein binding sites within the 279-bp fragment were identified that are critical for promoter activity: CCAAT (at -120 to -116) and ACTTTG (at -56 to -51) ( 556 ). Factor X also lacks a typical TATA box. In the human factor X promoter, the binding proteins HNF-4 (at -73) ( 558 ), nuclear factor-Y (at -128) ( 558 ), GATA-4 (GATA element at -96) ( 559 ), the Sp family of transcription factors I footprinted sites (at -165 and -195) ( 559 ) have been identified as playing crucial roles in modulating the activity of the proximal promoter of factor X.

**BIOCHEMISTRY** Human factor X is a vitamin K-dependent glycoprotein of molecular weight 59,000 that circulates in plasma (10 µg/ml or 170 nmol/L) as a two-chain molecule composed of a disulfide-linked light chain ( $M_r = 16,500$ ) and heavy chain ( $M_r = 42,000$ ) ( 560 , 561 ) ( Table 21.1 ). Its structure contains an NH<sub>2</sub>-terminal light chain consisting of a Gla domain (11 Gla residues), with a single β-hydroxy aspartic acid residue, and two EGF-like domains (EGF-1 and EGF-2) ( Fig. 21.3 ). The COOH-terminal heavy chain consists of an activation peptide region and a catalytic (serine protease) domain. Most of the carbohydrate moieties (~15%) are contained within the heavy chain ( 537 ) in the activation peptide domain ( 562 ). Ca<sup>2+</sup> binding in the first EGF domain has been proposed to enhance the structural rigidity of the factor X molecule ( 382 ).

**ACTIVATION** Factor X is activated to its serine protease form factor Xa through a cleavage of the activation peptide at Arg<sup>194</sup>-Ile<sup>195</sup> (Arg<sup>52</sup>-Ile<sup>53</sup> of the heavy chain) ( Fig. 21.3 ). A 52-amino acid activation peptide is released with a relative molecular mass of 12,000. The resulting catalytic serine protease, factor Xa, has a molecular weight of 48,000 and is composed of a light chain ( $M_r = 18,000$ ) and a disulfide-linked heavy chain ( $M_r = 30,000$ ). The activation of factor X is catalyzed by factor VIIa-tissue factor (the extrinsic tenase complex) ( 447 ) and factor IXa-factor VIIIa (the intrinsic tenase complex) ( 563 ). *In vitro* studies have determined that factor X has to be bound to the membrane before activation ( 45 , 564 ).

**FUNCTION** The main function of factor Xa is to form the prothrombinase complex (factor Xa-factor Va-membrane-Ca<sup>2+</sup>) ( Fig. 21.4 ). Factor Xa is the serine protease enzyme in the prothrombinase complex that catalytically activates prothrombin to thrombin, the key enzyme in blood coagulation. The prothrombinase complex activates prothrombin to thrombin 10<sup>5</sup>-fold faster than factor Xa alone ( 42 ). Factor Xa is a unique regulatory enzyme in that it is formed through both the extrinsic tenase and intrinsic tenase complexes (as mentioned in section [Factor IX \(Plasma Thromboplastin Component, Christmas Factor, Hemophilia B Factor section\)](#)). During the initial stages of the hemostatic event, low levels of both factor Xa and factor IXa are generated. Once generated, the limited amounts of factor Xa produced by extrinsic tenase bind to available membrane sites and convert picomolar amounts of prothrombin to thrombin ( 39 , 565 , 566 ) ( Fig. 21.7B ). This thrombin then activates factor VIII ( 567 ) and factor V ( 568 ), allowing the initial formation of the intrinsic tenase and prothrombinase complexes. Thus, the time period in which factor Xa directly generates picomolar amounts of thrombin is referred to as the *initiation phase of blood coagulation*. The burst or propagation phase of thrombin generation is then obtained from additional factor Xa generated via the intrinsic tenase complex (factor IXa-factor VIIIa-Ca<sup>2+</sup>-membrane) ( Fig. 21.7 ). The intrinsic tenase complex activates factor X at a 50- to 100-fold higher rate than the extrinsic tenase complex ( 62 , 63 and 64 ). This burst in factor Xa levels overcomes the levels of factor Xa inhibitors such as TFPI and achieves maximal prothrombinase activity and propagation of the procoagulant event. There is evidence that factor Xa can also trigger intracellular



signaling events by increasing endothelial cell cytosolic  $\text{Ca}^{2+}$  and the release of endothelial cell mitogens ( 569 ). Mitogenic activity toward smooth muscle cells ( 570 ) and lymphocytes ( 571 ) has also been identified. An alternative initiation of factor X to factor Xa has been identified on stimulated cells of monocytic and myeloid differentiation involving the specific adhesive receptor Mac-1 ( 572 ). A novel factor Xa receptor, effector cell protease receptor-1, has been identified on the surface of a monocytic cell line ( 573 ). A platelet factor Xa receptor has been described as important in mediating prothrombin binding via factor Xa binding to platelet factor Va ( 574 ).

**REGULATION** Once assembled, the extrinsic tenase (factor VIIa-tissue factor-Ca<sup>2+</sup>-membrane) is rapidly inactivated along with its product factor Xa through the action of TFPI ( Fig. 21.6 ). The factor Xa active site associates with the COOH-terminus of TFPI ( 575 , 576 ) to localize the TFPI to the membrane. Once localized, the factor Xa-TFPI complex rapidly inactivates tissue factor-factor VIIa, forming a stable quaternary complex, tissue factor-factor VIIa-TFPI-factor Xa. The factor Xa-TFPI complex has been shown to be elevated in cancer patients ( 577 ). Factor Xa is also inhibited by antithrombin-III ( 578 ) when not in complex with prothrombinase ( 579 , 580 ). Its inhibition is enhanced through the use of heparin, which increases the affinity of antithrombin-III for its substrates (i.e., factor Xa). Because factor Xa is a major player in the coagulation cascade, it is a target for regulation by synthetic inhibitors in treating ischemic heart disease and cerebrovascular disease. Many studies are currently under way to develop a new class of antithrombotic agents that target factor Xa ( 581 , 582 and 583 ). One compound, fondaparinux, a synthetic pentasaccharide, has finished a phase III clinical trial, and results show superiority to the low-molecular-weight heparins in reducing venous thromboembolism ( 584 ).

## Factor II (Prothrombin)

*Factor I*, also known as *prothrombin*, is a single-chain vitamin K-dependent zymogen that, when activated, yields factor IIa (thrombin), the key enzyme in blood coagulation. The zymogen prothrombin ( $M_r = 72,000$ ) is the most abundant of the vitamin K-dependent proteins and circulates in plasma at a mean concentration of 1.4  $\mu\text{mol/L}$  or 100  $\mu\text{g/ml}$  ( 585 , 586 and 587 ) ( Table 21.1 ). Prothrombin is primarily synthesized in the liver with a  $t_{1/2}$  of approximately 2.5 days. Low levels of prothrombin expression have been identified in other tissues including brain, diaphragm, stomach, kidney, spleen, intestine, uterine, placental, and adrenal ( 588 , 589 ). Increased prothrombin levels have been associated with an increased risk of venous thrombosis.

Human prothrombin deficiency is rare because of the autosomal nature of its expression. It was first described by Quick in 1943 ( 590 ). Deficiencies in prothrombin are classified as either hypoprothrombinemia or dysprothrombinemia and occur due to genetic disorders affecting either transcriptional regulation or protein function ( 591 , 592 ). These disorders are characterized by variable pathologies extending from mild bruising to clinically severe bleeding ( 593 ). Homozygotes are characterized by severe bleeding, and heterozygotes either have mild bleeding or are asymptomatic. Prothrombin complex concentrates have been used for prophylaxis and bleeding episodes in individuals with prothrombin deficiency ( 403 ). The importance of a-thrombin to hemostasis is demonstrated in prothrombin-deficient mice, which experience embryonic and neonatal lethality ( 594 , 595 and 596 ).

**GENE STRUCTURE AND EXPRESSION** The 21-kb human prothrombin gene is located

on chromosome 11 bands p11–q12 and has been extensively studied ( [597](#), [598](#), [599](#) and [600](#)). The prothrombin gene contains 14 exons and 13 introns ( [598](#)) and is transcribed as a pre-propeptide of 622 amino acids ( [599](#), [600](#)). The 43–amino acid propeptide mediates posttranslational processing to generate the mature protein of 579 amino acids. The promoter region of the prothrombin gene lacks a TATA box. Many studies have been conducted on the prothrombin gene to identify the polymorphisms that exist and to determine their relationships to thrombophilia. One common polymorphism is the G20210A transition in the 3′–untranslated region of the promoter. This mutation has been linked to familial thrombosis. The G20210A polymorphism of the prothrombin gene has been associated with elevated prothrombin levels and an increased risk for venous thrombosis ( [601](#)). It is one of the most commonly identified genetic risk factors for thrombosis. An additional polymorphism, A19911G, in the prothrombin gene has been identified that can modulate the risk of the G20210A polymorphism in developing deep vein thrombosis ( [602](#)). Several recent reviews have been written on the influence of genetic polymorphisms (including the prothrombin G20210A) and the laboratory diagnosis of thrombophilia ( [603](#), [604](#) and [605](#)).

**BIOCHEMISTRY** Factor II, prothrombin, is a vitamin K–dependent glycoprotein with a relative molecular weight of 72,000 (8% carbohydrate) and circulates in plasma ( $t_{1/2} = 2.5$  days) at a mean plasma concentration of 1.4  $\mu\text{mol/L}$  or 100  $\mu\text{g/ml}$  ( [Table 21.1](#)). The initial observations about the structure/function relationship characterizing the prothrombin molecule came about from the partial primary structures of bovine and human prothrombins. Subsequently, the complete primary structure of human prothrombin 2 (residues 272 to 579), which is the precursor of thrombin, was determined ( [606](#)). Finally, the primary structure for bovine prothrombin ( [607](#)) and human prothrombin ( [600](#)) were deduced from isolated cDNAs. The elucidated structure of prothrombin is characterized by an NH<sub>2</sub>–terminal Gla domain (residues 1 to 40 with ten Gla residues), followed by two kringle domains (kringle 1, residues 65 to 143; kringle 2, residues 170 to 248) and the serine protease precursor domain (residues 272 to 579). There are three N–linked sugar chains—two in the first kringle domain and one in the catalytic domain of human prothrombin ( [608](#)). The first x–ray crystal structure of a blood coagulation protein fragment, bovine prothrombin kringle 1, was determined in Tulinsky’s laboratory in 1986 ( [348](#)). Kringles have been identified as common motifs in many plasma proteins, including prothrombin, plasminogen, t–PA, urokinase, factor XII, and apolipoprotein A ( [609](#), [610](#)). The kringle 1 domain contains four cysteine residues participating in two disulfide bonds. The role of the kringle 1 domain of prothrombin is still unclear but is suggested to be involved with the interaction of prothrombin and factor Va in the prothrombinase complex ( [611](#), [612](#)). The NH<sub>2</sub>–terminal Gla domain and the first kringle domain together are referred to as *prothrombin fragment 1*. The kringle 2 domain of prothrombin, located in prothrombin fragment 2 (residues 156 to 271), is similar in sequence and presumably in structure. The kringle 2 domain also binds Ca<sup>2+</sup> and appears to be the primary region in prothrombin that mediates the interaction of the prothrombin molecule with factor Va in the prothrombinase complex ( [613](#), [614](#)). This latter interaction has been suggested to initiate conformational changes that make reaction sites accessible for enzymatic cleavage of prothrombin ( [615](#)). The sequence of the enzyme a–thrombin is contained within prothrombin 2 (residues 272 to 579).

**ACTIVATION** Prothrombin is activated to the procoagulant a–thrombin by two cleavages: one at Arg<sup>271</sup>–Thr<sup>272</sup> and another at Arg<sup>320</sup>–Ile<sup>321</sup> by the prothrombinase complex (factor Xa–factor Va–phospholipid membrane–Ca<sup>2+</sup>) ( [Fig. 21.3](#)). Membrane–bound factor Va serves as the receptor for factor Xa, the catalytic serine protease. The rate of a–thrombin generation by prothrombinase is  $3 \times 10^5$ –fold faster than the rate for factor Xa alone at potential physiologic concentrations of the proteins ( [42](#)). The phospholipid membrane surface that supports the prothrombinase complex *in vivo* is assumed to be



primarily provided by platelets but can also be provided by other circulating blood cells, such as monocytes and lymphocytes, and by vascular endothelial cells (616). The activation of prothrombin by prothrombinase proceeds through an initial cleavage of prothrombin at Arg<sup>320</sup>-Ile<sup>321</sup>, giving rise to meizothrombin, a two-chain disulfide-linked molecule (Fig. 21.8; pathway A, cleavage at 1). Meizothrombin expresses some of the activities of  $\alpha$ -thrombin. However, meizothrombin has impaired fibrinogen clotting ability compared to  $\alpha$ -thrombin (617). Meizothrombin is subsequently cleaved at Arg<sup>271</sup>-Thr<sup>272</sup> (Fig. 21.8; pathway A, cleavage at 2), yielding the NH<sub>2</sub>-terminal half of the molecule consisting of the Gla domain and two kringle domains (prothrombin fragment 1.2: residues 1 to 271) and  $\alpha$ -thrombin.  $\alpha$ -Thrombin consists of an NH<sub>2</sub>-terminal 49-residue A-chain (residues 272 to 320) disulfide-linked to a COOH-terminal 259-residue B-chain (residues 321 to 579) containing the catalytic triad.



**Figure 21.8.** Schematic representation of the pathways for prothrombin activation. The generation of  $\alpha$ -thrombin from its precursor, the zymogen prothrombin, by factor Xa involves the cleavage of two peptide bonds. The reaction begins either via step 1 (cleavage at R<sup>320</sup>-I<sup>321</sup>) or step 2 (cleavage at R<sup>271</sup>-T<sup>272</sup>). Cleavage at 1 (R<sup>320</sup>), pathway A, produces meizothrombin. Meizothrombin is composed of a prothrombin fragment consisting of fragment 1 (F1, residues 1 to 155: Gla domain + kringle 1), fragment 2 (F2, residues 156 to 271: kringle 2), and residues 272 to 320 (A-chain) linked by a disulfide bond to the catalytic domain (B-chain). Meizothrombin is generated when the full prothrombinase complex is assembled. Subsequent cleavage at R<sup>271</sup> (cleavage at 2, pathway A) generates prothrombin fragment 1.2 (F1 and F2) and the disulfide-linked heterodimer  $\alpha$ -thrombin (A- and B-chains). Without a membrane surface present, the pattern of prothrombin cleavage by factor Xa follows pathway B, and cleavage occurs first at site 2, R<sup>271</sup>, pathway B, generating prothrombin fragment 1.2 (F1 and F2) and prethrombin-2. Subsequent cleavage at R<sup>320</sup> produces the A- and B-chains of  $\alpha$ -thrombin.

An alternative cleavage pathway occurs when factor Xa alone acts on prothrombin. In the presence of factor Xa and Ca<sup>2+</sup>, the initial cleavage occurs at Arg<sup>271</sup>-Thr<sup>272</sup> and gives rise to prothrombin fragment 1.2 and prethrombin 2 (Fig. 21.8; pathway B, cleavage at 2). Cleavage at Arg<sup>320</sup> in prethrombin 2 (Fig. 21.8; pathway B, cleavage at 2) yields  $\alpha$ -thrombin. Prothrombin fragment 1.2 remains noncovalently associated with  $\alpha$ -thrombin. *In vitro*,  $\alpha$ -thrombin is associated (K<sub>d</sub> = 10 nmol/L) with prothrombin fragment 2 (618) or the latter's precursor prothrombin fragment 1.2, or both (619). In contrast to other vitamin K-dependent proteins, the phospholipid binding region is no longer covalently attached to the serine protease domain after prothrombin conversion to thrombin. Thrombin and meizothrombin catalyze cleavage at Arg<sup>155</sup> of prothrombin, yielding a truncated molecule called *prethrombin 1* (residues 156 to 579) that lacks the Gla domain. Thrombin can also cleave at Arg<sup>284</sup>, yielding a truncated  $\alpha$ -thrombin species (residues 284 to 579), which is the form of thrombin found in commercial preparations.

**FUNCTION**  $\alpha$ -Thrombin can be considered the central enzyme in blood coagulation in

that it contributes to reactions at all levels allowing for the overall maintenance of vascular fidelity. Its main role is in stemming blood loss through fibrin clot formation (620). The series of events that lead up to and occur after fibrin formation also involve protein activation by  $\alpha$ -thrombin. These include activation of platelets (621), factor VII (5), factor V (622), factor VIII (623), factor XI (4), and factor XIII (14).  $\alpha$ -Thrombin activity also extends from the procoagulant process to anticoagulation and suppression of fibrinolytic reactions. For example,  $\alpha$ -thrombin-thrombomodulin activates the anticoagulant protein, protein C (624), and the antifibrinolytic protein, TAFI (17). Relatively minute concentrations of thrombin are generated during the initiation phase of blood coagulation, primarily due to the factor Xa generated from the extrinsic tenase complex (Fig. 21.7). These levels of thrombin, in the range of 0.5 to 2.0 nmol/L, have been shown to be sufficient for the initiation of rapid activation of platelets, factor XIII, and factor V and fibrin formation in an *ex vivo* whole blood model (526). All of these processes occur before the major burst of thrombin generation during the propagation phase of the reaction.  $\alpha$ -Thrombin's role continues into the tissue repair and remodeling phase that is necessary to regenerate damaged vascular tissue.  $\alpha$ -Thrombin is a potent mitogen (625, 626) and stimulates cell division in macrophages (627), smooth muscle cells (628), and endothelial cells (629).  $\alpha$ -Thrombin also appears to be involved in the growth and metastasis of tumors by promoting angiogenesis (630, 631), possibly through vascular endothelial growth factor (632). The roles that thrombin plays in coagulation and beyond are outlined in a recent review (633).

**REGULATION** *In vivo*, the activity of the prothrombinase complex has to be tightly regulated to ensure that adequate but limited levels of  $\alpha$ -thrombin are generated. If too much thrombin is continuously generated, localized clot formation can lead to occlusion or systemic thrombosis. Equally, if too little thrombin is generated, hemorrhagic conditions result. Two reaction systems, one covalent and one proteolytic, regulate thrombin generation. Antithrombin-III heparin (or heparan sulfate) is a potent inhibitor of blood coagulation and inhibits both  $\alpha$ -thrombin and factor Xa via covalent interactions (634, 635).  $\alpha$ -Thrombin also participates in its own down-regulation by binding to thrombomodulin on the vascular cell surface and converting protein C to APC. This anticoagulant serine protease then cleaves factor Va and factor VIIIa. The cofactors for the vitamin K-dependent complexes are no longer available for ongoing reactions, thereby eliminating thrombin generation. In *ex vivo* models of blood coagulation, prothrombin levels and antithrombin-III appear to have the most significant impact on  $\alpha$ -thrombin generation (636). Increased levels of antithrombin-III reduce  $\alpha$ -thrombin generation by inhibiting  $\alpha$ -thrombin activity and preventing positive feedback (636). Decreased levels of antithrombin-III allow for higher levels of prothrombin activation and prolongation of  $\alpha$ -thrombin generation (636).

## PROCOAGULANT PROTEINS: PROCOAGULANT COFACTOR PROTEINS

There are two categories of procoagulant cofactor proteins: the plasma-derived soluble procoagulant procofactors factor V and factor VIII [and its circulating carrier von Willebrand factor (vWF)] and the cell-associated coagulation cofactor, tissue factor. Factor V and factor VIII are highly homologous (40% identity), sharing many structural and functional similarities. The cell-associated cofactor tissue factor is a single-chain transmembrane protein that is composed of extracellular, transmembrane, and cytoplasmic domains.

### Tissue Factor (Tissue Thromboplastin, CD142, Coagulation Factor III)

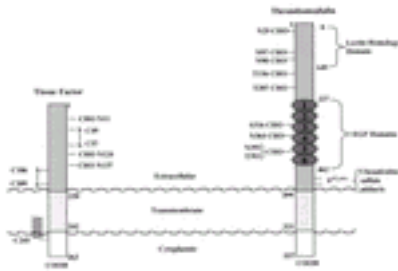
*Tissue factor*, also known as *tissue thromboplastin*, *CD142*, and *coagulation factor III*, is a transmembrane protein that functions as a nonenzymatic cofactor for factor VIIa in the

extrinsic tenase complex. In the absence of injury or stimulus, tissue factor is not ordinarily expressed on cellular surfaces in direct contact with circulating blood. Presentation of tissue factor to the circulation is the event that triggers the procoagulant primary pathway of coagulation ( [Fig. 21.1](#)). There are no known mutations or deficiencies of human tissue factor, leading to the speculation that tissue factor is essential for life. In mice, inactivation of the tissue factor gene to create homozygous tissue factor-null mice proves to be lethal during embryonic development ( [426](#), [637](#), [638](#), [639](#) and [640](#)).

**GENE STRUCTURE AND EXPRESSION** The tissue factor gene is located on chromosome 1p21–22 ( [642](#), [643](#)) and spans 12.4 kb ( [Table 21.2](#)). The gene contains five introns and six exons ( [644](#)). Tissue factor expression can be induced in a number of cultured cell types. Fibroblasts express tissue factor on exposure to serum or mitogenic cytokines ( [645](#), [646](#)) as do vascular smooth muscle cells and keratinocytes ( [647](#), [648](#)). Monocytic cells and monocytes isolated from peripheral blood also express tissue factor when stimulated by bacterial endotoxin or other proinflammatory agents ( [647](#), [648](#)). The presence of these cells may be associated with DIC ( [649](#)). *In vitro*, certain leukemic cell lines constitutively express low levels of tissue factor ( [650](#), [651](#) and [652](#)). Tissue factor expression by circulating and nonvascular cells plays key roles in cancer, sepsis, and, perhaps, atherosclerotic plaque formation ( [56](#), [653](#), [654](#), [655](#), [656](#) and [657](#)). However, tissue factor in the endothelial cell layer is proposed to trigger coagulation on exposure to the circulation. Cultured vascular endothelial cells express tissue factor on stimulation by IL-1, tumor necrosis factor (TNF)- $\alpha$ , and bacterial endotoxin ( [647](#), [648](#)). *In vivo*, there is little or no detectable tissue factor expression on unstimulated endothelial cells. Certain conditions such as sepsis, placental villitis, and graft rejection induce tissue factor expression on endothelial cells *in vivo* ( [649](#), [658](#), [659](#) and [660](#)). The mechanism governing tissue factor expression under nonpathologic conditions is presently unknown. Studies of transcriptional control of tissue factor expression in various cell lines have demonstrated that Sp1 sites are important in basal transcription of the tissue factor gene. EGR-1, activation peptide-1, and NF- $\kappa$ B sites mediate tissue factor expression in response to pathologic stimulation ( [640](#), [661](#), [662](#), [663](#), [664](#) and [665](#)).

**BIOCHEMISTRY** Tissue factor is a single-chain glycoprotein [ $M_r = 44,000$  ( [666](#))] of 261 or 263 amino acids ( [Table 21.1](#)). It is synthesized with a signal peptide of 32 amino acids. The variability in protein size is due to heterogeneity at the NH<sub>2</sub>-terminus ( [642](#), [667](#), [668](#)). Tissue factor is a member of the class 2 cytokine receptor superfamily ( [669](#)) and a type I integral membrane protein. The type I designation refers to the location of the NH<sub>2</sub>- and COOH-termini. The NH<sub>2</sub>-terminus of tissue factor (residues 1 to 219) is extracellular, whereas the COOH-terminus of the protein is intracellular (residues 243 to 263). Tissue factor also contains a hydrophobic membrane-spanning domain (residues 220 to 242) ( [Fig. 21.9](#)). This domain appears to function solely to anchor tissue factor in the membrane ( [670](#)). The NH<sub>2</sub>-terminal domain of tissue factor is composed of two fibronectin type III domains and is glycosylated at Asn<sup>11</sup>, Asn<sup>124</sup>, and Asn<sup>137</sup> ( [671](#)). X-ray crystal structures of tissue factor show that the two fibronectin type III domains are joined at an angle of approximately 120 degrees ( [672](#), [673](#), [674](#), [675](#), [676](#) and [677](#)). There are also two disulfide bonds (Cys<sup>49</sup>-Cys<sup>57</sup> and Cys<sup>186</sup>-Cys<sup>209</sup>) in the NH<sub>2</sub>-terminal extracellular region ( [678](#)). At least one of the disulfide bonds is required for tissue factor activity. Glycosylation does not appear to play a key role in determining protein function ( [671](#), [679](#), [680](#)). The COOH-terminal cytoplasmic domain is quite short and contains a single cysteine residue (Cys<sup>245</sup>) that is linked to a palmitate or stearate fatty acyl chain via a thioester bond ( [678](#)). The COOH-terminus also contains a serine that may be phosphorylated ( [681](#)). The function of the COOH-terminus and the importance of these two modifications are

not clear, as deletion of this domain has no significant effect on tissue factor procoagulant activity ( [670](#) ).



**Figure 21.9.** Transmembrane cofactors. Tissue factor is composed of an extracellular domain (residues 1 to 219), a transmembrane domain (residues 220 to 242), and a cytoplasmic domain (residues 243 to 263). Two disulfide bonds (S–S) and the sites of the three carbohydrate moieties (CHO) are identified by amino acid residue. One cysteine (C 245) contains a thiol ester linkage to a fatty acid. Tissue factor is the cofactor for factor VIIa in the extrinsic tenase complex and is exposed on the subendothelial surface after injury. Thrombomodulin is an endothelial cell–surface glycoprotein composed of five distinct domains. The domain structures include a lectinlike domain (residues 6 to 149), a domain containing six epidermal growth factor (EGF)–like regions (residues 227 to 462), a small extracellular domain rich in threonine and serine residues (two, S 472 and S 474, have been identified as sites of chondroitin sulfate adducts), a membrane–spanning region (residues 499 to 521), and a cytoplasmic tail (residues 522 to 557). There are nine known glycosylation sites (CHO) on the thrombomodulin molecule. Thrombomodulin functions as the cofactor in the protein Case complex and assists in the generation of activated protein C.

**FUNCTION** The nonenzymatic cofactor tissue factor can bind either factor VII or factor VIIa in a  $\text{Ca}^{2+}$ –dependent manner and form a high–affinity 1:1 complex. Once bound to tissue factor, the zymogen factor VII is rapidly converted to an active enzyme via limited proteolysis ( [682](#) ). The tissue factor–factor VIIa or extrinsic tenase complex activates factor IX and factor X. When tissue factor is exposed or expressed, or both, subsequent to vascular perturbation, low levels of circulating factor VIIa bind to tissue factor, and the extrinsic tenase triggers the procoagulant cascade. Factor VII bound to tissue factor is converted to factor VIIa, augmenting factor IXa and Xa generation. The primary role of the complex is to provide factor IXa and low levels of factor Xa, which serve to promote factor IXa production ( [61](#), [62](#), [63](#) and [64](#) ) and to directly catalyze the conversion of trace amounts of prothrombin to thrombin. In the absence of tissue factor, factor VIIa is relatively inert. Once bound to tissue factor, the catalytic activity of factor VIIa is increased 20– to 100–fold depending on the substrate ( [444](#), [683](#), [684](#) and [685](#) ). Tissue factor alters the active site of factor VIIa, thus functioning as an allosteric activator of the enzyme. Although the cofactor is necessary for enzymatic activity, complex formation between tissue factor and factor VIIa does not share the same requirements for an anionic phospholipid membrane surface as the other procoagulant complexes. The membrane dependency of the extrinsic tenase complex arises from membrane–mediated substrate delivery. Both factors X and IX bind to anionic membrane surfaces for efficient two–dimensional transfer to the extrinsic tenase.

**REGULATION** Tissue factor is regulated through availability. The common accepted source of functional tissue factor is through exposure of the subendothelium on vascular damage. However, there is controversy regarding the source and presentation of active tissue factor and whether functional tissue factor circulates in blood ( [686](#), [687](#), [688](#), [689](#) and [690](#) ). Once the tissue factor–factor VIIa complex is formed in the vicinity of an injury, the extrinsic tenase activity is then modulated by TFPI and antithrombin–III reduction of enzymatic activity.

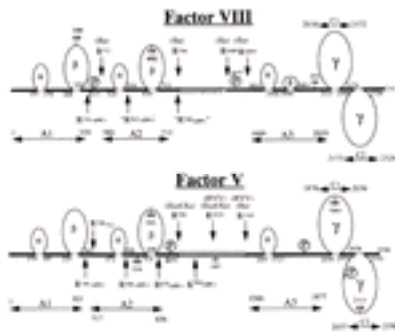
## Factor VIII (Antihemophilic Factor, Factor VIII:Antigen, Factor VIII:Coagulant)

*Factor VIII*, or *antihemophilic factor*, is a nonenzymatic procofactor that circulates in plasma in complex with the large multi-meric protein vWF. Initially, factor VIII and vWF were thought to be a single entity, and early reports on factor VIII were actually measuring facets of vWF structure and function. The factor VIII protein is designated as *factor VIII:Ag* (antigen; VIII:Ag is vWF), and its procoagulant function is designated *factor VIII:C* (coagulant) (691). Factor VIII circulates at an average concentration of 0.2 µg/ml (0.7 nmol/L) (Table 21.1). The ratio of factor VIII to vWF is fairly constant and in the range of 1 molecule of factor VIII to 50 to 100 molecules of vWF monomeric units (692, 693). vWF acts to regulate the plasma concentration of factor VIII. 1-Deamino-8-D-arginine vasopressin administration elicits an increase in the plasma concentration of vWF and, in turn, increases the plasma level of factor VIII (694). vWF also stabilizes factor VIII in plasma. Factor VIII in complex with vWF has a plasma  $t_{1/2}$  of approximately 12 hours, whereas factor VIII alone undergoes rapid clearance and has a  $t_{1/2}$  of approximately 2 hours (695, 696, 697, and 698). Deficiency of factor VIII, or hemophilia A, is a well-characterized X-linked bleeding disorder. Hemophilia A, therefore, occurs almost exclusively in males and occurs at a frequency of 1:5000 to 1:10,000 males. Females with one abnormal factor VIII gene are unaffected carriers. The severity of bleeding in hemophilia A patients is correlated with the level of functional factor VIII in plasma (31, 699). Approximately 50 to 60% of hemophilia A cases are severe with factor VIII coagulant activity less than 1% of normal. Severe hemophilia A is manifested in frequent episodes of spontaneous bleeding into joints, muscles, and internal organs. Factor VIII coagulant activity in the range of 1 to 5% of normal (25 to 30% of patients) results in moderate hemophilia A. In the moderate form, abnormal bleeding is generally linked to any trauma, including minor injury. The remaining patients have 6 to 30% of normal factor VIII activity and exhibit mild hemophilia A. In the mild form, factor VIII deficiency results in bleeding events only subsequent to significant trauma or surgery (700).

**GENE STRUCTURE AND EXPRESSION** The factor VIII gene has been mapped to the long arm of the X chromosome in band q28 (701, 702, 703, 704, and 705). The factor VIII gene is 186 kb in length and contains 25 introns and 26 exons (6, 703, 706). The liver and spleen are thought to be the primary sites of factor VIII biosynthesis (707, 708, 709, 710, 711, 712, and 713), although factor VIII mRNA has been detected in other cell types as well (713).

**BIOCHEMISTRY** Human factor VIII has a relative molecular weight in the range of 280,000 (Table 21.1). The heterogeneity in molecular weight is due to proteolysis of the protein in circulation or processing, or both. It is a glycoprotein of 2351 amino acids that is synthesized as a precursor molecule with a 19-amino acid signal peptide (6, 714). The sequence of factor VIII is highly homologous to factor V (715). The procofactors factor VIII and factor V are organized into discreet structural domains. The NH<sub>2</sub>-terminal heavy chains of both proteins contain the A1 and A2 domains (Fig. 21.10). The COOH-terminal light chains contain the A3, C1, and C2 domains. The heavy and light chains are separated by the B domain. The three A domains of factor VIII are homologous to each other and to the A domains of factor V and ceruloplasmin (714, 715, and 716). The C domains of factor VIII share similar intra- and interprotein homology. The C domains of factor VIII are homologous to each other and to the C domains of factor V. The C domains are also homologous to milk fat globule protein and the A-, C-, and D-chains of discoidin 1 (717, 718). The B domain of factor VIII is not homologous to the factor V B domain, nor do the B domains of either protein share homology with any known proteins.





**Figure 21.10.** Soluble cofactor domain structures (factor VIII and factor V). The disulfide loop structures of factor VIII and factor V defining the  $\alpha$ ,  $\beta$ , and  $\gamma$  loops are illustrated as bubbles.  $\alpha$ -Thrombin (IIa), activated protein C (APC), factor Xa, and Russell viper venom (RVV) cleavage sites are shown with vertical arrows. The linear domain structures (A1–A2–A3–C1–C2) are illustrated with horizontal arrows bracketed by the beginning and ending amino acid number. The B regions (factor V, residues 710 to 1545; factor VIII, residues 741 to 1649) are represented by the crosshatched regions. Phosphorylation sites are illustrated by a P inscribed in a circle and the phosphoamino acid, serine (S) or threonine (T), illustrated above or below it. Free cysteine thiols are represented by SH and identified by residue number.

The factor VIII molecule is secreted as a two-chain heterodimer as a result of intracellular proteolysis at the B–A3 junction (Arg<sup>1649</sup>). Additional cleavages within the B-chain yield A1–A2–B fragments that are variable in length (719, 720 and 721). The B domain (residues 741 to 1649) contains 18 of the 25 potential N-linked glycosylation sites in factor VIII and is highly glycosylated. The murine factor VIII B-chain is also heavily glycosylated, suggesting that glycosylation of the B-chain may be important for protein expression or function, or both (722). The B domains of factor VIII and factor V are excised during activation of the proteins to generate the cofactor molecules factor VIIIa and factor Va. Factor VIII shares homology with the copper ion (Cu<sup>+1</sup>)-binding protein ceruloplasmin and contains a Cu<sup>+1</sup>-binding site in the A1 domain (723, 724). This site is important for protein function. A similar Cu<sup>+1</sup>-binding site in the A3 domain does not appear to play a role in protein function. Factor VIII also contains binding sites for vWF, anionic phospholipids, factor IXa, and, potentially, factor X. Factor VIII interaction with vWF requires the NH<sub>2</sub>- and COOH-termini of the factor VIII light chain (A3, C1, and C2 domains), although a specific vWF-binding site has been identified between residues 1673 to 1684 on the light chain (692, 725, 726 and 727). The vWF-binding site is removed from the factor VIII protein by  $\alpha$ -thrombin cleavage at Arg<sup>1689</sup>. A phospholipid binding domain is located on the factor VIII C2 domain between residues 2303 to 2332 (728). High-affinity factor IXa binding is mediated by the light chain of the factor VIII molecule. The A3 domain contains a high-affinity site for factor IXa localized between residues Glu<sup>1811</sup> to Lys<sup>1818</sup> (729, 730). Residues 552 to 565 in the A2 domain of the factor VIII heavy chain may also play a role in factor VIII interaction with factor IXa (731, 732, 733 and 734). Mutations within this region have been documented in the hemophilia A mutation database (735). Specifically, Ser558Phe, Val559Ala, Asp560Ala, and Gln565Arg have been described as CRM+ with defective activity resulting in mild hemophilia A. These residues have been shown to be essential for the catalytic efficiency of the factor VIIIa–factor IXa complex while not affecting the binding affinity between the two species (736). A model of factor VIII based on the x-ray crystal structure of ceruloplasmin has been used to examine structure/function relationships in the factor VIII molecule (546, 737). Based on homology between factor VIII and ceruloplasmin, the factor IXa binding sites in the A2 and A3 domains are likely located in close proximity on the same side of the factor VIII molecule. A factor X binding site may exist on the COOH-terminus of the factor VIII A1

domain ( [738](#), [739](#) ). Factor VIII also contains several tyrosine residues modified by addition of sulfate ( [740](#) ). The tyrosine sulfate residues enhance  $\alpha$ -thrombin cleavage of the procofactor ( [741](#) ). In addition, factor VIII contains biantennary complex-type sugar chains with blood group A or H, or both, determinants ( [742](#) ).

**FUNCTION** The procofactor factor VIII is activated by  $\alpha$ -thrombin to generate the cofactor factor VIIIa. Activation by  $\alpha$ -thrombin involves cleavages at Arg<sup>372</sup> (the A1–A2 junction), Arg<sup>740</sup> (the A2–B junction), and Arg<sup>1689</sup> in the light chain ( [Fig. 21.10](#) ). The resulting molecule contains three separate polypeptide chains: a light-chain region (A3–C1–C2) bound to the NH<sub>2</sub> region of the heavy chain (A1) in a Ca<sup>2+</sup>-dependent manner and the noncovalently associated A2 region of the heavy chain. Once formed, the cofactor factor VIIIa binds its serine protease enzyme factor IXa to form the Ca<sup>2+</sup>- and membrane-dependent complex, the intrinsic tenase ( [Fig. 21.4](#) ). This complex is homologous to the prothrombinase complex. The intrinsic tenase complex catalyzes factor X conversion to factor Xa at a rate several orders of magnitude greater than the enzyme factor IXa alone ( [743](#) ). Factor Xa generated via the intrinsic tenase complex (factor IXa–factor VIIIa–Ca<sup>2+</sup>-membrane) yields the propagation phase of thrombin generation by raising the factor Xa concentration approximately 100-fold over that achieved by the extrinsic tenase complex ( [Fig. 21.7B](#) ) ( [524](#) ). Without formation of the intrinsic complex, as occurs in a situation like that of hemophilia A or B, factor Xa is not generated in levels sufficient to produce the propagation phase of thrombin generation ( [Fig. 21.7A](#) ) ( [418](#), [525](#), [526](#) ). Like the prothrombinase complex, the cofactor (factor VIIIa) interaction with the enzyme (factor IXa) in the presence of divalent cations and an anionic phospholipid surface is a high-affinity interaction with a K<sub>d</sub> of 2 nmol/L. The interaction of factor IXa with phospholipid in the absence of its cofactor is of approximately 100-fold lower affinity ( [744](#), [745](#) ).

**REGULATION** Factor VIIIa function is primarily regulated by dissociation of a fragment (residues 373 to 740) containing the A2 subunit from the heterotrimer. Once the A2 subunit is displaced, factor VIIIa loses all cofactor function. Dissociation is spontaneous and occurs rapidly under physiologic conditions. Factor IXa stabilizes factor VIIIa, delaying dissociation of the heterotrimer and prolonging the transient activity of factor VIIIa ( [746](#), [747](#) ). Factor VIIIa is also regulated by limited proteolysis. Factor IXa cleaves the factor VIIIa A1 subunit at Arg<sup>336</sup> and eliminates factor VIIIa function ( [747](#), [748](#) and [749](#) ). In addition to factor IXa, the A1 subunit of factor VIIIa is cleaved by factor Xa and  $\alpha$ -thrombin ( [8](#), [740](#), [747](#), [750](#) ). APC is a key anticoagulant enzyme that likewise cleaves the A1 subunit at Arg<sup>336</sup>. APC also cleaves the factor VIIIa A2 subunit at Arg<sup>562</sup> ( [8](#), [751](#) ). The APC cleavages occur sequentially with the A1 cleavage first and the A2 cleavage second ( [752](#) ). Factor IXa protects factor VIIIa from APC cleavage at Arg<sup>562</sup>; however, protein S blocks the protective effect ( [753](#) ). Although factor VIIIa is proteolytically inactivated by a number of enzymes, spontaneous dissociation is the key regulator of cofactor function.

### Factor V (Labile Factor)

Factor V was first recognized as an unstable plasma component necessary for the generation of  $\alpha$ -thrombin ( [590](#) ). *Factor V* is a large single-chain glycoprotein that circulates in plasma at an average concentration of 6.6  $\mu$ g/ml (20 nmol/L) ( [Table 21.1](#) ). Factor V is also contained in the  $\alpha$ -granules of human platelets, with approximately 18 to 25% of the total factor V present in platelets ( [754](#) ). A recent review by Mann and Kalafatis discusses the identification, role in coagulation, and overall importance of factor V in



hemostasis ( [755](#) ).

*Congenital factor V deficiency*, or *parahemophilia*, is an extremely rare disorder inherited in an autosomal-recessive manner. Patients can exhibit severe bleeding diatheses. Although complete lack of factor V in humans does not appear to be lethal, factor V-deficient mice experience fatal hemorrhage *in utero* ( [756](#) ). Combined deficiencies of factor V and factor VIII have also been observed. Interestingly, combined cofactor deficiencies occur more commonly than factor V deficiency alone ( [757](#) ). Recently, the gene for ERGIC-53, a calcium-dependent lectin that serves as a glycoprotein-sorting receptor between the endoplasmic reticulum and the Golgi complex, has been linked to combined factor V and factor VIII deficiency ( [758](#) ). Mutations in this gene in patients with combined hemophilia have been described. Factor V deficiency becomes even more complex when platelet factor V is taken into consideration. Patients have been identified with normal functional levels of plasma factor V but deficiencies of platelet factor V that result in bleeding disorders ( [759](#), [760](#), [761](#) and [762](#) ). Lack of platelet  $\alpha$ -granules and their contents in storage pool disorders leads to deficiency of platelet factor V ( [760](#), [761](#) ). Factor V<sup>Quebec</sup> is an autosomal-dominant bleeding disorder characterized by mild thrombocytopenia, normal levels of plasma factor V, and degraded platelet factor V with very low activity ( [759](#), [762](#) ). A database on factor V mutation has been compiled by Dr. Hans L. Vos (Hemostasis and Thrombosis Research Center, Leiden University Medical Center, Leiden, The Netherlands; e-mail: [h.l.vos@lumc.nl](mailto:h.l.vos@lumc.nl)) and is available on request.

**GENE STRUCTURE AND EXPRESSION** The human factor V gene is located on chromosome 1 bands q21-q25 ( [763](#) ) ( [Table 21.2](#) ). The gene spans approximately 80 kb and consists of 24 introns and 25 exons. Transcription and processing yield an mRNA species of 6.8 kb. The intron-exon structure of the factor V and factor VIII genes are quite similar, and the genes likely evolved from a common ancestor. The liver appears to be the primary site of factor V biosynthesis ( [715](#), [764](#), [765](#) ). Human megakaryocytes express factor V as well ( [766](#), [767](#) and [768](#) ). Platelet factor V may be derived from circulating plasma factor V ( [769](#), [770](#) ); however, the source of platelet factor V has not been definitively determined ( [771](#) ). Bovine aortic endothelial cells ( [772](#) ) and vascular smooth muscle cells ( [773](#) ) also have been reported to express factor V.

**BIOCHEMISTRY** Human factor V [ $M_r = 330,000$  ( [774](#), [775](#), [776](#) and [777](#) )] is a single-chain glycoprotein of 2196 amino acids derived from a precursor molecule with an amino acid signal peptide ( [Table 21.1](#) and [Fig. 21.10](#) ). Factor V consists of an NH<sub>2</sub>-terminal heavy chain (residues 1 to 709: A1-A2 domains), a central B domain (residues 710 to 1545), and a COOH-terminal light chain (residues 1546 to 2196: A3-C1-C2 domains). The A domains are homologous to those found in FVIII and plasma ceruloplasmin; the C domains are homologous to the slime mold protein discoidin ( [778](#) ). Like factor VIII and ceruloplasmin, factor V is also a copper-binding protein ( [779](#) ). Factor V undergoes extensive posttranslational modification, including phosphorylation, sulfation, glycosylation, and formation of mixed disulfides between its five free cysteine residues and circulating thiols like cysteine and homocysteine ( [780](#) ). Phosphorylation occurs at sites in the heavy chain, B region, and light chain. Phosphorylation at Ser<sup>692</sup> affects the rate of inactivation of factor Va by APC ( [781](#) ). Factor V is sulfated at a number of sites in the heavy chain (Tyr<sup>665</sup>, Tyr<sup>696</sup>, and Tyr<sup>698</sup>), the B region (Tyr<sup>1494</sup>, Tyr<sup>1510</sup>, and Tyr<sup>1515</sup>) and the light chain (Tyr<sup>1565</sup>). The sulfation status of factor V has been related to its function ( [782](#), [783](#) ). Carbohydrate accounts for 13 to 25% of the mass of factor V ( [784](#) ). The heavy chain has nine potential N-linked glycosylation sites. In the B region, 25 asparagine residues are candidates for modification with carbohydrate; carbohydrate accounts for approximately

50% of the mass of the B region. The light chain of factor V has three N-linked glycosylation sites. Differential glycosylation of Asn<sup>2182</sup> in the C2 domain is reported to be responsible for the factor V1 and factor V2 variants observed in plasma. The two variants have slightly different molecular masses and charges (785). Factors Va1 and Va2 are distinguished by functional differences as well. Factor Va1 does not appear to bind to anionic phospholipid as efficiently as factor Va2 and is not as competent a cofactor in the prothrombinase complex as factor Va2 (784, 786, 787 and 788). The presence of an oligosaccharide at Asn<sup>2182</sup> apparently reduces the affinity of factor Va1 for the phospholipid surface and interferes with prothrombinase complex assembly and function. The COOH-terminal fragment of the factor Va light chain (residues 1753 to 2183) that contains the Asn<sup>2182</sup> glycosylation site is one of the two regions that mediate membrane association (789).

**ACTIVATION** The procofactor factor V does not bind factor Xa and is essentially completely inactive (42). Limited proteolysis of the factor V molecule yields the active cofactor factor Va. Factor Va functions as both factor Xa receptor and positive modulator of factor Xa catalytic potential in the prothrombinase complex. Rate enhancements of 300,000-fold derive from the participation of factor Va in the process of factor Xa activation of prothrombin.  $\alpha$ -Thrombin is the primary catalyst of factor V activation *in vivo*.  $\alpha$ -Thrombin cleaves factor V at Arg<sup>709</sup>, Arg<sup>1018</sup>, and Arg<sup>1545</sup> (778) (Fig. 21.10). The  $\alpha$ -thrombin-generated form of factor Va is a heterodimer consisting of an NH<sub>2</sub>-terminal heavy chain [M<sub>r</sub> = 105,000 (A1–A2 domains)] linked noncovalently to a COOH-terminal light chain [M<sub>r</sub> = 73,000 (A3–C1–C2 domains)] (776, 790, 791, 792 and 793). The association of the heavy and light chains of factor Va shows a divalent cation dependence. The B domain is excised during proteolysis (12, 790, 792). Factor Xa cleaves factor V at Arg<sup>709</sup>, Arg<sup>1018</sup>, and Arg<sup>1545</sup>, producing a factor Va molecule similar to the factor Va produced by  $\alpha$ -thrombin cleavage (568, 794). Factor Xa cleavage of factor V is less efficient than  $\alpha$ -thrombin cleavage (568, 794), although factor V released from stimulated platelets is partially activated and is more efficiently cleaved by factor Xa than plasma factor V (795). Other enzymes may also activate or partially activate factor V. Platelet calpain (796), cathepsin G, and human neutrophil elastase (797, 798) partially activate factor V. The fibrinolytic enzyme plasmin both activates and inactivates factor V (799, 800 and 801). Plasmin cleavage and inactivation of factor V are hypothesized to play a role in hemorrhage subsequent to thrombolytic therapy by decreasing the level of factor Va cofactor activity (802).

**FUNCTION** Activation of the procofactor factor V yields the functional form factor Va. Factor Va acts as a cofactor for the serine protease factor Xa in the prothrombinase complex. Factor Va forms at least part of the receptor for factor Xa on platelets and serves to anchor factor Xa to the membrane surface (755). Factor Va stabilizes the prothrombinase complex and enhances prothrombin activation (21, 622).

**FACTOR VA REGULATION AND FACTOR V LEIDEN** Factor Va is regulated by proteolytic inactivation by APC. An anionic membrane surface is required for complete cleavage and full inactivation of the cofactor; in the absence of phospholipid, factor Va cleavage is not complete, and the cofactor retains some activity. Protein S, a suggested cofactor for APC, only functions in the presence of a phospholipid bilayer as well. In the presence of a membrane surface, APC cleaves factor Va sequentially at three sites: Arg<sup>506</sup>, Arg<sup>306</sup>, and Arg<sup>679</sup>. Factor Va is initially cleaved at Arg<sup>506</sup>. Subsequently, the membrane-dependent cleavage at Arg<sup>306</sup> results in complete loss of factor Va cofactor activity. An additional APC-mediated cleavage of factor Va fragments occurs at Arg<sup>679</sup>. Loss of cofactor activity coincides with dissociation of the A2 domain of APC-cleaved factor Va in a process similar to the spontaneous dissociation of factor VIIIa (803, 804). The importance of this regulatory mechanism is demonstrated by the “APC resistance”

syndrome associated with factor V<sup>Leiden</sup> (805). Individuals with factor V<sup>Leiden</sup> have a G to A substitution at nucleotide 1691 in the factor V gene that results in an Arg<sup>506</sup>→Gln mutation at the protein level (806). Factor Va<sup>Leiden</sup> has normal cofactor activity as part of the prothrombinase complex. However, unlike normal factor Va, factor Va<sup>Leiden</sup> is not readily inactivated by APC. The Arg<sup>506</sup>→Gln mutation hinders the first step in the sequential series of inactivating cleavages by APC. Factor Va<sup>Leiden</sup> retains cofactor activity and continues to promote a-thrombin generation for an extended period of time. Inactivation of factor Va<sup>Leiden</sup> by cleavage of the Arg<sup>306</sup> bond occurs eventually but is markedly slower than normal factor Va (807). The prevalence of the factor V<sup>Leiden</sup> mutation is approximately 5% in whites (808). Individuals heterozygous for factor V<sup>Leiden</sup> have a sevenfold greater risk of thrombosis than normal individuals, whereas individuals homozygous for factor V<sup>Leiden</sup> have an 80-fold greater risk of thrombosis (809). The risk of thrombosis in individuals with factor V<sup>Leiden</sup> is also exacerbated by other genetic and acquired risk factors such as protein C or protein S deficiency, or both, and use of oral contraceptives (755). The effects of factor V<sup>Leiden</sup> are of considerable interest, as factor V<sup>Leiden</sup> is the most common prothrombotic risk factor yet identified (810, 811 and 812).

### **von Willebrand Factor (von Willebrand Factor:Antigen, Ristocetin Cofactor, von Willebrand Factor Ristocetin:Cofactor)**

*vWF* is a multifunctional protein with several key roles in coagulation. *vWF* circulates in plasma at an average concentration of 10 µg/ml (813) (Table 21.1) and is also contained in the α-granules of human platelets (814). However, ABO blood type has a significant influence on *vWF* levels, with individuals of types A, B, or AB blood having much higher levels of *vWF* than individuals with type O blood (815, 816). *vWF* is also known for its role in ristocetin-induced platelet aggregation (817, 818), which is the basis of clinical assays. *vWF* was first recognized as the missing or defective factor in a severe autosomal-dominant bleeding disorder (819, 820, 821 and 822). von Willebrand disease is fairly common and is estimated to occur in 1 to 2% of the general population (823, 824, 825 and 826). *vWF* is also an acute phase reactant, and *vWF* levels are elevated as a result of stress, pregnancy, or surgical trauma (827, 828, 829 and 830).

**GENE STRUCTURE AND EXPRESSION** The *vWF* gene is located on chromosome 12 band 12p-12pter and is 178 kb long with 51 introns and 52 exons (831, 832 and 833) (Table 21.2). A pseudogene with approximately 98% homology to the *vWF* gene has been mapped to chromosome 22 (832, 833). *vWF* is expressed only by endothelial cells and megakaryocytes (834, 835 and 836). *vWF* is stored in Weibel-Palade bodies in endothelial cells and in α-granules in platelets (837, 838 and 839). There are several regulatory elements that control *vWF* expression including GATA-binding consensus sequences in the promoter region (840). Endothelial cell-specific expression appears to be regulated by NF1 and Oct-1 binding sites (837, 840, 841, 842 and 843). *vWF* expression is also regulated by complex signaling pathways that are directed by specific cellular environments (841, 844, 845 and 846). In addition, *vWF* plasma levels can be regulated through release of *vWF* from endothelial cell and platelet storage compartments. Platelet activation results in the release of *vWF*, and endothelial cell *vWF* release is induced by histamine and 1-deamino-8-D-arginine vasopressin (847, 848 and 849).

**BIOCHEMISTRY** *vWF* is a large adhesive glycoprotein that circulates in plasma as a heterogeneous mixture of disulfide-linked multimers. *vWF* is synthesized as a pre-pro

molecule containing a 22-amino acid signal peptide, a propeptide of 741 amino acids, and the mature vWF protein of 2050 amino acids ( [850](#), [851](#), [852](#), [853](#), [854](#) and [855](#) ). The pre-pro vWF molecule is comprised of internally repeated A, B, C, and D domains arranged in the sequence D1-D2-D'-D3-A1-A2-A3-D4-B-C1-C2. The A repeats share homology with complement factor B, collagen type IV, chicken cartilage matrix protein, and the I domain of the integrin  $\alpha$ -subunit ( [856](#), [857](#) ). Portions of the C domains are homologous to sequences in procollagen and thrombospondin ( [858](#) ). Pre-pro vWF undergoes extensive posttranslational modification to yield the mature vWF protein lacking the D1 and D2 domains. The large vWF propolypeptide copurifies with factor VIII and vWF and is designated *vWF antigen-I*. The mature vWF monomer has a molecular weight of approximately 255,000 based on protein sequence and carbohydrate content ( [850](#), [851](#), [854](#), [855](#), [859](#) ). The disulfide-linked multimers range in size from dimers ( $M_r = 600,000$ ) to extremely large multimers of 20 million d. vWF has binding sites for factor VIII, heparin, collagen, platelet glycoprotein (gp) Ib, and platelet gpIIb-IIIa ( [860](#), [861](#), [862](#), [863](#), [864](#), [865](#), [866](#), [867](#), [868](#), [869](#), [870](#), [871](#), [872](#), [873](#) and [874](#) ).

**FUNCTION** vWF has multiple functions in hemostasis. vWF stabilizes factor VIII and protects it from inactivation by APC ( [875](#), [876](#) ), thus significantly prolonging factor VIII half-life in circulation ( [695](#), [697](#), [698](#) ). vWF is a structural protein and is part of the subendothelial matrix. vWF also acts as a bridge between platelets and promotes platelet aggregation. The primary platelet binding site for vWF is the gpIb-IX-V receptor complex. gpIb-IX-V is an active receptor on unstimulated platelets and serves to promote platelet aggregation and adhesion to vWF in the absence of platelet activation ( [373](#) ). This is likely a key element in the procoagulant response serving to recruit and localize platelets to the site of damage before the events that induce platelet activation ( [877](#) ). Subsequent platelet activation also induces expression of another receptor complex, gpIIb-IIIa. The gpIIb-IIIa complex recognizes a number of adhesive proteins including vWF. gpIIb-IIIa receptor binding of these adhesive proteins creates a strong network of platelets, other cells, and matrix components. Endothelial cells secrete vWF multimers, which are larger than those found circulating in plasma ( [878](#) ). The function of these large multimeric forms of vWF is to bind to and agglutinate blood platelets under high shear rates. These large multimers of vWF are degraded by a specific metalloprotease called a disintegrin-like and metalloprotease domain with thrombospondin in type I motifs (ADAMTS)-13 ( [879](#) ). In familial and acquired thrombotic thrombocytopenic purpura, ultra-large vWF multimers have been identified and correlated to defective ADAMTS-13 activity ( [880](#), [881](#) ).

## PROCOAGULANT PROTEINS: THROMBIN (FACTOR IIA)

The enzyme  $\alpha$ -thrombin, or factor IIA, is the central enzyme in blood coagulation and plays myriad roles in hemostasis as well as additional roles in tissue repair, development, and pathogenic processes ( [627](#), [882](#), [883](#), [884](#), [885](#) and [886](#) ).  $\alpha$ -Thrombin cleaves fibrinogen to generate the fibrin clot ( [620](#), [887](#), [888](#) and [889](#) ), converts factor XIII to factor XIIIa to cross-link and stabilize the clot ( [14](#), [890](#) ), and, in association with thrombomodulin, activates TAFI, which delays dissolution of the fibrin clot ( [17](#), [891](#) ).  $\alpha$ -Thrombin also acts directly and indirectly to amplify its own production. The procofactors V and VIII are activated by  $\alpha$ -thrombin ( [622](#), [623](#), [715](#), [892](#) ) as are factor XI ( [4](#) ) and, potentially, factor VII ( [5](#) ). In an analysis of a whole blood model of coagulation, a time course of thrombin generation and of the protein products of its catalytic activities illustrates that most procoagulant responses to  $\alpha$ -thrombin occur during the initiation phase before fibrin formation ( [Fig. 21.11](#) ) ( [526](#) ). Less than 0.2% of the final thrombin produced is required to achieve the activation of its primary substrates in blood. After fibrin clot formation, during

the propagation phase, the bulk of thrombin is formed (~95%).

In addition,  $\alpha$ -thrombin's realm extends to cellular effects.  $\alpha$ -Thrombin is the most potent activator of circulating platelets, thus providing the requisite surface for procoagulant activities. The enzyme also acts as a mitogen in a variety of cell types ( [625](#), [626](#), [627](#), [628](#) and [629](#), [893](#), [894](#), [895](#), [896](#) and [897](#) ); induces the release of cytokines ( [898](#), [899](#), [900](#), [901](#) and [902](#) ), vasoactive compounds ( [903](#), [904](#) and [905](#) ), and chemoattractants ( [906](#) ) as part of the response to vascular damage; and stimulates events that initiate tissue repair ( [907](#), [908](#), [909](#), [910](#) and [911](#) ).

$\alpha$ -Thrombin likewise acts to indirectly inhibit its own generation through the protein C anticoagulation pathway, a dynamic inhibitory system.  $\alpha$ -Thrombin forms the protein Case complex with its cofactor thrombomodulin and activates protein C to APC ( [624](#), [912](#) ). APC cleaves factors Va and VIIIa, thus inhibiting prothrombinase and intrinsic tenase function and blocking  $\alpha$ -thrombin formation. The binding of  $\alpha$ -thrombin to thrombomodulin both produces a potent anticoagulant and alters  $\alpha$ -thrombin reactivity. Once bound to thrombomodulin,  $\alpha$ -thrombin no longer recognizes fibrinogen as a substrate and no longer acts in a procoagulant capacity ( [913](#), [914](#) ).

$\alpha$ -Thrombin generation must be tightly regulated to ensure that localized, adequate levels of the enzyme are produced. Markedly decreased levels of  $\alpha$ -thrombin due to hypoprothrombinemia or reduced  $\alpha$ -thrombin activity due to genetic mutation (dysprothrombinemia) are often characterized by bleeding diatheses ( [633](#), [915](#) ). Conversely, elevated levels of  $\alpha$ -thrombin promote the risk of thrombosis. A G?A transition at nucleotide position 20210 (G20210A) in the 3'-untranslated region of the prothrombin gene results in elevated plasma levels of prothrombin ( [601](#) ) and is strongly associated with venous thrombotic events ( [916](#), [917](#), [918](#) and [919](#) ).

## Roles in Coagulation

Most prothrombin activation to  $\alpha$ -thrombin proceeds through the obligate intermediate meizothrombin. Both meizothrombin and  $\alpha$ -thrombin possess catalytic activity and cleave a variety of substrates. Although meizothrombin is a short-lived intermediate in the activation process, it appears to play several important roles in coagulation. Meizothrombin is a potent vasoactive agent and acts on the adrenergic receptor to induce vascular constriction. The vasoactive potency of meizothrombin is five to seven times greater than that of  $\alpha$ -thrombin ( [920](#), [921](#) ). However, the ability of meizothrombin to activate platelets and cleave fibrinogen is greatly reduced compared to that of  $\alpha$ -thrombin ( [617](#), [923](#) ). These are major roles for  $\alpha$ -thrombin in promoting an efficient and effective procoagulant response.  $\alpha$ -Thrombin has long been recognized as the most potent platelet agonist ( [621](#) ).  $\alpha$ -Thrombin induces release of platelet  $\alpha$ -granule contents, including a number of procoagulant and adhesive proteins ( [177](#), [218](#), [754](#), [814](#), [924](#), [925](#), [926](#), [927](#), [928](#), [929](#), [930](#) and [931](#) ), and of adenosine diphosphate from the platelet dense granules.  $\alpha$ -Thrombin also triggers the translocation of anionic phospholipid to the outer leaflet of the platelet membrane.  $\alpha$ -Thrombin thus provides a cross-linked platelet mesh and an anionic surface appropriate for procoagulant complex assembly and function.

In addition,  $\alpha$ -thrombin generates and stabilizes the fibrin clot.  $\alpha$ -Thrombin cleaves the Arg<sup>16</sup>-Gly<sup>17</sup> bond in the A $\alpha$ -chain and the Arg<sup>14</sup>-Gly<sup>15</sup> bond in the B $\beta$ -chain of fibrinogen releasing fibrinopeptide A (FPA) and fibrinopeptide B (FPB), respectively ( [620](#) ). FPA and FPB release allow formation of overlapping fibrin strands ( [887](#), [888](#) and [889](#) ).



$\alpha$ -Thrombin cleavage of the 37-residue NH<sub>2</sub>-terminal activation peptide of factor XIII generates the transglutaminase factor XIIIa ( [14](#), [890](#) ). Factor XIIIa cross-links and stabilizes the fibrin clot by catalyzing the formation of intermolecular  $\gamma$ -glutamyl  $\epsilon$ -lysyl isopeptide bonds between fibrin molecules ( [14](#) ). TAFI, also known as *plasma carboxypeptidase E* or *carboxypeptidase U*, is likewise activated in an  $\alpha$ -thrombin-dependent manner to provide activated TAFI (TAFIa) ( [17](#), [891](#) ). TAFIa has carboxypeptidase B-like activity and is a key link between the coagulation and fibrinolytic cascades. TAFIa prevents premature clot lysis by cleaving COOH-terminal lysine and arginine residues on fibrin, rendering it a less suitable cofactor in t-PA-dependent plasminogen activation ( [932](#) ). At elevated concentrations, TAFIa also directly inhibits plasmin and therefore clot lysis ( [932](#) ). In addition, TAFI is a substrate for factor XIIIa and is cross-linked to fibrin and incorporated into the fibrin clot ( [933](#) ). The  $\alpha$ -thrombin-dependent processes involved in clot formation and stabilization likely occur simultaneously to generate a mature clot that effectively alleviates blood loss ( [934](#) ).

$\alpha$ -Thrombin has other key roles in procoagulant events as well.  $\alpha$ -Thrombin activates factor XI ( [4](#), [566](#) ) and the procofactors factor V, factor VIII ( [622](#), [623](#), [715](#), [892](#) ), and, potentially, factor VII ( [5](#) ). Meizothrombin likewise is an efficient activator of factor XI ( [935](#) ) and possibly factor V ( [936](#) ). Meizothrombin is thought to function to enhance  $\alpha$ -thrombin generation by activating factor XI before its final processing to form  $\alpha$ -thrombin.

### Roles in Anticoagulation

Although  $\alpha$ -thrombin is the central enzyme in the procoagulant response, it is also a key mediator of anticoagulant events as well. When  $\alpha$ -thrombin binds to the cell membrane-associated cofactor thrombomodulin, the reactivity of  $\alpha$ -thrombin is altered.  $\alpha$ -Thrombin bound to thrombomodulin no longer cleaves fibrinogen or acts as a procoagulant enzyme ( [913](#), [914](#) ). Instead, the  $\alpha$ -thrombin-thrombomodulin complex, or protein Case, cleaves protein C to generate the enzyme APC. APC is a potent anticoagulant and inactivates the cofactors factor Va and factor VIIIa ( [913](#), [937](#) ).  $\alpha$ -Thrombin activation of platelets also induces the release of anticoagulant and inhibitory proteins from the  $\alpha$ -granules ( [282](#), [938](#), [939](#) and [940](#) ).

### Roles in Tissue Repair and Regeneration

Tissue repair and regeneration is the final phase of the hemostatic response to injury. Subsequent to lysis of the fibrin clot, multiple cell types choreograph the restructuring of the damaged vasculature. Vascular permeability is increased, and inflammatory cells accumulate at the site of injury. Smooth muscle cells, fibroblasts, and endothelial cells migrate to the site and proliferate. Cellular differentiation, as well as production and remodeling of the extracellular matrix, restores the vascular tissue.  $\alpha$ -Thrombin contributes to these processes through a variety of interactions with different cell types.  $\alpha$ -Thrombin is a potent mitogen ( [625](#), [893](#), [894](#), [895](#) and [896](#), [941](#) ) and stimulates proliferation of smooth muscle cells ( [628](#), [897](#), [941](#) ), macrophages ( [627](#) ), and endothelial cells ( [627](#), [629](#) ). The mitogenic effects of  $\alpha$ -thrombin are due to direct activation of cellular proliferation or  $\alpha$ -thrombin-induced secretion of a variety of growth factors, or both. Platelet activation, an early event in the procoagulant response, results in the release of a plethora of  $\alpha$ -granule proteins that regulate cell growth, vascular permeability, and chemotaxis ( [294](#), [942](#), [943](#), [944](#), [945](#), [946](#), [947](#), [948](#) and [949](#) ).  $\alpha$ -Thrombin thus mediates multiple aspects of the hemostatic response to vascular injury from the formation and stabilization

of the initial fibrin plug to the final stages of tissue repair and regeneration.

## Thrombin Receptors

Many of the effects of  $\alpha$ -thrombin on platelets and cells are elicited through  $\alpha$ -thrombin interaction with receptor molecules in which  $\alpha$ -thrombin binds to a receptor and initiates a signal transduction mechanism. The interaction between  $\alpha$ -thrombin and the human platelet thrombin receptor, protease-activated receptor (PAR)-1, however, is characterized by a more unusual mechanism in which the receptor is also a substrate for  $\alpha$ -thrombin (911, 950, 951). PAR-1 is a 425-amino acid transmembrane protein with a large NH<sub>2</sub>-terminal extracellular domain (911, 951).  $\alpha$ -Thrombin cleaves the extracellular region of the receptor at Arg<sup>41</sup>, producing a “tethered ligand.” The new NH<sub>2</sub>-terminus binds back to and activates the receptor (911, 951). PAR-1 is also found on T lymphocytes, monocytes, and endothelial cells and mediates the  $\alpha$ -thrombin-induced responses of these cells as well.

Two additional  $\alpha$ -thrombin receptors homologous to PAR-1 have also been identified: PAR-3 and PAR-4. PAR-3 is expressed on human platelets and endothelial cells—although at much lower levels than PAR-1 (952). PAR-3 is required for normal  $\alpha$ -thrombin-dependent platelet activation in mice (677), but in the human system, the role of PAR-3 appears to be primarily in cellular development. PAR-3 is expressed at high levels on human megakaryocytes, the precursor cells of platelets (677). PAR-4, however, is believed to act in combination with PAR-1 as a dual mechanism to elicit the multiple effects of  $\alpha$ -thrombin on human platelets.

## Structure/Function Relationships

*In vivo*,  $\alpha$ -thrombin is derived from proteolytic cleavage of prothrombin by the prothrombinase complex (Fig. 21.3 and Fig. 21.8). Cleavage of the Arg<sup>320</sup>-Ile<sup>321</sup> bond in prothrombin yields meizothrombin. Subsequent cleavage of the Arg<sup>271</sup>-Thr<sup>272</sup> bond gives rise to fragment 1.2 and  $\alpha$ -thrombin. Human  $\alpha$ -thrombin cleaves its own NH<sub>2</sub>-terminus at Arg<sup>284</sup>-Thr<sup>285</sup> to generate a stable  $\alpha$ -thrombin molecule. The initial form of human  $\alpha$ -thrombin has an NH<sub>2</sub>-terminal A-chain of 49 residues, whereas the autocatalytically generated stable protein has an A-chain of 36 residues. The COOH-terminal B-chain of  $\alpha$ -thrombin has 259 amino acid residues including the catalytic triad residues His<sup>363</sup>, Asp<sup>419</sup>, and Ser<sup>525</sup>.

$\alpha$ -Thrombin is subject to further degradation resulting in stable, degraded thrombin molecules with reduced reactivity (953, 954 and 955). These degraded forms are designated  $\beta$ - and  $\gamma$ -thrombin. The degradation of  $\alpha$ -thrombin may be autocatalytic or may be due to proteolysis by enzymes other than  $\alpha$ -thrombin. Human  $\beta$ -thrombin is generated by cleavage at Arg<sup>382</sup> and Arg<sup>393</sup>, which deletes a segment of the  $\alpha$ -thrombin B-chain (956, 957). Cleavage of  $\beta$ -thrombin at Arg<sup>443</sup> and Lys<sup>474</sup> deletes an additional segment of the B-chain and results in formation of  $\gamma$ -thrombin.  $\beta$ - and  $\gamma$ -thrombin retain some activity toward small peptide substrates (921, 958), factor XIII (959), antithrombin-III (960), and prothrombin (961). However, both  $\beta$ - and  $\gamma$ -thrombin have no significant ability to cleave fibrinogen or protein C (585, 960, 962, 963). These proteolyzed forms of  $\alpha$ -thrombin have been identified as products of the blood clotting reaction *in vivo* (964), but their



mechanism of production and function is unknown.

The stable form of human  $\alpha$ -thrombin possesses at least five distinct binding sites for substrates, inhibitors, cofactors, apolar molecules, and sodium ions ( $\text{Na}^{+1}$ ). The apolar binding site is located near the catalytic center of  $\alpha$ -thrombin (965). The  $\text{Na}^{+1}$  binding site is in the B-chain in a cavity formed by three antiparallel  $\beta$  sheets and appears to play a role in determining whether  $\alpha$ -thrombin acts as a procoagulant or an anticoagulant. In the presence of  $\text{Na}^{+1}$ ,  $\alpha$ -thrombin recognizes fibrinogen as a substrate and acts as a procoagulant. In the absence of  $\text{Na}^{+1}$ ,  $\alpha$ -thrombin has increased specificity for protein C and functions in an anticoagulant capacity (966, 967). The binding of  $\text{Na}^{+1}$  therefore appears to mediate the dual nature of  $\alpha$ -thrombin as both a procoagulant and an anticoagulant.

Exosite I, the fibrinogen binding site, is an anion-binding, electropositive site distinct from, but acting in concert with, the active site of the  $\alpha$ -thrombin molecule (967). In addition to fibrinogen, exosite I also recognizes the COOH-terminal domain of hirudin, the hirudinlike region of PAR-1, and the fifth and sixth EGF-like domains of thrombomodulin (967). Detailed information about exosite I is available from the x-ray crystal structure of the  $\alpha$ -thrombin-hirudin complex. In solution, the COOH-terminal domain of hirudin is disordered (968, 969). However, in the  $\alpha$ -thrombin-hirudin complex, the COOH-terminus of hirudin inserts into the large groove in the  $\alpha$ -thrombin molecule to interact with exosite I. Hirudin also inserts into the active site of  $\alpha$ -thrombin (970, 971 and 972). The high-affinity interaction ( $K_d = 2 \times 10^{-14}$  mol/L) between  $\alpha$ -thrombin and the inhibitor hirudin is thus stabilized by electrostatic, polar, and hydrophobic interactions (970, 973).

Exosite II is a second electropositive, anion-binding site located on the opposite side of the  $\alpha$ -thrombin molecule compared to exosite I. Exosite II recognizes the COOH-terminal region of the B-chain of thrombin and sulfated polysaccharides such as heparin and the chondroitin sulfate moiety of thrombomodulin (967).

The active site of  $\alpha$ -thrombin is responsible for mediating interactions with substrate molecules including fibrinogen, protein C, and antithrombin-III (967). The active site of  $\alpha$ -thrombin is similar to the active sites of trypsin and chymotrypsin. However, unlike the relatively nonspecific pancreatic enzymes,  $\alpha$ -thrombin also has secondary binding sites, exosites I and II, that confer specificity to  $\alpha$ -thrombin. For substrates such as fibrinogen, there may be multiple secondary binding sites (974).

## Regulation

$\alpha$ -Thrombin regulates its own production through complex formation with thrombomodulin and activation of protein C (Fig. 21.6).  $\alpha$ -Thrombin enzymatic activity is mediated mainly by antithrombin-III. The inhibitory activity of antithrombin-III is potentiated *in vivo* by cell-expressed heparan sulfate GAGs or by pharmaceutical heparins (634, 635). Antithrombin-III inhibits  $\alpha$ -thrombin through formation of a covalent complex with the active site of  $\alpha$ -thrombin (975).  $\alpha$ -Thrombin-antithrombin-III (TAT) complexes are rapidly cleared from the circulation by the liver (976).

$\alpha$ -Thrombin is also inhibited by  $\alpha_2$ -macroglobulin, a broad specificity proteinase inhibitor.  $\alpha_2$ -Macroglobulin does not appear to be a primary inhibitor of  $\alpha$ -thrombin but rather functions as a secondary inhibitor (921). Unlike antithrombin-III, a  $\alpha_2$ -macroglobulin does

not complex with the active site of its target enzymes. Enzymes in complex with a  $\alpha_2$ -macroglobulin retain the ability to cleave small peptidyl substrates although they are unable to cleave large substrates (977).  $\alpha$ -Thrombin interaction with a  $\alpha_2$ -macroglobulin involves limited proteolysis of a  $\alpha_2$ -macroglobulin. Subsequent to cleavage, a  $\alpha_2$ -macroglobulin undergoes a conformation change that traps the enzyme inside the  $\alpha_2$ -macroglobulin molecule (978, 979). The  $\alpha_2$ -macroglobulin-enzyme complexes are rapidly cleared from circulation (980, 981).

## ANTICOAGULANT PROTEINS: DYNAMIC INHIBITORY SYSTEM

The protein C pathway provides a dynamic inhibitory system to regulate  $\alpha$ -thrombin production. The activity of this anticoagulant pathway is directly dependent on the level of  $\alpha$ -thrombin production. The protein C activating complex, or protein Case, is a membrane-dependent multiprotein complex similar to the membrane-dependent procoagulant complexes (Fig. 21.4 and Fig. 21.6). The key proteins in the protein C pathway are  $\alpha$ -thrombin, thrombomodulin, protein C, and protein S.

### Protein C

*Protein C*, first identified as a thrombin inhibitory activity or autoproteolytic activity of prothrombin II-A (982), is the zymogen form of the enzyme APC. Protein C circulates at a concentration of 4  $\mu\text{g/ml}$  (65 nmol/L) with a  $t_{1/2}$  of 8 to 10 hours (983, 984 and 985) (Table 21.4). The  $t_{1/2}$  of protein C is markedly shorter than most other members of the vitamin K-dependent protein family and is the likely basis of the transient hypercoagulable state subsequent to administration of coumarin-based anticoagulants (986, 987, 988, 989 and 990). Homozygous protein C deficiency is associated with severe thrombotic tendencies and can result in fatal neonatal thrombotic events (991). Heterozygous protein C deficiency is associated with increased risk of thrombosis (992, 993 and 994). The mutation in factor V<sup>Leiden</sup>, which blocks a key APC cleavage site in factor Va<sup>Leiden</sup>, is another defect leading to an alteration in the protein C anticoagulant pathway and predisposition to thrombosis.

**GENE STRUCTURE AND EXPRESSION** The protein C gene is located on chromosome 2 bands q14-q21 and spans 11 kb with eight introns and nine exons (491, 995, 996) (Table 21.5). The promoter region contains HNF-1, HNF-3, and Sp1 binding sites that promote gene expression (997, 998). HNF-3 is a liver-specific transcription factor.

**TABLE 21.5. Molecular Genetics of Human Anticoagulant Proteins and Their Inhibitors**

| Protein                         | Molecular Weight (d) | Gene Location: Chromosome | Gene Size (kb) | Gene Organization: Number of Exons | mRNA Size (kb) |
|---------------------------------|----------------------|---------------------------|----------------|------------------------------------|----------------|
| Protein C                       | 62,000               | 2q14-q21                  | 11             | 9                                  | 1.8 (1.6)      |
| Protein S                       | 69,000               | 3                         | 80             | 15                                 | 3.5            |
| Protein Z                       | 62,000               | 13q34                     | 14             | 9                                  | —              |
| Thrombomodulin                  | 100,000              | 20p-12cen                 | 3.7            | Intronless                         | 3.7            |
| $\alpha_2$ -Macroglobulin       | 735,000              | 12p12.3-p13.3             | 48             | 36                                 | 4.6            |
| Tissue factor pathway inhibitor | 40,000               | 2q31-32.1                 | 85             | 9                                  | 1.4, 4.0       |
| Antithrombin-III                | 58,000               | 1q23-q25                  | 13.5           | 7                                  | 1.4            |
| Heparin cofactor II             | 66,000               | 22q11                     | 14             | 5                                  | 2.3            |

|                                  |                     |      |   |   |
|----------------------------------|---------------------|------|---|---|
| $\alpha_1$ -Proteinase inhibitor | 53,000 14q32.1      | 5    | 7 | — |
| C1 esterase inhibitor            | 104,000 11q11.2–q13 | 17   | 8 | — |
| Protein C inhibitor              | 57,000 14q32.1      | 11.5 | 5 | — |

**BIOCHEMISTRY** Protein C is synthesized in the liver as a single-chain polypeptide with a pre-pro sequence of 42 amino acids. The pre-pro protein is subsequently processed to remove the leader sequence and the dipeptide Lys<sup>156</sup>–Arg<sup>157</sup>. Thus, in plasma, most protein C circulates as a heterodimer consisting of a disulfide-linked (Cys<sup>141</sup>–Cys<sup>277</sup>) heavy and light chain (999, 1000, 1001, 1002, 1003 and 1004). However, approximately 5 to 10% of circulating protein C is the single-chain form (338). The two-chain form of human protein C ( $M_r = 62,000$ ) is a 419-amino acid glycoprotein with approximately 23% carbohydrate (Table 21.4 and Fig. 21.3B). The NH<sub>2</sub>-terminal light chain (residues 1 to 155;  $M_r = 21,000$ ) contains the Gla domain (residues 6 to 29; nine Gla residues) and a hydrophobic region that connects the Gla domain to two EGF domains (residues 55 to 90 and 94 to 134). The COOH-terminal heavy chain (residues 158 to 419;  $M_r = 41,000$ ) contains the serine protease domain. Residues 158 to 169 constitute the activation peptide domain. A  $\beta$ -hydroxy aspartate residue (Asp<sup>71</sup>) in the first EGF domain is required for Ca<sup>2+</sup>-dependent alterations in protein C. Ca<sup>2+</sup> binding is mediated by the first EGF domain as well as the Gla domain and the serine protease domain (332, 371, 375, 1006, 1007, 1008, 1009, 1010 and 1011). Leu<sup>5</sup> in the NH<sub>2</sub>-terminus is important in mediating phospholipid binding (373). There are several glycosylation variants (Asn<sup>97</sup>, Asn<sup>248</sup>, Asn<sup>313</sup>, and Asn<sup>329</sup>) with two to four N-linked carbohydrate chains (338). The major forms,  $\alpha$ -protein C and  $\beta$ -protein C, have four and three carbohydrate moieties, respectively. All the protein C carbohydrate variants can be activated but appear to have different anticoagulant properties and rates of activation (339).

**ACTIVATION** Protein C is the zymogen form of the enzyme APC. Protein C is cleaved at the Arg<sup>169</sup>–Leu<sup>170</sup> bond, releasing its activation peptide from the heavy chain to generate the active enzyme (1012, 1013). The  $\alpha$ -thrombin–thrombomodulin complex is likely the major physiologic activator of protein C (1014). There are other activators as well. Plasmin activates and then inactivates protein C (987, 1015). Meizothrombin also binds thrombomodulin and can efficiently activate protein C (617, 1016). Factor Xa has likewise been reported to bind to thrombomodulin and activate protein C (1017); however, this mechanism has not been confirmed in subsequent studies (1018, 1019). Copperhead snake venom also contains a protein C activator (1020).

**FUNCTION** APC is a serine protease with key anticoagulant functions. The most important anticoagulant role for the protein C, or dynamic inhibitory, pathway is the proteolytic inactivation of factor Va. APC inactivates factor Va via a series of proteolytic cleavages, thus inhibiting the generation of  $\alpha$ -thrombin. APC also cleaves and inactivates factor VIIIa, although the spontaneous dissociation of the factor VIIIa A2 domain is the probable physiologic regulator of factor Xa generation. Full inactivation of factor Va by APC requires an anionic phospholipid surface, and the rates of APC inactivation of factors Va and VIIIa are enhanced by protein S. APC also has a profibrinolytic effect. This effect is due to TAFI. TAFI is activated by the  $\alpha$ -thrombin–thrombomodulin complex and acts to prolong clot lysis. APC cleavage of factor Va inhibits  $\alpha$ -thrombin generation, thus reducing  $\alpha$ -thrombin–thrombomodulin-mediated TAFI activation (1021). The prolongation of clot lysis by TAFIa likely contributes to the prothrombotic tendencies associated with factor V Leiden (1022). The endothelial cell protein C receptor provides cell-specific

binding sites for both protein C and APC ( [1023](#), [1024](#) ). Endothelial cell protein C receptor is down-regulated by TNF- $\alpha$  ( [1023](#) ). Monocytes appear to express specific binding sites for APC that are distinct from endothelial cell protein C receptor ( [1025](#), [1026](#) ). The cell-expressed binding sites may be important in the antiinflammatory properties of APC. APC blocks the septic shock response in animal models ( [1027](#), [1028](#) ) and reduces the levels of inflammatory cytokines such as TNF- $\alpha$  ( [1028](#), [1029](#) ). The antiinflammatory properties of APC are also due to inhibition of  $\alpha$ -thrombin generation and, therefore, inhibition of the proinflammatory properties of  $\alpha$ -thrombin.

**REGULATION** Protein C activation and APC activity are controlled on several levels. Inflammatory agents such as endotoxin, IL-1 $\beta$ , transforming growth factor- $\beta$  (TGF- $\beta$ ), and TNF- $\alpha$  regulate protein C activation on endothelial cells ( [1030](#), [1031](#), [1032](#), [1033](#), [1034](#), [1035](#), [1036](#), [1037](#), [1038](#) and [1039](#) ). TNF- $\alpha$  is responsible for down-regulation of thrombomodulin on the endothelial cell surface ( [1033](#), [1036](#), [1037](#), [1038](#) and [1039](#) ). There are multiple other factors that down-regulate thrombomodulin as well. APC activity is regulated mainly by the protein C inhibitor or PAI-3 ( [1040](#), [1041](#) and [1042](#) ).

## Protein S

*Protein S* is a vitamin K-dependent protein that is not a serine protease precursor. Protein S circulates at a plasma concentration at 20  $\mu\text{g}/\text{ml}$  (300 nmol/L) ( [1043](#), [1044](#) ) ( [Table 21.4](#) ). Approximately 40% of protein S circulates in the free form, and the remaining 60% circulates as a 1:1 complex with C4b-binding protein (C4bBP), a regulatory protein of the complement system ( [1043](#) ). Protein S is thought to function as a cofactor for APC in the inactivation of factors Va and VIIIa ( [175](#), [1045](#), [1046](#), [1047](#), [1048](#), [1049](#) and [1050](#) ). The protein S cofactor effect is minimal, however, and does not correlate with the thrombotic pathologies manifested in protein S-deficient patients ( [1051](#), [1052](#), [1053](#), [1054](#), [1055](#), [1056](#) and [1057](#) ). Protein S has also been reported to inhibit prothrombin activation through several mechanisms ( [636](#), [1058](#), [1059](#) and [1060](#) ). Although the precise function of protein S is not clear, protein S is important in anticoagulation.

**GENE STRUCTURE AND EXPRESSION** The gene for protein S is located on chromosome 3 and spans at least 80 kb ( [1061](#), [1062](#) ) ( [Table 21.5](#) ). The gene contains 15 exons and 14 introns ( [1063](#), [1064](#) and [1065](#) ). A second copy of the protein S gene has also been identified; however, this second gene is likely a pseudogene ( [1066](#), [1067](#) ). The pseudogene spans approximately 55 kb and differs from the protein S gene in that it lacks exon 1 and has multiple nucleotide substitutions. Protein S is synthesized in the liver ( [1068](#), [1069](#) ) and by a variety of other cell types including endothelial cells ( [1070](#), [1071](#) and [1072](#) ), osteoclasts ( [1073](#) ), and lymphoid cells ( [1074](#) ). Protein S is also found in the  $\alpha$ -granules of platelets ( [939](#) ).

**BIOCHEMISTRY** Protein S ( $M_r = 69,000$ ) is a single-chain glycoprotein with approximately 8% carbohydrate and 11 Gla residues ( [537](#), [1075](#) ) ( [Table 21.4](#) and [Fig. 21.3B](#) ). Protein S is synthesized with a signal sequence and propeptide region of 41 amino acids ( [1063](#), [1065](#), [1069](#), [1076](#) ). The mature form of the protein has 635 amino acids and is organized into eight domains: an NH<sub>2</sub>-terminal Gla domain (residues 1 to 45), an aromatic stack, a 29-residue thrombin-sensitive domain (residues 46 to 75), four EGF domains (residues 76 to 242), and a COOH-terminal domain homologous to the sex hormone-binding globulin and androgen-binding protein ( [1077](#), [1078](#) ). The Gla domain and EGF domains mediate Ca<sup>2+</sup> binding ( [1079](#) ). The Gla domain is also involved in interactions with phospholipid membranes ( [1080](#) ). C4bBP binds to the COOH-terminal sex hormone-binding globulin

domain ( [1081](#), [1082](#) ). Protein S reversibly self-associates in the absence of  $\text{Ca}^{2+}$  ( [1083](#) ). **FUNCTION** The precise function of protein S in the protein C inhibitory pathway is not clearly defined. Protein S enhances APC inactivation of factors Va and VIIIa in a phospholipid-dependent fashion ( [175](#), [1045](#), [1046](#), [1047](#), [1048](#), [1049](#) and [1050](#) ). The interaction between protein S and APC alters the structure of APC and moves the APC active site closer to the membrane surface ( [1084](#) ). Protein S may also serve directly in an anticoagulant capacity. Protein S has been reported to bind to factor Xa ( [1059](#) ), factor VIII ( [1085](#) ), and factor Va ( [1058](#) ) and compete for prothrombinase binding sites on the membrane surface ( [636](#), [1060](#) ). These interactions serve to inhibit prothrombin activation *in vitro* ( [1086](#) ). The C4bBP-protein S complex may inhibit factor X activation as well ( [1087](#) ). Protein S also has additional potential roles outside of anticoagulation. Protein S interaction with T cells promotes T-cell aggregation and proliferation and may serve to regulate inflammatory processes ( [1088](#) ).

**REGULATION**  $\alpha$ -Thrombin cleavage of protein S at Arg<sup>49</sup>, Arg<sup>60</sup>, or Arg<sup>70</sup> in the thrombin-sensitive domain inhibits the ability of protein S to act as a cofactor for APC ( [1049](#), [1089](#), [1090](#) and [1091](#) ). Protein S activity is also regulated by interaction with C4bBP. The 1:1 complex between protein S and C4bBP neutralizes the anticoagulant capacity of protein S. Approximately 60% of plasma protein S circulates bound to C4bBP.

## Protein Z

*Protein Z*, a vitamin K-dependent glycoprotein, is an enzymatically inactive homolog of factors VII, IX, and X and protein C ( [341](#) ). Protein Z was first identified in bovine plasma by Prowse and Esnouf in 1977 ( [1092](#) ) and later in human plasma by Broze and Miletich in 1984 ( [1093](#) ). The name *protein Z* came about from its being the last of the vitamin K-dependent proteins to elute during anion exchange chromatography ( [1094](#) ). Protein Z circulates in plasma in a complex with protein Z-dependent protease inhibitor (ZPI). This inhibitor, ZPI, has been identified as a 72-kd member of the serpin superfamily that contains a tyrosine at its reactive center.

Reports suggest that protein Z behaves as a negative acute phase reactant ( [1095](#), [1096](#) ). Protein Z levels have been found to be low in newborn infants ( [1097](#), [1098](#) ) and in individuals with DIC ( [1099](#) ), liver disease ( [1100](#) ), and amyloidosis ( [1101](#) ). High plasma levels have been found in individuals on chronic hemodialysis and with idiopathic thrombocytopenic purpura ( [1102](#), [1103](#) ). Protein Z levels also appear to be more susceptible to warfarin therapy, drastically lowering its levels to less than 1% over other vitamin K-dependent proteins ( [1104](#) ).

**GENE STRUCTURE AND EXPRESSION** The gene for protein Z is located on chromosome 13 at band q34 ( [Table 21.5](#) ). It spans approximately 14 kb and consists of nine exons, including one alternative exon ( [341](#) ). The gene organization was similar to that of the other vitamin K-dependent proteins, factors VII, IX, and X, and protein C. Homozygous and heterozygous protein Z-deficient mice showed no abnormalities in growth and development. Protein Z deficiency has been reported to be prothrombotic in nature in factor V<sup>Leiden</sup> mice ( [1105](#) ). Protein Z-deficient mice crossed with factor V<sup>Leiden</sup> mice did not have viable progeny. Several clinical studies identified diminished levels of plasma protein Z in patients with unidentified bleeding disorders ( [1106](#), [1107](#) ). Protein Z has also been identified in liver disease ( [1100](#) ) and atherosclerosis ( [1108](#) ).

**BIOCHEMISTRY** Protein Z has a molecular weight of 62,000 and circulates in plasma at a mean concentration of 2.9 plus or minus 1.0  $\mu\text{g/ml}$  ( [1093](#), [1104](#) ) ( [Table 21.4](#) ). The plasma t



$1/2$  of protein Z is 2.5 days ( [1104](#) ). Structurally, protein Z is similar to factors VII, IX, and X and protein C containing a Gla domain (13 residues) and two EGF domains at its NH<sub>2</sub>-terminus ( [341](#), [1109](#), [1110](#) ) ( [Fig. 21.3B](#) ). However, like protein S, protein Z does not function as a protease. The COOH-terminus contains a region homologous to the catalytic domains present in the serine protease zymogens. The catalytic triad is not present in protein Z, except for the conserved Asp residue ( [1109](#), [1110](#) ).

**FUNCTION** Protein Z is a vitamin K-dependent protein that does not function as a serine protease enzyme. Protein Z circulates in plasma in complex with the serpin protein Z-dependent protease inhibitor (ZPI). The function of protein Z *in vivo* is still unclear to date. It has recently been reported *in vitro* that protein Z inactivates factor Xa by forming a Ca<sup>2+</sup>-dependent complex with factor Xa bound to phospholipid with the help of ZPI ( [1111](#) ). The significance of this protein Z/ZPI activity is unclear. *In vitro*, protein Z has also been shown to have a weak interaction ( $K_d = 8.9 \mu\text{mol/L}$ ) with thrombin that facilitates the binding of thrombin to phospholipid surfaces ( [1112](#) ). It is also consumed, like all other coagulation factors and inhibitors, during the course of DIC.

## Thrombomodulin

*Thrombomodulin* is a type 1 transmembrane protein constitutively expressed on the surface of vascular endothelial cells ( [Fig. 21.9](#) ). Thrombomodulin is a high-affinity receptor for  $\alpha$ -thrombin and acts as a cofactor for the  $\alpha$ -thrombin-dependent activation of protein C and TAFI. Thrombomodulin activity on the surface of endothelial cells is decreased by inflammatory cytokines and may contribute to the hypercoagulation characteristic of inflammatory states. Thrombomodulin is expressed widely during fetal development ( [1114](#) ). Homozygous thrombomodulin-deficient mice die *in utero* before the formation of the cardiovascular system, suggesting a potential role for thrombomodulin in mammalian development ( [1115](#) ).

**GENE STRUCTURE AND EXPRESSION** The human thrombomodulin gene is located on chromosome 20 band p-12cen and spans 3.7 kb ( [1116](#), [1117](#) ) ( [Table 21.5](#) ). The gene is unusual in that it lacks introns ( [1118](#), [1119](#) ). Thrombomodulin expression has been reported in a variety of cell types, including vascular endothelial cells ( [1120](#), [1121](#) ), neutrophils ( [1122](#) ), monocytes ( [1123](#), [1124](#) ), platelets ( [1125](#) ), synovial cells ( [1126](#) ), and squamous epithelial cells ( [1127](#), [1128](#) and [1129](#) ). Vascular expression is limited to endothelial cells. Thrombomodulin activity on the surface of endothelial cells is decreased by homocysteine, lipopolysaccharide, IL-1 $\beta$ , and TNF- $\alpha$  ( [1030](#), [1031](#), [1130](#), [1131](#), [1132](#) and [1133](#) ). Many of these same inflammatory agents that down-regulate thrombomodulin also up-regulate tissue factor, contributing to the hypercoagulation associated with inflammation. Hypoxia also down-regulates thrombomodulin expression ( [1134](#) ). Likewise, thrombomodulin expression is decreased by glucose-modified albumin, which may provide a link to diabetic thrombotic complications ( [1135](#) ). Conversely, dibutyl cyclic adenosine monophosphate, retinoic acid, shear stress, and increased temperature (42° C) up-regulate thrombomodulin activity on endothelial cells ( [1136](#), [1137](#), [1138](#), [1139](#) and [1140](#) ). Up-regulation of thrombomodulin expression by TNF- $\alpha$  may involve a consensus sequence of a cyclic adenosine monophosphate response element in the 3'-untranslated region of the thrombomodulin gene ( [1141](#) ). Increased thrombomodulin gene transcription due to elevated temperature is mediated by consensus sequence recognition sites for a heat shock element in the 5'-promoter region ( [1140](#) ). Up-regulation of thrombomodulin expression in response to elevated temperature may be a protective mechanism to compensate for the procoagulant effects of the inflammatory mechanism.

**BIOCHEMISTRY** Human thrombomodulin is synthesized with an 18-amino acid signal

sequence followed by a 557-residue polypeptide chain of the mature protein ( [1116](#), [1118](#), [1119](#), [1142](#) ). Thrombomodulin has five different domain structures: an NH<sub>2</sub>-terminal domain having weak homology to lectins (residues 6 to 149) such as the asialoglycoprotein receptor ( [1143](#) ), six EGF-like domains (residues 227 to 462), a 34-residue region rich in serine and threonine corresponding to potential O-linked glycosylation sites (residues 463 to 497), a 23-residue hydrophobic transmembrane region (residues 499 to 521), and a COOH-terminal domain (residues 522 to 557) containing several potential phosphorylation sites and one free cysteine residue (Cys<sup>536</sup>) ( [Fig. 21.9](#) ). The fifth and sixth EGF domains support a-thrombin association ( [1144](#) ). The region required for efficient protein C activation extends from the linker region between EGF domains 3 and 4 through EGF-6 ( [1145](#), [1146](#), [1147](#) and [1148](#) ). Ser<sup>472</sup> and Ser<sup>474</sup> in the serine- and threonine-rich region are potential sites for chondroitin sulfate addition ( [1149](#) ). The presence of chondroitin sulfate increases the affinity for a-thrombin more than tenfold ( [1150](#) ), thus increasing the ability of thrombomodulin to block fibrinogen cleavage and platelet activation by a-thrombin ( [1151](#), [1152](#) ). The chondroitin sulfate moiety also enhances inactivation of a-thrombin by antithrombin-III ( [1151](#), [1153](#) ) and modulates the Ca<sup>2+</sup>-dependence of protein C activation ( [1150](#), [1153](#) ). The O-linked sugar domain of thrombomodulin is required for APC generation on cellular surfaces. This domain is extended and rigid and rises approximately perpendicular to the membrane surface. The O-linked sugar domain likely functions to elevate a-thrombin from the membrane surface ( [1154](#) ). The active site of a-thrombin bound to thrombomodulin is located approximately 65 Å from the membrane surface ( [1155](#) ). Although no consensus sequence for internalization via coated pit-mediated endocytosis is found in thrombomodulin, coated and noncoated pit-mediated endocytosis has been observed ( [1156](#) ). Internalization appears to be mediated by the NH<sub>2</sub>-terminal lectinlike domain ( [1157](#) ).

**FUNCTION** Thrombomodulin functions as a cofactor for a-thrombin in the activation of protein C and TAFI. Production of APC by the a-thrombin-thrombomodulin complex is approximately 1000 times faster than by equivalent concentrations of protein C and thrombin. Once bound to thrombomodulin, a-thrombin's procoagulant activities are neutralized. The high-affinity a-thrombin-thrombomodulin interaction is mediated mainly by exosite I on the a-thrombin molecule. Exosite I also binds fibrinogen, and the interaction of a-thrombin with thrombomodulin therefore blocks fibrinogen binding and cleavage. In addition, thrombomodulin induces conformational changes in a-thrombin ( [1158](#), [1159](#), [1160](#), [1161](#), [1162](#) and [1163](#) ). The changes that occur on a-thrombin interaction with thrombomodulin reduce the ability of a-thrombin to generate fibrin, to activate factor V and platelets ( [1164](#), [1165](#) ), while increasing the inactivation of a-thrombin by antithrombin-III ( [1166](#), [1167](#) and [1168](#) ). a-Thrombin-thrombomodulin, or protein Case, functions solely in an anticoagulant and antifibrinolytic capacity.

**REGULATION** There are several potential mechanisms of thrombomodulin regulation on the cell surface. Thrombomodulin expression is down-regulated by endotoxin and inflammatory cytokines ( [1036](#) ). Shear stress, homocysteine, and hypoxia likewise down-regulate thrombomodulin expression ( [1132](#), [1133](#) and [1134](#), [1139](#) ). a-Thrombin may also regulate thrombomodulin activity although the results are somewhat controversial. Thrombomodulin-dependent a-thrombin internalization has been reported ( [1169](#), [1170](#) and [1171](#) ). However, the a-thrombin-thrombomodulin complex appears to be stable under some conditions ( [937](#), [1172](#) ). In addition, thrombomodulin activity can be regulated proteolytically, mainly by neutrophil elastase ( [1173](#), [1174](#) ). Neutrophils decrease thrombomodulin activity via oxidation as well ( [1175](#) ).



## ANTICOAGULANT PROTEINS: PROTEINASE INHIBITORS

*Proteinases*, enzymes that hydrolyze peptide bonds, are found in a wide array of biologic systems, including the blood coagulation process (clot formation and fibrinolysis), digestive system, apoptotic cascades, and the immune system. To keep these systems in balance between activation and inhibition, a complex system of proteinase inhibitors has evolved. In blood, proteinase inhibitors constitute a significant percentage of circulating proteins. In general, proteinases that activate the coagulation and fibrinolytic cascades have highly defined substrate specificities. Coagulation is kept in check through the action of several specific and broad-spectrum proteinase inhibitors. Specific clot formation inhibitors are antithrombin-III and TFPI. Fibrinolysis-specific inhibitors are PAI-1 and a  $\alpha_2$ -antiplasmin. Together, specific and broad-spectrum inhibitors function to localize, limit, and control hemostasis.

### **$\alpha_2$ -Macroglobulin**

$\alpha_2$ -Macroglobulin is a nonspecific proteinase inhibitor that targets a broad spectrum of protease substrates. It is present in human plasma ( $M_r = 735,000$ ) at concentrations ranging from 2 to 4  $\mu\text{mol/L}$  (2 to 3 mg/ml) ( [Table 21.4](#)).  $\alpha_2$ -Macroglobulin can also be found at higher concentrations in extravascular fluids ( [1176](#)). This protease inhibitor can be produced in a variety of cells including hepatocytes, fibroblasts, and macrophages ( [980](#), [1177](#)).  $\alpha_2$ -Macroglobulin is also found in several species including the horseshoe crab ( [1178](#), [1179](#)). There are several recent reviews on a  $\alpha_2$ -macroglobulin ( [1180](#)).

Reduced levels of serum  $\alpha_2$ -macroglobulin in humans have been observed in individuals with chronic obstructive lung disease ( [1181](#)) and cancer metastasis ( [1182](#)). In humans, no absolute deficiency has been reported to date, leading to the suggestion that such a congenital deficiency is incompatible with survival. The inactivation of the mouse  $\alpha_2$ -macroglobulin gene results in viable mice that produce normal-sized litters but are more resistant to endotoxin challenge ( [1183](#)). In a later study, it was suggested that this phenotype in mice functions as a neutralizer of transforming growth factor- $\beta$  and as an inducer of nitric oxide synthesis ( [1184](#)).

**GENE STRUCTURE AND EXPRESSION** The gene encoding human  $\alpha_2$ -macroglobulin spans approximately 48 kb and consists of 36 exons and 35 introns ( [1185](#)) ( [Table 21.5](#)). It is located on chromosome 12p12.3-13.3 ( [1186](#), [1187](#) and [1188](#)). The  $\alpha_2$ -macroglobulin gene is a single copy gene in the human genome.  $\alpha_2$ -Macroglobulin is synthesized in the liver as a pro- $\alpha_2$ -macroglobulin, which contains a 23-residue signal peptide. Three transcription initiation sites, including a TATA box, a TATA-like structure (ATAAA), and a potential HP-1 binding site, have been identified in liver ( [1185](#)).

**BIOCHEMISTRY** Human  $\alpha_2$ -macroglobulin circulates in plasma as a tetramer with four identical single-chain subunits with an individual relative molecular weight of 180,000 and a total relative molecular weight of 735,000 ( [1186](#), [1189](#), [1190](#)). An unusual feature of this protein is that multiple forms may be found in various species and may appear only during acute phase reactions ( [980](#), [1176](#), [1177](#)). A dimeric form termed *pregnancy zone protein* has been found in human plasma at peak levels during the last trimester; therefore, this protein may be found in human plasma composed either of two or four identical subunits ( [1191](#), [1192](#)).  $\alpha_2$ -Macroglobulin has a unique mechanism by which it achieves broad

specificity. The initial step involves the “bait region” of a  $\alpha_2$ -macroglobulin ( 979 ). This region consists of a 25-amino acid sequence that has sequence motifs appropriate for many proteases ( 1193 ). After proteolysis in this bait region, a  $\alpha_2$ -macroglobulin undergoes conformational changes that trap the proteinase inside the molecule ( 979 ). These conformational changes have been referred to as a *slow to fast transition* ( 978 , 979 ). The active site of the substrate proteinase is not found in complex with the inhibitor. Studies have shown that the entrapped proteinase is no longer able to interact with macromolecular substrates, inhibitors, and antibodies but still appears to retain its ability to react with small substrates and inhibitors ( 979 ). These complexes are rapidly cleared from the circulation by the endocytic  $\alpha_2$ -macroglobulin receptor also known as the *low-density lipoprotein receptor-related protein* (LRP). This receptor is found on most mast cells and tissues. The proteinase-inhibitor complex has an approximate  $t_{1/2}$  of 2 to 5 minutes ( 980 ). Another important feature of a  $\alpha_2$ -macroglobulin is the presence of a  $\beta$ -cysteinyl- $\gamma$ -glutamyl thiol ester ( 1194 , 1195 ). Studies have shown that these thiol esters may directly react with small nucleophiles, such as ammonia or methylamine, induce a conformational change, and prevent proteinase binding ( 1196 ). The conformational changes associated with proteolysis of the bait region generate a thiol ester more susceptible to nucleophilic attack, with the result that surface Lys residues of the trapped proteinase can react with it and become covalently linked to a  $\alpha_2$ -macroglobulin. Binding studies *in vitro* have identified specific high-affinity receptors for a  $\alpha_2$ -macroglobulin-proteinase complexes on many cell types, including fibroblasts, macrophages, and hepatocytes ( 981 ).

**FUNCTION** One role for a  $\alpha_2$ -macroglobulin is to inhibit a broad range of proteinases. It is distinctive in its capacity to inhibit members from each of four mechanistic classes of proteinases (serine, cysteine, and aspartic proteinases and metalloproteinases). a  $\alpha_2$ -Macroglobulin functions as a secondary inhibitor to serine proteinases in plasma by inhibiting thrombin, kallikrein, and plasmin ( 1197 , 1198 ). It may also be important in preventing thromboembolic events when there is a congenital deficiency of antithrombin-III or sepsis ( 1199 , 1200 ). a  $\alpha_2$ -Macroglobulin also inhibits various growth factors and cytokines, including TGF- $\beta$  ( 1201 ), IL-1 $\beta$  ( 1202 ), IL-6 ( 1203 ), acidic fibroblast growth factor ( 1204 ), basic fibroblast growth factor ( 1204 ), TNF- $\alpha$  ( 1205 ), and IL-2 ( 1206 ). Polymorphisms identified in a  $\alpha_2$ -macroglobulin have been thought to play a role in Alzheimer disease ( 1207 , 1208 and 1209 ). Overall, the biologic role of a  $\alpha_2$ -macroglobulin *in vivo* is still being elucidated.

### Tissue Factor Pathway Inhibitor

TFPI, formerly called *extrinsic pathway inhibitor* or *lipoprotein-associated coagulation inhibitor*, is a multivalent, Kunitz-type plasma proteinase inhibitor. TFPI modulates tissue factor-dependent coagulation *in vivo* by rapidly inhibiting the extrinsic tenase complex (factor VIIa-tissue factor) as soon as it is formed ( 230 , 231 , 1210 ) ( Fig. 21.6 ). It circulates in plasma at approximately 0.1  $\mu\text{g}/\text{ml}$  ( 1211 ) as a heterogeneous collection of partially proteolyzed forms ( 229 , 1212 , 1213 and 1214 ) ( Table 21.4 ). Ninety percent of circulating TFPI is found associated with lipoproteins, primarily low-density lipoprotein ( 1213 , 1215 , 1216 ). Parenteral TFPI is cleared from the circulation primarily by the liver and has an unusually short  $t_{1/2}$  (minutes) compared to other proteinase inhibitors.

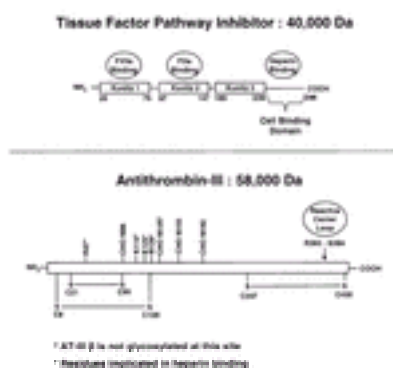
Many reviews of TFPI have been published ( 1217 , 1218 , 1219 , 1220 , 1221 , 1222 and 1223 ). The importance of TFPI in blood coagulation has been best illustrated through transgenic mice

that have a complete deficiency (–/–) of TFPI. This deficiency is incompatible with birth and survival ( [1224](#) ). However, this lethality in mice can be rescued by heterozygous or homozygous factor VII deficiency ( [1225](#) ). This implies that diminishing the level of factor VII lessens the need for TFPI-mediated inhibition of the factor VIIa-tissue factor coagulation pathway during embryogenesis ( [1225](#) ). When mice are generated that have a combined heterozygous TFPI deficiency and homozygous apolipoprotein E deficiency, they exhibit a greater atherosclerotic burden ( [1226](#) ). These observations suggest a role for TFPI in protection from atherosclerosis and as a potential regulator of thrombosis.

To date, there are no known human TFPI-deficient individuals described, which suggests that human embryos with TFPI –/– genotype fail to develop. A role for TFPI in preventing thrombosis and other cardiovascular diseases is currently under intensive clinical and *in vitro* investigation ( [1218](#) ). One application and ongoing clinical trial for recombinant TFPI is in the area of sepsis in which patients frequently have reduced TFPI levels ( [1227](#) ).

**GENE STRUCTURE AND EXPRESSION** The human TFPI gene has been localized to chromosome 2 bands q31–q32.1 ( [1228](#) , [1229](#) , and [1230](#) ) ( [Table 21.5](#) ). It spans 85 kb, over half of which consists of the 5' noncoding region. The coding region is distributed over nine exons ( [1231](#) ); mature TFPI contains three Kunitz domains that are encoded on separate exons. The gene specifies a protein of 304 amino acids; the first 28 residues comprise a signal peptide. Two variants of TFPI (isoforms  $\alpha$  and  $\beta$ ) arising from alternative splicing have been identified; the variable region involves residues 210 to 251 of the primary gene product, spanning a large portion of the third Kunitz domain. TFPI is expressed constitutively by cultured endothelial cells, and its level of synthesis is hardly affected by endotoxin or inflammatory cytokines ( [1214](#) , [1232](#) ). TFPI is not expressed by hepatocytes. TFPI is found bound to low- and high-density lipoproteins located within platelets or noncovalently associated with endothelial cell heparin sulfate proteoglycans ( [1211](#) ). TFPI is catabolized in the liver and kidney by uptake/degradation via the low-density LRP or its homologs ( [1233](#) ).

**BIOCHEMISTRY** TFPI ( $M_r = 40,000$ ) is a single-chain glycoprotein of the Kunitz proteinase inhibitor family ( [1234](#) , [1235](#) ). As isolated, the COOH-terminus of TFPI displays some degradation. Structurally, mature full-length TFPI (276 amino acids in the  $\alpha$  isoform) consists of an acidic NH<sub>2</sub>-terminal region, three tandem Kunitzlike serine protease inhibitor domains (K1 to K3), and a positively charged COOH-terminal region ( [1233](#) , [1234](#) ) ( [Fig. 21.12](#) ). The tandem Kunitz domains are essential for the function of TFPI ( [1211](#) ). The Kunitz 1 inhibitor domain (residues 26 to 76) binds factor VIIa-tissue factor. The second Kunitz domain (residues 97 to 147) of TFPI binds the factor Xa active site. The function of Kunitz 3 (residues 189 to 239) still remains unclear. Heparin binds at two heparin-binding sites: a high-affinity site in the COOH-terminal basic region and a low-affinity site between Gly<sup>212</sup> and Phe<sup>243</sup> in the third Kunitz domain ( [575](#) , [576](#) , [1236](#) ).



**Figure 21.12.** Soluble stoichiometric inhibitors. Tissue factor pathway inhibitor (TFPI) has a molecular weight of 40,000 d and contains three Kunitz domains (the residues are illustrated below each domain). TFPI inhibits the serine proteases factor VIIa (FVIIa) and factor Xa (FXa), shutting down the extrinsic pathway of coagulation. Kunitz 1 domain binds factor VIIa, and Kunitz 2 domain binds factor Xa. The COOH-terminus of TFPI contains a basic region, the cell-binding domain, which binds to heparin. Antithrombin-III (AT-III) has a molecular weight of 58,000 d and contains two intrachain disulfide bonds (-S-S-) in its NH<sub>2</sub>-terminus and one in its COOH-terminus with a carbohydrate-rich domain (CHO) in between. Asn<sup>135</sup> is not glycosylated in the β form of AT-III. The region of interaction between the active sites of target proteases and AT-III is illustrated as a circle (reactive center loop) above the reactive site bond R<sup>393</sup>-S<sup>394</sup>. Heparin binding occurs in the NH<sub>2</sub>-terminus [residues are shown with an asterisk (\*)] and enhances the rate of inhibition of serine proteases.

TFPI contains three potential N-linked glycosylation sites (Asn<sup>117</sup>, Asn<sup>167</sup>, and Asn<sup>228</sup>), with one or more of these oligosaccharides sulfated during expression by cultured endothelial cells ( [1237](#) ). Two O-linked glycosylation sites have also been identified (Ser<sup>202</sup> and Thr<sup>203</sup> ). A significant proportion of TFPI molecules in the blood is truncated to variable extents at the COOH-terminal end (some lacking most of the third Kunitz domain) and has compromised inhibitory activity ( [229](#) ). In contrast, TFPI released by heparin infusion is full-length and more active than the truncated forms ( [1235](#) ). The inhibitory activity of TFPI is enhanced by heparin. The normal plasma concentration of TFPI is 0.1 μg/ml. It is found either associated with lipoproteins, such as low- and high-density lipoproteins or lipoprotein(a), or complexed to endothelial cell heparan sulfate proteoglycans ( [1238](#) ). On heparin administration, TFPI is released from endothelial cells, causing a two- to tenfold increase in circulating TFPI levels ( [1235](#), [1239](#), [1240](#) ). TFPI release on heparin therapy is responsible for the observed elevation in PT and raises the possibility that a portion of the antithrombotic effect of the polysaccharide may be mediated by TFPI. A minor pool of TFPI (~10% of total TFPI in blood) is located within platelets and is released after stimulation by an agonist such as thrombin ( [940](#) ). A large pool of TFPI is rapidly released into the circulation after heparin administration. The qualitative and quantitative properties of TFPI can be altered both by the genotype of an individual and by environmental factors. This is illustrated by *in vitro* experiments in which factor V<sup>Leiden</sup> is combined with reduced levels of TFPI. Factor V<sup>Leiden</sup>, when combined with low normal (50%) TFPI levels, can produce an unregulated propagation phase of thrombin generation in a synthetic plasma system ( [1241](#) ). In a control with normal factor V, the propagation phase of thrombin generation is attenuated substantially at the tissue factor concentrations used in this experiment (i.e., it is near threshold). With factor V<sup>Leiden</sup> and low normal TFPI, the propagation phase of thrombin generation is equivalent to a situation in which the protein C regulatory system is totally dysfunctional. This observation suggests the risk of thrombotic pathology. An *in vivo* parallel to this *in vitro* experiment has been reported by Eitzman et al. ( [1242](#) ), who showed factor V<sup>Leiden</sup> (+, +) mice with reduced but low levels of TFPI (+, -) died of thrombosis.

**FUNCTION** TFPI is the principal stoichiometric inhibitor of the extrinsic pathway (factor VIIa-tissue factor) of coagulation ( [Fig. 21.6](#) ). The extrinsic pathway generates low levels of the serine proteases, factor IXa (~1 pmol/L), and factor Xa (~10 pmol/L) ( [524](#) ). As soon as the proteases are formed, factor Xa can activate prothrombin to generate thrombin, and factor IXa can combine with its cofactor factor VIIIa and form the intrinsic tenase complex to generate more factor Xa. This is followed by the formation of the prothrombinase complex (factor Xa-factor Va), which converts prothrombin to thrombin. The TFPI mechanism allows the factor VIIa-tissue factor complex to initiate factor Xa formation but then suppresses high levels of factor Xa product formation by this complex.

TFPI is the principal regulator of the initiation phase of thrombin generation ( [524](#) ) ( [Fig. 21.11](#) ). The actual mechanism involves a rapid interaction between the second Kunitz domain of TFPI with the factor Xa active site; localization of the complex to the membrane surface is mediated by the Gla domain of factor Xa ( [576](#) , [1243](#) , [1244](#) ). Once surface-bound, the factor Xa-TFPI complex rapidly inactivates tissue factor-factor VIIa. This complex formation depends on the binding of the first Kunitz domain of TFPI to the factor VIIa active site. These interactions together form a stable quaternary complex, tissue factor-factor VIIa-TFPI-factor Xa. Ethylenediaminetetraacetic acid can readily dissociate this inhibited quaternary complex. Inhibition of factor VIIa-tissue factor by TFPI is not completely dependent on the presence of factor Xa because the factor IXa-TFPI complex can also bind to and inhibit factor VIIa-tissue factor. However, the binding affinity of TFPI for factor IXa is significantly less than for factor Xa. The physiologic relevance of this route of inhibition is thus debatable because high plasma concentrations of TFPI are required. At normal plasma concentrations, this multicomponent interaction of TFPI allows basal function of the factor VIIa-tissue factor complex but inhibits it after more extensive activation occurs. When combined with the stoichiometric inhibitor antithrombin-III, a synergistic regulatory effect of blood coagulation occurs by inducing kinetic “thresholds” such that the initiating tissue factor stimulus must achieve a significant magnitude to propel thrombin generation ( [1245](#) ). Tissue factor concentrations below the threshold concentration are ineffective in promoting robust thrombin generation because of the cooperative influence of the inhibitors; concentrations in excess of the threshold yield robust and almost equivalent thrombin generation. In a similar fashion, TFPI and the dynamic protein C-thrombomodulin-thrombin system cooperate to provide a threshold-limited, synergistic inhibition of thrombin production ( [1246](#) ). In this instance, TFPI slows the initiation phase, whereas the APC system reduces the availability of the cofactors factors Va and VIIIa, thereby shutting down the propagation phase of thrombin generation ( [Fig. 21.11](#) ).

**REGULATION** TFPI administered intravenously to rats and mice is cleared rapidly from the circulation by liver hepatocytes, which recognize its COOH-terminal region (third Kunitz domain and basic COOH-terminus) ( [1247](#) , [1248](#) and [1249](#) ). TFPI is cleared by the promiscuous endocytic receptor, low-density LRP. Several lines of evidence suggest that TFPI binding to heparinlike sites on the cell surface may precede its catabolism by LRP. In addition, TFPI appears to be important for factor Xa catabolism. TFPI-factor Xa complexes are cleared by a liver receptor that is distinct from LRP.

## ANTICOAGULANT PROTEINS: SERINE PROTEASE INHIBITOR SUPERFAMILY (SERPIN)

Inhibitory serpins are irreversible covalent suicide protease inhibitors. These inhibitors target serine proteases, a family of proteolytic enzymes sharing common active site architectures and common catalytic mechanisms. Key features of these enzymes include a nucleophilic serine hydroxyl moiety that attacks the carbonyl group of the targeted bond and the formation of a transient acyl-enzyme intermediate between the enzyme and the NH<sub>2</sub>-terminal part of the substrate polypeptide. *In vivo*, when a serpin successfully reacts with a protease, catalysis of serpin proteolysis is arrested at the acyl-enzyme stage, and the serpin-enzyme complex is cleared from the circulation by specific receptor-mediated processes. Members of this multigene inhibitor family include antithrombin-III, heparin cofactor II, a<sub>1</sub>-proteinase inhibitor (also known as a<sub>1</sub>-antitrypsin), C1 esterase inhibitor, protein C inhibitor, PAI-1, a<sub>2</sub>-antiplasmin, and protein Z-dependent protease inhibitor. Plasminogen activator-1 and a<sub>2</sub>-antiplasmin are discussed in detail in the section [Inhibitors of the Fibrinolytic System](#), and protein Z-dependent protease inhibitor is discussed briefly in the section [Protein Z](#). Serpins function in diverse physiologic processes including blood coagulation, fibrinolysis, complement activation, angiogenesis, apoptosis, inflammation, neoplasia, and viral pathogenesis ( [1250](#) ) ( [Table 21.6](#) ). When a member of the serpin family is either deficient



or dysfunctional, several biologic disorders are evidenced, including thrombosis ( [1251](#), [1252](#) ), emphysema ( [1253](#) ), lupus erythematosus ( [1254](#) ), liver disease ( [1255](#) ), and dementia ( [1256](#) ).

**TABLE 21.6. Inhibitors**

| Serpin  | System(s) Regulated | Target Protease(s)  | Deficiency State               |
|---|---------------------|---|--------------------------------|
| Antithrombin-III  | Coagulation         | Thrombin, FXa, FIXa, kallikrein <sup>a</sup> , FXIa, and FVIIa <sup>b</sup> | Thrombosis                     |
| Heparin cofactor II   | Coagulation         | Thrombin  | Thrombosis in some individuals |
| Protein C inhibitor<br>α <sub>1</sub> -Proteinase inhibitor | Coagulation         | APC, kallikrein   | None reported                  |
|   | Inflammation        | Elastase  | Pulmonary emphysema            |
|   | Tissue remodeling   | Cathepsin G   | —                              |
| Plasminogen activator inhibitor-1                           | Coagulation         | APC, FXIa, and FXa  | —                              |
|   | Fibrinolysis        | Tissue-type plasminogen activator, urokinase-type plasminogen activator     | Bleeding                       |
| α <sub>2</sub> -Antiplasmin                                 | Fibrinolysis        | Plasmin   | Bleeding                       |
| C1 esterase inhibitor                                       | Complement          | C1r, C1s  | Angioedema                     |
|   | Contact factors     | FXIIa, kallikrein   | —                              |
|   | Coagulation         | FXIa  | —                              |
| Protease nexin-1  | Coagulation         | Thrombin  | None reported                  |

APC, activated protein C; F, factor.

<sup>a</sup> Reaction also requires the presence of high-molecular-weight kininogen.

<sup>b</sup> Antithrombin III-heparin inhibits factor VIIa only when bound to tissue factor.

In the past several years, advances have been made to further understand the mechanism of action of serpins ( [975](#), [1257](#), [1258](#), [1259](#), [1260](#), [1261](#), [1262](#), [1263](#) and [1264](#) ). Serpins in uncleaved states (native or latent) and cleaved states have been crystallized ( [1265](#), [1266](#) and [1267](#) ). Achievement of the first crystal structure for a serpin-protease complex (α<sub>1</sub>-antitrypsin-trypsin) ( [1268](#) ) has confirmed the physical displacement of the tethered protease: The conformation of α<sub>1</sub>-antitrypsin in the complex is superimposable with that of the isolated cleaved α<sub>1</sub>-antitrypsin. The crystal structure also revealed that the translocated, tethered protease has undergone an overall 37% loss of structure with its catalytic site radically disrupted.

Inhibitory serpins share a similar backbone structure but expose a variable reactive site loop. This loop binds to the catalytic groove of the target proteases. Serpin specificity derives in part from the sequence of the reactive site loop and also from secondary binding sites ( [1269](#), [1270](#) ). Initially, the reaction of a serpin and serine protease involves formation of a noncovalent Michaelis complex between the exposed reactive site loop and

the protease active site. Exosite interactions between the two molecules or, in some cases, exosite binding of a cofactor, induce structural changes that increase the availability of the reactive site loop. Reversible complex formation is followed by reaction of the active site serine residue of the protease with the serpin “bait” peptide bond to form an acyl-enzyme intermediate. Trapping of this covalent complex between the reactive site loop and the protease appears to involve a process that both physically translocates the reactive loop-protease complex approximately 71 Å from the initial docking site and induces a general disordering of the protease’s conformation with consequent loss of any further catalytic activity ( [1268](#) ). The energy for translocation and structural alteration of the protease derives from the insertion of the proteolytically released reactive site loop of the serpin into  $\beta$  sheet A of its central core. A kinetic partitioning of serpin protease reactions between stable inhibited complexes and mixtures of regenerated enzyme and proteolyzed serpin reflects the relative rates of reactive site loop insertion versus deacylation ( [1271](#) ). A number of recent reviews have been written on the known serpin conformations and their biologic significance ( [1250](#), [1272](#), [1273](#), [1274](#), [1275](#), [1276](#), [1277](#), [1278](#) and [1279](#) ).

### Antithrombin-III

*Antithrombin-III* is a member of the serpin proteinase inhibitory family and circulates in blood as a single-chain glycoprotein with a relative molecular weight of 58,000 ( [278](#) ) ( [Table 21.4](#) ). The plasma concentration of human antithrombin-III is approximately 140  $\mu\text{g}/\text{ml}$  (2.4  $\mu\text{mol}/\text{L}$ ) ( [1280](#) ). Its  $t_{1/2}$  is approximately 61 to 72 hours ( [1281](#), [1282](#) ). Other names for antithrombin-III include *antithrombin-heparin cofactor* and *heparin cofactor*. Despite its name, antithrombin-III inhibits not only thrombin but also many of the other enzymes in the coagulation pathway.

Congenital antithrombin-III deficiency exhibits an autosomal-dominant pattern of inheritance, with an incidence of 1:2000 to 1:5000 ( [1283](#) ). The complete absence of antithrombin-III is lethal. Individuals with this deficiency have partial expression of antithrombin-III and are prone to thromboembolic disease ( [1284](#) ). Inherited deficiency is categorized by either quantitative defect with a reduction in antigen and activity (type I) or qualitative with reduced antithrombin-III functional activity and normal antigen levels (type II) ( [1285](#) ). These defects are caused by a variety of mutations that include insertions, deletions, and missense mutations ( [1283](#), [1286](#) ). Function can be compromised by mutations in the thrombin binding domain or the heparin-binding domain. Unstable variants of antithrombin have been identified in families with severe episodic thrombotic disease. Acquired antithrombin-III deficiency occurs in patients with sepsis or severe traumatic shock ( [1287](#), [1288](#) ). Therefore, studies are being conducted on the use of antithrombin-III as an agent for treating coagulation abnormalities associated with sepsis or other inflammation disorders ( [1289](#), [1290](#) and [1291](#) ).

**GENE STRUCTURE AND EXPRESSION** The gene encoding antithrombin-III is located on chromosome 1 in the q23-q25 region ( [1292](#) ) and spans 13.5 kb of genomic DNA ( [1293](#) ) ( [Table 21.5](#) ). The gene is composed of seven exons and six introns ( [1293](#) ). The mechanisms underlying antithrombin-III gene expression are not well established. It is primarily expressed in the liver with low levels detected in the brain and kidney. *Cis*-acting elements and *trans*-acting factors have been identified that regulate constitutive expression of the human antithrombin gene ( [1294](#) ).

**BIOCHEMISTRY** Human antithrombin-III is a single-chain glycoprotein ( $M_r = 58,000$ ) that circulates in blood at a concentration of approximately 140  $\mu\text{g}/\text{ml}$  (2.4  $\mu\text{mol}/\text{L}$ ) ( [278](#), [1280](#) ). It circulates as two glycoforms,  $\alpha$  and  $\beta$  variants, that contain identical polypeptide



backbones but differ in carbohydrate content and heparin affinity ( [1295](#) ). The antithrombin-III a variant is the predominant form (~90%) ( [1295](#) ). The structure of antithrombin-III a consists of 432 amino acid residues, with three disulfide bonds and four sialylated oligosaccharides at Asn <sup>96</sup>, Asn <sup>135</sup>, Asn <sup>155</sup>, and Asn <sup>192</sup> ( [Fig. 21.12](#) ). The carbohydrate residues account for 15% of total mass ( [1296](#), [1297](#), [1298](#) and [1299](#) ). The antithrombin-III B variant is not glycosylated at Asn <sup>135</sup>. Antithrombin-III B binds heparin more tightly than does antithrombin-III a and is observed to preferentially accumulate on the vessel wall when heparan sulfate proteoglycans are exposed ( [1300](#) ). The reactive site peptide bond is Arg <sup>393</sup>-Ser <sup>394</sup>. The first x-ray crystal structure of antithrombin-III that was determined was a cleaved form that diffracted to 3.2 Å resolution ( [1301](#) ). Significant differences between structures of antithrombin-III and another serpin, a <sub>1</sub>-antitrypsin, were identified in the NH <sub>2</sub>-terminal region that defines the heparin-binding site. Since then, several x-ray crystal structures of intact antithrombin-III have been solved to 2.6 to 3.0 Å ( [1302](#), [1303](#) ). Interestingly, the crystals that diffracted to 2.6 Å were grown under microgravity conditions on space shuttle mission STS-67 ( [1303](#) ). This structural data indicated that antithrombin-III is present in two different conformations: an active form that can inhibit thrombin and form a stable complex with the protease and a form that was inactive as an inhibitor and did not act as a substrate for thrombin. Better definition was also obtained of the residues implicated in the binding of the heparin pentasaccharide (Arg <sup>47</sup>, Lys <sup>114</sup>, Lys <sup>125</sup>, and Arg <sup>129</sup>).

**FUNCTION** Antithrombin-III has a broad spectrum of inhibitory activity with most of its target proteases participating in the coagulation cascade. It is primarily an inhibitor of the serine protease thrombin as well as factor Xa, factor IXa, factor VIIa-tissue factor, factor XIa, factor XIIa, plasma kallikrein, and HMWK ( [1304](#), [1305](#) and [1306](#) ). Antithrombin-III plays a key role in maintaining hemostasis. Antithrombin-III also displays antiproliferative and antiinflammatory properties that primarily derive from its ability to inhibit thrombin. In addition, latent or cleaved forms of antithrombin-III have antiangiogenic activities ( [1307](#) ). Heparins and heparan sulfates potentiate these reactions and are used in the treatment of thrombosis. When antithrombin-III is complexed with heparin, its rate of binding to thrombin increases 1000-fold. The general mechanism of inhibition involves reaction of the active site of the enzyme with a peptide loop structure of the serpin to form a tight, equimolar (1:1) complex. Inactivation is suspected to proceed through covalent bond formation between antithrombin-III and the protease, followed by inactivating structural rearrangements of both antithrombin-III and the protease. However, the exact mechanism of inhibition of serine proteases by antithrombin-III is uncertain. Antithrombin-III inhibits at a slower rate when not bound to heparin because the reactive site loop of antithrombin-III is not completely exposed in the absence of heparin.

## Heparin Cofactor II (Leuserpin 2)

*Heparin cofactor II*, also called *leuserpin 2*, is a relatively newly discovered member of the serpin family. Like antithrombin-III, heparin cofactor II inhibits thrombin in a reaction that is accelerated more than 1000-fold by heparin ( [1308](#) ). However, heparin cofactor II is unique in that it is also stimulated by the proteoglycan dermatan sulfate. The plasma concentration of heparin cofactor II is 0.5 to 1.4 μmol/L ( [1309](#), [1310](#) ) ( [Table 21.4](#) ). Its plasma t <sub>1/2</sub> is approximately 2.5 days. The physiologic role of heparin cofactor II is uncertain at the present time. Low levels of thrombin-heparin cofactor II complexes are detected in normal plasma samples; elevated levels were detected in patients with DIC ( [1311](#) ). Although inherited deficiency of heparin cofactor II has been associated with thrombosis, this is not always the case ( [1312](#), [1313](#) ). The incidence of heparin cofactor II deficiency in patients with thromboembolytic disorders appears to be similar to that in the

normal population ( [1314](#) ).

**GENE STRUCTURE AND EXPRESSION** The gene encoding human heparin cofactor II, consisting of five exons and four introns, spans approximately 14 kb on chromosome 22 in the q11 region proximal to the breakpoint cluster region ( [1315](#), [1316](#) ). The human heparin cofactor II gene is expressed exclusively in the liver and by a hepatoma-derived cell line ( [1317](#), [1318](#) and [1319](#) ).

**BIOCHEMISTRY** Human heparin cofactor II ( $M_r = 66,000$ ) circulates as a single-chain protein of 480 amino acid residues that contains 10% carbohydrate ( [1309](#), [1316](#), [1320](#) ). It is glycosylated at Asn<sup>30</sup>, Asn<sup>169</sup>, and Asn<sup>368</sup> and is sulfated at Tyr<sup>60</sup> and Tyr<sup>73</sup>. It has three cysteines with no identified disulfide bonds. A cationic region of the molecule encompassing residues 163 to 194 constitutes the GAG binding site; dermatan sulfate and heparin bind to heparin cofactor II at nonidentical but overlapping sites in this region ( [1321](#), [1322](#) ). Residues Lys<sup>173</sup>, Arg<sup>184</sup>, Lys<sup>185</sup>, Arg<sup>189</sup>, Arg<sup>192</sup>, and Arg<sup>193</sup> have been specifically implicated in heparin binding ( [1323](#) ). The NH<sub>2</sub>-terminal region of heparin cofactor II contains a cluster of acidic residues that are thought to interact with the positively charged GAG binding site ( [1324](#), [1325](#) ). This “acidic” tail of heparin cofactor II contains two so-called hirudin domains—Glu<sup>56</sup>AspAspAspTyrLeuAsp<sup>62</sup> and Glu<sup>69</sup>AspAspAspTyrIleAsp<sup>75</sup>; in each, the Tyr residue is sulfated. It has been proposed that the NH<sub>2</sub>-terminal “acidic” tail is constrained in the native structure through association with the highly cationic heparin-binding region. In the presence of GAG, the acidic region is displaced from the heparin-binding site, thus making it available for binding to the anion-binding exosite I of thrombin ( [1326](#) ). However, crystallographic studies of heparin cofactor II indicate that the acidic tail of heparin cofactor II is flexible in the crystal and not associated with the heparin-binding site ( [1265](#) ). Other functionally important regions of heparin cofactor II include a chemotactic peptide harbored between residues Asp<sup>49</sup> and Tyr<sup>60</sup> that is released by leukocyte proteases ( [1327](#) ). Residues Phe<sup>456</sup> to Ile<sup>460</sup> constitute a pentapeptide recognition motif for the hepatic serpin enzyme complex receptor that may be involved in clearance of heparin cofactor II-enzyme complexes ( [1328](#) ). The domain of heparin cofactor II with homology to other serpins is at the COOH-terminus of the protein. It exhibits approximately 30% homology to antithrombin-III and other serpins. The reactive site peptide bond is Leu<sup>444</sup>-Ser<sup>445</sup> ( [1329](#) ). This reactive center loop sequence is consistent for an inhibitor with specificity for proteases with a preference for nonpolar residues with relatively bulky side chains in the P1 position. Two such proteases, chymotrypsin and cathepsin G, do react with heparin cofactor II. Thrombin reactivity with heparin cofactor II is unusual because thrombin generally prefers substrates with arginine in the P1 position. Exosite binding interactions, such as that between the hirudinlike sequences of heparin cofactor II and exosite I of thrombin, compensate for the less-than-ideal structure of the P1 residue and allow thrombin to form a productive Michaelis complex with heparin cofactor II ( [1265](#) ).

**FUNCTION** The only coagulation enzyme inhibited by heparin cofactor II appears to be thrombin ( [1330](#) ). However, the rate of thrombin inhibition by heparin cofactor II in the absence or presence of GAGs is significantly slower than by antithrombin-III under similar conditions. Considering that the plasma concentration of heparin cofactor II is 25 to 50% that of antithrombin-III and that low levels of heparin cofactor II are not strongly associated with thrombosis, the physiologic role of heparin cofactor II as a systemic thrombin inhibitor has been questioned. *In vitro*, heparin cofactor II inhibition of thrombin is stimulated by dermatan sulfate proteoglycans synthesized by fibroblasts and vascular smooth muscle cells ( [1331](#) ). Thus, heparin cofactor II may be uniquely suited to regulate extravascular thrombin in areas of vascular endothelium disruption, in which heparin cofactor II would be exclusively stimulated by dermatan sulfate in the subendothelial

layers. In addition, heparin cofactor II may participate in regulation of acute inflammation and wound healing by harboring a peptide chemotactic for neutrophils and monocytes that is released by leukocyte proteolysis ( 1327 ). Heparin cofactor II may also have a role in protection from thrombosis during pregnancy. Increased levels of dermatan sulfate in the maternal and fetal circulation ( 1332 ) along with increased levels of heparin cofactor II in pregnant women have been reported ( 1333 , 1334 ).

### **$\alpha_1$ -Proteinase Inhibitor (a $\alpha_1$ -Antitrypsin)**

$\alpha_1$ -Proteinase inhibitor is the most abundant circulating inhibitor of the serpin family. It circulates in blood at a concentration of 1.5 to 3.5 mg/ml (28  $\mu$ mol/L) with a relative molecular weight of 53,000 ( 1177 ) ( Table 21.4 ). It is synthesized predominantly in the liver and has a  $t_{1/2}$  of 6 days ( 1335 ).  $\alpha_1$ -Proteinase inhibitor is considered an acute phase reactant ( 1336 ).

Deficiency in a  $\alpha_1$ -proteinase inhibitor is a common autosomal-recessive disorder (1:1600 to 1:1800) that can potentially be lethal ( 1337 ). It is found associated with emphysema ( 1253 ), liver cirrhosis ( 1255 ), and hepatocellular carcinoma ( 1255 ). To date, there is no known treatment for a  $\alpha_1$ -proteinase inhibitor deficiency. Progress is under way to develop a therapy based on gene repair ( 1338 , 1339 and 1340 ).

**GENE STRUCTURE AND EXPRESSION** The gene for a  $\alpha_1$ -proteinase inhibitor is located on chromosome 14 band q32.1, is approximately 5 kb long ( 1341 ), and contains seven exons and six introns ( 1341 , 1342 , 1343 and 1344 ) ( Table 21.5 ). Uniquely, a  $\alpha_1$ -antichymotrypsin, corticosteroid-binding globulin, kallistatin, and protein C inhibitor also map to the same region on chromosome 14 ( 1343 , 1345 , 1346 ). These genes are actively transcribed in the liver and cultured hepatoma cells. However, a few other cell types (macrophages and intestinal epithelial cells) express some of these serpin genes ( 1347 ). Hepatocyte nuclear factor-1a and hepatocyte nuclear factor-4 play important roles in expression of the  $\alpha_1$ -proteinase inhibitor gene in hepatic, intestinal, and pulmonary epithelial cells ( 1348 ).

**BIOCHEMISTRY**  $\alpha_1$ -Proteinase inhibitor circulates in plasma at 1.5 to 3.5 mg/ml as a single-chain glycoprotein with a relative molecular weight of 53,000 ( 1349 ) ( Table 21.4 ).  $\alpha_1$ -Proteinase inhibitor is the most studied of the serpins, with high-resolution crystal structures achieved for the inhibitor by itself and in complex with a target protease ( 1268 ). The 452-amino acid sequence for human  $\alpha_1$ -proteinase inhibitor shows two disulfide bridges and four glucosamine-based carbohydrate chains ( 1350 , 1351 ). The reactive site bond that is targeted by serine proteinases is between Met<sup>358</sup> and Ser<sup>359</sup> ( 1352 ). Studies using <sup>13</sup>C nuclear magnetic resonance spectroscopy of the complex between human [ <sup>13</sup>C ] methionine-labeled  $\alpha_1$ -proteinase inhibitor and porcine pancreatic elastase have shown that a tetrahedral intermediate complex is formed during the serpin-proteinase interactions ( 1353 ). The three-dimensional x-ray crystal structure of cleaved  $\alpha_1$ -proteinase inhibitor identified that for activity  $\alpha_1$ -proteinase inhibitor requires the insertion of a single residue, Thr<sup>345</sup>, into  $\beta$  sheet A ( 1354 ). This was supported by the x-ray crystal structures of a  $\alpha_1$ -proteinase inhibitor complexed with synthetic peptides that correspond to the unprimed NH<sub>2</sub>-terminal side of the active site loop ( 1355 ). The five-stranded  $\beta$  sheet A of a  $\alpha_1$ -proteinase inhibitor undergoes conformational changes

that facilitate and stabilize the insertion into sheet A of the reactive center loop after cleavage by its target serine proteases. The solution structure of a  $\alpha_1$ -proteinase inhibitor has also been characterized by high-flux neutron scattering and by synchrotron x-ray scattering ( [1356](#) ).

**FUNCTION**  $\alpha_1$ -Proteinase inhibitor can inhibit a wide range of serine proteases. Its primary physiologic target is the inhibition of neutrophil elastase to protect the elastin fibers of the lung. The role of a  $\alpha_1$ -proteinase inhibitor in blood coagulation is minimal. It has been shown to inhibit factor XIa *in vivo* ( [1357](#) , [1358](#) ) and factor Xa in purified and plasma systems ( [578](#) ). APC complexes with a  $\alpha_1$ -proteinase inhibitor have also been detected by enzyme-linked immunosorbent assay in patients with DIC ( [1359](#) ). Inhibition by a  $\alpha_1$ -proteinase inhibitor is heparin independent.

## C1 Esterase Inhibitor

*C1 esterase inhibitor* is a member of the serpin proteinase inhibitor family that is present at 170  $\mu\text{g/ml}$  in blood with a relative molecular weight of 104,000 ( [1360](#) ) ( [Table 21.4](#) ). It is predominantly synthesized in the liver. When complexed with a protease (i.e., factor XIa), it has a  $t_{1/2}$  of 95 to 104 minutes ( [1357](#) ). Targets for C1 esterase inhibitor are found in the complement cascade and the coagulation cascade.

Deficiency in C1 esterase inhibitor can result in hereditary angioedema ( [1361](#) ) and has been identified in a patient with lupus erythematosus ( [1254](#) ). Cases of acquired C1 esterase inhibitor deficiency have been reported associated with splenic lymphoma ( [1362](#) , [1363](#) ). C1 esterase inhibitor-deficient mice show no obvious phenotypic abnormality ( [1364](#) ), although, in conjunction with a bradykinin type 2 receptor knock-out, diminished vascular permeability was observed ( [1364](#) ). The potential use of C1 esterase inhibitor in the treatment of sepsis, ischemia, and reperfusion is being investigated ( [1365](#) , [1366](#) and [1367](#) ).

**GENE STRUCTURE AND EXPRESSION** The primary structure of human C1 esterase inhibitor was initially determined by peptide and DNA sequencing ( [1368](#) ). The only proteolytic processing that occurs is that a 22-residue signal peptide required for secretion is cleaved. The C1 esterase inhibitor gene is located on chromosome 11, bands p11.2-q13 ( [1368](#) ) ( [Table 21.5](#) ). The C1 esterase inhibitor gene consists of eight exons and seven introns and is approximately 17 kb in length ( [1369](#) ). *In vivo*, androgens enhance expression of C1 esterase inhibitor. *In vitro* studies show that C1 esterase inhibitor mRNA and protein levels increase after stimulation with  $\gamma$ - and  $\alpha$ -interferon, TNF- $\alpha$ , IL-6, and monocyte colony-stimulating factor ( [1369](#) ). The molecular defects found associated with C1 esterase inhibitor deficiency include *Alu* repeat-mediated deletions, missense mutations, frameshifts, stop codon mutations, promoter variants, splice site mutations, or deletions of a few amino acids ( [1370](#) ). The clinical manifestation of this deficiency is predominantly angioedema.

**BIOCHEMISTRY** C1 esterase inhibitor is a single-chain glycoprotein containing 478 amino acid residues that circulates with an apparent molecular mass of 104,000 when analyzed by SDS-PAGE. The amino acids account for only 51% of the apparent molecular mass of the circulating protein, with 35% of the remaining mass accounted for by carbohydrate moieties ( [1360](#) ). Neutron scattering, x-ray crystal structure determinations,  $^1\text{H}$  nuclear magnetic resonance spectroscopy, and Fourier transform infrared spectroscopy have been used to study the structure of C1 esterase inhibitor, revealing a two-domain structure ( [1371](#) , [1372](#) and [1373](#) ). The NH<sub>2</sub>-terminus, containing 113 amino acids, is heavily glycosylated with three N-linked and seven O-linked oligosaccharides. The

COOH-terminus contains 365 amino acids with three N-linked oligosaccharides. When C1 esterase reacts with target proteases, the serpin undergoes changes in its whole secondary structure—not only the reactive site loop.

**FUNCTION** C1 esterase inhibitor is a member of the serpin inhibitor family. It plays an important role in the regulation of the classic complement pathway, specifically as the sole regulator of the activities of C1r and C1s ( [1374](#) ). C1 esterase inhibitor's role in coagulation is mainly targeted to the contact activation pathway through the regulation of kallikrein ( [166](#) , [1375](#) ), factor XII ( [126](#) ), factor XIIa ( [128](#) ), and factor XIa ( [275](#) , [1357](#) , [1376](#) ). Unlike other serpin inhibitors, such as antithrombin-III, protein C inhibitor, or PAI-1, the activity of C1 esterase inhibitor is not affected by heparin ( [1377](#) ).

### Protein C Inhibitor (Plasminogen Activator Inhibitor-3)

*Protein C inhibitor* is a member of the serine proteinase inhibitor family. It is also known as *PAI-3*. Protein C inhibitor is considered nonspecific in that its targets range from the procoagulant, anticoagulant, and fibrinolytic enzymes to plasma and tissue kallikreins, the sperm protease acrosin, and prostate-specific antigen ( [1378](#) , [1379](#) ). It is a 57,000 d protein that circulates in blood at a concentration of 5 µg/ml ( [1380](#) , [1381](#) ) ( [Table 21.4](#) ). Protein C inhibitor is cleared from the circulation with a  $t_{1/2}$  of 1 day. When in complex with a target (i.e., APC), it is cleared from circulation with a  $t_{1/2}$  of 20 minutes ( [1382](#) ).

Hereditary or acquired protein C inhibitor deficiency has not been documented to date ( [1383](#) ). A case-control study of thrombophilia showed that high levels of protein C inhibitor might constitute a mild risk factor for venous thrombosis. Protein C inhibitor-deficient mice (-/-) show impaired spermatogenesis and male infertility ( [1384](#) ).

**GENE STRUCTURE AND EXPRESSION** The gene for protein C inhibitor has been mapped to chromosome 14 band q32.1 ( [Table 21.5](#) ). It is 11.5 kb in length and consists of five exons separated by four introns ( [1385](#) , [1386](#) ). The organization and location of this gene are similar to those of the genes for a  $\alpha_1$ -antitrypsin and a  $\alpha_1$ -antichymotrypsin, suggesting a common ancestor for these genes ( [1385](#) , [1387](#) , [1388](#) ). Human protein C inhibitor is mainly synthesized in the liver ( [1381](#) ) but has also been identified in platelets and megakaryocytes ( [1389](#) , [1390](#) ), the kidney ( [1391](#) ), and the testes, seminal vesicle, and prostate ( [1391](#) ).

**BIOCHEMISTRY** Human protein C inhibitor has a relative molecular weight of 57,000 and circulates at 5 µg/ml ( [1380](#) , [1387](#) ). The mature protein contains 387 amino acids; a 19-amino acid signal peptide is present before secretion. Five potential N-linked glycosylation sites were found in the mature protein ( [1387](#) ), and their roles in protein C inhibitor activity have been studied by mutational analysis ( [1392](#) ). The reactive site bond is located at Arg<sup>354</sup>-Ser<sup>355</sup>, and a stable 1:1 molar complex is formed between protein C inhibitor and its target proteinases. Protein C inhibitor binds heparin, and its activity is accelerated when in complex with heparin ( [1393](#) ); unlike other related heparin-binding serpins such as antithrombin-III, heparin cofactor II, and protease nexin, the primary heparin-binding site of protein C inhibitor is in the H helix, not the D helix ( [1394](#) ).

**FUNCTION** Protein C inhibitor is a nonspecific inhibitor of serine proteinases and inhibits enzymes in blood coagulation, fibrinolysis, and fertility. The major target of protein C inhibitor, as its name suggests, is APC ( [1382](#) , [1395](#) , [1396](#) ). This is the physiologically most important inhibitor of APC. Protein C inhibitor has been shown to regulate TAFI activation by inhibiting the thrombin-thrombomodulin complex ( [1397](#) ). Its importance as a dual regulator of coagulation and fibrinolysis remains unresolved ( [1398](#) ). The importance of the regulation of APC by protein C inhibitor is evident by the use of this complex as a marker



for detection of deep vein thrombosis by immunofluorometric assay measurements ( [1399](#) ). Other targets for protein C inhibitor include human plasma kallikrein ( [173](#) ), factor XIa ( [173](#) ), factor Xa, and thrombin. Because there are no documented patients with a deficiency to date, the actual function of protein C inhibitor *in vivo* is yet to be elucidated.

## PROTEINS OF CLOT FORMATION

Early efforts to understand how blood clots form were directed at dissecting the vertebrate coagulation system and determining its components. This work revealed the central event in blood coagulation to be the conversion of soluble fibrinogen (factor I) to insoluble fibrin. Basically, this is accomplished when the coagulation enzyme thrombin (factor IIa) removes small polar peptides (termed *fibrinopeptides*) from each fibrinogen molecule forming fibrin. These fibrin molecules noncovalently interact with each other, forming a fibrin web. Fibrin stabilization is accomplished by the action of a second coagulation enzyme (factor XIIIa) that introduces numerous covalent cross-links between these fibrin molecules. The resulting fibrin web is able to capture platelets and red blood cells, effectively sealing the wound and stemming plasma loss.

### Factor XIII (Fibrin Stabilizing Factor)

The first apparent suggestion of cross-linked fibrin by factor XIII came in 1923 from Barkan and Gaspar, who reported that fibrinogen preparations, when clotted in the presence of Ca<sup>2+</sup>, generated clots that were insoluble in weak bases ( [1400](#), [1401](#) ). Later, in the 1940s, work by Robbins ( [1402](#) ), Laki and Lorand ( [1403](#) ), and Lorand ( [1404](#) ) confirmed the presence of a serum factor that caused the transition to an insoluble clot and termed it *fibrin stabilizing factor*. It was not until 1963 that the International Committee on Blood Clotting Factors acknowledged fibrin stabilizing factor as a clotting factor and termed it *factor XIII* ( [1401](#) ).

Factor XIII functions as a transglutaminase that can form cross-linked amide bonds between specific glutamine and lysine residues on polypeptide chains. It plays an important role in hemostasis and thrombosis as well as participating in physiologic processes of cell proliferation and cell migration. FXIII(a) has multiple substrates including fibrin(ogen), fibronectin, a  $\alpha_2$ -plasmin inhibitor, collagen, vitronectin, vWF, actin, myosin, factor V, and thrombospondin ( [1405](#), [1406](#), [1407](#), [1408](#), [1409](#), [1410](#), [1411](#), [1412](#) and [1413](#) ).

**GENE STRUCTURE AND EXPRESSION** Plasma factor XIII circulates as a heterotetramer comprised of two A-chains and two B-chains. The genes are located on different chromosomes. The gene for the factor XIII A subunit is located on chromosome 6, bands p24–25 ( [1414](#), [1415](#) ), and spans approximately 160 kb ( [1416](#) ) ( [Table 21.2](#) ). The gene has 15 exons specifying a mature protein of 730 amino acids. The circulating product of the B subunit gene is a protein of 641 amino acids. The gene is located on chromosome 1, bands q31–32.1 ( [1417](#) ), spans approximately 28 kb, and has 12 exons ( [1418](#) ) ( [Table 21.2](#) ). Ten short homologous units, termed *sushi* or *glycoprotein-1 domains*, are coded for by exons 2 to 11 in the B subunit gene ( [1419](#), [1420](#) ). Proteins associated with regulation of the complement system also contain sushi domains ( [1421](#), [1422](#) ). Factor XIII deficiency is autosomal recessive and is a rare bleeding disorder. It has a frequency in the general population of 1 in 2 million ( [1423](#) ). The phenotype displays varying degrees of bleeding and is typically associated with the absence of cross-linking of fibrin monomers and impaired cross-linking of a  $\alpha_2$ -antiplasmin inhibitor to fibrin ( [1424](#) ). Mutations have been identified in both the A and B subunits, with the latter being the least common. Recent reviews by Loewy et al. ( [1424](#) ) and Ariens et al. ( [1425](#) ) describe the deficiency mutations and

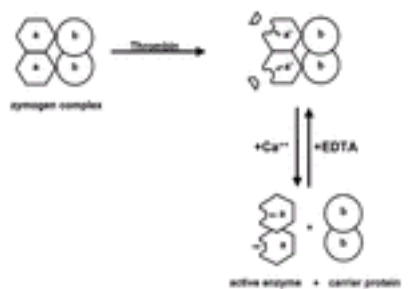
polymorphisms for both gene products that have been identified to date. Five common polymorphisms in the A subunit have been identified. Three of these (Val34Leu, Pro564Leu, and Glu651Gln) have allele frequencies greater than 0.2. Adverse effects have not been associated with the Glu651Gln variation; however, young women with the Leu564/Leu564 genotype may be at increased risk of hemorrhagic stroke ( [1426](#) ). The (Val34?Leu) polymorphism in the A subunit is found in approximately 25% of the population ( [1427](#) ). This Val to Leu replacement takes place three amino acids away from the thrombin cleavage site at Arg<sup>37</sup>–Gly<sup>38</sup> ( [1427](#) ). Due to its close proximity to the thrombin cleavage site, it has been postulated that this mutation might modulate FXIII activation. Studies suggest that this polymorphism is a determining factor in arterial and venous thrombosis ( [1428](#), [1429](#), [1430](#), [1431](#), [1432](#), [1433](#) and [1434](#) ). This polymorphism has been suggested to be associated with a protective effect against myocardial infarction ( [1428](#), [1435](#) ). The Leu encoding allele is lower in patients exhibiting myocardial infarction, deep vein thrombosis, and cerebral infarction. Studies also showed that the Leu34 mutation accelerates factor XIII activation by thrombin and affects fibrin cross-linking ( [1436](#), [1437](#), [1438](#) and [1439](#) ). This acceleration has been proposed to account for the wide reference range reported for factor XIII activity. A study by Undas et al. ( [1440](#) ) demonstrated in a bleeding time blood model that aspirin has a more pronounced effect on factor XIII activation when individuals are carriers of the Leu34 allele. The mechanism underlying the lower risk for myocardial infarction observed in the Leu34 carriers despite faster FXIII activation is still unclear.

**BIOCHEMISTRY** There are two pools of factor XIII—a plasma pool and an intracellular platelet pool. Plasma factor XIII circulates as a 320-kd A<sub>2</sub>B<sub>2</sub> heterotetramer composed of two identical A-chains (M<sub>r</sub> = 83.2 kd) and two B chains (M<sub>r</sub> = 79.7 kd) ( [1441](#) ) ( [Table 21.1](#) ). The A- and B-chains associate noncovalently with an apparent binding constant of 0.4 μmol/L ( [1442](#) ). Plasma concentration of factor XIII is approximately 30 μg/ml (94 nmol/L) ( [1443](#) ), with a reference interval in the population of 66 to 134% ( [1444](#) ). The A subunit contains 730 residues, is not glycosylated, and contains three important functional sites: the catalytic site (Cys<sup>314</sup>–His<sup>373</sup>–Asp<sup>396</sup>), a calcium binding site, and the activation peptide ( [1445](#), [1446](#) ). The A subunit is arranged into five distinct structural domains: the activation peptide (residues 1 to 37); the beta sandwich (residues 38 to 184); the catalytic core (residues 185 to 515); barrel 1 (residues 516 to 628); and barrel 2 (629 to 730). The activation peptide of one A subunit limits access to the active site cysteine of the other A subunit of the dimer. The B subunit contains 641 residues, is glycosylated, and contains ten sushi domain repeats ( [1419](#) ). Each sushi domain repeat contains approximately 60 amino acids and is stabilized by two disulfide bonds. By electron microscopy, the B domain appears as strands that are thin, flexible, and kinked ( [1447](#) ). The B-chain has no enzymatic activity and has been thought to function as a carrier of the A subunit ( [889](#), [1448](#), [1449](#) ). Several x-ray crystal structures of the zymogen factor XIII A<sub>2</sub> subunit have been solved to 2.8 Å ( [890](#), [1450](#) ). These studies revealed a catalytic triad of Cys<sup>314</sup>–His<sup>373</sup>–Asp<sup>396</sup> similar in structure to that observed in cysteine proteases. Crystal structures of thrombin-activated factor XIII have been solved with ( [1451](#) ) and without Ca<sup>2+</sup> ( [1452](#), [1453](#) and [1454](#) ). The bone marrow is the primary site of synthesis for the plasma factor XIII A-chain ( [1455](#), [1456](#) and [1457](#) ). Intracellular factor XIII is present in platelets, megakaryocytes, and monocytes as the 160-kd A<sub>2</sub> homodimer ( [1458](#), [1459](#), [1460](#) and [1461](#) ). The intracellular A<sub>2</sub> dimer, located in the cell cytosol, does not contain a leader sequence or carbohydrate, and its amino terminus is acetylated. How the A<sub>2</sub> dimer is transferred out of the cell and which cell type is the primary source of plasma A<sub>2</sub> are not clearly understood ( [1462](#) ). Secretion may be accomplished by the same pathway used by other nonclassically secreted proteins in blood, including fibroblast growth factor ( [1463](#) )



and the interleukins ( [1464](#) ). Approximately 50% of the total potential factor XIII A-chain activity in human blood is found in platelets ( [1458](#) ). During fibrin formation, platelet A<sub>2</sub> can be expressed on the platelet surface and plays an important role in fibrin cross-linking. Plasma factor XIII A-chains can also bind to thrombin-activated platelets ( [1465](#), [1466](#) ). This binding is enhanced by thrombin cleavage of the A-chains as well as the thrombin-dependent activation of the platelet. The association of the factor XIIIa molecule with the activated platelet surface allows it to participate at the platelet-fibrin interface, thereby stabilizing hemostatic plugs. The factor XIIIa binding site on platelets can be degraded by plasmin ( [1465](#) ). The B subunit is solely synthesized in the hepatocyte ( [1456](#), [1467](#) ) and is secreted as a monomer ( [1467](#) ). After being secreted, the A and B subunits associate, becoming an A<sub>2</sub>B<sub>2</sub> tetrameric molecule in the blood.

**ACTIVATION** The process by which plasma factor XIII is activated is quite complex. Activation of the zymogen by thrombin occurs in the NH<sub>2</sub>-terminus of the A-chains at Arg<sup>37</sup>-Gly<sup>38</sup> and releases a 36-amino acid activation peptide from each of the A-chains ( [1468](#) ) ( [Fig. 21.13](#) ). Whether immediate dissociation of the activation peptide from the rest of the molecule is part of the activation process is not clear because crystals of thrombin-activated FXIII showed no change in the location and conformation of the activation peptides ( [1451](#) ). This was also seen in the ion-bound structures ( [1452](#), [1453](#) and [1454](#) ), in which the active site residues remained inaccessible to solvent and substrate. These combined results suggest that exposure of the catalytic residues is likely to occur on substrate binding ( [1424](#) ). Calcium is required for factor XIIIa to expose its active site cysteine ( [1469](#), [1470](#) and [1471](#) ). Catalytic activity is expressed only after the A-chain dimer is dissociated from the B-chain through a Ca<sup>2+</sup>-dependent process after thrombin proteolysis ( [1448](#), [1449](#) ). Fibrin and fibrinogen play important roles as cofactors in the dissociation of the B-chains from thrombin-cleaved factor XIII ( [1457](#), [1463](#) ). The intracellular form of factor XIII only contains the A-chain; therefore, it does not require the dissociation of the B-chain, but it still requires a calcium-dependent thrombin proteolysis.



**Figure 21.13.** Activation of plasma factor XIII. The thrombin-catalyzed activation of plasma factor XIII (A<sub>2</sub>B<sub>2</sub>; 320,000 d) occurs in two steps. In the first step, thrombin cleaves the (R<sup>37</sup>-G<sup>38</sup>) bond. This releases the activation peptides (residues 1 to 37) from the A-chains, producing the inactive intermediate A'<sub>2</sub>B<sub>2</sub>. Fibrinogen, factor XIII, and thrombin interactions promote this event. In the second step, Ca<sup>2+</sup> now causes the B-chains to dissociate from the A'<sub>2</sub>B<sub>2</sub> intermediate, exposing the active site cysteine, Cys<sup>314</sup>, of the A subunits. These chains can reassociate in the presence of divalent cation chelators like ethylenediaminetetraacetic acid (EDTA). The enzyme A\*<sub>2</sub> is now capable of catalyzing the formation of isopeptide bonds between glutamine residues and lysine residues of adjoining polypeptide chains. In this model, the A-chains are oriented in such a way as to promote cross-linking of fibrin polymers in an antiparallel configuration.

The process of factor XIII activation in whole blood has been correlated with fibrin formation ( [934](#) ). This creates a carefully regulated system that has cross-linked polymers

occurring as soon as fibrin is being formed. The rate of thrombin cleavage of plasma factor XIII has been shown to be greatly accelerated by the presence of fibrin polymers ( [1472](#), [1473](#), [1474](#) and [1475](#) ). This positive feedback network between thrombin, fibrin(ogen), and factor XIIIa ensures that a stable clot can form rapidly to maintain hemostasis.

**FUNCTION** Activated factor XIII is essential for normal hemostasis and performs numerous functions in pathologic processes ( [1401](#), [1424](#) ). Being a transglutaminase, activated factor XIII forms isopeptide bonds between the  $\gamma$ -carboxylamide and  $\epsilon$ -amino groups of glutamyl and lysyl residues, respectively. Factor XIIIa is the only enzyme in the blood coagulation cascade that uses a cysteine for catalysis. To date, no known endogenous inhibitor has been described to regulate this important enzyme. Substrates for factor XIII include fibrin(ogen), fibronectin, a  $2$ -plasmin inhibitor, collagen, vitronectin, vWF, actin, myosin, factor V, and thrombospondin ( [1405](#), [1406](#), [1407](#), [1408](#), [1409](#), [1410](#), [1411](#), [1412](#) and [1413](#) ). Fibrin is the main physiologic substrate for factor XIIIa. The basic mechanism involves  $\gamma$ -chain dimerization and  $\alpha$ -chain polymerization by creating isopeptide cross-links. This reaction is extremely specific because only protein-bound glutamine residues can be a substrate for factor XIIIa. The structural specificity for this reaction remains poorly defined. It appears to reside within the primary amino acid sequence of the surface-exposed glutamine residues ( [1476](#), [1477](#) ). How clot stabilization occurs in fibrin formation is covered in the section [Polymerization \(Fibrin Formation\)](#).

## Fibrinogen (Factor I) and Fibrin

This section focuses on the gene structure, structure/function relationships, and the regulation of fibrinogen and its insoluble counterpart fibrin. These topics, although extensively discussed within, have also been the subject of several comprehensive reviews ( [1478](#), [1479](#) and [1480](#) ), as well as a 2000 New York Academy of Sciences symposium ( [1481](#) ).

Fibrinogen is composed of six polypeptide chains (two A $\alpha$ -chains, two B $\beta$ -chains, and two  $\gamma$ -chains); after posttranslational modification, the mature protein circulates in the blood with an average molecular weight of 340,000 d ( [Table 21.1](#) ). The polypeptide chains are distributed into two symmetrical half molecules each containing one A $\alpha$ -, one B $\beta$ -, and one  $\gamma$ -chain with the NH $_2$  and COOH-termini oriented in the same direction. The half molecules are linked by noncovalent and disulfide bonds at their amino termini, yielding a linear arrangement of three nodular structures. The outside two domains, formed by the carboxyl-terminal regions of the B $\beta$ - and  $\gamma$ -chains of fibrinogen are designated *D*, whereas the central domain that contains the amino termini of all the chains is designated *E*. Between 1.7 and 5.0 g of fibrinogen are synthesized per day by the liver ( [1482](#), [1483](#) ) with approximately 75% of this fibrinogen secreted into the plasma and the remainder distributed between the lymph and interstitial fluids ( [1483](#) ). This translates into a mean plasma level of 2.5 mg/ml with a normal  $t_{1/2}$  of 3 to 5 days ( [1484](#), [1485](#) ). Fibrinogen is considered to be an acute phase reactant, and as such, it is up-regulated two- to tenfold in response to a variety of physiologic stresses including trauma, pregnancy, and tissue inflammation.

Fibrinogen has been found in the blood plasma of all vertebrates, including the most primitive vertebrate, the lamprey. Early phylogenetic work on fibrinogen began with protein sequences obtained for various fibrinopeptides ( [1486](#), [1487](#) and [1488](#) ). It was immediately obvious that although these peptides were exceptionally variable, certain features were conserved; without exception, they all contained an arginyl-glycine bond required for thrombin cleavage ( [1489](#) ). Determination of the protein sequences for all three chains revealed that they were homologous and were evolved from a common ancestor ( [1490](#) ).

The  $\beta$ - and  $\gamma$ -chains share 42% identity within the fragment D domain, although they share no homology with the C-terminal  $\alpha$ -chain ( [1491](#), [1492](#), [1493](#) and [1494](#) ). The C-terminal  $\alpha$ -chain varies greatly between species (molecular weight ranges from 60 to 120 kd).

Sequence data, especially the detailed work determining intron/exon junctures, support the hypothesis that all three fibrinogen genes evolved from a common ancestor through a series of duplications that began approximately 1 billion years ago ( [1495](#), [1496](#), [1497](#), [1498](#) and [1499](#) ). At this point, the ancestral gene duplicated to form both the  $\text{A}\alpha$ -chain and a  $\beta/\gamma$ -chain precursor gene. Then, sometime before the last time lampreys and mammals shared a common ancestor (450 million years ago), the  $\beta/\gamma$  gene duplicated, forming today's  $\beta$ - and  $\gamma$ -chains. There is now a growing collection of proteins that share more than 30% sequence identity with both the  $\beta$ - and  $\gamma$ -chains, including a  $\text{E}_\text{C}$  domains ( [1500](#), [1501](#) and [1502](#) ), chicken cytotactin ( [1503](#) ), mouse T-cell protein ( [1503](#) ), sea cucumber ( [1504](#) ), and scabrous gene product from the fruit fly ( [1505](#) ).

**GENE STRUCTURE AND EXPRESSION** The fibrinogen locus is comprised of three closely linked genes (specifying the polypeptides  $\text{A}\alpha$ ,  $\text{B}\beta$ , and  $\gamma$ ) found as single copies in a region of approximately 50 kb (bands q23 to q32) of chromosome 4 (1506–1509; reviewed in 1510) ( [Table 21.2](#) ). Both the  $\text{A}\alpha$ - and  $\gamma$ -chains are transcribed from the same DNA strand, whereas the  $\text{B}\beta$ -chain is transcribed from the opposing strand ( [1495](#) ). The  $\text{A}\alpha$  gene contains six exons, whereas the  $\text{B}\beta$  has eight and the  $\gamma$ -chain has ten ( [1511](#), [1512](#) and [1513](#) ). Expression of all three genes appears to share a common regulatory mechanism, potentially via their 5'-flanking regions ( [1514](#), [1515](#) and [1516](#) ). Therefore, expression for the three chains is coordinately controlled and, at least for the hepatocyte, results in almost equal levels of mRNA for each chain in the cell ( [1510](#), [1512](#), [1517](#), [1518](#) ). A single transcription initiation event at the promoter of each chain produces multiple mRNAs due to alternative polyadenylation site selection in all three chains, as well as alternative splicing for both  $\text{A}\alpha$ - and  $\gamma$ -chains ( [1502](#), [1519](#), [1520](#) and [1521](#) ). In the case of the  $\gamma$ -chain, normal processing results in a polypeptide chain ending at  $\gamma\text{Val}^{411}$  (human numbering); however, approximately 10% of the time during splicing, the last intron is retained as an exon, resulting in a new chain,  $\gamma'$ , which ends at  $\gamma\text{Leu}^{427}$  ( [1510](#), [1522](#) ). The  $\alpha$ -chain also fails to remove the last intron, producing a translated protein product that is 27-kd larger ( [1500](#), [1501](#), [1523](#) ). The resulting larger form of fibrinogen is called *fibrinogen-42C* (1 to 2% of circulating human molecules), and the  $\alpha$ -chain extension is called a  $\text{E}_\text{C}$  ( [1524](#) ). Interestingly, this new domain shares as much sequence identity (~40%) with the COOH-terminal domain of the  $\beta$ - and  $\gamma$ -chains as the two share with each other ( [1523](#) ). Common polymorphisms of the fibrinogen genes are associated with plasma fibrinogen concentrations as well as susceptibility to, or severity of, atherothrombotic disease ( [1525](#) ). Epidemiologic studies have shown a strong association between two polymorphisms of the fibrinogen  $\beta$ -chain gene and fibrinogen plasma concentration ( [1526](#), [1527](#) ). However, the majority of the studies did not find any relation with fibrinogen polymorphisms and cardiovascular disease ( [1526](#), [1527](#) ). The effect of these polymorphisms and vascular disease still remains in question because environmental or intermediate conditions of the phenotype can influence the outcome. This supports the notion of individualized susceptibility to disease, which is determined by the genotype and environmental risk factors.

**Afibrinogenemia** *Inherited or congenital afibrinogenemia* is an autosomal-recessive disorder characterized by a total lack of fibrinogen in the plasma. This disorder, originally described in 1920, now affects more than 150 families, putting the estimated prevalence in the general population at approximately 1:1 million ( [1510](#), [1528](#), [1529](#) ). It is usually detected at birth with uncontrollable bleeding from the umbilical cord. The phenotype

varies from mild to severe with some patients experiencing spontaneous intracranial hemorrhage and splenic rupture throughout life, as well as bleeding after minor trauma ( [1530](#), [1531](#) ). It has been suggested that the presence of functional vWF, which allows platelet thrombus formation in the absence of fibrin, may be responsible for the phenotypic variation observed ( [1532](#), [1533](#) ). Most patients respond well to replacement therapy ( [1534](#) ). To date, 86% of all afibrinogenemia results from a truncation mutation in the fibrinogen alpha gene ( [1529](#) ). Investigation of the roles that both fibrinogen and fibrin play *in vivo* has been greatly enhanced by the creation of transgenic mice either lacking fibrinogen ( [1535](#) ) or expressing a modified form of fibrinogen ( [1536](#) ). The fibrinogen-deficient mice (Fib Aa<sup>-/-</sup>) were often able to survive to sexual maturity even though they had no immunologically detectable levels of any chain (Aa, Bβ, ?) in circulation ( [1535](#) ). As expected, plasma from these deficient mice was unable to clot *in vitro* even when combined with exogenous thrombin. In addition, the plasma did not support platelet aggregation *in vitro*. This is consistent with the view that fibrinogen bridges platelets via activated receptors (e.g., α<sub>IIb</sub>β<sub>3</sub>) ( [1537](#) ). However, *in vivo*, these mice are able to form platelet thrombi and are often able to withstand spontaneous bleeding episodes ( [1533](#) ). The resilience of the Fib Aa<sup>-/-</sup> mice is probably due to the fact that all factors required for thrombin generation and platelet activation are present and that platelets have alternative ligands for their activated receptors that are capable of supporting adhesion and thrombus formation ( [1528](#) ). Breeding experiments crossing fibrinogen-deficient mice with other mice deficient in a hemostatic factor are providing insights into the roles fibrinogen and fibrin play *in vivo*. For example, mice with combined deficiency in both fibrinogen and vWF were found to form stable thrombi, although platelet deposition was found to be delayed and unstable ( [1533](#) ). However, crossbreeding plasminogen (Plg<sup>-/-</sup>)-deficient mice with fibrinogen-deficient mice eliminated many of the spontaneous pathologies [conjunctivitis, pulmonary lesions, terminal vessel thrombosis, ulceration or prolapse of the rectum, and wasting ( [1538](#), [1539](#) )] normally associated with the Plg<sup>-/-</sup> genotype, including death at 6 months. In addition, the delayed tissue repair observed in Plg<sup>-/-</sup> mice after arterial challenge ( [1540](#) ), corneal damage ( [1541](#), [1542](#) ), or skin incision were all corrected by the removal of fibrinogen. These data, in combination with other data not discussed here, support the concept that the physiologic role for the plasminogen activation system is fibrin lysis ( [1543](#) ).

**Hereditary Dysfibrinogenemias** Like many of the other coagulation disorders, classic dysfibrinogenemias were frequently recognized by the mother when her child bled abnormally. These disorders are associated with prolonged thrombin times usually caused by a point mutation in one of the chains, but clinically, the patient presents with normal plasma fibrinogen concentrations. Hypofibrinogenemias, on the other hand, are associated with low plasma fibrinogen concentrations (<1.5 mg/ml) due to a mutation(s) that can affect transcription, mRNA processing, translation, chain processing and assembly, excretion, or stability of the mature protein ( [1544](#) ). Hypofibrinogenemias can be classified into four groups according to the effect of the mutation: (a) mutations that affect intracellular processing, (b) retention in the endoplasmic reticulum, (c) intracellular assembly, and (d) Aa-chain truncations ( [1530](#), [1531](#), [1544](#) ). Dysfibrinogenemias can be divided into five groups based on their specific action: (a) mutations that impair or impede thrombin, (b) defects in the construction of protofibrils, (c) impaired lateral association of protofibrils, (d) defects in interactions with other substances, and (e) other unknown mechanisms ( [1544](#) ). Thus, most common mutations are those that impede conversion of fibrinogen to fibrin by thrombin, which catalyzes the hydrolysis of the bonds between Argα<sup>16</sup>-Glyα<sup>17</sup> and Argβ<sup>14</sup>-Glyβ<sup>15</sup> releasing FPA and FPB, respectively. The active site of thrombin is highly specific for an arginine in the P1 position as observed by the human variant replacement of Argα<sup>16</sup> by His, which leads to delayed release of FPA ( [1545](#) ) or

Cys, resulting in no release of FPA (1546, 1547). In the case of Arg $\beta$ <sup>14</sup>, only a Cys variant [fibrinogen Christchurch (1548)] has been observed. The identification of these mutations, originally through protein chemistry methods and now using DNA technology, has provided unique insights into the structural/function relationships of fibrinogen and fibrin. These mutants were originally gathered and published in the *Index of Variant Human Fibrinogen* (1549), but with the advent of the Web, the material has been converted to a dynamic database (<http://www.geht.org/databaseang/fibrinogen/>) (1550). As of October 2002, 300 molecular abnormalities were present in the database, with 185 found in the Aa-chain (74 were Arg $\alpha$ <sup>16</sup> mutations), 33 in the BB-chain, and 82 in the ?-chain (26 were Arg?<sup>275</sup> mutations).

**Biosynthesis** Pulse chase experiments in a human hepatic carcinoma line have shown that there is a large intercellular pool of both Aa- and ?-chains, but it is the BB-chain synthesis that limits assembly in the rough endoplasmic reticulum (1551, 1552). However, in both chicken and rat hepatocytes, it seems to be the Aa-chain that limits fibrinogen assembly (1552, 1553). Several extrahepatic sites of fibrinogen synthesis have been identified, including human cervical epithelial cells (1554) and lung alveolar epithelial cells (1555). ?-Chain-only synthesis has been observed *in vivo* in the brain, lung, and bone marrow (1556, 1557). The physiologic role remains to be determined for any of these proteins. After synthesis but before secretion, a number of posttranslational modifications occur (Table 21.7). For example, all three chains are originally synthesized with signal peptides that are removed during or after passage across the membrane (1558). In addition, both the BB- and ?-chains are glycosylated with a biantennary carbohydrate (M<sub>r</sub> 2500 d) being added to Asn?<sup>52</sup> on the ?-chain much earlier than the Asn $\beta$ <sup>364</sup> on the BB-chain (1556, 1559, 1560, 1561 and 1562). When synthesized, fibrinogen is fully phosphorylated (Sera<sup>3</sup> and Ser3a<sup>46</sup>), but in its circulating form, only 20 to 30% of these sites are still phosphorylated (1563). The first residue on the BB-chain is also posttranslationally modified to form pyroglutamic acid, thus removing its free amino terminus.

**TABLE 21.7. Key Features of Human Fibrinogen Chains**

|                                   | Aa                                   | aEC     | BB                                   | ?       | ?’ |
|-----------------------------------|--------------------------------------|---------|--------------------------------------|---------|----|
| Total number of residues          | 610                                  | 236 461 |                                      | 411 427 |    |
| Expression level (%)              | 98                                   | 2 100   |                                      | 90 10   |    |
| Fibrinopeptide length             | 16                                   | 14      |                                      |         |    |
| Thrombin cleavage site            | Arg <sup>16</sup> -Gly <sup>17</sup> |         | Arg <sup>14</sup> -Gly <sup>15</sup> |         |    |
| Newly exposed N-termini           | Gly <sup>17</sup> -Pro-Arg-Val       |         | Gly <sup>15</sup> -His-Arg-Pro       |         |    |
| Cross-linking sites               |                                      |         |                                      |         |    |
| Acceptor (Gln)                    | 328, 366                             |         |                                      | 398     |    |
| Donor (Lys)                       | 508-584                              |         |                                      | 406     |    |
| Number of calcium-binding sites ? |                                      | 1 2     |                                      | 1 1     |    |
| Carbohydrate linkage site         |                                      | 667 364 |                                      | 52 52   |    |
| Phosphorylation site              | 3, 346                               |         |                                      |         |    |

**BIOCHEMISTRY AND ACTIVATION** The fibrinogen molecule contains two copies of three separate polypeptide chains designated Aa, BB, and ? (Table 21.7). These are arranged into two identical half molecules containing a single copy of each polypeptide chain. The region of interaction between the two half molecules, involving the six NH<sub>2</sub>-termini of the polypeptides, is called the *central domain*, or the *N-disulfide knot* (1486, 1564). There are 11



disulfide bonds in this region, three of which link the two half molecules. A variety of experiments, in which one or more of the 29 intra- and interchain disulfides were removed or small deletions made, revealed that for dimer formation both disulfide bonds and the noncovalent interactions of the amino termini are important ( [1565](#), [1566](#), [1567](#), [1568](#) and [1569](#) ). The common form of the Aa-chain contains 610 amino acid residues with a  $M_r$  of 66,500. It is not glycosylated but does have two phosphorylation sites (Ser<sup>3</sup> and Ser<sup>346</sup> ).

Thrombin cleavage of the Arg<sup>16</sup>-Gly<sup>17</sup> bond of the Aa-chain releases FPA. The Aa-chain of fibrinogen has sites appropriate for factor XIIIa-catalyzed formation of cross-links ( [1570](#) ) as well as consensus integrin recognition sites at residues 95 to 98 and residues 572 to 575. The BB-chain is comprised of 461 amino acids and displays a  $M_r$  of 52,000. It is glycosylated at a single site (Asn<sup>364</sup> ) and has a Ca<sup>+2</sup> binding site (residues 381 to 385). Thrombin cleavage of the Arg<sup>14</sup>-Gly<sup>15</sup> bond releases FPB. No residues in the BB-chain participate in cross-link formation. The  $\gamma$ -chain of fibrinogen is made up of 411 amino acids with a  $M_r$  of 46,500. It is glycosylated at Asn<sup>52</sup> and has a Ca<sup>2+</sup> binding site (residues 318 to 324) and donor (Gln<sup>398</sup> ) and acceptor (Lys<sup>406</sup> ) sites for cross-link formation. A comprehensive history of early fibrinogen and fibrin structure/function relationships can be found in an excellent review by Blombäck ( [1481](#) ). In the first recorded structural experiment, Bailey et al. ( [1571](#) ) placed both a concentrated solution of fibrinogen (which forms a viscous strand) and a fibrin thread in an x-ray beam. The resulting patterns were indistinguishable not only from each other, but also from the patterns of keratin and myosin. They all showed a characteristic 5.1 Å-repeat spacing that was later determined to be due to supercoiled a helices ( [1572](#) ). Around this same time, a different physiochemical "picture" of fibrinogen was emerging. Techniques including electrophoresis, ultracentrifugation, viscosity measurements, and light scattering were coming into vogue and determined that fibrinogen was a prolate ellipsoid with a length between 500 to 700 Å, an axial ratio between 5 to 20 Å, and a molecular weight near 340 kd ( [1573](#), [1574](#), [1575](#) and [1576](#) ). Hall and Slayter ( [1577](#) ) produced shadow-cast photographs of fibrinogen and observed three, unconnected globules in a line. The center globule was the smallest, with a diameter of approximately 50 Å; the terminal globules were found to be of equivalent size, approximately 60 Å. The total molecule length was estimated to be 475 Å; thus, the connections between the globules were approximated to 150 Å, and Cohen ( [1578](#) ) suggested that these globules could be linked by a helices, which would explain the characteristic a-helix 5.1 Å-repeat spacing observed in the fiber diffraction. This trinodular structure has become known as the *Hall and Slayter model of fibrinogen*. A period of debate ensued because the images of the three globules could not be repeated with any of the new and more sensitive electron micrograph techniques becoming available; rather, often a single large globule was observed, prompting other models for fibrinogen ( [1579](#), [1580](#) ). The matter was finally resolved in 1979, when Fowler and Erickson ( [1581](#) ) produced a definitive series of electron micrographs using both the newer negative staining and older shadow-cast techniques to produce images equivalent to Hall and Slayter's. In retrospect, the long delay in confirming Hall and Slayter's work is due to the fact that native fibrinogen is a fragile entity that is easily denatured under many of the conditions used. The reconstruction of fibrinogen from both enzymatic and chemical fragmentation products has allowed an exact picture of the structure and function of fibrinogen to emerge. Many fragments were subjected to protein sequencing, and the sequences reassembled until the whole structure was determined. These fragments also gave insights into the polymerization process as well as the shape of fibrinogen. Because plasmin is the natural protease for fibrin removal, it was the obvious choice for initial fragmentation. Nussenzweig et al. ( [1582](#) ) characterized such a fibrinogen lysate that was chromatographed using a diethylaminoethyl cellulose column. The resulting peaks were denoted A through E, and it was determined that the pools D and E contained the bulk of the material, with an approximate mass ratio of 2:1. This coordinated well with the Hall and Slayter model in which pool E would represent the

center globule and the terminal globules would be found in pool D and called *fragment E* and the terminal globules would be found in pool D and called *fragment D* (1583). Thus, fibrinogen is a symmetric molecule, with a dyad axis drawn through fragment E. Much effort has been expended in trying to crystallize fibrinogen. The first view was an 18-Å structure of a modified bovine fibrinogen (1584), later refined to approximately 4 Å (1585). The modification was a partial proteolysis that predominantly removed the C-terminal  $\alpha$ -chains. However, the density for the central domain was “poorly defined.” The first look at an unmodified fibrinogen was the 5.5-Å followed by 2.7-Å structures of chicken fibrinogen (1586, 1587). Chicken fibrinogen was chosen as a target because it has the shortest  $\alpha$ -chains that lack a series of repeated sequences found in most other species (1500, 1588, 1589) (Fig. 21.14). This structure provided the first atomic resolution view of the central domain of fibrinogen, although the  $\alpha$  domains were too disordered to allow the chain to be traced. Recently, a 35-kd digestion product of fragment E (FE<sub>5</sub>) was solved at 1.4 Å (1590), which correlates well with the observed fragment E region in the 2.7-Å chicken fibrinogen structure described above.



**Figure 21.14.** Chicken fibrinogen (PDB: 1M1J). A ribbon diagram depicting the 2.7-Å structure of chicken fibrinogen. All six NH<sub>2</sub>-termini are gathered together in the central or E domain. Three chains [ $\alpha$ -,  $\beta$ -, and  $\gamma$ - (shaded differently)] extend out from this domain through coiled-coils in either direction forming the terminal or D domains. Individual subdomains ( $\beta$ C,  $\gamma$ C,  $\beta\gamma$ C,  $\gamma\gamma$ C) of the D domains as well as carbohydrates (CHO) are indicated. Note the carboxy termini of the  $\alpha$ -chains are not visible in this structure. (Adapted from Yang Z, Kollman JM, Pandi L, et al. Crystal structure of native chicken fibrinogen at 2.7 Å resolution. *Biochemistry* 2001;40:12515–12523.)

The structure of the  $\alpha$ -chain extension ( $\alpha_{\text{E}}\text{C}$ ) from fibrinogen-420 (1591) confirmed the strong sequence homology observed between the  $\beta$  and  $\gamma$ , with a root mean square difference of less than 1.3 Å measured between chains (1521). As predicted, a calcium-binding site and a carbohydrate cluster were found. The most striking difference between the  $\alpha_{\text{E}}\text{C}$  domain and either the  $\beta$  or  $\gamma$  domains was the binding “hole”; although it still remains well defined by loops, none of the charged residues required for sequestering a charged “knob” remain. It has been speculated that this “hole” may be reminiscent of an archetypical fibrinogen molecule with a role in lectin binding (1591). The first atomic resolution structure in the fibrinogen field was for a human recombinant  $\gamma$ -chain (1592). As predicted, the fold of the  $\gamma$ -chain was unique and was not represented in the structural databases (1491). The 2.9-Å structure of a core fragment of human fibrinogen (fragment D) has been achieved. Fragment D, an 86-kd three-chained structure, consists of a “plough shape” with coiled-coils forming the handle and the two globular  $\beta$  and  $\gamma$  domains forming the furrow (887). As expected, the  $\beta$  and  $\gamma$  domains share the same fold (1592, 1593) and are oriented approximately 130 degrees apart. These observations have been confirmed in a recent structure of lamprey fragment D (1594) and a recombinant human fragment D (1595). These structures, although informative, failed to explain how the three chains interacted with each other or how they were arranged in the globules observed in Hall and Slayter’s electron micrographs. To date, a crystal structure of intact human fibrinogen has not been solved.

**POLYMERIZATION (FIBRIN FORMATION)** In 1952, Ferry (1596) proposed a half-staggered overlap model to explain the polymerization process. This model can be expressed succinctly in terms of “knobs” and “holes” (1490). When thrombin removes the fibrinopeptides, it creates new amino termini on the  $\alpha$ - and  $\beta$ -chains called *knobs*.



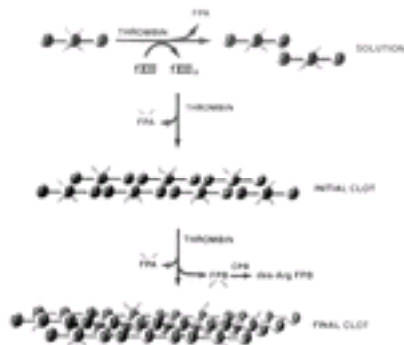
Because the knobs are located in the central globule E domain of the Hall and Slayter model, the holes for them to fit into must be present on the terminal D domains. To accommodate the half-staggered overlap model, the knobs on one molecule interact with holes in two different molecules. Reciprocally, a knob from each of these molecules fits into the holes on the first molecule's fragment D. The availability of holes in fibrinogen has been experimentally demonstrated when it is bound to immobilized fibrin on a Sepharose column (1597). The NH<sub>2</sub>-terminal disulfide knot (produced by cyanogen bromide cleavage of fibrinogen and containing fragment E), when activated by thrombin, could bind either fibrinogen or fragment D (1598). Therefore, the knobs must reside in the central domain and the holes in the fragment Ds. The binding site of the  $\alpha$  and  $\beta$  knobs were localized to the  $\alpha$ - and  $\beta$ -chains, respectively, using fragment D digested to different extents (1599). To identify the polymerization hole in the  $\alpha$ -chain, recombinant  $\alpha$ -chain crystals were soaked in a solution containing a peptide mimic of the knob (1593). As was expected, the hole was preformed and contained a strong electronegative potential that was neutralized on the binding of the doubly positively charged peptide. The binding interaction was noncovalent and comprised of only ionic and hydrogen bonds (1600). The existence of a  $\beta$ -chain hole and that this hole binds the  $\beta$ -chain knob were confirmed with a double-D x-ray crystal structure in which peptide knobs for the  $\alpha$ - and  $\beta$ -chains were present (1601). In another study using combinations of peptide knobs, it was determined that the  $\beta$  hole is not fully formed until the knob is present (1602). Apparently, when the peptide enters the hole, one side of the hole swings approximately 10 Å to hold the  $\beta$  knob securely, releasing a Ca<sup>2+</sup>. This conformational change may be the basis for the acceleration of fibrin formation observed in the presence of the peptide ligand GHRP (1480, 1599). No evidence has been found for an analogous mechanism with the  $\alpha$  hole; rather, the  $\alpha$  hole seems always ready to accept an  $\alpha$  knob. In that regard, in the absence of an  $\alpha$  knob, the  $\beta$  knob readily binds to both holes (1602). No examples of an  $\alpha$  knob ever occupying a  $\beta$  hole have been seen. This process, the conversion of fibrinogen to fibrin, can be separated into three congruent processes: (a) removal of the fibrinopeptides, (b) assembly, and (c) covalent stabilization. We examine each in depth in the following sections.

***Fibrinopeptide Release*** Many early investigators tried to determine the differences between fibrinogen and fibrin. Their molecular weights were identical, and fibrinogen was the more electronegative of the two (1603). In the conversion of fibrinogen to fibrin, thrombin catalyzes the hydrolysis of Arg-Gly bonds removing small, polar amino terminal pieces (fibrinopeptides) from the  $\alpha$ - and  $\beta$ -chains (1604, 1605). Cleavage of A $\alpha$ -Arg<sup>16</sup> by thrombin releases FPA and forms fibrin I. The release of two FPA peptides exposes a site in the E domain that aligns with a complementary site in the D domain to form overlapping fibrils. Subsequent cleavage by thrombin at B $\beta$ -Arg<sup>14</sup> releases FPB and leads to the formation of fibrin II, presumably increasing lateral aggregation of the protofibrils. FPA and FPB vary in length (between 13 to 21 amino acids in various mammals) and constitute less than 2% of the total mass (1606). Early studies in citrated plasmas or purified fibrinogen found that FPA and FPB are released at very different rates, with FPA being released first (1604, 1607, 1608 and 1609). A sequential model for release has been postulated in which thrombin binds equally to both chains, but the presence of FPA hinders the release of FPB because thrombin is unable to undergo a required conformation change (1610, 1611, 1612 and 1613). As polymerization process proceeds, the FPB release rate continues to increase, suggesting that a polymerization-induced structure change facilitates its release (1610, 1611, 1614). When the fibrinogen to fibrin conversion is studied in a nonanticoagulated whole blood system, the pattern of fibrin formation based on fibrinopeptide release is different from that seen in citrated plasma or purified fibrinogen (934). Bettelheim and Bailey (1615) first hypothesized that on FPA and FPB release these newly exposed amino termini (knobs) must be the principal contact sites during

polymerization. In human fibrinogen, the  $\alpha$ -chain knob, after FPA release, begins with the sequence GPRVV, whereas the  $\beta$ -chain, after FPB release, starts with GHRPL. Synthetic peptide GPR derivatives based on the  $\alpha$  knob were found to bind to both fibrinogen and fragment D and inhibit fibrin monomer polymerization (1599). Peptides based on the  $\beta$  knob also bound to both fibrinogen and fragment D but were unable to inhibit fibrin monomer polymerization. In analogous studies, venoms can be used to selectively remove only FPA without activating factor XIII, and fibrin will still form (1616, 1617). Although it appears morphologically the same, this type of fibrin lacks the normal strength of fibrin (1618, 1619 and 1620). Removal of only FPB (without FPA release) results in fibrin formation in lampreys (1489), but human fibrinogen clots only if the temperature is maintained below 15° C (1621). In fact, Doolittle et al. (1480) postulated that the  $\beta$  knobs act like clasps in  $\beta$  holes, thus holding abutting molecules together rather than being involved in lateral growth.

**Fibrin Assembly** The release of the fibrinopeptides from fibrinogen results in the formation of an intermediate termed *fibrin monomer*, which is all but indistinguishable from fibrinogen. In purified systems, removal of either FPA or FPB leads to the formation of the fibrin dimer through the noncovalent-charge-charge (salt links) and hydrogen-bonds between the knobs and the holes (1622). As fibrin monomers continue to be generated, the dimer elongates from both ends as a two-stranded molecule until it reaches approximately 30 monomers when it becomes a protofibril (1607, 1623, 1624). The second step in fibrin assembly is the lateral association of protofibrils into thicker fibrin fibers (1623, 1624). These fibers are formed from the association of between 14 and 22 protofibrils (1625). Because protofibrils, not dimers, are required for this step, it is believed that the forces involved in lateral association are weak and, therefore, only become “strong” in large numbers. Fragment D, specifically the  $\beta$ -chain, is likely responsible for this aspect of fiber growth (888, 1626, 1627). Clots are known to branch, although how this is accomplished is not clear. For example, perhaps a protofibril can attach and form a link between two growing fibers (888, 1628), or perhaps this is the role for the C-terminal region of the  $\alpha$ -chains (1629, 1630). The presence or absence of carbohydrates also seems to affect branching (1562). Fibrin lore specified that removal of only FPA produced fine clots composed of only protofibrils and thin fibers and that FPB removal was required for lateral growth and the formation of thicker clots (1607, 1631). This myth was dispelled by Weisel (1632), who performed extensive electron micrograph analysis on fibrin created with only FPA, only FPB, or both removed and found an almost invariant fiber diameter of 85 plus or minus 13 nm. The goal of a clot is to build a scaffold of sufficient mechanical strength to serve as a hemostatic plug. Interestingly, only 20% of a clot is actually protein—the remainder is solvent (1633). The description of fibrinogen activation and fibrin assembly has been based on studies using citrated plasmas or purified proteins, or both. To understand the *in vivo* process of fibrin formation, a system with nonanticoagulated blood has been used; in this experimental model, the pattern of fibrin formation based on fibrinopeptide release is different from systems using citrated plasma or purified fibrinogen (934) (Fig. 21.15). In this study, cleavage of FPA and subsequent clot formation occur just before the propagation phase of thrombin generation. At the point of visual clot formation, virtually all fibrinogen (and some product already cross-linked) disappears from the fluid phase of the reaction. Thus, the “clot” appears to be a mixture composed of fibrin I and fibrinogen. The insoluble material present in the fibrin clot is virtually all cross-linked by factor XIIIa, whose activation is nearly simultaneous with FPA removal. Therefore, the transglutaminase factor XIIIa is available to cross-link the  $\gamma$ -chains of initial fibrinogen/fibrin I clot. In purified systems, it has been observed that FPB removal precedes the cross-linking reaction. However, in the whole blood clotting model, the FPB antigen epitope is found associated with the  $\beta$ -chain after clot formation has occurred. FPB release proceeds at a slower rate than FPA release, occurs after  $\gamma$ - $\gamma$  dimer formation, and only reaches approximately 38% of its theoretical maximum value. These

results makes one wonder about the true role of  $\beta$  knobs in clot formation because FPB release does not appear to be required for factor XIIIa cross-linking to occur. Subsequent to FPB release in whole blood, a carboxypeptidase B-like enzyme cleaves FPB, generating des Arg FPB ( [934](#) ).



**Figure 21.15.** Schematic representation of whole blood fibrin formation. Thrombin at the beginning of clot formation simultaneously acts on fibrinogen (D–E–D) and factor XIII (fXIII). A portion (~40%) of fibrinopeptide A (FPA) is released from fibrinogen, and an initial clot is formed from the complementary overlap of the exposed sites between the E and D domains of adjacent molecules. Activated factor XIII (fXIIIa) simultaneously cross-links adjacent D domains (D=D). Thus, the initial soluble fibrin clot is composed of fibrinogen, fibrin, and  $\beta$ - $\beta$  dimers with fibrinopeptide B (FPB) still attached. The initial clot is continuously acted on by thrombin, releasing the remaining FPA and some of the FPB to yield a final clot with the majority of FPB still attached. The released FPB is selectively acted on by a carboxypeptidase B-like enzyme (CPB) cleaving the carboxyl terminal arginine to produce des-Arg FPB. The significance of this cleavage is still unclear. See [Color Plate](#). (From Brummel KE, Butenas S, Mann KG. An integrated study of fibrinogen during blood coagulation. *J Biol Chem* 1999;274:22862–22870, with permission.)

**Fibrin Cross-Linking** To strengthen the “weak” (noncovalent) interactions holding the dimers and protofibrils together, factor XIII (a transglutaminase found circulating in the plasma) is activated to factor XIIIa by thrombin in the presence of  $\text{Ca}^{2+}$  to link the side chains of lysyl and glutamyl residues by isopeptide bonds. Thrombin activation of factor XIII activation has been shown to coincide with FPA release during the initiation phase of thrombin generation ( [526](#), [934](#) ). The concentrations of thrombin (based on thrombin–antithrombin III complex) needed for factor XIII activation, FPA release, and FPB release have been calculated to be 0.8 plus or minus 0.3 nmol/L, 1.3 plus or minus 0.4 nmol/L, and 1.7 plus or minus 0.5 nmol/L, respectively ( [526](#) ). It has been proposed that as many as six cross-links can form between a fibrin monomer and its neighbors ( [1634](#), [1635](#) ) and that the presence of these cross-links increases the strength, chemical resistance to urea, and lysis by plasmin ( [1402](#), [1403](#), [1636](#), [1637](#), [1638](#), [1639](#) and [1640](#) ). Early in fibrin assembly, factor XIIIa has been shown to link Gln<sup>398</sup> and Lys<sup>406</sup> in reciprocal cross-links between adjacent C-terminal  $\beta$ -chains ( [1408](#), [1641](#) ). These cross-links are termed *longitudinal* or *end-to-end cross-links* when linked between adjacent monomers in the same strand of the protofibril ( [1642](#) ). However, if the cross-link exists between monomers on opposing strands, then the link is termed *transverse* ( [1627](#), [1630](#) ). This has created some controversy in the field: The crystallographers believe in only longitudinal cross-links based purely on distance constraints, because the links were not resolved in the electron density ( [887](#), [1602](#) ); however, the electron micrograph people believe that their data prove transverse cross-links exist, and the crystallographers become confused on a rearrangement that occurs in the formation of the plasmin-derived DD fragment ( [1643](#), [1644](#) ). Once the majority of  $\beta$ -chain cross-links are inserted, then a much slower process begins to insert multiple cross-links between neighboring  $\alpha$ -chains ( [1645](#) ). Because each

$\alpha$ -chain has two glutamyl acceptor sites and five potential lysine donor sites, a complex cross-linked network can result ( 1646 ). The result is cross-linked fibrin, which is more resistant to clot lysis ( 1640, 1647 ). Factor XIIIa also covalently attaches a  $\gamma$ -plasmin inhibitor (the principal fibrinolytic inhibitor) to a chains in the clot, thereby increasing resistance to degradation ( 1648, 1649 ).

**FUNCTION** Fibrinogen is the final clotting factor that is activated during the coagulation cascade. Its function in hemostasis is to stem blood loss. It serves as a molecular bridge to support intraplatelet aggregation, and it is the precursor of fibrin, which is the main component of the protein scaffolding of the forming hemostatic plug. Platelet aggregation critically depends on fibrinogen binding to activated platelets via the platelet fibrinogen receptor gpIIb-IIIa. Fibrin adhesion to stimulated platelets is also important in thrombus formation. Fibrinogen/fibrin also regulates thrombin activity by interactions that include the proteolytic cleavage by thrombin of fibrinopeptides to form a fibrin clot and thrombin exosite binding to fibrin, which potentially limits the diffusion of thrombin, thereby regulating clot propagation. The structure, stability, and duration of the insoluble counterpart fibrin are controlled by an interplay between fibrin formation and fibrinolysis, which includes other molecular and cellular components. An important enzyme for the structure and stability of the fibrin clot is the transglutaminase factor XIIIa. Its function is to cross-link fibrin and other adhesive proteins including integrin receptors providing a stable network. Once activated, the fibrinolysis inhibitor called *TAFI* functions to attenuate fibrinolysis by removing C-terminal lysines from fibrin. This appears to be critical in the stabilization of the fibrin clot by reducing the number of sites available for plasminogen binding, thus reducing the rate of plasmin generation with consequent prolongation of fibrin dissolution ( 1650, 1651 ). *TAFI* has also been shown to play a role in the premature lysis of clots from hemophilic plasma ( 1652 ). Fibrinogen is primarily recognized for its role in hemostasis but is also required for competent inflammatory reactions. Fibrinogen is an acute phase reactant, with levels increasing during inflammation. During these situations, fibrinogen functions as a bridging molecule in cell-cell interactions. Fibrin and fibrinogen constitute a matrix that can allow for the modulation of cellular responses through a variety of different cell types including endothelial cells, epithelial cells, leukocytes, platelets, and fibroblasts. Cellular receptors that can bind fibrinogen and fibrin include the integrins  $\alpha_{IIb}\beta_3$ ,  $\alpha_V\beta_3$ , and  $\alpha_5\beta_1$  and the cellular adhesion molecules intercellular adhesion molecule-1 and vascular endothelial cadherin. Although the function of fibrinogen and fibrin as a barrier to stemming blood loss through the dense fibrin network appears central to hemostasis, the findings from fibrinogen-deficient mice suggest that compensating mechanisms exist. Homozygous  $\alpha$ -chain-deficient mice are born with normal appearance and without elevated fetal mortality ( 1535 ). These mice have no detectable levels of the  $\alpha$ -,  $\beta$ -, and  $\gamma$ -chains in their blood ( 1535 ). Therefore, the maintenance of hemostasis in these animals is most likely derived from normal thrombin generation and the support of platelet aggregation and adhesion by vWF. Most clinical assays use fibrin formation as a means to assess hemostatic status (PT and activated partial thromboplastin time). The formation of a visible fibrin clot occurs during the initiation phase of coagulation at very low levels of thrombin (10 to 30 nmol/L), or approximately 3 to 5% of the total amount of thrombin produced ( 526, 565 ). The majority of thrombin (~95%) is generated after clot formation during the propagation phase, which is overlooked when a fibrin endpoint assay is used ( 526 ). In congenital hemophilia A and B, only a slight prolongation of clot time is observed; the major impairment is in thrombin generation during the propagation phase of the reaction ( Fig. 21.7 ) ( 804 ). Thus, most catalyst and thrombin formation is ignored using the current technology for evaluating clinical hemorrhagic risk or thrombosis. The survivability of the afibrinogenemic genotype in mice and male patients also supports this concept that critically important events are taking place beyond the endpoint of fibrin formation.

**REGULATION OF FIBRIN LYSIS** The coagulation system prevents blood loss at the site of injury, filling one role in hemostasis. However, there must also exist mechanisms to limit the coagulation system and processes to remove a clot once it is no longer needed.

This role is filled by the fibrinolytic system that uses elements from plasma, platelets, tissue, and other blood cells to regulate the degradation of fibrin. The main player is the zymogen plasminogen that on activation becomes plasmin, a serine protease, whose primary physiologic role is the degradation of the fibrin clot and extracellular matrix molecules. Even though the plasmin cleavage sites are similar for both fibrinogen and fibrin, we consider them separately for clarity.

**Fibrinogenolysis** Marder ( [1653](#) , [1654](#) ) proposed a scheme for fragmentation of fibrinogen based on his own detailed studies and the work of others ( [1655](#) , [1656](#) ). In the first step, fibrinogen is converted to fragment X ( $M_r \approx 247,000$ ) by the removal of the C-terminal  $\alpha$ -chain as well as the first 42 amino acids of the  $\beta$ -chain ( [1657](#) , [1658](#) ) ( [Fig. 21.16](#) ). Fragment X remains clottable before it is split asymmetrically, forming fragment Y ( $M_r \approx 150,000$ ), fragment D ( $M_r \approx 88,000$ ), and some small detritus relating to the coiled-coil region. Finally, fragment Y is further split into fragment D and fragment E ( $M_r \approx 50,000$ ), and some more detritus are released.

**Fibrinolysis** Differences observed in the degradation products between fibrinogen and fibrin are due to the presence of the cross-links, not a change in the specificity of plasmin, which predominantly attacks the coiled-coil region between fragment E and fragment D. Degradation of cross-linked fibrin is much slower than fibrinogen in large part due to the inaccessibility of the plasmin cleavage sites ( [1657](#) , [1659](#) , [1660](#) ). The first step in degrading cross-linked fibrin is the removal of the  $\alpha$ -chains so that the coiled-coils are exposed. As the coiled-coils are cleaved, different-sized fragments are released ( [1661](#) ). The smallest of these degradation products are double-D ( $M_r \approx 180,000$ ), also known as *D-dimer*, a soluble fragment in which the two D fragments are linked by two isopeptide linkages, and a fragment with the stoichiometry  $D_2E$  (termed *DY*;  $M_r \approx 235,000$ ), a double-D and a fragment E held in place by strong, noncovalent bonding ( [1662](#) , [1663](#) ). A large number of intermediate-sized fibrin degradation products arising from cleavages between the fragment D and fragment E region are also generated ( [Fig. 21.16](#) ). The largest of these fragments is the XXD (two fragment Xs and a fragment D) with a mass in the range of 595 kd. Some of these complexes (i.e., D-dimer) have been identified in the blood of patients with various thrombotic or thrombolytic disorders.

## PROTEINS OF THE FIBRINOLYTIC SYSTEM

Clot formation is integrated with clot dissolution to maintain hemostasis. The biochemical mechanisms of clot dissolution center on fibrin-specific activation of plasminogen to plasmin. The key proteins involved are plasminogen, plasminogen activators (t-PA and u-PA), PAI-1, a  $2$ -antiplasmin, and TAFI ( [Fig. 21.17](#) ).

### Plasminogen

*Plasminogen* is the inactive precursor of the enzyme plasmin, which is the primary catalyst of fibrin degradation. Plasminogen circulates in plasma at an approximate concentration of 200 mg/L (2  $\mu$ mol/L) ( [Table 21.8](#) ). Hereditary plasminogen deficiency has been described and displays either as a deficiency of plasminogen antigen and activity (type I) or a normal antigen level but reduced activity (type II, dysplasminogenemia) ( [1664](#) ). Thrombophilia and ligueous conjunctivitis are clinical manifestations associated with homozygous deficiency; the impact of heterozygous deficiency remains in dispute. Homozygous plasminogen-deficient mice are viable but exhibit severe thrombosis with systemic fibrin deposition and die prematurely ( [1665](#) , [1666](#) ).

TABLE 21.8. Proteins and Inhibitors of the Fibrinolytic System: Biochemical Properties



| Name  | Molecular Weight (d) <sup>a</sup> | Amino Acid Number | Plasma Concentration |          | Half-Life           | Carbohydrates (%) |
|---|-----------------------------------|-------------------|----------------------|----------|---------------------|-------------------|
|   |                                   |                   | (mg/L)               | (nmol/L) |                     |                   |
| Plasminogen                                 | 88,000                            | 791               | 200                  | 2000     | 2.2 days            | 2                 |
| Tissue-type plasminogen activator           | 70,000                            | 527               | 0.005                | 0.07     | 2.4 min             | 7/13              |
| Urokinase-type plasminogen activator        | 54,000                            | 411               | 0.002                | 0.04     | 5 min               | 7                 |
| Thrombin-activatable fibrinolysis inhibitor | 58,000                            | 401               | 4.5                  | 75       | 10 min <sup>a</sup> | 23 <sup>b</sup>   |
| PAI-1                                       | 50,000                            | 379               | 0.01                 | 0.20     | <10 min             | 13                |
| PAI-2                                       | 60,000                            | 415               | <0.005               | <0.07    | —                   | 22 <sup>b</sup>   |
| $\alpha_2$ -Antiplasmin                     | 70,000                            | 464               | 70                   | 1000     | 2.6 days            | 13                |
| Factor VII-activating protease              | 64,000                            | 537               | 12                   | 190      | —                   | 5                 |

<sup>a</sup> Activated form.

<sup>b</sup> Estimated value calculated from difference of molecular weight determined by sodium dodecyl sulfate-polyacrylamide gel electrophoresis and weight of sum of amino acids derived from complementary DNA.

**GENE STRUCTURE AND EXPRESSION** The plasminogen gene is located on the long arm of chromosome 6 at band q26–q27 ( [1667](#), [1668](#) ) ( [Table 21.9](#) ). It spans 52.5 kb of DNA with 19 exons. It is in close proximity to two genes for apolipoprotein A and for the plasminogen-related genes A and B ( [1669](#), [1670](#) and [1671](#) ). The first exon codes for the signal sequence; each of the five kringle domains is encoded by two exons as is the activation peptide. Plasminogen expression is normally stable with the regulation of the activity of the fibrinolytic system occurring mainly via the regulation of the plasminogen activators and their inhibitors. However, levels of plasminogen increase in response to inflammatory processes; plasminogen is an acute phase reactant protein ( [1570](#), [1668](#) ). Two sequence elements common to acute phase reactant genes have been located at position 76–81 and –553 to –558 ( [1668](#) ). Other potential regulatory transcriptional elements have been identified including HNF-1, AP-1, CREB, and GATA ( [1671](#) ).

**TABLE 21.9. Proteins and Inhibitors of the Fibrinolytic System: Molecular Genetics**

| Name  | Molecular Weight (d) | Chromosome | Gene (kb) | Exons | Messenger RNA (kb) |
|---|----------------------|------------|-----------|-------|--------------------|
| Plasminogen                                 | 88,000               | 6p26–q27   | 52.5      | 19    | 2.9                |
| Tissue-type plasminogen activator           | 70,000               | 8p12–q11.2 | 32.7      | 14    | 2.7                |
| Urokinase-type plasminogen activator        | 54,000               | 10q24      | 6.4       | 11    | 2.4                |
| Thrombin-activatable fibrinolysis inhibitor | 58,000               | 13q14.11   | 48        | 11    | 1.8                |
| PAI-1                                       | 50,000               | 7q21.3–q22 | 12.2      | 9     | 3.2                |
| PAI-2                                       | 60,000               | 18q22.1    | 16.5      | 8     | 1.9                |
| $\alpha_2$ -Antiplasmin                     | 70,000               | 17p13      | 16        | 10    | 2.2                |

**BIOCHEMISTRY** Plasminogen is synthesized in the liver and is present in a wide variety of tissues and body fluids, including saliva, lacrimal gland secretions, seminal vesicle fluid, and prostate secretions (1672). Plasminogen circulates in plasma at an approximate concentration of 200 mg/L (2  $\mu$ mol/L). It has a circulating  $t_{1/2}$  of 2.2 days (1673). The  $t_{1/2}$  in disease states in which the fibrinolytic system is activated can be shortened dramatically. Human plasminogen is a single-chain glycoprotein of a relative molecular weight of 88,000 containing 2% carbohydrate (Table 21.8 and Fig. 21.18). Two major carbohydrate variants of plasminogen are found in roughly equal amounts in human plasma; plasminogen variant 1 is glycosylated at two sites, Asn<sup>289</sup> and Thr<sup>346</sup>, whereas plasminogen variant 2 is glycosylated only at Thr<sup>346</sup>. Isoelectric focusing of either of these major carbohydrate variants, even when the proteins are isolated from a single plasma donor, reveals additional heterogeneity derived from variable sialic acid content (1674, 1675, 1676 and 1677). Heterogeneity in the primary sequence of plasminogen has also been observed, reflecting the presence of two high-incidence polymorphisms and a number of low-incidence polymorphisms in the human population. Functional differences between the two major carbohydrate forms have been reported (1678, 1679, 1680, 1681 and 1682). An additional glycosylation site at Ser<sup>249</sup> containing a trisaccharide has been identified (1683).



**Figure 21.18.** Schematic of plasminogen. Plasminogen is the inactive precursor of the enzyme plasmin, which is the primary catalyst of fibrin degradation. Human plasminogen is a single-chain glycoprotein of a relative molecular weight of 88,000 d containing 2% carbohydrate (CHO). CHO variants are shown for plasminogens 1 and 2. The primary structure of plasminogen contains 791 amino acids segregated into an NH<sub>2</sub>-terminal activation peptide domain (residues E<sup>1</sup>-K<sup>77</sup>), a region containing five kringles (K1-K5; residues K<sup>78</sup>-R<sup>561</sup>), and a catalytic domain (residues V<sup>562</sup>-N<sup>791</sup>). Proteolysis by plasmin at one of several potential sites in this NH<sub>2</sub>-terminal region results in a degraded form of plasminogen; the most common product is K<sup>78</sup>-plasminogen. Cleavage by plasminogen activators at R<sup>561</sup>-V<sup>562</sup> results in plasmin.

The primary structure of plasminogen contains 791 amino acids segregated into an NH<sub>2</sub>-terminal activation peptide domain (residues Glu<sup>1</sup>-Lys<sup>77</sup>), a region containing five kringles (K1-K5; residues Lys<sup>78</sup>-Arg<sup>541</sup>), and a catalytic domain (residues Val<sup>562</sup>-Asn<sup>791</sup>) (1667, 1684, 1685) (Fig. 21.18). As secreted into the blood, plasminogen has a glutamic acid at its NH<sub>2</sub>-terminus. Proteolysis by plasmin at one of several potential sites in this NH<sub>2</sub>-terminal region results in a degraded form of plasminogen; the most common product is Lys<sup>78</sup>-plasminogen. Removal of the NH<sub>2</sub>-terminal peptide region results in a major structural change in the plasminogen molecule, yielding a species of plasminogen that has a higher affinity than Glu-plasminogen for fibrin and is a better substrate for plasminogen activators (1686). The primary site for Lys-plasminogen formation is at the



fibrin clot; the  $t_{1/2}$  of Lys-plasminogen is shorter than the full-length molecule ( $t_{1/2} = 0.8$  days). Each kringle domain contains 78 to 80 amino acids. The K1 and K4 kringle domains have been identified as containing sites that are responsible for regulating the binding of plasminogen to fibrin (1687, 1688), a  $\alpha_2$ -antiplasmin (1689), histidine-rich glycoprotein (1690), the kininogens (1691), thrombospondin (1692), and cell-surface receptors. These sites on the plasminogen kringles (called *lysine binding sites*) bind lysyl residues in the target molecules; COOH-terminal lysyl residues are bound more avidly. Lysine analogs (i.e.,  $\epsilon$ -aminocaproic acid and tranexamic acid) can compete with lysyl residues in proteins for binding to plasminogen and, hence, are useful inhibitors of fibrinolysis (1693, 1694). The conformational change associated with the removal of the NH<sub>2</sub>-terminal activation peptide also occurs on binding of lysine or its analogs to the appropriate kringles in Glu-plasminogen (1694, 1695 and 1696). The shape of the Glu-plasminogen molecule changes from a prolate ellipsoid of axial ratio 2.6 to a more random coil-type structure of axial ratio greater than 5, similar in dimension to Lys-plasminogen (1697, 1698). A fragment of plasminogen comprising K1-K4, also known as *angiostatin*, has been shown to inhibit angiogenesis (1699). The catalytic domain of plasminogen (Val<sup>562</sup>-Asn<sup>791</sup>) shows considerable homology to trypsin and other serine proteases and includes the catalytic triad (His<sup>603</sup>, Asp<sup>646</sup>, and Ser<sup>741</sup>) typical of these proteases.

**FUNCTION** Plasminogen is a zymogen devoid of enzymatic activity until converted to the serine protease plasmin by cleavage of the Arg<sup>561</sup>-Val<sup>562</sup> peptide bond by plasminogen activators such as u-PA and t-PA (Fig. 21.19). In plasma or bound to fibrin in a blood clot, cleavage of this peptide bond by either t-PA or u-PA converts Glu-plasminogen into Glu-plasmin, a two-chain enzyme that can degrade fibrin, fibrinogen, and a number of other molecules. Plasmin is composed of a heavy chain (kringle domains) and a light chain (catalytic domain) that are attached by two disulfide bonds. Glu-plasmin can autolyse by cleaving itself—most commonly at Lys<sup>77</sup> to generate Lys-plasmin (1700, 1701). Inhibition of plasmin by a  $\alpha_2$ -antiplasmin is the primary route for regulation of plasmin's hemostatic function; suppression of plasmin activity beyond the locale of fibrin deposition is imperative if systemic fibrinogenolysis is to be prevented. Plasmin bound through its lysine binding sites to fibrin reacts more slowly with a  $\alpha_2$ -antiplasmin than when free in solution: This differential reactivity effectively localizes plasmin activity to the fibrin surface.



**Figure 21.19.** Molecular forms of plasmin(ogen). Plasminogen in its native form has a glutamic acid at residue 1 and is referred to as *glu-plasminogen*. Glu-plasminogen has a molecular weight of 88,000 d and contains 791 amino acids. Cleavage at R<sup>561</sup>-V<sup>562</sup> in glu-plasminogen by plasminogen activators [tissue-type plasminogen activator (t-PA) and urokinase-type plasminogen activator (u-PA)] yields glu-plasmin. Glu-plasmin consists of an NH<sub>2</sub>-terminal heavy chain linked by two disulfide bonds to a catalytic domain. At the localized clot level, plasmin that is formed can cleave glu-plasminogen at the NH<sub>2</sub>-terminal bond K<sup>77</sup>-K<sup>78</sup> to yield lys-plasminogen. Lys-plasminogen can be activated by plasminogen activators that hydrolyze the R<sup>561</sup>-V<sup>562</sup> bond to yield lys-plasmin.

## Plasminogen Activators

The process of plasminogen activation can occur through three distinct pathways: (a) the intrinsic activator system (analogous to the contact system of blood coagulation), (b) the extrinsic activators (t-PA and u-PA), and (c) an exogenous activator system involving pharmacologic agents (thrombolytic drugs). The pathway used *in vivo* appears to be the extrinsic pathway. However, both the intrinsic as well as exogenous activator systems could play an important role in human disease.

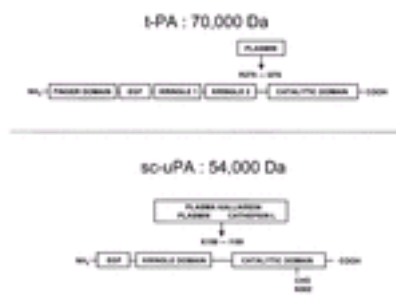
**INTRINSIC ACTIVATORS** The body has evolved a mechanism to recognize invasion by foreign substances. Many of these foreign substances contain negatively charged surfaces that allow the activation of the intrinsic (contact) pathway consisting of factor XII, prekallikrein, HMWK, and factor XI. Plasminogen can interact with this intrinsic pathway of blood coagulation to generate plasmin. There is continued debate as to the extent to which the intrinsic pathway functions in regulating normal fibrinolysis. It has been estimated that this pathway contributes only approximately 15% of the total fibrinolytic activity in human plasma (1702). Several studies have established that kallikrein and factors IXa and XIIa can directly activate plasminogen to plasmin (1703, 1704, 1705 and 1706). At this time, it is best to conclude that the physiologic significance and relevance of the contact system in fibrinolysis are not entirely clear. It has been suggested that individuals with factor XII deficiency as well as deficiencies in some of the other intrinsic coagulation factors may have a subtle, but potentially significant, defect in fibrinolysis under certain clinical conditions. Additional studies are needed to address this controversial subject.

**EXTRINSIC ACTIVATOR: TISSUE PLASMINOGEN ACTIVATOR** There are two dominant extrinsic activator systems in the body: t-PA and u-PA. These activators have unique structures and properties that affect the specificity and rate of plasmin generation. The t-PA molecule is predominantly a product of endothelial cells (1707, 1708, 1709, 1710 and 1711); it is also produced by vascular smooth muscle cells (1712), neuronal cells (1713), megakaryocytes (1714, 1715), mast cells (1716, 1717), monocytes (1718), and fibroblasts (1719). Factors that regulate its secretion and release from the endothelium are important mediators of blood clotting or inflammation. These include thrombin, histamine, acetylcholine, bradykinin, epinephrine, ILs, shear stress, and vasoocclusion (1720, 1721). t-PA antigen is present in normal plasma at approximately 5 µg/L (70 pmol/L) (1722, 1723, 1724, 1725 and 1726) (Table 21.8). Functional concentrations have been reported to be less than 20 pmol/L with remainder of the t-PA antigen found in complex with PAI-1 (1723, 1727, 1728). The  $t_{1/2}$  in plasma is quite short, with pharmacokinetic modeling indicating a  $t_{1/2}$  of 2.4 minutes for active t-PA and 5 minutes for the t-PA/PAI-1 complex (1729, 1730). The t-PA molecule and the t-PA/PAI-1 complex are cleared from the plasma by two specific cell receptor systems in the liver as well as receptor-mediated clearance by endothelial cells [1731 (review), 1732, 1733].

**Gene Structure and Expression** The human gene for t-PA is found on chromosome 8, bands p12-q11.2, and spans 32.7 kb (1734) (Table 21.9). There are 14 exons with distinct structural motifs encoded by individual exons (1735, 1736 and 1737). The processed transcript codes for a protein product of 562 amino acids: Residues 1 to 23 comprise the signal peptide, whereas residues 24 to 32 function as a propeptide region. Further processing removes residues 32 to 35 to yield the circulating protein product. The 5'-flanking region of the t-PA gene extends more than 9500 bp with a functional retinoic acid response element identified at -7300 bp (1738) and a multihormone responsive enhancer localized to the region -7145 to -9758 bp (1739, 1740 and 1741). A number of

*cis*-acting elements have been identified in the proximal promoter region. A transcription initiation site 209 bp upstream of the translation start site was initially identified. A consensus TATA sequence was identified 22 bp upstream from this transcription start site (1736, 1737). Subsequently, a TATA-independent transcript initiation site 99 bp upstream from the translation start site was identified as the primary site of transcription initiation in fibroblasts (1742) and endothelial cells (1743). The significance of t-PA transcripts with different-length 5'-untranslated regions is not established; deletion of the entire 5'-untranslated region of t-PA was observed to increase the stability of the t-PA transcript (1744). Translational control of t-PA gene expression has been observed in some cell types, implicating a regulatory role for the 3'-untranslated region of the t-PA transcript (1745, 1746). A number of polymorphisms of the t-PA gene have been identified. A 311-bp *A*/ $\mu$  insertion/deletion polymorphism within the eighth intron of the t-PA gene has been extensively studied (1747, 1748, 1749, 1750, 1751 and 1752). A similar polymorphism in the angiotensin-converting enzyme gene has been linked to plasma levels of this enzyme (1753). In contrast, no correlation of plasma t-PA levels with its *A*/ $\mu$  polymorphism has been observed (1749, 1750 and 1751). With one exception (1747), clinical studies have indicated no correlation between this polymorphism and the incidence of stroke or myocardial infarction (1749, 1750 and 1751). A single nucleotide polymorphism (-7351 C/T) in a Sp1 binding site in the far upstream enhancer element of the t-PA gene has been linked to the vascular release rate of t-PA *in vivo* (1754) and to the frequency of occurrence of first myocardial infarction (1755). No cases of congenital deficiency of t-PA have been reported. Transgenic mice lacking a functional t-PA gene developed normally and displayed a normal basal hemostatic phenotype (1756). Mice in which both the t-PA and u-PA genes were disabled had shortened lifespans and experienced severe, spontaneous thrombotic episodes (1756, 1757).

**Biochemistry** The t-PA molecule is a serine proteinase with molecular weight of 70 kd (1758) (Table 21.8 and Fig. 21.20). It was originally isolated as a single polypeptide chain of 527 amino acids (1759) with an NH<sub>2</sub>-terminal serine residue; full-length t-PA has an NH<sub>2</sub>-terminal extension of three amino acids (Gly-Ala-Arg) (1760, 1761 and 1762). Numbering in this chapter is based on Ser<sup>1</sup>-t-PA, the most extensively studied form due to its availability as a recombinant product.



**Figure 21.20.** Fibrinolytic proteins tissue-type plasminogen activator (t-PA) and single-chain urokinase-type plasminogen activator (sc-uPA). The t-PA molecule is a serine proteinase with a molecular weight of 70,000 d. The single-chain t-PA molecule is an efficient plasminogen activator in the presence of fibrin and is converted into a somewhat more active two-chain molecule by cleavage of the peptide bond between R 275 and I 276. This cleavage is performed primarily by the action of plasmin during fibrinolysis. The A-chain contains a fibronectin fingerlike domain, an epidermal growth factor (EGF)-like domain, and two kringle domains. The kringle 2 domain and the finger domain of t-PA are involved in the binding of t-PA to fibrin. The light or B-chain of t-PA contains the active site catalytic triad. sc-uPA is a serine protease of 411 amino acids with a molecular weight of 54,000 d and is an ineffective catalyst. Plasmin or plasma

kallikrein can hydrolyze the K<sup>158</sup>-I<sup>159</sup> peptide bond, converting sc-uPA into the fully active two-chain form (two-chain urokinase-type plasminogen activator). u-PA is composed of an EGF domain (EGF, residues 7 to 43), a single kringle domain (residues 50 to 131), a connecting peptide region (residues 132 to 157), and the serine protease-type catalytic domain (residues 159 to 411). One glycosylation site (CHO) is present in the serine protease domain.

The single-chain t-PA molecule is an efficient plasminogen activator in the presence of fibrin ( [1763](#), [1764](#), [1765](#) and [1766](#) ) and is converted into a somewhat more active two-chain molecule by cleavage of the peptide bond between Arg<sup>275</sup> and Ile<sup>276</sup> ( [1675](#), [1764](#), [1765](#), [1766](#) and [1767](#) ). This cleavage is performed primarily by the action of plasmin during fibrinolysis; factor Xa and kallikrein can also catalyze this conversion. The t-PA molecule divides structurally and functionally into two major regions with the Arg<sup>275</sup>-Ile<sup>276</sup> bond as the boundary: The 38-kd NH<sub>2</sub>-terminal portion (Ser<sup>1</sup>-Arg<sup>275</sup>), called the *heavy* or *A-chain* in the two-chain molecule, contains structures involved in fibrin binding, fibrin-specific plasminogen activation, and plasma clearance mechanisms; and the 28-kd catalytic region (Ile<sup>276</sup>-Pro<sup>527</sup>), called the *light* or *B-chain*, is homologous to the proteolytic domain of other serine proteases. Specifically, the A-chain contains a fibronectin fingerlike domain ( [1768](#) ), an EGF-like domain ( [1769](#) ), and two kringle domains ( [348](#), [1770](#) ). The finger domain extends from residues 4 to 50 and is involved in the binding of t-PA to fibrin ( [1771](#), [1772](#) ). The binding of the finger region to fibrin is not blocked by ε-aminocaproic acid ( [1773](#) ). The finger domain of t-PA has sequence homology and structural homology ( [1774](#) ) to similar structures found in fibronectin. Selected mutations in the finger or the EGF domain have been shown to result in prolonged half-lives *in vivo* for the modified t-PA molecules, indicating a role for these regions in uptake mechanisms ( [1775](#), [1776](#) ). The kringle domains of t-PA span residues 87 to 176 (kringle 1) and residues 176 to 262 (kringle 2). The biologic role of kringle 1 remains undiscovered ( [1771](#), [1772](#) and [1773](#) ). The kringle 2 domain is involved in the binding of t-PA to fibrin ( [1771](#), [1772](#) ). This binding interaction is blocked by lysine and its analogs such as ε-amino-caproic acid ( [1771](#) ), indicating the presence of a plasminogen-like lysine binding pocket. The overall crystal structure of t-PA kringle 2 ( [1777](#) ) resembles that of kringle 4 of plasminogen although differences are observed in the arrangement of residues forming the lysine binding sites ( [1777](#), [1778](#), [1779](#) and [1780](#) ). The light or B-chain of t-PA contains the active site catalytic triad of this serine protease (His<sup>322</sup>, Asp<sup>371</sup>, and Ser<sup>478</sup>) ( [609](#), [1759](#), [1781](#) ). Both the single- and two-chain forms of t-PA cleave plasminogen at Arg<sup>561</sup>-Val<sup>562</sup> to yield the enzyme plasmin. The catalytic efficiency of single-chain t-PA toward plasminogen in solution and toward tripeptide paranitroanilide substrates is lower than the two-chain form ( [1764](#), [1766](#), [1782](#) ). Both forms exhibit enhanced and roughly equivalent rates of proteolysis of plasminogen when fibrin is present ( [1764](#) ). The t-PA molecule has three potential N-linked glycosylation sites and one O-linked site. The O-linked site is found at Thr<sup>61</sup> in the EGF domain ( [1783](#) ). The presence of a fucose at this site appears to facilitate the uptake of t-PA by hepatocytes ( [1784](#) ). Two major carbohydrate variants of t-PA have been identified. Type I is glycosylated at Asn<sup>117</sup> (kringle 1), Asn<sup>184</sup> (kringle 2), and Asn<sup>448</sup> (catalytic domain), whereas type II is glycosylated only at Asn<sup>117</sup> and Asn<sup>448</sup> ( [1785](#), [1786](#) ). The presence of carbohydrate at Asn<sup>184</sup> appears to down-regulate the fibrinolytic activity of type I t-PA by interfering with the association between the lysine binding site of its kringle 2 domain and fibrin.

**Regulation** Regulation of t-PA activity in blood is accomplished by three primary mechanisms: control of its catalytic potential via the fibrin dependence of plasminogen

activation; control of systemic levels of functional t-PA by the concerted processes of rapid t-PA removal by hepatic clearance and of inhibition by the circulating serpin PAI-1; and control of t-PA activity levels at the site of injury by the competing processes of increased t-PA secretion by traumatized and recruited cells versus PAI-1 release by activated platelets. t-PA manifests its full fibrinolytic potential only when bound to fibrin (1787, 1788 and 1789). This binding interaction aligns t-PA and plasminogen on the fibrin surface so that the catalytic efficiency of t-PA is enhanced several hundred-fold. This is vital to the localization of plasmin generation at the site of fibrin deposition. Systemic t-PA levels in blood are under highly dynamic control characterized by maintenance of relatively low levels of the protein (70 pmol/L) with a high clearance rate ( $t_{1/2} = 2.4$  minutes) and by maintenance of an extremely effective inhibitor, PAI-1 (second-order rate constant for complex formation =  $10^7$  to  $10^8 \text{ M}^{-1}\text{second}^{-1}$ ), at a circulating concentration several-fold higher than t-PA. The release of t-PA from the vessel wall is another important regulator of fibrinolysis (1790, 1791). The rate at which clots lyse is dependent on how rapidly t-PA is secreted by the relevant cells in the vicinity of an injury (1792, 1793). For example, activated platelets secrete serotonin that can induce endothelial cells to release t-PA; they also release PAI-1 from their  $\alpha$ -granules. Although only a fraction of this PAI-1 is in the active form, it functions to down-regulate plasminogen activation (1794, 1795 and 1796).

**EXTRINSIC ACTIVATOR: UROKINASE PLASMINOGEN ACTIVATOR** The other major extrinsic activator in the blood is u-PA. This activator was first identified in the urine (1797, 1798 and 1799), where it is present at relatively high concentrations (40 to 80  $\mu\text{g/L}$ ) (1799, 1800). It was subsequently detected in the media of cultured human kidney cells, endothelial cells, malignant cell lines, tumors, and in plasma (1801, 1802, 1803 and 1804). u-PA is a serine protease and is synthesized as a single-chain molecule called *prourokinase* or *single-chain u-PA* (scu-PA). The plasma concentration of scu-PA ranges from 2 to 4 ng/ml (37 to 74 pmol/L) (1805) (Table 21.8); the  $t_{1/2}$  of scu-PA is quite short, approximately 5 minutes, and metabolism occurs in both the liver and the kidney. scu-PA has a very low level of proteolytic activity (1806). Plasmin can hydrolyze the Lys<sup>158</sup>-Ile<sup>159</sup> peptide bond converting scu-PA into the two-chain form (tcu-PA) (248, 1797, 1807, 1808). The mechanism in blood by which scu-PA is converted into tcu-PA still remains poorly defined. It has been postulated that, within a thrombus, t-PA initially activates plasminogen bound to fibrin to form plasmin, and that it is this fibrin-localized plasmin that then converts scu-PA into tcu-PA (1809, 1810 and 1811). This process results in an amplification of the rate of plasmin formation. The main site of urokinase-driven plasminogen activation appears to be extravascular where it has an important role in promoting degradation of extracellular matrix by triggering the activation of plasminogen and, possibly, matrix metalloproteinases (1812). Regulation of urokinase is important to normal and pathologic processes including embryogenesis, wound healing, tumor cell invasion, and metastasis (1813, 1814). Inhibitors of urokinase have been shown to suppress the growth of primary tumors and to interfere with metastasis of tumor cells (1815, 1816, 1817, 1818, 1819, 1820, 1821 and 1822).

**Gene Structure and Expression** The human u-PA gene spans 6.4 kb with 11 exons (1823) and is located on chromosome 10, band q24 (1824) (Table 21.9). The overall intron-exon arrangement is similar to that of the t-PA gene. The primary amino acid sequence of the purified, intact two-chain molecule has been determined (1825, 1826 and 1827), and the cDNA has been isolated and sequenced (1828): The gene specifies a protein of 431 amino acids, with the first 20 residues constituting a signal peptide. The disruption of the urokinase gene (u-PA  $-/-$ ) in mice is not lethal (1756). These mice did not display spontaneous thrombi in their vasculature. The phenotype of u-PA  $-/-$  mice included occasional minor fibrin deposits in the liver and intestine, excessive fibrin deposits in



chronic nonhealing skin lesions, and increased susceptibility to bacterial infections ( [1756](#), [1829](#), [1830](#) and [1831](#) ).

**Biochemistry** u-PA is a single-chain glycoprotein containing 411 amino acids ( $M_r = 54,000$ ) ( [Table 21.8](#) and [Fig. 21.20](#) ). It has 12 disulfide bonds with one (Cys<sup>148</sup>-Cys<sup>279</sup>) serving to link the catalytic domain (B-chain) to the NH<sub>2</sub>-terminal domain (A-chain).

Posttranslational modifications include glycosylation at Asn<sup>302</sup>, addition of a single fucose residue at Thr<sup>18</sup> ( [1832](#) ), and regulatory phosphorylation at Ser<sup>138</sup>/Ser<sup>303</sup> ( [1833](#) ). u-PA is composed of an EGF domain (residues 7 to 43), a single kringle domain (residues 50 to 131), a connecting peptide region (residues 132 to 157), and the serine protease-type catalytic domain (residues 159 to 411). The EGF domain contains the residues essential for urokinase binding to the urokinase receptor ( [1834](#) ) and appears to be the domain responsible for the ability of urokinase to induce cellular proliferation and differentiation ( [1835](#), [1836](#) and [1837](#) ). The function of the kringle domain of urokinase remains to be established. It displays no binding affinity for fibrin. Recent evidence indicates that the kringle domain may have a role in mediating the process by which urokinase stimulates smooth muscle migration ( [1838](#), [1839](#) and [1840](#) ). Residues His<sup>204</sup>, Asp<sup>255</sup>, and Ser<sup>356</sup> form the catalytic triad of urokinase; unlike the single-chain form of t-PA, they are not properly positioned for efficient catalysis. scu-PA does not form complexes with PAI-1 or react with peptidyl chloromethylketones that inhibit the two-chain form; scu-PA-catalyzed hydrolysis of tripeptide paranitroanilide substrates proceeds with 0.1 to 0.4% the efficiency of tcu-PA ( [1841](#), [1842](#) ), and plasminogen activation by scu-PA appears to be equally inefficient when compared to tcu-PA ( [1811](#), [1843](#) ). The urokinase molecule is asymmetric in shape with the growth factor, kringle, and catalytic domains arranged like differently configured beads on a string ( [1832](#), [1844](#), [1845](#) and [1846](#) ). A crystal structure for the entire urokinase molecule has not been accomplished. However, a crystal structure at a resolution of 2.5 Å has been reported for the catalytic domain. The molecule used was a recombinant, nonglycosylated human u-PA (residues 159 to 411) with its active site histidine residue derivatized with a peptidyl chloromethylketone ( [1847](#) ). The catalytic domain of u-PA has the expected overall topography and S1 specificity pocket of a trypsinlike protease, an S2 pocket of hydrophobic character, and a solvent-accessible S3 pocket suitable for binding a wide range of amino acid side chains. The crystal structure of a mutant urokinase catalytic domain (residues 159 to 404: C122A and N302Q) at a resolution of 1.5 Å has also been reported ( [1848](#) ).

**Activation** Conversion of single-chain urokinase to an active two-chain form occurs principally through hydrolysis of the Lys<sup>158</sup>-Ile<sup>159</sup> bond. This molecular form, referred to as *high-molecular-weight tcu-PA*, is comprised of NH<sub>2</sub>-terminal heavy chain (residues 1 to 158) linked by one disulfide bond to the catalytic domain. In the blood, during fibrinolysis, plasmin is the primary catalyst of this conversion; in addition, both kallikrein and factor XIIa ( [248](#) ), products of the intrinsic pathway of coagulation, hydrolyze this bond. A number of other proteases that cleave the Lys<sup>158</sup>-Ile<sup>159</sup> bond have also been identified including several cathepsins ( [1849](#), [1850](#), [1851](#) and [1852](#) ), mast cell tryptase ( [1853](#) ), nerve growth factor-? ( [1854](#) ), human T-cell serine proteinase-1 ( [1855](#) ), and FSAP ( [1856](#) ). A second, catalytically active form of two-chain urokinase, known as *low-molecular-weight tcu-PA*, is found in plasma when fibrinolysis is stimulated. It is formed by an additional plasmin cleavage at Lys<sup>135</sup>-Lys<sup>136</sup>. This yields a truncated heavy chain containing most of the connecting peptide region (residues 136 to 158) linked to the catalytic domain by the Cys<sup>148</sup>-Cys<sup>279</sup> disulfide bond. This cleavage produces a more efficient enzyme, and this low-molecular-weight form is used clinically for thrombolytic therapy. Another low-molecular-weight form of scu-PA arises from cleavage of the Glu<sup>143</sup>-Leu<sup>144</sup> bond by the matrix metalloproteinases Pump 1 and metalloproteinase 3 ( [1857](#), [1858](#) and [1859](#) ). This form appears to be a better clot-lysing agent

than low-molecular-weight tcu-PA ( [1860](#)). Neutrophil cathepsin G and elastase from granulocytes cleave scu-PA at the Ile<sup>159</sup>-Ile<sup>160</sup> bond yielding a two-chain molecule that is inactive ( [1861](#), [1862](#)). Thrombin ( [248](#), [1863](#), [1864](#)) and, more efficiently, the thrombin-thrombomodulin complex ( [1865](#)) cleave scu-PA at Arg<sup>156</sup>-Phe<sup>157</sup> yielding an inactive two-chain urokinase species. The release of the dipeptide Phe<sup>157</sup>-Lys<sup>158</sup> from the catalytic domain is catalyzed by cathepsin C ( [1850](#)) or plasmin ( [1866](#)).

**Function** t-PA appears to be the primary plasminogen activator in the vasculature, with fibrin-localized scu-PA conversion to tcu-PA acting as an amplifying rather than initiating mechanism for plasmin formation ( [1811](#), [1867](#)). Direct scu-PA activation of Glu-plasminogen bound to COOH-terminal lysine residues found in partially proteolyzed fibrin has been proposed as contributing to clot lysis ( [1868](#), [1869](#) and [1870](#)). This catalytic role of scu-PA, although direct, still depends temporally on t-PA-derived plasmin to create the circumstance (plasmin proteolyzed fibrin) under which it can contribute to overall fibrinolysis.

**EXTRINSIC ACTIVATOR: FACTOR VII-ACTIVATING PROTEASE** Recently, a novel serine protease in human plasma has been described that can support coagulation by activating factor VII ( [446](#), [1871](#), [1872](#)). It was originally described as plasma hyaluronan binding protein and was isolated by adsorption to immobilized hyaluronic acid as a disulfide-linked heterodimer ( [1872](#)). Independently, a thrombinlike amidolytic activity was purified from commercial prothrombin complex concentrates ( [1873](#), [1874](#)). Sequencing data indicated that this protease and plasma hyaluronan binding protein were the same proteins. Subsequently, the protease from prothrombin complex concentrates was shown to be a potent activator of factor VII and termed *FSAP* ( [446](#)). This protease has also been shown to be an efficient activator of single-chain urokinase. Its single-chain precursor has been purified from plasma ( [1875](#)).

**Gene Structure and Expression** FSAP has been mapped to chromosome 10, bands q25-q26 ( [1876](#)). It spans 35 kb and is composed of 13 exons ( [Table 21.8](#)). Its transcript specifies a protein of 560 amino acids; the first 23 amino acids comprise the signal peptide sequence. Two single nucleotide polymorphisms have been identified: One, called *FSAP Marburg I* (SNP-1), yields a Gly511Glu substitution near the COOH-terminus of the protease resulting in impairment of its scu-PA activating properties ( [1877](#)). The clinical relevance of this polymorphism has not been assessed. The second polymorphism, Marburg II, contains a Glu370Gln mutation that does not appear to have an effect on the catalytic properties of FSAP.

**Biochemistry and Activation** FSAP is a single-chain glycoprotein containing 537 amino acids with a M<sub>r</sub> of 64 d ( [1872](#)). It circulates at a concentration of approximately 12 μg/ml (190 nmol/L; [Table 21.8](#)). It is composed of 5% carbohydrate and is glycosylated at Asn<sup>31</sup> (NH<sub>2</sub>-terminal strand) and Asn<sup>184</sup> (kringle domain) ( [1875](#)). The structure consists of an amino terminal strand (residues 1 to 52) that is followed by three EGF-like domains (residues 53 to 166), a kringle domain (residues 170 to 254), and a COOH-terminus serine protease domain (residues 290 to 537). FSAP has structural regions that are homologous to those found in hepatocyte growth factor activator ( [1878](#)). It binds to GAGs such as heparin. The conversion to the active two-chain form requires cleavage of the Arg<sup>290</sup>-Ile<sup>291</sup> bond. This generates a heavy chain (residues 1 to 290) and a light chain or catalytic domain (residues 291 to 537). The two chains are linked by a single disulfide bond (Cys<sup>278</sup>-Cys<sup>412</sup>). The active site residues of this serine protease are Asp<sup>382</sup>, His<sup>339</sup>, and Ser<sup>486</sup>. Preparations of single-chain FSAP rapidly convert to the two-chain form. Whether this is due to an intrinsic activity of the single-chain molecule or to trace amounts of the two-chain form in single-chain preparations has not been resolved ( [1879](#)). Heparin promotes conversion of single-chain FSAP preparations to the two-chain form ( [1880](#)).



The high-molecular-weight form of two-chain urokinase has been shown to convert single-chain FSAP to the two-chain form and may represent a physiologic activator ( [1875](#) ). The rate of this reaction is affected by heparin. In addition to factor VII and single-chain urokinase, other substrates for FSAP, determined from *in vitro* assays, include factor V/factor Va, factor VIII/factor VIIIa, fibrinogen, single-chain t-PA, fibronectin, and vitronectin ( [1871](#) ). Similar to plasmin, two-chain FSAP binds to aprotinin. *In vitro* assays indicate that it also complexes with serpins such as C1-inhibitor ( [1881](#) ), a  $\alpha_2$ -antiplasmin, and antithrombin III-heparin ( [1856](#), [1882](#) ).

**Function** The physiologic function of FSAP still is unclear. The ability of two-chain FSAP to convert factor VII to factor VIIa in the absence of tissue factor suggests that it could contribute to the maintenance of normal factor VIIa (100 pmol/L) levels in blood or perhaps contribute to the localized production of factor VIIa at the site of vascular injury. In a system of synthetic hemophilia (factor VIII deficiency), two-chain FSAP has been shown to correct the hemostatic defect ( [446](#) ). Similar results have been found with the addition of exogenous factor VIIa to hemophilia blood ( [418](#) ). The two-chain form of FSAP appears to be an efficient activator of single-chain urokinase, comparing favorably with plasmin when heparin is present ( [1856](#) ). It has been suggested ( [1871](#) ) that GAG binding properties of FSAP may localize it to cell surfaces and extracellular matrix proteins where it may play a role as an initiator of urokinase-dependent proteolytic cascades.

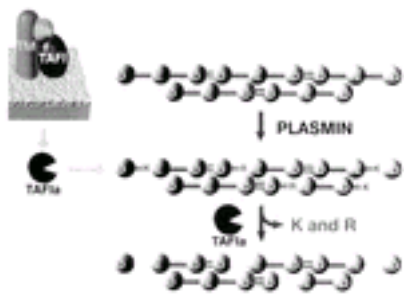
## INHIBITORS OF THE FIBRINOLYTIC SYSTEM

A wide variety of natural inhibitors of fibrinolysis exist in plasma, blood cells, tissues, and extracellular matrices. These natural inhibitors can act either to inhibit plasmin directly or to block the conversion of plasminogen to plasmin ( [Fig. 21.17](#) ). In this section, TAFI, PAI-1, PAI-2, and a  $\alpha_2$ -antiplasmin inhibitor are reviewed in terms of their gene structure and expression, biochemistry, and function.

### Thrombin-Activatable Fibrinolysis Inhibitor

TAFI (E.C.3.4.17.20) (reviews: [1883](#), [1884](#)) is a plasma zymogen with homology to procarboxypeptidases A and B. Its plasma concentration is 75 nmol/L (4.5  $\mu$ g/ml) ( [Table 21.8](#) ). TAFI is synthesized in the liver and is thought to circulate in blood in complex with plasminogen. Activation of TAFI yields an exopeptidase (TAFIa) with carboxypeptidase B-like substrate specificity: It catalyzes the removal of basic amino acids (arginines, lysines) from the COOH-termini of polypeptides. Its primary physiologic activator appears to be the thrombin-thrombomodulin complex, thus defining TAFIa as a coagulation-dependent activity ( [891](#) ). COOH-terminal lysines that appear in fibrin as it degrades have been identified as the primary substrates for TAFIa ( [Fig. 21.21](#) ). The initial phase of plasmin proteolysis of fibrin produces products that amplify plasminogen activation by t-PA. These fibrin degradation products thus constitute a positive feedback process, thereby accelerating clot lysis. COOH-terminal lysines that appear in fibrin as it is degraded by plasmin function as additional binding sites where efficient plasminogen activation can occur. Removal of these terminal lysine residues by TAFIa reduces the number of plasminogen binding sites, thus serving to down-regulate the rate of plasmin generation and thereby the rate of clot lysis. Thus, TAFI/TAFIa functions as an antifibrinolytic factor by suppressing the positive feedback pathway of fibrinolysis. The importance *in vivo* of the TAFI/TAFIa-mediated regulation of fibrinolysis remains to be established. Several studies involving animal models of thrombosis ( [1885](#), [1886](#), [1887](#) and [1888](#) ) have provided *in vivo* evidence consistent with the proposed role of the TAFI/TAFIa system in regulating fibrinolysis. However, TAFI knock-out mice develop normally and prove no more sensitive to a wide range of hemostatic challenges than their wild-type littermates ( [1889](#) ). In humans, TAFI antigen concentration has been correlated with an

increase in risk for deep vein thrombosis ( [1890](#), [1891](#) ).



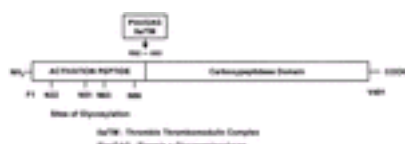
**Figure 21.21.** Mechanism of thrombin-activatable fibrinolysis inhibitor (TAFI) effects toward fibrinolysis. Thrombin-thrombomodulin (IIa-TM) cleaves TAFI to its active carboxypeptidase form TAFIa. TAFIa interferes with fibrinolysis by cleaving COOH-terminal Arg (R) or Lys (K) residues made available as a consequence of partial plasmin digestion of the fibrin clot. Removing these residues attenuates the self-amplifying mechanism of fibrin-based plasmin formation wherein partial plasmin proteolysis of fibrin increases the number of binding sites (COOH-terminal lysines) available for efficient plasminogen activation. See [Color Plate](#). (From Mann KG. Coagulation explosion. Vermont Business Graphics, 1997, with permission.)

The nomenclature associated with carboxypeptidase B-type activity in serum reflects the history of its isolation and characterization. The presence of a carboxypeptidase B-type activity in serum that differed from that of carboxypeptidase N, a previously characterized enzyme found in plasma, was first reported by two groups: Hendriks et al. ( [15](#), [1892](#), [1893](#) ) named the enzyme *carboxypeptidase unstable* because of its short  $t_{1/2}$  compared to carboxypeptidase N; Campbell and Okada ( [1894](#) ) named their activity *carboxypeptidase R* because of its apparent preference for substrates with COOH-terminal arginine residues, again in contrast to carboxypeptidase N, which showed a selectivity for COOH-terminal lysines. Subsequently, Eaton et al. ( [16](#), [1895](#) ) purified a novel plasminogen-binding protein from human plasma, which, based on sequence homology and enzymatic properties, proved to be a procarboxypeptidase. They named this *protein plasma procarboxypeptidase B*. Independently, Bajzar et al. ( [17](#) ), using an assay designed to detect the factor responsible for thrombin-dependent inhibition of fibrinolysis, purified a protein from human plasma. Initial characterization of this protein indicated that it was a procarboxypeptidase B-type protein, which converted to an active carboxypeptidase on treatment with thrombin. This group named the protein *TAFI*. Further characterization established that TAFI is identical to protein plasma procarboxypeptidase B ( [16](#), [932](#) ). Whether carboxypeptidase R and carboxypeptidase unstable are identical to TAFI has not been resolved because of differences in the reported molecular mass and subunit structure of these proteins.

**GENE STRUCTURE AND EXPRESSION** TAFI is a member of a multigene family that includes the pancreatic and mast cell carboxypeptidases but not other carboxypeptidases with a specificity for basic amino acids such as carboxypeptidases N, M, H, and D ( [1896](#), [1897](#) ). TAFI shares a 34 to 40% amino acid identity with its family members and exact conservation of cysteine residues and residues critical for catalysis, zinc binding, and substrate binding. The human gene for TAFI maps to chromosome 13 ( [1898](#) ) and is comprised of 11 exons within 48 kb of DNA ( [1896](#) ) ( [Table 21.9](#) ). When the TAFI gene is compared with the genes from rat pancreatic carboxypeptidases A1, A2, and B and human mast cell carboxypeptidase A, the positions of intron/exon boundaries are conserved,

whereas the intron lengths diverge significantly. The TAFI promoter lacks a consensus TATA sequence but does have a 70-bp sequence in the 5'-flanking region of the gene that is required for liver-specific transcription (1896). Transcription is initiated at multiple sites. Primer extension analysis of human liver Poly (A)<sup>+</sup> RNA identified nine major transcription start sites with similar frequencies of usage (1896). The TAFI transcript is polyadenylated at three different sites. The TAFI transcript encodes a gene product of 423 amino acids. The first 22 amino acids comprise a signal peptide that is absent in the circulating form of the protein. Three single nucleotide polymorphisms in the coding region of the human TAFI gene have been identified, resulting in two distinct isoforms of TAFI: a base change of C to T at base 678, resulting in a silent mutation; a base change of A to G at base 505, yielding a Thr to Ala substitution at amino acid position 147; and a base change of C to T at base 1057, resulting in an Ile to Thr substitution at TAFI residue 325. No functional difference was observed between purified TAFIa (Ala<sup>147</sup>) and TAFIa (Thr<sup>147</sup>) (1899). However, purified TAFIa (Ile<sup>325</sup>) showed greater activity and stability than TAFIa (Thr<sup>325</sup>). The plasma concentration of TAFI antigen has been observed to vary approximately tenfold in the human population. The origin of this variability appears to be primarily genetic (1900). Polymorphisms in the TAFI gene that have been shown to be strongly associated with plasma TAFI levels include a number in the 5'-flanking region (1890, 1901), the 3'-untranslated region (1901), and the coding region (1902).

**BIOCHEMISTRY** The TAFI transcript specifies a preprotein of 423 amino acids comprised of a signal peptide, an activation peptide domain, and a catalytic domain. Removal of the signal peptide yields the circulating zymogen of 401 amino acids (45 kd); when analyzed by SDS-PAGE, the apparent molecular weight of TAFI is 58 kd (Fig. 21.22). The difference in mass derives from a high level of glycosylation involving all four of the potential sites (Asn<sup>22</sup>, Asn<sup>51</sup>, Asn<sup>63</sup>, and Asn<sup>86</sup>) present in the activation peptide domain (residues 1 to 92). In addition to its structural role in suppressing the catalytic potential of TAFI, the activation peptide domain mediates the association in blood of TAFI with plasminogen (16). The sequence of the catalytic domain (residues 93 to 401; 35 kd) displays exact conservation when compared to pancreatic and mast cell carboxypeptidases of cysteine residues and residues critical for catalysis, Zn<sup>+2</sup> binding, and substrate binding (16, 1896). The activated form of TAFI is a carboxypeptidase that catalyzes the removal of arginine or lysine residues from the COOH-termini of polypeptides. TAFIa is inhibited by agents that can chelate Zn<sup>2+</sup>, such as o-phenanthroline, and by 2-guanidinoethylmercaptosuccinic acid, a specific inhibitor of pancreatic and mast cell carboxypeptidases (16, 17). TAFIa is an unstable enzyme at physiologic pH and temperature (15, 16 and 17). At 37° C, TAFIa has a functional t<sub>1/2</sub> of approximately 10 minutes; its loss of activity is coincident with a significant change in conformation (1903).



**Figure 21.22.** Schematic of thrombin-activatable fibrinolysis inhibitor (TAFI). Activation of TAFI ( $M_r = 58,000$ ) yields an exopeptidase (TAFIa) with carboxypeptidase B-like substrate specificity: It catalyzes the removal of basic amino acids (arginines, lysines) from the COOH-termini of polypeptides. TAFI contains 401 amino acids with four glycosylation sites in its activation peptide region. It is activated by thrombin-thrombomodulin (IIa/TM) and plasmin-glycosaminoglycan complexes (Plm/GAG) by hydrolysis of the R<sup>92</sup>-A<sup>93</sup> bond.

**ACTIVATION** The activation of TAFI requires the cleavage of the zymogen at Arg<sup>92</sup>, yielding an activation peptide of approximately 15 kd and an active carboxypeptidase of 35

kd ( [Fig. 21.22](#)). Trypsin ( [16](#)), plasmin ( [16](#), [1904](#)), plasmin–anionic GAG complex ( [1904](#)), thrombin ( [16](#), [17](#)), thrombin–thrombomodulin complex ( [891](#)), and meizothrombin–thrombomodulin complex ( [1016](#)) all catalyze this reaction *in vitro*. A ranking of these catalysts in terms of relative catalytic efficiency shows the following order: thrombin–thrombomodulin (1.0) > meizothrombin–thrombin (0.1) = plasmin–anionic GAG (0.1) > plasmin (0.006) > thrombin (0.0008). The relative contributions of thrombin and plasmin to TAFI generation *in vivo* may be regulated by the availability of their respective cofactors at the site of vascular injury: cell–associated thrombomodulin versus the extent of exposure of subendothelial extracellular matrix.

**FUNCTION** Thrombin cleavage of fibrinogen yields insoluble fibrin polymers and soluble fibrinopeptides, all bearing COOH–terminal arginine residues. These COOH–terminal arginines are substrates for TAFIa, and the kinetics of their release in an *in vitro* clot lysis system ( [1651](#)) and whole blood system where des–Arg FPB was detected ( [934](#)) have been reported. The significance of this removal of arginine residues from these sites is not known. The activation of many of the cofactors and zymogens of the coagulation and fibrinolytic cascades results in the generation of functional proteins with COOH–terminal arginines or lysines. Their status as TAFIa substrates is unknown. Bradykinin and several enkephalins have been shown *in vitro* to be good TAFIa substrates ( [1895](#)); to date, only circumstantial evidence connects TAFIa and bradykinin *in vivo* ( [1905](#)). Extensive *in vitro* data ( [1021](#), [1650](#), [1651](#) and [1652](#), [1903](#), [1906](#), [1907](#)) attest to the ability of TAFIa to slow the rate of fibrin degradation by plasmin generated *in situ*. Proteolysis of insoluble fibrin by plasmin proceeds through repetitive cleavages at lysine residues terminating in the formation of soluble fibrin degradation products. Before solubilization, each cleavage shortens the fibrin molecule and generates a new COOH–terminal lysine residue. COOH–terminal lysines in partially degraded fibrin have been shown to function as potent cofactors for t–PA–catalyzed activation of Glu–plasminogen ( [1908](#), [1909](#), [1910](#), [1911](#) and [1912](#)). Removal of the COOH–terminal lysines by TAFIa thus reduces the number of sites available for plasminogen binding, thereby reducing the rate of plasmin generation with consequent prolongation of fibrin dissolution ( [1650](#), [1651](#)) ( [Fig. 21.21](#)). TAFIa functions as an attenuator of fibrinolysis ( [1883](#)), and thus an adequate rate of TAFIa generation may be critical in the stabilization of the blood clot. For example, plasmas with specific deficiencies in the coagulation pathway showed reduced rates of thrombin production, decreased levels of TAFIa, and premature clot lysis ( [1652](#), [1886](#), [1913](#)).

**REGULATION** TAFI circulates in plasma bound to plasminogen ( [16](#)) and is a substrate for FXIIIa, which catalyzes its covalent attachment to fibrin ( [933](#)). Whether these two mechanisms for concentrating TAFI at the site of fibrin formation contribute to the function of TAFI *in vivo* is not established. It has been proposed ( [1884](#)), because the thrombin–thrombomodulin complex has a Km 10 to 20 times the plasma concentration of TAFI, that rates of TAFI activation would vary directly with changes in TAFI concentration. A plasma inhibitor of TAFIa has not been described. Carboxypeptidase inhibitors from potato ( [1914](#)) and the leech ( [1915](#)) active against TAFIa have been identified. TAFIa is an unstable enzyme under physiologic conditions ( [15](#), [16](#) and [17](#)). It undergoes a spontaneous conformational change with a  $t_{1/2}$  of 10 minutes at 37° C ( [1903](#)). This appears to be the primary route of inactivation because proteolytic cleavage at Arg<sup>302</sup> by thrombin or plasmin has now been identified as secondary to and dependent on the inactivating conformation change ( [1916](#), [1917](#)). TAFI plasma concentrations vary significantly in the human population. Although genetic factors appear to be the largest contributor to this variation ( [1901](#)), a growing number of stimuli have been shown to affect TAFI plasma concentration ( [1891](#), [1900](#), [1918](#), [1919](#), [1920](#) and [1921](#)). It has been proposed, in light of the intrinsic instability of TAFIa and the absence of a specific inhibitor, that control of the concentration of TAFIa through control of the level of TAFI gene expression is the primary regulator of TAFI/TAFIa system *in vivo* ( [1922](#)).

## Plasminogen Activator Inhibitor-1

PAI-1 is the primary physiologic inhibitor of plasminogen activation in blood, targeting u-PA and t-PA. It also appears to have a role, independent of its antiproteolytic function, in tissue remodeling by interfering with vitronectin-dependent processes of cell adhesion and migration. Congenital deficiency of PAI-1 is rare with homozygous individuals displaying abnormal bleeding in response to trauma ( [1923](#), [1924](#), [1925](#), [1926](#) and [1927](#) ). In a normal population, plasma PAI-1 concentration varies over a 15-fold range (6 ng/ml to 80 ng/ml) ( [1928](#), [1929](#) ) and exhibits a circadian variation ( [1930](#) ) ( [Table 21.8](#) ). Some of this variability stems from polymorphisms in the PAI-1 gene; however, a larger fraction of the variability appears to derive from the responsiveness of PAI-1 gene expression to a wide variety of physiologic effectors and conditions as well as pharmacologic agents ( [1931](#) ). Higher levels of plasma PAI-1 prolong fibrin removal by shortening the functional lifetime of plasminogen activators, thereby shifting hemostasis to a more thrombotic state ( [1932](#) ). The  $t_{1/2}$  of PAI-1 in blood is less than 10 minutes. Potential sites of constitutive PAI-1 synthesis in humans include the liver, spleen, adipose tissue, and cells of the vasculature including endothelial cells, smooth muscle cells, macrophages, and megakaryocytes. The relative contributions from these sources to plasma PAI-1 levels in normal or specific pathologic conditions remain unresolved. The major fraction of PAI-1 in blood is present in platelets, apparently synthesized and stored in the  $\alpha$ -granules during the maturation of megakaryocytes ( [1933](#) ). Although 75 to 80% of platelet PAI-1 is present in the latent form, there appears to be enough active PAI-1 released from platelets at sites of thrombus formation to contribute to the suppression of fibrinolysis ( [1794](#), [1795](#) and [1796](#) ).

PAI-1 is a single-chain protein with an  $M_r$  of 50,000 with 13% of its mass comprised of carbohydrate ( [Table 21.8](#) ). It is a typical serpin with its reactive site bond, Arg<sup>346</sup>-Met<sup>347</sup>, positioned in an exposed loop region ( [1934](#) ) where it is available for complexation with its target proteases. However, this conformation, with the reactive site accessible to proteases, is unstable ( $t_{1/2}$ =90 minutes), reverting spontaneously to a latent form of the inhibitor in which the reactive loop is buried in  $\beta$  sheet A of the protein core; this positioning of the reactive loop is observed in PAI-1 and other serpins after cleavage of the reactive site bond ( [1935](#) ). Plasma PAI-1 circulates in noncovalent association with vitronectin ( [1928](#), [1936](#) ) ( $K_d$  =0.05 nmol/L); *in vitro*, this association results in a twofold increase in its functional  $t_{1/2}$  and, in the presence of heparin, increases PAI-1 reactivity with thrombin ( [1472](#) ).

**GENE STRUCTURE AND EXPRESSION** PAI-1 is an inhibitory serpin with significant sequence homology to a  $\alpha_1$ -antitrypsin, antithrombin-III, and a  $\alpha_1$ -antichymotrypsin ( [1277](#), [1937](#), [1938](#), [1939](#), [1940](#), [1941](#), [1942](#) and [1943](#) ). It shares the fundamental structural plan of these serpins: three  $\beta$  sheets, nine  $\alpha$ -helices, and a reactive site loop. PAI-1 is distinguished from the other inhibitory serpins in that it lacks cysteine residues. The human gene for PAI-1 is located on chromosome 7 bands q21.3-q22 in close proximity to the loci for erythropoietin, paraoxonase, and cystic fibrosis ( [1944](#), [1945](#) ) ( [Table 21.9](#) ). It covers 12.2 kb of DNA with nine exons specifying the 23 amino acids of the signal peptide and 379 amino acids of the mature protein ( [1946](#), [1947](#), [1948](#) and [1949](#) ). Introns, totaling approximately 9000 bp, define boundaries of individual structural subdomains or are found in random coil regions of the protein ( [1946](#), [1947](#) ). The transcription start site is located 25 bp downstream of a consensus TATA sequence ( [1947](#), [1949](#) ). The 5'-flanking region of the PAI-1 gene shows an extensive region of nucleotide sequence identity with the 5'-flanking region of the gene encoding t-PA ( [1948](#), [1949](#) ). The 3' region of the human



PAI-1 gene contains alternative polyadenylation sites resulting in two mRNA species of different lengths (2.4 and 3.2 kb) ( [1946](#) ). Normal plasma levels of PAI-1 antigen range between 6 and 80 ng/ml. Polymorphisms in the PAI-1 gene appear to correlate with different plasma levels of PAI-1; thus, genotype-specific regulation of PAI-1 regulation accounts for some of the observed variation in the normal population. Nine polymorphisms have been described, with three of these the subject of human population studies ( [1950](#) ). A polymorphism located 675 bp upstream of the transcription start site consists of a single guanine insertion/deletion variation (4G/5G) leading to a sequence of four or five guanine nucleotides in the promoter ( [1951](#) ). Individuals homozygous for the 4G polymorphism have the highest levels of PAI-1, heterozygotes show intermediate levels, and those homozygous for the 5G allele have the lowest levels ( [1952](#), [1953](#), [1954](#), [1955](#) and [1956](#) ). The basis of this differential expression of the PAI-1 gene appears to be the specificity of a transcriptional repressor protein that binds the 5G allele and not the 4G allele ( [1956](#) ). The predictive relationship between the 4G/5G genotype, plasma PAI-1 level, and the risk of thrombosis is controversial ( [1957](#), [1958](#) ). The two other polymorphisms investigated both *in vitro* and in human population studies include an eight-allele (CA)<sub>n</sub> repeat in intron 3 ( [1959](#) ) and a two-allele Hind III restriction fragment length polymorphism of the 3'-flanking region. Individuals with one of the homozygous genotypes associated with the Hind III site exhibit higher plasma PAI-1 activity than the complementary homozygous individuals ( [1959](#) ). *In vitro* studies of the Hind III polymorphism have shown genotype-specific regulation of PAI-1 synthesis by a number of effector molecules ( [1960](#), [1961](#), [1962](#) and [1963](#) ). Congenital PAI-1 deficiency is a rare disorder with homozygous PAI-1-deficient individuals showing abnormal bleeding after trauma or surgery ( [1923](#), [1924](#) ). A study of an extended family with 19 heterozygotes and 7 individuals homozygous for a null mutation in the PAI-1 gene found no significant developmental or other abnormalities in the homozygotes beyond abnormal bleeding episodes ( [1926](#) ). Homozygous PAI-1-deficient mice display normal fertility, viability, and development with no identified histologic abnormalities ( [1964](#), [1965](#) ). A mild hyperfibrinolytic state and greater resistance to venous thrombosis were reported. Mice with combined homozygous deficiency of PAI-1 and a  $\alpha_2$ -antiplasmin show normal fertility and development while displaying a higher fibrinolytic capacity ( [1966](#) ). However, this increase appears to depend on the  $\alpha_2$ -antiplasmin deficiency alone, suggesting a less critical role for PAI-1 in the regulation of fibrinolysis.

**BIOCHEMISTRY** PAI-1 is a single-chain glycoprotein of 379 amino acids that has no cysteine residues. It is an inhibitory serpin with a reactive site bond, Arg<sup>346</sup>-Met<sup>347</sup>, positioned in a surface-exposed, disordered loop of 20 amino acids ( [1934](#) ). Reaction with t-PA or u-PA involves rapid formation (second-order rate constant =  $10^7$  to  $10^8$  M<sup>-1</sup>second<sup>-1</sup>) of a reversible complex; specific interactions between a negatively charged region (amino acids 350 to 355) of the PAI-1 molecule and positively charged regions in t-PA ( [1967](#), [1968](#) ) or in u-PA ( [1969](#) ) are important to this initial association. Cleavage of the reactive site Arg<sup>346</sup>Met<sup>347</sup> bond in PAI-1 by the protease triggers a large conformational change in both the inhibitor and protease that renders the protease unable to efficiently hydrolyze the normally transient ester linkage between its active site serine residue and the carboxyl moiety of a targeted peptide bond. PAI-1 converts to an inactive (latent) form spontaneously; it can be returned to its active conformation by treatment with denaturants ( [1970](#) ). The crystal structure of latent PAI-1 indicates that the reactive site loop is inserted into the  $\beta$  sheet A of the molecule making it unavailable to proteases ( [1971](#) ). The crystal structure of a mutant PAI-1 stabilized in the active conformation by substitutions at four sites (N150?H; K154?T; Q319?L; M354?I) shows the reactive site bond to be located at the apex of a flexible, exterior loop ( [1934](#) ). The vitronectin binding site of PAI-1 involves five residues located on the exterior of the molecule ( [1972](#) ). Extensive structural differences have been noted when this region is compared in active

and latent conformations of PAI-1 (1934). Stabilization of the conformation of this region of PAI-1 by the PAI-1 vitronectin binding interaction presumably impedes the insertion of the reactive site loop into  $\beta$  sheet A of the molecule.

**FUNCTION** PAI-1 is the central physiologic inhibitor of the plasminogen activator t-PA in blood. It reacts with both the secreted, single-chain form of t-PA and the two-chain form generated by plasmin during the process of fibrin dissolution. Both PAI-1 and t-PA are characterized by high turnover rates (t-PA,  $t_{1/2} = 3$  to 4 minutes; PAI-1,  $t_{1/2} = 10$  minutes) with functional PAI-1 circulating concentrations maintained at least at several-fold molar excess over the concentration of functional t-PA (14 pmol/L). From the circulating concentration of PAI-1 and the second-order rate constant for the association of PAI-1 with either form of t-PA ( $10^7$  to  $10^8$  M<sup>-1</sup>second<sup>-1</sup>), the predicted  $t_{1/2}$  of t-PA is less than 1 minute: This is consistent with the observation that approximately 80% of the t-PA antigen in plasma (70 pmol/L) is found complexed with PAI-1. PAI-1-t-PA complexes have a clearance half-time of approximately 5 minutes (1729). Although other plasma proteins have been identified *in vitro* with inhibitory activity toward plasminogen activators (PAI-2, PAI-3, protease nexin), only PAI-1-plasminogen activator complexes have been detected *in vivo* (1040, 1973). PAI-1 is an important inhibitor of u-PA. Unlike t-PA, PAI-1 forms complexes only with the two-chain form of urokinase; it does not complex with the single-chain form of urokinase. The second-order rate constant for the association of PAI-1 and t-PA is in the range of  $10^8$  M<sup>-1</sup>second<sup>-1</sup>. Conversion of circulating scu-PA (37 to 74 pmol/L) to t-PA occurs at sites of fibrin lysis. Urokinase also is involved in physiologic and pathologic processes such as embryo development, wound healing, cell migration, inflammation, and metastasis of tumor cells. A large body of *in vitro* work supports a regulatory role for PAI-1 as a protease inhibitor in u-PA-mediated events outside the vasculature. PAI-1 also appears to be involved in regulating cell adhesion and migration by a mechanism independent of its function as a protease inhibitor. Its high-affinity association with the somatomedin B domain of vitronectin makes it an effective competitor with other ligands such as urokinase-type plasminogen activator receptor (uPAR) (1974, 1975, 1976 and 1977) and integrins including a  $\alpha_3\beta_3$  (1978) that also bind to vitronectin at this site. The ability to interfere with the binding of such cell-associated ligands to matrix-associated vitronectin suggests a role for PAI-1 as a regulator of the interaction of cells with the extracellular matrix.

## Plasminogen Activator Inhibitor-2

PAI-2 is a member of the serpin subfamily designated the *ovalbumin-related serpins*. It was initially identified in human placenta as an inhibitor of urokinase (1979). It has also been referred to as the *placental-type PAI* (1979, 1980, 1981, 1982, 1983 and 1984). It is not normally detected in plasma although it has been detected in human thrombi (1985). During pregnancy, PAI-2 is found in plasma at levels that may exceed those of PAI-1 (1973). PAI-2 appears to have significant functions within the cytoplasm of certain cell types and in the extracellular region outside of the vasculature where it may regulate urokinase-dependent events. Its role in hemostasis remains problematic. PAI-2 (-/-) null mice developed normally and did not display any phenotypic abnormalities (1986).

**GENE STRUCTURE AND EXPRESSION** The gene for PAI-2 is located on chromosome 18, band q22.1, and spans 16.5 kb (1987, 1988, 1989, 1990, 1991 and 1992) (Table 21.9). Its transcript specifies a protein of 415 amino acids that lacks a cleavable NH<sub>2</sub>-terminal signal sequence. PAI-2 is synthesized and secreted by human white blood cells such as monocytes and macrophages and cells of epithelial lineage such as keratinocytes and certain tumor cells (1993, 1994, 1995 and 1996). A large number of agonists have been shown to affect transcription rates of the PAI-2 gene (reviewed in 1997-1999). For example, the



PAI-2 gene has been shown to respond dramatically to TNF (2000) and to lipopolysaccharide (2001). In human monocytes, exposure to lipopolysaccharide induced approximately a 100-fold increase in PAI-2 mRNA levels (2002). Posttranscriptional regulation of PAI-2 mRNA levels has also been documented (2003, 2004). Regulation of the stability of PAI-2 mRNA has been shown to derive in part from an AU rich-mRNA destabilizing determinant in the 3'-untranslated region (2004) and from an mRNA instability element identified within exon 4 of the coding region (2005).

**BIOCHEMISTRY AND FUNCTION** There are two forms of PAI-2: an intracellular nonglycosylated form ( $M_r = 47$  kd) and a secreted glycosylated form ( $M_r = 60$  kd) (Table 21.8). Glycosylation occurs at Asn<sup>75</sup>, Asn<sup>115</sup>, and Asn<sup>339</sup>. PAI-2 is structurally distinguished from other serpins by the presence of a unique 33-residue long loop (CD loop: residues 66 to 98) positioned between helices C and D. This solvent-exposed loop region has two glutamine residues (Gln<sup>83</sup> and Gln<sup>86</sup>) that have been shown to be sites for FXIIIa-catalyzed cross-linking of PAI-2 to fibrinogen (1985, 2006). PAI-2 cross-linked to fibrinogen remains functional after its fibrinogen carrier is converted to insoluble fibrin (2006). The CD loop has also been implicated in the association of intracellular PAI-2 with other cytoplasmic proteins (2007). The crystal structure of PAI-2 at 2 Å-resolution has recently been reported using a PAI-2 mutant lacking the CD loop (2008). The reactive site bond (Arg<sup>380</sup>-Thr<sup>381</sup>) is located in a highly disordered reactive center loop extending from Thr<sup>367</sup> to Pro<sup>386</sup>. PAI-2 is a serpin inhibitor that can inhibit plasminogen activators: The second-order rate constants defining its interactions with two-chain urokinase ( $1 \times 10^6 \text{ M}^{-1}\text{second}^{-1}$ ) and two-chain t-PA ( $2 \times 10^5 \text{ M}^{-1}\text{second}^{-1}$ ) are approximately 100-fold lower than those characterizing the reaction of PAI-1 with these proteases. Unlike PAI-1, PAI-2 reacts very slowly with the single-chain form of t-PA. Unlike PAI-1, PAI-2-t-PA or PAI-2-u-PA complexes have not been detected in plasma. Thus, it has been suggested that PAI-2 may not play an important role in regulating intravascular clot lysis; however, fibrin deposition at sites of chronic inflammation within blood vessels may represent an instance in which monocyte-derived PAI-2 could end up cross-linked to fibrin, thereby exerting some effect in the vasculature (1985, 2006). An extravascular role for PAI-2 in aspects of tissue remodeling and wound healing that depend on urokinase catalysis is consistent with the observed induction of PAI-2 production by inflammatory mediators in cell types such as keratinocytes and macrophages. The nonglycosylated form of PAI-2 is found in the cytosol of a number of cell types. Data supporting a diverse set of roles for intracellular pools of PAI-2 include effects on cellular differentiation (2009), cell proliferation (2010), TNF- $\alpha$ -induced apoptosis (2011, 2012), signal transduction (2013), and, in monocytes, multiple roles in modulating adhesion, proliferation, and differentiation (2014).

### **$\alpha_2$ -Antiplasmin**

$\alpha_2$ -Antiplasmin (or a  $\alpha_2$ -plasmin inhibitor) is the primary plasmin inhibitor in human plasma (2015, 2016, 2017 and 2018) and thus is an important regulator of fibrinolysis. Congenital deficiency of a  $\alpha_2$ -antiplasmin is rare, with homozygous individuals displaying a severe to moderate bleeding disorder (2019).  $\alpha_2$ -Antiplasmin is a single-chain glycoprotein with a calculated mass of 58 kd (2020) and a relative molecular weight of 70 kd when assessed by SDS-PAGE. It is present in plasma at a concentration of 70 mg/L (Table 21.8). The primary site of synthesis is the liver although the kidney may be another contributing source (2021); its *in vivo*  $t_{1/2}$  is 2.6 days (2022, 2023). Two NH<sub>2</sub>-terminal variants of a  $\alpha_2$ -antiplasmin are isolated from human plasma in roughly equivalent amounts: a

$\alpha_2$ -antiplasmin Met<sup>1</sup>, the full-length protein secreted into the blood, and a  $\alpha_2$ -antiplasmin Asn<sup>1</sup>, lacking the first 12 amino acids (Asn<sup>13</sup> in a  $\alpha_2$ -antiplasmin Met<sup>1</sup>) (2024, 2025).  $\alpha_2$ -Antiplasmin is a member of the serine protease inhibitor superfamily. It forms a stable 1:1 stoichiometric complex with plasmin that has no proteolytic or esterase activity (2017, 2018, 2026). It is structurally distinct from related serpins in having a 51-amino acid extension at its COOH-terminus (1350, 1351). This region mediates a  $\alpha_2$ -antiplasmin binding to specific regions (lysine binding sites) on the kringle domains of plasminogen and plasmin (2027, 2028 and 2029). Approximately 30% of a  $\alpha_2$ -antiplasmin in human plasma lacks part of this COOH-terminal region (residues 449 to 464). This truncated form appears to be functionally inert in plasma (2029, 2030), although it has been shown, when purified, to slowly form complexes with plasmin (2031, 2032).

The  $\alpha_2$ -antiplasmin molecule has three domains defining its role in fibrinolysis: the reactive site (Arg<sup>376</sup>-Met<sup>377</sup>) and the plasminogen binding site, both of which are critical to its reactivity with plasmin (2027, 2028, 2033), and a cross-linking site mediating the attachment of a  $\alpha_2$ -antiplasmin to the  $\alpha$ -chain of fibrin during clotting (1407). The binding of the plasminogen binding domain of a  $\alpha_2$ -antiplasmin to a lysine binding site of plasmin has been shown to occur more rapidly than the association between the active site of plasmin and the reactive site of a  $\alpha_2$ -antiplasmin (2034). Thus, the rate of binding of a  $\alpha_2$ -antiplasmin depends primarily on the availability of the lysine binding sites(s) of plasmin. This dependence of the rate of inhibition on an exosite interaction between the two molecules results in the differential reactivity of a  $\alpha_2$ -antiplasmin with its primary targets in clotting blood: plasmin released into the circulating blood ( $t_{1/2}$  = 0.1 second) versus plasmin bound through its lysine binding sites to fibrin or cellular sites at the site of vascular injury ( $t_{1/2}$  = 10 seconds).

**GENE STRUCTURE AND EXPRESSION**  $\alpha_2$ -Antiplasmin is a member of a multigene family of serine protease inhibitors that includes a  $\alpha_1$ -antitrypsin, antithrombin-III, PAI-1, and a  $\alpha_1$ -antichymotrypsin (1277, 1351, 1937). These serpins interact with their target proteases at a reactive Arg-X peptide bond positioned in a loop structure located 30 to 40 amino acids from the inhibitor COOH-terminus.  $\alpha_2$ -Antiplasmin differs from other members of its family in having a 51-amino acid extension at its COOH-terminus. The human gene for a  $\alpha_2$ -antiplasmin is located on chromosome 17, band p13 (2035), and is comprised of ten exons distributed over 16 kilobases of DNA (2036) (Table 21.9). The 5'-untranslated region and leader sequence are interrupted by three introns; a TATA box sequence is found 17 nucleotides upstream from the transcription initiation site. Exons 4 through 10 code for the protein, with exon 10 specifying both the reactive site and the unique COOH-terminal plasminogen binding site. To date, only 13 cases of congenital  $\alpha_2$ -antiplasmin deficiency have been described; five of these cases have been characterized at the molecular level, with family members in each case providing cohorts of heterozygotes for study (2019). The transmission is autosomal recessive. Bleeding problems vary from severe to moderate in homozygotes; the majority of heterozygotes have no bleeding problems, although exceptions have been described (2037, 2038). One instance of congenital deficiency, a  $\alpha_2$ -antiplasmin Enschede (2039), is characterized by dysfunctional full-length  $\alpha_2$ -antiplasmin at normal plasma concentrations. All other cases involve quantitative defects with the four characterized instances showing mutations in the coding exons (2040, 2041 and 2042) or an intron splicing donor site (2043) with consequent truncated, nonsecreted peptide products. Homozygous a

$\alpha_2$ -antiplasmin-deficient mice have been generated (2044). They display normal fertility, viability, and development and show no overt bleeding disorder.

**BIOCHEMISTRY**  $\alpha_2$ -Antiplasmin is a single-chain glycoprotein of 464 amino acids containing 13% carbohydrate with an apparent molecular weight of 70 kd when analyzed by SDS-PAGE (Table 21.8). Glycosylation occurs at Asn<sup>99</sup>, Asn<sup>268</sup>, Asn<sup>282</sup>, and Asn<sup>289</sup>.  $\alpha_2$ -Antiplasmin contains four cysteine residues but only one S-S bridge (2045). It is a member of the  $\alpha_1$ -proteinase inhibitor class of the serine proteinase inhibitor superfamily (1277, 1351).  $\alpha_2$ -Antiplasmin functions as the primary inhibitor of plasmin in blood (2022). It is synthesized primarily in the liver with a signal peptide of 27 amino acids and circulates at a concentration of 1  $\mu\text{mol/L}$  with a  $t_{1/2}$  of 2.6 days (2022, 2023). Isolation from plasma yields both Met<sup>1</sup>- $\alpha_2$ -antiplasmin (464 amino acids) and a truncated form with an NH<sub>2</sub>-terminal Asn (Asn<sup>13</sup>- $\alpha_2$ -antiplasmin) (2024); whether the truncated form is an artifact of purification is not established (2044). Plasma  $\alpha_2$ -antiplasmin is also found to have two COOH-terminal forms: a slow-reacting, nonplasminogen binding form (30%) that lacks the terminal 26 amino acids and the fully active molecule with an intact COOH-terminal extension (2029, 2031). Conversion to the nonplasminogen binding form occurs in the blood (2030).  $\alpha_2$ -Antiplasmin has three functionally important domains: a reactive site, a plasmin/plasminogen binding site, and a cross-linking site. The reactive site of the inhibitor is the Arg<sup>376</sup>-Met<sup>377</sup> peptide bond (1350).  $\alpha_2$ -Antiplasmin reacts with plasmin in a two-step process: first, a rapid (second-order rate constant = 2 to 4  $\times 10^7 \text{ M}^{-1} \text{ second}^{-1}$ ), reversible interaction to yield a 1:1 complex ( $K_d = 10^{-10} \text{ M}$ ); second, a slower first-order ( $t_{1/2} = 166 \text{ seconds}$ ) formation of a covalent bond between the active site seryl residue of plasmin and Arg<sup>376</sup> of a  $\alpha_2$ -antiplasmin with subsequent release of a COOH-terminal fragment (residues 377 to 464) of a  $\alpha_2$ -antiplasmin. The plasmin/plasminogen binding domain is located within residues 439 to 464, with Lys<sup>452</sup> acting as the key residue (2027, 2028). It complexes with lysine binding site(s) located in the kringle structures of plasminogen and plasmin, exhibiting at least a tenfold stronger binding to plasmin (1689). Lysine binding sites on kringles 1 (1689, 2046) and 4 (2047) have been identified as the points of interaction with a  $\alpha_2$ -antiplasmin although their relative importance individually is not resolved (2047). Maximum rates of a  $\alpha_2$ -antiplasmin inhibition of plasmin require the unimpeded interaction of both the plasminogen binding domain and the reactive site of a  $\alpha_2$ -antiplasmin with their respective target domains in the plasmin molecule (2034). Cross-linking of a  $\alpha_2$ -antiplasmin at Gln<sup>14</sup> to the  $\alpha$ -chain of fibrin is catalyzed by activated FXIII (2048). *In vitro*, Asn<sup>13</sup>  $\alpha_2$ -antiplasmin is more efficiently cross-linked to fibrin (2049).

**FUNCTION**  $\alpha_2$ -Antiplasmin is the primary plasmin inhibitor in human plasma. Its effective concentration in plasma is in the range of 0.5  $\mu\text{mol/L}$ : Approximately one-third of the circulating pool (1  $\mu\text{mol/L}$ ) is poorly reactive (2029, 2031), and another fraction is bound to circulating plasminogen ( $K_d = 4 \mu\text{mol/L}$ ) (2034).  $\alpha_2$ -Antiplasmin stabilizes the fibrin scaffolding of the developing blood clot by attenuating the rate of plasmin-driven fibrinolysis and protects against systemic degradation of fibrinogen and other proteins by plasmin. Fibrin, as the key cofactor for efficient t-PA activation of plasminogen, localizes plasmin generation to the site of fibrin formation. Generated plasmin is partitioned: One fraction is surface-associated through binding interactions between its lysine binding sites and active site and insoluble fibrin; the other fraction mixes with the circulating blood.  $\alpha_2$ -Antiplasmin rapidly inhibits solution phase plasmin ( $t_{1/2} \approx 0.1 \text{ second}$ ), preventing systemic fibrinogen degradation until more than 50% of its neutralizing capacity has been

exhausted ( [2022](#) ). The rate of inhibition *in vitro* of fibrin-bound plasmin by a  $\alpha_2$ -antiplasmin decreases by at least a factor of 100 ( $t_{1/2} = 10$  seconds) ( [2050](#) ). This decrease in reactivity reflects the dependence of the rate of inhibition on the availability of both the lysine binding and active sites of plasmin. Offsetting this, a  $\alpha_2$ -antiplasmin is accumulated on fibrin through a factor XIIIa-catalyzed tethering of the NH<sub>2</sub>-terminal of a  $\alpha_2$ -antiplasmin to the  $\alpha$ -chain of fibrin. Approximately 20% of the available  $\alpha_2$ -antiplasmin is rapidly bound to fibrin. This process has been shown to play a significant role in stabilizing the fibrin clot against lysis ( [1649](#) ).

## PHYSIOLOGIC REGULATION OF FIBRINOLYSIS

The physiologic regulation of fibrinolysis centers on controlling the rate and location of plasmin formation. Under quiescent conditions, there is little systemic plasmin formation. t-PA is a poor catalyst of the conversion of plasminogen to plasmin in the absence of fibrin; in addition, circulating levels of active t-PA are continually suppressed by reaction with PAI-1, thus further reducing the potential for solution phase plasminogen activation by t-PA. scu-PA has negligible activity toward plasminogen in solution. Further, there is no gradual accumulation of plasmin in the blood because the circulating concentration and efficacy of a  $\alpha_2$ -antiplasmin limit the  $t_{1/2}$  of plasmin formed away from a fibrin surface to 0.1 second. Thus, significant plasmin formation occurs only after the formation of fibrin. t-PA and plasminogen bind to fibrin as the clot forms, localizing plasmin generation to the clot. Initial plasmin degradation of fibrin actually increases the number of plasminogen binding sites in the fibrin, thus amplifying plasmin formation rates. Plasmin also cleaves scu-PA to generate the active two-chain form of the catalyst, further enhancing rates of plasmin activation. In addition, fibrin-bound plasmin is protected from inactivation by circulating a  $\alpha_2$ -antiplasmin. These mechanisms ensure that plasmin formation is not premature, that plasmin formation is localized to the clot, and that the extent of plasmin formation is tied to the amount of fibrin present, thus allowing the process to efficiently dissolve thrombi of different sizes.

Regulation of fibrinolysis is achieved through a dynamic balance between profibrinolytic and antifibrinolytic processes maintained by complex interactions between circulating proteins, clot-based factors, and endothelial cells. Recruitment of the proteins key to fibrinolysis to the site of injury occurs simultaneously with the initiation of fibrin formation. The fibrin clot not only serves as a substrate, but also acts in a role similar to the phospholipid surface in coagulation, functioning as a surface for the activation and localization of fibrinolytic proteins. The association of plasminogen and t-PA with fibrin enhances the rate of plasminogen activation by t-PA. Plasmin bound to fibrin is protected from inhibition by a  $\alpha_2$ -antiplasmin ( [1993](#) , [2034](#) , [2051](#) ). These mechanisms both enhance fibrinolysis and serve to limit proteolytic activity to the clot. However, profibrinolytic processes are balanced by antifibrinolytic responses. PAI-1 associates with fibrin and inactivates t-PA and u-PA within the meshwork of the clot ( [2052](#) ). Factor XIIIa cross-links and stabilizes the fibrin clot and renders it less susceptible to plasmin proteolysis. Factor XIIIa also cross-links a  $\alpha_2$ -antiplasmin to fibrin; this incorporation has been shown to play an important role in fibrin clot stabilization ( [1648](#) , [1649](#) ). TAFIa removes COOH-terminal lysines from partially proteolyzed fibrin, thus reducing the number of plasminogen binding sites and attenuating the rate of plasmin formation. In addition, activated platelets release PAI-1 and a  $\alpha_2$ -antiplasmin at the fibrin surface, thus supplementing the ongoing down-regulation of plasmin levels by the plasma pools of these serpins ( [2053](#) , [2054](#) , [2055](#) , [2056](#) and [2057](#) ).

### Cellular Regulation of Fibrinolysis

The fibrin clot and, thus, fibrinolysis are localized to the surface of the blood vessel at sites where the normally nonthrombogenic façade presented by the endothelium is either mechanically removed or altered in its molecular composition. The unperturbed endothelium secretes PAI-1 ( [2058](#) ) and is actively antifibrinolytic. Once the endothelial layer is disturbed, a-thrombin is generated, and fibrin formation proceeds at that site ( [2059](#) ). Intact endothelial surfaces in the vicinity of the injury become “activated” via interaction with products of the coagulation cascade, shifting from an antifibrinolytic to a profibrinolytic state. “Activated” endothelial cells express t-PA and u-PA as well as specific receptors for the plasminogen activators ( [2060](#), [2061](#) and [2062](#) ). t-PA is likely the primary activator of plasminogen at the fibrin surface ( [1787](#), [1860](#), [2063](#) ). u-PA has profibrinolytic activity but appears to be primarily associated with extracellular matrix degradation and initiation of tissue repair and remodeling ( [2064](#), [2065](#) and [2066](#) ).

In addition to receptors for plasminogen activators, receptors for plasminogen have been identified on a number of cell types including platelets, monocytes, fibroblasts, and endothelial cells in which they appear to localize and accelerate plasmin formation. Plasmin generated at the cell surface is protected from serpin inhibitors by binding to specific cell receptors. Therefore, the cell surface can serve as a sanctuary for plasmin activity.

### **Urokinase-Type Plasminogen Activator Receptor**

uPAR is synthesized and expressed by normal and malignant cells including monocytes, neutrophils, fibroblasts, platelets, and endothelial cells ( [2064](#), [2067](#), [2068](#), [2069](#), [2070](#), [2071](#), [2072](#) and [2073](#) ). The primary function of uPAR is to localize u-PA-mediated plasmin generation to the cell surface. uPAR binds both single-chain u-PA and plasminogen via high-affinity interactions forming a ternary complex that enhances plasminogen activation ( [2069](#), [2074](#) ) and initiates proteolysis of the extracellular matrix ( [2075](#) ). The receptor is a heterogeneously glycosylated single-chain polypeptide ( $M_r = 50,000$  to  $60,000$ ) of 313 amino acids ( [2076](#) ). Although uPAR is an integral membrane protein, there is no defined transmembrane sequence. uPAR is instead anchored to the cellular membrane by a glycosyl-phosphatidylinositol moiety ( [2077](#) ). The glycolipid is most likely attached to Gly 283 indicating that the mature protein consists of 283 amino acids ( [2077](#), [2078](#) ). The neutrophils of individuals experiencing the hematopoietic stem cell disorder paroxysmal nocturnal hemoglobinuria, a disease in which these glycosyl-phosphatidylinositol moieties are lacking, show impaired transendothelial migration ( [2071](#), [2079](#) ). The absence of the receptor may play a role in the hypercoagulable state associated with this disorder.

### **Tissue-Type Plasminogen Activator Receptors**

Many structurally unrelated components that bind t-PA have been described. These receptors can be separated into two distinct functional groups: activation receptors and clearance receptors. Activation receptors are described as localizing t-PA onto a cell surface and enhancing the activation of plasminogen by t-PA ( [2080](#) ). Receptors in the activation category include annexin II (42 kd) ( [2081](#) ), heparan sulfate and chondroitin sulfate-like proteoglycans ( [2082](#) ), cytokeratin 8 and 18 ( [2083](#), [2084](#) ), and tubulin ( [2085](#) ). In patients with promyelocytic leukemia, overexpression of the t-PA receptor annexin II has been associated with a hyperfibrinolytic state resulting in bleeding ( [2086](#) ). The t-PA receptor(s) on endothelial cells is poorly defined [for descriptions of these receptors see



Bachmann ( [1664](#) )].

Clearance receptors are responsible for clearing t-PA from the circulation and its subsequent degradation. These receptors control not only the plasma concentration of t-PA but also the levels of inactive t-PA/PAI-1 complexes. t-PA clearance occurs principally in the liver and involves two different receptors: the mannose receptor and the LRP/a<sub>2</sub>-macroglobulin receptor. The mannose receptor is a major t-PA receptor and binds t-PA with a high-affinity K<sub>d</sub> of 1 to 4 nmol/L ( [2087](#), [2088](#) and [2089](#) ). Liver endothelial cells and Kupffer's cells bind t-PA via the mannose receptor. The other major pathway for t-PA clearance is through the LRP/a<sub>2</sub>-macroglobulin receptor. This receptor has a relative molecular weight of 600 kd ( [1664](#) ). This receptor mediates the clearance of t-PA, t-PA/PAI-1, and u-PA/PAI-1 complexes; toxins; cytokines; apolipoprotein E-enriched chylomicron remnants; and complexes of a<sub>2</sub>-macroglobulin ( [2090](#) ). Free and PAI-1-complexed t-PA have also been shown to be cleared from the circulation through a glycoprotein 330-kd LRP receptor and a 130-kd very-low-density lipoprotein receptor ( [2090](#), [2091](#) and [2092](#) ).

### Role of Platelets in Regulation of Fibrinolysis

Platelets are vital to procoagulant events and contribute to the fibrinolytic process as well. Platelets bind both t-PA and plasminogen and support plasmin generation ( [2093](#), [2094](#) and [2095](#) ). Plasmin bound to the platelet surface is also protected from inhibition by a<sub>2</sub>-antiplasmin ( [2096](#) ). Platelets likewise contribute to the antifibrinolytic mechanism. Activated platelets release PAI-1, a<sub>2</sub>-antiplasmin, C1-esterase inhibitor, and a<sub>2</sub>-macroglobulin, which function to inhibit plasminogen activators and plasmin. Therefore, platelets, when present at high concentration, can promote thrombosis and inhibit fibrinolysis.

Several studies have shown that plasmin can directly modify the function of platelets ( [2097](#), [2098](#), [2099](#), [2100](#), [2101](#) and [2102](#) ). When plasmin is present at a low concentration, it can inhibit platelet aggregation by arachidonic acid metabolism or by proteolysis of membrane glycoproteins. At high plasmin concentration, a proteolytic modification of the platelets occurs that affects fibrinogen binding and platelet aggregation. Plasmin is also able to increase the number of plasminogen binding sites on the surface of platelets, an alteration that may function as a positive feedback loop for t-PA-mediated plasmin production. Increasing the size of the pool of fibrin-localized, platelet-bound plasminogen would augment the other readily activatable pool, plasminogen bound to fibrin, thereby increasing the amount of plasminogen available for efficient t-PA activation. Plasmin has also been shown to degrade the platelet-binding site for factor XIIIa, decreasing the rate of clot stabilization ( [2074](#) ).

### CONCLUSION

This chapter describes the process of blood coagulation by dividing it into sections based on procoagulant, anticoagulant, and fibrinolytic enzymes, cofactors, and inhibitors in the overall process of fibrin formation and fibrin dissolution. The role of each protein is described as either essential or accessory to hemostasis. The overall process of blood coagulation and fibrinolysis is better described when all the players are considered as contributing to a threshold-limited, complex, intertwined process that together promotes hemostasis.

Our understanding of the coagulation process has ancient historical roots; the accomplishments of numerous clinical and basic investigators has provided a relatively complete description of the inventory, connectivity, and dynamics of the overall process that occurs after vascular injury. Significant progress has been made in achieving a complete set of x-ray crystal structures for all the proteins involved in these processes ( [Table 21.10](#)). The challenge for the future is the use of this knowledge in the development of new technology for the advancement of diagnosis, prophylaxis, and treatment of vascular disease.

**TABLE 21.10. Highest Resolution X-Ray Structures of Human Procoagulant, Anticoagulant, and Fibrinolytic Proteins and Their Inhibitors**

| Protein                         | Structure   | Resolution (Å) | PDB Code <sup>a</sup> |
|---------------------------------|---|----------------|-----------------------|
| <b>Procoagulant proteins</b>    |   |                |                       |
| <b>Intrinsic pathway</b>        |   |                |                       |
| Factor XII                      | N/A   |                |                       |
| Prekallikrein                   | N/A   |                |                       |
| High-molecular-weight kininogen | N/A   |                |                       |
| Low-molecular-weight kininogen  | N/A   |                |                       |
| Factor XI                       | N/A   |                |                       |
| <b>Vitamin K-dependent</b>      |   |                |                       |
| Factor VII                      | VII zymogen (des Gla)                                     | 2.0            | 1JBU                  |
|                                 | VIIa (des Gla)  | 2.4            | 1KLJ                  |
|                                 | VIIa + TF extracellular domain                            | 2.0            | 1DAN                  |
| Factor IX                       | IXa + inhibitor (benzamidine)                             | 2.8            | 1RFN                  |
| Factor X                        | Xaβ (des Gla)   | 2.2            | 1HCG                  |
| Factor II                       | Prethrombin 2 + inhibitor (hirugen)                       | 2.0            | 1HAG                  |
|                                 | Prothrombin fragment 1 (bovine)                           | 2.3            | 2PF1                  |
|                                 | α-IIa + inhibitor (D-Phe-L-Pro-L-Arg-chloromethyl ketone) | 2.4            | 1ABJ                  |
|                                 | α-IIa + inhibitor (borolog)                               | 1.8            | 1A3B                  |
| <b>Cofactors</b>                |   |                |                       |
| TF                              | Extracellular domain                                      | 1.7            | 2HFT                  |
|                                 | VIIa + TF extracellular domain                            | 2.0            | 1DAN                  |
| Factor VIII                     | C2 domain   | 1.5            | 1D7P                  |
| Factor V                        | C2 domain   | 1.9            | 1CZT                  |
| von Willebrand factor           | A1 domain   | 2.3            | 1AUQ                  |
|                                 | A3 domain   | 1.8            | 1ATZ                  |
| <b>Anticoagulant proteins</b>   |   |                |                       |
| <b>Dynamic inhibition</b>       |   |                |                       |
| PC                              | APC (des Gla)   | 2.8            | 1AUT                  |
|                                 | Gla domain of APC + PC receptor                           | 1.6            | 1LQV                  |
| Protein S                       | N/A   |                |                       |
| Protein Z                       | N/A   |                |                       |



|                                      |  |     |      |
|--------------------------------------|--|-----|------|
| Thrombomodulin                       | Epidermal growth factor-like domains 4-6 of thrombomodulin + IIa | 2.3 | 1DX5 |
| Proteinase inhibitors                |  |     |      |
| $\alpha_2$ -Macroglobulin            | N/A  |     |      |
| TFPI                                 | Second Kunitz domain of TFPI + trypsin                           | 2.6 | 1TFX |
| ATIII                                | Intact-active ATIII + intact-latent ATIII                        | 3.2 | 1ATH |
|                                      | Plasma $\alpha$ -ATIII   | 2.6 | 1E05 |
|                                      | Plasma $\beta$ -ATIII  | 2.6 | 1E04 |
| Heparin cofactor II                  | Heparin cofactor II  | 2.4 | 1JMJ |
| $\alpha_1$ -Proteinase inhibitor     | $\alpha_1$ -Proteinase inhibitor                                 | 2.0 | 1QLP |
| C1 esterase inhibitor                | N/A  |     |      |
| PC inhibitor                         | Elastase cleaved form  | 2.4 | 1LQ8 |
| Proteins of clot formation           |  |     |      |
| Factor XIII                          | XIII zymogen   | 2.0 | 1EVU |
|                                      | XIIIa  | 2.5 | 1FIE |
| Fibrinogen                           | (Chicken)  | 2.7 | 1M1J |
| Fibrin                               | D-dimer  | 2.3 | 1FZC |
| Fibrinolytic system                  |  |     |      |
| Proteins                             |  |     |      |
| Plasminogen                          | Catalytic domain   | 2.0 | 1QRZ |
| Tissue-type plasminogen activator    | Single-chain + inhibitor (EGR-cmk)                               | 3.3 | 1BDA |
|                                      | Two-chain + inhibitor (benzamidine)                              | 2.3 | 1RTF |
| Urokinase-type plasminogen activator | Two-chain + inhibitor (BMZ)                                      | 1.8 | 1GI8 |
| Factor VII-activating protease       | N/A  |     |      |
| Inhibitors                           |  |     |      |
| TAFI                                 | N/A  |     |      |
| PAI-1                                | Latent form  | 2.1 | 1DVN |
|                                      | Active form  | 2.4 | 1DVM |
| PAI-2                                | Stabilized mutant  | 2.0 | 1BY7 |
| $\alpha_2$ -Antiplasmin              | N/A  |     |      |

APC, activated protein C; AT, antithrombin; BMZ, 2-2-hydroxy-phenyl-1-benzoimidazole-5-carboxamide; EGR-cmk, Glu-Gly-Arg chloromethyl ketone; N/A, not currently available; PAI, plasminogen activator inhibitor; PC, protein C; TAFI, thrombin-activatable fibrinolysis inhibitor; TF, tissue factor; TFPI, tissue factor pathway inhibitor.

<sup>a</sup> Protein Data Bank, <http://www.rcsb.org>

## ACKNOWLEDGMENT

We, the authors, would like to thank Matthew Gissel for his assistance in the preparation of this chapter.

## REFERENCES

1. Mann KG. Normal hemostasis. In: Kelley WN, ed. Textbook of internal medicine. Philadelphia: JB

Lippincott Co, 1992:1240–1245.

2. MacFarlane RG. An enzyme cascade in the blood clotting mechanism and its function as a biochemical amplifier. *Nature* 1964;202:498–499.
3. Davie EW, Ratnoff OD. Waterfall sequence for intrinsic blood clotting. *Science* 1964;145:1310–1312.
4. Gailani D, Broze GJ, Jr. Factor XI activation in a revised model of blood coagulation. *Science* 1991;253:909–912.
5. Radcliffe R, Nemerson Y. Activation and control of factor VII by activated factor X and thrombin. Isolation and characterization of a single chain form of factor VII. *J Biol Chem* 1975;250:388–395.
6. Toole JJ, Knopf JL, Wozney JM, et al. Molecular cloning of a cDNA encoding human antihaemophilic factor. *Nature* 1984;312:342–347.
7. Hill-Eubanks DC, Parker CG, Lollar P. Differential proteolytic activation of factor VIII–von Willebrand factor complex by thrombin. *Proc Natl Acad Sci U S A* 1989;86:6508–6512.
8. Eaton D, Rodriguez H, Vehar GA. Proteolytic processing of human factor VIII. Correlation of specific cleavages by thrombin, factor Xa, and activated protein C with activation and inactivation of factor VIII coagulant activity. *Biochemistry* 1986;25:505–512.
9. Lollar P, Hill-Eubanks DC, Parker CG. Association of the factor VIII light chain with von Willebrand factor. *J Biol Chem* 1988;263:10451–10455.
10. Nesheim ME, Mann KG. Thrombin–catalyzed activation of single chain bovine factor V. *J Biol Chem* 1979;254:1326–1334.
11. Nesheim ME, Foster WB, Hewick R, et al. Characterization of Factor V activation intermediates. *J Biol Chem* 1984;259:3187–3196.
12. Suzuki K, Dahlback B, Stenflo J. Thrombin–catalyzed activation of human coagulation factor V. *J Biol Chem* 1982;257:6556–6564.
13. Naito K, Fujikawa K. Activation of human blood coagulation factor XI independent of factor XII. Factor XI is activated by thrombin and factor XIa in the presence of negatively charged surfaces. *J Biol Chem* 1991;266:7353–7358.
14. Lorand L, Konishi K. Activation of the fibrin–stabilizing factor of plasma by thrombin. *Arch Biochem Biophys* 1964;105:58.
15. Hendriks D, Wang W, Scharpe S, et al. Purification and characterization of a new arginine carboxypeptidase in human serum. *Biochim Biophys Acta* 1990;1034:86–92.
16. Eaton DL, Malloy BE, Tsai SP, et al. Isolation, molecular cloning, and partial characterization of a novel carboxypeptidase B from human plasma. *J Biol Chem* 1991;266:21833–21838.
17. Bajzar L, Manuel R, Nesheim ME. Purification and characterization of TAFI, a thrombin–activable fibrinolysis inhibitor. *J Biol Chem* 1995;270:14477–14484.
18. Kalafatis M, Swords NA, Rand MD, et al. Membrane–dependent reactions in blood coagulation: role of the vitamin K–dependent enzyme complexes. *Biochim Biophys Acta* 1994;1227:113–129.
19. Collen D, Lijnen HR. Molecular basis of fibrinolysis, as relevant for thrombolytic therapy. *Thromb Haemost* 1995;74:167–171.
20. Henkin J, Marcotte P, Yang HC. The plasminogen–plasmin system. *Prog Cardiovasc Dis* 1991;34:135–164.
21. Mann KG, Nesheim ME, Church WR, et al. Surface–dependent reactions of the vitamin K–dependent enzyme complexes. *Blood* 1990;76:1–16.

22. Mann KG, Butenas S, Brummel KE. The dynamics of thrombin formation. *Arterioscler Thromb Vasc Biol* 2003 (*in press*).
23. Mann KG, Brummel KE, Butenas S. What is all that thrombin for? *J Thromb Haemost* 2003 (*in press*).
24. Warner ED, Brinkhous KM, Smith HP. A quantitative study of blood clotting. *Am J Physiol* 1936;114:667-675.
25. Quick AJ. On the constitution of prothrombin. *Am J Physiol* 1999;140:212-220.
26. Langdell RD, Wagner RH, Brinkhous KM, et al. Effect of antihemophilic factor on one-stage clotting tests: a presumptive test of hemophilia and a single one-stage anti-hemophilic factor assay procedure. *J Lab Clin Med* 1953;41:7637-7647.
27. Hathaway WE, Belhasen LP, Hathaway HS. Evidence for a new plasma thromboplastin factor. I. Case report, coagulation studies and physicochemical properties. *Blood* 1965;26:521-532.
28. Colman RW, Bagdasarian A, Talamo RC, et al. Williams trait. Human kininogen deficiency with diminished levels of plasminogen proactivator and prekallikrein associated with abnormalities of the Hageman factor-dependent pathways. *J Clin Invest* 1975;56:1650-1662.
29. Hoak JC, Swanson LW, Warner ED, et al. Myocardial infarction associated with severe factor-XII deficiency. *Lancet* 1966;2:884-886.
30. Hoyer LW. Factor VIII. In: Colman RW, Hirsh J, Marder VJ, et al., eds. *Hemostasis and thrombosis: basic principles and clinical practice*. Philadelphia: JB Lippincott Co, 1987:48-59.
31. Hoyer LW. Molecular pathology and immunology of factor VIII (hemophilia A and factor VIII inhibitors). *Hum Pathol* 1987;18:153-161.
32. Biggs R, Douglas AS, MacFarlane RG. Christmas disease: a condition previously mistaken for hemophilia. *Br Med J* 1952;2:1384.
33. Tefler TP, Denson KW, Wright DR. A "new" coagulation defect. *Br J Haematol* 1956;2:308-312.
34. Owren PA, Cooper T. Parahemophilia. *Arch Intern Med* 1955;95:194-201.
35. Roberts HR, Foster PA. Inherited disorders of prothrombin conversion. JB Lippincott Co, 1987:162-181.
36. Rapaport SI, Proctor RR, Patch MJ. The mode of inheritance of PTA deficiency: evidence for the existence of major PTA deficiency and minor PTA deficiency. *Blood* 1961;18:149-155.
37. Sidi A, Seligsohn U, Jonas P. Factor XI deficiency: detection and management during urological surgery. *J Urol* 1978;119:528-530.
38. Schmaier A, Silverberg M, Kaplan AP, et al. Contact activation and its abnormalities. In: Colman RW, Hirsh J, Marder VJ, et al., eds. *Hemostasis and thrombosis: basic principles and clinical practice*. Philadelphia: JB Lippincott Co, 1987:18-33.
39. Lawson JH, Kalafatis M, Stram S, et al. A model for the tissue factor pathway to thrombin. I. An empirical study. *J Biol Chem* 1994;269:23357-23366.
40. Bone R. Sepsis and multiple organ failure: consensus and controversy. In: Lamy M, Thijs LG, eds. *Mediators of sepsis*. New York: Springer-Verlag New York, 1992:3-12.
41. Colman RW. Contact activation pathway: inflammatory, fibrinolytic, anticoagulant, antiadhesive and antiangiogenic activities. In: Colman RW, Hirsh J, Marder VJ, et al., eds. *Hemostasis and thrombosis: basic principles and clinical practice*. Philadelphia: Lippincott Williams & Wilkins, 2001:103-121.
42. Nesheim ME, Taswell JB, Mann KG. The contribution of bovine Factor V and Factor Va to the activity

of prothrombinase. *J Biol Chem* 1979;254:10952–10962.

43. Krishnaswamy S. Prothrombinase complex assembly. Contributions of protein–protein and protein–membrane interactions toward complex formation. *J Biol Chem* 1990;265:3708–3718.
44. Tracy PB, Nesheim ME, Mann KG. Coordinate binding of factor Va and factor Xa to the unstimulated platelet. *J Biol Chem* 1981;256:743–751.
45. Krishnaswamy S, Field KA, Edgington TS, et al. Role of the membrane surface in the activation of human coagulation factor X. *J Biol Chem* 1992;267:26110–26120.
46. Mann KG. Prothrombin. *Methods Enzymol* 1976;45:123–156.
47. Kalafatis M, Xue J, Lawler CM, et al. Contribution of the heavy and light chains of factor Va to the interaction with factor Xa. *Biochemistry* 1994;33:6538–6545.
48. Walker RK, Krishnaswamy S. The influence of factor Va on the active site of factor Xa. *J Biol Chem* 1993;268:13902–13909.
49. Nemerson Y. Tissue factor and hemostasis. *Blood* 1988;71:1–8.
50. Edgington TS, Mackman N, Brand K, et al. The structural biology of expression and function of tissue factor. *Thromb Haemost* 1991;66:67–79.
51. Nakagaki T, Foster DC, Berkner KL, et al. Initiation of the extrinsic pathway of blood coagulation: evidence for the tissue factor dependent autoactivation of human coagulation factor VII. *Biochemistry* 1991;30:10819–10824.
52. Morrissey JH, Macik BG, Neuenschwander PF, et al. Quantitation of activated factor VII levels in plasma using a tissue factor mutant selectively deficient in promoting factor VII activation. *Blood* 1993;81:734–744.
53. Drake TA, Morrissey JH, Edgington TS. Selective cellular expression of tissue factor in human tissues. Implications for disorders of hemostasis and thrombosis. *Am J Pathol* 1989;134:1087–1097.
54. Rodgers GM, Greenberg CS, Shuman MA. Characterization of the effects of cultured vascular cells on the activation of blood coagulation. *Blood* 1983;61:1155–1162.
55. Maynard JR, Dreyer BE, Stemerman MB, et al. Tissue–factor coagulant activity of cultured human endothelial and smooth muscle cells and fibroblasts. *Blood* 1977;50:387–396.
56. Wilcox JN, Smith KM, Schwartz SM, et al. Localization of tissue factor in the normal vessel wall and in the atherosclerotic plaque. *Proc Natl Acad Sci U S A* 1989;86:2839–2843.
57. Callander NS, Varki N, Rao LV. Immunohistochemical identification of tissue factor in solid tumors. *Cancer* 1992;70:1194–1201.
58. Fleck RA, Rao LV, Rapaport SI, et al. Localization of human tissue factor antigen by immunostaining with monospecific, polyclonal anti–human tissue factor antibody [corrected and republished article originally printed in *Thromb Res* 1990 Mar 1;57(5):765–781]. *Thromb Res* 1990;59:421–437.
59. Rodgers GM. Hemostatic properties of normal and perturbed vascular cells. *FASEB J* 1988;2:116–123.
60. Conkling PR, Greenberg CS, Weinberg JB. Tumor necrosis factor induces tissue factor–like activity in human leukemia cell line U937 and peripheral blood monocytes. *Blood* 1988;72:128–133.
61. Butenas S, Mann KG. Kinetics of human factor VII activation. *Biochemistry* 1996;35:1904–1910.
62. Mann KG, Krishnaswamy S, Lawson JH. Surface–dependent hemostasis. *Semin Hematol* 1992;29:213–226.
63. Lawson JH, Mann KG. Cooperative activation of human factor IX by the human extrinsic pathway of

blood coagulation. *J Biol Chem* 1991;266:11317–11327.

64. Ahmad SS, Rawala–Sheikh R, Walsh PN. Components and assembly of the factor X activating complex. *Semin Thromb Hemost* 1992;18:311–323.
65. Revak SD, Cochrane CG, Johnston AR, et al. Structural changes accompanying enzymatic activation of human Hageman factor. *J Clin Invest* 1974;54:619–627.
66. Saito H, Ratnoff OD, Pensky J. Radioimmunoassay of human Hageman factor (factor XII). *J Lab Clin Med* 1976;88:506–514.
67. Gordon EM, Williams SR, Frenchek B, et al. Dose–dependent effects of postmenopausal estrogen and progestin on antithrombin III and factor XII. *J Lab Clin Med* 1988;111:52–56.
68. Mitropoulos KA, Martin JC, Burgess AI, et al. The increased rate of activation of factor XII in late pregnancy can contribute to the increased reactivity of factor VII. *Thromb Haemost* 1990;63:349–355.
69. Gordon EM, Johnson TR, Ramos LP, et al. Enhanced expression of factor XII (Hageman factor) in isolated livers of estrogen– and prolactin–treated rats. *J Lab Clin Med* 1991;117:353–358.
70. Citarella F, Tripodi M, Fantoni A, et al. Assignment of human coagulation factor XII (fXII) to chromosome 5 by cDNA hybridization to DNA from somatic cell hybrids. *Hum Genet* 1988;80:397–398.
71. Royle NJ, Nigli M, Cool D, et al. Structural gene encoding human factor XII is located at 5q33–qter. *Somat Cell Mol Genet* 1988;14:217–221.
72. Cool DE, MacGillivray RT. Characterization of the human blood coagulation factor XII gene. Intron/exon gene organization and analysis of the 5′–flanking region. *J Biol Chem* 1987;262:13662–13673.
73. Citarella F, Misiti S, Felici A, et al. The 5′ sequence of human factor XII gene contains transcription regulatory elements typical of liver specific, estrogen–modulated genes. *Biochim Biophys Acta* 1993;1172:197–199.
74. Griffin JH, Cochrane CG. Human factor XII (Hageman factor). *Methods Enzymol* 1976;45:56–65.
75. McMullen BA, Fujikawa K, Kisiel W. The occurrence of beta–hydroxyaspartic acid in the vitamin K–dependent blood coagulation zymogens. *Biochem Biophys Res Commun* 1983;115:8–14.
76. Fujikawa K, McMullen BA. Amino acid sequence of human beta–factor XIIa. *J Biol Chem* 1983;258:10924–10933.
77. McMullen BA, Fujikawa K. Amino acid sequence of the heavy chain of human alpha–factor XIIa (activated Hageman factor). *J Biol Chem* 1985; 260:5328–5341.
78. Cool DE, Edgell CJ, Louie GV, et al. Characterization of human blood coagulation factor XII cDNA. Prediction of the primary structure of factor XII and the tertiary structure of beta–factor XIIa. *J Biol Chem* 1985;260:13666–13676.
79. Harris RJ, Ling VT, Spellman MW. O–linked fucose is present in the first epidermal growth factor domain of factor XII but not protein C. *J Biol Chem* 1992;267:5102–5107.
80. Pixley RA, Colman RW. Factor XII: Hageman factor. *Methods Enzymol* 1993;222:51–65.
81. Rojkaer R, Schousboe I. Partial identification of the Zn<sup>2+</sup>–binding sites in factor XII and its activation derivatives. *Eur J Biochem* 1997;247:491–496.
82. Schousboe I. Contact activation in human plasma is triggered by zinc ion modulation of factor XII (Hageman factor). *Blood Coagul Fibrinolysis* 1993;4:671–678.
83. Bernardo MM, Day DE, Olson ST, et al. Surface–independent acceleration of factor XII activation by zinc ions. I. Kinetic characterization of the metal ion rate enhancement. *J Biol Chem* 1993;268:12468–12476.
84. Bernardo MM, Day DE, Halvorson HR, et al. Surface–independent acceleration of factor XII activation

- by zinc ions. II. Direct binding and fluorescence studies. *J Biol Chem* 1993;268:12477–12483.
85. Cochrane CG, Revak SD, Wuepper KD. Activation of Hageman factor in solid and fluid phases. A critical role of kallikrein. *J Exp Med* 1973;138:1564–1583.
86. Revak SD, Cochrane CG, Griffin JH. The binding and cleavage characteristics of human Hageman factor during contact activation. A comparison of normal plasma with plasmas deficient in factor XI, prekallikrein, or high molecular weight kininogen. *J Clin Invest* 1977;59:1167–1175.
87. Griffin JH. Role of surface in surface-dependent activation of Hageman factor (blood coagulation factor XII). *Proc Natl Acad Sci U S A* 1978;75:1998–2002.
88. Kirby EP, McDevitt PJ. The binding of bovine factor XII to kaolin. *Blood* 1983;61:652–659.
89. Wiggins RC, Cochrane CC. The autoactivation of rabbit Hageman factor. *J Exp Med* 1979;150:1122–1133.
90. Miller G, Silverberg M, Kaplan AP. Autoactivatability of human Hageman factor (factor XII). *Biochem Biophys Res Commun* 1980;92:803–810.
91. Silverberg M, Dunn JT, Garen L, et al. Autoactivation of human Hageman factor. Demonstration utilizing a synthetic substrate. *J Biol Chem* 1980;255:7281–7286.
92. Dunn JT, Silverberg M, Kaplan AP. The cleavage and formation of activated human Hageman factor by autodigestion and by kallikrein. *J Biol Chem* 1982;257:1779–1784.
93. Espana F, Ratnoff OD. Activation of Hageman factor (factor XII) by sulfa-tides and other agents in the absence of plasma proteases. *J Lab Clin Med* 1983;102:31–45.
94. Tankersley DL, Finlayson JS. Kinetics of activation and autoactivation of human factor XII. *Biochemistry* 1984;23:273–279.
95. Thorisdottir H, Ratnoff OD, Maniglia AJ. Activation of Hageman factor (factor XII) by bismuth subgallate, a hemostatic agent. *J Lab Clin Med* 1988;112:481–486.
96. Ziats NP, Pankowsky DA, Tierney BP, et al. Adsorption of Hageman factor (factor XII) and other human plasma proteins to biomedical polymers. *J Lab Clin Med* 1990;116:687–696.
97. Ratnoff OD. Activation of Hageman factor by L-homocystine. *Science* 1968;162:1007–1009.
98. Becker CG, Wagner M, Kaplan AP, et al. Activation of factor XII-dependent pathways in human plasma by hematin and protoporphyrin. *J Clin Invest* 1985;76:413–419.
99. Kurachi K, Fujikawa K, Davie EW. Mechanism of activation of bovine factor XI by factor XII and factor XIIa. *Biochemistry* 1980;19:1330–1338.
100. Fujikawa K, Heimark RL, Kurachi K, et al. Activation of bovine factor XII (Hageman factor) by plasma kallikrein. *Biochemistry* 1980;19:1322–1330.
101. Tans G, Rosing J, Griffin JH. Sulfatide-dependent autoactivation of human blood coagulation Factor XII (Hageman Factor). *J Biol Chem* 1983;258:8215–8222.
102. Hojima Y, Cochrane CG, Wiggins RC, et al. In vitro activation of the contact (Hageman factor) system of plasma by heparin and chondroitin sulfate E. *Blood* 1984;63:1453–1459.
103. Koenig JM, Chahine A, Ratnoff OD. Inhibition of the activation of Hageman factor (factor XII) by soluble human placental collagens types III, IV, and V. *J Lab Clin Med* 1991;117:523–527.
104. Silverberg M, Diehl SV. The autoactivation of factor XII (Hageman factor) induced by low-Mr heparin and dextran sulphate. The effect of the Mr of the activating polyanion. *Biochem J* 1987;248:715–720.
105. Tans G, Verkleij AJ, Yu J, et al. Sulfatide bilayers as a surface for contact activation in human

plasma. *Biochem Biophys Res Commun* 1987;149:1002–1007.

106. Griep MA, Fujikawa K, Nelsestuen GL. Possible basis for the apparent surface selectivity of the contact activation of human blood coagulation factor XII. *Biochemistry* 1986;25:6688–6694.

107. Schmaier A. Contact activation. In: Loscalzo J, Schafer AI, eds. *Thrombosis and hemorrhage*. Baltimore: Williams & Wilkins, 1998:105–127.

108. Motta G, Rojkaer R, Hasan AA, et al. High molecular weight kininogen regulates prekallikrein assembly and activation on endothelial cells: a novel mechanism for contact activation. *Blood* 1998;91:516–528.

109. Rojkaer R, Hasan AA, Motta G, et al. Factor XII does not initiate prekallikrein activation on endothelial cells. *Thromb Haemost* 1998;80:74–81.

110. Hovinga JK, Schaller J, Stricker H, et al. Coagulation factor XII Locarno: the functional defect is caused by the amino acid substitution Arg 353>Pro leading to loss of a kallikrein cleavage site. *Blood* 1994;84:1173–1181.

111. Clarke BJ, Cote HC, Cool DE, et al. Mapping of a putative surface-binding site of human coagulation factor XII. *J Biol Chem* 1989;264:11497–11502.

112. Citarella F, Ravon DM, Pascucci B, et al. Structure/function analysis of human factor XII using recombinant deletion mutants. Evidence for an additional region involved in the binding to negatively charged surfaces. *Eur J Biochem* 1996;238:240–249.

113. Kaplan AP, Austen KF. A pre-albumin activator of prekallikrein. *J Immunol* 1970;105:802–811.

114. Wuepper KD, Tucker ESI, Cochrane CG. Plasma kinin system: proenzyme components. *J Immunol* 1970;105:1307–1311.

115. Cochrane CG, Griffin JH. Molecular assembly in the contact phase of the Hageman factor system. *Am J Med* 1979;67:657–664.

116. Kaplan AP, Austen KF. A prealbumin activator of prekallikrein. II. Derivation of activators of prekallikrein from active Hageman factor by digestion with plasmin. *J Exp Med* 1971;133:696–712.

117. Revak SD, Cochrane CG, Bouma BN, et al. Surface and fluid phase activities of two forms of activated Hageman factor produced during contact activation of plasma. *J Exp Med* 1978;147:719–729.

118. Revak SD, Cochrane CG. The relationship of structure and function in human Hageman factor. The association of enzymatic and binding activities with separate regions of the molecule. *J Clin Invest* 1976;57:852–860.

119. Gordon EM, Gallagher CA, Johnson TR, et al. Hepatocytes express blood coagulation factor XII (Hageman factor). *J Lab Clin Med* 1990;115:463–469.

120. Kaplan AP, Silverberg M, Ghebrehiwet B. The intrinsic coagulation/kinin pathway—the classical complement pathway and their interactions. *Adv Exp Med Biol* 1986;198(Pt B):11–25.

121. Chien P, Pixley RA, Stumpo LG, et al. Modulation of the human monocyte binding site for monomeric immunoglobulin G by activated Hageman factor. *J Clin Invest* 1988;82:1554–1559.

122. Toossi Z, Sedor JR, Mettler MA, et al. Induction of expression of monocyte interleukin 1 by Hageman factor (factor XII). *Proc Natl Acad Sci U S A* 1992;89:11969–11972.

123. Wachtfogel YT, Pixley RA, Kucich U, et al. Purified plasma factor XIIa aggregates human neutrophils and causes degranulation. *Blood* 1986;67:1731–1737.

124. Mandle R, Jr., Kaplan AP. Hageman factor substrates. Human plasma prekallikrein: mechanism of activation by Hageman factor and participation in Hageman factor-dependent fibrinolysis. *J Biol Chem* 1977;252:6097–6104.



125. Forbes CD, Pensky J, Ratnoff OD. Inhibition of activated Hageman factor and activated plasma thromboplastin antecedent by purified serum C1 inactivator. *J Lab Clin Med* 1970;76:809–815.
126. Schreiber AD, Kaplan AP, Austen KF. Inhibition by C1INH of Hageman factor fragment activation of coagulation, fibrinolysis, and kinin generation. *J Clin Invest* 1973;52:1402–1409.
127. de Agostini A, Lijnen HR, Pixley RA, et al. Inactivation of factor XII active fragment in normal plasma. Predominant role of C-1-inhibitor. *J Clin Invest* 1984;73:1542–1549.
128. Pixley RA, Schapira M, Colman RW. The regulation of human factor XIIa by plasma proteinase inhibitors. *J Biol Chem* 1985;260:1723–1729.
129. Stead N, Kaplan AP, Rosenberg RD. Inhibition of activated factor XII by antithrombin-heparin cofactor. *J Biol Chem* 1976;251:6481–6488.
130. Pixley RA, Schapira M, Colman RW. Effect of heparin on the inactivation rate of human activated factor XII by antithrombin III. *Blood* 1985;66:198–203.
131. Berrettini M, Schleef RR, Espana F, et al. Interaction of type 1 plasminogen activator inhibitor with the enzymes of the contact activation system. *J Biol Chem* 1989;264:11738–11743.
132. Kleniewski J, Donaldson VH. Endothelial cells produce a substance that inhibits contact activation of coagulation by blocking the activation of Hageman factor. *Proc Natl Acad Sci U S A* 1993;90:198–202.
133. Ratnoff OD, Everson B, Embury P, et al. Inhibition of the activation of Hageman factor (factor XII) by human vascular endothelial cell culture supernates. *Proc Natl Acad Sci U S A* 1991;88:10740–10743.
134. Ratnoff OD, Gleich GJ, Shurin SB, et al. Inhibition of the activation of Hageman factor (factor XII) by eosinophils and eosinophilic constituents. *Am J Hematol* 1993;42:138–145.
135. Niwano H, Embury PB, Greenberg BD, et al. Inhibitory action of amyloid precursor protein against human Hageman factor (factor XII). *J Lab Clin Med* 1995;125:251–256.
136. Fisher CA, Schmaier AH, Addonizio VP, et al. Assay of prekallikrein in human plasma: comparison of amidolytic, esterolytic, coagulation, and immunochemical assays. *Blood* 1982;59:963–970.
137. McConnell DJ, Mason B. The isolation of human plasma prekallikrein. *Br J Pharmacol* 1970;38:490–502.
138. Mandle RJ, Colman RW, Kaplan AP. Identification of prekallikrein and high-molecular-weight kininogen as a complex in human plasma. *Proc Natl Acad Sci U S A* 1976;73:4179–4183.
139. Scott CF, Colman RW. Function and immunochemistry of prekallikrein-high molecular weight kininogen complex in plasma. *J Clin Invest* 1980;65:413–421.
140. Castaman G, Ruggeri M, Rodeghiero F. A new Italian family with severe prekallikrein deficiency. Desmopressin-induced fibrinolysis and coagulation changes in homozygous and heterozygous members. *Ric Clin Lab* 1990;20:239–244.
141. Beaubien G, Rosinski-Chupin I, Mattei MG, et al. Gene structure and chromosomal localization of plasma kallikrein. *Biochemistry* 1991;30:1628–1635.
142. Yu H, Anderson PJ, Freedman BI, et al. Genomic structure of the human plasma prekallikrein gene, identification of allelic variants, and analysis in end-stage renal disease. *Genomics* 2000;69:225–234.
143. Veloso D, Shilling J, Shine J, et al. Recent evolutionary divergence of plasma prekallikrein and factor XI. *Thromb Res* 1986;43:153–160.
144. Chung DW, Fujikawa K, McMullen BA, et al. Human plasma prekallikrein, a zymogen to a serine protease that contains four tandem repeats. *Biochemistry* 1986;25:2410–2417.
145. Ciechanowicz A, Bader M, Wagner J, et al. Extra-hepatic transcription of plasma prekallikrein gene in

human and rat tissues. *Biochem Biophys Res Commun* 1993;197:1370–1376.

146. Asakai R, Davie EW, Chung DW. Organization of the gene for human factor XI. *Biochemistry* 1987;26:7221–7228.

147. Scott CF, Liu CY, Colman RW. Human plasma prekallikrein: a rapid high-yield method for purification. *Eur J Biochem* 1979;100:77–83.

148. McMullen BA, Fujikawa K, Davie EW. Location of the disulfide bonds in human plasma prekallikrein: the presence of four novel apple domains in the amino-terminal portion of the molecule. *Biochemistry* 1991;30:2050–2056.

149. Page JD, You JL, Harris RB, et al. Localization of the binding site on plasma kallikrein for high-molecular-weight kininogen to both apple 1 and apple 4 domains of the heavy chain. *Arch Biochem Biophys* 1994;314:159–164.

150. Herwald H, Jahnen-Dechent W, Alla SA, et al. Mapping of the high molecular weight kininogen binding site of prekallikrein. Evidence for a discontinuous epitope formed by distinct segments of the prekallikrein heavy chain. *J Biol Chem* 1993;268:14527–14535.

151. McMullen BA, Fujikawa K, Davie EW. Location of the disulfide bonds in human coagulation factor XI: the presence of tandem apple domains. *Biochemistry* 1991;30:2056–2060.

152. Wuepper KD, Cochrane CG. Plasma prekallikrein: isolation, characterization, and mechanism of activation. *J Exp Med* 1972;135:1–20.

153. Bouma BN, Miles LA, Beretta G, et al. Human plasma prekallikrein. Studies of its activation by activated factor XII and of its inactivation by diisopropyl phosphofluoridate. *Biochemistry* 1980;19:1151–1160.

154. van der GF, Tans G, Bouma BN, et al. Isolation and functional properties of the heavy and light chains of human plasma kallikrein. *J Biol Chem* 1982;257:14300–14305.

155. Burger D, Schleuning WD, Schapira M. Human plasma prekallikrein. Immunoaffinity purification and activation to alpha- and beta-kallikrein. *J Biol Chem* 1986;261:324–327.

156. Colman RW, Wachtfogel YT, Kucich U, et al. Effect of cleavage of the heavy chain of human plasma kallikrein on its functional properties. *Blood* 1985;65:311–318.

157. Nagasawa S, Nakayasu T. Human plasma prekallikrein as a protein complex. *J Biochem (Tokyo)* 1973;74:401–403.

158. Habal FM, Movat HZ, Burrowes CE. Isolation of two functionally different kininogens from human plasma—separation from proteinase inhibitors and interaction with plasma kallikrein. *Biochem Pharmacol* 1974;23:2291–2303.

159. Toda N, Okamura T. Endothelium-dependent and -independent responses to vasoactive substances of isolated human coronary arteries. *Am J Physiol* 1989;257:H988–H995.

160. Hong SL. Effect of bradykinin and thrombin on prostacyclin synthesis in endothelial cells from calf and pig aorta and human umbilical cord vein. *Thromb Res* 1980;18:787–795.

161. Gurewich V, Johnstone M, Loza JP, et al. Pro-urokinase and prekallikrein are both associated with platelets. Implications for the intrinsic pathway of fibrinolysis and for therapeutic thrombolysis. *FEBS Lett* 1993;318:317–321.

162. Loza JP, Gurewich V, Johnstone M, et al. Platelet-bound prekallikrein promotes pro-urokinase-induced clot lysis: a mechanism for targeting the factor XII dependent intrinsic pathway of fibrinolysis. *Thromb Haemost* 1994;71:347–352.

163. Wachtfogel YT, Kucich U, James HL, et al. Human plasma kallikrein releases neutrophil elastase during blood coagulation. *J Clin Invest* 1983;72:1672–1677.

164. Schapira M, Scott CF, Colman RW. Protection of human plasma kallikrein from inactivation by C1

- inhibitor and other protease inhibitors. The role of high molecular weight kininogen. *Biochemistry* 1981;20:2738-2743.
165. van der GF, Koedam JA, Bouma BN. Inactivation of kallikrein in human plasma. *J Clin Invest* 1983;71:149-158.
166. Schapira M, Scott CF, Colman RW. Contribution of plasma protease inhibitors to the inactivation of kallikrein in plasma. *J Clin Invest* 1982;69:462-468.
167. van der GF, Koedam JA, Griffin JH, et al. Interaction of human plasma kallikrein and its light chain with C1 inhibitor. *Biochemistry* 1983;22:4860-4866.
168. Schapira M, Scott CF, James A, et al. High molecular weight kininogen or its light chain protects human plasma kallikrein from inactivation by plasma protease inhibitors. *Biochemistry* 1982;21:567-572.
169. Schmaier AH, Gustafson E, Idell S, et al. Plasma prekallikrein assay: reversible inhibition of C-1 inhibitor by chloroform and its use in measuring prekallikrein in different mammalian species. *J Lab Clin Med* 1984;104:882-892.
170. DeLa Cadena RA, Colman RW. The sequence HGLGHEQGHGLGHEQ in the light chain of high molecular weight kininogen serves as a primary structural feature for zinc-dependent binding to an anionic surface. *Protein Sci* 1992;1:151-160.
171. Bjork I, Olson ST, Sheffer RG, et al. Binding of heparin to human high molecular weight kininogen. *Biochemistry* 1989;28:1213-1221.
172. Olson ST, Sheffer R, Francis AM. High molecular weight kininogen potentiates the heparin-accelerated inhibition of plasma kallikrein by antithrombin: role for antithrombin in the regulation of kallikrein. *Biochemistry* 1993;32:12136-12147.
173. Meijers JC, Kanters DH, Vlooswijk RA, et al. Inactivation of human plasma kallikrein and factor XIa by protein C inhibitor. *Biochemistry* 1988;27:4231-4237.
174. Espana F, Estelles A, Griffin JH, et al. Interaction of plasma kallikrein with protein C inhibitor in purified mixtures and in plasma. *Thromb Haemost* 1991;65:46-51.
175. Koedam JA, Meijers JC, Sixma JJ, et al. Inactivation of human factor VIII by activated protein C. Cofactor activity of protein S and protective effect of von Willebrand factor. *J Clin Invest* 1988;82:1236-1243.
176. Schmaier AH, Bradford H, Silver LD, et al. High molecular weight kininogen is an inhibitor of platelet calpain. *J Clin Invest* 1986;77:1565-1573.
177. Schmaier AH, Zuckerberg A, Silverman C, et al. High-molecular weight kininogen. A secreted platelet protein. *J Clin Invest* 1983;71:1477-1489.
178. Scott CF, Shull B, Muller-Esterl W, et al. Rapid direct determination of low and high molecular weight kininogen in human plasma by Particle Concentration Fluorescence Immunoassay (PCFIA). *Thromb Haemost* 1997;77:109-118.
179. Cheung PP, Kunapuli SP, Scott CF, et al. Genetic basis of total kininogen deficiency in Williams' trait. *J Biol Chem* 1993;268:23361-23365.
180. Takagaki Y, Kitamura N, Nakanishi S. Cloning and sequence analysis of cDNAs for human high molecular weight and low molecular weight prekininogens. Primary structures of two human prekininogens. *J Biol Chem* 1985;260:8601-8609.
181. Kitamura N, Kitagawa H, Fukushima D, et al. Structural organization of the human kininogen gene and a model for its evolution. *J Biol Chem* 1985;260:8610-8317.
182. Cheung PP, Cannizzaro LA, Colman RW. Chromosomal mapping of human kininogen gene (KNG) to 3q26?pter. *Cytogenet Cell Genet* 1992;59:24-26.
183. Schmaier AH, Kuo A, Lundberg D, et al. The expression of high molecular weight kininogen on human

umbilical vein endothelial cells. *J Biol Chem* 1988;263:16327–16333.

184. Chen LM, Chung P, Chao S, et al. Differential regulation of kininogen gene expression by estrogen and progesterone in vivo. *Biochim Biophys Acta* 1992;1131:145–151.

185. Chhibber G, Cohen A, Lane S, et al. Immunoblotting of plasma in a pregnant patient with hereditary angioedema. *J Lab Clin Med* 1990;115:112–121.

186. Takano M, Yokoyama K, Yayama K, et al. Murine fibroblasts synthesize and secrete kininogen in response to cyclic-AMP, prostaglandin E2 and tumor necrosis factor. *Biochim Biophys Acta* 1995;1265:189–195.

187. Takano M, Kondo J, Yayama K, et al. Expression of low-molecular-weight kininogen mRNA in human fibroblast WI38 cells. *Jpn J Pharmacol* 1996;71:341–343.

188. Higashiyama S, Ohkubo I, Ishiguro H, et al. Heavy chain of human high molecular weight and low molecular weight kininogens binds calcium ion. *Biochemistry* 1987;26:7450–7458.

189. Salvesen G, Parkes C, Abrahamson M, et al. Human low-Mr kininogen contains three copies of a cystatin sequence that are divergent in structure and in inhibitory activity for cysteine proteinases. *Biochem J* 1986;234:429–434.

190. Bradford HN, Schmaier AH, Colman RW. Kinetics of inhibition of platelet calpain II by human kininogens. *Biochem J* 1990;270:83–90.

191. Zini JM, Schmaier AH, Cines DB. Bradykinin regulates the expression of kininogen binding sites on endothelial cells. *Blood* 1993;81:2936–2946.

192. Meloni FJ, Schmaier AH. Low molecular weight kininogen binds to platelets to modulate thrombin-induced platelet activation. *J Biol Chem* 1991; 266:6786–6794.

193. Meloni FJ, Gustafson EJ, Schmaier AH. High molecular weight kininogen binds to platelets by its heavy and light chains and when bound has altered susceptibility to kallikrein cleavage. *Blood* 1992;79:1233–1244.

194. Jiang YP, Muller-Esterl W, Schmaier AH. Domain 3 of kininogens contains a cell-binding site and a site that modifies thrombin activation of platelets. *J Biol Chem* 1992;267:3712–3717.

195. Wachtfogel YT, DeLa Cadena RA, Kunapuli SP, et al. High molecular weight kininogen binds to Mac-1 on neutrophils by its heavy chain (domain 3) and its light chain (domain 5). *J Biol Chem* 1994;269:19307–19312.

196. Puri RN, Zhou F, Hu CJ, et al. High molecular weight kininogen inhibits thrombin-induced platelet aggregation and cleavage of aggregin by inhibiting binding of thrombin to platelets. *Blood* 1991;77:500–507.

197. Hasan AA, Cines DB, Zhang J, et al. The carboxyl terminus of bradykinin and amino terminus of the light chain of kininogens comprise an endothelial cell binding domain. *J Biol Chem* 1994;269:31822–31830.

198. Hasan AA, Amenta S, Schmaier AH. Bradykinin and its metabolite, Arg-Pro-Pro-Gly-Phe, are selective inhibitors of alpha-thrombin-induced platelet activation [published erratum appears in *Circulation* 1996;94(7):1794]. *Circulation* 1996;94:517–528.

199. Reddigari SR, Kuna P, Miragliotta G, et al. Human high molecular weight kininogen binds to human umbilical vein endothelial cells via its heavy and light chains. *Blood* 1993;81:1306–1311.

200. Hasan AA, Cines DB, Herwald H, et al. Mapping the cell binding site on high molecular weight kininogen domain 5. *J Biol Chem* 1995;270:19256–19261.

201. Retzios AD, Rosenfeld R, Schiffman S. Effects of chemical modifications on the sur. *J Biol Chem* 1987;262:3074–3081.

202. Tait JF, Fujikawa K. Identification of the binding site for plasma prekallikrein in human high molecular weight kininogen. A region from residues 185 to 224 of the kininogen light chain retains full binding activity.

J Biol Chem 1986;261:15396–15401.

203. Tait JF, Fujikawa K. Primary structure requirements for the binding of human high molecular weight kininogen to plasma prekallikrein and factor XI. *J Biol Chem* 1987;262:11651–11656.
204. Vogel R, Kaufmann J, Chung DW, et al. Mapping of the prekallikrein-binding site of human H-kininogen by ligand screening of lambda gt11 expression libraries. Mimicking of the predicted binding site by anti-idiotypic antibodies. *J Biol Chem* 1990;265:12494–12502.
205. Kerbirou DM, Griffin JH. Human high molecular weight kininogen. Studies of structure–function relationships and of proteolysis of the molecule occurring during contact activation of plasma. *J Biol Chem* 1979;254:12020–12027.
206. Bock PE, Shore JD. Protein–protein interactions in contact activation of blood coagulation. Characterization of fluorescein-labeled human high molecular weight kininogen–light chain as a probe. *J Biol Chem* 1983;258:15079–15086.
207. Gustafson EJ, Schmaier AH, Wachtfogel YT, et al. Human neutrophils contain and bind high molecular weight kininogen. *J Clin Invest* 1989;84:28–35.
208. Gustafson EJ, Schutsky D, Knight LC, et al. High molecular weight kininogen binds to unstimulated platelets. *J Clin Invest* 1986;78:310–318.
209. Greengard JS, Heeb MJ, Ersdal E, et al. Binding of coagulation factor XI to washed human platelets. *Biochemistry* 1986;25:3884–3890.
210. van Iwaarden F, de Groot PG, Bouma BN. The binding of high molecular weight kininogen to cultured human endothelial cells. *J Biol Chem* 1988;263:4698–4703.
211. Schmaier AH, Smith PM, Purdon AD, et al. High molecular weight kininogen: localization in the unstimulated and activated platelet and activation by a platelet calpain(s). *Blood* 1986;67:119–130.
212. Greengard JS, Griffin JH. Receptors for high molecular weight kininogen on stimulated washed human platelets. *Biochemistry* 1984;23:6863–6869.
213. van Iwaarden F, de Groot PG, Sixma JJ, et al. High-molecular weight kininogen is present in cultured human endothelial cells: localization, isolation, and characterization. *Blood* 1988;71:1268–1276.
214. Walsh PN, Sinha D, Koshy A, et al. Functional characterization of platelet-bound factor XIa: retention of factor XIa activity on the platelet surface. *Blood* 1986;68:225–230.
215. Saito H, Goldsmith GH, Jr. Plasma thromboplastin antecedent (PTA, factor XI): a specific and sensitive radioimmunoassay. *Blood* 1977;50:377–385.
216. Thompson RE, Mandle R, Jr., Kaplan AP. Association of factor XI and high molecular weight kininogen in human plasma. *J Clin Invest* 1977;60:1376–1380.
217. Lipscomb MS, Walsh PN. Human platelets and factor XI. Localization in platelet membranes of factor XI-like activity and its functional distinction from plasma factor XI. *J Clin Invest* 1979;63:1006–1014.
218. Tuszynski GP, Bevacqua SJ, Schmaier AH, et al. Factor XI antigen and activity in human platelets. *Blood* 1982;59:1148–1156.
219. Schiffman S, Yeh CH. Purification and characterization of platelet factor XI. *Thromb Res* 1990;60:87–97.
220. Walsh PN. The effects of collagen and kaolin on the intrinsic coagulant activity of platelets. Evidence for an alternative pathway in intrinsic coagulation not requiring factor XII. *Br J Haematol* 1972;22:393–405.
221. Schiffman S, Rapaport SI, Chong MM. Platelets and initiation of intrinsic clotting. *Br J Haematol* 1973;24:633–642.
222. Asakai R, Chung DW, Ratnoff OD, et al. Factor XI (plasma thromboplastin antecedent) deficiency in

Ashkenazi Jews is a bleeding disorder that can result from three types of point mutations. *Proc Natl Acad Sci U S A* 1989;86:7667–7671.

223. Asakai R, Chung DW, Davie EW, et al. Factor XI deficiency in Ashkenazi Jews in Israel. *N Engl J Med* 1991;325:153–158.

224. Seligsohn U, Peretz H. Molecular genetics aspects of factor XI deficiency and Glanzmann thrombasthenia. *Haemostasis* 1994;24:81–85.

225. Leiba H, Ramot B, Many A. Heredity and coagulation studies in ten families with Factor XI (plasma thromboplastin antecedent) deficiency. *Br J Haematol* 1965;11:654–665.

226. Seligsohn U. Factor XI deficiency. *Thromb Haemost* 1993;70:68–71.

227. Reference deleted.

228. Osterud B, Rapaport SI. Activation of factor IX by the reaction product of tissue factor and factor VII: additional pathway for initiating blood coagulation. *Proc Natl Acad Sci U S A* 1977;74:5260–5264.

229. Broze GJ, Jr., Warren LA, Novotny WF, et al. The lipoprotein-associated coagulation inhibitor that inhibits the factor VII-tissue factor complex also inhibits factor Xa: insight into its possible mechanism of action. *Blood* 1988;71:335–343.

230. Broze GJ, Jr., Girard TJ, Novotny WF. Regulation of coagulation by a multivalent Kunitz-type inhibitor. *Biochemistry* 1990;29:7539–7546.

231. Rapaport SI. The extrinsic pathway inhibitor: a regulator of tissue factor-dependent blood coagulation. *Thromb Haemost* 1991;66:6–15.

232. Hu CJ, Baglia FA, Mills DC, et al. Tissue-specific expression of functional platelet factor XI is independent of plasma factor XI expression. *Blood* 1998;91:3800–3807.

233. Ragni MV, Sinha D, Seaman F, et al. Comparison of bleeding tendency, factor XI coagulant activity, and factor XI antigen in 25 factor XI-deficient kindreds. *Blood* 1985;65:719–724.

234. Bolton-Maggs PH, Young Wan-Yin B, McCraw AH, et al. Inheritance and bleeding in factor XI deficiency. *Br J Haematol* 1988;69:521–528.

235. Baglia FA, Walsh PN. Prothrombin is a cofactor for the binding of factor XI to the platelet surface and for platelet-mediated factor XI activation by thrombin. *Biochemistry* 1998;37:2271–2281.

236. Kato A, Asakai R, Davie EW, et al. Factor XI gene (F11) is located on the distal end of the long arm of human chromosome 4. *Cytogenet Cell Genet* 1989;52:77–78.

237. Gailani D, Sun MF, Sun Y. A comparison of murine and human factor XI. *Blood* 1997;90:1055–1064.

238. Clarkson K, Rosenfeld B, Fair J, et al. Factor XI deficiency acquired by liver transplantation. *Ann Intern Med* 1991;115:877–879.

239. Hsu TC, Shore SK, Seshsamma T, et al. Molecular cloning of platelet factor XI, an alternative splicing product of the plasma factor XI gene. *J Biol Chem* 1998;273:13787–13793.

240. Pugh RE, McVey JH, Tuddenham EG, et al. Six point mutations that cause factor XI deficiency. *Blood* 1995;85:1509–1516.

241. Meijers JC, Davie EW, Chung DW. Expression of human blood coagulation factor XI: characterization of the defect in factor XI type III deficiency. *Blood* 1992;79:1435–1440.

242. Wistinghausen B, Reischer A, Oddoux C, et al. Severe factor XI deficiency in an Arab family associated with a novel mutation in exon 11. *Br J Haematol* 1997;99:575–577.

243. Martincic D, Zimmerman SA, Ware RE, et al. Identification of mutations and polymorphisms in the factor XI genes of an African American family by dideoxyfingerprinting [published erratum appears in *Blood*

1999;93(5):1786]. *Blood* 1998;92:3309–3317.

244. Hancock JF, Wieland K, Pugh RE, et al. A molecular genetic study of factor XI deficiency. *Blood* 1991;77:1942–1948.

245. Peretz H, Zivelin A, Usher S, et al. A 14–bp deletion (codon 554 del AAGgtaacagagtg) at exon 14/intron N junction of the coagulation factor XI gene disrupts splicing and causes severe factor XI deficiency. *Hum Mutat* 1996;8:77–78.

246. Walsh PN. Factor XI. In: Colman RW, Hirsh J, Marder VJ, et al., eds. *Hemostasis and thrombosis: basic principles and clinical practice*. Philadelphia: Lippincott Williams & Wilkins, 2001:191–202.

247. Fujikawa K, Chung DW, Hendrickson LE, et al. Amino acid sequence of human factor XI, a blood coagulation factor with four tandem repeats that are highly homologous with plasma prekallikrein. *Biochemistry* 1986;25:2417–2424.

248. Ichinose A, Fujikawa K, Suyama T. The activation of pro-urokinase by plasma kallikrein and its inactivation by thrombin. *J Biol Chem* 1986;261:3486–3489.

249. Wiggins RC, Bouma BN, Cochrane CG, et al. Role of high–molecular–weight kininogen in surface–binding and activation of coagulation Factor XI and prekallikrein. *Proc Natl Acad Sci U S A* 1977;74:4636–4640.

250. Baglia FA, Walsh PN. A binding site for thrombin in the apple 1 domain of factor XI. *J Biol Chem* 1996;271:3652–3658.

251. Baglia FA, Jameson BA, Walsh PN. Identification and chemical synthesis of a substrate–binding site for factor IX on coagulation factor XIa. *J Biol Chem* 1991;266:24190–24197.

252. Sun Y, Gailani D. Identification of a factor IX binding site on the third apple domain of activated factor XI. *J Biol Chem* 1996;271:29023–29028.

253. Sun MF, Zhao M, Gailani D. Identification of amino acids in the factor XI apple 3 domain required for activation of factor IX. *J Biol Chem* 1999;274:36373–36378.

254. Walsh PN, Griffin JH. Contributions of human platelets to the proteolytic activation of blood coagulation factors XII and XI. *Blood* 1981;57:106–118.

255. Baglia FA, Jameson BA, Walsh PN. Identification and characterization of a binding site for platelets in the Apple 3 domain of coagulation factor XI. *J Biol Chem* 1995;270:6734–6740.

256. Baglia FA, Seaman FS, Walsh PN. The Apple 1 and Apple 4 domains of factor XI act synergistically to promote the surface–mediated activation of factor XI by factor XIIa. *Blood* 1995;85:2078–2083.

257. Ho DH, Baglia FA, Walsh PN. Factor XI binding to activated platelets is mediated by residues R(250), K(255), F(260), and Q(263) within the apple 3 domain. *Biochemistry* 2000;39:316–323.

258. Baglia FA, Jameson BA, Walsh PN. Identification and characterization of a binding site for factor XIIa in the Apple 4 domain of coagulation factor XI. *J Biol Chem* 1993;268:3838–3844.

259. Bouma BN, Griffin JH. Human blood coagulation Factor XI. Purification, properties, and mechanism of activation by activated Factor XII. *J Biol Chem* 1977;252:6432–6437.

260. Kurachi K, Davie EW. Activation of human factor XI (plasma thromboplastin antecedent) by factor XIIa (activated Hageman factor). *Biochemistry* 1977;16:5831–5839.

261. Broze GJ, Jr., Gailani D. The role of factor XI in coagulation. *Thromb Haemost* 1993;70:72–74.

262. Baglia FA, Walsh PN. Thrombin–mediated feedback activation of factor XI on the activated platelet surface is preferred over contact activation by factor XIIa or factor XIa. *J Biol Chem* 2000;275:20514–20519.

263. Walsh PN. Platelets and factor XI bypass the contact system of blood coagulation. *Thromb Haemost*



1999;82:234-242.

264. Fujikawa K, Legaz ME, Kato H, et al. The mechanism of activation of bovine factor IX (Christmas factor) by bovine factor XIa (activated plasma thromboplastin antecedent). *Biochemistry* 1974;13:4508-4516.

265. DiScipio RG, Kurachi K, Davie EW. Activation of human factor IX (Christmas factor). *J Clin Invest* 1978;61:1528-1538.

266. Reference deleted.

267. Osterud B, Bouma BN, Griffin JH. Human blood coagulation factor IX. Purification, properties, and mechanism of activation by activated factor XI. *J Biol Chem* 1978;253:5946-5951.

268. Heck LW, Kaplan AP. Substrates of Hageman factor. I. Isolation and characterization of human factor XI (PTA) and inhibition of the activated enzyme by alpha 1-antitrypsin. *J Exp Med* 1974;140:1615-1630.

269. Beeler DL, Marcum JA, Schiffman S, et al. Interaction of factor XIa and antithrombin in the presence and absence of heparin. *Blood* 1986;67:1488-1492.

270. Scott CF, Schapira M, Colman RW. Effect of heparin on the inactivation rate of human factor XIa by antithrombin-III. *Blood* 1982;60:940-947.

271. Scott CF, Schapira M, James HL, et al. Inactivation of factor XIa by plasma protease inhibitors: predominant role of alpha 1-protease inhibitor and protective effect of high molecular weight kininogen. *J Clin Invest* 1982;69:844-852.

272. Walsh PN, Sinha D, Kueppers F, et al. Regulation of factor XIa activity by platelets and alpha 1-protease inhibitor. *J Clin Invest* 1987;80:1578-1586.

273. Damus PS, Hicks M, Rosenberg RD. Anticoagulant action of heparin. *Nature* 1973;246:355-357.

274. Soons H, Janssen-Claessen T, Tans G, et al. Inhibition of factor XIa by antithrombin III. *Biochemistry* 1987;26:4624-4629.

275. Meijers JC, Vlooswijk RA, Bouma BN. Inhibition of human blood coagulation factor XIa by C-1 inhibitor. *Biochemistry* 1988;27:959-963.

276. Saito H, Goldsmith GH, Moroi M, et al. Inhibitory spectrum of alpha 2-plasmin inhibitor. *Proc Natl Acad Sci U S A* 1979;76:2013-2017.

277. Scott CF, Colman RW. Factors influencing the acceleration of human factor XIa inactivation by antithrombin III. *Blood* 1989;73:1873-1879.

278. Rosenberg RD, Damus PS. The purification and mechanism of action of human antithrombin-heparin cofactor. *J Biol Chem* 1973;248:6490-6505.

279. Reference deleted.

280. Espana F, Berrettini M, Griffin JH. Purification and characterization of plasma protein C inhibitor. *Thromb Res* 1989;55:369-384.

281. Soons H, Janssen-Claessen T, Hemker HC, et al. The effect of platelets in the activation of human blood coagulation factor IX by factor XIa. *Blood* 1986;68:140-148.

282. Cronlund AL, Walsh PN. A low molecular weight platelet inhibitor of factor XIa: purification, characterization, and possible role in blood coagulation. *Biochemistry* 1992;31:1685-1694.

283. Bush AI, Martins RN, Rumble B, et al. The amyloid precursor protein of Alzheimer's disease is released by human platelets. *J Biol Chem* 1990;265:15977-15983.

284. Smith RP, Higuchi DA, Broze GJ, Jr. Platelet coagulation factor XIa-inhibitor, a form of Alzheimer

amyloid precursor protein. *Science* 1990;248:1126–1128.

285. Van Nostrand WE, Schmaier AH, Farrow JS, et al. Protease nexin-II (amyloid beta-protein precursor): a platelet alpha-granule protein. *Science* 1990;248:745–748.

286. Zhang Y, Scandura JM, Van Nostrand WE, et al. The mechanism by which heparin promotes the inhibition of coagulation factor XIa by protease nexin-2. *J Biol Chem* 1997;272:26139–26144.

287. Dam H. Cholesterinstoffwechsel in huhnereiern und huhnchen. *Biochem Z* 1929;215:475–492.

288. Dam H. Cholesterol synthesis in the animal body. *Biochem Z* 1930;220:158–163.

289. Dam H. Hemorrhages in chicks reared on artificial diets. A new deficiency disease. *Nature (London)* 1934;133:909–910.

290. Dam H. Antihaemorrhagic vitamin of chick. *Biochem J* 1935;29:1273–1285.

291. Doisy EA, Binkley SB, Thayer SA. Vitamin K. *Chem Rev* 1941;28:477–517.

292. Owen CA, Bowie EWJ. The history of the development of oral anticoagulant of oral anticoagulant drugs. In: Poller L, Hirsch J, eds. *Oral anticoagulants*. London: Arnold, 1996:1–8.

293. Magnusson S, Sottrup-Jensen L, Petersen TE, et al. Primary structure of the vitamin K-dependent part of prothrombin. *FEBS Lett* 1974;44:189–193.

294. Stenflo J, Ferlund P, Egan W, et al. Vitamin K dependent modifications of glutamic acid residues in prothrombin. *Proc Natl Acad Sci U S A* 1974;71: 2730–2733.

295. Stenflo J. Vitamin K and the biosynthesis of prothrombin. IV. Isolation of peptides containing prosthetic groups from normal prothrombin and the corresponding peptides from dicoumarol-induced prothrombin. *J Biol Chem* 1974;249:5527–5535.

296. Nelsestuen GL, Zytkevich TH, Howard JB. The mode of action of vitamin K. Identification of gamma-carboxyglutamic acid as a component of prothrombin. *J Biol Chem* 1974;249:6347–6350.

297. Kulman JD, Harris JE, Haldeman BA, et al. Primary structure and tissue distribution of two novel proline-rich gamma-carboxyglutamic acid proteins. *Proc Natl Acad Sci U S A* 1997;94:9058–9062.

298. Hauschka PV, Lian JB, Cole DE, et al. Osteocalcin and matrix Gla protein: vitamin K-dependent proteins in bone. *Physiol Rev* 1989;69:990–1047.

299. Olivera BM. E.E. Just Lecture, 1996. Conus venom peptides, receptor and ion channel targets, and drug design: 50 million years of neuropharmacology. *Mol Biol Cell* 1997;8:2101–2109.

300. Olivera BM, Rivier J, Clark C, et al. Diversity of Conus neuropeptides. *Science* 1990;249:257–263.

301. Olivera BM, Rivier J, Scott JK, et al. Conotoxins. *J Biol Chem* 1991;266: 22067–22070.

302. Leytus SP, Foster DC, Kurachi K, et al. Gene for human factor X: a blood coagulation factor whose gene organization is essentially identical with that of factor IX and protein C. *Biochemistry* 1986;25:5098–5102.

303. Patthy L. Evolutionary assembly of blood coagulation proteins. *Semin Thromb Hemost* 1990;16:245–259.

304. Stenberg LM, Brown MA, Nilsson E, et al. A functional prothrombin gene product is synthesized by human kidney cells. *Biochem Biophys Res Commun* 2001;280:1036–1041.

305. Sacchi E, Tagliabue L, Scoglio R, et al. Plasma factor VII levels are influenced by a polymorphism in the promoter region of the FVII gene. *Blood Coagul Fibrinolysis* 1996;7:114–117.

306. Spek CA, Koster T, Rosendaal FR, et al. Genotypic variation in the promoter region of the protein C gene is associated with plasma protein C levels and thrombotic risk. *Arterioscler Thromb Vasc Biol*

1995;15:214–218.

307. Green F, Kelleher C, Wilkes H, et al. A common genetic polymorphism associated with lower coagulation factor VII levels in healthy individuals. *Arterioscler Thromb* 1991;11:540–546.
308. Burns P, Hoffman CJ, Katz JP, et al. Vitamin K–dependent clotting factors are elevated in young adults who have close relatives with ischemic heart disease. *J Lab Clin Med* 1993;122:720–727.
309. Hoffman CJ, Lawson WE, Miller RH, et al. Correlation of vitamin K–dependent clotting factors with cholesterol and triglycerides in healthy young adults. *Arterioscler Thromb* 1994;14:1737–1740.
310. Bladbjerg EM, Tholstrup T, Marckmann P, et al. Dietary changes in fasting levels of factor VII coagulant activity (FVII:C) are accompanied by changes in factor VII protein and other vitamin K–dependent proteins. *Thromb Haemost* 1995;73:239–242.
311. Mukherjee M, Dawson G, Sembhi K, et al. Triglyceride dependence of factor VII coagulant activity in deep venous thrombosis. *Thromb Haemost* 1996;76:500–501.
312. Talstad I, Gamst ON. Warfarin resistance due to malabsorption. *J Intern Med* 1994;236:465–467.
313. O'Reilly RA. Warfarin metabolism and drug–drug interactions. *Adv Exp Med Biol* 1987;214:205–212.
314. Bilik R, Superina RA, Poon AO. Coagulation plasma factor levels are early indicators of graft nonfunction following liver transplantation in children. *J Pediatr Surg* 1992;27:302–306.
315. Bilik R, Yellen M, Superina RA. Surgical complications in children after liver transplantation. *J Pediatr Surg* 1992;27:1371–1375.
316. Casella JF, Lewis JH, Bontempo FA, et al. Successful treatment of homozygous protein C deficiency by hepatic transplantation. *Lancet* 1988;1:435–438.
317. Cransac M, Carles J, Bernard PH, et al. Heterozygous protein C deficiency and dysfibrinogenemia acquired by liver transplantation. *Transpl Int* 1995;8:307–311.
318. Gronke RS, VanDusen WJ, Garsky VM, et al. Aspartyl beta–hydroxylase: in vitro hydroxylation of a synthetic peptide based on the structure of the first growth factor–like domain of human factor IX. *Proc Natl Acad Sci U S A* 1989;86:3609–3613.
319. Stenflo J, Ohlin AK, Owen WG, et al. beta–Hydroxyaspartic acid or beta–hydroxyasparagine in bovine low density lipoprotein receptor and in bovine thrombomodulin. *J Biol Chem* 1988;263:21–24.
320. Bristol JA, Ratcliffe JV, Roth DA, et al. Biosynthesis of prothrombin: intracellular localization of the vitamin K–dependent carboxylase and the sites of gamma–carboxylation. *Blood* 1996;88:2585–2593.
321. Wallin R, Stanton C, Hutson SM. Intracellular maturation of the gamma–carboxyglutamic acid (Gla) region in prothrombin coincides with release of the propeptide. *Biochem J* 1993;291(Pt 3):723–727.
322. Drews R, Paleyanda RK, Lee TK, et al. Proteolytic maturation of protein C upon engineering the mouse mammary gland to express furin. *Proc Natl Acad Sci U S A* 1995;92:10462–10466.
323. Wasley LC, Rehemtulla A, Bristol JA, et al. PACE/furin can process the vitamin K–dependent pro–factor IX precursor within the secretory pathway. *J Biol Chem* 1993;268:8458–8465.
324. Foster DC, Holly RD, Sprecher CA, et al. Endoproteolytic processing of the human protein C precursor by the yeast Kex2 endopeptidase coexpressed in mammalian cells. *Biochemistry* 1991;30:367–372.
325. Wu SM, Cheung WF, Frazier D, et al. Cloning and expression of the cDNA for human gamma–glutamyl carboxylase. *Science* 1991;254:1634–1636.
326. Suttie JW. Vitamin K–dependent carboxylase. *Annu Rev Biochem* 1985;54:459–477.
327. Gardill SL, Suttie JW. Vitamin K epoxide and quinone reductase activities. Evidence for reduction by

a common enzyme. *Biochem Pharmacol* 1990;40:1055–1061.

328. Furie B, Furie BC. Molecular basis of vitamin K-dependent gamma-carboxylation. *Blood* 1990;75:1753–1762.
329. Cosgriff SW. The effectiveness of an oral vitamin K in controlling excessive hypofibrinogenemia during anticoagulant therapy. *Ann Intern Med* 1956;45:14–22.
330. Hirsh J. Optimal intensity and monitoring warfarin. *Am J Cardiol* 1995;75:39B–42B.
331. Hirsh J, Dalen JE, Deykin D, et al. Oral anticoagulants. Mechanism of action, clinical effectiveness, and optimal therapeutic range. *Chest* 1995;108:231S–246S.
332. Drakenberg T, Fernlund P, Roepstorff P, et al. beta-Hydroxyaspartic acid in vitamin K-dependent protein C. *Proc Natl Acad Sci U S A* 1983;80:1802–1806.
333. McMullen BA, Fujikawa K, Kisiel W, et al. Complete amino acid sequence of the light chain of human blood coagulation factor X: evidence for identification of residue 63 as beta-hydroxyaspartic acid. *Biochemistry* 1983;22: 2875–2884.
334. Stenflo J, Lundwall A, Dahlback B. beta-Hydroxyasparagine in domains homologous to the epidermal growth factor precursor in vitamin K-dependent protein S. *Proc Natl Acad Sci U S A* 1987;84:368–372.
335. Sunnerhagen MS, Persson E, Dahlqvist I, et al. The effect of aspartate hydroxylation on calcium binding to epidermal growth factor-like modules in coagulation factors IX and X. *J Biol Chem* 1993;268:23339–23344.
336. Derian CK, VanDusen W, Przysiecki CT, et al. Inhibitors of 2-ketoglutarate-dependent dioxygenases block aspartyl beta-hydroxylation of recombinant human factor IX in several mammalian expression systems. *J Biol Chem* 1989;264:6615–6618.
337. Nelson RM, VanDusen WJ, Friedman PA, et al. beta-Hydroxyaspartic acid and beta-hydroxyasparagine residues in recombinant human protein S are not required for anticoagulant cofactor activity or for binding to C4b-binding protein. *J Biol Chem* 1991;266:20586–20589.
338. Miletich JP, Broze GJ, Jr. Beta protein C is not glycosylated at asparagine 329. The rate of translation may influence the frequency of usage at asparagine-X-cysteine sites. *J Biol Chem* 1990;265:11397–11404.
339. Grinnell BW, Hermann RB, Yan SB. Human protein C inhibits selectin-mediated cell adhesion: role of unique fucosylated oligosaccharide. *Glycobiology* 1994;4:221–225.
340. Baker ME, French FS, Joseph DR. Vitamin K-dependent protein S is similar to rat androgen-binding protein. *Biochem J* 1987;243:293–296.
341. Fujimaki K, Yamazaki T, Taniwaki M, et al. The gene for human protein Z is localized to chromosome 13 at band q34 and is coded by eight regular exons and one alternative exon. *Biochemistry* 1998;37:6838–6846.
342. Brenner B, Tavori S, Zivelin A, et al. Hereditary deficiency of all vitamin K-dependent procoagulants and anticoagulants. *Br J Haematol* 1990;75:537–542.
343. Boneh A, Bar-Ziv J. Hereditary deficiency of vitamin K-dependent coagulation factors with skeletal abnormalities. *Am J Med Genet* 1996;65:241–243.
344. Spronk HM, Farah RA, Buchanan GR, et al. Novel mutation in the gamma-glutamyl carboxylase gene resulting in congenital combined deficiency of all vitamin K-dependent blood coagulation factors. *Blood* 2000;96:3650–3652.
345. Brenner B, Sanchez-Vega B, Wu SM, et al. A missense mutation in gamma-glutamyl carboxylase gene causes combined deficiency of all vitamin K-dependent blood coagulation factors. *Blood* 1998;92:4554–4559.
346. Soriano-Garcia M, Park CH, Tulinsky A, et al. Structure of Ca<sup>2+</sup> prothrombin fragment 1 including

the conformation of the Gla domain. *Biochemistry* 1989;28:6805–6810.

347. Tulinsky A, Park CH, Skrzypczak-Jankun E. Structure of prothrombin fragment 1 refined at 2.8 Å resolution. *J Mol Biol* 1988;202:885–901.

348. Park CH, Tulinsky A. Three-dimensional structure of the kringle sequence: structure of prothrombin fragment 1. *Biochemistry* 1986;25:3977–3982.

349. Soriano-Garcia M, Padmanabhan K, de Vos AM, et al. The Ca<sup>2+</sup> ion and membrane binding structure of the Gla domain of Ca-prothrombin fragment 1. *Biochemistry* 1992;31:2554–2566.

350. Bode W, Mayr I, Baumann U, et al. The refined 1.9 Å crystal structure of human alpha-thrombin: interaction with D-Phe-Pro-Arg chloromethylketone and significance of the Tyr-Pro-Pro-Trp insertion segment. *EMBO J* 1989;8:3467–3475.

351. Rydel TJ, Ravichandran KG, Tulinsky A, et al. The structure of a complex of recombinant hirudin and human alpha-thrombin. *Science* 1990;249:277–280.

352. Banner DW, Hadvary P. Crystallographic analysis at 3.0-Å resolution of the binding to human thrombin of four active site-directed inhibitors. *J Biol Chem* 1991;266:20085–20093.

353. Martin PD, Robertson W, Turk D, et al. The structure of residues 7–16 of the A alpha-chain of human fibrinogen bound to bovine thrombin at 2.3-Å resolution. *J Biol Chem* 1992;267:7911–7920.

354. Vitali J, Martin PD, Malkowski MG, et al. The structure of a complex of bovine alpha-thrombin and recombinant hirudin at 2.8-Å resolution. *J Biol Chem* 1992;267:17670–17678.

355. Padmanabhan K, Padmanabhan KP, Tulinsky A, et al. Structure of human des(1–45) factor Xa at 2.2 Å resolution. *J Mol Biol* 1993;232:947–966.

356. Brandstetter H, Bauer M, Huber R, et al. X-ray structure of clotting factor IXa: active site and module structure related to Xase activity and hemophilia B. *Proc Natl Acad Sci U S A* 1995;92:9796–9800.

357. Kembell-Cook G, Johnson DJ, Tuddenham EG, et al. Crystal structure of active site-inhibited human coagulation factor VIIa (des-Gla). *J Struct Biol* 1999;127:213–223.

358. Nelsestuen GL, Shah AM, Harvey SB. Vitamin K-dependent proteins. *Vitam Horm* 2000;58:355–389.

359. Stenflo J. Contributions of Gla and EGF-like domains to the function of vitamin K-dependent coagulation factors. *Crit Rev Eukaryot Gene Expr* 1999;9:59–88.

360. Sunnerhagen M, Olah GA, Stenflo J, et al. The relative orientation of Gla and EGF domains in coagulation factor X is altered by Ca<sup>2+</sup> binding to the first EGF domain. A combined NMR-small angle X-ray scattering study. *Biochemistry* 1996;35:11547–11559.

361. Prendergast FG, Mann KG. Differentiation of metal ion-induced transitions of prothrombin fragment 1. *J Biol Chem* 1977;252:840–850.

362. Gerads I, Govers-Riemslog JW, Tans G, et al. Prothrombin activation on membranes with anionic lipids containing phosphate, sulfate, and/or carboxyl groups. *Biochemistry* 1990;29:7967–7974.

363. Pei G, Powers DD, Lentz BR. Specific contribution of different phospholipid surfaces to the activation of prothrombin by the fully assembled prothrombinase. *J Biol Chem* 1993;268:3226–3233.

364. McDonald JF, Shah AM, Schwalbe RA, et al. Comparison of naturally occurring vitamin K-dependent proteins: correlation of amino acid sequences and membrane binding properties suggests a membrane contact site. *Biochemistry* 1997;36:5120–5127.

365. Kung C, Hayes E, Mann KG. A membrane-mediated catalytic event in prothrombin activation. *J Biol Chem* 1994;269:25838–25848.

366. Nelsestuen GL, Kisiel W, Di Scipio RG. Interaction of vitamin K dependent proteins with membranes.

Biochemistry 1978;17:2134–2138.

367. Schwalbe RA, Ryan J, Stern DM, et al. Protein structural requirements and properties of membrane binding by gamma-carboxyglutamic acid-containing plasma proteins and peptides. *J Biol Chem* 1989;264:20288–20296.
368. Arni RK, Padmanabhan K, Padmanabhan KP, et al. Structure of the non-covalent complex of prothrombin kringle 2 with PPACK-thrombin. *Chem Phys Lipids* 1994;67–68:59–66.
369. Sunnerhagen M, Forsen S, Hoffren AM, et al. Structure of the Ca(2+)-free Gla domain sheds light on membrane binding of blood coagulation proteins. *Nat Struct Biol* 1995;2:504–509.
370. Sunnerhagen MS, Forsen S, Hoffren AM, et al. Structure of the calcium-free GLA domain sheds light on membrane binding of blood coagulation proteins. *Nature Struct Biol* 1995;2:504–509.
371. Christiansen WT, Jalbert LR, Robertson RM, et al. Hydrophobic amino acid residues of human anticoagulation protein C that contribute to its functional binding to phospholipid Vesicles. *Biochemistry* 1995;34:10376–10382.
372. Jalbert LR, Chan JC, Christiansen WT, et al. The hydrophobic nature of residue-5 of human protein C is a major determinant of its functional interactions with acidic phospholipid vesicles. *Biochemistry* 1996;35:7093–7099.
373. Zhang L, Castellino FJ. The binding energy of human coagulation protein C to acidic phospholipid vesicles contains a major contribution from leucine 5 in the gamma-carboxyglutamic acid domain. *J Biol Chem* 1994;269:3590–3595.
374. Doolittle RF, Feng DF, Johnson MS. Computer-based characterization of epidermal growth factor precursor. *Nature* 1984;307:558–560.
375. Ohlin AK, Landes G, Bourdon P, et al. Beta-hydroxyaspartic acid in the first epidermal growth factor-like domain of protein C. Its role in Ca<sup>2+</sup> binding and biological activity. *J Biol Chem* 1988;263:19240–19248.
376. Sugo T, Bjork I, Holmgren A, et al. Calcium-binding properties of bovine factor X lacking the gamma-carboxyglutamic acid-containing region. *J Biol Chem* 1984;259:5705–5710.
377. Sugo T, Fernlund P, Stenflo J. erythro-beta-Hydroxyaspartic acid in bovine factor IX and factor X. *FEBS Lett* 1984;165:102–106.
378. Stenflo J, Fernlund P. Beta-hydroxyaspartic acid in vitamin K-dependent plasma proteins from scorbutic and warfarin-treated guinea pigs. *FEBS Lett* 1984;168:287–292.
379. Baron M, Norman DG, Harvey TS, et al. The three-dimensional structure of the first EGF-like module of human factor IX: comparison with EGF and TGF-alpha. *Protein Sci* 1992;1:81–90.
380. Ullner M, Selander M, Persson E, et al. Three-dimensional structure of the apo form of the N-terminal EGF-like module of blood coagulation factor X as determined by NMR spectroscopy and simulated folding. *Biochemistry* 1992;31:5974–5983.
381. Montelione GT, Wuthrich K, Burgess AW, et al. Solution structure of murine epidermal growth factor determined by NMR spectroscopy and refined by energy minimization with restraints. *Biochemistry* 1992;31:236–249.
382. Selander-Sunnerhagen M, Ullner M, Persson E, et al. How an epidermal growth factor (EGF)-like domain binds calcium. High resolution NMR structure of the calcium form of the NH<sub>2</sub>-terminal EGF-like domain in coagulation factor X. *J Biol Chem* 1992;267:19642–19649.
383. Muranyi A, Finn BE, Gippert GP, et al. Solution structure of the N-terminal EGF-like domain from human factor VII. *Biochemistry* 1998;37:10605–10615.
384. Campbell ID, Downing AK. Building protein structure and function from modular units. *Trends Biotechnol* 1994;12:168–172.

385. Stenflo J, Stenberg Y, Muranyi A. Calcium-binding EGF-like modules in coagulation proteinases: function of the calcium ion in module interactions. *Biochim Biophys Acta* 2000;1477:51-63.
386. Giannelli F, Green PM, Sommer SS, et al. Haemophilia B: database of point mutations and short additions and deletions—eighth edition. *Nucleic Acids Res* 1998;26:265-268.
387. Husten EJ, Esmon CT, Johnson AE. The active site of blood coagulation factor Xa. Its distance from the phospholipid surface and its conformational sensitivity to components of the prothrombinase complex. *J Biol Chem* 1987;262:12953-12961.
388. Kelly CR, Dickinson CD, Ruf W. Ca<sup>2+</sup> binding to the first epidermal growth factor module of coagulation factor VIIa is important for cofactor interaction and proteolytic function. *J Biol Chem* 1997;272:17467-17472.
389. Rand MD, Lindblom A, Carlson J, et al. Calcium binding to tandem repeats of EGF-like modules. Expression and characterization of the EGF-like modules of human Notch-1 implicated in receptor-ligand interactions. *Protein Sci* 1997;6:2059-2071.
390. Handford P, Downing AK, Rao Z, et al. The calcium binding properties and molecular organization of epidermal growth factor-like domains in human fibrillin-1. *J Biol Chem* 1995;270:6751-6756.
391. Bajaj SP, Rapaport SI, Brown SF. Isolation and characterization of human factor VII. Activation of factor VII by factor Xa. *J Biol Chem* 1981;256:253-259.
392. Fair DS. Quantitation of factor VII in the plasma of normal and warfarin-treated individuals by radioimmunoassay. *Blood* 1983;62:784-791.
393. Rivard GE, Kovac I, Kunschak M, et al. Clinical study of recovery and half-life of vapor-heated factor VII concentrate. *Transfusion* 1994;34:975-979.
394. Seligsohn U, Kasper CK, Osterud B, et al. Activated factor VII: presence in factor IX concentrates and persistence in the circulation after infusion. *Blood* 1979;53:828-837.
395. Connelly JB, Roderick PJ, Cooper JA, et al. Positive association between self-reported fatty food consumption and factor VII coagulant activity, a risk factor for coronary heart disease, in 4246 middle-aged men. *Thromb Haemost* 1993;70:250-252.
396. Giansily-Blaizot M, Aguilar-Martinez P, Schved JF. Genotypic heterogeneity may explain phenotypic variations in inherited factor VII deficiency. *Haematologica* 2002;87:328-329.
397. Iannello S, Prestipino M, Belfiore F. Genetic deficiency of factor VII and hemorrhagic diathesis. A case report and literature review. *Panminerva Med* 1998;40:226-238.
398. Ragni MV, Lewis JH, Spero JA, et al. Factor VII deficiency. *Am J Hematol* 1981;10:79-88.
399. Triplett DA, Brandt JT, Batard MA, et al. Hereditary factor VII deficiency: heterogeneity defined by combined functional and immunochemical analysis. *Blood* 1985;66:1284-1287.
400. Baribeau G. Congenital hypoproconvertinemia. *Union Med Can* 1971;100:240-247.
401. Carew JA, Pollak ES, High KA, et al. Severe factor VII deficiency due to a mutation disrupting an Sp1 binding site in the factor VII promoter. *Blood* 1998;92:1639-1645.
402. Boyer C, Wolf M, Rothschild C, et al. An enzyme immunoassay (ELISA) for the quantitation of human factor VII. *Thromb Haemost* 1986;56:250-255.
403. Lechler E. Use of prothrombin complex concentrates for prophylaxis and treatment of bleeding episodes in patients with hereditary deficiency of prothrombin, factor VII, factor X, protein C, protein S, or protein Z. *Thromb Res* 1999;95:S39-S50.
404. Cohen LJ, McWilliams NB, Neuberger R, et al. Prophylaxis and therapy with factor VII concentrate (human) immuno, vapor heated in patients with congenital factor VII deficiency: a summary of case reports.



Am J Hematol 1995;50:269–276.

405. Levi D, Pefkarou A, Fort JA, et al. Liver transplantation for factor VII deficiency. *Transplantation* 2001;72:1836–1837.

406. Berrettini M, Mariani G, Schiavoni M, et al. Pharmacokinetic evaluation of recombinant, activated factor VII in patients with inherited factor VII deficiency. *Haematologica* 2001;86:640–645.

407. Eskandari N, Feldman N, Greenspoon JS. Factor VII deficiency in pregnancy treated with recombinant factor VIIa. *Obstet Gynecol* 2002;99:935–937.

408. Hunault M, Bauer KA. Recombinant factor VIIa for the treatment of congenital factor VII deficiency. *Semin Thromb Hemost* 2000;26:401–405.

409. Lusher JM, Roberts HR, Davignon G, et al. A randomized, double-blind comparison of two dosage levels of recombinant factor VIIa in the treatment of joint, muscle and mucocutaneous haemorrhages in persons with haemophilia A and B, with and without inhibitors. rFVIIa Study Group. *Haemophilia* 1998;4:790–798.

410. Shapiro AD, Gilchrist GS, Hoots WK, et al. Prospective, randomised trial of two doses of rFVIIa (NovoSeven) in haemophilia patients with inhibitors undergoing surgery. *Thromb Haemost* 1998;80:773–778.

411. Shapiro AD. Recombinant factor VIIa in the treatment of bleeding in hemophilic children with inhibitors. *Semin Thromb Hemost* 2000;26:413–419.

412. Negrier C, Hay CR. The treatment of bleeding in hemophilic patients with inhibitors with recombinant factor VIIa. *Semin Thromb Hemost* 2000; 26:407–412.

413. Ingerslev J. Efficacy and safety of recombinant factor VIIa in the prophylaxis of bleeding in various surgical procedures in hemophilic patients with factor VIII and factor IX inhibitors. *Semin Thromb Hemost* 2000;26:425–432.

414. Hedner U. Recombinant activated factor VII as a universal haemostatic agent. *Blood Coagul Fibrinolysis* 1998;9[Suppl 1]:S147–S152.

415. van 't Veer C, Mann KG. The regulation of the factor VII-dependent coagulation pathway: rationale for the effectiveness of recombinant factor VIIa in refractory bleeding disorders. *Semin Thromb Hemost* 2000;26:367–372.

416. Monroe DM, Hoffman M, Oliver JA, et al. Platelet activity of high-dose factor VIIa is independent of tissue factor. *Br J Haematol* 1997;99:542–547.

417. Hoffman M, Monroe DM III, Roberts HR. Activated factor VII activates factors IX and X on the surface of activated platelets: thoughts on the mechanism of action of high-dose activated factor VII. *Blood Coagul Fibrinolysis* 1998;9[Suppl 1]:S61–S65.

418. Butenas S, Brummel KE, Branda RF, et al. Mechanism of factor VIIa-dependent coagulation in hemophilia blood. *Blood* 2002;99:923–930.

419. Borensztajn K, Chafa O, Alhenc-Gelas M, et al. Characterization of two novel splice site mutations in human factor VII gene causing severe plasma factor VII deficiency and bleeding diathesis. *Br J Haematol* 2002;117:168–171.

420. Carew JA, Pollak ES, Lopaciuk S, et al. A new mutation in the HNF4 binding region of the factor VII promoter in a patient with severe factor VII deficiency. *Blood* 2000;96:4370–4372.

421. Hunault M, Arbini AA, Carew JA, et al. Characterization of two naturally occurring mutations in the second epidermal growth factor-like domain of factor VII. *Blood* 1999;93:1237–1244.

422. Hunault M, Arbini AA, Carew JA, et al. Mechanism underlying factor VII deficiency in Jewish populations with the Ala244Val mutation. *Br J Haematol* 1999;105:1101–1108.

423. Takamiya O, Seta M, Tanaka K, et al. Human factor VII deficiency caused by S339C mutation located

adjacent to the specificity pocket of the catalytic domain. *Clin Lab Haematol* 2002;24:233–238.

424. McVey JH, Boswell E, Mumford AD, et al. Factor VII deficiency and the FVII mutation database. *Hum Mutat* 2001;17:3–17.

425. Aasrum M, Prydz H. Gene targeting of tissue factor, factor X, and factor VII in mice: their involvement in embryonic development. *Biochemistry (Mosc)* 2002;67:25–32.

426. Rosen ED, Chan JC, Idusogie E, et al. Mice lacking factor VII develop normally but suffer fatal perinatal bleeding. *Nature* 1997;390:290–294.

427. de Grouchy J, Dautzenberg MD, Turleau C, et al. Regional mapping of clotting factors VII and X to 13q34. Expression of factor VII through chromosome 8. *Hum Genet* 1984;66:230–233.

428. O'Hara PJ, Grant FJ, Haldeman BA, et al. Nucleotide sequence of the gene coding for human factor VII, a vitamin K-dependent protein participating in blood coagulation. *Proc Natl Acad Sci U S A* 1987;84:5158–5162.

429. Gilgenkrantz S, Briquel ME, Andre E, et al. Structural genes of coagulation factors VII and X located on 13q34. *Ann Genet* 1986;29:32–35.

430. Marder VJ, Shulman NR. Clinical aspects of the congenital factor VII deficiency. *Am J Med* 1964;37:182.

431. Greenberg D, Miao CH, Ho WT, et al. Liver-specific expression of the human factor VII gene. *Proc Natl Acad Sci U S A* 1995;92:12347–12351.

432. Pollak ES, Hung HL, Godin W, et al. Functional characterization of the human factor VII 5'-flanking region. *J Biol Chem* 1996;271:1738–1747.

433. Erdmann D, Heim J. Orphan nuclear receptor HNF-4 binds to the human coagulation factor VII promoter. *J Biol Chem* 1995;270:22988–22996.

434. Berkner K, Busby S, Davie E, et al. Isolation and expression of cDNAs encoding human factor VII. *Cold Spring Harb Symp Quant Biol* 1986;51(Pt 1):531–541.

435. Hagen FS, Gray CL, O'Hara P, et al. Characterization of a cDNA coding for human factor VII. *Proc Natl Acad Sci U S A* 1986;83:2412–2416.

436. Sabharwal AK, Birktoft JJ, Gorka J, et al. High affinity Ca<sup>2+</sup>-binding site in the serine protease domain of human factor VIIa and its role in tissue factor binding and development of catalytic activity. *J Biol Chem* 1995;270:15523–15530.

437. Higashi S, Nishimura H, Fujii S, et al. Tissue factor potentiates the factor VIIa-catalyzed hydrolysis of an ester substrate. *J Biol Chem* 1992;267:17990–17996.

438. Toomey JR, Smith KJ, Stafford DW. Localization of the human tissue factor recognition determinant of human factor VIIa. *J Biol Chem* 1991;266:19198–19202.

439. Kumar A, Fair DS. Specific molecular interaction sites on factor VII involved in factor X activation. *Eur J Biochem* 1993;217:509–518.

440. Wildgoose P, Nemerson Y, Hansen LL, et al. Measurement of basal levels of factor VIIa in hemophilia A and B patients. *Blood* 1992;80:25–28.

441. Neuenschwander PF, Fiore MM, Morrissey JH. Factor VII autoactivation proceeds via interaction of distinct protease-cofactor and zymogen-cofactor complexes. Implications of a two-dimensional enzyme kinetic mechanism. *J Biol Chem* 1993;268:21489–21492.

442. Lawson JH, Krishnaswamy S, Butenas S, et al. Extrinsic pathway proteolytic activity. *Methods Enzymol* 1993;222:177–195.

443. Seligsohn U, Osterud B, Brown SF, et al. Activation of human factor VII in plasma and in purified

systems: roles of activated factor IX, kallikrein, and activated factor XII. *J Clin Invest* 1979;64:1056–1065.

444. Lawson JH, Butenas S, Mann KG. The evaluation of complex-dependent alterations in human factor VIIa. *J Biol Chem* 1992;267:4834–4843.

445. Kisiel W, Fujikawa K, Davie EW. Activation of bovine factor VII (proconvertin) by factor XIIa (activated Hageman factor). *Biochemistry* 1977;16:4189–4194.

446. Romisch J, Feussner A, Vermohlen S, et al. A protease isolated from human plasma activating factor VII independent of tissue factor. *Blood Coagul Fibrinolysis* 1999;10:471–479.

447. Jesty J, Silverberg SA. Kinetics of the tissue factor-dependent activation of coagulation Factors IX and X in a bovine plasma system. *J Biol Chem* 1979;254:12337–12345.

448. Morrison SA, Jesty J. Tissue factor-dependent activation of tritium-labeled factor IX and factor X in human plasma. *Blood* 1984;63:1338–1347.

449. Krishnaswamy S. The interaction of human factor VIIa with tissue factor. *J Biol Chem* 1992;267:23696–23706.

450. Silverberg SA, Nemerson Y, Zur M. Kinetics of the activation of bovine coagulation factor X by components of the extrinsic pathway. Kinetic behavior of two-chain factor VII in the presence and absence of tissue factor. *J Biol Chem* 1977;252:8481–8488.

451. Osterud B, Miller-Andersson M, Abildgaard U, et al. The effect of antithrombin III on the activity of the coagulation factors VII, IX and X. *Thromb Haemost* 1976;35:295–304.

452. Jesty J. The inhibition of activated bovine coagulation factors X and VII by antithrombin III. *Arch Biochem Biophys* 1978;185:165–173.

453. Rao LV, Nordfang O, Hoang AD, et al. Mechanism of antithrombin III inhibition of factor VIIa/tissue factor activity on cell surfaces. Comparison with tissue factor pathway inhibitor/factor Xa-induced inhibition of factor VIIa/tissue factor activity. *Blood* 1995;85:121–129.

454. Lawson JH, Butenas S, Ribarik N, et al. Complex-dependent inhibition of factor VIIa by antithrombin III and heparin. *J Biol Chem* 1993;268:767–770.

455. Rao LV, Rapaport SI, Hoang AD. Binding of factor VIIa to tissue factor permits rapid antithrombin III/heparin inhibition of factor VIIa. *Blood* 1993;81:2600–2607.

456. Rapaport SI, Rao LV. Initiation and regulation of tissue factor-dependent blood coagulation. *Arterioscler Thromb* 1992;12:1111–1121.

457. Biggs R, Denson KW. The fate of prothrombin and factors VIII, IX, and X transfused to patients deficient in these factors. *Br J Haematol* 1963;9:687–688.

458. Thompson AR. Structure, function, and molecular defects of factor IX. *Blood* 1986;67:565–572.

459. Stern DM, Knitter G, Kisiel W, et al. In vivo evidence of intravascular binding sites for coagulation factor IX. *Br J Haematol* 1987;66:227–232.

460. Wolberg AS, Stafford DW, Erie DA. Human factor IX binds to specific sites on the collagenous domain of collagen IV. *J Biol Chem* 1997;272:16717–16720.

461. Gui T, Lin HF, Jin DY, et al. Circulating and binding characteristics of wild-type factor IX and certain Gla domain mutants in vivo. *Blood* 2002;100:153–158.

462. Cheung WF, van den BJ, Kuhn K, et al. Identification of the endothelial cell binding site for factor IX. *Proc Natl Acad Sci U S A* 1996;93:11068–11073.

463. van Hylckama Vlieg A, van der Linden IK, Bertina RM, et al. High levels of factor IX increase the risk of venous thrombosis. *Blood* 2000;95:3678–3682.

464. Thompson AR, Chen SH. Characterization of factor IX defects in hemophilia B patients. *Methods Enzymol* 1993;222:143–169.
465. Shetty S, Ghosh K, Mohanty D. Hemophilia B in a female. *Acta Haematol* 2001;106:115–117.
466. Espinos C, Lorenzo JI, Casana P, et al. Haemophilia B in a female caused by skewed inactivation of the normal X-chromosome. *Haematologica* 2000;85: 1092–1095.
467. Boggio LN, Green D. Acquired hemophilia. *Rev Clin Exp Hematol* 2001;5:389–404.
468. Giannelli F, Green PM, Sommer SS, et al. Haemophilia B: database of point mutations and short additions and deletions, 7th edition. *Nucleic Acids Res* 1997;25:133–135.
469. Reiner AP, Davie EW. The physiology and biochemistry of factor IX. In: Bloom AL, Forbes CD, Thomas DP, Tuddenham EG, eds. *Haemostasis and thrombosis*. New York: Churchill Livingstone, 1994:309–331.
470. Krepischi-Santos AC, Carneiro JD, Svartman M, et al. Deletion of the factor IX gene as a result of translocation t(X;1) in a girl affected by haemophilia B. *Br J Haematol* 2001;113:616–620.
471. Vianello F, Belvini D, Dal Bello F, et al. Mild bleeding diathesis in a boy with combined severe haemophilia B (C(10400) ?T) and heterozygous factor V Leiden. *Haemophilia* 2001;7:511–514.
472. Ljung R, Petrini P, Tengborn L, et al. Haemophilia B mutations in Sweden: a population-based study of mutational heterogeneity. *Br J Haematol* 2001;113:81–86.
473. Ivaskevicius V, Jurgutis R, Rost S, et al. Lithuanian haemophilia A and B registry comprising phenotypic and genotypic data. *Br J Haematol* 2001;112:1062–1070.
474. Chowdhury MR, Kabra M, Menon PS. Factor IX gene polymorphisms in Indian population. *Am J Hematol* 2001;68:246–248.
475. Chan V, Yam I, Yip B, et al. Single nucleotide polymorphisms of the factor IX gene for linkage analysis in the southern Chinese population. *Br J Haematol* 2000;111:540–543.
476. Lefkowitz JB, Nuss R, Haver T, et al. Factor IX Denver, ASN 346?ASP mutation resulting in a dysfunctional protein with defective factor VIIIa interaction. *Thromb Haemost* 2001;86:862–870.
477. Wu PC, Hamaguchi N, Yu YS, et al. Hemophilia B with mutations at glycine-48 of factor IX exhibited delayed activation by the factor VIIa-tissue factor complex. *Thromb Haemost* 2000;84:626–634.
478. Bowen DJ. Haemophilia A and haemophilia B: molecular insights. *Mol Pathol* 2002;55:127–144.
479. Roth DA, Kessler CM, Pasi KJ, et al. Human recombinant factor IX: safety and efficacy studies in hemophilia B patients previously treated with plasma-derived factor IX concentrates. *Blood* 2001;98:3600–3606.
480. DiMichele DM, Kroner BL. The North American Immune Tolerance Registry: practices, outcomes, outcome predictors. *Thromb Haemost* 2002;87:52–57.
481. High K. Gene-based approaches to the treatment of hemophilia. *Ann N Y Acad Sci* 2002;961:63–64.
482. Herzog RW, Hagstrom JN. Gene therapy for hereditary hematological disorders. *Am J Pharmacogenomics* 2001;1:137–144.
483. VandenDriessche T, Collen D, Chuah MK. Viral vector-mediated gene therapy for hemophilia. *Curr Gene Ther* 2001;1:301–315.
484. Lynch CM. Gene therapy for hemophilia. *Curr Opin Mol Ther* 1999;1:493–499.
485. Nathwani AC, Davidoff AM, Hanawa H, et al. Sustained high-level expression of human factor IX (hFIX) after liver-targeted delivery of recombinant adeno-associated virus encoding the hFIX gene in

rhesus macaques. *Blood* 2002;100:1662–1669.

486. White SJ, Page SM, Margaritis P, et al. Long-term expression of human clotting factor IX from retrovirally transduced primary human keratinocytes in vivo. *Hum Gene Ther* 1998;9:1187–1195.

487. Cherington V, Chiang GG, McGrath CA, et al. Retroviral vector-modified bone marrow stromal cells secrete biologically active factor IX in vitro and transiently deliver therapeutic levels of human factor IX to the plasma of dogs after reinfusion. *Hum Gene Ther* 1998;9:1397–1407.

488. Buckle V, Craig IW, Hunter D, et al. Fine assignment of the coagulation factor IX gene. *Cytogenet Cell Genet* 1985;40:593–594.

489. Camerino G, Grzeschik KH, Jaye M, et al. Regional localization on the human X chromosome and polymorphism of the coagulation factor IX gene (hemophilia B locus). *Proc Natl Acad Sci U S A* 1984;81:498–502.

490. Chance PF, Dyer KA, Kurachi K, et al. Regional localization of the human factor IX gene by molecular hybridization. *Hum Genet* 1983;65:207–208.

491. Reference deleted.

492. Anson DS, Choo KH, Rees DJ, et al. The gene structure of human anti-haemophilic factor IX. *EMBO J* 1984;3:1053–1060.

493. Choo KH, Gould KG, Rees DJ, et al. Molecular cloning of the gene for human anti-haemophilic factor IX. *Nature* 1982;299:178–180.

494. Picketts DJ, Mueller CR, Lillicrap D. Transcriptional control of the factor IX gene: analysis of five cis-acting elements and the deleterious effects of naturally occurring hemophilia B Leyden mutations. *Blood* 1994;84:2992–3000.

495. Naka H, Brownlee GG. Transcriptional regulation of the human factor IX promoter by the orphan receptor superfamily factor, HNF4, ARP1 and COUP/Ear3. *Br J Haematol* 1996;92:231–240.

496. Graves BJ, Johnson PF, McKnight SL. Homologous recognition of a promoter domain common to the MSV LTR and the HSV tk gene. *Cell* 1986;44:565–576.

497. Paonessa G, Gounari F, Frank R, et al. Purification of a NF1-like DNA-binding protein from rat liver and cloning of the corresponding cDNA. *EMBO J* 1988;7:3115–3123.

498. Sladek FM, Zhong WM, Lai E, et al. Liver-enriched transcription factor HNF-4 is a novel member of the steroid hormone receptor superfamily. *Genes Dev* 1990;4:2353–2365.

499. Mueller CR, Maire P, Schibler U. DBP, a liver-enriched transcriptional activator, is expressed late in ontogeny and its tissue specificity is determined posttranscriptionally. *Cell* 1990;61:279–291.

500. Kurachi S, Deyashiki Y, Takeshita J, et al. Genetic mechanisms of age regulation of human blood coagulation factor IX. *Science* 1999;285:739–743.

501. Nguyen P, Cornillet P, Potron G. A new case of severe hemophilia B Leyden, associated with a G to C mutation at position -6 of the factor IX promoter. *Am J Hematol* 1995;49:259–260.

502. Reijnen MJ, Peerlinck K, Maasdam D, et al. Hemophilia B Leyden: substitution of thymine for guanine at position -21 results in a disruption of a hepatocyte nuclear factor 4 binding site in the factor IX promoter. *Blood* 1993;82:151–158.

503. Briet E, Bertina RM, van Tilburg NH, et al. Hemophilia B Leyden: a sex-linked hereditary disorder that improves after puberty. *N Engl J Med* 1982;306:788–790.

504. Briet E, Wijnands MC, Veltkamp JJ. The prophylactic treatment of hemophilia B Leyden with anabolic steroids. *Ann Intern Med* 1985;103:225–226.

505. Brady JN, Notley C, Cameron C, et al. Androgen effects on factor IX expression: in-vitro and in-vivo

studies in mice. *Br J Haematol* 1998;101:273–279.

506. Fujikawa K, Davie EW. Bovine factor IX (Christmas factor). *Methods Enzymol* 1976;45:74–83.

507. Kurachi K, Davie EW. Isolation and characterization of a cDNA coding for human factor IX. *Proc Natl Acad Sci U S A* 1982;79:6461–6464.

508. Harris RJ, van Halbeek H, Glushka J, et al. Identification and structural analysis of the tetrasaccharide NeuAc alpha(2?6)Gal beta(1?4)GlcNAc beta(1?3)Fuc alpha 1?O-linked to serine 61 of human factor IX. *Biochemistry* 1993;32:6539–6547.

509. Agarwala KL, Kawabata S, Takao T, et al. Activation peptide of human factor IX has oligosaccharides O-glycosidically linked to threonine residues at 159 and 169. *Biochemistry* 1994;33:5167–5171.

510. Nishimura H, Takao T, Hase S, et al. Human factor IX has a tetrasaccharide O-glycosidically linked to serine 61 through the fucose residue. *J Biol Chem* 1992;267:17520–17525.

511. Kuraya N, Omichi K, Nishimura H, et al. Structural analysis of O-linked sugar chains in human blood clotting factor IX. *J Biochem (Tokyo)* 1993;114:763–765.

512. Rao Z, Handford P, Mayhew M, et al. The structure of a Ca(2+)-binding epidermal growth factor-like domain: its role in protein-protein interactions. *Cell* 1995;82:131–141.

513. Celie PH, Lenting PJ, Mertens K. Hydrophobic contact between the two epidermal growth factor-like domains of blood coagulation factor IX contributes to enzymatic activity. *J Biol Chem* 2000;275:229–234.

514. Christophe OD, Lenting PJ, Kolkman JA, et al. Blood coagulation factor IX residues Glu78 and Arg94 provide a link between both epidermal growth factor-like domains that is crucial in the interaction with factor VIII light chain. *J Biol Chem* 1998;273:222–227.

515. Brandstetter H, Bauer M, Huber R, et al. X-ray structure of clotting factor IXa: active site and module structure related to Xase activity and hemophilia B. *Proc Natl Acad Sci U S A* 1995;92:9796–9800.

516. Braunstein KM, Noyes CM, Griffith MJ, et al. Characterization of the defect in activation of factor IX Chapel Hill by human factor XIa. *J Clin Invest* 1981;68:1420–1426.

517. Griffith MJ, Bretkreutz L, Trapp H, et al. Characterization of the clotting activities of structurally different forms of activated factor IX. Enzymatic properties of normal human factor IXa alpha, factor IXa beta, and activated factor IX Chapel Hill. *J Clin Invest* 1985;75:4–10.

518. Jackson CM, Nemerson Y. Blood coagulation. *Annu Rev Biochem* 1980;49:765–811.

519. Baglia FA, Sinha D, Walsh PN. Functional domains in the heavy-chain region of factor XI: a high molecular weight kininogen-binding site and a substrate-binding site for factor IX. *Blood* 1989;74:244–251.

520. Kurachi K, Fujikawa K, Schmer G, et al. Inhibition of bovine factor IXa and factor Xbeta by antithrombin III. *Biochemistry* 1976;15:373–377.

521. Lenting PJ, ter Maat H, Clijsters PP, et al. Cleavage at arginine 145 in human blood coagulation factor IX converts the zymogen into a factor VIII binding enzyme. *J Biol Chem* 1995;270:14884–14890.

522. Noyes CM, Griffith MJ, Roberts HR, et al. Identification of the molecular defect in factor IX Chapel Hill: substitution of histidine for arginine at position 145. *Proc Natl Acad Sci U S A* 1983;80:4200–4202.

523. Giannelli F, Green PM, High KA, et al. Haemophilia B: database of point mutations and short additions and deletions—fourth edition, 1993. *Nucleic Acids Res* 1993;21:3075–3087.

524. Hockin MF, Jones KC, Everse SJ, et al. A model for the stoichiometric regulation of blood coagulation. *J Biol Chem* 2002;277:18322–18333.

525. Cawthorn KM, van 't Veer C, Lock JB, et al. Blood coagulation in hemophilia A and hemophilia C. *Blood* 1998;91:4581–4592.

526. Brummel KE, Paradis SG, Butenas S, et al. Thrombin functions during tissue factor-induced blood coagulation. *Blood* 2002;100:148-152.
527. Rosenberg J, McKenna PW, Rosenberg RD. Inhibition of human factor IXa by human antithrombin. *J Biol Chem* 1975;250:8883-8888.
528. Schmaier AH, Dahl LD, Hasan AA, et al. Factor IXa inhibition by protease nexin-2/amyloid beta-protein precursor on phospholipid vesicles and cell membranes. *Biochemistry* 1995;34:1171-1178.
529. Isawa H, Yuda M, Yoneda K, et al. The insect salivary protein, prolixin-S, inhibits factor IXa generation and Xase complex formation in the blood coagulation pathway. *J Biol Chem* 2000;275:6636-6641.
530. Bauer KA. Selective inhibition of coagulation factors: advances in antithrombotic therapy. *Semin Thromb Hemost* 2002;28[Suppl 2]:15-24.
531. Nishimura S, Ishida T, Imai K. Monoclonal antibody therapy for disorders of hemostasis and coagulation. *Nippon Rinsho* 2002;60:525-530.
532. Refino CJ, Jeet S, DeGuzman L, et al. A human antibody that inhibits factor IX/IXa function potently inhibits arterial thrombosis without increasing bleeding. *Arterioscler Thromb Vasc Biol* 2002;22:517-522.
533. Antman EM. Hirudin in acute myocardial infarction. Safety report from the Thrombolysis and Thrombin Inhibition in Myocardial Infarction (TIMI) 9A Trial. *Circulation* 1994;90:1624-1630.
534. Randomized trial of intravenous heparin versus recombinant hirudin for acute coronary syndromes. The Global Use of Strategies to Open Occluded Coronary Arteries (GUSTO) IIa Investigators. *Circulation* 1994;90:1631-1637.
535. Adams TE, Everse SJ, Mann KG. Predicting the pharmacology of thrombin inhibitors. *J Thromb Haemost* 2003 (*in press*).
536. Davie EW, Fujikawa K, Kurachi K, et al. The role of serine proteases in the blood coagulation cascade. *Adv Enzymol Relat Areas Mol Biol* 1979;48:277-318.
537. Di Scipio RG, Hermodson MA, Yates SG, et al. A comparison of human prothrombin, factor IX (Christmas factor), factor X (Stuart factor), and protein S. *Biochemistry* 1977;16:698-706.
538. Roberts HR, Lechler E, Webster WP, et al. Survival of transfused factor X in patients with Stuart Disease. *Thromb Diath Haemorrh* 1965;13:305-313.
539. de Visser MC, Poort SR, Vos HL, et al. Factor X levels, polymorphisms in the promoter region of factor X, and the risk of venous thrombosis. *Thromb Haemost* 2001;85:1011-1017.
540. Uprichard J, Perry DJ. Factor X deficiency. *Blood Rev* 2002;16:97-110.
541. Peyvandi F, Menegatti M, Santagostino E, et al. Gene mutations and three-dimensional structural analysis in 13 families with severe factor X deficiency. *Br J Haematol* 2002;117:685-692.
542. Morishita E, Yamaguchi K, Asakura H, et al. One missense mutation in the factor X gene causing factor X deficiency—factor X Kanazawa. *Int J Hematol* 2001;73:390-392.
543. Simioni P, Vianello F, Kalafatis M, et al. A dysfunctional factor X (factor X San Giovanni Rotondo) present at homozygous and double heterozygous level: identification of a novel microdeletion (delC556) and missense mutation (Lys(408)→Asn) in the factor X gene. A study of an Italian family. *Thromb Res* 2001;101:219-230.
544. Deam S, Srinivasan N, Westby J, et al. F X Nottingham and F X Taunton. Two novel mutations in factor X resulting in loss of functional activity and an interpretation using molecular modelling. *Thromb Haemost* 2001;85:265-269.
545. Millar DS, Elliston L, Deex P, et al. Molecular analysis of the genotype-phenotype relationship in



factor X deficiency. *Hum Genet* 2000;106:249–257.

546. Cooper DN, Millar DS, Wacey A, et al. Inherited factor X deficiency: molecular genetics and pathophysiology. *Thromb Haemost* 1997;78:161–172.

547. Denson KW, Lurie A, de Cataldo F, et al. The factor-X defect: recognition of abnormal forms of factor X. *Br J Haematol* 1970;18:317–327.

548. Vianello F, Lombardi AM, Boldrin C, et al. A new factor X defect (factor X Padua 3): a compound heterozygous between true deficiency (Gly(380) ?Arg) and an abnormality (Ser(334) ?Pro). *Thromb Res* 2001;104:257–264.

549. Choufani EB, Sanchowala V, Ernst T, et al. Acquired factor X deficiency in patients with amyloid light-chain amyloidosis: incidence, bleeding manifestations, and response to high-dose chemotherapy. *Blood* 2001;97: 1885–1887.

550. Beardell FV, Varma M, Martinez J. Normalization of plasma factor X levels in amyloidosis after plasma exchange. *Am J Hematol* 1997;54:68–71.

551. Girmann G, Wilker D, Stadie H, et al. Acquired isolated factor X deficiency associated with systemic amyloidosis. Case report and review of literature. *Klin Wochenschr* 1980;58:859–862.

552. Dewerchin M, Liang Z, Moons L, et al. Blood coagulation factor X deficiency causes partial embryonic lethality and fatal neonatal bleeding in mice. *Thromb Haemost* 2000;83:185–190.

553. Miao CH, Leytus SP, Chung DW, et al. Liver-specific expression of the gene coding for human factor X, a blood coagulation factor. *J Biol Chem* 1992;267:7395–7401.

554. Scambler PJ, Williamson R. The structural gene for human coagulation factor X is located on chromosome 13q34. *Cytogenet Cell Genet* 1985;39:231–233.

555. Rocchi M, Roncuzzi L, Santamaria R, et al. Mapping through somatic cell hybrids and cDNA probes of protein C to chromosome 2, factor X to chromosome 13, and alpha 1-acid glycoprotein to chromosome 9. *Hum Genet* 1986;74:30–33.

556. Huang MN, Hung HL, Stanfield-Oakley SA, et al. Characterization of the human blood coagulation factor X promoter. *J Biol Chem* 1992;267:15440–15446.

557. Wilberding JA, Castellino FJ. Characterization of the murine coagulation factor X promoter. *Thromb Haemost* 2000;84:1031–1038.

558. Hung HL, High KA. Liver-enriched transcription factor HNF-4 and ubiquitous factor NF-Y are critical for expression of blood coagulation factor X. *J Biol Chem* 1996;271:2323–2331.

559. Hung HL, Pollak ES, Kudaravalli RD, et al. Regulation of human coagulation factor X gene expression by GATA-4 and the Sp family of transcription factors. *Blood* 2001;97:946–951.

560. Di Scipio RG, Hermodson MA, Davie EW. Activation of human factor X (Stuart factor) by a protease from Russell's viper venom. *Biochemistry* 1977;16:5253–5260.

561. Fujikawa K, Davie EW. Bovine factor X (Stuart factor). *Methods Enzymol* 1976;45:89–95.

562. Nakagawa H, Takahashi N, Fujikawa K, et al. Identification of the oligosaccharide structures of human coagulation factor X activation peptide at each glycosylation site. *Glycoconj J* 1995;12:173–181.

563. Osterud B, Rapaport SI. Synthesis of intrinsic factor X activator. Inhibition of the function of formed activator by antibodies to factor VIII and to factor IX. *Biochemistry* 1970;9:1854–1861.

564. McGee MP, Li LC, Xiong H. Diffusion control in blood coagulation. Activation of factor X by factors IXa/VIIIa assembled on human monocyte membranes. *J Biol Chem* 1992;267:24333–24339.

565. Rand MD, Lock JB, van't Veer C, et al. Blood clotting in minimally altered whole blood. *Blood*

1996;88:3432–3445.

566. Butenas S, van't Veer C, Mann KG. Evaluation of the initiation phase of blood coagulation using ultrasensitive assays for serine proteases. *J Biol Chem* 1997;272:21527–21533.

567. Neuenschwander PF, Morrissey JH. Deletion of the membrane anchoring region of tissue factor abolishes autoactivation of factor VII but not cofactor function. Analysis of a mutant with a selective deficiency in activity. *J Biol Chem* 1992;267:14477–14482.

568. Monkovic DD, Tracy PB. Activation of human factor V by factor Xa and thrombin. *Biochemistry* 1990;29:1118–1128.

569. Gajdusek C, Carbon S, Ross R, et al. Activation of coagulation releases endothelial cell mitogens. *J Cell Biol* 1986;103:419–428.

570. Gasic GP, Arenas CP, Gasic TB, et al. Coagulation factors X, Xa, and protein S as potent mitogens of cultured aortic smooth muscle cells. *Proc Natl Acad Sci U S A* 1992;89:2317–2320.

571. Altieri DC, Stamnes SJ. Protease-dependent T cell activation: ligation of effector cell protease receptor-1 (EPR-1) stimulates lymphocyte proliferation. *Cell Immunol* 1994;155:372–383.

572. Altieri DC, Morrissey JH, Edgington TS. Adhesive receptor Mac-1 coordinates the activation of factor X on stimulated cells of monocytic and myeloid differentiation: an alternative initiation of the coagulation protease cascade. *Proc Natl Acad Sci U S A* 1988;85:7462–7466.

573. Altieri DC, Edgington TS. Identification of effector cell protease receptor-1. A leukocyte-distributed receptor for the serine protease factor Xa. *J Immunol* 1990;145:246–253.

574. Tracy PB, Nesheim ME, Mann KG. Platelet factor Xa receptor. *Methods Enzymol* 1992;215:329–360.

575. Lindhout T, Willems G, Blezer R, et al. Kinetics of the inhibition of human factor Xa by full-length and truncated recombinant tissue factor pathway inhibitor. *Biochem J* 1994;297(Pt 1):131–136.

576. Huang ZF, Wun TC, Broze GJ, Jr. Kinetics of factor Xa inhibition by tissue factor pathway inhibitor. *J Biol Chem* 1993;268:26950–26955.

577. Iversen N, Lindahl AK, Abildgaard U. Elevated plasma levels of the factor Xa-TFPI complex in cancer patients. *Thromb Res* 2002;105:33–36.

578. Gitel SN, Medina VM, Wessler S. Inhibition of human activated factor X by antithrombin III and alpha 1-proteinase inhibitor in human plasma. *J Biol Chem* 1984;259:6890–6895.

579. Miletich JP, Jackson CM, Majerus PW. Properties of the factor Xa binding site on human platelets. *J Biol Chem* 1978;253:6908–6916.

580. Marciniak E. Factor-Xa inactivation by antithrombin. 3. Evidence for biological stabilization of factor Xa by factor V-phospholipid complex. *Br J Haematol* 1973;24:391–400.

581. Leadley RJ, Jr. Coagulation factor Xa inhibition: biological background and rationale. *Curr Top Med Chem* 2001;1:151–159.

582. Pauls HW, Ewing WR. The design of competitive, small-molecule inhibitors of coagulation factor Xa. *Curr Top Med Chem* 2001;1:83–100.

583. Zhu BY, Huang W, Su T, et al. Discovery of transition state factor Xa inhibitors as potential anticoagulant agents. *Curr Top Med Chem* 2001;1:101–119.

584. Bauer KA, Hawkins DW, Peters PC, et al. Fondaparinux, a synthetic pentasaccharide: the first in a new class of antithrombotic age. *Cardiovasc Drug Rev* 2002;20:37–52.

585. Lundblad RL, Kingdon HS, Mann KG. Thrombin. *Methods Enzymol* 1976;45:156–176.

586. McDuffie FC, Giffin C, Niedringhaus R, et al. Prothrombin, thrombin and prothrombin fragments in

plasma of normal individuals and of patients with laboratory evidence of disseminated intravascular coagulation. *Thromb Res* 1979;16:759–773.

587. Kisiel W, Hanahan DJ. Purification and characterization of human factor II. *Biochim Biophys Acta* 1973;304:103–113.

588. Chow BK, Ting V, Tufaro F, et al. Characterization of a novel liver-specific enhancer in the human prothrombin gene. *J Biol Chem* 1991;266:18927–18933.

589. Bancroft JD, McDowell SA, Degen SJ. The human prothrombin gene: transcriptional regulation in HepG2 cells. *Biochemistry* 1992;31:12469–12476.

590. Quick AJ. On the constitution of prothrombin. *Am J Physiol* 1943;140:212–214.

591. Roberts HR, Lefkowitz JB. Inherited disorders of prothrombin conversion. In: Colman RW, Hirsh J, Marder VJ, Salzman EW, eds. *Hemostasis and thrombosis: basic principles and clinical practice*. Philadelphia: Lippincott Williams & Wilkins, 1994:200–218.

592. Rouvier J, Braude R, Altman R. Proceedings: fibrinogenolysis: studies on its degradation products. *Thromb Diath Haemorrh* 1975;34:340.

593. Girolami A, Scarano L, Saggiorato G, et al. Congenital deficiencies and abnormalities of prothrombin. *Blood Coagul Fibrinolysis* 1998;9:557–569.

594. Sun WY, Degen SJ. Gene targeting in hemostasis. Prothrombin. *Front Biosci* 2001;6:D222–D238.

595. Xue J, Wu Q, Westfield LA, et al. Incomplete embryonic lethality and fatal neonatal hemorrhage caused by prothrombin deficiency in mice. *Proc Natl Acad Sci U S A* 1998;95:7603–7607.

596. Sun WY, Witte DP, Degen JL, et al. Prothrombin deficiency results in embryonic and neonatal lethality in mice. *Proc Natl Acad Sci U S A* 1998;95:7597–7602.

597. Bancroft JD, Schaefer LA, Degen SJ. Characterization of the Alu-rich 5'-flanking region of the human prothrombin-encoding gene: identification of a positive cis-acting element that regulates liver-specific expression. *Gene* 1990;95:253–260.

598. Degen SJ. The prothrombin gene and its liver-specific expression. *Semin Thromb Hemost* 1992;18:230–242.

599. Degen SJ, Davie EW. Nucleotide sequence of the gene for human prothrombin. *Biochemistry* 1987;26:6165–6177.

600. Degen SJ, MacGillivray RT, Davie EW. Characterization of the complementary deoxyribonucleic acid and gene coding for human prothrombin. *Biochemistry* 1983;22:2087–2097.

601. Poort SR, Rosendaal FR, Reitsma PH, et al. A common genetic variation in the 3'-untranslated region of the prothrombin gene is associated with elevated plasma prothrombin levels and an increase in venous thrombosis. *Blood* 1996;88:3698–3703.

602. Perez-Ceballos E, Corral J, Alberca I, et al. Prothrombin A19911G and G20210A polymorphisms' role in thrombosis. *Br J Haematol* 2002;118:610–614.

603. Tripodi A, Mannucci PM. Laboratory investigation of thrombophilia. *Clin Chem* 2001;47:1597–1606.

604. Nguyen A. Prothrombin G20210A polymorphism and thrombophilia. *Mayo Clin Proc* 2000;75:595–604.

605. Martinelli I. Risk factors in venous thromboembolism. *Thromb Haemost* 2001;86:395–403.

606. Butkowski RJ, Elion J, Downing MR, et al. Primary structure of human prothrombin 2 and alpha-thrombin. *J Biol Chem* 1977;252:4942–4957.

607. MacGillivray RT, Davie EW. Characterization of bovine prothrombin mRNA and its translation

product. *Biochemistry* 1984;23:1626–1634.

608. Mizuochi T, Fujii J, Kisiel W, et al. Studies on the structures of the carbohydrate moiety of human prothrombin. *J Biochem (Tokyo)* 1981;90:1023–1031.

609. Patthy L. Evolution of the proteases of blood coagulation and fibrinolysis by assembly from modules. *Cell* 1985;41:657–663.

610. Castellino FJ, Beals JM. The genetic relationships between the kringle domains of human plasminogen, prothrombin, tissue plasminogen activator, urokinase, and coagulation factor XII. *J Mol Evol* 1987;26:358–369.

611. Deguchi H, Takeya H, Gabazza EC, et al. Prothrombin kringle 1 domain interacts with factor Va during the assembly of prothrombinase complex. *Biochem J* 1997;321:729–735.

612. Sugo T, Nakamikawa C, Tanabe S, et al. Activation of prothrombin by factor Xa bound to the membrane surface of human umbilical vein endothelial cells: its catalytic efficiency is similar to that of prothrombinase complex on platelets. *J Biochem (Tokyo)* 1995;117:244–250.

613. Bajaj SP, Butkowski RJ, Mann KG. Prothrombin fragments. Ca<sup>2+</sup> binding and activation kinetics. *J Biol Chem* 1975;250:2150–2156.

614. Kotkow KJ, Deitcher SR, Furie B, et al. The second kringle domain of prothrombin promotes factor Va-mediated prothrombin activation by prothrombinase. *J Biol Chem* 1995;270:4551–4557.

615. Krishnaswamy S, Walker RK. Contribution of the prothrombin fragment 2 domain to the function of factor Va in the prothrombinase complex. *Biochemistry* 1997;36:3319–3330.

616. Tracy PB, Eide LL, Mann KG. Human prothrombinase complex assembly and function on isolated peripheral blood cell populations. *J Biol Chem* 1985;260:2119–2124.

617. Doyle MF, Mann KG. Multiple active forms of thrombin. IV. Relative activities of meizothrombins. *J Biol Chem* 1990;265:10693–10701.

618. Myrnel KH, Lundblad RL, Mann KG. Characteristics of the association between prothrombin fragment 2 and alpha-thrombin. *Biochemistry* 1976;15:1767–1773.

619. Nesheim ME, Abbott T, Jenny R, et al. Evidence that the thrombin-catalyzed feedback cleavage of fragment 1.2 at Arg154–Ser155 promotes the release of thrombin from the catalytic surface during the activation of bovine prothrombin. *J Biol Chem* 1988;263:1037–1044.

620. Mosesson MW. The roles of fibrinogen and fibrin in hemostasis and thrombosis. *Semin Hematol* 1992;29:177–188.

621. Davey MG, Luscher EF. Actions of thrombin and other coagulant and proteolytic enzymes on blood platelets. *Nature* 1967;216:857–858.

622. Mann KG, Jenny RJ, Krishnaswamy S. Cofactor proteins in the assembly and expression of blood clotting enzyme complexes. *Annu Rev Biochem* 1988;57:915–956.

623. Fay PJ. Subunit structure of thrombin-activated human factor VIIIa. *Biochim Biophys Acta* 1988;952:181–190.

624. Kisiel W, Canfield WM, Ericsson LH, et al. Anticoagulant properties of bovine plasma protein C following activation by thrombin. *Biochemistry* 1977;16:5824–5831.

625. Fenton JW. Regulation of thrombin generation and functions. *Semin Thromb Hemost* 1988;14:234–240.

626. Bar-Shavit R, Benezra M, Eldor A, et al. Thrombin immobilized to extracellular matrix is a potent mitogen for vascular smooth muscle cells: nonenzymatic mode of action. *Cell Regul* 1990;1:453–463.

627. Bar-Shavit R, Kahn AJ, Mann KG, et al. Identification of a thrombin sequence with growth factor

- activity on macrophages. *Proc Natl Acad Sci U S A* 1986;83:976–980.
628. McNamara CA, Sarembock IJ, Gimble LW, et al. Thrombin stimulates proliferation of cultured rat aortic smooth muscle cells by a proteolytically activated receptor. *J Clin Invest* 1993;91:94–98.
629. Sago H, Iinuma K. Cell shape change and cytosolic Ca<sup>2+</sup> in human umbilical-vein endothelial cells stimulated with thrombin. *Thromb Haemost* 1992;67:331–334.
630. Tsopanoglou NE, Pipili-Synetos E, Maragoudakis ME. Thrombin promotes angiogenesis by a mechanism independent of fibrin formation. *Am J Physiol* 1993;264:C1302–C1307.
631. Folkman J. Tumor angiogenesis. *Adv Cancer Res* 1985;43:175–203.
632. Tsopanoglou NE, Maragoudakis ME. On the mechanism of thrombin-induced angiogenesis. Potentiation of vascular endothelial growth factor activity on endothelial cells by up-regulation of its receptors. *J Biol Chem* 1999;274:23969–23976.
633. Jenny NS, Mann KG. Thrombin. In: Colman RW, Hirsh J, Marder VJ, et al., eds. *Hemostasis and thrombosis: basic principles and clinical practice*. Philadelphia: Lippincott Williams & Wilkins, 2001:171–189.
634. Bjork I, Lindahl U. Mechanism of the anticoagulant action of heparin. *Mol Cell Biochem* 1982;48:161–182.
635. Rosenberg RD. Chemistry of the hemostatic mechanism and its relationship to the action of heparin. *Fed Proc* 1977;36:10–18.
636. Butenas S, van't Veer C, Mann KG. “Normal” thrombin generation. *Blood* 1999;94:2169–2178.
637. Toomey JR, Kratzer KE, Lasky NM, et al. Targeted disruption of the murine tissue factor gene results in embryonic lethality. *Blood* 1996;88:1583–1587.
638. Bugge TH, Xiao Q, Kombrinck KW, et al. Fatal embryonic bleeding events in mice lacking tissue factor, the cell-associated initiator of blood coagulation. *Proc Natl Acad Sci U S A* 1996;93:6258–6263.
639. Carmeliet P, Mackman N, Moons L, et al. Role of tissue factor in embryonic blood vessel development. *Nature* 1996;383:73–75.
640. Carmeliet P, Moons L, Dewerchin M, et al. Insights in vessel development and vascular disorders using targeted inactivation and transfer of vascular endothelial growth factor, the tissue factor receptor, and the plasminogen system. *Ann N Y Acad Sci* 1997;811:191–206.
641. Reference deleted.
642. Scarpati EM, Wen D, Broze GJ, Jr., et al. Human tissue factor: cDNA sequence and chromosome localization of the gene. *Biochemistry* 1987;26:5234–5238.
643. Kao FT, Hartz J, Horton R, et al. Regional assignment of human tissue factor gene (F3) to chromosome 1p21–p22. *Somat Cell Mol Genet* 1988;14:407–410.
644. Mackman N, Morrissey JH, Fowler B, et al. Complete sequence of the human tissue factor gene, a highly regulated cellular receptor that initiates the coagulation protease cascade. *Biochemistry* 1989;28:1755–1762.
645. Mackman N, Fowler BJ, Edgington TS, et al. Functional analysis of the human tissue factor promoter and induction by serum. *Proc Natl Acad Sci U S A* 1990;87:2254–2258.
646. Ranganathan G, Blatti SP, Subramaniam M, et al. Cloning of murine tissue factor and regulation of gene expression by transforming growth factor type beta 1. *J Biol Chem* 1991;266:496–501.
647. Geczy CL. Cellular mechanisms for the activation of blood coagulation. *Int Rev Cytol* 1994;152:49–108.
648. Camerer E, Kolsto AB, Prydz H. Cell biology of tissue factor, the principal initiator of blood

coagulation. *Thromb Res* 1996;81:1-41.

649. Morrissey JH. Tissue factor and factor VII initiation of coagulation. In: Colman RW, Hirsh J, Marder VJ, et al., eds. *Hemostasis and thrombosis: basic principles and clinical practice*. Philadelphia: Lippincott Williams & Wilkins, 2001:89-101.

650. Andoh K, Kubota T, Takada M, et al. Tissue factor activity in leukemia cells. Special reference to disseminated intravascular coagulation. *Cancer* 1987;59:748-754.

651. Tanaka M, Yamanishi H. The expression of tissue factor antigen and activity on the surface of leukemic cells. *Leuk Res* 1993;17:103-111.

652. Tallman MS, Hakimian D, Kwaan HC, et al. New insights into the pathogenesis of coagulation dysfunction in acute promyelocytic leukemia. *Leuk Lymphoma* 1993;11:27-36.

653. Osterud B, Flaegstad T. Increased tissue thromboplastin activity in monocytes of patients with meningococcal infection: related to an unfavourable prognosis. *Thromb Haemost* 1983;49:5-7.

654. Kadish JL, Wenc KM, Dvorak HF. Tissue factor activity of normal and neoplastic cells: quantitation and species specificity. *J Natl Cancer Inst* 1983;70:551-557.

655. Silberberg JM, Gordon S, Zucker S. Identification of tissue factor in two human pancreatic cancer cell lines. *Cancer Res* 1989;49:5443-5447.

656. Bauer KA, Conway EM, Bach R, et al. Tissue factor gene expression in acute myeloblastic leukemia. *Thromb Res* 1989;56:425-430.

657. Mueller BM, Reisfeld RA, Edgington TS, et al. Expression of tissue factor by melanoma cells promotes efficient hematogenous metastasis. *Proc Natl Acad Sci U S A* 1992;89:11832-11836.

658. Faulk WP, Labarrere CA, Carson SD. Tissue factor: identification and characterization of cell types in human placentae. *Blood* 1990;76:86-96.

659. Blakely ML, Van der Werf WJ, Berndt MC, et al. Activation of intragraft endothelial and mononuclear cells during discordant xenograft rejection. *Transplantation* 1994;58:1059-1066.

660. Salom RN, Maguire JA, Hancock WW. Endothelial activation and cytokine expression in human acute cardiac allograft rejection. *Pathology* 1998;30:24-29.

661. Mackman N. Regulation of the tissue factor gene. *Thromb Haemost* 1997;78:747-754.

662. Gertler JP, Weibe DA, Ocasio VH, et al. Hypoxia induces procoagulant activity in cultured human venous endothelium. *J Vasc Surg* 1991;13:428-433.

663. O'Rourke JF, Pugh CW, Bartlett SM, et al. Identification of hypoxically inducible mRNAs in HeLa cells using differential-display PCR. Role of hypoxia-inducible factor-1. *Eur J Biochem* 1996;241:403-410.

664. Herbert JM, Corseaux D, Lale A, et al. Hypoxia primes endotoxin-induced tissue factor expression in human monocytes and endothelial cells by a PAF-dependent mechanism. *J Cell Physiol* 1996;169:290-299.

665. Yan SF, Zou YS, Gao Y, et al. Tissue factor transcription driven by Egr-1 is a critical mechanism of murine pulmonary fibrin deposition in hypoxia. *Proc Natl Acad Sci U S A* 1998;95:8298-8303.

666. Broze GJ, Jr., Leykam JE, Schwartz BD, et al. Purification of human brain tissue factor. *J Biol Chem* 1985;260:10917-10920.

667. Morrissey JH, Fakhrai H, Edgington TS. Molecular cloning of the cDNA for tissue factor, the cellular receptor for the initiation of the coagulation protease cascade. *Cell* 1987;50:129-135.

668. Spicer EK, Horton R, Bloem L, et al. Isolation of cDNA clones coding for human tissue factor: primary structure of the protein and cDNA. *Proc Natl Acad Sci U S A* 1987;84:5148-5152.

669. Bazan JF. Structural design and molecular evolution of a cytokine receptor superfamily. *Proc Natl*

Acad Sci U S A 1990;87:6934–6938.

670. Paborsky LR, Caras IW, Fisher KL, et al. Lipid association, but not the transmembrane domain, is required for tissue factor activity. Substitution of the transmembrane domain with a phosphatidylinositol anchor. *J Biol Chem* 1991;266:21911–21916.

671. Paborsky LR, Harris RJ. Post-translational modifications of recombinant human tissue factor. *Thromb Res* 1990;60:367–376.

672. Harlos K, Martin DM, O'Brien DP, et al. Crystal structure of the extracellular region of human tissue factor. *Nature* 1994;370:662–666.

673. Muller YA, Ultsch MH, Kelley RF, et al. Structure of the extracellular domain of human tissue factor: location of the factor VIIa binding site. *Biochemistry* 1994;33:10864–10870.

674. Huang M, Syed R, Stura EA, et al. The mechanism of an inhibitory antibody on TF-initiated blood coagulation revealed by the crystal structures of human tissue factor, Fab 5G9 and TF.G9 complex. *J Mol Biol* 1998;275:873–894.

675. Muller YA, Kelley RF, de Vos AM. Hinge bending within the cytokine receptor superfamily revealed by the 2.4 Å crystal structure of the extracellular domain of rabbit tissue factor. *Protein Sci* 1998;7:1106–1115.

676. Muller YA, Ultsch MH, de Vos AM. The crystal structure of the extracellular domain of human tissue factor refined to 1.7 Å resolution. *J Mol Biol* 1996;256:144–159.

677. Kahn ML, Zheng YW, Huang W, et al. A dual thrombin receptor system for platelet activation. *Nature* 1998;394:690–694.

678. Bach R, Konigsberg WH, Nemerson Y. Human tissue factor contains thioester-linked palmitate and stearate on the cytoplasmic half-cystine. *Biochemistry* 1988;27:4227–4231.

679. Rehemtulla A, Ruf W, Edgington TS. The integrity of the cysteine 186–cysteine 209 bond of the second disulfide loop of tissue factor is required for binding of factor VII. *J Biol Chem* 1991;266:10294–10299.

680. Paborsky LR, Tate KM, Harris RJ, et al. Purification of recombinant human tissue factor. *Biochemistry* 1989;28:8072–8077.

681. Zioncheck TF, Roy S, Vehar GA. The cytoplasmic domain of tissue factor is phosphorylated by a protein kinase C-dependent mechanism. *J Biol Chem* 1992;267:3561–3564.

682. Nemerson Y, Repke D. Tissue factor accelerates the activation of coagulation factor VII: the role of a bifunctional coagulation cofactor. *Thromb Res* 1985;40:351–358.

683. Ruf W, Rehemtulla A, Morrissey JH, et al. Phospholipid-independent and -dependent interactions required for tissue factor receptor and cofactor function. *J Biol Chem* 1991;266:16256.

684. Pedersen AH, Nordfang O, Norris F, et al. Recombinant human extrinsic pathway inhibitor. Production, isolation, and characterization of its inhibitory activity on tissue factor-initiated coagulation reactions. *J Biol Chem* 1990;265:16786–16793.

685. Neuenschwander PF, Branam DE, Morrissey JH. Importance of substrate composition, pH and other variables on tissue factor enhancement of factor VIIa activity. *Thromb Haemost* 1993;70:970–977.

686. Giesen PL, Rauch U, Bohrmann B, et al. Blood-borne tissue factor: another view of thrombosis. *Proc Natl Acad Sci U S A* 1999;96:2311–2315.

687. Osterud B. The role of platelets in decrypting monocyte tissue factor. *Semin Hematol* 2001;38:2–5.

688. Zillmann A, Luther T, Muller I, et al. Platelet-associated tissue factor contributes to the collagen-triggered activation of blood coagulation. *Biochem Biophys Res Commun* 2001;281:603–609.

689. Santucci RA, Erlich J, Labriola J, et al. Measurement of tissue factor activity in whole blood. *Thromb*



Haemost 2000;83:445–454.

690. Takahashi H, Satoh N, Wada K, et al. Tissue factor in plasma of patients with disseminated intravascular coagulation. *Am J Hematol* 1994;46:333–337.

691. Marder VJ, Mannucci PM, Firkin BG, et al. Standard nomenclature for factor VIII and von Willebrand factor: a recommendation by the International Committee on Thrombosis and Haemostasis. *Thromb Haemost* 1985;54:871–872.

692. Leyte A, Verbeet MP, Brodniewicz-Proba T, et al. The interaction between human blood-coagulation factor VIII and von Willebrand factor. Characterization of a high-affinity binding site on factor VIII. *Biochem J* 1989;257:679–683.

693. Bendetowicz AV, Morris JA, Wise RJ, et al. Binding of factor VIII to von Willebrand factor is enabled by cleavage of the von Willebrand factor propeptide and enhanced by formation of disulfide-linked multimers. *Blood* 1998;92:529–538.

694. Mannucci PM. Desmopressin (DDAVP) in the treatment of bleeding disorders: the first 20 years. *Blood* 1997;90:2515–2521.

695. Tuddenham EG, Lane RS, Rotblat F, et al. Response to infusions of polyelectrolyte fractionated human factor VIII concentrate in human haemophilia A and von Willebrand's disease. *Br J Haematol* 1982;52:259–267.

696. Over J, Sixma JJ, Bruine MH, et al. Survival of <sup>125</sup>iodine-labeled Factor VIII in normals and patients with classic hemophilia. Observations on the heterogeneity of human Factor VIII. *J Clin Invest* 1978;62:223–234.

697. Weiss HJ, Sussman II, Hoyer LW. Stabilization of factor VIII in plasma by the von Willebrand factor. Studies on posttransfusion and dissociated factor VIII and in patients with von Willebrand's disease. *J Clin Invest* 1977;60:390–404.

698. Brinkhous KM, Sandberg H, Garris JB, et al. Purified human factor VIII procoagulant protein: comparative hemostatic response after infusions into hemophilic and von Willebrand disease dogs. *Proc Natl Acad Sci U S A* 1985;82:8752–8756.

699. Rizza CR, Spooner RJ. Treatment of haemophilia and related disorders in Britain and Northern Ireland during 1976–80: report on behalf of the directors of haemophilia centres in the United Kingdom. *Br Med J (Clin Res Ed)* 1983;286:929–933.

700. Kaufman RJ, Antonarakis SE, Fay PJ. Factor VIII and hemophilia A. In: Colman RW, Hirsh J, Marder VJ, et al., eds. *Hemostasis and thrombosis: basic principles and clinical practice*. Philadelphia: Lippincott Williams & Wilkins, 2001:135–156.

701. Freije D, Schlessinger D. A 1.6-Mb contig of yeast artificial chromosomes around the human factor VIII gene reveals three regions homologous to probes for the DXS115 locus and two for the DXYS64 locus. *Am J Hum Genet* 1992;51:66–80.

702. Migeon BR, McGinniss MJ, Antonarakis SE, et al. Severe hemophilia A in a female by cryptic translocation: order and orientation of factor VIII within Xq28 [published erratum appears in *Genomics* 1993;16(3):792]. *Genomics* 1993;16:20–25.

703. Gitschier J, Wood WI, Goralka TM, et al. Characterization of the human factor VIII gene. *Nature* 1984;312:326–330.

704. Purrello M, Alhadeff B, Esposito D, et al. The human genes for hemophilia A and hemophilia B flank the X chromosome fragile site at Xq27.3. *EMBO J* 1985;4:725–729.

705. Tantravahi U, Murty VV, Jhanwar SC, et al. Physical mapping of the factor VIII gene proximal to two polymorphic DNA probes in human chromosome band Xq28: implications for factor VIII gene segregation analysis. *Cytogenet Cell Genet* 1986;42:75–79.

706. Wood WI, Capon DJ, Simonsen CC, et al. Expression of active human factor VIII from recombinant

DNA clones. *Nature* 1984;312:330–337.

707. Webster WP, Zukoski CF, Hutchin P, et al. Plasma factor VIII synthesis and control as revealed by canine organ transplantation. *Am J Physiol* 1971;220:1147–1154.

708. Groth CG, Hathaway WE, Gustafsson A, et al. Correction of coagulation in the hemophilic dog by transplantation of lymphatic tissue. *Surgery* 1974;75:725–733.

709. Lewis JH, Bontempo FA, Spero JA, et al. Liver transplantation in a hemophiliac. *N Engl J Med* 1985;312:1189–1190.

710. Bontempo FA, Lewis JH, Gorenc TJ, et al. Liver transplantation in hemophilia A. *Blood* 1987;69:1721–1724.

711. Liu L, Xia S, Seifert J. Transplantation of spleen cells in patients with hemophilia A. A report of 20 cases. *Transpl Int* 1994;7:201–206.

712. Kelly DA, Summerfield JA, Tuddenham EG. Localization of factor VIIIc: antigen in guinea-pig tissues and isolated liver cell fractions. *Br J Haematol* 1984;56:535–543.

713. Wion KL, Kelly D, Summerfield JA, et al. Distribution of factor VIII mRNA and antigen in human liver and other tissues. *Nature* 1985;317:726–729.

714. Vehar GA, Keyt B, Eaton D, et al. Structure of human factor VIII. *Nature* 1984;312:337–342.

715. Jenny RJ, Pittman DD, Toole JJ, et al. Complete cDNA and derived amino acid sequence of human factor V. *Proc Natl Acad Sci U S A* 1987;84:4846–4850.

716. Koschinsky ML, Funk WD, van Oost BA, et al. Complete cDNA sequence of human preceruloplasmin. *Proc Natl Acad Sci U S A* 1986;83:5086–5090.

717. Poole S, Firtel RA, Lamar E, et al. Sequence and expression of the discoidin I gene family in *Dictyostelium discoideum*. *J Mol Biol* 1981;153:273–289.

718. Stubbs JD, Lekutis C, Singer KL, et al. cDNA cloning of a mouse mammary epithelial cell surface protein reveals the existence of epidermal growth factor-like domains linked to factor VIII-like sequences. *Proc Natl Acad Sci U S A* 1990;87:8417–8421.

719. Fass DN, Knutson GJ, Katzmann JA. Monoclonal antibodies to porcine factor VIII coagulant and their use in the isolation of active coagulant protein. *Blood* 1982;59:594–600.

720. Andersson LO, Forsman N, Huang K, et al. Isolation and characterization of human factor VIII: molecular forms in commercial factor VIII concentrate, cryoprecipitate, and plasma. *Proc Natl Acad Sci U S A* 1986;83:2979–2983.

721. Fay PJ, Anderson MT, Chavin SI, et al. The size of human factor VIII heterodimers and the effects produced by thrombin. *Biochim Biophys Acta* 1986;871:268–278.

722. Elder B, Lakich D, Gitschier J. Sequence of the murine factor VIII cDNA. *Genomics* 1993;16:374–379.

723. Bihoreau N, Pin S, de Kersabiec AM, et al. Copper-atom identification in the active and inactive forms of plasma-derived FVIII and recombinant FVIII-delta II. *Eur J Biochem* 1994;222:41–48.

724. Tagliavacca L, Moon N, Dunham WR, et al. Identification and functional requirement of Cu(I) and its ligands within coagulation factor VIII. *J Biol Chem* 1997;272:27428–27434.

725. Saenko EL, Shima M, Rajalakshmi KJ, et al. A role for the C2 domain of factor VIII in binding to von Willebrand factor. *J Biol Chem* 1994;269:11601–11605.

726. Saenko EL, Scandella D. The acidic region of the factor VIII light chain and the C2 domain together form the high affinity binding site for von Willebrand factor. *J Biol Chem* 1997;272:18007–18014.

727. Foster PA, Fulcher CA, Houghten RA, et al. An immunogenic region within residues Val1670–Glu1684

of the factor VIII light chain induces antibodies which inhibit binding of factor VIII to von Willebrand factor. *J Biol Chem* 1988;263:5230–5234.

728. Shima M, Scandella D, Yoshioka A, et al. A factor VIII neutralizing monoclonal antibody and a human inhibitor alloantibody recognizing epitopes in the C2 domain inhibit factor VIII binding to von Willebrand factor and to phosphatidylserine. *Thromb Haemost* 1993;69:240–246.

729. Lenting PJ, Donath MJ, van Mourik JA, et al. Identification of a binding site for blood coagulation factor IXa on the light chain of human factor VIII. *J Biol Chem* 1994;269:7150–7155.

730. Lenting PJ, van de Loo JW, Donath MJ, et al. The sequence Glu1811–Lys1818 of human blood coagulation factor VIII comprises a binding site for activated factor IX. *J Biol Chem* 1996;271:1935–1940.

731. Fay PJ, Beattie T, Huggins CF, et al. Factor VIIIa A2 subunit residues 558–565 represent a factor IXa interactive site. *J Biol Chem* 1994;269:20522–20527.

732. Reference deleted.

733. O'Brien LM, Medved LV, Fay PJ. Localization of factor IXa and factor VIIIa interactive sites. *J Biol Chem* 1995;270:27087–27092.

734. Fay PJ, Koshiu K. The A2 subunit of factor VIIIa modulates the active site of factor IXa. *J Biol Chem* 1998;273:19049–19054.

735. Kembell-Cook G, Tuddenham EG. The Factor VIII Mutation Database on the World Wide Web: the haemophilia A mutation, search, test and resource site. HAMSTeRS update (version 3.0). *Nucleic Acids Res* 1997;25: 128–132.

736. Jenkins PV, Freas J, Schmidt KM, et al. Mutations associated with hemophilia A in the 558–565 loop of the factor VIIIa A2 subunit alter the catalytic activity of the factor Xase complex. *Blood* 2002;100:501–508.

737. Pemberton S, Lindley P, Zaitsev V, et al. A molecular model for the triplicated A domains of human factor VIII based on the crystal structure of human ceruloplasmin. *Blood* 1997;89:2413–2421.

738. Lapan KA, Fay PJ. Localization of a factor X interactive site in the A1 subunit of factor VIIIa. *J Biol Chem* 1997;272:2082–2088.

739. Regan LM, O'Brien LM, Beattie TL, et al. Activated protein C-catalyzed proteolysis of factor VIIIa alters its interactions within factor Xase. *J Biol Chem* 1996;271:3982–3987.

740. Pittman DD, Wang JH, Kaufman RJ. Identification and functional importance of tyrosine sulfate residues within recombinant factor VIII. *Biochemistry* 1992;31:3315–3325.

741. Michnick DA, Pittman DD, Wise RJ, et al. Identification of individual tyrosine sulfation sites within factor VIII required for optimal activity and efficient thrombin cleavage. *J Biol Chem* 1994;269:20095–20102.

742. Hironaka T, Furukawa K, Esmon PC, et al. Comparative study of the sugar chains of factor VIII purified from human plasma and from the culture media of recombinant baby hamster kidney cells. *J Biol Chem* 1992;267:8012–8020.

743. van Dieijen G, Tans G, Rosing J, et al. The role of phospholipid and factor VIIIa in the activation of bovine factor X. *J Biol Chem* 1981;256:3433–3442.

744. van Dieijen G, van Rijn JL, Govers-Riemslog JW, et al. Assembly of the intrinsic factor X activating complex—interactions between factor IXa, factor VIIIa and phospholipid. *Thromb Haemost* 1985;53:396–400.

745. Duffy EJ, Parker ET, Mutucumarana VP, et al. Binding of factor VIIIa and factor VIII to factor IXa on phospholipid vesicles. *J Biol Chem* 1992;267:17006–17011.

746. Lollar P, Knutson GJ, Fass DN. Stabilization of thrombin-activated porcine factor VIII: C by factor IXa phospholipid. *Blood* 1984;63:1303–1308.

747. Lamphear BJ, Fay PJ. Factor IXa enhances reconstitution of factor VIIIa from isolated A2 subunit and A1/A3-C1-C2 dimer. *J Biol Chem* 1992;267:3725-3730.
748. Lamphear BJ, Fay PJ. Proteolytic interactions of factor IXa with human factor VIII and factor VIIIa. *Blood* 1992;80:3120-3126.
749. Fay PJ, Beattie TL, Regan LM, et al. Model for the factor VIIIa-dependent decay of the intrinsic factor Xase. Role of subunit dissociation and factor IXa-catalyzed proteolysis. *J Biol Chem* 1996;271:6027-6032.
750. O'Brien DP, Johnson D, Byfield P, et al. Inactivation of factor VIII by factor IXa. *Biochemistry* 1992;31:2805-2812.
751. Fay PJ, Smudzin TM, Walker FJ. Activated protein C-catalyzed inactivation of human factor VIII and factor VIIIa. Identification of cleavage sites and correlation of proteolysis with cofactor activity. *J Biol Chem* 1991;266:20139-20145.
752. Lu D, Kalafatis M, Mann KG, et al. Comparison of activated protein C/protein S-mediated inactivation of human factor VIII and factor V. *Blood* 1996;87:4708-4717.
753. Regan LM, Lamphear BJ, Huggins CF, et al. Factor IXa protects factor VIIIa from activated protein C. Factor IXa inhibits activated protein C-catalyzed cleavage of factor VIIIa at Arg562. *J Biol Chem* 1994;269:9445-9452.
754. Tracy PB, Eide LL, Bowie EJ, et al. Radioimmunoassay of factor V in human plasma and platelets. *Blood* 1982;60:59-63.
755. Mann KG, Kalafatis M. Factor V: a combination of Dr Jekyll and Mr Hyde. *Blood* 2003;101:20-30.
756. Cui J, O'Shea KS, Purkayastha A, et al. Fatal haemorrhage and incomplete block to embryogenesis in mice lacking coagulation factor V. *Nature* 1996;384:66-68.
757. Seligsohn U, Zivelin A, Zwang E. Combined factor V and factor VIII deficiency among non-Ashkenazi Jews. *N Engl J Med* 1982;307:1191-1195.
758. Dansako H, Ishimaru F, Takai Y, et al. Molecular characterization of the ERGIC-53 gene in two Japanese patients with combined factor V-factor VIII deficiency. *Ann Hematol* 2001;80:292-294.
759. Tracy PB, Giles AR, Mann KG, et al. Factor V (Quebec): a bleeding diathesis associated with a qualitative platelet factor V deficiency. *J Clin Invest* 1984;74:1221-1228.
760. Baruch D, Lindhout T, Dupuy E, et al. Thrombin-induced platelet factor Va formation in patients with a gray platelet syndrome. *Thromb Haemost* 1987;58:768-771.
761. Weiss HJ, Lages B. Platelet prothrombinase activity and intracellular calcium responses in patients with storage pool deficiency, glycoprotein IIb-IIIa deficiency, or impaired platelet coagulant activity—a comparison with Scott syndrome. *Blood* 1997;89:1599-1611.
762. Janeway CM, Rivard GE, Tracy PB, et al. Factor V Quebec revisited. *Blood* 1996;87:3571-3578.
763. Wang H, Riddell DC, Guinto ER, et al. Localization of the gene encoding human factor V to chromosome 1q21-25. *Genomics* 1988;2:324-328.
764. Kane WH, Ichinose A, Hagen FS, et al. Cloning of cDNAs coding for the heavy chain region and connecting region of human factor V, a blood coagulation factor with four types of internal repeats. *Biochemistry* 1987;26:6508-6514.
765. Mazzorana M, Baffet G, Kneip B, et al. Expression of coagulation factor V gene by normal adult human hepatocytes in primary culture. *Br J Haematol* 1991;78:229-235.
766. Gewirtz AM, Shen YM. Effect of phorbol myristate acetate on c-myc, beta-actin, and FV gene expression in morphologically recognizable human megakaryocytes: a kinetic analysis employing in situ

hybridization. *Exp Hematol* 1990;18:945–952.

767. Gewirtz AM, Shapiro C, Shen YM, et al. Cellular and molecular regulation of factor V expression in human megakaryocytes. *J Cell Physiol* 1992;153:277–287.

768. Gewirtz AM, Keefer M, Doshi K, et al. Biology of human megakaryocyte factor V. *Blood* 1986;67:1639–1648.

769. Camire RM, Pollak ES, Kaushansky K, et al. Secretable human platelet-derived factor V originates from the plasma pool. *Blood* 1998;92:3035–3041.

770. Handagama P, Rappolee DA, Werb Z, et al. Platelet alpha-granule fibrinogen, albumin, and immunoglobulin G are not synthesized by rat and mouse megakaryocytes. *J Clin Invest* 1990;86:1364–1368.

771. Colman RW. Where does platelet factor V originate? *Blood* 1999;93:3152–3153.

772. Cerveny TJ, Fass DN, Mann KG. Synthesis of coagulation factor V by cultured aortic endothelium. *Blood* 1984;63:1467–1474.

773. Rodgers GM. Vascular smooth muscle cells synthesize, secrete and express coagulation factor V. *Biochim Biophys Acta* 1988;968:17–23.

774. Kane WH, Majerus PW. Purification and characterization of human coagulation factor V. *J Biol Chem* 1981;256:1002–1007.

775. Nesheim ME, Myrnel KH, Hibbard L, et al. Isolation and characterization of single chain bovine factor V. *J Biol Chem* 1979;254:508–517.

776. Dahlback B. Human coagulation factor V purification and thrombin-catalyzed activation. *J Clin Invest* 1980;66:583–591.

777. Katzmann JA, Nesheim ME, Hibbard LS, et al. Isolation of functional human coagulation factor V by using a hybridoma antibody. *Proc Natl Acad Sci U S A* 1981;78:162–166.

778. Jenny RJ, Pittman DD, Toole JJ, et al. Complete cDNA and derived amino acid sequence of human factor V. *Proc Natl Acad Sci U S A* 1987;84:4846–4850.

779. Mann KG, Lawler CM, Vehar GA, et al. Coagulation factor V contains copper ion. *J Biol Chem* 1984;259:12949–12951.

780. Undas A, Williams EB, Butenas S, et al. Homocysteine inhibits inactivation of factor Va by activated protein C. *J Biol Chem* 2001;276:4389–4397.

781. Kalafatis M. Identification and partial characterization of factor Va heavy chain kinase from human platelets. *J Biol Chem* 1998;273:8459–8466.

782. Pittman DD, Tomkinson KN, Michnick D, et al. Posttranslational sulfation of factor V is required for efficient thrombin cleavage and activation and for full procoagulant activity. *Biochemistry* 1994;33:6952–6959.

783. Pittman DD, Tomkinson KN, Kaufman RJ. Post-translational requirements for functional factor V and factor VIII secretion in mammalian cells. *J Biol Chem* 1994;269:17329–17337.

784. Fernandez JA, Hackeng TM, Kojima K, et al. The carbohydrate moiety of factor V modulates inactivation by activated protein C. *Blood* 1997;89:4348–4354.

785. Nicolaes GA, Villoutreix BO, Dahlback B. Partial glycosylation of Asn2181 in human factor V as a cause of molecular and functional heterogeneity. Modulation of glycosylation efficiency by mutagenesis of the consensus sequence for N-linked glycosylation. *Biochemistry* 1999;38:13584–13591.

786. Hoekema L, Nicolaes GA, Hemker HC, et al. Human factor Va1 and factor Va2: properties in the procoagulant and anticoagulant pathways. *Biochemistry* 1997;36:3331–3335.

787. Rosing J, Bakker HM, Thomassen MC, et al. Characterization of two forms of human factor Va with different cofactor activities. *J Biol Chem* 1993;268:21130–21136.
788. Kim SW, Ortel TL, Quinn–Allen MA, et al. Partial glycosylation at asparagine–2181 of the second C–type domain of human factor V modulates assembly of the prothrombinase complex. *Biochemistry* 1999;38:11448–11454.
789. Kalafatis M, Rand MD, Mann KG. Factor Va–membrane interaction is mediated by two regions located on the light chain of the cofactor. *Biochemistry* 1994;33:486–493.
790. Esmon CT. The subunit structure of thrombin–activated factor V. Isolation of activated factor V, separation of subunits, and reconstitution of biological activity. *J Biol Chem* 1979;254:964–973.
791. Guinto ER, Esmon CT. Formation of a calcium–binding site on bovine activated factor V following recombination of the isolated subunits. *J Biol Chem* 1982;257:10038–10043.
792. Kane WH, Majerus PW. The interaction of human coagulation factor Va with platelets. *J Biol Chem* 1982;257:3963–3969.
793. Laue TM, Johnson AE, Esmon CT, et al. Structure of bovine blood coagulation factor Va. Determination of the subunit associations, molecular weights, and asymmetries by analytical ultracentrifugation. *Biochemistry* 1984;23:1339–1348.
794. Thorelli E, Kaufman RJ, Dahlback B. Cleavage requirements for activation of factor V by factor Xa. *Eur J Biochem* 1997;247:12–20.
795. Vicic WJ, Lages B, Weiss HJ. Release of human platelet factor V activity is induced by both collagen and ADP and is inhibited by aspirin. *Blood* 1980;56:448–455.
796. Bradford HN, Annamalai A, Doshi K, et al. Factor V is activated and cleaved by platelet calpain: comparison with thrombin proteolysis. *Blood* 1988;71:388–394.
797. Allen DH, Tracy PB. Human coagulation factor V is activated to the functional cofactor by elastase and cathepsin G expressed at the monocyte surface. *J Biol Chem* 1995;270:1408–1415.
798. Camire RM, Kalafatis M, Tracy PB. Proteolysis of factor V by cathepsin G and elastase indicates that cleavage at Arg1545 optimizes cofactor function by facilitating factor Xa binding. *Biochemistry* 1998;37:11896–11906.
799. Kalafatis M, Mann KG. The role of the membrane in the inactivation of factor va by plasmin. Amino acid region 307–348 of factor V plays a critical role in factor Va cofactor function. *J Biol Chem* 2001;276:18614–18623.
800. Zeibdawi AR, Pryzdial EL. Mechanism of factor Va inactivation by plasmin. Loss of A2 and A3 domains from a Ca<sup>2+</sup>–dependent complex of fragments bound to phospholipid. *J Biol Chem* 2001;276:19929–19936.
801. Lee CD, Mann KG. Activation/inactivation of human factor V by plasmin. *Blood* 1989;73:185–190.
802. Tracy RP, Rubin DZ, Mann KG, et al. Thrombolytic therapy and proteolysis of factor V. *J Am Coll Cardiol* 1997;30:716–724.
803. Mann KG, Hockin MF, Begin KJ, et al. Activated protein C cleavage of factor Va leads to dissociation of the A2 domain. *J Biol Chem* 1997;272:20678–20683.
804. Hockin MF, Cawthern KM, Kalafatis M, et al. A model describing the inactivation of factor Va by APC: bond cleavage, fragment dissociation, and product inhibition. *Biochemistry* 1999;38:6918–6934.
805. Dahlback B, Carlsson M, Svensson PJ. Familial thrombophilia due to a previously unrecognized mechanism characterized by poor anticoagulant response to activated protein C: prediction of a cofactor to activated protein C. *Proc Natl Acad Sci U S A* 1993;90:1004–1008.

806. Bertina RM, Koeleman BP, Koster T, et al. Mutation in blood coagulation factor V associated with resistance to activated protein C. *Nature* 1994;369: 64–67.
807. Kalafatis M, Bernardi F, Simioni P, et al. Phenotype and genotype expression in pseudohomozygous factor VLEIDEN: the need for phenotype analysis. *Arterioscler Thromb Vasc Biol* 1999;19:336–342.
808. Ridker PM, Miletich JP, Hennekens CH, et al. Ethnic distribution of factor V Leiden in 4047 men and women. Implications for venous thromboembolism screening. *JAMA* 1997;277:1305–1307.
809. Kalafatis M, Mann KG. Factor V Leiden and thrombophilia. *Arterioscler Thromb Vasc Biol* 1997;17:620–627.
810. Beauchamp NJ, Daly ME, Hampton KK, et al. High prevalence of a mutation in the factor V gene within the U.K. population: relationship to activated protein C resistance and familial thrombosis. *Br J Haematol* 1994;88: 219–222.
811. Ridker PM, Hennekens CH, Lindpaintner K, et al. Mutation in the gene coding for coagulation factor V and the risk of myocardial infarction, stroke, and venous thrombosis in apparently healthy men [see comments]. *N Engl J Med* 1995;332:912–917.
812. Dahlback B. Factor V gene mutation causing inherited resistance to activated protein C as a basis for venous thromboembolism. *J Intern Med* 1995;237:221–227.
813. Abildgaard CF, Suzuki Z, Harrison J, et al. Serial studies in von Willebrand's disease: variability versus "variants". *Blood* 1980;56:712–716.
814. Koutts J, Walsh PN, Plow EF, et al. Active release of human platelet factor VIII-related antigen by adenosine diphosphate, collagen, and thrombin. *J Clin Invest* 1978;62:1255–1263.
815. Gill JC, Endres-Brooks J, Bauer PJ, et al. The effect of ABO blood group on the diagnosis of von Willebrand disease. *Blood* 1987;69:1691–1695.
816. Percy ME, Rusk AC, Garvey MB, et al. Carrier detection in hemophilia A: ABO blood group, multiple measurements, and application of logistic discrimination. *Am J Med Genet* 1988;31:871–879.
817. Moake JL, Olson JD, Troll JH, Jr., et al. Interaction of platelets, von Willebrand factor, and ristocetin during platelet agglutination. *J Lab Clin Med* 1980;96:168–184.
818. Weiss HJ, Rogers J, Brand H. Defective ristocetin-induced platelet aggregation in von Willebrand's disease and its correction by factor VIII. *J Clin Invest* 1973;52:2697–2707.
819. Von Willebrand EA. Hereditary pseudohaemophilia. *Haemophilia* 1999;5:223–231.
820. Jorpes EJ. von Willebrand och von Willebrans sjukdom. *Nord Med* 1962;67:729.
821. Nilsson IM, Blomback M, Jorpes EJ, et al. von Willebrand's disease and its correction with human plasma fraction I-O. *Acta Med Scand* 1957;159:179.
822. Biggs R, Matthews JM. The treatment of haemorrhage in von Willebrand's disease and the blood level of Factor VIII (AHG). *Br J Haematol* 1963;9:203.
823. Rodeghiero F, Castaman G, Dini E. Epidemiological investigation of the prevalence of von Willebrand's disease. *Blood* 1987;69:454–459.
824. Werner EJ, Broxson EH, Tucker EL, et al. Prevalence of von Willebrand disease in children: a multiethnic study. *J Pediatr* 1993;123:893–898.
825. Berliner SA, Seligsohn U, Zivelin A, et al. A relatively high frequency of severe (type III) von Willebrand's disease in Israel. *Br J Haematol* 1986;62:535–543.
826. Lenk H, Nilsson IM, Holmberg L, et al. Frequency of different types of von Willebrand's disease in the



GDR. Acta Med Scand 1988;224:275–280.

827. Ates E, Bakkaloglu A, Saatci U, et al. von Willebrand factor antigen compared with other factors in vasculitic syndromes. Arch Dis Child 1994;70:40–43.
828. Stevens TR, James JP, Simmonds NJ, et al. Circulating von Willebrand factor in inflammatory bowel disease. Gut 1992;33:502–506.
829. Blann AD. von Willebrand factor antigen as an acute phase reactant and marker of endothelial cell injury in connective tissue diseases: a comparison with CRP, rheumatoid factor, and erythrocyte sedimentation rate. Z Rheumatol 1991;50:320–322.
830. Pottinger BE, Read RC, Paleolog EM, et al. von Willebrand factor is an acute phase reactant in man. Thromb Res 1989;53:387–394.
831. Mancuso DJ, Tuley EA, Westfield LA, et al. Structure of the gene for human von Willebrand factor. J Biol Chem 1989;264:19514–19527.
832. Mancuso DJ, Tuley EA, Westfield LA, et al. Human von Willebrand factor gene and pseudogene: structural analysis and differentiation by polymerase chain reaction. Biochemistry 1991;30:253–269.
833. Shelton-Inloes BB, Chehab FF, Mannucci PM, et al. Gene deletions correlate with the development of alloantibodies in von Willebrand disease. J Clin Invest 1987;79:1459–1465.
834. Jaffe EA, Hoyer LW, Nachman RL. Synthesis of von Willebrand factor by cultured human endothelial cells. Proc Natl Acad Sci U S A 1974;71:1906–1909.
835. Sporn LA, Chavin SI, Marder VJ, et al. Biosynthesis of von Willebrand protein by human megakaryocytes. J Clin Invest 1985;76:1102–1106.
836. Wagner DD, Olmsted JB, Marder VJ. Immunolocalization of von Willebrand protein in Weibel–Palade bodies of human endothelial cells. J Cell Biol 1982;95:355–360.
837. Schwachtgen JL, Janel N, Berek L, et al. Ets transcription factors bind and transactivate the core promoter of the von Willebrand factor gene. Oncogene 1997;15:3091–3102.
838. Slot JW, Bouma BN, Montgomery R, et al. Platelet factor VIII-related antigen: immunofluorescent localization. Thromb Res 1978;13:871–881.
839. Coller BS, Hirschman RJ, Gralnick HR. Studies on the Factor VIII/von Willebrand factor antigen on human platelets. Thromb Res 1975;6:469–480.
840. Guan J, Guillot PV, Aird WC. Characterization of the mouse von Willebrand factor promoter. Blood 1999;94:3405–3412.
841. Jahroudi N, Lynch DC. Endothelial-cell-specific regulation of von Willebrand factor gene expression. Mol Cell Biol 1994;14:999–1008.
842. Schwachtgen JL, Remale JE, Janel N, et al. Oct-1 is involved in the transcriptional repression of the von Willebrand factor gene promoter. Blood 1998;92:1247–1258.
843. Ardekani AM, Greenberger JS, Jahroudi N. Two repressor elements inhibit expression of the von Willebrand factor gene promoter in vitro. Thromb Haemost 1998;80:488–494.
844. Aird WC, Edelberg JM, Weiler-Guettler H, et al. Vascular bed-specific expression of an endothelial cell gene is programmed by the tissue microenvironment. J Cell Biol 1997;138:1117–1124.
845. Edelberg JM, Aird WC, Wu W, et al. PDGF mediates cardiac microvascular communication. J Clin Invest 1998;102:837–843.
846. Collins CJ, Underdahl JP, Levene RB, et al. Molecular cloning of the human gene for von Willebrand factor and identification of the transcription initiation site. Proc Natl Acad Sci U S A 1987;84:4393–4397.

847. Hamilton KK, Sims PJ. Changes in cytosolic Ca<sup>2+</sup> associated with von Willebrand factor release in human endothelial cells exposed to histamine. Study of microcarrier cell monolayers using the fluorescent probe indo-1. *J Clin Invest* 1987;79:600-608.
848. Menon C, Berry EW, Ockelford P. Beneficial effect of D.D.A.V.P. on bleeding-time in von Willebrand's disease. *Lancet* 1978;2:743-744.
849. Takeuchi M, Nagura H, Kaneda T. DDAVP and epinephrine-induced changes in the localization of von Willebrand antigen in endothelial cells of human oral mucosa. *Blood* 1988;72:850-854.
850. Sadler JE, Shelton-Inloes BB, Sorace JM, et al. Cloning and characterization of two cDNAs coding for human von Willebrand factor. *Proc Natl Acad Sci U S A* 1985;82:6394-6398.
851. Lynch DC, Zimmerman TS, Collins CJ, et al. Molecular cloning of cDNA for human von Willebrand factor: authentication by a new method. *Cell* 1985;41:49-56.
852. Shelton-Inloes BB, Titani K, Sadler JE. cDNA sequences for human von Willebrand factor reveal five types of repeated domains and five possible protein sequence polymorphisms. *Biochemistry* 1986;25:3164-3171.
853. Verweij CL, Diergaarde PJ, Hart M, et al. Full-length von Willebrand factor (vWF) cDNA encodes a highly repetitive protein considerably larger than the mature vWF subunit. *EMBO J* 1986;5:1839-1847.
854. Titani K, Kumar S, Takio K, et al. Amino acid sequence of human von Willebrand factor. *Biochemistry* 1986;25:3171-3184.
855. Ginsburg D, Handin RI, Bonthron DT, et al. Human von Willebrand factor (vWF): isolation of complementary DNA (cDNA) clones and chromosomal localization. *Science* 1985;228:1401-1406.
856. Koller E, Winterhalter KH, Trueb B. The globular domains of type VI collagen are related to the collagen-binding domains of cartilage matrix protein and von Willebrand factor. *EMBO J* 1989;8:1073-1077.
857. Sadler JE, Mancuso DJ, Randi AM, et al. Molecular biology of von Willebrand factor. *Ann N Y Acad Sci* 1991;614:114-124.
858. Hunt LT, Barker WC. von Willebrand factor shares a distinctive cysteine-rich domain with thrombospondin and procollagen. *Biochem Biophys Res Commun* 1987;144:876-882.
859. Verweij CL, Hofker M, Quadt R, et al. RFLP for a human von Willebrand factor (vWF) cDNA clone, pvWF1100. *Nucleic Acids Res* 1985;13:8289.
860. Santoro SA. Adsorption of von Willebrand factor/factor VIII by the genetically distinct interstitial collagens. *Thromb Res* 1981;21:689-691.
861. Cruz MA, Yuan H, Lee JR, et al. Interaction of the von Willebrand factor (vWF) with collagen. Localization of the primary collagen-binding site by analysis of recombinant vWF a domain polypeptides. *J Biol Chem* 1995;270:10822-10827.
862. Reference deleted.
863. Weiss HJ, Turitto VT, Baumgartner HR. Effect of shear rate on platelet interaction with subendothelium in citrated and native blood. I. Shear rate-dependent decrease of adhesion in von Willebrand's disease and the Bernard-Soulier syndrome. *J Lab Clin Med* 1978;92:750-764.
864. Sakariassen KS, Nievelstein PF, Coller BS, et al. The role of platelet membrane glycoproteins Ib and IIb-IIIa in platelet adherence to human artery subendothelium. *Br J Haematol* 1986;63:681-691.
865. Matsushita T, Sadler JE. Identification of amino acid residues essential for von Willebrand factor binding to platelet glycoprotein Ib. Charged-to-alanine scanning mutagenesis of the A1 domain of human von Willebrand factor. *J Biol Chem* 1995;270:13406-13414.
866. Bockenstedt P, Greenberg JM, Handin RI. Structural basis of von Willebrand factor binding to platelet

- glycoprotein Ib and collagen. Effects of disulfide reduction and limited proteolysis of polymeric von Willebrand factor. *J Clin Invest* 1986;77:743–749.
867. Girma JP, Kalafatis M, Pietu G, et al. Mapping of distinct von Willebrand factor domains interacting with platelet GPIb and GPIIb/IIIa and with collagen using monoclonal antibodies. *Blood* 1986;67:1356–1366.
868. Pareti FI, Fujimura Y, Dent JA, et al. Isolation and characterization of a collagen binding domain in human von Willebrand factor. *J Biol Chem* 1986;261:15310–15315.
869. Ruggeri ZM, De Marco L, Gatti L, et al. Platelets have more than one binding site for von Willebrand factor. *J Clin Invest* 1983;72:1–12.
870. Schullek J, Jordan J, Montgomery RR. Interaction of von Willebrand factor with human platelets in the plasma milieu. *J Clin Invest* 1984;73:421–428.
871. Goto S, Salomon DR, Ikeda Y, et al. Characterization of the unique mechanism mediating the shear-dependent binding of soluble von Willebrand factor to platelets. *J Biol Chem* 1995;270:23352–23361.
872. Ruggeri ZM, Bader R, De Marco L. Glanzmann thrombasthenia: deficient binding of von Willebrand factor to thrombin-stimulated platelets. *Proc Natl Acad Sci U S A* 1982;79:6038–6041.
873. Fujimoto T, Hawiger J. Adenosine diphosphate induces binding of von Willebrand factor to human platelets. *Nature* 1982;297:154–156.
874. Fujimoto T, Ohara S, Hawiger J. Thrombin-induced exposure and prostacyclin inhibition of the receptor for factor VIII/von Willebrand factor on human platelets. *J Clin Invest* 1982;69:1212–1222.
875. Koedam JA, Meijers JC, Sixma JJ, et al. Inactivation of human factor VIII by activated protein C. Cofactor activity of protein S and protective effect of von Willebrand factor. *J Clin Invest* 1988;82:1236–1243.
876. Fay PJ, Coumans JV, Walker FJ. von Willebrand factor mediates protection of factor VIII from activated protein C-catalyzed inactivation. *J Biol Chem* 1991;266:2172–2177.
877. Swords NA, Mann KG. The assembly of the prothrombinase complex on adherent platelets. *Arterioscler Thromb* 1993;13:1602–1612.
878. Furlan M, Lammle B. Assays of von Willebrand factor-cleaving protease: a test for diagnosis of familial and acquired thrombotic thrombocytopenic purpura. *Semin Thromb Hemost* 2002;28:167–172.
879. Chung DW, Fujikawa K. Processing of von Willebrand factor by ADAMTS-13. *Biochemistry* 2002;41:11065–11070.
880. Fujikawa K, Suzuki H, McMullen B, et al. Purification of human von Willebrand factor-cleaving protease and its identification as a new member of the metalloproteinase family. *Blood* 2001;98:1662–1666.
881. Gerritsen HE, Robles R, Lammle B, et al. Partial amino acid sequence of purified von Willebrand factor-cleaving protease. *Blood* 2001;98:1654–1661.
882. Schmidt A. *Zur Blutlehre*. Leipzig: FCW Vogel, 1892.
883. Morawitz P. Die chemie der blutgerinnung. *Ergebn Physiol* 1905;4:307.
884. Fuld E, Spiro K. Der einfluß einiger gerrinnungshemmender agentien auf das Vogel plasma. *Beitr z Chem Phys u Path (Hofmeister's)* 1904;5:171.
885. Xue J, Wu Q, Westfield LA, et al. Incomplete embryonic lethality and fatal neonatal hemorrhage caused by prothrombin deficiency in mice. *Proc Natl Acad Sci U S A* 1998;95:7603–7607.
886. Bar-Shavit R, Kahn A, Mudd MS, et al. Localization of a chemotactic domain in human thrombin. *Biochemistry* 1984;23:397–400.
887. Spraggon G, Everse SJ, Doolittle RF. Crystal structures of fragment D from human fibrinogen and its

crosslinked counterpart from fibrin. *Nature* 1997;389:455–462.

888. Hantgan R, McDonagh J, Hermans J. Fibrin assembly. *Ann N Y Acad Sci* 1983;408:344–366.

889. Lorand L, Jeong JM, Radek JT, et al. Human plasma factor XIII: subunit interactions and activation of zymogen. *Methods Enzymol* 1993;222:22–35.

890. Yee VC, Pedersen LC, Le Trong I, et al. Three-dimensional structure of a transglutaminase: human blood coagulation factor XIII. *Proc Natl Acad Sci U S A* 1994;91:7296–7300.

891. Bajzar L, Morser J, Nesheim M. TAFI, or plasma procarboxypeptidase B, couples the coagulation and fibrinolytic cascades through the thrombin–thrombomodulin complex. *J Biol Chem* 1996;271:16603–16608.

892. Lollar P, Parker CG. Subunit structure of thrombin-activated porcine factor VIII. *Biochemistry* 1989;28:666–674.

893. Berk BC, Taubman MB, Cragoe EJ, Jr., et al. Thrombin signal transduction mechanisms in rat vascular smooth muscle cells. Calcium and protein kinase C-dependent and -independent pathways. *J Biol Chem* 1990;265:17334–17340.

894. Michel MC, Brass LF, Williams A, et al. Alpha 2-adrenergic receptor stimulation mobilizes intracellular Ca<sup>2+</sup> in human erythroleukemia cells. *J Biol Chem* 1989;264:4986–4991.

895. He CJ, Rondeau E, Medcalf RL, et al. Thrombin increases proliferation and decreases fibrinolytic activity of kidney glomerular epithelial cells. *J Cell Physiol* 1991;146:131–140.

896. Glenn KC, Carney DH, Fenton JW, et al. Thrombin active site regions required for fibroblast receptor binding and initiation of cell division. *J Biol Chem* 1980;255:6609–6616.

897. Herbert JM, Lamarche I, Dol F. Induction of vascular smooth muscle cell growth by selective activation of the thrombin receptor. Effect of heparin. *FEBS Lett* 1992;301:155–158.

898. Harlan JM, Thompson PJ, Ross RR, et al. Alpha-thrombin induces release of platelet-derived growth factor-like molecule(s) by cultured human endothelial cells. *J Cell Biol* 1986;103:1129–1133.

899. Vlodevsky I, Folkman J, Sullivan R, et al. Endothelial cell-derived basic fibroblast growth factor: synthesis and deposition into subendothelial extracellular matrix. *Proc Natl Acad Sci U S A* 1987;84:2292–2296.

900. Ross R, Glomset J, Kariya B, et al. A platelet-dependent serum factor that stimulates the proliferation of arterial smooth muscle cells in vitro. *Proc Natl Acad Sci U S A* 1974;71:1207–1210.

901. Majesky MW, Lindner V, Twardzik DR, et al. Production of transforming growth factor beta 1 during repair of arterial injury. *J Clin Invest* 1991;88:904–910.

902. Clinton SK, Fleet JC, Loppnow H, et al. Interleukin-1 gene expression in rabbit vascular tissue *in vivo*. *Am J Pathol* 1991;138:1005–1114.

903. Douglas SA, Loudon C, Vickery-Clark LM, et al. A role for endogenous endothelin-1 in neointimal formation after rat carotid artery balloon angioplasty. Protective effects of the novel nonpeptide endothelin receptor antagonist SB 209670. *Circ Res* 1994;75:190–197.

904. Sigal SL, Gellman J, Sarembock IJ, et al. Effects of serotonin-receptor blockade on angioplasty-induced vasospasm in an atherosclerotic rabbit model. *Arterioscler Thromb* 1991;11:770–783.

905. Mugge A, Heistad DD, Densen P, et al. Activation of leukocytes with complement C5a is associated with prostanoid-dependent constriction of large arteries in atherosclerotic monkeys in vivo. *Atherosclerosis* 1992;95:211–222.

906. Seino Y, Ikeda U, Ikeda M, et al. Interleukin 6 gene transcripts are expressed in human atherosclerotic lesions. *Cytokine* 1994;6:87–91.

907. Malik AB, Fenton JW. Thrombin-mediated increase in vascular endothelial permeability. *Semin*

Thromb Hemost 1992;18:193–199.

908. Sugama Y, Malik AB. Thrombin receptor 14-amino acid peptide mediates endothelial hyperadhesivity and neutrophil adhesion by P-selectin-dependent mechanism. *Circ Res* 1992;71:1015–1019.

909. Hollenberg MD, Yang SG, Laniyonu AA, et al. Action of thrombin receptor polypeptide in gastric smooth muscle: identification of a core pentapeptide retaining full thrombin-mimetic intrinsic activity. *Mol Pharmacol* 1992;42:186–191.

910. Vouret-Craviari V, Obberghen-Schilling E, Rasmussen UB, et al. Synthetic alpha-thrombin receptor peptides activate G protein-coupled signaling pathways but are unable to induce mitogenesis. *Mol Biol Cell* 1992;3:95–102.

911. Vu TK, Hung DT, Wheaton VI, et al. Molecular cloning of a functional thrombin receptor reveals a novel proteolytic mechanism of receptor activation. *Cell* 1991;64:1057–1068.

912. Walker FJ. Regulation of bovine activated protein C by protein S: the role of the cofactor protein in species specificity. *Thromb Res* 1981;22:321–327.

913. Esmon CT. The roles of protein C and thrombomodulin in the regulation of blood coagulation. *J Biol Chem* 1989;264:4743–4746.

914. Walker FJ, Fay PJ. Regulation of blood coagulation by the protein C system. *FASEB J* 1992;6:2561–2567.

915. Poort SR, Michiels JJ, Reitsma PH, et al. Homozygosity for a novel missense mutation in the prothrombin gene causing a severe bleeding disorder. *Thromb Haemost* 1994;72:819–824.

916. Reuner KH, Ruf A, Grau A, et al. Prothrombin gene G20210>A transition is a risk factor for cerebral venous thrombosis. *Stroke* 1998;29:1765–1769.

917. Hillarp A, Zoller B, Svensson PJ, et al. The 20210 A allele of the prothrombin gene is a common risk factor among Swedish outpatients with verified deep venous thrombosis [see comments]. *Thromb Haemost* 1997;78:990–992.

918. Ferraresi P, Marchetti G, Legnani C, et al. The heterozygous 20210 G/A prothrombin genotype is associated with early venous thrombosis in inherited thrombophilias and is not increased in frequency in artery disease. *Arterioscler Thromb Vasc Biol* 1997;17:2418–2422.

919. Margaglione M, Brancaccio V, Giuliani N, et al. Increased risk for venous thrombosis in carriers of the prothrombin G>A20210 gene variant. *Ann Intern Med* 1998;129:89–93.

920. Lundblad RL, Noyes CM, Mann KG, et al. The covalent differences between bovine  $\alpha$ - and  $\beta$ -thrombin: a structural explanation for the changes in catalytic activity. *J Biol Chem* 1979;254:8524–8528.

921. Witting JI, Miller TM, Fenton JW. Human  $\alpha$ - and  $\gamma$ -thrombin specificity with tripeptide p-nitroanalide substrates under physiologically relevant conditions. *Thromb Res* 1987;46:567–574.

922. Reference deleted.

923. Stevens WK, Cote HF, MacGillivray RT, et al. Calcium ion modulation of meizothrombin autolysis at Arg55–Asp56 and catalytic activity. *J Biol Chem* 1996;271:8062–8067.

924. Niewiarowski S, Thomas DP. Platelet factor 4 and adenosine diphosphate release during human platelet aggregation. *Nature* 1969;222:1269–1270.

925. Levine SP, Wohl H. Human platelet factor IV: purification and characterization by affinity chromatography. Purification of human platelet factor IV. *J Biol Chem* 1976;251:324–328.

926. Lawler JW, Slayter HS, Coligan JE. Isolation and characterization of a high molecular weight glycoprotein from human blood platelets. *J Biol Chem* 1978;253:8609–8616.

927. Keenan JP, Solum NO. Quantitative studies on the release of platelet fibrinogen by thrombin. *Br J*

Haematol 1972;23:461-466.

928. Zucker MB, Mosesson MW, Broekman MJ, et al. Release of platelet fibronectin (cold-insoluble globulin) from alpha granules induced by thrombin or collagen; lack of requirement for plasma fibronectin in ADP-induced platelet aggregation. *Blood* 1979;54:8-12.

929. Viskup RW, Tracy PB, Mann KG. The isolation of human platelet factor V. *Blood* 1987;69:1188-1195.

930. Larsen E, Celi A, Gilbert GE, et al. PADGEM protein: a receptor that mediates the interaction of activated platelets with neutrophils and monocytes. *Cell* 1989;59:305-312.

931. Hamburger SA, McEver RP. GMP-140 mediates adhesion of stimulated platelets to neutrophils. *Blood* 1990;75:550-554.

932. Wang W, Boffa MB, Bajzar L, et al. A study of the mechanism of inhibition of fibrinolysis by activated thrombin-activable fibrinolysis inhibitor. *J Biol Chem* 1998;273:27176-27181.

933. Valnickova Z, Enghild JJ. Human procarboxypeptidase U, or thrombin-activable fibrinolysis inhibitor, is a substrate for transglutaminases. Evidence for transglutaminase-catalyzed cross-linking to fibrin. *J Biol Chem* 1998;273:27220-27224.

934. Brummel KE, Butenas S, Mann KG. An integrated study of fibrinogen during blood coagulation. *J Biol Chem* 1999;274:22862-22870.

935. dem Borne PA, Mosnier LO, Tans G, et al. Factor XI activation by meizothrombin: stimulation by phospholipid vesicles containing both phosphatidylserine and phosphatidylethanolamine. *Thromb Haemost* 1997;78:834-839.

936. Tans G, Nicolaes GA, Thomassen MC, et al. Activation of human factor V by meizothrombin. *J Biol Chem* 1994;269:15969-15972.

937. Esmon CT, Owen WG. Identification of an endothelial cell cofactor for thrombin-catalyzed activation of protein C. *Proc Natl Acad Sci U S A* 1981;78:2249-2252.

938. Bagdasarian A, Colman RW. Subcellular localization and purification of platelet alpha1-antitrypsin. *Blood* 1978;51:139-156.

939. Schwarz HP, Heeb MJ, Wencel-Drake JD, et al. Identification and quantitation of protein S in human platelets. *Blood* 1985;66:1452-1455.

940. Novotny WF, Girard TJ, Miletich JP, et al. Platelets secrete a coagulation inhibitor functionally and antigenically similar to the lipoprotein associated coagulation inhibitor. *Blood* 1988;72:2020-2025.

941. Bar-Shavit R, Benezra M, Eldor A, et al. Thrombin immobilized to extracellular matrix is a potent mitogen for vascular smooth muscle cells: nonenzymatic mode of action. *Cell Regul* 1990;1:453-463.

942. Antoniades HN. Human platelet-derived growth factor (PDGF): purification of PDGF-I and PDGF-II and separation of their reduced subunits. *Proc Natl Acad Sci U S A* 1981;78:7314-7317.

943. Heldin CH, Westermark B, Wasteson A. Platelet-derived growth factor. Isolation by a large-scale procedure and analysis of subunit composition. *Biochem J* 1981;193:907-913.

944. Deuel TF, Huang JS, Proffitt RT, et al. Human platelet-derived growth factor. Purification and resolution into two active protein fractions. *J Biol Chem* 1981;256:8896-8899.

945. Raines EW, Ross R. Platelet-derived growth factor. I. High yield purification and evidence for multiple forms. *J Biol Chem* 1982;257:5154-5160.

946. Childs CB, Proper JA, Tucker RF, et al. Serum contains a platelet-derived transforming growth factor. *Proc Natl Acad Sci U S A* 1982;79:5312-5316.

947. Clemmons DR, Isley WL, Brown MT. Dialyzable factor in human serum of platelet origin stimulates

- endothelial cell replication and growth. *Proc Natl Acad Sci U S A* 1983;80:1641-1645.
948. King GL, Buchwald S. Characterization and partial purification of an endothelial cell growth factor from human platelets. *J Clin Invest* 1984;73:392-396.
949. Harrison P, Cramer EM. Platelet alpha-granules. *Blood Rev* 1993;7:52-62.
950. Hou L, Howells GL, Kapas S, et al. The protease-activated receptors and their cellular expression and function in blood-related cells. *Br J Haematol* 1998;101:1-9.
951. Vu TK, Wheaton VI, Hung DT, et al. Domains specifying thrombin-receptor interaction. *Nature* 1991;353:674-677.
952. Schmidt VA, Nierman WC, Maglott DR, et al. The human proteinase-activated receptor-3 (PAR-3) gene. Identification within a Par gene cluster and characterization in vascular endothelial cells and platelets. *J Biol Chem* 1998;273:15061-15068.
953. Seegers WH, McCoy L, Kipfer RK, et al. Preparation and properties of thrombin. *Arch Biochem Biophys* 1968;128:194-201.
954. Mann KG, Batt CW. The molecular weights of bovine thrombin and its primary autolysis products. *J Biol Chem* 1969;244:6555-6557.
955. Rosenberg RD, Waugh DF. Multiple bovine thrombin components. *J Biol Chem* 1970;245:5049-5056.
956. Boissel JP, Le Bonniec B, Rabiet MJ, et al. Covalent structures of beta and gamma autolytic derivatives of human alpha-thrombin. *J Biol Chem* 1984;259:5691-5697.
957. Fenton JW, Landis BH, Walz DA, et al. Human thrombins. In: Lundblad RL, Fenton JW, Mann KG, eds. *The chemistry and biology of thrombin*. Ann Arbor: Ann Arbor Press, 1977:43-70.
958. Lottenberg R, Hall JA, Fenton JW, et al. The action of thrombin on peptide p-nitroanilide substrates: hydrolysis of Tos-Gly-Pro-Arg-pNA and D-Phe-Pip-Arg-pNA by human alpha and gamma and bovine alpha and beta-thrombins. *Thromb Res* 1982;28:313-332.
959. Lorand L, Credo RB. Thrombin and fibrin stabilization. In: Lundblad RL, Fenton JW, Mann KG, eds. *The chemistry and biology of thrombin*. Ann Arbor: Ann Arbor Press, 1977:311-323.
960. Bezeaud A, Denninger MH, Guillin MC. Interaction of human alpha-thrombin and gamma-thrombin with antithrombin III, protein C and thrombomodulin. *Eur J Biochem* 1985;153:491-496.
961. Seegers WH, McCoy LE, Walz DA, et al. Isolation of thrombin-E and the evolution of enzyme activity from prothrombin. *Experientia* 1974;30:1130-1132.
962. Lundblad RL, Nesheim ME, Straight DL, et al. Bovine alpha- and beta-thrombin. Reduced fibrinogen-clotting activity of beta-thrombin is not a consequence of reduced affinity for fibrinogen. *J Biol Chem* 1984;259:6991-6995.
963. Lundblad RL, Nesheim ME, Straight DL, et al. Bovine alpha- and beta-thrombin. Reduced fibrinogen clotting activity of beta-thrombin is not a consequence of reduced affinity for fibrinogen. *J Biol Chem* 1984;259:6991-6995.
964. Bovill EG, Tracy RP, Hayes TE, et al. Evidence that meizothrombin is an intermediate product in the clotting of whole blood. *Arterioscler Thromb Vasc Biol* 1995;15:754-758.
965. Berliner LJ, Shen YY. Physical evidence for an apolar binding site near the catalytic center of human alpha-thrombin. *Biochemistry* 1977;16:4622-4626.
966. Di Cera E, Guinto ER, Vindigni A, et al. The Na<sup>+</sup> binding site of thrombin. *J Biol Chem* 1995;270:22089-22092.
967. Tulinsky A. Molecular interactions of thrombin. *Semin Thromb Hemost* 1996;22:117-124.



968. Folkers PJ, Clore GM, Driscoll PC, et al. Solution structure of recombinant hirudin and the Lys-47?Glu mutant: a nuclear magnetic resonance and hybrid distance geometry-dynamical simulated annealing study. *Biochemistry* 1989;28:2601-2617.
969. Haruyama H, Wuthrich K. Conformation of recombinant desulfatohirudin in aqueous solution determined by nuclear magnetic resonance. *Biochemistry* 1989;28:4301-4312.
970. Stone SR, Braun PJ, Hofsteenge J. Identification of regions of alpha-thrombin involved in its interaction with hirudin. *Biochemistry* 1987;26:4617-4624.
971. Braun PJ, Dennis S, Hofsteenge J, et al. Use of site-directed mutagenesis to investigate the basis for the specificity of hirudin. *Biochemistry* 1988;27:6517-6522.
972. Chang JY, Ngai PK, Rink H, et al. The structural elements of hirudin which bind to the fibrinogen recognition site of thrombin are exclusively located within its acidic C-terminal tail. *FEBS Lett* 1990;261:287-290.
973. Stone SR, Hofsteenge J. Kinetics of the inhibition of thrombin by hirudin. *Biochemistry* 1986;25:4622-4628.
974. Gorman JJ. Inhibition of human thrombin assessed with different substrates and inhibitors. Characterization of fibrinopeptide binding interaction. *Biochim Biophys Acta* 1975;412:273-282.
975. Olson ST, Bock PE, Kvassman J, et al. Role of the catalytic serine in the interactions of serine proteinases with protein inhibitors of the serpin family. Contribution of a covalent interaction to the binding energy of serpin-proteinase complexes. *J Biol Chem* 1995;270:30007-30017.
976. Fuchs HE, Shifman MA, Pizzo SV. In vivo catabolism of alpha 1-proteinase inhibitor-trypsin, antithrombin III-thrombin and alpha 2-macroglobulin-methylamine. *Biochim Biophys Acta* 1982;716:151-157.
977. Ganrot PO. Inhibition of plasmin activity by alpha-2-macroglobulin. *Clin Chim Acta* 1967;16:328-329.
978. Barrett AJ. Alpha 2-macroglobulin. *Methods Enzymol* 1981;80(Pt C):737-754.
979. Barrett AJ, Starkey PM. The interaction of alpha 2-macroglobulin with proteinases. Characteristics and specificity of the reaction, and a hypothesis concerning its molecular mechanism. *Biochem J* 1973;133:709-724.
980. Pizzo SV, Gonias SL. Receptor-mediated protease regulation. In: Conn PM, ed. *The receptors*. Orlando: Academic Press, 1984:177-206.
981. Gonias SL, Pizzo SV. Chemical and structural modifications of alpha 2-macroglobulin: effects on receptor binding and endocytosis studied in an in vivo model. *Ann N Y Acad Sci* 1983;421:457-471.
982. Mammen EF, Thomas WR, Seegers WH. Activation of purified prothrombin to autoprothrombin I or autoprothrombin II (platelet cofactor II) or autoprothrombin II-A. *Thromb Diath Haemorrh* 2002;5:218-250.
983. Miletich J, Sherman L, Broze G, Jr. Absence of thrombosis in subjects with heterozygous protein C deficiency. *N Engl J Med* 1987;317:991-996.
984. Okajima K, Koga S, Kaji M, et al. Effect of protein C and activated protein C on coagulation and fibrinolysis in normal human subjects. *Thromb Haemost* 1990;63:48-53.
985. Marlar RA, Sills RH, Groncy PK, et al. Protein C survival during replacement therapy in homozygous protein C deficiency. *Am J Hematol* 1992;41:24-31.
986. Bauer KA. Coumarin-induced skin necrosis. *Arch Dermatol* 1993;129:766-768.
987. Epstein DJ, Bergum PW, Bajaj SP, et al. Radioimmunoassays for protein C and factor X. Plasma antigen levels in abnormal hemostatic states. *Am J Clin Pathol* 1984;82:573-581.
988. McGehee WG, Klotz TA, Epstein DJ, et al. Coumarin necrosis associated with hereditary protein C

deficiency. *Ann Intern Med* 1984;101:59–60.

989. Broekmans AW, Bertina RM, Loeliger EA, et al. Protein C and the development of skin necrosis during anticoagulant therapy. *Thromb Haemost* 1983;49:251.

990. Goldberg SL, Orthner CL, Yalisove BL, et al. Skin necrosis following prolonged administration of coumarin in a patient with inherited protein S deficiency. *Am J Hematol* 1991;38:64–66.

991. Thompson AR. Molecular genetics of hemostatic proteins. In: Colman RW, Hirsh J, Marder VJ, Salzman EW, eds. *Hemostasis and thrombosis: basic principles and clinical practice*. Philadelphia: Lippincott Williams & Wilkins, 1994:55–80.

992. Bovill EG, Hasstedt SJ, Leppert MF, et al. Hereditary thrombophilia as a model for multigenic disease. *Thromb Haemost* 1999;82:662–666.

993. Lu D, Bovill EG, Long GL. Molecular mechanism for familial protein C deficiency and thrombosis in protein C Vermont (Glu20?Ala and Val34?Met). *J Biol Chem* 1994;269:29032–29038.

994. Hasstedt SJ, Bovill EG, Callas PW, et al. An unknown genetic defect increases venous thrombosis risk, through interaction with protein C deficiency. *Am J Hum Genet* 1998;63:569–576.

995. Plutzky J, Hoskins JA, Long GL, et al. Evolution and organization of the human protein C gene. *Proc Natl Acad Sci U S A* 1986;83:546–550.

996. Kato A, Miura O, Sumi Y, et al. Assignment of the human protein C gene (PROC) to chromosome region 2q14?q21 by in situ hybridization. *Cytogenet Cell Genet* 1988;47:46–47.

997. Spek CA, Greengard JS, Griffin JH, et al. Two mutations in the promoter region of the human protein C gene both cause type I protein C deficiency by disruption of two HNF-3 binding sites. *J Biol Chem* 1995;270:24216–24221.

998. Miao CH, Ho WT, Greenberg DL, et al. Transcriptional regulation of the gene coding for human protein C. *J Biol Chem* 1996;271:9587–9594.

999. Furie B, Furie BC. The molecular basis of blood coagulation. *Cell* 1988;53:505–518.

1000. Taylor FB, Jr., Chang A, Hinshaw LB, et al. A model for thrombin protection against endotoxin. *Thromb Res* 1984;36:177–185.

1001. Comp PC. Hereditary disorders predisposing to thrombosis. *Prog Hemost Thromb* 1986;8:71–102.

1002. Grinnell BW, Walls JD, Gerlitz B, et al. Native and modified recombinant human protein C: function, secretion, and posttranslational modifications. In: Bruley DF, Drohan WN, eds. *Protein C and related anticoagulants*. Houston: Gulf Publishing Company, 1991:29–63.

1003. Esmon CT. Protein C. *Prog Hemost Thromb* 1984;7:25–54.

1004. Stenflo J. Structure and function of protein C. *Semin Thromb Hemost* 1984;10:109–121.

1005. Reference deleted.

1006. Preissner KT. Biological relevance of the protein C system and laboratory diagnosis of protein C and protein S deficiencies. *Clin Sci (Lond)* 1990;78:351–364.

1007. Ohlin AK, Stenflo J. Calcium-dependent interaction between the epidermal growth factor precursor-like region of human protein C and a monoclonal antibody. *J Biol Chem* 1987;262:13798–13804.

1008. Ohlin AK, Linse S, Stenflo J. Calcium binding to the epidermal growth factor homology region of bovine protein C. *J Biol Chem* 1988;263:7411–7417.

1009. Rezaie AR, Mather T, Sussman F, et al. Mutation of Glu-80?Lys results in a protein C mutant that no longer requires Ca<sup>2+</sup> for rapid activation by the thrombin-thrombomodulin complex. *J Biol Chem*

1994;269:3151–3154.

1010. Cheng CH, Geng JP, Castellino FJ. The functions of the first epidermal growth factor homology region of human protein C as revealed by a charge-to-alanine scanning mutagenesis investigation. *Biol Chem* 1997;378:1491–1500.

1011. Castellino FJ. Human protein C and activated protein C. *Trends Cardiovasc Med* 1995;5:55–62.

1012. Kiesel W. Human plasma protein C: isolation, characterization, and mechanism of activation by alpha-thrombin. *J Clin Invest* 1979;64:761–769.

1013. Kiesel W, Canfield WM. Snake venom proteases that activate blood-coagulation factor V. *Methods Enzymol* 1981;80:275–285.

1014. Weiler-Guettler H, Christie PD, Beeler DL, et al. A targeted point mutation in thrombomodulin generates viable mice with a prethrombotic state. *J Clin Invest* 1998;101:1983–1991.

1015. Varadi K, Philipitsch A, Santa T, et al. Activation and inactivation of human protein C by plasmin. *Thromb Haemost* 1994;71:615–621.

1016. Cote HC, Bajzar L, Stevens WK, et al. Functional characterization of recombinant human meizothrombin and Meizothrombin(desF1). Thrombomodulin-dependent activation of protein C and thrombin-activatable fibrinolysis inhibitor (TAFI), platelet aggregation, antithrombin-III inhibition. *J Biol Chem* 1997;272:6194–6200.

1017. Haley PE, Doyle MF, Mann KG. The activation of bovine protein C by factor Xa. *J Biol Chem* 1989;264:16303–16310.

1018. Thompson EA, Salem HH. Factors IXa, Xa, XIa and activated protein C do not have protein C activating ability in the presence of thrombomodulin. *Thromb Haemost* 1988;59:339.

1019. Wu Q, Tsiang M, Lentz SR, et al. Ligand specificity of human thrombomodulin. Equilibrium binding of human thrombin, meizothrombin, and factor Xa to recombinant thrombomodulin. *J Biol Chem* 1992;267:7083–7088.

1020. Klein JD, Walker FJ. Purification of a protein C activator from the venom of the southern copperhead snake (*Agkistrodon contortrix contortrix*). *Biochemistry* 1986;25:4175–4179.

1021. Bajzar L, Nesheim ME, Tracy PB. The profibrinolytic effect of activated protein C in clots formed from plasma is TAFI-dependent. *Blood* 1996;88:2093–2100.

1022. Bajzar L, Kalafatis M, Simioni P, et al. An antifibrinolytic mechanism describing the prothrombotic effect associated with factor V Leiden. *J Biol Chem* 1996;271:22949–22952.

1023. Fukudome K, Esmon CT. Identification, cloning, and regulation of a novel endothelial cell protein C/activated protein C receptor. *J Biol Chem* 1994;269:26486–26491.

1024. Bangalore N, Drohan WN, Orthner CL. High affinity binding sites for activated protein C and protein C on cultured human umbilical vein endothelial cells. Independent of protein S and distinct from known ligands. *Thromb Haemost* 1994;72:465–474.

1025. Hancock WW, Grey ST, Hau L, et al. Binding of activated protein C to a specific receptor on human mononuclear phagocytes inhibits intracellular calcium signaling and monocyte-dependent proliferative responses. *Transplantation* 1995;60:1525–1532.

1026. Ahmad MF, Bach FH, Esmon CT, et al. Cloning and *in vitro* analysis of the endothelial protein C receptor (EPCR) on human monocytes show that monocyte EPCR does not mediate the anti-inflammatory effects of activated protein C. *Blood* 1997;90:32a.

1027. Taylor FB, Jr., Chang A, Esmon CT, et al. Protein C prevents the coagulopathic and lethal effects of *Escherichia coli* infusion in the baboon. *J Clin Invest* 1987;79:918–925.

1028. Hancock WW, Tsuchida A, Hau H, et al. The anticoagulants protein C and protein S display potent antiinflammatory and immunosuppressive effects relevant to transplant biology and therapy. *Transplant*

Proc 1992;24:2302–2303.

1029. Taoka Y, Okajima K, Uchiba M, et al. Activated protein C reduces the severity of compression-induced spinal cord injury in rats by inhibiting activation of leukocytes. *J Neurosci* 1998;18:1393–1398.
1030. Moore KL, Andreoli SP, Esmon NL, et al. Endotoxin enhances tissue factor and suppresses thrombomodulin expression of human vascular endothelium in vitro. *J Clin Invest* 1987;79:124–130.
1031. Nawroth PP, Handley DA, Esmon CT, et al. Interleukin 1 induces endothelial cell procoagulant while suppressing cell-surface anticoagulant activity. *Proc Natl Acad Sci U S A* 1986;83:3460–3464.
1032. Hirokawa K, Aoki N. Regulatory mechanisms for thrombomodulin expression in human umbilical vein endothelial cells in vitro. *J Cell Physiol* 1991;147:157–165.
1033. Maruyama I, Soejima Y, Osame M, et al. Increased expression of thrombomodulin on the cultured human umbilical vein endothelial cells and mouse hemangioma cells by cyclic AMP. *Thromb Res* 1991;61:301–310.
1034. Ohji T, Urano H, Shirahata A, et al. Transforming growth factor beta 1 and beta 2 induce down-modulation of thrombomodulin in human umbilical vein endothelial cells. *Thromb Haemost* 1995;73:812–818.
1035. Moore KL, Esmon CT, Esmon NL. Tumor necrosis factor leads to the internalization and degradation of thrombomodulin from the surface of bovine aortic endothelial cells in culture. *Blood* 1989;73:159–165.
1036. Conway EM, Rosenberg RD. Tumor necrosis factor suppresses transcription of the thrombomodulin gene in endothelial cells. *Mol Cell Biol* 1988;8:5588–5592.
1037. Lentz SR, Tsiang M, Sadler JE. Regulation of thrombomodulin by tumor necrosis factor-alpha: comparison of transcriptional and posttranscriptional mechanisms. *Blood* 1991;77:542–550.
1038. Ohdama S, Takano S, Ohashi K, et al. Pentoxifylline prevents tumor necrosis factor-induced suppression of endothelial cell surface thrombomodulin. *Thromb Res* 1991;62:745–755.
1039. Yu K, Morioka H, Fritze LM, et al. Transcriptional regulation of the thrombomodulin gene. *J Biol Chem* 1992;267:23237–23247.
1040. Heeb MJ, Espana F, Geiger M, et al. Immunological identity of heparin-dependent plasma and urinary protein C inhibitor and plasminogen activator inhibitor-3. *J Biol Chem* 1987;262:15813–15816.
1041. Stief TW, Radtke KP, Heimburger N. Inhibition of urokinase by protein C-inhibitor (PCI). Evidence for identity of PCI and plasminogen activator inhibitor 3. *Biol Chem Hoppe Seyler* 1987;368:1427–1433.
1042. Espana F, Griffin JH. Plasma protein C inhibitor (PCI) inhibits procoagulant and profibrinolytic enzymes. *Blood* 1987;70:401a.
1043. Dahlback B. Purification of human C4b-binding protein and formation of its complex with vitamin K-dependent protein S. *Biochem J* 1983;209:847–856.
1044. Fair DS, Revak DJ. Quantitation of human protein S in the plasma of normal and warfarin-treated individuals by radioimmunoassay. *Thromb Res* 1984; 36:527–535.
1045. Walker FJ. Regulation of activated protein C by a new protein. A possible function for bovine protein S. *J Biol Chem* 1980;255:5521–5524.
1046. Suzuki K, Nishioka J, Matsuda M, et al. Protein S is essential for the activated protein C-catalyzed inactivation of platelet-associated factor Va. *J Biochem (Tokyo)* 1984;96:455–460.
1047. Walker FJ, Chavin SI, Fay PJ. Inactivation of factor VIII by activated protein C and protein S. *Arch Biochem Biophys* 1987;252:322–328.

1048. Walker FJ. Protein S and the regulation of activated protein C. *Semin Thromb Hemost* 1984;10:131–138.
1049. Walker FJ. Regulation of vitamin K-dependent protein S. Inactivation by thrombin. *J Biol Chem* 1984;259:10335–10339.
1050. Solymoss S, Tucker MM, Tracy PB. Kinetics of inactivation of membrane-bound factor Va by activated protein C. Protein S modulates factor Xa protection. *J Biol Chem* 1988;263:14884–14890.
1051. Comp PC, Nixon RR, Cooper MR, et al. Familial protein S deficiency is associated with recurrent thrombosis. *J Clin Invest* 1984;74:2082–2088.
1052. Schwarz HP, Fischer M, Hopmeier P, et al. Plasma protein S deficiency in familial thrombotic disease. *Blood* 1984;64:1297–1300.
1053. Comp PC, Esmon CT. Recurrent venous thromboembolism in patients with a partial deficiency of protein S. *N Engl J Med* 1984;311:1525–1528.
1054. Broekmans AW, Bertina RM, Reinalda-Poot J, et al. Hereditary protein S deficiency and venous thrombo-embolism. A study in three Dutch families. *Thromb Haemost* 1985;53:273–277.
1055. Kamiya T, Sugihara T, Ogata K, et al. Inherited deficiency of protein S in a Japanese family with recurrent venous thrombosis: a study of three generations. *Blood* 1986;67:406–410.
1056. Mahasandana C, Suvatte V, Chuansumrit A, et al. Homozygous protein S deficiency in an infant with purpura fulminans. *J Pediatr* 1990;117:750–753.
1057. Pegelow CH, Ledford M, Young JN, et al. Severe protein S deficiency in a newborn. *Pediatrics* 1992;89:674–676.
1058. Heeb MJ, Mesters RM, Tans G, et al. Binding of protein S to factor Va associated with inhibition of prothrombinase that is independent of activated protein C. *J Biol Chem* 1993;268:2872–2877.
1059. Heeb MJ, Rosing J, Bakker HM, et al. Protein S binds to and inhibits factor Xa. *Proc Natl Acad Sci U S A* 1994;91:2728–2732.
1060. Mitchell CA, Kelemen SM, Salem HH. The anticoagulant properties of a modified form of protein S. *Thromb Haemost* 1988;60:298–304.
1061. Ploos van Amstel JK, van der Zanden AL, Bakker E, et al. Two genes homologous with human protein S cDNA are located on chromosome 3. *Thromb Haemost* 1987;58:982–987.
1062. Watkins PC, Eddy R, Fukushima Y, et al. The gene for protein S maps near the centromere of human chromosome 3. *Blood* 1988;71:238–241.
1063. Schmidel DK, Tatro AV, Phelps LG, et al. Organization of the human protein S genes. *Biochemistry* 1990;29:7845–7852.
1064. Ploos van Amstel HK, Reitsma PH, van der Logt CP, et al. Intron-exon organization of the active human protein S gene PS alpha and its pseudogene PS beta: duplication and silencing during primate evolution. *Biochemistry* 1990;29:7853–7861.
1065. Edenbrandt CM, Lundwall A, Wydro R, et al. Molecular analysis of the gene for vitamin K dependent protein S and its pseudogene. Cloning and partial gene organization. *Biochemistry* 1990;29:7861–7868.
1066. Ploos van Amstel HK, Reitsma PH, Bertina RM. The human protein S locus: identification of the PS alpha gene as a site of liver protein S messenger RNA synthesis. *Biochem Biophys Res Commun* 1988;157:1033–1038.
1067. Ploos van Amstel HK, Huisman MV, Reitsma PH, et al. Partial protein S gene deletion in a family with hereditary thrombophilia. *Blood* 1989;73:479–483.

1068. Fair DS, Marlar RA. Biosynthesis and secretion of factor VII, protein C, protein S, and the protein C inhibitor from a human hepatoma cell line. *Blood* 1986;67:64–70.
1069. Hoskins J, Norman DK, Beckmann RJ, et al. Cloning and characterization of human liver cDNA encoding a protein S precursor. *Proc Natl Acad Sci U S A* 1987;84:349–353.
1070. Fair DS, Marlar RA, Levin EG. Human endothelial cells synthesize protein S. *Blood* 1986;67:1168–1171.
1071. Stern D, Brett J, Harris K, et al. Participation of endothelial cells in the protein C–protein S anticoagulant pathway: the synthesis and release of protein S. *J Cell Biol* 1986;102:1971–1978.
1072. Hooper WC, Phillips DJ, Ribeiro MJ, et al. Tumor necrosis factor–alpha downregulates protein S secretion in human microvascular and umbilical vein endothelial cells but not in the HepG–2 hepatoma cell line. *Blood* 1994;84:483–489.
1073. Maillard C, Berruyer M, Serre CM, et al. Protein–S, a vitamin K–dependent protein, is a bone matrix component synthesized and secreted by osteoblasts. *Endocrinology* 1992;130:1599–1604.
1074. Smiley ST, Boyer SN, Heeb MJ, et al. Protein S is inducible by interleukin 4 in T cells and inhibits lymphoid cell procoagulant activity. *Proc Natl Acad Sci U S A* 1997;94:11484–11489.
1075. DiScipio RG, Davie EW. Characterization of protein S, a gamma–carboxyglutamic acid containing protein from bovine and human plasma. *Biochemistry* 1979;18:899–904.
1076. Lundwall A, Dackowski W, Cohen E, et al. Isolation and sequence of the cDNA for human protein S, a regulator of blood coagulation. *Proc Natl Acad Sci U S A* 1986;83:6716–6720.
1077. Joseph DR, Baker ME. Sex hormone–binding globulin, androgen–binding protein, and vitamin K–dependent protein S are homologous to laminin A, merosin, and *Drosophila* crumbs protein. *FASEB J* 1992;6:2477–2481.
1078. Gershagen S, Fernlund P, Edenbrandt CM. The genes for SHBG/ABP and the SHBG–like region of vitamin K–dependent protein S have evolved from a common ancestral gene. *J Steroid Biochem Mol Biol* 1991;40:763–769.
1079. Stenberg Y, Linse S, Drakenberg T, et al. The high affinity calcium–binding sites in the epidermal growth factor module region of vitamin K–dependent protein S. *J Biol Chem* 1997;272:23255–23260.
1080. Walker FJ. Properties of chemically modified protein S: effect of the conversion of gamma–carboxyglutamic acid to gamma–methylglutamic acid on functional properties. *Biochemistry* 1986;25:6305–6311.
1081. Van Wijnen M, Stam JG, Chang GT, et al. Characterization of mini–protein S, a recombinant variant of protein S that lacks the sex hormone binding globulin–like domain. *Biochem J* 1998;330(Pt 1):389–396.
1082. He X, Shen L, Malmberg AC, et al. Binding site for C4b–binding protein in vitamin K–dependent protein S fully contained in carboxy–terminal laminin–G–type repeats. A study using recombinant factor IX–protein S chimeras and surface plasmon resonance. *Biochemistry* 1997;36:3745–3754.
1083. Pauls JE, Hockin MF, Long GL, et al. Self–association of human protein S. *Biochemistry* 2000;39:5468–5473.
1084. Yegneswaran S, Wood GM, Esmon CT, et al. Protein S alters the active site location of activated protein C above the membrane surface. A fluorescence resonance energy transfer study of topography. *J Biol Chem* 1997;272: 25013–25021.
1085. Koppelman SJ, Hackeng TM, Sixma JJ, et al. Inhibition of the intrinsic factor X activating complex by protein S: evidence for a specific binding of protein S to factor VIII. *Blood* 1995;86:1062–1071.
1086. Hackeng TM, Hessing M, van't Veer C, et al. Protein S binding to human endothelial cells is required

for expression of cofactor activity for activated protein C. *J Biol Chem* 1993;268:3993–4000.

1087. Koppelman SJ, van't Veer C, Sixma JJ, et al. Synergistic inhibition of the intrinsic factor X activation by protein S and C4b-binding protein. *Blood* 1995;86:2653–2660.

1088. Smiley ST, Stitt TN, Grusby MJ. Cross-linking of protein S bound to lymphocytes promotes aggregation and inhibits proliferation. *Cell Immunol* 1997;181:120–126.

1089. Chang GT, Aaldering L, Hackeng TM, et al. Construction and characterization of thrombin-resistant variants of recombinant human protein S. *Thromb Haemost* 1994;72:693–697.

1090. Dahlback B. Purification of human vitamin K-dependent protein S and its limited proteolysis by thrombin. *Biochem J* 1983;209:837–846.

1091. Suzuki K, Nishioka J, Hashimoto S. Regulation of activated protein C by thrombin-modified protein S. *J Biochem (Tokyo)* 1983;94:699–705.

1092. Prowse CV, Esnouf MP. The isolation of a new warfarin-sensitive protein from bovine plasma. *Biochem Soc Trans* 1977;5:255–256.

1093. Broze GJ, Jr., Miletich JP. Human Protein Z. *J Clin Invest* 1984;73:933–938.

1094. Broze GJ, Jr. Protein Z-dependent regulation of coagulation. *Thromb Haemost* 2001;86:8–13.

1095. Undar L, Karadogan I, Ozturk F. Plasma protein Z levels inversely correlate with plasma interleukin-6 levels in patients with acute leukemia and non-Hodgkin's lymphoma. *Thromb Res* 1999;94:131–134.

1096. Raczkowski CA, Reichlin M, Esmon CT, et al. Protein Z is a negatively responding acute phase protein. *Blood* 1987;70[Suppl 1]:393a.

1097. Yurdakok M, Gurakan B, Ozbag E, et al. Plasma protein Z levels in healthy newborn infants. *Am J Hematol* 1995;48:206–207.

1098. Kemkes-Matthes B, Matthes KJ. Protein Z. *Semin Thromb Hemost* 2001;27:551–556.

1099. Bertolino G, Montani N, Lorezutti F, et al. Behavior of plasma protein Z levels in patients with abnormal haemostasis: correlation with coagulation screening times. *Thromb Haemost* 1997;78[Suppl 1]:235a.

1100. Kemkes-Matthes B, Matthes KJ. Protein Z, a new haemostatic factor, in liver diseases. *Haemostasis* 1995;25:312–316.

1101. Bertolino G, Montani N, Anesi E, et al. Plasma protein Z levels in patients with systemic AL amyloidosis. *Thromb Haemost* 1999;82:136a.

1102. Usalan C, Erdem Y, Altun B, et al. Protein Z levels in haemodialysis patients. *Int Urol Nephrol* 1999;31:541–545.

1103. Cobankara V, Ozatly D, Haznedaroglu IC, et al. Circulating protein Z in reactive and clonal thrombocytosis and in ITP. *Thromb Haemost* 1999;82:563a.

1104. Miletich JP, Broze GJ, Jr. Human plasma protein Z antigen: range in normal subjects and effect of warfarin therapy. *Blood* 1987;69:1580–1586.

1105. Yin ZF, Huang ZF, Cui J, et al. Prothrombotic phenotype of protein Z deficiency. *Proc Natl Acad Sci U S A* 2000;97:6734–6738.

1106. Kemkes-Matthes B, Matthes KJ, Sutor AH. Protein Z bei Kindern mit Blutungsereignissen unklarer Genese. Erste klinische Daten. In: Scharrer I, Schramm W, eds. Hamburg: Hamophilie-Symposium, 1995:325.

1107. Kemkes-Matthes B, Matthes KJ. Protein Z deficiency: a new cause of bleeding tendency. *Thromb*



Res 1995;79:49–55.

1108. Greten J, Kreis I, Liliensiek B, et al. Localisation of protein Z in vascular lesions of patients with atherosclerosis. *Vasa* 1998;27:144–148.

1109. Ichinose A, Takeya H, Espling E, et al. Amino acid sequence of human protein Z, a vitamin K-dependent plasma glycoprotein. *Biochem Biophys Res Commun* 1990;172:1139–1144.

1110. Sejima H, Hayashi T, Deyashiki Y, et al. Primary structure of vitamin K-dependent human protein Z. *Biochem Biophys Res Commun* 1990;171:661–668.

1111. Han X, Fiehler R, Broze GJ, Jr. Isolation of a protein Z-dependent plasma protease inhibitor. *Proc Natl Acad Sci U S A* 1998;95:9250–9255.

1112. Hogg PJ, Stenflo J. Interaction of human protein Z with thrombin: evaluation of the species difference in the interaction between bovine and human protein Z and thrombin. *Biochem Biophys Res Commun* 1991;178:801–807.

1113. Reference deleted.

1114. Imada S, Yamaguchi H, Nagumo M, et al. Identification of fetomodulin, a surface marker protein of fetal development, as thrombomodulin by gene cloning and functional assays. *Dev Biol* 1990;140:113–122.

1115. Healy AM, Rayburn HB, Rosenberg RD, et al. Absence of the blood-clotting regulator thrombomodulin causes embryonic lethality in mice before development of a functional cardiovascular system. *Proc Natl Acad Sci U S A* 1995;92:850–854.

1116. Wen DZ, Dittman WA, Ye RD, et al. Human thrombomodulin: complete cDNA sequence and chromosome localization of the gene. *Biochemistry* 1987;26:4350–4357.

1117. Espinosa R III, Sadler JE, Le Beau MM. Regional localization of the human thrombomodulin gene to 20p12-cen. *Genomics* 1989;5:649–650.

1118. Jackman RW, Beeler DL, Fritze L, et al. Human thrombomodulin gene is intron depleted: nucleic acid sequences of the cDNA and gene predict protein structure and suggest sites of regulatory control. *Proc Natl Acad Sci U S A* 1987;84:6425–6429.

1119. Shirai T, Shiojiri S, Ito H, et al. Gene structure of human thrombomodulin, a cofactor for thrombin-catalyzed activation of protein C. *J Biochem (Tokyo)* 1988;103:281–285.

1120. Maruyama I, Bell CE, Majerus PW. Thrombomodulin is found on endothelium of arteries, veins, capillaries, and lymphatics, and on syncytiotrophoblast of human placenta. *J Cell Biol* 1985;101:363–371.

1121. DeBault LE, Esmon NL, Olson JR, et al. Distribution of the thrombomodulin antigen in the rabbit vasculature. *Lab Invest* 1986;54:172–178.

1122. Conway EM, Nowakowski B, Steiner-Mosonyi M. Human neutrophils synthesize thrombomodulin that does not promote thrombin-dependent protein C activation. *Blood* 1992;80:1254–1263.

1123. Satta N, Freyssinet JM, Toti F. The significance of human monocyte thrombomodulin during membrane vesiculation and after stimulation by lipopolysaccharide. *Br J Haematol* 1997;96:534–542.

1124. McCachren SS, Diggs J, Weinberg JB, et al. Thrombomodulin expression by human blood monocytes and by human synovial tissue lining macrophages. *Blood* 1991;78:3128–3132.

1125. Suzuki K, Nishioka J, Hayashi T, et al. Functionally active thrombomodulin is present in human platelets. *J Biochem (Tokyo)* 1988;104:628–632.

1126. Conway EM, Nowakowski B. Biologically active thrombomodulin is synthesized by adherent synovial fluid cells and is elevated in synovial fluid of patients with rheumatoid arthritis. *Blood* 1993;81:726–733.

1127. Raife TJ, Lager DJ, Madison KC, et al. Thrombomodulin expression by human keratinocytes.

- Induction of cofactor activity during epidermal differentiation. *J Clin Invest* 1994;93:1846–1851.
1128. Jackson DE, Mitchell CA, Bird P, et al. Immunohistochemical localization of thrombomodulin in normal human skin and skin tumours. *J Pathol* 1995;175:421–432.
1129. Lager DJ, Callaghan EJ, Worth SF, et al. Cellular localization of thrombomodulin in human epithelium and squamous malignancies. *Am J Pathol* 1995;146:933–943.
1130. Scarpati EM, Sadler JE. Regulation of endothelial cell coagulant properties. Modulation of tissue factor, plasminogen activator inhibitors, and thrombomodulin by phorbol 12-myristate 13-acetate and tumor necrosis factor. *J Biol Chem* 1989;264:20705–20713.
1131. Ishii H, Horie S, Kizaki K, et al. Retinoic acid counteracts both the downregulation of thrombomodulin and the induction of tissue factor in cultured human endothelial cells exposed to tumor necrosis factor. *Blood* 1992;80:2556–2562.
1132. Hayashi T, Honda G, Suzuki K. An atherogenic stimulus homocysteine inhibits cofactor activity of thrombomodulin and enhances thrombomodulin expression in human umbilical vein endothelial cells. *Blood* 1992;79:2930–2936.
1133. Lentz SR, Sadler JE. Inhibition of thrombomodulin surface expression and protein C activation by the thrombogenic agent homocysteine. *J Clin Invest* 1991;88:1906–1914.
1134. Ogawa S, Gerlach H, Esposito C, et al. Hypoxia modulates the barrier and coagulant function of cultured bovine endothelium. Increased monolayer permeability and induction of procoagulant properties. *J Clin Invest* 1990;85:1090–1098.
1135. Esposito C, Gerlach H, Brett J, et al. Endothelial receptor-mediated binding of glucose-modified albumin is associated with increased monolayer permeability and modulation of cell surface coagulant properties. *J Exp Med* 1989;170:1387–1407.
1136. Archipoff G, Beretz A, Bartha K, et al. Role of cyclic AMP in promoting the thromboresistance of human endothelial cells by enhancing thrombomodulin and decreasing tissue factor activities. *Br J Pharmacol* 1993;109:18–28.
1137. Dittman WA, Nelson SC, Greer PK, et al. Characterization of thrombomodulin expression in response to retinoic acid and identification of a retinoic acid response element in the human thrombomodulin gene. *J Biol Chem* 1994;269:16925–16932.
1138. Takada Y, Shinkai F, Kondo S, et al. Fluid shear stress increases the expression of thrombomodulin by cultured human endothelial cells. *Biochem Biophys Res Commun* 1994;205:1345–1352.
1139. Malek AM, Jackman R, Rosenberg RD, et al. Endothelial expression of thrombomodulin is reversibly regulated by fluid shear stress. *Circ Res* 1994;74:852–860.
1140. Conway EM, Liu L, Nowakowski B, et al. Heat shock of vascular endothelial cells induces an up-regulatory transcriptional response of the thrombomodulin gene that is delayed in onset and does not attenuate. *J Biol Chem* 1994;269:22804–22810.
1141. Tazawa R, Yamamoto K, Suzuki K, et al. Presence of functional cyclic AMP responsive element in the 3'-untranslated region of the human thrombomodulin gene. *Biochem Biophys Res Commun* 1994;200:1391–1397.
1142. Suzuki K, Kusumoto H, Deyashiki Y, et al. Structure and expression of human thrombomodulin, a thrombin receptor on endothelium acting as a cofactor for protein C activation. *EMBO J* 1987;6:1891–1897.
1143. Petersen TE. The amino-terminal domain of thrombomodulin and pancreatic stone protein are homologous with lectins. *FEBS Lett* 1988;231:51–53.
1144. Kurosawa S, Stearns DJ, Jackson KW, et al. A 10-kDa cyanogen bromide fragment from the epidermal growth factor homology domain of rabbit thrombomodulin contains the primary thrombin binding site. *J Biol Chem* 1988;263:5993–5996.
1145. Stearns DJ, Kurosawa S, Esmon CT. Microthrombomodulin. Residues 310–486 from the epidermal

- growth factor precursor homology domain of thrombomodulin will accelerate protein C activation. *J Biol Chem* 1989;264:3352–3356.
1146. Suzuki K, Hayashi T, Nishioka J, et al. A domain composed of epidermal growth factor-like structures of human thrombomodulin is essential for thrombin binding and for protein C activation. *J Biol Chem* 1989;264:4872–4876.
1147. Zushi M, Gomi K, Honda G, et al. Aspartic acid 349 in the fourth epidermal growth factor-like structure of human thrombomodulin plays a role in its Ca<sup>2+</sup>-mediated binding to protein C. *J Biol Chem* 1991;266:19886–19889.
1148. Zushi M, Gomi K, Yamamoto S, et al. The last three consecutive epidermal growth factor-like structures of human thrombomodulin comprise the minimum functional domain for protein C-activating cofactor activity and anticoagulant activity. *J Biol Chem* 1989;264:10351–10353.
1149. Lin JH, McLean K, Morser J, et al. Modulation of glycosaminoglycan addition in naturally expressed and recombinant human thrombomodulin. *J Biol Chem* 1994;269:25021–25030.
1150. Ye J, Rezaie AR, Esmon CT. Glycosaminoglycan contributions to both protein C activation and thrombin inhibition involve a common arginine-rich site in thrombin that includes residues arginine 93, 97, and 101. *J Biol Chem* 1994;269:17965–17970.
1151. Bourin MC, Lindahl U. Glycosaminoglycans and the regulation of blood coagulation. *Biochem J* 1993;289(Pt 2):313–330.
1152. Bourin MC, Ohlin AK, Lane DA, et al. Relationship between anticoagulant activities and polyanionic properties of rabbit thrombomodulin. *J Biol Chem* 1988;263:8044–8052.
1153. He X, Ye J, Esmon CT, et al. Influence of Arginines 93, 97, and 101 of thrombin to its functional specificity. *Biochemistry* 1997;36:8969–8976.
1154. Tsiang M, Lentz SR, Sadler JE. Functional domains of membrane-bound human thrombomodulin. EGF-like domains four to six and the serine/threonine-rich domain are required for cofactor activity. *J Biol Chem* 1992;267:6164–6170.
1155. Lu RL, Esmon NL, Esmon CT, et al. The active site of the thrombin-thrombomodulin complex. A fluorescence energy transfer measurement of its distance above the membrane surface. *J Biol Chem* 1989;264:12956–12962.
1156. Conway EM, Boffa MC, Nowakowski B, et al. An ultrastructural study of thrombomodulin endocytosis: internalization occurs via clathrin-coated and non-coated pits. *J Cell Physiol* 1992;151:604–612.
1157. Conway EM, Pollefeyt S, Collen D, et al. The amino terminal lectin-like domain of thrombomodulin is required for constitutive endocytosis. *Blood* 1997;89:652–661.
1158. Ye J, Liu LW, Esmon CT, et al. The fifth and sixth growth factor-like domains of thrombomodulin bind to the anion-binding exosite of thrombin and alter its specificity. *J Biol Chem* 1992;267:11023–11028.
1159. Vindigni A, White CE, Komives EA, et al. Energetics of thrombin-thrombomodulin interaction. *Biochemistry* 1997;36:6674–6681.
1160. Ye J, Esmon NL, Esmon CT, et al. The active site of thrombin is altered upon binding to thrombomodulin. Two distinct structural changes are detected by fluorescence, but only one correlates with protein C activation. *J Biol Chem* 1991;266:23016–23021.
1161. Ye J, Esmon CT, Johnson AE. The chondroitin sulfate moiety of thrombomodulin binds a second molecule of thrombin. *J Biol Chem* 1993;268:2373–2379.
1162. Musci G, Berliner LJ, Esmon CT. Evidence for multiple conformational changes in the active center of thrombin induced by complex formation with thrombomodulin: an analysis employing nitroxide spin-labels. *Biochemistry* 1988;27:769–773.
1163. Liu LW, Rezaie AR, Carson CW, et al. Occupancy of anion binding exosite 2 on thrombin determines

Ca<sup>2+</sup> dependence of protein C activation. *J Biol Chem* 1994;269:11807–11812.

1164. Esmon CT, Esmon NL, Harris KW. Complex formation between thrombin and thrombomodulin inhibits both thrombin-catalyzed fibrin formation and factor V activation. *J Biol Chem* 1982;257:7944–7947.

1165. Esmon NL, Carroll RC, Esmon CT. Thrombomodulin blocks the ability of thrombin to activate platelets. *J Biol Chem* 1983;258:12238–12242.

1166. Hofsteenge J, Taguchi H, Stone SR. Effect of thrombomodulin on the kinetics of the interaction of thrombin with substrates and inhibitors. *Biochem J* 1986;237:243–251.

1167. Bourin MC, Boffa MC, Bjork I, et al. Functional domains of rabbit thrombomodulin. *Proc Natl Acad Sci U S A* 1986;83:5924–5928.

1168. Preissner KT, Delves U, Muller-Berghaus G. Binding of thrombin to thrombomodulin accelerates inhibition of the enzyme by antithrombin III. Evidence for a heparin-independent mechanism. *Biochemistry* 1987;26:2521–2528.

1169. Maruyama I, Majerus PW. Protein C inhibits endocytosis of thrombin-thrombomodulin complexes in A549 lung cancer cells and human umbilical vein endothelial cells. *Blood* 1987;69:1481–1484.

1170. Maruyama I, Majerus PW. The turnover of thrombin-thrombomodulin complex in cultured human umbilical vein endothelial cells and A549 lung cancer cells. Endocytosis and degradation of thrombin. *J Biol Chem* 1985;260:15432–15438.

1171. Horvat R, Palade GE. Thrombomodulin and thrombin localization on the vascular endothelium; their internalization and transcytosis by plasmalemmal vesicles. *Eur J Cell Biol* 1993;61:299–313.

1172. Beretz A, Freyssinet JM, Gauchy J, et al. Stability of the thrombin-thrombomodulin complex on the surface of endothelial cells from human saphenous vein or from the cell line EA.hy 926. *Biochem J* 1989;259:35–40.

1173. Boehme MW, Deng Y, Raeth U, et al. Release of thrombomodulin from endothelial cells by concerted action of TNF- $\alpha$  and neutrophils: in vivo and in vitro studies. *Immunology* 1996;87:134–140.

1174. Takano S, Kimura S, Ohdama S, et al. Plasma thrombomodulin in health and diseases. *Blood* 1990;76:2024–2029.

1175. Glaser CB, Morser J, Clarke JH, et al. Oxidation of a specific methionine in thrombomodulin by activated neutrophil products blocks cofactor activity. A potential rapid mechanism for modulation of coagulation. *J Clin Invest* 1992;90:2565–2573.

1176. Sottrup-Jensen L.  $\alpha_2$ -Macroglobulin and related thiol ester plasma proteins. In: Putnam FW, ed. *The plasma proteins*. Orlando: Academic Press, 1987:191–287.

1177. Travis J, Salvesen GS. Human plasma proteinase inhibitors. *Annu Rev Biochem* 1983;52:655–709.

1178. Starkey PM, Barrett AJ. Evolution of  $\alpha_2$ -macroglobulin. The structure of a protein homologous with human  $\alpha_2$ -macroglobulin from plaice (*Pleuronectes platessa* L.) plasma. *Biochem J* 1982;205:105–115.

1179. Starkey PM, Barrett AJ. Evolution of  $\alpha_2$ -macroglobulin. The demonstration in a variety of vertebrate species of a protein resembling human  $\alpha_2$ -macroglobulin. *Biochem J* 1982;205:91–95.

1180. Pizzo SV, Wu SM.  $\alpha$ -Macroglobulins and Kunins. In: Colman RW, Hirsh J, Marder VJ, et al., eds. *Hemostasis and thrombosis: basic principles and clinical practice*. Philadelphia: Lippincott Williams & Wilkins, 2001:367–379.

1181. Kruger U. Chronic obstructive lung disease and  $\alpha_2$ -macroglobulin deficiency in serum—case report. *Pneumologie* 1993;47:531–534.

1182. Kanoh Y, Ohtani H, Koshiba K. Studies on  $\alpha_2$  macroglobulin deficiency in association with

cancer metastasis. *Nihon Rinsho Meneki Gakkai Kaishi* 1997;20:30-43.

1183. Umans L, Serneels L, Overbergh L, et al. Targeted inactivation of the mouse alpha 2-macroglobulin gene. *J Biol Chem* 1995;270:19778-19785.

1184. Webb DJ, Wen J, Lysiak JJ, et al. Murine alpha-macroglobulins demonstrate divergent activities as neutralizers of transforming growth factor-beta and as inducers of nitric oxide synthesis. A possible mechanism for the endotoxin insensitivity of the alpha2-macroglobulin gene knock-out mouse. *J Biol Chem* 1996;271:24982-24988.

1185. Matthijs G, Devriendt K, Cassiman JJ, et al. Structure of the human alpha-2 macroglobulin gene and its promotor. *Biochem Biophys Res Commun* 1992;184:596-603.

1186. Kan CC, Solomon E, Belt KT, et al. Nucleotide sequence of cDNA encoding human alpha 2-macroglobulin and assignment of the chromosomal locus. *Proc Natl Acad Sci U S A* 1985;82:2282-2286.

1187. Fukushima Y, Bell GI, Shows TB. The polymorphic human alpha 2-macroglobulin gene (A2M) is located in chromosome region 12p12.3?p13.3. *Cytogenet Cell Genet* 1988;48:58-59.

1188. Devriendt K, Zhang J, Van Leuven F, et al. A cluster of alpha 2-macroglobulin-related genes (alpha 2 M) on human chromosome 12p: cloning of the pregnancy-zone protein gene and an alpha 2M pseudogene. *Gene* 1989;81:325-334.

1189. Swenson RP, Howard JB. Structural characterization of human alpha2-macroglobulin subunits. *J Biol Chem* 1979;254:4452-4456.

1190. Sottrup-Jensen L, Stepanik TM, Wierzbicki DM, et al. The primary structure of alpha 2-macroglobulin and localization of a factor XIIIa cross-linking site. *Ann N Y Acad Sci* 1983;421:41-60.

1191. Carlsson-Bosted L, Moestrup SK, Gliemann J, et al. Three different conformational states of pregnancy zone protein identified by monoclonal antibodies. *J Biol Chem* 1988;263:6738-6741.

1192. Christensen U, Simonsen M, Harrit N, et al. Pregnancy zone protein, a proteinase-binding macroglobulin. Interactions with proteinases and methylamine. *Biochemistry* 1989;28:9324-9331.

1193. Mortensen SB, Sottrup-Jensen L, Hansen HF, et al. Primary and secondary cleavage sites in the bait region of alpha 2-macroglobulin. *FEBS Lett* 1981; 135:295-300.

1194. Sottrup-Jensen L, Petersen TE, Magnusson S. A thiol-ester in alpha 2-macroglobulin cleaved during proteinase complex formation. *FEBS Lett* 1980;121:275-279.

1195. Howard JB. Reactive site in human alpha 2-macroglobulin: circumstantial evidence for a thiolester. *Proc Natl Acad Sci U S A* 1981;78:2235-2239.

1196. Gonias SL, Reynolds JA, Pizzo SV. Physical properties of human alpha 2-macroglobulin following reaction with methylamine and trypsin. *Biochim Biophys Acta* 1982;705:306-314.

1197. Harpel PC. Human plasma alpha 2-macroglobulin. An inhibitor of plasma kallikrein. *J Exp Med* 1970;132:329-352.

1198. Harpel PC. Alpha2-plasmin inhibitor and alpha2-macroglobulin-plasmin complexes in plasma. Quantitation by an enzyme-linked differential antibody immunosorbent assay. *J Clin Invest* 1981;68:46-55.

1199. Mitchell L, Piovella F, Ofosu F, et al. Alpha-2-macroglobulin may provide protection from thromboembolic events in antithrombin III-deficient children. *Blood* 1991;78:2299-2304.

1200. Abbink JJ, Nuijens JH, Eerenberg AJ, et al. Quantification of functional and inactivated alpha 2-macroglobulin in sepsis. *Thromb Haemost* 1991;65:32-39.

1201. Huang SS, O'Grady P, Huang JS. Human transforming growth factor beta. alpha 2-macroglobulin complex is a latent form of transforming growth factor beta. *J Biol Chem* 1988;263:1535-1541.

1202. Borth W, Luger TA. Identification of alpha 2-macroglobulin as a cytokine binding plasma protein.

- Binding of interleukin-1 beta to "F" alpha 2-macroglobulin. *J Biol Chem* 1989;264:5818-5825.
1203. Matsuda T, Hirano T, Nagasawa S, et al. Identification of alpha 2-macroglobulin as a carrier protein for IL-6. *J Immunol* 1989;142:148-152.
1204. Dennis PA, Saksela O, Harpel P, et al. Alpha 2-macroglobulin is a binding protein for basic fibroblast growth factor. *J Biol Chem* 1989;264:7210-7216.
1205. Wollenberg GK, LaMarre J, Rosendal S, et al. Binding of tumor necrosis factor alpha to activated forms of human plasma alpha 2 macroglobulin. *Am J Pathol* 1991;138:265-272.
1206. Legres LG, Pochon F, Barray M, et al. Evidence for the binding of a biologically active interleukin-2 to human alpha 2-macroglobulin. *J Biol Chem* 1995;270:8381-8384.
1207. Zappia M, Cittadella R, Manna I, et al. Genetic association of alpha2-macroglobulin polymorphisms with AD in southern Italy. *Neurology* 2002;59:756-758.
1208. McGeer PL, McGeer EG. Polymorphisms in inflammatory genes and the risk of Alzheimer disease. *Arch Neurol* 2001;58:1790-1792.
1209. Kovacs DM. alpha2-macroglobulin in late-onset Alzheimer's disease. *Exp Gerontol* 2000;35:473-479.
1210. Broze GJ, Jr. The role of tissue factor pathway inhibitor in a revised coagulation cascade. *Semin Hematol* 1992;29:159-169.
1211. Broze GJ, Jr. Tissue factor pathway inhibitor and the revised theory of coagulation. *Annu Rev Med* 1995;46:103-112.
1212. Broze GJ, Jr., Lange GW, Duffin KL, et al. Heterogeneity of plasma tissue factor pathway inhibitor. *Blood Coagul Fibrinolysis* 1994;5:551-559.
1213. Novotny WF, Girard TJ, Miletich JP, et al. Purification and characterization of the lipoprotein-associated coagulation inhibitor from human plasma. *J Biol Chem* 1989;264:18832-18837.
1214. Bajaj MS, Kuppaswamy MN, Saito H, et al. Cultured normal human hepatocytes do not synthesize lipoprotein-associated coagulation inhibitor: evidence that endothelium is the principal site of its synthesis. *Proc Natl Acad Sci U S A* 1990;87:8869-8873.
1215. Sanders NL, Bajaj SP, Zivelin A, et al. Inhibition of tissue factor/factor VIIa activity in plasma requires factor X and an additional plasma component. *Blood* 1985;66:204-212.
1216. Lesnik P, Vonica A, Guerin M, et al. Anticoagulant activity of tissue factor pathway inhibitor in human plasma is preferentially associated with dense subspecies of LDL and HDL and with Lp(a). *Arterioscler Thromb* 1993;13:1066-1075.
1217. Golino P, Ragni M, Cimmino G, et al. Role of tissue factor pathway inhibitor in the regulation of tissue factor-dependent blood coagulation. *Cardiovasc Drug Rev* 2002;20:67-80.
1218. Kato H. Regulation of functions of vascular wall cells by tissue factor pathway inhibitor: basic and clinical aspects. *Arterioscler Thromb Vasc Biol* 2002;22:539-548.
1219. Broze GJ, Jr. Tissue factor pathway inhibitor. *Thromb Haemost* 1995;74:90-93.
1220. Broze GJ, Jr., Tollefen DM. Regulation of blood coagulation by protease inhibitors. In: Stamatoyanopolous G, Nienhuis AW, Majerus PW, eds. *The molecular basis of blood diseases*. Philadelphia: WB Saunders, 1994:629-656.
1221. Sandset PM. Tissue factor pathway inhibitor (TFPI)—an update. *Haemostasis* 1996;26[Suppl 4]:154-165.
1222. Lindahl AK. Tissue factor pathway inhibitor: from unknown coagulation inhibitor to major antithrombotic principle. *Cardiovasc Res* 1997;33:286-291.

1223. Schwartz AL, Broze GJ, Jr. Tissue factor pathway inhibitor. *Trends Cardiovasc Med* 1997;7:234–239.
1224. Huang ZF, Higuchi D, Lasky N, et al. Tissue factor pathway inhibitor gene disruption produces intrauterine lethality in mice. *Blood* 1997;90:944–951.
1225. Chan JC, Carmeliet P, Moons L, et al. Factor VII deficiency rescues the intrauterine lethality in mice associated with a tissue factor pathway inhibitor deficit. *J Clin Invest* 1999;103:475–482.
1226. Westrick RJ, Bodary PF, Xu Z, et al. Deficiency of tissue factor pathway inhibitor promotes atherosclerosis and thrombosis in mice. *Circulation* 2001;103:3044–3046.
1227. Abraham E, Reinhart K, Svoboda P, et al. Assessment of the safety of recombinant tissue factor pathway inhibitor in patients with severe sepsis: a multicenter, randomized, placebo-controlled, single-blind, dose escalation study. *Crit Care Med* 2001;29:2081–2089.
1228. Girard TJ, Eddy R, Wesselschmidt RL, et al. Structure of the human lipoprotein-associated coagulation inhibitor gene. Intro/exon gene organization and localization of the gene to chromosome 2. *J Biol Chem* 1991;266:5036–5041.
1229. van der Logt CP, Reitsma PH, Bertina RM. Intron-exon organization of the human gene coding for the lipoprotein-associated coagulation inhibitor: the factor Xa dependent inhibitor of the extrinsic pathway of coagulation. *Biochemistry* 1991;30:1571–1577.
1230. van der Logt CP, Kluck PM, Wiegant J, et al. Refined regional assignment of the human tissue factor pathway inhibitor (TFPI) gene to chromosome band 2q32 by non-isotopic in situ hybridization. *Hum Genet* 1992;89:577–578.
1231. Enjyoji K, Emi M, Mukai T, et al. Human tissue factor pathway inhibitor (TFPI) gene: complete genomic structure and localization on the genetic map of chromosome 2q. *Genomics* 1993;17:423–428.
1232. Ameri A, Kuppaswamy MN, Basu S, et al. Expression of tissue factor pathway inhibitor by cultured endothelial cells in response to inflammatory mediators. *Blood* 1992;79:3219–3226.
1233. Broze GJ, Jr., Miletich JP. Isolation of the tissue factor inhibitor produced by HepG2 hepatoma cells. *Proc Natl Acad Sci U S A* 1987;84:1886–1890.
1234. Wun TC, Kretzmer KK, Girard TJ, et al. Cloning and characterization of a cDNA coding for the lipoprotein-associated coagulation inhibitor shows that it consists of three tandem Kunitz-type inhibitory domains. *J Biol Chem* 1988;263:6001–6004.
1235. Novotny WF, Palmier M, Wun TC, et al. Purification and properties of heparin-releasable lipoprotein-associated coagulation inhibitor. *Blood* 1991;78: 394–400.
1236. Enjyoji K, Miyata T, Kamikubo Y, et al. Effect of heparin on the inhibition of factor Xa by tissue factor pathway inhibitor: a segment, Gly212–Phe243, of the third Kunitz domain is a heparin-binding site. *Biochemistry* 1995;34:5725–5735.
1237. Smith PL, Skelton TP, Fiete D, et al. The asparagine-linked oligosaccharides on tissue factor pathway inhibitor terminate with SO<sub>4</sub>-4GalNAc beta 1, 4GlcNAc beta 1,2 Mana alpha. *J Biol Chem* 1992;267:19140–19146.
1238. Broze GJ, Jr. Tissue factor pathway inhibitor and the current concept of blood coagulation. *Blood Coagul Fibrinolysis* 1995;6[Suppl 1]:S7–13.
1239. Sandset PM, Abildgaard U, Larsen ML. Heparin induces release of extrinsic coagulation pathway inhibitor (EPI). *Thromb Res* 1988;50:803–813.
1240. Lindahl AK, Abildgaard U, Stokke G. Release of extrinsic pathway inhibitor after heparin injection: increased response in cancer patients. *Thromb Res* 1990;59:651–656.
1241. van't Veer C, Kalafatis M, Bertina RM, et al. Increased tissue factor-initiated prothrombin activation



as a result of the Arg506?Gln mutation in factor VLEIDEN. *J Biol Chem* 1997;272:20721–20729.

1242. Eitzman DT, Westrick RJ, Bi X, et al. Lethal perinatal thrombosis in mice resulting from the interaction of tissue factor pathway inhibitor deficiency and factor V Leiden. *Circulation* 2002;105:2139–2142.

1243. Hamamoto T, Yamamoto M, Nordfang O, et al. Inhibitory properties of full-length and truncated recombinant tissue factor pathway inhibitor (TFPI). Evidence that the third Kunitz-type domain of TFPI is not essential for the inhibition of factor VIIa-tissue factor complexes on cell surfaces. *J Biol Chem* 1993;268:8704–8710.

1244. Wesselschmidt RL, Girard TJ, Likert KM. Tissue factor pathway inhibitor: the carboxyterminus is required for optimal inhibition of factor Xa. *Blood* 1992;79:2004–2010.

1245. van't Veer C, Mann KG. Regulation of tissue factor initiated thrombin generation by the stoichiometric inhibitors tissue factor pathway inhibitor, antithrombin-III, and heparin cofactor-II. *J Biol Chem* 1997;272:4367–4377.

1246. van't Veer C, Golden NJ, Kalafatis M, et al. Inhibitory mechanism of the protein C pathway on tissue factor-induced thrombin generation. Synergistic effect in combination with tissue factor pathway inhibitor. *J Biol Chem* 1997;272:7983–7994.

1247. Warshawsky I, Broze GJ, Jr., Schwartz AL. The low density lipoprotein receptor-related protein mediates the cellular degradation of tissue factor pathway inhibitor. *Proc Natl Acad Sci U S A* 1994;91:6664–6668.

1248. Narita M, Bu G, Olins GM, et al. Two receptor systems are involved in the plasma clearance of tissue factor pathway inhibitor in vivo. *J Biol Chem* 1995;270:24800–24804.

1249. Warshawsky I, Bu G, Mast A, et al. The carboxy terminus of tissue factor pathway inhibitor is required for interacting with hepatoma cells in vitro and in vivo. *J Clin Invest* 1995;95:1773–1781.

1250. Janciauskiene S. Conformational properties of serine proteinase inhibitors (serpins) confer multiple pathophysiological roles. *Biochim Biophys Acta* 2001;1535:221–235.

1251. Kuhle S, Lane DA, Jochmanns K, et al. Homozygous antithrombin deficiency type II (99 Leu to Phe mutation) and childhood thromboembolism. *Thromb Haemost* 2001;86:1007–1011.

1252. Yamamoto K, Takeshita K, Shimokawa T, et al. Plasminogen activator inhibitor-1 is a major stress-regulated gene: implications for stress-induced thrombosis in aged individuals. *Proc Natl Acad Sci U S A* 2002;99:890–895.

1253. Khan H, Salman KA, Ahmed S. Alpha-1 antitrypsin deficiency in emphysema. *J Assoc Physicians India* 2002;50:579–582.

1254. Koide M, Shirahama S, Tokura Y, et al. Lupus erythematosus associated with C1 inhibitor deficiency. *J Dermatol* 2002;29:503–507.

1255. Propst T, Propst A, Dietze O, et al. Alpha-1-antitrypsin deficiency and liver disease. *Dig Dis* 1994;12:139–149.

1256. Davis RL, Shrimpton AE, Carrell RW, et al. Association between conformational mutations in neuroserpin and onset and severity of dementia. *Lancet* 2002;359:2242–2247.

1257. Stratikos E, Gettins PG. Formation of the covalent serpin-proteinase complex involves translocation of the proteinase by more than 70 Å and full insertion of the reactive center loop into beta-sheet Å. *Proc Natl Acad Sci U S A* 1999;96:4808–4813.

1258. Kaslik G, Patthy A, Balint M, et al. Trypsin complexed with alpha 1-proteinase inhibitor has an increased structural flexibility. *FEBS Lett* 1995;370:179–183.

1259. Stavridi ES, O'Malley K, Lukacs CM, et al. Structural change in alpha-chymotrypsin induced by complexation with alpha 1-antichymotrypsin as seen by enhanced sensitivity to proteolysis. *Biochemistry*

1996;35:10608–10615.

1260. Fa M, Bergstrom F, Karolin J, et al. Conformational studies of plasminogen activator inhibitor type 1 by fluorescence spectroscopy. Analysis of the reactive centre of inhibitory and substrate forms, and of their respective reactive-centre cleaved forms. *Eur J Biochem* 2000;267:3729–3734.

1261. Fa M, Bergstrom F, Hagglof P, et al. The structure of a serpin–protease complex revealed by intramolecular distance measurements using donor–donor energy migration and mapping of interaction sites. *Structure Fold Des* 2000;8:397–405.

1262. Herve M, Ghelis C. Conformational stability of the covalent complex between elastase and alpha 1–proteinase inhibitor. *Arch Biochem Biophys* 1991;285:142–146.

1263. Streusand VJ, Bjork I, Gettins PG, et al. Mechanism of acceleration of antithrombin–proteinase reactions by low affinity heparin. Role of the antithrombin binding pentasaccharide in heparin rate enhancement. *J Biol Chem* 1995;270:9043–9051.

1264. Plotnick MI, Mayne L, Schechter NM, et al. Distortion of the active site of chymotrypsin complexed with a serpin. *Biochemistry* 1996;35:7586–7590.

1265. Baglin TP, Carrell RW, Church FC, et al. Crystal structures of native and thrombin–complexed heparin cofactor II reveal a multistep allosteric mechanism. *Proc Natl Acad Sci U S A* 2002;99:11079–11084.

1266. Im H, Woo MS, Hwang KY, et al. Interactions causing the kinetic trap in serpin protein folding. *J Biol Chem* 2002;277:46347–46354.

1267. Whisstock J, Skinner R, Lesk AM. An atlas of serpin conformations. *Trends Biochem Sci* 1998;23:63–67.

1268. Huntington JA, Read RJ, Carrell RW. Structure of a serpin–protease complex shows inhibition by deformation. *Nature* 2000;407:923–926.

1269. Djie MZ, Stone SR, Le Bonniec BF. Intrinsic specificity of the reactive site loop of alpha1–antitrypsin, alpha1–antichymotrypsin, antithrombin III, and protease nexin I. *J Biol Chem* 1997;272:16268–16273.

1270. Zhou A, Carrell RW, Huntington JA. The serpin inhibitory mechanism is critically dependent on the length of the reactive center loop. *J Biol Chem* 2001;276:27541–27547.

1271. Lawrence DA, Olson ST, Muhammad S, et al. Partitioning of serpin–proteinase reactions between stable inhibition and substrate cleavage is regulated by the rate of serpin reactive center loop insertion into beta–sheet A. *J Biol Chem* 2000;275:5839–5844.

1272. Potempa J, Korzus E, Travis J. The serpin superfamily of proteinase inhibitors: structure, function, and regulation. *J Biol Chem* 1994;269:15957–15960.

1273. Laskowski M, Qasim MA. What can the structures of enzyme–inhibitor complexes tell us about the structures of enzyme substrate complexes? *Biochim Biophys Acta* 2000;1477:324–337.

1274. Silverman GA, Bird PI, Carrell RW, et al. The serpins are an expanding superfamily of structurally similar but functionally diverse proteins. Evolution, mechanism of inhibition, novel functions, and a revised nomenclature. *J Biol Chem* 2001;276:33293–33296.

1275. Gils A, Declerck PJ. Structure–function relationships in serpins: current concepts and controversies. *Thromb Haemost* 1998;80:531–541.

1276. Wright HT. The structural puzzle of how serpin serine proteinase inhibitors work. *Bioessays* 1996;18:453–464.

1277. Huber R, Carrell RW. Implications of the three–dimensional structure of alpha 1–antitrypsin for structure and function of serpins. *Biochemistry* 1989;28:8951–8966.

1278. Ye S, Goldsmith EJ. Serpins and other covalent protease inhibitors. *Curr Opin Struct Biol*

2001;11:740–745.

1279. Bode W, Huber R. Structural basis of the endoproteinase–protein inhibitor interaction. *Biochim Biophys Acta* 2000;1477:241–252.

1280. Murano G, Williams L, Miller–Andersson M, et al. Some properties of antithrombin–III and its concentration in human plasma. *Thromb Res* 1980;18:259–262.

1281. Collen D, Schetz J, De Cock F, et al. Metabolism of antithrombin III (heparin cofactor) in man: effects of venous thrombosis and of heparin administration. *Eur J Clin Invest* 1977;7:27–35.

1282. Menache D, O'Malley JP, Schorr JB, et al. Evaluation of the safety, recovery, half–life, and clinical efficacy of antithrombin III (human) in patients with hereditary antithrombin III deficiency. Cooperative Study Group [see comments]. *Blood* 1990;75:33–39.

1283. Perry DJ, Carrell RW. Molecular genetics of human antithrombin deficiency. *Hum Mutat* 1996;7:7–22.

1284. Harper PL, Luddington RJ, Daly M, et al. The incidence of dysfunctional antithrombin variants: four cases in 210 patients with thromboembolic disease. *Br J Haematol* 1991;77:360–364.

1285. Lane DA, Kunz G, Olds RJ, et al. Molecular genetics of antithrombin deficiency. *Blood Rev* 1996;10:59–74.

1286. van Boven HH, Lane DA. Antithrombin and its inherited deficiency states. *Semin Hematol* 1997;34:188–204.

1287. Vinazzer H. Hereditary and acquired antithrombin deficiency. *Semin Thromb Hemost* 1999;25:257–263.

1288. White B, Perry D. Acquired antithrombin deficiency in sepsis. *Br J Haematol* 2001;112:26–31.

1289. Wiedermann C, Romisch J. The anti–inflammatory actions of antithrombin—a review. *Acta Med Austriaca* 2002;29:89–92.

1290. Baudo F, de Cataldo F. Antithrombin III concentrates in the treatment of sepsis and septic shock: indications, limits and future prospects. *Minerva Anesthesiol* 2000;66:3–23.

1291. Baudo F, Redaelli R, Caimi TM, et al. The continuous infusion of recombinant activated factor VIIa (rFVIIa) in patients with factor VIII inhibitors activates the coagulation and fibrinolytic systems without clinical complications. *Thromb Res* 2000;99:21–24.

1292. Bock SC, Harris JF, Balazs I, et al. Assignment of the human antithrombin III structural gene to chromosome 1q23–25. *Cytogenet Cell Genet* 1985;39:67–69.

1293. Olds RJ, Lane DA, Chowdhury V, et al. Complete nucleotide sequence of the antithrombin gene: evidence for homologous recombination causing thrombophilia. *Biochemistry* 1993;32:4216–4224.

1294. Fernandez–Rachubinski FA, Weiner JH, Blajchman MA. Regions flanking exon 1 regulate constitutive expression of the human antithrombin gene. *J Biol Chem* 1996;271:29502–29512.

1295. Peterson CB, Blackburn MN. Isolation and characterization of an antithrombin III variant with reduced carbohydrate content and enhanced heparin binding. *J Biol Chem* 1985;260:610–615.

1296. Prochownik EV, Markham AF, Orkin SH. Isolation of a cDNA clone for human antithrombin III. *J Biol Chem* 1983;258:8389–8394.

1297. Bock SC, Wion KL, Vehar GA, et al. Cloning and expression of the cDNA for human antithrombin III. *Nucleic Acids Res* 1982;10:8113–8125.

1298. Franzen LE, Svensson S, Larm O. Structural studies on the carbohydrate portion of human antithrombin III. *J Biol Chem* 1980;255:5090–5093.

1299. Mizuochi T, Fujii J, Kurachi K, et al. Structural studies of the carbohydrate moiety of human

antithrombin III. *Arch Biochem Biophys* 1980;203:458–465.

1300. Turk B, Brieditis I, Bock SC, et al. The oligosaccharide side chain on Asn-135 of alpha-antithrombin, absent in beta-antithrombin, decreases the heparin affinity of the inhibitor by affecting the heparin-induced conformational change. *Biochemistry* 1997;36:6682–6691.

1301. Mourey L, Samama JP, Delarue M, et al. Crystal structure of cleaved bovine antithrombin III at 3.2 Å resolution. *J Mol Biol* 1993;232:223–241.

1302. Wardell MR, Abrahams JP, Bruce D, et al. Crystallization and preliminary X-ray diffraction analysis of two conformations of intact human antithrombin. *J Mol Biol* 1993;234:1253–1258.

1303. Skinner R, Abrahams JP, Whisstock JC, et al. The 2.6 Å structure of antithrombin indicates a conformational change at the heparin binding site. *J Mol Biol* 1997;266:601–609.

1304. Olson ST, Bjork I, Shore JD. Kinetic characterization of heparin-catalyzed and uncatalyzed inhibition of blood coagulation proteinases by antithrombin. *Methods Enzymol* 1993;222:525–559.

1305. Olson ST, Shore JD. Demonstration of a two-step reaction mechanism for inhibition of alpha-thrombin by antithrombin III and identification of the step affected by heparin. *J Biol Chem* 1982;257:14891–14895.

1306. Casu B, Oreste P, Torri G, et al. The structure of heparin oligosaccharide fragments with high anti-(factor Xa) activity containing the minimal antithrombin III-binding sequence. Chemical and <sup>13</sup>C nuclear-magnetic-resonance studies. *Biochem J* 1981;197:599–609.

1307. O'Reilly MS, Pirie-Shepherd S, Lane WS, et al. Antiangiogenic activity of the cleaved conformation of the serpin antithrombin. *Science* 1999;285:1926–1928.

1308. Tollefsen DM, Pestka CA, Monafó WJ. Activation of heparin cofactor II by dermatan sulfate. *J Biol Chem* 1983;258:6713–6716.

1309. Tollefsen DM, Majerus DW, Blank MK. Heparin cofactor II. Purification and properties of a heparin-dependent inhibitor of thrombin in human plasma. *J Biol Chem* 1982;257:2162–2169.

1310. Griffith MJ, Carraway T, White GC, et al. Heparin cofactor activities in a family with hereditary antithrombin III deficiency: evidence for a second heparin cofactor in human plasma. *Blood* 1983;61:111–118.

1311. Andersson TR, Sie P, Pelzer H, et al. Elevated levels of thrombin-heparin cofactor II complex in plasma from patients with disseminated intravascular coagulation. *Thromb Res* 1992;66:591–598.

1312. Simioni P, Lazzaro AR, Coser E, et al. Hereditary heparin cofactor II deficiency and thrombosis: report of six patients belonging to two separate kindreds. *Blood Coagul Fibrinolysis* 1990;1:351–356.

1313. Weisdorf DJ, Edson JR. Recurrent venous thrombosis associated with inherited deficiency of heparin cofactor II [published erratum appears in *Br J Haematol* 1991;77(3):446]. *Br J Haematol* 1991;77:125–126.

1314. Andersson TR, Larsen ML, Handeland GF, et al. Heparin cofactor II activity in plasma: application of an automated assay method to the study of a normal adult population. *Scand J Haematol* 1986;36:96–102.

1315. Blinder MA, Marasa JC, Reynolds CH, et al. Heparin cofactor II: cDNA sequence, chromosome localization, restriction fragment length polymorphism, and expression in *Escherichia coli*. *Biochemistry* 1988;27:752–759.

1316. Herzog R, Lutz S, Blin N, et al. Complete nucleotide sequence of the gene for human heparin cofactor II and mapping to chromosomal band 22q11. *Biochemistry* 1991;30:1305–1307.

1317. Jaffe EA, Armellino D, Tollefsen DM. Biosynthesis of functionally active heparin cofactor II by a human hepatoma-derived cell line. *Biochem Biophys Res Commun* 1985;132:368–374.

1318. Ragg H, Preibisch G. Structure and expression of the gene coding for the human serpin hLS2. *J Biol*

Chem 1988;263:12129–12134.

1319. Zhang GS, Mehringer JH, Van Deerlin VM, et al. Murine heparin cofactor II: purification, cDNA sequence, expression, and gene structure. *Biochemistry* 1994;33:3632–3642.
1320. Ragg H. A new member of the plasma protease inhibitor gene family. *Nucleic Acids Res* 1986;14:1073–1088.
1321. Whinna HC, Blinder MA, Szewczyk M, et al. Role of lysine 173 in heparin binding to heparin cofactor II. *J Biol Chem* 1991;266:8129–8135.
1322. Blinder MA, Tollefsen DM. Site-directed mutagenesis of arginine 103 and lysine 185 in the proposed glycosaminoglycan-binding site of heparin cofactor II. *J Biol Chem* 1990;265:286–291.
1323. Tollefsen DM. Heparin cofactor II. *Adv Exp Med Biol* 1997;425:35–44.
1324. Ragg H, Ulshofer T, Gerewitz J. On the activation of human leuserpin-2, a thrombin inhibitor, by glycosaminoglycans. *J Biol Chem* 1990;265:5211–5218.
1325. Van Deerlin VM, Tollefsen DM. The N-terminal acidic domain of heparin cofactor II mediates the inhibition of alpha-thrombin in the presence of glycosaminoglycans. *J Biol Chem* 1991;266:20223–20231.
1326. Sheehan JP, Wu Q, Tollefsen DM, et al. Mutagenesis of thrombin selectively modulates inhibition by serpins heparin cofactor II and antithrombin III. Interaction with the anion-binding exosite determines heparin cofactor II specificity. *J Biol Chem* 1993;268:3639–3645.
1327. Church FC, Pratt CW, Hoffman M. Leukocyte chemoattractant peptides from the serpin heparin cofactor II. *J Biol Chem* 1991;266:704–709.
1328. Joslin G, Wittwer A, Adams S, et al. Cross-competition for binding of alpha 1-antitrypsin (alpha 1 AT)-elastase complexes to the serpin-enzyme complex receptor by other serpin-enzyme complexes and by proteolytically modified alpha 1 AT. *J Biol Chem* 1993;268:1886–1893.
1329. Griffith MJ, Noyes CM, Church FC. Reactive site peptide structural similarity between heparin cofactor II and antithrombin III. *J Biol Chem* 1985;260:2218–2225.
1330. Parker KA, Tollefsen DM. The protease specificity of heparin cofactor II. Inhibition of thrombin generated during coagulation. *J Biol Chem* 1985;260:3501–3505.
1331. McGuire EA, Tollefsen DM. Activation of heparin cofactor II by fibroblasts and vascular smooth muscle cells. *J Biol Chem* 1987;262:169–175.
1332. Andrew M, Mitchell L, Berry L, et al. An anticoagulant dermatan sulfate proteoglycan circulates in the pregnant woman and her fetus. *J Clin Invest* 1992;89:321–326.
1333. Massouh M, Jatoui A, Gordon EM, et al. Heparin cofactor II activity in plasma during pregnancy and oral contraceptive use. *J Lab Clin Med* 1989;114:697–699.
1334. Liu L, Dewar L, Song Y, et al. Inhibition of thrombin by antithrombin III and heparin cofactor II in vivo. *Thromb Haemost* 1995;73:405–412.
1335. Jeppsson JO, Laurell CB, Nosslin B, et al. Catabolic rate of alpha1-antitrypsin of Pi types S, and MMalton and of asialylated M-protein in man. *Clin Sci Mol Med* 1978;55:103–107.
1336. Shalygin VA, Eroshenko LB, Solnyshko AL, et al. Diagnostic and prognostic significance of study of acute phase proteins in children with appendicular peritonitis. *Klin Lab Diagn* 2002;(7):7–9.
1337. Primhak RA, Tanner MS. Alpha-1 antitrypsin deficiency. *Arch Dis Child* 2001;85:2–5.
1338. Metz R, DiCola M, Kurihara T, et al. Mode of action of RNA/DNA oligonucleotides: progress in the development of gene repair as a therapy for alpha(1)-antitrypsin deficiency. *Chest* 2002;121:91S–7S.
1339. Davies JC, Geddes DM, Alton EW. Prospects for gene therapy in lung disease. *Curr Opin Pharmacol*

2001;1:272-277.

1340. Vadolas J, Williamson R, Ioannou PA. Gene therapy for inherited lung disorders: an insight into pulmonary defence. *Pulm Pharmacol Ther* 2002;15:61-72.
1341. Leicht M, Long GL, Chandra T, et al. Sequence homology and structural comparison between the chromosomal human alpha 1-antitrypsin and chicken ovalbumin genes. *Nature* 1982;297:655-659.
1342. Rabin M, Watson M, Kidd V, et al. Regional location of alpha 1-antichymotrypsin and alpha 1-antitrypsin genes on human chromosome 14. *Somat Cell Mol Genet* 1986;12:209-214.
1343. Purrello M, Alhadeff B, Whittington E, et al. Comparison of cytologic and genetic distances between long arm subtelomeric markers of human autosome 14 suggests uneven distribution of crossing-over. *Cytogenet Cell Genet* 1987;44:32-40.
1344. Darlington GJ, Astrin KH, Muirhead SP, et al. Assignment of human alpha 1-antitrypsin to chromosome 14 by somatic cell hybrid analysis. *Proc Natl Acad Sci U S A* 1982;79:870-873.
1345. Bao JJ, Reed-Fourquet L, Sifers RN, et al. Molecular structure and sequence homology of a gene related to alpha 1-antitrypsin in the human genome. *Genomics* 1988;2:165-173.
1346. Hofker MH, Nelen M, Klasen EC, et al. Cloning and characterization of an alpha 1-antitrypsin like gene 12 KB downstream of the genuine alpha 1-antitrypsin gene. *Biochem Biophys Res Commun* 1988;155:634-642.
1347. Rollini P, Fournier RE. Differential regulation of gene activity and chromatin structure within the human serpin gene cluster at 14q32.1 in macrophage microcell hybrids. *Nucleic Acids Res* 2000;28:1767-1777.
1348. Hu C, Perlmutter DH. Cell-specific involvement of HNF-1beta in alpha(1)-antitrypsin gene expression in human respiratory epithelial cells. *Am J Physiol Lung Cell Mol Physiol* 2002;282:L757-L765.
1349. Jeppsson JO, Laurell CB, Fagerhol M. Properties of isolated human alpha1-antitrypsins of Pi types M, S and Z. *Eur J Biochem* 1978;83:143-153.
1350. Holmes WE, Nelles L, Lijnen HR, et al. Primary structure of human alpha 2-antiplasmin, a serine protease inhibitor (serpin). *J Biol Chem* 1987;262:1659-1664.
1351. Lijnen HR, Holmes WE, Van Hoef B, et al. Amino-acid sequence of human alpha 2-antiplasmin. *Eur J Biochem* 1987;166:565-574.
1352. Johnson D, Travis J. Structural evidence for methionine at the reactive site of human alpha-1-proteinase inhibitor. *J Biol Chem* 1978;253:7142-7144.
1353. Matheson NR, van Halbeek H, Travis J. Evidence for a tetrahedral intermediate complex during serpin-proteinase interactions. *J Biol Chem* 1991;266: 13489-13491.
1354. Loebermann H, Tokuoka R, Deisenhofer J, et al. Human alpha 1-proteinase inhibitor. Crystal structure analysis of two crystal modifications, molecular model and preliminary analysis of the implications for function. *J Mol Biol* 1984;177:531-557.
1355. Schulze AJ, Frohnert PW, Engh RA, et al. Evidence for the extent of insertion of the active site loop of intact alpha 1 proteinase inhibitor in beta-sheet A. *Biochemistry* 1992;31:7560-7565.
1356. Smith KF, Harrison RA, Perkins SJ. Structural comparisons of the native and reactive-centre-cleaved forms of alpha 1-antitrypsin by neutron- and x-ray-scattering in solution. *Biochem J* 1990;267:203-212.
1357. Wuillemin WA, Hack CE, Bleeker WK, et al. Inactivation of factor XIa in vivo: studies in chimpanzees and in humans. *Thromb Haemost* 1996;76:549-555.
1358. Murakami T, Komiyama Y, Masuda M, et al. Evaluation of factor XIa-alpha 1-antitrypsin in plasma, a contact phase-activated coagulation factor-inhibitor complex, in patients with coronary artery disease.

Arterioscler Thromb Vasc Biol 1995;15:1107–1113.

1359. Scully MF, Toh CH, Hoogendoorn H, et al. Activation of protein C and its distribution between its inhibitors, protein C inhibitor, alpha 1-antitrypsin and alpha 2-macroglobulin, in patients with disseminated intravascular coagulation. *Thromb Haemost* 1993;69:448–453.

1360. Carter PE, Dunbar B, Fothergill JE. Genomic and cDNA cloning of the human C1 inhibitor. Intron-exon junctions and comparison with other serpins. *Eur J Biochem* 1988;173:163–169.

1361. Orfan NA, Kolski GB. Angioedema and C1 inhibitor deficiency. *Ann Allergy* 1992;69:167–172.

1362. Phanish MK, Owen A, Parry DH. Spontaneous regression of acquired C1 esterase inhibitor deficiency associated with splenic marginal zone lymphoma presenting with recurrent angio-oedema. *J Clin Pathol* 2002;55:789–790.

1363. Shiozawa S, Shiozawa K. Angioedema and acquired C1 esterase inhibitor deficiency. *Intern Med* 2002;41:333–334.

1364. Han ED, MacFarlane RC, Mulligan AN, et al. Increased vascular permeability in C1 inhibitor-deficient mice mediated by the bradykinin type 2 receptor. *J Clin Invest* 2002;109:1057–1063.

1365. Caliezi C, Zeerleder S, Redondo M, et al. C1-inhibitor in patients with severe sepsis and septic shock: beneficial effect on renal dysfunction. *Crit Care Med* 2002;30:1722–1728.

1366. Horstick G. C1-esterase inhibitor in ischemia and reperfusion. *Immunobiology* 2002;205:552–562.

1367. Kirschfink M, Mollnes TE. C1-inhibitor: an anti-inflammatory reagent with therapeutic potential. *Expert Opin Pharmacother* 2001;2:1073–1083.

1368. Bock SC, Skriver K, Nielsen E, et al. Human C1 inhibitor: primary structure, cDNA cloning, and chromosomal localization. *Biochemistry* 1986;25:4292–4301.

1369. Zahedi K, Prada AE, Davis AE, III. Structure and regulation of the C1 inhibitor gene. *Behring Inst Mitt* 1993;115–119.

1370. Tosi M. Molecular genetics of C1 inhibitor. *Immunobiology* 1998;199:358–365.

1371. Perkins SJ, Smith KF, Amatayakul S, et al. Two-domain structure of the native and reactive centre cleaved forms of C1 inhibitor of human complement by neutron scattering. *J Mol Biol* 1990;214:751–763.

1372. Perkins SJ, Smith KF, Nealis AS, et al. Secondary structure changes stabilize the reactive-centre cleaved form of SERPINS. A study by <sup>1</sup>H nuclear magnetic resonance and Fourier transform infrared spectroscopy. *J Mol Biol* 1992;228:1235–1254.

1373. Perkins SJ. Three-dimensional structure and molecular modelling of C1-inhibitor. *Behring Inst Mitt* 1993;63–80.

1374. Laurell AB, Johnson U, Martensson U, et al. Formation of complexes composed of C1r, C1s, and C1 inactivator in human serum on activation of C1. *Acta Pathol Microbiol Scand Sect C Immunol* 1978;86:299.

1375. Forbes CD, Pensky J, Ratnoff OD. Inhibition of activated Hageman factor and activated plasma thromboplastin antecedent by purified serum C1 inactivator. *J Lab Clin Med* 1979;76:809.

1376. Wuillemin WA, Minnema M, Meijers JC, et al. Inactivation of factor XIa in human plasma assessed by measuring factor XIa-protease inhibitor complexes: major role for C1-inhibitor. *Blood* 1995;85:1517–1526.

1377. Nilsson T. On the interaction between human plasma kallikrein and C1-esterase inhibitor. *Thromb Haemost* 1983;49:193–195.

1378. Geiger M, Zechmeister-Machhart M, Uhrin P, et al. Protein C inhibitor (PCI). *Immunopharmacology* 1996;32:53–56.

1379. Seregini E, Botti C, Ballabio G, et al. Biochemical characteristics and recent biological knowledge on



prostate-specific antigen. *Tumori* 1996;82:72-77.

1380. Suzuki K, Nishioka J, Hashimoto S. Protein C inhibitor. Purification from human plasma and characterization. *J Biol Chem* 1983;258:163-168.

1381. Laurell M, Christensson A, Abrahamsson PA, et al. Protein C inhibitor in human body fluids. Seminal plasma is rich in inhibitor antigen deriving from cells throughout the male reproductive system. *J Clin Invest* 1992;89:1094-1101.

1382. Laurell M, Stenflo J, Carlson TH. Turnover of  $\alpha_1$ -protein C inhibitor and  $\alpha_1$ -antitrypsin and their complexes with activated protein C. *Blood* 1990;76:2290-2295.

1383. Meijers JC, Marquart JA, Bertina RM, et al. Protein C inhibitor (plasminogen activator inhibitor-3) and the risk of venous thrombosis. *Br J Haematol* 2002;118:604-609.

1384. Uhrin P, Dewerchin M, Hilbert M, et al. Disruption of the protein C inhibitor gene results in impaired spermatogenesis and male infertility. *J Clin Invest* 2000;106:1531-1539.

1385. Meijers JC, Chung DW. Organization of the gene coding for human protein C inhibitor (plasminogen activator inhibitor-3). Assignment of the gene to chromosome 14. *J Biol Chem* 1991;266:15028-15034.

1386. Billingsley GD, Walter MA, Hammond GL, et al. Physical mapping of four serpin genes: alpha 1-antitrypsin, alpha 1-antichymotrypsin, corticosteroid-binding globulin, and protein C inhibitor, within a 280-kb region on chromosome 11q32.1. *Am J Hum Genet* 1993;52:343-353.

1387. Suzuki K, Deyashiki Y, Nishioka J, et al. Characterization of a cDNA for human protein C inhibitor. A new member of the plasma serine protease inhibitor superfamily. *J Biol Chem* 1987;262:611-616.

1388. Seixas S, Garcia O, Trovada MJ, et al. Patterns of haplotype diversity within the serpin gene cluster at 14q32.1: insights into the natural history of the alpha1-antitrypsin polymorphism. *Hum Genet* 2001;108:20-30.

1389. Nishioka J, Ning M, Hayashi T, et al. Protein C inhibitor secreted from activated platelets efficiently inhibits activated protein C on phosphatidylethanolamine of platelet membrane and microvesicles. *J Biol Chem* 1998;273:11281-11287.

1390. Krebs M, Uhrin P, Vales A, et al. Protein C inhibitor is expressed in keratinocytes of human skin. *J Invest Dermatol* 1999;113:32-37.

1391. Radtke KP, Fernandez JA, Greengard JS, et al. Protein C inhibitor is expressed in tubular cells of human kidney. *J Clin Invest* 1994;94:2117-2124.

1392. Fujita M, Izutani W, Takahashi K, et al. Role of each Asn-linked glycan in the anticoagulant activity of human protein C inhibitor. *Thromb Res* 2002;105:95-102.

1393. Pratt CW, Church FC. General features of the heparin-binding serpins antithrombin, heparin cofactor II and protein C inhibitor. *Blood Coagul Fibrinolysis* 1993;4:479-490.

1394. Neese LL, Wolfe CA, Church FC. Contribution of basic residues of the D and H helices in heparin binding to protein C inhibitor. *Arch Biochem Biophys* 1998;355:101-108.

1395. Heeb MJ, Espana F, Griffin JH. Inhibition and complexation of activated protein C by two major inhibitors in plasma. *Blood* 1989;73:446-454.

1396. Hoogendoorn H, Nesheim ME, Giles AR. A qualitative and quantitative analysis of the activation and inactivation of protein C in vivo in a primate model. *Blood* 1990;75:2164-2171.

1397. Espana F, Vicente V, Tabernero D, et al. Determination of plasma protein C inhibitor and of two activated protein C-inhibitor complexes in normals and in patients with intravascular coagulation and thrombotic disease. *Thromb Res* 1990;59:593-608.

1398. Mosnier LO, Elisen MG, Bouma BN, et al. Protein C inhibitor regulates the thrombin-thrombomodulin complex in the up- and down regulation of TAFI activation. *Thromb Haemost*

2001;86:1057-1064.

1399. Strandberg K, Astermark J, Bjorgell O, et al. Complexes between activated protein C and protein C inhibitor measured with a new method: comparison of performance with other markers of hypercoagulability in the diagnosis of deep vein thrombosis. *Thromb Haemost* 2001;86:1400-1408.

1400. Barkan G, Gaspar A. Zur Frage der Reversibilitat der Fibringerinnung II. *Biochem Ztschr* 1923;139:291-301.

1401. Muszbek L, Yee VC, Hevessy Z. Blood coagulation factor XIII: structure and function. *Thromb Res* 1999;94:271-305.

1402. Robbins KC. A study on the conversion of fibrinogen to fibrin. *Am J Physiol* 1944;142:581-588.

1403. Laki K, Lorand L. On the solubility of fibrin clots. *Science* 1948;108:280.

1404. Lorand L. A study on the solubility of fibrin clots in urea. *Acta Physiol Acad Sci Hung* 1948;1:192-196.

1405. Procyk R, Adamson L, Block M, et al. Factor XIII catalyzed formation of fibrinogen-fibronectin oligomers—a thiol enhanced process. *Thromb Res* 1985;40:833-852.

1406. Procyk R, Blomback B. Factor XIII-induced crosslinking in solutions of fibrinogen and fibronectin. *Biochim Biophys Acta* 1988;967:304-313.

1407. Tamaki T, Aoki N. Cross-linking of alpha 2-plasmin inhibitor to fibrin catalyzed by activated fibrin-stabilizing factor. *J Biol Chem* 1982;257:14767-14772.

1408. Chen R, Doolittle RF. Cross-linking sites in human and bovine fibrin. *Biochemistry* 1971;10:4487-4491.

1409. Kanaide H, Shainoff JR. Cross-linking of fibrinogen and fibrin by fibrin-stabilizing factor (factor XIIIa). *J Lab Clin Med* 1975;85:574-597.

1410. Mosher DF, Schad PE. Cross-linking of fibronectin to collagen by blood coagulation Factor XIIIa. *J Clin Invest* 1979;64:781-787.

1411. Mosher DF. Cross-linking of fibronectin to collagenous proteins. *Mol Cell Biochem* 1984;58:63-68.

1412. Mui PT, Ganguly P. Cross-linking of actin and fibrin by fibrin-stabilizing factor. *Am J Physiol* 1977;233:H346-H349.

1413. Lynch GW, Slayter HS, Miller BE, et al. Characterization of thrombospondin as a substrate for factor XIII transglutaminase. *J Biol Chem* 1987;262:1772-1778.

1414. Weisberg LJ, Shiu DT, Greenberg CS, et al. Localization of the gene for coagulation factor XIII a-chain to chromosome 6 and identification of sites of synthesis. *J Clin Invest* 1987;79:649-652.

1415. Board PG, Webb GC, McKee J, et al. Localization of the coagulation factor XIII A subunit gene (F13A) to chromosome bands 6p24?p25. *Cytogenet Cell Genet* 1988;48:25-27.

1416. Ichinose A, Davie EW. Characterization of the gene for the a subunit of human factor XIII (plasma transglutaminase), a blood coagulation factor. *Proc Natl Acad Sci U S A* 1988;85:5829-5833.

1417. Webb GC, Coggan M, Ichinose A, et al. Localization of the coagulation factor XIII B subunit gene (F13B) to chromosome bands 1q31-32.1 and restriction fragment length polymorphism at the locus. *Hum Genet* 1989;81:157-160.

1418. Grundmann U, Nerlich C, Rein T, et al. Complete cDNA sequence encoding the B subunit of human factor XIII. *Nucleic Acids Res* 1990;18:2817-2818.

1419. Ichinose A, McMullen BA, Fujikawa K, et al. Amino acid sequence of the b subunit of human factor

- XIII, a protein composed of ten repetitive segments. *Biochemistry* 1986;25:4633–4638.
1420. Bottenus RE, Ichinose A, Davie EW. Nucleotide sequence of the gene for the b subunit of human factor XIII. *Biochemistry* 1990;29:11195–11209.
1421. Morley BJ, Campbell RD. Internal homologies of the Ba fragment from human complement component Factor B, a class III MHC antigen. *EMBO J* 1984;3:153–157.
1422. Chung LP, Gagnon J, Reid KB. Amino acid sequence studies of human C4b-binding protein: N-terminal sequence analysis and alignment of the fragments produced by limited proteolysis with chymotrypsin and the peptides produced by cyanogen bromide treatment. *Mol Immunol* 1985; 22:427–435.
1423. Miloszewski KJA, Losowsky MS. Fibrin stabilization and factor XIII deficiency. In: Horwood E, ed. *Fibrinogen, fibrin stabilization and fibrinolysis*. Chichester: L Francis, 1988:175–202.
1424. Lowey AG, McDonagh J, Mikkola H, et al. Structure and function of factor XIII. In: Colman RW, Hirsh J, Marder VJ, et al., eds. *Hemostasis and thrombosis: basic principles and clinical practice*. Philadelphia: Lippincott Williams & Wilkins, 2001:233–247.
1425. Ariens RA, Lai TS, Weisel JW, et al. Role of factor XIII in fibrin clot formation and effects of genetic polymorphisms. *Blood* 2002;100:743–754.
1426. Reiner AP, Schwartz SM, Frank MB, et al. Polymorphisms of coagulation factor XIII subunit A and risk of nonfatal hemorrhagic stroke in young white women. *Stroke* 2001;32:2580–2587.
1427. Mikkola H, Syrjala M, Rasi V, et al. Deficiency in the A-subunit of coagulation factor XIII: two novel point mutations demonstrate different effects on transcript levels. *Blood* 1994;84:517–525.
1428. Kohler HP, Stickland MH, Ossei-Gerning N, et al. Association of a common polymorphism in the factor XIII gene with myocardial infarction. *Thromb Haemost* 1998;79:8–13.
1429. Wartiovaara U, Perola M, Mikkola H, et al. Association of FXIII Val34Leu with decreased risk of myocardial infarction in Finnish males. *Atherosclerosis* 1999;142:295–300.
1430. Catto AJ, Kohler HP, Coore J, et al. Association of a common polymorphism in the factor XIII gene with venous thrombosis. *Blood* 1999;93:906–908.
1431. Franco RF, Reitsma PH, Lourenco D, et al. Factor XIII Val34Leu is a genetic factor involved in the etiology of venous thrombosis. *Thromb Haemost* 1999;81:676–679.
1432. Elbaz A, Poirier O, Canaple S, et al. The association between the Val34Leu polymorphism in the factor XIII gene and brain infarction. *Blood* 2000;95:586–591.
1433. Renner W, Koppel H, Hoffmann C, et al. Prothrombin G20210A, factor V Leiden, and factor XIII Val34Leu. Common mutations of blood coagulation factors and deep vein thrombosis in Austria. *Thromb Res* 2000;99:35–39.
1434. Reference deleted.
1435. Lorand L. Factor XIII: structure, activation, and interactions with fibrinogen and fibrin. *Ann N Y Acad Sci* 2001;936:291–311.
1436. Kohler HP, Ariens RA, Whitaker P, et al. A common coding polymorphism in the FXIII A-subunit gene (FXIIIVal34Leu) affects cross-linking activity [Letter]. *Thromb Haemost* 1998;80:704.
1437. Kangsadalampai S, Board PG. The Val34Leu polymorphism in the A subunit of coagulation factor XIII contributes to the large normal range in activity and demonstrates that the activation peptide plays a role in catalytic activity. *Blood* 1998;92:2766–2770.
1438. Anwar R, Gallivan L, Edmonds SD, et al. Genotype/phenotype correlations for coagulation factor XIII: specific normal polymorphisms are associated with high or low factor XIII specific activity. *Blood* 1999;93: 897–905.

1439. Ariens RA, Philippou H, Nagaswami C, et al. The factor XIII V34L polymorphism accelerates thrombin activation of factor XIII and affects cross-linked fibrin structure. *Blood* 2000;96:988-995.
1440. Undas A, Wojciech, JS, et al. Aspirin alters the cardioprotective effects of the factor XIII Val34Leu polymorphism. *Circulation* 2003;107:17-20.
1441. Schwartz ML, Pizzo SV, Hill RL, et al. Human Factor XIII from plasma and platelets. Molecular weights, subunit structures, proteolytic activation, and cross-linking of fibrinogen and fibrin. *J Biol Chem* 1973;248:1395-1407.
1442. Radek JT, Jeong JM, Wilson J, et al. Association of the A subunits of recombinant placental factor XIII with the native carrier B subunits from human plasma. *Biochemistry* 1993;32:3527-3534.
1443. Yorifuji H, Anderson K, Lynch GW, et al. B protein of factor XIII: differentiation between free B and complexed B. *Blood* 1988;72:1645-1650.
1444. Katona E, Haramura G, Karpati L, et al. A simple, quick one-step ELISA assay for the determination of complex plasma factor XIII (A2B2). *Thromb Haemost* 2000;83:268-273.
1445. Takahashi N, Takahashi Y, Putnam FW. Primary structure of blood coagulation factor XIIIa (fibrinolytic, transglutaminase) from human placenta. *Proc Natl Acad Sci U S A* 1986;83:8019-8023.
1446. Ichinose A, Hendrickson LE, Fujikawa K, et al. Amino acid sequence of the a subunit of human factor XIII. *Biochemistry* 1986;25:6900-6906.
1447. Carrell NA, Erickson HP, McDonagh J. Electron microscopy and hydrodynamic properties of factor XIII subunits. *J Biol Chem* 1989;264:551-556.
1448. McDonagh J. Structure and function of factor XIII. In: Colman RW, Hirsh J, Marder VJ, Sandberg H, eds. *Hemostasis and thrombosis: basic principles and clinical practice*. Philadelphia: Lippincott, 1994:301-313.
1449. Ichinose A, Kaetsu H. Molecular approach to structure-function relationship of human coagulation factor XIII. *Methods Enzymol* 1993;222:36-51.
1450. Pedersen LC, Yee VC, Bishop PD, et al. Transglutaminase factor XIII uses proteinase-like catalytic triad to crosslink macromolecules. *Protein Sci* 1994;3:1131-1135.
1451. Yee VC, Pedersen LC, Bishop PD, et al. Structural evidence that the activation peptide is not released upon thrombin cleavage of factor XIII. *Thromb Res* 1995;78:389-397.
1452. Fox BA, Yee VC, Pedersen LC, et al. Identification of the calcium binding site and a novel ytterbium site in blood coagulation factor XIII by x-ray crystallography. *J Biol Chem* 1999;274:4917-4923.
1453. Yee VC, Le Trong I, Bishop PD, et al. Structure and function studies of factor XIIIa by x-ray crystallography. *Semin Thromb Hemost* 1996;22:377-384.
1454. Pedersen LC. X-ray structure determination of factor XIII [thesis/dissertation]. Seattle: University of Washington, 1994.
1455. Weisberg LJ, Shiu DT, Conkling PR, et al. Identification of normal human peripheral blood monocytes and liver as sites of synthesis of coagulation factor XIII a-chain. *Blood* 1987;70:579-582.
1456. Wolpl A, Lattke H, Board PG, et al. Coagulation factor XIII A and B subunits in bone marrow and liver transplantation. *Transplantation* 1987;43:151-153.
1457. Poon MC, Russell JA, Low S, et al. Hemopoietic origin of factor XIII A subunits in platelets, monocytes, and plasma. Evidence from bone marrow transplantation studies. *J Clin Invest* 1989;84:787-792.
1458. McDonagh J, McDonagh RP, Jr., Delage JM, et al. Factor XIII in human plasma and platelets. *J Clin Invest* 1969;48:940-946.

1459. Henriksson P, Becker S, Lynch G, et al. Identification of intracellular factor XIII in human monocytes and macrophages. *J Clin Invest* 1985;76:528–534.
1460. Muszbek L, Adany R, Szegedi G, et al. Factor XIII of blood coagulation in human monocytes. *Thromb Res* 1985;37:401–410.
1461. Takagi T, Doolittle RF. Amino acid sequence studies on factor XIII and the peptide released during its activation by thrombin. *Biochemistry* 1974;13:750–756.
1462. Kaetsu H, Hashiguchi T, Foster D, et al. Expression and release of the a and b subunits for human coagulation factor XIII in baby hamster kidney (BHK) cells. *J Biochem (Tokyo)* 1996;119:961–969.
1463. Mignatti P, Morimoto T, Rifkin DB. Basic fibroblast growth factor, a protein devoid of secretory signal sequence, is released by cells via a pathway independent of the endoplasmic reticulum–Golgi complex. *J Cell Physiol* 1992;151:81–93.
1464. Rubartelli A, Cozzolino F, Talio M, et al. A novel secretory pathway for interleukin-1 beta, a protein lacking a signal sequence. *EMBO J* 1990;9:1503–1510.
1465. Kreager JA, Devine DV, Greenberg CS. Cytofluorometric identification of plasmin-sensitive factor XIIIa binding to platelets. *Thromb Haemost* 1988;60:88–93.
1466. Greenberg CS, Shuman MA. Specific binding of blood coagulation factor XIIIa to thrombin-stimulated platelets. *J Biol Chem* 1984;259:14721–14727.
1467. Nagy JA, Kradin RL, McDonagh J. Biosynthesis of factor XIII A and B subunits. *Adv Exp Med Biol* 1988;231:29–49.
1468. Mikuni Y, Iwanaga S, Konishi K. A peptide released from plasma fibrin stabilizing factor in the conversion to the active enzyme by thrombin. *Biochem Biophys Res Commun* 1973;54:1393–1403.
1469. Credo RB, Curtis CG, Lorand L. Ca<sup>2+</sup>-related regulatory function of fibrinogen. *Proc Natl Acad Sci U S A* 1978;75:4234–4237.
1470. Curtis CG, Brown KL, Credo RB, et al. Calcium-dependent unmasking of active center cysteine during activation of fibrin stabilizing factor. *Biochemistry* 1974;13:3774–3780.
1471. Hornyak TJ, Shafer JA. Role of calcium ion in the generation of factor XIII activity. *Biochemistry* 1991;30:6175–6182.
1472. Naski MC, Lorand L, Shafer JA. Characterization of the kinetic pathway for fibrin promotion of alpha-thrombin-catalyzed activation of plasma factor XIII. *Biochemistry* 1991;30:934–941.
1473. Janus TJ, Lewis SD, Lorand L, et al. Promotion of thrombin-catalyzed activation of factor XIII by fibrinogen. *Biochemistry* 1983;22:6269–6272.
1474. Lewis SD, Janus TJ, Lorand L, et al. Regulation of formation of factor XIIIa by its fibrin substrates. *Biochemistry* 1985;24:6772–6777.
1475. Greenberg CS, Miraglia CC, Rickles FR, et al. Cleavage of blood coagulation factor XIII and fibrinogen by thrombin during in vitro clotting. *J Clin Invest* 1985;75:1463–1470.
1476. Chung SI, Folk JE. Kinetic studies with transglutaminases. The human blood enzymes (activated coagulation factor 13 and the guinea pig hair follicle enzyme). *J Biol Chem* 1972;247:2798–2807.
1477. Gorman JJ, Folk JE. Structural features of glutamine substrates for human plasma factor XIIIa (activated blood coagulation factor XIII). *J Biol Chem* 1980;255:419–427.
1478. Everse SJ. New insights into fibrin(ogen) structure and function. *Vox Sang* 2002;83[Suppl 1]:375–382.
1479. Hantgan RR, Simpson PJ, Francis CW, et al. Fibrinogen structure and physiology. In: Colman RW,

- Hirsh J, Marder VJ, et al., eds. Hemostasis and thrombosis: basic principles and clinical practice. Philadelphia: Lippincott Williams & Wilkins, 2001:203–232.
1480. Doolittle RF, Yang Z, Mochalkin I. Crystal structure studies on fibrinogen and fibrin. *Ann N Y Acad Sci* 2001;936:31–43.
1481. Blomback B. Fibrinogen: evolution of the structure–function concept. Keynote address at fibrinogen 2000 congress. *Ann N Y Acad Sci* 2001;936:1–10.
1482. Straub PW. A study of fibrinogen production by human liver slices in vitro by immunoprecipitin method. *J Clin Invest* 1963;42:130.
1483. Studies of the metabolism and distribution of fibrinogen in healthy men with autologous <sup>125</sup>I-labeled fibrinogen. *J Clin Invest* 1966;45:103.
1484. Collen D, Tytgat GN, Claeys H, et al. Metabolism and distribution of fibrinogen. I. Fibrinogen turnover in physiological conditions in humans. *Br J Haematol* 1972;22:681–700.
1485. Rausen AA, Cruchaud A, McMillan CW. A study of fibrinogen turnover in classical hemophilia and congenital afibrinogenemia. *Blood* 1961;18:710.
1486. Blomback B, Blomback M, Henschen A, et al. N-terminal disulphide knot of human fibrinogen. *Nature* 1968;218:130–134.
1487. Doolittle RF, Blomback B. Amino acid investigations of fibrinopeptides from various mammals: evolutionary implications. *Nature* 1964;202:147–152.
1488. Doolittle RF. Evolution of fibrinogen molecules. *Thromb Diath Haemorrh Suppl* 1970;39:25–42.
1489. Doolittle RF. Difference in the clotting of lamprey fibrinogen by lamprey and bovine thrombins. *Biochem J* 1965;94:735–741.
1490. Doolittle RF. The structure and evolution of vertebrate fibrinogen. *Ann N Y Acad Sci* 1983;408:13–27.
1491. Doolittle RF. A detailed consideration of a principal domain of vertebrate fibrinogen and its relatives. *Protein Sci* 1992;1:1563–1577.
1492. Henschen A, Lottspeich F. Sequence homology between gamma-chain and beta-chain in human fibrin. *Thromb Res* 1977;11:869–880.
1493. Takagi T, Doolittle RF. Amino acid sequence studies on the alpha chain of human fibrinogen. Location of four plasmin attack points and a covalent cross-linking site. *Biochemistry* 1975;14:5149–5156.
1494. Watt KW, Takagi T, Doolittle RF. Amino acid sequence of the beta chain of human fibrinogen: homology with the gamma chain. *Proc Natl Acad Sci U S A* 1978;75:1731–1735.
1495. Kant JA, Fornace AJ, Jr., Saxe D, et al. Evolution and organization of the fibrinogen locus on chromosome 4: gene duplication accompanied by transposition and inversion. *Proc Natl Acad Sci U S A* 1985;82:2344–2348.
1496. Doolittle RF, Cottrell BA, Riley M. Amino acid compositions of the subunit chains of lamprey fibrinogen. Evolutionary significance of some structural anomalies. *Biochim Biophys Acta* 1976;453:439–452.
1497. Strong DD, Laudano AP, Hawiger J, et al. Isolation, characterization, and synthesis of peptides from human fibrinogen that block the staphylococcal clumping reaction and construction of a synthetic clumping particle. *Biochemistry* 1982;21:1414–1420.
1498. Crabtree GR, Comeau CM, Fowlkes DM, et al. Evolution and structure of the fibrinogen genes. Random insertion of introns or selective loss? *J Mol Biol* 1985;185:1–19.
1499. Morgan JG, Holbrook NJ, Crabtree GR. Nucleotide sequence of the gamma chain gene of rat

- fibrinogen: conserved intronic sequences. *Nucleic Acids Res* 1987;15:2774–2776.
1500. Weissbach L, Grieninger G. Bipartite mRNA for chicken alpha-fibrinogen potentially encodes an amino acid sequence homologous to. *Proc Natl Acad Sci U S A* 1990;87:5198–5202.
1501. Pan Y, Doolittle RF. cDNA sequence of a second fibrinogen alpha chain in lamprey: an archetypal version alignable with full-length beta and gamma chains. *Proc Natl Acad Sci U S A* 1992;89:2066–2070.
1502. Francis CW, Muller E, Henschen A, et al. Carboxyl-terminal amino acid sequences of two variant forms of the gamma chain of human plasma fibrinogen. *Proc Natl Acad Sci U S A* 1988;85:3358–3362.
1503. Jones FS, Hoffman S, Cunningham BA, et al. A detailed structural model of cytotactin: protein homologies, alternative RNA splicing, and binding regions. *Proc Natl Acad Sci U S A* 1989;86:1905–1909.
1504. Xu X, Doolittle RF. Presence of a vertebrate fibrinogen-like sequence in an echinoderm. *Proc Natl Acad Sci U S A* 1990;87:2097–2101.
1505. Baker NE, Mlodzik M, Rubin GM. Spacing differentiation in the developing *Drosophila* eye: a fibrinogen-related lateral inhibitor encoded by *scabrous*. *Science* 1990;250:1370–1377.
1506. Olaisen B, Teisberg P, Gedde-Dahl T, Jr. Fibrinogen gamma chain locus is on chromosome 4 in man. *Hum Genet* 1982;61:24–26.
1507. Henry I, Uzan G, Weil D, et al. The genes coding for A alpha-, B beta-, and gamma-chains of fibrinogen map to 4q2. *Am J Hum Genet* 1984;36:760–768.
1508. Rixon MW, Chan WY, Davie EW, et al. Characterization of a complementary deoxyribonucleic acid coding for the alpha chain of human fibrinogen. *Biochemistry* 1983;22:3237–3244.
1509. Chung DW, Chan WY, Davie EW. Characterization of a complementary deoxyribonucleic acid coding for the gamma chain of human fibrinogen. *Biochemistry* 1983;22:3250–3256.
1510. Crabtree GR. The molecular biology of fibrinogen. In: Stamatoyanopoulos G, Nienhuis AW, Leder P, Majerus PW, eds. *The molecular basis of blood diseases*. Philadelphia: WB Saunders, 1987:631–661.
1511. Chung DW, Harris JE, Davie EW. Nucleotide sequences of the three genes coding for human fibrinogen. *Adv Exp Med Biol* 1990;281:39–48.
1512. Crabtree GR, Kant JA. Molecular cloning of cDNA for the alpha, beta, and gamma chains of rat fibrinogen. A family of coordinately regulated genes. *J Biol Chem* 1981;256:9718–9723.
1513. Crabtree GR, Kant JA, Fornace AJ, Jr., et al. Regulation and characterization of the mRNAs for the A alpha, B beta and gamma chains of fibrinogen. *Ann N Y Acad Sci* 1983;408:457–468.
1514. Hu CH, Harris JE, Davie EW, et al. Characterization of the 5'-flanking region of the gene for the alpha chain of human fibrinogen. *J Biol Chem* 1995;270:28342–28349.
1515. Mizuguchi J, Hu CH, Cao Z, et al. Characterization of the 5'-flanking region of the gene for the gamma chain of human fibrinogen. *J Biol Chem* 1995;270:28350–28356.
1516. Fowlkes DM, Mullis NT, Comeau CM, et al. Potential basis for regulation of the coordinately expressed fibrinogen genes: homology in the 5' flanking regions. *Proc Natl Acad Sci U S A* 1984;81:2313–2316.
1517. Crabtree GR, Kant JA. Coordinate accumulation of the mRNAs for the alpha, beta, and gamma chains of rat fibrinogen following defibrination. *J Biol Chem* 1982;257:7277–7279.
1518. Otto JM, Grenett HE, Fuller GM. The coordinated regulation of fibrinogen gene transcription by hepatocyte-stimulating factor and dexamethasone. *J Cell Biol* 1987;105:1067–1072.
1519. Chung DW, Davie EW. gamma and gamma' chains of human fibrinogen are produced by alternative mRNA processing. *Biochemistry* 1984;23:4232–4236.



1520. Fornace AJ, Jr., Cummings DE, Comeau CM, et al. Structure of the human gamma-fibrinogen gene. Alternate mRNA splicing near the 3' end of the gene produces gamma A and gamma B forms of gamma-fibrinogen. *J Biol Chem* 1984;259:12826-12830.
1521. Fu Y, Grieninger G. Fib420: a normal human variant of fibrinogen with two extended alpha chains. *Proc Natl Acad Sci U S A* 1994;91:2625-2628.
1522. Francis CW, Mosesson MW. Terminology for fibrinogen gamma-chains differing in carboxyl terminal amino acid sequence. *Thromb Haemost* 1989;62:813-814.
1523. Fu Y, Weissbach L, Plant PW, et al. Carboxy-terminal-extended variant of the human fibrinogen alpha subunit: a novel exon conferring marked homology to beta and gamma subunits. *Biochemistry* 1992;31:11968-11972.
1524. Grieninger G. Contribution of the alpha EC domain to the structure and function of fibrinogen-420. *Ann N Y Acad Sci* 2001;936:44-64.
1525. Green FR. Fibrinogen polymorphisms and atherothrombotic disease. *Ann N Y Acad Sci* 2001;936:549-559.
1526. Vischetti M, Zito F, Donati MB, et al. Analysis of gene-environment interaction in coronary heart disease: fibrinogen polymorphisms as an example. *Ital Heart J* 2002;3:18-23.
1527. Iacoviello L, Vischetti M, Zito F, et al. Genes encoding fibrinogen and cardiovascular risk. *Hypertension* 2001;38:1199-1203.
1528. Degen JL. Genetic interactions between the coagulation and fibrinolytic systems. *Thromb Haemost* 2001;86:130-137.
1529. Martinez J. Congenital dysfibrinogenemia. *Curr Opin Hematol* 1997;4:357-365.
1530. Menart C, Sprunck N, Duhaut P, et al. Recurrent spontaneous intracerebral hematoma in a patient with afibrinogenemia. *Thromb Haemost* 1998;79:241-242.
1531. Ehmann WC, al Mondhiry H. Splenic rupture in afibrinogenemia: conservative versus surgical management. *Am J Med* 1995;99:444.
1532. De Marco L, Girolami A, Zimmerman TS, et al. von Willebrand factor interaction with the glycoprotein IIb/IIa complex. Its role in platelet function as demonstrated in patients with congenital afibrinogenemia. *J Clin Invest* 1986;77:1272-1277.
1533. Ni H, Denis CV, Subbarao S, et al. Persistence of platelet thrombus formation in arterioles of mice lacking both von Willebrand factor and fibrinogen. *J Clin Invest* 2000;106:385-392.
1534. Parameswaran R, Dickinson JP, de Lord S, et al. Spontaneous intracranial bleeding in two patients with congenital afibrinogenemia and the role of replacement therapy. *Haemophilia* 2000;6:705-708.
1535. Suh TT, Holmback K, Jensen NJ, et al. Resolution of spontaneous bleeding events but failure of pregnancy in fibrinogen-deficient mice. *Genes Dev* 1995;9:2020-2033.
1536. Holmback K, Danton MJ, Suh TT, et al. Impaired platelet aggregation and sustained bleeding in mice lacking the fibrinogen motif bound by integrin alpha IIb beta 3. *EMBO J* 1996;15:5760-5771.
1537. Phillips DR, Charo IF, Parise LV, et al. The platelet membrane glycoprotein IIb-IIIa complex. *Blood* 1988;71:831-843.
1538. Bugge TH, Kombrinck KW, Flick MJ, et al. Loss of fibrinogen rescues mice from the pleiotropic effects of plasminogen deficiency. *Cell* 1996;87:709-719.
1539. Drew AF, Kaufman AH, Kombrinck KW, et al. Ligneous conjunctivitis in plasminogen-deficient mice. *Blood* 1998;91:1616-1624.

1540. Drew AF, Tucker HL, Kombrinck KW, et al. Plasminogen is a critical determinant of vascular remodeling in mice. *Circ Res* 2000;87:133–139.
1541. Kao WW, Kao CW, Kaufman AH, et al. Healing of corneal epithelial defects in plasmin. *Invest Ophthalmol Vis Sci* 1998;39:502–508.
1542. Drew AF, Schiman HL, Kombrinck KW, et al. Persistent corneal haze after excimer laser photokeratectomy in plasminogen-deficient mice. *Invest Ophthalmol Vis Sci* 2000;41:67–72.
1543. Degen JL, Drew AF, Palumbo JS, et al. Genetic manipulation of fibrinogen and fibrinolysis in mice. *Ann N Y Acad Sci* 2001;936:276–290.
1544. Brennan SO, Fellowes AP, George PM. Molecular mechanisms of hypo- and afibrinogenemia. *Ann N Y Acad Sci* 2001;936:91–100.
1545. Higgins DL, Shafer JA. Fibrinogen Petoskey, a dysfibrinogenemia characterized by replacement of Arg-A alpha 16 by a histidyl residue. Evidence for thrombin-catalyzed hydrolysis at a histidyl residue. *J Biol Chem* 1981;256: 12013–12017.
1546. Henschen A, Kehl M, Southan C. Genetically abnormal fibrinogens—strategies for structure elucidation, including fibrinopeptide analysis. *Curr Probl Clin Biochem* 1984;14:273–320.
1547. Matsuda M. Molecular abnormalities of fibrinogen—the present status of structure elucidation. In: Iwanaga S, Takada A, Henschen A, eds. *Fibrinogen 4. Current basis and clinical aspects*. Amsterdam: Excerpta Medica, 1990:139–152.
1548. Kaudewitz H, Henschen A, Soria C, et al. The molecular defect of the genetically abnormal fibrinogen Christchurch II. In: Muller-Berghaus G, Scheefers-Borchel V, Selmayr E, Henschen A, eds. *Fibrinogen and its derivatives*. Amsterdam: Elsevier, 1986:31–36.
1549. Ebert RF. *Index of variant human fibrinogen*. Boca Raton: CRC Press, 1994.
1550. Hanss M, Biot F. A database for human fibrinogen variants. *Ann N Y Acad Sci* 2001;936:89–90.
1551. Yu S, Sher B, Kudryk B, et al. Intracellular assembly of human fibrinogen. *J Biol Chem* 1983;258:13407–13410.
1552. Yu S, Sher B, Kudryk B, et al. Fibrinogen precursors. Order of assembly of fibrinogen chains. *J Biol Chem* 1984;259:10574–10581.
1553. Hirose S, Oda K, Ikehara Y. Biosynthesis, assembly and secretion of fibrinogen in cultured rat hepatocytes. *Biochem J* 1988;251:373–377.
1554. Lee SY, Lee KP, Lim JW. Identification and biosynthesis of fibrinogen in human uterine cervix carcinoma cells. *Thromb Haemost* 1996;75:466–470.
1555. Haidaris PJ. Induction of fibrinogen biosynthesis and secretion from cultured pulmonary epithelial cells. *Blood* 1997;89:873–882.
1556. Haidaris PJ, Courtney MA. Tissue-specific and ubiquitous expression of fibrinogen gamma-chain mRNA. *Blood Coagul Fibrinolysis* 1990;1:433–437.
1557. Haidaris PJ, Courtney MA. Liver-specific RNA processing of the ubiquitously transcribed rat fibrinogen gamma-chain gene. *Blood* 1992;79:1218–1224.
1558. Nickerson JM, Fuller GM. In vitro synthesis of rat fibrinogen: identification of preA alpha, preB beta, and pre gamma polypeptides. *Proc Natl Acad Sci U S A* 1981;78:303–307.
1559. Nickerson JM, Fuller GM. Modification of fibrinogen chains during synthesis: glycosylation of B beta and gamma chains. *Biochemistry* 1981;20:2818–2821.
1560. Townsend RR, Hilliker E, Li YT, et al. Carbohydrate structure of human fibrinogen. Use of 300-MHz

- <sup>1</sup>H-NMR to characterize glycosidase-treated glycopeptides. *J Biol Chem* 1982;257:9704-9710.
1561. Kottgen E, Hell B, Muller C, et al. Demonstration of glycosylation variants of human fibrinogen, using the new technique of glycoprotein lectin immunosorbent assay (GLIA). *Biol Chem Hoppe Seyler* 1988;369:1157-1166.
1562. Langer BG, Hong SK, Schmelzer CH, et al. Deglycosylation of a native, protease-sensitive glycoprotein by peptide N-glycosidase F without protease inhibitors. *Anal Biochem* 1987;166:212-217.
1563. Seydewitz HH, Kaiser C, Rothweiler H, et al. The location of a second in vivo phosphorylation site in the A alpha-chain of human fibrinogen. *Thromb Res* 1984;33:487-498.
1564. Blomback B, Hessel B, Hogg D. Disulfide bridges in NH<sub>2</sub>-terminal part of human fibrinogen. *Thromb Res* 1976;8:639-658.
1565. Zhang JZ, Kudryk B, Redman CM. Symmetrical disulfide bonds are not necessary for assembly and secretion of human fibrinogen. *J Biol Chem* 1993;268:11278-11282.
1566. Zhang JZ, Redman C. Fibrinogen assembly and secretion. Role of intrachain disulfide loops. *J Biol Chem* 1996;271:30083-30088.
1567. Zhang JZ, Redman CM. Identification of B beta chain domains involved in human fibrinogen assembly. *J Biol Chem* 1992;267:21727-21732.
1568. Zhang JZ, Redman CM. Role of interchain disulfide bonds on the assembly and secretion of human fibrinogen. *J Biol Chem* 1994;269:652-658.
1569. Zhang JZ, Redman CM. Assembly and secretion of fibrinogen. Involvement of amino-terminal domains in dimer formation. *J Biol Chem* 1996;271:12674-12680.
1570. Jenkins GR, Seiffert D, Parmer RJ, et al. Regulation of plasminogen gene expression by interleukin-6. *Blood* 1997;89:2394-2403.
1571. Bailey K, Astbury WT, Rudall KM. Fibrinogen and fibrin as members of the keratin-myosin group. *Nature* 1943;151:716-717.
1572. Crick FHC, Kendrew JC. X-ray analysis and protein structure. *Adv Protein Chem* 1957;12:133-214.
1573. Scheraga HA, Laskowski M. The fibrinogen-fibrin conversion. *Adv Protein Chem* 1957;12:1-131.
1574. Caspary EA, Kekwick RGO. Physicochemical properties of human fibrinogen. *Biochem J* 1957;67:41.
1575. Edsall JT. Configuration of certain protein molecule. An inquiry concerning the present status of our knowledge. *Polym Sci* 1954;12:253-280.
1576. Shulman S. The size and shape of bovine fibrinogen. Studies of sedimentation, diffusion and viscosity. *J Am Chem Soc* 1953;75:5846-5852.
1577. Hall CE, Slayter HS. The fibrinogen molecule: its size, shape and mode of polymerization. *J Biophys Biochem Cy* 1959;5:11-15.
1578. Cohen C. Invited discussion at 1960 Symposium on Protein Structure. *J Polym Sci* 1961;49:144-145.
1579. Koppel G. Shape, size and structure of the fibrinogen molecule. *Thromb Diath Haemorrh* 1968;19:602-603.
1580. Pouit L, Hudry-Clergeon G, Sussillon M. Electron microscopy study of positive charges on fibrin fibers. *Biochim Biophys Acta* 1973;317:99-105.
1581. Fowler WE, Erickson HP. Trinodular structure of fibrinogen. Confirmation by both shadowing and negative stain electron microscopy. *J Mol Biol* 1979;134:241-249.

1582. Nussenzweig V, Seligmann M, Pelimont J, et al. Les produits de degradation du fibrinogene humain par la plasmine. I. Separation et proprietes physico-chemiques. *Ann Inst Pasteur* 1961;100:377-389.
1583. Marder VJ, Shulman NR, Carroll WR. High molecular weight derivatives of human fibrinogen produced by plasmin. I. Physicochemical and immunological characterization. *J Biol Chem* 1969;244:2111-2119.
1584. Rao SP, Poojary MD, Elliott BW, Jr., et al. Fibrinogen structure in projection at 18 Å resolution. Electron density by co-ordinated cryo-electron microscopy and X-ray crystallography. *J Mol Biol* 1991;222:89-98.
1585. Brown JH, Volkmann N, Jun G, et al. The crystal structure of modified bovine fibrinogen. *Proc Natl Acad Sci U S A* 2000;97:85-90.
1586. Yang Z, Mochalkin I, Veerapandian L, et al. Crystal structure of native chicken fibrinogen at 5.5-Å resolution. *Proc Natl Acad Sci U S A* 2000;97:3907-3912.
1587. Yang Z, Kollman JM, Pandi L, et al. Crystal structure of native chicken fibrinogen at 2.7 Å resolution. *Biochemistry* 2001;40:12515-12523.
1588. Doolittle RF, Watt KW, Cottrell BA, et al. The amino acid sequence of the alpha-chain of human fibrinogen. *Nature* 1979;280:464-468.
1589. Murakawa M, Okamura T, Kamura T, et al. Diversity of primary structures of the carboxy-terminal regions of mammalian fibrinogen A alpha-chains. Characterization of the partial nucleotide and deduced amino acid sequences in five mammalian species; rhesus monkey, pig, dog, mouse and Syrian hamster. *Thromb Haemost* 1993;69:351-360.
1590. Madrazo J, Brown JH, Litvinovich S, et al. Crystal structure of the central region of bovine fibrinogen (E5 fragment) at 1.4-Å resolution. *Proc Natl Acad Sci U S A* 2001;98:11967-11972.
1591. Spraggon G, Applegate D, Everse SJ, et al. Crystal structure of a recombinant alphaEC domain from human fibrinogen-420. *Proc Natl Acad Sci U S A* 1998;95:9099-9104.
1592. Yee VC, Pratt KP, Cote HC, et al. Crystal structure of a 30 kDa C-terminal fragment from the gamma chain of human fibrinogen. *Structure* 1997;5:125-138.
1593. Pratt KP, Cote HC, Chung DW, et al. The primary fibrin polymerization pocket: three-dimensional structure of a 30-kDa C-terminal gamma chain fragment complexed with the peptide Gly-Pro-Arg-Pro. *Proc Natl Acad Sci U S A* 1997;94:7176-7181.
1594. Yang Z, Spraggon G, Pandi L, et al. Crystal structure of fragment D from lamprey fibrinogen complexed with the peptide Gly-His-Arg-Pro-amide. *Biochemistry* 2002;41:10218-10224.
1595. Kostelansky MS, Betts L, Gorkun OV, et al. 2.8 Å crystal structures of recombinant fibrinogen fragment D with and without two peptide ligands: GHRP binding to the "b" site disrupts its nearby calcium-binding site. *Biochemistry* 2002;41:12124-12132.
1596. Ferry JD. The mechanism of polymerization of fibrinogen. *Proc Natl Acad Sci U S A* 1952;38:5980-5984.
1597. Heene DL, Matthias FR. Adsorption of fibrinogen derivatives on insolubilized fibrinogen and fibrin. *Thromb Res* 1973;2:137-154.
1598. Kudryk BJ, Collen D, Woods KR, et al. Evidence for localization of polymerization sites in fibrinogen. *J Biol Chem* 1974;249:3322-3325.
1599. Laudano AP, Doolittle RF. Synthetic peptide derivatives that bind to fibrinogen and prevent the polymerization of fibrin monomers. *Proc Natl Acad Sci U S A* 1978;75:3085-3089.
1600. Southan C. The elucidation of molecular defects in congenital dysfibrinogenemia. In: Francis JL, ed.

Fibrinogen, fibrin stabilisation, and fibrinolysis. Chichester: Ellis Horwood, 1998:100–127.

1601. Everse SJ, Spraggon G, Veerapandian L, et al. Crystal structure of fragment double-D from human fibrin with two different bound ligands. *Biochemistry* 1998;37:8637–8642.

1602. Everse SJ, Spraggon G, Veerapandian L, et al. Conformational changes in fragments D and double-D from human fibrin(ogen) upon binding the peptide ligand Gly-His-Arg-Pro-amide. *Biochemistry* 1999;38:2941–2946.

1603. Mihalyi E. Electrophoretic investigation of fibrin and fibrinogen dissolved in urea solutions. *Acta Chem Scand* 1950;4:351–358.

1604. Bailey K, Bettelheim FR, Lorand L, et al. Action of thrombin in the clotting of fibrinogen. *Nature* 1951;167:233–234.

1605. Blomback B. Studies on the action of thrombotic enzymes on bovine fibrinogen as measured by N-terminal analysis. *Arkiv Kemi* 2003;12:321.

1606. Doolittle RF. Structural aspects of the fibrinogen to fibrin conversion. *Adv Protein Chem* 1973;27:1–109.

1607. Blomback B, Hessel B, Hogg D, et al. A two-step fibrinogen-fibrin transition in blood coagulation. *Nature* 1978;275:501–505.

1608. Blomback B, Vestermark A. Isolation of fibrinopeptides by chromatography. *Arkiv Kemi* 1958;12:173.

1609. Shainoff JR, Page IH. Cofibrins and fibrin intermediates as indicators of thrombin activity in vivo. *Circ Res* 1960;8:1013–1022.

1610. Hanna LS, Scheraga HA, Francis CW, et al. Comparison of structures of various human fibrinogens and a derivative thereof by a study of the kinetics of release of fibrinopeptides. *Biochemistry* 1984;23:4681–4687.

1611. Lewis SD, Shields PP, Shafer JA. Characterization of the kinetic pathway for liberation of fibrinopeptides during assembly of fibrin. *J Biol Chem* 1985;260:10192–10199.

1612. Mihalyi E. Clotting of bovine fibrinogen. Kinetic analysis of the release of fibrinopeptides by thrombin and of the calcium uptake upon clotting at high fibrinogen concentrations. *Biochemistry* 1988;27:976–982.

1613. Vindigni A, Di Cera E. Release of fibrinopeptides by the slow and fast forms of thrombin. *Biochemistry* 1996;35:4417–4426.

1614. Martinelli RA, Scheraga HA. Steady-state kinetic study of the bovine thrombin-fibrinogen interaction. *Biochemistry* 1980;19:2343–2350.

1615. Bettelheim FR, Bailey K. The products of the action of thrombin on fibrinogen. *Biochim Biophys Acta* 1952;9:578–579.

1616. Barlow GH, Holleman WH, Lorand L. The action of Arvin on fibrin stabilizing factor (factor XIII). *Res Commun Chem Pathol Pharmacol* 1970;83:39–42.

1617. Edgar W, Prentice CRM. The proteolytic actions of ancrod on human fibrinogen and polypeptide chains. *Thromb Res* 1973;2:85–96.

1618. Dyr JE, Blomback B, Hessel B, et al. Conversion of fibrinogen to fibrin induced by preferential release of fibrinopeptide B. *Biochim Biophys Acta* 1989;990:18–24.

1619. Mosesson MW, DiOrio JP, Muller MF, et al. Studies on the ultrastructure of fibrin lacking fibrinopeptide B (beta-fibrin). *Blood* 1987;69:1073–1081.

1620. Shainoff JR, Dardik BN. Fibrinopeptide B in fibrin assembly and metabolism: physiologic significance

- in delayed release of the peptide. *Ann N Y Acad Sci* 1983;408:254–268.
1621. Shainoff JR, Dardik BN. Fibrinopeptide B and aggregation of fibrinogen. *Science* 1979;204:200–202.
1622. Doolittle RF. Fibrinogen and fibrin. In: Bloom AL, Thomas DP, eds. *Haemostasis and thrombosis*. Edinburgh: Churchill Livingstone, 1981:163–191.
1623. Hantgan RR, Hermans J. Assembly of fibrin. A light scattering study. *J Biol Chem* 1979;254:11272–11281.
1624. Hantgan R, Fowler W, Erickson H, et al. Fibrin assembly: a comparison of electron microscopic and light scattering results. *Thromb Haemost* 1980;44:119–124.
1625. Weisel JW, Phillips GN, Jr., Cohen C. The structure of fibrinogen and fibrin: II. Architecture of the fibrin clot. *Ann N Y Acad Sci* 1983;408:367–379.
1626. Fowler WE, Hantgan RR, Hermans J, et al. Structure of the fibrin protofibril. *Proc Natl Acad Sci U S A* 1981;78:4872–4876.
1627. Mosesson MW, Siebenlist KR, Amrani DL, et al. Identification of covalently linked trimeric and tetrameric D domains in crosslinked fibrin. *Proc Natl Acad Sci U S A* 1989;86:1113–1117.
1628. Kudryk B, Okada M, Redman CM, et al. Biosynthesis of dog fibrinogen. Characterization of nascent fibrinogen in the rough endoplasmic reticulum. *Eur J Biochem* 1982;125:673–682.
1629. Gorkun OV, Veklich YI, Medved LV, et al. Role of the alpha C domains of fibrin in clot formation. *Biochemistry* 1994;33:6986–6997.
1630. Weisel JW, Papsun DM. Involvement of the COOH-terminal portion of the alpha-chain of fibrin in the branching of fibers to form a clot. *Thromb Res* 1987;47:155–163.
1631. Muller MF, Ris H, Ferry JD. Electron microscopy of fine fibrin clots and fine and coarse fibrin films. Observations of fibers in cross-section and in deformed states. *J Mol Biol* 1984;174:369–384.
1632. Weisel JW. Fibrin assembly. Lateral aggregation and the role of the two pairs of fibrinopeptides. *Biophys J* 1986;50:1079–1093.
1633. Carr ME, Jr., Hermans J. Size and density of fibrin fibers from turbidity. *Macromolecules* 1978;11:46–50.
1634. Folk JE, Finlayson JS. The epsilon-(gamma-glutamyl)lysine crosslink and the catalytic role of transglutaminases. *Adv Protein Chem* 1977;31:1–133.
1635. Pisano JJ, Finlayson JS, Peyton MP. Cross-link in fibrin polymerized by factor 13: epsilon-(gamma-glutamyl)lysine. *Science* 1968;160:892–893.
1636. Shen LL, Hermans J, McDonagh J, et al. Effects of calcium ion and covalent crosslinking on formation and elasticity of fibrin cells. *Thromb Res* 1975;6:255–265.
1637. Gerth C, Roberts WW, Ferry JD. Rheology of fibrin clots. II. Linear viscoelastic behavior in shear creep. *Biophys Chem* 1974;2:208–217.
1638. McDonagh RP, Jr., McDonagh J, Duckert F. The influence of fibrin crosslinking on the kinetics of urokinase-induced clot lysis. *Br J Haematol* 1971;21: 323–332.
1639. Shen LL, McDonagh RP, McDonagh J, et al. Early events in the plasmin digestion of fibrinogen and fibrin. Effects of plasmin on fibrin polymerization. *J Biol Chem* 1977;252:6184–6189.
1640. Francis CW, Marder VJ. Increased resistance to plasminic degradation of fibrin with highly crosslinked alpha-polymer chains formed at high factor XIII concentrations. *Blood* 1988;71:1361–1365.
1641. Chen R, Doolittle RF. Identification of the polypeptide chains involved in the cross-linking of fibrin.

Proc Natl Acad Sci U S A 1969;63:420.

1642. Fowler WE, Erickson HP, Hantgan RR, et al. Cross-linked fibrinogen dimers demonstrate a feature of the molecular packing in fibrin fibers. *Science* 1981;211:287-289.

1643. Siebenlist KR, Meh DA, Wall JS, et al. Orientation of the carboxy-terminal regions of fibrin gamma chain dimers determined from the crosslinked products formed in mixtures of fibrin, fragment D, and factor XIIIa. *Thromb Haemost* 1995;74:1113-1119.

1644. Mosesson MW. Fibrinogen and fibrin polymerization: appraisal of the binding events that accompany fibrin generation and fibrin clot assembly. *Blood Coagul Fibrinolysis* 1997;8:257-267.

1645. McKee PA, Mattock P, Hill RL. Subunit structure of human fibrinogen, soluble fibrin, and cross-linked insoluble fibrin. *Proc Natl Acad Sci U S A* 1970;66:738-744.

1646. Cottrell BA, Strong DD, Watt KW, et al. Amino acid sequence studies on the alpha chain of human fibrinogen. Exact location of cross-linking acceptor sites. *Biochemistry* 1979;18:5405-5410.

1647. Gaffney PJ, Whitaker AN. Fibrin crosslinks and lysis rates. *Thromb Res* 1979;14:85-94.

1648. Sakata Y, Aoki N. Cross-linking of alpha 2-plasmin inhibitor to fibrin by fibrin-stabilizing factor. *J Clin Invest* 1980;65:290-297.

1649. Sakata Y, Aoki N. Significance of cross-linking of alpha 2-plasmin inhibitor to fibrin in inhibition of fibrinolysis and in hemostasis. *J Clin Invest* 1982;69:536-542.

1650. Sakharov DV, Plow EF, Rijken DC. On the mechanism of the antifibrinolytic activity of plasma carboxypeptidase B. *J Biol Chem* 1997;272:14477-14482.

1651. Wang W, Boffa MB, Bajzar L, et al. A study of the mechanism of inhibition of fibrinolysis by activated thrombin-activable fibrinolysis inhibitor. *J Biol Chem* 1998;273:27176-27181.

1652. Broze GJ, Jr., Higuchi DA. Coagulation-dependent inhibition of fibrinolysis: role of carboxypeptidase-U and the premature lysis of clots from hemophilic plasma. *Blood* 1996;88:3815-3823.

1653. Marder VJ. Immunologic structure of fibrinogen and its plasmin degradation products. Theoretical and clinical considerations. In: Laki K, ed. *Fibrinogen*. New York: Marcel Dekker Inc, 1968:339-358.

1654. Marder VJ. Physicochemical studies of intermediate and final products of plasmin digestion of human fibrinogen. *Thromb Diath Haemorrh* 1970;80:187-195.

1655. Larrieu MJ, Marder VJ, Inceman S. Effects of fibrinogen degradation products on platelets and coagulation. *Thromb Diath Haemorrh Suppl* 1966;20:215-226.

1656. Marder VJ, Shulman NR, Carroll WR. The importance of intermediate degradation products of fibrinogen in fibrinolytic hemorrhage. *Trans Assoc Am Physicians* 1967;80:156-167.

1657. Francis CW, Marder VJ, Barlow GH. Plasmic degradation of crosslinked fibrin. Characterization of new macromolecular soluble complexes and a model of their structure. *J Clin Invest* 1980;66:1033-1043.

1658. Pizzo SV, Taylor LM, Jr., Schwartz ML, et al. Subunit structure of fragment D from fibrinogen and cross-linked fibrin. *J Biol Chem* 1973;248:4584-4590.

1659. Marder VJ, Francis CW. Plasmin degradation of cross-linked fibrin. *Ann N Y Acad Sci* 1983;408:397-406.

1660. Francis CW, Marder VJ. A molecular model of plasmic degradation of crosslinked fibrin. *Semin Thromb Hemost* 1982;8:25-35.

1661. Gaffney PJ, Brasher M. Subunit structure of the plasmin-induced degradation products of crosslinked fibrin. *Biochim Biophys Acta* 1973;295:308-313.

1662. Hudry-Clergeon G, Patural L, Suscillon M. Identification d'un complexe (D-D)E dans les produits de



degradation de la fibrine bovine stabilisee par le Factor XIII. *Pathol Biol* 1974;22[Suppl]:47-52.

1663. Gaffney PJ, Lane DA, Kakkar VV, et al. Characterisation of a soluble D dimer-E complex in crosslinked fibrin digests. *Thromb Res* 1975;7:89-99.

1664. Bachmann F. Plasminogen-plasmin enzyme system. In: Colman RW, Hirsh J, Marder VJ, et al., eds. *Hemostasis and thrombosis: basic principles and clinical practice*. Philadelphia: Lippincott Williams & Wilkins, 2001:275-320.

1665. Bugge TH, Flick MJ, Daugherty CC, et al. Plasminogen deficiency causes severe thrombosis but is compatible with development and reproduction. *Genes Dev* 1995;9:794-807.

1666. Ploplis VA, Carmeliet P, Vazirzadeh S, et al. Effects of disruption of the plasminogen gene on thrombosis, growth, and health in mice. *Circulation* 1995;92:2585-2593.

1667. Murray JC, Buetow KH, Donovan M, et al. Linkage disequilibrium of plasminogen polymorphisms and assignment of the gene to human chromosome 6q26-6q27. *Am J Hum Genet* 1987;40:338-350.

1668. Petersen TE, Martzen MR, Ichinose A, et al. Characterization of the gene for human plasminogen, a key proenzyme in the fibrinolytic system. *J Biol Chem* 1990;265:6104-6111.

1669. Ichinose A. Multiple members of the plasminogen-apolipoprotein(a) gene family associated with thrombosis. *Biochemistry* 1992;31:3113-3118.

1670. Magnaghi P, Citterio E, Margaretti N, et al. Molecular characterisation of the human apo(a)-plasminogen gene family clustered on the telomeric region of chromosome 6 (6q26-27). *Hum Mol Genet* 1994;3:437-442.

1671. Kida M, Wakabayashi S, Ichinose A. Characterization of the 5'-flanking regions of plasminogen-related genes A and B. *FEBS Lett* 1997;404:95-99.

1672. Raum D, Marcus D, Alper CA, et al. Synthesis of human plasminogen by the liver. *Science* 1980;208:1036-1037.

1673. Collen D, Tytgat G, Claeys H, et al. Metabolism of plasminogen in healthy subjects: effect of tranexamic acid. *J Clin Invest* 1972;51:1310-1318.

1674. Wallen P, Wiman B. Characterization of human plasminogen. I. On the relationship between different molecular forms of plasminogen demonstrated in plasma and found in purified preparations. *Biochim Biophys Acta* 1970;221:20-30.

1675. Wallen P, Wiman B. Characterization of human plasminogen. II. Separation and partial characterization of different molecular forms of human plasminogen. *Biochim Biophys Acta* 1972;257:122-134.

1676. Summaria L, Arzadon L, Bernabe P, et al. Studies on the isolation of the multiple molecular forms of human plasminogen and plasmin by isoelectric focusing methods. *J Biol Chem* 1972;247:4691-4702.

1677. Pirie-Shepherd SR, Jett EA, Andon NL, et al. Sialic acid content of plasminogen 2 glycoforms as a regulator of fibrinolytic activity. Isolation, carbohydrate analysis, and kinetic characterization of six glycoforms of plasminogen. *J Biol Chem* 1995;270:5877-5881.

1678. Takada A, Takada Y. Physiology of plasminogen: with special reference to activation and degradation. *Haemostasis* 1988;18[Suppl 1]:25-35.

1679. Molgaard L, Ponting CP, Christensen U. Glycosylation at Asn-289 facilitates the ligand-induced conformational changes of human Glu-plasminogen. *FEBS Lett* 1997;405:363-368.

1680. Gonzalez-Gronow M, Grenett HE, Fuller GM, et al. The role of carbohydrate in the function of human plasminogen: comparison of the protein obtained from molecular cloning and expression in *Escherichia coli* and COS cells. *Biochim Biophys Acta* 1990;1039:269-276.

1681. Hatton MW, Southward S, Ross-Ouellet B. Catabolism of plasminogen glycoforms I and II in rabbits:

- relationship to plasminogen synthesis by the rabbit liver in vitro. *Metabolism* 1994;43:1430–1437.
1682. Hatton MW, Day S, Ross B, et al. Plasminogen II accumulates five times faster than plasminogen I at the site of a balloon de-endothelializing injury in vivo to the rabbit aorta: comparison with other hemostatic proteins. *J Lab Clin Med* 1999;134:260–266.
1683. Pirie-Shepherd SR, Stevens RD, Andon NL, et al. Evidence for a novel O-linked sialylated trisaccharide on Ser-248 of human plasminogen 2. *J Biol Chem* 1997;272:7408–7411.
1684. Forsgren M, Raden B, Israelsson M, et al. Molecular cloning and characterization of a full-length cDNA clone for human plasminogen. *FEBS Lett* 1987;213:254–260.
1685. Malinowski DP, Sadler JE, Davie EW. Characterization of a complementary deoxyribonucleic acid coding for human and bovine plasminogen. *Biochemistry* 1984;23:4243–4250.
1686. Rakoczi I, Wiman B, Collen D. On the biological significance of the specific interaction between fibrin, plasminogen and antiplasmin. *Biochim Biophys Acta* 1978;540:295–300.
1687. Wiman B, Wallen P. The specific interaction between plasminogen and fibrin. A physiological role of the lysine binding site in plasminogen. *Thromb Res* 1977;10:213–222.
1688. Thorsen S, Clemmensen I, Sottrup-Jensen L, et al. Adsorption to fibrin of native fragments of known primary structure from human plasminogen. *Biochim Biophys Acta* 1981;668:377–387.
1689. Wiman B, Lijnen HR, Collen D. On the specific interaction between the lysine-binding sites in plasmin and complementary sites in alpha2-antiplasmin and in fibrinogen. *Biochim Biophys Acta* 1979;579:142–154.
1690. Lijnen HR, Hoylaerts M, Collen D. Isolation and characterization of a human plasma protein with affinity for the lysine binding sites in plasminogen. Role in the regulation of fibrinolysis and identification as histidine-rich glycoprotein. *J Biol Chem* 1980;255:10214–10222.
1691. Selim TE, Ghoneim HR, Uknis AB, et al. High-molecular-mass and low-molecular-mass kininogens block plasmin-induced platelet aggregation by forming a complex with kringle 5 of plasminogen/plasmin. *Eur J Biochem* 1997;250:532–538.
1692. Silverstein RL, Leung LL, Harpel PC, et al. Complex formation of platelet thrombospondin with plasminogen. Modulation of activation by tissue activator. *J Clin Invest* 1984;74:1625–1633.
1693. Thorsen S, Astrup T. Substrate composition and the effect of epsilon-aminocaproic acid on tissue plasminogen activator and urokinase-induced fibrinolysis. *Thromb Diath Haemorrh* 1974;32:306–324.
1694. Violand BN, Byrne R, Castellino FJ. The effect of alpha-, omega-amino acids on human plasminogen structure and activation. *J Biol Chem* 1978;253:5395–5401.
1695. Sjöholm I. Studies on the conformational changes of plasminogen induced during activation to plasmin and by 6-aminohexanoic acid. *Eur J Biochem* 1973;39:471–479.
1696. Castellino FJ. Biochemistry of human plasminogen. *Semin Thromb Hemost* 1984;10:18–23.
1697. Mangel WF, Lin BH, Ramakrishnan V. Characterization of an extremely large, ligand-induced conformational change in plasminogen. *Science* 1990;248:69–73.
1698. Ramakrishnan V, Patthy L, Mangel WF. Conformation of Lys-plasminogen and the kringle 1–3 fragment of plasminogen analyzed by small-angle neutron scattering. *Biochemistry* 1991;30:3963–3969.
1699. O'Reilly MS, Holmgren L, Shing Y, et al. Angiostatin: a novel angiogenesis inhibitor that mediates the suppression of metastases by a Lewis lung carcinoma. *Cell* 1994;79:315–328.
1700. Violand BN, Castellino FJ. Mechanism of the urokinase-catalyzed activation of human plasminogen. *J Biol Chem* 1976;251:3906–3912.
1701. Claeys H, Vermeylen J. Physico-chemical and proenzyme properties of NH<sub>2</sub>-terminal glutamic acid

and NH<sub>2</sub>-terminal lysine human plasminogen. Influence of 6-aminohexanoic acid. *Biochim Biophys Acta* 1974;342:351-359.

1702. Kluft C, Dooijewaard G, Emeis JJ. Role of the contact system in fibrinolysis. *Semin Thromb Hemost* 1987;13:50-68.

1703. Colman RW. Activation of plasminogen by human plasma kallikrein. *Biochem Biophys Res Commun* 1969;35:273-279.

1704. Mandle RJ, Jr., Kaplan AP. Hageman-factor-dependent fibrinolysis: generation of fibrinolytic activity by the interaction of human activated factor XI and plasminogen. *Blood* 1979;54:850-862.

1705. Goldsmith GH, Jr., Saito H, Ratnoff OS. The activation of plasminogen by Hageman factor (Factor XII) and Hageman factor fragments. *J Clin Invest* 1978;62:54-60.

1706. Schousboe I, Feddersen K, Rojkaer R. Factor XIIa is a kinetically favorable plasminogen activator. *Thromb Haemost* 1999;82:1041-1046.

1707. Booyse FM, Scheinbuks J, Radek J, et al. Immunological identification and comparison of plasminogen activator forms in cultured normal human endothelial cells and smooth muscle cells. *Thromb Res* 1981;24:495-504.

1708. Goldsmith GH, Jr., Ziats NP, Robertson AL, Jr. Studies on plasminogen activator and other proteases in subcultured human vascular cells. *Exp Mol Pathol* 1981;35:257-264.

1709. Levin EG, Loskutoff DJ. Cultured bovine endothelial cells produce both urokinase and tissue-type plasminogen activators. *J Cell Biol* 1982;94:631-636.

1710. Levin EG. Latent tissue plasminogen activator produced by human endothelial cells in culture: evidence for an enzyme-inhibitor complex. *Proc Natl Acad Sci U S A* 1983;80:6804-6808.

1711. Allen RA, Pepper DS. Isolation and properties of human vascular plasminogen activator. *Thromb Haemost* 1981;45:43-50.

1712. Papadaki M, Ruef J, Nguyen KT, et al. Differential regulation of protease activated receptor-1 and tissue plasminogen activator expression by shear stress in vascular smooth muscle cells. *Circ Res* 1998;83:1027-1034.

1713. Wang Y, Hand AR, Wang YH, et al. Functional and morphologic evidence of the presence of tissue-plasminogen activator in vascular nerves: implications for a neurologic control of vessel wall fibrinolysis and rigidity. *J Neurosci Res* 1998;53:443-453.

1714. Brisson-Jeanneau C, Solberg LA, Jr., Sultan Y. Presence of functionally active tissue plasminogen activator in human CFU-M derived megakaryocytes in vitro. *Fibrinolysis* 1990;4:107-115.

1715. Brisson-Jeanneau C, Nelles L, Rouer E, et al. Tissue-plasminogen activator RNA detected in megakaryocytes by in situ hybridization and biotinylated probe. *Histochemistry* 1990;95:23-26.

1716. Bankl HC, Grossschmidt K, Pikula B, et al. Mast cells are augmented in deep vein thrombosis and express a profibrinolytic phenotype. *Hum Pathol* 1999;30:188-194.

1717. Sillaber C, Baghestanian M, Bevec D, et al. The mast cell as site of tissue-type plasminogen activator expression and fibrinolysis. *J Immunol* 1999;162:1032-1041.

1718. Hart PH, Vitti GF, Burgess DR, et al. Human monocytes can produce tissue-type plasminogen activator. *J Exp Med* 1989;169:1509-1514.

1719. Tyagi SC, Lewis K, Pikes D, et al. Stretch-induced membrane type matrix metalloproteinase and tissue plasminogen activator in cardiac fibroblast cells. *J Cell Physiol* 1998;176:374-382.

1720. Collen D, Lijnen HR, Todd PA, et al. Tissue-type plasminogen activator. A review of its pharmacology and therapeutic use as a thrombolytic agent. *Drugs* 1989;38:346-388.

1721. Lucas RV, Miller ML. The fibrinolytic system. Recent advances. *Cleve Clin J Med* 1988;55:531-541.
1722. Rijken DC, Juhan-Vague I, De Cock F, et al. Measurement of human tissue-type plasminogen activator by a two-site immunoradiometric assay. *J Lab Clin Med* 1983;101:274-284.
1723. Stalder M, Hauert J, Kruihof EK, et al. Release of vascular plasminogen activator (v-PA) after venous stasis: electrophoretic-zymographic analysis of free and complexed v-PA. *Br J Haematol* 1985;61:169-176.
1724. Holvoet P, Cleemput H, Collen D. Assay of human tissue-type plasminogen activator (t-PA) with an enzyme-linked immunosorbent assay (ELISA) based on three murine monoclonal antibodies to t-PA. *Thromb Haemost* 1985;54:684-687.
1725. Nicoloso G, Hauert J, Kruihof EK, et al. Fibrinolysis in normal subjects—comparison between plasminogen activator inhibitor and other components of the fibrinolytic system. *Thromb Haemost* 1988;59:299-303.
1726. Takada Y, Takada A. Plasma levels of t-PA free PAI-1 and a complex of t-PA with PAI-1 in human males and females at various ages. *Thromb Res* 1989;55:601-609.
1727. Booth NA, Walker E, Maughan R, et al. Plasminogen activator in normal subjects after exercise and venous occlusion: t-PA circulates as complexes with C1-inhibitor and PAI-1. *Blood* 1987;69:1600-1604.
1728. Eitzman DT, Fay WP, Ginsburg D. Plasminogen activator inhibitor-1. In: Becker RC, ed. *Textbook of coronary thrombosis and thrombolysis*. Boston: Kluwer Academic Publishers, 1997:65-78.
1729. Chandler WL, Alessi MC, Aillaud MF, et al. Clearance of tissue plasminogen activator (TPA) and TPA/plasminogen activator inhibitor type 1 (PAI-1) complex: relationship to elevated TPA antigen in patients with high PAI-1 activity levels. *Circulation* 1997;96:761-768.
1730. Garabedian HD, Gold HK, Leinbach RC, et al. Dose-dependent thrombolysis, pharmacokinetics and hemostatic effects of recombinant human tissue-type plasminogen activator for coronary thrombosis. *Am J Cardiol* 1986;58:673-679.
1731. Camani C, Kruihof EK. Clearance receptors for tissue-type plasminogen activator. *Int J Hematol* 1994;60:97-109.
1732. Emeis JJ, van den Hoogen CM, Jense D. Hepatic clearance of tissue-type plasminogen activator in rats. *Thromb Haemost* 1985;54:661-664.
1733. Bakhit C, Lewis D, Billings R, et al. Cellular catabolism of recombinant tissue-type plasminogen activator. Identification and characterization of a novel high affinity uptake system on rat hepatocytes. *J Biol Chem* 1987;262:8716-8720.
1734. Benham FJ, Spurr N, Povey S, et al. Assignment of tissue-type plasminogen activator to chromosome 8 in man and identification of a common restriction length polymorphism within the gene. *Mol Biol Med* 1984;2:251-259.
1735. Browne MJ, Tyrrell AW, Chapman CG, et al. Isolation of a human tissue-type plasminogen-activator genomic DNA clone and its expression in mouse L cells. *Gene* 1985;33:279-284.
1736. Fisher R, Waller EK, Grossi G, et al. Isolation and characterization of the human tissue-type plasminogen activator structural gene including its 5' flanking region. *J Biol Chem* 1985;260:11223-11230.
1737. Degen SJ, Rajput B, Reich E. The human tissue plasminogen activator gene. *J Biol Chem* 1986;261:6972-6985.
1738. Bulens F, Ibanez-Tallon I, Van Acker P, et al. Retinoic acid induction of human tissue-type plasminogen activator gene expression via a direct repeat element (DR5) located at -7 kilobases. *J Biol Chem* 1995;270:7167-7175.
1739. Bulens F, Merchiers P, Ibanez-Tallon I, et al. Identification of a multihormone responsive enhancer

- far upstream from the human tissue-type plasminogen activator gene. *J Biol Chem* 1997;272:663-671.
1740. Merchiers P, Bulens F, Stockmans I, et al. 1,25-Dihydroxyvitamin D(3) induction of the tissue-type plasminogen activator gene is mediated through its multihormone-responsive enhancer. *FEBS Lett* 1999;460:289-296.
1741. Merchiers P, Bulens F, De Vriese A, et al. Involvement of Sp1 in basal and retinoic acid induced transcription of the human tissue-type plasminogen activator gene. *FEBS Lett* 1999;456:149-154.
1742. Henderson BR, Sleight MJ. TATA box-independent transcription of the human tissue plasminogen activator gene initiates within a sequence conserved in related genes. *FEBS Lett* 1992;309:130-134.
1743. Costa M, Shen Y, Maurer F, et al. Transcriptional regulation of the tissue-type plasminogen-activator gene in human endothelial cells: identification of nuclear factors that recognise functional elements in the tissue-type plasminogen-activator gene promoter. *Eur J Biochem* 1998;258:123-131.
1744. Ouyang Y, Huang P, Huang C. Influence of 5'-untranslated region (UTR) sequence on the regulation of tissue plasminogen activator (t-PA) mRNA expression. *Sci China B* 1995;40:1378-1383.
1745. Huarte J, Belin D, Vassalli A, et al. Meiotic maturation of mouse oocytes triggers the translation and polyadenylation of dormant tissue-type plasminogen activator mRNA. *Genes Dev* 1987;1:1201-1211.
1746. Ouyang Y, Huang P, Huang C. Inhibitory effect of 3'-untranslated region (3'-UTR) of human tissue-plasminogen activator (ht-PA) mRNA on its expression. *Sci China B* 1995;38:1253-1260.
1747. van der Bom JG, de Knijff P, Haverkate F, et al. Tissue plasminogen activator and risk of myocardial infarction. The Rotterdam Study. *Circulation* 1997;95:2623-2627.
1748. Tishkoff SA, Ruano G, Kidd JR, et al. Distribution and frequency of a polymorphic Alu insertion at the plasminogen activator locus in humans. *Hum Genet* 1996;97:759-764.
1749. Iacoviello L, Di Castelnuovo A, de Knijff P, et al. Alu-repeat polymorphism in the tissue-type plasminogen activator (t-PA) gene, t-PA levels and risk of familial myocardial infarction (AMI). *Fibrinolysis* 1996;10[Suppl 2]:13-16.
1750. Ridker PM, Baker MT, Hennekens CH, et al. Alu-repeat polymorphism in the gene coding for tissue-type plasminogen activator (t-PA) and risks of myocardial infarction among middle-aged men. *Arterioscler Thromb Vasc Biol* 1997;17:1687-1690.
1751. Steeds R, Adams M, Smith P, et al. Distribution of tissue plasminogen activator insertion/deletion polymorphism in myocardial infarction and control subjects. *Thromb Haemost* 1998;79:980-984.
1752. Ludwig M, Wohn KD, Schleuning WD, et al. Allelic dimorphism in the human tissue-type plasminogen activator (TPA) gene as a result of an Alu insertion/deletion event. *Hum Genet* 1992;88:388-392.
1753. Rigat B, Hubert C, Alhenc-Gelas F, et al. An insertion/deletion polymorphism in the angiotensin I-converting enzyme gene accounting for half the variance of serum enzyme levels. *J Clin Invest* 1990;86:1343-1346.
1754. Ladenvall P, Wall U, Jern S, et al. Identification of eight novel single-nucleotide polymorphisms at human tissue-type plasminogen activator (t-PA) locus: association with vascular t-PA release in vivo. *Thromb Haemost* 2000;84:150-155.
1755. Ladenvall P, Johansson L, Jansson JH, et al. Tissue-type plasminogen activator -7,351C/T enhancer polymorphism is associated with a first myocardial infarction. *Thromb Haemost* 2002;87:105-109.
1756. Carmeliet P, Schoonjans L, Kieckens L, et al. Physiological consequences of loss of plasminogen activator gene function in mice. *Nature* 1994;368:419-424.
1757. Carmeliet P, Collen D. Targeted gene manipulation and transfer of the plasminogen and coagulation systems in mice. *Fibrinolysis* 1996;10:195-213.
1758. Pohl G, Kallstrom M, Bergsdorf N, et al. Tissue plasminogen activator: peptide analyses confirm an

indirectly derived amino acid sequence, identify the active site serine residue, establish glycosylation sites, and localize variant differences. *Biochemistry* 1984;23:3701–3707.

1759. Pennica D, Holmes WE, Kohr WJ, et al. Cloning and expression of human tissue-type plasminogen activator cDNA in *E. coli*. *Nature* 1983;301:214–221.

1760. Wallen P, Pohl G, Bergsdorf N, et al. Structural characterization of tissue plasminogen activator purified by immunosorbent chromatography. In: Davidson JF, Bachmann F, Bouvier CA, et al., eds. *Progress in fibrinolysis*. Edinburgh: Churchill Livingstone, 1983:338–343.

1761. Berg DT, Grinnell BW. Signal and propeptide processing of human tissue plasminogen activator: activity of a pro-tPA derivative. *Biochem Biophys Res Commun* 1991;179:1289–1296.

1762. Jornvall H, Pohl G, Bergsdorf N, et al. Differential proteolysis and evidence for a residue exchange in tissue plasminogen activator suggest possible association between two types of protein microheterogeneity. *FEBS Lett* 1983;156:47–50.

1763. Boose JA, Kuismanen E, Gerard R, et al. The single-chain form of tissue-type plasminogen activator has catalytic activity: studies with a mutant enzyme that lacks the cleavage site. *Biochemistry* 1989;28:635–643.

1764. Rijken DC, Hoylaerts M, Collen D. Fibrinolytic properties of one-chain and two-chain human extrinsic (tissue-type) plasminogen activator. *J Biol Chem* 1982;257:2920–2925.

1765. Rijken DC, Groeneveld E. Isolation and functional characterization of the heavy and light chains of human tissue-type plasminogen activator. *J Biol Chem* 1986;261:3098–3102.

1766. Ranby M, Bergsdorf N, Nilsson T. Enzymatic properties of the one- and two-chain form of tissue plasminogen activator. *Thromb Res* 1982;27:175–183.

1767. Ny T, Elgh F, Lund B. The structure of the human tissue-type plasminogen activator gene: correlation of intron and exon structures to functional and structural domains. *Proc Natl Acad Sci U S A* 1984;81:5355–5359.

1768. Banyai L, Varadi A, Patthy L. Common evolutionary origin of the fibrin-binding structures of fibronectin and tissue-type plasminogen activator. *FEBS Lett* 1983;163:37–41.

1769. Verde P, Stoppelli MP, Galeffi P, et al. Identification and primary sequence of an unspliced human urokinase poly(A)<sup>+</sup> RNA. *Proc Natl Acad Sci U S A* 1984;81:4727–4731.

1770. Holland SK, Harlos K, Blake CC. Deriving the generic structure of the fibronectin type II domain from the prothrombin Kringle 1 crystal structure. *EMBO J* 1987;6:1875–1880.

1771. van Zonneveld AJ, Veerman H, Pannekoek H. On the interaction of the finger and the kringle-2 domain of tissue-type plasminogen activator with fibrin. Inhibition of kringle-2 binding to fibrin by epsilon-amino caproic acid. *J Biol Chem* 1986;261:14214–14218.

1772. Verheijen JH, Caspers MP, Chang GT, et al. Involvement of finger domain and kringle 2 domain of tissue-type plasminogen activator in fibrin binding and stimulation of activity by fibrin. *EMBO J* 1986;5:3525–3530.

1773. de Munk GA, Caspers MP, Chang GT, et al. Binding of tissue-type plasminogen activator to lysine, lysine analogues, and fibrin fragments. *Biochemistry* 1989;28:7318–7325.

1774. Downing AK, Driscoll PC, Harvey TS, et al. Solution structure of the fibrin binding finger domain of tissue-type plasminogen activator determined by 1H nuclear magnetic resonance. *J Mol Biol* 1992;225:821–833.

1775. Lijnen HR, Collen D. Strategies for the improvement of thrombolytic agents. *Thromb Haemost* 1991;66:88–110.

1776. Madison EL. Probing structure-function relationships of tissue-type plasminogen activator by site-specific mutagenesis. *Fibrinolysis* 2002;8[Suppl 1]:221.

1777. de Vos AM, Ultsch MH, Kelley RF, et al. Crystal structure of the kringle 2 domain of tissue plasminogen activator at 2.4-Å resolution. *Biochemistry* 1992;31:270-279.
1778. De Serrano VS, Sehl LC, Castellino FJ. Direct identification of lysine-33 as the principal cationic center of the omega-amino acid binding site of the recombinant kringle 2 domain of tissue-type plasminogen activator. *Arch Biochem Biophys* 1992;292:206-212.
1779. Chang Y, Zajicek J, Castellino FJ. Role of tryptophan-63 of the kringle 2 domain of tissue-type plasminogen activator in its thermal stability, folding, and ligand binding properties. *Biochemistry* 1997;36:7652-7663.
1780. Chang Y, Nilsen SL, Castellino FJ. Functional and structural consequences of aromatic residue substitutions within the kringle-2 domain of tissue-type plasminogen activator. *J Pept Res* 1999;53:656-664.
1781. Davie EW, Ichinose A, Leytus SP. Structural features of the proteins participating in blood coagulation and fibrinolysis. *Cold Spring Harbor Symp Quant Biol* 1986;51:509-514.
1782. Andreasen PA, Petersen LC, Dano K. Diversity in catalytic properties of single chain and two chain tissue-type plasminogen activator. *Fibrinolysis* 1991;5:207-215.
1783. Harris RJ, Leonard CK, Guzzetta AW, et al. Tissue plasminogen activator has an O-linked fucose attached to threonine-61 in the epidermal growth factor domain. *Biochemistry* 1991;30:2311-2314.
1784. Hajjar KA, Reynolds CM. alpha-Fucose-mediated binding and degradation of tissue-type plasminogen activator by HepG2 cells. *J Clin Invest* 1994;93:703-710.
1785. Parekh RB, Dwek RA, Thomas JR, et al. Cell-type-specific and site-specific N-glycosylation of type I and type II human tissue plasminogen activator. *Biochemistry* 1989;28:7644-7662.
1786. Spellman MW, Basa LJ, Leonard CK, et al. Carbohydrate structures of human tissue plasminogen activator expressed in Chinese hamster ovary cells. *J Biol Chem* 1989;264:14100-14111.
1787. Hoylaerts M, Rijken DC, Lijnen HR, et al. Kinetics of the activation of plasminogen by human tissue plasminogen activator. Role of fibrin. *J Biol Chem* 1982;257:2912-2919.
1788. Zamarron C, Lijnen HR, Collen D. Kinetics of the activation of plasminogen by natural and recombinant tissue-type plasminogen activator. *J Biol Chem* 1984;259:2080-2083.
1789. Loscalzo J. Structural and kinetic comparison of recombinant human single- and two-chain tissue plasminogen activator. *J Clin Invest* 1988;82:1391-1397.
1790. Dichek D, Quertermous T. Thrombin regulation of mRNA levels of tissue plasminogen activator and plasminogen activator inhibitor-1 in cultured human umbilical vein endothelial cells. *Blood* 1989;74:222-228.
1791. Diamond SL, Eskin SG, McIntire LV. Fluid flow stimulates tissue plasminogen activator secretion by cultured human endothelial cells. *Science* 1989;243:1483-1485.
1792. Emeis JJ. Regulation of the acute release of tissue-type plasminogen activator from the endothelium by coagulation activation products. *Ann N Y Acad Sci* 1992;667:249-258.
1793. Eijnden-Schrauwen Y, Kooistra T, de Vries RE, et al. Studies on the acute release of tissue-type plasminogen activator from human endothelial cells in vitro and in rats in vivo: evidence for a dynamic storage pool. *Blood* 1995;85:3510-3517.
1794. Fay WP, Eitzman DT, Shapiro AD, et al. Platelets inhibit fibrinolysis in vitro by both plasminogen activator inhibitor-1-dependent and -independent mechanisms. *Blood* 1994;83:351-356.
1795. Levi M, Biemond BJ, van Zonneveld AJ, et al. Inhibition of plasminogen activator inhibitor-1 activity results in promotion of endogenous thrombolysis and inhibition of thrombus extension in models of experimental thrombosis. *Circulation* 1992;85:305-312.



1796. Braaten JV, Handt S, Jerome WG, et al. Regulation of fibrinolysis by platelet-released plasminogen activator inhibitor 1: light scattering and ultrastructural examination of lysis of a model platelet-fibrin thrombus. *Blood* 1993;81:1290-1299.

1797. Steffens GJ, Gunzler WA, Otting F, et al. The complete amino acid sequence of low molecular mass urokinase from human urine. *Hoppe Seylers Z Physiol Chem* 1982;363:1043-1058.

1798. Gunzler WA, Steffens GJ, Otting F, et al. The primary structure of high molecular mass urokinase from human urine. The complete amino acid sequence of the A chain. *Hoppe Seylers Z Physiol Chem* 1982;363:1155-1165.

1799. Husain SS, Gurewich V, Lipinski B. Purification and partial characterization of a single-chain high-molecular-weight form of urokinase from human urine. *Arch Biochem Biophys* 1983;220:31-38.

1800. Stump DC, Thienpont M, Collen D. Urokinase-related proteins in human urine. Isolation and characterization of single-chain urokinase (pro-urokinase) and urokinase-inhibitor complex. *J Biol Chem* 1986;261:1267-1273.

1801. Shatos MA, Orfeo T, Doherty JM, et al. Alpha-thrombin stimulates urokinase production and DNA synthesis in cultured human cerebral microvascular endothelial cells. *Arterioscler Thromb Vasc Biol* 1995;15:903-911.

1802. van Hinsbergh VW. Regulation of the synthesis and secretion of plasminogen activators by endothelial cells. *Haemostasis* 1988;18:307-327.

1803. Wun TC, Schleuning WD, Reich E. Isolation and characterization of urokinase from human plasma. *J Biol Chem* 1982;257:3276-3283.

1804. Stump DC, Lijnen HR, Collen D. Purification and characterization of single-chain urokinase-type plasminogen activator from human cell cultures. *J Biol Chem* 1986;261:1274-1278.

1805. Darras V, Thienpont M, Stump DC, et al. Measurement of urokinase-type plasminogen activator (u-PA) with an enzyme-linked immunosorbent assay (ELISA) based on three murine monoclonal antibodies. *Thromb Haemost* 1986;56:411-414.

1806. Collen D, Zamarron C, Lijnen HR, et al. Activation of plasminogen by pro-urokinase. II. Kinetics. *J Biol Chem* 1986;261:1259-1266.

1807. Kasai S, Arimura H, Nishida M, et al. Primary structure of single-chain pro-urokinase. *J Biol Chem* 1985;260:12382-12389.

1808. Stump DC, Lijnen HR, Collen D. Purification and characterization of a novel low molecular weight form of single-chain urokinase-type plasminogen activator. *J Biol Chem* 1986;261:17120-17126.

1809. Gurewich V, Pannell R, Broeze RJ, et al. Characterization of the intrinsic fibrinolytic properties of pro-urokinase through a study of plasmin-resistant mutant forms produced by site-specific mutagenesis of lysine(158). *J Clin Invest* 1988;82:1956-1962.

1810. Gurewich V, Pannell R. Fibrin binding and zymogenic properties of single-chain urokinase (pro-urokinase). *Semin Thromb Hemost* 1987;13:146-151.

1811. Pannell R, Gurewich V. Activation of plasminogen by single-chain urokinase or by two-chain urokinase—a demonstration that single-chain urokinase has a low catalytic activity (pro-urokinase). *Blood* 1987;69:22-26.

1812. Lijnen HR. Elements of the fibrinolytic system. *Ann N Y Acad Sci* 2001;936:226-236.

1813. Blasi F. Proteolysis, cell adhesion, chemotaxis, and invasiveness are regulated by the u-PA-u-PAR-PAI-1 system. *Thromb Haemost* 1999;82:298-304.

1814. Quax PH, van Leeuwen RT, Verspaget HW, et al. Protein and messenger RNA levels of plasminogen

- activators and inhibitors analyzed in 22 human tumor cell lines. *Cancer Res* 1990;50:1488–1494.
1815. Evans DM, Sloan–Stakleff K, Arvan M, et al. Time and dose dependency of the suppression of pulmonary metastases of rat mammary cancer by amiloride. *Clin Exp Metastasis* 1998;16:353–357.
1816. Banerji A, Fernandes A, Bane S, et al. The field bean protease inhibitor has the potential to suppress B16F10 melanoma cell lung metastasis in mice. *Cancer Lett* 1998;129:15–20.
1817. Kobayashi H, Gotoh J, Shinohara H, et al. Inhibition of the metastasis of Lewis lung carcinoma by antibody against urokinase–type plasminogen activator in the experimental and spontaneous metastasis model. *Thromb Haemost* 1994;71:474–480.
1818. Xiao G, Liu YE, Gentz R, et al. Suppression of breast cancer growth and metastasis by a serpin myoepithelium–derived serine proteinase inhibitor expressed in the mammary myoepithelial cells. *Proc Natl Acad Sci U S A* 1999;96:3700–3705.
1819. Rabbani SA, Harakidas P, Davidson DJ, et al. Prevention of prostate–cancer metastasis in vivo by a novel synthetic inhibitor of urokinase–type plasminogen activator (uPA). *Int J Cancer* 1995;63:840–845.
1820. Alonso DF, Tejera AM, Farias EF, et al. Inhibition of mammary tumor cell adhesion, migration, and invasion by the selective synthetic urokinase inhibitor B428. *Anticancer Res* 1998;18:4499–4504.
1821. Alonso DF, Farias EF, Ladeda V, et al. Effects of synthetic urokinase inhibitors on local invasion and metastasis in a murine mammary tumor model. *Breast Cancer Res Treat* 1996;40:209–223.
1822. Jankun J, Keck RW, Skrzypczak–Jankun E, et al. Inhibitors of urokinase reduce size of prostate cancer xenografts in severe combined immunodeficient mice. *Cancer Res* 1997;57:559–563.
1823. Riccio A, Grimaldi G, Verde P, et al. The human urokinase–plasminogen activator gene and its promoter. *Nucleic Acids Res* 1985;13:2759–2771.
1824. Tripputi P, Blasi F, Verde P, et al. Human urokinase gene is located on the long arm of chromosome 10. *Proc Natl Acad Sci U S A* 1985;82:4448–4452.
1825. Gunzler WA, Steffens GJ, Otting F, et al. Structural relationship between human high and low molecular mass urokinase. *Hoppe Seylers Z Physiol Chem* 1982;363:133–141.
1826. Steffens GJ, Gunzler WA, Otting F, et al. The complete amino acid sequence of low molecular mass urokinase from human urine. *Hoppe Seylers Z Physiol Chem* 1982;363:1043–1058.
1827. Gunzler WA, Steffens GJ, Otting F, et al. The primary structure of high molecular mass urokinase from human urine. The complete amino acid sequence of the A chain. *Hoppe Seylers Z Physiol Chem* 1982;363:1155–1165.
1828. Holmes WE, Pennica D, Blaber M. Cloning and expression of the gene for pro–urokinase in *Escherichia coli*. *Biotechnology* 1985;3:923–929.
1829. Gyetko MR, Chen GH, McDonald RA, et al. Urokinase is required for the pulmonary inflammatory response to *Cryptococcus neoformans*. A murine transgenic model. *J Clin Invest* 1996;97:1818–1826.
1830. Shapiro RL, Duquette JG, Nunes I, et al. Urokinase–type plasminogen activator–deficient mice are predisposed to staphylococcal botryomycosis, pleuritis, and effacement of lymphoid follicles. *Am J Pathol* 1997;150:359–369.
1831. Beck JM, Preston AM, Gyetko MR. Urokinase–type plasminogen activator in inflammatory cell recruitment and host defense against *Pneumocystis carinii* in mice. *Infect Immun* 1999;67:879–884.
1832. Li X, Bokman AM, Llinas M, et al. Solution structure of the kringle domain from urokinase–type plasminogen activator. *J Mol Biol* 1994;235:1548–1559.
1833. Franco P, Iaccarino C, Chiaradonna F, et al. Phosphorylation of human pro–urokinase on Ser138/303 impairs its receptor–dependent ability to promote myelomonocytic adherence and motility. *J*

Cell Biol 1997;137:779–791.

1834. Mazar AP, Buko A, Petros AM, et al. Domain analysis of urokinase plasminogen activator (u-PA): preparation and characterization of intact A-chain molecules. *Fibrinolysis* 2003;6[Suppl 1]:49–55.

1835. He CJ, Rebibou JM, Peraldi MN, et al. Growth factor-like effect of urokinase type plasminogen activator in human renal cells. *Biochem Biophys Res Commun* 1991;176:1408–1416.

1836. Koopman JL, Slomp J, de Bart AC, et al. Mitogenic effects of urokinase on melanoma cells are independent of high affinity binding to the urokinase receptor. *J Biol Chem* 1998;273:33267–33272.

1837. Rabbani SA, Gladu J, Mazar AP, et al. Induction in human osteoblastic cells (SaOS2) of the early response genes *fos*, *jun*, and *myc* by the amino terminal fragment (ATF) of urokinase. *J Cell Physiol* 1997;172:137–145.

1838. Goncharova EA, Vorotnikov AV, Gracheva EO, et al. Activation of p38 MAP-kinase and caldesmon phosphorylation are essential for urokinase-induced human smooth muscle cell migration. *Biol Chem* 2002;383:115–126.

1839. Lee KN, Jackson KW, McKee PA. Effect of a synthetic carboxy-terminal peptide of alpha(2)-antiplasmin on urokinase-induced fibrinolysis. *Thromb Res* 2002;105:263–270.

1840. Mukhina S, Stepanova V, Traktouev D, et al. The chemotactic action of urokinase on smooth muscle cells is dependent on its kringle domain. Characterization of interactions and contribution to chemotaxis. *J Biol Chem* 2000;275:16450–16458.

1841. Gurewich V, Pannell R, Louie S, et al. Effective and fibrin-specific clot lysis by a zymogen precursor form of urokinase (pro-urokinase). A study in vitro and in two animal species. *J Clin Invest* 1984;73:1731–1739.

1842. Pannell R, Gurewich V. Pro-urokinase: a study of its stability in plasma and of a mechanism for its selective fibrinolytic effect. *Blood* 1986;67:1215–1223.

1843. Ellis V, Scully MF, Kakkar VV. Plasminogen activation by single-chain urokinase in functional isolation. A kinetic study. *J Biol Chem* 1987;262:14998–15003.

1844. Nowak UK, Li X, Teuten AJ, et al. NMR studies of the dynamics of the multidomain protein urokinase-type plasminogen activator. *Biochemistry* 1993;32:298–309.

1845. Hansen AP, Petros AM, Meadows RP, et al. Backbone dynamics of a two-domain protein: 15N relaxation studies of the amino-terminal fragment of urokinase-type plasminogen activator. *Biochemistry* 1994;33:15418–15424.

1846. Hansen AP, Petros AM, Meadows RP, et al. Solution structure of the amino-terminal fragment of urokinase-type plasminogen activator. *Biochemistry* 1994;33:4847–4864.

1847. Spraggon G, Phillips C, Nowak UK, et al. The crystal structure of the catalytic domain of human urokinase-type plasminogen activator. *Structure* 1995;3:681–691.

1848. Nienaber V, Wang J, Davidson D, et al. Re-engineering of human urokinase provides a system for structure-based drug design at high resolution and reveals a novel structural subsite. *J Biol Chem* 2000;275:7239–7248.

1849. Kobayashi H, Schmitt M, Goretzki L, et al. Cathepsin B efficiently activates the soluble and the tumor cell receptor-bound form of the proenzyme urokinase-type plasminogen activator (Pro-uPA). *J Biol Chem* 1991;266:5147–5152.

1850. Nauland U, Rijken DC. Activation of thrombin-inactivated single-chain urokinase-type plasminogen activator by dipeptidyl peptidase I (cathepsin C). *Eur J Biochem* 1994;223:497–501.

1851. Schmitt M, Goretzki L, Chucholowski N, et al. Effective activation of the proenzyme form of the urokinase-type plasminogen activator (pro-uPA) by the cysteine protease cathepsin L. *Fibrinolysis* 1992;6[Suppl 2]:122.

1852. Drag B, Petersen LC. Activation of pro-urokinase by cathepsin G in the presence of glucosaminoglycans. *Fibrinolysis* 1994;8:192-199.
1853. Stack MS, Johnson DA. Human mast cell tryptase activates single-chain urinary-type plasminogen activator (pro-urokinase). *J Biol Chem* 1994;269:9416-9419.
1854. Wolf BB, Vasudevan J, Henkin J, et al. Nerve growth factor-gamma activates soluble and receptor-bound single chain urokinase-type plasminogen activator. *J Biol Chem* 1993;268:16327-16331.
1855. Brunner G, Simon MM, Kramer MD. Activation of pro-urokinase by the human T cell-associated serine proteinase HuTSP-1. *FEBS Lett* 1990;260:141-144.
1856. Romisch J, Vermohlen S, Feussner A, et al. The FVII activating protease cleaves single-chain plasminogen activators. *Haemostasis* 1999;29:292-299.
1857. Marcotte PA, Kozan IM, Dorwin SA, et al. The matrix metalloproteinase pump-1 catalyzes formation of low molecular weight (pro)urokinase in cultures of normal human kidney cells. *J Biol Chem* 1992;267:13803-13806.
1858. Ugwu F, Van Hoef B, Bini A, et al. Proteolytic cleavage of urokinase-type plasminogen activator by stromelysin-1 (MMP-3). *Biochemistry* 1998;37:7231-7236.
1859. Orgel D, Schroder W, Hecker-Kia A, et al. The cleavage of pro-urokinase type plasminogen activator by stromelysin-1. *Clin Chem Lab Med* 1998;36: 697-702.
1860. Collen D, Lijnen HR. Basic and clinical aspects of fibrinolysis and thrombolysis. *Blood* 1991;78:3114-3124.
1861. Schmitt M, Kanayama N, Henschen A, et al. Elastase released from human granulocytes stimulated with N-formyl-chemotactic peptide prevents activation of tumor cell prourokinase (pro-uPA). *FEBS Lett* 1989;255:83-88.
1862. Learmonth MP, Li W, Namiranian S. Modulation of the cell binding property of single chain urokinase-type plasminogen activator by neutrophil cathepsin G. *Fibrinolysis* 1992;6[Suppl 4]:113-116.
1863. Braat EA, Levi M, Bos R, et al. Inactivation of single-chain urokinase-type plasminogen activator by thrombin in human subjects. *J Lab Clin Med* 1999;134:161-167.
1864. Braat EA, Rijken DC. The inactivation of single-chain urokinase-type plasminogen activator by thrombin may provide an additional explanation for the antifibrinolytic effect of factor XI. *Thromb Haemost* 1999;81:657.
1865. de Munk GA, Parkinson JF, Groeneveld E, et al. Role of the glycosaminoglycan component of thrombomodulin in its acceleration of the inactivation of single-chain urokinase-type plasminogen activator by thrombin. *Biochem J* 1993;290(Pt 3):655-659.
1866. Lijnen HR, Van Hoef B, Collen D. Activation with plasmin of two-chain urokinase-type plasminogen activator derived from single-chain urokinase-type plasminogen activator by treatment with thrombin. *Eur J Biochem* 1987;169:359-364.
1867. Robbins KC, Summaria L, Hsieh B, et al. The peptide chains of human plasmin. Mechanism of activation of human plasminogen to plasmin. *J Biol Chem* 1967;242:2333-2342.
1868. Fleury V, Lijnen HR, Angles-Cano E. Mechanism of the enhanced intrinsic activity of single-chain urokinase-type plasminogen activator during ongoing fibrinolysis. *J Biol Chem* 1993;268:18554-18559.
1869. Longstaff C, Clough AM, Gaffney PJ. Kinetics of plasmin activation of single chain urinary-type plasminogen activator (scu-PA) and demonstration of a high affinity interaction between scu-PA and plasminogen. *J Biol Chem* 1992;267:173-179.
1870. Lenich C, Pannell R, Gurewich V. The effect of the carboxy-terminal lysine of urokinase on the

catalysis of plasminogen activation. *Thromb Res* 1991;64:69–80.

1871. Romisch J. Factor VII activating protease (FSAP): a novel protease in hemostasis. *Biol Chem* 2002;383:1119–1124.

1872. Choi-Miura NH, Tobe T, Sumiya J, et al. Purification and characterization of a novel hyaluronan-binding protein (PHBP) from human plasma: it has three EGF, a kringle and a serine protease domain, similar to hepatocyte growth factor activator. *J Biochem (Tokyo)* 1996;119:1157–1165.

1873. Hunfeld A, Etscheid M, König H, et al. Identification of the thrombin-like activity of PCC's. *Ann Haematol* 1998;76:A101.

1874. Hunfeld A, Etscheid M, König H, et al. Detection of a novel plasma serine protease during purification of vitamin K-dependent coagulation factors. *FEBS Lett* 1999;456:290–294.

1875. Kannemeier C, Feussner A, Stohr HA, et al. Factor VII and single-chain plasminogen activator-activating protease: activation and autoactivation of the proenzyme. *Eur J Biochem* 2001;268:3789–3796.

1876. Sumiya J, Asakawa S, Tobe T, et al. Isolation and characterization of the plasma hyaluronan-binding protein (PHBP) gene (HABP2). *J Biochem (Tokyo)* 1997;122:983–990.

1877. Romisch J, Feussner A, Nerlich C, et al. The frequent Marburg I polymorphism impairs the pro-urokinase activating potency of the factor VII activating protease (FSAP). *Blood Coagul Fibrinolysis* 2002;13:433–441.

1878. Miyazawa K, Shimomura T, Kitamura A, et al. Molecular cloning and sequence analysis of the cDNA for a human serine protease responsible for activation of hepatocyte growth factor. Structural similarity of the protease precursor to blood coagulation factor XII. *J Biol Chem* 1993;268:10024–10028.

1879. Etscheid M, Hunfeld A, König H, et al. Activation of proPHBSP, the zymogen of a plasma hyaluronan binding serine protease, by an intermolecular autocatalytic mechanism. *Biol Chem* 2000;381:1223–1231.

1880. Choi-Miura NH, Takahashi K, Yoda M, et al. Proteolytic activation and inactivation of the serine protease activity of plasma hyaluronan binding protein. *Biol Pharm Bull* 2001;24:448–452.

1881. Choi-Miura NH, Saito K, Takahashi K, et al. Regulation mechanism of the serine protease activity of plasma hyaluronan binding protein. *Biol Pharm Bull* 2001;24:221–225.

1882. Etscheid M, Beer N, Seitz R, et al. Regulation of the plasma hyaluronan-binding serine protease. *Ann Haematol* 2002;81:A16.

1883. Nesheim M. Fibrinolysis and the plasma carboxypeptidase. *Curr Opin Hematol* 1998;5:309–313.

1884. Bajzar L. Thrombin activatable fibrinolysis inhibitor and an antifibrinolytic pathway. *Arterioscler Thromb Vasc Biol* 2000;20:2511–2518.

1885. Redlitz A, Nicolini FA, Malycky JL, et al. Inducible carboxypeptidase activity. A role in clot lysis in vivo. *Circulation* 1996;93:1328–1330.

1886. Minnema MC, Friederich PW, Levi M, et al. Enhancement of rabbit jugular vein thrombolysis by neutralization of factor XI. In vivo evidence for a role of factor XI as an anti-fibrinolytic factor. *J Clin Invest* 1998;101:10–14.

1887. Nagashima M, Werner M, Wang M, et al. An inhibitor of activated thrombin-activatable fibrinolysis inhibitor potentiates tissue-type plasminogen activator-induced thrombolysis in a rabbit jugular vein thrombolysis model. *Thromb Res* 2000;98:333–342.

1888. Gresele P, Momi S, Berrettini M, et al. Activated human protein C prevents thrombin-induced thromboembolism in mice. Evidence that activated protein C reduces intravascular fibrin accumulation through the inhibition of additional thrombin generation. *J Clin Invest* 1998;101:667–676.

1889. Nagashima M, Yin ZF, Broze GJ, Jr., et al. Thrombin-activatable fibrinolysis inhibitor (TAFI)

deficient mice. *Front Biosci* 2002;7:556–568.

1890. Franco RF, Fagundes MG, Meijers JC, et al. Identification of polymorphisms in the 5′-untranslated region of the TAFI gene: relationship with plasma TAFI levels and risk of venous thrombosis. *Haematologica* 2001;86:510–517.

1891. van Tilburg NH, Rosendaal FR, Bertina RM. Thrombin activatable fibrinolysis inhibitor and the risk for deep vein thrombosis. *Blood* 2000;95:2855–2859.

1892. Hendriks D, Scharpe S, van Sande M, et al. Characterisation of a carboxypeptidase in human serum distinct from carboxypeptidase N. *J Clin Chem Clin Biochem* 1989;27:277–285.

1893. Wang W, Hendriks DF, Scharpe SS. Carboxypeptidase U, a plasma carboxypeptidase with high affinity for plasminogen. *J Biol Chem* 1994;269:15937–15944.

1894. Campbell W, Okada H. An arginine specific carboxypeptidase generated in blood during coagulation or inflammation which is unrelated to carboxypeptidase N or its subunits. *Biochem Biophys Res Commun* 1989;162:933–939.

1895. Tan AK, Eaton DL. Activation and characterization of procarboxypeptidase B from human plasma. *Biochemistry* 1995;34:5811–5816.

1896. Boffa MB, Reid TS, Joo E, et al. Characterization of the gene encoding human TAFI (thrombin-activable fibrinolysis inhibitor; plasma procarboxypeptidase B). *Biochemistry* 1999;38:6547–6558.

1897. Skidgel RA. Basic carboxypeptidases: regulators of peptide hormone activity. *Trends Pharmacol Sci* 1988;9:299–304.

1898. Vanhoof G, Wauters J, Schatteman K, et al. The gene for human carboxypeptidase U (CPU)—a proposed novel regulator of plasminogen activation—maps to 13q14.11. *Genomics* 1996;38:454–455.

1899. Zhao L, Morser J, Bajzar L, et al. Identification and characterization of two thrombin-activatable fibrinolysis inhibitor isoforms. *Thromb Haemost* 1998;80:949–955.

1900. Juhan-Vague I, Renucci JF, Grimaux M, et al. Thrombin-activatable fibrinolysis inhibitor antigen levels and cardiovascular risk factors. *Arterioscler Thromb Vasc Biol* 2000;20:2156–2161.

1901. Henry M, Aubert H, Morange PE, et al. Identification of polymorphisms in the promoter and the 3′ region of the TAFI gene: evidence that plasma TAFI antigen levels are strongly genetically controlled. *Blood* 2001;98:2053–2058.

1902. Brouwers GJ, Vos HL, Leebeek FW, et al. A novel, possibly functional, single nucleotide polymorphism in the coding region of the thrombin-activatable fibrinolysis inhibitor (TAFI) gene is also associated with TAFI levels. *Blood* 2001;98:1992–1993.

1903. Boffa MB, Wang W, Bajzar L, et al. Plasma and recombinant thrombin-activable fibrinolysis inhibitor (TAFI) and activated TAFI compared with respect to glycosylation, thrombin/thrombomodulin-dependent activation, thermal stability, and enzymatic properties. *J Biol Chem* 1998;273:2127–2135.

1904. Mao SS, Cooper CM, Wood T, et al. Characterization of plasmin-mediated activation of plasma procarboxypeptidase B. Modulation by glycosaminoglycans. *J Biol Chem* 1999;274:35046–35052.

1905. Koschinsky ML, Boffa MB, Nesheim ME, et al. Association of a single nucleotide polymorphism in CPB2 encoding the thrombin-activable fibrinolysis inhibitor (TAFI) with blood pressure. *Clin Genet* 2001;60:345–349.

1906. dem Borne PA, Bajzar L, Meijers JC, et al. Thrombin-mediated activation of factor XI results in a thrombin-activatable fibrinolysis inhibitor-dependent inhibition of fibrinolysis. *J Clin Invest* 1997;99:2323–2327.

1907. Plow EF, Herren T, Redlitz A, et al. The cell biology of the plasminogen system. *FASEB J* 1995;9:939–945.

1908. Suenson E, Lutzen O, Thorsen S. Initial plasmin-degradation of fibrin as the basis of a positive

feed-back mechanism in fibrinolysis. *Eur J Biochem* 1984;140:513–522.

1909. Pannell R, Black J, Gurewich V. Complementary modes of action of tissue-type plasminogen activator and pro-urokinase by which their synergistic effect on clot lysis may be explained. *J Clin Invest* 1988;81:853–859.

1910. Norrman B, Wallen P, Ranby M. Fibrinolysis mediated by tissue plasminogen activator. Disclosure of a kinetic transition. *Eur J Biochem* 1985;149:193–200.

1911. Fleury V, Angles-Cano E. Characterization of the binding of plasminogen to fibrin surfaces: the role of carboxy-terminal lysines. *Biochemistry* 1991;30:7630–7638.

1912. Sakharov DV, Rijken DC. Superficial accumulation of plasminogen during plasma clot lysis. *Circulation* 1995;92:1883–1890.

1913. Bouma BN, Mosnier LO, Meijers JC, et al. Factor XI dependent and independent activation of thrombin activatable fibrinolysis inhibitor (TAFI) in plasma associated with clot formation. *Thromb Haemost* 1999;82:1703–1708.

1914. Ryan CA, Hass GM, Kuhn RW. Purification and properties of a carboxypeptidase inhibitor from potatoes. *J Biol Chem* 1974;249:5495–5499.

1915. Reverter D, Vendrell J, Canals F, et al. A carboxypeptidase inhibitor from the medical leech *Hirudo medicinalis*. Isolation, sequence analysis, cDNA cloning, recombinant expression, and characterization. *J Biol Chem* 1998;273:32927–32933.

1916. Boffa MB, Bell R, Stevens WK, et al. Roles of thermal instability and proteolytic cleavage in regulation of activated thrombin-activable fibrinolysis inhibitor. *J Biol Chem* 2000;275:12868–12878.

1917. Marx PF, Hackeng TM, Dawson PE, et al. Inactivation of active thrombin-activable fibrinolysis inhibitor takes place by a process that involves conformational instability rather than proteolytic cleavage. *J Biol Chem* 2000;275:12410–12415.

1918. Sato T, Miwa T, Akatsu H, et al. Pro-carboxypeptidase R is an acute phase protein in the mouse, whereas carboxypeptidase N is not. *J Immunol* 2000;165:1053–1058.

1919. Silveira A, Schatteman K, Goossens F, et al. Plasma procarboxypeptidase U in men with symptomatic coronary artery disease. *Thromb Haemost* 2000;84:364–368.

1920. Schatteman KA, Goossens FJ, Scharpe SS, et al. Assay of procarboxypeptidase U, a novel determinant of the fibrinolytic cascade, in human plasma. *Clin Chem* 1999;45:807–813.

1921. Chetaille P, Alessi MC, Kouassi D, et al. Plasma TAFI antigen variations in healthy subjects. *Thromb Haemost* 2000;83:902–905.

1922. Boffa MB, Hamill JD, Bastajian N, et al. A role for CCAAT/enhancer-binding protein in hepatic expression of thrombin-activable fibrinolysis inhibitor. *J Biol Chem* 2002;277:25329–25336.

1923. Dieval J, Nguyen G, Gross S, et al. A lifelong bleeding disorder associated with a deficiency of plasminogen activator inhibitor type 1. *Blood* 1991;77:528–532.

1924. Fay WP, Shapiro AD, Shih JL, et al. Brief report: complete deficiency of plasminogen-activator inhibitor type 1 due to a frame-shift mutation. *N Engl J Med* 1992;327:1729–1733.

1925. Lee MH, Vosburgh E, Anderson K, et al. Deficiency of plasma plasminogen activator inhibitor 1 results in hyperfibrinolytic bleeding. *Blood* 1993;81:2357–2362.

1926. Fay WP, Parker AC, Condrey LR, et al. Human plasminogen activator inhibitor-1 (PAI-1) deficiency: characterization of a large kindred with a null mutation in the PAI-1 gene. *Blood* 1997;90:204–208.

1927. Minowa H, Takahashi Y, Tanaka T, et al. Four cases of bleeding diathesis in children due to congenital plasminogen activator inhibitor-1 deficiency. *Haemostasis* 1999;29:286–291.



1928. Declerck PJ, De Mol M, Alessi MC, et al. Purification and characterization of a plasminogen activator inhibitor 1 binding protein from human plasma. Identification as a multimeric form of S protein (vitronectin). *J Biol Chem* 1988;263:15454–15461.
1929. Declerck PJ, Alessi MC, Verstreken M, et al. Measurement of plasminogen activator inhibitor 1 in biologic fluids with a murine monoclonal antibody-based enzyme-linked immunosorbent assay. *Blood* 1988;71:220–225.
1930. Wiman B, Hamsten A. The fibrinolytic enzyme system and its role in the etiology of thromboembolic disease. *Semin Thromb Hemost* 1990;16:207–216.
1931. Stiko A, Hervio L, Loskutoff DJ. Plasminogen activator inhibitors. In: Colman RF, Hirsh J, Marder VJ, et al., eds. *Hemostasis and thrombosis: basic principles and clinical practice*. Philadelphia: Lippincott Williams & Wilkins, 2002:355–365.
1932. Huber K. Plasminogen activator inhibitor type-1 (part two): role for failure of thrombolytic therapy. PAI-1 resistance as a potential benefit for new fibrinolytic agents. *J Thromb Thrombolysis* 2001;11:195–202.
1933. Alessi MC, Chomiki N, Berthier R, et al. Detection of plasminogen activator inhibitor-1 (PAI-1) mRNA in human megakaryocytes by in situ hybridization. *Thromb Haemost* 1994;72:931–936.
1934. Sharp AM, Stein PE, Pannu NS, et al. The active conformation of plasminogen activator inhibitor 1, a target for drugs to control fibrinolysis and cell adhesion. *Structure Fold Des* 1999;7:111–118.
1935. Aertgeerts K, De Bondt HL, De Ranter CJ, et al. Mechanisms contributing to the conformational and functional flexibility of plasminogen activator inhibitor-1. *Nat Struct Biol* 1995;2:891–897.
1936. Wiman B, Almquist A, Sigurdardottir O, et al. Plasminogen activator inhibitor 1 (PAI) is bound to vitronectin in plasma. *FEBS Lett* 1988;242:125–128.
1937. Schulze AJ, Huber R, Bode W, et al. Structural aspects of serpin inhibition. *FEBS Lett* 1994;344:117–124.
1938. Ginsburg D, Zeheb R, Yang AY, et al. cDNA cloning of human plasminogen activator-inhibitor from endothelial cells. *J Clin Invest* 1986;78:1673–1680.
1939. Ny T, Sawdey M, Lawrence D, et al. Cloning and sequence of a cDNA coding for the human beta-migrating endothelial-cell-type plasminogen activator inhibitor. *Proc Natl Acad Sci U S A* 1986;83:6776–6780.
1940. Sawdey M, Ny T, Loskutoff DJ. Messenger RNA for plasminogen activator inhibitor. *Thromb Res* 1986;41:151–160.
1941. Pannekoek H, Veerman H, Lambers H, et al. Endothelial plasminogen activator inhibitor (PAI): a new member of the Serpin gene family. *EMBO J* 1986;5:2539–2544.
1942. Andreasen PA, Riccio A, Welinder KG, et al. Plasminogen activator inhibitor type-1: reactive center and amino-terminal heterogeneity determined by protein and cDNA sequencing. *FEBS Lett* 1986;209:213–218.
1943. Wun TC, Kretzmer KK. cDNA cloning and expression in *E. coli* of a plasminogen activator inhibitor (PAI) related to a PAI produced by Hep G2 hepatoma cell. *FEBS Lett* 1987;210:11–16.
1944. Klinger KW, Winqvist R, Riccio A, et al. Plasminogen activator inhibitor type 1 gene is located at region q21.3–q22 of chromosome 7 and genetically linked with cystic fibrosis. *Proc Natl Acad Sci U S A* 1987;84:8548–8552.
1945. Schwartz CE, Stanislovitis P, Phelan MC, et al. Deletion mapping of plasminogen activator inhibitor, type I (PLANH1) and beta-glucuronidase (GUSB) in 7q21?q22. *Cytogenet Cell Genet* 1991;56:152–153.
1946. Loskutoff DJ, Linders M, Keijer J, et al. Structure of the human plasminogen activator inhibitor 1

gene: nonrandom distribution of introns. *Biochemistry* 1987;26:3763-3768.

1947. Strandberg L, Lawrence D, Ny T. The organization of the human-plasminogen-activator-inhibitor-1 gene. Implications on the evolution of the serine-protease inhibitor family. *Eur J Biochem* 1988;176:609-616.

1948. Bosma PJ, Kooistra T, Siemieniak DR, et al. Further characterization of the 5'-flanking DNA of the gene encoding human plasminogen activator inhibitor-1. *Gene* 1991;100:261-266.

1949. Bosma PJ, van den Berg EA, Kooistra T, et al. Human plasminogen activator inhibitor-1 gene. Promoter and structural gene nucleotide sequences. *J Biol Chem* 1988;263:9129-9141.

1950. Nordt TK, Lohrmann J, Bode C. Regulation of PAI-1 expression by genetic polymorphisms. Impact on atherogenesis. *Thromb Res* 2001;103[Suppl 1]:S1-S5.

1951. Dawson SJ, Wiman B, Hamsten A, et al. The two allele sequences of a common polymorphism in the promoter of the plasminogen activator inhibitor-1 (PAI-1) gene respond differently to interleukin-1 in HepG2 cells. *J Biol Chem* 1993;268:10739-10745.

1952. Nordenhem A, Wiman B. Plasminogen activator inhibitor-1 (PAI-1) content in platelets from healthy individuals genotyped for the 4G/5G polymorphism in the PAI-1 gene. *Scand J Clin Lab Invest* 1997;57:453-461.

1953. Ye S, Green FR, Scarabin PY, et al. The 4G/5G genetic polymorphism in the promoter of the plasminogen activator inhibitor-1 (PAI-1) gene is associated with differences in plasma PAI-1 activity but not with risk of myocardial infarction in the ECTIM study. *Etude CasTemoins de l'infarctus du Myocarde. Thromb Haemost* 1995;74:837-841.

1954. Margaglione M, Cappucci G, Colaizzo D, et al. The PAI-1 gene locus 4G/5G polymorphism is associated with a family history of coronary artery disease. *Arterioscler Thromb Vasc Biol* 1998;18:152-156.

1955. Margaglione M, Cappucci G, d'Addetta M, et al. PAI-1 plasma levels in a general population without clinical evidence of atherosclerosis: relation to environmental and genetic determinants. *Arterioscler Thromb Vasc Biol* 1998;18:562-567.

1956. Eriksson P, Kallin B, van't Hooft FM, et al. Allele-specific increase in basal transcription of the plasminogen-activator inhibitor 1 gene is associated with myocardial infarction. *Proc Natl Acad Sci U S A* 1995;92:1851-1855.

1957. Ridker PM, Hennekens CH, Lindpaintner K, et al. Arterial and venous thrombosis is not associated with the 4G/5G polymorphism in the promoter of the plasminogen activator inhibitor gene in a large cohort of US men. *Circulation* 1997;95:59-62.

1958. Huber K, Christ G, Wojta J, et al. Plasminogen activator inhibitor type-1 in cardiovascular disease. Status report 2001. *Thromb Res* 2001;103[Suppl 1]:S7-19.

1959. Dawson S, Hamsten A, Wiman B, et al. Genetic variation at the plasminogen activator inhibitor-1 locus is associated with altered levels of plasma plasminogen activator inhibitor-1 activity. *Arterioscler Thromb* 1991;11:183-190.

1960. Grenett HE, Benza RL, Li XN, et al. Expression of plasminogen activator inhibitor type I in genotyped human endothelial cell cultures: genotype-specific regulation by insulin. *Thromb Haemost* 1999;82:1504-1509.

1961. Booyse FM, Aikens ML, Grenett HE. Endothelial cell fibrinolysis: transcriptional regulation of fibrinolytic protein gene expression (t-PA, u-PA, and PAI-1) by low alcohol. *Alcohol Clin Exp Res* 1999;23:1119-1124.

1962. Li XN, Grenett HE, Benza RL, et al. Genotype-specific transcriptional regulation of PAI-1 expression by hypertriglyceridemic VLDL and Lp(a) in cultured human endothelial cells. *Arterioscler Thromb Vasc Biol* 1997;17:3215-3223.

1963. Grenett HE, Benza RL, Fless GM, et al. Genotype-specific transcriptional regulation of PAI-1 gene by insulin, hypertriglyceridemic VLDL, and Lp(a) in transfected, cultured human endothelial cells.

Arterioscler Thromb Vasc Biol 1998;18:1803–1809.

1964. Carmeliet P, Kieckens L, Schoonjans L, et al. Plasminogen activator inhibitor-1 gene-deficient mice. I. Generation by homologous recombination and characterization. *J Clin Invest* 1993;92:2746–2755.

1965. Carmeliet P, Stassen JM, Schoonjans L, et al. Plasminogen activator inhibitor-1 gene-deficient mice. II. Effects on hemostasis, thrombosis, and thrombolysis. *J Clin Invest* 1993;92:2756–2760.

1966. Dewerchin M, Collen D, Lijnen HR. Enhanced fibrinolytic potential in mice with combined homozygous deficiency of alpha2-antiplasmin and PAI-1. *Thromb Haemost* 2001;86:640–646.

1967. Madison EL, Goldsmith EJ, Gething MJ, et al. Restoration of serine protease-inhibitor interaction by protein engineering. *J Biol Chem* 1990;265:21423–21426.

1968. Madison EL, Goldsmith EJ, Gerard RD, et al. Serpin-resistant mutants of human tissue-type plasminogen activator. *Nature* 1989;339:721–724.

1969. Adams DS, Griffin LA, Nachajko WR, et al. A synthetic DNA encoding a modified human urokinase resistant to inhibition by serum plasminogen activator inhibitor. *J Biol Chem* 1991;266:8476–8482.

1970. Hekman CM, Loskutoff DJ. Endothelial cells produce a latent inhibitor of plasminogen activators that can be activated by denaturants. *J Biol Chem* 1985;260:11581–11587.

1971. Mottonen J, Strand A, Symersky J, et al. Structural basis of latency in plasminogen activator inhibitor-1. *Nature* 1992;355:270–273.

1972. Lawrence DA, Berkenpas MB, Palaniappan S, et al. Localization of vitronectin binding domain in plasminogen activator inhibitor-1. *J Biol Chem* 1994;269:15223–15228.

1973. Kruihof EK, Tran-Thang C, Gudinchet A, et al. Fibrinolysis in pregnancy: a study of plasminogen activator inhibitors. *Blood* 1987;69:460–466.

1974. Kjoller L, Kanse SM, Kirkegaard T, et al. Plasminogen activator inhibitor-1 represses integrin- and vitronectin-mediated cell migration independently of its function as an inhibitor of plasminogen activation. *Exp Cell Res* 1997;232:420–429.

1975. Waltz DA, Natkin LR, Fujita RM, et al. Plasmin and plasminogen activator inhibitor type 1 promote cellular motility by regulating the interaction between the urokinase receptor and vitronectin. *J Clin Invest* 1997;100:58–67.

1976. Kanse SM, Kost C, Wilhelm OG, et al. The urokinase receptor is a major vitronectin-binding protein on endothelial cells. *Exp Cell Res* 1996;224:344–353.

1977. Deng G, Curriden SA, Wang S, et al. Is plasminogen activator inhibitor-1 the molecular switch that governs urokinase receptor-mediated cell adhesion and release? *J Cell Biol* 1996;134:1563–1571.

1978. Stefansson S, Lawrence DA. The serpin PAI-1 inhibits cell migration by blocking integrin alpha V beta 3 binding to vitronectin. *Nature* 1996;383:441–443.

1979. Kawano T, Morimoto K, Uemura Y. Partial purification and properties of urokinase inhibitor from human placenta. *J Biochem (Tokyo)* 1970;67:333–342.

1980. Kawano T, Uemura Y. Inhibition of tissue activator by urokinase inhibitor. *Thromb Diath Haemorrh* 1971;25:129–133.

1981. Kawano T, Morimoto K, Uemura Y. Urokinase inhibitor in human placenta. *Nature* 1968;217:253–254.

1982. Astedt B, Hagerstrand I, Lecander I. Cellular localisation in placenta of placental type plasminogen activator inhibitor. *Thromb Haemost* 1986;56:63–65.

1983. Holmberg L, Lecander I, Persson B, et al. An inhibitor from placenta specifically binds urokinase and inhibits plasminogen activator released from ovarian carcinoma in tissue culture. *Biochim Biophys Acta*

1978;544:128–137.

1984. Astedt B, Lecander I, Brodin T, et al. Purification of a specific placental plasminogen activator inhibitor by monoclonal antibody and its complex formation with plasminogen activator. *Thromb Haemost* 1985;53:122–125.

1985. Ritchie H, Robbie LA, Kinghorn S, et al. Monocyte plasminogen activator inhibitor 2 (PAI-2) inhibits u-PA-mediated fibrin clot lysis and is cross-linked to fibrin. *Thromb Haemost* 1999;81:96–103.

1986. Dougherty KM, Pearson JM, Yang AY, et al. The plasminogen activator inhibitor-2 gene is not required for normal murine development or survival. *Proc Natl Acad Sci U S A* 1999;96:686–691.

1987. Webb AC, Collins KL, Snyder SE, et al. Human monocyte Arg-Serpin cDNA. Sequence, chromosomal assignment, and homology to plasminogen activator-inhibitor. *J Exp Med* 1987;166:77–94.

1988. Samia JA, Alexander SJ, Horton KW, et al. Chromosomal organization and localization of the human urokinase inhibitor gene: perfect structural conservation with ovalbumin. *Genomics* 1990;6:159–167.

1989. Schleuning WD, Medcalf RL, Hession C, et al. Plasminogen activator inhibitor 2: regulation of gene transcription during phorbol ester-mediated differentiation of U-937 human histiocytic lymphoma cells. *Mol Cell Biol* 1987;7:4564–4567.

1990. Wun TC, Reich E. An inhibitor of plasminogen activation from human placenta. Purification and characterization. *J Biol Chem* 1987;262:3646–3653.

1991. Ye RD, Wun TC, Sadler JE. cDNA cloning and expression in *Escherichia coli* of a plasminogen activator inhibitor from human placenta. *J Biol Chem* 1987;262:3718–3725.

1992. Ye RD, Ahern SM, Le Beau MM, et al. Structure of the gene for human plasminogen activator inhibitor-2. The nearest mammalian homologue of chicken ovalbumin. *J Biol Chem* 1989;264:5495–5502.

1993. Kruithof EK. Plasminogen activator inhibitors—a review. *Enzyme* 1988;40:113–121.

1994. Chapman HA, Jr., Stone OL. A fibrinolytic inhibitor of human alveolar macrophages. Induction with endotoxin. *Am Rev Respir Dis* 1985;132:569–575.

1995. Saksela O, Hovi T, Vaheri A. Urokinase-type plasminogen activator and its inhibitor secreted by cultured human monocyte-macrophages. *J Cell Physiol* 1985;122:125–132.

1996. Wohlwend A, Belin D, Vassalli JD. Plasminogen activator-specific inhibitors produced by human monocytes/macrophages. *J Exp Med* 1987;165:320–339.

1997. Bachmann F. The enigma PAI-2. Gene expression, evolutionary and functional aspects. *Thromb Haemost* 1995;74:172–179.

1998. Kruithof EK, Baker MS, Bunn CL. Biological and clinical aspects of plasminogen activator inhibitor type 2. *Blood* 1995;86:4007–4024.

1999. Dear AE, Medcalf RL. The cellular and molecular biology of plasminogen activator inhibitor type-2. *Fibrinolysis* 1995;9:321–330.

2000. Medcalf RL, Kruithof EK, Schleuning WD. Plasminogen activator inhibitor 1 and 2 are tumor necrosis factor/cachectin-responsive genes. *J Exp Med* 1988;168:751–759.

2001. Schwartz BS, Monroe MC, Levin EG. Increased release of plasminogen activator inhibitor type 2 accompanies the human mononuclear cell tissue factor response to lipopolysaccharide. *Blood* 1988;71:734–741.

2002. Suzuki T, Hashimoto S, Toyoda N, et al. Comprehensive gene expression profile of LPS-stimulated human monocytes by SAGE. *Blood* 2000;96:2584–2591.

2003. Maurer F, Tierney M, Medcalf RL. An AU-rich sequence in the 3'-UTR of plasminogen activator inhibitor type 2 (PAI-2) mRNA promotes PAI-2 mRNA decay and provides a binding site for nuclear HuR.

Nucleic Acids Res 1999;27:1664–1673.

2004. Maurer F, Medcalf RL. Plasminogen activator inhibitor type 2 gene induction by tumor necrosis factor and phorbol ester involves transcriptional and post-transcriptional events. Identification of a functional nonameric AU-rich motif in the 3'-untranslated region. *J Biol Chem* 1996;271:26074–26080.

2005. Tierney MJ, Medcalf RL. Plasminogen activator inhibitor type 2 contains mRNA instability elements within exon 4 of the coding region. Sequence homology to coding region instability determinants in other mRNAs. *J Biol Chem* 2001;276:13675–13684.

2006. Ritchie H, Lawrie LC, Crombie PW, et al. Cross-linking of plasminogen activator inhibitor 2 and alpha 2-antiplasmin to fibrin(ogen). *J Biol Chem* 2000;275:24915–24920.

2007. Jensen PH, Jensen TG, Laug WE, et al. The exon 3 encoded sequence of the intracellular serine proteinase inhibitor plasminogen activator inhibitor 2 is a protein binding domain. *J Biol Chem* 1996;271:26892–26899.

2008. Harrop SJ, Jankova L, Coles M, et al. The crystal structure of plasminogen activator inhibitor 2 at 2.0 Å resolution: implications for serpin function. *Structure Fold Des* 1999;7:43–54.

2009. Jensen PJ, Wu Q, Janowitz P, et al. Plasminogen activator inhibitor type 2: an intracellular keratinocyte differentiation product that is incorporated into the cornified envelope. *Exp Cell Res* 1995;217:65–71.

2010. Hibino T, Matsuda Y, Takahashi T, et al. Suppression of keratinocyte proliferation by plasminogen activator inhibitor-2. *J Invest Dermatol* 1999;112:85–90.

2011. Dickinson JL, Bates EJ, Ferrante A, et al. Plasminogen activator inhibitor type 2 inhibits tumor necrosis factor alpha-induced apoptosis. Evidence for an alternate biological function. *J Biol Chem* 1995;270:27894–27904.

2012. Dickinson JL, Norris BJ, Jensen PH, et al. The C-D interhelical domain of the serpin plasminogen activator inhibitor-type 2 is required for protection from TNF-alpha induced apoptosis. *Cell Death Differ* 1998;5:163–171.

2013. Shafren DR, Gardner J, Mann VH, et al. Picornavirus receptor down-regulation by plasminogen activator inhibitor type 2. *J Virol* 1999;73:7193–7198.

2014. Yu H, Maurer F, Medcalf RL. Plasminogen activator inhibitor type 2: a regulator of monocyte proliferation and differentiation. *Blood* 2002;99:2810–2818.

2015. Collen D, De C, Verstraete M. Immunochemical distinction between antiplasmin and alpha-antitrypsin. *Thromb Res* 1975;7:245–249.

2016. Collen D. Identification and some properties of a new fast-reacting plasmin inhibitor in human plasma. *Eur J Biochem* 1976;69:209–216.

2017. Mullertz S, Clemmensen I. The primary inhibitor of plasmin in human plasma. *Biochem J* 1976;159:545–553.

2018. Moroi M, Aoki N. Isolation and characterization of alpha2-plasmin inhibitor from human plasma. A novel proteinase inhibitor which inhibits activator-induced clot lysis. *J Biol Chem* 1976;251:5956–5965.

2019. Favier R, Aoki N, de Moerloose P. Congenital alpha(2)-plasmin inhibitor deficiencies: a review. *Br J Haematol* 2001;114:4–10.

2020. Aoki N, Sumi Y, Miura O, et al. Human alpha 2-plasmin inhibitor. *Methods Enzymol* 1993;223:185–197.

2021. Menoud PA, Sappino N, Boudal-Khoshbeen M, et al. The kidney is a major site of alpha(2)-antiplasmin production. *J Clin Invest* 1996;97:2478–2484.

2022. Collen D, Wiman B. Turnover of antiplasmin, the fast-acting plasmin inhibitor of plasma. *Blood*

1979;53:313–324.

2023. Mast AE, Enghild JJ, Pizzo SV, et al. Analysis of the plasma elimination kinetics and conformational stabilities of native, proteinase-complexed, and reactive site cleaved serpins: comparison of alpha 1-proteinase inhibitor, alpha 1-antichymotrypsin, antithrombin III, alpha 2-antiplasmin, angiotensinogen, and ovalbumin. *Biochemistry* 1991;30:1723–1730.

2024. Bangert K, Johnsen AH, Christensen U, et al. Different N-terminal forms of alpha 2-plasmin inhibitor in human plasma. *Biochem J* 1993;291(Pt 2):623–625.

2025. Koyama T, Koike Y, Toyota S, et al. Different NH<sub>2</sub>-terminal form with 12 additional residues of alpha 2-plasmin inhibitor from human plasma and culture media of Hep G2 cells. *Biochem Biophys Res Commun* 1994;200:417–422.

2026. Wiman B, Collen D. Purification and characterization of human antiplasmin, the fast-acting plasmin inhibitor in plasma. *Eur J Biochem* 1977;78:19–26.

2027. Hortin GL, Gibson BL, Fok KF. Alpha 2-antiplasmin's carboxy-terminal lysine residue is a major site of interaction with plasmin. *Biochem Biophys Res Commun* 1988;155:591–596.

2028. Wiman B, Almquist A, Ranby M. The non-covalent interaction between plasmin and alpha 2-antiplasmin. *Fibrinolysis* 1989;3:231–235.

2029. Sugiyama N, Sasaki T, Iwamoto M, et al. Binding site of alpha 2-plasmin inhibitor to plasminogen. *Biochim Biophys Acta* 1988;952:1–7.

2030. Wiman B, Nilsson T, Cedergren B. Studies on a form of alpha 2-antiplasmin in plasma which does not interact with the lysine-binding sites in plasminogen. *Thromb Res* 1982;28:193–199.

2031. Christensen U, Clemmensen I. Purification and reaction mechanisms of the primary inhibitor of plasmin from human plasma. *Biochem J* 1978;175:635–641.

2032. Clemmensen I, Thorsen S, Mullertz S, et al. Properties of three different molecular forms of the alpha 2 plasmin inhibitor. *Eur J Biochem* 1981;120: 105–112.

2033. Hortin GL, Trimpe BL, Fok KF. Plasmin's peptide-binding specificity: characterization of ligand sites in alpha 2-antiplasmin. *Thromb Res* 1989;54:621–632.

2034. Wiman B, Collen D. On the kinetics of the reaction between human antiplasmin and plasmin. *Eur J Biochem* 1978;84:573–578.

2035. Kato A, Hirosawa S, Toyota S, et al. Localization of the human alpha 2-plasmin inhibitor gene (PLI) to 17p13. *Cytogenet Cell Genet* 1993;62:190–191.

2036. Hirosawa S, Nakamura Y, Miura O, et al. Organization of the human alpha 2-plasmin inhibitor gene. *Proc Natl Acad Sci U S A* 1988;85:6836–6840.

2037. Kordich L, Feldman L, Porterie P, et al. Severe hemorrhagic tendency in heterozygous alpha 2-antiplasmin deficiency. *Thromb Res* 1985;40:645–651.

2038. Griffin GC, Mammen EF, Sokol RJ, et al. Alpha 2-antiplasmin deficiency. An overlooked cause of hemorrhage. *Am J Pediatr Hematol Oncol* 1993;15:328–330.

2039. Holmes WE, Lijnen HR, Nelles L, et al. Alpha 2-antiplasmin Enschede: alanine insertion and abolition of plasmin inhibitory activity. *Science* 1987;238:209–211.

2040. Miura O, Sugahara Y, Aoki N. Hereditary alpha 2-plasmin inhibitor deficiency caused by a transport-deficient mutation (alpha 2-PI-Okinawa). Deletion of Glu137 by a trinucleotide deletion blocks intracellular transport. *J Biol Chem* 1989;264:18213–18219.

2041. Miura O, Hirosawa S, Kato A, et al. Molecular basis for congenital deficiency of alpha 2-plasmin inhibitor. A frameshift mutation leading to elongation of the deduced amino acid sequence. *J Clin Invest*

1989;83:1598–1604.

2042. Yoshinaga H, Nakahara M, Koyama T, et al. A single thymine nucleotide deletion responsible for congenital deficiency of plasmin inhibitor. *Thromb Haemost* 2002;88:144–148.

2043. Yoshinaga H, Hirosawa S, Chung DH, et al. A novel point mutation of the splicing donor site in the intron 2 of the plasmin inhibitor gene. *Thromb Haemost* 2000;84:307–311.

2044. Lijnen HR. Gene targeting in hemostasis. Alpha2–antiplasmin. *Front Biosci* 2001;6:D239–D247.

2045. Christensen S, Valnickova Z, Thogersen IB, et al. Assignment of a single disulphide bridge in human alpha2–antiplasmin: implications for the structural and functional properties. *Biochem J* 1997;323(Pt 3):847–852.

2046. Mimuro J, Koike Y, Sumi Y, et al. Monoclonal antibodies to discrete regions in alpha 2–plasmin inhibitor. *Blood* 1987;69:446–453.

2047. Christensen U, Bangert K, Thorsen S. Reaction of human alpha2–antiplasmin and plasmin stopped–flow fluorescence kinetics. *FEBS Lett* 1996;387:58–62.

2048. Reed GL, Matsueda GR, Haber E. Platelet factor XIII increases the fibrinolytic resistance of platelet–rich clots by accelerating the crosslinking of alpha 2–antiplasmin to fibrin [see comments]. *Thromb Haemost* 1992;68:315–320.

2049. Sumi Y, Ichikawa Y, Nakamura Y, et al. Expression and characterization of pro alpha 2–plasmin inhibitor. *J Biochem (Tokyo)* 1989;106:703–707.

2050. Wiman B, Collen D. On the role of alpha2–antiplasmin in the regulation of fibrinolysis. In: Collen D, Wiman B, Verstraete M, eds. *The physiological inhibitors of coagulation and fibrinolysis*. North Holland: Elsevier, 1979:177–185.

2051. Sprengers ED, Kluft C. Plasminogen activator inhibitors. *Blood* 1987;69:381–387.

2052. Reilly CF, Hutzelmann JE. Plasminogen activator inhibitor–1 binds to fibrin and inhibits tissue–type plasminogen activator–mediated fibrin dissolution. *J Biol Chem* 1992;267:17128–17135.

2053. Plow EF, Miles LA, Collen D. Platelet alpha 2–antiplasmin. *Methods Enzymol* 1989;169:296–300.

2054. Plow EF, Collen D. The presence and release of alpha 2–antiplasmin from human platelets. *Blood* 1981;58:1069–1074.

2055. Gogstad GO, Stormorken H, Solum NO. Platelet alpha 2–antiplasmin is located in the platelet alpha–granules. *Thromb Res* 1983;31:387–390.

2056. Erickson LA, Hekman CM, Loskutoff DJ. The primary plasminogen–activator inhibitors in endothelial cells, platelets, serum, and plasma are immunologically related. *Proc Natl Acad Sci U S A* 1985;82:8710–8714.

2057. Kruihof EK, Tran–Thang C, Bachmann F. Studies on the release of a plasminogen activator inhibitor by human platelets. *Thromb Haemost* 1986;55:201–205.

2058. Philips M, Juul AG, Thorsen S. Human endothelial cells produce a plasminogen activator inhibitor and a tissue–type plasminogen activator–inhibitor complex. *Biochim Biophys Acta* 1984;802:99–110.

2059. Stern D, Nawroth P, Handley D, et al. An endothelial cell–dependent pathway of coagulation. *Proc Natl Acad Sci U S A* 1985;82:2523–2527.

2060. Levin EG, Santell L, Osborn KG. The expression of endothelial tissue plasminogen activator in vivo: a function defined by vessel size and anatomic location. *J Cell Sci* 1997;110(Pt 2):139–148.

2061. Grant PJ, Medcalf RL. Hormonal regulation of haemostasis and the molecular biology of the fibrinolytic system. *Clin Sci (Colch)* 1990;78:3–11.



2062. Hajjar KA, Hamel NM, Harpel PC, et al. Binding of tissue plasminogen activator to cultured human endothelial cells. *J Clin Invest* 1987;80:1712–1719.
2063. Bachmann F, Kruithof IE. Tissue plasminogen activator: chemical and physiological aspects. *Semin Thromb Hemost* 1984;10:6–17.
2064. Blasi F, Vassalli JD, Dano K. Urokinase-type plasminogen activator: proenzyme, receptor, and inhibitors. *J Cell Biol* 1987;104:801–804.
2065. Dano K, Andreasen PA, Grondahl-Hansen J, et al. Plasminogen activators, tissue degradation, and cancer. *Adv Cancer Res* 1985;44:139–266.
2066. Blasi F. Surface receptors for urokinase plasminogen activation. *Fibrinolysis* 1988;2:73.
2067. Miles LA, Levin EG, Plescia J, et al. Plasminogen receptors, urokinase receptors, and their modulation on human endothelial cells. *Blood* 1988;72:628–635.
2068. Miles LA, Plow EF. Receptor mediated binding of the fibrinolytic components, plasminogen and urokinase, to peripheral blood cells. *Thromb Haemost* 1987;58:936–942.
2069. Cubellis MV, Nolli ML, Cassani G, et al. Binding of single-chain prourokinase to the urokinase receptor of human U937 cells. *J Biol Chem* 1986;261:15819–15822.
2070. Vassalli JD, Baccino D, Belin D. A cellular binding site for the Mr 55,000 form of the human plasminogen activator, urokinase. *J Cell Biol* 1985;100:86–92.
2071. Ploug M, Plesner T, Ronne E, et al. The receptor for urokinase-type plasminogen activator is deficient on peripheral blood leukocytes in patients with paroxysmal nocturnal hemoglobinuria. *Blood* 1992;79:1447–1455.
2072. Romer J, Lund LR, Eriksen J, et al. The receptor for urokinase-type plasminogen activator is expressed by keratinocytes at the leading edge during re-epithelialization of mouse skin wounds. *J Invest Dermatol* 1994;102:519–522.
2073. Pyke C, Kristensen P, Ralfkiaer E, et al. Urokinase-type plasminogen activator is expressed in stromal cells and its receptor in cancer cells at invasive foci in human colon adenocarcinomas. *Am J Pathol* 1991;138:1059–1067.
2074. Ellis V, Dano K. Potentiation of plasminogen activation by an anti-urokinase monoclonal antibody due to ternary complex formation. A mechanistic model for receptor-mediated plasminogen activation. *J Biol Chem* 1993;268:4806–4813.
2075. Ellis V, Ploug M, Plesner T, et al. Gene expression and function of the cellular receptor for uPA (uPAR). In: Glas-Greenwalt P, ed. *Fibrinolysis in disease*. Boca Raton: CRC Press, 1995:30–42.
2076. Roldan AL, Cubellis MV, Masucci MT, et al. Cloning and expression of the receptor for human urokinase plasminogen activator, a central molecule in cell surface, plasmin dependent proteolysis. *EMBO J* 1990;9:467–474.
2077. Ploug M, Ronne E, Behrendt N, et al. Cellular receptor for urokinase plasminogen activator. Carboxyl-terminal processing and membrane anchoring by glycosyl-phosphatidylinositol. *J Biol Chem* 1991;266:1926–1933.
2078. Moller LB, Ploug M, Blasi F. Structural requirements for glycosyl-phosphatidylinositol-anchor attachment in the cellular receptor for urokinase plasminogen activator. *Eur J Biochem* 1992;208:493–500.
2079. Ploug M, Eriksen J, Plesner T, et al. A soluble form of the glycolipid-anchored receptor for urokinase-type plasminogen activator is secreted from peripheral blood leukocytes from patients with paroxysmal nocturnal hemoglobinuria. *Eur J Biochem* 1992;208:397–404.
2080. Hajjar KA. Cellular receptors in the regulation of plasmin generation. *Thromb Haemost*

1995;74:294-301.

2081. Dudani AK, Ganz PR. Endothelial cell surface actin serves as a binding site for plasminogen, tissue plasminogen activator and lipoprotein(a). *Br J Haematol* 1996;95:168-178.

2082. Bohm T, Geiger M, Binder BR. Isolation and characterization of tissue-type plasminogen activator-binding proteoglycans from human umbilical vein endothelial cells. *Arterioscler Thromb Vasc Biol* 1996;16:665-672.

2083. Kralovich KR, Li L, Hembrough TA, et al. Characterization of the binding sites for plasminogen and tissue-type plasminogen activator in cytokeratin 8 and cytokeratin 18. *J Protein Chem* 1998;17:845-854.

2084. Hembrough TA, Kralovich KR, Li L, et al. Cytokeratin 8 released by breast carcinoma cells in vitro binds plasminogen and tissue-type plasminogen activator and promotes plasminogen activation. *Biochem J* 1996;317(Pt 3):763-769.

2085. Beebe DP, Wood LL, Moos M. Characterization of tissue plasminogen activator binding proteins isolated from endothelial cells and other cell types. *Thromb Res* 1990;59:339-350.

2086. Menell JS, Cesarman GM, Jacovina AT, et al. Annexin II and bleeding in acute promyelocytic leukemia. *N Engl J Med* 1999;340:994-1004.

2087. Taylor ME, Conary JT, Lennartz MR, et al. Primary structure of the mannose receptor contains multiple motifs resembling carbohydrate-recognition domains. *J Biol Chem* 1990;265:12156-12162.

2088. Otter M, Barrett-Bergshoeff MM, Rijken DC. Binding of tissue-type plasminogen activator by the mannose receptor. *J Biol Chem* 1991;266:13931-13935.

2089. Noorman F, Barrett-Bergshoeff MM, Rijken DC. Role of carbohydrate and protein in the binding of tissue-type plasminogen activator to the human mannose receptor. *Eur J Biochem* 1998;251:107-113.

2090. Andreasen PA, Sottrup-Jensen L, Kjoller L, et al. Receptor-mediated endocytosis of plasminogen activators and activator/inhibitor complexes. *FEBS Lett* 1994;338:239-245.

2091. Moestrup SK. The alpha 2-macroglobulin receptor and epithelial glycoprotein-330: two giant receptors mediating endocytosis of multiple ligands. *Biochim Biophys Acta* 1994;1197:197-213.

2092. Kasza A, Petersen HH, Heegaard CW, et al. Specificity of serine proteinase/serpin complex binding to very-low-density lipoprotein receptor and alpha2-macroglobulin receptor/low-density-lipoprotein-receptor-related protein. *Eur J Biochem* 1997;248:270-281.

2093. Miles LA, Plow EF. Binding and activation of plasminogen on the platelet surface. *J Biol Chem* 1985;260:4303-4311.

2094. Miles LA, Ginsberg MH, White JG, et al. Plasminogen interacts with human platelets through two distinct mechanisms. *J Clin Invest* 1986;77:2001-2009.

2095. Adelman B, Rizk A, Hanners E. Plasminogen interactions with platelets in plasma. *Blood* 1988;72:1530-1535.

2096. Redlitz A, Fowler BJ, Plow EF, et al. The role of an enolase-related molecule in plasminogen binding to cells. *Eur J Biochem* 1995;227:407-415.

2097. Schafer AI, Adelman B. Plasmin inhibition of platelet function and of arachidonic acid metabolism. *J Clin Invest* 1985;75:456-461.

2098. Schafer AI, Zavoico GB, Loscalzo J, et al. Synergistic inhibition of platelet activation by plasmin and prostaglandin I<sub>2</sub>. *Blood* 1987;69:1504-1507.

2099. Niewiarowski S, Senyi AF, Gillies P. Plasmin-induced platelet aggregation and platelet release reaction. Effects on hemostasis. *J Clin Invest* 1973;52:1647-1659.

2100. Miller JL, Katz AJ, Feinstein MB. Plasmin inhibition of thrombin-induced platelet aggregation.

Thromb Diath Haemorrh 1975;33:286–309.

2101. Guccione MA, Kinlough–Rathbone RL, Packham MA, et al. Effects of plasmin on rabbit platelets. *Thromb Haemost* 1985;53:8–14.

2102. Torr SR, Winters KJ, Santoro SA, et al. The nature of interactions between tissue–type plasminogen activator and platelets. *Thromb Res* 1990;59:279–293.

2004 Lippincott Williams & Wilkins  
John P. Greer, John Foerster, John N. Lukens  
George M. Rodgers, Frixos Paraskevas, Bertil Glader  
Wintrobe's Clinical Hematology

## Endothelium: Angiogenesis and the Regulation of Hemostasis

### NORMAL ANGIOGENESIS

[Vascular Endothelial Growth Factor and Its Receptors](#)

[Angiopoietins and Their Receptors](#)

[Angiogenesis in Normal and Malignant Hematopoiesis](#)

### ENDOTHELIAL CELL STRUCTURE

[Endothelial Cell Phenotypes: Resting versus Activated](#)

### THE VESSEL WALL AND HEMOSTASIS: GENERAL CONCEPTS

#### ANTITHROMBOTIC PROPERTIES OF UNPERTURBED ENDOTHELIUM

[Antiplatelet Activities](#)

[Anticoagulant Activities](#)

[Fibrinolytic Activities](#)

#### PROTHROMBOTIC PROPERTIES OF UNPERTURBED ENDOTHELIUM

#### HEMOSTATIC PROPERTIES OF PERTURBED ENDOTHELIUM

[Diversity of Endothelial Cell Hemostatic Properties](#)

[Clinical Relevance of Vascular Endothelial Cell Hemostatic Properties](#)

### REFERENCES

## NORMAL ANGIOGENESIS

Blood circulation requires the production and maintenance of a vast network of vessels that have specialized functions depending on their organ location. The vascular network involves a complex interaction between endothelial cells (EC), specialized cells such as smooth muscle cells and pericytes, and the extracellular matrix. *Vasculogenesis* is the *de novo* development of vessels ( [1](#) ). It is mainly seen at the embryonic stage of development with the differentiation of a common pluripotent precursor, the hemangioblast, into endothelial and hematopoietic cells. *Angiogenesis* is the development of new vessels from preexisting vessels ( [1](#) ). It is an essential process for wound healing and the maintenance of the integrity of the vascular network. Pathologic angiogenesis is seen in disease states including cancer, retinal, and autoimmune diseases ( [2](#) ).

As outlined by Conway, Cullen, and Carmeliet ( [1](#) ), physiologic angiogenesis is a well-organized stepwise process that involves dilation and increased permeability of the parent vessel, dissolution of the extracellular matrix, division and migration of EC, cord formation and the development of lumina, and, finally, the maintenance of new vessel integrity. The entire process involves the complex and choreographed effects of multiple inducers and inhibitors ( [Table 22.1](#) ).

**TABLE 22.1. Activators and Inhibitors of Angiogenesis**

| Activators | Function | Inhibitors | Function |
|------------|----------|------------|----------|
|------------|----------|------------|----------|

|   |   |   |   |
|---|---|---|---|
| VEGF, VEGF-C, PIGF, and homologs  | Stimulate angiogenesis, permeability; stimulate lymphangiogenesis, pathologic angiogenesis.                                   | VEGFR-1, soluble VEGFR-1, and NP-1                      | Sink for VEGF, VEGF-B, PIGF (VEGFR-1), and VEGFR <sub>165</sub> (NP-1)      |
| VEGFR   | VEGFR-2: angiogenic signaling; VEGFR-3: (lymph) angiogenic signaling.   | Ang2  | Ang1 antagonist; induces vessel regression in absence of angiogenic signals |
| Ang1 and Tie2 receptor  | Ang1: stabilizes vessels, TSP-1 inhibits permeability.  |   | ECM proteins; inhibits EC migration, growth, and adhesion                   |
|   | Ang2: destabilizes vessels before sprouting.  | TSP-2   | Inhibits angiogenesis   |
| Platelet-derived growth factor-BB and receptors   | Recruit smooth muscle cells.  | Meth-1, Meth-2  | Contain metalloprotease, thrombospondin, and disintegrin domains            |
| TGF- $\beta$ <sub>1</sub> , endoglin, TGF- $\beta$ receptors                                      | Stabilize vessels by stimulating ECM production.  | Angiostatin and related plasminogen kringle             | Inhibit EC survival and migration   |
| Fibroblast growth factor, hepatocyte growth factor, monocyte chemotactic protein-1                | Stimulate angiogenesis, stimulate arteriogenesis.   | Endostatin  | Inhibits EC survival and migration  |
| Integrins $\alpha$ <sub>v</sub> $\beta$ <sub>3</sub> , $\alpha$ <sub>v</sub> $\beta$ <sub>5</sub> | MMP receptors.  | Vasostatin, calreticulin                                | Inhibit EC growth   |
| VE-cadherin, platelet-EC adhesion molecule  | EC junctional molecules, promote EC survival.   | Platelet factor-4                                       | Heparin-binding molecule; inhibits binding of bFGF and VEGF                 |
| Ephrins   | Regulate arterial/venous specifications.  | Tissue inhibitors of metalloproteinases, MMP inhibitors | Suppress pathologic angiogenesis  |
|   |   | Proteolytic fragment of MMP                             | Inhibits binding of MMP2 to $\alpha$ <sub>v</sub> $\beta$ <sub>3</sub>      |
| Plasminogen activators, MMPs  | Cell migration and matrix remodeling; liberate bFGF/VEFG from ECM; activate TGF- $\beta$ <sub>1</sub> ; generate angiostatin. |   |   |
| Plasminogen-activator-inhibitor-1   | Stabilizes nascent vessels (prevents ECM dissolution).  | IFN- $\alpha$ , - $\beta$ , - $\gamma$ ; IL-4, -12, -18 | Inhibit EC migration, IFN- $\alpha$ down-regulates bFGF                     |
| Nitric oxide synthase, cyclooxygenase-2   | Nitric oxide/prostaglandins stimulate angiogenesis and vasodilation.  | Prothrombin kringle 2 antithrombin fragment             | Suppresses EC growth  |

|       |                             |   |  |
|-------|-----------------------------|---|--|
| AC133 | Angioblast differentiation. | Prolactin fragment; secreted protein (acidic and rich in cysteine) fragment | Inhibits bFGF and VEGF; inhibits EC binding and activity of VEGF |
|-------|-----------------------------|---|--|

Ang, angiopoietin; bFGF, b-fibroblast growth factor; EC, endothelial cells; ECM, extracellular matrix; IFN, interferon; IL, interleukin; Meth, metalloproteinase and thrombospondin; MMP, matrix metalloproteinase; NP, neuropilin; PIGF, placental growth factor; TGF, transforming growth factor; TSP, thrombospondin; VEGF, vascular endothelial growth factor; VEGFR, vascular endothelial growth factor receptor.

Adapted from Conway EM, Collen D, Carmeliet P. Molecular mechanisms of blood vessel growth. *Cardiovasc Res* 2001;49:507–521.

---

The first step in angiogenesis is vasodilation. This is mediated through the activation of the soluble guanylate cyclase by nitric oxide (NO) ( [3](#) ). NO also up-regulates vascular endothelial growth factor (VEGF) production ( [4](#) ). By causing intercellular adhesion molecules to redistribute (platelet-EC adhesion molecule-1 and VE-cadherin, among others), VEGF induces an increase in vascular permeability ( [5](#), [6](#) ). The VEGF-induced increase in vascular permeability is negatively controlled by angiopoietin-1 (Ang1) through its receptor, Tie2 ( [7](#) ). The next key step to vascular development is the dissolution of the extracellular matrix, which is accomplished by proteases belonging to the matrix metalloproteinase family ( [8](#), [9](#) ). These proteases also induce the liberation of EC growth factors from the extracellular matrix, including VEGF and basic fibroblast growth factor. The action of matrix metalloproteinases is negatively controlled by a family of protease inhibitors, the tissue inhibitors of metalloproteinases ( [10](#) ).

Degradation of the extravascular matrix allows the development of the key element of the angiogenesis process, namely, EC division and migration. The list of factors that stimulate this process is extensive ( [Table 22.1](#) ), but a key role is played by VEGF in concert with Ang1 ( [6](#), [11](#), [12](#), [14](#), [15](#) and [16](#) ). Angiopoietin-2 (Ang2) could have angiogenic effects in the presence of VEGF, whereas it is antiangiogenic in the absence of VEGF ( [14](#), [15](#), [16](#) and [17](#) ). The role played by the endothelial NO synthase and NO has been the subject of controversy, with reports showing that NO has both pro- and antiangiogenic effects ( [18](#), [19](#), [20](#) and [21](#) ). Other factors that stimulate angiogenesis include basic fibroblast growth factor and platelet-derived growth factor ( [22](#), [23](#) and [24](#) ). EC growth is negatively controlled by endogenous angiogenesis inhibitors that include angiostatin, endostatin, interferons, and antithrombin III ( [25](#), [26](#), [27](#) and [28](#) ). EC then migrate in large part through the action of integrins (a  $\nu\beta_3$  and a  $\nu\beta_1$ ) ( [29](#) ). The end result of EC division and migration is sprouting and the formation of cords ( [1](#) ). This is followed by lumen formation, which is controlled by different VEGF isoforms, Ang1, and integrins ( [1](#), [15](#) ). Thrombospondin-1 acts as an endogenous inhibitor of lumen development ( [1](#) ).

Once formed, new vessels survive for years ( [1](#) ). This prolonged survival is maintained by the interaction of VEGF with its receptor VEGFR-2, phosphoinositide 3-kinase,  $\beta$ -catenin, and VE-cadherin ( [1](#), [30](#) ). The angiopoietins also play a role in maintaining vessel survival through their receptors Tie1 and Tie2. Ang1 stabilizes the vessel, whereas Ang2 has an opposite effect ( [14](#), [15](#), [31](#) ) (see below). An essential element in the maintenance of the integrity of vessels is their “coating” with smooth muscle cells and pericytes ( [32](#) ). Evidence suggests that vascular smooth muscle cells and EC have a

common precursor ( 33 ). On stimulation with platelet-derived growth factor-BB, these precursor cells differentiate into smooth muscle cells, whereas VEGF stimulation drives them to differentiate into EC ( 33 ). Besides providing physical support for endothelial vessels, smooth muscle cells and pericytes are a source of factors that are important for the maintenance and control of vascular integrity and function ( 1 , 32 ). The extracellular matrix plays a key role in that respect by being a dynamic storage site for growth factors and proenzymes that are important in vessel function and angiogenesis ( 1 ).

## Vascular Endothelial Growth Factor and Its Receptors

VEGF is the pivotal factor controlling angiogenesis. As such, it is the best-studied angiogenic factor. Several proteins belong to the VEGF family and include VEGF (also known as *VEGF-A*), VEGF-B, VEGF-C, VEGF-D, and placental growth factor ( 14 ). Although VEGF-A is the main angiogenic factor discussed here, VEGF-B seems to play an important role in coronary vascular development ( 34 ). VEGF-C is essential for lymphangiogenesis by interacting with the VEGFR-3 receptor ( 35 ). The function of VEGF-D has yet to be determined ( 14 ).

Being the major regulator of angiogenesis, VEGF is a mitogen and survival factor for EC ( 11 , 14 ). As mentioned above, it is also a potent inducer of vascular permeability, an essential step in the angiogenic process ( 1 , 11 , 14 ). It has two well-characterized receptors, VEGFR-1 and VEGFR-2 (also known as *Flt-1* and *Flk-1/kinase domain receptor*, respectively) ( 14 ). They are both tyrosine kinases. VEGFR-2 is the main effector of a VEGF-induced chemotactic and mitogenic response in EC. VEGFR-2 also mediates the EC's permeability effects ( 14 ). The role of VEGFR-1 in EC response to VEGF has not been totally elucidated. However, it seems to negatively control the VEGF effects by acting as a decoy ( 14 , 36 , 37 ). Indeed, mice that have been engineered not to express VEGFR-1 have evidence of excess and disorganized angiogenesis ( 36 ).

## Angiopoietins and Their Receptors

Angiopoietins and Tie receptors play an important role in angiogenesis. To date, four angiopoietins have been identified ( 14 ). However, only Ang1 and Ang2 have been fully characterized. They interact with the Tie tyrosine kinase receptors, mainly Tie2. Ang1 plays an important role in stabilizing the vasculature ( 14 ). Supportive cells express Ang1 and interact with EC through the Tie2 receptor. Genetically engineered mouse embryos that lack Ang1 develop a normal primary vasculature. However, they do not undergo further vascular remodeling ( 16 ). Transgenic mice that overexpress Ang1 have evidence of vascularization characterized by larger vessels rather than a greater number of vessels ( 15 ). Additionally, those vessels are resistant to leak, further supporting the role of Ang1 as a stabilizing factor.

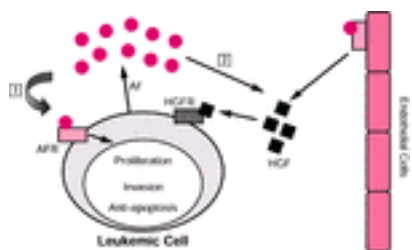
The function of Ang2 has been more difficult to characterize ( 14 , 17 ). It too binds with high affinity to the Tie2 receptor. Transgenic overexpression of Ang2 in mice is embryonically lethal and induces a phenotype that is similar to Ang1 or Tie2 knock-out experiments. Thus, it has been suggested that Ang2, by acting as an antagonist of Tie2, negates the stabilizing effects of Ang1 on the vasculature. As such, Ang2 may be a destabilizing factor that helps initiate angiogenesis and vascular remodeling ( 14 ).



## Angiogenesis in Normal and Malignant Hematopoiesis

There has been mounting evidence suggesting the presence of a common precursor for EC and hematopoietic cells (38). This hemangioblast gives rise to both EC and hematopoietic cells in embryonic development. Embryonic stem cells express VEGFR-2 and can give rise, depending on culture conditions, to hematopoietic progenitor cells and angioblasts (38). Stimulation of hematopoietic stem cells with growth factors, including kit ligand, interleukin-3, granulocyte-macrophage colony-stimulating factor and granulocyte colony-stimulating factor, induces the release by those cells of VEGF, which then induces the release of hematopoietic growth factors by bone marrow EC (38). Thus, there is a dynamic interaction between hematopoietic and endothelial elements in the bone marrow. This interaction seems to modulate, at least in part, hematopoiesis.

Several recent studies have shown evidence of increased angiogenesis in hematopoietic malignancies (39). Such evidence has been demonstrated in multiple myeloma and lymphomas, as well as acute and chronic leukemias (39, 40, 41, 42, 43, 44, 45, 46, 47 and 48). Malignant hematopoietic cells have been shown to produce angiogenic factors, including VEGF (39). Expression of angiogenic factors has been suggested to have prognostic significance in hematopoietic malignancies, although results have been variable (39). Similar to the effect observed in normal hematopoiesis, VEGF stimulates the production of hematopoietic growth factors by EC (39). Consequently, malignant cells exploit their environment to their advantage by developing a synergistic relationship with EC (Fig. 22.1). This has led to the active investigation of antiangiogenic agents as a novel therapeutic strategy for hematologic malignancies.



**Figure 22.1.** Hypothesis for the role of angiogenesis in leukemia. **1:** Angio-genic factors (AFs) produced by leukemic cells can stimulate cell growth and invasion or inhibit apoptosis (autocrine mechanism). **2:** AFs produced by leukemic cells can also stimulate endothelial cell proliferation and the production of endothelial cell hematopoietic growth factors (HGFs) (paracrine mechanism). AFR, angiogenic factor receptor; HGFR, hematopoietic growth factor receptor. (From Dickson DJ, Shami PJ. Angiogenesis in acute and chronic leukemias. *Leuk Lymphoma* 2001;42:847-853, with permission.)

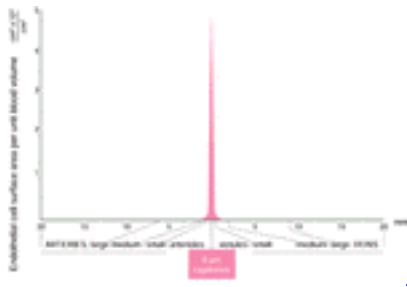
In addition to the effects of vascular endothelium in modulating and responding to angiogenic stimuli, vascular endothelium also influences other functions (49, 50), including vasoconstriction, selective permeability, hemostasis, antigen presentation, and the inflammatory response. The EC surface is a dynamic interface between soluble and cellular constituents of the blood and the remainder of the body. Techniques to culture endothelium (51) have permitted investigation into the multifaceted roles of this tissue. However, there are biologic differences between *in vivo* and cultured EC; for example, cultured EC have at least a tenfold greater proliferation rate than *in vivo* EC (50). There

may be other functional differences between native and cultured EC as well.

Vascular injury results in a complex host response. Atherogenesis is one of the best characterized vascular responses and is extensively reviewed elsewhere ([52](#), [53](#)). A brief discussion of EC structure and EC regulation of hemostasis follows.

## ENDOTHELIAL CELL STRUCTURE

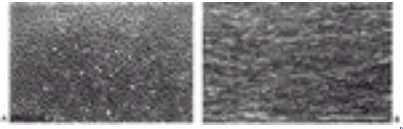
Individual EC measure approximately  $20 \times 50 \mu\text{m}^2$  in surface area. The total vascular surface area in a normal adult is estimated to be greater than  $1000 \text{ m}^2$  ([54](#)). However, the geometry of the vascular system is not static. As indicated in [Figure 22.2](#), the surface area facing a unit volume of blood differs, depending on the vascular bed being considered. For example, the surface area to volume ratio is approximately 1000 times greater in capillaries than in large blood vessels ([55](#)). This vascular geometry has implications for regulation of hemostasis and is discussed below.



**Figure 22.2.** Relationship of vascular surface area to volume in the vascular system. Diameters are plotted from published data. (From Rushmer RF. Properties of the vascular system. In: Cardiovascular dynamics. Philadelphia: WB Saunders, 1976. Modified from reference [55](#), with permission.)

EC are anchored to the vessel wall by basement membrane secreted by EC and smooth muscle cells. Basement membrane contains a large number of connective tissue components, including collagen, microfibrils, glycosaminoglycans (GAG), fibronectin, and thrombospondin ([54](#)). These components may serve as ligands for a number of cell adhesion processes important in angiogenesis, hemostasis, vascular repair, and inflammation ([50](#), [56](#)).

EC typically exist as a cell monolayer, exhibiting contact inhibition and a cobblestone appearance ([Fig. 22.3](#)). Two types of cell-cell junctional structures have been reported—adherens junctions and tight junctions. These structures regulate permeability and maintain polarity ([57](#)). Two cell receptors thought to be important in EC monolayer organization are platelet-EC adhesion molecule-1 ([58](#)) and vascular cadherin ([59](#)). CD146 (MelCAM) is associated with the EC cytoskeleton and likely serves as an EC junction component ([60](#)). Members of the junctional adhesion molecule family appear to be components of tight junctions ([61](#)).



**Figure 22.3.** Endothelial cell morphology. **A:** Cultured human umbilical arterial endothelial cells with the typical cobblestone appearance (phase-contrast,  $\times 100$ ). **B:** Scanning electron photomicrograph of a primate aorta. The bar indicates a distance of 100  $\mu\text{m}$ . (From Faggiotto A, Ross R, Harker L. Studies of hypercholesterolemia in the nonhuman primate. I. Changes that lead to fatty streak formation. *Arteriosclerosis* 1984;4:323–340, with permission of the American Heart Association.)

EC contain unique intracellular structures called *Weibel–Palade bodies* ( [62](#) ); these organelles contain the adhesion protein von Willebrand factor, which is secreted constitutively and also in response to cell stimulation ( [63](#) ). The Weibel–Palade body membrane contains P–selectin, which is expressed on the EC surface after EC activation. When expressed on the vascular surface, P–selectin mediates neutrophil and monocyte adhesion to the vessel wall ( [64](#) ). Selectin–independent platelet adhesion to endothelium has also been reported ( [65](#) ). Integrins mediating platelet–EC and leukocyte–EC interactions are discussed in [Chapter 20](#) and [Chapter 10](#), respectively. Additional EC proteins have been reported to undergo regulated release or cell–surface expression, including tissue plasminogen activator (TPA), interleukin–8, endothelin–1, and multimerin ( [66](#) ). These and other proteins may be contained in Weibel–Palade bodies or other distinct organelles. The regulated secretion of these EC proteins has been reviewed ( [66](#) ).

### Endothelial Cell Phenotypes: Resting versus Activated

The concept of differing EC phenotypes [e.g., resting (constitutive) vs. activated] has been applied to numerous EC functions ( [67](#) ), including the inflammatory response, regulation of coagulation, angiogenesis, and so forth. This chapter focuses on EC phenotypes as related to the functions of angiogenesis, and hemostasis and thrombosis. Other EC functions have been reviewed elsewhere ( [50](#), [52](#), [67](#) ).

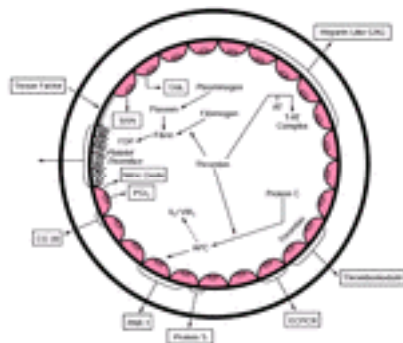
## THE VESSEL WALL AND HEMOSTASIS: GENERAL CONCEPTS

The three major cell types of the normal vessel wall are EC (intima), smooth muscle cells (media), and connective tissue elements, such as fibroblasts (adventitia). The circulating coagulation proteins contained in the blood are in immediate contact with quiescent vascular endothelium that normally presents a thromboresistant surface in that EC are unable to initiate coagulation ( [68](#), [69](#) ) or promote platelet adhesion and activation ( [70](#), [71](#), [72](#) and [73](#) ). Thus, in the absence of vascular trauma or perturbation (activation), blood remains fluid as a result of antithrombotic activities expressed by EC. However, after traumatic vascular injury, exposure of blood to cells within the vessel wall, especially fibroblasts, or to extracellular matrix (subendothelium) results in rapid initiation of coagulation because fibroblasts ( [68](#) ) and subendothelium containing EC remnants ( [74](#) ) constitutively express tissue factor (TF) procoagulant activity. Alternatively, perturbation (activation) of EC by stimuli, such as cytokines ( [75](#) ), may induce altered EC hemostatic function (in the absence of vascular injury), resulting in net EC expression of thrombotic activity. These hemostatic properties of unperturbed and perturbed EC are critical in determining the coagulant balance of the vessel wall and the extent of activation of coagulation.

A cell-based model of hemostasis has been presented in which fibroblasts or perturbed EC express TF to initiate coagulation; amplification and propagation of coagulation then occur on the platelet surface. Modulation of coagulation occurs via EC antithrombotic activities and plasma protease inhibitors ( [76](#) ).

## ANTITHROMBOTIC PROPERTIES OF UNPERTURBED ENDOTHELIUM

Antithrombotic mechanisms responsible for unperturbed (native) EC thromboresistance are illustrated in [Figure 22.4](#). Major antithrombotic properties can be classified as antiplatelet activities, anticoagulant activities, and fibrinolytic activities.



**Figure 22.4.** Vessel wall antithrombotic properties. The major antithrombotic properties are depicted in boxes. Heparin-like glycosaminoglycans (GAG), such as heparan sulfate, catalyze inactivation of serine proteases, such as thrombin (T) and factor Xa, by antithrombin (AT). Formation of the T-thrombomodulin complex activates protein C to activated protein C (APC). The endothelial cell (EC) protein C receptor (ECPCR) promotes protein C activation. Binding of APC to EC-bound protein S (and factor V) promotes proteolysis of factors Va and VIIIa ( *dotted line* ), inhibiting coagulation. APC also possesses antiinflammatory properties that are mediated by EC protease-activated receptor (PAR)-1. This APC activity requires ECPCR (not shown). Secretion of vessel wall prostacyclin (PGI<sub>2</sub>) and nitric oxide and expression of CD39 limit platelet thrombus formation at sites of vascular injury. Tissue plasminogen activator (tPA) is secreted and bound to EC to initiate fibrinolysis. Secretion of tissue factor pathway inhibitor (TFPI) by EC suppresses tissue factor-mediated initiation of coagulation. Dermatan sulfate-catalyzed activation of heparin cofactor II and an inhibitor to contact activation are not illustrated in the figure. FDP, fibrin degradation products. (Modified from Rodgers GM. Hemostatic properties of normal and perturbed vascular cells. *FASEB J* 1988;2:116-123.)

### Antiplatelet Activities

Vascular endothelium inhibits platelet function by several mechanisms. The EC plasma membrane does not permit adherence of resting platelets ( [77](#) ). Additionally, EC synthesize and secrete three potent antiplatelet agents: prostacyclin (PGI<sub>2</sub>), NO (also called *endothelium-derived relaxing factor*), and certain adenine nucleotides. PGI<sub>2</sub> is constitutively synthesized by EC cyclooxygenase (prostaglandin H synthase) and phospholipase A<sub>2</sub> in response to thrombin ( [78](#) ) and other vasoactive agonists ( [79](#) ). In addition to PGI<sub>2</sub>'s ability to prevent adhesion of activated platelets to EC, this agent also possesses potent vasodilating properties ( [71](#) ). PGI<sub>2</sub> inhibits platelet function by

increasing levels of platelet cyclic adenosine monophosphate. Aspirin inhibits the synthesis of PGI<sub>2</sub> by irreversibly acetylating and inactivating EC cyclooxygenase (80). Recovery of PGI<sub>2</sub> production by EC occurs with subsequent EC synthesis of cyclooxygenase.

A second inducible form of cyclooxygenase, called *cyclooxygenase-2*, has been identified in a variety of cells, including EC (81, 82). Both cyclooxygenase proteins are homologous, with similar molecular weights and structural features. Investigators believe that cyclooxygenase-2 mediates the vascular response to injury and inflammation.

NO is thought to be important primarily in regulating vascular tone (83, 84), although this agent is also a potent inhibitor of platelet adhesion to vascular endothelium (72). Constitutive and inducible pathways generate NO from the terminal guanidino nitrogen of arginine in a reaction catalyzed by NO synthetase (83, 85). The constitutive mechanism generates small amounts of NO and mediates physiologic responses. Increased synthesis of NO occurs in response to cytokines (inducible pathway), such as tumor necrosis factor, to mediate inflammatory events (84). Both the constitutive and inducible forms of NO synthetase are present in EC (86). Other stimuli to NO generation include adenosine diphosphate (ADP), thrombin, shear stress, and bradykinin (50). EC-derived NO also inhibits leukocyte adhesion, as well as vascular smooth muscle cell proliferation. Elevated levels of cyclic guanosine monophosphate result from NO stimulation and mediate the biologic activities of this antiplatelet agent. Synthesis of NO is insensitive to the effects of aspirin.

A third EC antiplatelet property is ectoenzymes that rapidly metabolize ADP and adenosine triphosphate to adenosine monophosphate and adenosine (87). ADP is a potent platelet agonist, and adenosine is a potent inhibitor of platelet function. Thus, EC can convert a platelet agonist to an antiplatelet agent by this mechanism. EC ectoenzymes are insensitive to the effects of aspirin. This ectoenzyme antiplatelet property of EC may explain earlier reports of EC thromboresistance to platelet adhesion. The EC ecto-ADPase responsible for inhibition of platelet function is CD39 (88). Deletion of this EC receptor in mice results in a prothrombotic state and platelet dysfunction (89).

### Anticoagulant Activities

Vascular EC synthesize and express heparinlike GAG, such as heparan sulfate and dermatan sulfate, on their luminal surface (90). These GAG catalyze the inactivation of serine proteases, such as thrombin and factor Xa, by protease inhibitors, such as antithrombin and heparin cofactor II, respectively, via formation of a covalent protease-antiprotease complex. Of these two protease inhibitors, antithrombin is considered to be more important (91). The molecular basis for the effect of heparin in promoting antithrombin neutralization of serine proteases involves interaction of a specific pentasaccharide sequence of the EC heparinlike molecule with an allosteric site on the antithrombin molecule (90, 91). This interaction results in conformational changes in antithrombin that permit more efficient binding to protease molecules. *In vivo*, antithrombin molecules are associated with EC GAG (90), providing a mechanism for instantaneous control over activation of coagulation. Surprisingly, mice deficient in the enzyme responsible for generating the pentasaccharide activity do not show a procoagulant phenotype (92). Nevertheless, this heparan sulfate-antithrombin mechanism is considered to be an important natural anticoagulant process because deficiency of antithrombin is associated with a thrombotic tendency (93). In contrast, the clinical

relevance of the heparin cofactor II mechanism is uncertain ( 94 ).

Another key vascular anticoagulant activity is the protein C pathway that consists of two plasma proteins—protein C and protein S—and an EC receptor, thrombomodulin ( Fig. 22.4). EC synthesize and express protein S ( 95 ) and thrombomodulin ( 96 ), whereas protein C is synthesized by the liver. Thrombin generation leads to thrombin's binding to thrombomodulin; the thrombin–thrombomodulin complex then activates protein C to generate activated protein C (APC) ( 97 ). APC binds to protein S, resulting in inhibition of coagulation by proteolysis of two coagulation cofactor proteins, factors Va and VIIIa. Inactivation of factors Va and VIIIa prevents further thrombin formation. The involvement of factor V in mediating the anticoagulant effect of APC has been described ( 98 ). It appears that APC down-regulation of coagulation (proteolysis of factors Va and VIIIa) occurs more efficiently on vascular endothelium, rather than on platelets ( 99 ).

An additional component of the protein C pathway exists—the EC protein C receptor (ECPCR). This protein binds protein C to enhance protein C activation by the thrombin–thrombomodulin complex ( 100 , 101 ). ECPCR is found primarily on large vessel endothelium ( 102 ) and is induced by thrombin stimulation. Blocking ECPCR with a monoclonal antibody in a primate model indicates that ECPCR plays a major role in *in vivo* protein C activation ( 103 ).

Certain components of the protein C pathway possess additional anticoagulant activities. For example, APC also possesses profibrinolytic activity that results from the ability of APC to neutralize plasminogen-activator inhibitor-3 (PAI-3) activity ( 96 ).

Thrombomodulin may also inhibit factor Xa ( 104 ). Recurrent thrombosis has been associated with deficiency or abnormality of the protein C pathway components, indicating that this anticoagulant mechanism is relevant for *in vivo* hemostasis.

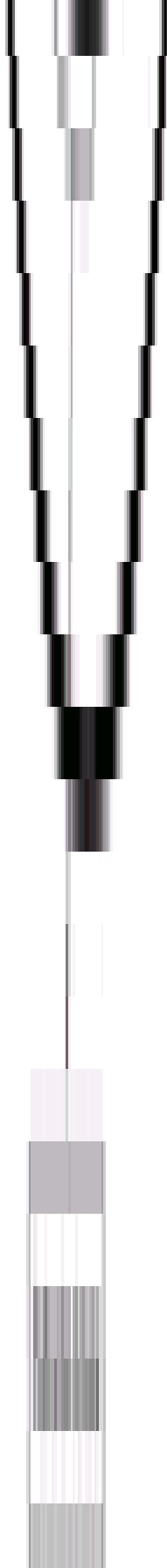
APC has recently been recognized to exert activities other than those associated with anticoagulant properties. In gene expression studies using microarray techniques, APC was found to modulate antiinflammatory and cell survival pathways. APC suppressed adhesion molecule expression, decreased activity of the nuclear factor- $\kappa$ B transcription pathway, and inhibited apoptosis ( 105 ). This regulated EC gene expression may explain the efficacy of APC in the treatment of sepsis ( 106 ). Recent information suggests that APC uses the ECPCR to signal EC via the protease-activated receptor (PAR)-1 pathway (discussed below) ( 107 ).

Regulation of TF procoagulant activity by a plasma protein called *TF pathway inhibitor* (TFPI) has been described ( 108 , 109 and 110 ). This protein is synthesized primarily by EC ( 111 ) and is an important regulator of TF-factor VIIa activation of factor X (discussed in Chapter 21). Additionally, TFPI can inhibit vascular cell proliferation ( 112 ). TFPI may be important in *in vivo* hemostasis because administration of this inhibitor in the setting of TF-induced disseminated intravascular coagulation reduces thrombosis ( 113 ); however, no link with human thrombotic disease has been definitively established ( 110 ). TFPI present in atherosclerotic plaque reduced TF activity ( 114 ). Heparin or low-molecular-weight heparin releases TFPI from EC storage sites ( 115 ).

### Fibrinolytic Activities

EC synthesize and secrete plasminogen activators, primarily TPA, in response to





proactive stimuli, such as histamine and vasopressin ( 116 ). Weibel–Palade organelles in EC ( 117 ). Specific EC In response to inflammatory mediators, EC synthesize ; urokinase ( 119 ), which activates plasminogen in the fluid Activation of plasminogen by TPA generates plasmin; nogen to the fibrin clot leads to physiologic fibrinolysis and lation products ( Fig. 22.4 ). Fibrin degradation products d antithrombin activities and contribute to the anticoagulant n of plasminogen is regulated by PAIs. The major inhibitor of ed by vascular EC ( 121 ) but is also present in platelet r also regulates urokinase activity ( 123 ). PAI–2 is a less marily found in placenta ( 123 ). Details of the fibrinolytic are discussed in Chapter 21.

### PROPERTIES OF UNPERTURBED ENDOTHELIUM

coagulant activities that promote coagulation after vascular wever, in the absence of initiating stimuli, these activities tribute to thrombosis. Major prothrombotic activities of s (receptors) for coagulation zymogens or proteases [factor rs X and Xa ( 126 , 127 , 128 and 129 ), factors IX and IXa ( 126 , nd cofactor proteins [high–molecular–weight kininogen ( 133 , tor Va ( 135 )]] and synthesis and expression of factor V ( 136 , ( 138 ). Resting EC can also activate bound factor XII and f prekallikrein ( 124 ). Investigators have also reported a y for prekallikrein activation on EC; this activation is d thiol protease ( 134 ). Additionally, when en is bound to EC, factor XI (XIa) can associate with EC to 139 ). On the other hand, EC also secrete an inhibitor to role of EC in activation of intrinsic coagulation has been mbotic activities are illustrated in Figure 22.5.

**Figure 22.5.** Vessel wall prothrombotic properties. The major prothrombotic properties are depicted in boxes. Expression of tissue factor activity initiates coagulation, and endothelial cell (EC) synthesis of factor V promotes thrombin formation. Thrombin formation is enhanced by feedback activation of factor XI. Vessel wall injury also promotes platelet adhesion and thrombus formation by exposure of subendothelial von Willebrand factor (VWF). An inducible EC prothrombin activator may directly generate thrombin. EC can be induced to express an activator of factor V (Va). Thrombin exerts



multiple procoagulant activities, including platelet activation and cleavage of fibrinogen, resulting in the fibrin clot. Thrombin binding to thrombomodulin activates thrombin-activatable fibrinolysis inhibitor to down-regulate fibrinolysis (not shown). EC secretion of tissue plasminogen activator (TPA) inhibitor further stabilizes the fibrin clot by preventing fibrinolysis. Also not shown are EC binding sites for coagulation zymogens or proteases. Protease-activated receptor (PAR)-2 is activated by the tissue factor-factor VIIa complex and factor Xa to contribute to EC activation by pathologic stimuli. (Modified from Rodgers GM. Hemostatic properties of normal and perturbed vascular cells. *FASEB J* 1988;2:116-123.)

EC receptors for coagulation proteases permit assembly of complexes consisting of cofactor proteins, proteases, and zymogen substrates that result in optimal activation and localization of coagulation ( [142](#) ). Whereas factor V is secreted primarily into the fluid phase ( [136](#) ), von Willebrand factor is secreted both into plasma and the subendothelium, providing a source of adhesive protein for the platelet response to vascular injury ( [143](#) ).

## HEMOSTATIC PROPERTIES OF PERTURBED ENDOTHELIUM

In this discussion, the term *EC perturbation* means exposure of EC to diverse stimuli, such as traumatic vascular injury, certain cytokines, atherogenic stimuli [homocysteine, modified low-density lipoprotein (LDL)], lipopolysaccharide (endotoxin), immune complexes, and certain infectious organisms. From this list, it is obvious that a variety of inflammatory, infectious, or malignant disorders, as well as metabolic defects, may be associated with hemostatic dysfunction due to altered EC hemostatic properties ( [Table 22.2](#) ). With the exception of traumatic vascular injury, alteration of these key EC coagulant properties is not associated with cytotoxicity or EC desquamation. The major hemostatic properties reviewed in this section include TF activity, thrombomodulin activity (protein C pathway), factor V activation, and fibrinolytic activities (TPA, PAI-1). In general, these activities are concordantly regulated, with stimuli that induce TF expression also suppressing protein C activation and fibrinolysis. The net result of these events is that the perturbed EC surface is converted from an antithrombotic surface to a prothrombotic surface.

**TABLE 22.2. Effect of Perturbing Stimuli on Endothelial Cell Hemostatic Properties**

| Stimulus                         | Tissue Factor   | Tissue Factor Pathway Inhibitor | Protein C Pathway                               | Fibrinolysis              |
|----------------------------------|---|---------------------------------|---|---------------------------|
| <b>Cytokines</b>                 |   |                                 |   |                           |
| Interleukin-1                    | ? ( <a href="#">193</a> )   | —                               | ? ( <a href="#">194</a> )                       | ? ( <a href="#">172</a> ) |
| Tumor necrosis factor            | ? ( <a href="#">195</a> )   | ? ( <a href="#">145</a> )       | ? ( <a href="#">195</a> )                       | ? ( <a href="#">196</a> ) |
| <b>Atherogenic stimuli</b>       |   |                                 |   |                           |
| Homocysteine                     | ? ( <a href="#">197</a> )   | —                               | ? ( <a href="#">198</a> )                       | ? ( <a href="#">199</a> ) |
| Oxidized low-density lipoprotein | ? ( <a href="#">187</a> , <a href="#">200</a> )   | —                               | ? ( <a href="#">187</a> )                       | ? ( <a href="#">201</a> ) |
| Lipopolysaccharide (endotoxin)   | ? ( <a href="#">202</a> )   | —                               | ? ( <a href="#">203</a> )                       | ? ( <a href="#">204</a> ) |
| Infectious organisms             | ? ( <a href="#">188</a> , <a href="#">189</a> , <a href="#">190</a> and <a href="#">191</a> ) | —                               | ? ( <a href="#">189</a> , <a href="#">192</a> ) | —                         |
| <b>Miscellaneous stimuli</b>     |   |                                 |   |                           |
| Thrombin                         | ? ( <a href="#">205</a> )   | —                               | ? ( <a href="#">96</a> )                        | ? ( <a href="#">206</a> ) |

|                  |                           |   |   |   |
|------------------|---------------------------|---|---|---|
| Phorbol esters   | ? ( <a href="#">207</a> ) | — | — | — |
| Immune complexes | ? ( <a href="#">208</a> ) | — | — | — |
| Shear            | ? ( <a href="#">174</a> ) | — | — | — |
| Fibrin           | ? ( <a href="#">209</a> ) | — | — | — |
| Nitric oxide     | ? ( <a href="#">13</a> )  | — | — | — |

?, increased activity; ?, decreased activity; —, not described.

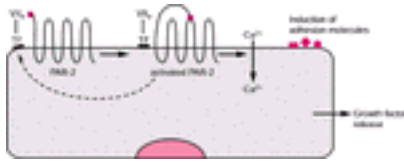
NOTE: The effects of cytokines, atherogenic stimuli, lipopolysaccharide, infectious organisms, and miscellaneous stimuli on endothelial cell tissue factor activity, protein C pathway, and fibrinolysis are summarized. In general, decreased endothelial cell fibrinolysis induced by these stimuli is associated with decreased tissue plasminogen activator secretion and increased plasminogen-activator inhibitor-1 secretion. In general, the protein C pathway refers to thrombomodulin and protein C activation. References are listed in parentheses.

---

The key hemostatic activity induced by EC perturbants is TF expression, because TF is considered to be the major initiator of coagulation ( [144](#) ). Details of the regulation of cellular TF activity are given in [Chapter 21](#). [Table 22.2](#) summarizes the stimuli reported to induce EC TF activity. Expression of EC TF antigen in pathologic human and primate tissues using immunohistochemical methods has been reported ( [145](#), [146](#), [147](#) and [148](#) ), including vascular tissue from patients with sickle cell anemia ( [149](#) ) and skin biopsies from patients treated with intradermal cytokines ( [145](#) ). EC TFPI activity is reduced in skin biopsies after cytokine treatment ( [145](#) ).

EC TF procoagulant activity may be modulated by a novel EC protease, PAR-2. PARs represent a group of G-protein coupled receptors present in EC and other tissues ( [150](#) ). Thrombin or other proteases cleave the amino terminus of the receptor exodomain; the amino terminus fragment then binds to the cell-associated domain of receptor to activate the protease ( [151](#) ). In EC and fibroblasts, activated PAR-1 is internalized and sorted to lysosomes; this process terminates thrombin signaling ( [150](#) ).

There are at least four members of the PAR family ( [150](#) ). Human PAR-1, PAR-3, and PAR-4 can be activated by thrombin, and it is proposed that their *in vivo* role is sensing thrombin generation ( [150](#) ). EC contain both PAR-1 and PAR-2 ( [150](#), [152](#) ), but thrombin does not activate PAR-2. Rather, data indicate that PAR-2 may be activated directly by TF-factor VIIa and indirectly by TF-factor VIIa-generated factor Xa ( [153](#) ). It has been proposed that PAR-2 may function as a coagulation protease “sensor” and thereby contribute to EC activation by pathologic stimuli ( [153](#) ). Stimulation of EC PAR-2 also increases TF expression ( [152](#) ). EC PAR-2 may mediate additional thrombin-induced vascular functions, including leukocyte adhesion ( [154](#) ) and mitogenesis ( [155](#), [156](#) and [157](#) ). Studies investigating embryonic development indicate that PAR-1 messenger RNA is abundant in EC, suggesting that PAR-1 signaling in EC is important in vascular development ( [158](#) ). PAR-1 also mediates the EC response to APC; APC and ECPCR cleave PAR-1 to initiate signaling events ( [107](#) ). [Figure 22.6](#) illustrates the interactions between the TF-factor VIIa complex and EC PAR-2, with resulting alteration of EC function.



**Figure 22.6.** Interactions of the tissue factor (TF)–factor VIIa complex with the endothelial cell protease–activated receptor (PAR)–2 and their consequences. Expression of endothelial cell TF results in TF–dependent factor VIIa activation of PAR–2. Cleavage of the amino terminus of PAR–2 reveals a tethered ligand sequence that binds to PAR–2 to initiate signaling, triggering responses that include calcium influx, expression of surface adhesion molecules for leukocytes, and release of growth factors ( [150](#), [153](#)). Activation of PAR–2 may also enhance endothelial cell expression of TF activity ( [152](#)) ( *dotted line*).

An additional mechanism for EC generation of thrombin has been reported. Perturbed EC express a prothrombin activator that can generate thrombin independent of the intrinsic and extrinsic coagulation pathways ( [159](#)). Nonvascular cells have also been reported as constitutively expressing a prothrombin activator ( [160](#)). The description of trypsin expression by cultured EC and by vascular EC *in situ* suggests that a variety of EC–derived proteases may also regulate blood coagulation ( [161](#)).

Because both EC ( [137](#)) and platelets ( [162](#)) can activate prothrombin, the question arises as to the importance of EC in thrombin generation. One study observed synergism of thrombin generation when a reconstituted model containing EC, platelets, and purified coagulation proteins was tested ( [163](#)). Synergy was maximal at platelet concentrations less than  $1 \times 10^8$ /ml ( [163](#)). Thus, in thrombocytopenic states, the large surface area of vascular endothelium, especially in the microcirculation ( [55](#)), may play a role in amplifying platelet prothrombin activation ( [163](#)).

Regulation of the anticoagulant protein C pathway by EC perturbants has also been a subject of interest because of the recurrent thrombotic disorders associated with deficiency of protein C pathway components (proteins C and S) ( [96](#), [97](#)). Down–regulation of the protein C pathway has focused on thrombomodulin, the EC membrane protein that activates protein C after complexing with thrombin. Several mechanisms have been identified to explain the role of thrombomodulin in down–regulating protein C activation. Thrombomodulin has structural homology to the native LDL receptor ( [164](#)), a prototypical membrane receptor involved in endocytosis. The effects of tumor necrosis factor on the protein C pathway appear to result from enhanced endocytosis and subsequent degradation of thrombomodulin ( [165](#)). Additionally, tumor necrosis factor, a cytokine that reduces protein C activation, has been reported to inhibit transcription of thrombomodulin RNA ( [166](#)).

Homocysteine suppression of thrombomodulin activity represents a unique mechanism by which a thrombotic stimulus reduces protein C activation. Blood levels of homocysteine are increased in a metabolic disorder associated with thrombosis and vascular disease (homocysteinemia, homocystinuria). Homocysteine possesses a free sulfhydryl group, whereas thrombomodulin and protein C both contain disulfide–rich domains. Reduction of key disulfide bonds in thrombomodulin and protein C by homocysteine (or other sulfhydryl amino acids) results in impaired function of these molecules and inhibition of protein C activation ( [167](#)). Inflammatory mediators also suppress activity of the ECPCR, contributing to diminished protein C activation ( [168](#)). Both thrombomodulin and the ECPCR are down–regulated in atherosclerotic vascular tissue from patients with coronary

artery disease ( [169](#) ).

Perturbed EC can activate cell-associated factor V to enhance vascular thrombin generation. For example, homocysteine treatment of cultured EC induced a factor V activator and increased factor Xa-catalyzed prothrombin activation. This cellular activator cleaved factor V in a manner distinct from the cleavage profile generated by thrombin ( [170](#) ). A similar factor V cleavage profile was induced by incubation of factor V with atherosclerotic vascular strips from an animal model of hypercholesterolemia ( [171](#) ).

Another important EC hemostatic property regulated by relevant perturbing stimuli is secretion of PAI-1 and TPA. Treatment of cultured EC with interleukin-1 results in both diminished TPA secretion and increased PAI-1 secretion ( [172](#) ). Increased amounts of PAI-1 relative to TPA diminish vascular fibrinolytic activity, resulting in enhanced thrombotic potential because of failure to lyse fibrin thrombi.

In addition to the humoral and biochemical stimuli discussed above, biomechanical forces (shear stress) can regulate EC gene expression. For example, either laminar or turbulent shear stress has been reported to differentially regulate a large number of EC genes, including adhesion molecules and growth factors, as well as hemostasis proteins ( [173](#) ). Shear stress also attenuates cytokine-induced EC TF expression ( [174](#) ). These data indicate that vascular endothelium is responsive to biomechanical stimuli. A uniquely flow-induced EC gene is the transcription factor, lung Kruppel-like factor, which may be an important regulator of EC function ( [175](#) ).

### **Diversity of Endothelial Cell Hemostatic Properties**

There is significant heterogeneity in arterial, venous, and capillary EC with regard to expression of hemostatic and other functional activities ( [176](#) ). For example, aortic EC express more factor V activity than do venous EC ( [127](#) ), and PGI<sub>2</sub>, a major metabolite secreted by human venous EC, is not substantially produced by human capillary cells ( [177](#) ). Different fibrinolytic and anticoagulant properties have been reported between cultured venous and capillary EC ( [178](#) ). Increases in blood flow lead to up-regulation of NO synthase messenger RNA in aortic, but not pulmonary, arterial EC ( [179](#) ). Vascular anticoagulant activity in the microcirculation is reinforced by geometric aspects of the vessel wall ( [55](#) ). For example, the thrombomodulin concentration in the microcirculation would increase more than 1000-fold ( [55](#) ) compared to a large vessel. Consequently, in large vessels, thrombin circulates freely to catalyze coagulation, whereas in the microcirculation, thrombin exists mostly bound to thrombomodulin, promoting anticoagulation ( [97](#) ).

The differential concentration of thrombomodulin in large versus small vessels may also affect vascular fibrinolysis in specific vascular beds. Thrombin-activatable fibrinolysis inhibitor is stimulated by low thrombomodulin concentrations but decreased at high concentrations of thrombomodulin ( [180](#) ). This implies that enhanced fibrinolysis would be seen in the microcirculation that contains high levels of thrombomodulin activity.

These data suggest a vascular model in which procoagulant activities are dominant in the arterial circulation and anticoagulant activities are dominant in the microcirculation. This distribution of vascular hemostatic properties is consistent with the necessity for rapid thrombin generation and fibrin clot formation after arterial injury, while providing the venous and microcirculation with anticoagulant mechanisms to protect against thrombosis

([75](#)). Unique EC environments may also explain localization of certain pathologic processes. For example, verotoxin-induced EC platelet thrombi localized to arterioles and capillaries may be explained by distinct responses of EC to verotoxin ([181](#)), and endogenously generated NO is more effective in inhibiting thrombosis in venules than in arterioles ([182](#)).

### Clinical Relevance of Vascular Endothelial Cell Hemostatic Properties

At least two types of clinical disorders relate directly to EC hemostatic dysfunction. Most obvious is the group of patients with inherited thrombotic disorders in which genetic abnormality of an EC-derived or -regulated protein is causal in thromboembolic disease. Known disorders in this group include deficiencies of protein C and protein S, defective synthesis or release of TPA, enhanced PAI-1 secretion, and mutant factor V (factor V Leiden) synthesis (also termed *APC resistance*). [Table 22.3](#) summarizes the inherited thrombotic disorders, which are discussed in greater detail in [Chapter 61](#). The lower portion of the table lists EC hemostatic properties that, if abnormal, would be predicted to result in a thrombotic tendency; however, these latter disorders have not yet been identified clinically in association with inherited thrombosis. One of the disorders, TFPI deficiency, may, however, be important as a thrombosis modifier ([183](#)).

**TABLE 22.3. Inherited Thrombotic Disorders and Their Relationship to Endothelial Cell Hemostatic Properties**

---

|  |
|--|
| Antithrombin deficiency  |
| Protein C deficiency   |
| Protein S deficiency <a href="#">a</a>                               |
| Activated protein C resistance (factor V Leiden) <a href="#">a</a>   |
| Thrombomodulin deficiency <a href="#">a</a>                          |
| Dysfibrinogenemia  |
| Plasminogen deficiency   |
| Tissue plasminogen activator deficiency <a href="#">a</a>            |
| Excess levels of plasminogen-activator inhibitor-1 <a href="#">a</a> |
| Homocysteinemia <a href="#">a</a>                                    |
| Heparan sulfate deficiency   |
| Endothelial cell protein C receptor deficiency                       |
| Tissue factor pathway inhibitor deficiency                           |

NOTE: The top portion of the table lists the known inherited thrombotic disorders. The bottom portion of the table lists three endothelial cell hemostatic properties that would be predicted to be associated with a thrombotic tendency, but have not yet been clinically proven.

<sup>a</sup> Disorders associated with defective endothelial cell hemostatic mechanisms. This association is made because vascular endothelium has been identified as a site of synthesis of the particular coagulation protein or because the particular condition alters endothelial cell function (as in homocysteinemia).

---

A second group of disorders consists of inherited or acquired diseases that result in accumulation of components in the blood that perturb EC hemostatic properties. Examples of the inherited disorders in this group include homocysteinemia and familial

hypercholesterolemia. Heterozygous or homozygous homocysteinemia leads to elevated levels of homocysteine, secondary vascular damage, and perturbation of EC hemostatic function and thrombosis ( [184](#), [185](#) ). In familial hypercholesterolemia, elevated levels of LDL lead to modification (oxidation) of the lipoprotein by the vessel wall with generation of oxidized LDL ( [186](#) ). Oxidized LDL can markedly perturb EC hemostatic function and thereby contribute to thrombotic events associated with vascular disease ( [187](#) ). Other acquired diseases associated with perturbed EC hemostatic function include inflammatory disorders in which elevation of plasma cytokine levels may occur or in certain infectious disorders associated with gram-negative bacteria (endotoxin) ( [75](#) ). Infection of vascular endothelium by *Enterococcus* ( [188](#) ), the herpes simplex virus ( [189](#) ), *Rickettsia rickettsii* ( [190](#) ), or *Chlamydia pneumoniae* ( [191](#) ) organisms has been reported to alter vascular coagulant properties, especially induction of TF activity. Topical administration of tumor necrosis factor enhanced EC expression of TF and down-regulated TFPI and thrombomodulin ( [145](#) ). Patients with meningococcal sepsis had skin biopsies demonstrating down-regulation of EC thrombomodulin and the ECPCR ( [192](#) ).

## REFERENCES

1. Conway EM, Collen D, Carmeliet P. Molecular mechanisms of blood vessel growth. *Cardiovasc Res* 2001;49:507–521.
2. Carmeliet P, Jain RK. Angiogenesis in cancer and other diseases. *Nature* 2000;407:249–257.
3. Nathan C. Nitric oxide as a secretory product of mammalian cells. *FASEB J* 1992;6:3051–3064.
4. Kimura H, Weisz A, Kurashima Y, et al. Hypoxia response element of the human vascular endothelial growth factor gene mediates transcriptional regulation by nitric oxide: control of hypoxia-inducible factor-1 activity by nitric oxide. *Blood* 2000;95:189–197.
5. Eliceiri BP, Paul R, Schwartzberg PL, et al. Selective requirement for Src kinases during VEGF-induced angiogenesis and vascular permeability. *Mol Cell* 1999;4:915–924.
6. Gale NW, Yancopoulos GD. Growth factors acting via endothelial cell-specific receptor tyrosine kinases: VEGFs, angiopoietins, and ephrins in vascular development. *Genes Dev* 1999;13:1055–1066.
7. Thurston G, Rudge JS, Ioffe E, et al. Angiopoietin-1 protects the adult vasculature against plasma leakage. *Nat Med* 2000;6:460–463.
8. Nelson AR, Fingleton B, Rothenberg ML, Matrisian LM. Matrix metalloproteinases: biologic activity and clinical implications. *J Clin Oncol* 2000;18:1135–1149.
9. Stetler-Stevenson WG. Matrix metalloproteinases in angiogenesis: a moving target for therapeutic intervention. *J Clin Invest* 1999;103:1237–1241.
10. Brew K, Dinakarpandian D, Nagase H. Tissue inhibitors of metalloproteinases: evolution, structure and function. *Biochim Biophys Acta* 2000;1477:267–283.
11. Ferrara N, Gerber HP. The role of vascular endothelial growth factor in angiogenesis. *Acta Haematol* 2001;106:148–156.
12. Veikkola T, Karkkainen M, Claesson-Welsh L, Alitalo K. Regulation of angiogenesis via vascular endothelial growth factor receptors. *Cancer Res* 2000;60:203–212.
13. Yang Y, Loscalzo J. Regulation of tissue factor expression in human microvascular endothelial cells by nitric oxide. *Circulation* 2000;101:2144–2148.
14. Yancopoulos GD, Davis S, Gale NW, et al. Vascular-specific growth factors and blood vessel

formation. *Nature* 2000;407:242–248.

15. Suri C, McClain J, Thurston G, et al. Increased vascularization in mice overexpressing angiopoietin-1. *Science* 1998;282:468–471.

16. Suri C, Jones PF, Patan S, et al. Requisite role of angiopoietin-1, a ligand for the TIE2 receptor, during embryonic angiogenesis. *Cell* 1996;87:1171–1180.

17. Maisonpierre PC, Suri C, Jones PF, et al. Angiopoietin-2, a natural antagonist for Tie2 that disrupts in vivo angiogenesis. *Science* 1997;277:55–60.

18. Pipili-Synetos E, Sakkoula E, Haralabopoulos G, et al. Evidence that nitric oxide is an endogenous antiangiogenic mediator. *Br J Pharmacol* 1994;111:894–902.

19. Ziche M, Morbidelli L, Masini E, et al. Nitric oxide mediates angiogenesis in vivo and endothelial cell growth and migration in vitro promoted by substance P. *J Clin Invest* 1994;94:2036–2044.

20. Papapetropoulos A, Garcia-Cardena G, Madri JA, Sessa WC. Nitric oxide production contributes to the angiogenic properties of vascular endothelial growth factor in human endothelial cells. *J Clin Invest* 1997;100:3131–3139.

21. Pipili-Synetos E, Kritikou S, Papadimitriou E, et al. Nitric oxide synthase expression, enzyme activity and NO production during angiogenesis in the chick chorioallantoic membrane. *Br J Pharmacol* 2000;129:207–213.

22. Fernandez B, Buehler A, Wolfram S, et al. Transgenic myocardial overexpression of fibroblast growth factor-1 increases coronary artery density and branching. *Circ Res* 2000;87:207–213.

23. Carmeliet P. Fibroblast growth factor-1 stimulates branching and survival of myocardial arteries: a goal for therapeutic angiogenesis? *Circ Res* 2000;87:176–178.

24. Lindahl P, Bostrom H, Karlsson L, et al. Role of platelet-derived growth factors in angiogenesis and alveogenesis. *Curr Top Pathol* 1999;93:27–33.

25. O'Reilly MS, Holmgren L, Shing Y, et al. Angiostatin: a novel angiogenesis inhibitor that mediates the suppression of metastases by a Lewis lung carcinoma. *Cell* 1994;79:315–328.

26. O'Reilly MS, Boehm T, Shing Y, et al. Endostatin: an endogenous inhibitor of angiogenesis and tumor growth. *Cell* 1997;88(2):277–285.

27. O'Reilly MS. Angiostatin: an endogenous inhibitor of angiogenesis and of tumor growth. *EXS* 1997;79:273–294.

28. Carmeliet P. Mechanisms of angiogenesis and arteriogenesis. *Nat Med* 2000;6:389–395.

29. Eliceiri BP, Cheresh DA. The role of  $\alpha_v$  integrins during angiogenesis: insights into potential mechanisms of action and clinical development. *J Clin Invest* 1999;103:1227–1230.

30. Carmeliet P, Lampugnani MG, Moons L, et al. Targeted deficiency or cyto-solic truncation of the VE-cadherin gene in mice impairs VEGF-mediated endothelial survival and angiogenesis. *Cell* 1999;98:147–157.

31. Holash J, Maisonpierre PC, Compton D, et al. Vessel cooption, regression, and growth in tumors mediated by angiopoietins and VEGF. *Science* 1999;284:1994–1998.

32. Hirschi KK, D'Amore PA. Pericytes in the microvasculature. *Cardiovasc Res* 1996;32:687–698.

33. Yamashita J, Itoh H, Hirashima M, et al. Flk1-positive cells derived from embryonic stem cells serve as vascular progenitors. *Nature* 2000;408(6808): 92–96.

34. Bellomo D, Headrick JP, Silins GU, et al. Mice lacking the vascular endothelial growth factor-B gene (*Vegfb*) have smaller hearts, dysfunctional coronary vasculature, and impaired recovery from cardiac



ischemia. *Circ Res* 2000;86:E29–E35.

35. Olofsson B, Jeltsch M, Eriksson U, Alitalo K. Current biology of VEGF-B and VEGF-C. *Curr Opin Biotechnol* 1999;10:528–535.

36. Fong GH, Rossant J, Gertsenstein M, Breitman ML. Role of the Flt-1 receptor tyrosine kinase in regulating the assembly of vascular endothelium. *Nature* 1995;376:66–70.

37. Hiratsuka S, Minowa O, Kuno J, et al. Flt-1 lacking the tyrosine kinase domain is sufficient for normal development and angiogenesis in mice. *Proc Natl Acad Sci U S A* 1998;95:9349–9354.

38. Ribatti D, Vacca A, De Falco G, et al. Role of hematopoietic growth factors in angiogenesis. *Acta Haematol* 2001;106:157–161.

39. Dickson DJ, Shami PJ. Angiogenesis in acute and chronic leukemias. *Leuk Lymphoma* 2001;42:847–853.

40. Tosi P, Tura S. Antiangiogenic therapy in multiple myeloma. *Acta Haematol* 2001;106:208–213.

41. Salven P. Angiogenesis in lymphoproliferative disorders. *Acta Haematol* 2001;106:184–189.

42. Hussong JW, Rodgers GM, Shami PJ. Evidence of increased angiogenesis in patients with acute myeloid leukemia. *Blood* 2000;95:309–313.

43. Padro T, Ruiz S, Bieker R, et al. Increased angiogenesis in the bone marrow of patients with acute myeloid leukemia. *Blood* 2000;95:2637–2645.

44. Aguayo A, Kantarjian H, Manshour T, et al. Angiogenesis in acute and chronic leukemias and myelodysplastic syndromes. *Blood* 2000;96:2240–2245.

45. Moehler TM, Neben K, Ho AD, Goldschmidt H. Angiogenesis in hematologic malignancies. *Ann Hematol* 2001;80:695–705.

46. Kini AR, Kay NE, Peterson LC. Increased bone marrow angiogenesis in B cell chronic lymphocytic leukemia. *Leukemia* 2000;14:1414–1418.

47. Albitar M. Angiogenesis in acute myeloid leukemia and myelodysplastic syndrome. *Acta Haematol* 2001;106:170–176.

48. Di Raimondo F, Palumbo GA, Molica S, Giustolisi R. Angiogenesis in chronic myeloproliferative disorders. *Acta Haematol* 2001;106:177–183.

49. Petty RG, Pearson JD. Endothelium—the axis of vascular health and disease. *J R Coll Physicians Lond* 1989;23:92–102.

50. Cines DB, Pollak ES, Buck CA, et al. Endothelial cells in physiology and in the pathophysiology of vascular disorders. *Blood* 1998;91:3527–3561.

51. Jaffe EA, Nachman RL, Becker CG, Minick CR. Culture of human endothelial cells derived from umbilical veins. Identification by morphologic and immunologic criteria. *J Clin Invest* 1973;52:2745–2756.

52. Ross R. The pathogenesis of atherosclerosis: a perspective for the 1990s. *Nature* 1993;362:801–809.

53. Steinberg D. Atherogenesis in perspective: hypercholesterolemia and inflammation as partners in crime. *Nat Med* 2002;8:1211–1217.

54. Jaffe EA. Cell biology of endothelial cells. *Hum Pathol* 1987;18:234–239.

55. Busch C, Cancilla PA, DeBault LE, et al. Use of endothelium cultured on microcarriers as a model for the microcirculation. *Lab Invest* 1982;47:498–504.

56. Carlos TM, Harlan JM. Leukocyte-endothelial adhesion molecules. *Blood* 1994;84:2068-2101.
57. Dejana E, Corada M, Lampugnani MG. Endothelial cell to cell junctions. *FASEB J* 1995;9:910-918.
58. Albelda SM, Oliver PD, Romer LH, Buck CA. Endo-CAM, a novel endothelial cell-cell adhesion molecule. *J Cell Biol* 1990;110:1227-1237.
59. Heimark RL, Degner M, Schwartz SM. Identification of a Ca<sup>++</sup>-dependent cell-cell adhesion molecule. *J Cell Biol* 1990;110:1745-1756.
60. Bardin N, Anfosso F, Masse JM, et al. Identification of CD146 as a component of the endothelial junction involved in the control of cell-cell cohesion. *Blood* 2001;98:3677-3684.
61. Aurrand-Lions M, Johnson-Leger C, Wong C, et al. Heterogeneity of endothelial junctions is reflected by differential expression and specific subcellular localization of the three JAM family members. *Blood* 2001;98:3699-3707.
62. Weibel ER, Palade GE. New cytoplasmic components in arterial endothelia. *J Cell Biol* 1964;23:101-113.
63. Wagner DD, Olmstead JB, Marder VJ. Immunolocalization of von Willebrand protein in Weibel-Palade bodies of human endothelial cells. *J Cell Biol* 1982;95:355-360.
64. McEver RP, Beckstead JH, Moore KL, et al. GMP-140, a platelet membrane alpha-granule protein, is also synthesized by vascular endothelial cells and is localized in Weibel-Palade bodies. *J Clin Invest* 1989;84:92-99.
65. André P, Denis CV, Ware J, et al. Platelets adhere to and translocate on von Willebrand factor presented by endothelium in stimulated veins. *Blood* 2000;96:3322-3328.
66. Datta YH, Ewenstein BM. Regulated secretion in endothelial cells: biology and clinical implications. *Thromb Haemost* 2001;86:1148-1155.
67. Augustin HG, Kozian DH, Johnson RC. Differentiation of endothelial cells: analysis of the constitutive and activated endothelial cell phenotypes. *Bioessays* 1994;16:901-906.
68. Rodgers GM, Greenberg CS, Shuman MA. Characterization of the effects of cultured vascular cells on the activation of blood coagulation. *Blood* 1983;61:1155-1162.
69. Rosenberg RD, Rosenberg JS. Natural anticoagulant mechanisms. *J Clin Invest* 1984;74:1-6.
70. Jaffe EA. Physiologic functions of normal endothelial cells. *Ann N Y Acad Sci* 1985;454:279-291.
71. Moncada S. Prostacyclin and arterial wall biology. *Arteriosclerosis* 1982;2:193-207.
72. Radomski MW, Palmer RMJ, Moncada S. Endogenous nitric oxide inhibits human platelet adhesion to vascular endothelium. *Lancet* 1987;2:1057-1058.
73. Zimmermann H. Nucleotides and CD39: principal modulatory players in hemostasis and thrombosis. *Nat Med* 1999;5:987-988.
74. Mulder AB, Hegge-Paping KSM, Magielse CPE, et al. Tumor necrosis factor  $\alpha$ -induced endothelial tissue factor is located on the cell surface rather than in the subendothelial matrix. *Blood* 1994;84:1559-1566.
75. Rodgers GM. Hemostatic properties of normal and perturbed vascular cells. *FASEB J* 1988;2:116-123.
76. Hoffman M, Monroe DM. A cell-based model of hemostasis. *Thromb Haemost* 2001;85:958-965.
77. Czervionke RL, Hoak JC, Fry GL. Effect of aspirin on thrombin-induced adherence of platelets to

- cultured cells from the blood vessel wall. *J Clin Invest* 1978;62:847–856.
78. Weksler BB, Marcus AJ, Jaffe EA. Synthesis of prostaglandin I<sub>2</sub> (prostacyclin) by cultured human and bovine endothelial cells. *Proc Natl Acad Sci U S A* 1977;74:3922–3926.
79. Jaffe EA. Endothelial cell structure and function. In: Hoffman R, Benz EJ, Shattil SJ, et al., eds. *Hematology: basic principles and practice*. New York: Churchill Livingstone, 1991:1198–1213.
80. Roth GJ, Siok CJ. Acetylation of the NH<sub>2</sub>-terminal serine of prostaglandin synthetase by aspirin. *J Biol Chem* 1978;253:3782–3784.
81. Hla T, Neilson K. Human cyclooxygenase-2 cDNA. *Proc Natl Acad Sci U S A* 1992;89:7384–7388.
82. Jones DA, Carlton DP, McIntyre TM, et al. Molecular cloning of human prostaglandin endoperoxidase synthase type II and demonstration of expression in response to cytokines. *J Biol Chem* 1993;268:9049–9054.
83. Moncada S, Palmer RM, Higgs EA. Nitric oxide: physiology, pathophysiology, and pharmacology. *Pharmacol Rev* 1991;43:109–142.
84. Lowenstein CJ, Dinerman JL, Snyder SH. Nitric oxide: a physiologic messenger. *Ann Intern Med* 1994;120:227–237.
85. Palmer RMJ, Ashton DS, Moncada S. Vascular endothelial cells synthesize nitric oxide from L-arginine. *Nature* 1988;333:664–666.
86. Rees DD, Higgs EA, Moncada S. Nitric oxide and the vessel wall. In: Colman RW, Hirsh J, Marder VJ, et al., eds. *Hemostasis and thrombosis: basic principles and clinical practice*, 4th ed. Philadelphia: Lippincott Williams & Wilkins, 2000:673–682.
87. Pearson JD, Gordon JL. Nucleotide metabolism by endothelium. *Annu Rev Physiol* 1985;47:617–627.
88. Marcus AJ, Broekman MJ, Drosopoulos JHF, et al. The endothelial cell ecto-ADPase responsible for inhibition of platelet function is CD39. *J Clin Invest* 1997;99:1351–1360.
89. Enjyoji K, Sevigny J, Lin Y, et al. Targeted disruption of CD39/ATP diphosphohydrolase results in disordered hemostasis and thromboregulation. *Nat Med* 1999;5:1010–1017.
90. Bourin M-C, Lindahl U. Glycosaminoglycans and the regulation of blood coagulation. *Biochem J* 1993;289:313–330.
91. Bock SC. Antithrombin III and heparin cofactor II. In: Colman RW, Hirsh J, Marder VJ, et al., eds. *Hemostasis and thrombosis: basic principles and clinical practice*, 4th ed. Philadelphia: Lippincott Williams & Wilkins, 2001:321–333.
92. HajMohammadi S, Enjyoji K, Princivalle M, et al. Normal levels of anticoagulant heparan sulfate are not essential for normal hemostasis. *J Clin Invest* 2003;111:989–999.
93. Hirsh J. Congenital antithrombin III deficiency. Incidence and clinical features. *Am J Med* 1989;87[Suppl 3B]:34s–38s.
94. Bertina RM, van der Linden IK, Engesser L, et al. Hereditary heparin cofactor II deficiency and the risk of development of thrombosis. *Thromb Haemost* 1987;57:196–200.
95. Stern D, Brett J, Harris K, Nawroth P. Participation of endothelial cells in the protein C–protein S anticoagulant pathway: the synthesis and release of protein S. *J Cell Biol* 1986;102:1971–1978.
96. Esmon CT. The regulation of natural anticoagulant pathways. *Science* 1987;235:1348–1352.
97. Esmon CT. The roles of protein C and thrombomodulin in the regulation of blood coagulation. *J Biol Chem* 1989;264:4743–4746.

98. Shen L, Dahlback B. Factor V and protein S as synergistic cofactors to activated protein C in degradation of factor VIII<sub>a</sub>. *J Biol Chem* 1994;269:18735–18738.
99. Oliver JA, Monroe DM, Church FC, et al. Activated protein C cleaves factor V<sub>a</sub> more efficiently on endothelium than on platelet surfaces. *Blood* 2002;100:539–546.
100. Fukudome K, Esmont CT. Identification, cloning and regulation of a novel endothelial cell protein C/activated protein C receptor. *J Biol Chem* 1994;269:26486–26491.
101. Esmont CT. The endothelial cell protein C receptor. *Thromb Haemost* 2000;83:639–643.
102. Laszik Z, Mitro A, Taylor FB, et al. Human protein C receptor is present primarily on endothelium of large blood vessels: implications for control of the protein C pathway. *Circulation* 1997;96:3633–3640.
103. Taylor FB, Peer GT, Lockhart MS, et al. Endothelial cell protein C receptor plays an important role in protein C activation *in vivo*. *Blood* 2001;97:1685–1688.
104. Thompson EA, Salem HH. Inhibition by thrombomodulin of factor X<sub>a</sub>-mediated cleavage of prothrombin. *J Clin Invest* 1986;78:13–17.
105. Joyce DE, Gelbert L, Ciaccia A, et al. Gene expression profile of antithrombotic protein C defines new mechanisms modulating inflammation and apoptosis. *J Biol Chem* 2001;276:11199–11203.
106. Bernard GR, Vincent JL, Laterre PF, et al. Efficacy and safety of recombinant human activated protein C for severe sepsis. *N Engl J Med* 2001;344:699–709.
107. Reiwald M, Petrovan RJ, Donner A, et al. Activation of endothelial cell protease activated receptor 1 by the protein C pathway. *Science* 2002;296:1880–1882.
108. Wun T-C, Kretzmer KK, Girard TJ, et al. Cloning and characterization of a cDNA coding for the lipoprotein-associated coagulation inhibitor shows that it consists of three tandem Kunitz-type inhibitory domains. *J Biol Chem* 1988;263:6001–6004.
109. Rapaport SI. Inhibition of factor VII<sub>a</sub>/tissue factor-induced blood coagulation: with particular emphasis upon a factor X<sub>a</sub>-dependent inhibitory mechanism. *Blood* 1989;73:359–365.
110. Novotny WF. Tissue factor pathway inhibitor. *Semin Thromb Hemost* 1994;20:101–108.
111. Bajaj MS, Kuppaswamy MN, Saito H, et al. Cultured normal human hepatocytes do not synthesize lipoprotein-associated coagulation inhibitor: evidence that endothelium is the principal site of its synthesis. *Proc Natl Acad Sci U S A* 1990;87:8869–8873.
112. Kato H. Regulation of functions of vascular wall cells by tissue factor pathway inhibitor: basic and clinical aspects. *Arterioscler Thromb Vasc Biol* 2002;22:535–548.
113. Day KC, Hoffman LC, Palmier MO, et al. Recombinant lipoprotein-associated coagulation inhibitor inhibits tissue thromboplastin induced intravascular coagulation in the rabbit. *Blood* 1990;76:1538–1545.
114. Caplice NM, Mueske CS, Kleppe LS, Simari RD. Presence of tissue factor pathway inhibitor in human atherosclerotic plaques is associated with reduced tissue factor activity. *Circulation* 1998;98:1051–1057.
115. Sandset PM, Abildgaard U, Larsen ML. Heparin induces release of extrinsic coagulation pathway inhibitor (EPI). *Thromb Res* 1988;50:803–813.
116. Grant PJ, Medcalf RL. Hormonal regulation of haemostasis and the molecular biology of the fibrinolytic system. *Clin Sci* 1990;78:3–11.
117. Huber D, Cramer EM, Kaufmann JE, et al. Tissue-type plasminogen activator (t-PA) is stored in Weibel-Palade bodies in human endothelial cells both *in vitro* and *in vivo*. *Blood* 2002;15:3637–3645.

118. Hajjar KA, Hamel NM, Harpel PC, Nachman RL. Binding of tissue plasminogen activator to cultured human endothelial cells. *J Clin Invest* 1987;80:1712–1719.
119. Levin EG, Loskutoff DJ. Cultured bovine endothelial cells produce both urokinase and tissue-type plasminogen activators. *J Cell Biol* 1982;94:631–636.
120. Lijnen HR, Collen D. Molecular and cellular basis of fibrinolysis. In: Hoffman R, Benz EJ, Shattil SJ, et al., eds. *Hematology: basic principles and practice*, 2nd ed. New York: Churchill Livingstone, 1995:1588–1596.
121. Philips M, Juul AG, Thorsen S. Human endothelial cells produce a plasminogen activator inhibitor and a tissue-type plasminogen activator-inhibitor complex. *Biochim Biophys Acta* 1984;802:99–110.
122. Erickson LA, Ginsberg MH, Loskutoff DJ. Detection and partial characterization of an inhibitor of plasminogen activator in human platelets. *J Clin Invest* 1984;74:1465–1472.
123. Sprengers ED, Kluft C. Plasminogen activator inhibitors. *Blood* 1987;69:381–387.
124. Reddigari SR, Shibayama Y, Brunnee T, Kaplan AP. Human Hageman factor (Factor XII) and high molecular weight kininogen compete for the same binding site on human umbilical vein endothelial cells. *J Biol Chem* 1993;268:11982–11987.
125. Shariat-Mader Z, Mahdi F, Schmaier AH. Factor XI assembly and activation on human umbilical vein endothelial cells in culture. *Thromb Haemost* 2001;85:544–551.
126. Heimark RL, Schwartz SM. Binding of coagulation factors IX and X to the endothelial cell surface. *Biochem Biophys Res Commun* 1983;111:723–731.
127. Rodgers GM, Shuman MA. Characterization of the interaction between factor X<sub>a</sub> and bovine aortic endothelial cells. *Biochim Biophys Acta* 1985;844:320–329.
128. Stern DM, Nawroth PP, Kiesel W, et al. A coagulation pathway on bovine aortic segments leading to generation of factor X<sub>a</sub> and thrombin. *J Clin Invest* 1984;74:1910–1921.
129. Bono F, Herault J-P, Avril C, et al. Human umbilical vein endothelial cells express high affinity receptors for factor X<sub>a</sub>. *J Cell Physiol* 1997;172:36–43.
130. Stern DM, Drillings M, Nossel HL, et al. Binding of factors IX and IX<sub>a</sub> to cultured vascular endothelial cells. *Proc Natl Acad Sci U S A* 1983;80:4119–4123.
131. Stern DM, Nawroth PP, Kiesel W, et al. The binding of factor IX<sub>a</sub> to cultured bovine aortic endothelial cells: induction of a specific site in the presence of factors VIII and X. *J Biol Chem* 1985;260:6717–6722.
132. Shuman MA. Thrombin-cellular interactions. *Ann N Y Acad Sci* 1986;485:228–239.
133. Van Iwaarden F, de Groot PG, Bouma BN. The binding of high molecular weight kininogen to cultured human endothelial cells. *J Biol Chem* 1988;263:4698–4703.
134. Motta G, Rojkaer R, Hasan AAK, et al. High molecular weight kininogen regulates prekallikrein assembly and activation on endothelial cells: a novel mechanism for contact activation. *Blood* 1998;91:516–528.
135. Maruyama I, Salem HH, Majerus PW. Coagulation factor V<sub>a</sub> binds to human umbilical vein endothelial cells and accelerates protein C activation. *J Clin Invest* 1984;74:224–230.
136. Cerveny TJ, Fass DN, Mann KG. Synthesis of coagulation factor V by cultured aortic endothelium. *Blood* 1984;63:1467–1474.
137. Rodgers GM, Shuman MA. Prothrombin is activated on vascular endothelial cells by factor X<sub>a</sub> and calcium. *Proc Natl Acad Sci U S A* 1983;80:7001–7005.

138. Jaffe EA, Hoyer LW, Nachman RL. Synthesis of antihemophilic factor antigen by cultured human endothelial cells. *J Clin Invest* 1973;52:2757–2764.
139. Berrettini M, Schleaf RR, Heeb MJ, et al. Assembly and expression of an intrinsic factor IX activator complex on the surface of cultured human endothelial cells. *J Biol Chem* 1992;267:19833–19839.
140. Ratnoff OD, Everson B, Embury P, et al. Inhibition of the activation of Hageman factor (factor XII) by human vascular endothelial cell supernates. *Proc Natl Acad Sci U S A* 1991;88:10740–10743.
141. Brinkman H-JM, van Mourik JA. Vessel wall-mediated activation of the blood coagulation system. In: van Hinsberg VWM, ed. *Vascular control of hemostasis*. Amsterdam: Harwood Academic Publishers, 1996:85–106.
142. Mann KG, Lawson JH. The role of the membrane in the expression of the vitamin K-dependent enzymes. *Arch Pathol Lab Med* 1992;116:1330–1336.
143. Houdijk WPM, deGroot PF, Nievelstein PFEM, et al. Subendothelial proteins and platelet adhesion: von Willebrand factor and fibronectin, not thrombospondin, are involved in platelet adhesion to extracellular matrix of human vascular endothelial cells. *Arteriosclerosis* 1986;6:24–33.
144. Nemerson Y. Tissue factor and hemostasis. *Blood* 1988;71:1–8.
145. Speiser W, Kapiotis S, Kopp CW, et al. Effect of intradermal tumor necrosis factor- $\alpha$ -induced inflammation on coagulation factors in dermal vessel endothelium: an in vivo study of human skin biopsies. *Thromb Haemost* 2001;85:362–367.
146. Courtney M-A, Haidaris PJ, Marder VJ, Sporn LA. Tissue factor mRNA expression in the endothelium of an intact umbilical vein. *Blood* 1996;87:174–179.
147. Drake TA, Cheng J, Chang A, Taylor FB. Expression of tissue factor, thrombomodulin, and E-selectin in baboons with lethal *Escherichia coli* sepsis. *Am J Pathol* 1993;142:1458–1470.
148. More L, Sim R, Hudson M, et al. Immunohistochemical study of tissue factor expression in normal intestine and idiopathic inflammatory bowel disease. *J Clin Pathol* 1993;46:703–708.
149. Hammerschmidt DE. Tissue factor expression in sickle cell anemia. *J Lab Clin Med* 2001;137:440.
150. Coughlin SR. How the protease thrombin talks to cells. *Proc Natl Acad Sci U S A* 1999;96:11023–11027.
151. Vu TK, Hung DT, Wheaton VI, Coughlin SR. Molecular cloning of a functional thrombin receptor reveals a novel proteolytic mechanism of receptor activation. *Cell* 1991;64:1057–1068.
152. Alm A-K, Norstrom E, Sundelin J, Nystedt S. Stimulation of proteinase activated receptor-2 causes endothelial cells to promote blood coagulation *in vitro*. *Thromb Haemost* 1999;81:984–988.
153. Camerer E, Huang W, Coughlin SR. Tissue factor- and factor X-dependent activation of protease-activated receptor-2 by factor VII<sub>a</sub>. *Proc Natl Acad Sci U S A* 2000;97:5255–5260.
154. Hattori R, Hamilton KK, Fugate RD, et al. Stimulated secretion of von Willebrand factor is accompanied by rapid redistribution to the cell surface of the intracellular granule membrane protein GMP-140. *J Biol Chem* 1989;264:7768–7771.
155. McNamara CA, Sarembock IJ, Gimble LW, et al. Thrombin stimulates proliferation of cultured rat aortic smooth muscle cells by a proteolytically activated receptor. *J Clin Invest* 1993;91:94–98.
156. Mirza H, Yatsula V, Bahou WF. The proteinase activated receptor-2 (PAR-2) mediates mitogenic responses in human vascular endothelial cells. *J Clin Invest* 1996;97:1705–1714.
157. Esmon CT. Introduction: are natural anticoagulants candidates for modulating the inflammatory response to endotoxin? *Blood* 2000;95:1113–1116.

158. Griffin CT, Srinivasan Y, Zheng Y-W, et al. A role for thrombin receptor signaling in endothelial cells during embryonic development. *Science* 2001;293:1666-1670.
159. Liu L, Rodgers GM. Characterization of an inducible endothelial cell prothrombin activator. *Blood* 1996;88:2989-2994.
160. Sekiya F, Usui H, Inoue K, et al. Activation of prothrombin by a novel membrane-associated protease: an alternative pathway for thrombin generation independent of the coagulation cascade. *J Biol Chem* 1994;269:32441-32445.
161. Koshikawa N, Nagashima Y, Miyagi Y, et al. Expression of trypsin in vascular endothelial cells. *FEBS Lett* 1997;409:442-448.
162. Miletich JP, Jackson CM, Majerus PW. Properties of the factor X<sub>a</sub> binding site on human platelets. *J Biol Chem* 1978;253:6908-6916.
163. Rodgers GM, Shuman MA. Enhancement of prothrombin activation on platelets by endothelial cells and mechanism of activation of factor V. *Thromb Res* 1987;45:145-152.
164. Jackman RW, Beeler DL, VandeWater L, Rosenberg RD. Characterization of a thrombomodulin cDNA reveals structural similarity to the low density lipoprotein receptor. *Proc Natl Acad Sci U S A* 1986;83:8834-8838.
165. Moore KL, Esmon CT, Esmon NL. Tumor necrosis factor leads to the internalization and degradation of thrombomodulin from the surface of bovine aortic endothelial cells in culture. *Blood* 1989;73:159-165.
166. Dittman WA, Majerus PW. Structure and function of thrombomodulin: a natural anticoagulant. *Blood* 1990;75:329-336.
167. Lentz SR, Sadler JE. Inhibition of thrombomodulin surface expression and protein C activation by the thrombogenic agent homocysteine. *J Clin Invest* 1991;88:1906-1914.
168. Esmon CT. Regulatory mechanisms in hemostasis: natural anticoagulants. In: Hoffman R, Benz EJ, Shattil SJ, et al., eds. *Hematology: basic principles and practice*, 3rd ed. New York: Churchill Livingstone, 2000:1814-1824.
169. Laszik ZG, Zhou XJ, Ferrell GL, et al. Down-regulation of endothelial expression of endothelial cell protein C receptor and thrombomodulin in coronary atherosclerosis. *Am J Pathol* 2001;159:797-802.
170. Rodgers GM, Kane WH. Activation of endogenous factor V by a homocysteine-induced vascular endothelial cell activator. *J Clin Invest* 1986;77:1909-1916.
171. Rodgers GM, Kane WH, Pitas RE. Formation of factor V<sub>a</sub> by atherosclerotic rabbit aorta mediates Factor X<sub>a</sub>-catalyzed prothrombin activation. *J Clin Invest* 1988;81:1911-1919.
172. Bevilacqua MP, Schleef RR, Gimbrone MA, Loskutoff DJ. Regulation of the fibrinolytic system of cultured human vascular endothelium by interleukin 1. *J Clin Invest* 1986;78:587-591.
173. Garcia-Cardena G, Comander J, Anderson KR, et al. Biomechanical activation of vascular endothelium as a determinant of its functional phenotype. *Proc Natl Acad Sci U S A* 2001;98:4478-4485.
174. Matsumoto Y, Kawai Y, Watanabe K, et al. Fluid shear stress attenuates tumor necrosis factor- $\alpha$ -induced tissue factor expression in cultured human endothelial cells. *Blood* 1998;91:4164-4172.
175. Dekker RJ, van Soest S, Fontijn RD, et al. Prolonged fluid shear stress induces a distinct set of endothelial cell genes, most specifically lung Kruppel-like factor (KLF2). *Blood* 2002;100:1689-1698.
176. Aird WC, Edelberg JM, Weiler-Guettler H, et al. Vascular bed-specific expression of an endothelial cell gene is programmed by the tissue microenvironment. *J Cell Biol* 1997;138:1117-1124.
177. Charo IF, Shak S, Karasek MA, et al. Prostaglandin I<sub>2</sub> is not a major metabolite of arachidonic acid



in cultured endothelial cells from human foreskin microvessels. *J Clin Invest* 1984;74:914–919.

178. Speiser W, Anders E, Preissner KT, et al. Differences in coagulant and fibrinolytic activities of cultured human endothelial cells derived from omental tissue microvessels and umbilical veins. *Blood* 1987;69:964–967.
179. Everett AD, Le Cras TD, Xue C, Johns RA. eNOS expression is not altered in pulmonary vascular remodeling due to increased pulmonary blood flow. *Am J Physiol* 1998;274:L1058–L1065.
180. Mosnier LO, Meijers JCM, Bouma BN. Regulation of fibrinolysis in plasma by TAFI and protein C is dependent on the concentration of thrombomodulin. *Thromb Haemost* 2001;85:5–11.
181. Morigi M, Galbusera M, Binda E, et al. Verotoxin-1-induced up-regulation of adhesive molecules renders microvascular endothelial cells thrombogenic at high shear stress. *Blood* 2001;98:1828–1835.
182. Broeders MAW, Tangelder G-J, Slaaf DW, et al. Endogenous nitric oxide protects against thromboembolism in venules but not in arterioles. *Arterioscler Thromb Vasc Biol* 1998;18:139–145.
183. Eitzman DT, Westrick RJ, Bi X, et al. Lethal perinatal thrombosis in mice resulting from the interaction of tissue factor pathway inhibitor deficiency and factor V Leiden. *Circulation* 2002;105:2139–2142.
184. Rees MM, Rodgers GM. Homocysteinemia: association of a metabolic disorder with vascular disease and thrombosis. *Thromb Res* 1993;71:337–359.
185. Cattaneo M. Hyperhomocysteinemia, atherosclerosis and thrombosis. *Thromb Haemost* 1999;81:165–176.
186. Steinberg D, Parthasarathy S, Carew TE, et al. Beyond cholesterol: modifications of low-density lipoprotein that increase its atherogenicity. *N Engl J Med* 1989;320:915–924.
187. Weis JR, Pitas RE, Wilson BD, Rodgers GM. Oxidized low-density lipoprotein increases cultured human endothelial cell tissue factor activity and reduces protein C activation. *FASEB J* 1991;5:2459–2465.
188. Drake TA, Rodgers GM, Sande MA. Tissue factor is a major stimulus for fibrin deposition in vegetations of enterococcal endocarditis in the rabbit. *J Clin Invest* 1984;73:1750–1753.
189. Key NS, Vercellotti GM, Winkelmann JC, et al. Infection of vascular endothelial cells with herpes simplex virus enhances tissue factor activity and reduces thrombomodulin expression. *Proc Natl Acad Sci U S A* 1990;87: 7095–7099.
190. Sporn LA, Haidaris PJ, Shi R-J, et al. *Rickettsia rickettsii* infection of cultured human endothelial cells induces tissue factor expression. *Blood* 1994;83: 1527–1534.
191. Fryer RH, Schwobe EP, Woods MC, Rodgers GM. *Chlamydia* species infect human vascular endothelial cells and induce procoagulant activity. *J Investig Med* 1997;45:168–174.
192. Faust SN, Levin M, Harrison OB, et al. Dysfunction of endothelial protein C activation in severe meningococcal sepsis. *N Engl J Med* 2001;345:408–416.
193. Bevilacqua MP, Pober JS, Majeau GR, et al. Interleukin 1 (IL-1) induces biosynthesis and cell surface expression of procoagulant activity in human vascular endothelial cells. *J Exp Med* 1984;160:618–623.
194. Nawroth PP, Handley DA, Esmon CT, Stern DM. Interleukin 1 induces endothelial cell procoagulant while suppressing cell-surface anticoagulant activity. *Proc Natl Acad Sci U S A* 1986;83:3460–3464.
195. Nawroth PP, Stern DM. Modulation of endothelial cell hemostatic properties by tumor necrosis factor. *J Exp Med* 1986;163:740–745.
196. Loskutoff DJ. Regulation of PAI-1 gene expression. *Fibrinolysis* 1991;5:197–206.
197. Fryer RH, Wilson BD, Gubler DB, et al. Homocysteine, a risk factor for premature vascular disease

and thrombosis, induces tissue factor activity in endothelial cells. *Arterioscler Thromb* 1993;13:1327–1333.

198. Rodgers GM, Conn MT. Homocysteine, an atherogenic stimulus reduces protein C activation by arterial and venous endothelial cells. *Blood* 1990;75:895–901.

199. Harpel PC, Chang VT, Borth W. Homocysteine and other sulfhydryl compounds enhance the binding of lipoprotein(a) to fibrin: a potential biochemical link between thrombosis, atherogenesis, and sulfhydryl compound metabolism. *Proc Natl Acad Sci U S A* 1992;89:10193–10197.

200. Drake TA, Hannani K, Fei H, et al. Minimally oxidized low-density lipoprotein induces tissue factor expression in cultured human endothelial cells. *Am J Pathol* 1991;138:601–607.

201. Latron Y, Chautan M, Anfosso F, et al. Stimulating effect of oxidized low density lipoproteins on plasminogen activator inhibitor-1 synthesis by endothelial cells. *Arterioscler Thromb* 1991;11:1821–1829.

202. Colucci M, Balconi G, Lorenzet R, et al. Cultured human endothelial cells generate tissue factor in response to endotoxin. *J Clin Invest* 1983;71:1893–1896.

203. Moore KL, Andreoli SP, Esmon NL, et al. Endotoxin enhances tissue factor and suppresses thrombomodulin expression of human vascular endothelium in vitro. *J Clin Invest* 1987;79:124–130.

204. Colucci M, Paramo JA, Collen D. Generation in plasma of a fast-acting inhibitor of plasminogen activator in response to endotoxin stimulation. *J Clin Invest* 1985;75:818–824.

205. Brox JH, Osterud B, Bjorklid E, Fenton JW. Production and availability of thromboplastin in endothelial cells: the effects of thrombin, endotoxin and platelets. *Br J Haematol* 1984;57:239–246.

206. Gelehrter TD, Sznycer-Laszuk R. Thrombin induction of plasminogen activator-inhibitor in cultured human endothelial cells. *J Clin Invest* 1986;77:165–169.

207. Lyberg T, Galdal KS, Evensen SA, Prydz H. Cellular cooperation in endothelial cell thromboplastin synthesis. *Br J Haematol* 1983;53:85–95.

208. Tannenbaum SH, Finko R, Cines DB. Antibody and immune complexes induce tissue factor production by human endothelial cells. *J Immunol* 1986;137:1532–1537.

209. Contrino J, Goralnick S, Qi J, et al. Fibrin induction of tissue factor expression in human vascular endothelial cells. *Circulation* 1997;96:605–613.

2004 Lippincott Williams & Wilkins  
John P. Greer, John Foerster, John N. Lukens  
George M. Rodgers, Frixos Paraskevas, Bertil Glader  
Wintrobe's Clinical Hematology

### RED BLOOD CELL ANTIGENS

[International Society of Blood Transfusion Terminology](#)

[Red Cell Blood Group Systems](#)

[Low-Incidence Antigens](#)

[High-Incidence Antigens](#)

[Collections of Antigens](#)

### PLATELET ANTIGENS

[Platelet Glycoprotein Polymorphisms](#)

[Alloimmune Thrombocytopenic Disorders](#)

[Platelet Polymorphisms as Risk Factors for Cardiovascular Disease](#)

### WHITE CELL ANTIGENS

[Granulocyte Antigens](#)

[Detecting Antibodies to Granulocyte Antigens](#)

### ACKNOWLEDGMENTS

### REFERENCES

This chapter reviews the biochemistry and importance of various blood group antigens with a focus on red cells, platelets, and white blood cells. Because the circulating blood cells originate from a common progenitor cell, it is not surprising that there are a number of common blood group antigens. But what is surprising is the fact that the various cell lineages have so many unique and different antigens. Studies characterizing the red cell antigens were first performed approximately 100 years ago, whereas studies investigating the platelet and white cell antigens were performed much more recently. There are a number of explanations for this, including the earlier recognition of red cells and the early attempts to transfuse these cells. Additionally, red cells have proved to be not only more plentiful but also easier for investigators to work with. Indeed, the early techniques used to study red cell antigens, such as primary and secondary agglutination reactions using direct and indirect antiglobulin tests, proved so robust that they are still used today.

The nomenclature used for red cells is complex, yet historically interesting. Until recently, there was no attempt to be systematic. In the past, some blood groups were named after the individual (*Kel* is derived from Mrs. Kellner) or animal (*Rh* is derived from the rhesus monkey) lacking the antigen. Others were named after the discoverers (e.g., LW was named for Landsteiner and Weiner). Finally, some names are best described as quaint (e.g., the Lutheran blood group system was named according to a mislabeled blood sample). As is discussed, a more systematic approach for naming antigenic systems of red cells, platelets, and white cells is now used. However, the traditional names are still frequently used and, to add to the confusion, a number of laboratories continue to use other traditional nomenclatures (e.g., the Fisher–Race terminology continues to be used for the Rh system).

For biologists, a compelling question presents itself: What are the purposes of blood group antigens? For the majority of antigens, the answer is unknown, but there is increasing evidence that suggests certain antigens participate in host defense. Blood group antigens of red cell, platelet, and white cells can be made of proteins, carbohydrates attached to proteins, or lipids. Within each category, the antigen can be intrinsically produced during

the formation of that cell, or it can be adsorbed from the plasma. Similarly, the antigens can be attached to the surface of the cell, can be partially embedded within the membrane (phosphatidyl-inositol glycan), or can be transmembrane. Recognizing this, investigators have grouped red cell antigens according to the functional activities of their associated carbohydrate, lipid, or protein (1). These include functions such as membrane stabilization, transport across the membrane, receptor function, enzymatic activity, and others. However, it is important to emphasize that although these blood group antigens are one component of this particular function, there is little evidence that they exist solely for this function. Consequently, although it is interesting to understand how a protein or carbohydrate associated with a blood group antigen contributes to a cell's integrity, it may not be the sole explanation for the presence of the antigen.

Any discussion of blood group antigens must touch on disease associations. In this review, we also comment on generally agreed on associations. Readers should be cautious about the reported associations between certain blood groups and diseases, as these associations could be collateral to other factors. However, there is general agreement that infectious agents, especially parasites and some bacteria, have led to blood group antigenic selection. Perhaps this is best exemplified by the geographic distribution of the Duffy blood group system, which is encoded by two alleles. The Fy(a-b-) phenotype is rare in most populations, with the exception being blacks originating from West Africa. Studies have demonstrated that the Duffy glycoprotein (gp) can serve as a receptor for *Plasmodium vivax*, an etiologic agent of malaria; hence, there is a strong selection advantage for those individuals not expressing this gp [i.e., Fy(a-b-)].

These dramatic observations and other studies provide indirect evidence that perhaps the major biologic advantage of antigens on cells is to enhance the ability of the species to distinguish self from nonself. Hence, one can anticipate in the ongoing "evolutionary warfare" between species and their invaders that when a microorganism uses a component of a blood group to invade that cell, spontaneous mutations producing another blood group would have a selective advantage. Additionally, nonhazardous mutations, which do not provide advantage or disadvantage, might not necessarily be deleted. It is likely that this helps to explain the enormous number of blood groups found on red cells, platelets, and white cells. Some of these blood groups are common (typically termed *public systems* within the platelet nomenclature), whereas others are rare (termed *private systems*).

This chapter summarizes red cell and platelet blood groups by first summarizing the approach to nomenclature and then reviewing the common blood groups.

## RED BLOOD CELL ANTIGENS

In humans, 26 blood group systems with 228 antigens have been identified. Additional antigens have been identified but have not been assigned to established systems. Red blood cell antigens may be proteins, glycoproteins, or glycolipids. Most red cell antigens are synthesized by the red cells; however, some antigens, such as those of the Lewis and Chido/Rogers systems, are adsorbed onto the red cell membrane from the plasma. Some red cell antigens are specific to red cells; however, others are found on other cells throughout the body.

The importance of red cell antigens is multifold. Since the work of Landsteiner in the early 1900s, it has been recognized that knowledge and understanding of blood groups are essential for transfusion therapy. In routine practice, it is necessary to determine the compatibility of certain red blood cell antigens between the blood donor and the blood recipient. This is because individuals who lack antigens on their red blood cells can form alloantigens, or be alloimmunized, if they are exposed to blood expressing the antigen.

This might occur with transfusion of blood products or during pregnancy. Antibodies that react with red blood cell antigens can cause problems such as delayed and immediate hemolytic transfusion reactions (HTRs) and hemolytic disease of the newborn (HDN). Furthermore, the study of red cell antigens and the associated membrane structures allows for a greater understanding of the physiology of red blood cells. For example, abnormalities of some blood group systems, such as Rh and Kell, may be associated with both functional and morphologic changes in the red cells. Finally, study of the inheritance of blood group antigens provides a greater understanding of the mechanisms of gene expression.

In this chapter, the red cell antigen groups are presented in order of clinical importance. The summary tables given in each antigen section list important clinical information and the most important antigens of each blood group system. As noted, many red cell antigens have an interesting but inconsistent approach to nomenclature. However, because these (as well as the platelet antigens) are commonly used, they are used along with the nomenclature proposed by the International Society of Blood Transfusion (ISBT).

### International Society of Blood Transfusion Terminology

The ISBT Working Party on Terminology for Red Cell Surface Antigens was established in 1980 with the goal of creating a uniform nomenclature. Blood antigens were categorized into systems, collections, and series. The most recent monograph produced by the Working Party was produced in 2001 and included blood group antigens categorized into 26 systems, five collections, and two series (2).

**SYSTEMS** A blood group system is genetically discrete from other blood group systems and consists of one or more antigens governed by either a single gene locus or a complex of two or more closely linked genes with virtually no recombination events occurring among them. There are currently 26 recognized systems (Table 23.1).

**TABLE 23.1. Blood Group Systems**

| ISBT Number | System Name | System Symbol | Number of Antigens | Antigens  | Gene Name                                     | Chromosomal Location |
|-------------|-------------|---------------|--------------------|---|---|----------------------|
| 001         | ABO         | ABO           | 4                  | A, B, AB, A1  | <i>ABO</i>                                    | 9q34.1–q34.2         |
| 002         | MNS         | MNS           | 43                 | M, N, S, s, U, He, Mi <sup>a</sup> , M <sup>c</sup> , Vw, Mur, M <sup>g</sup> , Vr, M <sup>e</sup> , Mt <sup>a</sup> , St <sup>a</sup> , Ri <sup>a</sup> , Ci <sup>a</sup> , Ny <sup>a</sup> , Hut, Hil, M <sup>v</sup> , Far, s <sup>D</sup> , Mit, Dantu, Hop, Nob, En <sup>a</sup> , ENKT, N', Or, DANE, TSEN, MINY, MUT, SAT, ERIK, Os <sup>a</sup> , ENEP, ENEH, HAG, ENAV, MARS | <i>GYPA</i> ,<br><i>GYPB</i> ,<br><i>GYPE</i> | 4q28–q31             |
| 003         | P           | P1            | 1                  | P1  | <i>P1</i>                                     | 22q11.2–qter         |

|     |          |     |   |  |                   |
|-----|----------|-----|---|--|-------------------|
| 004 | Rh       | RH  | 45 D, C, E, c, e, f, Ce, <i>RHD</i> ,<br>C <sup>w</sup> , C <sup>x</sup> , V, E <sup>w</sup> , <i>RHCE</i><br>G, Hr <sub>o</sub> , Hr, hr <sup>s</sup> ,<br>VS, C <sup>G</sup> , CE, D <sup>w</sup> ,<br>c-like, cE, hr <sup>H</sup> ,<br>Rh29, Go <sup>a</sup> , hr <sup>B</sup> ,<br>Rh32, Rh33, Hr <sup>B</sup> ,<br>Rh35, Be <sup>a</sup> ,<br>Evans, Rh39, Tar,<br>Rh41, Rh42,<br>Crawford, Nou,<br>Riv, Sec, Dav,<br>JAL, STEM,<br>FPTT, MAR,<br>BARC |  | 1p36.2-p34        |
| 005 | Lutheran | LU  | 18 Lu <sup>a</sup> , Lu <sup>b</sup> , Lu3, <i>LU</i><br>Lu4, Lu5, Lu6,<br>Lu7, Lu8, Lu9,<br>Lu11, Lu12, Lu13,<br>Lu14, Lu16, Lu17,<br>Au <sup>a</sup> , Au <sup>b</sup> , Lu20   |  | 19q13.2-q13.3     |
| 006 | Kell     | KEL | 23 K, k, Kp <sup>a</sup> , Kp <sup>b</sup> , <i>KEL</i><br>Ku, Js <sup>a</sup> , Js <sup>b</sup> , Ul<br><sup>a</sup> , K11, K12, K13,<br>K14, K16, K17,<br>K18, K19, Km, Kp<br><sup>c</sup> , K22, K23, K24,<br>VLAN, TOU  |  | 7q33              |
| 007 | Lewis    | LE  | 6 Le <sup>a</sup> , Le <sup>b</sup> , LbH, <i>FUT3</i><br>ALe <sup>b</sup> , BLe <sup>b</sup>   |  | 19p13.3           |
| 008 | Duffy    | FY  | 6 Fy <sup>a</sup> , Fy <sup>b</sup> , Fy3, <i>FY</i><br>Fy4, Fy5, Fy6   |  | 1q22-q23          |
| 009 | Kidd     | JK  | 3 Jk <sup>a</sup> , Jk <sup>b</sup> , JK3 <i>SLC14A1</i>  |  | 18q11.1-q11.2     |
| 010 | Diego    | DI  | 21 Di <sup>a</sup> , Di <sup>b</sup> , Wr <sup>a</sup> , Wr <sup>b</sup> , <i>SLC4A1</i><br>Wd <sup>a</sup> , Rb <sup>a</sup> ,<br>WARR, ELO, Wu,<br>Bp <sup>a</sup> , Mo <sup>a</sup> , Hg <sup>a</sup> ,<br>Vg <sup>a</sup> , Sw <sup>a</sup> , BOW,<br>NFLD, Jn <sup>a</sup> ,<br>KREP, Tr <sup>a</sup> , Fr <sup>a</sup> ,<br>SW1   |  | 17q21-q22         |
| 011 | Yt       | YT  | 2 Yt <sup>a</sup> , Yt <sup>b</sup> <i>ACHE</i>   |  | 7q22.1            |
| 012 | Xg       | XG  | 2 Xg <sup>a</sup> , CD99 <i>XG, MIC2</i>  |  | Xp22.3,<br>Yp11.3 |
| 013 | Scianna  | SC  | 3 Sc1, Sc2, Sc3 <i>SC</i>   |  | 1p35-p32          |
| 014 | Dombrock | DO  | 5 Do <sup>a</sup> , Do <sup>b</sup> , Gy <sup>a</sup> , <i>DO</i><br>Hy, Jo <sup>a</sup>  |  | 12p13.2-p12.1     |

|     |                    |       |    |  |                 |               |
|-----|--------------------|-------|----|--|-----------------|---------------|
| 015 | Colton             | CO    | 3  | Co <sup>a</sup> , Co <sup>b</sup> , Co <sup>3</sup>  | <i>AQP1</i>     | 7p14          |
| 016 | Landsteiner–Wiener | LW    | 3  | LW <sup>a</sup> , LW <sup>ab</sup> , LW <sup>b</sup>   | <i>LW</i>       | 19p13.3       |
| 017 | Chido/Rodgers      | CH/RG | 9  | Ch1–6, Rg1, Rg2, WH  | <i>C4A, C4B</i> | 6p21.3        |
| 018 | Hh                 | H     | 1  | H  | <i>FUT1</i>     | 19q13         |
| 019 | Kx                 | XK    | 1  | Kx   | <i>XK</i>       | Xp21.1        |
| 020 | Gerbich            | GE    | 7  | Ge <sup>2</sup> , Ge <sup>3</sup> , Ge <sup>4</sup> , W <sup>b</sup> , Ls <sup>a</sup> , An <sup>a</sup> , Dh <sup>a</sup>                                 | <i>GYPC</i>     | 2q14–q21      |
| 021 | Cromer             | CROM  | 10 | Cr <sup>a</sup> , Tc <sup>a</sup> , Tc <sup>b</sup> , Tc <sup>c</sup> , Dr <sup>a</sup> , Es <sup>a</sup> , IFC, WES <sup>a</sup> , WES <sup>b</sup> , UMC | <i>DAF</i>      | 1q32          |
| 022 | Knops              | KN    | 7  | Kn <sup>a</sup> , Kn <sup>b</sup> , McC <sup>a</sup> , Sl <sup>a</sup> , Yk <sup>a</sup> , McC <sup>b</sup> , Vil  | <i>CR1</i>      | 1q32          |
| 023 | Indian             | IN    | 2  | In <sup>a</sup> , In <sup>b</sup>  | <i>CD44</i>     | 11p13         |
| 024 | Ok                 | OK    | 1  | Ok <sup>a</sup>  | <i>CD147</i>    | 19p13.3–p13.2 |
| 025 | Raph               | RAPH  | 1  | MER2   | <i>MER2</i>     | 11p15.5       |
| 026 | John Milton Hagen  | JMH   | 1  | JMH1   | <i>SEMA7A</i>   | 15q23–24      |

Adapted from Daniels GL, Anstee DJ, Cartron JP, et al. International Society of Blood Transfusion Working Party on Terminology for Red Cell Surface Antigens. *Vox Sang* 2001;80(3):193–197; Daniels GL, Anstee DJ, Cartron JP, et al. Terminology for red cell surface antigens. ISBT Working Party Oslo Report. International Society of Blood Transfusion. *Vox Sang* 1999;77(1):52–57; Denomme GA, Rios M, Reid ME. Molecular protocols in transfusion medicine. San Diego: Academic Press, 2000; and International Society of Blood Transfusion Working Party on Terminology for Red Cell Antigens web site: <http://www.iccbba.com/wpantigentables.htm> (Last updated September 2000). 2000. Accessed January 5, 2003.

**COLLECTIONS** The concept of collections was introduced into the ISBT terminology in 1988 to bring together related sets of antigens (genetically, biochemically, or serologically), which could not correctly be classified as systems because they have not been shown to be genetically distinct from all existing systems. Eleven collections were first identified. Three of these collections have subsequently been recognized as systems (Gerbich, Cromer, and Indian), and three of these collections have been incorporated into other systems (Auberger, Gregory, and Wright into Lutheran, Dombrock, and Diego, respectively); thus, five collections are currently recognized ( [Table 23.2](#)).

**TABLE 23.2. Collections of Antigens**

| ISBT Number | Name | Symbol | Antigen Number | Antigen Symbol              | Antigen Incidence (%) |
|-------------|------|--------|----------------|-----------------------------|-----------------------|
| 205         | Cost | COST   | 205001         | C <sub>s</sub> <sup>a</sup> | 95                    |
|             |      |        | 205002         | C <sub>s</sub> <sup>b</sup> | 34                    |
| 207         | Ii   | I      | 207001         | I                           | >99                   |
|             |      |        | 207002         | i                           | Low incidence         |
| 208         | Er   | ER     | 208001         | Er <sup>a</sup>             | >99                   |
|             |      |        | 208002         | Er <sup>b</sup>             | <1                    |



|     |      |        |                 |               |
|-----|------|--------|-----------------|---------------|
| 209 | GLOB | 209001 | P               | >99           |
|     |      | 209002 | p <sup>k</sup>  | Low incidence |
|     |      | 209003 | LKE             | 98            |
| 210 |      | 210001 | Le <sup>c</sup> | 1             |
|     |      | 210002 | Le <sup>d</sup> | 6             |

NOTE: Obsolete collections include 201 Gerbich, 202 Cromer, 203 Indian, 204 Auberger, 206 Gregory, and 211 Wright.

**SERIES** An antigen may be assigned a number if it is a low-frequency antigen (the 700 series) or if it is a high-frequency antigen (the 901 series). A *low-frequency antigen* is an antigen that has an incidence of less than 1% in most populations tested, similar to the platelet designation of “private.” The 700 series currently consists of 21 antigens ( [Table 23.3](#)). *High-frequency antigens* are antigens with an incidence of greater than 90% in most populations, similar to the platelet “public” system. Originally, high-frequency antigens were assigned to the 900 series. However, because so many of the original antigens assigned to the 900 series have been reassigned to collections, the 901 series was created. There are currently 11 antigens in the 901 series ( [Table 23.4](#)).

**TABLE 23.3. The 700 Series (Low-Incidence Antigens)**

| ISBT Number | Name         | Symbol           |
|-------------|--------------|------------------|
| 700002      | Batty        | By               |
| 700003      | Christiansen | Chr <sup>a</sup> |
| 700005      | Biles        | Bi               |
| 700006      | Box          | Bx <sup>a</sup>  |
| 700015      | Radin        | Rd               |
| 700017      | Torkildsen   | To <sup>a</sup>  |
| 700018      | Peters       | Pt <sup>a</sup>  |
| 700019      | Reid         | Re <sup>a</sup>  |
| 700021      | Jensen       | Je <sup>a</sup>  |
| 700028      | Livesay      | Li <sup>a</sup>  |
| 700039      | Milne        | (Milne)          |
| 700040      | Rasmussen    | RASM             |
| 700043      | Oldeide      | OI <sup>a</sup>  |
| 700044      |              | JFV              |
| 700045      | Katagiri     | Kg               |
| 700047      | Jones        | JONES            |
| 700049      |              | HJK              |
| 700050      |              | HOFM             |
| 700052      |              | SARA             |
| 700053      |              | LOCR             |
| 700054      |              | REIT             |

**TABLE 23.4. The 901 Series (High-Incidence Antigens)**

| ISBT Number | Name      | Symbol          | Incidence (%) | Implicated in Hemolytic Disease of the Newborn and/or Hemolytic Transfusion Reaction |
|-------------|-----------|-----------------|---------------|--|
| 901001      |           | Vel             | >99           | Yes  |
| 901002      | Langereis | Lan             | >99           | Yes  |
| 901003      | August    | At <sup>a</sup> | >99           | Yes  |
| 901005      |           | Jr <sup>a</sup> | >99           | Yes  |
| 901008      |           | Emm             | >99           | No   |
| 901009      | Anton     | AnWj            | >99           | Yes  |
| 901012      | Sid       | Sd <sup>a</sup> | 91            | No   |
| 901013      | Duclos    | (Duclos)        | >99           | No   |
| 901014      |           | PEL             | >99           | Yes  |
| 901015      |           | ABTI            | >99           | Yes  |
| 901016      |           | MAM             | >99           | Yes  |

Each blood group antigen is given an identification number consisting of six digits. The first three numbers represent the system to which the antigen has been assigned. The second three digits identify the antigen. Each system also has an alphabetic symbol. For example, the ABO system is number 001, and the A antigen is the first antigen of that system; thus, it has the ISBT number 001001 or ABO001. By convention, the zeros may be omitted, and numbers are separated by a dot (i.e., the A antigen would be 1.1 or ABO1). This terminology is useful for databases and as a classification system; however, most clinical laboratories still use traditional terminology.

## Red Cell Blood Group Systems

### ABO (ISBT 001) AND HH (ISBT 018) BLOOD GROUP SYSTEMS

Summary of Important Characteristics of ABO Antibodies

| Antibody Specificity | Clinically Significant | Antibody Class                  | HDN | HTR | Frequency of Antigen-Negative Blood (White Population) |
|----------------------|------------------------|---------------------------------|-----|-----|--|
| Anti-A               | Yes                    | Immunoglobulin (Ig) M; some IgG | Yes | Yes | Common (53%)   |
| Anti-B               | Yes                    | IgM; some IgG                   | Yes | Yes | Common (87%)   |

The ABO blood group system was discovered by Landsteiner in 1900 when he noticed that the red cells of some individuals could be agglutinated by the serum of others. It remains the most important of all blood group systems for several reasons: (a) When the ABO antigen is not expressed on the red cell, individuals always have ABO antibodies in their plasma, with the stimulus for antibody production being a variety of environmental agents; and (b) the ABO antibodies formed are frequently mixtures of both IgM and IgG antibodies, both having thermal reactivity at 37° C and both capable of activating complement. These unique characteristics of the antigens and antibodies of the ABO blood group system provide optimal conditions for rapid red cell destruction if ABO-incompatible blood is transfused—a clinical scenario termed an *acute HTR*. There are three allelic genes in the ABO blood group system ( *A*, *B*, and *C*) that are inherited in mendelian fashion ( [Table 23.1](#)). Both *A* and *B* are codominant alleles, whereas *C* is a recessive allele. Hence, these three genes result in four different phenotypes: A, B, AB,

and O. An individual with the A phenotype can be homozygous for the A gene ( $AA$ ) or heterozygous ( $AO$ ). Similarly, the B phenotype can be the result of homozygous ( $BB$ ) or heterozygous ( $BO$ ) gene inheritance. The genotype of the AB phenotype is  $AB$ , and the group O phenotype is always genetically  $OO$ . Thus, there are four ABO group phenotypes (A, B, AB, and O) that arise from six possible genotypes ( $AA, AO, BB, BO, AB$ , and  $OO$ ). The frequencies of ABO phenotypes are variable among different ethnic populations. In whites, the O and A phenotypes are the most common, occurring in greater than 40% of the population. The B phenotype is found in approximately 10% of whites, and the AB phenotype is the least frequently encountered in only 3% of individuals. Around the world, the  $B$  gene is the rarest ABO blood allele, with the highest distribution frequency in central Asia. The  $A$  allele is found in 10 to 35% of individuals throughout the world. The populations with the highest frequency of the  $A$  gene are unrelated and distributed in the aborigines of northern Scandinavia and northern America. The  $C$  gene is the most common of the ABO alleles; hence, the O phenotype tends to be the predominate phenotype throughout the world, particularly in South and Central America. The population with the lowest frequency of individuals with the group O phenotype is found in central Asia where blood group B is more common. The alleles normally occupy the same position of a paired chromosome. Rarely, individuals may inherit both  $A$  and  $B$  alleles on the same chromosome ( $cisAB$  alleles) due to mutation or unequal crossing over of the chromosomes.

**ABO Genes** The  $A$ ,  $B$ , and  $O$  genes all locate together: 9q34.1–q34.2. The genes consist of at least seven exons spanning over 18 kb in the DNA genome.  $A$  and  $B$  genes differ in seven nucleotides, resulting in different substrate specificity of the encoded enzyme. The difference in substrate specificity is mainly determined by the amino acids 266 and 268 in exon 7 (<sup>3</sup>). The  $C$  gene is due to either a frameshift mutation leading to a stop codon or, rarely, a mutation producing a nonfunctional enzyme. Numerous mutations are found for  $A$ ,  $B$ , and  $C$  genes, but the most common mutation is  $A_2$ . The  $A_2$  gene has two nucleotides different from the  $A_1$  gene, which results in diminished enzymatic activity and, consequently, weakened antigen expression. For example, a red cell with  $A_1$  phenotype carries more than 800,000 A antigens, but only 250,000 A antigens are present in a red cell with the phenotype  $A_2$  (<sup>4</sup>). Similarly, weak subgroups of group B have been described due to mutations of the  $B$  gene.

**ABO Antigens** The antigens of the ABO system are located on carbohydrate oligosaccharide chains, which are parts of glycosphingolipids or gp molecules. There are four different types oligosaccharide chains: Type 2 and type 4 oligosaccharide chains are predominantly on the red cell membrane; type 1 chains are found in plasma, saliva, and body fluids; and type 3 chains are found in the mucins secreted by gastric mucosa or ovarian cysts. The genes of the ABO system do not encode directly for the antigens but encode for enzymes that add specific sugars to the red cell membrane. These sugars are the ABO red cell antigens that are detectable with serologic testing. The  $A$  gene encodes for the transferase  $\alpha(1,3)N$ -acetyl-galactosaminyl-transferase, which adds an  $N$ -acetyl-galactosamine to the red cell membrane. The  $B$  gene encodes for the transferase [ $\alpha(1,3)$  galactosyl-transferase], which adds a galactose to the red cell membrane. In an individual with the AB phenotype, the A and B transferases coexist and compete for the same substrate. The  $C$  allele encodes for a nonfunctional transferase; hence, a specific sugar is not attached to the red cell membrane as a result of inheriting this gene. Mutations of the  $A$  and  $B$  genes result in amino acid substitutions within the transferases, and this translates into weakened expression of the A and B antigens (frequently classified as subgroups). The most common subgroups associated with the  $A$  gene are  $A_1$  and  $A_2$ . The  $A_1$  subgroup occurs in approximately 80% of group A individuals, and the  $A_2$  subgroup is present in approximately 20%. The other subgroups of A are less frequently encountered, with the  $A_3$  subgroup occurring in 1 in 1000 individuals. The clinical relevance of A and B subgroups is of greater significance in blood donors than recipients. Because of the weakened antigen expression on the red cells of an individual who has inherited a subgroup gene, it is possible that serologic phenotyping

of red cells results in misclassification of the red cell phenotype as group O. For a blood recipient, this would not be a problem, as group O blood is compatible with all other groups (universal donor); however, if a donor unit of blood from an individual with an A or B subgroup is misclassified as group O and transfused to an O individual, intravascular hemolysis could result. Both the A and B transferases add sugar moieties to a substrate on the red cell membrane, which is encoded by the *H* gene. The *H* gene locus is located at chromosome 19q13.3, and the genes inherited at this locus are inherited in a mendelian manner. Two genes have been identified at this locus: *H* is the gene most frequently inherited, and it encodes for an enzyme termed *H transferase type 1* [a(1,2) fucosyl-transferase; FUT1], which adds an L-fucose to the terminal galactose molecule of oligosaccharide chains in an a(1 and 2) linkage. This structure is called *H substance*, and it is to this structure that the A and B transferases add specific sugars resulting in A and B antigens. The rare allele sometimes inherited at the *H* locus is *h*. This *h* gene encodes for a nonfunctional transferase. If the *h* gene is inherited in the homozygous state (*hh*), L-fucose molecules (*H substance*) are not present on the red cell membrane. Without the presence of *H substance* on the red cell membrane, the A and B transferases, even when present, are not able to add the specific sugars that give A and B antigen specificity. This *hh* genotype is known as the *Bombay phenotype*: Serologically, the red cells group as an O; however, unlike the true O phenotype, which has large amounts of *H* antigen on the red cells, red cells from the Bombay phenotype lack *H* antigen ( Fig. 23.1). Children of a parent with the Bombay phenotype (*hh*) may have normal A or B antigen expression, or both, if they inherit the dominant *H* gene from the other parent. The clinical relevance of the Bombay phenotype relates to the ability of these individuals to form not only anti-A and anti-B but also anti-H. The presence of all three of these antibodies makes it difficult to find compatible blood if transfusion is required. The only compatible blood for an individual with the Bombay (*hh*) phenotype is blood from another Bombay individual, and this phenotype is extremely rare.



**Figure 23.1.** Biosynthesis of ABO blood group antigens. The antigens of the ABO system are located on the carbohydrate of type II oligosaccharides. *H* transferase is required to add fucose to the oligosaccharide chain and form *H substance*. Without the presence of *H substance*, *A* transferase and *B* transferase are not able to add terminal sugar moieties to the oligosaccharide chain. Fuc, L-fucose; Gal, D-galactose; Glc-NAc, D-N-acetyl-glucosamine.

The ABO(H) antigens are found not only on red cells but also on other blood cells, in most body fluids (except cerebrospinal fluid), and on the cell membranes of tissues such as intestine, urothelium, and vascular endothelium. The expression of ABO(H) antigens on the red cell membrane and tissue membranes is controlled by the *Hh* genes. The expression of ABO(H) antigens into body fluids is controlled by the *Sese* genes. The *Sese* genes, similar to the *Hh* gene, are located at chromosome 19q13.3; however, they are not part of the ABO system. The dominant *Se* gene codes for *H transferase type 1* [a(1,2) fucosyl-transferase; FUT2]. Without the prior addition of a fucose to the oligosaccharide chains, *A* and *B* antigens would not be expressed in the body secretions, irrespective of the presence of *A* and *B* transferases ( Fig. 23.1). Despite the wide distribution of ABO(H) antigens in various cell membranes and body fluids, the normal physiologic function of these glycoproteins and glycolipids is largely unclear. The carbohydrate moieties of the ABO(H) antigens might contribute to the formation of glycocalyx. However, based on the

observation that individuals who lack all ABH antigens (Bombay phenotype) have normal red cell survival and function, the role of ABO antigens in maintaining a state of health is unknown (5). There is some evidence that ABO blood groups may be associated with certain diseases. Gastric cancer has been reported to be more prevalent in individuals with blood group A, but peptic ulcer is more often in those with group O (6). The normal range of von Willebrand factor (vWF) antigen level varies among individuals with different ABO blood groups. Individuals with blood group O have the lowest vWF antigen level, followed by group A, then group B, and, last, group AB (7).

**Antibodies and Clinical Significance** All immunocompetent individuals produce antibodies against the missing ABO(H) blood group antigens (Table 23.5). Anti-A and anti-B production does not require red cell stimulation through transfusion or pregnancy but occurs predominately through environmental exposure, such as bacteria (8). Anti-A and anti-B are usually detectable within 3 to 6 months after birth (9). By 5 years of age, the titers of anti-A and anti-B antibodies reach maximum and persist throughout adulthood. The titers of IgM anti-A and anti-B antibodies may gradually decline with advanced age (10). Newborn infants do not usually have a significant amount of anti-A or anti-B in their plasma; therefore, pretransfusion testing is not usually required for transfusions within the first 4 months of life. Infants born to alloimmunized mothers are an exception to this rule, as other specific blood group antibodies may have crossed the placenta and may be present in the infant's circulation.

**TABLE 23.5. Summary of ABO Genes and Antigens**

| Phenotype      | Antibody  | Antigen                               | Gene Product                               | Gene                         |
|----------------|---|---------------------------------------|--|------------------------------|
| A              | Anti-B  | N-acetylgalactosamine                 | A transferase                              | 9q34.1-q34.2                 |
| B              | Anti-A  | D-galactose                           | B transferase                              | 9q34.1-q34.2                 |
| AB             | None  | N-acetylgalactosamine and D-galactose | A transferase and B transferase            | 9q34.1-q34.2                 |
| O              | Anti-A and anti-B                                 | L-fucose                              | Absent or nonfunctional A or B transferase | Absent or nonfunctional gene |
| A <sub>2</sub> | Anti-B and variable amount of anti-A <sub>1</sub> | N-acetylgalactosamine                 | A transferase                              | 9q34.1-q34.2                 |

The “naturally occurring” anti-A and anti-B antibodies are predominantly IgM, although variable amounts of IgG may be present. Like most IgM immunoglobulins, these antibodies can activate complement. ABO antibodies are especially effective at complement activation for two reasons: The antibodies have thermal activity reacting at body temperature, and the high density of antigen sites on the red cell membrane allows for large numbers of antibody to bind to the cell membrane. Therefore, the transfusion of ABO-incompatible blood typically presents as acute intravascular hemolysis. ABO antibodies are not a major cause of HDN for several reasons: Antibody inhibition can occur by soluble A or B substance, or both, in the plasma of some infants; A and B antigens are not specific for only red cells (hence, the red cell is not the only target); and antibodies specific for sugar molecules tend to have a weaker binding affinity than antibodies reacting with protein antigens such as the D antigen. In routine blood group typing, the transfusion recipient's red cells are typed using commercial sources of anti-A and anti-B antibodies (forward or cell typing). The presence of anti-A and anti-B in the serum/plasma of the recipient is detected by testing the serum/plasma against group A and group B red cells (reverse or serum typing). The interpretation of these two tests must agree for the patient's blood group to be assigned. Sometimes, the serum and cell

grouping do not agree; this is termed *ABO discrepancy*. The laboratory proceeds with additional testing in these circumstances to correctly identify the patient's ABO group. Discrepancies in ABO grouping are found in various diseases. For example, the ABO(H) antigens may be weakened in some types of leukemia or cancer, mutations of *ABO* alleles, and diseases associated with chromosome 9 translocations. Alternatively, an individual may acquire an ABO antigen on his or her red cells (i.e., acquiring a B antigen after bacterial infections and acquiring an A antigen associated with Tn activation of the red cells) (11).

## RH BLOOD GROUP SYSTEM (ISBT 004)

### Summary of Important Characteristics

| Antibody Specificity | Clinically Significant | Antibody Class | HDN | HTR | Frequency of Antigen-Negative Blood (White Population) |
|----------------------|------------------------|----------------|-----|-----|--|
| Anti-D               | Yes                    | IgG; some IgM  | Yes | Yes | Common (15%)   |

The Rh blood group system was discovered by Landsteiner and Weiner in 1940 (12). They injected rabbits with red cells from the Rhesus monkey, and the antibody produced was initially termed *Rh* and is now known as *anti-D*. Unlike the ABO blood group system, Rh antibodies are not environmentally stimulated; however, the D antigen is highly immunogenic, causing anti-D formation in up to 70% of D-negative individuals who are exposed to D-positive blood. Anti-D is IgG and is known to cause HTRs and HDN.

**Rh Terminology** Three different systems of nomenclature have been developed to describe the genes and antigens of the Rh blood group system antigens: the Wiener system, the Fisher-Race system, and the Rosenfield numeric terminology. Wiener proposed that the Rh antigens were the products of a single gene (13). The Fisher-Race nomenclature was based on the theory that reactions observed with various Rh antisera could be explained by three pairs of allelic genes: Cc, Dd, and Ee (14). Genetic analysis does not support either of these models. However, both the Wiener notation and the Fisher-Race nomenclature remain widely used today because of familiarity. In 1962, Rosenfield proposed a system of nomenclature that was based on serologic findings (15). The symbols were used to convey phenotypic information rather than genetic information (16). In this system, the antigens are numerically named in order of their discovery or assignment to the Rh blood group system. The various nomenclatures for common Rh system antigens are listed in [Table 23.6](#).

**TABLE 23.6. Rh Blood Group System: Antigens**

|      | Rosenfield Numeric Terminology | Fisher-Race Terminology | Wiener Terminology |
|------|--------------------------------|-------------------------|--------------------|
| Rh1  | D                              |                         | Rho                |
| Rh2  | C                              |                         | rh'                |
| Rh3  | E                              |                         | rh?                |
| Rh4  | c                              |                         | hr'                |
| Rh5  | e                              |                         | hr?                |
| Rh6  | ce (f)                         |                         | hr                 |
| Rh7  | Ce                             |                         | rh <sub>i</sub>    |
| Rh8  | C <sup>w</sup>                 |                         | rh <sup>w1</sup>   |
| Rh9  | C <sup>x</sup>                 |                         | rh <sup>x</sup>    |
| Rh10 | V (Ce <sup>s</sup> )           |                         | hr <sup>v</sup>    |



|      |                |                  |
|------|----------------|------------------|
| Rh11 | E <sup>w</sup> | rh <sup>w2</sup> |
| Rh12 | G              | rh <sup>G</sup>  |

**Genes** The Rh antigens are encoded by two genes: *RHD* and *RHCE*. The genes are located at chromosome 1p36.2–p34 (Table 23.1). *RHD* encodes the D antigen, whereas *RHCE* encodes for the Cc and Ee antigens. The d antigen does not exist; however, by convention, *a* is used to connote the absence of the D antigen. *RHD* and *RHCE* each contain ten exons and are distributed over 69 kilobase pairs (kbp) (17). Both the *RHD* and the *RHCE* genes encode for similar polypeptides of 417 amino acids with 12

membrane-spanning domains (17). In the red cell membrane, these two polypeptides form a complex with a gp termed the *Rh-associated glycoprotein* (RhAG), which is encoded by the *RHAG* gene (*RH5C*) on chromosome 6. The functions of the Rh antigens are unknown, although, based on the phenotype of Rh<sub>null</sub> cells (see section Rhnull Phenotype), there is a suggestion that the Rh antigens might play a structural role in the red cell membrane. The structure of the Rh antigens suggests that they are transport proteins and the RhAG protein may play a role in the transport of ammonium (15).

**Antigens** There are 45 antigens that have been assigned to the Rh blood group system: D, C, E, c, e, f, Ce, C<sup>w</sup>, C<sup>x</sup>, V, E<sup>w</sup>, G, Hr<sub>o</sub>, Hr, hr<sup>s</sup>, VS, C<sup>G</sup>, CE, D<sup>w</sup>, c-like, cE, hr<sup>H</sup>, Rh29, Go<sup>a</sup>, hr<sup>B</sup>, Rh32, Rh33, Hr<sup>B</sup>, Rh35, Be<sup>a</sup>, Evans, Rh39, Tar, Rh41, Rh42, Crawford, Nou, Riv, Sec, Dav, JAL, STEM, FPTT, MAR, and BARC (Table 23.1). Of the 45 antigens in the Rh blood group system, the most common and important are D, C, E, c, and e. Although individuals can become alloimmunized to the C, c, E, and e antigens after red cell exposure through transfusion or pregnancy, these antigens are much less immunogenic than D. Less than 3% of individuals exposed to the C, c, E, and e antigens become alloimmunized; hence, pretransfusion testing is not routinely performed to match for these antigens. The principal phenotypes of the Rh blood group system and their frequencies are outlined in Table 23.7.

**TABLE 23.7. Rh Blood Group System: Principal Phenotypes**

| Haplotype Based on Antigens Present |                | Frequency (%) |        |        |
|-------------------------------------|----------------|---------------|--------|--------|
| Fisher–Race                         | Wiener         | Whites        | Blacks | Asians |
| DCe                                 | R <sup>1</sup> | 42            | 17     | 70     |
| DcE                                 | R <sup>2</sup> | 14            | 11     | 21     |
| Dce                                 | R <sup>0</sup> | 4             | 44     | 3      |
| DCE                                 | R <sup>z</sup> | <0.01         | <0.01  | 1      |
| ce                                  | r              | 37            | 26     | 3      |
| Ce                                  | r'             | 2             | 2      | 2      |
| cE                                  | r?             | 1             | <0.01  | <0.01  |
| CE                                  | r <sup>y</sup> | <0.01         | <0.01  | <0.01  |

An individual is considered to be Rh positive if his or her red cells express the D antigen. The term *Rh negative* refers to the absence of the D antigen. The absence of the D antigen occurs in approximately 15 to 17% of individuals in white populations and is less frequent in other populations (18). In white populations, the absence of the D antigen is usually due to the deletion of the *RHD* gene (18). In Asian and black populations, the



absence of the D antigen is usually due to an inactive RHD rather than a gene deletion ( [19](#), [20](#) ).

**Cis Product Antigens**  $Ce(rh_1)$  is an antigen that almost always accompanies C and e when they are encoded by the same haplotype ( [16](#) ).

**Cc and Ee Variant Antigens** Various Rh antigens appear to be determined by alleles of the Cc and Ee antigens. Variants of C include  $C^w$ (Rh8),  $C^x$ (Rh9), and MAR. Variants of the E antigen include  $E^w$ (Rh11) and  $E^T$ (Rh24). Variants of the e antigen include  $hr^B$  (Rh31),  $hr^s$  (Rh19), or  $e^s$ (Rh20).

**G Antigen (Rh12)** The G antigen is found on any red cell that also has the C or D antigen.

**Weak D Phenotype** Some red cells that express the D antigen require prolonged incubation with the anti-D reagent for agglutination to occur. These red cells are

considered to be D antigen-positive and are described as *weak D*, formerly termed  $D^u$ . The weak D phenotype is thought to occur by one of three mechanisms: (a) inheritance of an RHD gene encoding for a weakened expression of D; (b) interaction of the D gene with other genes; and (c) inheritance of an RHD gene missing some epitopes. In the first mechanism, the weak D phenotype is due to an RHD gene encoding for a D protein with reduced D antigen expression ( [16](#) ). This is more common in the black population and generally occurs in association with the *Dce* haplotype. In the white population, weak D is less common but may occur in association with the haplotype *DCe* or *DcE* ( [16](#) ). In the second mechanism, the weak D phenotype occurs as a result of the position of the D gene. This is most easily conceptualized using the Fisher-Race terminology. Red cells from individuals with a C gene in a *trans* position to the D gene (i.e., *Dce/Ce*) have weakened expression of the D gene due to the C gene on the opposite chromosome. Individuals with the weak D phenotype by either of these two mechanisms do not form alloantibodies after exposure to D-positive red cells. Finally, the third mechanism, sometimes termed *partial D*, occurs when individuals lack part of the D antigen complex. The D antigen is thought to be a mosaic consisting of several individual parts or epitopes. Most D-positive individuals inherit the gene encoding the entire D antigen. However, the partial D phenotype describes red cells that are deficient in components of D, resulting in a decreased expression of the D antigen (weak D). Individuals with partial D may produce anti-D if transfused with D-positive red cells. The weak D and partial D phenotypes have implications for the practice of transfusion medicine. Donors with weak D red cells should be considered Rh(D) positive. It is important that donor blood with weak D not be mislabeled as Rh(D) negative because the weak D antigen would be capable of inducing an immune response if this blood were transfused to an Rh(D)-negative individual ( [16](#) ). It is generally recommended that patients who phenotype as weak D can be transfused with Rh(D)-positive blood, and weak D individuals who are pregnant do not require prophylaxis with Rh immune globulin.

**Rh<sub>null</sub> Phenotype** The Rh<sub>null</sub> phenotype occurs when red cells do not express Rh antigens. This phenotype occurs because of at least two mechanisms. First, the inheritance of an abnormal *RHAG* gene appears to result in the absence of the Rh antigen expression despite the presence of normal *RHD* and *RHCE* genes ( [21](#) ). This is termed *regulator type* Rh<sub>null</sub>. The second mechanism is termed *amorph type of* Rh<sub>null</sub> and involves the inheritance of a mutation in the RHCE genes in association with a D-negative background ( [21](#) ). The Rh<sub>null</sub> phenotype is associated with abnormalities in the red cell membrane causing stomatocytosis and hemolysis. The presence of the Rh proteins in the red cell membrane appears to be necessary for the expression of other membrane proteins such as the LW, Duffy, and U antigens. Rh<sub>null</sub> cells have been demonstrated to lack the LW and Fy5 antigens and have weakened expression of the S, s, and U antigens ( [22](#) ). Fortunately, the Rh<sub>null</sub> phenotype is rare, as these individuals form an alloantibody (anti-Rh29) that reacts with all other red cells except Rh<sub>null</sub> when they are transfused. Thus, obtaining compatible blood can be challenging.

**Antibodies and Clinical Significance** Most Rh antibodies are IgG, although some may be

IgM. They are usually not capable of activating complement. Anti-D is one of the most common Rh antibodies due to the high immunogenicity of the D antigen. Anti-D can cause severe HDN and HTR. The frequency of anti-D has greatly decreased with the use of prophylactic Rh immune globulin administration to Rh(D)-negative mothers during pregnancy and at delivery if the infant is Rh(D) positive. Antibodies against C, c, E, and e can be associated with mild HTR or HDN (18).

### KELL BLOOD GROUP SYSTEM (ISBT 006)

#### Summary of Important Characteristics

| Antibody Specificity | Clinically Significant | Antibody Class  | HDN | HTR | Frequency of Antigen-Negative Blood (White Population) |
|----------------------|------------------------|-----------------|-----|-----|--|
| Anti-K               | Yes                    | IgG; rarely IgM | Yes | Yes | Very common (98%)                                      |
| Anti-k               | Yes                    | IgG; rarely IgM | Yes | Yes | Rare (<2%)   |

The Kell blood group system was discovered in 1946 and was named after Mrs. Kellner, the mother of the first child discovered to be affected with HDN due to Kell antibodies (18).

**Genes and Antigens** The Kell blood group system consists of 23 antigens: K, k, Kp<sup>a</sup>, Kp<sup>b</sup>, Ku, Js<sup>a</sup>, Js<sup>b</sup>, Ul<sup>a</sup>, K11, K12, K13, K14, K16, K17, K18, K19, Km, Kp<sup>c</sup>, K22, K23, K24, VLAN, and TOU. The antigens are coded by a complex of genetic loci, known as the *Kell locus*, which is located at 7q33 (Table 23.1). The *KEL* gene contains 19 exons distributed over 21.5 kbp (17). There are at least four subloci in the complex, each of which has an allele for a high-frequency antigen (k, Kp<sup>b</sup>, Js<sup>b</sup>, and KEL11) and for one or more alleles for a lower-frequency antigen (K, Kp<sup>a</sup> and Kp<sup>c</sup>, Js<sup>a</sup>, and KEL17) (23). The most common haplotype is k/Kp<sup>b</sup>/Js<sup>b</sup>/Kel11. The phenotype frequency of the Kell antigens is shown in Table 23.8. The k antigen is a high-frequency antigen that is present in more than 98% of whites and blacks. The K antigen is much less common.

TABLE 23.8. Principal Phenotypes of Blood Systems

| System | Phenotype | Frequency (%) |                 | System  | Phenotype | Frequency (%)              |                            |                 |
|--------|-----------|---------------|-----------------|---------|-----------|----------------------------|----------------------------|-----------------|
|        |           | Whites        | Other           |         |           | Whites                     | Other                      |                 |
| ABO    | O         | 45            | 49 <sup>a</sup> | Xg      | Xg(a+)    | Males, 65.6; females, 88.7 |                            |                 |
|        | A         | 40            | 27              |         |           | Xg(a-)                     | Males, 34.4; females, 11.3 |                 |
|        | B         | 11            | 20              |         |           |                            |                            |                 |
| MNS    | AB        | 4             | 4               | Scianna | Sc:1,-2   | 99.7 <sup>c</sup>          |                            |                 |
|        | M+N-      | 28            | 26 <sup>a</sup> |         | Sc:1,2    | 0.3                        |                            |                 |
|        | M+N+      | 50            | 44              |         | Sc:-1,2   | Very rare                  |                            |                 |
|        | M-N+      | 22            | 30              |         | Sc:-1,-2  | Very rare                  |                            |                 |
|        | S+s-U+    | 11            | 3               |         | Dombrock  | Do(a+b-)                   | 17.2                       | 11 <sup>a</sup> |
|        | S+s+U+    | 44            | 28              |         |           |                            |                            |                 |

|          |                |           |                        |                    |   |           |                             |
|----------|----------------|-----------|------------------------|--------------------|---|-----------|-----------------------------|
|          | S-s+U+         | 45        | 69                     |                    | Do(a+b+)  | 49.5      | 44                          |
|          | S-s-U-         | 0         | <1                     |                    | Do(a-b+)  | 33.3      | 45                          |
|          | S-s-U+w        | 0         | Rare                   | Colton             | Co(a+b-)  | 89.3      |                             |
| P        | P <sub>1</sub> | 79        | 94 <a href="#">a</a>   |                    | Co(a+b+)  | 10.4      |                             |
| Lutheran | Lu(a+b-)       | 0.15      |                        |                    | Co(a-b+)  | 0.3       |                             |
|          | Lu(a+b+)       | 7.5       |                        |                    | Co(a-b-)  | Very rare |                             |
|          | Lu(a-b+)       | 92.35     |                        | Landsteiner-Wiener | LW(a+b-)  | >99       | 93.9 <a href="#">d</a>      |
|          | Lu(a-b-)       | Very rare |                        |                    | LW(a+b+)  | <1        | 6.0                         |
| Kell     | K+k-           | 0.2       | Rare <a href="#">a</a> |                    | LW(a-b+)  | Very rare | 0.1                         |
|          | K+k+           | 8.8       | 2                      |                    | LW(a-b-)  | Very rare | Very rare                   |
|          | K-k+           | 91.0      | 98                     | Chido/Rodgers      | Ch+, Rg+  | 95.0      |                             |
|          | Kp(a+b-)       | Rare      | 0                      |                    | Ch-, Rg+  | 2.0       |                             |
|          | Kp(a+b+)       | 2.3       | Rare                   |                    | Ch+, Rg-  | 3.0       |                             |
|          | Kp(a-b+)       | 97.7      | 100                    |                    | Ch-, Rg-  | Very rare |                             |
|          | Js(a+b-)       | 0         | 1                      | Hh                 | H+  | >99.9     |                             |
|          | Js(a+b+)       | Rare      | 19                     | Kx                 | Kx+   | ~100      |                             |
|          | Js(a-b+)       | 100       | 80                     |                    | Kx-   | Rare      |                             |
|          | K <sub>o</sub> | Very rare | Very rare              | Gerbich            | Ge2, Ge3, Ge4   | 100       |                             |
| Lewis    | Le(a+b-)       | 22        | 23 <a href="#">a</a>   |                    | Wb, Ls <sup>a</sup> , An <sup>a</sup> , Dh <sup>a</sup>   | Rare      |                             |
|          | Le(a+b+)       | 72        | 55                     | Cromer             | Cr <sup>a</sup> , Tc <sup>a</sup> , Dr <sup>a</sup> , Es <sup>a</sup> , IFC, WES <sup>b</sup> , UMC | 100       |                             |
|          | Le(a-b+)       | 6         | 22                     |                    |   |           |                             |
|          | Le(a-b-)       | Rare      | Rare                   |                    | Tc <sup>b</sup> , Tc <sup>c</sup> , WES <sup>a</sup>  | Rare      |                             |
| Duffy    | Fy (a+b-)      | 17        | 9 <a href="#">a</a>    | Knops              | Kn(a+b-)  | 94.5      | 99.9 <a href="#">a</a>      |
|          | Fy(a+b+)       | 49        | 1                      |                    | Kn(a-b+)  | 1         | 0                           |
|          | Fy(a-b+)       | 34        | 22                     |                    | Kn(a+b+)  | 4.5       | 0.1                         |
|          | Fy(a-b-)       | Rare      | 68                     |                    | McC(a+)   | 98        | 94                          |
| Kidd     | Jk(a+b-)       | 28        | 57 <a href="#">a</a>   |                    | Sl(a+)  | 98        | 60                          |
|          | Jk(a+b+)       | 49        | 34                     |                    | Yka(a+)   | 92        | 98                          |
|          | Jk(a-b+)       | 23        | 9                      | Indian             | In(a+b-)  | Very rare | Very rare <a href="#">e</a> |
|          | Jk(a-b-)       | Very rare | Very rare              |                    | In(a+b+)  | <1        | 7                           |
| Diego    | Di(a+b-)       | Rare      | Rare <a href="#">a</a> |                    | In(a-b+)  | >99       | 93                          |
|          | Di(a+b+)       | Rare      | Rare                   | Ok                 | Ok(a+)  | 100       |                             |
|          | Di(a-b+)       | >99.9     | >99.9                  | Raph               | MER2+   | 92        |                             |
| Yt       | Yt(a+b-)       | 91.9      | 97 <a href="#">b</a>   |                    | MER2-   | 8         |                             |
|          | Yt(a+b+)       | 7.9       | 23                     |                    |   |           |                             |
|          | Yt(a-b+)       | 0.2       | 0                      |                    |   |           |                             |

<sup>a</sup> Blacks.

<sup>b</sup> Israelis.

<sup>c</sup> Most populations.

<sup>d</sup> Finns.

<sup>e</sup> Iranians/Arabs.

Adapted from AABB Technical Manual, 14th ed. Bethesda, Maryland: American Association of Blood Banks, 2002; and Denomme GA, Rios M, Reid ME. Molecular protocols in transfusion medicine. San Diego: Academic Press, 2000.

---

The *KEL* gene encodes a type 2 integral membrane protein containing 732 amino acids ( [17](#) ). The protein has enzymatic activity, and it has been demonstrated *in vitro* to cleave big endothelin-3, which is a peptide with vasoconstrictor activity ( [24](#) ). The Kell protein is associated with the Kx protein in the red cell membrane [see section [Kx Blood Group System \(ISBT 019\)](#)] ( [25](#) ). Individuals have been identified who do not express the Kell protein (Kell<sub>null</sub> phenotype) and who are healthy with no structural or functional abnormalities of their red cells identified.

**Antibodies and Clinical Significance** The K antigen is very immunogenic. Only the D antigen has greater potential to induce alloimmunization. Because of this, anti-K is often encountered. Anti-K typically is induced by blood transfusion. The antibody tends to be IgG. Anti-K is clinically significant and has been implicated in both HTR and HDN. There is poor correlation with maternal anti-K titer and disease severity ( [26](#) ). Furthermore, HDN associated with anti-K tends to be less severe than HDN caused by anti-D. This is thought to occur because the Kell antigens are well expressed on fetal cells and appear on erythroid progenitor cells. It is postulated that anti-K, in addition to causing hemolysis, also causes a suppression of erythropoiesis ( [27](#), [28](#) ). The k antigen is also highly immunogenic. However, because only individuals not expressing the k antigen (i.e., KK phenotype) produce anti-k, and because the k antigen is present in most individuals, anti-k is much less common. Anti-k has been associated with both HDN and HTR. The other Kell blood group system antibodies are much less common but are also clinically significant.

## DUFFY BLOOD GROUP SYSTEM (ISBT 008)

### Summary of Important Characteristics

| Antibody Specificity | Clinically Significant | Antibody Class | HDN | HTR | Frequency of Antigen-Negative Blood (White Population) |
|----------------------|------------------------|----------------|-----|-----|--|
| Fy <sup>a</sup>      | Yes                    | IgG            | Yes | Yes | Common (34%)   |
| Fy <sup>b</sup>      | Yes                    | IgG            | Yes | Yes | Common (17%)   |

The Duffy blood group system was discovered in 1950 in the serum of a multiply transfused male, Mr. Duffy ( [18](#) ).

**Gene and Antigens** The Duffy system consists of six antigens, Fy<sup>a</sup>, Fy<sup>b</sup>, Fy3, Fy4, Fy5, and Fy6, which are encoded at the Duffy locus on chromosome 1 (1q22 and q23) ( [Table 23.1](#) ). The gene, *FY*, contains two exons distributed over 1.521 kbp ( [17](#) ). The antigens, Fy<sup>a</sup> and Fy<sup>b</sup>, are encoded by a pair of codominant alleles. The phenotypes of the Duffy system and their frequencies are presented in [Table 23.8](#). The most common phenotype in the white population is Fy(a+b+), and the most common phenotype in the black population is Fy(a-b-). The Fy<sup>x</sup> antigen represents a form of weak Fy<sup>b</sup>. The Fy5 antigen

is defined by an interaction of the Duffy and Rh gene products ( [16](#)). The antigens Fy<sup>a</sup>, Fy<sup>b</sup>, and Fy6 are sensitive to denaturation by enzymes such as papain, ficin, or a-chymotrypsin. Fy3 and Fy5 are not sensitive to enzyme denaturation. The Duffy gene encodes for a glycoprotein that is found on red cells as well as other tissues including brain, heart, lung, kidney, and spleen. On red cells, the gp has been identified as a receptor for various chemokines ( [29](#)). The gp is also the receptor for *Plasmodium vivax*. Therefore, individuals who do not express Fy<sup>a</sup> or Fy<sup>b</sup> on their red cells are not susceptible to this form of malaria. In parts of Africa where malarial infection is common, most individuals are Fy(a-b-), likely due to natural selection ( [16](#)).

**Antibodies and Clinical Significance** The Duffy antibodies are usually IgG. Anti-Fy<sup>a</sup> is a common alloantigen. Fy<sup>a</sup> is considered clinically significant, as it has been associated with HDN and HTR. Anti-Fy<sup>b</sup> is uncommon. It has been associated with mild HTR but not HDN ( [16](#)). The other Duffy antibodies are much less common.

**KIDD BLOOD GROUP SYSTEM (ISBT 009)**

Summary of Important Characteristics

| Antibody Specificity | Clinically Significant | Antibody Class  | HDN | HTR | Frequency of Antigen-Negative Blood (White Population) |
|----------------------|------------------------|-----------------|-----|-----|--|
| Jk <sup>a</sup>      | Yes                    | IgG; rarely IgM | Yes | Yes | Common (23%)   |
| Jk <sup>b</sup>      | Yes                    | IgG; rarely IgM | Yes | Yes | Common (28%)   |

The Kidd blood group system consists of three antigens: Jk<sup>a</sup>, Jk<sup>b</sup>, and JK3 ( [Table 23.1](#)). The system was named for the woman (Mrs. Kidd) whose serum was found to contain the antibody, and the antigen was named Jk for the initials of the woman's child (John Kidd) affected by HDN ( [30](#)).

**Gene and Antigens** The Kidd blood group system gene is located at chromosome 18q11-q12. The gene, *SLC14A1*, also known as *JK* or *HUT11*, is distributed over 30 kbp and contains 11 exons ( [17](#)). It encodes for the urea transporter hUT-B1 ( [31](#)). The principal phenotypes of the Kidd blood group system and their frequencies are outlined in [Table 23.8](#). The antigens Jk<sup>a</sup> and Jk<sup>b</sup> are found at relatively the same frequencies in the white populations but differ in other ethnic groups such as blacks and Asians ( [17](#)). The Jk(a-b-) phenotype is rare and is found primarily in the Polynesian population ( [32](#)). These null red cells have been demonstrated to be resistant to lysis by 2M urea; however, this phenotype is not associated with shortened red cell survival or clinical symptoms ( [33](#)).

**Antibodies and Clinical Significance** The Kidd antibodies are usually IgG but occasionally are IgM. These antibodies tend to be short-lived; therefore, they are frequently not detected before transfusion. However, they are capable of a rapid amnestic response and have been associated with severe delayed HTRs. The antibodies have also been associated with HDN.

**MNS BLOOD GROUP SYSTEM (ISBT 002)**

Summary of Important Characteristics

| Antibody Specificity | Clinically Significant | Antibody Class | HDN | HTR | Frequency of Antigen-Negative Blood (White Population) |
|----------------------|------------------------|----------------|-----|-----|--|
| Anti-M               | Seldom                 | IgG; some IgM  | Few | Few | Common (22%)   |

|        |              |                    |     |     |                 |
|--------|--------------|--------------------|-----|-----|-----------------|
| Anti-N | No           | IgM; rarely<br>IgG | No  | No  | Very rare (<1%) |
| Anti-S | Occasionally | IgG; some<br>IgM   | Yes | Yes | Common (45%)    |
| Anti-s | Yes          | IgG; rarely<br>IgM | Yes | Yes | Very rare (<1%) |

The MNS blood group system was discovered in 1927. The M and N antigens get their names from the letters in the word immune, because anti-M and anti-N antibodies were discovered in the sera of rabbits immunized with human red cells. The letter J was not used because it was felt this would be confused with the number 1 ( [34](#), [35](#)). The S antigen was named after the city in which it was discovered—Sydney ( [35](#)).

**Genes and Antigens** The MNS blood group system consists of 43 antigens: M, N, S, s, U, He, Mi<sup>a</sup>, M<sup>c</sup>, Vw, Mur, M<sup>g</sup>, Vr, M<sup>e</sup>, Mt<sup>a</sup>, St<sup>a</sup>, Ri<sup>a</sup>, Cl<sup>a</sup>, Ny<sup>a</sup>, Hut, Hil, M<sup>v</sup>, Far, s<sup>D</sup>, Mit, Dantu, Hop, Nob, En<sup>a</sup>, ENKT, N', Or, DANE, TSEN, MINY, MUT, SAT, ERIK, Os<sup>a</sup>, ENEP, ENEH, HAG, ENAV, and MARS ( [Table 23.1](#)). The M and N antigens are carried on glycoprotein A, whereas the antithetical antigens, S and s, are carried on glycoprotein B. They are encoded by the *GYP A* and *GYP B* genes located at chromosome 4q28–q31.

*GYP A* has seven exons distributed over 60 kbp ( [17](#)). *GYP B* has five exons and is distributed over 58 kbp ( [17](#)). Glycoprotein A has been demonstrated to be a receptor for certain malarial parasites as well as for bacteria and viruses. Other proposed functions of glycoprotein A include regulation of transport of band 3 to the red cell membrane and complement regulation ( [32](#), [36](#), [37](#)). The main phenotypes and frequencies of the MNS blood group system are listed in [Table 23.8](#).

**Antibodies and Clinical Significance** Anti-M and anti-N antibodies are typically IgM and are reactive at cold temperatures. Antibodies against M and N are naturally occurring (environmentally stimulated). They are not generally considered to be clinically significant. Rarely, anti-M has been implicated in cases of HDN and HTR ( [38](#), [39](#), [40](#) and [41](#)). Anti-N has not been associated with HDN or HTR. In contrast, antibodies against S, s, and U are capable of causing HTR and HDN ( [32](#)). Anti-S and anti-s tend to be IgG and occasionally are IgM.

## P BLOOD GROUP SYSTEM AND RELATED ANTIGENS (ISBT 003)

### Summary of Important Characteristics

| Antibody Specificity | Clinically Significant | Antibody Class     | HDN | HTR  | Frequency of Antigen-Negative Blood (White Population) |
|----------------------|------------------------|--------------------|-----|------|--|
| P1                   | Rare                   | IgM; rarely<br>IgG | No  | Rare | Common (21%)   |

The first P system antigen was discovered by Landsteiner and Levine in 1927 ( [16](#)).

Initially, the group was thought to include the P, P<sup>k</sup>, and LKE antigens, but these antigens have subsequently been assigned to the globoside antigens [see section [GLOB Collection \(ISBT 209\)](#)] ( [16](#)).

**Genes and Antigens** The P blood group system consists of a single antigen: P1 ( [Table 23.1](#)). P1 is the product of a galactosyl-transferase encoded by the gene *P1*, which is located at chromosome 22q11.2–qter ( [17](#)). The P1 antigen is similar to the ABO antigens because it is comprised of a chain of sugars linked to glycolipids on red cells ( [Fig. 23.2](#)).

P1 is formed when β-D-galactose (Gal) is added in an ( [1](#), [2](#), [3](#) and [4](#)) linkage to



paragloboside ( [16](#)). In the white population, 79% of individuals express the P1 antigen ( [16](#)).



**Figure 23.2.** The relationship among ABO, P, and Ii blood group systems. These antigens are located on terminal oligosaccharides. Among these blood groups, the structure in common is lactosylceramide (red sugar moieties). Lewis blood group antigens also share similar structures, but they are not synthesized in red cells. Fuc, L-fucose; Gal, D-galactose; Gal-NAc, D- *N*-acetyl-galactosamine; Glc, D-glucosamine; Glc-NAc, D- *N*-acetyl-glucosamine.

**Antibodies and Clinical Significance** Anti-P1 is naturally occurring and is commonly found in individuals lacking the P1 antigen. Anti-P1 is usually IgM. It has not been reported to cause HDN and has been associated with HTR only in rare instances ( [42](#)). Identification of anti-P1 is aided by the fact that the activity of the antibodies is inhibited by hydatid cyst fluid or pigeon egg white ( [16](#)). Individuals who lack the P1 antigen who also do not express the P and P<sup>k</sup> antigens may produce anti-P,P1,P<sup>k</sup>, also known as *anti-T<sub>J</sub>*<sup>a</sup>. This antibody is IgM and has been associated with severe hemolytic reactions ( [43](#), [44](#)).

#### LUTHERAN BLOOD GROUP SYSTEM (ISBT 005)

##### Summary of Important Characteristics

| Antibody Specificity | Clinically Significant | Antibody Class | HDN HTR | Frequency of Antigen-Negative Blood (White Population) |
|----------------------|------------------------|----------------|---------|--|
| Lu <sup>a</sup>      | Seldom                 | IgM; some IgG  | Mild No | Very common (92%)                                      |
| Lu <sup>b</sup>      | Seldom                 | IgG; some IgM  | Mild No | Very rare (0.1%)                                       |

The first Lutheran blood group antibody (anti-Lu<sup>a</sup>) was found in 1946 in the serum of a previously transfused patient named Lutteran. The label on the sample was misread, and the blood group system was named Lutheran ( [32](#)).

**Genes and Antigens** The Lutheran blood group system consists of 18 antigens: four pairs of antigens (Lu<sup>a</sup>/Lu<sup>b</sup>, Lu6/Lu9, Lu8/Lu14, and Au<sup>a</sup>/Au<sup>b</sup>) and ten independent antigens (Lu3, Lu4, Lu5, Lu7, Lu11, Lu12, Lu13, Lu16, Lu17, and Lu20) ( [Table 23.1](#)) ( [32](#)). The antigens are encoded by the *LU* gene located at chromosome 19q13.2–q13.3. The gene contains 15 exons and is distributed over approximately 12 kbp ( [17](#)). The gene products include the Lutheran gp, which is 597 amino acids long, and a spliced version of the B-cell adhesion molecule, which is 557 amino acids in length ( [17](#), [32](#)). The Lutheran gp is a member of the Ig superfamily and has been demonstrated to act as a receptor for laminin ( [45](#), [46](#)). The principal phenotypes of the Lutheran blood group system and their frequencies are outlined in [Table 23.8](#).

**Antibodies and Clinical Significance** The Lutheran antigens are not very immunogenic; therefore, antibodies in this system are rare ( [32](#)). Anti-Lu<sup>a</sup> and anti-Lu<sup>b</sup> are usually IgG and are reactive on the indirect antiglobulin test. Anti-Lu<sup>a</sup> has not been implicated in HTR but has been implicated in mild HDN ( [32](#)). Anti-Lu<sup>b</sup> has been associated with mild,



subclinical HDN ( 47 ).  
**LEWIS BLOOD GROUP SYSTEM (ISBT 007)**

Summary of Important Characteristics

| Antibody Specificity | Clinically Significant | Antibody Class | HDN HTR | Frequency of Antigen-Negative Blood (in White Population) |
|----------------------|------------------------|----------------|---------|---|
| Le <sup>a</sup>      | Seldom                 | IgM            | No      | Rare Rare (6%)  |
| Le <sup>b</sup>      | Seldom                 | IgM            | No      | Rare Common (22%)   |

The Lewis blood group system is different from other blood group systems, as the antigens (Le<sup>a</sup> and Le<sup>b</sup>) are formed in the plasma and absorbed onto the red cell membrane. This unique feature has implications for transfusion practices for several reasons: (a) Transfused red cells always absorb Lewis antigens from the plasma of the transfusion recipient; hence, within several days of the transfusion, the phenotype of the circulating transfused red cells is the same as the patient's red cell phenotype; and (b) soluble antigen in transfused plasma has the potential to inhibit Lewis system antibodies that may be in the plasma of some individuals.

**Genes and Antigens** The two alleles ( *L<sub>e</sub>* and *l<sub>e</sub>* ) are inherited in mendelian fashion. *L<sub>e</sub>* is the dominant allele, and *l<sub>e</sub>* is the recessive allele. The *L<sub>e</sub>* ( *FUT3* ) gene is located on chromosome 19 (19p13.3) ( 48 , 49 ) and is closely linked to the *Hh* and *Sese* genes. There are 11 different mutations of *L<sub>e</sub>* gene ( 50 , 51 ). The silent *l<sub>e</sub>* allele is due to mutations that result in defective gene products. The *L<sub>e</sub>* gene encodes for an enzyme, α(1,3/1,4) fucosyl-transferase (FUT3, H transferase type 3), which adds fucose molecules to carbohydrate precursor chains ( Fig. 23.3 ). The enzyme itself is a type II membrane-bound protein of 361 amino acids ( 52 ).



**Figure 23.3.** Differences between ABO (A) and Lewis (B) blood groups. ABO blood group antigens are synthesized in the red cells on type II oligosaccharides, but Lewis blood group antigens are produced in the plasma on type I oligosaccharides and then adsorbed onto the red cell surface. Type II oligosaccharide chains differ from type I chains in the linking position of the terminal galactose moiety. The Le gene encodes type III H transferase, which adds a fucose group (red-colored fucose group) to the second-last sugar moiety of the type I oligosaccharide chain. Synthesis of the Le<sup>c</sup> and Le<sup>d</sup> antigens does not depend on the activity of the Le gene. Fuc, L-fucose; Gal, D-galactose; Gal-NAc, D- *N*-acetyl-galactosamine; Glc, D-glucosamine; Glc-NAc, D- *N*-acetyl-glucosamine.

**Antigens** As mentioned previously, Lewis antigens (Le<sup>a</sup> and Le<sup>b</sup>) on the red cells are not intrinsic to the red cell membrane but are absorbed from the plasma onto the cells ( 53 ). The antigenic epitopes are located at the fucose moieties of glycosphingolipids. The biosynthesis of the antigens Le<sup>a</sup> and Le<sup>b</sup> involves two different pathways. The formation

of antigen Le<sup>a</sup> is catalyzed by the enzyme FUT3 that adds a fucose group to the type 1 oligosaccharide precursor chain ( Fig. 23.3). In individuals with FUT2 ( *SeSe* or *Sese* genotypes), most type 1 oligosaccharide precursor chains are converted to an intermediate product similar to the H antigen. The intermediate product is subsequently catalyzed by the enzyme FUT3 and forms the Le<sup>b</sup> antigen. Therefore, the phenotypes Le(a-b+) and Le(a+b-) are not due entirely to the *Le* gene but depend on the presence or absence of the *Se* gene. This relationship between the *Se* and *Le* genes has practical implications for the laboratory. For example, the easiest way to determine an individual's secretor status is to type his or her red cells to determine their Lewis phenotype. The Le(a+b-) phenotype indicates that the individual is a nonsecretor; the Le(a-b+) phenotype indicates that the individual is a secretor; and the Le(a-b-) phenotype does not allow secretor status to be assigned. If the *Se* gene product (FUT2) is partially active, such as in individuals with *Se<sup>n</sup>*, some type 1 precursor chain is converted to Le<sup>a</sup> antigen, and the remaining is converted to Le<sup>b</sup>. The resultant phenotype, Le(a+b+), is rare in whites but common in Asians. The fucose residual may also be added to type 2 oligosaccharide precursor chain and form the Le<sup>x</sup> and Le<sup>y</sup> antigens that are similar to ABO(H) antigens in biochemical structure. In the Lewis blood group system, the phenotype distribution varies among different ethnic groups. The Le(a-b+) phenotype is found in 70% of the white population and approximately 50% of the black population. The Le(a-b-) phenotype is less common in the white population but is found in approximately 30% of the black population. The Le(a+b+) phenotype is rare in both the white and black populations ( Table 23.8). In addition to red blood cells, Lewis antigens are found on other cell surfaces, such as gastric mucosa. They are also found in the lipopolysaccharide envelope of *Helicobacter pylori* ( 54). Although the gastric mucosa predominately expresses Le<sup>a</sup> and Le<sup>b</sup>, the cell envelop of *H. pylori* mainly expresses Le<sup>x</sup> and Le<sup>y</sup> ( 54). The relationship between the Lewis antigens and the pathogenesis of *H. pylori* infection is uncertain. The similarity of the antigens may deceive the host immune system and facilitate the colonization of *H. pylori* ( 55). In a murine model, *H. pylori* infection has been shown to induce antibodies cross-reactive to gastric mucosa and contribute to the development of chronic gastritis and peptic ulcers ( 56). However, this has not been firmly established in humans because no concordance in the expression of the Lewis antigen has been found between the bacteria and the host ( 57, 58). Some studies showed that Le<sup>b</sup> and H antigens on the gastric mucosa mediated the binding of *H. pylori* ( 59) via a binding protein (blood group antigen-binding adhesin) ( 60). However, other studies demonstrated that *H. pylori* adherence is not dependent on the Lewis antigen ( 61). Similarly, it is disputed whether blood group O is a risk factor for peptic ulcer disease ( 62, 63 and 64). The isoform antigens Le<sup>x</sup> and Le<sup>y</sup> may be found as neoantigens on malignant tissue ( 65).

**Antibodies and Clinical Significance** Like the ABO system, antibodies specific for Lewis antigens are naturally occurring, being formed through exposure to environmental antigens. The antibodies are usually IgM, complement activating, and reactive at or below room temperature. Although Lewis antibodies have been reported to cause HTRs, this does not usually occur for several reasons. First, although Lewis antibodies can activate complement, the process is relatively slow, thus allowing the inhibitors within the complement cascade to stop the process before the membrane attack complex is activated. Second, soluble antigen present in the plasma of the transfused blood product can cause inhibition of the antibody, preventing subsequent binding of antibody to transfused red cells. Finally, within 24 to 48 hours of transfusion, the transfused red cells absorb Lewis antigens from the patient's plasma, taking on the Lewis phenotype of the patient's own red cells. This latter mechanism also prevents delayed transfusion reactions from occurring. Lewis antibodies have the potential to be clinically relevant if the antibody causes *in vitro* hemolysis during serologic laboratory testing. When these "*in vitro* hemolytic antibodies" are detected, they should be considered clinically relevant, and antigen-negative blood should be selected for transfusion. Lewis antibodies do not cause

HDN because they are IgM and do not cross the placenta. Furthermore, Lewis antigens are poorly developed on fetal red cells. Anti-Le<sup>a</sup> antibody is more common than anti-Le<sup>b</sup> antibody. Both anti-Le<sup>a</sup> and Le<sup>b</sup> antibody are found in individuals with the Le(a-b-) phenotype. In contrast, individuals with the Le(a-b+) phenotype do not develop anti-Le<sup>a</sup> because of the presence of residual Le<sup>a</sup> antigen in the secretions.

### DIEGO BLOOD GROUP SYSTEM (ISBT 010)

#### Summary of Important Characteristics

| Antibody Specificity | Clinically Significant | Antibody Class | HDN HTR | Frequency of Antigen-Negative Blood (White Population) |
|----------------------|------------------------|----------------|---------|--|
| Di <sup>a</sup>      | Yes                    | IgG; some IgM  | Yes     | Rare Very common (>99.9%)                              |
| Di <sup>b</sup>      | Yes                    | IgG; some IgM  | Yes     | Rare Very rare (<0.1%)                                 |

The Diego blood group system consists of 21 antigens: Di<sup>a</sup>, Di<sup>b</sup>, Wr<sup>a</sup>, Wr<sup>b</sup>, Wd<sup>a</sup>, Rb<sup>a</sup>, WARR, ELO, Wu, Bp<sup>a</sup>, Mo<sup>a</sup>, Hg<sup>a</sup>, Vg<sup>a</sup>, Sw<sup>a</sup>, BOW, NFLD, Jn<sup>a</sup>, KREP, Tr<sup>a</sup>, Fr<sup>a</sup>, and SW1 (Table 23.1). Fr<sup>a</sup> and SW1 represent recent additions to the system (2).

**Gene and Antigens** The Diego system antigens are carried on the band 3 protein. The antigens are encoded by the gene *Di*, which is found at chromosome 17q21-q22 (Table 23.1). *Di* contains 20 exons and is distributed over 228 kbp (17). Band 3 is a multipass transmembrane protein that serves as an anion transporter. The Di<sup>a</sup> antibody was initially found in the serum of a Venezuelan woman and was implicated in HDN (66). The principal phenotypes of the Diego blood group system and their frequencies are outlined in Table 23.8. The expression of the antigen Di<sup>a</sup> is almost exclusively restricted to populations of Mongolian descent, such as American Indians, Chinese, and Japanese (67).

**Antibodies and Clinical Significance** Anti-Di<sup>a</sup> and anti-Di<sup>b</sup> are usually IgG and are detected by the indirect antiglobulin test. HDN has been reported with both anti-Di<sup>a</sup> and anti-Di<sup>b</sup> (68, 69, 70 and 71). HTR is rare but has been reported (72).

### YT BLOOD GROUP SYSTEM (CARTWRIGHT) (ISBT 011)

#### Summary of Important Characteristics

| Antibody Specificity | Clinically Significant | Antibody Class | HDN HTR | Frequency of Antigen-Negative Blood (White Population) |
|----------------------|------------------------|----------------|---------|--|
| Yt <sup>a</sup>      | Rare                   | IgG            | No      | Yes Very rare (0.2%)                                   |
| Yt <sup>b</sup>      | Rare                   | IgG            | No      | Yes Very common (91.9%)                                |

The Yt system consists of two antigens: Yt<sup>a</sup> and Yt<sup>b</sup> (Table 23.1). The system was named after Cartwright, the individual discovered producing the antibody. Because all of the other letters in the individual's name were already being used, the last letter, Y, was selected. The letter Y was placed first to denote "why not T?" (32).

**Gene and Antigens** The *ACHE* gene is located at chromosome 7q22.1. It encodes for an acetylcholinesterase, which is a dimerized glycosyl phosphatidylinositol (GPI)-linked gp in the red blood cell membrane. Its function is unknown; however, the molecule is enzymatically active. Yt<sup>a</sup> and Yt<sup>b</sup> antigens result from a single amino acid substitution,

which does not appear to affect the enzymatic activity of acetylcholinesterase (73). The antigens are antithetical. Yt<sup>a</sup> occurs with a frequency of approximately 99%, and Yt<sup>b</sup> has a frequency of approximately 8% (Table 23.8) (74).

**Antibodies and Clinical Significance** Antibodies against the Yt antigens are usually IgG. They do not activate complement. Yt antibodies have been implicated in delayed HTR but not in HDN.

### XG BLOOD GROUP SYSTEM (ISBT 012)

Summary of Important Characteristics

| Antibody Specificity | Clinically Significant | Antibody Class | HDN | HTR | Frequency of Antigen-Negative Blood (White Population) |
|----------------------|------------------------|----------------|-----|-----|--|
| Xg                   | No                     | IgG            | No  | No  | Common (males, 34.4%; females, 11.3%)                  |

The Xg blood group system consists of two antigens: Xg<sup>a</sup> and CD99 (Table 23.1). The Xg antigen was discovered in 1962 by Mann in the serum of a multiply transfused male. Because the antigen frequency appeared to differ between males and females, the antigen was named Xg<sup>a</sup>, as it appeared to be controlled by the X chromosome. The g in the name stands for Grand Rapids, the hometown of the patient (75).

**Gene and Antigens** The gene encoding Xg<sup>a</sup> is found at Xp22.3. The gene is not subject to lyonization or X inactivation. The Xg<sup>a</sup> antigen is located on a sialoglycoprotein. The antigen is only weakly expressed on the red cells of infants. The Xg<sup>a</sup> antigen is resistant to treatment by sialidase and dithiothreitol (DTT); however, it is sensitive to treatment with proteolytic enzymes (76). The principal phenotypes of the Xg blood group system and their frequencies are outlined in Table 23.8.

**Antibodies and Clinical Significance** Anti-Xg<sup>a</sup> antibodies are usually IgG and may be able to activate complement. There have been no documented cases of HTR or HDN with these antibodies.

### SCIANNA BLOOD GROUP SYSTEM (ISBT 013)

Summary of Important Characteristics

| Antibody Specificity | Clinically Significant | Antibody Class | HDN  | HTR | Frequency of Antigen-Negative Blood (White Population) |
|----------------------|------------------------|----------------|------|-----|--|
| Sc1                  | No                     | IgG            | Rare | No  | Very rare (<1%)  |
| Sc2                  | No                     | IgG            | Rare | No  | Very common (>99%)                                     |

The Scianna blood group system consists of three antigens: Sc1, Sc2, and Sc3 (Table 23.1).

**Gene and Antigens** The gene for this system is located on chromosome 1p35-p32 and is linked to Rh. The Scianna gene has not yet been cloned. The Scianna gene encodes a gp, the function of which is not known. The Sc1 antigen is a high-frequency antigen, with the incidence in most populations being close to 99.9% (Table 23.8) (17). Sc2 is antithetical to Sc1 and is present in approximately 1% of the population (17). The antigens are resistant to treatment of red cells with proteolytic enzymes such as papain, ficin, trypsin, a-chymotrypsin, and sialidase (32).

**Antibodies and Clinical Significance** The Scianna antibodies are usually IgG. Scianna antibodies can activate complement and have been reported to cause mild HDN (77). The

antibodies have not been associated with HTR.  
**DOMBROCK BLOOD GROUP SYSTEM (ISBT 014)**

Summary of Important Characteristics

| Antibody Specificity | Clinically Significant | Antibody Class | HDN | HTR | Frequency of Antigen-Negative Blood (White Population) |
|----------------------|------------------------|----------------|-----|-----|--|
| Do <sup>a</sup>      | Rare                   | IgG            | No  | Yes | Common (33.3%)   |
| Do <sup>b</sup>      | Rare                   | IgG            | No  | Yes | Common (17.2%)   |

The Dombrock blood group system consists of five antigens: Do<sup>a</sup>, Do<sup>b</sup>, Gy<sup>a</sup>, Hy, and Jo<sup>a</sup> (Table 23.1).

**Gene and Antigens** The gene for the Dombrock blood group system, *DC*, is found at chromosome 12p13.2–p12.1 (78). The antigens in the Dombrock system have been demonstrated to be carried on a GPI-linked gp (79, 80 and 81). Homology studies suggest that the Dombrock gp is a member of the adenosine 5'-diphosphate ribosyl-transferase ectoenzyme gene family (82). However, the function of this molecule is uncertain, as no enzymatic activity has been demonstrated on the red cells (83). The antigens Do<sup>a</sup> and Do<sup>b</sup> are antithetical. The frequencies of the three main phenotypes defined by these antigens are listed in Table 23.8. The antigens Gy<sup>a</sup>, Hy, and Jo<sup>a</sup> are high-incidence antigens, with gene frequencies of greater than 99% in all populations studied (84). The antigens are resistant to papain or ficin treatment but sensitive to trypsin, pronase, or DTT (200 mmol/L) treatment (83).

**Antibodies and Clinical Significance** The Dombrock antibodies are usually IgG and do not activate complement. They have not been associated with HDN, but the antibodies have been associated with severe HTR (85).

**COLTON BLOOD GROUP SYSTEM (ISBT 015)**

Summary of Important Characteristics

| Antibody Specificity | Clinically Significant | Antibody Class | HDN | HTR | Frequency of Antigen-Negative Blood (White Population) |
|----------------------|------------------------|----------------|-----|-----|--|
| Co <sup>a</sup>      | Yes                    | IgG            | No  | Yes | Very rare (0.3%)                                       |
| Co <sup>b</sup>      | Yes                    | IgG            | No  | Yes | Very common (90.3%)                                    |

The Colton blood group system was discovered in 1967. It consists of three antigens: Co<sup>a</sup>, Co<sup>b</sup>, and Co3 (Table 23.1).

**Gene and Antigens** The Colton blood group antigens are encoded by a gene located at 7q14. The gene, *CC*, contains four exons distributed over 2.2 kbp (17). The gene encodes a gp called the *channel-forming integral protein-1* or *aquaporin-1*. Channel-forming integral protein-1 functions as a water transport channel. The antigen is strongly expressed in the proximal tubules and cortical collecting ducts of the kidney and is responsible for 80% of water reabsorption in the kidney (83). In red cells, channel-forming integral protein-1 is responsible for osmotic water permeability (1). Individuals with the null phenotype, Co(a-b-), have red cells with markedly reduced osmotic water permeability but no obvious phenotype abnormality and are apparently healthy (1). The principal phenotypes of the Colton blood group system and their frequencies are outlined

in [Table 23.8](#).

**Antibodies and Clinical Significance** Antibodies against the Colton blood group antigens are usually IgG and may activate complement. These antibodies are clinically significant and have been implicated in acute and delayed transfusion reactions ([86](#)).

### LANDSTEINER–WIENER BLOOD GROUP SYSTEM (ISBT 016)

Summary of Important Characteristics

| Antibody Specificity | Clinically Significant | Antibody Class | HDN | HTR | Frequency of Antigen–Negative Blood (White Population) |
|----------------------|------------------------|----------------|-----|-----|--|
| LW <sup>a</sup>      | Yes                    | IgG; some IgM  | Yes | Yes | Very rare (<1%)  |
| LW <sup>b</sup>      | Yes                    | IgG; some IgM  | Yes | Yes | Very common (>99%)                                     |

The Landsteiner–Wiener blood group system consists of three antigens: LW<sup>a</sup>, LW<sup>ab</sup>, and LW<sup>b</sup> ([Table 23.1](#)).

**Genes and Antigens** The gene encoding the Landsteiner–Wiener blood group system antigens, LW, is found at chromosome 19p13.3. The *LW* gene contains three exons distributed over 2.6 kbp ([17](#)). It encodes the LW gp. The LW gp is an intercellular adhesion molecule and has been demonstrated to bind to CD11/CD18 integrins located on leukocytes ([87](#)). It is hypothesized that its function may involve being a marker for lymphocyte maturation and differentiation ([32](#)). The frequencies of the

Landsteiner–Wiener blood group system phenotypes are outlined in [Table 23.5](#). LW<sup>a</sup> is the most commonly expressed antigen, found in more than 99% of whites. The expression of LW antigens is influenced by the expression of the Rh blood group system D antigen. Individuals who are D antigen–positive have increased expression of LW antigens compared to those individuals who are D antigen–negative ([88](#)).

**Antibodies and Clinical Significance** Antibodies to the LW antigens are usually IgG but are occasionally IgM. The antibodies have been associated with mild HDN and HTR. Production of LW autoantibodies may occur in conditions associated with transient loss of LW antigens ([89](#)). Conditions associated with loss of LW antigens include Hodgkin disease, lymphoma, leukemia, sarcoidosis, and solid malignancies ([32](#)).

### CHIDO/RODGERS BLOOD GROUP SYSTEM (ISBT 017)

Summary of Important Characteristics

| Antibody Specificity | Clinically Significant | Antibody Class | HDN | HTR | Frequency of Antigen–Negative Blood (White Population) |
|----------------------|------------------------|----------------|-----|-----|--|
| Ch                   | No                     | IgG            | No  | No  | Rare (2%)  |
| Rg                   | No                     | IgG            | No  | No  | Rare (2%)  |

The Chido and Rodgers system consists of nine antigens: Ch1–6, Rg1, Rg2, and WH ([Table 23.1](#)). The Chido antigen was initially described by Harris et al. ([90](#)). The antigen was described as nebulous because the antigen strength was variable. The Chido and Rodgers system is not comprised of true red cell antigens, as they are not actually located on intrinsic structures of the red cell. Instead, they are on the fourth component of the complement system (C4), which becomes bound to red cells. However, the antigens are detected on the surface of red cells by conventional methods and were therefore initially considered to be red cell antigens and were included in the ISBT terminology as



the seventeenth system (ISBT 017).

**Genes and Antigens** The genetic loci of the Rodgers and Chido antigens are closely linked and are located on chromosome 6 in genes closely linked to major histocompatibility complex (MHC) II. Both genes encode complement components. The *CH* gene contains 41 exons and encodes for C4b (17). The *RG* gene contains 41 exons distributed over 21 kbp and encodes for C4a (17). The Chido antigen is located on the C4d fragment of C4b (91, 92 and 93). The expression of the antigen is variable, as it is determined by the concentration of plasma complement, which is genetically determined (94). The Rodgers antigen is located on the C4a component of complement (91, 93). The principal phenotypes of the Chido/Rodgers blood group system and their frequencies are outlined in Table 23.8. Ch1 to 6 and Rg1 and Rg2 have frequencies greater than 90%, whereas WH has a frequency of approximately 15%. The antigens are sensitive to treatment with proteases and resistant to treatment with sialidase, DTT, and acid (76). Inherited low levels of C4 have been demonstrated to be associated with various autoimmune disorders including autoimmune chronic active hepatitis (95, 96). Individuals who are Ch- (lack C4b) have an increased risk of bacterial meningitis. Individuals who are Rg- (lack C4a) have an increased risk of systemic lupus erythematosus (96, 97).

**Antibodies and Clinical Significance** Antibodies in the Chido/Rodgers system are usually IgG and do not activate complement. They are not clinically significant. Antibodies to these antigens are typically found in individuals who have been transfused. They generally do not cause HTR but may result in anaphylactic reactions if large volumes of plasma are transfused (98, 99). These antibodies have not been implicated in HDN.

#### KX BLOOD GROUP SYSTEM (ISBT 019)

##### Summary of Important Characteristics

| Antibody Specificity | Clinically Significant | Antibody Class | HDN | HTR | Frequency of Antigen-Negative Blood (White Population) |
|----------------------|------------------------|----------------|-----|-----|--|
| Kx                   | No                     | IgG            | No  | No  | Very rare (<0.1%)                                      |

The Kx blood group system consists of one antigen: Kx (Table 23.1).

**Genes and Antigens** The Kx antigen is carried on the XK protein, which is encoded by the *XK* gene. The *XK* gene is located on the short arm of the X chromosome (Xp21.1). The structure of XK resembles a glutamate transporter; however, its actual cellular function has not yet been determined (26). In the red blood cell membrane, the XK protein is found in a complex with the Kell gp. The two proteins are covalently linked by a disulfide bond (25). It is thought that the expression of the XK protein is required for the normal expression of the Kell antigens on red cells. The XK protein has the structure of a membrane transporter protein; however, its function is not known (100). Patients with absent XK, due to gene deletions or mutations, are said to have McLeod syndrome. The McLeod phenotype is inherited in an X-linked pattern, unlike the *KEL* gene, which has an autosomal mode of inheritance (26). The *McLeod syndrome* is a condition occurring in males characterized by decreased expression of the Kell blood group system antigens, acanthocytes, hemolytic anemia, and elevated serum creatinine kinase (1). Associated symptoms include muscle wasting, decreased deep tendon reflexes, choreiform movements, and cardiomyopathy (100). The McLeod phenotype may also occur in patients with X-linked chronic granulomatous disease. X-linked chronic granulomatous disease has been demonstrated to occur because of deletion of or mutations in the *CYBB* gene, which is also located on the X chromosome at a location discrete from that of the *KEL* locus. The association between the two disorders is due to deletions of parts of the X chromosome that include both genes (101). Other X-linked conditions that have been associated with the McLeod phenotype include retinitis pigmentosa and Duchenne



muscular dystrophy ( [102](#), [103](#) and [104](#) ).

**Antibodies and Clinical Significance** Patients who lack the Kx antigen form alloantibodies if they are transfused with antigen-positive blood. Patients with the McLeod phenotype who have been transfused have been reported to form anti-Kx ( [105](#), [106](#) ). It is suggested that these patients receive Kx-negative blood, but there are no reports of the antibody causing HDN or HTR. Furthermore, some patients without clinical or hematologic features of the McLeod syndrome have been demonstrated to form an IgG autoantibody with Kx specificity ( [107](#) ). The autoantibody does not appear to cause hemolysis.

### GERBICH BLOOD GROUP SYSTEM (ISBT 020)

#### Summary of Important Characteristics

| Antibody Specificity                                    | Clinically Significant | Antibody Class | HDN HTR   | Frequency of Antigen-Negative Blood (White Population) |
|---|------------------------|----------------|-----------|--|
| Ge2, Ge3, Ge4   | Rare                   | IgG            | Rare Rare | Very rare (<0.1%)                                      |
| Wb, Ls <sup>a</sup> , An <sup>a</sup> , Dh <sup>a</sup> | Rare                   | IgG            | Rare Rare | Very common (>99%)                                     |

The Gerbich blood group system was discovered in 1960 and is named for a patient who lacked the antigen, Mrs. Gerbich ( [32](#) ).

**Gene and Antigens** The Gerbich blood group system contains seven antigens: Ge2, Ge3, and Ge4, which occur at high frequencies, and Wb, Ls<sup>a</sup>, An<sup>a</sup>, and Dh<sup>a</sup>, which occur at low frequencies ( [Table 23.1](#) ). The principal phenotypes of the Gerbich blood group system and their frequencies are outlined in [Table 23.8](#). The antigens are encoded by the *GYPC* gene on chromosome 2 (2q14 and q21) ( [81](#) ). The gene contains four exons distributed over 13.5 kbp ( [17](#) ). The antigens are carried on glyophorin C or glyophorin D, or both. The functions of glyophorin C and glyophorin D are thought to involve the structural integrity of the red cell membrane, as the glycoproteins are involved in linking the red cell membrane and the membrane skeleton ( [108](#) ). This is supported by the fact that red cells deficient in the Gerbich antigens, called the *Leach phenotype*, are elliptocytes ( [109](#) ). Glyco-phorin C can serve as a binding site for *Plasmodium falciparum* ( [110](#) ).

**Antibodies and Clinical Significance** The antibodies against the Gerbich blood group system tend to be IgG. These antibodies have only rarely been reported to cause HDN or HTR ( [32](#), [111](#) ).

### CROMER BLOOD GROUP SYSTEM (ISBT 021)

#### Summary of Important Characteristics

| Antibody Specificity | Clinically Significant | Antibody Class | HDN HTR | Frequency of Antigen-Negative Blood (White Population) |
|----------------------|------------------------|----------------|---------|--|
| Cr <sup>a</sup>      | Seldom                 | IgG            | No Yes  | Very rare (<1%)  |

The Cromer blood group system was discovered in 1965 and named after Mrs. Cromer, the first patient found to produce the antibodies ( [32](#) ).

**Genes and Antigens** The Cromer blood group system consists of ten antigens: Cr<sup>a</sup>, Tc<sup>a</sup>, Tc<sup>b</sup>, Tc<sup>c</sup>, Dr<sup>a</sup>, Es<sup>a</sup>, IFG, WES<sup>a</sup>, WES<sup>b</sup>, and UMC ( [Table 23.1](#) ). The antigens in the Cromer blood group system are encoded by the *CROM* gene located at chromosome

1q32. The gene contains 11 exons and is distributed over 40 kbp (17). The antigens are located on a gp called *decay-accelerating factor* (DAF). DAF accelerates the decay of C3 and C5 convertases, thus inhibiting the amplification of complement activation by both the classic and alternate pathways. DAF is also a receptor for *Escherichia coli* and enterovirus (112). Individuals with the null phenotype of the Cromer system, known as the *Inab phenotype*, have been described but do not have significant complement-induced lysis *in vivo* (113). Tc<sup>a</sup>, Tc<sup>b</sup>, and Tc<sup>c</sup> are antithetical antigens, as are WES<sup>a</sup> and WES<sup>b</sup>. Tc<sup>b</sup>, Tc<sup>c</sup>, and WES<sup>a</sup> are low-incidence antigens, whereas the rest are high-incidence antigens (Table 23.8).

**Antibodies and Clinical Significance** Antibodies to Cromer antigens do not cause HDN, perhaps because DAF is strongly expressed on the apical surface of trophoblasts and, therefore, absorbs antibodies from the maternal serum (1).

### KNOPS BLOOD GROUP SYSTEM (ISBT 022)

#### Summary of Important Characteristics

| Antibody Specificity | Clinically Significant | Antibody Class | HDN | HTR | Frequency of Antigen-Negative Blood (White Population) |
|----------------------|------------------------|----------------|-----|-----|--|
| Kn <sup>a</sup>      | No                     | IgG            | No  | No  | Very rare (<1%)  |
| Kn <sup>b</sup>      | No                     | IgG            | No  | No  | Very common (>99.9%)                                   |

The Knops blood group system was established in 1991. It is named after Mrs. Knops, the first antibody producer (32).

**Genes and Antigens** The Knops system consists of seven antigens: Kn<sup>a</sup>, Kn<sup>b</sup>, McC<sup>a</sup>, SI<sup>a</sup>, Yk<sup>a</sup>, McC<sup>b</sup>, and Vil (Table 23.1). Most of the antigens are common, occurring with a prevalence of greater than 90% in most populations (Table 23.8). The SI<sup>a</sup> antigen occurs with a much greater prevalence in white populations (98%) than in black populations (60%) (1). Kn<sup>b</sup> occurs at a low incidence. The antigens in the Knops blood group system are encoded by the *KN* gene found at chromosome 1q32 (17). The antigens are found on a gp called *complement receptor 1* (CR1). The gene is located within the regulation of the complement activation cluster at 1q32. CR1 is a member of the complement control family. It inhibits both the classic and alternate pathways of complement activation by cleavage of C4b and C3b, thus protecting the red cells from hemolysis. It is hypothesized that low levels of CR1 on red cells may increase deposition of immune complexes on blood vessel walls, resulting in damage to the blood vessels (114). Some antigens in the Knops blood group system (CR1 and S1<sup>a</sup>) may act as a binding site for *P. falciparum*.

**Antibodies and Clinical Significance** Antibodies in the Knops blood group system are usually IgG and do not bind complement (32). They have not been implicated in HDN or HTR.

### INDIAN BLOOD GROUP SYSTEM (ISBT 023)

#### Summary of Important Characteristics

| Antibody Specificity | Clinically Significant | Antibody Class | HDN | HTR  | Frequency of Antigen-Negative Blood (White Population) |
|----------------------|------------------------|----------------|-----|------|--|
| In <sup>a</sup>      | No                     | IgG            | No  | No   | Very common (>99%)                                     |
| In <sup>b</sup>      | Seldom                 | IgG            | No  | Rare | Very rare (<1%)  |

The Indian blood group was so named because 4% of Indians from Bombay express the antigen ( [32](#) ).

**Genes and Antigens** The Indian blood group system consists of two antigens: In<sup>a</sup> and In<sup>b</sup> ( [Table 23.1](#) ). The antigens of the Indian blood group system are encoded by the *IN* gene located at chromosome 11p13. The gene contains at least 19 exons and is distributed over 50 kbp ( [17](#) ). The gene product is CD44. CD44 is thought to be the major human hyaluron receptor and also may bind fibrinogen, laminin, collagen, and osteopontin ( [1](#) ). The interaction between CD44 and hyaluron is likely required for the adhesion of lymphoid and erythroid cells to the bone marrow stroma during lymphopoiesis and erythropoiesis. A patient with a novel form of congenital dyserythropoietic anemia and CD44 deficiency was noted to have the In(a-b-) phenotype ( [115](#) ). The principal phenotypes of the Indian blood group system and their frequencies are outlined in [Table 23.8](#).

**Antibodies and Clinical Significance** Antibodies in the Indian system are usually IgG and do not activate complement ( [32](#) ). These antibodies have not been associated with HDN, but anti-In<sup>b</sup> has been implicated in one immediate HTR ( [116](#) ).

#### OK BLOOD GROUP SYSTEM (ISBT 024)

##### Summary of Important Characteristics

| Antibody Specificity | Clinically Significant | Antibody Class | HDN | HTR | Frequency of Antigen-Negative Blood (White Population) |
|----------------------|------------------------|----------------|-----|-----|--|
| Ok <sup>a</sup>      | No                     | IgG            | No  | No  | Very rare (<0.1%)                                      |

The Ok blood group system consists of one antigen: Ok<sup>a</sup> ( [Table 23.1](#) ). Antibodies against the Ok<sup>a</sup> antigen were initially identified in 1979 in the serum of a Japanese woman, Mrs. Okbutso ( [32](#) ).

**Genes and Antigens** The Ok<sup>a</sup> antigen is encoded by the *OK* gene, which is located at 19p13.3-p13.2. The *OK* gene contains seven exons distributed over 1.8 kbp ( [17](#) ). The gene encodes for CD147, an extracellular matrix metalloproteinase inducer. The function of CD147 is unknown, but it is speculated that it may be involved in lymphocyte inactivation and the function of the blood-brain barrier ( [117](#), [118](#) ). The Ok<sup>a</sup> antigen is resistant to treatment with proteases, sialidase, DTT, and acid ( [76](#) ).

**Antibodies and Clinical Significance** Antibodies in the initial patient with anti-Ok<sup>a</sup> were IgG and did not activate complement. Anti-Ok<sup>a</sup> has not been associated with HTR or HDN, but it has been demonstrated to cause decreased red cell survival.

#### RAPH BLOOD GROUP SYSTEM (ISBT 025)

##### Summary of Important Characteristics

| Antibody Specificity | Clinically Significant | Antibody Class | HDN | HTR | Frequency of Antigen-Negative Blood (White Population) |
|----------------------|------------------------|----------------|-----|-----|--|
| MER2                 | No                     | IgG            | No  | No  | Rare (8%)  |

The RAPH blood group system consists of one antigen: MER2 ( [Table 23.1](#) ). The RAPH blood group system is named after the first patient known to have antibodies against the antigen. The MER2 antigen was given system status in 1999.

**Genes and Antigens** The gene, *MER2*, is found on chromosome 11p15. Although the function of MER2 is unknown, anti-MER2 was found in three individuals with renal failure,

suggesting that MER2 is possibly required for normal renal function ([1](#), [119](#)). Ninety-two percent of English blood donors are positive for MER2 ([Table 23.8](#)) ([32](#)).  
**Antibodies and Clinical Significance** Antibodies against MER2 are IgG. They have not been documented to cause HDN or HTR.

## JOHN MILTON HAGEN BLOOD GROUP SYSTEM (ISBT 026)

### Summary of Important Characteristics

| Antibody Specificity | Clinically Significant | Antibody Class | HDN | HTR | Frequency of Antigen-Negative Blood (White Population) |
|----------------------|------------------------|----------------|-----|-----|--|
| JMH1                 | No                     | IgG            | No  | No  | Very rare (<0.1%)                                      |

The John Milton Hagen blood group system consists of one antigen: JMH1 ([Table 23.1](#)). The antigen was previously listed as 901007 but was recognized as a system by the ISBT Working Party in July 2000 ([2](#)).

**Genes and Antigens** The JMH antigen is located on CDw108 gp. It is encoded by *SEMA7A*, which is located on chromosome 15q23-24.

**Antibodies and Clinical Significance** Antibodies against JMH are usually autoimmune and do not tend to be clinically significant. Individuals producing allo-anti-JMH have been reported ([120](#)). The antibodies tend to be IgG. They have not been documented to cause HDN or HTR.

### Low-Incidence Antigens

An antigen is considered to be a low-incidence antigen if (a) it occurs in less than 1% of a population tested; (b) it is not part of an existing blood group system or related closely enough to another antigen to merit collection status; and (c) it is serologically distinct from other low-incidence antigens. Furthermore, to allow identification of further examples, red cells containing the antigen and antibody must be available. [Table 23.3](#) lists the low-incidence antigens. These antigens comprise the 700 series of the ISBT terminology ([121](#)).

Typically, these antibodies arise as a result of no known stimulus. Occasionally, antibodies to these antigens may be discovered in mothers of neonates with HDN. Because of the low frequency of these antigens, initial screening against a standard red cell panel is negative; however, the serum is positive when tested against paternal cells. Family studies often detect other individuals with the antigen.

### High-Incidence Antigens

An antigen is considered to be a high-incidence antigen if it is found on more than 90% of individuals in populations tested. Antigens that are found in more than 99% of the population are termed *public antigens*. As noted previously, high-incidence antigens were initially included in the 900 series but are now contained in the 901 series. The 901 series currently contains 11 antigens ([Table 23.4](#)).

The significance of high-incidence antigens is that the rare individual lacking a high-incidence antigen may experience severe HTRs when transfused with antigen-positive blood. Because by definition the majority of the population expresses the antigen, it is very difficult to find compatible blood for such a patient.

## Collections of Antigens

In the ISBT terminology, related sets of antigens (genetically, biochemically, or serologically) that cannot correctly be classified as systems, as they have not been shown to be genetically distinct from all existing systems, are designated as collections. Five collections are currently recognized: Cost, Ii, Er, GLOB, and Le<sup>c</sup>/Le<sup>d</sup> (Table 23.2).

### II COLLECTION (ISBT 207)

Summary of Important Characteristics

| Antibody Specificity | Clinically Significant | Antibody Class | HDN HTR |    | Frequency of Antigen-Negative Blood (White Population) |
|----------------------|------------------------|----------------|---------|----|--|
| I                    | Seldom                 | IgM            | No      | No | Very uncommon (adults)                                 |
| i                    | Seldom                 | IgM            | No      | No | Very common (adults)                                   |

The I antigen was described in 1956 by Weiner et al. (122). The antigen was named I for *individuality*.

**Genes and Antigens** The Ii antigens are synthesized on red blood cells and are located on the same carbohydrate chains on which the ABH antigens are located (Fig. 23.2). The I antigens are located below the ABH antigens. The synthesis of the antigens requires the actions of  $\beta$ -3- *N*-acetylglucosaminyl-transferase and  $\beta$ -4-galactosyl-transferase (101). The i antigen consists of the disaccharides, galactose-*N*-acetyl-glucosamine, linked in a straight, nonbranched chain. The I antigen consists of the linear chains modified into branched chains (123). Adult red blood cells express predominantly the I antigen. Conversely, fetal cells predominantly express the i antigen with little or no I expression. However, during the first 18 months of life, the infant's red cells gradually express more I and less i. Very rarely, adult red blood cells express predominantly the i antigen. The gene involved is most likely *IGnt*, which is found on chromosome 6p24; however, other genes at different locations have been found to code for I branch-forming enzymes (124). *IGnt* encodes  $\beta$ (1, 2, 3, 4, 5 and 6)-*N*-acetylglucosaminyl-transferase.

**Antibodies and Clinical Significance** The anti-I antibody is found as an IgM autoantibody in most normal individuals. The antibody is generally reactive at low temperatures and is not clinically significant. Anti-I cold agglutinins increase in titer after infection with *Mycoplasma pneumoniae* and tend to be polyclonal in nature (125). Monoclonal anti-I autoantibodies are found in high titers in cold hemolytic agglutinin disease. These antibodies are clinically significant and cause hemolysis. Anti-I alloantibodies are rare because the i phenotype is very uncommon. When they occur in adults with the i phenotype, they are clinically significant and can cause hemolysis. The anti-i autoantibody may be found in individuals commonly with lymphoproliferative disorders such as chronic lymphocytic leukemia, lymphoma, and Hodgkin disease. Patients with mononucleosis secondary to Epstein-Barr virus infection may have transient anti-i, which causes hemolysis.

**GLOB COLLECTION (ISBT 209)** The GLOB or globoside collection of antigens includes P, Pk, and LKE antigens (Table 23.2). The antigens of the GLOB collection were initially considered to be part of the P blood group system, and they are related to the P1 antigen. The P antigen, also known as *globoside*, has been demonstrated to be on almost all human red blood cells (16).

**Antibodies and Clinical Significance** Autoantibodies against the P antigen are uncommon and may be idiopathic or secondary to other disorders such as syphilis and infections with various agents (e.g., measles, mumps, Epstein-Barr virus, cytomegalovirus,

varicella-zoster virus, adenovirus, influenza A, *M. pneumoniae*, *Haemophilus influenzae*, and *E. coli*) ( [126](#)). Anti-P has been implicated in paroxysmal cold hemoglobinuria and is known as the *Donath-Landsteiner antibody*. This antibody is IgG and has biphasic activity in that it binds to red blood cells and fixes complement component C1 at low temperatures (0° to 4° C) and causes hemolysis at higher temperatures. Please see [Chapter 34](#) and [Chapter 35](#) for a more complete discussion of paroxysmal cold hemoglobinuria.

## PLATELET ANTIGENS

Alloantibodies directed against platelet surface antigens can cause isolated thrombocytopenia. The antibodies most commonly play a role in neonatal alloimmune thrombocytopenia (NAT) and posttransfusion purpura (PTP), but they also mediate the destruction of platelets in passive alloimmune thrombocytopenia (PAT), posttransfusion refractoriness (PTR), and transplantation-associated thrombocytopenia (TAT) ( [127](#)). Although the mechanisms of platelet clearance are understood in some disorders (e.g., NAT), the platelet-antibody interaction and resulting thrombocytopenia are less well understood in others (e.g., PTP). Limiting factors have been the lack of appropriate investigational technology and the rarity of some of the disorders. Until recently, the identification of incompatible antigens has relied on serologic methods that require well-characterized antisera. After the identification of the genetic basis for the major platelet alloantigens, a number of different genotyping techniques were developed over the past decade. This advance has made it possible for more laboratories to perform platelet alloantigen investigations based on DNA methodology rather than relying on the requirements for sufficient platelets and appropriate typing antisera for serologic studies.

Immunization to platelet alloantigens can occur in normal individuals when exposed during pregnancy, transfusion, or transplantation to alloantigens they lack. Unlike red cell alloantibodies, it is uncommon for alloantibodies against platelets to form spontaneously.

### Platelet Glycoprotein Polymorphisms

Alloantigens are expressed on platelet proteins, glycoproteins, and carbohydrates. Many of these proteins are found exclusively on platelets as complexes containing two or more different polypeptide chains and are termed *platelet-specific proteins*. Most of these platelet glycoproteins also function as cell receptors. These receptors play a major role in the interaction of platelets with the damaged vessel wall (adhesion) and with other platelets (aggregation).

On platelets, most alloantigens are caused by a structural change in a protein due to an altered amino acid that is encoded by a polymorphism in the gene. Many of these polymorphisms arise from single base pair mutations within the gene. To date, all the polymorphisms on platelets have been diallelic, with only a single mutation recorded at each respective locus ( [Fig. 23.4](#)).







certain loci, mainly on gpIIIa. Thus, their HPA designations are not considered at present to be true antigen systems, because there is, as yet, no evidence that the antithetical high-frequency polymorphism induces structural changes that would be immunogenic in an individual homozygous for the low-frequency allele. Only HPA-1 to HPA-5 and HPA-15 alloantigens constitute complete systems in which alloantibodies to both alleles have been reported.

**TABLE 23.9. Human Platelet Alloantigens**

| HPA System | Antigen          | Original Designation                                 | Amino Acid Substitution | Glycoprotein | Reference           |
|------------|------------------|--|-------------------------|--------------|---------------------|
| 1          | HPA-1a           | Zw <sup>a</sup> , PL <sup>A1</sup>                   | Leu33                   | BIIIa        | <a href="#">168</a> |
|            | HPA-1b           | Zw <sup>b</sup> , PL <sup>A2</sup>                   | Pro33                   |              |                     |
| 2          | HPA-2a           | Ko <sup>b</sup>                                      | Thr145                  | Iba          | <a href="#">385</a> |
|            | HPA-2b           | Ko <sup>a</sup> , Sib <sup>a</sup>                   | Met145                  |              |                     |
| 3          | HPA-3a           | Bak <sup>a</sup> , Lek <sup>a</sup>                  | Ile843                  | aIIb         | <a href="#">182</a> |
|            | HPA-3b           | Bak <sup>b</sup>                                     | Ser843                  |              |                     |
| 4          | HPA-4a           | Yuk <sup>b</sup> , Pen <sup>a</sup>                  | Arg143                  | BIIIa        | <a href="#">195</a> |
|            | HPA-4b           | Yuk <sup>a</sup> , Pen <sup>b</sup>                  | Gln143                  |              |                     |
| 5          | HPA-5a           | Br <sup>b</sup> , Zav <sup>b</sup>                   | Glu505                  | Ia           | <a href="#">178</a> |
|            | HPA-5b           | Br <sup>a</sup> , Zav <sup>a</sup> , Hc <sup>a</sup> | Lys505                  |              |                     |
| HPA-6bw    |                  | Ca <sup>a</sup> , Tu <sup>a</sup>                    | Gln489                  | BIIIa        | <a href="#">198</a> |
|            |                  |  | Arg489                  |              |                     |
| HPA-7bw    | Mo <sup>a</sup>  |  | Ala407                  | BIIIa        | <a href="#">200</a> |
|            |                  |  | Pro407                  |              |                     |
| HPA-8bw    | Sr <sup>a</sup>  |  | Cys636                  | BIIIa        | <a href="#">178</a> |
|            |                  |  | Arg636                  |              |                     |
| HPA-9bw    | Max <sup>a</sup> |  | Met837                  | aIIb         | <a href="#">202</a> |
|            |                  |  | Val837                  |              |                     |
| HPA-10bw   | La <sup>a</sup>  |  | Gln62                   | BIIIa        | <a href="#">203</a> |
|            |                  |  | Arg62                   |              |                     |
| HPA-11bw   | Gro <sup>a</sup> |  | His633                  | BIIIa        | <a href="#">205</a> |
|            |                  |  | Arg633                  |              |                     |
| HPA-12bw   | Iy <sup>a</sup>  |  | Glu15                   | Ibβ          | <a href="#">207</a> |
|            |                  |  | Gly15                   |              |                     |
| HPA-13bw   | Sit <sup>a</sup> |  | Met799                  | Ia           | <a href="#">209</a> |
|            |                  |  | Thr799                  |              |                     |
| HPA-14bw   | Oe <sup>a</sup>  |  | Deleted-Lys611          | BIIIa        | <a href="#">210</a> |
|            |                  |  | Lys611                  |              |                     |
| 15         | HPA-15a          | Gov <sup>b</sup>                                     | Ser703                  | CD109        | <a href="#">181</a> |
|            | HPA-15b          | Gov <sup>a</sup>                                     | Tyr703                  |              |                     |
| HPA-16bw   | Duv <sup>a</sup> |  | Ile140                  | BIIIa        | <a href="#">211</a> |
|            |                  |  | Thr140                  |              |                     |

HPA, human platelet antigen.

The HPA system is useful when considering the alloimmune thrombocytopenias, especially for the simple identification of the relevant pathologic alloantibody and the zygosity of the patient for that allele. However, it should be noted that the HPA system is misleading from a genetic point of view ( [132](#) ). Many polymorphisms evolved at different loci on the PL<sup>A1</sup> variant of the gpIIIa gene. Thus, there are two HPA designations (i.e., HPA-1a and HPA-4a) for the single gpIIIa gene encoding Leu33 and Arg143. Furthermore, Newman et al. noted that if alloantibodies were found to all the high-frequency alleles on gpIIIa, then the designations PL<sup>A1</sup>, Pen<sup>a</sup>, Mo<sup>b</sup>, Ca<sup>b</sup>, and Sr<sup>b</sup> all would refer to the same molecular entity. However, although a description of the gene by its haplotype would be of benefit when considering the concept that combinations of polymorphisms could have different effects on protein function, at present, there is no nomenclature that can efficiently describe haplotypes.

### PLATELET-SPECIFIC ALLOANTIGENS: BIOCHEMISTRY AND GENETICS

**Glycoprotein IIb/IIIa (aIIbB3)** Glycoproteins IIb and IIIa form a heterodimer complex that is a member of the integrin family of integral membrane proteins, a superfamily of noncovalently associated  $\alpha$  and  $\beta$  subunits involved in cell-cell and cell-vessel contact. Of these, gpIIb/IIIa, with 50,000 to 80,000 surface copies, is by far expressed most abundantly on platelets ( [133](#) ). Activated gpIIb/IIIa mediates platelet aggregation through binding to fibrinogen and vWF. A complex of the  $\alpha$  and  $\beta$  subunits is required for expression of the gpIIb and gpIIIa subunits on the surface. A deficiency of gpIIb/IIIa results in Glanzmann thrombasthenia, an inherited bleeding disorder ( [134](#), [135](#) ). The gene for gpIIIa, located on chromosome 17, may be the most polymorphic of the human integrin subunits ( [136](#), [137](#), [138](#), [139](#) and [140](#) ). Hence, a large number of platelet alloantigens, including PL<sup>A</sup>, Pen, Ca/Tu, Mo, Sr, La, Gro, Oe, and Duv determinants, are located on gpIIIa. Polymorphisms of the gene on chromosome 17 encoding the  $\alpha$  subunit, gpIIb, are responsible for the Bak and Max alloantigens. gpIIb is synthesized exclusively by megakaryocytes; thus, gpIIb/IIIa is unique to platelets. However, the gpIIIa subunit also is expressed on endothelial cells in association with the subunit  $\alpha$ v to form the vitronectin receptor, also expressed in low numbers on the platelet surface.

**Glycoprotein Ia/IIa (a2B1)** The collagen receptor, gpIa/IIa, is a member of the integrin family of cell-surface receptors. These membrane gp heterodimers consist of noncovalently associated  $\alpha$  and  $\beta$  subunits ( [141](#), [142](#), [143](#), [144](#) and [145](#) ). Patients in whom deficiencies of gpIa/IIa are reported demonstrate chronic mucocutaneous bleeding associated with prolonged bleeding times ( [146](#), [147](#) ). Three or more alleles of the  $\alpha 2$  gene regulate the level of expression of gpIa/IIa on platelets ( [148](#), [149](#) and [150](#) ). Quantitative binding of platelets to type I or III collagens correlates with the number of gpIa/IIa molecules expressed on the platelet surface ( [149](#) ). Alloantibodies to the Br and Sit determinants are expressed on gpIa.

**Glycoprotein CD109** CD109 is a monomeric 175-kd gp that is anchored to the platelet membrane by GPI ( [151](#) ). The precise function for the GPI-anchored protein is not known. However, the recent determination of the cDNA sequence for CD109 indicates that it is a novel member of the  $\alpha 2$ M/C3, C4, C5 family of thioester-containing proteins and thus may mediate covalent cell-substrate and cell-cell interactions ( [152](#) ). Although CD109 expression has been reported to be activation-dependent on platelets, this has not been established. It is possible that the protein is constitutively expressed on the resting platelet and undergoes structural changes after activation that expose epitopes for certain monoclonal antibodies ( [151](#), [153](#), [154](#) ). The Gov<sup>a</sup> and Gov<sup>b</sup> alloantigens are expressed on CD109 ( [151](#), [153](#) ).

**Glycoprotein Ib/IX/V** gpIb consists of two disulfide-linked proteins (gpIba and gpIbB) and is found on the platelet surface in association with gpIX and gpV ( [155](#) ). The four polypeptides share similar structural features, including a region in each of leucine-rich gp

repeats, and are encoded by four separate genes. The short arm of chromosome 22 contains the gene for gpIba; the long arm contains the gene for gpIbβ ( [156](#), [157](#) ). The genes for gpIX and gpV are located on chromosome 3 ( [158](#) ). The gpIb-IX-V complex resides on the platelet surface as a heptamer, with one molecule of gpV flanked by two molecules each of gpIX, gpIba, and gpIbβ ( [155](#), [159](#) ). A region within the amino-terminal domain of gpIba functions as the major receptor for vWF, which mediates platelet contact and adhesion to damaged endothelium ( [160](#), [161](#) and [162](#) ). A deficiency or lack of gpIb-IX-V is associated with the Bernard-Soulier syndrome, an inherited bleeding disorder ( [163](#), [164](#) and [165](#) ). Platelets express approximately 25,000 copies of the gpIb-IX-V complex ( [166](#) ). Alloantibodies have been reported that recognize the Ko and Iy determinants on gpIba and gpIbβ, respectively.

**CLINICALLY SIGNIFICANT PLATELET ALLOANTIGENS**

*PI<sup>A</sup> Polymorphism: HPA-1*

Summary: HPA-1 Antigens

| Antibody Specificity | Clinically Significant | NAT | PTP | PAT | PTR | TAT | Comments                                |
|----------------------|------------------------|-----|-----|-----|-----|-----|---|
| HPA-1a               | Yes                    | Yes | Yes | Yes | Yes | Yes | Associated with severe thrombocytopenia |
| HPA-1b               | Seldom                 | Yes | Yes | No  | Yes | No  |   |

The PL<sup>A1/A2</sup> (Zw<sup>a/b</sup>) alloantigen system has been associated with all of the alloimmune thrombocytopenic syndromes and is the primary cause of NAT and PTP in whites ( [167](#) ). Alloimmunization to the PL<sup>A</sup> antigens is important both for the frequency (>75%) and for the severity of thrombocytopenia, which often is greater for syndromes involving the gpIIb/IIIa complex ( [127](#) ). A Leu (PL<sup>A1</sup>) to Pro (PL<sup>A2</sup>) change at residue 33 is encoded by a T to C substitution at position 196 of gpIIIa cDNA ( [168](#) ). The gene frequencies in the white population are 0.85 and 0.15 for PL<sup>A1</sup> and PL<sup>A2</sup>, respectively. A second substitution, Leu to Arg at residue 40, of less than 3% of PL<sup>A2</sup> alleles, has no known clinical significance ( [169](#), [170](#) ). Alloimmunization to PL<sup>A1</sup> is associated with the immune response genes HLA-DRB3\*0101 or -DQB1\*02. Heterogeneity in the binding of anti-PL<sup>A1</sup> antibodies to platelets may be a consequence of a complex and disulfide-bonded structure in the amino-terminal portion of gpIIIa that imposes a three-dimensional structural constraint on the PL<sup>A1</sup> antigen ( [171](#), [172](#), [173](#) and [174](#) ). Further evidence for structural factors distant to the Leu33Pro substitution in the control over the expression of the PL<sup>A1</sup> epitope was recently reported in 1 of 6000 individuals tested for antigen status using phenotyping and genotyping. An Arg93Gln substitution on the Leu33 allele disrupted the formation of the PL<sup>A1</sup> antigen phenotype in an individual who had been typed positive for PL<sup>A1</sup> using genotyping ( [175](#) ). Alloantibodies to PL<sup>A1</sup> inhibit clot retraction and platelet aggregation, possibly by blocking fibrinogen binding ( [176](#), [177](#) ).

*Br Polymorphism: HPA-5*

Summary: HPA-5 Antigens

| Antibody Specificity | Clinically Significant | NAT | PTP | PAT | PTR | TAT | Comments |
|----------------------|------------------------|-----|-----|-----|-----|-----|----------|
|----------------------|------------------------|-----|-----|-----|-----|-----|----------|

|        |     |     |     |     |     |     |  |
|--------|-----|-----|-----|-----|-----|-----|--|
| HPA-5a | Yes | Yes | Yes | No  | Yes | No  | Usually causes moderate thrombocytopenia |
| HPA-5b | Yes | Yes | Yes | Yes | Yes | Yes |  |

The Br<sup>a/b</sup> (Zav<sup>a/b</sup>, Hc<sup>a</sup>) alloantigens have been associated with all of the alloimmune thrombocytopenic syndromes and are the second most common cause of NAT in whites (167). A Glu (Br<sup>b</sup>) to Lys (Br<sup>a</sup>) change at residue 505 is encoded by a G to A substitution at position 1648 of gpIa cDNA (178). The gene frequencies in the white population are 0.89 and 0.11 for Br<sup>b</sup> and Br<sup>a</sup>, respectively. The Br<sup>a</sup> allele is in linkage disequilibrium with the -52T polymorphism associated with lower levels of surface gpIaIIa (148, 150). However, platelets from Br<sup>a/a</sup> and Br<sup>b/b</sup> homozygous donors do not demonstrate differences in their static adhesion to collagen (178).

**Gov Polymorphism: HPA-15**

Summary: HPA-15 Antigens

| Antibody Specificity | Clinically Significant | NAT | PTP | PAT | PTR | TAT | Comments                                 |
|----------------------|------------------------|-----|-----|-----|-----|-----|--|
| HPA-15a              | Yes                    | Yes | No  | No  | Yes | No  | Usually causes moderate thrombocytopenia |
| HPA-15b              | Yes                    | Yes | ?   | No  | Yes | No  |  |

The Gov<sup>a/b</sup> alloantigens have been associated with NAT, PTP, and PTR (151, 153, 179). Large studies on the frequency of the Gov<sup>a/b</sup> alloantibodies have recently been made possible by the adaptation of the monoclonal antibody immobilization of platelet antigens (MAIPA) technology to include monoclonal capture antibodies for CD109. These studies indicate that immunization to the Gov alloantigens is second only to the PL<sup>A1</sup> antigen, occurring as often as Br<sup>a/b</sup> antibodies (180). The Gov<sup>a/b</sup> antigens are the result of a Ser (Gov<sup>b</sup>) to Tyr (Gov<sup>a</sup>) change at residue 703 encoded by a C to A substitution at position 2108 of CD109 cDNA (181). Large European studies indicate that the gene frequencies for the Gov<sup>a</sup> and Gov<sup>b</sup> antigens are 0.41 and 0.59, respectively. The Gov<sup>a/b</sup> alloantigens are unique because they can be removed from the platelet surface by the action of phospholipase on the membrane anchor (151).

**Bak Polymorphism: HPA-3**

Summary: HPA-3 Antigens

| Antibody Specificity | Clinically Significant | NAT | PTP | PAT | PTR | TAT | Comments                          |
|----------------------|------------------------|-----|-----|-----|-----|-----|-----------------------------------|
| HPA-3a               | Yes                    | Yes | Yes | No  | No  | No  | Can cause severe thrombocytopenia |
| HPA-3b               | Seldom                 | ?   | Yes | No  | Yes | No  |                                   |

The Bak<sup>a/b</sup> (Lek<sup>a</sup>) alloantigens have been associated with NAT and PTP. Although less common, anti-Bak antibodies can occasionally cause thrombocytopenia as severe as the PL<sup>A1</sup>-mediated disease. An Ile (Bak<sup>a</sup>) to Ser (Bak<sup>b</sup>) change at residue 843 is encoded

by a T to G substitution at position 2622 of gpIIb cDNA ( [182](#) ), creating the Bak epitopes on the heavy chain of the integrin subunit. The gene frequencies in the white population are 0.61 and 0.39 for Bak <sup>a</sup> and Bak <sup>b</sup>, respectively. Unlike other platelet-specific alloantigens, posttranslational glycosylation modifications may contribute to the expression of the Bak <sup>a/b</sup> epitopes ( [182](#), [183](#) and [184](#) ).

**Ko Polymorphism: HPA-2**

Summary: HPA-2 Antigens

| Antibody Specificity | Clinically Significant | NAT | PTP | PAT | PTR | TAT | Comments                                 |
|----------------------|------------------------|-----|-----|-----|-----|-----|--|
| HPA-2a               | Yes                    | ?   | No  | No  | ?   | No  | Usually causes moderate thrombocytopenia |
| HPA-2b               | Yes                    | Yes | No  | No  | Yes | No  |  |

The Ko <sup>a/b</sup> (Sib <sup>a/b</sup>) antigens have been associated with NAT and PTR and are expressed on gpIba ( [185](#), [186](#), [187](#), [188](#) and [189](#) ). A Thr (Ko <sup>b</sup>) to Met (Ko <sup>a</sup>) change at residue 145 is encoded by a G to A substitution at position 524 of gpIba cDNA. The gene frequencies in the white population are 0.911 and 0.089 for Ko <sup>b</sup> and Ko <sup>a</sup>, respectively ( [187](#) ). Some evidence has been reported that shows anti-Ko alloantibodies prevent ristocetin-induced agglutination ( [187](#) ); however, this has not been confirmed in other studies ( [190](#), [191](#) ). The Ko antigens may be in linkage disequilibrium with a variable numbers of tandem repeat (VNTR) polymorphism that is responsible for four different molecular weights for the gpIba molecule. A tandem of 13 amino acids in the mucin-rich domain can be expressed with one to four repeats, thus encoding polypeptides of different lengths (VNTR-A, -B, -C, and -D alleles have 4, 3, 2, and 1 repeats, respectively) ( [192](#) ). The Ko <sup>a</sup> allele may have originated on the VNTR-B allele, from which the VNTR-A allele was derived. Because less than 1000 base pairs separate the Ko and VNTR loci, the rate of crossover during meiosis would be low, and, in most populations, the Ko <sup>a</sup> antigen is expressed on the VNTR-A and -B alleles ( [186](#), [193](#) ). However, there is evidence that crossover may have occurred ( [194](#) ).

**Pen Polymorphism: HPA-4**

Summary: HPA-4 Antigens

| Antibody Specificity | Clinically Significant | NAT | PTP | PAT | PTR | TAT | Comments                                 |
|----------------------|------------------------|-----|-----|-----|-----|-----|--|
| HPA-4a               | Yes <a href="#">a</a>  | Yes | Yes | No  | No  | No  | Usually causes moderate thrombocytopenia |
| HPA-4b               | Yes <a href="#">a</a>  | Yes | No  | No  | No  | No  |  |

<sup>a</sup> Anti-HPA-4 alloantibodies are important in the Asian population due to the higher frequency of the HPA-4b allele.

The Pen <sup>a/b</sup> (Yuk <sup>b/a</sup>) alloantigens have been associated with NAT and PTP. An Arg (Pen <sup>a</sup>) to Gln (Pen <sup>b</sup>) change at residue 143 is encoded by a G to A substitution at position 525 of gpIIIa cDNA ( [195](#) ). Because the gene frequencies in the white population are greater than 0.99 and less than 0.01 for Pen <sup>a</sup> and Pen <sup>b</sup>, respectively, this alloantigen system is of little consequence clinically in North America and Europe. However, Pen <sup>b</sup> is

expressed in approximately 1% of Asians and contributes significantly to platelet alloimmunization. Anti-Pen<sup>a</sup> antibodies can inhibit platelet aggregation, consistent with the proximity of the epitope to the RGD binding domain ([176](#)).

**LOW-FREQUENCY ANTIGENS** Genetic variations of the gpIIb and gpIIIa genes that entered the human genome after the PL<sup>A1/A2</sup> and Bak<sup>a/b</sup> polymorphisms have been reported in association with alloimmunization causing NAT. The majority of the low-frequency antigens on gpIIIa have occurred as mutations on the Leu33 form of the  $\beta$ 3 gene. The low-frequency antigen reported on gpIIb is a result of a mutation on the Ser843 form of the aIIb gene. Until alloimmunization to the antithetical antigen is demonstrated in an individual homozygous for the low-frequency antigen, these polymorphisms are not considered true alloantigen systems within the HPA nomenclature. Alloimmunization to low-frequency antigens on gpIa and gpIb $\beta$  also have been reported.

**Ca/Tu Polymorphism: HPA-6w** The Ca<sup>a</sup> (Tu<sup>a</sup>) platelet alloantigen is the result of an Arg to Gln (Ca<sup>a</sup>) change at residue 489 encoded by a G to A substitution at position 1564 of gpIIIa cDNA ([196](#), [197](#) and [198](#)). The gene frequency for the Ca<sup>a</sup> allele is approximately 0.003 in the white population and has been detected in a few unrelated families distributed across three ethnic groups ([199](#)).

**Mo Polymorphism: HPA-7w** The Mo<sup>a</sup> antigen results from a Pro to Ala (Mo<sup>a</sup>) replacement at residue 407 encoded by a C to G substitution at position 1317 of gpIIIa cDNA ([200](#)). This low-frequency antigen has been found in one other individual outside the proband family.

**Sr Polymorphism: HPA-8w** A C to T substitution at position 2004 of the Leu33 form of the  $\beta$ 3 cDNA encodes an Arg to Cys (Sr<sup>a</sup>) change at residue 636 ([201](#)). This private alloantigen system has been found only in one family in the white population. The polymorphism results in the creation of an unpaired cysteine that does not appear to compromise the integrity or function of gpIIb/IIIa in these individuals.

**Max Polymorphism: HPA-9w** The Max<sup>a</sup> platelet alloantigen results from of a Val to Met (Max<sup>a</sup>) change at residue 837 encoded by a G to A substitution at position 2603 of gpIIb cDNA ([202](#)). The mutation for the Max<sup>a</sup> antigen is found only in Bak<sup>b</sup> individuals.

**La Polymorphism: HPA-10w** The La<sup>a</sup> platelet alloantigen is the result of an Arg to Gln (La<sup>a</sup>) change at residue 62 encoded by a G to A substitution at position 281 of gpIIIa cDNA ([203](#)).

**Gro Polymorphism: HPA-11w** The Gro<sup>a</sup> alloantigen results from an Arg to His (Gro<sup>a</sup>) change at residue 633 encoded by a G to A substitution at position 1996 of gpIIIa cDNA ([204](#), [205](#)).

**Iy Polymorphism: HPA-12w** A low-frequency platelet allo-antigen called Iy<sup>a</sup> located on gpIb $\beta$  has been associated with NAT ([206](#)). A Gly to Glu (Iy<sup>a</sup>) change at residue 15 is encoded by a G to A substitution at position 141 of gpIb $\beta$  cDNA ([207](#)). This polymorphism is rare, found with a gene frequency less than 0.0016 in Asians and in only 1 of 249 German subjects ([208](#)).

**Sit Polymorphism: HPA-13w** The low-frequency platelet alloantigen called Sit<sup>a</sup> located on gpIa has been associated with NAT. A Met to Thr (Sit<sup>a</sup>) change at residue 799 is encoded by a T to C substitution at position 2531 of gpIa cDNA. This rare polymorphism has a gene frequency of 0.0025 ([209](#)).

**Oe Polymorphism: HPA-14w** The Oe<sup>a</sup> antigen is unique because it appears to be induced by tertiary structure changes that result from the deletion of the amino acid lysine at residue 611 of the gpIIIa cDNA ([210](#)). The “in-frame” deletion of the codon AAG1929-1931 occurred on the Pro33 form of the  $\beta$ 3 gene. Thus, all individuals who express Oe<sup>a</sup> are also PL<sup>A2</sup> positive. There is no apparent effect on receptor function



due to the deletion of the amino acid.

**Duv Polymorphism: HPA-16w** The Duv<sup>a</sup> antigen is the result of a Thr to Ile (Duv<sup>a</sup>) change at residue 140 due to a C to T substitution at position 517 of gpIIIa cDNA ( [211](#) ).

The antigen has been found only in one family to date. Antibodies to the Duv<sup>a</sup> antigen may inhibit platelet function due to the proximity of the polymorphism to the RGD binding site.

**OTHER PLATELET ANTIGENS** Some platelet alloantibodies have been localized to epitopes on platelet glycoproteins, but their genetic basis has not yet been reported. Va<sup>a</sup> is a low-frequency antigen on gpIIb/IIIa that is associated with NAT ( [212](#) ). The Nak<sup>a</sup> antibody originally was reported in a multitransfused Japanese patient ( [213](#) ). The antibody bound to gpIV on approximately 90% of donor platelets. However, further studies demonstrated that individuals who formed the anti-Nak<sup>a</sup> antibodies actually lacked gpIV on their platelets ( [214](#), [215](#) ). The antibody bound to epitopes on gpIV that were not encoded by polymorphisms; thus, anti-Nak<sup>a</sup> is more correctly called an *isoantibody*, similar to the anti-gpIIb/IIIa antibodies induced in transfused individuals who lack gpIIb/IIIa on their platelets (Glanzmann thrombasthenia).

**PLATELET NONSPECIFIC ALLOANTIGENS** Alloantigens that are not restricted to the megakaryocyte lineage can also be expressed on platelets. These include the ABH blood determinants and MHC class I molecules.

**ABH Blood Group Antigens** It is now known that most of the membrane proteins on the surface of platelets can express determinants of the ABH blood groups. These include the gpIb/IX/V, gpIIb/IIIa, gpIV, gpV, CD31, and CD109 molecules ( [216](#), [217](#), and [218](#) ).

Approximately 25% of platelets mismatched for the A or B blood groups are immediately cleared when transfused to an incompatible recipient. The remaining ABO-incompatible platelets have a normal survival, possibly explained by the platelet-to-platelet variability in the number of A and B antigens ( [219](#), [220](#), and [221](#) ).

**HLAs** The class I HLAs are expressed on the surface of platelets. These highly polymorphic antigens are the major cause of refractoriness to platelet transfusion. In contrast to the relatively constant numbers of molecules on lymphocytes, the level of expression of the HLA molecule on platelets can vary tremendously (up to 35-fold) among different individuals ( [222](#), [223](#) ). Because the HLA-C antigen levels are very low on platelets, only the HLA-A and -B antigens are a consideration when crossmatching for transfusion ( [224](#) ).

## Alloimmune Thrombocytopenic Disorders

Platelet-specific alloantibodies play a major role in the immunopathology and thrombocytopenia observed in NAT and PTP. Alloantibodies also mediate platelet clearance in two less common syndromes: PAT and TAT. In addition, antiplatelet antibodies may play a role in refractoriness to platelet transfusions. However, more commonly in these patients, the thrombocytopenia is complicated by septicemia or by HLA antibodies.

**NEONATAL ALLOIMMUNE THROMBOCYTOPENIA** NAT is caused by maternal IgG alloantibodies that cross the placenta and cause the destruction of fetal platelets. Maternal alloimmunization to paternally derived alloantigens on the fetal platelets can occur early, often within the first trimester of the first pregnancy. Although analogous to HDN, alloimmunization to inherited paternal platelet antigens and the destruction of fetal platelets can occur during the first pregnancy with an antigen-incompatible fetus. Thus, NAT often presents as unexpected isolated severe thrombocytopenia in an otherwise healthy neonate. Thrombocytopenia can be severe, with the platelet count falling to less than  $10 \times 10^9/L$  within the first few days after birth, and may take several weeks to return to normal. Clinical findings include petechiae in 90%; gastrointestinal tract



hemorrhage in 30%; and hemoptysis, hematuria, and retinal bleeding in less than 10% of patients. Intracranial hemorrhage is found in 10 to 20% of neonates and can occur early during pregnancy. Hydrocephalus, porencephalic cysts, and epilepsy can complicate recovery from fetal and neonatal intracranial bleeding. Anemia and hyperbilirubinemia can occur from extravasation and resorption of blood. Although more than 16 different platelet alloantigen systems have been established, most cases of NAT are caused by alloantibodies to HPA-1a (PL<sup>A1</sup>, Zw<sup>a</sup>) (78%), HPA-5b (Br<sup>a</sup>, Zav<sup>a</sup>), and HPA-15b (Gov<sup>a</sup>). Recent evidence suggests that alloimmunization to Gov<sup>a/b</sup> antigens in NAT can occur more often than thought previously and can be as frequent as immunization to Br<sup>a/b</sup> antigens. Other alloantigens implicated in NAT include PL<sup>A2</sup>, Ko<sup>a</sup>, Bak<sup>a</sup>, Bak<sup>b</sup>, Pen<sup>a</sup>, Pen<sup>b</sup>, Br<sup>b</sup>, and Gov<sup>b</sup>. However, it is now clear that immunization to “private” alloantigens also can cause NAT. The majority of these have been found as rare polymorphisms on paternal BIIIa. The mother carries the common form of the gene and becomes immunized to alloantigens expressed only in the fetus and on platelets from the father and his immediate family (e.g., Sr<sup>a</sup>). In some cases, a polymorphism has also been detected in a few unrelated individuals in the general population and is termed a *low-frequency antigen* (e.g., Ca/Tu). These rare alloantigens have been, to date, reported only in NAT, which requires only one exposure to paternal alloantigens during pregnancy. This is in contrast to the other classic alloimmune syndrome, PTP, which is associated with two temporally distinct exposures to the immunizing antigen. The PTP patient is usually immunized initially via pregnancy and is later reexposed via transfusion. This requirement for two exposure events would exclude the rare platelet alloantigens from a role in PTP. However, it is possible that a selection bias could eventually increase the relative frequency of the rare antigens in the general population and allow for their participation in PTP and other transfusion and transplantation-mediated alloimmune disorders. In theory, directed donations of blood, organs, or bone marrow to family members could cause alloimmunization involving a rare alloantigen. In large studies, antibodies to the PL<sup>A1</sup> alloantigen are found in the majority (78%) of serologically confirmed cases of NAT, with antibodies to Br<sup>a/b</sup> and Gov<sup>a/b</sup> antigens identified in approximately 20%. All other specificities account for the remaining small percentage of alloantibodies found. However, up to 60% of clinically identified cases of NAT lack serologic evidence of antiplatelet alloantibodies (<sup>167</sup>). In some cases, a portion of clinically identified NAT may be reported antibody-negative due to a lack of assay sensitivity or specificity. The first report of platelet alloantibodies in 1969 was followed by almost 20 years in which only three additional alloantibody specificities were detected using then-current methodology, including the platelet suspension immunofluorescence test and direct binding enzyme immunoassays. When the use of gp-specific assays for antiplatelet antibody studies became established in some laboratories, the rate of detection of new alloantibodies and antigens increased significantly (<sup>127</sup>). By measuring the binding of maternal IgG to specific platelet glycoproteins, the MAIPA and radioimmunoprecipitation assays are able to detect specific antiplatelet alloantibodies binding to proteins expressed in low numbers on the platelet surface (e.g., IaIIa) and discriminate this from background binding of IgG to non-platelet-specific epitopes (e.g., anti-HLA). Although the sensitive and specific MAIPA assay is used widely in reference laboratories to screen for alloantibodies, it too is limited by the requirement for specific monoclonal antibodies to various platelet glycoproteins to detect antiplatelet antibodies. Thus, some clinical NAT cases may not be corroborated with a positive laboratory test for alloantibodies because the maternal immunization is directed against epitopes on platelet proteins to which monoclonal antibodies are unavailable. This was demonstrated by the report of alloimmunization to epitopes on a novel platelet protein, CD109. Although no alloantibodies were detected using the routine MAIPA assay with capture monoclonal antibodies to glycoproteins Ia/IIa, Ib/IX, and IIb/IIIa, anti-Gov<sup>a/b</sup> reactivity was readily identified using radioimmunoprecipitation. Until monoclonal antibodies to CD109 are used routinely in the MAIPA, the radioimmunoprecipitation assay may be used to detect Gov

<sup>a/b</sup> alloantibodies. The enhanced sensitivity imparted by radiolabeling the majority of platelet proteins, including those expressed in low numbers on the platelet surface, has established the radioimmunoprecipitation assay as a universal screening method for platelet alloantibodies in NAT. NAT is estimated to occur in 1 in 1000 to 2500 births. The alloantibodies most often involved are directed against PL <sup>A1</sup>. Because the PL <sup>A1</sup>-negative phenotype is approximately 2% in the North American population, the theoretical risk for NAT in newborns is approximately 1 in 50 births, which is much higher than observed cases. Although it is possible that limitations in recognition and technical issues in testing for alloantibodies might play a role in the underdiagnosis of some cases of NAT, the lower-than-expected responsiveness to the PL <sup>A1</sup> antigen in susceptible women demonstrates that additional factors play a role in alloimmunization (225). Maternal immunization to PL <sup>A1</sup> shows an HLA restriction, wherein PL <sup>A1</sup>-negative women who produce alloantibodies are almost exclusively HLA-DRB3\*0101 or -DQB1\*02. The risk factor in the case of -DQB1\*02 is 141, similar to that for the HLA-B27 restriction in the autoimmune disease ankylosing spondylitis (226). In one case of NAT, T cells were shown to play a role in the HLA restriction. Peptides that contain the same Leu33 polymorphism that is recognized by anti-PL <sup>A1</sup> antibodies were able to stimulate T cells sharing CDR3 motifs (227). However, alloimmunization to the PL <sup>A2</sup> antigen is not associated with a specific HLA type and has a much lower incidence in NAT (228, 229). This may explain the observation that although phenotype frequencies for PL <sup>A1</sup> and PL <sup>A2</sup> predict that anti-PL <sup>A2</sup> should be observed six times more frequently than anti-PL <sup>A1</sup>, alloimmunization to PL <sup>A1</sup> accounts for far more cases of NAT than anti-PL <sup>A2</sup> (127). In a large study of clinically suspected NAT, alloantibodies to PL <sup>A1</sup> were found more frequently by a ratio greater than 100:1 when compared with anti-PL <sup>A2</sup> (167). Immunization to the Br <sup>a/b</sup> alloantigens also has been associated with specific class II genes (230, 231). However, unlike the reversed relative risk versus the expected rates of immunization reported for the PL <sup>A1/A2</sup> system, the theoretical ratio of alloimmunization against Br <sup>a</sup> versus Br <sup>b</sup> is similar to the observed ratio (127, 232). The differences in the rate of immunization to platelet alloantigens also vary between different racial or ethnic populations. The distribution and frequency of platelet alloantigen genes in the worldwide population is a major factor in determining which alloantigens are most important in the investigation of NAT in different countries (Table 23.10). Although studies have shown that the PL <sup>A1</sup> antigen accounts for the majority of NAT cases in the white population, it has rarely been shown to play a role in the Japanese. This may be explained by the lower gene frequency for PL <sup>A2</sup> in the Japanese population compared with whites (0.02 vs. 0.15). Without accounting for differences in the frequency of immune response genes, alloimmunization to PL <sup>A1</sup> should be at least 50 times less in the Japanese population. Antibodies to Pen <sup>a</sup> and Pen <sup>b</sup> are most frequently reported in Japanese cases of alloimmunization. This may be related directly to the higher gene frequency for Pen <sup>a</sup> in the Japanese population compared with whites (0.0083 vs. <0.001), which would increase the number of individuals homozygous for the rare allele who may be susceptible to alloimmunization to Pen <sup>b</sup>.

**TABLE 23.10. Human Platelet Antigen (HPA) Frequency by Ethnic Group**

| Antigen | Gene Frequency |       |           | References                      |
|---------|----------------|-------|-----------|---------------------------------|
|         | White          | Black | Asian     |                                 |
| HPA-1a  | 0.85–0.89      | 0.92  | 0.99–1.00 | 199, 385, 386, 387, 388 and 389 |

|        |           |           |   |
|--------|-----------|-----------|---|
| HPA-1b | 0.11-0.15 | 0.08      | 0.00-0.01   |
| HPA-2a | 0.91-0.93 | 0.82-0.88 | 0.87-0.92 <a href="#">194</a> , <a href="#">386</a> , <a href="#">387</a> , <a href="#">389</a> , <a href="#">390</a>   |
| HPA-2b | 0.07-0.09 | 0.11-0.18 | 0.08-0.13   |
| HPA-4a | 1.00      | 1.00      | 0.99-1.00 <a href="#">199</a> , <a href="#">387</a> , <a href="#">388</a> , <a href="#">389</a> and <a href="#">390</a> |
| HPA-4b | 0.00      | 0.00      | 0.00-0.01   |
| HPA-5a | 0.87-0.95 | 0.79      | 0.95-0.97 <a href="#">386</a> , <a href="#">387</a> , <a href="#">388</a> , <a href="#">389</a> and <a href="#">390</a> |
| HPA-5b | 0.05-0.13 | 0.21      | 0.03-0.05   |

---

Immunization to platelet nonspecific alloantigens such as ABO and HLA is more likely to play a role in transfusion- and transplantation-associated thrombocytopenia rather than NAT. As these antibodies pass from the mother into the fetal circulation, they are likely to be targeted to the larger population of HLA and ABO-bearing cells rather than to platelets. In cases in which only ABO or HLA antibodies are observed in NAT, it is possible that platelet-specific alloantibodies are present but go undetected due to the technical limitations of current assays. Diagnostic tests for NAT should be designed to determine the maternal and paternal platelet alloantigen haplotypes to assess the presence of antigen incompatibilities. Genotyping should be used to determine the alloantigen status because few laboratories have adequate typing sera available to perform immunophenotyping for all the relevant alloantigens. Because this uses very little sample, genotyping also allows for the determination of fetal platelet antigens directly, rather than inferring them from the paternal platelet typing. To detect platelet-specific alloantibodies in maternal serum, a specific and sensitive assay should be used that can discriminate the presence of coexisting platelet nonspecific antibodies (e.g., anti-HLA). Due to the possibility of maternal alloimmunization to relatively low-frequency

alloantigens, including Br<sup>a</sup>, it is preferable to test for antiplatelet antibodies using the father's platelets as a target. Although it is important to assess the risk for NAT in future pregnancies, this can be complicated by the presence of both alleles in a heterozygous father. In such cases, the fetal platelet alloantigens can be determined by genotyping fetal amniocytes obtained between 16 to 20 weeks' gestation.

**POSTTRANSFUSION PURPURA** PTP typically presents as severe thrombocytopenia resulting within 7 to 10 days after an immunogenic blood transfusion. It usually affects elderly women who have been sensitized to the platelet alloantigen during previous pregnancy ([127](#), [233](#)). Because prior transfusion also has been reported as the initial immunizing event, occasionally males can develop PTP. As in NAT, the most common alloantibody implicated in PTP is directed against PL<sup>A1</sup> and follows transfusion of antigen-positive blood to PL<sup>A1</sup>-negative/HLA-DR3-positive individuals.

Thrombocytopenia can follow the transfusion of any blood product—not only platelets—and is most commonly seen after the infusion of packed red cells. Fever and chills are often observed during the transfusion; this is followed by petechiae and ecchymoses once thrombocytopenia develops. It is important to recognize this rare disorder because the severe thrombocytopenia can cause mucosal surface bleeding and subsequent anemia, with fatal intracranial hemorrhage observed in approximately 10% of patients. Therapy using high-dose intravenous  $\gamma$ -globulin has been shown to be effective and may be augmented with transfusion of antigen-negative platelets. Because PTP often presents in postoperative patients, the differential diagnosis of PTP includes other common thrombocytopenic syndromes such as heparin-induced thrombocytopenia and bacteremia. However, unlike PTP, these other disorders do not commonly present with severe thrombocytopenia ( $<10 \times 10^9/L$ ). In addition, heparin-induced thrombocytopenia is often associated with thrombotic complications rather than the overt bleeding that characterizes PTP. The major challenge of PTP is to understand the mechanism underlying the destruction of autologous platelets that follows the exposure and sensitization to immunizing blood product. A number of theories have been proposed to explain the clearance of the antigen-negative (PL<sup>A2/A2</sup>) platelets in the presence of

anti-PL<sup>A1</sup> antibodies. The mechanisms proposed include the adsorption of alloantigen–alloantibody immune complexes to receptors on recipient platelets with subsequent clearance mediated by complement or by the reticuloendothelial system (innocent bystander syndrome); the binding to autologous platelets of soluble or microparticle–associated alloantigen derived from the destruction of transfused blood product, thus making the recipient platelets a target for the alloantibodies; or, finally, the presence of pseudospecific alloantibodies that are produced in the early phase of the anamnestic response and can bind to determinants on autologous platelets, leading to their destruction (127, 233). As in NAT, platelet typing and antiplatelet antibody testing are necessary to identify the pathogenic alloantibodies. However, because of the severe thrombocytopenia in the acute stages of PTP, genotyping is required to assess the risk for alloimmunization. Although anti-PL<sup>A1</sup> is most often implicated, PTP also is reported in association with alloimmunization to other platelet–specific antigens, including PL<sup>A2</sup>, Bak<sup>a</sup>, Bak<sup>b</sup>, Pen<sup>a</sup>, Br<sup>a</sup>, Br<sup>b</sup>, Ko<sup>a</sup>, and Gov<sup>a</sup>. Some of these antigens are distributed with relatively low frequencies in the population, and screening for antiplatelet antibodies should therefore use sensitive and specific assays and an informative panel of target platelets.

**PASSIVE ALLOIMMUNE THROMBOCYTOPENIA** The abrupt onset of thrombocytopenia within a few hours after transfusion of a blood product is a hallmark of PAT.

Platelet–specific alloantibodies in the blood product (usually plasma) rapidly clear the recipient’s antigen–positive platelets. Although similar to PTP, this syndrome manifests within hours of transfusion and has a shorter duration of thrombocytopenia, which is mediated by the amount and specificity of the transfused alloantibody. Testing for PAT has shown that it is difficult to measure alloantibody in the recipient’s plasma, suggesting that the transfused antibodies are limited and bind to the incompatible platelets soon after transfusion. However, the alloantibody can be detected in the donor plasma, and in one case, sensitization of recipient platelets by the transfused alloantibody *in vivo* was demonstrated using direct radioimmunoprecipitation to measure IgG bound to platelet gpIIa directly on the patient’s platelets (234). Alloantibodies against the PL<sup>A1</sup> and Br<sup>a</sup> antigens have been implicated in passive alloimmune thrombocytopenia (127, 233). Severe thrombocytopenia is found in association with the transfusion of blood products containing alloantibodies to the PL<sup>A1</sup> antigen. The finding that even red blood cell concentrates can cause PAT due to anti-PL<sup>A1</sup> antibodies correlates with reports that as little as 10 ml of plasma containing alloantibodies can cause thrombocytopenia in transfused volunteers (235). Because thrombocytopenia can occur in multiple transfusion recipients, it is important to investigate cases of suspect PAT to ensure that the alloimmunized blood donor does not donate blood in the future (236).

**TRANSPLANTATION–ASSOCIATED ALLOIMMUNE THROMBOCYTOPENIA** Alloimmune mechanisms can explain the rare syndrome of transplantation–associated alloimmune thrombocytopenia that can complicate transplantation either with a solid organ or with allogeneic bone marrow (127). Both anti-PL<sup>A1</sup> and anti-Br<sup>a</sup> alloantibodies can cause thrombocytopenia that may develop very soon or very long after transplantation. In one case, a man with Ph1 chromosome–positive chronic myelogenous leukemia developed severe thrombocytopenia ( $17 \times 10^9/L$ ) 18 months after receiving an allogeneic bone marrow transplant from his HLA–matched sister (237). An immune mechanism was suggested by the repeated platelet count increase after treatment with high–dose intravenous  $\gamma$ –globulin and remission after splenectomy. Anti-PL<sup>A1</sup> antibodies were detected in Ig eluted from the patient’s platelets. Although chromosome analysis of the patient’s marrow demonstrated a normal Ph1–negative female karyotype, sensitive Southern blot analysis of splenic cell DNA identified a small amount (3%) of residual male cells. The patient’s sister was PL<sup>A1</sup>–positive, and another brother was PL<sup>A1</sup>–negative. Although pretransplant platelet alloantigen studies were not done, it was deduced that the

patient was likely PL<sup>A1</sup>-negative and that the thrombocytopenia was mediated by a host-versus-donor alloimmune thrombocytopenia in which the patient's residual lymphoid cells developed an anti-PL<sup>A1</sup> alloimmune response to PL<sup>A1</sup>-positive platelets derived from the engrafted bone marrow. Alloimmune-mediated platelet destruction due to a bone marrow transplant recipient's preexisting anti-Br<sup>a</sup> antibodies was suggested by a rapid transient increase in platelet count from 43 to 108 × 10<sup>9</sup>/L after administration of intravenous  $\gamma$ -globulins ( [238](#) ). The patient received the allogeneic marrow from her HLA-matched brother who typed positive for Br<sup>a</sup>. The detection of a small amount of group A (<5%) blood cells in the recipient after transplantation with her brother's group O marrow indicated that a chimeric state existed in this patient. The thrombocytopenia eventually improved as the level of circulating antibody decreased. Thrombocytopenia that may also have an alloimmune mechanism was reported in patients after autologous peripheral blood cell transplantation for metastatic breast carcinoma ( [239](#) ). Both patients had preexisting anti-PL<sup>A1</sup> antibodies that rose in titer after transplantation. Because moderate to severe thrombocytopenia is expected soon after transplantation due to marrow ablative treatment, variable rate of engraftment of donor marrow-derived megakaryocyte precursors, and fever and other comorbid clinical factors, it is difficult to determine the pathogenic mechanism in these patients. Although the thrombocytopenia may have resulted from a refractory state caused by the rapid clearance of transfused platelets by alloantibodies, it is also possible that platelets derived from engrafted autologous marrow were destroyed in a PTP-like syndrome. Solid organ transplants rarely can lead to alloimmune thrombocytopenia. Donor-derived immunocompetent lymphoid cells contained within the organs transplanted from a single donor to three recipients (two kidneys, one liver) are suspected to be the cause of severe thrombocytopenia (platelet count nadirs: 2, 2, and 12 × 10<sup>9</sup>/L) that developed within 5 to 8 days ( [240](#) ). The severe thrombocytopenia in the renal transplant patients was refractory to intravenous  $\gamma$ -globulins and platelet transfusions. One patient recovered after splenectomy 50 days after transplantation, and the other died due to multiorgan failure associated with bacteremia and severe thrombocytopenia. The thrombocytopenia resolved in the liver transplant recipient after receiving a new liver after rejection of the first transplant. Serum from the multiparous female organ donor was shown to contain anti-PL<sup>A1</sup> alloantibodies. Platelet typing and antibody studies of the transplant recipients showed that although they typed PL<sup>A1</sup>-positive, anti-PL<sup>A1</sup> antibodies were detected in their posttransplant, but not pretransplant, sera. These observations suggest that anti-PL<sup>A1</sup> antibodies derived from transplanted immunocompetent lymphoid cells were responsible for the severe thrombocytopenia in these patients. A similar case of donor lymphocyte-induced thrombocytopenia was caused by a liver transplant obtained from a donor who died of bleeding related to severe autoimmune thrombocytopenia. Anti-gpIIb/IIIa antibodies without allospecificity were detected in both the organ donor and the posttransplant recipient serum ( [241](#) ).

**PLATELET TRANSFUSION REFRACTORINESS** Nonimmune patient-dependent factors usually are involved when unexpectedly poor platelet count increments are observed after transfusion. Although ABO or HLA incompatibility and platelet storage can contribute to reduced platelet count recovery ( [217](#), [242](#), [243](#) and [244](#) ), more often septicemia, drugs, and increased platelet consumption in severely thrombocytopenic patients are responsible for platelet transfusion refractoriness. Although there is only anecdotal evidence that platelet-specific alloantibodies can cause platelet transfusion refractoriness ( [189](#), [245](#) ), some refractory patients do benefit from transfusion with platelets that are HLA- and platelet alloantigen-compatible ( [246](#) ). However, in a prospective study, platelet-specific alloantibodies accounted for, at most, 5% of the patients with platelet transfusion refractoriness ( [247](#) ).



## Platelet Polymorphisms as Risk Factors for Cardiovascular Disease

There is increasing evidence that ischemic vascular disease may result from interactions between environmental factors (e.g., smoking), genetic susceptibility, and concurrent diseases (e.g., diabetes). There is good evidence to show that platelets can play a major role in the formation of an occlusive thrombus at the site of a ruptured atherosclerotic plaque ( [248](#) ). The rate of formation or the susceptibility for platelets to participate in thrombus formation may depend partly on factors that include certain polymorphisms on the platelet glycoproteins.

Measures of platelet reactivity using *in vitro* assays demonstrate heterogeneous results, indicating that there is a range of platelet reactivity among individuals. For example, some individuals' platelets may be considered hyperreactive based on the lower epinephrine dose threshold that induces platelet aggregation. The major platelet glycoproteins that function as receptors and mediate aggregation and adhesion can also differ antigenically and structurally between individuals. Recent evidence suggests that certain polymorphisms on glycoproteins IIb/IIIa, Ib/IX/V, and IaIIa may be associated with enhanced platelet function *in vivo*.

Platelet aggregation is mediated by gpIIb/IIIa, the major receptor for fibrinogen and vWF. GpIIb/IIIa is highly polymorphic, having four known alleles of the  $\alpha$ IIb subunit and eight alleles of the  $\beta$ 3 subunit ( [249](#) ). The Leu33Pro alleles on  $\beta$ 3 are the most clinically important. The Leu33 allele encodes the PL<sup>A1</sup> alloantigen, which is highly immunogenic to some Pro33 (PL<sup>A1</sup>-negative) individuals. Although these alleles are distributed within the general white population with gene frequencies of 0.85 (PL<sup>A1</sup>) and 0.15 (PL<sup>A2</sup>), the gene frequency for PL<sup>A2</sup> was found to be almost four times higher among younger patients with myocardial infarction or unstable angina ( [250](#) ). Since that first report, numerous studies have not been able either to establish or to exclude PL<sup>A2</sup> as a risk factor for ischemic vascular disease ( [251](#) ).

However, *in vitro* studies indicate that gpIIb/IIIa-mediated functions such as aggregation, adhesion, spreading, and clot retraction demonstrate heterogeneity and that the PL<sup>A2</sup> phenotype was associated with a lower activity threshold ( [252](#), [253](#) ). Interactions between platelet integrins and the extracellular matrix are important for cell migration, which is directly involved in restenosis after angioplasty. Recent studies using the PL<sup>A1</sup> or PL<sup>A2</sup> forms of gpIIIa transfected into Chinese hamster ovary cells demonstrated enhanced migration activity when the PL<sup>A2</sup> form of the protein was a constituent of the integrin complex, as either  $\alpha$ IIb $\beta$ 3 or  $\alpha$ v $\beta$ 3 ( [254](#) ). Further, a reduced affinity of the platelet function inhibitor abciximab for platelets with the PL<sup>A2</sup> phenotype suggested that patients with this allele may have a less favorable outcome to treatment after percutaneous coronary intervention ( [255](#) ). Other studies involving the Ile843Ser polymorphism responsible for the Bak alloantigens on  $\alpha$ IIb have not established an association with cardiovascular disease. Although small studies have reported a link with both the Bak<sup>a</sup> and Bak<sup>b</sup> antigens with either stroke or myocardial infarction, larger studies have not reported a similar association ( [256](#), [257](#), [258](#) and [259](#) ).

Three dimorphisms of gpIba have potential relevance in thrombotic risk. The Thr145Met alleles encode the Ko alloantigens, which are in linkage disequilibrium with a VNTR polymorphism in the macroglycopeptide region of gpIba. This results in a duplication of the

13-amino acid sequence one to four times (VNTR D to VNTR A) and would result in an increasingly longer polypeptide. However, the few studies that report an association between any of the variable polymorphisms and the risk for coronary artery disease have not been supported in others ( [260](#), [261](#) and [262](#) ). An additional polymorphism in the Kozak region of the molecule may be important for regulating the efficiency of translation of gpIba, thus affecting the number of receptors expressed ( [263](#), [264](#) ). However, an association between this dimorphism and a risk for arterial thrombosis could not be demonstrated in subsequent studies ( [265](#), [266](#) and [267](#) ). One study from Australia did report an association between the Kozak polymorphism and ischemic stroke, suggesting that further studies may be warranted ( [268](#) ).

The level of expression of a major collagen receptor, gpIIa, can vary up to threefold depending on the inheritance of linked, allelic polymorphisms in the  $\alpha 2$  (gpIa) gene. The 807-T/C/G polymorphism segregates independently of the alleles encoding the Br<sup>a</sup>/Br<sup>b</sup> and Sit<sup>a</sup> alloantigens. Although some studies suggested an association of the 807T allele (high receptor density) with myocardial infarction or stroke, other studies were unable to confirm this observation ( [269](#), [270](#), [271](#) and [272](#) ). However, in a large study of 2237 male patients, an association between younger patients with the 807T allele and myocardial infarction was reported ( [273](#) ).

## WHITE CELL ANTIGENS

Antigens expressed on granulocytes, monocytes, and lymphocytes are traditionally known as the *self-antigens*. These include the MHC genes, as well as other antigens expressed on subsets of white cells, including those expressed primarily on neutrophils and monocytes. The MHC has several subloci, including genes encoding the HLA class I and II antigens. The class I antigens are present on every cell and tissue in the body, except for red cells, sperm, and some placental cells. The class II antigens are expressed mainly on select cells of the immune system (e.g., T and B cells and macrophages). In addition, the white cells express some antigens that are shared with other cells of the body, including red cells and platelets.

The white cell antigens can play a pivotal role in host defense, self-recognition, and autoimmunity. They have been implicated in graft rejection and graft-versus-host disease (GVHD) after transplantation and are responsible for transfusion reactions and fetal neutropenia due to expression of incompatible alloantigens. Because of their high polymorphism, these antigens are used in forensic medicine, paternity testing, and anthropologic studies.

Finally, many white cell antigens are recognized by monoclonal antibodies. The majority of these antibodies identify proteins that are markers of differentiation, cell adhesion molecules, and various phagocytic, complement, and chemotactic receptors.

### Granulocyte Antigens

**GRANULOCYTE-SPECIFIC ANTIGENS** The antigens on granulocytes were initially defined using human alloantisera, most often through the diagnosis and investigation of infants with alloimmune neonatal neutropenia (ANN), but are also implicated in autoimmune neutropenia of childhood, febrile transfusion reactions (FTRs), and transfusion-related acute lung injury. The NA and NB antigens are most often implicated in alloimmune neutropenia, and the availability of monoclonal antibodies to the target proteins has facilitated the characterization of these alloantigens. Alloantibodies to the 5b, Ond<sup>a</sup>, and Mart<sup>a</sup> antigens are much less common. Alloimmunization to these antigens



has been recorded in FTRs, ANN, and transfusion-related acute lung injury (5b), as well as in the sera of multiparous women (Mart<sup>a</sup>) and in a multitransfused male with aplastic anemia (Ond<sup>a</sup>).

**Nomenclature** Standardization of the nomenclature for the neutrophil antigens has modified the original *N* designations to *HNA* (human neutrophil antigen) (274, 275). The Granulocyte Working Party of the ISBT is charged with the allocation of new antibody/antigen specificities after confirmation of their reactivity and biochemical and molecular characterization. Unlike the HPA nomenclature system for platelet alloantigens, the neutrophil alloantigen nomenclature assigns different antigens on the same gp to the same HNA antigen system, with alleles distinguished by lowercase letters (Table 23.11). Thus, the NA1, NA2, and SH antigens are all expressed on Fc $\gamma$ RIIIb and are, therefore, designated as alleles of the gene for Fc $\gamma$ RIIIb (HNA-1a, -1b, and -1c, respectively), with the base modifications encoding the alleles at distinct locations (276). Seven alloantigens have been assigned HNA designations on five glycoproteins (HNA-1 to HNA-5). However, other specificities, including ND1, 5a, 9a, and NB2, have been reported but cannot be confirmed due to a lack of available antisera.

**TABLE 23.11. Human Neutrophil Alloantigens**

| HNA System | Antigen Original Designation          | Glycoprotein                       |
|------------|---------------------------------------|------------------------------------|
| 1          | HNA-1a NA1<br>HNA-1b NA2<br>HNA-1c SH | Fc $\gamma$ RIIIbCD16              |
| 2          | HNA-2a NB1                            | CD177                              |
| 3          | HNA-3a 5b                             | Unknown                            |
| 4          | HNA-4a Mart <sup>a</sup>              | CR3/CD11b                          |
| 5          | HNA-5a Ond <sup>a</sup>               | Leukocyte function antigen-1/CD11a |

HNA, human neutrophil antigen.

Modified from Stronek D. Neutrophil alloantigens. *Trans Med Rev* 2002;16:67-75.

The HNA system has improved the nomenclature for the neutrophil antigens; however, it does not account for the different haplotypes possible for certain genes (e.g., Fc $\gamma$ RIIIb). The nomenclature works best for antigen systems with two alleles but has the same problems as the HPA system used to designate the platelet alloantigens. These systems are not able to completely define the haplotypes due to the possibility of crossover between alleles. Thus, although the majority of base substitutions at position 266 of Fc $\gamma$ RIIIb encoding the SH antigen have been found on the NA2 form of the gene, SH can also occur with variants of NA2. Modifications to the nomenclature may be required in the future to clarify these issues and to address the NB antigen system after its molecular characterization.

**HNA-1a, -1b, and -1c (NA1, NA2, and SH)** The most clinically important of granulocyte-specific antigens are the HNA-1a and -1b alleles, which are most commonly associated with ANN. This antigen system was first described in 1960 by Lalezari (277). It consists of gene products for two antithetical antigens, NA1 and NA2, which are expressed on the low-affinity Fc $\gamma$  receptor, Fc $\gamma$ RIIIb. Monoclonal antibodies to this gp are specific for CD16. Fc $\gamma$ RIIIb is a 233-amino acid gp secured to the membrane via a GPI anchor (278, 279, 280 and 281). The NA1 gene on chromosome 1 differs from the NA2 gene by five nucleotide bases at positions 141, 147, 227, 277, and 349. Four of these changes encode a different amino acid, two of which result in a different glycosylation pattern because of the changes at bases 227 and 277. Thus, NA2-Fc $\gamma$ RIIIb has two additional glycosylation sites, which accounts for the larger molecular mass of this form of the gene

product (65- to 80-kd gp) compared with the NA1-Fc $\gamma$ RIIIb product (50- to 65-kd gp). The soluble Fc $\gamma$ RIIIb found in plasma has the same NA antigens as those found on neutrophils, which have been shown to be the source of the soluble gp ( [282](#) ). The gene frequencies for NA1 and NA2 demonstrate marked differences among different racial groups. The NA1 gene frequency in whites ranges from 0.30 to 0.37, and that of NA2 ranges from 0.63 to 0.70. However, in the Asian population, the frequency of NA1 ranges between 0.60 and 0.66, whereas NA2 ranges from 0.30 to 0.33 ( [283](#) , [284](#) , [285](#) , [286](#) and [287](#) ). The gene for Fc $\gamma$ RIIIb shares homology with the gene for the Fc $\gamma$ RIIIa receptor, differing only by four nucleotides. A C to T change at position 733 creates a stop codon in the gene for Fc $\gamma$ RIIIb, resulting in a GPI-anchored protein that is 21 amino acids shorter than Fc $\gamma$ RIIIa, which is a transmembrane protein. However, the genes for the two forms of Fc receptor share similarities, and special care is required when using polymerase chain reaction and restriction enzymes for genotyping the NA antigens. The Fc $\gamma$ RIIIA gene shares partial homology with both the NA1 and NA2 forms of Fc $\gamma$ RIIIb. At positions 227 and 349, Fc $\gamma$ RIIIA is the same as the NA1 form of Fc $\gamma$ RIIIb but is homologous to NA2-Fc $\gamma$ RIIIb at positions 141, 147, and 277. Neither anti-NA1 nor anti-NA2 antibodies recognize Fc $\gamma$ RIIIa, which suggests that these alloantigens, like platelet alloantigens, depend on tertiary conformations. The conformational changes, in turn, are induced by the amino acid polymorphisms. However, genotyping procedures with genomic DNA require multisite analysis to ensure differentiation of the NA1 and NA2 partial polymorphisms on Fc $\gamma$ RIIIA from those on the actual gene of interest, Fc $\gamma$ RIIIb ( [284](#) , [286](#) , [288](#) ). Alternate alleles of the NA1 and NA2 genes have been described ( [286](#) ). These are single nucleotide substitutions at one of the five NA-Fc $\gamma$ RIIIb polymorphic sites. They have been detected only by genotyping, because the changes have not been reported to induce an immune response. However, changes at certain sites can directly affect the level of expression of Fc $\gamma$ RIIIb and the NA1/NA2 antigens. This has been confirmed using studies on cells transfected with variants of the Fc $\gamma$ RIIIb gene ( [281](#) ). The SH polymorphism (HNA-1c) results from an alanine to aspartate amino acid change at position 78 due to a C to A substitution at nucleotide 266 in Fc $\gamma$ RIIIb ( [289](#) ). SH is expressed on neutrophils in 4 to 5% of whites, but it is expressed much more frequently (25 to 38%) on neutrophils from black individuals ( [289](#) , [290](#) and [291](#) ). In many individuals with the SH polymorphism, the Fc $\gamma$ RIIIb gene is duplicated on the same chromosome ( [292](#) , [293](#) ). In most cases, SH is expressed on the NA2 form of Fc $\gamma$ RIIIb, suggesting that the mutation at nucleotide 266 occurred after those encoding the NA2 allele. However, reports of some cases of SH-positive individuals having an NA1 phenotype suggest that crossover between NA1-Fc $\gamma$ RIIIb and NA2-Fc $\gamma$ RIIIb, or NA2-Fc $\gamma$ RIIIb and Fc $\gamma$ RIIIA, may have taken place ( [286](#) ).

**HNA-2a (NB1)** The neutrophil NB1 alloantigen has been implicated in ANN, FTRs, autoimmune neutropenia, and transfusion-related lung injury ( [294](#) , [295](#) ). It is expressed on a 58- to 64-kd GPI-anchored gp (CD177) on neutrophils in 97% of individuals in the white population ( [275](#) , [296](#) ). The NB1 gene on chromosome 19q13.2 has been sequenced and has been determined to belong to the Ly-6 gene family ( [297](#) ). Proteins encoded by Ly-6 family genes are characterized by repeating cysteine-rich domains and include the urokinase-type plasminogen activator, the reactive inhibitor of lysis receptor (CD59), and polycythemia rubra vera-1 ( [298](#) ). A genetic polymorphism associated with the NB1 antigen has not been identified. This may have implications for the genetic basis of the anti-NB1 antibodies. The putative antithetical antigen to NB1, NB2, has not been reliably characterized due to a lack of alloantisera. Polyclonal antibodies that react to the NB1 gp do not recognize a gp determinant on individuals lacking the NB1 antigen ( [299](#) ), suggesting that NB1-negative individuals may lack CD177. This would indicate that the anti-NB1 antibodies may not result from an immune response to the gp product of a polymorphism in the NB1 gene. The antibodies may be more similar to the isoantibodies reported in patients who lack specific surface glycoproteins and who are exposed to these polypeptides through transfusion or pregnancy (e.g., gpIIb/IIIa in Glanzmann thrombasthenia and gpIV in Nak<sup>a</sup>-negative individuals). Similarly, in some individuals with

paroxysmal nocturnal hemoglobinuria and in families with individuals who lack the Fc $\gamma$ RIIIB gene, a deficiency of Fc $\gamma$ RIIIB is associated with an absence of the NA1 and NA2 antigens ( [300](#), [301](#) and [302](#) ). Unlike other neutrophil polymorphisms, the NB1 antigen is expressed only on a subpopulation of cells (56 to 64%) and has a higher level of expression on neutrophils from women compared with men ( [286](#), [296](#), [302](#) ). The level of NB1 antigen declines with age in women but remains constant in men.

**HNA-3a (5b)** The 5b antigen is located on a 70- to 95-kd protein on neutrophils but has also been reported on lymphocytes, platelets, and endothelial cells ( [303](#) ). However, the biochemical and molecular nature of the gp carrying the 5b antigen has not been reported. Alloimmunization to 5b has been associated with FTRs, alloimmune NAT, and transfusion-related lung injury ( [304](#) ).

**HNA-4a (Mart<sup>a</sup>)** Mart<sup>a</sup> is recognized by antibodies in sera from nontransfused multiparous women ( [305](#) ). The alloantigen is located on the  $\alpha$ M-chain of the C3bi receptor (CR3, CD11b) and is expressed on granulocytes, monocytes, and lymphocytes in 99% of the white population. A single nucleotide substitution of G to A at position 302 encodes an Arg to His polymorphism at amino acid 61 that is associated with the Mart<sup>a</sup> antigen ( [306](#) ). The clinical significance of immunization to Mart<sup>a</sup> is unknown because none of the infants of the women with anti-Mart<sup>a</sup> was reported to have evidence of neutropenia.

**HNA-5a (Ond<sup>a</sup>)** Antibodies to the Ond<sup>a</sup> antigen were discovered in the serum from a multiply transfused male with aplastic anemia. Biochemical and molecular analysis has demonstrated that Ond<sup>a</sup> is expressed on the  $\alpha$ L integrin unit (leukocyte function antigen-1, CD11a) and is associated with a G to C nucleotide substitution at position 2446, which encodes an Arg to Thr amino acid change at 766 ( [306](#) ).

## Detecting Antibodies to Granulocyte Antigens

The study of antibodies to granulocytes uses techniques evolved from leukoagglutinin assays with reactive antisera. The two most commonly used tests are the granulocyte agglutination test (GAT) and the granulocyte immunofluorescence test (GIFT) for investigation of granulocyte-specific antibodies. GAT currently is used in modified form using a microtechnique with purified granulocyte suspensions in microtest plates. However, the basis of this test is unlike that of red cell agglutination. The granulocyte agglutination measures the response of the cells after interaction with antibody. The GIFT assay is performed in microtiter plates in which antibodies bound to the cells are detected with fluorescein-conjugated antihuman Ig.

Problems are associated with the GAT and GIFT assays, primarily due to coexisting antibodies to HLA and other granulocyte-specific antigens. These may mask or confuse the reactivity of interest. Even with the use of well-characterized test sera and procedures to eliminate HLA reactivity using absorption techniques or chloroquine stripping, the GAT and GIFT assays have limited sensitivity and specificity.

Biochemical characterization of granulocyte antigens has facilitated the development of more specific methods for investigation of granulocyte-specific antibodies. These include antigen capture (e.g., the monoclonal antibody-specific immobilization of granulocyte antigens assay), immunoblot, and immunoprecipitation assays, similar to the assays used to study platelets.

**SHARED ANTIGENS** Granulocytes also express antigens that are associated with other peripheral blood cells and tissues. The class I (HLA-A, -B, and -C) antigens can be demonstrated on granulocytes, but not using cytotoxicity tests as used for lymphocytes. The concentration of HLA on granulocytes is lower than on lymphocytes. Although

granulocyte precursors also carry HLA, it is not known if the HLAs on mature granulocytes are intrinsic or adsorbed from the plasma. Although no class II can be detected on mature granulocytes, they are present on immature cells. Various blood group antigens have been reported on neutrophils. Initially ABO antigens were reported on granulocytes; however, more specific and sensitive assays failed to confirm the presence of ABH on granulocytes. There is evidence for the expression of the Ii, Lex, and P system antigens on granulocytes, but there is no evidence of MN, Rh, Kidd, Duffy, or Kell antigens on the surface of normal granulocytes.

#### ***Clinical Significance of Granulocyte Antigens***

***Alloantibodies*** Alloantibodies specific for the HNA-1 antigens on Fc $\gamma$ RIIIb are most commonly implicated in ANN ( [307](#), [308](#) ). They have also been identified in FTRs and transfusion-related lung injury. The HNA-2a and HNA-3a antigens are also associated with these diseases. ANN can occur in the fetus and in newborns born to mothers who lack the respective antigen. The mother becomes immunized during pregnancy to the incompatible fetal-paternal alloantigen. The resulting maternal alloantibodies can cross the placenta and mediate the destruction of fetal neutrophils, similar to the mechanism of cell clearance seen in NAT and HDN. The neutropenia is self-limiting and transient, and most infants recover spontaneously within 2 weeks to 6 months ( [275](#) ). Although it is common for the neutropenic infants to contract mild infections, overwhelming sepsis can occur, with a mortality rate of approximately 5%. FTRs are associated with granulocyte-specific antibodies in the recipient that mediate destruction of the transfused cells. It can be associated with transfusion-related lung injury, resulting in acute respiratory distress and pulmonary edema. The syndrome is most commonly associated with transfusion of plasma containing HLA or neutrophil-specific antibodies. Bone marrow transplantation can result in immune-mediated granulopenia. It is common to match donor and recipient for HLAs but not for granulocyte-specific antigens, and the presence of granulocyte-specific antibody can delay neutrophil engraftment.

***Autoantibodies*** Granulocyte-specific antibodies are observed in primary and secondary autoimmune neutropenia. Unlike alloantibodies, these autoantibodies are directed to epitopes expressed on protein and carbohydrates present on all normal granulocytes. Primary autoimmune neutropenia is seen most often in children 3 to 30 months of age and usually resolves spontaneously after 1 to 2 years. In some cases, NA1 and NA2 antibodies are found in children with autoimmune neutropenia ( [309](#) ). In the majority of patients, granulocyte-specific antibodies can be detected. Secondary autoimmune neutropenia is most often associated with another autoimmune disease such as Felty syndrome, systemic lupus erythematosus, or malignancy (e.g., lymphoma). Unlike primary autoimmune neutropenia, granulocyte-specific antibodies are not detected as readily in autoimmune neutropenia secondary to other autoimmune diseases.

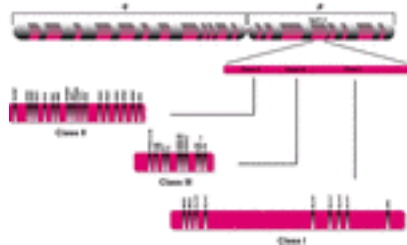
***Monocyte Antigens*** Monocytes express both class I and II HLAs, as well as some shared antigens discussed previously, including HNA-4a.

***Lymphocyte Antigens*** Numerous monoclonal antibodies recognize a number of molecules associated with various aspects of lymphocyte function and differentiation. These antibodies and antigens have been well characterized and are assigned to cluster designation (CD) antigens based on their patterns of reactivity. These antigens are discussed elsewhere (see [Chapter 10](#)). Lymphocytes also express a number of shared antigens, including HNA-3a, HNA-4a, and HNA-5a. Some ABH and Lewis antigens can be adsorbed to the lymphocyte surface from the plasma. Ii and P1 and P antigens are also expressed on lymphocytes; however, the major antigens associated with lymphocytes are the HLAs.

***HLAs*** The HLAs are encoded by the MHC, a cluster of genes encompassing approximately one-thousandth of the human genome. The MHC is located on the short arm of chromosome 6 (band 6p 21.3) and was defined initially by investigation of antibodies to HLAs in individuals immunized through pregnancy or transfusion ( [310](#) ). These antigens are distributed on many types of cells and tissues and are important in the regulation of the immune response. They play a primary role in graft rejection and GVHD in transplantation and transfusion. The immune response to specific antigens is controlled by immune response genes (Ir), also located in the MHC (for discussion

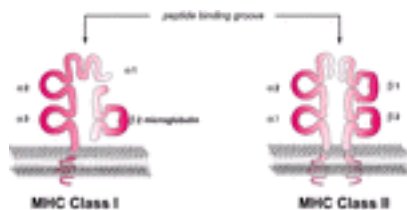
elsewhere, see [Chapter 18](#)).

**MOLECULAR STRUCTURE OF HLAS** The HLA complex on chromosome 6 has over 200 genes, more than 40 of which encode leukocyte antigens ( [Fig. 23.5](#)). Of the three coding regions in the MHC, only the class I and II antigens are involved in the immune response. The class I genes encode HLA-A, -B, -C, -E, -F, and -G, and the class II genes encode HLA-DP, -DQ, -DR, -DN, and -DO. These class I and II gene products are both structurally and functionally different. The class III genes encode complement components C2, C4A, C4B, Bf, 21-hydroxylase, and tumor necrosis factor- $\alpha$  and - $\beta$  ( [311](#)).



**Figure 23.5.** Organization of the major histocompatibility complex on chromosome 6. A partial gene map of the HLA complex is shown. The major loci of the genes expressed in the HLA class I and class II regions are depicted, as well as the unrelated class III genes. The following genes are shown in order, but not to scale: BF (complement factor B), C2 (complement component 2), C21B (cytochrome P-450, subfamily 21), C4A/C4B (complement components C4A/C4B), HSP (heat shock protein), LMP (large multifunctional protease), LTA/LTB (lymphotoxins A and B), MICA/MICB (MHC class I chains A and B), P450 (cytochrome P-450), PSMB8 and 9 (proteasome beta 8 and 9), TAP1/TAP2 (transporter proteins associated with antigen processing), TAPBP (TAP-binding protein, tapasin), TNF- $\alpha$  (tumor necrosis factor- $\alpha$ ), and HSPA1A/HSPA1B/HSPA1L (heat shock proteins 1A A-type/1A B-type/1A-like).

The class I molecule consists of two polypeptide chains,  $\alpha$  and  $\beta$ , each encoded by different genes ( [312](#), [313](#), [314](#), [315](#) and [316](#)) ( [Fig. 23.6](#)). The HLA-A, -B, and -C genes encode the larger  $\alpha$ -chain, a 45-kd transmembrane protein with three amino acid domains. Two of these,  $\alpha$ 1 and 2, account for most of the variation in the molecule. Polymorphisms of the HLA genes are found in these parts of the molecule. A constant region, similar to those found in Ig molecules, is in the  $\alpha$ 3 region close to the cell membrane. The class I  $\alpha$ -chain is noncovalently associated with a smaller molecule,  $\beta$ 2-microglobulin. No polymorphisms have been reported on this 12-kd extracellular protein encoded by a gene on chromosome 15.



**Figure 23.6.** Schematic representation of the HLA class I and class II molecules. The class I and class II molecules are each composed of two polypeptide chains that are manufactured separately in the endoplasmic reticulum. A peptide-binding groove is created by the  $\alpha$ 1 and  $\alpha$ 2 peptide-binding domains of the class I molecule. A similar peptide-binding structure is created in the class II molecule by the association of the  $\alpha$ 1 and  $\beta$ 1 peptide-binding domains. The HLA class I and II molecules also have immunoglobulin-like domains ( $\alpha$ 3: class I;  $\alpha$ 1 and  $\beta$ 1: class II) proximal to a transmembrane domain and cytoplasmic tail.

X-ray crystallography demonstrates further similarities to Ig molecules. The membrane-proximal  $\alpha$ 3 and  $\beta$ 2-microglobulin portions of the HLA molecule have Ig-like folds, in contrast with the  $\alpha$ 1 and 2 portions, which form a platform topped by a helices. A



groove between these helices is the binding site for a peptide fragment from a processed antigen. Class II molecules also share similarities with Igs. Like the class I molecules, they also consist of a heavy and a light chain ( Fig. 23.6). The heavy  $\alpha$ -chain has a molecular weight of 34 kd, and the smaller  $\beta$ -chain has a molecular weight of 29 kd. Both chains are transmembrane molecules, each with two structural domains. Similar to the class I molecule, the class II molecule has a functional antigen-binding groove formed by the distal  $\alpha 1$  and  $\beta 1$  domains ( 317). The  $\alpha 2$  and  $\beta 2$  constant regions share homology with Ig constant regions,  $\beta_2$ -microglobulin, T-cell receptors, and class I heavy chains. This homology may account for similarity in the crystallographic structure of the class I and class II antigens ( 318).

**NOMENCLATURE** The nomenclature of the HLAs has been standardized by the World Health Organization nomenclature committee, which regularly reviews newly reported specificities and genetic loci to determine the nomenclature for the HLAs, partly defined by the results of International Histocompatibility Testing Workshops ( 319, 320 and 321.) ( Table 23.12).

**TABLE 23.12. Serologic Antigens and DNA Polymorphisms of the HLA System**

| Locus           | Serologic Antigens (Number of Antigens) | DNA Polymorphisms (Number of Alleles) |
|-----------------|---|---------------------------------------|
| <b>Class I</b>  |   |                                       |
| HLA-A           | A1 to A80 ( 20)                         | A*0101 to A*8001 ( 59)                |
| HLA-B           | B7 to B81 ( 30)                         | B*0701 to B*8201 ( 118)               |
| HLA-C           | Cw1 to Cw11 ( 8)                        | Cw*0101 to Cw*1802 ( 36)              |
| <b>Class II</b> |   |                                       |
| HLA-DR          | None                                    | DRA*0101, DRA*0102 ( 2)               |
|                 | DR1 to DR8 ( 18)                        | DRB1*0101... ( 184)                   |
|                 | DRw52 ( 1)                              | DRB3*01011... ( 11)                   |
|                 | DRw53 ( 1)                              | DRB4*01... ( 9)                       |
|                 | DR51 ( 1)                               | DRB5*01011... ( 12)                   |
| HLA-DQ          | None                                    | DQA1*0101... ( 18)                    |
|                 | DQw1 to DQw9                            | DQB1*0101... ( 31)                    |
| HLA-DP          | None                                    | DPA1*0101... ( 10)                    |
|                 | None                                    | DPB1*0101... ( 77)                    |

Modified from Troup GM, Williams TM. HLA: the molecular age. In: Rossi EC, Simon TK, Moss GS, et al., eds. Principles of transfusion medicine, 2nd ed. Baltimore: Williams & Wilkins, 1996:817.

The nomenclature for the class I and class II antigens is similar, consisting of the region of the gene (e.g., HLA-A) and a number. A *w* is assigned to antigens that await confirmation of their reproducibility and specificity. A *w* is assigned to the Bw4 and Bw6 antigens and to the DW and DP specificities defined by cellular techniques. However, the HLA-C antigens are also recorded with a *w* to avoid confusion with the complement components. Because the antigens are originally defined by the reactivity of antisera, some early specificities have been further defined with more restricted antisera. These subspecificities are called *splits* and usually are written to incorporate the parent antigen in parentheses [e.g., HLA-A9 is split to HLA-23(9) and HLA-24(9)]. It is also common among the HLA-A and -B alleles to find specific antisera that cross-react with more than one antigen. Antisera that react with one specificity in these cross-reactive groups may demonstrate reactions with other antigens in the same group [e.g., HLA-A2 and -A28, or -A19 (consisting of A29 to A33)] ( 322, 323 and 324). The Bw4 and Bw6 antigens are public antigens expressed on the HLA-B molecule. The HLA-B specificity includes both this

public antigen (Bw4 or B7 and Bw6) and a private specificity [e.g., B44(12)], written as B7(Bw6). Those HLA regions and genes that have been defined using molecular techniques are identified using a unique nomenclature. The nomenclature for the class I antigens consists of the locus name, a star (\*), and a four-digit number (e.g., HLAA\*0101). The first two digits of the number refer to the serologic specificity. Because both the  $\alpha$  and  $\beta$  (A and B) genes are polymorphic for the class II antigens, the chain also must be specified (e.g., HLA-DRB1\*0101 or HLA-DQA1\*0101) ( [Table 23.12](#) ).

**CLASS I HLAs** The class I (class I-a) antigens are expressed on all nucleated cells and on the anucleate platelets. In addition, soluble HLA-A and -B antigens can be found in plasma where they circulate in association with high-density lipoproteins (released from cell membranes) ( [325](#), [326](#), [327](#) and [328](#) ). Adsorption of these vesicles into other cell membranes may explain why red cells also carry these antigens. The class I antigens are products of the highly polymorphic HLA-A, -B, and -C genes ( [313](#), [316](#), [329](#) ). A description and list of the class I antigens can be found in the review by Bodmer et al. ( [330](#) ). Molecular techniques have increased the number of HLA-A specificities to more than 80 from the 20 defined serologically. Similarly, HLA-B and -C loci have 30 and 8 serologically defined antigens and more than 118 and 36 specificities, respectively, identified using molecular techniques. It may not be appropriate to designate the molecularly defined polymorphisms as antigens, because the resulting proteins do not initiate alloantibody formation. Hence, these alleles are more correctly referred to as *genetic polymorphisms*. The HLA-E, -F, and -G molecules (class I-b) are similar in structure to the class I-a molecules but have a different tissue distribution ( [331](#), [332](#) and [333](#) ).

#### **Methods of Detecting Class I HLAs and Antibodies**

**Antigen Typing** Both serologic and molecular techniques have been used to identify polymorphisms of the class I genes. Serologic methods use lymphocytotoxic (functional) assays, in which sera with known anti-HLA-A, -B, and -C specificities are incubated with test cells. Cell viability is monitored after the addition of complement, which damages the cell membrane of antibody-sensitized lymphocytes, allowing the uptake of dye such as eosin ( [334](#), [335](#) ). Because of the requirement for a relatively large and informative number of specific typing sera, commercial kits are generally used for serotyping. Molecular methods are used to detect polymorphisms, and sequencing is used to identify changes at each locus.

**Antibody Detection and Identification** Testing for anti-HLA antibodies uses lymphocytotoxic techniques similar to those used for HLA typing. For these assays, patient serum is screened against a panel of typed cells. Generally, 30 to 60 different target cell phenotypes are required to identify the antibody specificities. These methods are used to select potentially compatible platelets for patients who are refractory to platelet transfusions.

**CLASS II HLAs** The class II HLAs are found on lymphocytes, monocytes, macrophages, endothelial cells, activated T cells, and Langerhans cells ( [311](#), [317](#) ). Many of these cells play an important role in initiating the immune response. The class II genes are proximal to the centromere on the short arm of chromosome 6 and consist of one  $\alpha$ -chain (DRA) and one or two  $\beta$ -chain (DRB) genes. Therefore, one DRA- and one DRB1-encoded polypeptide are expressed by all individuals. The other DRB genes (DRB2 to DRB9) do not always encode a polypeptide that is coexpressed with the DRB1 product. Only the DRB3, 4, and 5 gene products are associated with a DRB1-encoded polypeptide. Although two  $\alpha$ -chain genes and two  $\beta$ -chain genes are found for the DQ and DP regions, only one product ( $\alpha + \beta$ ) is expressed ( [336](#) ). A list of class II antigens can be found in the review by Bodmer et al. ( [330](#) ).

**Methods of Detecting Class II HLAs and Antibodies** The class II antigens have been detected using both serologic and cellular assays. The International Histocompatibility Workshop in 1977 initially defined the class II antigens identified using serologic techniques ( [337](#) ). Serologic typing for the class II antigens is performed using a method similar to that used for the class I antigens. However, instead of using unfractionated lymphocytes, the typing of class II antigens uses only B lymphocytes. These are first



isolated from peripheral blood and incubated with specific anti-DR/-DQ sera to determine the class II phenotype. To date, 21 HLA-DR and 9 HLA-DQ antigens have been serologically identified. It is now known that a single gene does not exist for HLA-D; however, the term continues to be applied to functional assays such as the mixed lymphocyte culture, the primed lymphocyte typing test, and T-cell clones ( [338](#) ). Because of the limitations of the functional assays, molecular methods have replaced the cellular assays for HLA class II typing. This typing is used for the identification of compatible bone marrow donors and recipients. More than 180 alleles at the HLA-DRB1 locus and more than 30 alleles at the HLA-DQB1 locus have been identified ( [339](#) ).

**CLASS III HLAS** A cluster of genes located between HLA-B and HLA-DR in the class III region of the MHC encode some components of the complement system, including C4A, C4B, C2, and properdin factor B (Bf). The C4A and C4B loci encode C4 variants. These polymorphic genes also are responsible for the Rodgers (C4A) and the Chido (C4B) red cell phenotypes ( [340](#) , [341](#) and [342](#) ). This area of the MHC also encodes other proteins, including 21-hydroxylase and tumor necrosis factor- $\alpha$  and - $\beta$ . Other genes on chromosome 6 linked to the HLA complex include sulfoxide dismutase,

phosphoglucosyltransferase-3, neuraminidase, glyoxalase, and coagulation factor XIIIa ( [343](#) ).

**INHERITANCE OF HLAS** Closely linked genes on one chromosome, such as those of the MHC, are often inherited as a unit cluster or haplotype. Thus, a child inherits one haplotype from each parent, resulting in four possible phenotypes. In some cases, an individual exhibits only two or three of the four HLA-A and -B antigens. This has been attributed to homozygosity or chromosome deletions. However, the limitations of serologic methods are demonstrated by molecular studies showing that some individuals are heterozygous at certain loci (e.g., HLA-A\*0201/HLA-A\*0202) who previously serotyped as homozygous HLA-A2. The chance that any two of the children are completely identical is 25%. However, crossover can occur during meiosis, thus creating a new haplotype. For the MHC, there is a crossover rate of 0.8% between the A and B loci and approximately 0.5% between the B and DR loci. Because of linkage disequilibrium, alleles at linked loci are associated more frequently than would be expected. Thus, HLA-A1 (13.8%) and HLA-B8 (9%) are in linkage disequilibrium because their actual haplotype frequency (6%) is much higher than would be expected (1.3%) if they were independently inherited. Linkage disequilibrium contributes to the observation that different racial groups have wide variations in their haplotypes. Antigen frequencies vary considerably between populations, such that some alleles are seen rarely (e.g., HLA-A1, -B8 in Orientals), whereas others are found almost exclusively within a certain race (e.g., HLA-A34 in blacks). Inheritance of the class III gene cluster as a closely linked unit, referred to as a *complotype*, is associated with certain disease states ( [340](#) , [344](#) ).

**CLINICAL SIGNIFICANCE OF THE MAJOR HISTOCOMPATIBILITY COMPLEX** Studies of the MHC and inheritance of specific alleles and haplotypes demonstrate a role in transplantation and transfusion and an association with certain diseases. The highly polymorphic antigens of the MHC also provide markers for use in forensic medicine and paternity testing and for anthropologic studies ( [345](#) , [346](#) and [347](#) ).

**Transplantation** Histocompatibility testing is used to identify compatible donors for the transplantation of solid organs and bone marrow. For solid organ transplants, HLA matching has reduced graft rejection and demonstrated better graft survival, with closer matches (6/6 for HLA-A, -B, and -DR) associated with more beneficial outcomes. This effect is in addition to the benefits of using immunosuppressants (e.g., cyclosporin or tacrolimus) and ABO compatibility matching. The benefit of HLA-A, -B, and -DR matching on graft survival has been demonstrated, especially for second kidney transplants ( [348](#) , [349](#) , [350](#) , [351](#) and [352](#) ). Although blood transfusion before kidney transplantation may be beneficial due to immunosuppressive mechanisms, leukocyte-depleted blood does not demonstrate the same effect, which suggests an immunosuppressive effect of the transfused white cells ( [353](#) , [354](#) and [355](#) ). ABO compatibility does not play a major role in bone marrow transplantation compatibility. This contrasts with solid organ transplantation. However, HLA compatibility has a significant benefit. Transplant success relates directly

to the HLA compatibility of the donor and recipient. Transplants with marrow donated from HLA-identical siblings shows lower incidences of delayed engraftment or rejection and GVHD than transplants with marrow from non-HLA-identical relatives ( 356 , 357 , 358 and 359 ). However, it is now clear that other genetic factors contribute to transplant success. The increased use of bone marrow transplantation for the treatment of certain hematologic diseases has required an increase in the number of unrelated marrow donors. Donor registries provide access to compatible donors for those patients without HLA-identical siblings. The use of marrow from unrelated HLA-A, -B, and -DR-identical donors has not eliminated the risk of acute GVHD and graft rejection ( 360 , 361 and 362 ). More precise matching using molecular techniques has demonstrated that although HLA-DP may not play a major role, DRB1, DQB, and HLA-C matching can result in decreased risk of graft failure and GVHD ( 363 , 364 and 365 ).

**Association with Disease** Many diseases have been associated with specific HLA-A, -B, -C, and -DR antigens and with complement allotypes and HLA haplotypes ( Table 23.13 ) ( 366 , 367 , 368 , 369 , 370 , 371 and 372 ). The first of these associations was reported for Hodgkin disease, with HLA typing demonstrating a higher frequency of A1, B5, and B18 in these patients. However, the A1, B8 haplotype is prevalent in long-term survivors, suggesting that it may have a protective effect ( 373 ). Many of the early associations with disease states were with the HLA-B antigens, such as ankylosing spondylitis and HLA-B27 ( 374 , 375 ). However, the use of molecular techniques has now demonstrated strong associations of some class II molecules with certain diseases, including those with an autoimmune mechanism. Three loci, DQB1, DQA1, and DRB1, may be associated with susceptibility or resistance to insulin-dependent diabetes mellitus. Patients with DRB1\*0405, 0401, or 0402 are susceptible to insulin-dependent diabetes mellitus, whereas those with DRB1\*0404, 0403, or 0406 are resistant to the disease ( 376 , 377 ). Whereas 95% of patients with insulin-dependent diabetes mellitus express HLA-DR3 or -DR4, those individuals heterozygous for both antigens have an increased risk of developing the disease ( 378 ). There is the possibility that the  $\alpha$ - and  $\beta$ -chains from each haplotype might form pairs of molecules with modified peptide-binding properties in concert with dosage effects that may play a role in accelerating the disease. The importance of specific peptide-binding grooves, possibly controlled by amino acids at key positions, is also demonstrated in celiac disease and rheumatoid arthritis ( 379 ).

**TABLE 23.13. Associations between Certain HLA Markers and Disease**

| Disease   | Associated HLA Antigens and Alleles | Relative Risk |
|---|-------------------------------------|---------------|
| Birdshot retinochoroidopathy                    | A29                                 | 109.0         |
| Ankylosing spondylitis                          | B27                                 | 87.4          |
| Reactive arthropathy, including Reiter syndrome | B27                                 | 37.0          |
| Dermatitis herpetiformis                        | DR3                                 | 15.9          |
| Idiopathic membranous glomerulonephritis        | DR3                                 | 12.0          |
| Celiac disease                                  | DR3                                 | 10.8          |
|   | DR7, DR11                           | 6.0–10.0      |
|   | DR7, DQB1*0201                      | Not assessed  |
|   | DR11, DQA1*0501                     |               |
|   | DQA1*0501                           |               |
| Sicca syndrome                                  | DQB1*0201                           |               |
|   | DR3                                 | 9.7           |
| Idiopathic Addison disease                      | DR3                                 | 6.3           |

|  |           |              |
|--|-----------|--------------|
| Systemic lupus erythematosus                 | DR3       | 5.8          |
| Grave disease                                | DR3       | 3.7          |
| Myasthenia gravis                            | DR3       | 2.5          |
|  | B8        | 3.4          |
| Type 1 diabetes mellitus (insulin dependent) | DR3       | 3.3          |
|  | DR4       | 6.4          |
|  | DR2       | 0.19         |
|  | DQB1*0302 | 9.5          |
|  | DQB1*0201 | 2.4          |
|  | DQB1*0602 | 0.15         |
|  | DRB*0101  | Not assessed |
|  | DRB*0101  |              |
| Goodpasture syndrome                         | DR2       | 15.9         |
| Multiple sclerosis                           | DR2       | 4.1          |
|  | DRB1*1501 | Not assessed |
|  | DRB5*0101 |              |
|  | DQB1*0602 |              |
| Pemphigus vulgaris (Ashkenazi Jews)          | DR4       | 14.1         |
| Postpartum thyroiditis                       | DR4       | 5.3          |
| Rheumatoid arthritis                         | DR4       | 4.2          |
| Behçet syndrome                              | B51       | 3.8          |
| Psoriasis vulgaris                           | Cw6       | 13.3         |
| Hashimoto disease                            | DR11      | 3.2          |

Modified from Klein J, Sato A. The HLA system. *N Engl J Med* 2000;343:782–786.

A specific HLA or haplotype is generally associated with susceptibility or resistance to a disease and does not directly play a role in the disease itself. Sometimes, the disease gene may be linked to HLA, probably due to linkage disequilibrium ([380](#), [381](#) and [382](#)). This is supported by observations of diseases associated with certain HLAs or haplotypes only within a family, but not in the general population. These associations may play a role in diseases such as leprosy and in MHC-linked immune response genes in PL

A1<sup>-</sup>negative/HLA-B8-DR3-positive individuals who develop PTP ([383](#), [384](#)). Although a number of mechanisms have been proposed to explain the association between certain diseases and specific HLAs, including cross-reactive antibody responses, linkage of an HLA locus with a non-HLA disease-associated gene, regulation of T-cell development, thymic selection of T-cell receptor repertoire on HLA molecules with self-peptides, and interaction of class II HLA molecules with superantigens (cross-reactive), the exact mechanisms are unknown.

## ACKNOWLEDGMENTS

Kathryn E. Webert and Howard H. W. Chan are supported by Fellowships in Transfusion Medicine with Canadian Blood Services. Nancy M. Heddle is an adjunct scientist with Canadian Blood Services. John G. Kelton is the recipient of a Canada Research Chair.

## REFERENCES

1. Reid ME, Yahalom V. Blood groups and their function. *Baillieres Best Pract Res Clin Haematol* 2000;13(4):485–509.
2. Daniels GL, Anstee DJ, Cartron JP, et al. International Society of Blood Transfusion Working Party on Terminology for Red Cell Surface Antigens. *Vox Sang* 2001;80(3):193–197.
3. Yamamoto F, Hakomori S. Sugar–nucleotide donor specificity of histo–blood group A and B transferases is based on amino acid substitutions. *J Biol Chem* 1990;265(31):19257–19262.
4. Cartron JP. [Quantitative and thermodynamic study of weak A erythrocyte phenotypes]. *Rev Fr Transfus Immunohematol* 1976;19(1):35–54.
5. Poschmann A, Fischer K, Seidl S, Spielmann W. ABH receptors and red cell survival in a ‘Bombay’ blood. Immunofluorescence studies by phytohemagglutinins and Helix agglutinins. *Vox Sang* 1974;27(4):338–346.
6. Reid ME, Bird GW. Associations between human red cell blood group antigens and disease. *Transfus Med Rev* 1990;4(1):47–55.
7. Gill JC, Endres–Brooks J, Bauer PJ, et al. The effect of ABO blood group on the diagnosis of von Willebrand disease. *Blood* 1987;69(6):1691–1695.
8. Springer GF, Horton RE. Blood group isoantibody stimulation in man by feeding blood group–active bacteria. *J Clin Invest* 1969;48(7):1280–1291.
9. Fong SW, Qaundah BY, Taylor WF. Developmental patterns of ABO isoagglutinins in normal children correlated with the effects of age, sex, and maternal isoagglutinins. *Transfusion* 1974;14(6):551–559.
10. Somers H, Kuhns WJ. Blood group antibodies in old age. *Proc Soc Exp Biol Med* 1972;141(3):1104–1107.
11. Roath S, Todd CE, Shaw D. Transient acquired blood group B antigen associated with diverticular bowel disease. *Acta Haematol* 1987;77(3):188–190.
12. Anstee DJ, Tanner MJ. Biochemical aspects of the blood group Rh (rhesus) antigens. *Baillieres Clin Haematol* 1993;6(2):401–422.
13. Weiner AS. Genetic theory of the Rh blood types. *Proceedings of the Society of Experimental Biology, New York* 1943;54:316–319.
14. Race RR. An ‘incomplete’ antibody in human serum. *Nature* 1944;153:771–772.
15. Rosenfield RE, Allen FH, Jr., Swisher SN, Kochwas S. A review of Rh serology and presentation of a new terminology. *Transfusion* 1962;2:287–312.
16. AABB Technical Manual. 14th ed. Bethesda, Maryland: American Association of Blood Banks, 2002.
17. Denomme GA, Rios M, Reid ME. *Molecular protocols in transfusion medicine*. San Diego: Academic Press, 2000.
18. Westhoff CM, Reid ME. Rh, Kell, Duffy, and Kidd blood group systems. In: Hillyer CD, Silberstein LE, Ness PM, Anderson KC, eds. *Blood banking and transfusion medicine: basic principles and practice*. Philadelphia: Churchill Livingstone, 2003:31–46.
19. Okuda H, Kawano M, Iwamoto S, et al. The RHD gene is highly detectable in RhD–negative Japanese donors. *J Clin Invest* 1997;100(2):373–379.
20. Singleton BK, Green CA, Avent ND, et al. The presence of an RHD pseudogene containing a 37 base pair duplication and a nonsense mutation in Africans with the Rh D–negative blood group phenotype. *Blood* 2000;95(1):12–18.
21. Huang CH, Chen Y, Reid ME, Seidl C. Rhnull disease: the amorph type results from a novel double

- mutation in RhCe gene on D-negative background. *Blood* 1998;92(2):664-671.
22. Tippett P. Regulator genes affecting red cell antigens. *Transfus Med Rev* 1990;4(1):56-68.
  23. Quinley ED. *Immunohematology: principles and practice*. Philadelphia: Lippincott, 1993.
  24. Lee S, Lin M, Mele A, et al. Proteolytic processing of big endothelin-3 by the Kell blood group protein. *Blood* 1999;94(4):1440-1450.
  25. Russo D, Redman C, Lee S. Association of XK and Kell blood group proteins. *J Biol Chem* 1998;273(22):13950-13956.
  26. Redman CM, Russo D, Lee S. Kell, Kx and the McLeod syndrome. *Baillieres Best Pract Res Clin Haematol* 1999;12(4):621-635.
  27. Vaughan JI, Warwick R, Letsky E, et al. Erythropoietic suppression in fetal anemia because of Kell alloimmunization. *Am J Obstet Gynecol* 1994;171(1):247-252.
  28. Weiner CP, Widness JA. Decreased fetal erythropoiesis and hemolysis in Kell hemolytic anemia. *Am J Obstet Gynecol* 1996;174(2):547-551.
  29. Horuk R, Chitnis CE, Darbonne WC, et al. A receptor for the malarial parasite *Plasmodium vivax*: the erythrocyte chemokine receptor. *Science* 1993;261(5125):1182-1184.
  30. Allen FH, Diamond LK, Niedziela B. A new blood-group antigen. *Nature* 1951;167:482.
  31. Lucien N, Sidoux-Walter F, Roudier N, et al. Antigenic and functional properties of the human red blood cell urea transporter hUT-B1. *J Biol Chem* 2002;277(37):34101-34108.
  32. Reid ME, Westhoff CM. Other blood group systems and antigens. In: Hillyer CD, Silberstein LE, Ness PM, Anderson KC, eds. *Blood banking and transfusion medicine: basic principles and practice*. Philadelphia: Churchill Livingstone, 2003:47-61.
  33. Heaton DC, McLoughlin K. Jk(a-b-) red blood cells resist urea lysis. *Transfusion* 1982;22(1):70-71.
  34. Levine P. A review of Landsteiner's contributions to human blood groups. *Transfusion* 1961;1:45-52.
  35. Garratty G, Dzik W, Issitt PD, et al. Terminology for blood group antigens and genes-historical origins and guidelines in the new millennium. *Transfusion* 2000;40(4):477-489.
  36. Hadley TJ, Miller LH, Haynes JD. Recognition of red cells by malaria parasites: the role of erythrocyte-binding proteins. *Transfus Med Rev* 1991;5(2):108-122.
  37. Tomita A, Radike EL, Parker CJ. Isolation of erythrocyte membrane inhibitor of reactive lysis type II. Identification as glycophorin A. *J Immunol* 1993;151(6):3308-3323.
  38. Furlong MB, Jr., Monaghan WP. Delayed hemolytic episodes due to anti-M. *Transfusion* 1981;21(1):45-49.
  39. Thompson DJ, Stults DZ, Daniel SJ. Anti-M antibody in pregnancy. *Obstet Gynecol Surv* 1989;44(9):637-641.
  40. Lin SW, Lin DT, Hsieh SW, et al. Hemolytic disease of the newborn caused by anti-M antibody. *J Formos Med Assoc* 1996;95(5):390-392.
  41. Alperin JB, Riglin H, Branch DR, et al. Anti-M causing delayed hemolytic transfusion reaction. *Transfusion* 1983;23(4):322-324.
  42. Chandeysson PL, Flye MW, Simpkins SM, Holland PV. Delayed hemolytic transfusion reaction caused by anti-P1 antibody. *Transfusion* 1981;21(1):77-82.
  43. Westhoff CM, Reid ME. ABO and related antigens. In: Hillyer CD, Silberstein LE, Ness PM, Anderson KC, eds. *Blood banking and transfusion medicine: basic principles and practice*. Philadelphia: Churchill

Livingstone, 2003:21–30.

44. Levene C, Sela R, Rudolphson Y, et al. Hemolytic disease of the newborn due to anti-PP1 P k (anti-Tj a). *Transfusion* 1977;17(6):568–572.
45. Telen MJ. Red cell antigens. In: Anderson KC, Ness PM, eds. *Scientific basis of transfusion medicine: implications for clinical practice*. Philadelphia: WB Saunders, 2000:145–162.
46. Udani M, Zen Q, Cottman M, et al. Basal cell adhesion molecule/Lutheran protein. The receptor critical for sickle cell adhesion to laminin. *J Clin Invest* 1998;101(11):2550–2558.
47. Dube VE, Zoes CS. Subclinical hemolytic disease of the newborn associated with IgG anti-Lub. *Transfusion* 1982;22(3):251–253.
48. Molthan L. Lewis phenotypes of American Caucasians, American Negroes and their children. *Vox Sang* 1980;39(6):327–330.
49. Reguigne–Arnould I, Couillin P, Mollicone R, et al. Relative positions of two clusters of human alpha-L-fucosyltransferases in 19q (FUT1–FUT2) and 19p (FUT6–FUT3–FUT5) within the microsatellite genetic map of chromosome 19. *Cytogenet Cell Genet* 1995;71(2):158–162.
50. Orntoft TF, Vestergaard EM, Holmes E, et al. Influence of Lewis alpha1–3/4–L-fucosyltransferase (FUT3) gene mutations on enzyme activity, erythrocyte phenotyping, and circulating tumor marker sialyl-Lewis a levels. *J Biol Chem* 1996;271(50):32260–32268.
51. Pang H, Koda Y, Soejima M, Kimura H. Significance of each of three missense mutations, G484A, G667A, and G808A, present in an inactive allele of the human Lewis gene (FUT3) for alpha(1,3/1,4)fucosyltransferase inactivation. *Glycoconj J* 1998;15(10):961–967.
52. Kukowska–Latallo JF, Larsen RD, Nair RP, Lowe JB. A cloned human cDNA determines expression of a mouse stage–specific embryonic antigen and the Lewis blood group alpha(1,3/1,4)fucosyltransferase. *Genes Dev* 1990;4(8):1288–1303.
53. Marcus DM, Cass LE. Glycosphingolipids with Lewis blood group activity: uptake by human erythrocytes. *Science* 1969;164(879):553–555.
54. Simoons–Smit IM, Appelmek BJ, Verboom T, et al. Typing of *Helicobacter pylori* with monoclonal antibodies against Lewis antigens in lipopolysaccharide. *J Clin Microbiol* 1996;34(9):2196–2200.
55. Appelmek BJ, Simoons–Smit I, Negrini R, et al. Potential role of molecular mimicry between *Helicobacter pylori* lipopolysaccharide and host Lewis blood group antigens in autoimmunity. *Infect Immun* 1996;64(6):2031–2040.
56. Guruge JL, Falk PG, Lorenz RG, et al. Epithelial attachment alters the outcome of *Helicobacter pylori* infection. *Proc Natl Acad Sci U S A* 1998;95(7):3925–3930.
57. Heneghan MA, McCarthy CF, Moran AP. Relationship of blood group determinants on *Helicobacter pylori* lipopolysaccharide with host Lewis phenotype and inflammatory response. *Infect Immun* 2000;68(2):937–941.
58. Heneghan MA, McCarthy CF, Janulaityte D, Moran AP. Relationship of anti–Lewis x and anti–Lewis y antibodies in serum samples from gastric cancer and chronic gastritis patients to *Helicobacter pylori*–mediated autoimmunity. *Infect Immun* 2001;69(8):4774–4781.
59. Boren T, Falk P, Roth KA, Larson G, Normark S. Attachment of *Helicobacter pylori* to human gastric epithelium mediated by blood group antigens. *Science* 1993;262(5141):1892–1895.
60. Ilver D, Arnqvist A, Ogren J, et al. *Helicobacter pylori* adhesin binding fucosylated histo–blood group antigens revealed by retagging. *Science* 1998; 279(5349):373–377.
61. Clyne M, Drumm B. Absence of effect of Lewis A and Lewis B expression on adherence of *Helicobacter pylori* to human gastric cells. *Gastroenterology* 1997;113(1):72–80.
62. Hein HO, Suadicani P, Gyntelberg F. Genetic markers for peptic ulcer. A study of 3387 men aged 54

- to 74 years: the Copenhagen Male Study. *Scand J Gastroenterol* 1997;32(1):16–21.
63. Niv Y, Fraser G, Delpre G, et al. *Helicobacter pylori* infection and blood groups. *Am J Gastroenterol* 1996;91(1):101–104.
64. Umlauf F, Keeffe EB, Offner F, et al. *Helicobacter pylori* infection and blood group antigens: lack of clinical association. *Am J Gastroenterol* 1996;91(10):2135–2138.
65. Garratty G. Blood group antigens as tumor markers, parasitic/bacterial/viral receptors, and their association with immunologically important proteins. *Immunol Invest* 1995;24(1–2):213–232.
66. Zelinski T. Erythrocyte band 3 antigens and the Diego Blood Group System. *Transfus Med Rev* 1998;12(1):36–45.
67. Layrisse M, Arends T, Dominguez Sisco R. Nuevo grupo sanguineo encontrado endescendientes de Indios. *Acta Med Venez* 1955;3:471–474.
68. Alves de Lima LM, Berthier ME, Sad WE, et al. Characterization of an anti-Dia antibody causing hemolytic disease in a newborn infant. *Transfusion* 1982;22(3):246–247.
69. Monestier M, Rigal D, Meyer F, et al. [Hemolytic disease of newborn infants caused by anti-Diego antibodies]. *Arch Fr Pediatr* 1984;41(9):641–643.
70. Kusnierz-Alejska G, Bochenek S. Haemolytic disease of the newborn due to anti-Dia and incidence of the Dia antigen in Poland. *Vox Sang* 1992;62(2):124–126.
71. Chen CC, Broadberry RE, Chang FC, et al. Hemolytic disease of the newborn caused by maternal anti-Dib: a case report in Taiwan. *Zhonghua Yi Xue Za Zhi (Taipei)* 1993;52(4):262–264.
72. Hinckley ME, Huestis DW. Case report. An immediate hemolytic transfusion reaction apparently caused by anti-Dia. *Rev Fr Transfus Immunohematol* 1979;22(5):581–585.
73. Spring FA, Gardner B, Anstee DJ. Evidence that the antigens of the Yt blood group system are located on human erythrocyte acetylcholinesterase. *Blood* 1992;80(8):2136–2141.
74. Levene C, Bar-Shany S, Manny N, et al. The Yt blood groups in Israeli Jews, Arabs, and Druse. *Transfusion* 1987;27(6):471–474.
75. Mann JD, Cahan A, Gelb AG, et al. A sex-linked blood group. *Lancet* 1962;1:8–10.
76. Reid ME, Lomas-Francis C. *The Blood Group Antigen Facts Book*. San Diego: Academic Press, 1996.
77. DeMarco M, Uhl L, Fields L, et al. Hemolytic disease of the newborn due to the Scianna antibody, anti-Sc2. *Transfusion* 1995;35(1):58–60.
78. Eiberg H, Mohr J. Dombrock blood group (DO): assignment to chromosome 12p. *Hum Genet* 1996;98(5):518–521.
79. Telen MJ, Rosse WF, Parker CJ, et al. Evidence that several high-frequency human blood group antigens reside on phosphatidylinositol-linked erythrocyte membrane proteins. *Blood* 1990;75(7):1404–1407.
80. Spring FA, Reid ME. Evidence that the human blood group antigens Gya and Hy are carried on a novel glycosylphosphatidylinositol-linked erythrocyte membrane glycoprotein. *Vox Sang* 1991;60(1):53–59.
81. Spring FA, Reid ME, Nicholson G. Evidence for expression of the Joa blood group antigen on the Gya/Hy-active glycoprotein. *Vox Sang* 1994;66(1):72–77.
82. Gubin AN, Njoroge JM, Wojda U, et al. Identification of the Dombrock blood group glycoprotein as a polymorphic member of the ADP-ribosyltransferase gene family. *Blood* 2000;96(7):2621–2627.
83. Reid ME. The Dombrock blood group system: a review. *Transfusion* 2003;43(1):107–114.
84. Banks JA, Hemming N, Poole J. Evidence that the Gya, Hy and Joa antigens belong to the Dombrock



blood group system. *Vox Sang* 1995;68(3):177–182.

85. Halverson G, Shanahan E, Santiago I, et al. The first reported case of anti-Dob causing an acute hemolytic transfusion reaction. *Vox Sang* 1994;66(3):206–209.

86. Reid ME, Oyen R, Marsh WL. Summary of the clinical significance of blood group alloantibodies. *Semin Hematol* 2000;37(2):197–216.

87. Bailly P, Tontti E, Hermand P, et al. The red cell LW blood group protein is an intercellular adhesion molecule which binds to CD11/CD18 leukocyte integrins. *Eur J Immunol* 1995;25(12):3316–3320.

88. Mallinson G, Martin PG, Anstee DJ, et al. Identification and partial characterization of the human erythrocyte membrane component(s) that express the antigens of the LW blood-group system. *Biochem J* 1986;234(3):649–652.

89. Giles CM. The LW blood group: a review. *Immunol Commun* 1980;9(2):225–242.

90. Harris JP, Tegoli J, Swanson J, et al. A nebulous antibody responsible for cross-matching difficulties (Chido). *Vox Sang* 1967;12(2):140–142.

91. O'Neill GJ, Yang SY, Tegoli J, et al. Chido and Rodgers blood groups are distinct antigenic components of human complement C4. *Nature* 1978;273(5664):668–670.

92. O'Neill GJ. The genetic control of Chido and Rodgers blood group substances. *Semin Hematol* 1981;18(1):32–38.

93. Tilley CA, Romans DG, Crookston MC. Localization of Chido and Rodgers determinants to the C4d fragment of human C4. *Nature* 1978;276(5689):713–715.

94. Daniels G. Blood group antigens as markers of complement and complement regulatory molecules. In: Cartron JP, Rouger P, eds. *Molecular basis of human blood group antigens*. New York: Plenum Press, 1995:397–419.

95. Constans J, Bernard P, Bioulac-Sage P, et al. [Familial autoimmune hepatitis and C4 deficiency]. *Rev Med Intern* 1998;19(10):731–733.

96. Sullivan KE. Complement deficiency and autoimmunity. *Curr Opin Pediatr* 1998;10(6):600–606.

97. Moulds JM, Warner NB, Arnett FC. Complement component C4A and C4B levels in systemic lupus erythematosus: quantitation in relation to C4 null status and disease activity. *J Rheumatol* 1993;20(3):443–447.

98. Lambin P, Le Pennec PY, Hauptmann G, et al. Adverse transfusion reactions associated with a precipitating anti-C4 antibody of anti-Rodgers specificity. *Vox Sang* 1984;47(3):242–249.

99. Westhoff CM, Sipherd BD, Wylie DE, Toalson LD. Severe anaphylactic reactions following transfusions of platelets to a patient with anti-Ch. *Transfusion* 1992;32(6):576–579.

100. Daniels G, Hadley A. Blood groups on red cells, platelets and neutrophils. In: Wsickramasinghe SN, McCullough J, eds. *Blood and bone marrow pathology*. London: Elsevier Science, 2003:615–635.

101. Daniels G. *Human blood groups*. Oxford: Blackwell Science, 1995.

102. Issitt PD. Race-related red cell alloantibody problems. *Br J Biomed Sci* 1994;51(2):158–167.

103. Redman CM, Lee S. The Kell blood group system. *Transfus Clin Biol* 1995;2(4):243–249.

104. Redman CM, Marsh WL. The Kell blood group system and the McLeod phenotype. *Semin Hematol* 1993;30(3):209–218.

105. Marsh WL, Redman CM. Recent developments in the Kell blood group system. *Transfus Med Rev* 1987;1(1):4–20.

106. Russo DC, Oyen R, Powell VI, et al. First example of anti-Kx in a person with the McLeod phenotype and without chronic granulomatous disease. *Transfusion* 2000;40(11):1371-1375.
107. Sullivan CM, Kline WE, Rabin BI, et al. The first example of autoanti-Kx. *Transfusion* 1987;27(4):322-324.
108. Daniels G. Functional aspects of red cell antigens. *Blood Rev* 1999;13(1):14-35.
109. Anstee DJ, Tanner MJ. Blood group antigen deficiencies associated with abnormal red cell shape. *Blood Rev* 1988;2(2):115-120.
110. Maier AG, Duraisingh MT, Reeder JC, et al. Plasmodium falciparum erythrocyte invasion through glycophorin C and selection for Gerbich negativity in human populations. *Nat Med* 2003;9(1):87-92.
111. Sacks DA, Johnson CS, Platt LD. Isoimmunization in pregnancy to Gerbich antigen. *Am J Perinatol* 1985;2(3):208-210.
112. Daniels GL, Anstee DJ, Cartron JP, et al. Terminology for red cell surface antigens. ISBT Working Party Oslo Report. International Society of Blood Transfusion. *Vox Sang* 1999;77(1):52-57.
113. Telen MJ, Green AM. The Inab phenotype: characterization of the membrane protein and complement regulatory defect. *Blood* 1989;74(1):437-441.
114. Ng YC, Schifferli JA, Walport MJ. Immune complexes and erythrocyte CR1 (complement receptor type 1): effect of CR1 numbers on binding and release reactions. *Clin Exp Immunol* 1988;71(3):481-485.
115. Parsons SF, Jones J, Anstee DJ, et al. A novel form of congenital dyserythropoietic anemia associated with deficiency of erythroid CD44 and a unique blood group phenotype [In(a-b-), Co(a-b-)]. *Blood* 1994;83(3):860-868.
116. Joshi SR. Immediate haemolytic transfusion reaction due to anti-Inb. *Vox Sang* 1992;63(3):232-233.
117. Ghebrehiwet B, Lu PD, Zhang W, et al. Identification of functional domains on gC1Q-R, a cell surface protein that binds to the globular "heads" of C1Q, using monoclonal antibodies and synthetic peptides. *Hybridoma* 1996;15(5):333-342.
118. Seulberger H, Unger CM, Risau W. HT7, Neurothelin, Basigin, gp42 and OX-47—many names for one developmentally regulated immuno-globulin-like surface glycoprotein on blood-brain barrier endothelium, epithelial tissue barriers and neurons. *Neurosci Lett* 1992;140(1):93-97.
119. Daniels GL, Levene C, Berrebi A, et al. Human alloantibodies detecting a red cell antigen apparently identical to MER2. *Vox Sang* 1988;55(3):161-164.
120. Mudar R, Rao N, Issitt PD, et al. JMH variants: serologic, clinical, and biochemical analyses in two cases. *Transfusion* 1995;35(11):925-930.
121. International Society of Blood Transfusion working party on terminology for red cell antigens web site: <http://www.iccbba.com/wpantigentables.htm> (Last updated September 2000). 2000. Accessed January 5, 2003.
122. Weiner AS, Unger LJ, Cohen L, Feldman J. Type-specific cold auto-antibodies as a cause of acquired hemolytic anemia and hemolytic transfusion reactions: biologic test with bovine red cells. *Ann Intern Med* 1956;44:221-240.
123. Hakomori S. Blood group ABH and Ii antigens of human erythrocytes: chemistry, polymorphism, and their developmental change. *Semin Hematol* 1981;18(1):39-62.
124. Yu LC, Twu YC, Chang CY, Lin M. Molecular basis of the adult i phenotype and the gene responsible for the expression of the human blood group I antigen. *Blood* 2001;98(13):3840-3845.
125. Gerbal A, Maslet C, Salmon C. Immunological aspects of the acquired B antigen. *Vox Sang*

1975;28(5):398–403.

126. Gehrs BC, Friedberg RC. Autoimmune hemolytic anemia. *Am J Hematol* 2002;69(4):258–271.

127. Warkentin TE, Smith JW. The alloimmune thrombocytopenic syndromes. *Transfus Med Rev* 1997;11(4):296–307.

128. Venter JC, Adams MD, Myers EW, et al. The sequence of the human genome. *Science* 2001;291(5507):1304–1351.

129. Cargill M, Altshuler D, Ireland J, et al. Characterization of single-nucleotide polymorphisms in coding regions of human genes. *Nat Genet* 1999;22(3):231–238.

130. Halushka MK, Mathews DJ, Bailey JA, Chakravarti A. GIST: A web tool for collecting gene information. *Physiol Genomics* 1999;1(2):75–81.

131. dem Borne AE, Decary F. Nomenclature of platelet-specific antigens. *Transfusion* 1990;30(5):477.

132. Newman PJ. Nomenclature of human platelet alloantigens: a problem with the HPA system? *Blood* 1994;83(6):1447–1451.

133. Phillips DR, Charo IF, Parise LV, Fitzgerald LA. The platelet membrane glycoprotein IIb–IIIa complex. *Blood* 1988;71(4):831–843.

134. Bray PF, Shuman MA. Identification of an abnormal gene for the GPIIIa subunit of the platelet fibrinogen receptor resulting in Glanzmann's thrombasthenia. *Blood* 1990;75(4):881–888.

135. Nurden AT, Nurden P. Inherited defects of platelet function. *Rev Clin Exp Hematol* 2001;5(4):314–334.

136. Bray PF, Rosa JP, Johnston GI, et al. Platelet glycoprotein IIb. Chromosomal localization and tissue expression. *J Clin Invest* 1987;80(6):1812–1817.

137. Wilhide CC, Jin Y, Guo Q, et al. The human integrin beta3 gene is 63 kb and contains a 5'-UTR sequence regulating expression. *Blood* 1997;90(10):3951–3961.

138. Zimrin AB, Eisman R, Vilaire G, et al. Structure of platelet glycoprotein IIIa. A common subunit for two different membrane receptors. *J Clin Invest* 1988;81(5):1470–1475.

139. Zimrin AB, Gidwitz S, Lord S, et al. The genomic organization of platelet glycoprotein IIIa. *J Biol Chem* 1990;265(15):8590–8595.

140. Jin Y, Wilhide CC, Dang C, et al. Human integrin beta3 gene expression: evidence for a megakaryocytic cell-specific cis-acting element. *Blood* 1998;92(8):2777–2790.

141. Albelda SM, Buck CA. Integrins and other cell adhesion molecules. *FASEB J* 1990;4(11):2868–2880.

142. Diamond MS, Springer TA. The dynamic regulation of integrin adhesiveness. *Curr Biol* 1994;4(6):506–517.

143. Hemler ME. VLA proteins in the integrin family: structures, functions, and their role on leukocytes. *Annu Rev Immunol* 1990;8:365–400.

144. Lawler J, Hynes RO. An integrin receptor on normal and thrombasthenic platelets that binds thrombospondin. *Blood* 1989;74(6):2022–2027.

145. Ruoslahti E, Engvall E. Integrins and vascular extracellular matrix assembly. *J Clin Invest* 1997;99(6):1149–1152.

146. Kehrel B. Platelet-collagen interactions. *Semin Thromb Hemost* 1995;21(2):123–129.

147. Saelman EU, Nieuwenhuis HK, Hese KM, et al. Platelet adhesion to collagen types I through VIII under conditions of stasis and flow is mediated by GPIa/IIa (alpha 2 beta 1-integrin). *Blood*

1994;83(5):1244–1250.

148. Kritzik M, Savage B, Nugent DJ, et al. Nucleotide polymorphisms in the alpha2 gene define multiple alleles that are associated with differences in platelet alpha2 beta1 density. *Blood* 1998;92(7):2382–2388.

149. Kunicki TJ, Orzechowski R, Annis D, Honda Y. Variability of integrin alpha 2 beta 1 activity on human platelets. *Blood* 1993;82(9):2693–2703.

150. Kunicki TJ, Kritzik M, Annis DS, Nugent DJ. Hereditary variation in platelet integrin alpha 2 beta 1 density is associated with two silent polymorphisms in the alpha 2 gene coding sequence. *Blood* 1997;89(6):1939–1943.

151. Smith JW, Hayward CP, Horsewood P, et al. Characterization and localization of the Gov<sup>a/b</sup> alloantigens to the glycosylphosphatidylinositol-anchored protein CDw109 on human platelets. *Blood* 1995;86(7):2807–2814.

152. Lin M, Sutherland DR, Horsfall W, et al. Cell surface antigen CD109 is a novel member of the alpha(2) macroglobulin/C3, C4, C5 family of thioester-containing proteins. *Blood* 2002;99(5):1683–1691.

153. Kelton JG, Smith JW, Horsewood P, et al. Gov<sup>a/b</sup> alloantigen system on human platelets. *Blood* 1990;75(11):2172–2176.

154. Sutherland DR, Yeo E, Ryan A, et al. Identification of a cell-surface antigen associated with activated T lymphoblasts and activated platelets. *Blood* 1991;77(1):84–93.

155. Modderman PW, Admiraal LG, Sonnenberg A, de Borne AE. Glycoproteins V and Ib-IX form a noncovalent complex in the platelet membrane. *J Biol Chem* 1992;267(1):364–369.

156. Clemetson KJ, Wenger RH, Wicki AN, et al. Molecular biology of human platelet membrane glycoprotein Ib. *Prog Clin Biol Res* 1990;356:77–88.

157. Kelly MD, Essex DW, Shapiro SS, et al. Complementary DNA cloning of the alternatively expressed endothelial cell glycoprotein Ib beta (GPIb beta) and localization of the GPIb beta gene to chromosome 22. *J Clin Invest* 1994;93(6):2417–2424.

158. Yagi M, Edelhoff S, Distechè CM, Roth GJ. Human platelet glycoproteins V and IX: mapping of two leucine-rich glycoprotein genes to chromosome 3 and analysis of structures. *Biochemistry* 1995;34(49):16132–16137.

159. Andrews RK, Shen Y, Gardiner EE, et al. The glycoprotein Ib-IX-V complex in platelet adhesion and signaling. *Thromb Haemost* 1999;82(2):357–364.

160. Rivera J, Lozano ML, Corral J, et al. Platelet GP Ib/IX/V complex: physiological role. *J Physiol Biochem* 2000;56(4):355–365.

161. Titani K, Takio K, Handa M, Ruggeri ZM. Amino acid sequence of the von Willebrand factor-binding domain of platelet membrane glycoprotein Ib. *Proc Natl Acad Sci U S A* 1987;84(16):5610–5614.

162. Vicente V, Houghten RA, Ruggeri ZM. Identification of a site in the alpha chain of platelet glycoprotein Ib that participates in von Willebrand factor binding. *J Biol Chem* 1990;265(1):274–280.

163. Drouin J, McGregor JL, Parmentier S, et al. Residual amounts of glycoprotein Ib concomitant with near-absence of glycoprotein IX in platelets of Bernard-Soulier patients. *Blood* 1988;72(3):1086–1088.

164. Lopez JA, Andrews RK, Afshar-Kharghan V, Berndt MC. Bernard-Soulier syndrome. *Blood* 1998;91(12):4397–4418.

165. Ware J, Russell SR, Vicente V, et al. Nonsense mutation in the glycoprotein Ib alpha coding sequence associated with Bernard-Soulier syndrome. *Proc Natl Acad Sci U S A* 1990;87(5):2026–2030.

166. Lopez JA, Dong JF. Structure and function of the glycoprotein Ib-IX-V complex. *Curr Opin Hematol* 1997;4(5):323–329.

167. Mueller-Eckhardt C, Kiefel V, Grubert A, et al. 348 cases of suspected neonatal alloimmune thrombocytopenia. *Lancet* 1989;1(8634):363–366.
168. Newman PJ, Derbes RS, Aster RH. The human platelet alloantigens, PIA1 and PIA2, are associated with a leucine33/proline33 amino acid polymorphism in membrane glycoprotein IIIa, and are distinguishable by DNA typing. *J Clin Invest* 1989;83(5):1778–1781.
169. Unkelbach K, Kalb R, Breitfeld C, et al. New polymorphism on platelet glycoprotein IIIa gene recognized by endonuclease Msp I: implications for PI<sup>A</sup> typing by allele-specific restriction analysis. *Transfusion* 1994;34(7):592–595.
170. Walchshofer S, Ghali D, Fink M, et al. A rare leucine 40/arginine40 polymorphism on platelet glycoprotein IIIa is linked to the human platelet antigen 1b. *Vox Sang* 1994;67(2):231–234.
171. Beer J, Coller BS. Evidence that platelet glycoprotein IIIa has a large disulfide-bonded loop that is susceptible to proteolytic cleavage. *J Biol Chem* 1989;264(29):17564–17573.
172. Honda S, Honda Y, Bauer B, et al. The impact of three-dimensional structure on the expression of PI<sup>A</sup> alloantigens on human integrin beta 3. *Blood* 1995;86(1):234–242.
173. Valentin N, Visentin GP, Newman PJ. Involvement of the cysteine-rich domain of glycoprotein IIIa in the expression of the human platelet alloantigen, PI<sup>A1</sup>: evidence for heterogeneity in the humoral response. *Blood* 1995;85(11):3028–3033.
174. Calvete JJ, Arias J, Alvarez MV, et al. Further studies on the topography of the N-terminal region of human platelet glycoprotein IIIa. Localization of monoclonal antibody epitopes and the putative fibrinogen-binding sites. *Biochem J* 1991;274(Pt 2):457–463.
175. Watkins NA, Schaffner-Reckinger E, Allen DL, et al. HPA-1a phenotype-genotype discrepancy reveals a naturally occurring Arg93Gln substitution in the platelet beta 3 integrin that disrupts the HPA-1a epitope. *Blood* 2002;99(5):1833–1839.
176. Furihata K, Nugent DJ, Bissonette A, et al. On the association of the platelet-specific alloantigen, Pen<sup>a</sup>, with glycoprotein IIIa. Evidence for heterogeneity of glycoprotein IIIa. *J Clin Invest* 1987;80(6):1624–1630.
177. van Leeuwen EF, Leeksa OC, van Mourik JA, et al. Effect of the binding of anti-Zw<sup>a</sup> antibodies on platelet function. *Vox Sang* 1984;47(4):280–289.
178. Santoso S, Kalb R, Walka M, et al. The human platelet alloantigens Br(a) and Br(b) are associated with a single amino acid polymorphism on glycoprotein Ia (integrin subunit alpha 2). *J Clin Invest* 1993;92(5):2427–2432.
179. Bordin JO, Kelton JG, Warner MN, et al. Maternal immunization to Gov system alloantigens on human platelets. *Transfusion* 1997;37(8):823–828.
180. Berry JE, Murphy CM, Smith GA, et al. Detection of Gov system antibodies by MAIPA reveals an immunogenicity similar to the HPA-5 alloantigens. *Br J Haematol* 2000;110(3):735–742.
181. Schuh AC, Watkins NA, Nguyen Q, et al. A tyrosine703serine polymorphism of CD109 defines the Gov platelet alloantigens. *Blood* 2002;99(5):1692–1698.
182. Lyman S, Aster RH, Visentin GP, Newman PJ. Polymorphism of human platelet membrane glycoprotein IIb associated with the Bak<sup>a</sup>/Bak<sup>b</sup> alloantigen system. *Blood* 1990;75(12):2343–2348.
183. Djaffar I, Vilette D, Pidard D, et al. Human platelet antigen 3 (HPA-3): localization of the determinant of the alloantibody Lek(a) (HPA-3a) to the C-terminus of platelet glycoprotein IIb heavy chain and contribution of O-linked carbohydrates. *Thromb Haemost* 1993;69(5):485–489.
184. Take H, Tomiyama Y, Shibata Y, et al. Demonstration of the heterogeneity of epitopes of the

- platelet-specific alloantigen, Baka. *Br J Haematol* 1990;76(3):395-400.
185. Bizzaro N, Dianese G. Neonatal alloimmune megakaryocytosis. Case report. *Vox Sang* 1988;54(2):112-114.
186. Ishida F, Saji H, Maruya E, Furihata K. Human platelet-specific antigen, Siba, is associated with the molecular weight polymorphism of glycoprotein Ib alpha. *Blood* 1991;78(7):1722-1729.
187. Kuijpers RW, Ouwehand WH, Bleeker PM, et al. Localization of the platelet-specific HPA-2 (Ko) alloantigens on the N-terminal globular fragment of platelet glycoprotein Ib alpha. *Blood* 1992;79(1):283-288.
188. Murata M, Furihata K, Ishida F, et al. Genetic and structural characterization of an amino acid dimorphism in glycoprotein Ib alpha involved in platelet transfusion refractoriness. *Blood* 1992;79(11):3086-3090.
189. Saji H, Maruya E, Fujii H, et al. New platelet antigen, Sib<sup>a</sup>, involved in platelet transfusion refractoriness in a Japanese man. *Vox Sang* 1989;56(4):283-287.
190. Li CQ, Dong JF, Lopez JA. The mucin-like macroglycopeptide region of glycoprotein Ib alpha is required for cell adhesion to immobilized von Willebrand factor (VWF) under flow but not for static VWF binding. *Thromb Haemost* 2002;88(4):673-677.
191. Mazzucato M, Pradella P, de A, et al. Frequency and functional relevance of genetic threonine145/methionine145 dimorphism in platelet glycoprotein Ib alpha in an Italian population. *Transfusion* 1996;36(10):891-894.
192. Lopez JA, Ludwig EH, McCarthy BJ. Polymorphism of human glycoprotein Ib alpha results from a variable number of tandem repeats of a 13-amino acid sequence in the mucin-like macroglycopeptide region. Structure/function implications. *J Biol Chem* 1992;267(14):10055-10061.
193. Ishida F, Furihata K, Ishida K, et al. The largest variant of platelet glycoprotein Ib alpha has four tandem repeats of 13 amino acids in the macroglycopeptide region and a genetic linkage with methionine145. *Blood* 1995;86(4):1357-1360.
194. Aramaki KM, Reiner AP. A novel isoform of platelet glycoprotein Ib alpha is prevalent in African Americans. *Am J Hematol* 1999;60(1):77-79.
195. Wang R, Furihata K, McFarland JG, et al. An amino acid polymorphism within the RGD binding domain of platelet membrane glycoprotein IIIa is responsible for the formation of the Pen<sup>a</sup>/Pen<sup>b</sup> alloantigen system. *J Clin Invest* 1992;90(5):2038-2043.
196. Kekomaki R, Jouhikainen T, Ollikainen J, et al. A new platelet alloantigen, Tu<sup>a</sup>, on glycoprotein IIIa associated with neonatal alloimmune thrombocytopenia in two families. *Br J Haematol* 1993;83(2):306-310.
197. McFarland JG, Blanchette V, Collins J, et al. Neonatal alloimmune thrombocytopenia due to a new platelet-specific alloantibody. *Blood* 1993;81(12):3318-3323.
198. Wang R, McFarland JG, Kekomaki R, Newman PJ. Amino acid 489 is encoded by a mutational "hot spot" on the beta 3 integrin chain: the CA/TU human platelet alloantigen system. *Blood* 1993;82(11):3386-3391.
199. Tanaka S, Taniue A, Nagao N, et al. Genotype frequencies of the human platelet antigen, Ca/Tu, in Japanese, determined by a PCR-RFLP method. *Vox Sang* 1996;70(1):40-44.
200. Kuijpers RW, Simsek S, Faber NM, et al. Single point mutation in human glycoprotein IIIa is associated with a new platelet-specific alloantigen (Mo) involved in neonatal alloimmune thrombocytopenia. *Blood* 1993;81(1):70-76.
201. Kroll H, Kiefel V, Santoso S, Mueller-Eckhardt C. Sr<sup>a</sup>, a private platelet antigen on glycoprotein IIIa associated with neonatal alloimmune thrombocytopenia. *Blood* 1990;76(11):2296-2302.
202. Noris P, Simsek S, Bruijne-Admiraal LG, et al. Max(a), a new low-frequency platelet-specific antigen localized on glycoprotein IIb, is associated with neonatal alloimmune thrombocytopenia. *Blood*

1995;86(3):1019–1026.

203. Peyruchaud O, Bourre F, Morel-Kopp MC, et al. HPA-10w(b) (La(a)): genetic determination of a new platelet-specific alloantigen on glycoprotein IIIa and its expression in COS-7 cells. *Blood* 1997;89(7):2422–2428.

204. Simsek S, Vlekke AB, Kuijpers RW, et al. A new private platelet antigen, Gro<sup>a</sup>, localized on glycoprotein IIIa, involved in neonatal alloimmune thrombocytopenia. *Vox Sang* 1994;67(3):302–306.

205. Simsek S, Folman C, van der Schoot CE, dem Borne AE. The Arg633His substitution responsible for the private platelet antigen Gro(a) unravelled by SSCP analysis and direct sequencing. *Br J Haematol* 1997;97(2):330–335.

206. Kiefel V, Vicariot M, Giovangrandi Y, et al. Alloimmunization against Iy, a low-frequency antigen on platelet glycoprotein Ib/IX as a cause of severe neonatal alloimmune thrombocytopenic purpura. *Vox Sang* 1995;69(3):250–254.

207. Sachs UJ, Kiefel V, Bohringer M, et al. Single amino acid substitution in human platelet glycoprotein Ibbeta is responsible for the formation of the platelet-specific alloantigen Iy(a). *Blood* 2000;95(5):1849–1855.

208. Ishida F, Ito T, Santoso S, et al. Low prevalence of a polymorphism of platelet membrane glycoprotein Ib beta associated with neonatal alloimmune thrombocytopenic purpura in Asian populations. *Int J Hematol* 1999;69(1):54–56.

209. Santoso S, Amrhein J, Hofmann HA, et al. A point mutation Thr(799)Met on the alpha(2) integrin leads to the formation of new human platelet alloantigen Sit(a) and affects collagen-induced aggregation. *Blood* 1999;94(12):4103–4111.

210. Santoso S, Kiefel V, Richter IG, et al. A functional platelet fibrinogen receptor with a deletion in the cysteine-rich repeat region of the beta(3) integrin: the Oe(a) alloantigen in neonatal alloimmune thrombocytopenia. *Blood* 2002;99(4):1205–1214.

211. Jallu V, Meunier M, Bremont M, Kaplan C. A new platelet polymorphism Duv(a+), localized within the RGD binding domain of glycoprotein IIIa, is associated with neonatal thrombocytopenia. *Blood* 2002;99(12):4449–4456.

212. Kekomaki R, Raivio P, Kero P. A new low-frequency platelet alloantigen, Va<sup>a</sup>, on glycoprotein IIbIIIa associated with neonatal alloimmune thrombocytopenia. *Transfus Med* 1992;2(1):27–33.

213. Tomiyama Y, Take H, Ikeda H, et al. Identification of the platelet-specific alloantigen, Nak<sup>a</sup>, on platelet membrane glycoprotein IV. *Blood* 1990;75(3):684–687.

214. Yanai H, Chiba H, Fujiwara H, et al. Phenotype-genotype correlation in CD36 deficiency types I and II. *Thromb Haemost* 2000;84(3):436–441.

215. Yamamoto N, Ikeda H, Tandon NN, et al. A platelet membrane glycoprotein (GP) deficiency in healthy blood donors: Nak<sup>a</sup>- platelets lack detectable GPIV (CD36). *Blood* 1990;76(9):1698–1703.

216. Kelton JG, Smith JW, Horsewood P, et al. ABH antigens on human platelets: expression on the glycosyl phosphatidylinositol-anchored protein CD109. *J Lab Clin Med* 1998;132(2):142–148.

217. Ogasawara K, Ueki J, Takenaka M, Furihata K. Study on the expression of ABH antigens on platelets. *Blood* 1993;82(3):993–999.

218. Stockelberg D, Hou M, Rydberg L, et al. Evidence for an expression of blood group A antigen on platelet glycoproteins IV and V. *Transfus Med* 1996;6(3):243–248.

219. Aster RH. Effect of anticoagulant and ABO incompatibility on recovery of transfused human platelets. *Blood* 1965;26(6):732–743.

220. Carr R, Hutton JL, Jenkins JA, et al. Transfusion of ABO-mismatched platelets leads to early platelet refractoriness. *Br J Haematol* 1990;75(3):408–413.



221. Dunstan RA, Mansbach CM. Biochemical characterization of A blood group activity on human platelets. *Vox Sang* 1985;49(2):149–153.
222. Kao KJ. Plasma and platelet HLA in normal individuals: quantitation by competitive enzyme-linked immunoassay. *Blood* 1987;70(1):282–286.
223. Kao KJ, Scornik JC, Riley WJ, McQueen CF. Association between HLA phenotype and HLA concentration in plasma or platelets. *Hum Immunol* 1988;21(2):115–124.
224. Snary D, Barnstable CJ, Bodmer WF, Crumpton MJ. Molecular structure of human histocompatibility antigens: the HLA-C series. *Eur J Immunol* 1977;7(8):580–585.
225. Davoren A, McParland P, Barnes CA, Murphy WG. Neonatal alloimmune thrombocytopenia in the Irish population: a discrepancy between observed and expected cases. *J Clin Pathol* 2002;55(4):289–292.
226. Bussel JB, Kunicki TJ, Michelson AD. Platelets: new understanding of platelet glycoproteins and their role in disease. *Hematology (Am Soc Hematol Educ Program)* 2000:222–240.
227. Maslanka K, Yassai M, Gorski J. Molecular identification of T cells that respond in a primary bulk culture to a peptide derived from a platelet glycoprotein implicated in neonatal alloimmune thrombocytopenia. *J Clin Invest* 1996;98(8):1802–1808.
228. Kuijpers RW, de Borne AE, Kiefel V, et al. Leucine33–proline33 substitution in human platelet glycoprotein IIIa determines HLA-DRw52a (Dw24) association of the immune response against HPA-1a (Zwa/PIA1) and HPA-1b (Zwb/PIA2). *Hum Immunol* 1992;34(4):253–256.
229. Uhrynowska M, Maslanka K, Zupanska B. Neonatal thrombocytopenia: incidence, serological and clinical observations. *Am J Perinatol* 1997;14(7):415–418.
230. Mueller-Eckhardt C, Santoso S, Kiefel V. Platelet alloantigens—molecular, genetic, and clinical aspects. *Vox Sang* 1994;67[Suppl 3]:89–93.
231. Semana G, Zazoun T, Alizadeh M, et al. Genetic susceptibility and anti-human platelet antigen 5b alloimmunization role of HLA class II and TAP genes. *Hum Immunol* 1996;46(2):114–119.
232. Santoso S, Kiefel V, Mueller-Eckhardt C. Immunochemical characterization of the new platelet alloantigen system Br<sup>a</sup>/Br<sup>b</sup>. *Br J Haematol* 1989;72(2):191–198.
233. Santoso S, Kiefel V. Human platelet alloantigens. *Wien Klin Wochenschr* 2001;113(20–21):806–813.
234. Warkentin TE, Smith JW, Hayward CP, et al. Thrombocytopenia caused by passive transfusion of anti-glycoprotein Ia/IIa alloantibody (anti-HPA-5b). *Blood* 1992;79(9):2480–2484.
235. Shulman NR, Aster RH, Leitner A, Hiller MC. Immunoreactions involving platelets. V. Post-transfusion purpura due to a complement fixing antibody against a genetically controlled platelet antigen. A proposed mechanism for thrombocytopenia and its relevance in autoimmunity. *J Clin Invest* 1961;40:1597–1620.
236. Scott EP, Moilan-Bergeland J, Dalmasso AP. Posttransfusion thrombocytopenia associated with passive transfusion of a platelet-specific antibody. *Transfusion* 1988;28(1):73–76.
237. Panzer S, Kiefel V, Bartram CR, et al. Immune thrombocytopenia more than a year after allogeneic marrow transplantation due to antibodies against donor platelets with anti-PI<sup>A1</sup> specificity: evidence for a host-derived immune reaction. *Br J Haematol* 1989;71(2):259–264.
238. Bierling P, Pignon JM, Kuentz M, et al. Thrombocytopenia after bone marrow transplantation caused by a recipient origin Br(a) allo-antibody: presence of mixed chimerism 3 years after the graft without hematologic relapse. *Blood* 1994;83(1):274–279.
239. Roy V, Verfaillie CM. Refractory thrombocytopenia due to anti-PL<sup>A1</sup> antibodies following autologous peripheral blood stem cell transplantation: case report and review of literature. *Bone Marrow Transplant*

1996;17(1):115–117.

240. West KA, Anderson DR, McAlister VC, et al. Alloimmune thrombocytopenia after organ transplantation. *N Engl J Med* 1999;341(20):1504–1507.

241. Friend PJ, McCarthy LJ, Filo RS, et al. Transmission of idiopathic (autoimmune) thrombocytopenic purpura by liver transplantation. *N Engl J Med* 1990;323(12):807–811.

242. Brand A, Sintnicolaas K, Claas FH, Eernisse JG. ABH antibodies causing platelet transfusion refractoriness. *Transfusion* 1986;26(5):463–466.

243. Heal JM, Blumberg N, Masel D. An evaluation of crossmatching, HLA, and ABO matching for platelet transfusions to refractory patients. *Blood* 1987;70(1):23–30.

244. Norol F, Nadjahi J, Bachir D, et al. [Transfusion and alloimmunization in sickle cell anemia patients]. *Transfus Clin Biol* 1994;1(1):27–34.

245. Langenscheidt F, Kiefel V, Santoso S, Mueller–Eckhardt C. Platelet transfusion refractoriness associated with two rare platelet–specific alloantibodies (anti–Bak<sup>a</sup> and anti–PI<sup>A2</sup>) and multiple HLA antibodies. *Transfusion* 1988;28(6):597–600.

246. Kekomaki R. Use of HLA– and HPA–matched platelets in alloimmunized patients. *Vox Sang* 1998;74[Suppl 2]:359–363.

247. Novotny VM. Platelet transfusion refractoriness—prevention and therapeutical approaches. *Transfus Clin Biol* 1995;2(1):47–49.

248. Rauch U, Osende JI, Fuster V, et al. Thrombus formation on atherosclerotic plaques: pathogenesis and clinical consequences. *Ann Intern Med* 2001;134(3):224–238.

249. Santoso S, Kiefel V. Human platelet–specific alloantigens: update. *Vox Sang* 1998;74[Suppl 2]:249–253.

250. Weiss EJ, Bray PF, Tayback M, et al. A polymorphism of a platelet glycoprotein receptor as an inherited risk factor for coronary thrombosis. *N Engl J Med* 1996;334(17):1090–1094.

251. Santoso S. Platelet polymorphisms in thrombotic disorders. *Transfus Clin Biol* 2001;8(3):261–266.

252. Michelson AD, Furman MI, Goldschmidt–Clermont P, et al. Platelet GP IIIa PI(A) polymorphisms display different sensitivities to agonists. *Circulation* 2000;101(9):1013–1018.

253. Vijayan KV, Goldschmidt–Clermont PJ, Roos C, Bray PF. The PI(A2) polymorphism of integrin beta(3) enhances outside–in signaling and adhesive functions. *J Clin Invest* 2000;105(6):793–802.

254. Sajid M, Vijayan KV, Souza S, Bray PF. PIA polymorphism of integrin beta 3 differentially modulates cellular migration on extracellular matrix proteins. *Arterioscler Thromb Vasc Biol* 2002;22(12):1984–1989.

255. Wheeler GL, Braden GA, Bray PF, et al. Reduced inhibition by abciximab in platelets with the PIA2 polymorphism. *Am Heart J* 2002;143(1):76–82.

256. Bottiger C, Kastrati A, Koch W, et al. Polymorphism of platelet glycoprotein IIb and risk of thrombosis and restenosis after coronary stent placement. *Am J Cardiol* 1999;84(9):987–991.

257. Carter AM, Catto AJ, Bamford JM, Grant PJ. Association of the platelet glycoprotein IIb HPA–3 polymorphism with survival after acute ischemic stroke. *Stroke* 1999;30(12):2606–2611.

258. Kroll H, Fechter A, Gardemann A. The role of the glycoprotein IIb fibrinogen receptor subunit T2622G gene polymorphism (HPA–3) on coronary artery disease and acute myocardial infarction. *Thromb Haemost* 2001;85(1):182–183.

259. Reiner AP, Schwartz SM, Kumar PN, et al. Platelet glycoprotein IIb polymorphism, traditional risk factors and non–fatal myocardial infarction in young women. *Br J Haematol* 2001;112(3):632–636.

260. Gonzalez-Conejero R, Lozano ML, Rivera J, et al. Polymorphisms of platelet membrane glycoprotein Ib associated with arterial thrombotic disease. *Blood* 1998;92(8):2771-2776.
261. Ito T, Ishida F, Shimodaira S, Kitano K. Polymorphisms of platelet membrane glycoprotein Ib alpha and plasma von Willebrand factor antigen in coronary artery disease. *Int J Hematol* 1999;70(1):47-51.
262. Murata M, Matsubara Y, Kawano K, et al. Coronary artery disease and polymorphisms in a receptor mediating shear stress-dependent platelet activation. *Circulation* 1997;96(10):3281-3286.
263. Afshar-Kharghan V, Li CQ, Khoshnevis-Asl M, Lopez JA. Kozak sequence polymorphism of the glycoprotein (GP) Ibalph gene is a major determinant of the plasma membrane levels of the platelet GP Ib-IX-V complex. *Blood* 1999;94(1):186-191.
264. Meisel C, Afshar-Kharghan V, Cascorbi I, et al. Role of Kozak sequence polymorphism of platelet glycoprotein Ibalph as a risk factor for coronary artery disease and catheter interventions. *J Am Coll Cardiol* 2001;38(4):1023-1027.
265. Corral J, Lozano ML, Gonzalez-Conejero R, et al. A common polymorphism flanking the ATG initiator codon of GPIb alpha does not affect expression and is not a major risk factor for arterial thrombosis. *Thromb Haemost* 2000;83(1):23-28.
266. Croft SA, Hampton KK, Daly ME, et al. Kozak sequence polymorphism in the platelet GPIbalph gene is not associated with risk of myocardial infarction. *Blood* 2000;95(6):2183-2184.
267. Frank MB, Reiner AP, Schwartz SM, et al. The Kozak sequence polymorphism of platelet glycoprotein Ibalph and risk of nonfatal myocardial infarction and nonfatal stroke in young women. *Blood* 2001;97(4):875-879.
268. Baker RI, Eikelboom J, Lofthouse E, et al. Platelet glycoprotein Ibalph Kozak polymorphism is associated with an increased risk of ischemic stroke. *Blood* 2001;98(1):36-40.
269. Carlsson LE, Santoso S, Spitzer C, et al. The alpha2 gene coding sequence T807/A873 of the platelet collagen receptor integrin alpha2beta1 might be a genetic risk factor for the development of stroke in younger patients. *Blood* 1999;93(11):3583-3586.
270. Corral J, Gonzalez-Conejero R, Rivera J, et al. Role of the 807 C/T polymorphism of the alpha2 gene in platelet GP Ia collagen receptor expression and function—effect in thromboembolic diseases. *Thromb Haemost* 1999;81(6):951-956.
271. Croft SA, Hampton KK, Sorrell JA, et al. The GPIa C807T dimorphism associated with platelet collagen receptor density is not a risk factor for myocardial infarction. *Br J Haematol* 1999;106(3):771-776.
272. Moshfegh K, Willemin WA, Redondo M, et al. Association of two silent polymorphisms of platelet glycoprotein Ia/IIa receptor with risk of myocardial infarction: a case-control study. *Lancet* 1999;353(9150):351-354.
273. Santoso S, Kunicki TJ, Kroll H, et al. Association of the platelet glycoprotein Ia C807T gene polymorphism with nonfatal myocardial infarction in younger patients. *Blood* 1999;93(8):2449-2453.
274. Bux J. Nomenclature of granulocyte alloantigens. ISBT Working Party on Platelet and Granulocyte Serology, Granulocyte Antigen Working Party. International Society of Blood Transfusion. *Transfusion* 1999;39(6):662-663.
275. McCullough J, Clay M, Press C, et al. *Granulocyte serology: a clinical laboratory guide*. ASCP Press, 1988.
276. Bux J, Bierling P, von dem Borne AEGKr, et al. ISBT Granulocyte antigen working party. Nomenclature of granulocyte alloantigens. *Vox Sang* 1999;77:251.
277. Lalezari P, Nussbaum M, Gelman S. Neonatal neutropenia due to maternal isoimmunization. *Blood* 1960;5:236-243.
278. Huizinga TW, Kleijer M, Tetteroo PA, et al. Biallelic neutrophil Na-antigen system is associated with a

- polymorphism on the phospho-inositol-linked Fc gamma receptor III (CD16). *Blood* 1990;75(1):213-217.
279. Ory PA, Goldstein IM, Kwoh EE, Clarkson SB. Characterization of polymorphic forms of Fc receptor III on human neutrophils. *J Clin Invest* 1989;83(5):1676-1681.
280. Ravetch JV, Perussia B. Alternative membrane forms of Fc gamma RIII(CD16) on human natural killer cells and neutrophils. Cell type-specific expression of two genes that differ in single nucleotide substitutions. *J Exp Med* 1989;170(2):481-497.
281. Trounstein ML, Peltz GA, Yssel H, et al. Reactivity of cloned, expressed human Fc gamma RIII isoforms with monoclonal antibodies which distinguish cell-type-specific and allelic forms of Fc gamma RIII. *Int Immunol* 1990;2(4):303-310.
282. Huizinga TW, de Haas M, Kleijer M, et al. Soluble Fc gamma receptor III in human plasma originates from release by neutrophils. *J Clin Invest* 1990;86(2):416-423.
283. Bierling P, Poulet E, Fromont P, et al. Neutrophil-specific antigen and gene frequencies in the French population. *Transfusion* 1990;30(9):848-849.
284. Hessner MJ, Curtis BR, Endean DJ, Aster RH. Determination of neutrophil antigen gene frequencies in five ethnic groups by polymerase chain reaction with sequence-specific primers. *Transfusion* 1996;36(10):895-899.
285. Lin M, Chen CC, Wang CL, Lee HL. Frequencies of neutrophil-specific antigens among Chinese in Taiwan. *Vox Sang* 1994;66(3):247.
286. Matsuo K, Procter J, Stroncek D. Variations in genes encoding neutrophil antigens NA1 and NA2. *Transfusion* 2000;40(6):645-653.
287. Ohto H, Matsuo Y. Neutrophil-specific antigens and gene frequencies in Japanese. *Transfusion* 1989;29(7):654.
288. Bux J, Stein EL, Santoso S, Mueller-Eckhardt C. NA gene frequencies in the German population, determined by polymerase chain reaction with sequence-specific primers. *Transfusion* 1995;35(1):54-57.
289. Bux J, Stein EL, Bierling P, et al. Characterization of a new alloantigen (SH) on the human neutrophil Fc gamma receptor IIIb. *Blood* 1997;89(3):1027-1034.
290. Kissel K, Hofmann C, Gittinger FS, et al. HNA-1a, HNA-1b, and HNA-1c (NA1, NA2, SH) frequencies in African and American Blacks and in Chinese. *Tissue Antigens* 2000;56(2):143-148.
291. Lehrnbecher T, Foster CB, Zhu S, et al. Variant genotypes of the low-affinity Fc gamma receptors in two control populations and a review of low-affinity Fc gamma receptor polymorphisms in control and disease populations. *Blood* 1999;94(12):4220-4232.
292. Koene HR, Kleijer M, Roos D, et al. Fc gamma RIIIB gene duplication: evidence for presence and expression of three distinct Fc gamma RIIIB genes in NA(1+,2+)SH(+) individuals. *Blood* 1998;91(2):673-679.
293. Steffensen R, Gulen T, Varming K, Jersild C. Fc gamma RIIIB polymorphism: evidence that NA1/NA2 and SH are located in two closely linked loci and that the SH allele is linked to the NA1 allele in the Danish population. *Transfusion* 1999;39(6):593-598.
294. Lalezari P. Alloimmune neonatal neutropenia and neutrophil-specific antigens. *Vox Sang* 1984;46(6):415-417.
295. Verheugt FW, dem Borne AE, Decary F, Engelfriet CP. The detection of granulocyte alloantibodies with an indirect immunofluorescence test. *Br J Haematol* 1977;36(4):533-544.
296. Goldschmeding R, van Dalen CM, Faber N, et al. Further characterization of the NB 1 antigen as a variably expressed 56-62 kD GPI-linked glycoprotein of plasma membranes and specific granules of neutrophils. *Br J Haematol* 1992;81(3):336-345.
297. Kissel K, Santoso S, Hofmann C, et al. Molecular basis of the neutrophil glycoprotein NB1 (CD177) involved in the pathogenesis of immune neutropenias and transfusion reactions. *Eur J Immunol*

2001;31(5):1301–1309.

298. Temerinac S, Klippel S, Strunck E, et al. Cloning of PRV-1, a novel member of the uPAR receptor superfamily, which is overexpressed in polycythemia rubra vera. *Blood* 2000;95(8):2569–2576.

299. Stroncek DF, Shankar RA, Plachta LB, et al. Polyclonal antibodies against the NB1-bearing 58- to 64-kDa glycoprotein of human neutrophils do not identify an NB2-bearing molecule. *Transfusion* 1993;33(5):399–404.

300. Huizinga TW, Kuijpers RW, Kleijer M, et al. Maternal genomic neutrophil FcRIII deficiency leading to neonatal isoimmune neutropenia. *Blood* 1990;76(10):1927–1932.

301. Stroncek DF, Skubitz KM, Plachta LB, et al. Alloimmune neonatal neutropenia due to an antibody to the neutrophil Fc-gamma receptor III with maternal deficiency of CD16 antigen. *Blood* 1991;77(7):1572–1580.

302. Stroncek DF, Shankar RA, Noren PA, et al. Analysis of the expression of NB1 antigen using two monoclonal antibodies. *Transfusion* 1996;36(2):168–174.

303. Lawler SD, Shatwell HS. A study of anti-5b leuco-agglutinins. *Vox Sang* 1967;13(2):187–193.

304. Lalezari P, Bernard GE. Identification of a specific leukocyte antigen: another presumed example of 5b. *Transfusion* 1965;5:135–142.

305. Kline WE, Press C, Clay M, et al. Three sera defining a new granulocyte-monocyte-T-lymphocyte antigen. *Vox Sang* 1986;50(3):181–186.

306. Simsek S, van der Schoot CE, Daams M, et al. Molecular characterization of antigenic polymorphisms (Ond(a) and Mart(a)) of the beta 2 family recognized by human leukocyte alloantisera. *Blood* 1996;88(4):1350–1358.

307. Bux J, Jung KD, Kauth T, Mueller-Eckhardt C. Serological and clinical aspects of granulocyte antibodies leading to alloimmune neonatal neutropenia. *Transfus Med* 1992;2(2):143–149.

308. Puig N, de Haas M, Kleijer M, et al. Isoimmune neonatal neutropenia caused by Fc gamma RIIBb antibodies in a Spanish child. *Transfusion* 1995;35(8):683–687.

309. Bux J, Behrens G, Jaeger G, Welte K. Diagnosis and clinical course of autoimmune neutropenia in infancy: analysis of 240 cases. *Blood* 1998;91(1):181–186.

310. Kedzierska A, Turowski G. [Histocompatibility HLA system of man. Consideration in the light of current concepts. I. Organization and polymorphism]. *Przegl Lek* 2001;58(5):459–462.

311. Klein J, Sato A. The HLA system. First of two parts. *N Engl J Med* 2000;343(10):702–709.

312. Borrego F, Kabat J, Kim DK, et al. Structure and function of major histocompatibility complex (MHC) class I specific receptors expressed on human natural killer (NK) cells. *Mol Immunol* 2002;38(9):637–660.

313. Boyington JC, Sun PD. A structural perspective on MHC class I recognition by killer cell immunoglobulin-like receptors. *Mol Immunol* 2002;38(14):1007–1021.

314. Maenaka K, Jones EY. MHC superfamily structure and the immune system. *Curr Opin Struct Biol* 1999;9(6):745–753.

315. Natarajan K, Li H, Mariuzza RA, Margulies DH. MHC class I molecules, structure and function. *Rev Immunogenet* 1999;1(1):32–46.

316. Stevanovic S. Structural basis of immunogenicity. *Transpl Immunol* 2002;10(2–3):133–136.

317. Brown JH, Jardetzky TS, Gorga JC, et al. Three-dimensional structure of the human class II histocompatibility antigen HLA-DR1. *Nature* 1993;364 (6432):33–39.

318. Forbes SA, Trowsdale J. The MHC quarterly report. *Immunogenetics* 1999;50(3-4):152-159.
319. Terminology: nomenclature for factors of the HLA system, 1980. World Health Organization. *Immunology* 1982;46(1):231-234.
320. Bodmer JG, Parham P, Albert ED, Marsh SG. Putting a hold on 'HLA-H'. The WHO Nomenclature Committee for Factors of the HLA System. *Nat Genet* 1997;15(3):234-235.
321. Klein J, Sato A. Birth of the major histocompatibility complex. *Scand J Immunol* 1998;47(3):199-209.
322. Duquesnoy RJ. HLA Matchmaker: a molecularly based algorithm for histocompatibility determination. I. Description of the algorithm. *Hum Immunol* 2002;63(5):339-352.
323. McKenna RM, Takemoto SK. Improving HLA matching for kidney transplantation by use of CREGs. *Lancet* 2000;355(9218):1842-1843.
324. Wujciak T, Opelz G. Evaluation of HLA matching for CREG antigens in Europe. *Transplantation* 1999;68(8):1097-1099.
325. Koelman CA, Ensink W, Mulder A, et al. Anti-HLA antibodies interfere in the detection of soluble HLA class I molecules. *Hum Immunol* 1999;60(5):414-423.
326. Steinborn A, Rebmann V, Scharf A, et al. Soluble HLA-DR levels in the maternal circulation of normal and pathologic pregnancy. *Am J Obstet Gynecol* 2003;188(2):473-479.
327. van Rood JJ, van Leeuwen A, van Santen MC. Anti HL-A2 inhibitor in normal human serum. *Nature* 1970;226(243):366-367.
328. Zavazava N, Wobst B, Ferstl R, Muller-Ruchholtz W. Soluble MHC class I molecules in human body fluids. *J Clin Lab Anal* 1994;8(6):432-436.
329. Bodmer J. World distribution of HLA alleles and implications for disease. *Ciba Found Symp* 1996;197:233-253.
330. Bodmer JG, Marsh SG, Albert ED, et al. Nomenclature for factors of the HLA System, 1996. *Hum Immunol* 1997;53(1):98-128.
331. Allan DS, Lepin EJ, Braud VM, et al. Tetrameric complexes of HLA-E, HLA-F, and HLA-G. *J Immunol Methods* 2002;268(1):43-50.
332. Gobin SJ, van den Elsen PJ. Transcriptional regulation of the MHC class Ib genes HLA-E, HLA-F, and HLA-G. *Hum Immunol* 2000;61(11):1102-1107.
333. O'Callaghan CA, Bell JI. Structure and function of the human MHC class Ib molecules HLA-E, HLA-F and HLA-G. *Immunol Rev* 1998;163:129-138.
334. Drew SI, Carter BM, Terasaki PI, et al. Cell surface antigens detected on mature and leukemic granulocytic populations by cytotoxicity testing. *Tissue Antigens* 1978;12(2):75-86.
335. Terasaki PI, Bernoco D, Park MS, et al. Microdroplet testing for HLA-A, -B, -C, and -D antigens. The Phillip Levine Award Lecture. *Am J Clin Pathol* 1978;69(2):103-120.
336. Schreuder GM, Hurley CK, Marsh SG, et al. The HLA dictionary 1999: a summary of HLA-A, -B, -C, -DRB1/3/4/5, -DQB1 alleles and their association with serologically defined HLA-A, -B, -C, -DR and -DQ antigens. *Tissue Antigens* 1999;54(4):409-437.
337. Albert E, Amos DB, Bodmer WF, et al. Nomenclature for factors of the HLA-system 1977. *Z Immunitätsforsch Immunobiol* 1977;153(5):373-379.
338. Festenstein H. The biological consequences of altered MHC expression on tumours. *Br Med Bull* 1987;43(1):217-227.

339. Sonderstrup G, McDevitt HO. DR, DQ, and you: MHC alleles and autoimmunity. *J Clin Invest* 2001;107(7):795-796.
340. Porter RR. The complement components coded in the major histocompatibility complexes and their biological activities. *Immunol Rev* 1985;87:7-17.
341. Porter RR. The polymorphism of the complement genes in HLA. *Ann Inst Pasteur Immunol* 1985;136C(1):91-101.
342. Yu CY, Campbell RD, Porter RR. A structural model for the location of the Rodgers and the Chido antigenic determinants and their correlation with the human complement component C4A/C4B isotypes. *Immunogenetics* 1988;27(6):399-405.
343. Newell WR, Trowsdale J, Beck S. MHCDB: database of the human MHC (release 2). *Immunogenetics* 1996;45(1):6-8.
344. Hobart MJ. Phenotypic genetics of complement components. *Philos Trans R Soc Lond B Biol Sci* 1984;306(1129):325-331.
345. Parham P, Ohta T. Population biology of antigen presentation by MHC class I molecules. *Science* 1996;272(5258):67-74.
346. Salmon D, Salmon C. Blood groups and genetic markers polymorphism and probability of paternity. *Transfusion* 1980;20(6):684-694.
347. Walker RH, Meyers MA, Phillips LM. The probability of exclusion of the HLA-A,B system in North American whites and blacks in parentage tests. *Transfusion* 1987;27(1):75-79.
348. Claas FH, de Waal LP, Beelen J, et al. Transplantation of highly sensitized patients on the basis of acceptable HLA-A and B mismatches. *Clin Transpl* 1989;185-190.
349. Hosenpud JD, Edwards EB, Lin HM, Daily OP. Influence of HLA matching on thoracic transplant outcomes. An analysis from the UNOS/ISHLT Thoracic Registry. *Circulation* 1996;94(2):170-174.
350. Opelz G. Impact of HLA compatibility on survival of kidney transplants from unrelated live donors. *Transplantation* 1997;64(10):1473-1475.
351. Terasaki PI, McClelland JD, Yuge J, et al. Advances in kidney transplantation: 1985-1995. *Clin Transpl* 1995;487-501.
352. Terasaki PI, Cecka JM, Gjertson DW, Takemoto S. High survival rates of kidney transplants from spousal and living unrelated donors. *N Engl J Med* 1995;333(6):333-336.
353. Opelz G, Sengar DP, Mickey MR, Terasaki PI. Effect of blood transfusions on subsequent kidney transplants. *Transplant Proc* 1973;5(1):253-259.
354. Singal DP, Ludwin D, Blajchman MA. Blood transfusion and renal transplantation. *Br J Haematol* 1985;61(4):595-602.
355. Takahashi H, Iwaki Y, Terasaki PI, et al. Deliberate buffy-coat transfusions and the risk of antibody formation. *Transplant Proc* 1982;14(2):349-354.
356. Anasetti C, Amos D, Beatty PG, et al. Effect of HLA compatibility on engraftment of bone marrow transplants in patients with leukemia or lymphoma. *N Engl J Med* 1989;320(4):197-204.
357. Beatty PG, Clift RA, Mickelson EM, et al. Marrow transplantation from related donors other than HLA-identical siblings. *N Engl J Med* 1985;313(13):765-771.
358. Storb R, Thomas ED. Allogeneic bone-marrow transplantation. *Immunol Rev* 1983;71:77-102.
359. Thomas ED. Marrow transplantation for nonmalignant disorders. *N Engl J Med* 1985;312(1):46-48.



360. Hansen JA, Clift RA, Thomas ED, et al. Transplantation of marrow from an unrelated donor to a patient with acute leukemia. *N Engl J Med* 1980;303(10):565–567.
361. Hows JM, Yin JL, Marsh J, et al. Histocompatible unrelated volunteer donors compared with HLA nonidentical family donors in marrow transplantation for aplastic anemia and leukemia. *Blood* 1986;68(6):1322–1328.
362. McGlave PB, Beatty P, Ash R, Hows JM. Therapy for chronic myelogenous leukemia with unrelated donor bone marrow transplantation: results in 102 cases. *Blood* 1990;75(8):1728–1732.
363. Nagler A, Brautbar C, Slavin S, Bishara A. Bone marrow transplantation using unrelated and family related donors: the impact of HLA–C disparity. *Bone Marrow Transplant* 1996;18(5):891–897.
364. Petersdorf EW, Longton GM, Anasetti C, et al. Definition of HLA–DQ as a transplantation antigen. *Proc Natl Acad Sci U S A* 1996;93(26):15358–15363.
365. Petersdorf EW, Longton GM, Anasetti C, et al. The significance of HLA–DRB1 matching on clinical outcome after HLA–A, B, DR identical unrelated donor marrow transplantation. *Blood* 1995;86(4):1606–1613.
366. Gebe JA, Swanson E, Kwok WW. HLA class II peptide–binding and autoimmunity. *Tissue Antigens* 2002;59(2):78–87.
367. Grumet FC. HLA and disease. *Clin Immunol Rev* 1983;2(1):123–155.
368. Haines JL, Bradford Y, Garcia ME, et al. Multiple susceptibility loci for multiple sclerosis. *Hum Mol Genet* 2002;11(19):2251–2256.
369. Moller P, Berg K. Family studies in Bechterew’s syndrome (ankylosing spondylitis) III. *Genetics. Clin Genet* 1983;24(2):73–89.
370. Pascual M, Mataran L, Jones G, et al. HLA haplotypes and susceptibility to rheumatoid arthritis. More than class II genes. *Scand J Rheumatol* 2002;31(5):275–278.
371. Troup GM, Williams TM. HLA: the molecular age. In: Rossi EC, Simon TK, Moss GS, Gould S, eds. *Principles of transfusion medicine*. Baltimore: Wil–liams & Wilkins, 1996:817.
372. Tsuchiya N, Ohashi J, Tokunaga K. Variations in immune response genes and their associations with multifactorial immune disorders. *Immunol Rev* 2002;190:169–181.
373. Hors J, Dausset J. HLA and susceptibility to Hodgkin’s disease. *Immunol Rev* 1983;70:167–192.
374. Caffrey MF, James DC. Human lymphocyte antigen association in ankylosing spondylitis. *Nature* 1973;242(5393):121.
375. Schlossman SF, Reinherz EL. Human T–cell subsets in health and disease. *Springer Semin Immunopathol* 1984;7(1):9–18.
376. Pociot F, McDermott MF. Genetics of type 1 diabetes mellitus. *Genes Immun* 2002;3(5):235–249.
377. Wong FS, Wen L. The study of HLA class II and autoimmune diabetes. *Curr Mol Med* 2003;3(1):1–15.
378. Bell JI. The major histocompatibility complex and disease. *Curr Opin Immunol* 1989;2(1):114–116.
379. Jawaheer D, Li W, Graham RR, et al. Dissecting the genetic complexity of the association between human leukocyte antigens and rheumatoid arthritis. *Am J Hum Genet* 2002;71(3):585–594.
380. Capon F, Munro M, Barker J, Trembath R. Searching for the major histocompatibility complex psoriasis susceptibility gene. *J Invest Dermatol* 2002;118(5):745–751.
381. Undlien DE, Lie BA, Thorsby E. HLA complex genes in type 1 diabetes and other autoimmune

diseases. Which genes are involved? *Trends Genet* 2001;17(2):93–100.

382. Zanelli E, Breedveld FC, de Vries RR. HLA class II association with rheumatoid arthritis: facts and interpretations. *Hum Immunol* 2000;61(12):1254–1261.

383. Mueller–Eckhardt C, Mueller–Eckhardt G, Willen–Ohff H, et al. Immunogenicity of and immune response to the human platelet antigen Zw<sup>a</sup> is strongly associated with HLA–B8 and DR3. *Tissue Antigens* 1985;26(1):71–76.

384. van Eden W, Gonzalez NM, de Vries RR, et al. HLA–linked control of predisposition to lepromatous leprosy. *J Infect Dis* 1985;151(1):9–14.

385. Kuijpers RW, Faber NM, Cuypers HT, et al. NH2–terminal globular domain of human platelet glycoprotein Ib alpha has a methionine 145/threonine145 amino acid polymorphism, which is associated with the HPA–2 (Ko) alloantigens. *J Clin Invest* 1992;89(2):381–384.

386. Kekomaki S, Partanen J, Kekomaki R. Platelet alloantigens HPA–1, –2, –3, –5 and –6b in Finns. *Transfus Med* 1995;5(3):193–198.

387. Kim HO, Jin Y, Kickler TS, et al. Gene frequencies of the five major human platelet antigens in African American, white, and Korean populations. *Transfusion* 1995;35(10):863–867.

388. Santoso S, Santoso S, Kiefel V, et al. Frequency of platelet–specific antigens among Indonesians. *Transfusion* 1993;33(9):739–741.

389. Simsek S, Faber NM, Bleeker PM, et al. Determination of human platelet antigen frequencies in the Dutch population by immunophenotyping and DNA (allele–specific restriction enzyme) analysis. *Blood* 1993;81(3):835–840.

390. Seo DH, Park SS, Kim DW, et al. Gene frequencies of eight human platelet–specific antigens in Koreans. *Transfus Med* 1998;8(2):129–132.

2004 Lippincott Williams & Wilkins  
John P. Greer, John Foerster, John N. Lukens  
George M. Rodgers, Frixos Paraskevas, Bertil Glader  
Wintrobe's Clinical Hematology

**BLOOD DONATION AND COLLECTION**[Donor Selection](#)[Donor Identification and Registration](#)[Donor Information](#)[Donor Health History](#)[Informed Consent](#)[Blood Collection Process](#)[Whole Blood \(Manual\) Collection](#)[Blood Component Separation](#)[Terminology](#)[“Closed” versus “Open” Systems](#)[Automated Blood Collection and Separation Devices: Apheresis](#)[Complications of Donation](#)[Donor Testing](#)**RED BLOOD CELL PRESERVATION AND STORAGE**[Anticoagulant/Preservative Solutions](#)[Packed Red Cells versus Red Cells in Additive Solutions](#)[Changes in Red Cells during Storage](#)[Rejuvenating Solutions](#)[In Vivo Recovery of Stored Red Cells](#)[Frozen Red Cells](#)**BLOOD COMPONENT MODIFICATION**[Leukocyte Reduction](#)[Washed Products](#)[Irradiation of Blood Products](#)**USE OF BLOOD COMPONENTS****ALTERNATIVES TO ALLOGENEIC DONOR BLOOD**[Autologous Blood Transfusion](#)[Preoperative Autologous Blood Donation](#)[Disadvantages of Autologous Donation](#)[Crossover of Autologous Units](#)[Erythropoietin](#)[Acute Normovolemic Hemodilution](#)[Intraoperative Salvage](#)[Postoperative Salvage](#)[Directed Donations](#)[Blood Substitutes](#)**RED CELL TRANSFUSION**[Indications for Red Cell Transfusion](#)[Pretransfusion Testing of Red Cells](#)[Selection of Red Cells for Transfusion](#)[Transfusions in the Newborn Period](#)[Selection of Blood for Emergency Transfusion](#)[Administration of Blood](#)**PLATELET TRANSFUSION**[Preparation of Platelet Concentrates](#)[Apheresis \(Pheresis\) Platelets](#)[Platelet Storage](#)[Selection of Platelet Donors](#)

- [Administration of Platelets](#)
- [Dosage and Expected Response](#)
- [Indications for Platelet Transfusion](#)
- [Platelet Refractoriness and Alloimmunization](#)
- GRANULOCYTE TRANSFUSIONS**
- [Donor Preparation/Selection](#)
- [Granulocyte Collection/Storage](#)
- [Administration of Granulocytes](#)
- [Clinical Indications and Efficacy](#)
- HEMATOPOIETIC STEM CELLS**
- TRANSFUSION OF PLASMA AND COMMERCIAL PROTEIN CONCENTRATES**
- [Noncommercial Plasma Components for Transfusion](#)
- [Commercial Plasma Derivatives](#)
- ADVERSE EFFECTS OF BLOOD TRANSFUSION**
- [Immunologic Transfusion Reactions](#)
- [Nonimmunologic Adverse Effects of Blood Transfusion](#)
- INFECTIOUS COMPLICATIONS OF BLOOD TRANSFUSION**
- [Overview of Blood Donor Screening for Infectious Diseases](#)
- [Transfusion-Associated Hepatitis](#)
- [Human Immunodeficiency Virus Type 1 and Type 2](#)
- [Human T-Lymphotropic Virus I and II](#)
- [Syphilis](#)
- [Cytomegalovirus](#)
- [Eosin-Barr Virus](#)
- [Parvovirus B19](#)
- [Infections Transmitted by Arthropods](#)
- [Transmissible Spongiform Encephalopathies: Creutzfeldt-Jakob Disease and Variant Creutzfeldt-Jakob Disease](#)
- [Bacterial Contamination](#)
- [Pathogen Inactivation Technologies](#)
- THERAPEUTIC APHERESIS**
- [Therapeutic Plasma Exchange](#)
- [Therapeutic Cytapheresis](#)
- [Therapeutic Absorption of Plasma Constituents](#)
- [Adverse Effects](#)
- SUMMARY**
- ACKNOWLEDGMENTS**
- REFERENCES**

Until Harvey's doctrine of the circulation of blood was proposed in 1616, the concept of blood transfusion had no rationale. The concept of transfusion therapy developed once it had been accepted that blood circulated and that the intravascular space might be replenished with fluids introduced from outside the body. The first transfusion of blood in humans occurred in 1667 ( <sup>1</sup> ). Progress was slow thereafter because of the complexities of transfusion, which we now recognize, particularly the incompatibility of interspecies transfusions ( <sup>2</sup> ). By the early twentieth century, transfusion as a therapeutic measure was still cumbersome and risky, but during and shortly after World War I, technical progress permitted the rapid expansion of blood banking and of blood transfusion as a therapeutic modality ( <sup>3</sup> ).

The understanding of genetic differences between individuals, pioneered by Landsteiner in 1901, was most important. The development of anticoagulants, blood preservatives, and sterile techniques allowed the collection and preservation of donor blood for later use. More recently, component therapy has broadened the application of transfusion therapy from blood volume support to the specific replacement of most blood cells and many plasma proteins. Technical advances continue, particularly in the more efficient use of components and fractions of donor blood, improvement of donor screening techniques, development of methods of pathogen inactivation, improved immunologic matching of donor blood products with the recipient, and development of recombinant products.

Transfusion medicine has recently been recognized as a specialty of its own. The acquired immunodeficiency syndrome (AIDS) epidemic and the transmission of other infectious agents through blood transfusion have revolutionized the practice of transfusion medicine. Increasing public awareness of the risks of transfusion has resulted in a more stringent approach to donor selection and testing and preparation of blood and its components, and it has led to an increase in the use of autologous blood. Blood centers are licensed in accordance with the manufacturing guidelines of the Food and Drug Administration (FDA) in the United States or its counterparts in other countries. Additional professional standards are set by the American Association of Blood Banks (AABB) ( [4](#) ). Blood centers must follow good manufacturing practices and must maintain uniform standards to maintain their licenses. Improved donor screening has resulted in a dramatic improvement in the safety of blood components. However, prudent use of these agents requires an understanding of their indications, limitations, potential benefits, and hazards ( [5](#) , [6](#) , [7](#) , [8](#) and [9](#) ).

## **BLOOD DONATION AND COLLECTION**

### **Donor Selection**

In the United States, donor eligibility criteria are established and strictly enforced by the FDA. Donor selection is undertaken with two goals in mind: to protect the health of the donor by ensuring that a donation does not place the donor at risk, and to protect the recipient by ensuring that the donor meets all health and screening criteria so that the risk of transmitting infectious agents or causing other adverse events is minimized ( [4](#) , [8](#) , [10](#) ).

In the United States, the majority of fresh blood products are collected from unpaid volunteers. The paying of donors for fresh blood products for transfusion was discontinued after studies in the early 1970s demonstrated that paid donors had a substantially higher prevalence of hepatitis ( [11](#) , [12](#) and [13](#) ). However, commercial fractionators continued to pay plasma donors.

### **Donor Identification and Registration**

Donor registration must be done in a way that permits accurate identification of the potential donor, including full name, date of birth, address, and telephone number, so that the donor can be traced if required. Records must be sufficient to link a donor to all previous donations and all prior test results. These records must be kept for a minimum of 10 years.

### **Donor Information**

The donor must be given educational material that describes the signs and symptoms of AIDS and the activities associated with an increased risk of acquiring human immunodeficiency virus (HIV). The donor must be informed that donor testing may not detect all infections, and that individuals who have engaged in risk behavior should not donate ( [10](#) ).

### **Donor Health History**

Information to be elicited is defined by the FDA and the AABB. Donors are screened by

appropriately trained personnel who administer a standardized questionnaire to each donor before each donation. The history includes a review of current health status to ensure that the donor is free of current signs of infection and that the donor's cardiovascular status is sufficient to tolerate an acute blood volume loss of 10 to 15%. The donor is questioned about recent exposures to blood, potential exposures to HIV or hepatitis, sexual contact with individuals at risk for HIV, a history of needle sharing by the donor or sexual partners, a history of travel to or residence in areas endemic for malaria or variant Creutzfeldt–Jakob disease, medications, and immunizations. The donor must be medically fit and must not have any identifiable risk factors that could result in an adverse outcome in either the donor or the recipient.

The donor must meet certain requirements of age and vital signs. The hemoglobin must be at least 125 g/L. Donor weight must be sufficient so that the donation constitutes no more than a 15% loss of blood volume. There must be no evidence on examination of the arms that the donor has ever used parenteral drugs other than those prescribed by a physician ( [4](#) ).

Confidential unit exclusion allowing donors to privately designate that their blood not be used for transfusion was initiated as a result of the AIDS epidemic. Although initially mandated by the FDA, confidential unit exclusion is now a voluntary option for blood centers ( [4](#) , [10](#) ).

## **Informed Consent**

The donor must sign the health history form indicating that the questions have been answered truthfully, that the donation process is understood, and that the donor consents to testing for infectious agents that can be transmitted by blood transfusion including HIV and hepatitis ( [8](#) , [10](#) ).

## **Blood Collection Process**

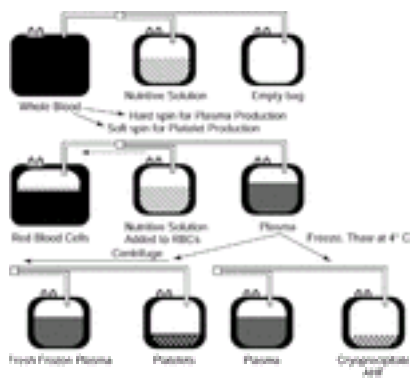
Phlebotomy and collection of blood proceed only if the donor appears suitable after predonation screening. Blood is collected from the donor in accordance with established standards ( [4](#) ). Blood may be collected either manually or using automated collection devices.

## **Whole Blood (Manual) Collection**

The phlebotomy site is swabbed with a disinfectant ( [14](#) ). Using a large bore needle to allow rapid flow of blood into the anticoagulant, blood is collected into a primary sterile plastic collection bag containing a measured volume of anticoagulant. The volume of blood drawn is standardized for the collection bag used (either 450 or 500 ml); the amount collected is controlled by scales that discontinue flow when the desired weight of blood is collected. The blood and anticoagulant are mixed gently during the collection process. At the beginning or end of the collection process, specimen tubes for testing of the donor are filled. Because most whole blood units will be separated into components, the primary bag has one to three satellite bags attached to allow separation of components while maintaining a sterile closed system. The collection tubing is heat-sealed into segments that are left attached to provide samples for crossmatching. The whole blood is transported to a laboratory where it can be separated into its components (red cells, plasma, platelets) by centrifugation.

## Blood Component Separation

Whole blood is centrifuged to sediment the red blood cells (RBCs) ( Fig. 24.1). Most of the supernatant “platelet-rich plasma” is pushed off through integrally attached tubing into a sterile satellite bag. The bag containing platelet-rich plasma may be centrifuged at a higher rate to sediment the platelets. All but 50 ml of plasma is then removed into a third satellite bag. The platelet pellet is resuspended in the residual 50 ml of plasma, called a *platelet concentrate*. The plasma is frozen at  $-18^{\circ}\text{C}$  or lower. If frozen within 8 hours of collection, it is called *fresh frozen plasma* (FFP). FFP may be further processed into cryoprecipitated antihemophilic factor (AHF) (“cryo”) by subsequently thawing the FFP at  $1^{\circ}$  to  $6^{\circ}\text{C}$ , removing the supernatant, and refreezing the cold, insoluble cryoprecipitate ( 8 ). The supernatant from the cryoprecipitate preparation, depleted in factor VIII and fibrinogen, may be labeled as plasma, cryoprecipitate reduced ( 8 ).



**Figure 24.1.** Preparation of components from a whole blood donation. AHF, antihemophilic factor; RBC, red blood cell. (Reprinted from Jeter EK, Spivey MA. Blood components and their use. In: Introduction to transfusion medicine: a case study approach. Bethesda, MD: American Association of Blood Banks Press, 1996:5, with permission.)

## Terminology

The 450 or 500 ml of whole blood in the original collection bag is referred to as *one whole blood unit*, and each component made from that unit is defined as one “unit” of that component. Because each whole blood unit constituted approximately 10% of a donor’s blood volume, each component can be considered roughly 10% replacement therapy for an adult patient.

## “Closed” versus “Open” Systems

If blood component manipulation is performed without opening the system to air, all blood components may be stored to the limit of their viability. If the blood bag or tubing is entered, however, the system is considered potentially open to bacteria, and the product is assigned a 4-hour outdate if stored at room temperature or 24 hours if kept refrigerated. Devices are now available that use high-temperature welds to attach additional containers or tubing to the original container in a way that prevents entry of bacteria. With these “sterile connection devices,” blood components may be split into aliquots, filtered, or otherwise manipulated without loss of shelf life ( 8 ).



## Automated Blood Collection and Separation Devices: Apheresis

The word *apheresis* is derived from a Greek word that means to separate or to take away. Initially, it referred to a manual process in which whole blood was withdrawn from the donor, centrifuged, plasma retained, and red cells returned to the donor. In 1914, Abel experimentally removed plasma from anephric dogs, and replaced it with crystalloid ( [15](#) ). It was not until the advent of plastic bags that manual apheresis could be used routinely in humans. Between 1950 and 1980, manual apheresis was the primary source of plasma for fractionation.

The development in the 1970s and 1980s of automated cell separator devices has changed the approach to apheresis and has resulted in the routine application of this methodology to the collection of blood components for transfusion, as well as the treatment of certain diseases ( [8](#) , [16](#) ).

In discontinuous centrifugal devices, anticoagulated blood is collected into a disposable bowl. When the bowl is spun, centrifugal force causes the red cells to move to the outside of the bowl, platelet-rich plasma to move to the inside, and white blood cells (WBCs) (buffy coat) to move in between. Using optical detectors, the desired component can be pumped into an attached plastic blood bag, and the remaining components can be reinfused into the donor.

There are now continuous flow devices in which incoming blood is continuously subjected to a centrifugal force. A standing cell gradient is established. The fraction(s) to be removed is pumped into a bag, and the rest is reinfused continuously. The volume of blood in the extracorporeal circuit is lower than with the discontinuous technique, and the procedure is faster. An increasing proportion of blood components are being collected using automated cell separation. These devices can collect multiple unit-equivalents of platelets or plasma from one donation. Apheresis is the primary source of plasma for fractionation because multiple units of plasma may be obtained without causing iron deficiency in the donor. Apheresis technology is commonly used to collect platelets because a full therapeutic dose of platelets (equivalent to six whole blood-derived platelet units) or even as many as three therapeutic doses (equivalent to 18 whole blood-derived units) can be obtained from one apheresis donation. If a donor is large enough, it may be possible to obtain two RBC unit-equivalents from one apheresis donation, returning plasma, platelets, and saline to the donor to minimize volume loss. Some apheresis devices can be programmed to collect any desired combination of red cells, plasma, or platelet products from the same donation. Apheresis technology is also used for therapeutic plasma exchange (TPE) and for collection of peripheral blood hematopoietic progenitor cells (HPCs), as discussed later in this chapter.

Membrane filtration can be combined with apheresis to collect plasma. Blood is pumped over a membrane with a specific pore size that permits passage of plasma but not cells. Such devices have been used to collect plasma for fractionation or to perform TPE.

### Complications of Donation

The most common complication of donation is a hematoma, which may be striking but resolves spontaneously. Most individuals tolerate whole blood donations well, compensating for the acute volume loss by increasing heart rate and increasing vascular resistance. Approximately 2 to 5% of donors, however, experience vasovagal reactions, with syncope occurring in 0.1 to 0.3% ( [17](#) ). Apheresis donors face the additional potential complication of transient hypocalcemia from the citrate infused when anticoagulated

blood components are returned to them from the apheresis device. Symptoms consist of tingling or muscle cramps. Citrate symptoms are treated by slowing the flow of the device or giving the donor oral calcium supplements ( [16](#) ). Intravenous calcium infusions are needed only during prolonged apheresis procedures such as those for HPC collection.

## Donor Testing

Every blood donation undergoes a series of tests to determine its suitability for transfusion. In the United States, the following tests must be performed on every unit collected: ABO group and Rh type, red cell antibody screen, tests for infectious markers including hepatitis B surface antigen (HBsAg) and antibodies to hepatitis B core (HBc) antigen, hepatitis C, HIV-1 and -2, human T-cell lymphotropic virus (HTLV)-I and -II, and a serologic test for syphilis. Tests for hepatitis C virus (HCV) and HIV nucleic acid were implemented under investigational protocols and will be required when licensed. These tests are performed on pools of 16 to 24 donor specimens, as nucleic acid detection methods remain too laborious to apply to individual donations. Nucleic acid testing for other viruses is likely to be implemented in the future.

Blood and its components are not released for transfusion unless all the tests for infectious markers are negative ( [4](#) ). Because of the extent of testing, there is typically a delay of 24 to 48 hours from the time of collection until a component can be released for transfusion.

## RED BLOOD CELL PRESERVATION AND STORAGE

Blood cells are isolated and preserved in such a way that they remain functional after transfusion. This involves three distinct but interrelated processes: anticoagulation, preservation of cell viability so that survival after transfusion is satisfactory, and preservation of cell function.

### Anticoagulant/Preservative Solutions

Blood banking and transfusion did not become practical until the development of anticoagulant and preservative solutions capable of preserving red cells in viable form.

The anticoagulant used for essentially all transfusable blood components today is citrate, which chelates ionized calcium in donor blood, making it unavailable to the calcium-dependent stages of coagulation. After transfusion, citrate is readily metabolized into bicarbonate by the liver of the recipient ( [18](#) ).

During World War I, a solution of sodium citrate and glucose was developed in which blood could be stored for several days, and this citrated blood was used to treat shock in British and American soldiers ( [18](#) ). During World War II, it was found that the addition of citric acid [acid citrate dextrose (ACD)] permitted preservation of red cell viability for up to 21 days. Continuing efforts were made to prolong red cell viability. Citrate phosphate dextrose (CPD) solution ( [19](#) ) is a modified ACD, with added  $\text{NaH}_2\text{PO}_4$  and a higher pH. Stored in CPD, red cell phosphate and 2,3-diphosphoglycerate (2,3-DPG) are maintained at a higher concentration than in ACD. However, red cell viability remains limited to 21 days.

In the 1950s, it was noted that red cells that had lost their adenosine triphosphate (ATP) did not survive well during storage ( [20](#) ). Nakao ( [21](#) ) demonstrated that the ATP content

and posttransfusion viability of aged red cells could be regenerated by the addition of adenine, which allows the red cells to maintain the adenine nucleotide pool. Simon et al. ( [22](#) ) described the maintenance of red cell ATP levels using preservatives containing glucose and low concentrations of adenine. These studies eventually led to the adenine-supplemented anticoagulant preservatives now in use ( [18](#) , [23](#) ).

CPDA-1 is CPD supplemented with adenine. It was made available in the United States in 1978, although it had been used extensively in Europe for several years before then. Initial concerns about potential toxicity of adenine in humans have proved to be unfounded. CPDA-1 is now one of the standard anticoagulant-preservative solutions in clinical use. The shelf life of RBC concentrates in CPDA-1 is 35 days ( [4](#) ).

### **Packed Red Cells versus Red Cells in Additive Solutions**

After whole blood is collected into CPD or CPDA-1, the red cells may be concentrated by centrifugation and removal of most of the plasma (“packed RBCs”). Approximately 20% of the anticoagulant-containing plasma must be left with the red cells to provide metabolic substrate for the red cells during storage. Another approach to red cell preservation involves virtually complete removal of the anticoagulated plasma from the red cells (“dry pack”), followed by resuspension of the red cells in 100 ml of an additive solution. Such additive solutions contain saline, adenine, and glucose, with or without mannitol to decrease hemolysis. The duration of red cell storage in additive solutions is extended to 42 days ( [8](#) , [18](#) ). Red cells in additive solution are now the most common preparations available for transfusion.

Red cells collected in any of the anticoagulants and preservatives must be stored at 1° to 6° C to maintain optimum function ( [4](#) ).

### **Changes in Red Cells during Storage**

When blood is stored in liquid medium, the red cells undergo a series of biochemical and structural changes that have major influences on their viability and function after transfusion ( [18](#) , [24](#) , [25](#) and [26](#) ).

**STRUCTURAL CHANGES** A number of red cell changes contribute to decreased cell viability after storage ( [24](#) , [25](#) and [26](#) ). Soon after storage begins, red cells, which normally have a disc shape, become spherical with surface projections (spherocytosis). Later defects include loss of membrane lipids and a small amount of protein, as well as other alterations in the structural proteins. Loss of membrane deformability correlates closely with viability ( [24](#) ). The more severe membrane changes are irreversible and probably contribute to the decrease in posttransfusion survival of red cells ( [25](#) ). The blood bag plasticizer appears to influence membrane stability. Red cells are currently stored in polyvinyl chloride (PVC) bags that contain di-2-ethylhexylphthalate (DEHP) as a plasticizer. Morphologic deterioration is greater in red cells stored in containers that do not contain DEHP, with increased red cell hemolysis and increased loss of deformability, suggesting that DEHP has a direct stabilizing effect on the membrane ( [27](#) , [28](#) ). Adding DEHP can prevent deterioration of stored red cells, with many of the spherical cells reverting to normal discoid morphology ( [29](#) ). Concerns, however, have been raised about potential toxic effects of DEHP, and efforts are being made to identify alternative containers with equivalent red cell storage capabilities ( [30](#) ).

**BIOCHEMICAL CHANGES** During storage, red cells metabolize glucose and produce lactic and pyruvic acid. This results in a drop in pH and a decrease in the rate of

glycolysis. As glycolysis slows, the red cells become depleted of ATP. Because human red cells contain no enzymes with which to synthesize adenine or other purines *de novo*, the nucleotide pool gradually becomes exhausted. In the presence of adenine, ATP may be regenerated. Understanding this has led to methods for prolonging red cell storage by the addition of exogenous adenine and inorganic phosphate, both of which improve the cells' ability to regenerate ATP ( [18](#) ). Red cells lose potassium and gain sodium during storage. This is because the  $\text{Na}^+ - \text{K}^+$  gradient is normally maintained by a  $\text{Na}^+ - \text{K}^+$  ATPase that does not function well at 4° C. Gamma irradiation of red cells to prevent graft-versus-host disease (GVHD) (see section [Graft-Versus-Host Disease](#)) doubles the rate of potassium leakage ( [31](#), [32](#) ). Red cells reabsorb potassium after transfusion ( [33](#) ).

**RED CELL 2,3-DIPHOSPHOGLYCERATE** One of the significant changes in stored red cells is 2,3-DPG depletion, which is not related to red cell viability but to the ability of the red cells to deliver oxygen ( [18](#), [34](#), [35](#) ). When blood is preserved in ACD, 2,3-DPG drops to below 50% within 48 hours. In CPD-, CPDA-1-, and additive solution-stored red cells, 2,3-DPG is better maintained but is essentially depleted after approximately 2 weeks. 2,3-DPG levels improve rapidly within the first 6 hours after transfusion, with return to near-normal levels by 24 hours after transfusion ( [33](#), [36](#) ). The clinical implications of transfusion of blood with decreased 2,3-DPG content remain controversial ( [18](#), [37](#), [38](#) and [39](#) ). The oxygen dissociation curve of cells that are 2,3-DPG-depleted is shifted to the left, resulting in increased hemoglobin oxygen affinity and decreased tissue oxygenation. These changes are thought to be of limited clinical significance because the stored red cells rapidly regain their 2,3-DPG in the circulation. They may be relevant only in a select group of patients such as those in shock. However, the acidosis that may be present in such patients shifts the oxygen dissociation curve to the right. Because of such compensatory mechanisms, the need for blood specifically altered to preserve or reconstitute red cell 2,3-DPG has not been demonstrated.

## Rejuvenating Solutions

A number of chemical agents—dihydroxyacetone ( [40](#) ), pyruvate ( [41](#) ), phosphoenolpyruvate ( [42](#) ), and inosine ( [43](#) )—are capable of maintaining near-normal red cell 2,3-DPG content during storage or of replenishing 2,3-DPG after storage. Although none of these chemicals are likely to be used in transfusion because of their side effects, studies with these agents have resulted in the development of rejuvenating solutions.

Rejuvenating solutions contain pyruvate, inosine, glucose, phosphate, and adenine and may be added to red cells up to 3 days after the expiration date. Treatment with rejuvenating solutions corrects the metabolic defects of the red cell, with a return to normal levels of ATP and 2,3-DPG. These rejuvenated red cells may either be washed and transfused within 24 hours or frozen for later use ( [8](#) ). Such rejuvenated red cells have a normal survival and oxygen affinity ( [44](#), [45](#) ).

## *In Vivo* Recovery of Stored Red Cells

After transfusion of stored blood, red cells that have developed lethal degrees of damage are removed promptly from the circulation of the recipient. Red cells that survive the first 24 hours after transfusion have normal survival thereafter ( [46](#), [47](#), [48](#) and [49](#) ). Therefore, the criterion by which the adequacy for transfusion of banked blood is assessed is the proportion of transfused red cells that remain in circulation at 24 hours after transfusion. Generally, 75% survival at 24 hours is considered evidence of adequate viability; the anticoagulant systems in current use readily achieve this goal. Work to develop optimal additive solutions capable of maintaining red cell ATP and 2,3-DPG levels and to prolong

red cell storage time continues.

## Frozen Red Cells

Red cell freezing is a labor-intensive process that is used primarily for storing rare blood types or prolonged storage of autologous red cells in the event of planned or postponed surgery. Glycerol is gradually added to the red cells as a cryoprotectant to a final concentration of 40% (weight/volume). The cells are then frozen at  $-65^{\circ}\text{C}$  or colder for up to 10 years. Immediately after thawing, an automated cell processor must be used to wash the glycerol from the cells. The washed cells are resuspended in isotonic saline and glucose. In most cases, postthaw storage is limited to 24 hours because an open system is used to process the cells (8). Recently, a closed cell processing system that maintains sterility was developed; cells glycerolized and deglycerolized with this system can be sterilely resuspended in an additive solution and stored in the refrigerator for up to 2 weeks after thawing (50).

## BLOOD COMPONENT MODIFICATION

### Leukocyte Reduction

When whole blood is separated by centrifugation, WBCs sediment at the interface between red cells and platelet-rich plasma. Therefore, WBCs typically contaminate both red cell and platelet components, with concentrations of WBCs approximately  $10^9$ /product. WBCs in blood components can mediate febrile transfusion reactions and stimulate HLA alloimmunization in transfusion recipients (51). Therefore, it may be desirable to remove the WBCs from transfusable blood components.

Historically, several methods have been used to reduce the number of WBCs in transfusable blood components. Relatively nonspecific methods were used initially, including saline washing of red cells or physical separation of RBCs from the WBC layer (buffy coat) (51). Later, a microaggregate filter was used to remove WBCs after centrifugation (52). These methods resulted in white cell reduction of 70 to 90% and were effective in preventing most febrile reactions to red cells. Freezing and deglycerolization of red cells have also been used to remove WBCs and result in approximately 2-log WBC removal. Most recently, selective leukoreduction filters have been developed that can remove 3-logs or more WBCs from blood components. These synthetic fiber filters remove WBCs by a combination of mesh density, chemical attraction, and active adhesion (51). All leukocyte-reduced red cells are now produced using these special filters and, by FDA criteria, contain fewer than  $5 \times 10^6$  WBCs/unit and at least 85% of the original RBC component.

Leukofiltration of RBC components may be performed at the blood collection center, in the hospital transfusion service, or at the bedside. In practice, most filtration is currently performed by the blood collection center. This provides a high level of assurance that the filtration is performed properly. The clinical importance of leukoreducing RBCs before storage, as opposed to after storage, is not well established. Although WBCs can produce cytokines in blood products that are stored at room temperature (i.e., platelets), the levels of cytokines in refrigerated RBC products are probably too low to cause febrile transfusion reactions (53, 54). Removal of WBCs from red cell products before storage provides a theoretical benefit in that WBC breakdown products in the blood component are reduced, and there is some evidence that red cell viability is better preserved if leukoreduction is performed before storage (51). However, there has been no



demonstrated *clinical* benefit from the removal of WBCs from red cell products before storage, compared to poststorage or bedside filtration.

Leukoreduction filters are also available for platelet components. Whole blood-derived platelet concentrates contain fairly large numbers of WBCs, and it appears that many of the febrile transfusion reactions to these products are due to cytokines produced by the WBCs in these products during room temperature storage ( [55](#), [56](#), [57](#) and [58](#) ). Therefore, removal of WBCs from whole blood-derived platelet concentrates *before* storage would be ideal. In the United States, the FDA does not permit pooling of platelet concentrates before storage; therefore, each platelet concentrate would have to be leukofiltered individually. In other countries, platelet concentrates may be pooled, leukofiltered, and then stored. It should be noted that apheresis platelets usually contain very few WBCs and usually qualify as leukoreduced ( $<5 \times 10^6$  WBCs) without need for filtration.

Leukoreduced products are indicated for patients with a history of febrile, nonhemolytic transfusion reactions to reduce the risk of HLA alloimmunization and as an alternative to cytomegalo-virus (CMV) antibody screening of donors to reduce the risk of transfusion-transmitted CMV. Although the use of leukoreduced products is becoming increasingly widespread, the medical necessity of universal leukoreduction remains controversial ( [59](#) ).

### Washed Products

Saline washing can be used to reduce the amount of plasma in cellular blood products. Automated cell washers similar to apheresis machines are the most efficient method, capable of removing approximately 99% of plasma proteins from red cell products ( [8](#) ). Although cell washing was previously used also as a means of leukocyte reduction, it is no longer the most effective method for this purpose. Today, washing is primarily used to prevent severe allergic reactions, which are thought to be triggered by donor plasma proteins. Washing on an automated cell processor takes 30 to 45 minutes/unit. Because the washing procedure is usually performed in an "open" system, the red cells have only a 24-hour shelf life after washing. A closed processing system has been developed that may permit longer storage of washed cells ( [50](#) ). Although many facilities perform red cell washing, few offer washed platelets. Use of automated cell washers to wash platelets has been described ( [8](#) ). However, in practice, it may be difficult to ensure adequate platelet recovery and viability after washing.

### Irradiation of Blood Products

Gamma irradiation of cellular blood components is used to prevent transfusion-related GVHD by impairing the proliferative capacity of lymphocytes in the blood component. The recommended dose for the irradiation of blood and blood products is 2500 cGy at the center of the irradiation field, with a minimum dose of 1500 cGy at any point in the field ( [4](#), [60](#) ). This dose of radiation has no significant adverse effect on red cell, platelet, or granulocyte function. However, there are changes in the red cell membrane that result in an increased loss of potassium from the cell, limiting the storage time of red cell concentrates to 28 days ( [31](#), [32](#) ). The amount of accumulated free potassium in the supernatant of irradiated red cells may be clinically important in massive transfusion, especially in the neonate ( [61](#) ). It may be reasonable to consider performing irradiation just before transfusion, or washing stored irradiated products, if massive transfusion of irradiated products is required for a patient at risk for hyperkalemia.

It should be noted that the dose of irradiation used for cellular blood components is not

sufficient to inactivate pathogens ( 62 ). The irradiation doses required for pathogen inactivation would irreparably damage blood components.

## USE OF BLOOD COMPONENTS

Table 24.1 lists the blood components available for clinical use and briefly summarizes the indications for use of each. The use of each component is discussed in detail below.

TABLE 24.1. Blood Components and Indications for Use

| Component   | Composition  | Volume                  | Indications and Expected Benefit   |
|---|--|-------------------------|--|
| Whole blood                                       | RBC and plasma (approx. Hct, 40%); WBCs; platelets <a href="#">a</a>   | 500 ml                  | To increase red cell mass and plasma volume (plasma deficient in labile clotting factors V and VIII); for hypovolemic anemia, massive transfusion, or exchange transfusion in neonates |
| Packed RBCs                                       | RBC and reduced plasma (approx. Hct, 75%); WBCs; platelets <a href="#">a</a>   | 250 ml                  | To increase red cell mass in symptomatic anemia; 10 ml/kg raises Hct by 10%  |
| RBCs, adenine-saline added                        | RBC and 100 ml of additive solution (approx. Hct, 60%); WBCs; platelets <a href="#">a</a> ; little plasma                              | 330 ml                  | To increase red cell mass in symptomatic anemia; 10 ml/kg raises Hct by 8%   |
| RBCs, leukocytes reduced (prepared by filtration) | >85% original volume of RBCs; <5 × 10 <sup>6</sup> WBCs  | >85% of original volume | To increase red cell mass; <5 × 10 <sup>6</sup> WBCs to decrease the likelihood of febrile reactions, immunization to leukocytes (HLA antigens), or CMV transmission                   |
| RBCs, washed                                      | RBCs (approx. Hct, 75%); reduced WBCs; no plasma   | 225 ml                  | To increase red cell mass; reduce risk of allergic reactions to plasma proteins; or reduce free potassium dose   |
| RBCs, frozen; RBCs, deglycerolized                | RBCs (approx. Hct, 75%); <5 × 10 <sup>6</sup> WBCs; no platelets; no plasma  | 225 ml                  | To increase red cell mass; minimize febrile or allergic transfusion reactions; use for prolonged RBC blood storage   |
| Granulocytes, pheresis                            | Granulocytes (>1.0 × 10 <sup>10</sup> polymorphonuclear cells/unit); lymphocytes; platelets (>2.0 × 10 <sup>11</sup> /unit); some RBCs | 220 ml                  | To provide granulocytes for selected patients with sepsis and severe neutropenia (<0.5 × 10 <sup>9</sup> /L)   |
| Platelet concentrates                             | Platelets (>5.5 × 10 <sup>10</sup> /unit); RBCs; WBCs; plasma  | 50 ml                   | Bleeding due to thrombocytopenia or thrombocytopathy; 1 unit/10 kg raises platelet count by 17–50 × 10 <sup>9</sup> /L   |



|  |  |        |  |
|--|--|--------|--|
| Platelets, pheresis                    | Platelets ( $>3 \times 10^{11}$ /unit); RBCs; WBCs; plasma                             | 300 ml | Same as platelets; sometimes HLA matched; benefit is equivalent to 6 platelet concentrates   |
| Platelets, leukocytes reduced          | Platelets (as above); $<5 \times 10^6$ WBCs/final dose of pooled or pheresis platelets | 300 ml | Same as platelets; $<5 \times 10^6$ WBCs to decrease the likelihood of febrile reactions, alloimmunization to leukocytes (HLA antigens), or CMV transmission                                       |
| FFP; thawed plasma                     | FFP: all coagulation factors; thawed plasma: reduced factors V and VIII                | 200 ml | Treatment of some coagulation disorders; 10 ml/kg of FFP raises factor levels by a maximum of 25% <sup>b</sup>   |
| Cryoprecipitated antihemophilic factor | Fibrinogen; factors VIII and XIII; von Willebrand factor                               | 15 ml  | Deficiency of fibrinogen, 1 unit/5 kg raises fibrinogen 70 mg/dl; also used for factor XIII replacement; not first choice therapy for hemophilia A, von Willebrand disease, topical fibrin sealant |

approx., approximate; CMV, cytomegalovirus; FFP, fresh frozen plasma; Hct, hematocrit; RBC, red blood cell; WBC, white blood cell.

<sup>a</sup> WBCs and platelets are nonfunctional.

<sup>b</sup> Lower recovery of some factors because of diffusion from the vascular space.

Modified from Triulzi DJ, ed. Blood transfusion therapy: a physician's handbook, 7th ed. Bethesda: American Association of Blood Banks, 2002.

## ALTERNATIVES TO ALLOGENEIC DONOR BLOOD

Allogeneic blood donation is blood donated by one individual that is intended for transfusion into a different individual. This blood represents the majority of blood transfused in the United States. Directed (or designated) donation is a donation made by a friend or family member of a patient, intended for transfusion specifically into that patient. Autologous blood donation is blood donated by a patient, intended for transfusion back into the same patient.

### Autologous Blood Transfusion

Blood for autologous transfusion may be collected pre- or perioperatively. In the 1980s and early 1990s, interest in and requests for autologous collections increased significantly. This was a result of the AIDS epidemic and the awareness that transfusion-transmitted infections cannot be totally eliminated by donor screening and testing. However, interest in autologous blood donation decreased in the late 1990s and early 2000s, possibly due to the substantial increase in safety of the blood supply (<sup>63</sup>).

### Preoperative Autologous Blood Donation

Preoperative autologous blood donation is most often used for patients who are likely to require transfusion during elective surgery and when there is minimal risk to the patient

by undergoing this procedure ( 64, 65 and 66 ). It is also used in patients for whom crossmatch-compatible blood cannot otherwise be made available, as in patients with rare blood groups or with multiple alloantibodies. For autologous collections, the donor selection criteria are not as stringent as for allogeneic donors. However, patients with advanced age or significant cerebral or cardiac disease such as arrhythmias or unstable angina must be evaluated before they are enrolled in an autologous donation program. Children are also eligible for autologous blood donation, but the volume of blood collected and anticoagulant used must be adjusted to body weight. The eligibility of each patient must be carefully assessed.

Autologous blood for transfusion during elective surgery can be obtained by collecting blood units from the patient on several occasions preoperatively. The hemoglobin concentration must be at least 110 g/L before the collection of each unit, and if not contraindicated, the patient/donor should receive iron supplements ( 65 ). An autologous donor may donate blood every 3 days as long as the donor's hemoglobin remains at or above 110 g/L. This "aggressive" donation schedule stimulates a more substantial endogenous erythropoietin response, resulting in more autologous units collected or a higher patient hemoglobin at surgery ( 67 ).

Some of the limitations of a preoperative autologous collection program are the condition of the patient, the storage interval, and the erythropoietic response, as well as socioeconomic, cultural, ethnic, and gender issues ( 64, 65, 66 and 67 ). In most instances, units of blood are stored in the liquid state for 35 to 42 days. They may be frozen if a longer interval between donation and surgery is required, but this significantly increases the cost and is not routinely recommended ( 68, 69 ).

All autologous collections must be tested for ABO group and Rh type. The units must be labeled *For Autologous Use Only*. There must also be a method of confirming identity and compatibility of the autologous unit with the recipient ( 4 ). If autologous blood is to be transfused at an institution that is not the collecting facility, the blood unit must be tested for transfusion-transmitted infectious diseases ( 4 ). Medical institutions vary in their policies and procedures concerning the receipt, storage, and transfusion of autologous blood with positive infectious disease markers. Although the presence of a positive infectious marker does not preclude the patient from being in an autologous program, some institutions do not release such units because of the risk to health care workers or the risk of accidental transfusion of the unit to the wrong patient. Patients with positive infectious markers are thereby excluded from an autologous program in these hospitals.

If units with positive infectious markers are released for transfusion, a biohazard label must be attached, and the units must be properly disposed of if they are not used. Proper labeling minimizes the risk of an infectious unit accidentally being transfused to the wrong patient.

### **Disadvantages of Autologous Donation**

Autologous transfusions cannot be considered risk-free. Some of the disadvantages of an autologous program include the logistics involved in organizing the procedure, collection of autologous blood for questionable indications, the underuse of predeposited autologous blood, and overtransfusion because of availability ( 70 ). Because the stringent donor criteria used in the selection of volunteer allogeneic blood donors do not apply, there are increased numbers of adverse reactions including hospitalization in this group of donors. There is a reported 12-fold increase in the number of autologous donors hospitalized

after a donation as compared to allogeneic donors, with an increased risk in the elderly ( [71](#) ). Another disadvantage is the development of anemia as a result of repeated phlebotomy, especially if the last unit of autologous blood is collected fewer than 15 days preoperatively. The requirement for both autologous and allogeneic blood increases in such patients ( [66](#) , [72](#) ). It may be preferable to leave the blood *in vivo*.

Transfusion reactions such as bacterial contamination, febrile nonhemolytic transfusion reactions (FNHTRs), allergic reactions, and volume overload can occur with autologous transfusion ( [73](#) ). The possibility of an accident or error such as the transfusion of the wrong unit or an allogeneic unit to the autologous donor/patient has been reported to be as high as 1.2% ( [74](#) ). The costs and benefits of this program must be addressed, especially at a time when the risks of allogeneic blood transfusion are so low ( [75](#) ). The indications for autologous transfusion should be better defined to provide this important service appropriately. Autologous transfusions are not without complications and are not risk-free. They do play an important role, however, especially in the younger patient.

### **Crossover of Autologous Units**

Autologous blood drawn from a patient/donor can be released for another patient but only under certain exceptional circumstances: The patient/donor does not need the unit; the blood meets all medical and laboratory criteria for a volunteer blood donor; and the blood tests negative for infectious markers. Situations that meet these conditions must be approved by the medical director on a case-by-case basis ( [4](#) ). Most facilities do not permit crossover because of concern about the safety of the unit of blood for allogeneic purposes and also for logistic and clerical reasons. The practice is not widely used ( [65](#) ).

### **Erythropoietin**

Erythropoietin has been used to stimulate red cell production, either to increase the number of units that can be collected preoperatively ( [67](#) , [76](#) ) or as an alternative to preoperative collection ( [67](#) , [77](#) , [78](#) ). Its routine use has not been recommended because of the high cost and the waste of autologous blood.

### **Acute Normovolemic Hemodilution**

A second approach to autologous blood transfusion involves the withdrawal of blood immediately before the surgical procedure and replacing the blood with crystalloid, colloid, or both, thereby acutely hemodiluting the patient and creating a normovolemic anemia ( [66](#) , [79](#) ). This procedure is performed in the operating room under controlled conditions. Patients who might not be eligible for preoperative autologous donation may benefit from acute normovolemic hemodilution (ANH). The blood collected is transfused during surgery as required, depending on the intraoperative blood loss. Patients most likely to benefit from ANH are those with anticipated large surgical blood losses who can tolerate low intraoperative hematocrits ( [80](#) , [81](#) ).

Units collected by ANH can be stored at room temperature for up to 8 hours or at 1° to 6° C for up to 24 hours ( [4](#) ); the blood so collected does not undergo any storage-related changes. The cost of such a program is significantly less than that of a preoperative autologous donation program ( [82](#) ).

## Intraoperative Salvage

A third approach to autologous transfusion is the collection and retransfusion of blood lost during intraoperative hemorrhage ( [8](#), [83](#) ). This method has become popular with the development of technical devices to facilitate the procedure. There are two basic techniques available. The most common is the use of an anticoagulated vacuum suction device, which delivers blood shed from the surgical field into a centrifugelike device that washes the shed blood with saline before it is reinfused. The other technique involves collection of shed blood into special collection devices equipped with filters and reinfusion either directly or after further processing (e.g., washing). The salvaged blood contains red cell stroma, free hemoglobin, activated clotting factors, and fibrin degradation products. The reinfused blood does not appear to cause problems in the recipients, but the exact risk is difficult to define. It also appears that the risk is not increased with unwashed blood if the volume of blood reinfused is limited to approximately 1 L.

There are contraindications to the use of salvaged blood. These include the possibility of bacterial or tumor cell contamination of the operative field and, therefore, the reinfused salvaged blood. Topical substances used during the surgical procedure can be aspirated into the salvaged blood and inadvertently reinfused into the patient (e.g., hemostatic materials, irrigation solutions with added antibiotics). During procedures using such products, care should be taken to minimize the aspiration of these materials.

## Postoperative Salvage

Blood can also be collected postoperatively for reinfusion. In the majority of instances, such blood is collected after cardiac or orthopedic surgery. The transfusion of such shed blood must begin within 6 hours of collection ( [4](#) ). Shed blood contains activated coagulation factors, complement, and factors derived from the fibrinolytic system. The blood must be filtered before transfusion to remove fat particles and any particulate matter that may be present. The volume of fluid collected may be small and generally has a hematocrit of less than 20%. Because the procedure is associated with a number of inherent difficulties, returns a very small number of RBCs to the patient, and is expensive, patient selection is important ( [84](#) ).

## Directed Donations

In comparison to preoperative autologous donation, the practice of directed blood donations is more controversial ( [85](#), [86](#) ). Directed donation programs exist primarily for emotional reasons, although these programs are required to be offered in certain states. In these programs, patients anticipating the need for blood can determine who their donors will be. Usually, friends or relatives are selected on the supposition of a decreased risk of infectious diseases in familiar donors. There is no scientific evidence of their increased safety in a setting in which volunteer blood donors are used ( [86](#) ). On the contrary, blood from donors coerced to give blood for a friend may be less safe, as the social pressure to donate may make donors with risk factors reluctant to self-exclude. Also, directed donors are more likely to be first-time donors, who have a higher incidence of positive tests for infectious markers ( [87](#) ).

An additional problem of a directed donor program is logistic: Collections from directed donors must be made with enough time so that they can be processed, tested, shipped, and received at the patient's hospital before the day of surgery. Often, hospital blood banks are unaware that patients have arranged for directed donations, and if these are

not received in advance of surgery, standard blood units are made available. Disappointments can be avoided only if an elaborate tracking system is in place ( 88 ).

There is no scientific evidence to support the use of directed donors such as parents for infants and children. In fact, the use of directed donations from family members is associated with an increased risk of certain complications. Use of a parent for blood support of a neonate may be associated with increased risks because of potential maternal–paternal–neonatal incompatibilities ( 85 ). The transfusion to a woman of childbearing age of blood from her husband or his relatives increases the risk of hemolytic disease of the newborn in future pregnancies ( 89 ). Because of an increased risk of GVHD, all blood that has been collected from a blood relative must be irradiated before transfusion ( 4 ).

## Blood Substitutes

Because blood can be in short supply or not readily available (e.g., at the location of accidents or on the battlefield), research into the development of a blood substitute has produced several substances that are in clinical trials. In South Africa, a stroma-free bovine hemoglobin product was approved for human use April 2001.

Currently, two main groups of oxygen-carrying substances exist. One group is based on cell-free hemoglobin from either bovine or human sources and is referred to as *hemoglobin-based oxygen carriers*, or HBOCs. The other group is a family of chemicals called *perfluorocarbons*, or PFCs.

PFCs are substances with high oxygen-carrying capacity. Although immiscible with blood, they can be emulsified and transfused, with a short survival in the circulation. The oxygen dissociation curve is linear, so useful oxygen transport requires that the patient be exposed to a high concentration of inspired oxygen. PFCs have a number of potential adverse effects, including flulike symptoms after infusion, possible complement activation, and immunologic effects caused by reticuloendothelial system blockade ( 90 , 91 and 92 ).

Stroma-free hemoglobin is prepared by controlled lysis of red cells in such a way as to avoid red cell membrane contamination. Because cell membranes are not present, blood group antigens are not expressed; therefore, HBOCs can be given to anyone regardless of blood type. They are capable of carrying oxygen, although with an altered P<sub>50</sub>. When given intravenously, HBOCs have significant osmotic activity and a short half-life in comparison to intact RBCs, limiting their clinical effectiveness. The oxygen-carrying capacity and half-life of all HBOCs have been improved by cross-linking, polymerization treatments, or both. Some side effects of HBOCs include vasoconstriction, interference with macrophage function, gastrointestinal distress, possible neurotoxicity, generation of free radicals in tissue, and interference with numerous laboratory tests ( 90 , 91 ). Both HBOCs and PFCs are in phase II and III clinical trials. Studies have shown efficacy in decreasing the number of allogeneic RBCs transfused to patients undergoing various surgical procedures ( 90 , 91 ). How useful and cost-effective these products will be when available for general medical use remains to be established.

## RED CELL TRANSFUSION

Red cell transfusion should be based on a careful assessment of each patient's unique clinical situation. Many guidelines for red cell transfusion have been published, but it must be remembered that they are *guidelines*—not absolutes. The treating physician must

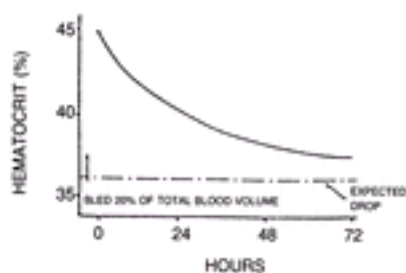
understand the limitations, risks, and benefits of red cell transfusion.

The main indication for RBC transfusion is inadequate oxygen delivery due to anemia and, in some cases, hypovolemia. Wound healing is not impaired in the presence of anemia, and transfusion does not improve wound healing. Patients with chronic diseases should never be transfused simply because of mild asymptomatic anemia or as part of supportive care.

Considering that approximately 12 million units of RBCs are transfused in the United States each year, it is somewhat unsettling to realize that their efficacy has never been demonstrated in well-designed trials. Some recent studies show an increase in mortality in specific groups of transfused intensive care unit patients when compared to untransfused matched controls (93, 94). In contrast, a study of elderly patients with anemia and myocardial infarction showed a transfusion-associated decrease in short-term mortality (95). The clinician must be aware that not all is known about blood transfusion and its potential to affect, both positively and negatively, a patient's health.

### Indications for Red Cell Transfusion

**HYPOVOLEMIA DUE TO HEMORRHAGE** One of the major indications for blood transfusion is the restoration of an adequate blood volume after the loss of large amounts of blood (96). In such situations, the rapid restoration of circulating blood volume is more important than maintaining a normal red cell mass; fluid resuscitation is accomplished initially by the infusion of a crystalloid solution such as saline or Ringer's lactate. The use of colloids such as albumin, hydroxyethyl starch, or low-molecular-weight dextran does not appear to be of any clinical advantage over crystalloids (97, 98). In general, adults losing less than 20% of their blood volume (or approximately 1 L) do well without red cell transfusion, providing that fluid resuscitation is adequate to maintain the circulating blood volume and that further blood loss is avoided. Young healthy patients can sustain losses of up to 30 to 40% of blood volume as long as intravascular blood volume is adequately maintained with IV fluids. When red cells are necessary, whole blood (if available) or red cell units may be transfused. In the resuscitation of hypotensive patients after hemorrhage, hemoglobin and hematocrit measurements are unreliable (Fig. 24.2). Clinical assessment of circulatory status (Table 24.2), including monitoring of pulse, blood pressure, respiratory rate, urinary output, and mental status, is essential. Measurements such as whole-body oxygen consumption, oxygen extraction ratio, and oxygen delivery are more reliable in judging the need for transfusion and may be indicated depending on the clinical status of the patient (99, 100 and 101).



**Figure 24.2.** After acute hemorrhage, the hematocrit may not reflect true red cell losses for up to 72 hours.

**TABLE 24.2. Clinical Signs of Blood Loss**

---

**Volume Lost**

---



| ml   | % of Blood Volume | Clinical Signs  |
|------|-------------------|---|
| 500  | 10                | None; occasionally vasovagal syncope  |
| 1000 | 20                | At rest, there may be no clinical evidence of volume loss; a slight postural drop in blood pressure may be seen; tachycardia with exercise            |
| 1500 | 30                | Resting supine blood pressure and pulse may be normal; neck veins flat when supine; postural hypotension  |
| 2000 | 40                | Central venous pressure, cardiac output, systolic blood pressure below normal even when supine and at rest; air hunger, cold clammy skin; tachycardia |
| 2500 | 50                | Signs of shock; tachycardia, hypotension, oliguria, drowsiness, or coma   |

**SURGERY** There is no rationale for the routine preoperative transfusion of patients with mild anemia. The optimal pre- and postoperative hemoglobin depends on the patient's clinical condition. The belief that a hemoglobin value of less than 100 g/L, or a hematocrit of less than 0.30 L/L, indicates a need for red cell transfusion preoperatively has been discarded. Each case must be considered individually, taking into account such variables as duration of anemia, the time of the surgical procedure, the probability of blood loss, and any coexistent clinical features such as underlying cardiovascular disease that may contribute to morbidity. An arbitrary threshold for transfusion cannot be defined ( [102](#), [103](#) and [104](#) ). The use of blood during and after surgery depends on the judgment of the surgeon and anesthesiologist. Patients should not be transfused simply to replace small amounts of blood lost during surgery. Surgery may often be performed with reasonable safety in patients refusing blood transfusions ( [105](#) ), and even cardiopulmonary bypass surgery may be performed without the need for homologous transfusions and, sometimes, with small volumes of autologous blood only ( [106](#), [107](#) ). Below a certain critical level, patients do require transfusion. Approximately 17 clinical practice guidelines have been published, none as exhaustively researched as the American Society of Anesthesiologists Task Force on Blood Component Therapy. This task force rejected the adoption of a single "transfusion trigger" but did advise clinicians that transfusion is rarely indicated if the hemoglobin is above 100 g/L, and transfusion is almost always indicated if the hemoglobin is below 60 g/L ( [103](#) ). Preoperative requests for blood should be in accordance with standard operating procedures that are predetermined on the likelihood of a procedure requiring a blood transfusion. Such maximum surgical blood order schedules represent transfusion practice guidelines for pretransfusion assessment, including the number of units that should be crossmatched for a variety of procedures ( [108](#), [109](#) ). A pretransfusion sample should be sent to the blood bank if it is likely that blood will be required for a specific surgical procedure. The request could be for a type and screen if it is unlikely that the patient will require blood, or for crossmatch for a specific number of units if it is likely.

**ANEMIA** RBCs are often transfused in the management of various types of anemia. The blood hemoglobin concentration or hematocrit alone should not determine the need for transfusion. Patients should be transfused only on the basis of clinical indications. Physiologic adaptations to anemia, including elevated red cell 2,3-DPG content and increased cardiac output, compensate to a significant extent for chronic anemia. Functional impairment is unusual, and transfusion is rarely required in anemic patients with a hemoglobin concentration above 100 g/L. Even when hemoglobin concentration is below 100 g/L, tissue oxygenation is usually maintained as long as the cardiac output is adequately increased, the perfusion of critical organs is not constrained, and oxygen consumption is not excessive (e.g., patient is not engaging in vigorous physical activity). When the hemoglobin is less than 60 to 70 g/L, transfusion is often required to prevent or treat symptoms of anemia (syncope, dyspnea, postural hypotension, tachycardia, angina, transient ischemic attacks). When hemoglobin is between 60 and 100 g/L, the decision to



transfuse should be based on a consideration of the patient's age, cardiovascular and respiratory status, activity level, symptoms, underlying diagnosis, and state of bone marrow activity. Many anemic patients with a stable hemoglobin concentration at the lower end of this range do not need transfusion. Children may tolerate even lower levels. In all patients, physiologic adjustments to chronic or acute anemia ultimately have a limit. In patients with limited ability to increase cardiac output or with impaired perfusion of vital organs, such as elderly patients with myocardial or vascular disease, anemia is poorly tolerated. Many types of anemia can be treated with medical therapy, and patients with chronic anemia are often well adapted. In such situations, it is usually possible to withhold blood transfusion and to await recovery of the patient's marrow function after specific replacement therapy (iron, folate, B<sub>12</sub>, erythropoietin).

### **INDICATIONS FOR TRANSFUSION OF ANEMIC PATIENTS**

**Deficiency States** Patients who are anemic solely because of deficiency of iron, folate, or B<sub>12</sub> rarely require transfusion. Elderly patients who present with pernicious or severe iron deficiency anemia may require a limited number of red cell transfusions, particularly when angina or congestive heart failure has been the cause of the patient seeking medical attention. More often, iron-deficient patients who are also bleeding actively from the gastrointestinal tract or other sites require red cell transfusions. In such situations, the goal of transfusion is not to correct the patient's hemoglobin concentration, but to raise it sufficiently to stabilize the patient; thereafter, the marrow should be permitted to correct the deficiency.

**Hemolytic Anemias** Patients with acute or chronic hemolytic anemias may require red cell transfusion; often, this need arises at the time of a hemolytic or aplastic crisis. Such patients are often critically ill, and safe transfusion requires careful clinical attention. In autoimmune hemolytic anemia ([110](#), [111](#)), the clinician may be faced with a severely anemic patient for whom crossmatch-compatible blood cannot be obtained. These patients produce an antibody that reacts with all RBCs including their own, and the cautious transfusion of "incompatible" red cells may be necessary. In these cases, withholding transfusion hoping to find "compatible" RBCs places the patient in needless danger. Consultation with a transfusion medicine specialist should allay the clinician's fears.

**Hypoproliferative Anemias** In aplastic and sideroblastic anemias, myelodysplastic states, and myelofibrosis, patients often depend on regular transfusion of red cells and may die of transfusion-induced iron overload after several years of such support unless precautions are taken to remove iron. The development and use of recombinant human erythropoietin have eliminated the need for transfusion in some patients with hypoproliferative anemia, such as those with end-stage renal disease ([67](#)). Patients with malignant diseases often require transfusions for relief of symptoms of anemia. In this situation, the marrow function may be severely depressed by chemotherapy or radiotherapy. Infections and thrombocytopenic bleeding may be present, and recovery of marrow function is delayed. Transfusions are indicated to ameliorate symptoms and many clinicians maintain hemoglobin levels above 80 to 90 g/L during ongoing marrow suppressive therapy.

**Hereditary Red Cell Disorders** In children with thalassemia (see [Chapter 42](#)), bone marrow hyperplasia with its undesirable effects on the skeleton may be ameliorated, and iron absorption may be decreased, by regular transfusions to maintain a near-normal hemoglobin concentration ([112](#)). Such a program is possible only in conjunction with an aggressive iron chelation program, as the predictable iron load otherwise leads to fatal hemosiderosis. In sickle cell disease (see [Chapter 40](#)), the adverse microvascular effects of sickle cells can be relieved temporarily by transfusion of normal red cells, thereby reducing the proportion of sickle cells in circulating blood. Red cell exchange may be indicated to reduce the proportion of sickle cells without increasing the hematocrit to unacceptable levels.

### **Pretransfusion Testing of Red Cells**

**COMPATIBILITY TESTING PROCESS** The process of selecting red cells for transfusion

involves three stages. Blood grouping involves determination of the ABO group and Rh type of both recipient and donor specimens. The recipient's serum or plasma is screened for the presence of unexpected red cell antibodies. Crossmatching either *in vitro* or electronically after selection of a donor unit of the appropriate group and type determines whether the donor cells are compatible with the recipient's plasma. Properly selected blood products will be compatible with the recipient, indicating that transfusion should not result in hemolysis of donor red cells. Because only the ABO and Rh(D) red cell antigens are prophylactically matched in routine transfusion practice, there are always significant antigenic differences between donor and recipient, both for red cells and the accompanying leukocytes, platelets, and plasma. Repeated exposure to foreign antigens with chronic transfusion or pregnancy may result in antibody formation in the recipient. There is no room for error in the provision of blood for transfusion. If clerical or laboratory error results in donor and recipient being mismatched for the ABO group, transfusion of even a few milliliters of red cells may lead to a life-threatening transfusion reaction with shock, intravascular coagulation, and acute renal failure. Such reactions are rare because of rigid adherence to a routine designed to maximize safety at all levels of the transfusion process. Careful identification of the patient for whom the blood is ordered, including complete labeling of the specimen at the bedside of that patient, is essential. Careful ABO blood grouping along with comparing results of ABO testing with historical records for each patient adds to the level of safety. Ensuring positive identification of crossmatched units of blood and verifying that the information identifying the unit with the intended recipient is reviewed in the presence of that recipient before the administration of the blood are crucial ( 4, 8).

**BLOOD GROUPING** The presence of ABO antigens is determined by testing the unknown RBCs with anti-A and anti-B sera by one of a variety of methods including slide, tube, gel, or microplate tests ( 8). Identifying which ABO antigens are on the surface of an individual's RBCs is called the *forward grouping* or *forward type*. Cells agglutinated only with anti-A serum are group A; those reacting only with anti-B are group B. Those reacting with both antisera are group AB, and red cells that fail to agglutinate with either anti-A or anti-B are group O. "Reverse grouping" or "reverse typing" should be performed to confirm the reaction obtained by the forward grouping test. This involves testing the reactions of the serum or plasma from the person of unknown type with the red cells of known A and B type. Agglutination of the red cells indicates the presence of anti-A or anti-B in the individual's serum. The conclusions of forward and reverse tests should agree as shown in [Table 24.3](#).

**TABLE 24.3. ABO Grouping**

| Patient Blood Group | Expected Reactions of |        |                      |         |
|---------------------|-----------------------|--------|----------------------|---------|
|                     | Patient's Cells with  |        | Patient's Serum with |         |
|                     | Anti-A                | Anti-B | A Cells              | B Cells |
| O                   | None                  | None   | +                    | +       |
| A                   | +                     | None   | None                 | +       |
| B                   | None                  | +      | +                    | None    |
| AB                  | +                     | +      | None                 | None    |

The antisera used in blood group antigen detection can be obtained from donors with naturally occurring high levels of antibodies, from people or animals specifically stimulated to produce antibodies against blood groups, or from monoclonal antibodies of mouse or human origin. The advantages of monoclonal antibodies include their high quality and stability and their ease of production in large quantities. Antisera must be of known specificity and potency, and control testing must be done on a routine basis ( 8). The Rh

type of red cells is determined by examining the cells' reaction with anti-D serum from commercial sources. Commercial antisera may be modified by the manufacturer with the addition of high concentrations of protein or by chemically altering the immunoglobulin (Ig) G molecules in such a way that they perform as direct agglutinins in the laboratory. This permits rapid, reliable testing to determine the D antigen status of the cells. However, these high-protein reagents may cause false-positive reactions because of spontaneous aggregation of the red cells in their presence. If this happens, an Rh-negative patient could be typed as Rh positive if the recommended Rh control is not simultaneously tested. This has resulted in the development of low-protein, saline-reactive monoclonal reagents. Monoclonal anti-D reagents contain both human IgM and polyclonal IgG antibodies and are currently most widely used. They can also be used in the antiglobulin test for weak D. As with all reagents, manufacturers' instructions must be followed (8).

**Weak D** Some red cells react weakly with anti-D reagents. If donor blood is being tested, the presence or absence of D must be confirmed. If the initial test for D is negative, a second test must be performed using a method that detects weak D. If D is detected by either method, the unit is labeled Rh positive. In recipients, it is not necessary to confirm the presence of D. Patients who type as Rh negative even though they are weak D-positive are not adversely affected by the transfusion of Rh-negative products. If the patient is known to be weak D-positive, Rh-positive donor blood may be administered. Before labeling a patient weak D-positive, care must be taken to ensure that the patient has not recently been transfused with Rh-positive red cells.

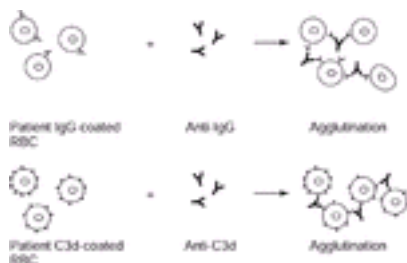
**TESTING FOR RED CELL ANTIBODIES** Antibodies in potential blood recipients fall into several categories. The most common blood group antibodies that are clinically significant and may be implicated in hemolytic transfusion reactions or hemolytic disease of the newborn are shown in [Table 24.4](#).

**TABLE 24.4. Significance of Certain Blood Group Antibodies**

| Blood Group System | Antibody | Relative Frequency in Antibody Screening | Clinical Significance          |                                  |
|--------------------|----------|--|--------------------------------|----------------------------------|
|                    |          |  | Hemolytic Transfusion Reaction | Hemolytic Disease of the Newborn |
| ABO                | Anti-A   | All group B and O                        | Yes                            | Yes                              |
|                    | Anti-B   | All group A and O                        | Yes                            | Yes                              |
| Rhesus             | Anti-D   | Common                                   | Yes                            | Yes                              |
|                    | Anti-c   | Common                                   | Yes                            | Yes                              |
|                    | Anti-E   | Common                                   | Yes                            | Yes                              |
|                    | Anti-C   | Common                                   | Yes                            | Yes                              |
|                    | Anti-e   | Uncommon                                 | Yes                            | Yes                              |
|                    | Anti-k   | Rare                                     | Yes                            | Yes                              |
| Kell               | Anti-K   | Common                                   | Yes                            | Yes                              |
|                    | Anti-k   | Rare                                     | Yes                            | Yes                              |
| Kidd               | Anti-Jka | Common                                   | Yes                            | Yes                              |
|                    | Anti-Jkb | Rare                                     | Yes                            | Yes                              |
| Duffy              | Anti-Fya | Common                                   | Yes                            | Yes                              |
|                    | Anti-Fyb | Rare                                     | Yes                            | Yes                              |
| MN                 | Anti-M   | Common                                   | Occasional                     | Occasional                       |
|                    | Anti-N   | Rare                                     | Rare                           | Rare                             |
| SsU                | Anti-S   | Uncommon                                 | Yes                            | Yes                              |
|                    | Anti-s   | Rare                                     | Yes                            | Yes                              |
| Lewis              | Anti-Lea | Common                                   | Yes                            | No                               |
|                    | Anti-Leb | Uncommon                                 | No                             | No                               |
| P                  | Anti-P1  | Uncommon                                 | Rare                           | No                               |

All human plasmas contain naturally occurring antibodies that react with the complementary antigens of the ABH system. These are of great importance in transfusion, as they are complement-fixing IgM antibodies; transfusion of incompatible red cells leads to immediate hemolytic reactions. Many people also have naturally occurring antibodies (usually low-titer IgM antibodies reacting at or below room temperature) reacting with some antigens of the Lewis, P, Ii, MN, or other systems; these are rarely active above room temperature and are only occasionally important in transfusion. Finally, people exposed to foreign red cells by prior transfusion or pregnancy may produce IgG antibodies to antigens of certain other systems, primarily Rh (C, c, D, E, e), Kell, Duffy, Kidd, and Ss, but many less common possibilities exist. These red cell antibodies are clinically significant. They do not often lead to intravascular hemolytic reactions, but transfused incompatible red cells may exhibit decreased survival caused by increased clearance in the reticuloendothelial system. Many of these IgG antibodies can also cause hemolytic disease of the newborn ([6](#), [8](#)). There are two major classes of antibodies that react with red cells. Complete or saline antibodies agglutinate red cells suspended in saline solution; these are usually IgM. Those that do not react visibly in saline and are capable of producing agglutination reactions only with special techniques to make their interaction with red cells detectable are called *incomplete agglutinins*; these are generally IgG antibodies. The best example of a room-temperature saline agglutination test is that used in ABO grouping. Other red cell antibodies readily detected in saline suspension are those belonging to the Lewis, MN, P, and Ii blood group systems. With the important exception of ABO system antibodies, many of the others detected with this test are of no clinical significance, as they are not reactive at 37° C. The best examples of incomplete agglutinins, or IgG antibodies, are those reacting with antigens of the Rh system. If such antibodies are not detected in the recipient, immediate hemolysis of transfused, incompatible red cells is extremely rare. However, their presence may lead to a significantly decreased survival of transfused cells and the development of an extravascular hemolytic syndrome [delayed hemolytic transfusion reaction (DHTR)].

**ANTIGLOBULIN TEST** The antiglobulin (Coombs) test ([Fig. 24.3](#) and [Fig. 24.4](#)) is based on the reaction between an antihuman globulin (AHG) reagent and antibody- or complement-coated red cells. AHG reagents are commercially available and are prepared either by the injection of an animal with human globulin or through hybridoma technology. AHG reagents may be polyspecific or monospecific. The polyspecific reagents contain antibodies with both anti-human IgG and anticomplement activity. Monospecific AHG reagents, anti-IgG, anti-C3b, and anti-C3d, are used to determine which protein is responsible for a positive direct antiglobulin test ([8](#)).



**Figure 24.3.** Direct antiglobulin test with anti-immunoglobulin G (IgG) and anti-C3d. RBC, red blood cell. (Reprinted from Jeter EK, Spivey MA. Pretransfusion testing. In: Introduction to transfusion medicine: a case study approach. Bethesda, MD: American Association of Blood Banks Press, 1996;56, with permission.)



**Figure 24.4.** Indirect antiglobulin test. IgG, immunoglobulin G; RBC, red blood cell. (Reprinted from Jeter EK, Spivey MA. Pretransfusion testing. In: Introduction to transfusion medicine: a case study approach. Bethesda, MD: American Association of Blood Banks Press, 1996;56, with permission.)

The *direct* antiglobulin test is performed by washing the test cells with saline, adding polyspecific AHG, and observing for agglutination ( Fig. 24.3). Positive reactions (agglutination) suggest the presence of IgG antibodies or complement bound to the red cell ( 8 ). The *indirect* antiglobulin test is used to determine the presence of red cell antibodies in serum or plasma ( Fig. 24.4). Reagent red cells are washed, incubated with the patient's serum or plasma, washed again to remove unbound immunoglobulins, mixed with AHG (usually monospecific anti-IgG), and then centrifuged briefly. The cell button is gently resuspended and examined for agglutination. A positive reaction suggests that IgG antibodies in the patient's plasma have bound to the reagent cells. A positive indirect antiglobulin test therefore indicates the presence of antibodies capable of reacting with red cells and capable of possibly hemolyzing such cells if they were transfused. Direct and indirect antiglobulin tests (Coombs test) are the simplest approaches to the detection of IgG anti-red cell antibodies. Because many of these serologic reactions are rather weak, the addition of various media has been used to enhance the agglutination reaction. These tests involve procedures that diminish the mutually repulsive electrostatic forces between red cells, permitting visible agglutination by IgG antibodies ( 8 ). Antigens that often require such enhancing tests include those of the Kidd (Jk<sup>a</sup> and Jk<sup>b</sup>), Rh (D, C, E, c, e), Kell, and Duffy (Fy<sup>a</sup> and Fy<sup>b</sup>) systems.

#### MEDIA THAT ENHANCE AGGLUTINATION

**Albumin** Mixing red cells with serum or plasma in the presence of albumin makes certain weak reactions (e.g., those involving Rh system antibodies) more easily detected. Although long thought to be the effect of albumin itself, the enhancement of reactions is most likely due to albumin's low ionic strength buffer ( 8 ).

**Enzymes** Pretreatment of the test red cells with various proteolytic enzymes, such as trypsin, papain, ficin, or bromelin, increases the sensitivity of the test for some antibodies, particularly those reacting with antigens of the Kidd and Rh systems. The M and N, Fy<sup>a</sup> and Fy<sup>b</sup>, and, in some cases, S and s antigens are destroyed or weakened by such treatment. Enzymes remove sialic acid from the red cell membrane, thereby diminishing the negative charge of the cell. Enzyme-treated cells should be used as an investigative tool in antibody investigation, not for antibody screening ( 8 ).

**Reduced Ionic Strength** Performance of serologic reactions in a solution of fixed low ionic strength also potentiates certain agglutination reactions and shortens the incubation period required for the detection of most antibodies ( 8 ).

**Polyethylene Glycol** Use of polyethylene glycol in the antiglobulin test has been reported to be superior to albumin for detection of clinically significant antibodies. Polyethylene glycol enhances antibody binding by excluding water molecules in the diluent, allowing for closer interaction between antibody and antigen. It has been shown to increase the detection of clinically significant red cell antibodies while decreasing the detection of insignificant ones ( 8 ).

**OTHER ANTIBODY IDENTIFICATION TESTS** Sera containing several antibodies may be analyzed by absorbing with one or more selected red cells ( 6, 8 ). Antibodies so adsorbed may be eluted from the cells, and their specificity may be determined. When necessary, the identity of certain antibodies may be confirmed by their inhibition by soluble antigens, such as A, B, and Lewis substances present in the saliva of secretors. Neonatal (cord) red cells exhibit a number of antigens very weakly and may be used to investigate antibody specificity.



**PRETRANSFUSION COMPATIBILITY TESTING** The purpose of compatibility testing is to detect antibodies in the recipient's serum that react with donor red cells and have the potential to destroy the transfused cells. Reactions examining this possibility are called *major crossmatches*. Serologic crossmatching of donor plasma with recipient red cells (minor crossmatch) is generally not performed. Donor antibodies directed at recipient ABO antigens are excluded by the selection of group-compatible plasma products. Donor plasma is screened for red cell antibodies other than ABO ( 4 ). Antibodies of other specificities are rare in donors, with an incidence of 0.32 to 0.34% ( 113 , 114 ), the most common ones being anti-D, -E, and -K. Plasma containing antibodies other than ABO is generally not transfused. Even if transfused, these antibodies would be unlikely to cause recipient hemolysis because they would be diluted greatly in the recipient's circulation ( 113 , 115 , 116 and 117 ).

### Selection of Red Cells for Transfusion

A series of serologic tests is used to select donor blood for patients. Although individual transfusion services prefer different specific methods, the general principles of compatibility testing are the same.

A properly labeled, fresh sample of patient blood must be provided. If the patient has been transfused or has been pregnant within the preceding 3 months, the specimen must be obtained within 3 days of the anticipated transfusion ( 4 ).

**DONOR** The ABO group of the donor unit must be confirmed. The Rh typing must be repeated if the unit is labeled as Rh negative. These tests are performed to confirm the blood group and to ensure that the unit has not been mislabeled.

**RECIPIENT** The recipient's ABO group and Rh type must be determined. The recipient's serum is screened for the presence of antibodies that may have been induced by prior pregnancy or transfusion. A set of commercially prepared group O red cells, expressing 18 clinically relevant antigens, is used in this test in accordance with FDA rules. The use of group O red cells avoids agglutination by anti-A or anti-B. The antigens expressed must include D, C, E, c, e, M, N, S, s, P<sub>1</sub>, Le<sup>a</sup>, Le<sup>b</sup>, K, k, Fy<sup>a</sup>, Fy<sup>b</sup>, Jk<sup>a</sup>, and Jk<sup>b</sup>. These cells are incubated with the patient's serum and tested with the indirect antiglobulin test for reactions indicating the presence of antibody in the serum ( 8 ). If such screening reactions are positive, the antibody specificity can be determined by reaction of the serum with a commercially prepared panel of reagent red cells of known antigenic composition. If an antibody has been found on the screen, it is best to withhold transfusion, if the patient's clinical status allows, until identification is complete. The incidence of unexpected RBC antibodies in patients requiring transfusion is low.

**TYPE AND SCREEN** If it is unlikely that blood will be required, for example, for a surgical procedure, a "type and screen" rather than a crossmatch should be requested. In this instance, the blood bank types the patient's blood and screens for unexpected antibodies; if antibodies are not found, the blood bank ensures that blood of the appropriate group is available for transfusion if necessary. In such an event, a telephone call can trigger a rapid crossmatch test and blood will be available with minimal delay. The appropriate use of type and screen improves the efficiency of the blood bank. It assists in inventory control by not segregating blood for patients who are unlikely to require it and is therefore cost-effective.

**CROSSMATCH** If no antibody has been detected on the screen and there is no record of the previous presence of a clinically significant antibody, only verification of ABO compatibility between the donor unit and recipient is required before transfusion. This can be done either by an immediate spin crossmatch or a computer crossmatch. The immediate spin crossmatch consists of mixing the patient's serum with donor saline-suspended red cells at room temperature, spinning the tube, and reading the

results immediately. The purpose of this test is to detect ABO incompatibility due to the presence of anti-A, anti-B, or both in the patient's serum ( 8 ). The conditions for computer crossmatch are outlined in the AABB standards ( 4 ). Briefly, the computer system must be validated to prevent release of ABO-incompatible blood. This computer crossmatch can be used only for patients who do not have a record of clinically significant antibodies. The recipient's ABO blood group must have been determined on at least two separate tests. The system must contain complete information on the donor unit and the recipient, including ABO group and Rh type. Data entered must be verified as correct before the release of blood. The system must contain logic to alert the user to discrepancies for either the donor unit or the recipient, including unit labeling, blood grouping, and ABO incompatibilities. If a clinically significant antibody has been found, antibody identification should be performed. Donor units lacking the specific antigen should be selected, and a major crossmatch using an indirect antiglobulin test should be performed on each unit to ensure compatibility. The physician should also be advised about the nature of the problem, as well as the potential for delays if further units are required. Once a unit of blood is crossmatched for a patient, there must be positive identification of the patient and the unit. Before every transfusion, the requisition, the label on the unit, and the patient's identification must be checked. This aspect of patient and unit identification is critical and must be documented.

### **CROSSMATCHING PROBLEMS**

***Pseudoagglutination*** *Pseudoagglutination* refers to red cell clumping (rouleaux formation) that typically occurs when the sedimentation rate is elevated, in the presence of dysproteinemias, or after the administration of dextran or hydroxyethyl starch. Dilution in saline abolishes the reaction ( 6 , 8 ).

***Autoagglutination*** *Autoagglutination* refers to red cell agglutination by the patient's own serum or plasma and often indicates the presence of a cold agglutinin. This artifact persists after dilution but is removed by washing the red cells and repeating the serologic test at 37° C. A positive indirect antiglobulin test against all screening and donor red cells often indicates the presence of an IgG, warm-reacting autoantibody. The patient's direct antiglobulin test is also positive. Often, such autoantibodies preclude the identification of any compatible donor units. If red cells must be transfused, it is essential that ABO compatibility be ensured. The patient's serum should be screened for alloantibodies that might be masked by the autoantibody ( 8 , 118 , 119 ). Such screening requires the removal of the autoantibody from the patient's serum, so that any alloantibodies present can be identified. If the patient has not been transfused within 4 months, this can be done by absorbing autoantibody from the serum with autologous red cells, from which already attached antibody has been removed by enzyme or chemical treatment. Alternatively, autoantibody may be removed by absorption with a panel of cells selected to lack the antigens to which the patient may become alloimmunized. The autoantibody-depleted serum can then be examined for the presence of residual alloantibodies, and a major crossmatch can be done. If only the autoreactive antibody is present, transfusion of red cells is generally well tolerated.

***Alloantibody to High-Incidence Antigens*** Occasionally, a patient may have a red cell antibody that does not react with the patient's own cells but reacts with all donor red cells. In many of these cases, it is not clear whether the antibody is likely to cause significant hemolysis. In such patients, if a transfusion is considered essential, a small amount (=5 ml) of <sup>51</sup>Cr-labeled, crossmatch-incompatible red cells may be transfused, and their survival may be determined over 24 hours. Survival of more than 70% of labeled cells at 24 hours indicates that the recipient's antibody is not likely to cause significant destruction of transfused cells ( 120 , 121 ). *In vitro* assays such as the monocyte monolayer assay may also be useful in this regard ( 122 ). These tests may also be used to evaluate apparent *in vivo* incompatibility of red cells that are crossmatch compatible in the laboratory ( 123 , 124 ).

***Drugs*** Drugs may cause the formation of antibodies and are one of the possible causes of serologic incompatibility. Incompatibility in a crossmatch may be due to the presence of a drug-induced antibody coating the donor cells. The situation of one positive crossmatch



among other negative crossmatches in a patient with a negative antibody screen directs an investigation into the possibility of a positive direct antiglobulin test in the suspect donor unit. Some drugs may stimulate an autoantibody in the patient that reacts with all reagent cells tested as well as donor red cell units crossmatched. Drugs implicated include  $\alpha$ -methyl dopa and procainamide. In some cases, the *in vitro* findings may be identical to those found in autoimmune hemolytic anemias. The presence of these antibodies may or may not be clinically significant but may result in a delay if a transfusion is required. In most cases, however, drug-induced antibodies are associated with a positive direct antiglobulin test that is not part of the standard pretransfusion or crossmatch testing, and the indirect antiglobulin test is negative. The mechanisms of drug-induced hemolytic anemias are discussed in [Chapter 36](#).

**Polyagglutination** Polyagglutination is the phenomenon in which a patient's red cells are agglutinated by most or all group-compatible sera. It is caused by alteration of antigenic structures on the red cell membrane with exposure of previously hidden red cell antigens ([6](#)). T (and, more rarely, Tn) antigens are in these cases exposed during bacterial or viral infection by enzymes associated with the infecting organism. Most adult sera contain naturally acquired antibodies capable of reacting with these determinants. The situation may be elucidated by testing the patient's red cells with cord serum, which lacks the antibodies necessary for this reaction, and by examining for reactions with lectins of plant origin that have specific activity with the antigens involved in polyagglutination ([125](#), [126](#)).

## Transfusions in the Newborn Period

**PRETRANSFUSION TESTING** The so-called naturally occurring IgM ABO antibodies do not begin to appear until approximately 3 to 6 months of age. However, IgG antibodies of maternal origin, including maternal anti-A or anti-B, may be passively transferred to the fetus. Thus, pretransfusion testing in the newborn consists of ABO and Rh typing of the infant's cells and an antibody screen for passively transferred maternal IgG antibodies, including anti-A or anti-B. If the initial antibody screen is negative, the infant may be transfused with products compatible with the patient's ABO/Rh type, and no further compatibility testing is required for the first 4 months of life. If a clinically significant antibody of maternal origin is detected, units that are antigen negative or crossmatch compatible must be issued until the antibody is no longer detectable in the infant's serum ([4](#)).

**SELECTION OF PRODUCTS FOR TRANSFUSION** Preterm infants may require multiple transfusions to replace blood drawn for laboratory tests. It has become common practice to limit donor exposure by reserving one unit or one-half of a unit for a single preterm infant. Serial aliquots may be obtained using a sterile connection device up to the outdate of the unit ([127](#), [128](#) and [129](#)). Blood products for low-birth-weight infants should be irradiated to prevent transfusion-related GVHD and should be CMV safe. Either CPDA-1 or additive red cells may be used for aliquot transfusions. However, the safety of additive solutions has not been demonstrated in the setting of massive transfusion of infants (i.e., one unit or more in a neonate). The amount of free potassium in the supernatant of the irradiated blood may also become clinically important in the setting of massive transfusion ([61](#)). For massively transfused infants at increased risk of hyperkalemia, the dose of free potassium in the transfused product may be decreased by delaying irradiation until just before issue or by washing the RBCs.

**EXCHANGE TRANSFUSION** The most common indication for exchange transfusion in the neonate is hyperbilirubinemia that has not responded adequately to phototherapy, particularly that associated with hemolytic disease of the newborn. Other indications may include disseminated intravascular coagulation or the removal of toxins. Usually, one to two blood volumes are exchanged. Red cells collected in CPD or CPDA-1 that are less than 1 week old are preferred. Because several clotting factors in newborns are at the low end of hemostatic levels, many centers perform exchanges using whole blood, or red cells reconstituted with FFP, to prevent further lowering of factor levels by the exchange. Red cells used for the exchange transfusion should be irradiated to prevent

transfusion-related GVHD ( 8 ).

### Selection of Blood for Emergency Transfusion

For patients in hemorrhagic shock, it is necessary to transfuse blood immediately, and no blood bank testing should be attempted before emergency transfusion. The risk of transfusing group O cells is extremely low and is certainly much lower than the risk of the patient's death if blood transfusion is delayed. For patients given uncrossmatched blood, a specimen of the patient's blood should be sent to the blood bank for an antibody screen and crossmatch, as the transfusion is proceeding.

If the patient's blood group is known, uncrossmatched blood of the same group may be used; otherwise, group O red cells should be chosen ( 4 ). Patients of blood group AB may be given either group A or group B cells. Such uncrossmatched blood should be Rh(D) negative when used in women of childbearing age in whom sensitization to D would be undesirable. As Rh-negative blood is often in limited supply, Rh-positive blood is often used for the emergent transfusion of older females and of males of unknown blood group. In such cases, sensitization may occur, but the risk of an immediate hemolytic reaction is low ( 6 ).

Despite the lack of a crossmatch, transfusion of group O blood under emergency situations is safe. The incidence of red cell alloantibodies in healthy people is low, and most such antibodies do not cause dangerous acute intravascular hemolytic transfusion reactions even if incompatible blood is given. However, the decision to use uncrossmatched blood is the responsibility of the attending physician, who must weigh the risks against the expected benefits and document in the patient's record the need for the uncrossmatched blood.

[Table 24.5](#) outlines the selection of blood and plasma by ABO type. If the blood group is known, group-compatible red cells and FFP can be selected. If the blood group is not known, group O red cells should be used; if plasma is required, group AB FFP should be used because it contains no anti-A or anti-B.

**TABLE 24.5. Selection of Blood and Plasma by ABO Type**

| Component           | Recipient ABO Type | Selection of Blood Component |           |
|---------------------|--------------------|------------------------------|-----------|
|                     |                    | Preferred                    | Alternate |
| Red blood cells     | O                  | O                            | None      |
|                     | A                  | A                            | O         |
|                     | B                  | B                            | O         |
|                     | AB                 | AB                           | A, B, O   |
| Fresh frozen plasma | O                  | O                            | A, B, AB  |
|                     | A                  | A                            | AB        |
|                     | B                  | B                            | AB        |
|                     | AB                 | AB                           | None      |

Modified from Jeter EK, Spivey MA. Introduction to transfusion medicine: a case study approach. Bethesda, MD: American Association of Blood Banks Press, 1996.

## Administration of Blood

The first step before the administration of blood or of a blood product is to obtain consent for the transfusion from the patient. Every hospital should set its own policy. A note in the chart indicating that the risks of transfusion as well as the indications have been discussed with the patient and that the patient has accepted this form of therapy is adequate. There must be a written order for the administration of the product (4).

All blood products should be given through an appropriate administration set containing a filter; careful aseptic technique should be practiced at all times. There must be confirmation and documentation that the information identifying the unit of blood with the patient has been verified in the presence of the patient (4).

Vital signs should be documented before and after transfusion and as clinically required. For the first 15 minutes after the infusion has begun, the patient should be kept under close observation to detect any signs of a serious transfusion reaction. If none is observed, the infusion rate may be increased. One unit of red cells is often given in 1 to 4 hours, depending on the amount to be transfused and on the patient's cardiovascular status. Infusion of a unit for longer than 4 hours is not recommended, as there is a risk of bacterial proliferation because the opened unit is at room temperature. Drugs or medications should not be injected into the blood. Normal (0.9%) saline, 5% albumin, or ABO-compatible plasma may be added to the red cell concentrate. No other solution and no medication should be added to or infused through the same tubing as blood unless there is documentation of compatibility and FDA approval (4). Dextrose causes red cells to agglutinate or hemolyze; hypotonic saline causes hemolysis. Ringer's lactate or other solutions containing calcium must never be added to blood because the calcium present leads to coagulation. After the transfusion has been completed, the transfusion tag or record should become part of the patient's chart.

When the patient being transfused is in severe congestive heart failure, additional measures should be taken. Administration of diuretics before or during the transfusion may not be adequate to prevent aggravation of heart failure by volume overload. In the presence of heart failure, transfusion should proceed slowly (e.g., 1 ml/kg/hour) with careful observation and additional diuretics given if clinically indicated. If slower rates than this are needed, the blood component may be divided by the blood bank into two or more parts and each part transfused over 4 hours. The unused portions should be kept in the blood bank until needed for transfusion. Alternatively, blood may be given safely by exchange transfusion, which can be accomplished by the simple means of removing blood from one vein while infusing concentrated red cells into another on the opposite limb. Removal of 500 ml of blood with a hematocrit of, for example, 0.15 L/L, accompanied by the infusion of two units of concentrated red cells, results in a significant increase in the patient's hemoglobin concentration.

## PLATELET TRANSFUSION

Platelet transfusion is often life-saving when hemorrhage is caused by thrombocytopenia. Modern chemotherapy for hematologic malignancies would not be possible without the ability to prevent or treat thrombocytopenic bleeding. Similarly, many open-heart surgical procedures would not be feasible without platelet transfusions. Whether this therapeutic modality is effective depends on recipient factors, such as the presence of sepsis, azotemia, drugs, and platelet antibodies, and on the ability of the blood bank to provide

functional platelets in sufficient numbers ( [130](#), [131](#) and [132](#) ).

## Preparation of Platelet Concentrates

Platelets, like erythrocytes, are actively metabolizing cells and require specific conditions for their preparation and storage in a viable, functional form ( [133](#), [134](#) ). They are prepared for transfusion either as platelet concentrates from whole blood or buffy coat or by apheresis from single donors. Although the method of preparation differs, both products are stored under the same conditions.

Platelet concentrates may be prepared from whole blood collected into bags with satellites ( [Fig. 24.1](#) ). The anticoagulants in current use, CPD and CPDA-1, are satisfactory for preparation of platelet concentrates. The whole blood is kept at room temperature and must be processed within 8 hours of collection. The unit of whole blood is centrifuged at low speed at room temperature, and the supernatant, platelet-rich plasma, is expressed into a satellite bag. The supernatant is centrifuged again to further concentrate the platelets. Most of the supernatant platelet-poor plasma is expressed, and after 1 hour, the platelets are gently resuspended in the remaining plasma (50 to 60 ml). Approximately 60 to 75% of the donor platelets, or a minimum of  $5.5 \times 10^{10}$  platelets/unit, are recovered ( [135](#) ).

In Europe, platelet concentrates are prepared from the buffy coat. Briefly, the whole blood unit is spun inverted at high speed, and the platelet-poor plasma and the buffy coat are withdrawn, each into its own satellite bag. The buffy coat is then centrifuged at low speed to separate the platelets from the red and white cells. The functional quality of these platelets is comparable to those prepared by the American method ( [135](#) ). Platelet concentrates prepared from buffy coat contain fewer white cells than those prepared from platelet-rich plasma, although filtration is necessary to meet the European standards for leukoreduced products. In some European countries, platelet concentrates are pooled, resuspended in an additive solution, and filtered before storage ( [136](#) ). In the United States, the pooling of platelets before storage is prohibited.

## Apheresis (Pheresis) Platelets

An alternative approach involves the collection of single donor platelets by apheresis using one of the automated collection devices described earlier ( [16](#) ). Platelets collected in this way contain at least  $3 \times 10^{11}$  platelets in approximately 300 ml of plasma, the approximate equivalent of six units of random donor platelets. Many pheresis platelets are leukocyte-reduced by the collection technology. Because the procedure is carried out in a closed system, the platelets can be stored for 5 days in the appropriate plastic bag ( [4](#), [8](#) ). Apheresis platelets are collected either from HLA-compatible donors to support alloimmunized patients or from random donors to supplement the platelet inventory. In some centers, apheresis products are the routine source of platelets. There is no significant functional difference between platelets collected by apheresis and those concentrated from whole blood donations ( [137](#) ). However, pheresis platelets typically contain fewer WBCs and, therefore, are less likely to cause febrile transfusion reactions than whole blood-derived platelet concentrates ( [138](#), [139](#) ). The use of apheresis platelets also results in fewer donor exposures for recipients.

## Platelet Storage

Platelet products must be kept under specific conditions to ensure optimal recovery and

function after transfusion. Unlike red cells, platelets stored at 4° C undergo shape changes and lose their viability; platelet survival and function are optimized by storage at room temperature (20° to 24° C) ( [140](#), [141](#) ). During storage, the platelets metabolize glucose to lactate and hydrogen, which is buffered by bicarbonate present in the plasma, resulting in a release of CO<sub>2</sub>. The nature of the bag in which platelet concentrates are stored is important. The plastics used in the early era of platelet transfusion were made of PVC and plasticizers and were not permeable to O<sub>2</sub> and CO<sub>2</sub>. In these bags, stored platelets become depleted of oxygen, resulting in a shift from oxidative to glycolytic metabolism, with increased lactate generation, decreased pH, and decreased platelet viability. As the pH decreases below 6.2, platelets undergo shape change, are damaged, and show reduced *in vivo* recovery. The platelets could not be stored for longer than 72 hours in the PVC bags. The plastic materials currently in use in the manufacture of blood bags are more permeable to gases. This permits continued oxidative metabolism and prolongation of storage time ( [142](#), [143](#) and [144](#) ). Although platelet viability is maintained for up to 7 days in the new plastic containers ( [145](#) ), storage of platelet concentrates at room temperature is recommended for only 5 days because of the risks of bacterial growth ( [146](#), [147](#) ). Viability is best preserved if the platelets are gently agitated during storage. Platelets must be stored in sufficient plasma to maintain a pH greater than 6.2 ( [4](#) ).

**PLATELET STORAGE AND FUNCTIONAL INTEGRITY** Even under optimum storage conditions, platelets, like red cells, develop a storage lesion ( [148](#) ). After storage at room temperature, the changes that occur in the platelets include decreased aggregation in response to single platelet agonists such as adenosine diphosphate and reduction in adenosine diphosphate and ATP content both in granules and in the metabolic pool. β-Thromboglobulin and platelet factor-4 are released, and both dense and α-granules are depleted ( [149](#) ). There is increased surface expression of P-selectin (CD62), a molecule derived from the α-granule membrane of the resting platelet. Platelets may develop morphologic changes and impaired responses to hypotonic shock. It has been difficult, however, to correlate the clinical response to platelet transfusions with specific *in vitro* findings. The *in vivo* effectiveness of stored platelets is dependent on the recovery of transfused platelets in the circulation of recipients. This has been assessed through platelet recovery and survival studies in normal volunteers using autologous radiolabeled platelets ( [150](#) ). Platelet recovery is the percentage of transfused platelets that are found in circulation immediately after transfusion. Even when fresh platelets are transfused, only approximately two-thirds of the transfused platelets are recovered in the circulation ( [132](#) ); the remaining 30 to 40% are pooled in the spleen ( [151](#) ). At the end of storage, mean platelet recovery is approximately 40 to 50% ( [144](#), [152](#) ). After the initial recovery, there is little difference in survival of fresh versus stored platelets; both show a half-life of 3 to 5 days in healthy adults ( [141](#) ). In patients, however, the observed recovery and survival of transfused platelets are often substantially lower than these figures (as discussed in the section [Dosage and Expected Response](#) ). The *in vivo* hemostatic efficacy of transfused platelets is difficult to assess. The use of bleeding times in thrombocytopenic patients as an indicator of function is not of value because of great variability in technique and lack of reproducibility of results ( [153](#) ). Function is best assessed through clinical assessment of hemostasis ( [154](#) ). The clinical response generally correlates with the posttransfusion platelet increment.

**PLATELET ADDITIVE SOLUTIONS** Recently, synthetic storage solutions for platelets have been studied. These solutions contain acetate, which functions both as a metabolic substrate and as a buffer. Platelets stored in one of these solutions (Platelet Additive Solution-2) showed increased P-selectin expression and decreased *in vivo* recovery compared to platelets stored in plasma ( [136](#), [155](#) ). Another solution, Platelet Additive Solution-3, however, appears to show suitable preservation of platelet function for 7 days. This latter solution is a component of the platelet pathogen inactivation system recently



approved in Europe ( [156](#) ).

**FROZEN PLATELETS** Frozen storage of platelets has been investigated. The role of such preparations has been established only for patients with alloantibodies for whom satisfactory donors cannot be found. Autologous platelets may be frozen using dimethyl sulfoxide as the cryoprotective agent. *In vitro* recovery of frozen and thawed platelets and posttransfusion increments may be satisfactory for clinical use, although only approximately half of the platelets survive the freeze-thaw process ( [157](#) , [158](#) ). A recent report suggests that recovery may be improved by combining a platelet additive solution with a reduced concentration of dimethyl sulfoxide ( [159](#) ). Theoretically, autologous frozen platelet transfusions may permit support of highly alloimmunized patients through periods of chemotherapy-induced myelosuppression ( [158](#) , [160](#) ). In practice, however, frozen platelets are not generally available.

### Selection of Platelet Donors

**ABO GROUP** The clinical importance of ABO compatibility in platelet transfusion is controversial. Platelets bear both intrinsic ( [161](#) ) and adsorbed ( [162](#) ) antigens of the ABH system. Transfusion of ABO-incompatible platelets may be associated with decreased posttransfusion platelet recovery and normal survival ( [163](#) , [164](#) , [165](#) and [166](#) ). The reduction in recovery is variable and may be related to the isohemagglutinin titer of the recipient. Rarely, a high titer of anti-A or anti-B may cause frank refractoriness to ABO-incompatible platelets ( [167](#) , [168](#) and [169](#) ). Platelet products contain a significant amount of donor plasma. Rarely, high-titered donor isoagglutinins in platelet products may cause intravascular hemolysis of recipient red cells ( [170](#) ). Some investigators have suggested that patients who receive platelets mismatched for ABO develop refractoriness at a higher rate than patients who receive ABO-compatible products ( [169](#) , [171](#) , [172](#) ). However, these studies were small, did not control for the presence of HLA antibodies, and differed in their observations as to whether it was cell or plasma compatibility that was important. Most important, patients who developed refractoriness to ABO-incompatible products did not show better responses when given ABO-identical products, suggesting that ABO may not have been the cause of refractoriness ( [172](#) ). In practice, it is difficult to ensure availability of ABO-identical platelet products, and many centers simply limit the volume of incompatible plasma transfused.

**RH TYPE** Platelets do not carry Rh antigens, and the donor's Rh type is important only because the red cells present in the platelet concentrate may immunize Rh-negative recipients. Although early studies found that as many as 19% of D-negative recipients of platelets from D-positive donors developed anti-D, several recent studies in hematology/oncology patients found that immunization did not occur ( [173](#) ). It is possible that the difference in observations is related both to an increase in intensity of chemotherapy as well as to a substantial improvement in the purity of platelet products. The red cell content of most apheresis platelets currently is below the dose thought to be immunizing. For most platelet recipients, anti-D prophylaxis would be of little benefit. For recipients with future childbearing potential, however, it may be reasonable to consider administration of intravenous anti-D Ig to prevent D immunization ( [174](#) ).

**ASPIRIN AND OTHER NONSTEROIDAL ANTIINFLAMMATORY DRUGS** Acetylsalicylic acid (ASA) irreversibly acetylates platelet cyclooxygenase and inhibits platelet aggregation. Platelet-mediated hemostasis is restored, however, if ASA-inhibited platelets are mixed with untreated platelets ( [175](#) ). After a single dose of aspirin, ASA-exposed platelets are inhibited for the rest of their lifespan, but platelets produced after clearance of the drug restore hemostatic function. Therefore, platelets from donors who have taken ASA are acceptable as long as 36 hours have elapsed from the last dose. Platelets donated within 36 hours of ASA ingestion are acceptable for use if mixed with platelets from unexposed donors ( [4](#) ). Other nonsteroidal antiinflammatory drugs may impair

platelet function, but the effects are reversible—that is, platelet function is restored once the platelets are removed from the offending drug (176). Therefore, platelets from donors taking nonaspirin antiinflammatory drugs are acceptable for transfusion.

### Administration of Platelets

Platelet concentrates may be provided by the blood bank in their individual plastic bags or pooled before transfusion. Once the blood bag is opened by puncturing one of the sealed ports, the platelets must be administered within 4 hours (4). Platelets must be administered through a filter approved for platelet use, either a standard 170- $\mu\text{m}$  filter or a leukoreduction platelet filter.

### Dosage and Expected Response

The usual dose of platelets is one unit for each 10 kg body weight or approximately six units (or one apheresis platelet) for a typical adult dose (177). The *in vivo* recovery of transfused platelets should be assessed by a platelet count obtained 10 minutes to 1 hour posttransfusion (178, 179).

As noted above, even under ideal circumstances, only two-thirds of transfused platelets are expected to be found in the circulation of the recipient. One can estimate the maximum expected increase in circulating platelet count after transfusion of one apheresis platelet product containing the minimum of  $3 \times 10^{11}$  platelets into a 70-kg adult with a blood volume of 5 L as follows: Maximum increase in count =  $2/3 \times 3 \times 10^{11}$  platelets distributed in 5 L blood volume =  $40 \times 10^9/\text{L}$ .

In practice, the observed posttransfusion platelet recovery in patients is often much lower than ideal. A recovery as low as 30% of the ideal is generally considered “acceptable” (180). This would correspond to an increase in platelet count of approximately  $13 \times 10^9/\text{L}$  after transfusion of one apheresis platelet product to a 70-kg adult. The expected and “acceptable” increases in platelet count would be proportionately lower in a larger adult and higher with transfusion of a larger dose of platelets.

Many investigators have assessed the acceptability of a posttransfusion platelet increment by calculating a corrected count increment (CCI). With the CCI, the measured increment in circulating platelet count is corrected for the patient’s size and for the dose of platelets given as follows:  $\text{CCI} = (\text{posttransfusion count} - \text{pretransfusion count}) \times \text{body surface area (m}^2\text{)}/\text{number of platelets administered (}10^{11}\text{)}$ .

The maximum achievable CCI is approximately  $25 \times 10^9/\text{L}$ . The typical CCI in patients is approximately one-half of this, and the lowest “acceptable” CCI is considered to be approximately  $7.5 \times 10^9/\text{L}$  (178, 180). Patients with *in vivo* recoveries or CCIs lower than acceptable values should be evaluated for causes of platelet refractoriness such as an enlarged spleen or alloimmunization (as discussed in the section [Platelet Refractoriness and Alloimmunization](#)).

In healthy adults, the half-life of transfused platelets is 3 to 5 days (141). In thrombocytopenic patients, however, platelet survival is reduced. A fixed rate of platelet consumption of  $7.1 \times 10^9/\text{L}/\text{day}$  has been measured in otherwise stable patients with



severe thrombocytopenia ( [181](#) ). It is assumed that this platelet consumption is associated with maintenance of vascular integrity. The rate of consumption may be higher in critically ill patients.

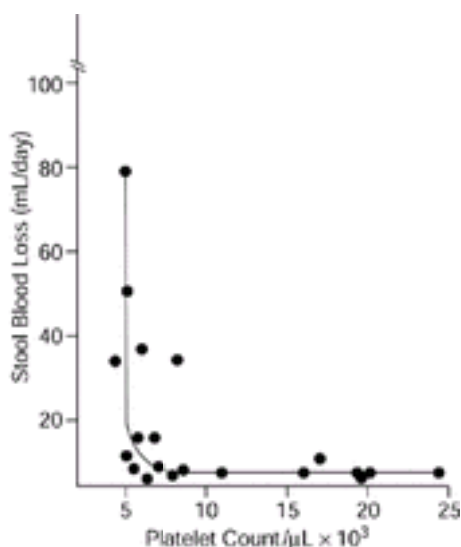
Given the limited absolute increase in platelet count achieved with the standard dose of platelets and the presence of ongoing platelet consumption, many patients return to their baseline platelet count within 1 to 2 days of platelet transfusion. In stable patients, the transfusion-free interval may be increased by administering larger doses of platelets with each transfusion ( [182](#), [183](#) ). Mathematic modeling suggests, however, that the total number of platelets transfused may be increased by this strategy ( [184](#) ).

### Indications for Platelet Transfusion

The risks of posttraumatic and spontaneous bleeding increase as the platelet count falls. In general, assuming that platelet function is normal, there is minimal risk of spontaneous bleeding due to thrombocytopenia at platelet counts above  $50 \times 10^9/L$ , and this level is usually sufficient to permit surgical procedures ( [185](#) ). As the count falls below this level, there is an increasing risk of microvascular bleeding, characterized by petechiae, ecchymoses, oozing at venipuncture and incision sites, epistaxis, menorrhagia, gastrointestinal bleeding, or intracranial hemorrhage.

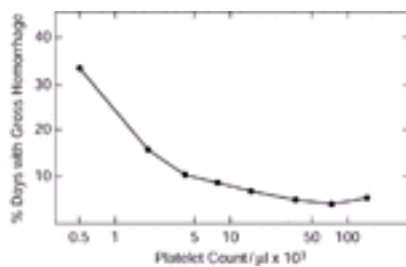
The precise degree of bleeding risk at any given platelet count is difficult to determine, as many other clinical variables have important effects. These include the cause of thrombocytopenia, the duration of thrombocytopenia, the nature of concurrent disease processes including sepsis, uremia, vasculitis, or malignant processes invading blood vessels or other organs; the coexistence of coagulopathies, such as liver disease, vitamin K deficiency, intravascular coagulation, or heparin treatment; and the presence of drugs such as ASA or semisynthetic penicillins that interfere with platelet function.

In general, the risk of significant spontaneous hemorrhage increases gradually as the platelet count drops below  $50 \times 10^9/L$  ( [186](#) ) and is high at counts below  $5 \times 10^9/L$  ( [130](#), [131](#) ) ( [Fig. 24.5](#) and [Fig. 24.6](#) ).



**Figure 24.5.** Stool blood loss as a measure of thrombocytopenic bleeding. When stool blood loss was determined in 20 aplastic thrombocytopenic patients, blood loss was less

than 5 ml/day at platelet counts greater than  $10 \times 10^9/L$ . At platelet counts between 5 and  $10 \times 10^9/L$ , blood loss averaged  $9 \pm 7$  ml/day. At levels less than  $5 \times 10^9/L$ , blood loss was markedly elevated at  $50 \pm 20$  ml/day). (From Slichter SJ. Controversies in platelet transfusion therapy. *Annu Rev Med* 1980;31:523, with permission; and modified from Slichter SJ, Harker LA. Thrombocytopenia: mechanisms and management of defects in platelet production. *Clin Haematol* 1978;7:523. Reprinted with permission from *Annu Rev Med* 1980;31 by Annual Reviews [www.annualreviews.org](http://www.annualreviews.org).)



**Figure 24.6.** Clinical bleeding as a manifestation of platelet count. Fraction of total bleeding days with grossly visible hemorrhage according to platelet count, in 92 thrombocytopenic leukemic patients. (From Slichter SJ. Controversies in platelet transfusion therapy. *Annu Rev Med* 1980;31:522; and modified from Gaydos LA, Freireich EJ, Mantel N. The quantitative relation between platelet count and hemorrhage in patients with acute leukemia. *N Engl J Med* 1962;266:907. Reprinted with permission from the *Annu Rev Med* 1980;31 by Annual Reviews [www.annualreviews.org](http://www.annualreviews.org).)

Several clinical practice guidelines for platelet transfusion have been published ([137](#), [177](#), [185](#)), and the conclusions are summarized below.

**PROPHYLACTIC PLATELET TRANSFUSION** Prophylactic platelet transfusion in the management of acute leukemia prevents major bleeding episodes, except perhaps during the terminal phase of the patient's illness ([187](#), [188](#)). However, no difference in mortality has been demonstrated between patients transfused prophylactically and those transfused only when bleeding occurred ([188](#)). Despite lack of such proof, it is common practice to attempt to prevent bleeding problems by administering prophylactic transfusions to thrombocytopenic patients. The indications for prophylactic transfusion remain controversial. Until recently, it was common practice to transfuse platelets when the count was below  $20 \times 10^9/L$ . This level was chosen arbitrarily and has recently been challenged ([189](#)). Several recent studies have reevaluated the platelet transfusion trigger in patients with acute leukemia and in recipients of hematopoietic cell transplants ([190](#), [191](#), [192](#), [193](#) and [194](#)). These studies all demonstrated that reducing the trigger for prophylactic platelet transfusion from  $20 \times 10^9$  to  $10 \times 10^9/L$  resulted in decreased platelet transfusion without an increased frequency of significant hemorrhage. In these studies, however, the trigger for transfusion was liberalized in the presence of clinical factors suspected to increase the risk of hemorrhage, such as fever, an increased WBC count, coagulopathy, bleeding, or invasive procedures. When significant hemorrhagic events occurred, they were often in patients with morning platelet counts above  $20 \times 10^9/L$  ([192](#), [193](#), [195](#)). Infection, vascular lesions, or prolonged duration of thrombocytopenia may contribute to the risk of significant hemorrhage ([193](#), [195](#)). Thus, it appears that a prophylactic transfusion trigger of  $10 \times 10^9/L$  is as safe as  $20 \times 10^9$  in most patients with acute leukemia or after myeloablative hematopoietic cell transplant. However, an assessment of individual clinical risk factors is appropriate. Prophylactic platelet

transfusion is usually recommended before major surgical procedures in patients with platelet count less than  $50 \times 10^9/L$  (103, 137, 177). The safety of performing surgical procedures at counts below this level has not been formally evaluated. It has been demonstrated that bone marrow aspirations and biopsies, bronchoscopies, and lumbar punctures may be safely performed in patients with platelet counts of less than  $20$  to  $25 \times 10^9/L$  (137). However, the minimum safe platelet level for specific invasive procedures remains to be defined. Prophylactic transfusion of platelets is generally *not* recommended in patients with platelet consumption disorders, such as idiopathic thrombocytopenic purpura (ITP) and thrombotic thrombocytopenic purpura (TTP). In ITP, there is reduced recovery and survival of transfused platelets; transfusion usually does not result in a measurable increase in platelet count. There is some evidence that platelet transfusion may be harmful in patients with TTP (196, 197). However, platelet transfusion may be used to treat life-threatening bleeding in patients with these disorders.

**THERAPEUTIC PLATELET TRANSFUSION** Rapid massive bleeding is unlikely to be due solely to thrombocytopenia and suggests the presence of a vascular injury. Rapid massive bleeding in the postoperative setting is usually surgical in nature and, therefore, not correctable by platelet transfusion. However, bypass-induced platelet dysfunction may contribute to bleeding after cardiac surgery (198); platelet transfusion may improve hemostasis in such situations. Platelet transfusion is most useful in thrombocytopenic patients with microvascular bleeding (e.g., oozing or mucous membrane or gastrointestinal bleeding). Transfusion to achieve a platelet count of  $50 \times 10^9/L$  is generally recommended (103, 177, 185) for bleeding patients. However, hemostasis may be achieved through repeated platelet transfusion even in the absence of a demonstrable rise in platelet count. Transfusion is indicated in bleeding patients with platelet dysfunction regardless of the platelet count. Dilutional thrombocytopenia may occur after massive transfusion of red cells and plasma volume expanders. However, a platelet count of less than  $50 \times 10^9/L$  is not generally seen unless more than two blood volumes (20 red cell units in an adult) have been replaced (199, 200). In this setting, the decision to administer platelets should be based on clinical assessment for evidence of microvascular bleeding and measured platelet counts (201); platelet transfusions should not be given routinely for a predetermined number of units of blood transfused. In all situations, the clinical decision regarding platelet transfusions requires consideration of several variables, including an estimation of platelet count and function, cause of thrombocytopenia, and state of the coagulation system; the presence or likelihood of bleeding (the development of petechiae, spontaneous mucous membrane oozing, and retinal hemorrhages are often danger signals indicating hemostatic incompetence); and the hazards of transfusion, which include all those encountered with the transfusion of any blood product.

### Platelet Refractoriness and Alloimmunization

*Refractoriness* to platelet transfusions is a clinical state that can be defined as an unacceptable recovery of transfused platelets on two or more occasions. As noted above, a CCI of less than 7500 measured at 10 minutes to 1 hour after the transfusion is a commonly used definition of an unacceptable response or, as a general rule of thumb, an absolute increment of less than  $13 \times 10^9/L$  after transfusion of six units of platelets to a 70-kg adult. Clinical factors reported to be associated with refractoriness to platelet transfusion are listed in Table 24.6 (132, 180, 202, 203 and 204).

**TABLE 24.6. Factors Reported to Be Associated with Platelet Refractoriness**

---

Immune factors  
Alloantibodies

- Anti-HLA
- Antiplatelet glycoprotein
- ABO
- Autoantibodies
  - Idiopathic thrombocytopenic purpura
  - Drug-related
- Nonimmune factors
  - Splenomegaly
  - Fever, infection
  - Disseminated intravascular coagulation
- Immune complexes
- Bone marrow transplantation
- Amphotericin

---

**IMMUNE CAUSES OF REFRACTORINESS** The major immune cause of refractoriness is the presence of anti-HLA antibodies. These antibodies are stimulated by pregnancy or by transfusion of WBC-containing blood products. Platelets bear HLA class I antigens on their surface. Anti-HLA antibodies are produced by 30 to 50% of recipients of WBC-containing blood products ( [Table 24.7](#) ) ( [51](#) ). They are found in up to 30% of untransfused women with a history of pregnancy ( [205](#) , [206](#) ). After exposure to blood products, up to two-thirds of women with a history of pregnancy produce HLA antibodies ( [207](#) ). Transfusion of platelets that are serologically incompatible with a preexisting HLA antibody typically results in no increase in platelet counts ( [208](#) , [209](#) ).

**TABLE 24.7. Efficacy of Leukocyte-Reduced Products in Preventing Transfusion-Induced HLA Alloimmunization**

| Author      | Type of Blood Products Received |               |
|-------------|---------------------------------|---------------|
|             | Control                         | Leukoreduced  |
| Elghouzzi   | 26/93 (0.28)                    | 10/67 (0.15)  |
| Schiffer    | 13/31 (0.42)                    | 5/25 (0.20)   |
| Andreu      | 11/35 (0.31)                    | 4/34 (0.12)   |
| Sniecinski  | 10/20 (0.50)                    | 3/20 (0.15)   |
| Rebulla     | 5/15 (0.33)                     | 4/16 (0.25)   |
| Van Marwijk | 11/26 (0.42)                    | 2/27 (0.07)   |
| Oksanen     | 3/15 (0.20)                     | 2/16 (0.12)   |
| Handa       | 9/23 (0.39)                     | 4/49 (0.08)   |
| Lane        | 7/20 (0.35)                     | 3/26 (0.11)   |
| Williamson  | 21/56 (0.37)                    | 15/67 (0.22)  |
| TRAP        | 59/131 (0.45)                   | 25/137 (0.18) |

NOTE: This is a summary of prospective controlled trials in hematology and oncology patients. Each numerator indicates the number of patients developing HLA antibodies; the denominator indicates the number of patients transfused with that type of blood product. The number in parentheses represents the calculated proportion of patients making antibodies.

Modified from Dzik WH. Leukoreduced blood components: laboratory and clinical aspects. In: Simon TL, Dzik WH, Snyder EL, et al., eds. Rossi's principles of transfusion medicine, 3rd ed. Philadelphia: Lippincott Williams & Wilkins, 2002:270-287.

The incidence of clinically significant alloantibodies to platelet-specific glycoproteins in transfusion recipients is unclear. Antibodies to platelet glycoproteins have been detected almost exclusively in patients who also have broadly reactive anti-HLA antibodies. Using the sensitive MAIPA ( *monoclonal antibody immobilization of platelet antigen*) assays, investigators have reported detection of antibodies to platelet glycoproteins in as many as 25% of HLA-alloimmunized transfusion recipients ( [210](#), [211](#) and [212](#)). A significant proportion of the antibodies detected have ill-defined specificity, and the contribution of such antibodies to platelet refractoriness is unclear. The presence of platelet-specific antibodies in patients who are broadly sensitized to HLA presents an enormous transfusion support challenge. Although many blood centers maintain HLA-typed donor registries, at present, very few of these donors are typed for platelet antigens. The solid-phase red cell adherence or recently developed MAIPA-based platelet crossmatching assays could theoretically be used to test HLA-selected products for compatibility with a patient's antiplatelet antibodies, although it has not yet been established whether these assays have adequate sensitivity and specificity for this application. As discussed above, high-titered ABO antibodies have been implicated in platelet refractoriness. Many investigators recommend a trial of ABO-compatible products in refractory patients, although studies have not demonstrated a high likelihood of improvement. Antiplatelet autoantibodies are usually associated with absolute refractoriness to platelet transfusion. However, in the event of life-threatening bleeding, patients with ITP may benefit clinically from repeated infusions of platelets even in the absence of a demonstrable rise in platelet count.

**NONIMMUNE CAUSES OF REFRACTORINESS** Of the nonimmune factors implicated in refractoriness, splenomegaly is the most potent. Transfused platelets pool in the enlarged spleen; increasing the dose of platelets does not necessarily improve the posttransfusion increment. Each of the other nonimmune factors listed in [Table 24.6](#) has been reported to be associated with refractoriness, although the importance of each factor has not been demonstrated consistently ( [132](#), [180](#), [202](#), [203](#), [213](#)).

**PREVENTION OF HLA ALLOIMMUNIZATION** Although platelets express HLA class I molecules on their surface, purified platelets do not appear to induce primary immunization to HLA antigens. It appears that the presence of WBCs is necessary, presumably because of their dual expression of both HLA class I and class II antigens ( [214](#) ). Multiple studies have demonstrated that the prophylactic use of leukoreduced blood products significantly decreases the incidence of HLA immunization in transfusion recipients ( [Table 24.7](#)) ( [51](#), [215](#), [216](#) ). Use of leukoreduced blood products is recommended for patients who are likely to require intensive platelet transfusion support, because the development of anti-HLA antibodies would complicate such support. Purified platelets can stimulate a secondary immune response to HLA ( [214](#) ). Patients with prior pregnancy are highly likely to produce HLA antibodies after transfusion. HLA alloimmunization has been observed in up to two-thirds of such patients. The use of leukoreduced products appears to be of limited benefit in such patients, with HLA antibodies produced by 33 to 44% of patients with a history of pregnancy despite the use of leukoreduced products ( [207](#), [215](#), [217](#) ). As an alternative to removing WBCs from blood products, *in vitro* studies indicate that ultraviolet (UV) irradiation of WBCs abrogates their ability to present HLA antigens in mixed lymphocyte culture ( [218](#), [219](#) ). *In vivo* studies demonstrate that UV irradiation of blood products is as effective as leukocyte reduction in preventing primary HLA alloimmunization ( [207](#) ). UV irradiation of platelet products requires special blood containers and equipment and is not currently available in the United States. A pathogen inactivation system involving psoralen and UV light has recently been approved in Europe ( [156](#) ). In the United States, however, this system will most likely be applied to apheresis platelets, which are already leukoreduced. Early studies suggested that HLA alloimmunization in platelet transfusion recipients could be reduced by minimizing donor exposure through the use of pheresis platelets rather than pooled platelet concentrates (



220, 221). Recently, however, it has been shown that if all products are leukoreduced, there is no incremental benefit to the use of pheresis products (207).

**DIAGNOSIS AND MANAGEMENT OF ALLOIMMUNIZATION** Historically, anti-HLA antibodies have been detected by lymphocytotoxicity assays. Newer methods of testing for HLA antibodies include an enzyme immunoassay in which HLA glycoproteins are immobilized on a plastic plate using monoclonal antibody (222). A commercially available solid-phase red cell adherence assay permits screening for serologic reactivity against platelets selected from inventory (223). Early studies demonstrated that thrombocytopenic patients with lymphocytotoxic antibodies could be successfully supported with platelets obtained from donors who were HLA identical to the patient or donors who were partially HLA matched and whose lymphocytes were serologically compatible with the patient's antibody (208, 224). These observations led to the practice of providing apheresis platelets from "HLA-matched" donors for patients with lymphocytotoxic antibodies. Depending on the availability of family members, the rarity of the patient's HLA type, and the size of the HLA-typed donor registry, it may be difficult or impossible to locate platelet donors who are HLA identical to the patient. Therefore, many platelets provided as HLA matched bear one or more antigens that are foreign to the recipient. Serologic crossmatching of partially mismatched products can be used to identify those that are more likely to result in a good posttransfusion increment (208, 209, 225). In most HLA-alloimmunized patients, the specificity of the antibody can be defined (213, 226, 227). Patients can be successfully supported with products that lack the HLA antigen(s) to which the antibodies are directed (213, 226). If the platelet inventory is HLA typed, products lacking the offending antigen(s) can usually be found in inventory; thus, many patients can be supported with products on the shelf without the need for special donor recruitment or serologic crossmatching. Alternatively, serologic crossmatching of HLA-untyped products may be used to support patients whose antibodies are not broadly reactive. For many alloimmunized patients, it is possible to identify serologically compatible platelets among HLA-untyped products in the blood center inventory using the solid-phase red cell adherence crossmatching assay (223). However, compatible products are unlikely to be found in inventory for patients who have broadly reactive antibodies; such patients require specific recruitment of HLA-selected donors. In summary, HLA-alloimmunized patients may be supported with (a) products from donors who are HLA identical to the patient or who lack HLA antigens foreign to the recipient; (b) products that are partially HLA matched and serologically compatible; (c) by identifying the specificity of the patient's HLA antibody and avoiding products bearing the offending antigen(s); or (d) by serologic crossmatching of products in inventory. These methods are equally effective clinically (213). The first method is often limited by the inadequate availability of donors. The last method is not applicable to patients with broadly reactive antibodies, who comprise approximately 10 to 15% of alloimmunized patients (223, 227). It should be noted that HLA antibodies may appear or disappear over the course of a patient's treatment (132, 213). It is important to monitor patients' responses to platelet transfusion and to reevaluate them serologically if they do not respond to products that were previously acceptable.

**PLATELET TRANSFUSIONS FOR REFRACTORY PATIENTS** A recent guideline suggests withholding prophylactic transfusion for nonbleeding patients who do not achieve acceptable posttransfusion increments in platelet counts (137). However, many clinicians arbitrarily transfuse one dose of platelets daily based on the assumption that some platelets are necessary for maintaining vascular integrity (181). For bleeding patients, many practitioners recommend infusion of larger or more frequent doses of platelets (180, 228).

**ROLE OF PHARMACOLOGIC AGENTS IN MANAGING THROMBOCYTOPENIC PATIENTS** In situations in which HLA-compatible products could not be obtained, some investigators have reported that intravenous Ig infusions improved responses to incompatible products. However, some authors found no improvement, improved

responses to compatible products only, or improved 1-hour but not 24-hour posttransfusion increments ( [132](#), [180](#), [229](#), [230](#), [231](#) and [232](#) ). Recent anecdotal reports suggest that recombinant factor VIIa may stop bleeding in severely thrombocytopenic patients ( [233](#), [234](#) ). The indications for use of this agent in thrombocytopenic patients remain to be defined. The antifibrinolytic agents aminocaproic acid and tranexamic acid have been reported to reduce bleeding in thrombocytopenic oncology patients ( [235](#), [236](#) and [237](#) ), although a beneficial effect has not been demonstrated consistently by all investigators. The use of these agents is contraindicated in patients with disseminated intravascular coagulation. The discovery of thrombopoietin (TPO) in 1994 initially caused optimism that this agent could be used clinically to prevent thrombocytopenia or enhance platelet recovery after myelosuppressive therapy. Two recombinant forms of TPO have been evaluated in clinical trials. One of these, a pegylated nonglycosylated form of the molecule, was found to be associated with the production of anti-TPO antibodies and thrombocytopenia ( [238](#) ); this agent is no longer in clinical development. In clinical trials, TPO did not improve the time to platelet recovery in patients undergoing chemotherapy for acute myelogenous leukemia or after myeloablative HPC transplants. However, TPO has been reported to improve the nadir platelet count and to reduce the duration of thrombocytopenia in patients receiving less myelosuppressive therapy. TPO was reported to increase platelet counts in patients with HIV-related thrombocytopenia, ITP, and the myelodysplastic syndrome ( [239](#), [240](#) ). TPO administration can improve platelet yield in apheresis donors, including autologous platelets being collected for freezing ( [159](#) ). The clinical safety of and appropriate indications for TPO remain to be defined; the agent is not yet FDA approved for clinical use.

## GRANULOCYTE TRANSFUSIONS

Severe bacterial and fungal infections in the setting of prolonged chemotherapy-associated neutropenia continue to be a significant source of morbidity and mortality in the modern treatment of malignancy. The risk of serious bacterial infection first appears as the neutrophil count falls below  $1.0 \times 10^9/L$  and increases rapidly below  $0.5 \times 10^9/L$ . Fungal infections occur with much higher frequency as the neutrophil count falls below  $0.2 \times 10^9/L$  ( [241](#) ). Other risk factors include the duration of neutropenia and the rate of fall of the neutrophil count ( [242](#) ). Although the use of growth factors [granulocyte colony-stimulating factor (G-CSF) and granulocyte-macrophage colony-stimulating factor] has reduced the severity and duration of neutropenia, many patients still experience prolonged periods of poor granulocyte production, often lasting 2 to 3 weeks or longer ( [243](#), [244](#) and [245](#) ). Although the concept of augmenting host defenses with granulocyte infusions dates back 60 years, difficulty in obtaining adequate yields of granulocytes as well as safety concerns stifled the initial interest generated after early clinical successes in the 1970s ( [246](#), [247](#) ). The introduction of modern apheresis techniques, the use of growth factors to increase donor granulocyte yields, and a number of positive results from clinical trials have led to renewed interest in applying this cellular therapy to a wider range of patients ( [248](#), [249](#) ).

### Donor Preparation/Selection

As early granulocyte transfusion studies used granulocytes prepared from patients with chronic myelogenous leukemia who had high granulocyte counts, the concept of patients receiving a very high granulocyte dose became a desirable goal in subsequent trials ( [250](#) ). This led to the development of methods to collect large quantities of granulocytes from normal donors. Centrifugal apheresis, using either continuous or discontinuous cell separators, became the standard method for the production of granulocyte concentrates (



[242](#), [251](#), [252](#)). The quantity and quality of granulocytes obtained depend on the apheresis collection technique as well as on the level of circulating neutrophils present in the donor. Infusion of hydroxyethyl starch or dextran to improve the sedimentation of donor red cells during centrifugation improves the efficiency of apheresis, but the granulocyte yield remains low ([242](#)). It has been suggested that a daily granulocyte dose in the order of  $10 \times 10^{10}$  cells would be necessary to achieve clear-cut benefit ([253](#)). Administration of oral corticosteroids produces a transient neutrophilia in the donor, but the collection yields remain in the range of  $2$  to  $3 \times 10^{10}$  ([254](#)). A number of clinical studies have shown the utility of G-CSF in increasing the dose/collection ([255](#), [256](#), [257](#), [258](#) and [259](#)). Donors treated with varying doses of G-CSF with or without cortico-steroids produce yields ranging from  $2.4$  to  $9.9 \times 10^{10}$  granulocytes. Although adverse effects occur in  $30$  to  $69\%$  of donors, most consist of mild to moderate degrees of bone pain, headache, myalgias, and fatigue. Data from the bone marrow transplant literature support the short-term safety of G-CSF administration in healthy donors, although rare serious adverse events have been reported; long-term follow-up data are limited and deserve further attention ([260](#)). G-CSF administration to healthy donors is generally performed under institutional review board-reviewed protocols. Based on available evidence, donor pretreatment with a single dose of G-CSF ( $300$  to  $600 \mu\text{g}$  subcutaneously) with dexamethasone ( $8 \text{ mg}$  orally)  $12$  hours before collection may allow reliable yields in a well-tolerated and cost-effective manner. Although repeated daily G-CSF stimulation and granulocyte collection have been reported ([261](#), [262](#)), standard practice is to perform a second collection no sooner than  $7$  days after the initial cytopheresis ([263](#)).

Prospective granulocyte donors should meet all FDA and AABB standards for donation. Because granulocyte products must usually be transfused before completion of donor infectious disease testing, donors who have been tested recently are strongly preferred. Donors should also be free of disorders that might be exacerbated by the administration of dexamethasone (e.g., diabetes) or G-CSF (e.g., arthritis, vasculitis, splenomeg-aly, gout, thrombocytopenia). Donor/recipient pairs should be ABO compatible due to the large number of RBCs contained in the product. RBC compatibility must be verified for each granulocyte product. CMV infections are a significant risk when seropositive donors are used for immunocompromised sero-negative patients; therefore, CMV-negative patients should receive CMV-negative products ([264](#)).

Patients requiring granulocyte transfusions may have become alloimmunized to HLA, RBC, or both antigens during the course of prior transfusion support or pregnancy. Studies suggest decreased recovery and survival as well as failure of granulocytes to localize at the site of inflammation in patients who have lymphocytotoxic or granulocyte-specific antibodies ([265](#), [266](#)). Recipients should, therefore, be screened for the presence of HLA antibodies. In alloimmunized patients, HLA-compatible random donors or family members should be used; random donors may be preferred over family members if related allogeneic transplantation is anticipated as part of treatment for the underlying disease. If laboratory tests for alloimmunization are not readily available, the likelihood of sensitization may be estimated by reviewing the patient's record for a history of platelet refractoriness or febrile transfusion reactions.

### **Granulocyte Collection/Storage**

Once an appropriate donor has been selected and prepared, centrifugal leukapheresis is performed by processing  $7$  to  $10 \text{ L}$  of blood over  $3$  to  $4$  hours using an agent such as hydroxyethyl starch to reduce the amount of contaminating RBCs by sedimentation. According to AABB standards, there should be at least  $1 \times 10^{10}$  granulocytes/unit collected ([4](#)); yields with current techniques achieve mean yields of  $2$  to  $3 \times 10^{10}$

$10^{10}$ /leukapheresis. Products contain 200 to 400 ml of plasma, 10 to 30 ml of RBCs, and 1 to  $6 \times 10^{11}$  platelets. Although granulocyte storage is permitted for up to 24 hours at room temperature, transfusion within 8 hours of collection is recommended. Biochemical assessments of the effects of storage on subsequent function (e.g., nicotinamide adenine dinucleotide phosphate oxidase activity, adhesion protein expression, respiratory burst activity, and bactericidal activity) reveal that effective storage may be possible for up to 48 hours at  $10^{\circ} \text{C}$  ( [267](#) ).

### Administration of Granulocytes

Granulocytes should be administered on a daily basis until the patient's endogenous neutrophil count rises to  $0.5 \times 10^9/\text{L}$  or until the infection clears. Granulocyte concentrates should be given through a standard filter set to ensure that aggregates are not administered. The concentrate should be given slowly (over 1 to 2 hours) with the patient under constant observation, including the use of pulse oximetry. Transfusion reactions occur in 10 to 50% of patients but are usually mild, consisting of fever and chills. Premedication with antihistamines, acetaminophen, or steroids is common practice before infusion. More severe reactions occur in 1 to 5% of patients and tend to be pulmonary in nature. A serious potential interaction between granulocyte transfusions and amphotericin B has been reported ( [268](#) ), but this association has not been substantiated by others ( [269](#) , [270](#) ). Nevertheless, many physicians administer granulocytes and amphotericin at least 8 hours apart to limit the potential for increased pulmonary toxicity. If there are any signs or symptoms of respiratory distress, the transfusion should be discontinued immediately, the recipient should be examined for hypoxemia or pulmonary edema, and a chest radiograph should be done and assessed for pulmonary infiltrates. If major adverse effects do occur, the recipient should be studied for the presence of antibodies that react with neutrophils. Granulocyte products contain a large number of lymphocytes and are, therefore, potentially capable of causing transfusion-associated GVHD (TA-GVHD). The current practice of irradiating all granulocyte products with 1500 to 3000 cGy should prevent transfusion-related GVHD without significantly impairing granulocyte function ( [267](#) ). Pre- and posttransfusion neutrophil counts should be determined to guide therapy. With large doses ( $>8 \times 10^{10}$ ), neutrophil increments may exceed  $2 \times 10^9/\text{L}$  immediately after infusion and may last for 24 to 48 hours ( [271](#) ).

### Clinical Indications and Efficacy

Prior clinical trials conducted on the use of granulocyte transfusions in the setting of neutropenia give some insight into the patient populations that may benefit from this therapy. A review of 32 papers ( [272](#) ) revealed that most studies have been uncontrolled, involved small heterogeneous populations of patients, and had different treatment approaches. Approximately 62% of the 206 patients with bacterial sepsis were reported to have benefited from granulocyte transfusion; conversely, 71% of 63 patients with invasive fungal infection did not respond to the infusions. Seven controlled trials were completed between 1972 and 1982: Three showed a positive effect, two showed benefit in specific patient populations, and two demonstrated no benefit. Some of the studies were likely limited by the cytopheresis techniques used and the low cell yields obtained, as most donors were pretreated with corticosteroids only. Further analysis confirmed the importance of higher neutrophil doses as well as leukocyte compatibility in the three positive trials. Recent trials ( [258](#) , [273](#) ) provide additional evidence to support the use of granulocyte transfusions in critically ill neutropenic patients with bacterial as well as candidal sepsis. Based on this information, granulocyte therapy may warrant consideration in severely neutropenic patients with bacterial infections unresponsive to typical

antimicrobial therapy.

The applicability of granulocyte infusions in the setting of invasive fungal infections remains unclear. No study has shown clear efficacy in patients with active aspergillosis, although often the neutrophil dose was not known or was suboptimal. Limited clinical and animal model data give some indication of usefulness in the setting of candidal and noninvasive fungal infections ( [258](#), [274](#) ). As the overall data are limited, a brief trial of granulocyte infusions may be warranted in patients with self-limited neutropenia and documented fungal infection who are refractory to standard antifungal therapy.

The effect of the prophylactic use of granulocyte transfusions to diminish the risk of serious infections in severely neutropenic patients during therapy of hematologic malignancies and after bone marrow transplantation has been investigated in a number of controlled trials ( [249](#) ). Although prophylactic granulocyte transfusion may decrease the risk of septicemia, the increased incidence of adverse effects observed with this therapy may outweigh the beneficial effects ( [264](#), [275](#), [276](#), [277](#), [278](#), [279](#) and [280](#) ). As no clinical efficacy has been observed, prophylactic transfusions are not recommended.

Granulocyte transfusions may also be indicated in infected patients with severe neutrophil dysfunction (e.g., chronic granulomatous disease and leukocyte adhesion deficiency) who are not responding to appropriate antimicrobial therapy. Although controlled trials have not been performed, transfused granulocytes do migrate within recipients and appear to be of therapeutic benefit ( [281](#), [282](#) and [283](#) ). Because of the adverse effects associated with the transfusion of granulocytes, they should be used judiciously in the patient with severe documented infections, as the infusions may result in alloimmunization of the recipient and render him or her unresponsive to granulocyte transfusion therapy at a later date.

Neonatal bacterial sepsis continues to be a major cause of morbidity and mortality. The function of the neutrophil in the neonate is impaired, with diminished chemotaxis and abnormal adhesion properties ( [284](#) ). Infection may result in neutropenia and depletion of the neutrophil storage pool ( [285](#), [286](#) and [287](#) ). Granulocyte transfusions have been used in the treatment of neonatal sepsis with varying results ( [285](#), [288](#), [289](#) and [290](#) ). The efficacy of this approach has been evaluated in six controlled trials with four studies demonstrating a survival benefit. Analysis of the overall data does not establish a clear benefit when other available therapies are considered ( [246](#) ). When compared with standard therapy of intravenous Ig, neonates with group B *Streptococcus* may experience increased survival after receiving granulocyte support ( [291](#) ). Although conflicting data exist, centers that experience a high mortality rate in septic infants with neutropenia and ongoing neutrophil storage pool depletion may consider a trial of granulocyte therapy. The recommended dose is  $1 \times 10^9$  granulocytes/kg of body weight ( [249](#) ).

## HEMATOPOIETIC STEM CELLS

Peripheral blood stem (progenitor) cells (PBPCs) collected by cytapheresis have become the standard source of hematopoietic cells for autologous transplantation ( [292](#) ). Grafts are collected after mobilization of the patient's PBPCs with chemotherapy or growth factor (G-CSF or granulocyte-macrophage colony-stimulating factor) administration ( [293](#), [294](#), [295](#) and [296](#) ). When autologous transplants are performed with mobilized progenitor cells, significant decreases are seen in the duration of neutropenia and thrombocytopenia. Extension of this practice into the area of allogeneic transplantation is rapidly gaining acceptance. Collecting PBPCs from matched related donors has been shown to yield

adequate numbers of cells for engraftment with minimal toxicity to the donor. A number of randomized trials comparing peripheral blood progenitor cells to bone marrow show that PBPCs are associated with faster engraftment of neutrophils and platelets ( 297 ). Despite a 1-log greater content of T cells in progenitor cells obtained from the peripheral blood, initial studies have not shown an overall increase in the incidence or severity of acute GVHD. However, the long-term risk for chronic GVHD may, in fact, be higher with PBPCs when compared to bone marrow-derived grafts ( 298 ). Similar findings are seen in studies comparing the source of progenitor cells in matched-unrelated donor transplantation ( 299 ). Although the data with regard to allogeneic PBPCs are encouraging, long-term follow-up is still needed to determine the impact of this therapeutic modality on relapse and overall survival.

PBPCs are collected using technology (cytapheresis) similar to that used for platelet collection ( 16 ). The mononuclear cells are collected until an adequate number have been obtained, often by daily pheresis via peripheral veins or an indwelling catheter for 1 to 3 days. The minimum target dose is  $2$  to  $5 \times 10^6$  CD34<sup>+</sup> cells/kg and  $20$  to  $50 \times 10^4$  colony-forming units granulocyte-monocyte/kg ( 300 , 301 ). The cells are collected and frozen for later use in autologous transplantation; allogeneic cells are most often infused fresh within 24 hours. After the recipient receives the appropriate preparative regimen (myeloablative or nonmyeloablative chemotherapy with or without radiotherapy), the stem cells are thawed, prepared, and infused, with successful marrow reconstitution over a period of 3 to 4 weeks ( 302 , 303 and 304 ).

The newest source of HPCs to be used in transplantation is umbilical cord blood (UCB). The blood can be collected from the umbilical vein and placenta immediately after birth using a collection bag and an appropriate volume of CPD anticoagulant. Although not found in large numbers, hematopoietic cells in UCB have proliferative advantages over traditional sources. Initial clinical studies were carried out in the related transplant setting where it was demonstrated that engraftment does occur with a relatively low incidence of GVHD ( 305 ). Similar results were seen with UCB transplants performed in the matched-unrelated setting, driving the subsequent development of cryopreserved cord blood banks. An increasing number of UCB transplants over recent years has allowed data to be collected on long-term survival. Patients who received related UCB had a 1-year survival of 63% compared with 29% in the unrelated setting ( 306 ). Because a strong association exists between cell dose and survival, the majority (>80%) of UCB transplants are performed in children. Despite limiting this approach primarily to children, a report by the Placental Blood Program at the New York Blood Center on a group of 562 unrelated UCB transplants showed a relatively high rate of incomplete/nonengraftment and increased 100-day mortality due to infectious complications ( 307 ). Further data on relapse and long-term survival must be collected to determine the utility of this source of HPCs. Unresolved questions include the need for *in vitro* expansion before infusion in adult patients as well as many ethical issues that surround the collection, storage, and use of UCB.

## TRANSFUSION OF PLASMA AND COMMERCIAL PROTEIN CONCENTRATES

The large-scale use of plasma dates from World War II, when plasma became invaluable as a volume expander in the treatment of hemorrhagic shock under field conditions. In current medical practice, plasma and products prepared from it have found numerous other roles. Plasma comes from two sources: whole blood donations and apheresis collections. Plasma may be used for transfusion, further processed by the blood center into cryoprecipitate, or sent to commercial facilities for manufacturing into plasma

derivatives. Recombinant protein products can be used in place of some plasma derivatives.

The therapeutic effectiveness of each plasma product can be estimated on the basis of the factor content of the product and its expected distribution into the plasma volume of the recipient (usually, approximately 40 ml/kg). However, the *in vivo* recovery of individual factors varies significantly.

### Noncommercial Plasma Components for Transfusion

These components, such as FFP, are produced from individual volunteer blood donors and are briefly described below.

**FRESH FROZEN PLASMA** FFP is prepared by separating citrated plasma from whole blood and freezing it within 8 hours of collection or by freezing citrated apheresis plasma within 6 hours of collection. FFP may be stored at  $-18^{\circ}$  C or below for up to 1 year. Under these conditions, there is minimal loss of activity of the labile coagulation factors V and VIII. One ml of FFP contains approximately one unit of coagulation factor activity. After thawing, FFP may be stored in the refrigerator for up to 24 hours before use. FFP is indicated for use in patients who are bleeding or having an invasive procedure *and* who are deficient in multiple coagulation factors or in a single factor for which there is no specific factor concentrate available. It is also indicated for replacement of clotting factors during massive transfusion, for reversal of warfarin (if immediate reversal is necessary), and as the replacement fluid for plasma exchange procedures in patients with TTP ( [9](#), [177](#) ). It should not be used as a volume expander, because alternative products with lower risk of infectious diseases and allergic reactions are available for this purpose (e.g., crystalloid, albumin, starch). Each unit of FFP prepared from whole blood contains approximately 200 ml of plasma. Apheresis plasma may be packaged into 200- or 400-ml bags. A typical dose of 10 to 15 ml/kg would constitute approximately 25 to 30% replacement therapy for coagulation factors (although there is lower recovery of some factors because of their diffusion into the extravascular space). FFP must be ABO compatible with the recipient's red cells.

**PLASMA FROZEN WITHIN 24 HOURS** This is plasma that has been stored in the refrigerator for up to 24 hours before freezing. The content of this product is similar to FFP except that factor VIII activity is reduced to 75% of normal ( [308](#) ). If used immediately after thawing, the factor VIII content of this product would be similar to that of an FFP unit that had been stored for 24 hours after thawing.

**LIQUID PLASMA, THAWED PLASMA** *Liquid plasma* is a term for plasma separated from refrigerated whole blood up to 5 days after its expiration date. It may be stored at  $1^{\circ}$  to  $6^{\circ}$  C or frozen at or below  $-18^{\circ}$  C. *Thawed plasma* is a term for FFP that has been stored in the refrigerator for more than 24 hours after thawing. The only significant difference between these products and FFP is the content of the labile coagulation factors (V and VIII). When plasma is stored at  $1^{\circ}$  to  $6^{\circ}$  C, factor VIII activity decreases by approximately 50% within the first few days of storage but falls only slowly thereafter. By the end of 40 days' storage, factor VIII activity remains approximately 30% of normal. Factor V levels decline steadily and reach approximately 30% of normal after 3 weeks of storage. Other coagulation factors, including fibrinogen and factors II, VII, IX, X, and XIII, are generally stable under refrigerated storage conditions ( [309](#), [310](#) ). Liquid plasma or thawed plasma should not be used for clotting factor replacement in patients who are deficient in factors V or VIII. However, it may be reasonable to use these products for plasma replacement in massively bleeding patients, as use of these products would still permit maintenance of clinically hemostatic factor levels (i.e., 30% of normal).

**PLASMA, CRYOPRECIPITATE-REDUCED** This is the supernatant remaining after removal of cryoprecipitate from FFP (see the section [Cryoprecipitated Antihemophilic Factor](#)). Storage conditions are the same as for liquid plasma. This product is deficient in fibrinogen, factor VIII, von Willebrand factor (vWF), and factor XIII. It may be used for the



same indications as liquid plasma. It is also useful in the treatment of TTP, because it is deficient in high-molecular-weight vWF multimers.

**CRYOPRECIPITATED ANTIHEMOPHILIC FACTOR** *Cryoprecipitated AHF, or cryoprecipitate*, is an extract of FFP that is enriched in high-molecular-weight plasma proteins. It is prepared by thawing one unit of FFP at 1° to 6° C. Under these conditions, the high-molecular-weight proteins remain as a precipitate. The precipitated protein is concentrated by centrifugation, and all except approximately 15 ml of supernatant is removed. The remaining 15 ml and the precipitate are refrozen. Each unit of this cryoprecipitate contains approximately 80 to 120 units of factor VIII and at least 150 mg of fibrinogen. It also contains factor XIII and the high-molecular-weight multimers of vWF. Cryoprecipitate was originally developed for the treatment of hemophilia A. It is no longer the treatment of choice for that disorder because less infectious alternatives are available. At the present time, cryoprecipitate is most often used for correction of hypofibrinogenemia (<100 mg/dl), particularly in patients with disseminated intravascular coagulation or in those whose fibrinogen is depleted from prolonged exposure to cardiopulmonary bypass circuits. Cryoprecipitate has also been used topically, along with thrombin and calcium, as a “fibrin glue.” However, commercial products that are much more effective as topical hemostatic or sealant agents are now available. The typical dose of cryoprecipitate of one unit/5 kg would be expected to raise the recipient’s fibrinogen level by approximately 70 mg/dl ( [9](#), [177](#) ). Multiple units of cryoprecipitate may be pooled before issue.

## Commercial Plasma Derivatives

Commercial plasma derivatives are made from pooled plasma derived from thousands of donors. In the United States, paid plasmapheresis donors provide most of the plasma derivatives, but excess (“recovered”) plasma from volunteer whole blood donations is also used. Thousands of plasma units are pooled and fractionated into a number of purified proteins. The usual fractionation procedure is based on Cohn’s cold ethanol fractionation process, developed in the 1940s ( [311](#), [312](#) ). As the temperature, ionic strength, pH, and ethanol concentration are varied, plasma can be separated into several fractions. Fraction I contains factor VIII and fibrinogen, fraction II contains the immunoglobulins, and fraction V contains albumin. Fractions III and IV contain a number of other coagulation factors and proteins. Although other approaches such as ion exchange chromatography have been applied to the preparation of certain plasma products, Cohn’s method still remains the standard. More recent advances have introduced affinity chromatography steps, using monoclonal antibodies, to obtain more highly purified preparations.

Because thousands of donors are represented in the plasma pools used for the production of plasma derivatives, contamination with infectious agents is common. Remarkably, albumin and intramuscular immune globulin preparations have not been associated with disease transmissions. Clotting factor concentrates, however, were highly infectious before the implementation of specific pathogen inactivation processes. Thus, most recipients of the early factor VIII concentrates produced in the 1970s developed evidence of exposure to hepatitis B, and 90% of recipients between 1979 and 1984 were exposed to HIV ( [313](#), [314](#) ). Methods of heat treatment developed in the early to mid-1980s reduced the risk of HIV—but not of hepatitis C. Today, almost all plasma derivatives are treated by methods demonstrated to inactivate HIV, HCV, and hepatitis B virus (HBV), such as prolonged heat and treatment with organic solvents and detergents, that inactivate lipid-coated viruses. Pooled plasma products, however, could still transmit infectious agents that lack a lipid coat and that are resistant to heat. Most recently, concerns have been raised about the potential for prion transmission through blood products, although available evidence suggests that these agents, if present in blood, would likely be removed from plasma products during the manufacturing process ( [315](#) ). Because the possibility of infectious disease transmission cannot be completely

eliminated, proteins produced through recombinant DNA techniques are generally considered preferable to derivatives from pooled plasma. Many recombinant products, however, contain albumin derived from pooled plasma.

There are many commercial plasma derivatives available. Some examples are described below.

**ALBUMIN** Albumin ( [316](#), [317](#) ) may be prepared by a variety of fractionation procedures, but the standard is cold ethanol (Cohn) fractionation; albumin so prepared is approximately 95% pure. A less complex preparative method yields plasma protein fraction that is approximately 85% albumin. Both products are heat treated to eliminate the risk of transmission of viral hepatitis and HIV. They are available as 4% or 5% solutions; albumin is also available at a 25% concentration. These products are generally pure and free of most of the side effects of plasma.

**SOLVENT DETERGENT-TREATED PLASMA** Solvent detergent-treated plasma is made from thousands of units of FFP that have been thawed, pooled, subjected to treatment with organic solvents and detergents, filtered, and refrozen. The product was developed to reduce the risk of transmitting enveloped viruses, such as HIV, HCV, and HBV. It is therapeutically equivalent to FFP and attractive for treatment of TTP in that it is deficient in the highest-molecular-weight vWF multimers ( [318](#), [319](#) ). Because it is a pooled product, however, it carries an increased risk of transmitting infectious agents that are not destroyed by solvent/detergent treatment, including nonenveloped viruses such as parvovirus B19 ( [320](#), [321](#) ). This product is no longer distributed in the United States.

**COAGULATION FACTOR CONCENTRATES** The coagulation factor concentrates, both the recombinant products and those made from plasma, are discussed in detail elsewhere as part of the management of hemophilia (see [Chapter 59](#) ). Factor concentrates made from human plasma are treated by methods such as pasteurization or solvent detergent sterilization that inactivate lipid-enveloped viruses such as HIV and most of the hepatitis viruses.

**FACTOR VIII** Several plasma-derived factor VIII preparations are available, each prepared in a slightly different way. Only some contain therapeutic amounts of von Willebrand's factor. Recombinant factor VIII concentrates are available and may be the treatment of choice for hemophilia A but do not contain vWF. These products are reviewed in detail in [Chapter 59](#) .

**FACTOR IX** Prothrombin complex concentrates contain variable concentrations of the vitamin K-dependent factors II, VII, IX, and X. Such concentrates have variable degrees of thrombogenic activity and are now used mainly in the treatment of patients with coagulation inhibitors. Activated factor IX complex concentrates such as Autoplex and FEIBA are prepared in such a way that factor VIII is bypassed in the coagulation cascade.

They are used in the management of patients with factor VIII inhibitors ( [322](#), [323](#) ). A recombinant factor VIIa product is also available for use in patients with factor VIII inhibitors (see [Chapter 59](#) ). More purified factor IX concentrates that do not appear to have thrombogenic activity have been developed using affinity chromatography. Among the plasma-derived factor IX preparations, these purified products are the most appropriate for the treatment of hemophilia B. However, recombinant factor IX products are also available (see [Chapter 59](#) ).

**ANTITHROMBIN III** Antithrombin III is a plasma protease inhibitor that circulates in plasma at a concentration of 180 to 300 mg/L ( [324](#) ). Antithrombin-deficient patients with thrombosis or in situations with a high risk of thrombosis have been managed by transfusion of antithrombin III ( [325](#) ). Antithrombin III deficiency may be treated by infusion of plasma ( [326](#) ). Antithrombin III concentrates are available, prepared from pooled plasma by affinity chromatography with heparin agarose ( [324](#) ).

**PROTEINS C AND S** There are no plasma-derived concentrates of proteins C or S available in the United States. However, a recombinant activated protein C product is available, which appears useful in the treatment of patients with sepsis ( [327](#) ).



**INTRAMUSCULAR IMMUNOGLOBULINS** Intramuscular immune globulin preparations are prepared from pooled plasma by cold ethanol fractionation. They are provided as 16.5% protein solutions, containing approximately 95% IgG and small amounts of IgA and IgM. They contain dimeric and polymeric IgG, artifacts of the fractionation procedure, which are capable of nonspecifically activating complement by both the classic and alternate pathways. This mechanism probably explains the major adverse effects that occur if these products are administered intravenously. Products labeled for intramuscular use must therefore not be given intravenously. Intramuscular immune globulins have not been associated with infectious disease transmission. Some, but not all, are solvent detergent-treated. Nonspecific immune globulin preparations contain a broad spectrum of antibodies naturally present in the donor population. They are most often used for passive immunization (e.g., to hepatitis A). Immune globulins against a particular agent are derived from the plasma of donors selected for high concentrations of antibodies to that agent. Such preparations include Rh immune globulin, hepatitis B immune globulin, and varicella zoster immune globulin.

**INTRAVENOUS IMMUNE GLOBULINS** A number of modified Ig products that permit intravenous administration are available. These are produced by various chemical modifications designed to decrease the aggregation of IgG. Nonspecific complement activation is reduced, whereas the ability of the Ig molecules to interact with pathogenic organisms and complement is retained ([328](#)). Intravenous immune globulin (IVIG) preparations are supplied as 3 to 12% protein solutions or powders that have to be reconstituted. Slow administration is necessary, however, to help prevent adverse reactions. The ability to administer IVIG in high doses has led to its use as an immune suppressant or immune modulator ([329](#), [330](#) and [331](#)). As is the case with the intramuscular immune globulins, nonspecific IVIG preparations contain a broad spectrum of antibodies naturally present in the donor population. These preparations are indicated for the prophylaxis of infections in patients with primary immunodeficiencies. Other FDA-approved indications include prophylaxis of infection in patients with B-cell chronic lymphocytic leukemia, treatment of Kawasaki syndrome, treatment of patients with ITP, the prevention of infections after bone marrow transplantation, and the treatment of pediatric HIV infections. There are many off-label uses for these products, with varying levels of evidence for benefit. Some applications with established clinical benefit include treatment of Guillain-Barré syndrome, dermatomyositis, red cell aplasia due to parvovirus B19 infection, and prenatal treatment of pregnant women with antiplatelet alloantibodies ([9](#), [332](#)). Compared to intramuscular immune globulins, there are fewer IVIG preparations targeted against specific agents. One preparation commonly available is intravenous Rh immune globulin, which may be used to suppress Rh immunization or for treatment of ITP in Rh-positive individuals. Unlike the intramuscular immunoglobulins, intravenous immunoglobulins have been associated with transmission of hepatitis C in the past ([333](#), [334](#), [335](#) and [336](#)). Today, these products are solvent detergent-treated and, therefore, unlikely to transmit lipid-enveloped viruses. IVIGs have been associated with some adverse reactions, including renal failure and thrombotic events. They should be used with caution in patients with IgA deficiency, because they may contain small quantities of IgA.

## ADVERSE EFFECTS OF BLOOD TRANSFUSION

The potential complications of blood transfusion therapy are many, but most present problems only in patients requiring repeated or large numbers of transfusions. The risks associated with the transfusion of any specific unit of blood are low. However, the risks must be weighed against the benefits at the time each transfusion is ordered.

Transfusion complications can be classified as immunologic and nonimmunologic ([Table 24.8](#)). Many of the immune reactions are caused by the stimulation of antibody production by foreign alloantigens present on transfused red cells, leukocytes, platelets, or plasma proteins. Such alloimmunization may lead to immunologically mediated reactions when

transfusions carrying these antigens are administered in the future. These include hemolytic reactions caused by red cell incompatibility; febrile or pulmonary reactions caused by leukocytes and platelet antigens; allergic or anaphylactic reactions caused by antibodies reacting with soluble antigens, usually plasma proteins, in the transfused material; and GVHD caused by engraftment of transfused lymphocytes in immunosuppressed recipients.

**TABLE 24.8. Adverse Effects of Transfusion**

---

|   |
|---|
| Immunologic                                       |
| Alloimmunization                                  |
| Red cell antigens                                 |
| HLA antigens                                      |
| Platelet-specific antigens                        |
| Neutrophil-specific antigens                      |
| Plasma proteins                                   |
| Hemolytic transfusion reactions                   |
| Immediate   |
| Delayed   |
| Febrile transfusion reactions                     |
| Transfusion-related acute lung injury             |
| Allergic transfusion reactions                    |
| Posttransfusion purpura                           |
| Immunosuppressive effects                         |
| Graft-versus-host disease                         |
| Nonimmunologic                                    |
| Volume overload                                   |
| Massive transfusion                               |
| Metabolic   |
| Hypothermia                                       |
| Dilutional  |
| Pulmonary microembolization                       |
| Miscellaneous                                     |
| Plasticizers                                      |
| Transfusion hemosiderosis                         |
| Infectious  |
| Hepatitis: A, B, C, delta, other                  |
| Human immunodeficiency virus-1/-2                 |
| Human T-lymphotropic virus-I/-II                  |
| Cytomegalovirus                                   |
| Epstein-Barr virus                                |
| Bacterial contamination                           |
| Syphilis  |
| Parasites: malaria, <i>Babesia</i> , trypanosomes |
| Other organisms                                   |

---

The nonimmune reactions are caused by the physical or chemical properties of the

transfused blood products, as well as contaminating infectious agents. Nonimmune reactions include circulatory overload and certain adverse effects encountered specifically when large numbers of transfusions are given.

## Immunologic Transfusion Reactions

### ALLOIMMUNIZATION TO TRANSFUSED ANTIGENS

***Alloantibodies Reacting with Red Cell Antigens*** Although the antigenic composition of transfused red cells always differs from that of the recipient, only a minority of multitransfused recipients develop red cell alloantibodies. The risk of red cell alloimmunization has been estimated at 1.0 to 1.4%/unit transfused ( 337 , 338 ); in multitransfused patients, the incidence of such antibodies ranges from 5 to 30% ( 339 , 340 and 341 ). The majority of patients who produce antibodies do so early, generally after the first ten or fewer transfusions. Multiple red cell antibodies may be encountered. Antibodies to Rh system antigens and to Kell (K) are most often detected. Antibodies to antigens of the Duffy (Fy) and Kidd (Jk) systems also occur, but transfusion-induced antibodies to other red cell antigens are less commonly found. The production of such antibodies is a property of both the recipient's immune response and the immunogenicity of the different red cell antigens. The incidence of antibodies does not appear to be related to the patient diagnosis. For example, patients with hemoglobinopathies, thalassemia, and leukemia and those undergoing surgery requiring multiple transfusions produce antibodies with approximately the same frequency ( 339 , 340 ). However, a group of hyperresponders has been found who make alloantibodies after a small number of transfusions. The majority of patients are nonresponders. The reported incidence of alloimmunization of thalassemics is 5 to 10%, whereas the overall risk of patients with sickle cell anemia is 20 to 30%. The increased incidence of alloimmunization in sickle cell patients has been attributed to the difference in race between the blood donor pool and the patient population, in that most of the donors are white ( 342 ). As a result, there is a greater likelihood of minor antigen incompatibility between donor and recipient. The differing immunogenicity of various red cell antigens also plays a role. Some blood banks select donors for sickle cell patients according to red cell phenotype. Others do not preselect because only a portion of transfused patients become alloimmunized and because of the cost involved ( 343 ).

***Alloantibodies Reacting with Leukocyte Antigens*** Alloimmunization to HLA and other leukocyte-associated antigens has been discussed earlier with respect to problems encountered in granulocyte and platelet transfusion. These antibodies occur mainly in multiparous women ( 206 , 344 ) and multitransfused patients. For example, after cardiac surgery, antibodies were detectable in 33% of males and 64% of females ( 345 ). In patients receiving transfusion support for aplastic anemia or acute leukemia, 20 to 70% become immunized to HLA antigens ( 346 ). As discussed in the section [Platelet Transfusion](#) and shown in [Table 24.7](#), the prophylactic use of leukocyte-reduced products reduces the incidence of HLA alloimmunization in transfusion recipients that have not been previously exposed to foreign HLA. However, the prevalence of HLA alloimmunization remains high in patients with a history of pregnancy.

***Alloantibodies Reacting with Plasma Proteins*** Although antibodies to soluble plasma proteins such as lipoproteins and to Gm and Inv determinants on IgG are often detectable in multitransfused patients, transfusion reactions have rarely been attributed to such antibodies ( 347 , 348 and 349 ). Some anaphylactic reactions are attributed to anti-IgA antibodies ( 350 , 351 and 352 ), especially in patients who are IgA deficient, although the presence of antibodies reacting with IgA is not always clearly correlated with the occurrence of this type of transfusion reaction ( 353 ).

**HEMOLYTIC TRANSFUSION REACTIONS** The development of antibodies capable of reacting with red cell antigens may lead to red cell destruction, usually involving transfused rather than recipient cells. The clinical significance of such reactions ranges

from life-threatening to trivial. Whether hemolysis occurs immediately within the circulation, more slowly within the reticuloendothelial system, or not at all depends on the antigen and antibody involved ( 354 , 355 , 356 and 357 ). The incidence of such reactions is variably reported. Several studies from the Mayo Clinic document a hemolytic reaction rate, both immediate and delayed, of between 1 in 6200 and 1 in 1400 red cell transfusions. In these reports, reactions caused by clerical error and ABO mismatching were virtually nonexistent, but some reactions were attributed to weak atypical antibodies missed in pretransfusion testing ( 354 , 358 , 359 ). The high reaction rate was related in part to a high index of suspicion and in part to the use of sensitive tests for serologic evidence of minor DHTRs. In contrast, in a review of fatal hemolytic reactions reported to the U.S. Bureau of Biologics, 86% were caused by ABO incompatibility, and of these 89% were caused by simple clerical error ( 360 , 361 ).

**Immediate (Intravascular) Hemolytic Transfusion Reactions** Immediate hemolytic transfusion reactions (IHTRs) are most typically associated with ABO incompatibility because anti-A and anti-B antibodies are predominantly IgM and are capable of binding complement and causing immediate destruction of red cells. An IHTR caused by ABO incompatibility is rare and is usually related to clerical error. Other red cell antigens such as Jk<sup>a</sup>, K, and Fy<sup>a</sup> (which may bind complement) may also lead to such reactions. Infrequently, hemolytic transfusion reactions may be caused by destruction of recipient red cells after the transfusion of plasma containing antibodies ( 362 , 363 ). For example, anti-A<sub>1</sub> occurring naturally in group A donors of subgroup A<sub>2</sub> has been reported to cause hemolytic transfusion reactions ( 364 ). Hemolytic reactions caused by the transfusion of plasma containing other antibodies are extremely rare, as blood donors are screened for red cell antibodies other than ABO.

**Signs and Symptoms** IHTRs occur soon after the incompatible transfusion has begun. Occasionally, they are mild; more typically, there is a sudden change clinically. Fever with or without chills is one of the most common manifestations of such reactions. Other signs and symptoms include anxiety, chest or back pain, flushing, dyspnea, tachycardia, and hypotension. If the patient is under general anesthesia, these symptoms may not be recognized; only severe hypotension and evidence of oozing or hemoglobinuria serve as clues to the presence of a hemolytic reaction. Such reactions are life-threatening and include acute renal failure, shock, and intravascular coagulation. It has been estimated that a fatal immediate hemolytic reaction occurs in approximately 1/600,000 red transfusions ( 357 ). The mortality of a severe IHTR increases with the amount of blood transfused, with a 44% mortality rate in patients receiving more than 1 L of incompatible blood.

**Pathophysiology** The primary event in IHTRs is the interaction between the antibody and the red cell membrane resulting in the development of immune complexes, the activation of the complement cascade (leading to the release of C3a and C5a with anaphylatoxic activity), and the coagulation mechanism via cytokines and factor XII (leading to both consumptive coagulopathy and generation of bradykinin). Vasomotor mediators implicated in the transfusion reaction include histamine, serotonin, and cytokines. Shock results from release of such vasoactive substances ( 356 , 357 ). The renal failure that may occur in this setting is of complex and poorly understood etiology but appears to be primarily ischemic, caused by a combination of hypotension, vasoconstriction, and intravascular coagulation. The free hemoglobin circulating in such patients was once thought to be the major cause of renal failure by precipitating in and obstructing the renal tubules, but there is adequate evidence to discount this hypothesis. Infusion of incompatible red cell stroma, free of hemoglobin, is sufficient to produce acute renal failure ( 355 ).

**Management** A transfusion must be discontinued immediately on any suspicion of a hemolytic transfusion reaction. A posttransfusion blood sample and the discontinued bag of blood should be sent to the blood bank for investigation of the cause of the reaction. The severity of the reaction is related to the volume of red cells infused. Although as few as 30 ml of incompatible blood may be lethal, most severe reactions require more than

200 ml. Hydration must be begun immediately to prevent renal failure. An infusion of normal saline is given to maintain the blood pressure and increase the urine flow rate to 100 ml/hour. Mannitol or furosemide may be used to maintain urine output. If oliguric renal failure develops, fluid challenges must be restricted. Vasoactive drugs such as dopamine may be effective against hypotension and impaired renal perfusion. Once renal failure is established, the usual supportive measures including fluid restriction, management of electrolyte balance, and dialysis are required. The coagulopathy may also require specific management. Some recommend early heparinization at moderate dose if no specific contraindication exists; its use remains controversial. The patient may require support of the defective hemostatic mechanisms with platelets and cryoprecipitate or FFP. In massive intravascular hemolytic transfusion reactions, exchange transfusion has been performed ( [365](#) ), but most reactions can be managed more conservatively.

**Investigation of Immediate Transfusion Reactions** The following steps must be carried out in the investigation of patients with immediate transfusion reactions. The patient's identity must be confirmed and all the records on the patient and the donor blood label must be checked for clerical errors. A new, properly labeled sample of blood must be drawn from the patient and sent to the blood bank with the discontinued unit of blood. The posttransfusion sample must be visually checked for hemolysis. In intravascular reactions, free plasma hemoglobin can be detected most quickly by centrifuging a tube of blood anticoagulated with ethylenediaminetetraacetic acid or heparin; pink plasma indicates intravascular hemolysis—that is, evidence of red cell destruction. There must be an investigation for possible alloantibodies. A direct antiglobulin test must be performed on the specimen submitted at the time of the reaction. If the test is positive, the pretransfusion sample should also be tested because the patient may have had a positive direct antiglobulin test before transfusion. Red cell typing should be repeated on all specimens. If the posttransfusion ABO and Rh type does not agree with pretransfusion results, there has been an error in patient identification or typing. Antibody detection tests should be repeated on the pre- and postreaction samples. The direct antiglobulin test on the postreaction specimen may reveal sensitization of red cells in the patient only if the antibody or complement-coated transfused incompatible cells have not been immediately destroyed. A repeat crossmatch should be positive, although the antibody may not be readily demonstrable in serum at the time the reaction is suspected clinically. The antibody specificity is identified by its reactions with a panel of red cells of known phenotype. It may be necessary to elute the offending antibody from the patient's red cells before it can be identified ( [8](#) ). In a minority of patients in whom there is a high clinical suspicion of a hemolytic transfusion reaction, no immunologic abnormality may be identified. In some, repeated examination for antibodies over a prolonged period of time may eventually reveal the cause; in others, results may be persistently negative. In such patients, <sup>51</sup>Cr red cell survival testing may be of value in documenting hemolysis caused by incompatibility ( [120](#), [121](#), [123](#), [124](#) ). Patients with major hemolytic transfusion reactions should be assessed for the possible presence of intravascular coagulation, and their renal function should be monitored closely. Urinary hemosiderin or free hemoglobin in the urine may also be detected; wine-colored urine is typical of intravascular hemolysis. The laboratory can confirm the identity of the pigment. Demonstration of methemalbuminemia, reduced serum haptoglobin, or hyperbilirubinemia may provide supportive evidence.

**Prevention** Most IHTRs are preventable. The most likely cause is human error, such as mislabeling of the patient sample, drawing the sample from the wrong patient, transcription errors, and improper identification of the unit with the recipient. Mechanisms to ensure positive identification of the patient (recipient), the blood sample, and the transfusion component must be in place to prevent IHTRs ( [4](#) ).

**Delayed Hemolytic Transfusion Reactions** DHTRs generally are much milder than those occurring immediately, and red cell destruction is predominantly extravascular ( [354](#), [359](#), [366](#), [367](#) ). The transfused red cells are destroyed beginning 2 to 10 days after a transfusion. Investigation may reveal the presence of a red cell antibody not detected in the pretransfusion blood sample. The direct antiglobulin test is often positive, but the reaction is transient and may be missed if performed too late. The test reverts to



negative as the incompatible red cells are removed from the circulation. DHTRs almost always represent secondary, or anamnestic, antibody responses. On first exposure to an immunogenic red cell antigen, a primary antibody response generally is delayed in onset and slow to reach its peak. For example, anti-D appears a minimum of 4 to 8 weeks after transfusion and may not develop for up to 5 months, after most or all the donor red cells have been removed by the aging process ( 354 ). The antibody level gradually declines, and antibody screening and crossmatch tests may be negative. After a subsequent transfusion, the previously sensitized recipient manifests a much more brisk immune response, with high concentrations of IgG antibody developing within days. Donor cells remaining in the circulation may become coated with antibody and removed by the reticuloendothelial system. Rarely, primary immunization after transfusion may lead to a DHTR ( 368 ). In delayed hemolytic reactions, destruction of the sensitized red cells is extravascular; that is, the IgG-coated red cells are removed by the reticuloendothelial system. Often, there are no symptoms, with a new red cell antibody and positive direct antiglobulin test detected incidentally ( 369 ). If present, symptoms and signs may include fever, falling hematocrit, jaundice, and, infrequently, hemoglobinemia and hemoglobinuria. Rarely, the reactions may be dramatic; renal failure is uncommon, but fatalities have been reported. The antibodies responsible for DHTRs are well defined. Antibodies to Kidd (Jk) antigens and to antigens of the Rh system are the major offenders, with anti-Kell and anti-Duffy (Fy) implicated in most other delayed reactions. Ten to twenty-five percent of patients have more than one alloantibody. Anti-Kidd antibodies are particularly troublesome because the plasma concentration of these antibodies declines more rapidly than others, so that pretransfusion tests are more commonly negative in patients who are in fact sensitized ( 6 ).

**Investigation of Delayed Hemolytic Transfusion Reaction** If a DHTR is suspected, a fresh blood sample should be obtained from the patient. This sample should be screened for the presence of previously undetectable red cell antibodies. A direct antiglobulin test should be done. If it is positive, the antibodies should be eluted from the red cells and identified. If the transfused cells have already been destroyed, the direct antiglobulin test will not be positive, but an antibody should be detectable in the patient's serum. The physician must be advised and the patient given a card indicating the presence of the antibody. The blood bank must retain a permanent record of clinically significant antibodies because the antibody may again become undetectable.

**Management** In most instances, no specific therapy is necessary. The few patients who experience severe reactions should be treated with adequate hydration. If clinically indicated, crossmatch-compatible blood negative for the offending antigen(s) should be administered. The physician and patient should be informed about the antibody so that transfusions may be administered safely in the future.

**Pseudo-hemolytic Transfusion Reactions** In patients manifesting a clinical syndrome consistent with intravascular hemolysis, but in whom no blood group incompatibility can be identified, other explanations should be considered. Conditions that mimic hemolytic transfusion reactions are called *pseudo-hemolytic transfusion reactions* ( 356 ). These include bacterial contamination with organisms such as *Yersinia*, resorption of large hematomas, and hemolysis caused by drug reactions or vascular prostheses. Pretransfusion hemolysis of donor blood caused by mechanical trauma, freezing, heat, hypotonic solutions, or outdated red cells should always be considered a potential cause of such a reaction ( 356 ).

**FEBRILE NONHEMOLYTIC TRANSFUSION REACTIONS** FNHTRs ( 370 , 371 and 372 ) have been reported in a variable proportion of patients receiving transfusions, ranging between 0.5% and 3.0%; they are more common in multiply transfused patients. The typical reaction consists of a chill followed by fever, usually during or within a few hours of the transfusion. Headache, nausea, and vomiting may occur. Occasionally, the reaction may be severe, including pulmonary symptoms, but usually these reactions are mild. Whatever their degree, febrile transfusion reactions usually run their course within a few hours. Some causes of FNHTRs are as follows. Alloimmunization to antigens on leukocytes and platelets is one of the most common causes of nonhemolytic febrile reactions. Early

studies detected the presence of leukoagglutinins in such patients ( 373 , 374 ). HLA antibodies are most commonly found, followed by platelet-specific antibodies; granulocyte-specific antibodies are detected in only a minority of patients ( 375 , 376 and 377 ). Another cause of FNHTRs is the transfusion of cytokines that have developed *in vitro*, especially in whole blood-derived platelet concentrates stored at room temperature ( 378 ). Recent studies have shown that during storage, the leukocytes in platelet concentrates release cytokines that may be responsible for the febrile reaction ( 55 ). The causative role of accumulated cytokines is supported by the observation that leukoreduction filtration after storage does not eliminate many of the FNHTRs to platelet concentrates ( 56 ). The incidence of FNHTRs to platelet concentrates increases with the age of the platelet concentrate and the leukocyte concentration in the product. The reactions appear to be mediated by the plasma supernatant of the platelet products ( 55 , 56 , 57 and 58 , 379 ). The concentration of cytokines in platelet concentrates can be reduced by leukoreducing the products soon after collection. Cytokine levels are reduced in apheresis platelets, most of which are leukoreduced by the collection technology ( 380 ). The possibility of bacterial contamination of the product must be considered as a possible cause of FNHTR. Symptoms caused by transfusion of bacteria or their toxins can be mild or may be fatal. Platelet components are involved more often because they are stored at room temperature. However, certain organisms such as *Yersinia enterocolitica* proliferate in red cells at storage temperatures of 1° to 6° C. Bacterial contamination is often not considered as a cause of a febrile reaction; it may be more prevalent than reported because of underinvestigation ( 381 , 382 and 383 ).

**Management of Febrile Reactions** The approach to management of febrile transfusion reactions must be based on an understanding of all the possible causes. Although many such reactions are caused by WBC alloimmunization or cytokines, fever may also be an indication of an unsuspected hemolytic transfusion reaction or contamination of the donor blood by bacteria or endotoxin. For these reasons, every transfusion complicated by a febrile transfusion reaction should be discontinued. The only exception to this rule may be some frequently transfused patients who predictably develop fever with most transfusions; in such cases, the physician, after very carefully assessing the patient, may elect to persist with the transfusion. The possibility of a hemolytic reaction should be considered when fever occurs. The donor unit, along with a patient serum specimen, should be returned to the blood bank for investigation. Other tests for hemolysis should be done as discussed previously, if clinically indicated. The donor unit and patient blood should be cultured if there is any suspicion of bacterial contamination. The symptoms of a febrile transfusion reaction may often be ameliorated with an antipyretic such as acetaminophen or hydrocortisone in patients who develop severe reactions. Meperidine may be used to decrease or stop severe shaking chills. Antihistamines are indicated only if the patient also has allergic symptoms such as hives.

**Prevention of Febrile Transfusion Reactions** Febrile transfusion reactions to red cells occur most commonly in patients who have been sensitized to WBC antigens by previous transfusions or pregnancies. In such patients, the risk of a febrile transfusion reaction varies with the leukocyte content of the donor unit. Use of leukoreduced red cells may decrease the incidence of FNHTRs ( 384 , 385 and 386 ). Every patient who experiences a reaction does not routinely need specific preventive measures because only a minority will have a second reaction. It is, therefore, common practice for blood banks to provide leukoreduced products only after two febrile reactions have been documented ( 387 , 388 ). When whole blood-derived platelets are given, febrile reactions are common. Removal of leukocytes from these components at the time of transfusion often fails to prevent FNHTR because of the high level of cytokines in these products ( 55 , 56 , 57 and 58 ). Reduction of the level of cytokines by using platelet concentrates stored for a shorter time, prestorage leukoreduction of platelet concentrates, or use of apheresis platelets reduces the incidence of FNHTR to platelet products ( 139 , 389 ). If reactions persist, premedication with antipyretics or corticosteroids may be required. Because granulocyte concentrates cannot be modified by leukoreduction, premedication should be routine in



patients who receive these products.

**TRANSFUSION-RELATED ACUTE LUNG INJURY** Transfusion-related acute lung injury most commonly presents as severe respiratory distress of sudden onset, caused by a syndrome of noncardiogenic pulmonary edema resembling the adult respiratory distress syndrome ( 390 , 391 ). Chills, fever, chest pain, hypotension, and cyanosis, as well as the usual manifestations of pulmonary edema, may be seen. The chest radiograph shows florid pulmonary edema. The reaction may occur within several hours of the transfusion; it may be severe initially but generally subsides within 48 to 96 hours with appropriate respiratory support, without residual effects. Transfusion-related acute lung injury occurs much less often than FNHTR, with a reported incidence of approximately 1 in 5000 transfusions ( 390 ), but it may be underdiagnosed. These reactions are thought to be caused by the transfusion of antibodies in donor plasma that are reactive with recipient granulocytes. Such antibodies may react with HLA- or granulocyte-specific antigens. Based on studies of adult respiratory distress syndrome, which has similar pulmonary manifestations, it has been suggested that agglutination of granulocytes and complement activation occur in the pulmonary vascular bed, leading to capillary endothelial damage with consequent fluid leak into the alveoli ( 390 , 392 ). Management involves supportive measures for the pulmonary edema and hypoxia, including ventilatory support if required. Hemodynamic monitoring may be required to determine whether fluid overload is a factor; if not, diuretics are of no proven value ( 393 ). Very high doses of corticosteroids may be of benefit in transfusion-related acute lung injury ( 392 ), probably by blocking granulocyte aggregation and consequent vascular damage. Donors whose plasma is implicated in such reactions should be examined for the presence of granulocyte-specific and HLA antibodies reacting with recipient leukocytes. Many of the donors involved in such reactions have been multiparous females. It would be reasonable to avoid further transfusion of plasma-containing products from donors who are found to have anti-HLA or antigranulocyte antibodies.

**ALLERGIC REACTIONS** Allergic reactions are also common in transfusion recipients, with an estimated incidence of 1 to 3% ( 371 ), but their actual incidence may be higher because they are often not reported. They range from urticarial lesions (hives), other skin rashes, bronchospasm, and angioedema to anaphylactic shock. Minor reactions are dose related, with an incidence related to the volume of plasma transfused. Whole blood and plasma are more likely than concentrated red cells to cause such reactions; washed red cells or albumin are rarely implicated. Minor urticarial reactions are the only transfusion reactions that do not necessitate immediate discontinuation of the transfusion. Fortunately, the incidence of severe anaphylactic transfusion reactions is very low, as such reactions can be life-threatening. Most allergic reactions are thought to be mediated by recipient IgE to proteins or other soluble substances in donor plasma. The interaction between the antigen and IgE stimulates the release of histamine from mast cells and basophils. Most patients do not have repeated allergic reactions, but those with a history of atopy are at higher risk for additional reactions. For patients with repeated allergic reactions, premedication with an H<sub>1</sub>-blocking antihistamine is usually sufficient for prevention. If maximal premedication fails to control the allergic response, reducing the plasma content of the transfused blood product is another option. This can be accomplished by centrifuging the product and removing almost all the plasma or by red cell washing. In patients with severe anaphylactoid or anaphylactic reactions, antibodies reacting with IgA in donor plasma should be considered. The incidence of genetically determined IgA deficiency in the otherwise normal population is high, ranging from 1 in 400 to 1 in 500 ( 394 ). Without necessarily having prior transfusion exposure, approximately 20 to 25% of such patients produce antibodies to IgA, generally class specific (i.e., reacting with all IgA molecules). In patients with anti-IgA titers of 1 in 256 or higher, there is a high likelihood of a major anaphylactic reaction after transfusion ( 395 ), often after administration of only a few milliliters of plasma. Such patients should be transfused, when necessary, with washed red cells ( 396 ) or with IgA-deficient blood products. In addition, many patients with normal IgA levels have antibodies that react with

some, but not all, IgA molecules; the incidence of such limited-specificity antibodies has been reported at 2% of normal adults ( [397](#) ), but the incidence may be as high as 21% in multiply transfused patients ( [370](#) ). The concentration of such limited-specificity antibodies generally is low, and the resulting reactions are usually milder, but the possibility of a major reaction exists ( [352](#) ).

**POSTTRANSFUSION PURPURA** Posttransfusion purpura ( [398](#) , [399](#) , [400](#) , [401](#) and [402](#) ) is the development of life-threatening thrombocytopenia 5 to 10 days after transfusion. This rare complication is caused by the development of alloantibodies directed against platelet-specific antigens; anti-HPA-1a is usually implicated, although antibodies with other specificities have also been reported (see [Chapter 53](#) ). Posttransfusion purpura is thought to occur as a result of a secondary immunologic response to the platelet-specific antigen, most patients having been sensitized by prior pregnancy or transfusion. The mechanism of destruction of the patient's own platelets is uncertain. Management includes high-dose IVIG ( [403](#) ); corticosteroids may be of value ( [404](#) ). Posttransfusion thrombocytopenia may also be associated with the passive administration of a platelet-specific antibody ( [405](#) , [406](#) and [407](#) ). Both anti-HPA-1a and anti-HPA-5a have been implicated; these cases can be defined as passive posttransfusion purpura, and the resulting thrombocytopenia occurs within hours of the transfusion. It is important to identify the donors of these blood products to prevent further infusion of plasma-containing products from such donors.

**TRANSFUSION-RELATED IMMUNOMODULATION** Allogeneic blood transfusion results in the transfer of not only RBCs, but also significant amounts of potential immune effector cells, their products (e.g., cytokines), and various substances that may be seen by the host immune system as foreign antigens. A large body of literature exists that substantiates the modulation of host immune systems by transfused substances, raising the possibility of the development of clinical syndromes generally referred to as *transfusion-related immunomodulation* (TRIM) ( [408](#) ). Although possible beneficial immunomodulatory effects have been reported in renal transplant patients receiving transfusion before surgery by mechanisms that are not well understood ( [409](#) , [410](#) , [411](#) , [412](#) and [413](#) ), TRIM is generally considered to have a number of deleterious effects ( [408](#) , [409](#) ). A large number (>150) of clinical studies have been performed over the last two decades specifically addressing two potential harmful TRIM-associated effects: cancer recurrence and postoperative bacterial infections. The aim of the studies has been to document TRIM and to ascertain the effect, if any, that removal of immune effector cells (leukoreduction) might have. Many observational cohort studies have been reported along with a number of randomized clinical trials attempting to measure the possible TRIM effect; still, contradictory findings exist today. Despite some reports of a transfusion-associated increased risk of cancer recurrence or postoperative infections, most studies include potential confounders or sources of bias. To date, no definitive association or causal relationship has been proven in a rigorous fashion. Randomized trials have not definitively established an increase in cancer-related death or relapse, nor have they clearly identified a reproducible increase in the rate of infection ( [414](#) , [415](#) , [416](#) , [417](#) , [418](#) , [419](#) , [420](#) , [421](#) and [422](#) ). Some investigators have argued for prophylactic leukoreduction of blood products for all patients based on observations that white cells in blood products mediate a TRIM effect in animal models ( [409](#) ). This recommendation has been questioned, however, in the face of randomized trials in humans that disagree regarding the existence of a clinically measurable TRIM effect and that fail to establish the reduction of this effect by leukoreduction ( [59](#) ). Similarly, arguments have been made that HIV-positive patients should receive leukoreduced blood because of *in vitro* studies suggesting that exposure to allogeneic leukocytes would induce HIV activation ( [423](#) ). However, a recent multicenter study in HIV-infected patients failed to demonstrate the activation of HIV or CMV by transfusion. Furthermore, this study revealed a tendency toward reduced, rather than improved, survival among the patients who received blood products that were leukoreduced, although this trend was not statistically significant ( [424](#) ). Thus, although the

practice of using leukoreduced blood products for all patients is becoming increasingly widespread, current evidence does not establish the efficacy of this blood product modification in reducing TRIM.

**GRAFT-VERSUS-HOST DISEASE** Most cellular blood products, including red cell, platelet, and granulocyte products, contain viable, immunocompetent T lymphocytes (425). When transfused into immunoincompetent recipients, these donor lymphocytes may proliferate in the patient and lead to the clinical syndrome of TA-GVHD (426, 427). TA-GVHD has also been reported in immunocompetent patients, especially those who receive transfusions from family members or from random donors who share HLA antigens, as is the case when the donor is homozygous for an HLA haplotype (428, 429). In these cases, the recipient does not recognize the donor cells as foreign, allowing the transfused lymphocytes to proliferate and cause TA-GVHD. A higher incidence has been reported in countries such as Japan whose populations are genetically similar. Transfusion of leukocyte or platelet concentrates or fresh blood has been responsible for most cases of posttransfusion GVHD. Frozen-thawed plasma products (FFP, cryoprecipitate) have not been definitively associated with TA-GVHD. TA-GVHD occurs earlier than that seen after bone marrow transplantation, usually within 1 to 2 weeks, but is otherwise similar (430). Fever is the most common symptom, followed by a typical erythematous, maculopapular skin rash that begins centrally and spreads peripherally to the hands and feet. Abnormalities of hepatic function, nausea, and bloody diarrhea often occur as the process progresses. Leukopenia followed by pancytopenia due to marrow failure is quite common in TA-GVHD and is seen most often 2 to 3 weeks after the onset of symptoms. The diagnosis is based on the clinical picture and can be confirmed histologically with a skin biopsy. Laboratory confirmation that the GVHD is transfusion induced can be obtained by demonstrating the presence of donor lymphocytes in the patient. This can be done by HLA typing of patient and donor cells by DNA methods for class I and II antigens, by cytogenetic analysis, or by analysis of DNA microsatellite polymorphisms or variable number tandem repeats (425). Severe systemic infections are the most common cause of death, which often occurs within 3 to 4 weeks from the time of the implicated transfusion. Despite aggressive treatment, the fatality rate in TA-GVHD is significantly higher than that associated with bone marrow transplantation and has been reported to be greater than 90% (430). Corticosteroids, antithymocyte globulin, cyclosporine, and growth factors have all been used with minimal success in the treatment of TA-GVHD. Although a few reports of spontaneous resolution have been reported, current treatment approaches have used combinations of immunosuppressant medications with lymphocyte-directed antibody therapy (anti-CD3, anti-interleukin-2 receptor, antithymocyte globulin). Because of the lack of effective treatment regimens, TA-GVHD should be prevented by pretransfusion irradiation of all blood products administered to patients at risk. Irradiation inhibits proliferation of donor lymphocytes but has no significant adverse effect on red cell, platelet, or granulocyte function. Changes in the red cell membrane do occur that result in an increased loss of potassium from the cell, limiting the storage time of irradiated red cells to 28 days. This may be important in neonates, as the dose of free potassium may be high in a relatively large-volume transfusion, necessitating the use of freshly irradiated or washed RBCs. The recommended dose for the irradiation of blood and blood products is 2500 cGy at the center of the irradiation field, with a minimum dose of 1500 cGy at any point in the field (4, 60). Based primarily on case reports and reviews, a number of immunosuppressed and immunocompetent patient groups can be stratified according to risk for developing TA-GVHD (430) (Table 24.9).

**TABLE 24.9. Patients at Increased Risk for Transfusion-Associated Graft-Versus-Host Disease**

---

|  |
|--|
| High risk  |
| Bone marrow transplant (allogeneic and autologous) |

Intrauterine transfusions  
HLA-matched platelet transfusions  
Transfusions from blood relatives  
Severe congenital immunodeficiency  
Hodgkin disease

Moderate risk

Hematologic malignancy (acute myelogenous leukemia/acute lymphocytic leukemia/non-Hodgkin lymphoma)  
Patients treated with purine analog drugs (e.g., chronic lymphocytic leukemia)  
Malignancies treated with intensive chemo-/radiotherapy  
Solid organ transplant recipients  
Preterm infants  
Newborns receiving exchange transfusion

Low/theoretical risk

Human immunodeficiency virus/acquired immunodeficiency syndrome  
Healthy term newborns

Modified from Schroeder ML. Transfusion-associated graft-versus-host disease. *Br J Haematol* 2002;117:275-287.

---

## Nonimmunologic Adverse Effects of Blood Transfusion

**VOLUME OVERLOAD** Transfusion of red cell preparations or plasma products may result in circulatory overload. In chronically anemic patients, the plasma volume expands so that the blood volume is normal. Virtually the entire volume of the blood product infused remains in the circulation; in elderly patients with limited cardiac reserve or in severely anemic patients in congestive heart failure, transfusion may lead to fatal pulmonary edema. Diuretic therapy and other measures to manage heart failure may be of some benefit; partial exchange transfusion may be indicated. Prevention of these reactions is most important. Transfusions should be administered slowly at a rate of 1 to 2 ml of blood/kg of body weight/hour, with the patient under close observation. Manipulation of the blood product as described above can be helpful in managing the most difficult cases.

### MASSIVE TRANSFUSION

**Metabolic Effects** Stored blood differs in its composition from that circulating in the body. If large amounts of stored blood are infused rapidly, one may observe adverse effects related to such differences. The elevated  $K^+$  content of stored red cells rarely leads to hyperkalemia, but it is a risk in the presence of renal failure, shock with acidosis, or of hemolysis. Plasma contains a significant amount of citrate as anticoagulant; recipients with normal circulatory status promptly metabolize this in the liver, but during plasma exchange or in patients in shock or severe liver failure, citrate excess may lead to hypocalcemia. Hypocalcemic reactions caused by citrate may be treated by intravenous calcium injection ( [431](#) ).

**Hypothermia** Hypothermia may occur if a large volume of cold blood is infused rapidly. Hypothermia is one of the most common complications of massive transfusion and contributes to the associated coagulopathy. Neonates and the elderly are particularly sensitive to this reaction. Hypothermia affects the way the liver metabolizes citrate, resulting in an increased risk of hypocalcemia. Rapid infusions of citrated blood products in such patients, especially through central venous lines, may lead to arrhythmias. Hypothermia interferes with platelet function and clotting, both of which are improved when the patient is warmed ( [431](#) ). One way of approaching this problem is with the use of warmed intravenous fluids or blood. Blood-warming devices are available that can warm adequately the blood administered even during a rapid and massive transfusion. All

patients who are receiving large amounts of red cells and plasma should have those products administered through blood-warming devices. Blood warmers must be checked regularly to ensure that they maintain their temperature. If the blood is overheated, hemolysis and the associated complications of transfusing hemolyzed blood may result. Any one of these potential problems alone is rarely significant. However, in the critically ill patient who requires massive transfusion, acidosis, hypoxemia, hypothermia, hypocalcemia, and hypo- or hyperkalemia often coexist, with a consequent risk of induction of cardiac arrhythmias. Neonates receiving exchange transfusions are particularly susceptible to such physical and metabolic effects ( [61](#), [432](#) ).

**Dilutional Effects** Transfusion of large volumes of blood products in patients requiring replacement of one or more blood volumes results in dilution of platelets and labile coagulation factors. Such patients are often affected by sepsis, shock, and intravascular coagulation, which may aggravate the dilutional hemostatic defects. In practice, most patients tolerate otherwise uncomplicated dilutional coagulopathy well. Factor VIII activity may rise as a response to stress; factor V falls, but rarely to dangerous levels. Moderately severe thrombocytopenia, accompanied in some cases by a significant degree of platelet dysfunction, may be a more significant problem. Transfusion therapy of such patients is best guided by laboratory measurements and clinical assessment. Most authors recommend against the routine transfusion, according to predetermined formulas, of platelets, FFP, or cryoprecipitate. Transfusion of platelets and coagulation factors is rarely necessary before the replacement of one to two blood volumes ( [199](#), [200](#) ).

**Microaggregates and Pulmonary Microembolization** Microaggregates form during storage of red cells; they are composed of platelets, leukocytes, and fibrin. All blood products are routinely administered through a filter with a pore size of 170  $\mu\text{m}$ , but these devices do not remove microaggregates, which are therefore transfused with the blood. A number of microaggregate filters with a pore size of 40  $\mu\text{m}$  have been devised to remove such debris from blood ( [388](#), [433](#) ). An extensive literature deals with the clinical significance of microaggregates and the utility of 40- $\mu\text{m}$  filters. In patients receiving large volumes of stored blood, a syndrome of pulmonary dysfunction with hypoxemia was thought to be caused by widespread pulmonary microvascular obstruction by such microaggregates. In patients transfused while on cardiopulmonary bypass, exclusion of the pulmonary vascular bed from the circulation was thought to permit transfused microaggregates to embolize to the cerebral, retinal, and renal circulation. Currently, the role of microaggregates in the genesis of these syndromes is in doubt; the numerous clinical variables that coexist in such patients make it difficult to be certain of the relationship between microaggregates and the observed problems. Studies have shown no benefit in the microaggregate filtration of up to six units of blood in surgical patients. The use of microaggregate filters has therefore decreased significantly.

**MISCELLANEOUS** Air embolism was a potential hazard when glass bottles, which had to be vented, were used; modern collapsible plastic bags have essentially eliminated this problem as long as the infusing system remains securely closed. Fat embolism may occur in the rare situation in which blood products are transfused via the bone marrow.

**Plasticizers** Some blood bags are made from plastic materials, such as PVC, that contain phthalates (DEHP), which maintain the flexibility of the bag. This substance is lipophilic and can be demonstrated to be eluted into the bag's contents, depending on the time and temperature of storage. In human recipients, no adverse effects have been demonstrated to date ( [30](#) ). However, because of concerns raised about potential toxicities, attempts are being made to identify different plasticizers that are less likely to leach into stored products. As these become available and are shown to be safe and suitable for storage of red cells and platelets, they will replace the bags currently in use.

**Iron Overload: Transfusion Hemosiderosis** Iron overload is a major problem in patients requiring long-term red cell transfusion support for chronic anemias due to bone marrow failure ( [434](#), [435](#) ). Each unit of red cells contains approximately 0.25 g of iron. After a large number of red cell transfusions, in the absence of blood loss, the recipient develops the stigmata of transfusion siderosis: impaired growth, failure of sexual maturation, myocardial and hepatic dysfunction, hyperpigmentation, and, often, diabetes. Patients such as those



with thalassemia who are at risk of this complication should receive prophylactic aggressive iron chelation therapy.

## INFECTIOUS COMPLICATIONS OF BLOOD TRANSFUSION

### Overview of Blood Donor Screening for Infectious Diseases

In the 1960s, transfusion-associated hepatitis (TAH) occurred in more than 30% of multiply transfused patients. The development and implementation of a screening test for HBsAg and the switch to an all-volunteer blood supply resulted in a dramatic reduction in the incidence of both B and non-A, non-B (NANB) TAH ( [Fig. 24.7](#) ) ( [436](#) ). However, a significant risk of NANB hepatitis persisted.



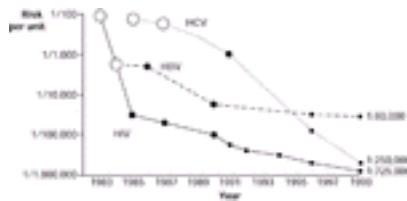
**Figure 24.7.** Annualized incidence of posttransfusion hepatitis B and non-A, non-B at the National Institutes of Health, 1964 to 1986. First-, second-, and third-generation tests refer to tests for hepatitis B surface antigen. ALT, alanine aminotransferase. (Reprinted from Alter HJ. You'll wonder where the yellow went: a 15-year retrospective of posttransfusion hepatitis. In: Moore SB, ed. Transfusion-transmitted viral diseases. Arlington, VA: American Association of Blood Banks, 1987, with permission.)

In the early 1980s, the blood banking industry was further challenged with the appearance of AIDS. In the early and mid-1980s, before the identification of the causative agents of AIDS or NANB hepatitis, the idea of using surrogate tests to identify donations at increased risk of transmitting one of these infections was introduced. Proposed tests included those that would detect the consequences of an infection [e.g., elevated alanine aminotransferase (ALT) in the case of NANB hepatitis or inverted helper to suppressor T-cell ratio in the case of AIDS] or those likely to be positive in individuals who engaged in high-risk sexual activity or needle sharing (e.g., antibody to HBc antigen) ( [437](#) , [438](#) , [439](#) and [440](#) ). Before the availability of a specific test for HIV, some blood suppliers implemented HBc antibody testing or donor T-cell testing in an attempt to reduce the risk of transmitting AIDS through blood transfusion.

After the development and implementation of a test for HIV antibody in 1985, it became clear that there is a delay between the onset of infection and the development of detectable antibody. A blood donation made during this “window period” could pass infectious disease screening tests but transmit infection. The FDA required blood centers to inform prospective donors about the window period and to directly question them about specific risk behaviors. Gradually, improvements in the sensitivity of the HIV antibody test led to shortening the HIV window period from 45 days to 22 to 25 days ( [441](#) , [442](#) ).

During the mid-1980s, surrogate tests for NANB hepatitis and risk activity (ALT and HBc antibody) became required in the United States. A donor screening test for the retrovirus

HTLV-I was implemented in 1988. The first donor screening test for antibodies to hepatitis C became available in 1990, and an improved test became available in 1992. In 1996, a donor screening test for HIV-1 p24 antigen was implemented because available information suggested that this test could shorten the HIV window period by an additional 6 days (442). By this time, the risks of transfusion-transmitted HIV and hepatitis were too low to measure prospectively and could only be estimated with the aid of mathematic modeling (Fig. 24.8) (443, 444).



**Figure 24.8.** Decline in risk of human immunodeficiency virus (HIV), hepatitis B virus (HBV), and hepatitis C virus (HCV) transmission by transfusion, 1983 to 1999. Estimates indicated by solid circles are based on recipient follow-up studies; estimates indicated by open circles are based on donor prevalence measurements; estimates indicated by solid squares represent projections based on mathematic modeling. (Reprinted from Busch MP. Closing the windows on viral transmission by blood transfusion. In: Stramer SL, ed. Blood safety in the new millennium. Bethesda, MD: American Association of Blood Banks, 2001, with permission; and modified from Kleinman SH, Busch MP. The risks of transfusion transmitted infection: direct estimation and mathematical modeling. *Baillieres Best Pract Res Clin Haematol* 2000;13:631-649.)

Despite the extremely low risk of transfusion-transmitted HIV and hepatitis, there continued to be immense public pressure to further improve transfusion safety. Most recently, efforts have turned to the development of donor screening tests that detect viral nucleic acid, which is theoretically detectable before antigen or antibody. Nucleic acid test systems that are presently available are labor intensive and not readily applicable to the rapid screening of large numbers of blood donations. Testing pools of specimens improves the feasibility of testing large numbers of samples. Recently, blood centers in the United States implemented the testing of minipools of 16 to 24 donor specimens for HIV and HCV nucleic acid. Because minipool nucleic acid testing detects HIV infection earlier than p24 antigen testing, the FDA has permitted discontinuation of the p24 antigen test.

Table 24.10 lists the tests currently performed on all volunteer blood donations in the United States. It is thought that the residual risk of transmitting these agents by transfusion is related mainly to window period donations. The probability that a donation was made in the window period can be calculated from the observed incidence of new infections in blood donors and the length of the window period (87, 445). As indicated in Table 24.11, the incidence of new infections in repeat blood donors is extremely low. Recently, the use of nucleic acid testing, which detects donors in the process of seroconversion, revealed that first-time donors are two to three times more likely than repeat blood donors to be in the process of acquiring a new infection at the time of donation (87). Thus, the overall probability that a unit will transmit infection is also a function of the relative proportions of units from first-time versus repeat donors. Table 24.11 indicates current overall risk estimates of window period donations based on these considerations.



**TABLE 24.10. Infectious Disease Testing Currently Performed on United States Blood Donations**

| Infection   | Tests Designed to Detect  |
|-------------|---|
| Hepatitis B | Hepatitis B surface antigen<br>IgM and IgG antibody to hepatitis B core antigen   |
| Hepatitis C | IgG antibody to hepatitis C peptides<br>Hepatitis C virus nucleic acid <sup>a</sup>                                     |
| HIV-1/-2    | IgM and IgG antibody to HIV-1/-2<br>HIV-1 nucleic acid <sup>a</sup>   |
| HTLV-I/-II  | IgG antibody to HTLV-I/-II  |
| Syphilis    | IgM and IgG antibody to treponemal antigens<br><i>Or</i> nontreponemal serologic reactivity (e.g., rapid plasma reagin) |

HIV, human immunodeficiency virus; HTLV, human T-cell lymphotropic virus; Ig, immunoglobulin.

<sup>a</sup> Nucleic acid testing is performed on minipools of 16 to 24 donor samples.

**TABLE 24.11. Current Estimated Risks of Transfusion-Transmitted Infection Based on Window Period/Incidence Estimates <sup>a</sup>**

| Agent  | Window Period (Days) <sup>b</sup> | Incidence of New Infections in Repeat Donors (per 100,000 Person-Years) | Estimated Risk/Unit Transfused <sup>c</sup> |
|--|-----------------------------------|---|---|
| Hepatitis B                                  | 59                                | 3.016   | 1:171,000                                   |
| Hepatitis C                                  | 10                                | 1.889   | 1:1,613,000                                 |
| Human immunodeficiency virus                 | 11                                | 1.554   | 1:1,779,000                                 |
| Human T-cell lymphotropic virus <sup>d</sup> | 51                                | 1.392   | 1:428,000                                   |

<sup>a</sup> Estimates are based on figures from Dodd RY, Notari EP IV, Stramer SL. Current prevalence and incidence of infectious disease markers and estimated window-period risk in the American Red Cross blood donor population. *Transfusion* 2002;42:975-979.

<sup>b</sup> Window period estimates are for the combinations of tests listed in [Table 24.10](#).

<sup>c</sup> Estimated risk/unit transfused is calculated based on the assumption that 20% of donations are from first-time donors with a twofold higher incidence of new infections compared to repeat donors, as recommended by Glynn SA, Kleinman SH, Wright DJ, et al. International application of the incidence rate/window period model. *Transfusion* 2002;42:966-972.

<sup>d</sup> For human T-cell lymphotropic virus, incidence figures for 1998 to 1999 were used because of potential underestimates during later observation periods.

Because the current risks of transmitting HIV and hepatitis are so low, the absolute benefit gained from further incremental improvements in blood donor testing for these

infections would be very small. The implementation of individual unit nucleic acid testing, for example, would be associated with extremely high cost with very little incremental improvement in blood safety ( 446 ). Similarly, the cost-effectiveness of implementing processes that would inactivate residual pathogens in blood products has also been questioned ( 447 ). However, pathogen inactivation systems might represent a reasonable approach toward reducing the risk of blood contamination by other infectious agents for which there is currently no testing, such as bacteria and parasites. At present, it appears that the public desire is to require implementation of any process that could potentially improve blood safety without regard to cost-effectiveness.

## Transfusion-Associated Hepatitis

Before the development of serologic tests capable of determining the cause of TAH, all TAH was thought to be due to the “serum hepatitis” agent, later called the *hepatitis B virus*. As sensitive tests for HBsAg were applied to the study of TAH, however, it became clear that only 25 to 30% of cases were caused by this virus ( 448 , 449 ). Subsequent studies excluded hepatitis A virus (HAV), CMV, and the Epstein-Barr virus (EBV) as common causes of TAH. The designation *NANB hepatitis* was created to describe the majority of cases ( 450 ). In 1988, the major causative agent of NANB hepatitis was identified as HCV ( 451 , 452 ). Widespread testing of all blood donations for this virus was implemented in 1990. An improved test for hepatitis C became available in 1992. Since then, TAH has become rare. A small number of cases of TAH that are negative for all serologic markers have been identified and can be called *non-ABC hepatitis* ( 453 ).

**HEPATITIS B VIRUS** HBV ( 454 , 455 and 456 ) is a DNA virus with a lipoprotein shell, in which the HBsAg is found, and an inner core. The inner core contains DNA, DNA polymerase, and protein kinases, and it expresses the antigenic determinant known as the *hepatitis B core* (HBc) antigen. The intact virus can be visualized with the electron microscope as a 42-nm double-shelled particle. The viral envelope material (HBsAg) circulates in the plasma, both as intact virions and as incomplete spheres and tubules. The HBsAg in serum can be identified by serologic methods. Hepatitis B infection is transmitted by people who have acute viral hepatitis or who are HBsAg carriers. HBV is transmitted parenterally, sexually, or perinatally from infected mothers to their infants. The incubation period ranges from 1 to 6 months. Only approximately 25 to 40% of hepatitis B infections are associated with jaundice. Fulminant infection, with a high mortality rate, occurs in 0.2 to 0.5% of cases. Most individuals, however, experience transient subclinical hepatitis detectable only by laboratory tests. Although it is often stated that 5 to 10% of infected adults go on to become chronic HBsAg carriers, more recent studies suggest that the development of chronic infection is far less common, approximately 1% ( 457 ). Of these, approximately 25% develop chronic hepatitis that may resolve after many years or may lead eventually to fatal cirrhosis or hepatocellular carcinoma. The infection pattern is different in the Far East and in Africa in that the disease is acquired primarily perinatally. Chronicity is more common in this population, as is the development of cirrhosis and hepatocellular carcinoma. In the West, the infection is more commonly sexually or parenterally acquired, mainly in young adults ( 456 ). Treatment of chronically infected patients with nucleoside analogs suppresses viral replication in some patients; however, long-term treatment is associated with the emergence of drug-resistant variants ( 458 ). Routine vaccination of infants and children with recombinant HBsAg is now recommended in the United States and should reduce the incidence of this infection. During the course of symptomatic infection, a well-defined sequence of serologically detectable changes occurs ( 453 ). The HBsAg is detectable during the late incubation period, an average of 59 days after exposure, and often before the development of symptoms. IgM antibody to HBc is almost always detectable at the time of illness and persists for 6 to 12 months, with IgG anti-HBc persisting indefinitely.

HBsAg usually becomes undetectable by 12 weeks after the onset of illness, followed by the appearance of anti-HBs. Patients developing the chronic carrier state usually exhibit high levels of HBsAg and anti-HBc, but no anti-HBs. Hepatitis Be antigen (HBeAg) is related to a core subcomponent; it is a soluble protein not associated with any visible structure that is detected in acute hepatitis and in patients who are in the process of becoming chronic HBsAg carriers. Its presence correlates with high levels of virus. It, therefore, indicates recent or ongoing infection and infectivity. HBeAg generally disappears from the serum before HBsAg and is followed by the development of anti-HBe. All people carrying HBsAg must be considered infectious, but they vary in degree of infectivity. In an HBsAg-positive person, the presence of HBeAg correlates with high infectivity, whereas the HBeAg-negative state is less infectious.

**Donor Screening for Hepatitis B** The discovery of HBsAg and development of serologic tests for this marker led to a dramatic reduction in the risk of hepatitis B transmission by transfusion ( [Fig. 24.7](#) ) ( [459](#) ). Screening of all blood products for HBsAg began in 1970 in the United States with low-sensitivity tests and was made mandatory in 1972. The high-sensitivity third-generation test in current use becomes positive an average of 59 days after exposure and detects most but not all donors infectious for hepatitis B. Residual infectivity has been associated largely with individuals who appear to clear HBsAg and who make anti-HBc antibody but who do not make anti-HBs antibody ( [460](#) ). Units from such individuals are currently interdicted in the United States by donor screening for anti-HBc, originally implemented in an effort to reduce the risk of NANB hepatitis ( [439](#) , [440](#) , [461](#) ). Recently, sensitive polymerase chain reaction assays have confirmed the presence of HBV DNA in some individuals with high-titered anti-HBc and absent anti-HBs ( [462](#) ). A recent study of anti-HBc-positive U.S. blood donations suggests that approximately 1 in 50,000 of these contains HBV DNA at low levels that would be detectable only by individual unit nucleic acid testing ( [463](#) ). Anti-HBc-positive donations therefore remain excluded from the U.S. blood supply, although testing for this marker is not performed in many other countries. Anti-HBc-positive donations are permitted to be included in pooled plasma products in the United States. However, HBV infectivity should be reliably eradicated by the pathogen inactivation processes to which these products are subjected. Circulating HBV DNA can also be detected in early HBV infection before the development of detectable HBsAg. More sensitive HBsAg assays or minipool HBV nucleic acid testing would detect some of these individuals ( [464](#) , [465](#) ). Based on currently implemented donor screening tests for HBV (i.e., HBsAg and anti-HBc), the current estimated risk of HBV transmission in the United States is 1 in 171,000 units ( [Table 24.11](#) ).

**HEPATITIS C VIRUS** HCV is now known to be the cause of approximately 90% of cases of NANB hepatitis ( [444](#) , [466](#) , [467](#) , [468](#) , [469](#) and [470](#) ). Before the identification of the causative agent, NANB hepatitis was defined clinically on the basis of elevated ALT levels in the absence of serologic evidence of other infections (HAV, HBV, CMV, and EBV). In 1988, the genome of HCV was cloned. Serologic studies using recombinant peptides produced from the cloned genome confirmed that this agent was the cause of the majority of cases of NANB hepatitis. HCV is now known to be a lipid-enveloped RNA virus in the Flaviviridae family. Today, the diagnosis of HCV infection can be made either serologically by the detection of antibodies to HCV (anti-HCV) or by the identification of viral genomic material using nucleic acid testing technology ( [469](#) ). The prevalence of HCV infection in the general population of the United States is estimated to be 1.8% ( [471](#) ). Just under one-half of cases are related to parenteral drug use, but the mode of transmission for the remainder of cases remains largely unknown ( [472](#) ). Although some studies have suggested that sexual exposure is a risk factor for HCV, most studies of long-term sexual partners have indicated very low rates of transmission by this route ( [473](#) ). Similarly, the rate of perinatal transmission of HCV is low (average, 5 to 6%) but is higher in the presence of co-infection with HIV ( [471](#) ). The average incubation period for HCV is 6 to 7 weeks. Sixty to seventy percent of infections are asymptomatic. Ten to twenty percent of cases are associated with nonspecific symptoms, and jaundice occurs in only 20 to 30% of cases.

Even icteric patients usually have a mild acute illness, although immunocompromised patients may develop severe infections. Fulminant hepatitis is rare. The most important aspect of HCV infection is its chronicity. Only 15 to 25% of individuals clear the virus; the rest remain chronically infected. Sixty to seventy percent of chronically infected patients show biochemical evidence of chronic hepatitis. Over a period of 20 to 30 years, it is estimated that cirrhosis develops in 10 to 20% of chronically infected patients, and hepatocellular carcinoma develops in 1 to 5% (471). Treatment with interferon and ribavirin suppresses viral replication in some patients, although only a minority achieves a sustained response (474).

**Donor Screening for Hepatitis C Virus** Before the discovery of and testing for HCV, the reported incidence of NANB hepatitis ranged between 7 and 10% of all patients receiving blood transfusions (461). This high incidence of TAH stimulated attempts to identify surrogate tests that would correlate with the NANB carrier state. The Transfusion-Transmitted Viruses Study reported in 1981 (438) that assay of donor blood for serum ALT levels was of value in predicting NANB infectivity. Patients receiving donor blood containing elevated serum ALT had an increased chance of developing TAH; this effect was demonstrable in recipients of both single and multiple units of blood and correlated with the degree of elevation of donor ALT level. Screening for anti-HBc was also found to be of predictive value for NANB infectivity; donor units positive for anti-HBc (but not anti-HBs) were associated with a high incidence of NANB transmission (439, 440, 461). Anti-HBc and ALT testing were, therefore, instituted as surrogate tests for the NANB (475). These tests, as well as changes in donor deferral policies related to HIV, resulted in more than a 50% decrease in the risk of transmitting NANB hepatitis (476). In 1990, the first donor screening test for anti-HCV became available. This test detected antibodies to the C100-3 recombinant peptide that represented only a small part of the viral genome. Although most patients with HCV infection ultimately made antibodies to this peptide, the detection of such antibodies was delayed for up to 26 weeks or longer, and some infected patients did not make antibodies to this peptide. The second-generation antibody test, which became available in 1992, contained additional peptides representing the core and NS3 regions of the genome, resulting in improved sensitivity, specificity, and earlier detection. Version 3 antibody tests, which contain NS5 peptides as well as improved sensitivity for antibodies to NS3, have been available since 1996, but implementation of these tests was not required because the improvement in sensitivity was thought to be marginal. Even with third-generation tests, however, antibodies are not reliably detected until an average of 10 weeks after infection. In 1999, testing of 16- to 24-member minipools of donor specimens for HCV nucleic acid was implemented in large nationwide trials. These trials detected HCV nucleic acid in approximately 1/300,000 units that passed all other testing (87, 477). Minipool testing for HCV nucleic acid is now required by the FDA. The window period for HCV is now estimated to be approximately 10 days, and the risk of HCV transmission by transfusion of fresh blood products is now estimated to be approximately 1 in 1.6 million (Table 24.11). Because HCV is lipid enveloped, HCV infectivity of pooled plasma products should be reliably removed by the solvent detergent treatment to which most of these products are subjected. After the discovery of HCV and testing for anti-HCV, there was little value in the continued use of ALT testing, and this testing is no longer required (478). However, anti-HBc testing has been retained for the foreseeable future because of its value in reducing the risk of HBV transmission and also its perceived value as a surrogate marker of high-risk sexual activity and intravenous drug use.

**HEPATITIS D VIRUS** The hepatitis D virus (HDV) (479, 480, 481 and 482) has a hybrid structure, consisting of HBs antigen enclosing a minute RNA genome that is incomplete and, therefore, incapable of survival without helper functions provided by HBV. Thus, it is found only in association with HBV. It is endemic in some areas. This agent may be transmitted with blood products in association with HBV, resulting in an episode of acute viral hepatitis similar to hepatitis B infection, although with an increased risk of fulminant or chronic disease. In HDV infections in people who are already hepatitis B carriers, the

resulting illness is particularly severe, as the helper virus, HBV, is well established at the time of infection. Transfusion of blood products containing HDV may in this way transform a benign HBsAg carrier state to fulminant hepatitis or to severe progressive liver disease. Chronic hepatitis B carriers requiring repeated transfusion are at risk of this infection, especially if they are recipients of pooled products that may contain HDV ( 483 ). Because HDV can be transmitted only with HBV, the testing of all blood donations for the presence of hepatitis B excludes virtually all transmission of HDV. HDV is not an independent risk factor, so specific testing for it alone is not warranted.

**HEPATITIS A VIRUS** HAV is much less significant than other hepatitis viruses in blood transfusion practice. HAV is a small, nonenveloped virus with a single positive-stranded RNA genome that belongs to the picornavirus family. HAV is spread by person-to-person contact, usually by the fecal-oral route; epidemics are associated with poor sanitation and contaminated water and food. The fatality rate is very low, and chronic hepatitis and carrier states do not occur. The incubation period for HAV is 25 to 30 days, with a range of approximately 15 to 45 days. Starting in the prodromal phase, during which time there may also be a viremia, HAV is shed almost exclusively in the feces. The viremia lasts for only a few days before symptoms appear. The diagnostic test is the appearance of anti-HAV IgM, which is followed by anti-HAV IgG. The presence of anti-HAV IgG is not of diagnostic importance, unless there is an increasing titer, because it persists indefinitely after HAV infection ( 484 , 485 ). Transfusion-transmitted infection occurs only if blood is collected during the brief asymptomatic viremic phase. Transfusion transmission of HAV by fresh blood products is rare. However, transmission of HAV has been associated with pooled plasma products ( 486 ). Because HAV is not lipid enveloped, infectivity is not eliminated by solvent detergent treatment. Therefore, immunization to HAV is recommended for patients who are expected to receive pooled plasma products, such as patients with clotting disorders. The FDA does not require donor screening for this agent. Some plasma derivative manufacturers, however, test plasma pools for HAV nucleic acid in an effort to reduce the risk of transmitting this agent.

**HEPATITIS E VIRUS** The hepatitis E virus is responsible for waterborne outbreaks; its spread is similar to HAV in that it is enterically transmitted. To date, there is no evidence of a chronic carrier state. It, therefore, does not appear to present a risk of transmission by transfusion ( 487 ).

**NON-A-E HEPATITIS** Approximately 10% of cases of chronic NANB hepatitis are not accounted for by HCV. Despite much effort, the cause of most of these cases remains unidentified. Attempts to isolate viruses from the blood of individuals with chronic NANB hepatitis led to the discovery of several new agents including GB virus/hepatitis G virus, SEN virus, and TT virus ( 488 ). Infection with each of these three agents is relatively common, and all three are transmissible by transfusion. TT virus and SEN virus are nonenveloped viruses and, therefore, would not be inactivated by solvent detergent treatment. However, there is currently no convincing evidence that any of these agents causes hepatitis.

## Human Immunodeficiency Virus Type 1 and Type 2

AIDS was first reported in 1981. In late 1982, the first cases of AIDS-like illness were reported in transfused patients ( 489 , 490 ). By early 1984, the responsible virus, HIV-1, initially called *HTLV-III*, was identified ( 491 , 492 , 493 and 494 ). HIV-1 is a retrovirus in the lentivirus family. It is a lipid-coated RNA virus with a reverse transcriptase. The immunogenic components include an envelope (gp41/gp120) and core (p24) proteins. HIV-2 is a closely related virus (>50% homology) identified initially in West Africa that bears a high degree of antigenic similarity to HIV-1 and causes a similar clinical disease.

Like HBV, HIV is transmitted parenterally, sexually, or peri-natally from infected mothers to their infants. Early reported cases of AIDS in the United States were clustered in men who had sex with men and intravenous drug users. Later, heterosexual transmission



became more prevalent ( [437](#) ). Although heterosexual spread is responsible for an increasing percentage of HIV cases in the United States, as of the year 2000, men who had sex with men and intravenous drug users continued to account for the majority of new HIV diagnoses ( [495](#) ). The majority of HIV infections in the United States are caused by HIV-1; HIV-2 infection is very rare.

Two to three weeks after exposure to HIV, the patient often develops an acute flu- or mononucleosis-like illness. The infection then enters a clinically latent stage during which viral replication continues. Untreated individuals, however, remain asymptomatic for an average of 10 years. Ultimately, the patient's CD4<sup>+</sup> T cells become depleted, and the patient develops severe immunodeficiency, resulting in opportunistic infections, neoplasms, or both, and death. Treatment of infected individuals with "highly active antiretroviral therapy" has dramatically reduced HIV-related morbidity and mortality in the United States, although the development of drug resistance and side effects limits the effectiveness of therapy ( [496](#) ).

**DONOR SCREENING FOR HUMAN IMMUNODEFICIENCY VIRUS** It is now known that in some parts of the United States, as many as 1% of units were infected with HIV in the early 1980s ( [497](#) ). After the first reports of transfusion-related AIDS and before the availability of a specific test for the causative agent, some U.S. blood centers implemented surrogate testing for markers of HIV infection or of risk activity, such as testing for inverted CD4 to CD8 ratio or anti-HBc ( [437](#) ). Retrospective testing of retained donor samples indicates that just before the implementation of the first HIV antibody test, the overall prevalence of HIV in U.S. blood donations was approximately 1/600 ( [498](#) ). A test for HIV-1 antibody became available in 1985 and was rapidly implemented. The sensitivity of the antibody test was improved over the years, with progressive shortening of the time to antibody detection from the initial 45 to 55 days to an average of 22 to 25 days ( [441](#), [442](#) ). The initial donor screening tests were designed to detect antibody to HIV-1 but would have detected the majority of HIV-2 infections as well because of the high degree of cross-reactivity. In 1992, the FDA required implementation of specific screening for antibodies to HIV-2 in addition to HIV-1. In 1996, testing for HIV-1 p24 antigen was implemented because available information suggested that this test could shorten the HIV window period by an additional 6 days ( [442](#) ). Minipool testing for HIV-1 nucleic acid was implemented in the United States in nationwide clinical trials in 1999 and became required in 2003. With the implementation of minipool nucleic acid testing, the requirement for HIV-1 p24 antigen testing was eliminated because minipool nucleic acid testing detects infections earlier than the antigen test. The window period for HIV, based on minipool nucleic acid screening, is currently estimated at 11 days ( [87](#) ). Along with improvements in donor testing, improvements in donor education and questioning processes have led to the selection of a blood donor population with an incidence of new HIV infections that is tenfold lower than that of the general population ( [499](#) ). The progressive improvement in donor selection and testing processes has resulted in the progressive lowering of the risk of HIV transmission by transfusion to the current low estimate of approximately 1/1.8 million units ( [Table 24.11](#) ).

### Human T-Lymphotropic Virus I and II

HTLV-I was the first human retrovirus discovered. It was isolated in 1978 from an individual with adult T-cell lymphoma ( [500](#) ). HTLV-II, a closely related retrovirus, was isolated in 1982 from a patient with hairy cell leukemia ( [501](#) ). Both viruses infect lymphocytes and cause lifelong infections. HTLV-I has been associated with adult T-cell leukemia/lymphoma as well as a neurologic disease called *HTLV-I-associated myelopathy* (HAM) or *tropical spastic paraparesis* (TSP). HTLV-II has been associated with

neurologic symptoms similar to HAM/TSP. Rarely, HTLV-II has been associated with lymphoid neoplasms. The likelihood of clinical disease in HTLV-II-infected individuals is not yet clearly defined ( [502](#) ).

HTLV-I infection is endemic in certain parts of Japan, the Caribbean, Brazil, Melanesia, and Africa. HTLV-II is endemic in some Native American populations. Infection is spread sexually, through breast-feeding, and through needle sharing. It is transmitted by transfusion of cellular blood components but not by frozen plasma components or plasma derivatives. In the United States, infections with these viruses are found primarily in immigrants from endemic areas, their sexual contacts, individuals who received transfusions before effective screening, and intravenous drug users. At least one-half of the infections in the United States are caused by HTLV-II.

The majority of individuals with HTLV-I or -II infections never develop any symptoms of infection. In endemic areas, the lifetime risk of adult T-cell lymphoma in HTLV-I-infected individuals is estimated at 2 to 4% ( [503](#) ). Adult T-cell lymphoma typically appears between the ages of 40 to 60 years, suggesting a long latent period of infection before the onset of disease. HAM/TSP develops in approximately 2% of HTLV-I-infected individuals. Although HAM/TSP develops after a long latency in endemic areas, in transfusion-transmitted infection, HAM/TSP symptoms may appear within only months or a few years of the implicated transfusion.

The diagnosis of HTLV-I and -II infection is based on detection of antibody by enzyme immunoassay tests. Confirmation is somewhat problematic in that there is no FDA-approved confirmatory assay. However, nonapproved supplemental assays are available and are useful for counseling patients. Some of these assays can differentiate between HTLV-I and -II infection ( [502](#) , [503](#) ).

**DONOR SCREENING FOR HUMAN T-LYMPHOTROPIC VIRUS** The first blood donor test for HTLV-I became available in 1988. This test detected antibodies to HTLV-I in approximately 1/4000 blood donors. It was noted that the screening tests for HTLV-I antibody did not reliably detect antibodies to HTLV-II, and, in 1997, the FDA required the addition of specific testing for HTLV-II antibody. The current tests detect only IgG and, therefore, have a relatively long window period of 51 days. As of 2002, the risk of transmitting HTLV-I/-II by transfusion is estimated at 1 in 428,000 units ( [Table 24.11](#) ).

## Syphilis

During the first half of the twentieth century before the availability of effective treatment for syphilis, more than 100 cases of transfusion-transmitted syphilis were described. With the advent of penicillin and the implementation of donor screening with a serologic test for syphilis in the 1940s, transfusion-transmitted syphilis became rare. There have been no documented cases of transfusion-transmitted syphilis in the United States in the last 35 years ( [504](#) ).

It is thought that *Treponema pallidum* circulates briefly early in primary disease. It circulates again during the secondary phase of infection, at which time the patient is typically symptomatic. Antibody tests are often negative in early syphilis, with antibodies becoming detectable approximately 3 to 5 weeks after exposure and 1 week after development of the primary chancre. There are two types of antibody tests for syphilis: nontreponemal tests, such as rapid plasma reagin, which detect antibodies to cardiolipin, and specific antitreponemal antibody tests. The former tests become nonreactive after successful treatment of infection, but the latter tests remain positive for life. Initially, nontreponemal tests were used for blood donor screening, although recently most



laboratories have switched to antitreponemal assays because these are more specific and are available in an automated format.

The necessity of screening blood donors for syphilis has been questioned recently ( [504](#) , [505](#) and [506](#) ). The viability of *T. pallidum* in blood components as they are currently stored is unclear. Even though spirochetes may be present in the blood of donors with syphilis, they appear to survive very poorly during cold storage. In experimental animals inoculated with spirochetes, infectivity is generally absent by 96 hours of storage, although infectivity may persist somewhat longer if large numbers of organisms are present ( [507](#) , [508](#) ). There is no information regarding the viability of spirochetes in platelet components. The major argument for retaining syphilis antibody testing, however, has been the claim that it has value as a surrogate marker for risk activity.

## Cytomegalovirus

CMV is a DNA virus in the herpesvirus family ( [509](#) ). Like other herpesviruses, it remains latent after acute infection, with the potential for reactivation. It is thought that CMV is spread primarily through oral secretions and sexual contact. It can also be spread transplacentally, through blood transfusion, and through organ transplantation. Observed seroprevalence rates in adults range from 40% upward with evidence of ongoing exposure and seroconversion throughout adulthood.

In immunologically normal adults, disease manifestations range from none to a mononucleosis-like syndrome. In immunosuppressed or immunodeficient patients, however, both primary and reactivation disease may be associated with overwhelming manifestations including thrombocytopenia, hemolytic anemia, pneumonitis, colitis, hepatitis, meningoencephalitis, and death. Effective antiviral treatment is available. The incidence of severe disease can be reduced by prophylactic treatment of high-risk patients with antiviral drugs or by careful monitoring of such patients and initiation of therapy with the first evidence of infection ( [509](#) ).

The occurrence of CMV infection after transfusion was first noted in the 1960s as a postpump syndrome after open-heart surgery. Patients who received large quantities of fresh blood developed a syndrome of fever, rash, lymphadenopathy, and splenomegaly, associated with an atypical lymphocytosis 8 to 12 weeks after surgery. It was later confirmed that this syndrome was associated with serologic evidence of CMV infection that had been transmitted by transfusion ( [510](#) ). Today, with use of stored blood components, the incidence of transmission of CMV by transfusion appears to be low (<1%) in immunologically normal recipients ( [511](#) ). The likelihood of CMV transmission by transfusion of unscreened blood is higher in immunodeficient patients, with observed transmission rates of 5 to 13% in low-birth-weight infants, 20% in seronegative recipients of seronegative solid organs, and 25 to 65% in seronegative recipients of seronegative bone marrow transplants. The risk of CMV transmission to these patients can be greatly reduced by restricting their transfusions to products obtained from CMV seronegative donors ( [512](#) , [513](#) ).

CMV is transmitted only through cellular blood components. As an alternative to screening blood donations for CMV antibody, many studies have demonstrated that the transmission of CMV can be greatly reduced by processes that remove the majority (2 to 3 logs) of WBCs from blood products ( [513](#) , [514](#) and [515](#) ). Most investigators have observed no transmission of CMV by leukoreduced blood components, although most studies involved small numbers of patients. The largest study evaluated the incidence of CMV infection and CMV disease in 502 bone marrow transplant recipients randomized to

receive either leukoreduced (i.e., leukofiltered) or antibody–screened blood components ( [516](#) ). CMV infection was observed in 1.3% of recipients of seronegative components and in 2.4% of recipients of leukoreduced components (difference not statistically significant). However, in the leukoreduced arm, all CMV–infected patients developed disease, and five out of six died; in the serologically screened arm, there were no cases of CMV–related disease or death. Despite these findings, most organizations have concluded that it is acceptable to use leukoreduced blood components in lieu of CMV antibody–screened blood components to reduce the risk of transfusion–related CMV ( [517](#) ).

It is generally recommended that cellular products with a reduced risk of transmitted CMV (i.e., antibody–screened or leukoreduced) be used for patients at high risk of severe primary CMV disease, including unborn babies (i.e., intrauterine transfusion), low–birth–weight infants of seronegative mothers, seronegative recipients of seronegative solid organ or HPC transplants, and seronegative patients with severe cellular immunodeficiency (e.g., HIV–infected patients). Products with reduced CMV risk are often provided also for seronegative patients who are likely to be treated with transplantation in the future to reduce their future risk of CMV reactivation disease. There is no demonstrated clinical benefit to providing products of reduced CMV risk to seropositive patients. Such patients are already at risk of reactivation disease. Although second–strain infections may occur, the clinical significance of these has not been demonstrated. Seronegative recipients of seropositive transplants are at high risk of CMV disease and are likely to be monitored closely, treated prophylactically, or both. It is unclear whether providing blood products with reduced CMV risk to such patients is of clinical benefit ( [513](#) , [514](#) ).

## Epstein–Barr Virus

EBV is even more ubiquitous than CMV; 90% of blood donors have antibodies against EBV. Because most blood recipients are also immune, posttransfusion EBV infection is rare but has been reported ( [518](#) ). Because EBV is cell associated, it has been suggested that the risk of transfusion–transmitted EBV may be reduced by the use of leukoreduced blood components.

## Parvovirus B19

Parvovirus B19 is a small nonenveloped DNA virus that is extremely resistant to physical inactivation. Infection is common; by age 15, approximately 50% of children have detectable antibody. Ongoing exposure occurs in adults, with an annual seroconversion rate of 1.5% found in women of childbearing age ( [519](#) ). The virus is spread chiefly through respiratory secretions. Disease manifestations include “fifth disease” (erythema infectiosum) and poly–arthropathy. In immunologically normal individuals, B19 causes an acute, self–limited (4 to 8 days) cessation of RBC production. In individuals with diseases involving increased RBC destruction, this can lead to an acute aplastic crisis. Immunosuppressed or immunodeficient patients may develop chronic anemia, which may be reversible by treatment with exogenous Ig. Intra–uterine infection can result in hydrops fetalis.

Individual blood donations are not currently screened for B19 infection. Transfusion transmission of B19 has been documented, particularly by pooled plasma products ( [320](#) , [321](#) ). B19 DNA is detectable in the majority of pooled plasma products ( [520](#) ). B19 is resistant to the viral inactivation processes usually applied to plasma derivatives, such as solvent detergent treatment and heat. Recently, many plasma derivative manufacturers have implemented processes to reduce the level of B19 virus in pooled products by

removing plasma units that contain high-titered B19 DNA ( [521](#) ).

## Infections Transmitted by Arthropods

Historically, it was thought that the risk of transfusion transmission of these diseases in the United States was rare. However, recent studies suggest that, with the exception of malaria, these infections may be vastly underrecognized.

Malaria is a common infection globally. However, transfusion-transmitted malaria is rare in the United States, with only zero to three cases/year occurring during the last decade ( [522](#) ). This degree of safety is remarkable considering that there is no donor screening test for malaria. Screening is accomplished entirely by donor questioning. According to current FDA guidelines, individuals are deferred from donation for 1 year after travel to a malarious area and for 3 years after living in a malarious area. Almost 3% of otherwise eligible donors are excluded on the basis of this questioning. Of the donors implicated in the recent cases of transfusion-transmitted malaria in the United States, approximately 60% (including the majority of *Plasmodium falciparum* infections) should have been excluded by donor deferral criteria. The remaining cases are largely related to chronic asymptomatic infections in donors who are beyond the deferral period ( [522](#) ).

Babesiosis is caused by a protozoan parasite that infects human RBCs. It is transmitted by the *Ixodes* tick, the same vector that transmits the causative agents of Lyme disease and human granulocytic ehrlichiosis. U.S. cases of babesiosis were first identified in the northeast United States but have now also been identified in Minnesota, Wisconsin, and California. Incubation ranges from 1 to 9 weeks or longer. Symptoms range from none to mild flulike symptoms to a malaria-type illness with hemolytic anemia. Rarely, infection can be fatal. The disease can be successfully treated with quinine and clindamycin ( [523](#) ). It is thought that many or most cases of human *Babesia* infection are subclinical. Using unlicensed tests, antibodies to *Babesia* have been found in 0.3 to 8.9% of the population in endemic areas ( [524](#) ). Asymptomatic individuals may remain infective for months or years ( [525](#) ). More than 40 cases of transfusion-transmitted babesiosis have been reported, including one cluster of cases in which an asymptomatic donor transmitted infection on four different occasions over a 6-month period ( [526](#) ). It appears likely that transfusion-transmitted babesiosis is vastly underrecognized. There is currently no donor screening test for this infection. Theoretically, infectious donations could be detected through antibody or nucleic acid testing, or the infectivity of these donations could be reduced through pathogen inactivation.

Lyme disease is caused by the spirochete *Borrelia burgdorferi*. It is transmitted by the same tick vector that transmits babesiosis. *B. burgdorferi* may be found in the blood during early infection. The organism has been found to survive the storage conditions of RBC and platelet components. However, there have been no documented cases of transfusion-transmitted Lyme disease ( [527](#) ).

*Trypanosoma cruzi*, the protozoan parasite that causes Chagas disease, is endemic in portions of Mexico, Central America, and South America. It is transmitted to humans by the reduviid bug. The parasite enters through the skin or mucosa, multiplies near the site of entry, and then disseminates. Acute infection is usually self-limited, although rarely it may involve myocarditis or meningoencephalitis and may be fatal, particularly in immunocompromised patients. In most cases, however, the acute infection goes undiagnosed, and the infection becomes chronic. After decades, 10 to 30% of chronically infected individuals develop cardiac or intestinal dysfunction that can be fatal. The transmission of *T. cruzi* by transfusion is well documented in endemic areas, and many of

these countries screen blood donations for *T. cruzi* antibody ( 528 ). In the United States, there is no test licensed for this purpose. Seroprevalence surveys have been performed in U.S. blood donor populations using unlicensed assays. Antibodies to *T. cruzi* have been found in 1/7500 donors in areas of the country with relatively large populations of immigrants from endemic areas (e.g., Los Angeles), with lower prevalence rates in other parts of the United States ( 529 ). The infectivity of antibody-positive donors in the United States remains the subject of investigation. To date, there have been only five cases of transfusion-transmitted *T. cruzi* documented in the United States and one in Canada. The most recent case, however, was recognized only because the unit was identified during a seroprevalence study ( 530 ). It is likely that the majority of *T. cruzi* transmissions are unrecognized. Recently documented transmissions of *T. cruzi* infection by organ transplantation in the United States have led to heightened concern about this agent ( 531 ). As is the case with babesiosis, potential mechanisms for reducing the risk of *T. cruzi* transmission by transfusion include screening donors for *T. cruzi* antibody or nucleic acid or subjecting blood components to pathogen inactivation processes.

West Nile virus (WNV) is a flavivirus that is transmitted to humans by the bite of an infected mosquito. Previously identified in other countries, WNV was first recognized in the northeast United States in 1999. By 2002, infections had been identified throughout the continental United States. Most WNV infections are subclinical. Approximately 20% of infected individuals develop fever. In approximately 1/150 cases, severe symptoms develop, such as meningitis, encephalitis, or flaccid paralysis. Severe infection may be fatal ( 532 ). There is preliminary evidence that WNV is transmissible by transfusion and by organ transplantation ( 533 , 534 ). It is likely that only nucleic acid testing will detect infections in blood donors before the onset of symptoms. Donor screening with investigational WNV nucleic acid tests was implemented in 2003.

### **Transmissible Spongiform Encephalopathies: Creutzfeldt–Jakob Disease and Variant Creutzfeldt–Jakob Disease**

Creutzfeldt–Jakob disease (CJD) is a rapidly progressive fatal infection of the nervous system caused by an agent called a *prion* ( 535 ). Sporadic cases occur in approximately 1/million population. CJD has also been transmitted iatrogenically through contact with infected tissues such as pituitary-derived human growth hormone and dura mater transplants. There is also a familial form of CJD. Although individuals at increased risk for CJD are currently excluded from blood donation in the United States, there is good evidence that CJD is not transmissible by transfusion ( 315 ).

A transmissible spongiform encephalopathy with different clinical features was first recognized in the United Kingdom (UK) in 1996. This disease, called *variant CJD* (vCJD), is now known to be caused by the same prion that causes bovine spongiform encephalopathy (BSE), or “mad cow disease.” A BSE epidemic occurred in the UK between 1980 to 1996, linked to the feeding of cattle with meat-and-bone meal, a practice that has since been discontinued. BSE has subsequently appeared, to a lesser extent, in other countries. The risk of human vCJD is thought to be proportional to exposure to BSE-contaminated beef products. As of the end of 2001, more than 100 cases of vCJD had been confirmed. Because the length of the incubation period is not known, it is not known how far the human epidemic has progressed. Concerns about the potential for secondary vCJD transmission by transfusion were triggered by the finding of prions in lymphatic tissues and further heightened when animal experiments demonstrated transmission of BSE by the blood of two asymptomatic cows ( 536 , 537 ). Worldwide, steps have been taken in an effort to minimize the theoretical risk of vCJD transmission by blood products in the absence of a screening test for the infection. In the United States, individuals are currently excluded from donating blood if they lived in the UK for 3 months

or more between 1980 and 1996, if they lived in Europe for 5 years or more since 1980, or if they received a transfusion in the UK since 1980 ( [315](#) ). Because of the pathologic evidence that the vCJD prion accumulates in lymphoid tissue, the UK has implemented leukoreduction of all transfusable blood components. However, there is no evidence that the risk of vCJD transmission would be reduced by leukoreduction of blood components ( [536](#) ). Because prions lack lipid coats and nucleic acid, the causative agent of vCJD would not be inactivated by any of the pathogen inactivation processes currently in use or under development.

## Bacterial Contamination

Bacterial contamination is a major cause of transfusion-related fatalities ( [361](#), [538](#) ). The majority of blood components are not currently screened for bacterial contamination.

Sources of contamination include the collection system (bags), a donor with asymptomatic bacteremia, inadequately cleaned skin, or a skin core from the collection needles. Bacteria can be cultured from 1/300 to 1/3000 cellular blood components ( [381](#), [539](#) ). Initially, levels of bacteria in the blood components are extremely low. The likelihood that the bacteria will multiply to levels that cause symptoms in recipients is higher for platelet components, which are stored at room temperature, compared to red cell products, which are refrigerated. The frequency of febrile reactions due to bacterial contamination has been estimated at 1/4000 to 1/15,000 platelet units and 1/30,000 RBC units ( [540](#), [541](#) ). Based on voluntarily reported cases, the likelihood of a fatal reaction due to bacterial contamination was estimated at 1/500,000 platelet units and 1/8 million RBC units ( [542](#) ). However, it is assumed that morbidity and mortality related to bacterial contamination are underrecognized and, therefore, underestimated and underreported.

The organisms most often implicated in fatal cases of red cell contamination are *Yersinia*, *Pseudomonas*, *Enterobacter*, and *Serratia* species ( [538](#) ). The organisms involved in fatal platelet contamination are more varied and include *Staphylococcus*, *Streptococcus*, *Klebsiella*, *Serratia*, and *Salmonella* species.

Symptoms in recipients of bacterially contaminated products range from none to symptoms indistinguishable from those of a nonhemolytic febrile reaction, to acute sepsis with fever, hypotension, and death. Severe symptoms are often associated with endotoxin-producing organisms. The transfusion should be discontinued, and cultures should be performed on both the blood product and the recipient. Suspected cases of bacterial contamination should be reported immediately to the blood supplier so that other components made from the same donation can be retrieved and quarantined pending the results of cultures. Treatment is the same as for sepsis of other etiologies. Treatment with recombinant activated protein C [drotrecogin alpha (activated)] may be of benefit ( [327](#) ). In some cases, the onset of symptoms may be delayed, even for days, and the linkage of the infection to the transfusion may go unrecognized ( [543](#) ).

The frequency of bacterial contamination can be minimized by careful questioning of donors for evidence of bacterial infection and careful attention to preparation of the venipuncture site. It has been suggested that the frequency of bacterial contamination could be reduced by diverting the first few milliliters of the blood collection. Although this might reduce the prevalence of skin flora, it has not been established that this would reduce the frequency of clinically relevant contamination. The risk of transfusion-related complications related to bacteria could also be reduced by systems that would detect pathogenic levels of bacteria in blood components or by processes that would inhibit the growth of bacteria in blood products. Both of these approaches have been investigated.



Detection systems evaluated include gram staining of older platelets before issue, bacterial culture of platelet products on the day after collection (for which commercial systems have been recently developed), and detection of metabolic changes induced by bacterial proliferation ( [538](#) ). The pathogen inactivation systems in development for cellular blood components all appear likely to inhibit the growth of bacteria ( [544](#) ).

## Pathogen Inactivation Technologies

Donor screening and testing cannot completely eliminate the possibility of transfusion-transmitted infection or blood product contamination. The ideal pathogen inactivation technology (PIT) would effectively inactivate residual pathogens without adversely affecting the function, toxicity, or immunogenicity of the blood component. Cellular blood components cannot withstand the heat- and solvent/detergent-PITs that are used in the production of plasma derivatives. Most of the PITs in development for cellular products consist of blood product additives that bind to and damage DNA and thereby prevent residual pathogens from proliferating in the blood component or in the recipient. These agents would theoretically also prevent transfusion-related GVHD because the DNA of WBCs in the blood product would also be affected. The efficacy of these agents is dependent on the agent's ability to penetrate cellular membranes or viral envelopes and reach the target nucleic acid. Because of concern that DNA-altering agents could cause long-term toxicity in transfusion recipients, many of these PITs include processes that remove the DNA-binding agent or inactivate it. Examples of PITs in development have been recently reviewed ( [544](#) , [545](#) ) and are described briefly below.

**PATHOGEN INACTIVATION TECHNOLOGIES FOR PLATELETS AND PLASMA** S-59 is synthetic psoralen that causes irreversible DNA cross-linking on exposure to UV light. Clinical trials of S-59/UV-treated platelets and FFP have been carried out. S-59/UV treatment does not appear to adversely affect the therapeutic effectiveness of FFP. However, treatment of platelets appears to cause some reduction in posttransfusion increments and *in vivo* platelet survival ( [546](#) , [547](#) ). An S-59/UV platelet treatment system has been approved for use in Europe. Methylene blue, when exposed to light, causes oxidation of nucleic acid guanosine residues. This treatment is ineffective against intracellular pathogens and is therefore applicable only to cell-free plasma products. Methylene blue/light-treated plasma has been used in parts of Europe. Riboflavin, on exposure to light, causes guanine oxidation and nucleic acid adducts. This system is being evaluated as a potential treatment for platelet products.

**PATHOGEN INACTIVATION TECHNOLOGIES FOR RED BLOOD CELLS** S-303 is a compound referred to as a *frangible anchor linker effector*. It consists of a nucleic acid binding ligand, an alkylating agent, and an alkyl chain. The "frangible" linker breaks down on exposure to blood, leading to inactivation of unreacted compound. S-303-treated red cells are in clinical trials. PEN110 (Inactine) is an aziridine compound. This compound is very small and can permeate tight virus capsids such as those of the parvovirus family. PEN110 inactivates DNA by binding covalently to guanine. PEN110 does not require activation by light; it is mixed with the RBCs for 6 to 24 hours at room temperature and then removed by washing. The shelf life of the RBCs can be preserved by processing the cells in a closed system and resuspending them in an additive solution. Clinical trials of this product are under way.

## THERAPEUTIC APHERESIS

Therapeutic apheresis is an important modality of therapy in the management of several diseases ( [16](#) , [548](#) , [549](#) , [550](#) , [551](#) , [552](#) , [553](#) and [554](#) ). The term *plasmapheresis* refers to the selective removal of plasma. This includes the collection of plasma from normal donors. A *therapeutic plasma exchange*, on the other hand, refers to the removal of a large proportion of a patient's plasma and replacement with crystalloid or colloid fluids. These

terms are often used interchangeably. Therapeutic cytopheresis, the removal of leukocytes or platelets, is used infrequently in the management of patients with leukostasis or thrombocytosis.

### Therapeutic Plasma Exchange

**INDICATIONS** The therapeutic goal of TPE is to remove plasma components such as monoclonal proteins and cryoglobulins ( 552 ), immune complexes ( 550 ), lipoproteins, or toxins ( 552 ) responsible for physical or metabolic problems. This may include removal of autoantibodies, as in myasthenia gravis ( 553 ) and Goodpasture syndrome ( 552 ), and alloantibodies in posttransfusion purpura or in patients with factor VIII inhibitors ( 551 ). The existence and pathogenic role of antibodies or immune complexes are presumed in several situations often treated with TPE, including neurologic disorders such as Guillain–Barré syndrome ( 548 , 553 , 555 , 556 ), polyneuropathy ( 553 ), and various nephritides ( 552 , 557 ). In TTP, TPE using cryoprecipitate–reduced plasma ( 558 ) or FFP as the replacement fluid serves to replace the missing vWF–cleaving metalloprotease as well as to remove autoantibodies to this protein ( 559 ). TPE or plasma transfusion ( 560 , 561 ) may be life–saving in this disease. Guidelines for clinical practice have been developed by the American Society for Apheresis. The disorders for which TPE has been used are divided into four categories: category I, TPE is standard and acceptable; category II, TPE is generally accepted but as a supportive rather than first–line therapy; category III, there is insufficient evidence to establish the efficacy of TPE; category IV, a lack of efficacy has been demonstrated through controlled trials ( 549 ). Some of the indications for TPE (categories I and II) are listed in [Table 24.12](#).

**TABLE 24.12. Some Indications for Therapeutic Plasma Exchange**

---

|   |
|---|
| Accepted as therapy (category I)                                  |
| Thrombotic thrombocytopenic purpura                               |
| Posttransfusion purpura   |
| Guillain–Barré syndrome   |
| Myasthenia gravis   |
| Chronic inflammatory demyelinating polyneuropathy                 |
| Goodpasture syndrome  |
| Refsum disease  |
| Accepted as supportive therapy (category II)                      |
| Cold agglutinin hemolytic anemia                                  |
| ABO–incompatible marrow transplant                                |
| Cryoglobulinemia  |
| Lambert–Eaton myasthenic syndrome                                 |
| Rapidly progressive glomerulonephritis                            |
| Autoimmune thrombocytopenia                                       |
| Myeloma and paraproteinemias with renal failure or hyperviscosity |
| Coagulation factor inhibitors                                     |
| Familial hypercholesterolemia                                     |

---

**TECHNICAL CONSIDERATIONS** The amount of plasma to be removed from the patient is determined by the physician, depending on the clinical situation. A patient’s plasma volume may be estimated at 40 ml/kg, determined from a nomogram based on the patient’s sex, height, weight, and hematocrit ( 562 ), or estimated according to the weight and hematocrit by the following formula:



$$\text{Circulating blood volume} = \text{patient weight (kg)} \times 70 \text{ ml/kg}$$

$$\text{Circulating plasma volume} = \text{circulating blood volume} \times [1.0 - \text{hematocrit (expressed as a decimal)}]$$

TPE is typically performed with 1.0 to 1.5 plasma volume exchanges or approximately 3000 to 4500 ml. If less than 1000 ml is removed from an adult, it may be possible to replace the loss with crystalloid alone; if a more extensive plasma exchange is performed, use of a colloid is necessary. Albumin (5%) is the replacement fluid most commonly used in the United States. FFP is indicated in certain instances, such as TTP or as a component of the replacement fluid in the setting of a coagulopathy. After exchange of one plasma volume, approximately 62% of the original plasma has been removed. The efficiency of plasma exchange decreases with further exchange ( [Table 24.13](#)).

**TABLE 24.13. Plasma Exchange: Theoretical Efficiency**

| Number of Plasma Volumes Exchanged | Percent (%) of Original Plasma Remaining |
|------------------------------------|--|
| 0.5                                | 60                                       |
| 1.0                                | 38                                       |
| 1.5                                | 22                                       |
| 2.0                                | 15                                       |

In practice, measurement of plasma protein concentrations after exchange has confirmed the approximate validity of these estimates. However, efficacy varies with the plasma factor to be removed. IgM and fibrinogen, which are largely confined to the intravascular space, are removed most efficiently ( [563](#), [564](#) and [565](#) ). IgG is removed less efficiently by plasma exchange because only 45 to 50% of the body's IgG is located in the intravascular space, although IgG levels can be reduced by repeated TPE. Patients receiving plasma exchange for immunologic diseases generally have 1.0 to 1.5 plasma volumes exchanged at each procedure; this is often repeated, for a total of 5 to 7 exchanges over a period of 7 to 10 days. Such plasma exchange schedules have been determined empirically; the optimal exchange regimens for different diseases are unknown.

### Therapeutic Cytapheresis

Therapeutic leukapheresis is used in the treatment of patients with leukostasis as a result of extremely high circulating concentrations of immature cells ( [551](#), [566](#), [567](#) ). At blast counts above  $100 \times 10^9/L$ , there is an increasing risk of cerebral and pulmonary leukostasis, resulting in impaired capillary blood flow due to obstruction of small vessels. This situation may be encountered in the acute leukemias but rarely in chronic lymphocytic leukemia or chronic myelogenous leukemia. Therapeutic leukapheresis decreases the circulating blast count more rapidly than chemotherapy alone; chemotherapy must be instituted promptly once the patient is stabilized to prevent rebound leukocytosis. The only exception is in pregnancy, in which leukapheresis may be indicated until after the delivery of the fetus, thereby protecting the fetus from the teratogenic effects of chemotherapy.

Therapeutic leukapheresis has also been used in the treatment of patients with other leukemic diseases, such as chronic lymphocytic leukemia resistant to drugs, Sézary syndrome, and hairy cell leukemia, and as maintenance therapy in chronic myelogenous leukemia. However, it has not found a distinct role in such conditions ( [551](#), [567](#), [568](#) ). Collection of leukocytes by apheresis, followed by *ex vivo* exposure of the leukocytes to UV light in the presence of a psoralen, and reinfusion of the treated leukocytes (“photopheresis”) has become standard therapy for cutaneous T-cell lymphoma. This

procedure may be useful in the treatment of other disorders such as GVHD ( [567](#) ).

Therapeutic plateletpheresis ( [551](#) , [569](#) , [570](#) ) is performed very rarely and is not considered to be first-line therapy. It is indicated in patients with very high platelet counts, usually above  $1.0$  to  $1.5 \times 10^{12}/L$ , in whom the high count is directly responsible for serious thrombotic or hemorrhagic problems, or in whom other urgent clinical situations necessitate immediate lowering of the platelet count. Therapeutic plateletpheresis must be followed by cytotoxic therapy to prevent rebound after the procedure, or its effect is very short lived.

Erythrocytapheresis (red cell exchange) is used in sickle cell disease to dilute sickled cells with normal erythrocytes and thereby prevent thromboses or improve capillary circulation. Stroke, acute chest syndrome, priapism, and retinal infarction are some of the indications for red cell exchange, although good studies are lacking to prove its effectiveness ( [551](#) ).

### **Therapeutic Absorption of Plasma Constituents**

Apheresis technology may be used to selectively remove constituents of plasma implicated in disease processes. In these procedures, a patient's plasma is withdrawn and separated by apheresis technology, passed over a selective absorption column, and reinfused into the patient. This technique has been used to selectively remove IgG (staphylococcal protein A columns) or low-density-lipoprotein cholesterol ( [567](#) ).

### **Adverse Effects**

Adverse reactions to therapeutic apheresis are common but usually mild ( [571](#) , [572](#) and [573](#) ). In a 1-year period in Canada, there were side effects in 12% of more than 5235 procedures in 627 patients ( [572](#) ). They included vasovagal reactions, fluid imbalance with hypovolemia or overload, fever, chills, and hypocalcemic citrate reactions ranging from paresthesias to arrhythmias. If plasma is used as the replacement fluid, urticarial reactions may be encountered. Mild dilutional coagulopathy and thrombocytopenia occur but are rarely significant ( [574](#) , [575](#) ). Problems related to venous access are common. The possibility of immunologic rebound after plasma exchange has been suggested but has not been observed clinically ( [576](#) , [577](#) ), perhaps because many patients so treated are also receiving immunosuppressive agents for the underlying diseases. Infections related to indwelling venous lines are not uncommon. Deaths have been reported with therapeutic apheresis ( [571](#) , [573](#) , [578](#) ). It is important that patients be carefully assessed and the indications reviewed before implementing this form of therapy.

## **SUMMARY**

Blood transfusion is an essential component of therapy for a wide variety of disorders. The menu of blood components and technologies for collecting, processing, and screening blood are constantly changing. Collaboration between transfusion medicine professionals and patient care teams ensures the most appropriate application of blood transfusion therapies.

## **ACKNOWLEDGMENTS**

The authors wish to thank Marlis Schroeder, MD, FRCPC, for the excellent previous

editions of this chapter, on which this work was built. We are extremely grateful to Michelle Perkins Harmon for providing the technical and organizational expertise that was essential to the preparation of this manuscript.

## REFERENCES

1. Farr AD. The first human blood transfusion. *Med Hist* 1980;24:143–162.
2. Diamond LK. A history of blood transfusion. In: Wintrobe MM, ed. *Blood, pure and eloquent*. New York: McGraw Hill, 1980.
3. Wain SL. The controversy of unmodified versus citrated blood transfusion in the early 20th century. *Transfusion* 1984;24:404–407.
4. American Association of Blood Banks. *Standards for blood banks and transfusion services*, 21st ed. Bethesda: American Association of Blood Banks, 2002.
5. Simon TL, Dzik WH, Snyder EL, et al., eds. *Rossi's principles of transfusion medicine*, 3rd ed. Philadelphia: Lippincott Williams & Wilkins, 2002.
6. Mollison PL, Engelfriet CP, Contreras M, eds. *Blood transfusion in clinical medicine*, 10th ed. Malden: Blackwell Science Inc., 1997.
7. Petz LD, Swisher SN, Kleinman S, et al., eds. *Clinical practice of transfusion medicine*, 3rd ed. New York: Churchill Livingstone, 1996.
8. Brecher ME, ed. *Technical manual*, 14th ed. Bethesda: American Association of Blood Banks, 2002.
9. Triulzi DJ, ed. *Blood transfusion therapy a physician's handbook*, 7th ed. Bethesda: American Association of Blood Banks, 2002.
10. Kleinman S. Blood donor screening: principles and policies. In: Petz LD, Swisher SN, Kleinman S, et al., eds. *Clinical practice of transfusion medicine*, 3rd ed. New York: Churchill Livingstone, 1996:245–269.
11. Cherubin CE, Prince AM. Serum hepatitis specific antigen (SH) in commercial and volunteer sources of blood. *Transfusion* 1971;11:25–27.
12. Szmunes W, Prince AM, Brotman B, et al. Hepatitis B antigen and antibody in blood donors: an epidemiologic study. *J Infect Dis* 1973;127:17–25.
13. Alter HJ, Holland PV, Purcell RH, et al. Post transfusion hepatitis after exclusion of commercial and hepatitis B antigen-positive donors. *Ann Intern Med* 1972;77:691–699.
14. Goldman M, Roy G, Frechette N, et al. Evaluation of donor skin disinfection methods. *Transfusion* 1997;37:309–312.
15. Abel JJ, Rowntree LG, Turner BB, et al. Plasma removal with return of corpuscles (plasmapheresis). *J Pharmacol Exp Ther* 1914;5:625.
16. Gilcher RO. Apheresis: principles and technology of hemapheresis. In: Simon TL, Dzik WH, Snyder EL, et al., eds. *Rossi's principles of transfusion medicine*, 3rd ed. Philadelphia: Lippincott Williams & Wilkins, 2002:648–658.
17. Newman BH. Donor reactions and injuries from whole blood donation. *Transfus Med Rev* 1997;11:64–75.
18. Beutler E. Liquid preservation of red blood cells. In: Simon TL, Dzik WH, Snyder EL, et al., eds. *Rossi's principles of transfusion medicine*, 3rd ed. Philadelphia: Lippincott Williams & Wilkins, 2002:50–61.
19. Gibson JG, Reese SB, McManus TJ, et al. A citrate-phosphate-dextrose solution for the preservation of whole blood. *Am J Clin Pathol* 1957;28:569–578.

20. Gabrio BW, Finch CA, Huennekens FM. Erythrocyte preservation: a topic in molecular biochemistry. *Blood* 1956;11:103–113.
21. Nakao T, Wada T, Kamiyama T, et al. A direct relationship between adenosine triphosphate level and in vivo viability of erythrocytes. *Nature* 1962;194: 877–878.
22. Simon ER. Red cell preservation: further studies with adenine. *Blood* 1962;20:485–491.
23. Peck CC, Moore GL, Bolin RB. Adenine in blood preservation. *Crit Rev Clin Lab Sci* 1981;13:173–212.
24. Card RT. Red cell membrane changes during storage. *Transfus Med Rev* 1988;2:40–47.
25. Wolfe LC. The membrane and the lesions of storage in preserved red cells. *Transfusion* 1985;25:185–203.
26. Wolfe L. The red cell membrane and the storage lesion. *Clin Haematol* 1985;14:259–276.
27. Estep TN, Pedersen RA, Miller TJ, et al. Characterization of erythrocyte quality during the refrigerated storage of whole blood containing di-(2-ethylhexyl) phthalate. *Blood* 1984;64:1270–1276.
28. Labow RS, Card RT, Rock G. The effect of the plasticizer di(2-ethylhexyl) phthalate on red cell deformability. *Blood* 1987;70:319–323.
29. Rock G, Tocchi M, Ganz PR, et al. Incorporation of plasticizer into red cells during storage. *Transfusion* 1984;24:493–498.
30. FDA Public Health Notification: PVC Devices Containing the Plasticizer DEHP. Rockville: U.S. Food and Drug Administration, Center for Devices and Radiological Health, 2002.
31. Jeter EK, Gadsden RH, Cate J IV. Effects of irradiation on red cells stored in CPDA-1 and CPD-ADSOL (AS-1). *Ann Clin Lab Sci* 1991;21:177–186.
32. Davey RJ, McCoy NC, Yu M, et al. The effect of prestorage irradiation on posttransfusion red cell survival. *Transfusion* 1992;32:525–528.
33. Valeri CR, Hirsch NM. Restoration in vivo of erythrocyte adenosine triphosphate, 2,3-diphosphoglycerate, potassium ion, and sodium ion concentrations following the transfusion of acid-citrate-dextrose-stored human red blood cells. *J Lab Clin Med* 1969;73:722–733.
34. Juel R. 2,3-Diphosphoglycerate: its role in health and disease. *CRC Crit Rev Clin Lab Sci* 1979;10:113–146.
35. Sohmer PR, Dawson RB. The significance of 2,3-DPG in red cell transfusion. *CRC Crit Rev Clin Lab Sci* 1979;11:107–174.
36. Beutler E, Wood L. The in vivo regeneration of red cell 2,3 diphosphoglyceric acid (DPG) after transfusion of stored blood. *J Lab Clin Med* 1969;74:300–304.
37. What is the clinical importance of alterations of the hemoglobin oxygen affinity in preserved blood, especially as produced by variations of red cell 2,3-DPG content? *Vox Sang* 1978;34:111–127.
38. Hechtman HB, Grindlinger GA, Vegas AM, et al. Importance of oxygen transport in clinical medicine. *Crit Care Med* 1979;7:419–423.
39. Valeri CR, Collins FB. Physiological effects of 2,3-DPG-depleted red cells with high affinity for oxygen. *J Appl Physiol* 1971;31:823–827.
40. Moore GL, Ledford ME, Brummell MR, et al. The potential use of dihydroxyacetone for improved 2,3-DPG maintenance in red blood cell storage: solution stability and use in packed cell storage. *Transfusion* 1980;20:24–31.
41. Dawson RB, Hershey RT, Myers CS. Blood preservation XXIX. Pyruvate maintains normal red cell

- 2,3-DPG for six weeks of storage in CPD-adenine. *Transfusion* 1980;20:218-223.
42. Hamasaki N, Hirota-Chigita C. Acid-citrate-dextrose-phosphoenolpyruvate medium as a rejuvenant for blood storage. *Transfusion* 1983;23:1-7.
43. Chanutin A. Effect of storage of blood in ACD-adenine-inorganic phosphate plus nucleosides on metabolic intermediates of human red cells. *Transfusion* 1967;7:409-419.
44. Valeri CR, Zaroules CG. Rejuvenation and freezing of outdated stored human red cells. *N Engl J Med* 1972;287:1307-1313.
45. Brecher ME, Zylstra-Halling VW, Pineda AA. Rejuvenation of erythrocytes preserved with AS-1 and AS-3. *Am J Clin Pathol* 1991;96:767-769.
46. Calhoun L. Blood product preparation and administration. In: Petz LD, Swisher SN, Kleinman S, et al., eds. *Clinical practice of transfusion medicine*, 3rd ed. New York: Churchill Livingstone, 1996:305-333.
47. Mollison PL. Methods of determining the post-transfusion survival of stored red cells. *Transfusion* 1984;24:93-96.
48. Moroff G, Sohmer PR, Button LN. Proposed standardization of methods for determining the 24-hour survival of stored red cells. *Transfusion* 1984;24:109-114.
49. Peck CC. Evaluating the survival of stored red cells. *Transfusion* 1984;24:97-99.
50. Valeri CR, Ragno G, Pivacek LE, et al. A multicenter study of *in vitro* and *in vivo* values in human RBCs frozen with 40 percent (wt/vol) glycerol and stored after deglycerolization for 15 days at 4° C in AS-3: assessment of RBC processing in the ACP 215. *Transfusion* 2001;41:933-939.
51. Dzik WH. Leukoreduced blood components: laboratory and clinical aspects. In: Simon TL, Dzik WH, Snyder EL, et al., eds. *Rossi's principles of transfusion medicine*, 3rd ed. Philadelphia: Lippincott Williams & Wilkins, 2002: 270-287.
52. Parravicini A, Rebulla P, Apuzzo J, et al. The preparation of leukocyte-poor red cells for transfusion by a simple cost-effective technique. *Transfusion* 1984;24:508-509.
53. Weisbach V, Wanke C, Zingsem J, et al. Cytokine generation in whole blood, leukocyte-depleted and temporarily warmed red blood cell concentrates. *Vox Sang* 1999;76:100-106.
54. Shanwell A, Kristiansson M, Remberger M, et al. Generation of cytokines in red cell concentrates during storage is prevented by prestorage white cell reduction. *Transfusion* 1997;37:678-684.
55. Heddle NM, Klama L, Singer J, et al. The role of plasma from platelet concentrates in transfusion reactions. *N Engl J Med* 1994;331:625-628.
56. Mangano MM, Chambers LA, Kruskall MS. Limited efficiency of leukopoor platelets for prevention of febrile transfusion reactions. *Am J Clin Pathol* 1991;95:733-738.
57. Muylle L, Wouters E, De Bock R, et al. Reactions to platelet transfusion; the effect of the storage time of the concentrate. *Transfus Med* 1992;2:289-293.
58. Heddle NM, Klama LN, Griffith L, et al. A prospective study to identify the risk factors associated with acute reactions to platelet and red cell transfusions. *Transfusion* 1993;33:794-797.
59. Vamvakas EC, Blajchman MA. Universal WBC reduction: the case for and against. *Transfusion* 2001;41:691-712.
60. Moroff G, Luban NLC. The irradiation of blood and blood components to prevent graft-versus-host disease: technical issues and guidelines. *Transfus Med Rev* 1997;11:15-26.
61. Holman P, Blajchman MA, Heddle N. Noninfectious adverse effects of blood transfusion in the neonate. *Transfus Med Rev* 1995;9:277-287.

62. Hiemstra H, Tersmette M, Vos AH, et al. Inactivation of human immunodeficiency virus by gamma radiation and its effect on plasma and coagulation factors. *Transfusion* 1991;31:32-39.
63. Brecher ME, Goodnough LT. The rise and fall of preoperative autologous blood donation. *Transfusion* 2002;42:1618-1622.
64. Segal JB, Guallar E, Powe NR. Autologous blood transfusion in the United States: clinical and nonclinical determinants of use. *Transfusion* 2001;41:1539-1547.
65. Silvergleid AJ. Autologous and designated donor programs. In: Petz LD, Swisher SN, Kleinman S, et al., eds. *Clinical practice of transfusion medicine*, 3rd ed. New York: Churchill Livingstone, 1996:271-293.
66. Goodnough LT. Red blood cell support in the perioperative setting. In: Simon TL, Dzik WH, Snyder EL, et al., eds. *Rossi's principles of transfusion medicine*, 3rd ed. Philadelphia: Lippincott Williams & Wilkins, 2002:590-601.
67. Goodnough LT, Skikne B, Brugnara C. Erythropoietin, iron and erythropoiesis. *Blood* 2000;96:823-833.
68. The National Blood Resource Education Program Expert Panel. The use of autologous blood. *JAMA* 1990;263:414-417.
69. Birkmeyer JD, Goodnough LT, AuBuchon JP, et al. The cost-effectiveness of preoperative autologous blood donation for total hip and knee replacement. *Transfusion* 1993;33:544-551.
70. Cohen JA, Brecher ME. Preoperative autologous blood donation: benefit or detriment? A mathematical analysis. *Transfusion* 1995;35:640-644.
71. Popovsky MA, Whitaker B, Arnold NL. Severe outcomes of allogeneic and autologous blood donation: frequency and characterization. *Transfusion* 1995;35:734-737.
72. Kanter MH, van Maanen D, Anders KH, et al. Preoperative autologous blood donations before elective hysterectomy. *JAMA* 1996;276:798-801.
73. Domen RE. Adverse reactions associated with autologous blood transfusion: evaluation and incidence at a large academic hospital. *Transfusion* 1998;38:296-300.
74. Mackey J, Lipton KS. Association Bulletin 95-4, AABB position on testing of autologous units. Bethesda: American Association of Blood Banks, 1995.
75. Etchason J, Petz L, Keeler E, et al. The cost effectiveness of preoperative autologous blood donations. *N Engl J Med* 1995;322:719-724.
76. Goodnough LT, Price TH, Friedman KD, et al. A phase III trial of recombinant human erythropoietin therapy in nonanemic orthopedic patients subjected to aggressive removal of blood for autologous use: dose, response, toxicity and efficacy. *Transfusion* 1994;34:66-71.
77. Canadian Orthopedic Perioperative Erythropoietin Study Group. Effectiveness of perioperative recombinant human erythropoietin in elective hip replacement. *Lancet* 1993;341:1227-1232.
78. Levine EA, Gould SA, Rosen AL, et al. Perioperative recombinant human erythropoietin. *Surgery* 1989;106:432-437.
79. Stehling L, Zauder HL, Vertrees R. Alternatives to allogeneic transfusion. In: Petz LD, Swisher SN, Kleinman S, et al., eds. *Clinical practice of transfusion medicine*, 3rd ed. New York: Churchill Livingstone, 1996:539-561.
80. Weiskopf RB. Mathematical analysis of isovolemic hemodilution indicates that it can decrease the need for allogeneic blood transfusion. *Transfusion* 1995;35:37-41.
81. Weiskopf RB. Efficacy of acute normovolemic hemodilution assessed as a function of fraction of blood volume lost. *Anesthesiology* 2001;94:439-446.

82. Monk TG, Goodnough LT, Brecher ME, et al. A prospective randomized comparison of three blood conservation strategies for radical prostatectomy. *Anesthesiology* 1999;91:24–33.
83. Williamson KR, Taswell HF. Intraoperative blood salvage: a review. *Transfusion* 1991;31:662–675.
84. Ritter MA, Keating EM, Faris PM. Closed wound drainage in total hip or total knee replacement. A prospective, randomized study. *J Bone Joint Surg Am* 1994;76:35–38.
85. Strauss RG, Sacher RA. Directed donations for pediatric patients. *Transfus Med Rev* 1988;2:58–64.
86. Moore SB. AIDS, blood transfusion, and directed donations. *N Engl J Med* 1986;314:1454.
87. Dodd RY, Notari EP IV, Stramer SL. Current prevalence and incidence of infectious disease markers and estimated window-period risk in the American Red Cross blood donor population. *Transfusion* 2002;42:975–979.
88. Allison MJ, Toy P. A quality improvement team on autologous and directed-donor blood availability. *Jt Comm J Qual Improv* 1996;22:801–810.
89. Kanter MH, Hodge SE. Risk of hemolytic disease of the newborn as a result of directed donations from relatives. *Transfusion* 1989;29:620–625.
90. Jahr JS, Nesargi SB, Lewis K, et al. Blood substitutes and oxygen therapeutics: an overview and current status. *Am J Ther* 2002;9:437–443.
91. Winslow RM. Blood substitutes. *Curr Opin Hematol* 2002;9:146–151.
92. Stowell CP, Levin J, Spiess BD, et al. Progress in the development of RBC substitutes. *Transfusion* 2001;41:287–299.
93. Hebert PC, Wells G, Blajchman MA, et al. A multicenter randomized controlled clinical trial of transfusion requirements in critical care. Transfusion Requirements in Critical Care Investigators, Canadian Critical Care Trials Group. *N Engl J Med* 1999;340:409–417.
94. Vincent JL, Baron JF, Reinhart K, et al. Anemia and blood transfusion in critically ill patients. *JAMA* 2002;288:1499–1507.
95. Wu WC, Rathore SS, Wang Y, et al. Blood transfusion in elderly patients with acute myocardial infarction. *N Engl J Med* 2001;345:1230–1236.
96. Ross S, Jeter E. Emergency surgery: trauma and massive transfusion. In: Petz LD, Swisher SN, Kleinman S, et al., eds. *Clinical practice of transfusion medicine*, 3rd ed. New York: Churchill Livingstone, 1996:563–579.
97. Mishler JM. Synthetic plasma volume expanders: their pharmacology, safety, and clinical efficacy. *Clin Haematol* 1984;13:75–92.
98. Weaver DW, Ledgerwood AM, Lucas CE, et al. Pulmonary effects of albumin resuscitation for severe hypovolemic shock. *Arch Surg* 1978;113:387–392.
99. Levy PS, Chavez RP, Crystal GJ, et al. Oxygen extraction ratio: a valid indicator of transfusion need in limited coronary vascular reserve? *J Trauma* 1992;32:769–773; discussion 773–774.
100. Gould SA, Sehgal LR, Sehgal HL, et al. Hypovolemic shock. *Crit Care Clin* 1993;9:239–259.
101. van Woerkens EC, Trouwborst A, van Lanschot JJ. Profound hemodilution: what is the critical level of hemodilution at which oxygen delivery-dependent oxygen consumption starts in an anesthetized human? *Anesth Analg* 1992;75:818–821.
102. National Institutes of Health Consensus Conference. Perioperative red blood cell transfusion. *JAMA* 1988;260:2700–2703.



103. Practice Guidelines for blood component therapy: A report by the American Society of Anesthesiologists Task Force on Blood Component Therapy. *Anesthesiology* 1996;84:732–747.
104. Weiskopf RB. More on the changing indications for transfusion of blood and blood components during anesthesia. *Anesthesiology* 1996;84:498–501.
105. Viele MK, Weiskopf RB. What can we learn about the need for transfusion from patients who refuse blood? The experience with Jehovah's Witnesses. *Transfusion* 1994;34:396–401.
106. Goodnough LT, Johnston MF, Shah T, et al. A two-institution study of transfusion practice in 78 consecutive adult elective open-heart procedures. *Am J Clin Pathol* 1989;91:468–472.
107. Love TR, Hendren WG, O'Keefe DD, et al. Transfusion of predonated autologous blood in elective cardiac surgery. *Ann Thorac Surg* 1987;43:508–512.
108. Friedman BA. An analysis of surgical blood use in United States hospitals with application to the maximum surgical blood order schedule. *Transfusion* 1979;19:268–278.
109. Axelrod FB, Pepkowitz SH, Goldfinger D. Establishment of a schedule of optimal preoperative collection of autologous blood. *Transfusion* 1989;29:677–680.
110. Petz LD. Blood transfusion in acquired hemolytic anemias. In: Petz LD, Swisher SN, Kleinman S, et al., eds. *Clinical practice of transfusion medicine*, 3rd ed. New York: Churchill Livingstone, 1996:469–499.
111. Petz LD, Garratty G. *Acquired immune hemolytic anemias*. New York: Churchill-Livingstone, 1980.
112. Greenwalt TJ, Zelenski KR. Transfusion support for haemoglobinopathies. *Clin Haematol* 1984;13:151–165.
113. Giblett ER. Blood group alloantibodies. An assessment of some laboratory practices. *Transfusion* 1977;17:299–308.
114. Myhre BA, et al. Incidence of irregular antibodies occurring in healthy blood donors. *Transfusion* 1965;5:350.
115. Giblett ER. Testing, testing. *Arch Intern Med* 1978;138:469.
116. Mohn JF, et al. Experimental transfusion of donor plasma containing blood group antibodies into incompatible normal human recipients. I. Absence of destruction of red cell mass with anti-Rh, anti-Kell, and anti-M. *Br J Haematol* 1961;7:112.
117. Bowman HS, et al. Experimental transfusion of donor plasma containing blood group antibodies into incompatible normal human recipients. II. Induction of isoimmune haemolytic anemia by a transfusion of plasma containing exceptional anti-CD antibodies. *Br J Haematol* 1961;7:130.
118. Laine ML, Beattie KM. Frequency of alloantibodies accompanying autoantibodies. *Transfusion* 1985;25:545–546.
119. Wallhermfecht MA, Pohl BA, Chaplin H. Alloimmunization in patients with warm autoantibodies. A retrospective study employing three donor alloabsorptions to aid in antibody detection. *Transfusion* 1984;24:482–485.
120. Davey RJ. The uses of radiolabeled red cells in transfusion medicine. *Transfus Med Rev* 1988;2:151–160.
121. International Committee for Standardization in Haematology. Recommended method for radioisotope red-cell survival studies. *Br J Haematol* 1980;45:659–666.
122. Nance SJ, Arndt P, Garratty G. Predicting the clinical significance of red cell alloantibodies using a monocyte monolayer assay. *Transfusion* 1987;27:449–452.
123. Baldwin ML, Barrasso C, Ness PM, et al. A clinically significant erythrocyte antibody detectable only

by <sup>51</sup>Cr survival studies. *Transfusion* 1983;23:40–44.

124. Davey RJ, Gustafson M, Holland PV. Accelerated immune red cell destruction in the absence of serologically detectable alloantibodies. *Transfusion* 1980;20:348–353.
125. Judd WJ. The role of lectins in blood group serology. *Crit Rev Clin Lab Sci* 1980;12:171–214.
126. Levene C, Levene NA, Buskila D, et al. Red cell polyagglutination. *Transfus Med Rev* 1988;2:176–185.
127. Hume H, Bard H. Small volume red blood cell transfusions for neonatal patients. *Transfus Med Rev* 1995;9:187–199.
128. Luban NLC, Strauss RG, Hume HA. Commentary on the safety of red cells preserved in extended-storage media for neonatal transfusions. *Transfusion* 1991;31:229–235.
129. Wang-Rodriguez J, Mannino FL, Liu E, et al. A novel strategy to limit blood donor exposure and blood waste in multiply transfused premature infants. *Transfusion* 1996;36:64–70.
130. Slichter SJ. Controversies in platelet transfusion therapy. *Ann Rev Med* 1980;31:509–540.
131. Slichter SJ, Harker LA. Thrombocytopenia: mechanisms and management of defects in platelet production. *Clin Haematol* 1978;7:523–539.
132. Slichter SJ. Mechanisms and management of platelet refractoriness. In: Nance ST, ed. *Transfusion medicine in the 1990's*. Arlington: American Association of Blood Banks 1990:95–179.
133. Slichter SJ, Harker LA. Preparation and storage of platelet concentrates. I. Factors influencing the harvest of viable platelets from whole blood. *Br J Haematol* 1976;34:395–402.
134. Slichter SJ, Harker LA. Preparation and storage of platelet concentrates. II. Storage variables influencing platelet viability and function. *Br J Haematol* 1976;34:403–419.
135. Murphy S, Heaton WA, Rebullia P. Platelet production in the Old World—and the New. *Transfusion* 1996;36:751–754.
136. Bunescu A, Hild M, Lundahl J, et al. Platelet storage in PAS-2 or autologous plasma: impact on functional parameters. *Transfus Med* 2001;11:105–110.
137. Schiffer CA, Anderson KC, Bennett CL, et al. Platelet transfusion for patients with cancer: clinical practice guidelines of the American Society of Clinical Oncology. *J Clin Oncol* 2001;19:1519–1538.
138. Sarkodee-Adoo CB, Kendall JM, Sridhara R, et al. The relationship between the duration of platelet storage and the development of transfusion reactions. *Transfusion* 1998;38:229–235.
139. Kelley DL, Mangini J, Lopez-Plaza I, et al. The utility of =3-day-old whole-blood platelets in reducing the incidence of febrile nonhemolytic transfusion reactions. *Transfusion* 2000;40:439–442.
140. Murphy S, Gardner FH. Effect of storage temperature on maintenance of platelet viability—deleterious effect of refrigerated storage. *N Engl J Med* 1969;280:1094–1098.
141. Murphy S. Platelet storage for transfusion. *Semin Hematol* 1985;22:165–177.
142. Murphy S, Gardner FH. Platelet storage at 22° C: role of gas transport across plastic containers in maintenance of viability. *Blood* 1975;46:209–218.
143. Murphy S, Gardner FH. Platelet storage at 22° C; metabolic, morphologic, and functional studies. *J Clin Invest* 1971;50:370–377.
144. Murphy S, Kahn RA, Holme S, et al. Improved storage of platelets for transfusion in a new container. *Blood* 1982;60:194–200.
145. Hogge DE, Thompson BW, Schiffer CA. Platelet storage for 7 days in second-generation bags.

Transfusion 1986;26:131-135.

146. Braine HG, Kickler TS, Charache P, et al. Bacterial sepsis secondary to platelet transfusion: an adverse effect of extended storage at room temperature. *Transfusion* 1986;26:391-393.
147. Heal JM, Singal S, Sardisco E, et al. Bacterial proliferation in platelet concentrates. *Transfusion* 1986;26:388-390.
148. Murphy S. Similarities among the events occurring during the storage of red cells and platelets for transfusion. *Transfus Med Rev* 1987;1:138-143.
149. Murphy S, Rebullia P, Bertolini F. In vitro assessment of the quality of stored platelet concentrates. The BEST (Biomedical Excellence for Safer Transfusion) Task Force of the International Society of Blood Transfusion. *Transfus Med Rev* 1994;8:29-36.
150. Slichter SJ. Poststorage platelet viability in thrombocytopenic recipients is reliably measured by radiochromium-labeled platelet recovery and survival measurements in normal volunteers. *Transfusion* 1986;26:8-13.
151. Harker LA. The role of the spleen in thrombokinetics. *J Lab Clin Med* 1971;77:247-253.
152. Snyder EL, Ezekowitz M, Aster R, et al. Extended storage of platelets in a new plastic container. II. In vivo response to infusion of platelets stored for 5 days. *Transfusion* 1985;25:209-214.
153. Rodgers RP, Levin JA. A critical reappraisal of bleeding time. *Semin Thromb Hemost* 1990;16:1-20.
154. Vostal JG, Reid TJ, Mondoro TH. Summary of a workshop on *in vivo* efficacy of transfused platelet components and platelet substitutes. *Transfusion* 2000;40:742-750.
155. de Wildt-Eggen J, Nauta S, Schrijver JG, et al. Reactions and platelet increments after transfusion of platelet concentrates in plasma or an additive solution: a prospective, randomized study. *Transfusion* 2000;40:398-403.
156. van Rhenen DJ, Vermeij J, Mayaudon V, et al. Functional characteristics of S-59 photochemically treated platelet concentrates derived from buffy coats. *Vox Sang* 2000;79:206-214.
157. Vecchione JJ, Melaragno AJ, Hollander A, et al. Circulation and function of human platelets isolated from units of CPDA-1, CPDA-2 and CPDA-3 anticoagulated blood and frozen with DMSO. *Transfusion* 1982;22:206-209.
158. Lazarus HM, Kaniecki-Green EA, Warm SE, et al. Therapeutic effectiveness of frozen platelet concentrates for transfusion. *Blood* 1981;57:243-249.
159. Vadhan-Raj S, Kavanagh JJ, Freedman RS, et al. Safety and efficacy of transfusions of autologous cryopreserved platelets derived from recombinant human thrombopoietin to support chemotherapy-associated severe thrombocytopenia: a randomised cross-over study. *Lancet* 2002;359:2145-2152.
160. Schiffer CA, Aisner J, Wiernik PH. Frozen autologous platelet transfusions for patients with leukemia. *N Engl J Med* 1978;299:7-12.
161. Dunstan RA, Simpson MB, Knowles RW, et al. The origin of ABH antigens on human platelets. *Blood* 1985;65:615-619.
162. Kelton JG, Hamid C, Aker S, et al. The amount of blood group A substance on platelets is proportional to the amount in the plasma. *Blood* 1982;59:980-985.
163. Aster RH. Effect of anticoagulant and ABO incompatibility on recovery of transfused human platelets. *Blood* 1965;26:732-743.
164. Duguesnoy RJ, Anderson AJ, Tomasulo PA, et al. ABO compatibility and platelet transfusions of alloimmunized thrombocytopenic patients. *Blood* 1979;54:595-599.

165. Heal JM, Blumberg N, Masel D. An evaluation of crossmatching, HLA, and ABO matching for platelet transfusions to refractory patients. *Blood* 1987;70:23–30.
166. Aster RH. New approaches to an old problem. Refractoriness to platelet transfusions. *Transfusion* 1988;28:95–96.
167. Brand A, Sintnicolaas K, Claas FH, et al. ABH antibodies causing platelet transfusion refractoriness. *Transfusion* 1986;26:463–466.
168. Murphy S. ABO blood groups and platelet transfusion. *Transfusion* 1988;28:401–402.
169. Lee EJ, Schiffer CA. ABO compatibility can influence the results of platelet transfusion. Results of a randomized trial. *Transfusion* 1989;29:384–389.
170. McManigal S, Sims KL. Intravascular hemolysis secondary to ABO incompatible platelet products. An underrecognized transfusion reaction. *Am J Clin Pathol* 1999;111:202–206.
171. Carr R, Hutton JL, Jenkins JA, et al. Transfusion of ABO-mismatched platelets leads to early platelet refractoriness. *Br J Haematol* 1990;75:408–413.
172. Heal JM, Rowe JM, McMican A, et al. The role of ABO matching in platelet transfusion. *Eur J Haematol* 1993;50:110–117.
173. Menitove JE. Immunoprophylaxis for D- patients receiving platelet transfusions from D+ donors? *Transfusion* 2002;42:136–138.
174. Sandler SG. Treating immune thrombocytopenic purpura and preventing Rh alloimmunization using intravenous rho (D) immune globulin. *Transfus Med Rev* 2001;15:67–76.
175. Cerskus AL, Ali M, Davies BJ, et al. Possible significance of small numbers of functional platelets in a population of aspirin-treated platelets *in vitro* and *in vivo*. *Thromb Res* 1980;18:389–397.
176. Schafer AI. Effects of nonsteroidal antiinflammatory drugs on platelet function and systemic hemostasis. *J Clin Pharmacol* 1995;35:209–219.
177. Practice parameter for the use of fresh frozen plasma, cryoprecipitate, and platelets. Fresh-Frozen Plasma, Cryoprecipitate, and Platelets Administration Practice Guidelines Development Task Force of the College of American Pathologists. *JAMA* 1994;271:777–781.
178. Daly PA, Schiffer CA, Aisner J, et al. Platelet transfusion therapy. One-hour posttransfusion increments are valuable in predicting the need for HLA-matched preparations. *JAMA* 1980;243:435–438.
179. O'Connell B, Lee EJ, Schiffer CA. The value of 10-minute post-transfusion platelet counts. *Transfusion* 1988;28:66–67.
180. Petz LD. Platelet transfusions. In: Petz LD, Swisher SN, Kleinman S, et al., eds. *Clinical practice of transfusion medicine*, 3rd ed. New York: Churchill Livingstone, 1996:359–412.
181. Hanson SR, Slichter SJ. Platelet kinetics in patients with bone marrow hypoplasia: evidence for a fixed platelet requirement. *Blood* 1985;66:1105–1109.
182. Norol F, Bierling P, Roudot-Thoraval F, et al. Platelet transfusion: a dose-response study. *Blood* 1998;92:1448–1453.
183. Klumpp TR, Herman JH, Gaughan JP, et al. Clinical consequences of alterations in platelet transfusion dose: a prospective, randomized, double-blind trial. *Transfusion* 1999;39:674–681.
184. Brecher ME, Hom EG, Hersh JK. Optimal platelet dosing. *Transfusion* 1999;39:431–434.
185. Consensus Conference. Platelet transfusion therapy. *JAMA* 1987;257:1777–1780.
186. Gaydos LA, Freireich EJ, Mantel N, et al. The quantitative relation between platelet count and

- hemorrhage in patients with acute leukemia. *N Engl J Med* 1962;266:905.
187. Higby DJ, Cohen E, Holland JF, et al. The prophylactic treatment of thrombocytopenic leukemic patients with platelets: a double blind study. *Transfusion* 1974;14:440-446.
188. Murphy S, Litwin S, Herring LM, et al. Indications for platelet transfusions in children with acute leukemia. *Am J Hematol* 1982;12:347-356.
189. Beutler E. Platelet transfusions: the 20,000/microL trigger. *Blood* 1993;81:1411-1413.
190. Gmur J, Burger J, Schanz U, et al. Safety of stringent prophylactic platelet transfusion policy for patients with acute leukemia. *Lancet* 1991;338:1223-1226.
191. Heckman KD, Weiner GJ, Davis CS, et al. Randomized study of prophylactic platelet transfusion threshold during induction therapy for adult acute leukemia: 10,000/microL versus 20,000/microL. *J Clin Oncol* 1997;15:1143-1149.
192. Rebutta P, Finazzi G, Marangoni F, et al. The threshold for prophylactic platelet transfusions in adults with acute myeloid leukemia. Gruppo Italiano Malattie Ematologiche Maligne dell'Adulto. *N Engl J Med* 1997;337:1870-1875.
193. Wandt H, Frank M, Ehninger G, et al. Safety and cost effectiveness of a  $10 \times 10^9/L$  trigger for prophylactic platelet transfusions compared with the traditional  $20 \times 10^9/L$  trigger: a prospective comparative trial in 105 patients with acute myeloid leukemia. *Blood* 1998;91:3601-3606.
194. Gil-Fernandez JJ, Alegre A, Fernandez-Villalta MJ, et al. Clinical results of a stringent policy on prophylactic platelet transfusion: non-randomized comparative analysis in 190 bone marrow transplant patients from a single institution. *Bone Marrow Transplant* 1996;18:931-935.
195. Bernstein SH, Nademanee AP, Vose JM, et al. A multicenter study of platelet recovery and utilization in patients after myeloablative therapy and hematopoietic stem cell transplantation. *Blood* 1998;91:3509-3517.
196. Harkness DR, Byrnes JJ, Lian EC, et al. Hazard of platelet transfusion in thrombotic thrombocytopenic purpura. *JAMA* 1981;246:1931-1933.
197. Gordon LI, Kwaan HC, Rossi EC. Deleterious effects of platelet transfusions and recovery thrombocytosis in patients with thrombotic microangiopathy. *Semin Hematol* 1987;24:194-201.
198. Harker LA, Malpass TW, Branson HE, et al. Mechanism of abnormal bleeding in patients undergoing cardiopulmonary bypass: acquired transient platelet dysfunction associated with selective alpha-granule release. *Blood* 1980;56:824-834.
199. Counts RB, Haisch C, Simon TL, et al. Hemostasis in massively transfused trauma patients. *Ann Surg* 1979;190:91-99.
200. Miller RD, Robbins TO, Tong MJ, et al. Coagulation defects associated with massive blood transfusions. *Ann Surg* 1971;174:794-801.
201. Noe DA, Graham SM, Luff R, et al. Platelet counts during rapid massive transfusion. *Transfusion* 1982;22:392-395.
202. Bishop JF, McGrath K, Wolf MM, et al. Clinical factors influencing the efficacy of pooled platelet transfusions. *Blood* 1988;71:383-387.
203. Novotny VM. Prevention and management of platelet transfusion refractoriness. *Vox Sang* 1999;76:1-13.
204. Alcorta I, Pereira A, Ordinas A. Clinical and laboratory factors associated with platelet transfusion refractoriness: a case-control study. *Br J Haematol* 1996;93:220-224.
205. Densmore TL, Goodnough LT, Ali S, et al. Prevalence of HLA sensitization in female apheresis

donors. *Transfusion* 1999;39:103–106.

206. Payne R. The development and persistence of leukoagglutinins in parous women. *Blood* 1962;19:411–424.

207. Leukocyte reduction and ultraviolet B irradiation of platelets to prevent alloimmunization and refractoriness to platelet transfusions. The Trial to Reduce Alloimmunization to Platelets Study Group. *N Engl J Med* 1997;337:1861–1869.

208. Yankee RA, Graff KS, Dowling R, et al. Selection of unrelated compatible platelet donors by lymphocyte HL-A matching. *N Engl J Med* 1973;288:760–764.

209. Friedberg RC, Donnelly SF, Mintz PD. Independent roles for platelet crossmatching and HLA in the selection of platelets for alloimmunized patients. *Transfusion* 1994;34:215–220.

210. Schnaidt M, Northoff H, Wernet D. Frequency and specificity of platelet-specific alloantibodies in HLA-immunized haematologic-oncologic patients. *Transfus Med* 1996;6:111–114.

211. Kurz M, Greinix H, Hocker P, et al. Specificities of anti-platelet antibodies in multitransfused patients with haemato-oncological disorders. *Br J Haematol* 1996;95:564–569.

212. Kickler T, Kennedy SD, Braine HG. Alloimmunization to platelet-specific antigens on glycoproteins IIb-IIIa and Ib/IX in multiply transfused thrombocytopenic patients. *Transfusion* 1990;30:622–625.

213. Petz LD, Garratty G, Calhoun L, et al. Selecting donors of platelets for refractory patients on the basis of HLA antibody specificity. *Transfusion* 2000;40:1446–1456.

214. Claas FH, Smeenk RJ, Schmidt R, et al. Alloimmunization against the MHC antigens after platelet transfusions is due to contaminating leukocytes in the platelet suspension. *Exp Hematol* 1981;9:84–89.

215. Vamvakas EC. Meta-analysis of randomized controlled trials of the efficacy of white cell reduction in preventing HLA-alloimmunization and refractoriness to random-donor platelet transfusions. *Transfus Med Rev* 1998;12:258–270.

216. Heddle NM. The efficacy of leukodepletion to improve platelet transfusion response: a critical appraisal of clinical studies. *Transfus Med Rev* 1994;8:15–28.

217. Sintnicolaas K, van Marwijk Kooij M, van Prooijen HC, et al. Leukocyte depletion of random single-donor platelet transfusions does not prevent secondary human leukocyte antigen-alloimmunization and refractoriness: a randomized prospective study. *Blood* 1995;85:824–828.

218. Lindahl-Kiessling K, Safwenberg J. Inability of UV-irradiated lymphocytes to stimulate allogeneic cells in mixed lymphocyte culture. *Int Arch Allergy Appl Immunol* 1971;41:670–678.

219. Kahn RA, Duffy BF, Rodey GG. Ultraviolet irradiation of platelet concentrate abrogates lymphocyte activation without affecting platelet function *in vitro*. *Transfusion* 1985;25:547–550.

220. Sintnicolaas K, Vriesendorp HM, Sizoo W, et al. Delayed alloimmunisation by random single donor platelet transfusions. A randomised study to compare single donor and multiple donor platelet transfusions in cancer patients with severe thrombocytopenia. *Lancet* 1981;1:750–754.

221. Gmur J, von Felten A, Osterwalder B, et al. Delayed alloimmunization using random single donor platelet transfusions: a prospective study in thrombocytopenic patients with acute leukemia. *Blood* 1983;62:473–479.

222. Lucas DP, Paparounis ML, Myers L, et al. Detection of HLA class I-specific antibodies by the QuikScreen enzyme-linked immunosorbent assay. *Clin Diagn Lab Immunol* 1997;4:252–257.

223. Gelb AB, Leavitt AD. Crossmatch-compatible platelets improve corrected count increments in patients who are refractory to randomly selected platelets. *Transfusion* 1997;37:624–630.

224. Yankee RA, Grumet FC, Rogentine GN. Platelet transfusion therapy: the selection of compatible

- platelet donors for refractory patients by lymphocyte HL-A typing. *N Engl J Med* 1969;281:1208-1212.
225. Moroff G, Garratty G, Heal JM, et al. Selection of platelets for refractory patients by HLA matching and prospective crossmatching. *Transfusion* 1992;32:633-640.
226. Bryant PC, Vayntrub TA, Schrandt HA, et al. HLA antibody enhancement by double addition of serum: use in platelet donor selection. *Transfusion* 1992;32:839-844.
227. Zimmermann R, Wittmann G, Zingsem J, et al. Antibodies to private and public HLA class I epitopes in platelet recipients. *Transfusion* 1999;39:772-780.
228. Murphy WG, Palmer JP, Green RH. The management of haemorrhage in the refractory non-alloimmunized thrombocytopenic patient. *Vox Sang* 1994;67[Suppl 3]:99-103.
229. Kekomaki R, Eifenbein G, Gardner R, et al. Improved response of patients refractory to random-donor platelet transfusions by intravenous gamma globulin. *Am J Med* 1984;76:199-203.
230. Schiffer CA, Hogge DE, Aisner J, et al. High-dose intravenous gammaglobulin in alloimmunized platelet transfusion recipients. *Blood* 1984;64:937-940.
231. Kickler T, Braine HG, Piantadosi S, et al. A randomized, placebo-controlled trial of intravenous gammaglobulin in alloimmunized thrombocytopenic patients. *Blood* 1990;75:313-316.
232. Zeigler ZR, Shaddock RK, Rosenfeld CS, et al. Intravenous gamma globulin decreases platelet-associated IgG and improves transfusion responses in platelet refractory states. *Am J Hematol* 1991;38:15-23.
233. Gerotziapas GT, Zervas C, Gavrielidis G, et al. Effective hemostasis with rFVIIa treatment in two patients with severe thrombocytopenia and life-threatening hemorrhage. *Am J Hematol* 2002;69:219-222.
234. Kristensen J, Killander A, Hippe E, et al. Clinical experience with recombinant factor VIIa in patients with thrombocytopenia. *Haemostasis* 1996;26[Suppl 1]:159-164.
235. Shpilberg O, Blumenthal R, Sofer O, et al. A controlled trial of tranexamic acid therapy for the reduction of bleeding during treatment of acute myeloid leukemia. *Leuk Lymphoma* 1995;19:141-144.
236. Benson K, Fields K, Hiemenz J, et al. The platelet-refractory bone marrow transplant patient: prophylaxis and treatment of bleeding. *Semin Oncol* 1993;20[5 Suppl 6]:102-109.
237. Garewal HS, Durie BG. Anti-fibrinolytic therapy with aminocaproic acid for the control of bleeding in thrombocytopenic patients. *Scand J Haematol* 1985;35:497-500.
238. Li J, Yang C, Xia Y, et al. Thrombocytopenia caused by the development of antibodies to thrombopoietin. *Blood* 2001;98:3241-3248.
239. Kuter DJ. Whatever happened to thrombopoietin? *Transfusion* 2002;42:279-283.
240. Basser R. The impact of thrombopoietin on clinical practice. *Curr Pharm Des* 2002;8:369-377.
241. Bodey GP, Buckley M, Sathe YS, et al. Quantitative relationships between circulating leukocytes and infection in patients with acute leukemia. *Ann Intern Med* 1966;64:328-340.
242. McCullough J. Granulocyte transfusion. In: Petz LD, Swisher SN, Kleinman S, et al., eds. *Clinical practice of transfusion medicine*, 3rd ed. New York: Churchill Livingstone, 1996:413-432.
243. Crawford J, Ozer H, Stoller R, et al. Reduction by granulocyte colony-stimulating factor of fever and neutropenia induced by chemotherapy in patients with small-cell lung cancer. *N Engl J Med* 1991;325:164-170.
244. Bishop MR, Tarantolo SR, Geller RB, et al. A randomized, double-blind trial of filgrastim (granulocyte colony-stimulating factor) versus placebo following allogeneic blood stem cell transplantation. *Blood* 2000;96:80-85.



245. Ojeda E, Garcia-Bustos J, Aguado M, et al. A prospective randomized trial of granulocyte colony-stimulating factor therapy after autologous blood stem cell transplantation in adults. *Bone Marrow Transplant* 1999;24:601-607.
246. Klein HG, Strauss RG, Schiffer CA. Granulocyte transfusion therapy. *Semin Hematol* 1996;33:359-368.
247. Dale DC, Liles WC, Price TH. Renewed interest in granulocyte transfusion therapy. *Br J Haematol* 1997;98:497-501.
248. Strauss RG. Therapeutic granulocyte transfusions in 1993. *Blood* 1993;81:1675-1678.
249. Strauss RG. Neutrophil collection and transfusion. In: Simon TL, Dzik WH, Snyder EL, et al., eds. *Rossi's principles of transfusion medicine*, 3rd ed. Philadelphia: Lippincott Williams & Wilkins, 2002:258-267.
250. Freireich EJ, Levin RH, Wang J, et al. The function and fate of transfused leukocytes from donors with chronic myelocytic leukemia in leukopenic recipients. *Ann N Y Acad Sci* 1965;113:1081.
251. McCullough J. Leukapheresis and granulocyte transfusion. *CRC Crit Rev Clin Lab Sci* 1979;10:275-327.
252. Menitove JE, Abrams RA. Granulocyte transfusions in neutropenic patients. *Crit Rev Oncol Hematol* 1987;7:89-113.
253. Bodey GP. Infection in cancer patients. A continuing association. *Am J Med* 1986;81:11-26.
254. Dale DC, Fauci AS, Guerry D IV, et al. Comparison of agents producing a neutrophilic leukocytosis in man. Hydrocortisone, prednisone, endotoxin, and etiocholanolone. *J Clin Invest* 1975;56:808-813.
255. Liles WC, Huang JE, Llewellyn C, et al. A comparative trial of granulocyte-colony-stimulating factor and dexamethasone, separately and in combination, for the mobilization of neutrophils in the peripheral blood of normal volunteers. *Transfusion* 1997;37:182-187.
256. McCullough J, Clay M, Herr G, et al. Effects of granulocyte-colony-stimulating factor on potential normal granulocyte donors. *Transfusion* 1999;39:1136-1140.
257. Adkins DR, Goodnough LT, Shenoy S, et al. Effect of leukocyte compatibility on neutrophil increment after transfusion of granulocyte colony-stimulating factor-mobilized prophylactic granulocyte transfusions and on clinical outcomes after stem cell transplantation. *Blood* 2000;95:3605-3612.
258. Price TH, Bowden RA, Boeckh M, et al. Phase I/II trial of neutrophil transfusions from donors stimulated with G-CSF and dexamethasone for treatment of patients with infections in hematopoietic stem cell transplantation. *Blood* 2000;95:3302-3309.
259. Liles WC, Rodger E, Dale DC. Combined administration of G-CSF and dexamethasone for the mobilization of granulocytes in normal donors: optimization of dosing. *Transfusion* 2000;40:642-644.
260. Gutierrez-Delgado F, Bensinger W. Safety of granulocyte colony-stimulating factor in normal donors. *Curr Opin Hematol* 2001;8:155-160.
261. Joos K, Herzog R, Einsele H, et al. Characterization and functional analysis of granulocyte concentrates collected from donors after repeated G-CSF stimulation. *Transfusion* 2002;42:603-611.
262. Worel N, Kurz M, Peters C, et al. Serial granulocytapheresis under daily administration of rHuG-CSF: effects on peripheral blood counts, collection efficiency, and yield. *Transfusion* 2001;41:390-395.
263. Stroncek DF, Yau YY, Oblitas J, et al. Administration of G-CSF plus dexamethasone produces greater granulocyte concentrate yields while causing no more donor toxicity than G-CSF alone. *Transfusion* 2001;41:1037-1044.
264. Winston DJ, Ho WG, Howell CL, et al. Cytomegalovirus infections associated with leukocyte

transfusion. *Ann Intern Med* 1980;93:671–675.

265. Dutcher JP, Schiffer CA, Johnston GS, et al. Alloimmunization prevents the migration of transfused <sup>111</sup>indium-labeled granulocytes to sites of infection. *Blood* 1983;62:354–360.

266. McCullough J, Clay M, Hurd D, et al. Effect of leukocyte antibodies and HLA matching on the intravascular recovery, survival, and tissue localization of <sup>111</sup>Indium granulocytes. *Blood* 1986;67:522–528.

267. Hübel K, Dale DC, Liles WC. Granulocyte transfusion therapy: update on potential clinical applications. *Curr Opin Hematol* 2001;8:161–164.

268. Wright DG, Robichaud KJ, Pizzo PS, et al. Lethal pulmonary reactions associated with the combined use of amphotericin B and leukocyte transfusions. *N Engl J Med* 1981;304:1185–1189.

269. Karp DD, Ervin TJ, Tuttle S, et al. Pulmonary complications during granulocyte transfusions: incidence and clinical features. *Vox Sang* 1982;42:57–61.

270. Dana BW, Durie BG, White RF, et al. Concomitant administration of granulocyte transfusions and amphotericin B in neutropenic patients: absence of significant pulmonary toxicity. *Blood* 1981;57:90–94.

271. Price TH. Granulocyte colony-stimulating factor-mobilized granulocyte concentrate transfusions. *Curr Opin Hematol* 1998;5:391–395.

272. Strauss RG. Clinical perspectives of granulocyte transfusions: efficacy to date. *J Clin Apheresis* 1995;10:114–118.

273. Peters C, Minkov M, Matthes-Martin S, et al. Leucocyte transfusions from rhG-CSF or prednisolone stimulated donors for treatment of severe infections in immunocompromised neutropenic patients. *Br J Haematol* 1999;106:689–696.

274. Lee JJ, Chung IJ, Park MR, et al. Clinical efficacy of granulocyte transfusion therapy in patients with neutropenia-related infections. *Leukemia* 2001;15:203–207.

275. Clift RA, Sanders JE, Thomas ED, et al. Granulocyte transfusions for the prevention of infection in patients receiving bone marrow transplants. *N Engl J Med* 1978;298:1052–1057.

276. Ford JM, Cullen MH, Roberts MM, et al. Prophylactic granulocyte transfusions. Results of a randomized controlled trial in patients with acute myelogenous leukemia. *Transfusion* 1982;22:311–316.

277. Schiffer CA, Aisner J, Daly PA, et al. Alloimmunization following prophylactic granulocyte transfusions. *Blood* 1979;54:766–774.

278. Strauss RG, Connett JE, Gale RP, et al. A controlled trial of prophylactic granulocyte transfusions during initial induction chemotherapy for acute myelogenous leukemia. *N Engl J Med* 1981;305:597–603.

279. Winston DJ, Ho WG, Young LS, et al. Prophylactic granulocyte transfusions during human bone marrow transplantation. *Am J Med* 1980;68:893–897.

280. Winston DJ, Ho WG, Gale RP. Prophylactic granulocyte transfusions during chemotherapy of acute nonlymphocytic leukemia. *Ann Intern Med* 1981;94:616–622.

281. Buescher ES, Gallin JI. Leukocyte transfusions in chronic granulomatous disease. Persistence of transfused leukocytes in sputum. *N Engl J Med* 1982;307:800–803.

282. Chusid MJ, Shea ML, Sarff LD. Determination of post-transfusion granulocyte kinetics by chemiluminescence in chronic granulomatous disease. *J Lab Clin Med* 1980;95:168–174.

283. Yomtovian R, Abramson J, Quie P, et al. Granulocyte transfusion therapy in chronic granulomatous disease. Report of a patient and review of the literature. *Transfusion* 1981;21:739–743.

284. Strauss RG. Granulopoiesis and neutrophil function in the neonate. In: Stockman JA, ed.

Developmental and neonatal hematology. New York: Raven Press, 1988:88.

285. Christensen RD, Rothstein G, Anstall HB, et al. Granulocyte transfusions in neonates with bacterial infection, neutropenia, and depletion of mature marrow neutrophils. *Pediatrics* 1982;70:1-6.
286. Koenig JM, Christensen RD. Incidence, neutrophil kinetics and natural history of neonatal neutropenia associated with maternal hypertension. *N Engl J Med* 1989;321:557-562.
287. Christensen RD. Granulocytopoiesis in the fetus and neonate. *Transfus Med Rev* 1990;4:8-13.
288. Baley JE, Stork EK, Warkentin PI, et al. Buffy coat transfusions in neutropenic neonates with presumed sepsis: a prospective, randomized trial. *Pediatrics* 1987;80:712-720.
289. Cairo MS, Worcester C, Rucker R, et al. Role of circulating complement and polymorphonuclear leukocyte transfusion in treatment and outcome in critically ill neonates with sepsis. *J Pediatr* 1987;110:935-941.
290. Laurenti F, Ferro R, Isacchi G, et al. Polymorphonuclear leukocyte transfusion for the treatment for sepsis in the newborn infant. *J Pediatr* 1981;98:118-123.
291. Cairo MS, Worcester CC, Rucker RW, et al. Randomized trial of granulocyte transfusions versus intravenous immune globulin therapy for neonatal neutropenia and sepsis. *J Pediatr* 1992;120:281-285.
292. Lasky LC, Ash RC, Kersey JH, et al. Collection of pluripotential hematopoietic stem cells by cytophoresis. *Blood* 1982;59:822-827.
293. Duhrsen U, Villeval JL, Boyd J, et al. Effects of recombinant human granulocyte colony stimulating factor on hematopoietic progenitor cells in cancer patients. *Blood* 1988;72:2074-2081.
294. Siena S, Bregni M, Brando B, et al. Circulation of CD34+ hematopoietic stem cells in the peripheral blood of high-dose cyclophosphamide-treated patients: enhancement by intravenous recombinant human granulocyte-macrophage colony-stimulating factor. *Blood* 1989;74:1905-1914.
295. Peters WP, Rosner G, Ross M, et al. Comparative effects of granulocyte-macrophage colony-stimulating factor (GM-CSF) and granulocyte colony-stimulating factor (G-CSF) on priming peripheral blood progenitor cells for use with autologous bone marrow after high-dose chemotherapy. *Blood* 1993;81:1709-1719.
296. Elias A, Ayash L, Anderson KC, et al. Mobilization of peripheral blood progenitor cells by chemotherapy and granulocyte-macrophage colony-stimulating factor for hematologic support and high-dose intensification for breast cancer. *Blood* 1992;79:3036-3044.
297. Körbling M. Allogeneic peripheral blood stem cell transplantation for hematologic diseases. *Cancer Treat Res* 1999;101:1-23.
298. Storek J, Gooley T, Siadak M, et al. Allogeneic peripheral blood stem cell transplantation may be associated with a high risk of chronic graft-versus-host disease. *Blood* 1997;90:4705-4709.
299. Ringden O, Remberger M, Runde V, et al. Peripheral blood stem cell transplantation from unrelated donors: a comparison with marrow transplantation. *Blood* 1999;94:455-464.
300. Bensinger W, Appelbaum F, Rowley S, et al. Factors that influence collection and engraftment of autologous peripheral-blood stem cells. *J Clin Oncol* 1995;13:2547-2555.
301. Weaver CH, Hazelton B, Birch R, et al. An analysis of engraftment kinetics as a function of the CD34 content of peripheral blood progenitor cell collections in 692 patients after the administration of myeloablative chemotherapy. *Blood* 1995;86:3961-3969.
302. Kessinger A, Armitage JO, Landmark JD, et al. Autologous peripheral hematopoietic stem cell transplantation restores hematopoietic function following marrow ablative therapy. *Blood* 1988;71:723-727.
303. Lasky LC, Hurd DD, Smith JA, et al. Peripheral blood stem cell collection and use in Hodgkin's

- disease. Comparison with marrow in autologous transplantation. *Transfusion* 1989;29:323–327.
304. Kessinger A, Armitage JO, Smith DM, et al. High dose therapy and autologous peripheral blood stem cell transplantation for patients with lymphoma. *Blood* 1989;74:1260–1265.
305. Wagner JE, Kernan NA, Steinbuch M, et al. Allogeneic sibling umbilical-cord-blood transplantation in children with malignant and non-malignant disease. *Lancet* 1995;346:214–219.
306. Gluckman E, Rocha V, Boyer-Chammard A, et al. Outcome of cord-blood transplantation from related and unrelated donors. Eurocord Transplant Group and the European Blood and Marrow Transplantation Group. *N Engl J Med* 1997;337:373–381.
307. Rubinstein P, Carrier C, Scaradavou A, et al. Outcomes among 562 recipients of placental-blood transplants from unrelated donors. *N Engl J Med* 1998;339:1565–1577.
308. Smith JF, Ness PM, Moroff G, et al. Retention of coagulation factors in plasma frozen after extended holding at 1–6° C. *Vox Sang* 2000;78:28–30.
309. Nilsson L, Hedner U, Nilsson IM, et al. Shelf-life of bank blood and stored plasma with special reference to coagulation factors. *Transfusion* 1983;23:377–381.
310. Bowie EJW, Thompson JH, Owen CA. The stability of antihemophilic globulin and labile factor in human blood. *Mayo Clin Proc* 1964;39:144–151.
311. Cohn EJ, et al. Preparation and properties of serum and plasma proteins. IV. A system for the separation into fractions of the protein and lipoprotein components of biological tissues and fluids. *J Am Chem Soc* 1946;68:459.
312. Watt JG. Plasma fractionation. *Clin Haematol* 1976;5:95.
313. Colombo M, Mannucci PM, Carnelli V, et al. Transmission of non-A, non-B hepatitis by heat-treated factor VIII concentrate. *Lancet* 1985;2:1–4.
314. Centers for Disease Control. Update: acquired immunodeficiency syndrome (AIDS) in persons with hemophilia. *MMWR* 1984;33:589–591.
315. Guidance for Industry: Revised preventive measures to reduce the possible risk of transmission of Creutzfeldt-Jakob disease (CJD) and variant Creutzfeldt-Jakob disease (vCJD) by blood and blood products. Rockville, MD. Food and Drug Administration. Center for Biologics Evaluation and Research. January 2002.
316. Alexander MR, Ambre JJ, Liskow BI, et al. Therapeutic use of albumin. *JAMA* 1979;241:2527–2529.
317. Tullis JL. Albumin 1. Background and use 2. Albumin 2. Guidelines for clinical use. *JAMA* 1977;237:355–360; 460–463.
318. Horowitz B, Bonomo R, Prince AM, et al. Solvent/detergent-treated plasma: a virus-inactivated substitute for fresh frozen plasma. *Blood* 1992;79:826–831.
319. Pehta JC. Clinical studies with solvent detergent-treated products. *Transfus Med Rev* 1996;10:303–311.
320. Koenigbauer UF, Eastlund T, Day JW. Clinical illness due to parvovirus B19 infection after infusion of solvent/detergent-treated pooled plasma. *Transfusion* 2000;40:1203–1206.
321. Davenport R, Geohas G, Cohen S, et al. Phase IV study of PLAS + SD: hepatitis A (HAV) and parvovirus B19 (B19) safety results. *Blood* 2000;96:(abst).
322. Lusher JM, Blatt PM, Penner JA, et al. Autoplex versus proplex: a controlled, double-blind study of effectiveness in acute hemarthroses in hemophiliacs with inhibitors to factor VIII. *Blood* 1983;62:1135–1138.
323. Sjamsoedin LJ, Heijnen L, Mauser-Bunschoten EP, et al. The effect of activated prothrombin-complex concentrate (FEIBA) on joint and muscle bleeding in patients with hemophilia A and

- antibodies to factor VIII. A double-blind clinical trial. *N Engl J Med* 1981;305:717-721.
324. Gallus S. Replacement therapy in antithrombin III deficiency. *Transfus Med Rev* 1989;3:253-263.
325. Miller N, Hultin MB, Gounder M, et al. Hereditary antithrombin III deficiency: case report and review of recent therapeutic advances. *Am J Hematol* 1986;21:215-221.
326. Inkster M, Sherman LA, Ahmed P, et al. Preservation of antithrombin III activity in stored whole blood. *Transfusion* 1984;24:57-59.
327. Bernard GR, Vincent JL, Laterre PF, et al. Efficacy and safety of recombinant human activated protein C for severe sepsis. *N Engl J Med* 2001;344:699-709.
328. Hassig A. Intravenous immunoglobulins: pharmacological aspects and therapeutic use. *Vox Sang* 1986;51:10-17.
329. Kobayashi RH, Stiehm ER. Immunoglobulin therapy. In: Petz LD, Swisher SN, Kleinman S, et al., eds. *Clinical practice of transfusion medicine*, 3rd ed. New York: Churchill Livingstone, 1996:985-1010.
330. Boshkov LK, Kelton JG. Use of intravenous gammaglobulin as an immune replacement and an immune suppressant. *Transfus Med Rev* 1989;3:82-120.
331. Kelton JG. The interaction of IgG with reticuloendothelial cells: biological and therapeutic implications. In: Garratty G, ed. *Current concepts in transfusion therapy*. American Association of Blood Banks, 1985:51.
332. van Aken WG. Preparation of plasma derivatives. In: Simon TL, Dzik WH, Snyder EL, et al., eds. *Rossi's principles of transfusion medicine*, 3rd ed. Philadelphia: Lippincott Williams & Wilkins, 2002:304-334.
333. Non-A non-B hepatitis and intravenous immunoglobulin. *Lancet* 1985;1:404-405.
334. Lehner PJ, Webster AD. Hepatitis C from immunoglobulin infusion. *BMJ* 1993;306:1541-1542.
335. Bjoro K, Froland SS, Yun Z, et al. Hepatitis C infection in patients with primary hypogammaglobulinemia after treatment with contaminated immune globulin. *N Engl J Med* 1994;331:1607-1611.
336. Centers for Disease Control. Outbreak of hepatitis C associated with intravenous immunoglobulin administration: United States, October 1993-June 1994. *MMWR* 1994;43:505-509.
337. Lostumbo MM, Holland PV, Schmidt PJ. Isoimmunization after multiple transfusions. *N Engl J Med* 1966;275:141-144.
338. Giblett ER. Critique of theoretical hazard of inter- vs intra-racial transfusion. *Transfusion* 1961;1:233.
339. Blumberg N, Peck K, Ross K, et al. Immune response to chronic red blood cell transfusion. *Vox Sang* 1983;44:212-217.
340. Coles SM, Klein HG, Holland PV. Alloimmunization in two multitransfused patient populations. *Transfusion* 1981;21:462-466.
341. Davies SC, McWilliam AC, Hewitt PE, et al. Red cell alloimmunization in sickle cell disease. *Br J Haematol* 1986;63:241-245.
342. Vichinsky EP, Earles A, Johnson RA, et al. Alloimmunization in sickle cell anemia and transfusion of racially unmatched blood. *N Engl J Med* 1990;322:1617-1621.
343. Sharon BI, Honig GR. Management of congenital hemolytic anemias. In: Simon TL, Dzik WH, Snyder EL, et al., eds. *Rossi's principles of transfusion medicine*, 3rd ed. Philadelphia: Lippincott Williams & Wilkins, 2002:463-482.
344. Overweg J, Engelfriet CP. Cytotoxic leucocyte iso-antibodies formed during the first pregnancy. *Vox*

Sang 1969;16:97–104.

345. Fauchet R, Genetet B, Gueguen M, et al. Transfusion therapy and HLA antibody response in patients undergoing open heart surgery. *Transfusion* 1982;22:320–322.

346. Dutcher JP, Schiffer CA, Aisner J, et al. Alloimmunization following platelet transfusion: the absence of a dose–response relationship. *Blood* 1981;57:395–398.

347. Allen JC, Kunkel HG. Antibodies against gamma–globulin after repeated blood transfusions in man. *J Clin Invest* 1966;45:29–39.

348. Kernoff PBA, Bowell PJ. Gm types and antibodies in multitransfused haemophiliacs. *Br J Haematol* 1973;24:443–450.

349. McVerry BA, Machin SJ. Incidence of allo–immunization and allergic reactions to cryoprecipitate in haemophilia. *Vox Sang* 1979;36:77–80.

350. Schmidt AP, Taswell HF, Gleich GJ. Anaphylactic transfusion reactions associated with anti–IgA antibody. *N Engl J Med* 1969;280:188–193.

351. Pineda AA, Taswell HF. Transfusion reactions associated with anti–IgA antibodies: report of four cases and review of the literature. *Transfusion* 1975;15:10–15.

352. Sandler SG, Mallory D, Malamut D, et al. IgA anaphylactic transfusion reactions. *Transfus Med Rev* 1995;9:1–8.

353. Rivat L, Rivat C, Daveau M, et al. Comparative frequencies of anti–IgA antibodies among patients with anaphylactic transfusion reactions and among normal blood donors. *Clin Immunol Immunopathol* 1977;7:340–348.

354. Taswell HF, Pineda AA, Moore SB. Hemolytic transfusion reactions: frequency and clinical and laboratory aspects. In: Bell CA, ed. *A Seminar on immune–related cell destruction*. Washington: American Association of Blood Banks, 1981:71–92.

355. Greenwalt TJ. Pathogenesis and management of hemolytic transfusion reactions. *Semin Hematol* 1981;18:84–94.

356. Beaugregard P, Blajchman MA. Hemolytic and pseudo–hemolytic transfusion reactions: an overview of the hemolytic transfusion reactions and the clinical conditions that mimic them. *Transfus Med Rev* 1994;8:184–199.

357. Davenport RD. Hemolytic transfusion reactions. In: Simon TL, Dzik WH, Snyder EL, et al., eds. *Rossi's principles of transfusion medicine*, 3rd ed. Philadelphia: Lippincott Williams & Wilkins, 2002:815–828.

358. Pineda AA, Brzica SM, Jr., Taswell HF. Hemolytic transfusion reaction: recent experience in a large blood bank. *Mayo Clin Proc* 1978;53:378–390.

359. Pineda AA, Taswell HF, Brzica SM, Jr. Transfusion reaction. An immunologic hazard of blood transfusion. *Transfusion* 1978;18:1–7.

360. Honig CL, Bove JR. Transfusion–associated fatalities: review of Bureau of Biologics reports 1976–1978. *Transfusion* 1980;20:653–661.

361. Sazama K. Reports of 355 transfusion–associated deaths: 1976 through 1985. *Transfusion* 1990;30:583–590.

362. Pierce L, Reich LM, Mayer K. Hemolysis following platelet transfusions from ABO incompatible donors. *Transfusion* 1985;25:60–62.

363. Zoes C, Dube VE, Miller HJ, et al. Anti–A1 in the plasma of platelet concentrates causing a hemolytic reaction. *Transfusion* 1977;17:29–32.

364. Lundberg WB, McGinniss MH. Hemolytic transfusion reaction due to anti–A1. *Transfusion*

1975;15:1-9.

365. Seager OA, Nesmith MA, Begelman KA, et al. Massive acute hemodilution for incompatible blood reaction. *JAMA* 1974;229:790-792.

366. Chaplin H. The implication of red cell-bound complement in delayed hemolytic transfusion reactions. *Transfusion* 1984;24:185-187.

367. Moore SB, Taswell HF, Pineda AA, et al. Delayed hemolytic transfusion reactions. *Am J Clin Pathol* 1980;74:94-97.

368. Patten E, Reddi CR, Riglin H, et al. Delayed hemolytic transfusion reaction caused by a primary immune response. *Transfusion* 1982;22:248-250.

369. Ness PM, Shirey RS, Thoman SK, et al. The differentiation of delayed serologic and delayed hemolytic transfusion reactions: incidence, long-term serologic findings, and clinical significance. *Transfusion* 1990;30:688-693.

370. Barton JC. Nonhemolytic, noninfectious transfusion reactions. *Semin Hematol* 1981;18:95-121.

371. Stack G, Pomper GJ. Febrile, allergic, and nonimmune transfusion reactions. In: Simon TL, Dzik WH, Snyder EL, et al., eds. *Rossi's principles of transfusion medicine*, 3rd ed. Philadelphia: Lippincott Williams & Wilkins, 2002:831-851.

372. Judd WJ, Barnes A. Clinical and serological aspects of transfusion reactions: a technical workshop. Arlington: American Association of Blood Banks, 1982.

373. Payne R, Rolfs MR. Further observations of leukoagglutinin transfusion reactions. *Am J Med* 1960;29:499.

374. Perkins HA, Payne R, Ferguson J, et al. Nonhemolytic febrile transfusion reactions. *Vox Sang* 1966;11:578-600.

375. Decary F, Ferner P, Giavedoni L, et al. An investigation of non-hemolytic transfusion reactions. *Vox Sang* 1984;46:277-285.

376. de Rie MA, van der Plas-van Dalen CM, Engelfriet CP, et al. The serology of febrile transfusion reactions. *Vox Sang* 1985;49:126-134.

377. Brubaker DB. Clinical significance of white cell antibodies in febrile nonhemolytic transfusion reactions. *Transfusion* 1990;30:733-737.

378. Davenport RD, Kunkel SL. Cytokine roles in hemolytic and nonhemolytic transfusion reactions. *Transfus Med Rev* 1994;8:157-168.

379. Muylle L, Peetermans ME. Effect of prestorage leukocyte removal of the cytokine levels in stored platelet concentrates. *Vox Sang* 1994;66:14-17.

380. Wadhwa M, Seghatchian MJ, Dilger P, et al. Cytokines in WBC-reduced apheresis PCs during storage: a comparison of two WBC-reduction methods. *Transfusion* 2000;40:1118-1126.

381. Goldman M, Blajchman MA. Blood product associated bacterial sepsis. *Transfus Med Rev* 1991;5:73-83.

382. Wagner SJ, Friedman LI, Dodd RY. Transfusion-associated bacterial sepsis. *Clin Microbiol Rev* 1994;7:290-302.

383. Sazama K. Bacteria in blood for transfusion. A review. *Arch Pathol Lab Med* 1994;118:350-365.

384. Meryman HT, Hornblower M. The preparation of red cells depleted of leukocytes. Review and evaluation. *Transfusion* 1986;26:101-106.

385. Bruil A, Beugeling T, Feijen J, et al. The mechanisms of leukocyte removal by filtration. *Transfus Med*



Rev 1995;9:145–166.

386. Lieden G, Hilden JO. Febrile transfusion reactions reduced by use of buffy-coat-poor erythrocyte concentrates. *Vox Sang* 1982;43:263–265.
387. Goldfinger D. Febrile transfusion reaction: what blood component should be given next? *Vox Sang* 1983;44:400–401.
388. When is the microfiltration of whole blood and red cell concentrates essential? When is it superfluous? *Vox Sang* 1986;50:54–64.
389. Heddle NM, Blajchman MA, Meyer RM, et al. A randomized controlled trial comparing the frequency of acute reactions to plasma-removed platelets and prestorage WBC-reduced platelets. *Transfusion* 2002;42:556–566.
390. Popovsky MA, Moore SB. Diagnostic and pathogenetic considerations in transfusion-related acute lung injury. *Transfusion* 1985;25:573–577.
391. Popovsky MA, Chaplin HC, Moore SB. Transfusion-related acute lung injury: a neglected, serious complication of hemotherapy. *Transfusion* 1992;32:589–592.
392. Jacob HS. Complement-mediated leucoembolization: a mechanism of tissue damage during extracorporeal perfusions, myocardial infarction and in shock: a review. *Q J Med* 1983;52:289–296.
393. Levy GJ, Shabot MM, Hart ME, et al. Transfusion-associated noncardiogenic pulmonary edema: Report of a case and a warning regarding treatment. *Transfusion* 1986;26:278–281.
394. Oen KG, Petty RE, Schroeder ML. Immunoglobulin A deficiency: genetic studies. *Tissue Antigens* 1982;19:174–182.
395. Burks AW, et al. Anaphylactic reactions after gamma globulin administration in patients with hypogammaglobulinemia: detection of IgG antibodies to IgA. *N Engl J Med* 1960;314:560.
396. Yap PL, Pryde EA, McClelland DB. IgA content of frozen-thawed-washed red blood cells and blood products measured by radioimmunoassay. *Transfusion* 1982;22:36–38.
397. Vyas GN, Perkins HA. Anti-IgA in blood donors. *Transfusion* 1976;16:289–290.
398. Abramson N, Eisenberg PD, Aster RH. Post-transfusion purpura: immunologic aspects and therapy. *N Engl J Med* 1974;291:1163–1166.
399. Pegels JG, Bruynes EC, Engelfriet CP, et al. Post-transfusion purpura: a serological and immunological study. *Br J Haematol* 1981;49:521–530.
400. Shulman NR, Aster RH, Leitner A, et al. Immunoreactions involving platelets. V. Post-transfusion purpura due to a complement-fixing antibody against a genetically controlled platelet antigen. A proposed mechanism for thrombocytopenia and its relevance in “autoimmunity.” *J Clin Invest* 1961; 40:1597.
401. Mueller-Eckhardt C. Post-transfusion purpura. *Br J Haematol* 1986;64:419–424.
402. Shulman NR, Jordan JV. Platelet immunology. In: Coleman RW, Hirsch J, Marder VJ, et al., eds. *Hemostasis and thrombosis*. Philadelphia: JB Lippincott, 1987:452–529.
403. Hamblin TJ, Naorose Abidi SM, Nee PA, et al. Successful treatment of post-transfusion purpura with high dose immunoglobulins after lack of response to plasma exchange. *Vox Sang* 1985;49:164–167.
404. Slichter SJ. Post-transfusion purpura: response to steroids and association with red blood cell and lymphocytotoxic antibodies. *Br J Haematol* 1982;50:599–605.
405. Ballem PJ, Buskard NA, Decary F, et al. Post-transfusion purpura secondary to passive transfer of anti-PLA1 by blood transfusion. *Br J Haematol* 1987;66:113–114.
406. Nijjar TS, Bonacossa IA, Israels LG. Severe acute thrombocytopenia following infusion of plasma

containing anti-PLA1. *Am J Hematol* 1987;25:219–221.

407. Scott EP, Moilan-Bergland J, Dalmasso AP. Posttransfusion thrombocytopenia associated with passive transfusion of a platelet-specific antibody. *Transfusion* 1988;28:73–76.

408. Vamvakas EC, Blajchman MA. Deleterious clinical effects of transfusion-associated immunomodulation: fact or fiction? *Blood* 2001;97:1180–1195.

409. Bordin JO, Blajchman MA. Transfusion-associated immunomodulation. In: Simon TL, Dzik WH, Snyder EL, et al., eds. *Rossi's principles of transfusion medicine*, 3rd ed. Philadelphia: Lippincott Williams & Wilkins, 2002:867–877.

410. Blajchman MA, Singal DP. The role of red blood cell antigens, histocompatibility antigens, and blood transfusions on renal allograft survival. *Transfus Med Rev* 1989;3:171–179.

411. Kahan BD. Effects of transfusion on recipient immune status: relationship to transplantation. *Prog Clin Biol Res* 1985;182:345–374.

412. Rodey GE. Blood transfusions and their influence on renal allograft survival. *Prog Hematol* 1986;14:99–122.

413. Singal DP, Ludwin D, Blajchman MA. Blood transfusion and renal transplantation. *Br J Haematol* 1985;61:595–602.

414. Heiss MM, Mempel W, Delanoff C, et al. Blood transfusion-modulated tumor recurrence: first results of a randomized study of autologous versus allogeneic blood transfusion in colorectal cancer surgery. *J Clin Oncol* 1994;12:1859–1867.

415. Jensen LS, Andersen AJ, Christiansen PM, et al. Postoperative infection and natural killer cell function following blood transfusion in patients undergoing elective colorectal surgery. *Br J Surg* 1992;79:513–516.

416. Heiss MM, Mempel W, Jauch KW, et al. Beneficial effect of autologous blood transfusion on infectious complications after colorectal cancer surgery. *Lancet* 1993;342:1328–1333.

417. Jensen LS, Kissmeyer-Nielsen P, Wolff B, et al. Randomised comparison of leucocyte-depleted versus buffy-coat-poor blood transfusion and complications after colorectal surgery. *Lancet* 1996;348:841–845.

418. van de Watering LM, Hermans J, Houbiers JG, et al. Beneficial effects of leukocyte depletion of transfused blood on postoperative complications in patients undergoing cardiac surgery: a randomized clinical trial. *Circulation* 1998;97:562–568.

419. Tartter PI, Mohandas K, Azar P, et al. Randomized trial comparing packed red cell blood transfusion with and without leukocyte depletion for gastrointestinal surgery. *Am J Surg* 1998;176:462–466.

420. Busch OR, Hop WC, Hoynck van Papendrecht MA, et al. Blood transfusions and prognosis in colorectal cancer. *N Engl J Med* 1993;328:1372–1376.

421. Houbiers JG, Brand A, van de Watering LM, et al. Randomised controlled trial comparing transfusion of leucocyte-depleted or buffy-coat-depleted blood in surgery for colorectal cancer. *Lancet* 1994;344:573–578.

422. Busch OR, Hop WC, Marquet RL, et al. Autologous blood and infections after colorectal surgery. *Lancet* 1994;343:668–669.

423. Busch MP, Lee T-H, Heitman J. Allogeneic leukocytes but not therapeutic blood elements induce reactivation and dissemination of latent human immunodeficiency virus type 1 infection. *Blood* 1992;80:2128–2135.

424. Collier AC, Kalish LA, Busch MP, et al. Leukocyte-reduced red blood cell transfusions in patients with anemia and human immunodeficiency virus infection: the Viral Activation Transfusion Study: a randomized controlled trial. *JAMA* 2001;285:1592–1601.

425. Carey PM, Sacher RA. Transfusion-associated graft versus host disease. In: Simon TL, Dzik WH, Snyder EL, et al., eds. *Rossi's principles of transfusion medicine*, 3rd ed. Philadelphia: Lippincott Williams & Wilkins, 2002:852-864.
426. Brubaker DB. Human posttransfusion graft-versus-host disease. *Vox Sang* 1983;45:401-420.
427. Anderson KC, Weinstein HJ. Transfusion associated graft versus host disease. *N Engl J Med* 1990;323:315-321.
428. Petz LD, Calhoun P, Yam M, et al. Transfusion-associated graft-versus-host disease in immunocompetent patients: report of a fatal case associated with transfusion of blood from a second-degree relative, and a survey of predisposing factors. *Transfusion* 1993;33:742-750.
429. McMilin KD, Johnson RL. HLA homozygosity and the risk of related-donor transfusion-associated graft-versus-host disease. *Transfus Med Rev* 1993;7:37-41.
430. Schroeder ML. Transfusion-associated graft-versus-host disease. *Br J Haematol* 2002;117:275-287.
431. Jenner PW, Holland PV. Diagnosis and management of transfusion reactions. In: Petz LD, Swisher SN, Kleinman S, et al., eds. *Clinical practice of transfusion medicine*, 3rd ed. New York: Churchill Livingstone, 1996:905-929.
432. Luban NLC. Massive transfusion in the neonate. *Transfus Med Rev* 1995;9:200-214.
433. Snyder EL, Bookbinder M. Role of microaggregate blood filtration in clinical medicine. *Transfusion* 1983;23:460-470.
434. Jacobs A. Iron overload: clinical and pathologic aspects. *Semin Hematol* 1977;14:89-113.
435. Ley TJ, Griffith P, Nienhuis AW. Transfusion haemosiderosis and chelation therapy. *Clin Haematol* 1982;11:437-464.
436. Alter HJ. You'll wonder where the yellow went: a 15-year retrospective of posttransfusion hepatitis. In: Moore SB, ed. *Transfusion-transmitted viral diseases*. Arlington: American Association of Blood Banks, 1987.
437. Galel SA, Lifson JD, Engleman EG. Prevention of AIDS transmission through screening of the blood supply. *Annu Rev Immunol* 1995;13:201-227.
438. Aach RD, Szmunes W, Mosley JW, et al. Serum alanine aminotransferase of donors in relation to the risk of non-A, non-B hepatitis in recipients. *N Engl J Med* 1981;304:989-994.
439. Alter HJ, Holland PV. Indirect tests to detect the non-A, non-B hepatitis carrier state. *Ann Intern Med* 1984;101:859-861.
440. Stevens CE, Aach RD, Hollinger FB, et al. Hepatitis B virus antibody in blood donors and the occurrence of non-A, non-B hepatitis in transfusion recipients. *Ann Intern Med* 1984;101:733-738.
441. Petersen LR, Satten GA, Dodd R, et al. Duration of time from onset of human immunodeficiency virus type 1 infectiousness to development of detectable antibody. The HIV Seroconversion Study Group. *Transfusion* 1994;34:283-289.
442. Busch MP, Lee LL, Satten GA, et al. Time course of detection of viral and serologic markers preceding human immunodeficiency virus type 1 seroconversion: implications for screening of blood and tissue donors. *Transfusion* 1995;35:91-97.
443. Busch MP. Closing the windows on viral transmission by blood transfusion. In: Stramer SL, ed. *Blood safety in the new millennium*. Bethesda: American Association of Blood Banks, 2001:33-54.
444. Schreiber GB, Busch MP, Kleinman SH, et al. The risk of transfusion-transmitted viral infections. *N Engl J Med* 1996;334:1685-1690.

445. Glynn SA, Kleinman SH, Wright DJ, et al. International application of the incidence rate/window period model. *Transfusion* 2002;42:966–972.
446. Busch MP, Dodd RY. NAT and blood safety: what is the paradigm? *Transfusion* 2000;40:1157–1160.
447. Jackson BR, AuBuchon JP, Birkmeyer JD. Update of cost-effectiveness analysis for solvent-detergent-treated plasma. *JAMA* 1999;282:329.
448. Aach RD, Kahn RA. Post-transfusion hepatitis: current perspectives. *Ann Intern Med* 1980;92:539–546.
449. Alter HJ, Holland PV, Purcell RH. The emerging pattern of post-transfusion hepatitis. *Am J Med Sci* 1975;270:329–334.
450. Prince AM, Brotman B, Grady GF, et al. Long-incubation post-transfusion hepatitis without serological evidence of exposure to hepatitis B virus. *Lancet* 1974;2:241–246.
451. Choo QL, Kuo G, Weiner AJ, et al. Isolation of cDNA clone derived from a blood-borne non-A, non-B viral hepatitis genome. *Science* 1989;244:359–362.
452. Kuo G, Choo QL, Alter HJ, et al. An assay for circulating antibodies to a major etiologic virus of human non-A, non-B hepatitis. *Science* 1989;244:362–364.
453. Sjogren MH. Serologic diagnosis of viral hepatitis. *Med Clin North Am* 1996;80:929–956.
454. Hoofnagle JH. Serological markers of hepatitis B virus infection. *Annu Rev Med* 1981;32:1–11.
455. Vyas GN, et al. *Viral hepatitis*. Philadelphia: The Franklin Institute Press, 1978.
456. Dienstag JL. Transfusion-transmitted hepatitis B, A, and D. In: Simon TL, Dzik WH, Snyder EL, et al., eds. *Rossi's principles of transfusion medicine*, 3rd ed. Philadelphia: Lippincott Williams & Wilkins, 2002:733–741.
457. Koff RS. Natural history of acute hepatitis B in adults re-examined. *Gastroenterology* 1987;92:2035–2037.
458. Yuen MF, Lai CL. Treatment of chronic hepatitis B. *Lancet Infect Dis* 2001;1:232–241.
459. Blumberg BS. Australia antigen and the prevention of post transfusion hepatitis. *Vox Sang* 1985;48:55–59.
460. Dodd RY, Popovsky MA. Antibodies to hepatitis B core antigen and the infectivity of the blood supply. Scientific Section Coordinating Committee. *Transfusion* 1991;31:443–449.
461. Alter HJ. Discovery of the non-A, non-B hepatitis virus: the end of the beginning or the beginning of the end. *Transfus Med Rev* 1989;3:77–81.
462. Yotsuyanagi H, Yasuda K, Moriya K, et al. Frequent presence of HBV in the sera of HBsAg-negative, anti-HBc-positive blood donors. *Transfusion* 2001;41:1093–1099.
463. Kleinman SH, Kuhns MC, Busch MP, et al. HBV DNA Detection in HBsAg EIA-negative, anti-HBc-positive units: implications for minipool and individual donation HBV nucleic acid testing. *Transfusion* 2001;41[Suppl]:7S.
464. Biswas R, Busch M, Hsia C, et al. Comparative sensitivity of HBV NAT and HBsAg donor testing. *Transfusion* 2001;41[Suppl]:8S.
465. Stramer SL, Brodsky JP, Preston SB, et al. Comparative sensitivity of HBsAg and HBV NAT. *Transfusion* 2001;41[Suppl]:8S–9S.
466. Alter HJ. Post-transfusion hepatitis: clinical features, risk, and donor testing. *Prog Clin Biol Res*

1985;182:47-61.

467. Dienstag JL. Non-A, non-B hepatitis. I. Recognition, epidemiology, and clinical features. *Gastroenterology* 1983;85:439-462.
468. Dienstag JL. Non-A, non-B hepatitis. II. Experimental transmission, putative virus agents and markers, and prevention. *Gastroenterology* 1983;85:743-768.
469. Dodd RY. Hepatitis. In: Petz LD, Swisher SN, Kleinman S, et al., eds. *Clinical practice of transfusion medicine*, 3rd ed. New York: Churchill Livingstone, 1996:847-873.
470. Aach RD, Stevens CE, Hollinger FB, et al. Hepatitis C virus infection in post-transfusion hepatitis: an analysis with first- and second-generation assays. *N Engl J Med* 1991;325:1325-1329.
471. Centers for Disease Control and Prevention. Recommendations for Prevention and Control of Hepatitis C Virus (HCV) Infection and HCV-Related Chronic Disease. *MMWR* 1998;47(RR19):1-39.
472. Alter MJ, Hadler SC, Judson FN, et al. Risk factors for acute non-A, non-B hepatitis in the United States and association with hepatitis C virus infection. *JAMA* 1990;264:2231-2235.
473. Gross JB. Hepatitis C: a sexually transmitted disease? *Am J Gastroenterol* 2001;96:3051-3053.
474. McHutchison JG. Hepatitis C advances in antiviral therapy: what is accepted treatment now? *J Gastroenterol Hepatol* 2002;17:431-441.
475. Menitove JE. Rationale for surrogate testing to detect non-A, non-B hepatitis. *Transfus Med Rev* 1988;2:65-75.
476. Donahue JG, Munoz A, Ness PM, et al. The declining risk of post-transfusion hepatitis C virus infection. *N Engl J Med* 1992;327:369-373.
477. Galel SA, Strong DM, Tegtmeier GE, et al. Comparative yield of HCV RNA testing in blood donors screened by 2.0 versus 3.0 antibody assays. *Transfusion* 2002;42:1507-1513.
478. Cable R, Badon S, Pray C, et al. Limited utility of alanine aminotransferase screening of hepatitis C antibody-screened blood donors. *Transfusion* 1997; 37:206-210.
479. De Cock K, Govindarajan S, Chin KP, et al. Delta hepatitis in the Los Angeles area: a report of 126 cases. *Ann Intern Med* 1986;105:108-114.
480. Hoofnagle JH. Type D (Delta) hepatitis. *JAMA* 1989;261:1321-1325.
481. Nishioka NS, Dienstag JL. Delta hepatitis: a new scourge? *N Engl J Med* 1985;312:1515-1516.
482. Rizzetto M. The delta agent. *Hepatology* 1983;3:729-737.
483. Rosina F, Saracco G, Rizzetto M. Risk of post-transfusion infection with the hepatitis delta virus. *N Engl J Med* 1985;312:1488-1491.
484. Hollinger FB, Khan NC, Oefinger PE, et al. Post-transfusion hepatitis type A. *JAMA* 1983;250:2313-2317.
485. Sherertz RJ, Russell BA, Reuman PD. Transmission of hepatitis A by transfusion of blood products. *Arch Intern Med* 1984;144:1579-1580.
486. Teitel JM. Viral safety of haemophilia treatment products. *Ann Med* 2000;32:485-492.
487. Arankalle VA, Ticehurst J, Sreenivasan MA, et al. Aetiological association of a virus-like particle with enterically transmitted non-A, non-B hepatitis. *Lancet* 1988;1:550-554.
488. Alter HJ. Transfusion-transmitted hepatitis C and non-A, non-B, non-C virus infections. In: Simon TL, Dzik WH, Snyder EL, et al., eds. *Rossi's principles of transfusion medicine*, 3rd ed. Philadelphia:

Lippincott Williams & Wilkins, 2002:718–741.

489. Centers for Disease Control. Update on acquired immune deficiency syndrome (AIDS) among patients with hemophilia A. *MMWR* 1982;31:644–6; 652.

490. Centers for Disease Control. Possible transfusion-associated acquired immune deficiency syndrome (AIDS): California. *MMWR* 1982;31:652–654.

491. Barre-Sinoussi F, Chermann JC, Rey F, et al. Isolation of a T-lymphotropic retrovirus from a patient at risk for acquired immune deficiency syndrome (AIDS). *Science* 1983;220:868–871.

492. Gallo RC, Salahuddin SZ, Popovic M, et al. Frequent detection and isolation of cytopathic retroviruses (HTLV-III) from patients with AIDS and at risk for AIDS. *Science* 1984;224:500–503.

493. Gallo RC, Wong-Staal F. A human T-lymphotropic retrovirus (HTLV-III) as the cause of the acquired immunodeficiency syndrome. *Ann Intern Med* 1985;103:679–689.

494. Montagnier L. Lymphadenopathy-associated virus: from molecular biology to pathogenicity. *Ann Intern Med* 1985;103:689–693.

495. Centers for Disease Control and Prevention. Diagnosis and Reporting of HIV and AIDS in States with HIV/AIDS Surveillance—United States, 1994–2000. *MMWR* 2002;51:595–598.

496. Centers for Disease Control and Prevention. Guidelines for Using Antiretroviral Agents Among HIV-Infected Adults and Adolescents: recommendations of the Panel on Clinical Practices for Treatment of HIV. *MMWR* 2002;51(RR-07):1–56.

497. Busch MP, Young MJ, Samson SM, et al. Risk of human immunodeficiency virus (HIV) transmission by blood transfusions before the implementation of HIV-1 antibody screening. The Transfusion Safety Study Group. *Transfusion* 1991;31:4–11.

498. Kleinman SH, Niland JD, Azen SP, et al. Prevalence of antibodies to human immunodeficiency virus type 1 among blood donors prior to screening; The Transfusion Safety Study/NHLBI Donor Repository. *Transfusion* 1989;29:572–580.

499. Dodd RY. Germs, gels, and genomes: a personal recollection of 30 years in blood safety testing. In: Stramer SL, ed. *Blood safety in the new millennium*. Bethesda: American Association of Blood Banks, 2001:97–122.

500. Poesz BJ, Rusetti FW, Gazdar AF, et al. Detection and isolation of type C retrovirus particles from fresh and cultured lymphocytes from a patient with cutaneous T-cell lymphoma. *Proc Natl Acad Sci U S A* 1980;77:7415–7419.

501. Kalyanaraman VS, Sarngadharan MG, Robert-Guroff M, et al. A new subtype of human T-cell leukemia virus (HTLV-II) associated with a T-cell variant of hairy cell leukemia. *Science* 1982;218:571–573.

502. Vrieling H, Zaaijer HL, Reesink H. The clinical relevance of HTLV type I and II in transfusion medicine. *Transfus Med Rev* 1997;11:173–179.

503. Guidelines for counseling persons infected with human T-lymphotropic virus type I (HTLV-I) and type II (HTLV-II). Centers for Disease Control and Prevention and the U.S.P.H.S. Working Group. *Ann Intern Med* 1993;118:448–454.

504. Orton S. Syphilis and blood donors: what we know, what we do not know, and what we need to know. *Transfus Med Rev* 2001;15:282–291.

505. Infectious Disease Testing for Blood Transfusions. NIH Consensus Statement, 1995;13:1–27.

506. Meeting Transcript: Department Of Health And Human Services, Food And Drug Administration, Center For Biologics Evaluation And Research, Blood Products Advisory Committee, September 15, 2000. <http://www.fda.gov/ohrms/dockets/ac/cber00.htm#Blood%20Prducts>

507. van der Sluis JJ, Onvlee PC, Kothe FC, et al. Transfusion syphilis, survival of *Treponema pallidum* in

donor blood. I. Reporting of an orientating study. *Vox Sang* 1984;47:197–204.

508. van der Sluis JJ, ten Kate FJ, Vuzevski VD, et al. Transfusion syphilis, survival of *Treponema pallidum* in stored donor blood. II. Dose dependence of experimentally determined survival times. *Vox Sang* 1985;49:390–399.

509. Crumpacker CS. Cytomegalovirus. In: Mandell GL, Bennett JE, Dolin R, eds. *Mandell: principles and practice of infectious diseases*, 5th ed. Philadelphia: Churchill Livingstone, 2000:1586–1596.

510. Adler SP. Transfusion-associated cytomegalovirus infections. *Rev Infect Dis* 1983;5:977–993.

511. Preiksaitis JK, Brown L, McKenzie M. The risk of cytomegalovirus infection in seronegative transfusion recipients not receiving exogenous immunosuppression. *J Infect Dis* 1988;157:523–529.

512. Tegtmeier GE. Posttransfusion cytomegalovirus infections. *Arch Pathol Lab Med* 1989;113:236–245.

513. Wong ECC, Luban NLC. Cytomegalovirus and parvovirus transmission by transfusion. In: Simon TL, Dzik WH, Snyder EL, et al., eds. *Rossi's principles of transfusion medicine*, 3rd ed. Philadelphia: Lippincott Williams & Wilkins, 2002:757–771.

514. Smith DM, Lipton KS. Leukocyte reduction for the prevention of transfusion-transmitted cytomegalovirus. *Association Bulletin #97–2*. Bethesda: American Association of Blood Banks, 1997.

515. Malloy D, Lipton KS. Update on provision of CMV-reduced risk cellular blood components. *Association Bulletin #02–4*. Bethesda: American Association of Blood Banks, 2002.

516. Bowden RA, Slichter SJ, Sayers M, et al. A comparison of filtered leukocyte-reduced and cytomegalovirus (CMV) seronegative blood products for the prevention of transfusion-associated CMV infection after marrow transplant. *Blood* 1995;86:3598–3603.

517. Centers for Disease Control and Prevention; the Infectious Diseases Society of America; the American Society of Blood and Marrow Transplantation. Guidelines for preventing opportunistic infections among hematopoietic stem cell transplant recipients. *Biol Blood Marrow Transplant* 2000;6:659–734.

518. Sayers MH. Cytomegalovirus and other herpesviruses. In: Petz LD, Swisher SN, Kleinman S, et al., eds. *Clinical practice of transfusion medicine*, 3rd ed. New York: Churchill Livingstone, 1996:875–889.

519. Brown KE. Parvovirus B19. In: Mandell GL, Bennett JE, Dolin R, eds. *Mandell: principles and practice of infectious diseases*, 5th ed. Philadelphia: Churchill Livingstone, 2000:1685–1693.

520. Schmidt I, Blumel J, Seitz H, et al. Parvovirus B19 DNA in plasma pools and plasma derivatives. *Vox Sang* 2001;81:228–235.

521. Weimer T, Streicher S, Watson C, et al. High-titer screening PCR: a successful strategy for reducing the parvovirus B19 load in plasma pools for fractionation. *Transfusion* 2001;41:1500–1504.

522. Mungai M, Tegtmeier G, Chamberland M, et al. Transfusion-transmitted malaria in the United States from 1963 through 1999. *N Engl J Med* 2001;344:1973–1978.

523. Krause PJ. Babesiosis. *Med Clin North Am* 2002;86:361–373.

524. McQuiston JH, Childs JE, Chamberland ME, et al. Transmission of tick-borne agents of disease by blood transfusion: a review of known and potential risks in the United States. *Transfusion* 2000;40:274–284.

525. Krause PJ, Spielman A, Telford S, et al. Persistent parasitemia after acute babesiosis. *N Engl J Med* 1998;339:160–165.

526. Herwaldt BL, Neitzel DF, Gorlin JB, et al. Transmission of *Babesia microti* in Minnesota through four blood donations from the same donor over a 6-month period. *Transfusion* 2002;42:1154–1158.

527. Benson K. Bacterial and parasitic infections. In: Petz LD, Swisher SN, Kleinman S, et al., eds. *Clinical practice of transfusion medicine*, 3rd ed. New York: Churchill Livingstone, 1996:891–903.



528. Shulman IA, Haimowitz MD. Transmission of parasitic infections by blood transfusion. In: Simon TL, Dzik WH, Snyder EL, et al., eds. *Rossi's principles of transfusion medicine*, 3rd ed. Philadelphia: Lippincott Williams & Wilkins, 2002:774–783.
529. Leiby DA. Parasites and other emergent infectious agents. In: Stramer SL, ed. *Blood safety in the new millennium*. Bethesda: American Association of Blood Banks, 2001:55–78.
530. Leiby DA, Lenes BA, Tibbals MA, et al. Prospective evaluation of a patient with *Trypanosoma cruzi* infection transmitted by transfusion. *N Engl J Med* 1999;341:1237–1239.
531. Centers for Disease Control and Prevention. Chagas disease after organ transplantation—United States, 2001. *MMWR* 2002;51:210–212.
532. Petersen LR, Marfin AA. West Nile Virus: a primer for the clinician. *Ann Intern Med* 2002;137:173–179.
533. Centers for Disease Control and Prevention. Update: Investigations of West Nile Virus infections in recipients of organ transplantation and blood transfusion. *MMWR* 2002;51:833–836.
534. Centers for Disease Control and Prevention. Update: Investigations of West Nile Virus infections in recipients of organ transplantation and blood transfusion—Michigan, 2002. *MMWR* 2002;51:879.
535. Tyler KL. Prions and prion diseases of the central nervous system (Transmissible Neurodegenerative Diseases). In: Mandell GL, Bennett JE, Dolin R, eds. *Mandell: principles and practice of infectious diseases*, 5th ed. Philadelphia: Churchill Livingstone, 2000:1971–1985.
536. Turner ML. Variant Creutzfeldt–Jakob disease and blood transfusion. *Curr Opin Hematol* 2001;8:372–379.
537. Hunter N, Foster J, Chong A, et al. Transmission of prion diseases by blood transfusion. *J Gen Virol* 2002;83:2897–2905.
538. Brecher ME. Bacterial contamination of blood components. In: Simon TL, Dzik WH, Snyder EL, et al., eds. *Rossi's principles of transfusion medicine*, 3rd ed. Philadelphia: Lippincott Williams & Wilkins, 2002:789–805.
539. Jacobs MR, Palavecino E, Yomtovian R. Don't bug me: the problem of bacterial contamination of blood components—challenges and solutions. *Transfusion* 2001;41:1331–1334.
540. Barrett BB, Andersen JW, Anderson KC. Strategies for the avoidance of bacterial contamination of blood components. *Transfusion* 1993;33:228–233.
541. Ness P, Braine H, King K, et al. Single-donor platelets reduce the risk of septic platelet transfusion reactions. *Transfusion* 2001;41:857–861.
542. Kuehnert MJ, Roth VR, Haley NR, et al. Transfusion-transmitted bacterial infection in the United States, 1998 through 2000. *Transfusion* 2001;41:1493–1499.
543. Rhame FS, Root RK, MacLowry JD, et al. Salmonella septicemia from platelet transfusion. Study of an outbreak traced to a hematogenous carrier of *Salmonella choleraesuis*. *Ann Intern Med* 1973;78:633–641.
544. Snyder EL, Dodd RY. Reducing the risk of blood transfusion. *Hematology (Am Soc Hematol Educ Program)* 2001;433–442.
545. Wagner SJ. Pathogen inactivation in blood components. In: Simon TL, Dzik WH, Snyder EL, et al., eds. *Rossi's principles of transfusion medicine*, 3rd ed. Philadelphia: Lippincott Williams & Wilkins, 2002:806–814.
546. Slichter SJ, Corash L, Grabowski M, et al. Viability and hemostatic function of photochemically treated (PCT) platelets (PLTS) in thrombocytopenic patients. *Blood* 1999;94[Suppl 1]:367a(abst).
547. van Rhenen D, Gulliksson H, Pamphilon D, et al. S-59 (HELINX) photochemically treated platelets (plt) are safe and effective for support of thrombocytopenia: results of the EUROSPRITE phase 3 trial.

Blood 2000;96[Suppl 1]:819a(abst).

548. McLeod BC. An approach to evidence-based therapeutic apheresis. *J Clin Apheresis* 2002;17:124-132.

549. McLeod BC. Introduction to the third special issue: clinical applications of therapeutic apheresis. *J Clin Apheresis* 2000;15:1-5.

550. Koo AP. Therapeutic apheresis in autoimmune and rheumatic diseases. *J Clin Apheresis* 2000;15:18-27.

551. Grima KM. Therapeutic apheresis in hematological and oncological diseases. *J Clin Apheresis* 2000;15:28-52.

552. Winters JL, Pineda AA, McLeod BC, et al. Therapeutic apheresis in renal and metabolic diseases. *J Clin Apheresis* 2000;15:53-73.

553. Weinstein R. Therapeutic apheresis in neurological disorders. *J Clin Apheresis* 2000;15:74-128.

554. Kim HC. Therapeutic pediatric apheresis. *J Clin Apheresis* 2000;15:129-157.

555. Kincaid JC. Apheresis in treatment of the inflammatory demyelinating peripheral neuropathies. *Ther Apher* 2002;6:53-56.

556. Randomised trial of plasma exchange, intravenous immunoglobulin, and combined treatments in Guillain-Barre syndrome. Plasma Exchange/Sandoglobulin Guillain-Barre Syndrome Trial Group. *Lancet* 1997;349:225-230.

557. Levy JB, Pusey CD. Still a role for plasma exchange in rapidly progressive glomerulonephritis? *J Nephrol* 1997;10:7-13.

558. Rock G, Shumak KH, Sutton DM, et al. Cryosupernatant as replacement fluid for plasma exchange in thrombotic thrombocytopenic purpura. Members of the Canadian Apheresis Group. *Br J Haematol* 1996;94:383-386.

559. Moake JL. Thrombotic thrombocytopenic purpura and the hemolytic uremic syndrome. *Arch Pathol Lab Med* 2002;126:1430-1433.

560. Rock GA, Shumak KH, Buskard NA, et al. Comparison of plasma exchange with plasma infusion in the treatment of thrombotic thrombocytopenic purpura. Canadian Apheresis Study Group. *N Engl J Med* 1991;325:393-397.

561. Bukowski RM, King JW, Hewlett JS. Plasmapheresis in the treatment of thrombotic thrombocytopenic purpura. *Blood* 1977;50:413-417.

562. Buffaloe GW, Heineken FG. Plasma volume nomograms for use in therapeutic plasma exchange. *Transfusion* 1983;23:355-357.

563. Derksen RH, Schuurman HJ, Meyling FH, et al. The efficacy of plasma exchange in the removal of plasma components. *J Lab Clin Med* 1984;104:346-354.

564. Keller AJ, Urbaniak SJ. Intensive plasma exchange on the cell separator: effects on serum immunoglobulins and complement components. *Br J Haematol* 1978;38:531-540.

565. Volkin RL, Starz TW, Winkelstein A, et al. Changes in coagulation factors, complement, immunoglobulins, and immune complex concentrations with plasma exchange. *Transfusion* 1982;22:54-58.

566. Lichtman MA, Rowe JM. Hyperleukocytic leukemias: rheological, clinical and therapeutic considerations. *Blood* 1982;60:279-283.

567. Vamvakas EC, Pineda AA. Specialized therapeutic hemapheresis procedures. In: Simon TL, Dzik WH, Snyder EL, et al., eds. *Rossi's principles of transfusion medicine*, 3rd ed. Philadelphia: Lippincott Williams &

Wilkins, 2002:685–698.

568. Porcu P, Danielson CF, Orazi A, et al. Therapeutic leukapheresis in hyperleucocytic leukaemias: lack of correlation between degree of cytoreduction and early mortality rate. *Br J Haematol* 1997;98:433–436.

569. Goldfinger D, Thompson R, Lowe C, et al. Long-term plateletpheresis in the management of primary thrombocytosis. *Transfusion* 1979;19:336–338.

570. Taft EG, Babcock RB, Scharfman WB, et al. Plateletpheresis in the management of thrombocytosis. *Blood* 1977;50:927–933.

571. Strauss RG, McLeod BC. Complications of therapeutic apheresis. In: Popovsky MA, ed. *Transfusion reactions*. Bethesda: AABB Press, 2001:315–338.

572. Sutton DM, Nair RC, Rock G. Complications of plasma exchange. *Transfusion* 1989;29:124–127.

573. McLeod BC, Sniecinski I, Ciavarella D, et al. Frequency of immediate adverse effects associated with therapeutic apheresis. *Transfusion* 1999;39:282–288.

574. Chirnside A, Urbaniak SJ, Prowse CV, et al. Coagulation abnormalities following intensive plasma exchange on the cell separator. II. Effects on factors I, II, V, VII, VIII, IX, X and antithrombin III. *Br J Haematol* 1981;48:627–634.

575. Keller AJ, Chirnside A, Urbaniak SJ. Coagulation abnormalities produced by plasma exchange on the cell separator with special reference to fibrinogen and platelet levels. *Br J Haematol* 1979;42:593–603.

576. Bystryn JC, Graf MW, Uhr JW. Regulation of antibody formation by serum antibody. II. Removal of specific antibody by means of exchange transfusion. *J Exp Med* 1970;132:1279–1287.

577. Derksen RH, Schuurman HJ, Gmelig Meyling FH, et al. Rebound and overshoot after plasma exchange in humans. *J Lab Clin Med* 1984;104:35–43.

578. Huestis DW. Mortality in therapeutic haemapheresis. *Lancet* 1983;1:1043.

2004 Lippincott Williams & Wilkins  
John P. Greer, John Foerster, John N. Lukens  
George M. Rodgers, Frixos Paraskevas, Bertil Glader  
Wintrobe's Clinical Hematology

HISTORICAL PERSPECTIVEEarly Preclinical StudiesEarly Clinical StudiesHEMATOPOIETIC STEM CELLSIdentification of Cell Populations Enriched for Hematopoietic Stem CellsSites of Hematopoiesis and Sources of Hematopoietic Stem CellsCOLLECTION OF HEMATOPOIETIC STEM CELLS FOR TRANSPLANTATIONMarrowPeripheral BloodCord BloodSELECTION OF STEM CELL SOURCEAutologous Source of Stem CellsAllogeneic Source of Stem CellsABO INCOMPATIBILITYCONDITIONING REGIMENSMyeloablativeNonmyeloablativeENGRAFTMENTREGIMEN-RELATED TOXICITIESGRAFT-VERSUS-HOST DISEASEAcute Graft-Versus-Host DiseaseChronic Graft-Versus-Host DiseaseGRAFT-VERSUS-TUMOR EFFECTIMMUNE RECONSTITUTIONB CellsT CellsEvaluation of Hematopoiesis and Immunity in Patients Surviving More Than 20 Years after TransplantationAdoptive Transfer of ImmunityINFECTIOUS COMPLICATIONS AFTER HEMATOPOIETIC STEM CELL TRANSPLANTATIONBacterial InfectionsCandidal InfectionsAspergillus InfectionsHerpes InfectionsPneumocystis and Toxoplasmosis InfectionsImmunizationsREFERENCES

Pluripotent hematopoietic stem cells (HSCs) have the ability to reconstitute immunohematopoiesis after myeloablative therapy and transplantation (<sup>1</sup>). There are many potential sources for HSCs, which may be used for transplantation, including both the marrow and peripheral blood from the patient (autologous), family members, or volunteer unrelated donors. Umbilical cord blood has also been identified as a potential source of HSCs. HSC transplantation (HSCT) is done for a variety of therapeutic indications: (a) to support hematopoiesis after myeloablative doses of total body irradiation (TBI) and chemotherapy used in the treatment of hematologic malignancies, (b) to establish a graft-versus-leukemia (GVL) reaction, or (c) to replace diseased tissues of hematologic or immunologic origins. The advances in supportive care after transplantation have resulted in HSCT being a therapeutic modality that is highly successful in otherwise fatal diseases (<sup>2, 3</sup>). The focus of this chapter is on the general indications for HSCT, sources of stem cells, conditioning regimens, transplant biology issues, and complications

of HSCT; other chapters provide detailed discussions of the indications and results of HSCT in relation to specific diseases ( [Table 25.1](#)).

**TABLE 25.1. Disorders Treated by Bone Marrow or Stem Cell Transplantation**

| Disease                             | Chapter   |
|-------------------------------------|-----------|
| <b>Nonmalignant</b>                 |           |
| Aplastic anemia                     | 44        |
| Fanconi anemia                      | 45        |
| Diamond–Blackfan syndrome           | 45        |
| Sickle cell disease                 | 40        |
| Thalassemia                         | 42        |
| Paroxysmal nocturnal hemoglobinuria | 37        |
| Myelofibrosis                       | 86        |
| Congenital neutropenia              | 63        |
| Chédiak–Higashi syndrome            | 64        |
| Chronic granulomatous disease       | 64        |
| Glanzmann thrombasthenia            | 58        |
| Osteopetrosis                       | —         |
| Gaucher disease                     | 65        |
| Mucopolysaccharidosis               | —         |
| Mucopolipidoses                     | 65        |
| Immune deficiencies                 | 68 and 69 |
| <b>Malignant</b>                    |           |
| Acute nonlymphoblastic leukemia     | 80 and 81 |
| Acute lymphoblastic leukemia        | 78 and 79 |
| Hairy cell leukemia                 | 93        |
| Myelodysplasia                      | 83        |
| Chronic myelogenous leukemia        | 84        |
| Chronic lymphocytic leukemia        | 92        |
| Hodgkin disease                     | 95        |
| Non–Hodgkin lymphoma                | 90        |
| Multiple myeloma                    | 98        |
| Solid tumors                        | —         |

## HISTORICAL PERSPECTIVE

### Early Preclinical Studies

After the effects of radiation on hematopoiesis became evident during World War II, Jacobson and colleagues reported in 1949 that mice could survive an otherwise lethal exposure to TBI if the spleen was shielded ( [4](#) ). Radiation protection could also be conferred by infusion of bone marrow ( [5](#), [6](#) ). A runting syndrome developed after recovery of hematopoiesis when the infused marrow was from a donor of a different strain ( [7](#) ). This syndrome was due to graft–versus–host (GVH) disease (GVHD), a complication that was soon recognized to limit the use of allogeneic marrow

transplantation in humans. In further studies in mice, methotrexate (MTX) and 6-mercaptopurine were found to be effective in inducing immune tolerance or ameliorating the GVH reaction ( [8](#), [9](#) and [10](#) ).

The dog served as a random-bred model for studies of principles and techniques of bone marrow transplantation applicable to humans. The dog was the first random-bred species in which it was demonstrated that the results of *in vitro* histocompatibility typing could predict the outcome of marrow transplantation ( [11](#), [12](#) ). Littermates genotypically identical to their donors for the major histocompatibility complex (MHC) survived longer after marrow transplantation than did those transplanted with marrow from MHC-nonidentical siblings. However, despite the MHC genotypic identity, GVHD was still potentially severe in many but not all dogs. This indicated that other factors, identified as minor histocompatibility antigens (mHC), were involved in the development of GVHD. Pharmacologic immunosuppression with cyclosporine (CSP) or MTX, given for prevention of GVHD, improved survival after allogeneic marrow grafting ( [13](#), [14](#) ). It was then established that these two drugs in combination were more effective than either used alone ( [15](#) ). This observation led to the use of the combination of MTX and CSP in human patients in 1981, and this remains the standard in many transplant programs ( [16](#), [17](#) and [18](#) ).

### Early Clinical Studies

Bone marrow was the first commonly used source of HSCs for transplantation. Bone marrow transplantation from HLA-identical donors was first successfully used by two groups in 1968 to treat patients with immunologic deficiencies ( [19](#), [20](#) ). After extensive preclinical studies of GVHD, the first report of a successful marrow transplant for aplastic anemia from an HLA-identical sibling donor was published in 1972 ( [21](#) ). A report of 100 patients with end-stage leukemia treated with marrow transplantation was presented by a Seattle group in 1977 ( [22](#) ). Allogeneic HSCT from HLA-matched related or unrelated donors is now considered standard therapy for many malignant and nonmalignant hematologic diseases.

## HEMATOPOIETIC STEM CELLS

The *HSC* is defined as a cell with the ability to achieve long-term reconstitution of both myeloid and lymphoid lineages. To fulfill these criteria, HSCs must be able to self-renew and to be pluripotent. Colony-forming units (CFU) (e.g., CFU granulocyte-monocyte, CFU megakaryocyte, CFU erythroid, burst-forming unit erythroid) and long-term culture-initiating cells are progenitor cells that cannot reconstitute hematopoiesis ( [23](#), [24](#) ). No universally accepted *in vitro* assays for HSCs are currently available. A population of small mononuclear cells containing HSC can be identified by (a) a repertoire of cell-surface antigen expression, including the presence of the CD34 antigen and the absence of lineage-specific antigens; and (b) the exclusion of fluorescent vital dyes including Rhodamine 123 and Hoechst 33342.

A small population of CD34-negative HSCs has been identified in mice ( [25](#), [26](#) and [27](#) ). These HSCs may be in a resting or activated self-renewing state in which CD34 is reversibly expressed on only those cells that are activated ( [28](#) ). However, successful transplantation of this CD34-negative subset of HSCs into lethally irradiated mice also requires the presence of the CD34-positive subset ( [29](#) ). In humans and other species, successful sustained engraftment was achieved with the CD34-positive subset of cells,

confirming their true “stem cell” nature ( [30](#), [31](#), [32](#) and [33](#) ).

Marrow-derived pluripotent HSCs may include nonhematopoietic cell lineages, as some studies have shown or suggested that the transplantation of HSCs may result in the regeneration of muscle, endothelial cells, osteoblasts, hepatocytes, and neuronal and nonneuronal cells of the brain ( [34](#), [35](#), [36](#), [37](#), [38](#), [39](#), [40](#), [41](#) and [42](#) ). However, some of the experimental observations may have resulted from cell fusion, changes of the cells in culture before transplantation, or mistakenly identifying a cell from a nonhematopoietic lineage as hematopoietic. If “transdifferentiation” of circulating HSCs occurs, it is likely a rare event ( [43](#) ).

### Identification of Cell Populations Enriched for Hematopoietic Stem Cells

The CD34 antigen is a cell surface type 1 transmembrane protein that is highly O-glycosylated and expressed primarily on hematopoietic progenitor cells and vascular endothelium derived from many tissues ( [44](#), [45](#) and [46](#) ). Cell-surface expression of CD34 is developmentally regulated in hematopoiesis and is inversely related to the stage of differentiation, as CD34 expression is lost beyond the committed progenitor stage. The functional significance of CD34 expression on hematopoietic progenitor cells and developing blood vessels is unknown, except that CD34 on vascular endothelial cells binds to L-selectin ( [47](#) ). The CD34 knock-out mouse has a decreased number of embryonic hematopoietic progenitors, however, development is otherwise normal. In the grown CD34 knock-out mice, reduced colony-forming activity of hematopoietic progenitors was found, but recovery of hematopoiesis after sublethal irradiation was indistinguishable from that seen in wild-type mice ( [48](#) ).

The CD34 antigen is expressed on 1 to 5% of normal human adult marrow cells, up to 1% of mobilized peripheral blood cells, and by 2 to 10% of normal fetal liver and marrow cells ( [44](#), [49](#) ). Approximately 90 to 95% of the CD34-positive cells express antigens indicating commitment to the lymphoid or myeloid lineages ( [50](#), [51](#) ). Purified populations of HSCs can be obtained with strategies that lineage-deplete a CD34-positive population of cells using monoclonal antibodies (MAb) directed against DR, CD33, CD38, CD71, and B- and T-cell markers ( [Table 25.2](#) ). In addition, human HSCs appear to be Thy-1<sup>low</sup>, c-kit<sup>low</sup>, Rhodamine 123<sup>low</sup>, and CD133-positive ( [52](#), [53](#), [54](#), [55](#), [56](#) and [57](#) ). *In vivo* preclinical models for studying populations of purified human HSCs based on the previously mentioned characteristics include transplantation into severe combined immunodeficiency syndrome (SCID)-Hu mice or into fetal sheep ( [56](#), [58](#) ).

**TABLE 25.2. Characteristics of Human Hematopoietic Stem Cells**

Cell-surface antigen expression

Positive

CD34-positive [a](#)

CD133-positive

Low positive

Thy 1 (CDw90), c-kit

Negative

CD38, CD33, T- and B-cell markers, CD71, DR

Dye exclusion

Rhodamine 123, Hoechst 33342



<sup>a</sup> CD34–negative hematopoietic stem cells have been identified in mice.

---

In both animal and human studies, enriched populations of autologous CD34–positive marrow cells or blood cells have been shown to protect against myeloablative doses of radiation or chemotherapy ( [31](#), [59](#), [60](#) ). Conversely, the CD34–negative subset of the marrow was not protective ( [61](#) ). An evaluation of the contributions of the CD34–positive cells to long–term hematopoiesis in these studies was obscured initially by the lack of a marker to distinguish the transplanted autologous cells from endogenous reconstitution. Later, allogeneic CD34–enriched populations of marrow cells depleted of T cells and B cells were demonstrated to reconstitute stable lymphopoiesis and myelopoiesis in lethally irradiated dogs and baboons ( [31](#), [62](#) ). Complete and stable donor hematopoietic chimerism was also shown in humans after transplantation with allogeneic CD34–enriched cells from the peripheral blood ( [33](#), [63](#), [64](#) and [65](#) ). These studies have confirmed that CD34–positive hematopoietic cells are capable of producing long–term stable hematopoiesis and reconstituting multiple hematopoietic lineages.

### Sites of Hematopoiesis and Sources of Hematopoietic Stem Cells

In the developing human embryo, the production of hematopoietic cells shifts to the liver from the yolk sac after 6 weeks of gestation. At 16 weeks of gestation, the most active site of hematopoiesis is the fetal liver. At the end of gestation, essentially all hematopoietic production derives from the marrow with only small contributions from the liver and spleen. Umbilical cord blood is enriched for hematopoietic progenitor cells. Similar numbers of progenitors were found in a single collection of cord blood as in the volume of adult marrow normally required for successful engraftment ( [66](#) ). Eventually, it was shown that there were also sufficient numbers of long–term reconstituting cells in a collection of cord blood to successfully engraft recipients after myeloablative chemoradiotherapy ( [67](#), [68](#) and [69](#) ).

Because almost all hematopoietic production in normal adults occurs in the bone marrow, this was historically the site from which HSCs were routinely collected ( [1](#) ). This site was clinically reliable and provided an easily accessible source of long–term reconstituting cells. The presence of HSCs in peripheral blood was first documented in preclinical studies ( [70](#), [71](#) ). In early clinical studies, transplantation of autologous peripheral blood stem cells collected without the prior administration of chemotherapy or cytokines resulted in protection from myeloablative chemotherapy or chemoradiotherapy ( [72](#) ). However, obtaining sufficient cell numbers required a prolonged period of collection.

Mobilization of HSCs into the peripheral blood overcame the practical problem of collecting sufficient stem cells from this site. The number of CD34–positive cells collected from the peripheral blood after mobilization with granulocyte colony–stimulating factor (G–CSF) alone was similar or greater than that collected from a marrow harvest ( [73](#), [74](#) ). Combined chemotherapy and G–CSF resulted in even higher CD34–positive cell collection than with G–CSF alone, but sufficient numbers of CD34–positive cells in either graft resulted in rapid engraftment regardless of how the HSCs were collected ( [75](#) ). Cytokines used in combination [e.g., G–CSF and stem cell factor] were synergistic in the mobilization of HSCs into peripheral blood ( [76](#), [77](#) and [78](#) ). Among other cytokines that have been demonstrated to mobilize HSC into peripheral blood are granulocyte–macrophage colony–stimulating factor, interleukin (IL)–6, IL–8, and flt–3

ligand ( [79](#), [80](#) ). Mobilization strategies including chemotherapy are now routinely used for the collection of autologous HSCs from the peripheral blood ( [81](#), [82](#) and [83](#) ). Normal donors receive only G-CSF for the mobilization of HSCs to be used in allogeneic transplants. In addition to cytokines and chemotherapy, MAb specific to the adhesion molecule VLA-4 (very late antigen-4) can also mobilize hematopoietic progenitors in nonhuman primates ( [84](#) ). Infusion of MAb specific for the VLA-4 ligand and VCAM-1 (vascular cell adhesion molecule-1) gave similar results. An essential step contributing to the release of hematopoietic progenitors from the marrow may be the cleavage of VCAM-1 expressed on stromal cells by neutrophil proteinases after the administration of G-CSF ( [85](#) ). Hematopoietic progenitors reversibly down-regulate  $\alpha 4\beta 1$  integrin expression and adhere significantly less to stroma and fibronectin during mobilization ( [86](#) ).  $\alpha 4\beta 1$  integrin expression is restored after progenitors are removed from the *in vivo* mobilizing milieu, which may account for their homing properties after transplantation. The ability of MAb specific for certain adhesion molecules to mobilize HSCs suggests that cytokines may be effecting mobilization or homing by modulating the expression of adhesion molecules in the marrow microenvironment or on the HSCs.

## COLLECTION OF HEMATOPOIETIC STEM CELLS FOR TRANSPLANTATION

### Marrow

Marrow is obtained by multiple aspirations from the posterior iliac crest under general or epidural anesthesia ( [87](#) ). The anterior iliac crest or the sternum may also be harvested if larger quantities of marrow are required. The target volume of marrow for transplant is 10 to 15 ml/kg of recipient or donor weight, whichever is the smaller individual. Marrow is collected with heparinized syringes through large-bore needles and placed into small amounts of culture medium. The collected marrow must be filtered before intravenous transfusion into the recipient to remove small particles or clots. If the patient and donor are ABO-incompatible and there are high anti-A or -B titers, the marrow can be red blood cell-depleted or plasma-depleted depending on whether it is a major or minor ABO mismatch ( [88](#) ). In some cases of a major ABO mismatch, plasmapheresis of the recipient may be effective in reducing the high anti-A or -B titers so that red blood cell depletion of marrow is not required. Marrow is usually infused immediately after harvesting, but delays of 24 hours may occur without adverse consequences. These delays occur not infrequently when marrow is shipped from distant sites, usually after harvest from unrelated donors. In an analysis of marrow characteristics harvested from 1549 donors, the median total nucleated cell count was  $2.5$  (range, 0.3 to 12.0)  $\times 10^8$ /kg recipient weight ( [89](#) ). Life-threatening complications from marrow harvesting, usually related to the administration of anesthesia, were reported as 0.4% in this study population. Similar complication rates have been cited in other studies ( [90](#) ).

### Peripheral Blood

HSCs circulate in the peripheral blood, but the concentration is very low and therefore multiple aphereses are required to collect adequate numbers of HSCs. The number of leukaphereses may be reduced to one or two when HSCs are mobilized to the peripheral blood after the administration of cytokines alone or in combination with chemotherapy. An effective mobilization strategy for patients with malignancy is cyclophosphamide (CY)-based chemotherapy and G-CSF, 6  $\mu\text{g}/\text{kg}/\text{day}$  ( [83](#) ). After chemotherapy, leukapheresis is started when the total white blood cell count has recovered to  $1 \times 10^9/\text{L}$ . Patients who do not require chemotherapy and normal allogeneic donors can be

mobilized with G-CSF alone ( [63](#), [64](#), [91](#) ). Administration of G-CSF (5 to 16 µg/kg) is by daily subcutaneous injections for 5 to 8 days and is generally well tolerated. Bone pains, myalgias, and flulike symptoms may occur. Leukapheresis is performed as early as day 4 using a continuous blood flow separation technique. Pheresed products may be cryopreserved in 5% dimethylsulfoxide for use after thawing on the day of transplant. A more rapid sustained hematopoietic recovery of both neutrophil and platelet counts occurs with increasing numbers of CD34-positive peripheral blood stem cells (up to  $5 \times 10^6$ /kg). Some investigators consider  $2.5 \times 10^6$ /kg of recipient weight a minimum dose of CD34-positive cells from the peripheral blood to achieve complete autologous recovery. Platelet recovery also is more rapid at higher CD34-positive cell doses ( [82](#), [83](#) ). Because this cell dose yields consistent and prompt engraftment after autologous infusion, it could be considered an appropriate target for collection of allogeneic HSCs from the peripheral blood. Donors of peripheral blood avoid general anesthesia and other complications of marrow harvesting. If peripheral veins are inadequate, vascular access by a large-bore double-lumen catheter may be required.

### Cord Blood

Experience with the collection and transplantation of umbilical cord blood cells is still limited. However, umbilical cord blood cells are now being collected routinely and cryopreserved at the National Marrow Donor Program Network of Cord Blood Banks ( [92](#), [93](#) ). After the separation of the placenta, umbilical cord blood cells are collected into a closed system, which uses a sterile donor blood collection set. The placenta and umbilical cord can be suspended on a frame and the blood drained as a “standard gravity phlebotomy” into CPD (citrate, phosphate, dextrose) anticoagulant. The median volume of umbilical cord blood collected in one study of 44 patients was 100 ml (range, 42 to 282 ml) ( [68](#) ). The median number of nucleated cells per kilogram of recipient weight was  $5.2 \times 10^7$  (range, 1 to 33).

## SELECTION OF STEM CELL SOURCE

There are three general categories of HSC—autologous, syngeneic, and allogeneic—that may be used to reconstitute hematopoiesis after high-dose myeloablative chemoradiotherapy ( [Table 25.3](#) ). In general, the selection of the source of the stem cells to be used for any individual patient is based on (a) the availability and (b) the type of disease for which the patient is being transplanted. Availability is often the critical determinant of the type of stem cell selected. Although autologous HSCs should be available for most patients, extensive prior cytotoxic therapy or heavy involvement of marrow or peripheral blood with malignant cells may preclude the use of this source of HSCs. Although the preferred allogeneic donor is an HLA-matched sibling, not more than 30% of patients have access to this source. There are even fewer HLA-matched sibling donors for pediatric patients because of the smaller family size now compared to previous generations. Syngeneic donors are available in less than 1% of cases, and phenotypically HLA-matched or one-antigen-mismatched haploidentical family donors are available in less than 5% of cases ( [94](#), [95](#) ). Approximately 30 to 40% of patients may find a phenotypically HLA-matched unrelated donor on volunteer registries ( [96](#) ). The availability of unrelated or related umbilical cord blood grafts increases the chance of success for the identification of an allogeneic donor for both pediatric and adult patients, but the experience is still very limited for adults ( [67](#), [68](#) and [69](#) ).

**TABLE 25.3. Sources of Hematopoietic Stem Cells** [a](#)

---

|            | Relationship of Donor  | Major Histocompatibility Complex (HLA) Matching | Genetically Identical Haplotype | Minor Histocompatibility Complex Matching <sup>b</sup> | Site of Hematopoietic Stem Cell Collection |
|------------|------------------------|---|---------------------------------|--|--|
| Syngeneic  | Sibling                | Identical                                       | 2                               | Identical  | Marrow or peripheral blood                 |
| Allogeneic | Sibling                | Identical                                       | 2                               | Shared   | Marrow or peripheral blood                 |
|            | Sibling, parent, child | Zero- or one-antigen mismatch <sup>c</sup>      | 1                               | Shared   | Marrow                                     |
|            | Sibling                | Identical                                       | 2                               | Shared   | Umbilical cord blood                       |
|            | Sibling                | Zero- or one-antigen mismatch                   | 1                               | Shared   | Umbilical cord blood                       |
|            | Unrelated              | Identical or one-antigen mismatch               | 0                               | Divergent  | Marrow                                     |
|            | Unrelated              | Zero- to three-antigen mismatch                 | 0                               | Divergent  | Umbilical cord blood                       |
| Autologous | Self                   | —   | —                               | —  | Marrow or peripheral blood                 |

<sup>a</sup> Potential sources of hematopoietic stem cells to reconstitute patients after myeloablative therapy. Umbilical cord blood as a site of hematopoietic stem cells for transplantation is being investigated.

<sup>b</sup> *Shared* indicates a higher probability of sharing minor histocompatibility complex antigens within the family. *Divergent* indicates that the probability of sharing minor histocompatibility complex antigens is no better than that expected by matching two unrelated individuals who were randomly chosen. There is currently no routine testing for minor histocompatibility complex compatibility.

<sup>c</sup> Two- or three-antigen-mismatched transplants of unmanipulated marrow grafts from adult or pediatric family donors have, in general, a high transplant-related mortality.

The patient's disease requiring stem cell transplantation is another important determinant. Autologous, syngeneic, or allogeneic HSCs can support hematopoietic recovery after myeloablative chemoradiotherapy for malignant hematologic and nonhematologic diseases. For acquired disorders of marrow function (e.g., aplastic anemia), syngeneic or allogeneic HSCs are needed ( <sup>2</sup> ). Patients with congenital hematopoietic or immunologic defects (e.g., thalassemia, SCID) ( <sup>97</sup>, <sup>98</sup> ) require transplantation with allogeneic stem cells.

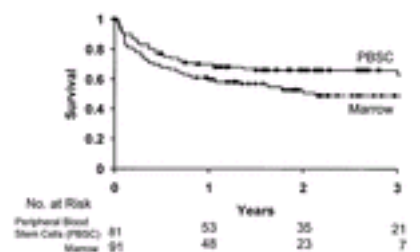
### Autologous Source of Stem Cells

Depending on the disease type, autologous marrow or peripheral blood stem cell grafts may be used when other donors are not available and may indeed be the stem cell of

choice. Autologous stem cell support is now most commonly derived from “mobilized” peripheral blood stem cells instead of marrow because of faster hematopoietic recovery in the recipient ( 81, 82). Peripheral blood stem cell transplants have decreased the time required for hospitalization. Before cryopreservation, autologous HSC graft may be treated with MAb, chemotherapeutic agents, or long-term culture to purge malignant cells from the graft. Autologous stem cell support after myeloablative therapy has been successful for treatment of acute myelogenous leukemia (AML), non-Hodgkin lymphoma, and Hodgkin disease ( 99, 100, 101, 102, 103 and 104). Disease-free survival was prolonged in patients with multiple myeloma ( 105, 106). Significant transplant-related complications encountered most frequently include liver or lung toxicity, caused in large part by high-dose myeloablative cytotoxic therapy. A GVHD-like syndrome involving the skin and gastrointestinal tract has been described, but it is generally not frequent or severe ( 107).

### Allogeneic Source of Stem Cells

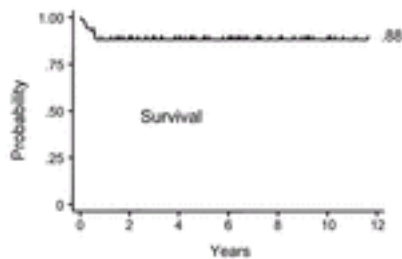
**TRANSPLANTATION FROM RELATED DONORS** The preferred allogeneic donor is a genotypically HLA-identical sibling. A genetic match at the HLA loci between siblings is confirmed by the genotyping of five HLA loci including HLA-A, HLA-B, HLA-C, HLA-DRB1, and HLA-DQB1. If an HLA-identical sibling is available, patients with hematologic malignancies should be transplanted with peripheral blood stem cells rather than marrow. Two phase 3 studies have now shown an improved disease-free and overall survival with transplantation of peripheral blood stem cells ( Fig. 25.1) ( 108, 109). A third study concluded that peripheral blood was an equivalent source of HSCs compared with marrow if administered to patients with standard-risk leukemia because a significant difference in survival could not be demonstrated ( 110). All three studies showed an accelerated recovery of neutrophil counts in the group receiving peripheral blood stem cells. Although most studies have not shown a significant increase in the incidence of acute GVHD in the peripheral blood stem cell group, the incidence of chronic GVHD is significantly greater ( 108, 109, 110 and 111). After longer follow-up in one study, a significant difference was not observed in the incidence of chronic GVHD between the two groups, but it was concluded that chronic GVHD may be more protracted and less responsive to treatment in those transplanted with peripheral blood HSCs ( 112). There was no difference in late transplant-related mortality or in the frequency of complications. Higher doses of CD34-positive cells in the peripheral blood stem cell graft ( $>8 \times 10^6/\text{kg}$ ) were associated significantly with the development of chronic GVHD ( 113). Because outcome is unlikely to be improved if peripheral blood stem cells result in an increased risk of chronic GVHD compared to marrow, patients with nonmalignant disorders should be transplanted with marrow. Survival of patients with aplastic anemia transplanted with marrow was 88% with a median follow-up of 6 years ( Fig. 25.2) ( 114). Similar results have been reported in patients transplanted with marrow for hemoglobinopathies ( 115, 116).



**Figure 25.1.** Probability of overall survival after myeloablative conditioning and transplantation with either peripheral blood stem cells or marrow. Survival at 2 years was improved in the peripheral blood stem cell group as compared to marrow (66% vs. 54%;  $p = .006$ ). Disease-free survival was also improved in the peripheral blood stem cell group ( $p = .003$ ). (From Bensinger WI, Martin PJ, Storer B, et al. Transplantation of bone marrow as



compared with peripheral-blood cells from HLA-identical relatives in patients with hematologic cancers. *N Engl J Med* 2001;344:175-181, with permission.)



**Figure 25.2.** Overall survival among the 94 patients with aplastic anemia who underwent transplantation from HLA-identical siblings after conditioning with cyclophosphamide and antithymocyte globulin. With a median follow-up of 6.0 (0.5 to 11.6) years, the Kaplan-Meier estimate of survival was 88%. Cyclosporine and methotrexate were administered after transplantation for graft-versus-host disease prophylaxis. (From Storb R, Blume KG, O'Donnell MR, et al. Cyclophosphamide and antithymocyte globulin to condition patients with aplastic anemia for allogeneic marrow transplantations: the experience in four centers. *Biol Blood Marrow Transplant* 2001;7:39-44, with permission.)

An HLA-haploidentical donor (parent, sibling, child) is available for almost all patients, but full haplotype differences (genotypically identical at one HLA haplotype but nonidentical at the other HLA haplotype) are associated with a high risk of severe GVHD, graft rejection, and increased mortality. However, transplants for hematologic malignancies from HLA-haploidentical family members mismatched for only one HLA antigen in the nonidentical HLA haplotype may have a similar overall survival to those transplanted with HSCs from HLA-identical siblings ([117](#)). In this situation, although the higher incidence of GVHD results in an increased transplant-related mortality, relapse is less frequent, resulting in no overall difference in long-term survival compared to transplants from HLA-matched siblings. Patients transplanted from HLA-haploidentical family members mismatched for two or more HLA loci had significantly lower overall survivals compared to patients transplanted from phenotypically matched unrelated donors ([118](#)). Transplantation of patients with advanced leukemia with high-dose CD34-positive cell grafts, which are highly T-cell depleted, resulted in 12 of 43 patients being alive and disease-free at 18 months ([119](#)). However, immune reconstitution after transplantation has been poor. Patients who lack a closely matched family donor should be offered a phenotypically matched unrelated donor before other investigational approaches are considered.

**TRANSPLANTATION FROM UNRELATED DONORS** After the initial success with transplantation of marrow from matched unrelated volunteers, large databanks were established around the world, including the National Marrow Donor Program in the United States. The worldwide registries, including the National Marrow Donor Program, contain more than 7 million volunteer donors who have been typed for HLA-A and -B antigens, and more than half of these are also typed for HLA-DR ([96](#)). The incidence of grade II to IV GVHD is approximately 70% after transplantation from matched unrelated donors, which is higher than the reported incidence of 35 to 40% for GVHD after transplants from HLA-matched siblings ([95](#), [120](#)). However, disease-free survival for patients with chronic myelogenous leukemia (CML) in chronic phase after transplantation from a matched unrelated volunteer within 1 year of diagnosis is comparable to that observed after HLA-matched sibling transplants ([121](#)). The Kaplan-Meier estimate of survival at 5 years is 57%. Survival at 5 years is 74% for patients who were 50 years of age or younger and who received a transplant from an HLA-matched donor within 1 year after diagnosis. More precise genotyping of the HLA loci improves outcome after transplantation from HLA-matched unrelated donors. DNA typing can identify unique alleles encoded by the

same serologic specificity ( [122](#), [123](#) ). Unrelated individuals, matched for HLA-A, -B, and -DR, may differ at other HLA loci ( [124](#), [125](#) ). Based on the availability of matched A, B, and DR donors listed in the Bone Marrow Worldwide Registry, a highly compatible donor (an allelic match for HLA-A/B/Cw/DRB1/DRB3/DRB5/DQB1 loci) was identified for 38.4% of the patients from whom at least a single blood sample could be obtained. If an HLA-DRB3, -DQB1, or -Cw mismatch was accepted, a potential donor would have been identified for 68.6% of patients. A single class I HLA antigen mismatch or two allelic mismatches without a single class I allelic mismatch were associated with a higher risk of graft failure ( [126](#) ). The presence of DRB1 mismatching correlated with a significantly worse survival and an increased incidence of grade III to IV acute GVHD ( [127](#) ). These results confirmed the importance of precise matching to improve outcome. Because of the higher risk of acute GVHD, studies of peripheral blood stem cell transplantation from unrelated donors started later than those done from HLA-identical donors. The rate of neutrophil and platelet recovery was increased with the use of peripheral blood stem cells, compared to what might have been expected with a marrow transplant ( [128](#), [129](#) ). The incidence of both acute and chronic GVHD appeared comparable between the two types of stem cell grafts. In one report, patients with CML in chronic phase had a better survival with peripheral blood stem cells than with marrow transplants ( [129](#) ). Prospective phase 3 studies are required to confirm the observations in these early reports.

**TRANSPLANTATION WITH UMBILICAL CORD BLOOD GRAFTS** The first successful cord blood cell transplant was done in 1988 ( [67](#) ). Two studies were then conducted of cord blood transplantation from HLA-matched or HLA-haploidentical allogeneic siblings (44 patients) and partially HLA-mismatched unrelated donors (25 patients) ( [68](#), [69](#) ). In the first report of a large experience in 562 recipients after transplantation with umbilical cord blood grafts from unrelated donors, the probability of engraftment at 42 days and grade III to IV GVHD was 81% and 23%, respectively ( [130](#) ). It was concluded from this study that stem cells derived from umbilical cord blood engraft regularly, cause a low rate of GVHD relative to the number of HLA mismatches, and produce survival rates comparable to those of transplantation of marrow from unrelated donors. This experience was confirmed in a retrospective analysis of 541 children with leukemia transplanted with stem cell grafts from unrelated donors of which 99 were from umbilical cord blood. Recipients of cord blood had an increased number of HLA mismatches but a significantly lower risk of both acute and chronic GVHD compared to recipients of unmanipulated marrow from unrelated donors. However, the day 100 mortality was higher in the cord blood group, possibly related to the significantly delayed recovery of hematopoiesis after transplantation ( [131](#) ). These results were later confirmed by another group ( [132](#) ). It was concluded that the use of umbilical cord blood was an option for children with acute leukemia lacking an acceptably matched unrelated marrow donor. In children who had received umbilical cord blood or bone marrow grafts from HLA-identical siblings, the umbilical cord blood group had a lower risk of acute and chronic GVHD, with a relative risk of 0.41 (  $p = .001$  ) and 0.35 (  $p = .02$  ), respectively ( [133](#) ). Survival was similar in both groups. The progenitor cell and CD34-positive cell content of the umbilical cord blood graft predicted the rate of neutrophil recovery after transplantation ( [134](#), [135](#) ). Recovery of neutrophil and platelet counts after transplantation may be improved with the use of multiple cord blood units ( [136](#) ). After the infusion of two umbilical cord blood grafts into adult patients, the median day to neutrophil recovery was 24 (range, 12 to 28) in 23 adult patients compared to 27 (range, 13 to 59) in another study of 68 adult patients who received only a single cord blood graft ( [137](#) ). Shortening the time to engraftment with the infusion of multiple cord blood units may improve outcome early after transplantation, but this experience needs to be confirmed with a larger study. The reported low incidence of severe GVHD after the transplantation of umbilical cord blood cells from unrelated donors (relative to the degree of HLA disparity) may be related to the decreased immunocompetence of the fetal blood cells compared to adult cells ( [138](#) ). Two years after transplantation, T-cell receptor rearrangement excision circles (TRECs) were greater in recipients of umbilical cord blood



than in recipients of marrow grafts, suggesting complete immune recovery despite the low number of cells infused ( [139](#) ). Recipients of umbilical cord blood cell transplants to date have been children predominantly, but recent studies in adults ( [140](#) ) suggest that results obtained are comparable to those reported in children, even though the numbers of cells infused per kg of body weight were lower ( [137](#) ). In 68 adult patients with life-threatening hematologic disorders, 48 (71%) had umbilical cord blood grafts that were mismatched for two or more HLA antigens. There were five cases of primary graft failure with a median of 27 (range, 13 to 59) days to neutrophil engraftment. The incidence of grade III to IV GVHD was 20%, and 18 of 68 patients were surviving disease-free at 40 months after transplantation. Umbilical cord blood grafts should therefore be considered for both pediatric and adult patients lacking a suitably matched unrelated donor or who are unable to wait for a search for an unrelated donor to be completed.

## ABO INCOMPATIBILITY

ABO incompatibility between the donor and the recipient occurs in approximately 30% of cases. A major ABO incompatibility is considered to occur when the isohemagglutinins in the recipient plasma are directed against the donor red blood cell antigens. A minor ABO incompatibility occurs when the isohemagglutinins in the donor plasma are directed against recipient red blood cell antigens. ABO incompatibility between the donor and the recipient has no significant effect on the incidence of graft rejection, GVHD, or survival ( [141](#), [142](#) ). However, these ABO incompatibilities may result in severe hemolytic episodes after transplantation. In major ABO incompatibilities with high isohemagglutinin titers in the recipient plasma, an acute hemolytic event can be prevented by red cell depletion of the graft. Conversely, plasmapheresis may be effective in reducing the antidonor isohemagglutinin in the recipient plasma. If the latter approach is chosen, the goal should be to reduce the isohemagglutinin titer to 1:16 or lower ( [143](#) ). If there is continued production of antidonor isohemagglutinins in the recipient plasma after transplantation, delayed erythropoiesis or even pure red cell aplasia and persistent hemolysis may result ( [144](#) ). Although plasmapheresis and erythropoietin may be of some benefit, the delayed hemolytic episode may persist for months after transplantation. If there are no contraindications, early withdrawal of immunosuppression may result in a more rapid resolution of the delayed hemolytic event, possibly because of a GVH reaction against the isohemagglutinin-producing cells of the recipient ( [145](#) ). To prevent hemolytic events related to minor ABO incompatibilities, the isohemagglutinins can be removed from the stem cell graft if the antirecipient titers are high. The risk of hemolysis from a minor ABO mismatch appears to be increased after peripheral blood stem cell transplantation, possibly related to the higher content of lymphoid B cells in the graft. The development of severe hemolysis may be prevented with the administration of MTX after transplantation ( [146](#) ).

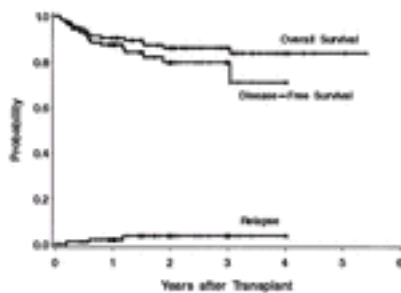
## CONDITIONING REGIMENS

### Myeloablative

Effective myeloablative conditioning regimens are necessary for successful treatment of hematologic malignancies and the achievement of allogeneic HSC engraftment. The ideal myeloablative conditioning regimen should (a) eliminate or reduce the tumor load, (b) suppress the host immune system to prevent graft rejection (this does not apply to hematopoietic support with autologous cells), and (c) have tolerable nonhematopoietic toxicity. The first conditioning regimens consisted of TBI alone or in combination with CY ( [1](#) ). TBI was an effective antineoplastic modality that was not cell cycle-specific and was also immunosuppressive. CY was a chemotherapeutic agent with immunosuppressive

properties that had few nonhematopoietic toxicities that were similar to TBI and therefore could be used in combination. Other conditioning regimens that have since been developed include (a) the replacement of CY with other chemotherapeutic agents (e.g., etoposide, cytarabine, and melphalan) in combination with TBI ( [147](#), [148](#) ); (b) other chemotherapeutic agents in combination with both CY and TBI ( [149](#), [150](#) ); and (c) chemotherapeutic agents used in combination with CY but without TBI, including busulfan (BU)/CY and carmustine–CY–etoposide ( [151](#), [152](#) ). In one study, carmustine–CY–etoposide was associated with a significant incidence of transplant–related complications and mortality ( [153](#) ). Other high–dose cytotoxic regimens have been used, especially with autologous stem cell support ( [154](#), [155](#) and [156](#) ).

Most preparative regimens used for the treatment of malignant diseases have not been tested in phase 3 studies, so it is unclear if any one regimen represents an improvement over those previously used. Two phase 3 studies in allogeneic marrow transplantation have compared differing intensities of TBI (1200 cGy vs. 1575 cGy) ( [157](#), [158](#) ). The relapse rate was reduced in the group of patients receiving the higher dose of TBI, but there was an increase in complications in this same group from regimen–related toxicity and GVHD, which negated any improvement in disease–free survival compared to the group receiving the lower dose of TBI. In several studies, the combination of BU and CY was determined to be an acceptable alternative to CY/TBI for patients with leukemia ( [3](#), [159](#), [160](#) ). However, in one study, patients in the BU/CY group had an increased risk of venoocclusive disease (VOD) of the liver, hemorrhagic cystitis, chronic GVHD, bronchiolitis obliterans, and alopecia ( [161](#) ). Since this last study, it has been demonstrated that targeting of BU levels in the plasma may decrease the risk of relapse and severe regimen–related toxicities, contributing to an improved disease–free survival ( [162](#) ) ( [Fig. 25.3](#) ). Monitoring of CY levels may also be important because increased exposure to its toxic metabolites may lead to increased liver toxicity and nonrelapse mortality ( [163](#) ).



**Figure 25.3.** Overall survival among 101 patients after hematopoietic stem cell transplantation from HLA–identical siblings for chronic myelogenous leukemia in chronic phase. The conditioning regimen included targeted busulfan (900 ng/mi) and cyclophosphamide. Graft–versus–host disease prophylaxis consisted of the combination of cyclosporine and methotrexate. Patients were transplanted between September 1995 and December 1999. The probability of survival was 85% at 5 years. (From unpublished data from the Fred Hutchinson Cancer Research Center.)

In patients suffering from SCID, engraftment of allogeneic stem cells from matched related siblings may occur without conditioning therapy ( [98](#) ). High–dose CY in combination with antithymocyte globulin (ATG) as a preparative regimen for patients with aplastic anemia was associated with graft rejection in less than 5% of cases ( [114](#) ). The actuarial survival rate was 88% at 6 years after transplantation ( [Fig. 25.2](#) ). For

transplantation of patients with thalassemia or sickle cell disease, a myeloablative conditioning regimen, usually consisting of the combination of BU and CY, is necessary to prevent a high incidence of graft rejection because most patients with these disorders have received multiple blood transfusions and are potentially sensitized to donor MHCs ( [97](#), [164](#) ).

Although HSC engraftment may be achieved after transplantation and some patients are cured, relapse remains an important problem in patients with advanced hematologic malignancies. Because further intensification of the conditioning regimen using current modalities is unlikely to improve overall survival because of the associated increase in toxicity, other strategies will be required to achieve a cure. Radiolabeled MAb specific for certain tissues or sites from which the malignancy originates might enhance the efficacy of the conditioning regimen and decrease the rates of relapse ( [165](#), [166](#) ).

### Nonmyeloablative

Myeloablative conditioning regimens are associated with the development of regimen-related toxicities resulting in prolonged periods of hospitalization and the development of significant morbidity and potential mortality including VOD of the liver and idiopathic interstitial pneumonitis. The development of nonmyeloablative regimens permits the application of this potentially curative treatment to a large number of patients, including older patients and patients with contraindications to intensive cytotoxic regimens. The success of the nonmyeloablative conditioning regimens in preclinical and clinical studies established new biologic principles, which formed the basis of our understanding of the engraftment process after allogeneic HSCT. The findings in these studies were consistent with the following conclusions regarding successful engraftment:

- Intensive cytotoxic myeloablative therapy is not needed to “create marrow space.”
- Stem cell grafts can “create their own marrow space” with a GVH effect.
- Engraftment is promoted by posttransplant suppression of the host-versus-graft reaction.

Many different nonmyeloablative conditioning regimens have been piloted. These fall into two broad categories: (a) reduced-intensity regimens and (b) minimally myelosuppressive regimens ( [167](#), [168](#), [169](#), [170](#), [171](#), [172](#), [173](#), [174](#) and [175](#) ). The reduced-intensity regimens still require the use of the cytotoxic therapies pretransplant to prevent graft rejection. The recipients usually become aplastic from the regimen, and complete chimerism is established early after transplantation. Because of the intensity of the regimen, a substantial antitumor effect may still be associated with the regimen, resulting in a tumor response early after transplantation. The reduced-intensity regimen is, however, still associated with myelosuppression and some significant regimen-related toxicities. The minimally myelosuppressive regimens rely on pretransplant and posttransplant immunosuppression to prevent graft rejection. After transplantation, a mixed chimeric state may persist for months before converting to full donor hematopoietic chimerism ( [Table 25.4](#) ) ( [174](#) ). The regimen is only mildly myelosuppressive, resulting in lower requirements for blood product ( [Fig. 25.4](#) ) ( [176](#) ). In some cases of a major ABO incompatibility, however, there may be delayed development of donor red cell chimerism resulting in an increased need for red blood cell products due to the persistence of antidonor isohemagglutinins. This may be prevented by adding an antimetabolite (MTX, mycophenolate mofetil) to the GVHD prophylaxis. If this approach is ineffective, withdrawal of CSP may induce a graft-mediated immune reaction against recipient isohemagglutinin-producing cells resulting in a decrease in isohemagglutinin levels and improvement in donor red blood cell chimerism ( [145](#) ). The onset of cytomegalovirus (CMV) infections is significantly delayed after nonmyeloablative transplantation ( [177](#) ).

After nonmyeloablative conditioning with a minimally myelosuppressive regimen, patients can generally be managed on an outpatient basis.

**TABLE 25.4. Median Percentage of Donor Cells and Chimerism Status after Stem Cell Transplant**

|                              | Median Percentage on Day 28 <sup>a</sup><br>(range) | Median Percentage on Day 56 <sup>b</sup><br>(range) |
|------------------------------|---|---|
| Donor cells                  |   |   |
| T cells                      | 60 (10–100)   | 91 (5–100)  |
| Peripheral blood neutrophils | 91 (0–100)  | 99 (4–100)  |
| Bone marrow                  | 87 (0–100)  | 95 (2–100)  |
| Chimerism                    |   |   |
| Mixed <sup>c</sup>           | 86  | 79  |
| Full donor <sup>d</sup>      | 14  | 21  |

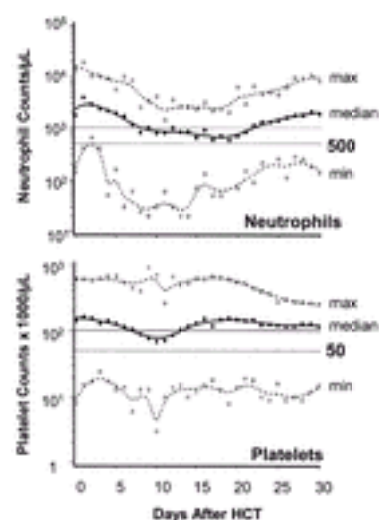
<sup>a</sup> 44 evaluable patients. One additional patient–donor pair had no identifiable DNA polymorphism, and evidence of donor cell engraftment was based on red blood cell polymorphisms.

<sup>b</sup> 41 evaluable patients.

<sup>c</sup> =1% and =5% T cells of donor origin.

<sup>d</sup> >95% T cells of donor origin.

From McSweeney PA, Niederwieser D, Shizuru JA, et al. Hematopoietic cell transplantation in older patients with hematologic malignancies: replacing high-dose cytotoxic therapy with graft-versus-tumor effects. *Blood* 2001;97:3390–3400, with permission.

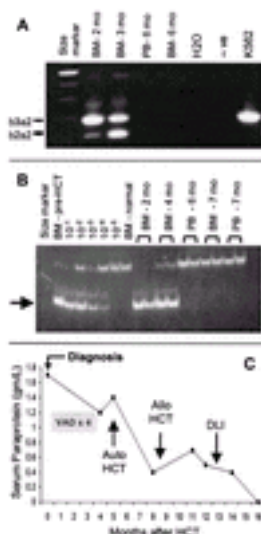


**Figure 25.4.** Engraftment after nonmyeloablative hematopoietic stem cell transplantation (HCT). Engraftment profile showing neutrophil and platelet changes after HCT. Graphs show the median ( *solid lines*) and range ( *broken lines*) of neutrophil and platelet counts of all 45 patients on days 0 through 30. Circles represent the minimum (min) and

maximum (max) values on each day. (From McSweeney PA, Niederwieser D, Shizuru JA, et al. Hematopoietic cell transplantation in older patients with hematologic malignancies: replacing high-dose cytotoxic therapy with graft-versus-tumor effects. *Blood* 2001;97:3390–3400, with permission.)

Early studies of nonmyeloablative transplantation focused on patients whose donors were HLA-identical siblings, because the risk of graft rejection and GVHD is less compared to alternative donors. When TBI, 200 cGy, was given for the conditioning regimen only, graft rejection was associated with a lack of prior intensive chemotherapy and a diagnosis of CML (174). When fludarabine was added to low-dose TBI, graft rejection was no longer observed as a significant problem. Nonmyeloablative conditioning regimens have also been effective for transplantation with alternative sources such as unrelated donors and umbilical cord blood (178, 179 and 180).

Allogeneic HSC grafts can induce a GVL or graft-versus-tumor (GVT) effect. The effectiveness of the GVT effect can best be seen in the responses patients have had with minimally myelosuppressive regimens ( Fig. 25.5) (174, 181). In patients not otherwise eligible for a myeloablative conditioning regimen, sustained responses have been noted in AML, the chronic leukemias, lymphoma, and myeloma. A minimally myelosuppressive conditioning regimen may be more appropriate for indolent hematologic malignancies including CML, chronic lymphocytic leukemia, agnogenic myeloid metaplasia, and low-grade lymphomas (174, 175, 182, 183 and 184). In diseases requiring cytoreduction, reduced-intensity regimens may be of more benefit. Another strategy that appears promising is high-dose cytotoxic therapy and autologous transplantation to debulk the disease or induce a clinical remission, followed by allogeneic nonmyeloablative transplantation (185, 186 and 187). The objective of this tandem approach is to consolidate the remission with a GVT reaction. The effect of the GVT reaction on solid tumors is also being explored, and significant responses have been seen in some patients with renal cell carcinoma (188). Careful assessment of the patient, the disease type, and the disease status are required to determine the optimal approach.



**Figure 25.5.** Complete disease responses after hematopoietic stem cell transplantation (HCT). **A:** Example of molecular remission of chronic myelogenous leukemia induced by nonmyeloablative HCT without donor lymphoid infusion, as documented by failure of reverse transcription-polymerase chain reaction to detect bcr-abl transcripts. The lane

described “-ve” is negative control of normal bone marrow (BM). K562 is a positive control for bcr-abl. **B:** Example of molecular remission of chronic lymphocytic leukemia induced by HCT without donor lymphocyte infusion as documented by polymerase chain reaction to detect a tumor-specific immunoglobulin heavy-chain gene arrangement ( *arrow*). Each posttransplantation sample was amplified in duplicate. The lanes designated  $10^{-1}$  to  $10^{-5}$  show a dilution series of the patient’s pretransplantation sample (more than 90% tumor cells) into normal bone marrow. **C:** Example of complete remission of multiple myeloma after allogeneic HCT. The patient was initially treated with four cycles of vincristine, adriamycin, and dexamethasone (VAD). High-dose cytoreduction with melphalan,  $200 \text{ mg/m}^2$ , and autologous transplantation (Auto HCT) were performed 3 months before allogeneic HCT (Allo HCT). Donor lymphocyte infusion (DLI) was given 4 months after HCT because of persistent tumor. After complete remission was achieved, trace levels of serum monoclonal paraprotein detected by immunofixation were present intermittently in follow-up testing. PB, peripheral blood. (From McSweeney PA, Niederwieser D, Shizuru JA, et al. Hematopoietic cell transplantation in older patients with hematologic malignancies: replacing high-dose cytotoxic therapy with graft-versus-tumor effects. *Blood* 2001;97:3390–3400, with permission.)

GVHD and infections are the major reasons for transplant-related treatment failures after nonmyeloablative transplantation. Because these patients, in general, are older and face a poor outcome because of preexisting complications, nonmyeloablative transplantation has been well-tolerated and effective compared to what could have been expected after myeloablative conditioning. Treatment-related mortality after nonmyeloablative transplantation was 22% in one study of 192 patients treated for a variety of hematologic diseases ( [175](#)). The day 100 treatment-related mortality was only 6%. Because the disease response is related to the development of a GVT response, early studies relied on short courses of immunosuppressive therapy or the early administration of donor lymphocyte infusions. GVHD tended to develop later than expected, in many cases at 3 to 6 months after transplantation. Because GVHD developed in many patients and full donor chimerism was being achieved as late as 6 to 12 months after transplantation (indicating an active GVH reaction during this period), immunosuppressive therapy for GVHD prophylaxis was administered for a longer period and donor lymphocyte infusions were delayed in later studies. Further follow-up is required to assess if this will reduce the incidence of transplant-related complications in this patient group. Strategies for the optimal management of GVHD are required so that complications are reduced. Although some patients have durable tumor responses after nonmyeloablative transplantation, further studies are required to determine whether outcomes will be comparable to those achieved in patients who had received myeloablative conditioning.

## ENGRAFTMENT

Successful engraftment results from the circulation, homing, and growth of HSCs. After autologous HSCT, a minimal number of CD34-positive cells is required to prevent delayed recovery of neutrophil and platelet counts. After allogeneic HSCT, adequate suppression of the host immune system is necessary to prevent graft rejection. Immunosuppression may be achieved by the use of myeloablative or nonmyeloablative conditioning regimens. The early establishment of donor T cells is important in the prevention of graft rejection even when substantial numbers of CD34-positive cells are administered ( [189](#)). A single stem cell may substantially reconstitute hematopoiesis (clonal dominance), but this occurs only infrequently in humans ( [190](#), [191](#)). However, this demonstrates the considerable proliferative potential of a normal HSC. In many studies of HSCT, engraftment has generally been defined as the achievement of a peripheral blood neutrophil count greater than  $0.5 \times 10^9/\text{L}$ . The rate of engraftment is dependent on the number of HSCs, especially the CD34-positive cell content, the purging strategies for



autologous marrow, the use of growth factors, and the use of MTX for GVHD prophylaxis ( [16](#), [83](#), [192](#) ). Graft failure may result from an infusion of inadequate numbers of HSCs, drug toxicity, infection (CMV), or, in the case of allogeneic marrow transplantation, from graft rejection. Graft function may be restored when incriminating drugs are discontinued or when recovery from infection occurs.

Graft rejection is infrequent (<1 to 2% incidence) after HSCT from HLA-matched siblings ( [193](#), [194](#) and [195](#) ). When grafts are rejected, as indicated by low blood counts, chimerism studies also demonstrate the loss of donor cells in the peripheral blood and marrow ( [195](#), [196](#) ). Factors that influence the risk of graft rejection include T-cell depletion of marrow grafts, increased HLA disparity, the intensity of the conditioning regimen and posttransplant immunosuppression, pretransplant immunization of the host against donor alloantigens, and the number of HSCs in the graft ( [194](#), [197](#), [198](#), [199](#) and [200](#) ). Hematopoietic growth factors have not been shown to be effective in preventing graft rejection. Historically, graft rejection after a myeloablative conditioning regimen and an allogeneic HSCT has almost always been fatal. The use of noncytotoxic immunosuppressive conditioning regimens and the infusion of donor peripheral blood stem cells may salvage patients after graft rejection ( [201](#) ). Aggressive medical management during the prolonged neutropenic period is required to prevent infectious deaths after transplantation of the second stem cell graft. Although the transplant-related mortality has been high in the pilot studies of nonmyeloablative transplantation, graft rejection has not been associated with a significant morbidity or mortality because the duration of the pancytopenic period has in general been short ( [174](#) ).

## REGIMEN-RELATED TOXICITIES

The severity of regimen-related toxicities is related to the intensity of the myeloablative therapy used, the type of cytotoxic therapy, the medical condition of the patient before transplantation, and the presence of posttransplant factors, including the use of MTX, CSP, and amphotericin B. Although many groups are investigating the potential benefits of nonmyeloablative transplantation, which reduces the severity of regimen-related toxicities, outcomes may still be better in good-risk patients undergoing myeloablative conditioning ( [202](#) ).

Oral mucositis occurs in more than 90% of patients, and many require pain relief with continuous intravenous infusions of narcotic drugs. Improvement occurs when the marrow recovers, approximately 2 to 3 weeks after transplantation. The severity of the oral mucositis depends on the intensity of myeloablative therapy and the use of MTX. Severe mucositis may result in upper airway obstruction or aspiration pneumonitis. Gastroenteritis induced by chemotherapy and irradiation results in nausea, vomiting, and diarrhea, which may persist for up to 2 to 3 weeks after transplantation. Central lines are placed before transplant for administration of fluids, drugs, and hyperalimentation during this period of therapy-induced mucositis and gastroenteritis.

Renal dysfunction is common after HSCT ( [203](#) ). Some factors associated with the development of severe renal failure requiring dialysis are hyperbilirubinemia, significant fluid retention after transplantation, amphotericin B administration, and pretransplant serum creatinine levels greater than 0.7 mg/dl. CSP may also contribute directly to renal dysfunction.

Lung and liver are the two organs that limit further escalation of myeloablative therapy. Idiopathic interstitial pneumonitis occurs in 8 to 18% of patients after marrow transplantation ( [204](#), [205](#) and [206](#) ). Clinical manifestations include dyspnea, nonproductive



cough, hypoxemia, and diffuse pulmonary infiltrates. This toxicity is most likely due to TBI, but high doses of chemotherapeutic agents like CY, BU, and bischloroethyl-nitrosourea, if part of the preparative regimens, may also be directly toxic to the lungs. Pulmonary VOD must be considered in patients with diffuse pulmonary infiltrates because VOD may have a favorable response to corticosteroids ( [207](#), [208](#) ). Treatment for idiopathic interstitial pneumonitis consists of supplemental oxygen and ventilatory support. Survival is poor (3%) for patients requiring intubation and mechanical ventilation for longer than 24 hours ( [209](#) ).

VOD of the liver is the most frequent cause of hyperbilirubinemia within 20 days after HSCT ( [210](#) ). This event is characterized by damage to vascular endothelial cells and to hepatocytes in zone 3 of the liver acinus. The overall incidence of VOD is 53%, and 15% of patients have severe disease. Risk factors for the development of severe VOD are pretransplant hepatitis with elevated serum levels of hepatocellular enzymes, the intensity of the conditioning regimen (TBI >13 Gy), and the use of BU. Targeting strategies for BU and CY may reduce the incidence of severe VOD. In uncontrolled studies, favorable responses to the administration of tissue plasminogen activator have been reported ( [211](#), [212](#) ). However, the risk of bleeding must be weighed against the potential benefit of this agent. Responses were also observed in patients treated with defibrotide, a single-stranded polydeoxyribonucleotide with fibrinolytic and antithrombotic activity ( [213](#) ).

Delayed complications related to myeloablative therapy include secondary malignancies, sterility, hypothyroidism, and cataracts ( [214](#), [215](#), [216](#), [217](#), [218](#), [219](#) and [220](#) ). After autologous HSCT, there is an increased risk of developing a myelodysplastic syndrome ( [221](#), [222](#), [223](#) and [224](#) ). Children may experience delays in growth and development ( [225](#) ).

## GRAFT-VERSUS-HOST DISEASE

GVHD occurs when genetically disparate lymphocytes are transferred into an immunologically compromised recipient incapable of rejecting the donor graft ( [226](#) ). The initial stages of a GVH reaction involve the recognition of the host's disparate minor and major histocompatibility antigens by T cells in the donor graft. There are two primary classes of major histocompatibility antigens (MHC): HLA class I antigens have a broad distribution and are expressed on all cells, whereas HLA class II antigens are expressed on antigen-presenting cells, including macrophages, dendritic cells, B cells, and activated T cells. mHCs represent genetic polymorphisms of endogenous cellular proteins that are presented to T cells as small peptides bound in the grooves of the major histocompatibility antigens. Some mHCs identified in humans as being associated with GVHD include CD31, HA-1, and the DBY (male-specific mHA) gene ( [227](#), [228](#), [229](#), [230](#) and [231](#) ). The association between the polymorphism within the adhesion molecule CD31 and the development of GVHD was not observed by other groups ( [232](#), [233](#) ).

In murine studies, the CD8-positive T cells react more specifically with class I molecules and CD4-positive T cells react more specifically with class II molecules ( [234](#), [235](#) and [236](#) ). The induction and release of cytokines (e.g., IL-1, IL-2, tumor necrosis factor) might be important in the development and maintenance of the GVHD reaction ( [237](#) ). Epithelial cells of the skin, bile ducts, and gastrointestinal tract are the primary tissues damaged by a GVH reaction. Target cells for the GVH reaction are epithelial stem cells, which are located in the rete ridges of the skin, the crypt cells of the gut, and the parafollicular bulge of the hair follicle ( [238](#) ). In the liver, the small interlobular and marginal bile ducts on the periphery of the portal spaces are damaged by the GVH reaction ( [239](#) ). In tissues involved with GVHD, a lymphoid infiltrate is present, and cell death occurs by apoptosis. Lymph nodes lack germinal centers, and these may not recover for many months after

HSCT. Abnormal CD4:CD8 ratios can be found in the lymph node as well as in the peripheral blood ( [240](#) ).

## Acute Graft–Versus–Host Disease

**CLINICAL EVALUATION** Acute GVHD involves three organ systems primarily—the skin, the gastrointestinal tract, and the liver. A maculopapular rash is often present and can be pruritic or painful. It may involve the palms and the soles. In severe cases, bullae and epidermal separation may occur, which resembles toxic epidermal necrolysis. Gastrointestinal GVHD involves the small and large intestine, which may result in nausea or vomiting, crampy abdominal pain, diarrhea, intestinal bleeding, and ileus. Lesions of the mouth may also occur. Patients may present only with symptoms of persistent anorexia, nausea, and vomiting as a manifestation of GVHD in the gastrointestinal tract ( [241](#) , [242](#) and [243](#) ). If severe GVHD of the gastrointestinal tract occurs, the bowel may be scarred permanently, and mucosal regeneration may not be possible ( [244](#) ). Cholestatic jaundice is common in GVHD involving the liver, but hepatic failure due solely to GVHD is unusual unless the GVHD is long–standing. A biopsy of these organs is useful in confirming the diagnosis of GVHD, although direct cytotoxic effects from the conditioning regimen can produce tissue damage that may confound the histopathologic diagnosis of GVHD in the first 3 weeks after marrow transplantation. Risk factors for the development of acute GVHD include the degree of the HLA match, a sex mismatch with the donor, a prior history of donor parity, an increased dose of TBI, and the type of acute GVHD prophylaxis used ( [120](#) , [245](#) ). The CD34–positive cell dose is an independent risk factor for acute GVHD after peripheral blood stem cell transplantation ( [246](#) ). The degree of HLA match is of primary importance in determining the risk of acute GVHD. After marrow transplantation from HLA–haploidentical (MHC–mismatched) siblings, the incidence of acute GVHD was greater than 70% compared with 42% in patients transplanted from HLA–matched siblings ( [117](#) ). The increased incidence of acute GVHD in patients transplanted from fully HLA–matched unrelated donors (=70%) is likely related to an increased disparity in mHC antigens or unrecognized disparities of the phenotypically matched major histocompatibility loci. To facilitate the study and prognostication of acute GVHD, a clinical staging and grading system (Glucksberg) was developed ( [1](#) , [247](#) ). The staging and grading system has since been updated ( [Table 25.5](#) ) ( [248](#) ). Grade I or very limited acute GVHD has a favorable prognosis and does not require treatment. Therapy is usually required for grade II GVHD because it is moderately severe and usually consists of multiorgan disease. Because patients who have anorexia, nausea and vomiting, and positive biopsies for GVHD from the upper gastrointestinal tract usually require therapy, they have been included under grade II. Grade III to IV disease is severe multiorgan GVHD and is associated with a decreased patient survival ( [120](#) ). An acute GVHD Severity Index has also been developed, grouping patients with patterns of organ involvement associated with similar risks of treatment–related mortality and treatment failure ( [249](#) ). The International Bone Marrow Transplant Registry (IBMTR) Severity Index was designed to avoid the need for subjective assessment of the performance status, which was included in the Glucksberg system. Another difference is that patients with a rash covering 25 to 50% of their skin (overall grade I, Glucksberg) would be placed in the IBMTR Index B group. Some HSCT programs are now using the IBMTR Severity Index for the grading of acute GVHD. Other approaches for assessing acute GVHD have also been described in which the overall clinical course across time is described rather than focusing on the peak grade achieved ( [250](#) ).

**TABLE 25.5. Recommended Staging and Grading of Acute Graft–Versus–Host Disease**

---

### Extent of Organ Involvement

---

|                 | Skin  | Liver                            | Gut   |
|-----------------|---|----------------------------------|---|
| <b>Stage</b>    |   |                                  |   |
| 1               | Rash on <25% of skin <sup>a</sup>               | Bilirubin 2–3 mg/dl <sup>b</sup> | Diarrhea >500 ml/day <sup>c</sup> or persistent nausea <sup>d</sup> |
| 2               | Rash on 25–50% of skin                          | Bilirubin 3–6 mg/dl              | Diarrhea >1000 ml/day   |
| 3               | Rash on >50% of skin                            | Bilirubin 6–15 mg/dl             | Diarrhea >1500 ml/day   |
| 4               | Generalized erythroderma with bullous formation | Bilirubin >15 mg/dl              | Severe abdominal pain with or without ileus                         |
| <b>Grade</b>    |   |                                  |   |
| <sup>e</sup> I  | Stage 1–2                                       | None                             | None  |
| II              | Stage 3 or                                      | Stage 1 or                       | Stage 1   |
| III             | —   | Stage 2–3 or                     | Stage 2–4   |
| IV <sup>f</sup> | Stage 4 or                                      | Stage 4                          | —   |

<sup>a</sup> Use “rule of nines” or burn chart to determine extent of rash.

<sup>b</sup> Range given as total bilirubin. Downgrade one stage if an additional cause of elevated bilirubin has been documented.

<sup>c</sup> Volume of diarrhea applies to adults. For pediatric patients, the volume of diarrhea should be based on body surface area. Gut staging criteria for pediatric patients were not discussed at the Consensus Conference. Downgrade one stage if an additional cause of diarrhea has been documented.

<sup>d</sup> Persistent nausea with histologic evidence of graft-versus-host disease in the stomach or duodenum.

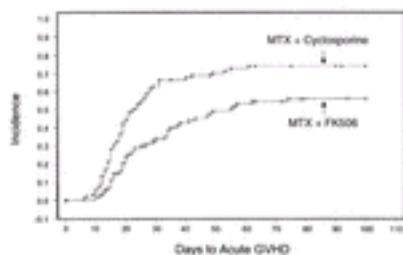
<sup>e</sup> Criteria for grading given as minimum degree of organ involvement required to confer that grade.

<sup>f</sup> Grade IV may also include lesser organ involvement with extreme decrease in performance status.

From Prezepiorka D, et al. Consensus conference on acute GVHD grading. Bone Marrow Transplant 1995;15:825–828, with permission.

**PREVENTION** There are two major approaches to the prevention of acute GVHD after allogeneic marrow transplantation: pharmacologic immunosuppression, T-cell depletion, or both. Agents for pharmacologic immunosuppression are generally more effective when used in combination ( [16](#), [17](#), [251](#) ). CSP (a calcineurin inhibitor) and MTX in combination are the agents used most commonly by transplant centers. The addition of prophylactic corticosteroids to the combination of CSP and MTX or to CSP alone provides a limited additional benefit, if any, and, in one study, a paradoxical increase in GVHD was observed in the corticosteroid arm ( [252](#), [253](#) and [254](#) ). CSP should be continued to day 180, especially in patients who have previously had acute GVHD, because patients who stopped at day 60 had a higher transplant-related mortality. Even for patients without GVHD by day 60 after transplantation and in whom CSP may be stopped safely, the practice has been to maintain immunosuppression on a tapering schedule until day 180. All three agents have significant adverse effects. MTX delays, but does not prevent, hematopoietic engraftment, and the severity of oral mucositis may be increased. Nephrotoxicity and neurotoxicity are complications associated with the administration of CSP, and microangiopathic hemolytic anemia has been described in association with this agent. Metabolic complications and aseptic necrosis are associated with the administration of corticosteroids. Another

calcineurin inhibitor, tacrolimus, in combination with MTX was compared with CSP and MTX in phase 3 studies for the prevention of GVHD. The incidence of acute GVHD was lower in the tacrolimus group when using HLA-identical sibling donors or unrelated donors ( Fig. 25.6) ( 255, 256 ). The incidence of chronic GVHD was similar in both groups. The patients in the CSP arm of the matched sibling study had a better disease-free and overall survival, largely as a result of imbalance in the underlying risk factors for death in the two groups, especially among patients in the advanced disease category ( 257 ). Disease-free and overall survival were similar between the two groups in the unrelated donor study ( 256 ). Some transplant programs now prefer tacrolimus in combination with MTX as their standard for GVHD prophylaxis because of the improved control of acute GVHD. Mycophenolate mofetil is a reversible inhibitor of inosine monophosphate dehydrogenase and is being studied after both myeloablative and nonmyeloablative transplantation in combination with either CSP or tacrolimus and without MTX ( 258 ).



**Figure 25.6.** Kaplan–Meier estimate of acute graft–versus–host disease (GVHD). The combination of tacrolimus (FK506) and methotrexate was compared to cyclosporine and methotrexate as GVHD prophylaxis after a myeloablative conditioning regimen and hematopoietic stem cell transplantation from an HLA–matched unrelated donor. There was less acute GVHD in the tacrolimus group at 100 days after hematopoietic stem cell transplantation than in the cyclosporine group (56% vs. 74%, respectively;  $p = .0002$ ). (From Nash RA, Antin JH, Karanes C, et al. Phase 3 study comparing methotrexate and tacrolimus with methotrexate and cyclosporine for prophylaxis of acute graft–versus–host disease after marrow transplantation from unrelated donors. *Blood* 2000;96:2062–2068, with permission.)

An alternative method of GVHD prophylaxis is T-cell depletion of the marrow. Strategies for T-cell depletion include the use of MAb, which are specific for T cells, selective agglutination to soybean lectin, and counter-flow centrifugation elutriation ( 259, 260, 261 and 262 ). Although reduction in acute and chronic GVHD has been observed with transplantation of T-cell depleted marrow, there was also an associated increase in graft rejection, the occurrence of lymphoproliferative disorders, and relapse ( 197 ). As a result, there was no improvement in overall survival. Many of the early T-cell depletion studies used techniques that targeted the total T-cell population ( 198 ). More recently, studies of T-cell subset depletion using MAb specific for CD6, CD8, or T-cell receptor- $\alpha\beta$  epitopes on T lymphocytes have not observed a high incidence of graft rejection ( 199, 200, 263, 264 ).

**TREATMENT** The most common agents used to treat acute GVHD are corticosteroids and ATG. In many marrow transplant centers, the administration of corticosteroids (methylprednisolone or prednisone, 2 mg/kg/day) is the standard treatment for acute GVHD ( 265, 266 and 267 ). High doses of methylprednisolone (10 mg/kg/day) did not prevent evolution to grade III to IV acute GVHD ( 268 ). Because complete remission of GVHD is only seen in 40% of cases after primary treatment, other immunosuppressive agents have been investigated in combination with prednisone. When a CD5-specific immunotoxin was added to prednisone at the start of treatment, GVHD manifestations were more effectively controlled during the first 5 weeks only, when compared to prednisone alone ( 269 ). Similarly, no long-term benefit was observed when ATG was added to prednisone as primary therapy ( 270 ). More effective treatment strategies are required to improve the

outcome of acute GVHD. Other immunosuppressive agents have been studied in patients with steroid-refractory GVHD, including ATG, daclizumab, rapamycin, mycophenolate mofetil, ABX-CBL (CD147-specific mAb), and visilizumab. Outcomes at 6 to 12 months after salvage therapy for steroid-resistant GVHD have been poor with a high transplant-related mortality ( [271](#), [272](#), [273](#), [274](#) and [275](#) ). In a multivariate analysis designed to identify factors associated with the likelihood of complete response to therapy, the combination of CSP and MTX as GVHD prophylaxis was better than CSP and MTX as single agents ( [265](#) ). In an analysis to identify covariates associated with failure of initial therapy or death not due to relapse of malignancy, treatment with ATG had a higher risk of failure than corticosteroids. Other factors associated with an unfavorable outcome were recipient HLA disparity with the donor, presence of a liver complication other than GVHD, and early onset of GVHD. Other therapies being investigated to improve local control of GVHD, which may permit a decrease in systemic immunosuppression, include psoralen and ultraviolet A irradiation therapy for the skin and oral nonadsorbable beclomethasone therapy for the gastrointestinal tract ( [276](#), [277](#) and [278](#) ). The massive secretory diarrhea of acute GVHD has been controlled in some cases with a somatostatin analog, octreotide acetate ( [279](#), [280](#) ).

## Chronic Graft-Versus-Host Disease

**CLINICAL EVALUATION** Chronic GVHD is a syndrome that may develop as early as 50 to 60 days or as late as 400 days after transplantation. The incidence of chronic GVHD is dependent on the degree of disparity in the major histocompatibility antigens. It was observed in 33% of HLA-identical sibling transplants, in 49% of HLA-nonidentical related transplants, and in 64% of matched-unrelated transplants ( [281](#) ). A prior history of acute GVHD is a significant risk factor for the development of chronic GVHD. Among patients without a history of acute GVHD, factors that were associated with an increased risk of *de novo* chronic GVHD were increasing patient age, the infusion of buffy coat cells in addition to marrow, and corticosteroid therapy before transplantation ( [282](#), [283](#) ). Corticosteroid use for GVHD prophylaxis may also increase the risk of development of chronic GVHD ( [252](#), [254](#) ). Clinical features of chronic GVHD include skin lesions that may initially resemble lichen planus and that may progress to generalized scleroderma, keratoconjunctivitis, buccal mucositis, esophageal and vaginal strictures, intestinal abnormalities, chronic liver disease, pulmonary insufficiency secondary to bronchiolitis obliterans, and a wasting syndrome ( [284](#) ). If generalized scleroderma occurs, it may lead to joint contractures and debility; however, this feature of chronic GVHD has not been seen as commonly in recent years. Elevations in alkaline phosphatase and serum bilirubin are often the first indication of hepatic involvement with chronic GVHD. Damage to the bile ducts has a similar histopathology to that seen in primary biliary cirrhosis. Liver biopsies are often helpful in establishing a diagnosis. Onset of bronchiolitis obliterans may occur at less than 150 days (40%) or more than 150 days (60%) after HSCT ( [285](#) ). Response to immunosuppressive treatment has been observed but is often incomplete. Prognosis is poor except for those patients with mild to moderate disease occurring more than 150 days after HSCT. Keratoconjunctivitis sicca is a common complication and is generally irreversible. This is managed by frequent eye drops and tear duct ligation. Screening studies and clinical manifestations of chronic GVHD are used in a clinical classification of chronic GVHD. Based on a retrospective clinical and pathologic review published in 1980, a staging system was developed in which chronic GVHD was classified into limited and extensive categories. Extensive disease was associated with more frequent infections ( [284](#) ). The utilization of this classification system was difficult because many patients were not classifiable by strict organ criteria, and other significant prognostic factors have since been identified. Poor prognostic factors are extensive skin involvement, thrombocytopenia, and progressive-type onset ( [286](#), [287](#) ). To clarify the ambiguities of the original classification, the group in Seattle revised the clinical criteria



for limited and extensive chronic GVHD ( [Table 25.6](#) ) ( [288](#) ). Prolonged immunosuppressive treatment is indicated for patients with clinically extensive chronic GVHD or other high-risk features, including platelet counts of less than  $100 \times 10^9/L$ , progressive onset, or corticosteroid treatment at the time of diagnosis of chronic GVHD.

**TABLE 25.6. Revised Seattle Classification for Limited and Extensive Chronic Graft-Versus-Host Disease (GVHD)**

---

Clinically limited

Oral abnormalities consistent with chronic GVHD, a positive skin or lip biopsy, and no other manifestations of chronic GVHD

Mild liver test abnormalities (alkaline phosphatase  $\leq 2 \times$  upper limit of normal, AST or ALT  $\leq 3 \times$  upper limit of normal, and total bilirubin  $\leq 1.6$ ), positive skin or lip biopsy, and no other manifestations of chronic GVHD

Less than six papulosquamous plaques, macular-papular or lichenoid rash involving  $<20\%$  of BSA, dyspigmentation involving  $<20\%$  BSA, or erythema involving  $<50\%$  BSA, positive skin biopsy, and no other manifestations of chronic GVHD

Ocular sicca (Schirmer test  $\leq 5$  mm with no more than minimal ocular symptoms), positive skin or lip biopsy, and no other manifestations of chronic GVHD

Vaginal or vulvar abnormalities, positive biopsy, and no other manifestations of chronic GVHD

Clinically extensive

Involvement of two or more organs with symptoms or signs of chronic GVHD with biopsy documentation of chronic GVHD in any organ

Karnofsky or Lansky Clinical Performance scores  $<60\%$ ,  $\geq 15\%$  weight loss, and recurrent infections not due to other causes, with biopsy documentation of chronic GVHD in any organ

Skin involvement more extensive than defined for clinically limited chronic GVHD, confirmed by biopsy

Scleroderma or morphea

Onycholysis or onychodystrophy believed to represent chronic GVHD with documentation of chronic GVHD in any organ

Decreased range of motion in wrist or ankle extension due to fasciitis caused by chronic GVHD

Contractures believed to represent chronic GVHD

Bronchiolitis obliterans not due to other causes

Positive liver biopsy or abnormal liver function tests not due to other causes with alkaline phosphatase  $>2 \times$  upper limit of normal, AST or ALT  $>3 \times$  upper limit of normal, or total bilirubin  $>1.6$ , and documentation of chronic GVHD in any organ

Positive upper or lower gastrointestinal biopsy

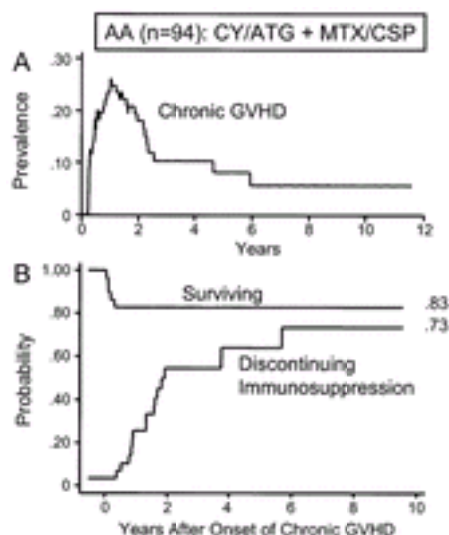
Fasciitis or serositis believed to represent chronic GVHD and not due to other causes  
ALT, alanine aminotransferase; AST, aspartate aminotransferase; BSA, body surface area.

---

In an attempt to prevent the development of chronic GVHD, patients without GVHD at day 80 after transplantation were given a 24-month course of CSP and compared with a group receiving CSP for 6 months ( [289](#) ). There were no significant differences between the groups in the incidence of chronic GVHD, transplant-related survival, or overall survival ( [289](#) ). It was concluded that patients without GVHD at day 80 would have a standard taper of CSP with discontinuation at 6 months.

**TREATMENT** Extensive chronic GVHD that is left untreated has a poor prognosis. In an original report of chronic GVHD, only 2 of 13 patients survived and there was significant morbidity ( [284](#) ). Prednisone given for 9 to 12 months reversed many of the signs and

symptoms of disease. The mortality in the group treated with prednisone was 21% (290). Patient survival was worse with the combination of azathioprine and prednisone compared to prednisone alone (287). The combination of CSP and prednisone was first used in patients with high-risk chronic GVHD who had a platelet count less than 100,000. The results of this study appeared promising compared to historical controls (291). In a randomized control study of patients with standard-risk chronic GVHD who had a platelet count greater than or equal to  $100 \times 10^9/L$  at diagnosis, in which prednisone alone was compared with a combination of CSP and prednisone, an early analysis suggested decreased morbidity and improved survival in the combination therapy arm (214). However, as the study matured, a trend toward improved survival was seen with prednisone alone (292). This study of combination therapy for standard-risk chronic GVHD suggested that more intense immunosuppression is not beneficial if manifestations of chronic GVHD are otherwise well controlled. A study of patients with high-risk chronic GVHD who had a platelet count of less than  $100 \times 10^9/L$  at diagnosis, in which patients were randomized between CSP alone and the combination of CSP and prednisone, indicated a trend toward improved survival and decreased morbidity in the combination therapy arm. Patients with clinically extensive chronic GVHD are treated for a period of 9 to 12 months. At the end of this time, they are reevaluated and, if there is no evidence of active chronic GVHD, the immunosuppressive agents are tapered. Other therapies that have been reported to have some limited efficacy for treatment of chronic GVHD include psoralen and ultraviolet A irradiation, extracorporeal photopheresis, and ursodeoxycholic acid treatment for GVHD of the liver (293, 294 and 295). Treatment with thalidomide, although initially believed to be promising, was found in other studies to be ineffective or too toxic for patients to maintain compliance (296, 297 and 298). By 3 to 5 years after initiation of therapy, many patients have inactive chronic GVHD, and immunosuppressive therapy has been discontinued (1, 114, 214) (Fig. 25.7). Approximately 75% of patients treated for extensive chronic GVHD survive with Karnofsky scores of greater than 80%. Infections are the major cause of excess mortality in patients with clinically extensive chronic GVHD.



**Figure 25.7. A:** Prevalence of chronic graft-versus-host disease (GVHD) after allogeneic marrow transplantation from HLA-identical sibling for aplastic anemia (AA). The prevalence curve accounts for the time of onset of chronic GVHD and the time of its resolution in response to therapy. **B:** Probability of survival among the 29 patients with chronic GVHD (83%) and probability of discontinuing immunosuppression given for chronic GVHD (73%). ATG, antithymocyte globulin; CSP, cyclosporine; CY, cyclophosphamide; MTX, methotrexate. (Modified from Storb R, Blume KG, O'Donnell MR, et al. Cyclophosphamide and antithymocyte globulin to condition patients with aplastic anemia



for allogeneic marrow transplantations: the experience in four centers. *Biol Blood Marrow Transplant* 2001;7:39–44.)

## GRAFT–VERSUS–TUMOR EFFECT

The first clinical report of a GVT effect after allogeneic marrow transplantation was published in 1979 ( [299](#) ). The term *GV7* is used to refer to the graft–versus–leukemia/lymphoma effect and the graft–versus–myeloma effect, as well as the antitumor effects of the graft on solid tumors such as renal cell carcinoma. It was observed that patients who developed GVHD had a lower risk of relapse after transplantation. These observations were confirmed in a subsequent study, but early attempts at inducing a GVT effect to reduce the relapse rate and improve survival were not successful ( [300](#) , [301](#) ). In 1990, Kolb and colleagues successfully treated three patients with CML who relapsed after marrow transplantation with donor lymphocyte infusions from the original HLA–identical sibling marrow donor ( [302](#) ). These early observations were expanded in a subsequent report of 135 patients, including 84 patients with CML ( [303](#) ). Complete remissions were achieved in 54 of 84 (72%) CML patients, 5 of 23 (29%) patients with AML, one of five (20%) patients with myelodysplastic syndrome, and 0 of 22 patients with acute lymphoblastic leukemia. GVHD developed in 41% of patients, and 34% showed signs of myelosuppression after donor lymphocyte infusions. Fourteen (10%) of patients died from complications related to GVHD or myelosuppression. This was confirmed in another large study of 140 patients with relapsed malignancy after marrow transplantation ( [304](#) ). Complete remissions were observed for patients with CML, AML, and myelodysplastic syndrome at a comparable rate to that described by Kolb et al. However, in patients with acute lymphoblastic leukemia, 18.2% of patients achieved a complete remission compared to none of these patients in the original study. Acute and chronic GVHD after the donor lymphocyte infusions correlated with disease response. Donor lymphocyte infusions may also be effective in patients with multiple myeloma who have relapsed after transplantation ( [304](#) , [305](#) ). The durability of the responses was confirmed with longer follow–up of patients who had achieved a complete remission after donor lymphocyte infusions ( [306](#) ). Twenty–five of 39 evaluable CML patients and 11 of 27 patients with other diseases had sustained remissions with a median follow–up of 32 months. Survival for patients with CML and other diseases was 61% at 3 years and 65% at 2 years, respectively. The number of CD3–positive cells infused into patients with relapse after T–depleted marrow transplant is likely an important parameter in determining clinical response and the risk for the development of GVHD ( [307](#) ). Patients with CML had a lower risk of GVHD, and efficacy of treatment was maintained with a strategy of escalating the dose of donor lymphocytes based on response of disease and GVHD ( [308](#) ). Comparable results of lymphocyte infusions from unrelated donors have now been demonstrated. The response, severity of GVHD, and the degree of myelosuppression were similar to those observed after lymphocyte infusions from HLA–matched sibling donors ( [309](#) ). Although patients may have an excellent response to infusions of donor lymphocytes, better strategies are required to minimize the severe complications of GVHD and myelosuppression associated with allogeneic cell therapy.

Many long–term remissions after transplantation are largely the result of a GVT effect directed at MHC and mHC molecules. Because mHC molecules may be expressed at varying levels in different host tissues, it may be possible to separate the syndrome of GVHD from GVT. Disparities of hematopoiesis–associated mHC molecules or the presence of leukemia–associated antigens on the patient’s leukemia cells might be targeted specifically. The tissue or tumor–restricted antigens could serve as targets for T–cell immunotherapy to enhance GVT activity without inducing GVHD. Peptides identified as minor histocompatibility molecules have been isolated and sequenced ( [231](#) ,

[310](#), [311](#) and [312](#)). Cytotoxic T-lymphocyte (CTL) clones specific for hematopoietic system-restricted MHC have been generated *ex vivo* ([312](#), [313](#)). These CTLs efficiently lyse leukemic cells from patients with AML and acute lymphoblastic leukemia and, in a NOD/SCID mouse model, inhibit the engraftment of human AML cells by direct CTL recognition of the SCID leukemia-initiating cells. The contribution of natural killer cells to the antitumor effect after allogeneic HSCT is still being investigated ([314](#)).

## IMMUNE RECONSTITUTION

After myeloablative therapy and autologous or allogeneic transplants, the patient's immune system may be impaired for 4 to 5 months. Immune reconstitution is most thoroughly studied after allogeneic transplantation. Recovery of the immune system due to cells derived from the donor graft occurs in phases over a period of 1 to 2 years in patients who do not develop GVHD. The first phase of recovery is defined by the increase in neutrophil counts that occurs 2 to 3 weeks after transplantation. Although the function of neutrophils is largely intact, they have impaired chemotaxis for a period up to 4 months ([315](#), [316](#)). Monocyte numbers in the peripheral blood return to normal within 3 to 4 weeks after transplantation. Monocyte counts in the peripheral blood were inversely correlated with infection rates between days 100 and 365 ([317](#)). Monocytes have been shown to be of donor origin within 41 days, and their function is generally normal ([318](#), [319](#)).

Macrophages in the liver and lung have been shown to be of donor type by day 80 ([320](#), [321](#)). Natural killer cells and cells capable of mediating antibody-dependent cytotoxicity have recovered to normal levels by 30 days after transplantation ([322](#)). Natural killer cells produce lymphokines, including IL-2, which may contribute to the recovery of the T-cell population in T-depleted grafts ([323](#)). The recovery of the immune system from donor origin is important in understanding the GVL effect and the complications after HSCT, including graft rejection, GVHD, and infections.

### B Cells

There are defects in serum immunoglobulin (Ig) production initially after the transplant. Serum antibody responses to different antigens, including FX174, keyhole limpet hemocyanin, pneumococcal, and meningococcal antigen, are lower than normal ([324](#), [325](#) and [326](#)). The defect in antibody production occurs in both T-dependent and T-independent systems. B lymphocytes respond to mitogenic stimulation, including staphylococcal aureus and cross-linked anti-IgM antibodies, after 2 months. By 3 months after transplantation, B lymphocytes with surface Ig have recovered to normal levels ([327](#)). Persistent deficiencies in B lymphopoiesis have been described in association with both acute and chronic GVHD or its treatment ([328](#)). The number of B-cell precursors in the marrow is not related to CD34-cell dose, type of transplant, donor age, or recipient age. Low B-cell counts on day 80 are associated with high infection rates from day 100 to 365 after transplantation ([317](#)).

Serum IgG and IgM achieve normal levels by 1 year after transplantation ([324](#)). Serum IgA may remain low for a period of 2 years. If serum IgG levels are below 4 g/L, patients are generally treated with intravenous Ig. Routine early administration of intravenous Ig has been demonstrated to decrease the rate of infections during the first 100 days after transplantation, as well as the incidence of acute GVHD ([329](#)).

### T Cells

Repopulation of donor T cells is poor initially in all recipients and remains defective in patients with chronic GVHD. A reversed CD4:CD8 ratio with low levels of CD4-positive cells and normal or high levels of CD8-positive cells has been demonstrated (330). If patients remain healthy and without chronic GVHD, the ratio of CD4 to CD8 cells normalizes eventually. In some patients, there can be an outgrowth of T cells with  $\alpha$ /d receptors, which are CD45 RO-positive (331). *In vivo* cellular immunity determined by skin testing to the recall antigens *Candida*, mumps, and trichophyton and the neoantigen dinitrochlorobenzene is diminished and may be prolonged if chronic GVHD develops (332).

T cells have a decreased proliferation in response to mitogenic stimuli such as phytohemagglutinin and CD3-specific antibody. After 3 months, the addition of exogenous IL-2 can normalize the proliferative response to phytohemagglutinin stimulation (333, 334). By 6 months, the response to phytohemagglutinin stimulation has normalized without the requirement for exogenous IL-2. T-cell immunity to herpes simplex virus (HSV) can be detected by day 40 (335, 336). CTL function against varicella-zoster virus (VZV) and CMV is acquired at a later time ( $\approx$ 3 months). Acquisition of T-cell immunity to herpes virus may be delayed by prophylaxis of viral infections with antiviral agents (335, 337).

After myeloablative conditioning and allogeneic transplantation, immunity may be restored by the adoptive transfer of mature T cells; this is important for establishing cellular immunity to infectious agents including the herpes viruses (337, 338 and 339). Vaccination protocols may enhance this infectious disease-specific cellular immunity. An inactivated varicella vaccine given before and during the first 90 days after transplantation significantly reduces the risk of developing VZV infections (340). CD4 T-cell proliferation in response to VZV is greater in patients who receive the vaccine. T-depleted HSCT or the development of GVHD requiring therapy may significantly delay the recovery of cellular immunity, resulting in an increased risk of infections. After transplantation with a peripheral blood stem cell graft, the rate of definite infections was significantly decreased compared to marrow (341). The counts of most lymphocyte subsets, especially CD4 T cells, were higher in the peripheral blood stem cell group. The thymus contributes to late immune reconstitution; it exports newly generated T cells to the periphery. Quantification of a DNA excision circle, generated during T-cell receptor rearrangement, can be used as a measure of thymic function. As these TRECs are lost on further cell division, cells in which they are present can be identified as recent thymic emigrants, and thymic output can thereby be quantitated. Increased thymic output (high TREC levels) was associated with an increased number of naïve T cells and a broader T-cell repertoire (342, 343). Younger patients had a more rapid recovery and higher TREC levels after HSCT. Low TREC levels correlated with the presence of chronic GVHD and severe opportunistic infections. The extent of the thymic rebound correlates with the patient's capacity to respond to vaccinations (344). Measures to enhance thymic output after transplantation, especially in older patients, may enhance immune reconstitution and decrease the risk of infections.

### **Evaluation of Hematopoiesis and Immunity in Patients Surviving More Than 20 Years after Transplantation**

It has now been more than 30 years since the first patients were transplanted with allogeneic HSCs after myeloablative conditioning. Donor-derived hematopoiesis and immunity were assessed in long-term survivors. All evaluable patients had normal complete blood counts (except one with concomitant liver disease) and polyclonal hematopoiesis and remained complete donor chimeras with greater than 97% donor-derived hematopoiesis (345). Some shortening of telomere length was

demonstrated, but it was concluded (within the limits of follow-up) that the stem cell proliferative potential was not compromised during hematopoietic reconstitution. Immunity of the recipients in long-term follow-up was normal or near-normal in comparison to the stem cell donor ( [346](#) ). The one exception was the observation that the number of TREC-positive CD4 cells was lower in transplant recipients who were age 18 years or older at the time of transplantation. The posttransplantation insufficiency of the thymus in older patients at the time of transplantation may not be fully reversible; however, this was not considered to be clinically significant.

### Adoptive Transfer of Immunity

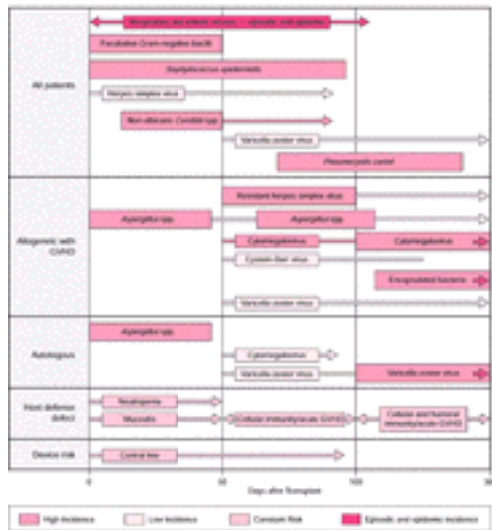
It has been demonstrated that the adoptive transfer of *ex vivo* cloned donor T cells specific for CMV may restore CMV-specific T-cell immunity in the early posttransplant period, preventing complications arising from these diseases ( [347](#) ). The development of GVHD and the need for immunosuppressive therapy limit the potential of this approach. The ability to transfer specific immune responses from the donor to the recipient has been shown for tetanus, diphtheria, and measles antigens without vaccination boosts after transplant. Specific serum antibody was noted within the first 3 months after transplant, as well as after 1 year ( [348](#) , [349](#) and [350](#) ).

Transfer of donor immunity causing disease in the recipient has also been reported. Allergen-specific IgE-mediated hypersensitivities of donors, including allergic rhinitis and asthma, were observed in recipients ( [351](#) ). Transfer of other immunologic conditions by HSCT, including myasthenia gravis, psoriasis, vitiligo, and autoimmune thyroiditis, has been reported ( [352](#) , [353](#) , [354](#) and [355](#) ). Serologic markers for systemic lupus erythematosus were adoptively transferred from the donor in one case report, but the recipient had not developed clinical disease by 3 years after transplantation ( [356](#) ). In another case report, a recipient transplanted from a donor with rheumatoid arthritis had not developed any manifestations of an autoimmune disease at 4 years after transplantation ( [357](#) ). There is a risk of adoptively transferring autoimmune diseases from stem cell donors, but the degree of that risk is not defined. Therefore, potential donors with autoimmune diseases should not be excluded solely on this basis. The decision to proceed should be based on the availability of other therapeutic options and a consent from the patient after being informed of the possible transmission of the autoimmune disease with the stem cell graft.

## INFECTIOUS COMPLICATIONS AFTER HEMATOPOIETIC STEM CELL TRANSPLANTATION

One of the most essential tasks in the care of patients after HSCT is to prevent or expeditiously treat opportunistic infections. There are periods after HSCT during which patients may be at greater risk from certain types of opportunistic pathogens ( [Fig. 25.8](#) ). Although the principles for preventing and managing infections in an immunosuppressed patient are widely accepted, the strategies for achieving these practices may vary from center to center. Two of the most important measures for reducing the risks of infection are an effective hand-washing policy and a strategy for preventing transmission of respiratory infections including respiratory syncytial virus, parainfluenza, and influenza. Effective screening of the blood supply has reduced the incidence of transfusion-related infections, especially hepatitis C. Risk factors for development of infection before engraftment are neutropenia and oral and gastrointestinal mucosal damage from the myeloablative therapy. After engraftment, a profound deficiency of both B-cell- and T-cell-mediated immunity persists. The integrity of mucosal barriers may be compromised by GVHD, the conditioning regimen, or viral infections. The degree of immunodeficiency in this period is influenced by the type of immunosuppressive therapy and the severity of GVHD, if present. Recovery from the immunodeficiency state is faster after autologous

stem cell support than after allogeneic HSCT. In 3 months, most patients have recovery of T-cell immunity specific for herpes viruses including CMV ( 358 ). If chronic GVHD develops, B-cell and T-cell immunodeficiencies may persist for years, and Ig production and reticuloendothelial function may also be impaired.



**Figure 25.8.** Periods of risk for opportunistic infections with standard prophylaxis after hematopoietic stem cell transplantation. Standard prophylaxis includes broad-spectrum antibiotics for neutropenia in the early posttransplant period, fluconazole to day 75, acyclovir early posttransplantation for herpes simplex virus and up to 1 year for prevention of reactivation of varicella-zoster virus, and trimethoprim and sulfamethoxazole for *Pneumocystis carinii* pneumonia. Strategies for preemptive treatment of cytomegalovirus still result in a significant incidence of viral reactivation but in a low incidence of cytomegalovirus disease. GVHD, graft-versus-host disease. (Adapted from D Armstrong, J Cohen. Infectious diseases. London: Harcourt Publishers Ltd., 1999.)

## Bacterial Infections

During the last part of the 1980s, gram-positive organisms, especially streptococcus or enterococcus species, accounted for 60% of all bacteremias in neutropenic patients who received HSCT ( 359 , 360 and 361 ). Previously, most infections had been due to gram-negative organisms ( 362 ). Most fevers in neutropenic patients are infectious in origin and potentially life-threatening. After a careful evaluation of the neutropenic patient with fever, empiric broad-spectrum antibiotic therapy should be initiated promptly and directed against the most likely causative organisms. If fever persists or recurs 4 to 7 days after initiation of antibiotics, empiric antifungal therapy should be considered ( 363 , 364 and 365 ). In neutropenic patients with severe infections, transfusion of neutrophils from donors stimulated with G-CSF plus dexamethasone can restore a severely neutropenic patient's neutrophil counts, which may contribute to the resolution of infections ( 366 ). Further studies are required to characterize the potential benefits and costs of this form of therapy in neutropenic patients. After engraftment, patients with intestinal GVHD are at risk for recurrent bacteremias. Patients with chronic GVHD are at risk for recurrent bacteremias with highly encapsulated bacteria and sino-pulmonary infections. Strategies for prevention of bacterial infections beyond day 80 after HSCT include the daily use of either penicillin or trimethoprim-sulfamethoxazole (TMP-SMX) until immunosuppressive



therapy is discontinued ( [367](#) ). Ig repletion should be considered in patients with documented Ig deficiency ( [329](#) ). Infrequent bacterial infections that should also be considered, especially in the presence of a pulmonary infiltrate or nodule, are those caused by *Legionella* (e.g., *L. pneumophila* and *L. micdadei*), *Nocardia*, *Mycobacterium tuberculosis*, and the atypical *Mycobacteria* ( [368](#), [369](#), [370](#) and [371](#) ).

## Candidal Infections

Before the routine administration of antifungal prophylaxis to patients, candidal infections were reported to occur in 11.4% of patients during the first 100 days after HSCT ( [372](#) ). The mortality associated with candidemia was 39%. In one report, *Candida albicans* caused 71% of documented cases of fungemia in cancer patients ( [373](#) ). Other *Candida* species are emerging as important pathogens ( [374](#) ). Often, blood cultures lack sensitivity in establishing a diagnosis of deep infection with *Candida* species ( [375](#) ). Fluconazole prophylaxis decreases the incidence of invasive and superficial *C. albicans* infections and may decrease the 100-day mortality from HSCT ( [376](#), [377](#) ). In addition, it was shown that 8 years after completion of the phase 3 studies, survival was significantly better in fluconazole recipients compared with placebo recipients ( [378](#) ). Fluconazole has limited activity against *Candida krusei*, *Torulopsis glabrata*, and *Aspergillus* species. Some, but not all, centers have reported an increase in the incidence of these resistant infections in patients on fluconazole ( [379](#), [380](#) ).

Treatment for systemic *Candida* infection consists of amphotericin B, although other newer antifungal agents are now available including voriconazole, posaconazole, and caspofungin ( [381](#), [382](#) ). Hepatosplenic candidiasis is not a contraindication to transplantation if antifungal therapy is given during the period of neutropenia ( [383](#) ).

## *Aspergillus* Infections

In some transplant centers, invasive aspergillosis is emerging as the most frequent cause of mortality from infection ( [379](#) ). Risk factors for the development of aspergillosis are older age, acute and chronic GVHD, treatment with prednisone, and secondary neutropenia. Use of peripheral blood stem cells instead of marrow was associated with a decreased risk of aspergillosis ( [384](#) ).

The respiratory tract is the portal of entry, and the most common clinical manifestations are pneumonia and sinusitis. *Aspergillus* is the most common cause of brain abscesses in patients after HSCT ( [385](#) ). Isolation of *Aspergillus* from bronchoalveolar lavage fluid of transplant patients is highly suggestive of pulmonary infection, but negative studies do not rule out *Aspergillus* ( [386](#), [387](#) ). High-efficiency particulate air filtration systems can reduce the risk of nosocomial *Aspergillus* infections ( [388](#) ).

Hyphal invasion in tissue specimens and a positive culture for *Aspergillus* species from the same specimen are required for the definitive diagnosis of invasive aspergillosis. The detection of circulating fungal antigens and DNA seems to be a promising, rapid, and sensitive diagnostic tool for early diagnosis of aspergillosis. The current antifungals available for the treatment of invasive aspergillosis include voriconazole, amphotericin B deoxycholate and lipid formulations, posaconazole, and caspofungin acetate ( [389](#), [390](#) ).

## Herpes Infections

**CYTOMEGALOVIRUS INFECTIONS** CMV is an important viral pathogen after HSCT. Infection occurs from reactivation of latent virus or is newly acquired from donor marrow or blood transfusions. Before the introduction of effective prevention strategies, CMV infection occurred in 70% of CMV-seropositive recipients and in 32% of CMV-seronegative recipients who received seronegative donor marrow and unscreened blood transfusions. Patients with CMV infections may be asymptomatic, but those with viremia are at high risk of developing CMV pneumonitis or gastroenteritis. In patients with CMV pneumonia, treatment is with a combination of ganciclovir and IVIg (391). The mortality associated with CMV pneumonitis remains greater than 50% (392). Treatment of CMV gastroenteritis may not require the administration of IVIg (393, 394). Foscarnet can be used in patients with ganciclovir-resistant CMV or during severe neutropenia. Cidofovir and foscarnet can be considered as second-line therapy for CMV disease failing other antiviral therapy (395). Because treatment of established CMV disease with antiviral agents has not been satisfactory, strategies for prophylaxis have been emphasized. The incidence of CMV infection was reduced in CMV-seronegative recipients to 3 to 6% when screened seronegative blood products were used (396, 397). Leukocyte depletion of blood products has also been effective in reducing the transmission of the virus (398). Ganciclovir was effective in preventing progression to disease at the time of first excretion of CMV as detected by culture of throat, blood, or urine (399, 400). Survival was improved in the group treated with ganciclovir in one study (399). However, disease was present at the time of first excretion in 12 to 30% of patients. When ganciclovir was given at the time of engraftment to CMV-seropositive recipients as early prophylaxis, CMV infection and disease were reduced, but there was no significant reduction in mortality (401, 402). Ganciclovir prophylaxis was associated with a higher incidence of neutropenic events and a delay in the reconstitution of CMV-specific T-cell immunity (337). Early treatment with ganciclovir or foscarnet strategies based on detection of CMV viremia by polymerase chain reaction technique or antigenemia by immunofluorescent studies was an effective strategy for preventing CMV disease (403, 404 and 405). Treatment of GVHD with doses of prednisone greater than 1 mg/kg was associated with rising CMV antigenemia levels during preemptive therapy (406). Continued induction dosing or reinduction may protect against early breakthrough CMV disease and CMV-related death among patients with rising antigenemia on preemptive therapy. The incidence of CMV disease late after transplantation has increased because the early use of ganciclovir blunts the recovery of CMV-specific immunity. Among seropositive patients who survive to day 80, approximately 18% develop late CMV disease. For those who receive treatment for GVHD, the incidence may exceed 30%. In view of this, high-risk patients require monitoring for reactivation for 1 year or longer after transplantation. The optimal strategy for prevention of CMV disease is likely to include prolonged surveillance and preemptive therapy or prophylaxis. Investigational strategies include enhancing the early restoration or the adoptive transfer of CMV-specific T-cell immunity (347).

**OTHER HERPES INFECTIONS** Without acyclovir prophylaxis, HSV infections occur in 80% of seropositive patients (407). Oral mucositis, cutaneous infections, esophagitis, genital herpes, and pneumonia are the most common clinical manifestations. Acyclovir is very effective for the prevention and treatment of HSV (379). Acyclovir is well tolerated immediately after transplantation with no effect on the recovery of neutrophil counts. HSV resistance to acyclovir can be managed with foscarnet. VZV infections occurred in 17% of VZV-seropositive patients (408). Median time to onset of infection was 5 months, with 85% occurring within 12 months of HSCT. VZV infections may manifest as herpes zoster only (84%) or as skin and visceral dissemination. Treatment with acyclovir within 24 to 48 hours of the onset of infection prevents dissemination and shortens the course of



cutaneous disease ( [408](#), [409](#) ). The case-fatality rate for untreated VZV infection is 35%. Primary herpes virus 4 [Epstein-Barr virus (EBV)] does not cause significant disease in HSCT patients ( [410](#), [411](#) and [412](#) ). Lympho-proliferative disorders after allogeneic HSCT, however, are associated with herpes virus 4 infection of B lymphocytes and loss of herpes virus 4-specific T-cell immunity ( [413](#) ). Risk factors for the development of EBV-associated lymphoproliferative disorders are the severity of acute GVHD, type of treatment of acute GVHD, HLA disparity between donor and recipient, and T-cell depletion of the marrow graft. Although this is an infrequent complication, it is often fatal. Patients at high risk for reactivation of herpes virus 4 should be monitored prospectively and considered for preemptive therapy ( [414](#), [415](#) ). Reports of the successful use of B-cell-specific antibodies as prevention after EBV reactivation or induction of remissions of EBV-associated lymphoproliferative disorders have been published ( [416](#), [417](#) ). Reconstitution of EBV-specific cell-mediated immunity may induce remissions in some patients ( [418](#), [419](#), [420](#) and [421](#) ). Human herpesvirus 6 (HHV-6) infections have been described more recently in stem cell transplant patients ( [422](#) ). HHV-6 DNA can be detected in approximately 60% of patients after HSCT ( [423](#) ). Detection of HHV-6 DNA after HSCT is more frequent in patients with moderate and severe acute GVHD. Many patients with reactivation remain asymptomatic ( [424](#) ). Primary HHV-6 infections have been associated with self-limited clinical symptoms including fever and rash. HHV-6-associated pneumonitis and encephalitis have been reported ( [425](#), [426](#) and [427](#) ). However, it is still uncertain if HHV-6 causes pneumonitis. Ganciclovir and foscarnet appear to be effective therapy, but *in vivo* response of HHV-6 to treatment is not well characterized ( [427](#), [428](#) ).

### ***Pneumocystis* and Toxoplasmosis Infections**

The incidence of *Pneumocystis* pneumonia without prophylaxis is 6.8% ( [429](#) ). The incidence may be as high as 28% between 41 to 80 days after HSCT. The mortality rate is 89% for patients who develop *Pneumocystis* pneumonia within 6 months of HSCT. TMP-SMX reduces the incidence of *Pneumocystis* pneumonia to 0.15%. If there is a history of an allergy to TMP-SMX, desensitization of patients should be attempted ( [429](#) ). Pentamidine (aerosolized and intravenous) and three times per week dapsone are ineffective for second-line prophylaxis ( [430](#), [431](#) ). Daily dapsone has been shown to be equivalent to TMP-SMX in human immunodeficiency virus-infected patients. Atovaquone may also be effective second-line prophylaxis, but there is still limited experience ( [432](#) ).

*Toxoplasma* infection occurred by reactivation in 1 to 2% of serologically positive allogeneic transplant recipients ( [433](#), [434](#) and [435](#) ). It was estimated that 15% of patients were seropositive before transplant, but this varies with the geography of the transplant program. The brain, heart, and lungs were the sites most commonly infected. *Toxoplasma* serology should be done routinely before HSCT to identify patients at risk for reactivation. Larger studies of seropositive patients are required to establish effective prophylaxis regimens ( [435](#), [436](#) ).

### **Immunizations**

After the first year, those patients without chronic GVHD are likely to have good responses to influenza, pneumococcal polysaccharide, inactivated polio virus, diphtheria, pertussis, tetanus toxoid, *Haemophilus influenzae* type B conjugate vaccines, and hepatitis B ( [437](#), [438](#) ). Patients who are being treated with immunosuppressive medications to control chronic GVHD may have an inadequate response after vaccinations, but there

may still be a potential benefit, and many transplantation programs are recommending this approach. In patients without chronic GVHD, immunization with a live attenuated measles, mumps, and rubella vaccine can be given safely when administered 2 years after transplantation ([439](#)).

## REFERENCES

1. Thomas ED, Storb R, Clift RA, et al. Bone-marrow transplantation. *N Engl J Med* 1975;292:832-843,895-902.
2. Storb R, Etzioni R, Anasetti C, et al. Cyclophosphamide combined with antithymocyte globulin in preparation for allogeneic marrow transplants in patients with aplastic anemia. *Blood* 1994;84:941-949.
3. Clift RA, Buckner CD, Thomas ED, et al. Marrow transplantation for chronic myeloid leukemia: a randomized study comparing cyclophosphamide and total body irradiation with busulfan and cyclophosphamide. *Blood* 1994;84: 2036-2043.
4. Jacobson LO, Marks EK, Robson MJ, et al. Effect of spleen protection on mortality following x-irradiation. *J Lab Clin Med* 1949;34:1538-1543.
5. Lorenz E, Uphoff D, Reid TR, et al. Modification of irradiation injury in mice and guinea pigs by bone marrow injections. *J Natl Cancer Inst* 1951;12:197-201.
6. Ford CE, Hamerton JL, Barnes DWH, et al. Cytological identification of radiation-chimaeras. *Nature* 1956;177:452-454.
7. Uphoff DE. Genetic factors influencing irradiation protection by bone marrow. I. The F1 hybrid effect. *J Natl Cancer Inst* 1957;19:123-125.
8. Schwartz R, Dameshek W. Drug-induced immunological tolerance. *Nature* 1959;183:1682-1683.
9. Uphoff DE. Alteration of homograft reaction by A-methopterin in lethally irradiated mice treated with homologous marrow. *Proc Soc Exp Biol Med* 1958;99:651-653.
10. Lochte HL Jr, Levy AS, Guenther DM, et al. Prevention of delayed foreign marrow reaction in lethally irradiated mice by early administration of methotrexate. *Nature* 1962;196:1110-1111.
11. Epstein RB, Storb R, Ragde H, et al. Cytotoxic typing antisera for marrow grafting in littermate dogs. *Transplantation* 1968;6:45-58.
12. Storb R, Rudolph RH, Thomas ED. Marrow grafts between canine siblings matched by serotyping and mixed leukocyte culture. *J Clin Invest* 1971;50:1272-1275.
13. Thomas ED, Collins JA, Herman EC Jr, et al. Marrow transplants in lethally irradiated dogs given methotrexate. *Blood* 1962;19:217-228.
14. Deeg HJ, Storb R, Weiden PL, et al. Cyclosporin A and methotrexate in canine marrow transplantation: engraftment, graft-versus-host disease, and induction of tolerance. *Transplantation* 1982;34:30-35.
15. Deeg HJ, Storb R, Appelbaum FR, et al. Combined immunosuppression with cyclosporine and methotrexate in dogs given bone marrow grafts from DLA-haploidentical littermates. *Transplantation* 1984;37:62-65.
16. Storb R, Deeg HJ, Whitehead J, et al. Methotrexate and cyclosporine compared with cyclosporine alone for prophylaxis of acute graft versus host disease after marrow transplantation for leukemia. *N Engl J Med* 1986;314:729-735.
17. Storb R, Deeg HJ, Farewell V, et al. Marrow transplantation for severe aplastic anemia: methotrexate alone compared with a combination of methotrexate and cyclosporine for prevention of acute graft-versus-host disease. *Blood* 1986;68:119-125.

18. Ringdén O, Horowitz MM, Sondel P, et al. Methotrexate, cyclosporine or both to prevent graft-versus-host disease after HLA-identical sibling bone marrow transplants for early leukemia? *Blood* 1993;81:1094-1101.
19. Bach FH, Albertini RJ, Joo P, et al. Bone-marrow transplantation in a patient with the Wiskott-Aldrich syndrome. *Lancet* 1968;2:1364-1366.
20. Gatti RA, Meuwissen HJ, Allen HD, et al. Immunological reconstitution of sex-linked lymphopenic immunological deficiency. *Lancet* 1968;2:1366-1369.
21. Thomas ED, Buckner CD, Storb R, et al. Aplastic anaemia treated by marrow transplantation. *Lancet* 1972;1:284-289.
22. Thomas ED, Buckner CD, Banaji M, et al. One hundred patients with acute leukemia treated by chemotherapy, total body irradiation, and allogeneic marrow transplantation. *Blood* 1977;49:511-533.
23. Spangrude GJ, Heimfeld S, Weissman IL. Purification and characterization of mouse hematopoietic stem cells. *Science* 1988;241:58-62.
24. Jones RJ, Wagner JE, Celano P, et al. Separation of pluripotent haematopoietic stem cells from spleen colony-forming cells. *Nature* 1990;347:188-189.
25. Osawa M, Hanada K, Hamada H, et al. Long-term lymphohematopoietic reconstitution by a single CD34-low/negative hematopoietic stem cell. *Science* 1996;273:242-245.
26. Goodell MA, Brose K, Paradis G, et al. Isolation and functional properties of murine hematopoietic stem cells that are replicating in vivo. *J Exp Med* 1996;183:1797-1806.
27. Goodell MA, Rosenzweig M, Kim H, et al. Dye efflux studies suggest that hematopoietic stem cells expressing low or undetectable levels of CD34 antigen exist in multiple species. *Nat Med* 1997;3:1337-1345.
28. Sato T, Laver JH, Ogawa M. Reversible expression of CD34 by murine hematopoietic stem cells. *Blood* 1999;94:2548-2554.
29. Zhao Y, Lin Y, Zhan Y, et al. Murine hematopoietic stem cell characterization and its regulation in BM transplantation. *Blood* 2000;96:3016-3022.
30. Bensinger WI, Buckner CD, Shannon-Dorcy K, et al. Transplantation of allogeneic CD34+ peripheral blood stem cells in patients with advanced hematologic malignancy. *Blood* 1996;88:4132-4138.
31. Bruno B, Nash RA, Wallace PM, et al. CD34+ selected bone marrow grafts are radioprotective and establish mixed chimerism in dogs given high dose total body irradiation. *Transplantation* 1999;68:338-344.
32. Bruno B, Goerner M, Nash RA, et al. Purified canine CD34<sup>+</sup>Lin<sup>-</sup> marrow cells transduced with retroviral vectors give rise to long-term multi-lineage hematopoiesis. *Biol Blood Marrow Transplant* 2001;7:543-551.
33. Link H, Arseniev L, Bahre O, et al. Transplantation of allogeneic CD34+ blood cells. *Blood* 1996;87:4903-4909.
34. Bittner RE, Schofer C, Weipoltshammer K, et al. Recruitment of bone-marrow-derived cells by skeletal and cardiac muscle in adult dystrophic mdx mice. *Anat Embryol* 1999;199:391-396.
35. Shi Q, Rafii S, Wu MHD, et al. Evidence for circulating bone marrow-derived endothelial cells. *Blood* 1998;92:362-367.
36. Horwitz EM, Prockop DJ, Fitzpatrick LA, et al. Transplantability and therapeutic effects of bone marrow-derived mesenchymal cells in children with osteogenesis imperfecta. *Nat Med* 1999;5:309-313.
37. Petersen BE, Bowen WC, Patrene KD, et al. Bone marrow as a potential source of hepatic oval cells. *Science* 1999;284:1168-1170.

38. Theise ND, Badve S, Saxena R, et al. Derivation of hepatocytes from bone marrow cells in mice after radiation-induced myeloablation. *Hepatology* 2000;31:235-240.
39. Theise ND, Nimmakayalu M, Gardner R, et al. Liver from bone marrow in humans. *Hepatology* 2000;32:11-16.
40. Brazelton TR, Rossi FM, Keshet GI, et al. From marrow to brain: expression of neuronal phenotypes in adult mice. *Science* 2000;290:1775-1779.
41. Mezey E, Chandross KJ, Harta G, et al. Turning blood into brain: cells bearing neuronal antigens generated in vivo from bone marrow. *Science* 2000;290:1779-1782.
42. Eglitis MA, Mezey E. Hematopoietic cells differentiate into both microglia and macroglia in the brains of adult mice. *Proc Natl Acad Sci U S A* 1997;94:4080-4085.
43. Wagers AJ, Sherwood RI, Christensen JL, et al. Little evidence for developmental plasticity of adult hematopoietic stem cells. *Science* 2002;297:2256-2259.
44. Civin CI, Strauss LC, Brovall C, et al. Antigenic analysis of hematopoiesis. III. A hematopoietic progenitor cell surface antigen defined by a monoclonal antibody raised against KG-1a cells. *J Immunol* 1984;133:157-165.
45. Andrews RG, Singer JW, Bernstein ID. Monoclonal antibody 12.8 recognizes a 115-kd molecule present on both unipotent and multipotent hematopoietic colony-forming cells and their precursors. *Blood* 1986;67:842-845.
46. Fina L, Molgaard HV, Robertson D, et al. Expression of the CD34 gene in vascular endothelial cells. *Blood* 1990;75:2417-2426.
47. Baumhuetter S, Singer MS, Henzel W, et al. Binding of L-selectin to the vascular sialomucin CD34. *Science* 1993;262:436-438.
48. Cheng J, Baumhueter S, Cacalano G, et al. Hematopoietic defects in mice lacking the sialomucin CD34. *Blood* 1996;87:479-490.
49. Baum CM, Weissman IL, Tsukamoto AS, et al. Isolation of a candidate human hematopoietic stem-cell population. *Proc Natl Acad Sci U S A* 1992;89:2804.
50. Strauss LC, Rowley SD, LaRussa VF, et al. Antigenic analysis of hematopoiesis. V. Characterization of My-10 antigen expression by normal lymphohematopoietic progenitor cells. *Exp Hematol* 1986;14:878-886.
51. Civin CI, Banquerigo ML, Strauss LC, et al. Antigenic analysis of hematopoiesis. VI. Flow cytometric characterization of My-10-positive progenitor cells in normal human bone marrow. *Exp Hematol* 1987;15:10-17.
52. Uchida N, Combs J, Chen S, et al. Primitive human hematopoietic cells displaying differential efflux of the rhodamine 123 dye have distinct biological activities. *Blood* 1996;88:1297-1305.
53. Humeau L, Bardin F, Maroc C, et al. Phenotypic, molecular, and functional characterization of human peripheral blood CD34<sup>+</sup>/THY1<sup>+</sup> cells. *Blood* 1996;87:949-955.
54. Gunji Y, Nakamura M, Osawa H, et al. Human primitive hematopoietic progenitor cells are more enriched in KIT<sup>low</sup> cells than in KIT<sup>high</sup> cells. *Blood* 1993;82:3283-3289.
55. Kawashima I, Zanjani ED, Almada-Porada G, et al. CD34<sup>+</sup> human marrow cells that express low levels of Kit protein are enriched for long-term marrow-engrafting cells. *Blood* 1996;87:4136-4142.
56. Yin AH, Miraglia S, Zanjani ED, et al. AC133, a novel marker for human hematopoietic stem and progenitor cells. *Blood* 1997;90:5002-5012.
57. Gallacher L, Murdoch B, Wu DM, et al. Isolation and characterization of human CD34(-)Lin(-) and CD34(+)-Lin(-) hematopoietic stem cells using cell surface markers AC133 and CD7. *Blood*

2000;95:2813–2820.

58. Fraser CC, Kaneshima H, Hansteeen G, et al. Human allogeneic stem cell maintenance and differentiation in a long-term multilineage SCID-hu graft. *Blood* 1995;86:1680–1693.
59. Berenson RJ, Andrews RG, Bensinger WI, et al. Antigen CD34<sup>+</sup> marrow cells engraft lethally irradiated baboons. *J Clin Invest* 1988;81:951–955.
60. Berenson RJ, Bensinger WI, Hill RS, et al. Engraftment after infusion of CD34<sup>+</sup> marrow cells in patients with breast cancer or neuroblastoma. *Blood* 1991;77:1717–1722.
61. McSweeney PA, Rouleau KA, Wallace PM, et al. Characterization of monoclonal antibodies that recognize canine CD34. *Blood* 1998;91:1977–1986.
62. Andrews RG, Bryant EM, Bartelmez SH, et al. CD34<sup>+</sup> marrow cells, devoid of T and B lymphocytes, reconstitute stable lymphopoiesis and myelopoiesis in lethally irradiated allogeneic baboons. *Blood* 1992;80:1693–1701.
63. Bensinger WI, Weaver CH, Appelbaum FR, et al. Transplantation of allogeneic peripheral blood stem cells mobilized by recombinant human granulocyte colony-stimulating factor. *Blood* 1995;85:1655–1658.
64. Schmitz N, Dreger P, Suttorp M, et al. Primary transplantation of allogeneic peripheral blood progenitor cells mobilized by filgrastim (granulocyte colony-stimulating factor). *Blood* 1995;85:1666–1672.
65. Korbling M, Huh YO, Durett A, et al. Allogeneic blood stem cell transplantation: peripheralization and yield of donor-derived primitive hematopoietic progenitor cells (CD34<sup>+</sup> Thy-1<sup>dim</sup>) and lymphoid subsets, and possible predictors of engraftment and graft-versus-host disease. *Blood* 1995;86:2842–2848.
66. Broxmeyer HE, Douglas GW, Hangoc G, et al. Human umbilical cord blood as a potential source of transplantable hematopoietic stem/progenitor cells. *Proc Natl Acad Sci U S A* 1989;86:3828–3832.
67. Gluckman E, Broxmeyer HE, Auerbach AD, et al. Hematopoietic reconstitution in a patient with Fanconi's anemia by means of umbilical-cord blood from an HLA-identical sibling. *N Engl J Med* 1989;321:1174–1178.
68. Wagner JE, Kernan NA, Steinbuch M, et al. Allogeneic sibling umbilical-cord-blood transplantation in children with malignant and non-malignant disease. *Lancet* 1995;346:214–219.
69. Kurtzberg J, Laughlin M, Graham ML, et al. Placental blood as a source of hematopoietic stem cells for transplantation into unrelated recipients. *N Engl J Med* 1996;335:157–166.
70. Goodman JW, Hodgson GS. Evidence for stem cells in the peripheral blood of mice. *Blood* 1962;19:702–714.
71. Epstein RB, Graham TC, Buckner CD, et al. Allogeneic marrow engraftment by cross circulation in lethally irradiated dogs. *Blood* 1966;28:692–707.
72. Kessinger A, Armitage JO, Landmark JD, et al. Autologous peripheral hematopoietic stem cell transplantation restores hematopoietic function following marrow ablative therapy. *Blood* 1988;71:723–727.
73. Molineux G, Pojda Z, Hampson IN, et al. Transplantation potential of peripheral blood stem cells induced by granulocyte colony-stimulating factor. *Blood* 1990;76:2153–2158.
74. Neben S, Marcus K, Mauch P. Mobilization of hematopoietic stem and progenitor cell subpopulations from the marrow to the blood of mice following cyclophosphamide and/or granulocyte colony-stimulating factor. *Blood* 1993;81:1960–1967.
75. Narayanasami U, Kanteti R, Morelli J, et al. Randomized trial of filgrastim versus chemotherapy and filgrastim mobilization of hematopoietic progenitor cells for rescue in autologous transplantation. *Blood* 2001;98:2059–2064.
76. de Revel T, Appelbaum FR, Storb R, et al. Effects of granulocyte colony stimulating factor and stem cell factor, alone and in combination, on the mobilization of peripheral blood cells that engraft lethally

irradiated dogs. *Blood* 1994;83:3795–3799.

77. Andrews RG, Briddell RA, Knitter GH, et al. Rapid engraftment by peripheral blood progenitor cells mobilized by recombinant human stem cell factor and recombinant human granulocyte colony-stimulating factor in nonhuman primates (Rapid Communication). *Blood* 1995;85:15–20.

78. Shpall EJ, Wheeler CA, Turner SA, et al. A randomized phase 3 study of peripheral blood progenitor cell mobilization with stem cell factor and filgrastim in high-risk breast cancer patients. *Blood* 1999;93:2491–2501.

79. Georges GE, Sandmaier BM, Storb R. Animal models. In: Reiffers J, Goldman J, Armitage J, eds. *Blood stem cell transplantation*. London: Martin Dunitz Publishers, 1998.

80. Brasel K, McKenna HJ, Charrier K, et al. Flt3 ligand synergizes with granulocyte-macrophage colony-stimulating factor or granulocyte colony-stimulating factor to mobilize hematopoietic progenitor cells into the peripheral blood of mice. *Blood* 1997;90:3781–3788.

81. Sheridan WP, Begley CG, Juttner CA, et al. Effect of peripheral-blood progenitor cells mobilised by filgrastim (G-CSF) on platelet recovery after high-dose chemotherapy. *Lancet* 1992;339:640–644.

82. Bensinger W, Singer J, Appelbaum F, et al. Autologous transplantation with peripheral blood mononuclear cells collected after administration of recombinant granulocyte stimulating factor. *Blood* 1993;81:3158–3163.

83. Weaver CH, Hazelton B, Birch R, et al. An analysis of engraftment kinetics as a function of the CD34 content of peripheral blood progenitor cell collections in 692 patients after the administration of myeloablative chemotherapy. *Blood* 1995;86:3961–3969.

84. Papayannopoulou T, Craddock C, Nakamoto B, et al. The VLA4/VCAM-1 adhesion pathway defines contrasting mechanisms of lodgement of transplanted murine hemopoietic progenitors between bone marrow and spleen. *Proc Natl Acad Sci U S A* 1995;92:9647–9651.

85. Levesque JP, Takamatsu Y, Nilsson SK, et al. Vascular cell adhesion molecule-1 (CD106) is cleaved by neutrophil proteases in the bone marrow following hematopoietic progenitor cell mobilization by granulocyte colony-stimulating factor. *Blood* 2001;98:1289–1297.

86. Prosper F, Stroncek D, McCarthy JB, et al. Mobilization and homing of peripheral blood progenitors is related to reversible downregulation of alpha4 beta1 integrin expression and function. *J Clin Invest* 1998;101:2456–2467.

87. Thomas ED, Storb R. Technique for human marrow grafting. *Blood* 1970;36:507–515.

88. Braine HG, Sensenbrenner LL, Wright SK, et al. Bone marrow transplantation with major ABO blood group incompatibility using erythrocyte depletion of marrow prior to infusion. *Blood* 1982;60:420–425.

89. Buckner CD, Petersen FB, Bolonesi BA. Bone marrow donors. In: Forman SJ, Blume KG, Thomas ED, eds. *Bone marrow transplantation*. Boston: Blackwell Scientific Publications, 1994:259–270.

90. Bortin MM, Buckner CD. Major complications of marrow harvesting for transplantation. *Exp Hematol* 1983;11:916–921.

91. Körbling M, Przepiorka D, Huh YO, et al. Allogeneic blood stem cell transplantation for refractory leukemia and lymphoma: potential advantage of blood over marrow allografts. *Blood* 1995;85:1659–1665.

92. Rubinstein P, Dobrila L, Rosenfield RE, et al. Processing and cryopreservation of placental/umbilical cord blood for unrelated bone marrow reconstitution. *Proc Natl Acad Sci U S A* 1995;92:10119–10122.

93. Harris DT, Schumacher MJ, Rychlik S, et al. Collection, separation and cryopreservation of umbilical cord blood for use in transplantation. *Bone Marrow Transplant* 1994;13:135–143.

94. Beatty PG, Anasetti C. Marrow transplantation from donors other than HLA identical siblings. In: Gale R, ed. *Bone marrow transplantation*. Boston: Blackwell, 1990.

95. Anasetti C, Hansen JA. Effect of HLA incompatibility in marrow transplantation from unrelated and

HLA-mismatched related donors. *Transfus Sci* 1994;15:221-230.

96. Anasetti C, Petersdorf EW, Martin PJ, et al. Trends in transplantation of hematopoietic stem cells from unrelated donors. *Curr Opin Hematol* 2001;8:337-341.

97. Lucarelli G, Galimberti M, Polchi P, et al. Bone marrow transplantation in patients with thalassemia. *N Engl J Med* 1990;322:417-421.

98. Fischer A, Landais P, Friedrich W, et al. European experience of bone-marrow transplantation for severe combined immunodeficiency. *Lancet* 1990;336:850-854.

99. Zittoun RA, Mandelli F, Willemze R, et al. Autologous or allogeneic bone marrow transplantation compared with intensive chemotherapy in acute myelogenous leukemia. *N Engl J Med* 1995;332:217-223.

100. Philip T, Guglielmi C, Hagenbeek A, et al. Autologous bone marrow transplantation as compared with salvage chemotherapy in relapses of chemotherapy-sensitive non-Hodgkin's lymphoma. *N Engl J Med* 1995;333:1540-1545.

101. Haioun C, Lepage E, Gisselbrecht C, et al. Survival benefit of high-dose therapy in poor-risk aggressive non-Hodgkin's lymphoma: final analysis of the prospective LNH87-2 protocol—a groupe d'Etude des lymphomes de l'Adulte study. *J Clin Oncol* 2000;18:3025-3030.

102. Haioun C, Lepage E, Gisselbrecht C, et al. Benefit of autologous bone marrow transplantation over sequential chemotherapy in poor-risk aggressive non-Hodgkin's lymphoma: updated results of the prospective study LNH87-2. Groupe d'Etude des Lymphomes de l'Adulte. *J Clin Oncol* 1997;15:1131-1137.

103. Schmitz N, Pfistner B, Sextro M, et al. Aggressive conventional chemotherapy compared with high-dose chemotherapy with autologous haemopoietic stem-cell transplantation for relapsed chemosensitive Hodgkin's disease: a randomised trial. *Lancet* 2002;359:2065-2071.

104. Budman DR, Wood W, Henderson IC, et al. Initial findings of CAL-GB 8541: a dose and dose intensity trial of cyclophosphamide (C), Doxorubicin (A), and 5-Fluorouracil (F) as adjuvant treatment of stage II, node+, female breast cancer. *Proc Am Soc Clin Oncol* 1992;11:51(abst).

105. Attal M, Harousseau J-L, Stoppa A-M, et al. A prospective, randomized trial of autologous bone marrow transplantation and chemotherapy in multiple myeloma. *N Engl J Med* 1996;335:91-97.

106. Lenhoff S, Hjorth M, Holmberg E, et al. Impact on survival of high-dose therapy with autologous stem cell support in patients younger than 60 years with newly diagnosed multiple myeloma: a population-based study. *Blood* 2000;95:7-11.

107. Tzung SP, Hackman RC, Hockenbery DM, et al. Lymphocytic gastritis resembling graft-vs.-host disease following autologous hematopoietic cell transplantation. *Biol Blood Marrow Transplant* 1998;4:43-48.

108. Bensinger WI, Martin PJ, Storer B, et al. Transplantation of bone marrow as compared with peripheral-blood cells from HLA-identical relatives in patients with hematologic cancers. *N Engl J Med* 2001;344:175-181.

109. Couban S, Simpson DR, Barnett MJ, et al. A randomized multicenter comparison of bone marrow and peripheral blood in recipients of matched sibling allogeneic transplants for myeloid malignancies. *Blood* 2002;100:1525-1531.

110. Schmitz N, Beksac M, Hasenclever D, et al. Transplantation of mobilized peripheral blood cells to HLA-identical siblings with standard-risk leukemia. *Blood* 2002;100:761-767.

111. Ringden O, Labopin M, Bacigalupo A, et al. Transplantation of peripheral blood stem cells as compared with bone marrow from HLA-identical siblings in adult patients with acute myeloid leukemia and acute lymphoblastic leukemia. *J Clin Oncol* 2002;20:4655-4664.

112. Flowers MED, Parker PM, Johnston LJ, et al. Comparison of chronic graft-versus-host disease after transplantation of peripheral blood stem cells versus bone marrow in allogeneic recipients: long-term follow-up of a randomized trial. *Blood* 2002;100:415-419.

113. Zaucha JM, Gooley T, Bensinger WI, et al. CD34 cell dose in granulocyte colony-stimulating



factor-mobilized peripheral blood mononuclear cell grafts affects engraftment kinetics and development of extensive chronic graft-versus-host disease after human leukocyte antigen-identical sibling transplantation. *Blood* 2001;98:3221-3227.

114. Storb R, Blume KG, O'Donnell MR, et al. Cyclophosphamide and antithymocyte globulin to condition patients with aplastic anemia for allogeneic marrow transplantations: the experience in four centers. *Biol Blood Marrow Transplant* 2001;7:39-44.

115. Walters MC, Storb R, Patience M, et al. Impact of bone marrow transplantation for symptomatic sickle cell disease: an interim report. *Blood* 2000;95:1918-1924.

116. Lucarelli G, Clift RA, Galimberti M, et al. Marrow transplantation for patients with thalassemia. Results in class 3 patients. *Blood* 1996;87:2082-2088.

117. Beatty PG, Clift RA, Mickelson EM, et al. Marrow transplantation from related donors other than HLA-identical siblings. *N Engl J Med* 1985;313:765-771.

118. Drobyski WR, Klein J, Flomenberg N, et al. Superior survival associated with transplantation of matched unrelated versus one-antigen-mismatched unrelated or highly human leukocyte antigen-disparate haploidentical family donor marrow grafts for the treatment of hematologic malignancies: establishing a treatment algorithm for recipients of alternative donor grafts. *Blood* 2002;99:806-814.

119. Aversa F, Tabilio A, Velardi A, et al. Treatment of high-risk acute leukemia with T-cell-depleted stem cells from related donors with one fully mismatched HLA haplotype. *N Engl J Med* 1998;339:1186-1193.

120. Nash RA, Pepe MS, Storb R, et al. Acute graft-versus-host disease: analysis of risk factors after allogeneic marrow transplantation and prophylaxis with cyclosporine and methotrexate. *Blood* 1992;80:1838-1845.

121. Hansen JA, Gooley TA, Martin PJ, et al. Bone marrow transplants from unrelated donors for patients with chronic myeloid leukemia. *N Engl J Med* 1998;338:962-968.

122. Scott I, O'Shea J, Bunce M, et al. Molecular typing shows a high level of HLA class I incompatibility in serologically well matched donor/patient pairs: implications for unrelated bone marrow donor selection. *Blood* 1998;92:4864-4871.

123. Prasad VK, Kernan NA, Heller G, et al. DNA typing for HLA-A and HLA-B identifies disparities between patients and unrelated donors matched by HLA-A and HLA-B serology and HLA-DRB1. *Blood* 1999;93:399-409.

124. Prasad VK, Heller G, Kernan NA, et al. The probability of HLA-C matching between patient and unrelated donor at the molecular level: estimations based on the linkage disequilibrium between DNA typed HLA-B and HLA-C alleles. *Transplantation* 1999;68:1044-1050.

125. Tiercy JM, Bujan-Lose M, Chapuis B, et al. Bone marrow transplantation with unrelated donors: what is the probability of identifying an HLA-A/B/Cw/DRB1/B3/B5/DQB1-matched donor? *Bone Marrow Transplant* 2000;26:437-441.

126. Petersdorf EW, Hansen JA, Martin PJ, et al. Major-histocompatibility-complex class I alleles and antigens in hematopoietic-cell transplantation. *N Engl J Med* 2001;345:1794-1800.

127. Petersdorf EW, Kollman C, Hurley CK, et al. Effect of HLA class II gene disparity on clinical outcome in unrelated donor hematopoietic cell transplantation for chronic myeloid leukemia: the US National Marrow Donor Program experience. *Blood* 2001;98:2922-2929.

128. Remberger M, Ringdén O, Blau I-W, et al. No difference in graft-versus-host disease, relapse, and survival comparing peripheral stem cells to bone marrow using unrelated donors. *Blood* 2001;98:1739-1745.

129. Elmaagacli AH, Basoglu S, Peceny R, et al. Improved disease-free-survival after transplantation of peripheral blood stem cells as compared with bone marrow from HLA-identical unrelated donors in patients with first chronic phase chronic myeloid leukemia. *Blood* 2002;99:1130-1135.

130. Rubinstein P, Carrier C, Scaradavou A, et al. Outcomes among 562 recipients of placental-blood

transplants from unrelated donors. *N Engl J Med* 1998;339:1565–1577.

131. Rocha V, Cornish J, Sievers EL, et al. Comparison of outcomes of unrelated bone marrow and umbilical cord blood transplants in children with acute leukemia. *Blood* 2001;97:2962–2971.

132. Barker JN, Davies SM, DeFor T, et al. Survival after transplantation of unrelated donor umbilical cord blood is comparable to that of human leukocyte antigen–matched unrelated donor bone marrow: results of a matched–pair analysis. *Blood* 2001;97:2957–2961.

133. Rocha V, Wagner JE, Sobocinski KA, et al. Graft–versus–host disease in children who have received a cord–blood or bone marrow transplant from an HLA–identical sibling. *N Engl J Med* 2000;342:1846–1854.

134. Wagner JE, Barker JN, Defor TE, et al. Transplantation of unrelated donor umbilical cord blood in 102 patients with malignant and nonmalignant diseases: influence of CD34 cell dose and HLA disparity on treatment–related mortality and survival. *Blood* 2002;100:1611–1618.

135. Migliaccio AR, Adamson JW, Stevens CE, et al. Cell dose and speed of engraftment in placental/umbilical cord blood transplantation: graft progenitor cell content is a better predictor than nucleated cell quantity. *Blood* 2000;96:2717–2722.

136. Barker JN, Weisdorf DJ, Defor TE, et al. Multiple unit unrelated donor umbilical cord blood transplantation in high risk adults with hematologic malignancies: impact on engraftment and chimerism. *Blood* 2002;100:41a(abst).

137. Laughlin MJ, Barker J, Bambach B, et al. Hematopoietic engraftment and survival in adult recipients of umbilical–cord blood from unrelated donors. *N Engl J Med* 2001;344:1815–1822.

138. Han P, Hodge G, Story C, et al. Phenotypic analysis of functional T–lymphocyte subtypes and natural killer cells in human cord blood: relevance to umbilical cord blood transplantation. *Br J Haematol* 1995;89:733–740.

139. Talvensaaari K, Clave E, Douay C, et al. A broad T–cell repertoire diversity and an efficient thymic function indicate a favorable long–term immune reconstitution after cord blood stem cell transplantation. *Blood* 2002;99:1458–1464.

140. Laporte JP, Gorin NC, Rubinstein P, et al. Cord–blood transplantation from an unrelated donor in an adult with chronic myelogenous leukemia. *N Engl J Med* 1996;335:167–170.

141. Buckner CD, Clift RA, Sanders JE, et al. ABO–incompatible marrow transplants. *Transplantation* 1978;26:233–238.

142. Lasky LC, Warkentin PI, Kersey JH, et al. Hemotherapy in patients undergoing blood group incompatible bone marrow transplantation. *Transfusion* 1983;23:277–285.

143. Bensinger WI, Buckner CD, Thomas ED, et al. ABO–incompatible marrow transplants. *Transplantation* 1982;33:427–429.

144. Gmur JP, Burger J, Schaffner A, et al. Pure red cell aplasia of long duration complicating major ABO–incompatible bone marrow transplantation. *Blood* 1990;75:290–295.

145. Bolan CD, Leitman SF, Griffith LM, et al. Delayed donor red cell chimerism and pure red cell aplasia following major ABO–incompatible nonmyeloablative hematopoietic stem cell transplantation. *Blood* 2001;98:1687–1694.

146. Gajewski JL, Petz LD, Calhoun L, et al. Hemolysis of transfused group O red blood cells in minor ABO–incompatible unrelated–donor bone marrow transplants in patients receiving cyclosporine without posttransplant methotrexate. *Blood* 1992;79:3076–3085.

147. Blume KG, Forman SJ, O'Donnell MR, et al. Total body irradiation and high–dose etoposide: a new preparatory regimen for bone marrow transplantation in patients with advanced hematologic malignancies. *Blood* 1987;69:1015–1020.

148. Powles RL, Milliken S, Helenglass G. The use of melphalan in conjunction with total body irradiation

as treatment for acute leukaemia. *Transplant Proc* 1989;21:2955–2957.

149. Lynch MHE, Petersen FB, Appelbaum FR, et al. Phase II study of busulfan, cyclophosphamide and fractionated total body irradiation as a preparatory regimen for allogeneic bone marrow transplantation in patients with advanced myeloid malignancies. *Bone Marrow Transplant* 1995;15:59–64.

150. Weaver CH, Petersen FB, Appelbaum FR, et al. High-dose fractionated total-body irradiation, etoposide, and cyclophosphamide followed by autologous stem-cell support in patients with malignant lymphoma. *J Clin Oncol* 1994;12:2559–2566.

151. Santos GW, Tutschka PJ, Brookmeyer R, et al. Marrow transplantation for acute nonlymphocytic leukemia after treatment with busulfan and cyclophosphamide. *N Engl J Med* 1983;309:1347–1353.

152. Zander AR, Culbert S, Jagannath S, et al. High dose cyclophosphamide, BCNU, and VP-16 (CBV) as a conditioning regimen for allogeneic bone marrow transplantation for patients with acute leukemia. *Cancer* 1987;59:1083–1086.

153. Demirer T, Weaver CH, Buckner CD, et al. High-dose cyclophosphamide, carmustine, and etoposide followed by allogeneic bone marrow transplantation in patients with lymphoid malignancies who had received prior dose-limiting radiation therapy. *J Clin Oncol* 1995;13:596–602.

154. Petersen FB, Bearman SI. Preparative regimens and their toxicity. In: Forman SJ, Blume KG, Thomas ED, eds. *Bone marrow transplantation*. Boston: Blackwell Scientific Publications, 1994:79–95.

155. Schiffman KS, Bensinger WI, Appelbaum FR, et al. Phase II study of high-dose busulfan, melphalan and thiotepa with autologous peripheral blood stem cell support in patients with malignant disease. *Bone Marrow Transplant* 1996;17:943–950.

156. Mills W, Chopra R, McMillan A, et al. BEAM chemotherapy and autologous bone marrow transplantation for patients with relapsed or refractory non-Hodgkin's lymphoma. *J Clin Oncol* 1995;13:588–595.

157. Clift RA, Buckner CD, Appelbaum FR, et al. Allogeneic marrow transplantation in patients with chronic myeloid leukemia in the chronic phase: a randomized trial of two irradiation regimens. *Blood* 1991;77:1660–1665.

158. Clift RA, Buckner CD, Appelbaum FR, et al. Allogeneic marrow transplantation in patients with acute myeloid leukemia in first remission: a randomized trial of two irradiation regimens. *Blood* 1990;76:1867–1871.

159. Clift RA, Radich J, Appelbaum FR, et al. Long-term follow-up of a randomized study comparing cyclophosphamide and total body irradiation with busulfan and cyclophosphamide for patients receiving allogeneic marrow transplants during chronic phase of chronic myeloid leukemia [Letter]. *Blood* 1999;94:3960–3962.

160. Devergie A, Blaise D, Attal M, et al. Allogeneic bone marrow transplantation for chronic myeloid leukemia in first chronic phase: a randomized trial of busulfan-cytosine versus cytosine-total body irradiation as preparative regimen: a report from the French Society of Bone Marrow Graft (SFGM). *Blood* 1995;85:2263–2268.

161. Ringdén O, Remberger M, Ruutu T, et al. Increased risk of chronic graft-versus-host disease, obstructive bronchiolitis, and alopecia with busulfan versus total body irradiation: long-term results of a randomized trial in allogeneic marrow recipients with leukemia. *Blood* 1999;93:2196–2201.

162. Slattery JT, Clift RA, Buckner CD, et al. Marrow transplantation for chronic myeloid leukemia: the influence of plasma busulfan levels on the outcome of transplantation. *Blood* 1997;89:3055–3060.

163. McDonald GB, Slattery JT, Bouvier ME, et al. Cyclophosphamide metabolism, liver toxicity, and mortality following hematopoietic stem cell transplantation. *Blood* 2003;101:2043–2048.

164. Walters MC, Patience M, Leisenring W, et al. Bone marrow transplantation for sickle cell disease. *N Engl J Med* 1996;335:369–376.

165. Matthews DC, Appelbaum FR, Eary JF, et al. Phase I study of <sup>131</sup>I-Anti-CD45 antibody plus cyclophosphamide and total body irradiation for advanced acute leukemia and myelodysplastic syndrome.

Blood 1999;94:1237-1247.

166. Press OW, Eary JF, Gooley T, et al. A phase I/II trial of iodine-131-tositumomab (anti-CD20), etoposide, cyclophosphamide, and autologous stem cell transplantation for relapsed B-cell lymphomas (Plenary paper). *Blood* 2000;96:2934-2942.
167. Giralt S, Estey E, Albitar M, et al. Engraftment of allogeneic hematopoietic progenitor cells with purine analog-containing chemotherapy: harnessing graft-versus-leukemia without myeloablative therapy. *Blood* 1997;89:4531-4536.
168. Giralt S, Thall PF, Khouri I, et al. Melphalan and purine analog-containing preparative regimens: reduced-intensity conditioning for patients with hematologic malignancies undergoing allogeneic progenitor cell transplantation. *Blood* 2001;97:631-637.
169. Khouri IF, Keating M, Körbling M, et al. Transplant-lite: induction of graft-versus-malignancy using fludarabine-based nonablative chemotherapy and allogeneic blood progenitor-cell transplantation as treatment for lymphoid malignancies. *J Clin Oncol* 1998;16:2817-2824.
170. Slavin S, Nagler A, Naparstek E, et al. Nonmyeloablative stem cell transplantation and cell therapy as an alternative to conventional bone marrow transplantation with lethal cytoreduction for the treatment of malignant and nonmalignant hematologic diseases. *Blood* 1998;91:756-763.
171. Nagler A, Slavin S, Varadi G, et al. Allogeneic peripheral blood stem cell transplantation using a fludarabine-based low intensity conditioning regimen for malignant lymphoma. *Bone Marrow Transplant* 2000;25:1021-1028.
172. Childs R, Clave E, Contentin N, et al. Engraftment kinetics after nonmyeloablative allogeneic peripheral blood stem cell transplantation: full donor T-cell chimerism precedes alloimmune responses. *Blood* 1999;94:3234-3241.
173. Spitzer TR, McAfee S, Sackstein R, et al. Intentional induction of mixed chimerism and achievement of antitumor responses after nonmyeloablative conditioning therapy and HLA-matched donor bone marrow transplantation for refractory hematologic malignancies. *Biol Blood Marrow Transplant* 2000;6:309-320.
174. McSweeney PA, Niederwieser D, Shizuru JA, et al. Hematopoietic cell transplantation in older patients with hematologic malignancies: replacing high-dose cytotoxic therapy with graft-versus-tumor effects. *Blood* 2001;97:3390-3400.
175. Sandmaier BM, Maloney DG, Gooley T, et al. Nonmyeloablative hematopoietic stem cell transplants (HSCT) from HLA-matched related donors for patients with hematologic malignancies: clinical results of a TBI-based conditioning regimen. *Blood* 2001;98:742a-743a(abst).
176. Weissinger F, Sandmaier BM, Maloney DG, et al. Decreased transfusion requirements for patients receiving nonmyeloablative compared with conventional peripheral blood stem cell transplants from HLA-identical siblings. *Blood* 2001;98:3584-3588.
177. Junghans C, Boeckh M, Carter RA, et al. Incidence and outcome of cytomegalovirus infections following nonmyeloablative compared with myeloablative allogeneic stem cell transplantation, a matched control study. *Blood* 2002;99:1978-1985.
178. Chakraverty R, Peggs K, Chopra R, et al. Limiting transplantation-related mortality following unrelated donor stem cell transplantation by using a nonmyeloablative conditioning regimen. *Blood* 2002;99:1071-1078.
179. Niederwieser D, Maris M, Shizuru JA, et al. Low-dose total body irradiation (TBI) and fludarabine followed by hematopoietic cell transplantation (HCT) from HLA-matched or mismatched unrelated donors and postgrafting immunosuppression with cyclosporine and mycophenolate mofetil (MMF) can induce durable complete chimerism and sustained remissions in patients with hematological diseases. *Blood* 2003;101:1620-1629.
180. Rizzieri DA, Long GD, Vredenburgh JJ, et al. Successful allogeneic engraftment of mismatched unrelated cord blood following a nonmyeloablative preparative regimen. *Blood* 2001;98:3486-3488.
181. Corradini P, Tarella C, Olivieri A, et al. Reduced-intensity conditioning followed by allografting of

hematopoietic cells can produce clinical and molecular remissions in patients with poor-risk hematologic malignancies. *Blood* 2002;99:75-82.

182. Sandmaier BM, Hegenbart U, Shizuru J, et al. Nonmyeloablative hematopoietic stem cell transplantation (HSCT) from HLA-identical siblings for treatment of chronic myelogenous leukemia (CML): induction of molecular remissions. *Blood* 2001;98:5259(abst).

183. Devine SM, Hoffman R, Verma A, et al. Allogeneic blood cell transplantation following reduced-intensity conditioning is effective therapy for older patients with myelofibrosis with myeloid metaplasia. *Blood* 2002;99:2255-2258.

184. Khouri IF, Saliba RM, Giralt SA, et al. Nonablative allogeneic hematopoietic transplantation as adoptive immunotherapy for indolent lymphoma: low incidence of toxicity, acute graft-versus-host disease, and treatment-related mortality. *Blood* 2001;98:3595-3599.

185. Kröger N, Schwerdtfeger R, Kiehl M, et al. Autologous stem cell transplantation followed by a dose-reduced allograft induces high complete remission rate in multiple myeloma. *Blood* 2002;100:755-760.

186. Maloney DG, Sahebi F, Stockerl-Goldstein KE, et al. Combining an allogeneic graft-vs-myeloma effect with high-dose autologous stem cell rescue in the treatment of multiple myeloma. *Blood* 2001;98:434a-435a(abst).

187. Carella AM, Cavaliere M, Lerma E, et al. Autografting followed by nonmyeloablative immunosuppressive chemotherapy and allogeneic peripheral-blood hematopoietic stem-cell transplantation as treatment of resistant Hodgkin's disease and non-Hodgkin's lymphoma. *J Clin Oncol* 2000;18:3918-3924.

188. Childs R, Chernoff A, Contentin N, et al. Regression of metastatic renal-cell carcinoma after nonmyeloablative allogeneic peripheral-blood stem-cell transplantation. *N Engl J Med* 2000;343:750-758.

189. Zaucha JM, Zellmer E, Georges G, et al. G-CSF-mobilized peripheral blood mononuclear cells added to marrow facilitates engraftment in nonmyeloablated canine recipients: CD3 cells are required. *Biol Blood Marrow Transplant* 2001;7:613-619.

190. Turhan AG, Humphries RK, Phillips GL, et al. Clonal hematopoiesis demonstrated by x-linked DNA polymorphisms after allogeneic bone marrow transplantation. *N Engl J Med* 1989;320:1655-1661.

191. Nash R, Storb R, Neiman P. Polyclonal reconstitution of human marrow after allogeneic bone marrow transplantation. *Blood* 1988;72:2031-2037.

192. Nemunaitis J, Rabinowe SN, Singer JW, et al. Recombinant granulocyte-macrophage colony-stimulating factor after autologous bone marrow transplantation for lymphoid cancer. *N Engl J Med* 1991;324:1773-1778.

193. Martin PJ. Determinants of engraftment after allogeneic marrow transplantation [Editorial]. *Blood* 1992;79:1647-1650.

194. Anasetti C, Amos D, Beatty PG, et al. Effect of HLA compatibility on engraftment of bone marrow transplants in patients with leukemia or lymphoma. *N Engl J Med* 1989;320:197-204.

195. Durnam DM, Anders KR, Fisher L, et al. Analysis of the origin of marrow cells in bone marrow transplant recipients using a Y-chromosome-specific in situ hybridization assay. *Blood* 1989;74:2220-2226.

196. McSweeney PA. Approaches to evaluation of chimerism and clonality. In: Burt RK, Deeg HJ, Lothian ST, et al., eds. *On call in bone marrow transplantation*. Austin, TX: RG Landes Co., 1996.

197. Martin PJ, Kernan NA. T-cell depletion for the prevention of graft-vs.-host disease. In: Burakoff SJ, Deeg HJ, Ferrara J, et al., eds. *Graft-vs.-host disease: immunology, pathophysiology, and treatment*. New York: Marcel Dekker Inc, 1990:371-387.

198. Martin PJ, Hansen JA, Torok-Storb B, et al. Graft failure in patients receiving T cell-depleted HLA-identical allogeneic marrow transplants. *Bone Marrow Transplant* 1988;3:445-456.

199. Champlin R, Ho W, Gajewski J, et al. Selective depletion of CD8+ T lymphocytes for prevention of

- graft-versus-host disease after allogeneic bone marrow transplantation. *Blood* 1990;76:418-423.
200. Soiffer RJ, Murray C, Mauch P, et al. Prevention of graft-versus-host disease by selective depletion of CD6-positive T lymphocytes from donor bone marrow. *J Clin Oncol* 1992;10:1191-1200.
201. Bjerke JW, Lorenz J, Martin PJ, et al. Treatment of graft failure with anti-CD3 antibody BC3, glucocorticoids and infusion of donor hematopoietic cells. *Blood* 1995;86[Suppl 1]:107a(abst).
202. Radich JP, Gooley T, Bensinger W, et al. HLA-matched related hematopoietic cell transplantation for CML chronic phase using a targeted busulfan and cyclophosphamide preparative regimen. *Blood* 2003;102:31-35.
203. Zager RA, O'Quigley J, Zager BK, et al. Acute renal failure following bone marrow transplantation: a retrospective study of 272 patients. *Am J Kidney Dis* 1989;13:210-216.
204. Meyers JD, Flournoy N, Thomas ED. Nonbacterial pneumonia after allogeneic marrow transplantation: a review of ten years' experience. *Rev Infect Dis* 1982;4:1119-1132.
205. Bearman SI, Appelbaum FR, Back A, et al. Regimen-related toxicity and early posttransplant survival in patients undergoing marrow transplantation for lymphoma. *J Clin Oncol* 1989;7:1288-1294.
206. Wingard JR, Mellits ED, Sostrin MB, et al. Interstitial pneumonitis after allogeneic bone marrow transplantation. Nine-year experience at a single institution. *Medicine* 1988;67:175-186.
207. Troussard X, Bernaudin JF, Cordonnier C, et al. Pulmonary veno-occlusive disease after bone marrow transplantation. *Thorax* 1984;39:956-957.
208. Hackman RC, Madtes DK, Petersen FB, et al. Pulmonary veno-occlusive disease following bone marrow transplantation. *Transplantation* 1989;47:989-992.
209. Rubenfeld GD, Crawford SW. Withdrawing life support from mechanically ventilated recipients of bone marrow transplants: a case for evidence-based guidelines. *Ann Intern Med* 1996;125:625-633.
210. McDonald GB, Hinds MS, Fisher LD, et al. Veno-occlusive disease of the liver and multiorgan failure after bone marrow transplantation: a cohort study of 355 patients. *Ann Intern Med* 1993;118:255-267.
211. Bearman SI, Shuhart MC, Hinds MS, et al. Recombinant human tissue plasminogen activator for the treatment of established severe venoocclusive disease of the liver after bone marrow transplantation. *Blood* 1992;80:2458-2462.
212. Leahey AM, Bunin NJ. Recombinant human tissue plasminogen activator for the treatment of severe hepatic veno-occlusive disease in pediatric bone marrow transplant patients. *Bone Marrow Transplant* 1996;17:1101-1104.
213. Richardson PG, Murakami C, Jin Z, et al. Multi-institutional use of defibrotide in 88 patients after stem cell transplantation with severe veno-occlusive disease and multisystem organ failure: response without significant toxicity in a high-risk population and factors predictive of outcome. *Blood* 2002;100:4337-4343.
214. Sullivan KM, Mori M, Sanders J, et al. Late complications of allogeneic and autologous marrow transplantation [Review]. *Bone Marrow Transplant* 1992;10:127-134.
215. Deeg HJ, Socié G, Schoch G, et al. Malignancies after marrow transplantation for aplastic anemia and Fanconi anemia: a joint Seattle and Paris analysis of results in 700 patients. *Blood* 1996;87:386-392.
216. Witherspoon RP, Fisher LD, Schoch G, et al. Secondary cancers after bone marrow transplantation for leukemia or aplastic anemia. *N Engl J Med* 1989;321:784-789.
217. Sanders JE, Hawley J, Levy W, et al. Pregnancies following high-dose cyclophosphamide with or without high-dose busulfan or total-body irradiation and bone marrow transplantation. *Blood* 1996;87:3045-3052.
218. Sanders JE, Buckner CD, Amos D, et al. Ovarian function following marrow transplantation for

aplastic anemia or leukemia. *J Clin Oncol* 1988;6:813-818.

219. Schubert MA, Sullivan KM, Schubert MM, et al. Gynecological abnormalities following allogeneic bone marrow transplantation. *Bone Marrow Transplant* 1990;5:425-430.

220. Benyunes MC, Sullivan KM, Deeg HJ, et al. Cataracts after bone marrow transplantation: long-term follow-up of adults treated with fractionated total body irradiation. *Int J Radiat Oncol Biol Phys* 1995;32:661-670.

221. Miller JS, Arthur DC, Litz CE, et al. Myelodysplastic syndrome after autologous bone marrow transplantation: an additional late complication of curative cancer therapy. *Blood* 1994;83:3780-3786.

222. Darrington DL, Vose JM, Anderson JR, et al. Incidence and characterization of secondary myelodysplastic syndrome and acute myelogenous leukemia following high-dose chemoradiotherapy and autologous stem-cell transplantation for lymphoid malignancies. *J Clin Oncol* 1994;12:2527-2534.

223. Stone RM, Neuberg D, Soiffer R, et al. Myelodysplastic syndrome as a late complication following autologous bone marrow transplantation for non-Hodgkin's lymphoma. *J Clin Oncol* 1994;12:2535-2542.

224. Gilliland DG, Gribben JG. Evaluation of the risk of therapy-related MDS/AML after autologous stem cell transplantation. *Biol Blood Marrow Transplant* 2002;8:9-16.

225. Sanders JE, Buckner CD, Sullivan KM, et al. Growth and development after bone marrow transplantation. In: Buckner CD, Gale RP, Lucarelli G, eds. *Advances and controversies in thalassemia therapy: bone marrow transplantation and other approaches*. New York: Alan R. Liss, 1989:375-382.

226. Billingham RE. *The biology of graft-versus-host reactions. The Harvey Lectures*. New York: Academic Press, 1966.

227. Grumet FC, Hiraki DD, Brown BW, et al. CD31 mismatching affects marrow transplantation outcome. *Biol Blood Marrow Transplant* 2001;7:503-512.

228. Behar E, Chao NJ, Hiraki DD, et al. Polymorphism of adhesion molecule CD31 and its role in acute graft-versus-host disease. *N Engl J Med* 1996;334:286-291.

229. Tseng L-H, Lin M-T, Hansen JA, et al. Correlation between disparity for the minor histocompatibility antigen HA-1 and the development of acute graft-versus-host disease after allogeneic marrow transplantation. *Blood* 1999;94:2911-2914.

230. Vogt MH, van den Muijsenberg JW, Goulmy E, et al. The DBY gene codes for an HLA-DQ5-restricted human male-specific minor histocompatibility antigen involved in graft-versus-host disease. *Blood* 2002;99:3027-3032.

231. Goulmy E, Schipper J, Pool J, et al. Mismatches of minor histocompatibility antigens between HLA-identical donors and recipients and the development of graft-versus-host disease after bone marrow transplantation. *N Engl J Med* 1996;334:281-285.

232. Kogler G, Middleton PG, Wilke M, et al. Recipient cytokine genotypes for TNF-alpha and IL-10 and the minor histocompatibility antigens HY and CD31 codon 125 are not associated with occurrence or severity of acute GVHD in unrelated cord blood transplantation: a retrospective analysis. *Transplantation* 2002;74:1167-1175.

233. Nichols WC, Antin JH, Lunetta KL, et al. Polymorphism of adhesion molecule CD31 is not a significant risk factor for graft-versus-host disease. *Blood* 1996;88:4429-4434.

234. Sprent J, Schaefer M, Lo D, et al. Properties of purified T cell subsets. II. In vivo responses to class I vs. class II H-2 differences. *J Exp Med* 1986;163:998-1011.

235. Sprent J, Schaefer M, Korngold R. Role of T cell subsets in lethal graft-versus-host disease (GVHD) directed to class I versus class II H-2 differences. II. Protective effects of L3T4+ cells in anti-class II GVHD. *J Immunol* 1990;144:2946-2954.

236. Sprent J, Schaefer M, Lo D, et al. Functions of purified L3T4+ and Lyt-2+ cells in vitro and in vivo



[Review]. *Immunol Rev* 1986;91:195–218.

237. Ferrara JLM, Deeg HJ. Graft-versus-host disease [Review]. *N Engl J Med* 1991;324:667–674.
238. Sale GE, Anderson P, Browne M, et al. Evidence of cytotoxic T-cell destruction of epidermal cells in human graft-versus-host disease: immunohistology with monoclonal antibody TIA-1. *Arch Pathol Lab Med* 1992;116:622–625.
239. Sale GE, Shulman HM, Hackman RC. Pathology of bone marrow transplantation. In: Forman SJ, Blume KG, Thomas ED, eds. *Bone marrow transplantation*. Boston: Blackwell Scientific Publications, 1994:189–203.
240. Sale GE, Alavaikko M, Schaeffers KM, et al. Abnormal CD4:CD8 ratios and delayed germinal center reconstitution in lymph nodes of human graft recipients with graft-versus-host disease (GVHD): an immunohistological study. *Exp Hematol* 1992;20:1017–1021.
241. Spencer GD, Hackman RC, McDonald GB, et al. A prospective study of unexplained nausea and vomiting after marrow transplantation. *Transplantation* 1986;42:602–607.
242. Weisdorf DJ, Snover DC, Haake R, et al. Acute upper gastrointestinal graft-versus-host disease: clinical significance and response to immunosuppressive therapy. *Blood* 1990;76:624–629.
243. Wu D, Hockenbery DM, Brentnall TA, et al. Persistent nausea and anorexia after marrow transplantation: a prospective study of 78 patients. *Transplantation* 1998;66:1319–1324.
244. Fox RJ, Vogelsang GB, Beschorner WE. Denuded bowel after recovery from graft-versus-host disease. *Transplantation* 1996;62:1681–1684.
245. Weisdorf D, Hakke R, Blazar B, et al. Risk factors for acute graft-versus-host disease in histocompatible donor bone marrow transplantation. *Transplantation* 1991;51:1197–1203.
246. Przepiorka D, Smith TL, Folloder J, et al. Risk factors for acute graft-versus-host disease after allogeneic blood stem cell transplantation. *Blood* 1999;94:1465–1470.
247. Glucksberg H, Storb R, Fefer A, et al. Clinical manifestations of graft-versus-host disease in human recipients of marrow from HL-A-matched sibling donors. *Transplantation* 1974;18:295–304.
248. Przepiorka D, Weisdorf D, Martin P, et al. Consensus conference on acute GVHD grading. *Bone Marrow Transplant* 1995;15:825–828.
249. Rowlings PA, Przepiorka D, Klein JP, et al. IBMTR Severity Index for grading acute graft-versus-host disease: retrospective comparison with Glucksberg grade. *Br J Haematol* 1997;97:855–864.
250. Al-Ghamdi H, Leisenring W, Bensinger WI, et al. A proposed objective way to assess results of randomized prospective clinical trials with acute graft-versus-host disease as an outcome of interest. *Br J Haematol* 2001;113:461–469.
251. Chao NJ, Schmidt GM, Niland JC, et al. Cyclosporine, methotrexate, and prednisone compared with cyclosporine and prednisone for prophylaxis of acute graft-versus-host disease. *N Engl J Med* 1993;329:1225–1230.
252. Deeg HJ, Lin D, Leisenring W, et al. Cyclosporine or cyclosporine plus methylprednisolone for prophylaxis of graft-versus-host disease: a prospective, randomized trial. *Blood* 1997;89:3880–3887.
253. Chao NJ, Snyder DS, Jain M, et al. Equivalence of 2 effective graft-versus-host disease prophylaxis regimens: results of a prospective double-blind randomized trial. *Biol Blood Marrow Transplant* 2000;6:254–261.
254. Storb R, Pepe M, Anasetti C, et al. What role for prednisone in prevention of acute graft-versus-host disease in patients undergoing marrow transplants? *Blood* 1990;76:1037–1045.
255. Ratanatharathorn V, Nash RA, Przepiorka D, et al. Phase III study comparing methotrexate and tacrolimus (Prograf, FK506) with methotrexate and cyclosporine for graft-versus-host-disease prophylaxis

- after HLA-identical sibling bone marrow transplantation. *Blood* 1998;92:2303-2314.
256. Nash RA, Antin JH, Karanes C, et al. Phase 3 study comparing methotrexate and tacrolimus with methotrexate and cyclosporine for prophylaxis of acute graft-versus-host disease after marrow transplantation from unrelated donors. *Blood* 2000;96:2062-2068.
257. Horowitz MM, Przepiorka D, Bartels P, et al. Tacrolimus vs. cyclosporine immunosuppression: results in advanced-stage disease compared with historical controls treated exclusively with cyclosporine. *Biol Blood Marrow Transplant* 1999;5:180-186.
258. Bornhauser M, Schuler U, Porksen G, et al. Mycophenolate mofetil and cyclosporine as graft-versus-host disease prophylaxis after allogeneic blood stem cell transplantation. *Transplantation* 1999;67:499-504.
259. Reisner Y, Kapoor N, Kirkpatrick D, et al. Transplantation for acute leukaemia with HLA-A and B nonidentical parental marrow cells fractionated with soybean agglutinin and sheep red blood cells. *Lancet* 1981;2:327-331.
260. Noga SJ, Donnenberg AD, Schwartz CL, et al. Development of a simplified counterflow centrifugation elutriation procedure for depletion of lymphocytes from human bone marrow. *Transplantation* 1986;41:220-229.
261. Filipovich AH, Vallera DA, Youle RJ, et al. Ex-vivo treatment of donor bone marrow with anti-T-cell immunotoxins for prevention of graft-versus-host disease. *Lancet* 1984;1:469-472.
262. Martin PJ, Hansen JA. Quantitative assays for detection of residual T cells in T-depleted human marrow. *Blood* 1985;65:1134-1140.
263. Drobyski WR, Ash RC, Casper JT, et al. Effect of T-cell depletion as graft-versus-host disease prophylaxis on engraftment, relapse, and disease-free survival in unrelated marrow transplantation for chronic myelogenous leukemia. *Blood* 1994;83:1980-1987.
264. Soiffer RJ, Weller E, Alyea EP, et al. CD6+ donor marrow T-cell depletion as the sole form of graft-versus-host disease prophylaxis in patients undergoing allogeneic bone marrow transplant from unrelated donors [erratum appears in *J Clin Oncol* 2001;19:2583]. *J Clin Oncol* 2001;19:1152-1159.
265. Martin PJ, Schoch G, Fisher L, et al. A retrospective analysis of therapy for acute graft-versus-host disease: initial treatment. *Blood* 1990;76:1464-1472.
266. Weisdorf D, Haake R, Blazar B, et al. Treatment of moderate/severe acute graft-versus-host disease after allogeneic bone marrow transplantation: an analysis of clinical risk features and outcome. *Blood* 1990;75:1024-1030.
267. Martin PJ, Schoch G, Fisher L, et al. A retrospective analysis of therapy for acute graft-versus-host disease: secondary treatment. *Blood* 1991;77:1821-1828.
268. Van Lint MT, Uderzo C, Locasciulli A, et al. Early treatment of acute graft-versus-host disease with high- or low-dose 6-methylprednisolone: a multicenter randomized trial from the Italian Group for Bone Marrow Transplantation. *Blood* 1998;92:2288-2293.
269. Martin PJ, Nelson BJ, Appelbaum FR, et al. Evaluation of a CD5-specific immunotoxin for treatment of acute graft-versus-host disease after allogeneic marrow transplantation. *Blood* 1996;88:824-830.
270. Cragg L, Blazar BR, DeFor T, et al. A randomized trial comparing prednisone with antithymocyte globulin/prednisone as an initial systemic therapy for moderately severe acute graft-versus-host disease. *Biol Blood Marrow Transplant* 2000;6:441-447.
271. Khoury H, Kashyap A, Adkins DR, et al. Treatment of steroid-resistant acute graft-versus-host disease with anti-thymocyte globulin. *Bone Marrow Transplant* 2001;27:1059-1064.
272. Deeg HJ, Blazar BR, Bolwell BJ, et al. Treatment of steroid-refractory acute graft-versus-host disease with anti-CD147 monoclonal antibody, ABX-CBL. *Blood* 2001;98:2052-2058.
273. Benito AI, Furlong T, Martin PJ, et al. Sirolimus (Rapamycin) for the treatment of steroid-refractory

acute graft-versus-host disease. *Transplantation* 2001;72:1924-1929.

274. Przepiorka D, Kernan NA, Ippoliti C, et al. Daclizumab, a humanized anti-interleukin-2 receptor alpha chain antibody, for treatment of acute graft-versus-host disease. *Blood* 2000;95:83-89.

275. Carpenter PA, Appelbaum FR, Corey L, et al. A humanized non-FcR-binding anti-CD3 antibody, visilizumab, for treatment of steroid-refractory acute graft-versus-host disease. *Blood* 2002;99:2712-2719.

276. Baehr PH, Levine DS, Bouvier ME, et al. Oral beclomethasone dipropionate for treatment of human intestinal graft-versus-host disease. *Transplantation* 1995;60:1231-1238.

277. McDonald GB, Bouvier M, Hockenbery DM, et al. Oral beclomethasone dipropionate for treatment of intestinal graft-versus-host disease: a randomized, controlled trial. *Gastroenterology* 1998;115:28-35.

278. Furlong T, Leisenring W, Storb R, et al. Psoralen and ultraviolet A irradiation (PUVA) as therapy for steroid-resistant cutaneous acute graft-versus-host disease. *Biol Blood Marrow Transplant* 2002;8:206-212.

279. Ely P, Dunitz J, Rogosheske J, et al. Use of a somatostatin analogue, octreotide acetate, in the management of acute gastrointestinal graft-versus-host disease. *Am J Med* 1991;90:707-710.

280. Bianco JA, Higano C, Singer J, et al. The somatostatin analog octreotide in the management of the secretory diarrhea of the acute intestinal graft-versus-host disease in a patient after bone marrow transplantation. *Transplantation* 1990;49:1194-1195.

281. Sullivan KM, Agura E, Anasetti C, et al. Chronic graft-versus-host disease and other late complications of bone marrow transplantation. *Semin Hematol* 1991;28:250-259.

282. Niederwieser D, Pepe M, Storb R, et al. Factors predicting chronic graft-versus-host disease and survival after marrow transplantation for aplastic anemia. *Bone Marrow Transplant* 1989;4:151-156.

283. Storb R, Prentice RL, Sullivan KM, et al. Predictive factors in chronic graft-versus-host disease in patients with aplastic anemia treated by marrow transplantation from HLA-identical siblings. *Ann Intern Med* 1983;98:461-466.

284. Shulman HM, Sullivan KM, Weiden PL, et al. Chronic graft-versus-host syndrome in man. A long-term clinicopathologic study of 20 Seattle patients. *Am J Med* 1980;69:204-217.

285. Clark JG, Crawford SW, Madtes DK, et al. Obstructive lung disease after allogeneic marrow transplantation. *Ann Intern Med* 1989;111:368-376.

286. Akpek G, Zahurak ML, Piantadosi S, et al. Development of a prognostic model for grading chronic graft-versus-host disease. *Blood* 2001;97:1219-1226.

287. Sullivan KM, Witherspoon RP, Storb R, et al. Prednisone and azathioprine compared with prednisone and placebo for treatment of chronic graft-versus-host disease: prognostic influence of prolonged thrombocytopenia after allogeneic marrow transplantation. *Blood* 1988;72:546-554.

288. Lee SJ, Vogelsang G, Flowers MED. Chronic graft versus host disease. *Biol Blood Marrow Transplant* (*in press*).

289. Kansu E, Gooley T, Flowers MED, et al. Administration of cyclosporine for 24 months compared with 6 months for prevention of chronic graft-versus-host disease: a prospective randomized clinical trial (brief report). *Blood* 2001;98:3868-3870.

290. Sullivan KM, Shulman HM, Storb R, et al. Chronic graft-versus-host disease in 52 patients: adverse natural course and successful treatment with combination immunosuppression. *Blood* 1981;57:267-276.

291. Sullivan KM, Witherspoon RP, Storb R, et al. Alternating-day cyclosporine and prednisone for treatment of high-risk chronic graft-versus-host disease. *Blood* 1988;72:555-561.

292. Koc S, Leisenring W, Flowers MED, et al. Therapy for chronic graft-versus-host disease: a

- randomized trial comparing cyclosporine plus prednisone versus prednisone alone. *Blood* 2002;100:48–51.
293. Eppinger T, Ehninger G, Steinert M, et al. 8-Methoxypsoralen and ultraviolet A therapy for cutaneous manifestations of graft-versus-host disease. *Transplantation* 1990;50:807–811.
294. Fried RH, Murakami CS, Fisher LD, et al. Ursodeoxycholic acid treatment of refractory chronic graft-versus-host of the liver. *Ann Intern Med* 1992;116:624–629.
295. Greinix HT, Volc-Platzer B, Rabitsch W, et al. Successful use of extracorporeal photochemotherapy in the treatment of severe acute and chronic graft-versus-host disease. *Blood* 1998;92:3098–3104.
296. Vogelsang GB, Farmer ER, Hess AD, et al. Thalidomide for the treatment of chronic graft versus host disease. *N Engl J Med* 1992;326:1055–1058.
297. Chao NJ, Parker PM, Niland JC, et al. Paradoxical effect of thalidomide prophylaxis on chronic graft-vs.-host disease. *Biol Blood Marrow Transplant* 1996;2:86–92.
298. Koc S, Leisenring W, Flowers MED, et al. Thalidomide for treatment of patients with chronic graft-versus-host disease. *Blood* 2000;96:3995–3996.
299. Weiden PL, Flournoy N, Thomas ED, et al. Antileukemic effect of graft-versus-host disease in human recipients of allogeneic-marrow grafts. *N Engl J Med* 1979;300:1068–1073.
300. Weiden PL, Sullivan KM, Flournoy N, et al. Antileukemic effect of chronic graft-versus-host disease. Contribution to improved survival after allogeneic marrow transplantation. *N Engl J Med* 1981;304:1529–1533.
301. Sullivan KM, Storb R, Buckner CD, et al. Graft-versus-host disease as adoptive immunotherapy in patients with advanced hematologic neoplasms. *N Engl J Med* 1989;320:828–834.
302. Kolb HJ, Mittermüller J, Clemm CH, et al. Donor leukocyte transfusions for treatment of recurrent chronic myelogenous leukemia in marrow transplant patients. *Blood* 1990;76:2462–2465.
303. Kolb HJ, Schattenberg A, Goldman JM, et al. Graft-versus-leukemia effect of donor lymphocyte transfusions in marrow grafted patients. European Group for Blood and Marrow Transplantation Working Party Chronic Leukemia. *Blood* 1995;86:2041–2050.
304. Collins RH Jr, Shpilberg O, Drobyski WR, et al. Donor leukocyte infusions in 140 patients with relapsed malignancy after allogeneic bone marrow transplantation. *J Clin Oncol* 1997;15:433–444.
305. Tricot G, Vesole DH, Jagannath S, et al. Graft-versus-myeloma effect: proof of principle. *Blood* 1996;87:1196–1198.
306. Porter DL, Collins RH Jr, Shpilberg O, et al. Long-term follow-up of patients who achieved complete remission after donor leukocyte infusions. *Biol Blood Marrow Transplant* 1999;5:253–261.
307. Mackinnon S, Papadopoulos EB, Carabasi MH, et al. Adoptive immunotherapy evaluating escalating doses of donor leukocytes for relapse of chronic myeloid leukemia after bone marrow transplantation: separation of graft-versus-leukemia responses from graft-versus-host disease. *Blood* 1995;86:1261–1268.
308. Dazzi F, Szydlo RM, Craddock C, et al. Comparison of single-dose and escalating-dose regimens of donor lymphocyte infusion for relapse after allografting for chronic myeloid leukemia. *Blood* 2000;95:67–71.
309. Porter DL, Collins RH Jr, Hardy C, et al. Treatment of relapsed leukemia after unrelated donor marrow transplantation with unrelated donor leukocyte infusions. *Blood* 2000;95:1214–1221.
310. den Haan JM, Sherman NE, Blokland E, et al. Identification of a graft versus host disease-associated human minor histocompatibility antigen. *Science* 1995;268:1476–1480.
311. Wang W, Meadows LR, den Haan JM, et al. Human H-Y: a male-specific histocompatibility antigen derived from the SMCY protein. *Science* 1995;269:1588–1590.
312. Warren EH, Greenberg PD, Riddell SR. Cytotoxic T-lymphocyte-defined human minor

histocompatibility antigens with a restricted tissue distribution. *Blood* 1998;91:2197-2207.

313. Mutis T, Verdijk R, Schrama E, et al. Feasibility of immunotherapy of relapsed leukemia with ex vivo-generated cytotoxic T lymphocytes specific for hematopoietic system-restricted minor histocompatibility antigens. *Blood* 1999;93:2336-2341.

314. Farag SS, Fehniger TA, Ruggeri L, et al. Natural killer cell receptors: new biology and insights into the graft-versus-leukemia effect [Review]. *Blood* 2002;100:1935-1947.

315. Clark RA, Johnson FL, Klebanoff SJ, et al. Defective neutrophil chemotaxis in bone marrow transplant patients. *J Clin Invest* 1976;58:22-31.

316. Territo MC, Gale RP, Cline MJ. Neutrophil function in bone marrow transplant recipients. *Br J Haematol* 1977;35:245-250.

317. Storek J, Espino G, Dawson MA, et al. Low B-cell and monocyte counts on day 80 are associated with high infection rates between day 100 and 365 after allogeneic marrow transplantation (brief report). *Blood* 2000;96:3290-3293.

318. Tsoi M-S, Dobbs S, Brkic S, et al. Cellular interactions in marrow-grafted patients. II. Normal monocyte antigen-presenting and defective T-cell-proliferative functions early after grafting and during chronic graft-versus-host disease. *Transplantation* 1984;37:556-561.

319. Winston DJ, Territo MC, Ho WG, et al. Alveolar macrophage dysfunction in human bone marrow transplant recipients. *Am J Med* 1982;73:859-866.

320. Thomas ED, Ramberg RE, Sale GE, et al. Direct evidence for a bone marrow origin of the alveolar macrophage in man. *Science* 1976;192:1016-1018.

321. Gale RP, Sparkes RS, Golde DW. Bone marrow origin of hepatic macrophages (Kupffer cells) in humans. *Science* 1978;201:937-938.

322. Livnat S, Seigneuret M, Storb R, et al. Analysis of cytotoxic effector cell function in patients with leukemia or aplastic anemia before and after marrow transplantation. *J Immunol* 1980;124:481-490.

323. Brenner MK, Reittie JE, Grob J-P, et al. The contribution of large granular lymphocytes to B cell activation and differentiation after T-cell-depleted allogeneic bone marrow transplantation. *Transplantation* 1986;42:257-261.

324. Witherspoon RP, Storb R, Ochs HD, et al. Recovery of antibody production in human allogeneic marrow graft recipients: influence of time posttransplantation, the presence or absence of chronic graft-versus-host disease, and antithymocyte globulin treatment. *Blood* 1981;58:360-368.

325. Witherspoon RP, Deeg HJ, Lum LG, et al. Immunologic recovery in human marrow graft recipients given cyclosporine or methotrexate for the prevention of graft-versus-host disease. *Transplantation* 1984;37:456-461.

326. Quinti I, Velardi A, Le Moli S, et al. Antibacterial polysaccharide antibody deficiency after allogeneic bone marrow transplantation. *J Clin Immunol* 1990;10:160-166.

327. Noel DR, Witherspoon RP, Storb R, et al. Does graft-versus-host disease influence the tempo of immunologic recovery after allogeneic human marrow transplantation? An observation on 56 long-term survivors. *Blood* 1978;51:1087-1105.

328. Storek J, Wells D, Dawson MA, et al. Factors influencing B-lymphopoiesis after allogeneic hematopoietic cell transplantation (brief report). *Blood* 2001;98:489-491.

329. Sullivan KM, Kopecky KJ, Jocom J, et al. Immunomodulatory and antimicrobial efficacy of intravenous immunoglobulin in bone marrow transplantation. *N Engl J Med* 1990;323:705-712.

330. Atkinson K, Hansen JA, Storb R, et al. T-cell subpopulations identified by monoclonal antibodies after human marrow transplantation. I. Helper-inducer and cytotoxic-suppressor subsets. *Blood* 1982;59:1292-1298.

331. van der Harst D, Brand A, van Luxemburg-Heijs SA, et al. Selective outgrowth of CD45RO+ V gamma 9+/V delta 2+ T-cell receptor gamma/delta T cells early after bone marrow transplantation. *Blood* 1991;78:1875-1881.
332. Witherspoon RP, Matthews D, Storb R, et al. Recovery of in vivo cellular immunity after human marrow grafting: influence of time postgrafting and acute graft-versus-host disease. *Transplantation* 1984;37:145-150.
333. Roosnek EE, Brouwer MC, Vossen JM, et al. The role of interleukin-2 in proliferative responses in vitro of T cells from patients after bone marrow transplantation. Evidence that minor defects can lead to in vitro unresponsiveness. *Transplantation* 1987;43:855-860.
334. Welte K, Ciobanu N, Moore MAS, et al. Defective interleukin 2 production in patients after bone marrow transplantation and in vitro restoration of defective T lymphocyte proliferation by highly purified interleukin 2. *Blood* 1984;64:380-385.
335. Ljungman P, Wilczek H, Gahrton G, et al. Long-term acyclovir prophylaxis in bone marrow transplant recipients and lymphocyte proliferation responses to herpes virus antigens in vitro. *Bone Marrow Transplant* 1986;1:185-192.
336. Gratama JW, Verdonck LF, van der Linden JA, et al. Cellular immunity to vaccinations and herpes virus infections after bone marrow transplantation. *Transplantation* 1986;41:719-724.
337. Li C-R, Greenberg PD, Gilbert MJ, et al. Recovery of HLA-restricted cytomegalovirus (CMV)-specific T-cell responses after allogeneic bone marrow transplant: correlation with CMV disease and effect of ganciclovir prophylaxis. *Blood* 1994;83:1971-1979.
338. Marshall NA, Howe JG, Formica R, et al. Rapid reconstitution of Epstein-Barr virus-specific T lymphocytes following allogeneic stem cell transplantation. *Blood* 2000;96:2814-2821.
339. Reusser P, Riddell SR, Meyers JD, et al. Cytotoxic T-lymphocyte response to cytomegalovirus after human allogeneic bone marrow transplantation: pattern of recovery and correlation with cytomegalovirus infection and disease. *Blood* 1991;78:1373-1380.
340. Hata A, Asanuma H, Rinki M, et al. Use of an inactivated varicella vaccine in recipients of hematopoietic-cell transplants. *N Engl J Med* 2002;347:26-34.
341. Storek J, Dawson MA, Storer B, et al. Immune reconstitution after allogeneic marrow transplantation compared with blood stem cell transplantation. *Blood* 2001;97:3380-3389.
342. Lewin SR, Heller G, Zhang L, et al. Direct evidence for new T-cell generation by patients after either T-cell-depleted or unmodified allogeneic hematopoietic stem cell transplantations. *Blood* 2002;100:2235-2242.
343. Douek DC, Vescio RA, Betts MR, et al. Assessment of thymic output in adults after haematopoietic stem-cell transplantation and prediction of T-cell reconstitution. *Lancet* 2000;355:1875-1881.
344. Roux E, Dumont-Girard F, Starobinski M, et al. Recovery of immune reactivity after T-cell-depleted bone marrow transplantation depends on thymic activity. *Blood* 2000;96:2299-2303.
345. Mathioudakis G, Storb R, McSweeney PA, et al. Polyclonal hematopoiesis with variable telomere shortening in human long-term allogeneic marrow graft recipients (brief report). *Blood* 2000;96:3991-3994.
346. Storek J, Joseph A, Espino G, et al. Immunity of patients surviving 20 to 30 years after allogeneic or syngeneic bone marrow transplantation (plenary paper). *Blood* 2001;98:3505-3512.
347. Walter EA, Greenberg PD, Gilbert MJ, et al. Reconstitution of cellular immunity against cytomegalovirus in recipients of allogeneic bone marrow by transfer of T-cell clones from the donor. *N Engl J Med* 1995;333:1038-1044.
348. Lum LG, Munn NA, Schanfield MS, et al. The detection of specific antibody formation to recall antigens after human bone marrow transplantation. *Blood* 1986;67:582-587.

349. Lum LG, Seigneuret MC, Storb R. The transfer of antigen-specific humoral immunity from marrow donors to marrow recipients. *J Clin Immunol* 1986;6:389-396.
350. Lum LG, Seigneuret MC, Shiobara S, et al. Adoptively transferred immunity persists in human marrow graft recipients. In: Truitt RL, Gale RP, Bortin MM, eds. *Cellular immunotherapy of cancer*. New York: Alan R. Liss, 1987:449-460.
351. Agosti JM, Sprenger JD, Lum LG, et al. Transfer of allergen-specific IgE-mediated hypersensitivity with allogeneic bone marrow transplantation. *N Engl J Med* 1988;319:1623-1628.
352. Bolger GB, Sullivan KM, Spencer AM, et al. Myasthenia gravis after allogeneic bone marrow transplantation: relationship to chronic graft-versus-host disease. *Neurology* 1986;36:1087-1091.
353. Aldouri M, Ruggier R, Epstein O, et al. Adoptive transfer of hyperthyroidism and autoimmune thyroiditis following allogeneic bone marrow transplantation for chronic myeloid leukaemia. *Br J Haematol* 1990;74:118-120.
354. Snowden JA, Heaton DC. Development of psoriasis after syngeneic bone marrow transplant from psoriatic donor: further evidence for adoptive autoimmunity. *Br J Dermatol* 1997;137:130-132.
355. Neumeister P, Strunk D, Apfelbeck U, et al. Adoptive transfer of vitiligo after allogeneic bone marrow transplantation for non-Hodgkin's lymphoma. *Lancet* 2000;355:1334-1335.
356. Sturfelt G, Lenhoff S, Sallerfors B, et al. Transplantation with allogenic bone marrow from a donor with systemic lupus erythematosus (SLE): successful outcome in the recipient and induction of an SLE flare in the donor. *Ann Rheum Dis* 1996;55:638-641.
357. Snowden JA, Atkinson K, Kearney P, et al. Allogeneic bone marrow transplantation from a donor with severe active rheumatoid arthritis not resulting in adoptive transfer of disease to recipient. *Bone Marrow Transplant* 1997;20:71-73.
358. Reusser P, Attenhofer R, Hebart H, et al. Cytomegalovirus-specific T-cell immunity in recipients of autologous peripheral blood stem cell or bone marrow transplants. *Blood* 1997;89:3873-3879.
359. Winston DJ. Prophylaxis and treatment of infection in the bone marrow transplant recipient. *Curr Clin Top Infect Dis* 1993;13:293-321.
360. Zinner SH. *New pathogens in the immunocompromised host. Recent results in cancer research*. Berlin-Heidelberg: Springer-Verlag, 1993:238-239.
361. Vancomycin added to empirical combination antibiotic therapy for fever in granulocytopenic cancer patients. European Organization for Research and Treatment of Cancer (EORTC) International Antimicrobial Therapy Cooperative Group and the National Cancer Institute of Canada-Clinical Trials Group [erratum appears in *J Infect Dis* 1991;164:832]. *J Infect Dis* 1991;163:951-958.
362. Meyers JD. Infections in marrow recipients. In: Mandell GL, Douglas RG, Bennett JE, eds. *Principles and practice of infectious diseases*, 2nd ed. New York: John Wiley and Sons, 1985:1674-1676.
363. Pizzo PA, Robichaud KJ, Gill FA, et al. Empiric antibiotic and antifungal therapy for cancer patients with prolonged fever and granulocytopenia. *Am J Med* 1982;72:101-111.
364. EORTC International Antimicrobial Therapy Project Group. Empiric antifungal therapy in febrile granulocytopenic patients. *Am J Med* 1989;86:668-672.
365. Walsh TJ, Pappas P, Winston DJ, et al. Voriconazole compared with liposomal amphotericin B for empirical antifungal therapy in patients with neutropenia and persistent fever. *N Engl J Med* 2002;346:225-234.
366. Price TH, Bowden RA, Boeckh M, et al. Phase I/II trial of neutrophil transfusions from donors stimulated with G-CSF and dexamethasone for treatment of patients with infections in hematopoietic stem cell transplantation. *Blood* 2000;95:3302-3309.
367. Sullivan KM, Dahlberg S, Storb R, et al. Infection prophylaxis in patients with chronic graft-vs-host



disease (GVHD). *Exp Hematol* 1983;11:346(abst).

368. Harrington RD, Woolfrey AE, Bowden R, et al. Legionellosis in a bone marrow transplant center. *Bone Marrow Transplant* 1996;18:361–368.

369. Schwebke JR, Hackman R, Bowden R. Pneumonia due to *Legionella micdadei* in bone marrow transplant recipients. *Rev Infect Dis* 1990;12:824–828.

370. Kurzrock R, Zander A, Vellekoop L, et al. Mycobacterial pulmonary infections after allogeneic bone marrow transplantation. *Am J Med* 1984;77:35–40.

371. van Burik J–A, Hackman RC, Nadeem SQ, et al. Nocardiosis after bone marrow transplantation. *Clin Infect Dis* 1997;24:1154–1160.

372. Goodrich JM, Reed EC, Mori M, et al. Clinical features and analysis of risk factors for invasive candidal infection after marrow transplantation. *J Infect Dis* 1991;164:731–740.

373. Lecciones JA, Lee JW, Navarro EE, et al. Vascular catheter–associated fungemia in patients with cancer: analysis of 155 episodes. *Clin Infect Dis* 1992;14:875–883.

374. Meunier F, Aoun M, Bitar N. Candidemia in immunocompromised patients. *Clin Infect Dis* 1992;14:S120–S125.

375. Pizzo PA, Walsh TJ. Fungal infections in the pediatric cancer patient. *Semin Oncol* 1990;17:6–9.

376. Goodman JL, Winston DJ, Greenfield RA, et al. A controlled trial of fluconazole to prevent fungal infections in patients undergoing bone marrow transplantation. *N Engl J Med* 1992;326:845–851.

377. Slavin MA, Osborne B, Adams R, et al. Efficacy and safety of fluconazole for fungal infections after marrow transplant—a prospective, randomized, double–blind study. *J Infect Dis* 1995;171:1545–1552.

378. Marr KA, Seidel K, Slavin M, et al. Prolonged fluconazole prophylaxis is associated with persistent protection against candidiasis–related death in allogeneic marrow transplant recipients: long–term follow–up of a randomized, placebo–controlled trial. *Blood* 2000;96:2055–2061.

379. Walter EA, Bowden RA. Infection in the bone marrow transplant recipient. *Infect Dis Clin North Am* 1995;9:823–847.

380. Wingard JR, Merz WG, Rinaldi MG, et al. Increase in *Candida krusei* infection among patients with bone marrow transplantation and neutropenia treated prophylactically with fluconazole. *N Engl J Med* 1991;324:1274–1277.

381. Pfaller MA, Diekema DJ, Jones RN, et al. Trends in antifungal susceptibility of *Candida* spp. isolated from pediatric and adult patients with bloodstream infections: SENTRY Antimicrobial Surveillance Program, 1997 to 2000. *J Clin Microbiol* 2002;40:852–856.

382. Mora–Duarte J, Betts R, Rotstein C, et al. Comparison of caspofungin and amphotericin B for invasive candidiasis. *N Engl J Med* 2002;347:2020–2029.

383. Bjerke JW, Meyers JD, Bowden RA. Hepatosplenic candidiasis—a contraindication to marrow transplantation? *Blood* 1994;84:2811–2814.

384. Marr KA, Carter RA, Boeckh M, et al. Invasive aspergillosis in allogeneic stem cell transplant recipients: changes in epidemiology and risk factors. *Blood* 2002;100:4358–4366.

385. Hagensee ME, Bauwens JE, Kjos B, et al. Brain abscess following marrow transplantation: experience at the Fred Hutchinson Cancer Research Center, 1984–1992. *Clin Infect Dis* 1994;19:402–408.

386. Kahn FW, Jones JM, England DM. The role of bronchoalveolar lavage in the diagnosis of invasive pulmonary *Aspergillus*. *Am J Clin Pathol* 1986;86:518–523.

387. Levy H, Horak DA, Tegtmeier BR, et al. The value of bronchoalveolar lavage and bronchial washings

in the diagnosis of invasive pulmonary aspergillosis. *Respir Med* 1992;86:243–248.

388. Pirsch JD, Maki DG. Infectious complications in adults with bone marrow transplantation and T-cell depletion of donor marrow. *Ann Intern Med* 1986;104:619–631.

389. Pfaller MA, Messer SA, Hollis RJ, et al. Antifungal activities of posaconazole, ravuconazole, and voriconazole compared to those of itraconazole and amphotericin B against 239 clinical isolates of *Aspergillus* spp. and other filamentous fungi: report from SENTRY Antimicrobial Surveillance Program, 2000. *Antimicrob Agents Chemother* 2002;46:1032–1037.

390. Perea S, Gonzalez G, Fothergill AW, et al. In vitro interaction of caspofungin acetate with voriconazole against clinical isolates of *Aspergillus* spp. *Antimicrob Agents Chemother* 2002;46:3039–3041.

391. Reed EC, Bowden RA, Dandliker PS, et al. Treatment of cytomegalovirus pneumonia with ganciclovir and intravenous cytomegalovirus immunoglobulin in patients with bone marrow transplants. *Ann Intern Med* 1988;109:783–788.

392. Ljungman P, Engelhard D, Link H, et al. Treatment of interstitial pneumonitis due to cytomegalovirus with ganciclovir and intravenous immune globulin: experience of European bone marrow transplant group. *Clin Infect Dis* 1992;14:831–835.

393. Reed EC, Wolford JL, Kopecky KJ, et al. Ganciclovir for the treatment of cytomegalovirus gastroenteritis in bone marrow transplant patients: a randomized, placebo-controlled trial. *Ann Intern Med* 1990;112:505–510.

394. Boeckh M, Bowden R. Cytomegalovirus infection in marrow transplantation. In: Buckner CD, Clift R, eds. *Technical and biological components of marrow transplantation*. Boston: Kluwer Academic Publishers, 1995:97–136.

395. Ljungman P, Deliliers GL, Platzbecker U, et al. Cidofovir for cytomegalovirus infection and disease in allogeneic stem cell transplant recipients. The Infectious Diseases Working Party of the European Group for Blood and Marrow Transplantation. *Blood* 2001;97:388–392.

396. Bowden RA, Sayers M, Flournoy N, et al. Cytomegalovirus immune globulin and seronegative blood products to prevent primary cytomegalovirus infection after marrow transplantation. *N Engl J Med* 1986;314:1006–1010.

397. Miller WJ, McCullough J, Balfour HH Jr, et al. Prevention of cytomegalovirus infection following bone marrow transplantation: a randomized trial of blood product screening. *Bone Marrow Transplant* 1991;7:227–234.

398. Bowden RA, Slichter SJ, Sayers M, et al. A comparison of filtered leukocyte-reduced and cytomegalovirus (CMV) seronegative blood products for the prevention of transfusion-associated CMV infection after marrow transplant. *Blood* 1995;86:3598–3603.

399. Goodrich JM, Mori M, Gleaves CA, et al. Early treatment with ganciclovir to prevent cytomegalovirus disease after allogeneic bone marrow transplantation. *N Engl J Med* 1991;325:1601–1607.

400. Schmidt GM, Horak DA, Niland JC, et al. A randomized, controlled trial of prophylactic ganciclovir for cytomegalovirus pulmonary infection in recipients of allogeneic bone marrow transplants. *N Engl J Med* 1991;324:1005–1011.

401. Goodrich JM, Bowden RA, Fisher L, et al. Ganciclovir prophylaxis to prevent cytomegalovirus disease after allogeneic marrow transplant. *Ann Intern Med* 1993;118:173–178.

402. Winston DJ, Ho WG, Bartoni K, et al. Ganciclovir prophylaxis of cytomegalovirus infection and disease in allogeneic bone marrow transplant recipients. *Ann Intern Med* 1993;118:179–184.

403. Boeckh M, Gooley TA, Myerson D, et al. Cytomegalovirus pp65 antigenemia-guided early treatment with ganciclovir versus ganciclovir at engraftment after allogeneic marrow transplantation: a randomized double-blind study. *Blood* 1996;88:4063–4071.

404. Einsele H, Steidle M, Vallbracht A, et al. Early occurrence of human cytomegalovirus infection after bone marrow transplantation as demonstrated by the polymerase chain reaction technique. *Blood*

1991;77:1104–1110.

405. Reusser P, Einsele H, Lee J, et al. Randomized multicenter trial of foscarnet versus ganciclovir for preemptive therapy of cytomegalovirus infection after allogeneic stem cell transplantation. *Blood* 2002;99:1159–1164.
406. Nichols WG, Corey L, Gooley T, et al. Rising pp65 antigenemia during preemptive anticytomegalovirus therapy after allogeneic hematopoietic stem cell transplantation: risk factors, correlation with DNA load, and outcomes. *Blood* 2001;97:867–874.
407. Meyers JD, Thomas ED. Infection complicating bone marrow transplantation. In: Rubin RH, Young LS, eds. *Clinical approach to infection in the immunocompromised host*. New York: Plenum Press, 1988:525–556.
408. Locksley RM, Flournoy N, Sullivan KM, et al. Infection with varicella–zoster virus infection after marrow transplantation. *J Infect Dis* 1985;152:1172–1181.
409. Meyers JD, Wade JC, Shepp DH, et al. Acyclovir treatment of varicella–zoster virus infection in the compromised host. *Transplantation* 1984;37:571–574.
410. Lange B, Henle W, Meyers JD, et al. Epstein–Barr virus related serology in marrow transplant recipients. *Int J Cancer* 1980;26:151–157.
411. Crawford DH, Mulholland N, Iliescu V, et al. Epstein–Barr virus infection and immunity in bone marrow transplant recipients. *Transplantation* 1986;42:50–54.
412. Morinet F, Icart J, Ruelle C, et al. Epstein–Barr virus serology in bone marrow transplantations: a one–year retrospective study with detection of EBV IgM–VCA–specific antibodies. *J Med Virol* 1986;18:349–360.
413. Zutter MM, Martin PJ, Sale GE, et al. Epstein–Barr virus lymphoproliferation after bone marrow transplantation. *Blood* 1988;72:520–529.
414. Hoshino Y, Kimura H, Tanaka N, et al. Prospective monitoring of the Epstein–Barr virus DNA by a real–time quantitative polymerase chain reaction after allogeneic stem cell transplantation. *Br J Haematol* 2001;115:105–111.
415. van Esser JW, van der Holt B, Meijer E, et al. Epstein–Barr virus (EBV) reactivation is a frequent event after allogeneic stem cell transplantation (SCT) and quantitatively predicts EBV–lymphoproliferative disease following T–cell–depleted SCT. *Blood* 2001;98:972–978.
416. Benkerrou M, Jais JP, Leblond V, et al. Anti–B–cell monoclonal antibody treatment of severe posttransplant B–lymphoproliferative disorder: prognostic factors and long–term outcome. *Blood* 1998;92:3137–3147.
417. Kuehnle I, Huls MH, Liu Z, et al. CD20 monoclonal antibody (rituximab) for therapy of Epstein–Barr virus lymphoma after hemopoietic stem–cell transplantation. *Blood* 2000;95:1502–1505.
418. Lucas KG, Small TN, Heller G, et al. The development of cellular immunity to Epstein–Barr virus after allogeneic bone marrow transplantation. *Blood* 1996;87:2594–2603.
419. Papadopoulos EB, Ladanyi M, Emanuel D, et al. Infusions of donor leukocytes to treat Epstein–Barr virus–associated lymphoproliferative disorders after allogeneic bone marrow transplantation. *N Engl J Med* 1994;330:1185–1191.
420. Rooney CM, Smith CA, Ng CY, et al. Use of gene–modified virus–specific T lymphocytes to control Epstein–Barr–virus–related lymphoproliferation. *Lancet* 1995;345:9–13.
421. Rooney CM, Smith CA, Ng CY, et al. Infusion of cytotoxic T cells for the prevention and treatment of Epstein–Barr virus–induced lymphoma in allogeneic transplant recipients. *Blood* 1998;92:1549–1555.
422. Asano Y, Yoshikawa T, Suga S, et al. Reactivation of herpesvirus type 6 in children receiving bone marrow transplants for leukemia. *N Engl J Med* 1991;324:634–635.
423. Wilborn F, Brinkmann V, Schmidt CA, et al. Herpesvirus type 6 in patients undergoing bone marrow

- transplantation: serologic features and detection by polymerase chain reaction. *Blood* 1994;83:3052–3058.
424. Cone RW, Huang M-LW, Corey L, et al. Human herpesvirus 6 infections after bone marrow transplantation: clinical and virologic manifestations. *J Infect Dis* 1999;179:311–318.
425. Cone RW, Hackman RC, Huang M-LW, et al. Human herpesvirus 6 in lung tissue from patients with pneumonitis after bone marrow transplantation. *N Engl J Med* 1993;329:156–161.
426. Drobyski WR, Knox KK, Majewski D, et al. Brief report: fatal encephalitis due to variant B human herpesvirus-6 infection in a bone marrow-transplant recipient. *N Engl J Med* 1994;330:1356–1360.
427. Zerr DM, Gooley TA, Yeung L, et al. Human herpesvirus 6 reactivation and encephalitis in allogeneic bone marrow transplant recipients. *Clin Infect Dis* 2001;33:763–771.
428. Tokimasa S, Hara J, Osugi Y, et al. Ganciclovir is effective for prophylaxis and treatment of human herpesvirus-6 in allogeneic stem cell transplantation. *Bone Marrow Transplant* 2002;29:595–598.
429. Walter E, Chauncey T, Boeckh M, et al. PCP prophylaxis after marrow transplantation: efficacy of trimethoprim sulfamethoxazole (TS), role of TS desensitization and IV pentamidine. *ICAAC* 1993;125(abst).
430. Souza JP, Boeckh M, Gooley TA, et al. High rates of *Pneumocystis carinii* pneumonia in allogeneic blood and marrow transplant recipients receiving dapsone prophylaxis. *Clin Infect Dis* 1999;29:1467–1471.
431. Vasconcelles MJ, Bernardo MV, King C, et al. Aerosolized pentamidine as pneumocystis prophylaxis after bone marrow transplantation is inferior to other regimens and is associated with decreased survival and an increased risk of other infections. *Biol Blood Marrow Transplant* 2000;6:35–43.
432. Colby C, McAfee S, Sackstein R, et al. A prospective randomized trial comparing the toxicity and safety of atovaquone with trimethoprim/sulfamethoxazole as *Pneumocystis carinii* pneumonia prophylaxis following autologous peripheral blood stem cell transplantation. *Bone Marrow Transplant* 1999;24:897–902.
433. Derouin F, Devergie A, Auber P, et al. Toxoplasmosis in bone marrow-transplant recipients: report of seven cases and review. *Clin Infect Dis* 1992;15:267–270.
434. Slavin MA, Meyers JD, Remington JS, et al. *Toxoplasma gondii* infection in marrow transplant recipients: a 20 year experience. *Bone Marrow Transplant* 1994;13:549–557.
435. Martino R, Bretagne S, Rovira M, et al. Toxoplasmosis after hematopoietic stem transplantation. Report of a 5-year survey from the Infectious Diseases Working Party of the European Group for Blood and Marrow Transplantation. *Bone Marrow Transplant* 2000;25:1111–1114.
436. Foot AB, Garin YJ, Ribaud P, et al. Prophylaxis of toxoplasmosis infection with pyrimethamine/sulfadoxine (Fansidar) in bone marrow transplant recipients. *Bone Marrow Transplant* 1994;14:241–245.
437. Engelhard D, Handsher R, Naparstek E, et al. Immune response to polio vaccination in bone marrow transplant recipients. *Bone Marrow Transplant* 1991;8:295–300.
438. Winston DJ, Ho WG, Schiffman G, et al. Pneumococcal vaccination of recipients of bone marrow transplants. *Arch Intern Med* 1983;143:1735–1737.
439. Ljungman P, Fridell E, Lönnqvist B, et al. Efficacy and safety of vaccination of marrow transplant recipients with a live attenuated measles, mumps, and rubella vaccine. *J Infect Dis* 1989;159:610–615.

2004 Lippincott Williams & Wilkins  
John P. Greer, John Foerster, John N. Lukens  
George M. Rodgers, Frixos Paraskevas, Bertil Glader  
Wintrobe's Clinical Hematology

## Gene Therapy for Hematologic Disorders, Human Immunodeficiency Virus Infection, and Cancer

### OVERVIEW OF BASIC CONCEPTS

#### NONVIRAL VECTORS

#### VIRAL VECTORS

##### Retroviral Vectors

##### Alternative Retroviral Vectors

##### Adenoviral Vectors

##### Adeno-Associated Viral Vectors

##### Miscellaneous Other Vectors

### HEMATOPOIETIC STEM AND PROGENITOR CELLS AS TARGETS FOR GENE TRANSFER

#### Preclinical Studies and Predictive Models

#### Human Clinical Trials

#### Gene Therapy for Globin Disorders

### LYMPHOCYTES AS TARGETS FOR GENE TRANSFER

#### Preclinical Studies

#### Clinical Studies

### GENE THERAPY FOR HUMAN IMMUNODEFICIENCY VIRUS INFECTION

#### Transdominant Proteins

#### Intracellular Anti-Human Immunodeficiency Virus Antibodies

#### Anti-Human Immunodeficiency Virus Nucleic Acids

#### Destruction of Human Immunodeficiency Virus-Infected Cells

### GENE THERAPY FOR BLEEDING DISORDERS

### GENE THERAPY FOR CANCER

#### Antioncogene or Pro-Tumor-Suppressor Gene Therapy

#### "Suicide" Cancer Gene Therapy

#### Enhanced Antitumor Immune Response

### APPROACHES TO IMPROVING GENE THERAPY

#### Engraftment without Ablation

#### In Vivo Selectable Markers

#### Ex Vivo Selection

#### Alternative Vectors

#### Gene Correction

#### Immune Responses to Vectors and Transgenes

### SAFETY CONSIDERATIONS

### CONCLUSIONS

### REFERENCES

The molecular characterization of a number of congenital and acquired human diseases has stimulated scientists and clinicians to envision genetic therapy as a new and exciting possibility ( <sup>1</sup> ). The technology has progressed sufficiently to offer real hope for successful widespread clinical application ( <sup>2</sup>, <sup>3</sup> and <sup>4</sup> ). The first replication-defective retroviral vector was described in 1983, offering a safe and feasible route for transfer of exogenous genes to nontransformed human cells ( <sup>5</sup> ). By 1989 to 1990, clinical studies using gene transfer began ( <sup>6</sup>, <sup>7</sup> and <sup>8</sup> ). Hundreds of clinical trials have been completed or are in progress and are summarized in [Table 26.1](#). However, it is important not to exaggerate the current status of the field, especially to patients. In 1996, an expert panel convened by the Director of the National Institutes of Health (NIH) was critical of the

premature initiation of clinical gene therapy trials and the subsequent overselling of results by investigators and the media (9). At the time of the report, no clinical gene “therapy” trial had shown unequivocal efficacy. The NIH report and a number of subsequent editorials stressed the need for rationally designed, small-scale clinical trials in diseases for which the pathophysiology is well understood, as well as the more important need for continued basic science investigations into vector systems and target cell biology (10, 11 and 12).

**TABLE 26.1. Characteristics of Active or Completed Human Clinical Studies**

|                        | No. of Protocols | Percent | No. of Patients | Percent |
|------------------------|------------------|---------|-----------------|---------|
| <b>Protocol type</b>   |                  |         |                 |         |
| Cancer                 | 403              | 63.4    | 2392            | 68.5    |
| Monogenic disorder     | 78               | 12.3    | 309             | 8.8     |
| Infectious disease     | 41               | 6.4     | 408             | 11.7    |
| Vascular disease       | 51               | 8.0     | 86              | 2.5     |
| Other disease          | 12               | 1.9     | 19              | 0.5     |
| Marking                | 49               | 7.7     | 274             | 7.8     |
| Volunteer              | 2                | 0.3     | 6               | 0.2     |
| Totals                 | 636              | 100.0   | 3496            | 100.0   |
| <b>Target cell</b>     |                  |         |                 |         |
| Autologous             | 368              | 57.9    | 2760            | 78.9    |
| Autologous/allogeneic  | 4                | 0.6     | 166             | 4.7     |
| Allogeneic             | 40               | 6.3     | 246             | 7.0     |
| Allogeneic/syngeneic   | 1                | 0.2     | 8               | 0.2     |
| Syngeneic              | 7                | 1.1     | 61              | 1.7     |
| Xenogeneic             | 3                | 0.5     | 30              | 0.9     |
| N/C                    | 213              | 33.5    | 225             | 6.4     |
| Totals                 | 636              | 100.0   | 3496            | 100.0   |
| <b>Vector system</b>   |                  |         |                 |         |
| Adeno-associated virus | 15               | 2.4     | 36              | 1       |
| Adenovirus             | 171              | 26.9    | 644             | 18.4    |
| Gene gun               | 5                | 0.8     | 35              | 1.0     |
| Herpes simplex virus   | 5                | 0.8     | 21              | 0.6     |
| Lipofection            | 77               | 12.1    | 619             | 17.7    |
| Naked/plasmid DNA      | 70               | 11.0    | 123             | 3.5     |
| Pox virus              | 39               | 6.1     | 88              | 2.5     |
| Retrovirus             | 217              | 34.1    | 1757            | 50.3    |
| RNA transfer           | 6                | 0.9     | 30              | 0.9     |
| N/C                    | 25               | 3.9     | 143             | 4.1     |
| Totals                 | 636              | 100.0   | 3496            | 100.0   |
| <b>Gene delivered</b>  |                  |         |                 |         |
| Antibody               | 4                | 0.6     | 7               | 0.2     |
| Antigen                | 76               | 11.9    | 725             | 20.7    |
| Antisense              | 5                | 0.8     | 5               | 0.1     |
| Cytokine               | 134              | 21.1    | 618             | 17.7    |
| Deficiency             | 67               | 10.5    | 293             | 8.4     |
| Drug resistance        | 17               | 2.7     | 55              | 1.6     |

|                    |     |       |      |       |
|--------------------|-----|-------|------|-------|
| Hormone            | 2   | 0.3   | N/C  | —     |
| Marker             | 40  | 6.3   | 262  | 7.5   |
| Transdominant      | 2   | 0.3   | N/C  | —     |
| Oncogene regulator | 3   | 0.5   | N/C  | —     |
| Receptor           | 27  | 4.2   | 107  | 3.1   |
| Ribozyme           | 4   | 0.6   | 15   | 0.4   |
| Suicide            | 55  | 8.6   | 567  | 16.2  |
| Tumor suppressor   | 55  | 8.6   | 290  | 8.3   |
| Others             | 40  | 6.3   | 51   | 1.5   |
| Multiple genes     | 99  | 15.6  | 497  | 14.2  |
| N/C                | 4   | 0.6   | 4    | 0.1   |
| Totals             | 636 | 100.0 | 3496 | 100.0 |

N/C, not classified.

From John Wiley and Sons, [www.wileyeurope.com/WileyCDA/](http://www.wileyeurope.com/WileyCDA/), with permission.

Laboratory and clinical hematologists have been critical to the development of gene transfer technologies, studying diseases that were early and obvious targets for therapeutic intervention. Hematopoietic stem cells (HSCs) and lymphocytes remain attractive target cell populations for two major reasons: First, they are relatively easy to manipulate *ex vivo*, and, second, many acquired and congenital diseases are potentially curable by their genetic correction (<sup>13</sup>, <sup>14</sup>). As shown in [Table 26.1](#), a significant fraction of ongoing human clinical trials target hematopoietic cells or are designed to treat congenital or acquired diseases of the hematopoietic or immune system. Moreover, many important experimental advances in our understanding of hematologic physiology have resulted from the application of gene transfer techniques in animal models or *in vitro* (<sup>15</sup>, <sup>16</sup>, <sup>17</sup>, <sup>18</sup>, <sup>19</sup>, <sup>20</sup> and <sup>21</sup>). For instance, retroviral tagging has allowed tracking and quantitative analysis of murine and nonhuman primate stem cell behavior, and experiments overexpressing oncogenes or cytokines in primary hematopoietic cells using similar techniques have helped elucidate the *in vivo* role of these proteins. Significant advances in gene transfer technology have occurred since the NIH report, and, through systematic preclinical testing in large animal models, clinically relevant gene transfer levels have now been achieved. These results predict success in humans, at least in disorders for which modest transfer rates of genes not requiring complex regulation could be curative, and unequivocal efficacy has since been realized in a study in which children with X-linked severe combined immunodeficiency (SCID) were treated with autologous bone marrow that had been modified to carry the corrective gene (<sup>22</sup>). A second successful trial in patients with adenosine deaminase (ADA)-deficient SCID was reported soon thereafter, along with an update of the study in X-linked SCID (<sup>23</sup>). These long-anticipated results represented a significant advance for the field, providing not only restoration of immunity in children with this disorder but proof of principle in the context of a human disorder, and a great deal of enthusiasm for returning to the clinic for these and other disorders quickly developed. However, two serious adverse events that appear to be direct results of the transferred gene were reported in the larger trial and resulted in a temporary halt of all such trials to allow full understanding of these events, development of additional safeguards, and adjustment of the risk-benefit assessment in the informed consent process. Thus, it is particularly important for hematologists to have a general understanding of the field, even if widespread clinical applications may be a decade or more in the future. This chapter reviews the fundamental features of gene transfer technologies and their applications in preclinical and early clinical trials. The pace of the field is rapid, and many details may become obsolete, but the central concepts



should remain relevant to any future gene therapy applications.

## OVERVIEW OF BASIC CONCEPTS

*Gene therapy* can be defined as the transfer of a gene or genetic material (DNA or RNA) into a cell with therapeutic intent. The *genotype* of the cell is thus altered, with subsequent gene expression altering the *phenotype* of the cell. The therapeutic agent is the gene product, generally a protein or, less frequently, RNA (e.g., ribozymes or antisense molecules). This is in contrast to conventional therapies that act by directly altering the phenotype, even if the congenital or acquired defect is a genetic one. Three examples illustrate the conventional approach to underlying genetic disorders. Dietary avoidance of phenylalanine can prevent the consequences of phenylketonuria by circumventing the genetic deficiency of phenylhydroxylase. Cancer chemotherapy acts by preferentially killing tumor cells based on their cell cycle characteristics, thus removing cells with an acquired genetic defect. And factor replacement in hemophilia directly replaces the defective or missing gene product by infusion of an exogenously manufactured or isolated protein.

The identification and cloning (isolation) of genes responsible for many congenital disorders, as well as of the cellular genes mutated in acquired disorders such as cancer, have led to the concept of genetic correction of affected cell populations. Ideally, actual substitution of a defective gene with a therapeutic gene would be the most desirable method for returning target cells to a normal genotype and phenotype (*gene replacement*). However, this goal requires *homologous recombination*, a complex and inefficient process, and current gene transfer methods instead either randomly insert new genes into the chromosomes or rely on extrachromosomal (episomal) maintenance of a newly introduced gene (*gene addition*) ( [24](#), [25](#) and [26](#) ). To date, efforts have focused on *somatic* (non-germ cell) therapy, with genotypic alteration of only the diseased target tissue. Manipulation of germ cells, with transmission of altered genetic material to subsequent generations, is not yet feasible in humans, but the profound ethical and societal implications need to be addressed through the political process before the technology progresses much further ( [27](#) ).

The vehicle for transferring new genetic material into a target cell is called a *vector*. At a minimum, a vector contains the gene or genes of interest along with regulatory elements such as promoters or enhancers, which govern expression of the gene product. A vector may be a simple particle consisting of a fragment of DNA encapsulated within a liposome or conjugated to proteins that facilitate uptake into cells, or it may be a more complex viral vector, capitalizing on the ability of viruses to enter cells easily and express genes robustly. Characteristics of the major vector systems are summarized in [Table 26.2](#) and [Figure 26.1](#) and are detailed in subsequent sections. The successful interaction of a vector with a target cell, leading to an alteration in that cell's genotype, is termed *transduction*.

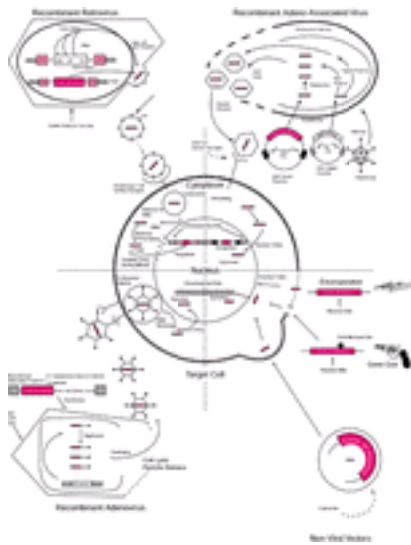
**TABLE 26.2. Gene Transfer Vector Systems**

| Vector System | Integration | Cell Cycle Dependence | Insert Size Limit | Clinical Experience | Advantages | Disadvantages |
|---------------|-------------|-----------------------|-------------------|---------------------|------------|---------------|
|---------------|-------------|-----------------------|-------------------|---------------------|------------|---------------|

|                        |                      |                        |          |           |  |  |
|------------------------|----------------------|------------------------|----------|-----------|--|--|
| Murine retrovirus      | Yes                  | Yes                    | 8–10 kb  | Extensive | Stable producer lines, no viral genes in vector, low immunogenicity, well-understood biology, efficient entry and integration in many cell types, proven clinical safety | Low-titer, fragile vector; requirement for cycling; erratic expression; insertional mutagenesis  |
| HIV-based lentivirus   | Yes                  | No                     | —        | None      | Faithful delivery of complex genes, well understood, efficient entry and integration, pseudotyping allows broad tissue range   | Labor-intensive production, erratic expression, insertional mutagenesis, recombination with wild-type HIV  |
| Adenovirus             | No                   | No                     | 8–10 kb  | Moderate  | High-titer, stable vector; transgene expression; efficient entry into many cell types  | No stable producer lines; potential for recombination and replication-competent virus; multiple viral genes expressed from vector; high immunogenicity (may be advantage as a vaccine vector!); preexisting immunity; inflammatory responses |
| Adeno-associated virus | Yes, but inefficient | Yes, but controversial | 4.5 kb   | Minimal   | High-titer, stable vector, extra- and intracellularly; high-level transgene expression; no expressed viral genes in vector   | No stable producer cell lines, high percentage of defective particles, requirement for helper adenovirus during production, very limited insert size, preexisting immunity   |
| Naked DNA              | No                   | No                     | No limit | Moderate  | Ease of production, high level of safety, no extraneous expressed vector genes, no immunogenicity of vector  | Inefficient cell entry and uptake into nucleus, poor stability within cell, low-level expression   |

|  |    |    |          |          |   |                              |
|--|----|----|----------|----------|---|------------------------------|
| Facilitated DNA (liposomes, polylysine conjugates, inactivated adenovirus, etc.) | No | No | No limit | Moderate | Same as naked DNA, plus can be targeted to specific cell types, more efficient uptake and intracellular stability | No mechanism for persistence |
|--|----|----|----------|----------|---|------------------------------|

HIV, human immunodeficiency virus.



**Figure 26.1.** Schematic representation of transduction of a generic target cell by the four major gene transfer vector systems. The same “gene of interest” is shown being transferred with each vector. AAV, adeno-associated virus; Ad, adenovirus; ITR, inverted terminal repeat; LTR, long terminal repeat.

Vector production procedures are unique to each system, but a number of considerations are common to all, especially those being developed for actual clinical use. A clinical vector must be easy and inexpensive to produce safely at pharmaceutical grade ([28](#), [29](#)). To prevent indiscriminate spread of viral genomes, viral vectors must be rendered *replication-defective*: Once a viral vector enters a target cell, the cell will produce no new viral particles. High-titer vector preparations, containing a high concentration of functional vector particles, are also very important, allowing exposure of target cells to the highest possible *multiplicity of infection*, defined as the ratio of vector particles to target cells; this increases the probability of successful vector-cell interaction.

Exposure of target cells to vectors can occur either *ex vivo* or *in vivo*. Autologous hematopoietic targets, such as stem cells or lymphocytes, are generally transduced *ex vivo*, because these cells can be easily collected, manipulated in culture, and then reinfused intravenously. *Ex vivo* transduction allows for a controlled exposure of only the desired target cells to large concentrations of vector and is less likely to generate an inflammatory or immune response or be hindered by vector inactivation by complement. Other cellular targets for *ex vivo* transduction have included hepatocytes, keratinocytes,

tumor cells, and muscle progenitor cells.

*In vivo* gene transfer has been used for applications involving cells that cannot successfully or easily be harvested and manipulated *ex vivo* such as airway epithelium, vascular endothelium, differentiated muscle cells, and neurons. The ideal *in vivo* system would allow intravenous injection of a vector followed by rapid and safe specific transduction of target cells around the body.

A number of important steps must occur between exposure of a target cell to a vector and successful transduction of that cell, with persistence of the transferred genetic material in the correct cellular compartment and expression of the gene of interest or *transgene*. The vector must cross the plasma membrane efficiently and without damaging the cell. Viral vectors enter cells via specific cell–surface receptors, and an important consideration is the number of functional receptors on the proposed target cell for the vector being used ( 30 ). A process called *pseudotyping* can be used to redirect viral vectors to different cell–surface receptors by substituting alternative viral envelope proteins during the vector production process ( 31 , 32 , 33 and 34 ). Nonviral vectors may cross the plasma membrane without need for a specific receptor.

After crossing the plasma membrane, the vector must then travel through the cytoplasm and cross the nuclear membrane to enter the nucleus and use the cell's transcriptional machinery for expression of the transgene. Nuclear entry of some vectors may be dependent on mitosis, with temporary breakdown of the nuclear membrane; others carry nuclear localization determinants that result in specific conveyance across the intact membrane. The transferred genetic material may integrate permanently into the target cell's own chromosomal DNA, ensuring passage of the new gene to all daughter cells with every cell division. The need for integration depends on the target cell and therapeutic application: It is absolutely required for gene transfer into HSCs in which the transgene must be transmitted to all progeny cells but is superfluous for cellular targets such as neurons or muscle cells that are not mitotic.

Current vector systems insert new genes randomly or semi–randomly within cellular chromosomes, but integration at a specific site would be more desirable ( 35 , 36 and 37 ). Random integration has the potential to alter the function or expression of endogenous cellular genes, a process termed *insertional mutagenesis* ( 38 ). The insertion of new DNA could interrupt a critical cellular gene, although this is unlikely because of the relative rarity of actual coding compared to noncoding sequences in the genome and because of the presence in each cell of two copies of all genes except those on the sex chromosome. More worrisome, instead, is inappropriate activation of a cellular gene involved in growth control. For instance, cellular oncogenes such as *c-myc* can be transcriptionally activated due to the insertional event. In the mouse, this is the mechanism of leukemia induction by the murine viruses that are used as backbones for gene transfer vectors ( 39 ).

Alternatively, the gene may remain *episomal*, or nonintegrated. Some vectors are very stable as nuclear episomes, with prolonged persistence of transgene expression as long as the cell does not undergo mitosis. Unless the episome can reproduce itself, cell division eventually dilutes out episomal DNA, limiting the application of nonintegrating vectors to nonmitotic tissues or to situations requiring only transient expression.

The level of transgene expression and the ability to restrict expression to specific target cell types are also important factors to consider. Expression of the transduced gene is dependent on both vector and target cell determinants. Transcriptional promoters must be included along with the actual transgene protein coding sequences in the vector, and

often *lineage* or *tissue-specific* promoter and enhancer elements are used to limit expression to a particular cell lineage derived from a target cell population ( 40, 41 and 42 ). For instance, hemoglobin gene regulatory sequences can be used to drive transgene expression specifically in erythroid cells. In other situations, *constitutive* control elements that can drive transcription continuously in most cell types can be used. Genetic control elements that are *inducible*, or turned on by some exogenous manipulation, such as the administration of an antibiotic, are also under development for inclusion in gene transfer vectors ( 43, 44 ). Endogenous cellular factors may shut off expression of transferred genes in some situations ( 45, 46 ). These factors have not been fully elucidated and vary from vector to vector. Silencing of transferred genes via methylation of vector sequences is one possible mechanism ( 47 ). The level of expression necessary for the desired therapeutic effect is very important to determine during *in vitro* and animal experiments and varies greatly depending on the target cell type and the proposed clinical application.

## NONVIRAL VECTORS

The simplest approach to gene transfer is to use only the DNA of the transgene, with the necessary control sequences, as the vector ( 29, 48 ). Recombinant DNA production in bacteria can result in purified plasmids containing the gene(s) of interest along with regulatory elements. For over two decades, scientists have introduced purified DNA into target cells *ex vivo* by a variety of physical and chemical means. The least complex technique is direct microinjection into individual cells, which has little clinical utility due to the impossibility of injecting enough cells to produce most of the desired effects. One exception is the recent observation that direct DNA injection into muscle or skin can stimulate a very potent immune response against antigens introduced as plasmid transgenes ( 49, 50 ). This has led to rapid preclinical and recent clinical development of a genetic vaccination strategy against bacterial and viral pathogens ( 51 ).

A number of other methods have been explored for getting plasmid DNA into cells. Liposomes, composed of phospholipid bilayers enclosing an aqueous space loaded with DNA, can directly fuse with the plasma membrane, releasing DNA into the cytoplasm ( 52 ). The *gene gun technique* involves bombardment of the cell membrane with gold microparticles complexed to DNA ( 53, 54, 55, 56 and 57 ). Electroporation and calcium phosphate precipitation are generally too toxic and inefficient for use in gene transfer strategies aimed at primary human cells ( 58, 59 and 60 ).

All of these methods lack mechanisms to stabilize intracellular vector DNA, nor do they allow transport into the nucleus; they therefore rarely result in chromosomal integration or long-term persistence and expression. The development of *cationic liposomes* has improved cellular uptake of plasmid DNA and has circumvented cytoplasmic degradation ( 61, 62 ). In aqueous solution, these positively charged liposomes bind with up to 100% of negatively charged DNA without size restrictions and can deliver DNA to the cell nucleus, albeit inefficiently, where it remains primarily episomal ( 63 ). If administered *in vivo*, liposomes demonstrate no target cell tropism and are rapidly cleared by the reticuloendothelium system. However, after intravenous injection of cationic liposomes, long-term low-level persistence of vector sequences in many murine organs has been demonstrated ( 64, 65 ).

Nonviral plasmid DNA transfer has been improved by conjugation of vector DNA to substances that improve cellular transport and allow target cell specificity via cell-surface receptors ( 66, 67 ). For example, adenoviral capsid elements (especially the penton base protein) help disrupt endosomes, releasing DNA more efficiently into the cytoplasm, and

inclusion of transferrin or other ligands in DNA–polylysine conjugates allows specific uptake via cell–surface receptors ( [68](#) , [69](#) , [70](#) , [71](#) and [72](#) ).

Manufacturing nonviral vectors is much simpler than manufacturing viral vectors and cannot generate potentially dangerous replication–competent infectious particles ( [29](#) , [73](#) ). Transduction is not dependent on target cell cycling, and no viral proteins are present to induce an antivector immune response. There are no size constraints. Limitations include a generally lower transduction efficiency than that of viral systems. Most important is the fact that transgene integration is poor and persistent expression is rare, limiting utility to situations allowing transient transgene expression.

## VIRAL VECTORS

Viral vectors are Trojan horses, taking advantage of the viral capsid or envelope and of the viral machinery to deliver nonviral transgene sequences efficiently to target cells ( [74](#) ). In general, the external capsid or envelope of the virus is unaltered in a viral vector, but the genome of the virus is in large part replaced by a transgene or genes. This strategy is limited by the space available in a viral particle for new genetic material. Viral vectors also depend on the presence of a specific viral receptor on target cells. The efficiency of gene transfer is the main advantage when compared to some of the physical and chemical cell entry methods described above. Furthermore, the relatively low toxicity of certain viral vectors [e.g., retroviruses, lentiviruses, and adeno–associated viruses (AAVs)] is another advantage when compared to physical or chemical methods. To modify a virus into a vector system, detailed understanding of the viral genome and life cycle is necessary to retain viral genome sequences required for packaging of vector nucleic acids into viral particles and for appropriate trafficking in the target cell, while removing sequences that might allow production of replication–competent viral particles.

### Retroviral Vectors

The murine retroviruses exemplified by the Moloney murine leukemia virus were the basis of the first practical viral vector system ( [75](#) , [76](#) and [77](#) ). These retroviruses consist of two single strands of linear viral RNA bound to protein core and coated by a lipid envelope that is acquired from the plasma membrane of the infected cell on viral release. The linear RNA genome can contain 2 to 9 kb of coding and regulatory sequences, flanked on each end by sequences termed *long terminal repeats* (LTRs) that permit integration into chromosomes. These retroviruses contain only three genes necessary for viral replication and packaging: *gag*, *pol*, and *env*. The retrovirus enters a cell after binding to a specific cell–surface receptor via the *env* gene product. These receptors are large, widely expressed proteins involved in phosphate transport and other cellular homeostatic functions ( [30](#) ). The *amphotropic receptor* is found on both rodent and primate cells and is the entry site for most murine retroviral vectors directed at human cells ( [78](#) , [79](#) and [80](#) ).

After cell entry, the viral RNA is reverse transcribed via the *pol* gene product into *proviral* complementary DNA (cDNA) and enters the nucleus. The LTR sequences allow random integration of the viral cDNA into the host chromosomes. The integrated retroviral genome, or *provirus*, relies on the host cell’s transcriptional machinery for expression of proviral genes and production of full–length viral RNA. The *gag*, *pol*, and *env* gene products are packaged along with the new viral RNA into viral particles, dependent on the presence of a *packaging* (?) sequence in the viral RNA, and viral particles are released from the cell via budding through the plasma membrane without damaging the infected cell.

*Recombinant retroviral vectors* are constructed by removing the *gag*, *pol*, and *env* gene



sequences from the viral nucleic acid backbone and replacing them with up to 7 to 8 kb of a gene or genes of interest, retaining only the LTRs and the  $\Psi$  signal (5). The resulting recombinant viral vector can integrate and express the gene or genes of interest but cannot replicate and produce new retrovirus once within a target cell because of the lack of *gag*, *pol*, and *env* genes within its genome. Thus, it is termed *replication defective*. Figure 26.1 diagrams the steps involved in making a retroviral vector. A *packaging cell line* is created by introducing a plasmid containing *gag*, *pol*, and *env* sequences but no  $\Psi$  sequence into an immortalized cell line such as NIH3T3. The lack of the  $\Psi$  sequence prevents these helper genes from being packaged into viral particles. A second plasmid containing the recombinant vector sequences (LTRs flanking the transgene or genes) is then introduced into these cells to create a *producer cell line*. Full-length vector RNA is transcribed from the vector plasmid sequences and packaged into viral particles using the *gag*, *pol*, and *env* proteins encoded by helper plasmid sequences. In this way, producer cell lines release helper-free, replication-defective vector particles containing the recombinant genome into cell culture media at a titer of up to  $10^7$  particles per ml. These particles contain the full-length vector RNA, consisting of the viral LTRs flanking the transgene or genes and the *env*, *gag*, and *pol* proteins, but, because they do not contain any actual *gag*, *pol*, or *env* viral gene sequences, no further infectious virus can be made once the vector infects the target cell.

The potential for generation of replication-competent virus through recombination events between the vector and helper sequences in the producer cell line is a significant safety concern (28, 81). To allow packaging of replication-competent viral particles, these recombination events must result in the transfer of an intact  $\Psi$  packaging sequence being transferred into the helper sequences containing the *gag*, *pol*, and *env* genes. The presence of replication-competent virus could allow spread of vector and helper particles indiscriminately to nontarget cells *in vivo*, thus greatly increasing the risk of insertional mutagenesis by repeated infection of susceptible cell populations (38, 81). The absolute need for avoidance of replication-competent viral particles in clinical vector preparations was inadvertently demonstrated when high-grade lymphomas occurred in rhesus monkeys transplanted with HSCs transduced with a vector preparation contaminated with high levels of replication-competent virus (82). Over the next several years, a number of modifications in the organization of genetic sequences included in the packaging cell lines have greatly decreased the risk of recombination events, and sensitive systems for detecting replication-competent virus have been developed (28, 83, 84 and 85). A number of investigators have used packaging cell lines derived from human instead of murine cells to make producer cell lines, in hopes that lower levels of endogenous retroviral sequences in human cells would also decrease recombination events and thus replication-competent viral contamination (86, 87).

As described below, retroviral vectors are capable of stable integrated transduction of a large number of cell types, including repopulating stem cells, but have a number of important limitations. Stable transduction and integration require passage of the target cell through the S-phase of the cell cycle, preventing transduction of quiescent cells (88). The amphotropic receptor density on certain target cell types may be too low to allow efficient transduction (89). Thus, redirection of receptor specificity via pseudotyping with alternative envelope proteins has been explored, with some success (32, 90, 91, 92, 93 and 94).

Biophysical considerations may also limit vector-target interactions. Vector particles are very fragile and degrade quickly in solution or within cells if cell division allowing nuclear entry and integration does not occur. A number of investigators have tried to increase the likelihood of successful transduction by flowing vector solution continuously over target cells or by co-localizing vector and target cells using culture dishes coated with



fibronectin fragments ( [95](#), [96](#)). New methods of concentrating and stabilizing vector preparations are also under development ( [33](#), [91](#), [97](#)).

## Alternative Retroviral Vectors

Over the past several years, there has been real progress toward the development of alternative retroviral systems that may overcome some of the limitations of the murine leukemia virus vectors. Human immunodeficiency virus (HIV)–derived lentiviral vectors have been most actively pursued. Relatively high–titer vectors have been reported using production strategies with numerous safeguards against recombination events that could result in generation of wild–type HIV ( [98](#), [99](#) and [100](#)). Vectors retaining the HIV gp120 envelope protein could be used to transduce CD4<sup>+</sup> T cells, monocyte/macrophages, or glial cells, whereas pseudotyping with alternative envelope proteins, such as vesicular stomatitis virus (VSV) or amphotropic leukemia virus envelope proteins, could be used for transduction of a wider range of cells. Lentiviral vectors can traverse an intact nuclear membrane, requiring the HIV *gag* protein and an accessory VpR protein, thus allowing transduction of nondividing cells ( [101](#), [102](#)). Although the promise for more efficient HSC transduction using lentiviral vectors remains an attractive feature, other features of HIV–based vectors have also stimulated interest. Specifically, the faithful delivery of nonrearranged genes with complex regulatory elements appears superior, and success in delivering the human  $\beta$  globin gene along with large portions of the locus control region has finally been achieved with HIV–based vectors ( [103](#)). A number of additional safety modifications have been used, the first clinical trial using lentiviral vectors for the treatment of HIV was proposed to the Recombinant DNA Advisory Committee, and additional concerns were raised to the investigators before approval ( [104](#)). The protocol has now been granted permission to proceed, and the first patients to receive lentiviral vector–transduced cells are now accruing. Despite the many safety modifications built into these systems to avoid generation of replication–competent HIV virus, the development of vectors based on nonhuman or less pathogenic lentiviruses would be much more desirable ( [105](#)).

The other member of the Retroviridae under consideration as a gene transfer vector is the human foamy virus (HFV). HFV, a poorly characterized retrovirus, has three potential advantages. It has never been associated with pathology in animals or humans, it infects a wide variety of primate cell types, and it has the capacity to package longer transgene(s) ( [106](#)). It does not appear, however, to transduce nondividing cells, although it may be more stable than conventional retroviruses within a target cell, tolerating a more prolonged period before cell division and then integration ( [107](#)). Virologists are trying to define the packaging signal and other important elements necessary for engineering a replication–incompetent HFV vector ( [108](#), [109](#)), and a method for the production of helper–free vector stocks has recently been described ( [110](#)). These foamy virus vectors appear efficient for transducing HSCs, with high gene transfer rates observed in human cord blood *in vitro* and in murine bone marrow *in vivo* after a single, overnight vector exposure ( [111](#)).

## Adenoviral Vectors

Adenoviruses (Ad) are nonenveloped, double–stranded, large DNA viruses ( [112](#)). The linear Ad genome contains 36 kb with an inverted terminal repeat (ITR) of 100 to 165 bp at each terminus. A set of early genes encodes for regulatory proteins that serve to initiate cell proliferation, DNA replication, and down–modulation of host immune defenses, whereas the late genes encode for structural proteins. The Ad readily cross the plasma membrane

of many cell types, whether replicating or not, via receptor-mediated endocytosis ([113](#)) through the receptor that is common to two distinct viral pathogens, coxsackie B and Ad 2 and 5, and termed the *coxsackie and adenovirus receptor* ([114](#)). The adenovirus escapes the endosome by altering the pH and then enters the nucleus, where it remains as a linear episome. In permissive cells, the Ad replicate and then enter a lytic cycle, destroying the host cell and releasing daughter viral particles. Of the 42 Ad serotypes, most are known to cause mild respiratory, gastrointestinal, and conjunctival infections in immunocompetent humans; no associated malignancies in humans have been reported, although some serotypes can transform cells in culture.

Recombinant Ad vectors have been engineered from adenovirus (usually serotype 5) by the removal of the E1 and E3 genes (regulating replication and immune recognition) and replacement by the gene or genes of interest, with space for 7 to 8 kb of new genetic material ([115](#), [116](#), [117](#), [118](#) and [119](#)). High-titer Ad vector, up to  $10^{12}$  plaque-forming units per ml, can be reliably packaged through the use of a human embryonic kidney transformed cell line ([293](#)), which provides the helper or replication E1 genes, followed by purification and concentrating procedures. The final product is a replication-defective Ad vector that is free of helper- or wild-type virus that can efficiently transduce nondividing cells ([117](#)). These vectors do not integrate into the target cell genome, avoiding insertional mutagenesis and resulting in only transient transgene expression in proliferative tissues. Because of the tropism of Ad for epithelial cells, these vectors were initially investigated for the treatment of pulmonary diseases and diseases in which liver gene transfer is desirable ([120](#), [121](#)).

Transient transgene expression also may result from host cellular and humoral immune responses directed at either transgene-encoded antigens or adenovirus proteins expressed from the large portions of the Ad genome retained in these vectors ([122](#), [123](#)). Another concern is inflammation resulting from *in vivo* transduction of certain cell types, especially airway epithelium ([124](#)). *In vivo* use may also be compromised by preexisting or new antiviral neutralizing antibodies, limiting the efficacy of repeated dosing, which may be required for applications directed at mitotic tissues ([125](#)). Nonessential adenoviral sequences are being gradually eliminated from the vectors ([126](#), [127](#)). Specific dosage schedules (e.g., neonatal or embryonic exposure) or coadministration of immune modulators such as cyclosporine or interleukin (IL)-12 may also prevent sensitization ([128](#), [129](#), [130](#), [131](#) and [132](#)).

In initial clinical trials, Ad vectors were used to transfer a normal cystic fibrosis transmembrane conductance regulator gene into airway cells (bronchial or nasal) of patients with cystic fibrosis ([133](#), [134](#) and [135](#)). Despite the demonstration that airway cells could be transduced with these vectors *in vivo* with correction of the chloride transport defect, clinical utility has been precluded by the harmful immune and inflammatory responses noted above. However, the active immune response induced by adenoviral vectors is also being explored as a possible advantage when Ad vectors are used to transduce tumor cells with cytokines or other immune modulators for tumor vaccine protocols ([136](#), [137](#) and [138](#)). The fact that most adenoviral gene transfers result in transient transgene expression (in contrast to retroviral-mediated gene transfer) has limited their use for congenital diseases in which permanent expression of a missing protein is desirable, such as hemophilia, ornithine transcarbamoylase (OTC) deficiency, or a  $\alpha_1$ -antitrypsin inhibitor deficiency. Nevertheless, because removal of most (if not all) adenovirus genes seems to prolong transgene expression, repeat administration might become feasible should the interval be sufficiently long to allow practical clinical application.

## Adeno-Associated Viral Vectors

AAVs are small, nonenveloped, single-stranded DNA viruses in the parvovirus family, Dependovirus subfamily, that require a helper virus (adenovirus or herpes simplex virus) for production of new viral particles ( [139](#), [140](#) and [141](#) ). The linear AAV genome is approximately 4.7 kb long and consists of two homologous ITRs of 145 bp flanking two groups of genes: the *rep* or nonstructural genes and the *cap* or structural genes. The AAV cell-surface receptor has not been identified, but AAV is known to bind to and infect a wide variety of human cell types ( [142](#) ). There are at least five serotypes of AAV, of which AAV-2 is the best characterized. AAV has oncoprotective and HIV-suppressive properties and is not known to cause disease in humans or other animals ( [143](#), [144](#) and [145](#) ). Prior infection with AAV in humans is common: Seroepidemiologic studies demonstrate that 80% of the adult population has antibodies ( [140](#), [146](#) ).

In the absence of helper virus, internalization occurs via interaction with heparan sulfate on the surface of the target cell and the capsid protein. Subsequently, AAV integrates within the host chromosome ( [147](#) ). Integration of multiple copies in tandem occurs in a site-specific manner within a relatively small area on chromosome 19; this site specificity appears to require rep protein ( [148](#), [149](#) ). Specifics of replication and integration are less well understood than for retroviruses.

Recombinant AAV vector DNA contains the AAV ITRs flanking a gene of interest, replacing the *rep* and *cap* genes. This plasmid is introduced into a cell line permissive for adenovirus, along with a helper plasmid containing the AAV *rep* and *cap* genes but no ITRs. On exposure to adenovirus or transfection with adenovirus genes such as E4 (particularly open reading frame 6), the cell line packages the recombinant vector sequences using the *rep* and *cap* gene products produced by the helper plasmid, and recombinant vector particles are released as the producer cell lyses ( [150](#), [151](#), [152](#), [153](#) and [154](#) ). Recombinant AAV vectors have size constraints: Vector sequences longer than 115% of the wild-type length are not packaged or encapsidated efficiently. Very high titers of recombinant AAV particles can be produced, but often a significant percentage are empty capsids or otherwise defective vector particles.

The need for live adenovirus during AAV vector production complicates the manufacturing and safety issues, because the adenovirus must be inactivated or removed before use. Some progress is being made toward introducing only the specific adenovirus genes necessary for AAV replication into producer cell lines, avoiding live adenovirus. The inability to harvest AAV vector without actual lysis and death of the producer cells also complicates production of pure and defined vector preparations. Generation of stable packaging cell lines is also hindered because the AAV *rep* gene product harms most cell types, but, recently, producer cell lines expressing *rep* from an inducible promoter have been isolated ( [155](#) ).

Integration of the recombinant vectors into target cell chromosomes appears to be very inefficient, and thus these vectors prove more useful in situations not requiring integration, because they have been shown to be stable as episomes for long periods ( [154](#), [156](#), [157](#) ). Site-specific integration in chromosome 19, which is very desirable to avoid random insertional mutagenesis, does not occur with the recombinant AAV vectors, presumably due to lack of rep protein in the vector particle ( [157](#) ). Many cell types can be efficiently transduced, including nondividing cells such as neurons, but integration and increased efficiency of transduction still appear to depend on cell division or other

DNA-disrupting events, although this conclusion is very controversial ( [158](#), [159](#), [160](#), [161](#) and [162](#) ).

It is possible that a number of other parvoviruses can be developed as vectors, including AAV-3, nonpathogenic strains of B19, or novel autonomous parvoviruses isolated from nonhuman primates or other animal species ( [163](#), [164](#) and [165](#) ). These viruses are similar to AAV, but some, such as B19, never integrate.

### Miscellaneous Other Vectors

Herpes viruses are large DNA viruses with marked neurotropism and are generating intense interest in their potential as vectors targeted at the nervous system ( [166](#), [167](#), [168](#) and [169](#) ). They can accommodate very large DNA sequences (up to 30 kb). More recently, these vectors have been reported to transduce some types of hematopoietic cells, including monocytes, leukemic blasts, and progenitor cells ( [170](#), [171](#) ). However, these vectors result in only transient expression in dividing cells and cause cytotoxicity, limiting clinical utility, at least for hematologic applications.

Vaccinia virus, a large DNA virus that replicates cytoplasmically, has also been considered for gene therapy applications ( [172](#), [173](#) ). It can accommodate very large transgenes (up to 30 kb) and expresses these genes at very high levels, but expression is transient, and production of replication-incompetent vectors has not yet been possible. Very high immunogenicity limits most clinical applications but may be advantageous for *in vivo* vaccination with vaccinia-transduced tumor cells ( [173](#), [174](#), [175](#) and [176](#) ).

## HEMATOPOIETIC STEM AND PROGENITOR CELLS AS TARGETS FOR GENE TRANSFER

After the development of helper-free retroviral gene transfer technology more than two decades ago, the HSC has been a primary target for gene therapy applications. The curative potential of HSCs carrying corrective genes has been well established through the use of allogeneic bone marrow transplantation (BMT) in genetic disorders whereby an individual carrying a normal genotype serves as the stem cell donor, yet procedural toxicities and finite donor availability limit this approach. The prospect of a curative, one-time therapy using genetically modified autologous stem cells for the treatment of a wide variety of congenital disorders such as hemoglobinopathies, immunodeficiencies, or metabolic storage diseases and of a new weapon against malignancies and HIV infection has proven irresistible ( [13](#), [14](#), [177](#), [178](#), [179](#) and [180](#) ). Gene therapy directed at the HSC must use an integrating vector, because ongoing self-renewal or proliferation/differentiation would rapidly dilute out an episomal vector in daughter cells. Thus, the vast majority of preclinical and clinical research in this field has used retroviral vectors. Some of the alternative vector systems described above, including HIV and AAV, continue to be developed and tested in hematopoietic cells.

Although efficient, reproducible gene transfer to long-term repopulating stem cells in rodents has been achieved, studies in larger animals and humans have been largely disappointing ( [14](#), [180](#) ). Clearly, better knowledge of stem cell biology and perhaps development of alternative vector systems may be necessary for clinical progress on a large scale. Diseases such as SCID, in which modest correction levels can revert the phenotype, have appropriately remained a focus, yet application to conditions such as sickle cell anemia, which require higher levels of regulated, lineage-specific gene expression, remains further from reach. Nevertheless, progress has been achieved at all

levels of gene transfer, and promise remains.

## Preclinical Studies and Predictive Models

First reported in 1984, retroviral gene transfer into murine hematopoietic repopulating stem cells has become routine in many laboratories ( [181](#), [182](#) and [183](#) ). The isolation and availability of various hematopoietic growth factors have allowed *ex vivo* maintenance and increased retroviral gene transfer into hematopoietic target cells. Several different combinations of growth factors have been successful, including at least two or three cytokines active on primitive cells such as IL-3, IL-6, and stem cell factor (SCF). Their mechanism of action probably includes both induction of cell cycling, a necessity for retroviral transduction and integration, and up-regulation of retroviral cell-surface receptors ( [89](#), [184](#), [185](#), [186](#), [187](#) and [188](#) ). Other manipulations found to increase gene transfer efficiency to murine stem cells include co-culture of target cells directly on a layer of retroviral producer cells, use of high-titer ( $>10^5$  viral particles per ml) vector, induction of stem cell cycling by pretreatment of donor mice with 5-fluorouracil, and co-localization of vector and target cells using fibronectin-coated culture dishes ( [96](#), [186](#), [189](#), [190](#) and [191](#) ). Using these techniques, successful gene transfer can now be achieved in virtually all mice transplanted with transduced syngeneic bone marrow stem cells, with long-term persistence of the vector sequences in 10 to 100% of cells from all hematopoietic lineages ( [186](#), [187](#), [189](#), [190](#), [192](#) ). The continued presence of vector sequences in short-lived granulocytes for the lifespan of the mouse and in multiple lineages of the blood of serial transplant recipients indicates that murine repopulating stem cells can be successfully modified with retroviral vectors ( [15](#), [17](#), [187](#), [193](#), [194](#) and [195](#) ). Insertion site analysis documenting the shared single-cell ancestry of gene-modified cells from different lineages has also supported this contention.

Despite the ability to produce mice with a high percentage of gene-modified circulating hematopoietic cells, actual levels of expression from the transgenes have often been quite low. Although high-level production of clinically relevant gene products, such as glucocerebrosidase, has been demonstrated for over 12 months in multiple lineages, other genes and retroviral vector constructs have resulted in extinction of vector-encoded gene expression over time, despite the persistence of the proviral sequences in the genome ( [187](#), [192](#), [196](#), [197](#), [198](#) and [199](#) ). Gradual methylation of transcriptional control sequences in the vectors has been found to correlate with decreased expression in some mouse cell types and may be overcome by use of stronger promoters within the vector, instead of relying on the viral LTR for transcription ( [47](#), [200](#), [201](#) ).

Selection for more primitive cell populations by exposure of whole bone marrow to antibodies directed against cell-surface antigens found only on primitive cells, such as CD34, followed by flow cytometric sorting or immunabsorption allows isolation of the 1 to 5% or less of total cells that are CD34<sup>+</sup>. This procedure greatly enriches for progenitor cells while retaining reconstituting activity in clinical transplantation protocols ( [202](#), [203](#), [204](#) and [205](#) ). Purification of CD34<sup>+</sup>/CD38<sup>-</sup> or HLA-DR<sup>-</sup> populations may further enrich for stem cells ( [206](#), [207](#) ). However, some stem cells may be CD34<sup>-</sup>, calling into question the use of purified cells for gene transfer and other applications ( [208](#), [209](#) and [210](#) ). The use of purified target cells permits more practical *ex vivo* transduction culture volumes and higher vector particle to target cell ratios (multiplicity of infection), possibly improving transduction efficiency ( [46](#), [211](#), [212](#), [213](#) and [214](#) ). Given their phylogenetic proximity to humans, nonhuman primates have been used most extensively for the preclinical testing of promising gene therapy strategies ( [215](#) ). The cross-reactivity of reagents used for human application adds to the practicality of these models. Long-term persistence of



vector sequences in the nonhuman primate was first demonstrated in 1989 after infusion of marrow cells transduced with a very high-titer retroviral vector producer cell line secreting greater than  $10^8$  to  $10^9$  viral particles per ml of culture media (216). However, recombination between vector and helper sequences in the producer line resulted in the generation of replication-competent helper virus, and high-grade T-cell lymphomas arose due to insertional mutagenesis in three of the recipient animals, underscoring the importance of large animal preclinical testing (82, 217). This setback led to a reassessment of safety issues and increased regulatory oversight of human clinical trials, with consensus that it is absolutely necessary to use producer cell lines and vector stocks that have been confirmed to be helper-free in any clinical application (82). In subsequent rhesus studies using helper-free vectors, two laboratories showed long-term genetic modification of multiple hematopoietic lineages using a number of different retroviral vectors. These successful transductions were all carried out in the presence of hematopoietic cytokines, using unpurified or CD34-enriched target marrow or mobilized peripheral blood cells. Much lower levels of gene-modified circulating cells than in the murine experiments were reported, generally less than 0.01 to 1.00% (216, 218, 219 and 220). Transduction in the presence of a cell line engineered to express a transmembrane form of human SCF resulted in animals with long-term levels of up to 4% gene-modified cells (216). Prolonged expression of vector-encoded murine ADA at 3 to 5% of endogenous rhesus ADA activity was also documented. Long-term expression of vector human glucocerebrosidase RNA in rhesus recipients has been reported (220). Subsequently, peripheral blood progenitor cells mobilized by granulocyte colony-stimulating factor (G-CSF) and SCF or bone marrow cells collected 2 weeks after a short G-CSF/SCF treatment period showed improved retroviral susceptibility, with over 5% positive circulating cells confirmed for the first time in a large animal by genomic Southern blotting as opposed to the less quantifiable polymerase chain reaction (PCR) analysis (221).

Optimization of retroviral gene transfer techniques using primary human hematopoietic cells has largely relied on *in vitro* progenitor cell assays, including short-term progenitors such as colony-forming units (CFU) or even more primitive cell populations such as long-term culture-initiating cells, yet these assays proved to be inadequate surrogates for true stem cell activity (222, 223, 224 and 225). Despite efficient gene transfer to these progenitor cell populations, circulating levels of vector-containing cells in early trials in humans undergoing autologous transplantation with bone marrow- or peripheral blood-derived progenitor cells genetically modified using marker genes were too low to predict clinical benefit, requiring highly sensitive PCR-based techniques for detection (226, 227, 228 and 229). Indeed, early human clinical gene therapy trials for disorders such as SCID and Fanconi anemia (FA) also produced only modest levels of engraftment, and clinical benefit could not be convincingly ascribed to the use of genetically modified cells in either setting (230, 231). A number of important plausible explanations for the poor results include loss of stem cell activity by forced *ex vivo* division, immune recognition of cells expressing foreign transgene products, and toxicity from the constitutive expression of the transferred gene products on HSC differentiation *in vivo*, along with the lack of conditioning in the clinical settings; these were among the questions to be addressed before returning to the clinic.

Large animal models thus became a focus, but outbred animals introduce significant experimental variability, and the high costs limit the breadth of experiments that can be performed. For this reason, a competitive repopulation model in which each animal serves as its own control has been used for the majority of subsequent comparative studies. In this model, hematopoietic progenitors are isolated and divided equally for transduction under two (or more) distinct experimental conditions using marking vectors that can be distinguished *in vivo* after reconstitution. Loss of stem cell activity during the *ex vivo* culture required to achieve gene transfer was a major concern generated by the early

human clinical trials, a concern supported by studies in the mouse in which *ex vivo* culture of HSCs resulted in a significant engraftment defect ( [232](#) ). Competitive experiments in the nonhuman primate tracking genetically modified cells subjected to either short or extended *ex vivo* culture supported this notion ( [233](#) ). The advent of newly characterized hematopoietic growth factors, however, allowed improved gene transfer rates to cells in short-term culture, especially with the inclusion of Flt-3 ligand. The use of autologous stroma or extracellular matrix proteins, such as the CH-296 fibronectin fragment, was associated with further improvements, allowing even extended culture and *ex vivo* division without apparent loss of stem cell activity ( [233](#) , [234](#) , [235](#) and [236](#) ). The low-level expression of the amphotropic receptor required for standard retroviral vectors on HSCs ( [89](#) ) has stimulated interest in exchanging or pseudotyping with alternative envelope proteins, including the gibbon ape leukemia virus (GALV) ( [94](#) ), VSV-G ( [237](#) ), and the feline endogenous retrovirus (RD114) ( [93](#) ), as a means to further increase gene transfer efficiency. By systematically comparing these and other modifications to retroviral transduction methods, clinically relevant levels of genetically modified cells have been reached, with stable levels of 5 to 10% or higher now achievable ( [233](#) , [234](#) and [235](#) ).

Establishing that transduction of the true HSC has been achieved, however, requires further evidence: rescue from lethal irradiation and long-term contribution by and pluripotency of the genetically modified product. The long-term persistence of vector in short-lived granulocytes along with the presence of vector in multiple hematopoietic lineages suggested successful stem cell transduction. The finding of common integration sites among myeloid and erythroid colonies as well as in peripheral blood T- and B-cell populations along with the prolonged contribution of some clones to myeloid progeny, however, satisfied the more strict criteria for transduction of the HSC, providing further optimism for eventual clinical application ( [238](#) , [239](#) and [240](#) ).

The canine autologous transplantation model has also been used to test retroviral gene transfer strategies. Successful transduction of G-CSF-mobilized peripheral blood engrafting cells was first demonstrated in the dog, as was the importance of partially or fully ablative conditioning radiation or chemotherapy for detectable engraftment with transduced primitive hematopoietic cells ( [241](#) , [242](#) and [243](#) ). Cross-reactivity of human reagents has proven more problematic in the dog model, yet continued progress in this model has led to clinically relevant gene transfer techniques ( [244](#) , [245](#) ). The value of the dog model as a large animal model is further strengthened by the presence of several disease states that mimic those in humans, which could allow stringent preclinical testing.

Although results from the large animal models have better correlated with results from early human clinical trials, the rhesus and canine experiments are expensive, slow, and technically difficult, not allowing large-scale testing of new approaches. Recently, xenograft models have gained in popularity, in part due to access, and investigators have begun to use engraftment of transduced human hematopoietic cell populations in immunodeficient mice as an alternative experimental model ( [246](#) , [247](#) , [248](#) and [249](#) ). This approach was initially limited by very low-level engraftment with human cells, but modifications including co-transplantation of stromal cells secreting human IL-3 and transplantation into immunodeficient transgenic mice expressing human cytokines have resulted in increased levels of human cell engraftment ( [246](#) , [247](#) ). In one study, common integration sites of a retroviral vector were demonstrated in human myeloid and T-cell clones isolated from a mouse 7 to 9 months after transplantation, suggesting that a very primitive pluripotent human cell had been transduced and could contribute to both myeloid and lymphoid human lineages ( [250](#) ). The long-term engraftment of human cells in the xenograft model was improved when transduced in the presence of an autologous stromal cell layer ( [251](#) ). Examples of the way in which the murine xenograft model has



since been used include the comparison of stem cell sources or vector systems, investigation of the expression of therapeutic genes in marrow-derived cells from individuals with specific genetic disorders, and the determination of copy number for new vector systems ( [252](#), [253](#), [253a](#), [254](#) ). The predictive value of these xenograft models, however, remains to be proven by direct comparison with human clinical trial results, tracking the same gene-modified cell population in both a patient and an immunodeficient mouse.

## Human Clinical Trials

**GENETIC MARKING** The first human clinical gene transfer trials used retroviral vectors carrying nontherapeutic marker genes and were critical for establishing proof of principle and allaying safety concerns ( [7](#), [255](#) ). In the case of HSC targets, patients already undergoing autologous transplantation as therapy for an underlying malignancy received genetically marked cells ( [256](#) ). Only a fraction of their graft was transduced, and the patient received no clinical benefit from the gene marking procedure. Genetic marking with an integrating vector is a unique method to track transplanted autologous cells and their progeny *in vivo*. Many patients have now been enrolled in clinical gene marking protocols in the setting of autologous transplantation. Several studies used retroviral marking to determine whether reinfused tumor cells contribute to relapse after autologous transplantation ( [257](#), [258](#) ). In two pioneering studies involving pediatric patients with acute myeloid leukemia or neuroblastoma at St. Jude Children's Research Hospital, unpurged autologous marrow was briefly exposed to a retroviral marking vector carrying the bacterial neomycin phosphotransferase gene (Neo) ( [229](#) ). Genetically marked tumor cells were unequivocally demonstrated in several patients at the time of relapse, suggesting that the reinfused marrow had contributed to progression and that investigation of purging strategies was worthwhile ( [259](#), [260](#) and [261](#) ). A smaller study of adult acute leukemia patients did not detect any marked tumor cells at the time of relapse, but overall transduction efficiencies in this study were much lower ( [262](#) ). Marked relapses after autologous transplantation have also been reported in chronic myelogenous leukemia (CML). Individual bcr/abl+ marrow CFU-culture (CFU-C) were shown to contain the retroviral marker gene ( [263](#) ). No marked relapses have been detected in adult patients with multiple myeloma and breast cancer transplanted with genetically marked bone marrow and mobilized peripheral blood cells, but the target marrow and blood cells had been CD34-enriched before transduction, probably purging at least 2 logs of tumor cells ( [204](#), [264](#) ). The other major objective of these gene-marking studies was to assess the efficiency of retroviral gene transfer into human long-term repopulating cells. In the pediatric St. Jude study, a fraction of the harvested bone marrow harvest was briefly exposed to retroviral supernatant without growth factors or supporting stroma ( [229](#) ). Although animal experiments and *in vitro* assays predicted poor marking using this transduction protocol, as high as 5 to 20% of nonleukemic CFU grown out of the marrow between 6 and 18 months after transplant contained the marker gene and were neomycin-resistant, indicating ongoing transgene expression. Only 0.1 to 1.0% of circulating mature cells were marked. The surprisingly high levels of stable marking of marrow progenitors may be explained in part by beneficial cell cycle kinetics of the primitive hematopoietic cells from these patients, because of their young age or ongoing hematopoietic recovery from high-dose induction chemotherapy just before bone marrow harvesting. An NIH trial treated adults undergoing autologous bone marrow and mobilized peripheral blood stem cell transplantation for multiple myeloma and breast cancer ( [226](#) ). In this marking trial, the transduction was for 3 days in the presence of the cytokines IL-3, IL-6, and SCF. Bone marrow and peripheral blood CD34-selected cells were transduced with different Neo-marking vectors (distinguishable by PCR) to assess the relative contribution to marking and engraftment of marrow and peripheral blood populations. Circulating marked cells were detected after engraftment in all patients; in

three of nine, marked cells were detected for over 18 months. Although granulocytes, B cells, and T cells were all positive for the transgene, the efficiency of gene transfer was much lower than that reported by the St. Jude group: Less than 0.1% of circulating cells were marked long term ( [226](#) , [265](#) ). Because both the bone marrow and peripheral blood grafts contributed to long-term marking, mobilized peripheral blood grafts can produce durable multilineage engraftment. This source of primitive cells should be useful in the allogeneic setting. These investigators have gone on to test the brief single transduction protocol that seemed more effective in the St. Jude pediatric study, but no persistent marking has been detected in these adult patients ( [266](#) ).

**THERAPEUTIC GENES** Despite the low efficiencies of gene transfer into long-term repopulating stem cells achieved in large animal models and early human marking trials, several phase I/II clinical trials investigating the transfer of potentially therapeutic genes were initiated. Important information has been obtained on safety and on the feasibility of stem cell engraftment without ablation, and, although these initial trials were largely disappointing, there were glimmers of hope regarding clinical benefit. SCID due to ADA deficiency has been a prototype target disease for gene therapy since the initial development of retroviral vectors in the 1990s ( [267](#) ), and children with ADA-deficient SCID were the subjects of the first clinical trial using a vector carrying a therapeutic gene directed at T-lymphocyte targets ( [267](#) ). HSCs are theoretically preferable to T cells as gene correction targets in this and other immunodeficiency disorders, due to the potential for permanent and complete reconstitution of the T-cell repertoire. To directly address this hypothesis, two ADA-deficient children received autologous bone marrow and mature lymphocytes transduced with two different retroviral vectors carrying the ADA gene and the Neo gene and then repeatedly reinfused without conditioning ( [231](#) ). In the first year after initiation of these infusions, vector-containing T cells originating from the transduced T cells were observed, but, with time, there was a shift to vector-containing T cells originating from transduced bone marrow cells. The proportion of gene-corrected clonable T cells was 2 to 4%, and analysis of T-cell receptor gene rearrangements indicated a wide repertoire of corrected clones. A surprisingly high number of marrow myeloid colonies resistant to neomycin was also reported, despite lack of conditioning, and an *in vivo* selective advantage for gene-corrected cells of all lineages was hypothesized. For genetic disorders diagnosed *in utero*, the use of cord blood cells as targets for gene transduction represents an exciting alternative approach ( [268](#) , [269](#) ). Cord blood may contain greater numbers of primitive reconstituting cells with higher proliferative potential that may prove more susceptible to retroviral transduction. Moreover, early treatment is crucial in diseases that progress to irreversible damage before a child is old enough to allow collection of mobilized peripheral blood or bone marrow cells ( [270](#) ). Three infants diagnosed *in utero* with ADA deficiency allowed the testing of this concept, and cord blood was collected at the time of delivery. The cells were CD34-enriched, transduced with an ADA/Neo retroviral vector, and infused in the absence of conditioning ( [271](#) ). Vector sequences were detected in circulating myeloid and lymphoid cells at low levels of less than 0.05% in all three children for longer than 18 months. Four to six percent of individual colonies grown from bone marrow aspirates at 1 year contained vector, and semiquantitative PCR performed on bone marrow mononuclear cell and on sorted CD34<sup>+</sup> cell samples suggested a higher contribution in the CD34<sup>+</sup> fraction. The finding of higher transduction levels in the more primitive population of cells was not explained but could be due to toxicity of either Neo or ADA to mature but not to primitive cells, protection by the marrow microenvironment of more immature cells from immune destruction, or a differential contribution of transduced cell populations to colony-forming progenitor cells as compared to those producing the actual circulating cell populations. The children remain clinically well but continue on ADA enzyme replacement therapy. Clonality analysis performed after 10 years shows that, although a single vector integrant was predominant in the T cells of one patient, a broad T-cell repertoire was represented, indicating transduction of a prethymic stem or progenitor cell ( [272](#) ). A gradual withdrawal of the exogenous ADA has been initiated. If corrected lymphocytes

have an *in vivo* selective advantage as hypothesized, the level of corrected T lymphocytes would be expected to increase over time ( [273](#) ). The long-term results of the original gene therapy trial were also recently reported, with 20% of lymphocytes in one patient still carrying the ADA gene more than 10 years after the infusion of transduced mature lymphocytes ( [274](#) ). FA is another genetic disorder of the hematopoietic system that appears to be an excellent candidate for gene therapy. This congenital syndrome is characterized by bone marrow failure, physical anomalies, and an increased susceptibility to marrow failure and leukemias. Cells from these patients are abnormally sensitive to chemically induced DNA cross-linking. Many of the complementation groups have been cloned and sequenced, making a genetic approach feasible for this disorder ( [275](#) ). The bone marrow failure seen in patients with FA parallels the poor *in vitro* growth of their CFU. Phenotypic correction of this abnormality in cells from one patient group was successful after transduction with viral vectors carrying the Fanconi complementation group C gene ( [276](#) , [277](#) ). A possible *in vivo* survival advantage for gene-corrected primitive cells and their progeny has made FA an attractive candidate disease for stem cell gene therapy. Even a very low efficiency of transduction might result in gradual *in vivo* expansion of corrected progenitor and stem cell populations. A clinical trial testing this hypothesis using G-CSF-mobilized peripheral blood CD34<sup>+</sup> cells as targets yielded disappointing results, in part due to the very poor mobilization in these subjects ( [278](#) ), yet engraftment with corrected CFU-C was demonstrated ( [230](#) ). Despite the numerous hurdles encountered in these early clinical gene transfer trials, efforts in the clinic have continued largely uninterrupted, with SCID remaining a prototype target disease. The parallel development of improved techniques in small and large animal models continued to fuel the clinical effort. Appropriately, the first definitive evidence for efficacy of any gene therapy trial was reported in children with SCID in 2000 ( [22](#) ). In this landmark trial, children with the X-linked form of SCID received autologous bone marrow CD34<sup>+</sup> cells transduced with a  $\gamma$ c-encoding vector under optimal conditions, and these cells were then infused in the absence of conditioning ( [22](#) ). T and natural killer cells reached normal levels in the blood within 4 months in four of the five treated patients. These long-awaited results have been duplicated by another group in children with the ADA-deficient form of SCID ( [23](#) ). In contrast to the first study, patients received genetically modified cells after conditioning with low-dose intravenous busulfan. Whereas the initial reports described relatively short follow-up in only a few patients, longer term follow-up is now available for the recipients of  $\gamma$ c-corrected bone marrow. Phenotypic and functional studies, including analysis of the T-cell repertoire and *in vitro* and *in vivo* T-cell function, appear nearly normal. Furthermore, thymopoiesis was documented, and thymic development appeared normal. Although B-cell numbers were low, serum immunoglobulin levels were sufficient to avoid intravenous immunoglobulin treatment. Furthermore, antibody production was observed after immunizations. Most important is the fact that the patients were able to leave the hospital and lead a normal life outside of the protection of a sterile environment. These results definitively established the therapeutic potential of HSC-based gene transfer and ushered in a great deal of enthusiasm for moving toward the clinic for other disorders such as the hemoglobinopathies, which have also remained a major focus for gene therapy application.

## Gene Therapy for Globin Disorders

The thalassemias and hemoglobinopathies represent a heterogeneous group of anemias characterized by absent/reduced or abnormal production of one or more of the globin-molecule subunits, respectively, and strategies that aim to replace the absent or defective globin gene have long been envisioned as potentially curative. Progress in the field suggests that this goal may one day be achievable. Indeed, retroviral vectors carrying globin genes were among the first to be tested in murine models ( [184](#) , [279](#) , [280](#) ). Attaining erythroid-specific gene expression, however, has remained a seemingly insurmountable

barrier. The incorporation of  $\beta$ -globin promoters and enhancers within vector constructs directs erythroid-specific expression but at very low levels ( [184](#), [279](#), [280](#), [281](#), [282](#), [283](#), [284](#) and [285](#) ). The finding that DNA sequences important in globin gene regulation are located upstream of the human  $\beta$  globin gene was crucial to the further development of this potential therapy ( [286](#), [287](#), [288](#) and [289](#) ). The region, designated the *locus control region* or *LCR*, is unfortunately too large to incorporate into standard retroviral vectors, and smaller fragments do not confer full LCR activity ( [290](#), [291](#), [292](#), [293](#), [294](#), [295](#), [296](#), [297](#), [298](#), [299](#), [300](#) and [301](#) ). As a result, other approaches to improve human  $\beta$ -globin expression, such as the use of alternative erythroid-specific control elements ( [302](#), [303](#) and [304](#) ) or preselection of transduced stem cells that express the vector at high levels ( [305](#), [306](#) ), have been pursued in parallel.

The development of vector systems that allow stable transmission of larger segments of the LCR and other transcriptional elements would theoretically improve on the results achieved to date. To test this approach, May et al. produced vectors derived from HIV-1 based on its unique properties, which allow regulated RNA splicing in ways that oncoretroviruses lack ( [307](#), [308](#) ). Using a modified HIV-1-derived vector ( [309](#) ), May et al. succeeded in stably transmitting the human  $\beta$  globin gene along with the promoter and enhancer and large segments of the LCR ( [103](#) ). This vector proved effective in a murine transplantation model, with sustained, high-level human  $\beta$ -globin expression achieved ( [103](#) ). Furthermore, human  $\beta$ -globin expression was sufficient to ameliorate the phenotype in mice with a form of  $\beta$ -thalassemia similar to human  $\beta$ -thalassemia intermedia. Equally encouraging results were subsequently reported in a novel human  $\beta$ -thalassemia major murine model ( [310](#) ). An HIV-1-based vector expressing a mutant, antisickling human  $\beta$  globin has also demonstrated efficacy in two different models of human sickle cell anemia ( [311](#) ). The results have set the stage for large animal, preclinical testing and predict eventual success in the clinic.

## LYMPHOCYTES AS TARGETS FOR GENE TRANSFER

The first human clinical gene transfer trial to be approved and accomplished involved marking tumor-infiltrating lymphocytes (TILs) ( [7](#), [255](#) ). Lymphocytes have several features that make them more attractive than HSCs as targets for gene therapy. They are easily harvested and circulate in large numbers and can be cultured *ex vivo* without major perturbation of phenotype, immune responsiveness, or proliferative potential ( [312](#) ). Lymphocytes may be repeatedly harvested, and ablative conditioning is not necessary for persistence of infused cells. These advantages have stimulated investigators to pursue lymphocytes as potential targets for many gene therapy applications. Recent *in vivo* human trials have yielded very important and often surprising information on the lifespan of these “terminally” differentiated cells in the body but also worrisome evidence of strong immune responses against exogenous genes expressed by these cells.

### Preclinical Studies

Using a retroviral vector containing both the neomycin resistance (Neo) and human ADA genes, investigators showed stable, long-term expression of transgenes in both murine and human T lymphocytes in culture ( [313](#) ). Transduced murine lymphocytes could be selected by growth in neomycin and subsequently expanded without changing their antigenic specificity. Infusion into nude mice demonstrated the persistence of Neo-resistant cells, which continued to produce human ADA for several months ( [313](#) ).

Further *in vitro* optimization of lymphocyte transduction protocols has involved the

pseudotyping of vector particles with a GALV envelope ( [314](#), [315](#) and [316](#) ). Lymphocytes have more GALV receptors than amphotropic receptors. Other technical improvements during transduction have included centrifugation to increase target–virus interactions, phosphate depletion to up–regulate the amphotropic or GALV receptors, and low–temperature incubation to stabilize vector particles. These methods have resulted in reports of successful transduction of up to 50% of cultured lymphocytes with preservation of viability, phenotype, and expansion capability ( [316](#) ). In a subsequent *in vivo* marking experiment using these optimized conditions, rhesus peripheral blood lymphocytes were transduced with a vector encoding the Neo gene and HIV–1 TAT/REV antisense sequences. After reinfusion, 3 to 30% of circulating CD4<sup>+</sup> cells contained the vector for at least several months, and lymph node sampling demonstrated that these cells could traffic normally ( [317](#) ).

## Clinical Studies

**GENE MARKING STUDIES** The first human gene transfer study used gene marking to monitor the fate of TILs *in vivo*. Persistence of low–level gene–marked cells was demonstrated, including in tumor deposits, although marking levels were too low to assess any preferential trafficking of TIL cells to residual tumor ( [7](#) ). More recently, gene marking studies in humans undergoing allogeneic BMT have helped to further characterize the behavior of lymphocytes that have been cultured *ex vivo*. Epstein–Barr virus (EBV)–specific T cells from patients at high risk for postallogeic BMT EBV lymphoproliferation were isolated, expanded, and gene marked *ex vivo* in culture with EBV–transformed donor lymphoblasts ( [318](#), [319](#) ). After BMT, the T cells were infused, and marked cells were detectable at levels suggesting expansion of two to three orders of magnitude. EBV–specific cytotoxicity in the peripheral blood was greatly enhanced after the infusions. Although circulating marked cells fell below the limit of detection by 4 to 5 months after infusion, the continued presence of memory cells derived from the infusion product was inferred in one patient who had detectable marked lymphocytes in the blood after reactivation of latent EBV ( [319](#) ).

**SUICIDE GENE STUDIES** A second group is using a similar approach in patients with EBV lymphoproliferation but has incorporated the herpes thymidine kinase (tk) gene into the retroviral vector ( [320](#) ). This *suicide gene* converts the nontoxic prodrug ganciclovir to a toxic metabolite that kills the tk–expressing cell by interfering with DNA synthesis ( [321](#) ). The inclusion of this gene in vectors allows postinfusion destruction of transduced cells simply by treating the patient with ganciclovir. For instance, ganciclovir treatment could abrogate graft–versus–host disease in allogeneic BMT recipients if most of the allogeneic T cells contain the tk gene ( [320](#), [322](#) ). This strategy depends on inclusion of a cell–surface marker gene in the vector to allow positive selection of transduced cells by flow cytometry before reinfusion, so that almost all infused cells will contain the tk gene ( [320](#), [323](#) ). With this approach, it may be feasible to transplant patients with T–depleted marrow grafts and then infusions of large numbers of tk gene–transduced T cells, specifically stimulated *ex vivo* to respond to viral infections or neoplastic cells ( [312](#), [324](#) ). The benefits of antiviral and antitumor immunity could be retained while allowing for immediate control of graft–versus–host disease by ganciclovir administration. Further, the inclusion of an *ex vivo* selectable marker with a suicide gene could enhance engraftment while providing protection from graft–versus–host disease ( [325](#) ). Another group grew HIV–specific autologous cytotoxic T–lymphocyte clones from patients with HIV disease. Because the safety of infusing these cells was unknown, the clones were transduced with a vector containing the tk gene (along with a hygromycin resistance gene allowing *in vitro* selection) to allow *in vivo* ablation of transduced cells if toxicity developed. Analysis of this adoptive immunotherapy strategy was precluded by the appearance of vigorous cell–mediated immunity to gene products encoded by the vector, including the tk protein



and the hygromycin resistance gene product, despite the patients' immunosuppression from their active HIV disease ( [326](#) ). Vector sequences were detectable soon after the first infusion of transduced cells but rapidly disappeared, especially after subsequent infusions, and active cell-mediated immunity against the hygromycin resistance gene protein was demonstrated. This observation serves as an important caution that foreign proteins introduced via lymphocytes may stimulate immune recognition and rejection.

**THERAPEUTIC GENES** T lymphocytes were the targets in the first human study using a potentially therapeutic gene, initiated in 1990 ( [8](#), [327](#) ). Two children with SCID due to ADA deficiency received multiple infusions of autologous T cells transduced with a retroviral vector encoding human ADA ( [6](#) ). Both patients showed improvements in circulating T-cell numbers and cellular and humoral immunity. In one child, over 30% of the circulating T cells were positive for the transgene, and ADA levels approached the normal range for more than 2 years. The persistence and continued expression of the transgene indicate that the extinction of transgene expression seen in some mice may not apply to immunodeficient humans. The second child had only 0.1 to 1.0% of circulating T cells containing the vector even after multiple infusions, clouding interpretation of how much of her clinical improvement was due to the gene transfer and how much to other factors, including the *ex vivo* lymphocyte expansion.

## GENE THERAPY FOR HUMAN IMMUNODEFICIENCY VIRUS INFECTION

The lack of effective, nontoxic, and practical conventional pharmacologic therapies for HIV infection and the current bleak outlook for the rapid development of a vaccine have made the gene therapy approach an attractive alternative ( [179](#), [328](#), [329](#) ). A number of ongoing and completed human clinical trials have already involved patients with HIV disease, and this activity is certain to increase over the next several years because so many gene therapy biotechnology companies have focused on HIV disease. After intensive investigation into the molecular biology of the HIV virus, scientists have identified a number of potential targets for genetic intervention ( [330](#) ). The concept of *intracellular immunization* against HIV, conceived over a decade ago, hypothesizes that an effective gene therapy strategy for HIV could be designed to confer nonimmunologic HIV resistance to mature cell populations by introducing a gene that interferes with the HIV life cycle into HSCs or lymphocyte precursors ( [331](#) ). A second approach uses gene transfer to introduce genes that result in the killing of infected cells, either directly or via enhanced immunity, and thus destroy the HIV viral reservoir. All strategies under current development will treat patients who are already HIV infected and involve one or more of the approaches listed in [Table 26.3](#).

**TABLE 26.3. Gene Therapy Strategies for Human Immunodeficiency Virus (HIV) Infection**

---

Interference with HIV replication or infection by gene transfer of an inhibitory transgene into target cells

Transdominant negative mutant proteins

Tat mutants

Rev mutants

Gag mutants

Env mutants

Intracellular single-chain antibodies

Anti-env antibody

Anti-rev antibody

Anti-reverse transcriptase antibody

- Antisense RNA
    - Complementary to critical HIV RNA sequences
  - Ribozymes
    - Complementary to critical HIV RNA sequences
  - RNA decoys
    - Trans*-activating response element
    - Rev-responsive element
  - Destruction of HIV-infected cells by increased immunity
    - Genetic delivery of HIV gene products
      - Env
      - Universal receptor introduction into effector cells
        - CD4/T-cell receptor-? chimera
  - Direct destruction of HIV-infected cells
    - Conditional genes expressed from HIV-dependent sequences
      - Diphtheria toxin
      - Herpes thymidine kinase
- 

Potential target cell populations for a strategy of conferring intracellular resistance to HIV include lymphocytes and HSCs. As already discussed in the previous two sections, gene transfer into lymphocytes has been more efficient than transfer into repopulating stem cells. For HIV disease, however, stem cells would be better targets. T cells, macrophages, or glial cells would be protected from HIV if they developed from stem cells successfully transduced with a gene or genes preventing HIV infection, integration, or replication. In time, the immune system could be reconstituted, despite the presence of replicating HIV in unprotected cells.

Stem cell gene therapy for HIV also makes more sense if stem cells are not already infected. Most investigators believe that primitive CD34<sup>+</sup> cells are not actually infected with HIV, although maturing cells of the monocyte-macrophage lineage can be infected ( [332](#), [333](#) and [334](#) ). The use of mature T cells as targets may be useful for testing specific genetic manipulations, but therapeutic benefit would probably require repeated infusions, and a lymphocyte strategy alone would not prevent HIV disease of the central nervous system. Because of the probable deleterious immune response against exogenous gene products expressed in lymphocytes, even in patients immunosuppressed by HIV infection, a stem cell approach may be absolutely necessary if the anti-HIV moiety is an expressed protein as opposed to an RNA decoy or antisense sequence ( [326](#), [335](#) ).

A number of gene therapy approaches to HIV are being tested in a unique clinical model at the NIH. A cohort of syngeneic twins has been identified in which one twin is infected with HIV and the second twin is not. T cells from the uninfected twin are collected by apheresis and then transduced with vectors encoding potential anti-HIV genes. Comparison of survival of these transduced cells with survival of cells transduced with a control vector may prove to be a very rational way to test the *in vivo* efficacy of various strategies ( [336](#) ). A preliminary gene marking study was initiated and followed by testing of several of the most promising anti-HIV vectors ( [337](#) ). In one report, transduced T cells were infused without incident and persisted long term, although no improvement in disease could definitively be ascribed to the infused cells ( [338](#) ).



## Transdominant Proteins

One promising strategy has been to express transdominant mutant proteins that interfere with the HIV life cycle, either by inactivating regulatory proteins such as Tat and Rev or by interfering with structural proteins such as gag, env, or reverse transcriptase ( [339](#), [340](#) and [341](#) ). These proteins are designed to interfere with the function of wild-type HIV proteins. Most transdominant mutant proteins work by complexing with the wild-type protein and interfering with normal function or by binding to the target of the wild-type protein and preventing normal function of the target. The HIV Tat protein is essential for high-level expression from the HIV LTR because it interacts with the region of the LTR in transcripts termed the trans *-activating response* element or *TAR* ( [330](#), [342](#) ). Mutant Tat proteins or peptides have been reported to decrease transcription from the HIV LTR, possibly through formation of inactive heterodimers with wild-type Tat, but the desired effect occurred only with large molar excess of mutant Tat, tempering enthusiasm for this approach ( [343](#) ). A number of subsequent studies described more potent inhibition, however ( [344](#), [345](#) ).

The investigation of transdominant Rev mutants has been more encouraging. Rev acts to increase expression of full-length HIV transcripts, specifically, facilitating transport of these transcripts to the cytoplasm ( [330](#), [342](#), [346](#) ). Rev binds to a target sequence of RNA termed the *Rev-responsive element*, or *RRE*. Mutant Rev proteins have been reported that interfere with Rev function, either by binding to and inactivating wild-type Rev or by competitively blocking binding of the wild-type Rev to the RRE ( [60](#), [347](#) ). Expression of one mutant, termed *Rev M10*, has been extensively studied *in vitro* and was used in a preliminary clinical trial ( [55](#), [348](#), [349](#) ). Production of HIV either from normal lymphocytes exposed to HIV in culture or from HIV-infected lymphocytes from patients was decreased after either retroviral or gene gun particle-mediated transduction with a vector expressing the Rev M10 mutant, compared to a nontranslated inactive control Rev mutant ( [55](#) ). A clinical trial used the gene gun to transduce autologous lymphocytes from HIV-infected patients with either the active Rev M10 vector or the inactive control Rev vector. These cells were then expanded *in vitro* and reinfused. The lymphocytes containing the active Rev M10 sequences survived preferentially *in vivo*, suggesting that the Rev M10 transgene improved T-cell survival in infected individuals ( [348](#) ). In another protocol, individuals with HIV infection and a refractory hematologic malignancy were offered allogeneic peripheral blood stem cell transplantation, and an aliquot of the allogeneic graft was CD34-selected, transduced with a transdominant Rev-encoding vector, and infused with the unmanipulated allograft. Although overall marking was low in the only recipient of genetically modified cells, rising vector copy number and nondetectable HIV over extended follow-up were encouraging ( [350](#) ).

In another approach, the oligomerization of gag protein is inhibited by a transdominant mutant form of gag; to date, there is *in vitro* evidence for decreased viral production from T-cell lines but not from primary T cells ( [351](#) ). The envelope protein is also a potential target. One mutant form of the gp41 subunit, which contains the fusion domain, interferes with HIV spread in culture ( [352](#) ). HIV-infected cells containing this transgene release virus that is unable to fuse normally with target cells. Another mutant lacking the CD4-binding domain of the gp120 subunit of HIV-2 interferes with production of infectious virus from a wild-type HIV genome ( [353](#) ). All the transdominant protein anti-HIV strategies share some common limitations. The mutant expressed proteins may induce an antitransgene immune response, and the anti-HIV effect follows integration of

HIV, which is, of course, less desirable than preventing infection of cells altogether.

### Intracellular Anti-Human Immunodeficiency Virus Antibodies

An alternative gene therapy approach for prevention of HIV release from cells is to introduce genes that code for antibody fragments binding to critical HIV proteins ( [354](#) ). The gene for a single-chain antibody recognizing the CD4-binding region of HIV gp120 was introduced into HIV-infected cells, and production of infectious virus decreased ( [355](#) ). The antibody fragment was shown to bind gp120 and to retain it in the endoplasmic reticulum, at least partially preventing release of infectious HIV virus. A similar approach was used to express a single-chain antibody fragment against Rev ( [356](#) ). The highly conserved Rev sequences were believed to be a logical target, especially because very high levels of intracellular Rev are necessary for HIV replication. The cells expressing the anti-Rev antibody sequences sequestered Rev in the cytoplasm, where it was unable to chaperone full-length HIV genomes out of the nucleus, thus decreasing viral production.

Another group has targeted single-chain antibodies to the HIV reverse transcriptase ( [357](#) ). This approach has the theoretic advantage of preventing infection altogether, because reverse transcriptase protein entering an HIV-susceptible cell with the HIV particle is necessary for synthesis of cDNA and integration. The investigators showed that expression of this transgene in susceptible T-cell lines made them resistant to infection. Testing of these antibody strategies using T-cell clones, primary T-cells, and even CD34<sup>+</sup> cells differentiated *in vitro* demonstrates their potential for *in vivo* use ( [358](#) , [359](#) , [360](#) and [361](#) ).

### Anti-Human Immunodeficiency Virus Nucleic Acids

In theory, introducing DNA sequences that encode anti-HIV RNA sequences but not proteins may have several advantages, the most important of which is the decreased immunogenicity of the gene product. A number of different strategies have been explored. Antisense RNAs or RNA sequences complementary to expressed messenger RNA (mRNA) decrease gene expression either by preventing normal translation of mRNAs or by interfering with RNA processing ( [362](#) , [363](#) and [364](#) ). Decreased HIV production has been the reported result of transduction with an AAV vector expressing antisense RNA sequences to part of the HIV LTR that includes the TAR sequence and the polyadenylation signal ( [365](#) ). However, a nonspecific effect of AAV vector transduction on HIV production was not ruled out by this study. A number of other studies using other HIV antisense sequences transfected into stable cell lines have also been reported ( [366](#) , [367](#) ).

A related strategy involves the use of anti-HIV ribozymes ( [368](#) , [369](#) ). Ribozymes are antisense RNA molecules that not only bind to complementary RNA sequences but actually catalytically cleave and thus inactivate target RNAs ( [179](#) , [370](#) ). Thus, one ribozyme molecule can destroy many target HIV RNAs, whereas a standard antisense molecule can bind to and inhibit expression from only one HIV RNA molecule. Also, ribozymes can cleave full-length viral RNA before reverse transcription and actual infection of a susceptible cell. A ribozyme that targeted gag RNA sequences was shown to reduce gag p24 levels ( [371](#) ). Since then, many other ribozymes targets have been explored ( [179](#) , [372](#) , [373](#) , [374](#) and [375](#) ).

A third nucleic acid strategy uses *decoy sequences* to sequester viral regulatory proteins such as Tat and Rev. Transduction of cells with retroviral vector containing either TAR or

RRE sequences results in decreased HIV replication ( [376](#), [377](#) and [378](#) ). The combination of ribozymes and decoy elements has also been pursued ( [379](#), [380](#) and [381](#) ). A clinical trial testing this approach in children infected with HIV was recently completed, although overall engraftment levels of genetically modified cells were too low to expect benefit ( [382](#) ).

Another strategy involves the use of defective interfering viruses, which are known to interfere with wild-type replication and spread. The application of defective interfering HIV vectors may result in competition with wild-type HIV and decrease viral load ( [383](#) ). A protocol using an HIV vector system mobilized via rescue by wild-type HIV has been proposed as the first gene transfer trial in humans using lentiviral vectors. This “defective interfering strategy” introduced additional concerns over the possibility of creation of a replication-competent recombination between the vector and the packaging sequences or inadvertent transfer of a mobilized vector to others by the research subject, requiring further development of sensitive replication-competent retrovirus testing before clinical use ( [104](#) ).

### **Destruction of Human Immunodeficiency Virus-Infected Cells**

Many investigators have taken the approach of using introduced transgenes to destroy HIV-infected cells, instead of trying to make living cells resistant to infection or productive HIV replication. Vectors have been developed that express the herpes simplex tk gene from genetic regulatory elements that are active only in HIV-infected cells. Exposure of a population of cells to ganciclovir would then kill only those transduced cells that are also infected with HIV ( [384](#) ). For instance, a vector expressing the tk gene from an HIV-2 promoter and the HIV TAR region was used to transduce human cell lines. Cells infected with HIV or expressing the HIV Tat gene were preferentially killed by ganciclovir exposure ( [385](#), [386](#) ). However, some cells not expressing HIV Tat were also killed, showing that the current promoters are not completely inactive in the absence of Tat protein. Other groups have used toxin genes, such as the diphtheria toxin, expressed from HIV-dependent control sequences, to kill HIV-infected cells ( [387](#) ). The large number of HIV-infected cells and the huge viral load present even in asymptomatic individuals make strategies dependent on direct killing less appealing, unless new T cells developing from stem cells could also be rendered resistant to infection. An alternative suicide gene has recently been developed for HIV-directed gene therapy ( [388](#) ).

Genetic vaccination approaches are also under development as a potentially more effective way to raise anti-HIV immunity ( [389](#) ). Fibroblasts transduced with a retroviral vector expressing the gp160 HIV envelope gene induced HIV-specific cell-mediated and humoral immunity in mice ( [390](#) ). Early clinical trials are using this approach in patients, either by direct injection of the vector into muscle or by *ex vivo* transduction of autologous fibroblasts that are then reimplanted ( [391](#) ). Another approach is to introduce a *universal receptor* transgene into cytotoxic T cells taken from patients infected with HIV. The extracellular portion of the chimeric gene product is the HIV gp120-binding moiety from CD4, and the intracellular portion is the  $\gamma$ -chain-transducing portion of the T-cell receptor complex. Cytotoxic T cells and other effector cells expressing this molecule specifically kill gp120-expressing HIV-infected cells ( [392](#) ). A current clinical trial uses a vector expressing this molecule to transduce T cells from a non-HIV-infected syngeneic twin before infusion into the infected twin ( [337](#) ).

### **GENE THERAPY FOR BLEEDING DISORDERS**

The primary bleeding disorders most commonly result from genetic deficiencies of specific clotting factors. Classic hemophilia, or hemophilia A, results from a deficiency of factor VIII, which is normally produced by hepatocytes and vascular endothelial cells. Hemophilia B results from a deficiency of factor IX, which is normally made by hepatocytes. Thus, both diseases are hematologic disorders resulting from deficiencies of soluble plasma proteins synthesized by nonhematopoietic cells. Each of these coagulation factors may be found in circulating platelets' storage granules ( [393](#) ), but the megakaryocyte is not likely a site of synthesis, and storage is likely to occur after uptake of the protein from plasma.

Hemophilia A and B have attracted a significant amount of attention from those interested in gene therapy for a variety of reasons. First, they are monogenic diseases for which numerous mutations are known ( [394](#) , [395](#) ), and the cDNAs have been cloned ( [396](#) , [397](#) ). The factor VIII and factor IX genes may be expressed in nearly any cell type as long as the appropriate posttranslational modifications are made and the protein is secreted into the circulation. The amount of circulating factor VIII or factor IX required to mediate an improvement in the bleeding phenotype can be as little as 1% of normal plasma levels. Furthermore, there may be a substantial margin for error with regard to overexpression due to regulation of the "tenase" (factor VIII/factor IX) enzyme complex and "prothrombinase" (factor V/factor X) complex by the protein C/protein S anticoagulant proteins and antithrombin III. Recent epidemiologic analysis suggests that elevated factor VIII or factor IX levels may be a risk factor for thrombotic diseases ( [398](#) , [399](#) ), but, thus far, it seems unlikely with current gene transfer practices that these supraphysiologic levels of factor VIII or factor IX would be sustained for prolonged periods of time (years). Preclinical testing of hemophilia gene therapy has been facilitated by the presence of several animal models of hemophilia, including factor VIII and factor IX knock-out mice ( [400](#) , [401](#) , [402](#) and [403](#) ) and spontaneous hemophilia A and B dog colonies ( [404](#) , [405](#) , [406](#) , [407](#) and [408](#) ). Furthermore, it has proved possible to detect epitope-tagged human factor VIII ( [409](#) ) or normal human factor IX ( [410](#) , [411](#) , [412](#) and [413](#) ) in normal rhesus macaques after gene transfer with various vectors, which permits not only safety testing of gene transfer but also some assessment of gene expression *in vivo*.

von Willebrand disease is a relatively common bleeding disorder that is due to a deficiency of von Willebrand factor, which is a cytoadhesive protein synthesized by endothelial cells. von Willebrand factor-deficient swine and dogs are known and could be used for testing of von Willebrand factor gene transfer *in vivo*. As a practical matter, more effort has been focused on gene therapy to correct deficiencies of factor VIII or factor IX than on von Willebrand disease because the von Willebrand factor cDNA is substantially larger than factor VIII or factor IX, and, unlike factor VIII, there does not appear to be any portion of the von Willebrand factor protein/cDNA that is dispensable for coagulant factor activity. In contrast to hemophilia A and B, von Willebrand disease is unlikely to be ameliorated by expression of protein levels as low as those that seem to ameliorate hemophilia A or B. For these reasons, little progress has been made in the development of clinical protocols for von Willebrand factor gene therapy.

Potential targets for gene transfer that have been addressed in preclinical studies *in vivo* include skin fibroblasts or keratinocytes, myocytes, hepatocytes, and bone marrow. Skin fibroblasts or keratinocytes are readily propagated in tissue culture and can be transduced by vectors that may include selectable markers. Cells selected *in vitro* can be reintroduced to the host, where the secreted protein enters the bloodstream. Preclinical studies using fibroblasts or keratinocytes transduced with factor IX or factor VIII retroviral vectors ( [414](#) , [415](#) , [416](#) , [417](#) , [418](#) and [419](#) ) in rodents have indicated that therapeutic levels of factor IX or factor VIII (>1% of normal) could be achieved by this approach. A

recurring issue is lack of sustained expression of the desired transgene, which may be due to loss of transduced cells due to cell-mediated immunity or promoter shutdown in implanted cells that remain viable (420). One clinical trial has been performed in which factor VIII-transfected skin fibroblasts were reimplanted in the omentum. The peak levels achieved were marginally therapeutic but not sustained (421). The need for customized (autologous) tissue culture of an individual patient's skin fibroblasts/keratinocytes might be addressed through the use of a standardized cell line expressing factor VIII or factor IX encapsulated in an immunoisolation chamber or device for use in multiple recipients as protected allografts (422), yet this approach has not been used in humans.

Gene transfer to muscle cells can be performed using appropriate muscle-specific promoters, nonspecific promoters, or both to direct gene expression. The engineered cells may be implanted in the host organism under the appropriate conditions. Factor IX has been expressed in mice using transduced primary myocytes or cell lines propagated as myotubes then induced to differentiate into myocytes before reimplantation (423, 424 and 425). Alternatively, differentiated myocytes or myoblasts have been encapsulated (e.g., in alginate compounds) before implantation to provide some degree of immunoisolation for the modified cells *in vivo* to express human factor IX in immunocompetent mice (426, 427). The latter approach in immunodeficient (nude) hemophilia B mice has been complicated in one study by the development of tumors of myoblast origin (428), raising concerns about using this method for hemophilia B gene therapy in humans. The lack of suitable human myoblast/myotube cell lines that could be used in immune-competent humans makes it much more practical to transduce myocytes *in vivo*. Appealing aspects of *in vivo* gene transfer to muscle as compared to *ex vivo* approaches include the relatively simple methodology (intramuscular injection), the ability to use one vector for various patients, and the lack of cumbersome *ex vivo* cultivation of individual patient myocytes. The most extensively studied and successful application of this approach has been through gene transfer with AAV vectors. AAV vectors are limited to gene transfer of DNA with a total length of approximately 4.5 kb or less, which is appropriate for factor IX gene transfer but of limited use for factor VIII gene transfer. *In vivo* preclinical studies with AAV vectors in hemophilia B knock-out mice and hemophilia B dogs have shown that it is possible to achieve clinically relevant levels of factor IX in the plasma for significant periods of time using this approach (429, 430, 431, 432, 433, 434, 435 and 436). A key problem directly related to the use of muscle as a target for gene transfer is poor delivery of recombinant factor IX by muscle into plasma due to binding of factor IX by type IV collagen, mediated by epidermal growth factor-like domain on factor IX (437). Further, it appears that AAV gene transfer efficiency into skeletal muscle is significantly greater in type X (slow-twitch) fibers as compared to type Y (fast-twitch) fibers, which appears to be a consequence of the much higher density of AAV receptors on the cell surface for the former muscle fiber type. Clinical trials of AAV-factor IX gene transfer *in vivo* targeting muscle have been performed and have demonstrated therapeutically significant plasma factor IX levels (~1% of normal) at doses of  $2 \times 10^{11}$  vector genomes per kg (438). Although the trial was an open-label study and a placebo effect cannot be ruled out, there was a lower frequency of joint bleeds as reported by patients (438). However, higher doses of the vector do not result in a greater therapeutic effect, perhaps due to binding of factor IX to type IV collagen that is present in muscle (439).

Non-viral-mediated factor IX gene transfer methods to muscle in mice and dogs using electroporation of plasmid DNA *in vivo* to facilitate gene transfer have been studied (440). Using these methods, it has been possible to establish transient expression of human factor IX to levels of approximately 1% of normal, the duration of which was limited by the expected antibody response to foreign factor IX. This technique requires confirmation of



factor IX activity in hemophilia B animals to establish its efficacy.

Factor VIII expression in muscle has thus far not proven to be a promising avenue for delivery of factor VIII to the circulation, and other targets warrant investigation. Liver hepatocytes synthesize most of the plasma proteins, including factors VIII and IX, and synthesize some proteins (e.g., albumin) in tremendous quantities. Hepatocytes are readily transduced by various vectors (especially Ad), and gene transfer to liver is an important avenue under investigation for gene therapy of hemophilia. Hepatocytes are not easily obtained and propagated *ex vivo*, but *in vivo* gene transfer has been successfully pursued in animal models using adenovirus, AAV, and retrovirus vectors. Adenovirus vectors are capable of near-quantitative gene transfer to hepatocytes *in vivo* when administered intravenously. It is not surprising that adenovirus vectors have been used for *in vivo* gene transfer of factor VIII or factor IX to liver cells in various animal models, including mice ( [131](#), [441](#), [442](#), [443](#), [444](#), [445](#), [446](#), [447](#), [448](#), [449](#), [450](#), [451](#) and [452](#) ), monkeys ( [409](#), [410](#), [412](#) ), and hemophilic dogs ( [453](#), [454](#), [455](#), [456](#) and [457](#) ). Unfortunately, adenovirus-mediated gene transfer is typically characterized by gradual loss of gene expression, and the presence of the adenovirus vector proteins in immune-competent animals induces the cytokine cascade ( [458](#) ) and has a significant adjuvant effect that may induce antibodies to the expressed gene ( [410](#), [454](#), [455](#), [459](#) ). Based on the observation that deletion of adenovirus vector genes may result in longer periods of gene expression and a decreased immune response ( [459](#) ), efforts have been made to create and test vectors with most or nearly all of the adenovirus genes removed for gene therapy of hemophilia ( [446](#), [449](#), [460](#), [461](#) and [462](#) ). Technical problems with production of large quantities of these highly deleted vectors have impeded the translation to clinical trials; however, there is at least one clinical trial under way in which a highly deleted adenovirus vector is being tested for *in vivo* factor VIII gene transfer in patients with hemophilia A. Any clinical use of adenovirus vectors will be limited by neutralizing antibodies to most common serotypes that are routinely present in most humans and which would be boosted substantially with administration of an adenovirus vector ( [463](#) ).

Although there are reports of AAV-mediated factor VIII gene transfer to liver *in vivo* ( [464](#), [465](#) and [466](#) ), gene transfer to liver hepatocytes using AAV vectors has focused largely on factor IX due to the previously noted size constraints of vector DNA packaging. *In vivo* gene transfer of factor IX by intravenous, portal vein, or hepatic artery injection of AAV vectors has resulted in gene transfer to liver and expression of factor IX in mice ( [47](#), [467](#), [468](#), [469](#), [470](#), [471](#), [472](#), [473](#), [474](#) and [475](#) ), dogs ( [231](#), [468](#), [476](#), [477](#) ), and nonhuman primates ( [478](#) ). The results of these preclinical studies have shown persistent expression of sufficient amounts of factor IX to justify clinical trials, one of which is under way in patients with hemophilia B. This trial was temporarily put on hold due to vector shedding in the semen of the first subject enrolled ( [479](#) ). After demonstration that the AAV vector was not incorporated in germ-line DNA, the trial was resumed; however, data on factor IX gene transfer and expression are not yet available.

Although typical Moloney-based retroviral vectors are not particularly effective at *in vivo* gene transfer to hepatocytes due to the relatively low rate of cell division, lentivirus vectors (which do not require cell division for gene transfer) may prove to be useful for hemophilia gene therapy. Several groups have used pseudotyped lentiviral vectors to transfer the factor VIII cDNA to liver ( [480](#), [481](#) and [482](#) ).

Cells of hematopoietic origin are logical targets for *ex vivo* gene transfer and reintroduction by marrow transplantation due to the fact that these cells circulate in the blood and, in the case of platelets, are concentrated at the site of vascular injury. Gene transfer to hematopoietic cells has been attempted as an experimental approach to

hemophilia A and hemophilia B. *Ex vivo* retroviral gene transfer of the (B domain–deleted) human factor VIII gene into hemophilia A knock–out mouse bone marrow did not result in detectable plasma levels of human factor VIII after transplantation with myeloablation; however, there was the remarkable effect of conferring immune tolerance to human factor VIII in recipients of transduced bone marrow ( [483](#) ). Because the marrow was transduced with a nonspecific viral (LTR) promoter, which could in theory direct expression in any differentiated cell type, along with the suggestion that bone marrow cells may contribute to many nonhematopoietic cell lineages, it is tempting to speculate that expression of factor VIII in hematopoietic cells, nonhematopoietic cells, or both might mediate the immune tolerance response acquired during marrow reconstitution.

Bone marrow stromal cells are readily obtained by modestly invasive methods (marrow aspiration) and are readily propagated and transduced by retroviral vectors *in vitro* ( [484](#) ). Human marrow stromal cells have been transduced *ex vivo* with a GALV–pseudotyped Moloney retroviral vector containing a (B domain–deleted) factor VIII expression cassette and reimplanted in the spleen of NOD–SCID mice. Clinically significant (6% of normal) factor VIII levels were obtained in these immu–nodeficient mice; however, expression of human factor VIII ceased after approximately 4 months due to promoter inactivation ( [484](#) ). Reinfusion of factor IX–expressing bone marrow stromal cells in canines after conditioning of marrow by irradiation led to detectable levels of factor IX in plasma ( [485](#) ). Analysis of hematopoietic cell lines transduced with lentivirus vectors containing factor VIII expression cassettes showed that erythroid and megakaryocytic cell lines secrete significantly higher levels of factor VIII than do B– or T–cell lines. Little effect on factor VIII expression was noted with the use of cytokines; however, differentiating agents such as phorbol myristic acid, which activates protein kinase C, induce two– to threefold greater factor VIII expression ( [486](#) ).

Factor IX has been expressed *in vitro* in human myeloid leukemia (HL–60) cells after transduction by various Moloney retroviral vectors under control of different viral promoters; expression from the cytomegalovirus promoter is increased with phorbol myristic acid (a monocytic differentiating agent) or dimethylsulfoxide (a granulocytic differentiating agent) ( [487](#) ). Factor IX has been expressed *in vitro* under the control of a megakaryocyte–specific (gpIIb) promoter in human erythroleukemia cells, suggesting that platelets might store the expressed protein in granules that might be released at the site of platelet aggregation ( [488](#) ). As in previous work with myelomonocytic leukemia cells ( [487](#) ), induction of differentiation resulted in increased levels of factor IX expression *in vitro*. Thus far, factor IX has not been expressed at clinically significant levels *in vivo* by hematopoietic cells.

Future issues to be addressed in the field of hemophilia gene therapy include minimizing the risk of inhibitors, developing vectors with the ability to direct sustained high levels of coagulation factor expression, and avoiding unintentional germ–line transmission of vector sequences. Novel (mainly viral) vectors continue to be discovered, and their suitability for clinical gene therapy is being assessed ( [435](#), [436](#), [489](#) ). Novel strategies for expression of the relatively large factor VIII cDNA in fragments (e.g., “split vectors”) may permit hemophilia A gene therapy with AAV vectors ( [490](#), [491](#) ). Vector constructs that may mediate integration by novel methods (e.g., “sleeping beauty” transposon approach) have been described ( [492](#), [493](#) and [494](#) ). Novel targets, such as intestinal epithelial cells that have been transduced by viral or nonviral vectors *in vitro*, need to be studied *in vivo* ( [495](#) ). These fertile areas are being addressed by many hemophilia investigators throughout the world.



## GENE THERAPY FOR CANCER

In contrast to heritable genetic disorders in which the genetic abnormality involves a single, identified, and well-studied gene, the genetic abnormalities in cancer are often acquired, multiple, and more poorly understood; they may also require delivery of a therapeutic gene to virtually every malignant cell. Despite these hurdles, a considerable amount of enthusiasm for the use of gene transfer strategies in the treatment of human malignancies has evolved over the past several years ( [48](#), [496](#), [497](#), [498](#), [499](#), [500](#), [501](#) and [502](#) ). As shown in [Table 26.1](#), the majority of clinical gene therapy trials involve patients with cancer, and the most frequent target cell is the tumor cell itself. These trials, at the very least, should offer considerable insights into cancer biology. Investigators have used a number of different conceptual approaches to the genetic treatment of cancer, including abrogation of oncogene function in cancer cells, restoration of tumor-suppressor gene function, enhancement of tumor cell drug sensitivity, enhancement of non-tumor cell drug resistance (e.g., bone marrow progenitor cells) to allow more intensive chemotherapy, and improvement of immune responses to tumor cells by genetically altered tumor cell vaccines or modified effector cells. Many of these approaches apply primarily to nonhematopoietic target cells or diseases but are briefly discussed here because the concepts involved may have future applications in hematologic malignancies.

### Antioncogene or Pro-Tumor-Suppressor Gene Therapy

The causal relationship between the expression of a mutated or chimeric and dysregulated oncogene and certain malignancies has stimulated the search for a way to specifically turn off the expression of these genes ( [498](#), [503](#) ). The expression of a gene product may be disrupted by small DNA sequences (“antisense” oligonucleotides) synthesized as exact reverse complements of the mRNA target responsible for the abnormal gene product ( [504](#), [505](#), [506](#) and [507](#) ).

The potential application of this strategy in CML became apparent when a pathogenic role for the *bcr/ab<sub>1</sub>* gene was proven in mice that developed a syndrome similar to human CML after expression of the p210 *bcr/ab<sub>1</sub>* gene product in primitive hematopoietic cells ( [18](#) ). Preliminary studies reported inhibition of malignant hematopoietic progenitor colony growth after *in vitro* exposure of the cells to antisense oligonucleotides specific to the *bcr/ab<sub>1</sub>* junction, correlating with decreased expression of the *bcr/ab<sub>1</sub>* gene product ( [508](#) ). However, subsequent *in vitro* studies have not shown a specific effect from antisense oligos directed to the *bcr/ab<sub>1</sub>* junction, and one group has reported more promising and specific results using antisense oligos directed at the *c-myc* oncogene, which also appears to be abnormally expressed in malignant CML cells ( [509](#), [510](#) and [511](#) ). A phase I clinical protocol using *c-myc* antisense oligonucleotides to purge autologous CML marrow before reinfusion was recently reported, and although the effect of purging in this manner could not be definitively assessed in this pilot trial, a 50% reduction in *bcr/ab<sub>1</sub>*-positive long-term culture-initiating cells was achieved before infusion ( [512](#), [513](#) ).

*In vivo* gene delivery of antisense oligos complementary to other oncogenes has also been explored in acute leukemia, but poor stability of these small DNA sequences has been problematic ( [514](#), [515](#) ). Efficacy *in vivo* is also limited by the need to successfully inhibit and kill virtually every leukemic cell, a limitation that may restrict this approach to the adjuvant setting ( [504](#), [516](#), [517](#) ).

p53 is a nuclear phosphoprotein that acts as a tumor-suppressor gene, and its protein product can arrest the replication of a cell that has undergone DNA damage, allowing

either repair or apoptosis ( [518](#) ). A cell deficient in p53 may continue to replicate even after DNA damage has occurred, allowing expansion of abnormal cell populations. Mutation of p53 was first described in colorectal cancer and has subsequently been found in many other human tumors ( [519](#) ). Strategies to deliver the p53 gene to tumors have largely relied on adenovirus-mediated gene transduction. In an animal model of human non-small cell lung cancer, tumor formation was prevented in a high proportion of inoculated animals that received tumors transduced with recombinant adenovirus p53 ( [168](#) ). Similar results were seen in nude mice models of human head and neck cancer using adenoviral vectors. As a result, clinical gene therapy protocols for lung and head and neck cancer in humans have been initiated ( [137](#) , [520](#) ). Preliminary results from a lung cancer treatment protocol using *in vivo* delivery of retroviral vectors have been published, and high-efficiency delivery of p53 was documented, along with some evidence for antitumor efficacy ( [521](#) ). The combination of gene transfer with radio- or chemotherapy has also been explored ( [522](#) , [523](#) ). Applications for these strategies in hematopoietic malignancies are difficult to imagine unless an *in vivo* injectable vector that targets tumor cells can be developed.

### “Suicide” Cancer Gene Therapy

The introduction of a *suicide gene* into a tumor offers another potential treatment approach. A tumor can be rendered sensitive to a particular agent by the expression of a gene product that converts nontoxic drugs into a toxic compound that can then kill the tumor cell ( [384](#) , [524](#) , [525](#) and [526](#) ). One example is the herpes virus tk gene. Nucleoside analogs such as ganciclovir are relatively nontoxic to human cells; however, after phosphorylation by tk, ganciclovir can be incorporated into the DNA of dividing cells, acting as a chain terminator and killing them efficiently.

In a glioblastoma model in the rat and subsequent primate studies, a novel approach using suicide gene transfer was developed ( [527](#) ). A retroviral producer cell line releasing a vector containing the herpes virus tk gene was injected directly into brain tumor masses. Dividing tumor cells specifically took up and integrated the vector, whereas nondividing normal neural cells did not. Tumor cells were then specifically killed by systemic administration of ganciclovir. It is interesting that a “bystander” effect was documented: Even tumor cells that had not been transduced with the vector were killed, as long as a significant fraction of the tumor cells was successfully transduced. Evidence for passage of the phosphorylated ganciclovir from transduced tumor cell to contiguous tumor cells has been found ( [528](#) ). Some of the killing of nontransduced cells may also be caused by destruction of vector-infected vascular endothelial cells within the tumor, as well as by an induced immune response against the tumor cells stimulated by the death of the vector-transduced cells ( [529](#) , [530](#) and [531](#) ). A clinical trial in humans evaluating this strategy for brain tumors demonstrated tumor reduction in 5 of 15 treated patients, but response was confined to patients with small tumors, indicating the need for further progress ( [532](#) ). Other potential suicide genes, such as cytosine deaminase, which converts 5-fluorocytosine to 5-fluorouracil, are in development ( [530](#) , [533](#) ). These cytosine deaminase suicide genes can also be targeted using tumor-specific antigens ( [534](#) , [535](#) , [536](#) and [537](#) ). Application of this strategy to hematologic malignancies would be limited to lymphomas and other solid tumors into which one can inject directly.

### Enhanced Antitumor Immune Response

A number of investigators have focused on gene transfer as a means to increase the immunogenicity of tumor cells ( [538](#) , [539](#) , [540](#) , [541](#) , [542](#) and [543](#) ). Various cytokines are effective in increasing T-cell immune responses against tumors, but systemic delivery

may not be optimal due to short cytokine half-life, toxicity, and low intratumor concentrations. Investigators have attempted to increase both nonspecific and cytotoxic T-cell responses to tumor cells by transducing the tumor with retroviral vectors carrying granulocyte-macrophage colony-stimulating factor, IL-2, interferon- $\gamma$ , or other cytokines ( [138](#) , [176](#) , [544](#) , [545](#) ). Efficacy has been demonstrated in murine models, both against transduced tumor cells expressing the cytokine and against nontransduced distant tumor deposits ( [546](#) ). Early clinical trials are in progress in melanoma, neuroblastoma, and renal cell carcinoma, which are tumors that other studies have implicated as possibly responsive to antitumor immunotherapy, as well as others such as prostate carcinoma. Primary autologous tumor cells or HLA-matched allogeneic tumor cell lines are first transduced *ex vivo* with a vector containing a cytokine gene, irradiated, and then used to vaccinate the patient ( [500](#) , [547](#) ). In one completed human gene therapy trial, eight patients received irradiated autologous tumor vaccines engineered to secrete granulocyte-macrophage colony-stimulating factor by *ex vivo* retroviral transduction of surgically harvested tumor cells, with evidence for induction of both a T- and B-cell response *in vivo* ( [548](#) ).

A second approach is to introduce either HLA molecules or co-stimulatory molecules, such as B71 or B72, into tumor cells to increase their immunogenicity ( [175](#) ). Tumor cells may escape immune surveillance by down-regulation of major histocompatibility complex molecules or co-stimulatory molecules. Expression of these molecules in tumor cells can allow an immune response to be generated against the tumor cells, even against those that do not express high levels of these molecules. This approach has been used in animal models of a number of different tumors. One early clinical trial involved patients with melanoma ( [549](#) ). Foreign HLA class I genes were expressed in tumor cells by direct injection of plasmid DNA-liposome complexes into melanoma nodules. Locally, lymphocyte migration into the lesions was enhanced, as was local TIL cytotoxic activity. Several patients had regression of the injected nodules. TIL cells could be grown from these lesions and, in one patient, were effective in generating a systemic antitumor response. The applicability of these types of approaches to hematologic malignancies is being tested with good results in animal lymphoma and leukemia models ( [550](#) ). Another exciting approach involves the use of vectors encoding fusion receptors that would allow T cells to be directed toward a target tumor antigen ( [502](#) ). The use of such an approach allowed the generation of T cells expressing fusion receptors directed against prostate-specific membrane antigen containing T-cell signaling elements that were able to specifically lyse tumors expressing this antigen, even after a greater than 2-log expansion ( [551](#) ).

## APPROACHES TO IMPROVING GENE THERAPY

### Engraftment without Ablation

For disorders such as SCID, a growth advantage conferred on genetically corrected cells enables engraftment without conditioning, yet for the majority of disorders in which HSC gene transfer may be applicable, no such advantage to the modified cells is conferred, and most investigators have relied instead on toxic myeloablative conditioning to permit engraftment of genetically modified cells. In the context of clinical trials, however, the potential complications arising from aggressive conditioning are not unacceptable. Chimerism can be achieved in mice in the absence of conditioning by using extremely large bone marrow grafts ( [552](#) , [553](#) , [554](#) , [555](#) and [556](#) ). Improved engraftment with reduced-intensity conditioning can be achieved when hematopoietic growth factors precede conditioning ( [557](#) , [558](#) and [559](#) ). Studies in the nonhuman primate support this notion but point out that some degree of conditioning is required ( [560](#) , [561](#) and [562](#) ). The further extension of studies focused on the development of nonmyelo-ablative

conditioning regimens with even lower toxicity in large animals with the aim of reaching clinically relevant levels of engraftment of genetically modified cells will be required to allow widespread clinical application.

Although specific tolerance to foreign transgenes can be obtained by introduction through the HSC population after ablative conditioning ( 563 ), host immune responses to cells expressing new or foreign transgenes may also be limiting in the absence of such ablative conditioning ( 564 ). The degree and type of conditioning required to prevent rejection of HSC progeny expressing foreign transgenes are currently being evaluated in both murine and nonhuman primate models, and results suggest that low-intensity conditioning may suffice ( 565 , 566 ).

The ability to attain significant engraftment of genetically modified cells without eliciting host immunity using low-intensity conditioning would allow the pursuit of gene transfer strategies for disorders such as the thalassemias and hemoglobinopathies. Indeed, stable gene transfer levels of 10% or more now achievable in the nonhuman primate with conditioning, if achievable in humans, might suffice for some disorders. Disease amelioration has been achieved after allogeneic transplantation for both thalassemia and sickle cell anemia even when only partial donor marrow chimerism is attained ( 567 , 568 , 569 and 570 ). Altogether, these observations suggest that the establishment of stable hematopoietic chimerism without aggressive cytoreduction may be feasible and that such chimerism resulting from transplantation of genetically corrected cells could be therapeutic for disorders of human globin.

### ***In Vivo* Selectable Markers**

One strategy to increase the efficiency of gene transfer entails the inclusion of selectable genes in vectors to confer an *in vivo* advantage to transduced cells ( 571 , 572 ). The prototype for this approach is the inclusion of the human multidrug resistance (MDR1) gene, which codes for a transmembrane glycoprotein (p-glycoprotein), an energy-dependent toxin efflux pump ( 573 , 574 ). Cells expressing this protein can extrude many of the chemotherapeutic agents derived from natural products, including the anthracyclines, Taxol, and vinca alkaloids, thereby revealing a drug-resistant phenotype. Mice engrafted with bone marrow cells transduced with an MDR-containing vector and subsequently treated with the cytotoxic drug paclitaxel showed substantial stable increases in the proportion of hematopoietic cells containing the vector, suggesting *in vivo* selection at a very primitive progenitor/stem cell level ( 190 , 195 , 575 ).

There are at least two possible applications for this *in vivo* drug selection strategy. Bicistronic vectors capable of coexpression of both a gene of interest (e.g., glucocerebrosidase) and an *in vivo* selectable gene such as MDR have been developed ( 65 , 576 , 577 ). If initial *ex vivo* retroviral transduction results in only low-efficiency correction of stem cells, post-BMT treatment with even low doses of MDR-effluxed drugs could result in an increase in the percentage of gene-modified cells to a therapeutically beneficial range. Second, transfer of drug resistance genes to normal marrow progenitor/stem cells has been developed as an approach for decreasing toxicity and increasing dose intensity in patients with nonhematologic malignancies ( 178 ). Mice engrafted with MDR-transduced marrow cells become increasingly resistant to the marrow-suppressive effects of MDR-effluxed drugs, allowing significant dose intensification ( 178 , 195 , 578 ). Based on these results, three human clinical trials piloting this marrow-protective approach were initiated for patients undergoing autologous BMT for solid tumors such as ovarian and breast cancer ( 579 , 580 and 581 ). Modest levels of engraftment were obtained with some evidence for selection after chemotherapy in one

trial ( [582](#), [583](#) ). In the interim, however, a direct toxicity from the transfer of the human MDR1 gene into hematopoietic cells, which were expanded *ex vivo*, was noted when murine recipients of such cells developed a myeloproliferative syndrome ( [584](#) ). Although experiments conducted in the nonhuman primate to determine the risk of this complication in large animals failed to document its occurrence, the low level of MDR1 expression attainable in the nonhuman primate, in which vector copy number is generally low, may not have been sufficient to produce the phenotype observed in the mice, in which high copy number and high MDR1 expression were seen ( [236](#) ).

A number of alternative drug resistance genes have been studied *in vitro* and in murine models, including O6-alkylguanine-DNA-alkyltransferase or glutathione S-transferase, which confer protection against alkylating agents, and mutant dihydrofolate reductases that confer resistance to trimetrexate and other antimetabolites ( [585](#), [586](#), [587](#), [588](#) and [589](#) ). When used as dose-intensification strategies in cancer patients, the dose-limiting toxicity of the treatment regimen must very clearly be bone marrow suppression or no benefit will ensue. Many of these drug resistance gene strategies have begun to show promise for their ability to allow selection at the level of the true HSC in both primary and secondary transplant experiments ( [590](#), [591](#), [592](#), [593](#) and [594](#) ).

### **Ex Vivo Selection**

Positive selection of transduced cells *in vitro* before reinfusion is another strategy to increase repopulation with gene-modified cells. Vectors containing genes for various cell-surface proteins have allowed flow cytometric sorting of successfully transduced cells. A number of studies have used the human cell-surface protein CD24 or heat stable antigen, the murine homolog. There is limited sequence homology between the murine and human forms, and non-cross-reactive antibodies are available. Their small size means that they take up little space in the vector construct. Murine marrow cells transduced with a vector containing human CD24 and sorted before reinfusion result in greatly increased long-term reconstitution with vector-containing cells ( [595](#) ). A vector expressing the murine equivalent, heat stable antigen, allows enrichment for transduced human progenitor cells ( [596](#) ). However, CD24 and heat stable antigen are glucose phosphate isomerase-linked surface proteins, a class of proteins that has been shown to be transferred from cell to cell both *in vitro* and *in vivo*, clouding the specificity of this marker and raising concerns about ectopic expression of these genes *in vivo* ( [156](#), [595](#), [596](#) ).

Retroviral vectors carrying a truncated, nonfunctional form of the human nerve growth factor receptor have also been developed as a selectable marker for use on hematopoietic targets, because hematopoietic cells do not express endogenous nerve growth factor receptor. Transduction and sorting of lymphocytes using this system are sensitive and specific; clinical trials using cells sorted for this transduction marker have begun ( [320](#), [323](#) ). The introduction of new cell-surface proteins has the theoretic disadvantage of altering trafficking or cell-cell interactions on infusion of transduced cells. Alternative cytoplasmic markers, such as green fluorescent protein and mutated murine protein, are naturally fluorescent, avoiding the need for preselection antibody staining ( [597](#) ). However, prolonged stable expression of these proteins has proved difficult, and there is evidence that these proteins are toxic to primary mammalian cells ( [598](#), [599](#) ). The use of selection for green fluorescent protein after retroviral-mediated transduction in the nonhuman primate model to increase engraftment by genetically modified cells results in increased short-term engraftment only, raising another concern that expression of transferred genes may be more efficient in differentiated cells than in stem cells,



effectively enriching for progenitors with only short-term potential ( [600](#) ).

*Ex vivo* selection strategies using these types of vectors have already been shown to be very useful for lymphocyte targets, where expansion of transduced cells does not appear to affect phenotype or *in vivo* function ( [320](#) ). However, low transduction efficiency of primitive human HSCs may preclude posttransduction sorting for a marker gene if, after sorting, too few stem cells remain to allow safe and rapid hematopoietic reconstitution; this is especially problematic after ablative chemotherapy. A potential solution to this problem would be *ex vivo* expansion of selected transduced cells before reinfusion, although it is unknown whether true long-term repopulating cells can be expanded or even maintained *ex vivo* using current culture conditions ( [233](#), [236](#), [601](#), [602](#) and [603](#) ). Most of the murine studies have assessed engraftment into lethally irradiated or genetically stem cell-deficient animals. When, however, *ex vivo* cultured cells compete against endogenous stem cells in a nonablative model, a significant engraftment defect is evident ( [232](#), [604](#) ). Moreover, when an *ex vivo* transduction protocol that routinely yielded high levels of marked cells after myeloablation was used in nonablated mice, very low levels of vector-containing cells were detected ( [605](#) ).

A number of alternative genetically based approaches aiming to enhance hematopoietic reconstitution have also been described ( [606](#) ). For example, mouse HSCs transduced with the homeobox gene, HOXB4, possess more than tenfold greater repopulating ability than nontransduced bone marrow ( [607](#) ). Furthermore, transgenic overexpression of the antiapoptotic protein Bcl-2 results in increased HSC numbers ( [608](#) ), and expression of a truncated form of the human erythropoietin (Epo) receptor can augment HSC engraftment through the use of exogenous Epo ( [609](#) ). Blau and colleagues have used inactive monomeric signaling domains derived from receptors such as Epo or thrombopoietin to permit controlled growth of genetically modified cells through the use of chemical inducers of dimerization ( [610](#), [611](#) ). Another approach involves selective enrichment of genetically modified cells using vectors encoding a fusion protein between the growth signaling portion of the G-CSF receptor and the hormone-binding domain of the estrogen receptor. This approach allows controlled growth of genetically modified cells using exogenous estrogen, and preclinical testing in the nonhuman primate has demonstrated the feasibility of this approach ( [612](#), [613](#) ). The optimization of such approaches could enable one to control the overall level of contribution toward hematopoiesis by genetically modified cells *in vivo* after transplantation such that therapeutic efficacy could be achieved in disorders in which no selective advantage is conferred on the corrected cells. The theoretic potential for accelerating HSC exhaustion and concern for an increased risk for leukemogenesis by applying such pressure on hematopoiesis require further safety testing.

## Alternative Vectors

Alternative vector systems continue to be explored given the overall low transduction efficiencies of human hematopoietic cells with standard retroviral vectors. *Pseudotyping*, or the replacement of the Moloney murine leukemia virus envelope protein with an alternative protein, has been developed as an approach to changing target cell specificity or the physical properties of the vector particle. The presence of the VSV envelope protein results in increased viral stability and ability to concentrate vector preparations but no increase in transduction efficiency of hematopoietic progenitor cells ( [31](#), [86](#), [614](#) ). Pseudotyping with gibbon-ape leukemia virus envelope protein improves the transduction efficiency of primate lymphocytes and may confer increased efficiency to HSCs when compared to standard amphotropic vectors ( [94](#), [214](#), [316](#) ). Amphotropic or ecotropic envelope proteins made chimeric by the addition of a ligand, such as SCF, have been

explored as a mechanism for targeting vectors to specific cell types such as primitive hematopoietic cells expressing the SCF receptor *c-kit*. Despite some encouraging reports and clear evidence of production of vectors containing modified envelope proteins that can bind specifically to receptor-bearing target cells, intracellular processing can be disrupted, with inefficient or nonexistent actual transduction and integration ( [34](#), [90](#), [615](#), [616](#) ). The low-level expression of the amphotropic receptor required for standard retroviral vectors on HSCs ( [89](#) ) has stimulated interest in pseudotyping with alternative envelope proteins, including the GALV ( [94](#) ), VSV-G ( [237](#) ), and the feline endogenous retrovirus (RD114) ( [93](#) ), as a means to further increase gene transfer efficiency.

A major limitation to the efficiency of retroviral gene transfer is the requirement for active cell cycling of the target cell at the time of, or very soon after, exposure to the viral vector. Optimal gene transfer would be accomplished by vectors capable of integrating into the host genome without cell division. As described earlier, this property is shared by HIV and other lentiviruses. Pseudotyping of HIV-based vectors with VSV or amphotropic envelope protein could allow transduction of hematopoietic progenitor and stem cells, whereas use of the HIV envelope would be applicable only to CD4<sup>+</sup> target cells ( [100](#) ). Indeed, lentiviral vectors have proven efficient in transducing nonhuman primate cells in the baboon model after a brief exposure *ex vivo*, yet significant marking levels were only observed when cells were cultured in the presence of multiple hematopoietic growth factors ( [617](#) ). HFVs have been shown to infect human hematopoietic progenitor cells but do not have clear advantages over standard retroviral vectors for hematopoietic applications, although HFV receptors may be more ubiquitous and highly expressed ( [109](#) ). Moreover, the problems encountered in the production of replication-competent, retrovirus-free vector have been overcome. The nonpathogenic nature of HFV makes vectors based on this virus more palatable.

Despite a great deal of initial enthusiasm for the use of AAV as a clinical gene transfer vector, more recent data argue against the use of AAV for most applications requiring stable integration in hematopoietic cells and their progeny. Several laboratories have reported high transduction efficiency of both human and murine hematopoietic progenitors, as assayed by PCR or transgene expression analysis on individual CFU-C ( [157](#), [618](#), [619](#) ). These results are difficult to interpret, however, given the stability of the AAV vector DNA and the very high efficiency of transient expression of transgenes for days to weeks without integration ( [156](#), [618](#), [619](#) ). Although *in vivo* studies indicate no advantage over retroviral vectors in terms of gene transfer into repopulating stem cells, efficient transfer to hematopoietic cells can be obtained using AAV vectors ( [620](#), [621](#) ). The need for integration has precluded extensive investigation of nonviral delivery systems for hematopoietic applications requiring long-term expression.

## Gene Correction

All the current vectors and protocols have attempted phenotypic correction or modification by gene addition, generally randomly in the genome. A different process, gene correction by homologous recombination in hematopoietic tissues, has been proposed as an alternative ( [35](#) ). Although correction of the genetic defect in lymphoblastoid cell lines derived from patients with sickle cell disease was described ( [36](#) ) using an RNA-DNA oligonucleotide, the general applicability of this approach has not been validated.

An alternative corrective approach for some disorders, including a sizable fraction of the human thalassemias, which result from aberrant RNA splicing, has recently been described. Constructs targeting aberrant splice sites in the form of oligonucleotides,



morpholinos, or U7 small nuclear RNAs lead to increased levels of correctly spliced  $\beta$ -globin mRNA by effectively blocking the aberrant splice site through the use of sequences complementary to the corrected sequence ( [622](#), [623](#) and [624](#) ). A major problem with this approach remains the difficulty in delivering such constructs *in vivo* with sufficient efficiency to correct the phenotype, and, recently, lentiviral vectors designed to permanently deliver modified U7 small nuclear RNAs have been tested in cell lines and in primary cells from individuals with thalassemia with encouraging early results ( [625](#) ).

## Immune Responses to Vectors and Transgenes

Immune responses against vector proteins or the transgene-encoded protein itself have only recently become the focus of intensive investigation. For *in vivo* vector administration, preexisting immunity to a vector such as adenovirus is at least a theoretic concern. Repeated *in vivo* administration of complex vectors clearly stimulates an active immune response to vector proteins and greatly hinders success. The expression of viral genes remaining in the vector sequences could also stimulate an immune response against transduced target cells. This is not a problem for retroviral vectors; as well, newer modifications of adenoviral vectors have been developed that no longer contain or express residual adenoviral genes ( [126](#), [127](#) ). Nonhuman marker genes, such as the neomycin resistance gene, or viral suicide genes, such as tk included in vectors for positive or negative selection, may also induce an immune response ( [326](#) ). Finally, the therapeutic gene itself may induce an immune response if the patient completely lacks the endogenous gene product ( [122](#) ).

Rejection of the foreign transgene itself can be the primary problem, even when highly immunogenic adenoviral vectors are used. Recombinant adenoviral vectors encoding either murine or human Epo genes or a control vector without an expressed gene were injected into murine muscle, and the mice were followed up for several months for Epo expression and presence of the vector sequences in muscle ( [122](#) ). Mice expressing either human or murine Epo transgenes developed high hematocrits, but the effect was transient in those expressing human Epo, as profound anemia, surprisingly, developed after the transient polycythemia. Immune responses to both the vector-expressed human Epo and endogenous murine Epo were documented in these animals, indicating that the active immune reaction against the human Epo had also generated cross-reactivity toward endogenous Epo. Adenoviral genomes were detectable long-term in the muscles of the murine Epo mice and the control mice but not in the human Epo mice. This suggests that the immune response was elicited by expression of the foreign transgene, not by viral proteins.

In a murine model of allogeneic skin graft survival, foreign genes expressed by HSCs and their progeny may be capable of inducing tolerance even across major histocompatibility complex barriers ( [626](#) ). This evidence and documentation in mice of very long-term persistence of expression of completely xenogeneic genes such as human glucocerebrosidase have led some to believe that immune responses against genes introduced via repopulating stem cells will not induce immune responses ( [187](#), [627](#) ). On the other hand, immune responses to a retroviral vector-introduced transgene in the canine MPS-1 autologous transplantation model have been shown to limit efficiency ( [628](#) ).

In the murine model, tolerance to xenogeneic genes can be achieved by introduction through the hematopoietic compartment ( [629](#) ). Long-term persistence of genetically modified cells at clinically relevant levels can be achieved even after very low-dose irradiation with 100 cGy, even when highly immunogenic genes are transferred. Large animal testing in the nonhuman primate confirms these observations, with equivalent

levels of long-term engraftment of cells transduced with a vector encoding the neomycin phosphotransferase (neo) and with a vector carrying but not expressing this gene product, but the overall levels of engraftment were much lower ( [562](#) ). Transduction of lymphocytes in the absence of conditioning, however, resulted in rapid clearance of the neo-expressing cells. However, if HSCs were transduced and transplanted first, long-term persistence of lymphocytes transduced with the neo-expressing vector was observed ( [563](#) ).

Various methods of immunosuppression have been at least partially successful in avoiding immune rejection of transduced cells. Neonatal exposure to vector has allowed repeated treatments with adenoviral vectors ( [630](#) ). Treatment with cyclosporine, cyclophosphamide, or IL-12 has been reported to prolong survival of transduced cells ( [128](#), [129](#), [130](#), [131](#) and [132](#) ). But these general pharmacologic approaches are not desirable or practical for most gene therapy applications, which are attractive only if they prevent life-long reliance on toxic pharmacologic agents. Instead, improved vector design and possible inclusion of antirejection mechanisms in the vectors themselves are more attractive approaches.

## SAFETY CONSIDERATIONS

The number of individuals who have safely received genetic material in the form of vectors or vector-modified cells is now in the thousands ( [Table 26.1](#) ), suggesting that current approaches carry a low risk to subjects; however, safety remains the primary goal of the majority of published or in-progress studies. Although clinical benefit is the ultimate goal of all such endeavors, early studies exploring new strategies are appropriately designed around safety endpoints. Pharmacokinetic principles dictate that drug toxicity is related to bioavailability, volume of distribution, clearance, and half-life, and these principles can also be applied in the setting of gene therapy. Considering that the overwhelming majority of gene therapy trials conducted thus far have not even approached the therapeutic window along with the general rule that toxicity often lies somewhere beyond the therapeutic threshold, it remains appropriate to conduct all current trials at the phase I/II level. Side effects of gene transfer can result from all levels of the process, including those inherent to the vector system, vector production, target cell manipulation, vector integration, transgene expression, or selective pressure applied after transfer ( [631](#) ).

The first reported serious complication of gene therapy occurred when an 18-year-old patient with OTC deficiency volunteered for a dose-escalation gene therapy trial and received a catheter-directed infusion of a high dose of an adenoviral vector encoding the corrective OTC into the hepatic artery. Within hours of the infusion, signs and symptoms of a systemic immune response syndrome appeared, and soon thereafter, the patient required extracorporeal membrane oxygenation for life support. Two days later, the patient died from multiorgan system failure.

Since his death, the case has been studied extensively, and many experiments have been performed to determine the exact mechanism for his death. Other patients on the study experienced liver toxicity at similar doses of the adenovirus-OTC vector, but the toxicity was mild and reversible. Preclinical studies of the vector in nonhuman primates have shown evidence for activation of the innate immune response attributable to the adenovirus capsids as well as a vigorous IL-6 response ( [410](#), [412](#) ). Thrombocytopenia and abnormal blood coagulation parameters (with or without evidence for damage to endothelial cells and disseminated intravascular coagulation) have also been seen in nonhuman primates ( [410](#), [412](#), [632](#) ). The induction of IL-6 and other acute phase reactants was anticipated from the preclinical data in nonhuman primates; however, the severity and duration of the fatal reaction observed were not expected at the dose level reached. It remains unclear even now whether the toxicity represented an idiosyncratic reaction to

the adenovirus vector or whether the patient was at the leading edge of a toxic dose–response curve. Whether the catabolic state induced by the adenovirus vector caused his OTC deficiency to decompensate remains another unresolved issue.

As a result of the death, many clinical gene therapy trials were temporarily put on hold, and the maximum doses of adenovirus (or other) vectors to be given to humans were scaled back as a precautionary measure. Furthermore, a number of issues with respect to the pace of clinical gene therapy trials, the informed consent process, subject eligibility, reporting of adverse events, and oversight of clinical gene therapy trials were raised, and measures to increase the protection of research subjects were uniformly instituted across all gene therapy trials.

Soon after the first unequivocal demonstration of clinical efficacy in a human gene therapy trial, in which 10 of 11 children with SCID who received retrovirally transduced autologous bone marrow cells were apparently cured ([22](#)), two patients developed a complication that appears to be directly related to the gene transfer. Both received retrovirally transduced bone marrow CD34<sup>+</sup> cells at a very young age and experienced rapid and complete immune reconstitution. Three years after the successful infusion, a precipitous rise in T-cell counts was observed, which progressed to overt leukemia ([633](#)). Retroviral integration site analysis demonstrated an insertion in or near the Lmo-2 gene, a transcription factor required for fetal hematopoietic development and already linked to spontaneous childhood T-cell leukemia ([634](#)), in both patients, suggesting that this complication arose as a direct result of insertional mutagenesis ([633](#)).

These events resulted in a rapid response from investigators and regulatory agencies worldwide, most initially stopping all accrual to gene therapy trials using integrating retroviral vectors in hematopoietic targets. Since that time, a number of U.S. Food and Drug Administration and Recombinant DNA Advisory Committee meetings have occurred to analyze and respond to these events. Clearly, further investigation is required, both of patients in clinical trials and of experimental models, to better understand the etiology of the leukemias observed. Although fatal malignancies were observed in the nonhuman primate model after retroviral gene transfer complicated by inadvertent contamination with replication-competent virus, no cases of insertional mutagenesis had been observed in human recipients of replication-competent retrovirus-free retrovirally transduced hematopoietic cells. However, 1 day after the report of the successful trial in humans, such a complication was reported in the mouse model ([635](#)). The observed leukemias were a direct result of insertional mutagenesis but were noted only in secondary transplant recipients who were followed up long term. These observations in both the patients and in preclinical models stressed the need for long-term toxicity assessment in preclinical models.

Integration in or near Lmo-2 in both patients has also challenged conventional dogma with respect to retroviral integration, which is generally believed to be random or semirandom. One recent report demonstrated an approximately twofold preference of HIV for chromosomal regions containing active genes. It is likely that several factors were required to result in leukemias in the children, including increased activity of Lmo-2 in the target cell population, the constitutive expression of a growth factor receptor (IL2R?) in hematopoietic cells perhaps at all levels of development, expansion of a target lymphoid progenitor population, marked *in vivo* expansion of corrected cells due to the underlying immune deficiency increasing the likelihood of a second hit, and, finally, rescue of a malignant phenotype by transfer of the corrective gene. These and a number of other issues remain to be investigated to better assess the potential of retrovirally mediated HSC gene therapy.

Although these examples of serious toxicity with gene transfer are the exception, both have occurred in trials that either approached or reached therapeutic efficacy and point out that there may be a narrow therapeutic index with certain approaches or clinical settings. One must also consider that the absence of toxicity in protocols that fail to achieve significant gene transfer rates may not be sufficient to establish safety, in much the same way that one could not establish the safety of a new drug delivered orally if the drug was either not absorbed or absorbed at a very low level. Small and large animal preclinical models along with carefully constructed phase I/II clinical trials in humans in the appropriate setting remain the priority for this young, promising field of medicine.

## CONCLUSIONS

The wide variety of imaginative approaches involving genetic manipulation of hematopoietic targets and other novel approaches to hematopoietic diseases, such as leukemia or hemophilia, are certain to eventually revolutionize therapy for a number of currently fatal or disabling conditions, but further basic scientific investigation of target cell biology and vector systems will be necessary before these goals can be realized on a large scale.

## REFERENCES

1. Blau HM, Springer ML. Gene therapy—a novel form of drug delivery. *N Engl J Med* 1995;333:1204–1207.
2. Mulligan RC. The basic science of gene therapy. *Science* 1993;260:926–932.
3. Miller AD. Human gene therapy comes of age. *Nature* 1992;357:455–460.
4. Kerr WG, Mule JJ. Gene therapy: current status and future prospects. *J Leukoc Biol* 1994;56:210–214.
5. Mann R, Mulligan RC, Baltimore D. Construction of a retrovirus packaging mutant and its use to produce helper-free defective retrovirus. *Cell* 1983;33:153–159.
6. Blaese RM, Culver KW, Miller AD, et al. T lymphocyte-directed gene therapy for ADA-SCID: initial trial results after 4 years. *Science* 1995;270:475–480.
7. Rosenberg SA, Aebersold P, Cornetta K, et al. Gene transfer into humans—immunotherapy of patients with advanced melanoma, using tumor-infiltrating lymphocytes modified by retroviral gene transduction. *N Engl J Med* 1990;323:570–578.
8. Anderson WF, Blaese RM, Culver K. The ADA human gene therapy clinical protocol: points to consider response with clinical protocol, July 6, 1990. *Hum Gene Ther* 1990;1:331–362.
9. Orkin SH, Motulsky AG. Report and recommendations of the panel to assess the NIH investment in research on gene therapy, report to the NIH director, 1995.
10. Greenberg DS. Gene therapy: caution and hope. *Lancet* 1995;346:1617.
11. Leiden JM. Gene therapy—promise, pitfalls, and prognosis. *N Engl J Med* 1995;333:871–873.
12. Marshall E. Less hype, more biology needed for gene therapy. *Science* 1995;270:1751.
13. Karlsson S. Treatment of genetic defects in hematopoietic cell function by gene transfer. *Blood* 1991;78:2481–2492.
14. Dunbar CE. Gene transfer to hematopoietic stem cells: implications for gene therapy of human disease. *Annu Rev Med* 1996;47:11–20.

15. Jordan CT, Lemischka IR. Clonal and systemic analysis of long-term hematopoiesis in the mouse. *Genes Dev* 1990;4:220-232.
16. Lemischka IR, Raulet DH, Mulligan RC. Developmental potential and dynamic behavior of hematopoietic stem cells. *Cell* 1986;45:917-927.
17. Lemischka IR. What we have learned from retroviral marking of hematopoietic stem cells. *Curr Top Microbiol Immunol* 1992;177:59-71.
18. Daley GQ, Van Etten RA, Baltimore D. Induction of chronic myelogenous leukemia in mice by the p210bcr/abl gene of the Philadelphia chromosome. *Science* 1990;247:824-830.
19. Brandt SJ, Bodine DM, Dunbar CE, Nienhuis AW. Dysregulated interleukin 6 expression produces a syndrome resembling Castleman's disease in mice. *J Clin Invest* 1990;86:592-599.
20. Wong PM, Chung SW, Dunbar CE, et al. Retrovirus-mediated transfer and expression of the interleukin-3 gene in mouse hematopoietic cells result in a myeloproliferative disorder. *Mol Cell Biol* 1989;9:798-808.
21. Wilson JM. Animal models of human disease for gene therapy. *J Clin Invest* 1996;97:1138-1141.
22. Cavazzana-Calvo M, Hacein-Bey S, de Saint Basile G, et al. Gene therapy of human severe combined immunodeficiency (SCID)-x1 disease [see comments]. *Science* 2000;288:669-672.
23. Aiuti A, Slavin S, Aker M, et al. Correction of ADA-SCID by stem cell gene therapy combined with nonmyeloablative conditioning. *Science* 2002;296:2410-2413.
24. Capecchi MR. Altering the genome by homologous recombination. *Science* 1989;244:1288-1292.
25. Camerini-Otero RD, Hsieh P. Homologous recombination proteins in prokaryotes and eukaryotes. *Annu Rev Genet* 1995;29:509-552.
26. Stasiak A. Getting down to the core of homologous recombination. *Science* 1996;272:828-829.
27. Peters T. "Playing god" and germline intervention. *J Med Philos* 1995;20:365-386.
28. Cornetta K, Morgan RA, Anderson WF. Safety issues related to retroviral-mediated gene transfer in humans. *Hum Gene Ther* 1991;2:5-14.
29. Cooper MJ. Noninfectious gene transfer and expression systems for cancer gene therapy. *Semin Oncol* 1996;23:172-187.
30. Miller AD. Cell-surface receptors for retroviruses and implications for gene transfer. *Proc Natl Acad Sci U S A* 1996;93:11407-11413.
31. Yang Y, Vanin EF, Whitt MA, et al. Inducible, high-level production of infectious murine leukemia retroviral vector particles pseudotyped with vesicular stomatitis virus g envelope protein. *Hum Gene Ther* 1995;6:1203-1213.
32. Burns JC, Friedmann T, Driever W, et al. Vesicular stomatitis virus g glycoprotein pseudotyped retroviral vectors: concentration to very high titer and efficient gene transfer into mammalian and nonmammalian cells. *Proc Natl Acad Sci U S A* 1993;90:8033-8037.
33. Hopkins N. High titers of retrovirus (vesicular stomatitis virus) pseudo-types, at last. *Proc Natl Acad Sci U S A* 1993;90:8759-8760.
34. Kasahara N, Dozy AM, Kan YW. Tissue-specific targeting of retroviral vectors through ligand-receptor interactions. *Science* 1994;266:1373-1376.
35. Boggs SS. Targeted gene modification for gene therapy of stem cells. *Int J Cell Cloning* 1990;8:80-96.
36. Cole-Strauss A, Yoon K, Xiang Y, et al. Correction of the mutation responsible for sickle cell anemia

by an RNA–DNA oligonucleotide. *Science* 1996;273:1386–1389.

37. Kmiec EB. Genomic targeting and genetic conversion in cancer therapy. *Semin Oncol* 1996;23:188–193.
38. Kurth R. Risk potential of the chromosomal insertion of foreign DNA. *Ann N Y Acad Sci* 1995;772:140–151.
39. Cuypers HT, Selten G, Quint W, et al. Murine leukemia virus–induced T–cell lymphomagenesis: integration of proviruses in a distinct chromosomal region. *Cell* 1984;37:141–150.
40. Holland CA, Anklesaria P, Sakakeeny MA, Greenberger JS. Enhancer sequences of a retroviral vector determine expression of a gene in multipotent hematopoietic progenitors and committed erythroid cells. *Proc Natl Acad Sci U S A* 1987;84:8662–8666.
41. Miller JL, Walsh CE, Ney PA, et al. Single–copy transduction and expression of human gamma–globin in k562 erythroleukemia cells using recombinant adeno–associated virus vectors: the effect of mutations in nf–e2 and gata–1 binding motifs within the hypersensitivity site 2 enhancer. *Blood* 1993;82:1900–1906.
42. Wu X, Holschen J, Kennedy SC, Ponder KP. Retroviral vector sequences may interact with some internal promoters and influence expression. *Hum Gene Ther* 1996;7:159–171.
43. Hofmann A, Nolan GP, Blau HM. Rapid retroviral delivery of tetracycline–inducible genes in a single autoregulatory cassette. *Proc Natl Acad Sci U S A* 1996;93:5185–5190.
44. Gossen M, Freundlieb S, Bender G, et al. Transcriptional activation by tetracyclines in mammalian cells. *Science* 1995;268:1766–1769.
45. Williams DA, Lim B, Spooncer E, et al. Restriction of expression of an integrated recombinant retrovirus in primary but not immortalized murine hematopoietic stem cells. *Blood* 1988;71:1738–1743.
46. Lu M, Maruyama M, Zhang N, et al. High efficiency retroviral–mediated gene transduction into CD34+ cells purified from peripheral blood of breast cancer patients primed with chemotherapy and granulocyte–macrophage colony–stimulating factor. *Hum Gene Ther* 1994;5:203–208.
47. Challita PM, Kohn DB. Lack of expression from a retroviral vector after transduction of murine hematopoietic stem cells is associated with methylation in vivo. *Proc Natl Acad Sci U S A* 1994;91:2567–2571.
48. Zhang WW, Fujiwara T, Grimm EA, Roth JA. Advances in cancer gene therapy. *Adv Pharmacol* 1995;32:289–341.
49. Wolff JA, Malone RW, Williams P, et al. Direct gene transfer into mouse muscle in vivo. *Science* 1990;247:1465–1468.
50. McDonnell WM, Askari FK. DNA vaccines. *N Engl J Med* 1996;334:42–45.
51. Donnelly JJ, Friedman A, Martinez D, et al. Preclinical efficacy of a prototype DNA vaccine: enhanced protection against antigenic drift in influenza virus. *Nat Med* 1995;1:583–587.
52. Mannino RJ, Gould–Fogerite S. Liposome mediated gene transfer. *Biotechniques* 1988;6:682–690.
53. Yang NS, Sun WH. Gene gun and other non–viral approaches for cancer gene therapy. *Nat Med* 1995;1:481–483.
54. Johnston SA, Tang DC. Gene gun transfection of animal cells and genetic immunization. *Methods Cell Biol* 1994;43:353–365.
55. Woffendin C, Yang ZY, Udaykumar, et al. Nonviral and viral delivery of a human immunodeficiency virus protective gene into primary human T cells. *Proc Natl Acad Sci U S A* 1994;91:11581–11585.
56. Klein RM, Wolf ED, Wu R, Sanford JC. High–velocity microprojectiles for delivering nucleic acids into

living cells. 1987. *Biotechnology* 1992;24:384–386.

57. Yang NS, Burkholder J, Roberts B, et al. In vivo and in vitro gene transfer to mammalian somatic cells by particle bombardment. *Proc Natl Acad Sci U S A* 1990;87:9568–9572.

58. Shigekawa K, Dower WJ. Electroporation of eukaryotes and prokaryotes: a general approach to the introduction of macromolecules into cells. *Biotechniques* 1988;6:742–751.

59. Chen CA, Okayama H. Calcium phosphate-mediated gene transfer: a highly efficient transfection system for stably transforming cells with plasmid DNA. *Biotechniques* 1988;6:632–638.

60. Andreason GL, Evans GA. Introduction and expression of DNA molecules in eukaryotic cells by electroporation. *Biotechniques* 1988;6:650–660.

61. Farhood H, Gao X, Son K, et al. Cationic liposomes for direct gene transfer in therapy of cancer and other diseases. *Ann N Y Acad Sci* 1994;716:23–34; discussion 34–35.

62. Felgner PL, Tsai YJ, Sukhu L, et al. Improved cationic lipid formulations for in vivo gene therapy. *Ann N Y Acad Sci* 1995;772:126–139.

63. Labat-Moleur F, Steffan AM, Brisson C, et al. An electron microscopy study into the mechanism of gene transfer with lipopolyamines. *Gene Ther* 1996;3:1010–1017.

64. Zhu N, Liggitt D, Liu Y, Debs R. Systemic gene expression after intravenous DNA delivery into adult mice. *Science* 1993;261:209–211.

65. Baudard M, Flotte TR, Aran JM, et al. Expression of the human multidrug resistance and glucocerebrosidase cDNAs from adeno-associated vectors: efficient promoter activity of AAV sequences and in vivo delivery via liposomes. *Hum Gene Ther* 1996;7:1309–1322.

66. Cristiano RJ, Roth JA. Molecular conjugates: a targeted gene delivery vector for molecular medicine. *J Mol Med* 1995;73:479–486.

67. Cristiano RJ, Curiel DT. Strategies to accomplish gene delivery via the receptor-mediated endocytosis pathway. *Cancer Gene Ther* 1996;3:49–57.

68. Cotten M, Wagner E, Zatloukal K, et al. High-efficiency receptor-mediated delivery of small and large (48 kilobase) gene constructs using the endosome-disruption activity of defective or chemically inactivated adenovirus particles. *Proc Natl Acad Sci U S A* 1992;89:6094–6098.

69. Wagner E, Zatloukal K, Cotten M, et al. Coupling of adenovirus to transferrin-polylysine/DNA complexes greatly enhances receptor-mediated gene delivery and expression of transfected genes. *Proc Natl Acad Sci U S A* 1992;89:6099–6103.

70. Michael SI, Huang CH, Romer MU, et al. Binding-incompetent adenovirus facilitates molecular conjugate-mediated gene transfer by the receptor-mediated endocytosis pathway. *J Biol Chem* 1993;268:6866–6869.

71. Schwarzenberger P, Spence SE, Gooya JM, et al. Targeted gene transfer to human hematopoietic progenitor cell lines through the c-kit receptor. *Blood* 1996;87:472–478.

72. Curiel DT. Adenovirus facilitation of molecular conjugate-mediated gene transfer. *Prog Med Virol* 1993;40:1–18.

73. Ledley FD. Nonviral gene therapy: the promise of genes as pharmaceutical products. *Hum Gene Ther* 1995;6:1129–1144.

74. Smith AE. Viral vectors in gene therapy. *Annu Rev Microbiol* 1995;49:807–838.

75. Gunzburg WH, Salmons B. Development of retroviral vectors as safe, targeted gene delivery systems. *J Mol Med* 1996;74:171–182.



76. Miller AD. Retroviral vectors. *Curr Top Microbiol Immunol* 1992;158:1–24.
77. Coffin JM, ed. *Retroviridae: the viruses and their replication*. Philadelphia: Lippincott–Raven Publishers, 1996.
78. Kozak SL, Siess DC, Kavanaugh MP, et al. The envelope glycoprotein of an amphotropic murine retrovirus binds specifically to the cellular receptor/phosphate transporter of susceptible species. *J Virol* 1995;69:3433–3440.
79. Miller DG, Edwards RH, Miller AD. Cloning of the cellular receptor for amphotropic murine retroviruses reveals homology to that for gibbon ape leukemia virus. *Proc Natl Acad Sci U S A* 1994;91:78–82.
80. Kavanaugh MP, Miller DG, Zhang W, et al. Cell–surface receptors for gibbon ape leukemia virus and amphotropic murine retrovirus are inducible sodium–dependent phosphate symporters. *Proc Natl Acad Sci U S A* 1994;91:7071–7075.
81. Boris–Lawrie K, Temin HM. The retroviral vector. Replication cycle and safety considerations for retrovirus–mediated gene therapy. *Ann N Y Acad Sci* 1994;716:59–70; discussion 71.
82. Donahue RE, Kessler SW, Bodine D, et al. Helper virus induced T cell lymphoma in nonhuman primates after retroviral mediated gene transfer. *J Exp Med* 1992;176:1125–1135.
83. Miller AD, Buttimore C. Redesign of retrovirus packaging cell lines to avoid recombination leading to helper virus production. *Mol Cell Biol* 1986;6:2895–2902.
84. Miller AD. Retrovirus packaging cells. *Hum Gene Ther* 1990;1:5–14.
85. Markowitz D, Goff S, Bank A. A safe packaging line for gene transfer: separating viral genes on two different plasmids. *J Virol* 1988;62:1120–1124.
86. Ory DS, Neugeboren BA, Mulligan RC. A stable human–derived packaging cell line for production of high titer retrovirus/vesicular stomatitis virus g pseudotypes. *Proc Natl Acad Sci U S A* 1996;93:11400–11406.
87. Rigg RJ, Chen J, Dando JS, et al. A novel human amphotropic packaging cell line: high titer, complement resistance, and improved safety. *Virology* 1996;218:290–295.
88. Miller DG, Adam MA, Miller AD. Gene transfer by retrovirus vectors occurs only in cells that are actively replicating at the time of infection. *Mol Cell Biol* 1990;10:4239–4242.
89. Orlic D, Girard LJ, Jordan CT, et al. The level of mRNA encoding the amphotropic retrovirus receptor in mouse and human hematopoietic stem cells is low and correlates with the efficiency of retrovirus transduction. *Proc Natl Acad Sci U S A* 1996;93:11097–11102.
90. Cosset FL, Morling FJ, Takeuchi Y, et al. Retroviral retargeting by envelopes expressing an N–terminal binding domain. *J Virol* 1995;69:6314–6322.
91. Yee JK, Friedmann T, Burns JC. Generation of high–titer pseudotyped retroviral vectors with very broad host range. *Methods Cell Biol* 1994;43:99–112.
92. Horn PA, Topp MS, Morris JC, et al. Highly efficient gene transfer into baboon marrow repopulating cells using GALV–pseudotype oncoretroviral vectors produced by human packaging cells. *Blood* 2002;100:3960–3967.
93. Kelly PF, Vandergriff J, Nathwani A, et al. Highly efficient gene transfer into cord blood nonobese diabetic/severe combined immunodeficiency repopulating cells by oncoretroviral vector particles pseudotyped with the feline endogenous retrovirus (rd114) envelope protein. *Blood* 2000;96:1206–1214.
94. Kiem HP, Heyward S, Winkler A, et al. Gene transfer into marrow repopulating cells: comparison between amphotropic and gibbon ape leukemia virus pseudotyped retroviral vectors in a competitive repopulation assay in baboons. *Blood* 1997;90:4638–4645.

95. Chuck AS, Palsson BO. Consistent and high rates of gene transfer can be obtained using flow-through transduction over a wide range of retroviral titers. *Hum Gene Ther* 1996;7:743-750.
96. Moritz T, Dutt P, Xiao X, et al. Fibronectin improves transduction of reconstituting hematopoietic stem cells by retroviral vectors: evidence of direct viral binding to chymotryptic carboxy-terminal fragments. *Blood* 1996;88:855-862.
97. Kotani H, Newton PB 3rd, Zhang S, et al. Improved methods of retroviral vector transduction and production for gene therapy. *Hum Gene Ther* 1994;5:19-28.
98. Shimada T, Fujii H, Mitsuya H, Nienhuis AW. Targeted and highly efficient gene transfer into CD4+ cells by a recombinant human immunodeficiency virus retroviral vector. *J Clin Invest* 1991;88:1043-1047.
99. Naldini L, Blomer U, Gallay P, et al. In vivo gene delivery and stable transduction of nondividing cells by a lentiviral vector. *Science* 1996;272:263-267.
100. Reiser J, Harmison G, Kluepfel-Stahl S, et al. Transduction of nondividing cells using pseudotyped defective high-titer HIV type 1 particles. *Proc Natl Acad Sci U S A* 1996;93:15266-15271.
101. Heinzinger NK, Bukinsky MI, Haggerty SA, et al. The vpr protein of human immunodeficiency virus type 1 influences nuclear localization of viral nucleic acids in nondividing host cells. *Proc Natl Acad Sci U S A* 1994;91:7311-7315.
102. Naldini L, Blomer U, Gage FH, et al. Efficient transfer, integration, and sustained long-term expression of the transgene in adult rat brains injected with a lentiviral vector. *Proc Natl Acad Sci U S A* 1996;93:11382-11388.
103. May C, Rivella S, Callegari J, et al. Therapeutic haemoglobin synthesis in beta-thalassaemic mice expressing lentivirus-encoded human beta-globin. *Nature* 2000;406:82-86.
104. Podsakoff GM. Lentiviral vectors approach the clinic but fall back: National Institutes of Health Recombinant DNA Advisory Committee review of a first clinical protocol for use of a lentiviral vector. *Mol Ther* 2001;4:282-283.
105. Poeschla E, Corbeau P, Wong-Staal F. Development of HIV vectors for anti-HIV gene therapy. *Proc Natl Acad Sci U S A* 1996;93:11395-11399.
106. Yu SF, Baldwin DN, Gwynn SR, et al. Human foamy virus replication: a pathway distinct from that of retroviruses and hepadnaviruses. *Science* 1996;271:1579-1582.
107. Bieniasz PD, Weiss RA, McClure MO. Cell cycle dependence of foamy retrovirus infection. *J Virol* 1995;69:7295-7299.
108. Russell DW, Miller AD. Foamy virus vectors. *J Virol* 1996;70:217-222.
109. Hirata RK, Miller AD, Andrews RG, Russell DW. Transduction of hematopoietic cells by foamy virus vectors. *Blood* 1996;88:3654-3661.
110. Trobridge GD, Russell DW. Helper-free foamy virus vectors. *Hum Gene Ther* 1998;9:2517-2525.
111. Vassilopoulos G, Trobridge G, Josephson NC, Russell DW. Gene transfer into murine hematopoietic stem cells with helper-free foamy virus vectors. *Blood* 2001;98:604-609.
112. Shenk T. Adenoviridae: the viruses and their replication. In: Fields BN, Knipe DM, Howley PM, et al., eds. *Fields virology*, 3rd ed. Philadelphia: Lippincott-Raven Publishers, 1996:2111-2148.
113. Huang S, Kamata T, Takada Y, et al. Adenovirus interaction with distinct integrins mediates separate events in cell entry and gene delivery to hematopoietic cells. *J Virol* 1996;70:4502-4508.
114. Bergelson JM, Cunningham JA, Droguett G, et al. Isolation of a common receptor for coxsackie b viruses and adenoviruses 2 and 5. *Science* 1997;275:1320-1323.

115. Berns KI, Giraud C. Adenovirus and adeno-associated virus as vectors for gene therapy. *Ann N Y Acad Sci* 1995;772:95-104.
116. Berkner KL. Expression of heterologous sequences in adenoviral vectors. *Curr Top Microbiol Immunol* 1992;158:39-66.
117. Wilson JM. Adenoviruses as gene-delivery vehicles. *N Engl J Med* 1996;334:1185-1187.
118. Brody SL, Crystal RG. Adenovirus-mediated in vivo gene transfer. *Ann N Y Acad Sci* 1994;716:90-101; discussion 101-103.
119. Siegfried W. Perspectives in gene therapy with recombinant adenoviruses. *Exp Clin Endocrinol* 1993;101:7-11.
120. Rosenfeld MA, Collins FS. Gene therapy for cystic fibrosis. *Chest* 1996;109:241-252.
121. Rosenfeld MA, Yoshimura K, Trapnell BC, et al. In vivo transfer of the human cystic fibrosis transmembrane conductance regulator gene to the airway epithelium. *Cell* 1992;68:143-155.
122. Tripathy SK, Black HB, Goldwasser E, Leiden JM. Immune responses to transgene-encoded proteins limit the stability of gene expression after injection of replication-defective adenovirus vectors. *Nat Med* 1996;2:545-550.
123. Yang Y, Su Q, Wilson JM. Role of viral antigens in destructive cellular immune responses to adenovirus vector-transduced cells in mouse lungs. *J Virol* 1996;70:7209-7212.
124. Crystal RG, McElvaney NG, Rosenfeld MA, et al. Administration of an adenovirus containing the human CFTR cDNA to the respiratory tract of individuals with cystic fibrosis. *Nat Genet* 1994;8:42-51.
125. Yang Y, Li Q, Ertl HC, Wilson JM. Cellular and humoral immune responses to viral antigens create barriers to lung-directed gene therapy with recombinant adenoviruses. *J Virol* 1995;69:2004-2015.
126. Amalfitano A, Begy CR, Chamberlain JS. Improved adenovirus packaging cell lines to support the growth of replication-defective gene-delivery vectors. *Proc Natl Acad Sci U S A* 1996;93:3352-3356.
127. Clemens PR, Kochanek S, Sunada Y, et al. In vivo muscle gene transfer of full-length dystrophin with an adenoviral vector that lacks all viral genes. *Gene Ther* 1996;3:965-972.
128. Yang Y, Trinchieri G, Wilson JM. Recombinant IL-12 prevents formation of blocking IgA antibodies to recombinant adenovirus and allows repeated gene therapy to mouse lung. *Nat Med* 1995;1:890-893.
129. Dai Y, Schwarz EM, Gu D, et al. Cellular and humoral immune responses to adenoviral vectors containing factor IX gene: tolerization of factor IX and vector antigens allows for long-term expression. *Proc Natl Acad Sci U S A* 1995;92:1401-1405.
130. Fang B, Eisensmith RC, Wang H, et al. Gene therapy for hemophilia B: host immunosuppression prolongs the therapeutic effect of adenovirus-mediated factor IX expression. *Hum Gene Ther* 1995;6:1039-1044.
131. Walter J, You Q, Hagstrom JN, et al. Successful expression of human factor IX following repeat administration of adenoviral vector in mice. *Proc Natl Acad Sci U S A* 1996;93:3056-3061.
132. Smith TA, White BD, Gardner JM, et al. Transient immunosuppression permits successful repetitive intravenous administration of an adenovirus vector. *Gene Ther* 1996;3:496-502.
133. Zabner J, Couture LA, Gregory RJ, et al. Adenovirus-mediated gene transfer transiently corrects the chloride transport defect in nasal epithelia of patients with cystic fibrosis. *Cell* 1993;75:207-216.
134. Crystal RG, Jaffe A, Brody S, et al. A phase 1 study, in cystic fibrosis patients, of the safety, toxicity, and biological efficacy of a single administration of a replication deficient, recombinant adenovirus carrying the cDNA of the normal cystic fibrosis transmembrane conductance regulator gene in the lung.

Hum Gene Ther 1995;6:643-666.

135. Crystal RG, Mastrangeli A, Sanders A, et al. Evaluation of repeat administration of a replication deficient, recombinant adenovirus containing the normal cystic fibrosis transmembrane conductance regulator cDNA to the airways of individuals with cystic fibrosis. *Hum Gene Ther* 1995;6:667-703.
136. Descamps V, Duffour MT, Mathieu MC, et al. Strategies for cancer gene therapy using adenoviral vectors. *J Mol Med* 1996;74:183-189.
137. Clayman GL, el-Naggar AK, Roth JA, et al. In vivo molecular therapy with p53 adenovirus for microscopic residual head and neck squamous carcinoma. *Cancer Res* 1995;55:1-6.
138. Caruso M, Pham-Nguyen K, Kwong YL, et al. Adenovirus-mediated interleukin-12 gene therapy for metastatic colon carcinoma. *Proc Natl Acad Sci U S A* 1996;93:11302-11306.
139. Flotte TR, Carter BJ. Adeno-associated virus vectors for gene therapy. *Gene Ther* 1995;2:357-362.
140. Berns KI. Parvoviridae: the viruses and their replication. In: Fields BN, Knipe DM, Howley PM, eds. *Fields virology*, 3rd ed. Philadelphia: Lippincott-Raven Publishers, 1996:2173-2198.
141. Bartlett JS, Samulski RJ. Genetics and biology of adeno-associated virus. In: Kaplitt MG, Loewy AD, eds. *Viral vectors: gene therapy and neuroscience applications*. San Diego: Academic Press, 1995:55-73.
142. Mizukami H, Young NS, Brown KE. Adeno-associated virus type 2 binds to a 150-kilodalton cell membrane glycoprotein. *Virology* 1996;217:124-130.
143. Mayor HD. Defective parvoviruses may be good for your health! *Prog Med Virol* 1993;40:193-205.
144. Hermonat PL. Inhibition of h-ras expression by the adeno-associated virus rep78 transformation suppressor gene product. *Cancer Res* 1991;51:3373-3377.
145. Antoni BA, Rabson AB, Miller IL, et al. Adeno-associated virus rep protein inhibits human immunodeficiency virus type 1 production in human cells. *J Virol* 1991;65:396-404.
146. Georg-Fries B, Biederlack S, Wolf J, zur Hausen H. Analysis of proteins, helper dependence, and seroepidemiology of a new human parvovirus. *Virology* 1984;134:64-71.
147. Cheung AK, Hoggan MD, Hauswirth WW, Berns KI. Integration of the adeno-associated virus genome into cellular DNA in latently infected human Detroit 6 cells. *J Virol* 1980;33:739-748.
148. Samulski RJ, Zhu X, Xiao X, et al. Targeted integration of adeno-associated virus (AAV) into human chromosome 19. *EMBO J* 1991;10:3941-3950.
149. Linden RM, Ward P, Giraud C, et al. Site-specific integration by adeno-associated virus. *Proc Natl Acad Sci U S A* 1996;93:11288-11294.
150. Kotin RM. Prospects for the use of adeno-associated virus as a vector for human gene therapy. *Hum Gene Ther* 1994;5:793-801.
151. Muzyczka N. Use of adeno-associated virus as a general transduction vector for mammalian cells. *Curr Top Microbiol Immunol* 1992;158:97-129.
152. Samulski RJ, Chang LS, Shenk T. Helper-free stocks of recombinant adeno-associated viruses: normal integration does not require viral gene expression. *J Virol* 1989;63:3822-3828.
153. Tratschin JD, Miller IL, Smith MG, Carter BJ. Adeno-associated virus vector for high-frequency integration, expression, and rescue of genes in mammalian cells. *Mol Cell Biol* 1985;5:3251-3260.
154. Shaughnessy E, Lu D, Chatterjee S, Wong KK. Parvoviral vectors for the gene therapy of cancer. *Semin Oncol* 1996;23:159-171.
155. Tamayose K, Hirai Y, Shimada T. A new strategy for large-scale preparation of high-titer recombinant adeno-associated virus vectors by using packaging cell lines and sulfonated cellulose column

chromatography. *Hum Gene Ther* 1996;7:507–513.

156. Anderson SM, Yu G, Giattina M, Miller JL. Intercellular transfer of a glycosylphosphatidylinositol (GPI)-linked protein: release and uptake of CD4-GPI from recombinant adeno-associated virus-transduced hela cells. *Proc Natl Acad Sci U S A* 1996;93:5894–5898.

157. Goodman S, Xiao X, Donahue RE, et al. Recombinant adeno-associated virus-mediated gene transfer into hematopoietic progenitor cells. *Blood* 1994;84:1492–1500.

158. Podsakoff G, Wong KK Jr, Chatterjee S. Efficient gene transfer into nondividing cells by adeno-associated virus-based vectors. *J Virol* 1994;68:5656–5666.

159. Russell DW, Miller AD, Alexander IE. Adeno-associated virus vectors preferentially transduce cells in S phase. *Proc Natl Acad Sci U S A* 1994;91:8915–8919.

160. Alexander IE, Russell DW, Miller AD. DNA-damaging agents greatly increase the transduction of nondividing cells by adeno-associated virus vectors. *J Virol* 1994;68:8282–8287.

161. Russell DW, Alexander IE, Miller AD. DNA synthesis and topoisomerase inhibitors increase transduction by adeno-associated virus vectors. *Proc Natl Acad Sci U S A* 1995;92:5719–5723.

162. Fisher-Adams G, Wong KK Jr, Podsakoff G, et al. Integration of adeno-associated virus vectors in CD34+ human hematopoietic progenitor cells after transduction. *Blood* 1996;88:492–504.

163. Brown KE, Green SW, Young NS. Goose parvovirus—an autonomous member of the Dependovirus genus? *Virology* 1995;210:283–291.

164. Muramatsu S, Mizukami H, Young NS, Brown KE. Nucleotide sequencing and generation of an infectious clone of adeno-associated virus 3. *Virology* 1996;221:208–217.

165. Brown KE, Green SW, O'Sullivan MG, Young NS. Cloning and sequencing of the simian parvovirus genome. *Virology* 1995;210:314–322.

166. Breakefield XO, DeLuca NA. Herpes simplex virus for gene delivery to neurons. *New Biol* 1991;3:203–218.

167. Ali M, Lemoine NR, Ring CJ. The use of DNA viruses as vectors for gene therapy. *Gene Ther* 1994;1:367–384.

168. Glorioso JC, DeLuca NA, Fink DJ. Development and application of herpes simplex virus vectors for human gene therapy. *Annu Rev Microbiol* 1995;49:675–710.

169. Glorioso J, Bender MA, Fink D, DeLuca N. Herpes simplex virus vectors. *Mol Cell Biol Hum Dis Ser* 1995;5:33–63.

170. Weir JP, Dacquel EJ, Aronovitz J. Herpesvirus vector-mediated gene delivery to human monocytes. *Hum Gene Ther* 1996;7:1331–1338.

171. Dilloo D, Rill D, Entwistle C, et al. A novel herpes vector for the high-efficiency transduction of normal and malignant human hematopoietic cells. *Blood* 1997;89:119–27.

172. Moss B. Poxvirus expression vectors. *Curr Top Microbiol Immunol* 1992;158:25–38.

173. Whitman ED, Tsung K, Paxson J, Norton JA. In vitro and in vivo kinetics of recombinant vaccinia virus cancer-gene therapy. *Surgery* 1994;116:183–188.

174. Qin HX, Chatterjee SK. Construction of recombinant vaccinia virus expressing GM-CSF and its use as tumor vaccine. *Gene Ther* 1996;3:59–66.

175. Hodge JW, Abrams S, Schlom J, Kantor JA. Induction of antitumor immunity by recombinant vaccinia viruses expressing b7-1 or b7-2 costimulatory molecules. *Cancer Res* 1994;54:5552–5555.

176. Lattime EC, Lee SS, Eisenlohr LC, Mastrangelo MJ. In situ cytokine gene transfection using vaccinia

virus vectors. *Semin Oncol* 1996;23:88–100.

177. Dunbar CE, Emmons RV. Gene transfer into hematopoietic progenitor and stem cells: progress and problems. *Stem Cells* 1994;12:563–576.

178. Hanania EG, Kavanagh J, Hortobagyi G, et al. Recent advances in the application of gene therapy to human disease. *Am J Med* 1995;99:537–552.

179. Yu M, Poeschla E, Wong-Staal F. Progress towards gene therapy for HIV infection. *Gene Ther* 1994;1:13–26.

180. Brenner MK. Gene transfer to hematopoietic cells. *N Engl J Med* 1996;335:337–339.

181. Williams DA, Lemischka IR, Nathan DG, Mulligan RC. Introduction of new genetic material into pluripotent haematopoietic stem cells of the mouse. *Nature* 1984;310:476–480.

182. Lim B, Apperley JF, Orkin SH, Williams DA. Long-term expression of human adenosine deaminase in mice transplanted with retrovirus-infected hematopoietic stem cells. *Proc Natl Acad Sci U S A* 1989;86:8892–8896.

183. Lim B, Williams DA, Orkin SH. Retrovirus-mediated gene transfer of human adenosine deaminase: expression of functional enzyme in murine hematopoietic stem cells in vivo. *Mol Cell Biol* 1987;7:3459–3465.

184. Bodine DM, Karlsson S, Nienhuis AW. Combination of interleukins 3 and 6 preserves stem cell function in culture and enhances retrovirus-mediated gene transfer into hematopoietic stem cells. *Proc Natl Acad Sci U S A* 1989;86:8897–8901.

185. Luskey BD, Rosenblatt M, Zsebo K, Williams DA. Stem cell factor, interleukin-3, and interleukin-6 promote retroviral-mediated gene transfer into murine hematopoietic stem cells. *Blood* 1992;80:396–402.

186. Fraser CC, Eaves CJ, Szilvassy SJ, Humphries RK. Expansion in vitro of retrovirally marked totipotent hematopoietic stem cells. *Blood* 1990;76:1071–1076.

187. Correll PH, Colilla S, Dave HP, Karlsson S. High levels of human glucocerebrosidase activity in macrophages of long-term reconstituted mice after retroviral infection of hematopoietic stem cells. *Blood* 1992;80:331–336.

188. Crooks GM, Kohn DB. Growth factors increase amphotropic retrovirus binding to human CD34+ bone marrow progenitor cells. *Blood* 1993;82:3290–3297.

189. Bodine DM, McDonagh KT, Seidel NE, Nienhuis AW. Survival and retrovirus infection of murine hematopoietic stem cells in vitro: effects of 5-flu and method of infection. *Exp Hematol* 1991;19:206–212.

190. Sorrentino BP, Brandt SJ, Bodine D, et al. Selection of drug-resistant bone marrow cells in vivo after retroviral transfer of human *mdr1*. *Science* 1992;257:99–103.

191. Hanenberg H, Xiao XL, Dilloo D, et al. Colocalization of retrovirus and target cells on specific fibronectin fragments increases genetic transduction of mammalian cells. *Nat Med* 1996;2:876–882.

192. Correll PH, Kew Y, Perry LK, et al. Expression of human glucocerebrosidase in long-term reconstituted mice following retrovirus-mediated gene transfer into hematopoietic stem cells. *Hum Gene Ther* 1990;1:277–287.

193. Jordan CT, McKearn JP, Lemischka IR. Cellular and developmental properties of fetal hematopoietic stem cells. *Cell* 1990;61:953–963.

194. de Revel T, Appelbaum FR, Storb R, et al. Effects of granulocyte colony-stimulating factor and stem cell factor, alone and in combination, on the mobilization of peripheral blood cells that engraft lethally irradiated dogs. *Blood* 1994;83:3795–3799.

195. Hanania EG, Deisseroth AB. Serial transplantation shows that early hematopoietic precursor cells are transduced by *mdr-1* retroviral vector in a mouse gene therapy model. *Cancer Gene Ther* 1994;1:21–25.

196. Wilson JM, Danos O, Grossman M, et al. Expression of human adenosine deaminase in mice reconstituted with retrovirus-transduced hematopoietic stem cells. *Proc Natl Acad Sci U S A* 1990;87:439-443.
197. Kaleko M, Garcia JV, Osborne WR, Miller AD. Expression of human adenosine deaminase in mice after transplantation of genetically modified bone marrow. *Blood* 1990;75:1733-1741.
198. Krall WJ, Challita PM, Perlmutter LS, et al. Cells expressing human glucocerebrosidase from a retroviral vector repopulate macrophages and central nervous system microglia after murine bone marrow transplantation. *Blood* 1994;83:2737-2748.
199. Apperley JF, Luskey BD, Williams DA. Retroviral gene transfer of human adenosine deaminase in murine hematopoietic cells: effect of selectable marker sequences on long-term expression. *Blood* 1991;78:310-317.
200. Naviaux RK, Verma IM. Retroviral vectors for persistent expression in vivo. *Curr Opin Biotechnol* 1992;3:540-547.
201. Scharfmann R, Axelrod JH, Verma IM. Long-term in vivo expression of retrovirus-mediated gene transfer in mouse fibroblast implants. *Proc Natl Acad Sci U S A* 1991;88:4626-4630.
202. Berenson RJ, Bensinger WI, Hill RS, et al. Engraftment after infusion of CD34+ marrow cells in patients with breast cancer or neuroblastoma. *Blood* 1991;77:1717-1722.
203. Civin CI, Strauss LC, Brovall C, et al. Antigenic analysis of hematopoiesis. III. A hematopoietic progenitor cell surface antigen defined by a monoclonal antibody raised against kg-1a cells. *J Immunol* 1984;133:157-165.
204. Shpall EJ, Jones RB, Bearman SI, et al. Transplantation of CD34+ hematopoietic progenitor cells. *J Hematother* 1994;3:145-147.
205. Shpall EJ, Jones RB, Bearman SI, et al. Transplantation of enriched CD34-positive autologous marrow into breast cancer patients following high-dose chemotherapy: influence of CD34-positive peripheral-blood progenitors and growth factors on engraftment. *J Clin Oncol* 1994;12:28-36.
206. Terstappen LW, Huang S, Safford M, et al. Sequential generations of hematopoietic colonies derived from single nonlineage-committed CD34+CD38- progenitor cells. *Blood* 1991;77:1218-1227.
207. Lord BI, Dexter TM. Which are the hematopoietic stem cells? [or: Don't debunk the history!]. *Exp Hematol* 1995;23:1237-1241.
208. Goodell MA, Brose K, Paradis G, et al. Isolation and functional properties of murine hematopoietic stem cells that are replicating in vivo. *J Exp Med* 1996;183:1797-1806.
209. Osawa M, Hanada K, Hamada H, Nakauchi H. Long-term lymphohematopoietic reconstitution by a single CD34-low/negative hematopoietic stem cell. *Science* 1996;273:242-245.
210. Goodell MA, Rosenzweig M, Kim H, et al. Dye efflux studies suggest that hematopoietic stem cells expressing low or undetectable levels of CD34 antigen exist in multiple species. *Nat Med* 1997;3:1337-1345.
211. Hughes PF, Thacker JD, Hogge D, et al. Retroviral gene transfer to primitive normal and leukemic hematopoietic cells using clinically applicable procedures. *J Clin Invest* 1992;89:1817-1824.
212. Lu L, Xiao M, Clapp DW, et al. High efficiency retroviral mediated gene transduction into single isolated immature and replatable CD34(3+) hematopoietic stem/progenitor cells from human umbilical cord blood. *J Exp Med* 1993;178:2089-2096.
213. Berenson RJ, Andrews RG, Bensinger WI, et al. Antigen CD34+ marrow cells engraft lethally irradiated baboons. *J Clin Invest* 1988;81:951-955.
214. von Kalle C, Kiem HP, Goehle S, et al. Increased gene transfer into human hematopoietic progenitor



cells by extended in vitro exposure to a pseudo-typed retroviral vector. *Blood* 1994;84:2890–2897.

215. Van Beusechem VW, Valerio D. Gene transfer into hematopoietic stem cells of nonhuman primates. *Hum Gene Ther* 1996;7:1649–1668.

216. Bodine DM, Moritz T, Donahue RE, et al. Long-term in vivo expression of a murine adenosine deaminase gene in rhesus monkey hematopoietic cells of multiple lineages after retroviral mediated gene transfer into CD34+ bone marrow cells. *Blood* 1993;82:1975–1980.

217. Vanin EF, Kaloss M, Broscius C, Nienhuis AW. Characterization of replication-competent retroviruses from nonhuman primates with virus-induced T-cell lymphomas and observations regarding the mechanism of oncogenesis. *J Virol* 1994;68:4241–4250.

218. van Beusechem VW, Kukler A, Heidt PJ, Valerio D. Long-term expression of human adenosine deaminase in rhesus monkeys transplanted with retrovirus-infected bone-marrow cells. *Proc Natl Acad Sci U S A* 1992;89:7640–7644.

219. van Beusechem VW, Bart-Baumeister JA, Hoogerbrugge PM, Valerio D. Influence of interleukin-3, interleukin-6, and stem cell factor on retroviral transduction of rhesus monkey CD34+ hematopoietic progenitor cells measured in vitro and in vivo. *Gene Ther* 1995;2:245–255.

220. Xu LC, Karlsson S, Byrne ER, et al. Long-term in vivo expression of the human glucocerebrosidase gene in nonhuman primates after CD34+ hematopoietic cell transduction with cell-free retroviral vector preparations. *Proc Natl Acad Sci U S A* 1995;92:4372–4376.

221. Dunbar CE, Seidel NE, Doren S, et al. Improved retroviral gene transfer into murine and rhesus peripheral blood or bone marrow repopulating cells primed in vivo with stem cell factor and granulocyte colony-stimulating factor. *Proc Natl Acad Sci U S A* 1996;93:11871–11876.

222. Nolta JA, Kohn DB. Comparison of the effects of growth factors on retroviral vector-mediated gene transfer and the proliferative status of human hematopoietic progenitor cells. *Hum Gene Ther* 1990;1:257–268.

223. Moore KA, Deisseroth AB, Reading CL, et al. Stromal support enhances cell-free retroviral vector transduction of human bone marrow long-term culture-initiating cells. *Blood* 1992;79:1393–1399.

224. Hughes PF, Eaves CJ, Hogge DE, Humphries RK. High-efficiency gene transfer to human hematopoietic cells maintained in long-term marrow culture. *Blood* 1989;74:1915–1922.

225. Moritz T, Patel VP, Williams DA. Bone marrow extracellular matrix molecules improve gene transfer into human hematopoietic cells via retroviral vectors. *J Clin Invest* 1994;93:1451–1457.

226. Dunbar CE, Cottler-Fox M, O'Shaughnessy JA, et al. Retrovirally marked CD34-enriched peripheral blood and bone marrow cells contribute to long-term engraftment after autologous transplantation. *Blood* 1995;85:3048–3057.

227. Emmons RV, Doren S, Zujewski J, et al. Retroviral gene transduction of adult peripheral blood or marrow-derived CD34+ cells for six hours without growth factors or on autologous stroma does not improve marking efficiency assessed in vivo. *Blood* 1997;89:4040–4046.

228. Stewart AK, Sutherland DR, Nanji S, et al. Engraftment of gene-marked hematopoietic progenitors in myeloma patients after transplant of autologous long-term marrow cultures. *Hum Gene Ther* 1999;10:1953–1964.

229. Brenner MK, Rill DR, Holladay MS, et al. Gene marking to determine whether autologous marrow infusion restores long-term haemopoiesis in cancer patients. *Lancet* 1993;342:1134–1137.

230. Liu JM, Kim S, Read EJ, et al. Engraftment of hematopoietic progenitor cells transduced with the Fanconi anemia group c gene (FANCC). *Hum Gene Ther* 1999;10:2337–2346.

231. Kohn DB, Hershfield MS, Carbonaro D, et al. T lymphocytes with a normal ADA gene accumulate after transplantation of transduced autologous umbilical cord blood CD34+ cells in ADA-deficient SCID neonates. *Nat Med* 1998;4:775–780.

232. Peters SO, Kittler EL, Ramshaw HS, Quesenberry PJ. Murine marrow cells expanded in culture with IL-3, IL-6, IL-11, and SCF acquire an engraftment defect in normal hosts. *Exp Hematol* 1995;23:461-469.
233. Tisdale JF, Hanazono Y, Sellers SE, et al. Ex vivo expansion of genetically marked rhesus peripheral blood progenitor cells results in diminished long-term repopulating ability. *Blood* 1998;92:1131-1141.
234. Wu T, Kim HJ, Sellers S, et al. Prolonged high-level detection of retrovirally marked hematopoietic cells in nonhuman primates after transduction of CD34+ progenitors using clinically feasible methods. *Mol Ther* 2000;1:285-293.
235. Kiem HP, Andrews RG, Morris J, et al. Improved gene transfer into baboon marrow repopulating cells using recombinant human fibronectin fragment ch-296 in combination with interleukin-6, stem cell factor, flt-3 ligand, and megakaryocyte growth and development factor. *Blood* 1998;92:1878-1886.
236. Sellers S, JF T, Agricola B, et al. Genetically marked rhesus peripheral blood progenitor cells (PBPC) ex vivo expanded in the presence of fibronectin 296 contribute to both short and long term engraftment. *Blood* 2000;96:589a.
237. Rebel VI, Tanaka M, Lee JS, et al. One-day ex vivo culture allows effective gene transfer into human nonobese diabetic/severe combined immune-deficient repopulating cells using high-titer vesicular stomatitis virus g protein pseudotyped retrovirus. *Blood* 1999;93:2217-2224.
238. Kim HJ, Tisdale JF, Wu T, et al. Many multipotential gene-marked progenitor or stem cell clones contribute to hematopoiesis in nonhuman primates. *Blood* 2000;96:1-8.
239. Schmidt M, Zickler P, Wissler M, et al. LAM-PCR: monitoring the clonal composition of the hematopoietic system in transplantation models in vivo. *Blood* 2000;96:518a.
240. Schmidt M, Zickler P, Hoffman G, et al. Polyclonal long-term repopulating stem cell clones in a primate model. *Blood* 2002;100:2737-2743.
241. Schuening FG, Kawahara K, Miller AD, et al. Retrovirus-mediated gene transduction into long-term repopulating marrow cells of dogs. *Blood* 1991;78:2568-2576.
242. Kiem HP, Darovsky B, von Kalle C, et al. Retrovirus-mediated gene transduction into canine peripheral blood repopulating cells. *Blood* 1994;83:1467-1473.
243. Barquinero J, Kiem HP, von Kalle C, et al. Myelosuppressive conditioning improves autologous engraftment of genetically marked hematopoietic repopulating cells in dogs. *Blood* 1995;85:1195-1201.
244. Kiem HP, McSweeney PA, Bruno B, et al. Improved gene transfer into canine hematopoietic repopulating cells using CD34-enriched marrow cells in combination with a gibbon ape leukemia virus-pseudotype retroviral vector. *Gene Ther* 1999;6:966-972.
245. Goerner M, Bruno B, McSweeney PA, et al. The use of granulocyte colony-stimulating factor during retroviral transduction on fibronectin fragment ch-296 enhances gene transfer into hematopoietic repopulating cells in dogs. *Blood* 1999;94:2287-2292.
246. Bock TA, Orlic D, Dunbar CE, et al. Improved engraftment of human hematopoietic cells in severe combined immunodeficient (SCID) mice carrying human cytokine transgenes. *J Exp Med* 1995;182:2037-2043.
247. Nolta JA, Hanley MB, Kohn DB. Sustained human hematopoiesis in immunodeficient mice by cotransplantation of marrow stroma expressing human interleukin-3: analysis of gene transduction of long-lived progenitors. *Blood* 1994;83:3041-3051.
248. Dick JE, Kamel-Reid S, Murdoch B, Doedens M. Gene transfer into normal human hematopoietic cells using in vitro and in vivo assays. *Blood* 1991;78:624-634.
249. Dick JE. Immune-deficient mice as models of normal and leukemic human hematopoiesis. *Cancer Cells* 1991;3:39-48.
250. Nolta JA, Dao MA, Wells S, et al. Transduction of pluripotent human hematopoietic stem cells

demonstrated by clonal analysis after engraftment in immune-deficient mice. *Proc Natl Acad Sci U S A* 1996;93:2414-2419.

251. Nolta JA, Smogorzewska EM, Kohn DB. Analysis of optimal conditions for retroviral-mediated transduction of primitive human hematopoietic cells. *Blood* 1995;86:101-110.

252. Schiedmeier B, Kuhlcke K, Eckert HG, et al. Quantitative assessment of retroviral transfer of the human multidrug resistance 1 gene to human mobilized peripheral blood progenitor cells engrafted in nonobese diabetic/severe combined immunodeficient mice. *Blood* 2000;95:1237-1248.

253. Larochelle A, Vormoor J, Lapidot T, et al. Engraftment of immune-deficient mice with primitive hematopoietic cells from beta-thalassemia and sickle cell anemia patients: implications for evaluating human gene therapy protocols. *Hum Mol Genet* 1995;4:163-172.

253a. Roesler J, Brenner S, Bukovsky AA, et al. Third generation, self-inactivating, gp91(phox) lentivector corrects the oxidase defect in NOD/SCID mouse-repopulating peripheral blood-mobilized CD34+ cells from patients with X-linked chronic granulomatous disease. *Blood* 2002;100:4381-4390.

254. Woods NB, Muessig A, Schmidt M, et al. Lentiviral vector transduction of NOD/SCID repopulating cells results in multiple vector integrations per transduced cell: risk of insertional mutagenesis. *Blood* 2003;101:1284-1289.

255. Cai Q, Rubin JT, Lotze MT. Genetically marking human cells—results of the first clinical gene transfer studies. *Cancer Gene Ther* 1995;2:125-136.

256. Brenner MK. The contribution of marker gene studies to hemopoietic stem cell therapies. *Stem Cells* 1995;13:453-461.

257. Brenner M. Gene marking. *Hum Gene Ther* 1996;7:1927-1936.

258. Dunbar CE, Young NS. Gene marking and gene therapy directed at primary hematopoietic cells. *Curr Opin Hematol* 1996;3:430-437.

259. Brenner MK, Rill DR, Moen RC, et al. Gene-marking to trace origin of relapse after autologous bone-marrow transplantation. *Lancet* 1993;341:85-86.

260. Rill DR, Santana VM, Roberts WM, et al. Direct demonstration that autologous bone marrow transplantation for solid tumors can return a multiplicity of tumorigenic cells. *Blood* 1994;84:380-383.

261. Brenner M, Krance R, Heslop HE, et al. Assessment of the efficacy of purging by using gene marked autologous marrow transplantation for children with AML in first complete remission. *Hum Gene Ther* 1994;5:481-499.

262. Cornetta K, Srour EF, Moore A, et al. Retroviral gene transfer in autologous bone marrow transplantation for adult acute leukemia. *Hum Gene Ther* 1996;7:1323-1329.

263. Deisseroth AB, Zu Z, Claxton D, et al. Genetic marking shows that ph+ cells present in autologous transplants of chronic myelogenous leukemia (CML) contribute to relapse after autologous bone marrow in CML. *Blood* 1994;83:3068-3076.

264. Vescio RA, Hong CH, Cao J, et al. The hematopoietic stem cell antigen, CD34, is not expressed on the malignant cells in multiple myeloma. *Blood* 1994;84:3283-3290.

265. Dunbar CE, Nienhuis AW, Stewart FM, et al. Amendment to clinical research projects. Genetic marking with retroviral vectors to study the feasibility of stem cell gene transfer and the biology of hematopoietic reconstitution after autologous transplantation in multiple myeloma, chronic myelogenous leukemia, or metastatic breast cancer. *Hum Gene Ther* 1993;4:205-222.

266. Emmons RV, Doren S, Zujewski J, et al. Retroviral gene transduction of adult peripheral blood or marrow-derived CD34+ cells for six hours without growth factors or on autologous stroma does not improve marking efficiency assessed in vivo. *Blood* 1997;89:4040-4046.

267. Blaese RM. Development of gene therapy for immunodeficiency: adenosine deaminase deficiency.

Pediatr Res 1993;33:S49–S53; discussion S53–S55.

268. Lu L, Shen RN, Broxmeyer HE. Stem cells from bone marrow, umbilical cord blood and peripheral blood for clinical application: current status and future application. *Crit Rev Oncol Hematol* 1996;22:61–78.

269. Gluckman E. Umbilical cord blood biology and transplantation. *Curr Opin Hematol* 1995;2:413–416.

270. Lu L, Xiao M, Shen RN, et al. Enrichment, characterization, and responsiveness of single primitive CD34 human umbilical cord blood hematopoietic progenitors with high proliferative and replating potential. *Blood* 1993;81:41–48.

271. Kohn DB, Weinberg KI, Nolta JA, et al. Engraftment of gene-modified umbilical cord blood cells in neonates with adenosine deaminase deficiency. *Nat Med* 1995;1:1017–1023.

272. Schmidt M, Carbonaro DA, Speckmann C, et al. Clonality analysis after retroviral-mediated gene transfer to CD34(+) cells from the cord blood of ADA-deficient SCID neonates. *Nat Med* 2003;9:463–468.

273. Bordignon C, Notarangelo LD, Nobili N, et al. Gene therapy in peripheral blood lymphocytes and bone marrow for ADA-immunodeficient patients. *Science* 1995;270:470–475.

274. Muul LM, Tuschong LM, Soenen SL, et al. Persistence and expression of the adenosine deaminase gene for 12 years and immune reaction to gene transfer components: long-term results of the first clinical gene therapy trial. *Blood* 2003;101:2563–2569.

275. Strathdee CA, Gavish H, Shannon WR, Buchwald M. Cloning of cDNAs for Fanconi's anaemia by functional complementation. *Nature* 1992;356:763–767.

276. Walsh CE, Nienhuis AW, Samulski RJ, et al. Phenotypic correction of Fanconi anemia in human hematopoietic cells with a recombinant adeno-associated virus vector. *J Clin Invest* 1994;94:1440–1448.

277. Walsh CE, Grompe M, Vanin E, et al. A functionally active retrovirus vector for gene therapy in Fanconi anemia group c. *Blood* 1994;84:453–459.

278. Croop JM, Cooper R, Fernandez C, et al. Mobilization and collection of peripheral blood CD34+ cells from patients with Fanconi anemia. *Blood* 2001;98:2917–2921.

279. Dzierzak EA, Papayannopoulou T, Mulligan RC. Lineage-specific expression of a human beta-globin gene in murine bone marrow transplant recipients reconstituted with retrovirus-transduced stem cells. *Nature* 1988;331:35–41.

280. Bender MA, Gelinis RE, Miller AD. A majority of mice show long-term expression of a human beta-globin gene after retrovirus transfer into hematopoietic stem cells. *Mol Cell Biol* 1989;9:1426–1434.

281. Trudel M, Costantini F. A 3' enhancer contributes to the stage-specific expression of the human beta-globin gene. *Genes Dev* 1987;1:954–961.

282. Behringer RR, Hammer RE, Brinster RL, et al. Two 3' sequences direct adult erythroid-specific expression of human beta-globin genes in transgenic mice. *Proc Natl Acad Sci U S A* 1987;84:7056–7060.

283. Kollias G, Hurst J, deBoer E, Grosfeld F. The human beta-globin gene contains a downstream developmental specific enhancer. *Nucleic Acids Res* 1987;15:5739–5747.

284. Miller AD, Bender MA, Harris EA, et al. Design of retrovirus vectors for transfer and expression of the human beta-globin gene. *J Virol* 1988;62:4337–4345.

285. Karlsson S, Bodine DM, Perry L, et al. Expression of the human beta-globin gene following retroviral-mediated transfer into multipotential hematopoietic progenitors of mice. *Proc Natl Acad Sci U S A* 1988;85:6062–6066.

286. Tuan D, Solomon W, Li Q, London IM. The "beta-like-globin" gene domain in human erythroid cells. *Proc Natl Acad Sci U S A* 1985;82:6384–6388.

287. Forrester WC, Takegawa S, Papayannopoulou T, et al. Evidence for a locus activation region: the

formation of developmentally stable hypersensitive sites in globin-expressing hybrids. *Nucleic Acids Res* 1987;15:10159-10177.

288. Grosveld F, van Assendelft GB, Greaves DR, Kollias G. Position-independent, high-level expression of the human beta-globin gene in transgenic mice. *Cell* 1987;51:975-985.
289. Blom van Assendelft G, Hanscombe O, Grosveld F, Greaves DR. The beta-globin dominant control region activates homologous and heterologous promoters in a tissue-specific manner. *Cell* 1989;56:969-977.
290. Ryan TM, Behringer RR, Townes TM, et al. High-level erythroid expression of human alpha-globin genes in transgenic mice. *Proc Natl Acad Sci U S A* 1989;86:37-41.
291. Curtin PT, Liu DP, Liu W, et al. Human beta-globin gene expression in transgenic mice is enhanced by a distant DNase I hypersensitive site. *Proc Natl Acad Sci U S A* 1989;86:7082-7086.
292. Talbot D, Philipsen S, Fraser P, Grosveld F. Detailed analysis of the site 3 region of the human beta-globin dominant control region. *EMBO J* 1990;9:2169-2177.
293. Caterina JJ, Ryan TM, Pawlik KM, et al. Human beta-globin locus control region: analysis of the 5' DNase I hypersensitive site HS 2 in transgenic mice. *Proc Natl Acad Sci U S A* 1991;88:1626-1630.
294. Liu D, Chang JC, Moi P, et al. Dissection of the enhancer activity of beta-globin 5' DNase I-hypersensitive site 2 in transgenic mice. *Proc Natl Acad Sci U S A* 1992;89:3899-3903.
295. Caterina JJ, Ciavatta DJ, Donze D, et al. Multiple elements in human beta-globin locus control region 5' HS 2 are involved in enhancer activity and position-independent, transgene expression. *Nucleic Acids Res* 1994;22:1006-1011.
296. Collis P, Antoniou M, Grosveld F. Definition of the minimal requirements within the human beta-globin gene and the dominant control region for high level expression. *EMBO J* 1990;9:233-240.
297. Ney PA, Sorrentino BP, McDonagh KT, Nienhuis AW. Tandem AP-1-binding sites within the human beta-globin dominant control region function as an inducible enhancer in erythroid cells. *Genes Dev* 1990;4:993-1006.
298. Talbot D, Grosveld F. The 5' HS2 of the globin locus control region enhances transcription through the interaction of a multimeric complex binding at two functionally distinct nf-e2 binding sites. *EMBO J* 1991;10:1391-1398.
299. Philipsen S, Talbot D, Fraser P, Grosveld F. The beta-globin dominant control region: hypersensitive site 2. *EMBO J* 1990;9:2159-2167.
300. Philipsen S, Pruzina S, Grosveld F. The minimal requirements for activity in transgenic mice of hypersensitive site 3 of the beta globin locus control region. *EMBO J* 1993;12:1077-1085.
301. Pruzina S, Hanscombe O, Whyatt D, et al. Hypersensitive site 4 of the human beta globin locus control region. *Nucleic Acids Res* 1991;19:1413-1419.
302. Sabatino DE, Wong C, Cline AP, et al. A minimal ankyrin promoter linked to a human gamma-globin gene demonstrates erythroid specific copy number dependent expression with minimal position or enhancer dependence in transgenic mice. *J Biol Chem* 2000;275:28549-28554.
303. Sabatino DE, Seidel NE, Aviles-Mendoza GJ, et al. Long-term expression of gamma-globin mRNA in mouse erythrocytes from retrovirus vectors containing the human gamma-globin gene fused to the ankyrin-1 promoter. *Proc Natl Acad Sci U S A* 2000;97:13294-13299.
304. Grande A, Piovani B, Aiuti A, et al. Transcriptional targeting of retroviral vectors to the erythroblastic progeny of transduced hematopoietic stem cells. *Blood* 1999;93:3276-3285.
305. Persons DA, Nienhuis AW. Gene therapy for the hemoglobin disorders: past, present, and future. *Proc Natl Acad Sci U S A* 2000;97:5022-5024.
306. Kalberer CP, Pawliuk R, Imren S, et al. Preselection of retrovirally transduced bone marrow avoids subsequent stem cell gene silencing and age-dependent extinction of expression of human beta-globin in

engrafted mice. *Proc Natl Acad Sci U S A* 2000;97:5411–5415.

307. Tang H, Kuhen KL, Wong–Staal F. Lentivirus replication and regulation. *Annu Rev Genet* 1999;33:133–170.

308. Sadelain M, Riviere I. The advent of lentiviral vectors: prospects for cancer therapy. In: Lattime E, Gerson S, eds. *Gene therapy of cancer*, 2nd ed. Academic Press, 2001 ( *in press*).

309. Zufferey R, Nagy D, Mandel RJ, et al. Multiply attenuated lentiviral vector achieves efficient gene delivery in vivo. *Nat Biotechnol* 1997;15:871–875.

310. Rivella S, May C, Chadburn A, et al. A novel murine model of Cooley’s anemia and its rescue by lentiviral mediated human  $\beta$ -globin gene transfer. *Blood* 2002;99:1902–1908.

311. Pawliuk R, Westerman KA, Fabry ME, et al. Correction of sickle cell disease in transgenic mouse models by gene therapy. *Science* 2001;294:2368–2371.

312. Riddell SR, Greenberg PD. Principles for adoptive T cell therapy of human viral diseases. *Annu Rev Immunol* 1995;13:545–586.

313. Culver K, Cornetta K, Morgan R, et al. Lymphocytes as cellular vehicles for gene therapy in mouse and man. *Proc Natl Acad Sci U S A* 1991;88:3155–3159.

314. Olah Z, Lehel C, Anderson WB, et al. The cellular receptor for gibbon ape leukemia virus is a novel high affinity sodium-dependent phosphate transporter. *J Biol Chem* 1994;269:25426–25431.

315. Lam JS, Reeves ME, Cowherd R, et al. Improved gene transfer into human lymphocytes using retroviruses with the gibbon ape leukemia virus envelope. *Hum Gene Ther* 1996;7:1415–1422.

316. Bunnell BA, Muul LM, Donahue RE, et al. High-efficiency retroviral-mediated gene transfer into human and nonhuman primate peripheral blood lymphocytes. *Proc Natl Acad Sci U S A* 1995;92:7739–7743.

317. Bunnell BA, Metzger M, Byrne E, et al. Efficient in vivo marking of primary CD4+ T lymphocytes in nonhuman primates using a gibbon ape leukemia virus-derived retroviral vector. *Blood* 1997;89:1987–1995.

318. Rooney CM, Smith CA, Ng CY, et al. Use of gene-modified virus-specific T lymphocytes to control Epstein-Barr-virus-related lymphoproliferation. *Lancet* 1995;345:9–13.

319. Heslop HE, Ng CY, Li C, et al. Long-term restoration of immunity against Epstein-Barr virus infection by adoptive transfer of gene-modified virus-specific T lymphocytes. *Nat Med* 1996;2:551–555.

320. Bordignon C, Bonini C, Verzeletti S, et al. Transfer of the HSV-tk gene into donor peripheral blood lymphocytes for in vivo modulation of donor anti-tumor immunity after allogeneic bone marrow transplantation. *Hum Gene Ther* 1995;6:813–819.

321. Mullen CA. Metabolic suicide genes in gene therapy. *Pharmacol Ther* 1994;63:199–207.

322. Tiberghien P, Reynolds CW, Keller J, et al. Ganciclovir treatment of herpes simplex thymidine kinase-transduced primary T lymphocytes: an approach for specific in vivo donor T-cell depletion after bone marrow transplantation? *Blood* 1994;84:1333–1341.

323. Mavilio F, Ferrari G, Rossini S, et al. Peripheral blood lymphocytes as target cells of retroviral vector-mediated gene transfer. *Blood* 1994;83:1988–1997.

324. Gallot G, Hallet MM, Gaschet J, et al. Human HLA-specific T-cell clones with stable expression of a suicide gene: a possible tool to drive and control a graft-versus-host- graft-versus-leukemia reaction? *Blood* 1996;88:1098–1103.

325. Fehse B, Kustikova OS, Li Z, et al. A novel ‘sort-suicide’ fusion gene vector for T cell manipulation. *Gene Ther* 2002;9:1633–1638.

326. Riddell SR, Elliott M, Lewinsohn DA, et al. T-cell mediated rejection of gene-modified HIV-specific

cytotoxic T lymphocytes in HIV-infected patients. *Nat Med* 1996;2:216–223.

327. Anderson WF. September 14, 1990: the beginning. *Hum Gene Ther* 1990;1:371–372.

328. Gilboa E, Smith C. Gene therapy for infectious diseases: the AIDS model. *Trends Genet* 1994;10:139–144.

329. Blaese RM. Steps toward gene therapy: 2. Cancer and AIDS. *Hosp Pract (Off Ed)* 1995;30:37–45.

330. Luciw P. Human immunodeficiency viruses and their replication. In: Fields BN, Knipe DM, Howley PM, et al. *Fields virology*. Philadelphia: Lippincott–Raven Publishers, 1996:1881–1952.

331. Baltimore D. Gene therapy: intracellular immunization. *Nature* 1988;335:396–398.

332. Davis BR, Schwartz DH, Marx JC, et al. Absent or rare human immunodeficiency virus infection of bone marrow stem/progenitor cells in vivo. *J Virol* 1991;65:1985–1990.

333. von Laer D, Hufert FT, Fenner TE, et al. CD34+ hematopoietic progenitor cells are not a major reservoir of the human immunodeficiency virus. *Blood* 1990;76:1281–1286.

334. Folks TM. Human immunodeficiency virus in bone marrow: still more questions than answers. *Blood* 1991;77:1625–1626.

335. Koenig S. A lesson from the HIV patient: the immune response is still the bane (or promise) of gene therapy. *Nat Med* 1996;2:165–167.

336. Walker R, Blaese RM, Carter CS, et al. A study of the safety and survival of the adoptive transfer of genetically marked syngeneic lymphocytes in HIV-infected identical twins. *Hum Gene Ther* 1993;4:659–680.

337. Walker RE. A phase I/II pilot study of the safety of the adoptive transfer of syngeneic gene-modified cytotoxic T lymphocytes in HIV-infected identical twins. *Hum Gene Ther* 1996;7:367–400.

338. Walker RE, Bechtel CM, Natarajan V, et al. Long-term in vivo survival of receptor-modified syngeneic T cells in patients with human immunodeficiency virus infection. *Blood* 2000;96:467–474.

339. Feinberg MB, Trono D. Intracellular immunization: trans-dominant mutants of HIV gene products as tools for the study and interruption of viral replication. *AIDS Res Hum Retroviruses* 1992;8:1013–1022.

340. Mautino MR, Keiser N, Morgan RA. Inhibition of human immunodeficiency virus type 1 (HIV-1) replication by HIV-1-based lentivirus vectors expressing transdominant rev. *J Virol* 2001;75:3590–3599.

341. Mautino MR, Morgan RA. Inhibition of HIV-1 replication by novel lentiviral vectors expressing transdominant rev and HIV-1 env antisense. *Gene Ther* 2002;9:421–431.

342. Wong-Staal F, Haseltine WA. Regulatory genes of human immunodeficiency viruses. *Mol Genet Med* 1992;2:189–219.

343. Pearson L, Garcia J, Wu F, et al. A transdominant tat mutant that inhibits tat-induced gene expression from the human immunodeficiency virus long terminal repeat. *Proc Natl Acad Sci U S A* 1990;87:5079–5083.

344. Rossi C, Balboni PG, Betti M, et al. Inhibition of HIV-1 replication by a tat transdominant negative mutant in human peripheral blood lymphocytes from healthy donors and HIV-1-infected patients. *Gene Ther* 1997;4:1261–1269.

345. Fraiser C, Abraham DA, van Oijen M, et al. Inhibition of tat-mediated transactivation and HIV replication with tat mutant and repressor domain fusion proteins. *Gene Ther* 1998;5:946–954.

346. Felber BK, Hadzopoulou-Cladaras M, Cladaras C, et al. Rev protein of human immunodeficiency virus type 1 affects the stability and transport of the viral mRNA. *Proc Natl Acad Sci U S A* 1989;86:1495–1499.

347. Malim MH, Bohnlein S, Hauber J, Cullen BR. Functional dissection of the HIV-1 rev



- trans-activator-derivation of a trans-dominant repressor of rev function. *Cell* 1989;58:205-214.
348. Woffendin C, Ranga U, Yang Z, et al. Expression of a protective gene prolongs survival of T cells in human immunodeficiency virus-infected patients. *Proc Natl Acad Sci U S A* 1996;93:2889-2894.
349. Fox BA, Woffendin C, Yang ZY, et al. Genetic modification of human peripheral blood lymphocytes with a transdominant negative form of rev: safety and toxicity. *Hum Gene Ther* 1995;6:997-1004.
350. Kang EM, de Witte M, Malech H, et al. Nonmyeloablative conditioning followed by transplantation of genetically modified HLA-matched peripheral blood progenitor cells for hematologic malignancies in patients with acquired immunodeficiency syndrome. *Blood* 2002;99:698-701.
351. Trono D, Feinberg MB, Baltimore D. HIV-1 gag mutants can dominantly interfere with the replication of the wild-type virus. *Cell* 1989;59:113-120.
352. Buchschacher GL Jr, Freed EO, Panganiban AT. Cells induced to express a human immunodeficiency virus type 1 envelope gene mutant inhibit the spread of wild-type virus. *Hum Gene Ther* 1992;3:391-397.
353. Steffy KR, Wong-Staal F. Transdominant inhibition of wild-type human immunodeficiency virus type 2 replication by an envelope deletion mutant. *J Virol* 1993;67:1854-1859.
354. Winter G, Milstein C. Man-made antibodies. *Nature* 1991;349:293-299.
355. Marasco WA, Haseltine WA, Chen SY. Design, intracellular expression, and activity of a human anti-human immunodeficiency virus type 1 gp120 single-chain antibody. *Proc Natl Acad Sci U S A* 1993;90:7889-7893.
356. Duan L, Bagasra O, Laughlin MA, et al. Potent inhibition of human immunodeficiency virus type 1 replication by an intracellular anti-rev single-chain antibody. *Proc Natl Acad Sci U S A* 1994;91:5075-5079.
357. Maciejewski JP, Weichold FF, Young NS, et al. Intracellular expression of antibody fragments directed against HIV reverse transcriptase prevents HIV infection in vitro. *Nat Med* 1995;1:667-673.
358. Duan L, Zhu M, Bagasra O, Pomerantz RJ. Intracellular immunization against HIV-1 infection of human T lymphocytes: utility of anti-rev single-chain variable fragments. *Hum Gene Ther* 1995;6:1561-1573.
359. Levin R, Mhashilkar AM, Dorfman T, et al. Inhibition of early and late events of the HIV-1 replication cycle by cytoplasmic fab intrabodies against the matrix protein, p17. *Mol Med* 1997;3:96-110.
360. Poznansky MC, Foxall R, Mhashilkar A, et al. Inhibition of human immunodeficiency virus replication and growth advantage of CD4+ T cells from HIV-infected individuals that express intracellular antibodies against HIV-1 gp120 or tat. *Hum Gene Ther* 1998;9:487-496.
361. Bai J, Sui J, Zhu RY, et al. Inhibition of tat-mediated transactivation and HIV-1 replication by human anti-hcyc1int1 intrabodies. *J Biol Chem* 2003;278:1433-1442.
362. Rittner K, Sczakiel G. Identification and analysis of antisense RNA target regions of the human immunodeficiency virus type 1. *Nucleic Acids Res* 1991;19:1421-1426.
363. Green PJ, Pines O, Inouye M. The role of antisense RNA in gene regulation. *Annu Rev Biochem* 1986;55:569-597.
364. Stein CA, Cheng YC. Antisense oligonucleotides as therapeutic agents—is the bullet really magical? *Science* 1993;261:1004-1012.
365. Chatterjee S, Johnson PR, Wong KK Jr. Dual-target inhibition of HIV-1 in vitro by means of an adeno-associated virus antisense vector. *Science* 1992;258:1485-1488.
366. Sczakiel G, Pawlita M. Inhibition of human immunodeficiency virus type 1 replication in human T cells stably expressing antisense RNA. *J Virol* 1991;65:468-472.
367. Joshi S, Van Brunschot A, Asad S, et al. Inhibition of human immunodeficiency virus type 1

- multiplication by antisense and sense RNA expression. *J Virol* 1991;65:5524–5530.
368. Rossi JJ, Elkins D, Zaia JA, Sullivan S. Ribozymes as anti-HIV-1 therapeutic agents: principles, applications, and problems. *AIDS Res Hum Retroviruses* 1992;8:183–189.
369. Dropulic B, Elkins DA, Rossi JJ, Sarver N. Ribozymes: use as anti-HIV therapeutic molecules. *Antisense Res Dev* 1993;3:87–94.
370. Pyle AM. Ribozymes: a distinct class of metalloenzymes. *Science* 1993;261: 709–714.
371. Sarver N, Cantin EM, Chang PS, et al. Ribozymes as potential anti-HIV-1 therapeutic agents. *Science* 1990;247:1222–1225.
372. Feng Y, Leavitt M, Tritz R, et al. Inhibition of CCR5-dependent HIV-1 infection by hairpin ribozyme gene therapy against cc-chemokine receptor 5. *Virology* 2000;276:271–278.
373. Ojwang JO, Hampel A, Looney DJ, et al. Inhibition of human immunodeficiency virus type 1 expression by a hairpin ribozyme. *Proc Natl Acad Sci U S A* 1992;89:10802–10806.
374. Klebba C, Ottmann OG, Scherr M, et al. Retrovirally expressed anti-HIV ribozymes confer a selective survival advantage on CD4+ T cells in vitro. *Gene Ther* 2000;7:408–416.
375. Bai J, Gorantla S, Banda N, et al. Characterization of anti-CCR5 ribozyme-transduced CD34+ hematopoietic progenitor cells in vitro and in a SCID-hu mouse model in vivo. *Mol Ther* 2000;1:244–254.
376. Sullenger BA, Gallardo HF, Ungers GE, Gilboa E. Analysis of trans-acting response decoy RNA-mediated inhibition of human immunodeficiency virus type 1 transactivation. *J Virol* 1991;65:6811–6816.
377. Sullenger BA, Gallardo HF, Ungers GE, Gilboa E. Overexpression of tar sequences renders cells resistant to human immunodeficiency virus replication. *Cell* 1990;63:601–608.
378. Lee TC, Sullenger BA, Gallardo HF, et al. Overexpression of RRE-derived sequences inhibits HIV-1 replication in cem cells. *New Biol* 1992;4:66–74.
379. Gervaix A, Li X, Kraus G, Wong-Staal F. Multigene antiviral vectors inhibit diverse human immunodeficiency virus type 1 clades. *J Virol* 1997;71:3048–3053.
380. Caputo A, Rossi C, Bozzini R, et al. Studies on the effect of the combined expression of anti-tat and anti-rev genes on HIV-1 replication. *Gene Ther* 1997;4:288–295.
381. Inouye RT, Du B, Boldt-Houle D, et al. Potent inhibition of human immunodeficiency virus type 1 in primary T cells and alveolar macrophages by a combination anti-rev strategy delivered in an adeno-associated virus vector. *J Virol* 1997;71:4071–4078.
382. Kohn DB, Bauer G, Rice CR, et al. A clinical trial of retroviral-mediated transfer of a rev-responsive element decoy gene into CD34(+) cells from the bone marrow of human immunodeficiency virus-1-infected children. *Blood* 1999;94:368–371.
383. Dropulic B, Hermankova M, Pitha PM. A conditionally replicating HIV-1 vector interferes with wild-type HIV-1 replication and spread. *Proc Natl Acad Sci U S A* 1996;93:11103–11108.
384. Caruso M. Gene therapy against cancer and HIV infection using the gene encoding herpes simplex virus thymidine kinase. *Mol Med Today* 1996;2:212–217.
385. Brady HJ, Miles CG, Pennington DJ, Dzierzak EA. Specific ablation of human immunodeficiency virus tat-expressing cells by conditionally toxic retroviruses. *Proc Natl Acad Sci U S A* 1994;91:365–369.
386. Caruso M, Klatzmann D. Selective killing of CD4+ cells harboring a human immunodeficiency virus-inducible suicide gene prevents viral spread in an infected cell population. *Proc Natl Acad Sci U S A* 1992;89:182–186.
387. Harrison GS, Maxwell F, Long CJ, et al. Activation of a diphtheria toxin gene by expression of

- human immunodeficiency virus-1 tat and rev proteins in transfected cells. *Hum Gene Ther* 1991;2:53-60.
388. Hamouda T, McPhee R, Hsia SC, et al. Inhibition of human immunodeficiency virus replication by the herpes simplex virus virion host shutoff protein. *J Virol* 1997;71:5521-5527.
389. Wang B, Ugen KE, Srikantan V, et al. Gene inoculation generates immune responses against human immunodeficiency virus type 1. *Proc Natl Acad Sci U S A* 1993;90:4156-4160.
390. Warner JF, Anderson CG, Laube L, et al. Induction of HIV-specific cTl and antibody responses in mice using retroviral vector-transduced cells. *AIDS Res Hum Retroviruses* 1991;7:645-655.
391. Haubrich R, McCutchan JA, Holdredge R, et al. An open label, phase I/II clinical trial to evaluate the safety and biological activity of HIV-it (v) (HIV-1iibenv/rev retroviral vector) in HIV-1-infected subjects. *Hum Gene Ther* 1995;6:941-955.
392. Roberts MR, Qin L, Zhang D, et al. Targeting of human immunodeficiency virus-infected cells by CD8+ T lymphocytes armed with universal T-cell receptors. *Blood* 1994;84:2878-2889.
393. Romp KG, Monroe DM, Hoffman M. Platelets contain releasable coagulation factor IX antigen. *Blood Coagul Fibrinolysis* 1993;4:905-910.
394. Kemball-Cook G, Barrowcliffe TW. Interaction of factor VIII with phospholipids: role of composition and negative charge. *Thromb Haemost* 1992;67:57-71.
395. Giannelli F, Green PM, Sommer SS, et al. Haemophilia B: database of point mutations and short additions and deletions, 7th ed. *Nucleic Acids Res* 1997;25:133-135.
396. Wood WI, Capon DJ, Simonsen CC, et al. Expression of active human factor VIII from recombinant DNA clones. *Nature* 1984;312:330-337.
397. Choo KH, Gould KG, Rees DJ, Brownlee GG. Molecular cloning of the gene for human anti-haemophilic factor IX. *Nature* 1982;299:178-180.
398. Lensen R, Bertina RM, Vandenbroucke JP, Rosendaal FR. High factor VIII levels contribute to the thrombotic risk in families with factor V Leiden. *Br J Haematol* 2001;114:380-386.
399. van H V, van dL I, Bertina RM, Rosendaal FR. High levels of factor IX increase the risk of venous thrombosis. *Blood* 2000;95:3678-3682.
400. Bi L, Lawler AM, Antonarakis SE, et al. Targeted disruption of the mouse factor VIII gene produces a model of haemophilia A. *Nat Genet* 1995;10:119-121.
401. Wang L, Zoppe M, Hackeng TM, et al. A factor IX-deficient mouse model for hemophilia B gene therapy. *Proc Natl Acad Sci U S A* 1997;94:11563-11566.
402. Lin H-F, Maeda N, Smithies O, et al. A coagulation factor IX-deficient mouse model for human hemophilia B. *Blood* 1997;90:3962-3966.
403. Kundu RK, Sangiorgi F, Wu LY, et al. Targeted inactivation of the coagulation factor IX gene causes hemophilia B in mice. *Blood* 1998;92:168-174.
404. Lozier JN, Dutra A, Pak E, et al. The Chapel Hill hemophilia A dog colony exhibits an inversion of the factor VIII gene. *Proc Natl Acad Sci* 2002;99: 12991-12996.
405. Graham JB, Buckwalter JA, Hartley LJ, Brinkhous KM. Canine hemophilia: observations on the course, the clotting anomaly, and the effects of blood transfusion. 1949;90:97-111.
406. Brinkhous KM, Graham JB. Hemophilia in the female dog. *Science* 1950;111:723.
407. Giles AR, Tinlin S, Greenwood R. A canine model of hemophilic (factor VIII:C deficiency) bleeding. *Blood* 1982;60:727-730.
408. Hough C, Kamisue S, Cameron C, et al. Aberrant splicing and premature termination of transcription

of the FVIII gene as a cause of severe canine hemophilia A: similarities with the intron 22 inversion mutation in human hemophilia. *Thromb Haemost* 2002;87:659–665.

409. Andrews JL, Shirley PS, Iverson WO, et al. Evaluation of the duration of human factor VIII expression in nonhuman primates after systemic delivery of an adenoviral vector. *Hum Gene Ther* 2002;13:1331–1336.

410. Lozier JN, Metzger ME, Donahue RE, Morgan RA. Adenovirus-mediated expression of human coagulation factor IX in the rhesus macaque is associated with dose-limiting toxicity. *Blood* 1999;94:3968–3975.

411. Lozier JN, Metzger ME, Donahue RE, Morgan RA. The rhesus macaque as an animal model for hemophilia B gene therapy. *Blood* 1999;93:1875–1881.

412. Lozier JN, Csako G, Mondoro TH, et al. Toxicity of a first-generation adenoviral vector in rhesus macaques. *Hum Gene Ther* 2002;13:113–124.

413. Nathwani AC, Davidoff AM, Hanawa H, et al. Sustained high-level expression of human factor IX (HFIX) after liver-targeted delivery of recombinant adeno-associated virus encoding the hfix gene in rhesus macaques. *Blood* 2002;100:1662–1669.

414. Palmer TD, Thompson AR, Miller AD. Production of human factor IX in animals by genetically modified skin fibroblasts: potential therapy for hemophilia B. *Blood* 1989;73:438–445.

415. Axelrod JH, Read MS, Brinkhous KM, Verma IM. Phenotypic correction of factor IX deficiency in skin fibroblasts of hemophilic dogs. *Proc Natl Acad Sci U S A* 1990;87:5173–5177.

416. Hoeben RC, Einerhand MP, Briet E, et al. Toward gene therapy in haemophilia A: retrovirus-mediated transfer of a factor VIII gene into murine haematopoietic progenitor cells. *Thromb Haemost* 1992;67:341–345.

417. Gerrard AJ, Hudson DL, Brownlee GG, Watt FM. Towards gene therapy for haemophilia B using primary human keratinocytes. *Nat Genet* 1993;3:180–183.

418. Gerrard AJ, Austen DEG, Brownlee GG. Recombinant factor IX secreted by transduced human keratinocytes is biologically active. *Br J Haematol* 1996;95.

419. White SJ, Page SM, Margaritis P, Brownlee GG. Long-term expression of human clotting factor IX from retrovirally transduced primary human keratinocytes in vivo. *Hum Gene Ther* 1998;9:1187–1195.

420. Palmer TD, Rosman GJ, Osborne WRA, Miller AD. Genetically modified skin fibroblasts persist long after transplantation but gradually inactivate introduced genes. *Proc Natl Acad Sci U S A* 1991;88:1330–1334.

421. Roth DA, Tawa NE Jr, O'Brien JM, et al. Nonviral transfer of the gene encoding coagulation factor VIII in patients with severe hemophilia A. *N Engl J Med* 2001;344:1735–1742.

422. Brauker J, Frost GH, Dwarki V, et al. Sustained expression of high levels of human factor IX from human cells implanted within an immunoisolation device into athymic rodents. *Hum Gene Ther* 1998;9:879–888.

423. Yao SN, Kurachi K. Expression of human factor IX in mice after injection of genetically modified myoblasts. *Proc Natl Acad Sci U S A* 1992;89:3357–3361.

424. Yao SN, Smith KJ, Kurachi K. Primary myoblast-mediated gene transfer: persistent expression of human factor IX in mice. *Gene Ther* 1994;1:99–107.

425. Wang JM, Zheng H, Blaivas M, Kurachi K. Persistent systemic production of human factor IX in mice by skeletal myoblast-mediated gene transfer: feasibility of repeat application to obtain therapeutic levels. *Blood* 1997;90:1075–1082.

426. Hortelano G, Xu N, Vandenberg A, et al. Persistent delivery of factor IX in mice: gene therapy for hemophilia using implantable microcapsules. *Hum Gene Ther* 1999;10:1281–1288.

427. Van Raamsdonk JM, Ross CJ, Potter MA, et al. Treatment of hemophilia B in mice with

nonautologous somatic gene therapeutics. 2002;139:35–42.

428. Hortelano G, Wang L, Xu N, Oforu FA. Sustained and therapeutic delivery of factor IX in nude haemophilia B mice by encapsulated c2c12 myoblasts: concurrent tumourigenesis. *Haemophilia* 2001;7:207–214.

429. Chao H, Samulski RJ, Bellinger D, et al. Persistent expression of canine factor IX in hemophilia B canines. *Gene Ther* 1999;6:1695–1704.

430. Herzog RW, Yang EY, Couto LB, et al. Long-term correction of canine hemophilia B by gene transfer of blood coagulation factor IX mediated by adeno-associated viral vector. *Nat Med* 1999;5:56–63.

431. Monahan PE, Samulski RJ, Tazelaar J, et al. Direct intramuscular injection with recombinant AAV vectors results in sustained expression in a dog model of hemophilia. *Gene Ther* 1998;5:40–49.

432. Hagstrom JN, Couto LB, Scallan C, et al. Improved muscle-derived expression of human coagulation factor IX from a skeletal actin/CMV hybrid enhancer/promoter. *Blood* 2000;95:2536–2542.

433. Fields PA, Arruda VR, Armstrong E, et al. Risk and prevention of anti-factor IX formation in AAV-mediated gene transfer in the context of a large deletion of f9. 2001;4:201–210.

434. Herzog RW, Mount JD, Arruda VR, et al. Muscle-directed gene transfer and transient immune suppression result in sustained partial correction of canine hemophilia B caused by a null mutation. 2001;4:192–200.

435. Chao H, Monahan PE, Liu Y, et al. Sustained and complete phenotype correction of hemophilia B mice following intramuscular injection of AAV1 serotype vectors. 2001;4:217–222.

436. Chao H, Liu Y, Rabinowitz J, et al. Several log increase in therapeutic transgene delivery by distinct adeno-associated viral serotype vectors. 2000;2:619–623.

437. Herzog RW, Hagstrom JN, Kung SH, et al. Stable gene transfer and expression of human blood coagulation factor IX after intramuscular injection of recombinant adeno-associated virus. *Proc Natl Acad Sci U S A* 1997;94:5804–5809.

438. Plantier JL, Rodriguez MH, Enjolras N, et al. A factor VIII minigene comprising the truncated intron 1 of factor IX highly improves the in vitro production of factor VIII. *Thromb Haemost* 2001;86:596–603.

439. Manno CS, Chew AJ, Hutchison S, et al. AAV-mediated factor IX gene transfer to skeletal muscle in patients with severe hemophilia B. *Blood* 2002 (*in process citation*).

440. Fewell JG, MacLaughlin F, Mehta V, et al. Gene therapy for the treatment of hemophilia B using pinc-formulated plasmid delivered to muscle with electroporation. 2001;3:574–583.

441. Connelly S, Smith TAG, Dhir G, et al. In vivo gene delivery and expression of physiological levels of functional human factor VIII in mice. *Hum Gene Ther* 1995;6:185–193.

442. Bristol JA, Shirley P, Idamakanti N, et al. In vivo dose threshold effect of adenovirus-mediated factor VIII gene therapy in hemophiliac mice. 2000;2:223–232.

443. Connelly S, Gardner JM, McClelland A, Kaleko M. High-level tissue-specific expression of functional human factor VIII in mice. *Hum Gene Ther* 1996;7:183–195.

444. Connelly S, Gardner JM, Lyons RM, et al. Sustained expression of therapeutic levels of human factor VIII in mice. *Blood* 1996;87:4671–4677.

445. Connelly S, Andrews JL, Gallo AM, et al. Sustained phenotypic correction of murine hemophilia A by in vivo gene therapy. *Blood* 1998;91:3273–3281.

446. Gorziglia MI, Lapcevich C, Roy S, et al. Generation of an adenovirus vector lacking e1, e2a, e3, and all of e4 except open reading frame 3. *J Virol* 1999;73:6048–6055.

447. Smith T, Idamakanti N, Kylefjord H, et al. In vivo hepatic adenoviral gene delivery occurs

independently of the coxsackievirus-adenovirus receptor. 2002;5:770-779.

448. Connelly S, Andrews JL, Gallo-Penn AM, et al. Evaluation of an adenoviral vector encoding full-length human factor VIII in hemophilic mice. *Thromb Haemost* 1999;81:234-239.

449. Balague C, Zhou J, Dai Y, et al. Sustained high-level expression of full-length human factor VIII and restoration of clotting activity in hemophilic mice using a minimal adenovirus vector. *Blood* 2000;95:820-828.

450. Smith TA, Mehaffey MG, Kayda DB, et al. Adenovirus mediated expression of therapeutic plasma levels of human factor IX in mice. *Nat Genet* 1993;5:397-402.

451. Kay MA, Holterman A-I, Meuse L, et al. Long-term hepatic adenovirus-mediated gene expression in mice following cta4ig administration. *Nat Genet* 1995;11:191-197.

452. Yao SN, Farjo A, Roessler BJ, et al. Adenovirus-mediated transfer of human factor IX gene in immunodeficient and normal mice: evidence for prolonged stability and activity of the transgene in liver. 1996;9:141-153.

453. Connelly S, Mount J, Mauser A, et al. Complete short-term correction of canine hemophilia A by in vivo gene therapy. *Blood* 1996;88:3846-3853.

454. Gallo-Penn AM, Shirley PS, Andrews JL, et al. Systemic delivery of an adenoviral vector encoding canine factor VIII results in short-term phenotypic correction, inhibitor development, and biphasic liver toxicity in hemophilia A dogs. *Blood* 2001;97:107-113.

455. Gallo-Penn AM, Shirley PS, Andrews JL, et al. In vivo evaluation of an adenoviral vector encoding canine factor VIII: high-level, sustained expression in hemophilic mice. *Hum Gene Ther* 1999;10:1791-1802.

456. Kay MA, Landen CN, Rothenberg SR, et al. In vivo hepatic gene therapy: complete albeit transient correction of factor IX deficiency in hemophilia B dogs. *Proc Natl Acad Sci U S A* 1994;91:2353-2357.

457. Fang B, Eisensmith RC, Wang H, et al. Gene therapy for hemophilia B: host immunosuppression prolongs the therapeutic effect of adenovirus-mediated factor IX expression. *Hum Gene Ther* 1995;6:1039-1044.

458. Schnell MA, Zhang Y, Tazelaar J, et al. Activation of innate immunity in nonhuman primates following intraportal administration of adenoviral vectors. 2001;3:708-722.

459. Bristol JA, Gallo-Penn A, Andrews J, et al. Adenovirus-mediated factor VIII gene expression results in attenuated anti-factor VIII-specific immunity in hemophilia A mice compared with factor VIII protein infusion. *Hum Gene Ther* 2001;12:1651-1661.

460. Andrews JL, Kadan MJ, Gorziglia MI, et al. Generation and characterization of e1/e2a/e3/e4-deficient adenoviral vectors encoding human factor VIII. 2001;3:329-336.

461. Reddy PS, Sakhuja K, Ganesh S, et al. Sustained human factor VIII expression in hemophilia A mice following systemic delivery of a gutless adenoviral vector. 2002;5:63-73.

462. Ehrhardt A, Kay MA. A new adenoviral helper-dependent vector results in long-term therapeutic levels of human coagulation factor IX at low doses in vivo. *Blood* 2002;99:3923-3930.

463. Nunes FA, Furth EE, Wilson JM, Raper SE. Gene transfer into the liver of nonhuman primates with e1-deleted recombinant adenoviral vectors: safety of readministration. *Hum Gene Ther* 1999;10:2515-2526.

464. Chao H, Mao L, Bruce AT, Walsh CE. Sustained expression of human factor VIII in mice using a parvovirus-based vector. *Blood* 2000;95:1594-1599.

465. Chao H, Walsh CE. Induction of tolerance to human factor VIII in mice. *Blood* 2001;97:3311-3312.

466. Chao H, Sun L, Bruce A, et al. Expression of human factor VIII by splicing between dimerized AAV vectors. 2002;5:716-722.

467. Snyder RO, Miao CH, Patijn GA, et al. Persistent and therapeutic concentrations of human factor IX

- in mice after hepatic gene transfer of recombinant AAV vectors. *Nat Genet* 1997;16:270–276.
468. Snyder RO, Miao C, Meuse L, et al. Correction of hemophilia B in canine and murine models using recombinant adeno-associated viral vectors. *Nat Med* 1999;5:64–70.
469. Ge Y, Powell S, Van Roey M, McArthur JG. Factors influencing the development of an anti-factor IX (FIX) immune response following administration of adeno-associated virus-fix. *Blood* 2001;97:3733–3737.
470. Miao CH, Snyder RO, Schowalter DB, et al. The kinetics of RAAV integration in the liver [Letter]. *1998;19:13–15*.
471. Nakai H, Herzog RW, Hagstrom JN, et al. Adeno-associated viral vector-mediated gene transfer of human blood coagulation factor IX into mouse liver. *Blood* 1998;91:4600–4607.
472. Nakai H, Thomas CE, Storm TA, et al. A limited number of transducible hepatocytes restricts a wide-range linear vector dose response in recombinant adeno-associated virus-mediated liver transduction. *J Virol* 2002;76:11343–11349.
473. Wang L, Takabe K, Bidlingmaier SM, et al. Sustained correction of bleeding disorder in hemophilia B mice by gene therapy. *1999;96:3906–3910*.
474. Nathwani AC, Davidoff A, Hanawa H, et al. Factors influencing in vivo transduction by recombinant adeno-associated viral vectors expressing the human factor IX cDNA. *Blood* 2001;97:1258–1265.
475. Koeberl DD, Alexander IE, Halbert CL, et al. Persistent expression of human clotting factor IX from mouse liver after intravenous injection of adeno-associated virus vectors. *Proc Natl Acad Sci U S A* 1997;94:1426–1431.
476. Mount JD, Herzog RW, Tillson DM, et al. Sustained phenotypic correction of hemophilia B dogs with a factor IX null mutation by liver-directed gene therapy. *Blood* 2002;99:2670–2676.
477. Wang L, Nichols TC, Read MS, et al. Sustained expression of therapeutic level of factor IX in hemophilia B dogs by AAV-mediated gene therapy in liver. *2000;1:154–158*.
478. Nathwani AC, Davidoff AM, Hanawa H, et al. Sustained high-level expression of human factor IX (HFIX) after liver-targeted delivery of recombinant adeno-associated virus encoding the hfix gene in rhesus macaques. *Blood* 2002;100:1662–1669.
479. Marshall E. Gene therapy. Panel reviews risks of germ line changes. *Science* 2001;294:2268–2269.
480. Vandendriessche T, Vanslembrouck V, Goovaerts I, et al. Long-term expression of human coagulation factor VIII and correction of hemophilia A after in vivo retroviral gene transfer in factor VIII-deficient mice. *1999;96:10379–10384*.
481. Park F, Ohashi K, Kay MA. Therapeutic levels of human factor VIII and IX using HIV-1-based lentiviral vectors in mouse liver. *Blood* 2000;96:1173–1176.
482. Stein CS, Kang Y, Sauter SL, et al. In vivo treatment of hemophilia A and mucopolysaccharidosis type vii using nonprimate lentiviral vectors. *2001;3:850–856*.
483. Evans GL, Morgan RA. Genetic induction of immune tolerance to human clotting factor VIII in a mouse model for hemophilia A. *1998;95:5734–5739*.
484. Chuah MK, Van Damme A, Zwinnen H, et al. Long-term persistence of human bone marrow stromal cells transduced with factor VIII-retroviral vectors and transient production of therapeutic levels of human factor VIII in nonmyeloablated immunodeficient mice. *Hum Gene Ther* 2000;11:729–738.
485. Hurwitz DR, Kirchgesser M, Merrill W, et al. Systemic delivery of human growth hormone or human factor IX in dogs by reintroduced genetically modified autologous bone marrow stromal cells. *Hum Gene Ther* 1997;8:137–156.
486. Tonn T, Herder C, Becker S, et al. Generation and characterization of human hematopoietic cell lines



expressing factor VIII. 2002;11:695–704.

487. Hao Q–L, Malik P, Salazar R, et al. Expression of biologically active human factor IX in human hematopoietic cells after retroviral vector–mediated gene transduction. *Hum Gene Ther* 1995;6:873–880.

488. Rodriguez MH, Enjolras N, Plantier JL, et al. Expression of coagulation factor IX in a haematopoietic cell line. *Thromb Haemost* 2002;87:366–373.

489. Xiao W, Chirmule N, Berta SC, et al. Gene therapy vectors based on adeno–associated virus type 1. *J Virol* 1999;73:3994–4003.

490. Burton M, Nakai H, Colosi P, et al. Coexpression of factor VIII heavy and light chain adeno–associated viral vectors produces biologically active protein. 1999;96:12725–12730.

491. Nakai H, Storm TA, Kay MA. Increasing the size of RAAV–mediated expression cassettes in vivo by intermolecular joining of two complementary vectors. 2000;18:527–532.

492. Olivares EC, Hollis RP, Chalberg TW, et al. Site–specific genomic integration produces therapeutic factor IX levels in mice. 2002;20:1124–1128.

493. Yant SR, Ehrhardt A, Mikkelsen JG, et al. Transposition from a gutless adeno–transposon vector stabilizes transgene expression in vivo. 2002;20:999–1005.

494. Gnatenko DV, Saenko EL, Jesty J, et al. Human factor VIII can be packaged and functionally expressed in an adeno–associated virus background: applicability to haemophilia A gene therapy. 1999;104:27–36.

495. Lozier JN, Yankaskas JR, Ramsey WJ, et al. Gut epithelial cells as targets for gene therapy of hemophilia. *Hum Gene Ther* 1997;8:1481–1490.

496. Mastrangelo MJ, Berd D, Nathan FE, Lattime EC. Gene therapy for human cancer: an essay for clinicians. *Semin Oncol* 1996;23:4–21.

497. Hussein AM. The potential applications of gene transfer in the treatment of patients with cancer: a concise review. *Cancer Invest* 1996;14:343–352.

498. Zhang WW. Antisense oncogene and tumor suppressor gene therapy of cancer. *J Mol Med* 1996;74:191–204.

499. Huber BE. Gene therapy strategies for treating neoplastic disease. *Ann N Y Acad Sci* 1994;716:6–11; discussion 20–22.

500. Dranoff G, Mulligan RC. Gene transfer as cancer therapy. *Adv Immunol* 1995;58:417–454.

501. McCormick F. Cancer gene therapy: fringe or cutting edge? *Nat Rev Cancer* 2001;1:130–141.

502. Sadelain M, Riviere I, Brentjens R. Targeting tumours with genetically enhanced T lymphocytes. *Nat Rev Cancer* 2003;3:35–45.

503. Oliff A, Gibbs JB, McCormick F. New molecular targets for cancer therapy. *Sci Am* 1996;275:144–149.

504. Ma DD, Doan TL. Antisense oligonucleotide therapies: are they the “magic bullets”? *Ann Intern Med* 1994;120:161–163.

505. Tseng BY, Brown KD. Antisense oligonucleotide technology in the development of cancer therapeutics. *Cancer Gene Ther* 1994;1:65–71.

506. Calabretta B, Skorski T, Ratajczak MZ, Gewirtz AM. Antisense strategies in the treatment of leukemias. *Semin Oncol* 1996;23:78–87.

507. Mercola D, Cohen JS. Antisense approaches to cancer gene therapy. *Cancer Gene Ther*

1995;2:47–59.

508. Szczylik C, Skorski T, Nicolaidis NC, et al. Selective inhibition of leukemia cell proliferation by bcr–abl antisense oligodeoxynucleotides. *Science* 1991;253:562–565.

509. O'Brien SG, Kirkland MA, Melo JV, et al. Antisense bcr–abl oligomers cause non–specific inhibition of chronic myeloid leukemia cell lines. *Leukemia* 1994;8:2156–2162.

510. Ratajczak MZ, Hijiya N, Catani L, et al. Acute– and chronic–phase chronic myelogenous leukemia colony–forming units are highly sensitive to the growth inhibitory effects of c–myb antisense oligodeoxynucleotides. *Blood* 1992;79:1956–1961.

511. Calabretta B, Sims RB, Valtieri M, et al. Normal and leukemic hematopoietic cells manifest differential sensitivity to inhibitory effects of c–myb antisense oligodeoxynucleotides: an in vitro study relevant to bone marrow purging. *Proc Natl Acad Sci U S A* 1991;88:2351–2355.

512. Gewirtz AM. Treatment of chronic myelogenous leukemia (CML) with c–myb antisense oligodeoxynucleotides. *Bone Marrow Transplant* 1994;14:S57–S61.

513. Luger SM, O'Brien SG, Ratajczak J, et al. Oligodeoxynucleotide–mediated inhibition of c–myb gene expression in autografted bone marrow: a pilot study. *Blood* 2002;99:1150–1158.

514. Bishop MR, Iversen PL, Bayever E, et al. Phase I trial of an antisense oligonucleotide ol(1)p53 in hematologic malignancies. *J Clin Oncol* 1996;14:1320–1326.

515. Bayever E, Iversen P. Oligonucleotides in the treatment of leukemia. *Hematol Oncol* 1994;12:9–14.

516. Mirabelli CK, Bennett CF, Anderson K, Crooke ST. In vitro and in vivo pharmacologic activities of antisense oligonucleotides. *Anticancer Drug Des* 1991;6:647–661.

517. Crooke RM. In vitro toxicology and pharmacokinetics of antisense oligonucleotides. *Anticancer Drug Des* 1991;6:609–646.

518. Vogelstein B, Kinzler KW. P53 function and dysfunction. *Cell* 1992;70:523–526.

519. Baker SJ, Fearon ER, Nigro JM, et al. Chromosome 17 deletions and p53 gene mutations in colorectal carcinomas. *Science* 1989;244:217–221.

520. Liu TJ, Zhang WW, Taylor DL, et al. Growth suppression of human head and neck cancer cells by the introduction of a wild–type p53 gene via a recombinant adenovirus. *Cancer Res* 1994;54:3662–3667.

521. Roth JA, Nguyen D, Lawrence DD, et al. Retrovirus–mediated wild–type p53 gene transfer to tumors of patients with lung cancer. *Nat Med* 1996;2:985–991.

522. Swisher SG, Roth JA. Clinical update of ad–p53 gene therapy for lung cancer. *Surg Oncol Clin North Am* 2002;11:521–535.

523. Swisher SG, Roth JA, Komaki R, et al. Induction of p53–regulated genes and tumor regression in lung cancer patients after intratumoral delivery of adenoviral p53 (ingn 201) and radiation therapy. *Clin Cancer Res* 2003;9:93–101.

524. Freeman SM, Whartenby KA, Freeman JL, et al. In situ use of suicide genes for cancer therapy. *Semin Oncol* 1996;23:31–45.

525. Dilber MS, Gahrton G. Suicide gene therapy: possible applications in haematopoietic disorders. *J Intern Med* 2001;249:359–367.

526. Yazawa K, Fisher WE, Brunicardi FC. Current progress in suicide gene therapy for cancer. *World J Surg* 2002;26:783–789.

527. Culver KW, Ram Z, Wallbridge S, et al. In vivo gene transfer with retroviral vector–producer cells for treatment of experimental brain tumors. *Science* 1992;256:1550–1552.

528. Bi WL, Parysek LM, Warnick R, Stambrook PJ. In vitro evidence that metabolic cooperation is responsible for the bystander effect observed with HSV tk retroviral gene therapy. *Hum Gene Ther* 1993;4:725-731.
529. Ram Z, Walbridge S, Shawker T, et al. The effect of thymidine kinase transduction and ganciclovir therapy on tumor vasculature and growth of 9l gliomas in rats. *J Neurosurg* 1994;81:256-260.
530. Mullen CA, Coale MM, Lowe R, Blaese RM. Tumors expressing the cytosine deaminase suicide gene can be eliminated in vivo with 5-fluorocytosine and induce protective immunity to wild type tumor. *Cancer Res* 1994;54:1503-1506.
531. Ramesh R, Munshi A, Abboud CN, et al. Expression of costimulatory molecules: B7 and ICAM up-regulation after treatment with a suicide gene. *Cancer Gene Ther* 1996;3:373-384.
532. Ram Z, Culver KW, Oshiro EM, et al. Therapy of malignant brain tumors by intratumoral implantation of retroviral vector-producing cells. *Nat Med* 1997;3:1354-1361.
533. Consalvo M, Mullen CA, Modesti A, et al. 5-Fluorocytosine-induced eradication of murine adenocarcinomas engineered to express the cytosine deaminase suicide gene requires host immune competence and leaves an efficient memory. *J Immunol* 1995;154:5302-5312.
534. Wang WJ, Tai CK, Kasahara N, Chen TC. Highly efficient and tumor-restricted gene transfer to malignant gliomas by replication-competent retroviral vectors. *Hum Gene Ther* 2003;14:117-127.
535. Ueda K, Iwahashi M, Nakamori M, et al. Carcinoembryonic antigen-specific suicide gene therapy of cytosine deaminase/5-fluorocytosine enhanced by the cre/loxp system in the orthotopic gastric carcinoma model. *Cancer Res* 2001;61:6158-6162.
536. Ueno M, Koyama F, Yamada Y, et al. Tumor-specific chemo-radio-gene therapy for colorectal cancer cells using adenovirus vector expressing the cytosine deaminase gene. *Anticancer Res* 2001;21:2601-2608.
537. Wybranietz WA, Gross CD, Phelan A, et al. Enhanced suicide gene effect by adenoviral transduction of a vp22-cytosine deaminase (cd) fusion gene. *Gene Ther* 2001;8:1654-1664.
538. Gilboa E. Immunotherapy of cancer with genetically modified tumor vaccines. *Semin Oncol* 1996;23:101-107.
539. Klingemann HG, Dougherty GJ. Site-specific delivery of cytokines in cancer. *Mol Med Today* 1996;2:154-159.
540. Zier KS, Gansbacher B. The impact of gene therapy on T cell function in cancer. *Hum Gene Ther* 1995;6:1259-1264.
541. Pardoll DM. New strategies for enhancing the immunogenicity of tumors. *Curr Opin Immunol* 1993;5:719-725.
542. Brenner MK. Human somatic gene therapy: progress and problems. *J Intern Med* 1995;237:229-239.
543. Rosenberg SA. Karnofsky memorial lecture. The immunotherapy and gene therapy of cancer. *J Clin Oncol* 1992;10:180-199.
544. Rosenthal FM, Cronin K, Bannerji R, et al. Augmentation of antitumor immunity by tumor cells transduced with a retroviral vector carrying the interleukin-2 and interferon-gamma cDNAs. *Blood* 1994;83:1289-1298.
545. Pardoll D. Releasing the brakes on antitumor immune response. *Science* 1996;271:1691.
546. Dranoff G, Jaffee E, Lazenby A, et al. Vaccination with irradiated tumor cells engineered to secrete murine granulocyte-macrophage colony-stimulating factor stimulates potent, specific, and long-lasting anti-tumor immunity. *Proc Natl Acad Sci U S A* 1993;90:3539-3543.

547. Berns AJ, Clift S, Cohen LK, et al. Phase I study of non-replicating autologous tumor cell injections using cells prepared with or without GM-CSF gene transduction in patients with metastatic renal cell carcinoma. *Hum Gene Ther* 1995;6:347-368.
548. Simons JW, Mikhak B, Chang JF, et al. Induction of immunity to prostate cancer antigens: results of a clinical trial of vaccination with irradiated autologous prostate tumor cells engineered to secrete granulocyte-macrophage colony-stimulating factor using ex vivo gene transfer. *Cancer Res* 1999;59:5160-5168.
549. Nabel GJ, Gordon D, Bishop DK, et al. Immune response in human melanoma after transfer of an allogeneic class I major histocompatibility complex gene with DNA-liposome complexes. *Proc Natl Acad Sci U S A* 1996;93:15388-15393.
550. Matulonis UA, Dosiou C, Lamont C, et al. Role of b7-1 in mediating an immune response to myeloid leukemia cells. *Blood* 1995;85:2507-2515.
551. Maher J, Brentjens RJ, Gunset G, et al. Human T-lymphocyte cytotoxicity and proliferation directed by a single chimeric TCRzeta /CD28 receptor. *Nat Biotechnol* 2002;20:70-75.
552. Micklem HS, Clarke CM, Evans EP, Ford CE. Fate of chromosome-marked mouse bone marrow cells transfused into normal syngeneic recipients. *Transplantation* 1968;6:299-302.
553. Brecher G, Ansell JD, Micklem HS, et al. Special proliferative sites are not needed for seeding and proliferation of transfused bone marrow cells in normal syngeneic mice. *Proc Natl Acad Sci U S A* 1982;79:5085-5087.
554. Stewart FM, Crittenden RB, Lowry PA, et al. Long-term engraftment of normal and post-5-fluorouracil murine marrow into normal nonmyeloablated mice. *Blood* 1993;81:2566-2571.
555. Ramshaw HS, Rao SS, Crittenden RB, et al. Engraftment of bone marrow cells into normal unprepared hosts: effects of 5-fluorouracil and cell cycle status. *Blood* 1995;86:924-929.
556. Rao SS, Peters SO, Crittenden RB, et al. Stem cell transplantation in the normal nonmyeloablated host: relationship between cell dose, schedule, and engraftment. *Exp Hematol* 1997;25:114-121.
557. Mardiney M 3rd, Malech HL. Enhanced engraftment of hematopoietic progenitor cells in mice treated with granulocyte colony-stimulating factor before low-dose irradiation: implications for gene therapy. *Blood* 1996;87:4049-4056.
558. Mardiney M 3rd, Jackson SH, Spratt SK, et al. Enhanced host defense after gene transfer in the murine p47phox-deficient model of chronic granulomatous disease. *Blood* 1997;89:2268-2275.
559. Giri N, Kaushiva A, Wu T, et al. The effects of SCF/G-CSF prestimulation on radiation sensitivity and engraftment in nonmyeloablated murine hosts. *Exp Hematol* 2001;29:779-785.
560. Huhn RD, Tisdale JF, Agricola B, et al. Retroviral marking and transplantation of rhesus hematopoietic cells by nonmyeloablative conditioning. *Hum Gene Ther* 1999;10:1783-1790.
561. Rosenzweig M, MacVittie TJ, Harper D, et al. Efficient and durable gene marking of hematopoietic progenitor cells in nonhuman primates after nonablative conditioning. *Blood* 1999;94:2271-2286.
562. Kang EM, Hanazano Y, Frare P, et al. Persistent low-level engraftment of rhesus peripheral blood progenitor cells transduced with the Fanconi anemia c gene after conditioning with low-dose irradiation. *Mol Ther* 2001;3:911-919.
563. Heim D, Hanazono Y, Giri N, et al. Introduction of a xenogeneic gene via hematopoietic stem cell leads to specific tolerance in a rhesus monkey model. *Mol Ther* 2000;1:533-544.
564. Shull R, Lu X, Dube I, et al. Humoral immune response limits gene therapy in canine MPS i [Letter]. *Blood* 1996;88:377-379.
565. Kang EM, Giri N, Wu T, et al. In vivo persistence of genetically modified murine hematopoietic progenitors is not limited by the expression of the neo or gfp gene after full or minimal myeloablation. *Blood*

1999;94:398a.

566. Kang EM, Hanazono Y, DeWitte M, et al. Persistent low level marking following non-myeloablative transplantation of rhesus PBSCs transduced with a retroviral vector carrying the Fanconi anemia c gene. *Blood* 1999;94:643a.

567. Nesci S, Manna M, Andreani M, et al. Mixed chimerism in thalassemic patients after bone marrow transplantation. *Bone Marrow Transplant* 1992;10:143-146.

568. Andreani M, Manna M, Lucarelli G, et al. Persistence of mixed chimerism in patients transplanted for the treatment of thalassemia. *Blood* 1996;87:3494-3499.

569. Bernaudin F, Souillet G, Vannier JP, et al. Bone marrow transplantation (BMT) in 14 children with severe sickle cell disease (SCD): the French experience. *GEGMO. Bone Marrow Transplant* 1993;12:118-121.

570. Gurgey A, Mesci L, Ozerkam K, Oner C. Analysis of chimerism by PCR using mutant-specific primers and sequencing of b-gene region after allogenic bone marrow transplantation in sickle cell anemia [Letter]. *Am J Hematol* 1995;50:318-319.

571. Licht T, Pastan I, Gottesman MM, Herrmann F. The multidrug-resistance gene in gene therapy of cancer and hematopoietic disorders. *Ann Hematol* 1996;72:184-193.

572. Koc ON, Allay JA, Lee K, et al. Transfer of drug resistance genes into hematopoietic progenitors to improve chemotherapy tolerance. *Semin Oncol* 1996;23:46-65.

573. Sikic BI. Modulation of multidrug resistance: at the threshold. *J Clin Oncol* 1993;11:1629-1635.

574. Gottesman MM. How cancer cells evade chemotherapy: sixteenth Richard and Hinda Rosenthal Foundation Award Lecture. *Cancer Res* 1993;53:747-754.

575. Podda S, Ward M, Himelstein A, et al. Transfer and expression of the human multiple drug resistance gene into live mice. *Proc Natl Acad Sci U S A* 1992;89:9676-9680.

576. Aran JM, Gottesman MM, Pastan I. Drug-selected coexpression of human glucocerebrosidase and p-glycoprotein using a bicistronic vector. *Proc Natl Acad Sci U S A* 1994;91:3176-3180.

577. Sokolic RA, Sekhsaria S, Sugimoto Y, et al. A bicistronic retrovirus vector containing a picornavirus internal ribosome entry site allows for correction of x-linked cgd by selection for mdr1 expression. *Blood* 1996;87:42-50.

578. Hanania EG, Fu S, Roninson I, et al. Resistance to Taxol chemotherapy produced in mouse marrow cells by safety-modified retroviruses containing a human mdr-1 transcription unit. *Gene Ther* 1995;2:279-284.

579. O'Shaughnessy JA, Cowan KH, Nienhuis AW, et al. Retroviral mediated transfer of the human multidrug resistance gene (mdr-1) into hematopoietic stem cells during autologous transplantation after intensive chemotherapy for metastatic breast cancer. *Hum Gene Ther* 1994;5:891-911.

580. Hesdorffer C, Antman K, Bank A, et al. Human mdr gene transfer in patients with advanced cancer. *Hum Gene Ther* 1994;5:1151-1160.

581. Deisseroth AB, Kavanagh J, Champlin R. Use of safety-modified retroviruses to introduce chemotherapy resistance sequences into normal hematopoietic cells for chemoprotection during the therapy of ovarian cancer: a pilot trial. *Hum Gene Ther* 1994;5:1507-1522.

582. Moscow JA, Huang H, Carter C, et al. Engraftment of mdr1 and neor gene-transduced hematopoietic cells after breast cancer chemotherapy. *Blood* 1999;94:52-61.

583. Abonour R, Williams DA, Einhorn L, et al. Efficient retrovirus-mediated transfer of the multidrug resistance 1 gene into autologous human long-term repopulating hematopoietic stem cells. *Nat Med* 2000;6:652-658.

584. Bunting KD, Galipeau J, Topham D, et al. Transduction of murine bone marrow cells with an mdr1

vector enables ex vivo stem cell expansion, but these expanded grafts cause a myeloproliferative syndrome in transplanted mice. *Blood* 1998;92:2269–2279.

585. Jelinek J, Fairbairn LJ, Dexter TM, et al. Long-term protection of hematopoiesis against the cytotoxic effects of multiple doses of nitrosourea by retrovirus-mediated expression of human o6-alkylguanine-DNA-alkyltransferase. *Blood* 1996;87:1957–1961.

586. Spencer HT, Sleep SE, Rehg JE, et al. A gene transfer strategy for making bone marrow cells resistant to trimetrexate. *Blood* 1996;87:2579–2587.

587. Corey CA, DeSilva AD, Holland CA, Williams DA. Serial transplantation of methotrexate-resistant bone marrow: protection of murine recipients from drug toxicity by progeny of transduced stem cells. *Blood* 1990;75:337–343.

588. Moritz T, Mackay W, Glassner BJ, et al. Retrovirus-mediated expression of a DNA repair protein in bone marrow protects hematopoietic cells from nitrosourea-induced toxicity in vitro and in vivo. *Cancer Res* 1995;55:2608–2614.

589. Vinh DB, McIvor RS. Selective expression of methotrexate-resistant dihydrofolate reductase (dhfr) activity in mice transduced with dhfr retrovirus and administered methotrexate. *J Pharmacol Exp Ther* 1993;267:989–996.

590. Davis BM, Koc ON, Gerson SL. Limiting numbers of g156a o(6)-methylguanine-DNA methyltransferase-transduced marrow progenitors repopulate nonmyeloablated mice after drug selection. *Blood* 2000;95:3078–3084.

591. Allay JA, Persons DA, Galipeau J, et al. In vivo selection of retrovirally transduced hematopoietic stem cells. *Nat Med* 1998;4:1136–1143.

592. Persons DA, Nienhuis AW. In vivo selection to improve gene therapy of hematopoietic disorders. *Curr Opin Mol Ther* 2002;4:491–498.

593. Zielske SP, Gerson SL. Lentiviral transduction of p140k mgmt into human cd34(+) hematopoietic progenitors at low multiplicity of infection confers significant resistance to bg/bcnu and allows selection in vitro. *Mol Ther* 2002;5:381–387.

594. Rappa G, Lorico A, Hildinger M, et al. Novel bicistronic retroviral vector expressing gamma-glutamylcysteine synthetase and the multidrug resistance protein 1 (mrp1) protects cells from mrp1-effluxed drugs and alkylating agents. *Hum Gene Ther* 2001;12:1785–1796.

595. Pawliuk R, Kay R, Lansdorp P, Humphries RK. Selection of retrovirally transduced hematopoietic cells using CD24 as a marker of gene transfer. *Blood* 1994;84:2868–2877.

596. Medin JA, Migita M, Pawliuk R, et al. A bicistronic therapeutic retroviral vector enables sorting of transduced CD34+ cells and corrects the enzyme deficiency in cells from Gaucher patients. *Blood* 1996;87:1754–1762.

597. Cheng L, Fu J, Tsukamoto A, Hawley RG. Use of green fluorescent protein variants to monitor gene transfer and expression in mammalian cells. *Nat Biotechnol* 1996;14:606–609.

598. Persons DA, Allay JA, Allay ER, et al. Retroviral-mediated transfer of the green fluorescent protein gene into murine hematopoietic cells facilitates scoring and selection of transduced progenitors in vitro and identification of genetically modified cells in vivo. *Blood* 1997;90:1777–1786.

599. Hanazono Y, Yu JM, Dunbar CE, Emmons RV. Green fluorescent protein retroviral vectors: low titer and high recombination frequency suggest a selective disadvantage. *Hum Gene Ther* 1997;8:1313–1319.

600. Kiem HP, Rasko JE, Morris J, et al. Ex vivo selection for oncoretrovirally transduced green fluorescent protein-expressing CD34-enriched cells increases short-term engraftment of transduced cells in baboons. *Hum Gene Ther* 2002;13:891–899.

601. Bodine DM, Seidel NE, Zsebo KM, Orlic D. In vivo administration of stem cell factor to mice increases the absolute number of pluripotent hematopoietic stem cells. *Blood* 1993;82:445–455.

602. Li CL, Johnson GR. Stem cell factor enhances the survival but not the self-renewal of murine hematopoietic long-term repopulating cells. *Blood* 1994;84:408-414.
603. Spangrude GJ, Brooks DM, Tumas DB. Long-term repopulation of irradiated mice with limiting numbers of purified hematopoietic stem cells: in vivo expansion of stem cell phenotype but not function. *Blood* 1995;85:1006-1016.
604. van der Loo JC, Ploemacher RE. Marrow- and spleen-seeding efficiencies of all murine hematopoietic stem cell subsets are decreased by preincubation with hematopoietic growth factors. *Blood* 1995;85:2598-2606.
605. Schiffmann R, Medin JA, Ward JM, et al. Transfer of the human glucocerebrosidase gene into hematopoietic stem cells of nonablated recipients: successful engraftment and long-term expression of the transgene. *Blood* 1995;86:1218-1227.
606. Sadelain M, Frassoni F, Riviere I. Issues in the manufacture and transplantation of genetically modified hematopoietic stem cells. *Curr Opin Hematol* 2000;7:364-377.
607. Thorsteinsdottir U, Sauvageau G, Humphries RK. Enhanced in vivo regenerative potential of hoxb4-transduced hematopoietic stem cells with regulation of their pool size. *Blood* 1999;94:2605-2612.
608. Domen J, Weissman IL. Hematopoietic stem cells need two signals to prevent apoptosis; bcl-2 can provide one of these, kitl/c-kit signaling the other. *J Exp Med* 2000;192:1707-1718.
609. Kirby S, Walton W, Smithies O. Hematopoietic stem cells with controllable tector transgenes have a competitive advantage in bone marrow transplantation. *Blood* 2000;95:3710-3715.
610. Blau CA, Neff T, Papayannopoulou T. Cytokine prestimulation as a gene therapy strategy: implications for using the *mdr1* gene as a dominant selectable marker. *Blood* 1997;89:146-154.
611. Jin L, Asano H, Blau CA. Stimulating cell proliferation through the pharmacologic activation of c-kit. *Blood* 1998;91:890-897.
612. Ito K, Ueda Y, Kokubun M, et al. Development of a novel selective amplifier gene for controllable expansion of transduced hematopoietic cells. *Blood* 1997;90:3884-3892.
613. Hanazono Y, Nagashima T, Shibata H, et al. In vivo expansion of gene-modified hematopoietic cells by the selective amplifier gene in a nonhuman primate model. *Blood* 2000;96:524a.
614. Sharma S, Cantwell M, Kipps TJ, Friedmann T. Efficient infection of a human T-cell line and of human primary peripheral blood leukocytes with a pseudotyped retrovirus vector. *Proc Natl Acad Sci U S A* 1996;93:11842-11847.
615. Han X, Kasahara N, Kan YW. Ligand-directed retroviral targeting of human breast cancer cells. *Proc Natl Acad Sci U S A* 1995;92:9747-9751.
616. Russell SJ, Hawkins RE, Winter G. Retroviral vectors displaying functional antibody fragments. *Nucleic Acids Res* 1993;21:1081-1085.
617. Horn PA, Morris JC, Bukovsky AA, et al. Lentivirus-mediated gene transfer into hematopoietic repopulating cells in baboons. *Gene Ther* 2002;9:1464-1471.
618. Miller JL, Donahue RE, Sellers SE, et al. Recombinant adeno-associated virus (RAAV)-mediated expression of a human gamma-globin gene in human progenitor-derived erythroid cells. *Proc Natl Acad Sci U S A* 1994;91:10183-10187.
619. Zhou SZ, Broxmeyer HE, Cooper S, et al. Adeno-associated virus 2-mediated gene transfer in murine hematopoietic progenitor cells. *Exp Hematol* 1993;21:928-933.
620. Chatterjee S, Li W, Wong CA, et al. Transduction of primitive human marrow and cord blood-derived hematopoietic progenitor cells with adeno-associated virus vectors. *Blood* 1999;93:1882-1894.



621. Nathwani AC, Hanawa H, Vandergriff J, et al. Efficient gene transfer into human cord blood CD34+ cells and the CD34+CD38- subset using highly purified recombinant adeno-associated viral vector preparations that are free of helper virus and wild-type AAV. *Gene Ther* 2000;7:183-195.
622. Sierakowska H, Sambade MJ, Agrawal S, Kole R. Repair of thalassemic human beta-globin mRNA in mammalian cells by antisense oligonucleotides. *Proc Natl Acad Sci U S A* 1996;93:12840-12844.
623. Gorman L, Mercatante DR, Kole R. Restoration of correct splicing of thalassemic beta-globin pre-mRNA by modified u1 snRNAs. *J Biol Chem* 2000;275:35914-35919.
624. Lacerra G, Sierakowska H, Carestia C, et al. Restoration of hemoglobin a synthesis in erythroid cells from peripheral blood of thalassemic patients. *Proc Natl Acad Sci U S A* 2000;97:9591-9596.
625. Vacek MM, Ma H, Gemignani F, et al. High-level expression of hemoglobin a in human thalassemic erythroid progenitor cells following lentiviral vector delivery of an antisense snRNA. *Blood* 2003;101:104-111.
626. Sykes M, Sachs DH, Nienhuis AW, et al. Specific prolongation of skin graft survival following retroviral transduction of bone marrow with an allogeneic major histocompatibility complex gene. *Transplantation* 1993;55:197-202.
627. Ally BA, Hawley TS, McKall-Faienza KJ, et al. Prevention of autoimmune disease by retroviral-mediated gene therapy. *J Immunol* 1995;155:5404-5408.
628. Shull R, Lu X, Dube I, et al. Humoral immune response limits gene therapy in canine mps i. *Blood* 1996;88:377-379.
629. Kang E, Giri N, Wu T, et al. In vivo persistence of retrovirally transduced murine long-term repopulating cells is not limited by expression of foreign gene products in the fully or minimally myeloablated setting. *Hum Gene Ther* 2001;12:1663-1672.
630. Walter J, You Q, Hagstrom JN, et al. Successful expression of human factor IX following repeat administration of an adenoviral vector in mice. *Proc Natl Acad Sci U S A* 1996;93:3056-3061.
631. Baum C, Dullmann J, Li Z, et al. Side effects of retroviral gene transfer into hematopoietic stem cells. *Blood* 2003;101:2099-2113.
632. Morral N, O'Neal WK, Rice K, et al. Lethal toxicity, severe endothelial injury, and a threshold effect with high doses of an adenoviral vector in baboons. *Hum Gene Ther* 2002;13:143-154.
633. Hacein-Bey-Abina S, von Kalle C, Schmidt M, et al. A serious adverse event after successful gene therapy for x-linked severe combined immunodeficiency. *N Engl J Med* 2003;348:255-256.
634. Boehm T, Feroni L, Kaneko Y, et al. The rhombotin family of cysteine-rich lim-domain oncogenes: distinct members are involved in T-cell translocations to human chromosomes 11p15 and 11p13. *Proc Natl Acad Sci U S A* 1991;88:4367-4371.
635. Li Z, Dullmann J, Schiedlmeier B, et al. Murine leukemia induced by retroviral gene marking. *Science* 2002;296:497.

2004 Lippincott Williams & Wilkins  
John P. Greer, John Foerster, John N. Lukens  
George M. Rodgers, Frixos Paraskevas, Bertil Glader  
Wintrobe's Clinical Hematology

**DEFINITION OF ANEMIA**[Anemia in Adults](#)[Hemoglobin Values in the Elderly](#)[Hemoglobin Values in Infants and Children](#)[Limitations in the Use of Hemoglobin, Hematocrit, and Red Blood Cell Measurements in Defining Anemia](#)**CLINICAL EFFECTS OF ANEMIA**[Cardiovascular and Pulmonary Features of Anemia](#)[Pallor](#)[Skin and Mucosal Changes](#)[Neuromuscular Features](#)[Ophthalmologic Findings](#)[Gastrointestinal Changes](#)**EVALUATION AND CLASSIFICATION OF ANEMIA**[History and Physical Examination](#)[Evaluation of Basic Hematology Laboratory Data](#)**APPROACH TO MACROCYTIC ANEMIA**[Megaloblastic Anemias](#)[Nonmegaloblastic Macrocytic Anemias](#)**APPROACH TO MICROCYTIC ANEMIA**[Iron Pathway Disorders](#)[Disorders of Hemoglobin Synthesis](#)[Sideroblastic Anemias](#)**APPROACH TO NORMOCYTIC ANEMIA****APPROACH TO HEMOLYSIS**[Pathogenesis and Classification](#)[Clinical Features of Congenital Hemolytic Anemia](#)[Clinical Features of Acquired Hemolytic Anemia](#)[Laboratory Features of Hemolysis](#)[Laboratory Tests Useful in the Differential Diagnosis of Hemolysis](#)[Diagnostic Strategy to the Patient with Hemolytic Anemia](#)**APPROACH TO ACUTE POSTHEMORRHAGIC ANEMIA****ACKNOWLEDGMENT****REFERENCES**

This introductory chapter focuses on the general concepts of anemia, the classification of the most common types of anemia, the approach to patients with hemolysis, and the assessment of posthemorrhagic anemia. Anemia rarely is a disease by itself; almost always it is a consequence of another acquired or genetic abnormality. The various medical conditions that result in anemia encompass nearly the full spectrum of human disease.

**DEFINITION OF ANEMIA**

Red blood cells (RBCs) circulate in the peripheral blood for 100 to 120 days, and approximately 1% of the body's red cells are lost and replaced each day. Red cells recognized as being old are removed from the circulation by macrophages in the spleen, liver, and bone marrow ( [Chapter 9](#)). An erythropoietic feedback loop ensures that the

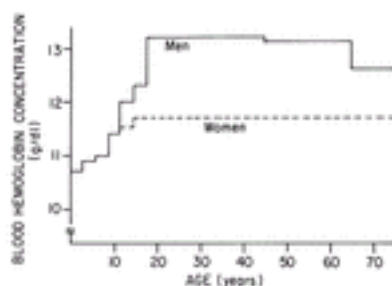
total red cell mass remains constant ( [Chapter 7](#)).

*Anemia* is functionally defined as an insufficient RBC mass to adequately deliver oxygen to peripheral tissues. For practical purposes, any of the three concentration measurements are used to establish the presence of anemia: hemoglobin (Hb) level (g/dl), hematocrit (%), RBC number ( $10^{12}/L$ ).

In the past, these parameters were measured using manual physical and chemical techniques, but now these assays are determined by electronic cell counters and Hb analyzers ( [Chapter 1](#)). In most of the current analyses, RBC number, Hb concentration, and mean corpuscular volume (MCV) are directly measured; these values are used to calculate the hematocrit, the mean corpuscular Hb (MCH), and the MCH concentration (MCHC). The electronic counters also generate an index of red cell size, the red cell distribution width (RDW). The RDW is a quantitative measure of the variation in red cell size, and the higher the values, the more heterogeneous the RBC population size. The mean normal Hb and hematocrit value and the lower limits of the normal range depend on the age and gender of the subjects, as well as their altitude of residence ( [Appendix A](#)).

### Anemia in Adults

Most references consider Hb concentrations of 14 g/dl and 12 g/dl as the lower limits of normal, at sea level, in adult men and women, respectively ( [1](#)). These values have received wide acceptance and often are used in population surveys ( [2](#)). However, data from a large, diverse, and carefully selected sample suggest that these values are somewhat high. The sample studied during the second National Health And Nutrition Examination Survey (NHANES II), 1976–1980, was selected statistically as representative of the entire population of the United States ( [3](#)). Age, gender, and race as well as geographic and socioeconomic factors were factored into the selection process. For the purpose of determining normal values, subjects were excluded if they were pregnant, if a hereditary hemoglobinopathy was detected, or if the transferrin saturation, MCV, or erythrocyte protoporphyrin value was abnormal. By these means, iron-deficient subjects were effectively excluded. The values of the remaining 11,547 subjects were used to calculate a 95% reference range. In adult subjects (age 10 to 44 years), the lower limit of normal was 13.2 g/dl in men and 11.7 g/dl in women ( [Fig. 27.1](#)). Values for black subjects were approximately 0.5 to 0.6 g/dl lower than those of white subjects.



**Figure 27.1.** The lower limit of normal blood hemoglobin concentration in men and women of various ages. Values were calculated from a sample of 11,547 subjects selected to represent the population of the United States. Subjects with iron deficiency, pregnancy, or an abnormal hemoglobin value were excluded from the sample. [From Dallman PR, Yip R, Johnson C. Prevalence and causes of anemia in the United States, 1976 to 1980. *Am J Clin Nutr* 1984;39(3):437–445, with permission.]

## Hemoglobin Values in the Elderly

From the NHANES II study, the normal Hb values decreased after the age of 65 years, but whether these lower levels of Hb in elderly subjects (especially men) represent a physiologic phenomenon or the development of a substantially increased prevalence of anemia in this age group is not known (4). By using 14 g/dl and 12 g/dl as the lower limits of normal in men and women, respectively, anemia was found in as many as 25% of apparently healthy individuals older than 65 years of age (5, 6). However, in most cases, careful clinical investigation did not uncover a specific cause of anemia. The lower levels therefore could result from decreased androgen secretion in men or from age-related decreases in stem cell proliferation (7). These results suggest that somewhat lower limits of normal might be used in evaluating the elderly. However, the too easy acceptance of mild anemia as a physiologic phenomenon in the elderly runs the risk of ignoring a potentially valuable, early clue to an important underlying disorder.

## Hemoglobin Values in Infants and Children

At the other extreme of life, the definition of anemia in infancy and childhood is different from adults. The lower limit of normal Hb concentration at birth is 14 g/dl, and this decreases to 11 g/dl by 1 year of age. This Hb decrement, referred to as the *physiologic anemia of infancy*, occurs as part of the normal physiologic adaptation from the relatively hypoxic intrauterine existence to the well-oxygenated extrauterine environment (Chapter 48). Also, as fetal erythropoiesis is replaced, the MCV decreases from birth (100 to 130 fl) to 1 year of age (70 to 85 fl).

Even after the first year of life, normal childhood Hb and MCV values remain considerably lower than those occurring in adolescents and adults (Table 27.1). From the NHANES II study, the lower limit of normal Hb concentration in both male and female children, ages 1 to 2 years, was 10.7 g/dl, and the value rose with advancing age until adult levels were reached at age 15 to 18 years.

**TABLE 27.1. Red Blood Cell Characteristics in Childhood**

| Age          | Lowest Normal Hb (g/dl) | Normal Red Blood Cell Size Mean Corpuscular Volume (fl) | Fetal Hb (%) |
|--------------|-------------------------|---|--------------|
| Birth        | 14.0                    | 100–130   | 55–90        |
| 1 mo         | 12.0                    | 90–110  | 50–80        |
| 2 mo         | 10.5                    | 80–100  | 30–55        |
| 3–6 mo       | 10.5                    | 75–90   | 5–25         |
| 6 mo–1 yr    | 11.0                    | 70–85   | <5           |
| 1–4 yr       | 11.0                    | 70–85   | <2           |
| 4 yr–puberty | 11.5                    | 75–90   | <2           |
| Adult female | 12.0                    | 80–95   | <2           |
| Adult male   | 14.0                    | 80–95   | <2           |

Hb, hemoglobin.

There has been no completely satisfactory explanation for these differences in normal Hb values of children and adults, but it is not due to nutritional deficiencies. Of interest, it has been demonstrated that serum inorganic phosphate is 50% higher in children compared to adults, and this hyperphosphatemia is associated with elevated erythrocyte adenosine triphosphate and 2,3-diphosphoglycerate content, and thus, the erythrocyte oxygen affinity is decreased in children compared to adults. On this basis, it has been postulated that lower Hb values in children may be due to altered Hb-oxygen affinity and thereby represent a physiologic anemia of childhood ( [8](#) ).

At puberty, the Hb concentration in children reaches the same levels seen in adults. The higher Hb levels in males presumably are a reflection of the effects of androgens on erythropoiesis.

### Limitations in the Use of Hemoglobin, Hematocrit, and Red Blood Cell Measurements in Defining Anemia

For practical purposes, the blood hemoglobin and hematocrit determinations are useful in assessing for anemia in most patients, but there are limitations that must be recognized:

1. Hb changes may reflect altered plasma volume, not a change in RBC mass ( [Table 27.2](#) ). In pregnancy, for example, the plasma volume increases, thereby decreasing the Hb concentrations, although, in fact, total RBC mass actually is increased, but to a lesser degree than the plasma volume ( [9](#) , [10](#) , [11](#) and [12](#) ) ( [Chapter 48](#) ). Similarly, individuals with massive splenomegaly may have some anemia because of hypersplenism ( [Chapter 38](#) ), but the degree of anemia may appear more severe because of an increased plasma volume. Conversely, burn patients lose plasma, not RBC, through the injured skin, leaving Hb concentrated at a higher level. Other causes of dehydration with depletion of intravascular space also produce a spuriously high Hb concentration. In chronically ill patients with a reduced red cell mass, the magnitude of anemia may be masked by an associated contraction of the plasma volume ( [13](#) , [14](#) , [15](#) , [16](#) and [17](#) ).

**TABLE 27.2. Conditions Associated with Discordance Between Hemoglobin Concentration and Red Cell Mass**

---

|   |
|---|
| Increase in plasma volume relative to RBC mass (Hb disproportionately low)                              |
| Hydremia of pregnancy   |
| Congestive splenomegaly   |
| Recumbency (vs. upright)  |
| Decrease in plasma volume relative to RBC mass (Hb high, normal, or low; but high relative to RBC mass) |
| Dehydration   |
| Prolonged diarrhea (especially in infants)  |
| Peritoneal dialysis with hypertonic solutions   |
| Diabetic acidosis   |
| Diabetes insipidus with restricted fluid intake   |
| Burn patients   |
| Stress erythrocytosis, spurious polycythemia  |
| Decrease in both plasma volume and RBC mass (Hb normal, RBC mass low)                                   |
| Acute blood loss  |
| Chronic disease   |

Hb, hemoglobin; RBC, red blood cell.

---

2. Another consideration is that Hb changes may reflect underlying physiologic conditions with different oxygen needs. For example, an emphysematous patient, or one with right to left cardiac shunt, or in an Andes dweller, oxygen needs are increased, and these individuals often are polycythemic with elevated Hb levels. A normal Hb level in such a patient actually may represent anemia by the functional criterion of adequately meeting tissue oxygen requirements. Conversely, patients with hypothyroidism (decreased oxygen needs) may have low Hb levels, but yet have adequate oxygen delivery for the apparent oxygen needs.
3. Some abnormal Hb variants have an altered ability to bind and release oxygen, and this can be associated with changes in Hb concentration. For example, Hb Yakima has increased oxygen affinity with a low P50, and higher than normal Hgb levels are characteristic. Conversely, Hb Kansas has decreased oxygen affinity, high P50, and lower than normal Hgb levels. Despite the disparate Hb levels in these cases, both satisfy the criteria of appropriate oxygen delivery for tissue oxygen needs.
4. Acute blood loss is another example of the problem of denoting anemia by the Hb concentration. Immediately after loss of a liter of blood, the Hb level is normal, because the initial response to acute hemorrhage is vasoconstriction. The shift of fluid from extravascular to intravascular space, and thus the decrease in Hb concentration, does not begin for 6 hours, and can continue for 48 to 72 hours. Reticulocytosis occurs after 24 to 48 hours.
5. Impaired partial synthesis of one globin-chain, as in thalassemia trait, may be reflected in a low Hb (10 g/dl) and a high RBC count (6.5 million/ $\mu$ l), thus giving anemia by one measure (Hb) and polycythemia by another (RBC).

In addition to the issues listed above, changes in posture also have effects on red cell concentration that can influence Hb and hematocrit measurements. When normal individuals assume a recumbent position, the hematocrit falls an average 7% (range, 4 to 10%) within 1 hour (18). When the upright position is resumed, the hematocrit increases by a similar amount within 15 minutes. These changes have been attributed to alterations in plasma volume as fluid moves between the circulation and the extravascular spaces in the lower limbs as a result of hydrostatic forces.

## CLINICAL EFFECTS OF ANEMIA

Patients with anemia usually seek medical attention because of decreased work or exercise tolerance, shortness of breath, palpitations, or other signs of cardiorespiratory adjustments to anemia. At times, they feel fine, but their friends or family have noted pallor. It is not uncommon that anemia in a child is first recognized by a visiting relative, the process sometimes occurring so slowly as to not be noted by parents or other immediate family members.

### Cardiovascular and Pulmonary Features of Anemia

The clinical manifestations of anemia depend on the magnitude and rate of reduction in the oxygen-carrying capacity of the blood, the capacity of the cardiovascular and pulmonary systems to compensate for the anemia, and the associated features of the underlying disorder that resulted in the development of anemia. The Hb concentration is not the only determinant of the observed symptoms. Coexistent cardiovascular or pulmonary disease, particularly in older individuals, may exaggerate the symptoms associated with a degree of anemia that would be well tolerated under other

circumstances.

If the anemia has been insidious in onset and there is no cardiopulmonary disease, the patient's adjustment may be so good that the blood Hb concentration may fall to 8 g/dl or even lower before the patient experiences enough symptoms to appreciate the situation ( [19](#) ). In cases of iron deficiency anemia, pernicious anemia, or other types of slowly developing anemia, Hb concentrations may reach levels of 6 g/dl or lower before patients are motivated to seek medical attention ( [20](#) ). This is particularly true in children where no limitations of physical activity may be apparent despite the existence of very severe anemia ( [21](#) ). The physiologic adjustments that take place with a slowly falling red cell mass chiefly involve the cardiovascular system and changes in the Hb-oxygen dissociation curve.

In many patients, respiratory and circulatory symptoms are noticeable only after exertion; however, when anemia is sufficiently severe, dyspnea and awareness of vigorous or rapid heart action may be noted even at rest. When anemia develops rapidly, shortness of breath, tachycardia, dizziness or faintness (particularly upon arising from a sitting or recumbent posture), and extreme fatigue are prominent. In chronic anemia, only moderate dyspnea or palpitation may occur, but in some patients, congestive heart failure ( [22](#) ), angina pectoris, or intermittent claudication ( [23](#) ) can be the presenting manifestation. In patients with severe chronic anemia, tachycardia and postural hypotension may not be present because the total blood volume actually may be increased due to an expanded plasma volume. It is in these cases that rapid administration of a blood transfusion may precipitate congestive heart failure by aggravating an already expanded blood volume.

Heart murmurs are a common cardiac sign associated with anemia. They usually are systolic in time and best heard in the pulmonic area ( [24](#) , [25](#) and [26](#) ). Often, they are moderate in intensity, and at times may be rough in quality and raise suspicion of organic valvular heart disease.

## **Pallor**

Pallor is a sign of anemia, but many factors other than Hb concentration affect skin color. These include the degree of dilation of peripheral vessels, the degree of pigmentation, and the fluid content of the subcutaneous tissues. Certain people routinely have pale-appearing skin without being anemic. Patients with myxedema may manifest pallor without anemia. In simple vasovagal syncope, pallor results from cutaneous vasoconstriction and is not a sign of anemia. Jaundice, cyanosis, racial skin pigmentation, and dilation of the peripheral vessels all can mask the pallor of anemia.

The pallor associated with anemia is best detected in the mucous membranes of the mouth and pharynx, the conjunctivae, the lips, and the nail beds. In the hands, the skin of the palms first becomes pale, but the creases may retain their usual pink color until the Hb concentration is less than 7 g/dl.

A distinctly sallow color implies chronic anemia. A lemon-yellow pallor suggests pernicious anemia, but it is observed only when the condition is well advanced. Definite pallor associated with mild scleral and cutaneous icterus suggests hemolytic anemia. Marked pallor associated with petechiae or ecchymoses suggests more generalized bone marrow failure due to acute leukemia, aplasia, or myelophthisis.

## **Skin and Mucosal Changes**



Other changes in the integument occur with anemia. Thinning, loss of luster, and early graying of the hair may occur, the last especially in patients with pernicious anemia, in whom it may precede the development of anemia. The nails may lose their luster, become brittle, and break easily. This finding is especially noticeable in chronic iron deficiency anemia ( [27](#) ), in which the nails may actually become concave instead of convex ( [Chapter 28](#) ). Chronic leg ulcers may occur, especially in patients with sickle cell anemia and rarely in those with other hemolytic anemias. Glossitis occurs in association with pernicious anemia. When nutritional deficiency is associated with anemia, symmetric dermatitis may develop, fissures may be present at the angles of the mouth, glossitis may occur, and erythematous lesions on the face, neck, hands, or elbows may be found.

### **Neuromuscular Features**

Headache, vertigo, tinnitus, faintness, scotomata, lack of mental concentration, drowsiness, restlessness, and muscular weakness are common symptoms of severe anemia. Paresthesias are common in pernicious anemia and may be associated with other symptoms and signs of peripheral neuropathy, and more especially with combined system disease (see [Chapter 43](#) ).

### **Ophthalmologic Findings**

A variety of ophthalmologic findings have been observed in anemic patients ( [28](#) , [29](#) and [30](#) ). Approximately 20% of such patients have flame-shaped hemorrhages, hard exudates, cottonwood spots, or venous tortuosity affecting the retina. The hemorrhages occur even in the absence of coexisting thrombocytopenia. Papilledema related solely to anemia has been described ( [31](#) , [32](#) ), and it clears when the anemia disappears.

### **Gastrointestinal Changes**

Gastrointestinal symptoms are common in anemic patients. Some are manifestations of the underlying disorder (e.g., hiatal hernia, duodenal ulcer, or gastric carcinoma); others may be a consequence of the anemic condition, whatever its cause. Glossitis and atrophy of the papillae of the tongue commonly occur in pernicious anemia and less often in iron deficiency anemia. Painful, ulcerative, and necrotic lesions in the mouth and pharynx occur in aplastic anemia and in acute leukemia, usually reflecting the neutropenia accompanying these conditions. Dysphagia may occur in chronic iron deficiency anemia.

## **EVALUATION AND CLASSIFICATION OF ANEMIA**

### **History and Physical Examination**

All aspects of the history and clinical examination are important. The duration of the symptoms and their onset, whether insidious or acute, should be established. It is very helpful to know the most recent date at which a routine hematologic examination was normal.

The family history is important with respect to history of jaundice, gallstones, and splenectomy (see [Approach to Hemolysis](#) ). A family history of any bleeding disorder also is important.

The patient's occupation, household customs, and hobbies must be ascertained because certain drugs, solvents, and other chemicals may produce hemolytic anemia or aplastic

anemia, as well as granulocytopenia and thrombocytopenia. Also, social habits (alcohol use), travel history (to malarious or other infectious areas), and drug history are all important in attempting to ascertain the underlying etiology.

The dietary history is critical to the analysis, and questions regarding the diet must be specific (i.e., meal-by-meal) in the hope of obtaining quantitative information. A record regarding dietary idiosyncrasies and cooking habits may be valuable, especially with reference to folic acid intake. In very young children, those who obtain the bulk of their nutrition from cow's milk (good for calories, very low in iron) are at great risk for iron deficiency anemia. Changes in weight are most important in both adults and children.

The patient should be questioned about early graying of the hair, burning sensations of the tongue, sores about the angles of the mouth, and discomfort and brittleness of the fingernails, which are symptoms of the anemias caused by the deficiency of specific nutrients.

Change in stool habits may be an important clue to neoplasms of the colon and rectum underlying the anemia. The significance of tarry stools often is not appreciated by patients, and specific inquiry is necessary. The amount of blood lost from hemorrhoids may be overlooked or overestimated. In men, occult blood loss most often is from the gastrointestinal tract.

In women, additional important information includes an appraisal of the amount of blood lost during menstruation. Data about number of pads or tampons used and the presence or absence of clots should be obtained. Menstrual flow should be deemed excessive if more than 12 pads are used each period, if clots are passed after the first day, or if the period duration exceeds 7 days. The number of pregnancies and abortions and the interval since the most recent of these are also important, for each represents significant iron loss.

The presence or absence of fever must be known; its presence suggests infection, lymphoma, or other neoplasm or collagen disease. Pains in the limbs, paresthesias, and difficulty in walking suggest pernicious anemia. Abnormal color of the urine, suggesting blood or Hb, may signify urinary tract disease or hematologic problems. Bilirubin is not detected in the urine of people with uncomplicated hemolytic anemia, but a darker than normal color may result from the increased excretion of urobilinogen and its conversion to urobilin.

Bruises, ecchymoses, and petechiae are other important points in the history. Their presence indicates that the disorder producing anemia may also involve platelets or the liver. Alternatively, the anemia itself may be the consequence of blood loss resulting from a disorder of hemostasis.

In all instances, the presence or absence of symptoms suggestive of an underlying disease such as chronic renal disease, liver disease, chronic infection, endocrinopathy, or malignancy must be explored. Anemia can be the presenting feature of many of these disorders.

The physical examination can provide further clues to the cause of anemia. Scleral icterus suggests the presence of hemolytic anemia or ineffective erythropoiesis. Sternal tenderness near the middle or lower one-third of the sternum, of which the patient may have been unaware, is a useful sign in some patients with acute leukemia. Palpation of the liver and spleen and a systemic check for lymphadenopathy is necessary as a clue to infection, lymphoma, leukemia, or metastatic carcinoma.

The initial patient evaluation should include a urinalysis. Even when the color of the urine does not suggest blood, the routine urinalysis should be tested for occult blood. A positive reaction may be due to hematuria, hemoglobinuria, or even myoglobinuria. Hematuria may be differentiated from the other conditions by finding RBCs on microscopic examination of the urine, or by centrifuging a fresh urine specimen, thereby clearing the bloody color from the supernatant and depositing the RBCs in the bottom of the tube. Hematuria reflects disease of the kidneys or urinary tract. Sick cell trait may be accompanied by innocuous hematuria. Hemoglobinuria implies intravascular hemolysis.

## Evaluation of Basic Hematology Laboratory Data

To identify the cause of anemia, information from the medical history and physical examination must be integrated with some key laboratory tests. There is no one simple classification of anemia. A useful approach entails asking several questions, outlined in the following sections ( [Fig. 27.2](#)).



**Figure 27.2.** Questions to ask in the initial evaluation of anemia. MCV, mean corpuscular volume (fl); ?, increased; ?, decreased.

**IS ANEMIA ASSOCIATED WITH OTHER HEMATOLOGIC ABNORMALITIES?** Specifically, is the anemia associated with thrombocytopenia or abnormalities in white blood cell numbers or the presence of abnormal leukocytes? If the answer to this question is yes, consideration must be given to the possibility of bone marrow failure due to aplastic anemia, leukemia, or other malignant marrow disease. Alternatively, pancytopenia can be secondary to peripheral destruction or sequestration of cells as in hypersplenism. In most cases, these disorders can be differentiated by careful review of screening hematologic studies and close attention to the medical history and physical examination.

**IS THERE AN APPROPRIATE RETICULOCYTE RESPONSE TO ANEMIA?** The number of erythrocytes in the circulation at a given time is the result of a dynamic equilibrium between the delivery of red cells into the circulation on one hand and their destruction or loss from the circulation on the other. Each day, approximately 1% of the RBC pool is replaced by young erythrocytes released from the marrow. The homeostatic mechanisms of the body bring about recovery from anemia by accelerating erythropoiesis, and this response of the normal marrow is brought about through the release of erythropoietin. At maximum stimulation, the bone marrow is capable of producing erythrocytes at six to eight times the normal rate. The reticulocyte count provides an initial assessment of whether the cause of anemia is due to impaired RBC production or due to increased loss in the peripheral circulation (e.g., blood loss, hemolysis) ( [Fig. 27.2](#)). The normal reticulocyte count is 0.5 to 1.5% of the total red cells. However, in the presence of anemia, this number must be corrected because it is spuriously elevated when it is related to the reduced number of RBC in an anemic patient. Moreover, an additional correction of this index needs to be made, because reticulocytes released under intense erythropoietin stimulation remain in the peripheral blood for approximately twice the usual 1-day survival time of nonstress reticulocytes.

**Reticulocyte count = % reticulocytes in RBC population**

**Reticulocyte count corrected for anemia =  
% reticulocytes × patient hematocrit/45**

**Reticulocyte count further corrected for extended  
presence of reticulocytes in the circulation =  
(% reticulocytes × patient hematocrit/45) × 0.5**

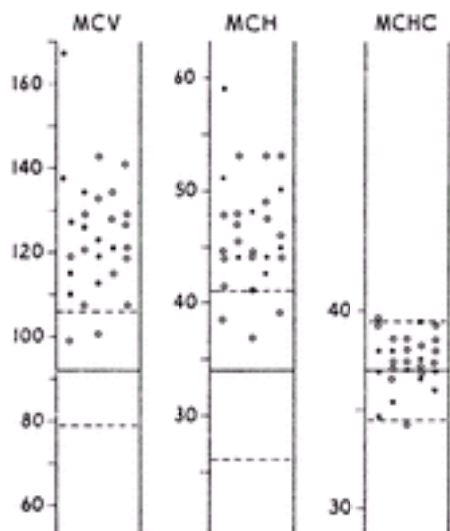
A practical alternative to the awkward construct of a corrected reticulocyte index is to assess the reticulocyte count in absolute numbers.

**Absolute reticulocyte count =  
% reticulocytes × RBC count/L<sup>3</sup>**

Normal values for the absolute reticulocyte count are from 25 to 75 × 10<sup>9</sup>/L. Any value greater than 100 × 10<sup>9</sup>/L is considered evidence of an erythroid marrow compartment that is responding normally. An absence of an appropriate reticulocytosis in the setting of anemia indicates that RBC production is impaired.

**IF ANEMIA IS ASSOCIATED WITH RETICULOCYTOSIS, IS THERE ANY EVIDENCE FOR HEMOLYSIS?** The most characteristic presentation of hemolysis is reticulocytosis with some degree of hyperbilirubinemia as a marker of increased heme catabolism. Other markers reflect direct red cell injury (e.g., increased serum lactic dehydrogenase) or increased excretion of Hb (e.g., low serum haptoglobin, hemoglobinemia, hemoglobinuria, and increased urinary hemosiderin). The evaluation and diagnostic considerations related to hemolytic anemia are complex and are considered separately elsewhere in this chapter (see [Approach to Hemolysis](#)).

**IF ANEMIA IS ASSOCIATED WITH A LESS THAN APPROPRIATE RETICULOCYTE RESPONSE, WHAT ARE THE RED CELL INDICES?** Anemia with low reticulocytes usually reflects some impairment of normal erythropoiesis, and this can be due to two kinds of defects. Erythropoiesis may be impaired because of a reduction in red cell precursors (hypogenerative). Alternatively, red cell production may be ineffective, a condition characterized by erythroid hyperplasia in the bone marrow, but with the production of essentially nonviable red cells, most of which do not reach circulation. There are numerous causes of anemia with low reticulocyte counts, and it is in this group that analysis of red blood cell indices is most helpful. Of these, the MCV tends to be the single most useful measurement ( [33](#), [34](#) and [35](#) ), although some clinicians prefer to use the MCH ( [36](#) ). The MCV and MCH almost always correlate closely ( [37](#), [38](#) ). An initial step in classification of anemias with low reticulocyte counts separates them into three groups on the basis of average cell size: the macrocytic, microcytic, and normocytic anemias ( [Fig. 27.2](#) ). Anemia is classified as macrocytic if MCV exceeds 100 fl. Usually, the MCH is also increased, whereas the MCHC remains within normal limits ( [Fig. 27.3](#) ). Microcytic anemia is identified when the MCV is less than 80 fl in adults. The anemia is normocytic when the indices are within normal limits, with an MCV between 80 and 100 fl. In children, MCV values vary as a function of age, and, correspondingly, the definition of microcytic, normocytic, and macrocytic differ accordingly ( [Table 27.1](#) ). As a practical matter for those who take care of children, it is important to know the age-related differences in RBC size, because many laboratory reports only contain adult normal values, often signaling the child's hematologic values as abnormal.



**Figure 27.3.** Erythrocyte indices in 28 patients with untreated or relapsed pernicious anemia. Dashed lines enclose the 95% confidence limits in normal subjects. Solid dots indicate males; open circles indicate females. MCH, mean corpuscular hemoglobin; MCHC, mean corpuscular hemoglobin concentration; MCV, mean corpuscular volume. (From Hallberg L. Blood volume, hemolysis and regeneration of blood in pernicious anemia. *Scand J Clin Lab Invest* 1965;7[Suppl 16], with permission.)

The MCHC is useful in detecting severe hypochromia, but it is rarely abnormal when the MCV is normal ([35](#), [36](#), [37](#), [38](#), [39](#) and [40](#)). A reduced value for MCHC is observed most often in association with iron deficiency, and this index tends to be the last to fall as iron deficiency worsens ([41](#), [42](#) and [43](#)). The changes in MCHC with iron deficiency were seen more frequently in the past when centrifugal methods were used to determine the hematocrit before the availability of electronic cell counting. Because of plasma trapping, centrifugal hematocrit methods overestimate the volume of packed red cells and, therefore, underestimate MCHC. Plasma trapping increases from 1 to 3% with normal blood to as much as 6% in iron deficiency, a consequence of anisocytosis and reduced cell deformability ([44](#)).

**IS THE ANEMIA ASSOCIATED WITH A LOW RETICULOCYTE RESPONSE AND MICROCYTIC RED BLOOD CELLS?** The large majority of patients in this category have defects in Hb synthesis due to either iron deficiency, thalassemia trait, or Hb E syndromes (see [Approach to Microcytic Anemia](#)).

**IS THE ANEMIA ASSOCIATED WITH A LOW RETICULOCYTE RESPONSE AND MACROCYTIC RED BLOOD CELLS?** In these patients, the anemia is characterized by reticulocytopenia with red cells having an increased MCV. Many of these disorders are due to megaloblastic anemia resulting in impaired nuclear development, and the formation of other blood cells is also affected (see [Approach to Macrocytic Anemia](#)).

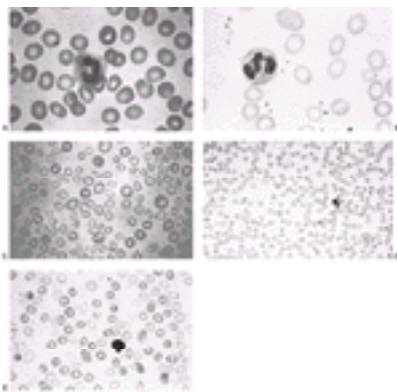
**IS THE ANEMIA ASSOCIATED WITH A LOW RETICULOCYTE RESPONSE AND NORMOCYTIC RED BLOOD CELLS?** Normocytic anemia, low reticulocyte count, and normal bilirubin levels characterize a large number of anemias. The anemia of chronic disease usually is normocytic, although rarely may be slightly microcytic. In these cases, there usually is clinical evidence of rheumatoid arthritis or other chronic illness. The anemia of renal failure is normocytic and largely is due to reduced erythropoietin production. Acquired pure red cell aplasia (PRCA) is a normocytic anemia, which occurs in adults and children (see [Approach to Normocytic Anemia](#)).

**IS THE ANEMIA ASSOCIATED WITH POPULATIONS OF RED CELLS OF DIFFERENT SIZE?** The red cell indices represent mean values and do not reveal any variation that may exist within a population of cells. Also, the indices do not detect two or more populations differing in size or other characteristics. The MCV can be normal if there are combined abnormalities, such as when iron deficiency (decreased MCV) is accompanied by a megaloblastic anemia (increased MCV). For these purposes, it is important to

examine the peripheral blood smear. Also, the electronically derived RDW allows for recognition of these phenomena because it quantifies the degree of heterogeneity of RBC size (i.e., anisocytosis) in a population of cells, and this has proven to be of value (33, 45). The upper limit of normal values for RDW is 14.6% (33). An increased RDW value is an early and pronounced finding in iron deficiency and most megaloblastic anemias; no differences from normal are seen in heterozygous thalassemia. In iron deficiency, the RDW value may become abnormal even before the MCV falls below the lower limits of normal.

#### IS THE ANEMIA ASSOCIATED WITH ABNORMALITIES SEEN ON THE BLOOD SMEAR?

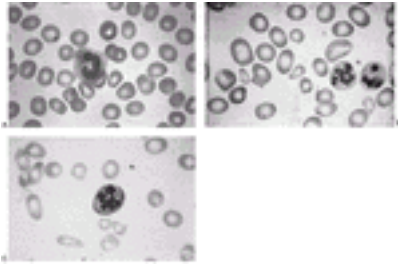
Despite the technical advances provided by current electronic complete blood cell count (CBC) measurements, review of the peripheral blood smear remains a critical aspect of the diagnostic evaluation for anemia. It confirms the electronically determined classification of RBC size. Most important, it also allows for recognition of the many variations in RBC size and shape that frequently are seen in patients with hemolysis. Microcytes and macrocytes can be detected on the blood smear on the basis of a change in red cell diameter. Normal red cells approximate the size of a small lymphocyte nucleus, and the area of central pallor is one-third to one-half of the diameter of the red cell (Fig. 27.4A). An increase in the area of central pallor of erythrocytes on the blood smear is indicative of hypochromia, and when the change is pronounced, little more than a faint ring of color in the periphery may be apparent (Fig. 27.4B). Hypochromia and microcytosis almost always occur together.



**Figure 27.4.** Peripheral blood smear of erythrocytes in a variety of hypochromic, microcytic anemia. **A:** Normal red cells. **B:** Iron deficiency anemia. Note the large area of central pallor. **C:** Dimorphic population of cells in iron deficiency anemia responding to treatment. **D:** Thalassemia minor. The cells are thin and appear pale but nearly normal in diameter. Note the basophilic stippling in one red corpuscle. **E:** Sideroblastic anemia. A hypochromic, microcytic population of cells is mixed with relatively normocytic red blood cell. See [Color Plate](#).

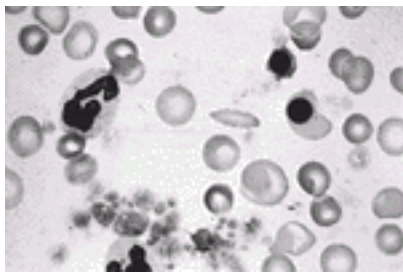
The automated analysis of the blood has made the erythrocyte indices more accurate and reproducible (46). However, the evaluation of the blood smear still remains important because it may reveal abnormal cell populations too small to affect the erythrocyte indices. For example, as iron deficiency develops, some microcytic cells are produced while the RBC indices are still normal. Furthermore, as folic acid deficiency progresses, some characteristic oval macrocytes and hypersegmented neutrophils may appear long before there are MCV or Hb changes (Fig. 27.5B and Fig. 27.5C). Moreover, examination of the smear is important for detecting conditions characterized by two populations of cells, only one of which is of abnormal size. This dimorphic anemia is particularly characteristic of sideroblastic anemias (Fig. 27.4E) (see [Chapter 29](#)). It also is seen in iron deficiency after iron therapy is started (Fig. 27.4C).





**Figure 27.5.** Megaloblastic anemia. **A:** Normal red cells. **B:** Macrocytes in pernicious anemia. **C:** Hypersegmented neutrophils seen in patient with megaloblastic anemia. See [Color Plate](#).

Review of the blood smear may reveal underlying causes of the anemia. A leukoerythroblastic picture (teardrop RBC, nucleated RBC, early white blood cell precursors, or abnormalities in platelet shape) suggests marrow infiltration by hematologic or other malignant cells ( [Fig. 27.6](#)). The marked elevation in serum proteins in multiple myeloma may result in a stacking of RBCs in rouleaux formation. The appearance of RBC in agglutinates (as opposed to their stacking into rouleaux) is seen with cold agglutinin disease. Also, probably one of the most valuable outcomes of reviewing the blood smear is that it often reveals abnormal red cell shapes characteristic of certain hemolytic anemias in particular. This assessment is discussed in detail in the section [Approach to Hemolysis](#).



**Figure 27.6.** Peripheral blood smear. A leukoerythroblastic response seen in patient with myeloid metaplasia. See [Color Plate](#).

### IS A BONE MARROW EXAMINATION NEEDED TO CLARIFY THE CAUSE OF ANEMIA?

Examination of the bone marrow is most useful in reticulocytopenic anemias, particularly when there is more than one hematopoietic cell line affected. Both hypoplasia and marrow infiltrative disease due to leukemia or tumor (myelophthitic anemia) may readily be demonstrated in the bone marrow aspirate and biopsy. Myelofibrosis can be recognized as a component of myeloid metaplasia. If the marrow is normocellular except for reduced erythropoiesis, the underlying cause may be red cell aplasia, renal disease, endocrinopathy, or certain chronic disorders. Examination of iron in bone marrow macrophages is considered the definitive way to demonstrate decreased iron stores. In most cases, however, the diagnosis of iron deficiency can be made by simple blood tests, thus obviating the need for an iron stain of the bone marrow. On the other hand, to make the diagnosis of sideroblastic anemia, a bone marrow examination is necessary to identify ringed sideroblasts. Megaloblastic anemias usually can be recognized by peripheral blood findings, but a marrow examination will confirm the diagnosis. In some anemias with low reticulocyte counts, marrow erythropoiesis surprisingly is quite active. This is referred to as *ineffective erythropoiesis*, and it occurs when developing red cells are defective and are destroyed before they leave the marrow or shortly thereafter. A very small fraction of erythropoiesis is ineffective, even in normal subjects; however, in certain conditions, especially megaloblastic anemias, thalassemias, and sideroblastic anemias, ineffective erythropoiesis becomes greatly exaggerated. The increased intramedullary destruction of erythroblast in these conditions is associated with accelerated heme catabolism, resulting in an elevated unconjugated bilirubin level in the plasma. Also, the serum lactic dehydrogenase level, a marker of cell destruction, is markedly elevated. Ineffective



erythropoiesis can be confused with hemolytic anemia because signs of excessive red cell destruction and erythroid hyperplasia of the bone marrow are found in both conditions. However, the two conditions are distinguished from one another by the degree of reticulocytosis, which is increased in hemolytic anemia and reduced in ineffective erythropoiesis.

## APPROACH TO MACROCYTIC ANEMIA

Macrocytosis is a common finding in clinical settings. In 1.7 to 3.6% of cases involving patients seeking medical care, MCV is increased, often in the absence of anemia ( [47](#), [48](#), [49](#), [50](#), [51](#) and [52](#)). Mild macrocytosis (MCV of 100 to 110 fl) is particularly common and often remains unexplained, even after careful study ( [47](#)). Even so, this finding should not be ignored, because it can be an important early clue to reversible disease. For example, it may appear 1 year or more before anemia develops in patients with pernicious anemia, and neurologic disease can progress during that interval ( [53](#)).

Morphologic and biochemical criteria allow macrocytic anemias to be divided into two groups: the megaloblastic anemias and the nonmegaloblastic macrocytic anemias. The types of macrocytic anemias clinicians encounter vary considerably depending on the population served. If alcoholism is common in the population, it is likely to be the most common cause. If an institution specializes in the treatment of cancer, high MCVs are most likely due to chemotherapy. In hospitals largely serving the elderly, pernicious anemia and other nutritional anemias may predominate ( [52](#)).

When confronted with a diagnostic problem involving macrocytic anemia, the physician should first distinguish between megaloblastic and nonmegaloblastic anemia ( [Fig. 27.7](#)). The most useful steps for this purpose are morphologic examinations.

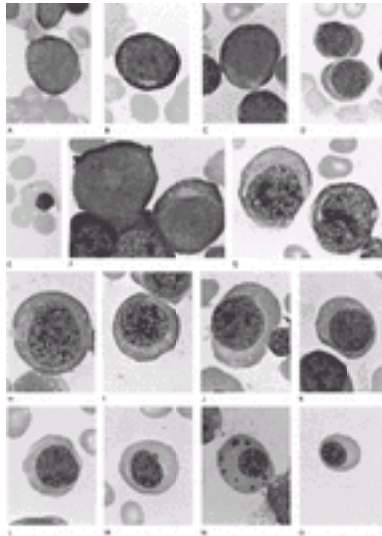


**Figure 27.7.** Diagnostic approach to a patient with macrocytic anemia.

### Megaloblastic Anemias

The term *megaloblast* is a designation that was first applied by Ehrlich to the abnormal erythrocyte precursors found in the bone marrow of patients with pernicious anemia. Megaloblasts are characterized by their large size and by specific alterations in the appearance of their nuclear chromatin ( [Fig. 27.8](#)). These distinctive cells are now known to be the morphologic expression of a biochemical abnormality: retarded DNA synthesis ( [54](#)). RNA synthesis remains unimpaired while cell division is restricted ( [55](#), [56](#)). As a result, cytoplasmic components, especially Hb, are synthesized in excessive amounts during the delay between cell divisions. An enlarged cell is the product of such a process. Megaloblastic anemias are defined by the presence of these cells or by other evidence of

defective DNA synthesis.



**Figure 27.8.** Normoblasts and megaloblasts contrasted (Wright stain  $\times 1000$ ). **A–E:** Normoblast. **A:** Pronormoblast. **B:** Basophilic normoblast. **C:** Early polychromatophilic normoblast. **D:** Late polychromatophilic normoblast. **E:** Orthochromatic normoblast with stippling. **F–O:** Megaloblasts. **F:** Promegaloblast (*left*) and basophilic megaloblast (*right*). **G–K:** Polychromatophilic megaloblasts. **L–O:** Orthochromatic megaloblasts. See [Color Plate](#).

A pathogenetic classification of the causes of megaloblastic anemias is presented in [Table 27.3](#). Most often, megaloblastic anemia is the consequence of deficiency of vitamin B<sub>12</sub> or folate, or both. Less commonly, megaloblastic anemia results from inherited or drug-induced disorders of DNA synthesis ([Chapter 43](#)).

**TABLE 27.3. Pathogenetic Classification of Megaloblastic Anemia**

---

|  |
|--|
| Vitamin B <sub>12</sub> deficiency   |
| Dietary deficiency (rare)  |
| Lack of intrinsic factor   |
| Pernicious anemia  |
| Gastric surgery  |
| Ingestion of caustic materials   |
| Functionally abnormal intrinsic factor   |
| Biologic competition for vitamin B <sub>12</sub>                                       |
| Small-bowel bacterial overgrowth   |
| Fish tapeworm disease  |
| Familial selective vitamin B <sub>12</sub> malabsorption (Imerslund-Gräsbeck syndrome) |
| Drug-induced vitamin B <sub>12</sub> malabsorption                                     |
| Chronic pancreatic disease   |
| Zollinger-Ellison syndrome   |
| Diseases of the ileum  |
| Previous ileum resection   |

- Regional enteritis
- Folate deficiency
  - Dietary deficiency
  - Increased requirements
    - Pregnancy
    - Infancy
    - Chronic hemolytic anemia
  - Alcoholism
  - Congenital folate malabsorption
  - Drug-induced folate deficiency
  - Extensive intestinal resection, jejunal resection
- Combined folate and vitamin B<sub>12</sub> deficiency
  - Tropical sprue
  - Gluten-sensitive enteropathy
- Inherited disorders of DNA synthesis
  - Orotic aciduria
  - Lesch-Nyhan syndrome
  - Thiamine responsive megaloblastic anemia
  - Methyl-tetrahydrofolate reductase
  - Formiminotransferase
  - Dihydrofolate reductase
  - Transcobalamin II deficiency
  - Homocystinuria and methylmalonic aciduria
- Drug- and toxin-induced disorders of DNA synthesis
  - Folate antagonists (e.g., methotrexate)
  - Purine antagonists (e.g., 6-mercaptopurine)
  - Pyrimidine antagonists (e.g., cytosine arabinoside)
  - Alkylating agents (e.g., cyclophosphamide)
  - Zidovudine (AZT, Retrovir)
  - Trimethoprim
  - Oral contraceptives
  - Nitrous oxide
  - Arsenic
  - Chlordane
  - Erythroleukemia

---

**HEMATOLOGIC FEATURES OF MEGALOBLASTIC ANEMIA** Examination of the blood smear often reveals the two most valuable findings for differentiating megaloblastic from nonmegaloblastic anemia: neutrophil hypersegmentation and oval macrocytes. Neutrophile hypersegmentation is one of the most sensitive and specific signs of megaloblastic anemia ( [Fig. 27.5C](#)). Normally, the nuclei of circulating, segmented neutrophils have fewer than five lobes. In megaloblastic anemia, neutrophils with six to ten or more lobes may be detected. In a large study, more than 98% of patients with megaloblastic anemia had at least one six-lobed neutrophil of the 100 cells examined, as compared with only 2% of normal control subjects ( [57](#)). Hypersegmentation is among the first hematologic abnormalities to appear as the megaloblastic state develops ( [58](#)). It persists for an average of 14 days after institution of specific therapy ( [59](#)). The main products of megaloblastic erythropoiesis are macrocytic erythrocytes with a distinctly oval shape. Such cells are well filled with Hb, and often central pallor is reduced or absent ( [Fig.](#)

[27.5B](#)). The oval shape may be useful in distinguishing megaloblastic anemias from other causes of macrocytosis; the macroreticulocytes that characterize accelerated erythropoiesis tend to be round and distinctly blue or gray in Romanowsky dyes. Although oval macrocytes are prominent in megaloblastic anemia, the size and shape of the erythrocytes may vary considerably. Quantitative measures of anisocytosis, such as the RDW, are substantially increased, and the increase may precede the development of anemia ([60](#)). Morphologic changes on the blood smear, however, are most conspicuous when anemia is pronounced. Megaloblastic anemias usually develop gradually, and the degree of anemia is often severe when first detected. Hb values less than 7 or 8 g/dl are not unusual. Macrocytosis characteristically precedes the development of anemia ([53](#), [61](#), [62](#)) and may even do so by several years. The MCV usually falls between 110 and 130 fl but may reach as high as 160 fl with extreme degrees of anemia.

**BONE MARROW** A megaloblastic marrow is cellular and usually hyperplastic, with erythrocyte precursors predominating. The characteristic megaloblasts are distinguished by their large size and especially by their delicate nuclear chromatin. The chromatin has been described as particulate or sievelike, as distinguished from the normal denser chromatin of normoblasts ([Fig. 27.8](#)). This morphologic change may be detected at all stages of erythrocyte development; however, the identification of orthochromatic megaloblasts is particularly useful in the recognition of megaloblastic anemia because they differ so markedly from any cell found in normal marrow. In the orthochromatic megaloblast, the abundant cytoplasm appears mature (pink), whereas the nucleus appears immature as the result of the megaloblastic change. Leukopoiesis is also abnormal; extraordinarily large (up to 20 or 30  $\mu\text{m}$ ) leukocytes are found. These abnormalities of cellular development may occur at any stage in the myeloid series, but they are particularly common among the metamyelocytes. The nucleus of these giant metamyelocytes is enlarged, both absolutely and in relation to the total cell size; it may be bizarre in shape and in chromatin structure or staining properties. In general, megakaryopoiesis is less disturbed than that of either of the other two cell lines; however, when megaloblastic change is severe, megakaryocytes may be reduced in number and abnormalities of nuclear chromatin may be evident.

**VITAMIN B<sub>12</sub> AND FOLATE LEVELS IN SERUM AND ERYTHROCYTES** Once it is established that a patient has megaloblastic anemia, serum vitamin B<sub>12</sub> and folate levels are measured to distinguish between the two most common causes of this problem ([Chapter 43](#)). Vitamin B<sub>12</sub> levels may be determined by microbiologic assay ([63](#), [64](#)) or by competitive-binding isotope techniques ([65](#)). Serum and erythrocyte folate concentrations may be determined microbiologically ([66](#)) or by isotope dilution ([67](#), [68](#) and [69](#)). Unlike serum vitamin B<sub>12</sub>, serum folate is labile, being sensitive to short-term changes in folate balance. Thus, serum folate concentration may increase within a few hours after consumption of folate-containing food. Furthermore, a low intake of folate may result in reduced serum levels before true deficiency develops ([58](#)). The erythrocyte folate level is a better index of tissue folate stores, and its significance with respect to folate deficiency is more nearly equivalent to that of serum vitamin B<sub>12</sub> levels in vitamin B<sub>12</sub> deficiency. Erythrocyte folate levels are established during formation of the red cell and persist throughout its lifespan. Thus, it may take 3 to 4 months of folate deprivation before low values are obtained. Other blood studies (serum homocysteine, serum methylmalonate, antibodies to intrinsic factor), urine studies (excretion of methylmalonic acid, excretion of formiminoglutamate), and vitamin B<sub>12</sub> absorption studies (Schilling test) can further define the specific causes of these disorders ([Chapter 43](#)).

### Nonmegaloblastic Macrocytic Anemias

Nonmegaloblastic anemias are not united by a common pathogenetic mechanism; they simply represent macrocytic anemias in which the RBC precursors appear normal without the characteristic nuclear and cytoplasmic findings of megaloblastosis. DNA synthesis is

unimpaired. When macrocytosis is found, it tends to be mild; the MCV usually ranges from 100 to 110 fl and rarely exceeds 120 fl (48). Several causes of nonmegaloblastic macrocytosis are recognized (Table 27.4).

**TABLE 27.4. Nonmegaloblastic Macrocytic Anemias**

---

Associated with accelerated erythropoiesis

    Hemolytic anemia

    Posthemorrhagic anemia

Alcoholism

Liver disease (Chapter 47)

Myelodysplastic syndrome (Chapter 43)

Myelophthistic anemias

Aplastic anemia (Chapter 44)

Acquired sideroblastic anemia (Chapter 29)

Hereditary dyserythropoietic anemia (congenital dyserythropoietic anemia types I and III) (Chapter 46)

Diamond–Blackfan anemia (Chapter 45)

Hypothyroidism (Chapter 47)

---

**ACCELERATED ERYTHROPOIESIS** Mild to moderate macrocytosis often follows erythropoietin-mediated acceleration of red cell production, as may be induced by blood loss or hemolysis. In part, this increased cell size occurs because reticulocytes are approximately 20% larger than mature red cells (70). Also, under conditions of accelerated red cell production, a premature release of bone marrow reticulocytes (shift reticulocytes) occurs, and these cells are even larger and contain more RNA than normal circulating reticulocytes (71). Last, an erythroblast cell division may be skipped under this erythropoietic stress, a phenomenon that results in a macroreticulocyte that is approximately twice the normal size (72).

**ALCOHOLISM** Macrocytosis, usually mild, is evident in 40 to 96% of chronic alcoholics, many of whom have no anemia (73, 74 and 75). The finding is so characteristic of the condition that testing for macrocytosis has been used as part of the screening procedure for the early detection of alcoholism. Macrocytosis and anemia in alcoholic individuals have several causes. Folate deficiency can lead to megaloblastic anemia, and alcoholic cirrhosis may be associated with spur-cell hemolytic anemia. Most often, however, alcoholic macrocytosis is associated with none of these factors and instead results from poorly defined direct effects of alcohol on the bone marrow. There are no morphologic stigmata of megaloblastic anemia. Serum and erythrocyte folate levels are usually normal, and the macrocytosis does not respond to folate treatment. If the patient abstains from alcohol use, the MCV returns to normal levels after 2 to 4 months.

**LIVER DISEASE** The causes of anemia in liver disease are multifactorial, resulting from intravascular dilution due to hypervolemia, impaired ability of the marrow to respond optimally to the anemia, and in some patients, a severe hemolytic anemia associated with morphologically abnormal erythrocytes (spur cells) (Chapter 47). The anemia is usually mild to moderate. In cirrhotic patients, the Hb level averages approximately 12 g/dl, and remains above 10 g/dl in the absence of bleeding or severe hemolysis. The anemia of liver disease is mildly macrocytic: The MCV rarely exceeds 115 fl in the absence of megaloblastic changes in the bone marrow. In addition, liver disease is associated with thin macrocytes, defined as cells with increased surface area (76) but without a corresponding increase in volume (77). The increased surface area of thin macrocytes is

the consequence of excessive membrane lipids, especially cholesterol ([76](#)), but also phospholipids. On the blood smear, thin macrocytes are characterized by an increased diameter and a visibly enlarged area of central pallor. The characteristic target cell of liver disease is a thin macrocyte. Because the volume of such cells is normal, their presence has no effect on the erythrocyte indices.

**MISCELLANEOUS ANEMIAS** Macrocytosis that accompanies various refractory anemias with low reticulocyte counts includes myelodysplastic and myelophthistic conditions ([Chapter 83](#)). The reason for macrocytosis in these disorders is not well understood. Evidence of disorders of the hematopoietic stem cell has been observed in elderly patients with unexplained macrocytosis ([78](#)). Congenital red cell hypoplasia or Diamond–Blackfan anemia (DBA) is a pure RBC aplasia in children that is due to impaired differentiation of developing erythroblasts ([Chapter 45](#)). This disorder is characterized by a life-long anemia that presents in the first few months of life. Many children with DBA have congenital abnormalities, including short stature and skeletal defects (usually affecting the thumb). The diagnosis of DBA is suggested by a macrocytic (although sometimes normocytic) anemia with reticulocytopenia presenting in the first 6 months of life. Bone marrow examination reveals decreased erythroid precursors. Congenital dyserythropoietic anemias (CDAs) are a group of anemias characterized by ineffective erythropoiesis and dys-erythropoiesis ([Chapter 46](#)). The term *dyserythropoiesis* refers to the presence of morphologically abnormal erythroblasts in the bone marrow with multinuclearity, karyorrhexis, or megaloblastic changes. Three major types of CDA have been distinguished on the basis of morphologic and serologic classification, and these have been designated CDA types I, II, and III. The degree of anemia encountered in the CDAs varies considerably. It may range from a mild to moderate anemia that is only discovered or diagnosed later in life to a severe anemia apparent in infancy. Morphologically, the anemia is generally mildly macrocytic in CDA types I and III and is normocytic in CDA type II. In all of the disorders, the bone marrow findings are consistent with ineffective erythropoiesis: There is erythroid hyperplasia along with morphologically abnormal precursors. An elevation in serum lactate dehydrogenase and indirect bilirubin levels may be observed. Spurious macrocytosis can result from laboratory artifacts. Cold agglutinins and marked leukocytosis can lead to an incorrect high MCV value ([49](#)). Care is needed so that these situations do not lead to a fruitless search for a disorder known to cause macrocytic anemia.

## APPROACH TO MICROCYTIC ANEMIA

Most microcytic anemias are due to deficient Hb synthesis, often associated with iron deficiency or impaired iron use ([Table 27.5](#)). The differentiation of iron deficiency from the anemia of chronic disease and the differentiation of iron deficiency from thalassemia trait syndromes are both common clinical issues. Significant microcytosis is detected in nearly 3% of all patients who require admission to the hospital ([40](#), [79](#)).

**TABLE 27.5. Pathogenic Classification of Microcytic Anemias**

---

### Disorders of iron metabolism

Iron deficiency anemia ([Chapter 28](#))

Anemia of chronic disorders ([Chapter 47](#))

### Disorders of globin synthesis

Alpha and beta thalassemias ([Chapter 42](#))

Hemoglobin E syndromes (AE, EE, E- $\beta$ -thalassemia) ([Chapter 39](#))

Hemoglobin C syndromes (AC, CC) ([Chapter 39](#))

Unstable hemoglobin disease ([Chapter 41](#))

Sideroblastic anemias ([Chapter 29](#))



- Hereditary sideroblastic anemia
  - X-linked
  - Autosomal
- Acquired sideroblastic anemia
  - Refractory anemia with ringed sideroblasts
  - Malignancies
  - Myeloproliferative disorders
- Reversible acquired sideroblastic anemia
  - Alcoholism
  - Drugs (isoniazid, chloramphenicol)
- Lead intoxication (usually normocytic)

---

The typical Hb levels seen in adults with a variety of microcytic anemias is depicted in [Table 27.6](#). The laboratory evaluation of microcytic anemias focuses on screening hematologic studies, followed by more definitive tests to distinguish iron deficiency anemia, the anemia of chronic disease, hemoglobinopathies, or sideroblastic anemias ( [Fig. 27.9](#)). A few commonly used studies are described below; others are described elsewhere in this text.

**TABLE 27.6. Typical Hemoglobin and Mean Corpuscular Volume Values in Adults with Certain Anemias**

| Condition                       | Hb Concentration (g/dl) | MCV (fl)     |
|---------------------------------|-------------------------|--------------|
| Normal men                      | 16 (14–18)              | 89 (80–100)  |
| Normal women                    | 14 (12–16)              | 89 (80–100)  |
| Iron deficiency anemia          | 8 (4–12)                | 74 (55–85)   |
| Anemia of chronic diseases      | 10 (8–13)               | 85 (75–95)   |
| β-Thalassemias minor            | 12 (9–14)               | 68 (55–75)   |
| β-Thalassemias major            | (2–7)                   | (48–72)      |
| Hemoglobin H disease            | 9 (7–11)                | 70 (53–88)   |
| Hemoglobin E trait (AE)         | 14 (12–17)              | 73 (71–78)   |
| Homozygous hemoglobin E (EE)    | 12 (11–15)              | 64 (58–76)   |
| Hemoglobin C disease (CC)       | 10 (7–14)               | 77 (55–93)   |
| Congenital sideroblastic anemia | 6 (4–10)                | 77 (49–104)  |
| Acquired sideroblastic anemia   | 10 (7–12)               | 104 (83–118) |

NOTE: Values are means, with approximate range in parentheses.  
Hb, hemoglobin; MCV, mean corpuscular volume.

---





**Figure 27.9.** Diagnostic approach to a patient with microcytic anemia. ↑, increased; ↓, decreased.

## Iron Pathway Disorders

The principal source of iron for Hb production is that carried by transferrin, the iron-transport protein in plasma. Under normal circumstances, plasma iron levels are not rate limiting in erythropoiesis, and transferrin is able to supply all the iron required for normal or accelerated production rates. However, in iron deficiency anemia, the storage sites in macrophages are depleted of iron and the plasma iron concentration falls. When transferrin saturation with iron is less than 16%, the red cell production rate decreases, and hypochromic, microcytic cells are manufactured. This state is known as *iron-deficient erythropoiesis*.

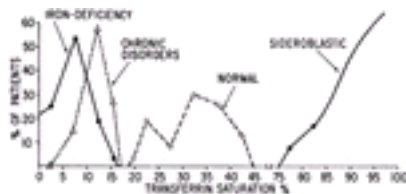
In the anemia associated with chronic disorders ( [Chapter 47](#)), the macrophage iron level is normal or increased, but flow to plasma and the bone marrow erythroblasts is partially blocked ( [80](#), [81](#) and [82](#)). Thus, iron accumulates in the macrophage, whereas the plasma level falls, and the marrow is deprived of adequate supplies.

Together, iron deficiency anemia and the anemia of chronic disease are among the most common causes of anemia. Iron deficiency predominates in children and young women, but it also occurs in older individuals in whom it may reflect occult bleeding due to underlying pathology. The anemia of chronic disorders is most common among elderly people ( [83](#)), but it also can occur in younger individuals affected by certain chronic inflammatory states.

Distinguishing typical iron deficiency anemia from the anemia of chronic disorders is usually not difficult. Anemia, hypochromia, and microcytosis are typically more pronounced in iron deficiency, as are the degrees of anisocytosis and poikilocytosis. The anemia of chronic disease is usually normocytic. However, when iron deficiency is early and mild, the morphologic findings in the two conditions may be similar.

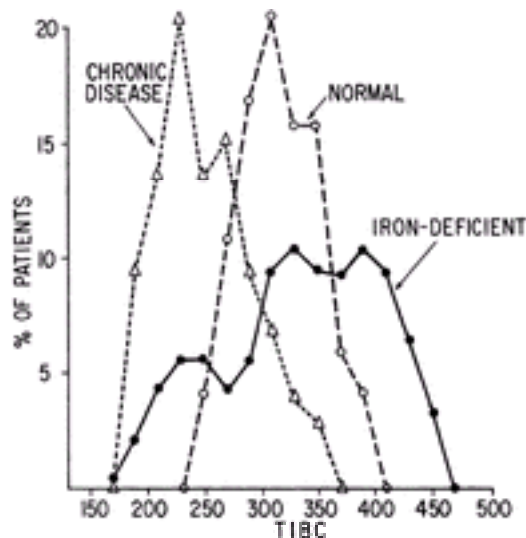
**MEASUREMENT OF SERUM IRON AND IRON-BINDING CAPACITY** Serum iron levels are a measure of the amount of iron bound to transferrin. Total iron-binding capacity (TIBC) is an indirect measurement of transferrin in terms of the amount of iron it will bind. A limitation in the use of serum iron determinations is the considerable variability in values ( [35](#), [46](#), [84](#), [85](#)). A technical problem relates to contamination of glassware and reagents with iron, although the use of disposable, plastic equipment has reduced such contamination considerably. Even if technical problems are eliminated, serum iron values in an individual can vary from 10 to 40% within a single day or from day to day ( [86](#), [87](#)); and many normal subjects demonstrate a predictable diurnal variation, with highest values in the morning and lowest values in the evening ( [35](#)). In contrast to serum iron, TIBC values show only slight day-to-day fluctuation or diurnal variation ( [84](#)). It also must be recognized that serum iron levels are influenced by the recent ingestion and absorption of iron medication. The normal mean serum iron value for men is approximately 120 μg/dl (21.8 μmol/L). The composite normal range is approximately 70 to 200 μg/dl (13 to 36

$\mu\text{mol/L}$ ); as discussed previously, however, values vary substantially from one laboratory to another. The TIBC averages  $340 \mu\text{g/L}$  ( $61 \mu\text{mol/L}$ ) in both men and women, with a composite normal range of  $250$  to  $435 \mu\text{g/dl}$  ( $45$  to  $78 \mu\text{mol/L}$ ). Transferrin saturation is calculated with the following formula:  $\text{transferrin saturation (\%)} = \text{serum iron} \times 100/\text{TIBC}$ . The normal value is  $20$  to  $45\%$ . Values below  $16\%$  are noted in association with both iron deficiency and the anemia of chronic disorders ( Fig. 27.10). The degree of reduction tends to be greater in iron deficiency than in chronic disorders, but considerable overlap exists between these two conditions. In both children and adults, however, a value of less than  $5\%$  is almost certainly due to iron deficiency anemia. In sideroblastic anemias, transferrin saturation invariably is increased and often approaches  $100\%$ .



**Figure 27.10.** Transferrin iron saturation in patients with several types of anemia. The values are low ( $>16\%$ ) in iron deficiency anemia and the anemia of chronic disorders, with considerable overlap. Values of less than  $5\%$  are found only in iron deficiency. Transferrin saturation is increased in sideroblastic anemia.

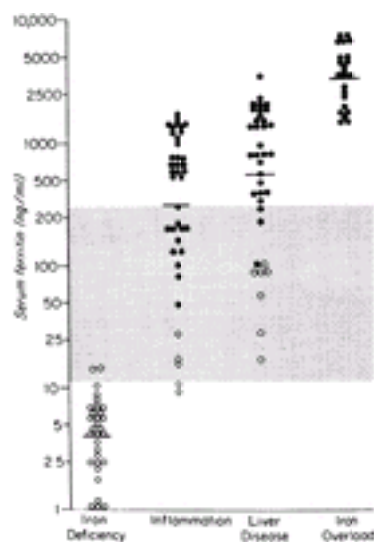
The absolute value for TIBC may be helpful in distinguishing between iron deficiency and the anemia of chronic disorders. The TIBC often is increased in iron deficiency and decreased in chronic disease ( Fig. 27.11), and some consider it to be the best test to distinguish these two disorders ( 88).



**Figure 27.11.** Total iron-binding capacity ( TIBC) in patients with iron deficiency and in those with chronic disease. A high value indicates iron deficiency. Low values are found in chronic disease but may also occur in iron deficiency.

**SERUM FERRITIN** Determination of serum ferritin concentration also is used for evaluating iron stores in patients with iron deficiency ( 89). Ferritin is chiefly an intracellular iron storage protein, but trace amounts are also secreted into plasma. The serum protein differs from the intracellular protein in that it is glycosylated ( 90) and contains little or no iron ( 89, 91, 92). In most clinical circumstances, the serum ferritin concentration is proportional to total body iron stores. In contrast to serum iron measurements, ferritin values are not influenced by recent iron therapy ( 93). The mean ferritin value for normal adult men is  $90$  to  $95 \mu\text{g/L}$ , with a range of approximately  $20$  to

500 µg/L. For women, mean values of approximately 35 µg/L are noted, with a usual range of 10 to 200 µg/L, when iron deficiency was excluded ( 92 ). In infants, values are high at birth but rapidly fall to approximately 30 µg/L, where they remain until puberty. Serum ferritin values in men tend to rise steadily with age. These levels show little or no diurnal variation. Day-to-day variation averages approximately 15%, mostly because of methodologic factors ( 92 ). In patients with uncomplicated iron deficiency, mean values of 3 to 6 µg/L have been reported. In patients with excessive iron stores, values are usually greater than 1000 µg/L and may reach 10,000 µg/L ( Fig. 27.12 ) ( 94 ). Also, the serum ferritin level in patients with anemia of chronic diseases may increase disproportionately relative to the increase in iron stores, probably because ferritin is an acute-phase reactant. This phenomenon complicates the diagnosis of iron deficiency when it coexists with inflammatory disease. In some other illnesses, the serum ferritin level increases because of factors other than augmented iron stores. One such condition is liver disease, in which damage to the hepatic cell can cause the release of intracellular ferritin (nonglycosylated and iron-rich) ( 94 ). Serum ferritin values also may be inappropriately increased in association with various malignancies, especially hematologic malignancies ( 92 , 95 , 96 ).



**Figure 27.12.** Measurements of serum ferritin in uncomplicated iron deficiency, inflammation, liver disease, and iron overload. Geometric mean values for each group ( *horizontal line*). Patients with iron deficiency (total iron-binding capacity >400 µg/100 ml and transferrin saturation below 16% or absent marrow iron or both) ( *open circles*). Normal range ( *shaded area*). (From Lipshitz D, Cook JD, Finch CA. A clinical evaluation of serum ferritin as an index of iron stores. N Engl J Med 1974;290:1213–1216, with permission.)

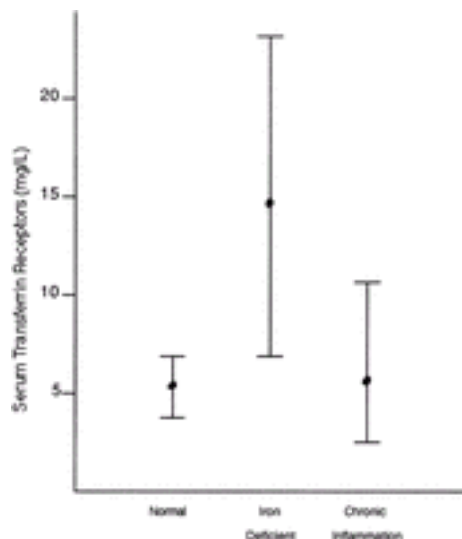
**EVALUATION OF BONE MARROW IRON STORES** In bone marrow aspirates, hemosiderin appears as golden-yellow refractile granules. More often, the specimen is stained by the Prussian blue method, which renders hemosiderin blue ( 97 ). Experienced observers can grade the marrow hemosiderin stores from 0 to 6+ ( [Table 27.7](#) ) ( 98 ). Normal marrow is graded 1+ to 3+. In iron deficiency, marrow hemosiderin is absent; in the anemia of chronic disorders, iron is always present, most often of grade 2 or 3+, but sometimes 4 or 5+. Iron stores are greatly increased (5 to 6+) in thalassemia major and in sideroblastic anemias. Nowadays the marrow assessment of iron is used much less, because serum ferritin provides a simple measurement that correlates with clinical iron states in the anemia of chronic disease and in iron deficiency states.

**TABLE 27.7. Criteria for Grading Iron Stains in Bone Marrow Aspirates**

| Grade | Criteria   | Iron Content (µg/g) |
|-------|--|---------------------|
| 0     | No iron granules observed  | 42 ± 23             |
| 1+    | Small granules in reticulum cells, seen only with oil-immersion lens | 130 ± 50            |
| 2+    | Few small granules visible with low-power lens                       | 223 ± 75            |
| 3+    | Numerous small granules in all narrow particles                      | 406 ± 131           |
| 4+    | Large granules in small clumps                                       | 762 ± 247           |
| 5+    | Dense, large clumps of granules                                      | 1618 ± 464          |
| 6+    | Very large deposits, obscuring marrow detail                         | 3681 ± 1400         |

Gale E, et al. The quantitative estimation of total iron stores in human bone marrow. J Clin Invest 1963;42:1076.

**TRANSFERRIN RECEPTORS** Transferrin receptors (TfRs) are disulfide-linked transmembrane proteins that facilitate the entry of transferrin-bound iron into cells (Chapter 48). A soluble, truncated form of the protein can be detected in plasma, and its immunologic quantification can be useful in detecting iron deficiency and distinguishing it from the anemia of chronic disease. Values in iron-deficient subjects are clearly increased, but, importantly, TfR values do not increase in the anemia of chronic disease (Fig. 27.13) (99, 100 and 101). Therefore, TfR determination is another test that may be useful in distinguishing iron deficiency from the anemia of chronic disease when serum ferritin levels are not definitive. Serum TfR levels also vary with the total mass of red cell precursors. Therefore, the value increases in hemolytic anemia, thalassemia, and polycythemia and decreases in hypoplastic anemia and renal failure (60).



**Figure 27.13.** Serum transferrin receptors in patients with iron deficiency and the anemia of chronic disorders. Bars indicate the mean (dot) and ranges of values in the three groups. [From Ferguson BJ, et al. Serum transferrin receptor distinguishes the anemia of chronic disease from iron deficiency anemia. J Lab Clin Med 1992;119(4):385-390, with permission.]

#### OTHER TESTS TO ASSESS IRON METABOLISM

**Erythrocyte Zinc Protoporphyrin** Red cell precursors normally synthesize slightly more protoporphyrin than is needed for heme synthesis. The excess remains with the cell throughout its lifespan and has been called free erythrocyte protoporphyrin (FEP). When

iron is not available for heme synthesis, protoporphyrin accumulates in excess as zinc protoporphyrin. Measurement of FEP is available as a screening test for iron deficiency, and the test requires only a drop of blood and 1 minute of processing ( [35](#), [102](#)). The level of FEP increases dramatically in iron deficiency and is a sensitive laboratory abnormality in this condition ( [35](#), [102](#), [103](#), [104](#) and [105](#)). The erythrocyte zinc protoporphyrin content also is greatly increased in lead poisoning but is normal in thalassemia ( [102](#), [103](#)).

**Liver Iron Stores** Iron stores can also be estimated by liver biopsy using both histochemical and chemical methods of analysis ( [106](#), [107](#)). Even gross inspection of a Prussian blue-stained biopsy specimen can provide a reasonably reliable estimate of iron stores ( [108](#)). Criteria for grading the preparations from 1 to 4+ have been established ( [106](#), [107](#), [109](#)), and these correlate well with chemical analysis. Chemical analysis is particularly important in evaluating hemochromatosis and transfusion-iron overload, because a disproportionate amount of iron is in parenchymal cells in the form of ferritin, which does not stain with Prussian blue ( [110](#)). Measurement of hepatic iron stores is used mainly to assess iron overload states, because the correlation between serum ferritin and true tissue iron content is not as good when there is elevated tissue iron content.

**Urinary Iron Excretion** Storage iron has been evaluated by urinary excretion of iron after the administration of a chelating agent ( [111](#), [112](#), [113](#) and [114](#)). The chelator most commonly used for this purpose is deferoxamine. A rough correlation exists between iron stores and urinary iron excretion after deferoxamine administration. The test is useful in detecting iron overload, but it is less reliable in assessing deficient stores, because the values found in normal and iron-deficient subjects overlap ( [114](#), [115](#) and [116](#)).

## Disorders of Hemoglobin Synthesis

The Hb disorders associated with microcytosis include the thalassemias and certain structural Hb variants.

The thalassemias are a group of inherited disorders in which synthesis of one of the normal polypeptide chains of globin is severely deficient ( [Chapter 42](#)). In mild forms of the disease (thalassemia minor), hypochromia and microcytosis are prominent, whereas anemia is absent or mild. In other thalassemic disorders, including homozygous  $\beta$ -thalassemia ( $\beta$ -thalassemia major) and Hb E  $\beta$ -thalassemia, hypochromic, microcytic anemia is usually quite severe.

Some structurally abnormal Hb also may be associated with moderate microcytosis. This is particularly characteristic of patients carrying a Hb E gene ( [Chapter 39](#)).

Heterozygotes for this hemoglobinopathy typically have microcytosis without anemia ( [117](#), [118](#) and [119](#)). Homozygotes have a greater degree of microcytosis and either mild or no anemia ( [37](#), [117](#), [118](#)). Like thalassemia, Hb E diseases are characterized by reduced  $\beta$ -chain synthesis ( [120](#)). Microcytosis also occurs in homozygous Hb C disease ( [121](#), [122](#)).

The possibility of thalassemia minor is often raised by finding that the microcytosis is more severe than might be expected for the mild degree of anemia. In addition, basophilic stippling and target cells tend to be more prominent in thalassemia than in iron deficiency. An important feature of thalassemia trait-like conditions (which include the Hb E syndromes) is that the RBC count often is very high normal to elevated despite having anemia and small RBC. This characteristic has allowed several different measures for differentiating iron deficiency from thalassemia trait and Hb E disorders. One of the most useful is a modification of the Mentzer index ( [123](#)), which is based on the MCV and RBC count:

MCV/RBC ( $10^6$ ) >14 (suggestive of iron deficiency)

MCV/RBC ( $10^6$ ) 12–14 (indeterminate)

MCV/RBC ( $10^6$ ) <12 (suggestive of thalassemia trait disorders)

Measures of anisocytosis (RDW) derived from erythrocyte volume distribution also have been advocated for distinguishing iron deficiency from thalassemia minor (33, 42, 45, 124). Anisocytosis is an early and prominent finding in iron deficiency, often detectable before significant microcytosis, hypochromia, or even anemia is apparent. In contrast, anisocytosis tends to be absent or mild in thalassemia minor. The normal value for RDW is  $13.4 \pm 1.2\%$  (mean, 2 SD), and the upper limit of normal is 14.6% (33). In iron deficiency, the value is  $16.3 \pm 1.8\%$ , whereas in  $\beta$ - or  $\alpha$ -thalassemia minor, the value is normal ( $13.6 \pm 1.6\%$ ). An increased RDW appears to be 90 to 100% sensitive for iron deficiency but only 50 to 70% specific (125). An increased value for RDW in an otherwise normal complete blood count most often represents early iron deficiency, but other nutritional deficiencies are also possible causes.

Homozygous hemoglobinopathies, especially Hb C (118) and Hb E (37, 119), tend to be microcytic and normochromic, and many target cells are apparent in the blood smear (Chapter 39).

Distinguishing homozygous  $\beta$ -thalassemia ( $\beta$ -thalassemia major) from  $\beta$ -thalassemia minor is rarely a problem, because the former is accompanied by signs of hemolysis and ineffective erythropoiesis; there also are characteristic findings on the blood smear, including nucleated red cells, extreme anisocytosis and poikilocytosis, and target cells (Chapter 42). However, it is a common diagnostic problem to distinguish patients with  $\beta$ -thalassemia trait from those with iron deficiency. In almost all cases of  $\beta$ -thalassemia trait, the fraction of Hb A<sub>2</sub> is increased, whereas the value for Hb A<sub>2</sub> is normal or decreased in iron deficiency (126).

$\alpha$ -Thalassemia syndromes result from decreased  $\alpha$ -globin chain synthesis that is directed by four structural genes. Four different  $\alpha$ -thalassemia syndromes have been recognized on chromosome 16. Silent carrier state ( $\alpha$ -thalassemia II) individuals lack one  $\alpha$  globin gene; the  $\alpha$ , $\beta$ -globin chain synthetic ratio is decreased from unity, but these individuals are hematologically normal and have no clinical problems.  $\alpha$ -Thalassemia trait ( $\alpha$ -thalassemia I) individuals lack two  $\alpha$ -globin genes,  $\alpha$ -globin synthesis is impaired, and there is a mild hypochromic microcytic anemia. Hb H disease is caused by the deletion of three  $\alpha$ -globin genes, and the consequence of this is a mild to moderate hemolytic anemia. Beyond the neonatal period, the unbalanced chain synthesis leads to an excess in  $\beta$ -globin chains which form Hb H ( $\beta_4$  tetramers). Hb H is mildly unstable, particularly in the presence of oxidant stress, thereby causing intermittent hemolysis. Homozygous  $\alpha$ -thalassemia (hydrops) is due to a deletion of all four  $\alpha$ -globin genes, resulting in severe anemia due to the complete absence of  $\alpha$ -globin chains. This disorder is incompatible with life, and fetuses are aborted early, are stillborn, or die within the first few hours of life.

A common clinical problem is to identify  $\alpha$ -thalassemia trait, which has a similar presentation to  $\beta$ -thalassemia trait and iron deficiency. The diagnosis often is a presumptive one, made after excluding iron deficiency,  $\beta$ -thalassemia trait, and any other abnormal Hb. Specific DNA-based testing is available, but it is seldom used for routine diagnostic purposes. Its major value is in prenatal diagnosis, and the counseling of potential parents at risk for having children with homozygous  $\alpha$ -thalassemia. The  $\alpha$ -thalassemia syndromes occur primarily in those of Asian and African descent, and it is of interest that in Africans with  $\alpha$ -thalassemia trait, the globin gene deletions occur on different chromosomes (i.e., trans deletions), whereas in Asians with  $\alpha$ -thalassemia trait,



the gene deletions occur on the same chromosome (i.e., cis deletion). As a consequence of these racial differences, Hb H disease and homozygous  $\alpha$ -thalassemia occurs only in Asians. Moreover, virtually all Africans with  $\alpha$ -thalassemia have  $\alpha$ -thalassemia trait ( [Chapter 42](#)).

Hb C, Hb E, and Hb H can be detected by electrophoresis; unstable Hbs are detected by the heat-denaturation test.

### Sideroblastic Anemias

The sideroblastic anemias are due to acquired and hereditary disorders of heme synthesis ( [Chapter 29](#)). A classic morphologic feature of this type of anemia, as seen in the peripheral blood smear, is the presence of erythrocyte dimorphism ( [Fig. 27.4E](#)), with a microcytic population of cells mixed with a normal red cell population and the presence of occasional, heavily stippled, hypochromic cells. In hereditary (X-linked) sideroblastic anemia, the anemia and microcytosis are pronounced ( [Table 27.6](#)), and these changes are accompanied by considerable anisocytosis and poikilocytosis. The serum iron concentration usually is elevated, and the TIBC is increased. In all cases of sideroblastic anemia, regardless of the specific etiology, impaired heme synthesis leads to retention of iron within the mitochondria. Morphologically, this is seen in marrow aspirates which reveal many nucleated red cells with iron granules (i.e., aggregates of iron in mitochondria) that have a perinuclear distribution ( [127](#), [128](#)). These unusual cells, known as *ringed sideroblasts*, are found only in pathologic states and are distinct from the sideroblasts (erythroblasts with diffuse cytoplasmic ferritin granules) seen in 30 to 50% of normal red blood cell precursors in marrow. Most common sideroblastic anemias occur in middle age and later life, and these acquired disorders can be idiopathic, secondary to drugs, alcohol, or myeloproliferative disorders ( [Table 27.5](#)). In addition, there are rare congenital sideroblastic anemias that conform to an X-linked pattern of inheritance, usually occurring in males, although skewed lyonization has resulted in affected females. Autosomal-dominant and sporadic cases also occur. Severe anemias are recognized in infancy or early childhood, whereas milder cases may not become apparent until early adulthood or later. Patients may present with pallor, icterus, moderate splenomegaly, or hepatomegaly. Iron overload is a major complication of this disorder. In some cases in which there is little or no anemia, there still may be clinical evidence of iron overload (i.e., diabetes mellitus and liver dysfunction).

### APPROACH TO NORMOCYTIC ANEMIA

Normocytic anemias are those in which the values for MCV are within normal limits, between 80 and 100 fl in adults. At times, however, the anemias that fall into this category also may be macrocytic or microcytic. For example, the anemia associated with hypothyroidism and liver disease may be either normocytic or slightly macrocytic. Also, because of reticulocytosis, the anemia associated with acute hemorrhage or chronic hemolysis may be normocytic or slightly macrocytic. The anemia of chronic disorders, although most often normocytic, is sometimes microcytic, and its pathogenesis is best understood in the context of microcytic anemias, as described above. Last, iron deficiency early in the course of anemia may be normocytic before becoming microcytic.

The normocytic anemias are not related to one another by common pathogenetic mechanisms. In many instances, anemia is only of incidental importance, a minor manifestation of a systemic disease with other, more serious consequences. Importantly, however, sometimes anemia is the first evidence of disease and the sign leading to discovery of the underlying disorder.

Despite the varied etiologic background and the often incidental nature of the normocytic



anemias, they can be classified in a way that forms a basis for diagnostic investigation ( [Fig. 27.14](#)). As a first step, it should be determined whether the erythropoietic response is appropriate to the degree of anemia. When bone marrow function is unimpaired and the iron supply is ample, erythropoiesis can increase manyfold. In most cases, marrow examination is not necessary to determine that the erythropoietic response is adequate, because reticulocytosis may be prominent, and polychromatophilic macrocytes may be detected on routinely stained smears. These manifestations of appropriate marrow response are typical of hemolytic anemia and posthemorrhagic anemia. The history, physical examination, and signs of excessive erythrocyte destruction (e.g., hyperbilirubinemia) provide the information necessary to differentiate these two conditions. The diagnostic approach to anemias due to hemolysis and after acute hemorrhage are discussed separately below.



**Figure 27.14.** Diagnostic approach to a patient with normocytic anemia.

When anemia is apparent but the erythropoietic response is less than appropriate, most likely the underlying disorder directly or indirectly affects the bone marrow. Indirect effects should be investigated first, because often a diagnosis can be made without resorting to marrow aspiration and biopsy. For example, several disorders are associated with reduced secretion of erythropoietin ( [Table 27.8](#)). In these conditions, screening tests usually uncover an underlying systemic disease, and for this purpose, renal function, liver function, and thyroid status should be assessed by use of appropriate biochemical tests. Although severe protein–calorie malnutrition is accompanied by reduced erythropoietin secretion and a mild normocytic anemia, such undernutrition is rare in temperate countries and thus is not likely to be confused with other systemic disorders. The anemia of chronic disease also can present as a normocytic anemia with low reticulocytes. This can be recognized by the underlying chronic illness and the previously described iron studies. One of the causes of this is thought to be a blunted erythropoietic response due to the presence of inflammatory cytokines ( [Chapter 47](#)).

**TABLE 27.8. Classification of the Normocytic Anemias**

|   |
|---|
| Anemia associated with appropriately increased erythrocyte production |
| Posthemorrhagic anemia  |
| Hemolytic anemia  |
| Decreased erythropoietin secretion                                    |
| Impaired source   |
| Renal: anemia of renal insufficiency ( <a href="#">Chapter 47</a> )   |
| Hepatic: anemia of liver disease ( <a href="#">Chapter 47</a> )       |
| Reduced stimulus (decreased tissue oxygen needs)                      |
| Anemia of endocrine deficiency ( <a href="#">Chapter 47</a> )         |
| Protein–calorie malnutrition  |

- Anemia of chronic disorders ( [Chapter 47](#))
  - Anemia with impaired marrow response
    - Bone marrow hypoplasia
      - Red blood cell aplasia ( [Chapter 45](#))
        - Acquired pure red cell aplasia in adults
        - Transient erythroblastopenia of childhood
        - Transient aplastic crises associated with hemolysis
      - Aplastic anemia (pancytopenia) ( [Chapter 44](#))
    - Bone marrow infiltrative disorders
      - Leukemia ( [Chapter 78](#), [Chapter 79](#), [Chapter 80](#), [Chapter 81](#) and [Chapter 82](#))
      - Myeloma ( [Chapter 98](#))
      - Other myelophthisic anemias
    - Myelodysplastic anemias ( [Chapter 83](#))
    - Dyserythropoietic anemias (congenital dyserythropoietic anemia type II) ( [Chapter 46](#))
    - Iron deficiency (early) ( [Chapter 28](#))
- 

Normocytic anemia with marked reticulocytopenia also is a characteristic of RBC aplasia. Acquired PRCA in adults represents a relatively rare group of disorders usually occurring in the fifth to seventh decades of life ( [Chapter 45](#)). The anemia can occur as a primary disorder or secondary to some other disease. Early studies suggested an association with thymoma, but more recent data indicate this is much less common. Most cases of PRCA are seen with a variety of hematologic malignancies (in particular chronic lymphocytic leukemia) and also with nonhematologic malignancies, rheumatoid arthritis, systemic lupus erythematosus and in association with a variety of drugs and chemicals. Laboratory data reveals isolated anemia, reticulocytopenia, and a bone marrow almost completely void of erythroblasts. The remainder of the CBC is normal.

Transient erythroblastopenia of childhood (TEC) is a form of RBC aplasia occurring in young children, caused by transient antibody-mediated suppression of normal erythropoiesis that frequently follows a viral infection ( [Chapter 45](#)). In contrast to Diamond-Blackfan syndrome, there are no congenital abnormalities and no abnormal RBC features. The natural history of transient erythroblastopenia of childhood is one of spontaneous recovery over a few weeks.

Aplastic crises with hemolytic anemia is a self-limiting form of red cell aplasia seen in patients with chronic hemolytic anemia. It is characterized by a rapid decrease in the steady-state Hb concentration and a very low reticulocyte count (see [Approach to Hemolysis](#)).

When the normocytic anemia with reticulocytopenia is associated with leukopenia and thrombocytopenia, there should be suspicion for intrinsic marrow disease due to aplastic anemia, leukemia, myelofibrosis or myelophthisis. Morphologic abnormalities suggestive of marrow infiltration found on the blood smear include nucleated red cells, teardrop poikilocytes, immature leukocytes, and large, bizarre platelets or megakaryocyte fragments ( [Fig 27.6](#)). When such changes are detected, as well as in any patient with anemia along with other cytopenias, marrow aspiration and biopsy should be performed.

Of the different congenital dyserythropoietic anemias (discussed in [Approach to Macrocytosis](#)), type II CDA is the most common, and it is the one that almost always presents as a normocytic anemia. This disorder is recognized by distinct multinuclearity

of the marrow normoblasts ( [Chapter 46](#) ).

## APPROACH TO HEMOLYSIS

Hemolytic disorders are characterized by signs of accelerated erythrocyte destruction together with those of vigorous blood regeneration. Under maximal stimulation, the normal marrow is capable of undergoing hyperplasia until its production rate increases approximately six to eight times ( [129](#) ). With optimal marrow compensation, the survival of red cells in the circulation can theoretically decrease from the normal 120 days to as few as 15 to 20 days without anemia developing. Such an increase in destruction and production of erythrocytes can result in a compensated hemolytic state without anemia being present. In this regard, it is of interest that a significant fraction of patients with hereditary spherocytosis patients are not anemic. However, when red cell survival is so short that anemia develops despite a vigorous erythropoietic response, the term *hemolytic anemia* is appropriate.

### Pathogenesis and Classification

Disorders associated with hemolytic anemia have been classified in various ways, none of which is entirely satisfactory.

On clinical grounds, hemolytic anemias have been divided into acute and chronic forms, but such a division is of limited usefulness because acute episodes may develop during the course of chronic hemolytic disorders.

Of somewhat greater use is a classification based on the site of hemolysis: whether it is predominantly within the circulation (intravascular) or within tissue macrophages (extravascular). Most hemolytic diseases are characterized by extravascular red cell destruction. The intravascular hemolytic disorders are accompanied by unique manifestations, such as hemoglobinemia, hemoglobinuria, and hemosiderinuria, and this type of hemolysis is easily recognized ( [Table 27.9](#) ) ( [130](#) ).

### TABLE 27.9. Hemolytic Anemias Characterized By Significant Intravascular Red Cell Destruction

---

|  |
|--|
| Paroxysmal nocturnal hemoglobinuria                                    |
| Erythrocyte fragmentation disorders                                    |
| Transfusion reactions resulting from ABO isoantibodies                 |
| Paroxysmal cold hemoglobinuria   |
| Acquired autoimmune hemolytic anemia (occasionally)                    |
| Associated with certain infections                                     |
| Blackwater fever in falciparum malaria                                 |
| Clostridial sepsis   |
| Caused by certain chemical agents                                      |
| Arsine poisoning   |
| Snake and spider venoms  |
| Acute drug reactions with glucose-6-phosphate dehydrogenase deficiency |
| Intravenous administration of distilled water                          |
| Thermal injury   |

---

Hemolytic disorders also may be considered to be caused by an intrinsic defect in the cell itself or caused by extrinsic agents acting on otherwise normal red cells. It is this classification which generally is most useful to the clinician ( [Table 27.10](#)). Most intrinsic defects are inherited, whereas the extrinsic ones are acquired. Exceptions to this generalization are few; these include paroxysmal nocturnal hemoglobinuria ( [Chapter 37](#)), an acquired disorder characterized by an intrinsic red cell defect. Also, certain inherited intrinsic defects [e.g., the most common form of glucose-6-phosphate dehydrogenase (G6PD) deficiency] are associated with no ill effects in the absence of an extrinsic agent, usually an infection or exposure to a drug (see [Chapter 33](#)).

**TABLE 27.10. Etiologic and Pathogenetic Classification of the Hemolytic Disorders**

**Inherited hemolytic disorders**

Defects in the erythrocyte membrane ( [Chapter 32](#))

Hereditary spherocytosis

Hereditary elliptocytosis syndromes

Common hereditary elliptocytosis

Homozygous (doubly heterozygous) hereditary elliptocytosis

Hereditary pyropoikilocytosis

Spherocytic elliptocytosis

Southeast Asian ovalocytosis

Stomatocytic disorders

Hereditary stomatocytosis

Hereditary xerocytosis

Intermediate stomatocytic syndromes

Rh-null syndrome

Acanthocytic disorders

Abetalipoproteinemia

Macleod phenotype

Echinocytic disorders

Target cell disorders

Familial lecithin-cholesterol acyltransferase deficiency

Hereditary enzyme disorders ( [Chapter 33](#))

Disorders of hexose monophosphate shunt and glutathione metabolism

Glucose-6-phosphate dehydrogenase deficiency

Related disorders of hexose monophosphate shunt and glutathione metabolism

Defects in glutathione synthesis

?-Glutamyl-cysteine synthetase deficiency

Glutathione synthetase deficiency

Disorders of glycolysis

Pyruvate kinase deficiency

Other glycolytic enzymopathies

Hexokinase deficiency

Glucosephosphate isomerase deficiency

Phosphofructokinase deficiency

Aldolase deficiency

Triose phosphate isomerase deficiency

- Phosphoglycerate kinase deficiency
  - Disorders of erythrocyte nucleotide metabolism
    - Pyrimidine 5' nucleotidase deficiency
    - Adenosine deaminase excess
    - Adenylate kinase deficiency
  - Inherited disorders of hemoglobin or synthesis
    - Unstable hemoglobin disorders ( [Chapter 41](#))
    - Sickle cell anemia syndromes ( [Chapter 40](#))
    - Other homozygous hemoglobinopathies (CC, DD, EE; [Chapter 39](#))
    - Thalassemia syndromes ( [Chapter 42](#))
  - Acquired hemolytic anemias
    - Immuno-hemolytic anemias ( [Chapter 34](#), [Chapter 35](#))
      - Transfusion of incompatible blood
      - Hemolytic disease of the newborn ( [Chapter 36](#))
      - Autoimmune hemolytic anemia caused by warm-reactive antibodies
        - Idiopathic
        - Secondary or symptomatic
        - Drug-induced
      - Autoimmune hemolytic anemia caused by cold-reactive antibodies
        - Cold hemagglutinin disease
        - Paroxysmal cold hemoglobinuria
    - Traumatic and microangiographic hemolytic anemias ( [Chapter 38](#))
      - Prosthetic valves and other cardiac abnormalities
      - Hemolytic uremic syndrome
      - Thrombotic thrombocytopenic purpura
      - Disseminated intravascular coagulation
      - Cancer-induced
      - Chemotherapy/drug-induced
    - Infectious agents ( [Chapter 38](#))
      - Protozoa: malaria, toxoplasmosis, leishmaniasis, trypanosomiasis, babesiosis
      - Bacteria: bartonellosis, clostridial infection, cholera, typhoid fever, and others
    - Chemicals, drugs, and venoms ( [Chapter 38](#))
      - Oxidant drugs and chemicals
      - Nonoxidant drugs and chemicals
      - Associated with hemodialysis and uremia
      - Venoms
    - Physical agents
      - Thermal injury ( [Chapter 38](#))
    - Hypophosphatemia ( [Chapter 38](#))
    - Paroxysmal nocturnal hemoglobinuria ( [Chapter 37](#))
    - Spur-cell anemia in liver disease ( [Chapter 47](#))
- 

Intrinsic and extrinsic abnormalities originally were defined by performing cross-transfusion erythrocyte survival studies ( [Table 27.11](#)). When normal erythrocytes are transfused to patients with an extrinsic cause for hemolysis, the donated cells are destroyed as rapidly as the patient's own cells. On the other hand, when the patient's RBCs are removed from their unfavorable environment and transfused to a normal recipient, their survival time is normal. In contrast, when the disorder is due to an intrinsic

red cell defect, the RBCs of the patient, when given to a normal recipient, are removed from the circulation more rapidly than those of the recipient; the normal erythrocytes, if transfused into the patient, maintain a normal lifespan. Such cross-transfusion experiments are not used in the study of hemolytic anemias nowadays, but, in the past, they played an important role in clarifying the pathogenesis of various hemolytic disorders.

**TABLE 27.11. Cross-Transfusion Erythrocyte Survival Technique for Distinguishing Intrinsic and Extrinsic Erythrocyte Red Blood Cell Abnormalities**

| Donor Red Blood Cells | Recipient      | Erythrocyte Survival  |                       |
|-----------------------|----------------|-----------------------|-----------------------|
|                       |                | Intrinsic Abnormality | Extrinsic Abnormality |
| Patient               | Normal subject | Reduced               | Normal                |
| Normal subject        | Patient        | Normal                | Reduced               |

The intrinsic disorders of the erythrocyte are due to defects affecting the red cell membrane ( [Chapter 32](#)), disorders of cell metabolism ( [Chapter 33](#)), or various Hb abnormalities ( [Chapter 39](#), [Chapter 40](#), [Chapter 41](#) and [Chapter 42](#)) ( [Table 27.10](#)).

The acquired hemolytic anemias are further subclassified on the basis of the extrinsic factors causing hemolysis. These include antibodies ( [Chapter 34](#), [Chapter 35](#) and [Chapter 36](#)), and other nonimmune causes ( [Chapter 38](#)) including physical trauma, infectious agents, physical agents, chemical agents, hypophosphatemia, and liver disease (spur cell anemia). A separate category is needed for paroxysmal nocturnal hemoglobinuria, which is unique among the acquired hemolytic anemias in that it is related to an intrinsic abnormality of the red cell ( [Chapter 37](#)).

Each of these different hemolytic anemias is discussed in detail elsewhere in this book. The remainder of this section focuses on the general clinical and laboratory features that are common to most congenital and acquired hemolytic anemias.

### Clinical Features of Congenital Hemolytic Anemia

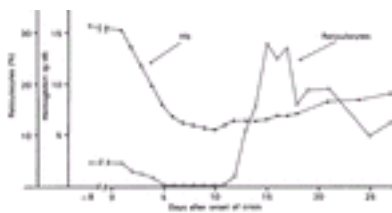
**DEGREE OF ANEMIA** The severity of anemia varies greatly, even among patients with the same congenital disorder. Most commonly, the anemia with congenital hemolytic disorders is mild to moderate because the shortened erythrocyte survival is partially offset by increased activity of the bone marrow. Often, patients accommodate remarkably well to the anemia and may exhibit few signs or symptoms. Consequently, detection can be delayed until later in childhood and discovered incidentally. Moreover, some patients have no anemia at all. The disease may then remain unsuspected until late in adult life unless jaundice, a crisis, or complications of gallbladder disease draw attention to the condition. Sometimes, such cases are discovered only in the course of a family study. In some congenital hemolytic disorders, such as homozygous  $\beta$ -thalassemia, the rate of red cell destruction far exceeds the erythropoietic capacity of the marrow, and these individuals usually have a very severe anemia, usually requiring life-long red cell transfusions.

**JAUNDICE** Jaundice often is first noted in the neonatal period ( [131](#)), and phototherapy frequently is used to reduce the hyperbilirubinemia and, sometimes, exchange transfusions are required. In some older children and adults with congenital hemolytic anemia, icterus is absent or mild enough to pass unnoticed. Careful inquiry often elicits a



history of episodes of jaundice or the passing of dark urine associated with trivial infections. In other cases, jaundice is persistent but never becomes intense. Often, slight scleral icterus is the only sign of hemolytic disease. The jaundice of hemolytic disease is acholuric; the bilirubin, being unconjugated, is not excreted in the urine. Furthermore, pruritus is absent. These features help to distinguish the icterus of hemolytic disease from that found with disorders of the hepatobiliary system.

**APLASTIC CRISES** Aplastic crises result from transient failure of red cell production ( [Fig. 27.15](#)) caused by infection with the type B19 human parvovirus (HPV) ( [132](#), [133](#), [134](#) and [135](#)). The same virus also causes erythema infectiosum (fifth disease, a common childhood exanthem) ( [136](#), [137](#)) and may cause an acute polyarthropathy syndrome in adults as well as aseptic meningitis ( [138](#)) and fetal death with hydrops fetalis ( [139](#), [140](#)). HPV infection may occur sporadically but most often is an epidemic disease that can affect several family members simultaneously or multiple people in a large geographic area. School-age children (age 5 to 10 years) are most at risk for HPV infection ( [135](#)), but cases have been reported of HPV infection in young adults ( [135](#), [141](#)). Any patient with moderately severe chronic hemolytic disease who becomes infected with HPV is at high risk for a crisis. Blood Hb concentrations fall several grams, sometimes to life-threatening levels ( [141](#)), and the reticulocyte count falls abruptly, usually to less than 1%. The magnitude of the crisis depends on the severity of the underlying hemolytic process. In most cases, leukocyte and platelet counts are unaffected, but neutropenia and thrombocytopenia can occur and, rarely, may be severe ( [134](#)). The bone marrow is cellular, but erythroid hypoplasia is the characteristic finding; in particular, the more mature erythrocyte precursors tend to disappear. Giant pronormoblasts may be observed. Recovery is heralded by reticulocytosis. The entire episode, from onset of symptoms to reappearance of reticulocytes, lasts approximately 10 to 12 days in subjects with normal immunologic responses but may persist much longer in patients with defective or suppressed immune systems ( [142](#)). HPV infection also produces erythroid aplasia in normal subjects, but the decrease in Hb concentration is minimal when erythrocyte survival is normal ( [143](#)), and such small changes go undetected. During the acute phase of aplastic crisis, HPV particles often can be detected in the serum by polymerase chain reaction assays ( [136](#)). The appearance of a specific immunoglobulin (Ig) M (IgM) antibody in serum is a marker of recent infection ( [135](#)). It is replaced by an IgG antibody that persists for years and is found in 60% of normal subjects. A single infection apparently confers life-long immunity.



**Figure 27.15.** Severe aplastic crisis in a patient with hereditary spherocytosis who previously had well-compensated hemolysis. Note the profound reticulocytopenia during the early phases of the reaction, followed by reticulocytosis. Hb, hemoglobin. (Plotted from Owren P. Congenital hemolytic jaundice. The pathogenesis of the “hemolytic crisis.” *Blood* 1948;3:231–248, with permission.)

**SPLENOMEGALY** The spleen typically is enlarged in patients with congenital hemolytic anemias, except for individuals with sickle cell anemia older than 5 years of age ( [Chapter 40](#)). Most often, the degree of enlargement is mild to moderate. At times, splenomegaly leads to discovery of the disease because the spleen is detected on a routine physical examination. It is not uncommon for children with hereditary spherocytosis to first be picked up by the finding of splenomegaly during a routine physical examination in an otherwise healthy child.



**CHOLELITHIASIS** Gallstones and its complications play a significant role in the clinical manifestations of congenital hemolytic anemias. Symptoms of gallbladder disease rarely may be the initial manifestations of a hemolytic process and the ones that bring the illness to the attention of a physician. Gallstones typical of hemolytic anemia are so-called black pigment stones ( [144](#), [145](#) ). They differ from brown pigment stones and cholesterol stones, neither of which is associated with hemolysis. The hepatic bile of patients with hemolytic anemia contains greatly increased amounts and concentrations of unconjugated bilirubin, decreased concentrations of bile acids ( [145](#), [146](#) ), and increased concentrations of ionized calcium ( [147](#) ). The prevalence of cholelithiasis in patients with hemolytic anemia increases with age and with the intensity of the hemolytic process. In a large study series involving Jamaican patients with sickle cell anemia, the prevalence ranged from 8% among patients 16 to 25 years old to 55% in patients older than age 35 years with reticulocyte counts greater than 15% ( [148](#) ).

**LEG ULCERS** Chronic ulcerations of the legs are peculiar and uncommon complications of chronic hemolytic disease. They are particularly characteristic of sickle cell anemia ( [Chapter 40](#) ) ( [150](#) ) but also occur in association with other hemolytic disorders ( [151](#), [152](#) and [153](#) ), such as hereditary spherocytosis ( [149](#) ) ( [Chapter 32](#) ). The ulcers often are bilateral and tend to involve the areas overlying or proximal to the medial or lateral malleoli. They tend to be chronic or recurrent and, upon healing, leave the skin indurated and pigmented.

**SKELETAL ABNORMALITIES** When hemolytic anemia is severe during active phases of growth and development, the pronounced expansion of erythroid bone marrow may lead to a tower-shaped skull, thickening and striation of frontal and parietal bones, maxillary and dental abnormalities, and other distortions of bony structures. Such abnormalities are particularly characteristic of severe thalassemia major, the so-called thalassemic facies ( [Chapter 42](#) ). Nowadays it is much less common to see these skeletal malformations, because patients with homozygous  $\beta$ -thalassemia are transfused aggressively with red cells to maintain a higher Hb level, and this suppresses expansion of the erythroid marrow and its subsequent effects on bone structure. However, in patients with thalassemia intermedia, a slightly milder clinical variant not necessitating RBC transfusions, the characteristic bone changes may occur because of the expanded size of the erythroid marrow. The skeletal changes also may occur in patients with sickle cell anemia and in exceptional patients with other forms of congenital hemolytic anemia ( [153](#) ).

### Clinical Features of Acquired Hemolytic Anemia

Hemolytic anemia sometimes develops acutely, such as after the transfusion of incompatible blood or the ingestion of an oxidant drug by patients with G6PD deficiency or in association with an acute febrile illness. Some instances of autoimmune hemolytic anemia, thrombotic thrombocytopenic purpura, and other hemolytic disorders may also begin abruptly ( [154](#) ). Aching pains in the back, abdomen, or limbs are common, as are headaches, malaise, vomiting, shaking chills, and fever ( [154](#) ). Abdominal pain may be severe, and the accompanying muscular spasm and rigidity may simulate the signs of an acute abdominal condition requiring surgical treatment. Pallor, jaundice, tachycardia, and other symptoms of severe anemia may be prominent.

Acquired hemolytic anemia also can begin insidiously, developing gradually over a period of weeks or months. Cardiovascular adjustments to the anemia may be adequate, and patients may have few symptoms. Pallor, scleral icterus, or a jaundiced complexion may be the first evidence of illness, and often, these signs are noticed by friends or associates before they are appreciated by the patient or the family. As in congenital hemolytic anemia, the course may be interrupted by aplastic crises ( [133](#) ).

In other instances, the clinical setting may be dominated by the manifestations of an

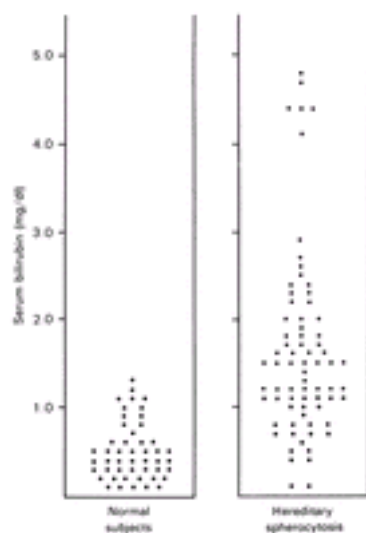
underlying disease of which the hemolytic anemia is one manifestation. For example, signs and symptoms of lymphoma, lupus erythematosus, or mycoplasma pneumonia may overshadow those of the associated hemolytic process.

### Laboratory Features of Hemolysis

The laboratory studies used to identify a hemolytic process include those related to the increase in erythrocyte destruction and those related to the compensatory increase in the rate of erythropoiesis. Once it is established that a patient has hemolysis, then more specific procedures are used to identify the precise cause. Some of these procedures are described in this section, and others are discussed elsewhere in the text.

#### SIGNS OF INCREASED RED BLOOD CELL DESTRUCTION

**Serum Bilirubin** The amount of bilirubin in the circulation depends in part on the rate at which the bilirubin is formed and in part on the efficiency with which it is excreted by the liver. Hyperbilirubinemia is a hallmark of hemolytic anemia ( [Fig. 27.16](#)), although occasionally the serum bilirubin is within the normal range despite brisk hemolytic disease ( [155](#)). The increased serum bilirubin level in hemolysis almost always consists of the unconjugated (indirect-reacting) pigment. The conjugated fraction remains within normal limits, and no bilirubin is evident in the urine. Except for during the neonatal period, values greater than 5 mg/dl are unusual in patients with hemolytic anemia and suggest coexisting hepatic dysfunction.

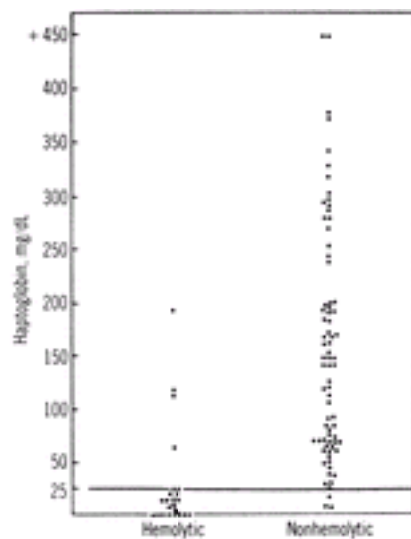


**Figure 27.16.** Total serum bilirubin values in 48 normal subjects and 72 patients with hereditary spherocytosis. (From Mackinney A, Norton NE, Kosower NS. Ascertaining genetic carriers of hereditary spherocytosis by statistical analysis of multiple laboratory tests. *J Clin Invest* 1962;41:554–567, with permission.)

**Serum Lactic Dehydrogenase** Serum lactic dehydrogenase (LDH) often is increased in patients with hemolytic anemia, although not to as great an extent as in megaloblastic anemia. The increase in LDH probably results from liberation of the erythrocyte enzyme into the plasma during hemolysis ( [156](#)). Increased serum LDH is a nonspecific finding, because it also is elevated in other medical conditions associated with tissue injury.

**Serum Haptoglobin** When Hb enters the plasma, it binds to haptoglobin, and the complex is removed by hepatocytes ( [Chapter 9](#)). As a result, serum haptoglobin decreases in individuals with hemolytic disease. Moreover, despite the intravascular site of haptoglobin function, this protein becomes depleted in association with both intravascular and extravascular hemolysis, such as sickle cell anemia ( [157](#)), hereditary spherocytosis ( [157](#), [158](#)), hereditary elliptocytosis ( [159](#)), and pyruvate kinase deficiency ( [153](#)). Haptoglobin also

disappears in megaloblastic anemia and other conditions with intramedullary hemolysis (ineffective erythropoiesis) ( [Fig. 27.17](#) ) ( [160](#) ). In microangiopathic hemolytic anemias with intravascular hemolysis, low haptoglobin levels are the most sensitive marker of red cell destruction, and may be seen in the absence of anemia or hemoglobinemia ( [Chapter 38](#) ).



**Figure 27.17.** Serum haptoglobin in hemolytic and nonhemolytic disease. (From Marchand A, Galen RS, Van Lente F. The predictive value of serum haptoglobin in hemolytic disease. JAMA 1980;243:1909, with permission.)

The interpretation of haptoglobin levels sometimes is complicated by the fact that haptoglobin is an acute phase reactant, the synthesis of which increases in response to inflammatory, infectious, or malignant disease. Haptoglobin values also may fall in association with liver disease because of impaired synthesis and in hereditary deficiency of the protein.

**Erythrocyte Survival** The strictest definition of hemolysis requires demonstration that the red cell lifespan is reduced, using methods described in [Chapter 9](#). From a practical perspective, however, erythrocyte lifespan determinations are rarely necessary, because they provide little additional information beyond what can be assessed by more easily obtained data, such as serial observations of the degree of anemia, reticulocytosis, and jaundice. For these reasons, determination of red cell survival is reserved for use in evaluating patients with especially difficult diagnostic problems.

**Rate of Carbon Monoxide Production** Determinations of the rate of endogenous carbon monoxide production ( [Chapter 9](#) ) provide accurate assessments of the rate of heme catabolism. With these methods, values of approximately two to ten times the normal rate have been detected in small groups of patients with hemolytic disease. At the present stage of development, however, these methods are not available for routine clinical use.

**Fecal Urobilinogen Excretion** Quantitative measurements of fecal urobilinogen excretion ( [Chapter 9](#) ) provide a sensitive index of hemolysis; however, it necessitates the accurate collection and processing of timed fecal specimens. These tests are rarely ever used nowadays.

**Glycosylated Hemoglobin** Glycosylated Hbs (Hb A1c) are regularly reduced in people with hemolytic disease ( [161](#) , [162](#) ), and this reflects the young RBC age in these patients. From a practical perspective, this measurement is rarely used to assess hemolysis in clinical situations.

**SIGNS OF INTRAVASCULAR HEMOLYSIS** When erythrocytes are destroyed within the circulation, and also when extravascular destruction is so rapid that it exceeds the capacity of the macrophage system, Hb is released into the plasma. The disposal of Hb and its heme group occurs by several mechanisms ( [Chapter 9](#) ), and characteristic laboratory abnormalities are found ( [Table 27.12](#) ).

**TABLE 27.12. Laboratory Signs of Hemolysis**

---

|   |
|---|
| Accelerated red cell destruction  |
| Decreased erythrocyte lifespan  |
| Increased heme catabolism   |
| Increased serum unconjugated bilirubin level  |
| Increased carbon monoxide production <a href="#">a</a>                              |
| Increase rate of urobilinogen excretion   |
| Increased serum lactate dehydrogenase <a href="#">a</a>                             |
| Decreased serum haptoglobin <a href="#">a</a>                                       |
| Signs of intravascular hemolysis  |
| Hemoglobinemia  |
| Hemoglobinuria <a href="#">a</a>  |
| Hemosiderinuria <a href="#">a</a>   |
| Methemalbuminemia   |
| Decreased serum hemopexin   |
| Reduced glycosylated hemoglobin   |
| Fall in blood hemoglobin level at a rate greater than 1.0 g/dl/wk <a href="#">a</a> |
| Accelerated erythropoiesis  |
| Complete blood count <a href="#">a</a>  |
| Reticulocytosis   |
| Macrocytosis  |
| Blood smear findings <a href="#">a</a>  |
| Polychromatophilia  |
| Basophilic, stippling   |
| Erythroblastosis  |
| Abnormal red blood cell forms   |
| Bone marrow (erythroid hyperplasia)   |
| Ferrokinetic (increased plasma iron turnover)                                       |
| Biochemical (increased erythrocyte creatine)  |

<sup>a</sup> Commonly used tests and observed laboratory features.

---

**Hemoglobinemia** At low concentrations, plasma Hb may be measured by means of the benzidine reaction, which allows detection not only of Hb but also of any other heme pigments that may be present. If special precautions are observed to avoid artifactual hemolysis during collection of blood, normal values of less than 1 mg/dl of plasma are found. Plasma usually appears visibly red when Hb exceeds 50 mg/dl. At levels greater than 100 mg/dl, Hb can be measured directly by the cyanomethemoglobin method. Plasma Hb levels are normal in most patients with hereditary hemolytic anemias, including hereditary spherocytosis, but can be increased in severe, acquired, immunohemolytic anemia, at times reaching 100 mg/dl ( [163](#) ). Particularly high values, up to 1000 mg/dl, are found only in patients with disorders associated with intravascular hemolysis ( [130](#) ).

**Hemoglobinuria** When plasma Hb exceeds the haptoglobin binding capacity, Hb dimers are excreted into the urine, resulting in hemoglobinuria. Urine that contains Hb ranges from faint pink to deeper red, or even to almost black, similar to a cola beverage. Hemoglobinuria can be distinguished from hematuria (whole RBCs in the urine) by microscopic examination of a freshly voided urine specimen. Urine also may appear red because of ingestion of certain drugs (Pyridium) or food (beets), or because of porphyrinuria ( [Chapter 31](#) ) or myoglobinuria. Of these various red urinary pigments, only

Hb and myoglobin produce a positive reaction in the commonly available tests for occult blood, which are based on the benzidine or orthotolidine reactions ( 164 ). Hemoglobinuria must be distinguished from myoglobinuria, which occurs as the result of massive muscle injury ( 165 , 166 and 167 ). Myoglobin is a heme pigment of low molecular weight (17,000 d); it is not bound by haptoglobin and therefore does not accumulate to an appreciable extent in plasma. Thus, inspection of the plasma can help to distinguish myoglobinuria from hemoglobinuria, the presence of a red color in the plasma favoring the latter. More precise identification is accomplished by spectroscopic analysis.

**Urine Hemosiderin and Urinary Iron Excretion** Hb in the glomerular filtrate is partially reabsorbed by the proximal tubular cells, and the Hb iron is incorporated into ferritin and hemosiderin. Subsequently, the iron-containing tubular cells are sloughed into the urine. Hemosiderinuria, therefore, constitutes reliable evidence that hemoglobinemia has occurred in the recent past ( 130 , 163 ). After an acute episode of intravascular hemolysis, however, several days may pass before increased iron excretion can be detected. Moreover, the abnormality may persist for some time after the episode has terminated. In most conditions associated with chronic intravascular hemolysis, such as in some of the fragmentation hemolysis syndromes, increased iron excretion is a constant finding, whereas hemoglobinuria occurs only intermittently. Hemosiderinuria may be detected by means of a qualitative test based on the Prussian blue reaction ( 163 ). Urinary iron content can be determined spectrophotometrically after wet digestion of a measured urine specimen ( 168 , 169 ). The normal value for urinary iron excretion is less than 0.1 mg/day, but in a variety of disorders associated with intravascular hemolysis, urinary iron values increase to between 3 and 11 mg/day ( 168 , 169 ). Measurement of urinary iron excretion is rarely used in assessing intravascular hemolysis; however, it is frequently used to assess efficacy of chelation therapy in iron-overload patients receiving chronic transfusions.

**Methemalbumin and Hemopexin** Hb in plasma is readily oxidized to methemoglobin, from which the heme group easily detaches. The liberated heme binds to hemopexin and also to albumin, forming methemalbumin. Hemopexin-heme and methemalbumin impart a coffee-brown color to plasma. With either combination, a spectral absorption band is observed at 620 to 630 nm, which, unlike a similar band in methemoglobin, does not disappear if hydrogen peroxide is added. With the addition of ammonium sulfide, the 620- to 630-nm band disappears and a band at 558 nm forms (Schumm test) ( 170 ). Although hemopexin can be depleted in the course of serving its function ( 171 ), depletion occurs less regularly than occurs with haptoglobin. Low hemopexin values usually indicate that the hemolytic anemia is severe ( 157 ). Low hemopexin values are seen in thalassemia major, sickle cell anemia, and the fragmentation hemolytic anemia that follows cardiac surgical procedures. The measurement of hemopexin is seldom used to assess hemolytic anemia.

**SIGNS OF ACCELERATED ERYTHROPOIESIS** Laboratory signs of increased erythropoiesis are almost always present in patients with chronic hemolytic disease. In patients who have had an acute hemolytic episode, signs of increased red cell production appear after 3 to 6 days ( Table 27.12 ). These same signs of increased RBC production also occur after hemorrhage and after specific therapy for anemia caused by iron, folate, or vitamin B<sub>12</sub> deficiency.

**Reticulocytosis** An increased number of reticulocytes continues to be the most readily available and most often used index of accelerated erythropoiesis. In cases of hemolytic anemia, the erythrocyte production rate and the absolute reticulocyte count is usually greatly increased when hemolysis is severe enough to produce anemia. In most types of hemolytic anemia, the reticulocyte count consistently increases to levels that correlate fairly well with the severity of the process. Exceptions occur during aplastic crises. Also, some patients with idiopathic acquired immunohemolytic anemia may have normal reticulocyte counts, and in one report, values of less than 2% were found in 26% of 35 such patients ( 154 ). In these cases, it is thought that the autoantibodies are directed against marrow erythroid precursors as well as circulating erythrocytes.

**Red Cell Creatine** Creatine levels in young red cells are six to nine times higher than those in older cells, and the elevation persists for as long as 20 days of erythrocyte lifespan, compared to the reticulocyte maturation time of 1 to 3 days ([172](#), [173](#)). Erythrocyte creatine level correlates with the reticulocyte count, but the relationship is not linear. The former appears to be a more sensitive indicator of red cell age than is the latter, so it may be increased in people with mild hemolytic processes when the reticulocyte count remains equivocal. It is not a commonly used test.

**Morphologic Findings in the Blood** When reticulocytes are increased, polychromatophilia and fine basophilic stippling are apparent on routinely stained smears of blood. Macrocytosis is found in association with most hemolytic disorders because of erythropoietin-mediated stimulation of Hb synthesis and because prematurely released (shift) reticulocytes are larger than normal erythrocytes. Exceptions occur in hereditary spherocytosis and sickle cell anemia, diseases in which the intrinsic defect of the cell tends to decrease its size. When hemolysis is brisk, nucleated erythrocytes may be found in the blood (erythroblastosis), usually in numbers below 1% of all the nucleated cells. In infants, however, erythroblastosis may be more striking, especially in hemolytic disease of the newborn. Neutrophilic leukocytosis and thrombocytosis may accompany hemolytic anemia. These findings tend to be most common and most pronounced in patients with acute hemolytic anemias. Platelets are not only numerous but also large. The changes are less pronounced in chronic hemolytic processes.

**Bone Marrow** The major alteration in the bone marrow in hemolytic anemia is erythroid hyperplasia, as manifested by a reduction in the myeloid to erythroid ratio.

**Ferrokinetic Studies** The plasma iron transport rate is considered a measure of total erythropoiesis and correlates well with the degree of erythroid hyperplasia ([174](#)). The erythrocyte iron turnover rate is a measure of effective erythropoiesis and correlates well with the reticulocyte production index. In hemolytic anemia, the plasma iron transport rate reaches two to eight times the normal rate, and the erythrocyte iron turnover rate increases two to four times. These determinations provide accurate information regarding rates of erythropoiesis, but they are unnecessary for most patients because other easily obtained determinations are simpler, faster, considerably less expensive, and nearly as accurate.

## Laboratory Tests Useful in the Differential Diagnosis of Hemolysis

**SPECIFIC MORPHOLOGIC ABNORMALITIES** Detection of certain distortions of red cell shape is of particular diagnostic use because their presence suggests only one or a few entities. Descriptive features of certain such abnormal red cells are presented in [Table 27.13](#) and illustrated in [Figure 27.18](#) and [Figure 27.19](#).

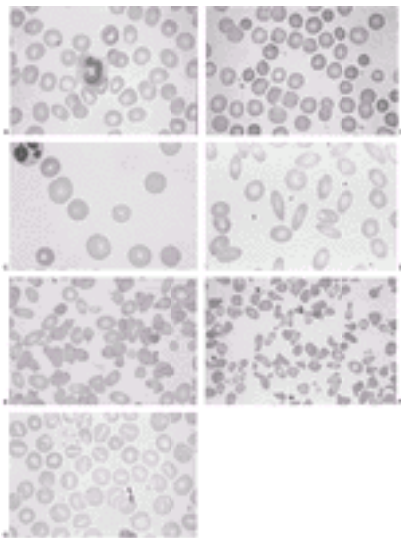
**TABLE 27.13. Morphologic Abnormalities in Hemolytic Anemia**

| Cell         | Description   | Clinical Disorders   |
|--------------|---|--|
| Spherocyte   | Spheric; appear microcytic with no central pallor                         | Hereditary spherocytosis<br>Immuno-hemolytic anemia<br>Burns |
| Elliptocytes | Oval cell   | Hereditary elliptocytosis<br>Megaloblastic anemia            |
| Stomatocytes | Uniconcave red cell; slitlike rather than circular area of central pallor | Hereditary stomatocytosis<br>Alcoholism                      |
| Acanthocytes | 5–10 spicules of various lengths, irregular in spacing and thickness      | Spur-cell anemia with liver disease<br>Abetalipoproteinemia  |



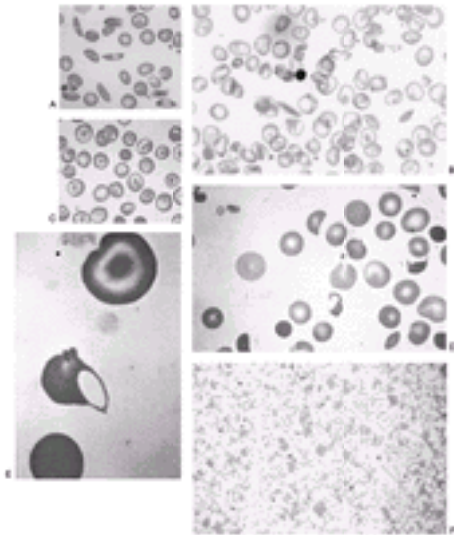
|              |  |  |
|--------------|--|--|
| Echinocytes  | 10–30 spicules evenly distributed over cell surface                    | Uremia   |
| Sickle cells | Cell with sickle shape   | Sickle cell anemia   |
| Target cells | Solid area in center of central pallor                                 | Thalassemia<br>Hemoglobin C disorders<br>Liver disease<br>Lecithin–cholesterol acyltransferase deficiency<br>Postsplenectomy |
| Schistocytes | Triangular, helmet–shaped, fragmented or greatly distorted cell; small | Microangiopathic anemia<br><br>Turbulent blood flow<br>Hemolytic uremic syndrome   |

---



**Figure 27.18.** Red blood cell abnormalities associated with hemolysis. **A:** Normal red blood cells for comparison. **B:** Microspherocytes from patient with hereditary spherocytosis. **C:** Spherocytes from patient with autoimmune hemolytic anemia. **D:** Hereditary elliptocytosis—common variant with minimal or no hemolysis. **E:** Hereditary elliptocytosis—hemolytic variant. **F:** Hereditary elliptocytosis—pyropoikilocytosis variant. **G:** Hereditary stomatocytosis. See [Color Plate](#).





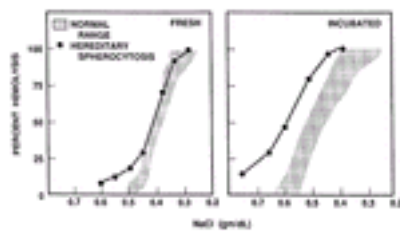
**Figure 27.19.** A: Sickle cell anemia. B: Sickle  $\beta$ -thalassemia. C: Target cells in hemoglobin C disease. D: Schistocytes in patient with thrombotic thrombocytopenic purpura. E: Blister cell from oxidative assault in patient with glucose-6-phosphate dehydrogenase deficiency. F: Autoagglutination in cold agglutinin disease. See [Color Plate](#).

Spherocytes, erythrocytes that lack an area of central pallor ([Fig. 27.18B](#)), are the hallmark of hereditary spherocytosis ([Chapter 32](#)). They are also found in most patients with acquired immunohemolytic anemias ([Fig. 27.18C](#)), thermal injury, hypophosphatemia, or certain kinds of chemical poisoning ([Chapter 35](#) and [Chapter 38](#)). Oval cells or elliptocytes ([Fig. 27.18D](#)) are the *sine qua non* of common hereditary elliptocytosis which usually is a morphologic curiosity, but not associated with significant hemolysis ([Chapter 32](#)). However, some hereditary elliptocytosis variants are also associated with marked poikilocytosis ([Fig. 27.18E](#) and [Fig. 27.18F](#)), and these individuals have significant hemolytic anemia. Stomatocytes ([Fig. 27.18G](#)), which suggest a disturbance in red cell cation content, are found in association with a rare inherited hemolytic disease (see [Chapter 32](#)) and also in liver disease. Acanthocytes indicate disturbed erythrocyte lipid composition; they occur in association with abetalipoproteinemia and the spur cell anemia that occasionally accompanies hepatic cirrhosis ([Chapter 32](#)). Echinocytes (sea urchin cells) are a nonspecific abnormality and are also found in uremia. Sickle cell anemia was named after the unmistakable sickle-shaped red cells that characterize that disorder ([Fig. 27.19A](#) and [Fig. 27.19B](#)) ([Chapter 40](#)). Target cells ([Fig. 27.19C](#)) are characteristic of thalassemia ([Chapter 42](#)), Hb E syndromes ([Chapter 39](#)) and Hb C disorders ([Chapter 39](#)). Target cells also occur in nonhemolytic states, such as obstructive jaundice and after splenectomy. Schistocytes, helmet cells, or other fragmented red cells ([Fig. 27.19D](#)) suggest hemolysis associated with physical trauma to the erythrocyte or with diseases affecting small blood vessels ([Chapter 38](#)). Bite cells are erythrocytes that look as if a semicircular bite has been taken from one edge. Hemighosts are red cells that look as if the Hb has shifted to one side of the cell, leaving the other side clear. These hemighosts also are referred to as *blister cells* and may appear to contain a coagulum of Hb that has separated from the membrane ([Fig. 27.19E](#)). These cells are seen in patients with oxidant-induced injury such as in G6PD deficiency ([Chapter 33](#)). Autoagglutination may be apparent in blood smears ([Fig. 27.19F](#)) or may even be visible to the naked eye when the blood is allowed to flow along the side of a glass container. The phenomenon is particularly characteristic of immunohemolytic disease caused by cold agglutinins. Autoagglutination must be distinguished from rouleau formation, a manifestation of multiple myeloma and related diseases and the phenomenon responsible for accelerated rates of erythrocyte sedimentation.

**DIRECT ANTIGLOBULIN TEST** The test used for detection of immunohemolytic anemia is the direct antiglobulin or Coombs test (see discussion in [Chapter 34](#) and [Chapter 35](#)). Positive test results indicate that the red cells are coated with IgG or complement components, especially C3. However, 2 to 5% of patients with immunohemolytic disease

have negative test results because the amount of globulin on the cell surface is below the detection limits ( 175 ). Rarely, patients have weakly positive test results and no clinical evidence of hemolysis. Positive tests are found in as many as 34% of patients with AIDS without other evidence of immunohemolytic disease ( 176 ).

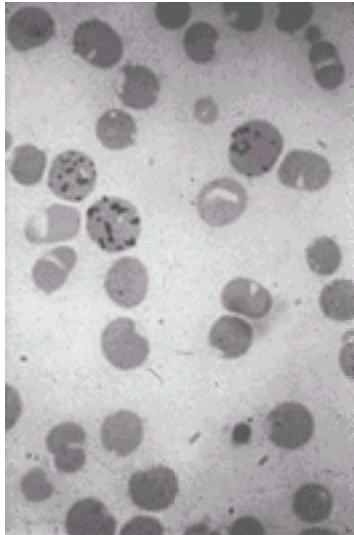
**OSMOTIC FRAGILITY TEST** The osmotic fragility test is a measure of the resistance of erythrocytes to hemolysis by osmotic stress. The test consists of exposing red cells to decreasing strengths of hypotonic saline solutions and measuring the degree of hemolysis. A symmetric, sigmoidal curve is obtained in most subjects ( Fig. 27.20 ). Increased fragility is indicated by a shift of the curve to the left, whereas osmotic resistance (reduced fragility) is signified by a rightward shift of the curve. Increased osmotic fragility is observed in conditions associated with spherocytosis. With prior incubation of sterile blood for 24 hours ( 177 ), the increased osmotic fragility of spherocytes is greatly accentuated, whereas normal cells become only slightly more fragile. The osmotic fragility of unincubated blood may be normal in some patients with hereditary spherocytosis, and for this reason, the test should be performed on incubated samples. Determination of osmotic fragility is of value chiefly in confirming important morphologic findings, especially the presence of spherocytes. In most cases, however, the osmotic fragility test does not provide information that was not already available from an expert examination of a well-prepared, stained blood smear. Osmotic gradient ektacytometry is more sensitive and specific than the osmotic fragility test for the diagnosis of hereditary spherocytosis but is not widely available ( 152 ).



**Figure 27.20.** Osmotic fragility (as manifested by percent hemolysis) of normal and hereditary spherocytosis (HS) erythrocytes after incubation in salt solutions of varying tonicity. In fresh HS erythrocytes, note the “tail” of cells with increased sensitivity as a result of splenic conditioning ( *left* ). In the incubated red blood cell (RBC), note that the entire HS population of RBCs is more osmotically sensitive ( *right* ). (From Glader BE, Naumovski L. Hereditary red blood cell disorders. In: Rimoin DL, Connor JM, Pyeritz RE, Emery AE, eds. Principles and practice of medical genetics. New York: Churchill Livingstone, 1996, with permission.)

### TESTS FOR HEMOLYTIC DISORDERS ASSOCIATED WITH HEINZ BODY FORMATION

In certain disorders, the hemolytic process involves precipitation of Hb, with the formation of inclusions known as *Heinz bodies*. These inclusions are rapidly removed by the spleen. Heinz body formation is the principal mechanism of hemolysis in G6PD deficiency and related disorders ( Chapter 33 ), in unstable Hb disease ( Chapter 41 ), in the thalassemias ( Chapter 42 ), and in certain kinds of chemical injury ( Chapter 38 ). Heinz bodies are not observed when ordinary staining procedures are used, but require the use of special supravital stains ( Fig. 27.21 ). Cells containing these inclusions may be found in the blood during an acute hemolytic episode in subjects with G6PD deficiency and also in splenectomized individuals with unstable Hb disease. When the spleen is intact, however, the inclusions are removed with such efficiency that the inclusion-containing cells often are not seen.



**Figure 27.21.** Heinz bodies (seen with brilliant cresyl blue supravital stains of blood during hemolytic episodes). See [Color Plate](#).

### Diagnostic Strategy to the Patient with Hemolytic Anemia

**ESTABLISHING THE PRESENCE OF HEMOLYTIC ANEMIA** The most common manifestations of chronic hemolytic anemia include anemia and reticulocytosis, often associated with various signs of excessive blood destruction. In contrast, an acute hemolytic anemia initially may not be accompanied by signs of accelerated red cell production. Such a diagnosis may be suspected because of the abrupt onset of hemoglobinuria or other signs of intravascular hemolysis or because of a rapid fall in blood Hb concentration from previously stable levels. As a rule, a decrease of more than 1.0 g/dl/week is indicative of hemolysis, hemorrhage, or hemodilution. If hemorrhage and hemodilution can be excluded, the presence of hemolytic anemia is established.

**CONDITIONS SOMETIMES MISTAKEN FOR HEMOLYTIC ANEMIA** Anemias associated with acute hemorrhage and those with partially treated deficiency states are characterized by transient anemia and reticulocytosis ( [Table 27.14](#)). They usually can be distinguished from hemolytic disease by the absence of icterus and by a rising hematocrit on subsequent determinations.

#### **TABLE 27.14. Conditions Sometimes Mistaken for Hemolytic Anemia**

---

|   |
|---|
| Associated with anemia and reticulocytosis                        |
| Hemorrhage  |
| Recovery from iron, folate, or vitamin B <sub>12</sub> deficiency |
| Recovery from marrow failure                                      |
| Associated with jaundice and anemia                               |
| Ineffective erythropoiesis (intramedullary hemolysis)             |
| Bleeding into a body cavity or tissue                             |
| Associated with jaundice without anemia                           |
| Defective bilirubin conjugation                                   |
| Crigler–Najjar syndrome   |
| Gilbert syndrome  |
| Marrow invasion (myelofibrosis, metastatic disease)               |
| Myoglobinuria   |

---

Anemias caused by ineffective erythropoiesis often are accompanied by jaundice and erythroid marrow hyperplasia; however, the reticulocyte count usually is not increased. In equivocal situations, this may be one of the rare instances where the measurement of erythrocyte survival might be useful. In hemolytic disease, the red cell survival is distinctly shortened, whereas it is normal or nearly so in association with ineffective erythropoiesis. A particularly confusing situation may arise after occult hemorrhage into the retroperitoneal space or other tissue compartments; anemia develops rapidly, and reticulocytosis follows. Furthermore, indirect hyperbilirubinemia may occur as the result of reabsorption of the products of Hb breakdown at the site of hemorrhage. Thus, the picture of hemolytic anemia may be simulated in several ways. Diagnosis depends on detecting signs of the hemorrhage itself or the disease process leading to it. If occult hemorrhage is suspected, serial observations usually clarify the situation; once the hemorrhage ceases, the hematocrit, reticulocyte count, and bilirubin values return to normal. In individuals with acholuric jaundice but without anemia, the differential diagnosis lies between a compensated hemolytic state and Gilbert syndrome or other disorders of bilirubin catabolism. Reticulocytosis or morphologic abnormalities of erythrocytes are typical findings in the former. In mild compensated hemolytic disease, however, one cannot always be certain that the hematologic values will be abnormal. Fasting induces an exaggerated increase in bilirubin levels in patients with Gilbert syndrome ( [178](#) ), and this phenomenon may be useful in distinguishing Gilbert syndrome from hemolytic anemia. Anemia associated with marrow invasion may be accompanied by erythroblastosis and bizarre abnormalities of erythrocyte shape. Mild reticulocytosis may develop because of premature release of cells from the marrow. Usually, however, patients do not have jaundice, and evidence of the invasive disease may be detected by examination of the bone marrow.

**DETERMINING THE SPECIFIC CAUSE OF HEMOLYSIS** Information from the medical history and physical examination, careful review of the CBC and peripheral blood smear, and results from the direct antiglobulin test, taken together, form the basis of the initial diagnosis assessment of hemolysis. From these data, five groups of patients can be distinguished.

1. Those patients in whom the diagnosis is clear because of medical history such as obvious exposure to infectious, chemical, or physical agents ( [Chapter 38](#) ). Some infections, such as malaria, can cause hemolysis directly ( [Chapter 38](#) ), whereas in other cases it is more indirect, associated with an underlying G6PD deficiency ( [Chapter 33](#) ) or an unstable Hb, such as Hb H ( [Chapter 41](#), [Chapter 42](#) ).
2. Those with a positive direct antiglobulin test. Such individuals may be presumed to have immunohemolytic anemia ( [Chapter 35](#), [Chapter 36](#) ). The subsequent investigation requires a search for an underlying disease as well as a serologic study of the nature of the antibody.
3. Those with antiglobulin–negative, spherocytic hemolytic anemia. Such patients probably have hereditary spherocytosis ( [Chapter 32](#) ). It is appropriate to confirm the presence of spherocytes by the osmotic fragility test and also to attempt to establish the familial nature of the illness by studying family members. Immunohemolytic anemia may be associated with spherocytosis and is occasionally associated with a negative antiglobulin reaction. Exposure to chemical or infectious agents producing spherocytosis may not always be easy to establish.
4. Those with other specific morphologic abnormalities of erythrocytes. The significance of various types of abnormally shaped red cells was discussed previously. Some poikilocytes, such as elliptocytes and sickle cells, are virtually pathognomonic findings. Others, such as extensive red cell fragmentation, identify a category to which several diseases belong ( [Chapter 38](#) ).
5. Those with no specific morphologic abnormalities and a negative reaction to the antiglobulin test. These patients warrant a battery of screening tests, including Hb electrophoresis, the heat denaturation test for unstable Hb disease ( [Chapter 41](#) ), tests for common red cell enzymes such as G6PD and pyruvate kinase ( [Chapter](#)

33), and a screening test for paroxysmal nocturnal hemoglobinuria ( [Chapter 37](#)).

If all of these procedures yield normal results, making the diagnosis is likely to be difficult. One of the rarer erythrocyte enzyme deficiencies is possible, but these entities can be established only by using specific assays ( [Chapter 33](#)).

## APPROACH TO ACUTE POSTHEMORRHAGIC ANEMIA

When blood loss occurs in small amounts over a prolonged period, no anemia develops until iron stores are depleted. In such circumstances, the hematologic findings are those of iron deficiency anemia ( [Chapter 48](#)). On the other hand, when larger amounts of blood are lost over shorter periods of time, anemia may develop, although iron stores remain adequate. This latter condition is called *acute posthemorrhagic anemia*.

The patient may be asymptomatic and appear to be in shock, or the entire situation might be confused with an acute hemolytic process.

The physiologic changes that occur with acute blood loss in otherwise healthy individuals are summarized in [Table 27.15](#). The immediate effects of acute hemorrhage are primarily cardiovascular. The plasma volume and red cell mass are reduced in proportional amounts; consequently, no decrease is observed in the hematocrit ( [179](#), [180](#)). Because of the time required for extracellular fluid to restore the blood volume, the amount of blood loss tends to be underestimated by the degree of anemia, especially early in the disease course. The platelet count increases, often reaching levels above normal within 1 hour, and values greater than 1 million platelets/L can be observed. There also is a neutrophilic leukocytosis over 2 to 5 hours. Typically, the leukocyte count is between 10 and 20  $10^9/L$ . The leukocytosis is explained in part by the effect of epinephrine on granulocyte demargination and release from the marrow granulocyte reserve.

**TABLE 27.15. Clinical Features of Acute Hemorrhage in Healthy Young Adults**

| Volume of Blood Loss (ml) | Blood Volume (%) | Symptoms   |
|---------------------------|------------------|--|
| 500–1000                  | 10–20            | Few if any symptoms  |
| 1000–1500                 | 20–30            | Asymptomatic while at rest in a recumbent position; light-headedness and hypotension when upright; tachycardia   |
| 1500–2000                 | 30–40            | Symptoms present when subject is recumbent; thirst, shortness of breath, clouding or loss of consciousness; blood pressure, cardiac output, venous pressure decrease; pulse usually becomes rapid; extremities become cold, clammy, and pale |
| 2000–2500                 | 40–50            | Lactic acidosis, shock; irreversible shock, death  |

When first detected, the anemia following acute hemorrhage is normocytic with few signs of erythrocyte regeneration. The hematocrit or Hb may not reach the minimum value until 3 days or more after the hemorrhage ceases.

Some increase in the number of reticulocytes is usually perceptible within 3 to 5 days,



and maximal values are reached at 6 to 11 days ( [181](#) ). The degree of reticulocytosis is related to the magnitude of hemorrhage, but rarely exceeds 15%. Other signs of erythrocyte regeneration include polychromatophilia and macrocytosis, and the MCV may transiently increase. If the patient is seen for the first time during this stage, the findings may be mistaken for those of hemolytic anemia; however, signs of increased bilirubin production are conspicuously absent, unless there has been bleeding into a body cavity or tissue space.

An external hemorrhage of a magnitude sufficient to cause significant anemia is usually evident. Similarly, substantial bleeding from the gastrointestinal or female reproductive tract is likely to be a dramatic event with readily detected signs and symptoms. Internal bleeding, as from a ruptured aneurysm, may be less apparent but should be suspected when there is the abrupt onset of shock or unexplained hypotension and tachycardia. Often, these manifestations are accompanied by symptoms referable to the site of bleeding. Hemorrhage into the retroperitoneal space, a body cavity, or a cyst sometimes presents a diagnostic problem. There may be a rapid onset of anemia accompanied by hyperbilirubinemia arising from the breakdown and absorption of RBCs. Under such circumstances, the picture may be transiently confused with acute hemolytic anemia. In all cases, the onset of a sudden, unexplained anemia should lead to the suspicion of covert bleeding. The suspicion is strengthened if signs of regeneration, such as reticulocytosis, appear and no evidence of excessive blood destruction is found.

Elective surgery is a special circumstance in which hemorrhage is predictable. Surgical mortality is clearly increased when patients are severely anemic. In Jehovah's Witness patients who refuse transfusion, surgical mortality is approximately 60% at Hb values less than 6 g/dl and more than 30% at values between 6 and 8 g/dl ( [182](#) ). At values greater than 8 g/dl, no increased mortality is observed. An older guideline requiring preoperative transfusion if the Hb is less than 10 g/dl has been replaced by a lower trigger point, 7 g/dl, in otherwise healthy, younger patients ( [183](#), [184](#) ). Surgeons and anesthesiologists use several techniques to avoid the need for allogeneic transfusions ( [185](#) ). These techniques include the use of autotransfusion of cells harvested during surgery ( [186](#) ) and preoperative harvesting of autologous blood ( [187](#), [188](#) ). The preoperative or postoperative use of erythropoietin injection or iron medication has proved disappointing ( [189](#), [190](#) ) but may have a role with severely anemic Jehovah's Witness patients ( [191](#) ).

If hemorrhage ceases, the Hb concentration may reach normal levels after 6 to 8 weeks. In a study of patients who underwent coronary bypass surgery, Hb levels fell, on average, from a preoperative value of 14 to 15 g/dl to 9.5 g/dl on the sixth postoperative day. They rose to 13.6 g/dl by postoperative day 59 ( [189](#) ). Morphologic evidence of active red cell regeneration should disappear after 10 to 14 days if hemorrhage does not recur. The leukocyte count should be normal after 3 to 4 days. Sustained reticulocytosis is suggestive of continued bleeding. Persistent leukocytosis may result from the same cause, from hemorrhage into body cavities, or from complications. The latter, particularly infections, tend to delay the hematopoietic response.

## ACKNOWLEDGMENT

The author wishes to acknowledge G. Richard Lee, MD, for the excellent previous chapters on anemia in the 10th Edition of *Wintrobe's Clinical Hematology*. These earlier contributions provided a substantial template for the current chapter in this 11th Edition of *Wintrobe's Clinical Hematology*.

## REFERENCES

1. Wintrobe M. Blood of normal men and women. *Bull Johns Hopkins Hosp* 1933;53:118–130.
2. AMA Council on Food and Nutrition. Iron deficiency in the United States. *JAMA* 1968;203(6):407–412.
3. Dallman PR, Yip R, Johnson C. Prevalence and causes of anemia in the United States, 1976 to 1980. *Am J Clin Nutr* 1984;39(3):437–445.
4. Freedman ML, Marcus DL. Anemia and the elderly: is it physiology or pathology? *Am J Med Sci* 1980;280(2):81–85.
5. Htoo MS, Kofkoff RL, Freedman ML. Erythrocyte parameters in the elderly: an argument against new geriatric normal values. *J Am Geriatr Soc* 1979;27(12):547–551.
6. Lipschitz DA, Mitchell CO, Thompson C. The anemia of senescence. *Am J Hematol* 1981;11(1):47–54.
7. Lipschitz DA, et al. Effect of age on hematopoiesis in man. *Blood* 1984;63(3):502–509.
8. Card RT, Brain MC. The “anemia” of childhood: evidence for a physiologic response to hyperphosphatemia. *N Engl J Med* 1973;288(8):388–392.
9. Gaton W, et al. Plasma volume and extravascular fluid volume during pregnancy and the puerperium. *Am J Obstet Gynecol* 1949;57:471–481.
10. Blekta M, et al. Volume of whole blood and absolute amount of serum proteins in the early stage of late toxemia of pregnancy. *Am J Obstet Gynecol* 1970;106(1):10–13.
11. Sturgeon P. Studies of iron requirements in infants. III. Influence of supplemental iron during normal pregnancy on mother and infant. A. The mother. *Br J Haematol* 1959;5:31–44.
12. Low J, Johnson EE, McBride RL. Blood volume adjustments in the normal obstetric patient with particular reference to the third trimester of pregnancy. *Am J Obstet Gynecol* 1965;91:356–63.
13. Bateman J. A study of blood volume and anemia in cancer patients. *Blood* 1951;6:639–651.
14. Berlin N, Hyde GM, Parsons RJ, et al. The blood volume in various medical and surgical conditions. *N Engl J Med* 1952;247:675–684.
15. Clark J, Nelson W, Lyons C, et al. Chronic shock: the problem of reduced blood volume in the chronically ill patient. Part III. Quantitative aspects of the anemia associated with malignant tumors. *Ann Surg* 1947;125:638–646.
16. Ellison E, Zollinger RM, Cedars N, et al. Value of blood volume determinations in gastrointestinal disease. *Arch Surg* 1953;66:869–877.
17. Peden J, Maxwell M, Ohin A, et al. A consideration of indications for preoperative transfusions based on analysis of blood volumes and circulating proteins in normal and malnourished patients with and without cancer. *Ann Surg* 1960;151:303–318.
18. Fawcett J, Wynn V. Effects of posture on plasma volume and some blood constituents. *J Clin Pathol* 1960;13:304–310.
19. Dawson AA, Ogston D, Fullerton HW. Evaluation of diagnostic significance of certain symptoms and physical signs in anaemic patients. *Br Med J* 1969;3(668):436–439.
20. Desforges JF. Anemia in uremia. *Arch Intern Med* 1970;126(5):808–811.
21. Cropp GJ. Cardiovascular function in children with severe anemia. *Circulation* 1969;39(6):775–784.
22. Bartels E. Anemia as the cause of severe congestive heart failure: report of a case. *Ann Intern Med*



1937;11:400-404.

23. Pickering G, Wayne EJ. Observations on angina pectoris and intermittent claudication in anemia. *Clin Sci* 1933;1:305-325.
24. Varat MA, Adolph RJ, Fowler NO. Cardiovascular effects of anemia. *Am Heart J* 1972;83(3):415-426.
25. Dawson AA, Palmer KN. The significance of cardiac murmurs in anemia. *Am J Med Sci* 1966;252(5):554-557.
26. Argano BJ. Phonocardiographic findings in anemia. *Chest* 1971;60(6):599-601.
27. Hogan GR, Jones B. The relationship of koilonychia and iron deficiency in infants. *J Pediatr* 1970;77(6):1054-1057.
28. Marshall R. A review of lesions on the optic fundus in various diseases of the blood. *Blood* 1959;14:882-891.
29. Aisen ML, et al. Retinal abnormalities associated with anemia. *Arch Ophthalmol* 1983;101(7):1049-1052.
30. Merin S, Freund M. Retinopathy in severe anemia. *Am J Ophthalmol* 1968;66(6):1102-1106.
31. Oski FA, et al. Red-cell 2,3-diphosphoglycerate levels in subjects with chronic hypoxemia. *N Engl J Med* 1969;280(21):1165-1166.
32. Schwaber J, Blumberg AG. Papilledema associated with blood loss anemia. *Ann Intern Med* 1961;55:1004-1007.
33. Bessman JD, Gilmer PR Jr, Gardner FH. Improved classification of anemias by MCV and RDW. *Am J Clin Pathol* 1983;80(3):322-326.
34. Fischer S, Fischer SP. Mean corpuscular volume. *Arch Intern Med* 1983;143:282-283.
35. Marsh WL Jr, Koenig HM. The laboratory evaluation of microcytic red blood cells. *Crit Rev Clin Lab Sci* 1982;16(3):195-254.
36. Hershko C, et al. Diagnosis of iron deficiency anemia in a rural population of children. Relative usefulness of serum ferritin, red cell protoporphyrin, red cell indices, and transferrin saturation determinations. *Am J Clin Nutr* 1981;34(8):1600-1610.
37. Fairbanks VF, et al. Homozygous hemoglobin E mimics beta-thalassemia minor without anemia or hemolysis: hematologic, functional, and biosynthetic studies of first North American cases. *Am J Hematol* 1980;8(1):109-121.
38. Hamilton PJ, Davidson RL. The interrelationships and stability of Coulter S-determined blood indices. *J Clin Pathol* 1973;26(9):700-705.
39. Gottfried EL. Erythrocyte indexes with the electronic counter. *N Engl J Med* 1979;300(22):1277.
40. Okuno T, Chou A. The significance of small erythrocytes. *Am J Clin Pathol* 1975;64(1):48-52.
41. Conrad M, Crosby WH. The natural history of iron deficiency induced by phlebotomy. *Blood* 1962;20:173-185.
42. England JM, Ward SM, Down MC. Microcytosis, anisocytosis and the red cell indices in iron deficiency. *Br J Haematol* 1976;34(4):589-597.
43. Klee GG, et al. Routine erythrocyte measurements in diagnosis of iron-deficiency anemia and thalassemia minor. *Am J Clin Pathol* 1976;66(5):870-877.
44. England JM, Walford DM, Waters DA. Re-assessment of the reliability of the haematocrit. *Br J*

Haematol 1972;23(2):247–256.

45. Bessman JD, Feinstein DI. Quantitative anisocytosis as a discriminant between iron deficiency and thalassemia minor. *Blood* 1979;53(2):288–293.
46. Dallman PR. Diagnosis of anemia and iron deficiency: analytic and biological variations of laboratory tests. *Am J Clin Nutr* 1984;39(6):937–941.
47. Breedveld FC, Bieger R, van Wermeskerken RK. The clinical significance of macrocytosis. *Acta Med Scand* 1981;209(4):319–322.
48. Davidson RJ, Hamilton PJ. High mean red cell volume: its incidence and significance in routine haematology. *J Clin Pathol* 1978;31(5):493–498.
49. Lindenbaum J. Status of laboratory testing in the diagnosis of megaloblastic anemia. *Blood* 1983;61(4):624–627.
50. McPhedran P, et al. Interpretation of electronically determined macrocytosis. *Ann Intern Med* 1973;78(5):677–683.
51. O'Neill BJ, Marlin GE, Streeter AM. Red-cell macrocytosis in chronic obstructive airway disease. *Med J Aust* 1972;1(6):283.
52. Colon-Otero G, Menke D, Hook CC. A practical approach to the differential diagnosis and evaluation of the adult patient with macrocytic anemia. *Med Clin North Am* 1992;76(3):581–597.
53. Carmel R. Macrocytosis, mild anemia, and delay in the diagnosis of pernicious anemia. *Arch Intern Med* 1979;139(1):47–50.
54. Wickramasinghe SN. Kinetics and morphology of haemopoiesis in pernicious anaemia. *Br J Haematol* 1972;22(2):111–115.
55. Beck W. The metabolic basis of megaloblastic erythropoiesis. *Medicine* 1964;43:715–726.
56. Ganzoni A, Hillman RS, Finch CA. Maturation of the macroreticulocyte. *Br J Haematol* 1969;16(1):119–135.
57. Lindenbaum J, Nath BJ. Megaloblastic anaemia and neutrophil hypersegmentation. *Br J Haematol* 1980;44(3):511–513.
58. Herbert V. Experimental nutritional folate deficiency in man. *Trans Assoc Am Physicians* 1962;75:307–320.
59. Nath BJ, Lindenbaum J. Persistence of neutrophil hypersegmentation during recovery from megaloblastic granulopoiesis. *Ann Intern Med* 1979;90(5):757–760.
60. Beguin Y, et al. Quantitative assessment of erythropoiesis and functional classification of anemia based on measurements of serum transferrin receptor and erythropoietin. *Blood* 1993;81(4):1067–1076.
61. Hall CA. Vitamin B12 deficiency and early rise in mean corpuscular volume. *JAMA* 1981;245(11):1144–1146.
62. Wilkinson J. Megalocytic anemias. *Lancet* 1949;1:249–255.
63. Anderson B. Investigations into the Euglena method for the assay of the vitamin B-12 in serum. *J Clin Pathol* 1964;17:14–26.
64. Matthews D. Observations on the estimation of serum vitamin B-12 using *Lactobacillus leichmanii*. *Clin Sci* 1962;22:101–111.
65. Lau KS, Gottlieb C, Wasserman LR. Measurement of serum vitamin B-12 level using radioisotope dilution and coated charcoal. *Blood* 1965;26:202–214.

66. Herbert V, Baker H, Frank O, et al. The measurement of folic acid activity in serum: a diagnostic aid in the differentiation of the megaloblastic anemias. *Blood* 1960;15:228.
67. Hoffbrand AV, Newcombe FA, Mollin DL. Method of assay of red cell folate activity and the value of the assay as a test for folate deficiency. *J Clin Pathol* 1966;19(1):17-28.
68. Johnson I, Rose M. Measurement of red cell folate with <sup>75</sup>Se-selenofolate radioassay. *J Clin Pathol* 1978;31(1):47-49.
69. Tisman G, Herbert V. B 12 dependence of cell uptake of serum folate: an explanation for high serum folate and cell folate depletion in B 12 deficiency. *Blood* 1973;41(3):465-469.
70. Killman SA. On the size of normal human reticulocytes. *Acta Med Scand* 1964;176:529-533.
71. Hillman RS, Finch CA. Erythropoiesis: normal and abnormal. *Semin Hematol* 1967;4(4):327-336.
72. Brecher G, Stohlman F. Reticulocyte size and erythropoietic stimulation. *Proc Soc Exp Biol Med* 1961;107:887-891.
73. Lindenbaum J. Folate and vitamin B-12 deficiencies in alcoholism. *Semin Hematol* 1980;17:119-129.
74. Stimmel B, et al. Failure of mean red cell volume to serve as a biologic marker for alcoholism in narcotic dependence. A randomized control trial. *Am J Med* 1983;74(3):369-374.
75. Unger KW, Johnson D Jr. Red blood cell mean corpuscular volume: a potential indicator of alcohol usage in a working population. *Am J Med Sci* 1974;267(5):281-289.
76. Werre JM, et al. Causes of macroplasia of erythrocytes in diseases of the liver and biliary tract with special reference to leptocytosis. *Br J Haematol* 1970;19(2):223-235.
77. Bingham J. The macrocytosis of Hepatic disease. *Blood* 1959;14:694-707.
78. Anttila P, et al. Idiopathic macrocytic anaemia in the aged: molecular and cytogenetic findings. *Br J Haematol* 1995;90(4):797-803.
79. Cunningham LO, Rising JA. Erythrocytic microcytosis: clinical implications in 100 patients. *Am J Med Sci* 1977;273(2):149-155.
80. Cartwright GE. The anemia of chronic disorders. *Semin Hematol* 1966;3(4):351-375.
81. Lee GR. The anemia of chronic disease. *Semin Hematol* 1983;20(2):61-80.
82. Cazzola M, et al. Defective iron supply for erythropoiesis and adequate endogenous erythropoietin production in the anemia associated with systemic-onset juvenile chronic arthritis. *Blood* 1996;87(11):4824-4830.
83. Yip R, Dallman PR. The roles of inflammation and iron deficiency as causes of anemia. *Am J Clin Nutr* 1988;48(5):1295-1300.
84. Statland BE, Winkel P. Relationship of day-to-day variation of serum iron concentrations to iron-binding capacity in healthy young women. *Am J Clin Pathol* 1977;67(1):84-90.
85. Itano M. CAP comprehensive chemistry. Serum iron survey. *Am J Clin Pathol* 1978;70[Suppl 3]:516-522.
86. Statland B, Winkel P, Bokelund H. Variation of serum iron concentration in young healthy men: within day- and day-to-day changes. *Clin Biochem* 1976;9:26-29.
87. Werkman HP, Trijbels JM, Schretlen ED. The "short-term" iron rhythm. *Clin Chim Acta* 1974;53(1):65-68.

88. Wians FH Jr, et al. Discriminating between iron deficiency anemia and anemia of chronic disease using traditional indices of iron status vs transferrin receptor concentration. *Am J Clin Pathol* 2001;115(1):112-118.
89. Finch CA, et al. Plasma ferritin determination as a diagnostic tool. *West J Med* 1986;145(5):657-663.
90. Worwood M, et al. Binding of serum ferritin to concanavalin A: patients with homozygous beta thalassaemia and transfusional iron overload. *Br J Haematol* 1980;46(3):409-416.
91. Worwood M. Serum ferritin. *Clin Sci (Lond)* 1986;70(3):215-220.
92. Worwood M. Serum ferritin. *CRC Crit Rev Clin Lab Sci* 1979;10(2):171-204.
93. Lipshitz D, Cook JD, Finch CA. A clinical evaluation of serum ferritin as an index of iron stores. *N Engl J Med* 1974;290:1213-1216.
94. Jacobs A, Worwood M. Ferritin in serum. Clinical and biochemical implications. *N Engl J Med* 1975;292(18):951-956.
95. Esumi N, et al. Hyperferritinemia in malignant histiocytosis and virus-associated hemophagocytic syndrome. *N Engl J Med* 1987;316(6):346-347.
96. Matzner Y, Konijn AM, Hershko C. Serum ferritin in hematologic malignancies. *Am J Hematol* 1980;9(1):13-22.
97. Rath C, Finch CA. Sternal marrow hemosiderin. 1948;33:81-86.
98. Gale E, Torrance J, Bothwell T. The quantitative estimation of total iron stores in human bone marrow. *J Clin Invest* 1963;42:1076-1082.
99. Ferguson BJ, et al. Serum transferrin receptor distinguishes the anemia of chronic disease from iron deficiency anemia. *J Lab Clin Med* 1992;119(4):385-390.
100. Punnonen K, Irjala K, Rajamaki A. Iron-deficiency anemia is associated with high concentrations of transferrin receptor in serum. *Clin Chem* 1994;40(5):774-776.
101. Kuvibidila S, et al. Serum transferrin receptor concentrations in women with mild malnutrition. *Am J Clin Nutr* 1996;63(4):596-601.
102. Marsh WL Jr, Nelson DP, Koenig HM. Free erythrocyte protoporphyrin (FEP) II. The FEP test is clinically useful in classifying microcytic RBC disorders in adults. *Am J Clin Pathol* 1983;79(6):661-666.
103. Stockman JA 3rd, et al. The measurement of free erythrocyte porphyrin (FEP) as a simple means of distinguishing iron deficiency from beta-thalassemia trait in subjects with microcytosis. *J Lab Clin Med* 1975;85(1):113-119.
104. Zanella A, et al. Sensitivity and predictive value of serum ferritin and free erythrocyte protoporphyrin for iron deficiency. *J Lab Clin Med* 1989;113(1):73-78.
105. Garrett S, Worwood M. Zinc protoporphyrin and iron-deficient erythropoiesis. *Acta Haematol* 1994;91(1):21-25.
106. Frey WG 3rd, Gardner MH, Pillsbury JA. Quantitative measurement of liver iron by needle biopsy. *J Lab Clin Med* 1968;72(1):52-57.
107. MacDonald R, Pechet GS. Tissue iron and hemochromatosis. *Arch Intern Med* 1965;116:381-391.
108. Conn HO, Strauss RH, Conn MB. Estimation of hepatic hemosiderin by gross inspection of iron-stained histologic sections. *Yale J Biol Med* 1972;45(2):133-138.
109. Lundin P, Lundquist A, Lundvall O. Evaluation of fine-needle aspiration biopsy smears in the

- diagnosis of liver iron overload. *Acta Med Scand* 1969;186(5):369–373.
110. Edwards CQ, et al. Hereditary hemochromatosis. Diagnosis in siblings and children. *N Engl J Med* 1977;297(1):7–13.
111. Cumming RL, et al. Clinical and laboratory studies on the action of desferrioxamine. *Br J Haematol* 1969;17(3):257–263.
112. Desenne JJ, Layrisse M. Mobilisation of iron by desferrioxamine in cases with low serum iron. *Acta Haematol* 1969;41(3):129–134.
113. Fielding J. Differential ferrioxamine test for measuring chelatable body iron. *J Clin Pathol* 1965;18:88–97.
114. Harker LA, Funk DD, Finch CA. Evaluation of storage iron by chelates. *Am J Med* 1968;45(1):105–115.
115. Ploem JE, et al. Sideruria following a single dose of desferrioxamine-B as a diagnostic test in iron overload. *Br J Haematol* 1966;12(4):396–408.
116. Walsh JR, Fredrickson M. Serum ferritin, free erythrocyte protoporphyrin, and urinary iron excretion in patients with iron disorders. *Am J Med Sci* 1977;273(3):293–300.
117. Craft J, et al. Hematologic abnormalities in Southeast Asian refugees. *JAMA* 1983;249(23):3204–3206.
118. Cunningham TM. Hemoglobin E in Indochinese refugees. *West J Med* 1982;137(3):186–190.
119. Fairbanks VF, et al. Hemoglobin E trait reexamined: a cause of microcytosis and erythrocytosis. *Blood* 1979;53(1):109–115.
120. Benz EJ Jr, et al. Molecular analysis of the beta-thalassemia phenotype associated with inheritance of hemoglobin E (alpha 2 beta2(26)Glu leads to Lys). *J Clin Invest* 1981;68(1):118–126.
121. Charache S, et al. Pathogenesis of hemolytic anemia in homozygous hemoglobin C disease. *J Clin Invest* 1967;46(11):1795–1811.
122. Fabry ME, et al. Some aspects of the pathophysiology of homozygous Hb CC erythrocytes. *J Clin Invest* 1981;67(5):1284–1291.
123. Mentzer WC Jr. Differentiation of iron deficiency from thalassaemia trait. *Lancet* 1973;1(7808):882.
124. Johnson CS, Tegos C, Beutler E. Thalassaemia minor: routine erythrocyte measurements and differentiation from iron deficiency. *Am J Clin Pathol* 1983;80(1):31–36.
125. McClure S, Custer E, Bessman JD. Improved detection of early iron deficiency in nonanemic subjects. *JAMA* 1985;253(7):1021–1023.
126. Wasi P, Disthasongchan P, Na-Nakorn S. The effect of iron deficiency on the levels of hemoglobins A2 and E. *J Lab Clin Med* 1968;71(1):85–91.
127. Mollin D. Sideroblasts and sideroblastic anaemia. *Br J Haematol* 1965;11:41–48.
128. Bessis M, Jensen WN. Sideroblastic anaemia, mitochondria and erythroblast iron. *Br J Haematol* 1965;11:49–51.
129. Crosby W, Akeroyd JH. The limit of hemoglobin synthesis in hereditary anemia. *Am J Med* 1952;13:273–283.
130. Ham T. Hemoglobinuria. *Am J Med* 1955;18:990–1006.
131. Stamey C, Diamond L. Congenital hemolytic anemia in the newborn: relationship to kernicterus. *Am J*

Dis Child 1957;94:616.

132. Owren P. Congenital hemolytic jaundice. The pathogenesis of the "hemolytic crisis." *Blood* 1948;3:231–248.
133. Lefrere JJ, et al. Human parvovirus and aplastic crisis in chronic hemolytic anemias: a study of 24 observations. *Am J Hematol* 1986;23(3):271–275.
134. Young N. Hematologic and hematopoietic consequences of B19 parvovirus infection. *Semin Hematol* 1988;25(2):159–172.
135. Young N, Mortimer P. Viruses and bone marrow failure. *Blood* 1984;63(4):729–737.
136. Chorba T, et al. The role of parvovirus B19 in aplastic crisis and erythema infectiosum (fifth disease). *J Infect Dis* 1986;154(3):383–393.
137. Plummer FA, et al. An erythema infectiosum-like illness caused by human parvovirus infection. *N Engl J Med* 1985;313(2):74–79.
138. Koduri PR, Naides SJ. Aseptic meningitis caused by parvovirus B19. *Clin Infect Dis* 1995;21(4):1053.
139. Anand A, et al. Human parvovirus infection in pregnancy and hydrops fetalis. *N Engl J Med* 1987;316(4):183–186.
140. Yaegashi N, et al. A study by means of a new assay of the relationship between an outbreak of erythema infectiosum and non-immune hydrops fetalis caused by human parvovirus B19. *J Infect* 1995;31(3):195–200.
141. Rao KR, et al. Infection with parvovirus-like virus and aplastic crisis in chronic hemolytic anemia. *Ann Intern Med* 1983;98(6):930–932.
142. Kurtzman GJ, et al. Immune response to B19 parvovirus and an antibody defect in persistent viral infection. *J Clin Invest* 1989;84(4):1114–1123.
143. Potter CG, et al. Variation of erythroid and myeloid precursors in the marrow and peripheral blood of volunteer subjects infected with human parvovirus (B19). *J Clin Invest* 1987;79(5):1486–1492.
144. Ostrow JD. The etiology of pigment gallstones. *Hepatology* 1984;4[Suppl 5]:215S–222S.
145. Trotman BW. Pigment gallstone disease. *Semin Liver Dis* 1983;3(2):112–119.
146. Trotman BW, et al. Hemolysis-induced gallstones in mice: increased unconjugated bilirubin in hepatic bile predisposes to gallstone formation. *Gastroenterology* 1981;81(2):232–236.
147. Trotman BW, et al. Interaction of hemolysis and genotype on ionized calcium in bile of mice with hemolysis-induced gallstones. *Gastroenterology* 1984;87(5):1127–1130.
148. McCall IW, et al. Cholelithiasis in Jamaican patients with homozygous sickle cell disease. *Am J Hematol* 1977;3:15–21.
149. Leger L, Orr TG. Chronic leg ulcerations in congenital hemolytic jaundice. *South Med* 1940;33:463–464.
150. Wolfort FG, Krizek TJ. Skin ulceration in sickle cell anemia. *Plast Reconstr Surg* 1969;43(1):71–77.
151. Gendel B. Chronic leg ulcer in diseases of the blood. *Blood* 1948;3:1283–1289.
152. Motulsky A, Singer K, Crosby WH, et al. Hereditary elliptocytosis and its relationship to other familial hemolytic diseases. *Blood* 1954;9:57–72.
153. Tanaka KR, Paglia DE. Pyruvate kinase deficiency. *Semin Hematol* 1971;8(4):367–396.

154. Wallerstein R, Aggeler PM. Acute hemolytic anemia. *Am J Med* 1964;37:92–104.
155. Mackinney A, Morton NE, Kosower NS. Ascertaining genetic carriers of hereditary spherocytosis by statistical analysis of multiple laboratory tests. *J Clin Invest* 1962;41:554–567.
156. Emerson PM, Wilkinson JH. Lactate dehydrogenase in the diagnosis and assessment of response to treatment of megaloblastic anaemia. *Br J Haematol* 1966;12(6):678–688.
157. Zinkham WH, et al. Observations on the rate and mechanism of hemolysis in individuals with Hb Zurich [His E7(63)beta leads to Arg]: II. Thermal denaturation of hemoglobin as a cause of anemia during fever. *Johns Hopkins Med J* 1979;144(4):109–116.
158. Danon D. A rapid micro method for recording red cell osmotic fragility by continuous decrease of salt concentration. *J Clin Pathol* 1963;16:377–382.
159. Brus I, Lewis SM. The haptoglobin content of serum in haemolytic anaemia. *Br J Haematol* 1959;5:348–355.
160. Marchand A, Galen RS, Van Lente F. The predictive value of serum haptoglobin in hemolytic disease. *JAMA* 1980;243(19):1909–1911.
161. Krauss JS, et al. The affinity glycosylated hemoglobin in a family with hereditary spherocytosis and in other non-hemoglobinopathic hemolytic anemias. *Ann Clin Lab Sci* 1987;17(5):331–338.
162. Panzer S, et al. Glycosylated hemoglobins (GHb): an index of red cell survival. *Blood* 1982;59(6):1348–1350.
163. Crosby W, Dameshek W. The significance of hemoglobinemia and associated hemosiderinuria, with particular reference to various types of hemolytic anemia. *J Lab Clin Med* 1951;38:829–841.
164. Leonards J. Simple test for hematuria compared with established tests. *JAMA* 1962;179:807–808.
165. Rowland L, Fahn S, Hirschberg E, et al. Myoglobinuria. *Arch Neurol* 1964;10:537–562.
166. Benoit F, Theil GB, Watten RH. Myoglobinuria and persistence of fetal myoglobin. *Ann Intern Med* 1964;61:1133–1139.
167. Schmid R, Mahler R. Chronic progressive myopathy with myoglobinuria: demonstration of a glycogenolytic defect in the muscle. *J Clin Invest* 1959;38:2044–2058.
168. Roesser H, Powell LW. Urinary iron excretion in valvular heart disease and after heart valve replacement. *Blood* 1970;36:785–792.
169. Sears DA, et al. Urinary iron excretion and renal metabolism of hemoglobin in hemolytic diseases. *Blood* 1966;28(5):708–725.
170. Rosen H, Sears DA, Meisenzahl D. Spectral properties of hemopexin-heme. The Schumm test. *J Lab Clin Med* 1969;74(6):941–945.
171. Foidart M, et al. Hemopexin metabolism in patients with altered serum levels. *J Lab Clin Med* 1983;102(5):838–846.
172. Fehr J, Knob M. Comparison of red cell creatine level and reticulocyte count in appraising the severity of hemolytic processes. *Blood* 1979;53(5):966–976.
173. Smith BJ, et al. Erythrocyte creatine levels in anemia. *Ann Clin Lab Sci* 1982;12(6):439–446.
174. Finch CA, et al. Ferrokinetics in man. *Medicine (Baltimore)* 1970;49(1):17–53.
175. Gilliland BC, Baxter E, Evans RS. Red-cell antibodies in acquired hemolytic anemia with negative



antiglobulin serum tests. *N Engl J Med* 1971;285(5):252–256.

176. De Angelis V, et al. Clinical significance of positive direct antiglobulin test in patients with HIV infection. *Infection* 1994;22(2):92–95.

177. Selwyn J, Dacie JV. Autohemolysis and other changes resulting from incubation in vitro of red cells from patients with congenital hemolytic anemia. *Blood* 1954;9:414–438.

178. Powell LW. Clinical aspects of unconjugated hyperbilirubinemia. *Semin Hematol* 1972;9(1):91–105.

179. Adamson J, Hillman RS. Blood volume and plasma protein replacement following acute blood loss in normal man. *JAMA* 1968;205(9):609–612.

180. Ebert R, Stead EA Jr, Gibson JG II. Response of normal subjects to acute blood loss. *Arch Intern Med* 1941;68:578–590.

181. Schidt E. Observations on blood regeneration in man. *Am J Med Sci* 1937;193:313–336.

182. Carson JL. Morbidity risk assessment in the surgically anemic patient. *Am J Surg* 1995;170[Suppl 6A]:32S–36S.

183. Greenburg AG. A physiologic basis for red blood cell transfusion decisions. *Am J Surg* 1995;170(Suppl 6A):44S–48S.

184. Spence RK. Surgical red blood cell transfusion practice policies. Blood Management Practice Guidelines Conference. *Am J Surg* 1995;170[Suppl 6A]:3S–15S.

185. Goldberg MA. Erythropoiesis, erythropoietin, and iron metabolism in elective surgery: preoperative strategies for avoiding allogeneic blood exposure. *Am J Surg* 1995;170(Suppl 6A):37S–43S.

186. Rickenbacker W, Myers JL, Waldhausen JA. Current status of cardiac surgery: a 40 year review. *J Am Coll Cardiol* 1989;14:535–544.

187. Goodnough LT, et al. A phase III trial of recombinant human erythropoietin therapy in nonanemic orthopedic patients subjected to aggressive removal of blood for autologous use: dose, response, toxicity, and efficacy. *Transfusion* 1994;34(1):66–71.

188. Goodnough LT, Shafron D, Marcus RE. The impact of preoperative autologous blood donation on orthopaedic surgical practice. *Vox Sang* 1990;59(2):65–69.

189. Crosby L, et al. Iron supplementation for acute blood loss anemia after coronary artery bypass surgery: a randomized, placebo-controlled study. *Heart Lung* 1994;23(6):493–499.

190. Kluiber RM, Wolff BG. Evaluation of anemia caused by hemorrhoidal bleeding. *Dis Colon Rectum* 1994;37(10):1006–1007.

191. Madura JA. Use of erythropoietin and parenteral iron dextran in a severely anemic Jehovah's Witness with colon cancer. *Arch Surg* 1993;128(10):1168–1170.

2004 Lippincott Williams & Wilkins  
John P. Greer, John Foerster, John N. Lukens  
George M. Rodgers, Frixos Paraskevas, Bertil Glader  
Wintrobe's Clinical Hematology

**NORMAL IRON PHYSIOLOGY**[Total Body Iron](#)[Iron Balance](#)[Intestinal Absorption](#)[Iron Cycle](#)[Plasma Transport](#)[Metabolism within Normoblasts](#)[Macrophage Iron Recycling](#)[Metabolism in Other Tissues](#)[Regulation of Intracellular Iron Metabolism](#)[Pathogenesis of Iron Deficiency Anemia](#)[Role of Copper in Erythropoiesis](#)**CLINICAL FEATURES OF IRON DEFICIENCY**[Stages in the Development of Iron Deficiency](#)[Prevalence](#)[Etiology](#)[Diet](#)[Impaired Absorption](#)[Blood Loss](#)[Chronic Renal Failure Treated with Hemodialysis](#)[Runner's Anemia](#)[Decreased Total Body Iron at Birth](#)[Growth](#)[Diet in Infancy and Childhood](#)[Blood Loss in Infancy](#)[Pregnancy and Lactation](#)[Signs and Symptoms of Iron Deficiency](#)**LABORATORY FINDINGS IN IRON DEFICIENCY**[Erythrocytes](#)[Leukocytes and Platelets](#)[Bone Marrow](#)[Iron Metabolism](#)[Ferrokinetic Studies](#)**MANAGEMENT OF IRON DEFICIENCY**[Oral Iron Therapy](#)[Side Effects of Oral Iron Therapy](#)[Failure of Oral Iron Therapy](#)[Parenteral Iron Therapy](#)[Side Effects of Parenteral Iron Therapy](#)[Response to Therapy](#)[Preventive Treatment](#)[Anemia after Acute Hemorrhage](#)[Acute Iron Intoxication](#)**ACKNOWLEDGMENTS****WEB SITES****REFERENCES**

Iron deficiency has been recognized since medieval times. *Chlorosis*, a term derived from

the Greek word meaning *green*, was applied by Varandaeus ( <sup>1</sup> ) to a disorder that was first described in 1554 by Johannes Lange who called it “ *De morbo virgineo* ” ( <sup>2</sup> ). The disease became well known, not only in medical circles, but also in the general population, who called it the “green-sickness.” It was depicted in many paintings by the Dutch masters and was alluded to by Shakespeare and other literary figures of the period.

Chlorosis occurred almost exclusively in girls between the ages of 14 and 17 years. A prominent manifestation was greenish pallor ( <sup>3</sup> ). Other clinical features were breathlessness, palpitations, slight ankle edema, and gastrointestinal complaints, including changes in appetite, flatulence, abdominal pain, and constipation. Emotional disturbances (“love sickness”), depression, irritability, and moodiness were common. Thrombophlebitis was a relatively frequent complication, and the incidence of cerebral sinus thrombosis was particularly striking.

Iron deficiency anemia undoubtedly played a prominent part in chlorosis. In the 1830s, anemia, hypochromia, and lack of iron in the blood were detected by Hoefer, Popp, and Foedisch, respectively ( <sup>4</sup> ). In 1832, Pierre Blaud described the response of chlorosis to his deservedly famous pills (ferrous sulfate plus potassium carbonate). He gave gradually increasing doses, from two pills on the first day to 12 pills on day 16. Many observers, including Nie-meyer and Osler, confirmed his findings ( <sup>5</sup> ). Ferrous sulfate remains a cornerstone of modern treatment of iron deficiency.

Today, most believe that chlorosis resulted from a combination of factors affecting adolescent girls: the demands of growth and the onset of menses, an inadequate diet, and a legacy of poor iron stores at birth from an iron-deficient mother. However, to reconcile this concept with observations on the fluctuations in the incidence of the disease is difficult ( <sup>1</sup> ). Chlorosis became especially common in the last decade of the nineteenth century. It then abruptly declined in incidence until only rare cases were observed after 1910. One prominent hypothesis offered to explain the changing incidence of chlorosis relates the disease to tight lacing of the body with a corset or similar garment, a hypothesis that continues to attract advocates ( <sup>1</sup> ).

In the late 1920s and early 1930s, a distinct hypochromic anemia was described, which corresponds to iron deficiency anemia as we know it today. Like chlorosis, chronic hypochromic anemia chiefly affected women; it differed from chlorosis in that it was detected later in life, especially in the fourth and fifth decades ( <sup>6</sup> ). Other distinguishing clinical features were epithelial changes involving the tongue and nails, as well as achlorhydria, which some believed was of specific differential diagnostic value. The anemia most often affected women with poor diets, multiple pregnancies, or menstrual irregularities. Today, menstruating women continue to be among the most likely individuals to develop iron deficiency, along with young children whose growth outstrips their iron supply. To best appreciate the varied causes of iron deficiency anemia, an understanding of normal iron physiology is essential.

## **NORMAL IRON PHYSIOLOGY**

### **Total Body Iron**

Iron endowment varies with age and sex. Full-term infants begin life with approximately 75 mg/kg body weight of iron, primarily acquired from their mothers during the third trimester of gestation. These abundant stores are rapidly depleted over the first few months of life, and most children are in rather tenuous iron balance, as their intake must keep pace with rapid growth. After adolescence, requirements decrease, and men have a

small, gradual increase in iron stores throughout life. The body iron content of normal adult men is 50 mg/kg body weight or greater. In contrast, postpubertal women have continuous loss of iron until they cease to menstruate, resulting in a body iron endowment averaging 35 mg/kg. After menopause, women accumulate iron linearly in parallel with adult men.

Most of the body iron is found in heme compounds, especially hemoglobin and myoglobin (Table 28.1). Very small amounts are incorporated into enzymes that use iron in electron transfer, including peroxidases, catalases, and ribonucleotide reductase. Some is used in enzymes containing iron-sulfur clusters. However, most nonheme iron (approximately 1 g in adult men) is stored as ferritin or hemosiderin in macrophages and hepatocytes. Only a tiny fraction (approximately 0.1%) is in transit in the plasma, bound to the carrier protein, transferrin.

**TABLE 28.1. Important Fe-Containing Compounds in the Human**

| Protein                                    | Function                                  | Fe Oxidation State | Amount (g) | Percent of Total |
|--|---|--------------------|------------|------------------|
| Hemoglobin                                 | Erythrocyte O <sub>2</sub> transport      | 2 (heme)           | 2.600      | 65.0             |
| Myoglobin                                  | Muscle O <sub>2</sub> storage             | 2 (heme)           | 0.130      | 6.0              |
| Transferrin                                | Plasma Fe transport                       | 3                  | 0.003      | 0.1              |
| Ferritin                                   | Intracellular Fe storage                  | 3                  | 0.520      | 13.0             |
| Hemosiderin                                | Intracellular Fe storage                  | 3                  | 0.480      | 12.0             |
| Catalase, peroxidase                       | H <sub>2</sub> O <sub>2</sub> degradation | 2                  | —          | —                |
| Cytochromes                                | Electron transport                        | 2/3 (heme)         | —          | —                |
| Aconitase                                  | Tricarboxylic acid cycle                  | 4Fe·4S cluster     | —          | —                |
| Ferrochelatase                             | Heme biosynthesis                         | 2Fe·2S cluster     | —          | —                |
| Duodenal cytochrome <i>b</i> -like protein | Intestinal Fe reduction                   | 2 (heme)           | —          | —                |
| Others                                     | Other oxidases, enzymes                   | —                  | 0.140      | 3.6              |

Adapted from Theil E, Raymond K. Transition-metal storage, transport, and biomineralization. In: Bertini I, Gray HB, Lippard SJ, Valentine JS, eds. Bioinorganic chemistry. Mill Valley, CA: University Science Books, 1994:611.

## Iron Balance

Iron is not actively excreted through the liver or kidneys. It is lost from the body only when cells are lost, particularly epithelial cells from the gastrointestinal tract, epidermal cells of the skin, and, in menstruating women, red blood cells. Urinary iron amounts to less than 0.05 mg/day and is largely accounted for by sloughed cells.

Although iron is a physiologic component of sweat, only a tiny amount of iron (22.5 µg/L)

is lost by this route ( [7](#) ). On the basis of long-term studies of body iron turnover, the total average daily loss of iron has been estimated at approximately 1.0 mg (range, 0.6 to 1.6 mg) in normal adult men and nonmenstruating women ( [8](#) ). Menstruating women lose an additional, highly variable amount averaging approximately 0.006 mg/kg/day prorated over the entire menstrual cycle. Occasionally, menstruation results in losses of more than 0.025 mg/kg/day ( [9](#), [10](#) ). In pregnant women, the rate of iron loss is approximately three and a half times as great as in normal men.

In the ideal situation, these losses are balanced by an equivalent amount of iron absorbed from the diet. However, only a fraction of dietary iron is absorbed. The bioavailability of iron in the American diet has been estimated to be approximately 16.6%, but the amount of bioavailable iron is lower in many parts of the world ( [9](#) ). Fractional absorption of dietary iron can increase up to three- to fivefold if iron stores are depleted. Conversely, the proportion absorbed decreases in states of iron overload. Thus, iron balance is primarily, if not exclusively, achieved by control of absorption rather than by control of excretion.

### Intestinal Absorption

Iron is absorbed in the proximal small intestine, close to the gastric outlet ( [11](#) ). The site of absorption is determined both by local intraluminal factors such as pH and redox potential and by the fact that key proteins of intestinal iron absorption are expressed at highest levels in the first part of the duodenum (see below). The importance of gastric acidity is apparent because nonheme iron absorption is impaired in patients who have undergone gastrectomy or have achlorhydria ( [12](#), [13](#) and [14](#) ).

Humans and other omnivorous mammals have at least two distinct pathways for iron absorption: one for uptake of heme iron ( [15](#) ) and another for ferrous ( $\text{Fe}^{2+}$ ) iron ( [16](#) ). Dietary iron must be converted to one of these two forms to be absorbed. Heme iron is derived from the hemoglobin, myoglobin, and other heme proteins in foods of animal origin. Exposure to acid and proteases present in gastric juices frees the heme from its apoprotein. This heme iron is probably oxidized to its ferric state, forming hemin. There is evidence that hemin enters the mucosal cell intact, probably by binding to an as yet unidentified receptor ( [15](#) ). In contrast, nonheme iron generally arrives in its ferric ( $\text{Fe}^{3+}$ ) form, which must be converted to ferrous ion to be absorbed ( [16](#) ).

Approximately 10 to 15% of the iron in nonvegetarian, Western diets is in the form of heme ( [17](#) ). Less dietary heme is present in the food consumed in most of the rest of the world. Dietary nonheme iron is largely in the form of ferric hydroxide or loosely bound to organic molecules such as phytates, oxalate, sugars, citrate, lactate, and amino acids. Certain foods, including flour and infant formulas, are commonly fortified with iron, and these may be an important source of iron in the diet ( [18](#) ).

Absorption of heme iron is relatively unaffected by the overall composition of the diet ( [17](#) ). However, other dietary constituents may have profound effects on the absorption of nonheme iron, making the bioavailability of food iron highly variable ( [17](#), [19](#) ). Depending on various combinations of enhancing and inhibitory factors, dietary iron assimilation can vary as much as tenfold. Ascorbate ( [20](#) ) and animal tissues ( [19](#), [21](#) ) are major dietary enhancers of inorganic iron absorption. Ascorbate exerts its effects, at least in part, by aiding in the reduction of ferric iron to the absorbable ferrous form. Beef, lamb, pork, chicken, and fish considerably enhance nonheme iron absorption, but the exact nature of the meat factor remains unknown. It may be that low-molecular-weight intermediates of

digested animal proteins bind iron in soluble complexes. For example, peptides containing cysteine have been shown to enhance nonheme iron absorption ( [22](#) ). Not all proteins enhance iron absorption, however. Vegetable proteins, notably soy protein, do not have this effect and may actually inhibit iron absorption, even when iron-binding plant substances are removed ( [23](#) ). It is interesting, however, to note that soy sauce and similar products that do not contain appreciable amounts of soy proteins appeared to enhance iron absorption in other studies ( [24](#) , [25](#) ). Bovine milk proteins inhibit absorption ( [26](#) ), although substances found in human breast milk improve absorption ( [27](#) ). Other possible enhancers of nonheme iron absorption include certain keto sugars, organic acids, and amino acids that form soluble iron chelates.

Other ingredients in foods can significantly inhibit nonheme iron absorption. Phytates, present in grains and some other vegetable foods, form stable, poorly absorbable complexes with iron ( [28](#) , [29](#) and [30](#) ). Bran ( [31](#) ) and other fibers ( [32](#) , [33](#) ) inhibit iron absorption mainly because of their phytate content ( [34](#) , [35](#) ). Polyphenols probably interfere with absorption of iron from legumes, tea, coffee, and wine ( [28](#) , [32](#) , [36](#) , [37](#) , [38](#) , [39](#) and [40](#) ). Phosphates and phosphoproteins inhibit absorption of iron from egg yolks and milk. Calcium inhibits intestinal iron absorption ( [41](#) , [42](#) and [43](#) ), and other metals, such as zinc ( [44](#) ), may compete for iron uptake.

Iron absorption must be considered as a process involving at least two distinct steps: (a) mucosal uptake, and (b) transfer of iron from the mucosal cell to the lamina propria, where it enters plasma. Both steps involve specific iron carriers and are discussed separately below.

Mucosal uptake begins at the brush border of the mucosal cell where it is mediated (in rodents and probably also in humans) by divalent metal ion transporter 1 (DMT1, also known as *Nramp2*, *DCT1*) ( [45](#) , [46](#) , [47](#) and [48](#) ). DMT1 is a protein with twelve predicted transmembrane segments, which is expressed on the apical surface of absorptive enterocytes. Levels of DMT1 are markedly increased in iron-deficient animals ( [49](#) , [50](#) ) and in some animals with increased intestinal iron absorption resulting from other causes ( [51](#) ). In addition to iron, DMT1 has been shown to transport a variety of divalent metal ions, including Mn<sup>2+</sup>, Co<sup>2+</sup>, Cu<sup>2+</sup>, Zn<sup>2+</sup>, Cd<sup>2+</sup>, and Pb<sup>2+</sup> ( [50](#) ). It appears to be a proton symporter; that is, there is evidence that protons accompany metal ions into the cell ( [50](#) ). This feature helps to explain why iron absorption takes place close to the gastric outlet. The acidic gastric fluid probably provides the required supply of protons for iron transport.

The importance of DMT1 in iron transport was shown by identification of a mutation in DMT1 in two rodent strains, microcytic mice and Belgrade rats, which have profound iron deficiency due to impaired apical transport of iron into their enterocytes ( [47](#) , [48](#) ). Remarkably, microcytic mice and Belgrade rats have the same codon change, glycine 185 to arginine, disrupting a critical transmembrane helix of the protein. *In vitro* experiments have shown that this mutation markedly impairs DMT1 function ( [52](#) ), and immunohistochemistry has shown that this mutant form of DMT1 is mislocalized *in vivo* in villous enterocytes ( [46](#) ). The severe phenotype of microcytic mice and Belgrade rats strongly suggests that DMT1 is the major, if not the only, transporter for dietary nonheme iron that functions in rodents. Although not yet proven, it is likely that this is also true in humans. To date, no DMT1 mutations have been identified in human patients.

DMT1 has a strict requirement for divalent cations, and it will not transport the Fe<sup>3+</sup> form of iron. As discussed above, most dietary nonheme iron arrives at the brush border

as Fe<sup>3+</sup> ion. A duodenal cytochrome *b*-like ferrireductase enzyme, Dcytb, is expressed at that site, and is induced in response to stimuli that increase iron absorption ( [53](#)). Although not formally proven yet, it is likely that Dcytb serves the function of reducing dietary iron to make it a substrate for transport by DMT1. No human or mouse mutations in this protein have been reported to date.

When heme iron enters the cell, the porphyrin ring is enzymatically cleaved ( [54](#)), probably by heme oxygenase ( [55](#)). The liberated iron then probably follows the same pathways as those used by nonheme iron. A small proportion of the heme iron may pass into the plasma intact ( [54](#)) and become bound to the heme-binding protein, hemopexin.

A variable proportion of iron taken into the cell is delivered to the plasma within a few hours. The remainder probably is incorporated into mucosal ferritin ( [56](#)), an intracellular iron protein that is discussed in a later section. Iron retained in mucosal ferritin is not absorbed—rather, it is lost from the body when the senescent mucosal cells are sloughed into the intestine at the end of their 3- to 4-day lifespan ( [57](#)). There seems to be regulated partitioning of iron between ferritin storage and serosal transfer, because a delayed phase of iron absorption has been observed that occurs between 3 and 24 hours and may represent later mobilization of iron from ferritin or other intracellular binding sites ( [58](#)). In a sense, the retention of iron by mucosal cells represents a mechanism for loss of iron from the body that may, at least on some levels, be regulated.

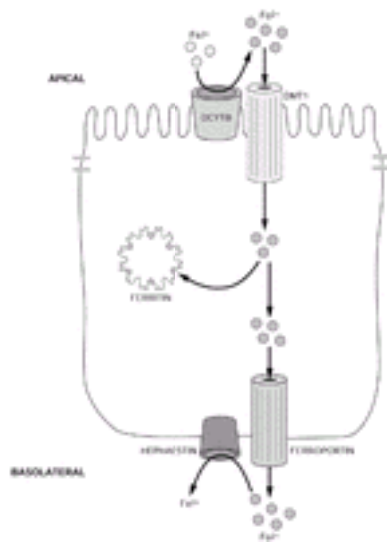
The iron that is not stored in the absorptive enterocytes is transferred across the basolateral membrane of the cell to the lamina propria and ultimately to the plasma. This is most likely accomplished, at least in part, by the transporter ferroportin (also known as *IREG1*, *MTP1*), a multitransmembrane domain protein that has many of the features expected of the basolateral iron carrier ( [59](#), [60](#) and [61](#)). Ferroportin was identified simultaneously by three groups of investigators. Donovan and co-workers found a mutation in the zebrafish ortholog of ferroportin in mutant zebrafish that were anemic due to a defect in transfer of iron from the yolk sac to the developing embryo ( [60](#)). McKie and co-workers used a subtractive hybridization strategy to identify messenger RNAs (mRNAs) that were induced in iron-deficient animals ( [61](#)). Abboud and Haile found the same mRNA using a selection for molecules containing RNA stem-loop structures termed *iron responsive elements* ( [59](#)). All three groups showed that ferroportin is expressed in enterocytes, that it has features of an iron-responsive mRNA, and that it appeared to mediate the efflux of iron from cells. However, none of the iron export assays that have been published are robust enough for quantitative analysis, making it difficult to use them in the biochemical characterization of this protein.

Although ferroportin is undoubtedly important for iron transfer in developing fish embryos, mutations have not yet been described in mice or rats, in which much more is known about normal iron physiology. However, some insights have been gained from the identification of ferroportin mutations in human patients. Heterozygosity for missense mutations and in-frame deletion mutations in ferroportin results in an autosomal-dominant iron overload disorder, characterized by disproportionately elevated serum ferritin and a macrophage-predominant pattern of iron deposition ( [62](#), [63](#), [64](#), [65](#) and [66](#)). Although initially attributed to a gain-of-function mutation in ferroportin that could increase intestinal iron absorption ( [62](#)), it now seems more likely that the disease results from a loss-of-function mutation ( [63](#)). Increased intestinal iron absorption appears to result, despite having only one normal copy of ferroportin present in the enterocyte. This paradox is probably explained by the fact that iron homeostasis is modulated at multiple levels. There is clear evidence for a block in macrophage iron release in patients with



ferroportin mutations, and this impairment appears to limit the amount of iron available for erythropoiesis. The working hypothesis is that, as a consequence, the amount of dietary iron absorption increases to compensate. This interpretation has several implications for the role of ferroportin in basolateral iron transfer. First, it may be that the amount of functional ferroportin is not limiting at that step. Alternatively, there may be redundancy in basolateral iron transfer, and another molecule might help accomplish increased iron flux across the basolateral surface. A third, and relatively unlikely, possibility is that ferroportin does not play a significant role in normal basolateral iron transfer, despite its expression at that site. These questions will be answered in the near future through analysis of mice with targeted disruption of the gene encoding ferroportin in duodenal enterocytes.

Similar to apical iron uptake, basolateral iron efflux is aided by an enzyme that changes the oxidation state of iron. In this case,  $\text{Fe}^{2+}$  iron leaving the cell must be oxidized to its  $\text{Fe}^{3+}$  form to bind to transferrin. A membrane-bound multicopper oxidase, hephaestin, has been implicated in this process. Hephaestin closely resembles ceruloplasmin, which has been shown to be involved in efflux of iron from hepatocytes (67) and macrophages (68, 69 and 70). Sex-linked anemia mice, carrying a large deletion in the X-chromosomal hephaestin gene (71), have impaired placental iron transfer and decreased intestinal iron absorption (72, 73). Their iron deficiency results in anemia during the neonatal period, but affected animals generally recover and show only subtle evidence of iron deficiency as adults (74). The simplest interpretation is that hephaestin is important in placental iron transport but dispensable for intestinal iron uptake. The functional relationship between hephaestin and ferroportin has not yet been defined in detail. A model incorporating current knowledge of nonheme iron transport is shown in Figure 28.1.



**Figure 28.1.** Nonheme iron absorption in the intestine. The figure shows a drawing of an absorptive enterocyte from the proximal duodenum. The apical brush border is at the top. Dietary nonheme iron enters the gut as the ferric ( $\text{Fe}^{3+}$ ) ion and is converted to the ferrous ( $\text{Fe}^{2+}$ ) ion by a surface reductase activity, probably mediated by the duodenal cytochrome *b*-like (DCYTB) protein. The  $\text{Fe}^{2+}$  iron enters the cell through the action of divalent metal ion transporter 1 (DMT1). Within the cell, some iron is stored, and some is transported across the basolateral membrane. Ferroportin is believed to function as a basolateral  $\text{Fe}^{2+}$  iron transporter. Hephaestin, a ferroxidase, facilitates basolateral iron export, possibly by oxidizing the iron as it exits the cell to the  $\text{Fe}^{3+}$  form to bind to

plasma apotransferrin.

Because the total body iron content is largely determined by the absorption of iron, the mechanisms by which the rate of absorption is regulated have been of great interest for many years. Two factors are of prime importance in determining absorptive rate. The first is the amount of storage iron in the body. When storage iron is depleted, iron absorption is increased; when it is excessive, iron absorption is decreased. This has been termed the *stores regulator* ( [75](#) ). It is capable of changing iron absorption modestly—iron flux increases two- to threefold in iron deficiency ( [76](#) ). The molecular details of the stores regulator are not known, but it may sense variations in the iron occupancy of plasma transferrin.

The second important factor is the overall rate of erythropoiesis and whether it is effective or ineffective. This *erythroid regulator* ( [75](#) ) mediates an increase in intestinal iron absorption when the red cell production rate is increased, if iron is limiting, or if erythroid precursors are destroyed relatively close to their site of origin in the bone marrow (ineffective erythropoiesis, as seen in thalassemia syndromes, congenital dyserythropoietic anemias, and sideroblastic anemias). It modulates iron absorption in response to erythropoietic need. It is logical that the erythron should have some influence on the rate of intestinal iron absorption, as it is the major consumer of body iron. Yet how it accomplishes this feat has remained mysterious. At the other extreme, iron absorption is decreased when erythrocyte production is decreased. The effect of accelerated erythropoiesis is especially evident when the erythropoietic rate exceeds the rate at which iron can be supplied to the marrow.

The potency of the erythroid regulator is dramatically demonstrated by studies of hypotransferrinemic ( *hpx* ) mice ( [77](#) , [78](#) , [79](#) , [80](#) and [81](#) ) and atransferrinemic human patients ( [82](#) , [83](#) ). In both cases, deficiency of plasma transferrin leads to the unusual combination of severely iron-limited erythropoiesis and massive tissue iron overload. The stores regulator should be acting to minimize intestinal iron absorption, but absorption is greatly increased, presumably in response to signals from the erythroid regulator. In homozygous *hpx* mice, expression of *Dmt1*, *Fpr*, and *Dcytb* mRNAs is markedly increased ( [51](#) , [53](#) , [61](#) ). It is likely that augmented production of these molecules plays a direct role in augmenting iron absorption.

In addition to these major influences, iron absorption also appears to be regulated in response to hypoxia ( [84](#) , [85](#) and [86](#) ) and inflammation ( [86](#) , [87](#) ), but even less is known about the molecular mechanisms in these situations.

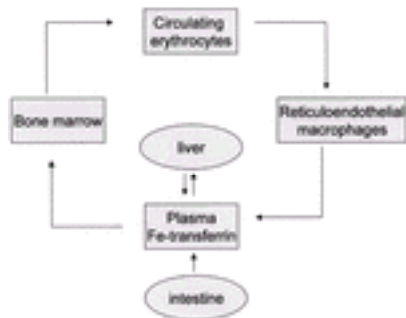
It is not yet known how the stores and erythroid regulators act to modulate intestinal iron absorption. At the time they begin to differentiate in the intestinal crypts of Lieberkuhn, the intestinal mucosal cells appear to be programmed to a certain level of iron absorption. Endogenous iron is incorporated into these mucosal cells within the crypts ( [88](#) , [89](#) ). It has been proposed that this iron helps to establish a cellular iron set point: more iron than normal being incorporated when iron stores are excessive or erythropoiesis is depressed, and reduced amounts being incorporated in iron deficiency states or during accelerated phases of erythropoiesis. Failure to demonstrate significantly reduced amounts of nonheme iron in mucosal epithelial cells in iron-deficient rats with increased iron absorption has been cited as evidence against the hypothesis ( [90](#) ). Other investigators, however, found mucosal iron to be reduced in a supernatant fraction of mucosal homogenate from both iron-deficient and hemolyzing animals ( [56](#) ).

Because the bone marrow, liver, and intestine are not contiguous tissues, it has been assumed that the erythroid and stores regulators must depend on soluble or cellular signals that circulate in the plasma. Some possible candidates, such as erythropoietin, have been definitively ruled out (91). Buys and co-workers tried to show evidence of a transferable factor by infusing normal animals with plasma from homozygous *hpx* mice, which, as discussed above, have marked activation of the erythroid regulator (79). They did not see any stimulation of iron absorption in the recipient animals, shedding doubt on the possibility that the erythroid regulator signal was a stable, soluble protein. It is important, however, that their experiment did not rule out the possibility that the erythroid regulator involved disappearance of a plasma protein rather than induction of a plasma protein. If a molecule normally functioned to suppress iron absorption, then plasma from anemic animals would not have it, and there would be no effect of transferring that plasma to another animal.

Recently, the discovery of a small peptide hormone has shed new light on possible mechanisms regulating intestinal iron absorption. *Hepcidin* is a small peptide of 20 to 25 amino acids, which is cleaved from a larger precursor. It is produced in the liver, but it is present in the plasma and excreted through the kidneys (92, 93). Hepcidin is structurally similar to antimicrobial peptides involved in innate immunity, and it has been shown to have antimicrobial properties (94, 95). Mice that inadvertently lost expression of hepcidin as a result of targeted disruption of the gene encoding upstream stimulatory factor 2 developed iron overload (96). This phenotype was clearly due to loss of hepcidin, rather than loss of upstream stimulatory factor 2, because a distinct upstream stimulatory factor 2 knock-out mouse with normal hepcidin expression did not develop iron overload (95). Hepcidin expression is increased in animals with iron overload induced by feeding of carbonyl iron, suggesting that its production might be part of a compensatory response to limit iron absorption (94). This conclusion is strongly supported by the recent finding that transgenic mice constitutively expressing hepcidin have severe iron deficiency anemia (95). Furthermore, expression of hepcidin is decreased in the setting of iron deficiency anemia, hypoxia, or inflammation (86, 97). Finally, human patients with inappropriate expression of hepcidin develop an iron-restricted anemia (97). Together, these observations make hepcidin an attractive candidate for a soluble regulator that acts to attenuate intestinal iron absorption (98). This interpretation is entirely consistent with the Buys experiment described above (79).

## Iron Cycle

Most functional iron in the body is not derived from daily intestinal absorption but rather from recycling of iron already present (Fig. 28.2). The most important source and destination of recycled iron, by far, is the erythron. At the end of their 4-month lifespan, effete erythrocytes are engulfed by reticuloendothelial macrophages, primarily in the spleen, which lyse the cells and disassemble hemoglobin to liberate their iron. This process is poorly understood, but it appears to involve the action of heme oxygenase for enzymatic degradation of heme. Some of this iron may remain stored in macrophages as ferritin or hemosiderin, but most is delivered to the plasma, where it becomes bound to transferrin, completing the cycle. In normal men, approximately 30 mg of iron completes the iron cycle each day. An additional small amount of iron, probably less than 2 mg, leaves the plasma each day to enter hepatic parenchymal cells and other tissues. Here, the iron is stored or used for synthesis of cellular heme proteins, such as myoglobin and the cytochromes.



**Figure 28.2.** Iron cycle in humans. Iron (Fe) enters the body through the small intestine and travels in the plasma bound to transferrin. It is delivered to the erythroid bone marrow, where it is incorporated into hemoglobin and released into the circulation in mature erythrocytes. After a lifespan of approximately 120 days, erythrocytes are engulfed by macrophages in the reticuloendothelial system. There the Fe is extracted from hemoglobin and returned to plasma, where it becomes bound to transferrin, completing the cycle. Fe in excess of tissue needs is stored in the liver.

## Plasma Transport

The plasma iron-binding protein, transferrin, is a glycoprotein with a molecular weight of approximately 80 kilodaltons ( [99](#) ). The transferrin gene is located on chromosome 3q21 near the genes for lactoferrin and ceruloplasmin. Transferrin is synthesized chiefly in the liver by parenchymal cells ( [100](#) ), but lesser amounts are made in other tissues, including the central nervous system, the ovary, the testis, and helper T lymphocytes (T4+ subset) ( [101](#) ). The rate of synthesis shows an inverse relationship to iron in stores; when iron stores are depleted, more transferrin is synthesized, and when iron stores are overfilled, the level of transferrin decreases. Transferrin is synthesized as a preprotein; a 19-amino acid leader sequence is removed and carbohydrate moieties are added to produce the mature, secreted protein. ( [102](#) ).

Studies with iodine 131-labeled transferrin have given insight into its distribution and kinetics ( [103](#) , [104](#) ). The protein is almost equally distributed between plasma and extravascular sites, and exchange takes place between the two compartments at the rate of approximately 5% per hour. Transferrin turnover follows first-order kinetics with a half-clearance time of approximately 10 days or approximately 17 mg/kg/day. Transferrin catabolism is not well understood.

The normal concentration of transferrin in the plasma is approximately 2 to 3 g/L. Clinically, transferrin is quantified in terms of the amount of iron it will bind, a measure called the *total iron-binding capacity* (TIBC). In the average normal subject, the plasma iron concentration is approximately 18  $\mu\text{mol/L}$  (100  $\mu\text{g/dl}$ ), and the TIBC is 56  $\mu\text{mol/L}$  (300  $\mu\text{g/dl}$ ). Thus, only approximately one-third of the available transferrin binding sites are normally occupied, leaving a large capacity to deal with excess iron. Plasma iron concentration varies over the course of the day, with the highest values in the morning and the lowest in the evening. This must be taken into account in interpreting transferrin saturation values. However, the levels of serum transferrin are more constant, and there is no apparent diurnal variation in TIBC. Data on normal values for plasma iron and TIBC are given in [Appendix A](#).

Transferrin has two homologous iron-binding domains, each of which binds an atom of trivalent (ferric) iron. The iron atoms are incorporated one at a time and appear to bind randomly at either or both of the two sites. Thus, iron-loaded transferrin exists as either

of two monoferric transferrins or as diferric transferrin. When binding is complete, the iron lies in a pocket formed by two polypeptide loops. Two tyrosine residues, a histidine residue, and an aspartic acid residue serve as metal ligands ( [105](#) ). One mole of anion, usually carbonate or bicarbonate, is taken up, and three moles of hydrogen ion are released for each mole of iron bound. There are functional differences between the two iron-binding sites ( [106](#) ), but it is not clear that these have physiologic importance.

The characteristic pink color of transferrin, with an absorption peak at a wavelength of 465 nm, results from the interaction between iron, bicarbonate, and the binding site. Under physiologic circumstances, ferric iron binds to transferrin with very high affinity, with an affinity constant of approximately  $10^{20}$ /mol. The affinity of iron–transferrin interaction is pH dependent, decreasing as pH is lowered. Other transition metals, such as copper, chromium, manganese, gallium, aluminum, indium, and cobalt, can be bound by transferrin but with less affinity than iron.

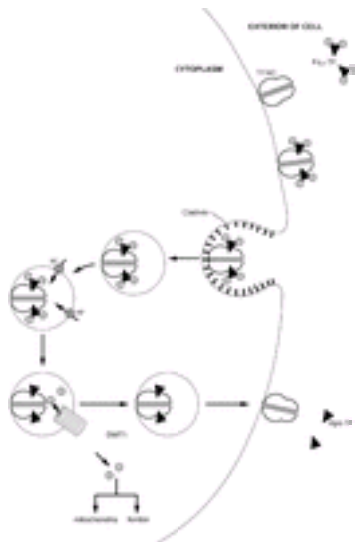
The transferrin-mediated delivery of iron to erythroid precursors imparts direction to the flow of iron in the cycle shown in [Figure 28.2](#). The biologic importance of transferrin in erythropoiesis is illustrated by the phenotype of patients and mice with congenital atransferrinemia ( [77](#), [80](#), [82](#), [83](#), [107](#), [108](#) and [109](#) ). When transferrin is severely deficient, red cells display the morphologic stigmata of iron deficiency. This occurs despite the fact that intestinal iron absorption is markedly increased, presumably in response to a perceived need for iron for erythropoiesis, and nonhematopoietic tissues avidly assimilate the nontransferrin-bound metal. Similarly, mutant mice lacking tissue receptors for transferrin die during embryonic development from severe anemia, apparently resulting from ineffective iron delivery to erythroid precursor cells ( [110](#) ).

Transferrin delivers its iron to developing normoblasts and other cells by binding to specific cell–surface receptors. Like many other receptors, the transferrin receptor (TFRC) is a disulfide-linked glycoprotein with a single membrane–spanning segment and a short cytoplasmic segment. It is a type II membrane protein, with its *N*-terminus located within the cell. The native molecular weight of TFRC is approximately 180,000 ( [102](#) ). The gene encoding TFRC is located on 3q29. Each TFRC homodimer can bind two transferrin molecules. Diferric transferrin is bound with higher affinity (association constant, 2 to  $7 \times 10^{-9}$  M) than monoferric transferrin. As a result, diferric transferrin has a competitive advantage in delivering iron to the erythrocyte precursors ( [111](#) ). Apotransferrin has little affinity for the receptor at physiologic pH but considerable affinity at lower pH, an important factor in intracellular iron release ( [112](#) ). There is a second, related molecule, TFR2, which shares approximately 45% homology with TFRC in its large extracellular domain ( [113](#) ). TFR2 binds transferrin with lower affinity, and its role in cellular iron uptake is unclear ( [114](#) ). It is highly expressed in the liver and in erythroid precursor cells ( [113](#), [115](#) ). It must have some function in iron metabolism, because patients carrying mutations in the *TFR2* gene develop an iron overload disorder that is clinically indistinguishable from classical hereditary hemochromatosis ( [116](#), [117](#) ).

The role of TFRC is relatively well understood. TFRC numbers are modulated during erythroid cell maturation, reaching their peak in intermediate normoblasts. Very few are found on burst-forming unit-erythroid cells, and only slightly greater numbers are found on colony-forming unit-erythroid cells. However, by the early normoblast stage, approximately 300,000 receptors are found on each cell, increasing to 800,000 at the intermediate stages. The rate of iron uptake is directly related to the number of receptors. The number decreases as reticulocytes mature, and late in maturation, erythroid cells shed all remaining receptors by exocytosis and by proteolytic cleavage ( [118](#) ). The shed receptors can be found in plasma in a concentration that correlates with the

rate of erythropoiesis ( [119](#), [120](#) ). An increase in plasma TFRC is a sensitive indicator of erythroid mass and tissue iron deficiency ( [120](#), [121](#) ).

After ligand and receptor interact, iron-loaded transferrin undergoes receptor-mediated endocytosis, beginning with invagination of clathrin-coated pits ( [Fig. 28.3](#) ) ( [122](#) ). Specialized endocytic vesicles form, which are acidified to a pH of 5 to 6 by influx of protons, facilitating release of iron from transferrin and strengthening the apotransferrin-receptor interaction ( [112](#) ). Released iron is reduced by an as yet unidentified ferrireductase and transferred to the cytosol by DMT1 ( [48](#) ). Because DMT1 is believed to cotransport protons with iron atoms ( [50](#) ), vesicle acidification is also important for the function of this transporter. After the iron enters the cytosol, the protein components of the endosome return to the membrane surface where the neutral pH causes the release of apotransferrin to the plasma ( [112](#) ). Both transferrin and TFRC participate in multiple rounds of iron delivery.



**Figure 28.3.** Uptake of transferrin (TF) by TF receptors (TFRC). Iron ( *gray circles* ) bound to plasma TF ( *dark triangles* ) is delivered to the cell by binding of Fe<sup>2+</sup>-TF to cell-surface TFRC. The ligand-receptor complex enters the cell through invagination of clathrin-coated pits to form specialized endosomes. The endosomes become acidified through the entry of protons, releasing iron from TF and strengthening the TF-TFRC complex at low pH. The iron exits the endosome through the divalent metal ion transporter 1 (DMT1) to go to sites of storage and use within the cell (ferritin, mitochondria). The TF-TFRC complex then returns to the cell surface, where it is externalized, and apo-TF is released. Both TF and TFRC participate in multiple rounds of iron delivery.

The rate of entry of iron into normoblasts is intimately related to heme biosynthesis ( [123](#) ). The addition of free heme inhibits reticulocyte iron uptake *in vitro* by reducing endocytosis of the TFRC complex. In less mature erythrocyte precursors, an optimal amount of heme may be necessary to sustain TFRC synthesis ( [124](#) ). Furthermore, a decrease in intracellular free heme concentration induced by inhibitors of heme synthesis (e.g., isoniazid) leads to increased iron uptake, and an increase in intracellular free heme induced by inhibitors of globin synthesis (e.g., cycloheximide) has the opposite effect. These phenomena appear to reflect a feedback inhibition system that regulates the



supply of iron according to the needs of the cell for hemoglobin synthesis. This is part of a highly coordinated erythroid regulatory system that acts to balance the amounts of alpha and beta globin proteins and heme, avoiding toxic buildup of any intermediates of hemoglobin production ( [125](#) ).

Ferritin is found in plasma in small amounts (12 to 300 µg/L), and the serum ferritin concentration correlates roughly with the amount of iron in stores. Circulating ferritin differs from tissue ferritin not only in its low concentration, but also in its composition—it is a glycosylated protein, suggesting that it is actively secreted ( [126](#) ). It is predominantly made up of L-ferritin subunits, and it is relatively iron poor. Although erythroid cells are able to take up ferritin through an as yet unidentified receptor ( [127](#) , [128](#) ), under normal circumstances, ferritin probably has little, if any, role in iron delivery to hemoglobinizing erythroid precursors.

### Metabolism within Normoblasts

In the normal subject, approximately 80 to 90% of the iron that enters erythroid precursor cells is ultimately taken up by mitochondria and incorporated into heme. Most of the remainder is stored in ferritin ( [129](#) , [130](#) ). Granules of ferritin in erythrocytes may sometimes be detected by means of the Prussian blue reaction ( [131](#) , [132](#) ). Normoblasts with Prussian blue-positive (siderotic) granules are called *sideroblasts*, and, if the granules persist after denucleation, the mature cells are called *siderocytes*. In normal individuals, approximately half of the normoblasts are sideroblasts, each containing less than five small granules ( [132](#) ). By electron microscopy, these normal siderotic granules are seen to be aggregations of ferritin, often surrounded by a membrane (siderosomes) ( [133](#) ). Isolated molecules of ferritin not surrounded by a membrane may also be seen by electron microscopy but not with light microscopy. Another kind of sideroblast, the ringed sideroblast, is found only under pathologic circumstances (sideroblastic anemias; see [Chapter 29](#) ). In the ringed sideroblast, the siderotic granules form a full or partial ring around the nucleus, and electron microscopy reveals that the iron is deposited in mitochondria ( [133](#) ). The spleen plays an active role in the removal of the iron-laden mitochondria when cells enter the circulation. Although critically important in heme biosynthesis, details of erythroid mitochondrial iron metabolism are not yet well understood.

### Macrophage Iron Recycling

Although there are many types of tissue macrophages, those that participate in the catabolism of red blood cells can be subdivided into two categories with respect to their role in iron metabolism. One type, exemplified by pulmonary alveolar macrophages and other tissue macrophages, is able to phagocytize erythrocytes and convert the iron they contain into storage forms, but it lacks the ability to return the iron to the circulation. This type of macrophage appears to retain the iron indefinitely within the tissues. The second type of macrophages, comprising the reticuloendothelial system, acquire iron in a similar fashion but are able to process it into a form that can be returned to the plasma. The latter macrophages, found especially in the sinuses of the spleen and the liver, play a primary role in the normal reutilization of iron from destroyed red cells. They acquire and store a relatively labile pool of iron, allowing completion of the iron cycle shown in [Figure 28.2](#).

Macrophages acquire most of their iron by erythrophagocytosis. Circulating monocytes lack transferrin receptors; however, receptors appear when they are transformed to macrophages, probably to allow the cells to acquire iron needed for cellular functions, including oxidative killing. However, it is doubtful that receptor-acquired iron makes a



major contribution to iron storage or reutilization.

After erythrophagocytosis by reticuloendothelial macrophages, the red cell membrane is destroyed, heme is released from hemoglobin, and iron is liberated by heme oxygenase. The subcellular localization of these events is not well defined. Subsequently, two phases of macrophage iron release are observed: an early phase, complete within a few hours after erythro-phagocytosis, and a later phase, taking place over a period of days ( [134](#) ). The early phase probably reflects immediate export of iron. The later phase probably results from storage of acquired iron and later mobilization in response to iron demand. Because there is a large iron flux through this system on a daily basis, approaching 30 mg, the partitioning of iron between immediate transport and storage functions is a critical determinant of the availability of iron for plasma transferrin and, consequently, for erythropoiesis. The *anemia of chronic inflammation*, characterized by macrophage iron retention, illustrates the deleterious effects of perturbing the delicate balance between macrophage iron storage and release.

Under equilibrium conditions (i.e., when the amount of iron that enters the macrophage approximates that which leaves it), relatively little interchange occurs between the newly liberated iron and the storage forms ( [135](#) ). Instead, iron from recently destroyed erythrocytes passes quickly through the macrophage and is presented to the plasma at the cell surface. The intermediate iron compounds in this process, if any, are not known. At the cell-plasma interface, however, the iron probably is in the form of ferrous iron, and its release is probably mediated by ferroportin ( [59](#), [60](#), [136](#) ). Released iron must be oxidized to be bound to transferrin. It has been proposed that the ferrous oxidation (ferroxidase) reaction is catalyzed by the plasma copper protein, ceruloplasmin ( [137](#), [138](#) ).

In nonequilibrium situations, iron either enters or leaves macrophage stores. When the red cell mass is expanding and erythrocytes are being produced more rapidly than they are being destroyed, iron is mobilized from macrophages. The amount of iron leaving the macrophages then exceeds that which enters. When red cell destruction exceeds production, iron is deposited in macrophage stores, and the amount of iron entering the macrophages exceeds that which leaves. Mechanisms must exist for coupling the rate at which iron leaves the macrophages to the rate of red cell production. The nature of the control mechanism remains unknown, although recent studies suggest that hepcidin, a small peptide hormone, may play a crucial role ( [86](#), [97](#) ).

Under normal circumstances, the rate at which iron leaves macrophages exhibits diurnal variation ( [139](#) ). The evening rate is approximately one-half of the morning rate. This phenomenon results in a well-known diurnal variation in plasma iron concentration.

Intracellular iron is stored in two compounds: ferritin and hemosiderin. Iron-free ferritin (apoferritin) exists as a sphere with a diameter of 13 nm ( [140](#) ). It has a hollow central cavity, 6 nm in diameter, which communicates with the surface by six channels through which iron and other small molecules can enter and leave. The protein shell is constructed of 24 molecules of two distinct ferritin subunits, designated *H* (for *heavy* or *heart*) and *L* (for *light* or *liver*). The molecular weights of the H and L subunits are approximately 21,000 and 19,000, respectively. The expressed gene for the H chain is located on chromosome 11, and that of the L chain is on chromosome 19 ( [141](#) ), but multiple copies of both genes, all but one (see below) of which are presumed to be pseudogenes, are found throughout the genome ( [142](#), [143](#) ). H and L ferritins are highly homologous, suggesting that they were derived from a common ancestral protein. However, there are functional differences between the two subunits. H chains contain a ferroxidase center not found in L chains and are able to oxidize iron ( [144](#), [145](#) ). Ferritins

rich in H chains reflect this property and acquire iron more rapidly ( [146](#) ). Ferritins rich in L chains appear to be more stable and resistant to denaturation.

Fully assembled, iron-free apoferritin has a molecular weight of approximately 440 kilodaltons. When iron is incorporated into the molecule, it is deposited in the central core. Rather than a smooth sphere, the iron core is partially divided into four lobes by protein indentations, a form that may account for the characteristic tetrads seen in ultrastructural studies of ferritin. Theoretically, a single ferritin molecule could hold up to approximately 4500 iron atoms. The whole molecule would then have a molecular weight of more than 800 kilodaltons. Fully saturated ferritin is unusual, however. More often, molecules with 2000 or fewer iron atoms are found. The iron is a trivalent polymer of ferric hydroxide and phosphate.

At least 20 distinct isoferritin proteins, with varying proportions of L and H chains, have been isolated from human tissue ( [147](#) ). They differ from one another in surface charge; acid iso-ferritins contain a high proportion of H chains, whereas basic isoferritins are rich in L chains. The various isoferritins may differ in relative rates of synthesis and in the ability to bind and release iron. Each tissue has a characteristic isoferritin profile. Acidic isoferritins predominate in cardiac, placental, and renal tissues. They are also found in lymphocytes, monocytes, and erythrocyte precursors. Basic isoferritins are found in the liver and spleen. The isoferritin in serum is a basic protein containing negligible amounts of H chains ( [148](#) ). Some differences in iso-ferritin distribution have been detected in association with certain diseases. In idiopathic hemochromatosis, the acid isoferritins in heart, kidney, and pancreatic tissues disappear, and the pattern resembles that of the liver and spleen. In contrast, in many types of cancer, the malignant tissues are rich in acidic isoferritins.

Although H and L chains make up the abundant tissue ferritin molecules, a novel ferritin protein has recently been described in mitochondria. Mitochondrial ferritin has been reported to be transcribed from a distinct, intronless gene on human chromosome 5q23 ( [149](#) ). It appears to have a ferroxidase activity, making it most analogous to H-ferritin.

In a wide variety of cell types, the synthesis of apoferritin has been shown to be stimulated by exposure to iron ( [150](#) ). This effect of iron takes place at the translational level of protein synthesis. A transcribed but untranslated nucleotide sequence found at the 5' end of the mRNAs encoding ferritin chains is both necessary and sufficient for the iron effect ( [151](#) ). In red cell precursors, hemin rather than iron itself may exert a similar function ( [124](#) , [152](#) ). The mechanisms for translational control are discussed in a later section.

Apoferritin is formed first, and iron is added later. Iron, in the form of  $\text{Fe}^{2+}$ , enters the molecule through one of the six penetrating channels. As it passes into the core, it is oxidized to the  $\text{Fe}^{3+}$  form by molecular oxygen, with apoferritin catalyzing the oxidative process ( [153](#) ). Iron is deposited irregularly and in varying amounts, forming microcrystals. The rate of iron deposition in each molecule is related in part to its iron content. Up to a point, perhaps 500 to 1000 iron atoms per molecule, iron uptake is stimulated by the presence of iron. At levels greater than 1000 atoms per molecule, iron uptake is slower. Mobilization of iron from ferritin depends on iron reduction or chelation.

Hemosiderin was formerly distinguished from ferritin on the basis of solubility and the Perls Prussian blue reaction. Ferritin was considered to be soluble and Prussian-blue negative; hemosiderin, insoluble and Prussian-blue positive. However, it is now clear that these distinctions are not reliable; ferritin can also be stained with Prussian blue and can

exist in insoluble forms. Hemosiderin is not a precisely definable chemical entity ( [154](#), [155](#) ). It appears to be formed by incomplete degradation of ferritin and conglomeration of iron, ferritin proteins, and other subcellular constituents. It differs from ferritin in having a higher iron to protein ratio as well as being less soluble in aqueous solutions. Standard hemosiderin preparations may contain a variety of organic constituents, including proteins, lipids, sialic acid, and porphyrins. In most instances, hemosiderin appears to be derived from ferritin. From a physiologic viewpoint, hemosiderin appears to represent a more stable and less available form of storage iron than ferritin. Newly deposited or newly mobilized iron enters or leaves the ferritin compartment. Only after prolonged storage or continued mobilization does the hemosiderin compartment change in size.

### Metabolism in Other Tissues

Iron is required in small amounts by all tissues for the synthesis of iron-containing enzymes and proteins, including cytochromes, catalase, ribonucleotide reductase, ferrochelatase, and myoglobin. Like red cells, these tissues are generally thought to acquire their iron from transferrin through binding to cell-surface TFRC, although there is little experimental evidence that this is the major iron acquisition mechanism. Aside from erythroid precursors and tumor cells, iron uptake by hepatic parenchymal cells has been most extensively studied. Normally, approximately 5% of iron leaving plasma is accounted for by this pathway ( [156](#) ). This fraction increases markedly when transferrin saturation increases or when erythropoiesis is depressed. It is important to note that transferrin is not essential for iron assimilation by hepatocytes or most other nonhematopoietic cells, as demonstrated by atransferrinemic human patients and *hpx* mice, both of which develop marked iron overload in nonhematopoietic tissues ( [77](#), [80](#), [82](#), [83](#), [107](#), [108](#) and [109](#) ).

The placenta also accepts iron from transferrin and may do so even at relatively low plasma iron levels, thus effectively competing with the maternal erythroid bone marrow. Under normal circumstances, efficient transfer of iron to the fetus occurs across the placenta, but some iron is stored within that tissue as ferritin and hemosiderin. The gut also accepts iron from transferrin, and this pathway has been thought to have a regulatory function in iron absorption ( [157](#), [158](#) ). Skeletal muscle uses iron for myoglobin synthesis and also maintains an iron storage pool that, although large, is not easily mobilized for use by other tissues ( [159](#) ). Proliferating cells in many tissues have increased numbers of transferrin receptors compared to their quiescent counterparts, presumably reflecting their need for iron.

### Regulation of Intracellular Iron Metabolism

Cells have developed mechanisms that make it possible for them to acquire the iron they need while avoiding the toxic effects of excess iron. This is accomplished, in part, by regulating production of transferrin receptors and apoferritin. Cells replete in iron synthesize apoferritin and inhibit synthesis of transferrin receptors, thereby limiting acquisition of iron and facilitating storage of any excess. In contrast, iron-depleted cells actively synthesize transferrin receptors and restrict the synthesis of apoferritin to optimize iron entry and utilization and to minimize diversion into stores. These effects are mediated at the translational level.

The noncoding portions of mRNAs for TFRC and ferritin subunits contain stem-loop structures that constitute iron-responsive elements (IREs; reviewed in reference 160). Five IREs are found in the 3' untranslated region of the mRNA encoding TFRC, and one each in the 5' untranslated regions of the mRNAs encoding L- and H-ferritins. The IREs bind iron regulatory proteins (IRPs). Currently, there are two known IRPs, designated *IRP1* and *IRP2*. IRP binding produces opposite effects on the different mRNAs: It stabilizes

TFRC mRNA by protecting it from endonucleolytic cleavage, resulting in an increase in synthesis of TFRCs. In contrast, protein binding blocks translational initiation in ferritin mRNAs by preventing the interaction of the cap-binding complex eIF4F and the small ribosomal subunit ( [161](#) ), but it does not alter mRNA stability.

The two IRPs are structurally similar, but they are regulated differently. IRP1 contains a 4Fe-4S iron-sulfur cluster that, when saturated with iron, acts as a cytosolic aconitase and catalyzes the conversion of citrate to isocitrate ( [162](#) ). In the enzyme form, it has low affinity for IREs in mRNAs. When iron-poor, IRP1 loses its aconitase activity and greatly increases its affinity for IREs ( [163](#), [164](#) ). This bifunctional property of the protein acts as a “ferrostat” to allow the cell to respond appropriately to its internal iron environment. IRP2 is less abundant than IRP1 and functions in a different manner. It does not have an identified enzyme function, and it is rapidly degraded in iron replete cells ( [165](#), [166](#) ). The degradation is mediated by the ubiquitin-mediated proteasome pathway ( [166](#), [167](#) ). By this means, its concentration and, therefore, its mRNA binding activity are increased when cellular iron concentration is low. In 2002, it was shown that IRP2 interacts with Y-box-binding protein YB-1, a molecule involved in chromatin modifications, alterations of mRNA translation, and RNA chaperoning ( [168](#) ). YB-1 may bind to the ferritin IRE independent of IRP2 and may act to modulate the effects of IRP2.

### **Pathogenesis of Iron Deficiency Anemia**

Three pathogenetic factors are implicated in the anemia of iron deficiency. The first is impaired hemoglobin synthesis, a consequence of reduced iron supply. The second is a generalized defect in cellular proliferation. Third, there may be reduced erythrocyte survival, particularly when the anemia is severe.

When transferrin saturation falls below 16%, the supply of iron to the marrow is inadequate to meet basal requirements for hemoglobin production (generally approximately 25 mg of iron daily in average adults). As a result of this defect, the amount of free erythrocyte protoporphyrin increases, reflecting the excess of protoporphyrin over iron in heme synthesis. Each cell produced contains less hemoglobin, resulting in microcytosis and hypochromia.

In addition, cellular proliferation is restricted in iron deficiency, and red blood cell numbers fall. Although there is relative erythroid hyperplasia in the bone marrow, both the degree of erythroid hyperplasia and the reticulocyte count are low for the degree of anemia. There is a significant component of “ineffective erythropoiesis” in iron deficiency, and a proportion of immature erythroid cells in iron-deficient subjects are so defective that they are rapidly destroyed. This iron is reused within the bone marrow, making the interpretation of ferrokinetic studies more complicated ( [169](#), [170](#) ).

In iron deficiency, survival of circulating erythrocytes is normal or somewhat shortened ( [171](#), [172](#), [173](#) and [174](#) ). Cross-transfusion studies indicate that the shortened survival results from an intracorporeal defect. There is a strong correlation between the degree to which red cell survival is shortened and the proportion of morphologically abnormal cells on blood smear ( [172](#) ). The principal site of destruction is the spleen ( [173](#) ). The reduced erythrocyte viability is associated with decreased membrane deformability ( [175](#) ). This abnormality appears to result from oxidative damage to the membrane ( [175](#), [176](#) ).

Other iron-containing proteins are also reduced in iron deficiency, and some of these may be responsible for clinical and pathologic manifestations. Iron is a component of various

heme proteins, including cytochromes, myoglobin, catalase, and peroxidase. Proteins containing iron–sulfur clusters and metalloflavoproteins are important in oxidation–reduction reactions, especially those that take place in mitochondria. Furthermore, iron is a cofactor for some enzymes, including aconitase and tryptophan pyrrolase.

At one time, it was thought that depletion of tissue iron proteins was a late manifestation of prolonged iron deficiency. It is now believed that many of the enzymes are depleted in proportion to the degree of anemia ( [177](#) ). Among the iron proteins reduced in iron deficiency are cytochrome *c* ( [177](#), [178](#) ), cytochrome oxidase ( [179](#), [180](#) ), α-glycerophosphate oxidase ( [181](#), [182](#) ), muscle myoglobin ( [177](#), [178](#) ), succinic dehydrogenase, and aconitase. Because it is also a heme protein, it is possible (but not yet proven) that protein levels of the intestinal ferrireductase, Dcytb, are also decreased.

In iron-deficient rats, impaired exercise performance correlated with reduced levels of α-glycerophosphate oxidase in muscle ( [181](#), [182](#) ). As a result, glycolysis was impaired, which led to lactic acidosis and, in turn, adversely affected work performance. Lactic acidosis was also noted in a patient with severe iron deficiency anemia ( [183](#) ).

Levels of catecholamines are increased in the blood and urine of iron-deficient patients and animals ( [184](#), [185](#) ). The increase is explained in part by decreased tissue levels of monoamine oxidase ( [186](#), [187](#) ). Conceivably, a disturbance in catecholamine metabolism may contribute to the behavioral disturbances seen in iron-deficient children ( [188](#), [189](#) ).

As described below, there are several characteristic epithelial changes in iron deficiency. The pathogenesis of these abnormalities is not understood, but it is reasonable to assume that deficiencies in tissue iron enzymes are at fault.

### **Role of Copper in Erythropoiesis**

It has long been known that copper deficiency is associated with abnormalities in iron metabolism and iron deficiency anemia. In recent years, it has become clear that this is due, at least in part, to the importance of the copper-containing ferroxidases ceruloplasmin and hephaestin. Ceruloplasmin is a plasma glycoprotein containing six to seven copper atoms. Ceruloplasmin acts as an oxidase for a variety of substrates ( [190](#), [191](#) ), one of which is ferrous iron ( [137](#) ). There is evidence that ceruloplasmin is required for the optimal mobilization of iron from cells to plasma. When the gene encoding ceruloplasmin is disrupted in mice, macrophages fail to release their iron at a normal rate, and this leads to hypoferremia in the presence of normal iron stores ( [138](#) ). The abnormality was promptly corrected by administering ceruloplasmin intravenously. A similar phenomenon was noted in aceruloplasminemic human subjects ( [192](#) ). Ceruloplasmin probably acts by catalyzing the oxidation of ferrous iron to the ferric form, which is a prerequisite for iron binding by apotransferrin.

The anemia of copper deficiency, however, is not completely explained by defective ceruloplasmin function. A second copper-containing ferroxidase, hephaestin, is expressed in the duodenal enterocytes responsible for iron absorption ( [71](#), [193](#) ). Mice carrying a deletion in the hephaestin gene, located on the X chromosome, have perinatal iron deficiency anemia and decreased intestinal iron absorption, due to defects in placental and duodenal iron transport, respectively ( [72](#), [73](#) ). Analogous to the function of ceruloplasmin in macrophage iron release, hephaestin probably oxidizes iron in concert with its transfer across the basolateral membrane to facilitate loading onto transferrin.

However, the activity of hephaestin is not as well understood as that of ceruloplasmin.

## CLINICAL FEATURES OF IRON DEFICIENCY

### Stages in the Development of Iron Deficiency

When not due to major blood loss, iron deficiency is the end result of a long period of negative iron balance. As the total body iron level begins to fall, a characteristic sequence of events ensues. First, the iron stores in the hepatocytes and the macrophages of the liver, spleen, and bone marrow are depleted. Once stores are gone, plasma iron content decreases, and the supply of iron to marrow becomes inadequate for normal hemoglobin production. Consequently, the amount of free erythrocyte protoporphyrin increases, production of microcytic erythrocytes begins, and the blood hemoglobin level decreases, eventually reaching abnormal levels.

This progression corresponds to three recognized stages. The first stage, also called *prelatent iron deficiency* or *iron depletion*, represents a reduction in iron stores without reduced serum iron levels ( [194](#), [195](#) ). This stage is usually detected by a low serum ferritin measurement. Latent iron deficiency is said to exist when iron stores are exhausted, but the blood hemoglobin level remains higher than the lower limit of normal ( [195](#), [196](#), [197](#), [198](#) and [199](#) ). In this second stage, certain biochemical abnormalities of iron-limited erythropoiesis may be detected, including reduced transferrin saturation ( [197](#) ), increased TIBC ( [200](#) ), increased free erythrocyte protoporphyrin ( [198](#) ), increased zinc protoporphyrin ( [201](#) ), and increased serum TFRC ( [202](#) ). Other findings include subnormal urinary iron excretion after deferoxamine injection ( [196](#), [203](#) ) and decreased tissue cytochrome oxidase levels ( [197](#) ). The mean corpuscular volume usually remains within normal limits, but a few microcytes may be detected on a blood smear. Many patients report generalized fatigue or malaise, even though they are not yet anemic.

Finally, in the third stage, the blood hemoglobin concentration falls below the lower limit of normal, and iron deficiency anemia is apparent. Iron-containing enzymes, such as the cytochromes, also reach abnormally low levels during this period. Epithelial manifestations of iron deficiency occur very late in iron deprivation. This progression forms the basis for the stages of iron deficiency outlined in [Table 28.2](#). It has been confirmed by experiments in which normal volunteers gradually were depleted of iron by phlebotomy ( [204](#), [205](#) ).

**TABLE 28.2. Stages in the Development of Iron Deficiency**

|  | Stage 1<br>(Prelatent) | Stage 2<br>(Latent) | Stage 3 (Anemia) |
|--|------------------------|---------------------|------------------|
| Bone marrow iron                                     | Reduced                | Absent              | Absent           |
| Serum ferritin                                       | Reduced                | <12 µg/L            | <12 µg/L         |
| Transferrin saturation                               | Normal                 | <16%                | <16%             |
| Free erythrocyte protoporphyrin, zinc protoporphyrin | Normal                 | ?                   | ?                |
| Serum transferrin receptor                           | Normal                 | ?                   | ?                |
| Reticulocyte hemoglobin content                      | Normal                 | ?                   | ?                |
| Hemoglobin   | Normal                 | Normal              | Reduced          |
| Mean corpuscular volume                              | Normal                 | Normal              | Reduced          |



|          |                                   |                                  |
|----------|-----------------------------------|----------------------------------|
| Symptoms | Fatigue, malaise in some patients | Pallor, pica, epithelial changes |
|----------|-----------------------------------|----------------------------------|

?, increased; ?, decreased.

---

## Prevalence

Iron deficiency is the most common nutritional deficiency in both developing and developed countries. Iron deficiency anemia may be defined by cutoff hemoglobin values of 11.7 g/dl in women and 13.2 g/dl in men. In the United States, the most comprehensive surveys for iron deficiency anemia have been the three National Health and Nutrition Examination Surveys (NHANES). According to data from NHANES III, covering the years 1988 to 1994, the prevalence of hypoferrremia in the United States is less than 1% in adult men younger than 50 years of age, 2 to 4% in adult men older than 50 years of age, 9 to 11% in menstruating teenagers and women, and 5 to 7% in postmenopausal women ( [206](#) ). Anemia was noted in no more than 1% of adult men and in 2 to 5% of adult women ( [206](#) ).

Iron deficiency is particularly common in infants and pregnant women. Iron deficiency was detected in 9% of infants and toddlers, with anemia in approximately one-third of those children ( [206](#) ). In infancy, the occurrence of iron deficiency is equal in both sexes. It is usually detected between the ages of 6 and 20 months. The peak incidence is at a younger age in infants born prematurely than in those born at term, because premature infants do not have full opportunity to acquire maternal iron during the third trimester. The prevalence of iron deficiency is also higher among people living in chronic poverty ( [207](#) ). Iron deficiency tends to run in families, possibly as a result of economic factors. If an iron-deficient child is identified, the mother and siblings of that child are frequently also deficient.

## Etiology

Iron deficiency occurs as a late manifestation of prolonged negative iron balance, as a result of major blood loss, or because of failure to meet an increased physiologic need for iron. The normal mechanisms for maintaining iron balance are discussed earlier in this chapter. Factors leading to negative iron balance, increased requirements, or inadequate iron for erythropoiesis are listed in [Table 28.3](#). In many instances, multiple etiologic factors are involved. The association of a marginal diet with some source of blood loss, such as that associated with menstruation, is a common combination. Another example is hookworm infection, which produces anemia primarily in those people whose diets are marginally adequate.

**TABLE 28.3. Etiologic Factors in Iron Deficiency Anemia**

---

|                       |
|-----------------------|
| Negative iron balance |
| Decreased iron intake |
| Inadequate diet       |
| Impaired absorption   |
| Achlorhydria          |
| Gastric surgery       |
| Celiac disease        |



- Duodenal bypass
- Drugs that increase gastric pH
- Tannins, phytates, bran
- Competing metals
- Increased iron loss
  - Gastrointestinal bleeding
    - Hookworm
    - Schistosomiasis
    - Trichuriasis
    - Hemorrhoids
    - Peptic ulcer
    - Gastritis
    - Hiatal hernia
    - Diverticulosis
    - Neoplasm
    - Inflammatory bowel disease
    - Arteriovenous malformation
    - Varices
    - Meckel's diverticulum
    - Milk-induced enteropathy (infants)
    - Salicylate use
  - Excessive menstrual flow
  - Gynecologic neoplasm
  - Bladder neoplasm
  - Epistaxis
  - Blood donation
  - Hemoglobinuria
  - Self-induced bleeding (autophlebotomy)
  - Pulmonary hemosiderosis
  - Tuberculosis
  - Bronchiectasis
  - Hereditary hemorrhagic telangiectasia
  - Coagulopathies
  - Chronic renal failure and hemodialysis
  - Runner's anemia
- Increased requirements
  - Infancy
  - Pregnancy
  - Lactation
- Inadequate presentation to erythroid precursors
  - Atransferrinemia
  - Antitransferrin receptor antibodies
- Abnormal iron balance
  - Aceruloplasminemia
  - Autosomal-dominant hemochromatosis due to mutations in ferroportin

---

## Diet

The total amount of iron in the diet roughly correlates with caloric content; in the United States, the diet contains approximately 6 mg of iron per 1000 kcal. The bioavailability of dietary iron in specific foods, however, varies considerably ( 208 ). Iron is absorbed either in the form of heme or as ferrous iron. Heme iron is well absorbed and unaffected by dietary composition and gastric acidity. Other forms of iron must be converted to ferrous iron, a process affected by gastric acidity, by dietary components that enhance absorption, such as ascorbate and meat ( 209 ), and by various dietary constituents that form insoluble complexes or chelates with iron, such as phosphates, phytates, and tannates.

The early stages of human evolution were characterized by hunter-gatherer food patterns and by diets rich in meat. In evolutionary terms, agriculture is a recent development to which humans have not fully adapted. Thus, individuals whose diets are rich in meat, a source of heme iron and an enhancer of the absorption of nonheme iron, usually absorb more iron from their diets than those who subsist on grains and vegetables. The increased prevalence of iron deficiency among the economically deprived and people in developing countries is explained in part by the fact that heme iron is almost totally absent from their diets.

Because many factors influence the bioavailability of iron, it is difficult to make recommendations about the optimal amount of iron in the diet. In the usual mixed diets of Western countries, adult men should consume 5 to 10 mg/day, and adult women should consume 7 to 20 mg/day ( 195 ). Because women are usually smaller and consume less food than men, and because their requirements are greater, their daily iron intake tends to be marginal. Iron deficiency is rarely seen in American men as a result of diet alone. Exceptions to this rule are sufficiently unusual to justify case reports ( 210 ).

In some countries, nutrient density of the diet is reduced because of poverty, war, unwise agricultural practices, or religious or social tenets. In many countries, foods are fortified to compensate for the insufficient amounts of iron in the diet ( 18, 211 ). Selection of the food to fortify and the iron compound to use in fortification requires consideration of a number of factors. The iron salt should be absorbable but should not affect appearance, taste, or shelf life. However, the most soluble and absorbable iron compounds are also the most chemically reactive. Salts such as ferric orthophosphate are used for fortification of flour in the United States because they are palatable and white, but they are so insoluble that they are of little nutritional benefit. Small-particle forms of elemental iron, NaFe ethylenediaminetetraacetic acid, and ferrous compounds each have their place as fortifying agents for particular foods. The salt must be chosen with consideration of the food to be fortified, and that choice must be individualized to the target population. In Western countries, wheat flour is a typical choice; its use is widespread, and highly available ferrous salts can be used in such products as bread because their shelf life is inherently short. Target foods in other countries include salt, sugar, rice, and condiments. For infants, fortified milk- or soy-based formulas and dry cereals are important sources of iron in the diet.

## Impaired Absorption

Achlorhydria is common in iron-deficient subjects, both as a result of the deficiency and as a factor in its development ( 14 ). Gastric acid facilitates absorption of nonheme iron ( 212 ), and absorption of inorganic iron is profoundly impaired in patients with atrophic gastritis. Therapeutic measures used to reduce gastric acidity, such as the administration of antacids and drugs that block acid production, also impair iron absorption but usually

not to a clinically significant degree.

Iron deficiency anemia is a common complication of gastric surgeries, including total gastrectomy ( [213](#) ), partial gastrectomy ( [214](#) , [215](#) and [216](#) ), and vagotomy with gastroenterostomy ( [217](#) , [218](#) ). Reduction in gastric acidity is only one factor in the impaired iron absorption that follows such operations. Other gastric secretions that aid in iron absorption may also be lost ( [12](#) ). Also, because most iron absorption takes place in the duodenum, the rapid intestinal transit that follows loss of the reservoir function of the stomach may lead to decreased absorption. For the same reason, iron deficiency is more common when the duodenum is surgically bypassed ( [218](#) ). Finally, recurrent bleeding, as well as increased sloughing of iron-containing epithelial cells, may contribute to the development of postgastrectomy anemia ( [219](#) ).

In addition to gastrectomy, other defects in the gastrointestinal tract may lead to malabsorption of iron, contributing to the development of iron deficiency. The anemia associated with celiac disease (gluten sensitivity, sprue, idiopathic steatorrhea) is often hypochromic rather than megaloblastic ( [220](#) , [221](#) and [222](#) ); in fact, iron deficiency anemia may be the initial and dominant manifestation of celiac disease, with steatorrhea detectable only by laboratory test analysis ( [221](#) , [223](#) ). Both malabsorption and intestinal blood loss are factors in the development of iron deficiency ( [222](#) ). Most patients with tropical sprue are deficient in iron ( [224](#) ).

Although the efficiency of iron absorption is usually increased in iron-deficient individuals, severe deficiency can be associated with impaired iron absorption ( [225](#) ). This defect, correctable by iron repletion, has been attributed to reduced activity of mucosal iron enzymes, such as cytochrome oxidase. However, the recent discovery of the brush border ferrereductase Dcytb ( [53](#) ), a heme-containing enzyme, raises the possibility that iron-reducing activity is also impaired in severe iron deficiency.

*Pica* is a peculiar manifestation of iron deficiency. It is the habitual ingestion of nonnutritive substances, the most common of which are earth or clay (geophagia), laundry starch (amylophagia), and ice (pagophagia), but many other substances have been reported ( [226](#) ). Pica disappears when iron deficiency is effectively treated. Although a relatively specific sign of iron deficiency, pica has been described as a practice rooted in custom, folklore, or superstition among certain cultural groups. Furthermore, iron deficiency is a common complication of both clay-eating and starch-eating ( [227](#) , [228](#) and [229](#) ). Clay can behave as an ion exchange resin in the gut, directly interfering with iron absorption. Normal subjects who absorbed 27% of a 5-mg iron dose absorbed only 2% when Turkish clay was ingested with the iron. Similarly, iron-deficient subjects absorbed 46% of the iron, and only 6% with Turkish clay ingestion ( [230](#) ). Other clays also inhibit absorption but to a lesser degree. In Iran, Egypt, and Turkey, geophagia is implicated in a syndrome consisting of iron deficiency anemia, zinc deficiency, hepatosplenomegaly, hypogonadism, and dwarfism ( [231](#) ).

Laundry starch may interfere with iron absorption ( [232](#) ). It is a nearly pure carbohydrate source that not only inhibits iron absorption but also has very low iron content. When it is consumed in large quantities to the exclusion of other foods, an extremely deficient diet results ( [229](#) ).

## Blood Loss

Blood loss is a major cause of iron deficiency anemia. It is important not only because of its frequency, but also because the accurate detection, precise diagnosis, and proper management of the bleeding lesion may be of far greater importance to the ultimate well-being of the patient than repletion of iron stores. In individuals with normal hematocrits, each 1.0 ml of blood contains approximately 0.5 mg of iron. Thus, assuming the consumption of an average diet, chronic blood loss of as little as 3 to 4 ml/day (1.5 to 2.0 mg of iron) can result in a negative iron balance. Acute hemorrhage resulting in major blood loss is discussed later in this chapter.

**GASTROINTESTINAL BLEEDING** Gastrointestinal bleeding is the most common cause of iron deficiency in adult men and is second only to menstrual blood loss as a cause in women. Any hemorrhagic lesion of the alimentary tract may cause iron deficiency. Most commonly, the lesions cause occult bleeding or the steady loss of small amounts of blood. They may go unnoticed or may be tolerated until the symptoms of anemia supervene. The list of etiologies presented here is not meant to be comprehensive; many other, less common lesions have been reported to occur in association with isolated cases of iron deficiency anemia. Two-thirds of patients with hemorrhoids experience rectal bleeding, which is usually obvious to the patient because blood streaks the outside of the stool or is visible on toilet tissue or in the water in the toilet bowl. Nevertheless, a large majority of patients allow at least 1 year to elapse before seeking medical attention, and perhaps one-third wait for more than 10 years. Some of these patients become accustomed to the periodic loss of small amounts of blood, and gradual depletion of their iron stores occurs without their becoming unduly alarmed. Nevertheless, although hemorrhoids are frequently associated with iron deficiency anemia, the clinician should be reluctant to accept them as the only bleeding lesions; a careful investigation is warranted because hemorrhoids may divert attention from another, less obvious lesion elsewhere in the alimentary tract. Upper gastrointestinal bleeding is typically due to duodenal or gastric ulcers or gastritis, all of which can cause sufficient blood loss to result in iron deficiency. Certain drugs are associated with gastrointestinal bleeding. Of these, nonsteroidal antiinflammatory drugs, including aspirin, are the most important. Nonsteroidal antiinflammatory drug administration causes mucosal damage manifested by petechial hemorrhage, erosions, and ulcers. The problem is more likely to occur in elderly patients and women and with higher (“antiinflammatory”) doses than with lower (“analgesic”) ones ( 233 ). Studies with aspirin demonstrate that at a daily dose of 2 to 6 g, 70% of patients have gastrointestinal bleeding at an average rate of 5 ml/day ( 234 ). After 7 days of treatment with only two aspirin tablets per day, or an equivalent dose of other salicylate-containing medications, excessive blood loss (1.0 to 4.5 ml/day) occurs. Regular use of aspirin more often than four times weekly is associated with bleeding ( 235 ). The incidence of aspirin-induced bleeding has probably decreased as the pattern of analgesic use has changed. Between 1965 and 1975 in the United States, acetaminophen, which is not associated with gastrointestinal bleeding, became more popular than aspirin as an over-the-counter analgesic. Newer nonsteroidal antiinflammatory drug preparations are also less likely to cause significant gastrointestinal blood loss. The popularity of aspirin is on the rise again for prophylaxis of coronary artery disease but in low doses. Other drugs associated with gastrointestinal bleeding include stanozolol, anticoagulants, corticosteroids, and ethacrynic acid. Iron deficiency anemia occurs in approximately 15% of patients with esophageal hiatal hernia ( 236 ). Anemia is particularly common (30%) with the paraesophageal variety of lesion and is more common when the hernias are large ( 237 ). Anemia may be the presenting manifestation and may occur even in the absence of dyspeptic symptoms. The average daily blood loss in anemic patients with hiatal hernia is 15 ml. Reasons for the bleeding include reflux esophagitis and trauma to the gastric mucosa at the neck of the hernial sac ( 236 ). Colonic diverticuli can also bleed in patients with diverticulosis and diverticulitis. Usually, the blood loss is small and intermittent and may resemble the pattern of hemorrhoidal bleeding. As with the latter, a careful

investigation for other sources of intestinal blood loss is warranted to exclude the possibility of a neoplasm. Intestinal bleeding can also result from the presence of adenomatous polyps. Iron deficiency anemia may be the first sign of a malignant neoplasm of the gastrointestinal tract, and the anemia may lead to its discovery at an operable stage. Carcinoma of the cecum is often clinically silent until anemia occurs. Less often, in carcinomas of other parts of the colon, as well as of the stomach and the ampulla of Vater, iron deficiency anemia may be the only initial symptom. In a survey of 32 patients with ulcerative colitis, 26 (81%) had iron deficiency anemia ( 238 ). Average fecal blood loss of 6 to 25 ml/day was noted in five patients who were moderately anemic with relatively mild symptoms of colitis. An important cause of gastrointestinal blood loss in tropical areas is infection with intestinal and genitourinary parasites ( 239 ), including whipworm, *Trichuris trichiura* ( 240 ); hookworm, *Necator americanus* or *Ancylostoma duodenale* ( 241, 242 ); and schistosomes ( 243 ). Hookworm is particularly important, affecting some 20% of the world's population ( 224 ). It is endemic in a zone extending from the southern United States to northern Argentina in the Western hemisphere, as well as in Mediterranean countries, South Asia, and Africa. The worms attach to the upper small intestine and suck blood from the host. The amount of blood lost is proportional to the number of worms harbored, which in turn can be estimated by the fecal excretion of hookworm eggs. With *Necator* infections, each worm accounts for a loss of approximately 0.05 ml of blood per day. Female subjects harboring more than 100 worms (5 ml/day of blood loss) and male subjects harboring more than 250 worms (12.5 ml/day of blood loss) tend to become anemic ( 241 ). The daily blood loss may be as great as 250 ml. Even larger amounts are lost in *Ancylostoma* infections—approximately 0.2 ml/worm/day. Other factors affecting iron balance determine whether the mildly infected person becomes anemic. An iron-deficient diet, repeated pregnancies, and achlorhydria are contributory factors in development of hookworm anemia. Among hookworm carriers in Argentina, those who consumed meat in substantial quantities were not anemic. At one time, many people believed that hookworm anemia resulted from elaboration of a toxin, but this is not the case. The anemia has all of the characteristics of iron deficiency and can be relieved with iron therapy, whether or not the worms are removed. Conversely, removal of worms with an effective antihelminthic agent does not correct the anemia unless iron stores are replenished. Schistosomiasis and trichuriasis are other parasitic infections associated with iron deficiency ( 239 ). With *Schistosoma mansoni*, blood loss is from the intestine, whereas with *Schistosoma haematobium*, the loss is from the urinary tract ( 243 ). *Trichuris* (whipworm) has caused iron deficiency in inhabitants of Central America ( 240 ).

**MENSTRUATION** Menstrual blood loss is the most common single cause of iron deficiency in women ( 9, 10, 244, 245 and 246 ). In healthy, hematologically normal women, menstrual blood flow averages approximately 35 ml per menstrual period, and the upper limit of normal is approximately 80 ml per period ( 10, 244, 245 ). Although flow varies considerably among different women, it is remarkably constant from one period to the next in the same person. In Swedish women with a dietary intake of approximately 10 mg of iron per day, 67% of women with menstrual blood loss exceeding 80 ml per period were anemic ( 10, 245 ). In another study, British women with iron deficiency anemia lost an average of 85 ml per period ( 244 ). In contrast, however, a better-nourished Canadian population tolerated flows greater than 80 ml per period without overt anemia or hypoferrremia ( 247 ). Menstrual blood flow is increased by the use of certain intrauterine contraceptive devices ( 248 ) and is reduced by the use of oral contraceptives. Estimating menstrual blood loss from information obtained in interviews is difficult because few women have a basis for determining the normality of their flow. It is important to elicit a history including a detailed description of the events during each menstrual period. Any of the following findings are indications of excessive menstrual flow: (a) inability to control flow with tampons alone; (b) use of more than 12 pads per period or 4 per day, unless the patient is unusually fastidious; (c) passage of clots, especially if they are larger than approximately 2 cm in diameter or if they persist after the first day; and (d) period

duration exceeding 7 days.

**BLOOD DONATION** Regular blood donation may be an important source of iron loss. Each unit of blood donated contains approximately 250 mg of iron. In most blood banks, blood hemoglobin concentration, a relatively insensitive determination, is the only index of donor iron status. As assessed by serum ferritin concentration, iron stores were reduced in 8% of male and 23% of female blood donors ( [249](#) ). Among donors, the prevalence of deficiency increased with the frequency of donation. After five donations in 1 year, 8% of male and 38% of female donors had reduced stores. The use of iron supplements decreased the incidence of deficiency and should be recommended to people who choose to donate more than once or twice a year.

**ALVEOLAR HEMORRHAGE** Acute hemorrhage into the pulmonary alveoli may be severe enough to cause the blood hemoglobin level to fall 1.5 to 3.0 g/dl in 24 hours ( [250](#) ). Reticulocytosis and hyperbilirubinemia often accompany such episodes, leading to an incorrect diagnosis of hemolytic anemia. Iron in the shed blood is converted to hemosiderin by pulmonary macrophages, but it cannot be used for hemoglobin synthesis. Thus, repeated hemorrhages can lead to iron deficiency despite a normal total amount of body iron. Hemoptysis and alveolar infiltrates are the other prominent manifestations. However, if the hemorrhages are small, the hemoptysis may be unnoticed, making the diagnosis difficult without a chest x-ray examination. Patients may swallow the blood-containing sputum, rendering the stools positive for occult blood and resulting in further diagnostic confusion. Idiopathic pulmonary hemosiderosis, an illness of children and young adults, is characterized by alveolar hemorrhage that is not due to another form of lung disease ( [251](#) , [252](#) , [253](#) and [254](#) ). Iron deficiency anemia almost invariably accompanies the disease and may be the initial and only symptom. Hemoptysis and alveolar infiltrates, however, are common manifestations. Interstitial fibrosis may develop after repeated episodes, with dyspnea, clubbing, and even cor pulmonale. Anemia is also a common finding in antiglomerular basement membrane antibody disease (Goodpasture syndrome) ( [254](#) , [255](#) ). The presence of renal disease distinguishes this illness from other forms of pulmonary hemosiderosis, but kidney involvement may not be evident early in the course of the disease or the degree of proteinuria or microscopic hematuria may be modest. Eventually, however, most patients develop azotemia. Focal or diffuse glomerulonephritis is evident from renal biopsy, and linear deposits of immunoglobulins (Igs) are characteristic of, although not completely specific for, the disease. Detection of antibasement membrane antibodies in serum is approximately 80 to 85% sensitive and 98% specific for the diagnosis ( [250](#) ). Other illnesses associated with pulmonary alveolar hemorrhage include rapidly progressive glomerulonephritis, systemic lupus erythematosus, and certain other collagen vascular diseases and systemic vasculitides ( [250](#) ). The presence of antineutrophil cytoplasm antibodies or other autoantibodies is considered a particularly poor prognostic sign in patients with pulmonary hemosiderosis ( [252](#) ). Alveolar hemorrhage is also observed as a toxic reaction to trimellitic anhydride, D-penicillamine, or lymphangiography.

**HEMOGLOBINURIA** Paroxysmal nocturnal hemoglobinuria can result in urinary iron losses averaging 1.8 to 7.8 mg/day ( [256](#) ). Consequently, this rare disorder often is complicated by hypoferrremia and hypochromic anemia ( [256](#) , [257](#) ). Hemoglobinuria in other disorders, such as the erythrocyte fragmentation syndromes associated with prosthetic cardiac valves, also may be complicated by iron deficiency ( [258](#) , [259](#) ).

**FACTITIOUS ANEMIA** Self-induced blood-letting (autophlebotomy) is an unusual cause of iron deficiency ( [260](#) , [261](#) and [262](#) ). In almost all reported instances, such anemia occurred in unmarried women in paramedical occupations. Blood was removed by venipuncture or injuring preexisting hemorrhoids, by laceration of the gastrointestinal tract with such instruments as knitting needles, or by means that remained obscure. In general, the women with this form of blood loss were described as hyperactive, obsessive, intelligent, and displaying unusual hostility or contempt toward the medical profession. A single case was reported in which an infant apparently developed severe iron deficiency as a result of



deliberate parental action ( [263](#) ). The parent elected to remove all iron from the child's diet. This act was considered a covert form of child abuse, falling into the category of the Munchausen syndrome by proxy (i.e., a syndrome induced or fabricated by someone other than the patient).

**HEREDITARY HEMORRHAGIC TELANGIECTASIA** Hereditary hemorrhagic telangiectasia is an uncommon disorder characterized by recurrent hemorrhages from the nose, gastrointestinal tract, and other sites. Iron deficiency anemia, sometimes very difficult to control, is an important complication of the illness ( [264](#) ).

**MASSIVE HEMORRHAGE** When blood loss occurs in small amounts over a prolonged period, no anemia develops until iron stores are depleted. In such circumstances, the hematologic findings are those of iron deficiency anemia. On the other hand, when larger amounts of blood are lost over shorter periods of time, acute anemia may develop, even though iron stores remain adequate. The manifestations of acute hemorrhage depend on the rate and magnitude of the bleeding, the time elapsed since it took place, and whether the site is external or occult. In addition, the presence of complicating diseases and the cardiovascular status of the patient, as well as age, nutritional adequacy, and emotional stability, may modify the response to bleeding. After a single acute hemorrhage of brief duration, a characteristic sequence of events occurs, which may be divided into two phases. The first phase, lasting approximately 2 to 3 days, is dominated by manifestations of hypovolemia, with little or no anemia. Anemia and signs of active erythrocyte regeneration characterize the second phase, which follows restoration of the blood volume to near normal levels. When the hemorrhage is prolonged or recurrent, the two phases are not distinct, and manifestations of hypovolemia and regenerative anemia may occur at the same time. Most young, healthy subjects can tolerate the rapid loss of 500 to 1000 ml of blood (10 to 20% of the blood volume) with few, if any, symptoms ( [265](#) ). Approximately 5% of patients, however, experience a vasovagal reaction to blood loss of this magnitude ( [266](#) , [267](#) ). With the rapid loss of 1000 to 1500 ml of blood (20 to 30% of the blood volume), previously healthy subjects remain asymptomatic while at rest in a recumbent position, but they may experience lightheadedness and hypotension when upright. When 1500 to 2000 ml (30 to 40% of the blood volume) is lost, symptoms develop even when the subject is recumbent. Thirst, shortness of breath, clouding or loss of consciousness, and sweating occur. The blood pressure, cardiac output, and central venous pressure decrease ( [268](#) , [269](#) ). The pulse usually becomes rapid and low in volume (thin and thready); however, some patients experience bradycardia. When rapid blood loss exceeds 2000 to 2500 ml (40 to 50% of the blood volume), a severe state of shock ensues. Lactate acidosis results from inadequate tissue perfusion. At this stage, there is significant risk that the shock will become irreversible, leading to death. After a hemorrhage, physiologic mechanisms are brought into play to restore blood volume by an influx of fluid containing electrolytes and protein. The restoration occurs in two phases ( [270](#) ). The first is a partial restitution brought about in response to a fall in capillary pressure. This phase is followed by a slower restoration of both volume and protein that may take several days. As volume is restored and anemia develops, erythropoietin secretion increases. Under the influence of this hormone, proliferation of erythrocyte precursors in the marrow is increased. Erythroid hyperplasia of the marrow is usually perceptible within 3 to 5 days after hemorrhage ( [271](#) ). With hemorrhagic anemia, in contrast to hemolytic anemia, the rate of red cell production may be restricted by the availability of iron, even in the absence of iron deficiency. Iron must be drawn from ferritin and hemosiderin stored in macrophages, a slow process compared to mobilization of iron newly extracted from destroyed red cells. Marrow production after hemorrhage may be limited to approximately three times the normal level, compared with five or even eight times the normal level in chronic hemolytic states ( [271](#) ). Also, iron supply may be restricted by the effects of concurrent inflammation ( [272](#) ). Trauma and surgery often trigger the mechanisms leading to the anemia of chronic disorders and the disturbance in iron metabolism that accompanies it.

**NOSOCOMIAL BLOOD LOSS** Diagnostic phlebotomy can result in substantial iron losses



in patients with chronic disorders and in hospitalized patients. In a study of 100 adult hospital inpatients in the 1980s, the average blood loss from diagnostic phlebotomy was 12.4 ml/day or 175.0 ml over the course of hospitalization on general wards ( [273](#) ). Patients in intensive care units lost an average of 41.5 ml/day or 762.0 ml during their stay. Of the 100 patients, 36 required blood transfusions, in part because of the losses from phlebotomy. Clearly, phlebotomy can contribute to a negative iron balance, and in patients with marginal iron stores, it may precipitate or aggravate iron deficiency anemia.

### **Chronic Renal Failure Treated with Hemodialysis**

Iron deficiency affects a significant fraction of patients treated with hemodialysis when transfusions are restricted ( [274](#) ). Absolute iron deficiency may result from the loss of blood associated with the dialysis process and diagnostic tests. Gastrointestinal blood losses may also be substantial, averaging 6.27 ml/day in one study ( [275](#) ). Telangiectasias are among the most common bleeding gastrointestinal lesions in patients with renal failure. Other factors contributing to negative iron balance include reduced dietary iron intake and malabsorption of iron caused by the aluminum hydroxide used to control hypophosphatemia.

Administration of erythropoietin may result in a “functional iron deficiency” even when body iron stores are replete. The intense, periodic erythropoietic stimulus resulting from erythropoietin treatments can drive red blood cell production in such a way that adequate transferrin-bound iron is not available. For this reason, parenteral iron supplementation is typically provided as an adjunct to erythropoietin therapy (reviewed in reference [276](#)).

### **Runner’s Anemia**

Iron deficiency anemia has been observed in long-distance runners ( [277](#) ). Over 50% of regular joggers and competitive runners become iron deficient ( [278](#) ). Three sources of blood loss appear to be of importance in this patient population. Mild mechanical hemolysis accompanies strenuous exercise, resulting in hemoglobinuria and hemoglobinemia (also called *march hemoglobinuria*). Gastrointestinal bleeding contributes to blood loss and iron deficiency ( [278](#) , [279](#) and [280](#) ). Fecal blood excretion increases substantially after a race or an intense training exercise and may reach 5 to 7 ml/day. Stress, intestinal ischemia, and the jarring effect of running have been advanced as possible explanations for the gastrointestinal blood loss.

### **Decreased Total Body Iron at Birth**

Body iron concentration in normal neonates averages approximately 75 to 100 mg/kg weight. Similar concentrations are found throughout fetal development, resulting in a linear relationship between body iron and body weight. Newborn babies in the upper range of normal birth weights have more iron than those in the lower range. Premature infants are at higher risk of iron deficiency during the first year of life, because they have not had the full opportunity to accumulate iron stores during the third trimester of gestation.

Newborn iron levels can be influenced by the technique that the obstetrician uses to clamp the umbilical cord at delivery ( [281](#) ). As much as 100 ml of fetal blood may remain in the placenta with early clamping of the cord. Cord clamping delayed for only 3 minutes can result in a 58% increase in red cell volume. If delayed clamping is impractical, as in cesarean section procedures, a similar effect can be achieved by clamping the cord at the placental end, raising the clamp, and allowing gravity to drain the cord ( [282](#) ). Although the newborn has no immediate need for these erythrocytes, the iron they contain can be

used later to meet the demands of growth.

The fetus is an effective scavenger of maternal iron. Therefore, depletion of maternal iron has little or no effect on the body iron stores of the newborn ( [283](#) ). No difference was found between the hemoglobin values in infants of anemic mothers and those in infants of nonanemic mothers either at birth or later ( [284](#) ). Furthermore, iron supplementation during pregnancy has no effect on the subsequent development of iron deficiency in the infant, although it may be protective for the mother. Finally, as measured by serum ferritin levels, maternal iron stores bear no relation to fetal stores ( [282](#) ). These observations are consistent with results of studies in animals that demonstrate iron transported across the placenta against a gradient, even at the expense of maternal iron stores ( [285](#) ).

## Growth

In the absence of disease, iron requirements of an adult man are relatively low and vary little. In contrast, in infancy, childhood, and adolescence, the requirements for iron are relatively great because of the increased needs of rapidly growing tissues. The most rapid relative growth rates in human development occur in the first year of life. Body weight and blood volume approximately triple, and the circulating hemoglobin mass nearly doubles. Still greater relative growth occurs in premature and low-birth-weight infants. Premature infants weighing 1.5 kg may increase their weight and blood volume sixfold and may triple the circulating hemoglobin mass in 1 year. To meet the demands imposed by growth, the normal-term infant must acquire 135 to 200 mg of iron during the first year of life. A premature infant may require as much as 350 mg in the same period ( [286](#) ).

The relatively slower rates of growth in children through the remainder of the first decade require a positive iron balance of approximately 0.2 to 0.3 mg/day. The growth spurt that occurs in the early teens requires a positive balance of approximately 0.5 mg/day in girls and 0.6 mg/day in boys ( [195](#) ). Toward the end of this period, the onset of menstruation occurs in girls, and their requirements then equal those of adult women.

## Diet in Infancy and Childhood

Iron stores in the infant are typically depleted by 4 to 6 months of age as a result of the demands of growth. During this critical period, a normal full-term infant must absorb approximately 0.4 to 0.6 mg of iron daily from the diet. To achieve this level of absorption, an iron intake of 1 mg/kg/day is recommended for full-term infants, 2 to 4 mg/kg/day for preterm infants, and at least 6 mg (to a maximum of 15 mg) for preterm infants receiving erythropoietin therapy ( [287](#) ). These amounts may be difficult to achieve without supplementation.

Both human milk and cow's milk contain relatively small amounts of iron, but the infant more readily absorbs the iron in human milk. In one study, 49% of the iron in human breast milk was absorbed, compared with 10% of the iron in cow's milk ( [27](#) ). As a result, iron deficiency is relatively uncommon in the first 6 months of life in infants exclusively fed breast milk.

Formula-fed infants are likely to become iron deficient unless iron-supplemented formulas are used. In the United States, such formulas are often supplemented with iron (10 to 12 mg/L) as ferrous sulfate, of which a variable proportion is absorbed ( [287](#) ). Approximately 7 to 12% of the iron in cow's milk-based formulas is absorbed, with the lower percentage seen when formulas with higher iron content are given ( [288](#) ). Less iron is absorbed from

soy-based formulas, but soy formulas containing 12 mg/L of iron appear to be adequate ( [289](#) ). Fortified dry cereals for infants are another important source of iron in the diet of both breast-fed and formula-fed infants. Currently, infant cereals are fortified with small-particle elemental iron at a concentration of 0.45 mg/g, from which approximately 4% is absorbed ( [290](#) ). Two servings per day will supply the needs of most infants.

Excessive intake of cow's milk is an important cause of iron deficiency in the first 2 years of life ( [286](#) , [291](#) ). Not only is cow's milk a poor source of iron, but it may cause gastrointestinal blood loss (see next section). Cow's milk should not be given to infants younger than 1 year of age. Some mothers allow their toddler children to use the bottle as a pacifier and constant companion, and the children become addicted ("milkoholics"). In one study, inadequate diet was considered the only factor in the development of iron deficiency in 20 of 55 infants ( [291](#) ); few patients in this series had iron deficiency resulting from defective stores at birth, unless the diet was also inadequate. A unique disorder termed *Bahima disease*, described in Uganda, was attributed to the practice of feeding children a diet of cow's milk almost exclusively ( [292](#) ).

### Blood Loss in Infancy

Occult hemorrhage, often without obvious anatomic lesions, may be observed in some iron-deficient infants ( [290](#) , [293](#) , [294](#) ). The process is often accompanied by diffuse disease of the bowel with protein-losing enteropathy and impaired absorption of other nutrients ( [295](#) , [296](#) ). It probably results from hypersensitivity to a heat-labile protein in cow's milk ( [297](#) , [298](#) ). The daily loss of 1 to 4 ml of blood, along with increased serum albumin turnover, was observed while fresh cow's milk was consumed, and these abnormalities ceased abruptly with the substitution of heat-treated or soybean-protein feeding formulas. Furthermore, in infants in whom fresh cow's milk was introduced into the diet at age 2 months, iron deficiency was considerably more common than in those receiving prepared formulas during the entire first year of life ( [297](#) , [298](#) ).

In another group of infants, however, iron deficiency anemia appeared to be the primary abnormality, with intestinal disease occurring as a secondary phenomenon ( [299](#) ). The number of mucosal secretory IgA-producing cells was deficient in the jejunum, and the possibility that the iron deficiency led to a defect in local immune defense mechanisms with resulting hypersensitivity to components of the diet was considered. Some confirmation of this view was obtained from the results of studies in rats ( [300](#) ). Iron-deficient rats had significantly decreased mitotic indices in their intestinal crypts, and this was associated with reduced numbers of secretory IgA- and IgM-containing cells. The abnormality was reversed after iron repletion.

### Pregnancy and Lactation

Pregnancy is a major drain on the limited iron reserves of young women. Each pregnancy results in an average loss to the mother of 680 mg of iron, the equivalent of 1300 ml of blood. An additional 450 mg of iron must be available to support the expanded blood volume during pregnancy. The latter amount of iron does not represent a net loss after delivery because the iron is returned to stores; it must be available, however, during the pregnancy or iron deficiency will supervene.

Prorated over the full term of pregnancy, the iron requirement amounts to approximately 2.5 mg/day ( [Table 28.4](#) ). Because most of the loss occurs during the third trimester, the requirement is small early in pregnancy and rises to as much as 3.0 to 7.5 mg/day in the

third trimester. These amounts are greater than those that can be absorbed from even the best of diets, and stores may be insufficient to meet them. For this reason, iron supplementation is frequently recommended as a component of prenatal care. In the absence of supplements, maternal iron deficiency may occur, usually manifesting in the third trimester.

**TABLE 28.4. Iron Balance in Pregnancy**

| Iron Fate  | Mean Amount (mg) | Range (mg) |
|--|------------------|------------|
| Lost to fetus  | 270              | 200–370    |
| Lost in placenta, cord   | 90               | 30–170     |
| Lost with bleeding at delivery                                       | 150              | 90–310     |
| Normal body iron loss  | 170              | 150–200    |
| Added to expanded red blood cell mass                                | 450              | 200–600    |
| Total  | 1130             | 670–1650   |
| Returned to stores when red blood cell mass contracts after delivery | 450              | 200–600    |
| Net loss (over 9 mo)   | 680              | 470–1050   |

Lactation results in a daily iron loss of approximately 0.5 to 1.0 mg. The iron content of human breast milk is probably not affected by the maternal iron stores (301). Because normal menstruation is usually inhibited while breast-feeding continues, iron requirements in the lactating mother approximate those of the menstruating woman.

### Signs and Symptoms of Iron Deficiency

Iron deficiency anemia, like all anemias, is not a disease but a manifestation of disease, and the clinical presentation may include features of the underlying disease process as well as those of the deficiency state. Many patients, however, seek medical attention because of symptoms of anemia alone. In a study from the 1960s, this mode of presentation was observed in 63% of 371 patients (220). Only 16% visited the physician because of symptoms of the disease causing the anemia. In the remaining 21%, anemia was discovered at the time of evaluation for an unrelated complaint.

The onset of iron deficiency anemia is usually insidious, and the progression of symptoms is gradual. As a result, patients accommodate remarkably well to advancing anemia and may delay a visit to their physicians for prolonged periods.

**GROWTH** Iron deficiency impairs growth in infancy, and the growth rate is restored when the deficiency is corrected (188). In one group, 78 of 156 iron-deficient children fell below the twenty-fifth percentile of expected weight.

**FATIGUE AND OTHER NONSPECIFIC SYMPTOMS** Iron deficiency anemia can be associated with irritability, palpitations, dizziness, breathlessness, headache, and fatigue. Fatigue is a particularly common complaint among patients. It is clear that even latent iron deficiency (i.e., iron deficiency without any anemia at all) may result in fatigue (302). A group of 44 nonanemic women reporting fatigue were treated both with iron and with placebo in random order. Symptomatic improvement in women receiving iron was

significantly better than that of women given the placebo but only in women whose iron stores were depleted. Other investigators have been unable to confirm this observation ( [303](#), [304](#) ), but many practitioners have cared for patients with recurrent iron deficiency who could tell when their stores became depleted because of symptoms that preceded anemia.

**NEUROMUSCULAR SYSTEM** Despite the lack of symptoms at rest, investigators have demonstrated that even mild degrees of iron deficiency anemia impair muscular performance, as measured by standardized exercise tests ( [189](#), [305](#), [306](#) ). Total exercise time, maximal workload, heart rate, and serum lactate levels after exercise are all affected adversely in proportion to the degree of anemia. Furthermore, work performance and productivity at tasks requiring sustained or prolonged activity are impaired in iron-deficient subjects and improve when iron is administered ( [307](#), [308](#) ). As a result, measures directed toward iron nutrition of a work force can produce important economic dividends, more than offsetting the costs of the treatment program ( [189](#), [307](#) ).

Abnormalities in muscle metabolism are noted even when deficiency is mild ( [309](#) ). Blood lactate levels were measured in mildly iron-deficient female athletes after standardized exercise tests. Peak lactate levels fell significantly after 2 weeks of iron treatment. This observation led to the suggestion that iron deficiency forces the muscles to depend to a greater extent on anaerobic metabolism than occurs in normal subjects. In contrast, no abnormalities of muscle function were noted in six nonanemic patients with long-standing iron deficiency, induced for the treatment of polycythemia vera ( [310](#) ). Animal studies confirm that muscle function is disturbed in iron deficiency. The spontaneous activity level of iron-deficient rats decreased ( [311](#) ), and short-term exercise tolerance in treadmill running tests was reduced ( [181](#), [182](#), [312](#), [313](#) ), even at mild degrees of deficiency ( [314](#) ). These abnormalities could not be explained by anemia alone, because they persisted after anemia was corrected by exchange transfusion ( [181](#), [182](#) ). All were corrected promptly when iron was administered. A variety of behavioral disturbances has been observed in iron-deficient children ( [188](#), [315](#), [316](#), [317](#), [318](#) and [319](#) ). These children have been reported to be irritable and disruptive, with short attention spans and a lack of interest in their surroundings. Neurologic development in infants ( [320](#) ) and scholastic performance in older children ( [321](#) ) may be impaired. Cognitive performance is defective in iron-deficient rats ( [322](#) ). All of these behavioral abnormalities are ameliorated with the initiation of iron therapy. The ability to maintain body temperature on exposure to cold is impaired in iron-deficient patients ( [323](#) ) and animals ( [324](#) ). Occasional patients experience neuralgia pains, vasomotor disturbances, or numbness and tingling. In children, iron deficiency has been associated with neurologic sequelae, including developmental delay, ischemic stroke, increased intracranial pressure, papilledema, and the clinical picture of pseudotumor cerebri ( [325](#) ). The pathogenesis is probably complex, involving severe anemia, thrombocytosis, and reduced levels of tissue iron enzymes.

**EPITHELIAL TISSUES** Patients with long-standing iron deficiency may develop a constellation of symptoms characterized by defective structure or function of epithelial tissue. Especially affected are the nails, the tongue and mouth, the hypopharynx, and the stomach. These epithelial lesions tend to occur together in the same patients at the same time ( [326](#), [327](#) ) but also may occur as isolated findings. In iron-deficient subjects, the fingernails may become brittle, fragile, or longitudinally ridged, but these findings are quite nonspecific. Alterations more typical of iron deficiency are nail thinning, flattening, and ultimately the development of koilonychia, concave or “spoon-shaped” nails ( [Fig. 28.4](#) ). Koilonychia is now rarely seen in clinical practice, but of 400 babies attending a well-baby clinic in West Virginia before 1970, 5.5% had koilonychia, and nearly all of these infants appeared to be iron-deficient ( [328](#) ). Koilonychia is a relatively nonspecific finding, which can also result from prolonged, repeated exposure to hot soapsuds and other caustic agents.



**Figure 28.4.** Koilonychia in a 11/2-year-old child with iron deficiency anemia.

Oral abnormalities, including atrophy of the lingual papillae, are the most common of iron deficiency-induced epithelial changes ( [Fig. 28.5](#), [Table 28.5](#)). These may present as soreness or burning of the tongue, either spontaneously or stimulated by food or drink, and by varying degrees of redness ( [326](#)). The filiform papillae over the anterior two-thirds of the tongue are the first to atrophy and may disappear completely. In severe cases, fungiform papillae also may be affected, leaving the tongue completely smooth and waxy or glistening ( [329](#)). These changes are generally reversed after 1 to 2 weeks of iron therapy. Angular stomatitis, characterized by ulcerations or fissures at the corners of the mouth, is a less specific sign of iron deficiency, and it also occurs in riboflavin and pyridoxine deficiencies.



**Figure 28.5.** Tongue of a patient with iron deficiency anemia. Moderately severe papillary atrophy evident before therapy (A) and restoration after iron repletion (B). (Courtesy of R.W. Monto, Detroit, MI.)

**TABLE 28.5. Epithelial Lesions Associated with Iron Deficiency**

| Site        | Finding  |
|-------------|--|
| Nails       | Flattening<br>Koilonychia  |
| Tongue      | Soreness<br>Mild papillary atrophy<br>Absence of filiform papillae |
| Mouth       | Angular stomatitis   |
| Hypopharynx | Dysphagia<br>Esophageal webs                                       |
| Stomach     | Achlorhydria<br>Gastritis  |



The association of dysphagia, angular stomatitis, and lingual abnormalities with hypochromic anemia was reported as early as the beginning of the twentieth century. Dysphagia affects women more often than men and is relatively uncommon in patients younger than age 30 years. However, it has been observed in adolescents ( [188](#), [326](#) ) and even toddlers ( *author's unpublished observations*). Patients with sideropenic dysphagia (also known as *Paterson–Kelly syndrome* and *Plummer–Vinson syndrome*) note a gradual onset of difficulty swallowing and describe discomfort localized to the area of the neck near the cricoid cartilage. They experience dysphagia with solid foods but have little problem with liquids. If not treated, the dysphagia worsens, and ultimately the diet is so restricted that it interferes with the maintenance of balanced nutrition. The most common anatomic lesion is a “web” of mucosa at the juncture between the hypopharynx and the esophagus ( [330](#) ). These webs, which may be multiple, usually extend from the anterior wall into the lumen of the esophagus, but they may encircle the lumen completely, forming a cufflike structure. In some patients, a benign stricture is noted, and the opening into the esophagus at the cricoid area may be reduced to the size of a pinhole or slit. Postcricoid webs may occur in the absence of documented iron deficiency, but nearly all affected patients were iron-deficient in one investigative series ( [327](#) ). Both webs and strictures may be demonstrated by radiographic examination (lateral view) of the neck after barium swallow ( [Fig. 28.6](#) ). Multiple exposures or cineradiography are required for optimal demonstration of these abnormalities.



**Figure 28.6.** Esophageal web ( *arrows*) in Plummer–Vinson syndrome.

At biopsy, the webs appear to be constructed of normal epithelium with underlying loose connective tissue, sometimes showing a chronic inflammatory reaction. In a small percentage, hyperchromatic nuclei and increased mitotic activity are observed in the basal cell layer. Biopsy of the strictures demonstrates chronic, nonspecific inflammation and degeneration of striated muscle. Carcinoma in the postcricoid area has been noted as a late complication of the syndrome in 4 to 16% of patients ( [326](#) ). For relief of the dysphagia, clinicians often must rupture the webs, dilate the stenosis, or both, although treatment with iron supplements often relieves dysphagia in mild cases if the associated webs are small ( [331](#), [332](#) ). The variation in the prevalence of sideropenic dysphagia suggests that factors other than iron deficiency may contribute to oroesophageal abnormalities. Genetic factors may be important, as may some unrecognized coexisting nutritional abnormalities. Gastric biopsy demonstrates the presence of gastritis of varying severity in a substantial fraction of iron-deficient patients. These lesions are nonspecific and often asymptomatic and may be indistinguishable from those seen in association with pernicious anemia. Varying degrees of reduction in gastric secretion are associated with



the gastritis. As gastric damage progresses, patients lose the ability to secrete acid, pepsin, and intrinsic factor. Achlorhydria has been reported to occur in infants and children as well as in adults ( 188 ). Antibodies to gastric parietal cells have been described in approximately one-third of patients with iron deficiency ( 326 , 333 ). Although the mechanism of production of these antibodies is not understood, they appear to be a manifestation, rather than a cause, of gastritis.

**IMMUNITY AND INFECTION** The relationship between iron deficiency and infection is complex ( 334 , 335 and 336 ). Iron deficiency clearly results in at least two abnormalities in the immune response: defective lymphocyte-mediated immunity and impaired bacterial killing by phagocytes. Evidence of defective cellular immunity includes as much as a 35% reduction in the number of circulating T cells. Both helper and suppressor T cells are affected ( 337 ). In addition, iron-deficient subjects do not respond as well as normal subjects to certain skin test antigens, such as to *Candida*, diphtheria, and *Trichophyton*. These abnormalities can be corrected by the administration of iron. No abnormalities have been noted in testing with tuberculin or dinitrochlorobenzene. Ribonucleotide reductase is an iron-containing enzyme required for the synthesis of DNA for cell division. Some authors have suggested that reduced levels of this enzyme might lead to impaired ability of the T cells to proliferate, thereby accounting for the defects in cell-mediated immunity, but others have reported changes in cytokine production in iron-deficient patients. The nitroblue tetrazolium dye test of phagocyte function yielded abnormal results in iron-deficient children, and the abnormality could be corrected by iron administration ( 338 , 339 ). Furthermore, a decrease in the magnitude of the “oxidative burst” accompanying phagocytosis was observed ( 340 ). Finally, killing of several types of pathogenic bacteria by neutrophils was defective ( 338 , 341 ). The sequence of changes in neutrophil function was studied as iron deficiency developed in rats. Myeloperoxidase activity was reduced to a greater extent and responded more slowly to iron therapy than did defects in the oxidative burst ( 342 ). Because the oxidative burst is considerably more important in bacterial killing than is myeloperoxidase, the observations suggest that the neutrophil conserves its most important function as the deficiency develops. The defect in the oxidative burst could be demonstrated only with the use of agents that induced phagocytosis; no defect was noted when the burst was stimulated by soluble agents. Thus, phagocytosis, rather than the oxidative burst itself, may be at fault. Taken together, these abnormalities provide a basis for an expectation that resistance to infection may be impaired in iron deficiency. Conversely, considerable data suggest that iron deficiency and iron sequestration by binding proteins protect against infection by depriving the invading organisms of the metal. Thus, optimal immune function is highly dependent on iron balance; both iron-deficient and iron-overloaded hosts are at higher risk for infection.

**PICA** Pica is a striking symptom of iron deficiency. Hippocrates wrote that a “craving to eat earth” was associated with “corruption of the blood.” Abnormal eating patterns were also a prominent manifestation of chlorosis. *Pagophagia*, defined as the purposeful eating of at least one tray of ice daily for 2 months, is a common form of pica. In one study, the ingestion of ice averaged nearly 2 kg/day, and some patients ate an astounding 4 to 9 kg/day ( 343 ). This dramatic symptom was relieved within 1 to 14 days after iron was administered. Another study found that pagophagia was a symptom of iron deficiency in 23 of 38 consecutive adult patients, and iron therapy was curative ( 344 ). Pica is especially striking when the patient consumes bizarre, nonfood substances ( 226 ). Crosby estimated the incidence of pica in his iron-deficient patients to be 50% ( 345 ). Approximately one-half of them ate ice; the rest experienced “food pica.” The latter consists of compulsively eating one food, often something that is brittle and makes a crunching sound when chewed ( 346 ). Because patients may be ashamed of this compulsive habit, they often do not volunteer the information during the medical interview. Direct, tactful inquiry is necessary to elicit the history of pica.

**GENITOURINARY SYSTEM** Disturbances in menstruation are common in iron deficiency, and not infrequently, iron deficiency results from, or is exacerbated by, excessive

menstrual blood loss. *Beeturia*, the excretion of a pink to red pigment in the urine after the ingestion of beets, has been reported to be more common in iron-deficient patients than in normal subjects ( [347](#) ). However, it is likely that a significant fraction of the normal population also has this symptom ( [348](#) ).

**SKELETAL SYSTEM** Changes in the skull similar to those found in association with thalassemia or chronic hemolytic anemia have been reported in children with iron deficiency anemia of long duration ( [349](#) , [350](#) ). The diploic spaces may be widened, and the outer tables thinned, at times with vertical striations producing a hair-on-end appearance. In addition, abnormalities of the long bones are noted, especially the metacarpals and phalanges, with expansion of the medulla and thinning of the cortices ( [350](#) ). These changes likely result from expansion of the erythroid marrow during bone growth and development.

## LABORATORY FINDINGS IN IRON DEFICIENCY

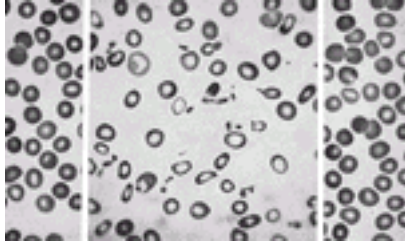
### Erythrocytes

The severity of anemia depends on the presenting circumstances of iron deficiency. If discovered when the patient is being evaluated for an underlying or unrelated disease, the anemia may be mild. If symptoms of anemia are the presenting complaint, the blood hemoglobin level is usually 8 g/dl or lower.

The mean corpuscular volume and mean corpuscular hemoglobin values are reduced in most patients, and the mean corpuscular hemoglobin concentration is reduced in long-standing or severe disease. The degree of change in the red cell indices is related in part to the duration and in part to the severity of the anemia. In mild iron deficiency of short duration, the indices may be within normal ranges.

In contrast, the content of reticulocyte hemoglobin is an early, sensitive indicator of iron deficiency ( [351](#) ). The content of reticulocyte hemoglobin directly examines the hemoglobin endowment of the youngest circulating erythrocytes, allowing detection of iron deficiency before the bulk population shows evidence of an effect. Similarly, the content of reticulocyte hemoglobin can show a response to iron therapy approximately 4 days after it is begun, which is much earlier than other hematologic measurements. However, this value is not measured by all clinical laboratory blood cell analyzers; at present, it is only measured by the Technicon H\*3 machine manufactured by the Bayer Corporation (Tarrytown, NY).

Anisocytosis is an important early sign in iron deficiency and one that has differential diagnostic value when quantified ( [352](#) , [353](#) ). The red cell distribution width is increased in iron deficiency. Both the percentage and the absolute number of reticulocytes may be normal or slightly increased. In experimentally induced iron deficiency in certain animal species, including rats, mice, and pigs, reticulocytosis is pronounced. The chief finding on blood smear is hypochromia, observed as an increase in the size of the region of central pallor ( [Fig. 28.7](#) ). The more severe the anemia, the more severe the hypochromia and the greater the percentage of erythrocytes affected. When hypochromia is extreme, most of the red blood cells appear as mere rings. Tiny microcytes and a moderate number of poikilocytes, particularly tailed and elongated elliptical forms (pencil cells), are also found. In almost all instances, however, a variable number of well-filled red corpuscles are present, and some macrocytes, often polychromatophilic, can be distinguished. The number of such cells increases as iron is made available.



**Figure 28.7.** Blood smear from a patient with hypochromic microcytic anemia caused by iron deficiency. Normal red blood cells are shown on each side for comparison (Wright stain,  $\times 900$ ).

## Leukocytes and Platelets

The leukocytes are usually normal in number, but mild granulocytopenia may occur in long-standing cases of iron deficiency. Recent large-volume hemorrhage may cause a slight neutrophilic leukocytosis, and occasional myelocyte may be found in peripheral blood. In iron deficiency due to parasitic infestation, eosinophilia may be present.

Thrombocytosis commonly accompanies iron deficiency ([354](#)). The platelet count usually increases to approximately twice the normal level, and values return to normal after iron therapy. The cause of the thrombocytosis of iron deficiency is unknown.

## Bone Marrow

Macrophage iron is absent or severely reduced in the marrow (and liver) of iron-deficient subjects. Fewer than 10% of the marrow normoblasts are sideroblasts. In addition, the iron-deficient bone marrow is characterized by mild to moderate erythroid hyperplasia. There may be striking nuclear distortions, resembling those found in dyserythropoietic anemias ([355](#)). Karyorrhexis and nuclear budding are particularly common, but multinuclearity, nuclear fragmentation, and even intranuclear bridging may be observed. The individual normoblasts appear small and may have scanty cytoplasm, often with irregular, ragged borders. When therapy is given, erythroid hyperplasia initially increases, but as erythropoiesis is restored to normal, the cellularity of the marrow likewise becomes normal.

## Iron Metabolism

Serum iron concentration is reduced in iron deficiency, and the TIBC is often increased, but it may be normal or even decreased. Patients with reduced TIBC values tend to have hypoalbuminemia, inflammation, or both as well. Saturation of transferrin is always reduced to less than 16%. At this level of saturation, iron delivery to erythroid precursors is limited.

Although they do not always show a linear relationship to iron stores, ferritin levels are the single best serum measure of storage iron. In iron deficiency anemia, the value is less than  $12 \mu\text{g/L}$  in the absence of a complicating disease. When an infectious or inflammatory disease like rheumatoid arthritis is also present, the serum ferritin level is usually higher, but it is generally less than 50 to  $60 \mu\text{g/L}$ . Of all the serum tests for iron deficiency, the serum ferritin determination is the most useful, and a low serum ferritin invariably signifies iron deficiency. However, the test lacks sensitivity, and a normal value does not reliably exclude iron deficiency.

Serum transferrin receptor (sTFR) fragments, as measured by immunologic methods, are substantially increased in iron-deficient patients (202). This determination is useful in distinguishing iron deficiency from the anemia of chronic disease, particularly when analyzed as the ratio of sTFR to the log of the ferritin value (356). When the ratio of sTFR to log ferritin is greater than 1.5, iron deficiency is usually present (with or without other processes); when it is less than 1.5, the patient most likely has impaired iron use due to the anemia of chronic inflammation, without frank iron deficiency. The sTFR values are also increased in conditions characterized by erythroid hyperplasia of the bone marrow with ineffective erythropoiesis (357).

### Ferrokinetic Studies

Although no longer routinely performed, it is possible to follow the movement of iron in the iron cycle by using radioactive tracers to study ferrokinetics. Typically, transferrin is labeled with iron 59, and the radioactive iron is monitored as it moves from the plasma to the bone marrow and into the circulating red cells. Because the kinetics of iron are intimately related to hemoglobin synthesis, such a study makes it possible to assess rates and sites of erythropoiesis and to evaluate ineffective and effective erythropoiesis.

In most ferrokinetic studies, iron 59 is injected directly as ferrous citrate or is first bound to transferrin by incubation with fresh plasma. After administration of the labeled iron or plasma, serial samples of blood are taken at frequent intervals during the first several hours and daily thereafter. These samples are analyzed for plasma and red cell radioactivity, plasma iron concentration, and volume of packed red blood cells. For some calculations, a separate determination of plasma volume is made, or it may be calculated from the extrapolated zero-time plasma radioactivity and the total injected radioactivity. The basic measurements calculated from these data are given in [Table 28.6](#).

**TABLE 28.6. Basic Ferrokinetic Measurements**

| Measurement                    | Calculation  | Average Normal Value                   |
|--------------------------------|--|--|
| $t_{1/2}$                      | Graphically, from semilogarithmic plot of plasma radioactivity disappearance   | 86 min                                 |
| PIT                            | $(0.693/t_{1/2}) \times \text{plasma Fe (mg/ml)} \times \text{plasma volume (ml)} \times 1440 \text{ min/d}$ <i>or</i><br>$[\text{plasma Fe } (\mu\text{g/dl)} \times 100 - \text{volume of packed red cells}]/(t_{1/2} \times 100)$         | 26 mg/d <i>or</i><br>0.7 mg/d/dl blood |
| RCU                            | $(\text{day 14 radioactivity/ml blood} \times 100)/(\text{0 time radioactivity/ml blood})$ <i>or</i><br>$[(\text{day 14 radioactivity/ml red blood cells}) \times \text{red cell mass (ml)} \times 100]/\text{total injected radioactivity}$ | 80%                                    |
| Erythrocyte iron turnover rate | PIT $\times$ RCU   | 21 mg/d <i>or</i> 0.56 mg/d/dl blood   |
| Marrow transit time            | Graphically, from a semilogarithmic plot, the time at which $100 - \text{RCU} = 50\%$  | 3.5 d                                  |

PIT, plasma iron transport rate; RCU, red blood cell utilization;  $t_{1/2}$ , plasma Fe half-life.

The plasma iron transport rate (PIT) is a measure of the rate at which iron leaves the plasma. It may be expressed either as a total daily rate (milligrams of iron per day) or as a rate per volume (dl) of blood. The latter mode of expression eliminates the need for determining plasma volume and incorporates a built-in correction for body size. It assumes, however, that the blood volume is approximately normal. The PIT is generally considered a good index of total erythropoiesis, whether effective or ineffective. The PIT correlates with the total nucleated red cell mass and with the rate of red cell production induced by phlebotomy ( [156](#) ). Its value as a measure of erythropoiesis, however, is limited by two phenomena. First, some iron leaves plasma by entering the extravascular space, the extravascular flux ( [358](#) ). Second, the plasma iron pool includes two main species, monoferric transferrin and diferric transferrin. The latter has a fourfold advantage in affinity for receptors and also delivers twice as much iron per molecule of transferrin taken up. For these reasons, PIT tends to increase as the serum iron increases, even when total erythropoiesis is unchanged. A suggested improvement over PIT is erythron transferrin uptake ( [359](#) , [360](#) ). This measurement is calculated by subtracting extravascular flux from PIT and then converting iron uptake to transferrin uptake by correcting for the predictable distribution of iron between monoferric and diferric transferrin species.

The erythrocyte iron turnover rate (EIT) is a measure of the rate at which iron moves from marrow to circulating red cells. Like PIT, it may be expressed as a total daily rate or as a rate per deciliter of blood, and the same advantages and disadvantages of the two modes of expression apply. It is an index of effective erythropoiesis and correlates well with an appropriately corrected reticulocyte index.

The observation that red cell iron utilization (RCU) is usually less than 100%, and therefore PIT is greater than EIT, means that some of the iron leaving plasma does not make its appearance in circulating red cells. There are several possible fates for this nonutilized iron. It may enter nonerythroid tissues; it may be lost with hemoglobin when normoblast denucleation occurs; it may be lost with intramedullary destruction of defective red cells (ineffective erythropoiesis); and, finally, it may enter the extravascular space, as noted previously. When RCU is reduced and the difference between PIT and EIT is relatively large, one of these pathways accounts for a larger than normal proportion of plasma iron turnover.

The marrow transit time may be used to evaluate erythropoietin response. In general, this value decreases in proportion to the degree of erythropoietic stimulation. In situations characterized by an appropriate marrow response to anemia, the relation between the volume of packed red blood cells and marrow transit time is predictable ( [156](#) ).

In addition to these determinations on blood specimens, it is possible to monitor iron movements within the body by surface counting over the liver, spleen, and sacrum (marrow). This procedure may be particularly useful in detecting extramedullary hematopoiesis.

Variations of ferrokinetic measurements in representative disease states are listed in [Table 28.7](#). When erythropoiesis is reduced, as in hypoplastic anemia, the PIT may be normal or only slightly reduced, but RCU and EIT are greatly reduced. Furthermore, iron appears early in the liver and is retained there. When erythropoiesis is accelerated in hemolytic anemia, both PIT and EIT are increased, and radioactivity accumulates at the sites of destruction (the spleen or liver). In states of ineffective erythropoiesis, such as thalassemia major, PIT is greatly increased, RCU is reduced, and EIT is relatively normal. Early iron uptake may occur over organs in which the defective cells are destroyed. The erythron transferrin uptake appears to be a more precise measure of erythropoiesis than

PIT. As compared with a mean normal erythron transferrin uptake value of 60  $\mu\text{mol/day/L}$  blood, the value in patients with aplastic anemia or pure red cell aplasia was 12, and that in patients with hemolytic anemia or ineffective erythropoiesis was over 400 ([360](#)).

**TABLE 28.7. Ferrokinetic Data in Representative Clinical Situations**

|   | Half-Life<br>(min) | Plasma Iron<br>Transport<br>Rate<br>(mg/d/dl) | Erythron<br>Transferrin<br>Uptake<br>( $\mu\text{mol/d/L}$ ) | Red Blood<br>Cell<br>Utilization<br>(%) | Erythrocyte<br>Iron Turnover<br>Rate (mg/d/dl) |
|---|--------------------|---|--|---|--|
| Normal  | 86                 | 0.70  | 60   | 80                                      | 0.56   |
| Hypoplastic anemia                                      | 267                | 0.45  | 12   | 23                                      | 0.10   |
| Hemolytic anemia<br>(hereditary<br>spherocytosis)       | 24                 | 3.42  | 400  | 57                                      | 1.87   |
| Ineffective<br>erythropoiesis<br>(thalassemia<br>major) | 21                 | 6.87  | 474  | 18                                      | 1.24   |

NOTE: Values are means.

Data from Finch CA, Deubelbeiss K, Cook JD, et al. Ferrokinetics in man. *Medicine* (Baltimore) 1970;49:17–53; and Cazzola M, Pootrakul P, Huebers HA, et al. Erythroid marrow function in anemic patients. *Blood* 1987;69:296–301.

Iron does not leave the plasma at a single exponential rate. The early part of the plasma disappearance curve does, in fact, approximate a straight line on a semilogarithmic plot. After several hours, however, a significant change occurs in the slope of the line until another, much slower, exponential disappearance rate is established. This phenomenon is explained by the return to plasma of approximately 35% of the iron that leaves it ([156](#)).

## MANAGEMENT OF IRON DEFICIENCY

Management is primarily focused on repletion of iron stores. Most of the time, this therapy is straightforward, simple, and inexpensive. The response to treatment is predictable and gratifying. There is, however, an important caveat: Correction of the iron deficiency is only part of the task confronting the clinician. Particularly in older adults, iron deficiency may be an early sign of a serious illness, such as an occult gastrointestinal malignancy. Clearly, correction of the anemia without recognition and treatment of a possible underlying disease is poorly practiced medicine. The cause of iron deficiency anemia can be defined in the great majority of cases. Once an etiologic diagnosis is made, appropriate therapy can begin.

Iron is highly effective in treating iron deficiency. It has no other legitimate therapeutic use. In particular, it is not beneficial for any of the numerous anemias that are not associated with iron deficiency. The practice of giving iron indiscriminately in undiagnosed anemia is questionable. Although this is often a reasonable approach in young children at high risk for iron deficiency and with no evidence of other pathology, it is harder to defend



in adult populations.

Iron can be administered orally or intravenously. The oral route is the safest and least expensive. Importantly, therapeutic doses are quite different for oral and intravenous preparations. Most iron-deficient patients respond well to oral therapy, but intravenous administration of iron may sometimes be required.

### Oral Iron Therapy

The most common preparation used orally is ferrous sulfate, which has been a mainstay of treatment for iron deficiency since it was first introduced by the French physician Pierre Bland in the nineteenth century. It is effective, reasonably well tolerated, and inexpensive. If equivalent amounts of elemental iron are given, ferrous gluconate and ferrous fumarate are equally satisfactory and have approximately the same incidence of side effects. Although iron deficiency clearly promotes increased absorption, individual variations are great, and absorption may be vastly different at varying degrees of anemia and in the presence of complicating illnesses.

The dose is best calculated in terms of elemental iron. For adults, the optimal response occurs when approximately 200 mg of elemental iron is given each day. Iron is absorbed more completely when the stomach is empty; when iron ingestion occurs after or with a meal, absorption decreases substantially (<sup>361</sup>). However, gastrointestinal irritation is common when the stomach is empty. Consequently, patients are frequently advised to take oral iron immediately after or even with a meal. The gain in patient acceptance may be more important than the reduced absorption of iron. However, it is important to remember that, whereas absorption is enhanced by the presence of orange juice, meat, poultry, and fish, other substances such as cereals, tea, and milk inhibit it. This is particularly important in toddlers, because administration of oral iron with milk often compromises therapy.

For iron-deficient children, the optimal dosage is 1.5 to 2.0 mg elemental iron per kilogram of body weight three times per day. Palatable elixirs and syrups are the most satisfactory pediatric preparations, although they can stain the teeth if not given carefully. Children usually tolerate this form of therapy on an empty stomach.

In adults, a 200-mg daily dose produces a maximal rate of hemoglobin regeneration. However, the maximal rate is not necessarily the only legitimate therapeutic goal. If the underlying disease has been corrected and the anemia is mild to moderate, a slower rate of response may be acceptable. Thus, if such patients cannot tolerate 200 mg/day of elemental iron, it is reasonable to reduce the dose to 100 mg/day (<sup>362</sup>). Because less iron is given, tolerance improves. In this circumstance, speed of response is exchanged for increased patient compliance, although it may be necessary to treat for longer. Regardless of the form of oral therapy used, treatment should be continued for at least 3 to 6 months after the anemia is relieved. If treatment does not continue, relapse is common. The continued therapy allows for repletion of iron stores.

### Side Effects of Oral Iron Therapy

Some patients given oral iron report gastrointestinal symptoms, including heartburn, nausea, abdominal cramps, and diarrhea. However, functional gastrointestinal symptoms are common in the general population, and patients may incorrectly ascribe them to iron treatment. Many studies of gastrointestinal intolerance to iron have not included adequate controls. In one excellent double-blind study, ferrous sulfate, ferrous gluconate, ferrous fumarate, and placebo were administered in identically appearing tablets (<sup>363</sup>). No



significant differences were found among the three iron salts. Approximately 12% of subjects had symptoms that could reasonably be ascribed to iron ingestion. Often, tolerance of iron salts improves when a small dose is given at first and increased over the course of several days to the full dose. Without such a gradual increase in dosage, gastrointestinal side effects are more likely to develop.

A polysaccharide-iron complex is marketed under the brand name Niferex. It is a ferric-polysaccharide polymer that is alleged to be as effective as ferrous sulfate while causing fewer side effects. The question of whether it is as well absorbed as ferrous sulfate has not been definitively resolved.

If given in sufficient quantities, both ascorbic acid and succinic acid increase absorption of ferrous iron. Ascorbate, however, also increases the side effects of iron therapy ([363](#)); thus, an increased dose of iron might achieve the same result at lower cost. Furthermore, many of the available iron and ascorbate preparations contain only small amounts of ascorbate.

Enteric-coated preparations are designed to reduce side effects by retarding dissolution of the iron. However, this effect may markedly decrease absorption, especially in achlorhydric individuals, whose gastric juice cannot dissolve the coating. Sustained release preparations also reduce side effects by retarding dissolution, but in so doing, the most actively absorbing regions of the intestine are bypassed. According to most ([364](#)) but not all ([365](#)) studies, absorption is therefore reduced.

### **Failure of Oral Iron Therapy**

Clinicians often encounter patients said to have iron deficiency anemia unresponsive to oral therapy. The most common explanations for failure to respond to oral iron include (a) incorrect diagnosis, (b) complicating illness, (c) failure of the patient to take prescribed medication, (d) inadequate prescription (dose or form), (e) continuing iron loss in excess of intake, and (f) malabsorption of iron.

In managing a problem of alleged failure to respond to iron, it is important to review the data on which the diagnosis of iron deficiency anemia was based and to take note of any laboratory procedures that might have yielded erroneous information. At times, even though iron deficiency is present, a coexisting cause for anemia may impair response. Examples are iron deficiency as a complication of the anemia of chronic disorders in rheumatoid arthritis as well as so-called dimorphic anemia, in which iron deficiency and pernicious anemia coexist.

Even apparently intelligent and cooperative patients may not take medications as prescribed, and this possibility should be considered. In some patients, blood loss is so great that oral iron therapy cannot keep up with it. If this situation is not correctable (e.g., in the case of hereditary hemorrhagic telangiectasia) parenteral therapy must be given. Finally, rare patients may be unable to absorb iron. This is unusual; even patients with sprue or total gastrectomy are usually able to absorb adequate amounts of ferrous sulfate. Although it is formally possible that patients may not absorb iron because of genetic defects in the proteins involved in intestinal iron transport, mutations in the genes encoding these proteins have not yet been described in patients who do not respond to oral iron therapy.

### **Parenteral Iron Therapy**

Parenteral iron therapy is highly effective, but it poses significant risks to some patients.

Parenteral iron therapy may be indicated when the patient (a) has severe iron deficiency anemia; (b) is unable to tolerate iron compounds given orally; (c) repeatedly does not heed instructions or is incapable of accepting or following them; (d) loses iron (blood) at a rate too rapid for the oral intake to compensate for the loss, such as in hereditary hemorrhagic telangiectasia; (e) has a disorder of the gastrointestinal tract, such as ulcerative colitis, in which symptoms may be aggravated by iron therapy; (f) is unable to absorb iron from the gastrointestinal tract; (g) is unable to maintain iron balance on treatment with hemodialysis; or (h) has functional iron deficiency because of concurrent treatment with erythropoietin (e.g., in the anemia of renal failure, in the anemia of chronic disease, or for autologous blood donation).

Iron can be administered parenterally, but preparations must have certain properties to be both safe and efficacious. It must be possible to give substantial doses in a form that is avidly taken up by reticuloendothelial macrophages, minimally excreted into the urine, and does not cause iron deposition in liver parenchymal cells or renal tubular cells (366). There are currently three parenteral iron preparations in clinical use (Table 28.8). Iron-dextran complex, which contains 50 mg of iron per milliliter of solution, is the most stable, allowing the total dose to be given at one time (367). It has been in use for the longest period of time. However, there is a small but significant incidence of anaphylaxis associated with iron dextran, which has convinced many practitioners to use either of two alternative preparations that have recently become available in the United States—sodium ferric gluconate (368) and iron sucrose (369). Sodium ferric gluconate can be toxic in large doses, and it is safest to give no more than 62.5 mg as a daily dose to adult patients. Rare anaphylactic reactions have been reported with iron sucrose, but they appear to be less frequent than with iron dextran. The total dose is calculated from the amount of iron needed to restore the hemoglobin deficit plus an additional amount to replenish stores. The following is a useful formula:

**TABLE 28.8. Parenteral Iron Preparations**

| Preparation                         | Concentration   | Administration  |
|-------------------------------------|-----------------|---|
| Iron-dextran complex (INFeD)        | 50.0 mg iron/ml | Must give 0.5 ml test dose before each administration to check for anaphylactic reaction. In iron deficiency, total replacement dose can be given in 1 d. Small doses can be infused undiluted no faster than 1 ml/min. Larger doses should be diluted 5 ml iron dextran into 100 ml normal saline and infused at 20–60 gtts/min, beginning slowly.                   |
| Sodium ferric gluconate (Ferrlecit) | 12.5 mg iron/ml | No more than 100 mg should be given per d; doses of 62.5 mg or less are recommended to avoid toxicity. Small doses can be infused undiluted no faster than 1 ml/min. Larger doses should be diluted 5 ml sodium ferric gluconate into 100 ml normal saline and infused over 1 hr.   |
| Iron sucrose (Venofer)              | 20.0 mg iron/ml | Anaphylactic reactions are rare but have been reported. Some practitioners give a test dose of 2.5 ml diluted in 50.0 ml normal saline over 5–10 min. No more than 300 mg should be given per d. Small doses can be infused undiluted no faster than 1 ml/min. Larger doses should be diluted 5 ml iron sucrose into 100 ml normal saline and infused over 60–90 min. |

$$\text{Iron to be injected (mg)} = \text{weight (kg)} \times [\text{normal hemoglobin value} - \text{actual hemoglobin value (g/dl)}] \times 2.4 + 500 \text{ mg}$$

Alternatively, a calculator is available on the Internet at <http://www.globalrph.com/irondextran.htm>. This site calculates a dose for milliliters of iron dextran; doses of other intravenous iron preparations can be determined taking into account the fact that the concentration of iron dextran is 50 mg/ml.

Parenteral iron preparations should be given intravenously, because experience with iron dextran complex shows that intramuscular injections can cause skin discoloration and formation of sterile abscesses and may predispose to local sarcomas (370). For iron dextran and possibly also iron sucrose, a small test dose should be given initially to test for hypersensitivity (Table 28.8). If this is well tolerated, the full dose may be given. Some practitioners prefer to give large doses of iron over several days, but a total dose infusion of iron dextran can be given to iron-deficient patients (367). Delayed reactions may be more common with total dose infusion; nevertheless, it has been used extensively in the United States, Great Britain, and continental Europe. The initial flow rate should be 20 drops per minute for 5 minutes. If no side effects are observed, the rate may be increased to 40 to 60 drops/minute.

### Side Effects of Parenteral Iron Therapy

Side effects may be local or systemic. With intravenous injection, rates of administration greater than 100 mg/minute are associated with pain in the vein injected, flushing, and a metallic taste (371). Such reactions are brief in duration and relieved immediately by slowing the injection. Systemic reactions may be either immediate or delayed. Immediate side effects include hypotension, headache, malaise, urticaria, nausea, and rare anaphylactoid reactions, particularly to iron dextran. Delayed reactions include lymphadenopathy, myalgia, arthralgia, and fever. Most of the reactions are mild and transient, but the anaphylactoid reactions may be life-threatening (371, 372).

Reactions occurred after 13% of 2099 intravenous injections of iron dextran; the reactions affected 26% of 481 patients treated (371). Of those patients who reacted, 5.0% experienced a reaction serious enough to limit ordinary activity, and 0.6% had a life-threatening anaphylactoid reaction. Another 1.0% experienced severe, delayed reactions resembling serum sickness. The clinician should be prepared for the possibility of anaphylaxis by having epinephrine, oxygen, and facilities for resuscitation available. Sodium ferric gluconate and iron sucrose are generally better tolerated than iron-dextran complex, as long as the recommended dosages are not exceeded.

Formerly, use of intravenous iron was discouraged in patients with rheumatoid arthritis, because it was thought to induce disease flares. However, recent reports suggest that it is safe and effective when given with erythropoietin in the treatment of the anemia of chronic disease associated with that disorder (373, 374).

### Response to Therapy

When specific iron therapy is given, patients often show rapid subjective improvement, with disappearance or marked diminution of fatigue, lassitude, and other nonspecific symptoms. This response may occur before any improvement in anemia is observed. Similarly, pica has been reported to be relieved within 1 week of therapy (343).

The earliest hematologic evidence of response to treatment is an increase in the

percentage of reticulocytes. The reticulocytes attain a maximal value on the fifth to tenth day after institution of therapy and thereafter gradually return to normal. The maximal value usually ranges from 5 to 10% and is inversely related to the level of hemoglobin. The reticulocyte response may not be detectable in mild iron deficiency anemia.

The blood hemoglobin level is the most accurate measure of the degree of anemia in iron deficiency. During the response to therapy, the red cell count may increase temporarily to values above normal, but the hemoglobin value lags behind. The red cell indices may remain abnormal for some time after the normal hemoglobin level is restored. As recovery occurs, a normocytic cell population gradually replaces the microcytic cell population. When treatment is effective, hemoglobin reaches normal levels by 2 months after therapy is initiated, regardless of starting values.

Of the epithelial lesions in iron deficiency, those affecting the tongue and nails are the most responsive to treatment. After 1 to 2 weeks, small regenerating filiform papillae are observed. After 3 months, the tongue has usually returned to normal; however, in patients with severe anemia, some atrophy may persist. Koilonychia usually disappears in 3 to 6 months, with the concavity moving toward the end of the nail as the nail grows. Gastritis and the associated defects in gastric secretion often do not respond to therapy, especially in older adults. In patients younger than 30 years of age, gastric acid secretion and normal epithelial architecture may be restored ( [333](#) ).

Dysphagia may be relieved by iron therapy if the associated postcricoid webs are small or medium sized ( [332](#) ). The webs themselves are not altered, however, and relapse of the anemia is associated with recurring dysphagia. With more severe lesions, dilatation of the esophagus is required for relief.

Relapse occurs in a significant fraction of patients who respond to iron treatment, in part because of failure to complete the full course of therapy and in part because of recurrence (or continuation) of the predisposing condition or illness.

## Preventive Treatment

Certain people are at such high risk for developing iron deficiency that prophylactic measures may be considered. These include infants, pregnant women, adolescents, regular blood donors, women with menorrhagia, and patients receiving continuous, high-dose aspirin therapy. Iron supplementation has been recommended for pregnant women for almost half a century. Although the advantages of this practice have not been definitively established ( [375](#) , [376](#) ), the large iron cost of pregnancy and delivery to the mother ( [Table 28.4](#) ) suggest that it is warranted.

In 1999, the Committee on Nutrition of the American Academy of Pediatrics made recommendations for iron supplementation in infants ( [287](#) ). They believe that breast-feeding is preferable for the first 5 to 6 months of life if it is feasible, and beyond 6 months of age, breast-fed infants should receive supplemental iron at 1 mg/kg/day. Infants who are not breast-fed should be given formula supplemented with 12 mg/L of iron through the first year of life. The Committee recommends using iron-fortified cereal at the time that a solid diet is begun. Finally, fresh cow's milk should be avoided until after the first birthday.

## Anemia after Acute Hemorrhage

Anemia after acute hemorrhage rarely requires specific therapy. If iron stores are adequate, the marrow is capable of replacing the lost red cells, and correction of anemia

is not accelerated by the administration of iron, folate, or vitamin B<sub>12</sub>. As a rule, no matter how great the blood loss, the rate of erythrocyte replacement is such that a level of approximately  $4.5 \times 10^{12}$  red cells/L is reached in approximately 33 days, with more accelerated erythropoiesis in subjects with more severe degrees of anemia ( [377](#), [378](#) and [379](#) ). If hemorrhage does not recur, the red cell count is usually restored entirely to normal in 4 to 6 weeks, although the hemoglobin value may lag behind, reaching normal levels only after 6 to 8 weeks.

Morphologic evidence of active red cell regeneration should disappear after 10 to 14 days, if hemorrhage does not recur. The leukocyte count should be normal after 3 to 4 days. Sustained reticulocytosis is suggestive of continued bleeding. Persistent leukocytosis may result from the same cause, from hemorrhage into body cavities, or from complications. The latter, particularly infections, tend to delay the hematopoietic response.

### **Acute Iron Intoxication**

The accidental ingestion of iron compounds by children who have mistaken the tablets for candy is a common problem, particularly with toddlers whose mothers are taking iron-containing prenatal vitamin supplements ( [380](#), [381](#), [382](#), [383](#), [384](#) and [385](#) ). A few cases have also been reported in adults ( [386](#) ). At one time, the associated mortality rate was as high as 50%. Those persons who died had swallowed 3 to 10 g or more.

Symptoms of iron intoxication have been classified in four stages. In the first stage, gastrointestinal symptoms predominate (vomiting, diarrhea, and melena). Shock may ensue, followed by dyspnea, lethargy, and coma. These events occur in the first 6 hours after ingestion. In the second stage, lasting from 6 to 24 hours after ingestion, transient improvement occurs and may continue to recovery. In stage three, metabolic acidosis is present. Death may take place 12 to 48 hours after ingestion. Stage four consists of intestinal obstruction as a late complication caused by scarring of the intestine.

These ill effects are the consequence of the local irritative action of the iron, resulting in mucosal ulceration and bleeding. Capillary dilatation and diapedesis of red cells may occur. Many factors cause the shock, including the absorption of iron in amounts far above the binding capacity of the plasma. Serum iron values as high as 3000 µg/dl have been observed. Late coma is the result of hypoxia, metabolic disturbances, and hepatic damage.

The introduction of deferoxamine as a therapeutic agent has greatly modified the outlook ( [383](#) ). This hexadentate chelator, which has a high specific affinity for iron, can be given orally and intravenously. The molecular complex is small and is excreted quickly by the kidneys. Nonetheless, it is prudent to manage iron poisoning in consultation with an experienced toxicologist.

### **ACKNOWLEDGMENTS**

Substantial portions of this chapter were adapted from previous chapters written by G. Richard Lee. Dr. Andrews is supported by the Howard Hughes Medical Institute and by grants HL51057, DK53813, and HL32262 from the National Institutes of Health.

### **WEB SITES**

For calculation of intravenous iron dextran dose:

## REFERENCES

1. Schwartz E. Chlorosis. *Acta Med Belg [Suppl]* 1951.
2. Lange J. *Medicinalium epistolarum miscelanea varia et rara*, 1554. *Am J Dis Child* 1932;48:393.
3. Cabot RC. Diseases of blood. In: *Modern medicine*. Osler Sir W, ed. Philadelphia: Lea & Febiger, 1913:650.
4. Fowler W. Chlorosis—an obituary. *Ann Med Hist* 1936;8:168.
5. Haden RL. Historical aspects of iron therapy in anemia. *JAMA* 1938;111:1059.
6. Wintrobe MM, Beebe RT. Idiopathic hypochromic anemia. *Medicine* 1933;12:187–243.
7. Brune M, Magnusson B, Persson H, Hallberg L. Iron losses in sweat. *Am J Clin Nutr* 1986;43:438–443.
8. Green R, Charlton R, Seftel H, et al. Body iron excretion in man: a collaborative study. *Am J Med* 1968;45:336–353.
9. Hallberg L, Rossander-Hulten L. Iron requirements in menstruating women. *Am J Clin Nutr* 1991;54:1047–1058.
10. Hallberg L, Hogdahl AM, Nilsson L, Rybo G. Menstrual blood loss—a population study. Variation at different ages and attempts to define normality. *Acta Obstet Gynecol Scand* 1966;45:320–351.
11. Wheby MS. Site of iron absorption in man. *Scand J Haematol* 1970;7:56–62.
12. Murray MJ, Stein N. Experimental achylia gastrica and iron absorption. *Br J Haematol* 1971;21:113–120.
13. Jacobs A, Owen GM. Effect of gastric juice on iron absorption in patients with gastric atrophy. *Gut* 1969;10:488–490.
14. Jacobs A, Rhodes J, Peters DK, et al. Gastric acidity and iron absorption. *Br J Haematol* 1966;12:728–736.
15. Weintraub LR, Weinstein MB, Huser HJ, Rafal S. Absorption of hemoglobin iron: the role of a heme-splitting substance in the intestinal mucosa. *J Clin Invest* 1968;47:531–539.
16. Moore C. Absorption of ferrous and ferric radioactive iron by human subjects and by dogs. *J Clin Invest* 1944;23:755.
17. Morris ER. An overview of current information on bioavailability of dietary iron to humans. *Fed Proc* 1983;42:1716–1720.
18. Hurrell RF. Fortification: overcoming technical and practical barriers. *J Nutr* 2002;132:806S–812S.
19. Hallberg L. Bioavailability of dietary iron in man. *Annu Rev Nutr* 1981;1:123–147.
20. Lynch SR, Cook JD. Interaction of vitamin C and iron. *Ann N Y Acad Sci* 1980;355:32–44.
21. Slatkavitz CA, Clydesdale FM. Solubility of inorganic iron as affected by proteolytic digestion. *Am J Clin Nutr* 1988;47:487–495.
22. Taylor PG, Martinez-Torres C, Romano EL, Layrisse M. The effect of cysteine-containing peptides released during meat digestion on iron absorption in humans. *Am J Clin Nutr* 1986;43:68–71.
23. Hurrell RF, Juillerat MA, Reddy MB, et al. Soy protein, phytate, and iron absorption in humans. *Am J*

Clin Nutr 1992;56:573–578.

24. Macfarlane BJ, van der Riet WB, Bothwell TH, et al. Effect of traditional oriental soy products on iron absorption. *Am J Clin Nutr* 1990;51:873–880.
25. Baynes RD, Macfarlane BJ, Bothwell TH, et al. The promotive effect of soy sauce on iron absorption in human subjects. *Eur J Clin Nutr* 1990;44:419–424.
26. Hurrell RF, Lynch SR, Trinidad TP, et al. Iron absorption in humans as influenced by bovine milk proteins. *Am J Clin Nutr* 1989;49:546–552.
27. Saarinen UM, Siimes MA, Dallman PR. Iron absorption in infants: high bioavailability of breast milk iron as indicated by the extrinsic tag method of iron absorption and by the concentration of serum ferritin. *J Pediatr* 1977;91:36–39.
28. Macfarlane BJ, Bezwoda WR, Bothwell TH, et al. Inhibitory effect of nuts on iron absorption. *Am J Clin Nutr* 1988;47:270–274.
29. Brune M, Rossander L, Hallberg L. Iron absorption: no intestinal adaptation to a high-phytate diet. *Am J Clin Nutr* 1989;49:542–545.
30. Hallberg L, Brune M, Rossander L. Iron absorption in man: ascorbic acid and dose-dependent inhibition by phytate. *Am J Clin Nutr* 1989;49:140–144.
31. Simpson KM, Morris ER, Cook JD. The inhibitory effect of bran on iron absorption in man. *Am J Clin Nutr* 1981;34:1469–1478.
32. Gillooly M, Bothwell TH, Charlton RW, et al. Factors affecting the absorption of iron from cereals. *Br J Nutr* 1984;51:37–46.
33. Brune M, Rossander-Hulten L, Hallberg L, et al. Iron absorption from bread in humans: inhibiting effects of cereal fiber, phytate and inositol phosphates with different numbers of phosphate groups. *J Nutr* 1992;122:442–449.
34. Hallberg L. Wheat fiber, phytates and iron absorption. *Scand J Gastroenterol Suppl* 1987;129:73–79.
35. Hallberg L, Rossander L, Skanberg AB. Phytates and the inhibitory effect of bran on iron absorption in man. *Am J Clin Nutr* 1987;45:988–996.
36. Gillooly M, Bothwell TH, Torrance JD, et al. The effects of organic acids, phytates and polyphenols on the absorption of iron from vegetables. *Br J Nutr* 1983;49:331–342.
37. Brune M, Rossander L, Hallberg L. Iron absorption and phenolic compounds: importance of different phenolic structures. *Eur J Clin Nutr* 1989;43:547–557.
38. Hurrell RF, Reddy M, Cook JD. Inhibition of non-haem iron absorption in man by polyphenolic-containing beverages. *Br J Nutr* 1999;81:289–295.
39. Reddy MB, Hurrell RF, Cook JD. Estimation of nonheme-iron bioavailability from meal composition. *Am J Clin Nutr* 2000;71:937–943.
40. Cook JD, Reddy MB, Hurrell RF. The effect of red and white wines on nonheme-iron absorption in humans. *Am J Clin Nutr* 1995;61:800–804.
41. Hallberg L, Rossander-Hulten L, Brune M, Gleerup A. Inhibition of haem-iron absorption in man by calcium. *Br J Nutr* 1993;69:533–540.
42. Hallberg L, Brune M, Erlandsson M, et al. Calcium: effect of different amounts on nonheme- and heme-iron absorption in humans. *Am J Clin Nutr* 1991;53:112–119.
43. Hallberg L, Rossander-Hulten L, Brune M, Gleerup A. Calcium and iron absorption: mechanism of action and nutritional importance. *Eur J Clin Nutr* 1992;46:317–327.



44. Rossander-Hulten L, Brune M, Sandstrom B, et al. Competitive inhibition of iron absorption by manganese and zinc in humans. *Am J Clin Nutr* 1991;54:152-156.
45. Gruenheid S, Canonne-Hergaux F, Gauthier S, et al. The iron transport protein NRAMP2 is an integral membrane glycoprotein that colocalizes with transferrin in recycling endosomes. *J Exp Med* 1999;189:831-841.
46. Canonne-Hergaux F, Fleming MD, Levy JE, et al. The Nramp2/DMT1 iron transporter is induced in the duodenum of microcytic anemia mk mice but is not properly targeted to the intestinal brush border. *Blood* 2000;96:3964-3970.
47. Fleming MD, Trenor CC, Su MA, et al. Microcytic anemia mice have a mutation in Nramp2, a candidate iron transporter gene. *Nat Genet* 1997;16:383-386.
48. Fleming MD, Romano MA, Su MA, et al. Nramp2 is mutated in the anemic Belgrade (b) rat: evidence of a role for Nramp2 in endosomal iron transport. *Proc Natl Acad Sci U S A* 1998;95:1148-1153.
49. Canonne-Hergaux F, Gruenheid S, Ponka P, Gros P. Cellular and subcellular localization of the Nramp2 iron transporter in the intestinal brush border and regulation by dietary iron. *Blood* 1999;93:4406-4417.
50. Gunshin H, Mackenzie B, Berger UV, et al. Cloning and characterization of a mammalian proton-coupled metal-ion transporter. *Nature* 1997;388:482-488.
51. Canonne-Hergaux F, Levy JE, Fleming MD, et al. Expression of the DMT1 (NRAMP2) iron transporter in mice with genetic iron overload disorders. *Blood* 2001;97:1138-1140.
52. Su MA, Trenor CC, Fleming JC, et al. The G185R mutation disrupts function of iron transporter Nramp2. *Blood* 1998;92:2157-2163.
53. McKie AT, Barrow D, Latunde-Dada GO, et al. An iron-regulated ferric reductase associated with the absorption of dietary iron. *Science* 2001;291:1755-1759.
54. Raffin SB, Woo CH, Roost KT, et al. Intestinal absorption of hemoglobin iron-heme cleavage by mucosal heme oxygenase. *J Clin Invest* 1974;54:1344-1352.
55. Bothwell TH. Overview and mechanisms of iron regulation. *Nutr Rev* 1995;53:237-245.
56. Sheehan RG, Frenkel EP. The control of iron absorption by the gastrointestinal mucosal cell. *J Clin Invest* 1972;51:224-231.
57. Schachter D, Manis JG. Active transport of iron by intestine: features of the two-step mechanism. *Am J Physiol* 1962;203:73-80.
58. Pinkerton PH. Control of iron absorption by the intestinal epithelial cell. Review and hypothesis. *Ann Intern Med* 1969;70:401-408.
59. Abboud S, Haile DJ. A novel mammalian iron-regulated protein involved in intracellular iron metabolism. *J Biol Chem* 2000;275:19906-19912.
60. Donovan A, Brownlie A, Zhou Y, et al. Positional cloning of zebrafish ferroportin1 identifies a conserved vertebrate iron exporter. *Nature* 2000;403:776-781.
61. McKie AT, Marciani P, Rolfs A, et al. A novel duodenal iron-regulated transporter, IREG1, implicated in the basolateral transfer of iron to the circulation. *Mol Cell* 2000;5:299-309.
62. Njajou OT, Vaessen N, Joosse M, et al. A mutation in SLC11A3 is associated with autosomal dominant hemochromatosis. *Nat Genet* 2001;28:213-214.
63. Montosi G, Donovan A, Totaro A, et al. Autosomal-dominant hemochromatosis is associated with a mutation in the ferroportin (SLC11A3) gene. *J Clin Invest* 2001;108:619-623.

64. Devalia V, Carter K, Walker AP, et al. Autosomal dominant reticuloendothelial iron overload associated with a 3-base pair deletion in the ferroportin 1 gene (SLC11A3). *Blood* 2002;100:695–697.
65. Roetto A, Merryweather-Clarke AT, Daraio F, et al. A valine deletion of ferroportin 1: a common mutation in hemochromatosis type 4. *Blood* 2002;100: 733–734.
66. Wallace DF, Pedersen P, Dixon JL, et al. Novel mutation in ferroportin1 is associated with autosomal dominant hemochromatosis. *Blood* 2002;100:692–694.
67. Osaki S, Johnson DA. Mobilization of liver iron by ferroxidase (ceruloplasmin). *J Biol Chem* 1969;244:5757–5758.
68. Roeser HP, Lee GR, Nacht S, Cartwright GE. The role of ceruloplasmin in iron metabolism. *J Clin Invest* 1970;49:2408–2417.
69. Frieden E. The copper connection. *Semin Hematol* 1983;20:114–117.
70. Lee GR, Nacht S, Lukens JN, Cartwright GE. Iron metabolism in copper-deficient swine. *J Clin Invest* 1968;47:2058–2069.
71. Vulpe CD, Kuo YM, Murphy TL, et al. Hephaestin, a ceruloplasmin homologue implicated in intestinal iron transport, is defective in the sla mouse. *Nat Genet* 1999;21:195–199.
72. Bannerman RM, Bannerman CE, Kingston PJ. Hereditary iron deficiency: X-linked anaemia (sla) in newborn and suckling mice. *Br J Haematol* 1973;25:280.
73. Edwards JA, Bannerman RM. Hereditary defect of intestinal iron transport in mice with sex-linked anemia. *J Clin Invest* 1970;49:1869–1871.
74. Levy JE, Montross LK, Andrews NC. Genes that modify the hemochromatosis phenotype in mice. *J Clin Invest* 2000;105:1209–1216.
75. Finch C. Regulators of iron balance in humans. *Blood* 1994;84:1697–1702.
76. Cook JD, Barry WE, Hershko C, et al. Iron kinetics with emphasis on iron overload. *Am J Pathol* 1973;72:337–343.
77. Bernstein SE. Hereditary hypotransferrinemia with hemosiderosis, a murine disorder resembling human atransferrinemia. *J Lab Clin Med* 1987;110:690–705.
78. Craven CM, Alexander J, Eldridge M, et al. Tissue distribution and clearance kinetics of non-transferrin-bound iron in the hypotransferrinemic mouse: a rodent model for hemochromatosis. *Proc Natl Acad Sci U S A* 1987;84:3457–3461.
79. Buys SS, Martin CB, Eldridge M, et al. Iron absorption in hypotransferrinemic mice. *Blood* 1991;78:3288–3290.
80. Trenor CC, Campagna DR, Sellers VM, et al. The molecular defect in hypotransferrinemic mice. *Blood* 2000;96:1113–1118.
81. Raja KB, Simpson RJ, Peters TJ. Plasma clearance of transferrin in control and hypotransferrinaemic mice: implications for regulation of transferrin turnover. *Br J Haematol* 1995;89:177–180.
82. Hamill RL, Woods JC, Cook BA. Congenital atransferrinemia: a case report and review of the literature. *Am J Clin Pathol* 1991;96:215–218.
83. Beutler E, Gelbart T, Lee P, et al. Molecular characterization of a case of atransferrinemia. *Blood* 2000;96:4071–4074.
84. Brittin GM, Haley J, Brecher G. Enhancement of intestinal iron absorption by a humoral effect of hypoxia in parabiotic rats. *Proc Soc Exp Biol Med* 1968;128:178–184.

85. Hathorn MK. The influence of hypoxia on iron absorption in the rat. *Gastroenterology* 1971;60:76–81.
86. Nicolas G, Chauvet C, Viatte L, et al. The gene encoding the iron regulatory peptide hepcidin is regulated by anemia, hypoxia, and inflammation. *J Clin Invest* 2002;110:1037–1044.
87. Cartwright GE. The anemia of chronic disorders. *Semin Hematol* 1966;3:351–375.
88. Wheby MS. Regulation of iron absorption. *Gastroenterology* 1966;50:888–892.
89. Conrad ME, Crosby WH. Intestinal mucosal mechanisms controlling iron absorption. *Blood* 1963;22:406–415.
90. Balcerzak SP, Greenberger NJ. Iron content of isolated intestinal epithelial cells in relation to iron absorption. *Nature* 1968;220:270–271.
91. Raja KB, Pippard MJ, Simpson RJ, Peters TJ. Relationship between erythropoiesis and the enhanced intestinal uptake of ferric iron in hypoxia in the mouse. *Br J Haematol* 1986;64:587–593.
92. Park CH, Valore EV, Waring AJ, Ganz T. Hepcidin, a urinary antimicrobial peptide synthesized in the liver. *J Biol Chem* 2001;276:7806–7810.
93. Krause A, Neitz S, Magert HJ, et al. LEAP–1, a novel highly disulfide–bonded human peptide, exhibits antimicrobial activity. *FEBS Lett* 2000;480:147–150.
94. Pigeon C, Ilyin G, Courselaud B, et al. A new mouse liver–specific gene, encoding a protein homologous to human antimicrobial peptide hepcidin, is overexpressed during iron overload. *J Biol Chem* 2001;276:7811–7819.
95. Nicolas G, Bennoun M, Porteu A, et al. Severe iron deficiency anemia in transgenic mice expressing liver hepcidin. *Proc Natl Acad Sci U S A* 2002;99:4596–4601.
96. Nicolas G, Bennoun M, Devaux I, et al. Lack of hepcidin gene expression and severe tissue iron overload in upstream stimulatory factor 2 (USF2) knockout mice. *Proc Natl Acad Sci U S A* 2001;98:8780–8785.
97. Weinstein D, Roy C, Fleming M, et al. Inappropriate expression of hepcidin is associated with iron refractory anemia: implications for the anemia of chronic disease. *Blood* 2002;100:3776–3781.
98. Fleming RE, Sly WS. Hepcidin: a putative iron–regulatory hormone relevant to hereditary hemochromatosis and the anemia of chronic disease. *Proc Natl Acad Sci U S A* 2001;98:8160–8162.
99. MacGillivray RT, Mendez E, Sinha SK, et al. The complete amino acid sequence of human serum transferrin. *Proc Natl Acad Sci U S A* 1982;79:2504–2508.
100. Thorbecke GJ, Liem HH, Knight S, et al. Sites of formation of the serum proteins transferrin and hemopexin. *J Clin Invest* 1973;52:725–731.
101. Lum JB, Infante AJ, et al. Transferrin synthesis by inducer T–lymphocytes. *J Clin Invest* 1986;77:841–849.
102. Huebers HA, Finch CA. The physiology of transferrin and transferrin receptors. *Physiol Rev* 1987;67:520–582.
103. Katz JH. Iron and protein kinetics studies by means of doubly labeled human crystalline transferrin. *J Clin Invest* 1961;40:2143–2152.
104. Awai M, Brown EB. Studies of the metabolism of I131–labeled human transferrin. *J Lab Clin Med* 1963;61:363–396.
105. MacGillivray RT, Moore SA, Chen J, et al. Two high–resolution crystal structures of the recombinant N–lobe of human transferrin reveal a structural change implicated in iron release. *Biochemistry*

1998;37:7919–7928.

106. Zak O, Aisen P. Evidence for functional differences between the two sites of rabbit transferrin: effects of serum and carbon dioxide. *Biochim Biophys Acta* 1990;1052:24–28.

107. Heilmeyer L, Keller W, Vivell O, et al. Congenital transferrin deficiency in a seven-year old girl. *German Medical Monthly* 1961;86:1745–1751.

108. Goya N, Miyazaki S, Kodate S, Ushio B. A family of congenital atransferrinemia. *Blood* 1972;40:239–245.

109. Kaplan J, Craven C, Alexander J, et al. Regulation of the distribution of tissue iron. Lessons learned from the hypotransferrinemic mouse. *Ann N Y Acad Sci* 1988;526:124–135.

110. Levy JE, Jin O, Fujiwara Y, et al. Transferrin receptor is necessary for development of erythrocytes and the nervous system. *Nat Genet* 1999;21:396–399.

111. Huebers H, Csiba E, Huebers E, Finch CA. Molecular advantage of diferric transferrin in delivering iron to reticulocytes: a comparative study. *Proc Soc Exp Biol Med* 1985;179:222–226.

112. Bali PK, Zak O, Aisen P. A new role for the transferrin receptor in the release of iron from transferrin. *Biochemistry* 1991;30:324–328.

113. Kawabata H, Yang R, Hiramata T, et al. Molecular cloning of transferrin receptor 2. A new member of the transferrin receptor-like family. *J Biol Chem* 1999;274:20826–20832.

114. Kawabata H, Germain RS, Vuong PT, et al. Transferrin receptor 2-[alpha] supports cell growth both in iron-chelated cultured cells and in vivo. *J Biol Chem* 2000;275:16618–16625.

115. Kawabata H, Nakamaki T, Ikonomi P, et al. Expression of transferrin receptor 2 in normal and neoplastic hematopoietic cells. *Blood* 2001;98:2714–2719.

116. Camaschella C, Roetto A, Cali A, et al. The gene TFR2 is mutated in a new type of haemochromatosis mapping to 7q22. *Nat Genet* 2000;25:14–15.

117. Roetto A, Totaro A, Piperno A, et al. New mutations inactivating transferrin receptor 2 in hemochromatosis type 3. *Blood* 2001;97:2555–2560.

118. Ahn J, Johnstone RM. Origin of a soluble truncated transferrin receptor. *Blood* 1993;81:2442–2451.

119. Flowers CH, Skikne BS, Covell AM, Cook JD. The clinical measurement of serum transferrin receptor. *J Lab Clin Med* 1989;114:368–377.

120. Huebers HA, Beguin Y, Pootrakul P, et al. Intact transferrin receptors in human plasma and their relation to erythropoiesis. *Blood* 1990;75:102–107.

121. R'zik S, Beguin Y. Serum soluble transferrin receptor concentration is an accurate estimate of the mass of tissue receptors. *Exp Hematol* 2001;29:677–685.

122. Miller K, Shipman M, Trowbridge IS, Hopkins CR. Transferrin receptors promote the formation of clathrin lattices. *Cell* 1991;65:621–632.

123. Ponka P, Neuwirt J. Regulation of iron entry into reticulocytes. I. Feedback inhibitory effect of heme on iron entry into reticulocytes and on heme synthesis. *Blood* 1969;33:690–707.

124. Battistini A, Coccia EM, Marziali G, et al. Intracellular heme coordinately modulates globin chain synthesis, transferrin receptor number, and ferritin content in differentiating Friend erythroleukemia cells. *Blood* 1991;78:2098–2113.

125. Han AP, Yu C, Lu L, et al. Heme-regulated eIF2alpha kinase (HRI) is required for translational regulation and survival of erythroid precursors in iron deficiency. *EMBO J* 2001;20:6909–6918.

126. Cragg SJ, Wagstaff M, Worwood M. Detection of a glycosylated subunit in human serum ferritin.

Biochem J 1981;199:565–571.

127. Konijn AM, Meyron–Holtz EG, Fibach E, Gelvan D. Cellular ferritin uptake: a highly regulated pathway for iron assimilation in human erythroid precursor cells. *Adv Exp Med Biol* 1994;356:189–197.

128. Gelvan D, Fibach E, Meyron–Holtz EG, Konijn AM. Ferritin uptake by human erythroid precursors is a regulated iron uptake pathway. *Blood* 1996;88:3200–3207.

129. Mazur A, Carleton A. Relation of ferritin iron to heme synthesis in marrow and reticulocytes. *J Biol Chem* 1963;238:1817–1824.

130. Primosigh JV, Thomas ED. Studies on the partition of iron in bone marrow cells. *J Clin Invest* 1968;47:1473–1482.

131. Deiss A, Kurth D, Cartwright GE, Wintrobe MM. Experimental production of siderocytes. *J Clin Invest* 1966;45:353–364.

132. Douglas AS, Dacie JV. The incidence and significance of iron containing granules in human erythrocytes and their precursors. *J Clin Pathol* 1953;6:307–313.

133. Bessis MC, Breton–Gorius J. Ferritin and ferruginous micelles in normal erythroblasts and hypochromic hypersideremic anemias. *Blood* 1959;14:423.

134. Fillet G, Beguin Y, Baldelli L. Model of reticuloendothelial iron metabolism in humans: abnormal behavior in idiopathic hemochromatosis and in inflammation. *Blood* 1989;74:844–851.

135. Noyes WD, Bothwell TH, Finch CA. The role of the reticuloendothelial cell in iron metabolism. *Br J Haematol* 1960;6:43–55.

136. Fleming RE, Sly WS. Ferroportin mutation in autosomal dominant hemochromatosis: loss of function, gain in understanding. *J Clin Invest* 2001;108:521–522.

137. Osaki S, Johnson DA, Frieden E. The possible significance of the ferrous oxidase activity of ceruloplasmin in normal human serum. *J Biol Chem* 1966;241:2746–2751.

138. Harris ZL, Durley AP, Man TK, Gitlin JD. Targeted gene disruption reveals an essential role for ceruloplasmin in cellular iron efflux. *Proc Natl Acad Sci U S A* 1999;96:10812–10817.

139. Uchida T, Akitsuki T, Kimura H, et al. Relationship among plasma iron, plasma iron turnover, and reticuloendothelial iron release. *Blood* 1983;61:799–802.

140. Harrison PM, Arosio P. The ferritins: molecular properties, iron storage function and cellular regulation. *Biochim Biophys Acta* 1996;1275:161–203.

141. Worwood M, Brook JD, et al. Assignment of human ferritin genes to chromosomes 11 and 19q13.3–19 qter. *Hum Genet* 1985;69:371–374.

142. Cragg SJ, Drysdale J, Worwood M. Genes for the ‘H’ subunit of human ferritin are present on a number of human chromosomes. *Hum Genet* 1985;71:108–112.

143. McGill JR, Naylor SL, Sakaguchi AY, et al. Human ferritin H and L sequences lie on ten different chromosomes. *Hum Genet* 1987;76:66–72.

144. Levi S, Luzzago A, Cesareni G, et al. Mechanism of ferritin iron uptake: activity of the H–chain and deletion mapping of the ferro–oxidase site. A study of iron uptake and ferro–oxidase activity of human liver, recombinant H–chain ferritins, and two H–chain deletion mutants. *J Biol Chem* 1988;263:18086–18092.

145. Lawson DM, Treffry A, Artymiuk PJ, et al. Identification of the ferroxidase centre in ferritin. *FEBS Lett* 1989;254:207–210.

146. Santambrogio P, Levi S, Cozzi A, et al. Production and characterization of recombinant heteropolymers of human ferritin H and L chains. *J Biol Chem* 1993;268:12744–12748.

147. Drysdale JW, Adelman TG, Arosio P, et al. Human isoferritins in normal and disease states. *Semin Hematol* 1977;14:71–88.
148. Bellotti V, Arosio P, Gazzola M, et al. Characteristics of a ferritin-binding protein present in human serum. *Br J Haematol* 1987;65:489–493.
149. Levi S, Corsi B, Bosisio M, et al. A human mitochondrial ferritin encoded by an intronless gene. *J Biol Chem* 2001;276:24437–24440.
150. Munro H. The ferritin genes: their response to iron status. *Nutr Rev* 1993;51:65–73.
151. Hentze MW, Rouault TA, et al. A cis-acting element is necessary and sufficient for translational regulation of human ferritin expression in response to iron. *Proc Natl Acad Sci U S A* 1987;84:6730–6734.
152. Lin JJ, Daniels-McQueen S, Patino MM, et al. Derepression of ferritin messenger RNA translation by hemin in vitro. *Science* 1990;247:74–77.
153. Theil EC, Takagi H, Small GW, et al. The ferritin iron entry and exit problem. *Inorganica Clinica Acta* 1999;297:242–251.
154. Bell SH, Weir MP, Dickson DP, et al. Mossbauer spectroscopic studies of human haemosiderin and ferritin. *Biochim Biophys Acta* 1984;787:227–236.
155. Weir MP, Sharp GA, Peters TJ. Electron microscopic studies of human haemosiderin and ferritin. *J Clin Pathol* 1985;38:915–918.
156. Finch CA, Deubelbeiss K, Cook JD, et al. Ferrokinetics in man. *Medicine (Baltimore)* 1970;49:17–53.
157. Fleming RE, Sly WS. Mechanisms of iron accumulation in hereditary hemochromatosis. *Annu Rev Physiol* 2002;64:663–680.
158. Roy CN, Enns CA. Iron homeostasis: new tales from the crypt. *Blood* 2000;96:4020–4027.
159. Torrance JD, Charlton RW, Schmaman A, et al. Storage iron in “muscle.” *J Clin Pathol* 1968;21:495–500.
160. Eisenstein RS. Iron regulatory proteins and the molecular control of mammalian iron metabolism. *Annu Rev Nutr* 2000;20:627–662.
161. Muckenthaler M, Gray NK, Hentze MW. IRP-1 binding to ferritin mRNA prevents the recruitment of the small ribosomal subunit by the cap-binding complex eIF4F. *Mol Cell* 1998;2:383–388.
162. Kaptain S, Downey WE, Tang C, et al. A regulated RNA binding protein also possesses aconitase activity. *Proc Natl Acad Sci U S A* 1991;88:10109–10113.
163. Constable A, Quick S, Gray NK, Hentze MW. Modulation of the RNA-binding activity of a regulatory protein by iron in vitro: switching between enzymatic and genetic function? *Proc Natl Acad Sci U S A* 1992;89:4554–4558.
164. Haile DJ, Rouault TA, Tang CK, et al. Reciprocal control of RNA-binding and aconitase activity in the regulation of the iron-responsive element binding protein: role of the iron-sulfur cluster. *Proc Natl Acad Sci U S A* 1992;89:7536–7540.
165. Samaniego F, Chin J, Iwai K, et al. Molecular characterization of a second iron-responsive element binding protein, iron regulatory protein 2. Structure, function, and post-translational regulation. *J Biol Chem* 1994;269: 30904–30910.
166. Guo B, Phillips JD, Yu Y, Leibold EA. Iron regulates the intracellular degradation of iron regulatory protein 2 by the proteasome. *J Biol Chem* 1995;270:21645–21651.
167. Iwai K, Drake SK, Wehr NB, et al. Iron-dependent oxidation, ubiquitination, and degradation of iron regulatory protein 2: implications for degradation of oxidized proteins. *Proc Natl Acad Sci U S A*

1998;95:4924–4928.

168. Ashizuka M, Fukuda T, Nakamura T, et al. Novel translational control through an iron-responsive element by interaction of multifunctional protein YB-1 and IRP2. *Mol Cell Biol* 2002;22:6375–6383.

169. Robinson SH. Increased formation of early-labeled bilirubin in rats with iron deficiency anemia: evidence for ineffective erythropoiesis. *Blood* 1969;33:909–917.

170. Cavill I, Ricketts C, Napier JA, Jacobs A. Ferrokinetics and erythropoiesis in man: red-cell production and destruction in normal and anaemic subjects. *Br J Haematol* 1977;35:33–40.

171. Loria A, Sanchez-Medal L, Lisker R, et al. Red cell life span in iron deficiency anaemia. *Br J Haematol* 1967;13:294–302.

172. Diez-Ewald M, Layrisse M. Mechanisms of hemolysis in iron deficiency anemia. Further studies. *Blood* 1968;32:884–894.

173. Macdougall LG, Judisch JM, Mistry SB. Red cell metabolism in iron deficiency anemia. II. The relationship between red cell survival and alterations in red cell metabolism. *J Pediatr* 1970;76:660–675.

174. Rasch CA, Cotton EK, Griggs RC, Harris JW. Shortened survival of autotransfused <sup>51</sup>Cr-labeled erythrocytes in infants with severe iron-deficiency anemia. *Semin Hematol* 1976;13:181–186.

175. Yip R, Mohandas N, Clark MR, et al. Red cell membrane stiffness in iron deficiency. *Blood* 1983;62:99–106.

176. Jain SK, Yip R, Hoesch RM, et al. Evidence of peroxidative damage to the erythrocyte membrane in iron deficiency. *Am J Clin Nutr* 1983;37:26–30.

177. Siimes MA, Refino C, Dallman PR. Manifestation of iron deficiency at various levels of dietary iron intake. *Am J Clin Nutr* 1980;33:570–574.

178. Hagler L, Askew EW, Neville JR, et al. Influence of dietary iron deficiency on hemoglobin, myoglobin, their respective reductases, and skeletal muscle mitochondrial respiration. *Am J Clin Nutr* 1981;34:2169–2177.

179. Dallman PR, Schwartz HC. Distribution of cytochrome c and myoglobin in rates with dietary iron deficiency. *Pediatrics* 1965;35:677–686.

180. Dallman PR, Goodman JR. Enlargement of mitochondrial compartment in iron and copper deficiency. *Blood* 1970;35:496–505.

181. Finch CA, Miller LR, Inamdar AR, et al. Iron deficiency in the rat. Physiological and biochemical studies of muscle dysfunction. *J Clin Invest* 1976;58:447–453.

182. Finch CA, Gollnick PD, Hlastala MP, et al. Lactic acidosis as a result of iron deficiency. *J Clin Invest* 1979;64:129–137.

183. Geerken RG, Gibbons RB. Lactic acidosis associated with iron deficiency anemia. *JAMA* 1972;221:292–293.

184. Wagner A, Fortier N, Giroux A, et al. Catecholamines in adult iron deficiency patients. *Experientia* 1979;35:681–682.

185. Voorhess ML, Stuart MJ, Stockman JA, Oski FA. Iron deficiency anemia and increased urinary norepinephrine excretion. *J Pediatr* 1975;86:542–547.

186. Symes AL, Sourkes TL, Youdim MB, et al. Decreased monoamine oxidase activity in liver of iron-deficient rats. *Can J Biochem* 1969;47:999–1002.

187. Youdim MB, Grahame-Smith DG, Woods HF. Some properties of human platelet monoamine oxidase in iron-deficiency anaemia. *Clin Sci Mol Med* 1976;50:479–485.



188. Oski FA. The nonhematologic manifestations of iron deficiency. *Am J Dis Child* 1979;133:315–322.
189. Dallman PR. Manifestations of iron deficiency. *Semin Hematol* 1982;19:19–30.
190. Osaki S, McDermott JA, Frieden E. Proof for the ascorbate oxidase activity of ceruloplasmin. *J Biol Chem* 1964;239:3570–3575.
191. Walshe JM. Studies on the oxidase properties of ceruloplasmin: factors in normal and Wilson's-disease serum affecting oxidase activity. *J Clin Invest* 1963;42:1048–1053.
192. Harris ED. The iron-copper connection: the link to ceruloplasmin grows stronger. *Nutr Rev* 1995;53:170–173.
193. Frazer DM, Vulpe CD, McKie AT, et al. Cloning and gastrointestinal expression of rat hephaestin: relationship to other iron transport proteins. *Am J Physiol Gastrointest Liver Physiol* 2001;281:G931–G939.
194. Bothwell TH. The diagnosis of iron deficiency. *N Z Med J* 1966;65[Suppl]: 880–883.
195. Heinrich HC. Iron deficiency without anemia. *Lancet* 1968;2:460.
196. Fielding J, O'Shaughnessy MC, Brunstrom GM. Iron deficiency without anaemia. *Lancet* 1965;2:9–12.
197. Dagg JH, Goldberg A, Lochhead A. Value of erythrocyte protoporphyrin in the diagnosis of latent iron deficiency (sideropenia). *Br J Haematol* 1966;12:326–330.
198. Koller ME, Romslo I, Finne PH, et al. The diagnosis of iron deficiency by erythrocyte protoporphyrin and serum ferritin analyses. *Acta Paediatr Scand* 1978;67:361–366.
199. Verloop MC. Iron depletion without anemia: a controversial subject. *Blood* 1970;36:657–671.
200. Ballas SK. Normal serum iron and elevated total iron-binding capacity in iron-deficiency states. *Am J Clin Pathol* 1979;71:401–403.
201. Labbe R, Vreman H, Stevenson D. Zinc protoporphyrin: a metabolite with a mission. *Clin Chem* 1999;45:2060–2072.
202. Cook JD. The measurement of serum transferrin receptor. *Am J Med Sci* 1999;318:269–276.
203. Ploem JE, de Wael J, Verloop MC, Punt K. Sideruria following a single dose of desferrioxamine-B as a diagnostic test in iron overload. *Br J Haematol* 1966;12:396–408.
204. Conrad ME, Crosby WH. The natural history of iron deficiency induced by phlebotomy. *Blood* 1962;20:173.
205. Jacob RA, Sandstead HH, Klevay LM, Johnson LK. Utility of serum ferritin as a measure of iron deficiency in normal males undergoing repetitive phlebotomy. *Blood* 1980;56:786–791.
206. Looker AC, Dallman PR, Carroll MD, et al. Prevalence of iron deficiency in the United States. *JAMA* 1997;277:973–976.
207. Karp RJ, Haaz WS, Starko K, Gorman JM. Iron deficiency in families of iron-deficient inner-city school children. *Am J Dis Child* 1974;128:18–20.
208. Bjorn-Rasmussen E, Hallberg L, Isaksson B, Arvidsson B. Food iron absorption in man. Applications of the two-pool extrinsic tag method to measure heme and nonheme iron absorption from the whole diet. *J Clin Invest* 1974;53:247–255.
209. Cook JD, Monsen ER. Food iron absorption in human subjects. III. Comparison of the effect of animal proteins on nonheme iron absorption. *Am J Clin Nutr* 1976;29:859–867.
210. Rosenbaum R, Leonard JW. Nutritional iron deficiency anemia in an adult male. *Ann Intern Med*

1964;60:683-688.

211. Salgueiro MJ, Zubillaga M, Lysionek A, et al. Fortification strategies to combat zinc and iron deficiency. *Nutr Rev* 2002;60:52-58.

212. Skikne BS, Lynch SR, Cook JD. Role of gastric acid in food iron absorption. *Gastroenterology* 1981;81:1068-1071.

213. Adams JF. The clinical and metabolic consequences of total gastrectomy. II. Anaemia. Metabolism of iron, vitamin B12 and folic acid. *Scand J Gastroenterol* 1968;3:145-151.

214. Hallberg L, Solvell L, Zederfeldt B. Iron absorption after partial gastrectomy. A comparative study on the absorption from ferrous sulphate and hemoglobin. *Acta Med Scand Suppl* 1966;445:269-275.

215. Hines JD, Hoffbrand AV, Mollin DL. The hematologic complications following partial gastrectomy. A study of 292 patients. *Am J Med* 1967;43:555-569.

216. Moeschlin S, Schmid JR, Schnider T, Solothurn. Increased absorption of radioiron in gastrectomized patients by the addition of hydrochloric acid. *Acta Haematol (Basel)* 1965;33:200-209.

217. Cox AG, Hutchinson HE, Wardrop AJ. Blood changes eight years after vagotomy with gastrojejunostomy compared with those after polyA partial gastrectomy. *Gut* 1968;9:411-413.

218. Magnusson BE. Iron absorption after antrectomy with gastroduodenostomy. Studies on the absorption from food and from iron salt using a double radioiron isotope technique and whole-body counting. *Scand J Haematol Suppl* 1976;26:1-111.

219. Sutton DR, Stewart JS, Baird IM, Coghill NF. "Free" iron loss in atrophic gastritis, post-gastrectomy states, and adult coeliac disease. *Lancet* 1970;2:387-389.

220. Beveridge BR. Hypochromic anemia. *QJM* 1965;34:135.

221. Kilpatrick ZM, Katz J. Occult coeliac disease as a cause of iron deficiency anemia. *JAMA* 1969;208:999-1001.

222. Kosnai I, Kuitunen P, Siimes MA. Iron deficiency in children with coeliac disease on treatment with gluten-free diet. Role of intestinal blood loss. *Arch Dis Child* 1979;54:375-378.

223. Egan-Mitchell B, Fottrell PF, McNicholl B. Early or pre-coeliac mucosa: development of gluten enteropathy. *Gut* 1981;22:65-69.

224. Fleming AF. Iron deficiency in the tropics. *Clin Haematol* 1982;11:365-388.

225. Kimber C, Weintraub LR. Malabsorption of iron secondary to iron deficiency. *N Engl J Med* 1968;279:453-459.

226. Moore DF, Sears DA. Pica, iron deficiency, and the medical history. *Am J Med* 1994;97:390-393.

227. Garretson FD, Conrad ME. Starch and iron absorption. *Rev Med Liege* 1966;21:304-308.

228. Mengel CE, Carter WA, Horton ES. Geophagia with iron deficiency and hypokalemia. *Arch Intern Med* 1964;114:470-474.

229. Roselle HA. Association of laundry starch and clay ingestion with anemia in New York City. *Arch Intern Med* 1970;125:57-61.

230. Minnich V, Okcuoglu A, Tarcon Y, et al. Pica in Turkey. II. Effect of clay upon iron absorption. *Am J Clin Nutr* 1968;21:78-86.

231. Cavdar AO, Arcasoy A, Cin S, et al. Geophagia in Turkey: iron and zinc deficiency, iron and zinc absorption studies and response to treatment with zinc in geophagia cases. *Prog Clin Biol Res* 1983;129:71-97.

232. Thomas FB, Falko JM, Zuckerman K. Inhibition of intestinal iron absorption by laundry starch. *Gastroenterology* 1976;71:1028–1032.
233. Graham DY, Smith JL. Gastroduodenal complications of chronic NSAID therapy. *Am J Gastroenterol* 1988;83:1081–1084.
234. Scott JT, Porter IH, Lewis SM, Dixon ASJ. Studies of gastrointestinal bleeding caused by corticosteroids, salicylates and other analgesics. *QJM* 1961;30:167–188.
235. Jick H. Effects of aspirin and acetaminophen in gastrointestinal hemorrhage. Results from the Boston Collaborative Drug Surveillance Program. *Arch Intern Med* 1981;141:316–321.
236. Windsor CW, Collis JL. Anaemia and hiatus hernia: experience in 450 patients. *Thorax* 1967;22:73–78.
237. Cameron AJ. Incidence of iron deficiency anemia in patients with large diaphragmatic hernia. A controlled study. *Mayo Clin Proc* 1976;51:767–769.
238. Beal RW, Skyring AP, McRae MB, Firkin BG. The anemia of ulcerative colitis. *Gastroenterology* 1963;45:589–603.
239. Stephenson LS, Latham MC, Ottesen EA. Malnutrition and parasitic helminth infections. *Parasitology* 2000;121:S23–S38.
240. Stephenson LS, Holland CV, Cooper ES. The public health significance of *Trichuris trichiura*. *Parasitology* 2000;121:S73–S95.
241. Roche M, Layrissé M. The nature and causes of “hookworm anemia.” *Am J Trop Med Hyg* 1966;15:1029–1102.
242. Stoltzfus RJ, Albonico M, Chwaya HM, et al. Hemoquant determination of hookworm-related blood loss and its role in iron deficiency in African children. *Am J Trop Med Hyg* 1996;55:399–404.
243. Stephenson L. The impact of schistosomiasis on human nutrition. *Parasitology* 1993;107:S107–S123.
244. Jacobs A, Butler EB. Menstrual blood loss in iron deficiency anemia. *Lancet* 1965;2:407.
245. Hallberg L, Hogdahl AM, Nilsson L, Rybo G. Menstrual blood loss and iron deficiency. *Acta Med Scand* 1966;180:639–650.
246. Hallberg L, Hulthen L, Bengtsson C, et al. Iron balance in menstruating women. *Eur J Clin Nutr* 1995;49:200–207.
247. Beaton GH, Thein M, Milne H, Veen MJ. Iron requirements of menstruating women. *Am J Clin Nutr* 1970;23:275–283.
248. Hefnawi F, Askalani H, Zaki K. Menstrual blood loss with copper intrauterine devices. *Contraception* 1974;9:133–139.
249. Simon TL, Garry PJ, Hooper EM. Iron stores in blood donors. *JAMA* 1981;245:2038–2043.
250. Leatherman JW, Davies SF, Hoidal JR. Alveolar hemorrhage syndromes: diffuse microvascular lung hemorrhage in immune and idiopathic disorders. *Medicine (Baltimore)* 1984;63:343–361.
251. Soergel KH, Sommers SC. Idiopathic pulmonary hemosiderosis and related syndromes. *Am J Med* 1962;32:499.
252. Le Clainche L, Le Bourgeois M, Fauroux B, et al. Long-term outcome of idiopathic pulmonary hemosiderosis in children. *Medicine (Baltimore)* 2000;79:318–326.
253. Saeed MM, Woo MS, MacLaughlin EF, et al. Prognosis in pediatric idiopathic pulmonary

hemosiderosis. *Chest* 1999;116:721–725.

254. Specks U. Diffuse alveolar hemorrhage syndromes. *Curr Opin Rheumatol* 2001;13:12–17.

255. van der Ent CK, Walenkamp MJ, Donckerwolcke RA, et al. Pulmonary hemosiderosis and immune complex glomerulonephritis. *Clin Nephrol* 1995;43:339–341.

256. Hartmann RC, Jenkins DEJ, McKee LC, Heyssel RM. Paroxysmal nocturnal hemoglobinuria: clinical and laboratory studies relating to iron metabolism and therapy with androgen and iron. *Medicine (Baltimore)* 1966;45:331–363.

257. Kann HE Jr, Mengel CE, Wall RL. Paroxysmal nocturnal hemoglobinuria “obscured” by the presence of iron deficiency. *Ann Intern Med* 1967;67:593–596.

258. Reynolds RD, Coltman CA Jr, Beller BM. Iron treatment in sideropenic intravascular hemolysis due to insufficiency of Starr–Edwards valve prostheses. *Ann Intern Med* 1967;66:659–666.

259. Roeser HP, Powell LW. Urinary iron excretion in valvular heart disease and after heart valve replacement. *Blood* 1970;36:785–792.

260. Granacher RP Jr. Autovenipuncture as a cause of factitial anemia. *J Nerv Ment Dis* 1982;170:308–310.

261. Quinn JP, O’Keefe JP. Factitious anemia due to surreptitious phlebotomy through a Hickman catheter. *Ann Intern Med* 1985;102:720–721.

262. Stone DR, Duran A, Fine KC. Lab–fraud anemia. *N Engl J Med* 1988;319:727–728.

263. Ernst TN, Philp M. Severe iron deficiency anemia. An example of covert child abuse (Munchausen by proxy). *West J Med* 1986;144:358–359.

264. Peery WH. Clinical spectrum of hereditary hemorrhagic telangiectasia (Osler–Weber–Rendu disease). *Am J Med* 1987;82:989–997.

265. Adamson J, Hillman RS. Blood volume and plasma protein replacement following acute blood loss in normal man. *JAMA* 1968;205:609–612.

266. Callahan R, Edelman EB, Smith MS, Smith JJ. Study of the incidence and characteristics of blood donor “reactors.” *Transfusion* 1963;3:76–82.

267. Ruetz PP, Johnson SA, Callahan R, et al. Fainting: a review of its mechanisms and a study in blood donors. *Medicine* 1967;46:363–384.

268. Howarth S, Sharpey–Schafer EP. Low blood–pressure phases following haemorrhage. *Lancet* 1947;1:18–20.

269. Tovey GH, Tennon GG. Blood volume studies in accidental hemorrhage. *Br J Obstet Gynaecol* 1962;5:749.

270. Gann DS, Carlson DE, Byrnes GJ, et al. Impaired restitution of blood volume after large hemorrhage. *J Trauma* 1981;21:598–603.

271. Hillman RS. Characteristics of marrow production and reticulocyte maturation in normal man in response to anemia. *J Clin Invest* 1969;48:443–453.

272. Biesma DH, Van de Wiel A, Beguin Y, et al. Post–operative erythropoiesis is limited by the inflammatory effect of surgery on iron metabolism. *Eur J Clin Invest* 1995;25:383–389.

273. Smoller BR, Kruskall MS. Phlebotomy for diagnostic laboratory tests in adults. Pattern of use and effect on transfusion requirements. *N Engl J Med* 1986;314:1233–1235.

274. Eckardt KU. Pathophysiology of renal anemia. *Clin Nephrol* 2000;53:S2–S8.

275. Rosenblatt SG, Drake S, Fadem S, et al. Gastrointestinal blood loss in patients with chronic renal failure. *Am J Kidney Dis* 1982;1:232-236.
276. Goodnough LT, Skikne B, Brugnara C. Erythropoietin, iron, and erythropoiesis. *Blood* 2000;96:823-833.
277. Dang CV. Runner's anemia. *JAMA* 2001;286:714-716.
278. Nachtigall D, Nielsen P, Fischer R, et al. Iron deficiency in distance runners. A reinvestigation using Fe-labelling and non-invasive liver iron quantification. *Int J Sports Med* 1996;17:473-479.
279. Stewart JG, Ahlquist DA, McGill DB, et al. Gastrointestinal blood loss and anemia in runners. *Ann Intern Med* 1984;100:843-845.
280. McMahon LF Jr, Ryan MJ, Larson D, Fisher RL. Occult gastrointestinal blood loss in marathon runners. *Ann Intern Med* 1984;100:846-847.
281. Pisacane A. Neonatal prevention of iron deficiency. *BMJ* 1996;312:136-137.
282. Daniel DG, Weerakkody AN. Neonatal prevention of iron deficiency. Blood can be transfused from cord clamped at placental end. *BMJ* 1996;312:1102-1103.
283. Rios E, Lipschitz DA, et al. Relationship of maternal and infant iron stores as assessed by determination of plasma ferritin. *Pediatrics* 1975;55:694-699.
284. Lanzkowsky P. The influence of maternal iron deficiency anaemia on the haemoglobin of the infant. *Arch Dis Child* 1961;36:186.
285. Fletcher J, Suter PE. The transport of iron by the human placenta. *Clin Sci* 1969;36:209-220.
286. Oski FA, Stockman JA, 3rd. Anemia due to inadequate iron sources or poor iron utilization. *Pediatr Clin North Am* 1980;27:237-253.
287. Iron fortification of infant formulas. American Academy of Pediatrics. Committee on Nutrition. *Pediatrics* 1999;104:119-123.
288. Saarinen UM, Siimes MA. Iron absorption from infant milk formula and the optimal level of iron supplementation. *Acta Paediatr Scand* 1977;66:719-722.
289. Hertrampf E, Cayazzo M, Pizarro F, Stekel A. Bioavailability of iron in soy-based formula and its effect on iron nutrition in infancy. *Pediatrics* 1986;78:640-645.
290. Rios E, Hunter RE, Cook JD, et al. The absorption of iron as supplements in infant cereal and infant formulas. *Pediatrics* 1975;55:686-693.
291. Dawson JP, Desforrest JF. Dietary and storage factors in iron-deficiency anemia of infancy. *Am J Dis Child* 1958;96:169-178.
292. Jelliffe D, Blackman V. Bahima disease. *J Pediatr* 1962;61:774-779.
293. Wilson JF, Lahey ME, Heiner DC. Studies on iron metabolism. V. Further observations on cow's milk-induced gastrointestinal bleeding in infants with iron-deficiency anemia. *J Pediatr* 1974;84:335-344.
294. Wilson JF, Heiner DC, Lahey ME. Milk-induced gastrointestinal bleeding in infant with hypochromic microcytic anemia. *JAMA* 1964;189:568-572.
295. Hoag M, Wallerstein R, Pollycove M. Occult blood loss in iron deficiency anemia of infancy. *Pediatrics* 1961;27:199-203.
296. Guha DK, Walia BN, Tandon BN, et al. Small bowel changes in iron-deficiency anaemia of childhood.

Arch Dis Child 1968;43:239–244.

297. Woodruff CW, Clark JL. The role of fresh cow's milk in iron deficiency. I. Albumin turnover in infants with iron deficiency anemia. *Am J Dis Child* 1972;124:18–23.
298. Woodruff CW, Wright SW, Wright RP. The role of fresh cow's milk in iron deficiency. II. Comparison of fresh cow's milk with a prepared formula. *Am J Dis Child* 1972;124:26–30.
299. Lundstrom U, Perkkio M, Savilahti E, Siimes M. Iron deficiency anaemia with hypoproteinaemia. *Arch Dis Child* 1983;58:438–441.
300. Perkkio MV, Jansson LT, Dallman PR, et al. sIgA- and IgM-containing cells in the intestinal mucosa of iron-deficient rats. *Am J Clin Nutr* 1987;46:341–345.
301. Celada A, Busset R, Gutierrez J, Herreros V. No correlation between iron concentration in breast milk and maternal iron stores. *Helv Paediatr Acta* 1982;37:11–16.
302. Beutler E. Iron therapy in chronically fatigued non-anemic women. *Ann Intern Med* 1960;52:378.
303. Elwood PC, Waters WE, Greene WJ, et al. Symptoms and circulating haemoglobin level. *J Chronic Dis* 1969;21:615–628.
304. Elwood PC. Assessing the functional significance of anaemia. *Proc R Soc Med* 1969;62:495–496.
305. Gardner GW, Edgerton VR, Senewiratne B, et al. Physical work capacity and metabolic stress in subjects with iron deficiency anemia. *Am J Clin Nutr* 1977;30:910–917.
306. Viteri FE, Torun B. Anemia and physical work capacity. In: Garby L, ed. *Clinics in hematology*. London: WB Saunders, 1974:609–626.
307. Basta SS, Soekirman, Karyadi D, Scrimshaw NS. Iron deficiency anemia and the productivity of adult males in Indonesia. *Am J Clin Nutr* 1979;32:916–925.
308. Edgerton VR, Gardner GW, Ohira Y, et al. Iron-deficiency anaemia and its effect on worker productivity and activity patterns. *BMJ* 1979;2:1546–1549.
309. Schoene RB, Escourrou P, Robertson HT, et al. Iron repletion decreases maximal exercise lactate concentrations in female athletes with minimal iron-deficiency anemia. *J Lab Clin Med* 1983;102:306–312.
310. Rector WG Jr, Fortuin NJ, Conley CL. Non-hematologic effects of chronic iron deficiency. A study of patients with polycythemia vera treated solely with venesections. *Medicine (Baltimore)* 1982;61:382–389.
311. Glover J, Jacobs A. Activity pattern of iron-deficient rats. *BMJ* 1972;2:627–628.
312. Edgerton VR, Bryant SL, Gillespie CA, Gardner GW. Iron deficiency anemia and physical performance and activity of rats. *J Nutr* 1972;102:381–399.
313. Ohira Y, Koziol BJ, Edgerton VR, Brooks GA. Oxygen consumption and work capacity in iron-deficient anemic rats. *J Nutr* 1981;111:17–25.
314. Koziol BJ, Ohira Y, Edgerton VR, Simpson DR. Changes in work tolerance associated with metabolic and physiological adjustment to moderate and severe iron deficiency anemia. *Am J Clin Nutr* 1982;36:830–839.
315. Lozoff B, Klein NK, Nelson EC, et al. Behavior of infants with iron-deficiency anemia. *Child Dev* 1998;69:24–36.
316. Lozoff B, Brittenham GM. Behavioral alterations in iron deficiency. *Hematol Oncol Clin North Am* 1987;1:449–464.
317. Lozoff B. Behavioral alterations in iron deficiency. *Adv Pediatr* 1988;35:331–359.

318. Lozoff B. Iron deficiency and infant development. *J Pediatr* 1994;125:577–578.
319. Oski FA, Honig AS, Helu B, Howanitz P. Effect of iron therapy on behavior performance in nonanemic, iron-deficient infants. *Pediatrics* 1983;71:877–880.
320. Lozoff B. Perinatal iron deficiency and the developing brain. *Pediatr Res* 2000;48:137–139.
321. Grantham-McGregor S, Ani C. A review of studies on the effect of iron deficiency on cognitive development in children. *J Nutr* 2001;131:649S–666S; discussion 666S–668S.
322. Massaro TF, Widmayer P. The effect of iron deficiency on cognitive performance in the rat. *Am J Clin Nutr* 1981;34:864–870.
323. Martinez-Torres C, Cubeddu L, Dillmann E, et al. Effect of exposure to low temperature on normal and iron-deficient subjects. *Am J Physiol* 1984;246:R380–R383.
324. Dillman E, Gale C, Green W, et al. Hypothermia in iron deficiency due to altered triiodothyronine metabolism. *Am J Physiol* 1980;239:R377–R381.
325. Yager J, Hartfield D. Neurologic manifestations of iron deficiency in childhood. *Pediatr Neurol* 2002;27:85–92.
326. Chisholm M. Tissue changes associated with iron deficiency. *Clin Haematol* 1973;2:303–321.
327. Chisholm M, Ardran GM, Callender ST, Wright R. Iron deficiency and autoimmunity in post-cricoid webs. *QJM* 1971;40:421–433.
328. Hogan GR, Jones B. The relationship of koilonychia and iron deficiency in infants. *J Pediatr* 1970;77:1054–1057.
329. Jacobs A, Cavill I. The oral lesions of iron deficiency anaemia: pyridoxine and riboflavin status. *Br J Haematol* 1968;14:291–295.
330. Ekberg O, Malmquist J, Lindgren S. Pharyngo-oesophageal webs in dys-phageal patients. A radiologic and clinical investigation in 1134 patients. *ROFO Fortschr Geb Rontgenstr Nuklearmed* 1986;145:75–80.
331. Khosla SN. Cricoid webs—incidence and follow-up study in Indian patients. *Postgrad Med J* 1984;60:346–348.
332. Chisholm M, Ardran GM, Callender ST, Wright R. A follow-up study of patients with post-cricoid webs. *QJM* 1971;40:409–420.
333. Jacobs A, Lawrie JH, Entwistle CC, Campbell H. Gastric acid secretion in chronic iron-deficiency anaemia. *Lancet* 1966;2:190–192.
334. Brock JH, Mulero V. Cellular and molecular aspects of iron and immune function. *Proc Nutr Soc* 2000;59:537–540.
335. Jurado RL. Iron, infections and anemia of inflammation. *Clin Infect Dis* 1997;25:888–895.
336. Ward CG, Bullen JJ, Rogers HJ. Iron and infection: new developments and their implications. *J Trauma* 1996;41:356–364.
337. Kuvibidila S, Dardenne M, Savino W, Lepault F. Influence of iron-deficiency anemia on selected thymus functions in mice: thymulin biological activity, T-cell subsets, and thymocyte proliferation. *Am J Clin Nutr* 1990;51:228–232.
338. Chandra RK. Reduced bactericidal capacity of polymorphs in iron deficiency. *Arch Dis Child* 1973;48:864–866.
339. Chandra RK, Saraya AK. Impaired immunocompetence associated with iron deficiency. *J Pediatr*



1975;86:899–902.

340. Yetgin S, Altay C, Ciliz G, Laleli Y. Myeloperoxidase activity and bactericidal function of PMN in iron deficiency. *Acta Haematol* 1979;61:10–14.

341. Dallman PR. Iron deficiency and the immune response. *Am J Clin Nutr* 1987;46:329–334.

342. Murakawa H, Bland CE, Willis WT, Dallman PR. Iron deficiency and neutrophil function: different rates of correction of the depressions in oxidative burst and myeloperoxidase activity after iron treatment. *Blood* 1987;69:1464–1468.

343. Coltman CA Jr. Pagophagia and iron lack. *JAMA* 1969;207:513–516.

344. Reynolds RD, Binder HJ, Miller MB, et al. Pagophagia and iron deficiency anemia. *Ann Intern Med* 1968;69:435–440.

345. Crosby WH. Pica. *JAMA* 1976;235:2765.

346. Crosby WH. Food pica and iron deficiency. *Arch Intern Med* 1971;127:960–961.

347. Tunnessen WW, Smith C, Oski FA. Beeturia. A sign of iron deficiency. *Am J Dis Child* 1969;117:424–426.

348. Watts AR, Lennard MS, Mason SL, et al. Beeturia and the biological fate of beetroot pigments. *Pharmacogenetics* 1993;3:302–311.

349. Aksoy M, Camli N, Erdem S. Roentgenographic bone changes in chronic iron deficiency anemia. A study in twelve patients. *Blood* 1966;27:677–686.

350. Lanzkowsky P. Radiological features of iron–deficiency anemia. *Am J Dis Child* 1968;116:16–29.

351. Brugnara C, Zurakowski D, DiCanzio J, et al. Reticulocyte hemoglobin content to diagnose iron deficiency in children. *JAMA* 1999;281:2225–2230.

352. Bessman JD, Feinstein DI. Quantitative anisocytosis as a discriminant between iron deficiency and thalassemia minor. *Blood* 1979;53:288–293.

353. Bessman JD, Gilmer PR Jr, Gardner FH. Improved classification of anemias by MCV and RDW. *Am J Clin Pathol* 1983;80:322–326.

354. Hicsonmez G, Suzer K, Suloglu G, Donmez S. Platelet counts in children with iron deficiency anemia. *Acta Haematol* 1978;60:85–89.

355. Hill RS, Pettit JE, Tattersall MH, et al. Iron deficiency and dyserythropoiesis. *Br J Haematol* 1972;23:507–512.

356. Punnonen K, Irjala K, Rajamaki A. Serum transferrin receptor and its ratio to ferritin in the diagnosis of iron deficiency. *Blood* 1997;89:1052–1057.

357. Cook JD, Baynes RD, Skikne BS. The physiological significance of circulating transferrin receptors. *Adv Exp Med Biol* 1994;352:119–126.

358. Cook JD, Marsaglia G, Eschbach JW, et al. Ferrokinetics: a biologic model for plasma iron exchange in man. *J Clin Invest* 1970;49:197–205.

359. Cazzola M, Huebers HA, Sayers MH, et al. Transferrin saturation, plasma iron turnover, and transferrin uptake in normal humans. *Blood* 1985;66:935–939.

360. Cazzola M, Pootrakul P, Huebers HA, et al. Erythroid marrow function in anemic patients. *Blood* 1987;69:296–301.

361. Grebe G, Martinez–Torres C, Layrisse M. Effect of meals and ascorbic acid on the absorption of a

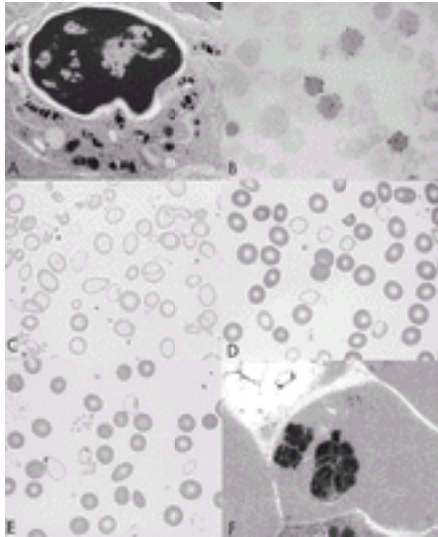
- therapeutic dose of iron as ferrous and ferric salts. *Curr Ther Res Clin Exp* 1975;17:382-97.
362. Crosby WH. The rationale for treating iron deficiency anemia. *Arch Intern Med* 1984;144:471-472.
363. Hallberg L, Ryttinger L, Solvell L. Side-effects of oral iron therapy. A double-blind study of different iron compounds in tablet form. *Acta Med Scand Suppl* 1966;459:3-10.
364. Callender ST. Quick- and slow-release iron: a double-blind trial with a single daily dose regimen. *BMJ* 1969;4:531-532.
365. Baird IM, Walters RL, Sutton DR. Absorption of slow-release iron and effects of ascorbic acid in normal subjects and after partial gastrectomy. *BMJ* 1974;4:505-508.
366. Geisser P, Baer M, Schaub E. Structure/histotoxicity relationship of parenteral iron preparations. *Arzneimittelforschung* 1992;42:1439-1452.
367. Auerbach M, Witt D, Toler W, et al. Clinical use of the total dose intravenous infusion of iron dextran. *J Lab Clin Med* 1988;111:566-570.
368. Fishbane S, Kowalski EA. The comparative safety of intravenous iron dextran, iron saccharate, and sodium ferric gluconate. *Semin Dial* 2000;13:381-384.
369. Van Wyck DB, Cavallo G, Spinowitz BS, et al. Safety and efficacy of iron sucrose in patients sensitive to iron dextran: North American clinical trial. *Am J Kidney Dis* 2000;36:88-97.
370. Fielding J. Does sarcoma occur in man after intramuscular iron? *Scand J Haematol Suppl* 1977;32:100-104.
371. Hamstra RD, Block MH, Shocket AL. Intravenous iron dextran in clinical medicine. *JAMA* 1980;243:1726-1731.
372. Becker CE, MacGregor RR, Walker KS, Jandl JH. Fatal anaphylaxis after intramuscular iron-dextran. *Ann Intern Med* 1966;65:745-748.
373. Cimmino MA, Parisi M, Querci G, et al. Intravenous iron is effective in treating the anaemia of rheumatoid arthritis and is not associated with flares of synovitis. *Clin Rheumatol* 1997;16:215-216.
374. Kaltwasser JP, Kessler U, Gottschalk R, et al. Effect of recombinant human erythropoietin and intravenous iron on anemia and disease activity in rheumatoid arthritis. *J Rheumatol* 2001;28:2430-2436.
375. Beaton GH. Iron needs during pregnancy: do we need to rethink our targets? *Am J Clin Nutr* 2000;2:265S-271S.
376. Haram K, Nilsen ST, Ulvik RJ. Iron supplementation in pregnancy—evidence and controversies. *Acta Obstet Gynecol Scand* 2001;80:683-688.
377. Schiødt E. Observations on blood regeneration in man. II. The influence of sex, age, form of hemorrhage, treatment and complications on erythrocyte regeneration after hematemeses and melena from peptic ulcer. *Am J Med Sci* 1937;193:327-336.
378. Schiødt E. Observations on blood regeneration in man. I. The rise in erythrocytes in patients with hematemeses of melena from peptic ulcer. *Am J Med Sci* 1937;193:313-327.
379. Schiødt E. Observations on blood regeneration in man. III. The rise in reticulocytes in patients with hematemeses or anemia from peptic ulcer. *Am J Med Sci* 1938;196:632-641.
380. Greengard J, McEnery JT. Iron poisoning in children. *GP* 1968;37:88-93.
381. Whitten CF, Brough AJ. The pathophysiology of acute iron poisoning. *Clin Toxicol* 1971;4:585-595.
382. Aisen P, Cohen G, Kang JO. Iron toxicosis. *Int Rev Exp Pathol* 1990;31:1-46.

383. Mills KC, Curry SC. Acute iron poisoning. *Emerg Med Clin North Am* 1994;12:397-413.
384. McGuigan MA. Acute iron poisoning. *Pediatr Ann* 1996;25:33-38.
385. Morris CC. Recent trends in pediatric iron poisonings. *South Med J* 2000;93:1229.
386. Wallack MK, Winkelstein A. Acute iron intoxication in an adult. *JAMA* 1974;229:1333-1334.

2004 Lippincott Williams & Wilkins  
John P. Greer, John Foerster, John N. Lukens  
George M. Rodgers, Frixos Paraskevas, Bertil Glader  
Wintrobe's Clinical Hematology

HISTORICAL ASPECTSHEME SYNTHESIS IN ERYTHROID CELLSHEREDITARY SIDEROBLASTIC ANEMIASHereditary Patterns and PathogenesisClinical and Laboratory FeaturesTreatment and PrognosisACQUIRED IDIOPATHIC SIDEROBLASTIC ANEMIAEtiology and PathogenesisClinical FeaturesLaboratory FindingsTreatment and PrognosisREVERSIBLE SIDEROBLASTIC ANEMIASAlcoholismDrugsCopper DeficiencyHypothermiaDISORDERS OF ERYTHROID HEME SYNTHESIS WITHOUT RING SIDEROBLASTSAnemia of Lead PoisoningCertain PorphyrriasMiscellaneousREFERENCES

The sideroblastic anemias are a heterogeneous group of disorders (<sup>1</sup>, <sup>2</sup>) with the unique characteristic of amorphous iron deposits in erythroblast mitochondria (<sup>3</sup>, <sup>4</sup> and <sup>5</sup>) ( [Fig. 29.1A](#)) that are housed within a distinct, mitochondrial ferritin (<sup>6</sup>, <sup>7</sup>). The iron-laden mitochondria often assume a perinuclear distribution, particularly in the later stages of erythroblast maturation, and account for the so-called ring sideroblast, a nucleated red cell in which large Prussian blue-positive granules form a full or partial ring around the nucleus ( [Fig. 29.1B](#)).



**Figure 29.1.** Morphologic features of sideroblastic anemia. **A:** Electron micrograph of an erythroblast with iron-laden mitochondria. **B:** Bone marrow smear (Prussian blue stain) with ring sideroblasts. **C,D:** Blood smears (Wright stain) of severe and mild sideroblastic anemia. **E:** Siderocytes (Wright stain). **F:** Electron micrograph of a Pappenheimer body in a peripheral red blood cell. See [Color Plate](#).

The basis for the mitochondrial iron accumulation in the various sideroblastic anemias is considered to be insufficient generation of heme as a result of decreased production of protoporphyrin or impaired incorporation of iron into protoporphyrin in the erythroid cell, creating an imbalance between mitochondrial iron import and its utilization ([8](#)). Globin synthesis is also impaired, but this effect is secondary as it can be corrected *in vitro* by the addition of heme ([9](#), [10](#)). Iron delivery to the erythroid cell is not down-regulated in the face of the diminished heme synthesis, and iron continues to be transported normally to mitochondria, where it accumulates ([11](#), [12](#)).

Kinetically, the sideroblastic anemias are characterized by ineffective erythropoiesis, like other erythroid disorders with defective cytoplasmic or nuclear maturation ([13](#), [14](#), [15](#), [16](#) and [17](#)). Erythroid hyperplasia of the bone marrow is accompanied by a normal or only slightly increased reticulocyte count. The plasma iron turnover rate is increased, but iron incorporation into circulating red cells is reduced. Red cell survival, as measured with the usual random labels (see [Chapter 9](#)), tends to be normal or slightly reduced. Slight hyperbilirubinemia may be noted, as well as an increase in urobilinogen excretion, as a result of a raised erythropoietic component of the “early-label” bilirubin peak ([18](#)). Thus, it can be inferred that a substantial proportion of the developing ring sideroblasts are nonviable, and their destruction through enhanced apoptotic mechanisms within the marrow ([19](#), [20](#) and [21](#)) accounts for the kinetic abnormalities.

The progeny of the ring sideroblasts are hypochromic and microcytic erythrocytes, a finding that provides morphologic evidence of impaired hemoglobin formation as well as the initial clue to the diagnosis. The degree of hypochromia and microcytosis varies considerably from one form of sideroblastic anemia to another ([Fig. 29.1C](#) and [Fig. 29.1D](#)). Often, dimorphism is pronounced, with a hypochromic/microcytic population of cells existing side by side with a normal or even a macrocytic one; this morphologic heterogeneity may also be evident in a distinctive bimodal erythrocyte distribution in the Coulter cell volume distribution curve. The siderotic mitochondria of the developing cell may be retained in some circulating erythrocytes (Pappenheimer bodies) and are regularly found with concomitant hypofunction or absence of the spleen; these cells are the nearly

pathognomonic siderocytes in the Wright–stained blood smear ( [22](#), [23](#) ) ( [Fig. 29.1E](#) and [Fig. 29.1F](#) ).

A constant feature of those sideroblastic anemias that are not reversible is an excess of total body iron. The serum iron concentration is increased, often to the point of complete saturation of transferrin, and the level of serum ferritin roughly reflects the degree of iron overload. The ineffective erythropoiesis mediates, in an unknown manner, increased intestinal absorption of iron ( [24](#), [25](#) and [26](#) ). The consequent iron overload state is called *erythropoietic hemochromatosis*, and its clinical and pathologic features and course are for the most part indistinguishable from those of hereditary hemochromatosis ( [27](#), [28](#) ) (see [Chapter 30](#) ). The concomitant presence of an allele(s) for hereditary hemochromatosis likely accentuates the iron overload ( [29](#), [30](#) and [31](#) ), but its prevalence in patients with sideroblastic anemia does not appear to be greater than in the general population ( [28](#), [32](#), [33](#), [34](#) and [35](#) ).

Diverse mechanisms impairing erythroid heme synthesis are reflected in the various forms of sideroblastic anemia ( [Table 29.1](#) ), whether inherited or acquired. Within the hereditary group, X–linked transmission is the most frequent. In several kindreds, the disorder appeared to be inherited as an autosomal trait, and an increasing number of sporadic congenital cases are being found in children as well as in adults without other affected family members. Acquired sideroblastic anemia is more common than the inherited forms and occurs as a primary erythropoietic disorder or in association with myelodysplastic or myeloproliferative diseases. Several diverse factors, such as ethanol, certain drugs, copper deficiency, and hypothermia, produce a ring sideroblast abnormality that is fully reversible.

**TABLE 29.1. Classification of the Sideroblastic Anemias (SAs)**

---

|   |
|---|
| Hereditary SA   |
| X–linked (XLSA)   |
| X–linked with ataxia (XLSA/A)   |
| Presumed autosomal  |
| Sporadic congenital   |
| Associated with erythropoietic protoporphyria                                     |
| Associated with thiamine–responsive megaloblastic anemia (TRMA)                   |
| Associated with mitochondrial cytopathy (Pearson syndrome)                        |
| Acquired idiopathic SA (AISA)   |
| Pure sideroblastic anemia (PSA)   |
| Refractory anemia with ring sideroblasts (RARS)                                   |
| Associated with hematologic malignancies, myeloproliferative disorders            |
| Reversible—associated with  |
| Alcoholism  |
| Certain drugs (isoniazid, chloramphenicol)  |
| Copper deficiency (nutritional, copper chelation, ? malabsorption, zinc toxicity) |
| Hypothermia   |

---

## HISTORICAL ASPECTS

Various clinical and morphologic features that characterize the sideroblastic anemias were described separately before their true relationship to these disorders was realized. Cooley reported the first family with X-linked hypochromic microcytic anemia in 1945 (36), recognizing its differentiating features from those of thalassemia, which he had described in 1925. In the following year, Rundles and Falls reported additional findings in the same family as well as in a second kindred (37). After spontaneous pyridoxine-responsive anemia was reported by Harris and colleagues in 1956 (38), a member of the family first described by Cooley was also shown to respond to pyridoxine administration (39). Many reports of familial and nonfamilial cases of pyridoxine-responsive anemia followed thereafter (13, 14). The first patients (three brothers) said to have responded to pyridoxine, however, were given the vitamin during the 1940s (40).

Iron-positive granules in erythroblasts, including their perinuclear distribution, were described in 1947 (41, 42). They were first associated with acquired sideroblastic anemia by Bjorkman (43) and were later also recognized as a constant finding in hereditary hypochromic microcytic anemia and in pyridoxine-responsive anemia (1, 25, 44). Electron microscopic studies revealed that the siderotic granules represented iron deposits in erythroblast mitochondria (3). Soon, ring sideroblasts were detected in numerous patients with refractory anemia of unknown cause, hereditary or acquired, and these observations formed the basis of a symposium in 1965, at which time the term *sideroblastic anemia* was adopted (1). By then, the iron overload of these disorders had also become fully appreciated (25, 45, 46).

The occurrence of sideroblastic anemia in patients receiving antituberculous agents with antipyridoxine properties indicated that erythroid heme synthesis can be impaired by depletion of active forms of vitamin B<sub>6</sub> in humans (47, 48). The condition was then reproduced experimentally in animals (49, 50). The spectrum of reversible sideroblastic anemia was widened further when other agents such as chloramphenicol (51) and alcohol (52) were found to produce it.

Investigations during the last three decades have defined the subcellular sites in which derangements impair the synthesis of erythroid heme in several sideroblastic anemia states. These include decreased production of 5-aminolevulinate (ALA) caused by mutant erythroid ALA synthase or by impaired metabolism of vitamin B<sub>6</sub>; mitochondrial dysfunction of genetic, nutritional, and toxic causes; and clonal hematopoietic disorders in which the basis for the faulty heme synthesis remains least understood.

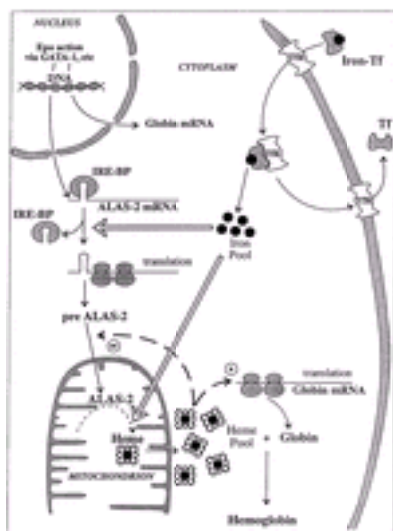
## HEME SYNTHESIS IN ERYTHROID CELLS

Characterization of the cellular and molecular biology of the sideroblastic anemia syndromes is facilitated by evolving insights concerning the synthesis of heme in erythroid tissue. Developing erythroid cells have the greatest requirement of any cell type for heme for hemoglobin, and they produce more than 80% of the heme in the body. The expression and regulation of erythroid heme synthesis are unique in that they are linked (a) to the differentiation events after the action of erythropoietin when erythroid precursors acquire the machinery for hemoglobin synthesis, (b) to the availability of iron, and (c) to the production of globin during development of the red cell. As in hepatocytes, ALA synthase and porphobilinogen (PBG) deaminase have considerably lower relative activities than the remaining enzymes in the heme biosynthetic pathway (see [Chapter 7](#))



and are sites of pathway regulation ( [53](#) ). In contrast to the liver, the relative activity of ferrochelatase, the terminal enzyme in the pathway, appears also to be low in erythroid cells ( [53](#) ). Furthermore, developing red cells express erythroid-specific isozymes or messenger RNA (mRNA) transcripts of the first four enzymes of heme synthesis, namely ALA synthase, ALA dehydratase, PBG deaminase, and uroporphyrinogen III synthase.

ALA synthase is synthesized in the cytosol as a precursor protein with an *N*-terminal signal sequence that is proteolytically cleaved and processed on transport of the protein into the mitochondrial matrix ( [54](#), [55](#) ). The mature mitochondrial protein catalyzes the formation of ALA from glycine and succinyl coenzyme A (CoA) and requires pyridoxal 5'-phosphate (PLP) as a cofactor. Two separate genes encode the ALA synthase isoenzymes ( [56](#), [57](#), [58](#) and [59](#) ). The housekeeping gene ( *ALAS1* ), located on chromosome 3 ( [56](#), [58](#), [60](#) ), is expressed ubiquitously ( [61](#) ), whereas the erythroid-specific gene ( *ALAS2* ) is on the X chromosome ( [57](#), [58](#), [62](#), [63](#) ). Expression of the housekeeping gene, at least in hepatocytes, is increased by certain steroids, various drugs, and chemicals and is repressed by administration of heme, the end product of the pathway, so that heme levels tightly regulate transcription of its mRNA in a feedback manner ( [61](#) ). Expression of the erythroid gene is essential for hemoglobin production, and *ALAS1* cannot compensate for *ALAS2* deficiency ( [64](#), [65](#) and [66](#) ). It is activated and transcribed in concert with other erythroid genes through the action of erythropoietin on erythroid transcription factors ( [54](#), [61](#) ) ( [Fig. 29.2](#) ); it is not repressed by heme but is up-regulated by hypoxia ( [67](#) ). Cellular iron levels may also control *ALAS2* mRNA expression or stability ( [68](#) ), whereas heme may inhibit translation of *ALAS2* mRNA ( [69](#) ), although the mechanisms by which these occur are not known. In addition, the erythroid ALA synthase mRNA, but not the housekeeping form, has in its 5' untranslated region a *cis*-acting iron-responsive element (IRE) ( [70](#), [71](#) ), so that cellular iron status modulates translation of the enzyme ( [72](#), [73](#) and [74](#) ) and thus its activity ( [Fig. 29.2](#) ), analogous to the regulation of apoferritin synthesis by iron ( [75](#) ). A candidate cytosolic IRE-binding protein in the erythroid cell may be ferrochelatase, which possesses an iron-sulfur cluster ( [76](#), [77](#) ) and binds to the IRE of *ALAS2* ( [78](#) ), analogous to the IRE-binding protein cytosolic aconitase ( [79](#) ). Thus, protoporphyrin production can be coupled to iron availability for the formation of heme. The low ALA synthase activity observed in erythroid cells in iron deficiency is consistent with such a control mechanism ( [80](#), [81](#) ). In addition, cellular levels of heme may influence mitochondrial import of ALA synthase in erythroid cells ( [Fig. 29.2](#) ) as in hepatocytes, in that the signal sequence of the *ALAS2* precursor protein contains the two heme-binding motifs implicated in regulating translocation of ALA synthase isozymes into mitochondria ( [82](#) ), and heme interacts with these motifs ( [83](#) ). Within the mitochondrion, the *ALAS2* isoform uniquely associates with the succinyl CoA synthetase  $\beta$ A subunit, seemingly to stabilize the *ALAS2*, to control the generation of its substrate succinyl CoA, or both ( [84](#) ).



**Figure 29.2.** The postulated regulation of erythroid 5-aminolevulinate synthase (ALAS2). Epo, erythropoietin; IRE-BP, iron-responsive element-binding protein; mRNA, messenger RNA; Tf, transferrin; TfR, transferrin receptor; [circled dash] denotes inhibition; [circled plus] denotes stimulation. (Modified from May BK, Dogra SC, Sadlon TJ, et al. Molecular regulation of heme biosynthesis in higher vertebrates. *Prog Nucleic Acid Res Mol Biol* 1995;51:1-51.)

For ALA dehydratase, a cytosolic enzyme, two tissue-specific isozymes are produced by a single gene, which contains two promoter regions, generating housekeeping and erythroid-specific transcripts with alternative first noncoding exons (exons 1A and 1B) ( [85](#) [86](#) ). Although both transcripts encode identical polypeptides, the erythroid-regulated form would provide for the production of the large amounts of heme for hemoglobin. Not being a rate-limiting enzyme for heme biosynthesis, its expression in erythroid cells in manifold excess amounts ( [53](#) ) may also serve as the proteasome inhibitor CF-2 to inhibit protein (hemoglobin) degradation ( [87](#) ).

In the case of PBG deaminase, which acts in the cytosol to form the linear tetrapyrrole hydroxymethylbilane from four molecules of PBG (see [Chapter 7](#) ), two tissue-specific isoenzymes also are produced by a single gene. The gene has two overlapping transcription units, each with its own promoter: an upstream ubiquitous promoter and another downstream promoter active only in erythroid cells ( [88](#) ). Two mRNAs are generated by alternative splicing, one encoding the PBG deaminase isoenzyme found in all cells and the other encoding the isoenzyme found only in erythroid cells. To what extent the erythroid-specific enzyme has a regulatory role in the overall production of heme in erythroid cells is not known. In response to erythropoietin or hypoxia, bone marrow PBG deaminase activity increased 3.5-fold, apparently by *de novo* synthesis, whereas the steady-state activity of ALA synthase and ferrochelatase was not significantly affected ( [89](#) ). Further regulation of this enzymatic step may occur through PBG oxygenase, which oxidizes PBG to 5-oxopyrrolines ( [90](#) , [91](#) ).

The gene for uroporphyrinogen III synthase likewise has two promoters generating housekeeping and erythroid-specific transcripts with unique 5'-untranslated sequences (exons 1 and 2A) ( [92](#) ). As for ALA dehydratase and PBG deaminase, the erythroid-promoter activity is increased during erythroid differentiation.

After translation, all three terminal enzymes of heme biosynthesis (coproporphyrinogen

oxidase, protoporphyrinogen oxidase, ferrochelatase), like ALA synthase, are transported to their mitochondrial sites of action. Single genes encode these enzymes, and erythroid-specific transcription products are not known for them. However, erythroid-specific regulation of their expression is accommodated by the presence of promoter sequences in their genes for binding of erythroid transcription factors (e.g., GATA-1, NFE-2) ( [93](#), [94](#) and [95](#) ) to enhance production of these enzymes during erythropoiesis ( [96](#) ). Ferrochelatase, the last enzyme of the heme synthetic pathway, catalyzes the insertion of iron into protoporphyrin to form heme. A repressor sequence in the promoter region of its gene is believed to be involved in the regulation of the binding of the erythroid transcription factors GATA-1 and NFE-2 to their recognition sites ( [95](#) ). The activity of this enzyme relative to the activity of ALA synthase is in considerable excess ( [53](#), [97](#) ) and is known to become rate-limiting only as a defective protein in hereditary protoporphyria (see [Chapter 31](#) ). Uroporphyrinogen decarboxylase, the fifth enzyme of the pathway with its site of action in the cytosol, is not known to have erythroid-regulatory features.

The large amounts of iron required for erythroid heme synthesis are delivered through transferrin receptor-mediated endocytosis of iron-transferrin (see [Chapter 28](#) ), and iron availability ultimately limits the normal rate of heme synthesis in erythroid cells ( [98](#) ). High expression of transferrin receptors is also linked to erythropoietin-induced differentiation ( [61](#), [98](#) ), as well as to translational modulation by erythropoietin ( [99](#) ). Moreover, an erythroid-specific isoform of human transferrin receptor has been described ( [100](#) ), and erythroid-active elements have been identified in the promoter of the murine gene ( [101](#), [102](#) ). With erythroid maturation and the accumulation of cellular hemoglobin, the transferrin receptor number progressively decreases ( [98](#) ). Transferrin receptors and iron uptake are increased in iron-deficient erythroblasts ( [103](#), [104](#) ) but are not altered in states of impaired heme synthesis, such as in the presence of succinylacetone ( [105](#) ) or in erythroid cells from patients with sideroblastic anemia ( [11](#) ). High levels of heme, if such occur, appear to block iron release from transferrin after endocytosis ( [98](#) ). How the transfer of iron to mitochondria and to apoferritin is accomplished and regulated is not understood. A transient mitochondrion-endosome interaction may be involved in iron translocation to ferrochelatase ( [106](#) ).

The molecular events coordinating the production of globin chains with the rate of heme synthesis may occur at more than one level. Heme is required for initiation of globin mRNA translation and acts by inhibiting a protein kinase that inactivates the translational initiation factor 2 (eIF-2a) ( [107](#) ) ( [Fig. 29.2](#) ). Heme also appears to be necessary for the induction of globin synthesis during erythroid differentiation ( [108](#) ), and findings of several studies indicate that heme affects globin production at the transcriptional level ( [109](#), [110](#) and [111](#) ).

## HEREDITARY SIDEROBLASTIC ANEMIAS

Inherited sideroblastic anemias are emerging as more common disorders than was previously believed and are clinically and genetically heterogeneous ( [Table 29.2](#) ). From descriptions of numerous families and of isolated cases that have been detected soon after birth or in early life, varied patterns of inheritance are apparent and indicate a spectrum of fundamental defects. Within the hereditary categories, severity of the anemia is also highly variable.

**TABLE 29.2. Genetic and Hematologic Features of the Hereditary Sideroblastic Anemias**

|   | Mode of Inheritance | Defective Enzyme/Protein       | Gene/Chromosomal Location of Gene | Erythrocyte Mean Corpuscular Volume |
|---|---------------------|--------------------------------|-----------------------------------|-------------------------------------|
| X-linked sideroblastic anemia             | X-linked            | ALAS2                          | <i>ALAS2</i> /Xp11.21             | Decreased <sup>a</sup>              |
| X-linked sideroblastic anemia with ataxia | X-linked            | ABC7 mitochondrial transporter | <i>ABC7</i> /Xq13.1–q13.3         | Decreased                           |
| Hereditary                                | Autosomal           | ?                              | ?                                 | Decreased                           |
| Hereditary <sup>b</sup>                   | Maternal            | ?                              | ?                                 | Increased                           |
| Congenital                                | Sporadic            | ?                              | ?                                 | Decreased                           |
| Thiamine-responsive megaloblastic anemia  | Autosomal           | Thiamine transporter           | <i>SLC19A2</i> /1q23.3            | Increased                           |
| Pearson syndrome                          | Sporadic/maternal   | Respiratory chain components   | Multiple/mitochondrial DNA        | Increased                           |

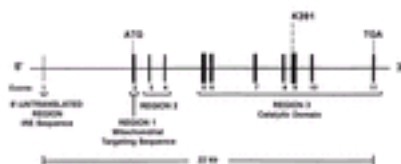
<sup>a</sup> Often normal or increased in females expressing the disorder.

<sup>b</sup> One family reported (reference [220](#)).

### Hereditary Patterns and Pathogenesis

**X-LINKED SIDEROBLASTIC ANEMIA** In many kindreds with sideroblastic anemia, inheritance is consistent with an X-linked pattern ([36](#), [37](#), [112](#), [113](#), [114](#), [115](#), [116](#), [117](#) and [118](#)). The anemia occurs primarily in males and their maternal uncles and cousins. Minimal expression of the erythroid abnormality is frequent but not uniform in carrier females and is consistent with variable X inactivation affecting the mutant locus of the disorder. However, in some kindreds, the anemia has occurred only in females and may have been lethal in hemizygous male conceptions ([115](#), [119](#), [120](#), [121](#) and [122](#)). Several earlier observations had implicated defects in ALA synthase as underlying the impaired heme biosynthesis in this form of sideroblastic anemia. In patients who respond to pyridoxine supplement, the incorporation of glycine, but not of ALA, into heme is reduced in reticulocytes ([40](#)). ALA synthase activity in bone marrow may be low before pyridoxine administration and returns to normal or supranormal levels after an erythropoietic response ([117](#), [123](#), [124](#) and [125](#)). Presumably, residual activity or stability of a defective erythroid ALA synthase is enhanced by additional supply of its coenzyme PLP [e.g., if the enzyme has a reduced affinity for the coenzyme ([124](#)) or is abnormally sensitive to proteolysis ([123](#))]. In two individuals, one-half the normal levels of erythroid ALA synthase mRNA were observed, whereas levels of the housekeeping ALA synthase mRNA were increased severalfold, perhaps in response to low levels of cellular heme, and contributing to the associated increased enzyme activity observed ([125](#)). Although the disorder closely

resembles the experimental anemia of vitamin B<sub>6</sub> deprivation (49, 50, 126, 127), no dietary lack or altered metabolism of the vitamin is evident; usually, pharmacologic amounts of pyridoxine are required when an erythropoietic response occurs, but the response is variable and rarely complete. Not infrequently, individuals have presented with profound anemia only in adulthood or even late in life (117, 128, 129 and 130), suggesting that the disorder may progress with time. In some cases, prior additional dietary or medicinal intake of pyridoxine (131), possible changes in pyridoxine metabolism with advancing age (132), or initiation of hemodialysis (133, 134) can be factors in unmasking mild phenotypes that were not symptomatic at younger age. In female patients, skewed lyonization in hematopoietic tissue related to age (135), if leading to progressive inactivation of the X chromosome bearing the normal *ALAS2* allele, seems to play a significant role when symptomatic anemia develops in adulthood (122) or late in life (136). After the cloning and characterization of the erythroid ALA synthase gene (70, 137) (Fig. 29.3) and its localization to the X chromosome, linkage of the disorder to the *ALAS2* locus was established (117, 138), and many heterogeneous missense mutations involving invariant or highly conserved amino acid residues in the catalytic domain of the enzyme have been found to cause the disorder (Table 29.3). A nonsense mutation in one case (122) and a recently identified mutation in the promoter region of the *ALAS2* gene (415) have been the exceptions. Hence, in at least four families described up to 58 years ago (36, 112, 116, 157), the underlying molecular defect in *ALAS2* could also be defined (31, 142, 151, 152). The majority of mutations identified to date reside in exon 9, which contains the PLP-binding lysine (K391) of the enzyme (158), although mutations are also frequent in exon 5 (Table 29.3). However, among the 40 distinct mutations so far encountered, only seven occurred in more than one unrelated family or proband. Sites of mutations and severity of anemia or extent of its responsiveness to pyridoxine supplements are not readily correlated. Moreover, marked variation in severity of anemia has been noted between some kindreds bearing the same mutation (Table 29.3) as well as among individuals within some kindreds (117, 118, 155), implicating modifying factors affecting penetrance. Activity of the recombinant enzyme is reduced for many, but not all, *ALAS2* mutants so far examined and is variably enhanced by PLP (117, 118, 130, 142, 153, 159). How any one mutation affects the function of the enzyme would be determined by alterations in the structure of the mutant protein to affect its properties such as binding of substrates or cofactor, its stability, or even its processing to its site of action in the mitochondrion. Toward this end, a three-dimensional structure model of the human enzyme has been constructed, allowing predictions of any structural basis for altered enzyme activity or pyridoxine responsiveness in some of the naturally occurring mutants that give rise to X-linked sideroblastic anemia (XLSA) (160). For example, mutations located in the vicinity of the PLP-binding site exhibit a response to pyridoxine, whereas mutations involving substrate binding or catalytic amino acids are refractory to pyridoxine. One *ALAS2* mutant (Asp190Val) was shown to lack the ability to associate with the adenosine triphosphate-specific β subunit of the enzyme succinyl CoA synthetase (84), presumably a prerequisite for availability of the substrate succinyl CoA for the enzyme.



**Figure 29.3.** The structure of the human erythroid 5-aminolevulinate synthase gene. IRE, iron-responsive element; K391, codon for the pyridoxal 5'-phosphate-binding lysine.

**TABLE 29.3. Single-Base Substitutions Found in the *ALAS2* Gene of Unrelated Probands with X-Linked Sideroblastic Anemia**

| Exon            | Nucleotide Change | Codon Change | Probands and Gender | Severity           | Response to Pyridoxine | Reference(s)  |
|-----------------|-------------------|--------------|---------------------|--------------------|------------------------|---|
| 5               | G514A             | M154I        | 1M                  | ?                  | ?                      | <a href="#">139</a>   |
| 5               | G527T             | D159Y        | 1M                  | Severe             | Partial                | <a href="#">140</a>   |
| 5               | G527A             | D159N        | 1M                  | Severe             | Partial ?              | <a href="#">134</a>   |
| 5               | A533G             | T161A        | 1M                  | ?                  | ?                      | <a href="#">141</a>   |
| 5               | C547A             | F165L        | 1M                  | Severe             | Partial                | <a href="#">142</a>   |
| 5               | C560A             | R170S        | 1M                  | Severe             | Partial                | <a href="#">a</a>   |
| 5               | C560T             | R170C        | 1?                  | ?                  | Partial                | <a href="#">143</a>   |
| 5               | G561A             | R170H        | 2F                  | Mild               | None                   | <a href="#">122</a>   |
| 5               | G561T             | R170L        | 1M                  | Severe             | Partial                | <a href="#">144</a>   |
| 5               | G566A             | A172T        | 1F                  | Severe             | Complete               | <a href="#">130</a>   |
| 5               | A621T             | D190V        | 1M                  | Moderate           | None                   | <a href="#">145</a>   |
| 5               | T647C             | Y199H        | 1M                  | Moderate           | Partial                | <a href="#">31</a>  |
| 5               | C662T             | R204Term     | 1F                  | Severe             | None                   | <a href="#">122</a>   |
| 5               | G663A             | R204Q        | 1M                  | Severe             | Partial                | <a href="#">146</a>   |
| 6               | C731T             | R227C        | 1F                  | Moderate           | None                   | <a href="#">122</a>   |
| 6               | T802C             | S251P        | 1F                  | Severe             | ?                      | <a href="#">147</a>   |
| 6               | G839A             | D263N        | 1M                  | Severe             | Probable               | <a href="#">a</a>   |
| 7               | C880G             | C276W        | 1F                  | Severe             | None                   | <a href="#">122</a>   |
| 7               | G923A             | G291S        | 1M                  | Severe             | Complete               | <a href="#">118</a>   |
| 7               | A947C             | K299Q        | 1M                  | Severe             | Complete               | <a href="#">130</a>   |
| 8               | G1103A            | G351R        | 1M                  | Moderate           | Complete               | <a href="#">a</a>   |
| 8               | C1215G            | T388S        | 1M                  | Severe             | Complete               | <a href="#">117</a>   |
| 9               | G1236A            | C395Y        | 1F                  | Severe             | Complete               | <a href="#">136</a>   |
| 9               | G1245A            | G398D        | 1F                  | Severe             | None                   | <a href="#">122</a>   |
| 9               | C1283T            | R411C        | 3M/1F               | Severe             | Partial                | <a href="#">31</a> , <a href="#">148</a> , <a href="#">149</a>  |
| 9               | G1284A            | R411H        | 1F                  | Moderate           | Partial                | <a href="#">122</a>   |
| 9               | G1299A            | G416D        | 1F                  | Moderate           | Partial                | <a href="#">150</a>   |
| 9               | A1331G            | M426V        | 1M                  | Severe             | Complete               | <a href="#">145</a>   |
| 9               | C1358T            | R436W        | 1F                  | Severe             | None                   | <a href="#">122</a>   |
| 9               | G1395A            | R448Q        | 4M                  | Mild to moderate   | None/partial           | <a href="#">31</a> , <a href="#">143</a> , <a href="#">150</a>  |
| 9               | C1406A            | R452S        | 2M                  | Moderate           | Partial                | <a href="#">150</a>   |
| 9               | C1407T            | R452C        | 4M                  | Mild               | Partial                | <a href="#">31</a> , <a href="#">143</a> , <a href="#">150</a>  |
| 9               | G1407A            | R452H        | 4M/1F               | Mild to severe     | None/partial           | <a href="#">143</a> , <a href="#">150</a> , <a href="#">151</a> and <a href="#">152</a> , <a href="#">a</a> |
| 9               | T1479A            | I476N        | 1M                  | Severe             | Complete               | <a href="#">153</a>   |
| 10              | A1574T            | T508S        | 1M                  | Moderate           | ?                      | <a href="#">a</a>   |
| 10              | C1601T            | R517C        | 1F                  | Severe             | None                   | <a href="#">122</a>   |
| 10              | C1622G            | H524D        | 1M                  | Severe             | Partial                | <a href="#">154</a>   |
| 11              | G1731A            | R560H        | 1M                  | Severe             | Partial                | <a href="#">155</a>   |
| 11              | A1754G            | S568G        | 2M                  | Moderate to severe | Partial                | <a href="#">156</a> , <a href="#">a</a>   |
| Promoter region | C?G at nt (-)206  | —            | 1F                  | Mild               | None/partial           | <a href="#">415</a>   |



F, female; M, male.

<sup>a</sup> Unpublished material.

---

In some kindreds with an X-linked inheritance pattern, examination of the exonic and promoter regions of the *ALAS2* gene has not revealed molecular defects, suggesting another locus for XLSA.

**X-LINKED SIDEROBLASTIC ANEMIA WITH ATAXIA** In a large kindred with XLSA with ataxia (XLSA/A) ([161](#)), linkage to the phosphoglycerate kinase locus at Xq13 was demonstrated ([162](#)) and linkage to *ALAS2* was excluded using a highly polymorphic repeat sequence within intron 7 of the *ALAS2* gene ([63](#)). Cloning and chromosomal mapping to Xq13.1-q13.3 of the human *ABC7* gene ([163](#), [164](#) and [165](#)), an ortholog of the *ATM1* gene in yeast that encodes a transporter protein required for mitochondrial iron homeostasis ([166](#)), led to identification of a mutation in this gene as the underlying defect in the kindred ([167](#)). Subsequently, distinct mutations in the *ABC7* gene have been identified in two additional families ([168](#), [169](#)). All three mutations result in substitutions of conserved amino acids (Ile400Met, Glu433Lys, and Val411Leu) and affect a region of the protein involved in binding and transport of substrate. It is postulated that ABC7 participates in the export of iron-sulfur (Fe/S) clusters generated in mitochondria for assembly of cytoplasmic Fe/S cluster-containing proteins. Expression of wild-type ABC7, but not mutant ABC7, in *Atm1p*-deficient cells restores phenotypic defects as well as the production of cytosolic Fe/S proteins ([168](#)). As in yeast ([170](#)), a defective ABC7 protein leads to mitochondrial siderosis in the human disorder. How heme synthesis becomes impaired is not understood and may be a consequence of mitochondrial iron-mediated oxygen radical effects. Because free protoporphyrin and zinc protoporphyrin accumulate in erythrocytes ([161](#), [168](#), [169](#)), generation of ferrochelatase ([171](#)), an Fe/S-containing protein, and iron availability may be reduced. Neither ALA synthase nor ferrochelatase has been examined in erythroid cells with the XLSA/A defects. The mechanism for the neural dysfunction in this disorder also remains elusive. As in Friedreich ataxia ([172](#)), disrupted mitochondrial iron homeostasis in neural cells is likely involved in the pathogenesis.

**PRESUMED AUTOSOMAL INHERITANCE** Two families have been described in which sideroblastic anemia occurred in a vertical distribution, including father to son transmission, consistent with a dominant trait ([173](#), [174](#)). In one kindred, the inheritance pattern appeared to be discordant for sideroblastic anemia and X-linked factor IX deficiency ([175](#)). In others, the disorder was found only in siblings and with equal severity ([176](#), [177](#), [178](#), [179](#), [180](#) and [181](#)), suggesting autosomal-recessive inheritance; a mutation in the *ALAS2* gene was excluded in one such family ([179](#)). Responsiveness to pyridoxine was not observed or documented in these reports. Studies of heme biosynthesis or DNA analysis have not been carried out to suggest the pathogenesis.

**SPORADIC CONGENITAL CASES** Over 20 young children, in whom molecular studies were not performed and who did not have other affected family members, have been reported with severe anemia since birth ([182](#), [183](#), [184](#), [185](#), [186](#), [187](#), [188](#), [189](#), [190](#), [191](#) and [192](#)). These cases may represent autosomal-recessive defects or new mutations in the *ALAS2* gene in a parental germ cell. In two patients, bone marrow ALA synthase activity was decreased without an *in vivo* response to pyridoxine ([182](#), [184](#)), and, in several, variable responses to pyridoxine were noted. More recently, at least 20 further child cases, as well as a number of isolated adult patients with the hereditary phenotype, have been encountered in whom *ALAS2* defects could not be found with DNA analysis (*unpublished data*).

**ASSOCIATION WITH ERYTHROPOIETIC PROTOPORPHYRIA** Deficiency of ferrochelatase underlies erythropoietic protoporphyria. It is manifested mainly, if not



exclusively, in erythroid cells and leads to accumulation of protoporphyrin, the substrate of the enzyme. The protoporphyrin accumulates during the final stages of erythroid maturation when the defective ferrochelatase becomes rate-limiting for heme production ( [193](#) ). However, heme synthesis is compromised in less than 30% of patients as reflected in a mild hypochromic microcytic anemia ( [193](#), [194](#) ), and bone marrow examination has generally not been performed in this disorder. Ring sideroblasts with typical mitochondrial iron deposits were observed in ten patients ( [195](#), [196](#) ) but not in one sibling pair ( [193](#) ). The genetic heterogeneity in protoporphyria now established (see [Chapter 31](#)) may account for phenotypic differences, or another coexisting defect may be present when the ring sideroblast abnormality is found.

**THIAMINE-RESPONSIVE MEGALOBLASTIC ANEMIA SYNDROME** Thiamine-responsive megaloblastic anemia (TRMA) syndrome, also known as *Rogers syndrome*, is a recessively inherited autosomal disorder that was described in 1969 ( [197](#) ). It is characterized by megaloblastic anemia, diabetes mellitus, and progressive sensorineural deafness. Associated hematologic features include the ring sideroblast abnormality and, variably, neutropenia and thrombocytopenia ( [198](#) ). Pharmacologic doses of thiamine (vitamin B<sub>1</sub>) ameliorate the anemia and diabetes. TRMA cells lack the high-affinity component of thiamine transport, and the gene, termed *SLC19A2*, encoding the transporter was recently mapped and cloned ( [199](#), [200](#), [201](#) and [202](#) ). Subsequently, distinct mutations have been described in many families ( [198](#) ) and lead to lack of the protein product or altered protein structure so that mutant proteins are not properly targeted to the cell membrane for their site of function ( [203](#), [204](#) ). Whereas the pathogenesis of the megaloblastic change may involve disordered ribose 5-phosphate synthesis ( [205](#) ) via the nonoxidative transketolase pathway, which requires thiamine pyrophosphate as cofactor, the basis for the ring sideroblast abnormality is undefined. It may relate to the role of thiamine as cofactor for  $\alpha$ -ketoglutarate dehydrogenase ( [206](#) ), which is involved in generation of succinyl CoA, a substrate of ALA synthase.

**MITOCHONDRIAL DNA MUTATIONS** In Pearson marrow-pancreas syndrome, a progressive, congenital multisystem mitochondrial disorder caused by sporadic major deletions, rearrangements, or duplications of mitochondrial DNA, an early feature is severe anemia associated with ring sideroblasts in the bone marrow ( [207](#), [208](#), [209](#), [210](#) and [211](#) ) and pronounced abnormalities in the ultrastructure of erythroblast mitochondria ( [212](#) ). Although the specific deranged gene products resulting from the deletions of the mitochondrial genome are not yet defined, respiratory enzyme defects are postulated. Whether erythroid heme biosynthesis is compromised is also uncertain because the peripheral erythrocytes are macrocytic, and there is associated neutropenia and thrombocytopenia. Moreover, a spectrum of mitochondrial cytopathies is recognized, and heterogeneity of mutant mitochondrial DNA content among different tissues has been noted ( [213](#) ). The degree to which any given tissue contains abnormal mitochondria (heteroplasmy) determines the tissue-specific clinical expression of the disease ( [210](#) ). In the majority of cases so far described, the infants did not survive beyond 2 to 3 years of age. In others, the disorder evolved into the Kearns-Sayre syndrome ( [214](#), [215](#) and [216](#) ). A milder form of mitochondrial cytopathy with myopathy, lactic acidosis, and sideroblastic anemia has been described in siblings in the second and third decades of life ( [217](#), [218](#) and [219](#) ). In one family with apparent maternally inherited sideroblastic anemia manifested in both genders, a defect in mitochondrial DNA was postulated ( [220](#) ). The anemia is mild and is characterized by erythrocyte dimorphism and macrocytosis. The free erythrocyte protoporphyrin (FEP) was slightly raised.

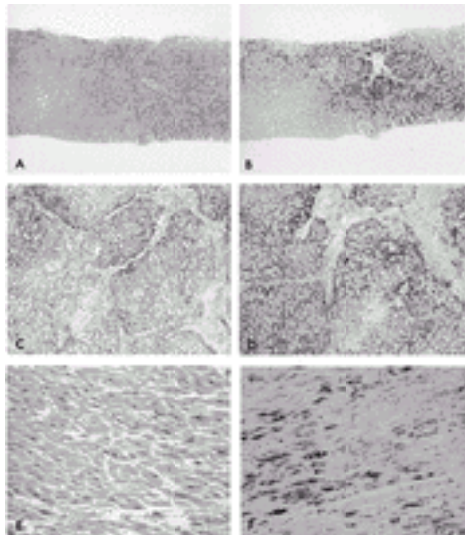
**ANIMAL MODELS OF SIDEROBLASTIC ANEMIA** The first genetically designed animal model of hereditary sideroblastic anemia was developed in zebrafish, in which hematopoiesis resembles that of higher vertebrates also at the molecular level, as hematopoietic gene expression and function are conserved ( [221](#) ). The chemically induced mutant gene encodes the zebrafish ortholog of human *ALAS2* and expresses embryonic

hypochromic anemia with severe heme deficiency. The two mutation sites, predicting Val249Asp and Leu305Gln substitutions, are in exon 6 and exon 7, respectively, and represent conserved amino acids across large phylogenetic boundaries, including the human. However, the mutants' blood cells did not reveal ring sideroblasts, perhaps due to species differences in cellular iron metabolism. In a transgenic mouse model with homozygous deficiency of *ALAS2*, erythroid differentiation is arrested, and embryos die by day 11.5 ( [64](#) ). Mice chimeric for *ALAS2*-null mutant cells exhibit the phenotype of human XLSA, with severe anemia and typical ring sideroblasts in the marrow. The combination of isoniazid (INH) and cycloserine administered to guinea pigs produces sideroblastic anemia in a few weeks ( [49](#) , [50](#) ). Blood PLP concentrations become reduced, and bone marrow ALA synthase as well as ferrochelatase activity is diminished ( [50](#) ). The latter may be secondary to mitochondrial damage by the iron deposits. The flexed-tail ( *f/t* ) mouse has a transient embryonic and neonatal anemia associated with siderotic granules (iron-laden mitochondria) in erythrocytes and reduced heme synthesis, which coincides with the physiologic cessation of hepatic erythropoiesis ( [222](#) , [223](#) ). The defect is a frameshift mutation in the *t* gene (sideroflexin, *sfxn1*) that encodes a protein proposed to facilitate transport of a component required for iron utilization into or out of mitochondria ( [224](#) ).

### Clinical and Laboratory Features

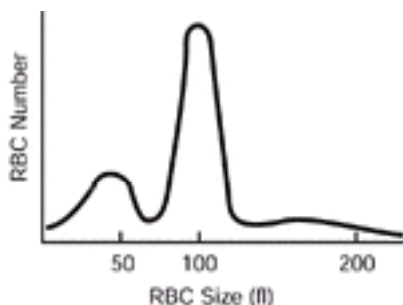
The clinical characteristics are similar in X-linked, autosomally inherited, and congenital forms but are most extensively known from the X-linked type. Severe forms of the anemia are recognized in infancy or early childhood. If milder or asymptomatic, the disorder may be discovered only in young adulthood or even in later life. Because severity of anemia can also vary within kindreds ( [117](#) , [118](#) , [155](#) ) ( [Table 29.3](#) ), diagnosis in family members may be delayed or overlooked unless complete pedigree studies or DNA analyses for an *ALAS2* mutation identified in the proband are performed.

In addition to symptoms and signs of anemia, all patients exhibit manifestations of iron overload that is not HLA-linked ( [28](#) ) and has been termed *erythropoietic hemochromatosis*. *HFE* mutations were underrepresented in a series of patients examined ( [33](#) ). Mild to moderate enlargement of the liver and spleen is common, but liver function usually is normal or only mildly disturbed at presentation. In untransfused patients, liver biopsy reveals iron deposition that is indistinguishable from hereditary hemochromatosis ( [25](#) , [46](#) ) ( [Fig. 29.4](#) ). The iron burden does not correlate with the severity of anemia, and, not infrequently, well-established but asymptomatic micronodular cirrhosis is discovered in the third or fourth decade ( [28](#) , [46](#) , [121](#) , [129](#) , [225](#) ); development of hepatocellular carcinoma has not been reported. Clinical diabetes or abnormal glucose tolerance may or may not be related to the iron overload process. Skin hyperpigmentation is uncommon. The most dangerous manifestations of the iron overload are cardiac arrhythmias and congestive heart failure, which usually occur late in the disease course. In severely affected infants or young children, growth and development tend to be impaired ( [114](#) ). Signs and symptoms of nutritional deficiency are absent. The neurologic and cutaneous manifestations of vitamin B<sub>6</sub> deficiency are not observed.



**Figure 29.4.** Histopathology of the iron overload in hereditary sideroblastic anemia. **A,B:** Liver section of a 26-year-old man with moderate hemochromatosis. **C,D:** Autopsy liver section of a 45-year-old man with micronodular cirrhosis and hemochromatosis. **E,F:** Section from the heart of the latter patient with marked hemosiderosis. (**A, C, and E:** hematoxylin stain; **B, D, and F:** Prussian blue stain.) See [Color Plate](#).

The anemia is highly variable. In severe cases, hypochromia and microcytosis are pronounced [mean corpuscular volume (MCV), 50 to 60 fl], and striking anisocytosis, poikilocytosis, target cells, and occasional siderocytes are prominent findings on blood smear ([Fig. 29.1](#)); the red cell volume distribution is abnormally wide. Some females with the X-linked trait have a biphasic Coulter counter red cell histogram ([31](#), [116](#)) ([Fig. 29.5](#)), or only a very small microcytic erythrocyte peak may be evident. Leukocyte and platelet values usually are normal but may be reduced in the presence of splenomegaly (hypersplenism). Erythroid hyperplasia is found on marrow examination, and maturation is usually normoblastic but with poorly developed cytoplasm. Megaloblastic changes may be observed if complicating folate deficiency is present. Marrow reticuloendothelial iron is increased, and the ring sideroblast abnormality is prominent in late, nondividing erythroblasts ([226](#), [227](#)). Transferrin saturation is increased, as is the serum ferritin level, and transferrin levels tend to be decreased. Ferrokinetic studies reflect ineffective erythropoiesis.



**Figure 29.5.** Dimorphic red cell distribution in a female patient with X-linked sideroblastic anemia. Redrawn from the output of a Coulter analyzer. RBC, red blood cell.

The FEP level usually is low or normal ([13](#), [25](#), [115](#)). In one female patient, the low FEP

level was shown to be restricted to the microcytic red cells ( [119](#) ). Kindreds in which the FEP was increased ( [25](#) , [115](#) , [173](#) ) can be expected to represent disorders other than XLSA due to *ALAS2* defects. In the recently reported mutant involving the *ALAS2* promoter region, the affected proband and her son had raised FEP levels, but an apparent abnormality of ferrochelatase was also observed ( [415](#) ).

In the XLSA/A variant among four kindreds so far encountered, the neurologic features are overriding and include delayed motor development, incoordination, and nonprogressive cerebellar atrophy with or without atrophy of pons and medulla ( [161](#) , [168](#) , [169](#) , [228](#) ). The anemia is mild to moderate, and morphologic features are indistinguishable from the other hereditary forms, including variable abnormalities in female carriers as observed in XLSA. The FEP is increased. Iron overload has not been evident.

**PEARSON SYNDROME** The refractory sideroblastic anemia in Pearson syndrome is a component of a multisystem disorder that is also characterized by complications of exocrine pancreatic insufficiency, episodes of lactic acidosis, and eventual hepatic and renal failure ( [207](#) , [208](#) and [209](#) ). The anemia is detected soon after birth or in early childhood. It is normocytic or slightly macrocytic, and the reticulocyte count is low. Variable degrees of neutropenia and thrombocytopenia occur concomitantly or shortly after the onset of anemia. Hemoglobin F levels are usually elevated, and FEP values have been increased when measured. The bone marrow is hypercellular or normocellular, and vacuolization of both erythroid and myeloid marrow precursors is striking. Marrow hemosiderin content is increased, and ring sideroblasts have been noted in most cases. Patients with variant forms of this mitochondrial disease appear to survive longer, and the anemia may remit ( [214](#) , [216](#) , [217](#) , [229](#) ).

### Treatment and Prognosis

Approximately 75% of patients with hereditary sideroblastic anemia due to identified *ALAS2* defects can be expected to respond to pyridoxine administration ( [Table 29.3](#) ). Doses of 50 to 100 mg/day are large compared with the estimated adult daily requirement for vitamin B<sub>6</sub> of 1.5 to 2.0 mg and are sufficient for a maximal response. Higher doses may be toxic. No convincing evidence is available that the parenteral route or PLP, the active coenzyme form, is more effective than oral administration. However, the response to pyridoxine is quite variable. With an optimal response, reticulocytosis is observed, blood hemoglobin concentration returns to normal or near normal levels in 1 to 2 months, and low FEP levels increase to normal ( [13](#) , [230](#) ). Morphologic abnormalities of the red cells, however, rarely completely disappear ( [13](#) ), even when ALA synthase activity and hemoglobin levels are restored with pyridoxine supplementation. Approximately two-thirds of responding patients experience a distinct but suboptimal improvement with pyridoxine administration ( [Table 29.3](#) ), and the hemoglobin concentration stabilizes at less than normal levels. When an effect of pyridoxine is achieved, continued maintenance treatment is necessary because relapses follow within several months after discontinuing the vitamin. In a few instances, subsequent remissions with resumed treatment were less complete ( [13](#) ). In the occasional case with accompanying megaloblastic changes, folic acid should be given, which usually leads to normoblastic maturation, suboptimal reticulocytosis, and some increase in hemoglobin levels. In severely anemic individuals who do not respond to pyridoxine, periodic red cell transfusions are necessary to relieve symptoms and, in children, to allow normal growth and development.

Based on the assessed extent of iron overload, including liver biopsy, an iron depletion program should be instituted to prevent or stabilize already established organ damage ( [121](#) , [231](#) , [232](#) ). Graded phlebotomies are well tolerated and preferred in patients with mild or

moderate anemia in the absence of contraindications such as heart disease ( [25](#) , [121](#) , [225](#) , [233](#) , [234](#) and [235](#) ). After the initial removal of all storage iron, maintenance phlebotomies should be continued indefinitely. For patients with severe anemia, or for those who depend on regular transfusions and thus become massively iron loaded ( [236](#) , [237](#) ), the iron-chelating agent deferoxamine is administered. As recommended for thalassemia ( [237](#) ), it is infused over 12 hours subcutaneously or intravenously, at 40 mg/kg/day, and for at least 5 days each week. Although iron removal with deferoxamine is enhanced by ascorbate, large supplements can cause acute cardiac toxicity by facilitating excessive mobilization of ferritin iron, and any intake of the vitamin should be limited to 200 mg daily ( [238](#) ). The risks of deferoxamine treatment are minimal ( [239](#) ). Occasional local reactions can be controlled with inclusion of small amounts of hydrocortisone in the infusate. Rare hypersensitivity is amenable to desensitization ( [240](#) ). Reported visual and auditory neurotoxicity is unlikely without excessive doses of the drug. The increased risk of infection with *Yersinia* (and perhaps other organisms) in iron overload, although uncommon, increases further with deferoxamine treatment ( [241](#) ). Removal of the iron excess has also reduced severity of the anemia ( [11](#) , [31](#) , [234](#) , [235](#) ) by improving erythroblast mitochondrial function, such as restoration of secondary ferrochelatase deficiency ( [235](#) ), and by diminishing the ineffective erythropoiesis ( [24](#) , [234](#) ).

Splenectomy in hereditary sideroblastic anemia appears to be invariably complicated by thromboembolic complications and, often, a fatal outcome ( [128](#) , [129](#) , [142](#) , [242](#) ). Factors other than persistent thrombocytosis seem to play a role. Control of the platelet count and anticoagulant therapy usually are not effective, so splenectomy is contraindicated.

Although gene therapy to correct these disorders may be possible in the future, the supportive measures available provide for a favorable prognosis and often for normal survival. Bone marrow transplantation has been carried out successfully in five cases ( [181](#) , [188](#) , [243](#) ). In contrast to acquired idiopathic sideroblastic anemia (AISA), predisposition to leukemic evolution has not been observed.

## ACQUIRED IDIOPATHIC SIDEROBLASTIC ANEMIA

Since the initial description of AISA by Bjorkman ( [43](#) ), a considerable spectrum of its manifestations has been recognized. The anemia may be associated with hematologic findings characteristic of certain stem cell disorders, namely the myeloproliferative diseases ( [244](#) , [245](#) and [246](#) ) and the myelodysplastic syndromes ( [247](#) , [248](#) , [249](#) , [250](#) and [251](#) ). Uncommonly, the ring sideroblast abnormality is observed in acute leukemia and in erythroleukemia at the time of diagnosis ( [252](#) , [253](#) ). The disorder is the result of clonal growth of an altered erythroid or hematopoietic progenitor cell with a proliferative advantage over the normal cell population and, thus, has been included among the myelodysplastic syndromes ( [254](#) ). Commonly, a variable iron overload state is also present ( [11](#) , [29](#) , [45](#) , [250](#) , [255](#) ).

### Etiology and Pathogenesis

**CLONALITY** That AISA has clonal features was first suspected from the morphologic and kinetic findings of two populations of red cells, the hypochromic, short-lived cell population being the product of the abnormal clone that bears the characteristic ring sideroblasts ( [255](#) , [256](#) and [257](#) ). The clonal derivation of the disorder was specifically indicated by the finding of a single glucose-6-phosphate dehydrogenase isoenzyme in hematopoietic cells, but not in fibroblasts, of an individual who was also heterozygous for



glucose-6-phosphate dehydrogenase polymorphism ( [258](#) ). Further evidence has been provided with simultaneous clonality and cytochemical analysis of erythroid progenitors ( [259](#) ). Findings of cytogenetic studies corroborated the clonality of the abnormal hematopoiesis ( [260](#), [261](#) and [262](#) ). Chromosomal abnormalities have been observed at the level of the multipotential stem cell, the trilineage myeloid stem cell, or only an erythroid precursor cell ( [262](#) ); cytogenetically abnormal ringed sideroblasts have also been demonstrated ( [263](#) ). Chromosomal abnormalities are detectable in bone marrow cells in approximately 50% of patients, and deletions in chromosomes 5, 11, and 20 as well as trisomy 8 and loss of Y in males occur most frequently ( [251](#), [264](#) ). Although structurally abnormal X chromosomes are uncommon, Xq13 breakpoints were particularly associated with myelodysplasia and ring sideroblasts in one study ( [265](#) ). These abnormalities cannot involve the gene for erythroid ALA synthase, which is located on Xp11.21 ( [62](#), [63](#) ), or the gene for the erythroid transcription factor GATA-1, located on Xp21.11 ( [266](#) ). In a few patients, abnormalities of the long arm of chromosome 3 have been associated with thrombocytosis ( [267](#), [268](#) ) and may involve the gene for cholinesterase, which has been mapped to the 3q-21-ter region and implicated in megakaryocyte development ( [269](#) ). In common with the myelodysplastic syndromes, mutations in the ras and fms genes have been demonstrated in blood cells of some patients with acquired sideroblastic anemia as another marker of clonality ( [270](#), [271](#) ). The pathogenetic significance of these mutational events is not known, and they do not clearly relate to the stage of the disorder or to the progression to acute leukemia. The factors or agents that might be responsible for the various genetic changes remain to be identified ( [272](#) ). The natural history of acquired sideroblastic anemia is commonly characterized by a chronic, stable anemia and, less often, by a progressive marrow failure state or leukemic evolution ( [250](#), [251](#) ). An initial genetic change causing expansion of an abnormal hematopoietic clone manifested by defective erythroid cell development is thus insufficient to result in a malignancy, even when persisting for many years. A “second hit” or mutation appears to be necessary for leukemic evolution ( [273](#), [274](#) ) that can be reversible, whereas the fundamental defect expressed in the sideroblastic state persists ( [275](#), [276](#) ). The occasional occurrence of the ring sideroblast abnormality in association with lymphoproliferative disorders may or may not reflect a defect at the level of the multipotential stem cell ( [8](#) ). Observations of a therapeutic response to immunosuppressive agents ( [277](#), [278](#) ) suggest potential defects in immune surveillance and removal of transformed stem cells by such therapy in the pathogenesis.

**ABNORMALITIES OF HEME SYNTHESIS** The defective erythropoiesis is mainly characterized by impaired hemoglobin synthesis. Various studies have indicated that the biosynthesis of heme is impaired, and any accompanying aberrations of globin synthesis appear to be secondary as they are reversed *in vitro* by the addition of heme ( [9](#), [10](#) ). Reduced activity of ALA synthase in marrow cells was the most consistent abnormality in earlier series of patients ( [124](#), [279](#), [280](#) and [281](#) ) and was particularly demonstrable in the youngest erythroblast fraction ( [282](#) ). In some patients, the addition of PLP enhanced the low enzyme activity *in vitro*, but reported erythropoietic responses to pyridoxine ( [2](#), [13](#) ) or to PLP administration ( [283](#) ), as well as restoration of low ALA synthase activity to normal ( [279](#), [284](#) ), were unusual and likely reflected an inherited defect of ALAS2 ( [122](#), [130](#) ). In a later study, the activity of detergent-solubilized ALA synthase in bone marrow cells was actually somewhat increased ( [125](#) ), suggesting enhanced translation of the enzyme in response to raised cellular iron levels. A common feature is mild to moderate elevation of the FEP ( [255](#) ), rarely reaching values encountered in hereditary protoporphyria ( [53](#), [250](#), [257](#), [285](#) ) and implicating marked ferrochelatase deficiency (see [Chapter 31](#)). The FEP increases further after pyridoxine administration but without improvement of the anemia (

[255](#), [286](#), [287](#)), suggesting a block at the ferrochelatase step. Impaired activity of this enzyme was found in approximately one-half of patients studied ([124](#), [281](#)), likely representing a secondary effect of the mitochondrial iron deposition. Studies of iron metabolism in erythroid cells revealed increased accumulation of nonheme iron into membrane or mitochondrial fractions and reduced incorporation of iron into heme ([11](#), [12](#)). Thus, impaired iron utilization for heme biosynthesis remained the common denominator in the pathogenesis. The current thesis is that a defect causing diminished heme production in the abnormal clone is intrinsic to mitochondria ([288](#)), which would also account for the decreased activity of several other mitochondrial enzymes in granulocytes as well as erythroblasts, namely cytochrome oxidase, oligomycin-sensitive adenosine triphosphatase, and mitochondrial serine protease ([289](#)). Recent findings indicate molecular defects in mitochondrial DNA of hematopoietic cells, involving subunits of enzyme complexes of the respiratory chain. Various heteroplasmic point mutations of conserved nucleotides in mitochondrial DNA, as well as in transfer RNAs and mitochondrial ribosomal RNAs, have been found in the colony-forming unit granulocyte-erythroid-macrophage-megakaryocyte cell lineages of patients with AISA ([290](#), [291](#)). A majority of these affect cytochrome *c* oxidase and can be implicated in impaired reduction of iron for its incorporation into protoporphyrin by ferrochelatase. Such defects are consistent with the heterogeneity of hemoglobin content found between individual erythroblasts by scanning microspectrophotometry ([292](#)), as well as with the variable size of hypochromic microcytic erythrocyte and ring sideroblast cell populations in the disorder. Heteroplasmic mutations of mitochondrial DNA with an increasing proportion of mutant mitochondrial DNA accumulating in some daughter cells through random partitioning during cytokinesis would generate normal and abnormal erythroid cells with respect to mitochondrial function ([293](#)). A gradual accumulation of affected erythroid precursors and the known higher mutation rate in mitochondrial DNA than in nuclear DNA would provide a basis for the slowly progressive nature of the anemia and its expression in later life, respectively ([294](#)). The mechanism(s) by which the mitochondrial defects and the attendant mitochondrial siderosis are related or lead to the clonal disorder remains to be defined.

**NUCLEAR ABNORMALITIES** The principal, often macrocytic, red cell population in the blood may represent the progeny of the normal residual erythroid precursors with a shortened marrow maturation time in response to raised erythropoietin levels. The commonly observed morphologic nuclear abnormalities of erythroid precursors and their defective DNA synthesis and mitosis ([295](#), [296](#)), however, suggest that more viable precursors of the dysplastic clone produce the macrocytic erythrocytes, whereas a greater proportion of developing cells expressing impaired heme synthesis is destroyed in the bone marrow. By analogy, various other aberrations of erythroid cell metabolism can occur in dysplastic hematopoietic clones ([297](#)), including altered genetic control of globin chain production ([298](#)). Thus, hemoglobin H disease was acquired in association with erythroleukemia, acute leukemia, and myelofibrosis ([298](#)), as well as in sideroblastic anemia with myeloproliferative features ([299](#)) and in patients with sideroblastic anemia before leukemia developed ([300](#)).

**IRON OVERLOAD** Excessive absorption of dietary iron occurs in many, if not all, patients with stable disease and can be inferred to be a consequence of the ineffective erythropoiesis, as in inherited sideroblastic anemias and other long-standing disorders with erythroid maturation defects ([301](#), [302](#)). The iron deposition closely resembles that of hereditary hemochromatosis. Although the presence of at least one allele for this disorder would likely contribute to the iron overload ([28](#)), the incidence of *HFE* mutations is no greater than in the normal population ([28](#), [32](#), [34](#), [35](#)). Inadvertent administration of iron for the anemia and red cell transfusions add predictably to the parenchymal iron deposition ([236](#), [250](#), [303](#)).

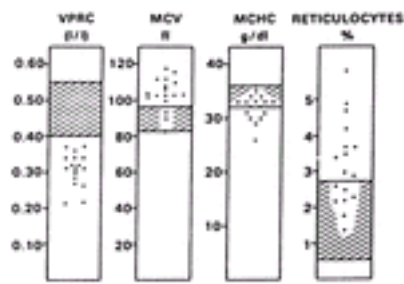


## Clinical Features

AISA usually occurs in middle-aged and older individuals, but younger persons, including children, are not spared. The anemia develops insidiously and may be discovered during a routine examination or in association with an unrelated complaint. The older individual more often experiences symptoms of fatigue and angina if there is coexisting coronary artery disease. Physical examination often reveals no abnormality except for pallor. Hepatosplenomegaly is found in one-third to one-half of patients. With advanced iron overload, usually after repeated red cell transfusions, symptoms and signs of liver decompensation as well as heart failure and arrhythmia occur.

## Laboratory Findings

The anemia is usually moderate and may be normocytic but more often is macrocytic ( [Fig. 29.6](#)). The mean corpuscular hemoglobin concentration is normal or slightly reduced, but a variable population of hypochromic cells is found on blood smear. A particularly characteristic finding is the presence of occasional basophilic stippling in hypochromic cells that stains positive for iron. Typical Pappenheimer bodies are uncommon unless there is associated hyposplenism or the spleen is absent. Leukocyte and platelet values are usually within the normal range. Moderate leukopenia, thrombocytopenia, or both tend to be accompanied by other myelodysplastic features, such as morphologically abnormal leukocytes (e.g., the pseudo-Pelger anomaly) or occasional immature forms in the peripheral blood ( [251](#), [304](#)). Leukocytosis, thrombocytosis, or both may be seen and suggest a myeloproliferative rather than a myelodysplastic clone ( [244](#), [245](#) and [246](#)).



**Figure 29.6.** Characteristics of anemia in 17 patients with idiopathic acquired sideroblastic anemia. Shaded areas indicate normal range (mean  $\pm$  two standard deviations). MCHC, mean corpuscular hemoglobin concentration; MCV, mean corpuscular volume; VPRC, volume of packed red cells. (From Kushner JP, Lee GR, Wintrobe MM, Cartwright GE. Idiopathic refractory sideroblastic anemia. Clinical and laboratory investigation of 17 patients and review of the literature. *Medicine* 1971;50:139–159, with permission.)

Erythroid hyperplasia is found on bone marrow examination. A feature claimed to be helpful in distinguishing idiopathic sideroblastic anemia from erythroleukemia is the lack of periodic acid-Schiff-positive material in the erythroblasts. Mild megaloblastic changes are common and may or may not be related to accompanying folate deficiency. Marrow hemosiderin content is increased, and ring sideroblasts constitute from 15 to 100% of the erythroblasts unless masked by concomitant iron deficiency ( [2](#), [305](#)). In contrast to hereditary sideroblastic anemia, ring sideroblasts are evident at all stages of erythroid maturation ( [226](#)). Because the hematologic phenotype often may not be distinguishable from XLSA in female patients ( [122](#)), their analysis of X-inactivation status and DNA for

*ALAS2* defects should be considered.

Transferrin saturation is increased in most patients and exceeds 90% in approximately one-third of them ( [255](#) ). Substantially increased deposition of iron is found in the liver, but hepatic dysfunction is rare at presentation. Serum ferritin levels are elevated.

Characteristically, the FEP is moderately increased, up to 300 µg per dl (normal is 20 to 65 µg per dl). Values ranged from 1055 to 10,514 µg per dl in a few patients, and some had associated dermal photosensitivity (see [Chapter 31](#)) ( [53](#) , [250](#) , [257](#) , [285](#) ).

## Treatment and Prognosis

Treatment consists of supportive measures. Pyridoxine administration cannot be expected to be beneficial because *ALAS2* defects are not involved in the pathogenesis. Occasional individuals reported to have shown a response ( [14](#) , [284](#) ) almost always manifested a low MCV and likely represent XLSA ( [122](#) , [130](#) ). Administration of large doses of androgen (e.g., 50 to 300 mg of oxymetholone per day) ( [255](#) ) is rarely useful and tends to produce or enhance fluid retention and hepatic dysfunction. The effectiveness of erythropoietin has been examined in patients with the myelodysplastic syndromes, including AISA. Most, if not all, patients with uncomplicated sideroblastic anemia have high levels of endogenous erythropoietin, and it would appear unlikely that additional administration of the hormone would be beneficial. However, recent studies indicate that prolonged administration of recombinant erythropoietin, with or without granulocyte colony-stimulating factor, can lead to gratifying improvement or even correction of the anemia ( [306](#) , [307](#) ). A response is also more likely to occur if the endogenous serum erythropoietin level is not commensurate with the degree of the anemia.

In studies evaluating various drug regimens for the myelo-dysplasias, the refractory anemia with ring sideroblasts category was also included. Agents used have included amifostine and 5-azacytidine, as well as thalidomide ( [288](#) ). On the average, major responses with improved erythropoiesis or hematopoiesis have been low (<30%) and often transient.

Many patients with AISA are not significantly incapacitated by the anemia. Without abnormalities of the other hematopoietic cell lines and with minimal iron overload, usually no progression occurs for many years ( [251](#) ). Such patients frequently succumb to other concurrent diseases, but continued medical follow-up is indicated. Iron status should also be assessed with laboratory studies once per year. Transfusion of packed red cells is necessary for patients with symptomatic anemia, but it should be kept to a minimum because it accelerates the iron overload.

Iron overload, particularly when accentuated by repeated transfusions, can be a significant cause of morbidity and mortality (liver failure or heart failure) ( [250](#) ). When the serum ferritin level is approximately 500 µg per L or higher, along with the increased transferrin saturation, treatment for the iron overload should be considered. Histologic and chemical determination of iron in the liver biopsy provides the optimal assessment of the degree of iron overload. In mildly or moderately anemic individuals, iron removal can be accomplished with graded phlebotomies. Patients with more severe anemia ( [308](#) ) or who are transfusion-dependent require subcutaneous deferoxamine infusion as described for hereditary sideroblastic anemia. Because each unit of blood deposits 200 mg of iron, iron overload develops fairly rapidly with regular transfusions, and it is controlled more easily if treatment with deferoxamine is begun after approximately 20 units of blood have been given. In some cases, anemia was improved after iron removal ( [11](#) , [309](#) , [310](#) and [311](#) );

an independent effect of deferoxamine on erythropoiesis was also implicated ( [310](#), [311](#) ).

The survival of patients with isolated anemia who are stable and not transfusion-dependent may not differ from that of healthy individuals. Retrospective and prospective studies of 94 and 232 patients, respectively, with AISA have provided prognostic information to propose two subtypes of the disorder ( [251](#), [304](#) ). In one, termed *pure sideroblastic anemia*, the marrow failure is restricted to the erythroid cell lineage, overall survival was as in age-matched controls, and leukemic transformation was not observed. In the other, termed *refractory anemia with ring sideroblasts* or a “true” myelodysplastic syndrome, features of impaired granulopoiesis, megakaryopoiesis, or both also occur. Survival in this group was reduced to 56% at 3 years, and, in approximately 5% of cases, evolution to acute leukemia occurred. Other factors associated with the development of leukemia are the presence of few ring sideroblasts, more severe ineffective erythropoiesis, and impaired bone marrow colony formation ( [250](#), [304](#), [312](#) ). The probability of leukemic transformation is also increased in the presence of certain bone marrow karyotype abnormalities (e.g., monosomy 7, deletion 20q, or complex defects) ( [250](#), [264](#), [313](#), [314](#) and [315](#) ). When sideroblastic anemia follows therapy for various malignant disorders, leukemic evolution is the rule ( [316](#), [317](#) ).

## REVERSIBLE SIDEROBLASTIC ANEMIAS

### Alcoholism

Anemia associated with alcoholism usually has numerous causes ( [318](#) ). A ring sideroblast abnormality is never the sole cause but occurs in 25 to 30% of anemic alcoholic patients ( [318](#), [319](#) ) and probably only in the presence of malnutrition and folate deficiency ( [52](#), [320](#) ).

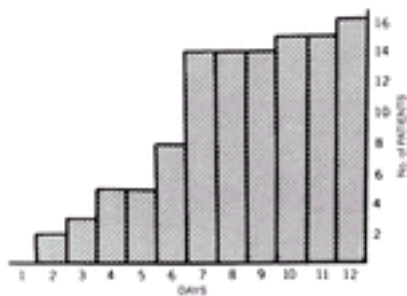
The production of heme is impaired by ethanol, as indicated by the ability of heme to restore the concomitantly inhibited globin synthesis in reticulocytes ( [321](#), [322](#) ) and by the observation that the hemin-regulated inhibitor activity of globin translation increases ( [323](#) ). Inhibitory effects of alcohol have been observed at several steps of the heme biosynthetic pathway. Reduced activity of erythrocyte ALA dehydratase ( [324](#), [325](#), [326](#), [327](#) and [328](#) ) was believed to be related to zinc depletion ( [327](#), [328](#) ). Activity levels of erythrocyte uroporphyrinogen decarboxylase, leukocyte coproporphyrinogen oxidase and ferrochelatase are also decreased in alcoholic patients; those of ALA synthase and PBG deaminase are increased ( [326](#), [329](#) ). Certain abnormalities of vitamin B<sub>6</sub> metabolism have been observed. Serum levels of PLP are low in chronically ill alcoholic persons ( [330](#), [331](#) ) but do not correlate with the presence or absence of ring sideroblasts ( [320](#) ).

Acetaldehyde enhanced the degradation of PLP ( [330](#), [332](#) ), and, in one study, alcohol-induced sideroblastic anemia responded to PLP but not to the combination of folic acid and pyridoxine ( [333](#) ). The colony formation of early (burst-forming unit erythroid) and late (colony-forming unit erythroid) human erythroid progenitor cells is preferentially suppressed by ethanol and acetaldehyde over that of myeloid cell progenitors at concentrations found *in vivo* and is partially reversed by folic acid and pyridoxine ( [334](#) ). Thus, a direct role of vitamin B<sub>6</sub> deficiency in the sideroblastic change is uncertain. Important in the pathogenesis may be the direct effects of ethanol, acetaldehyde, or both on the heme biosynthetic steps or on mitochondrial metabolism because these agents also inhibit hepatic mitochondrial protein synthesis ( [335](#) ).

Blood hemoglobin values range from 6 to 10 g per dl, and the MCV is normal or increased.

The transient sideroblastic change is commonly evident in dimorphic circulating erythrocytes. Siderocytes, present in approximately one-third of patients, are a specific finding ( 318 ) and provide the most persistent clue of the ethanol-associated ring sideroblast defect. Megaloblastic hematopoiesis resulting from folate deficiency is frequent but is not always present ( 318 ). Another common finding is vacuolization of pronormoblasts. The percentage of marrow ring sideroblasts ranges from 10 to 70%, and they typically represent later stage normoblasts. Marrow iron stores usually are increased, as are the serum transferrin saturation and the serum ferritin level.

Withdrawal of alcohol is followed by disappearance of ring sideroblasts within a few days to 2 weeks ( 319 ) ( Fig. 29.7 ). Recovery from the anemia may occur over several weeks and also depends on the presence of other erythroid defects induced by alcohol ( 319 ) (see Chapter 43) as well as any associated medical illness that affects erythropoiesis. A prompt recovery phase may exhibit reticulocytosis and erythroid hyperplasia in the bone marrow resembling hemolytic anemia ( 319 ).



**Figure 29.7.** The rate of clearance in days of ring sideroblasts in 16 alcoholic patients after alcohol intake ceased. (From Eichner ER, Hillman RS. The evolution of anemia in alcoholic patients. *Am J Med* 1971;50:218–232, with permission.)

## Drugs

**ANTITUBERCULOUS AGENTS** Reversible sideroblastic anemia occurs in association with the treatment of tuberculosis with INH; in a few patients, pyrazinamide and cycloserine also were implicated ( 8 ). These drugs interfere with vitamin B<sub>6</sub> metabolism, and deprivation of PLP reduces ALA synthesis and, thus, heme production ( 8 ). INH reacts with pyridoxal to form a hydrazone and inhibits pyridoxal phosphokinase. Bone marrow ALA synthase activity is also inhibited by INH in a dose-dependent manner *in vitro* and is restored by PLP ( 124 ). Cycloserine inhibits PLP-requiring enzyme reactions and directly inactivates pyridoxal ( 8 ). Pyrazinamide appears to have anti-vitamin B<sub>6</sub> properties ( 48 ), but a specific mechanism has not been determined. The sideroblastic anemia that is inducible in guinea pigs with pharmacologic doses of INH and cycloserine ( 49, 50 ) is accompanied by reduced levels of blood PLP and PLP-dependent enzyme activities, including bone marrow ALA synthase ( 50 ). The relative incidence of severe anemia in relation to the extensive use of these drugs appears to be low, perhaps because of the regular concomitant administration of pyridoxine. Unknown contributory factors or another hematologic disorder may render certain individuals more susceptible to the antipyridoxine effects of the drugs ( 8 ). In one study, ring sideroblasts or increased erythroblast iron was found in 58% of all patients treated for tuberculosis ( 336 ). Anemia has occurred from 1 to 10 months after institution of INH treatment. It is moderately

severe (volume of packed red cells, 0.20 to 0.26 L per L), the red cell indices are usually reduced, and the erythrocytes show dimorphic morphologic features with prominent hypochromia and microcytosis ( 337 ). Ring sideroblasts are invariably present in the bone marrow. Serum pyridoxal concentrations were subnormal in most patients studied ( 338 , 339 ). Transferrin saturation tends to be increased. The anemia usually is promptly and fully reversed on withdrawal of the drug or by administering large doses of pyridoxine while continuing use of the drug.

**CHLORAMPHENICOL** The dose-dependent and reversible hematologic toxicity of chloramphenicol is characterized by suppression of erythropoiesis ( 340 ) and by the ring sideroblast abnormality ( 5 , 51 , 341 , 342 ). A primary mitochondrial injury by the drug impairs heme synthesis as well as erythroid differentiation and proliferation. Therapeutic concentrations of chloramphenicol (10 µg/ml) inhibit the synthesis of mitochondrial membrane proteins, such as cytochrome *a* + *a*<sub>3</sub> and *b*, and, thus, mitochondrial respiration ( 343 , 344 ). Impaired heme synthesis is evident in reduced activities of ferrochelatase ( 345 ) and ALA synthase ( 346 ), which appear to be secondary effects because these enzymes are synthesized in the cytosol. The greater sensitivity of the erythroid cell line to chloramphenicol has been demonstrated *in vitro* in that therapeutic concentrations of the drug inhibit erythroid colony growth but not granulocyte colony growth ( 347 ). Higher concentrations of serine and glycine in erythroid cell mitochondria were considered to play a role ( 348 ). Erythrokinetic parameters reflect a hypoproliferative state. Reticulocytopenia, increased serum iron values, and prolonged plasma iron clearance are characteristic ( 340 ). These abnormalities, as well as the ring sideroblasts and anemia, disappear when the drug is withdrawn.

## Copper Deficiency

Copper deficiency generally does not occur in humans because daily requirements are low relative to its wide distribution in food ( 349 ). It has developed after gastrectomy ( 350 ) and in the settings of prolonged parenteral nutrition ( 351 , 352 , 353 , 354 and 355 ) and forced enteral feeding ( 356 , 357 and 358 ) if copper was not included in the formulations. Copper deficiency also occurs with the use of copper chelating agents ( 359 ) and after consumption of zinc supplements for prolonged periods ( 360 ). In two instances, the deficiency developed from ingestion of coins and was attributed to their zinc content ( 361 , 362 ). A unique syndrome of severe sidero-blastic anemia, central nervous system demyelination, and profound copper deficiency with or without increased serum zinc levels for which no source could be identified has recently been described in four cases ( 363 , 364 and 365 ). Except for the latter syndrome, the manifestations are limited to anemia regularly accompanied by neutropenia.

The pathogenesis is understood in part from extensive studies of the severe anemia that develops late in the course of dietary copper deficiency in swine ( 366 ). The microcytic hypochromic anemia is associated with several defects of iron metabolism. Intestinal absorption and mobilization of iron from reticuloendothelial cells and hepatocytes to transferrin are impaired because of the associated lack of ceruloplasmin (ferroxidase). In reticulocytes of deficient animals, protoporphyrin production from glycine and ALA and ferrochelatase activity are not reduced ( 367 ), but iron metabolism in erythroid mitochondria is impaired in that heme synthesis from ferric iron and protoporphyrin is decreased ( 368 ). It was postulated that the reduction of ferric iron to ferrous iron is defective, being somehow linked to the diminished levels of cytochrome oxidase also observed. Low levels of intracellular copper enzymes, such as cytochrome oxidase, may interfere with hematopoiesis in other ways and also account for the neutropenia. The

cause of copper deficiency after ingestion of excess zinc is attributed to induction of the intestinal protein metallothionein by zinc ( 369 ). The metallothionein then preferentially binds copper ( 370 ), prevents its absorption, and enhances its excretion ( 371 ). In the syndrome with central nervous system demyelination, a derangement of copper uptake by the enterocyte, which may also be somehow linked to increased uptake of zinc, is hypothesized.

The anemia is progressive and may be profound if untreated; the hemoglobin reached a level of 3.5 g per dl in one patient ( 360 ). The MCV usually is normal or slightly increased at presentation, but a hypochromic microcytic red cell population is detectable on the blood smear. The granulocytes are usually less than 1000 per mm<sup>3</sup>; the platelet count is normal. The bone marrow tends to be hypoplastic, and vacuolization of early erythroid and granulocytic precursors is another typical finding. In most instances, moderate numbers of ring sideroblasts are observed. Serum iron levels and transferrin saturation are normal. The serum copper and ceruloplasmin levels are uniformly low. In cases of zinc-induced copper deficiency, serum zinc levels are increased from two- to threefold above the mean normal value.

With correction of the copper deficit, recovery is prompt and complete. In some cases, recovery followed discontinuation of the excess zinc intake alone. Zinc as a therapeutic agent should thus be prescribed with caution ( 372 , 373 ), and its use as a supplement promulgated by food faddists is discouraged.

### **Hypothermia**

In 1982, O'Brien and co-workers described three patients who, during episodic hypothermia, exhibited erythroid hypoplasia and ring sideroblasts as well as thrombocytopenia in the presence of a normal number of megakaryocytes ( 374 ). As the body temperature returned to normal, these changes slowly reversed. The ring sideroblast abnormality might be explained by the well-known inhibition of the translocation of proteins into mitochondria by reduced temperature ( 374 , 375 ). Heme synthesis ( 376 ) and iron incorporation into hemoglobin by reticulocytes ( 377 ) have also been shown to be diminished at lowered temperatures.

## **DISORDERS OF ERYTHROID HEME SYNTHESIS WITHOUT RING SIDEROBLASTS**

### **Anemia of Lead Poisoning**

Lead poisoning has occurred from a wide array of sources that includes lodged bullets, inhaled fumes in various industries or from lead particles in a firing range, ingested contaminated herbs and food supplements, and beverages containing lead solubilized from glazes of utensils and linings of stills ( 378 , 379 ). In children, the primary source is ingestion of lead-based paint chips. Organic lead is acquired by absorption through the skin or by gasoline sniffing. Heterozygotes of hereditary ALA dehydratase deficiency are said to be more susceptible to lower levels of lead exposure ( 380 ), as are persons with one or both genes for the less common allele ( *ALAD2* ) of the enzyme ( 381 ). Although lead has been eliminated from various consumer products and occupational exposure is monitored, it remains the most common cause of occupational poisoning worldwide ( 382 ).

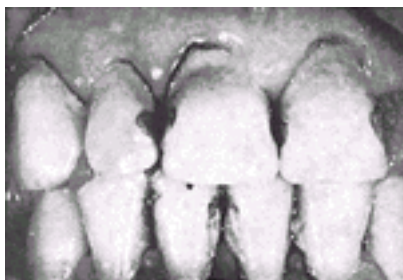
The anemia that accompanies lead poisoning (plumbism) is in part the result of various



inhibitory effects of lead on heme biosynthesis ( [383](#), [384](#) ). Most steps in the heme biosynthetic pathway are inhibited by lead to varying degrees. Presumably, lead displaces an essential metal or reacts with active-site thiol groups of the enzymes, but the precise mechanism is not worked out in most cases. ALA dehydratase is most sensitive to lead *in vitro* and *in vivo*, followed by the ferrochelatase, coproporphyrinogen oxidase, and PBG deaminase steps, respectively. The effects of lead on the production of heme are also interrelated with iron metabolism. In erythroid cells, lead limits the intracellular delivery of iron to the site of ferrochelatase, and the surrogate metal zinc is inserted into protoporphyrin by ferrochelatase as in iron deficiency ( [385](#), [386](#) ) so that zinc protoporphyrin accumulates. The reduced iron supply to the site of heme synthesis probably accounts for the usual absence of the ring sideroblast abnormality in persons with lead intoxication. Ferrochelatase may be directly inhibited in acute and more severe lead intoxication, and, only then, nonchelated protoporphyrin accumulates in erythrocytes ( [387](#), [388](#) and [389](#) ). Lead also impairs globin synthesis ( [390](#), [391](#) ). With prolonged lead exposure, erythroid hypoplasia may occur ( [392](#) ).

Other effects of lead increase the rate of red cell destruction. Changes in the spatial arrangement of red cell membrane proteins caused by lead are believed to inhibit adenosine triphosphatase, leading to cellular loss of  $K^+$  ( [393](#) ). If the lead burden is sufficiently severe (i.e., with blood lead concentrations of 200  $\mu\text{g}$  per dl or greater), impaired erythrocyte pyrimidine 5'-nucleotidase activity causes accumulation of nucleotides that inhibit the pentose phosphate shunt ( [394](#) ) and promote hemolysis as in the genetically determined deficiency of the enzyme ( [395](#) ) (see [Chapter 33](#)).

The typical clinical manifestations are autonomic neuropathy causing abdominal pain and ileus (lead colic) and motor neuropathy (lead palsy) ( [396](#) ). A lead line may be seen on the gums ( [Fig. 29.8](#) ) and tonsils. Occasionally, renal dysfunction (lead nephropathy) may prompt the diagnosis. These classic features denote advanced lead toxicity, and more recent experience indicates that insidious, nonspecific musculoskeletal and neuropsychiatric complaints are more prevalent ( [378](#) ).



**Figure 29.8.** Lead “line” in a patient with plumbism. Under a hand lens, the lead line of blue-black sulfide, actually deposited in the gums immediately opposite to the teeth, appears as a clear row of dots or vertical streaks. (From Belknap EL. Differential diagnosis of lead poisoning. JAMA 1949;139:818–825, with permission.)

The hematologic changes in lead poisoning are variable, perhaps because of the diverse effects on the erythron. In a recent series of adult patients, anemia was present in only 25% of individuals ( [378](#) ). Anemia in children is also a late sign of lead poisoning by current standards ( [397](#) ) and frequently is compounded by iron deficiency ( [398](#) ). The severity of the anemia ranges from mild to moderate, and the red cells tend to be mildly hypochromic and microcytic ( [Table 29.4](#) ). The reticulocyte count may be raised in patients with overt

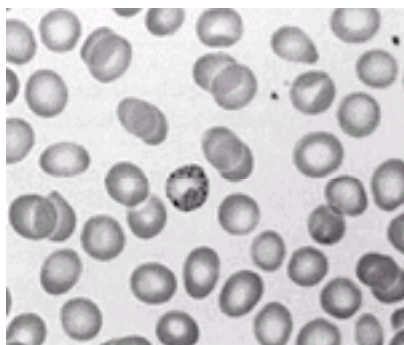


hemolysis ( 396 ). Coarse basophilic stippling may be prominent ( Fig. 29.9 ), representing aggregated ribosomes that presumably are retained because RNA degradation is impaired as a result of the pyrimidine 5'-nucleotidase deficiency, but it is not always found and does not correlate with the lead burden ( 399 ). Osmotic fragility of the erythrocytes is decreased; mechanical fragility is increased consequent to the membrane injury ( 399 ). An electrophoretically "fast" hemoglobin similar to hemoglobin A<sub>3</sub> may be found ( 400 ). In some patients, increased levels of hemoglobins A<sub>2</sub> and F were reported ( 401 ). The bone marrow usually reveals erythroid hyperplasia, but it may be hypoplastic. Authentic ring sideroblasts are uncommon, if they occur at all.

**TABLE 29.4. Hematologic Changes in the Anemia of Lead Poisoning in Adults**

|  | Normal<br>(Range)                      | Lead Poisoning<br>(Range) |
|--|--|---------------------------|
| Hemoglobin (g/dl)                                | &male; 14.0–18.0<br>&female; 12–16     | 10.7<br>(8–13)            |
| Volume packed red cells (L/L)                    | &male; 0.40–0.54<br>&female; 0.37–0.47 | 0.35<br>(0.29–0.43)       |
| Mean corpuscular volume (fl)                     | 89 (83–96)                             | 79 (70–92)                |
| Mean corpuscular hemoglobin concentration (g/dl) | 34 (32–36)                             | 31 (27–36)                |
| Reticulocytes (%)                                | 1.6 (0.6–2.7)                          | 4.4 (1.5–11.6)            |
| Stippled cells (%)                               | Rare                                   | 1.8 (0.1–7.5)             |
| Leukocytes ( × 10 <sup>9</sup> /L)               | 4–11                                   | 4–15                      |

Adapted from Dagg JH, Goldberg A, Lochhead A, Smith JA. The relationship of lead poisoning to acute intermittent porphyria. *QJM* 1965;34:163–175; and Griggs RC. Lead poisoning: hematologic aspects. *Prog Hematol* 1964;4:117–137.



**Figure 29.9.** Hypochromia and red cell stippling in lead poisoning. See [Color Plate](#).

The mean red cell lifespan is reduced with a random pattern of destruction despite problems with the accelerated <sup>51</sup>Cr elution from red cells due to lead effects on the red cell membrane ( 402 ). Serum iron levels tend to be normal or slightly increased unless the patient has associated iron deficiency. The findings of ferrokinetic studies are consistent

with ineffective erythropoiesis accompanied by mild hemolysis ( 402 ).

Parameters of heme biosynthesis (porphyrin changes) reflect the inhibition of the various enzymatic steps and correlate with the lead burden ( 383 ). ALA dehydratase activity in erythrocytes is reduced in proportion to blood lead levels, and, in contrast to the hereditary deficiency of the enzyme, its *in vitro* activity is restored to normal by reducing agents such as glutathione or dithiothreitol ( 383 ). As a consequence of the reduced activity, urinary ALA is greatly increased, whereas levels of PBG are rarely increased, a combination that helps to distinguish plumbism from acute intermittent porphyria, in which PBG is excreted in greater excess than ALA. Urinary coproporphyrin, and to a lesser degree uroporphyrin, levels are also increased in lead poisoning. The zinc protoporphyrin level in erythrocytes is increased more than in iron deficiency.

The upper limit of the “normal” level of blood lead, which is mostly contained in erythrocytes ( 403 ), is 30 µg per dl of whole blood. Adults with concentrations of 30 to 75 µg per dl show decreased ALA dehydratase activity, increased urinary excretion of ALA, and an increase in erythrocyte protoporphyrin ( 404 ) and may have nonspecific mild symptoms of lead poisoning. Clear symptoms usually are associated with concentrations that exceed 75 µg per dl. Concentrations in urine greater than 0.1 mg per 24 hours also establish the diagnosis of lead intoxication. When urinary lead excretion is borderline, response to slow intravenous infusion of 25 mg/kg (not to exceed 2 g) of the chelator calcium disodium ethylenediaminetetraacetic acid can confirm the diagnosis; excretion of more than 0.2 mg of lead in 24 hours indicates an increased lead burden.

Treatment consists of removal of the lead source and administration of ethylenediaminetetraacetic acid, 50 mg/kg/day in two divided doses, by slow intravenous infusion with ample fluids for 5 days ( 379 , 404 ). This regimen may be repeated in 3 to 4 weeks, depending on the response of blood lead levels. Renal function should be monitored. Recovery usually is prompt. An oral chelating agent, 2,3-dimercaptosuccinic acid, is available for use in children ( 405 ).

## Certain Porphyrrias

Heme biosynthesis is strikingly perturbed in the various porphyrias that result from heterogeneous molecular defects at any specific step of the pathway beyond the ALA synthase step (see [Chapter 31](#)). Tissue-specific differences of expression and of regulation of most of the heme pathway enzymes likely account for the usual absence of anemia because, in the porphyrias, the defective enzymes do not become rate-limiting in the erythroid cell. In a few of them, erythroid heme production may be minimally compromised, as noted for protoporphyria previously, or accumulation of biosynthetic intermediates perturbs erythroid cell development, survival, or both.

**CONGENITAL ERYTHROPOIETIC PORPHYRIA** In this rare disorder, expressed as an autosomal-recessive trait, erythroid heme biosynthesis is not diminished ( 406 , 407 ). Because of the low residual uroporphyrinogen III synthase activity, uroporphyrin I is overproduced and occurs mainly in erythroid cells. Variable anemia is associated with dyserythropoiesis and varying degrees of peripheral hemolysis. The porphyrin accumulates in the nuclei of developing erythroblasts and is believed to affect their maturation. Anemia often is not the principal clinical problem. In some patients, the hemolytic process is improved by splenectomy.

**HEPATOERYTHROPOIETIC PORPHYRIA** Hepatoerythropoietic porphyria represents the homozygous deficiency of uroporphyrinogen decarboxylase and usually is expressed as a severe form of porphyria cutanea tarda from birth ( 408 ). More than 20 cases have been

reported, and mild anemia was noted in one elderly sibling pair ( 409 ). The level of FEP as zinc protoporphyrin was elevated in all cases and is attributed to a relatively increased conversion of uroporphyrinogen III to protoporphyrin late in erythroid maturation when ferrochelatase becomes rate-limiting. The anemia, if it occurs in some homozygotes, has not been characterized.

**HEREDITARY COPROPORPHYRIA (HARDEROPORPHYRIA)** Anemia has been encountered only in the harderoporphyria variant of coproporphyrin (see [Chapter 31](#)), in which large amounts of the tricarboxylic harderoporphyrin accumulate ( 410 , 411 ). Affected individuals carry homozygous or compound heterozygous mutations in the coproporphyrinogen III oxidase gene, and the expressed mutant enzyme has approximately 24% residual activity. Clinically, a hemolytic anemia is evident at birth, with hyperbilirubinemia, hepatosplenomegaly, and photosensitivity, but neurovisceral symptoms of acute porphyrias are absent. The anemia seems attributable to, at least, a photohemolysis component, in that erythrocyte porphyrin (reported as protoporphyrin) was increased approximately eightfold when compared to values in related asymptomatic heterozygotes, and it lessened with age. The mechanism has not been further characterized.

### Miscellaneous

Several patients with congenital hypochromic microcytic anemia, hyperferremia, and iron overload of the liver but with reduced bone marrow iron content have been described ( 412 , 413 and 414 ). Findings of morphologic and ferrokinetic studies suggest a defect in the delivery of iron to erythroid cells. In two patients, bone marrow ferrochelatase activity was reduced by 80%, although its activity in the liver was normal ( 414 ). In a third patient, reticulocyte ferrochelatase activity was 6% of normal, and several mitochondrial enzymes were similarly affected in the liver ( 413 ). None of these patients exhibited ring sideroblasts, and the precise defects remain to be defined.

### REFERENCES

1. Mollin DL. Sideroblasts and sideroblastic anaemia. *Br J Haematol* 1965;11:41-48.
2. Bottomley SS. Sideroblastic anaemia. *Clin Haematol* 1982;11:389-409.
3. Caroli J, Bernard J, Bessis M, et al. Hemochromatose avec anemie hypochrome et absence d'hémoglobine anormale. *Presse Med* 1957;65:1991-1992.
4. Sorenson GD. Electron microscopic observations of bone marrow from patients with sideroblastic anemia. *Am J Pathol* 1962;40:297-314.
5. Goodman JR, Hall SG. Accumulation of iron in mitochondria of erythroblasts. *Br J Haematol* 1967;13:335-340.
6. Levi S, Corsi B, Bosisio M, et al. A human mitochondrial ferritin gene. *J Biol Chem* 2001;276:24437-24440.
7. Cazzola M, Invernizzi R, Bergamaschi G, et al. Mitochondrial ferritin expression in erythroid cells from patients with sideroblastic anemia. *Blood* 2003;101:1996-2000.
8. Bottomley SS. Sideroblastic anaemia. In: Jacobs A, Worwood M, eds. *Iron in biochemistry and medicine II*. London: Academic Press, 1980:363-392.
9. White JM, Brain MC, Ali MAM. Globin synthesis in sideroblastic anaemia. I.  $\alpha$  and  $\beta$  peptide chain synthesis. *Br J Haematol* 1971;20:263-275.
10. White JM, Ali MAM. Globin synthesis in sideroblastic anaemia. II. The effect of pyridoxine,

- d-aminolevulinic acid and haem, in vitro. *Br J Haematol* 1973;24:481–489.
11. Bottomley SS. The spectrum and role of iron overload in sideroblastic anemia. *Ann N Y Acad Sci* 1988;526:331–332.
  12. May A, deSouza P, Barnes K, et al. Erythroblast iron metabolism in sideroblastic marrows. *Br J Haematol* 1982;52:611–621.
  13. Harris JW, Horrigan DL. Pyridoxine-responsive anemia: analysis of 62 cases. *Adv Intern Med* 1964;12:103–174.
  14. Harris JW, Horrigan DL. Pyridoxine-responsive anemia—prototype and variations on the theme. *Vitam Horm* 1964;22:721–753.
  15. Wickramasinghe SN, Chalmers DG, Cooper EH. A study of ineffective erythropoiesis in sideroblastic anaemia and erythraemic myelosis. *Cell Tissue Kinet* 1968;1:43–50.
  16. Singh AK, Shinton NK, Williams JDF. Ferrokinetic abnormalities and their significance in patients with sideroblastic anaemia. *Br J Haematol* 1970;18:67–77.
  17. Barosi G, Cazzola M, Morandi S, et al. Estimation of ferrokinetic parameters by a mathematical model in patients with primary acquired sideroblastic anaemia. *Br J Haematol* 1978;39:409–423.
  18. Barrett PVD, Cline MJ, Berlin NI. The association of the urobilin “early peak” and erythropoiesis in man. *J Clin Invest* 1966;45:1657–1667.
  19. Muta K, Krantz SB. Inhibition of heme synthesis induces apoptosis in human erythroid progenitor cells. *J Cell Physiol* 1995;163:38–50.
  20. Matthes TW, Meyer G, Samii K, Beris P. Increased apoptosis in acquired sideroblastic anaemia. *Br J Haematol* 2000;111:843–852.
  21. Hellstrom-Lindberg E, Schmidt-Mende J, Forsblom AM, et al. Apoptosis in refractory anaemia with ringed sideroblasts is initiated at the stem cell level and associated with increased activation of caspases. *Br J Haematol* 2001;112:714–726.
  22. Dacie JV, Mollin DL. Siderocytes, sideroblasts and sideroblastic anaemia. *Acta Med Scand (Suppl)* 1966;445:237–248.
  23. Cartwright GE, Deiss A. Sideroblasts, siderocytes and sideroblastic anemia. *N Engl J Med* 1975;292:185–193.
  24. Weintraub LR, Conrad ME, Crosby WH. Iron-loading anemia. Treatment with repeated phlebotomies and pyridoxine. *N Engl J Med* 1966;275:169–176.
  25. Heilmeyer von L. Disturbances in heme synthesis: special considerations of the sideroachrestic anemias and erythropoietic porphyrias. Springfield, IL: Charles C. Thomas, 1966.
  26. Pippard MJ, Weatherall DJ. Iron absorption in non-transfused iron loading anaemias: prediction of risk for iron loading and response to iron chelation treatment, in  $\beta$  thalassemia intermedia and congenital sideroblastic anaemias. *Haematologia* 1984;17:2–24.
  27. Bottomley SS. Secondary iron overload disorders. *Semin Hematol* 1998;35:77–86.
  28. Bottomley SS. Iron overload in sideroblastic and other non-thalassemic anemias. In: Barton JC, Edwards CQ, eds. *Hemochromatosis: genetics, pathophysiology, diagnosis and treatment*. Cambridge: Cambridge University Press, 2000:442–452.
  29. Cartwright GE, Edwards CQ, Skolnick MH, Amos DB. Association of HLA-linked hemochromatosis with idiopathic refractory sideroblastic anemia. *J Clin Invest* 1980;65:989–992.
  30. Yaouanq J, Grosbois B, Jouanolle AM, et al. Haemochromatosis Cys282Tyr mutation in

pyridoxine-responsive sideroblastic anaemia. *Lancet* 1997;349: 1475–1476.

31. Cotter PD, May A, Li L, et al. Four new mutations in the erythroid-specific 5-aminolevulinic acid synthase (ALAS2) gene causing X-linked sideroblastic anemia: increased pyridoxine responsiveness after removal of iron overload by phlebotomy and coinheritance of hereditary hemochromatosis. *Blood* 1999;93:1757–1769.

32. Simon M, Beaumont C, Briere J, et al. Is the HLA-linked haemochromatosis allele implicated in idiopathic refractory sideroblastic anaemia? *Br J Haematol* 1985;60:75–80.

33. Bottomley SS, Wasson EG, Wise PD. Role of the hemochromatosis HFE gene mutation(s) in the iron overload of hereditary sideroblastic anemia. *Blood* 1997;90[Suppl 1]:11b(abst).

34. Beris P, Samii K, Darbellay R, et al. Iron overload in patients with sideroblastic anaemia is not related to the presence of the haemochromatosis Cys282Tyr and His63Asp mutations. *Br J Haematol* 1999;104:97–99.

35. Grosbois B, Bibes B, Jouanolle AM, et al. Haemochromatosis mutations and idiopathic acquired sideroblastic anemia (IASA). *Blood* 1999;94[Suppl 1]:15b(abst).

36. Cooley TB. A severe type of hereditary anemia with elliptocytosis. Interesting sequence of splenectomy. *Am J Med Sci* 1945;209:561–568.

37. Rundles RW, Falls HF. Hereditary (? sex-linked) anemia. *Am J Med Sci* 1946;211:641–658.

38. Harris JW, Whittington RM, Weisman R Jr, Horrigan DL. Pyridoxine-responsive anemia in the human adult. *Proc Soc Exp Biol Med* 1956;91:427–432.

39. Bishop RC, Bethell FH. Hereditary hypochromic anemia with transfusion hemosiderosis treated with pyridoxine. *N Engl J Med* 1959;261:486–489.

40. Vogler WR, Mingioli ES. Heme synthesis in pyridoxine-responsive anemia. *N Engl J Med* 1965;273:347–353.

41. Dacie JV, Doniach I. The basophilic property of the iron-containing granules in siderocytes. *J Pathol* 1947;59:684–686.

42. McFadzean AJS, Davis LJ. Iron-staining erythrocytic inclusions with special reference to acquired haemolytic anaemia. *Glasgow Med J* 1947;28:237–264.

43. Bjorkman SE. Chronic refractory anemia with sideroblastic bone marrow. A study of four cases. *Blood* 1956;11:250–259.

44. Gehrman G. Pyridoxine-responsive anemias. *Br J Haematol* 1965;11:86–91.

45. Brain MC, Herdan A. Tissue iron stores in sideroblastic anaemia. *Br J Haematol* 1965;11:107–113.

46. Hathway D, Harris JW, Stenger RJ. Histopathology of the liver in pyridoxine-responsive anemia. *Arch Pathol Lab Med* 1967;83:175–179.

47. Verwilghen R, Reybrouck G, Callens L, Cosemans J. Antituberculous drugs and sideroblastic anaemia. *Br J Haematol* 1965;11:92–98.

48. McCurdy PR, Donohoe RF. Reversible sideroblastic anemia caused by pyrazinoic acid (pyrazinamide). *Ann Intern Med* 1966;64:1280–1284.

49. Harriss EB, MacGibbon BH, Mollin DL. Experimental sideroblastic anaemia. *Br J Haematol* 1965;11:99–106.

50. Tanaka M, Bottomley SS. Bone marrow 5-aminolevulinic acid synthetase in experimental sideroblastic anemia. *J Lab Clin Med* 1974;84:92–98.

51. Beck EA, Ziegler G, Schmid R, Ludin H. Reversible sideroblastic anemia caused by chloramphenicol.

Acta Haematol (Basel) 1967;38:1–10.

52. Hines JD. Reversible megaloblastic and sideroblastic marrow abnormalities in alcoholic patients. *Br J Haematol* 1969;16:87–101.

53. Bottomley SS, Muller–Eberhard U. Pathophysiology of heme synthesis. *Semin Hematol* 1988;25:282–302.

54. Sadlon TJ, Dell'Oso T, Surinya KH, May BK. Regulation of erythroid 5–aminolevulinate synthase expression during erythropoiesis. *Int J Biochem Cell Biol* 1999;31:1153–1167.

55. Dzikaite V, Konopka A, Brock JH, et al. A novel endoproteolytic processing activity in mitochondria of erythroid cells and the role in heme synthesis. *Blood* 2000;96:740–746.

56. Sutherland GR, Baker E, Callen DF, et al. 5–Aminolevulinate synthase is at 3p21 and thus not the primary defect in X–linked sideroblastic anemia. *Am J Hum Genet* 1988;43:331–335.

57. Cox TC, Bawden MJ, Abraham NG, et al. Erythroid 5–aminolevulinate synthase is located on the X chromosome. *Am J Hum Genet* 1990;46:107–111.

58. Bishop DF, Henderson AS, Astrin KH. Human d–aminolevulinate synthase: assignment of the housekeeping gene to 3p21 and the erythroid–specific gene to the X chromosome. *Genomics* 1990;7:207–214.

59. Bishop DF. Two different genes encode d–aminolevulinate synthase in humans: nucleotide sequences of cDNAs for the housekeeping and erythroid genes. *Nucleic Acids Res* 1990;18:7187–7188.

60. Cotter PD, Drabkin HA, Varkony T, et al. Assignment of the human housekeeping d–aminolevulinate synthase gene (ALAS1) to chromosome band 3p21.1 by PCR analysis of somatic cell hybrids. *Cytogenet Cell Genet* 1995;69:207–208.

61. May BK, Dogra SC, Sadlon TJ, et al. Molecular regulation of heme biosynthesis in higher vertebrates. *Prog Nucleic Acid Res Mol Biol* 1995;51:1–51.

62. Cotter PD, Willard HF, Gorski JL, Bishop DF. Assignment of human erythroid d–aminolevulinate synthase (ALAS2) to a distal subregion of band Xp11.21 by PCR analysis of somatic cell hybrids containing X;autosome translocations. *Genomics* 1992;13:211–212.

63. Cox TC, Kozman HM, Raskind WH, et al. Identification of a highly polymorphic marker within intron 7 of the ALAS2 gene and suggestion of at least two loci for X–linked sideroblastic anemia. *Hum Mol Genet* 1992;1:639–641.

64. Nakajima O, Takahashi S, Harigae H, et al. Heme deficiency in erythroid lineage causes differentiation arrest and cytoplasmic iron overload. *EMBO J* 1999;18:6282–6289.

65. Harigae H, Suwabe N, Weinstock PH, et al. Deficient heme and globin synthesis in embryonic stem cells lacking the erythroid–specific d–aminolevulinate synthase gene. *Blood* 1998;91:798–805.

66. Yin X, Dailey HA. Erythroid 5–aminolevulinate synthase is required for erythroid differentiation in mouse embryonic stem cells. *Blood Cells Mol Dis* 1998;24:41–53.

67. Hofer T, Wenger H, Kramer MF, et al. Hypoxic up–regulation of erythroid 5–aminolevulinate synthase. *Blood* 2003;101:348–350.

68. Fuchs O, Ponka P. The role of iron supply in the regulation of 5–aminolevulinate synthase mRNA levels in murine erythroleukemia cells. *Neoplasma* 1996;43:31–36.

69. Smith SJ, Cox TM. Translation control of erythroid 5–aminolevulinate synthase in immature human erythroid cells by heme. *Cell Mol Biol* 1997;43:103–114.

70. Cox TC, Bawden MJ, Martin A, May BK. Human erythroid 5–aminolevulinate synthase: promoter analysis and identification of an iron–responsive element in the mRNA. *EMBO J* 1991;10:1891–1902.

71. Dandekar T, Stripecke R, Gray NK, et al. Identification of a novel iron-responsive element in murine and human erythroid d-aminolevulinic acid synthase mRNA. *EMBO J* 1991;10:1903-1909.
72. Melefors O, Goossen B, Johansson HE, et al. Translational control of 5-aminolevulinate synthase mRNA by iron-responsive elements in erythroid cells. *J Biol Chem* 1993;268:5974-5978.
73. Bhasker CR, Burgiel G, Neupert B, et al. The putative iron-responsive element in the human erythroid 5-aminolevulinate synthase mRNA mediates translational control. *J Biol Chem* 1993;268:12699-12705.
74. Gray NK, Hentze MW. Iron regulatory protein prevents binding of the 43s translation pre-initiation complex to ferritin and eALAS mRNAs. *EMBO J* 1994;13:3882-3891.
75. Hentze MW, Caughman SW, Rouault TA, et al. Identification of the iron-responsive element for the translational regulation of human ferritin mRNA. *Science* 1987;238:1570-1573.
76. Ferreira GC, Franco R, Lloyd SG, et al. Mammalian ferrochelatase, a new addition to the metalloenzyme family. *J Biol Chem* 1994;269:7062-7065.
77. Dailey HA, Finnegan MG, Johnson MK. Human ferrochelatase is an iron-sulfur protein. *Biochemistry* 1994;33:403-407.
78. Ferreira GC. Ferrochelatase binds the iron-responsive element present in the erythroid 5-aminolevulinate synthase mRNA. *Biochem Biophys Res Commun* 1995;214:875-878.
79. Klausner RD, Rouault TA, Harford JB. Regulating the fate of mRNA: the control of cellular iron metabolism. *Cell* 1993;72:19-28.
80. Takaku F, Yano Y, Aoki Y, et al. d-Aminolevulinic acid synthetase activity of human bone marrow erythroid cells in various hematological disorders. *Tohoku J Exp Med* 1972;107:217-228.
81. Houston T, Moore MR, McColl KEL, Fitzsimons E. Erythroid 5-aminolaevulinate synthase activity during normal and iron deficient erythropoiesis. *Br J Haematol* 1991;78:561-564.
82. Lathrop JT, Timko MP. Regulation by heme of mitochondrial protein transport through a conserved amino acid motif. *Science* 1993;259:522-525.
83. Goodfellow BJ, Dias JS, Ferreira GC, et al. The solution structure and heme binding of the presequence of murine 5-aminolevulinate synthase. *FEBS Lett* 2001;505:325-331.
84. Furuyama K, Sassa S. Interaction between succinyl Co-A synthetase and the heme-biosynthetic enzyme ALAS-E is disrupted in sideroblastic anemia. *J Clin Invest* 2000;105:757-764.
85. Kaya AH, Plewinska M, Wong DM, et al. Human d-aminolevulinate dehydratase (ALAD) gene: structure and alternative splicing of the erythroid and housekeeping mRNAs. *Genomics* 1994;19:242-248.
86. Bishop TR, Miller MW, Beall J, et al. Genetic regulation of d-aminolevulinate dehydratase during erythropoiesis. *Nucleic Acids Res* 1996;24:2511-2518.
87. Guo GG, Gu M, Etlinger JD. 240-kDa proteasome inhibitor (CF-2) is identical to d-aminolevulinic acid dehydratase. *J Biol Chem* 1994;269:12399-12402.
88. Chretien S, Dubart A, Beaupain D, et al. Alternative transcription and splicing of the human porphobilinogen deaminase gene results either in tissue-specific or in housekeeping expression. *Proc Natl Acad Sci U S A* 1988;85:6-10.
89. Beru N, Goldwasser E. Studies of the effect of erythropoietin on heme synthesis. *Adv Exp Med Biol* 1989;271:87-94.
90. Frydman RB, Rosenfeld J, Camoretti-Mercado B, Peisach J. Porphobilinogen oxygenase. Purification and evidence of its hemoprotein structure. *J Biol Chem* 1988;262:15118-15126.
91. Frydman RB, Tomaro ML, Sburlati A, Gutniski A. The regulation of porphobilinogen oxygenase and



- porphobilinogen deaminase activities in rat bone marrow under conditions of erythropoietic stress. *Biochim Biophys Acta* 1986;870:520–529.
92. Aizencang G, Solis C, Bishop D, et al. Human uroporphyrinogen-III synthase: genomic organization, alternative promoters, and erythroid-specific expression. *Genomics* 2000;90:223–231.
93. Takahashi S, Taketani S, Akasaka J, et al. Differential regulation of coproporphyrinogen oxidase gene between erythroid and nonerythroid cells. *Blood* 1998;92:3436–3444.
94. Taketani S, Inazawa J, Abe T, et al. The human protoporphyrinogen oxidase gene (PPOX): organization and location to chromosome 1. *Genomics* 1995;29:698–703.
95. Magness ST, Tugores A, Diala ES, Brenner DA. Analysis of the human ferrochelatase promoter in transgenic mice. *Blood* 1998;92:320–328.
96. Busfield SJ, Riches KJ, Sainsbury AJ, et al. Retrovirally produced erythropoietin effectively induces differentiation and proliferation of J2E erythroid cells. *Growth Factors* 1993;9:87–97.
97. Houston T, Moore MR, McColl KEL, Fitzsimons EJ. Regulation of haem biosynthesis in normoblastic erythropoiesis: role of 5-aminolaevulinic acid synthase and ferrochelatase. *Biochim Biophys Acta* 1994;1201:85–93.
98. Ponka P. Tissue-specific regulation of iron metabolism and heme synthesis: distinct control mechanisms in erythroid cells. *Blood* 1997;89:1–25.
99. Weiss G, Houston T, Katner S, et al. Regulation of cellular iron metabolism by erythropoietin: activation of iron-regulatory protein and upregulation of transferrin receptor expression in erythroid cells. *Blood* 1997;89:680–687.
100. Cotner T, DasGupta A, Papayannopoulou TH, Stamatoyannopoulos G. Characterization of a novel form of transferrin receptor preferentially expressed on normal erythroid progenitors and precursors. *Blood* 1989;73:214–221.
101. Lok CN, Ponka P. Identification of an erythroid active element in the transferrin receptor gene. *J Biol Chem* 2000;275:24185–24190.
102. Marziali G, Perrotti E, Ilari R, et al. Role of Ets-1 in transcription and regulation of transferrin receptor and erythroid differentiation. *Oncogene* 2002;21:7933–7944.
103. Bottomley SS, Moore MZ. Regulation of iron metabolism in erythroblasts. *Blood* 1985;66:43a(abst).
104. Muta K, Nishimura J, Ideguchi H, et al. Erythroblast transferrin receptors and transferrin kinetics in iron deficiency and various anemias. *Am J Hematol* 1987;25:155–163.
105. Bottomley SS, Wolfe LC, Bridges KR. Iron metabolism in K562 erythroleukemia cells. *J Biol Chem* 1985;260:6811–6815.
106. Ponka P, Sheftel AD, Zhang A-S. Iron targeting to mitochondria in erythroid cells. *Biochem Soc Trans* 2002;30:735–738.
107. Crosby JS, Chefalo PJ, Yeh J, et al. Regulation of hemoglobin differentiating erythroid cells by heme-regulated eIF-2a kinase. *Blood* 2000;96:3241–3248.
108. Beru N, Sahr K, Goldwasser E. Inhibition of heme synthesis in bone marrow cells by succinylacetone: effect on globin synthesis. *J Cell Biochem* 1983;21:93–105.
109. Ross J, Sautner D. Induction of globin mRNA accumulation by hemin in cultured erythroleukemic cells. *Cell* 1976;8:513–520.
110. Hoffman LM, Ross J. The role of heme in the maturation of erythroblasts: the effects of inhibition of pyridoxine metabolism. *Blood* 1980;55:762–771.
111. Charnay P, Maniatis T. Transcriptional regulation of globin gene expression in the human erythroid

cell line K562. *Science* 1983;220:1281–1283.

112. Losowsky MS, Hall R. Hereditary sideroblastic anaemia. *Br J Haematol* 1965;11:70–85.
113. Elves MW, Bourne MS, Israels MCG. Pyridoxine-responsive anaemia determined by an X-linked gene. *J Med Genet* 1966;3:1–4.
114. Prasad AS, Tranchida L, Konno ET, et al. Hereditary sideroblastic anemia and glucose-6-phosphate dehydrogenase deficiency in a Negro family. *J Clin Invest* 1968;47:1415–1424.
115. Pasanen AVO, Salmi M, Vuopio P, Tenhunen R. Heme biosynthesis in sideroblastic anemia. *Int J Biochem* 1980;12:969–974.
116. Holmes J, May A, Geddes D, Jacobs A. A family study of congenital X-linked sideroblastic anaemia. *J Med Genet* 1990;27:26–28.
117. Cox TC, Bottomley SS, Wiley JS, et al. X-linked pyridoxine-responsive sideroblastic anemia due to a Thr<sup>388</sup>-to-Ser substitution in erythroid 5-aminolevulinic synthase. *N Engl J Med* 1994;330:675–679.
118. Prades E, Chambon C, Dailey TA, et al. A new mutation of the ALAS2 gene in a large family with X-linked sideroblastic anemia. *Hum Genet* 1995;95: 424–428.
119. Lee GR, McDiarmid WD, Cartwright GE, Wintrobe MM. Hereditary, X-linked, sideroachrestic anemia. The isolation of two erythrocyte populations differing in Xga blood type and porphyrin content. *Blood* 1968;32:59–70.
120. Weatherall DJ, Pembrey ME, Hall EG, et al. Familial sideroblastic anaemia: problem of Xg and X chromosome inactivation. *Lancet* 1970;2:744–748.
121. Peto TEA, Pippard MJ, Weatherall DJ. Iron overload in mild sideroblastic anaemias. *Lancet* 1983;1:375–378.
122. Bottomley SS, Wise PD, Wasson EG, Carpenter NJ. X-linked sideroblastic anemia in ten female probands due to ALAS2 mutations and skewed X chromosome inactivation. *Am J Hum Genet* 1998;63[Suppl]:A352(abst).
123. Aoki Y, Maranaka S, Nakabayashi K, Ueda Y. d-Aminolevulinic acid synthetase in erythroblasts of patients with pyridoxine-responsive anemia. *J Clin Invest* 1979;64:1196–1203.
124. Konopka L, Hoffbrand AV. Haem synthesis in sideroblastic anaemia. *Br J Haematol* 1979;42:73–83.
125. Bottomley SS, Healy HM, Brandenburg MA, May BK. 5-Aminolevulinic acid synthase in sideroblastic anemias: mRNA and enzyme activity levels in bone marrow cells. *Am J Hematol* 1992;41:76–83.
126. Wintrobe MM, Follis RH Jr, Miller MH, et al. Pyridoxine deficiency in swine. With particular reference to anemia, epileptiform convulsions and fatty liver. *Bull Johns Hopkins Hosp* 1943;72:1–25.
127. Deiss A, Kurth D, Cartwright GE, Wintrobe MM. Experimental production of siderocytes. *J Clin Invest* 1966;45:353–364.
128. Byrd RB, Cooper T. Hereditary iron-loading anemia with secondary hemochromatosis. *Ann Intern Med* 1961;55:103–123.
129. Bottomley SS. Sideroblastic anemia: death from iron overload. *Hosp Pract* 1991;26[Suppl 3]:55–56.
130. Cotter PD, May A, Fitzsimons EJ, et al. Late-onset X-linked sideroblastic anemia. *J Clin Invest* 1995;96:2090–2096.
131. Rosenberg SJ, Bennett JM. Pyridoxine-responsive anemia. *N Y State J Med* 1969;69:1430–1433.
132. Joosten E, van den Berg A, Riezler R, et al. Metabolic evidence that deficiencies of vitamin B-12

(cobalamin), folate and vitamin B-6 occur commonly in elderly people. *Am J Clin Nutr* 1993;58:468-476.

133. Nankivell BJ. Vitamin B<sub>6</sub> deficiency on hemodialysis causing sideroblastic anemia. *Nephron* 1991;59:674-675.

134. Furuyama K, Harigae H, Kinoshita C, et al. Late-onset X-linked sideroblastic anemia following hemodialysis. *Blood* 2003;101:4623-4624.

135. Busque L, Mio R, Mattioli J, et al. Nonrandom X-inactivation patterns in normal females: lyonization ratios vary with age. *Blood* 1996;88:59-65.

136. Cazzola M, May A, Bergamisci G, et al. Familial-skewed X-chromosome inactivation as a predisposing factor for late-onset X-linked sideroblastic anemia in carrier females. *Blood* 2000;96:4363-4365.

137. Conboy JG, Cox TC, Bottomley SS, et al. Human erythroid 5-aminolevulinate synthase: gene structure and species-specific differences in alternative RNA splicing. *J Biol Chem* 1992;267:18753-18758.

138. Noble JS, Taylor GR, Losowsky MS, et al. Linkage analysis of a large pedigree with hereditary sideroblastic anaemia. *J Med Genet* 1995;32:389-392.

139. Xu WL, Zhu P. G514A mutation in the erythroid-specific 5-aminolevulinate synthase gene leading to X-linked sideroblastic anemia in a family. *Blood* 2002;100[Suppl]:15b(abst).

140. Hurford MT, Marshal-Taylor C, Vicki SL, et al. A novel mutation in exon 5 of the *ALAS2* gene results in X-linked sideroblastic anemia. *Clin Chim Acta* 2002;321:49-53.

141. Zhu P, Bu D. A novel mutation of the *ALAS2* gene in a family with X-linked sideroblastic anemia. *Zhonghua Xue Ye Xue Za Zhi* 2000;21:478-481.

142. Cotter PD, Rucknagel DL, Bishop DF. X-linked sideroblastic anemia: identification of the mutation in the erythroid-specific d-aminolevulinate synthase gene (*ALAS2*) in the original family described by Cooley. *Blood* 1994;84:3915-3924.

143. Furuyama K, Sassa S. Multiple mechanisms for hereditary sideroblastic anemia. *Cell Mol Biol* 2002;48:5-10.

144. Edgar AJ, Vidyatilake HMS, Wickramasinghe SN. X-linked sideroblastic anaemia due to a mutation in the erythroid 5-aminolaevulinate synthase gene leading to an arginine<sup>170</sup> to leucine substitution. *Eur J Haematol* 1998;61:55-58.

145. Furuyama K, Fujita H, Nagai R, et al. Pyridoxine refractory X-linked sideroblastic anemia caused by a point mutation in the erythroid 5-aminolevulinate synthase gene. *Blood* 1997;90:822-830.

146. Harigae H, Furuyama K, Kudo K, et al. A novel mutation of the erythroid-specific d-aminolevulinate synthase gene in a patient with non-inherited pyridoxine responsive sideroblastic anemia. *Am J Hematol* 1999;62:112-114.

147. Rivera CE, Heath AP. Identification of a new mutation in erythroid-specific d-aminolevulinate synthase in a patient with congenital sideroblastic anemia. *Blood* 1999;94[Suppl]:19b(abst).

148. Bishop DF, Cotter PD, May A, et al. A novel mutation in exon 9 of the erythroid 5-aminolevulinate synthase gene shows phenotypic variability leading to X-linked sideroblastic anemia in two unrelated male children but to the late-onset form of this disorder in an unrelated female. *Am J Hum Genet* 1996;59[Suppl]:A248(abst).

149. Furuyama K, Uno R, Urabe A, et al. R411C mutation of the *ALAS2* gene encodes a pyridoxine-responsive enzyme with low activity. *Br J Haematol* 1998;103:839-841.

150. Bottomley SS, May BK, Cox TC, et al. Molecular defects of erythroid 5-aminolevulinate synthase in X-linked sideroblastic anemia. *J Bioenerg Biomembr* 1995;27:161-168.

151. Edgar AJ, Losowsky MS, Noble JS, Wickramasinghe SN. Identification of an arginine<sup>452</sup> to histidine

- substitution in the erythroid 5-aminolaevulinate synthase gene in a large pedigree with X-linked sideroblastic anaemia. *Eur J Haematol* 1997;58:1-4.
152. Koc S, Bishop DF, Li L, et al. Iron overload in pyridoxine-responsive X-linked sideroblastic anemia: greater severity in a heterozygote than in her hemizygous brother. *Blood* 1997;90[Suppl]:16b(abst).
153. Cotter PD, Baumann M, Bishop DF. Enzymatic defect in "X-linked" sideroblastic anemia: molecular evidence for erythroid d-aminolaevulinate synthase deficiency. *Proc Natl Acad Sci U S A* 1992;89:4028-4032.
154. Edgar AJ, Wickramasinghe SN. Hereditary sideroblastic anaemia due to a mutation in exon 10 of the erythroid 5-aminolaevulinate synthase gene. *Br J Haematol* 1998;100:389-392.
155. Cazzola M, May A, Bergamisci G, et al. Absent phenotypic expression of X-linked sideroblastic anemia in one of 2 brothers with a novel ALAS2 mutation. *Blood* 2002;100:4236-4238.
156. Harigae H, Furuyama K, Kimura A, et al. A novel mutation of the erythroid-specific d-aminolaevulinate synthase gene in a patient with X-linked sideroblastic anaemia. *Br J Haematol* 1999;196:175-177.
157. Cotton HB, Harris JW. Familial pyridoxine-responsive anemia. *J Clin Invest* 1962;31:1352(abst).
158. Ferreira GC, Neame PJ, Dailey HA. Heme biosynthesis in mammalian systems: evidence of a Schiff base linkage between pyridoxal 5' phosphate cofactor and a lysine residue in 5-aminolevulinate synthase. *Protein Sci* 1993;2:1959-1965.
159. Bottomley SS, Wise PD, Wasson EG, Carpenter NJ. The spectrum of molecular defects in the erythroid 5-aminolevulinate synthase gene in hereditary sideroblastic anemia. *Blood* 1998;92[Suppl 1]:669a(abst).
160. Shoolingin-Jordan PM, Al-Dihan S, Alexeev D, et al. 5-Aminolevulinic acid synthase: mechanism, mutations and medicine. *Biochim Biophys Acta* 2003;1647:361-366.
161. Pagon RA, Bird TD, Detter JC, Pierce I. Hereditary sideroblastic anaemia and ataxia: an X-linked recessive disorder. *J Med Genet* 1985;22:267-273.
162. Raskind WH, Wijsman E, Pagon RA, et al. X-linked sideroblastic anemia and ataxia: linkage to phosphoglycerate kinase at Xq13. *Am J Hum Genet* 1991;48:335-341.
163. Allikmets R, Hutchinson A, Gerard B, Dean M. Characterization of the human ABC superfamily: isolation and mapping of 21 new genes using the EST data base. *Hum Mol Genet* 1996;5:1649-1655.
164. Savary S, Allikmets R, Denizot F, et al. Isolation and chromosomal mapping of a novel ATP-binding cassette transporter conserved in mouse and human. *Genomics* 1997;41:275-278.
165. Shimada Y, Okuno S, Kawai A, et al. Cloning and chromosomal mapping of a novel ABC transporter gene (*hABC7*), a candidate for X-linked sideroblastic anemia with cerebellar ataxia. *J Hum Genet* 1998;43:115-122.
166. Kispal G, Csere P, Prohl C, Lill R. The mitochondrial proteins Atmp and Nfs1p are required for biogenesis of cytosolic Fe/S proteins. *EMBO J* 1999;18:3981-3989.
167. Allikmets R, Raskind WH, Hutchinson A, et al. Mutation of a putative mitochondrial iron transporter gene (*ABC7*) in X-linked sideroblastic anemia and ataxia (XLSA/A). *Hum Mol Genet* 1999;8:743-749.
168. Bekri S, Kispal G, Lange H, et al. Human ABC7 transporter: gene structure and mutation causing X-linked sideroblastic anemia with ataxia with disruption of cytosolic iron-sulfur protein maturation. *Blood* 2000;96:3256-3264.
169. Maguire A, Hellier K, Hammans S, May A. X-linked cerebellar ataxia and sideroblastic anaemia associated with a missense mutation in the ABC7 gene predicting V411L. *Br J Haematol* 2001;115:910-917.
170. Kispal G, Csere P, Guiard B, Lill R. The ABC transporter Atm1p is required for mitochondrial iron

homeostasis. *FEBS Lett* 1997;418:346–350.

171. Taketani S, Kakimoto K, Ueta H, et al. Involvement of ABC7 in the biosynthesis of heme in erythroid cells: interaction of ABC7 with ferrochelatase. *Blood* 2003;101:3274–3280.

172. Pandolfo M. Iron metabolism and mitochondrial abnormalities in Friedreich ataxia. *Blood Cells Mol Dis* 2002;29:536–547.

173. van Waveren Hogervorst GD, van Roermund HPC, Snijders PJ. Hereditary sideroblastic anaemia and autosomal inheritance of erythrocyte dimorphism in a Dutch family. *Eur J Haematol* 1987;38:405–409.

174. Amos RJ, Miller ALC, Amess JAL. Autosomal inheritance of sideroblastic anaemia. *Clin Lab Haematol* 1988;10:347–353.

175. Hast R, Miale T, Westin J, et al. Hereditary ring sideroblastic anaemia and Christmas disease in a Swedish family. *Scand J Haematol* 1983;30:444–450.

176. Kasturi J, Basha HM, Smeda SH, Swehli M. Hereditary sideroblastic anaemia in 4 siblings of a Libyan family—autosomal inheritance. *Acta Haematol (Basel)* 1982;68:321–324.

177. Brien WF, Mant MJ, Etches WS. Variant congenital dyserythropoietic anaemia with ringed sideroblasts. *Clin Lab Haematol* 1985;7:231–237.

178. Andersen K, Kaad PH. Congenital sideroblastic anaemia with intrauterine symptoms and early lethal outcome. *Acta Paediatr* 1992;81:652–653.

179. Jardine PE, Cotter PD, Johnson SA, et al. Pyridoxine–refractory congenital sideroblastic anaemia with evidence for autosomal inheritance: exclusion of linkage to ALAS2 at Xp11.21 by polymorphism analysis. *J Med Genet* 1994;31:213–218.

180. Kardos G, Veerman AJP, deWaal FC, et al. Familial sideroblastic anemia with emergence of monosomy 5 and myelodysplastic syndrome. *Med Pediatr Oncol* 1996;26:54–56.

181. Gonzalez MI, Caballero D, Vazquez L, et al. Allogeneic peripheral stem cell transplantation in a case of hereditary sideroblastic anaemia. *Br J Haematol* 2000;109:658–660.

182. Buchanan GR, Bottomley SS, Nitschke R. Bone marrow delta–aminolevulinate synthase deficiency in a female with congenital sideroblastic anemia. *Blood* 1980;55:109–115.

183. Hamel BCJ, Schretlen EDAM. Sideroblastic anaemia. A review of seven paediatric cases. *Eur J Pediatr* 1982;138:130–135.

184. Manabe Y, Seto S, Furusho K, Aoki Y. A study of a female with congenital sideroblastic anemia. *Am J Hematol* 1982;12:63–67.

185. Clausters M, Vannereau H, Bellet H, et al. A paediatric case of sideroblastic anaemia. *Eur J Pediatr* 1986;145:422–427.

186. Agrawal MB. Congenital sideroblastic anemia in a female. *Indian J Pediatr* 1988;25:685–688.

187. Dolan G, Reid MM. Congenital sideroblastic anemia in two girls. *J Clin Pathol* 1991;44:464–465.

188. Urban C, Binder B, Hauer C, Lanzer G. Congenital sideroblastic anemia successfully treated by allogeneic bone marrow transplantation. *Bone Marrow Transplant* 1992;10:373–375.

189. Scimeca PG, Weinblatt ME, Kahn E, Kochen JA. Does rapidly progressive iron overload in a young girl with sideroblastic anemia also signify the presence of hereditary hemochromatosis? *Pediatr Hematol Oncol* 1994;11:99–104.

190. Altay C, Gumruk F. Pyridoxine–responsive sideroblastic anemia in four children [Letter]. *Pediatr Hematol Oncol* 1995;12:205–208.

191. Lynch SA, deBerker D, Lehmann AR, et al. Trichothiodystrophy with sideroblastic anaemia and

- developmental delay. *Arch Dis Child* 1995;73:249–251.
192. Das R, Trehan A, Marwaha N, Marwaha RK. Congenital sideroblastic anemia. *Indian J Pediatr* 1999;36:1158–1161.
193. Bottomley SS, Tanaka M, Everett MA. Diminished erythroid ferrochelatase activity in protoporphyria. *J Lab Clin Med* 1975;86:126–131.
194. Mathews–Roth MM. Anemia in erythropoietic protoporphyria. *JAMA* 1974;230:824.
195. Scott AJ, Ansford AJ, Webster BH, Stringer HCW. Erythropoietic protoporphyria with features of a sideroblastic anemia terminating in liver failure. *Am J Med* 1973;54:251–259.
196. Rademakers LHPM, Koningsberger JC, Sorber CWJ, et al. Accumulation of iron in erythroblasts of patients with erythropoietic protoporphyria. *Eur J Clin Invest* 1993;23:130–138.
197. Porter FS, Rogers LE, Sidbury JB Jr. Thiamine–responsive megaloblastic anemia. *J Pediatr* 1969;74:494–504.
198. Neufeld EJ, Fleming JC, Tartaglino E, Steinkamp P. Thiamine–responsive megaloblastic anemia syndrome: a disorder of high–affinity thiamine transport. *Blood Cells Mol Dis* 2001;27:135–138.
199. Taz T, Barrett T, Szargel R, et al. Refined mapping of the gene for thiamine–responsive megaloblastic anemia syndrome and evidence for genetic heterogeneity. *Hum Genet* 1998;103:455–461.
200. Labay V, Raz T, Baron D, et al. Mutations in SLC19A2 cause thiamine–responsive megaloblastic anaemia associated with diabetes mellitus and deafness. *Nat Genet* 1999;22:300–304.
201. Fleming JC, Tartaglino E, Steinkamp MP, et al. The gene mutated in thiamine–responsive anaemia with diabetes and deafness (TRMA) encodes a functional thiamine transporter. *Nat Genet* 1999;22:305–308.
202. Diaz GA, Banikazemi M, Oishi K, et al. Mutations in a new gene encoding a thiamine transporter cause thiamine–responsive megaloblastic anaemia syndrome. *Nat Genet* 1999;22:309–312.
203. Baron D, Asaraf YG, Cohen N, Aronheim A. Lack of plasma membrane targeting of a G172D mutant thiamine transporter derived from Rogers syndrome family. *Mol Med* 2002;8:462–474.
204. Subramanian VS, Marchant JS, Parker I, Said HM. Cell biology of the human thiamine transporter–1 (hTHTRD). *J Biol Chem* 2003;278:3976–3984.
205. Steinkamp MP, Fleming JC, Boros LG, Neufeld EJ. Thiamine depletion in thiamine–responsive megaloblastic anemia (TRMA) mutant fibroblasts leads to a reduction in non–oxidative ribose synthesis. *FASEB J* 2000;14:A1547(abst).
206. Abboud MR, Alexander D, Najjar SS. Diabetes mellitus, thiamine–dependent megaloblastic anemia, and sensorineural deafness associated with deficient alpha–ketoglutarate dehydrogenase activity. *J Pediatr* 1985;107:537–541.
207. Pearson HA, Lobel JS, Kocoshis SA, et al. A new syndrome of refractory sideroblastic anemia with vacuolization of marrow precursors and exocrine pancreatic dysfunction. *J Pediatr* 1979;95:976–984.
208. Cormier V, Rotig A, Quartino AR, et al. Widespread multitissue deletions of the mitochondrial genome in the Pearson marrow–pancreas syndrome. *J Pediatr* 1990;117:599–602.
209. Rotig A, Cormier V, Blanche S, et al. Pearson’s marrow–pancreas syndrome. A multisystem mitochondrial disorder of infancy. *J Clin Invest* 1990;86:1601–1608.
210. Rotig A, Bourgeron T, Chretien D, et al. Spectrum of mitochondrial DNA rearrangements in the Pearson marrow pancreas syndrome. *Hum Mol Genet* 1995;4:1327–1330.
211. Smith OP, Hann IM, Woodward CE, Brockington M. Pearson’s marrow/pancreas syndrome: haematological features associated with deletion and duplication of mitochondrial DNA. *Br J Haematol*

1995;90:469–472.

212. Bader–Neunier B, Mielot F, Breton–Gorius J, et al. Hematologic involvement in mitochondrial cytopathies in childhood. A retrospective study of bone marrow smears. *Pediatr Res* 1999;46:158–162.
213. Sano T, Ban K, Ichiki T, et al. Molecular and genetic analysis of two patients with Pearson's marrow–pancreas syndrome. *Pediatr Res* 1993;34:105–110.
214. McShane MA, Hammans SR, Sweeney M, et al. Pearson syndrome and mitochondrial encephalomyopathy in a patient with a deletion of mtDNA. *Am J Hum Genet* 1991;48:39–42.
215. Nelson I, Bonne G, Degoul F, et al. Kearns–Sayre syndrome with sideroblastic anemia: molecular investigations. *Neuropediatrics* 1992;23:199–205.
216. Simonz HJ, Barlocher K, Rotig A. Kearns–Sayre's syndrome developing in a boy who survived Pearson's syndrome caused by mitochondrial DNA deletion. *Doc Ophthalmol* 1992;82:73–79.
217. Rawles JM, Weller RO. Familial association of metabolic myopathy, lactic acidosis and sideroblastic anemia. *Am J Med* 1974;56:891–897.
218. Casademont J, Barrientos A, Cardellach F, et al. Multiple deletions of mtDNA in two brothers with sideroblastic anemia and mitochondrial myopathy and in their asymptomatic mother. *Hum Mol Genet* 1994;3:1945–1949.
219. Inbal A, Avissar N, Shaklai M, et al. Myopathy, lactic acidosis, and sideroblastic anemia: a new syndrome. *Am J Med Genet* 1995;55:372–378.
220. Tuckfield A, Ratnaike S, Hussein S, Metz J. A novel form of hereditary sidero–blastic anaemia with macrocytosis. *Br J Haematol* 1997;97:279–285.
221. Brownlie A, Donovan A, Pratt SJ, et al. Positional cloning of the zebrafish *sauternes* gene: a model for congenital sideroblastic anaemia. *Nat Genet* 1998;20:244–250.
222. Gruneberg H. The anaemia of flexed–tail mice (*mus musculus* 1). I. Static and dynamic haematology. *J Genet* 1942;43:45–68.
223. Chui DH, Sweeney GD, Patterson M, Russell ES. Hemoglobin synthesis in siderocytes of *flexed–tai* mutant (*f/f*) fetal mice. *Blood* 1977;50:165–177.
224. Fleming MD, Campagna DR, Haslett JN, et al. A mutation in a mitochondrial transmembrane protein is responsible for the pleiotropic hematological and skeletal phenotype of *flexed–tai* (*f/f*) mice. *Genes Dev* 2001;15:652–657.
225. Fairbanks VF, Dickson ER, Thompson ME. Hereditary sideroblastic anemia. *Hosp Pract* 1991;26[Suppl 3]:53–55.
226. Hall R, Losowsky MS. The distribution of erythroblast iron in sideroblastic anaemias. *Br J Haematol* 1966;12:334–340.
227. Wickramasinghe SN, Fulker MJ, Losowsky MS, Hall R. Microspectrophotometric and electron microscopic studies of bone marrow in hereditary sidero–blastic anaemia. *Acta Haematol (Basel)* 1971;45:236–244.
228. Hellier KD, Hatchwell E, Duncombe AS, et al. X–linked sideroblastic anaemia with ataxia: another mitochondrial disease? *J Neurol Neurosurg Psychiatry* 2001;70:65–69.
229. Blaw ME, Mize CE. Juvenile Pearson syndrome. *J Child Neurol* 1990;5:186–190.
230. Raab SO, Haut A, Cartwright GE, Wintrobe MM. Pyridoxine–responsive anemia. *Blood* 1961;18:285–302.
231. Schafer AI, Rabinowe S, LeBoff MS, et al. Long–term efficacy of desferrioxamine iron chelation



- therapy in adults with acquired transfusional iron overload. *Arch Intern Med* 1985;145:1217–1221.
232. Hoffbrand AV, Wonke B. Results of long-term subcutaneous desferrioxamine therapy. *Bailliere's Clin Haematol* 1989;2:345–362.
233. Harris JW, Danish EH, Brittenham GM, McLaren CE. Pyridoxine responsive hereditary sideroblastic erythropoiesis and iron overload: two microcytic subpopulations in the affected male, one normocytic and one microcytic subpopulation in the obligate female carrier. *Am J Hematol* 1993;42:400–401.
234. Hines JD. Effect of pyridoxine plus chronic phlebotomy on the function and morphology of bone marrow and liver in pyridoxine-responsive anaemia. *Semin Hematol* 1976;13:133–140.
235. Vogler WR, Mingioli ES. Porphyrin synthesis and heme synthetase activity in pyridoxine-responsive anemia. *Blood* 1968;32:979–988.
236. Marcus RE, Huehns ER. Transfusional iron overload. *Clin Lab Haematol* 1985;7:195–212.
237. Olivieri NF, Brittenham GM. Iron-chelating therapy and the treatment of thalassemia. *Blood* 1997;89:739–761.
238. Nienhuis AW, Benz EJ, Propper R, et al. Thalassemia major: molecular and clinical aspects. *Ann Intern Med* 1979;91:883–897.
239. Kushner JP, Porter JB, Olivieri NF. Secondary iron overload. *Hematology (Am Soc Hematol Educ Program)* 2001:47–61.
240. Miller KB, Rosenwasser LJ, Bessette JM, et al. Rapid desensitisation for desferrioxamine anaphylactic reaction. *Lancet* 1981;1:1059.
241. Robins-Browne R, Prpic J. Effects of iron and desferrioxamine on infections with *Yersinia enterocolitica*. *Infect Immun* 1985;47:774–779.
242. Aleali SH, Castro O, Spencer RP, Finch SC. Sideroblastic anemia with splenic abscess and fatal thromboemboli after splenectomy. *Ann Intern Med* 1975;83:661–663.
243. Ayas M, Al-Jefri A, Mustafa MM, et al. Congenital sideroblastic anaemia successfully treated using allogeneic stem cell transplantation. *Br J Haematol* 2001;113:938–939.
244. Streeter RR, Pfesant CA, Reinhard E. Prognostic significance of thrombocytosis in idiopathic sideroblastic anemia. *Blood* 1977;50:427–432.
245. Gupta R, Abdalla SH, Bain BJ. Thrombocytosis with sideroblastic erythropoiesis: a mixed myeloproliferative myelodysplastic syndrome. *Leuk Lymphoma* 1999;34:615–619.
246. Schmitt-Graeff A, Thiele J, Zuk I, Kvasnicka HM. Essential thrombocythemia with ringed sideroblasts: a heterogeneous spectrum of diseases, but not a distinct entity. *Haematologica* 2002;87:392–399.
247. Linman JW, Bagby GC. The preleukemic syndrome (hemopoietic dysplasia). *Cancer* 1978;42:854–864.
248. Juneja SK, Imbert M, Sigaux F, et al. Prevalence and distribution of ringed sideroblasts in primary myelodysplastic syndromes. *J Clin Pathol* 1983;36:566–569.
249. Vallespi T, Torrabadella M, Julia A, et al. Myelodysplastic syndromes: a study of 101 cases according to the FAB classification. *Br J Haematol* 1985;61:83–92.
250. Cazzola M, Barosi G, Gobbi PG, et al. Natural history of idiopathic refractory sideroblastic anemia. *Blood* 1988;71:305–312.
251. Germing U, Gattermann N, Aivado M, et al. Two types of acquired idiopathic sideroblastic anaemia (AISA): a time-tested distinction. *Br J Haematol* 2000;108:724–728.
252. Catovsky D, Shaw MT, Hoffbrand AV, Dacie JV. Sideroblastic anaemia and its association with

leukaemia and myelomatosis: a report of five cases. *Br J Haematol* 1971;20:385–393.

253. Eastman PM, Schwartz R, Schrier SL. Distinctions between idiopathic ineffective erythropoiesis and di Guglielmo's disease: clinical and biochemical differences. *Blood* 1972;40:487–499.

254. Bennett JM. Classification of the myelodysplastic syndromes. *Clin Haematol* 1986;15:909–923.

255. Kushner JP, Lee GR, Wintrobe MM, Cartwright GE. Idiopathic refractory sideroblastic anemia. Clinical and laboratory investigation of 17 patients and review of the literature. *Medicine* 1971;50:139–159.

256. Dacie JV, Smith MD, White JC, Mollin DL. Refractory normoblastic anaemia: a clinical and haematological study of seven cases. *Br J Haematol* 1959;5:56–82.

257. Riedler GF, Straub PW. Abnormal iron incorporation, survival, protoporphyrin content and fluorescence of one red cell population in preleukemic sideroblastic anemia. *Blood* 1972;40:345–352.

258. Prchal JT, Throckmorton DW, Carroll AJ, et al. A common progenitor for human myeloid and lymphoid cells. *Nature* 1978;274:590–591.

259. Suzuki H, Asano H, Ohashi H, et al. Clonality analysis of refractory anemia with ring sideroblasts: simultaneous study of clonality and cytochemistry of bone marrow progenitors. *Leukemia* 1999;13:130–134.

260. Amenomori T, Tomonaga M, Jinnai I, et al. Cytogenetic and cytochemical studies on progenitor cells of primary acquired sideroblastic anemia (PASA): involvement of multipotent myeloid stem cells in PASA clone and mosaicism with normal clone. *Blood* 1987;70:1367–1372.

261. Lawrence HJ, Broudy VC, Magenis RE. Cytogenetic evidence for involvement of B lymphocytes in acquired idiopathic sideroblastic anemia. *Blood* 1987;70:1003–1005.

262. Beris P. Primary clonal myelodysplastic syndromes. *Semin Hematol* 1989;26:216–233.

263. Bennett DD, Stanley WS, Johnson CB. Combined phenotypic and genotypic analysis of ringed sideroblasts in acquired idiopathic sideroblastic anaemia. *Acta Haematol (Basel)* 1985;73:235–238.

264. Heim S, Mitelman F. Chromosome abnormalities in the myelodysplastic syndromes. *Clin Haematol* 1986;15:1003–1021.

265. Dewald GW, Brecher M, Travis LB, Stupca PJ. Twenty-six patients with hematologic disorders and X chromosome abnormalities. Frequent idic(x) (q13) chromosomes and Xq13 anomalies associated with pathologic ringed sideroblasts. *Cancer Genet Cytogenet* 1989;42:173–185.

266. Zon LI, Tsai S-F, Burgess S, et al. The major human erythroid DNA-binding protein (GF-1): primary sequence and localization of the gene to the X chromosome. *Proc Natl Acad Sci U S A* 1990;87:668–672.

267. Carroll AJ, Poon M-C, Robinson NC, Crist WM. Sideroblastic anemia associated with thrombocytosis and a chromosome 3 abnormality. *Cancer Genet Cytogenet* 1986;22:183–187.

268. Fukuoka T, Kameoka H, Yasukawa M, et al. Translocation t(1;3) (p36;q21) in sideroblastic anaemia. *Acta Haematol (Basel)* 1989;82:146–149.

269. Patinkin D, Seidman S, Eckstein F, et al. Manipulations of cholinesterase gene expression modulate murine megakaryocytopoiesis in vitro. *Mol Cell Biol* 1990;10:6046–6050.

270. Jacobs A, Carter G, Ridge S, et al. Haematopoietic and molecular abnormalities in the myelodysplastic syndrome. In: Sachs L, Abraham NG, Wiedermann CJ, et al., eds. *Molecular biology of haematopoiesis*. Andover: Intercept, 1990:571–577.

271. Ridge SA, Worwood M, Oscier D, et al. FMS mutations in myelodysplastic, leukemic and normal subjects. *Proc Natl Acad Sci U S A* 1990;87:1377–1380.

272. Farrow A, Jacobs A, West RR. Myelodysplasia, chemical exposure and other environmental studies. *Leukemia* 1989;3:33–35.

273. Raskind WH, Tirumali N, Jacobson R, et al. Evidence for a multistep pathogenesis of a myelodysplastic syndrome. *Blood* 1984;63:1318–1323.
274. Jacobs A. Myelodysplastic syndromes: pathogenesis, functional abnormalities and clinical implications. *J Clin Pathol* 1985;38:1201–1217.
275. Barton JC, Conrad ME, Parmley RT. Acute lymphoblastic leukemia in idiopathic refractory sideroblastic anemia. Evidence for a common lymphoid and myeloid progenitor cell. *Am J Hematol* 1980;9:109–115.
276. Hussein KK, Salem Z, Bottomley SS, Livingston RB. Acute leukemia in idiopathic sideroblastic anemia: response to combination chemotherapy. *Blood* 1982;59:652–656.
277. Zervas J, Geary CG, Oleesky S. Sideroblastic anemia treated with immunosuppressive therapy. *Blood* 1974;44:117–125.
278. Ritchey AK, Hoffman R, Dainiak N, et al. Antibody-mediated acquired sideroblastic anemia: response to Cytoxan therapy. *Blood* 1979;54:734–741.
279. Bottomley SS, Tanaka M, Self J.  $\delta$ -Aminolevulinic acid synthetase activity in normal bone marrow and in patients with idiopathic sideroblastic anemia. *Enzyme* 1973;16:138–145.
280. Aoki Y, Urata G, Wada O, Takaku F. Measurement of  $\delta$ -aminolevulinic acid synthetase activity in human erythroblasts. *J Clin Invest* 1974;53:1326–1334.
281. Bottomley SS. Porphyrin and iron metabolism in sideroblastic anemia. *Semin Hematol* 1977;14:169–185.
282. Fitzsimons EJ, May A, Elder GH, Jacobs A.  $\delta$ -Aminolaevulinic acid synthase activity in developing human erythroblasts. *Br J Haematol* 1988;69:281–285.
283. Mason DY, Emerson PM. Primary acquired sideroblastic anaemia: response to treatment with pyridoxal-5-phosphate. *Br Med J* 1973;1:389–390.
284. Meier PJ, Fehr J, Meyer UA. Pyridoxine-responsive primary acquired sideroblastic anaemia. In vitro and in vivo effect of vitamin B<sub>6</sub> on decreased  $\delta$ -aminolaevulinate synthase activity. *Scand J Haematol* 1982;29:421–424.
285. Lim HW, Cooper D, Sassa S, et al. Photosensitivity, abnormal porphyrin profile, and sideroblastic anemia. *J Am Acad Dermatol* 1992;27:287–292.
286. Bottomley SS. Observations on free erythrocyte protoporphyrin in sideroachrestic anemia. *Clin Chim Acta* 1965;12:542–545.
287. Lee GR, Cartwright GE, Wintrobe MM. Response of free erythrocyte protoporphyrin to pyridoxine therapy in a patient with sideroachrestic (sideroblastic) anemia. *Blood* 1966;27:557–567.
288. Greenberg PL, Young NS, Gattermann N. Myelodysplastic syndromes. *Hematology (Am Soc Hematol Educ Program)* 2002:136–161.
289. Aoki Y. Multiple enzymatic defects in mitochondria in hematological cells of patients with primary sideroblastic anemia. *J Clin Invest* 1980;66:43–49.
290. Gattermann N, Retzlaff S, Wang Y-L, et al. Heteroplasmic point mutations of mitochondrial DNA affecting subunit I of cytochrome c oxidase in two patients with acquired idiopathic sideroblastic anemia. *Blood* 1997;90:4961–4972.
291. Gattermann N. From sideroblastic anemia to the role of mitochondrial DNA mutations in myelodysplastic syndrome. *Leuk Res* 1999;24:141–151.
292. Coulombel L, Tchernia G, Mielot F, Mohandas N. Hemoglobin content of individual erythroblasts in

- hematopoietic dysplasia. Marked heterogeneity at late stages of maturation. *Exp Hematol* 1984;12:587–593.
293. Wallace DC. Mitotic segregation of mitochondrial DNA in human hybrids and expression of chloramphenicol resistance. *Somat Cell Mol Genet* 1986;12:41–49.
294. Linnane AW, Ozawa T, Marzuki S, Tanaka M. Mitochondrial DNA mutations as an important contributor to ageing and degenerative diseases. *Lancet* 1989;1:642–645.
295. Huber C, Huber H, Stacher A, Braunsteiner H. Autoradiographic and cytophotometric studies on hematopoiesis in primarily refractory and sidero-achrestic anemia. *Blut* 1972;24:142–152.
296. Wickramasinghe SN, Hughes M. Capacity of ringed sideroblasts to synthesize nucleic acids and protein in patients with primary acquired sideroblastic anaemia. *Br J Haematol* 1978;38:345–352.
297. Jacobs A, Clark RE. Pathogenesis and clinical variations in the myelodysplastic syndromes. *Clin Haematol* 1986;15:925–951.
298. Higgs DR, Wood WG, Barton C, Weatherall DJ. Clinical features and molecular analysis of acquired hemoglobin H disease. *Am J Med* 1983;75:181–191.
299. Yoo D, Schechter GP, Amigable AN, Nienhuis AW. Myeloproliferative syndrome with sideroblastic anemia and acquired hemoglobin H disease. *Cancer* 1980;45:78–83.
300. Boehme WM, Piira TA, Kurnick JE, Bethlenfalvay NC. Acquired hemoglobin H in refractory sideroblastic anemia. A preleukemic marker. *Arch Intern Med* 1978;138:603–606.
301. Pootrakul P, Kitcharoen K, Yansukon P, et al. The effect of erythroid hyperplasia on iron balance. *Blood* 1988;71:1124–1129.
302. Finch C. Regulation of iron balance in humans. *Blood* 1994;84:1697–1702.
303. Schafer AI, Cheron RG, Dluhy R, et al. Clinical consequences of acquired transfusional iron overload in adults. *N Engl J Med* 1981;304:319–324.
304. Gattermann N, Aul C, Schneider W. Two types of acquired idiopathic sidero-blastic anaemia (AISA). *Br J Haematol* 1990;74:45–52.
305. Stavem P, Rorvik TO, Rootwelt K, Josepsen JO. Severe iron deficiency causing loss of ring sideroblasts. *Scand J Haematol* 1983;31:389–391.
306. Mantovani L, Lentini G, Hentschel B, et al. Treatment of anaemia in myelodysplastic syndromes with prolonged administration of recombinant human granulocyte colony-stimulating factor and erythropoietin. *Br J Haematol* 2000;109:367–375.
307. Terpos E, Mougiou A, Kouraklis A, et al. Prolonged administration of erythropoietin increases erythroid response rate in myelodysplastic syndromes: a phase II trial in 281 patients. *Br J Haematol* 2002;118:174–180.
308. Zoller WG, Hehlman R. Sideroachrestic anemia with iron loading: treatment with desferrioxamine. *Klin Wochenschr* 1986;64:417–422.
309. French TJ, Jacobs P. Sideroblastic anaemia associated with iron overload treated by repeated phlebotomy. *S Afr Med J* 1976;50:594–596.
310. Jensen PD, Heickendorf L, Pedersen B, et al. The effect of iron chelation on haemopoiesis in MDS patients with transfusional iron overload. *Br J Haematol* 1996;94:288–299.
311. Garma JDR, Lago CF, Fondrodona FJB. Desferrioxamine in the treatment of myelodysplastic syndromes. *Haematologica* 1997;82:639–640.
312. Hast R. Studies on human preleukaemia. IV. Clinical and prognostic significance in aregenerative anaemia with hypercellular bone marrow. *Scand J Haematol* 1978;21:396–402.

313. Mende S, Weissenfels I, Pribilla W. Zytogenetische und hamatologische Verlaufsbeobachtungen bei idiopathischer refraktärer sideroblastischer Anämie (IRSA). *Blut* 1980;41:367–376.
314. Yunis JJ, Rydell RE, Oken MM, et al. Refined chromosome analysis as an independent prognostic indicator in de novo myelodysplastic syndromes. *Blood* 1986;67:1721–1730.
315. Yunis JJ, Lobell M, Arnesen MA. Refined chromosome study helps define prognostic subgroups in most patients with primary myelodysplastic syndrome and acute myelogenous leukaemia. *Br J Haematol* 1988;68:189–194.
316. Kitahara M, Cosgriff TM, Eyre HJ. Sideroblastic anemia as a preleukemic event in patients treated for Hodgkin's disease. *Ann Intern Med* 1980;92:625–627.
317. Khaleeli M, Keane WM, Lee GR. Sideroblastic anemia in multiple myeloma: a preleukemic change. *Blood* 1973;41:17–25.
318. Savage D, Lindenbaum J. Anemia in alcoholics. *Medicine* 1986;65:322–338.
319. Eichner ER, Hillman RS. The evolution of anemia in alcoholic patients. *Am J Med* 1971;50:218–232.
320. Pierce HI, McGuffin RG, Hillman RS. Clinical studies in alcoholic sideroblastosis. *Arch Intern Med* 1976;136:283–289.
321. Ali MAM, Brain MC. Ethanol inhibition of haemoglobin synthesis: in vitro evidence for a haem correctable defect in normal subjects and in alcoholics. *Br J Haematol* 1974;28:311–316.
322. Freedman ML, Cohen HS, Rosman J, Forte FJ. Ethanol inhibition of reticulocyte protein synthesis: the role of haem. *Br J Haematol* 1975;30:351–363.
323. Freedman MC, Rosman J. A rabbit reticulocyte model for the role of hemin-controlled repressor in hypochromic anemias. *J Clin Invest* 1976;57:594–603.
324. Moore MR, Beattie AD, Thompson GG, Goldberg A. Depression of d-aminolevulinic acid dehydrase activity by ethanol in man and rat. *Clin Sci* 1971;40:81–88.
325. Krasner N, Moore MR, Thompson GG, et al. Depression of erythrocyte d-aminolevulinic acid dehydratase activity in alcoholics. *Clin Sci* 1974;46:415–418.
326. McColl KL, Thompson GG, Moore MR, Goldberg A. Acute ethanol ingestion and haem biosynthesis in healthy subjects. *Eur J Clin Invest* 1980;10:107–112.
327. Abdulla M, Haeger-Aronsen B, Svensson S. Effect of ethanol and zinc on ALA-dehydratase activity in red blood cells. *Enzyme* 1976;21:248–252.
328. Abdulla M, Svensson S. Effect of oral zinc intake on d-aminolevulinic acid dehydratase in red blood cells. *Scand J Clin Lab Invest* 1979;39:31–36.
329. Frazer MB, Schachter BA. Increased bone marrow delta-aminolevulinic acid synthetase activity in acute reversible sideroblastic anemia of alcoholics. *Am J Hematol* 1980;8:149–156.
330. Lumeng L, Li T. Vitamin B<sub>6</sub> metabolism in chronic alcohol abuse. Pyridoxal phosphate levels in plasma and the effects of acetaldehyde on pyridoxal phosphate synthesis and degradation in human erythrocytes. *J Clin Invest* 1974;53:693–704.
331. Hines JD. Hematologic abnormalities involving vitamin B<sub>6</sub> and folate metabolism in alcoholic subjects. *Ann N Y Acad Sci* 1975;252:316–327.
332. Lumeng L. The role of acetaldehyde in mediating the deleterious effect of ethanol on pyridoxal-5-phosphate metabolism. *J Clin Invest* 1986;62:286–293.
333. Hines JD, Cowan DH. Studies on the pathogenesis of alcohol-induced sidero-blastic bone marrow

abnormalities. *N Engl J Med* 1970;283:441-446.

334. Meagher RC, Sieber F, Spivak JL. Suppression of hematopoietic-progenitor-cell proliferation by ethanol and acetaldehyde. *N Engl J Med* 1982;307:845-849.

335. Burke JP, Rubin E. The effects of ethanol and acetaldehyde on the products of protein synthesis by liver mitochondria. *Lab Invest* 1979;41:393-400.

336. Roberts PD, Hoffbrand AV, Mollin DL. Iron and folate metabolism in tuberculosis. *Br Med J* 1966;2:198-202.

337. Haden HT. Pyridoxine-responsive sideroblastic anemia due to antituberculous drugs. *Arch Intern Med* 1967;120:602-606.

338. Hines JD, Love DS. Determination of serum and blood pyridoxal phosphate concentrations in purified rabbit skeletal muscle apophosphorylase. *J Lab Clin Med* 1969;73:343-349.

339. Standal BR, Kao-Chen SM, Yang G, Char DFB. Early changes in pyridoxine status in patients receiving isoniazid therapy. *Am J Clin Nutr* 1974;27:479-484.

340. Scott JL, Finegold SM, Belkin GA, Lawrence JS. A controlled double-blind study of the hematologic toxicity of chloramphenicol. *N Engl J Med* 1965;272:1137-1142.

341. Smith U, Smith DS, Yunis AA. Chloramphenicol-related changes in mitochondrial ultrastructure. *J Cell Sci* 1970;7:501-521.

342. Skinnider LF, Ghadially FN. Chloramphenicol-induced mitochondrial and ultrastructural changes in hemopoietic cells. *Arch Pathol Lab Med* 1976;100:601-605.

343. Martelo OJ, Manyan DR, Smith US, Yunis AA. Chloramphenicol and bone marrow mitochondria. *J Lab Clin Med* 1969;74:927-942.

344. Firkin FC. Mitochondrial lesions in reversible erythropoietic depression due to chloramphenicol. *J Clin Invest* 1972;51:2085-2092.

345. Manyan DR, Arimura GK, Yunis AA. Chloramphenicol-induced erythroid suppression and bone marrow ferrochelatase activity in dogs. *J Lab Clin Med* 1972;79:137-144.

346. Rosenberg A, Marcus O. Effect of chloramphenicol on reticulocyte d-aminolaevulinic acid synthetase in rabbits. *Br J Haematol* 1974;26:79-83.

347. Yunis AA, Adamson JW. Differential in vitro sensitivity of marrow erythroid and granulocytic colony forming cells to chloramphenicol. *Am J Hematol* 1977;2:355-363.

348. Abou-Khalil S, Abou-Khalil WH, Whitney PL, Yunis AA. Importance of the mitochondrial amino acid pool in the sensitivity of erythroid cells to chloramphenicol. Role of glycine and serine. *Pharmacology* 1987;35:308-316.

349. Williams DM. Copper deficiency in humans. *Semin Hematol* 1983;20:118-128.

350. Hayton BA, Broome HE, Lilenbaum RC. Copper deficiency-induced anemia and neutropenia secondary to intestinal malabsorption. *Am J Hematol* 1995;48:45-47.

351. Dunlap WM, James GW, Hume DM. Anemia and neutropenia caused by copper deficiency. *Ann Intern Med* 1974;80:470-476.

352. Vilter RW, Bozian RC, Hess EV, et al. Manifestations of copper deficiency in a patient with systemic sclerosis on intravenous hyperalimentation. *N Engl J Med* 1974;291:188-191.

353. Zidar BL, Shaddock RK, Zeigler Z, Winkelstein A. Observations on the anemia and neutropenia of human copper deficiency. *Am J Hematol* 1977;3:177-185.

354. Hirase N, Abe Y, Sadamura S, et al. Anemia and neutropenia in a case of copper deficiency: role of

copper in normal hematopoiesis. *Acta Haematol (Basel)* 1992;87:195–197.

355. Takeuchi M, Tada A, Yoshimoto S, Takahashi K. Anemia and neutropenia due to copper deficiency during long term total parenteral nutrition. *Jpn J Clin Hematol* 1993;34:171–176.
356. Banno S, Niita K, Kikuchi M, et al. Anemia and neutropenia in elderly patients caused by copper deficiency for long-term enteral nutrition. *Jpn J Clin Hematol* 1994;35:1276–1281.
357. Masugi J, Amano M. Copper deficiency anemia and prolonged enteral feeding. *Ann Intern Med* 1994;121:386.
358. Tamura H, Hirose S, Watanabe O, et al. Anemia and neutropenia due to copper deficiency in enteral nutrition. *J Parenter Enter Nutr* 1994;18:185–189.
359. Perry AR, Pagliuca A, Fitzsimons EJ, et al. Acquired sideroblastic anaemia induced by a copper-chelating agent. *Int J Hematol* 1996;64:69–72.
360. Fiske DN, McCoy HE III, Kitchens CS. Zinc-induced sideroblastic anemia: report of a case, review of the literature, and description of the hematologic syndrome. *Am J Hematol* 1994;46:147–150.
361. Broun ER, Greist A, Tricot G, Hoffman R. Excessive zinc ingestion. A reversible cause of sideroblastic anemia and bone marrow depression. *JAMA* 1990;264:1441–1443.
362. Kumar A, Jazieh AR. Case report of sideroblastic anemia caused by ingestion of coins. *Am J Hematol* 2001;66:126–129.
363. Schleper B, Stuerenburg HJ. Copper deficiency-associated myelopathy in a 46-year old woman. *J Neurol* 2001;248:705–706.
364. Prodan CI, Holland NR, Wisdom PJ, et al. CNS demyelination associated with copper deficiency and hyperzincemia. *Neurology* 2002;59:1453–1456.
365. Gregg XT, Reddy V, Prchal JT. Copper deficiency masquerading as myelodysplastic syndrome. *Blood* 2002;100:1493–1495.
366. Lee GR, Nacht S, Lukens JN, Cartwright GE. Iron metabolism in copper-deficient swine. *J Clin Invest* 1968;47:2058–2069.
367. Lee GR, Cartwright GE, Wintrobe MM. Heme biosynthesis in copper deficient swine. *Proc Soc Exp Biol Med* 1968;127:977–981.
368. Williams DM, Loukopoulos D, Lee GR, Cartwright GE. Role of copper in mitochondrial iron metabolism. *Blood* 1976;48:77–85.
369. Cousins RJ. Absorption, transport, and hepatic metabolism of copper and zinc: special reference to metallothionein and ceruloplasmin. *Physiol Rev* 1985;65:238–309.
370. Day FA, Panemangalore M, Brady FO. In vivo and ex vivo effects of copper on rat liver metallothionein. *Proc Soc Exp Med* 1981;168:306–310.
371. Brewer GJ, Gretchen MH, Prasad AS, et al. Oral zinc therapy for Wilson's disease. *Ann Intern Med* 1983;99:314–320.
372. Porter KG, McMaster D, Elmes ME, Love AHG. Anemia and low serum-copper during zinc therapy. *Lancet* 1977;2:774.
373. Frambach DA, Bendel RE. Zinc supplementation and anemia. *JAMA* 1991;265:869.
374. O'Brien H, Amess JAL, Mollin DL. Recurrent thrombocytopenia, erythroid hypoplasia and sideroblastic anaemia associated with hypothermia. *Br J Haematol* 1982;51:451–456.
375. Pfanner N, Hartl F-U, Neupert W. Import of proteins into mitochondria: a multi-step process. *Eur J*



Biochem 1988;175:205–212.

376. Morrell H, Savoie JC, London IM. The biosynthesis of heme and incorporation of glycine into globin in rabbit bone marrow in vitro. *J Biol Chem* 1958;233:923–929.

377. Jandl JH, Inman JK, Simmons RL, Allen DW. Transfer of iron from serum iron binding protein to human reticulocytes. *J Clin Invest* 1959;38:161–185.

378. Cullen MR, Robins JM, Eskenazi B. Adult inorganic lead intoxication: presentation of 31 new cases and a review of recent advances in the literature. *Medicine* 1983;62:221–247.

379. Rempel D. The lead-exposed worker. *JAMA* 1989;262:532–534.

380. Doss M, Baumann H, Lorrek M, et al. Lead poisoning as a toxogenetic disease. *Klin Wochenschr* 1984;62:430–431.

381. Wetmur JG, Kaya AH, Plewinska M, Desnick RJ. Molecular characterization of the human d-aminolevulinic acid dehydratase 2 (ALAD<sup>2</sup>) allele: implications for molecular screening of individuals for genetic susceptibility to lead poisoning. *Am J Hum Genet* 1991;49:757–763.

382. Pagliuca A, Mufti GJ. Lead poisoning: an age old problem. *Br Med J* 1990;300:830.

383. Sassa S. Toxic effects of lead, with particular reference to porphyrin and heme metabolism. In: DeMatteis F, Aldridge WN, eds. *Heme and hemoproteins*. New York: Springer, 1978:333–371.

384. Moore MR, Meredith PA, Goldberg A. Lead and heme biosynthesis. In: Singhal RL, Thomas JA, eds. *Lead toxicity*. Baltimore: Urban & Schwarzenberg, 1980:80–117.

385. Labbe RF, Rettmer RL, Shah AG, Turnlund JR. Zinc protoporphyrin: past, present and future. *Ann N Y Acad Sci* 1987;514:7–14.

386. Labbe RF, Rettmer RL. Zinc protoporphyrin: a product of iron-deficient erythropoiesis. *Semin Hematol* 1989;26:40–46.

387. Schwartz S, Stephenson B, Sarkar D, et al. Quantitative assay of erythrocyte “free” and zinc protoporphyrin: clinical and genetic studies. *Int J Biochem* 1980;12:1053–1057.

388. Labbe RF. Lead poisoning mechanisms. *Clin Chem* 1990;36:1870.

389. Rossi E, Costin KA, Garcia-Webb P. Effect of occupational lead exposure on lymphocyte enzymes involved in heme biosynthesis. *Clin Chem* 1990;36:1980–1983.

390. Piddington SK, White JM. The effect of lead on total globin and  $\alpha$ - and  $\beta$ -chain synthesis; in vitro and in vivo. *Br J Haematol* 1974;27:415–427.

391. Ali MAM, Quinlan A. Effect of lead on globin synthesis in vitro. *Am J Clin Pathol* 1977;67:77–79.

392. Leikin S, Eng G. Erythrokinetic studies of the anemia of lead poisoning. *Pediatrics* 1963;31:996–1002.

393. White JM, Selhi HS. Lead and the red cell. *Br J Haematol* 1975;30:133–138.

394. Lachant NA, Tomoda A, Tanaka KR. Inhibition of the pentose phosphate shunt by lead: a potential mechanism for hemolysis in lead poisoning. *Blood* 1984;63:518–524.

395. Paglia DE, Valentine WN, Fink K. Further observations on erythrocyte pyrimidine-nucleotidase deficiency and intracellular accumulation of pyrimidine nucleotides. *J Clin Invest* 1977;60:1362–1366.

396. Dagg JH, Goldberg A, Lochhead A, Smith JA. The relationship of lead poisoning to acute intermittent porphyria. *QJM* 1965;34:163–175.

397. Schwartz J, Landrigan PJ, Baker EL, et al. Lead-induced anemia: dose-response relationships and

evidence for a threshold. *Am J Public Health* 1990;80:165–168.

398. Clark M, Royal J, Seeler R. Interaction of iron deficiency and lead and the hematologic findings in children with severe lead poisoning. *Pediatrics* 1988;81:247–254.

399. Griggs RC. Lead poisoning: hematologic aspects. *Prog Hematol* 1964;4:117–137.

400. Charache S, Weatherall DJ. Fast hemoglobin in lead poisoning. *Blood* 1966;28:377–386.

401. Albahary C. Lead and hemopoiesis. The mechanism and consequences of the erythropathy of occupational lead poisoning. *Am J Med* 1972;52:367–378.

402. Berk PD, Tschudy DP, Shepley LA, et al. Hematologic and biochemical studies in a case of lead poisoning. *Am J Med* 1970;48:137–144.

403. Bambach K, Kehoe RA, Logan MA. The plasma cell partition of blood lead. *J Pharmacol* 1942;76:326–337.

404. Klaassen CD. Heavy metals and heavy-metal antagonists. In: Hardman JG, Limbird LE, eds. *Goodman & Gilman's The pharmacological basis of therapeutics*, 10th ed. New York: McGraw-Hill, 2001:1851–1875.

405. Lolocono NJ, Moulton T, Mitchell ME, et al. Controlled study of meso-2,3-dimercaptosuccinic acid for the management of childhood lead intoxication. *J Pediatr* 1992;120:133–139.

406. Nordmann Y, Deybach JC. Congenital erythropoietic porphyria. *Semin Liver Dis* 1982;2:154–163.

407. Fritsch C, Bolsen K, Ruzicka T, Goerz G. Congenital erythropoietic porphyria. *J Am Acad Dermatol* 1997;36:594–610.

408. Anderson KE, Sassa S, Bishop DF, Desnick RJ. Disorders of heme biosynthesis: X-linked sideroblastic anemia and the porphyrias. In: Scriver CR, Beaudet AL, Sly WS, et al., eds. *The metabolic and molecular bases of inherited disease*, 8th ed. New York: McGraw-Hill, 2001:2991–3062.

409. Simon N, Berko GY, Schneider I. Hepato-erythropoietic porphyria presenting as scleroderma and acrosclerosis in a sibling pair. *Br J Dermatol* 1977;96:663–668.

410. Nordmann Y, Grandchamp B, de Verneuil H, et al. Harderoporphyria: a variant hereditary coproporphyria. *J Clin Invest* 1983;72:1139–1149.

411. Lamoril J, Puy H, Gouya L, et al. Neonatal hemolytic anemia due to inherited harderoporphyria: clinical characteristics and molecular basis. *Blood* 1998;91:1453–1457.

412. Shahidi NT, Nathan DG, Diamond LK. Iron deficiency anemia associated with an error of iron metabolism in two siblings. *J Clin Invest* 1964;43:510–521.

413. Carpentieri U, Buck ED, Minguell JJ, et al. Ferrochelatase deficiency in an infant with anemia and growth delay. *Pediatrics* 1979;63:757–760.

414. Stavem P, Romslo I, Hovig T, et al. Ferrochelatase deficiency in the bone marrow in a syndrome of congenital hypochromic microcytic anemia, hyperferremia, and iron overload of the liver. *Scand J Gastroenterol* 1985;20[Suppl 107]:73–81.

415. Bekri S, May A, Cotter PD, et al. A promoter mutation in the erythroid-specific 5-aminolevulinic acid synthase (*ALAS2*) gene causes X-linked sideroblastic anemia. *Blood* 2003;102:698–704.

2004 Lippincott Williams & Wilkins  
John P. Greer, John Foerster, John N. Lukens  
George M. Rodgers, Frixos Paraskevas, Bertil Glader  
Wintrobe's Clinical Hematology

**IRON OVERLOAD  
HEMOCHROMATOSIS****Definition****History****Etiology****CLONING OF THE HEMOCHROMATOSIS GENE  
FUNCTION OF THE HEMOCHROMATOSIS GENE  
EFFECTS OF THE HEMOCHROMATOSIS GENE MUTATION  
PATHOPHYSIOLOGY  
HEMOCHROMATOSIS GENE****Hemochromatosis Gene Mutations****Hemochromatosis Gene Mutations in Hemochromatosis Patients****Prevalence of Hemochromatosis Gene Mutations in Different Populations****Association of Iron Loading and Hemochromatosis Gene Mutations****FREQUENCY OF HEMOCHROMATOSIS IN MEN AND WOMEN  
CLINICAL FEATURES OF HEMOCHROMATOSIS****Symptoms****Physical Examination Abnormalities****Laboratory Abnormalities****Liver Biopsy Findings****HEMOCHROMATOSIS GENE MUTATIONS AND OTHER CONDITIONS****Hereditary Spherocytosis****Arthritis****Diabetes Mellitus****Other Endocrinopathy****Hepatocellular Carcinoma****Other Types of Cancer****Porphyria Cutanea Tarda** **$\beta$ -Thalassemia Minor****Steatohepatitis****Acquired Refractory Sideroblastic Anemia****X-Linked Sideroblastic Anemia****Infections****Coronary Artery Disease****DIAGNOSIS****History and Physical Examination Findings****Laboratory Findings****EVALUATION OF RELATIVES  
DIFFERENTIAL DIAGNOSIS OF IRON OVERLOAD  
MANAGEMENT****Phlebotomy Therapy****Dietary Changes****Alcohol Intake****Vitamins****PROGNOSIS****IMAGING OF THE LIVER****Computed Tomographic Scanning of the Liver****Magnetic Resonance Imaging of the Liver****Cost****IRON CHELATION****Deferoxamine****Deferiprone**

## IRON OVERLOAD

Iron overload can result from any process that causes iron accumulation in excess of iron loss. Examples of this include (a) red blood cell transfusions in individuals who do not experience blood loss (hemolytic anemia, aplastic anemia, sideroblastic anemia); (b) absorption of excessive amounts of normal daily dietary iron (hemochromatosis); and (c) absorption of increased amounts of excessive dietary iron (high-dose medicinal iron, African iron overload, wine with high iron content).

## HEMOCHROMATOSIS

### Definition

The proper definition of *hemochromatosis* is the presence of two copies of a mutation of the hemochromatosis gene (called *HFE gene*). An individual can have two copies of HFE gene mutations with or without iron overload and with or without illness or organ injury.

### History

The first report of a person with hemochromatosis was included in a discussion of diabetes mellitus in 1865 (<sup>1</sup>). The patient was a 28-year-old Parisian man who sold newspapers and who died of a febrile illness complicating diabetes mellitus. His autopsy revealed hepatomegaly and hypertrophic cirrhosis.

The second case report of hemochromatosis was in 1871, involving a 51-year-old man who lived in Paris (<sup>2</sup>). He had skin bronzing of his face and hands. His autopsy revealed a chocolate-colored, enlarged liver. Microscopic examination of his liver showed pigment granules inside and outside of hepatocytes.

In 1886, the term *pigmentation cirrhosis* was used to describe the triad of skin bronzing, diabetes mellitus, and hepatic cirrhosis (<sup>3</sup>). The name *hämochromatose* was first used by von Recklinghausen in his 1889 description of 12 individuals who had pigmentation of multiple organs (<sup>4</sup>). He believed that the iron that accumulated in organs came from red blood cells.

### Etiology

Before 1975, the cause of hemochromatosis was vigorously debated. Some investigators believed the disorder was heritable (<sup>5</sup>), whereas others insisted that its cause was alcohol abuse (<sup>6</sup>); additional considerations of cause included copper loading or ingestion of excessive dietary or medicinal iron.

In 1974, the results of segregation analysis in pedigree studies indicated that hemochromatosis was transmitted as an autosomal-recessive condition (<sup>7</sup>). One year later, a high frequency of the HLA-A3 alloantigen was observed in five of seven subjects who had hemochromatosis (<sup>8</sup>). Linkage analysis in several centers provided strong evidence that the hemochromatosis allele was linked to the HLA locus on the short arm of chromosome 6 and that hemochromatosis was transmitted as an autosomal-recessive

disorder ( [9](#), [10](#), [11](#), [12](#), [13](#), [14](#) and [15](#)).

## CLONING OF THE HEMOCHROMATOSIS GENE

In 1996, the hemochromatosis gene was isolated by positional cloning ( [16](#)). The discoverers called the gene *HLA-h*, because its organization and structure were similar to genes in the HLA region that coded for HLA class I heavy chains. However, subsequent review determined that an HLA class I pseudogene located between the HLA-A and HLA-B loci had already been named and included in the Genome Databank as *HLA-h* ( [17](#)). The Genome Databank also already included the designation *HFE* for the as yet unidentified hemochromatosis gene. To resolve this confusion, the name of the newly cloned and sequenced hemochromatosis gene was changed to *HFE* ( [18](#), [19](#)).

## FUNCTION OF THE HEMOCHROMATOSIS GENE

Before the isolation and cloning of the HFE gene, an animal model of iron loading was developed. The  $\beta_2$ -microglobulin knock-out mouse expressed the hepatic iron-loading phenotype of human hemochromatosis ( [20](#), [21](#) and [22](#)). These findings suggested that  $\beta_2$  microglobulin was involved in the regulation of iron absorption.

The normal HFE gene encodes for the production of normal HFE protein, which is expressed in crypt cells in the duodenum and in reticuloendothelial cells ( [23](#)). In a normal individual with adequate body iron stores, the HFE protein binds to  $\beta_2$  microglobulin, which decreases the affinity of cell membrane transferrin receptors for transferrin, its ligand ( [24](#), [25](#), [26](#) and [27](#)). This results in decreased iron absorption. In an iron-deficient individual, synthesis of HFE protein is decreased, there is less binding of HFE protein to  $\beta_2$  microglobulin, there is increased affinity of the transferrin receptor for transferrin, and more iron is absorbed by duodenal crypt cells.

## EFFECTS OF THE HEMOCHROMATOSIS GENE MUTATION

The  $\beta_2$ -microglobulin binding site on the HFE protein has two cysteine molecules that form a disulfide bridge in the binding site. In an iron-loaded individual with the Cys282Tyr mutation, tyrosine replaces a cysteine molecule. Because there are not two cysteine molecules, the disulfide bridge is absent. This prevents the abnormal HFE protein from binding to  $\beta_2$  microglobulin appropriately on the cell surface. Excessive iron is then absorbed through the crypt cells and passed into the circulation. The mechanism of HFE regulation of iron absorption remains unknown and is the subject of vigorous investigation ( [28](#), [29](#), [30](#), [31](#), [32](#) and [33](#)).

## PATHOPHYSIOLOGY

Normal humans absorb and lose approximately 1 mg of iron each day. Duodenal absorption of iron increases when iron deficiency occurs then drops to 1 mg/day after iron deficiency is corrected. Iron absorption decreases when iron stores are repleted.

In iron-loaded subjects with hemochromatosis, iron absorption usually is greater than 2 mg/day at a time when iron absorption should have decreased to nearly zero. After phlebotomy therapy induces iron deficiency in people with hemochromatosis, iron absorption may increase up to 10 mg/day and remains inappropriately elevated long after

iron deficiency resolves ( 34, 35 and 36 ).

The basic cause of iron accumulation in hemochromatosis is the failure to down-regulate duodenal enterocyte absorption of iron. After iron absorption remains elevated for many years, liver iron storage sites become overloaded, and iron accumulates in the spleen, myocardium, pancreas, anterior pituitary, and other organs. Individuals with hemochromatosis may have a body iron burden that is more than ten times normal. Usually, such individuals do not develop symptoms or signs of illness until after they have been iron loaded for four to five decades. This suggests that heavy iron overload must be present for many years before sufficient organ injury occurs to cause recognizable symptoms or signs. Exceptions include the organ damage and death that occur in a few heavily iron-loaded children or teenagers in juvenile hemochromatosis.

Iron that is stored in modest amounts in ferritin is thought to be nontoxic. In the presence of excessive iron stores, reactive oxygen species are generated, especially the hydroxyl radical ( 37, 38, 39 and 40 ). It seems likely that the hydroxyl radical and the alkoxy and peroxy radicals are involved in lipid peroxidation, which damages microsomes, mitochondria, and lysosomes. Hydroxyl radicals are also thought to be involved in iron-related injury and damage of enzymes, DNA, and polysaccharides. Lipid peroxidation, lysosomal injury, and damage of mitochondria, endoplasmic reticulum, cell membranes, and DNA were discussed recently ( 37, 38 ).

## HEMOCHROMATOSIS GENE

The HFE gene is located approximately 4 megabases telomeric to the HLA region. The HFE gene is structurally somewhat similar to other HLA class I-like genes. The HFE gene is composed of seven exons, of which the first six exons encode for the six domains of the HFE protein. The seven exons of HFE result in formation of a messenger RNA transcript that is approximately 4.2 kilobases in size. This in turn results in the synthesis of the HFE product, which consists of 343 amino acids. The most common iron-loading mutation of HFE (C282Y) is caused by a mutation of one nucleotide base (845G?A) in exon 4 of the HFE gene ( 16 ).

### Hemochromatosis Gene Mutations

More than 30 mutations of the HFE gene have been reported ( Table 30.1 ). The most common mutation that occurs in people who have hemochromatosis is a change in nucleotide 845 from the normal guanine to adenine in exon 4 of the HFE gene (referred to as 845G? A). This nucleotide change results in the substitution of tyrosine in place of the normal cysteine in position 282, referred to as *Cysteine282Tyrosine*, *Cys282Tyr*, or *C282Y*. This mutation causes the majority of iron accumulation in subjects who have hemochromatosis ( 16 ).

**TABLE 30.1. Twenty-Three Mutations of the Hemochromatosis Gene (HFE) in Hemochromatosis Type 1: Nucleotide and Amino Acid Changes, Type of Mutation, Exon or Intron Involved, and Effect of the Mutation on Iron Loading**

| Change                                      |                    | Type of Mutation     | Effect on Iron Loading        |
|---|--------------------|----------------------|-------------------------------|
| Nucleotide<br>Complementary<br>DNA Position | Amino Acid Symbols | Missense<br>Nonsense | Exon or<br>Intron<br>Affected |
|   |                    |                      | Homozygotes Reference         |

|                |              |             |     |     |          |        |                    |
|----------------|--------------|-------------|-----|-----|----------|--------|--------------------|
| 845G?A         | Cys282Tyr    | C282Y       | Yes | —   | Exon 4   | ??     | <a href="#">16</a> |
| 187C?G         | His63Asp     | H63D        | Yes | —   | Exon 2   | ?      | <a href="#">16</a> |
| 193A?T         | Ser65Cys     | S65C        | Yes | —   | Exon 2   | ?      | <a href="#">41</a> |
| 277G?C         | Gly93Arg     | G93R        | Yes | —   | Exon 2   | ?      | <a href="#">42</a> |
| 314T?C         | Ile105Thr    | I105T       | Yes | —   | Exon 2   | ?      | <a href="#">42</a> |
| 157G?A         | Val53Met     | V53M        | Yes | —   | Exon 2   | ?      | <a href="#">43</a> |
| 175G?A         | Val59Met     | V59M        | Yes | —   | Exon 2   | ?      | <a href="#">43</a> |
| 381A?C         | Gln127His    | Q127H       | Yes | —   | Exon 3   | ?      | <a href="#">43</a> |
| 989G?T         | Arg330Met    | R330M       | Yes | —   | Exon 5   | ??     | <a href="#">43</a> |
| 829G?A         | Glu277Lys    | E277K       | Yes | —   | Exon 4   | None   | <a href="#">44</a> |
| 502G?C         | Glu168Gln    | E168Q       | Yes | —   | —        | Mild ? | <a href="#">45</a> |
| 502G?T         | Glu168Stop   | E168X       | —   | Yes | —        | ??     | <a href="#">46</a> |
| 845G?C         | Cys282Ser    | C282S       | Yes | —   | —        | ??     | <a href="#">47</a> |
| 211C?T         | Arg74Stop    | R74X        | —   | Yes | Exon 2   | ??     | <a href="#">48</a> |
| 814G?T         | Val272Leu    | V272L       | Yes | —   | Exon 4   | ?      | <a href="#">49</a> |
| 189T?C         | His63His     | H63H        | No  | No  | Exon 2   | None   | <a href="#">43</a> |
| 636G?C         | Val212Val    | V212V       | No  | No  | Exon 4   | None   | <a href="#">50</a> |
| IVS3 (+1)G?T   | Splice error | Null allele | —   | Yes | Exon 3   | ??     | <a href="#">51</a> |
| IVS5 (+1)G?A   | Splice error | —           | —   | Yes | Intron 5 | ??     | <a href="#">52</a> |
| IVS4 (+37)A?G  | Splice error | —           | —   | Yes | Intron 4 | None   | <a href="#">43</a> |
| IVS4 (+109)A?G | Splice error | —           | —   | Yes | Intron 4 | None   | —                  |
| IVS4 (+115)T?C | Splice error | —           | —   | Yes | Intron 4 | None   | <a href="#">43</a> |
| IVS2 (+4)T?C   | Splice error | —           | —   | —   | Intron 2 | ?      | <a href="#">53</a> |

?, increased??, markedly increased;?, effect unknown; A, adenine; C, cytosine; G, guanine; IVS, intron sequence variant; T, thymine.

The second most common HFE gene mutation in hemochromatosis patients is a change in nucleotide 187 from the normal cytidine to guanidine (187C?G) in exon 2. This results in substitution of aspartate for the normal histidine at amino acid position 63. Both the C282Y and H63D mutations were identified in the initial report of the isolation and cloning of HFE ([16](#)). It is expected that additional mutations of the HFE gene will be identified in adults with hemochromatosis.

Of the known mutations of the HFE gene, 13 are missense mutations that result in substitution of the normal amino acid by another. There are seven known nonsense mutations of the HFE gene, six of which are splice errors that are associated with intron sequence variants. Two mutations involve a nucleotide change that does not result in an amino acid substitution. Some of the important known HFE gene mutations appear in [Table 30.1](#). Mutations that occurred in noncoding regions of the HFE gene were discussed in detail in 2000 ([54](#)).



## Hemochromatosis Gene Mutations in Hemochromatosis Patients

In the first report of the discovery of the HFE gene and its mutations, 83% of subjects with hemochromatosis were C282Y homozygotes (<sup>16</sup>). The prevalence of homozygosity for C282Y varies among populations from 33 to 100%. In the United States, 59 to 89% of hemochromatosis patients are C282Y/C282Y homozygotes. The percentage of hemochromatosis patients from 13 countries and Scandinavia with the C282Y and H63D genotypes appears in [Table 30.2](#).

**TABLE 30.2. Prevalence (%) of C282Y, H63D, and Wild Type (wt) Genotypes in Hemochromatosis Patients in 13 Countries and Scandinavia**

| Country        | Studied (N) | C282Y/C282Y       | C282Y/wt     | C282Y/H63D    | H63D/H63D    | H63D/wt       | wt/wt         |
|----------------|-------------|-------------------|--------------|---------------|--------------|---------------|---------------|
| United States  | 818         | 59.4–88.6         | 0.6–26.7     | 4.5–20.3      | 0–7.0        | 0–8.1         | 0.6–12.0      |
| Canada         | 128         | 95.3              | 0            | 0             | 0            | 1.6           | 3.1           |
| France         | 1097        | 67.2–92.4         | 0.9–4.4      | 2.3–7.1       | 1.1–8.2      | 1.5–4.9       | 0–9.8         |
| Germany        | 288         | 72.0–94.6         | 1.1–2.0      | 0–8.3         | 2.8          | 0–6.0         | 0–5.3         |
| United Kingdom | 277         | 90.0–100.0        | 0–1.7        | 0–5.5         | 0–0.9        | 0             | 0–4.3         |
| Spain          | 259         | 57.0–92.8         | 0–6.0        | 0–11.0        | 0–4.5        | 0–11.0        | 3.2–13.6      |
| Portugal       | 25          | 88.0              | 6.2          | 1.5           | 0            | 0             | 4.6           |
| Italy          | 263         | 33.3–69.0         | 2.7–6.3      | 4.4–10.0      | 1.3–3.3      | 4.0–13.3      | 11.3–36.7     |
| Scandinavia    | 125         | 89.0–92.0         | 1.1          | 3.4           | 1.1          | 1.1           | 1.1           |
| Australia      | 184         | 88.8–100.0        | 0–5.6        | 0–1.4         | 0            | 0             | 0–4.0         |
| Greece         | 10          | 50.0              | —            | —             | —            | —             | 50.0          |
| Brazil         | 15          | 53.3              | 6.6          | 0             | 0            | 6.6           | 33.5          |
| Austria        | 40          | 77.5              | 0            | 7.5           | 2.5          | 2.5           | 10.0          |
| Belgium        | 49          | 93.9              | 0            | 4.1           | 0            | 2.0           | 0             |
| <b>Total</b>   | <b>3578</b> | <b>33.0–100.0</b> | <b>0–6.6</b> | <b>0–11.0</b> | <b>0–8.2</b> | <b>0–13.0</b> | <b>0–50.0</b> |

wt, wild type.

<sup>a</sup> de Sousa M, personal communication.

## Prevalence of Hemochromatosis Gene Mutations in Different Populations

There are some populations that have a high prevalence of HFE mutations, such as Central, Western, and Northern Europe, and countries that were populated by people who originated in these areas, including the United States, Canada, and Australia (<sup>67, 93</sup>). It is expected that the population prevalence of HFE mutations should be very low in parts of

the world with little or no ancestry in Central and Western Europe, including sub-Saharan Africa, the Middle East, the Orient, and Native Americans in North, Central, and South America. The reported frequency of the C282Y and H63D mutations in several areas and populations of the United States appears in [Table 30.3](#). The frequency of the C282Y mutation in the United States varies from 0 to 1.00% in whites; 0 to 0.22% in Mexican Americans; and 0 to 0.06% in blacks ( [Table 30.3](#)). Comprehensive tabular data about genotype frequencies in many countries and in regions of different countries have been published ( [93](#), [100](#) ).

**TABLE 30.3. Prevalence (%) of C282Y, H63D, and Wild Type (wt) Genotypes in the United States**

| Population               | Studied (N)   | C282Y/C282Y   | C282Y/wt          | C282Y/H63D       | H63D/H63D        | H63D/wt          | wt/wt            |
|--------------------------|---------------|---------------|-------------------|------------------|------------------|------------------|------------------|
| <b>Whites</b>            |               |               |                   |                  |                  |                  |                  |
| Kaiser                   | 31,088        | 0.44          | 9.80              | 1.80             | 2.40             | 23.3             | 62.4             |
| NHANES III               | 2016          | 0.30          | 9.50              | 2.40             | 2.20             | 23.6             | 62.1             |
| Connecticut              | 100           | 1.00          | 8.00              | 0                | 4.00             | 24.0             | 63.0             |
| Alabama                  | 176           | 0             | 13.10             | 6.80             | 3.40             | 15.4             | 60.3             |
| Maine                    | 1001          | 0.70          | 9.70              | 2.20             | 1.70             | 24.6             | 61.1             |
| New Mexico               | 287           | 0             | 9.80              | 2.40             | 2.40             | 19.9             | 65.5             |
| Alabama                  | 142           | 0.70          | 10.60             | 3.50             | 2.80             | 19.7             | 62.7             |
| California               | 193           | 0             | 15.00             | 1.00             | 3.60             | 24.3             | 58.0             |
| Missouri                 | 1450          | 0.40          | 8.90              | 2.40             | 3.50             | 23.9             | 61.0             |
| <b>Total</b>             | <b>36,453</b> | <b>0–1.00</b> | <b>8.00–13.10</b> | <b>0–6.80</b>    | <b>1.70–4.00</b> | <b>15.4–24.6</b> | <b>58.0–65.0</b> |
| <b>Blacks</b>            |               |               |                   |                  |                  |                  |                  |
| Kaiser                   | 1493          | 0             | 3.50              | 0.30             | 0.20             | 8.4              | 87.5             |
| NHANES III               | 1600          | 0.06          | 2.30              | 0.06             | 0.32             | 5.6              | 91.7             |
| Connecticut              | 56            | 0             | 2.00              | 0                | 0                | 3.5              | 94.5             |
| Michigan                 | 172           | 0             | 3.00              | 0                | 0                | 3.0              | 94.0             |
| <b>Total</b>             | <b>3321</b>   | <b>0–0.06</b> | <b>2.00–3.50</b>  | <b>0–0.30</b>    | <b>0–0.32</b>    | <b>3.0–8.4</b>   | <b>87.5–95.0</b> |
| <b>Mexican Americans</b> |               |               |                   |                  |                  |                  |                  |
| Kaiser                   | 4149          | 0.22          | 3.50              | 0.84             | 1.40             | 20.6             | 73.4             |
| NHANES III               | 1555          | 0.03          | 2.75              | 0.19             | 1.10             | 19.7             | 76.3             |
| Connecticut              | 100           | 0             | 3.00              | 1.00             | 1.00             | 15.0             | 82.0             |
| <b>Total</b>             | <b>5804</b>   | <b>0–0.22</b> | <b>2.80–3.50</b>  | <b>0.19–1.00</b> | <b>1.00–1.40</b> | <b>15.0–21.0</b> | <b>73.0–82.0</b> |

wt, wild type.

<sup>a</sup> Beutler E, personal communication.

### Association of Iron Loading and Hemochromatosis Gene Mutations

Some mutations are associated with major iron loading, such as C282Y, R330M, IVS3 (+1) G?T, E168X, C282S, and R74X ( [Table 30.1](#)). Some mutations are believed to have a modest or moderate effect on iron accumulation, such as H63D, S65C, G93R, I105T, and E168Q. Other mutations of HFE have been identified in individuals in whom iron loading

was not present or in whom the effect of the mutation on iron accumulation could not be determined, such as V53M, V59M, Q127H, E277K, and in several intron sequence variants. The HFE mutations with major, mild, or unknown effects on iron accumulation are shown in [Table 30.1](#).

## FREQUENCY OF HEMOCHROMATOSIS IN MEN AND WOMEN

Because hemochromatosis is transmitted as an autosomal-recessive condition, there should be equal numbers of male and female homozygotes. Overt iron overload organ injury and illness occur more frequently in men than in women with this disorder. Comparing groups of homozygotes, men with hemochromatosis have approximately two and a half times as much mobilizable body storage iron as women. Of course, any woman with this disorder may be more heavily iron loaded than an affected man, but usually this is not the case. Women are protected somewhat by the loss of 15 to 25 mg of iron each month and by the transfer of approximately 750 mg of iron to the fetus during pregnancy.

Menstrual blood losses and pregnancy do not seem to explain all of the differences in body iron stores between male and female homozygotes. It is possible that an additional factor(s) prevents most women with hemochromatosis from absorbing and accumulating as much iron as affected men. [Table 30.4](#) contains the frequency of symptoms and signs in groups of men and women with hemochromatosis from nine studies.

**TABLE 30.4. Clinical Observations (%) in Subjects with Hemochromatosis [a](#) from Nine Studies**

|  | Sheldon<br>1935 | Finch<br>1955 | Milder<br>1980 | Edwards<br>1982 | Adams<br>1991 | Milman<br>1991 | Fargion<br>1992 | Niederau<br>1996 | Moirand<br>1997 |
|--|-----------------|---------------|----------------|-----------------|---------------|----------------|-----------------|------------------|-----------------|
| Number of patients                               | 311             | 787           | 34             | 41              | 118           | 179            | 212             | 251              | 352             |
| Men  | 295             | 711           | 34             | 26              | 94            | 140            | 181             | 224              | 176             |
| Women  | 16              | 76            | —              | 15              | 24            | 39             | 31              | 27               | 176             |
| Symptoms (% of patients)                         |                 |               |                |                 |               |                |                 |                  |                 |
| Weakness   | 13              | 70            | 73             | 22              | 9             | 79             | —               | 82               | 54              |
| Weight loss                                      | —               | 44            | 53             | 7               | —             | 69             | —               | —                | —               |
| Arthralgias                                      | —               | —             | 47             | 56              | 13            | 44             | —               | 44               | 40              |
| Abdominal pain                                   | 26              | 29            | 50             | 20              | 6             | 34             | —               | 56               | —               |
| Loss of libido<br>and/or impotence               | 6               | 14            | 56             | 24 <sup>b</sup> | 1             | 41             | —               | 36               | —               |
| Amenorrhea                                       | —               | —             | —              | —               | —             | 10             | —               | 15               | —               |
| Cardiac complaints                               | —               | 33            | 35             | 39              | —             | —              | —               | —                | —               |
| Asymptomatic                                     | —               | —             | 15             | 37              | 18            | —              | —               | —                | —               |
| Physical and laboratory findings (% of patients) |                 |               |                |                 |               |                |                 |                  |                 |
| Skin pigmentation                                | 84              | 85            | 82             | 49.0            | —             | 70             | 35              | 72               | 52              |
| Hepatomegaly                                     | 92              | 93            | 76             | 54.0            | —             | 84             | 75              | 81               | —               |
| Abnormal hepatic<br>function tests               | —               | —             | 54             | 61.0            | 13            | 92             | —               | —                | —               |
| Cirrhosis  | 92              | —             | 94             | 41.0            | —             | 84             | 69              | 57               | 20              |
| Hepatoma   | 6               | 14            | 18             | 2.4             | —             | —              | 12              | —                | —               |
| Splenomegaly                                     | 55              | 50            | 38             | 37.0            | —             | 12             | —               | 10               | —               |
| Diabetes   | 79              | 82            | 53             | 12.0            | 10            | 47             | 30              | —                | 12              |
| Testicular atrophy                               | —               | 16            | 50             | 20.0            | —             | —              | —               | —                | —               |

|                               |   |    |                  |                   |   |    |                 |    |    |
|-------------------------------|---|----|------------------|-------------------|---|----|-----------------|----|----|
| Hypogonadism, documented      | — | —  | 40 <sup>b</sup>  | 20.0 <sup>b</sup> | — | —  | 20 <sup>b</sup> | —  | —  |
| Hypogonadotropic hypogonadism | — | —  | 100 <sup>b</sup> | 80.0 <sup>b</sup> | — | —  | —               | —  | —  |
| Arthropathy                   | — | —  | 44               | 68.0              | — | —  | 13              | —  | —  |
| Cardiac arrhythmia            | — | 35 | 26               | 7.0               | — | —  | 20              | 35 | 14 |
| Congestive heart failure      | — | 33 | 35               | 2.4               | — | 15 | —               | —  | —  |

<sup>a</sup> These symptoms of illness, abnormal physical examination findings, and laboratory abnormalities were observed in patients in nine studies from seven countries.

<sup>b</sup> Findings in men only; not all men were studied.

From Barton JC, Edwards CQ, eds. Hemochromatosis: genetics, pathophysiology, diagnosis and treatment. Cambridge, UK: Cambridge University Press, 2000:313, with permission.

## CLINICAL FEATURES OF HEMOCHROMATOSIS

### Symptoms

The presence or absence of symptoms in subjects with hemochromatosis is related directly to the stage at which the diagnosis is established. Individuals who are found to have hemochromatosis during a routine office visit are expected to have no organ injury at the time, and they often are not heavily iron loaded. This is a common occurrence among women, young men, and children, and among the healthy siblings who undergo family screening after a proband is discovered.

Subjects in whom the diagnosis of hemochromatosis is established after seeking medical attention because of illness are expected to have symptoms of illness. These individuals usually are iron overloaded and have evidence of organ injury. The frequency of symptoms, physical signs, and laboratory abnormalities in subjects with hemochromatosis (sick probands) compared to probands who are identified during screening compared to their homozygous relatives who were identified during family evaluation (clinically unselected homozygotes) appear in [Table 30.5](#), [Table 30.7](#), and [Table 30.8](#). Approximately 90% of people who are found to have hemochromatosis during screening are asymptomatic.

**TABLE 30.5. Clinical Observations in Hemochromatosis Probands Identified Due to Illness or during Utah Screening Studies <sup>a</sup>**

| Abnormality        | 59 Sick Probands (%) | 38 Screening Probands (%) | <i>p</i> Value <sup>b</sup> |
|--------------------|----------------------|---------------------------|-----------------------------|
| <b>Symptoms</b>    |                      |                           |                             |
| Asymptomatic       | 0                    | 90                        | <.0001                      |
| Abdominal pain     | 48                   | 5                         | <.0001                      |
| Weakness, lethargy | 54                   | 5                         | <.0001                      |
| Palpitations       | 37                   | 5                         | <.0010                      |
| Impotence (men)    | 25                   | 3                         | <.0080                      |
| Weight loss        | 17                   | 5                         | <.0160                      |

|   |    |    |        |
|---|----|----|--------|
| Clinical findings                       |    |    |        |
| Skin pigmentation                       | 71 | 19 | <.0001 |
| Arthropathy                             | 48 | 10 | <.0001 |
| Hepatomegaly                            | 56 | 3  | <.0001 |
| Liver enzyme elevation                  | 68 | 8  | <.0001 |
| Liver iron stain grade 3–4 <sup>c</sup> | 98 | 21 | <.0001 |
| Hepatic cirrhosis                       | 42 | 0  | <.0001 |
| Diabetes mellitus                       | 27 | 0  | <.0010 |
| Cardiomegaly                            | 14 | 0  | <.0370 |
| Documented hypogonadism                 | 16 | 0  | <.0260 |

<sup>a</sup> Data summarized from Witte DL, Crosby WH, Edwards CQ, et al. Development Task Force of the College of American Pathologists. Hereditary Hemochromatosis. Clin Chim Acta 1996;245:139–200.

<sup>b</sup> *p* Values calculated by chi-square test.

<sup>c</sup> Scale of 0–4; normal grade 0–1.

From Edwards CQ, Griffen LM, Bulaj ZJ, et al. Hemochromatosis: genetics, pathophysiology, diagnosis and treatment. Cambridge, UK: Cambridge University Press, 2000;314, with permission.

**TABLE 30.7. Demographic Characteristics and Iron Phenotypes of Probands and Their Clinically Unselected Homozygous Relatives: Utah Studies of 505 Homozygotes**

| Variable                                    | Probands Identified Due to Illness (Sick) (N = 184) |           | Probands Identified by Elevated Transferrin Saturation (Screening) (N = 107) |          | Clinically Unselected Homozygous Relatives of Probands <sup>a</sup> (N = 214) |         |
|---|---|-----------|--|----------|---|---------|
|   | Men   | Women     | Men  | Women    | Men   | Women   |
| N   | 136   | 48        | 66   | 41       | 113   | 101     |
| Age (yr)                                    | 51 ± 13   | 51 ± 14   | 37 ± 15  | 45 ± 19  | 41 ± 17   | 44 ± 19 |
| Transferrin saturation (%)                  | 87 ± 10   | 81 ± 13   | 82 ± 13  | 79 ± 12  | 82 ± 14   | 69 ± 16 |
| Ferritin concentration (ng/ml) <sup>b</sup> |   |           |  |          |   |         |
| Median                                      | 1300  | 657       | 421  | 319      | 552   | 170     |
| Tenth, ninetieth percentiles                | 518, 3164   | 242, 2682 | 99, 1274   | 69, 1023 | 147, 1495   | 28, 580 |

NOTE: Plus-minus values are means ± standard deviation.

<sup>a</sup> The homozygous relatives were 164 siblings, 10 parents, 19 offspring, 7 nieces, 6 nephews, 1 aunt, 2 uncles, 1 grandmother, and 4 persons who married into an affected family and had transferrin-saturation values similar to those of homozygotes.

<sup>a</sup> The *p* values calculated by the Kruskal–Wallis nonparametric test for the comparison of ferritin concentrations were as follows: clinically affected probands as compared with probands identified because of elevated transferrin–saturation values: <.001 for men, .002 for women; clinically affected probands as compared with clinically unselected homozygous relatives: <.001 for men, <.001 for women; probands identified because of elevated transferrin–saturation values compared with clinically unselected homozygous relatives: .37 for men, .004 for women.

From Bulaj ZJ, Ajioka RS, Phillips JD, et al. Disease–related conditions in relatives of patients with hemochromatosis. *N Engl J Med* 2000;343:1530, with permission.

**TABLE 30.8. Disease–Related Conditions and Other Clinical Findings in Three Groups of Subjects with Hemochromatosis: Utah Study of 505 Homozygotes**

| Variable  | Sick Probands Identified Due to Illness (N = 184) |                  | Screening Probands Identified by Elevated Transferrin Saturation (N = 107) |                  | Clinically Unselected Homozygous Relatives of Probands (N = 214) |                  |
|---|---|------------------|--|------------------|--|------------------|
|   | Men   | Women            | Men  | Women            | Men  | Women            |
| N   | 136   | 48               | 66   | 41               | 113  | 101              |
| Liver biopsies (N)  | 123   | 44               | 54   | 33               | 78   | 40               |
| Disease–related conditions (N) <sup>a</sup>                 |   |                  |  |                  |  |                  |
| Cirrhosis   | 55  | 10               | 3  | 2                | 14   | 2                |
| Fibrosis  | 32  | 9                | 6  | 2                | 13   | 4                |
| Aminotransferase elevation                                  | 16  | 7                | 9  | 7                | 11   | 2                |
| Arthropathy   | 5   | 3                | 1  | 3                | 5  | 2                |
| Subjects with at least one disease–related condition, N (%) | 108 ( <u>79</u> )                                 | 29 ( <u>60</u> ) | 19 ( <u>29</u> )   | 14 ( <u>34</u> ) | 43 ( <u>38</u> )   | 10 ( <u>10</u> ) |
| Other clinical findings (N)                                 |   |                  |  |                  |  |                  |
| Diabetes  | 32  | 6                | 2  | 0                | 3  | 5                |
| Hypogonadotropic hypogonadism                               | 16  | 3                | 0  | 1                | 4  | 0                |
| Cardiac arrhythmia <sup>b</sup>                             | 21  | 5                | 2  | 1                | 10   | 3                |
| Portal hypertension with splenomegaly                       | 25  | 4                | 0  | 0                | 9  | 2                |
| Hepatocellular carcinoma                                    | 14  | 0                | 0  | 0                | 2  | 0                |
| Porphyria cutanea tarda                                     | 10  | 9                | 0  | 0                | 1  | 1                |

<sup>a</sup> If a subject had more than one of the four conditions listed, he or she was classified as having only the condition listed first.

<sup>b</sup> Arrhythmia was documented by electrocardiography.

From Bulaj ZJ, Ajioka RS, Phillips JD, et al. Disease–related conditions in relatives of patients with hemochromatosis. *N Engl J Med* 2000;343:1531, with permission.

The most common symptom in hemochromatosis patients is arthralgias, present in approximately 40% of homozygotes at the time of diagnosis ( [101](#), [102](#) ). The joints most commonly involved are the metacarpal–phalangeal joints, especially the second and third ( [103](#) ). Knees, hips, shoulders, and other joints also can be symptomatic.

Other symptoms that are common in subjects with hemochromatosis include weakness, fatigue, and lethargy. These symptoms are nonspecific. Weight loss, abdominal pain, loss of libido in men, and palpitations also may occur in iron–loaded homozygotes. The frequency of arthralgias, abdominal pain, loss of libido or impotence, and palpitations from different study populations appears in [Table 30.4](#) and [Table 30.5](#).

### Physical Examination Abnormalities

Gray or bronze pigmentation is the most common physical examination abnormality in hemochromatosis homozygotes, occurring in approximately 35 to 84%. Other common physical examination findings include arthropathy (13 to 68%), hepatomegaly (54 to 93%), splenomegaly (10 to 55%), irregular heart beat, congestive heart failure, telangiectases, and loss of midline body hair or testicular atrophy. The frequency of physical abnormalities in hemochromatosis from nine studies is shown in [Table 30.4](#).

### Laboratory Abnormalities

The most common laboratory abnormalities in subjects with hemochromatosis are elevation of serum iron concentration, percent saturation of transferrin average, and serum ferritin concentration. Transferrin saturation may be elevated in children or teenage homozygotes before serum ferritin elevation occurs, long before symptoms or physical examination abnormalities develop. The results of transferrin saturation and serum ferritin concentration in normal individuals, hemochromatosis heterozygotes, compound heterozygotes, and homozygotes according to HFE genotype from a very recent and large U.S. population study appear in [Table 30.6](#). The typical values of transferrin saturation according to method of ascertainment in 505 Utah homozygotes appear in [Table 30.7](#).

**TABLE 30.6. Values of Transferrin Saturation and Serum Ferritin Concentration in Men and Women According to the Hemochromatosis Gene Genotype from a U.S. Population Study**

|                                     | wt/wt  | C282Y/wt | C282Y/H63D | C282Y/C282Y |
|-------------------------------------|--------|----------|------------|-------------|
| Men (N)                             | 12,601 | 1603     | 300        | 73          |
| Transferrin saturation (%)          | 27     | 31       | 40         | 64          |
| Serum ferritin (ng/ml)              | 118    | 122      | 191        | 395         |
| Women (N)                           | 13,674 | 1690     | 305        | 79          |
| Transferrin saturation (%)          | 23     | 27       | 32         | 46          |
| Serum <sup>a</sup> ferritin (ng/ml) | 52     | 56       | 70         | 159         |

wt, wild type.

<sup>a</sup> Geometric mean.



From Beutler E, Felitti VJ, Koziol JA, et al. Penetrance of 845G?A (G282Y) HFE hereditary haemochromatosis mutation in the USA. *Lancet* 2002;359:211–218, with permission.

Radiographs of hands are often abnormal in homozygotes who have arthralgias. Approximately 50% of homozygotes have radiographic changes. The plain films reveal narrowing of the metacarpal–phalangeal joint spaces, subperiosteal bone resorption, and periarticular demineralization (103). Plain films of knees may reveal chondrocalcinosis, calcium deposition in the cartilage that is visible across the joint space.

The next most common laboratory abnormality in patients with hemochromatosis is elevation of liver enzymes in serum alanine aminotransferase and aspartate aminotransferase, which occurs in 2 to 16% of subjects (Table 30.4, Table 30.5, Table 30.8, and Table 30.9). Usually, these enzymes are elevated to approximately two to five times the upper limit of normal. If hepatic failure is present, the enzymes may be very elevated, and jaundice may be present. Other common laboratory abnormalities include elevation of serum glucose concentration (8 to 36%); an arrhythmia on electrocardiography; cardiomegaly on chest radiography; a decreased ejection fraction on echocardiography; an elevated or very low thyroid–stimulating hormone in hypothyroidism or hyperthyroidism, respectively; and blood test evidence of hypogonadism, usually the hypogonadotropic type with decreased serum concentrations of testosterone, dehydrotestosterone, leuteinizing hormone, and follicle–stimulating hormone (104). Table 30.4, Table 30.5, Table 30.8, and Table 30.9 show the frequency of lab abnormalities in individuals who have hemochromatosis.

**TABLE 30.9. Age, Iron Phenotype, and Clinical Features of 194 Canadian Hemochromatosis Homozygotes a**

|  | 141 Men (M)     |          | 53 Women (W)    |          | Normal Values  |
|--|-----------------|----------|-----------------|----------|----------------|
|  | Discovered<br>a | Probands | Discovered<br>a | Probands |                |
| N  | 46              | 95       | 28              | 25       | —              |
| Age (yr)                                       | 48              | 53       | 54              | 63       | —              |
| Transferrin saturation (%)                     | 70              | 83       | 68              | 72       | <55            |
| Serum ferritin (ng/ml)                         | 876             | 2658     | 524             | 1555     | M <300, W <200 |
| Hepatic iron concentration (µmol/g) dry weight | 225             | 321      | 208             | 292      | <35            |
| Hepatic iron index                             | 4.7             | 6.6      | 4.1             | 5        | <1.9           |
| Weakness (%)                                   | 72              | 60       | 67              | 59       | —              |
| Skin pigmentation (%)                          | 9               | 49       | 4               | 36       | —              |
| Hepatomegaly (%)                               | 12              | 60       | 9               | 61       | —              |
| Arthritis (%)                                  | 26              | 42       | 25              | 52       | —              |
| Testicular atrophy (%)                         | 7               | 24       | —               | —        | —              |
| Cardiac failure (%)                            | 6               | 15       | 4               | 35       | —              |
| Diabetes mellitus (%)                          | 14              | 36       | 8               | 22       | —              |
| Hepatic disease (%)                            | 3               | 46       | 8               | 48       | —              |

|                              |   |    |   |    |   |
|------------------------------|---|----|---|----|---|
| Cardiac arrhythmia (%)       | 3 | 20 | 0 | 29 | — |
| Hepatocellular carcinoma (%) | 1 | 5  | 0 | 5  | — |

<sup>a</sup> These data include observations on 120 probands and 74 other homozygotes discovered during evaluation of relatives or during screening, not due to illness. These data were adapted from Adams PC, Valberg LS. Evolving expression of hereditary hemochromatosis. *Semin Liver Dis* 1996;16:47–54. Frequency (%) was estimated from bar graphs. Numerical data not presented in original text.

From Barton JC, Edwards CQ, eds. *Hemochromatosis: genetics, pathophysiology, diagnosis and treatment*. Cambridge, UK: Cambridge University Press, 2000:315, with permission.

---

## Liver Biopsy Findings

Liver biopsy usually is normal in young homozygotes whose serum ferritin is not elevated. When serum ferritin concentration is elevated, the hepatic parenchymal cell stainable iron is usually increased. The same comments apply to the measured hepatic iron concentration.

Many 40- to 50-year-old male homozygotes already have hepatic fibrosis at the time the diagnosis of hemochromatosis is established (2 to 32%) ( [Table 30.8](#) ). Approximately 20 to 92% of male homozygotes have cirrhosis at the time of diagnosis ( [Table 30.4](#) ). Most women with hemochromatosis do not have hepatic fibrosis or cirrhosis at the time of diagnosis. Hepatic cirrhosis is not expected to occur until the hepatic iron concentration is enormously elevated at approximately 22,000 µg (22 mg) of iron per gram of liver dry weight (normal, approximately 1000 µg iron per gram dry weight) ( [105](#) ).

Among homozygotes who are identified very late, 10 to 29% of those with cirrhosis develop hepatocellular carcinoma ( [106](#) , [107](#) , [108](#) and [109](#) ). Hepatocellular carcinoma in hemochromatosis may be multifocal rather than focal and may not cause the marked elevation of α-fetoprotein that is common in individuals who have a large nodular hepatoma. Multifocal hepatocellular carcinoma may not be visible by ultrasonography until nodules reach 1 cm in diameter. The frequency of hepatic fibrosis, cirrhosis, and hepatocellular carcinoma in hemochromatosis patients appears in [Table 30.4](#), [Table 30.5](#), [Table 30.8](#), and [Table 30.9](#).

## HEMOCHROMATOSIS GENE MUTATIONS AND OTHER CONDITIONS

### Hereditary Spherocytosis

Individuals who have hereditary spherocytosis may become heavily iron loaded and may develop hepatic cirrhosis when they are homozygous for HFE mutations. In a family that was studied in Utah, two brothers who were C282Y homozygotes were iron loaded ( [110](#) ). The proband who had both hereditary spherocytosis and hemochromatosis had a much heavier body iron burden than his sibling who had hemochromatosis without spherocytosis. The son of the proband was a C282Y/wild type (wt) heterozygote and had spherocytosis. His serum ferritin concentration and liver iron stores were only modestly elevated. The occurrence of homozygosity (or heterozygosity) for hemochromatosis and spherocytosis has been reported in several studies ( [109](#) , [111](#) , [112](#) , [113](#) , [114](#) , [115](#) , [116](#) and [117](#) ). In a 2002 report from Switzerland, a 37-year-old man who had

hereditary spherocytosis was found to be homozygous for the C282Y mutation ([118](#)). After larger studies are performed and published, it will be possible to estimate the prevalence of one or more HFE mutations in subjects who have hereditary spherocytosis.

## Arthritis

Hemochromatosis homozygotes with arthritis usually experience the onset of arthralgias in the second and third metacarpal–phalangeal joints ([119](#)). In some homozygotes, this may seem somewhat like rheumatoid arthritis, but the rheumatoid factor is usually negative. What looks like seronegative rheumatoid arthritis may in fact be the arthropathy of hemochromatosis. The knees are the next most frequently affected joints. Other joints also may be affected, including the proximal interphalangeal joints of the hands, wrists, hips, and shoulders ([101](#), [103](#), [106](#), [119](#), [120](#), [121](#), [122](#), [123](#), [124](#), [125](#), [126](#), [127](#), [128](#), [129](#), [130](#), [131](#), [132](#), [133](#), [134](#) and [135](#)). Initially, the metacarpal–phalangeal joints often are swollen, and there is decreased range of motion and limited ability to make a claw or fist. Hand radiographs reveal periarticular demineralization, loss of joint space, subperiosteal bone resorption, and the presence of spurs. Radiographs of the knees often reveal chondrocalcinosis ([103](#)).

There are reports of HFE gene mutation testing in patients who have arthritis. In a 1998 report, HFE mutations were sought in a group of 1000 patients who had inflammatory arthritis and in 1000 normal control subjects ([136](#)). Nearly all (94%) were whites who were born in England. Five patients in both the inflammatory arthritis group and the control group were found to be homozygous for the C282Y mutation of the HFE gene. This is the same as the frequency of homozygosity in the general European white population. These results are not surprising because the arthritis of hemochromatosis usually is of gradual onset rather than an acute inflammatory arthritis. Additional studies of HFE gene mutations in patients who have arthritis have been published. There are reports of rheumatoid factor–positive rheumatoid arthritis and homozygosity for the C282Y mutation ([130](#)).

In a study of the prevalence of the C282Y and the H63D mutations in a group of 92 patients who had rheumatoid arthritis and in 87 control subjects, 6.5% of the rheumatoid patients had the C282Y mutation, no different than in controls (6.9%) ([137](#)). The H63D mutation was present in 40% of the rheumatoid arthritis patients compared with 21% of control subjects. The increased frequency of the H63D mutation was present in the rheumatoid arthritis patients who were positive for a chromosome 6p HLA–DR epitope that is associated with increased susceptibility to, and severity of, rheumatoid arthritis (HLA–DRB1 QKRAA/QKRAA). The authors considered both H63D and the HLA–DRB1 QKRAA/QKRAA epitope to individually convey susceptibility to rheumatoid arthritis and that the combination of H63D and the epitope strengthened this susceptibility.

## Diabetes Mellitus

Diabetes was present in the original case report of a patient with hemochromatosis. Although diabetes and hemochromatosis are known to segregate independently as genetic traits ([7](#)), diabetes is common in patients with far advanced hemochromatosis with cirrhosis ([Table 30.4](#), [Table 30.5](#), [Table 30.8](#), and [Table 30.9](#)) ([107](#), [138](#), [139](#) and [140](#)). Uncontrolled studies have been performed to determine the prevalence of hemochromatosis in patients who have diabetes mellitus (ranging from 0.49 to 0.96%) ([141](#), [142](#) and [143](#)). In a study that was designed to identify hemochromatosis on the basis of blood tests and liver tests of iron stores, 894 diabetics (777 type II; 117 type I) and 467 control subjects were evaluated. Twelve type II diabetics (1.3%) and one control subject (0.2%) were found to have previously undiagnosed hemochromatosis. The diagnosis of

hemochromatosis was not considered in these 12 individuals despite lengthy follow-up for diabetes type II. Transferrin saturation was 70 to 100%, and serum ferritin concentration was elevated at 620 to 3200 in the 12 patients found to have hemochromatosis ( [144](#) ).

In a study of HFE mutations in 220 male patients with diabetes type II, 0.45% were C282Y homozygotes, and 1.30% were C282Y/H63D compound heterozygotes. These results were similar to the prevalence of HFE mutations in the normal control group ( [145](#) ). In a study of the prevalence of late-onset type I diabetes, 1.30% of 716 diabetics were C282Y/C282Y homozygotes compared with 0.25% of 9174 control subjects. The prevalence of C282Y/H63D compound heterozygosity was similar in the diabetic and the control populations ( [146](#) ). A large study of the prevalence of HFE mutations and diabetes was published in 2002. Of 22,347 control subjects who did not have mutations of the HFE gene, 8.4% had diabetes compared with 5.6% of 124 C282Y homozygotes. Diabetes was present in 7.0% of C282Y/H63D compound heterozygotes ( [147](#) ). A thorough review of diabetes and hemochromatosis was published in 2000 ( [148](#) ).

### Other Endocrinopathy

Hypogonadism, thyroid disease, and adrenal insufficiency also occur in hemochromatosis patients, usually only in those who have been heavily iron loaded for decades. Of nondiabetic endocrinopathy in hemochromatosis, the second most common type is hypogonadism ( [Table 30.4](#), [Table 30.5](#), [Table 30.8](#), and [Table 30.9](#) ). This is usually of the hypogonadotrophic type. Iron is deposited in the anterior pituitary secretory cells ( [5](#), [104](#), [149](#), [150](#) and [151](#) ). In a study of mostly iron-depleted male hemochromatosis patients, 47% had hypogonadotrophic hypogonadism. The evidence for this was that these patients had low baseline serum concentrations of testosterone and low gonadotrophin concentrations, and these did not increase after administration of gonadotrophin-releasing hormone ( [152](#) ). Other smaller studies have demonstrated similar results ( [104](#), [152](#), [153](#), [154](#), [155](#), [156](#), [157](#) and [158](#) ).

Hypothalamic dysfunction may occur in hemochromatosis patients ( [159](#), [160](#), [161](#) and [162](#) ). A very good discussion of the pituitary-adrenal axis, the thyroid and parathyroid glands, testicles and ovaries, and their function in patients with hemochromatosis was published in 2000 ( [104](#) ).

### Hepatocellular Carcinoma

Individuals with hemochromatosis who have cirrhosis have a 219-fold increased risk for the development of hepatocellular carcinoma ( [107](#) ). In those patients with end-stage hemochromatosis and cirrhosis, 10 to 29% develop hepatoma, although the great majority do not ( [106](#), [107](#), [108](#) and [109](#) ) ( [Table 30.8](#) and [Table 30.9](#) ). There are also reports of hepatoma in hemochromatosis patients who did not have cirrhosis ( [163](#), [164](#) and [165](#) ). The histologic classification of primary liver cancer in hemochromatosis reveals heterogeneity. Although the majority of primary liver cancers in hemochromatosis are of the hepatocellular type, biliary cancers also occur, including cholangiocarcinoma and combined hepatocellular cholangiocarcinoma ( [109](#), [165](#) ).

In a study from Italy, 81 individuals with hepatocellular carcinoma and without known hemochromatosis were tested for the C282Y and H63D mutations. These results were compared to mutation testing in 128 normal individuals who did not have liver disease. Of the patients with hepatoma, 8.6% had a C282Y mutation, and 30.0% had an H63D mutation.

Of the healthy controls, 1.6% had a C282Y mutation, and 24.0% had an H63D mutation. In the same study, the authors found an association between the C282Y mutation, serologic evidence of viral hepatitis, alcohol intake, and hepatocellular carcinoma ([166](#)). There are some reports that did not reveal an increased prevalence of HFE mutations in patients with hepatoma compared to control subjects ([167](#)). In a study of 61 cirrhotic patients without known hemochromatosis who underwent resection of the liver because of hepatoma, the prevalence of HFE mutations was significantly greater than in normal individuals ([168](#)).

## Other Types of Cancer

There is evidence in the literature that iron can be carcinogenic. Possible mechanisms of carcinogenesis include redox cycling of iron, resulting in the production of reactive oxygen species and free radicals, which in turn causes lipid peroxidation and damage to proteins and DNA ([169](#)). Iron may facilitate tumor cell growth and may modify responses in the immune system. This very broad topic was discussed in detail recently ([170](#), [171](#)).

## Porphyria Cutanea Tarda

The single most common type of porphyria is porphyria cutanea tarda. An elevated amount of storage iron is characteristic of this disorder. The interaction of iron and porphyria cutanea tarda was reviewed recently ([172](#), [173](#)). Also, the presence of one or two mutations of HFE is common in subjects who have this type of porphyria and increased storage iron. Patients with porphyria cutanea tarda (either sporadic or familial) and heavy iron loading may be homozygous for HFE mutations ([174](#), [175](#)).

Evidence for an association of the uroporphyrinogen decarboxylase gene on chromosome 1q and hemochromatosis alleles on chromosome 6p was first presented in 1989 ([176](#)). This was substantiated after the HFE gene was cloned and sequenced, and HFE mutations were identified ([173](#), [175](#), [177](#)). In a study of 108 subjects in Utah who had porphyria cutanea tarda, 19% were C282Y homozygotes, and 7% were C282Y/H63D compound heterozygotes ([175](#)). The HFE mutation(s) causes increased iron absorption, which further depresses the already decreased activity of the enzyme uroporphyrinogen decarboxylase. This in turn results in the accumulation of uroporphyrin I in organs. Deposition of porphyrin in skin causes photosensitivity, blistering, and scarring.

Risk factors for the expression of porphyria cutanea tarda include mutations of HFE, hepatitis C, alcoholism, and oral estrogen (but possibly not transdermal estrogen) ([174](#)). Hepatitis C is a potent risk factor, present in up to 28 to 74% of individuals with this type of porphyria. A 2002 study from Galveston was performed to assess the factors involved in the expression of porphyria cutanea tarda ([178](#)). In 39 consecutive porphyric patients, 9% had HFE genotype C282Y/C282Y, 9% were C282Y/wt, 12% were C282Y/H63D, 9% were H63D/H63D, and 26% were H63D/wt; none had the S65C mutation. Of the porphyric patients, 79% drank alcohol, 73% of 11 women took estrogens, 86% were smokers, and 74% were positive for the hepatitis C virus antibody. The authors concluded that HFE mutations were common and that the expression of porphyria cutanea tarda was multifactorial. They found that 92% of their patients had three or more risk factors for the expression of porphyria.

A study was performed in France in 2002 to identify factors that contribute to the expression of the sporadic common type of porphyria cutanea tarda ([179](#)). The prevalence of the C282Y, H63D, and S65C mutations of HFE and antibody to the hepatitis C virus

was compared in 65 patients with sporadic porphyria cutanea tarda and in 108 control subjects. Of the porphyria patients, 17% had the C282Y mutation (4% of controls); there was no significant difference in the prevalence of the H63D and S65C mutations or compound heterozygosity between groups; 28% of porphyrics had antibodies to the hepatitis C virus. The authors agreed with other reports that the expression of sporadic porphyria cutanea is multifactorial.

A large study was performed in Germany to compare the prevalence of mutations of the HFE gene in 190 patients who had sporadic porphyria cutanea tarda and 115 age-matched healthy blood donors ( [180](#) ). Among the porphyrics, 39% had the C282Y mutation (3% in control subjects); 12% were C282Y homozygotes (0% in controls). The H63D mutation was present in 45% of porphyrics (10% in controls); 9% of porphyrics were C282Y/H63D compound heterozygotes.

### **β-Thalassemia Minor**

There are published reports of the occurrence of both β-thalassemia minor and hemochromatosis in the same person. In one family, an index case who had β-thalassemia minor and hemochromatosis had a brother without β-thalassemia minor who was homozygous for the C282Y mutation. The proband's wife was also a C282Y homozygote. One of their children had β-thalassemia minor and hemochromatosis, whereas the other had hemochromatosis alone. The proband's brother married a woman who was a C282Y/wt heterozygote. Both of their children were C282Y homozygotes ( [181](#) ). This report was published long before the HFE gene was identified. The C282Y testing was performed in the family after DNA testing became available.

There are recent reports of the presence of mutations of the HFE gene in patients with β-thalassemia minor who become iron loaded ( [182](#), [183](#), [184](#) and [185](#) ). In a study of 22 iron-loaded Italian patients with β-thalassemia minor and 62 relatives, it was concluded that the β-thalassemia trait worsens the iron-related complications of homozygosity for the C282Y mutation. It is believed that the mild ineffective erythropoiesis of β-thalassemia trait results in exaggeration of the amount of iron absorbed by the duodenum. The authors presented evidence that C282Y heterozygotes and H63D heterozygotes with β-thalassemia trait did not become iron loaded ( [183](#) ).

On the island of Sardinia, an area not reached by Celtic influence, the presence of the C282Y mutation is very rare. The H63D mutation prevalence is similar to other populations ( [93](#) ), and the prevalence of β-thalassemia minor is 13% ( [184](#) ). A study of 15 Sardinian men with β-thalassemia minor was conducted to estimate the prevalence of the H63D mutation in 152 Sardinian men who had β-thalassemia minor. Approximately 2.6% were H63D homozygotes, 29.5% were H63D/wt heterozygotes, and 68% were wt/wt normal. Concurrent control subjects were not studied.

In a study from Turin, 71 subjects with transfusion-dependent β-thalassemia major and 200 control subjects were tested for C282Y and H63D ( [185](#) ). None of the patients (or controls) was homozygous for the C282Y mutation; one patient (1.4%) was a C282Y/H63D compound heterozygote (similar to 0% among controls); 21.0% of patients (20.0% of controls) were H63D heterozygotes; and one patient (1.4%) was homozygous for the H63D mutation (1.0% in controls). The patient who was homozygous for the H63D mutation was much more heavily iron loaded than expected. The authors concluded that two copies of the H63D mutation caused the heavy hepatic iron accumulation that was associated with advanced hepatic fibrosis. Individuals with either the H63D or the C282Y mutation were more heavily iron loaded than could be explained by transfusion-dependent homozygous



β-thalassemia.

## Steatohepatitis

The prevalence of HFE gene mutations in subjects with nonalcoholic steatohepatitis has been studied. In a group of 36 men in Massachusetts who had nonalcoholic steatohepatitis, 2.8% were C282Y homozygotes, 17.0% were C282Y heterozygotes, 5.6% were H63D homozygotes, and 44.0% were H63D heterozygotes. In 348 control subjects, none was a C282Y homozygote, 11.0% were C282Y heterozygotes, 2.9% were H63D homozygotes, and 26.0% were heterozygous for the H63D mutation. Individuals with nonalcoholic steatohepatitis who had an HFE mutation had higher values of transferrin saturation and serum ferritin concentration, and those with the C282Y mutation had significantly higher levels of alanine aminotransferase and hepatic fibrosis than those who did not have a C282Y mutation of HFE ( [186](#) ). There are data in the literature indicating that insulin resistance syndrome is associated with the metabolic abnormality that is present in subjects with nonalcoholic steatohepatitis, with or without mutations of HFE ( [187](#), [188](#), [189](#) and [190](#) ).

## Acquired Refractory Sideroblastic Anemia

In the acquired, refractory, nonpyridoxine-responsive type of sideroblastic anemia, iron accumulation varies ( [191](#) ). In a study of 30 patients with this refractory myelodysplastic disorder, there was no difference in the prevalence of HFE mutations compared to the normal population in Oklahoma ( [192](#) ). In a study of 40 patients from Switzerland, Greece, and France who had primary acquired sideroblastic anemia with nontransfusional iron overload, 1.25% had the C282Y mutation, which was not different from the 200 normal controls (2.50%). The prevalence of the H63D mutation also was not significantly different in the patients with sideroblastic anemia (19%) and the controls (13%) ( [193](#) ). Ineffective erythropoiesis alone may adequately explain the increased intestinal absorption of iron, resulting in iron overload, in the acquired refractory type of sideroblastic anemia.

## X-Linked Sideroblastic Anemia

There are reports of individuals who have both X-linked pyridoxine-responsive anemia with ring sideroblasts and heavy iron overload. The first known report of coinheritance of X-linked sideroblastic anemia and HFE gene mutations described a 59-year-old man in France. He had hepatic iron overload and was a C282Y/H63D compound heterozygote. He was much more iron loaded than his 61-year-old brother, who had the X-linked sideroblastic anemia but no HFE mutation ( [194](#) ).

In a study of 18 unrelated subjects with X-linked sideroblastic anemia, 17.0% of patients had the C282Y mutation (5.5% in white controls), and 23.0% had the H63D mutation (15.0% in controls) ( [195](#) ). The difference for the C282Y mutation was significant, but the difference was not significant for the H63D mutation. After iron depletion, the responsiveness to pyridoxine supplementation increased in some of the patients.

## Infections

Individuals who have hemochromatosis are susceptible to infection by organisms that rarely cause illness in people with normal body iron stores, including *Vibrio vulnificus* and *Yersinia enterocolitica* ( [196](#), [197](#), [198](#), [199](#), [200](#), [201](#), [202](#), [203](#), [204](#), [205](#), [206](#) and [207](#) ). *Listeria* ( [208](#) ), *Escherichia coli* ( [209](#) ), and zygomycosis ( [210](#) ) also may occur in hemochromatosis



patients ( [208](#), [209](#) ).

*V. vulnificus* is a motile free-living, gram-negative bacillus that grows as normal marine flora in warm coastal saline waters. It usually does not cause infection in humans except in iron-loaded individuals. When ingested with raw shellfish, it can cause gastroenteritis, septic arthritis, or fatal septicemia ( [206](#), [207](#), [211](#) ). Invasive organisms are encapsulated. The organism thrives in blood that has elevated iron content ( [200](#), [212](#) ).

*Y. enterocolitica* belongs to the family Enterobacteriaceae. It can cause transfusion-induced sepsis, gastroenteritis, septic arthritis, hepatic abscesses, osteomyelitis, or bloody diarrhea. Usually, it is ingested in contaminated water, pork, milk, bean sprouts, or chocolate ( [213](#), [214](#) ). Whereas *Vibrio* is usually present in warm, salty, coastal waters, *Yersinia* is often present in colder climates or as a contaminant in any climate. In patients with hemochromatosis, *Yersinia* can cause severe infections ( [212](#) ), including multiple hepatic abscesses, as in recent reports ( [213](#), [214](#), [215](#) and [216](#) ). The literature concerning 46 known cases of hepatic abscesses caused by *Yersinia* was reviewed in 2001 ( [213](#) ).

## Coronary Artery Disease

It is known that hemochromatosis can cause cardiac arrhythmias or congestive heart failure ( [217](#), [218](#), [219](#), [220](#), [221](#), [222](#), [223](#), [224](#), [225](#) and [226](#) ). Patients with hemochromatosis have a 300-fold increased risk of developing cardiomyopathy ( [107](#) ). There has been increasing interest in the possibility that hemochromatosis may be causally associated with the occurrence of coronary artery disease ( [227](#), [228](#) ), perhaps by lipid peroxidation. A 2002 report includes data about measurement of serum ferritin concentration, the C282Y mutation, C-reactive protein, and malondialdehyde in 849 individuals in Italy who underwent cardiac catheterization to establish or disprove the presence of coronary artery disease ( [229](#) ). Serum ferritin concentration values were higher in subjects whose C-reactive protein was elevated. There was no difference in the prevalence of elevated serum ferritin concentration between the group of 546 patients with coronary artery disease and the 303 individuals whose coronary arteries were normal. In the group with coronary artery disease, 4.8% were C282Y heterozygotes compared with 6.6% percent of the subjects with normal coronary arteries. The authors concluded that neither serum ferritin nor the C282Y mutation correlated with or allowed prediction of angiographically proved coronary artery disease.

In a comparison of 160 patients with severe coronary artery disease from Brazil and 160 age- and sex-matched control subjects, the prevalence of the C282Y mutation in the two groups was identical. The prevalence of H63D was similar in both groups. Compound heterozygosity for C282Y/H63D was minimally higher in the healthy control group (1.2%) than in those with coronary artery disease (0.6%) ( [230](#) ). In two additional studies of the prevalence of C282Y and H63D mutations in patients with coronary artery disease, the prevalence of C282Y and H63D mutations was similar in patients with or without coronary artery disease ( [231](#), [232](#) ). In an autopsy review of 41 iron-loaded subjects compared with 82 age-, sex-, and race-matched control subjects without iron overload from the Johns Hopkins Hospital, 33% of controls had three-vessel coronary artery disease compared with only 12% of the iron-loaded individuals ( [233](#) ). To date, the results of controlled studies do not provide evidence of increased prevalence of coronary artery disease in hemochromatosis or of an increased prevalence of hemochromatosis in patients with coronary artery disease.

## DIAGNOSIS

### History and Physical Examination Findings

The diagnosis of hemochromatosis may be suspected in an individual who has some combination of the following: arthralgias, right upper quadrant abdominal pain, impotence, palpitations, unexplained fatigue or weight loss, gray-bronze skin, hepatomegaly, stigmata of portal hypertension, diabetes, or hypogonadism. Of course, most hemochromatosis homozygotes do not have all of these findings. Individuals in whom the diagnosis is established during routine screening are nearly always asymptomatic and have no physical examination abnormalities. People in whom the diagnosis is established after seeking evaluation because of illness usually have several of the symptoms and physical examination abnormalities stated above. Only patients with far-advanced organ injury have all of the above symptoms and physical examination abnormalities. The frequency of symptoms and signs of hemochromatosis from nine reports appears in [Table 30.4](#).

### Laboratory Findings

Transferrin saturation is the first blood to become elevated in hemochromatosis homozygotes and usually is greater than 60% in symptomatic men and greater than 50% in symptomatic women ( [219](#), [234](#), [235](#) ). Unbound iron-binding capacity is usually decreased in homozygotes ( [236](#), [237](#) ). In iron-loaded patients, serum ferritin concentration is elevated. Liver-stainable iron and the hepatic iron index are also elevated in iron-loaded homozygotes ( [237](#) ). The sensitivity of elevated transferrin saturation to identify a patient with hemochromatosis is 94 to 98%, and its specificity is 70 to 98% ( [234](#), [235](#), [237](#) ). Typical results of transferrin saturation, serum ferritin concentration, hepatic iron concentration, and hepatic iron index in groups of hemochromatosis homozygotes appear in [Table 30.7](#) and [Table 30.9](#). The sensitivity of homozygosity for the C282Y mutation to identify patients with hemochromatosis in the Utah studies was 89% ( [59](#) ) whether or not iron overload was present.

## EVALUATION OF RELATIVES

After the diagnosis of hemochromatosis is established in an individual, it is important to study the siblings of the proband. A choice of tests to perform are the same as for the index case: transferrin saturation, serum ferritin concentration, and DNA testing by polymerase chain reaction for mutations of the HFE gene.

Young homozygous siblings of a proband with hemochromatosis may have a normal serum ferritin concentration. Serum ferritin can be measured at 2- or 3-year intervals to determine when it becomes elevated. When serum ferritin becomes elevated, it is reasonable to begin intermittent phlebotomy therapy to prevent accumulation of excess iron in the liver and other organs.

Homozygous relatives who have a marked elevation of serum ferritin concentration (greater than 700 ng/ml in men; greater than 400 ng/ml in women) and elevated serum concentrations of liver enzymes may have hepatic injury. Liver biopsy in such individuals determines the presence or absence of hepatic fibrosis or cirrhosis and allows measurement of hepatic iron stores. Typical liver biopsy findings in probands and homozygous relatives appear in [Table 30.5](#), [Table 30.8](#), and [Table 30.9](#). The great majority of homozygous relatives who are identified during family screening are less iron loaded and have fewer complications than the proband in the family ( [Table 30.5](#), [Table 30.7](#),

[Table 30.8](#), and [Table 30.9](#)).

Because approximately 10% of whites of Central, Western, and Northern European ancestry are hemochromatosis heterozygotes, the occurrence of hemochromatosis in whites in consecutive generations is common. It seems reasonable to measure transferrin saturation or unbound iron-binding capacity in the interested parents and children of homozygotes in addition to all siblings of the proband. In a study of the relatives of 291 hemochromatosis probands, 214 homozygous relatives were identified ([59](#)). When these 214 clinically unselected individuals were stratified by age and sex, it became apparent that 90% of the homozygous male relatives were iron loaded by age 40 years, and 52% had iron-related organ injury. Clinically unselected female homozygous relatives became iron loaded on average approximately one decade later than men. After 50 years, 88% of clinically unselected female homozygous relatives became iron loaded, and 16% had iron-related organ injury ([59](#)).

The results of transferrin saturation and serum ferritin concentration tests in the 291 probands and their 214 clinically unselected homozygous relatives in the Utah studies appear in [Table 30.7](#). The frequency of iron-related complications in the 291 Utah probands and their 214 homozygous relatives appears in [Table 30.8](#).

## DIFFERENTIAL DIAGNOSIS OF IRON OVERLOAD

Many disorders are known to be associated with increased body iron stores. Some of these heritable or acquired conditions appear in [Table 30.10](#), including gene location, mode of heritability, and gene mutation responsible for the disorder. After the initial report of the isolation and cloning of the HFE gene, it became clear that a small percentage of hemochromatosis patients did not have a C282Y or H63D mutation ([16](#)). In fact, some people with hemochromatosis do not have an HFE mutation at all, such as people with hemochromatosis type 2 (juvenile hemochromatosis, chromosome 1q21) and hemochromatosis type 3 (mutation that inactivates transferrin receptor 2, chromosome 7q22) ([91](#), [238](#), [239](#), [240](#), [241](#), [242](#), [243](#), [244](#), and [245](#)). It is probable that additional mutations of non-chromosome 6 genes will be found to cause iron loading. Perhaps a mutation of any gene that normally down-regulates iron absorption will be found to result in accumulation of excess organ storage iron.

**TABLE 30.10. Heritable and Acquired Disorders Associated with Iron Overload: Differential Diagnosis**

| Heritable Disorder                  | Chromosomal Assignment | Heritability        | Cause of Iron Loading                         | References   |
|-------------------------------------|------------------------|---------------------|---|--|
| Hemochromatosis type 1              | 6p21.3                 | Autosomal recessive | Mutations of HFE                              | <a href="#">16</a>   |
| Hemochromatosis type 2 <sup>a</sup> |                        |                     |   |  |
| Type 2A                             | 1q21                   | Autosomal recessive | Unknown                                       | <a href="#">91</a> , <a href="#">238</a> , <a href="#">239</a> , <a href="#">240</a> , <a href="#">241</a> and <a href="#">242</a> |
| Type 2B                             | 19q13                  | Autosomal recessive | Hepcidin antimicrobial peptide gene mutations | <a href="#">242a</a> , <a href="#">242b</a> , <a href="#">242c</a> and <a href="#">242d</a>  |

|  |                      |                                |   |   |
|--|----------------------|--------------------------------|---|---|
| Hemochromatosis type 3                             | 7q22                 | Autosomal recessive            | Inactivation of transferrin receptor 2                            | <a href="#">243</a> , <a href="#">244</a> and <a href="#">245</a>   |
| Hemochromatosis type 4                             | 2q32                 | Autosomal dominant             | Ferroportin gene mutations  | <a href="#">246</a> , <a href="#">247</a> , <a href="#">248</a> , <a href="#">249</a> , <a href="#">250</a> , <a href="#">251</a> , and <a href="#">252</a>   |
| Hemochromatosis type 5                             | 11q 12–q13           | Autosomal dominant             | H-ferritin gene mutation  | —   |
| Porphyria cutanea tarda                            | 1p34                 | Autosomal dominant or sporadic | Heterogeneous   | <a href="#">171</a> , <a href="#">173</a> , <a href="#">174</a> , <a href="#">175</a> and <a href="#">176</a> , <a href="#">253</a> , <a href="#">254</a> , <a href="#">255</a> , <a href="#">256</a> , <a href="#">257</a> , <a href="#">258</a> , <a href="#">259</a> , <a href="#">260</a> , <a href="#">261</a> , <a href="#">262</a> , <a href="#">263</a> , <a href="#">264</a> , <a href="#">265</a> , <a href="#">266</a> , <a href="#">267</a> , <a href="#">268</a> and <a href="#">269</a> |
| African iron overload                              | Unknown              | Autosomal dominant             | Unknown   | <a href="#">98</a> , <a href="#">270</a> , <a href="#">271</a> , <a href="#">272</a> , <a href="#">273</a> , <a href="#">274</a> and <a href="#">275</a>  |
| Neonatal iron overload                             | Unknown              | Heterogeneous                  | <i>In utero</i> iron transfer                                     | <a href="#">276</a> , <a href="#">277</a> , <a href="#">278</a> , <a href="#">279</a> , <a href="#">280</a> , <a href="#">281</a> and <a href="#">282</a>   |
| Atransferrinemia                                   | 3q21                 | Autosomal recessive            | Transferrin gene mutations and red cell transfusions              | <a href="#">283</a> , <a href="#">284</a>   |
| Aceruloplasminemia                                 | 3q23–q24             | Autosomal recessive            | Ceruloplasmin gene mutations                                      | <a href="#">285</a> , <a href="#">286</a> , <a href="#">287</a> , <a href="#">288</a> , <a href="#">289</a> , <a href="#">290</a> , <a href="#">291</a> and <a href="#">292</a>   |
| Hereditary hyperferritinemia and cataract syndrome | 19q13.1–q13.3        | Autosomal dominant             | L-Ferritin gene mutations   | <a href="#">293</a> , <a href="#">294</a> , <a href="#">295</a> , <a href="#">296</a> , <a href="#">297</a> , <a href="#">298</a> , <a href="#">299</a> , <a href="#">300</a> , <a href="#">301</a> , <a href="#">302</a> and <a href="#">303</a>   |
| Friedreich ataxia                                  | 9p23–p11,9q13        | Autosomal recessive            | Frataxin gene mutations   | <a href="#">304</a> , <a href="#">305</a> , <a href="#">306</a> , <a href="#">307</a> , <a href="#">308</a> , <a href="#">309</a> , <a href="#">310</a> , <a href="#">311</a> and <a href="#">312</a>   |
| Panthonase kinase-associated neurodegeneration     | 20p13–p12.3          | Autosomal recessive            | Panthonase kinase gene mutations                                  | <a href="#">330</a> , <a href="#">331</a> and <a href="#">332</a>   |
| β-Thalassemia major                                | 11p15.5              | Autosomal recessive            | β-Globin gene mutations, chronic hemolysis, red cell transfusions | —   |
| Other chronic hemolytic anemias                    |                      |                                |   |   |
| Hereditary X-linked sideroblastic anemia           | Xp11.21              | X-linked                       | d-Aminolevulinic acid synthase gene mutations                     | <a href="#">313</a> , <a href="#">314</a> and <a href="#">315</a>   |
| Pyruvate kinase deficiency                         | 1q21                 | Autosomal recessive            | Pyruvate kinase gene mutations                                    | <a href="#">316</a> , <a href="#">317</a> and <a href="#">318</a>   |
| G6PD deficiency                                    | Xq28                 | X-linked                       | G6PD gene mutations   | <a href="#">319</a> , <a href="#">320</a>   |
| Congenital dyserythropoietic anemias               | Type I 15q15.1–q15.3 | Autosomal recessive            | Ineffective erythropoiesis  | <a href="#">323</a> , <a href="#">325</a> , <a href="#">329</a>   |

|                                       | Type II 20q11.2           | Autosomal recessive | Ineffective erythropoiesis | <a href="#">321</a> , <a href="#">322</a> , <a href="#">324</a>   |
|---------------------------------------|---------------------------|---------------------|----------------------------|---|
|                                       | Type III 15q21            | Autosomal dominant  | Ineffective erythropoiesis | <a href="#">326</a> , <a href="#">327</a> and <a href="#">328</a> |
| Acquired Disorder                     | Cause of Iron Loading     |                     |                            |   |
| Transfusions                          | Red cell iron infusion    |                     |                            |   |
| Medicinal iron                        | Excessive iron ingestion  |                     |                            |   |
| Myelodysplasia with ring sideroblasts | Excessive iron absorption |                     |                            |   |
| Portocaval shunt                      | Excessive iron absorption |                     |                            |   |

G6PD, glucose-6-phosphate dehydrogenase.

<sup>a</sup> Or juvenile hemochromatosis.

Often, it is simple for the physician to recognize the cause of excess iron stores, such as in patients with chronic hemolytic anemias or in the acquired disorders at the bottom of [Table 30.10](#). In other patients, it may be more difficult to identify the cause of iron loading. An iron-loaded teenager with hypogonadism, decreased luteinizing hormone and follicle-stimulating hormone, cardiac arrhythmia, and congestive heart failure is more likely to have hemochromatosis type 2 (chromosome 1q21) than hemochromatosis type 1 (chromosome 6p21.3). Although the DNA tests for the C282Y and H63D mutations are widely available, commercial tests are not widely available to identify the mutations responsible for hemochromatosis types 2 and 3. [Table 30.10](#) may provide ideas for the physician to consider and pursue for an individual whose iron overload does not have an obvious cause.

## MANAGEMENT

### Phlebotomy Therapy

**INITIAL WEEKLY PHLEBOTOMY SCHEDULE** The main treatment of hemochromatosis is phlebotomy therapy ([234](#), [333](#)). In a phlebotomy of 500 ml of whole blood with a hematocrit of 40%, 200 ml of packed red blood cells are removed. Because each 1 ml of packed red cells contains approximately 1 mg of iron, each 500-ml phlebotomy removes approximately 200 mg of iron. When the diagnosis of iron overload due to hemochromatosis is established, it is important to start the first phase of phlebotomy therapy. Most iron-loaded homozygotes tolerate removal of 500 ml of whole blood each week quite well. Some women, small individuals, or elderly patients may only tolerate removal of 250 ml of whole blood each week. Twice-weekly phlebotomy may be performed for very heavily iron-loaded patients who have cardiac arrhythmias or hepatic failure in an effort to improve cardiac and hepatic function quickly. Phlebotomy therapy should be continued until the hematocrit drops by approximately 1 to 2 g/dl below baseline, the red cell mean corpuscular volume drops by approximately 3 to 5 fl below baseline, and serum ferritin concentration drops to 20 to 50 ng/ml. These findings provide evidence of iron-limited erythropoiesis, which concludes the initial rapid sequence phase of

phlebotomy therapy. The patient then enters the second, life-long maintenance phase of phlebotomy therapy ( [334](#), [335](#) and [336](#) ).

**LIFE-LONG MAINTENANCE PHLEBOTOMY SCHEDULE** After the initial iron depletion is accomplished, the patient enters the life-long maintenance phase of phlebotomy therapy. Removal of 500 ml of whole blood every 2 to 4 months (every 3 to 6 months in women) prevents reaccumulation of excessive organ storage iron. The goals of life-long maintenance phlebotomy therapy include maintenance of a normal hematocrit and maintenance of the serum ferritin concentration at approximately 50 ng/ml. If the ferritin is measured each year, a value greater than 100 ng/ml suggests that the frequency of phlebotomy needs to be increased to every 2 months. A very low serum ferritin and the presence of anemia indicate that the frequency of phlebotomy therapy can be decreased to 4- or 6-month intervals. Most patients and physicians want to know how to estimate how long it may take to cause iron depletion by weekly phlebotomy therapy. In hemochromatosis patients whose serum ferritin is not elevated due to hepatocellular injury and release of ferritin unrelated to body iron stores, a reasonable estimate of total body storage iron can be offered. Based on a study of the correlation of serum ferritin to the number of grams of iron removed by phlebotomy therapy, it was estimated that 1 ng/ml of pretreatment serum ferritin corresponded to nearly 8 mg of mobilizable iron ( [337](#) ). A person whose pretreatment serum ferritin concentration is 600 ng/ml is likely to have approximately 4800 mg of mobilizable storage iron. Because each 500-ml unit of blood with a hematocrit of 40% contains approximately 200 mg of iron, the patient is likely to undergo approximately 24 units of phlebotomy to achieve iron depletion. This simple estimate holds up reasonably well except in patients whose serum ferritin is markedly elevated and out of proportion to storage iron due to hepatic necrosis or another source of inflammation that causes ferritinemia. After the patient becomes iron depleted by rapid-sequence phlebotomy, the number of units of whole blood removed, multiplied by 200 mg iron per phlebotomy, provides a reliable measurement of the number of grams of iron that were removed.

**CLINICAL CHANGES AFTER IRON DEPLETION** If hepatic cirrhosis and arthropathy are not present before iron depletion therapy, these complications of hemochromatosis may be preventable by initial iron depletion followed by life-long maintenance phlebotomy therapy. Phlebotomy therapy for hemochromatosis patients has been discussed in considerable detail in recent publications ( [234](#), [332](#), [338](#) ). Overall, men require approximately twice as many units of phlebotomy to induce iron depletion as women ( [120](#), [339](#) ). Complications of hemochromatosis that respond to and complications that do not improve after phlebotomy therapy appear in [Table 30.11](#). Treatment for specific problems usually should be managed as in patients who do not have hemochromatosis.

**TABLE 30.11. Clinical Changes after Phlebotomy Therapy**

| Observed Complications of Iron Overload              | Expected Treatment Outcome  |
|--|---|
| None   | Prevention of complications of iron overload; normal life expectancy. |
| Weakness, fatigue, lethargy                          | Resolution or marked improvement.                                     |
| Elevated serum concentrations of hepatic enzymes     | Resolution or marked improvement.                                     |
| Hepatomegaly   | Resolution often occurs.  |
| Hepatic cirrhosis                                    | No change.  |
| Increased risk for primary liver cancer <sup>a</sup> | No change.  |
| Right upper quadrant pain <sup>b</sup>               | Resolution or marked improvement.                                     |



|   |  |
|---|--|
| Arthropathy   | Improvement in arthralgias sometimes occurs; change in joint deformity is rare; progression is sometimes seen. |
| Hypogonadotrophic hypogonadism                                  | Resolution is rare.  |
| Diabetes mellitus   | Occasional improvement, often temporary.   |
| Hyperthyroidism, hypothyroidism                                 | Resolution is rare.  |
| Cardiomyopathy  | Resolution sometimes occurs.   |
| Hyperpigmentation   | Resolution usually occurs.   |
| Hyperferritinemia <sup>c</sup>                                  | Resolution.  |
| Hyperferremia   | Little or no change.   |
| Excess absorption and storage of nonferrous metals <sup>d</sup> | Little or no change.   |
| Infection with <i>Vibrio vulnificus</i> or other bacteria       | Little or no change.   |

<sup>a</sup> Increased risk occurs only in persons with hepatic cirrhosis.

<sup>b</sup> Right upper quadrant pain in persons with hemochromatosis is often related to hepatic iron overload. In these cases, therapeutic phlebotomy usually results in marked improvement or resolution. However, right upper quadrant pain may also be caused by primary liver cancer portal vein thrombosis, gallbladder disease, lesions in the hepatic flexure or nephrolithiasis. Iron depletion alone does not alleviate right upper quadrant pain.

<sup>c</sup> Serum iron levels may be normal or subnormal in persons with hemochromatosis due to severe iron deficiency, chronic inflammatory or infectious disease, vitamin C deficiency, or prolonged fasting.

<sup>d</sup> Cobalt, manganese, zinc, and lead.

From Barton JC, McDonnell SM, Adams PC, et al. Management of hemochromatosis. *Ann Intern Med* 1998;129:935, with permission.

---

## Dietary Changes

Subjects with hemochromatosis have increased risk to develop a life-threatening infection with *V. vulnificus* from raw shellfish (see the section [Infections](#)). Because of this risk, it is prudent to advise these individuals not to consume raw shellfish. Much more iron can be removed in each 500-ml whole blood phlebotomy each week than can be absorbed that week. For this reason, it is not necessary to impose severe dietary restrictions in an attempt to avoid all foods that contain iron. It is reasonable to advise the intake of less saturated fat and animal protein and more fresh vegetables and fruit, as for anyone else who desires to follow a prudent cardiovascular diet ( [332](#) ).

## Alcohol Intake

Alcohol can be hepatotoxic. Individuals with hepatic damage from iron overload may benefit from avoiding drinks containing alcohol. It is estimated that 30 g of alcohol per day can worsen iron-related liver damage ( [109](#) , [332](#) , [340](#) ). The same amount of alcohol in a person with cirrhosis may also increase the individual's risk for the development of



hepatocellular carcinoma ( [109](#) ).

## Vitamins

It is reasonable for an individual who has hemochromatosis to avoid medicinal intake of vitamin C because it can increase the absorption of dietary iron ( [332](#) , [341](#) ). Vitamin C also may cause oxidative damage of the myocardium and cardiac conduction system, resulting in rare fatal arrhythmias in iron-loaded patients who have hemochromatosis or thalassemia major ( [340](#) , [342](#) , [343](#) and [344](#) ).

## PROGNOSIS

The outlook for a patient with hemochromatosis is related to whether the patient undergoes iron depletion therapy before the development of cirrhosis or diabetes mellitus. In a study of 111 hemochromatosis patients in England, the average survival of 85 people who underwent phlebotomy therapy was 63 months, compared to 18 months in the 26 subjects who did not become iron depleted ( [106](#) ). In a study of survival among 251 hemochromatosis patients in Germany, those who became iron depleted experienced survival similar to the background population ( [140](#) ). Hemochromatosis patients with diabetes had a 10-year survival of 65% compared to 90% in the nondiabetics. The 10-year survival of hemochromatosis subjects with cirrhosis was 72% compared to 82% in the noncirrhotics. Very heavy iron overload that could not be depleted within 18 months from the onset of phlebotomy therapy was also associated with decreased survival. There are additional valuable reports of survival and prognosis in patients who have hemochromatosis ( [138](#) , [139](#) ).

## IMAGING OF THE LIVER

### Computed Tomographic Scanning of the Liver

Single-energy computed tomographic (CT) scanning is not adequately sensitive to distinguish hepatic iron overload from a fatty liver. CT scanning also has very limited value in the assessment of sources of hepatic inhomogeneity, including edema, regenerative nodules, perfusion abnormalities, iron and fibrosis, or cirrhosis ( [345](#) ).

Dual-energy CT scanning is able to distinguish hepatic iron from fat ( [346](#) ). In a dual-energy CT scan, an iron-loaded liver appears brighter than paraspinal muscles.

### Magnetic Resonance Imaging of the Liver

Magnetic resonance (MR) imaging has largely replaced CT scanning in the evaluation of livers that are presumed to be cirrhotic. Some of the advantages of MR scanning include superior contrast resolution, multiplanar capability, greater sensitivity and specificity in the detection and characterization of abnormalities, and no use of ionizing radiation ( [345](#) ). MR imaging can be used to identify hepatic cirrhosis, regenerating nodules, and hepatocellular carcinoma in subjects who have hemochromatosis.

Iron is a paramagnetic element that becomes magnetized in a magnetic field. The result is that the transverse (T2) relaxation time of iron becomes shortened compared to the longitudinal (T1) relaxation time. In an iron-loaded liver, the shortened T2 relaxation time causes a decrease in signal intensity. The result is that an iron-loaded liver appears

darker than paraspinous muscles on T2-weighted MR images ( [347](#) ).

Gradient-echo MR scanning after gadolinium is considered to provide the most useful information about iron stores, using both T1- and T2-weighted images. An MR magnet strength of 1.5 Tesla provides better predictive ability than the 0.5-Tesla magnet. The intensity of the signal in liver commonly is compared to signal intensity in paraspinous muscles. Iron causes increased attenuation of the gradient-echo signal in hepatocytes ( [345](#) , [348](#) , [349](#) ), which means that iron-loaded liver tissue appears darker than paraspinous muscle. Whereas CT cannot quantitate iron stores that are less than five times normal, gradient-echo MR allows quantification of iron stores that are minimally increased ( [347](#) , [350](#) , [351](#) , [352](#) and [353](#) ).

Gradient-echo sequences allow quantitation of storage iron that correlates quite well with chemical quantitation on a liver biopsy sample. This means that MR scanning can provide credible estimation of the hepatic iron concentration in patients who, for any reason, do not undergo liver biopsy. After iron depletion, there is a decreased amount of attenuation of the gradient-echo signal, so the liver appears lighter than before ( [347](#) , [350](#) , [351](#) , [352](#) and [353](#) ).

## Cost

The total charge for an MR scan of the liver is approximately \$1000. The total charge for a needle biopsy of the liver is approximately \$1800.

## IRON CHELATION

Iron has little solubility in water. The amount of urinary iron excretion in normal and iron-loaded individuals is approximately 50 to 100 µg per 24 hours. Some compounds bind and make a water-soluble complex with iron, which results in urinary iron excretion that is much greater than normal. Two drugs are currently available for iron chelation therapy: deferoxamine and deferiprone. Deferoxamine is a biologic product of *Streptomyces pilosus*. Deferiprone is a synthetic hydroxypyridone. Good reviews about deferoxamine and deferiprone have been published recently ( [354](#) , [355](#) , [356](#) and [357](#) ).

## Deferoxamine

**PHARMACOKINETICS** Deferoxamine is not absorbed from the gastrointestinal tract, so it must be administered parenterally by the subcutaneous, intramuscular, or intravenous route. This chemical enters cells and binds iron with great affinity. The deferoxamine-iron complex is water soluble, and nearly all deferoxamine is excreted by glomerular filtration and renal tubular secretion. Intravenous deferoxamine causes the greatest amount of urinary iron excretion, followed by the intramuscular and the subcutaneous routes. The intravenous route is associated with the greatest risk for infection. The intramuscular route usually requires injection of 2 ml into each buttock twice daily (for a daily dose of 2 g), and these large volumes are painful and not accepted well by patients. Overnight, 12-hour subcutaneous infusions usually are tolerated well and are reasonably effective. Details about pharmacokinetics have been published ( [354](#) , [358](#) ). High-dose deferoxamine may result in the excretion of 20 to 40 mg of iron per day. A patient with 8 g of excess storage iron whose deferoxamine-induced urinary iron excretion is 20 mg of iron per day has to receive deferoxamine therapy for 400 nights to become iron depleted. Deferoxamine therapy may have to be continued indefinitely in a patient who is heavily iron loaded.

**EFFICACY** There are no known reports of the therapeutic use of deferoxamine in a large

group of individuals with hemochromatosis. The urinary iron excretion induced by deferoxamine was studied in five normal adults (three women, two men) and in six adult male hemochromatosis patients ( [358](#) ). The amount of iron excreted in urine during 6 hours was determined before and after the intramuscular administration of a small dose of deferoxamine (10 mg/kg body weight—15.24  $\mu\text{mol/kg}$ ). In normal subjects, the 6-hour urinary iron excretion averaged 6  $\mu\text{g}$  (0.1  $\mu\text{mol}$ ) before and 464  $\mu\text{g}$  (8.3  $\mu\text{mol}$ ) after deferoxamine. In the hemochromatosis patients, the 6-hour urinary iron excretion averaged 71  $\mu\text{g}$  (1.2  $\mu\text{mol}$ ) before and 6764  $\mu\text{g}$  (121.0  $\mu\text{mol}$ ) after deferoxamine administration. In a 2000 study from Ferrara, deferoxamine-induced urinary iron excretion was measured in 27 consecutive iron-loaded subjects ( [359](#) ). Of these 27, 11 patients who were not transfusion-dependent included one person who had both hemochromatosis (a C282Y/C282Y homozygote) and hereditary spherocytosis. These 11 subjects received a 10-minute subcutaneous bolus of 1 g of deferoxamine every 12 hours. Their mean 48-hour urinary iron excretion was 5360  $\mu\text{g}$  (range, 2240 to 13,885  $\mu\text{g}$ ). After an average of 18 months of deferoxamine therapy, the mean value of serum ferritin decreased by 72% (from 1625 to 456 ng/ml) but remained elevated in all three women and in three of the eight men. After 18 months of deferoxamine therapy, only 1 of the 11 individuals had a serum ferritin value that was less than 100 ng/ml. The patient who had both spherocytosis and homozygous hemochromatosis still had a moderately high serum ferritin concentration of 740 ng/ml after 28 months of deferoxamine therapy ( [359](#) ).

**SIDE EFFECTS** Most patients who are treated with deferoxamine experience painless swelling at the infusion site for approximately 15 minutes after subcutaneous infusion; pain and erythema at the site of administration occur in approximately 4% of patients ( [359](#) ). Individuals who have a large body iron burden are unlikely to experience complications from deferoxamine. The reason for this is that in iron-loaded subjects, most of the circulating deferoxamine binds iron, forming ferrioxamine. Ferrioxamine does not undergo oxidative deamination, so toxic metabolites (referred to as *B* and *C*) are not formed ( [355](#) ). The opposite of this occurs in subjects with a small iron burden who receive large doses of deferoxamine. Because not much iron is present, not much ferrioxamine is formed. The non-iron bound deferoxamine then undergoes deamination to the B and C metabolites, which can cause toxicity ( [355](#) ). Deferoxamine has been identified as a cause of retinal and auditory neurotoxicity ( [355](#), [360](#), [361](#), [362](#) and [363](#) ). There are reports of growth failure and metaphyseal bone deformities of the tibia, ulna, and radius in children with  $\beta$ -thalassemia major who were treated with deferoxamine ( [364](#), [365](#) ). In children with  $\beta$ -thalassemia who were treated with large doses of deferoxamine, renal and pulmonary complications were observed ( [366](#), [367](#) ). Recently, some very good discussions of deferoxamine have been published ( [354](#), [355](#), [359](#), [368](#) ).

**COST** The daily cost of 2 g of deferoxamine in Salt Lake City is approximately \$60 or \$22,000 per year. The tubing that connects the subcutaneous needle to the infusion pump costs approximately \$1 per day. An additional cost is an infusion pump that can accept a 10-cc syringe (2 ml final volume per gram of deferoxamine; 4 to 8 ml per night), which costs approximately \$1000.

## Deferiprone

Deferoxamine is expensive, it requires a parenteral route of administration, it must be administered twice daily or for several hours each day, and it can cause side effects. Many oral iron chelators have been evaluated for efficiency and toxicity. The only currently acceptable oral iron chelator for use in iron-loaded subjects is the bidentate iron chelator 1,2-dimethyl-3-hydroxypyrid-4-one, which is called *deferiprone*, *CP20*, or *L1*.

**PHARMACOKINETICS** The mean absorption half-time of deferiprone is approximately 22 minutes, suggesting the stomach or duodenum as the site of absorption ( [369](#) ). Elimination

is principally via kidneys, with approximately 75% recovery in urine as a glucuronide within 24 hours. Approximately 70% of the urinary excretion of deferiprone-iron occurs within 6 hours of ingestion. The 24-hour urinary iron excretion after a total dose of deferiprone, 75 mg/kg/day, is 5 to 30 mg, with a mean of 15 mg (370), or approximately 0.6 mg iron/body weight/day (369). Because of its rapid elimination, deferiprone is administered 2 to 4 times per day.

**DOSAGE** A typical dosage schedule for deferiprone is 50 to 100 mg/kg/day total, divided into two to four doses per day. In two recent studies, a total daily dose of 75 mg/kg was given, divided into three doses of 25 mg/kg each (356, 357).

**EFFICACY** In a study of 84 iron-loaded subjects who were treated with deferiprone, the mean serum concentration of ferritin decreased from an initial mean of 4207 ng/ml to 3139 ng/ml after 12 months (a 1-year decrease of 25%). After 48 months of treatment with deferiprone, the mean serum ferritin dropped to 1779 ng/ml (a 4-year decrease of 58%) (370). These mean values remained markedly elevated compared with upper normal values of approximately 325 ng/ml for men and 125 ng/ml for women. The results of a study that was designed to assess the efficacy and safety of deferiprone were published in 2002 (371). In this study, 532 Italian patients (age 6 to 54 years) with thalassemia major and iron overload were treated with oral deferiprone, 75 mg/kg body weight per day, divided into three daily doses. In the 151 patients who completed 3 years of deferiprone therapy, the mean serum ferritin decreased modestly from an initial value of 2579 to 2230 ng/ml (a 14% decline) (371).

**LONG-TERM EFFECTS** The long-term effects of deferiprone have been studied in 84 patients with transfusional iron overload for 167 patient years (370). Of these 84 patients, 77% had thalassemia major; none was known to be a hemochromatosis homozygote. After oral deferiprone, 70 to 80 mg/kg/day, the average 24-hour urinary iron excretion was approximately 0.5 mg/kg. This amount of urinary iron excretion was greater than the amount associated with deferoxamine (358). After 48 months of oral deferiprone therapy, the average serum ferritin value decreased from approximately 3100 ng/ml to approximately 1800 ng/ml but obviously did not drop into the normal range (370).

**SIDE EFFECTS** In a study of side effects in 151 patients with thalassemia who took oral deferiprone, 75 mg/kg body weight per day for 3 years, agranulocytosis (reversible) occurred in 0.4%, neutropenia in 3.9%, alanine aminotransferase rose in 2.8%, nausea with abdominal pain and vomiting affected 3.2%, and arthralgias occurred in 3.9% of the patients (371). In a study of the 84 iron-loaded patients cited above, the principal side effects were agranulocytosis (3.6%), severe nausea (4.7%), zinc deficiency (14.0%), arthropathy (20.0%), and elevation of aminotransferases in serum (45.0%). Treatment was discontinued in 20% of patients because of side effects or low compliance. The two patients who died did not have a cause of death related to deferiprone—neither patient took the drug in the 2 months before death (370). Hepatic injury and progressive hepatic fibrosis associated with deferiprone therapy have been reported (370, 372). Recently, a large study was performed to evaluate the possibility of progressive hepatic fibrosis in 56 patients with thalassemia major who underwent liver biopsy before and after deferiprone therapy (357). The authors concluded that after an average of 3 years of therapy between liver biopsies, deferiprone did not cause progressive hepatic fibrosis.

**COST AND AVAILABILITY** Deferiprone is not commercially available in the United States, so a cost in the United States has not been established.

### Combination Chelation Therapy: Deferiprone Plus Deferoxamine

Interest is increasing in the use of combination chelation therapy for iron-loaded individuals who are transfusion dependent. In a study from London, five transfusion-dependent patients (age 17 to 58 years) were treated with oral deferiprone (75 to 110 mg/kg body weight per day) plus subcutaneous deferoxamine (various doses

and rates of infusion) on 2 to 6 days per week ( [373](#) ). After 7 to 15 months of combination chelation therapy, the serum ferritin value decreased in all five patients (  $p = .791$ ; not statistically significant).

Collaborators in Israel and Thailand studied different iron pools and clarified a rationale for the use of concurrent deferiprone and deferoxamine in iron-loaded, transfusion-dependent individuals ( [368](#) ). These investigators suggested that deferiprone enters cells, binds iron, and shuttles iron into plasma. Deferoxamine then binds the deferiprone iron in plasma, which makes iron-free deferiprone available to reenter cells to repeat this cycle of iron binding and shuttling. Other investigators made recent contributions to the understanding of the iron-shuttling property of deferiprone and also the interaction of deferiprone and deferoxamine ( [374](#), [375](#) and [376](#) ). The time seems right for the performance of randomized controlled trials to compare the use of deferiprone alone, deferoxamine alone, and combination chelation therapy, including deferiprone and deferoxamine, in transfusion-dependent, iron-loaded individuals ( [377](#) ).

It is important to note that phlebotomy therapy remains the treatment standard for hemochromatosis homozygotes.

## REFERENCES

1. Trousseau A. Glycosurie, diabete sucre. Clinique Med de l'hotel de Paris 1865;2:663.
2. Troisier M. Diabete sucre. Bull Soc Anat Paris 1871;44:231.
3. Hanot V, Schachmann M. Sur la cirrhose pigmentaire dans de diabete sucre. Arch Physiol Norm Pathol 1886;7:50.
4. von Recklinghausen FD. Uber hamochromatose. Tagebl der (62) Versamml Deutsch Natur und Arzte in Heidelberg 1889;62:324.
5. Sheldon JH. Haemochromatosis. London: Oxford University Press, 1935.
6. MacDonald RA. Hemochromatosis and cirrhosis in different geographic areas. Am J Med Sci 1965;249:36-46.
7. Saddi R, Feingold J. Idiopathic haemochromatosis: an autosomal recessive disease. Clin Genet 1974;5:234-241.
8. Simon M, Pawlotsky Y, Bourel M, et al. Hemochromatose idiopathique: maladie associee a l'antigene tissulaire HL-A3? Nouv Presse Med 1975;4:1432.
9. Cartwright GE, Skolnick M, Amos DB, et al. Inheritance of hemochromatosis: linkage to HLA. Trans Assoc Am Physicians 1978;91:273-281.
10. Edwards CQ, Cartwright GE, Skolnick MH, Amos DB. Genetic mapping of the hemochromatosis locus on chromosome six. Hum Immunol 1980;1:19-22.
11. Edwards CQ, Skolnick MH, Kushner JP. Hereditary hemochromatosis: contributions of genetic analyses. Prog Hematol 1981;12:43-71.
12. Lipinski M, Hors J, Saleun J-P, et al. Idiopathic hemochromatosis: linkage with HLA. Tissue Antigens 1978;11:471-474.
13. Simon M, Bourel M, Genetet B, Fauchet R. Idiopathic hemochromatosis: demonstration of recessive transmission and early detection by family HLA typing. N Engl J Med 1977;297:1017-1021.
14. Kravitz K, Skolnick M, Cannings C, et al. Genetic linkage between hereditary hemochromatosis and

HLA. *Am J Hum Genet* 1979;31:601–619.

15. Cartwright GE, Edwards CQ, Kravitz K, et al. Hereditary hemochromatosis. Phenotypic expression of the disease. *N Engl J Med* 1979;301:175–179.
16. Feder JN, Gnirke A, Thomas W, et al. A novel MHC class I-like gene is mutated in patients with hereditary haemochromatosis. *Nat Genet* 1996;13:399–408.
17. Chorney MJ, Sawada I, Gillespie GA, et al. Transcription analysis, physical mapping, and molecular characterization of a nonclassical human leukocyte antigen class I gene. *Mol Cell Biol* 1990;10:243–253.
18. Mercier B, Mura C, Ferec C. Putting a hold on “HLA-H.” *Nat Genet* 1997;15:234.
19. Bodmer JG, Parham P, Albert ED, et al. Putting a hold on “HLA-H.” The WHO nomenclature committee for factors of the HLA system. *Nat Genet* 1997;15:234–235.
20. de Sousa M, Reimao R, Lacerda R, et al. Iron overload in beta 2-microglobulin-deficient mice. *Immunol Lett* 1994;39:105–111.
21. Rothenberg BE, Volland JR. Beta2 knockout mice develop parenchymal iron overload: a putative role for class I genes of the major histocompatibility complex in iron metabolism. *Proc Natl Acad Sci U S A* 1996;93:1529–1534.
22. Santos M, Schilham MW, Rademakers LH, et al. Defective iron homeostasis in beta 2-microglobulin knockout mice recapitulates hereditary hemochromatosis in man. *J Exp Med* 1996;184:1975–1985.
23. Parkkila S, Waheed A, Britton RS, et al. Immunohistochemistry of HLA-H, the protein defective in patients with hereditary hemochromatosis, reveals unique pattern of expression in gastrointestinal tract. *Proc Natl Acad Sci U S A* 1997;94:2534–2539.
24. Feder JN, Penny DM, Irrinki A, et al. The hemochromatosis gene product complexes with the transferrin receptor and lowers its affinity for ligand binding. *Proc Natl Acad Sci U S A* 1998;95:1472–1477.
25. Lebron JA, Bennett MJ, Vaughn DE, et al. Crystal structure of the hemochromatosis protein HFE and characterization of its interaction with transferrin receptor. *Cell* 1998;93:111–123.
26. Bacon BR, Schilsky ML. New knowledge of genetic pathogenesis of hemochromatosis and Wilson’s disease. *Adv Intern Med* 1999;44:91–116.
27. Lebron JA, West AP Jr, Bjorkman PJ. The hemochromatosis protein HFE competes with transferrin for binding to the transferrin receptor. *J Mol Biol* 1999;294:239–245.
28. Philpott CC. Molecular aspects of iron absorption: insights into the role of HFE in hemochromatosis. *Hepatology* 2002;35:993–1001.
29. Townsend A, Drakesmith H. Role of HFE in iron metabolism, hereditary haemochromatosis, anaemia of chronic disease, and secondary iron overload. *Lancet* 2002;359:786–790.
30. Fletcher LM, Halliday JW. Haemochromatosis: understanding the mechanism of disease and implications for diagnosis and patient management following the recent cloning of novel genes involved in iron metabolism. *J Intern Med* 2002;251:181–192.
31. Fleming RE, Sly WS. Mechanisms of iron accumulation in hereditary hemochromatosis. *Annu Rev Physiol* 2002;64:663–680.
32. Waheed A, Grubb JH, Zhou XY, et al. Regulation of transferrin-mediated iron uptake by HFE, the protein defective in hereditary hemochromatosis. *Proc Natl Acad Sci U S A* 2002;99:3117–3122.
33. Parkkila S, Niemela O, Britton RS, et al. Molecular aspects of iron absorption and HFE expression. *Gastroenterology* 2001;121:1489–1496.
34. Crosby WH, Conrad ME, Wheby MS. The rate of iron accumulation in iron storage disease. *Blood*

1963;22:429-440.

35. Adams PC, Kertesz AE, Valbert LS. Rate of iron reaccumulation following iron depletion in hereditary hemochromatosis. Implications for venesection therapy. *J Clin Gastroenterol* 1993;16:207-210.

36. Sargent T, Saito H, Winchell HS. Iron absorption in hemochromatosis before and after phlebotomy therapy. *J Nucl Med* 1971;12:660-667.

37. Eaton JW, Qian M. Molecular bases of cellular iron toxicity(1)(2). *Free Radic Biol Med* 2002;32:833-840.

38. Britton RS. Mechanisms of iron toxicity. In: Barton JC, Edwards CQ, eds. *Hemochromatosis: genetics, pathophysiology, diagnosis and treatment*. Cambridge, UK: Cambridge University Press, 2000;229-238.

39. Gordeuk VR, McLaren GD, Samowitz W. Etiologies, consequences, and treatment of iron overload. *Crit Rev Clin Lab Sci* 1994;31:89-133.

40. Britton RS. Metal-induced hepatotoxicity. *Semin Liver Dis* 1996;16:3-12.

41. Henz S, Reichen J, Liechti-Gallati S. HLA-H gene mutations and haemochromatosis: the likely association of H63D with mild phenotype and the detection of S65C, a novel variant in exon 2. *J Hepatol* 1997;26:57.

42. Barton JC, Sawada-Hirai R, Rothenberg BE, et al. Two novel missense mutations of the HFE gene (I105T and G93R) and identification of the S65C mutation in Alabama hemochromatosis probands. *Blood Cells Mol Dis* 1999;25:147-155.

43. de Villiers JN, Hillermann R, Loubser L, et al. Spectrum of mutations in the HFE gene implicated in haemochromatosis and porphyria. *Hum Mol Genet* 1999;8:1517-1522.

44. Bradbury R, Fagan E, Payne SJ. Two novel polymorphisms (E277K and V212V) in the haemochromatosis gene HFE. *Hum Mutat* 2000;15:120.

45. Oberkanins C, Moritz A, de Villiers JN, et al. A reverse-hybridization assay for the rapid and simultaneous detection of nine HFE gene mutations. *Genet Test* 2000;4:121-124.

46. Piperno A, Arosio C, Fossati L, et al. Two novel nonsense mutations of HFE gene in five unrelated Italian patients with hemochromatosis. *Gastroenterology* 2000;119:441-445.

47. Rosmorduc O, Poupon R, Nion I, et al. Differential HFE allele expression in hemochromatosis heterozygotes. *Gastroenterology* 2000;119:1075-1086.

48. Beutler E, Griffin M, Gelbart T, et al. A previously undescribed nonsense mutation of the HFE gene. *Clin Genet* 2002;61:40-42.

49. Worwood M, Shearman MD, Wallace DR, et al. A simple genetic test identifies 90% of UK patients with haemochromatosis. *Gut* 1997;41:841-844.

50. Bradbury R, Fagan E, Goodson, et al. New mutations in the HFE gene for haemochromatosis. *J Med Genet*, 1999;36[Suppl 1]:S96.

51. Wallace DF, Dooley JS, Walker AP. A novel mutation of HFE explains the classical phenotype of genetic hemochromatosis in a C282Y heterozygote. *Gastroenterology* 1999;116:1409-1412.

52. Steiner M, Ocran K, Genschel J, et al. A homozygous HFE gene splice site mutation (IVS5+1 G/A) in a hereditary hemochromatosis patient of Vietnamese origin. *Gastroenterology* 2002;122:789-795.

53. Beutler E, West C. New diallelic markers in the HLA region of chromosome 6. *Blood Cells Mol Dis* 1997;23:219-229.

54. Pointon JJ, Wallace D, Merryweather-Clarke AT, et al. Uncommon mutations and polymorphisms in the hemochromatosis gene. *Genet Test* 2000;4:151-161.



55. Beutler E, Gelbart T, West C, et al. Mutation analysis in hereditary hemochromatosis. *Blood Cells Mol Dis* 1996;22:187–194.
56. Calandro L, Thorsen T, Barcellos L, et al. Mutation analysis in hereditary haemochromatosis—commentary. *Blood Cells Mol Dis* 1996;22:194A–194B.
57. Sham RL, Ou CY, Cappuccio J, et al. Correlation between genotype and phenotype in hereditary hemochromatosis: analysis of 61 cases. *Blood Cells Mol Dis* 1997;23:314–320.
58. Barton JC, Shih WW, Sawada-Hirai R, et al. Genetic and clinical description of hemochromatosis probands and heterozygotes: evidence that multiple genes linked to the major histocompatibility complex are responsible for hemochromatosis. *Blood Cells Mol Dis* 1997;23:135–145.
59. Bulaj ZJ, Ajioka RS, Phillips JD, et al. Disease-related conditions in relatives of patients with hemochromatosis. *N Engl J Med* 2000;343:1529–1535.
60. Brandhagen DJ, Fairbanks VF, Baldus WP, et al. Prevalence and clinical significance of HFE gene mutations in patients with iron overload. *Am J Gastroenterol* 2000;95:2910–2914.
61. Adams PC, Chakrabarti S. Genotypic/phenotypic correlations in genetic hemochromatosis: evolution of diagnostic criteria. *Gastroenterology* 1998;114:319–323.
62. Jouanolle AM, Fergelot P, Gandon G, et al. A candidate gene for hemochromatosis: frequency of the C282Y and H63D mutations. *Hum Genet* 1997;100:544–547.
63. Mura C, Ragueneas O, Ferec C. HFE mutations analysis in 711 hemochromatosis probands: evidence for S65C implication in mild form of hemochromatosis. *Blood* 1999;93:2502–2505.
64. Aguilar-Martinez P, Ciron C, Blanc F, et al. Compound heterozygotes for hemochromatosis gene mutations: may they help to understand the pathophysiology of the disease? *Blood Cells Mol Dis* 1997;23:269–276.
65. Borot N, Roth M, Malfroy L, et al. Mutations in the MHC class I-like candidate gene for hemochromatosis in French patients. *Immunogenetics* 1997;45:320–324.
66. Mercier G, Burckel A, Bathelier C, et al. Mutation analysis of the HFE gene in French hemochromatosis patients, and genetic counseling in families. *Genet Couns* 1998;9:181–186.
67. Rochette J, Pointon JJ, Fisher CA, et al. Multicentric origin of hemochromatosis gene (HFE) mutations. *Am J Hum Genet* 1999;64:1056–1062.
68. Erhardt A, Niederau C, Osman Y, et al. [Demonstration of HFE polymorphism in German patients with hereditary hemochromatosis.] *Dtsch Med Wochenschr* 1999;124:1448–1452.
69. Gottschalk R, Seidl C, Schilling S, et al. Iron-overload and genotypic expression of HFE mutations H63D/C282Y and transferrin receptor Hin6I and BanI polymorphism in German patients with hereditary haemochromatosis. *Eur J Immunogenet* 2000;27:129–134.
70. Hellerbrand C, Bosserhoff AK, Seegers S, et al. Mutation analysis of the HFE gene in German Hemochromatosis patients and controls using automated SSCP-based capillary electrophoresis and a new PCR-ELISA technique. *Scand J Gastroenterol* 2001;36:1211–1216.
71. Nielsen P, Carpinteiro S, Fischer R, et al. Prevalence of the C282Y and H63D mutations in the HFE gene in patients with hereditary haemochromatosis and in control subjects from Northern Germany. *Br J Haematol* 1998;103:842–845.
72. Willis G, Jennings BA, Goodman E, et al. A high prevalence of HLA-H 845A mutations in hemochromatosis patients and the normal population in eastern England. *Blood Cells Mol Dis* 1997;23:288–291.
73. Murphy S, Curran MD, McDougall N, et al. High incidence of the Cys 282 Tyr mutation in the HFE

gene in the Irish population—implications for haemochromatosis. *Tissue Antigens* 1998;52:484–488.

74. Ryan E, O'Keane C, Crowe J. Hemochromatosis in Ireland and HFE. *Blood* 1998;24:428–432.

75. Miedzybrodzka Z, Loughlin S, Baty D, et al. Haemochromatosis mutations in North–East Scotland. *Br J Haematol* 1999;106:385–387.

76. De Juan D, Reta A, Castiella A, et al. HFE gene mutations analysis in Basque hereditary haemochromatosis patients and controls. *Eur J Hum Genet* 2001;9:961–964.

77. Guix P, Picornell A, Parera M, et al. Prevalence of the C282Y mutation for haemochromatosis on the Island of Majorca. *Clin Genet* 2000;58:123–128.

78. Sanchez M, Bruguera M, Quintero E, et al. Hereditary hemochromatosis in Spain. *Genet Test* 2000;4(2):171–176.

79. Fabrega E, Castro B, Sanchez–Castro L, et al. [The prevalence of the Cys282Tyr mutation in the hemochromatosis gene in Cantabria in patients diagnosed with hereditary hemochromatosis.] *Med Clin (Barc)* 1999;112:451–453.

80. Sanchez M, Bruguera M, Bosch J, et al. Prevalence of the Cys282Tyr and His63Asp HFE gene mutations in Spanish patients with hereditary hemochromatosis and in controls. *J Hepatol* 1998;29:725–728.

81. Moreno L, Vallcorba P, Boixeda D, et al. [The usefulness of the detection of Cys282Tyr and His63Asp mutations in the diagnosis of hereditary hemochromatosis.] *Rev Clin Esp* 1999;199:632–636.

82. Jorquera F, Dominguez A, Diaz–Golpe V, et al. C282Y and H63D mutations of the haemochromatosis gene in patients with iron overload. *Rev Esp Enferm Dig* 2001;93:293–302.

83. Carella M, D'Ambrosio L, Totaro A, et al. Mutation analysis of the HLA–H gene in Italian hemochromatosis patients. *Am J Hum Genet* 1997;61:762–764.

84. Piperno A, Sampietro M, Pietrangelo A, et al. Heterogeneity of Hemochromatosis in Italy. *Gastroenterology* 1998;114:996–1002.

85. Cardoso EM, Stal P, Hagen K, et al. HFE mutations in patients with hereditary haemochromatosis in Sweden. *J Intern Med* 1998;243:203–208.

86. Olsson KS, Ritter B, Sandberg L, et al. The ancestral haplotype in patients with genetic haemochromatosis from central and western Sweden. Saint–Malo, France: International Symposium, Iron in Biology and Medicine, 1997:253.

87. Jazwinska EC, Cullen LM, Busfield F, et al. Haemochromatosis and HLA–H. *Nat Genet* 1996;14:249–251.

88. Rossi E, Henderson S, Chin CY, et al. Genotyping as a diagnostic aid in genetic haemochromatosis. *J Gastroenterol Hepatol* 1999;14:427–430.

89. Papanikolaou G, Politou M, Roetto A, et al. Linkage to chromosome 1q in Greek families with juvenile hemochromatosis. *Blood Cells Mol Dis* 2001;27:744–749.

90. Bittencourt PL, Palacios SA, Couto CA, et al. Analysis of HLA–A antigens and C282Y and H63D mutations of the HFE gene in Brazilian patients with hemochromatosis. *Braz J Med Biol Res* 2002;35:329–335.

91. Datz C, Lalloz MR, Vogel W, et al. Predominance of the HLA–H Cys282Tyr mutation in Austrian patients with genetic haemochromatosis. *J Hepatol* 1997;27:773–779.

92. van Vlierberghe H, Messiaen L, Hautekeete M, et al. Prevalence of the Cys282Tyr and His63Asp mutation in Flemish patients with hereditary hemochromatosis. *Acta Gastroenterol Belg* 2000;63:250–253.

93. Merryweather–Clarke AT, Pointon JJ, Jouanolle AM, et al. Geography of HFE C282Y and H63D

mutations. *Genet Test* 2000;4:183–198.

94. Steinberg KK, Cogswell ME, Chang JC, et al. Prevalence of C282Y and H63D mutations in the hemochromatosis (HFE) gene in the United States. *JAMA* 2001;285:2216–2222.

95. Marshall DS, Linfert DR, Tsongalis GJ. Prevalence of the C282Y and H63D polymorphisms in a multi-ethnic control population. *Int J Mol Med* 1999;4:389–393.

96. Bradley LA, Johnson DD, Palomaki GE, et al. Hereditary haemochromatosis mutation frequencies in the general population. *J Med Screen* 1998;5:34–36.

97. Garry PJ, Montoya GD, Baumgartner RN, et al. Impact of HLA-H mutations on iron stores in healthy elderly men and women. *Blood Cells Mol Dis* 1997;23:277–287.

98. McDonnell SM, Hover A, Gloe D, et al. Population-based screening for hemochromatosis using phenotypic and DNA testing among employees of health maintenance organizations in Springfield, Missouri. *Am J Med* 1999;107:30–37.

99. Monaghan KG, Rybicki BA, Shurafa M, et al. Mutation analysis of the HFE gene associated with hereditary hemochromatosis in African Americans. *Am J Hematol* 1998;58:213–217.

100. Hanson EH, Imperatore G, Burke W. HFE gene and hereditary hemochromatosis: a HuGE review. *Human Genome Epidemiology. Am J Epidemiol* 2001;154:193–206.

101. Edwards CQ, Cartwright GE, Skolnick MH, et al. Homozygosity for hemochromatosis: clinical manifestations. *Ann Intern Med* 1980;93:519–525.

102. Edwards CQ, Dadone MM, Skolnick MH, et al. Hereditary haemochromatosis. *Clin Haematol* 1982;11:411–435.

103. Rull M, Schumacher HR. The arthropathy of hemochromatosis. In: Barton JC, Edwards CQ, eds. *Hemochromatosis: genetics, pathophysiology, diagnosis and treatment*. Cambridge, UK: Cambridge University Press, 2000;258–267.

104. Walsh CH. Non-diabetic endocrinopathy in hemochromatosis. In: Barton JC, Edwards CQ, eds. *Hemochromatosis: genetics, pathophysiology, diagnosis and treatment*. Cambridge, UK: Cambridge University Press, 2000;278–289.

105. Bassett ML, Halliday JW, Powell LW. Value of hepatic iron measurements in early hemochromatosis and determination of the critical iron level associated with fibrosis. *Hepatology* 1986;6:24–29.

106. Bomford A, Williams R. Long term results of venesection therapy in idiopathic haemochromatosis. *QJM* 1976;45:611–623.

107. Niederau C, Fischer R, Sonnenbert A, et al. Survival and causes of death in cirrhotic and in noncirrhotic patients with primary hemochromatosis. *N Engl J Med* 1985;313:1256–1262.

108. Tiniakos G, Williams R. Cirrhotic process, liver cell carcinoma and extrahepatic malignant tumors in idiopathic haemochromatosis. Study of 71 patients treated with venesection therapy. *Appl Pathol* 1988;6:128–138.

109. Deugnier YM, Guyader D, Crantock L, et al. Primary liver cancer in genetic hemochromatosis: a clinical, pathological and pathogenetic study of 54 cases. *Gastroenterology* 1993;104:228–234.

110. Edwards CQ, Skolnick MH, Dadone MM, et al. Iron overload in hereditary spherocytosis: association with HLA-linked hemochromatosis. *Am J Hematol* 1982;13:101–109.

111. Barry M, Scheuer PJ, Sherlock S, et al. Hereditary spherocytosis with secondary haemochromatosis. *Lancet* 1968;2:481–485.

112. Mohler DN, Wheby MS. Hemochromatosis heterozygotes may have significant iron overload when they also have hereditary spherocytosis. *Am J Med Sci* 1986;292:320–324.

113. O'Mahony S, O'Brien PA, Whelton MJ. Genetic haemochromatosis and congenital spherocytosis. *Lancet* 1987;1:282.
114. Blacklock HA, Meerkin M. Serum ferritin in patients with hereditary spherocytosis. *Br J Haematol* 1981;49:117-122.
115. Zimelman AP, Miller A. Primary hemochromatosis with hereditary spherocytosis. *Arch Intern Med* 1980;140:983-984.
116. Takegoshi T, Nishino T, Tanino M, et al. An autopsy case of hemochromatosis and hepatoma combined with hereditary spherocytosis. *Jpn J Med* 1984;23:48-52.
117. Fargion S, Cappellini MD, Piperno A, et al. Association of hereditary spherocytosis and idiopathic hemochromatosis. A synergistic effect in determining iron overload. *Am J Clin Pathol* 1986;86:645-649.
118. Brandenberg JB, Demarmels Biasutti F, Lutz HU, et al. Hereditary spherocytosis and hemochromatosis spherocytosis and hemochromatosis. *Ann Hematol* 2002;81:202-209.
119. Schumacher HR. Hemochromatosis and arthritis. *Arthritis Rheum* 1964;7:41.
120. Edwards CQ, Dadone MM, Skolnick MH, Kushner JP. Hereditary haemochromatosis. *Clin Haematol* 1982;11:411-435.
121. Dymock IW, Hamilton EB, Laws JW, Williams R. Arthropathy of haemochromatosis: clinical and radiological analysis of 63 patients with iron overload. *Ann Rheum Dis* 1970;29:469-476.
122. Schumacher HR, Straka PC, Krikker MA, Dudley AT. The arthropathy of hemochromatosis: recent studies. *Ann N Y Acad Sci* 1988;526:224-233.
123. Jones AC, Chuck AJ, Arie EA, et al. Diseases associated with calcium pyrophosphate deposition disease. *Semin Arthritis Rheum* 1992;22:188-202.
124. Olynyk JK, Hall P, Ahern M, et al. Screening for genetic haemochromatosis in a rheumatology clinic. *Aust N Z J Med* 1994;24:22-25.
125. Eustace S, Buff B, McCarthy C, et al. Magnetic resonance imaging of hemochromatosis arthropathy. *Skeletal Radiol* 1994;23:547-549.
126. Moore EA, Vennart W, Jacoby RK, et al. Magnetic resonance imaging manifestations of idiopathic haemochromatosis in the wrist. *Br J Rheumatol* 1993;32:917-922.
127. Matthews JL, Williams HJ. Arthritis in hereditary hemochromatosis. *Arthritis Rheum* 1987;30:1137-1141.
128. Adams PC, Speechley M. The effect of arthritis on the quality of life in hereditary hemochromatosis. *J Rheumatol* 1996;23:707-710.
129. McDonnell SM, Preston BL, Jewell SA, et al. A survey of 2,851 patients with hemochromatosis: symptoms and response to treatment. *Am J Med* 1999;106:619-624.
130. Lonardo A, Neri P, Mascia MT, et al. Hereditary hemochromatosis masquerading as rheumatoid arthritis. *Ann Ital Med Int* 2001;16:46-49.
131. Sinigaglia L, Fargion S, Fracanzani AL, et al. Bone and joint involvement in genetic hemochromatosis: role of cirrhosis and iron overload. *J Rheumatol* 1997;24:1809-1813.
132. Tanglao EC, Stern MA, Agudelo CA. Case report: arthropathy as the presenting symptom in hereditary hemochromatosis. *Am J Med Sci* 1996;312:306-309.
133. Axford JS, Bomford A, Revell P, et al. Hip arthropathy in genetic hemochromatosis. Radiographic and histologic features. *Arthritis Rheum* 1991;34:357-361.

134. de Jonge-Bok JM, Macfarlane JD. The articular diversity of early haemochromatosis. *J Bone Joint Surg Br* 1987;69:41-44.
135. Montgomery KD, Williams JR, Sculco TP, et al. Clinical and pathologic findings in hemochromatosis hip arthropathy. *Clin Orthop* 1998;347:179-187.
136. Willis G, Scott DG, Jennings BA, et al. HFE mutations in an inflammatory arthritis population. *Rheumatology* 2002;41:176-179.
137. Li J, Zhu Y, Singal DP. HFE gene mutations in patients with rheumatoid arthritis. *J Rheumatol* 2000;27:2074-2077.
138. Fargion S, Mandelli C, Piperno A. Survival and prognostic factors in 212 Italian patients with genetic hemochromatosis. *Hepatology* 1992;15:655-659.
139. Adams PC, Speechley M, Kertesz AE. Long-term survival analysis in hereditary hemochromatosis. *Gastroenterology* 1991;101:368-372.
140. Niederau C, Fischer R, Purschel A, et al. Long-term survival in patients with hereditary hemochromatosis. *Gastroenterology* 1996;110:1107-1119.
141. Singh BM, Grunewald RA, Press M, et al. Prevalence of haemochromatosis amongst patients with diabetes mellitus. *Diabetic Med* 1992;9:730-731.
142. O'Brien T, Barrett B, Murray DM, et al. Usefulness of biochemical screening of diabetic patients for hemochromatosis. *Diabetes Care* 1990;13:532-534.
143. Phelps G, Chapman I, Hall P, et al. Prevalence of genetic haemochromatosis among diabetic patients. *Lancet* 1989;2:233-234.
144. Conte D, Manachino D, Colli A, et al. Prevalence of Genetic Hemochromatosis in a cohort of Italian patients with diabetes mellitus. *Ann Intern Med* 1998;128:370-373.
145. Sampson MJ, Williams T, Heyburn PJ, et al. Prevalence of HFE (hemochromatosis gene) mutations in unselected male patients with type 2 diabetes. *J Lab Clin Med* 2000;135:170-173.
146. Ellervik C, Mandrup-Poulsen T, Nordestgaard BG, et al. Prevalence of hereditary haemochromatosis in late-onset type 1 diabetes mellitus: a retrospective study. *Lancet* 2001;358:1405-1409.
147. Beutler E, Felitti VJ, Koziol JA, et al. Penetrance of 845G>A (C282Y) HFE hereditary haemochromatosis mutation in the USA. *Lancet* 2002;359:211-218.
148. Strohmeyer G, Niederau C. Diabetes mellitus and hemochromatosis. In: Barton JC, Edwards CQ, eds. *Hemochromatosis: genetics, pathophysiology, diagnosis and treatment*. Cambridge, UK: Cambridge University Press, 2000;268-277.
149. McDonald RA, Mallor GK. Hemochromatosis and hemosiderosis. Study of 211 autopsied cases. *Arch Intern Med* 1960;105:686-700.
150. Peillon F, Racadot J. Modifications histopathologiques de l'hypophyse dans six cas d'hémochromatose. *Ann of Endocrinol (Paris)* 1969;30:800-807.
151. Bergeron C, Kovacs K. Pituitary siderosis: a histologic, immunocytologic, and ultrastructural study. *Am J Pathol* 1978;93:295-310.
152. Charbonnel B, Chupin M, Le Grand A, et al. Pituitary function in idiopathic haemochromatosis: hormonal study in 36 male patients. *Acta Endocrinol* 1981;98:178-183.
153. Kelly TM, Edwards CQ, Meikle AW, et al. Hypogonadism in hemochromatosis: reversal with iron depletion. *Ann Intern Med* 1984;101:629-632.
154. Tweed MJ, Roland JN. Haemochromatosis: a forgotten cause of hypogonadotropic hypogonadism. *J*

Endocrinol 1996;148:P355(S).

155. McNeill WL, McKee LC, Lorber D, et al. The endocrine manifestations of hemochromatosis. *Am J Med Sci* 1983;285:7-13.
156. Wilkinson H. Haemochromatosis associated with arthritis and hypopituitarism. *Ann Clin Biochem* 1996;33:171-173.
157. Altman JJ, Zygelman M, Roger M, et al. The GnRH test in idiopathic hemochromatosis. *J Endocrinol Invest* 1980;3:223-227.
158. Duranteau L, Chanso P, Blumbert-Tick J, et al. Non-responsiveness of serum gonadotropins and testosterone to pulsatile GnRH in haemochromatosis suggesting a pituitary defect. *Acta Endocrinol* 1993;128:351-354.
159. Siminoski K, D'Costa M, Walfish PG. Hypogonadotropic hypogonadism in idiopathic haemochromatosis: evidence for combined hypothalamic and pituitary involvement. *J Endocrinol Invest* 1990;13:849-853.
160. Piperno A, Rivolta MR, D'Alba R, et al. Pre-clinical hypogonadism in genetic hemochromatosis in the early stage of the disease: evidence of hypothalamic dysfunction. *J Endocrinol Invest* 1992;15:423-428.
161. Williams TC, Frohman LA. Hypothalamic dysfunction associated with haemochromatosis. *Ann Int Med* 1985;103:550-551.
162. Lufkin EG, Baldus WP, Bergstralh EJ, et al. Influence of phlebotomy treatment on abnormal hypothalamic-pituitary function in genetic haemochromatosis. *Mayo Clin Proc* 1987;62:473-479.
163. Blanc JF, De Ledinghen V, Bernard PH, et al. Increased incidence of HFE C282Y mutations in patients with iron overload and hepatocellular carcinoma developed in non-cirrhotic liver. *J Hepatol* 2000;32:805-811.
164. Bralet MP, Degott C, Belghini J, et al. Prevalence of the haemochromatosis gene mutation in non-cirrhotic liver with hepatocellular carcinoma. *J Hepatol* 1998;28:740-741.
165. Morcos M, Dubois S, Bralet MP, et al. Primary liver carcinoma in genetic hemochromatosis reveals a broad histologic spectrum. *Am J Clin Pathol* 2001;116:738-743.
166. Fargion S, Stazi MA, Fracanzani AL, et al. Mutations in the HFE gene and their interaction with exogenous risk factors in hepatocellular carcinoma. *Blood Cells Mol Dis* 2001;27:505-511.
167. Racchi O, Mangerini R, Rapezzi D, et al. Mutations of the HFE gene and the risk of hepatocellular carcinoma. *Blood Cells Mol Dis* 1999;25:350-353.
168. Pirisi M, Toniutto P, Uzzau A, et al. Carriage of HFE mutations and outcome of surgical resection for hepatocellular carcinoma in cirrhotic patients. *Cancer* 2000;89:297-302.
169. Meneghini R. Iron homeostasis, oxidative stress, and DNA damage. *Free Radic Biol Med* 1997;23:783-792.
170. Deugnier YM, Loreal O. Iron as a carcinogen. In: Barton JC, Edwards CQ, eds. *Hemochromatosis: genetics, pathophysiology, diagnosis and treatment*. Cambridge, UK: Cambridge University Press, 2000;239-249.
171. Deugnier Y, Turlin B, Loreal O. Iron and neoplasia. *J Hepatol* 1998;28[Suppl 1]:21-25.
172. Bonkovsky HL, Lambrecht RW. Hemochromatosis, iron overload, and porphyria cutanea tarda. In: Barton JC, Edwards CQ, eds. *Hemochromatosis: genetics, pathophysiology, diagnosis and treatment*. Cambridge, UK: Cambridge University Press, 2000;453-467.
173. Bonkovsky HL, Poh-Fitzpatrick M, Pimstone N, et al. Porphyria cutanea tarda, hepatitis C, and HFE gene mutations in North America. *Hepatology* 1998;27:1661-1669.

174. Bulaj ZJ, Franklin MR, Phillips JD, et al. Transdermal estrogen replacement therapy in postmenopausal women previously treated for porphyria cutanea tarda. *J Lab Clin Med* 2000;136:482-488.
175. Bulaj ZJ, Phillips JD, Ajioka RS, et al. Hemochromatosis genes and other factors contributing to the pathogenesis of porphyria cutanea tarda. *Blood* 2000;95:1565-1571.
176. Edwards CQ, Griffen LM, Goldgar DE, et al. HLA-linked hemochromatosis alleles in sporadic porphyria cutanea tarda. *Gastroenterology* 1989;97:972-981.
177. Roberts AG, Whatley SD, Morgan RR, et al. Increased frequency of the haemochromatosis Cys282Tyr mutation in sporadic porphyria cutanea tarda. *Lancet* 1997;349:321-323.
178. Egger NG, Goeger DE, Payne DA, et al. Porphyria cutanea tarda: multiplicity of risk factors including HFE mutations, hepatitis C, and inherited uroporphyrinogen decarboxylase deficiency. *Dig Dis Sci* 2002;47:419-426.
179. Lamoril J, Andant C, Gouya L, et al. Hemochromatosis (HFE) and transferrin receptor-1 (TFRC1) genes in sporadic porphyria cutanea tarda (sPCT). *Cell Mol Biol* 2002;48:33-41.
180. Tannapfel A, Stolzel U, Kostler E, et al. C282Y and H63D mutation of the hemochromatosis gene in German porphyria cutanea tarda patients. *Virchows Arch* 2001;439:1-5.
181. Edwards CQ, Skolnick MH, Kushner JP. Coincidental nontransfusional iron overload and thalassemia minor: association with HLA-linked hemochromatosis. *Blood* 1981;58:844-848.
182. Fargion S, Sampietro M, Cappellini MD. Thalassemias and their interactions with hemochromatosis. In: Barton JC, Edwards CQ, eds. *Hemochromatosis: genetics, pathophysiology, diagnosis and treatment*. Cambridge, UK: Cambridge University Press, 2000;435-441.
183. Piperno A, Mariani R, Arosio C, et al. Haemochromatosis in patients with  $\beta$ -thalassaemia trait. *Br J Haematol* 2000;111:908-914.
184. Melis MA, Cau M, Diedda F, et al. H63D mutation in the HFE gene increases iron overload in  $\beta$ -thalassaemia carriers. *Haematologica* 2002;87:242-245.
185. Longo F, Zecchina G, Sbaiz L, et al. The influence of hemochromatosis mutations on iron overload of thalassemia major. *Haematologica* 1999;84:799-803.
186. Bonkovsky HL, Jawaid Q, Tortorelli K, et al. Non-alcoholic steatohepatitis and iron: increased prevalence of mutations of the HFE gene in non-alcoholic steatohepatitis. *J Hepatol* 1999;31:421-429.
187. Bacon BR, Farahvash MJ, Janney CG, et al. Nonalcoholic steatohepatitis: an expanded clinical entity. *Gastroenterology* 1994;107:1103-1109.
188. George KD, Goldwurm S, MacDonald GA, et al. Increased hepatic iron concentration in nonalcoholic steatohepatitis is associated with increased fibrosis. *Gastroenterology* 1998;114:311-318.
189. Mendler MH, Turlin B, Moirand R, et al. Insulin resistance-associated hepatic iron overload. *Gastroenterology* 1999;117:1155-1163.
190. Fargion S, Mattioli M, Fracanzani AL, et al. Hyperferritinemia, iron overload, and multiple metabolic alterations identify patients at risk for nonalcoholic steatohepatitis. *Am J Gastroenterol* 2001;96:2448-2455.
191. Cazzola M, Skoda RC. Translational pathophysiology: a novel molecular mechanism of human disease. *Blood* 2000;95:3280-3288.
192. Bottomley SS. Iron overload in sideroblastic and other non-thalassemic anemias. In: Barton JC, Edwards CQ, eds. *Hemochromatosis: genetics, pathophysiology, diagnosis and treatment*. Cambridge, UK: Cambridge University Press, 2000;442-452.
193. Beris P, Samii K, Darbellay R, et al. Iron overload in patients with sideroblastic anaemia is not related to the presence of the haemochromatosis Cys282Tyr and His63Asp mutations. *Br J Haematol*



1999;104:97–99.

194. Yaouanq J, Grobois B, Jouanolle AM, et al. Haemochromatosis Cys282Tyr mutation in pyridoxine-responsive sideroblastic anaemia. *Lancet* 1997;349:1475–1476.

195. Cotter PD, May A, Liping L, et al. Four new mutations in the erythroid-specific 5-aminolevulinate synthase (ALAS2) gene causing X-linked sideroblastic anemia: increased pyridoxine responsiveness after removal of iron overload by phlebotomy and coinheritance of hereditary hemochromatosis. *Blood* 1999;93:1757–1789.

196. Blake PA, Merson MH, Weaver RE, et al. Disease caused by a marine *Vibrio*; clinical characteristics and epidemiology. *N Engl J Med* 1979;300:1–5.

197. McManus R. Highly invasive new bacterium isolated from US East Coast waters. *JAMA* 1984;251:323–325.

198. Abbott M, Galloway A, Cunningham JL. Case report: haemochromatosis presenting with a double *Yersinia* infection. *J Infect* 1986;13:143–145.

199. Muench KH. Hemochromatosis and infection: alcohol and iron, oysters and sepsis. *Am J Med* 1989;87:40N–43N.

200. Bullen JJ, Spalding PB, Ward CG, et al. Hemochromatosis, iron, and septicemia caused by *Vibrio vulnificus*. *Arch Intern Med*, 1991;151:1606–1609.

201. Robins-Brown RM, Rabson AR, Koornhof HJ. Generalized infection with *Yersinia enterocolitica* and the role of iron. *Contrib Microbiol Immunol* 1979;5:277–282.

202. Olesen LL, Ejlersen T, Paulsen SM, et al. Liver abscesses due to *Yersinia enterocolitica* in patients with haemochromatosis. *J Intern Med* 1989;225:351–354.

203. Conway SP, Dudley N, Sheridan P, et al. Haemochromatosis and aldosterone deficiency presenting with *Yersinia pseudotuberculosis* septicaemia. *Postgrad Med J* 1989;65:174–176.

204. Munoz-Martinez T, Garcia-Perez J, Collazos Gonzalez J, et al. Bacteriemia por *Yersinia enterocolitica* y hemochromatosis. *Rev Clin Esp* 1991;189–192.

205. Vadillo M, Corbella X, Pac V, et al. Multiple liver abscesses due to *Yersinia enterocolitica* discloses primary hemochromatosis: three case reports and review. *Clin Infect Dis* 1994;18:938–941.

206. Kumamoto KS, Vukich DJ. Clinical infections of *Vibrio vulnificus*: a case report and review of the literature. *J Emerg Med* 1998;16:61–66.

207. Johnson RW, Arnett FC. A fatal case of *Vibrio vulnificus* presenting as septic arthritis. *Arch Intern Med* 2001;161:2616–2618.

208. Manso C, Rivas I, Peraire J, et al. Fatal *Listeria meningitis*, endocarditis and pericarditis in a patient with haemochromatosis. *Scand J Infect Dis* 1997;29:308–309.

209. MacSween RNM. Acute abdominal crises, circulatory collapse and sudden death in haemochromatosis. *QJM* 1966;35:589.

210. McNab AA, McKelvie P. Iron overload is a risk factor for zygomycosis. *Arch Ophthalmol* 1997;115:919–921.

211. Gerhard GS, Levin KA, Goldstein JP, et al. *Vibrio vulnificus* septicemia in a patient with the hemochromatosis HFE C282Y mutation. *Arch Pathol Lab Med* 2001;125:1107–1109.

212. Bullen JJ. Bacterial infections in hemochromatosis. In: Barton JC, Edwards CQ, eds. *Hemochromatosis: genetics, pathophysiology, diagnosis and treatment*. Cambridge, UK: Cambridge University Press, 2000;381–386.

213. Bergmann TK, Vinding K, Hey H. Multiple hepatic abscesses due to *Yersinia enterocolitica* infection

- secondary to primary haemochromatosis. *Scand J Gastroenterol* 2001;36:891–895.
214. Hopfner M, Nitsche R, Rohr A, et al. *Yersinia enterocolitica* infection with multiple liver abscesses uncovering a primary hemochromatosis. *Scand J Gastroenterol* 2001;36:220–224.
215. Abdelli N, Thieffin G, Chevalier P, et al. Abcès hépatique à *Yersinia enterocolitica* spontanément régressifs révélant une hémochromatose génétique: deuxième cas. *Gastroenterol Clin Biol* 1996;20:212–213.
216. Collazos J, Guerra E, Fernandez A, et al. Biliary liver abscesses and skin infection due to *Yersinia enterocolitica* in a patient with unsuspected hemochromatosis. *Clin Infect Dis* 1995;21:223–224.
217. Cutler DJ, Isner JM, Bracey AW, et al. Hemochromatosis heart disease: an unemphasized cause of potentially reversible restrictive cardiomyopathy. *Am J Med* 1980;69:923–928.
218. Didelot JM, Epeirier JM, Martinez PA, et al. First clinical manifestations of hereditary hemochromatosis: about 498 patients. *St. Malo Symposium*, 1997.
219. Adams PC, Valberg LS. Evolving expression of hereditary hemochromatosis. *Semin Liver Dis* 1996;16:47–54.
220. Milder MS, Cook JD, Stray S, Finch CA. Idiopathic hemochromatosis, an interim report. *Medicine* 1980;59:39–49.
221. Cecchetti G, Binda A, Piperno A, et al. Cardiac alterations in 36 consecutive patients with idiopathic haemochromatosis: polygraphic and echocardiographic evaluation. *Eur Heart J* 1991;12:224–230.
222. Olson LJ, Baldus WD, Tajik AJ. Echocardiographic features of idiopathic hemochromatosis. *Am J Cardiol* 1987;60:885–889.
223. Dabestani A, Child JS, Perloff JK, et al. Cardiac abnormalities in primary hemochromatosis. *Ann N Y Acad Sci* 1988;526:234–244.
224. Buja LM, Roberts WC. Iron in the heart: etiology and clinical significance. *Am J Med* 1971;51:209–221.
225. Olson LJ, Edwards WD, Holmes DR. Endomyocardial biopsy in hemochromatosis: clinicopathologic correlates in six cases. *J Am Coll Cardiol* 1989;13:116–120.
226. Muhlestein JB. Cardiac abnormalities in hemochromatosis. In: Barton JC, Edwards CQ, eds. *Hemochromatosis: genetics, pathophysiology, diagnosis and treatment*. Cambridge, UK: Cambridge University Press, 2000:297–311.
227. Sullivan JL. Hemochromatosis and coronary artery disease. *JAMA* 1995;273:25–26.
228. Herbert V. Iron worsens high-cholesterol-related coronary artery disease. *Am J Clin Nutr* 1994;60:299–300.
229. Bozzini C, Girelli D, Tinazzi E, et al. Biochemical and genetic markers of iron status and the risk of coronary artery disease: an angiography-based study. *Clin Chem* 2002;48:601–603.
230. Calado RT, Franco RF, Pazin-Filho A, et al. HFE gene mutations in coronary atherothrombotic disease. *Braz J Med Biol Res* 2000;33:301–306.
231. Battiloro E, Ombres D, Pascale E, et al. Haemochromatosis gene mutations and risk of coronary artery disease. *Eur J Hum Genet* 2000;8:389–392.
232. Nassar BA, Zayed EM, Title LM, et al. Relation of HFE gene mutations, high iron stores and early onset coronary artery disease. *Can J Cardiol* 1998;14:215–220.
233. Miller M, Hutchins GM. Hemochromatosis, multiorgan hemosiderosis, and coronary artery disease. *JAMA* 1994;272:231–233.
234. Witte DL, Crosby WH, Edwards CQ, et al. Practice parameter for hereditary hemochromatosis. *Clin*

Chim Acta 1996;245:139–200.

235. Powell LW, George DK, McDonnell SM, et al. Diagnosis of hemochromatosis. *Ann Intern Med* 1998;129:925–931.
236. Adams PC, Kertesz AE, McLaren CE, et al. Population screening for hemochromatosis: a comparison of unbound iron-binding capacity, transferrin saturation, and C282Y genotyping in 5,211 voluntary blood donors. *Hepatology* 2000;31:1160–1164.
237. Witte DL. Screening tests for hemochromatosis. In: Barton JC, Edwards CQ, eds. *Hemochromatosis: genetics, pathophysiology, diagnosis and treatment*. Cambridge, UK: Cambridge University Press, 2000;519–524.
238. Roetto A, Totaro A, Cazzola M, et al. Juvenile hemochromatosis locus maps to chromosome 1q. *Am J Hum Genet*. 1999;64:1388–1393.
239. Camaschella C, Roetto A, Cicilano M, et al. Juvenile and adult hemochromatosis are distinct genetic disorders. *Eur J Hum Genet* 1997;5:371–375.
240. Rivard SR, Mura C, Simard H, et al. Clinical and molecular aspects of juvenile hemochromatosis in Saquenay–Lac–Saint–Jean (Quebec, Canada). *Blood Cells Mol Dis* 2000;26:10–14.
241. Roetto A, Alberti F, Daraio F, et al. Exclusion of ZIRT1 as candidate gene of juvenile hemochromatosis and refinement of the critical interval on 1q21. *Blood Cells Mol Dis* 2000;26:205–210.
242. Camaschella C, Fargion S, Sampietro M, et al. Inherited HFE-unrelated hemochromatosis in Italian families. *Hepatology* 1999;29:1563–1564.
- 242a. Krause A, Neitz S, Magert H–J, et al. LEAP–1, a novel highly disulfide-bonded human peptide, exhibits antimicrobial activity. *FEBS Lett* 2000;480:147–150.
- 242b. Park CH, Valore EV, Waring AJ, Ganz T. Hepcidin, a urinary antimicrobial peptide synthesized in the liver. *J Biol Chem* 2001;276:7806–7810.
- 242c. Pigeon C, Ilyin G, Courselaud B, et al. A new mouse liver-specific gene, encoding a protein homologous to human antimicrobial peptide hepcidin, is overexpressed during iron overload. *J Biol Chem* 2001;276:7811–7819.
- 242d. Roetto A, Papanikolaou G, Politou M, et al. Mutant antimicrobial peptide hepcidin is associated with severe juvenile hemochromatosis. *Nat Genet* 2003;33:21–22.
243. Camaschella C, Roetto A, Cali A, et al. The gene TFR2 is mutated in a new type of haemochromatosis mapping to 7q22. *Nat Genet* 2000;25:14–15.
244. Roetto A, Totaro A, Piperno A, et al. New mutations inactivating transferrin receptor 2 in hemochromatosis type 3. *Blood* 2001;97:2555–2560.
245. Girelli D, Bozzini C, Roetto A, et al. Clinical and pathologic findings in hemochromatosis type 3 due to a novel mutation in transferrin receptor 2 gene. *Gastroenterology* 2002;122:1295–1302.
246. Kato J, Fujikawa K, Kanda M, et al. A mutation, in the iron-responsive element of H ferritin mRNA, causing autosomal dominant iron overload. *Am J Hum Genet* 2001;69:191–197.
247. Montosi G, Donovan A, Totaro A, et al. Autosomal-dominant hemochromatosis is associated with a mutation in the ferroportin (SLC11A3) gene. *J Clin Invest* 2001;108:619–623.
248. Papadopoulos P, Bhavsar D, Zappone E, et al. A second human ferritin H locus on chromosome 11. *Cytogenet Cell Genet* 1992;61:107–108.
249. Richard CW, Withers DA, Meeker TC, et al. A radiation hybrid map of the proximal long arm of human chromosome 11 containing the MEN–1 and bcl–1 disease locus. *Cytogenet Cell Genet* 1991;58:1970.
250. Gatti RA, Shaked R, Mohandas TK, et al. Human ferritin genes: chromosomal assignments and

polymorphisms. *Am J Hum Genet* 1987;41:654–667.

251. Cragg SJ, Drysdale J, Worwood M. Genes for the “H” subunit of human ferritin are present on a number of human chromosomes. *Hum Genet* 1985;71:108–112.

252. Worwood M, Brook JD, Cragg SJ, et al. Assignment of human ferritin genes to chromosomes 11 and 19q13.3–19qter. *Hum Genet* 1985;69:371–374.

253. Skowron F, Berard F, Grezard P, et al. [Role of the hemochromatosis gene in porphyria cutanea tarda. Prospective study of 56 cases.] *Ann Dermatol Venereol* 2001;128:600–604.

254. Dereure O, Aguilar–Martinez P, Bessis D, et al. HFE mutations and transferrin receptor polymorphism analysis in porphyria cutanea tarda: a prospective study of 36 cases from southern France. *Br J Dermatol* 2001;144:533–539.

255. Trombini P, Mauri V, Salvioni A, et al. S65c frequency in Italian patients with hemochromatosis, porphyria cutanea tarda and chronic viral hepatitis with iron overload. *Haematologica* 2001;86:316–317.

256. Bonkovsky HL, Lambrecht RW. Iron–induced liver injury. *Clin Liver Dis* 2000;4:409–429.

257. Malina L, Zd’arsky E, Dandova S, et al. Significance and prevalence of the C282Y gene mutation of primary hemochromatosis in the pathogenesis of porphyria cutanea tarda. *Cas Lek Cesk* 2000;139:728–730.

258. Martinelli AL, Zago MA, Roselino AM, et al. Porphyria cutanea tarda in Brazilian patients: association with hemochromatosis C282Y mutation and hepatitis C virus infection. *Am J Gastroenterol* 2000;95:3516–3521.

259. Brady JJ, Jackson HA, Roberts AG, et al. Co–inheritance of mutations in the uroporphyrinogen decarboxylase and hemochromatosis genes accelerates the onset of porphyria cutanea tarda. *J Invest Dermatol* 2000;115:868–874.

260. Bonkovsky HL, Obando JV. Role of HFE gene mutations in liver diseases other than hereditary hemochromatosis. *Curr Gastroenterol Rep* 1999;1:30–37.

261. Christiansen L, Bygum A, Thomsen K, et al. Denaturing gradient gel electrophoresis analysis of the hemochromatosis (HFE) gene: impact of HFE gene mutations on the manifestation of porphyria cutanea tarda. *Clin Chem* 1999;45:2025–2026.

262. Sampietro M, Fiorelli G, Fargion S. Iron overload in porphyria cutanea tarda. *Haematologica* 1999;84:248–253.

263. Mendez M, Sorkin L, Rossetti MV. Familial porphyria cutanea tarda: characterization of seven novel uroporphyrinogen decarboxylase mutations and frequency of common hemochromatosis alleles. *Am J Hum Genet* 1998;63:1363–1375.

264. Elder GH. Porphyria cutanea tarda. *Semin Liver Dis* 1998;18:67–75.

265. Stuart KA, Busfield F, Jazwinska EC, et al. The C282Y mutation in the haemochromatosis gene (HFE) and hepatitis C virus infection are independent cofactors for porphyria cutanea tarda in Australian patients. *J Hepatol* 1998;28:404–409.

266. Elder GH, Worwood M. Mutations in the hemochromatosis gene, porphyria cutanea tarda, and iron overload. *Hepatology* 1998;27:289–291.

267. Sampietro M, Piperno A, Lupica L, et al. High prevalence of the His63Asp HFE mutation in Italian patients with porphyria cutanea tarda. *Hepatology* 1998;27:181–184.

268. O’Reilly FM, Darby C, Fogarty J, et al. Screening of patients with iron overload to identify hemochromatosis and porphyria cutanea tarda. *Arch Dermatol* 1997;133:1098–1101.

269. Roberts AG, Whatley SD, Nicklin S, et al. The frequency of hemochromatosis–associated alleles is increased in British patients with sporadic porphyria cutanea tarda. *Hepatology* 1997;25:159–161.

270. Gangaidzo IT, Moyo VM, Saungwerne T, et al. Iron overload in urban Africans in the 1990s. *Gut* 1999;45:278–283.
271. Moyo VM, Mandishona E, Hasstedt SJ, et al. Evidence of genetic transmission in African iron overload. *Blood* 1998;91:1076–1082.
272. Wurapa RK, Gordeuk VR, Brittenham GM, et al. Primary iron overload in African Americans. *Am J Med* 1996;101:9–18.
273. Baer D. Hereditary iron overload and African Americans. *Am J Med* 1996;101:5–8.
274. Barton JC, Edwards CQ, Bertoli LF. Iron overload in African Americans. *Am J Med* 1995;99:616–623.
275. Gordeuk V, Mukiibi J, Hasstedt SJ, et al. Iron overload in Africa: interaction between a gene and dietary iron content. *N Engl J Med* 1992;326:95–100.
276. Elleder M, Chlumská A, Hadravská S, et al. Neonatal (perinatal) hemochromatosis. *Cesk Patol* 2001;37:146–153.
277. Murray KF, Kowdley KV. Neonatal hemochromatosis. *Pediatrics* 2001;108:960–964.
278. Vohra P, Haller C, Emre S, et al. Neonatal hemochromatosis: the importance of early recognition of liver failure. *J Pediatr* 2000;136:537–541.
279. Liet JM, Urtin-Hostein C, Joubert M, et al. [Neonatal hemochromatosis.] *Arch Pediatr* 2000;7:40–44.
280. Oddone M, Bellini C, Bonacci W, et al. Diagnosis of neonatal hemochromatosis with MR imaging and duplex Doppler sonography. *Eur Radiol* 1999;9:1882–1885.
281. Rodriguez VA, Garcia GR, Tejada VS, et al. [Neonatal hemochromatosis. Report of 3 autopsy cases.] *Rev Invest Clin* 1999;51:81–87.
282. Sigurdsson L, Reyes J, Kocoshis SA, et al. Neonatal hemochromatosis: outcomes of pharmacologic and surgical therapies. *J Pediatr Gastroenterol Nutr* 1998;26:85–89.
283. Beutler E, Gelbart T, Lee P, et al. Molecular characterization of a case of atransferrinemia. *Blood* 2000;96:4071–4074.
284. Hromec A, Payer J Jr, Killinger Z, et al. Congenital atransferrinemia. *Dtsch Med Wochenschr* 1994;119:663–666.
285. Yoshida K, Kaneko K, Miyajima H, et al. Increased lipid peroxidation in the brains of aceruloplasminemia patients. *J Neurol Sci* 2000;175:91–95.
286. Harris ZL, Durley AP, Man TK, et al. Targeted gene disruption reveals an essential role for ceruloplasmin in cellular iron efflux. *Proc Natl Acad Sci U S A* 1999;96:10812–10817.
287. Yazaki M, Yoshida K, Nakamura A, et al. A novel splicing mutation in the ceruloplasmin gene responsible for hereditary ceruloplasmin deficiency with hemosiderosis. *J Neurol Sci* 1998;156:30–34.
288. Harris ZL, Klomp LW, Gitlin JD. Aceruloplasminemia: an inherited neurodegenerative disease with impairment of iron homeostasis. *Am J Clin Nutr* 1998;67:972S–977S.
289. Klomp LW, Gitlin JD. Expression of the ceruloplasmin gene in the human retina and brain: implications for a pathogenic model in aceruloplasminemia. *Hum Mol Genet* 1996;5:1989–1996.
290. Okamoto N, Wada S, Oga T, et al. Hereditary ceruloplasmin deficiency with hemosiderosis. *Hum Genet* 1996;97:755–758.
291. Takahashi Y, Miyajima H, Shirabe S, et al. Characterization of a nonsense mutation in the

- ceruloplasmin gene resulting in diabetes and neurodegenerative disease. *Hum Molec Genet* 1996;5:81–84.
292. Yoshida K, Furihata K, Takeda S, et al. A mutation in the ceruloplasmin gene is associated with systemic hemosiderosis in humans. *Nature Genet* 1995;9:267–272.
293. Brooks DG, Manova–Todorova K, Farmer J, et al. Ferritin crystal cataracts in hereditary hyperferritinemia cataract syndrome. *Invest Ophthalmol Vis Sci* 2002;43:1121–1126.
294. Perez de Nanclares G, Castano L, Martul P, et al. Molecular analysis of hereditary hyperferritinemia–cataract syndrome in a large Basque family. *J Pediatr Endocrinol Metab* 2001;14:295–300.
295. Cremonesi L, Fumagalli A, Soriani N, et al. Double–gradient denaturing gradient gel electrophoresis assay for identification of L–ferritin iron–responsive element mutations responsible for hereditary hyperferritinemia–cataract syndrome: identification of the new mutation C14G. *Clin Chem* 2001;47:491–497.
296. Cazzola M, Skoda RC. Translational pathophysiology: a novel molecular mechanism of human disease. *Blood* 2000;95:3280–3288.
297. Allerson CR, Cazzola M, Rouault TA. Clinical severity and thermodynamic effects of iron–responsive element mutations in hereditary hyperferritinemia–cataract syndrome. *J Biol Chem* 1999;274:26439–26447.
298. Balas A, Aviles MJ, Garcia–Sanchez F, et al. Description of a new mutation in the L–ferritin iron–responsive element associated with hereditary hyperferritinemia–cataract syndrome in a Spanish family. *Blood* 1999;93:4020–4021.
299. Barton JC, Beutler E, Gelbart T. Coinheritance of alleles associated with hemochromatosis and hereditary hyperferritinemia–cataract syndrome. *Blood* 1998;92:4480.
300. Martin ME, Fargion S, Brissot P, et al. A point mutation in the bulge of the iron–responsive element of the L ferritin gene in two families with the hereditary hyperferritinemia–cataract syndrome. *Blood* 1998;91:319–323.
301. Piperno A. Classification and diagnosis of iron overload. *Haematologica* 1998;83:447–455.
302. Gasparini P, Calvano S, Memeo E, et al. Assignment of ferritin L gene (FTL) to human chromosome band 19q13.3 by in situ hybridization. *Ann Genet* 1997;40:227–228.
303. Girelli D, Corrocher R, Bisceglia L, et al. Hereditary hyperferritinemia–cataract syndrome caused by a 29–base pair deletion in the iron responsive element of ferritin L–subunit gene. *Blood* 1997;90:2084–2088.
304. Pianese L, Tammara A, Turano M, et al. Identification of a novel transcript of X25, the human gene involved in Friedreich ataxia. *Neurosci Lett* 2002;320:137–140.
305. Miranda CJ, Santos MM, Ohshima K, et al. Frataxin knockin mouse. *FEBS Lett* 2002;512:291–297.
306. Kaplan J. Spinocerebellar ataxias due to mitochondrial defects. *Neurochem Int* 2002;40:553–557.
307. McCabe DJ, Wood NW, Ryan F, et al. Intrafamilial phenotypic variability in Friedreich ataxia associated with a G130V mutation in the FRDA gene. *Arch Neurol* 2002;59:296–300.
308. Juvonen V, Kulmala SM, Ignatius J, et al. Dissecting the epidemiology of a trinucleotide repeat disease—example of FRDA in Finland. *Hum Genet* 2002;110:36–40.
309. Berciano J, Mateo I, De Pablas C, et al. Friedreich ataxia with minimal GAA expansion presenting as adult–onset spastic ataxia. *J Neurol Sci* 2002;194:75–82.
310. Albano LM, Zatz M, Kim CA, et al. Friedreich’s ataxia: clinical and molecular study of 25 Brazilian cases. *Rev Hosp Clin Fac Med Sao Paulo* 2001;56:143–148.
311. McDaniel DO, Keats B, Vedanarayanan VV, et al. Sequence variation in GAA repeat expansions may cause differential phenotype display in Friedreich’s ataxia. *Mov Disord* 2001;16:1153–1158.

312. Pandolfo M. Molecular basis of Friedreich ataxia. *Mov Disord* 2001;16:815–821.
313. Cotter PD, May A, Fitzsimons EJ, et al. Late-onset X-linked sideroblastic anemia: missense mutations in the erythroid delta-aminolevulinate synthase (ALAS2) gene in two pyridoxine-responsive patients initially diagnosed with acquired refractory anemia and ringed sideroblasts. *J Clin Invest* 1995;96:2090–2096.
314. Cox TC, Bottomley SS, Wiley JS, et al. X-linked pyridoxine-responsive sideroblastic anemia due to a thr388-to-ser substitution in erythroid 5-aminolevulinate synthase. *N Engl J Med* 1994;330:675–679.
315. Cotter PD, Willard HF, Gorski JL, et al. Assignment of human erythroid delta-aminolevulinate synthase (ALAS2) to a distal subregion of band Xp11.21 by PCR analysis of somatic cell hybrids containing X-autosome translocations. *Genomics* 1992;13:211–212.
316. Manco L, Abade A. Pyruvate kinase deficiency: prevalence of the 1456C>T mutation in the Portuguese population. *Clin Genet* 2001;60:472–473.
317. Zanella A, Bianchi P, Iurlo A, et al. Iron status and HFE genotype in erythrocyte pyruvate kinase deficiency: study of Italian cases. *Blood Cells Mol Dis* 2001;27:653–661.
318. Wang C, Chiarelli LR, Bianchi P, et al. Human erythrocyte pyruvate kinase: characterization of the recombinant enzyme and a mutant form (R510Q) causing nonspherocytic hemolytic anemia. *Blood* 2001;98:3113–3120.
319. Vulliamy T, Beutler E, Luzzatto L. Variants of glucose-6-phosphate dehydrogenase are due to missense mutations spread throughout the coding region of the gene. *Hum Mutat* 1993;2:159–167.
320. Pai GS, Sprenkle JA, Do TT, et al. Localization of loci for hypoxanthine phosphoribosyltransferase and glucose-6-phosphate dehydrogenase and biochemical evidence of nonrandom X chromosome expression from studies of a human X-autosome translocation. *Proc Natl Acad Sci U S A* 1980;77:2810–2813.
321. Iolascon A, Delaunay J, Wickramasinghe SN, et al. Natural history of congenital dyserythropoietic anemia type II. *Blood* 2001;98:1258–1260.
322. Perrotta S, del Giudice EM, Carbone R, et al. Gilbert's syndrome accounts for the phenotypic variability of congenital dyserythropoietic anemia type II (CDA-II). *J Pediatr* 2000;136:556–559.
323. Tamary H, Shalmon L, Shalev H, et al. Localization of the gene for congenital dyserythropoietic anemia type I to a less than 1-cM interval on chromosome 15q15.1–15.3. *Am J Hum Genet* 1998;62:1062–1069.
324. Gasparini P, del Giudice EM, Delaunay J, et al. Localization of the congenital dyserythropoietic anemia II locus to chromosome 20q11.2 by genomewide search. *Am J Hum Genet* 1997;61:1112–1116.
325. Tamary H, Shalmon L, Shalev H, et al. Localization of the gene for congenital dyserythropoietic anemia type I to chromosome 15q15.1–15.3. *Blood* 1996;88:144a.
326. Lind L, Sandstrom H, Wahlin A, et al. Localization of the gene for congenital dyserythropoietic anemia type III, CDAN3, to chromosome 15q21–q25. *Hum Mol Genet* 1995;4:109–112.
327. Lind L, Sikstrom C, Sandstrom H, Wahlin A, et al. The locus for congenital dyserythropoietic anemia type III (CDA III), associated with monoclonal gammopathy and myeloma, is localized on chromosome 15q21. *Am J Hum Genet* 1993;53:A1035.
328. Wickramasinghe SN, Wahlin A, Anstee D, et al. Observations on two members of the Swedish family with congenital dyserythropoietic anaemia, type III. *Eur J Haematol* 1993;50:213–221.
329. Facon T, Mannessier L, Lepelley P, et al. Congenital dyserythropoietic [sic] anemia type I: report on monozygotic twins with associated hemochromatosis and short stature. *Blut* 1990;61:248–250.
330. Zhou B, Westaway SK, Levinson B, et al. A novel pantothenate kinase gene (PANK2) is defective in



Hallervorden-Spatz syndrome. *Nat Genet* 2001;28:345-349.

331. Taylor TD, Kramer P, Litt M, et al. Homozygosity mapping of Hallervorden-Spatz disease to chromosome 20p12.3-p13. *Am J Hum Genet* 1996;59:A18.

332. Taylor TD, Litt M, Kramer P, et al. Homozygosity mapping of Hallervorden-Spatz syndrome to chromosome 20p12.3-p13. *Nat Genet* 1996;14:479-481.

333. Barton JC, McDonnell SM, Adams PC, et al. Management of hemochromatosis. *Ann Intern Med* 1998;129:932-939.

334. Barton JC, Bertoli LF, Rothenberg BE. Screening for hemochromatosis in routine medical care: an evaluation of mean corpuscular volume and mean corpuscular hemoglobin. *Genet Test* 2000;4:103-110.

335. Barton JC, Bottomley SS. Iron deficiency due to excessive therapeutic phlebotomy in hemochromatosis. *Am J Hematol* 2000;65:223-226.

336. Bolan CD, Conry-Cantilena C, Mason G, et al. MCV as a guide to phlebotomy therapy for hemochromatosis. *Transfusion* 2001;41:819-827.

337. Bassett ML, Halliday JW, Ferris RA, et al. Diagnosis of hemochromatosis in young subjects: predictive accuracy of biochemical screening tests. *Gastroenterology* 1984;87:628-633.

338. Barton JC, McDonnell SM, et al. Hemochromatosis: management of hemochromatosis. In: Barton JC, Edwards CQ, eds. *Hemochromatosis: genetics, pathophysiology, diagnosis and treatment*. Cambridge, UK: Cambridge University Press, 2000:329-338.

339. Moirand R, Adams PC, Bicheler V, et al. Clinical features of genetic hemochromatosis in women compared with men. *Ann Intern Med* 1997;127:105-110.

340. LeSage GD, Baldus WP, Fairbanks VF, et al. Hemochromatosis: genetic or alcohol-induced? *Gastroenterology* 1983;84:1471-1477.

341. Nienhuis AW. Vitamin C and iron. *N Engl J Med* 1981;304:170-171.

342. McLaran CJ, Bett JH, Nye JA, et al. Congestive cardiomyopathy and hemochromatosis—rapid progression possibly accelerated by excessive ingestion of ascorbic acid. *Aust N Z J Med* 1982;12:187-188.

343. O'Brien RT. Ascorbic acid enhancement of desferrioxamine-induced urinary iron excretion in thalassemia major. *Ann N Y Acad Sci* 1974;232:221-225.

344. Henry W. Echocardiographic evaluation of the heart in thalassemia major. *Ann Intern Med* 1979;91:892.

345. Vitellas KM, Tzalonikou MT, Bennett WF, et al. Cirrhosis: spectrum of findings on unenhanced and dynamic gadolinium-enhanced MR imaging. *Abdom Imaging* 2001;26:601-615.

346. Duvauferrier R, Bellanger P, Campillo M, et al. Dual energy CT in hereditary hemochromatosis. *Diagn Interv Radiol* 1990;2:39-47.

347. Guyader D, Gandon Y. Computed tomography and magnetic resonance imaging in the diagnosis of hemochromatosis. In: Barton JC, Edwards CQ, eds. *Hemochromatosis: genetics, pathophysiology, diagnosis and treatment*. Cambridge, UK: Cambridge University Press, 2000:219-225.

348. Siegelman ES, Mitchell DG, Rubin R, et al. Parenchymal versus reticuloendothelial iron overload in the liver: distinction with MR imaging. *Radiology* 1991;179:361-366.

349. Pomerantz S, Siegelman ES. MR Imaging of iron depositional disease. *Magn Reson Imaging Clin N Am* 2002;10:105-120.

350. Guyader D, Gandon Y. Quantification of iron overload. *Bull Acad Natl Med* 2000;184:337-347.

351. Ernst O, Sergent G, Bonvarlet P, et al. Hepatic iron overload: diagnosis and quantification with MR

imaging. *Am J Roentgenol* 1997;168:1205–1208.

352. Kreeftenberg HG Jr, Mooyaart EL, Huizenga JR, et al. Quantification of liver iron concentration with magnetic resonance imaging by combining T1-,T2-weighted spin echo sequences and a gradient echo sequence. *Neth J Med* 2000;56:133–137.

353. Larrubia JR, Mendoza JL, Perez JA, et al. Diagnostico de la hemocromatosis por resonancia megnetica. *An Med Interna* 2000;17:419–421.

354. Hershko C, Link G, Konijn A. Chelation therapy in iron overload. In: Barton JC, Edwards CQ, eds. *Hemochromatosis: genetics, pathophysiology, diagnosis and treatment*. Cambridge, UK: Cambridge University Press, 2000:339–354.

355. Porter JB. Deferoxamine pharmacokinetics. *Semin Hematol* 2001;38[Suppl 1]:63–68.

356. Cohen AR, Galanello R, Piga A, et al. Safety profile of the oral iron chelator deferiprone: a multicentre study. *Br J Haematol* 2000;108:305–312.

357. Wanless I, Sweeney G, Dhillon A, et al. Lack of progressive hepatic fibrosis during long-term therapy with deferiprone in subjects with transfusion-dependent beta-thalassemia. *Blood* 2002;100:1566–1569.

358. Allain P, Mauras Y, Chaleil D, et al. Pharmacokinetics and renal elimination of desferrioximine and ferrioxamine in healthy subjects and patients with haemochromatosis. *Br J Clin Pharmacol* 1987;24:207–212.

359. Franchini M, Gandini G, deGironcoli M, et al. Safety and efficacy of subcutaneous bolus injection of deferoxamine in adult patients with iron overload. *Blood* 2000;95:2776–2779.

360. Szwarcberg J, Mack G, Flament J. Ocular toxicity of deferoxamine: description and analysis of three observations. *J Fr Ophtalmol* 2002;25:609–614.

361. Arden GB, Wonke B, Kennedy C, et al. Ocular changes in patients undergoing long-term desferrioxamine treatment. *Br J Ophthalmol* 1984;68:873–877.

362. Olivieri NF, Buncic RJ, Chew E, et al. Visual and auditory neurotoxicity in patients receiving sub-cutaneous deferoxamine. *N Engl J Med* 1986;314:869–873.

363. Porter JB, Jaswon MB, Huehns ER, et al. Desferrioxamine ototoxicity: evaluation of risk factors in thalassaemic patients and guidelines for safe dosage. *Br J Haematol* 1989;73:403–409.

364. Olivieri NF, Koren G, Harris J, et al. Growth failure and bony changes induced by deferoxamine. *Am J Pediatr Hematol Oncol* 1992;14:48–56.

365. Piga A, Luzzatto L, Capalbo P, et al. High-dose desferrioxamine as a cause of growth failure in thalassaemic patients. *Eur J Haematol* 1988;40:380–381.

366. Koren G, Bentur Y, Strong D, et al. Acute changes in renal function associated with deferoxamine therapy. *Am J Dis Child* 1989;143:1077–1080.

367. Freedman MH, Grisaru D, Olivieri N, et al. Pulmonary syndrome in patients with thalassemia major receiving intravenous deferoxamine infusions. *Am J Dis Child* 1990;144:565–569.

368. Breuer W, Ermers MJJ, Pootrakul P, et al. Desferrioxamine-chelatable iron, a component of serum non-transferrin-bound iron, used for assessing chelation therapy. *Blood* 2001;97:792–798.

369. al-Refaie FN, Sheppard LN, Nortey P, et al. Pharmacokinetics of the oral iron chelator deferiprone (L1) in patients with iron overload. *Br J Haematol* 1995; 89:403–408.

370. al Refaie FN, Hershko C, Hoffbrand AV, et al. Results of long-term deferiprone (L1) therapy: a report by the International Study Group on Oral Iron Chelators. *Br J Haematol* 1995; 91:224–229.

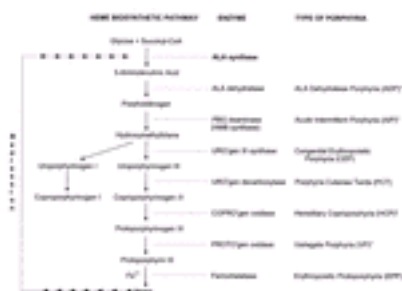
371. Ceci A, Baiardi P, Felisi M, et al. The safety and effectiveness of deferiprone in a large-scale, 3-year study in Italian patients. *Br J Haematol* 2002;118:330–336.

372. Olivieri NF, Brittenham GM, McLaren CE, et al. Long-term safety and effectiveness of iron-chelation therapy with deferiprone for thalassemia major. *N Engl J Med* 1998;339:417-423.
373. Wonke B, Wright C, Hoffbrand AV. Combined therapy with deferiprone and desferrioxamine. *Br J Haematol* 1998;103:361-364.
374. Link G, Konijn AM, Breuer W, et al. Exploring the "iron shuttle" hypothesis in chelation therapy: effects of combined deferoxamine and deferiprone in hypertransfused rats with labeled iron stores and in iron-loaded rat heart cells in culture. *J Lab Clin Med* 2001;138:130-138.
375. Giardina PJ, Grady RW. Chelation therapy in beta-thalassemia: an optimistic update. *Semin Hematol* 2001;38:360-366.
376. Hershko C, Link G, Konijn AM, et al. The iron-loaded gerbil model revisited: effects of desferrioxamine and deferiprone treatment. *J Lab Clin Med* 2002;139:50-58
377. Richardson DR. Deferiprone: greater efficacy at depleting myocardial than hepatic iron? *Lancet* 2002;360:501-502.

2004 Lippincott Williams & Wilkins  
John P. Greer, John Foerster, John N. Lukens  
George M. Rodgers, Frixos Paraskevas, Bertil Glader  
Wintrobe's Clinical Hematology

**PORPHYRIAS WITH CUTANEOUS PHOTOSENSITIVITY**[Congenital Erythropoietic Porphyria](#)[Porphyria Cutanea Tarda](#)[Erythropoietic Protoporphyrria](#)**ACUTE OR INDUCIBLE PORPHYRIAS WITH NEUROLOGIC MANIFESTATIONS**[Acute Intermittent Porphyria](#)[5-Aminolevulinic Acid Dehydratase Deficiency Porphyria](#)**ACUTE OR INDUCIBLE PORPHYRIAS WITH BOTH NEUROLOGIC AND CUTANEOUS MANIFESTATIONS**[Variegate Porphyria](#)[Hereditary Coproporphyrria](#)**DUAL PORPHYRIAS****REFERENCES**

The *porphyrias* are diverse disorders that result from various inherited enzyme defects in the heme biosynthetic pathway ( [Fig. 31.1](#)). The first authentic cases of porphyria were described in 1874 ( [1](#), [2](#)). Since that time, seven different kinds of porphyria have been distinguished ( [Fig. 31.1](#), [Table 31.1](#)), representing discrete, partial deficiencies of each of the seven enzymes beyond the first and rate-limiting (or 5-aminolevulinic acid synthase) step of the pathway ( [Table 31.2](#)). The genes encoding these enzymes have been cloned, their chromosomal location is defined, and DNA analyses have revealed many heterogeneous molecular defects in all the porphyrias. The biosynthetic blocks resulting from the defective enzymes are largely expressed in the liver or bone marrow, the sites where the majority of heme is produced, but the clinical and pathologic phenotype of each porphyria is dictated by the associated enzyme defect and the mode of inheritance ( [Table 31.2](#)) and is often influenced by certain metabolic and environmental factors. In some “late-onset porphyrias,” acquired clonal hematopoietic disorders appear to contribute to the expression of an inherited but previously clinically silent enzyme defect.



**Figure 31.1.** The heme biosynthetic pathway, its enzymes, and the seven forms of human porphyria associated with deficiencies of these enzymes. The major compound excreted in excess in each of the human porphyrias is the substrate of the specific defective enzyme. In the acute or inducible porphyrias (\*), increased hepatic 5-aminolevulinic acid (ALA) production results from release of the normal negative feedback on ALA synthase exerted by heme ( [620](#)), indicated by the trail of arrows. CoA, coenzyme A; HMB, hydroxymethylbilane; PBG, porphobilinogen.

**TABLE 31.1. Classification of the Porphyrrias**

|   |
|---|
| Porphyrrias with only cutaneous photosensitivity<br>Congenital erythropoietic porphyria<br>Porphyria cutanea tarda<br>Erythropoietic protoporphyria<br>Acute or inducible porphyrias<br>Porphyrrias with only neurologic manifestations<br>Acute intermittent porphyria<br>5-aminolevulinic acid dehydratase porphyria<br>Porphyrrias with both neurologic manifestations and cutaneous photosensitivity<br>Variegate porphyria<br>Hereditary coproporphyria<br>Dual porphyrias |
|---|

**TABLE 31.2. Genetic and Metabolic Features of the Porphyrrias**

| Type of Porphyria           | Autosomal Inheritance | Defective Enzyme               | Gene (Symbol/Location <sup>a</sup> ) | Enzyme Activity (%) <sup>b</sup> |                         |
|-----------------------------|-----------------------|--------------------------------|--------------------------------------|----------------------------------|-------------------------|
|                             |                       |                                |                                      | Heterozygote                     | Homozygote <sup>c</sup> |
| ALA dehydratase             | Recessive             | ALA dehydratase                | ALAD/9q                              | 50                               | 1                       |
| Acute intermittent          | Dominant              | PBG deaminase                  | HMBS/11q23.3                         | 50                               | 16                      |
| Congenital erythropoietic   | Recessive             | Uroporphyrinogen III synthase  | UROS/10q                             | 50                               | 1–20                    |
| Cutanea tarda               | Dominant              | Uroporphyrinogen decarboxylase | UROD/1p34                            | 50                               | 3–27                    |
| Hereditary coproporphyria   | Dominant              | Coproporphyrinogen oxidase     | CPO/9                                | 50                               | 2–10                    |
| Variegate                   | Dominant              | Protoporphyrinogen oxidase     | PPOX/1q22                            | 50                               | 0–20                    |
| Protoporphyria <sup>d</sup> | “Recessive”           | Ferrochelatase                 | FECH/18q                             | 20–30                            | <10                     |

ALA, 5-aminolevulinic acid; PBG, porphobilinogen.

<sup>a</sup> Gene symbol and chromosomal location as listed in the Human Gene Mutation Database, located at <http://www.hgmd.org>

<sup>b</sup> Percentage of normal.

<sup>c</sup> Often a compound heterozygote.

<sup>d</sup> The major metabolite and route are shown in bold face. The route of porphyrin excretion is determined by the number of carboxyl groups on the porphyrin and hence by its water solubility.

<sup>e</sup> Usually one allele is mutant and the other, normal allele is underexpressed (see text).

Although the pathophysiologic mechanisms of the clinical manifestations of the porphyrias are only partly understood, two cardinal features prevail: cutaneous photosensitivity and neurologic symptoms of intermittent autonomic neuropathy, motor nerve palsies, and central nervous system disturbances. The cutaneous photosensitivity is a manifestation of the unique fluorescent properties of the porphyrins that accumulate in those porphyrias in which the enzyme defects lie beyond the porphobilinogen (PBG) deaminase (PBG-D) step in the heme pathway ( [Fig. 31.1](#)). The neurologic manifestations are associated with increased production and excretion of the porphyrin precursors 5-aminolevulinic acid (ALA) and PBG, which characterize the acute or inducible porphyrias. Among these, however, photosensitivity also occurs when the enzyme defect leads to accumulation of porphyrins. The distinguishing clinical manifestations of the porphyrias form the basis for the classification in [Table 31.1](#). The diagnosis of a specific porphyria is ascertained by its characteristic profile of accumulated and excreted metabolic intermediates of the heme synthetic pathway ( [Table 31.2](#)).

## PORPHYRIAS WITH CUTANEOUS PHOTSENSITIVITY

### Congenital Erythropoietic Porphyria

*Congenital erythropoietic porphyria* (CEP) (Gunther porphyria), the second least common of the porphyrias, is characterized by a marked accumulation in erythroid precursors of uroporphyrin and coproporphyrin, which are predominantly of the isomer I type because defects reside in the gene for the enzyme uroporphyrinogen III synthase (UROIII-S) ( [Fig. 31.1](#)). Many marrow erythroblasts and immature circulating erythrocytes exhibit intense red fluorescence in ultraviolet light. The large amounts of porphyrins released from these cells cause the most intense photosensitivity of all the porphyrias.

Probably first recognized by Schultz ( [1](#)) and Baumstark ( [2](#)) in 1874, CEP was described comprehensively and distinguished from other porphyrias by Gunther in 1911 ( [3](#)). It is a very rare disease, with approximately 150 cases reported ( [4](#)). It occurs with equal frequency in males and females and in a wide variety of racial groups. Usually, the illness is first detected in infancy ( [5](#)) but, in a number of instances, was not apparent until later in life ( [6](#)). Most evidence is consistent with transmission of the disorder as an autosomal-recessive trait ( [4](#), [5](#)).

**MOLECULAR BASIS AND PATHOGENESIS** The pattern of porphyrin accumulation in CEP reflects a defect in the conversion of PBG to uroporphyrinogen III. This conversion requires two enzymes: PBG-D and UROIII-S ( [Fig. 31.1](#)). Affected people are homozygotes or compound heterozygotes for mutations in the *UROIII-S* gene that result in decreased activity of UROIII-S, leading to the overproduction of uroporphyrinogen I in erythroid precursors ( [4](#), [5](#), [7](#), [8](#)). The activity of UROIII-S is severely impaired (1 to 20% of normal) in erythrocytes ( [9](#)) and fibroblasts ( [10](#), [11](#)). In heterozygotes (parents and some siblings of patients with the disease), the activity of the synthase is intermediate (approximately 50%) between that found in affected individuals and that in normal subjects ( [12](#), [13](#)). Variation among patients in the amount of residual UROIII-S activity measured in cultured fibroblasts suggested heterogeneity of the genetic defect ( [10](#)). This suggestion has been substantiated by the many varied mutations identified in the *UROIII-S* gene, which resides on chromosome 10 (10q25.3-q26.3) ( [14](#)) and has alternative promoters that generate housekeeping and erythroid-specific transcripts ( [4](#)). Molecular defects include

point mutations, deletions, insertions, splicing defects, intron branch chain mutations, and erythroid-specific promoter mutations ( [4](#), [5](#) ). Among some 60 unrelated cases analyzed to date, close to 40 different mutant alleles have been reported ( [4](#), [5](#) ). Approximately one-third are homoallelic (for 11 different mutations), and approximately 20% of alleles remain undefined. The most common mutation (Cys73Arg) has occurred in one-third of alleles (and in one-half of homoallelic cases) and correlates with the most severe phenotype of nonimmune hydrops fetalis, transfusion-dependent anemia from birth, or both, particularly in homoallelic cases ( [5](#), [7](#), [8](#) ). In most instances, mild forms of the disease have been heteroallelic or only one mutant allele could be identified. Residual enzyme activity of the mutant proteins expressed in prokaryotic systems, or gene promoter-reporter activities in cases of promoter mutations, have provided more precise genotype/phenotype correlations ( [4](#), [5](#) ). Although defective UROIII-S operating in the erythron characterizes the primary inherited abnormality, no overall deficiency of heme production is evident, perhaps because normal UROIII-S activity appears to be the highest relative to all other heme biosynthetic enzymes in erythroid cells. It is more than 1000 times greater than ALA synthase ( [15](#) ), the rate-limiting enzyme, so that even very low residual enzyme activity seems to be sufficient to meet the cellular requirements for heme. Uroporphyrin I is the predominant urinary porphyrin, but increased excretion of uroporphyrin III also invariably occurs, implying up-regulation of the UROIII-S or of enzymes higher up in the pathway. These findings are consistent with the idea that the pathophysiology of CEP is a result of the accumulation of uroporphyrin I rather than of subnormal production of uroporphyrinogen III and heme ( [16](#) ). However, it is unclear why uroporphyrin I, not coproporphyrin I, is the main porphyrin excreted. Because uroporphyrinogen decarboxylase (URO-D) can use uroporphyrinogen I as a substrate ( [Chapter 7](#) ), one would expect coproporphyrin I to be the major porphyrin excreted when excessive amounts of uroporphyrinogen I are produced, although the relative URO-D activity in normal erythroid cells is on the order of one-tenth of that of UROIII-S ( [15](#) ). URO-D activity has been measured in two patients with typical CEP and was found to be normal ( [17](#) ). Laboratory parameters of hemolysis correlate with severity of anemia. Associated splenic sequestration leads to splenomegaly and variable leukopenia and thrombocytopenia. Whether photolysis of the porphyrin-laden erythrocytes occurs *in vivo* is not known. It has been suggested that, in some cases, two defects may be involved for the full clinical expression of the CEP ( [6](#), [18](#) ), one an inherited defect in UROIII-S and the other an inherited or an acquired dyserythropoietic disorder. Most patients with CEP appearing in adult life had no prior history of hematologic disease ( [6](#) ). Anemia with clinical and biochemical evidence of the disorder appeared at the same time, and a somatic mutation(s) in an acquired dyserythropoietic cell line may account for deficient UROIII-S activity. An equally plausible explanation is that an acquired erythropoietic disorder developed and contributed to an inherited but clinically silent enzymatic defect. Molecular studies of such cases have not been reported. Not all cases with a clinical phenotype of CEP seem to be associated with defects in UROIII-S. In a Norwegian boy with typical clinical findings, the pattern of porphyrins produced in the marrow and excreted in the urine strongly suggested that URO-D, not UROIII-S, was the defective enzyme ( [19](#), [20](#) ). A similar case was reported in the United States ( [18](#) ). Enzyme assays and pedigree studies demonstrated that the American patient was heterozygous for a dominantly transmitted defect in URO-D and probably was also homozygous for the trait responsible for dyserythropoietic anemia type I. Such observations suggest that apparent CEP in some cases may be a syndrome rather than a disease entity related only to a specific inherited defect. The anemia commonly resembles congenital dyserythropoietic anemia type I, and the inherited enzymatic defect in heme biosynthesis may not be the only cause of the anemia. The large amounts of porphyrins released from erythroid cells and deposited in multiple tissues ( [21](#) ) exert the principal damage in the skin and subcutaneous regions through oxygen-dependent phototoxic reactions on excitation by light (see section [Porphyrin Cutanea Tarda](#)) ( [22](#), [23](#) ). This relentless process leads in varying degrees to the



formation of subepidermal bullae, secondary infection, scarring, epidermal atrophy, and resorption of acral structures.

**CLINICAL DESCRIPTION** The first sign of the disease is often discoloration of the infant's diapers by the urine, which ranges in color from pink to deep burgundy. The most prominent manifestation is pronounced cutaneous photosensitivity. Exposure to sunlight is followed by the development of vesicular or bullous lesions containing a porphyrin-rich, fluorescent fluid. The lesions tend to heal slowly, leaving pigmented scars. Often, they become infected, ulcerated, and necrotic. Over a period of years, patients develop progressive mutilation and disfigurement with loss of portions of the fingers, nose, eyelids, or ears ( [Fig. 31.2](#)). Corneal scarring can lead to blindness ( [5](#)). Skin not exposed to light is unaffected. Hypertrichosis is prominent and fine hair growth may cover much of the face and extremities. The patients often adopt extreme precautions to avoid the sun. Deposition of porphyrin in the dentin of the teeth causes them to appear red (erythrodontia), brown, or yellowish. Even if discoloration is not apparent in ordinary light, the teeth exhibit red fluorescence in ultraviolet light. At necropsy, the entire skeleton has this red fluorescence ( [21](#)). Osteopenia and osteolytic lesions can occur ( [24](#)).



**Figure 31.2.** Congenital erythropoietic porphyria. **A:** In an Indian boy. Note facial hirsutism, scarring, and discoloration of the teeth. **B:** In a 50-year-old white man. Note the severe photomutilation. (Courtesy of Dr. Neville Pimstone, University of California, Davis, CA.)

Anemia, the result of both hemolysis and ineffective erythropoiesis, is detected in most patients, and usually the spleen is enlarged.

**LABORATORY FINDINGS** The anemia is normocytic, normochromic, and of variable severity. Detailed morphologic descriptions of the blood and bone marrow have been reported in a few patients. Anisocytosis, poikilocytosis, polychromasia, basophilic stippling, and nucleated erythrocytes are fairly common features of the peripheral blood ( [25](#)). Morphologic abnormalities of the bone marrow range from erythroid hyperplasia to striking dyserythropoiesis ( [18](#), [25](#), [26](#)). Nuclear inclusions containing hemoglobin may be present ( [18](#), [26](#), [27](#)). Results of studies of the marrow with light and fluorescence microscopy suggest the coexistence of normal and abnormal erythropoietic cells ( [18](#), [26](#), [27](#)). Fluorescence is restricted to the morphologically abnormal cells and is most marked in cell nuclei ( [18](#), [26](#), [27](#), [28](#) and [29](#)). Evidence of a dual nature of the erythroid precursors has been supported by ultrastructural studies in two cases ( [18](#), [30](#)). Kinetic features of the anemia have been studied in several patients, and both a shortened red cell survival and ineffective erythropoiesis were observed ( [31](#)). The ineffective erythropoiesis is manifested by a pronounced increase in early-labeled bile pigments ( [Chapter 9](#)) ( [32](#)). Kinetic studies also support the morphologic findings by demonstrating the production of both normal and abnormal erythrocytes in the same subject ( [33](#), [34](#)). The morphologic and kinetic features of the anemia of CEP closely resemble those of congenital dyserythropoietic anemia type I ( [Chapter 46](#)). The most characteristic metabolic abnormality is greatly increased urinary excretion of uroporphyrin I, a biologically useless isomer that cannot be converted to heme. Urinary excretion of uroporphyrin III and coproporphyrins I and III is also increased but to a lesser extent than uroporphyrin I ( [5](#), [16](#)). High-pressure liquid chromatography analysis reveals a slight increase in urinary porphyrins with seven, six, and five carboxyl groups ( [35](#)). Total urinary porphyrin excretion

may exceed 100,000 µg daily (normal is <300 µg), and the urine usually fluoresces on exposure to ultraviolet light. Fecal excretion of porphyrins, especially coproporphyrin I, is greatly increased ( [16](#), [36](#) ). The concentration of uroporphyrin I is increased in erythrocytes and plasma, but the marrow porphyrin content exceeds that of the peripheral blood or other tissues ( [16](#) ).

**TREATMENT** Splenectomy may partially or completely relieve the hemolytic anemia and may also lead to reduced porphyrinuria and photosensitivity ( [25](#), [26](#), [37](#), [38](#) ). However, this operation is not always beneficial ( [29](#), [39](#) ) and is not always warranted by the degree of anemia. Suppression of erythropoiesis by transfusion decreases porphyrin excretion ( [5](#), [40](#) ). A young boy with CEP was successfully treated with chronic hypertransfusion ( [41](#) ); transfusion-induced iron overload was avoided by means of concomitant chelation therapy with a regimen similar to that developed for the treatment of thalassemia major ( [Chapter 42](#) ). After puberty, his relapse on this regimen was controlled with the addition of hydroxyurea ( [42](#) ). Another patient was treated successfully with long-term orally administered charcoal at a dose of 60 g three times daily ( [43](#) ). Oral charcoal appeared to act by binding porphyrins excreted in bile and serving as a sump that diverted circulating and skin porphyrins to a fecal route of elimination in two cases ( [44](#), [45](#) ) but had no effect in others ( [5](#) ). Brief courses of treatment with hematin brought about reductions in urinary and fecal porphyrins but no clinical improvement ( [46](#), [47](#) ). Longer courses of such therapy, perhaps by infusion pump, may deserve consideration in selected patients. In two patients, severe anemia improved with administration of the antioxidants α-tocopherol and ascorbic acid ( [24](#) ). Stem cell transplantation was successful in seven of nine patients ( [4](#), [5](#) ). In theory, the most definitive method to control the disease would be transfer of the normal gene into hematopoietic stem cells of the affected patient. To date, *in vitro* correction of the enzyme defect was achieved by retroviral transfer of the normal gene into deficient fibroblasts ( [48](#), [49](#) ) and lymphoblasts ( [49](#), [50](#) ) as well as into deficient hematopoietic progenitor cells ( [51](#) ). Techniques for efficient gene transfer into sufficient cells for infusion to permit long-term repopulation of the bone marrow continue to be under development. Prenatal diagnosis or exclusion of the disorder is possible with enzyme assay or DNA analysis of amniotic fluid cells ( [52](#), [53](#) ). Most patients must rely on avoidance of exposure to sunlight. They should be instructed to wear photoprotective clothing, including gloves and broad-brimmed hats. Conventional sunscreen agents are ineffective because they do not screen out the wavelengths in the Soret band of the nearly visible spectrum (around 400 nm) that are responsible for inducing porphyrin-mediated photosensitivity ( [54](#) ). To be effective, a local agent must be visible on the skin. Reflective materials, such as zinc oxide and titanium oxide, are useful, as is ordinary pigmented theatrical makeup ( [55](#) ). Preparations containing substituted quinones (such as Lawsone) and dihydroxyacetone turn the skin a cosmetically acceptable brownish-tan and may be effective ( [56](#) ). Therapy with β-carotene beadlets may also offer some protection from the deleterious effects of light ( [57](#) ) (see section [Erythropoietic Protoporphyrin](#)).

**CONGENITAL ERYTHROPOIETIC PORPHYRIA IN ANIMALS** CEP (pink tooth) in cattle appears to be milder than the human disorder. The disease is inherited as an autosomal-recessive trait, and heterozygous animals are clinically and biochemically normal ( [58](#), [59](#) ), although an increased ratio of coproporphyrin I to coproporphyrin III in the urine has been reported ( [60](#) ). Photosensitivity of the skin areas not covered by pigmented hair and hemolytic anemia have been observed ( [61](#) ). The teeth and bones are stained red ( [59](#) ). Furthermore, UROIII-S activity is severely impaired in erythrocyte lysates ( [27](#), [62](#), [63](#) ). A similar disorder has been observed in pigs and cats, but the inheritance pattern appears to be dominant ( [64](#), [65](#), [66](#) and [67](#) ). In the fox squirrel ( *Sciurus niger* ), as part of the apparently normal physiology of the species, large amounts of uroporphyrin I are

deposited in the tissues and excreted in the urine ( [68](#) ). As in human CEP, the normoblasts and young erythrocytes show a red fluorescence; however, hemolytic anemia is lacking, and the fox squirrel seems to suffer no ill effects. Erythroid UROIII-S activity is lower than that found in the closely related but nonporphyric gray squirrel ( *S. carolinensis* ) ( [68](#) ).

## Porphyria Cutanea Tarda

*Porphyria cutanea tarda* (PCT) is the most commonly encountered porphyric disorder. It is caused by defects of URO-D ( [Fig. 31.1](#) ) that are expressed in the liver, leading to accumulation of uroporphyrins, their release into plasma, and excretion in the urine ( [16](#) ). Clinical manifestations are limited to the skin in the form of a photosensitive bullous dermatosis as a consequence of the circulating uroporphyrins. Neurovisceral symptoms never occur. Symptoms usually arise in mid or later life (hence the name *tarda* ) and are nearly always brought on by genetic and environmental factors, most often hepatic siderosis, alcohol abuse, hepatitis C virus, and estrogen therapy. Since the first comprehensive description of the disease in 1937 ( [69](#) ), three variant forms of the illness have been recognized: familial, sporadic, and acquired (toxic).

**MOLECULAR BASIS AND PATHOGENESIS** Among the variants of the disorder, a genetic basis has been established for one, designated *familial PCT* (type II), and it accounts for 20 to 30% of cases ( [70](#) , [71](#) , [72](#) , [73](#) and [74](#) ). Studies of patients with subnormal URO-D activity in both hepatic and extrahepatic tissues, and their relatives, revealed that the enzyme defect is inherited as an autosomal-dominant trait ( [75](#) , [76](#) , [77](#) , [78](#) and [79](#) ). Enzyme activity is one-half normal in all tissues, as is the amount of URO-D protein detected with antibodies ( [80](#) , [81](#) and [82](#) ). In the rare homozygous form, also designated *hepatoerythropoietic porphyria (HEP)*, residual enzyme activity ranges from 3 to 27% of normal ( [16](#) , [82](#) , [83](#) , [84](#) and [85](#) ), but immunoreactive enzyme is variable ( [81](#) , [82](#) , [86](#) ). Since the cloning of the human *URO-D* gene ( [87](#) ), located on chromosome 1 (1p34) ( [88](#) ), 57 different mutations in the gene have been identified at last count ( [89](#) ). Usually, a given mutation is found in one or in a few kindreds. The majority are various point mutations in the coding region of the gene or splice site mutations, resulting in changes of amino acids, frameshifts, or deletions of an exon. In some instances, large nucleotide deletions were detected. The defects usually result in the production of an unstable or inactive enzyme from the mutant allele. Structural consequences of many of the mutations were recently defined or predicted on the crystal structure of the enzyme ( [90](#) ). In the homozygous version, ten different mutations have been identified, with only one mutation occurring in several unrelated families ( [89](#) ). The mutations are homoallelic or heteroallelic, usually causing instability or impaired catalytic activity of the enzyme. In one instance, the clinical phenotype is unusually mild ( [91](#) ). When the URO-D defect is restricted to the liver and a genetic basis for the disorder is not evident, it is called *sporadic PCT* (type I) ( [78](#) , [80](#) , [92](#) ). Both the catalytic activity and the immunoreactivity of erythrocyte URO-D are normal in this variant ( [81](#) , [92](#) ). In the liver, catalytic activity of URO-D is subnormal, but immunoreactive enzyme is present in normal or increased amounts ( [93](#) ). After prolonged remission is induced by phlebotomy therapy, both catalytic activity and immunoreactivity become normal ( [93](#) ). These findings, coupled with lack of a family history in most cases of sporadic PCT, suggest that this form of the disease is acquired and not inherited. At the molecular level, no mutations could be found in the *URO-D* gene or its promoter region ( [94](#) ). However, in a few families, clinically manifest PCT was associated with decreased URO-D activity in liver and normal activity in erythrocytes and other tissues ( [89](#) ). These cases have been called *type III PCT*; molecular studies have not identified *URO-D* mutations in them ( [73](#) ). The cutaneous damage produced by the increased concentration

of uroporphyrins in plasma and skin of patients with PCT is based on the fundamental properties of the porphyrins. As they absorb light at 400 to 410 nm (Soret band), not only does their photoexcitation yield energy as fluorescence, but in the aerobic environment of tissues, reactive oxygen species (superoxide anion and other reactive metabolites) are produced ( [95](#) ) that are damaging to cells. *In vivo*, superoxide anions are generated by activation of xanthine oxidase ( [96](#) ). The complement system is light activated *in vitro* in sera containing porphyrins and *in vivo* in the skin of porphyric patients, promoting release of proteases from dermal mast cells ( [23](#) ). Chemotactic activity is also generated under these conditions, and the peroxides produced by photoexcitation of the porphyrin and those arising from polymorphonuclear leukocytes with activation of the complement system may act synergistically to contribute to the development of the cutaneous lesions. As a consequence of these events, the dermal–epidermal junction becomes disrupted and leads to skin fragility and the formation of vesicles and bullae that easily rupture. Sclerodermoid changes of the skin result from a light–independent effect (the “dark effect”) of the uroporphyrin on collagen synthesis by skin fibroblasts ( [97](#) ). The pathogenesis of the hyperpigmentation, hypopigmentation, and the hypertrichosis is not understood. Most family members carrying a defective gene of familial PCT do not have clinically apparent disease and have little or no uroporphyrin accumulation or excretion; in occasional pedigrees, overt manifestations of the disease have been noted in several generations ( [76](#) ). Clinical expression of both familial and sporadic PCT can nearly always be associated with prevalent confounding factors that cause hepatic injury, so the disorder remains silent without these. In large series of PCT, most patients had more than one of the four cardinal risk factors, namely iron excess, alcohol, viral infection (hepatitis C), and estrogen ( [73](#), [74](#) ).

**Iron** The central role of iron in the clinical expression of PCT has been recognized for over 40 years ( [98](#), [99](#) ). Numerous studies documented hepatocellular siderosis in most patients with significant uroporphyrinuria ( [100](#), [101](#), [102](#), [103](#), [104](#), [105](#), [106](#) and [107](#) ). The iron deposits generally are moderate in amount, 1.5 to 4 times normal, but are usually greater with concomitant HLA–linked hemochromatosis ( [Chapter 30](#) ) ( [102](#), [108](#), [109](#), [110](#), [111](#) and [112](#) ). Except for the geographic variation in the frequency of the hemochromatosis *HFE* alleles ( [89](#) ), on the average, 35% of patients with sporadic PCT are heterozygous for the Cys282Tyr mutation, and 15% are homozygous or compound heterozygotes with the His63Asp mutation ( [73](#), [74](#), [113](#), [114](#) and [115](#) ). Transfusional iron overload is being recognized as another mechanism promoting clinical expression of PCT ( [116](#), [117](#) ). Removal of iron by repeated phlebotomy ( [118](#), [119](#) and [120](#) ) or by administration of deferoxamine ( [121](#) ) uniformly induces both clinical and biochemical remissions. Replenishment of iron stores is followed by prompt relapse in patients in whom a remission has been induced by phlebotomy ( [102](#), [122](#) ). Iron somehow plays an important part in impairing the residual activity of hepatic URO–D to levels that produce symptoms. It may inhibit the enzyme ( [123](#), [124](#) and [125](#) ), either through possible direct oxidant effects ( [126](#) ) or by participating in reactions that generate singlet oxygen ( [127](#) ), which then reacts with the enzyme. Iron may also promote oxidation of uroporphyrinogen to uroporphyrin. It has been proposed that an inhibitor is generated in liver cells that partially inactivates hepatic URO–D in an iron–dependent manner, as hepatic URO–D activity in the sporadic variant of PCT is diminished without reduction in enzyme protein, and iron depletion leads to normalization of enzyme activity ( [73](#), [92](#), [93](#) ).

**Alcohol** Ethanol exacerbates PCT. Heavy alcohol intake has been reported in 25 to 100% of patients in several studies ( [73](#), [74](#), [105](#), [128](#), [129](#) ), and hepatic cirrhosis is not uncommon ( [105](#), [106](#) ). Yet the porphyria is an uncommon complication of alcoholic liver disease, occurring in only approximately 2% of cases ( [130](#) ). The association of clinically expressed PCT with alcoholism may relate to its hepatotoxicity or its role in stimulating iron absorption ( [131](#), [132](#) ). In this regard, PCT is particularly common among the Bantu

population of South Africa, where it is associated with excessive consumption of alcoholic beverages brewed in iron containers ( 133 , 134 ), thus providing a double threat to susceptible people. Studies have suggested that an iron-loading gene other than the HLA-linked hemochromatosis gene plays a role in the iron overload of this population when iron intake is excessive ( Chapter 30 ) ( 135 ).

**Hepatitis C** A striking association between symptomatic PCT, familial and sporadic, and hepatitis C is well recognized but is variable around the world. Although most patients with hepatitis C infection do not have the porphyria, as many as 80% of PCT patients are chronically infected with the virus in some locations ( 73 , 74 , 89 , 114 , 136 , 137 , 138 , 139 , and 140 ). This infection may explain, at least in part, the liver damage often found in PCT; how it may help unmask the disorder or affect URO-D is not known ( 141 ). Some association of PCT with human immunodeficiency virus (HIV) infection has also been described ( 140 , 142 , 143 ), and many such patients may be infected with both HIV and the hepatitis C virus ( 140 , 144 ). Dual infection causes more severe hepatic disease; whether the HIV virus per se plays a role in the expression of PCT is not known. Because patients with at least the sporadic form often have underlying viral infection, they should be assessed for the presence of hepatitis C and HIV antibodies at the time of diagnosis ( 140 ).

**Estrogen** The association of estrogen ingestion and expression of PCT has been reported numerous times but only in a very small percentage of patients who ingest estrogens, consistent with an underlying predisposition to the disease. The cutaneous symptoms have occurred with the use of estrogen as postmenopausal supplement ( 73 , 145 , 146 and 147 ), for contraception ( 145 , 146 , 147 , 148 , 149 and 150 ), and for prostatic carcinoma ( 145 , 151 , 152 and 153 ). Uncommonly, patients present with the disorder during pregnancy ( 154 , 155 and 156 ), but pregnancy has also been reported as not exacerbating PCT ( 157 , 158 ). The mechanism of the estrogen effect is not known. It may be a minor factor, as phlebotomy alone has brought about full recovery. Most women needing estrogen supplements at the usual dose can probably use them, provided that storage iron is removed and maintained at a low level.

**Renal Failure** PCT occurs in patients with renal failure undergoing hemodialysis ( 159 , 160 ). Symptoms may first arise in this setting for several reasons. Iron overload has been common in such patients ( 160 ), and intravenous iron now used in conjunction with erythropoietin may precipitate clinical PCT ( 161 ). Hemodialysis or peritoneal dialysis does not effectively clear circulating plasma uroporphyrins ( 162 , 163 ), presumably because porphyrins are bound to proteins ( 164 ). The uremic state may also contribute to an inhibited URO-D and uroporphyrin accumulation independent of an underlying enzyme defect or inhibition ( 165 ). In two patients, erythrocyte URO-D assays indicated that familial PCT was present ( 166 , 167 ). In most reported cases, the lack of family studies makes it difficult to classify the porphyria.

**CLINICAL DESCRIPTION** Cutaneous changes are the principal clinical manifestations of PCT ( 16 , 105 , 168 , 169 ). Skin lesions are found predominantly on light-exposed areas such as the face and hands and, in women, on the legs and feet as well. There is little discomfort with sun exposure per se, and blue (visible) light triggers only an insidious cutaneous damage. The most common complaint is marked skin fragility in areas subjected to repeated minor trauma, such as the hands and forearms ( Fig. 31.3 ). Vesicles and bullae form primarily on the dorsa of the hands and may erode, leaving atrophic scars that often display zones of both hyperpigmentation and hypopigmentation. Small, 1- to 2-mm, firm, whitish papules (milia) are commonly noted on the hands and, at times, on the face.





**Figure 31.3.** Porphyria cutanea tarda in a 60-year-old man. Note denuded skin areas over the fingers, an erosion, blisters, and milia. See [Color Plate](#).

Facial hypertrichosis occurs in most patients, is generally more noticeable in women, and may be an isolated presenting feature ([170](#)). Hypertrichosis, sometimes striking, is occasionally observed on areas of the skin that are rarely exposed to the sun, such as the trunk and legs. Other findings include hyperpigmentation of facial skin, alopecia, and scleroderma-like changes on the skin of the face, neck, and hands. The histologic appearance of the scleroderma-like lesions is identical to that seen in patients with systemic scleroderma ([169](#)). Occasionally, patients have overt signs and symptoms of underlying liver disease, but no good correlation exists between the degree of liver disease and the occurrence or severity of the porphyria. In the homozygous form of familial PCT or HEP, the skin changes just described usually occur before the age of 5 years and may be severe ([82](#), [83](#), [89](#), [171](#)). Hepatosplenomegaly is occasionally noted, and dental fluorescence has been reported.

**LABORATORY FINDINGS** Patients with PCT excrete greatly increased amounts of porphyrins in the urine. Uroporphyrin and heptacarboxylic porphyrin predominate, with lesser amounts of coproporphyrin and small amounts of 5- and 6-carboxylate porphyrins ([105](#), [169](#), [172](#), [173](#)). Usually, the daily urinary excretion of uroporphyrin is approximately 3000  $\mu\text{g}$  (normal,  $<50 \mu\text{g}$ ) ([105](#), [173](#)), but considerably higher values may be found. Uroporphyrin in the urine is predominantly isomer I, whereas the heptacarboxylic porphyrin is predominantly isomer III ([16](#), [105](#), [174](#), [175](#)). Photosensitive cutaneous symptoms rarely occur when the daily urinary excretion of uroporphyrin is less than 1000  $\mu\text{g}$ . Excretion of urinary coproporphyrin is slightly increased but rarely exceeds 600  $\mu\text{g}$  daily ([105](#)). An unusual and distinctive tetracarboxylic porphyrin, isocoporphyrin, is excreted in feces ([176](#)), and a slight increase may be noted in total fecal porphyrin excretion ([16](#), [173](#)). Homozygotes for the defect have mild anemia, and the erythrocyte protoporphyrin was found to be moderately increased when measured ([89](#), [177](#)). The serum iron concentration and, hence, transferrin saturation are often increased ([73](#), [105](#)). Values for liver function tests vary considerably from one patient to another. Some patients have mild degrees of jaundice and slight to moderate elevations in serum transaminase levels. Liver biopsy specimens display characteristic reddish-pink fluorescence ([105](#), [178](#), [179](#)). On microscopic examination, siderosis, periportal inflammation, focal necrosis, fatty infiltration, and some evidence of fibrosis are common findings ([105](#), [106](#), [175](#), [178](#), [179](#)). Often, fluorescent and birefringent needle inclusions are noted ([179](#), [180](#)). Electron microscopic studies reveal needlelike lucent areas, which appear to be in lysosomes ([179](#), [181](#)). Microscopic examinations of skin biopsy specimens show bullae formed by the separation of the epidermis from the dermis; periodic acid-Schiff-positive, diastase-resistant material around vessel walls in the upper dermis; and a sparse inflammatory cell infiltrate ([105](#), [169](#), [182](#), [183](#)). Immunofluorescence studies show deposition of immunoglobulin G (and less often immunoglobulin M) or complement around upper dermal vessels and at the dermal-epidermal junction ([183](#)).

**TREATMENT** Exposure to alcohol and excessive estrogen supplements in women should be avoided. Abstinence from alcohol can lead to remissions in some patients with the

porphyria associated with alcoholic liver disease ( [118](#) , [119](#) , [184](#) ); however, removal of iron by phlebotomy can induce remissions even if alcohol intake continues. It is also of interest that a remission was achieved in patients with PCT and hepatitis C after treatment with  $\alpha$ -interferon alone ( [185](#) , [186](#) ). Transdermal administration of estrogen was found to be safe in a small number of patients ( [187](#) ) and avoids any possible first-pass effects of the hormone on the liver. The definitive treatment of both sporadic and familial PCT is the removal of iron stores by phlebotomy, which leads to clinical and biochemical remission in virtually every case and may improve concomitant hepatitis C virus infection. If there are no contraindications, 500 ml of blood can be removed every 2 weeks. Initial serum transferrin saturation and ferritin values are obtained to estimate the iron burden. Liver biopsy must also be considered to assess the disease status of associated viral hepatitis and hemochromatosis. Clinical remissions often occur after the removal of approximately 3 L of blood ( [105](#) , [118](#) , [175](#) ); patients who also have hemochromatosis usually require considerably more therapy and indefinite regular maintenance phlebotomies. The optimal approach is to achieve mild iron deficiency, defined by onset of iron-limited erythropoiesis in which the mean corpuscular volume is decreased to low normal, the serum transferrin saturation is normal, and the serum ferritin is near 20  $\mu\text{g/L}$  or lower. Although further overproduction of uroporphyrins is halted thereafter, the chronically accumulated, relatively hydrophobic porphyrins are released slowly from the liver. Patients should be advised that formation of new skin lesions ceases gradually, and full recovery often extends over several months to a year or more ( [105](#) ). Remissions for years are the rule ( [105](#) , [118](#) ) and are permanent when the known precipitating factors are avoided; any clinical and biochemical relapse responds to another course of phlebotomies. Chloroquine has also been used in the treatment of PCT ( [188](#) , [189](#) , [190](#) , [191](#) and [192](#) ). After the administration of 0.5 to 1.0 g/day for several days, a large amount of the porphyrins stored in the liver was mobilized and excreted in the urine ( [188](#) , [193](#) ). This purging effect results from the formation of an easily excreted water-soluble complex between uroporphyrin and the drug ( [194](#) ). The chloroquine effect was often accompanied by malaise, anorexia, fever, and signs of hepatocellular damage. The subsequent use of lower doses made it possible to avoid the toxic response without impairing efficacy ( [189](#) , [195](#) ), but this maneuver does not always preclude toxicity ( [105](#) ). Because of the potential danger of the hepatic reaction to chloroquine and because phlebotomy is usually safe and effective, administration of low doses of chloroquine should be reserved for patients for whom phlebotomy is unsuitable. The use of sunscreen agents effective in the Soret band of the spectrum and avoidance of sunlight through protective clothing can be useful until the beneficial effects of phlebotomy occur. These measures are the only means to help patients with the homozygous form of PCT because phlebotomy is not effective. Anemia and cutaneous symptoms responded to erythropoietin in one case ( [196](#) ). Efforts toward somatic gene therapy have been initiated by demonstrating correction of the enzyme defect with retroviral gene transfer *in vitro* in transformed B-cell lines ( [197](#) ). Prenatal exclusion of HEP has been possible ( [198](#) ). Treatment of patients with PCT complicating renal failure presents special challenges. The disorder may be particularly severe because such patients lack the renal excretory pathway for porphyrins, leading to higher porphyrin levels in plasma and tissues. Chloroquine-porphyrin complexes are not filtered out by standard hemodialysis. High-flux hemodialysis appears to remove porphyrins from plasma better and may be of some benefit ( [199](#) ). The treatment of choice is administration of recombinant erythropoietin to mobilize stored iron and relieve the anemia so that phlebotomies can be performed as necessary to induce remission ( [200](#) , [201](#) ). This method is preferable to the alternative of depleting iron stores with the iron chelator deferoxamine ( [201](#) , [202](#) ). In patients refractory to these treatment methods, the porphyria fully resolved after renal transplantation ( [203](#) , [204](#) ).

**TOXIC PORPHYRIA CUTANEA TARDA** In Turkey between 1956 and 1961, an epidemic of acquired porphyria affecting more than 3000 people occurred as the result of exposure



to flour contaminated with a seed wheat fungicide, hexachlorobenzene ( [205](#), [206](#) and [207](#) ). Members of both sexes were affected, and many of the subjects were children. Affected people developed hepatomegaly, hypertrichosis, hyperpigmentation, uroporphyrinuria, and a photosensitive dermatosis. Uroporphyrinuria and a variety of other signs and symptoms persisted in some individuals for more than 25 years ( [208](#), [209](#) ), and no effective therapy has been devised for this toxic porphyria. Subsequent studies in animals demonstrated that hexachlorobenzene, or one of its metabolites, is a potent inhibitor of hepatic URO-D ( [210](#), [211](#), [212](#), [213](#) and [214](#) ). Iron magnifies this inhibitory effect ( [213](#) ), and clear genetic susceptibility to this type of acquired porphyria has been shown in mice ( [215](#) ). Other polyhalogenated aromatic hydrocarbons also have produced a toxic porphyria in humans. 2,3,7,8-Tetrachlorodibenzo-*p*-dioxin, a by-product in the manufacture of the herbicides 2,4-dichlorophenoxyacetic acid, 2,4,5-trichlorophenoxyacetic acid, and some polychlorinated biphenyls, has proved porphyrinogenic for humans ( [216](#), [217](#) and [218](#) ). Animal studies indicate that compounds of this class inhibit hepatic URO-D activity ( [219](#), [220](#) ). As in the case of hexachlorobenzene-induced porphyria, iron magnifies the inhibition of URO-D activity, and iron depletion minimizes the inhibitory effect of these agents ( [221](#) ). The parallel between the permissive effects of iron in acquired toxic porphyria and the role of iron in the pathogenesis of both familial and sporadic PCT is striking.

**HEPATOCELLULAR CARCINOMA** An increased frequency of hepatocellular carcinomas has been reported in patients with PCT ( [222](#), [223](#), [224](#), [225](#) and [226](#) ), and such tumors are associated with a long symptomatic period before the start of treatment as well as with the presence of cirrhosis or chronic active hepatitis ( [225](#), [227](#) ). The body iron status is not known in these cases, but iron overload could also play a role. In contrast, documented evidence supports a PCT-like illness as a manifestation of porphyrin-producing hepatoma in an otherwise normal liver in several cases ( [228](#), [229](#), [230](#), [231](#), [232](#) and [233](#) ). When the tumor could be surgically removed, the cutaneous symptoms and biochemical abnormalities remitted ( [228](#), [233](#) ).

**ANIMAL MODELS OF PORPHYRIA CUTANEA TARDA** The first genetically designed animal model of PCT and HEP was developed in zebrafish ( [234](#) ). Heterozygous and homozygous mutants have 67% and 36% of wild-type URO-D activity, respectively. The enzyme deficiency was linked to a missense mutation in the *URO-D* gene, predicting a Met38Arg substitution that involves a conserved amino acid across all species examined, including humans. The mutant phenotype could be rescued by transient and germline expression of the wild-type allele. Transgenic mice with one disrupted *URO-D* allele ( *URO-D*<sup>+/-</sup> ) have half the wild-type hepatic URO-D protein and enzyme activity but no accumulation of porphyrins ( [235](#) ). However, in response to iron loading, hepatic porphyrins accumulate, and URO-D activity declines to 20%. When bred to *HFE*<sup>-/-</sup> mice, *URO-D*<sup>+/-</sup>/*HFE*<sup>-/-</sup> animals developed a porphyric phenotype with further reduction of URO-D activity to 14%, resembling the human condition. *HFE*<sup>-/-</sup> mice that are fed ethanol also develop uroporphyrinuria and reduced hepatic URO-D activity, seemingly mediated by effects of ethanol on hepatic iron metabolism ( [236](#) ).

## Erythropoietic Protoporphyrin

*Erythropoietic protoporphyria* (EPP), the third porphyric disorder with mainly cutaneous manifestations, is not uncommon, with an estimated prevalence of 1 per 75,000 to 200,000. Since the first clear description of the disease by Magnus et al. in 1961 ( [237](#) ), hundreds of cases have been reported throughout the world ( [16](#), [238](#), [239](#), [240](#), [241](#) and [242](#) ). Defects in the gene encoding ferrochelatase (FECH), the last enzyme in the heme biosynthetic pathway ( [Fig. 31.1](#) ), are responsible for the disorder and result in accumulation of protoporphyrin, mainly in erythroid tissue. The cutaneous manifestations

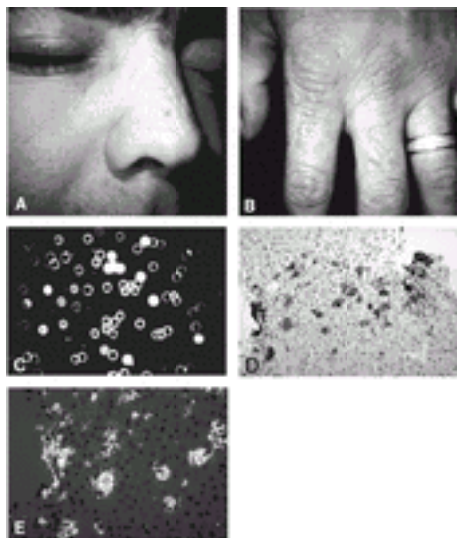
are distinctive, but considerable individual variation is noted in clinical severity as well as in biochemical abnormalities. The inheritance pattern was considered heterogeneous ( [239](#), [240](#) and [241](#) ). Based on recent findings, transmission of EPP is favored as a recessive trait ( [243](#) ).

**MOLECULAR BASIS AND PATHOGENESIS** Subnormal FECH activity is found in all tissues examined from patients with EPP, which include bone marrow ( [244](#) ), reticulocytes ( [245](#) ), lymphocytes ( [246](#), [247](#) ), liver, and cultured skin fibroblasts ( [248](#) ). The protoporphyrin accumulates principally if not entirely in erythroid cells ( [238](#) ), whose contribution to heme production far exceeds that of all other tissues. Studies attempting to quantify the protoporphyrin tissue source in individual patients have been indirect, and different conclusions were reached ( [249](#), [250](#) and [251](#) ), likely reflecting the heterogeneity of the disorder. Although the normal relative activity of FECH in erythroid tissue, in contrast to liver, is the second lowest among the enzymes of the heme biosynthetic pathway and is only three times higher than 5-aminolevulinatase synthase ( [15](#) ), defective FECH in EPP does not appear to be rate-limiting until late in erythroid development, so patients often exhibit a mild hypochromic-microcytic anemia ( [244](#), [252](#), [253](#) ). Protoporphyrin begins to accumulate in bone marrow erythroblasts just before the nucleus is lost ( [254](#), [255](#) ), and reticulocytes still within the marrow probably are the major source of protoporphyrin in plasma on its rapid release from these cells ( [256](#), [257](#) ). Because of its low water solubility, the protoporphyrin is not excreted in urine but is taken up by the liver and excreted exclusively through the biliary tract. Why some cases exhibit the ring sideroblast abnormality in erythroblasts ( [Chapter 29](#) ) ( [258](#), [259](#) ) but others do not ( [244](#) ) is not clear and may relate to the nature of the defect or to the presence of an independent abnormality involving heme biosynthesis. Based on clinical features and FECH activity in many pedigrees, inheritance of this porphyria was considered most often to follow an autosomal-dominant pattern ( [241](#), [253](#), [260](#), [261](#) and [262](#) ). In a few families, autosomal-recessive inheritance was suggested ( [240](#), [241](#), [263](#) ). Much individual variation is noted in the severity of clinical features and biochemical abnormalities ( [16](#) ). FECH activity in tissue lysates from patients with clinical EPP is only 20 to 30% of normal ( [16](#), [238](#) ), not the 50% value expected for an autosomal-dominant enzyme deficiency. Neither levels of FECH activity nor levels of erythrocyte and fecal protoporphyrin consistently correlate with severity of symptoms. Moreover, most obligate carriers of the disorder have no symptoms ( [261](#) ). Their erythrocyte and fecal protoporphyrin levels are usually normal ( [16](#) ), and tissue FECH activity is approximately 50% of normal ( [16](#), [238](#) ). To explain the great variability in the clinical phenotype, it was proposed that more than one allele is involved in the full expression of the disease ( [239](#), [264](#) ). This proposal was also supported by the finding that, within a family, FECH activity in mitogen-stimulated lymphocytes was lower in EPP patients than in those with a latent defect ( [247](#) ). The human *FECH* gene is located on chromosome 18 (18q21.3) and expresses two messenger RNAs (mRNAs), the housekeeping and the erythroid-specific form, differing in their 3' end ( [265](#), [266](#) and [267](#) ). Over 65 different mutations have been identified and are highly heterogeneous, including missense and nonsense mutations, nucleotide deletions and insertions, and intronic point mutations near intron/exon splice sites in one *FECH* allele ( [242](#) ). Most often, the defects lead to frameshifts or exon deletions, resulting in a truncated protein ("null allele") ( [242](#), [268](#), [269](#) ). The entire *FECH* gene was absent in one patient as a result of a chromosome 18q deletion ( [270](#) ). In a few instances, a mutation was found on each allele ( [263](#), [271](#), [272](#) ). Although these few compound heterozygotes clarified the phenotypic differences between symptomatic and asymptomatic members of the families, in all other cases, despite similar phenotypes, only one mutant allele was found ( [242](#), [268](#), [269](#) and [270](#) ). Then, it was established that co-inheritance of a "low-expression" normal allele of *FECH* along with

the mutant allele determines clinical expression of the disorder ( 273, 274 ). The low-expression allele is highly associated with a specific ancestral haplotype that occurs in approximately 10% of whites at a single nucleotide polymorphism site in the *FECH* gene (IVS3-48T/C) that influences the use of a constitutive aberrant acceptor splice site in the gene ( 275 ). The aberrantly spliced RNA fraction is degraded, decreasing the steady-state level of *FECH* mRNA expressed by the allele. This discovery also correlates with the finding that only approximately 10% of individuals with a mutant *FECH* allele develop clinical symptoms. Alternatively, in some kindreds in which clinical disease is transmitted from generation to generation, a dominant-negative effect of *FECH* mutants may be operative ( 276 ). Because the enzyme activity is restricted to its homodimers ( 277 ), a mutant monomer could generate nonfunctional homodimers and heterodimers, and the average residual enzyme activity of approximately 25% would be accounted for by the wild-type homodimers. The ultimate effects of a specific mutation in the *FECH* gene should depend on how the mutation affects the integrity of the protein and whether the nonmutated allele is expressed at a lower level to reduce *FECH* activity to the 20 to 30% of normal as found in clinically overt EPP. The great variability in phenotype is also consistent with unique mutations encountered in most pedigrees of EPP ( 242 ), with only a few mutations so far recurring in unrelated families ( 242, 278, 279 ). The extent to which the enzyme deficiency affects heme biosynthesis in different tissues remains unsettled. Although erythroid cells accumulate the majority of protoporphyrin and release it into plasma, the liver may be a significant source in some patients ( 238, 249 ). Regardless of its origin, the protoporphyrin is extracted from plasma by the liver and is secreted unchanged into the bile. The liver is capable of clearing large amounts of protoporphyrin, but its secretion across the canalicular membrane and into the bile appears to be rate-limiting ( 280, 281 and 282 ). Cholestasis results when large amounts of protoporphyrin are cleared and secreted, leading to obstruction of biliary radicles, protoporphyrin accumulation in hepatocytes, and liver damage. Yet despite microscopic evidence of hepatobiliary changes in many EPP patients, cirrhosis and hepatic failure occur in only a few (<5%) ( 283, 284 ). This complication tends to be an abrupt event, is unrelenting, and is not predictable from prior biochemical features or the clinical course of the patient. Likewise, genetic factors do not explain this fatal form of the disease. Whereas it occurred in two young siblings who were compound heterozygotes for two mutations ( 272 ), another compound heterozygote for different *FECH* mutations had no liver dysfunction at 27 years of age ( 271 ), and liver failure has occurred in heterozygotes ( 285, 286 ). Among eight unrelated EPP patients requiring liver transplantation, genetic heterogeneity was also observed; the mutations found shared only the property of causing a major structural alteration in the *FECH* protein ( 287 ). In a recent analysis of 112 EPP patients, all 18 who developed liver disease carried a null allele mutation, whereas none of 20 patients having missense mutations had liver disease as yet ( 288 ). Additional undetected molecular derangements or undefined hepatic factors, including a greater hepatic source of the excess protoporphyrin related to the defect, can be postulated. Excess alcohol intake ( 289 ) and viral hepatitis ( 290 ) have been reported to accentuate the genetic disorder. The deposition of protoporphyrin in endothelial cells of skin capillaries after release of the porphyrin into plasma is responsible for the light-induced skin damage in patients with EPP ( 291, 292 ). Porphyrin-sensitized, oxygen-dependent histochemical reactions and the activation of complement eliciting an inflammatory response are involved in the pathogenesis of the photodynamic skin damage ( 22, 23 ). The extensive double-bond structure of the protoporphyrin seems to render it particularly photoactive, resulting in the typical acute epidermal phototoxicity ( 237 ), in contrast to the porphyrins that accumulate in the other porphyrias with cutaneous photosensitivity. The activated porphyrin also stimulates fibroblast proliferation, accounting for a characteristic waxy thickening of the sun-exposed skin ( 23 ).

**CLINICAL DESCRIPTION** Usually, EPP first manifests in childhood or early adolescence (

16, 253, 261, 293). It has occasionally developed as a similar phenotype in later years in the setting of acquired idiopathic sideroblastic anemia (Chapter 29) (15) or a myelodysplastic syndrome (294, 295 and 296), with a chromosome 18q deletion in bone marrow cells of some of the cases. The cutaneous features of photosensitivity are unlike those seen in patients with other porphyrias; bullae, scarring, sensitivity to trauma, hirsutism, and hyperpigmentation are extremely unusual (291). In some patients, the symptoms are subjective. Most patients, after exposure to the sun for periods of a few minutes up to several hours, have intensely unpleasant sensations of prickling, itching, or burning (photoparesthesias) followed by the development of erythema, urticaria, and edema (253, 291). Less commonly, solar urticaria, a confluent, hivelike rash, occurs within minutes of exposure and lasts approximately 30 minutes (237, 291). In general, the signs and symptoms involve only the uncovered areas of the body and subside in the course of hours or days without significant sequelae. Occasionally, these early reactions are followed within a day or two by vesicular, eczematous lesions (solar eczema) that become crusted (297), last for several weeks, and heal with scar formation (253, 291). Chronic skin changes may include shallow, pitted scars or pseudovesicles over the cheeks and nose and thickened, leathery skin (pachydermia) over the dorsa of the hands (Fig. 31.4A and Fig. 31.4B) (253, 291, 297). Many cutaneous manifestations of EPP do not differ greatly from those found in patients with photosensitivity of unknown cause (so-called polymorphic light eruptions), which is more common and is not associated with abnormal porphyrin metabolism. In one study of over 600 light-sensitive patients, only 8% were found to have laboratory evidence of EPP (298).



**Figure 31.4.** Protoporphyrin. **A** and **B**: In a 29-year-old man. Note cobblestonelike, flesh-colored, lichenoid papules over the nose and dorsum of the hand joints. **C**: Dilute suspension of erythrocytes under the fluorescence microscope. Note a fraction of fluorescing cells. (Courtesy of Dr. Maureen Poh-Fitzpatrick, Columbia University, NY.) **D** and **E**: Needle biopsy section of liver. Note deposits of protoporphyrin pigment in the parenchyma and a portal triad (**D**), and birefringence of the deposits, including a dark Maltese cross figure near the left center (**E**). See [Color Plate](#).

Cholelithiasis tends to develop early in life (253, 299) and ultimately occurs in approximately 10% of patients. The gallstones fluoresce and consist, in part, of precipitated protoporphyrin (16, 300). Although EPP is generally a benign disorder with clinical manifestations limited to the skin, a subset of patients develops progressive liver disease, leading to a fatal cirrhosis in the second to fourth decades of life (283, 284). At autopsy, massive hepatic deposits of protoporphyrin are found (283, 301). Associated with the fulminant liver failure are rising blood protoporphyrin levels with progressive



cholestasis, hemolysis, increasing photosensitivity, and neurologic crises resembling those of the acute porphyrias ( 302 , 303 ). The neurologic dysfunction was best correlated with a markedly increased level of plasma protoporphyrin and was believed to cause neurotoxicity ( 302 ).

**LABORATORY FINDINGS** The free erythrocyte protoporphyrin (FEP) concentration is greatly increased in symptomatic patients. Reported values range from 300 to 4500  $\mu\text{g}/\text{dl}$  (normal,  $<50 \mu\text{g}/\text{dl}$ ) ( 16 , 253 , 261 ). Increased levels of FEP are observed in certain other conditions, especially iron deficiency anemia, but only rarely do they exceed 300  $\mu\text{g}/\text{dl}$ . The FEP may be as high in lead poisoning as in EPP ( 304 ); however, differentiation between the two is usually simple ( 256 ). In both lead poisoning and iron deficiency, the excess FEP is present as a zinc chelate ( 305 ) and can be distinguished spectrally from the nonchelated protoporphyrin found in EPP ( 306 ). Plasma protoporphyrin is usually increased as well, and a normal plasma porphyrin in a patient with increased FEP effectively excludes EPP. In asymptomatic carriers, the FEP ranges from normal values to 200  $\mu\text{g}/\text{dl}$  ( 261 ). The life-threatening liver disease may be predicted by increasing FEP and plasma protoporphyrin levels along with altered liver function tests. In patients with severe protoporphyrinic liver disease, the FEP concentration generally exceeds 2000  $\mu\text{g}/\text{dl}$ , and values greater than 8000  $\mu\text{g}/\text{dl}$  have been reported ( 283 ). Fluorescence microscopy of a dilute suspension of freshly obtained blood reveals fluorescence in a variable proportion of erythrocytes ( Fig. 31.4C ) ( 237 ). Protoporphyrin is increased chiefly in young erythrocytes ( 256 , 307 ) but is heterogeneous, and a population of reticulocytes without protoporphyrin is also present, reflecting a nonuniform expression of the genetic defect at the cellular level ( 257 ). In asymptomatic carriers, a small population of such fluorescetes may be detected even when the FEP concentration is normal ( 239 , 261 , 308 ). Many patients with EPP have mild, slightly hypochromic anemia ( 252 , 253 , 298 ). Studies of red cell survival and iron kinetics have failed to detect a characteristic abnormality ( 16 , 298 ), but hemolysis is occasionally reported ( 309 , 310 ). Severe hemolytic anemia may occur with advanced hepatic disease that is exacerbated by photooxidative stress occurring during the prolonged operative procedure of liver transplantation ( 311 ). Sideroblastic anemia was reported in a patient with EPP and severe protoporphyrinic liver disease ( 258 ) and was subsequently documented in nine additional patients with EPP ( 259 ). Fecal protoporphyrin excretion usually is increased in symptomatic patients ( 253 , 312 ). Values may be as high as 1400  $\mu\text{g}/\text{g}$  (dry weight) (normal,  $<100 \mu\text{g}/\text{g}$ ) and vary widely from patient to patient, although variations in a given patient are not great ( 313 ). In some carriers, fecal protoporphyrin is increased even when the FEP is normal ( 312 ). An increasing ratio of FEP to fecal protoporphyrin and an increasing ratio of biliary protoporphyrin to biliary bile acids may also suggest impending hepatic decompensation ( 284 , 313 , 314 ). Urinary porphyrin and porphyrin precursor concentrations are normal. The majority of patients with EPP have no clinical evidence of liver disease, and liver function tests are generally normal. However, in most if not all cases, the liver contains dark brown pigment deposits ( Fig. 31.4D ) in hepatocytes, Kupffer cells, and portal macrophages as well as within the lumens of ductules and interlobular ducts that exhibit the characteristic red fluorescence of protoporphyrin when transilluminated with light of wavelength 380 to 500 nm ( 315 ). These deposits are crystalline in nature on electron microscopy. They also exhibit a distinctive type of birefringence, not shared by any other pigment known to occur in the liver, that is demonstrable in routinely fixed and stained paraffin-embedded sections and is as sensitive as the red fluorescence ( Fig. 31.4E ) ( 315 ). Not infrequently, the pigmentation is accompanied by bile stasis and varying degrees of portal inflammation, fibrosis, and ductular proliferation. In patients who have developed the protoporphyrinic liver disease, liver histology shows micronodular or macronodular cirrhosis and massive deposits of the pigment throughout ( 283 ).

**TREATMENT** Therapy is directed at reducing the consequences of sun exposure and minimizing the hepatotoxic effects of protoporphyrin. Topical sunscreens must be effective in the 400-nm portion of the spectrum to be useful. The only readily available effective topical preparations are opaque formulations containing oxidates of zinc or titanium. Most proprietary sunscreens contain compounds that reduce transmission only of the sun-burning portion of the spectrum between 290 and 320 nm. The induction of carotenemia (serum carotene levels above 400 µg/dl) is effective in reducing photosensitivity in many patients with EPP ( 291 ). Carotenemia is best induced by the administration of synthetic β-carotene beadlets (Lumitene, Tishcon Corporation, Westbury, NY) in adults at a dose of 120 to 180 mg/day, but doses up to 300 mg/day may be needed ( 316 , 317 ). The ability of carotene to quench photoexcited oxygen and to scavenge highly reactive free radicals probably explains its action ( 318 , 319 and 320 ). Increased tolerance to sunlight occurs in many but not all patients after 3 to 4 weeks of treatment, and the protective effect may last 4 to 8 weeks after cessation of the drug ( 291 ). In northern climates, this therapy may be required only in spring and summer, but winter sports enthusiasts may benefit from more prolonged therapy. To date, no significant side effects have been reported in patients using β-carotene. In patients unresponsive to β-carotene, narrow band ultraviolet B (TL-01) phototherapy and psoralen and ultraviolet A light treatment have been effective ( 321 , 322 ). Two patients experienced marked reduction in photosensitivity with administration of pyridoxine ( 323 ). Oral cysteine also appears to be effective as a free radical quencher ( 324 ), and, in a preliminary report, a flavonoid mixture (hydroxyethylrutinosides) was effective as an antioxidant ( 325 ). Attempts to minimize the hepatotoxic effects of protoporphyrin have been directed at both reducing the amount of protoporphyrin presented to the liver for excretion and depleting hepatic protoporphyrin stores. Suppression of erythropoiesis and the erythrocyte protoporphyrin accumulation can be achieved with transfusion therapy ( 326 , 327 ), but the hazards of transfusion-induced iron overload and the risk of transfusion-related infectious disorders make this form of therapy undesirable ( 328 ). In two patients, severe acute cholestasis and hepatitis were averted by blood exchange plus transfusions ( 329 ). Intravenous hematin, which diminishes the production of porphyrins and porphyrin precursors in other forms of porphyria (see [Acute Intermittent Porphyria](#)), has been administered to several patients with EPP ( 330 , 331 ). Modest decreases in protoporphyrin accumulation were observed, but no evidence establishes that hematin infusions have the potential to ameliorate or prevent protoporphyrin liver disease. In one patient, administration of iron, either as carbonyl iron or ferrous sulfate, was followed by decreases in stool and erythrocyte porphyrins and improved liver function ( 332 ), but, in others, the disease was exacerbated by oral iron therapy ( 333 ). Whether protoporphyrin secreted in bile is reabsorbed by an enterohepatic circulation and secreted again by the liver ( 334 ) has been questioned ( 335 , 336 and 337 ). Administration of cholestyramine, which binds protoporphyrin ( 335 ), has produced a significant decline in erythrocyte and plasma protoporphyrin concentrations, a decrease in fecal excretion of protoporphyrin, and improvement of protoporphyrin liver disease ( 338 , 339 ), but no controlled studies have been reported. More recently, the drug was found to promote urinary excretion of protoporphyrin through a presorption effect ( 340 ). Activated charcoal, a nonabsorbable porphyrin binder, has also been used successfully to interrupt the enterohepatic circulation of porphyrins ( 341 ). The potential for malabsorption of essential nutrients must be considered when therapy with cholestyramine or activated charcoal is considered. The excretion of protoporphyrin by the liver depends on bile salt excretion ( 280 ), and the administration of bile acids in both *in vitro* and *in vivo* experiments stimulates biliary secretion of protoporphyrin ( 342 ) and reduces hepatic protoporphyrin accumulation ( 343 , 344 ). Administration of chenodeoxycholic acid in patients with EPP also results in a sharp decrease of fecal protoporphyrin excretion ( 345 ), but the early ultrastructural changes in

the liver are not improved ( [346](#) ). If biliary excretion of protoporphyrin is enhanced by the administration of bile salts, these agents, coupled with nonabsorbable porphyrin-binding compounds such as cholestyramine or charcoal, might provide a means of preventing or treating protoporphyric liver disease. Once severe liver damage has occurred, no form of medical therapy is effective. Thus, liver transplantation has been undertaken as a life-saving measure in approximately 30 cases ( [287](#) , [303](#) , [347](#) , [348](#) and [349](#) ). The results have been favorable in part, with some patients surviving for up to 10 years. However, the protoporphyrin burden from erythroid tissue remains, and protoporphyrin hepatopathy has recurred in the graft. It is possible that bone marrow transplantation should be performed early in the disease to optimally correct the metabolic defect, but better indicators for patients who are at risk of liver failure would be needed to justify this approach. In one patient with coincidental acute leukemia, a marrow transplant from a sibling with less severe EPP was beneficial for the patient's EPP ( [350](#) ). The most definitive treatment for the disease would be replacement of the defective gene in affected tissues. Targeting the hematopoietic stem cells with gene therapy will probably suffice once it is technically feasible. *In vitro* studies have demonstrated effective transfer of normal FECH complementary DNA into cultured fibroblasts from patients with EPP with correction of the biochemical defect ( [351](#) , [352](#) ). Genetic analysis of EPP patients' spouses for a low-output *FECH* allele now allows assessment for the probability of clinical disease in offspring.

**ERYTHROPOIETIC PROTOPORPHYRIA IN ANIMALS** Bovine EPP was described in 1977 ( [353](#) ) and is transmitted as an autosomal-recessive trait ( [354](#) ). Affected calves have acute photosensitization during the first few weeks of life, the erythrocyte and fecal protoporphyrin is greatly increased, and FECH is reduced to 10% in all tissues examined ( [238](#) ). The animals do not develop anemia or hepatobiliary disease. Carrier dams have approximately half the normal FECH activity. Immunochemical studies of the enzyme suggested a structural defect ( [355](#) ), and subsequent DNA analysis revealed a novel stop codon mutation (X417L) ( [356](#) ). A protoporphyric disorder occurs in mice that are fed a diet containing 2.5% by weight of griseofulvin ( [357](#) ) and exhibits a pronounced hepatic component ( [358](#) ). It is similar in many respects to the human disease, and the hepatic histopathologic abnormalities are indistinguishable by light or electron microscopy ( [359](#) , [360](#) and [361](#) ). Another murine EPP ( *fch* ) is produced by chemical mutagenesis with ethylnitrosourea ( [362](#) ). It is characterized by photosensitivity, mild hemolytic anemia, and severe hepatobiliary dysfunction in early life. FECH activity in various tissues is 2.7 to 6.3% of normal in homozygotes and approximately 50% in heterozygotes. A point mutation has been identified in the *FECh* gene ( *Fechm1Pas* ), and prokaryotic expression studies have substantiated it as the basis for the porphyria ( [363](#) ). Bone marrow transplantation is effective in this mouse model ( [364](#) ). Moreover, reversal of the phenotype and restoration of normal hematopoiesis have been achieved with preselective gene therapy ( [365](#) , [366](#) ) as well as with the use of a self-inactivating erythroid-specific lentiviral vector without preselection ( [367](#) ). A genetically designed model of EPP has been developed in zebrafish ( [368](#) ). Protoporphyrin IX accumulates in the mutant embryos, and the phenotype shows light-dependent hemolysis and liver disease. The mutation is a G?T transversion at a splice donor site in the *FECh* gene and creates a stop codon.

## ACUTE OR INDUCIBLE PORPHYRIAS WITH NEUROLOGIC MANIFESTATIONS

Porphyrias manifesting neurologic and psychiatric illness are called *acute porphyrias* to reflect the often abrupt onset of symptoms. They are also referred to as *inducible porphyrias* because symptoms are commonly brought on by endogenous or exogenous factors that stimulate heme biosynthesis through certain biochemical mechanisms. These



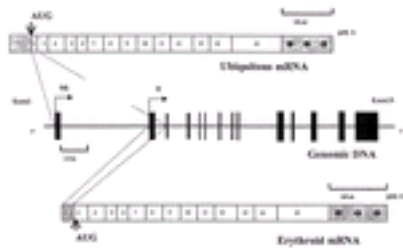
disorders are deficiencies of the remaining four enzymes of the heme synthetic pathway that restrict the capacity for the production of heme and lead to derepression of ALA synthase: PBG-D, ALA dehydratase (ALA-D), coproporphyrinogen oxidase (CP-O), and protoporphyrinogen oxidase (PP-O) ( Fig. 31.1). During acute attacks, hepatic ALA synthase is markedly induced, and the porphyrin precursors (ALA and PBG) accumulate because PBG-D becomes rate-limiting, having the second lowest relative activity among the enzymes of the heme synthetic pathway ( 15). These events are best understood in the liver, and they may occur in neural tissue. Deficiencies of CP-O and PP-O also result in accumulation of their respective porphyrin substrates and therefore can be accompanied by photosensitivity, whereas only the precursors accumulate with deficient PBG-D and ALA-D, and photosensitivity does not occur.

## Acute Intermittent Porphyria

Patients with *acute intermittent porphyria* (AIP) (pyrroloporphyria, Swedish porphyria) were probably reported by Gunther ( 3). The extensive family studies in Sweden by Waldenstrom provided the first comprehensive description of the disorder ( 369). It is transmitted in an autosomal-dominant manner with low penetrance and results from mutations in the gene encoding PBG-D (hydroxymethylbilane synthase, uroporphyrinogen I synthase) ( Fig. 31.1) ( 370). The prevalence of the trait in most countries had been estimated at 1 to 2 per 100,000 ( 16). More recent population screening studies in northern Europe with enzyme assays and DNA analysis indicate a much higher prevalence of carriers, ranging from 1 to 2 per 10,000, and an even higher prevalence in Sweden and France ( 16). A similar frequency was reported in psychiatric patients in the United States ( 371).

**MOLECULAR BASIS AND PATHOGENESIS** A decreased conversion of PBG to porphyrins observed in liver tissue from patients with AIP provided the first evidence that the enzyme PBG-D is defective ( 372). Decreased catalytic activity of PBG-D to approximately half of normal was subsequently demonstrated in all tissues examined, including liver ( 373), erythrocytes ( 374, 375), cultured skin fibroblasts ( 376, 377 and 378), cultured amniotic cells ( 378), and mitogen-stimulated lymphocytes ( 379). Considerable heterogeneity of the defect became evident from biochemical and immunologic studies of the enzyme in erythrocytes from patients with AIP. Up to 10% of unrelated and clinically affected people had either normal or indeterminate levels of erythrocyte PBG-D activity ( 380, 381 and 382). Overlapping enzyme activity levels could be resolved with internal family reference values ( 383), consistent with apparent genetic regulation of the enzyme activity ( 384, 385). Patients with normal erythrocyte PBG-D activity responded to an ALA loading test with increased excretion of PBG and reduced excretion of fecal protoporphyrin, just like patients with low PBG-D activity in erythrocytes, suggesting that the defect is expressed in the liver but not in erythrocytes ( 386). Approximately 80% of patients with half-normal PBG-D catalytic activity were found to have half-normal PBG-D protein concentration, referred to as *cross-reacting immunologic material-negative*, and approximately 20% of pedigrees were *cross-reacting immunologic material-positive* (i.e., the PBG-D catalytic activity was half-normal, but the PBG-D protein was normal or even increased) ( 370, 387). In addition, molecular heterogeneity was indicated by detection of differing restriction haplotypes for the *PBG-D* gene locus ( 388, 389 and 390). After the cloning and sequencing of the *PBG-D* gene, the molecular basis for two isoforms of the enzyme was established ( 391, 392, 393 and 394), and genetic defects responsible for AIP could be identified. A single *PBG-D* gene, located in the chromosomal region 11q24 ( 395), under the control of two independently regulated promoters, produces two transcripts through alternative transcription and splicing. In the mRNA of the enzyme produced in all

cells (ubiquitous mRNA), exon 1 is spliced to exon 3, whereas exon 1 is excluded in the transcript in erythroid cells, and translation begins in exon 3 ( Fig. 31.5). Thus, the erythroid-specific protein lacks the 17 amino acids that are encoded by exon 1 for the ubiquitous enzyme.



**Figure 31.5.** Structure of the human porphobilinogen deaminase gene and its two transcripts produced by alternative splicing. E, erythroid promoter; mRNA, messenger RNA; NE, nonerythroid promoter. (From Deybach J-C, Puy H. Acute intermittent porphyria: from clinical to molecular aspects. In: Kadish KM, et al., eds. The porphyrin handbook—medical aspects of porphyrins, vol. 14. Amsterdam: Academic Press, 2003:23–41, with permission.)

Approximately 200 different mutations have been identified in the *PBG-D* gene, most of which were found in single pedigrees ( [269](#), [370](#), [390](#), [396](#)). High frequencies of a few mutations in restricted geographic areas (e.g., Sweden, Holland, Switzerland, Canada, Argentina) are believed to represent founder effects ( [390](#)). On the other hand, approximately 3% of all index cases with AIP may have *de novo* mutations ( [397](#)). Approximately 75% of mutations are single-base substitutions, and the remaining mutations consist of small insertions or deletions, resulting in a spectrum of splice defects of transcripts, frameshifts, stop codons, unstable proteins, or reduced catalytic activities of the enzyme ( [390](#)). The least common mutations (i.e., involving the exon 1–intron 1 junction or exon 1) restrict the *PBG-D* defect to nonerythroid tissues and account for the normal activity of the enzyme in erythrocytes observed in such cases. In two families, compound heterozygotes (and in one family, a homozygote) for point mutations had severe *PBG-D* deficiency ( [398](#), [399](#) and [400](#)). Although, in general, no correlation between the genotypes and phenotypes has been found, a few prevalent mutations exhibit higher penetrance ( [401](#), [402](#)). Using the knowledge of the three-dimensional structure of *PBG-D*, structural and functional outcomes of the mutations can be predicted ( [403](#), [404](#)). For instance, many mutations change amino acids in the vicinity of the active site of the enzyme, and a number of these are involved in binding the primer or substrate of the enzyme; others perturb conformation of the protein. The genetic lesion and its wide spectrum underlying AIP are now well defined, but the pathogenesis of the clinical manifestations remains poorly understood. Several mechanisms have been postulated for the neurovisceral symptoms and signs that characterize the disorder. One is that the porphyrin precursor ALA, which accumulates after the induction of ALA synthase ( [405](#), [406](#), [407](#), [408](#) and [409](#)) in response to diminished cellular heme because of the *PBG-D* deficiency, is toxic to the nervous system. Studies in animals indicate that ALA can alter neural structure and function as an agonist for  $\gamma$ -aminobutyric acid receptors ( [410](#), [411](#)), it inhibits release of neurotransmitters at neuromuscular junctions ( [412](#), [413](#)) and spinal cord synapses ( [414](#)), and it exerts lethal effects on neuronal and glial cells in culture ( [415](#)). Additional support for ALA as the responsible neurotoxin includes the observation that patients with severe ALA-D deficiency and patients with hereditary tyrosinemia ( [416](#), [417](#)), both of whom excrete ALA but not PBG, display neurologic features similar to those of patients with AIP. On the other hand, urine and serum levels of ALA, along with PBG, correlate only roughly with symptoms and signs ( [409](#)). Furthermore, it has not been possible to produce an acute

porphyric attack by administering ALA to animals ( 418 , 419 ), normal human subjects ( 420 , 421 ), or even patients with latent porphyria ( 422 ), although convulsion can be induced by intraventricular injection of ALA and PBG in rats ( 422 , 423 ). A second postulated mechanism is that episodic depletion of cellular heme from marginal to critical levels deprives enzymatic oxidations and energy-producing reactions involving hemoproteins in neural tissues ( 423 ). Experimental inhibition of the heme biosynthetic pathway in dorsal root ganglia cultures causes severe segmental degeneration ( 424 ). The administration of heme to patients suffering an acute porphyric attack often reverses the neuropathic manifestations, but this effect may result from inhibition of hepatic ALA production by heme or its direct action on neural cells; it is not known whether intravenously administered heme enters the brain. Another mechanism was suggested by studies in animals that implicated accumulation of neurotoxic levels of tryptophan and serotonin. Heme depletion impairs catabolism of tryptophan by the heme-dependent enzyme hepatic tryptophan pyrrolase ( 425 , 426 ). In one study, patients with attacks of AIP had serum levels of tryptophan, serotonin, and urinary 5-hydroxyindoleacetic acid that were above normal and that declined after hematin administration ( 427 ). Levels of melatonin, implicated in the regulation of the circadian rhythm, were found to be decreased ( 427 ). Results of studies in animals and in cultured pineal glands suggested that melatonin may also be involved in the regulation of heme synthesis in some manner ( 428 ). Most people (approximately 90%) heterozygous for the PBG-D defect are asymptomatic, but certain precipitating factors cause both biochemical and clinical evidence of the porphyric diathesis. Steroid compounds, both endogenous and synthetic, and drugs ( Table 31.3 ) are the most commonly identified precipitating factors of symptoms ( 16 ). They stress the defective heme biosynthetic pathway. Gonadal hormones, especially the 5-β steroids and ovarian hormones or their metabolites, are most significant and have been shown to induce hepatic ALA synthase ( 16 ). They probably account for the typical onset of symptoms at or shortly after puberty, as well as for the susceptibility of women to porphyric attacks during the luteal phase of the menstrual cycle, when progesterone is high. Hence, the benefit of a luteinizing hormone-releasing hormone analog peptide can be attributed to induction of pituitary refractoriness to luteinizing hormone-releasing hormone to suppress production of progesterone and its 5-β metabolites ( 429 ). The barbiturates and sulfonamides head the list of countless drugs that can precipitate porphyric attacks and usually do so by inducing hepatic apocytochrome P-450 for their metabolism via microsomal hydroxylation, thereby increasing the need for hepatocellular heme ( 16 ), or by direct transcriptional activation of ALA synthase ( 430 ). However, the response of patients is highly variable ( 16 , 431 ). Decreased caloric intake with intercurrent illness may precede acute attacks. Starvation is believed to contribute to the induction of hepatic ALA synthase by depleting cellular heme through mechanisms such as enhanced generation of cytochrome P-450 hemoproteins, induction of heme oxygenase, or both ( 16 ). With carbohydrate administration, urinary excretion of PBG often strikingly decreases, and symptoms tend to improve ( 409 , 432 , 433 ).

**TABLE 31.3. Safe and Unsafe Drugs for Patients with Acute Porphyrias**

| Unsafe                    |                             |                |
|---------------------------|-----------------------------|----------------|
| Aminoglutethimide         | Ethanol excess <sup>a</sup> | Nifedipine     |
| Barbiturates <sup>a</sup> | Ethchlorvynol               | Novobiocin     |
| Bupropion                 | Fentanyl                    | Phenylbutazone |
| Carbamazepine             | Glutethimide                | Primidone      |
| Carbromal                 | Griseofulvin <sup>a</sup>   | Progestins     |
| Carisoprodol              | Isopropyl meprobamate       | Rifampin       |
| Chloroquine               | Ketoconazole                | Succinimides   |

|                                |                                |                            |
|--------------------------------|--------------------------------|----------------------------|
| Chlorpropamide                 | Lamotrigine                    | Sulfonamides <sup>a</sup>  |
| Danazol                        | Mephenytoin <sup>a</sup>       | Sulfonyleureas             |
| Dapsone                        | Meproamate <sup>a</sup>        | Tramadol                   |
| Diclofenac                     | Methyprylon                    | Tranlycypromine            |
| Diphenylhydantoin <sup>a</sup> | Metoclopramide                 | Trimethadione              |
| Enalapril                      | Nefazodone                     | Valproic acid <sup>a</sup> |
| Ergot preparations             |                                |                            |
| Potentially unsafe             |                                |                            |
| Alfadolone                     | Estrogens (synthetic)          | Nikethamide                |
| Alphaxalone                    | Etomidate                      | Nitrazepam                 |
| Alkylating agents              | 5-Fluorouracil                 | Nitrofurantoin             |
| 2-Allyloxy-3-methylbenzamide   | Fluoxetine                     | Pentazocine                |
| Benzodiazepines                | Heavy metals                   | Phenoxybenzamine           |
| Cephalosporins                 | Hydralazine                    | Procarbazine               |
| Chloramphenicol                | Iron chelators (DFO)           | Propofol                   |
| Clonidine                      | Ketamine                       | Pyrazinamide               |
| Colistin                       | Mefenamic acid                 | Spirolactone               |
| Cyclosporin                    | Methyldopa                     | Theophylline               |
| Diphenhydramine                | Metyrapone                     | Tricyclic antidepressants  |
| Erythromycin                   | Nalidixic acid                 | Troglitazone               |
| Believed to be safe            |                                |                            |
| Acetaminophen                  | Digoxin                        | Nitrous oxide              |
| Acetazolamide                  | Estrogens (natural/endogenous) | Penicillin and derivatives |
| Adrenaline                     | Fluoxetine                     | Phenothiazines             |
| Allopurinol                    | Gabapentin                     | Procaine                   |
| Aminoglycosides                | Gentamycin                     | Propanidid                 |
| Amitriptyline                  | Guanethidine                   | Propranolol                |
| Aspirin                        | Ibuprofen                      | Neostigmine                |
| Atropine                       | Indomethacin                   | Ranitidine                 |
| Azathioprine                   | Insulin                        | Rauwolfia alkaloids        |
| Chloral hydrate                | Labetalol                      | Streptomycin               |
| Chlordiazepoxide               | Lithium                        | Succinylcholine            |
| Cimetidine                     | Losartan                       | Tetracyclines              |
| Colchicine                     | Methenamine mandelate          | 6-Thioguanine              |
| Corticosteroids                | Methylphenidate                | Thiouracil                 |
| Coumarins                      | Naproxen                       | Thyroxine                  |
| Cytarabine                     | Narcotic analgesics            | Vigabatrin                 |
| Daunorubicin                   | Neostigmine                    | Vitamin C                  |

NOTE: Statements about drugs in acute porphyrias are based on experience with patients, on tests in animals with experimental porphyria, and on studies in cell cultures. As most commonly used drugs have not been tested, they should be avoided if possible.

<sup>a</sup> Drugs that have most often been cited as agents precipitating acute attacks.

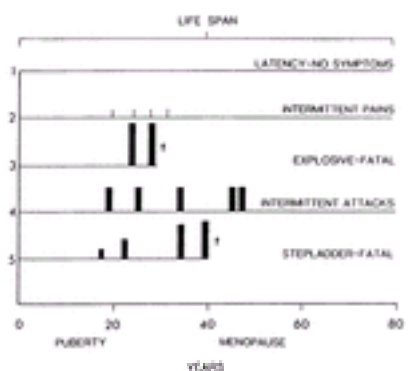
Adapted from Anderson KE, Sassa S, Bishop DF, Desnick RJ. Disorders of heme biosynthesis: X-linked sideroblastic anemia and the porphyrias. In: Scriver CS, Beaudet AI, Sly WS, Valle D, eds. The molecular and metabolic bases of inherited disease, 8th ed. New York: McGraw-Hill, 2001:2961-3062.

**CLINICAL DESCRIPTION** The clinical features of the defect are typically acute symptoms and signs reflecting neurovisceral and psychiatric deficits ( [Table 31.4](#) ). They are more common in women and are highly variable, even among affected siblings. Attacks usually last for several days to several months and are interspersed with long and variable asymptomatic periods. Patients may have as few as three attacks in a lifetime or as many as two or three per year ( [Fig. 31.6](#) ) ( [409](#) , [434](#) , [435](#) ). Most often, the acute attack is an autonomic neuropathy manifested by moderate to severe colicky abdominal pain that is variable in location and characteristically accompanied by constipation, which may be severe, and often vomiting ( [Table 31.4](#) ). In some cases, pain is predominant in the back and limbs. The abdomen is usually soft, with no rebound tenderness or other signs of peritoneal irritation, and dilated bowel loops may be palpable. The abdominal radiograph may show evidence of segmental intestinal dilation and spasm. Other common findings are tachycardia, labile hypertension or hypotension, and urinary retention ( [409](#) ). The pulse rate is often considered a good index for judging the activity of the disease and even the diagnosis ( [436](#) ).

**TABLE 31.4. Signs and Symptoms of Acute Intermittent Porphyria**

| Signs and Symptoms    | Incidence (%) |
|-----------------------|---------------|
| Abdominal pain        | 85–95         |
| Vomiting              | 43–88         |
| Constipation          | 48–84         |
| Tachycardia           | 28–80         |
| Muscle weakness       | 42–68         |
| Mental changes        | 40–58         |
| Hypertension          | 36–54         |
| Extraabdominal pain   | 50–52         |
| Sensory deficit       | 9–38          |
| Fever                 | 9–37          |
| Convulsions           | 10–20         |
| Respiratory paralysis | 9–14          |

Data from three reports, 417 patients: Stein JA, Tschudy DP. Acute intermittent porphyria. A clinical and biochemical study of 46 patients. *Medicine* 1970;49:1–16; Waldenstrom J. The porphyrias as inborn errors of metabolism. *Am J Med* 1957;22:758–773; and Goldberg A. Acute intermittent porphyria: a study of 50 cases. *QJM* 1959;28:183–209.





**Figure 31.6.** Typical courses of acute intermittent porphyria. (From Moore MR, et al. Disorders of porphyrin metabolism. New York: Plenum Publishing, 1987:79, with permission.)

Less often, and with prolonged or more severe attacks, peripheral motor neuropathy occurs. Symptoms include weakness in one or more extremities, especially the upper extremities and proximal musculature, that may progress to flaccid quadriparesis ( 435 , 437 , 438 and 439 ). Bulbar and respiratory muscle paralysis may be life-threatening. Blindness has resulted from both optic nerve and occipital lobe involvement ( 409 , 440 , 441 ). Sensory abnormalities occur less often. The extreme variability of neurologic abnormalities is further illustrated by manifestations of central nervous system disturbances. Acute anxiety and emotional lability can progress to confusion, frank psychosis, and coma ( 438 , 442 , 443 , 444 and 445 ). Tonic-clonic seizures occurred in 17 to 32% in two series of patients ( 409 , 446 ), but, from a recent assessment, lifetime prevalence of seizures among patients in Sweden was only 5% ( 447 ). Seizures may result from profound hyponatremia caused by inappropriate antidiuretic hormone secretion ( 448 ), reflecting hypothalamic dysfunction, or may be a cerebral manifestation of the metabolic defect ( 16 ). In older reports, the mortality rate from neurologic involvement was approximately 30% ( 449 ). Improvement in supportive care in the 1970s reduced the mortality rate to approximately 10% ( 431 , 433 ), and the introduction of therapy with intravenous hematin reduced the mortality rate further ( 446 ). If peripheral nerve deficits develop, they may clear slowly, over months or even years. Depression, including suicidal tendencies, may follow an attack. Chronic hypertension and renal impairment are reported to develop in up to 50% of patients with AIP ( 431 , 449 , 450 and 451 ). The hypertension may predispose to renal insufficiency. The few reported children homozygous for the genetic defect ( 399 , 400 , 452 ) manifested central nervous system defects, including hypoplasia of brain structures, rather than the usual neurovisceral features. In one infant, the clinical phenotype appeared to be normal ( 399 ).

**LABORATORY FINDINGS** Results of routine hematologic measurements usually are within normal limits; however, leukocytosis occasionally is observed during acute attacks ( 409 ), a finding that may support an erroneous impression of an abdominal condition requiring an emergency operation. Anemia is an uncommon finding and, when present, may not be related to the porphyria ( 409 ). Some patients have an unexplained reduction in both the plasma volume and the red cell mass even though the volume of packed red cells is normal ( 453 ). Red cell survival is normal, suggesting that the decreased red cell mass results from reduced effective erythropoiesis ( 453 ). The biochemical hallmark is the excessive urinary excretion of the porphyrin precursors, PBG and, to a lesser extent, ALA. These compounds are accurately quantified by ion exchange chromatography ( 454 ). Normally, less than 7 mg of ALA and less than 4 mg of PBG are excreted in 24 hours regardless of the analytic method used. During acute attacks, the urinary excretion of PBG ranges from 20 to 200 mg daily ( 409 , 455 , 456 ). In one study, 21 symptomatic patients excreted an average of 83 mg of PBG in 24 hours (range, 8 to 150 mg) ( 409 ). A rough correlation exists between the amount of PBG excreted and the severity of clinical symptoms. ALA and PBG excretion diminishes during remission but rarely returns to normal. In 12 asymptomatic patients, the average urinary PBG excretion was 32 mg in 24 hours (range, 12 to 60 mg), and ALA excretion was 10 mg in 24 hours (range, 6 to 18 mg) ( 409 ). Serum normally contains only trace amounts of ALA and PBG, but patients with AIP may have serum PBG concentrations as high as 300 µg/dl during acute attacks ( 16 ). Increases in the liver content of ALA and PBG have been noted at autopsy in patients who died during acute attacks. A rapid qualitative method of detecting excess PBG in urine is the Watson-Schwartz test ( 457 ). This test yields negative results in normal subjects and positive results when PBG excretion exceeds approximately 6 mg/L ( 457 ).

Other urinary chromogens, particularly urobilinogen, as well as certain drugs and drug metabolites may also form a similar color when they react with Ehrlich reagent, but only the PBG–Ehrlich complex is water soluble and cannot be extracted with chloroform and butanol. When properly performed and interpreted, the Watson–Schwartz test is reliable. In inexperienced hands, false–positive results are common; in one referral center, 75% of patients with supposedly positive findings had normal values when quantified by chromatography ( 409 ). A variation of the Watson–Schwartz test, the Hoesch test, has been advocated for bedside screening ( 458 ). The sensitivity and specificity are less than those of the Watson–Schwartz test ( 459 ), but the simplicity of the Hoesch test may make it more reliable in inexperienced hands ( 457 ). A newer test, although more complicated, is more sensitive ( 460 ). A positive qualitative test should always be confirmed by ion exchange chromatography. Because PBG is a colorless compound, freshly excreted urine from patients with AIP appears normal in color. On exposure to light and air, two reactions are accelerated that cause PBG–containing urine to darken on storage. First, PBG is oxidized to porphobilin, a dark brown, amorphous product ( 461 ). Second, PBG may be nonenzymatically converted to a mixture of porphyrins, especially uroporphyrin, a reaction favored at acidic pH (approximately 4.0), and quantitation of uroporphyrin and coproporphyrin in urine can then detect mild to moderate elevations ( 457 ). Therefore, the so–called urine porphyrin screen commonly carried out is also positive. However, it merely detects an increased concentration of coproporphyrin, which can also be associated with a variety of illnesses, and is of little if any diagnostic value. Fecal porphyrin excretion is normal or only slightly increased ( 16, 462, 463 ). Another useful measurement for diagnosis and detection of relatives with the latent defect, in whom urinary PBG excretion is often normal ( 375, 382 ), is the erythrocyte PBG–D activity, provided that it is recognized that the erythrocyte value may be indeterminate or normal in up to 10% of cases because of heterogeneity of *PBG–D* mutations and, rarely, because the enzyme is not affected in red cells ( 380, 381, 382 and 383 ). DNA analysis constitutes the definitive means to identify a PBG–D defect, but the marked genetic heterogeneity encountered precludes the feasibility of a routine genetic test for diagnosis. However, molecular techniques have been refined for routine DNA analysis of new probands to localize the region of a mutation and simplify sequencing of the relevant DNA segment ( 396, 464, 465 ). Then, carriers within the family are easy to detect for preventive measures. Hyponatremia, reduced blood volume, and mild elevation of blood urea nitrogen often are observed during acute attacks ( 409 ). The findings may be attributed to vomiting. The syndrome of inappropriate antidiuretic hormone secretion has been documented ( 409, 448, 466, 467 ) and is presumably the result of a hypothalamic abnormality. When carefully sought, other evidence for hypothalamic involvement is found, such as disturbed regulation of growth hormone and adrenocorticotrophic hormone secretion. However, the increased antidiuretic hormone secretion may be an appropriate response in patients with unexplained reduction in total blood volume ( 468 ), and fluid restriction would not be appropriate therapy for such patients. In one study of 45 patients hospitalized for acute porphyric attacks, hyponatremia was more often related to vomiting, poor intake, and excess renal sodium loss than to inappropriate secretion of antidiuretic hormone ( 469 ). Hypomagnesemia associated with tetany has also been reported ( 433, 448 ). Abnormal electroencephalographic patterns are a common laboratory sign of the neurologic dysfunction. Diffuse, nonspecific slowing of the wave pattern was found in 14 of 24 patients during an acute attack ( 409 ). Reversible abnormalities on both sides of the brain may be detected by magnetic resonance imaging ( 470, 471 ). The pattern suggests a vascular ischemia as the cause of cerebral dysfunction. In two cases with cortical blindness, similar lesions were limited to the occipital lobes ( 472 ). The cerebrospinal fluid usually is normal. The peripheral neuropathy is a “dying back” process in which neuron damage follows axonal demyelination ( 16, 438 ). Electrophysiologic studies and microscopic



examination of nervous tissue ( [473](#) , [474](#) , [475](#) and [476](#) ) indicate that the acute attack affects primarily neuronal bodies, leading to an acute axonal degeneration of peripheral and autonomic nerves and to neuronal loss and gliosis in the central nervous system. In patients with latent porphyria, slower motor and sensory conduction velocities are detectable ( [477](#) ), as is parasympathetic dysfunction of peripheral nerves when assessed with bedside tests of cardiovascular reflexes ( [478](#) ). Parasympathetic dysfunction has also been demonstrated by spectral analysis of heart rate variability ( [479](#) ), which may predispose to arrhythmias in symptomatic and latent disease.

**TREATMENT** When an acute attack occurs, patients usually require hospitalization because the clinical course is difficult to predict, and causes for the symptoms other than porphyria must be excluded. Precipitating factors should be removed if possible, but often the specific factor in a particular attack cannot be identified. Pain should be treated with safe analgesics and narcotics such as morphine. Fluid, electrolyte, and caloric deficits should be restored. Carbohydrate is administered intravenously (as 10% dextrose) so that the equivalent of 300 to 500 g of glucose is given daily ( [409](#) , [433](#) , [480](#) ). Propranolol has been effective in reducing tachycardia and hypertension in some patients ( [481](#) ) but must be used very cautiously if at all in patients with hypovolemia ( [482](#) ). Maintenance of the patient's morale and alleviation of fear are also important and facilitate recovery. In very ill patients without improvement within 24 hours and in those who have progressive neurologic manifestations, therapy with intravenous hematin (soluble crystalline heme chloride) should be initiated. This compound has been used in therapeutic trials since the early 1970s ( [483](#) , [484](#) , [485](#) , [486](#) , [487](#) and [488](#) ), with the rationale being to correct the apparent heme deficiency and repress the overproduction of porphyrin precursors. Hematin became commercially available in 1983 (Panhematin, currently supplied by Ovation Pharmaceuticals, Inc., Deerfield, IL, 313 mg of hematin/vial), and its use in the treatment of the acute attack has been a significant advance. The benefits are most marked when the compound is given early in an attack, before potentially irreversible neuronal damage has occurred ( [480](#) , [485](#) , [487](#) , [489](#) , [490](#) ). Hematin, reconstituted with albumin, is administered in a dose of 3 to 5 mg/kg body weight once daily for 4 to 5 days. High doses (e.g., 1000 mg infused over 15 minutes) may produce acute renal failure ( [491](#) ), and local venous irritation at the site of injection may occur ( [487](#) , [488](#) and [489](#) ). After infusion of hematin, a rapid decrease in ALA and PBG concentrations in serum and urine is observed, and clinical symptoms generally, but not always, improve within 48 hours. Because of instability of the hematin in solution, thrombocytopenia and a mild transient coagulopathy manifested by prolongation of both the partial thromboplastin time and the prothrombin time occur with some regularity during hematin infusion therapy ( [492](#) ) and are attributed to degradation products of hematin ( [493](#) , [494](#) ). Clinical signs of bleeding are rarely observed and are usually associated with the simultaneous administration of heparin ( [489](#) , [495](#) ). A Finnish preparation, heme arginate, is more stable ( [496](#) ) and does not produce coagulopathy ( [497](#) , [498](#) ). Tin protoporphyrin, an inhibitor of heme oxygenase, in combination with heme arginate restored efficacy when tolerance to the heme developed ( [499](#) ), and it is being evaluated. The management of seizures is a considerable challenge. If they are related to metabolic disturbances of hyponatremia and hypomagnesemia, correction of these derangements may control them. However, if seizures are related to the porphyric diathesis or are a chronic associated problem, their management may be difficult because most effective anticonvulsants are contraindicated ( [Table 31.3](#) ) ( [500](#) , [501](#) and [502](#) ). The use of bromides, a nineteenth-century mode of therapy, has been suggested as an alternative ( [500](#) ), but evidence is lacking for their effectiveness in this setting. An agent such as clonazepam appears to be safe ( [438](#) ), but its efficacy in the control of grand mal seizures is not documented. Magnesium sulfate has been advised ( [503](#) ) and was used effectively in one reported case ( [504](#) ). Two newer antiepileptic drugs, gabapentin and vigabatrin, are not metabolized by the liver and are probably the therapy of choice for

epilepsy in acute hepatic porphyrias (505). Prevention of acute attacks is the cornerstone of treating the patient in whom the diagnosis has been established and includes identification of carriers among relatives. Avoidance of most drugs is important, and patients should receive a list of drugs to avoid (Table 31.3). The most extensive current list of safe and unsafe drugs is provided by Hift et al. (506). For anesthesia purposes, an adequate number of agents that are considered safe have been evaluated (507). Patients should be warned that fasting may induce attacks (508); they should take in sufficient calories to maintain a normal body weight and promptly consult a physician whenever adequate oral intake is interrupted by intercurrent illness. In women whose attacks are related to the menstrual cycle, prevention may be achieved by suppression of ovulation with oral contraceptives (16, 409). Paradoxically, oral contraceptive steroids can also worsen symptoms in some women (16). A long-acting agonist of luteinizing hormone-releasing hormone that permits suppression of ovulation without the administration of exogenous steroids is effective in women who have frequent cyclical attacks; it can be taken continuously (429) or intermittently with a progesterone (509). Association of AIP with pregnancy is rare, and reports consist of small series (510). Although earlier reports indicated a high rate of exacerbation and maternal mortality, meticulous prenatal and perinatal care can assure good maternal outcome. Low-dose estrogen replacement is probably safe in women with an acute porphyria who are naturally menopausal. A first step toward gene therapy has been taken with nonviral gene transfer in PBG-D-deficient fibroblasts from an AIP patient with restoration of PBG-D activity (511).

**HEPATOCELLULAR CARCINOMA** Several studies indicate an association between primary liver cancer and AIP. In Scandinavia, where the incidence of AIP is high, a retrospective population-based mortality study revealed that hepatocellular carcinoma was the cause of death in approximately one-fourth of patients with AIP (512). The relative risk for men was 70 and for women was 140. Liver cirrhosis was considerably more common in the patients (12.0%) than in controls (0.5%). Impaired detoxification capacity of mutagenic substances by the liver with impaired heme synthesis and cirrhosis are believed to enhance a genetic change over time. It was advised that all patients carrying an acute porphyria gene be screened for hepatocellular carcinoma after age 55. A cohort study in Denmark and Sweden found a standardized incidence ratio of 1.8 for 296 patients with AIP (513). In France, among 650 patients with acute hepatic porphyrias who were followed for 7 years, seven developed primary liver cancer (514). In two sisters elsewhere with AIP, hepatocellular carcinoma was associated with excessive intake of alcohol (515). In one patient with hepatoma but not porphyria, the tumor produced large amounts of PBG as an apparent paraneoplastic feature (516).

**ANIMAL MODEL OF ACUTE INTERMITTENT PORPHYRIA** That the neurologic syndrome representing the clinical features of AIP is related to the PBG-D defect has been verified in transgenic mouse experiments (517). The PBG-D-deficient mice exhibit the typical biochemical characteristics as well as the neuropathologic features of the human disease when treated with phenobarbital (518). The data suggest that heme deficiency and consequent dysfunction of heme proteins can cause porphyric neuropathy. Moreover, the limited heme synthesis in the PBG-D-deficient mice impairs activation of cytochrome P-450 genes by phenobarbital (519), whereas zinc mesoporphyrin represses the induced hepatic ALA synthase and reduces heme oxygenase activity (520), making this compound a potential candidate for treatment of acute porphyrias.

## 5-Aminolevulinic Acid Dehydratase Deficiency Porphyria

*ALA dehydratase deficiency porphyria* (ADP) (plumboporphyria) is the most recently identified porphyria and has been described in seven unrelated cases. It is inherited as an

autosomal-recessive trait, and mutations in both *ALA-D* alleles are responsible for the disorder. The clinical phenotype is strikingly similar to that of AIP.

**MOLECULAR BASIS AND PATHOGENESIS** ALA-D is the second enzyme in the heme biosynthetic pathway ( Fig. 31.1) and is encoded by a single gene, located on chromosome 9 (9q34) ( 521). Analogous to the *PBG-D* gene, the *ALA-D* gene contains two promoter regions that generate housekeeping (ubiquitous) and erythroid-specific transcripts by alternative splicing of a separate exon 1 in each case to exon 2, but both transcripts encode identical ALA-D polypeptides ( 522). In seven reported patients (including two siblings), the erythrocyte enzyme activity was close to 1% of normal, and, in the asymptomatic parents and relatives carrying the trait, it was approximately 50% ( 16, 523, 524, 525, 526 and 527), in keeping with an earlier study of a family with heterozygous ALA-D deficiency and absence of clinical manifestations ( 528). Immunologic studies demonstrated considerably more enzyme protein (20 to 33%) than catalytic activity, implying that a structural defect affects the active site of the enzyme ( 529, 530 and 531). In three of the cases, mutations have been identified in both alleles of the *ALA-D* gene ( 532, 533 and 534), and they were compound heterozygotes. The mutations occurred near the catalytic site of the enzyme and would likely cause marked instability of the protein or may affect binding of the structural zincs of the enzyme. In an asymptomatic child heterozygous for a novel *ALA-D* mutation, enzyme activity was only 12%, whereas it was 30% in family members carrying the mutation ( 535). In the case with late onset ( 526), likewise, only a single mutation was identified, ALA-D activity was 1% of normal, and the late clinical expression of the disease was proposed to be related to the patient's coincidental acquisition of the clonal disorder polycythemia vera ( 536). Heterogeneity of the genetic defects probably accounts for the great phenotypic variation among the patients. The mechanisms for the dominating neurologic features present in all the cases appear to be similar to those discussed for AIP, and the large accumulation of ALA caused by the biosynthetic block supports its implicated importance as a neurotoxin in the pathogenesis. The neuropathies of hereditary tyrosinemia ( 416, 417) and lead intoxication are likewise associated with ALA accumulation, and ALA-D is the enzyme in the heme synthetic pathway that is most susceptible to lead. The identification of two common alleles of human ALA-D (*ALAD1* and *ALAD2*), resulting in three polymorphic isozyme phenotypes ( 537, 538), led to the demonstration that patients with *ALAD1-2* and *ALAD2-2* phenotypes had higher blood lead levels than those homozygous for the *ALAD-1* allele ( 538, 539) and are thus at increased risk for lead poisoning effects. The molecular difference of one amino acid substitution accounts for the two alleles ( 540), but the mechanism for the increased binding of lead by the enzyme has not been established. Patients with a genetic ALA-D deficiency who also possess a susceptible isozyme phenotype may be at greater risk of developing signs of lead intoxication at a lower lead burden.

**CLINICAL DESCRIPTION** The clinical findings have varied widely among the small number of cases with ADP. A child had recurrent severe neurovisceral manifestations as well as severe respiratory muscle compromise since birth ( 524). Two unrelated male patients had onset of major symptoms of abdominal pain and motor neuropathies, with some respiratory muscle involvement in adolescence ( 523); they are reported as surviving more than 20 years later ( 541). Two brothers in their twenties manifested an acute episode of autonomic symptoms but no other neurologic deficits when the diagnosis was established ( 527). In these cases, precipitating factors were not clarified, but the symptomatology and course resemble the variable neural manifestations of acute porphyrias. In contrast, symptoms of motor neuropathy but no abdominal symptoms first developed in a man at age 63, persisted, and progressed in association with development of a hematopoietic clonal disorder ( 526, 536). Heterozygotes for ALA-D deficiency are asymptomatic.

**LABORATORY FINDINGS** The distinguishing laboratory finding in ADP is a markedly increased urinary excretion of ALA that has ranged from 8 to 80 times the normal value

and correlates with clinical severity; the PBG values are slightly increased, up to four times normal ( 523 , 524 , 527 , 534 ). Plasma ALA concentration is increased approximately tenfold ( 526 ). Urinary coproporphyrin (isomer III) is also typically raised 10– to 60–fold but remains unexplained. Fecal porphyrins are normal in most cases ( 523 , 527 , 534 ). The FEP is increased, from 3 to 30 times normal ( 523 , 524 , 527 , 534 ). This spectrum of biochemical abnormalities closely resembles those found in lead poisoning, although usually the abnormal values are considerably lower, and blood lead determinations would exclude this diagnosis. Despite the defects in both alleles, erythropoiesis does not appear to be compromised as hemoglobin values are normal. Heterozygotes for an ALA-D defect have no biochemical abnormalities except for the reduced levels of ALA-D activity ( 528 ).

**TREATMENT** Supportive measures as outlined for AIP are generally helpful for acute episodes of ADP as well. Hematin infusions appeared to be of benefit in one case ( 525 ). In the small child, the disease was reported to markedly impair nutrition and normal development. At age 6, liver transplantation was performed to attempt to reduce the metabolic abnormalities ( 542 ). The high basal urinary excretion of ALA and porphyrin was not influenced by this procedure, indicating that these products originate mainly in extrahepatic tissues. However, clinical challenges with drugs and intercurrent illnesses no longer increased the urinary ALA and PBG, so heme synthesis does not appear to be induced in nonhepatic tissues ( 542 ). It was hypothesized that a bone marrow transplant might more effectively remove the major source of the abnormal metabolites.

## ACUTE OR INDUCIBLE PORPHYRIAS WITH BOTH NEUROLOGIC AND CUTANEOUS MANIFESTATIONS

### Variegate Porphyria

*Variegate porphyria* (VP) (South African porphyria) is inherited as an autosomal-dominant trait with low penetrance and is caused by mutations in the gene encoding PP-O, the enzyme that catalyzes the penultimate step of heme biosynthesis ( Fig. 31.1 ). Consequent accumulation of protoporphyrin (and coproporphyrin) leads to skin fragility and photosensitivity. Because the production of heme also is reduced and ALA synthesis is induced, acute neurovisceral attacks occur that closely mimic the picture of AIP.

Although Gunther ( 3 ) and Waldenstrom ( 69 ) recognized cases of porphyria in which neurologic and cutaneous manifestations occurred together, the extensive investigations of Dean and Barnes in South Africa provided the most complete information about this disease and clearly distinguished it from AIP. They identified 300 patients whose lineage was traced to a couple who migrated from Holland in 1688 ( 134 ). This common ancestor of almost all South African patients explained the prevalence of the disease of approximately 3 per 1000 among the white (Afrikaner) population ( 543 ). VP is less common outside South Africa, but hundreds of cases have been reported from other countries ( 544 ). The prevalence of VP in Finland has been estimated at 1.3 per 100,000 ( 545 ). In the United States and Europe, it has probably been underestimated or overlooked ( 546 , 547 ) because the cutaneous manifestations tend to be more mild in temperate and cold latitudes than in South Africa. Indirect evidence suggests that George III of England and other members of the royal houses of Stuart, Hanover, and Prussia suffered from this form of porphyria (often called *the royal malady*) ( 548 ). Attempts at retrospective diagnosis with DNA material from deceased relatives of George III were undertaken but have not proven conclusively that he had VP ( 549 ).

**MOLECULAR BASIS AND PATHOGENESIS** PP-O activity is half normal in cultured skin fibroblasts ( 550 ) and blood lymphocytes ( 551 ) and accounts for the observed pattern of

porphyrin excretion ( [Table 31.2](#)). The gene for the enzyme is the last of the heme synthesis enzymes to be cloned and characterized ( [552](#), [553](#), [554](#), [555](#) and [556](#) ), and it has been mapped to chromosome 1 (1q23) ( [553](#), [555](#) ). To date, at least 118 distinct mutations in the *PP-C* gene have been identified in patients with VP throughout the world ( [16](#), [544](#) ) and include insertions, deletions, missense and nonsense mutations, and splice site mutations. Most of the mutations occur in single pedigrees, and only approximately 8% occur in four or more families. One mutation (C452T) in exon 3 of the gene, causing replacement of arginine by tryptophan in codon 59 (R59W), is found in 94% of VP patients in South Africa ( [557](#), [558](#) ). It is also found in Holland, and it is fairly well established by linkage analysis that the families are related ( [544](#) ). When expressed in *Escherichia coli*, this mutant protein had an almost undetectable catalytic activity, presumably related to its location in the binding motif of flavin adenine dinucleotide, an essential cofactor for the enzyme ( [559](#) ). On average, mutations in heterozygotes are associated with a PP-O activity of 50%, with loss of all enzyme activity from the mutant allele, and thus are referred to as *severe* mutations. In compound heterozygotes and homozygotes, enzyme activities are less than 20% of normal, which would be contributed by residual activity of the mutant protein encoded by at least one of the alleles in heteroallelic cases or by residual activity from both alleles in homoallelic cases. Such mutations are referred to as *mild*. The photosensitivity symptoms are accounted for by the accumulating protoporphyrin and, to some extent, coproporphyrin, which are released into plasma and exert the photochemical reactions in the skin ( [23](#) ). Protoporphyrinogen is a competitive inhibitor of CP-O ( [560](#) ) and, as such, is believed to account for the accumulation of coproporphyrinogen and the increased excretion of coproporphyrin. The neurovisceral symptoms in VP can be attributed to a relative deficiency of PBG-D ( [561](#) ). This enzyme is inhibited by coproporphyrinogen and protoporphyrinogen in an allosteric manner, and their accumulation can account for the relative PBG-D deficiency ( [562](#) ). The inhibition may be insufficient to produce biochemical changes of increased PBG (and ALA) excretion during quiescent periods. With increased demands for heme and induction of ALA synthase by endogenous or exogenous porphyrinogenic agents, the PBG-D step becomes rate-limiting so that the porphyrin precursors accumulate and may account for the neurologic manifestations, as in AIP.

**CLINICAL DESCRIPTION** VP is rarely expressed before puberty, and it is not uncommon for the disease to remain clinically and biochemically latent throughout life ( [544](#) ). Previously, in South Africa, 90% of patients were symptomatic, and cutaneous involvement was the initial symptom in one-half of patients ( [543](#) ). More recent experience reflects a changing pattern with less than 10% of VP patients experiencing a neurovisceral attack ( [563](#) ), and, with the advent of genetic testing, up to 60% are asymptomatic ( [544](#) ). The changes are attributed to more sensitive diagnostic testing, physician and patient education, and less use of drugs that precipitate symptoms. In the United States and Europe, skin manifestations are uncommon and, when present, tend to be mild and rarely are the initial manifestation of the disease ( [544](#), [545](#) ). The characteristic cutaneous feature is severe mechanical fragility of the skin that is limited to sun-exposed areas, especially the face and hands ( [Fig. 31.7](#) ), and is often indistinguishable from PCT. Trivial mechanical trauma to these areas results in detachment of the epidermis from the dermis, with formations of bullae or erosions. The light microscopic and ultrastructural changes in the skin of patients with VP are also similar to those found in PCT. Vascular walls are particularly affected, and the pathologic changes are observed in asymptomatic patients with increased porphyrin excretion ( [564](#) ). In addition, facial hirsutism and hyperpigmentation are common.





**Figure 31.7.** Cutaneous manifestations of variegate porphyria. **A:** Bulla on index finger, pigmented scars, and collapsed blisters at fingertips of a 27-year-old woman. **B:** Hands of a 36-year-old man. Note erosions on back of hands, depigmented scars of past lesions, and subungual involvement. (Courtesy of Dr. Lennox Eales, University of Cape Town, South Africa.)

The neurovisceral attacks of VP do not differ in any important respect from those of AIP, although hyponatremia was quite common (543); psychiatric features are uncommon (544). Acute attacks are somewhat less common in VP than in AIP and usually have occurred after exposure to a porphyrinogenic drug (Table 31.3) (543, 565). In early studies, the mortality rate during an acute attack approached 25% but was subsequently reduced dramatically (566). To date, 12 unrelated compound heterozygotes and two homozygotes for PP-O defects have been encountered (544). The major clinical features are severe photosensitivity and, commonly, mental retardation, seizures, sensory neuropathy, retarded growth, and skeletal abnormalities. With onset in adolescence, the permanent neurologic features are absent, but neurovisceral attacks may occur.

**LABORATORY FINDINGS** Patients with symptomatic VP with skin disease or with neurovisceral features uniformly have abnormal biochemical findings. The most characteristic and consistent laboratory abnormality is the excretion of large amounts of protoporphyrin and coproporphyrin in the feces (16, 543, 566). In South African patients, fecal protoporphyrin excretion reached 1500  $\mu\text{g/g}$  dry weight, and fecal coproporphyrin excretion reached 1300  $\mu\text{g/g}$  dry weight (normal total fecal porphyrin excretion is  $<200$   $\mu\text{g/g}$ ) (543). A particularly significant feature is the presence of 5-COOH porphyrins (567). The diagnosis of VP can be established by fecal analysis during an acute attack, during periods when only cutaneous manifestations are present, or during a clinically latent stage of the disease with high-performance liquid chromatography techniques. However, up to 30% of asymptomatic patients have normal fecal porphyrin profiles (544). Measurement of porphyrins in bile sampled by duodenal aspiration has been shown in a series of patients to provide a clearer differentiation between patients or carriers and normal subjects, particularly in people in whom fecal porphyrin values are indeterminate (568). The mean biliary porphyrin value in patients with VP was 68.0  $\mu\text{mol/L}$ , as compared with 0.7  $\mu\text{mol/L}$  in normal controls, and the lowest patient value was more than nine times the highest control value. Because the plasma porphyrins are commonly increased, examination of plasma for the characteristic fluorescence emission spectrum observed in VP (emission maximum, 626 nm, at neutral pH) (16) is probably the fastest way to establish the diagnosis. For the detection of asymptomatic carriers, this method was found to be 100% specific and 86% sensitive in one study (569) but was not considered sufficiently sensitive in another (570). During acute attacks, ALA and PBG are excreted in large amounts in the urine, as in AIP. However, the demonstration of excessive urinary ALA or PBG justifies only the diagnosis of acute porphyric attack, and a more specific diagnosis is not possible without analysis of the feces or plasma. In contrast to AIP, urinary excretion of ALA and PBG generally returns to normal after an acute attack (16, 543, 544) and usually is normal or only slightly increased in patients in whom the only clinical manifestations are cutaneous. During latent periods, urinary porphyrin excretion is usually normal; during acute attacks, or in the presence of superimposed liver dysfunction, it may be greatly increased (16, 543, 566). When cutaneous symptoms alone are present, coproporphyrin is the major urinary porphyrin, but uroporphyrin excretion may also be increased (543). During acute attacks, nonenzymatic conversion of PBG to uroporphyrin may occur, giving rise to an artifactually dramatic elevation of urinary uroporphyrin excretion (543).

Measurement of PP-O activity can establish the diagnosis. Because it is a mitochondrial enzyme, the assay requires nucleated cells, such as Epstein-Barr-transformed lymphocytes ( 561, 562). Time and costs involved make it impractical as a routine diagnostic test. The FEP is somewhat increased in heterozygotes. In homozygotes or compound heterozygotes, it ranges from five to ten times above normal, but anemia is usually absent.

**TREATMENT** Acute attacks should be prevented and treated as outlined for AIP. Hematin or heme arginate is used for severe attacks and is most effective if administered early in the course of the attack ( 485, 490). Glucose may be of benefit ( 543). Protection against sun exposure is the only practical way to deal with the photosensitivity. Identifying abnormal gene carriers, feasible only by fecal or plasma analysis, is important because, as in AIP, most acute attacks can be prevented by avoiding precipitating drugs or other factors. Because of the great heterogeneity of *PP-C* mutations recognized, DNA mutational analysis is less practical except in the rare areas where a single mutation is prevalent.

**ANIMAL MODEL OF VARIEGATE PORPHYRIA** A mouse model for South African VP with the R59W mutation has been established by targeted gene replacement ( 571). The biochemical features closely resemble the human disease.

### Hereditary Coproporphyrin

*Hereditary coproporphyrin* (HCP) is transmitted as an autosomal-dominant trait with a low penetrance. Mutations in the gene encoding CP-O ( Fig. 31.1) result in suboptimal activity of the enzyme and lead to accumulation and excessive excretion of coproporphyrin. Analogous to VP, the porphyrin produces photosensitivity, and neurovisceral attacks occur with induction of heme biosynthesis.

Excessive fecal excretion of coproporphyrin by a patient with porphyria was first noted in 1936 ( 572), clinical features were recorded in 1949 ( 573), and the first comprehensive description of the disorder was that of Berger and Goldberg ( 574). A review describing clinical and laboratory findings in 111 patients with HCP appeared in 1977 ( 575). The disorder is less common than AIP and VP.

**MOLECULAR BASIS AND PATHOGENESIS** CP-O activity is reduced to half normal in all tissues examined, including cultured skin fibroblasts ( 576), mixed leukocytes ( 575), lymphocytes ( 577), liver ( 578, 579), and kidney ( 579). In homozygous cases, enzyme activity ranged from 2 to 10% of normal ( 580, 581 and 582); in a compound heterozygous case, it was 22% ( 583). In the harderoporphyria variant of HCP, unique kinetic characteristics of the enzyme are associated with accumulation of a tricarboxylic coproporphyrin (harderoporphyrin) ( 581, 582 and 583). The cloning and characterization of the *CP-O* gene ( 584, 585 and 586), which is located on chromosome 3 (3q12) ( 587), led to the identification of numerous mutations in the gene. To date, at least 34 different mutations have been reported, and all but two have been restricted to single families ( 588, 589). The mutations are predominantly missense mutations affecting enzyme function or stability or leading to production of incomplete proteins. Despite the marked allelic heterogeneity at the molecular level and a wide range of residual enzyme activities of mutant proteins, clinical features are similar. The proteins of two mutant alleles associated with harderoporphyria impair the second decarboxylation of coproporphyrinogen III from harderoporphyrinogen ( 588). The pathogenesis of the clinical features can be viewed as the same as in VP, with induction of ALA synthase during attacks ( 590). The photosensitivity occurs mainly during periods of a neurovisceral attack, probably because plasma levels of the photosensitizing coproporphyrin become



sufficiently elevated. Coproporphyrin is transported efficiently from the hepatocyte into bile or plasma and does not accumulate in the liver ( 591 ). In harderoporphyria, the mechanism for the anemia has not been characterized. It seems attributable to at least a photohemolysis component in that erythrocyte porphyrin (reported as protoporphyrin) was increased approximately eightfold when compared to related asymptomatic heterozygotes, and it lessened with age ( 583 ).

**CLINICAL DESCRIPTION** The disease is generally latent before puberty, and two-thirds of patients have no symptoms ( 575 , 592 ). In one patient, the first attack occurred at age 84 ( 592 ). Acute attacks are usually precipitated by drugs ( 593 ), and acute peripheral neuropathy may be the only manifestation ( 594 , 595 ). The neuropathic findings are similar to those of AIP ( 596 , 597 ) but are generally less severe; occasionally, only psychiatric features are evident ( 593 ). Photosensitivity is less common than in VP, and unlike in the latter, it tends to occur mainly in the presence of neurovisceral episodes. Rarely, intermittent episodes of cutaneous symptoms may be the only clinical manifestation of the disease ( 575 ). The cutaneous symptoms are similar to those of VP and PCT. In the few homozygotes reported, the clinical picture does not appear to differ greatly from that in heterozygotes. In harderoporphyria, jaundice, hepatosplenomegaly, and anemia were present after birth and diminished with time ( 581 , 582 and 583 ).

**LABORATORY FINDINGS** The fecal coproporphyrin level is invariably increased after puberty and may approach or exceed 10,000 µg/g dry weight during an attack. An increase in the fecal coproporphyrin isomer III to isomer I ratio is also a distinguishing feature, particularly in latent heterozygotes ( 598 ). During acute attacks, urinary coproporphyrin excretion may be profoundly increased but usually is normal during remissions. As in VP, urinary ALA and PBG are typically increased only during attacks. In harderoporphyria, the predominant fecal porphyrin is tricarboxylic coproporphyrin; in urine, it is detectable only in trace amounts. In some homozygotes, the hemoglobin is decreased, there is brisk reticulocytosis, and the accumulated erythrocyte porphyrin is protoporphyrin ( 581 , 582 ).

**TREATMENT** HCP should be managed as described under AIP and VP. Heme arginate is effective ( 599 , 600 ). Detection of affected relatives of patients is important because avoiding specific drugs will probably prevent overt symptoms. CP-O assays are not widely available, leaving stool porphyrin determinations as the only practical screening method.

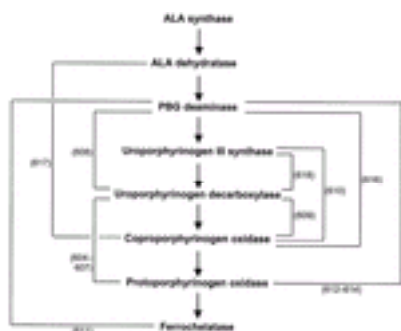
**HEPATOCELLULAR CARCINOMA** One case of hepatocellular carcinoma associated with HCP has been reported ( 601 ). After surgical resection, no recurrence was observed at 5 years of follow-up.

## DUAL PORPHYRIAS

During the last three decades, a number of families have been discovered to have defects of two distinct porphyrias. In two families, individuals had one or the other trait. Two cases of PCT were described in a family in which five other members had VP ( 602 ). In the second instance, a father had PCT and a daughter had typical EPP ( 603 ).

Nine different combinations have been described in which patients possessed two porphyria defects ( Fig. 31.8 ). The first such type reported involved the occurrence of VP and PCT ( 604 ). In South Africa, 25 of 106 patients with VP excreted porphyrins typical of PCT as well. The clinical features and subsequent enzyme assays ( 605 ) were consistent with those of both porphyrias. Biochemical data in further cases were also consistent with concomitant defects of VP and PCT, but family studies were not reported ( 606 , 607 ). Additional dual porphyrias consisting of an acute form plus a cutaneous form that have been encountered include AIP with PCT, with clinical manifestations of both defects ( 608 ); HCP with PCT ( 609 ); HCP with CEP in a child manifesting hepatosplenomegaly,

hemolytic anemia, severe photodermatosis, and impaired growth and mental development (610); and AIP with possible EPP and severe neurovisceral manifestations that were fatal (611). In the latter case, biochemical studies reflected a PBG-D defect as well as FECH deficiency. Analysis of the sciatic nerve revealed reduced PBG-D activity coupled with increased activity of ALA synthase, representing the first such data in human neural tissue.



**Figure 31.8.** Enzyme defects in dual porphyrias. Pairs of the respective enzymes involved in the nine reported forms of dual porphyria are joined by brackets. Reference numbers are in parentheses. ALA, 5-aminolevulinic acid; PBG, porphobilinogen.

In 1985, a large kindred of 200 descendants stemming from a marriage in 1886 was encountered in Chester, Scotland, in which clinical presentations had been typical of AIP and, in some cases, were severe and fatal (612, 613 and 614). Biochemical studies reflected values ranging from those observed in AIP to those found in VP. Clinically affected patients had both deficient PBG-D and PP-O activities in peripheral blood leukocytes, although there appeared to be some overlap with control values in some cases (612). A linkage analysis with polymorphic markers suggested that the locus for the disease is on chromosome 11 but is separate from the *PBG-D* gene (615). A second form of two coexisting acute porphyria defects involved PBG-D and CP-O (616). Among 17 family members examined, the dual enzyme deficiency was found in five, PBG-D deficiency alone in four, and CP-O deficiency alone in two (616). Only the proband with both defects suffered mild acute attacks of porphyria and had the most marked changes in porphyrin and porphyrin precursor excretions, probably involving a precipitating factor. In a third example, HCP with partial ALA-D deficiency was characterized by a severe neurologic attack (617). Dual deficiency of two nonacute porphyria defects, UROIII-S and URO-D, in a boy caused severe photosensitivity and hemolytic anemia (618), with subsequent development of severe osteoporosis, renal and liver siderosis, and nephrotic syndrome (619).

In all of the cases of dual porphyria reported, the diagnosis was based on quantitation of metabolic intermediates as well as enzyme analysis. Their occurrence, for the most part, probably represents coincidental inheritance of two defects. In some instances, consanguinity of parents was noted. Identification of specific molecular defects would further substantiate the various forms of dual porphyria. Atypical findings of porphyrins and their precursors encountered in the diagnostic evaluation may indicate the presence of a complex porphyric state.

## REFERENCES

1. Schultz JH. Ein Fall von Pemphigus leprosus, kompliziert durch Lepra visceralis. Inaugural dissertation. University of Griefswald, 1874.
2. Baumstark F. Zwei Pathologische Harnfarbstoffe. *Pflüger's Arch Gesamte Physiol* 1874;9:568–584.
3. Gunther H. Die Haematoporphyrinurie. *Dtsch Arch Klin Med* 1911;105:89–146.
4. Desnick RJ, Astrin KH. Congenital erythropoietic porphyria: advances in pathogenesis and treatment. *Br J Haematol* 2002;117:779–795.
5. de Verneuil H, Ged C, Moreau-Gaudry F. Congenital erythropoietic porphyria In: Kadish KM, Smith KM, Guillard R, eds. *The porphyrin handbook— medical aspects of porphyrins*. Amsterdam: Academic Press, 2003;14:43–65.
6. Kontos AP, Ozog D, Bichakjian C, et al. Congenital erythropoietic porphyria associated with myelodysplasia presenting in a 72-year-old man: report of a case and review of the literature. *Br J Haematol* 2003;148:160–164.
7. Xu W, Astrin KH, Desnick RJ. Molecular basis for congenital erythropoietic porphyria: mutations in the human uroporphyrinogen III synthase gene. *Hum Mutat* 1996;7:187–192.
8. Fontanellas A, Bensidhoum M, de Salamanca ER, et al. A systematic analysis of the mutations of the uroporphyrinogen III synthase gene in congenital erythropoietic porphyria. *Eur J Hum Genet* 1996;4:274–282.
9. Romeo G, Levin EY. Uroporphyrinogen III cosynthetase in human congenital erythropoietic porphyria. *Proc Natl Acad Sci U S A* 1969;63:856–863.
10. Romeo G, Kaback MM, Levin EY. Uroporphyrinogen III cosynthetase activity in fibroblasts from patients with congenital erythropoietic porphyria. *Biochem Genet* 1970;4:659–664.
11. Grandchamp B, Deybach JC, Grelier M, et al. Studies of porphyrin synthesis in fibroblasts of patients with congenital erythropoietic porphyria and one patient with homozygous coproporphyrinuria. *Biochim Biophys Acta* 1980;629:577–586.
12. Deybach JC, de Verneuil H, Phung N, et al. Congenital erythropoietic porphyria (Gunther's disease): enzymatic studies on two cases of late onset. *J Lab Clin Med* 1981;97:551–558.
13. Romeo G, Glenn BL, Levin EY. Uroporphyrinogen III cosynthetase in asymptomatic carriers of congenital erythropoietic porphyria. *Biochem Genet* 1970;4:719–726.
14. Astrin KH, Warner CA, Yoo HW, et al. Regional assignment of the human uroporphyrinogen III synthase (URO III S) gene to chromosome 10q25.3–q26.3. *Hum Genet* 1991;87:18–22.
15. Bottomley SS, Muller-Eberhard U. Pathophysiology of heme synthesis. *Semin Hematol* 1988;25:282–302.
16. Anderson KE, Sassa S, Bishop DF, et al. Disorders of heme biosynthesis: X-linked sideroblastic anemia and the porphyrias. In: Scriver CS, Beaudet AI, Sly WS, Valle D, eds. *The molecular and metabolic bases of inherited disease*, 8th ed. New York: McGraw-Hill, 2001:2961–3062.
17. Moore MR, Thompson GG, Goldberg A, et al. The biosynthesis of haem in congenital (erythropoietic) porphyria. *Int J Biochem* 1978;9:933–938.
18. Kushner JP, Pimstone NR, Kjeldsberg CR, et al. Congenital erythropoietic porphyria, diminished activity of uroporphyrinogen decarboxylase and dyserythropoiesis. *Blood* 1982;59:725–737.
19. Ericksen L, Hofstad F, Seip M. Congenital erythropoietic porphyria. The effect of light shielding. *Acta Paediatr Scand* 1973;62:385–390.
20. Rimington C, et al. Porphyrin studies in congenital erythropoietic porphyria. *Dan Med Bull* 1973;20:5–12.

21. Bhutani LK, Sood SK, Das PK, et al. Congenital erythropoietic porphyria: an autopsy report. *Arch Dermatol* 1974;110:427-431.
22. Poh-Fitzpatrick MB. Molecular and cellular mechanisms of porphyrin photosensitization. *Photodermatology* 1986;3:148-157.
23. Lim HW. Pathophysiology of cutaneous lesions in porphyrias. *Semin Hematol* 1989;26:114-119.
24. Fritsch C, Bolsen K, Ruzicka T, et al. Congenital erythropoietic porphyria. *J Am Acad Dermatol* 1997;36:594-610.
25. Haining RG, Cowger L, Shurtleff DB, et al. Congenital erythropoietic porphyria. I. Case report, special studies and therapy. *Am J Med* 1968;45:624-637.
26. Varadi S. Haematological aspects in a case of erythropoietic porphyria. *Br J Haematol* 1958;4:270-280.
27. Levin EY. Comparative aspects of porphyria in man and animals. *Ann N Y Acad Sci* 1975;241:347-349.
28. Schmid R, Schwartz S, Watson CJ. Porphyrin content of bone marrow and liver in the various forms of porphyria. *Arch Intern Med* 1954;93:167-190.
29. Gross S. Hematologic studies on erythropoietic porphyria: a new case with severe hemolysis, chronic thrombocytopenia and folic acid deficiency. *Blood* 1964;23:762-775.
30. Gross S, Schoenberg MD, Mumaw VR. Electron microscopy of the red cells in erythropoietic porphyria. *Blood* 1965;25:49-55.
31. Grinstein M, Aldrich RA, Hawkinson V, et al. An isotopic study of porphyrin and hemoglobin metabolism in a case of porphyria. *J Biol Chem* 1949;179:983-984.
32. London IM, West R, Shemin D, et al. Porphyrin formation and hemoglobin metabolism in congenital porphyria. *J Biol Chem* 1950;184:365-378.
33. Gray CH, Muir H, Neuberger A. Studies in congenital porphyria. 3. The incorporation of <sup>15</sup>N into the haem and glycine of haemoglobin. *Biochemistry* 1950;47:542-548.
34. Gray CH. Isotope studies in porphyria. *Br Med Bull* 1952;8:229-233.
35. Gray CH, Lim CK, Nicholson DC. The differentiation of the porphyrias by means of high pressure liquid chromatography. *Clin Chim Acta* 1977;77:167-178.
36. Kench JE, Langley FA, Wilkenson JF. Biochemical and pathological studies of congenital porphyria. *QJM* 1953;22:285-295.
37. Aldrich RA, Hawkinson V, Grinstein M, et al. Photosensitive or congenital porphyria with hemolytic anemia. I. Clinical and fundamental studies before and after splenectomy. *Blood* 1951;6:685-698.
38. Schmid R, Schwartz S, Sundberg RD. Erythropoietic (congenital) porphyria: a rare abnormality of the normoblasts. *Blood* 1955;10:416-428.
39. Kaufman BM, Vickers HR, Rayne J, et al. Congenital erythropoietic porphyria: report of a case. *Br J Dermatol* 1967;79:210-220.
40. Haining RG, Cowger ML, Labbe RF, et al. Congenital erythropoietic porphyria. The effects of induced polycythemia. *Blood* 1970;36:297-309.
41. Piomelli S, Poh-Fitzpatrick MB, Seaman C, et al. Complete suppression of the symptoms of congenital erythropoietic porphyria by long-term treatment with high-level transfusions. *N Engl J Med* 1986;314:1029-1031.
42. Guarini L, Piomelli S, Poh-Fitzpatrick MB. Hydroxyurea in congenital erythropoietic porphyria. *N Engl*

J Med 1994;330:1091–1092.

43. Pimstone NR, Gandhi SN, Mukerji SK. Therapeutic efficacy of chronic charcoal therapy in congenital erythropoietic porphyria. *N Engl J Med* 1987;316: 390–393.
44. Mukerji SK, Pimstone NR, Gandhi SN, et al. Biochemical diagnosis and monitoring therapeutic modulation of disease activity in an unusual case of congenital erythropoietic porphyria. *Clin Chem* 1985;31:1946–1951.
45. Tishler PV, Winston SH. Rapid improvement in the chemical pathology of congenital erythropoietic porphyria with treatment with superactivated charcoal. *Methods Find Exp Clin Pharmacol* 1990;12:645–648.
46. Rank JM, Straka JG, Weimer MK, et al. Hematin therapy in late onset congenital erythropoietic porphyria. *Br J Haematol* 1990;75:617–618.
47. Oliveri MB, Mautalen C, Mega M, et al. Congenital erythropoietic porphyria: skeletal manifestations and effect of pamidronate treatment. *Bone* 1994;15:101–104.
48. Moreau-Gaudry F, Ged C, Barbot C, et al. Correction of the enzyme defect in cultured congenital erythropoietic porphyria disease cells by retroviral-mediated gene transfer. *Hum Gene Ther* 1995;6:13–20.
49. Kauppinen R, Glass IA, Aizencang G, et al. Congenital erythropoietic porphyria: prolonged high-level expression and correction of the heme biosynthetic defect by retroviral-mediated gene transfer into porphyric and erythroid cells. *Mol Genet Metab* 1998;65:10–17.
50. Moreau-Gaudry F, Mazurier F, Bensidhoum M, et al. Metabolic correction of congenital erythropoietic porphyria by retroviral mediated gene transfer into lymphoblastoid cell lines. *Blood* 1995;85:1449–1453.
51. Mazurier F, Geronimi F, Lamrissi-Garcia I, et al. Correction of deficient CD34+ cells from peripheral blood after mobilization in a patient with congenital erythropoietic porphyria. *Mol Ther* 2001;3:411–417.
52. Deybach JC, Grandchamp B, Grelier M, et al. Prenatal exclusion of congenital erythropoietic porphyria (Gunther's disease) in a fetus at risk. *Hum Genet* 1980;53:217–221.
53. Ged C, Moreau-Gaudry F, Taine L, et al. Prenatal diagnosis in congenital erythropoietic porphyria by metabolic measurement and DNA mutation analysis. *Prenat Diag* 1996;16:83–86.
54. Jori G, Spikes JD. The photobiochemistry of porphyrins. In: Smith KC, ed. *Topics in photomedicine*. New York: Plenum, 1983.
55. Magnus IA. The cutaneous porphyrias. *Semin Hematol* 1968;5:380–407.
56. Fusaro RM, Runge WJ. Clinical experience with a topical light filter. *JAMA* 1962;182:1120–1121.
57. Mathews-Roth MM. Beta carotene therapy for erythropoietic protoporphyria and other photosensitivity diseases. In: Regan JD, Parrish JA, eds. *The Science of Photomedicine*. New York: Plenum, 1982.
58. Joergensen SK, With TK. Congenital porphyria in swine and cattle in Denmark. *Nature* 1955;176:156–158.
59. Watson CJ, Perman V, Spurrell FA, et al. Some studies of the comparative biology of human and bovine porphyria erythropoietica. *Trans Assoc Am Phys* 1958;71:196–206.
60. Moore WE, Stephenson BD, Anderson AS, et al. Detection of the heterozygous state of bovine porphyria: analysis of urinary coproporphyrin isomers. *Proc Soc Exp Biol Med* 1970;134:926–928.
61. Kaneko JJ. Erythrokinetics and iron metabolism in bovine porphyria erythropoietica. *Ann N Y Acad Sci* 1963;104:689–700.
62. Levin EY. Uroporphyrinogen III cosynthetase in bovine erythropoietic porphyria. *Science* 1968;161:907–908.

63. Battle AM, Wider de Xifra EA, Stella AM, et al. Studies on porphyrin biosynthesis and the enzymes involved in bovine congenital erythropoietic porphyria. *Clin Sci Mol Med* 1979;57:63-70.
64. Clare NT, Stephens EH. Congenital porphyria in pigs. *Nature* 1944;153:252-253.
65. Joergensen SK, With TK. Porphyria in domestic animals: Danish observations in pigs and cattle and comparison with human porphyria. *Ann N Y Acad Sci* 1963;104:701-709.
66. Tobias G. Congenital porphyria in a cat. *J Am Vet Med Assoc* 1964;145:462-463.
67. Glenn BL, Glenn HG, Omtvedt I. Congenital porphyria in the domestic cat (*Felis catus*): preliminary investigations on inheritance pattern. *Am J Vet Res* 1968;29:1653-1657.
68. Levin EY, Flyger V. Uroporphyrinogen III cosynthetase activity in the fox squirrel (*Sciurus niger*). *J Clin Invest* 1973;52:96-105.
69. Goldberg A, Rimington C. Diseases of porphyrin metabolism. Springfield: Charles C Thomas, 1962:110-136.
70. Held JL, Sassa S, Kappas A, et al. Erythrocyte uroporphyrinogen decarboxylase activity in porphyria cutanea tarda: a study of 40 consecutive patients. *J Invest Dermatol* 1989;93:332-334.
71. Elder GH, Roberts AG, de Salamanca RE. Genetics and pathogenesis of human uroporphyrinogen decarboxylase defects. *Clin Biochem* 1989;22:163-168.
72. Koszo F, Morvay M, Dobozy A, et al. Erythrocyte uroporphyrinogen decarboxylase activity in 80 unrelated patients with porphyria cutanea tarda. *Br J Dermatol* 1992;126:446-449.
73. Bulaj ZJ, Phillips JD, Ajioka RS, et al. Hemochromatosis genes and other factors contributing to the pathogenesis of porphyria cutanea tarda. *Blood* 2000;95:1565-1571.
74. Egger NG, Goeger DE, Payne DA, et al. Porphyria cutanea tarda: multiplicity of risk factors including HFE mutations, hepatitis C, and inherited uroporphyrinogen decarboxylase deficiency. *Dig Dis Sci* 2002;47:419-426.
75. Kushner JP, Barbuto AJ, Lee GR. An inherited enzymatic defect in porphyria cutanea tarda: decreased uroporphyrinogen decarboxylase activity. *J Clin Invest* 1976;58:1089-1097.
76. Benedetto AV, Kushner JP, Taylor JS. Porphyria cutanea tarda in three generations of a single family. *N Engl J Med* 1978;298:358-362.
77. Felsher BF, Norris ME, Shih JC. Red-cell uroporphyrinogen decarboxylase activity in porphyria cutanea tarda and in other forms of porphyria. *N Engl J Med* 1978;299:1095-1098.
78. de Verneuil H, Aitken G, Nordmann Y. Familial and sporadic porphyria cutanea tarda: two different diseases. *Hum Genet* 1978;44:145-151.
79. Alleman MA, Wilson JHP, van den Berg JWO, et al. Familial porphyria cutanea tarda: the pattern of porphyrins formed from porphobilinogen by hemolysates. *Clin Chem* 1982;28:1144-1147.
80. Felsher BF, Carpio N, Engleking DW, et al. Decreased hepatic uroporphyrinogen decarboxylase activity in porphyria cutanea tarda. *N Engl J Med* 1982;306:766-769.
81. Elder GH, Sheppard DM, Tovey JA, et al. Immunoreactive uroporphyrinogen decarboxylase in porphyria cutanea tarda. *Lancet* 1983;1:1301-1304.
82. de Verneuil H, Beaumont C, Deybach DC, et al. Enzymatic and immunological studies of uroporphyrinogen decarboxylase in familial porphyria cutanea tarda and hepatoerythropoietic porphyria. *Am J Hum Genet* 1984;36:613-622.
83. Elder GH, Smith SG, Herrero C, et al. Hepatoerythropoietic porphyria: a new uroporphyrinogen

decarboxylase defect or homozygous porphyria cutanea tarda? *Lancet* 1981;1:916-919.

84. Lazaro P, de Salamanca RE, Elder GH, et al. Is hepatoerythropoietic porphyria a homozygous form of porphyria cutanea tarda? Inheritance of uroporphyrinogen decarboxylase deficiency in a Spanish family. *Br J Dermatol* 1984;110:613-617.

85. Toback AC, Sassa S, Poh-Fitzpatrick MB. Hepatoerythropoietic porphyria: clinical, biochemical and enzymatic studies in a three-generation family lineage. *N Engl J Med* 1987;316:645-650.

86. Fujita H, Sassa S, Toback AC, et al. Immunochemical study of uroporphyrinogen decarboxylase in a patient with mild hepatoerythropoietic porphyria. *J Clin Invest* 1987;79:1533-1537.

87. Romeo PH, Raich N, Dubart A, et al. Molecular cloning and nucleotide sequence of a complete human uroporphyrinogen decarboxylase cDNA. *J Biol Chem* 1986;261:9825-9831.

88. Dubart A, Mattei MG, Raich N, et al. Assignment of human uroporphyrinogen decarboxylase (URO-D) to the p34 band on chromosome 1. *Hum Genet* 1986;73:277-279.

89. Elder GH. Porphyria cutanea tarda and related disorders. In: Kadish KM, Smith KM, Guillard R, eds. *The porphyrin handbook--medical aspects of porphyrins*. Amsterdam: Academic Press, 2003;14:67-92.

90. Phillips JD, Parker TL, Schubert HL, et al. Functional consequences of naturally occurring mutations in human uroporphyrinogen decarboxylase. *Blood* 2001;98:3179-3185.

91. Meguro K, Fujita H, Ishido N, et al. Molecular defects of uroporphyrinogen decarboxylase in a patient with mild hepatoerythropoietic porphyria. *J Invest Dermatol* 1994;102:681-685.

92. Elder GH, Lee GB, Tovey JA. Decreased activity of hepatic uroporphyrinogen decarboxylase in sporadic porphyria cutanea tarda. *N Engl J Med* 1978;299:274-278.

93. Elder GH, Urquhart AJ, deSalamanca RE, et al. Immunoreactive uroporphyrinogen decarboxylase in the liver in porphyria cutanea tarda. *Lancet* 1985;2:229-232.

94. Garey JR, Franklin KF, Brown DA, et al. Analysis of uroporphyrinogen decarboxylase complementary DNAs in sporadic porphyria cutanea tarda. *Gastroenterology* 1993;105:165-169.

95. Spikes JD. Photobiology of porphyrins. *Prog Clin Biol Res* 1984;170:19-39.

96. Athar M, Elmets CA, Bickers DR, et al. A novel mechanism for the generation of superoxide anions in hematoporphyrin derivative-mediated cutaneous photosensitization. Activation of the xanthine oxidase pathway. *J Clin Invest* 1989;83:1137-1143.

97. Varigos G, Schiltz JR, Bickers DR. Uroporphyrin I stimulation of collagen biosynthesis in human skin fibroblasts. A unique dark effect of porphyrins. *J Clin Invest* 1982;69:129-135.

98. Ippen H. Allgemeinsymptome der späten Hautporphyrie (Porphyria cutanea tarda) als Hinweise für deren Behandlung. *Dtsch Med Wochenschr* 1961;86:127-133.

99. Lamont NM, Hathorn M, Joubert SM. Porphyria in the African: a study of 100 cases. *Q J Med NS* 1961;30:373-392.

100. Uys CJ, Eales EL. The histopathology of the liver in acquired (symptomatic) porphyria. *S Afr J Lab Clin Med* 1963;9:190-197.

101. Lundvall O, Weinfeld A, Lundin P. Iron storage in porphyria cutanea tarda. *Acta Med Scand* 1970;188:37-53.

102. Felsher BF, Jones ML, Redeker AG. Iron and hepatic uroporphyrin synthesis: relation in porphyria cutanea tarda. *JAMA* 1973;226:663-665.

103. Turnbull A, Baker H, Vernon-Roberts B, et al. Iron metabolism in porphyria cutanea tarda and in erythropoietic protoporphyria. *QJM* 1973;42:341-355.



104. Reizenstein P, Hoglund S, Landergren J, et al. Iron metabolism in porphyria cutanea tarda. *Acta Med Scand* 1975;198:95–99.
105. Grossman ME, Bickers DR, Poh-Fitzpatrick MB, et al. Porphyria cutanea tarda: clinical features and laboratory findings in 40 patients. *Am J Med* 1979;67:277–286.
106. Cortes JM, Oliva H, Paradinas FJ, et al. The pathology of the liver in porphyria cutanea tarda. *Histopathology* 1980;4:471–485.
107. Ostrowski J, Michalak T, Zawirska B, et al. The function and morphology of the liver in porphyria cutanea tarda. *Ann Clin Res* 1984;16:195–200.
108. Brugsch J. Hamochromatose und Melanodermieporphyrie als verschiedene Formen der Hamsynthesestörung bei Pigment Zirrhose und Bronzediabetes. *Z Gesamte Inn Med* 1958;13:411–415.
109. Tuffanelli DL. Porphyria cutanea tarda associated with hemochromatosis. *U S Armed Forces Med J* 1960;11:1210–1216.
110. Strickland GT. Porphyria cutanea tarda associated with hemosiderosis of the liver. *Am J Gastroenterol* 1968;50:202–207.
111. Sauer GF, Funk DD. Iron overload in cutaneous porphyria. *Arch Intern Med* 1969;124:190–196.
112. Bottomley SS. Porphyria cutanea tarda and hereditary hemochromatosis. *Boll Instituto Dermatol S Gallicano* 1986–87;8:237–240.
113. Roberts AG, Whatley SD, Morgan RR, et al. Increased frequency of the haemochromatosis Cys282Tyr mutation in sporadic porphyria cutanea tarda. *Lancet* 1997;349:321–323.
114. Bonkovsky H, Poh-Fitzpatrick M, Pimstone N, et al. Porphyria cutanea tarda, hepatitis C and HFE gene mutations in North America. *Hepatology* 1998;27:1661–1669.
115. Tannapfel A, Stolzel U, Kostler E, et al. C282Y and H63D mutation of the hemochromatosis gene in German porphyria cutanea tarda patients. *Virchows Arch* 2001;439:1–5.
116. Oubre D, Cruz J, Keung Y. Porphyria cutanea tarda in a patient with post-transplant MDS. *Bone Marrow Transplant* 2001;27:219–220.
117. Sivakumaran M, Hudson P. Blood and blisters: porphyria cutanea tarda in myelodysplastic syndrome. *Br J Haematol* 2002;116:1.
118. Ippen H. Treatment of porphyria cutanea tarda by phlebotomy. *Semin Hematol* 1977;14:253–259.
119. Lundvall O. Phlebotomy treatment of porphyria cutanea tarda. *Acta Derm Venereol* 1982;(Suppl 100):107–118.
120. Ramsay CA, Magnus IA, Turnbull A, et al. Treatment of porphyria cutanea tarda by venesection. *QJM* 1974;43:1–24.
121. Rocchi E, Gibertini P, Cassanelli M, et al. Iron removal therapy in porphyria cutanea tarda: phlebotomy versus slow subcutaneous desferrioxamine infusion. *Br J Dermatol* 1986;114:621–629.
122. Lundvall O. The effect of replenishment of iron stores after phlebotomy therapy in porphyria cutanea tarda. *Acta Med Scand* 1971;189:51–63.
123. Kushner JP, Lee GR, Nacht S. The role of iron in the pathogenesis of porphyria cutanea tarda. An in vitro model. *J Clin Invest* 1972;51:3044–3051.
124. Kushner JP, Steinmuller DP, Lee GR. The role of iron in the pathogenesis of porphyria cutanea tarda. II. Inhibition of uroporphyrinogen decarboxylase. *J Clin Invest* 1975;56:661–667.
125. Straka JG, Kushner JP. Purification and characterization of bovine hepatic uroporphyrinogen

decarboxylase. *Biochemistry* 1983;22:4664–4672.

126. Mukerji SK, Pimstone NR. In vitro studies of the mechanism of inhibition of rat liver uroporphyrinogen decarboxylase activity by ferrous iron under anaerobic conditions. *Arch Biochem Biophys* 1986;244:619–629.

127. Mukerji SK, Pimstone NR, Burns M. Dual mechanism of inhibition of rat liver uroporphyrinogen decarboxylase activity by ferrous iron: its potential in the genesis of porphyria cutanea tarda. *Gastroenterology* 1984;87:1248–1254.

128. Brunstig LA. Observations on porphyria cutanea tarda. *Arch Dermatol* 1954;70:551–564.

129. Elder GH. Alcohol intake and porphyria cutanea tarda. *Dermatol* 1999;17: 431–436.

130. Hallen J, Krook H. Follow-up studies on an unselected ten-year material of 360 patients with liver cirrhosis in one community. *Acta Med Scand* 1963;479–493.

131. Charlton RW, Jacobs P, Seftel H, et al. Effect of alcohol on iron absorption. *Br Med J* 1964;2:1427–1429.

132. Felsher BF, Kushner JP. Hepatic siderosis and porphyria cutanea tarda: relation of iron excess to the metabolic defect. *Semin Hematol* 1977;14:243–251.

133. Eales L. Porphyria as seen in Cape Town. *S Afr J Lab Clin Med* 1963;9:151–161.

134. Dean G. The porphyrias: a study of inheritance and environment. Great Britain: Pitman Medical, 1971.

135. Gordeuk V, Mukiibi J, Med M. Iron overload in Africa. Interaction between a gene and dietary iron content. *N Engl J Med* 1992;326:95–100.

136. Fargion S, Piperno A, Cappellini MD, et al. Hepatitis-C virus and porphyria cutanea tarda: evidence of a strong association. *Hepatology* 1992;16:1322–1326.

137. Lacouar JP, Bodokh I, Castanet J, et al. Porphyria cutanea tarda and antibodies to hepatitis-C virus. *Br J Dermatol* 1993;128:121–123.

138. Carpintero P, DeCastro M, Garcia-Monzon C, et al. Hepatitis C virus infection detected by viral RNA analysis in porphyria cutanea tarda. *J Infect* 1997;34:61–64.

139. Stolzel U, Kostler E, Koszka C, et al. Low prevalence of hepatitis C virus infection in porphyria cutanea tarda in Germany. *Hepatology* 1995;21:1500–1503.

140. Blauvelt A. Hepatitis C virus and human immunodeficiency virus infection can alter porphyrin metabolism and lead to porphyria cutanea tarda. *Arch Dermatol* 1996;132:1503–1504.

141. Herrero C, Vicente A, Bruguera M, et al. Is hepatitis C virus infection a trigger of porphyria cutanea tarda? *Lancet* 1993;341:788–789.

142. Wissel PS, Sordillo P, Anderson KE, et al. Porphyria cutanea tarda associated with the acquired immune deficiency syndrome. *Am J Hematol* 1987;25:107–113.

143. Cohen PR. Porphyria cutanea tarda in human immunodeficiency virus-seropositive men: case report and literature review. *J Acquir Immune Defic Syndr* 1991;4:1112–1117.

144. Gafa S, Zannini A, Gabrielli C. Porphyria cutanea tarda and HIV infection: effect of zidovudine treatment on a patient. *Infection* 1992;20:373–374.

145. Taylor JS, Roenigk HH Jr. Estrogen-induced porphyria cutanea tarda symptomatica. In: Doss M, ed. *Porphyrias in human diseases*. Basel: S. Karger, 1976:328–335.

146. Haberman HF, Rosenberg F, Menon IA. Porphyria cutanea tarda: comparison of cases precipitated by alcohol and estrogens. *Can Med Assoc J* 1975;113:653–655.

147. deSalamanca RE, Mingo D, Chinarro S, et al. Patterns of porphyrin excretion in female

oestrogen-induced porphyria cutanea tarda. *Arch Dermatol Res* 1982;274:179-184.

148. Behm AR, Unger WB. Oral contraceptives and porphyria cutanea tarda. *Can Med Assoc J* 1974;110:1052-1054.
149. Gilchrest B, Pathak MA, Parrish JA. Porphyria cutanea tarda in young women. *Arch Dermatol* 1975;111:263-264.
150. Sixel-Dietrich F, Doss M. Hereditary uroporphyrinogen-decarboxylase deficiency predisposing porphyria cutanea tarda (chronic hepatic porphyria) in females after oral contraceptive medication. *Arch Dermatol Res* 1985;278:13-16.
151. Malina L, Chlumsky J. Oestrogen-induced familial porphyria cutanea tarda. *Br J Dermatol* 1975;92:707-709.
152. White MI. Porphyria cutanea tarda induced by estrogen therapy. *Br J Urol* 1977;49:468.
153. Weimar VM, Weimar GW, Ceilley RI. Estrogen-induced porphyria cutanea tarda complicating treatment of prostatic carcinoma. *J Urol* 1978;120:643-644.
154. Lamon JM, Frykholm BC. Pregnancy and porphyria cutanea tarda. *Johns Hopkins Med J* 1979;145:235-236.
155. Baxi LV, Rubeo TJ Jr, Katz B, et al. Porphyria cutanea tarda and pregnancy. *Am J Obstet Gynecol* 1983;146:333-334.
156. Rajka G. Pregnancy and porphyria cutanea tarda. *Acta Dermatol Venereol* 1984;64:444-445.
157. Goerz G, Hammer G. Porphyria cutanea tarda and pregnancy. *Dermatologica* 1983;166:316-318.
158. Urbanek RW, Cohen DJ. Porphyria cutanea tarda: pregnancy versus estrogen effect. *J Am Acad Dermatol* 1994;31:390-392.
159. Poh-Fitzpatrick MB, Masullo AS, Grossman ME. Porphyria cutanea tarda associated with chronic renal disease and hemodialysis. *Arch Dermatol* 1980;116:191-195.
160. Goldsman CI, Taylor JS. Porphyria cutanea tarda and bullous dermatoses associated with chronic renal failure: a review. *Cleve Clin Q* 1983;50:151-161.
161. McKane W, Green CA, Farrington K. Porphyria cutanea tarda precipitated by intravenous iron in a hemodialysis patient. *Nephrol Dial Transplant* 2001;16:1936-1938.
162. Seubert S, Seubert A, Rumpf KW, et al. A porphyria cutanea tarda like distribution pattern of porphyrins in plasma, hemodialysate, hemofiltrate and urine in patients on chronic hemodialysis. *J Invest Dermatol* 1985;85:107-109.
163. Hebert AA, Farmer KL, Poh-Fitzpatrick MB. Peritoneal dialysis does not reduce serum porphyrin levels in porphyria cutanea tarda. *Nephron* 1992;60:240.
164. Koskelo P, Toivonen I, Rintola P. The binding of <sup>14</sup>C-labeled porphyrins by plasma proteins. *Clin Chim Acta* 1970;29:559-565.
165. Mamet R, Gafter U, Korzets A, et al. Decreased uroporphyrinogen decarboxylase activity in patients with end-stage renal disease undergoing hemodialysis. *Nephron* 1995;70:202-206.
166. Garcia-Parilla I, Ortega R, Pena ML, et al. Porphyria cutanea tarda during maintenance hemodialysis. *BMJ* 1980;280:1358.
167. Lichtenstein JR, Babb EJ, Felsher BF. Porphyria cutanea tarda (PCT) in a patient with chronic renal failure on haemodialysis. *Br J Dermatol* 1981;104:575-578.
168. Sweeny GD, Jones KG. Porphyria cutanea tarda: clinical and laboratory features. *Can Med Assoc J*

1979;120:803-807.

169. Grossman ME, Poh-Fitzpatrick MB. Porphyria cutanea tarda: diagnosis and management. *Med Clin North Am* 1980;64:807-827.
170. Boffa MJ, Reed P, Weinkove C, et al. Hypertrichosis as the presenting feature of porphyria cutanea tarda. *Clin Exp Dermatol* 1995;20:62-64.
171. Smith SG. Hepatoerythropoietic porphyria. *Semin Dermatol* 1986;5:125-137.
172. Elder GH. Porphyrin metabolism in porphyria cutanea tarda. *Semin Hematol* 1977;14:227-242.
173. Pimstone NR. Porphyria cutanea tarda. *Semin Liver Dis* 1982;2:132-142.
174. Englert E Jr, Wayne AW, Wales EE, et al. A rapid, new method for isolation and measurement of porphyrins in biological samples by high performance liquid chromatography. *HRC CC J High Resolut Chromatogr Chromatogr Commun* 1979;2:570-574.
175. DiPadova C, Marchesi L, Cainelli T. Effects of phlebotomy on urinary porphyrin pattern and liver histology in patients with porphyria cutanea tarda. *Am J Med Sci* 1983;285:2-12.
176. Elder GH. Differentiation of porphyria cutanea tarda symptomatica from other types of porphyria by measurement of isocoproporphyrin in feces. *J Clin Pathol* 1975;28:601-607.
177. Lim HW, Poh-Fitzpatrick MB. Hepatoerythropoietic porphyria: a variant of childhood-onset porphyria cutanea tarda. *J Am Acad Dermatol* 1984;11:1103-1111.
178. Lundvall O, Enerback L. Hepatic fluorescence in porphyria cutanea tarda. Studies in fine needle aspiration biopsy smears. *J Clin Pathol* 1969;22:704-709.
179. James KR, Cortes JM, Paradinas FJ. Demonstration of intracytoplasmic needle-like inclusions in hepatocytes of patients with porphyria cutanea tarda. *J Clin Pathol* 1980;33:899-900.
180. Waldo ED, Tobais H. Needle-like cytoplasmic inclusions in the liver in porphyria cutanea tarda. *Arch Pathol Lab Med* 1973;96:368-371.
181. Biempica L, Kosower N. Hepatic porphyrias: cytochemical and ultrastructural studies of liver in acute intermittent porphyria and porphyria cutanea tarda. *Arch Pathol Lab Med* 1974;98:336-343.
182. Cormane RH, Szabo E, Hoo TT. Histopathology of the skin in acquired and hereditary porphyria cutanea tarda. *Br J Dermatol* 1971;85:531-539.
183. Epstein JH, Tuffanelli DL, Epstein WL. Cutaneous changes in the porphyrias (a microscopic study). *Arch Dermatol* 1973;107:689-698.
184. Topi GC, Amantea A, Griso D. Recovery from porphyria cutanea tarda with no specific therapy other than avoidance of hepatic toxins. *Br J Dermatol* 1984;111:75-82.
185. Takikawa H, Yamazaki R, Shoji S, et al. Normalization of urinary porphyrin level and disappearance of skin lesions after successful interferon therapy in a case of chronic hepatitis C complicated with porphyria cutanea tarda. *J Hepatol* 1995;22:249-250.
186. Sheikh MY, Wright RA, Burruss JB. Dramatic resolution of skin lesions associated with porphyria cutanea tarda after interferon-alpha therapy in a case of chronic hepatitis C. *Dig Dis Sci* 1998;43:529-533.
187. Bulaj Z, Franklin MR, Phillips JD, et al. Transdermal estrogen replacement therapy in postmenopausal women previously treated for porphyria cutanea tarda. *J Lab Clin Med* 2000;136:482-488.
188. Vogler WR, Galambos JT, Olansky S. Biochemical effects of chloroquine therapy in porphyria cutanea tarda. *Am J Med* 1970;49:316-321.
189. Taljaard JJF, Shanley BC, Stewart-Wynne EG, et al. Studies on low dose chloroquine therapy and

the action of chloroquine in symptomatic porphyria. *Br J Dermatol* 1972;87:261–269.

190. Kordac V, Papezova R, Semradova M. Chloroquine in the treatment of porphyria cutanea tarda. *N Engl J Med* 1977;296:949.
191. Malkinson FD, Levitt L. Hydroxychloroquine treatment of porphyria cutanea tarda. *Arch Dermatol* 1980;116:1147–1150.
192. Tsega E, Besrat A, Damtew B, et al. Chloroquine in the treatment of porphyria cutanea tarda. *Trans R Soc Trop Med Hyg* 1982;75:401–404.
193. Felsher BF, Redeker G. Effect of chloroquine on hepatic uroporphyrin metabolism in patients with porphyria cutanea tarda. *Medicine* 1966;45:575–583.
194. Scholnick PL, Epstein JH, Marver HS. The molecular basis of the action of chloroquine in porphyria cutanea tarda. *J Invest Dermatol* 1973;61:226–232.
195. Ashton RE, Hawk JLM, Magnus IA. Low-dose oral chloroquine in the treatment of porphyria cutanea tarda. *Br J Dermatol* 1984;111:609–613.
196. Horina JH, Wolf P. Epoetin for severe anemia in hepatoerythropoietic porphyria. *N Engl J Med* 2000;342:1294–1295.
197. Fontanellas A, Mazurier F, Moreau-Gaudry F, et al. Correction of uroporphyrinogen decarboxylase deficiency (hepatoerythropoietic porphyria) in Epstein-Barr virus-transformed B-cell lines by retrovirus-mediated selection of transduced cells. *Blood* 1999;94:465–474.
198. Ged C, Ozalla D, Herrero C, et al. Description of a new mutation in hepatoerythropoietic porphyria and prenatal exclusion of a homozygous fetus. *Arch Dermatol* 2002;138:957–960.
199. Carson RW, Dunnigan EJ, DuBose TD Jr, et al. Removal of plasma porphyrins with high-flux hemodialysis in porphyria cutanea tarda associated with end-stage renal disease. *J Am Soc Nephrol* 1992;2:1445–1450.
200. Anderson KE, Goeger DE, Carson RW, et al. Erythropoietin for the treatment of porphyria cutanea tarda in a patient on long-term hemodialysis. *N Engl J Med* 1990;322:315–317.
201. Shieh S, Cohen JL, Lim HW. Management of porphyria cutanea tarda in the setting of chronic renal failure: a case report and review. *J Am Acad Dermatol* 2000;42:645–652.
202. Praga M, deSalamanca ED, Andres A, et al. Treatment of hemodialysis-related porphyria cutanea tarda with deferoxamine. *N Engl J Med* 1987;316:547–548.
203. Stevens BR, Fleischer AB, Piering F, et al. Porphyria cutanea tarda in the setting of renal failure: response to renal transplantation. *Arch Dermatol* 1993;129:337–339.
204. Ewing S, Crosby DL. Renal transplantation for porphyria cutanea tarda. *N Engl J Med* 1997;336:811.
205. Schmid R. Cutaneous porphyria in Turkey. *N Engl J Med* 1960;263:397–398.
206. Ockner RK, Schmid R. Acquired porphyria in man and rat due to hexachlorobenzene intoxication. *Nature* 1961;189:499–500.
207. Cam C, Nogogosyan G. Acquired toxic porphyria cutanea tarda due to hexachlorobenzene. *JAMA* 1963;183:88–91.
208. Peters HA, Gocmen A, Cripps DJ, et al. Epidemiology of hexachlorobenzene-induced porphyria in Turkey. Clinical and laboratory follow-up after 25 years. *Arch Neurol* 1982;39:744–749.
209. Cripps DJ, Peters HA, Gocmen A, et al. Porphyria turcica due to hexachlorobenzene: a 20 to 30 year follow-up study in 204 patients. *Br J Dermatol* 1984;111:413–422.
210. Debets FMH, Hamers W, Strik J. Metabolism as a prerequisite for the porphyrinogenic action of

polyhalogenated aromatics with special reference to hexachlorobenzene and polybrominated biphenyls (Firemaster BP-6). *Int J Biochem* 1980;12:1019-1025.

211. Rios de Molina MC, Wainstock de Calmanovici R, SanMartin deViale LC. Investigations on the presence of porphyrinogen carboxy-lyase inhibitor in the liver of rats intoxicated with hexachlorobenzene. *Int J Biochem* 1980;12:1027-1032.

212. Smith AG, Francis JE. Increased inhibition of hepatic uroporphyrinogen decarboxylase by hexachlorobenzene in male rats given the oestrogenic drugs diethylstilbestrol and chlorotriarsene. *Biochem Pharmacol* 1981;30:1849-1853.

213. Smith AG, Francis JE. Synergism of iron and hexachlorobenzene inhibits hepatic uroporphyrinogen decarboxylase in inbred mice. *Biochem J* 1983;214:909-913.

214. Wainstock de Calmanovici R, Rios de Molina MDC, Tairade Yamasato MC, et al. Mechanism of hexachlorobenzene-induced porphyria in rats. *Biochem J* 1984;218:753-763.

215. Smith AG, Francis JE. Genetic variation of iron-induced uroporphyrin in mice. *Biochem J* 1993;291:29-35.

216. Poland AP, Smith D, Metter G, et al. A health survey of workers in a 2,4-D and 2,4,5-T plant. With special attention to chloracne, porphyria cutanea tarda, and psychologic parameters. *Arch Environ Health* 1971;22:316-327.

217. Pazderova-Vejlupkova J, Lukas E, Nemcova M, et al. The development and prognosis of chronic intoxication by tetrachlorodibenzo-p-dioxin in men. *Arch Environ Health* 1981;36:5-11.

218. Poland A, Knutson JC. 2,3,7,8-Tetrachlorodibenzo-p-dioxin and related halogenated aromatic hydrocarbons: examination of the mechanism of toxicity. *Annu Rev Pharmacol Toxicol* 1982;22:517-554.

219. Smith AG, Francis JE, Kay SJE, et al. Hepatic toxicity and uroporphyrinogen decarboxylase activity following a single dose of 2,3,7,8-tetrachlorodibenzo-p-dioxin to mice. *Biochem Pharmacol* 1981;30:2825-2830.

220. Sinclair PR, Bement W, Bonkovsky H, et al. Inhibition of uroporphyrinogen decarboxylase by halogenated biphenyls in chick hepatocyte cultures. *Biochem J* 1984;222:737-748.

221. Sweeney GD, Jones KG, Cole FM, et al. Iron deficiency prevents liver toxicity of 2,3,7,8-tetrachlorodibenzo-p-dioxin. *Science* 1979;204:332-335.

222. Kordac V. Frequency of occurrence of hepatocellular carcinoma in patients with porphyria cutanea tarda in long-term followup. *Neoplasma* 1972;19:135-139.

223. Solis JA, Betancor P, Campos R, et al. Association of porphyria cutanea tarda and primary liver cancer: report of ten cases. *J Dermatol* 1982;9:131-137.

224. Salata H, Cortes JM, de Salamanca RE, et al. Porphyria cutanea tarda and hepatocellular carcinoma. Frequency of occurrence and related factors. *J Hepatol* 1985;1:477-487.

225. Siersma PD, ten Kate FJW, Mulder PGH, et al. Hepatocellular carcinoma in porphyria cutanea tarda: frequency and factors related to its occurrence. *Liver* 1992;12:56-61.

226. Fracanzani AL, Raioli E, Sampietro M, et al. Liver cancer risk is increased in patients with porphyria cutanea tarda in comparison to matched control patients with chronic liver disease. *J Hepatol* 2001;35:498-503.

227. Packe GF, Clarke CWF. Is porphyria cutanea tarda a risk factor in the development of hepatocellular carcinoma? A case report and review of the literature. *Oncology* 1985;42:44-47.

228. Tio TH, Leijnse B, Jarrett A, et al. Acquired porphyria from a liver tumor. *Clin Sci* 1957;16:517-527.

229. Denk R, Holzman H. Paraneoplastische porphyria cutanea tarda. *Med Welt* 1969;25:1446-1447.

230. Thompson PPH, Nicholson DC, Farnan T, et al. Cutaneous porphyria due to a malignant primary hepatoma. *Gastroenterology* 1970;59:779–783.
231. Keczkcs K, Barker DJ. Malignant hepatoma associated with acquired hepatic cutaneous porphyria. *Arch Dermatol* 1976;112:78–82.
232. O'Reilly K, Snape J, Moore MR. Porphyria cutanea tarda resulting from primary hepatocellular carcinoma. *Clin Exp Dermatol* 1988;13:44–48.
233. Ochiai R, Morishima T, Kondo M. Symptomatic porphyria secondary to hepatocellular carcinoma. *Br J Dermatol* 1997;136:129–131.
234. Wang H, Long Q, Marty SD, et al. A zebrafish model for hepatoerythropoietic porphyria. *Nat Genet* 1998;20:239–243.
235. Phillips JD, Jackson LK, Bunting M, et al. A mouse model of familial porphyria cutanea tarda. *Proc Natl Acad Sci U S A* 2001;98:259–264.
236. Sinclair PR, Gorman N, Trask HW, et al. Uroporphyrinemia caused by ethanol in Hfe(–/–) mice as a model for porphyria cutanea tarda. *Hepatology* 2003; 37:351–358.
237. Magnus IA, Jarrett A, Prankerd TAJ, et al. Erythropoietic protoporphyria: a new porphyria syndrome with solar urticaria due to protoporphyrinemia. *Lancet* 1961;2:448–451.
238. Bloomer JR, Hill HD, Kools AM, et al. Heme synthesis in protoporphyria. *Curr Probl Dermatol* 1990;20:135–147.
239. Went LN, Klasen EC. Genetic aspects of erythropoietic protoporphyria. *Ann Hum Genet* 1984;48:105–117.
240. Norris PG, Nunn AV, Hawk JLM, et al. Genetic heterogeneity in erythropoietic protoporphyria: a study of the enzymatic defect in nine affected families. *J Invest Dermatol* 1990;95:260–263.
241. Goerz G, Bunselmeyer S, Bolsen K, et al. Ferrochelatase activities in patients with erythropoietic protoporphyria and their families. *Br J Dermatol* 1996;134:880–885.
242. Schneider–Yin X, Gouya L, Meier–Weinaud A, et al. New insights into the pathogenesis of erythropoietic protoporphyria and their impact on patient care. *Eur J Pediatr* 2000;159:719–725.
243. Cox TM. Protoporphyrin. In: Kadish KM, Smith KM, Guillard R, eds. *The porphyrin handbook—medical aspects of porphyrins*. Amsterdam: Academic Press, 2003, 14:121–149.
244. Bottomley SS, Tanaka M, Everett MA. Diminished ferrochelatase activity in protoporphyria. *J Lab Clin Med* 1975;86:126–131.
245. deGoeij A FPM, Christianse K, van Steveninck J. Decreased haem synthetase activity in blood cells of patients with erythropoietic protoporphyria. *Eur J Clin Invest* 1975;5:397–400.
246. Brodie MJ, Moore MR, Thompson GG, et al. Haem biosynthesis in peripheral blood in erythropoietic protoporphyria. *Clin Exp Dermatol* 1977;2:381–388.
247. Sassa S, Zalai GL, Poh–Fitzpatrick MB, et al. Studies in porphyria: functional evidence of a partial deficiency of ferrochelatase activity in mitogen–stimulated lymphocytes from patients with erythropoietic protoporphyria. *J Clin Invest* 1982;69:809–815.
248. Bonkowsky HL, Bloomer JR, Ebert PS, et al. Heme synthetase deficiency in human protoporphyria. Demonstration of the defect in liver and cultured skin fibroblasts. *J Clin Invest* 1975;56:1139–1148.
249. Scholnick P, Marver HS, Schmid R. Erythropoietic protoporphyria: evidence for multiple sites of excess protoporphyrin formation. *J Clin Invest* 1971;50:203–207.
250. Schwartz S, Johnson JA, Stephenson BD, et al. Erythropoietic defects in protoporphyria: a study of



factors involved in labeling of porphyrins and bile pigments from ALA-3H and glycine-14C. *J Lab Clin Med* 1971;78:411-434.

251. Nicholson DC, Cowger ML, Kalivas J, et al. Isotopic studies of the erythropoietic and hepatic components of congenital porphyria and erythropoietic protoporphyria. *Clin Sci* 1973;44:135-150.

252. Mathews-Roth MM. Anemia in erythropoietic protoporphyria. *JAMA* 1974;230:824.

253. DeLeo VA, Poh-Fitzpatrick M, Mathews-Roth M, et al. Erythropoietic protoporphyria: ten years experience. *Am J Med* 1976;60:8-22.

254. Clark KGA, Nicholson DC. Erythrocyte protoporphyrin and iron uptake in erythropoietic protoporphyria. *Clin Sci* 1971;41:363-370.

255. Cripps DJ, MacEachern WN. Hepatic and erythropoietic protoporphyria. Aminolevulinic acid synthetase, fluorescence and microfluorospectrophotometric study. *Arch Pathol* 1971;91:497-505.

256. Piomelli S, Lamola AA, Poh-Fitzpatrick MB, et al. Erythropoietic protoporphyria and lead intoxication: the molecular basis for difference in cutaneous photosensitivity. I. Different rates of disappearance of protoporphyrin from the erythrocytes, both in vivo and in vitro. *J Clin Invest* 1975;56:1519-1527.

257. Brun A, Steen H, Sandberg S. Erythropoietic protoporphyria: two populations of reticulocytes, with and without protoporphyrin. *Eur J Clin Invest* 1996;26:270-278.

258. Scott AJ, Ansford AJ, Webster BH, et al. Erythropoietic protoporphyria with features of a sideroblastic anemia terminating in liver failure. *Am J Med* 1973;54:251-259.

259. Rademakers LHPM, Koningsberger JC, Sorber CWJ, et al. Accumulation of iron in erythroblasts of patients with erythropoietic protoporphyria. *Eur J Clin Invest* 1993;23:130-138.

260. Haeger-Aronsen B, Krook G. Erythropoietic protoporphyria. A study of known cases in Sweden. *Acta Med Scand* 1966;445:48-55.

261. Reed WB, Wuepper KD, Epstein JH, et al. Erythropoietic protoporphyria: a clinical study. *JAMA* 1970;214:1060-1066.

262. Bloomer JR, Bonkowsky HL, Ebert PS, et al. Inheritance in protoporphyria: comparison of heme synthetase activity in skin fibroblasts with clinical features. *Lancet* 1976;2:226-228.

263. Deybach JC, DaSilva V, Pasquier Y, et al. Ferrochelatase in human erythropoietic protoporphyria: the first case of a homozygous form of the enzyme deficiency. In: Nordmann Y, ed. *Porphyrins and porphyrias*. Paris: John Libbey, 1986:163-173.

264. Schmidt H, Snitker G, Thomsen K, et al. Erythropoietic protoporphyria. A clinical study based on 29 cases in 14 families. *Arch Dermatol* 1974;110:58-64.

265. Nakahashi Y, Taketani S, Okuda M, et al. Molecular cloning and sequence analysis of cDNA encoding human ferrochelatase. *Biochem Biophys Res Commun* 1990;173:748-755.

266. Whictombe DM, Carter NP, Albertson DG, et al. Assignment of the human ferrochelatase gene (FECH) and a locus for protoporphyria to chromosome 18q22. *Genomics* 1991;11:1152-1154.

267. Taketani S, Inazawa J, Nakahashi Y, et al. Structure of the human ferrochelatase gene. Exon/intron gene organization and location of the gene to chromosome 18. *Eur J Biochem* 1992;205:217-222.

268. Taketani S, Fujita H. The ferrochelatase gene structure and molecular defects associated with erythropoietic protoporphyria. *J Bioenerg Biomembr* 1995;27:231-238.

269. Human Gene Mutation Database: [www.hgmd.org](http://www.hgmd.org).

270. Magness ST, Tugores A, Christensen SR, et al. Deletion of the ferrochelatase gene in a patient with protoporphyria. *Hum Mol Genet* 1994;3:1695-1697.

271. Lamoril J, Boulechfar S, de Veneuil H, et al. Human erythropoietic protoporphyria: two point mutations in the ferrochelatase gene. *Biochem Biophys Res Commun* 1991;181:594–599.
272. Sarkany RPE, Cox TM. Autosomal recessive erythropoietic protoporphyria: a syndrome of severe photosensitivity and liver failure. *QJM* 1995;88:541–549.
273. Gouya L, Deybach JC, Lamoril J, et al. Modulation of the phenotype in dominant erythropoietic protoporphyria by a low expression of the normal ferrochelatase allele. *Am J Hum Genet* 1996;58:292–299.
274. Gouya L, Puy H, Lamoril J, et al. Inheritance of erythropoietic protoporphyria: a common wild-type ferrochelatase allelic variant with low expression accounts for clinical manifestations. *Blood* 1999;93:2105–2110.
275. Gouya L, Puy H, Robreau AM, et al. The penetrance of dominant erythropoietic protoporphyria is modulated by expression of wildtype FECH. *Nat Genet* 2002;30:27–28.
276. Magness ST, Maeda N, Brenner DA. An exon 10 deletion in the mouse ferrochelatase gene has a dominant-negative effect and causes mild protoporphyria. *Blood* 2002;100:1470–1477.
277. Burden AE, Wa C, Dailey TA, et al. Human ferrochelatase: crystallization, characterization of the [2Fe–2S] cluster and determination that the enzyme is a homodimer. *Biochim Biophys Acta* 1999;1435:191–197.
278. Todd DJ, Hughes AE, Ennis KT, et al. Identification of a single base pair deletion (40delG) in exon 1 of the ferrochelatase gene in patients with erythropoietic protoporphyria. *Hum Mol Genet* 1993;2:1495–1496.
279. Rufenacht UB, Gouya L, Schneider–Yin X, et al. Systematic analysis of molecular defects in the ferrochelatase gene from patients with erythropoietic protoporphyria. *Am J Hum Genet* 1998;62:1341–1352.
280. Avner DL, Lee RG, Berenson MM. Protoporphyrin-induced cholestasis in the isolated in situ perfused rat liver. *J Clin Invest* 1981;67:385–394.
281. Avner DL, Berenson MM. Hepatic clearance and biliary secretion of protoporphyrin in the isolated, in situ perfused rat liver. *J Lab Clin Med* 1982;99:885–894.
282. Lee RG, Avner DL, Berenson MM. Structure–function relationships of protoporphyrin-induced liver injury. *Arch Pathol Lab Med* 1984;108:744–746.
283. Bloomer JR. The liver in protoporphyria. *Hepatology* 1988;8:402–407.
284. Nordmann Y. Erythropoietic protoporphyria and hepatic complications. *J Hepatol* 1992;16:4–6.
285. Nakahashi Y, Miyazaki H, Kadota Y, et al. Molecular defect in human erythropoietic protoporphyria with fatal liver failure. *Hum Genet* 1993;91:303–306.
286. Schneider–Yin X, Schafer BW, Mohr P, et al. Molecular defects in erythropoietic protoporphyria with terminal liver failure. *Hum Genet* 1994;93:711–713.
287. Bloomer J, Bruzzone C, Shu L, et al. Molecular defects in ferrochelatase in patients with protoporphyria requiring liver transplantation. *J Clin Invest* 1998;102:107–114.
288. Minder EI, Gouya L, Schneider–Yin X, et al. A genotype–phenotype correlation between null-allele mutations in the ferrochelatase gene and liver complications in patients with erythropoietic protoporphyria. *Cell Mol Biol* 2002;48:91–96.
289. Bonkovsky HL, Schned AR. Fatal liver failure in protoporphyria. Synergism between ethanol excess and the genetic defect. *Gastroenterology* 1986;90:191–201.
290. Poh–Fitzpatrick MB, Whitlock RT, Leftkowitz JH. Changes in protoporphyrin distribution dynamics during liver failure and recovery in a patient with protoporphyria and Epstein–Barr viral hepatitis. *Am J Med* 1986;80:943–950.

291. Baart de la Faille H, Bijlmer-Iest JC, van Hattum J, et al. Erythropoietic protoporphyria: clinical aspects with emphasis on the skin. *Curr Prob Dermatol* 1990;20:123-134.
292. Brun A, Western A, Malik Z, et al. Erythropoietic protoporphyria: photodynamic transfer of protoporphyrin from intact erythrocytes to other cells. *Photochem Photobiol* 1990;51:573-577.
293. Prentice RTW, Goldberg A, Thompson G. Photosensitivity: familial incidence, clinical features and incidence of erythropoietic protoporphyria. *Br J Dermatol* 1969;81:414-419.
294. Lim HW, Cooper D, Sassa S, et al. Photosensitivity, abnormal porphyrin profile and sideroblastic anemia. *J Am Acad Dermatol* 1992;27:287-292.
295. Murphy GM, Hawk JL, Magnus IA. Late-onset erythropoietic protoporphyria with unusual cutaneous features. *Arch Dermatol* 1985;121:1309-1312.
296. Aplin C, Whatley SD, Thompson P, et al. Late-onset erythropoietic porphyria caused by chromosome 18q deletion in erythroid cells. *J Invest Dermatol* 2001;117:1647-1649.
297. Redeker AG, Berke M. Erythropoietic protoporphyria with eczema solare. *Arch Dermatol* 1962;86:569-574.
298. Poh-Fitzpatrick MB. Erythropoietic porphyrias: current mechanistic, diagnostic, and therapeutic considerations. *Semin Hematol* 1977;14:211-219.
299. Cripps DJ, Scheuer PJ. Hepatobiliary changes in erythropoietic protoporphyria. *Arch Pathol* 1965;80:500-508.
300. Goerz G, Krieg TH, Bolsen K, et al. Porphyrin-Untersuchungen eines Gallensteines bei der erythropoetischen Protoporphyrrie. *Arch Dermatol Res* 1976;256:283-289.
301. Bloomer JR, Enriquez R. Evidence that hepatic crystalline deposits in a patient with protoporphyria are composed of protoporphyrin. *Gastroenterology* 1982;82:569-572.
302. Rank J, Carithers R, Bloomer J. Evidence for neurological dysfunction in end-stage protoporphyric liver disease. *Hepatology* 1993;18:1404-1409.
303. Lock G, Holstege A, Mueller AR. Liver failure in erythropoietic protoporphyria associated with choledocholithiasis and severe post-transplantation polyneuropathy. *Liver* 1996;16:211-217.
304. Nelson JD, Dorn P, Rogers LE, et al. Fluorescence of erythrocytes in relation to erythrocyte protoporphyrin and to urinary lead excretion. *Am J Clin Pathol* 1968;50:297-301.
305. Lamola AA, Yamane T. Zinc protoporphyrin in the erythrocytes of patients with lead intoxication and iron deficiency anemia. *Science* 1974;186:936-938.
306. Lamola AA, Piomelli S, Poh-Fitzpatrick MB, et al. Erythropoietic protoporphyria and lead intoxication: the molecular basis for difference in cutaneous photosensitivity. II. Different binding of erythrocyte protoporphyrin to hemoglobin. *J Clin Invest* 1975;46:1528-1535.
307. Clark KGA, Nicholson DC. Erythrocyte protoporphyrin and iron uptake in erythropoietic protoporphyria. *Clin Sci* 1971;41:363-370.
308. Wuepper KD, Epstein JH. Erythrocyte fluorescence in relatives of patients with erythropoietic protoporphyria. *JAMA* 1967;200:176-178.
309. Porter FS, Lowe BA. Congenital erythropoietic protoporphyria. Case reports, clinical studies and porphyrin analyses in two brothers. *Blood* 1963;22:521-531.
310. Rosenmund A, Ziegler G, Ruegg R, et al. Lienale and intravasale korpuskulare Hamolyse bei erythropoietischer Protoporphyrrie. *Schweiz Med Wochenschr* 1975;105:1596.
311. Key NS, Rank JM, Freese D, et al. Hemolytic anemia in protoporphyria: possible precipitating role of

liver failure and photic stress. *Am J Hematol* 1992;39:202-207.

312. Donaldson EM, Donaldson AD, Rimington C. Erythropoietic protoporphyria: a family study. *BMJ* 1967;1:659-663.
313. Poh-Fitzpatrick MB. Protoporphyrin metabolic balance in human protoporphyria. *Gastroenterology* 1985;88:1239-1242.
314. Morton KO, Schneider F, Weimer MK, et al. Hepatic and bile porphyrins in patients with protoporphyria and liver failure. *Gastroenterology* 1988;94:1488-1492.
315. Klatskin G, Bloomer JR. Birefringence of hepatic pigment deposits in erythropoietic protoporphyria. *Gastroenterology* 1974;67:294-302.
316. Mathews-Roth MM, Pathak MA, Fitzpatrick TB, et al. Beta-carotene as an oral photoprotective agent in erythropoietic protoporphyria. *JAMA* 1974;228:1004-1008.
317. Thomsen K, Schmidt H, Fischer A. Beta-carotene in erythropoietic protoporphyria: 5 years experience. *Dermatologica* 1979;159:82-86.
318. Foote CS, Chang YC, Denny RW. Chemistry of singlet-excited oxygen. X. Carotenoid quenching parallels biological protection. *J Am Chem Soc* 1970;92:5216-5218.
319. Foote CS, Chang YC, Denny RW. Chemistry of singlet oxygen. XI. Cis-trans isomerization of carotenoids by singlet-excited oxygen and probable quenching mechanism. *J Am Chem Soc* 1970;92:5218-5219.
320. Moshell AN, Bjornson L. Photoprotection in erythropoietic protoporphyria: mechanism of photoprotection by beta carotene. *J Invest Dermatol* 1977;68:157-160.
321. Collins P, Ferguson J. Narrow band UVB (TL-01) phototherapy: an effective preventative treatment for the photodermatoses. *Br J Dermatol* 1995;132:956-963.
322. Roelandts R. Photo(chemo)therapy and general management of erythropoietic protoporphyria. *Dermatologica* 1995;190:330-331.
323. Ross JB, Moss MA. Relief of photosensitivity of erythropoietic protoporphyria by pyridoxine. *J Am Acad Dermatol* 1990;22:340-342.
324. Mathews-Roth MM, Rosner B, Benfell K, et al. A double-blind study of cysteine photoprotection in erythropoietic protoporphyria. *Photodermatol Photoimmunol Photomed* 1994;10:244-248.
325. Schoemaker JH, Bousema MT, Zijlstra H, et al. Treatment of erythropoietic protoporphyria with hydroxyethylrutosides. *Dermatologica* 1995;191:36-38.
326. Bechetel MA, Bertolone SJ, Hodge SJ. Transfusion therapy in a patient with erythropoietic protoporphyria. *Arch Dermatol* 1981;117:99-101.
327. Dobozy A, Csato M, Siklosi C, et al. Transfusion therapy for erythropoietic protoporphyria. *Br J Dermatol* 1983;109:571-576.
328. Todd DJ, Callender ME, Mayne EE, et al. Erythropoietic protoporphyria, transfusion therapy, and liver disease. *Br J Dermatol* 1992;127:534-537.
329. Van Vijk HJ, van Hattum J, Baart de la Faille H, et al. Blood exchange and transfusion therapy for acute cholestasis in protoporphyria. *Dig Dis Sci* 1988;33:1621-1625.
330. Lamom JM, Poh-Fitzpatrick MB, Lamola AA. Hepatic protoporphyrin production in human protoporphyria. Effects of intravenous hematin and analysis of erythrocyte protoporphyrin distribution. *Gastroenterology* 1980;70:115-125.
331. Bloomer JR, Pierach CA. Effect of hematin administration to patients with protoporphyria and liver

disease. *Hepatology* 1982;2:817–821.

332. Gordeuk VR, Brittenham GM, Hawkins CW, et al. Iron therapy for hepatic dysfunction in erythropoietic protoporphyria. *Ann Intern Med* 1986;105:27–31.

333. Milligan A, Graham–Brown RAC, Sarkany I, et al. Erythropoietic protoporphyria exacerbated by oral iron therapy. *Br J Dermatol* 1988;119:63–66.

334. Ibrahim GW, Watson CJ. Enterohepatic circulation and conversion of protoporphyrin to bile pigment in man. *Proc Soc Exp Biol Med* 1968;127:890–895.

335. Stathers GM. Porphyrin-binding effect of cholestyramine. Results in vitro and in vivo studies. *Lancet* 1966;2:780–782.

336. Stathers GM, Aronsen KF, Haeger–Aronsen B. Studies on the entero–hepatic circulation of <sup>14</sup>C porphyrins. *Br J Dermatol* 1969;81:276–279.

337. Pimstone NR, Ghandi SN, Mukerji SK. Enterohepatic circulation of porphyrins in man: does it exist? *Hepatology* 1982;2:718.

338. Bloomer JR. Pathogenesis and therapy of liver disease in protoporphyria. *Yale J Biol Med* 1979;52:39–48.

339. McCullough AJ, Barron D, Mullen KD, et al. Fecal protoporphyrin excretion in erythropoietic protoporphyria: effect of cholestyramine and bile acid feeding. *Gastroenterology* 1988;94:177–181.

340. Beukeveld GJJ, Wolthers BG. Cholestyramine orally administered to patients with erythropoietic protoporphyria results in urinary excretion of protoporphyrin: to be explained by the Herbst–Volkheimer effect? *Clin Chim Acta* 1995;233:119–126.

341. Gorschein A, Foster GR. Liver failure in protoporphyria: long-term treatment with oral charcoal. *Hepatology* 1999;29:995–996.

342. Berenson MM, Marin JJ, Larsen R, et al. Effect of bile acids on hepatic protoporphyrin metabolism in perfused rat liver. *Gastroenterology* 1987;93:1086–1093.

343. Poh–Fitzpatrick MB, Sklar JA, Goldsman C, et al. Protoporphyrin hepatopathy. Effects of cholic acid ingestion in murine griseofulvin-induced protoporphyria. *J Clin Invest* 1983;72:1449–1458.

344. Lefkowitz JH, Feng–Chen K–C, Sklar JA, et al. Cholic acid amelioration of light and electron microscopic lesions in experimental protoporphyria. *Hepatology* 1983;3:399–406.

345. Van Hattum J, Baart de la Faille H, van den Berg JWO, et al. Chenodeoxycholic acid therapy in erythropoietic protoporphyria. *J Hepatol* 1986;3:407–412.

346. Rademakers LHPM, Cleton MI, Kooijman C, et al. Early involvement of hepatic parenchymal cells in erythrohepatic protoporphyria? An ultrastructural study of patients with and without overt liver disease and the effect of chenodeoxycholic acid treatment. *Hepatology* 1990;11:449–457.

347. deTorres I, Demetris AJ, Randhawa PS. Recurrent hepatic allograft injury in erythropoietic protoporphyria. *Transplantation* 1996;61:1412–1413.

348. Bloomer JR, Rank JM, Payne WD, et al. Follow-up after liver transplantation for protoporphyric liver disease. *Liver Transpl Surg* 1996;2:269–275.

349. Gross U, Frank M, Doss MO. Hepatic complications of erythropoietic protoporphyria. *Photodermatol Photoimmunol Photomed* 1998;14:52–57.

350. Poh–Fitzpatrick MB, Wang X, Anderson KE, et al. Erythropoietic protoporphyria: altered phenotype after bone marrow transplantation for myelogenous leukemia in a patient heteroallelic for ferrochelatase mutations. *J Am Acad Dermatol* 2002;46:861–866.

351. Mathews–Roth MM, Michel JL, Wise RJ. Amelioration of the metabolic defect in erythropoietic

- protoporphyrin by expression of human ferrochelatase in cultured cells. *J Invest Dermatol* 1995;104:497-499.
352. Magness ST, Brenner DA. Ferrochelatase cDNA delivered by adenoviral vector corrects biochemical defect in protoporphyrin cells. *Hum Gene Ther* 1995;6:1285-1290.
353. Ruth GR, Schwartz S, Stephenson B. Bovine protoporphyrin: the first nonhuman model of this hereditary photosensitizing disease. *Science* 1977;198:199-201.
354. Bloomer JR, Morton KO, Reuter RJ, et al. Bovine protoporphyrin: documentation of autosomal recessive inheritance and comparison with the human disease through measurement of heme synthase activity. *Am J Hum Genet* 1982;34:322-330.
355. Straka JG, Hill HD, Krikava JM, et al. Immunochemical studies of ferrochelatase protein: characterization of the normal and mutant protein in bovine and human protoporphyrin. *Am J Hum Genet* 1991;48:72-78.
356. Jenkins MM, LeBoeuf RD, Ruth GR, et al. A novel stop codon mutation (X417L) of the ferrochelatase gene in bovine protoporphyrin, a natural animal model of the human disease. *Biochim Biophys Acta* 1998;1408:18-24.
357. DeMatteis F, Rimington C. Disturbance of porphyrin metabolism caused by griseofulvin in mice. *Br J Dermatol* 1963;75:91-104.
358. Nakao K, Wada O, Takaku F, et al. The origin of the increased protoporphyrin in erythrocytes of mice with experimentally induced porphyria. *J Lab Clin Med* 1967;70:923-932.
359. Matilla A, Molland EA. A light and electron microscopic study of the liver in case of erythrohepatic protoporphyrin and in griseofulvin-induced porphyria in mice. *J Clin Pathol* 1974;27:698-709.
360. Gschnait F, Konrad K, Honigsmann H, et al. Mouse model for protoporphyrin. I. The liver and hepatic protoporphyrin crystals. *J Invest Dermatol* 1975;65:290-299.
361. Konrad K, Honigsmann H, Gschnait F, et al. Mouse model for protoporphyrin. II. Cellular and subcellular events in the photosensitivity flare of the skin. *J Invest Dermatol* 1975;65:300-310.
362. Tutois S, Montgutelli X, DaSilva V, et al. Erythropoietic protoporphyrin in the house mouse. A recessive inherited ferrochelatase deficiency with anemia, photosensitivity and liver disease. *J Clin Invest* 1991;88:1730-1736.
363. Boulechfar S, Lamoril J, Montgutelli X, et al. Ferrochelatase structural mutant (*Fechm1Pas*) in the house mouse. *Genomics* 1993;16:645-648.
364. Fontanellas A, Mazurier F, Landry M, et al. Reversion of hepatobiliary alterations by bone marrow transplantation in a murine model of erythropoietic protoporphyrin. *Hepatology* 2000;32:73-81.
365. Pawliuk R, Bachelot T, Wise RJ, et al. Long-term cure of the photosensitivity of murine erythropoietic protoporphyrin by preselective gene therapy. *Nat Med* 1999;5:768-773.
366. Fontanellas A, Mendez M, Mazurier F, et al. Successful therapeutic effect in a mouse model of erythropoietic protoporphyrin by partial genetic correction and fluorescence-based selection of hematopoietic cells. *Gene Ther* 2001;8:618-626.
367. Richard E, Mendez M, Mazurier F, et al. Gene therapy of a mouse model of protoporphyrin with a self-inactivating erythroid-specific lentiviral vector without preselection. *Mol Ther* 2001;4:331-338.
368. Childs S, Weinstein BM, Manzoor-Ali PK, et al. Zebrafish *Dracula* encodes ferrochelatase and its mutation provides a model for erythropoietic protoporphyrin. *Current Biol* 2001;10:1001-1004.
369. Waldenstrom J. Studien uber Porphyrie. *Acta Med Scand* 1937;82:120-121.
370. Deybach JC, Puy H. Porphobilinogen deaminase gene structure and molecular defects. *J Bioenerg*

Biomembr 1995;27:197-205.

371. Tishler PV, Woodward B, O'Connor J, et al. High prevalence of intermittent acute porphyria in a psychiatric patient population. *Am J Psychiatry* 1985;142:1430-1436.
372. Strand LJ, Felsher BF, Redeker AG, et al. Heme biosynthesis in intermittent acute porphyria: decreased hepatic conversion of porphobilinogen to porphyrins and increased delta-aminolevulinic acid synthetase activity. *Proc Natl Acad Sci U S A* 1970;67:1315-1320.
373. Miyagi K, Cardinal R, Bossenmaier I, et al. The serum porphobilinogen and hepatic porphobilinogen deaminase in normal and porphyric individuals *J Lab Clin Med* 1971;78:683-695.
374. Strand LJ, Meyer UA, Felsher BF, et al. Decreased red cell uroporphyrinogen I synthetase activity in intermittent acute porphyria. *J Clin Invest* 1972;51:2530-2536.
375. Meyer UA, Strand LJ, Doss M, et al. Intermittent acute porphyria: demonstration of a genetic defect in porphobilinogen metabolism. *N Engl J Med* 1972;286:1277-1282.
376. Meyer UA. Intermittent acute porphyria. Clinical and biochemical studies of disordered heme biosynthesis. *Enzyme* 1973;16:334-342.
377. Bonkowsky HL, Tschudy DP, Weinbach EC, et al. Porphyrin synthesis and mitochondrial respiration in acute intermittent porphyria: studies using cultured human fibroblasts. *J Lab Clin Med* 1975;85:93-102.
378. Sassa S, Solish G, Levere RD, et al. Studies in porphyria. IV. Expression of the gene defect of acute intermittent porphyria in cultured human skin fibroblasts and amniotic cells: prenatal diagnosis of the porphyric trait. *J Exp Med* 1975;142:722-731.
379. Sassa S, Zalar GL, Kappas A. Studies in porphyria. VII. Induction of uroporphyrinogen-synthase and expression of the gene defect of acute intermittent porphyria in mitogen-stimulated human lymphocytes. *J Clin Invest* 1978;61:499-508.
380. Lamon JM, Frykholm BC, Tschudy DP. Family evaluations in acute intermittent porphyria using red cell uroporphyrinogen I synthase. *J Med Genet* 1979;16:134-139.
381. Wilson JHP, van den Berg JWO, Brouwers D, et al. Erythrocyte uroporphyrinogen-I-synthase activity in acute intermittent porphyria. *Neth J Med* 1979;22:13-16.
382. Bottomley SS, Bonkowsky HL, Kreimer-Birnbaum M. The diagnosis of acute intermittent porphyria. Usefulness and limitations of the erythrocyte uroporphyrinogen I synthase assay. *Am J Clin Pathol* 1981;76:133-139.
383. Astrup EG. Family studies on the activity of uroporphyrinogen I synthase in diagnosis of acute intermittent porphyria. *Clin Sci Mol Med* 1978;54:551-556.
384. Sassa S, Granick S, Bickers D, et al. Studies on the inheritance of human erythrocyte aminolevulinic acid dehydratase and uroporphyrinogen synthetase. *Enzyme* 1973;16:326-333.
385. Wetterberg L, Floderus Y, Thunell S, et al. Genetic regulation of the red cell uroporphyrinogen-I-synthetase level in families with acute intermittent porphyria. *Clin Genet* 1983;24:403-406.
386. Mustajoki P, Tenhunen R. Variant of acute intermittent porphyria with normal erythrocyte uroporphyrinogen-I-synthase activity. *Eur J Clin Invest* 1985;15:281-284.
387. Anderson PM, Reddy RM, Anderson KE, et al. Characterization of the porphobilinogen deaminase deficiency in acute intermittent porphyria. Immunologic evidence for heterogeneity of the genetic defect. *J Clin Invest* 1981;68:1-12.
388. Lee JS, Anvert M. A *Pst*I polymorphism for the human porphobilinogen deaminase gene. *Nucleic Acids Res* 1987;5:6307.
389. Lee JS, Lundin G, Lannfelt L, et al. Genetic heterogeneity of the porphobilinogen deaminase gene in



- Swedish families with acute intermittent porphyria. *Hum Genet* 1991;87:484–488.
390. Deybach J-C, Puy H. Acute intermittent porphyria: from clinical to molecular aspects. In: Kadish KM, Smith KM, Guillard R, eds. *The porphyrin handbook—medical aspects of porphyrins*. Amsterdam: Academic Press, 2003:14:23–41.
391. Raich N, Romeo PH, Dubart A, et al. Molecular cloning and complete primary sequence of human erythrocyte porphobilinogen deaminase. *Nucleic Acids Res* 1986;14:5955–5968.
392. Grandchamp B, de Verneuil H, Beaumont C, et al. Tissue-specific expression of porphobilinogen deaminase. Two isozymes from a single gene. *Eur J Biochem* 1987;162:105–110.
393. Chretien S, Dubart A, Beaupain D, et al. Alternative transcription and splicing of the human porphobilinogen deaminase gene result either in tissue-specific or in housekeeping expression. *Proc Natl Acad Sci U S A* 1988;85:6–10.
394. Yoo HW, Warner CA, Chen CH, et al. Hydroxymethylbilane synthase: complete genomic sequence and amplifiable polymorphisms in the human gene. *Genomics* 1993;15:21–29.
395. Namba M, Narahara K, Tsuji K, et al. Assignment of human PBGD to 11q24.1?11q24.2 by in situ hybridization and gene dosage studies. *Cytogenet Cell Genet* 1991;67:105–108.
396. Puy H, Deybach JC, Lamoril J, et al. Molecular epidemiology and diagnosis of PBG deaminase gene defects in acute intermittent porphyria. *Am J Hum Genet* 1997;60:1373–1383.
397. Whatley SD, Roberts AG, Elder GH. De-novo mutation and sporadic presentation of acute intermittent porphyria. *Lancet* 1995;346:1007–1008.
398. Picat C, Delfau MH, deRoos FWM, et al. Identification of the mutations in the parents of a patient with a putative compound heterozygosity for acute intermittent porphyria. *J Inherited Metab Dis* 1990;13:684–686.
399. Llewellyn DH, Smyth SJ, Elder GH, et al. Homozygous acute intermittent porphyria: compound heterozygosity for adjacent base transitions in the same codon of the porphobilinogen deaminase gene. *Hum Genet* 1992;89:97–98.
400. Xu W, Solis C, Bermejo AM, et al. Clinical and molecular delineation of severe homozygous dominant acute intermittent porphyria. *Pediatr Res* 1995;37:155A.
401. Schreiber WE, Jamani A, Armstrong JG. Acute intermittent porphyria in a native North American family. Biochemical and molecular analysis. *Am J Clin Pathol* 1995;103:730–734.
402. Andersson C, Floderus Y, Wikberg A, et al. The W198X and R173W mutations in the porphobilinogen deaminase gene in acute intermittent porphyria have higher clinical penetrance than R167W. A population-based study. *Scand J Clin Lab Invest* 2000;60:643–648.
403. Brownlie PD, Lambert R, Louie GV, et al. The three-dimensional structures of mutants of porphobilinogen deaminase: toward an understanding of the structural basis of acute intermittent porphyria. *Protein Sci* 1994;3:1644–1650.
404. Shoolingin-Jordan PM. Porphobilinogen deaminase and uroporphyrinogen III synthase: structure, molecular biology, and mechanism. *J Bioenerg Biomembr* 1995;27:181–195.
405. Tschudy DP, Perloth MG, Marver HS, et al. Acute intermittent porphyria: the first “overproduction disease” localized to a specific enzyme. *Proc Natl Acad Sci U S A* 1965;53:841–847.
406. Nakao K, Wada O, Kitamura T. Activity of aminolaevulinic acid synthetase in normal and porphyric human livers. *Nature* 1966;210:838–839.
407. Sweeney VP, Pathak MA, Asbury AK. Acute intermittent porphyria: increased ALA-synthetase activity during an acute attack. *Brain* 1970;93:369–380.
408. Kaufman L, Marver HS. Biochemical defects in two types of human hepatic porphyria. *N Engl J Med*

1970;283:954–958.

409. Stein JA, Tschudy DP. Acute intermittent porphyria. A clinical and biochemical study of 46 patients. *Medicine* 1970;49:1–16.

410. Brennan MJW, Cantrill RC. d-Aminolaevulinic acid is a potent agonist for GABA autoreceptors. *Nature* 1979;280:514–515.

411. Brennan MJW, Cantrill RC, Kramer S. Effect of d-aminolaevulinic acid on GABA receptor binding in synaptic plasma membranes. *Int J Biochem* 1980;12:833–835.

412. Feldman DS, Levere RD, Lieberman JS. Presynaptic neuromuscular inhibition by delta-aminolevulinic acid, a porphyrin precursor. *Trans Am Neurol Assoc* 1968;93:206–208.

413. Bornstein JC, Pickett JB, Diamond I. Inhibition of the evoked release of acetylcholine by the porphyrin precursor d-aminolevulinic acid. *Ann Neurol* 1979;5:94–96.

414. Loots JM, Becker DM, Meyer BJ, et al. The effect of porphyrin precursors on monosynaptic reflex activity in the isolated hemisectioned frog spinal cord. *J Neural Transm* 1975;36:71–81.

415. Percy VA, Lamm MCL, Taljaard JJF. d-Aminolaevulinic acid uptake, toxicity and effect on [14C][–?–] aminobutyric acid uptake into neurons and glia in culture. *J Neurochem* 1981;36:69–76.

416. Sassa S, Kappas A. Hereditary tyrosinemia and the heme biosynthetic pathway: profound inhibition of d-aminolevulinic acid dehydratase activity by succinylacetone. *J Clin Invest* 1983;71:625–634.

417. Mitchell G, Larochelle J, Lambert M, et al. Neurologic crises in hereditary tyrosinemia. *N Engl J Med* 1990;322:432–437.

418. Marcus RJ, Wetterberg L, Yuwiler A, et al. Electroencephalographic and behavioral effects of experimental porphyria in the rat. *Electroencephalogr Clin Neurophysiol* 1970;29:602–607.

419. Shanley BC, Percy VA, Neethling AC. Neurochemistry of acute porphyria. Experimental studies of d-aminolaevulinic acid and porphobilinogen. In: Doss M, ed. *Porphyria in human diseases*. Basel: Karger, 1976:155–162.

420. Dowdle E, Mustard P, Spong N, et al. The metabolism of [5-14C] d-aminolaevulinic acid in normal and porphyric human subjects. *Clin Sci* 1968;34:233–251.

421. Mustajoki K, Timonen K, Gorchein A, et al. Sustained high plasma 5-aminolevulinic acid concentration in a volunteer: no porphyric symptoms. *Eur J Clin Invest* 1992;22:407–411.

422. Pierach CA, Edwards PS. Neurotoxicity of d-aminolevulinic acid and porphobilinogen. *Exp Neurol* 1978;62:810–814.

423. Shanley BC, Percy VA, Neethling AC. Pathogenesis of neural manifestations in acute porphyria. *S Afr Med J* 1977;51:458–460.

424. Whetsell WO Jr, Sassa S, Kappas A. Porphyrin-heme biosynthesis in organotypic cultures of mouse dorsal root ganglia. Effects of heme and lead on porphyrin synthesis and peripheral myelin. *J Clin Invest* 1984;74:600–607.

425. Litman DA, Correia MA. L-Tryptophan: a common denominator of biochemical and neurological events of acute hepatic porphyria? *Science* 1983;222:1031–1033.

426. Litman DA, Correia MA. Elevated brain tryptophan and enhanced 5-hydroxytryptamine turnover in acute hepatic heme deficiency: clinical implications. *J Pharmacol Exp Ther* 1985;232:337–345.

427. Puy H, Deybach JC, Baudry P, et al. Decreased nocturnal plasma melatonin levels in patients with recurrent acute intermittent porphyria attacks. *Life Sci* 1993;53:621–627.

428. Puy H, Deybach JC, Bogdan A, et al. Increased d-aminolevulinic acid and decreased pineal melatonin

production. A common event in acute porphyria studies in the rat. *J Clin Invest* 1996;97:104–110.

429. Anderson KE, Spitz IM, Bardin W, et al. A gonadotropin releasing hormone analogue prevents cyclical attacks of porphyria. *Arch Int Med* 1990;150: 1469–1474.

430. Fraser DJ, Pdvinec M, Kaufmann MR, et al. Drugs mediate the transcriptional activation of the 5-aminolevulinic acid synthase (ALAS1) gene via the chicken xenobiotic-sensing nuclear receptor (CXR). *J Biol Chem* 2002;277:34717–34726.

431. Kaupinen R, Mustajoki P. Prognosis of acute porphyria: occurrence of acute attacks, precipitating factors, and associated diseases. *Medicine* 1992;71:1–13.

432. Welland FH, Hellmann ES, Gaddis EM, et al. Factors affecting the excretion of porphyrin precursors by patients with acute intermittent porphyria. I. The effect of diet. *Metabolism* 1964;13:232–249.

433. Tschudy DP, Valsamis M, Magnussen CR. Acute intermittent porphyria: clinical and selected research aspects. *Ann Intern Med* 1975;83:851–864.

434. Waldenstrom J. The porphyrias as inborn errors of metabolism. *Am J Med* 1957;22:758–773.

435. Goldberg A. Acute intermittent porphyria: a study of 50 cases. *QJM* 1959;28:183–209.

436. Ridley A, Hierons R, Cavanagh JB. Tachycardia and neuropathy of porphyria. *Lancet* 1968;2:708–710.

437. Ridley A. The neuropathy of acute intermittent porphyria. *QJM* 1969;38:307–333.

438. Bonkowsky HL, Schady W. Neurologic manifestations of acute porphyria. *Semin Liver Dis* 1982;2:108–124.

439. Moore MR, McColl KEL, Rimington C, et al. Disorders of porphyrin metabolism. New York: Plenum, 1987:77–86.

440. Lai CW, Hung TP, Lin WS. Blindness of cerebral origin in acute intermittent porphyria. *Arch Neurol* 1977;34:310–312.

441. DeFrancisco M, Savino PJ, Schatz NJ. Optic atrophy in acute intermittent porphyria. *Am J Ophthalmol* 1979;87:221–224.

442. Ackner B, Cooper JE, Gray CH, et al. Acute porphyria: a neuropsychiatric and biochemical study. *J Psychosom Res* 1962;6:1–24.

443. Carney MWP. Hepatic porphyria with mental symptoms: four missed cases. *Lancet* 1972;2:100–101.

444. Guidotti TL, Charness ME, Lamon JM. Acute intermittent porphyria and the Kluver–Bucy syndrome. *Johns Hopkins Med J* 1979;145:233–235.

445. Crimlisk HL. The little imitator–porphyria: a neuropsychiatric disorder. *J Neurol Neurosurg Psychiatry* 1997;62:319–328.

446. Jeans JB, Savik K, Gross CR, et al. Mortality in patients with acute intermittent porphyria requiring hospitalization: a United States case series. *Am J Med Genet* 1996;65:269–273.

447. Bylesjo I, Forsgren L, Lithner F, et al. Epidemiology and clinical characteristics of seizures in patients with acute intermittent porphyria. *Epilepsia* 1996;37:230–235.

448. Nielsen B, Thorn NA. Transient excess urinary excretion of antidiuretic material in acute intermittent porphyria with hyponatremia and hypomagnesemia. *Am J Med* 1965;38:345–358.

449. Beattie AD, Goldberg A. Acute intermittent porphyria. Natural history and prognosis. In: Doss M, ed. *Porphyrias in human diseases*. Basel: Karger, 1976:245–250.

450. Church SE, McColl KEL, Moore MR, et al. Hypertension and renal impairment as complications of

acute porphyria. *Nephrol Dial Transplant* 1992;7:986–990.

451. Andersson C, Lithner F. Hypertension and renal disease in patients with acute intermittent porphyria. *J Int Med* 1994;236:169–175.

452. Beukeveld GJJ, Wolthers BG, Nordmann Y, et al. A retrospective study of a patient with homozygous form of acute intermittent porphyria. *J Inherited Metab Dis* 1990;13:673–683.

453. Bloomer JR, Berk PD, Bonkowsky HL, et al. Blood volume and bilirubin production in acute intermittent porphyria. *N Engl J Med* 1971;284:17–20.

454. Mauzerall D, Granick S. Occurrence and determination of d-aminolevulinic acid and porphobilinogen in urine. *J Biol Chem* 1956;219:435–446.

455. Watson CJ, Bossenmaier I, Cardinal R. Acute intermittent porphyria: urinary porphobilinogen and other Ehrlich reactors in the diagnosis. *JAMA* 1961;175:1987–1089.

456. Ackner B, Cooper JE, Gray CH, et al. Excretion of porphobilinogen and d-aminolaevulinic acid in acute porphyria. *Lancet* 1961;1:1256–1260.

457. Bissell DM. Laboratory evaluation in porphyria. *Semin Liver Dis* 1982;2:100–107.

458. Lamon JM, Frykholm BC, Tschudy DP. Screening tests in acute porphyria. *Arch Neurol* 1977;34:709–712.

459. Pierach CA, Cardinal R, Bossenmaier I, et al. Comparison of the Hoesch and the Watson–Schwartz tests for urinary porphobilinogen. *Clin Chem* 1977;23:1666–1668.

460. BATTERY JE, Chamberlain BR, Beng CG. A sensitive method for screening urinary porphobilinogen. *Clin Chem* 1989;35:2311–2312.

461. Waldenstrom J, Vahlquist BC. Studien uber die Entstehung der roten Harnpigments (Uroporphyrin und Porphobilin) bei der akuten Porphyrie aus ihrer farblosen Vorstufe (Porphobilinogen). *Hoppe–Seyler's Z Physiol Chem* 1939;260:189–209.

462. Haeger–Aronsen B. Fecal porphyrins in porphyria acute intermittens, porphyria cutanea tarda and intoxicatio plumbi. *Scand J Clin Lab Invest* 1962;14:397–402.

463. Cripps DJ, Peters HA. Stool porphyrins in acute intermittent and hereditary coproporphyria. Adverse effect of tranquilizers. *Arch Neurol* 1970;23:80–84.

464. Puy H, Aquaron R, Lamoril J, et al. Acute intermittent porphyria: rapid molecular diagnosis. *Cell Mol Biol* 1997;43:37–45.

465. Nissen H, Petersen NE, Mustajoki S, et al. Diagnostic strategy, genetic diagnosis and identification of new mutations in intermittent porphyria by denaturing gradient gel electrophoresis. *Hum Mutat* 1997;9:122–130.

466. Hellman ES, Tschudy DP, Bartter FC. Abnormal electrolyte and water metabolism in acute intermittent porphyria. *Am J Med* 1962;32:734–746.

467. Perlroth MG, Tschudy DP, Marver HS, et al. Acute intermittent porphyria: new morphologic and biochemical findings. *Am J Med* 1966;41:149–162.

468. Stein JA, Curl FD, Valsamis M, et al. Abnormal ion and water metabolism in acute intermittent porphyria with new morphologic findings. *Am J Med* 1972;53:784–789.

469. Eales L, Dowdle EB, Sweeney GD. The electrolyte disorder of the acute porphyric attack and the possible role of delta-aminolaevulinic acid. *S Afr J Lab Clin Med* 1971;17:89–97.

470. King PH, Bragdon AC. MRI reveals multiple reversible cerebral lesions in an attack of acute intermittent porphyria. *Neurology* 1991;41:1300–1302.

471. Celik M, Forta A, Dalkilic T, et al. MRI reveals reversible lesions resembling posterior reversible encephalopathy in porphyria. *Neuroradiology* 2002;44:839–841.
472. Kupferschmidt H, Bont A, Schnorf H, et al. Transient cortical blindness and occipital brain lesions in two patients with acute intermittent porphyria. *Ann Intern Med* 1995;123:598–600.
473. Ten Eyck FW, Martin WJ, Kernohan JW. Acute porphyria: necropsy studies in nine cases. *Proc Staff Meet Mayo Clinic* 1961;36:409–422.
474. Cavanagh JB, Mellick RS. On the nature of the peripheral nerve lesions associated with acute intermittent porphyria. *J Neurol Neurosurg Psychiatry* 1965;28:320–327.
475. Albers JW, Roberts WC, Daube JR. Electrodiagnostic findings in acute porphyric neuropathy. *Muscle Nerve* 1978;1:292–296.
476. Thorner PS, Bilbao JM, Sima AAF, et al. Porphyric neuropathy: an ultrastructural and quantitative case study. *Can J Neurol Sci* 1981;8:281–287.
477. Mustajoki P, Seppalainen AM. Neuropathy in latent hereditary hepatic porphyria. *BMJ* 1975;2:310–312.
478. Laiwah ACY, MacPhee GJA, Boyle P, et al. Autonomic neuropathy in acute intermittent porphyria. *J Neurol Neurosurg Psychiatry* 1985;48:1025–1030.
479. Blom H, Andersson C, Olofsson BO, et al. Assessment of autonomic nerve function in acute intermittent porphyria; a study based on spectral analysis of heart rate variability. *J Int Med* 1996;240:73–79.
480. Dhar GJ, Bossenmaier I, Petryka J, et al. Effects of hematin in hepatic porphyria: further studies. *Ann Intern Med* 1975;83:20–30.
481. Douer D, Weinberger A, Pinkhas J, et al. Treatment of acute intermittent porphyria with large doses of propranolol. *JAMA* 1978;240:766–768.
482. Bonkowsky HL, Tschudy DP. Hazard of propranolol in treatment of acute porphyria. *BMJ* 1974;4:47–48.
483. Bonkowsky HL, Tschudy DP, Collins A, et al. Repression of the overproduction of porphyrin precursors in acute intermittent porphyria by intravenous infusions of hematin. *Proc Natl Acad Sci U S A* 1971;68:2725–2729.
484. Bosch EP, Pierach CA, Bossenmaier I, et al. Effect of hematin in porphyric neuropathy. *Neurology* 1977;27:1053–1056.
485. Watson CJ, Pierach CA, Bossenmaier I, et al. Use of hematin in the acute attack of “inducible” hepatic porphyrias. *Adv Intern Med* 1978;23:256–286.
486. Lamon JM, Frykholm BC, Bennett M, et al. Prevention of acute porphyric attacks by intravenous hematin. *Lancet* 1978;2:492–494.
487. Lamon JM, Frykholm BC, Hess RA, et al. Hematin therapy for acute porphyria. *Medicine* 1979;58:252–269.
488. McColl KEL, Moore MR, Thompson GG, et al. Treatment with haematin in acute hepatic porphyria. *QJM* 1981;50:161–174.
489. Pierach CA. Hematin therapy for the porphyric attack. *Semin Liver Dis* 1982;2:1125–1131.
490. Mustajoki P, Nordmann Y. Early administration of heme arginate for acute porphyric attacks. *Arch Intern Med* 1993;153:2004–2008.
491. Dhar GJ, Bossenmaier I, Cardinal R, et al. Transitory renal failure following rapid administration of a

relatively large amount of hematin in a patient with acute intermittent porphyria in clinical remission. *Acta Med Scand* 1978;203:437-443.

492. Morris DL, Dudley MD, Pearson RD. Coagulopathy associated with hematin treatment for acute intermittent porphyria. *Ann Intern Med* 1981;95:700-701.
493. Goetsch CA, Bissell DM. Instability of hematin used in the treatment of acute hepatic porphyria. *N Engl J Med* 1986;315:235-238.
494. Green D, Ts'ao CH. Hematin: effects on hemostasis. *J Lab Clin Med* 1990;115:144-147.
495. Manning DJ, Gray TA. Haem arginate in acute hereditary coproporphyrin. *Arch Dis Child* 1991;66:730-731.
496. Tenhunen R, Tokola O, Linden IB. Haem arginate: a new stable haem compound. *J Pharm Pharmacol* 1987;39:780-786.
497. Volin L, Rasi V, Vahtera E, et al. Heme arginate: effects on hemostasis. *Blood* 1988;71:625-628.
498. Tenhunen R, Mustajoki P. Acute porphyria: treatment with heme. *Semin Liver Dis* 1998;18:53-55.
499. Dover SB, Graham A, Fitzsimons E, et al. Haem-arginate plus tin-protoporphyrin for acute hepatic porphyria. *Lancet* 1991;338:263.
500. Magnussen CR, Doherty JM, Hess RA, et al. Grand mal seizures and acute intermittent porphyria. *Neurology* 1975;25:1121-1125.
501. Larson AW, Wasserstrom WR, Felsher BF, et al. Post-traumatic epilepsy and acute intermittent porphyria: effects of phenytoin, carbamazepine and clonazepam. *Neurology* 1978;28:824-828.
502. Bonkowsky HL, Sinclair PR, Emery S, et al. Seizure management in acute porphyria: risks of valproate and clonazepam. *Neurology* 1980;30:588-592.
503. Taylor RL. Magnesium sulfate for AIP seizures. *Neurology* 1981;31:1371-1372.
504. Sadeh M, Blatt I, Martonovits G, et al. Treatment of porphyric convulsions with magnesium sulfate. *Epilepsia* 1991;32:712-715.
505. Hahn M, Gildemeister OS, Krauss GL, et al. Effects of new anticonvulsant medications on porphyrin synthesis in cultured liver cells: potential implications for patients with acute porphyria. *Neurology* 1997;49:97-106.
506. Hift RJ, Meissner PN, Moore MR. Porphyria: a toxicogenic disease. In: Kadish KM, Smith KM, Guillard R, eds. *The porphyrin handbook--medical aspects*. Amsterdam: Academic Press, 2003;14:303-338.
507. James MFM, Hift RJ. Porphyrias. *Br J Anaesth* 2000;85:143-153.
508. Knudsen KB, Sparberg M, Lecocq F. Porphyria precipitated by fasting. *N Engl J Med* 1967;277:350-351.
509. Bargetzi MJ, Meyer UA, Birkhaeuser MH. Premenstrual exacerbations in hepatic porphyria: prevention by intermittent administration of an LH-RH agonist in combination with a gestagen. *JAMA* 1989;261:864.
510. Aggarwal N, Bagga R, Sawhney H, et al. Pregnancy with acute intermittent porphyria: a case report and review of literature. *J Obstet Gynaecol Res* 2002;28:160-162.
511. Johansson A, Moller C, Gellerfors P, et al. Non-viral mediated gene transfer of porphobilinogen deaminase into mammalian cells. *Scan J Clin Lab Invest* 2002;62:105-113.
512. Andersson C, Bjersing L, Lithner F. The epidemiology of hepatocellular carcinoma in patients with acute intermittent porphyria. *J Int Med* 1996;240:195-201.

513. Linet MC, Gridley G, Nyren O, et al. Primary liver cancer, other malignancies, and mortality risks following porphyria: a cohort study in Denmark and Sweden. *Am J Epidemiol* 1999;149:1010–1015.
514. Andant C, Puy H, Bogard C, et al. Hepatocellular carcinoma in patients with acute hepatic porphyrias: frequency of occurrence and related factors. *J Hepatol* 2000;32:933–939.
515. Gubler JG, Bargetzi MJ, Meyer UA. Primary liver carcinoma in two sisters with acute intermittent porphyria. *Am J Med* 1990;89:540–541.
516. Pierach CA, Bossenmaier I, Cardinal RA, et al. Pseudo-porphyrin in a patient with hepatocellular carcinoma. *Am J Med* 1984;76:545–548.
517. Lindberg RLP, Porcher C, Grandchamp B, et al. Porphobilinogen deaminase deficiency in mice causes a neuropathy resembling that of human acute hepatic porphyria. *Nat Genet* 1996;12:195–199.
518. Lindberg RLP, Martini R, Baumgartner M, et al. Motor neuropathy in porphobilinogen deaminase-deficient mice imitates the peripheral neuropathy of human acute porphyria. *J Clin Invest* 1999;103:1127–1134.
519. Jover R, Hoffmann F, Scheffler-Koch V, Lindberg RL. Limited heme synthesis in porphobilinogen deaminase-deficient mice impairs transcriptional activation of specific cytochrome P450 genes by phenobarbital. *Eur J Biochem* 2000;267:7128–7137.
520. Schuurmans MM, Hoffmann F, Lindberg RL, et al. Zinc mesoporphyrin represses induced hepatic 5-aminolevulinic acid synthase and reduces heme oxygenase activity in a mouse model of acute hepatic porphyria. *Hepatology* 2001;33:1217–1222.
521. Potluri VR, Astrin KH, Wetmur JG, et al. Human d-aminolevulinic acid dehydratase: chromosomal localization to 9q34 by in situ hybridization. *Hum Genet* 1987;76:236–239.
522. Kaya AH, Plewinska M, Wong DM, et al. Human d-aminolevulinic acid dehydratase (ALAD) gene: structure and alternative splicing of the erythroid and housekeeping mRNAs. *Genomics* 1994;19:242–248.
523. Doss M, von Tiepermann R, Schneider J, et al. New type of hepatic porphyria with porphobilinogen synthase defect and intermittent acute clinical manifestation. *Klin Wochenschr* 1979;57:1123–1127.
524. Thunell S. Aminolaevulinic acid dehydratase porphyria in infancy. A clinical and biochemical study. *J Clin Chem Clin Biochem* 1987;25:5–14.
525. Hassoun A, Verstraeten L, Mercelis R, et al. Biochemical diagnosis in a 63-year-old man. *J Clin Chem Clin Biochem* 1989;27:781–786.
526. Mercelis R, Hassoun A, Verstraeten L, et al. Porphyrin neuropathy and hereditary d-aminolevulinic acid dehydratase deficiency in an adult. *J Neurol Sci* 1990;95:39–47.
527. Wolff C, Piderit F, Armas-Merino R. Deficiency of porphobilinogen synthase associated with acute crisis. Diagnosis of the first two cases in Chile by laboratory methods. *Eur J Clin Chem Clin Biochem* 1991;29:313–315.
528. Bird TD, Hamernyik P, Nutter JY, et al. Inherited deficiency of delta-amino-levulinic acid dehydratase. *Am J Hum Genet* 1979;31:662–668.
529. de Verneuil H, Doss M, Brusco N, et al. Hereditary hepatic porphyria with delta aminolevulinic acid dehydratase deficiency: immunologic characterization of the non-catalytic enzyme. *Hum Genet* 1985;69:174–177.
530. Fujita H, Sassa S, Lundgren J, et al. Enzymatic defect in a child with hereditary hepatic porphyria due to homozygous d-aminolevulinic acid dehydratase deficiency: immunochemical studies. *Pediatrics* 1987;80:880–885.
531. Sassa S, Fujita H, Doss M, et al. Hereditary hepatic porphyria due to homozygous d-aminolevulinic



- acid dehydratase deficiency: studies in lymphocytes and erythrocytes. *Eur J Clin Invest* 1991;21:244–248.
532. Plewinska M, Thunell S, Holmberg L, et al. d-Aminolevulinatase deficient porphyria: identification of the molecular lesions in a severely affected homozygote. *Am J Hum Genet* 1991;49:167–174.
533. Ishida N, Fujita H, Fukuda Y, et al. Cloning and expression of the defective genes from a patient with d-aminolevulinatase porphyria. *J Clin Invest* 1992;89:1431–1437.
534. Maruno M, Furuyama K, Akagi R, et al. Highly heterogeneous nature of d-aminolevulinatase (ALAD) deficiencies in ALAD porphyria. *Blood* 2001;97:2972–2978.
535. Akagi R, Yasui Y, Harper P, et al. A novel mutation of d-aminolevulinatase dehydratase in a healthy child with 12% erythrocyte enzyme activity. *Br J Haematol* 1999;106:931–937.
536. Akagi R, Nishitani C, Harigae H, et al. Molecular analysis of d-aminolevulinatase deficiency in a patient with an unusual late-onset porphyria. *Blood* 2000;96:3618–3623.
537. Battistuzzi G, Petrucci R, Silvagus L, et al. d-Aminolevulinatase: a new genetic polymorphism in man. *Ann Hum Genet* 1981;45:223–229.
538. Astrin KH, Bishop DF, Wetmur JG, et al. d-Aminolevulinatase isozymes and lead toxicity. *Ann N Y Acad Sci* 1987;514:23–29.
539. Ziemsen B, Angerer J, Lehnert G, et al. Polymorphism of delta-aminolevulinic acid dehydratase in lead-exposed workers. *Int Arch Occup Environ Health* 1986;58:245–247.
540. Wetmur JG, Kaya AH, Plewinska M, et al. Molecular characterization of the human d-aminolevulinatase 2 (ALAD<sup>2</sup>) allele: implications for molecular screening of individuals for genetic susceptibility to lead poisoning. *Am J Hum Genet* 1991;49:757–763.
541. Gross U, Sassa S, Arndt T, et al. Survival of two patients with severe delta-aminolevulinic acid dehydratase deficiency porphyria. *J Inher Metab Dis* 2001;24:60–64.
542. Thunell S, Henrichson A, Floderus Y, et al. Liver transplantation in a boy with acute porphyria due to aminolaevulinatase deficiency. *Eur J Clin Chem Clin Biochem* 1992;30:599–606.
543. Eales L, Day RS, Blekkenhorst GH. The clinical and biochemical features of variegate porphyria: an analysis of 300 cases studied at Groote Schuur Hospital, Capetown. *Int J Biochem* 1980;12:837–853.
544. Meissner P, Hift R, Corrigan A. Variegate porphyria. In: Kadish KM, Smith KM, Guillard R, eds. *The porphyrin handbook—medical aspects of porphyrins*. Amsterdam: Academic Press, 2003;14:89–120.
545. Mustajoki P. Variegate porphyria. Twelve years' experience in Finland. *QJM* 1980;44:191–203.
546. Fromke VL, Bossenmaier I, Cardinal R, et al. Porphyria variegata. Study of a large kindred in the United States. *Am J Med* 1978;65:80–88.
547. Muhlbauer JE, Pathak MA, Tishler PV, et al. Variegate porphyria in New England. *JAMA* 1982;247:3095–3102.
548. MacAlpine I, Hunter R, Rimington C, et al. *Porphyria: a royal malady*. London: British Medical Association, 1968.
549. Rohl JCG, Warren M, Hunt D. *Purple secret: genes, madness and the royal houses of Europe*. Transworld Publishers: London, 1998.
550. Brenner DA, Bloomer JR. The enzymatic defect in variegate porphyria. *N Engl J Med* 1980;302:765–769.
551. Deybach JC, de Verneuil H, Nordmann Y. The inherited enzymatic defect in porphyria variegata. *Hum Genet* 1981;58:425–428.

552. Nishimura K, Taketani S, Inokuchi H. Cloning of a human cDNA for protoporphyrinogen oxidase by complementation in vivo of a hemG mutant of *Escherichia coli*. *J Biol Chem* 1995;270:8076–8080.
553. Taketani S, Inazawa J, Abe T, et al. The human protoporphyrinogen oxidase gene (PPOX): organization and location to chromosome 1. *Genomics* 1995;29:698–703.
554. Dailey TA, Dailey HA. Human protoporphyrinogen oxidase: expression, purification, and characterization of the cloned enzyme. *Protein Sci* 1996;5:98–105.
555. Roberts AG, Whatley SD, Daniels J, et al. Partial characterization and assignment of the gene for protoporphyrinogen oxidase and variegate porphyria to human chromosome 1q23. *Hum Mol Genet* 1995;4:2387–2390.
556. Puy H, Robr'eu A-M, Rosipal R, et al. Protoporphyrinogen oxidase: complete genomic sequence and polymorphisms in the human gene. *Biochem Biophys Res Commun* 1996;226:226–230.
557. Meissner PN, Dailey TA, Hift RJ, et al. A R59W mutation in human protoporphyrinogen oxidase results in decreased enzyme activity and is prevalent in South Africans with variegate porphyria. *Nat Genet* 1996;13:95–97.
558. Warnich L, Kotze MJ, Groenewald IM, et al. Identification of three mutations and associated haplotypes in the protoporphyrinogen oxidase gene in South African families with variegate porphyria. *Hum Mol Genet* 1996;5:981–984.
559. Dailey HA, Dailey TA. Characteristics of human protoporphyrinogen oxidase in controls and variegate porphyrias. *Cell Mol Biol* 1997;43:67–73.
560. Elder GH, Evans JO. A radiochemical method for the measurement of coproporphyrinogen oxidase and the utilization of substrates other than coproporphyrinogen III by the enzyme from rat liver. *Biochem J* 1978;169:205–214.
561. Meissner PN, Day RS, Moore MR, et al. Protoporphyrinogen oxidase and porphobilinogen deaminase in variegate porphyria. *Eur J Clin Invest* 1986;16:257–261.
562. Meissner P, Adams P, Kirsch R. Allosteric inhibition of human lymphoblast and purified porphobilinogen deaminase by protoporphyrinogen and coproporphyrinogen: a possible mechanism for the acute attack of variegate porphyria. *J Clin Invest* 1993;91:1436–1444.
563. Hift RJ, Meissner PN, Corrigan AV, et al. Variegate porphyria in South Africa, 1688–1996—new developments in an old disease. *S Afr Med J* 1997;87:722–731.
564. Timonen K, Niemi KM, Mustajoki P, et al. Skin changes in variegate porphyria. Clinical, histopathological, and ultrastructural study. *Arch Dermatol Res* 1990;282:108–114.
565. Eales L. Acute porphyria: the precipitating and aggravating factors. *S Afr J Lab Clin Med* 1971;17:120–125.
566. Mustajoki P. Variegate porphyria. *Ann Intern Med* 1978;89:238–244.
567. Kirsch RE, Meissner PN, Hift RJ. Variegate porphyria. *Semin Liver Dis* 1998;18:33–41.
568. Logan GM, Weimer MK, Ellefson M, et al. Bile porphyrin analysis in the evaluation of variegate porphyria. *N Engl J Med* 1991;324:1408–1411.
569. Long C, Smyth SJ, Woolf J, et al. Detection of latent variegate porphyria by fluorescence emission spectroscopy of plasma. *Br J Dermatol* 1993;129:9–13.
570. DaSilva V, Simonin S, Deybach JC, et al. Variegate porphyria: diagnostic value of fluorometric scanning of plasma porphyrins. *Clin Chim Acta* 1995;238:163–168.
571. Medlock AE, Meissner PN, Davidson BP, et al. A mouse model for South African (R59W) variegate

porphyria: construction and initial characterization. *Cell Mol Biol* 2002;48:71–78.

572. Dobriner K. Simultaneous excretion of coproporphyrin I and III in a case of chronic porphyria. *Proc Soc Exp Biol Med* 1936;35:175–176.

573. Watson C, Schwartz S, Schulze W, et al. Studies in coproporphyrin III. Coproporphyrinuria; a hitherto unrecognized form characterized by lack of symptoms in spite of the excretion of large amount of coproporphyrin. *J Clin Invest* 1949;28:465–468.

574. Berger H, Goldberg A. Hereditary coproporphyria. *BMJ* 1955;2:85–88.

575. Brodie MJ, Thompson GG, Moore MR, et al. Hereditary coproporphyria. Demonstration of the abnormalities of haem biosynthesis in peripheral blood. *QJM* 1977;182:229–241.

576. Elder GH, Evans JO, Thomas N, et al. The primary enzyme defect in hereditary coproporphyria. *Lancet* 1976;2:1217–1219.

577. Grandchamp B, Nordman Y. Decreased lymphocyte coproporphyrinogen III oxidase activity in hereditary coproporphyria. *Biochem Biophys Res Commun* 1977;74:1089–1095.

578. Hawk JLM, Magnus I, Elder GH, et al. Deficiency of hepatic coproporphyrinogen oxidase in hereditary coproporphyria. *J R Soc Med* 1978;71:775–777.

579. Doss M, von Tiepermann R, Pfluger KH. Coexistence of hereditary coproporphyria and epilepsy: coproporphyrinogen oxidase deficiency in liver and kidney. *J Neurol* 1981;226:25–33.

580. Grandchamp B, Phung N, Nordmann Y. Homozygous case of hereditary coproporphyria. *Lancet* 1977;2:1348–1349.

581. Nordmann Y, Grandchamp B, de Verneuil H, et al. Harderoporphyria: a variant hereditary coproporphyria. *J Clin Invest* 1983;72:1139–1149.

582. Doss M, von Tiepermann R, Kopp W. Harderoporphyrin coproporphyria. *Lancet* 1984;1:292.

583. Lamoril PJ, Puy H, Gouya L, et al. Neonatal hemolytic anemia due to inherited harderoporphyria; clinical characteristics and molecular basis. *Blood* 1998;91:1453–1457.

584. Martasek P, Camadro JM, Delfau-Larue MH, et al. Molecular cloning, sequencing and functional expression of a cDNA encoding human coproporphyrinogen oxidase. *Proc Natl Acad Sci U S A* 1994;91:3024–3028.

585. Taketani S, Kohno H, Furukawa T, et al. Molecular cloning, sequencing and expression of a cDNA encoding human coproporphyrinogen oxidase. *Biochim Biophys Acta* 1994;1183:547–549.

586. Delfau-Larue MH, Martasek P, Grandchamp B. Coproporphyrinogen oxidase: gene organization and description of a mutation leading to exon 6 skipping. *Hum Mol Genet* 1994;3:1325–1330.

587. Cacheux V, Martasek P, Fougerousse F, et al. Localization of the human coproporphyrinogen oxidase gene to chromosome band 3q12. *Hum Genet* 1994;94:557–559.

588. Lamoril J, Puy H, Whatley SD, et al. Characterization of mutations in the CPO gene in British patients demonstrates absence of genotype-phenotype correlation and identifies relationship between hereditary coproporphyria and harderoporphyria. *Am J Hum Genet* 2001;68:1130–1138.

589. Wiman A, Floderus Y, Harper P. Two novel mutations and coexistence of the 991C>7 and the 1339C>T mutation on a single allele in the coproporphyrinogen oxidase gene in Swedish patients with hereditary coproporphyria. *J Hum Genet* 2002;47:407–412.

590. McIntyre N, Pearson AJG, Allan DJ, et al. Hepatic d-aminolaevulinic acid synthetase in an attack of hereditary coproporphyria and during remission. *Lancet* 1971;1:560–564.

591. Haeger-Aronsen B, Stathers G, Swahn G. Hereditary coproporphyria. Study of a Swedish family. *Ann*

Intern Med 1968;69:221–227.

592. Andrews J, Erdjument H, Nicholson DC. Hereditary coproporphyrinuria: incidence in a large English family. *J Med Genet* 1984;21:341–349.
593. Goldberg A, Rimington C, Lochhead AC. Hereditary coproporphyrinuria. *Lancet* 1967;1:632–636.
594. Barohn RJ, Sanchez JA, Anderson KE. Acute peripheral neuropathy due to hereditary coproporphyrinuria. *Muscle Nerve* 1994;17:793–799.
595. Lane PR, Massey KL, Worobetz LJ, et al. Acute hereditary coproporphyrinuria induced by the androgenic/anabolic steroid methandrostrenolone (Dianabol). *J Am Acad Dermatol* 1994;30:308–312.
596. Casali C, LoMonaco M, D'Alessandro L, et al. Hereditary coproporphyrinuria: unusual nervous system involvement in two cases. *J Neurol* 1984;231:99–101.
597. DiTrapani G, Casali C, Tonali P, et al. Peripheral nerve findings in hereditary coproporphyrinuria. Light and ultrastructural studies in two sural nerve biopsies. *Acta Neuropathol* 1984;63:96–107.
598. Kuhnel A, Gross U, Doss MO. Hereditary coproporphyrinuria in Germany: clinical–biochemical studies in 53 patients. *Clin Biochem* 2000;33:465–473.
599. Manning DJ, Gray TA. Haem arginate in acute hereditary coproporphyrinuria. *Arch Dis Child* 1991;66:730–731.
600. Schoenfeld N, Mamet R, Dotan I, et al. Relation between uroporphyrin excretion, acute attacks of hereditary coproporphyrinuria and successful treatment with haem arginate. *Clin Sci* 1995;88:365–369.
601. Andant C, Puy H, Deybach JC, et al. Occurrence of hepatocellular carcinoma in a case of hereditary coproporphyrinuria. *Am J Gastroenterol* 1997;92:1389–1390.
602. Watson CJ, Cardinal RA, Bossenmaier I, et al. Porphyria variegata and porphyria cutanea tarda in siblings: chemical and genetic aspects. *Proc Natl Acad Sci U S A* 1975;72:5126–5129. Addendum. *Idem* 1976;73:1323.
603. Levine J, Johnson WT, Tschudy DP. The coexistence of two types of porphyria in one family. *Arch Dermatol* 1978;114:613–614.
604. Day RS, Eales L, Meissner D. Coexistent variegate porphyria and porphyria cutanea tarda. *N Engl J Med* 1982;307:36–41.
605. Sturrock ED, Meissner PN, Maeder DL, et al. Uroporphyrinogen decarboxylase and protoporphyrinogen oxidase in dual porphyria. *S Afr Med J* 1989;76:405–408.
606. Chan KM, Ladenson JH, Vaidya HO, et al. Dual porphyria: an underdiagnosed entity? *Clin Chem* 1987;33:1190–1193.
607. Sieg I, Bhutani LK, Doss MO. Dual porphyria of coexisting variegata and cutanea tarda. *Eur J Clin Chem Clin Biochem* 1995;33:405–410.
608. Doss MO. Dual porphyria in double heterozygotes with porphobilinogen deaminase and uroporphyrinogen decarboxylase deficiencies. *Clin Genet* 1989;35:146–151.
609. Doss MO, Gross U, Puy H, et al. Coexistence of hereditary coproporphyrinuria and porphyria cutanea tarda: a new form of dual porphyria. *Med Klin* 2002;97:1–5.
610. Nordmann Y, Amram D, Deybach JC, et al. Coexistent hereditary coproporphyrinuria and congenital erythropoietic porphyria (Gunther disease). *J Inher Metab Dis* 1990;13:687–691.
611. Yamada M, Kondo M, Tanaka M, et al. An autopsy case of acute porphyria with a decrease of both uroporphyrinogen I synthetase and ferrochelatase activities. *Acta Neuropathol* 1984;64:6–11.
612. McColl KEL, Thompson GG, Moore MR, et al. Chester porphyria: biochemical studies of a new form

of acute porphyria. *Lancet* 1985;2:796–799.

613. Qadiri MR, Church SE, McColl KEL, et al. Chester porphyria: a clinical study of a new form of acute porphyria. *BMJ* 1986;292:455–459.

614. Youngs EGR. Dobson's complaint: the story of the Chester porphyria. Royal College of Physicians, 1999.

615. Norton B, Lanyon WG, Moore MR, et al. Evidence for involvement of a second genetic locus on chromosome 11q in porphyrin metabolism. *Hum Genet* 1993;91:576–578.

616. Gregor A, Kostrzevska E, Tarczynska-Nosal S, et al. Coexistence of hereditary coproporphyria with acute intermittent porphyria. *Ann Med* 1994;26:125–127.

617. Kaido M, Fukada K, Moriya M, et al. Porphyria with double errors in the heme biosynthetic pathway. *J Neurol* 2001;248:328–329.

618. Freeseemann AG, Hofweber K, Doss MO. Coexistence of deficiencies of uroporphyrinogen III synthase and decarboxylase in a patient with congenital erythropoietic porphyria and in his family. *Eur J Clin Chem Clin Biochem* 1997;35:35–39.

619. Lange B, Hofweber K, Waldherr R, et al. Congenital erythropoietic porphyria associated with nephrotic syndrome and renal siderosis. *Acta Paediatr* 1995;84:1325–1328.

620. May BK, Dogra SC, Sadlon TJ, et al. Molecular regulation of heme biosynthesis in higher vertebrates. *Prog Nucleic Acid Res Mol Biol* 1995;51:1–51.

2004 Lippincott Williams & Wilkins  
John P. Greer, John Foerster, John N. Lukens  
George M. Rodgers, Frixos Paraskevas, Bertil Glader  
Wintrobe's Clinical Hematology

## Hereditary Spherocytosis and Other Anemias Due to Abnormalities of the Red Cell Membrane

### GENERAL CONSIDERATIONS OF THE RED CELL MEMBRANE

#### HEREDITARY SPHEROCYTOSIS

##### Prevalence and Genetics

##### Pathogenesis

##### Clinical Features

##### Laboratory Features

##### Diagnosis

##### Treatment

#### HEREDITARY ELLIPTOCYTOSIS SYNDROMES

##### Prevalence of All Hereditary Elliptocytosis Variants

##### Pathogenesis of Common Hereditary Elliptocytosis Disorders

##### Clinical and Laboratory Features of Hereditary Elliptocytosis Syndromes

##### Laboratory Evaluation

##### Treatment

#### STOMATOCYTIC DISORDERS

##### Hereditary Stomatocytosis

##### Hereditary Xerocytosis

##### Intermediate Stomatocytic Syndromes

##### Rh-Null Disease

#### ACANTHOCYTIC DISORDERS

##### Abetalipoproteinemia

##### Neuroacanthocytosis

##### Macleod Phenotype

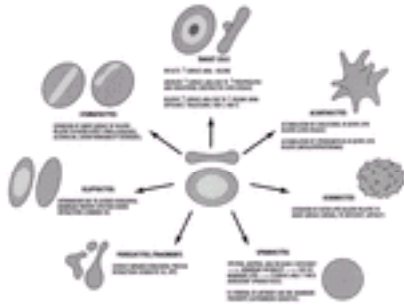
#### ECHINOCYTIC DISORDERS

#### TARGET CELL DISORDERS

##### Familial Lecithin-Cholesterol Acyltransferase Deficiency

#### REFERENCES

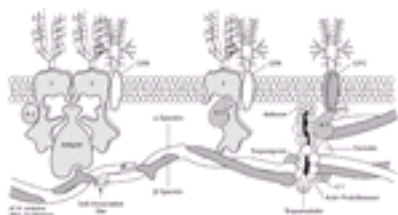
This chapter focuses on hemolytic disorders resulting from primary abnormalities of the red cell membrane. The major emphasis is on hereditary spherocytosis (HS) and the hereditary elliptocytosis (HE) syndromes because these are the ones most commonly encountered by clinicians. The traditional classification of red cell membrane disorders has been based on red blood cell (RBC) shape changes, and this classification has been retained in this chapter because of its clinical applicability ([Fig. 32.1](#)). However, during the past several years, there has been an explosion of knowledge regarding the biology of the RBC membrane, and a basic understanding of this erythrocyte membrane structure and function is essential to appreciate the diverse pathophysiology of these disorders.



**Figure 32.1.** Diagrammatic representation of abnormal cells associated with red blood cell (RBC) membrane disorders. ↑, increased; ↓, decreased; →, leads to; HE, hereditary elliptocytosis; HGB, hemoglobin; HPP, hereditary pyropoikilocytosis; MCV, mean corpuscular volume; PK, pyruvate kinase; R-E, reticulo-endothelial.

## GENERAL CONSIDERATIONS OF THE RED CELL MEMBRANE

The RBC membrane structure is a bilayer of phospholipids intercalated with molecules of unesterified cholesterol and glycolipids. The phospholipids are asymmetrically organized, with the choline phospholipids (phosphatidylcholine and sphingomyelin) primarily on the outside of the bilayer and the amino phospholipids (phosphatidylethanolamine and phosphatidylserine) on the inside. The membrane also contains proteins that are asymmetrically organized. All glycoproteins are exposed on the outer membrane surface, and these are red cell antigens and receptors (e.g., glycoporphins) or transport proteins (i.e., the anion transport channel). These integral membrane proteins penetrate or span the lipid bilayer, interact with the hydrophobic lipid core, and are tightly bound to the membrane. A separate protein network forms the membrane cytoskeleton, which interacts with both the integral membrane proteins and the lipid bilayer. This cytoskeleton is composed of spectrin, ankyrin, protein 4.1, pallidin (protein 4.2), and actin ( [Fig. 32.2](#)). The biochemical and genetic characteristics of these RBC membrane proteins are depicted in [Table 32.1](#). Spectrin is made up of  $\alpha\beta$ -heterodimers that, at the head end, interact with other spectrin  $\alpha\beta$ -dimers to form heterotetramers  $(\alpha\beta)_2$  in which the *N*-terminal end of  $\alpha$ -spectrin and the C-terminus of  $\beta$ -spectrin form the head region of the heterodimer. These spectrin tetramers are the major structural subunits of the membrane skeleton. The spectrin dimer-tetramer interconversion is governed by a simple thermodynamic equilibrium that favors spectrin tetramer formation. Near the dimer-dimer association site, spectrin tetramers interact with protein 3 (the anion exchange channel) via ankyrin, and this interaction is most important for the attachment of the cytoskeleton to the membrane. At the opposite end of the spectrin molecule, spectrin tetramers interact with actin via protein 4.1. In addition, there are other membrane protein interactions not directly involving spectrin. These interactions include glycoporphin C to protein 4.1 and pallidin (protein 4.2) to band 3; the latter interaction is thought to stabilize ankyrin in the membrane. The horizontal protein interactions, mainly the interactions of spectrin dimers, are responsible for the lateral deformability of the cytoskeleton. Thus, these protein interactions are responsible for the overall stability of the membrane, thereby allowing the RBC to be deformable during its lifespan within the circulation ( [1](#), [2](#), [3](#), [4](#) and [5](#)).





**Figure 32.2.** Schematic model of the red cell membrane. The relative position of the various proteins is correct, but the proteins and lipids are not drawn to scale. GP, glycophorin. (Reprinted with permission from Lux SE, Palek J. Disorders of the red cell membrane. In: Handin RJ, Lux SE, Stossel TP, eds. *Blood: principles and practice of hematology*, 2nd ed. Philadelphia: Lippincott Williams & Wilkins, 2002.)

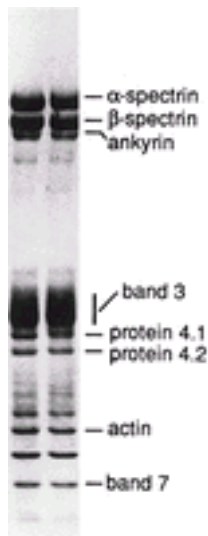
**TABLE 32.1. Characteristics of Red Blood Cell Membrane Cytoskeletal Proteins**

| SDS-PAGE Band | Protein                                  | Molecular Weight (kd) | Total (%) | Chromosome Localization | Involvement in Hemolytic Anemias                            |
|---------------|--|-----------------------|-----------|-------------------------|---|
| 1             | α-Spectrin                               | 240                   | 16.0      | 1 q22–q23               | HE, HS  |
| 2             | β-Spectrin                               | 220                   | 14.0      | 14 q23–q24.2            | HE, HS  |
| 2.1           | Ankyrin                                  | 210                   | 4.5       | 8 p11.2                 | HS  |
| 3             | Anion exchange protein                   | 90–100                | 27.0      | 17 q21–qter             | HS, Southeast Asian ovalocytosis, hereditary acanthocytosis |
| 4.1           | Protein 4.1                              | 80                    | 5.0       | 1 p33–p34.2             | HE  |
| 4.2           | Pallidin                                 | 72                    | 5.0       | 15 q15–q21              | HS  |
| 5             | Actin                                    | 43                    | 5.5       | 7 pter–q22              |   |
| 6             | Glyceraldehyde-3-phosphate dehydrogenase | 35                    | 3.5       | 12 p13.31–p13.1         |   |
| 7             | Stomatin                                 | 31                    | 2.5       | 9 q 34.1                | Hereditary stomatocytosis                                   |

HE, hereditary elliptocytosis; HS, hereditary spherocytosis; SDS-PAGE, sodium dodecyl sulfate–polyacrylamide gel electrophoresis.

Modified from Palek J, Jarolim P. Red cell membrane disorders. In: Hoffman R, Benz E, Shatill S, et al., eds. *Hematology: basic principles and practice*, 2nd ed. Edinburgh: Churchill Livingstone, 1995;667–709.

Hereditary RBC membrane disorders result from alterations in the quantity or quality (or both) of these individual proteins and their interactions with each other. HS is caused by an uncoupling of the cytoskeleton from the lipid bilayer, thereby leading to membrane instability with loss of lipids and some integral membrane proteins. HE disorders are the result of defects in spectrin dimer interactions, thereby leading to disruption of the skeletal lattice and RBC fragmentation. The development of methods using polyacrylamide gel electrophoresis of sodium dodecyl sulfate–solubilized red cell membrane proteins has allowed the separation and quantification of membrane proteins ( [Fig. 32.3](#) ) and the detection of membrane protein abnormalities in many hereditary red cell disorders. In some cases, the specific DNA mutations have been identified, and several excellent reviews of the molecular advances in these diseases are available ( [2](#), [3](#) and [4](#) ).



**Figure 32.3.** Protein composition of the red blood cell membrane skeleton. The major components of the erythrocyte membrane as separated by sodium dodecyl sulfate–polyacrylamide gel electrophoresis (Fairbanks G, Steck TL, Wallach DF. Electrophoretic analysis of the major polypeptides of the human erythrocyte membrane. *Biochemistry* 1971;10:2606) and revealed by Coomassie blue staining. (Reprinted from Costa FF, Agre P, Watkins PC, et al. Linkage of dominant hereditary spherocytosis to the gene for the erythrocyte membrane–skeleton protein ankyrin. *N Engl J Med* 1990;323:1046, with permission.)

## HEREDITARY SPHEROCYTOSIS

*HS* is a familial hemolytic disorder characterized by anemia, intermittent jaundice, splenomegaly, and responsiveness to splenectomy. However, there is marked heterogeneity of the clinical features, ranging from an asymptomatic condition to a fulminant hemolytic anemia. The morphologic hallmark of HS is the microspherocyte, which is caused by loss of membrane surface area and is characterized by an abnormal osmotic fragility *in vitro*. The interesting history of HS is recounted in detail by Dacie ([6](#)) and by Packman ([7](#)). The earliest clinical account of the disorder is probably the 1871 report of Vanlair and Masius ([8](#)), and the 1934 studies of Haden drew attention to a probable structural abnormality of the membrane as the basis for hemolysis ([9](#)). Subsequent investigation of HS afforded important insights into the structure and function of cell membranes and the role of the spleen in maintaining RBC integrity ([10](#)). It is now recognized that the intrinsic genetic defect causes qualitative and quantitative defects in membrane proteins; in turn, these are the result of a variety of molecular defects that are being defined.

### Prevalence and Genetics

HS is the most common of the hereditary hemolytic anemias among people of Northern European descent. In the United States, the incidence of the disorder is approximately 1 in 5000 ([11](#)). However, this figure is probably an underestimate, not accounting for the patients with asymptomatic and mild forms, as suggested by the screening of blood donors for abnormal osmotic fragility ([12](#), [13](#)). The disease is encountered worldwide, but its incidence and prevalence in other ethnic groups are not clearly established.

In most affected families, HS is transmitted as an autosomal–dominant trait, and the

identification of the disorder in multiple generations of affected families is the rule. Homozygosity for this dominantly transmitted HS gene has not been identified, thus suggesting that the homozygous state is incompatible with life. Nearly one-fourth of all newly diagnosed patients do not demonstrate a dominant inheritance pattern, and the parents of these patients are clinically and hematologically normal ( [11](#), [14](#), [15](#) ). New mutations have been implicated that may explain some of these sporadic cases; in support of this is the fact that approximately 50% of the offspring of individuals with sporadic HS also have the disease. An autosomal-recessive mode of inheritance also occurs, and this is supported by the descriptions of families in which apparently normal parents have had more than one affected child ( [14](#), [16](#), [17](#), [18](#) and [19](#) ). This recessive pattern may account for 20 to 25% of all HS cases ( [12](#), [20](#) ). It is manifested only in homozygous or compound heterozygous individuals and often is associated with severe hemolytic anemia ( [12](#), [20](#) ).

## Pathogenesis

Hemolysis in HS results from the interplay of an intact spleen and an intrinsic membrane protein defect that leads to an abnormal RBC.

**MEMBRANE PROTEIN DEFECTS** Current concepts are that the primary lesion in HS erythrocytes is caused by membrane protein defects resulting in cytoskeleton instability. The first biochemical defect recognized in patients with HS was spectrin deficiency, and the degree of spectrin deficiency was reported to correlate with the extent of spherocytosis, the degree of abnormality of the osmotic fragility test, and severity of hemolysis ( [Fig. 32.4](#) ) ( [12](#), [21](#) ). In some cases, spectrin deficiency is the result of impaired synthesis, whereas in other instances, it is caused by quantitative or qualitative deficiencies of other proteins that integrate spectrin into the cell membrane. In the absence of these binding proteins, free spectrin is degraded, thereby leading to spectrin deficiency. Analysis of red cell membrane proteins in patients with HS has identified four abnormal patterns: spectrin deficiency alone, combined spectrin and ankyrin deficiency, band 3 deficiency, and protein 4.2 defects. Each of these subsets is associated with a variety of mutations that result in different protein abnormalities and varied clinical expression ( [Table 32.2](#) ). Most of these mutations have been tabulated recently ( [22](#), [23](#) ) and are available through web sites at Boston Children's Hospital ( [www.kidscancer.net/membrane/mutation.htm](http://www.kidscancer.net/membrane/mutation.htm) ) or at the Human Gene Mutation Database in Cardiff ( <http://archive.uwcm.ac.uk/uwcm/mg/ns/7/1198974.html> ).

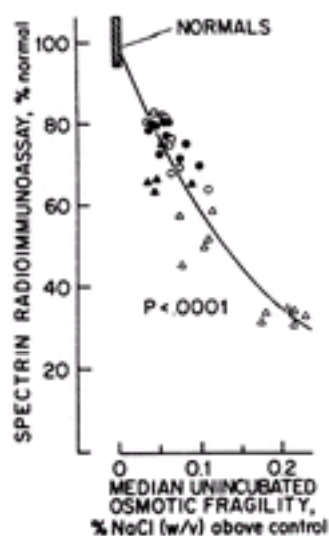


Figure 32.4. Relationship between spectrin deficiency and unincubated osmotic fragility in

hereditary spherocytosis (HS) red cells. Spectrin content (measured by radioimmunoassay) is shown on the vertical axis, and osmotic fragility (measured by NaCl concentration producing 50% hemolysis of red blood cells) is shown on the horizontal axis. Circles represent patients with typical autosomal-dominant HS. Triangles represent patients with nondominant HS. Open symbols represent patients who have undergone splenectomy. (Reprinted from Agre P, Asimos A, Casella JF, et al. Inheritance pattern and clinical response to splenectomy as a reflection of erythrocyte spectrin deficiency in hereditary spherocytosis. *N Engl J Med* 1986;315:1579, with permission.)

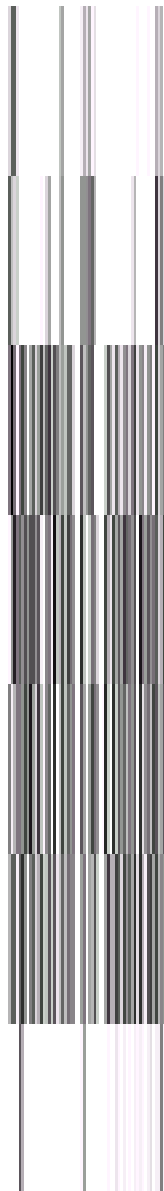
**TABLE 32.2. Clinical Classification of Hereditary Spherocytosis (HS)**

|  | Silent Carrier HS  | Mild HS          | Moderate HS            | Severe HS                        |
|--|--------------------|------------------|------------------------|----------------------------------|
| Fraction of HS cases (%)                 | —                  | 20–30            | 60–75                  | 5–10                             |
| Hemoglobin (g/dl)                        | Normal             | 11–15            | 8–12                   | <6                               |
| Reticulocytes (%)                        | 1–3                | 3–8              | >8                     | >10                              |
| Peripheral blood smear                   | Normal             | Few spherocytes  | Moderate spherocytosis | Spherocytosis and poikilocytosis |
| Osmotic fragility                        |                    |                  |                        |                                  |
| Fresh                                    | Normal             | Normal/increased | Increased              | Increased                        |
| Incubated                                | Slightly increased | Increased        | Increased              | Increased                        |
| Spectrin content (% normal) <sup>a</sup> | 100                | 80–100           | 50–80                  | 20–55                            |

<sup>a</sup> Estimated from those cases associated with spectrin deficiency.

Modified from Lux SE, Palek J. Disorders of the red cell membrane. In: Handin RI, Lux SE, Stossel TO, eds. *Blood: principles and practice of hematology*. Philadelphia: JB Lippincott, 1995:1701.

**Spectrin Deficiency** Mutations of  $\alpha$ -spectrin are associated with recessive forms of HS, whereas mutations of  $\beta$ -spectrin occur in families with autosomal-dominant forms of HS ([23](#)). This difference reflects that the synthesis of  $\alpha$ -spectrin is threefold greater than that of  $\beta$ -spectrin, and the excess  $\alpha$ -chains normally are degraded ([24](#), [25](#) and [26](#)). Heterozygotes for  $\alpha$ -spectrin defects would still be expected to produce sufficient normal  $\alpha$ -spectrin to approximately balance normal  $\beta$ -spectrin production. Therefore, heterozygotes have a normal phenotype, and clinical abnormalities caused by  $\alpha$ -spectrin deficiencies are found only in the homozygous or compound heterozygous states. In contrast, defects of  $\beta$ -spectrin are more likely to be clinically apparent in the heterozygous state because synthesis of  $\beta$ -spectrin is the rate-limiting factor for assembly of  $\alpha\beta$ -spectrin heterodimers into the membrane. Red cell membranes isolated from individuals with autosomal-recessive HS have only 40 to 50% the normal amount of spectrin (relative to band protein 3), whereas red cell spectrin levels range from 60 to 80% of normal in the autosomal-dominant form of HS ([20](#)) (Table 32.2). A relatively common splice site mutation in the  $\alpha$ -spectrin gene at codon 1729,  $\alpha$ -spectrin LEPRA, is associated with a second mutation at codon 969 and low expression of  $\alpha$ -spectrin. When inherited together with another low-expression  $\alpha$ -spectrin mutation in *trans*,  $\alpha$ -spectrin LEPRA is a common cause of severe, recessively inherited HS ([27](#), [28](#) and [29](#)). Mutations involving the  $\beta$ -spectrin gene also lead to spectrin deficiency ([23](#)). Many of these mutations impair  $\beta$ -spectrin synthesis ([30](#), [31](#) and [32](#)). Others produce truncated



**Figure 32.5.** Relationship between spectrin and ankyrin content in red cells of patients with dominant hereditary spherocytosis. Each point, expressed as a percentage of control taken as 100%, represents the mean value for a kindred for both spectrin and ankyrin levels. The line represents a computer-generated fitting of the data for 19 of the 20 kindreds. The one discordant kindred (*open circle*) is relatively ankyrin deficient. (Reprinted from Savvides P, Shalev O, John KM, et al. Combined spectrin and ankyrin deficiency is common in autosomal dominant hereditary spherocytosis. *Blood* 1993;82:2953, with permission.)

**Band 3 Deficiency** Band 3 deficiency mutations are found in 10 to 20% of patients with mild to moderate autosomal-dominant HS ( [46](#), [47](#), [48](#), [49](#) and [50](#)). These patients who are heterozygotes for a band 3 mutation have a 20 to 40% decrease of band 3 content (detected by an increased spectrin to band 3 ratio). In some HS subjects deficient in band 3, the deficiency is considerably greater in older RBCs, thus suggesting that band 3 protein is unstable because of a poor binding or a defective assembly of band 3 on the membrane ( [51](#)). Protein 4.2 content in the membrane is decreased ( [52](#)) or absent ( [53](#)) in band 3-deficient HS patients. At least 45 band 3 mutations, the majority missense or small deletions in type, have been identified in HS patients ( [22](#), [54](#)). Heterozygotes may be clinically silent ( [52](#)) or exhibit mild to moderate HS ( [54](#)). Homozygotes or compound

( [33](#)) or do not bind to ankyrin and, thus, are not assembled and undergo proteolytic degradation ( [34](#)).  $\beta$ -Spectrin mutation leading to defective binding of spectrin to protein 4.1

any defect in the structure or function of ankyrin also might first suggested by linkage studies that related dominant HS to the genes for  $\alpha$ -spectrin,  $\beta$ -spectrin, or protein 4.1 ( [37](#)) in patients with translocation of chromosome 8 or chromosome 8 where the ankyrin gene is located ( [38](#), [39](#)); of chromosome 8 were shown to have a decrease in red ankyrin is the principal binding site for spectrin on the red cell cytoskeletal protein assembly in reticulocytes indicate that decreased incorporation of spectrin on the membrane ( [41](#)). In any ankyrin deficiency, there is a proportional decrease in spectrin synthesis is normal. Of particular interest, the use of techniques to measure spectrin and ankyrin proteins has patients with autosomal-dominant HS have combined spectrin and the two proteins are diminished equally ( [Fig. 32.5](#)) ( [42](#)). Mutations, primarily frameshift or nonsense in type, have been identified ( [2a](#), [43](#) and [44](#)). Most are associated with reduced or absent ankyrin. Ankyrin gene mutations are the most common cause of hereditary spherocytosis. Motor mutations may be silent in the heterozygous state if both ankyrin alleles are affected ( [45](#)).

heterozygotes for band 3 mutations usually exhibit more severe HS ( 55, 56, 57, and 58 ). Homozygosity for band 3 Coimbra was seen in a hydropic infant who had extremely severe HS and required regular red cell transfusions after birth ( 56 ). Her red cells entirely lacked band 3. She and members of another family who had less severe HS and were heterozygotes for another band 3 mutation ( 59 ) exhibited renal tubular acidosis, whereas renal handling of bicarbonate has been normal in most band 3-deficient HS patients, despite the fact that the anion exchanger mutation is expressed in both erythrocytes and the kidney ( 60 ).

**Protein 4.2 (Pallidin) Deficiency** Autosomal-recessive hereditary hemolytic anemia has been described in several patients with a complete or almost complete deficiency of protein 4.2. The phenotypes described in these reports have been quite heterogeneous, with RBC morphology characterized by spherocytes, elliptocytes, or spheroovalocytes. Deficiency of protein 4.2 in HS is relatively common in Japan ( 61 ). A few mutations have been described in these patients ( 22 ). One that appears to be common in the Japanese population (protein 4.2<sup>Nippon</sup>) is associated in the homozygous state with a red cell morphology described as spherocytic, ovalocytic, and elliptocytic ( 62 ). Another mutant protein 4.2 (protein 4.2<sup>Lisboa</sup>) is caused by a deletion that results in a complete absence of protein 4.2, and this is associated with a typical HS phenotype ( 63 ).

**Red Blood Cell Membrane Protein Abnormalities in Animal Models of Hereditary Spherocytosis** Early studies to identify a defect in the RBC protein skeleton were given impetus by the demonstration of marked spectrin deficiency associated with a spherocytic hemolytic anemia that occurs in house mice ( 64, 65, and 66 ). The severity of hemolysis in these mice is a function of the degree of spectrin deficiency ( 66 ). Animals with the most severe anemia lacked both  $\alpha$ - and  $\beta$ -chains of spectrin and had massive hepatosplenomegaly, spherocytes approaching 100%, and reticulocyte counts exceeding 90%. Subsequently, other mutant HS mice have been identified, and, just as in human HS red cells, defects of  $\alpha$ -spectrin,  $\beta$ -spectrin, and ankyrin have been described. The *ja/ja* mouse has a  $\beta$ -spectrin gene mutation with no detectable spectrin on the membrane ( 67 ). A very similar  $\beta$ -spectrin mutation associated with spherocytic hemolytic anemia has been found in zebra fish ( 68 ). In contrast to the human  $\beta$ -spectrin HS mutation, the heterozygous mouse appears normal with no evidence of hemolysis or spherocytosis, whereas the homozygous mouse is severely anemic. The *sph/sph* mouse mutants are characterized by a defect of  $\alpha$ -spectrin, with only a small amount of  $\beta$ -spectrin on the membrane ( 24 ). *sph/sph* and *ja/ja* mice that survive the neonatal period exhibit secondary hemochromatosis and often develop thrombi in major organs ( 69, 70 ). The *nb/nb* mice have ankyrin deficiency ( 24, 71 ). Both *sph/sph* and *nb/nb* spherocytes exhibit increased passive permeability to monovalent cations, as do their human counterparts ( 72 ). A naturally occurring total deficiency of red cell band 3 has been reported in cattle, which exhibit spherocytic anemia ( 73 ). Several transgenic mouse models with homozygous deficiency of band 3 have also been established; their RBCs are completely devoid of band 3 as well as protein 4.2 ( 74, 75 ). Despite their lack of these two proteins, the membrane cytoskeleton is intact ( 75 ). Although these homozygous mice survive *in utero*, they are born severely anemic and require RBC transfusions to survive. Like *sph/sph* and *ja/ja* mice, band 3-deficient mice exhibit a hypercoagulable state, with thrombosis contributing to their high mortality ( 76 ). Finally, targeted disruption of the  $\beta$ -adducin gene ( *Add 2* ) causes spherocytic anemia in mice ( 77 ). An equivalent disorder in humans has not been identified.

**RED BLOOD CELL ABNORMALITIES** Loss of membrane surface area is the major pathologic feature of HS RBCs ( Fig. 32.6 ) and begins at the reticulocyte stage of red cell development ( 78 ). It has been known for years that HS red cells lose lipid and that the phospholipid and cholesterol content of HS membranes is decreased 15 to 20% ( 79, 80, 81 ).



and [82](#)). In most cases, it is thought that membrane loss occurs because the spectrin–deficient cytoskeleton is unable to provide adequate support for the lipid bilayer. Less often, band 3 defects are responsible for disruption of the lipid bilayer. The loss of membrane is characterized by release of small (0.2 to 0.5 μm) lipid vesicles that may contain band 3 but are devoid of spectrin ([21](#), [83](#)). The loss of membrane surface area transforms red cells from biconcave discs to spherocytic forms. An important physiologic consequence of this is that cellular deformability of spherocytes is decreased compared with normal discoid red cells with a larger membrane surface. For HS red cells, this limits their ability to pass through the small fenestrations in the venous sinuses of the spleen (discussed in Splenic Entrapment) ([84](#), [85](#)). Despite their membrane skeletal defects and lipid loss, HS red cells retain a normal transbilayer phospholipid distribution ([86](#)).



**Figure 32.6.** The pathophysiology of hereditary spherocytosis is a consequence of spectrin, ankyrin, or band 3 abnormalities that lead to membrane instability, loss of lipid microvesicles, decreased red cell surface area, reduced cellular deformability, and stagnation of red blood cells (RBCs) in the splenic cords (see text for details). ? , leads to.

The primary cytoskeleton defect in HS results in a variety of secondary metabolic changes. These metabolic effects include increased sodium and potassium flux across the HS membrane ([87](#), [88](#), [89](#) and [90](#)), which leads to increased membrane sodium–potassium adenosine triphosphatase activation; accelerated adenosine triphosphate (ATP) breakdown ([91](#)); increased rate of glycolysis ([89](#)); and a decreased concentration of 2,3-diphosphoglycerate (2,3-DPG). The latter is probably a consequence of a lower intracellular pH. However, because the decrease in red cell 2,3-DPG and intracellular acidosis both are corrected by splenectomy, they have been attributed to detention of spherocytes within the spleen ([92](#), [93](#)). At one time, the above defects were considered part of the pathophysiology of HS, but it is now recognized that these are secondary events. Interestingly, HS red cells are slightly dehydrated, although the reason for decreased RBC water content is not known. One possibility is that it is related to K–Cl cotransport, a pathway that leads to dehydration and is activated by acid pH ([94](#)). This is an intriguing possibility because the pH is reduced in the splenic cords (discussed further in the section [Splenic Conditioning](#)). However, some investigators have found that K–Cl cotransport is decreased rather than increased in HS red cells ([95](#)). Another possibility is that red cell dehydration is caused by the increased Na<sup>+</sup>/K<sup>+</sup> pump activity stimulated in response to the increased passive cation leaks. Because two K ions are transported in for every three Na ions extruded out of the cell, this can lead to a decrease in total cation content, water efflux from the red cell, and cellular dehydration ([96](#)). This dehydration of HS red cells is important because it can further impair their deformability ([84](#), [97](#)).

**ROLE OF THE SPLEEN IN PATHOPHYSIOLOGY** The survival of infused HS red cells into normal recipients is reduced, whereas the survival of normal red cells in HS subjects is normal ([98](#)). This basic observation demonstrates an intrinsic defect in HS red cells. A second fundamental observation is that the survival of HS red cells in most splenectomized recipients is nearly normal ([10](#)). Moreover, despite the persistence of spherocytosis after splenectomy, red cell survival is normal or only slightly reduced ([99](#),



[100](#)). Taken together, these observations from several years ago demonstrated that an intrinsic red cell defect leads to RBC destruction, but only in the presence of an extrinsic factor—an intact spleen. The role of the spleen in ameliorating hemolysis appears to differ in band 3-deficient spherocytosis compared to spherocytosis due to spectrin-actin deficiency. In both types of spherocytosis, splenectomy prevents the premature loss of young red cells. In addition, as spectrin-actin-deficient cells age, they lose band 3-rich vesicles as a consequence of their lack of adequate cytoskeletal binding sites for band 3. Clustering of band 3 is thus minimized in these older spectrin-actin-deficient spherocytes, limiting the accumulation of naturally occurring autoantibodies that bind to sites on the band 3 molecule. Because band 3-deficient spherocytes have an excess of cytoskeletal binding sites, they do not lose additional band 3 as they age; consequently, they accumulate increasing amounts of surface-bound autoantibodies. Antibody coating contributes to shortened red cell survival, and its elimination may explain the greater improvement in postsplenectomy survival noted in spectrin-actin-deficient spherocytes as compared to band 3-deficient red cells ([101](#)).

**Splenic Entrapment** Radiolabeled spherocytes are sequestered selectively in the spleen ([102](#), [103](#) and [104](#)); this occurs because of the unique anatomy of the splenic vasculature ([105](#), [106](#) and [107](#)). Arterial blood enters directly into the splenic cords, a network of channels formed by reticulum cells and lined by macrophages. Most of the blood that enters the splenic cords passes rapidly through direct channels, which reenter the venous system after traversing fenestrations between the lining endothelial cells. A small fraction of blood in the splenic cords percolates more slowly through this maze before reaching the venous sinuses. The hematocrit of blood from the splenic cords is high, the environment is acidic, and the red cells are exposed to macrophages that line these channels. The size of fenestrations in the venous sinuses is small relative to the RBC size, and to pass through requires some degree of deformability of the red cell membrane. This, however, is a major problem for HS red cells, which have lost surface area and are dehydrated. Examination of spleens removed from patients with HS demonstrates congested cords and relatively empty venous sinuses ([108](#), [109](#) and [110](#)). With electron microscopy, few spherocytes can be seen traversing sinus walls ([108](#), [110](#)). The most severely damaged spherocytes, cells unable to negotiate the fenestrations in the venous sinus, are removed from the circulation by macrophages ([110](#)). However, impaired deformability of HS red cells is only significant for the passage of these cells through the spleen. After splenectomy, red cell survival is normal, even though spherocytes persist and sometimes are increased ([10](#)). Recent studies indicate that splenectomy has no effect on surface area loss by HS reticulocytes or mature red cells, because surface area loss is due to the intrinsic membrane lesion in these cells. Thus, although the role of the spleen in sequestering HS cells is unquestioned, the generation of spherocytes is an independent event that continues even after splenectomy ([78](#)).

**Splenic Conditioning** In addition to trapping HS red cells, the spleen also “conditions” these cells in a way that accelerates membrane loss and spherocyte formation. Some conditioned red cells reenter the systemic circulation, demonstrated most convincingly with Fe<sup>59</sup> labeling of HS cells. Cohorts of cells so labeled gradually shift from osmotically normal to osmotically fragile cells during their circulation in patients with intact spleens ([102](#)). Osmotically fragile microspherocytes are concentrated in and emanate from the splenic pulp ([10](#), [111](#)). The more conditioned or spheroidal cells are responsible for the most fragile portion of the fresh osmotic fragility curve. The mechanism of splenic conditioning is not clear. It may be the result of hemoconcentration and erythrostasis with macrophage-induced membrane injury ([112](#), [113](#) and [114](#)). It may be related to the lower pH in the spleen ([115](#)) as well as in the sequestered red cells. As discussed in the section [Red Blood Cell Abnormalities](#), this pH change may activate K-Cl cotransport, lead to cell dehydration, and further decrease deformability. Because the calculated transit time for spherocytes is short relative to the time required for severe metabolic compromise, it is unlikely that metabolic depletion is important, and the ATP content of

HS cells in the spleen is normal ( [112](#) ). The conditioning effect of the spleen is a cumulative injury, thought to result from several passages through this organ.

## Clinical Features

Anemia, jaundice, and splenomegaly are the clinical features of HS most commonly encountered. However, signs and symptoms are highly variable, both with respect to age of onset and severity. For example, anemia or hyperbilirubinemia may be of such magnitude as to require exchange transfusion in the neonatal period ( [116](#), [117](#) and [118](#) ). On the other hand, the disorder may escape clinical recognition altogether, and in one reported case, the initial anemic problem was first recognized at 75 years of age ( [119](#) ). Anemia usually is mild to moderate, but sometimes, it is very severe, and, in some pedigrees, there may be no anemia. Jaundice is likely to be most prominent in the newborn. Approximately 30 to 50% of adults with HS have a history of jaundice during the first week of life ( [117](#), [118](#) ). The magnitude of hyperbilirubinemia may be such as to require exchange transfusion ( [119a](#) ). Virtually all HS infants who are homozygous for the mutation responsible for Gilbert syndrome are jaundiced enough to require phototherapy ( [120](#) ). In contrast to the frequency of jaundice, most newborns with HS are not anemic ( [121](#) ). However, anemia develops rapidly in the first month of life in many infants and often requires one or more RBC transfusions. Maturation of the splenic filtering function and development of the splenic circulation appear to increase the rate of hemolysis after birth; at the same time, the erythropoietic response to anemia is blunted. Within a few months, erythropoiesis increases, anemia improves, and the need for red cell transfusions disappears in all but the most severely affected infants ( [121](#) ). Beyond the neonatal period, jaundice is rarely intense. Characteristically, icterus is intermittent and is associated with fatigue, cold exposure, emotional distress, or pregnancy. An increase in scleral icterus and a darker urine color is commonly seen in children with nonspecific viral infections. Even when patients have no detectable jaundice, there usually is laboratory evidence of ongoing hemolysis ( [17](#), [122](#), [123](#) ). Splenomegaly is the rule, and in large family studies, palpable spleens have been detected in more than 75% of affected members ( [17](#), [116](#) ). No apparent correlation exists between spleen size and disease severity ( [17](#) ). The liver is normal in size and function.

From a clinical perspective, it has been useful to classify HS according to the severity of disease ( [Table 32.2](#) ). Moderate HS is the most common presentation, recognized as a chronic hemolytic disorder with characteristic red cell spherocytes on the peripheral blood smear. In most cases, the pattern of transmission is autosomal dominant, although recessive inheritance also is seen. Moderate HS accounts for 60 to 75% of all HS cases. It is associated with mild to moderate anemia, modest splenomegaly, and intermittent jaundice ( [124](#) ). Mild HS occurs in 20 to 30% of cases of autosomal-dominant HS. In these patients, anemia is not generally present because the bone marrow is able to fully compensate for the persistent destruction of red cells, and there is little or no splenomegaly ( [124](#) ). Because patients in this group usually are asymptomatic, they often are not diagnosed until later in life. Sometimes, they are identified as a result of hemolytic or aplastic episodes triggered by infection ( [125](#) ). Occasionally, the condition is identified only through family surveys performed to document the hereditary nature of hemolytic disease in a relative. Severe HS occurs in approximately 5% of all HS patients ( [21](#), [126](#) ). It is characterized by severe hemolytic anemia, the need for red cell transfusion, and usually an incomplete response to splenectomy ( [126](#) ). The pattern of inheritance is almost always recessive. The silent carrier of HS exists in families with autosomal-recessive HS. In most of these cases, the parents of an affected patient have no signs of HS or only a mild increase in the reticulocyte count, a few spherocytes on peripheral blood smear, a minimally abnormal incubated osmotic fragility, or an abnormal spectrin content detected

when using sensitive techniques ( 20 ). Given that the incidence of HS in the United States is 1 in 5000 and that approximately 25% of all HS is autosomal recessive, it has been calculated that the HS silent carrier state might exist in 1.4% of the population ( 2 ).

The two major complications seen in HS are episodes of worsening anemia and the development of gallstones. Exacerbations of anemia occur in almost all HS patients, even in the large majority of HS patients who have mild or clinically silent disease. For example, previously mild anemia can become much more severe during pregnancy, usually because of the increased plasma volume but, occasionally, as a consequence of accelerated hemolysis ( 127 , 128 and 129 ). As with other chronic hemolytic states, some anemic crises are preceded by a febrile illness and may be observed concurrently in more than one affected member of a single family ( 130 , 131 ). In some cases, there may be increased hemolysis (decreased hemoglobin, increased reticulocytes, increased bilirubin concentration) associated with nonspecific viral infections. In other cases, just as with other individuals with chronic hemolysis, hypoplastic crises resulting from human parvovirus infection are seen ( 132 , 133 ). These transient aplastic crises caused by an arrest of erythropoiesis are characterized by sudden decrease in hemoglobin concentration and reticulocytopenia. Recovery occurs within 7 to 10 days and is heralded by reticulocytosis and thrombocytosis ( 132 ). Less commonly, exaggeration of anemia is the result of exhaustion of folate reserves by the sustained increase in net DNA synthesis ( 132 ). Megaloblastic arrest of erythropoiesis has been observed most commonly during pregnancy or in association with liver disease ( 17 , 134 , 135 ). Cholelithiasis is common in HS just as in other chronic hemolytic disorders. Gallstones of the pigment type (caused by bilirubin) may be found in very young children ( 136 ), but the incidence of gallstones increases markedly with age, and they are present in 40 to 80% of adults ( 137 ). The history of family members with cholelithiasis in the second or third decade of life is a clue to the possibility of HS or other chronic hemolytic disorder. In patients with mild HS, cholelithiasis may be the first sign of an underlying red cell disorder. The development of gallstones is increased approximately fivefold in HS patients who are homozygotes for the uridine diphosphate–glucuronosyltransferase mutation responsible for Gilbert syndrome ( 138 ).

A few other unusual complications have been noted in HS patients. Heterotopia of the bone marrow has been noted rarely in the renal pelvis ( 139 ) or along the vertebral column ( 140 , 141 , 142 , 143 and 144 ). These extramedullary masses of marrow may be mistaken for malignant tumors. After the spleen is removed, they undergo fatty metamorphosis ( 144 ). Hemosiderosis and multiple endocrine disorders resulting from transfusion–induced iron overload have been described ( 145 ). Interestingly, symptomatic iron overload also has been reported in some nontransfused HS patients who are heterozygous for the hemochromatosis gene ( 146 , 147 and 148 ). Multiple myeloma has been reported in a few non–splenectomized HS patients ( 149 ), but the relationship with HS, if more than coincidental, remains to be determined. Chronic leg ulcers are an unusual complication in adults with HS ( 150 ).

## Laboratory Features

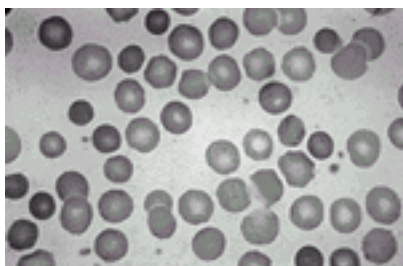
The classic laboratory features of HS include minimal or no anemia, reticulocytosis, an increased mean corpuscular hemoglobin concentration (MCHC), spherocytes on the peripheral blood smear, hyperbilirubinemia, and an abnormal osmotic fragility test.

Although reticulocytosis with values of 5 to 20% is common, some mild HS patients first

come to medical attention during a hypoplastic anemic crisis, and in these instances, the initial reticulocyte count can be extremely low. Usually, however, these patients have hyperbilirubinemia as evidence of accelerated RBC destruction. The reason for the marked reticulocytosis seen in mild to moderate HS in the face of minimal anemia is not clearly understood. At one time, it was thought to be caused by reduced 2,3-DPG levels; however, the partial pressure at which hemoglobin is half saturated with oxygen (p50) is normal ( [112](#) ). The reason for this compensated hemolysis in HS remains an enigma, but recent data indicate that serum erythropoietin levels are elevated in such patients, even when anemia is absent ( [151](#) ).

An increased MCHC obtained from an electronic cell counter is a characteristic feature of HS red cells ( [152](#) ). MCHC values greater than the upper limit of normal (35 to 36%) are common. This increased MCHC is a result of mild cellular dehydration ( [122](#) ). Examination of the indices obtained by automated cell counters is an excellent screening test for HS. An MCHC greater than 35.4 g per dl combined with a red cell distribution width greater than 14 has a sensitivity of 63% and a specificity of 100% ( [153](#) ). The mean corpuscular volume (MCV) usually is normal. However, considering the degree of reticulocytosis, the MCV in HS patients actually is low. This relatively low MCV may reflect membrane loss and cell dehydration. Fluctuations of mean corpuscular hemoglobin parallel those of the MCV.

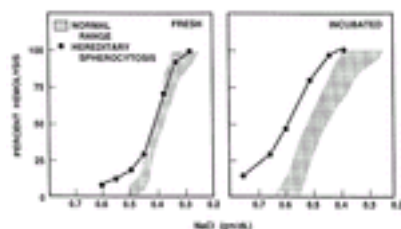
RBC morphology is distinctive yet not diagnostic. Varying degrees of polychromatophilia and anisocytosis are noted. Anisocytosis is prominent, and the smaller cells are spherocytes, recognized by the intensity of staining, lack of central pallor, and size. Because the degree of spherocytosis or “conditioning” is a function of cell age, reticulocytes and young red cells are morphologically normal ( [154](#) ). The number of microspherocytes varies considerably from patient to patient; as few as 1 to 3 in mild HS to as many as 20 to 30 per high-power field in moderate HS ( [Fig. 32.7](#) ). In severe HS patients, many odd-shaped poikilocytes also are present in addition to the spherocytosis. Unlike the spherocytes associated with immune hemolytic disease and thermal injury, most HS spherocytes are fairly uniform in size and density. Acanthocytes are a feature of  $\beta$ -spectrin deficiency HS cells ( [35](#) ), and pincerred spherocytes may be noted in band 3-deficient HS cells ( [22](#) ).



**Figure 32.7.** Typical smear (Wright stain) from patient with autosomal-dominant hereditary spherocytosis.

The bone marrow is characterized by erythroid hyperplasia. Normoblasts may constitute 25 to 60% of all nucleated cells. When complicated by folate deficiency, megaloblastic features of both myeloid and erythroid precursors are prominent ( [134](#) , [135](#) , [155](#) ). Examination of the bone marrow is not needed to diagnose HS.

**OSMOTIC FRAGILITY TEST** Red cells behave as osmometers when suspended in varying concentrations of salt solutions, and osmotic fragility of red cells is a measure of their spheroidicity. With a decreased membrane surface area relative to volume, spherocytes are unable to withstand the introduction of small amounts of free water that occurs when they are placed in progressively more hypotonic solutions. As a consequence, spherocytes “hemolyze” more than discoid RBCs at any salt concentration ( [Fig. 32.8](#)). Hemolysis is determined by measuring the fraction of total hemoglobin released from red cells into the extracellular fluid at progressively more dilute salt concentrations. The fresh osmotic fragility test detects circulating spherocytes, those red cells that have been conditioned by the spleen. This appears as a “tail” produced by a small population of abnormal cells that undergo hemolysis at salt concentrations that do not affect normal red cells ( [109](#)). The most sensitive test to detect HS is the incubated osmotic fragility test performed after incubating RBCs 18 to 24 hours under sterile conditions at 37° C. This procedure takes advantage of the observation that all erythrocytes lose membrane under these incubation conditions; however, the process is markedly accelerated in HS red cells. Hemolysis of HS cells may be complete at solute concentrations that cause little or no lysis of normal cells. HS individuals may have a normal fresh osmotic fragility if reduced surface area is balanced by a reduction in volume (due to cell dehydration) ( [152](#)), but the osmotic fragility after prolonged incubation at 37° C is usually abnormal ( [10](#), [15](#), [109](#), [156](#)). Although osmotic fragility correlates well with the magnitude of spherocytosis, no correlation is observed between osmotic fragility and hemoglobin concentration ( [111](#)). Osmotic gradient ektacytometry is more sensitive and specific than the osmotic fragility test for the diagnosis of HS but is not widely available ( [152](#)). Other laboratory tests used to diagnose HS include the autohemolysis test ( [157](#)) and the glycerol lysis test ( [158](#)), but these rarely are used nowadays, and they offer no advantage over the osmotic fragility test. A new flow cytometric test uses a fluorescent dye, is rapid and simple, and has high sensitivity and specificity ( [159](#)) but has not yet been widely used.



**Figure 32.8.** Osmotic fragility (as manifested by percent hemolysis) of normal and hereditary spherocytosis (HS) erythrocytes after incubation in salt solutions of varying tonicity. In fresh HS erythrocytes, note the “tail” of cells with increased sensitivity as a result of splenic conditioning ( *left*). In the incubated red blood cells (RBCs), note that the entire HS population of RBCs is more osmotically sensitive ( *right*). (Reprinted from Glader BE, Naumovski L. Hereditary red blood cell disorders. In: Rimoin DL, Connor JM, Pyeritz RE, et al., eds. Principles and practice of medical genetics. New York: Churchill Livingstone, 1996, with permission.)

In the past, doubt existed whether HS could be diagnosed in the newborn period because many HS infants have few circulating spherocytes. Moreover, fresh red cells from normal neonates are relatively resistant to osmotic lysis, whereas incubated infant erythrocytes are osmotically more fragile ( [160](#)). However, it now has been shown that osmotic gradient ektacytometry reliably detects HS in newborns ( [121](#)). The osmotic fragility test also detects HS in many but not all infants if appropriate normal neonatal RBC controls are used ( [152](#), [160](#)).

**MEMBRANE PROTEIN STUDIES** Once the diagnosis of HS is made, it is possible to further characterize the specific membrane lesion. Studies using polyacrylamide gel electrophoresis separation of membrane proteins and specific radioimmunoassays allow quantification of membrane proteins, looking for abnormalities in spectrin, ankyrin, pallidin,



or band 3. These studies, however, are not routine and are available only in select research laboratories. These membrane protein data are extremely important for enhancing our understanding of the biology of HS. However, there are no data yet to suggest that these analyses will identify clinically significant HS disorders not presently detected with the incubated osmotic fragility ( [2](#) ).

## Diagnosis

The diagnosis of HS generally is straightforward. Often, there is a family history of HS or a history of a family member having had a splenectomy or cholecystectomy before the fourth decade of life. The signs and symptoms of HS are those associated with all chronic hemolytic states (mild pallor, intermittent jaundice, splenomegaly). Typical laboratory features include minimal or no anemia, reticulocytosis, increased MCHC and red cell distribution width, normal MCV despite reticulocytosis, spherocytes on the peripheral blood smear, hyperbilirubinemia, and an abnormal incubated osmotic fragility test. Other disorders, such as immune hemolytic disease, glucose-6-phosphate dehydrogenase deficiency, certain syndromes of red cell fragmentation, and thermal and chemical injury of red cells, also are associated with spherocytosis. In most of these conditions, however, spherocytes are but one of several types of abnormal RBCs present, whereas in HS, there are few abnormal forms other than spherocytes. In addition, HS spherocytes tend to be more uniform than those noted in other hemolytic anemias. The differentiation between HS and immune hemolytic disease is distinguished by a positive antiglobulin reaction.

## Treatment

For practical purposes, the treatment of HS revolves around presplenectomy supportive care, the role of splenectomy, and postsplenectomy complications.

Neonates with severe hyperbilirubinemia caused by HS are at risk for kernicterus, and such infants should be treated with phototherapy or exchange transfusion, or both, as clinically indicated. During the first few months of life, erythropoietin therapy may diminish the need for red cell transfusions until erythropoiesis reaches its full postnatal expression ( [161](#) ). Aplastic crises occasionally can cause the hemoglobin to fall precipitously because the ongoing accelerated destruction of spherocytes is not balanced by new RBC production. Under these conditions, red cell transfusions often are necessary and may be life-saving. Folic acid is required to sustain erythropoiesis, and normal dietary folate may be inadequate for children with chronic hemolytic anemia. For this reason, HS patients are instructed to take supplementary folic acid (1 mg/day) to prevent the rare megaloblastic crises, although in mild cases, this is probably unnecessary ( [162](#) ).

HS is unique among the congenital hemolytic anemias in that splenectomy is permanently curative except in the unusual autosomal-recessive variant ( [126](#) ). Within days of removal of the spleen, jaundice fades, and the hemoglobin concentration rises ( [163](#) ). Nevertheless, red cell survival, although much improved, is not absolutely normal ( [99](#), [100](#) ). High normal values for reticulocytes and serum bilirubin reflect an ongoing but modest increase in red cell turnover ( [163](#) ). The numbers of peripheral blood microspherocytes are unchanged or may increase ( [15](#) ). The MCV usually falls, but the MCHC does not change significantly. Both leukocytosis and thrombocytosis are expected corollaries of splenectomy ( [139](#) ). Several reports indicate an increased rate of thrombotic events years after splenectomy for HS ( [164](#), [165](#) ). The degree of risk, although not clearly defined, should influence decisions as to whether to perform or avoid splenectomy. Anticoagulation with aspirin or

other agents has not been evaluated in this setting.

In the past, splenectomy was recommended for all patients with HS, irrespective of the severity of anemia. The rationale for this opinion was that splenectomy eliminated the need for transfusion therapy, ensured freedom from aplastic crises, and minimized the risk of symptomatic cholelithiasis and its complications ( [166](#) ). This position has been tempered in recent years because it is now known that the spleen has a critical immunologic role in protecting against certain types of infections, and fatal sepsis caused by *Streptococcus pneumoniae* is a recognized complication in splenectomized children ( [116](#), [167](#), [168](#) ). The risk of postsplenectomy sepsis is greatest in children younger than 5 years of age, but even older children and adults also are at a somewhat increased risk compared with nonsplenectomized individuals. Death from sepsis may occur decades after splenectomy ( [169](#), [170](#) ). In one comprehensive review, postsplenectomy infection was assessed in 850 HS patients, 786 of whom were children ( [171](#) ). Most patients had undergone surgery during the first 5 years of life. Thirty cases of septicemia and 19 septic deaths were identified. The estimated rate of mortality from sepsis was approximately 200 times greater than that expected in the general population. Although most septic episodes were observed in children whose spleens were removed in the first years of life, older children and adults were also susceptible.

The rationale that splenectomy prevents development of gallstones and symptomatic biliary tract disease, as well as obviates the need for major gallbladder surgery, probably is not as valid today as it was in the past. The availability of laparoscopic cholecystectomy to remove gallstones has had a significant impact on the management of nonanemic patients with mild HS who have gallstones. In these patients, if they have no signs or symptoms related to their hemolytic anemia or splenomegaly, it is reasonable to follow them without splenectomy. If surveillance ultrasound examinations reveal gallstones, it seems reasonable to perform a prophylactic laparoscopic cholecystectomy, particularly if symptoms of biliary colic occur. This procedure prevents significant biliary tract disease and, in some mild HS patients, avoids the need for splenectomy. Prophylactic cholecystectomy in patients without gallstones is unnecessary ( [172](#) ).

Children who are candidates for splenectomy include those with severe HS requiring red cell transfusions and those with moderate HS who manifest growth failure or other signs and symptoms of anemia. Whenever possible, splenectomy for children with HS should be done after 5 years of age. In a majority of cases, it is possible to perform the surgery using laparoscopic techniques ( [173](#) ). The one disadvantage of this procedure is that it takes longer and thereby requires approximately twice the anesthesia time. However, distinct advantages of laparoscopic splenectomy are the shorter hospitalization and the smaller surgical scar. Another interesting approach has been the use of partial splenectomy to retain splenic immunologic function while, at the same time, reducing the rate of hemolysis ( [174](#), [175](#) ). In 37 of 40 children who underwent subtotal splenectomy, the procedure was successful. Three children required a secondary total splenectomy for recurrent jaundice and anemia 5 months to 6 years after their initial surgery ( [175](#) ). This approach might be particularly useful in children younger than 5 years of age who need frequent transfusions ( [174](#) ).

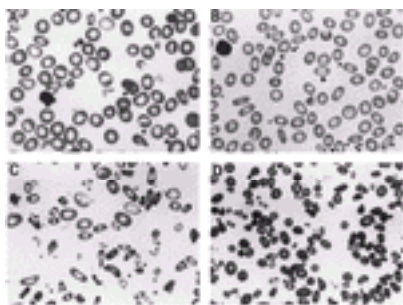
Any child who is to undergo splenectomy should receive pneumococcal vaccine before the spleen is removed. However, because not all pneumococcal subtypes are included in the current vaccine, one must be aware that overwhelming sepsis can occur in vaccinated children. The most important aspect of this awareness is to have parents alert their physician at the first sign of fever in a splenectomized child. The role of prophylactic antibiotics for immunized asplenic children is a matter of current controversy, and few good data exist to provide unequivocal recommendations. Our present policy is extremely



conservative, in that all splenectomized children previously vaccinated with pneumococcal vaccine also are prescribed penicillin prophylactically (125 to 250 mg twice a day). How long to continue penicillin prophylaxis also is a matter of considerable controversy. In the absence of data from clinical studies, our current approach is to continue prophylaxis to at least 10 years of life. In addition, at the onset of fever ( $>38.5^{\circ}\text{C}$ ) patients/parents are advised to see their physician. Management usually includes obtaining a blood culture and administering a parenteral cephalosporin antibiotic. The problem of postsplenectomy sepsis today is compounded by the emergence of penicillin-resistant *S. pneumoniae* ( [176](#), [177](#) ). To date, no vancomycin-resistant pneumococci have emerged, and this can be given as a second antibiotic for a very sick patient.

## HEREDITARY ELLIPTOCYTOSIS SYNDROMES

The *HE syndromes* are a family of genetically determined RBC disorders characterized by elliptical red cells on the peripheral blood smear ( [Fig. 32.9](#) ). Some HE syndromes are associated with symptomatic hemolytic disease, although most are clinically silent and often discovered accidentally when a blood smear is reviewed. The varied clinical and hematologic manifestations of HE are an expression of the numerous molecular defects that give rise to the elliptocyte. Several disorders now are classified under HE. *Common HE* is a dominantly inherited condition characterized by many elliptocytes in the peripheral blood smear. However, the clinical severity of common HE is extremely variable, ranging from an incidental asymptomatic condition to a moderate hemolytic anemia. The clinical expression of coinheritance of two common HE genes, homozygous HE, ranges from moderate anemia to fatal hydrops fetalis. *Hereditary pyropoikilocytosis* (HPP) is a severe recessively inherited hemolytic anemia, with red cell fragments, microspherocytes, and poikilocytes seen on the peripheral smear. From a clinical perspective, it is difficult to distinguish HPP from homozygous or doubly heterozygous common HE. Once regarded as a separate condition, HPP is biochemically related to common HE, occurs in families in which other members have common HE, and now is considered to be a variant of this disorder. Spherocytic HE is a rare condition in which both ovalocytes and spherocytes are present on the blood smear. *Southeast Asian ovalocytosis* (SAO), also known as *stomatocytic elliptocytosis*, is an HE variant prevalent in the malaria-infested belt of Southeast Asia and the South Pacific, and it is characterized by rigid spoon-shaped cells that have either a longitudinal slit or a transverse ridge. The following sections discuss the membrane biology, pathophysiology, clinical characteristics, and laboratory features of these HE disorders.



**Figure 32.9.** Wright-stained peripheral blood smears (original magnification  $\times 500$ ) of different hereditary elliptocytosis syndromes. **A:** Micropoikilocytes and elliptocytes in a neonate with transient poikilocytosis and a  $\text{Sp a}^{1/65}$  mutation. **B:** Same child at 7 months of age now exhibiting common hereditary elliptocytosis. **C:** Compound heterozygous hereditary elliptocytosis due to two  $\alpha$ -spectrin mutations ( $\text{Sp a}^{1/65}$  and  $\text{Sp a}^{1/50a}$ ). Note distorted red cell shapes, elliptocytes, fragments, and budding forms. **D:** Hereditary pyropoikilocytosis. Red cell abnormalities are similar to those in **(C)** but with the addition

of numerous spherocytes. (Reprinted from Iarocci TA, Wagner GM, Mohandas N, et al. Hereditary poikilocytic anemia associated with the co-inheritance of two alpha spectrin abnormalities. Blood 1988;71:1390–1396, with permission.)

## Prevalence of All Hereditary Elliptocytosis Variants

When considered together, the HE variants occur with an estimated frequency of 1 in 1000 to 1 in 5000 ( [178](#), [179](#) ). The distribution of HE is worldwide, and no racial or ethnic group appears to be spared. In the U.S. population, the prevalence of HE is approximately 3 to 5 per 10,000 ( [178](#) ), and it appears to be much more common among blacks. In areas where malaria is endemic, HE occurs considerably more frequently, with common HE having a prevalence of 0.6% ( [180](#) ) in equatorial Africa. Resistance of hereditary elliptocytes to invasion by malaria parasites may explain the high frequency of HE (30%) in Malayan aborigines ( [181](#) ). Like HS, HE is transmitted as an autosomal-dominant trait ( [182](#), [183](#) ) and, in most cases, is associated with no or minimal clinical abnormalities. Both homozygous HE and compound heterozygosity for different HE mutations occur, and these cases account for the cases of clinically severe hemolytic anemia.

## Pathogenesis of Common Hereditary Elliptocytosis Disorders

The HE disorders are caused by intrinsic membrane protein abnormalities, which lead to an alteration in RBC membrane function, changes in RBC shape, and, in some cases, hemolysis.

**MEMBRANE PROTEIN DEFECTS** That the primary defect in HE resides in the membrane cytoskeleton is suggested by the retention of an elliptical shape by ghosts and membrane skeletons prepared from hereditary elliptocytes, uniform instability of HE membrane skeletons and ghosts to mechanical stress, and abnormal heat sensitivity of spectrin prepared from the red cells of some patients with HE ( [184](#) ). In addition, a similar biochemical lesion is seen in red cells of patients with HPP, an autosomal-recessive congenital hemolytic disorder characterized by severe anemia and extreme micropoikilocytosis ( [185](#), [186](#) ). The similarity of red cell morphology in HPP to that associated with heat injury of RBCs prompted an assessment of the thermal stability of patient cells. Whereas normal red cells fragment at temperatures exceeding 49° C, cells in this disorder exhibited striking membrane instability at 45° to 46° C ( [187](#) ). Subsequent studies demonstrated that the susceptibility of HPP red cells to heat injury is the result of thermal instability of HPP spectrin ( [187](#) ). Spectrin extracted from most HE red cells is quantitatively normal but is structurally abnormal. Whereas more than 90% of spectrin extracted from normal red cells is in the form of tetramers ( [188](#), [189](#) ), a major portion of the spectrin extracted from hereditary elliptocytic RBCs, including erythrocytes from patients with HPP, is present as dimers ( [190](#), [191](#) ). Moreover, spectrin dimers prepared from HE red cells do not form tetramers in solution, in ghosts, or on inside-out vesicles ( [191](#), [192](#) ). The spectrin dimer-tetramer interconversion is governed by a simple thermodynamic equilibrium that normally favors spectrin tetramer formation. The impaired self-association of spectrin  $\alpha\beta$ -dimers into tetramers is thought to be responsible for RBC membrane instability in the HE syndromes ( [193](#), [194](#) ). A large number of reports now have documented that HE is associated with dysfunction or deficiencies of spectrin, protein 4.1, and glyophorin ( [2](#), [3](#), [195](#), [196](#) ).

**Spectrin Abnormalities** In more than 60% of all patients with HE, mutations of spectrin are found ( [197](#), [198](#) ). A recent compilation listed 25  $\alpha$ -spectrin mutations and 15  $\beta$ -spectrin mutations associated with a clinical phenotype of HE/HPP ( [199](#) ). The majority of these

mutations were missense with smaller numbers of splicing, deletion, or insertion abnormalities also reported. Individuals inheriting a single copy of an  $\alpha$ -spectrin mutation generally have asymptomatic elliptocytosis, whereas those with two copies often have severe hemolytic disease. The clinical phenotype produced by  $\alpha$ -spectrin mutants is determined by two factors: the relative amount of spectrin present as dimer ( [200](#) ) and the total spectrin content of the membrane ( [197](#) ). In HE cells, the percentage of spectrin present as dimer is high, and spectrin content is normal; in HPP red cells, the percentage of spectrin dimers also is high, but the spectrin content is decreased ( [197](#), [201](#) ). Tryptic digestion of spectrin followed by electrophoretic separation allows identification of specific tryptic peptide patterns and may be a useful step in identifying the location of a spectrin mutation ( [196](#), [202](#), [203](#) ). The 80-kd aI domain peptide is the largest tryptic peptide, contains the N-terminal end of the spectrin molecule, and, importantly, contains the self-association site of normal spectrin heterodimers ( [204](#), [205](#) ). Almost all  $\alpha$ -spectrin mutations seen in HE syndromes are found within the 80-kd aI domain. Molecular modeling reveals that the clinical severity of these mutations is a function of the extent to which they disrupt the self-association of  $\alpha$ - and  $\beta$ -spectrin subunits ( [206](#) ). Mutations contained within the 80-kd aI domain yield tryptic peptides of abnormal size, different from the normal 80-kd aI domain peptide. Mutations are designated by a superscript identifying the abnormal domain and the most prevalent tryptic peptide that is generated. Sp  $\alpha^{I/74}$ , an abnormal spectrin in which tryptic digestion of domain I of the  $\alpha$ -spectrin chains generates a peptide of 74 kd instead of the normal 80-kd peptide, is the most common of these molecular variants ( [207](#), [208](#), [209](#), [210](#) and [211](#) ). It is the result of one of four amino acid substitutions at codon 28 of the  $\alpha$ -spectrin chain ( [211](#), [212](#) ). Sp  $\alpha^{I/74}$  is the most severe of the  $\alpha$ -spectrin mutations. Sp  $\alpha^{I/65}$  is a variant that results in a similar but milder clinical phenotype than that associated with the Sp  $\alpha^{I/74}$  variant ( [213](#), [214](#), [215](#), [216](#) and [217](#) ), and this mutation is very common. Sp  $\alpha^{I/46}$  (also identified as Sp  $\alpha^{I/50}$ ) occurs primarily in black individuals, but occasionally, it is reported as a cause of HE in whites ( [218](#) ). Mutations distant from the aI domain also have been detected ( [219](#), [220](#) ). It is postulated that they exert a long-range effect on spectrin self-association by disrupting the transfer of information between spectrin repeats, by the loss of cross-reactions with  $\beta$ -spectrin near the ankyrin binding site, or, in the case of exon deletions, by register shifts between  $\alpha$  and  $\beta$  subunits ( [221](#) ). One particularly interesting variant is Sp  $\alpha^{V/41}$ , also referred to as Sp  $\alpha^{Lely}$  (Lely: low-expression allele from Lyon) ( [222](#), [223](#) ). Sp  $\alpha^{V/41}$  has a reduced propensity to form dimers with  $\alpha$ -spectrin ( [222](#), [223](#) ). When Sp  $\alpha^{V/41}$  is present as a sole mutation, it is clinically silent because normal  $\alpha$ -spectrin is synthesized in large excess of  $\beta$ -spectrin ( [224](#) ). However, when Sp  $\alpha^{V/41}$  is present in *trans* to an  $\alpha$ -spectrin mutant that causes HE, incorporation of the latter into  $\alpha\beta$ -heterodimers is favored, thereby leading to an increased proportion of the elliptocytogenic spectrin in the red cells and increased clinical severity. Conversely, when coinherited in *cis* to an HE  $\alpha$ -spectrin mutation, it reduces the amount of the mutation incorporated into dimers and ameliorates clinical severity. In this way, Sp  $\alpha^{V/41}$  plays an important role in modifying the clinical expression of HE. This particular polymorphism is common, affecting approximately 30% of the  $\alpha$ -spectrin alleles of Europeans and 20% of Japanese and West Africans ( [224a](#) ). Mutations in  $\beta$ -spectrin may also lead to common HE. Inheritance of two  $\beta$ -spectrin mutations can be associated with an unusually severe clinical phenotype. Homozygosity for  $\beta$ -spectrin Providence was associated with recurrent hydrops fetalis ( [225](#) ), and homozygosity for  $\beta$ -spectrin Buffalo was associated with fatal and near-fatal neonatal hemolytic anemia ( [226](#) ).

**Protein 4.1 Defects** Protein 4.1 abnormalities associated with HE are much less common than spectrin mutations. One site on protein 4.1 binds to the distal end of the spectrin  $\alpha\beta$ -heterodimer, thereby increasing the binding of spectrin to actin. Protein 4.1 interacts with glycophorin C at a second site, thereby enhancing attachment of spectrin to the

membrane ( [188](#), [227](#), [228](#), [229](#), [230](#), [231](#), [232](#) and [233](#) ). Deficiency of protein 4.1 has been described in several kindreds from southern France and northern Africa ( [234](#), [235](#), [236](#), [237](#) and [238](#) ). A partial deficiency of protein 4.1 is associated with mild dominantly inherited HE. Heterozygotes have approximately 50% of the normal amount of protein 4.1 and have mild hemolytic anemia. Homozygotes have no detectable protein 4.1 and a severe transfusion-dependent hemolytic anemia with prominent elliptocytosis and spherocytosis ( [236](#), [238](#) ). Structural abnormalities of protein 4.1 have also been found that interfere with the normal function of the molecule and lead to elliptocytosis ( [239](#), [240](#) ).

**Glycophorin C Deficiency** Mutations associated with glycophorin C deficiency occasionally are associated with HE. These cases usually also include partial deficiency of protein 4.1. Glycophorin C is decreased in patients with protein 4.1 deficiency, presumably because the two proteins stabilize each other on the membrane ( [241](#), [242](#) ). In contrast to other forms of HE, heterozygous carriers of glycophorin C deficiency are asymptomatic with normal RBC morphology. Homozygous-deficient individuals have mild elliptocytosis but no anemia ( [243](#) ).

**MEMBRANE ABNORMALITIES LEADING TO ELLIPTOCYTE FORMATION** Most abnormalities in HE are caused by spectrin mutations that affect the spectrin heterodimer contact site, thereby leading to decreased spectrin tetramer formation and, consequently, disrupting the horizontal integrity of the membrane skeleton. As a result, membrane skeletons and whole cells are mechanically unstable ( [193](#), [194](#) ). The red cell lesion in protein 4.1 deficiency is thought to affect the spectrin-actin interaction, which also is a horizontal interaction ( [194](#) ). Abnormalities in cellular deformability and membrane fragility are proportional to reduced levels of protein 4.1 ( [238](#) ), reflecting the role of this protein in enhancing the interaction of spectrin and actin ( [188](#) ). The mechanical stability of protein 4.1-deficient membranes can be restored *in vitro* by adding back purified protein 4.1 to the membrane skeleton ( [244](#) ). The basis for elliptocytosis and mechanical instability of glyco-phorin C-deficient red cells is not known. It appears to be related to a concomitant partial deficiency of protein 4.1, as evidenced by a full correction of membrane instability by introduction of protein 4.1 into the cells. The mechanism by which these protein defects result in elliptocyte formation is not clear. It is of particular interest that HE red cells acquire their shape after release from the bone marrow and as they age *in vivo* ( [179](#), [245](#), [246](#) ). It also is significant that normal red cells assume an elliptical shape in capillaries ( [247](#) ) and *in vitro* when exposed to shear stress ( [248](#) ), and, with passage through the microcirculation or with removal of shear stress, they resume a normal biconcave shape. However, if mechanical distortion is maintained for long periods, even normal red cells remain misshapen ( [249](#) ), thus suggesting that the membrane skeleton is altered as a consequence of sustained shape changes. In the case of HE, it is possible that weakened spectrin heterodimer contacts may lead to skeletal reorganization after less extensive deformation or shear stress. With repeated distortions imposed by passage through small capillaries, cells with unstable membrane skeletons thus may gradually elongate to form irreversible elliptocytes. Red cells with even more severe skeletal defects presumably are unable to withstand the shear stresses experienced in the normal circulation and thus may undergo fragmentation. This process may explain the poikilocytosis seen in homozygous HE and HPP and in mild HE associated with neonatal poikilocytosis. In all of the hemolytic HE syndromes, the more severely distorted cells are retained in splenic cords ( [104](#), [250](#), [251](#) ). As a result, splenectomy markedly ameliorates the anemia associated with these clinically symptomatic variants.

**ANIMAL MODELS OF HEREDITARY ELLIPTOCYTOSIS** A spontaneously occurring mouse model of severe HE is associated with neonatal thrombosis, premature death, and accumulation of renal hemosiderin. Aberrant splicing leads to the absence of exon 11 of  $\alpha$ -spectrin and a truncated protein that is not capable of supporting normal dimer/tetramer stability. These mice are also severely deficient in membrane spectrin and ankyrin ( [252](#) ). Absence of erythrocyte  $\beta$ -adducin, a protein that enhances spectrin-actin

binding, was induced by gene targeting in mice and led to a mild sphero-elliptocytic hemolytic anemia reminiscent of human spherocytic elliptocytosis ( [253](#) ).

### Clinical and Laboratory Features of Hereditary Elliptocytosis Syndromes

Although all HE variants are marked by the presence of at least 15% elliptical red cells, they are clinically and hematologically quite heterogeneous ( [Table 32.3](#) ). This heterogeneity, in part, reflects the diverse causes of HE, and there is much overlap when these disorders are classified on a clinical, biochemical, or molecular basis.

**TABLE 32.3. Clinical Classification of Hereditary Elliptocytosis (HE) Syndrome**

|                        | Common HE  | Homozygous HE                         | Hereditary Pyropoikilocytosis                                | Spherocytic Elliptocytes  | Southeast Asian Ovalocytosis   |
|------------------------|--|---------------------------------------|--|---------------------------|--|
| Anemia                 | None   | Moderate-severe                       | Severe   | Mild-moderate             | None   |
| Hemolysis              | None-mild  | Moderate-severe                       | Severe   | Mild-moderate             | None   |
| Splenomegaly           | None   | Present                               | Present  | Present                   | None   |
| Peripheral blood smear | 15-90% elliptocytes  | Poikilocytes; elliptocytes; fragments | Poikilocytosis; RBC budding with fragments; microspherocytes | Elliptocytes; spherocytes | Rounded elliptocytes, some having a transverse bar that divides the cell |
| Osmotic fragility      | Normal   | Increased                             | Increased  | Increased                 | Normal-decreased   |
| Inheritance            | Dominant   | Recessive                             | Recessive  | Dominant                  | Dominant   |
| Other                  | Poikilocytosis with severe hemolysis, seen transiently in some infants | Low MCV                               | Low MCV  |                           | Rigid RBC resistant to penetration by malaria parasites                  |

MCV, mean corpuscular volume; RBC, red blood cell.

**Common Hereditary Elliptocytosis** In most cases, individuals with common HE are discovered accidentally when elliptocytes are identified during routine evaluation of the peripheral blood film. These individuals usually are not anemic, their red cell survival is normal, and there is no splenomegaly ( [179](#), [198](#), [245](#), [254](#) ). In contrast to the clinical picture, the peripheral blood smear is striking, containing 15 to 100% elliptocytes ( [179](#), [245](#) ) ( [Fig. 32.8](#) ). Other common HE cases involve mild compensated hemolysis without anemia. However, in 5 to 20% of cases, the hemolytic process is incompletely compensated, and patients have a moderate to severe hemolytic anemia (hemoglobin concentration, 9 to 12 g per dl; reticulocyte count, =20 to 25%) ( [182](#), [255](#), [256](#) ). Of particular interest, the peripheral blood smear in these hemolytic cases reveals many poikilocytes, as well as numerous elliptocytes. The spleen may be enlarged ( [256](#) ), and gallstones ( [254](#) ) occur with increased frequency. As in other hemolytic states, abrupt episodes of more severe anemia may occur ( [183](#) ). In some families, hemolytic HE has been transmitted through several generations. In other families, however, not all individuals with HE manifest chronic hemolysis, and this presumably reflects other genetic factors that modify disease expression. The reason for the variable clinical expression of common HE, even within



families, has been a puzzle. A partial answer to this variability has been provided by the recognition of the Sp a<sup>V/41</sup> allele, which modifies the clinical phenotype by allowing greater expression of the variant  $\alpha$ -spectrin (222). For example, in one family, heterozygosity for both Sp a<sup>I/65</sup> and the Sp a<sup>V/41</sup> mutation resulted in markedly increased elliptocytosis compared with siblings with only the Sp a<sup>I/65</sup> mutation (Sp a/Sp a<sup>I/65</sup>) (222). Also, individuals heterozygous for Sp a<sup>I/74</sup> and Sp a<sup>V/41</sup> have marked elliptocytosis, poikilocytosis, and hemolysis compared with their siblings who have only the Sp a<sup>I/74</sup> mutation (Sp a/Sp a<sup>I/74</sup>) (222). Coinheritance of other erythrocyte disorders, such as thalassemia, may also accentuate the clinical abnormalities that accompany common HE (257). HE with infantile poikilocytosis is a clinical manifestation of HE that occurs almost exclusively in black families. Affected young infants have moderately severe hemolytic anemia and hyperbilirubinemia in the newborn period, the latter often necessitating exchange transfusion (258, 259). The blood smear is characterized by marked red cell fragmentation and poikilocytosis in addition to elliptocytosis (Fig. 32.9B) (258, 259 and 260). These morphologic changes are indistinguishable from those noted in patients with HPP. In contrast to HPP, however, hemolysis gradually lessens, and the clinical and hematologic features convert to those of mild HE by 6 to 12 months of age (Fig. 32.9C). The basis for this curious phenomenon in the neonatal period is not known. In part, it is thought to be the result of an increased concentration of free 2,3-DPG, the latter having a destabilizing influence on protein 4.1-actin interactions and thus causing membrane skeleton instability (261, 262). The increase in free 2,3-DPG reflects the well-known lack of interaction of this intermediate with fetal hemoglobin.

#### **HOMOZYGOUS (DOUBLY HETEROZYGOUS) HEREDITARY ELLIPTOCYTOSIS**

Homozygous and doubly heterozygous HE are characterized by chronic hemolytic anemia of variable severity. Morphologic characteristics include marked poikilocytosis, microelliptocytosis, and red cell fragmentation (179, 215, 263, 264). In many cases, both parents have nonhemolytic HE, or, because many individuals with a single  $\alpha$ -spectrin mutation are clinically silent, parental anemia or RBC abnormalities may not be present. These disorders and HPP often have a very similar clinical presentation. The homozygous state for the Sp a<sup>I/65</sup> variant (214) and the Sp a<sup>I/74</sup> variant (207) have been described. Those individuals homozygous for Sp a<sup>I/65</sup> have moderate hemolysis, whereas those patients homozygous for the Sp a<sup>I/74</sup> mutation have much more severe hemolytic anemia, often requiring splenectomy (207). The latter homozygous group of HE subjects may have numerous small microspherocytes in their peripheral blood, and their clinical presentation is indistinguishable from HPP (265). Several cases presumed to result from homozygosity now are known to be a consequence of double heterozygosity for different spectrin mutations. The doubly heterozygous states for the Sp a<sup>I/65</sup> and Sp a<sup>I/46</sup> variants and the Sp a<sup>I/74</sup> and Sp a<sup>I/61</sup> variants (266) have been described. These double heterozygote variants are associated with the homozygous HE or HPP clinical phenotypes.

**HEREDITARY PYROPOIKILOCYTOSIS** This severe congenital hemolytic anemia, which clinically is very similar to homozygous HE, is characterized by extreme micropoikilocytosis and an autosomal mode of inheritance. HPP is the result of a double heterozygous state for an  $\alpha$ -spectrin mutant and a defect involving spectrin synthesis. In many pedigrees, one parent or a sibling has an  $\alpha$ -spectrin variant with or without nonhemolytic HE, whereas the other parent is normal (267, 268). The abnormality is silent when present in isolation because  $\alpha$ -spectrin normally is produced in excess (224). Although HPP once was regarded as a distinct entity, it now is considered a subtype of common HE. Both HE and HPP often exist in the same family, and the same molecular spectrin defects are seen in HPP and severe HE (discussed in Spectrin Abnormalities). The one fundamental difference between these two entities is that red cells of the HPP

subjects also are partially deficient in spectrin as detected by a decreased spectrin to band 3 ratio ( [197](#), [201](#) ). In part, this may reflect that some elliptocytogenic  $\alpha$ -spectrin mutants are unstable, and this might lead to spectrin deficiency ( [201](#), [269](#) ). Whatever the mechanism, decreased red cell spectrin is a constant feature of HPP and probably explains the abundance of microspherocytes noted in association with this disorder. In infancy or early childhood, affected individuals manifest moderately severe hemolytic anemia (hemoglobin concentration, 5 to 9 g per dl; reticulocyte count, 13 to 35%). Splenectomy is followed by an increase in hemoglobin concentration (to 9 to 11 g per dl) and a decrease in reticulocytes (to 3 to 7%) ( [267](#), [268](#) ). Most ( [186](#), [270](#), [271](#) ), but not all, cases involve blacks. Growth retardation related to anemia, frontal bossing, and premature gallbladder disease are reported complications. Most impressive are changes in red cell morphology, which include extreme poikilocytosis, microspherocytosis, microelliptocytosis, membrane budding, and cell fragments. The MCV may be extremely low, 30 to 50 fl ( [271](#) ); MCHC is normal; and osmotic fragility is increased ( [186](#), [271](#) ).

**SPHEROCYTIC ELLIPTOCYTOSIS** This syndrome is characterized morphologically by two populations of cells: red cells that are more rounded than typical hereditary elliptocytes and a variable number of microspherocytes. In contrast to other HE syndromes with hemolysis, no poikilocytes or fragments are seen. The disorder has been seen primarily in families of European descent ( [182](#), [255](#), [272](#), [273](#), [274](#), [275](#) and [276](#) ) and may account for as many as 15 to 25% of cases of HE in whites. Affected individuals have an incompletely compensated hemolytic process with mild anemia and predisposition to aplastic crises. The relative numbers of spherocytes and elliptocytes vary considerably, even within families ( [182](#), [274](#) ). As in HS, the osmotic fragility ( [182](#), [275](#) ) and mechanical fragility ( [182](#), [272](#), [275](#) ) may be increased. Splenectomy is curative ( [182](#), [251](#), [255](#), [256](#), [273](#) ).

**SOUTHEAST ASIAN OVALOCYTOSIS** This interesting variant, also known as *stomatocytic elliptocytosis*, is characterized morphologically by round elliptocytes (ovalocytes), many of which have one or two transverse ridges. These red cells are found in people from Malaysia, New Guinea, Indonesia, and the Philippines ( [277](#), [278](#), [279](#) and [280](#) ). Their presence is not associated with any significant anemia or hemolysis. The RBCs in SAO manifest increased red cell rigidity ( [181](#), [281](#) ), increased thermal stability ( [282](#), [283](#) ), and decreased osmotic fragility ( [284](#) ). Also, these red cells are resistant *in vitro* to invasion by several strains of malaria ( [282](#), [283](#), [285](#), [286](#) ). In populations in which SAO is prevalent, its frequency is increased in older individuals, suggesting a favorable effect on longevity ( [287](#) ). The molecular defect in SAO results from an abnormal band 3 protein. This is a consequence of two mutations on the same gene: a deletion of 9 codons encoding for amino acids 400 to 408 ( [288](#), [289](#) ) and a missense mutation resulting in a substitution of lysine for glutamate at amino acid 56 ( [290](#) ). All carriers of the SAO phenotype are heterozygotes, with one normal band 3 allele and one mutant band 3. Tight binding of band 3 protein to ankyrin ( [291](#) ) is present in SAO red cells ( [292](#) ), restricting lateral mobility of this protein. Because band 3 protein is a receptor for malarial parasites ( [293](#) ), its reduced mobility may limit invagination and penetration by the parasite ( [181](#), [281](#) ). Studies in children in Papua New Guinea indicate that SAO does not actually reduce the incidence of infection with *Plasmodium falciparum*, but it does provide remarkable protection against cerebral malaria. This effect is likely due to reduced cytoadherence of SAO red cells to the cerebral vasculature, but the exact mechanism is not yet known ( [294](#) ). Resistance of SAO red cells to malaria most likely is related to the altered band 3 protein because this protein is a receptor for the parasite ( [293](#) ). The reduced lateral mobility of band 3 protein in SAO red cells may limit invagination and penetration by the parasite ( [181](#), [281](#) ).

## Laboratory Evaluation



Initial laboratory studies in a patient with a suspected HE syndrome should assess whether the patient is anemic (hemoglobin concentration/hematocrit), whether the anemia is well compensated (reticulocyte count), and whether the anemia is caused by accelerated RBC destruction (increased serum lactate dehydrogenase and bilirubin concentration). The mean cell volume (MCV) also is important because hemolytic variants with RBC fragmentation often manifest severe microcytosis as a result of RBC fragmentation. A careful evaluation of the blood smear is essential both for the diagnosis of HE and the classification of the disorder into major subtypes. At least 15% and often as many as 50 to 90% of red cells are oval, whereas smears from normal subjects contain fewer than 15% elliptocytes ( [179](#), [245](#) ). In patients in whom elliptocytosis is the only morphologic abnormality, hemolysis is usually minimal or absent with the exception of spherocytic elliptocytosis, in which the presence of “fat” ovalocytes is associated with accelerated red cell destruction. In other patients with hemolytic forms of HE, poikilocytosis almost always is seen on the blood film, and in homozygous HE and HPP, many red cells circulate as cell fragments, producing a marked decrease in mean cell volume. The finding of red cell fragments together with a striking microspherocytosis and often only occasional elliptocytes is characteristic of HPP. Osmotic fragility is normal in nonhemolytic HE ( [157](#), [295](#) ) but is increased in spherocytic elliptocytosis and HPP and in those hemolytic HE variants with poikilocytosis on their peripheral blood film ( [2](#), [255](#) ). The osmotic fragility is decreased (i.e., resistant to hemolysis) in SAO red cells ( [284](#) ).

The finding of more than 30% oval red cells on the peripheral blood film, some containing a central slit or a transverse ridge, together with an absence of clinical and laboratory evidence of hemolysis in an individual from Southeast Asia or the South Pacific is highly suggestive of SAO. A screening test for SAO is the failure of ovalocytes to undergo membrane changes (form spicules) after metabolic depletion or when suspended in hypertonic salt solutions ( [281](#), [282](#) ). The mechanism of this resistance to change in shape presumably is because of the extreme rigidity of the red cell membrane. Also, as noted previously, the osmotic fragility is decreased.

Once the diagnosis of an HE syndrome is established, additional laboratory studies can further define the cellular and molecular defect ( [3](#) ). Sodium dodecyl sulfate–polyacrylamide gel electrophoresis of solubilized membrane proteins may reveal proteins of abnormal mobility. A partial deficiency of spectrin may be detected by a decreased spectrin to band 3 ratio, and this is helpful to diagnose HPP ( [197](#), [201](#) ). Nondenaturing gel electrophoresis can be used to analyze the ratio of tetrameric and dimeric spectrin and, thereby, detect the most common functional abnormality in HE (an increase in the fraction of dimeric spectrin) ( [196](#), [202](#) ). Tryptic peptide digestion of spectrin followed by electrophoretic separation can detect tryptic peptides of abnormal size that reflect underlying  $\alpha$ -spectrin mutations responsible for elliptocytosis syndromes.

## Treatment

In view of the benign nature of autosomal–dominant HE, therapeutic intervention is not indicated in most individuals. Also, in those individuals with SAO, no therapy is needed. However, patients with variants that are associated with chronic hemolytic anemia (homozygous HE, HPP, spherocytic HE) may benefit from splenectomy. In HE cases associated with hemolysis, the cords of the spleen are congested with red cells ( [104](#), [296](#) ). Removal of the spleen is followed by improvement or normalization of the hemoglobin concentration and decrease in the reticulocyte count, despite persistence of elliptocytes ( [254](#) ).

## STOMATOCYTIC DISORDERS

*Stomatocytes* are erythrocytes with a central slit or stoma instead of a circular area of pallor when examined on dried smears. In wet preparations, they are uniconcave rather than biconcave, giving them a bowl-like appearance. *In vitro*, stomatocytes are produced by drugs that intercalate into the inner half of the lipid bilayer, thereby expanding the inner lipid surface area relative to that of the outer half of the bilayer ( 297 ). In contrast, echinocytes (RBCs with numerous fine spicules) are thought to be the result of preferential expansion of the outer lipid bilayer relative to the inner layer. A few stomatocytes may be observed in blood smears prepared from normal individuals, as well as from patients with acute alcoholism and hepatobiliary disease ( 298 ). In addition, acquired stomatocytosis occurs in individuals receiving vinca alkaloids [vinblastine (Velban), vincristine] ( 299 ). Large numbers of stomatocytes are associated with rare hereditary disorders of red cell cation permeability ( 300 ) leading to increased red cell water content (hereditary stomatocytosis) ( 301 , 302 ) or cellular dehydration (hereditary xerocytosis or dehydrated stomatocytosis) ( 303 ). Stomatocytosis also is associated with an absence of Rh blood group antigens on the red cell membrane (Rh-null phenotype). Each of these stomatocytic disorders is associated with mild to moderate hemolysis.

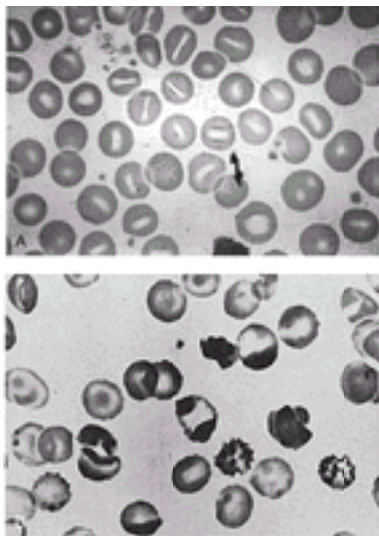
To appreciate the pathophysiology of hereditary stomatocytosis and hereditary xerocytosis, an understanding of normal red cell cation and water transport is essential. The RBC membrane, which is freely permeable to water, controls its volume primarily through regulation of the monovalent cation content. Small passive cation leaks (sodium in, potassium out) are normally balanced by the active outward transport of sodium (3 mEq per l of red cells per hour) and inward transport of potassium (2 mEq per l per hour). These cation pumps are linked, require ATP, and are dependent on the membrane enzyme Na-K adenosine triphosphatase. If the membrane permeability leak to monovalent cations increases, cation pumps have limited compensatory ability, and, if this capacity is exceeded, red cell volume changes in parallel with the total cation change. Red cells swell when the inward sodium leak exceeds the potassium leak out; red cells shrink when the potassium leak out exceeds the inward sodium leak. These membrane permeability abnormalities are recognized by observing altered RBC hydration (decreased or increased MCHC) and altered red cell sodium, potassium, and total monovalent cation content.

### Hereditary Stomatocytosis

*Hereditary stomatocytosis* (also known as *hereditary hydrocytosis*) refers to a heterogeneous group of autosomal-dominant hemolytic anemias caused by altered sodium permeability of the red cell membrane ( 302 , 304 , 305 , and 306 ). The major pathophysiologic abnormality is the result of a marked increase in sodium permeability (15 to 40 times normal), and this leads to an increase in RBC sodium, a lesser decrease in intracellular potassium, an increase in total monovalent cation content, and, thereby, an increase in cell water ( 301 , 305 , 307 ). Despite a marked compensatory increase of active sodium and potassium transport, increased pump activity is unable to compensate for the markedly increased inward sodium leak ( 301 , 305 , 308 ). Treatment of these cells with dimethyl adipimidate (a bifunctional imidoester that cross-links proteins) normalizes membrane permeability, corrects cell cation and water content, improves membrane deformability, and corrects the abnormal RBC morphology ( 309 ). Moreover, these treated RBCs have an improved survival *in vivo* ( 309 ). In most patients, excess cation permeability is associated with an absence of red cell membrane protein band 7 on sodium dodecyl sulfate gels ( 310 , 311 , and 312 ). This protein is referred to as *band 7.2* or *stomatin* ( 313 , 314 , 315 , 316 , and 317 ), and its function is currently unknown. No abnormalities in the stomatin gene, which has

been isolated and cloned ( [318](#), [319](#) ), have been identified in stomatin-deficient individuals with hereditary stomatocytosis ( [300](#) ). Homozygous knock-out mice that completely lack the murine analog of erythrocyte band 7.2 exhibit no features of the hereditary stomatocytosis syndrome seen in humans, suggesting that 7.2 deficiency is not the proximate cause of the disease in humans, although it may be a marker for another membrane defect that is responsible ( [320](#) ).

The severity of hemolytic disease is diverse, both between different families and among affected members of the same family ( [307](#) ). In most patients, symptoms related to intermittent anemia and jaundice are so mild that no therapy is required ( [305](#), [306](#) and [307](#) ). Rarely, the anemia is of sufficient severity to require transfusion therapy ( [301](#), [307](#) ). Exchange transfusion for severe neonatal hyperbilirubinemia was required in one case ( [301](#) ). Splenomegaly is an expected corollary of severe anemia ( [301](#), [305](#) ). Anemia characteristically is mild. Reticulocytosis is moderate (10 to 20%) in most patients, but wide variation is noted. The MCV is elevated, often strikingly, whereas the MCHC is normal or low (as a result of increased cell water content). Approximately 10 to 50% of circulating red cells are stomatocytes ( [Fig. 32.10A](#) ). Osmotic fragility is increased ( [305](#), [306](#), [321](#) ). Measurement of red cell sodium (increased content) and potassium (decreased content) identifies these abnormalities. In most patients, hemolytic anemia is improved after splenectomy ( [301](#), [308](#), [322](#) ), but there is a high risk of postsplenectomy thromboembolic disease so that splenectomy is usually considered contraindicated ( [323](#) ).



**Figure 32.10. A:** Peripheral blood smear (Wright stain) from a patient with hereditary hydrocytosis. Note the characteristic red blood cells (RBCs) have a mouthlike appearance—hence the term *stomatocytosis*. **B:** Peripheral blood smear (Wright stain) from a patient with hereditary xerocytosis showing dense, abnormal RBC forms where hemoglobin appears puddled at the periphery.

### Hereditary Xerocytosis

*Hereditary xerocytosis* (also known as *dehydrated stomatocytosis*) is a rare autosomal-dominant hemolytic anemia characterized by red cell dehydration and decreased osmotic fragility ( [303](#), [324](#), [325](#) ). The mechanism of cellular dehydration involves

net potassium loss from cells that is not accompanied by a proportional gain of sodium. Measurement of RBC cations reveals a slight increase in cell sodium content, a greater decrease in potassium concentration, and, thus, a decrease in the net intracellular cation content and cell dehydration (303). In some cases, reduced red cell 2,3-DPG has been noted (321, 326). Also, in several families, an increase in erythrocyte phosphatidylcholine content has been observed (327, 328). The specific relationship between elevated membrane lecithin and the increased leakiness of the membrane to potassium is not known. Although the total red cell membrane protein content may be elevated (329), specific abnormalities of stomatin or other membrane proteins are not seen (300, 325). The red cells in hereditary xerocytosis are sensitive to shear stress and readily undergo membrane fragmentation (324, 325). The locus for both hereditary xerocytosis and pseudohyperkalemia (see [Intermediate Stomatocytic Syndromes](#)) maps to the same region of chromosome 16, but the affected gene has not yet been identified (330, 331). A subset of patients with hereditary xerocytosis also exhibits transient perinatal edema, which is unrelated to the degree of anemia and uninfluenced by red cell transfusion. The basis for ascites is unknown (332).

These patients characteristically have moderate to severe hemolysis. The MCHC is increased, reflecting cellular dehydration, whereas the MCV is slightly increased, reflecting the increase in reticulocyte count (303). Peripheral blood film reveals stomatocytes, target cells, spiculated cells, and some cells in which hemoglobin is concentrated (“puddled”) in discrete areas on the cell periphery (Fig. 32.10B). The osmotic fragility is characteristically decreased. Splenectomy has minimal effect on the hemolytic anemia (303), increases the risk of thrombosis (323), and is, therefore, to be avoided.

### Intermediate Stomatocytic Syndromes

Some cases of hereditary RBC cation permeability abnormalities share features of both hereditary stomatocytosis and xerocytosis (Table 32.4). Affected individuals have stomatocytes and target cells on the peripheral blood smear. The osmotic fragility of red cells is either normal or slightly increased. The sodium and potassium permeability is somewhat increased, but the intracellular cation concentration and the red cell volume usually are normal or slightly reduced. In the variant known as *cryohydrocytosis*, RBCs *in vitro* at 5° C gain sodium and manifest greater autohemolysis than at 37° C (333, 334). In another variant, potassium loss is accelerated in the cold, and blood samples left at room temperature for a few hours may manifest pseudohyperkalemia as a result of potassium efflux from red cells into the plasma (335, 336). In contrast to cryohydrocytosis, these RBCs in the cold manifest greater potassium loss than sodium gain and thereby lose water (cryoxerocytes) (335, 336). Despite the mildly dehydrated red cells, no anemia or hemolysis is associated with this defect. Careful analysis of potassium loss at low temperatures is an excellent way to distinguish between cryohydrocytosis, pseudohyperkalemia, and intermediate forms; at least five different phenotypes can be distinguished (337, 338, 339, 340 and 341).

**TABLE 32.4. Features of Hereditary Stomatocytic Syndromes**

|           | Stomatocytosis | Cryohydrocytosis | Pseudohyperkalemia | Xerocytosis   |
|-----------|----------------|------------------|--------------------|---------------|
| Anemia    | Severe         | Mild–moderate    | None               | Mild–moderate |
| Hemolysis | Severe         | Moderate         | Mild               | Moderate      |

|  |  |  |                                   |  |
|--|--|--|-----------------------------------|--|
| Peripheral blood smear   | Stomatocytes                           | Stomatocytes   | Target cells; stomatocytes        | RBCs with puddled hemoglobin; target cells; stomatocytes |
| Mean corpuscular volume (80–100 fl)                                | 110–150                                | 90–105   | 83–91                             | 84–122   |
| Mean corpuscular hemoglobin concentration ( 32, 33, 34, 35 and 36) | 24–30                                  | 34–40  | 34–36                             | 34–38  |
| Fresh osmotic fragility  | Increased                              | Normal   | Normal/decreased                  | Decreased  |
| RBC Na <sup>+</sup> (5–12 mEq/l)                                   | 60–100                                 | 40–50  | SI increased                      | 10–30  |
| RBC K <sup>+</sup> (90–103 mEq/l)                                  | 20–55                                  | 55–65  | SI increased                      | 60–90  |
| RBC Na <sup>+</sup> + K <sup>+</sup> (95–110 mEq/l)                | 110–140                                | 100–105  | Low normal                        | 75–99  |
| Other features   | Absence of protein band 7 (stomatatin) | Cold Na leak in > cold K leak out = cold autohemolysis | Cold K leak out ? RBC dehydration | Increased phosphatidylcholine content                    |

RBC, red blood cell; SI, slightly.

Modified from Lux SE, Palek J. Disorders of the red cell membrane. In: Handin RI, Lux SE, Stossel TO, eds. Blood: principles and practice of hematology. Philadelphia: JB Lippincott, 1995;1701.

## Rh-Null Disease

Most hematologists are familiar with the Rh antigen because of the immune sensitization that occurs in Rh-negative individuals exposed to Rh-positive red cells. However, the importance of the Rh antigen for normal functional integrity of red cell membranes was recognized through the discovery of red cells lacking all Rh antigens (Rh<sub>null</sub>) ( 342 ). Rh-null hemolytic disease occurs in those rare individuals who have no Rh antigen expression, and this is different from the Rh-negative phenotype (cde) in which Rh proteins are present. The Rh-null phenotype is estimated to occur with a frequency of 1 in 6 million ( 343 ), and there is a high incidence of consanguinity among parents of affected individuals. Studies of the Rh locus have revealed two closely linked genes, one encoding the D polypeptide and the other encoding the Cc, Ee protein ( 344 , 345 , 346 and 347 ). These Rh proteins are linked to the red cell membrane skeleton ( 348 , 349 ), but their function is unknown. The Rh-null phenotype is the result of mutations in the Rh antigen locus (called the *amorph type*) or in a regulator protein (Rh 50) located on a different chromosome that modulates Rh expression ( 350 , 351 and 352 ).

Rh-null disease is characterized by mild to moderate normocytic, normochromic

hemolytic anemia ( 342 , 343 , 353 ). The hemoglobin concentration is decreased (8 to 13 g per dl), and reticulocytes are increased (6 to 20%). Numerous stomatocytes and some spherocytes are seen on peripheral blood smears. The red cell total monovalent cation and water content is decreased, and these cells are dehydrated. However, the osmotic fragility of incubated cells is increased, thus reflecting a marked reduction of membrane surface area ( 354 , 355 ). The half-survival time of <sup>51</sup>Cr-labeled red cells is 10 to 12 days, but the reason for shortened red cell survival is not known ( 343 , 353 ). Hemolytic anemia is improved by splenectomy ( 356 ).

## ACANTHOCYTIC DISORDERS

*Acanthocytes* are dense, contracted red cells with several irregularly spaced “thorny” projections on the surface. Acanthocytes differ from echinocytes in that there are fewer projections, and the width and length of these projections vary considerably ( 357 ). No central pallor is evident. By contrast, echinocytic spicules are similar in dimension and evenly distributed around the cell periphery. Acquired acanthocytosis is encountered in malnourished states such as anorexia nervosa ( 358 ), in hypothyroidism, after splenectomy ( 359 ), and in severe hepatocellular disease. Acanthocytosis also is seen in hereditary disorders such as abetalipoproteinemia and in patients with the Macleod phenotype.

Acanthocytosis in liver disease (hepatocellular injury) is attributable to a marked increase in the cholesterol content and the cholesterol to phospholipid ratio of red cell membranes ( 360 ). This red cell lipid profile is in contrast to the equal increase in both cholesterol and phospholipid seen in obstructive liver disease ( 361 ). In cirrhotic liver disease, abnormal lipoproteins produced by the liver are loaded with cholesterol; this excess cholesterol is readily transferred to RBCs, resulting in the formation of flat, scalloped cells ( 361 , 362 ). These cells, however, are further conditioned by the spleen, resulting in membrane fragmentation, and the evolution of acanthocytes that look like “spurs.”

These spur RBCs are cholesterol loaded, with a decreased surface area to volume ratio, and their cellular deformability is decreased. Once formed in the spleen, spur cells over time are destroyed by the spleen, thereby accounting for the hemolytic anemia associated with severe liver disease. Affected patients usually have moderate-to-severe hemolysis, hyperbilirubinemia, splenomegaly, and clinical and laboratory evidence of laboratory liver dysfunction. The peripheral blood contains numerous acanthocytes, very similar in appearance to those seen in abetalipoproteinemia. This spur cell anemia can occur in any condition associated with severe hepatocyte injury.

### Abetalipoproteinemia

*Abetalipoproteinemia* (also known as *Bassen-Kornzweig syndrome*) is a rare, genetic disorder characterized by acanthocytosis, malabsorption of fat, hypolipidemia, retinitis pigmentosa, and progressive ataxia ( 363 , 364 and 365 ). The primary biochemical lesion is defective synthesis of apoprotein B ( 365a ) and, consequently, an absence of several lipoprotein fractions: low-density lipoproteins, very-low-density lipoproteins, and chylomicrons ( 366 , 367 and 368 ). Also, the metabolic activities of these lipoproteins (mobilization of triglycerides from the liver, transport of preformed triglycerides from the intestinal mucosa, and transport of phospholipid and cholesterol between phospholipid membranes) are impaired. Plasma cholesterol, phospholipid, and triglyceride levels are very low ( 364 , 365 , 369 , 370 ); the serum appears transparent.

The relationship between the disturbance in plasma lipid content and acanthocyte

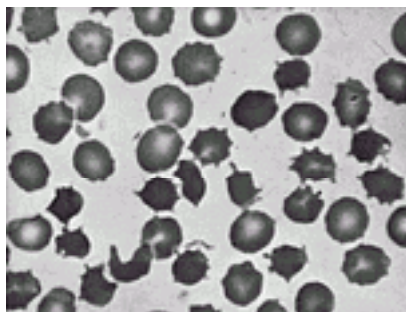


formation is not clear. Total red cell lipid and phospholipid content is normal ( [369](#) ), but there is a net increase in sphingomyelin concentration, thereby reversing the usual phosphatidylcholine to sphingomyelin ratio ( [370](#), [371](#), [372](#) and [373](#) ). This phospholipid distribution is similar to that seen in the plasma in which a similar increase in sphingomyelin exists relative to phosphatidylcholine ( [370](#), [372](#), [374](#) ). Red cell precursors and young erythrocytes are of normal shape in this disorder. Acanthocyte formation increases as RBCs age in the circulation ( [361](#) ). Moreover, normal red cells become acanthocytic when infused into individuals with abetalipoproteinemia.

Unlike acanthocytes produced in liver disease, those from subjects with abetalipoproteinemia do not revert to a discoid shape when incubated in normal serum. However, this acanthocytosis is reversed *in vitro* after lipids are extracted with detergents ( [375](#) ). Acanthocyte formation is thought to reflect an increase in the surface area of the outer lipid bilayer relative to the inner bilayer, presumably because of increased sphingomyelin in the outer bilayer leaflet ( [376](#) ). Acanthocytes do resume a discocyte morphology after incubation with chlorpromazine, an agent known to expand the inner lipid bilayer, thereby normalizing the bilayer asymmetry ( [377](#) ).

Although affected infants ostensibly are normal at birth, steatorrhea, abdominal distention, and growth failure develop in the first months of life. Retinitis pigmentosa and progressive ataxia are first noted in children between 5 and 10 years of age. Treatment with vitamin E prevents or reverses the neurologic abnormalities ( [378](#) ). Without treatment, neurologic disability is progressive, with death usually occurring during the second or third decade ( [379](#), [380](#) and [381](#) ). In some cases, cardiac arrhythmias ( [382](#) ) and heart failure ( [381](#) ) precede death. Because several instances of consanguinity among parents of affected children have been noted ( [363](#), [380](#), [382](#) ), an autosomal-recessive mode of transmission is assumed.

For unknown reasons, the membrane lesion in abetalipoproteinemia (increased sphingomyelin) is less damaging than that which occurs in the spur cells of liver disease (increased cholesterol). The latter is associated with a moderate-to-severe hemolysis, whereas anemia in abetalipoproteinemia usually is mild or nonexistent ( [363](#), [364](#), [382](#), [383](#) and [384](#) ). Occasionally, in children with abetalipoproteinemia, the anemia is severe ( [380](#), [384](#) ); this most likely is a result of broad nutritional deficiencies related to malabsorption in children. Folate deficiency as a cause of anemia in some patients is well documented ( [364](#), [384](#) ). The lifespan of labeled acanthocytes in abetalipoproteinemia is shortened only slightly ( [370](#), [380](#), [385](#) ). Reticulocyte counts are normal or slightly increased ( [365](#), [380](#), [382](#), [385](#) ). The most striking hematologic feature is the presence of large numbers of acanthocytes (50 to 70%) on the blood smear ( [Fig. 32.11](#) ) ( [364](#) ). Osmotic fragility is normal or slightly decreased.





**Figure 32.11.** Blood smear of acanthocytes from a patient with abetalipoproteinemia.

The diagnosis of abetalipoproteinemia is suggested by the demonstration of acanthocytes in an individual with severe malabsorption, retinitis pigmentosa, or a disorder resembling Friedreich ataxia. The most helpful screening test is the determination of serum cholesterol, phospholipid, and triglyceride levels, which are very low. The diagnosis is confirmed by demonstrating the absence of beta lipoproteins in plasma.

### Neuroacanthocytosis

Acanthocytes are a feature of the peripheral blood smear in a group of patients with a degenerative neurologic disorder characterized by movement abnormalities, psychiatric symptoms, areflexia, and an elevated plasma creatine kinase ( [378](#) ). Serum lipoprotein electrophoresis is normal. Anemia, if present, is mild ( [382](#) , [386](#) ).

### Macleod Phenotype

The Macleod phenotype, named after the first patient described, is characterized by a decreased expression of the Kell antigen on the red cell surface and decreased reactivity to Kell antiserum ( [387](#) ). Associated findings include acanthocytosis, polychromasia, a mild well-compensated hemolytic anemia ( [388](#) , [389](#) , [390](#) and [391](#) ), and susceptibility to alloimmunization by Kell antigens. Elevated serum creatine phosphokinase levels are seen, often accompanied by myopathy and peripheral neuropathy. Central nervous system abnormalities may appear, particularly after the fourth decade of life ( [392](#) ). The number of acanthocytes in blood smears ranges from 25 to 85%. Just as in other cases of acanthocytoses, the surface projections of these acanthocytes are thought to be related to asymmetry of the lipid bilayer because agents that expand the inner lipid layer correct the acanthocytosis ( [393](#) ). Studies of membrane lipid and protein composition, membrane fluidity, and intercellular enzyme at ATP levels are normal ( [394](#) , [395](#) ).

The Macleod phenotype is the result of an absence of the XK antigen, a protein precursor necessary for Kell antigen expression. The gene controlling XK synthesis is not part of the Kell autosomal gene complex, but rather is located on the X chromosome. A second, larger protein also exists, which carries the Kell blood group antigen ( [396](#) , [397](#) ); RBCs with the Macleod phenotype lack this protein, as well as the XK antigen. In contrast, Kell-null RBCs lack the larger protein, but have more than normal amounts of the XK antigen; Kell-null RBCs are normal in shape ( [398](#) ). At least 19 different mutations affecting the XK gene locus lead to the Macleod phenotype ( [399](#) ). Eight of these are deletions, some of which extend to adjacent genes on the X chromosome, giving rise to varying phenotypes that may include chronic granulomatous disease, Duchenne's muscular dystrophy, and retinitis pigmentosa along with the Macleod phenotype ( [374](#) , [380](#) , [400](#) , [401](#) and [402](#) ). Only a small subset of boys who inherit X-linked chronic granulomatous disease have large deletions such as those mentioned above and express the Macleod phenotype. They lack erythrocyte XK, have an increased number of reticulocytes and shortened red cell survival, and may occasionally require red cell transfusions. Their carrier mothers have a dual population of XK-positive and XK-negative erythrocytes and variable numbers of acanthocytes. Most X-linked chronic granulomatous disease patients do not exhibit the Macleod phenotype. Their red cells are morphologically and serologically normal.

## ECHINOCYTIC DISORDERS

*Echinocytes* are RBCs with numerous fine uniform spicules equally throughout the cell surface. These cells differ morphologically from acanthocytes, which have fewer projections, and the spicules vary in size. It is thought that echinocytes are the result of preferential expansion of the outer lipid bilayer relative to the inner layer ( 297 ). As mentioned previously, stomatocytes, in contrast, are produced by agents that expand the inner lipid surface area relative to the outer half of the bilayer. The presence of echinocytes on the peripheral blood film often is an artifact caused by interactions of red cells with glass ( 359 ). However, echinocytes also are seen in association with hemolytic anemias in patients with hypophosphatemia ( 403 ), in patients with pyruvate kinase deficiency ( 359 ), in patients with uremia ( 404 ), and in some long-distance runners ( 405 ). The mechanism of echinocytosis in these diverse disorders is not entirely clear. However, *in vitro*, it is known that a variety of factors, such as exposure of red cells to certain drugs ( 406 ), loading by calcium ( 407 ), or ATP depletion ( 408 , 409 ), can induce echinocyte formation. In the case of echinocytes produced by ATP depletion or calcium loading, the altered phospholipid distribution may be a consequence of decreased aminophospholipid translocase activity, an ATP-dependent enzyme that actively translocates aminophospholipids from the outer half of the bilayer to the inner half ( 410 ).

## TARGET CELL DISORDERS

*Target cells* are discoid RBCs with a centralized hemoglobinized area in the clear center, thereby resembling a target. Target cells are the morphologic expression of an increase in the ratio of the cell-surface area to cell volume. This ratio is influenced by increases in the surface area, as well as decreases in cell volume. Causes of target cell formation may be both acquired and hereditary. In microcytic red cells of patients with iron deficiency, thalassemia disorders, and certain hemoglobinopathies, a decreased cell volume caused by less hemoglobinization results in a relative excess of cell-surface area. Thus, the surface area to volume ratio is increased and, hence, the expression of target cells. In obstructive liver disease and disorders of intrahepatic cholestasis, target cell formation is the result of an absolute increase of the cell-surface area because of a net membrane accumulation of both phospholipids and cholesterol ( 361 ). The accumulation is caused by abnormal low-density lipoproteins that occur in obstructive jaundice; these low-density lipoproteins are laden with cholesterol and lecithin, which is readily transferable to red cell membrane, thereby leading to an expansion of the cell membrane surface ( 361 ). Target cells have a decreased osmotic fragility, as the excess of membrane surface area leads to an increase of the critical hemolytic volume. These target cells have a normal survival in circulation.

### Familial Lecithin-Cholesterol Acyltransferase Deficiency

Lecithin-cholesterol acyltransferase (LCAT) catalyzes the transfer of fatty acids from phosphatidylcholine to cholesterol. This enzyme is in the circulation complexed with high-density lipoproteins. Familial LCAT deficiency is a rare disorder characterized by mild anemia, corneal opacities, renal disease, and premature atherosclerosis ( 411 , 412 , 413 and 414 ). Most descriptions of the condition have come from Norway, although it has been detected throughout Europe, Canada, and Japan. Results of family studies support an autosomal-recessive mode of transmission ( 415 ). Several mutations in LCAT leading to deficient enzyme activity have been described ( 413 , 414 ). Deficient plasma LCAT activity is responsible for a marked decrease in plasma levels of unesterified cholesterol and an increase in the amount of free cholesterol. The red cell membrane may contain twice the normal amounts of unesterified cholesterol, but phosphatidylcholine also is increased, whereas sphingomyelin and phosphatidylethanolamine are reduced ( 416 ). These RBC lipid changes are reversible when the target cells are incubated with normal plasma. The

anemia is mild, and target cells are prominent on the peripheral blood smear. Both hemolysis and decreased erythropoiesis have been implicated in the pathogenesis of the anemia; the latter may relate to coexistent renal disease.

Foam cells and “sea-blue histiocytes” have been noted in both the bone marrow and the spleen of all patients studied (411, 417). The material accumulated within histiocytes is possibly unesterified cholesterol and phosphatidylcholine.

## REFERENCES

1. Bennett V, Gilligan DM. The spectrin-based membrane skeleton and micron-scale organization of the plasma membrane. *Ann Rev Cell Biol* 1993;9:27-66.
2. Lux SE, Palek J. Disorders of the red cell membrane. In: Handin RI, Lux SE, Stossel TO, eds. *Blood: principles and practice of hematology*. Philadelphia: JB Lippincott Co, 1995:1701-1818.
3. Palek J, Jarolim P. Red cell membrane disorders. In: Hoffman R, Benz E, Shatill S, et al., eds. *Hematology: basic principles and practice*, 2nd ed. Edinburgh: Churchill Livingstone, 1995:667-709.
4. Palek J (ed). Cellular and molecular biology of the red blood cell membrane proteins in health and disease. *Semin Hematol* 1992;29:229-319. 1993;30:1-283.
5. Palek J, Sahr KE. Mutations of the red blood cell membrane proteins; from clinical evaluations to detection of the underlying genetic defect. *Blood* 1992;80:308-330.
6. Dacie JV. The life span of the red blood cell and circumstances of its premature death. In: Wintrobe MM, ed. *Blood pure and eloquent*. New York: McGraw-Hill, 1980:211-256.
7. Packman CH. The spherocytic haemolytic anaemias. *Br J Haematol* 2001;112:888-899.
8. Vanlair C, Masius JR. De la microcythemie. *Bull Acad R Med Belg* 1871; 5(3rd.series):515-613.
9. Haden RL. The mechanism of the increased fragility of the erythrocytes in congenital hemolytic jaundice. *Am J Med Sci* 1934;188:441-449.
10. Young LE, Platzer RF, Ervin DM, et al. Hereditary spherocytosis. II. Observations on the role of the spleen. *Blood* 1951;6:1099-1113.
11. Morton NE, Mackinney AA, Kosower N. Genetics of spherocytosis. *Am J Hum Genet* 1962;14:170-184.
12. Eber SW, Peckrun A, Neufeldt A, et al. Prevalence of increased osmotic fragility of erythrocytes in German blood donors—screening using a modified glycerol lysis test. *Ann Hematol* 1992;64:88-92.
13. Godal HC, Heisto H. High prevalence of increased osmotic fragility of red blood cells among Norwegian blood donors. *Scand J Haematol* 1981;27:30-34.
14. Young LE. Observations on inheritance and heterogeneity of chronic spherocytosis. *Trans Assoc Am Physicians* 1955;68:141-147.
15. Young LE, Izzo MJ, Platzer RF. Hereditary spherocytosis. I. Clinical, hematologic and genetic features in 28 cases, with particular reference to the osmotic and mechanical fragility of incubated erythrocytes. *Blood* 1951;6:1073-1098.
16. Bischel MGD. Inheritance of familial spherocytosis. *J Am Med Womens Assoc* 1964;19:214-217.
17. MacKinney AA Jr. Hereditary spherocytosis. *Arch Intern Med* 1965;116:257-265.
18. Rozier JC. Sporadic cases of hereditary spherocytosis. *N C Med J* 1971;32:136-140.
19. Zipursky A, Israels LG. Significance of erythrocyte sodium flux in the pathophysiology and genetic

expression of hereditary spherocytosis. *Pediatr Res* 1971;5:614–617.

20. Agre P, Asimos A, Casella JF, et al. Inheritance pattern and clinical response to splenectomy as a reflection of erythrocyte spectrin deficiency in hereditary spherocytosis. *N Engl J Med* 1986;315:1579–1583.

21. Eber SW, Armbrust R, Schroter W. Variable clinical severity of hereditary spherocytosis: relation to erythrocytic spectrin concentration, osmotic fragility and autohemolysis. *J Pediatr* 1990;177:409–416.

22. Gallagher PG, Forget BG. Hematologically important mutations: band 3 and protein 4.2 variants in hereditary spherocytosis. *Blood Cells Mol Dis* 1997;23:417–421.

23. Gallagher PG, Forget BG. Hematologically important mutations: spectrin and ankyrin variants in hereditary spherocytosis. *Blood Cells Mol Dis* 1998;24:539–543.

24. Bodine DM 4th, Birkenmeier CS, Barker JE. Spectrin-deficient inherited hemolytic anemia in the mouse: characterization by spectrin synthesis and mRNA activity in reticulocytes. *Cell* 1984;37:721–729.

25. Hanspal M, Hanspal JS, Kalraiya R, et al. Asynchronous synthesis of membrane skeletal proteins during terminal maturation of murine erythroblasts. *Blood* 1992;80:530–539.

26. Moon RT, Lazarides E.  $\beta$ -Spectrin limits  $\alpha$ -spectrin assembly on membranes following synthesis in a chicken erythroid cell lysate. *Nature* 1983;305:62–65.

27. Wichterle H, Hanspal M, Palek J, et al. Combination of two mutant alpha spectrin alleles underlies a severe spherocytic hemolytic anemia. *J Clin Invest* 1996;98:2300–2307.

28. Tse WT, Gallagher PG, Jenkins PB, et al. Amino-acid substitution in  $\alpha$ -spectrin commonly coinherited with nondominant hereditary spherocytosis. *Am J Hematol* 1997;54:233–241.

29. Dhermy D, Steen-Johnson J, Bournier O, et al. Coinheritance of two  $\alpha$ -spectrin gene defects in a recessive spherocytosis family. *Clin Lab Haematol* 2000;22: 329–336.

30. Hassoun H, Vassiliadis JN, Murray J, et al. Characterization of the underlying molecular defect in hereditary spherocytosis associated with spectrin deficiency. *Blood* 1997;90:398–406.

31. Garbarz M, Galand C, Bibas D, et al. A 5' splice region G?C mutation in exon 3 of the human  $\beta$ -spectrin mRNA leads to decreased levels of  $\beta$ -spectrin mRNA and is responsible for dominant hereditary spherocytosis (spectrin Guemene-Penfao). *Br J Haematol* 1998;100:90–98.

32. Basseres D, Vicentim DL, Costa FF, et al.  $\beta$ -spectrin Promissao: a translation initiation codon mutation of the  $\beta$ -spectrin gene (ATG?GTG) associated with hereditary spherocytosis and spectrin deficiency in a Brazilian family. *Blood* 1998;91:368–369.

33. Hassoun H, Vassiliadis JN, Murray J, et al. Hereditary spherocytosis with spectrin deficiency due to an unstable truncated  $\beta$ -spectrin. *Blood* 1996;87:2538–2545.

34. Basseres DS, Duarte ASS, Hassoun H, et al.  $\beta$ -spectrin S<sup>ta</sup>-Barbara: a novel frameshift mutation in hereditary spherocytosis associated with detectable levels of mRNA and a germ cell line mosaicism. *Br J Haematol* 2001;115:347–353.

35. Becker PS, Tse WT, Lux SE, et al.  $\beta$ -Spectrin Kissimmee—a spectrin variant associated with autosomal dominant hereditary spherocytosis and defective binding to protein 4.1. *J Clin Invest* 1993;92:612–616.

36. Wolfe L, John KM, Falcone JC, et al. A genetic defect in the binding of protein 4.1 to spectrin in a kindred with hereditary spherocytosis. *N Engl J Med* 1982;307:1367–1374.

37. Costa FF, Agre P, Watkins PC, et al. Linkage of dominant hereditary spherocytosis to the gene for the erythrocyte membrane-skeleton protein ankyrin. *N Engl J Med* 1990;323:1046–1050.

38. Cohen H, Walker H, Delhanty JD, et al. Congenital spherocytosis, B19 parvovirus infection and inherited interstitial deletion of the short arm of chromosome 8. *Br J Haematol* 1991;78:251–257.

39. Lux SE, Tse WT, Menninger JC, et al. Hereditary spherocytosis associated with deletion of human erythrocyte ankyrin gene on chromosome 8. *Nature* 1990;345:736.
40. Hanspal M, Yoon SH, Yu H, et al. Molecular basis of spectrin and ankyrin deficiencies in severe hereditary spherocytosis: evidence implicating a primary defect of ankyrin. *Blood* 1991;77:165–173.
41. Coetzer TL, Lawler J, Liu SC, et al. Partial ankyrin and spectrin deficiency in severe, atypical hereditary spherocytosis. *N Engl J Med* 1988;318:230–234.
42. Savvides P, Shalev O, John KM, et al. Combined spectrin and ankyrin deficiency is common in autosomal dominant hereditary spherocytosis. *Blood* 1993;82:2953–2960.
- 42a. Gallagher PG, Ferreira JDS, Costa FF, et al. A recurrent frameshift mutation of the ankyrin gene associated with severe hereditary spherocytosis. *Br J Haematol* 2000;111:1190–1193.
43. Eber SW, Gonzalez JM, Lux ML, et al. Ankyrin-1 mutations are a major cause of dominant and recessive hereditary spherocytosis. *Nat Genet* 1996;13:214–218.
44. Peters LL, Lux SE. Ankyrins: structure and function in normal cells and hereditary spherocytes. *Semin Hematol* 1993;30:85–118.
45. Gallagher PG, Sabatino DE, Basseres DS, et al. Erythrocyte ankyrin promoter mutations associated with recessive hereditary spherocytosis cause significant abnormalities in ankyrin expression. *J Biol Chem* 2001;276:41683–41689.
46. Dhermy D, Bernier O, Bourgeois M, et al. The red cell band 3 variant (Band 3 Bicetre I: R490C) associated with dominant hereditary spherocytosis causes defective membrane targeting of the molecule and a dominant negative effect. *Mol Membr Biol* 1999;16:305–312.
47. Jarolim P, Rubin HL, Liu SC, et al. Duplication of 10 nucleotides in the erythroid band 3 (AE1) gene is a kindred with hereditary spherocytosis and band 3 protein deficiency (Band 3<sup>PRAGUE</sup>). *J Clin Invest* 1994;93:121–130.
48. Jarolim P, Rubin HL, Brabec V, et al. Mutations of conserved arginines in the membrane domain of erythroid band 3 lead to a decrease in membrane-associated band 3 and to the phenotype of hereditary spherocytosis. *Blood* 1995;85:634–640.
49. Iwase S, Ideguchi H, Takao M, et al. Band 3 Tokyo: Thr 837?Ala 837 substitution in erythrocyte band 3 protein associated with spherocytic anemia. *Acta Haematol* 1998;100:200–203.
50. Dhermy D, Galand C, Bournier O, et al. Heterogeneous band 3 deficiency in hereditary spherocytosis related to different band 3 gene defects. *Br J Haematol* 1997;98:32–40.
51. Saad STO, Liu SC, Golan D, et al. Mechanism underlying band 3 deficiency in a subset of patients with hereditary spherocytosis (HS). *Blood* 1991;78 [Suppl 1]:81a.
52. Inoue T, Kanzaki A, Kaku M, et al. Homozygous missense mutation (band 3 Fukuoka: G130R): a mild form of hereditary spherocytosis with near-normal band 3 content and minimal changes of membrane ultrastructure despite moderate protein 4.2 deficiency. *Br J Haematol* 1998;102:932–939.
53. Kanzaki A, Hayatte S, Morle L, et al. Total absence of protein 4.2 and partial deficiency of band 3 in hereditary spherocytosis. *Br J Haematol* 1997;99:522–530.
54. Jarolim P, Murray JL, Rubin HL, et al. Characterization of 13 novel band 3 gene defects in hereditary spherocytosis with band 3 deficiency. *Blood* 1996;88:4366–4374.
55. Bracher NA, Lyons CA, Wessels G, et al. Band 3 Cape Town (E90K) causes severe hereditary spherocytosis in combination with band 3 Prague III. *Br J Haematol* 2001;113:689–693.
56. Ribeiro ML, Alloisio N, Almeida H, et al. Severe hereditary spherocytosis and distal renal tubular acidosis associated with the total absence of band 3. *Blood* 2000;96:1602–1604.

57. Alloisio N, Maillet P, Carre G, et al. Hereditary spherocytosis with band 3 deficiency. Association with a nonsense mutation of the band 3 gene (allele Lyon), and aggravation by a low-expression allele occurring in *trans* (Allele Genas). *Blood* 1996;88:1062–1069.
58. Alloisio N, Texier P, Vallier A, et al. Modulation of clinical expression and band 3 deficiency in hereditary spherocytosis. *Blood* 1997;90:414–420.
59. Lima PRM, Gontijo JAR, Lopes de Faria JB, et al. Band 3 Campinas: a novel splicing mutation in the Band 3 gene (AE1) associated with hereditary spherocytosis, hyperactivity of  $\text{Na}^+/\text{Li}^-$  countertransport and an abnormal renal bicarbonate handling. *Blood* 1997;90:2810–2818.
60. Tanner MJA. Band 3 anion exchanger and its involvement in erythrocyte and kidney disorders. *Curr Opin Hematol* 2002;9:133–139.
61. Hayashi S, Koomoto R, Yano A, et al. Abnormality in a specific protein of the erythrocyte membrane in hereditary spherocytosis. *Biochem Biophys Res Commun* 1974;57:1038–1044.
62. Bouhassira EE, Schwartz RS, Yawata Y, et al. An alanine-to-threonine substitution in protein 4.2 cDNA associated with Japanese form of hereditary hemolytic anemia (protein 4.2<sup>NIPPON</sup>). *Blood* 1992;79:1846–1852.
63. Hayette S, Dhermy D, dos Santos ME, et al. A deletional frameshift mutation in protein 4.2 gene (allele 4.2<sup>LISBOA</sup>) associated with hereditary hemolytic anemia. *Blood* 1995;85:250–256.
64. Bernstein SE. Inherited hemolytic disease in mice: a review and update. *Lab Anim Sci* 1980;30:197–205.
65. Greenquist A, Shohet SB, Bernstein SE. Marked reduction of spectrin in hereditary spherocytosis in the common house mouse. *Blood* 1978;51:1149–1155.
66. Lux SE, Pease B, Tomaselli MB, et al. Hemolytic anemias associated with deficient or dysfunctional spectrin. In: Lux SE, Marchesi VT, Fox CG, eds. *Normal and abnormal red cell membranes*. New York: Alan R Liss, 1979:463–470.
67. Bloom ML, Kaysser TM, Birkenmeier CS, et al. The murine mutation jaundiced is caused by replacement of an arginine with a stop codon in the mRNA encoding the ninth repeat of  $\beta$ -spectrin. *Proc Natl Acad Sci U S A* 1994;91:10099–10103.
68. Liao EC, Paw BH, Peters LH, et al. Hereditary spherocytosis in zebrafish reisling illustrates evolution of erythroid  $\beta$ -spectrin structure and function in red cell morphogenesis and membrane stability. *Development* 2000;127:5123–5132.
69. Kaysser TM, Wandersee NJ, Bronson RT, et al. Thrombosis and secondary hemochromatosis play major roles in the pathogenesis of jaundiced and spherocytic mice, murine models for hereditary spherocytosis. *Blood* 1997;90:4610–4619.
70. Wandersee NJ, Lee JC, Deveau SA, et al. Reduced incidence of thrombosis in mice with hereditary spherocytosis following neonatal treatment with normal hematopoietic cells. *Blood* 2001;97:3972–3975.
71. Peters LL, Birkenmeier CS, Bronson RT, et al. Purkinje cell degeneration associated with erythroid ankyrin deficiency in nb/nb mice. *J Cell Biol* 1991;114:1233–1241.
72. Joiner CH, Franco RS, Jiang M, et al. Increased cation permeability in mutant mouse red blood cells with defective membrane skeletons. *Blood* 1995;86:4307–4314.
73. Inaba M, Yawata A, Koshino I, et al. Defective anion transport and marked spherocytosis with membrane instability caused by hereditary total deficiency of red cell band 3 in cattle due to a nonsense mutation. *J Clin Invest* 1996;97:1804–1817.
74. Peters LL, Shivdasani RA, Liu SC, et al. Anion exchanger 1 (band 3) is required to prevent erythrocyte membrane surface loss but not to form the membrane skeleton. *Cell* 1996;86:917–929.

75. Southgate CD, Chishti AH, Mitchell B, et al. Targeted disruption of the murine erythroid band 3 gene results in spherocytosis and severe haemolytic anaemia despite a normal membrane skeleton. *Nat Genet* 1996;14:227–230.
76. Hassoun H, Wang Y, Vassiliadis JN, et al. Targeted inactivation of murine band 3. (AE1) gene produces a hypercoagulable state causing widespread thrombosis *in vivo*. *Blood* 1998;92:1785–1792.
77. Gilligan DM, Lozovatsky L, Gwynn B, et al. Targeted disruption of the B adducin gene (Add 2) causes red blood cell spherocytosis in mice. *Proc Natl Acad Sci U S A* 1999;96:10717–10722.
78. Da Costa L, Mohandas N, Sorette M, et al. Temporal differences in membrane loss lead to distinct reticulocyte features in hereditary spherocytosis and in immune hemolytic anemia. *Blood* 2001;98:2894–2899.
79. Cooper RA, Jandl JH. The selective and conjoint loss of red cell lipids. *J Clin Invest* 1969;48:906–914.
80. Johnsson R. Red cell membrane proteins and lipids in spherocytosis. *Scand J Haematol* 1978;20:341–350.
81. Langley GR, Felderhof CH. Atypical autohemolysis in hereditary spherocytosis as a reflection of two cell populations: relationship of cell lipids to conditioning by the spleen. *Blood* 1968;32:569–585.
82. Reed CF, Swisher SN. Erythrocyte lipid loss in hereditary spherocytosis. *J Clin Invest* 1966;45:777–781.
83. Liu SC, Derick LH, Agre P, et al. Alteration of the erythrocyte membrane skeletal ultrastructure in hereditary spherocytosis, hereditary elliptocytosis, and pyropoikilocytosis. *Blood* 1990;76:198–205.
84. Mohandas N, Clark MR, Jacobs MS, et al. Analysis of factors regulating erythrocyte deformability. *J Clin Invest* 1980;66:563–573.
85. Nakashima K, Beutler E. Erythrocyte cellular and membrane deformability in hereditary spherocytosis. *Blood* 1979;53:481–485.
86. De Jong K, Larkin SK, Eber S, et al. Hereditary spherocytosis and elliptocytosis erythrocytes show a normal transbilayer phospholipid distribution. *Blood* 1999;94:319–325.
87. Bertles JF. Sodium transport across the surface membrane of red blood cell in hereditary spherocytosis. *J Clin Invest* 1957;36:816–824.
88. Harris EJ, Prankerd TAJ. The rate of sodium extrusion from human erythrocytes. *J Physiol (Lond)* 1953;121:470–486.
89. Jacob HS, Jandl JH. Increased cell membrane permeability in the pathogenesis of hereditary spherocytosis. *J Clin Invest* 1964;43:1704–1720.
90. Wiley JS. Co-ordinated increase of sodium leak and sodium pump in hereditary spherocytosis. *Br J Haematol* 1972;22:529–542.
91. Mohler DN. Adenosine triphosphatase metabolism in hereditary spherocytosis. *J Clin Invest* 1965;44:1417–1424.
92. Fernandez LA, Erslev AJ. Oxygen affinity and compensated hemolysis in hereditary spherocytosis. *J Lab Clin Med* 1972;80:780–785.
93. Palek J, Mircevova L, Brabec V. 2,3-Diphosphoglycerate metabolism in hereditary spherocytosis. *Br J Haematol* 1969;17:59–72.
94. Lauf PK, Bauer J, Adragna NC, et al. Erythrocyte K–Cl cotransport: properties and regulation. *Am J Physiol* 1992;263:C917–932.
95. De Franceschi L, Olivieri O, del Giudice EM, et al. Membrane cation and anion transport activities in



erythrocytes of hereditary spherocytosis: effects of different membrane protein defects. *Am J Hematol* 1997;55:121–128.

96. Clark MR, Guatelli JC, White AT, et al. Study of dehydrating effect of the red cell  $\text{Na}^+/\text{K}^+$  pump in nystatin-treated cells with varying  $\text{Na}^+$  and water content. *Biochim Biophys Acta* 1981;646:422–432.

97. Erslev AJ, Atwater J. Effect of mean corpuscular hemoglobin concentration on viscosity. *J Lab Clin Med* 1963;62:401–406.

98. Dacie JV, Mollison PL. Survival of normal erythrocytes after transfusion to patient with familial haemolytic anaemia (acholuric jaundice). *Lancet* 1943;1:550.

99. Baird RN, Macpherson AI, Richmond J. Red blood-cell survival after splenectomy in congenital spherocytosis. *Lancet* 1971;2:1060–1061.

100. Chapman RG, McDonald LL. Red cell life span after splenectomy in hereditary spherocytosis. *J Clin Invest* 1968;47:2263–2267.

101. Reliene R, Mariani M, Zanella A, et al. Splenectomy prolongs *in vivo* survival of erythrocytes differently in spectrin/ankyrin- and band 3-deficient hereditary spherocytosis. *Blood* 2002;100:2208–2215.

102. Griggs RC, Weisman R Jr, Harris JW. Alterations in osmotic and mechanical fragility related to an *in vivo* erythrocyte aging and splenic sequestration in hereditary spherocytosis. *J Clin Invest* 1960;39:89–101.

103. Jandl JH, Greenberg MS, Yonemoto RH. Clinical determination of the sites of red cell sequestration in hemolytic anemias. *J Clin Invest* 1956;35:842–867.

104. Lusher JM, Barnhardt MI. The role of the spleen in the pathophysiology of hereditary spherocytosis and hereditary elliptocytosis. *Am J Pediatr Hematol Oncol* 1980;2:31–39.

105. Chen LT, Weiss L. The role of the sinus wall in the passage of erythrocytes through the spleen. *Blood* 1973;41:529–537.

106. Weiss L. The structure of fine splenic arterial vessels in relation to hemoconcentration and red cell destruction. *Am J Anat* 1962;111:131–179.

107. Weiss L. The red pulp of the spleen: structural basis of blood flow. *Baillieres Clin Haematol* 1983;12:375–393.

108. Barnhardt MI, Lusher JM. The human spleen as revealed by scanning electron microscopy. *Am J Hematol* 1976;1:243–264.

109. Dacie JV. Familial haemolytic anaemia (acholuric jaundice), with particular reference to changes in fragility produced by splenectomy. *Q J Med* 1943;12:101–118.

110. Molnar Z, Rappaport H. Fine structure of the red pulp of the spleen in hereditary spherocytosis. *Blood* 1972;39:81–98.

111. Emerson CP, Shen SC, Ham TH, et al. Studies on the destruction of red blood cells. IX. The mechanism of increased hemolysis in hereditary spherocytosis. *Arch Intern Med* 1956;97:1–38.

112. Mayman D, Zipursky A. Hereditary spherocytosis: the metabolism of erythrocytes in peripheral blood and the splenic pulp. *Br J Haematol* 1974;27:201–217.

113. Orringer EP. A further characterization of the selective K movements observed in human red blood cells following acetylphenylhydrazine exposure. *Am J Hematol* 1984;16:355–366.

114. Vercellotti GM, Van Ashbeck BS, Jacob HS. Oxygen radical-induced erythrocyte hemolysis by neutrophils. Critical role of iron and lactoferrin. *J Clin Invest* 1985;76:956–962.

115. Murphy JR. The influence of pH and temperature on some physical properties of normal erythrocytes and erythrocytes from patients with hereditary spherocytosis. *J Lab Clin Med*

1967;69:758-775.

116. Burman D. Congenital spherocytosis in infancy. *Arch Dis Child* 1958;33:335-341.

117. Stamey CC, Diamond LK. Congenital hemolytic anemia in the newborn. *Am J Dis Child* 1957;94:616-622.

118. Trucco JI, Brown AK. Neonatal manifestations of hereditary spherocytosis. *Am J Dis Child* 1967;113:263-270.

119. Mendelbaum H. Congenital hemolytic jaundice: initial hemolytic crisis occurring at the age of 75. *Ann Intern Med* 1939;13:872-883.

119a. Rubins J, Young LE. Hereditary spherocytosis and glucose-6-phosphate dehydrogenase deficiency: double hemolytic jeopardy. *JAMA* 1977;237:797-798.

120. Iolascon A, Faienza MF, Moretti A, et al. UGT1 promoter polymorphism accounts for increased neonatal appearance of hereditary spherocytosis. *Blood* 1998;91:1093.

121. Delhommeau F, Cynober T, Schischmanoff PO, et al. Natural history of hereditary spherocytosis during the first year of life. *Blood* 2000;95:393-397.

122. MacKinney AA Jr, Morton NE, Kosower NS, et al. Ascertaining genetic carriers of hereditary spherocytosis by statistical analysis of multiple laboratory tests. *J Clin Invest* 1962;41:554-567.

123. Tison W. Hemolytic jaundice. *Medicine* 1922;1:355-388.

124. Tse WT, Lux SE. Hereditary spherocytosis and hereditary elliptocytosis. In: Scriver CR, Beaudet AL, Sly WS, et al., eds. *The metabolic and molecular basis of inherited disease*. New York: McGraw-Hill, 3rd ed. 2001:4665-4730.

125. Gehlbach SH, Cooper BA. Hemolytic anemia in infectious mononucleosis due to inapparent congenital spherocytosis. *Scand J Haematol* 1970;7:141-144.

126. Agre P, Orringer E, Bennett V. Deficient red cell spectrin in severe, recessively inherited spherocytosis. *N Engl J Med* 1982;306:1155-1161.

127. Maberry MC, Mason RA, Cunningham FG, et al. Pregnancy complicated by hereditary spherocytosis. *Obstet Gynecol* 1992;79:735-738.

128. Pajor A, Lehoczy D, Szakaes Z. Pregnancy and hereditary spherocytosis: report of 8 patients and a review. *Arch Gynecol Obstet* 1993;253:37-42.

129. Ventura CS. Hereditary spherocytosis with haemolytic crisis during pregnancy. *Aust N Z J Obstet Gynaecol* 1982;22:50-53.

130. Dameshek W, Bloom ML. The events in the hemolytic crisis of hereditary spherocytosis, with particular reference to the reticulocytopenia, pancytopenia and an abnormal splenic mechanism. *Blood* 1948;3:1381-1410.

131. Wright CS, Gardner E Jr. A study of the role of acute infections in precipitating crises in chronic hemolytic states. *Ann Intern Med* 1960;52:530-537.

132. Kelleher JF, Luban NL, Mortimer PP, et al. Human serum "parvovirus." A specific cause of aplastic crises in children with hereditary spherocytosis. *J Pediatr* 1983;102:720-722.

133. Lefrere JJ, Courouce AM, Girot R, et al. Six cases of spherocytosis revealed by human parvovirus infection. *Br J Haematol* 1986;62:653-658.

134. Delamore IW, Richmond J, Davies SH. Megaloblastic anaemia in congenital spherocytosis. *Br Med J* 1961;1:543-545.

135. Kohler HG, Meynell MJ, Cooke WT. Spherocytic anaemia complicated by megaloblastic anaemia of

pregnancy. *Br Med J* 1960;1:779–781.

136. Gardiner D. Association of gallstones with acholuric jaundice in children. *Arch Dis Child* 1939;14:109–120.

137. Bates GC, Brown CH. Incidence of gallbladder disease in chronic hemolytic anemia (spherocytosis). *Gastroenterology* 1952;21:104–109.

138. Del Giudice EM, Perrotta S, Nobili B, et al. Coinheritance of Gilbert syndrome increases the risk for developing gallstones in patients with hereditary spherocytosis. *Blood* 1999;94:2259–2262.

139. Dawson L. Hume lectures on hemolytic icterus. *Br Med J* 1931;1:963–966.

140. Abe T, Yachi A, Ishii Y, et al. Thoracic extramedullary hematopoiesis associated with hereditary spherocytosis. *Intern Med* 1992;341:1151–1154.

141. Bastion Y, Coiffier B, Felman P, et al. Massive mediastinal extramedullary hematopoiesis in hereditary spherocytosis: a case report. *Am J Hematol* 1990;35:263–265.

142. Coventry WD, LaBree RH. Heterotopia of bone marrow simulating mediastinal tumor. *Ann Intern Med* 1960;53:1042–1052.

143. Hanford RB, Schneider GF, Maccarthy JD. Massive thoracic extramedullary hemopoiesis. *N Engl J Med* 1960;263:120–123.

144. Martin J, Palacio A, Petit J, et al. Fatty transformation of thoracic extramedullary hematopoiesis following splenectomy: CT features. *J Comput Assist Tomogr* 1990;14:477–478.

145. Falconer EH. Familial hemolytic icterus associated with endocrine dysfunction. *Endocrinology* 1936;20:174–179.

146. Blacklock H, Meerkin M. Serum ferritin in patients with hereditary spherocytosis. *Br J Haematol* 1981;49:117–122.

147. Edwards CQ, Skolnick MH, Dadone MM, et al. Iron overload in hereditary spherocytosis: association with HLA-linked hemochromatosis. *Am J Hematol* 1982;13:101–109.

148. Mohler DN, Wheby MS. Hemochromatosis heterozygotes may have significant iron overload when they also have hereditary spherocytosis. *Am J Med Sci* 1986;292:320–324.

149. Schafer AI, Miller JB, Lester EP, et al. Monoclonal gammopathy in hereditary spherocytosis: a possible pathogenic relation. *Ann Intern Med* 1978;88:45–46.

150. Taylor ES. Chronic ulcer of the leg associated with congenital hemolytic jaundice. *JAMA* 1939;112:1574–1576.

151. Guarnone R, Centenara E, Zappa M, et al. Erythropoietin production and erythropoiesis in compensated and anaemic states of hereditary spherocytosis. *Br J Haematol* 1996;92:150–154.

152. Cynober T, Mohandas N, Tchernia G. Red cell abnormalities in hereditary spherocytosis: relevance to diagnosis and understanding of the variable expression of clinical severity. *J Lab Clin Med* 1996;128:259–269.

153. Michaels LA, Cohen AR, Zhao H, et al. Screening for hereditary spherocytosis by use of automated erythrocyte indexes. *J Pediatr* 1997;130:957–960.

154. Paolino W. Variations of the mean diameter in the ripening of the erythrocyte. *Acta Med Scand* 1949;136:141–147.

155. Komninos ZD, Minogue WF, Sarvjić-Dottor J. Folic acid deficiency in hereditary spherocytosis. *Arch Intern Med* 1965;115:663–666.

156. Korones D, Pearson HA. Normal erythrocyte osmotic fragility in hereditary spherocytosis. *J Pediatr*

1989;114:264–266.

157. Young LE, Izzo MJ, Altman KI, et al. Studies on spontaneous *in vitro* autohemolysis in hemolytic disorders. *Blood* 1956;11:977–997.

158. Rutherford CJ, Postlewaigh BF, Hallowes M. An evaluation of the acidified glycerol lysis test. *Br J Haematol* 1986;63:119–121.

159. King MJ, Behrens J, Rogers C, et al. Rapid flow cytometric test for the diagnosis of membrane cytoskeleton-associated haemolytic anaemia. *Br J Haematol* 2000;111:923–933.

160. Schroter W, Kahsnitz E. Diagnosis of hereditary spherocytosis in newborn infants. *J Pediatr* 1983;103:460–463.

161. Tchernia G, Delhommeau F, Perrotta S, et al. Recombinant erythropoietin therapy as an alternative to blood transfusions in infants with hereditary spherocytosis. *Hematol J* 2000;1:146–152.

162. Bolton-Maggs PHB. The diagnosis and management of hereditary spherocytosis. *Baillieres Clin Haematol* 2000;13:327–342.

163. Schilling RF. Hereditary spherocytosis: a study of splenectomized persons. *Semin Hematol* 1976;13:169–176.

164. Schilling RF. Spherocytosis, splenectomy, strokes, and heart attacks. *Lancet* 1997;350:1677–1678.

165. Hayag-Barin JE, Smith RE, Tucker FC. Hereditary spherocytosis, thrombocytosis, and chronic pulmonary emboli: a case report and review of the literature. *Am J Hematol* 1998;57:82–84.

166. Diamond LK. Indications for splenectomy in childhood. *Am J Surg* 1938;39:400–421.

167. King H, Shumacker HB. Splenic studies. I. Susceptibility to infection after splenectomy performed in infancy. *Ann Surg* 1952;136:239–242.

168. Hansen K, Singer DB. Asplenic-hyposplenic overwhelming sepsis: postsplenectomy sepsis revisited. *Pediatr Dev Pathol* 2001;4:105–121.

169. Eber SW, Langendorfer CM, Ditzig M, et al. Frequency of very late fatal sepsis after splenectomy for hereditary spherocytosis: impact of insufficient antibody response to pneumococcal infection. *Ann Hematol* 1999;78:524–528.

170. Schilling RF. Estimating the risk for sepsis after splenectomy in hereditary spherocytosis. *Ann Intern Med* 1995;122:187–188.

171. Singer DB. Postsplenectomy sepsis. *Perspect Pediatr Pathol* 1973;1:285–311.

172. Sandler A, Winkel G, Kimura K, et al. The role of prophylactic cholecystectomy during splenectomy in children with hereditary spherocytosis. *J Pediatr Surg* 1999;34:1077–1078.

173. Lobe TE, Presbury GJ, Smith BM, et al. Laparoscopic splenectomy. *Pediatr Ann* 1993;22:671–674.

174. Tchernia G, Gauthier F, Mielot F, et al. Initial assessment of the beneficial effect of partial splenectomy in hereditary spherocytosis. *Blood* 1993;81:2014–2020.

175. Bader-Meunier B, Gauthier F, Archambaud F, et al. Long-term evaluation of the beneficial effect of subtotal splenectomy for management of hereditary spherocytosis. *Blood* 2001;97:399–403.

176. Caputo GM, Appelbaum PC, Liu HH. Infections due to penicillin-resistant pneumococci: clinical, epidemiologic and microbiologic features. *Arch Intern Med* 1993;153:1301–1310.

177. Chesney PJ. The escalating problem of antimicrobial resistance in *Streptococcus pneumoniae*. *Am J Dis Child* 1992;146:912–916.

178. Bannerman RM, Renwick JH. The hereditary elliptocytoses: clinical and linkage data. *Ann Hum Genet*

1962;26:23–38.

179. Wyandt H, Bancroft PM, Winship TG. Elliptic erythrocytes in man. *Arch Intern Med* 1941;68:1043–1065.

180. Le Comte MC, Dhermy D, Gautero H, et al. L'elliptocytose hereditaire en Afrique de l'Quest. Frequence et repartition des variants de la spectrin. *C R Acad Sci III* 1988;306:43–46.

181. Mohandas N, Lie-Injo LE, Friedman M, et al. Rigid membranes of Malayan ovalocytosis: a likely genetic barrier against malaria. *Blood* 1984;63:1385–1392.

182. Cutting HO, McHugh WJ, Conrad FG. Autosomal dominant hemolytic anemia characterized by ovalocytosis. *Am J Med* 1965;39:21–34.

183. Geerdink RA, Halleman PW, Verloop MC. Hereditary elliptocytosis and hyperhaemolysis. *Acta Med Scand* 1966;179:715–728.

184. Tomaselli MB, John KM, Lux SE. Elliptical erythrocyte membrane skeletons and heat-sensitive spectrin in hereditary elliptocytosis. *Proc Natl Acad Sci U S A* 1981;78:1911–1915.

185. Zarkowsky HS. Heat-induced erythrocyte fragmentation in neonatal elliptocytosis. *Br J Haematol* 1979;41:515–518.

186. Zarkowsky HS, Mohandas N, Speaker CB, et al. A congenital haemolytic anemia with thermal sensitivity of the erythrocyte membrane. *Br J Haematol* 1975;29:537–543.

187. Chang K, Williamson JR, Zarkowsky HS. Effect of heat on the circular dichroism of spectrin in hereditary pyropoikilocytosis. *J Clin Invest* 1979;64:326–328.

188. Cohen CM. The molecular organization of the red cell membrane skeleton. *Semin Hematol* 1983;20:141–158.

189. Liu SC, Palek J. Spectrin tetramer-dimer equilibrium and the stability of erythrocyte membrane skeletons. *Nature* 1980;285:586–588.

190. Coetzer T, Zail S. Spectrin tetramer-dimer equilibrium in hereditary elliptocytosis. *Blood* 1982;59:900–905.

191. Liu SC, Palek J, Prchal J, et al. Altered spectrin dimer-dimer association and instability of erythrocyte membrane skeletons in hereditary pyropoikilocytosis. *J Clin Invest* 1981;69:597–605.

192. Liu SC, Palek J, Prchal J. Defective spectrin dimer-dimer association in hereditary elliptocytosis. *Proc Natl Acad Sci U S A* 1982;79:2072–2076.

193. Liu SC, Derick LH. Molecular anatomy of the red blood cell membrane skeleton. Structure-function relationships. *Semin Hematol* 1992;29:231–243.

194. Mohandas N, Chasis JA. Red blood cell deformability, membrane material proteins and lipids. *Semin Hematol* 1993;30:171–192.

195. Palek J. Hereditary elliptocytosis, spherocytosis and related disorders: consequences of a deficiency of a mutation of membrane skeletal proteins. *Blood Rev* 1987;1:147–168.

196. Palek J, Sahr KE. Mutations of the red blood cell membrane proteins: from clinical evaluations to detection of the underlying genetic defect. *Blood* 1992;80:308–330.

197. Coetzer T, Lawler J, Prchal JT, et al. Molecular determinants of clinical expression of hereditary elliptocytosis and pyropoikilocytosis. *Blood* 1987;70:766–772.

198. Dhermy D, Garbarz M, Lecomte MC, et al. Hereditary elliptocytosis: clinical, morphological and biochemical studies of 38 cases. *Nouv Rev Fr Hematol* 1986;28:129–140.

199. Gallagher PG, Forget BG. Hematologically important mutations: spectrin variants in hereditary

elliptocytosis and hereditary pyropoikilocytosis. *Blood Cells Mol Dis* 1996;22:254–258.

200. Marchesi SL, Knowles WJ, Morrow JS, et al. Abnormal spectrin in hereditary elliptocytosis. *Blood* 1986;67:141–151.

201. Coetzer TL, Palek J. Partial spectrin deficiency in hereditary pyropoikilocytosis. *Blood* 1986;67:919–924.

202. Delaunay J, Dhery D. Mutations involving the spectrin heterodimer contact site: clinical expression and alterations in specific function. *Semin Hematol* 1993;30:21–33.

203. Gallagher PG, Forget BG. Spectrin genes in health and disease. *Semin Hematol* 1993;30:4–20.

204. Knowles WJ, Marchesi SL, Marchesi VT. Spectrin: structure, function and abnormalities. *Semin Hematol* 1983;20:159–174.

205. Morrow JS, Speicher DW, Knowles WJ, et al. Identification of functional domains of human erythrocyte spectrin. *Proc Natl Acad Sci U S A* 1980;77:6592–6596.

206. Zhang Z, Weed SA, Gallagher PG, et al. Dynamic molecular modeling of pathogenic mutations in the spectrin self-association domain. *Blood* 2001;98:1645–1653.

207. Dhery D, Lecomte MC, Garbarz M, et al. Molecular defect of spectrin in the family of a child with congenital hemolytic poikilocytic anemia. *Pediatr Res* 1984;18:1005–1012.

208. Knowles WJ, Morrow JS, Speicher DW, et al. Molecular and functional changes in spectrin from patients with hereditary pyropoikilocytosis. *J Clin Invest* 1983;71:1867–1877.

209. Lawler J, Liu SC, Palek J, et al. A molecular defect of spectrin in a subgroup of patients with hereditary elliptocytosis: alterations in the alpha subunit domain involved in spectrin self-association. *J Clin Invest* 1984;73:1688–1695.

210. Le Comte MC, Dhery D, Garbarz M, et al. Hereditary elliptocytosis with a spectrin molecular defect in a white patient. *Acta Haematol* 1984;71:235–240.

211. Coetzer TL, Sahr K, Prchal J, et al. Four different mutations in codon 28 of a spectrin are associated with structurally and functionally abnormal spectrin  $\alpha^{I/74}$  in hereditary elliptocytosis. *J Clin Invest* 1991;88:743–749.

212. Palek J, Jarolim P. Clinical expression and laboratory detection of red blood cell membrane protein mutations. *Semin Hematol* 1993;30:249–283.

213. Alloisio N, Guetarni D, Morle L, et al. Sp  $\alpha^{I/65}$  hereditary elliptocytosis in North Africa. *Am J Hematol* 1986;23:113–122.

214. Garbarz M, Lecomte MC, Dhery D, et al. Double inheritance of an  $\alpha^{I/65}$  spectrin variant in a child with homozygous elliptocytosis. *Blood* 1986;67:1661–1667.

215. Iarocci TA, Wagner GM, Mohandas N, et al. Hereditary poikilocytic anemia associated with the co-inheritance of two alpha spectrin abnormalities. *Blood* 1988;71:1390–1396.

216. Lawler J, Coetzer TL, Palek J, et al. Sp  $\alpha^{I/65}$ : a new variant of the  $\alpha$  subunit of spectrin in hereditary elliptocytosis. *Blood* 1985;66:706–709.

217. Le Comte MC, Dhery D, Solis C, et al. A new abnormal variant of spectrin in black patients with hereditary elliptocytosis. *Blood* 1985;65:1208–1217.

218. Morris SA, Ohanian V, Lewis ML, et al. Prenatal diagnosis of hereditary red cell membrane defect. *Br J Haematol* 1986;63:763–772.

219. Alloisio N, Morle L, Pothier B, et al. Spectrin Oran ( $\alpha^{II/21}$ ), a new spectrin variant concerning the  $\alpha II$

domain and causing severe elliptocytosis in the homozygous state. *Blood* 1988;71:1039–1047.

220. Alloisio N, Wilmotte R, Morle L, et al. Spectrin Jendouba: an  $\alpha^{II/31}$  spectrin variant that is associated with elliptocytosis and carries a mutation distant from the dimer self-association site. *Blood* 1992;80:809–815.

221. Georgi M, Cianci CD, Gallagher PG, et al. Spectrin oligomerization is cooperatively coupled to membrane assembly: a linkage targeted by many hereditary hemolytic anemias? *Exp Mol Pathol* 2001;70:215–230.

222. Alloisio N, Morle L, Marechal J, et al. Sp  $\alpha^{V/41}$  a common spectrin polymorphism at the  $\alpha^{IV-aV}$  domain junction. Relevance to the expression level of hereditary elliptocytosis due to  $\alpha$ -spectrin variants located in trans. *J Clin Invest* 1991;87:2169–2177.

223. Wilmotte R, Marechal J, Morle L, et al. Low expression allele  $\alpha^{LELY}$  of red cell spectrin is associated with mutations in exon 40 ( $\alpha^{V/41}$  polymorphism) and intron 45 with partial skipping of exon 46. *J Clin Invest* 1993;91:2091–2096.

224. Hanspal M, Palek J. Biogenesis of normal and abnormal red blood cell membrane skeleton. *Semin Hematol* 1992;29:305–319.

224a. Marechal J, Wilmotte R, Kanzaki A, et al. Ethnic distribution of allele  $\alpha^{LELY}$ , a low-expression allele of red-cell spectrin  $\alpha$ -gene. *Br J Haematol* 1995;90:553–556.

225. Gallagher PG, Weed SA, Tse WT, et al. Recurrent fatal hydrops fetalis associated with a nucleotide substitution in the erythroid  $\beta$ -spectrin gene. *J Clin Invest* 1995;95:1174–1182.

226. Gallagher PG, Petruzzi MJ, Weed SA, et al. Mutation of a highly conserved residue of  $\beta 1$  spectrin associated with fatal and near-fatal neonatal hemolytic anemia. *J Clin Invest* 1997;99:267–277.

227. Anderson RA, Lovrien RE. Glycophorin is linked by band 4.1 protein to the human erythrocyte membrane skeleton. *Nature* 1984;307:655–658.

228. Bennett V. The molecular basis for membrane-cytoskeleton association in human erythrocytes. *J Cell Biochem* 1982;18:49–65.

229. Bennett V. The spectrin-actin junction of erythrocyte membrane skeletons. *Biochim Biophys Acta* 1989;988:107–121.

230. Cohen AM, Liu SC, Lawler J, et al. Identification of the protein 4.1 binding site to phosphatidylserine vesicles. *Biochemistry* 1988;27:614–619.

231. Marchesi VT. Stabilizing infrastructure of cell membranes. *Annu Rev Cell Biol* 1985;1:531–561.

232. Pasternack GR, Anderson RA, Leto TL, et al. Interactions between proteins 4.1 and band 3: an alternative binding site for an element of the membrane skeleton. *J Biol Chem* 1985;260:3676–3683.

233. Rybicki AC, Heath R, Lubin B, et al. Human erythrocyte protein 4.1 is a phosphatidylserine binding protein. *J Clin Invest* 1988;82:255–260.

234. Alloisio N, Morle L, Dorleac E, et al. The heterozygous form of 4.1(-) hereditary elliptocytosis [the 4.1(-) trait]. *Blood* 1985;65:46–51.

235. Conboy J, Mohandas N, Tchernia G, et al. Molecular basis of hereditary elliptocytosis due to protein 4.1 deficiency. *N Engl J Med* 1986;315:680–685.

236. Feo C, Fischer S, Piau JP, et al. Première observation de l'absence d'une protéine de la membrane érythrocytaire (band 4.1) dans un cas d'anémie elliptocytaire familiale. *Nouv Rev Fr Hematol* 1980;22:315–325.

237. Garbarz M, Dhery D, Lecomte MC, et al. A variant of erythrocyte membrane skeletal protein band



- 4.1 associated with hereditary elliptocytosis. *Blood* 1984;64:1006–1015.
238. Tchernia G, Mohandas N, Shohet SB. Deficiency of skeletal membrane protein band 4.1 in homozygous hereditary elliptocytosis. Implications for erythrocyte membrane stability. *J Clin Invest* 1981;68:454–460.
239. Marchesi SL, Conboy J, Agre P, et al. Molecular analysis of insertion/deletion mutations in protein 4.1 in elliptocytosis. I. Biochemical identification of rearrangements in the spectrin/actin binding domain and functional characterizations. *J Clin Invest* 1990;86:516–523.
240. Conboy J, Marchesi S, Kim R, et al. Molecular analysis of insertion/deletion mutations in protein 4.1 in elliptocytosis. II. Determination of molecular genetic origins of rearrangements. *J Clin Invest* 1990;86:524–530.
241. Alloisio N, Morle L, Bachir D, et al. Red cell membrane sialoglycoprotein in homozygous and heterozygous 4.1(–) hereditary elliptocytosis. *Biochim Biophys Acta* 1985;816:57–62.
242. Mueller T, Morrison M. Glycoconnectin (PAS 2) a membrane attachment site for the human erythrocyte cytoskeleton. In: Kruckeberg W, Eaton J, Brewer G, eds. *Erythrocyte membranes, vol 2, Recent clinical and experimental advances*. In: *Progress in clinical and biological research*. New York: Alan R Liss, 1981:95–112.
243. Cartron JP, Le Van Kim C, Colin Y. Glycophorin C and related glycoproteins. Structure, function and regulation. *Semin Hematol* 1993;30:152–168.
244. Takakuwa Y, Tchernia G, Rossi M, et al. Restoration of normal membrane stability to unstable protein 4.1-deficient erythrocyte membranes by incorporation of purified protein 4.1. *J Clin Invest* 1986;78:80–85.
245. Florman AL, Wintrobe MM. Human elliptical red corpuscles. *Bull Johns Hopkins Hosp* 1938;63:209–220.
246. Rebuck JW, van Slyck EJ. An unsuspected ultrastructural fault in human elliptocytes. *Am J Clin Pathol* 1968;49:19–25.
247. Gaetgens P, Duhrsen C, Albrecht KH. Motion, deformation, and interaction of blood cells and plasma during flow through narrow capillary tubes. *Blood Cells* 1980;6:799–812.
248. Mohandas N, Chasis JA, Shohet SB. The influence of membrane skeleton on red cell deformability, membrane material properties, and shape. *Semin Hematol* 1983;20:225–242.
249. Hochmuth RM, Evans EA, Colvard DF. Viscosity of human red cell membranes in plastic flow. *Microvasc Res* 1976;11:155–159.
250. Blackburn EK, Jordon A, Lytle WJ, et al. Hereditary elliptocytic hemolytic anaemia. *J Clin Pathol* 1958;11:316–320.
251. Matsumoto N, Ishihara T, Takahashi M, et al. Fine structure of the spleen in hereditary elliptocytosis. *Acta Pathol Jpn* 1976;26:533–542.
252. Wandersee WJ, Roesch AN, Hamblen NR, et al. Defective spectrin integrity and neonatal thrombosis in the first mouse model for severe hereditary elliptocytosis. *Blood* 2001;97:543–550.
253. Muro AF, Marro ML, Gajovic S, et al. Mild spherocytic hereditary elliptocytosis and altered levels of  $\alpha$ - and  $\beta$ -adducins in  $\beta$ -adducin-deficient mice. *Blood* 2000;95:3978–3985.
254. Motulsky AG, Singer K, Crosby WH, et al. The life span of the elliptocyte. *Blood* 1953;9:57–72.
255. Dacie JV. *The haemolytic anaemias. Part I. The congenital anaemias*, 3rd ed. New York: Grune & Stratton, 1985:216–259.
256. Wilson HE, Long MJ. Hereditary ovalocytosis (elliptocytosis) with hypersplenism. *Arch Intern Med* 1955;95:438–444.

257. Maehara T, Tsukamoto N, Nojima Y, et al. Enhanced haemolysis with  $\beta$ -thalassaemia trait due to the unstable  $\beta$  chain variant, Hb Gunma, accompanied by hereditary elliptocytosis due to protein 4.1 deficiency in a Japanese family. *Br J Haematol* 2002;117:193–197.
258. Austin RF, Desforges JF. Hereditary elliptocytosis: an unusual presentation of hemolysis in the newborn associated with transient morphologic abnormalities. *Pediatrics* 1969;44:196–200.
259. Macdougall LG, Moodley G, Quirk M. The pyropoikilocytosis–elliptocytosis syndrome in a black South African infant: clinical and hematological features. *Am J Pediatr Hematol Oncol* 1982;4:344–349.
- 259a. Carpentieri U, Gustavson LP, Haggard ME. Pyknocytosis in a neonate: an unusual presentation of hereditary elliptocytosis. *Clin Pediatr (Phila)* 1977;16:76–78.
260. Josephs HW, Avery ME. Hereditary elliptocytosis associated with increased hemolysis. *Pediatrics* 1955;16:741–752.
261. Mentzer WC, Iarocci TA, Mohandas N, et al. Modulation of erythrocyte membrane mechanical stability by 2,3-diphosphoglycerate in the neonatal poikilocytosis/elliptocytosis syndrome. *J Clin Invest* 1987;79:943–949.
262. Sheetz MP, Casaly J. 2,3-Diphosphoglycerate and ATP dissociate erythrocyte membrane skeletons. *J Biol Chem* 1980;255:9955–9960.
263. Evans JP, Baines AJ, Hann IM, et al. Defective spectrin dimer–dimer association in a family with transfusion dependent homozygous hereditary elliptocytosis. *Br J Haematol* 1983;54:163–172.
264. Nielsen JA, Strunk KW. Homozygous hereditary elliptocytosis as the cause of haemolytic anemia in infancy. *Scand J Haematol* 1964;5:486–496.
265. Coetzer T, Palek J, Lawler J, et al. Structural and functional heterogeneity of  $\alpha$ -spectrin mutations involving the spectrin heterodimer self-association site: relationships to hematologic expression of homozygous hereditary elliptocytosis and hereditary pyropoikilocytosis. *Blood* 1990;75:2235–2244.
266. Lawler J, Coetzer TL, Mankad VN, et al. Spectrin  $\alpha^{I/61}$ : a new structural variant of  $\alpha$ -spectrin in a double-heterozygous form of hereditary pyropoikilocytosis. *Blood* 1988;72:1412–1415.
267. Lawler J, Palek J, Liu SC, et al. Molecular heterogeneity of hereditary pyropoikilocytosis: identification of a second variant of the spectrin  $\alpha$ -subunit. *Blood* 1983;62:1182–1189.
268. Palek J. Hereditary elliptocytosis and related disorders. *Clin Haematol* 1985;14:45–87.
269. Hanspal M, Hanspal JS, Sahr KE, et al. Molecular basis of spectrin deficiency in hereditary pyropoikilocytosis (HPP). *Blood* 1993;82:1652–1660.
270. Palek J, Liu SC, Liu PY, et al. Altered assembly of spectrin in red cell membranes in hereditary pyropoikilocytosis. *Blood* 1981;57:130–139.
271. Wiley JS, Gill FM. Red cell calcium leak in congenital hemolytic anemia with extreme microcytosis. *Blood* 1976;47:197–210.
272. Davidson RJL, Strauss WT. Hereditary elliptocytic anemia. *J Clin Pathol* 1961;14:615–621.
273. Greenberg LH, Tanaka KR. Hereditary elliptocytosis with hemolytic anemia. A family study of five affected members. *Calif Med* 1969;110:389–393.
274. Griffin HZ, Watkins CH. Ovalocytosis with features of hemolytic icterus. *Trans Assoc Am Physicians* 1939;54:355–358.
275. Weiss HJ. Hereditary elliptocytosis with hemolytic anemia. Report of six cases. *Am J Med* 1963;35:455–466.
276. Jarolim P, Wichterle H, Hanspal M, et al.  $\beta$ -spectrin <sup>PRAGUE</sup>: a truncated  $\beta$  spectrin producing

spectrin deficiency, defective spectrin heterodimer self-association and a phenotype of spherocytic elliptocytosis. *Br J Haematol* 1995;91:502-510.

277. Fix AG, Baer AS, Lie-Injo LE. The mode of inheritance of ovalocytosis/elliptocytosis in Malaysian Orang Asli families. *Hum Genet* 1982;61:250-253.

278. Holt M, Hogan PF, Nurse GT, et al. The ovalocytosis polymorphism on the western border of Papua New Guinea. *Hum Biol* 1981;53:23-34.

279. Lie-Injo LE. Hereditary ovalocytosis and haemoglobin E-ovalocytosis in Malayan aborigines. *Nature* 1965;208:1329.

280. Serjeantson S, Bryson K, Amato D, et al. Malaria and hereditary ovalocytosis. *Hum Genet* 1977;37:161-167.

281. Saul A, Lamont G, Sawyer WH, et al. Decreased membrane deformability in Melanesian ovalocytes from Papua New Guinea. *J Cell Biol* 1984;98:1348-1354.

282. Castelino D, Saul A, Myler P, et al. Ovalocytosis in Papua New Guinea: dominantly inherited resistance to malaria. *Southeast Asian J Trop Med Public Health* 1981;12:549-555.

283. Kidson C, Lamont G, Saul A, et al. Ovalocytic erythrocyte from Melanesians are resistant to invasion by malaria parasites in culture. *Proc Natl Acad Sci U S A* 1981;78:5829-5832.

284. Honig GR, Lacson PS, Maurer HS. A new familial disorder with abnormal erythrocyte morphology and increased permeability of the erythrocytes to sodium and potassium. *Pediatr Res* 1971;5:159-166.

285. Cattani JA, Gibson FD, Alpers MP, et al. Hereditary ovalocytosis and reduced susceptibility to malaria in Papua New Guinea. *Trans R Soc Trop Med Hyg* 1987;81:705-709.

286. Hadley T, Saul A, Lamont G, et al. Resistance of Melanesian elliptocytes (ovalocytes) to invasion by *Plasmodium knowlesi* and *Plasmodium falciparum* malaria parasites *in vitro*. *J Clin Invest* 1983;71:780-782.

287. Foo LC, Rekhraj V, Chiang GL, et al. Ovalocytosis protects against severe malaria parasitemia in the Malayan aborigines. *Am J Trop Med Hyg* 1992;47:271-275.

288. Jarolim P, Palek J, Amato D, et al. Deletion in the band 3 gene in malaria resistant Southeast Asian ovalocytosis. *Proc Natl Acad Sci U S A* 1991;88:11022-11026.

289. Sarabia VE, Caseu JR, Reithmeier RA. Molecular characterization of the band 3 protein from Southeast Asian ovalocytes. *J Biol Chem* 1993;268:10676-10680.

290. Mohandas N, Winardi R, Knowles D, et al. Molecular basis for membrane rigidity of hereditary ovalocytosis: a novel mechanism involving the cytoplasmic domain of band 3. *J Clin Invest* 1992;89:686-692.

291. Liu SC, Zhai S, Palek J, et al. Molecular defect of the band 3 protein in Southeast Asian ovalocytosis. *N Engl J Med* 1990;323:1530-1538.

292. Liu SC, Palek J, Scott J, et al. Molecular basis of altered red blood cell membrane properties in Southeast Asian ovalocytosis: role of the mutant band 3 protein in band 3 oligomerization and retention by the membrane skeleton. *Blood* 1995;86:349-358.

293. Okoye VCN, Bennett V. *Plasmodium falciparum* malaria. Band 3 as a possible receptor during invasion of human erythrocytes. *Science* 1985;227:169-171.

294. Allen SJ, O'Donnell A, Alexander NDE, et al. Prevention of cerebral malaria in children in Papua New Guinea by Southeast Asian ovalocytosis band 3. *Am J Trop Med Hyg* 1999;60:1056-1060.

295. De Gruchy GC, Loder PB, Hennessy IV. Haemolysis and glycolytic metabolism in hereditary elliptocytosis. *Br J Haematol* 1962;8:168-179.

296. Shneidman D, Kiessling P, Onstad J, et al. Red pulp of the spleen in hereditary elliptocytosis.

Virchows Arch A Pathol Anat Histol 1977;372:337-342.

297. Sheetz MP, Singer SJ. Biological membranes as bilayer couples: a molecular mechanism of drug-erythrocyte interactions. *Proc Natl Acad Sci U S A* 1974;71:4457-4461.
298. Davidson RJ, How J, Lessels S. Acquired stomatocytosis: its prevalence and significance in routine hematology. *Scand J Haematol* 1977;19:47-53.
299. Ohsaka A, Kano Y, Sakamoto S, et al. A transient hemolytic reaction and stomatocytosis following vinca alkaloid administration. *Acta Haematol Jpn* 1989;52:7-17.
300. Stewart GW, Turner EJH. The hereditary stomatocytoses and allied disorders: congenital disorders of erythrocyte membrane permeability to Na and K. *Baillieres Clin Haematol* 1999;12:707-727.
301. Mentzer WC, Smith WB, Goldstone J, et al. Hereditary stomatocytosis: membrane and metabolism studies. *Blood* 1975;46:659-669.
302. Nathan DG, Shohet SB. Erythrocyte ion transport defects and hemolytic anemia: "hydrocytosis" and "desiccocytosis." *Semin Hematol* 1970;7:381-408.
303. Glader BE, Fortier N, Albala MM, et al. Congenital hemolytic anemia associated with dehydrated erythrocytes and increased potassium loss. *N Engl J Med* 1974;291:491-496.
304. Lock SP, Smith SP, Hardisty RM. Stomatocytosis: a hereditary red cell anomaly associated with haemolytic anaemia. *Br J Haematol* 1961;7:303-314.
305. Zarkowsky HS, Oski FA, Shaafi R, et al. Congenital hemolytic anemia with high sodium, low potassium red cells. *N Engl J Med* 1968;278:573-581.
306. Oski FA, Naiman JL, Blum SF, et al. Congenital hemolytic anemia with high-sodium, low-potassium red cells. *N Engl J Med* 1969;280:909-916.
307. Miller DR, Rickles FR, Lichtman MA, et al. A new variant of hereditary hemolytic anemia with stomatocytosis and erythrocyte cation abnormality. *Blood* 1971;38:184-204.
308. Schroter W, Ungefehr K, Tillmann W. Role of the spleen in congenital stomatocytosis associated with high sodium low potassium erythrocytes. *Klin Wochenschr* 1981;59:173-179.
309. Mentzer WC, Lubin BH, Emmons S. Correction of the permeability defect in hereditary stomatocytosis by dimethyl adipimidate. *N Engl J Med* 1976;294:1200-1204.
310. Lande WM, Thiemann PVW, Mentzer WC Jr. Missing band 7 membrane protein in two patients with high Na<sup>+</sup>, low K<sup>+</sup> erythrocytes. *J Clin Invest* 1982;70:1273.
311. Morle L, Pothier B, Alloisio N, et al. Reduction of membrane band 7 and activation of volume stimulated (K<sup>+</sup>, Cl<sup>-</sup>-cotransport in a case of congenital stomatocytosis. *Br J Haematol* 1989;71:141-146.
312. Eber SW, Lande WM, Iarocci TA, et al. Hereditary stomatocytosis: consistent association with an integral membrane protein deficiency. *Br J Haematol* 1989;72:452-455.
313. Gallagher PG, Forget BG. Structure, organization, and expression of the human band 7.2b gene, a candidate gene for hereditary hydrocytosis. *J Biol Chem* 1995;270:26358-26363.
314. Hiebl-Dirschmied CM, Adolf GR, Prohaska R. Isolation and partial characterization of the human erythrocyte band 7 integral membrane protein. *Biochim Biophys Acta* 1991;1065:195-202.
315. Stewart GW. The membrane defect in hereditary stomatocytosis. *Baillieres Clin Haematol* 1993;6:371-399.
316. Wang D, Turetsky T, Perrine S, et al. Further studies on RBC membrane protein 7.2b deficiency in hereditary stomatocytosis, abstracted. *Blood* 1992;80[Suppl 1]:275a.
317. Wang D, Mentzer WC, Cameron T, et al. Purification of band 7.2b a 31-kDA integral membrane

- phosphoprotein absent in hereditary stomatocytosis. *J Biol Chem* 1991;266:17826–17831.
318. Hiebl–Dirschmied CM, Entler B, Glotzmann C, et al. Cloning and nucleotide sequence of cDNA encoding human erythrocyte band 7 integral membrane protein. *Biochim Biophys Acta* 1991;1090:123–124.
319. Stewart GW, Hepworth–Jones BE, Keen JN, et al. Isolation of cDNA coding for an ubiquitous membrane protein deficient in high Na<sup>+</sup>, low K<sup>+</sup> stomatocytic erythrocytes. *Blood* 1992;79:1593–1601.
320. Zhu Y, Paszty C, Turetsky T, et al. Stomatocytosis is absent in “stomatin”–deficient murine red blood cells. *Blood* 1999;93:2404–2410.
321. Wiley JS, Ellory JC, Shuman MA, et al. Characteristics of the membrane defect in the hereditary stomatocytosis syndrome. *Blood* 1975;46:337–356.
322. Mutoh S, Sasaki R, Takaku F, et al. A family of hereditary stomatocytosis associated with normal level of Na<sup>+</sup>–K<sup>+</sup>–ATPase activity of red blood cells. *Am J Hematol* 1983;14:113–120.
323. Stewart GW, Arness JA, Eber SW, et al. Thrombo–embolic disease after splenectomy for hereditary stomatocytosis. *Br J Haematol* 1996;93:303–310.
324. Platt OS, Lux SE, Nathan DG. Exercise–induced hemolysis in xerocytosis: erythrocyte dehydration and shear sensitivity. *J Clin Invest* 1981;68:631–638.
325. Snyder LM, Lutz HU, Sauberman N, et al. Fragmentation and myelin formation in hereditary xerocytosis and other hemolytic anemias. *Blood* 1978;52:750–761.
326. Albala MM, Fortier NL, Glader BE. Physiologic features of hemolysis associated with altered cation and 2,3–diphosphoglycerate content. *Blood* 1978;52:135–141.
327. Clark MR, Shohet SB, Gottfried EL. Hereditary hemolytic disease with increased red blood cell phosphatidylcholine and dehydration: one, two or many disorders? *Am J Hematol* 1993;42:25–30.
328. Jaffe ER, Gottfried EL. Hereditary nonspherocytic hemolytic disease associated with an altered phospholipid composition of the erythrocytes. *J Clin Invest* 1968;47:1375–1388.
329. Lane P, Kuypers FA, Clark MR, et al. Excess of red cell membrane proteins in hereditary high–phosphatidylcholine hemolytic anemia. *Am J Hematol* 1990;34:186–192.
330. Carella M, Stewart G, Ajetunmobi JF, et al. Genomewide search for dehydrated hereditary stomatocytosis (hereditary xerocytosis): mapping of locus to chromosome 16 (16q23?qter). *Am J Hum Genet* 1998;63:810–816.
331. Iolascon A, Stewart GW, Ajetunmobi JF, et al. Familial pseudohyperkalemia maps to the same locus as dehydrated hereditary stomatocytosis (hereditary xerocytosis). *Blood* 1999;93:3120–3123.
332. Grootenboer S, Schischmanoff PO, Cynober T, et al. A genetic syndrome associating dehydrated hereditary stomatocytosis, pseudohyperkalaemia and perinatal oedema. *Br J Haematol* 1998;103:383–386.
333. Mentzer WC Jr, Lande WM. Hemolytic anemia resulting from abnormal red cell membrane cation permeability–hydrocytosis and cryohydrocytosis. In: Srivastava SK, ed. *Red blood cell and lens metabolism*. New York: Elsevier/North Holland, 1980:311–314.
334. Miller G, Townes PL, MacWhinney JB. A new congenital hemolytic anemia with deformed erythrocytes (“stomatocytes”) and remarkable susceptibility of erythrocytes to cold hemolysis *in vitro*. *Pediatrics* 1965;35:906–915.
335. Stewart GW, Corrall RJ, Fyffe JA, et al. A familial pseudohyperkalemia. *Lancet* 1979;2:175–177.
336. Stewart GW, Ellory JC. A family with mild hereditary xerocytosis showing high membrane cation permeability at low temperatures. *Clin Sci* 1985;69:309–319.
337. Gore DM, Chetty MC, Fisher J, et al. Familial pseudohyperkalaemia Cardiff: a mild version of

cryohydrocytosis. *Br J Haematol* 2002;117:212–214.

338. Coles SE, Stewart GW. Temperature effects on cation transport in hereditary stomatocytosis and allied disorders. *Int J Exp Pathol* 1999;80:251–258.

339. Haines PG, Crawley C, Chetty MC, et al. Familial pseudohyperkalaemia Chiswick: a novel congenital thermotropic variant of K and Na transport across the human red cell membrane. *Br J Haematol* 2001;112:469–474.

340. Haines PG, Jarvis HG, King S, et al. Two further British families with the ‘cryohydrocytosis’ form of hereditary stomatocytosis. *Br J Haematol* 2001;113:932–937.

341. Delaunay J, Stewart G, Iolascon A. Hereditary dehydrated and overhydrated stomatocytosis: recent advances. *Curr Opin Hematol* 1999;6:110–114.

342. Sturgeon P. Hematological observations on the anemia associated with blood type Rh null. *Blood* 1970;36:310–320.

343. Seidl S, Spielmann W, Martin H. Two siblings with Rh null disease. *Vox Sang* 1972;23:182–189.

344. Agre P, Cartron JP. Biochemistry and molecular genetics of Rh antigens. *Baillieres Clin Haematol* 1991;4:793–819.

345. Agre P, Cartron JP. Molecular biology of the Rh antigens. *Blood* 1991;78:553–563.

346. Anstee DJ, Tanner MJA. Biochemical aspects of the blood group Rh (Rhesus) antigens. *Baillieres Clin Haematol* 1993;6(2):401–422.

347. Cartron J, Agre P. Rh blood group antigens: protein and gene structure. *Semin Hematol* 1993;30:193–208.

348. Gahmberg CG, Karhi KK. Association of the Rho (D) polypeptides with the membrane skeleton in Rho (D) positive human red cells. *J Immunol* 1984;133:334–337.

349. Ridgwell K, Tanner MJA, Anstee DJ. The Rhesus (D) polypeptide is linked to the human erythrocyte cytoskeleton. *FEBS Lett* 1984;174:7–10.

350. Huang CH, Cheng G, Liu Z, et al. Molecular basis for Rh<sub>null</sub> syndrome: identification of three new missense mutations in the Rh50 glycoprotein gene. *Am J Hematol* 1999;62:25–32.

351. Cherif-Zahar B, Matassi G, Raynal V, et al. Molecular defects of the RHCE gene in Rh-deficient individuals of the amorph type. *Blood* 1998;92:639–646.

352. Kato-Yamazaki M, Okuda H, Kawano M, et al. Molecular genetic analysis of the Japanese amorph Rh null phenotype. *Transfusion* 2000;40:617–618.

353. Schmidt PJ, Lostumbo MM, English CT, et al. Aberrant U blood group accompanying RH null. *Transfusion* 1967;7:33–34.

354. Ballas SK, Clark MR, Mohandas N, et al. Red cell membrane and cation deficiency in Rh null syndrome. *Blood* 1984;63:1046–1055.

355. Wiley JS. Cation fluxes in Rh Null red cells. *Blood* 1978;51:555–557.

356. Nash R, Shojania AM. Hematological aspect of Rh deficiency syndrome: a case report and a review of the literature. *Am J Hematol* 1987;24:267–275.

357. Kayden HJ, Bessis M. Morphology of normal erythrocyte and acanthocyte using Nomarski optics and the scanning electron microscope. *Blood* 1970;35:427–436.

358. Mant MJ, Faragher BS. The hematology of anorexia nervosa. *Br J Haematol* 1972;23:737–749.

359. Bessis M. Blood smears reinterpreted. Berlin: Springer-Verlag New York, 1977:1-265.
360. Cooper RA. Anemia with spur cells: a red cell defect acquired in serum and modified in the circulation. *J Clin Invest* 1969;48:1820-1831.
361. Cooper RA. Hemolytic syndromes and red cell membrane abnormalities in liver disease. *Semin Hematol* 1980;17:103-112.
362. Cooper RA, Diloy-Puray M, Lando P, et al. An analysis of lipoproteins, bile acids and red cell membranes associated with target cells and spur cells in patients with liver disease. *J Clin Invest* 1972;51:3182-3192.
363. Bassen FA, Kornweig AL. Malformation of the erythrocytes in a case of atypical retinitis pigmentosa. *Blood* 1950;5:381-387.
364. Salt HB, Wolff OH, Lloyd JK, et al. On having no beta-lipoprotein. A syndrome comprising a-betalipoproteinaemia, acanthocytosis, and steatorrhea. *Lancet* 1960;2:325-329.
365. Schwartz JF, Rowland LP, Eder H, et al. Bassen-Kornzweig syndrome: deficiency of serum  $\beta$ -lipoprotein. *Arch Neurol* 1963;8:438-454.
- 365a. Gotto AM, Levy RI, John K, et al. On the protein defect in abetalipoproteinemia. *N Engl J Med* 1971;284:813-818.
366. Isselbacher KJ, Scheig R, Plotkin GR, et al. Congenital  $\beta$ -lipoprotein deficiency: an hereditary disorder involving defect in the absorption and transport of lipids. *Medicine* 1964;43:347-361.
367. Kayden HJ. Abetalipoproteinemia. *Annu Rev Med* 1972;23:285-296.
368. Lees RS, Wilson DE, Shonfeld G, et al. The familial dyslipoproteinemias. *Prog Med Genet* 1973;9:237-290.
369. Phillips GB. Quantitative analysis of plasma and red blood cell lipids in patients with acanthocytosis. *J Lab Clin Med* 1962;59:357-362.
370. Jones JW, Ways P. Abnormalities of high density lipoproteins in abetalipoproteinemia. *J Clin Invest* 1967;46:1151-1161.
371. Cooper RA, Gulbrandsen CL. The relationship between serum lipoproteins and red cell membranes in abetalipoproteinemia: deficiency of lecithin-cholesterol acyltransferase. *J Lab Clin Med* 1971;78:323-335.
372. McBride JA, Jacob HS. Abnormal kinetics of red cell membrane cholesterol in acanthocytes: studies in genetic and experimental abetalipoproteinemia and in spur cell anemia. *Br J Haematol* 1970;18:383-397.
373. Phillips GB, Dodge JT. Phospholipid and phospholipid fatty acid and aldehyde composition of red cells of patients with abetalipoproteinemia (acanthocytosis). *J Lab Clin Med* 1968;71:629-637.
374. de Saint-Basile G, Bohler MC, Fischer A, et al. Xp21 DNA microdeletion in a patient with chronic granulomatous disease, retinitis pigmentosa and MacLeod phenotype. *Hum Genet* 1988;80:85-89.
375. Switzer S, Eder HA. Interconversion of acanthocytes and normal erythrocytes with detergents. *J Clin Invest* 1962;41:1404.
376. Zwaal RFA, Roelofsen B, Comfurius P, et al. Organization of phospholipids in human red cell membranes as detected by the action of various purified phospholipases. *Biochim Biophys Acta* 1975;406:83-96.
377. Lange Y, Steck TL. Mechanism of red blood cell acanthocytosis and echinocytosis *in vivo*. *J Membr Biol* 1984;77:153-159.
378. Stevenson VL, Hardie RJ. Acanthocytosis and neurological disorders. *J Neurol* 2001;248:87-94.



379. Levine IM, Estes JW, Looney JM, et al. Hereditary neurological disease with acanthocytosis. A new syndrome. *Arch Neurol* 1968;19:403–409.
380. Mier M, Schwartz SO, Boshes B. Acanthocytosis, pigmentary degeneration of the retina and ataxia neuropathy: a genetically determined syndrome with associated metabolic disorder. *Blood* 1960;16:1586–1608.
381. Sobrevilla LA, Goodman ML, Kane CA. Demyelinating central nervous system disease, macular atrophy and acanthocytosis (Bassen–Kornzweig syndrome). *Am J Med* 1964;37:821–828.
382. Druetz G. Un nouveau cas d'acanthocytose. *Nouv Rev Fr Hematol* 1959;14:3.
383. Estes JW, Morley TJ, Levine IM, et al. A new hereditary acanthocytosis syndrome. *Am J Med* 1967;42:868–881.
384. Singer K, Fisher B, Perlstein MA, et al. Acanthocytosis. *Blood* 1952;7:577–591.
385. Simon ER, Ways P. Incubation hemolysis and red cell metabolism in acanthocytosis. *J Clin Invest* 1964;43:1311–1321.
386. Critchley EMR, Nicholson JT, Betts JJ, et al. Acanthocytosis, normolipidemia and multiple tics. *Postgrad Med J* 1970;46:698–701.
387. Allen FH, Krabbe SM, Corcoran PA. A new phenotype (MacLeod) in the Kell blood-group system. *Vox Sang* 1961;6:555–560.
388. Symmans WA, Shepherd CS, Marsh WL, et al. Hereditary acanthocytosis associated with the MacLeod phenotype of the Kell blood group system. *Br J Haematol* 1979;42:575–583.
389. Taswell HF, Lewis JC, Marsh WL, et al. Erythrocyte morphology in genetic defects of the Rh and Kell blood group systems. *Mayo Clin Proc* 1977;52:157–159.
390. Wimer BM, Marsh WL, Taswell HF, et al. Haematological changes associated with the MacLeod phenotype of the Kell blood group system. *Br J Haematol* 1977;36:219–224.
391. Wimer BM, Marsh WL, Taswell HF. Clinical characteristics of the MacLeod blood group phenotype. *Blood* 1976;48:959.
392. Danek A, Rubio JP, Rampoldi L, et al. McLeod neuroacanthocytosis: genotype and phenotype. *Ann Neurol* 2001;50:755–764.
393. Redman CM, Huima T, Robbins E, et al. Effect of phosphatidylserine on the shape of MacLeod red cell acanthocytes. *Blood* 1989;74:1826–1835.
394. Galey WR, Evan AP, Van Nice PS, et al. Morphology and physiology of the MacLeod erythrocyte. I. Scanning electron microscopy and electrolyte and water transport properties. *Vox Sang* 1978;34:152–161.
395. Tang LL, Redman CM, Williams D, et al. Biochemical studies on MacLeod phenotype erythrocytes. *Vox Sang* 1981;40:17–26.
396. Marsh WL. Molecular defects associated with the MacLeod blood group phenotype. In: Salmon C, ed. *Blood groups and other red cell surface markers in health and disease*. New York: Masson, 1982:17.
397. Redman CM, Marsh WL, Scarborough A, et al. Biochemical studies on MacLeod phenotype red cells and isolation of Kx antigen. *Br J Haematol* 1988;68:131–136.
398. Marsh WL, Oyen R, Nichols ME. Kx antigen, the MacLeod phenotype, and chronic granulomatous disease: further studies. *Vox Sang* 1976;31: 356–362.
399. Russo DCW, Lee S, Reid ME, et al. Point mutations causing the McLeod phenotype. *Transfusion* 2002;42:287–293.

400. Bertelson CJ, Pogo AO, Chaudhuri A, et al. Localization of the MacLeod locus (XK) within Xp21 by deletion analysis. *Am J Hum Genet* 1988;42:703–711.
401. Francke U, Ochs HD, de Martinville B, et al. Minor Xp21 chromosome deletion in a male associated with expression of Duchenne muscular dystrophy, chronic granulomatous disease, retinitis pigmentosa and MacLeod's syndrome. *Am J Hum Genet* 1985;37:250–267.
402. Frey D, Machler M, Seger R, et al. Gene deletion in a patient with chronic granulomatous disease and MacLeod syndrome: fine mapping of the Xk gene locus. *Blood* 1988;71:252–255.
403. Jacob HS, Amsden T. Acute hemolytic anemia with rigid red cell in hypophosphatemia. *N Engl J Med* 1971;285:1446–1450.
404. Cooper RA. Pathogenesis of burr cells in uremia, abstracted. *J Clin Invest* 1974;49:22a.
405. Selby GB, Frame DC, Eichner LK, et al. Athlete's echinocytes: new cause of exertional hemolysis? *Blood* 1987;70[Suppl 1]:56a.
406. Owen JS, Brown DJ, Harry DS, et al. Erythrocyte echinocytosis in liver disease. *J Clin Invest* 1985;76:2275–2285.
407. White JG. Effects of an ionophore, A23187, on the surface morphology of normal erythrocytes. *Am J Pathol* 1974;77:507–518.
408. Nakao M, Nakao T, Yamazoe S. Adenosine triphosphate and maintenance of shape of the human red cells. *Nature* 1960;187:945–946.
409. Seigneuret M, Devaux PF. ATP-dependent asymmetric distribution of spinlabeled phospholipids in the erythrocyte membrane: relation to shape changes. *Proc Natl Acad Sci U S A* 1984;81:3751–3755.
410. Devaux PF. Protein involvement in transmembrane lipid asymmetry. *Annu Rev Biophys Biomol Struct* 1992;21:417–439.
411. Gjone E. Familial lecithin-cholesterol acyltransferase deficiency. A clinical survey. *Scand J Clin Lab Invest Suppl* 1974;137:73–82.
412. Jain SK, Mohandas N, Sensabaugh GF, et al. Hereditary plasma lecithin-cholesterol acyltransferase deficiency. *J Lab Clin Med* 1982;99:816–826.
413. Argyropoulos G, Jenkins A, Klein RL. Transmission of two novel mutations in a pedigree with familial lecithin: cholesterol acyltransferase deficiency: structure-function relationships and studies in a compound heterozygous proband. *J Lipid Res* 1998;39:1870–1876.
414. Guerin M, Dachet C, Goulinet S, et al. Familial lecithin: cholesterol acyltransferase deficiency: molecular analysis of a compound heterozygote: LCAT (Arg1<sup>47</sup>?Trp) and LCAT (Tyr<sup>171</sup>?Stop). *Atherosclerosis* 1997;131:85–95.
415. Albers JJ, Utermann G. Genetic control of lecithin: cholesterol acyltransferase. Measurement of LCAT mass in a large kindred with LCAT deficiency. *Am J Hum Genet* 1981;33:702–708.
416. Godin DV, Gray GR, Frohlich J. Erythrocyte membrane alterations in lecithin-cholesterol acyltransferase deficiency. *Scand J Clin Lab Invest Suppl* 1978;150:162–167.
417. Jacobsen CD, Gjone E, Hovig T. Sea-blue histiocytes in familial lecithin: cholesterol acyltransferase deficiency. *Scand J Haematol* 1972;9:106–113.

2004 Lippincott Williams & Wilkins  
John P. Greer, John Foerster, John N. Lukens  
George M. Rodgers, Frixos Paraskevas, Bertil Glader  
Wintrobe's Clinical Hematology

## Hereditary Hemolytic Anemias Due to Enzyme Disorders

### OVERVIEW OF RED BLOOD CELL METABOLISM

#### DISORDERS OF HEXOSE MONOPHOSPHATE SHUNT AND GLUTATHIONE METABOLISM

##### Glucose-6-Phosphate Dehydrogenase Deficiency

##### Related Disorders of Hexose Monophosphate Shunt and Glutathione Metabolism

#### DISORDERS OF GLYCOLYSIS: GENERAL CONSIDERATIONS

##### Pyruvate Kinase Deficiency

##### Other Glycolytic Enzymopathies

##### Glycolytic Enzymopathies of Doubtful Clinical Significance

#### DISORDERS OF ERYTHROCYTE NUCLEOTIDE METABOLISM

##### Pyrimidine 5' Nucleotidase Deficiency

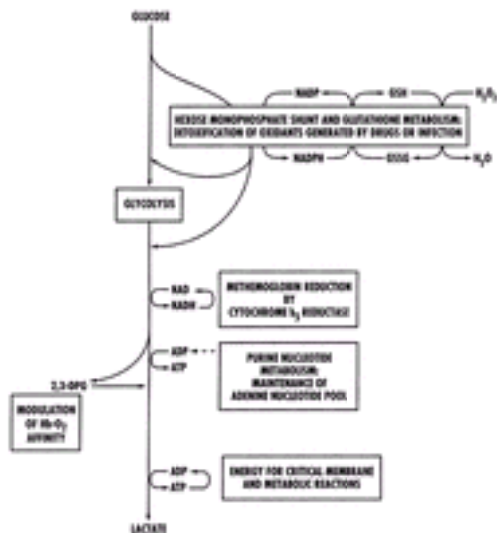
##### Adenosine Deaminase Excess

##### Adenylate Kinase Deficiency

#### REFERENCES

## OVERVIEW OF RED BLOOD CELL METABOLISM

Mature red blood cells (RBCs) are anucleate (thereby incapable of cell division), devoid of ribosomes (thereby incapable of protein synthesis), and lack mitochondria (thereby incapable of oxidative phosphorylation) (see [Chapter 8](#)). Despite these limitations, RBCs survive 100 to 120 days in the circulation and effectively deliver oxygen to peripheral tissues. Glucose is the main metabolic substrate of RBCs, and it is metabolized by two major pathways: the glycolytic or “energy-producing” pathway and the hexose monophosphate (HMP) shunt or “protective” pathway. Under normal conditions, approximately 90% of glucose flows through glycolysis, with a much smaller fraction being channeled through the HMP pathway. However, the fraction of glucose entering the pentose phosphate pathway can increase significantly under conditions of increased oxidative stress. The major products of glycolysis are adenosine triphosphate (ATP; a source of energy for numerous RBC membrane and metabolic reactions), reduced nicotinamide adenine dinucleotide (a necessary cofactor for methemoglobin reduction by cytochrome *b*<sub>5</sub> reductase), and 2,3-diphosphoglycerate (2,3-DPG; an important intermediate that modulates hemoglobin-oxygen affinity) ( [Fig. 33.1](#)). Mature RBCs are incapable of *de novo* purine or pyrimidine synthesis, although many enzymes of nucleotide metabolism are present in erythrocytes. The latter are now known to be important for RBC preservation *in vitro*, and it also is recognized that abnormalities in purine and pyrimidine metabolism are associated with inherited hemolytic disease.



**Figure 33.1.** Summary of overall glycolysis, hexose monophosphate shunt, glutathione metabolism, and red blood cell nucleotide metabolism. ADP, adenosine diphosphate; ATP, adenosine triphosphate; 2,3-DPG, 2,3-diphosphoglycerate; GSH, reduced glutathione; GSSG, oxidized glutathione; Hb, hemoglobin; NAD, nicotinamide adenine dinucleotide; NADH, reduced nicotinamide adenine dinucleotide; NADP, nicotinamide adenine dinucleotide phosphate; NADPH, reduced nicotinamide adenine dinucleotide phosphate.

The consequences of red cell enzymopathies are diverse. Some enzyme variants cause hemolytic disease with anemia being the sole expression of the enzymopathy. In other enzyme disorders, hemolysis is one feature of a multisystem disease affecting many tissues. Also, in some cases, erythrocyte enzyme abnormalities have no adverse effects on RBC function, and, if they occur in patients with hemolytic anemia, it is not always clear that the enzyme deficiency and hemolysis are causally related. This chapter focuses on the varied enzyme defects associated with hemolysis. These RBC enzyme disorders are due to abnormalities in the HMP shunt and glutathione metabolism, glycolytic enzyme deficiencies, and abnormalities in purine and pyrimidine metabolism.

## DISORDERS OF HEXOSE MONOPHOSPHATE SHUNT AND GLUTATHIONE METABOLISM

The HMP shunt pathway metabolizes 5 to 10% of glucose used by RBCs, and this is critical for protecting red cells against oxidant injury ( [Fig. 33.2](#)). The HMP pathway is the only RBC source of reduced nicotinamide adenine dinucleotide phosphate (NADPH), a cofactor important in glutathione metabolism. RBCs contain relatively high concentrations of reduced glutathione (GSH), a sulfhydryl-containing tripeptide (glutamylcysteinylglycine) that functions as an intracellular reducing agent that protects cells against oxidant injury. Oxidants, such as superoxide anion ( $O_2^-$ ) and hydrogen peroxide ( $H_2O_2$ ), are produced by exogenous factors (i.e., drugs, infection) and also are formed within red cells as a consequence of reactions of hemoglobin with oxygen. However, when these oxidants accumulate within red cells, hemoglobin and other proteins are oxidized, leading to loss of function and RBC death. Under normal circumstances, this does not occur because GSH, in conjunction with the enzyme glutathione peroxidase (GSH-Px), rapidly inactivates these compounds. During the oxidant detoxification process, however, GSH itself is converted to oxidized glutathione (GSSG), and GSH levels fall. To sustain protection against persistent oxidant injury, GSH levels must be maintained, and this is accomplished by glutathione reductase (GSSG-Red), which catalyzes reduction of GSSG to GSH. This reaction requires the NADPH generated by glucose-6-phosphate dehydrogenase (G6PD), the first enzymatic reaction of the HMP

shunt and glutathione metabolism that is responsible for protecting intracellular proteins from oxidative assault. Almost all hemolytic episodes related to altered HMP shunt and glutathione metabolism are due to G6PD deficiency, and this enzyme deficiency is known to affect millions of people throughout the world ( [1](#), [2](#) and [3](#)). Rare cases of hemolysis associated with decreased GSSG-Red activity, GSH-Px deficiency, and deficiencies of GSH synthetic enzymes also have been described.



**Figure 33.2.** Hexose monophosphate shunt, enzymes of glutathione metabolism, protection from oxidant assault, and relationship to glycolytic metabolism. Enzymes are shown in boxes. ADP, adenosine diphosphate; ATP, adenosine triphosphate; G-3-P, glyceraldehyde-3-phosphate; G-6-PD, glucose-6-phosphate dehydrogenase; ?-Glu-Cys-Synth, ?-glutamyl-cysteine synthetase; GSH, reduced glutathione; GSH-Px, glutathione peroxidase; GSH-Synth, glutathione synthetase; GSSG, oxidized glutathione; GSSG-Red, glutathione reductase; NADP, nicotinamide adenine dinucleotide phosphate; NADPH, reduced nicotinamide adenine dinucleotide phosphate; 6-P-G, 6-phosphogluconate; 6-PGD, 6-phosphogluconate dehydrogenase; Ribose-5-P, ribose-5-phosphate.

### Glucose-6-Phosphate Dehydrogenase Deficiency

The importance of this enzyme for red cell integrity was first recognized after the observation that some African-American soldiers taking the antimalarial drug primaquine would develop acute hemolytic anemia with hemoglobinuria. Initially, it was observed that GSH was decreased in the RBCs of susceptible individuals during acute hemolytic episodes. Subsequently, the activity of G6PD, one of the enzymes needed to keep adequate GSH levels, was found to be deficient in affected red cells ( [4](#), [5](#)). Soon thereafter, the worldwide distribution of G6PD deficiency became apparent, and the variation of clinical expression of enzyme deficiency was discovered. In most individuals with G6PD deficiency, there is no anemia in the steady state and reticulocyte counts are normal, but RBC survival may be slightly decreased. However, episodic exacerbations of hemolysis accompanied by anemia occur in association with the administration of certain drugs and with some infections. In a minority of cases, G6PD deficiency is associated with a chronic hemolytic process. To date, over 400 G6PD biochemical variants have been recognized ( [1](#), [6](#), [7](#) and [8](#)).

**GENETICS** The gene for G6PD is located on the X chromosome (band X q28) ( [9](#), [10](#) and [11](#) ). The fact that normal males and females have the same enzyme activity in their red cells is explained by the Lyon hypothesis ( [12](#)). This hypothesis maintains that one of two X chromosomes in each cell of the female embryo is inactivated and remains inactive throughout subsequent cell divisions for the duration of life. In fact, studies by Beutler on females with G6PD deficiency were used in proof of the Lyon hypothesis ( [13](#)). Enzyme deficiency is expressed in males carrying a variant gene, whereas heterozygous females usually are clinically normal. However, depending on the degree of lyonization and the degree to which the abnormal G6PD variant is expressed, the mean RBC enzyme activity in females may be normal, moderately reduced, or grossly deficient. A female with 50%

normal G6PD activity has 50% normal red cells and 50% G6PD-deficient red cells. The G6PD-deficient cells in females, however, are as vulnerable to hemolysis as enzyme-deficient RBCs in males. The concept of X chromosome inactivation and the study of G6PD has been informative in other areas. In particular, it has facilitated our understanding of monoclonal and multiclonal disorders of cell proliferation. Most tumors, both benign and malignant, can be demonstrated to have a clonal origin, being derived from one cell ( [14](#), [15](#) and [16](#) ). For example, analysis of the G6PD enzyme in uterine myomata of women heterozygous for G6PD A and G6PD B revealed that any given tumor had either G6PD A or enzyme B but not both ( [17](#) ). The same principle has been used to demonstrate the clonal origin of the malignant transformation of acute leukemia ( [18](#), [19](#) ) and chronic myelocytic leukemia ( [20](#) ), and also the clonal nature of polycythemia vera ( [21](#) ), primary thrombocythemia ( [22](#) ), and paroxysmal nocturnal hemoglobinuria ( [23](#) ).

**PREVALENCE AND GEOGRAPHIC DISTRIBUTION** Deficiency of G6PD is the most common metabolic disorder of RBCs and has been estimated to affect over 400 million people worldwide ( [24](#) ). Although global in its distribution, G6PD deficiency is encountered with greatest frequency in the tropical and subtropical zones of the Eastern Hemisphere. The incidence of the deficiency state is approximately 20% among African Bantu males ( [25](#), [26](#) ), 12% in African-American men ( [27](#), [28](#) ), and 8% in Brazilian blacks. As many as 20% of female African Americans may be heterozygous for G6PD mutants ( [29](#) ), and as many as 1% are homozygous. In Sardinia, the incidence varies from 35% at low altitudes to 3% in areas above 600 meters ( [30](#) ). The deficiency state has been reported from most areas of Greece, again with greatest frequency (20 to 32%) in the lowlands ( [31](#) ). The condition is also prevalent among Sephardic Jews, and as many as 60 to 70% of Kurdish Jews may be affected ( [1](#), [6](#), [32](#) ). In the male Asian population, the incidence of G6PD deficiency is estimated to be 14.0% in Cambodia ( [33](#) ), 5.5% in South China ( [34](#), [35](#) ), 2.6% in India ( [33](#) ), and less than 0.1% in Japan ( [36](#) ). It is rare among native Americans ( [37](#) ). Because of its high incidence among populations in which malaria was once endemic, G6PD deficiency is believed to have conferred a selective advantage against infection by *Plasmodium falciparum* malaria ( [38](#), [39](#) and [40](#) ). Partial indirect support for this is that G6PD deficiency in Sardinia is more common at sea level compared to higher elevations, and this also parallels the endemicity of malaria. In addition, it has been observed that parasitized female heterozygotes for G6PD deficiency (who therefore have normal and G6PD-deficient RBCs) have more malaria parasites in their normal erythrocytes compared to their G6PD-deficient cells ( [41](#) ). Moreover, it has been demonstrated that the *in vitro* growth of malarial parasites is inhibited in G6PD-deficient red cells ( [42](#) ). The precise reasons for the observed inhibition of parasite growth in G6PD-deficient red cells are not known. One possibility is that the oxidant stress that causes GSH instability and destroys the host RBC also kills the parasite ( [43](#), [44](#) and [45](#) ). An alternative explanation is provided by the observation that infected, G6PD-deficient red cells are unable to generate the ribose derivatives needed by the parasite for nucleic acid synthesis ( [46](#) ). Thus, inhibition of parasite growth rather than oxidative destruction of the parasite, host cell, or both may be an important mechanism for the balanced polymorphism of the G6PD gene.

**THE ENZYME AND ITS VARIANTS** The monomeric form of G6PD contains 515 amino acids and has a molecular weight of 59 kd ( [47](#), [48](#) ). The active form of G6PD *in vivo* is a dimer, which requires nicotinamide adenine dinucleotide phosphate (NADP) for its stability ( [24](#) ). The G6PD gene has been cloned and sequenced. It is known to contain 13 exons and is over 18 kb in length ( [48](#), [49](#) and [50](#) ). The normal or wild-type enzyme is G6PD B, although hundreds of variant enzymes now have been identified. By international agreement, standardized methods have been used to characterize these enzyme variants, which differ on the basis of biochemical properties such as kinetic activity, electrophoretic mobility, the Michaelis constant for its substrate glucose-6-phosphate



and cofactor NADP, the ability to use different substrate analogs, heat stability, and pH optima. Throughout the years, the published list of recognized G6PD biochemical variants has been periodically updated ( [51](#), [52](#) ), and over 400 biochemical variant forms of G6PD are recognized ( [1](#) ). However, differences between some variants are subtle and most likely reflect minor technical differences between laboratories rather than true enzyme differences. Moreover, the advances in molecular biology have revealed that many so-called G6PD variants, in fact, have the same DNA defect (see below). The World Health Organization has classified G6PD variants on the magnitude of the enzyme deficiency and also on the severity of hemolysis ( [53](#) ). *Class I variants* have very severe enzyme deficiency (less than 10 to 20% of normal) and have chronic hemolytic anemia. *Class II variants* also have severe enzyme deficiency (less than 10% of normal), but there is usually only intermittent hemolysis. *Class III variants* have moderate enzyme deficiency (10 to 60% of normal) with intermittent hemolysis usually associated with infection or drugs. *Class IV variants* have no enzyme deficiency or hemolysis. *Class V variants* are those in which enzyme activity is increased. Variants in the last two groups, although of much interest to biologists, geneticists, and anthropologists, are of no major clinical significance. The normal wild-type enzyme, G6PD B, is found in most whites and Asians and in a majority of blacks. It has normal catalytic activity and is not associated with hemolysis (class IV). A commonly encountered variant is G6PD A+, which is found in 20 to 30% of blacks from Africa ( [54](#) ). It has normal catalytic properties and does not cause hemolysis (class IV). It differs from G6PD B in that it has a much faster electrophoretic mobility (the letters A and B refer to relative electrophoretic mobilities). The structure of G6PD A+ differs from that of G6PD B by the substitution of a single amino acid, an asparagine for aspartate at the 126th position of the protein ( [55](#) ). Another common variant, G6PD A-, is the enzyme responsible for primaquine sensitivity in blacks, and it is the most common variant associated with mild to moderate hemolysis (class III). This G6PD variant is found in 10 to 15% of African Americans, with similar frequencies in western and central Africa ( [56](#) ). It has an electrophoretic mobility identical to that of G6PD A+. However, this is an unstable enzyme, and its catalytic activity, although nearly normal in bone marrow cells and reticulocytes ( [57](#) ), decreases markedly in older RBCs ( [58](#) ). Hence, this variant is designated G6PD A- compared with G6PD A+ (the + and - denote enzyme activity). G6PD Mediterranean is the most common abnormal variant found in whites, particularly those whose origins are in the Mediterranean area. The electrophoretic mobility of G6PD Mediterranean is identical to that of G6PD B, but it is synthesized at a reduced rate ( [57](#) ), its catalytic activity is markedly reduced, and hemolysis can be severe (class II). G6PD Canton is a common variant enzyme seen in Asians ( [59](#) ). Its biochemical properties are very similar to those of G6PD Mediterranean. Recent advances in molecular biology have further enhanced our understanding of G6PD deficiency, and now over 140 different gene mutations or mutation combinations have been identified ( [2](#), [8](#), [60](#) ). These DNA changes are almost all missense mutations leading to single amino acid substitutions in the enzyme. Large deletions have not been identified, suggesting that complete absence of G6PD might be lethal ( [1](#) ). The mutations are located throughout the entire coding region of the gene ( [3](#) ). However, in class I variants associated with chronic hemolysis, mutations are clustered around exon 10, an area that governs the formation of the active G6PD dimer ( [3](#), [61](#) ). The correlation between the different biochemical variants, the site of genetic mutation, and the extent of hemolysis is a matter of current investigation ( [1](#), [3](#), [61](#), [62](#) and [63](#) ). An interesting example of how molecular biology has enhanced our understanding relates to G6PD A-, once believed to be a single unstable variant found in blacks throughout the world. However, molecular analysis now has demonstrated that G6PD A- may have more than one genotype. In all cases, there is a mutation at nucleotide 376 (A?G), which is also the nucleotide substitution characteristic of G6PD A+. In addition, the G6PD A- variants have a second mutation; in the majority of cases, it is at nucleotide 202 (G?A) ( [1](#), [64](#) ). A smaller fraction of G6PD A- subjects have the second substitution at nucleotide 680 (G?T) or at



nucleotide 968 (T?C) ( [65](#) ). Thus, the G6PD A<sup>-</sup> variant, once believed to be a single homogeneous mutation in Africans, now turns out to represent at least three different genotypes ( [1](#) ). Also, a number of G6PD variants originally described in non-Africans are now found to have one of the known G6PD A<sup>-</sup> mutations ( [Table 33.1](#) ). For example, G6PD Betica ( [66](#) ), a Spanish variant, and G6PD Matera ( [67](#) ), an Italian variant, have demonstrated base substitutions at nucleotides 202 and 376, identical to the common G6PD A<sup>-</sup> variant. They are examples, therefore, of G6PD A<sup>-</sup>. One subject with G6PD Betica had base substitutions at nucleotides 376 and 968, identical to the less common G6PD A<sup>-</sup> variant ( [66](#) ).

**TABLE 33.1. Biochemical, Epidemiologic, and Clinical Features of Select Glucose-6-Phosphate Dehydrogenase (G6PD) Variants**

| G6PD Variant Classification                                | Nucleotide Substitution | Amino Acid Substitution  | Population   | World Health Organization Classification |
|--|-------------------------|--------------------------|--|--|
| A <sup>-</sup> (Alabama, Betica, Ferrara, Septic)          | 202 G?A; 376 A?G        | 68 Val?Met; 126 Asn?Asp  | Africa, Italy, Spain, Canary Islands, Mexico           | 3  |
| A <sup>+</sup>   | 376 A?G                 | 126 Asn?Asp              | Africa   | 4  |
| A <sup>-</sup>   | 376 A?G; 680 G?T        | 126 Asn?Asp; 227 Asn?Asp | Africa, Spain, Canary Islands                          | 3  |
| A <sup>-</sup> (Betica, Selma)                             | 376 A?G; 968 T?C        | 126 Asn?Asp; 387 Arg?Cys | —  | 3  |
| Mahidol  | 487 G?A                 | 163 Gly?Asp              | Southeast Asia, China, Taiwan                          | 3  |
| Mediterranean, Birmingham, Cagili, Dallas, Panama, Sassari | 563 C?T                 | 188 Ser?Phe              | Italy, Greece, Saudi Arabia, Iran, Iraq, Israel, Egypt | 2  |
| Walter Reed, Iowa, Iowa City, Springfield Union            | 1156 A?G                | 386 Lys?Glu              | —  | 1  |
|  | 1360 C?T                | 454 Arg?Cys              | Philippines, Spain, Italy                              | 2  |
| Canton, Maewo  | 1376 G?T                | 459 Arg?Leu              | China, Taiwan  | 3  |
| Kaiping, Anant, Dhon, Petrichlike, Sapporolike             | 1388 G?A                | 463 Arg?His              | —  | 2  |

Modified from Beutler E. G6PD deficiency. *Blood* 1994;84:3613–3636; Beutler E. Glucose-6-phosphate dehydrogenase deficiency. *N Engl J Med* 1991;324:169–174; and Miwa S, Fujii H. Molecular basis of erythroenzymopathies associated with hereditary hemolytic anemia: tabulation of mutant enzymes. *Am J Hematol* 1996;51:122–132.

There are several other variants that appear clinically heterogeneous but have been found to be genetically more uniform. For example, G6PD Mediterranean involves many different ethnic groups, although most subjects have the same genetic defect, a single base substitution (C?T) at nucleotide 563 ( [66](#) , [67](#) and [68](#) ). Moreover, just as in the case of G6PD A<sup>-</sup>, many of the different biochemical variants have turned out to have the same molecular defect as G6PD Mediterranean ( [Table 33.1](#) ). Because leukocyte and platelet G6PD is regulated by the same gene as that of red cells, documentation of decreased activity in the white blood cells ( [69](#) , [70](#) and [71](#) ) and platelets ( [70](#) ) of deficient individuals is not surprising. Because of the normally short survival of leukocytes and platelets,

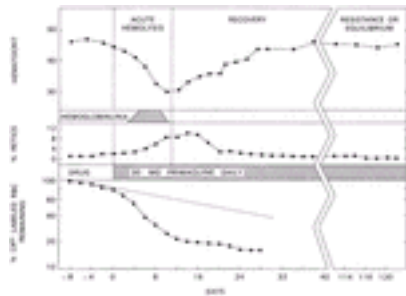
however, most individuals with G6PD deficiency do not manifest impairment of phagocytosis or bactericidal activity of granulocytes ( [70](#), [71](#) ). The exception to this occurs with class I G6PD deficiency, in which some affected individuals have neutrophil dysfunction and increased susceptibility to infection ( [72](#), [73](#) ).

**PATHOPHYSIOLOGY** As red cells age, the activity of G6PD declines exponentially. The normal enzyme (G6PD B) has an *in vivo* half-life of 62 days ( [57](#) ). Despite this loss of enzyme activity, normal old RBCs contain sufficient G6PD activity to generate NADPH and thereby sustain GSH levels in the face of oxidant stress. In contrast, the G6PD variants associated with hemolysis are unstable and have much shorter half-lives. The activity of G6PD A<sup>-</sup> in reticulocytes is normal, but it declines rapidly thereafter with a half-life of only 13 days ( [57](#), [74](#) ). The instability of G6PD Mediterranean is even more pronounced, with a half-life measured in hours ( [57](#) ). The clinical correlate of this age-related enzyme instability is that hemolysis in patients with G6PD A<sup>-</sup> generally is mild and limited to older deficient erythrocytes. In contrast, the enzymatic defect in G6PD Mediterranean is due to much greater enzyme instability, and RBCs of all ages are grossly deficient. Consequently, the entire RBC population of individuals with G6PD Mediterranean is susceptible to oxidant-induced injury, and this can lead to severe hemolytic anemia. G6PD-deficient erythrocytes exposed to oxidants (infection, drugs, fava beans) become depleted of GSH. This reaction is central to the cell injury in this disorder because once GSH is depleted, there is further oxidation of other RBC sulfhydryl-containing proteins. Oxidation of the sulfhydryl groups on hemoglobin leads to the formation of denatured globin or sulfhemoglobin. The latter form insoluble masses that attach to the red cell membrane by disulfide bridges; these are known as *Heinz bodies* ( [75](#) ). Also, with some class I variants, the oxidation of membrane sulfhydryl groups leads to the accumulation of membrane polypeptide aggregates, presumably due to disulfide bond formation between spectrin dimers and between spectrin and other membrane proteins ( [76](#), [77](#), [78](#) and [79](#) ). The end result of these changes is the production of rigid, nondeformable erythrocytes that are susceptible to stagnation and destruction by reticuloendothelial macrophages in the spleen and liver ( [80](#), [81](#) ). Both extravascular and intravascular hemolysis occurs in G6PD-deficient individuals, the latter giving rise to hemoglobinemia and hemoglobinuria. It should also be noted that some patients with unstable hemoglobinopathies also may manifest oxidant injury because these abnormal hemoglobins are inordinately susceptible to mild oxidant stress. In almost all cases, however, acute hemolysis with oxidant injury is due to G6PD deficiency.

**CLINICAL AND HEMATOLOGIC FEATURES** The clinical expression of G6PD variants encompasses a continuous spectrum of hemolytic syndromes. In most affected individuals, the deficiency state goes unrecognized, whereas in some it causes episodic or chronic anemia. The common clinical entities encountered are acute hemolytic anemia, favism, congenital nonspherocytic hemolytic anemia, and neonatal hyperbilirubinemia.

**Acute Hemolytic Anemia** With the most prevalent G6PD variants (G6PD A<sup>-</sup> and G6PD Mediterranean), severe hemolysis occurs only after exposure to certain offending agents. In the steady state, there is no anemia or alteration in blood morphology. Sudden destruction of enzyme-deficient erythrocytes is triggered by drugs having a high redox potential and by selected infectious or metabolic perturbations. The clinical and laboratory features of an acute hemolytic episode are best illustrated in a figure from a classic study with primaquine-induced hemolysis in subjects with G6PD A<sup>-</sup> ( [Fig. 33.3](#) ) ( [4](#), [5](#) ). After 2 to 4 days of primaquine ingestion, all the signs, symptoms, and laboratory results characteristic of an acute hemolytic episode are observed. Jaundice, pallor, and dark urine, with or without abdominal and back pain, are sudden in onset. An abrupt decrement of 3 to 4 g per dl in hemoglobin concentration occurs. Cell fragments, microspherocytes, and eccentrocytes, also referred to as “blister” or “bite” cells, are observed on blood smears. In response to anemia, red cell production increases; an increase in reticulocytes is apparent within 5 days and is maximal by 7 to 10 days after onset of hemolysis. Despite continued drug exposure, the acute hemolytic process ends spontaneously after approximately 1 week, and the hemoglobin concentration thereafter returns to normal

levels. The anemia is self-limited because the old susceptible population of erythrocytes is replaced by younger RBCs with sufficient G6PD activity to withstand an oxidative assault. Although red cell survival remains shortened as long as use of the drug continues, compensation by the erythroid marrow effectively abolishes the anemia in subjects with G6PD A-. In contrast, hemolysis occurring with the G6PD Mediterranean variant is more severe because this variant has a very short intraerythrocytic half-life, and thus a larger population of circulating erythrocytes is vulnerable to injury (82). Hemolytic crises occur in heterozygous female subjects, as well as in hemizygous male patients. In virtually all cases, acute hemolytic episodes are due to administration of drugs or are associated with infection or fava bean exposure.



**Figure 33.3.** The course of primaquine-induced hemolysis in the glucose-6-phosphate dehydrogenase A- variant. RBC, red blood cell. (From Alving A, et al. Mitigation of the haemolytic effect of primaquine and enhancement of its action against exoerythrocytic forms of the Chesson strain of *Plasmodium vivax* by intermittent regimens of drug administration. Bull World Health Organ 1960;22:621-631, with permission.)

**Drug-Induced Hemolysis** Primaquine is but one of several drugs that can precipitate hemolysis. The common denominator of these drugs is their interaction with hemoglobin and oxygen, thus accelerating the intracellular formation of  $H_2O_2$  and other oxidizing radicals. The published lists of suspect drugs are lengthy; however, many of the putative hemolytic agents were incriminated before it was recognized that infections often mimic the adverse effects of drugs. Consequently, many hemolytic events previously ascribed to drugs may, in fact, have resulted from infections for which drugs were given. Aspirin is such a drug, and it now is recognized that it can safely be given to individuals with class II and III G6PD variants. Some drugs and chemicals, however, are predictably injurious for all G6PD-deficient subjects (1, 6), and these agents are listed in Table 33.2. Other drugs, although producing a modest shortening of survival of G6PD-deficient red cells, can be given safely in usual therapeutic doses to individuals with class II and III G6PD variants (Table 33.2). Ascorbic acid is safe in usual therapeutic doses, although large amounts may pose problems (83). Similarly, acetaminophen (Tylenol), aminoptyrine, sulfoxazole (Gantrisin), sulfamethoxazole, and vitamin K can be given safely in usual therapeutic doses (6).

**TABLE 33.2. Drugs and Chemicals Associated with Hemolysis in Glucose-6-Phosphate Dehydrogenase (G6PD) Deficiency**

Unsafe (class I, II, and III G6PD variants)

- Acetanilid
- Furazolidone (Furoxone)
- Methylene blue
- Nalidixic acid (NegGram)
- Naphthalene (Mothballs)
- Nitrofurantoin (Furadantin)
- Phenazopyridine (Pyridium)
- Phenylhydrazine

Primaquine  
Sulfacetamide  
Sulfamethoxazole (Gantanol)  
Sulfanilamide  
Sulfapyridine  
Thiazolsulfone  
Toluidine blue  
Trinitrotoluene (TNT)

Safe in usual therapeutic doses (class II and III G6PD variants) <sup>a</sup>

Acetaminophen  
Ascorbic acid  
Aspirin  
Chloramphenicol  
Chloroquine  
Colchicine  
Diphenhydramine  
Isoniazid  
Phenacetin  
Phenylbutazone  
Phenytoin  
Probenecid  
Procainamide  
Pyrimethamine  
Quinidine  
Quinine  
Streptomycin  
Sulfamethoxypyridazine  
Sulfisoxazole  
Trimethoprim  
Tripeleminamine  
Vitamin K

<sup>a</sup> Safety for class I G6PD variants is not known.

Modified from Beutler E. G6PD deficiency. *Blood* 1994;84:3613–3636; and Beutler E. Glucose-6-phosphate dehydrogenase deficiency. *N Engl J Med* 1991;324:169–174.

---

**Infection-Induced Hemolysis** Infection is probably the most common factor inciting hemolysis ( <sup>84</sup>, <sup>85</sup> ). Approximately 20% of G6PD-deficient subjects with pneumonia experience an abrupt drop in hemoglobin concentration ( <sup>84</sup> ). In a study of the role of G6PD deficiency in the anemia associated with acute infection, 12 of 17 black patients with infection and anemia were found to have G6PD deficiency ( <sup>26</sup> ). A variety of infectious agents have been implicated: salmonella ( <sup>86</sup>, <sup>87</sup> and <sup>88</sup> ), *Escherichia coli* ( <sup>84</sup> ), β-hemolytic streptococci ( <sup>89</sup> ), and rickettsiae ( <sup>90</sup> ). Hemolysis is particularly prominent in G6PD-deficient subjects with viral hepatitis ( <sup>88</sup>, <sup>91</sup>, <sup>92</sup> ). The accelerated destruction of red cells imposes a bilirubin load on an already damaged liver, resulting in an exaggerated increase in serum bilirubin level. Despite the magnitude of bilirubin retention, however, convalescence is generally complete and uneventful. Although hemolysis triggered by infection characteristically is mild, on rare occasions, acute renal failure secondary to massive intravascular hemolysis has been observed ( <sup>90</sup>, <sup>91</sup> ). The mechanism for

destruction of G6PD-deficient red cells during infection is not known. One possible explanation for this relationship is that oxidants generated by phagocytosing macrophages may diffuse into the extracellular medium, where they pose an oxidative threat to G6PD-deficient erythrocytes ( 93 ).

**Hemolysis Associated with Diabetic Acidosis** Diabetic ketoacidosis rarely is associated with triggering destruction of G6PD-deficient red cells ( 94 ). Correction of acidosis and restoration of glucose homeostasis reverse the hemolytic process. Changes in blood pH, glucose ( 95 ), and pyruvate ( 96 ) have been proposed as possible mechanisms for hemolysis. Also, occult infection may be a common trigger for inducing both acute hemolysis and diabetic acidosis.

**Favism** That exposure to the fava bean ( *Vicia faba*, broad bean) is toxic and potentially fatal for some individuals has been known, allegedly, since the time of Pythagoras. Subsequent investigation revealed that individuals made ill by the fava bean invariably are deficient in G6PD ( 97 ). Unlike other agents capable of inducing hemolysis, the fava bean is toxic for only a few G6PD-deficient individuals. The variant most frequently implicated is G6PD Mediterranean and, as a result, favism is encountered most commonly in Italy, Greece, and the Middle East ( 1, 98 ). It also is found in Asia ( 33 ) and other areas to which this gene mutation has traveled. It is of particular interest that Africans and African Americans with G6PD deficiency are much less susceptible, although hemolytic episodes have been reported ( 99 ). Most cases of favism result from ingestion of fresh beans. Consequently, the peak seasonal incidence of this disorder (April and May) coincides with harvesting of the bean ( 100 ). Hemolysis of comparable severity can follow consumption of dried beans. The syndrome has been observed in nursing infants of mothers who have eaten the beans ( 100 ), as well as in a newborn infant whose mother had eaten fava beans 5 days before delivery ( 101 ). Enzyme deficiency was held responsible for fatal hydrops fetalis in the male infant of a hematologically normal Chinese woman who ingested fava beans during the final month of pregnancy ( 102 ). Moreover, inhalation of pollen from the fava plant has been incriminated ( 103 ). Favism occurs most commonly in children between the ages of 1 and 5 years. As with other clinical manifestations of G6PD deficiency syndromes, it is seen primarily in males, although it also can occur in females with severe enzyme deficiency. Symptoms of acute intravascular hemolysis occur within 5 to 24 hours of ingestion of the bean. Headache, nausea, back pain, chills, and fever are followed by hemoglobinuria, anemia, and jaundice. The drop in hemoglobin concentration is precipitous, often severe, and may require a red cell transfusion. Favism does not occur in all susceptible G6PD-deficient individuals ( 104 ), and it is believed that additional genetic factors are involved, presumably related to how fava bean oxidants are metabolized. Furthermore, the reaction to the fava bean by the same individual at different times may not be consistent ( 100 ). Clearly, a factor other than enzyme deficiency is operative. Two pyrimidine aglycones, divicine and isouramil, have been implicated as the toxic components of fava beans ( 105, 106 ). Both compounds rapidly overwhelm the GSH-generating capacity of G6PD-deficient cells and reproduce many of the metabolic derangements noted during hemolytic episodes ( 107 ). To date, however, there are no convincing data to explain the erratic hemolytic episodes seen in favism.

**Chronic Nonspherocytic Hemolytic Anemia** A small fraction of G6PD-deficient individuals have chronic life-long hemolysis in the absence of infection or drug exposure. These class I G6PD variants are extremely heterogeneous with respect to biochemical kinetics but have in common very low *in vitro* activity, marked instability, or both ( 61 ). Over 90 different G6PD variants have been identified on the basis of their biochemical properties ( 51 ), whereas 61 have been characterized at a molecular level ( 61 ). As noted previously, most of these variants have DNA mutations at exon 10, an area that affects monomer-dimer interactions and thereby enzyme activity ( 61 ). The hemolytic anemia associated with class I variants is indistinguishable from the congenital nonspherocytic hemolytic syndromes related to glycolytic enzyme deficiencies. Anemia and jaundice often



are noted first in the newborn period. Hyperbilirubinemia often necessitates exchange transfusion. Typically, hemolysis occurs in the absence of a recognized triggering factor, although exposure to drugs or chemicals with oxidant potential exaggerates an already established hemolytic process. Beyond infancy, signs and symptoms of the hemolytic disorder are subtle and inconstant. Pallor is observed infrequently, scleral icterus is noted intermittently, and rarely the spleen is enlarged. As with other chronic hemolytic anemias, the course may be complicated by parvovirus-induced aplastic crises. A temporary arrest of erythropoiesis, usually associated with a febrile illness, is attended by an abrupt drop in hemoglobin concentration. Often such a "crisis" is the event that first leads to examination of the blood. Exaggeration of anemia occurs after exposure to drugs with oxidant properties, even those that are safe for individuals with class II and III G6PD variants. Hemolysis also can be accelerated with exposure to fava beans ([108](#)). No hematologic alterations of the class I variants are distinctive. The hemolytic process may be fully compensated, although mild to moderate anemia is the rule (hemoglobin, 8 to 10 g per dl). Under basal conditions, the usual reticulocyte count is 10 to 15%. Splenectomy generally is of little benefit ([109](#)). In a few instances, leukocyte dysfunction due to G6PD deficiency has been described in severely deficient patients ([72](#), [73](#), [110](#)). The abnormality is characterized functionally by defective bactericidal activity (but normal chemotaxis and phagocytosis) and clinically by recurrent infections with catalase-positive organisms. Overall, however, clinical infections are not a major problem in G6PD deficiency.

**Neonatal Hyperbilirubinemia** Hemolysis, hyperbilirubinemia, or both resulting from G6PD deficiency are well documented in the newborn period ([111](#)) and may occur *in utero* ([112](#)). At particular risk are those neonates with the rare class I G6PD variants. Close monitoring of serum bilirubin levels in infants known to be G6PD deficient is warranted ([112](#), [113](#) and [114](#)). From a practical perspective, however, neonatal hyperbilirubinemia is seen with the more common G6PD Mediterranean (class II) and also has been reported in enzyme-deficient infants from both Greece ([115](#), [116](#)) and Italy ([117](#)). An increase in the incidence of neonatal hyperbilirubinemia also is seen in Southeast Asia ([33](#), [118](#)) and China ([119](#)); a significant fraction in China is associated with G6PD Canton ([120](#)). African-American infants with G6PD A- (class III) appear to be at minimal risk, whereas African and Jamaican black infants have an increased incidence of neonatal hyperbilirubinemia ([121](#), [122](#) and [123](#)). Moreover, in the latter group, untreated hyperbilirubinemia often leads to kernicterus with severe neurologic injury or death ([123](#), [124](#)). Because black Africans and African Americans have the same G6PD A- genotypes, the adverse outcomes in Africa are believed to relate to local customs and differences in oxidant exposure. Another example suggesting that local environmental variables are probably important is the observation that the incidence of hyperbilirubinemia in G6PD-deficient infants born in Australia to Greek immigrants is lower than that noted in deficient infants in Greece ([125](#)). Herbs used in traditional Chinese medicine and clothing impregnated with naphthalene also are examples of covert oxidants to which susceptible infants may be exposed. Moreover, drugs (e.g., sulfonamides), chemicals (e.g., ascorbate), and fava bean ingestion by mothers in late gestation have been implicated as the inciting stimulus of hemolysis in newborns ([102](#), [126](#)). Although the cause of hyperbilirubinemia in G6PD-deficient infants sometimes reflects accelerated red cell breakdown ([111](#), [123](#), [127](#)), often there is no obvious RBC destruction or oxidant exposure, and it has been suggested that hyperbilirubinemia may have another etiology, possibly related to impaired liver clearance of bilirubin. In support of this hypothesis are the observations that carboxyhemoglobin production, a marker of hemolysis or RBC breakdown, is the same in G6PD Mediterranean-deficient neonates with or without hyperbilirubinemia ([128](#)). It is now believed that the variable degree of hyperbilirubinemia in G6PD-deficient neonates reflects the presence or absence of the variant form of uridine-diphosphoglucoronylsyl-transferase responsible for Gilbert syndrome ([112](#)). The relative importance of the latter is underscored by the observation that most jaundiced G6PD-deficient neonates are not anemic and that evidence for increased bilirubin

production secondary to hemolysis often is lacking ( [129](#) ).

**DIAGNOSIS** Because of its prevalence and worldwide distribution, G6PD deficiency should be given serious consideration in the differential diagnosis of any nonimmune hemolytic anemia. Most commonly, anemia is first recognized during or after an infectious illness or after exposure to one of several suspect drugs or chemicals. Clinical and hematologic features reflect the severity of hemolysis but are not themselves specifically from G6PD deficiency. Irregularly contracted erythrocytes (eccentrocytes with hemoglobin puddled to one side of the RBC) and “bite” cells are seen in the Wright-stained peripheral blood smear. Previously, these bite cells were considered a consequence of splenic removal of Heinz bodies. Now, however, it is recognized that these RBCs contain a coagulum of hemoglobin that has separated from the membrane, often leaving an unstained non-hemoglobin-containing cell membrane (i.e., having the appearance of a bite removed from the cell) ( [79](#) ). These morphologic alterations are a consequence of the oxidative assault on hemoglobin. Brilliant cresyl blue supravital stains of the peripheral blood may reveal Heinz bodies during hemolytic episodes. The specific diagnosis of G6PD deficiency is made by adding a measured amount of hemolysate to an assay mixture containing substrate (glucose-6-phosphate) and cofactor (NADP) and then spectrophotometrically measuring the rate of NADPH generation ( [130](#) ). Alternatively, a variety of screening tests that use hemolysate as a source of enzyme also can be used. The fluorescent spot test is the simplest, most reliable, and most sensitive of the screening methods ( [131](#) ). This test is based on the fluorescence of NADPH after glucose-6-phosphate and NADP are added to a hemolysate of test cells. Other screening methods detect NADPH generation indirectly by measuring the transfer of hydrogen ions from NADPH to an acceptor. In the methemoglobin reduction test ( [132](#) ), methylene blue is the acceptor used for the transfer of hydrogen from NADPH to methemoglobin, thereby facilitating its reduction. It is important to mention this test because, when combined with a technique for the elution of methemoglobin from intact cells, it can be used to detect relative G6PD sufficiency of individual RBCs ( [133](#) ), thereby detecting the carrier state with approximately 75% reliability. Regardless of the specific test used to detect G6PD deficiency, however, false-negative reactions occur if the most severe enzyme-deficient RBCs have been removed by hemolysis. This generally is not critical in testing male whites, but it certainly is a problem in diagnosing some white females and blacks of both sexes, especially during the reticulocytosis after acute hemolysis. In these cases, family members can be studied. An alternative approach to diagnosis is to wait until the hemolytic crisis is over and reevaluate the patient after the RBC mass is repopulated with cells of all ages (approximately 2 to 3 months).

**TREATMENT** Management of the patient with G6PD deficiency is determined by the clinical syndrome with which it is associated. Individuals having variants associated with acute hemolysis on rare occasions may have a significant fall in hemoglobin concentration requiring a RBC transfusion. This is more commonly the case in G6PD Mediterranean (class II) than in G6PD A- (class III). All affected individuals should avoid exposure to drugs known to trigger hemolysis. Pregnant and nursing women known to be heterozygous for the deficiency also should avoid ingestion of drugs with oxidant potential because some drugs gain access to the fetal circulation and to breast milk. If the indication for its use is sound, however, an offending drug justifiably may be given despite modest shortening of red cell survival. For example, primaquine can be safely given to individuals with the G6PD A- variant, provided it is started cautiously (15 mg/day or 45 mg once or twice weekly) and the blood count is monitored closely ( [134](#) ). The mild anemia caused by its administration is rapidly corrected by a compensatory erythropoietic effort and does not recur unless the dose of drug is escalated. Chronic nonspherocytic hemolytic anemia due to class I G6PD variants may require more active intervention. Exchange transfusion during the first week of life often is required to prevent bilirubin encephalopathy. Beyond the newborn period, anemia persists, but it rarely is of such severity as to require regular blood transfusions. During aplastic crises, however, transfusions may be life-saving. As with other syndromes resulting from G6PD deficiency, drugs capable of exaggerating hemolysis should be avoided. Splenectomy, although occasionally bringing about a modest



improvement in hemoglobin concentration ( [135](#) ), is generally without benefit ( [109](#) ). Because of its antioxidant properties, vitamin E has been proposed as a therapeutic agent ( [136](#) , [137](#) and [138](#) ), but subsequent evaluation of large doses of the vitamin failed to demonstrate an ameliorative effect on anemia ( [139](#) ). Therapy for neonatal hemolysis and hyperbilirubinemia resulting from G6PD deficiency includes the following: phototherapy or exchange transfusion to prevent kernicterus, RBC transfusion for symptomatic anemia, removal of potential oxidants that may be contributing to hemolysis, and treatment of associated infections. In infants known to be G6PD deficient, prevention of severe hyperbilirubinemia by administration of a single intramuscular dose of Sn-mesoporphyrin, an inhibitor of heme oxygenase, is highly effective and safe ( [140](#) ). A study from Nigeria has reported a much poorer outcome for G6PD-deficient infants born at home, presumably a reflection of delayed identification and treatment of hyperbilirubinemia in these neonates ( [123](#) ). In the United States, there is concern that changes in health care delivery that include early discharge of newborn infants may have similar consequences. In support of this is the report of four newborn infants with G6PD deficiency (three African-American and one mixed Peruvian/Chinese) who developed kernicterus after early hospital discharge ( [141](#) ). This report is disturbing because kernicterus in the United States has been rare in recent years and because the adverse outcomes in these four cases occurred despite adherence to the early neonatal discharge guidelines of the American Academy of Pediatrics and the American College of Obstetricians and Gynecologists.

**SCREENING** Generalized screening for G6PD deficiency does not exist because most common variants responsible for acquired hemolytic anemia pose little serious health hazard. It could be argued that certain Mediterranean populations, especially Kurdish Jews with a 60 to 70% incidence of G6PD deficiency, might benefit from knowing their G6PD status and thereby avoid obvious oxidant exposures. Also, neonatal screening for G6PD deficiency has been very effective in reducing the incidence of favism later in life in Sardinia ( [142](#) ) and other regions where this potentially fatal complication is common ( [111](#) ). In the United States, where the most common G6PD mutation is the A- variant found in African Americans (who are much less susceptible to favism and in whom life-threatening hemolytic episodes are rare), neonatal screening is not considered to be cost-effective. The class I G6PD variants associated with chronic hemolysis are so rare as to render screening impractical. Similarly, prenatal diagnosis using molecular techniques is potentially available, but the benign course of most G6PD variants has precluded its development ( [143](#) ). Routine blood bank screening likewise appears to be unwarranted, and G6PD deficiency is not considered a problem in transfusion medicine. Even in areas where G6PD deficiency is endemic, screening of blood donors is not required. One careful evaluation of the recipients of G6PD-deficient blood uncovered no deleterious consequences ( [144](#) ). However, patients receiving G6PD Mediterranean blood may have an increased serum bilirubin and lactate dehydrogenase (LDH) concentration after transfusion, and this can be confused with a transfusion reaction ( [145](#) ). In premature infants, simple transfusions with G6PD-deficient red cells have been associated with hemolysis and severe hyperbilirubinemia requiring exchange transfusion ( [146](#) ). Also, massive intravascular hemolysis has occurred in an Indian neonate after an exchange transfusion with G6PD-deficient blood ( [147](#) ). In view of these occurrences, it has been recommended that, in areas where G6PD deficiency (presumably class II variants) is common, donor blood should be screened for the enzyme before transfusing premature infants ( [146](#) ) or using the blood for a neonatal exchange transfusion ( [147](#) ). This recommendation currently is not standard blood-banking practice.

## Related Disorders of Hexose Monophosphate Shunt and Glutathione Metabolism

In addition to G6PD, other enzymes of the HMP shunt pathway [6-phosphogluconate dehydrogenase (6PGD)], the closely linked reactions of glutathione metabolism

(GSSG-Red, GSH-Px), and the glutathione synthetic pathway are important in protecting RBCs against oxidant injury. Rare abnormalities in several of these enzymes have been reported, and, in some cases, they are associated with hemolysis.

**6-Phosphogluconate Dehydrogenase Deficiency** The enzyme 6PGD catalyzes the conversion of 6-phosphogluconate to pentose-5-phosphate ( Fig. 33.2), and, in the process, NADPH is generated from NADP. Although deficiency of 6PGD is well documented, it appears to have little or no significance for red cell viability. Presumably, this reflects the fact that NADPH is generated by the proximal enzyme, G6PD, suggesting that the second dehydrogenase may not be necessary for cell integrity. A mutant 6PGD (the "Whitechapel" variant) is transmitted as an autosomal-recessive trait. Heterozygotes have one-half normal activity and are asymptomatic ( 148, 149). Homozygotes have only 2 to 5% normal enzyme activity, but there rarely are hematologic or other clinical expressions of the enzyme deficiency ( 150, 151).

**GLUTATHIONE REDUCTASE DEFICIENCY** GSSG is reduced in the presence of NADPH by glutathione reductase (GSSG-Red) ( Fig. 33.2). The amino acid sequence of the purified enzyme has been determined ( 152). It contains flavin adenine dinucleotide as a prosthetic component, and, as a result, normal enzyme activity is dependent on the dietary availability of riboflavin. Not surprisingly, partial GSSG-Red deficiency is a relatively common feature of disorders that are compounded by suboptimal nutrition ( 153). GSSG-Red levels are restored within days by the administration of physiologic quantities of riboflavin ( 154). The association between riboflavin-induced GSSG-Red deficiency and various disease states is of no hematologic consequence ( 154, 155). Genetically determined GSSG-Red deficiency has been documented in three siblings who were offspring of a consanguineous marriage ( 156). Enzyme activity was not enhanced by incubation of hemolysates with flavin adenine dinucleotide. Despite near absence of erythrocyte GSSG-Red activity, the siblings were hematologically normal, except for episodes of hemolysis after the ingestion of fava beans. Very low activity of GSSG-Red was found also in leukocytes, but no increased susceptibility to infection was noted ( 157). Two of the siblings acquired cataracts at an early age. During the past 20 years, there have been no new reports of hereditary GSSG-Red deficiency associated with hemolysis.

**GLUTATHIONE PEROXIDASE DEFICIENCY** GSH-Px catalyzes the oxidation of GSH by peroxides, including hydrogen peroxide and organic hydroperoxides ( Fig. 33.2). Rare cases of hemolysis in association with moderate deficiency of erythrocyte GSH-Px activity have been described in adults and children ( 158, 159 and 160). Of all the reported cases suggesting a relationship between hemolysis and GSH-Px deficiency, one of the most persuasive was that of a 9-month-old Japanese girl with chronic nonspherocytic hemolytic anemia ( 161). This patient's erythrocyte GSH-Px activity was 17% of control activity, whereas her hematologically normal parents had 51 to 66% of control enzyme activity. However, it is not known whether this specific enzyme defect was responsible for the patient's chronic hemolytic anemia. The general consensus today is that GSH-Px deficiency is probably not a cause of hemolysis or other hematologic problems. The reason for this opinion is that many healthy normal individuals, particularly those of Jewish or Mediterranean ancestry, have reduced GSH-Px activity without evidence of hemolysis ( 162). Moreover, low GSH-Px activity in the absence of hemolysis also is observed in normal people from New Zealand with selenium deficiency (selenium being an integral part of GSH-Px) ( 163, 164). In view of these observations, the putative role of GSH-Px deficiency as a cause of hemolysis is being questioned. Some argue that GSH-Px is only one of the cellular mechanisms available to detoxify peroxides. Under physiologic conditions, catalase and nonenzymatic reduction of oxidants by GSH also may be important factors regulating the rate of H<sub>2</sub>O<sub>2</sub> detoxification. From a clinical perspective, however, because of the controversial role of GSH-Px as a cause of hemolysis, any patient with hemolytic anemia and reduced GSH-Px activity should also be evaluated for another enzymopathy. Levels of GSH-Px in the erythrocytes of healthy

newborn infants are approximately one-half those seen in older children and adults ( [165](#) ). Adult levels generally are achieved by 6 to 10 months of age. GSH-Px deficiency has been incriminated as a cause for neonatal jaundice ( [166](#) ), although a relationship between GSH-Px levels and magnitude of bilirubinemia has not been identified in prospective studies. When cord RBCs are stressed with peroxide under conditions preventing regeneration of GSH, the amount of GSH oxidized is similar for cord and adult erythrocytes ( [167](#) ). Low GSH-Px activity in cord RBCs thus appears to be without functional significance.

**DEFECTS IN GLUTATHIONE SYNTHESIS** Glutathione is actively synthesized in RBCs and has an intracellular half-life of only 4 days, in part due to cellular efflux of GSSG. RBCs are capable of *de novo* GSH synthesis, and this is accomplished by two critical enzymes ( [Fig. 33.2](#) ).  $\gamma$ -Glutamyl-cysteine synthetase ( $\gamma$ -GCSynth) catalyzes the first step in GSH synthesis, the formation of  $\gamma$ -glutamyl-cysteine from glutamic acid and cysteine. Glutathione synthetase (GSHSynth) catalyzes the formation of GSH from glutamyl-cysteine and glycine. In many tissues, but not in RBCs, these two enzymes are part of the  $\gamma$ -glutamyl cycle, which is involved with the synthesis and degradation of GSH and is also believed to have a role in amino acid transport across cell membranes. Hereditary hemolytic anemia, characterized by reduced GSH content, has been reported in patients with deficiencies of both  $\gamma$ -GCSynth and GSHSynth activity. The clinical effects of these disorders depend on the severity of enzyme deficiency and whether the  $\gamma$ -glutamyl cycle also is affected in nonerythroid tissues.

***$\gamma$ -Glutamyl-Cysteine Synthetase Deficiency***  $\gamma$ -GCSynth is a rare hemolytic anemia that was first described in two adults who were brother and sister ( [168](#) ). Both of these patients had a life-long history of mild hemolytic anemia, intermittent jaundice, cholelithiasis, and splenomegaly. They also manifested severe neurologic dysfunction and generalized aminoaciduria ( [169](#) ). This disorder appeared to be an autosomal-recessive condition, and, in the family studied, presumed carriers had reduced  $\gamma$ -GCSynth activity, although erythrocyte GSH levels were normal. Hemolytic anemia was seen only in the homozygous state in which erythrocyte GSH levels were approximately 5% of normal, and there was markedly reduced  $\gamma$ -GCSynth activity. A second patient with  $\gamma$ -GCSynth deficiency, unrelated to the first cases, was a 22-year-old woman with markedly reduced RBC GCSynth activity, severely reduced erythrocyte GSH concentration, and chronic hemolytic anemia ( [170](#) ). Family members of this patient had 50% reduced enzyme activity but no decrease in RBC glutathione content or evidence of hemolysis. Of particular interest, in contrast to the first patients described with GCSynth deficiency, this patient had no neurologic disease. Subsequently, there have been reports of a few other affected families with  $\gamma$ -GCSynth deficiency manifested by hemolytic disease without neurologic involvement; the molecular defect in these cases was associated with different missense mutations ( [171](#), [172](#) ). There is no specific therapy for GCSynth deficiency, although it would seem prudent to obtain periodic gallbladder ultrasound examinations because affected patients have had cholecystectomies.

***Glutathione Synthetase Deficiency*** GSHSynth deficiency has been incriminated as the cause of chronic hemolytic anemia alone (due to isolated RBC enzyme deficiency) and as the cause of a generalized syndrome (due to enzyme deficiency in many tissues) characterized by mild hemolytic disease, severe metabolic acidosis, and mental deterioration. The first syndrome, mild hemolytic anemia and intermittent jaundice, has been described in several families ( [173](#), [174](#), [175](#), [176](#), [177](#), [178](#), [179](#) and [180](#) ). Exposure to oxidant drugs and to fava beans has occasioned temporary acceleration of hemolysis. Splenomegaly has been noted in approximately one-half of the reported cases. A concurrent deficiency of glutathione S-transferase (GSH-ST) is believed to be caused by the instability of this enzyme in the absence of adequate intracellular GSH ( [173](#) ). The second, more generalized syndrome is characterized by mild hemolytic anemia, persistent metabolic acidosis presenting in the newborn period, and progressive cerebral and cerebellar degeneration ( [179](#), [181](#), [182](#) ). The latter is characterized pathologically by atrophy of the granular cell layer of the cerebellum and focal lesions in the cortex and

thalamus ( [183](#) ). Acidosis is caused by the accumulation of 5-oxoproline, a metabolic product of  $\gamma$ -glutamyl-cysteine. Abnormally large quantities of the dipeptide are produced because of the loss of feedback inhibition of  $\gamma$ -GCSynth by GSH. This disorder is suspected in patients with hemolytic anemia and markedly reduced RBC GSH content. Virtually no GSHSynth activity is detected in homozygous deficient individuals ( [168](#) , [174](#) , [184](#) ). Rarely, therapy is required for the hematologic consequences of GSH deficiency. Exposure to drugs and chemicals with oxidant potential should be avoided by those individuals with chronic hemolytic anemia. In some cases, splenectomy has been efficacious in modifying the anemia, although hemolysis may continue as manifested by persistent reticulocytosis ( [177](#) , [180](#) ). In those individuals with GSHSynth deficiency and oxoprolinemia, oral sodium citrate administration is necessary to control acidosis ( [182](#) ).

**Glutathione S-Transferase Deficiency** GSH-ST conjugates GSH with electrophilic xenobiotics to detoxify them. The enzyme may play a role in the active transport of GSH-xenobiotic conjugates from the red cell. Isolated deficiency of GSH-ST was detected in an adult man with mild hemolytic anemia and splenomegaly ( [185](#) ). Because family members were not available for study, a causal relationship between the GSH-ST deficiency and hemolysis could not be established. The significance of this enzyme deficiency remains to be defined.

## DISORDERS OF GLYCOLYSIS: GENERAL CONSIDERATIONS

Hemolytic anemias due to glycolytic enzymopathies are relatively rare, affecting only a few thousand individuals ( [8](#) , [186](#) , [187](#) ) in contrast to G6PD deficiency, which affects millions throughout the world. Abnormalities in virtually every glycolytic enzyme have been described, although over 90% of cases associated with hemolysis are due to pyruvate kinase (PK) deficiency ( [Fig. 33.4](#) ). Most glycolytic enzymopathies manifest an autosomal-recessive pattern of inheritance. Heterozygotes are almost always hematologically normal, although their RBCs contain less than normal levels of enzyme activity. It once was believed that hemolysis occurred only in those individuals who were homozygous for the enzyme deficiency. However, true homozygosity for a given mutant enzyme now is known to be less common and is usually restricted to consanguineous kindred. The vast majority of cases of hemolytic anemia due to glycolytic enzyme deficiencies are a consequence of double heterozygosity for two different enzyme variants, and this accounts for the diverse biochemical and clinical heterogeneity of the red cell glycolytic enzymopathies. The one exception to this autosomal mode of inheritance for glycolytic enzymopathies is phosphoglycerate kinase (PGK) deficiency, which is an X-linked disorder.



**Figure 33.4.** Overall metabolic pathway of glycolysis in the erythrocyte. Enzymes are shown in boxes. ADP, adenosine diphosphate; ATP, adenosine triphosphate; DHAP, dihydroxyacetone phosphate; DPG, diphosphoglycerate; DPGM, diphosphoglycerate mutase; DPGP, diphosphoglycerate phosphatase; G-3-P, glyceraldehyde-3-phosphate; G-3-PD, glyceraldehyde-3-phosphate dehydrogenase; GPI, glucosephosphate isomerase; HK, hexokinase; NAD, nicotinamide adenine dinucleotide; NADH, reduced nicotinamide adenine dinucleotide; PEP, phosphoenolpyruvate; PFK, phosphofructokinase; PG, phosphoglycerate; PGK, phosphoglycerate kinase; PGM, phosphoglycerate mutase; PK, pyruvate kinase; LDH, lactate dehydrogenase; TPI, triose phosphate isomerase.

Clinical manifestations of hemolysis due to glycolytic enzymopathies include chronic anemia, reticulocytosis, and some degree of hyperbilirubinemia. In the vast majority of cases, the hemolytic process is recognized and diagnosed in childhood. Frequently, there is a history of neonatal jaundice, often requiring an exchange transfusion and rarely causing kernicterus. The magnitude of chronic anemia varies; there may be accelerated hemolysis with some nonspecific infections or transient aplastic crises associated with parvovirus infection. In some enzymopathies, such as PK deficiency, the adverse consequences are restricted to the erythrocyte. In other cases, such as in phosphofructokinase (PFK), aldolase, triose phosphate isomerase (TPI), and PGK deficiencies, hemolytic anemia is but one feature of multisystem disease ([Table 33.3](#)).

**TABLE 33.3. Features of Glycolytic and Nucleotide Enzymopathies**

| Enzymopathy                | Approximate Fraction of Enzymopathies (%) <sup>a</sup> | Mode of Inheritance | Molecular Abnormalities Identified to Date (Reference) | Effects of Enzymopathy                      |
|----------------------------|--|---------------------|--|---|
| Hexokinase                 | <1   | AR                  | 2 ( <a href="#">262</a> , <a href="#">263</a> )        | Mild/severe CNSHA                           |
| Glucosephosphate isomerase | 3-5  | AR                  | 29 ( <a href="#">272</a> , <a href="#">278</a> )       | Moderate/severe CNSHA ± neurologic deficits |
| Phosphofructokinase        | <1   | AR                  | 15 ( <a href="#">303</a> )                             | Mild CNSHA ± myopathy                       |



|                            |       |                    |   |  |
|----------------------------|-------|--------------------|---|--|
| Aldolase                   | <1    | AR                 | 4 ( <a href="#">316</a> , <a href="#">317</a> , <a href="#">318</a> and <a href="#">319</a> ) | Mild/moderate CNSHA ± myopathy                     |
| Triose phosphate isomerase | <1    | AR                 | 14 ( <a href="#">325</a> )  | Moderate/severe CNSHA, neurologic deficits         |
| Phosphoglycerate kinase    | <1    | X-linked           | 14 ( <a href="#">302</a> )  | Mild/severe CNSHA ± neurologic deficits ± myopathy |
| Pyruvate kinase            | 80–90 | AR                 | 133 ( <a href="#">208</a> )   | Moderate/severe CNSHA                              |
| Pyrimidine 5' nucleotidase | 2–3   | AR                 | —   | Moderate CNSHA                                     |
| Adenosine deaminase excess | <1    | Autosomal dominant | —   | Mild CNSHA   |
| Adenylate kinase           | <1    | AR                 | 6 ( <a href="#">413</a> )   | CNSHA  |

AR, autosomal recessive; CNSHA, chronic nonspherocytic hemolytic anemia.

<sup>a</sup> Approximate estimates derived from references [186](#), [187](#), [266](#), and Mentzer W. Pyruvate kinase deficiency and disorders of glycolysis. In: Nathan DG, et al., eds. Hematology of infancy and childhood. Philadelphia: WB Saunders, 2003.

The possibility of a glycolytic defect usually is considered when chronic hemolytic anemia cannot be explained by the more common causes (i.e., hereditary spherocytosis or hemoglobinopathies). There are no specific morphologic abnormalities, although anisocytosis and poikilocytosis are common. In virtually all cases, a specific assay of RBC enzyme activity is necessary to make the diagnosis. Screening tests are readily available, but these have limited value when there is a partial deficiency or a mixed population of RBCs. A particular problem in identifying glycolytic enzymopathies relates to the fact that the most severely deficient cells are removed (i.e., hemolyzed), and the remaining cells may be biochemically less abnormal. Consequently, “false-negative” assays can obscure the correct diagnosis. For this reason, it is sometimes helpful to study parents and other family members for the presumed heterozygous state of the enzyme deficiency. In some cases, DNA-based molecular diagnostic tests may be available.

Therapy for RBC glycolytic defects is similar to that for other chronic hemolytic anemias. RBC transfusions often are indicated. Splenectomy usually is beneficial in severely anemic patients because the spleen (along with the liver) participates in the destruction of enzymatically abnormal cells. In most cases, however, the response to splenectomy is only partial, and hemolysis usually continues, although RBC transfusion requirements may decrease. Cholelithiasis is a common problem, and all patients with glycolytic enzymopathies should have periodic gallbladder ultrasound examinations, even after splenectomy. The biologic and clinical features of specific glycolytic disorders are summarized in the following paragraphs.

### Pyruvate Kinase Deficiency

Of the enzymatic deficiencies involving glycolysis, PK deficiency is the most common, the most extensively studied, and the first to be recognized. Over 400 cases have been reported ( [188](#), [189](#), [190](#), [191](#) and [192](#) ). Undoubtedly, there many more cases, because newly diagnosed patients currently are not reported unless there are unusual associated

findings.

**GEOGRAPHIC DISTRIBUTION** Most cases of PK deficiency have been reported from Northern Europe, the United States, and Japan; however, the disorder occurs worldwide ( [186](#), [189](#), [190](#) ). The frequency of the heterozygote state has been estimated on the basis of studies that screened various populations for low enzyme activity. In Germany and in the United States, the prevalence of apparent heterozygosity for PK deficiency has been estimated to be approximately 1% ( [189](#) ). In one report from Hong Kong, 3% of newborn infants were noted to be heterozygous for a PK variant ( [193](#) ). A particularly high frequency exists among the Pennsylvania Amish, in whom the disorder can be traced to a single immigrant couple ( [194](#), [195](#) and [196](#) ). In studies of the most common PK mutations found in a white population, a prevalence of PK deficiency has been estimated to be 51 per million population ( [197](#) ).

**BIOCHEMICAL GENETICS** PK catalyzes the conversion of phosphoenolpyruvate to pyruvate; this is one of the two glycolytic reactions resulting in net ATP production ( [Fig. 33.4](#) ). The enzyme is allosterically activated by fructose-1,6-diphosphate (FDP) and is inhibited by its product, ATP. PK is a tetrameric protein with a molecular weight of 230 kd. There are two different PK genes (PKM2 and PKLR), which encode for four distinct PK isozymes. The PKM2 gene has been cloned and assigned to chromosome 15 (15q22) ( [198](#) ); it encodes for two isozymes (PK-M2 and PK-M1). PK-M2 is the isozyme present in all tissues during fetal life. As fetal maturation proceeds, other tissue-specific PK isozymes begin to appear. PK-M2 persists as the predominant isozyme in mature leukocytes and certain other tissues (platelets, lung, kidney, spleen, adipose tissue). In addition, PK-M2 is the major isozyme in erythroid precursors ( [8](#) ). PK-M1, which differs from PK-M2 as a result of alternative splicing, is the PK isozyme present in mature muscle and brain tissue ( [199](#) ). The PKLR gene has been cloned and assigned to chromosome 1(1q21) ( [200](#) ); it also encodes for two isozymes (PK-L and PK-R). PK-L is the predominant isozyme in hepatocytes ( [201](#) ). PK-R is the isozyme present in mature erythrocytes ( [202](#), [203](#) ). The chemical differences between PK-L and PK-R are due to tissue-specific promoters. The hemolytic anemia associated with PK deficiency is due to mutations of the PKLR gene. In some patients with hemolytic anemia, a decrease in the liver PK-L isozyme has also been observed, but this is of no clinical significance because the liver also has residual PK-M2 activity ( [204](#), [205](#) and [206](#) ). During normal erythroid differentiation, the PK isozyme switches from the M2- to the R-type ( [8](#) ). It is of interest that in one severe form of PK deficiency (PK Beppu), PK-M2-type persists in mature erythrocytes, and it has been proposed that this compensatory PK-M2 production allows affected red cells to survive, analogous to the beneficial effect of persistent fetal hemoglobin production in homozygous  $\beta$ -thalassemia ( [8](#) ). At last report, 133 different mutations of the PKLR gene have been identified as causes of chronic hemolytic anemia ( [190](#), [207](#), [208](#) and [209](#) ). Most of these are missense mutations (approximately 70%), although a few are either nonsense or insertional mutations, deletions, or splicing abnormalities ( [8](#), [208](#) ). Most of the known PK mutations are very rare, occurring only once; however, three mutations are seen with some frequency ( [190](#) ). A significant fraction of affected whites (30 to 40%) have at least one 1529G>A mutation resulting in an amino acid change (510Arg>Gln) ( [209](#), [210](#) ). This particular mutation is found in the United States and in northern Europe. A second common mutation, 1456C>T (484Arg>Trp), is observed in Spain, Portugal, and Italy where it accounts for approximately 30% of all cases. However, in this area of southern Europe, the 1529G>A mutation is rare. A third common mutation, 1468C>T (Arg490>Trp), is found predominantly in the Eastern Hemisphere. The PK deficiency seen in the Amish population is associated with one mutation 1436G>A (479Arg>His) ( [196](#) ). The variable phenotypic expression of PK deficiency undoubtedly reflects the heterogeneity of these different PK mutants. At one time, PK deficiency was



believed to be a consequence of decreased production of a structurally normal enzyme, but it is now recognized that most PK variants are abnormal proteins that differ with respect to their biochemical kinetics and physical properties ( [211](#), [212](#) and [213](#) ). The heterozygous state for a PK variant is clinically silent. In a few cases, mild hemolytic disease has been attributed to heterozygosity for a single mutant PK enzyme ( [193](#), [213](#), [214](#) ); however, the diagnostic methods used do not exclude the possibility of a second PK mutant. There is little or no relationship between severity of hemolysis and the assessment of PK activity *in vitro* ( [8](#), [189](#) ). In part, this reflects the fact that *in vitro* assay conditions are very different from what exists *in vivo*. In addition, the presence of young RBCs with elevated enzyme activity can mask the presence of a very unstable PK variant, or there can be persistence of PK-M2 in mature RBCs ( [8](#), [215](#), [216](#) ). Moreover, because most individuals with PK deficiency are doubly heterozygous for two different PKLR mutants ( [8](#) ), the study of RBCs from affected subjects characterizes the mixture of PK variants without providing specific information about the individual enzymes. In the minority of individuals with homozygous disease, a relationship between defective PK enzymes and severity of hemolysis occasionally is apparent ( [192](#), [211](#), [212](#) ). The characteristics of PK variants associated with severe hemolysis in these presumed homozygotes include decreased affinity for phosphoenolpyruvate, increased inhibition by ATP, thermal instability, and impaired response to the allosteric activator FDP ( [211](#), [212](#), [217](#), [218](#) ). Clearly, the current molecular biology studies to identify PKLR mutations associated with PK deficiency should further clarify the relationship of gene structure and hemolysis ( [190](#) ).

**PATHOPHYSIOLOGY** PK deficiency results in impaired glucose utilization and, thereby, decreased pyruvate and lactate production. In addition, glycolytic intermediates proximal to the block accumulate in red cells, and the levels of 2,3-DPG may increase up to threefold ( [219](#), [220](#) ). The major impairment due to PK deficiency is a diminished capacity to generate ATP ( [221](#) ). Paradoxically, however, PK-deficient patients with high reticulocyte counts may have normal or even elevated levels of ATP ( [221](#) ). This occurs because PK-deficient reticulocytes generate ATP through mitochondrial oxidative phosphorylation, and this is associated with a six- to sevenfold increase in oxygen consumption compared to normal reticulocytes ( [221](#), [222](#) ). The advantage of oxidative phosphorylation for PK-deficient reticulocytes is that ATP can be generated, requiring minimal flow of pyruvate from glycolysis. When reticulocytes mature, however, mitochondria disappear, oxidative phosphorylation ceases, and ATP levels fall. The effects of this vary because there are marked cellular differences in the enzyme content of PK-deficient red cells. In severely PK-deficient RBCs, the fall in ATP leads to cell injury, although the precise ATP-dependent reactions leading to irreversible membrane injury are not known. In some cases, this injury is characterized by an increase in membrane calcium, accelerated potassium loss, decreased total monovalent cation content, and cellular dehydration ( [222](#) ). The end result of these changes is a loss of membrane plasticity and the formation of rigid RBCs marked for premature destruction in the spleen ( [223](#), [224](#) ). Those reticulocytes most deficient in PK are doomed to almost immediate extinction once they lose their mitochondria. Less severely deficient cells survive to a nearly normal age, their ATP needs satisfied despite marginal metabolic resources ( [222](#) ). This vulnerability of enzyme-deficient reticulocytes is seen in erythrokinetic studies, which demonstrate that reticulocyte-rich fractions of blood from PK-deficient subjects have a shorter survival than do reticulocyte-poor fractions ( [222](#), [224](#) ). Given the unique metabolic abnormalities of the PK-deficient reticulocyte, it is understandable why the spleen poses a problem for them. Because of their greater adhesive tendencies, reticulocytes endure a longer sojourn in the spleen ( [223](#), [224](#) ), where limited oxygen and glucose restrict effective oxidative phosphorylation ( [222](#) ). Impaired ATP production then leads to RBC destruction in the spleen or in the liver after escape from the spleen ( [223](#),

224). Because severely deficient reticulocytes are metabolically more stable in the absence of the spleen, an exaggerated and sustained reticulocytosis follows splenectomy (189). As noted previously, the concentration of 2,3-DPG may be up to three times normal (219). This increase is responsible for a rightward shift in the oxygen dissociation curve of hemoglobin. As a result, PK-deficient subjects have a greater exercise tolerance than would be expected from the degree of anemia (220).

**CLINICAL FEATURES** The clinical expression of PK deficiency is quite variable, ranging from hydrops fetalis (225, 226) to pronounced neonatal jaundice requiring multiple exchange transfusions (193, 227, 228) and occasionally complicated by kernicterus (194, 229) to a fully compensated hemolytic process detected as an incidental finding in adults (188). Unlike hemolysis associated with G6PD deficiency, the jaundice noted in PK-deficient infants invariably is associated with anemia and often with splenomegaly. The PK deficiency observed among the Pennsylvania Amish is particularly severe (194). Beyond the neonatal period, anemia of varying degree, jaundice, and splenomegaly characterize erythrocyte PK deficiency. There are no specific or distinguishing clinical characteristics of this disorder, and no tissues are affected besides the red cells. Anemia may be surprisingly well tolerated because of the increased red cell 2,3-DPG content, which is responsible for a rightward shift in the oxygen dissociation curve of hemoglobin. The clinical course may be complicated by aplastic crises, characterized by an abrupt but temporary arrest of erythropoiesis and a precipitous drop in hemoglobin concentration and reticulocyte count. These crises usually are related to infection with a parvovirus-like agent that is cytotoxic for erythroid progenitors (230, 231). After the first decade of life, gallstones are detected with increased frequency (189). Bone changes associated with hyperplastic bone marrow, such as those seen in thalassemia, occasionally may result in frontal bossing (232). Chronic leg ulcers occur rarely (233, 234). Pregnancy has been tolerated without unusual complications (221). Iron overload is a predictable complication of chronic transfusion therapy (234), but it may also occur in patients with limited or no history of transfusions (235, 236 and 237). Because hemosiderosis occurring in minimally transfused PK-deficient individuals is rare, it has been suggested that this may be due to coexistent inheritance of the more common hereditary hemochromatosis gene (235, 236).

**DIAGNOSIS** Anemia due to PK deficiency is moderate to severe in degree. The hemoglobin concentration characteristically is 6 to 12 g per dl (189). The peripheral blood reveals all the morphologic hallmarks of accelerated erythropoiesis: polychromatophilia, anisocytosis, poikilocytosis, and variable numbers of nucleated red cells. Irregularly contracted erythrocytes with surface spicules (238), tailed poikilocytes (221), and acanthocytes (229) have been observed in the smears of some affected individuals. Before splenectomy, the reticulocyte count may be increased (5 to 15%), but after splenectomy, reticulocyte counts as high as 70% occasionally are noted (189, 212). This is due to the longer survival of PK-deficient reticulocytes after splenectomy. The hematologic features of PK deficiency are not distinctive. The specific diagnosis rests on laboratory documentation. The once used autohemolysis test has no current use in the diagnosis of PK deficiency (239). Simple specific enzyme screening tests are available, but false-negative results are common because of the many different variant enzyme kinetics. In cases in which PK deficiency is suspected, a direct quantitative assay of the enzyme is essential. Leukocytes must be excluded from the system because the leukocyte PKM2 gene is not affected in hemolytic variants of PK deficiency, and the PK activity of white blood cells is 300 times that of normal red cells (240). Most deficient individuals have 5 to 25% of the normal mean activity. Heterozygous carriers of a PK variant have approximately one-half normal activity, although there is considerable overlap with normal. The biochemical heterozygote sometimes is difficult to detect. Recommended methods for the characterization of PK variants have been established by the International Committee for Standardization in Hematology (211). In patients, usually infants, who are

transfused before the enzyme disorder is recognized, the dilution of enzyme-deficient RBCs with transfused cells often makes it difficult to make the diagnosis based on chemical enzyme analysis. In these cases, molecular diagnostic techniques that require small amounts of DNA may become very useful ( [209](#) ). In families with a child with PK deficiency, the issue of prenatal diagnosis in subsequent pregnancies is a matter of concern. There is one report in which biochemical techniques were used successfully to assay for red cell PK deficiency at 30 weeks of gestation ( [241](#) ). However, because of the large volume of blood necessary to characterize the enzyme and distinguish PKLR and PKM gene products, biochemical enzyme assays most likely will have limited utility in the prenatal diagnosis of PK deficiency. For this reason, direct DNA analysis is preferred whenever possible ( [242](#) ). In one family in which both parents were heterozygotes for PK deficiency and the DNA defect was known, analysis of amniocytes indicated that the fetus was not involved ( [242](#) ). In another family with a known mutation, PK-deficiency was diagnosed on the basis of cord blood DNA studies ( [242](#) ). In the latter case, the family did not want prenatal testing, but the results indicate that a positive diagnosis of this disorder could have been made prenatally. Most assuredly, molecular diagnostic techniques for the prenatal diagnosis of PK deficiency will prove to be useful. In particular, this should be helpful in diagnosing those fetuses with the more common mutation described above, believed to account for 45% of cases of PK deficiency in non-Gypsy whites. The large number of cases of PK deficiency in Gypsies is associated with a unique deletional mutation that also could be used for molecular diagnosis ( [242](#) ). Acquired erythrocyte PK deficiency has been observed in patients with acute leukemia, preleukemia, and refractory sideroblastic anemia and after exposure to chemotherapy ( [243](#) , [244](#) ). The causes of acquired enzyme deficiency are multifactorial. In some cases, injury of bone marrow stem cells with disturbance of protein synthesis is likely, whereas in other cases a posttranslational modification of the enzyme may be responsible ( [243](#) ). In cases of acquired PK deficiency, the degree of enzyme deficiency is not severe enough to cause hemolytic anemia.

**TREATMENT** During the first years of life, severe anemia is managed with red cell transfusions. Maintenance of the hemoglobin concentration above 8 g per dl permits normal growth and development while minimizing the risk of life-threatening aplastic crises. The decision for transfusion therapy must relate to patient tolerance of anemia rather than an arbitrary level of hemoglobin. Because of increased red cell 2,3-DPG content, patients may tolerate moderately severe anemia with little problem ( [220](#) ). Splenectomy is useful for long-term control of anemia. However, because of the well-known risk of postsplenectomy sepsis due to *Streptococcus pneumoniae* in young children, surgery should be delayed until 5 years of age whenever possible. Preoperative assessment of red cell survival and splenic sequestration is of no value in selecting patients for splenectomy, and this in part reflects the importance of the liver as a site of red cell destruction. Splenectomy is followed by improvement, but not correction, of the hemolytic disorder ( [189](#) , [221](#) , [224](#) ). Transfusion requirements, if present before splenectomy, decrease or are eliminated. In almost all patients, an incompletely compensated hemolytic process with reticulocytosis, some degree of hyperbilirubinemia, and an ongoing risk for gallstone formation usually persist. A severe hemolytic anemia associated with PK deficiency in basenji dogs has been corrected by bone marrow transplantation ( [245](#) ). Similarly, marrow transplantation has been shown to be effective in mutant mice with splenomegaly and chronic hemolytic anemia due to PK deficiency ( [246](#) ). These successes with bone marrow transplantation in animals clearly indicate a possible role for this therapy in humans. There is one report of a 5-year-old boy with transfusion-dependent hemolytic anemia due to PK deficiency who received an HLA-identical bone marrow transplant from his sister; he is alive and well at 8 years of age without evidence of hemolysis ( [247](#) ). Despite the success in this one patient, in almost all cases of hemolytic anemia due to PK deficiency, the risk-benefit ratio currently remains weighted in favor of splenectomy over bone marrow transplantation. In the future,

this may change. Moreover, PK deficiency (as a single-gene defect, of recessive inheritance, affecting primarily one cell line, and being amenable to hematopoietic stem cell modification) is considered a candidate disease for gene therapy, and preliminary studies are in progress in this area ( [248](#) ). A variant associated with increased PK activity has been described. RBCs from affected family members displayed high levels of ATP and low levels of 2,3-DPG with an associated erythrocytosis ( [249](#) ).

## Other Glycolytic Enzymopathies

**Hexokinase Deficiency** Hexokinase (HK) catalyzes the conversion of glucose to glucose-6-phosphate ( [Fig. 33.4](#) ). As the first enzyme in the glycolytic pathway, HK has a strategic role in the regulation of glucose consumption. The activity of HK declines rapidly as red cells age, and, in older cells, HK activity is lower than that of any other glycolytic enzyme. Deficiency of HK is responsible for subnormal glucose consumption and lactate production ( [250](#) ). The concentrations of glycolytic intermediates and ATP are decreased ( [250](#), [251](#) ). The concentration of 2,3-DPG also may be low, and this has consequences on hemoglobin-oxygen affinity and work performance (see below). There are four HK isozymes, and each one is coded for by a different gene (HK1, HK2, HK3, HK4). The HK1 gene codes for the HK found in erythrocytes, and this gene maps to chromosome 10 ( [252](#), [253](#) and [254](#) ). Type I HK isozyme also is present in lymphocytes and platelets. However, deficiency of type I HK isozyme in lymphocytes is offset by an increase in the amount of type III isozyme ( [255](#) ). As with PK deficiency, deficient HK activity may result from quantitative deficiency of an apparently normal enzyme ( [251](#), [256](#) ) or from abnormalities that affect substrate affinity ( [250](#), [257](#), [258](#) ) or heat stability ( [259](#), [260](#) and [261](#) ). The molecular defect in HK deficiency has been identified in one individual with HK deficiency (HK Melzo) associated with chronic hemolytic anemia ( [262](#) ). In this mutation, one allele has a 96 bp deletion, whereas the other allele has a single base pair substitution causing a single amino acid substitution. In a Dutch family with HK deficiency (HK Utrecht) and hemolytic anemia, a missense mutation (2039C>G) also has been identified ( [263](#) ). Seventeen different kindred with HK deficiency have been described in families of European, Mediterranean, Scandinavian, and Asian background ( [251](#), [254](#), [256](#), [257](#) and [258](#) ). The inheritance pattern is consistent with an autosomal-recessive mode of transmission. In approximately 25% of reported cases, neonatal hyperbilirubinemia can occur and may require exchange transfusion ( [250](#), [256](#), [264](#) ). In many affected individuals, mild anemia or recurrent episodes of jaundice are not noted until after the first decade of life. Splenomegaly is common. Regular RBC transfusions may be required in severely affected patients ( [256](#) ). Splenectomy ameliorates but does not cure the hemolytic process ( [250](#), [256](#), [257](#) ). Symptoms may be out of proportion to the degree of anemia because low levels of erythrocyte 2,3-DPG reduce oxygen release to tissues at any given oxygen tension ( [220](#), [265](#) ). There are no unique RBC features associated with HK deficiency. The diagnosis rests on the assay of red cell HK activity. Because HK is among the most age dependent of red cell enzymes, its activity must be considered in relation to the reticulocyte count or the activity of other age-dependent enzymes ( [256](#) ).

**GLUCOSEPHOSPHATE ISOMERASE DEFICIENCY** Glucosephosphate isomerase (GPI) catalyzes the interconversion of fructose-6-phosphate and glucose-6-phosphate ( [Fig. 33.4](#) ). Although a very rare cause of hemolysis, GPI deficiency is the third most common enzymatic defect associated with hemolytic disease, exceeded only by deficiencies of G6PD and PK ( [266](#) ). Since the first description of the disorder in 1968 ( [267](#) ), approximately 50 cases have been reported ( [8](#), [268](#), [269](#), [270](#), [271](#) and [272](#) ). Just as in the case of PK deficiency, many more cases probably exist but are not published or listed in any rare disease registry. It is estimated that 0.2% of North Americans are heterozygous for a GPI mutant ( [273](#) ). The gene for GPI is located on chromosome 19, and it has been



isolated and sequenced ( [274](#), [275](#) ). Twenty-nine different gene mutations of GPI associated with hemolysis have been identified ( [8](#), [272](#), [276](#), [277](#) and [278](#) ). A single form of GPI is synthesized by all cells of the body; consequently, structural mutations of the enzyme are expressed in all tissues ( [270](#), [279](#) ). Because most mutations result in enzyme instability ( [280](#) ), the defect imposes functional compromise only in older mature erythrocytes. Both missense mutations and gene deletion have been described ( [272](#), [276](#), [281](#), [282](#) ). It is inherited in an autosomal-recessive manner. Obligate heterozygotes for mutant alleles are hematologically normal but have reduced red cell GPI activity. Symptomatic GPI deficiency results equally from homozygosity for a single mutant gene and compound heterozygosity for two different abnormal alleles ( [8](#), [276](#), [281](#), [283](#) ). Compared with normal red cells of similar age, GPI-deficient cells accumulate glucose-6-phosphate and are deficient in ATP and 2,3-DPG ( [279](#) ). Also, GPI-deficient RBCs are less able to support increased metabolic flow through the HMP shunt because fructose-6-phosphate must pass through the GPI reaction in reverse direction. An animal model of GPI deficiency in the mouse may help clarify the pathophysiology ( [284](#) ). The severity of hemolytic disease varies considerably. Hydrops fetalis with death in neonates has been reported ( [283](#), [285](#), [286](#) ), and anemia and hyperbilirubinemia complicate the postnatal course in many patients ( [270](#), [279](#) ). Chronic transfusion therapy may be required. As with other chronic hemolytic anemias, the clinical course may be complicated by aplastic and hyperhemolytic crises. Mental retardation and excessive stores of hepatic glycogen were noted in a single patient ( [283](#) ). Neuromuscular impairment (hypotonia, ataxia, dysarthria, mental retardation) occasionally has been seen, but only in five of the known variants ( [272](#) ). Splenectomy has eliminated or dramatically reduced the transfusion requirement in most patients ( [267](#), [269](#), [270](#), [273](#) ). Postsplenectomy hemoglobin concentrations are 8 to 10 g per dl. After splenectomy, reticulocyte counts may increase dramatically (50 to 75%) ( [273](#) ). Red cell morphology is characterized by anisocytosis, poikilocytosis, polychromatophilia, and often the presence of nucleated forms. Definitive diagnosis requires specific enzyme assay of a RBC hemolysate. Prenatal diagnosis of GPI by enzymatic assay of amniotic fluid cells was demonstrated in a kindred with unusually severe hemolytic disease ( [285](#) ). Antenatal diagnosis also is possible by direct enzyme assay of trophoblastic cells ( [287](#) ). Although several abnormal GPI mutations have been identified, to date there is no reported experience using molecular techniques for prenatal diagnosis.

**PHOSPHOFRUCTOKINASE DEFICIENCY** PFK catalyzes the phosphorylation of fructose-6-phosphate to FDP, and this is one of the rate-limiting reactions of glycolysis ( [Fig. 33.4](#) ). The PFK enzyme in RBCs is a tetrameric protein made up of varying combinations of muscle or M-type subunits, liver or L-type subunits, and platelet or P-type subunits ( [288](#), [289](#) and [290](#) ). Three different structural loci encode for these M, L, and P subunits of PFK. The M-type subunit is encoded for a gene on chromosome 1 ( [291](#) ), and this gene has been characterized ( [292](#) ) and cloned ( [293](#), [294](#) ). The L-type PFK subunit is encoded by a gene located on chromosome 21 ( [295](#) ), and the structural organization of this gene also has been characterized ( [296](#) ) and cloned ( [297](#) ). The gene encoding for the P subunits of PFK is located on chromosome 10 ( [298](#) ). The subunits are variably expressed in different tissues. Muscle and liver PFKs are composed exclusively of M<sub>4</sub> and L<sub>4</sub> tetramers, respectively. The RBC contains equal amounts of M and L subtypes, and all possible tetrameric variations are present (L<sub>4</sub>, L<sub>3</sub>M<sub>1</sub>, L<sub>2</sub>M<sub>2</sub>, L<sub>1</sub>M<sub>3</sub>, M<sub>4</sub>) ( [290](#) ). Neutrophil PFK is composed primarily of L<sub>4</sub> homotetramers, and platelet PFK consists of both P and L subunits. The variable structure of PFK in different tissues provides an explanation for the diversity of syndromes associated with deficiency states. These syndromes include chronic hemolytic disease with myopathy, hemolytic disease alone, and myopathy alone ( [299](#) ). The first PFK deficiency syndrome described was

characterized by congenital nonspherocytic hemolytic disease and myopathy (Tarui disease, glycogenosis type VII) ( [300](#), [301](#) ). More than 39 unrelated families have been identified ( [302](#) ). It is inherited as an autosomal-recessive disorder. The myopathy is characterized by muscle fatigue and cramping with exercise and pathologically by increased muscle glycogen ( [300](#) ). There is a mild compensated hemolytic anemia. The hemoglobin concentration is normal or even increased. Both myopathy and hemolytic disease result from the total lack of M subunit expression. Biopsies of muscle reveal that PFK activity is completely lacking, whereas erythrocyte PFK activity is approximately 50% of normal ( [300](#), [301](#), [303](#) ). The red cell PFK in these patients is composed exclusively of L4 subunits ( [290](#), [300](#) ). Glycolytic intermediates proximal to PFK are increased in concentration, and those distal to the block are decreased ( [303](#), [304](#) ). Of particular interest, 2,3-DPG is decreased ( [305](#) ), and this presumably leads to an unfavorable shift of the hemoglobin-oxygen affinity, thereby accounting for the mild erythrocytosis in some patients and absence of anemia despite shortened red cell survival in others. PFK deficiency also has been implicated as the cause of hemolytic disease in the absence of myopathy ( [290](#), [304](#), [306](#), [307](#) ). Some individuals manifest mild myopathic symptoms during ischemic exercise tolerance tests ( [304](#) ). This syndrome is attributed to the synthesis of an unstable but catalytically active M subunit. Muscle cells are protected because of continued synthesis of the enzyme, whereas anucleate erythrocytes, incapable of protein synthesis, sustain early loss of enzyme activity ( [306](#) ). Although myopathy without hemolysis has also been attributed to PFK deficiency, hemolytic disease may have been dismissed because of the absence of anemia ( [304](#) ). Heterozygosity for L subunit deficiency is associated with approximately one-half normal red cell PFK activity, but with no myopathic or hemolytic features ( [304](#), [308](#), [309](#) ).

**ALDOLASE DEFICIENCY** Aldolase catalyzes the conversion of fructose-1,6-diphosphate to dihydroxyacetone and glyceraldehyde-3-phosphate ( [Fig. 33.4](#) ). Aldolase is a tetrameric protein, and three tissue isozymes (A, B, C) have been identified ( [310](#) ). Type A aldolase, the main isozyme in RBCs and muscle, has been characterized and cloned ( [311](#), [312](#) ). The gene that encodes aldolase A is located on chromosome 16 ( [313](#) ). Aldolase deficiency as a cause of hemolytic anemia is very rare and has been identified in only four kindred. The first case was documented in a child whose parents were first cousins. In addition to mild hemolytic anemia, the child had hepatomegaly associated with increased glycogen deposition and psychomotor retardation ( [314](#) ). A second report of aldolase deficiency, in a Japanese family, described more severe hemolytic anemia (hemoglobin, 6 g per dl; 7 to 8% reticulocytes) without attendant hepatomegaly or developmental delay ( [315](#) ). In a third case, a 4-1/2-year-old boy in Germany was identified with aldolase deficiency ( [316](#) ). He had a history of neonatal jaundice, recurrent episodes of jaundice beyond the newborn period, and anemia requiring red cell transfusions in the first year of life. In addition, however, he had a myopathy characterized by severe muscle weakness, exercise intolerance, and laboratory evidence of rhabdomyolysis in association with fever and an upper respiratory infection. In a fourth reported case, a young girl of Sicilian extraction had a transfusion-dependent hemolytic anemia requiring splenectomy at 40 months of age ( [317](#) ). She also had a myopathy with recurrent and progressive episodes of rhabdomyolysis. She died due to hyperkalemia and rhabdomyolysis during a febrile illness associated with gastrointestinal hemorrhage at 54 months of age. Molecular analysis in each of the above cases has identified several different missense or nonsense mutations, each resulting in a thermolabile unstable enzyme ( [316](#), [317](#), [318](#) and [319](#) ). The mechanism of hemolysis in these cases is uncertain. Deficient red cells accumulate proximal glycolytic intermediates, especially FDP.

**TRIOSE PHOSPHATE ISOMERASE DEFICIENCY** TPI catalyzes the reversible isomerization of glyceraldehyde-3-phosphate and dihydroxyacetone phosphate (DHAP) ( [Fig. 33.4](#) ). TPI is a dimeric enzyme composed of identical subunits. Several electrophoretically distinct bands result from posttranslational modification of a single

protein ( [320](#) ) that is encoded by a single structural gene located on the short arm of chromosome 12 ( [321](#) ). Only one isozyme of TPI is produced, and, thus, enzyme deficiency involves all body tissues. Enzyme activity is greatly reduced in red cells as well as in leukocytes, muscle, and skin fibroblasts ( [271](#) ). Thirty-five cases of TPI deficiency with hemolytic anemia have been identified. The enzyme abnormality in almost all cases is due to a single amino acid substitution that results in an unstable enzyme ( [322](#) ). Fourteen different point mutations in the TPI gene have been identified and reviewed ( [323](#) , [324](#) and [325](#) ). Eleven are missense mutations resulting in a single amino acid substitution and one is due to a deletion. The majority of the mutants result in heat-labile enzymes with residual catalytic activity. All clinically affected patients have been homozygotes or, less commonly, compound heterozygotes. Of the 14 known mutations, one accounts for the molecular defect in most studied families with TPI deficiency; this variant is due to a 315G>C mutation that results in an amino acid substitution (104Glu>Asp) ( [323](#) , [325](#) ). Hemolysis due to TPI deficiency is one aspect of a multiple system disease. A most unique feature of this enzymopathy is an associated severe neurologic disorder characterized by spasticity, motor retardation, and hypotonia ( [325](#) , [326](#) ). It is inherited as an autosomal-recessive disorder. Heterozygotes, with one-half normal erythrocyte TPI activity, are clinically normal. It is of interest that the frequency of the heterozygous state for TPI deficiency is relatively high (0.1 to 0.5% in whites, 5.5% in blacks) ( [327](#) ). Despite this estimate, only 35 individuals with symptomatic disease have been identified ( [8](#) , [299](#) , [325](#) ). The rare incidence of clinically significant homozygous TPI deficiency suggests incompatibility with fetal life. TPI deficiency is a progressive, ultimately fatal disease. In most cases, anemia and hyperbilirubinemia have been noted at birth or during the first weeks of life ( [325](#) , [326](#) , [328](#) ). The degree of anemia is variable, but most affected infants and children require periodic blood transfusions. Death from hemolytic anemia in the first week of life occurred in a sibling and in a cousin of the patient described in the first reported case ( [326](#) ). Splenectomy appears to have no discernible benefit ( [326](#) ). Late in the first year of life, spasticity and a delay in the acquisition of motor skills are noted. Neurologic involvement generally is progressive, giving rise to paraparesis, weakness, and hypotonia. Recurrent systemic infections are a problem in most affected children, but it is not known whether these are related to impaired TPI activity in phagocytes. Death, probably from cardiac arrhythmias, usually occurs before the fifth birthday. In the only adult thus far identified as having TPI deficiency ( [329](#) ), neurologic dysfunction, although profound, was stable. An interesting report of TPI deficiency with chronic hemolytic anemia has been described in a 13-year-old boy and his 23-year-old brother. Noteworthy was the observation that the 13-year-old boy had hyperkinetic torsion dyskinesia, but his 23-year-old brother had no neurologic abnormalities ( [330](#) , [331](#) ). The diagnosis of TPI deficiency is suspected in young children with chronic hemolytic disease that is not due to the more common causes of hemolysis. Associated motor neurologic symptoms raise the index of suspicion for TPI deficiency. There are no specific RBC abnormalities. In suspected cases, it is necessary to assay for TPI activity in an RBC hemolysate. Prenatal diagnosis of TPI deficiency initially relied on biochemical analyses of cultured fetal amniocytes, and in one published report, this was successful ( [332](#) ). Later, prenatal diagnosis of TPI was attempted by assaying fetal RBCs obtained by ultrasound-guided cordocentesis. The wide variability of normal activity levels and the lack of sufficient control data, however, limited the interpretation of these assays ( [333](#) ). Another inherent problem with tests that require fetal blood from cordocentesis is that the procedures cannot be done before 20 weeks of gestation. More recently, the large number of cases associated with the codon 104 mutation has allowed the use of chorionic villous biopsy samples and molecular techniques for prenatal diagnosis ( [334](#) , [335](#) ). The pathophysiologic basis for hemolytic disease is not known. DHAP accumulates 20- to 60-fold ( [326](#) ), but the significance of this is unknown because a similar accumulation of DHAP occurs in diphosphoglyceromutase (DPGM) deficiency without any apparent effect.



**PHOSPHOGLYCERATE KINASE DEFICIENCY** PGK catalyzes the conversion of 1,3-DPG to 3-phosphoglycerate, and this is one of two glycolytic reactions resulting in net ATP generation from adenosine diphosphate ( [Fig. 33.1](#)). An alternative fate of 1,3-DPG is the formation of 2,3-DPG, a reaction catalyzed by 2,3-DPGM. The product of the latter reaction is 2,3-DPG, an important intermediate that is known to enhance oxygen release from hemoglobin. Hereditary deficiency of PGK activity has been recognized as a rare cause of chronic hemolytic anemia for over 30 years ( [336](#)). Red cells severely deficient in PGK predictably accumulate DHAP ( [337](#)), have higher than normal concentrations of 2,3-DPG ( [337](#)), and have decreased concentrations of ATP ( [336](#)). The altered intermediate profile in PGK-deficient RBCs thus reflects an increased flow of triose phosphates through the DPG pathway at the expense of ATP generation. The genetics of this disorder are unique amongst glycolytic enzymopathies in that it is X-linked ( [336](#)). PGK is known to be encoded by a single structural gene on the X-chromosome q13 ( [338](#)). The complete amino acid sequence ( [339](#), [340](#)) and genomic organization of PGK ( [341](#)) have been defined. Biochemical variants of PGK with abnormal kinetics, enzyme instability, or both have been observed in 23 separate families, and the single amino acid substitutions and genomic structure have been identified for 14 variants ( [8](#), [302](#)), including PGK Amiens ( [342](#)), PGK Munchen ( [343](#)), PGK Uppsala ( [344](#)), PGK Tokyo ( [345](#)), PGK Matsue ( [346](#)), PGK Shizuoka ( [347](#)), PGK Michigan ( [348](#)), and others. Almost all of these are due to missense mutations leading to amino acid substitutions ( [8](#), [302](#)). Similar to G6PD deficiency, male hemizygotes with little or no enzyme activity are symptomatic with chronic hemolysis that can be severe, often requiring RBC transfusions ( [336](#), [349](#), [350](#)). In contrast, females who are mosaics have normal and PGK-deficient red cells, and there may be variable degrees of hemolysis ( [336](#), [351](#)). Clinical exacerbations of hemolysis, most of which appear to be triggered by intercurrent infections, are responsible for recurrent episodes of jaundice. Splenectomy obviates transfusion in most patients but does not fully correct the hemolytic process. In deficient male subjects, PGK activity is decreased in leukocytes ( [336](#)), platelets, muscle, liver, and brain, as well as in red cells ( [352](#)). Although leukocyte PGK activity also is low, there is no evidence that affected individuals have leukocyte dysfunction or increased infections. Of far greater consequence is progressive neurologic deterioration. Deficient male infants experience apparent normal development until 3 to 4 years of age, when motor regression, expressive aphasia, and emotional lability become apparent. Seizures and progressive extrapyramidal disease follow late in the first decade ( [336](#), [337](#), [349](#), [353](#)). Most PGK variants manifest both hemolysis and neurologic disease (PGK Uppsala, PGK Tokyo, PGK Matsue, PGK Michigan); however, there are exceptions. PGK Shizuoka is characterized by hemolysis and muscle disease ( [347](#)), whereas PGK San Francisco has only hemolysis without other symptoms ( [354](#)). At the other extreme, recurrent exertional rhabdomyolysis producing renal failure but without associated hematologic or neurologic disease has been observed in PGK Creteil ( [355](#)). Also, clinically silent variants producing PGK deficiency have been described, and these variants differ from the normal enzyme with respect to electrophoretic mobility and isoelectric focusing ( [338](#)). The reasons for these phenotypic differences in PGK deficiency remain to be defined.

### **Glycolytic Enzymopathies of Doubtful Clinical Significance**

Hemolysis has been associated with deficiencies of other glycolytic enzymes, but the causal relationship between enzymopathy and reported hematologic disturbances is far from clear ( [266](#)).

**Glyceraldehyde-3-Phosphate Dehydrogenase Deficiency** The enzyme glyceraldehyde-3-phosphate dehydrogenase catalyzes the reversible conversion of

glyceraldehyde-3-phosphate to 1,3-DPG ( [Fig. 33.4](#)). This reaction is coupled to the reversible reduction of nicotinamide adenine dinucleotide to reduced nicotinamide adenine dinucleotide. The latter is the major cofactor for methemoglobin reduction by cytochrome *b*<sub>5</sub> reductase. Mild hemolytic anemia attributed to glyceraldehyde-3-phosphate

dehydrogenase deficiency was described in two brief reports over 30 years ago ( [356](#), [357](#)). The limited content of these reports precludes conclusions regarding the relationship between glyceraldehyde-3-phosphate dehydrogenase deficiency and hemolysis.

**2,3-DIPHOSPHOGLYCEROMUTASE DEFICIENCY** The enzyme 2,3-DPGM has more than one metabolic role. Its main function relates to its catalytic role in the conversion of 1,3-DPG to 2,3-DPG ( [Fig. 33.4](#)). This reaction is of special interest because 2,3-DPG reduces the affinity of hemoglobin for oxygen, thereby shifting the oxygen-hemoglobin dissociation curve to the right (see [Chapter 8](#)). A second function of the enzyme relates to its phosphatase activity, which catalyzes the degradation of 2,3-DPG to 3-phosphoglyceric acid (3-PGA). These two different actions of 2,3-DPGM reflect two different active sites on the same molecule ( [358](#)). Deficiency of red cell 2,3-DPGM is associated with deficiency of 2,3-DPG phosphatase of comparable magnitude ( [358](#), [359](#)). The third metabolic role of this enzyme is to facilitate the conversion of 3-PGA to 2-PGA. The reports of 2,3-DPGM deficiency are too few and too disparate to permit a unified clinical description. Total deficiency of the mutase and phosphatase activity of DPGM and 2,3-DPG phosphatase activity was described in a 42-year-old man who was well except for ruddy cyanosis and a hemoglobin of 19 g per dl ( [359](#)). Erythrocyte 2,3-DPG content was low, as was the p50 determination. Two of his children had approximately 55% normal 2,3-DPGM activity, suggesting that they were heterozygous and their father was homozygous, with fully compensated hemolytic process ( [360](#), [361](#)). Deficiency of 2,3-DPGM imparts no known metabolic lesion having implications for cell survival. Deficient cells consume glucose normally and contain normal or increased amounts of ATP and reduced levels of glutathione and triose phosphates ( [359](#), [361](#)). It seems doubtful that 2,3-DPGM deficiency is a cause of significant clinical disease.

**ENOLASE DEFICIENCY** Enolase catalyzes the conversion of 2-PGA to phospho-enolpyruvate ( [Fig. 33.4](#)). Chronic hemolytic anemia associated with erythrocyte enolase deficiency was identified in two sisters ( [362](#)). Ingestion of nitrofurantoin exacerbated the condition, an occurrence not explained by the enzyme deficiency.

**LACTATE DEHYDROGENASE DEFICIENCY** LDH catalyzes the terminal reaction in glycolysis, the conversion of pyruvate to lactate ( [Fig. 33.4](#)). The enzyme is a tetrameric protein composed of H and M subunits. Severe deficiency of LDH in erythrocytes, leukocytes, platelets, and serum of a 65-year-old Japanese man has been reported ( [363](#)). This individual was homozygous for an autosomal-recessively transmitted deficiency of the H subunit of LDH. Although no anemia or evidence of hemolysis was noted, red cells contained a marked increase of glyceraldehyde-3-phosphate, DHAP, and FDP. This severe LDH deficiency was without effect on red cell integrity.

## DISORDERS OF ERYTHROCYTE NUCLEOTIDE METABOLISM

Mature RBCs are incapable of *de novo* purine or pyrimidine synthesis, although many enzymes of nucleotide metabolism are present in erythrocytes ( [Fig. 33.5](#)). The latter are now known to be important for RBC preservation *in vitro*; it also is recognized that abnormalities in purine and pyrimidine metabolism are associated with inherited hemolytic disease.



passively diffuse from the cell. P5'N thus rids maturing reticulocytes of pyrimidine degradation products of RNA without compromising the adenine nucleotide pool necessary for energy-dependent reactions. Another enzyme, thymidylate nucleotidase, is believed to catalyze the degradation of thymidine monophosphate in a similar manner. This is supported by the observation that P5'N-deficient cells exhibit brisk nucleotidase activity when thymidine and deoxyuridine monophosphates are used as substrates ( [372](#), [373](#), [374](#) and [375](#) ).

Reticulocytes deficient in P5'N accumulate large quantities of cytidine and uridine compounds, increasing the total nucleotide pool to more than five times that present in normal red cells ( [373](#), [376](#), [377](#) ). Cases of P5'N deficiency formerly were classified as "high ATP syndromes" owing to the erroneous assumption that the large amount of nucleotide within deficient cells was adenine phosphate rather than pyrimidine phosphate ( [378](#), [379](#) ). In addition to the increased nucleotide pool content, elevated levels of GSH ( [380](#) ) and decreased activity of PRPP synthetase are consistent but unexplained findings of P5'N deficiency ( [378](#), [379](#) ). As a consequence of impaired ribosomal degradation, intracellular aggregates form in P5'N-deficient cells, and these appear as basophilic stippling on Wright-stained peripheral blood smears. The molecular biology of P5'N is not clearly defined at this time, and the P5'N gene has not been identified.

P5'N deficiency is a rare RBC defect, yet it is the most common enzyme abnormality affecting nucleotide metabolism and is overall the fourth most common enzyme abnormality associated with hereditary hemolytic anemia ( [266](#), [375](#) ). Approximately 35 unrelated kindred representing wide geographic distribution have been reported with a predisposition for people of Mediterranean, Jewish, and African ancestry ( [375](#), [381](#) ). In all families studied, the disorder follows an autosomal-recessive mode of transmission ( [378](#), [379](#), [382](#), [383](#) and [384](#) ). Family members who are biochemical heterozygotes are hematologically normal, whereas homozygotes with less than 5 to 10% normal P5'N activity have life-long hemolytic anemia associated with splenomegaly and intermittent jaundice. The disorder is characterized by mild to moderate anemia, reticulocytosis, and hyperbilirubinemia. Transfusions usually are not required. Splenectomy is followed by a modest increase in hemoglobin concentration but affords no significant benefit ( [379](#), [381](#), [384](#) ). There are no P5'N abnormalities in platelets or leukocytes of affected patients. Developmental retardation has been noted ( [382](#) ).

The possibility of P5'N deficiency as the cause of hemolysis is suggested by the presence of marked basophilic stippling, a unique RBC morphologic feature characteristic of this hemolytic disorder. Definitive diagnosis requires demonstration of decreased RBC nucleotidase activity ( [381](#) ) or increased pyrimidine nucleotides in erythrocytes. Normally, RBC nucleotides are almost entirely adenine nucleotides. However, in P5'N deficiency, up to 80% of the nucleotide pool may be pyrimidine nucleotides. This is the basis for a simple screening test that uses ultraviolet spectroscopy to demonstrate a shift in the absorption spectrum of red cell lysates ( [384](#) ).

The reason why P5'N deficiency leads to hemolytic anemia is not known, although there have been a variety of proposed mechanisms ( [385](#), [386](#) ). One curious explanation relates to a concomitant decrease in the G6PD activity of P5'N-deficient cells ( [387](#) ), which is associated with decreased pentose phosphate shunt activity and increased incubated Heinz body formation. The mechanism whereby P5'N deficiency affects pentose phosphate shunt activity involves both competitive inhibition of glucose-6-phosphate and noncompetitive inhibition of NADP for G6PD by pyrimidine nucleotides ( [387](#) ). It is interesting that both P5'N and G6PD deficiencies are characterized by hemolytic crises

complicating intercurrent infections. Also of interest was the report of a Bangladeshi family that had the genes for both hemoglobin E and P5'N deficiency ( [388](#) ). One individual homozygous for both conditions had a severe hemolytic anemia, whereas family members homozygous for hemoglobin E were asymptomatic and those homozygous for P5'N had a mild hemolytic anemia. Globin-chain synthetic studies indicated that the interaction between these two genotypes was due to decreased hemoglobin E stability in P5'N-deficient erythrocytes. Because, as described above, the HMP shunt is impaired in P5'N deficiency, it was postulated that the marked hemoglobin instability in enzyme-deficient cells was due to oxidant stresses exerting their effects on hemoglobin E that normally is mildly unstable ( [388](#) ).

The P5'N enzyme is readily inactivated by heavy metals such as lead, and it has been proposed that the basophilic stippling in lead poisoning is secondary to acquired P5'N deficiency ( [389](#) , [390](#) ). As blood lead levels approach 200 µg per dl packed red cells, P5'N activity decreases to levels comparable to those associated with the homozygous deficiency state, intracellular pyrimidine nucleotides accumulate, and basophilic stippling can be demonstrated ( [373](#) , [390](#) ). As in congenital P5'N deficiency, pyrimidine nucleotide accumulation inhibits pentose phosphate shunt activity, further compounding a direct inhibitory action of lead on G6PD ( [391](#) ).

### Adenosine Deaminase Excess

Adenosine is a common substrate for two different enzymes, adenosine kinase (ADK) and ADA. The Km (adenosine) is much lower for ADK than for ADA, and, thus, normal metabolism is believed to proceed through ADK with phosphorylation of adenosine to form adenosine monophosphate (AMP) ( [Fig. 33.5](#) ). In the presence of plasma adenosine, ADK thereby helps maintain the red cell adenine nucleotide pool ( [392](#) , [393](#) ). ADA leads to the deamination of adenosine with the formation of inosine, and this enzyme is critical for normal immune function. Hereditary deficiency of ADA is associated with severe combined immunodeficiency ( [366](#) ), and because the enzyme deficiency also exists in erythrocytes, assay of red cell ADA can be used to diagnose this immune disorder. Red cell adenine nucleotide content is increased in severe ADA deficiency, but this has no adverse effects on RBCs, and there is no anemia ( [394](#) , [395](#) ). Surprisingly, however, hereditary hemolytic anemia occurs in association with a 60- to 100-fold excess of normal ADA activity ( [396](#) ), and this has been described in a few families including a large kindred of English-Irish ancestry and in a Japanese family ( [397](#) ). In these patients with hemolysis and increased RBC-ADA activity, erythrocyte ATP content is reduced ( [396](#) , [397](#) ). The decrease in adenine nucleotides presumably occurs because elevated ADA activity effectively competes with ADK, producing a "relative" deficiency of the latter enzyme ( [381](#) , [393](#) ).

In patients with hemolytic anemia and marked ADA excess, the purified enzyme exhibits normal biochemical properties, and the defect appears to be due to excess production of a structurally normal enzyme ( [398](#) , [399](#) and [400](#) ). The synthesis of this enzyme is directed by a gene on chromosome 20, and posttranslational modifications result in different tissue isozymes. No specific DNA mutation has been identified to account for increased ADA production in patients with hemolytic anemia.

This rare hemolytic enzymopathy is unique because it is associated with an enzyme excess and also because it is inherited in an autosomal-dominant pattern ( [396](#) , [401](#) ). Clinical features include mild to moderate anemia, reticulocytosis, and hyperbilirubinemia. No other tissues share in enzyme excess, and there are no other systemic effects. There



are no distinguishing clinical, hematologic, or morphologic features to aid in the diagnosis of this condition. The specific diagnosis can be suspected if red cell ATP levels are low and confirmed by demonstrating increased ADA activity in a hemolysate. Usually, no specific therapy is indicated because most patients have very mild anemia. In contrast to the rare patients with a marked excess of enzyme activity and hemolytic anemia, a much smaller increase in enzyme activity (two- to fourfold) has been observed in most patients with congenital hypoplastic anemia (Diamond–Blackfan syndrome) ( 402 , 403 ) (see Chapter 45). The pathophysiologic significance of this modest increase is unknown.

### Adenylate Kinase Deficiency

AK catalyzes the interconversion of adenine nucleotides ( $AMP + ATP \rightleftharpoons 2ADP$ ) ( Fig. 33.5). This is believed to be the only enzyme reaction in mature RBCs that can lead to adenosine diphosphate synthesis from AMP, and, thus, AK would appear to have a critical role in salvaging AMP and protecting the erythrocyte adenine nucleotide pool ( 404 ). In erythrocytes, AMP is formed in two reactions: the ADK-mediated phosphorylation of adenosine and the adenine phosphoribosyl transferase-mediated phosphorylation of PRPP. There are three isozymes: AK1, AK2, and AK3 ( 405 ). AK1 is the isozyme in red cells, muscle, and brain.

Hereditary nonspherocytic hemolytic anemia in association with AK deficiency has been described in nine different kindred distributed worldwide ( 404 , 406 , 407 , 408 , 409 , 410 , 411 , 412 and 413 ). This is an autosomal-recessive disorder, and heterozygote-deficient individuals are not affected. A moderate to severe chronic nonspherocytic hemolytic anemia has been reported in almost all homozygous or compound heterozygous enzyme-deficient individuals. Splenectomy sometimes is beneficial ( 410 ). Mental retardation has been reported in some cases with severe erythrocyte AK deficiency ( 407 , 410 , 411 and 412 ), and this may reflect that AK1 is the isozyme in both RBCs and brain.

The causal relationship of this enzyme abnormality to hemolysis is not entirely clear because some individuals with profound AK deficiency have no evidence of hemolysis ( 404 ). In one sibship, there was congenital hemolytic anemia and less than 1% normal erythrocyte AK activity in an 8-year-old girl, whereas her brother also had no detectable AK activity but was hematologically normal ( 404 ). In another family with AK deficiency, a 4-year-old girl had chronic hemolysis with occasional exacerbations during infections and occasionally required RBC transfusions ( 409 ). Her RBCs had no detectable AK activity, whereas her parents had half-normal activity. In this patient, decreased activity of other phosphotransferases was noted; in particular, PRPP synthetase activity was reduced, just as in P5N deficiency. The authors proposed that defects in multiple phosphotransferases may be responsible for the shortened lifespan of AK-deficient RBCs ( 409 ). The significance of these observations is unknown.

Molecular analysis has revealed the gene defect in six of the known kindred with chronic hemolysis and AK deficiency. In the first case, a single nucleotide substitution resulting in an amino acid change (Arg121→Trp) was detected ( 8 , 405 ). Analysis of subsequent probands has revealed other missense mutations ( 411 , 413 ), nonsense mutations ( 412 ), and deletion mutations ( 413 ).

### REFERENCES

1. Beutler E. G6PD deficiency. *Blood* 1994;84:3613–3636.

2. Luzzatto L, Mehta A, Vulliamy T. Glucose-6-phosphate dehydrogenase deficiency. In: Scriver C, et al., eds. The metabolic and molecular bases of inherited disease. New York: McGraw-Hill, 2001:4517-4553.
3. Mehta A, Mason PJ, Vulliamy TJ. Glucose-6-phosphate dehydrogenase deficiency. Baillieres Best Pract Res Clin Haematol 2000;13:21-38.
4. Carson PE, Ickes CE, et al. Enzymatic deficiency in primaquine sensitive erythrocytes. Science 1956;124:484-485.
5. Alving A, et al. Mitigation of the haemolytic effect of primaquine and enhancement of its action against exoerythrocytic forms of the Chesson strain of *Plasmodium vivax* by intermittent regimens of drug administration. Bull World Health Organ 1960;22:621-631.
6. Beutler E. Glucose-6-phosphate dehydrogenase deficiency. N Engl J Med 1991;324:169-174.
7. Mason PJ. New insights into G6PD deficiency. Br J Haematol 1996;94:585-591.
8. Miwa S, Fujii H. Molecular basis of erythroenzymopathies associated with hereditary hemolytic anemia: tabulation of mutant enzymes. Am J Hematol 1996;51:122-132.
9. Kirkman H, Hendrikson E. Sex-linked electrophoretic differences in glucose-6-phosphate dehydrogenase. Am J Hum Genet 1963;15:241-258.
10. Pai GS, et al. Localization of loci for hypoxanthine phosphoribosyltransferase and glucose-6-phosphate dehydrogenase and biochemical evidence of nonrandom X chromosome expression from studies of a human X-autosome translocation. Proc Natl Acad Sci U S A 1980;77:2810-2813.
11. Szabo P, et al. Cytological mapping of the human glucose-6-phosphate dehydrogenase gene distal to the fragile-X site suggests a high rate of meiotic recombination across this site. Proc Natl Acad Sci U S A 1984;81:7855-7859.
12. Lyon MF. Gene action in the X-chromosome of the mouse (*mus musculus* L). Nature 1961;190:372.
13. Beutler E. The normal human female as a mosaic of X-chromosome activity: studies using the gene for G6PD deficiency as a marker. Proc Natl Acad Sci U S A 1962;48:9.
14. Beutler E. Value of genetic variants of glucose-6-phosphate dehydrogenase. N Engl J Med 1967;276:389-391.
15. Fialkow PJ. Clonal origin of human tumors. Biochim Biophys Acta 1976;458:283-321.
16. Fialkow PJ, et al. Acute nonlymphocytic leukemia: expression in cells restricted to granulocytic and monocytic differentiation. N Engl J Med 1979;301:1-5.
17. Linder D, Gartler SM. Glucose-6-phosphate dehydrogenase mosaicism: utilization as a cell marker in the study of leiomyomas. Science 1965;150:67-69.
18. Beutler E, West C, Johnson C. Involvement of the erythroid series in acute myeloid leukemia. Blood 1979;53:1203-1205.
19. Wiggans RG, et al. Probable clonal origin of acute myeloblastic leukemia following radiation and chemotherapy of colon cancer. Blood 1978;52:659-663.
20. Fialkow PJ, Gartler SM, Yoshida A. Clonal origin of chronic myelocytic leukemia in man. Proc Natl Acad Sci U S A 1967;58:1468-1471.
21. Adamson JW, et al. Polycythemia vera: stem-cell and probable clonal origin of the disease. N Engl J Med 1976;295:913-916.
22. Gaetani GF, et al. Primary thrombocythemia: clonal origin of platelets, erythrocytes, and granulocytes in a GdB/GdMediterranean subject. Blood 1982;59:76-79.



23. Oni SB, Osunkoya BO, Luzzatto L. Paroxysmal nocturnal hemoglobinuria: evidence for monoclonal origin of abnormal red cells. *Blood* 1970;36:145-152.
24. Mason P. New insights into G6PD deficiency. *Br J Haematol* 1996;94:585-591.
25. Bienzle U. Glucose-6-phosphate dehydrogenase deficiency. Part 1: Tropical Africa. *Clin Haematol* 1981;10:785-799.
26. Motulsky AG, Vandepitte J, Fraser GR. Population genetic studies in the Congo. I. Glucose-6-phosphate dehydrogenase deficiency, hemoglobin S, and malaria. *Am J Hum Genet* 1966;18:514-537.
27. Petrakis NL, et al. Prevalence of sickle-cell trait and glucose-6-phosphate dehydrogenase deficiency. *N Engl J Med* 1970;282:767-770.
28. Uddin DE, Dickson LG, Brodine CE. Glucose-6-phosphate dehydrogenase deficiency in military recruits. *JAMA* 1974;227:1408-1409.
29. Tarlov AR, Carson PE, et al. Primaquine sensitivity. *Arch Intern Med* 1962;109:209-234.
30. Siniscalco M, Bernini L. Favism and thalassemia in Sardinia and their relationship to malaria. *Nature* 1961;190:1179-1180.
31. Stamatoyannopoulos G, Panayotopoulos A, Motulsky AG. The distribution of glucose-6-phosphate dehydrogenase deficiency in Greece. *Am J Hum Genet* 1966;18:296-308.
32. Oppenheim A, Jury CL, Rund D, et al. G6PD Mediterranean accounts for the high prevalence of G6PD deficiency in Kurdish Jews. *Hum Genet* 1993;91:293-294.
33. Panich V. Glucose-6-phosphate dehydrogenase deficiency. Part 2. Tropical Asia. *Clin Haematol* 1981;10:800-814.
34. Chan TK, Todd D. Characteristics and distribution of glucose-6-phosphate dehydrogenase-deficient variants in South China. *Am J Hum Genet* 1972;24:475-484.
35. McCurdy PR, et al. Further studies on glucose-6-phosphate dehydrogenase deficiency in Chinese subjects. *J Lab Clin Med* 1970;75:788-797.
36. Nakatsujii T, Miwa S. Incidence and characteristics of glucose-6-phosphate dehydrogenase variants in Japan. *Hum Genet* 1979;51:297-305.
37. Lisker R, Linares C, Motulsky AG. Glucose-6-phosphate dehydrogenase Mexico. A new variant with enzyme deficiency, abnormal mobility, and absence of hemolysis. *J Lab Clin Med* 1972;79:788-793.
38. Motulsky A. Metabolic polymorphisms and the role of infectious disease in human evolution. *Hum Biol* 1961;32:28-62.
39. Luzzatto L. Genetics of red cells and susceptibility to malaria. *Blood* 1979;54:961-976.
40. Nagel RL, Roth EF Jr. Malaria and red cell genetic defects. *Blood* 1989;74:1213-1221.
41. Luzzatto L, Usanga FA, Reddy S. Glucose-6-phosphate dehydrogenase deficient red cells: resistance to infection by malarial parasites. *Science* 1969;164:839-842.
42. Luzzatto L, Sodeinde O, Martini G. Genetic variation in the host and adaptive phenomena in *Plasmodium falciparum* infection. *Ciba Found Symp* 1983;94:159-173.
43. Eckman JR. Glutathione metabolism in malaria infected erythrocytes. *Prog Clin Biol Res* 1984;155:1-12.
44. Roth EF Jr, et al. Pathways for the reduction of oxidized glutathione in the *Plasmodium falciparum*-infected erythrocyte: can parasite enzymes replace host red cell glucose-6-phosphate

dehydrogenase? Blood 1986;67:827-830.

45. Yoshida A, Roth EF Jr. Glucose-6-phosphate dehydrogenase of malaria parasite *Plasmodium falciparum*. Blood 1987;69:1528-1530.
46. Roth EF Jr, et al. Ribose metabolism and nucleic acid synthesis in normal and glucose-6-phosphate dehydrogenase-deficient human erythrocytes infected with *Plasmodium falciparum*. J Clin Invest 1986;77:1129-1135.
47. Cohen P, Rosemeyer MA. Human glucose-6-phosphate dehydrogenase: purification of the erythrocyte enzyme and the influence of ions on its activity. Eur J Biochem 1969;8:1-7.
48. Persico MG, et al. Isolation of human glucose-6-phosphate dehydrogenase (G6PD) cDNA clones: primary structure of the protein and unusual 5' non-coding region. Nucleic Acids Res 1986;14:2511-2522.
49. Martini G, et al. Structural analysis of the X-linked gene encoding human glucose 6-phosphate dehydrogenase. Embo J 1986;5:1849-1855.
50. Takizawa T, et al. Human glucose-6-phosphate dehydrogenase: primary structure and cDNA cloning. Proc Natl Acad Sci U S A 1986;83:4157-4161.
51. Beutler E. The genetics of glucose-6-phosphate dehydrogenase deficiency. Semin Hematol 1990;27:137-164.
52. Yoshida A, Beutler E, Motulsky AG. Human glucose-6-phosphate dehydrogenase variants. Bull World Health Organ 1971;45:243-253.
53. Beutler E. The molecular biology of enzymes of erythrocyte metabolism. In: Stamatoyannopoulos G, Majerus PW, Varmus H, eds. The molecular basis of blood disease, ed. NAW. Philadelphia: WB Saunders, 1993.
54. Boyer S, Porter IH, Weilbacher RG. Electrophoretic heterogeneity for glucose-6-phosphate dehydrogenase and its relationship to enzyme deficiency in man. Proc Natl Acad Sci U S A 1962;48:1868-1876.
55. Yoshida A. A single amino acid substitution (asparagine to aspartic acid) between normal (B+) and the common Negro variant (A+) of human glucose-6-phosphate dehydrogenase. Proc Natl Acad Sci U S A 1967;57:835-840.
56. Reys L, Manso C, Stamatoyannopoulos G. Genetic studies on southeastern Bantu of Mozambique. I. Variants of glucose-6-phosphate dehydrogenase. Am J Hum Genet 1970;22:203-215.
57. Piomelli S, et al. In vivo lability of glucose-6-phosphate dehydrogenase in GdA- and GdMediterranean deficiency. J Clin Invest 1968;47:940-948.
58. Morelli A, et al. Biochemical mechanisms of glucose-6-phosphate dehydrogenase deficiency. Proc Natl Acad Sci U S A 1978;75:1979-1983.
59. McCurdy PR, et al. A Chinese variant of glucose-6-phosphate dehydrogenase. J Lab Clin Med 1966;67:374-385.
60. Beutler E, Vulliamy TJ. Hematologically important mutations: glucose-6-phosphate dehydrogenase. Blood Cells Mol Dis 2002;28:93-103.
61. Fiorelli G, Martinez di Montemuros F, Cappellini MD. Chronic non-spherocytic haemolytic disorders associated with glucose-6-phosphate dehydrogenase variants. Baillieres Best Pract Res Clin Haematol 2000;13:39-55.
62. Hsia YE, et al. Frequency of glucose-6-phosphate dehydrogenase (G6PD) mutations in Chinese, Filipinos, and Laotians from Hawaii. Hum Genet 1993;92:470-476.
63. Mason PJ, et al. New glucose-6-phosphate dehydrogenase mutations associated with chronic anemia.

Blood 1995;85:1377-1380.

64. Hirono A, Beutler E. Molecular cloning and nucleotide sequence of cDNA for human glucose-6-phosphate dehydrogenase variant A(-). Proc Natl Acad Sci U S A 1988;85:3951-3954.
65. Beutler E, et al. Molecular heterogeneity of glucose-6-phosphate dehydrogenase A. Blood 1989;74:2550-2555.
66. Beutler E. Glucose-6-phosphate dehydrogenase: new perspectives. Blood 1989;73:1397-1401.
67. Vulliamy TJ, et al. Diverse point mutations in the human glucose-6-phosphate dehydrogenase gene cause enzyme deficiency and mild or severe hemolytic anemia. Proc Natl Acad Sci U S A 1988;85:5171-5175.
68. De Vita G, et al. Two point mutations are responsible for G6PD polymorphism in Sardinia. Am J Hum Genet 1989;44:233-240.
69. Cooper MR, et al. Complete deficiency of leukocyte glucose-6-phosphate dehydrogenase with defective bactericidal activity. J Clin Invest 1972;51:769-778.
70. Miller DR, Wollman MR. A new variant of glucose-6-phosphate dehydrogenase deficiency hereditary hemolytic anemia, G6PD Cornell: erythrocyte, leukocyte, and platelet studies. Blood 1974;44:323-331.
71. Schiliro G, et al. Leukocyte function and characterization of leukocyte glucose-6-phosphate dehydrogenase in Sicilian mutants. Pediatr Res 1976;10:739-742.
72. Costa E, et al. Neutrophil dysfunction in a case of glucose-6-phosphate dehydrogenase deficiency. J Pediatr Hematol Oncol 2002;24:164-165.
73. van Bruggen R, et al. Deletion of leucine 61 in glucose-6-phosphate dehydrogenase leads to chronic nonspherocytic anemia, granulocyte dysfunction, and increased susceptibility to infections. Blood 2002;100:1026-1030.
74. Yoshida A, Stamatoyannopoulos G, Motulsky AG. Negro variant of glucose-6-phosphate dehydrogenase deficiency (A-) in man. Science 1967;155:97-99.
75. Jacob HS. Mechanisms of Heinz body formation and attachment to red cell membrane. Semin Hematol 1970;7:341-354.
76. Coetzer T, Zail S. Membrane protein complexes in GSH-depleted red cells. Blood 1980;56:159-167.
77. Allen DW, Flynn TP, Johnson GJ. Erythrocyte membrane protein changes in glucose-6-phosphate dehydrogenase mutants with chronic hemolytic disease: an example of postsynthetic modification of membrane proteins. Prog Clin Biol Res 1982;97:33-43.
78. Allen DW, et al. Membrane polypeptide aggregates in glucose 6-phosphate dehydrogenase-deficient and in vitro aged red blood cells. J Lab Clin Med 1978;91:321-327.
79. Arese P, De Flora A. Pathophysiology of hemolysis in glucose-6-phosphate dehydrogenase deficiency. Semin Hematol 1990;27:1-40.
80. Rifkind RA. Heinz body anemia: an ultrastructural study. II. Red cell sequestration and destruction. Blood 1965;26:433-448.
81. Tizianello A, et al. Sites of destruction of red cells in G-6-PD deficient Caucasians and in phenylhydrazine treated patients. Scand J Haematol 1968;5:116-128.
82. Pannacciulli I, et al. Hemolytic effects of standard single dosages of primaquine and chloroquine on G-6-PD-deficient Caucasians. J Lab Clin Med 1969;74:653-661.
83. Udomratn T, et al. Effects of ascorbic acid on glucose-6-phosphate dehydrogenase-deficient erythrocytes: studies in an animal model. Blood 1977;49:471-475.

84. Burka E, Weaver Z III, Marks P. Clinical spectrum of hemolytic anemia associated with glucose-6-phosphate dehydrogenase deficiency. *Ann Intern Med* 1966;64:817-825.
85. Shannon K, Buchanan GR. Severe hemolytic anemia in black children with glucose-6-phosphate dehydrogenase deficiency. *Pediatrics* 1982;70:364-369.
86. Chan TK, et al. The survival of glucose-6-phosphate dehydrogenase-deficient erythrocytes in patients with typhoid fever on chloramphenicol therapy. *J Lab Clin Med* 1971;77:177-184.
87. Constantopoulos A, Economopoulos P, Kandylas J. Fulminant diarrhoea and acute haemolysis due to G-6-PD deficiency in salmonellosis. *Lancet* 1973;1:1522.
88. Hersko C, Vardy PA. Haemolysis in typhoid fever in children with G-6-PD deficiency. *Br Med J* 1967;1:214-215.
89. Mengel CE, Metz E, Yancey WS. Anemia during acute infections. Role of glucose-6-phosphate dehydrogenase deficiency in Negroes. *Arch Intern Med* 1967;119:287-290.
90. Whelton A, Donadio JV Jr, Elisberg BL. Acute renal failure complicating rickettsial infections in glucose-6-phosphate dehydrogenase-deficient individuals. *Ann Intern Med* 1968;69:323-328.
91. Phillips SM, Silvers NP. Glucose-6 phosphate dehydrogenase deficiency, infectious hepatitis, acute hemolysis, and renal failure. *Ann Intern Med* 1969;70:99-104.
92. Salen G, et al. Acute hemolytic anemia complicating viral hepatitis in patients with glucose-6-phosphate dehydrogenase deficiency. *Ann Intern Med* 1966;65:1210-1220.
93. Baehner RL, Nathan DG, Castle WB. Oxidant injury of Caucasian glucose-6-phosphate dehydrogenase-deficient red blood cells by phagocytosing leukocytes during infection. *J Clin Invest* 1971;50:2466-2473.
94. Gellady AM, Greenwood RD. G-6-PD hemolytic anemia complicating diabetic ketoacidosis. *J Pediatr* 1972;80:1037-1038.
95. Glader BE. Role of elevated glucose concentrations in the hemolysis of glucose-6-phosphate dehydrogenase deficient erythrocytes (38474). *Proc Soc Exp Biol Med* 1975;148:50-53.
96. Beutler E, Guinto E. Mechanism of stimulation of the hexose monophosphate shunt of erythrocytes by pyruvate. *Enzyme* 1974;18:7-18.
97. Szeinberg A, Asher Y, Sheba C. Studies on glutathione stability in erythrocytes of cases with past history of favism or sulfa drug-induced hemolysis. *Blood* 1958;13:348-358.
98. Vulliamy T, Luzzatto L. Glucose-6-phosphate dehydrogenase deficiency and related disorders. In: Handin R, Lux S, Stossel T, eds. *Blood: principles and practice of hematology*. Philadelphia: Lippincott Williams & Wilkins, 2003:1921-1950.
99. Galiano S, et al. Favism in the African type of glucose-6-phosphate dehydrogenase deficiency (A-). *BMJ* 1990;300:236.
100. Kattamis CA, Kyriazakou M, Chaidas S. Favism: clinical and biochemical data. *J Med Genet* 1969;6:34-41.
101. Corchia C, et al. Favism in a female newborn infant whose mother ingested fava beans before delivery. *J Pediatr* 1995;127:807-808.
102. Mentzer WC, Collier E. Hydrops fetalis associated with erythrocyte G-6-PD deficiency and maternal ingestion of fava beans and ascorbic acid. *J Pediatr* 1975;86:565-567.
103. Luisada A. Favism. *Medicine* 1941;20:229-250.
104. Stamatoyannopoulos G, et al. On the familial predisposition to favism. *Am J Hum Genet*

1966;18:253–263.

105. Chevion M, et al. The chemistry of favism-inducing compounds. The properties of isouramil and divicine and their reaction with glutathione. *Eur J Biochem* 1982;127:405–409.

106. Razin A, et al. The oxidant effect of isouramil on red cell glutathione and its synergistic enhancement by ascorbic acid or 3,4-dihydroxyphenylalanine. Possible relation to the pathogenesis of favism. *Isr J Med Sci* 1968;4:852–857.

107. De Flora A, et al. Favism: disordered erythrocyte calcium homeostasis. *Blood* 1985;66:294–297.

108. Rattazzi MC, et al. G6PD deficiency and chronic hemolysis: four new mutants—relationships between clinical syndrome and enzyme kinetics. *Blood* 1971;38:205–218.

109. BenBassat J, Ben-Ishay D. Hereditary hemolytic anemia associated with glucose-6-phosphate dehydrogenase deficiency (Mediterranean type). *Isr J Med Sci* 1969;5:1053–1059.

110. Corrons J, Feliu E, Pujades MA, et al. Severe glucose-6-phosphate dehydrogenase (G6PD) deficiency associated with chronic hemolytic anemia, granulocyte dysfunction, and increased susceptibility to infections: description of a new molecular variant (G6PD Barcelona). *Blood* 1982;59:428–434.

111. Valaes T. Severe neonatal jaundice associated with glucose-6-phosphate dehydrogenase deficiency: pathogenesis and global epidemiology. *Acta Paediatr Suppl* 1994;394:58–76.

112. Kaplan M, Algur N, Hammerman C. Onset of jaundice in glucose-6-phosphate dehydrogenase-deficient neonates. *Pediatrics* 2001;108:956–959.

113. Kaplan M, et al. PredischARGE bilirubin screening in glucose-6-phosphate dehydrogenase-deficient neonates. *Pediatrics* 2000;105:533–537.

114. Kaplan M, Hammerman C, Beutler E. Hyperbilirubinaemia, glucose-6-phosphate dehydrogenase deficiency and Gilbert syndrome. *Eur J Pediatr* 2001;160:195.

115. Doxiadis S, Fessas PH, Valaes T. Glucose-6-phosphate dehydrogenase deficiency. *Lancet* 1961;1:297–301.

116. Drew JH, Smith MB, Kitchen WH. Glucose-6-phosphate dehydrogenase deficiency in immigrant Greek infants. *J Pediatr* 1977;90:659–660.

117. Sansone G, Perroni L, Yoshida A. Glucose-6-phosphate dehydrogenase variants from Italian subjects associated with severe neonatal jaundice. *Br J Haematol* 1975;31:159–165.

118. Poon MC, et al. G6PD Viangchan: a new glucose 6-phosphate dehydrogenase variant from Laos. *Hum Genet* 1988;78:98–99.

119. Tan KL. Phototherapy for neonatal jaundice in erythrocyte glucose-6-phosphate dehydrogenase-deficient infants. *Pediatrics* 1977;59[Suppl]:1023–1026.

120. Huang CS, et al. Neonatal jaundice and molecular mutations in glucose-6-phosphate dehydrogenase deficient newborn infants. *Am J Hematol* 1996;51:19–25.

121. Gibbs WN, Gray R, Lowry M. Glucose-6-phosphate dehydrogenase deficiency and neonatal jaundice in Jamaica. *Br J Haematol* 1979;43:263–274.

122. Bienzle U, Effiong C, Luzzatto L. Erythrocyte glucose 6-phosphate dehydrogenase deficiency (G6PD type A-) and neonatal jaundice. *Acta Paediatr Scand* 1976;65:701–703.

123. Slusher TM, et al. Glucose-6-phosphate dehydrogenase deficiency and carboxyhemoglobin concentrations associated with bilirubin-related morbidity and death in Nigerian infants. *J Pediatr* 1995;126:102–108.

124. Oyebola DD. Care of the neonate and management of neonatal jaundice as practised by Yoruba

traditional healers of Nigeria. *J Trop Pediatr* 1983;29:18–22.

125. Drew JH, Kitchen WH. Jaundice in infants of Greek parentage: the unknown factor may be environmental. *J Pediatr* 1976;89:248–252.

126. Brown AK. Hyperbilirubinemia in black infants. Role of glucose-6-phosphate dehydrogenase deficiency. *Clin Pediatr (Phila)* 1992;31:712–715.

127. Valaes T. Pathophysiology of spontaneous neonatal bilirubinemia associated with glucose-6-phosphate dehydrogenase deficiency. *J Pediatr* 1996;128:863–864.

128. Kaplan M, et al. Contribution of haemolysis to jaundice in Sephardic Jewish glucose-6-phosphate dehydrogenase deficient neonates. *Br J Haematol* 1996;93:822–827.

129. Kaplan M, et al. Neonatal hyperbilirubinemia in glucose-6-phosphate dehydrogenase-deficient heterozygotes. *Pediatrics* 1999;104:68–74.

130. Beutler E. Red cell metabolism: a manual of biochemical methods. New York: Grune & Stratton, 1984.

131. Fairbanks V, Beutler E. A simple method for detection of erythrocyte glucose-6-phosphate dehydrogenase (G-6-PD spot test). *Blood* 1962;20:591–601.

132. Brewer G, Tarlov AR, Alving AS. The methemoglobin reduction test for primaquine-type sensitivity of erythrocytes. *JAMA* 1962;180:386–388.

133. Gall J. Studies of glucose-6-phosphate dehydrogenase activity of individual erythrocytes: the methemoglobin elution test for identification of females heterozygous for G6PD deficiency. *Am J Hum Genet* 1965;17:359–368.

134. Brewer G, Zarafonitis CJD. The haemolytic effect of various regimens of primaquine with chloroquine in American negroes with G6PD deficiency and the lack of an effect of various antimalarial suppressive agents on erythrocyte metabolism. *Bull World Health Organ* 1976;36:303–308.

135. Balinsky D, et al. Glucose-6-phosphate dehydrogenase Johannesburg: a new variant with reduced activity in a patient with congenital non-spherocytic haemolytic anaemia. *Br J Haematol* 1973;25:385–392.

136. Corash L, et al. Reduced chronic hemolysis during high-dose vitamin E administration in Mediterranean-type glucose-6-phosphate dehydrogenase deficiency. *N Engl J Med* 1980;303:416–420.

137. Hafez M, et al. Improved erythrocyte survival with combined vitamin E and selenium therapy in children with glucose-6-phosphate dehydrogenase deficiency and mild chronic hemolysis. *J Pediatr* 1986;108:558–561.

138. Spielberg SP, et al. Improved erythrocyte survival with high-dose vitamin E in chronic hemolyzing G6PD and glutathione synthetase deficiencies. *Ann Intern Med* 1979;90:53–54.

139. Johnson GJ, et al. High-dose vitamin E does not decrease the rate of chronic hemolysis in glucose-6-phosphate dehydrogenase deficiency. *N Engl J Med* 1983;308:1014–1017.

140. Kappas A, Drummond GS, Valaes T. A single dose of Sn-mesoporphyrin prevents development of severe hyperbilirubinemia in glucose-6-phosphate dehydrogenase-deficient newborns. *Pediatrics* 2001;108:25–30.

141. MacDonald MG. Hidden risks: early discharge and bilirubin toxicity due to glucose 6-phosphate dehydrogenase deficiency. *Pediatrics* 1995;96:734–738.

142. Meloni T, Forteleoni G, Meloni GF. Marked decline of favism after neonatal glucose-6-phosphate dehydrogenase screening and health education: the northern Sardinian experience. *Acta Haematol* 1992;87:29–31.

143. Beutler E. Red blood cell enzyme disorders. In: Bern M, ed. Hematologic disorders in maternal-fetal medicine. New York: Wiley-Liss, 1990:199.

144. McCurdy PR, Morse EE. Glucose-6-phosphate dehydrogenase deficiency and blood transfusion. *Vox Sang* 1975;28:230-237.
145. Shalev O, Manny N, Sharon R. Posttransfusional hemolysis in recipients of glucose-6-phosphate dehydrogenase-deficient erythrocytes. *Vox Sang* 1993;64:94-98.
146. Mimouni F, Shohat S, Reisner SH. G6PD-deficient donor blood as a cause of hemolysis in two preterm infants. *Isr J Med Sci* 1986;22:120-122.
147. Kumar P, Sarkar S, Narang A. Acute intravascular haemolysis following exchange transfusion with G-6-PD deficient blood. *Eur J Pediatr* 1994;153:98-99.
148. Dern RJ, et al. Hereditary variation of erythrocytic 6-phosphogluconate dehydrogenase. *J Lab Clin Med* 1966;67:255-264.
149. Parr CW. Erythrocyte phosphogluconate dehydrogenase polymorphism. *Nature* 1966;210:487-489.
150. Parr CW, Fitch LI. Inherited quantitative variations of human phosphogluconate dehydrogenase. *Ann Hum Genet* 1967;30:339-353.
151. Caprari P, et al. 6-Phosphogluconate dehydrogenase deficiency in an Italian family. *Ann Hematol* 2001;80:41-44.
152. Krauth-Siegel RL, et al. Glutathione reductase from human erythrocytes. The sequences of the NADPH domain and of the interface domain. *Eur J Biochem* 1982;121:259-267.
153. Jaffe ER. Hereditary hemolytic disorders and enzymatic deficiencies of human erythrocytes. *Blood* 1970;35:116-134.
154. Beutler E. Effect of flavin compounds on glutathione reductase activity: in vivo and in vitro studies. *J Clin Invest* 1969;48:1957-1966.
155. Beutler E, Srivastava SK. Relationship between glutathione reductase activity and drug-induced haemolytic anaemia. *Nature* 1970;226:759-760.
156. Loos H, et al. Familial deficiency of glutathione reductase in human blood cells. *Blood* 1976;48:53-62.
157. Richards F 2nd, et al. Thymic irradiation. An approach to chronic lymphocytic leukemia. *Am J Med* 1974;57:862-869.
158. Necheles TF, et al. Homozygous erythrocyte glutathione-peroxidase deficiency: clinical and biochemical studies. *Blood* 1969;33:164-169.
159. Necheles TF, Steinberg MH, Cameron D. Erythrocyte glutathione-peroxidase deficiency. *Br J Haematol* 1970;19:605-612.
160. Steinberg M, Brauer MJ, Necheles TF. Acute hemolytic anemia associated with erythrocyte glutathione-peroxidase deficiency. *Arch Intern Med* 1970;125:302-303.
161. Nishimura Y, et al. Homozygous glutathione-peroxidase deficiency of erythrocytes and leukocytes. *Tohoku J Exp Med* 1972;108:207-217.
162. Beutler E, Matsumoto F. Ethnic variation in red cell glutathione peroxidase activity. *Blood* 1975;46:103-110.
163. Perona G, et al. In vivo and in vitro variations of human erythrocyte glutathione peroxidase activity as result of cells ageing, selenium availability and peroxide activation. *Br J Haematol* 1978;39:399-408.
164. Thomson CD, et al. Selenium concentrations and glutathione peroxidase activities in whole blood of New Zealand residents. *Br J Nutr* 1977;37:457-460.
165. Gross RT, et al. Hydrogen peroxide toxicity and detoxification in the erythrocytes of newborn infants.



Blood 1967;29:481-493.

166. Necheles T, Boles T, Allen D. Erythrocyte glutathione-peroxidase deficiency and hemolytic disease of the newborn infant. *J Pediatr* 1968;72:319-324.

167. Glader BE, Conrad ME. Decreased glutathione peroxidase in neonatal erythrocytes: lack of relation to hydrogen peroxide metabolism. *Pediatr Res* 1972;6:900-904.

168. Konrad PN, et al. Glutamyl-cysteine synthetase deficiency. A cause of hereditary hemolytic anemia. *N Engl J Med* 1972;286:557-561.

169. Prins HK, et al. Congenital nonspherocytic hemolytic anemia, associated with glutathione deficiency of the erythrocytes. Hematologic, biochemical and genetic studies. *Blood* 1966;27:145-166.

170. Beutler E, et al. Gamma-glutamylcysteine synthetase deficiency and hemolytic anemia. *Blood* 1990;75:271-273.

171. Beutler E, et al. The molecular basis of a case of gamma-glutamylcysteine synthetase deficiency. *Blood* 1999;94:2890-2894.

172. Ristoff E, et al. A missense mutation in the heavy subunit of gamma-glutamylcysteine synthetase gene causes hemolytic anemia. *Blood* 2000;95:2193-2196.

173. Beutler E, Gelbart T, Pegelow C. Erythrocyte glutathione synthetase deficiency leads not only to glutathione but also to glutathione-S-transferase deficiency. *J Clin Invest* 1986;77:38-41.

174. Boivin P, Galand C. (Glutathione synthesis during congenital hemolytic anemia with reduced glutathione deficiency. Congenital erythrocytic glutathione-synthetase deficiency?) *Nouv Rev Fr Hematol* 1965;5:707-720.

175. Hirono A, et al. Three cases of hereditary nonspherocytic hemolytic anemia associated with red blood cell glutathione deficiency. *Blood* 1996;87:2071-2074.

176. Lo SS, Marti HR, Hitzig WH. Hemolytic anemia associated with decreased concentration of reduced glutathione in red cells. *Acta Haematol* 1971;46:14-23.

177. Mohler DN, et al. Glutathione synthetase deficiency as a cause of hereditary hemolytic disease. *N Engl J Med* 1970;283:1253-1257.

178. Prins H, Oort M, Loos JA, et al. Congenital nonspherocytic hemolytic anemia, associated with glutathione deficiency of the erythrocytes. *Blood* 1966;27:145-166.

179. Prchal JT, et al. Hemolytic anemia, recurrent metabolic acidosis, and incomplete albinism associated with glutathione synthetase deficiency. *Blood* 1983;62:754-757.

180. Corrons JL, et al. Hereditary non-spherocytic haemolytic anaemia due to red blood cell glutathione synthetase deficiency in four unrelated patients from Spain: clinical and molecular studies. *Br J Haematol* 2001;112:475-482.

181. Jellum E, et al. Pyroglutamic aciduria—a new inborn error of metabolism. *Scand J Clin Lab Invest* 1970;26:327-335.

182. Skullerud K, et al. The cerebral lesions in a patient with generalized glutathione deficiency and pyroglutamic aciduria (5-oxoprolinuria). *Acta Neuropathol (Berl)* 1980;52:235-238.

183. Roos D, et al. A metabolic comparison between human blood monocytes and neutrophils. *Adv Exp Med Biol* 1979;121:29-36.

184. Minnich V, et al. Glutathione biosynthesis in human erythrocytes. I. Identification of the enzymes of glutathione synthesis in hemolysates. *J Clin Invest* 1971;50:507-513.

185. Beutler E, et al. Erythrocyte glutathione S-transferase deficiency and hemolytic anemia. *Blood*

1988;72:73–77.

186. Tanaka KR, Zerez CR. Red cell enzymopathies of the glycolytic pathway. *Semin Hematol* 1990;27:165–185.

187. Eber SW. Disorders of erythrocyte glycolysis and nucleotide metabolism. In: Handin R, Lux S, Stosfel T, eds. *Blood: principles and practice of hematology*. Philadelphia: Lippincott Williams & Wilkins, 2003:1887–1920.

188. Tanaka K, Valentine W, Miwa S. Pyruvate kinase (PK) deficiency hereditary nonspherocytic hemolytic anemia. *Blood* 1962;19:267–295.

189. Tanaka KR, Paglia DE. Pyruvate kinase deficiency. *Semin Hematol* 1971;8:367–396.

190. Zanella A, Bianchi P. Red cell pyruvate kinase deficiency: from genetics to clinical manifestations. *Baillieres Best Pract Res Clin Haematol* 2000;13:57–81.

191. Miwa S. Pyruvate kinase deficiency and other enzymopathies of the Embden–Meyerhof pathway. *Clin Haematol* 1981;10:57–80.

192. Shinohara K, Tanaka KR. Pyruvate kinase deficiency hemolytic anemia: enzymatic characterization studies in twelve patients. *Hemoglobin* 1980;4:611–625.

193. Fung RH, Keung YK, Chung GS. Screening of pyruvate kinase deficiency and G6PD deficiency in Chinese newborn in Hong Kong. *Arch Dis Child* 1969;44:373–376.

194. Bowman H. Pyruvate kinase deficient hemolytic anemia in an Amish isolate. *Am J Hum Genet* 1965;17:1–8.

195. Muir WA, Beutler E, Wasson C. Erythrocyte pyruvate kinase deficiency in the Ohio Amish: origin and characterization of the mutant enzyme. *Am J Hum Genet* 1984;36:634–639.

196. Kanno H, et al. Molecular abnormality of erythrocyte pyruvate kinase deficiency in the Amish. *Blood* 1994;83:2311–2316.

197. Beutler E, Gelbart T. Estimating the prevalence of pyruvate kinase deficiency from the gene frequency in the general white population. *Blood* 2000;95:3585–3588.

198. Tani K, et al. Human M2-type pyruvate kinase: cDNA cloning, chromosomal assignment and expression in hepatoma. *Gene* 1988;73:509–516.

199. Noguchi T, Inoue H, Tanaka T. The M1- and M2-type isozymes of rat pyruvate kinase are produced from the same gene by alternative RNA splicing. *J Biol Chem* 1986;261:13807–13812.

200. Tani K, et al. Human liver type pyruvate kinase: cDNA cloning and chromosomal assignment. *Biochem Biophys Res Commun* 1987;143:431–438.

201. Kahn A, et al. The genetic system of the L-type pyruvate kinase forms in man. Subunit structure, interrelation and kinetic characteristics of the pyruvate kinase enzymes from erythrocytes and liver. *Biochim Biophys Acta* 1978;523:59–74.

202. Imamura K, Tanaka T. Multimolecular forms of pyruvate kinase from rat and other mammalian tissues. I. Electrophoretic studies. *J Biochem (Tokyo)* 1972;71:1043–1051.

203. Takegawa S, Shinohara T, Miwa S. Hemin-induced conversion of pyruvate kinase isozymes in K562 cells. *Blood* 1984;64:754–757.

204. Bigley RH, Koler RD. Liver pyruvate kinase (PK) isozymes in a PK-deficient patient. *Ann Hum Genet* 1968;31:383–388.

205. Imamura K, et al. Studies on pyruvate kinase (PK) deficiency. II. Electrophoretic, kinetic and immunological studies on pyruvate kinase of erythrocytes and other tissues. *J Biochem (Tokyo)*

1973;74:1165–1175.

206. Nakashima K, et al. Characterization of pyruvate kinase from the liver of a patient with aberrant erythrocyte pyruvate kinase, PK Nagasaki. *J Lab Clin Med* 1977;90:1012–1020.

207. Baronciani L, Beutler E. Molecular study of pyruvate kinase deficient patients with hereditary nonspherocytic hemolytic anemia. *J Clin Invest* 1995;95:1702–1709.

208. Bianchi P, Zanella A. Hematologically important mutations: red cell pyruvate kinase (third update). *Blood Cells Mol Dis* 2000;26:47–53.

209. Baronciani L, Beutler E. Analysis of pyruvate kinase-deficiency mutations that produce nonspherocytic hemolytic anemia. *Proc Natl Acad Sci U S A* 1993;90:4324–4327.

210. Lenzner C, et al. Mutations in the pyruvate kinase L gene in patients with hereditary hemolytic anemia. *Blood* 1994;83:2817–2822.

211. Miwa S. Pyruvate kinase variants characterized by the methods recommended by the International Committee for Standardization in Haematology. *Hemoglobin* 1980;4:627–633.

212. Miwa S, et al. Seven pyruvate kinase variants characterized by the ICSH recommended methods. *Br J Haematol* 1980;45:575–583.

213. Miwa S, et al. Four new pyruvate kinase (PK) variants and a classical PK deficiency. *Br J Haematol* 1975;29:157–169.

214. Kahn A, et al. Chronic haemolytic anaemia in two patients heterozygous for erythrocyte pyruvate kinase deficiency. Electrofocusing and immunological studies of erythrocyte and liver pyruvate kinase. *Scand J Haematol* 1976;16:250–257.

215. Baronciani L, et al. Study of the molecular defects in pyruvate kinase deficient patients affected by nonspherocytic hemolytic anemia. *Blood Cells Mol Dis* 1995;21:49–55.

216. Beutler E, Forman L, Rios-Larrain E. Elevated pyruvate kinase activity in patients with hemolytic anemia due to red cell pyruvate kinase “deficiency.” *Am J Med* 1987;83:899–904.

217. Kahn A, Kaplan JC, Dreyfus JC. Advances in hereditary red cell enzyme anomalies. *Hum Genet* 1979;50:1–27.

218. Paglia DE, et al. Pyruvate kinase isozyme (PK-Greenville) with defective allosteric activation by fructose-1,6-diphosphate: the role of F-1,6-P modulation in normal erythrocyte metabolism. *Blood* 1983;62:972–979.

219. Grimes A, Meisler A, Dacie JV. Hereditary non-spherocytic haemolytic anaemia. A study of red-cell carbohydrate metabolism in twelve cases of pyruvate-kinase deficiency. *Br J Haematol* 1964;10:403–411.

220. Oski FA, et al. The role of the left-shifted or right-shifted oxygen-hemoglobin equilibrium curve. *Ann Intern Med* 1971;74:44–46.

221. Keitt AS. Pyruvate kinase deficiency and related disorders of red cell glycolysis. *Am J Med* 1966;41:762–785.

222. Mentzer WC Jr, et al. Selective reticulocyte destruction in erythrocyte pyruvate kinase deficiency. *J Clin Invest* 1971;50:688–699.

223. Nathan D, Oski FA, Sidel VW, et al. Extreme hemolysis and red-cell distortion in erythrocyte pyruvate kinase deficiency. *N Engl J Med* 1965;272:118–123.

224. Nathan DG, et al. Life-span and organ sequestration of the red cells in pyruvate kinase deficiency. *N Engl J Med* 1968;278:73–81.

225. Hennekam RC, et al. Hydrops fetalis associated with red cell pyruvate kinase deficiency. *Genet*

Couns 1990;1:75–79.

226. Ferreira P, et al. Hydrops fetalis associated with erythrocyte pyruvate kinase deficiency. *Eur J Pediatr* 2000;159:481–482.
227. Matthay KK, Mentzer WC. Erythrocyte enzymopathies in the newborn. *Clin Haematol* 1981;10:31–55.
228. Volpato S, Vigi V, Cattarozzi G. Nonspherocytic haemolytic anaemia and severe jaundice in a newborn with partial pyruvate kinase deficiency. *Acta Paediatr Scand* 1968;57:59–64.
229. Oski F, Nathan DG, Sidel VW, et al. Extreme hemolysis and red-cell distortion in erythrocyte pyruvate kinase deficiency. *N Engl J Med* 1964;270:1023–1030.
230. Blacklock HA, Mortimer PP. Aplastic crisis and other effects of the human parvovirus infection. *Clin Haematol* 1984;13:679–691.
231. Duncan JR, et al. Aplastic crisis due to parvovirus infection in pyruvate kinase deficiency. *Lancet* 1983;2:14–16.
232. Becker MH, et al. Roentgenographic manifestations of pyruvate kinase deficiency hemolytic anemia. *Am J Roentgenol Radium Ther Nucl Med* 1971;113:491–498.
233. Muller-Soyano A, et al. Pyruvate kinase deficiency and leg ulcers. *Blood* 1976;47:807–813.
234. Vives-Corrons JL, et al. Hereditary erythrocyte pyruvate-kinase (PK) deficiency and chronic hemolytic anemia: clinical, genetic and molecular studies in six new Spanish patients. *Hum Genet* 1980;53:401–408.
235. Nagai H, et al. An autopsy case of pyruvate kinase deficiency anemia associated with severe hemochromatosis. *Intern Med* 1994;33:56–59.
236. Rowbotham B, Roeser HP. Iron overload associated with congenital pyruvate kinase deficiency and high dose ascorbic acid ingestion. *Aust N Z J Med* 1984;14:667–669.
237. Salem HH, Van Der Weyden MB, Firkin BG. Iron overload in congenital erythrocyte pyruvate kinase deficiency. *Med J Aust* 1980;1:531–532.
238. Nathan DG, et al. Studies of erythrocyte spicule formation in haemolytic anaemia. *Br J Haematol* 1966;12:385–395.
239. Beutler E. Editorial: Why has the autohemolysis test not gone the way of the cephalin flocculation test? *Blood* 1978;51:109–110.
240. Hanel HK. Pyruvate kinase in human erythrocytes. *Scand J Haematol* 1969;6:173–174.
241. Gilsanz F, et al. Fetal anaemia due to pyruvate kinase deficiency. *Arch Dis Child* 1993;69:523–524.
242. Baronciani L, Beutler E. Prenatal diagnosis of pyruvate kinase deficiency. *Blood* 1994;84:2354–2356.
243. Boivin P, et al. Acquired red cell pyruvate kinase deficiency in leukemias and related disorders. *Enzyme* 1975;19:294–299.
244. Etiemble J, Picat C, Boivin P. Studies on the mechanism of the erythrocyte enzyme abnormalities induced by chemotherapy. *Scand J Haematol* 1980;25:394–400.
245. Weiden PL, et al. Severe hereditary haemolytic anaemia in dogs treated by marrow transplantation. *Br J Haematol* 1976;33:357–362.
246. Morimoto M, et al. Pyruvate kinase deficiency of mice associated with nonspherocytic hemolytic anemia and cure of the anemia by marrow transplantation without host irradiation. *Blood* 1995;86:4323–4330.
247. Tanphaichitr VS, et al. Successful bone marrow transplantation in a child with red blood cell pyruvate

kinase deficiency. *Bone Marrow Transplant* 2000;26:689–690.

248. Tani K, et al. Retrovirus-mediated gene transfer of human pyruvate kinase (PK) cDNA into murine hematopoietic cells: implications for gene therapy of human PK deficiency. *Blood* 1994;83:2305–2310.

249. Max-Audit I, Rosa R, Marie J. Pyruvate kinase hyperactivity genetically determined metabolic consequences and molecular characterization. *Blood* 1980;56:902–909.

250. Necheles TF, Rai US, Cameron D. Congenital nonspherocytic hemolytic anemia associated with an unusual erythrocyte hexokinase abnormality. *J Lab Clin Med* 1970;76:593–602.

251. Beutler E, Dymont PG, Matsumoto F. Hereditary nonspherocytic hemolytic anemia and hexokinase deficiency. *Blood* 1978;51:935–940.

252. Altay C, Alper CA, Nathan DG. Normal and variant isoenzymes of human blood cell hexokinase and the isoenzyme patterns in hemolytic anemia. *Blood* 1970;36:219–227.

253. Daniele A, et al. Mapping of human hexokinase 1 gene to 10q11?qter. *Hum Hered* 1992;42:107–110.

254. Kanno H. Hexokinase: gene structure and mutations. *Baillieres Best Pract Res Clin Haematol* 2000;13:83–88.

255. Rijksen G, et al. Generalized hexokinase deficiency in the blood cells of a patient with nonspherocytic hemolytic anemia. *Blood* 1983;61:12–18.

256. Valentine WN, et al. Hereditary hemolytic anemia with hexokinase deficiency. Role of hexokinase in erythrocyte aging. *N Engl J Med* 1967;276:1–11.

257. Keitt AS. Hemolytic anemia with impaired hexokinase activity. *J Clin Invest* 1969;48:1997–2007.

258. Siimes MA, Rahiala EL, Leisti J. Hexokinase deficiency in erythrocytes: a new variant in 5 members of a Finnish family. *Scand J Haematol* 1979;22:214–218.

259. Board PG, et al. Congenital nonspherocytic hemolytic anemia with an unstable hexokinase variant. *Blood* 1978;51:111–118.

260. Magnani M, et al. Hereditary nonspherocytic hemolytic anemia due to a new hexokinase variant with reduced stability. *Blood* 1985;66:690–697.

261. Newman P, Muir A, Parker AC. Non-spherocytic haemolytic anaemia in mother and son associated with hexokinase deficiency. *Br J Haematol* 1980;46:537–547.

262. Bianchi M, Magnani M. Hexokinase mutations that produce nonspherocytic hemolytic anemia. *Blood Cells Mol Dis* 1995;21:2–8.

263. van Wijk R, et al. HK Utrecht: missense mutation in the active site of human hexokinase associated with hexokinase deficiency and severe nonspherocytic hemolytic anemia. *Blood* 2003;101:345–347.

264. Rijksen G, Staal GE. Human erythrocyte hexokinase deficiency. Characterization of a mutant enzyme with abnormal regulatory properties. *J Clin Invest* 1978;62:294–301.

265. Delivoria-Papadopoulos M, Oski FA, Gottlieb AJ. Oxygen-hemoglobin dissociation curves: effect of inherited enzyme defects of the red cell. *Science* 1969;165:601–602.

266. Beutler E. Red cell enzyme defects as nondiseases and as diseases. *Blood* 1979;54:1–7.

267. Baughan MA, et al. Hereditary hemolytic anemia associated with glucosephosphate isomerase (GPI) deficiency—a new enzyme defect of human erythrocytes. *Blood* 1968;32:236–249.

268. Arnold H, et al. Glucose phosphate isomerase deficiency with congenital nonspherocytic hemolytic anemia: a new variant (type Nordhorn). II. Purification and biochemical properties of the defective enzyme. *Pediatr Res* 1974;8:26–30.

269. Beutler E, et al. Glucosephosphate-isomerase (GPI) deficiency: GPI Elyria. *Ann Intern Med* 1974;80:730-732.
270. Hutton JJ, Chilcote RR. Glucose phosphate isomerase deficiency with hereditary nonspherocytic hemolytic anemia. *J Pediatr* 1974;85:494-497.
271. Valentine WN. Deficiencies associated with Embden-Meyerhof pathway and other metabolic pathways. *Semin Hematol* 1971;8:348-366.
272. Kugler W, Lakomek M. Glucose-6-phosphate isomerase deficiency. *Baillieres Best Pract Res Clin Haematol* 2000;13:89-101.
273. Paglia DE, et al. Occurrence of defective hexosephosphate isomerization in human erythrocytes and leukocytes. *N Engl J Med* 1969;280:66-71.
274. McMorris FA, et al. Chromosome assignments in man of the genes for two hexosephosphate isomerases. *Science* 1973;179:1129-1131.
275. Walker JI, Faik P, Morgan MJ. Characterization of the 5' end of the gene for human glucose phosphate isomerase (GPI). *Genomics* 1990;7:638-643.
276. Xu W, Beutler E. The characterization of gene mutations for human glucose phosphate isomerase deficiency associated with chronic hemolytic anemia. *J Clin Invest* 1994;94:2326-2329.
277. Fujii H, et al. Hematologically important mutations: molecular abnormalities of glucose phosphate isomerase deficiency. *Blood Cells Mol Dis* 1996;22:96-97.
278. Beutler E, et al. Glucosephosphate isomerase (GPI) deficiency mutations associated with hereditary nonspherocytic hemolytic anemia (HNSHA). *Blood Cells Mol Dis* 1997;23:402-409.
279. Schroter W, et al. Glucose phosphate isomerase deficiency with congenital nonspherocytic hemolytic anemia: a new variant (type Nordhorn). I. Clinical and genetic studies. *Pediatr Res* 1974;8:18-25.
280. Zanella A, et al. The first stable variant of erythrocyte glucose-phosphate isomerase associated with severe hemolytic anemia. *Am J Hematol* 1980;9:1-11.
281. Baronciani L, et al. Study of the molecular defects in glucose phosphate isomerase-deficient patients affected by chronic hemolytic anemia. *Blood* 1996;88:2306-2310.
282. Yuan PM, et al. A deletion mutation in glucosephosphate isomerase (GPI Denton). *Clin Chim Acta* 1979;92:481-489.
283. Van Biervliet JP, et al. A new variant of glucosephosphate isomerase deficiency. *Humangenetik* 1975;30:35-40.
284. Merkle S, Pretsch W. Glucose-6-phosphate isomerase deficiency associated with nonspherocytic hemolytic anemia in the mouse: an animal model for the human disease. *Blood* 1993;81:206-213.
285. Whitelaw AG, et al. Congenital haemolytic anaemia resulting from glucose phosphate isomerase deficiency: genetics, clinical picture, and prenatal diagnosis. *J Med Genet* 1979;16:189-196.
286. Ravindranath Y, Paglia DE, Warriar I, et al. Glucose phosphate isomerase deficiency as a cause of hydrops fetalis. *N Engl J Med* 1987;316:258-261.
287. Dallapiccola B, et al. First trimester monitoring of a pregnancy at risk for glucose phosphate isomerase deficiency. *Prenat Diagn* 1986;6:101-107.
288. Kahn A, et al. Phosphofructokinase (PFK) isozymes in man. I. Studies of adult human tissues. *Hum Genet* 1979;48:93-108.
289. Meienhofer MC, et al. Phosphofructokinase in human blood cells. *Blood* 1979;54:389-400.

290. Vora S, et al. Isozymes of human phosphofructokinase: identification and subunit structural characterization of a new system. *Proc Natl Acad Sci U S A* 1980;77:62-66.
291. Vora S, et al. Assignment of the human gene for muscle-type phosphofructokinase (PFKM) to chromosome 1 (region cen leads to q32) using somatic cell hybrids and monoclonal anti-M antibody. *Somatic Cell Genet* 1982;8:95-104.
292. Yamasaki T, et al. Structure of the entire human muscle phosphofructokinase-encoding gene: a two-promoter system. *Gene* 1991;104:277-282.
293. Nakajima H, et al. Cloning of human muscle phosphofructokinase cDNA. *FEBS Lett* 1987;223:113-116.
294. Vaisanen PA, et al. Cloning and characterization of the human muscle phosphofructokinase gene. *DNA Cell Biol* 1992;11:461-470.
295. Van Keuren M, et al. Regional assignment of human liver-type 6-phospho-fructokinase to chromosome 21q22.3 by using somatic cell hybrids and a monoclonal anti-L antibody. *Hum Genet* 1986;74:34-40.
296. Elson A, et al. The structure of the human liver-type phosphofructokinase gene. *Genomics* 1990;7:47-56.
297. Levanon D, et al. Construction of a cDNA clone containing the entire coding region of the human liver-type phosphofructokinase. *Biochem Biophys Res Commun* 1987;147:1182-1187.
298. Vora S, et al. Regional assignment of the human gene for platelet-type phosphofructokinase (PFKP) to chromosome 10p: novel use of polyspecific rodent antisera to localize human enzyme genes. *Hum Genet* 1983;63:374-379.
299. Valentine WN, Paglia DE. Erythrocyte enzymopathies, hemolytic anemia, and multisystem disease: an annotated review. *Blood* 1984;64:583-591.
300. Layzer RB, Rowland LP, Ranney H. Muscle phosphofructokinase deficiency. *Trans Am Neurol Assoc* 1967;92:99-101.
301. Tarui S, et al. Enzymatic basis for the coexistence of myopathy and hemolytic disease in inherited muscle phosphofructokinase deficiency. *Biochem Biophys Res Commun* 1969;34:77-83.
302. Fujii H, Miwa S. Other erythrocyte enzyme deficiencies associated with non-haematological symptoms: phosphoglycerate kinase and phosphofructokinase deficiency. *Baillieres Best Pract Res Clin Haematol* 2000;13:141-148.
303. Tani K, et al. Phosphofructokinase deficiency associated with congenital nonspherocytic hemolytic anemia and mild myopathy: biochemical and morphological studies on the muscle. *Tohoku J Exp Med* 1983;141:287-293.
304. Vora S, et al. Heterogeneity of the molecular lesions in inherited phospho-fructokinase deficiency. *J Clin Invest* 1983;72:1995-2006.
305. Tarui S, et al. Hereditary and acquired abnormalities in erythrocyte phosphofructokinase activity: the close association with altered 2,3-diphosphoglycerate levels. *Hemoglobin* 1980;4:581-592.
306. Kahn A, et al. Erythrocyte phosphofructokinase deficiency associated with an unstable variant of muscle phosphofructokinase. *Clin Chim Acta* 1975;61:415-419.
307. Waterbury L, Frenkel EP. Hereditary nonspherocytic hemolysis with erythrocyte phosphofructokinase deficiency. *Blood* 1972;39:415-425.
308. Etiemble J, et al. A liver-type mutation in a case of pronounced erythrocyte phosphofructokinase deficiency without clinical expression. *Biochim Biophys Acta* 1983;759:236-242.



309. Etiemble J, et al. Inherited erythrocyte phosphofructokinase deficiency: molecular mechanism. *Hum Genet* 1980;55:383–390.
310. Penhoet E, Rajkumar T, Rutter WJ. Multiple forms of fructose diphosphate aldolase in mammalian tissues. *Proc Natl Acad Sci U S A* 1966;56:1275–1282.
311. Izzo P, et al. Human aldolase A gene. Structural organization and tissue-specific expression by multiple promoters and alternate mRNA processing. *Eur J Biochem* 1988;174:569–578.
312. Sakakibara M, Mukai T, Hori K. Nucleotide sequence of a cDNA clone for human aldolase: a messenger RNA in the liver. *Biochem Biophys Res Commun* 1985;131:413–420.
313. Kukita A, et al. Molecular gene mapping of human aldolase A (ALDOA) gene to chromosome 16. *Hum Genet* 1987;76:20–26.
314. Beutler E, et al. Red cell aldolase deficiency and hemolytic anemia: a new syndrome. *Trans Assoc Am Physicians* 1973;86:154–166.
315. Miwa S, et al. Two cases of red cell aldolase deficiency associated with hereditary hemolytic anemia in a Japanese family. *Am J Hematol* 1981;11:425–437.
316. Kreuder J, et al. Brief report: inherited metabolic myopathy and hemolysis due to a mutation in aldolase A. *N Engl J Med* 1996;334:1100–1104.
317. Neufeld N, et al. Hemolytic anemia and severe rhabdomyolysis due to compound heterozygous mutations of the gene for erythrocyte/muscle isozyme of aldolase: ALDOA(Arg303X/Cys338Tyr). *Blood* 2002;100:225(a).
318. Kishi H, et al. Human aldolase A deficiency associated with a hemolytic anemia: thermolabile aldolase due to a single base mutation. *Proc Natl Acad Sci U S A* 1987;84:8623–8627.
319. Takasaki Y, et al. Human aldolase A of a hemolytic anemia patient with Asp-128?Gly substitution: characteristics of an enzyme generated in *E. coli* transfected with the expression plasmid pHAAD128G. *J Biochem (Tokyo)* 1990;108:153–157.
320. Yuan PM, Talent JM, Gracy RW. Molecular basis for the accumulation of acidic isozymes of triosephosphate isomerase on aging. *Mech Ageing Dev* 1981;17:151–162.
321. McKusick VA. The anatomy of the human genome. *Am J Med* 1980;69:267–276.
322. Daar IO, et al. Human triose-phosphate isomerase deficiency: a single amino acid substitution results in a thermolabile enzyme. *Proc Natl Acad Sci U S A* 1986;83:7903–7907.
323. Schneider A, et al. Triosephosphate isomerase deficiency: repetitive occurrence of point mutation in amino acid 104 in multiple apparently unrelated families. *Am J Hematol* 1995;50:263–268.
324. Schneider A, Cohen-Solal M. Hematologically important mutations: triosephosphate isomerase. *Blood Cells Mol Dis* 1996;22:82–84.
325. Schneider AS. Triosephosphate isomerase deficiency: historical perspectives and molecular aspects. *Baillieres Best Pract Res Clin Haematol* 2000;13:119–140.
326. Schneider A, Valentine WN, Hattori M, et al. Hereditary hemolytic anemia with triosephosphate isomerase deficiency. *N Engl J Med* 1965;272:229–235.
327. Mohrenweiser HW, Fielek S. Elevated frequency of carriers for triosephosphate isomerase deficiency in newborn infants. *Pediatr Res* 1982;16:960–963.
328. Valentine W, Schneider AS, Baughan MA, et al. Hereditary hemolytic anemia with triosephosphate isomerase deficiency. *Am J Med* 1966;41:27–41.
329. Harris S, Paglia DE, Jaffe ER, et al. Triosephosphate isomerase deficiency in an adult. *Clin Res*

1970;18:529–530.

330. Hollan S, et al. Hereditary triosephosphate isomerase (TPI) deficiency: two severely affected brothers one with and one without neurological symptoms. *Hum Genet* 1993;92:486–490.

331. Hollan S, et al. Search for the pathogenesis of the differing phenotype in two compound heterozygote Hungarian brothers with the same genotypic triosephosphate isomerase deficiency. *Proc Natl Acad Sci U S A* 1997;94:10362–10366.

332. Clark AC, Szobolotzky MA. Triose phosphate isomerase deficiency: prenatal diagnosis. *J Pediatr* 1985;106:417–420.

333. Bellingham AJ, et al. Prenatal diagnosis of a red-cell enzymopathy: triose phosphate isomerase deficiency. *Lancet* 1989;2:419–421.

334. Arya R, et al. Prenatal diagnosis of triosephosphate isomerase deficiency. *Blood* 1996;87:4507–4509.

335. Pekrun A, et al. Triosephosphate isomerase deficiency: biochemical and molecular genetic analysis for prenatal diagnosis. *Clin Genet* 1995;47:175–179.

336. Valentine WN, et al. Hereditary hemolytic anemia associated with phosphoglycerate kinase deficiency in erythrocytes and leukocytes. A probable X-chromosome-linked syndrome. *N Engl J Med* 1969;80:528–534.

337. Konrad PN, et al. Erythrocyte and leukocyte phosphoglycerate kinase deficiency with neurologic disease. *J Pediatr* 1973;82:456–460.

338. Chen SH, et al. Phosphoglycerate kinase: an X-linked polymorphism in man. *Am J Hum Genet* 1971;23:87–91.

339. Huang IY, Rubinfiel E, Yoshida A. Complete amino acid sequence of human phosphoglycerate kinase. Isolation and amino acid sequence of tryptic peptides. *J Biol Chem* 1980;255:6408–6411.

340. Huang IY, Fujii H, Yoshida A. Structure and function of normal and variant human phosphoglycerate kinase. *Hemoglobin* 1980;4:601–609.

341. Michelson AM, et al. Structure of the human phosphoglycerate kinase gene and the intron-mediated evolution and dispersal of the nucleotide-binding domain. *Proc Natl Acad Sci U S A* 1985;82:6965–6969.

342. Turner G, et al. Molecular defect of a phosphoglycerate kinase variant associated with haemolytic anaemia and neurological disorders in a large kindred. *Br J Haematol* 1995;91:60–65.

343. Fujii H, Krietsch WKG, Yoshida A. A single amino acid substitution (Asp-Asn) in a phosphoglycerate kinase variant (PGK M (-um-) junchen) associated with enzyme deficiency. *J Biol Chem* 1980;255:6421–6423.

344. Fujii H, Yoshida A. Molecular abnormality of phosphoglycerate kinase-Uppsala associated with chronic nonspherocytic hemolytic anemia. *Proc Natl Acad Sci U S A* 1980;77:5461–5465.

345. Fujii H, et al. Use of cultured lymphoblastoid cells for the study of abnormal enzymes: molecular abnormality of a phosphoglycerate kinase variant associated with hemolytic anemia. *Proc Natl Acad Sci U S A* 1981;78:2587–2590.

346. Maeda M, Yoshida A. Molecular defect of a phosphoglycerate kinase variant (PGK-Matsue) associated with hemolytic anemia: Leu?Pro substitution caused by T/A?C/G transition in exon 3. *Blood* 1991;77:1348–1352.

347. Fujii H, et al. A single amino acid substitution (157 Gly?Val) in a phosphoglycerate kinase variant (PGK Shizuoka) associated with chronic hemolysis and myoglobinuria. *Blood* 1992;79:1582–1585.

348. Maeda M, et al. Molecular abnormalities of a phosphoglycerate kinase variant generated by spontaneous mutation. *Blood* 1992;79:2759–2762.

349. Dodgson SJ, et al. Erythrocyte phosphoglycerate kinase deficiency: enzymatic and oxygen binding studies. *Aust N Z J Med* 1980;10:614-621.
350. Hjelm M, Wadam B, Yoshida A. A phosphoglycerate kinase variant, PGK Uppsala, associated with hemolytic anemia. *J Lab Clin Med* 1980;96:1015-1021.
351. Kraus AP, Langston MF Jr, Lynch BL. Red cell phosphoglycerate kinase deficiency. A new cause of non-spherocytic hemolytic anemia. *Biochem Biophys Res Commun* 1968;30:173-177.
352. Svirklys LG, O'Sullivan WJ. Tissue levels of glycolytic enzymes in phosphoglycerate kinase deficiency. *Clin Chim Acta* 1980;108:309-315.
353. Miwa S, et al. Phosphoglycerate kinase (PKG) deficiency hereditary nonspherocytic hemolytic anemia: report of a case found in a Japanese family. *Nippon Ketsueki Gakkai Zasshi* 1972;35:511-514.
354. Guis MS, Karadsheh N, Mentzer WC. Phosphoglycerate kinase San Francisco: a new variant associated with hemolytic anemia but not with neuromuscular manifestations. *Am J Hematol* 1987;25:175-182.
355. Rosa R, et al. A new case of phosphoglycerate kinase deficiency: PGK Creteil associated with rhabdomyolysis and lacking hemolytic anemia. *Blood* 1982;60:84-91.
356. Harkness D. A new erythrocytic enzyme defect with hemolytic anemia. Glyceraldehyde-3-phosphate dehydrogenase deficiency. *J Lab Clin Med* 1966;68:879-880.
357. Oski F, Whaun J. Hemolytic anemia and red cell glyceraldehyde-3-phosphate dehydrogenase (G-3-PD) deficiency. *Clin Res* 1969;17:427.
358. Rosa R, Gaillardon J, Rosa J. Diphosphoglycerate mutase and 2,3-diphosphoglycerate phosphatase activities of red cells: comparative electrophoretic study. *Biochem Biophys Res Commun* 1973;51:536-542.
359. Rosa R, et al. The first case of a complete deficiency of diphosphoglycerate mutase in human erythrocytes. *J Clin Invest* 1978;62:907-915.
360. Cartier P, et al. (Familial diphosphoglycerate mutase deficiency: hematological and biochemical study.) *Nouv Rev Fr Hematol* 1972;12:269-287.
361. Travis SF, et al. Study of a kindred with partial deficiency of red cell 2,3-diphosphoglycerate mutase (2,3-DPGM) and compensated hemolysis. *Blood* 1978;51:1107-1116.
362. Stefanini M. Chronic hemolytic anemia associated with erythrocyte enolase deficiency exacerbated by ingestion of nitrofurantoin. *Am J Clin Pathol* 1972;58:408-414.
363. Kitamura M, et al. Hereditary deficiency of subunit H of lactate dehydrogenase. *Clin Chim Acta* 1971;34:419-423.
364. Mollison P. *Blood transfusion in clinical medicine*, vol. 10. Oxford: Blackwell Scientific Publications, 1997.
365. Glader BE, Sullivan DW. The red blood cell as a biopsy tool. *Clin Haematol* 1981;10:209-222.
366. Giblett ER, et al. Adenosine-deaminase deficiency in two patients with severely impaired cellular immunity. *Lancet* 1972;2:1067-1069.
367. Giblett ER, et al. Nucleoside-phosphorylase deficiency in a child with severely defective T-cell immunity and normal B-cell immunity. *Lancet* 1975;1:1010-1013.
368. Nyhan WL. The Lesch-Nyhan syndrome. *Annu Rev Med* 1973;24:41-60.
369. Kelley WN, et al. A specific enzyme defect in gout associated with overproduction of uric acid. *Proc Natl Acad Sci U S A* 1967;57:1735-1739.

370. Becker MA, et al. Human phosphoribosylpyrophosphate synthetase: increased enzyme specific activity in a family with gout and excessive purine synthesis. *Proc Natl Acad Sci U S A* 1973;70:2749–2752.
371. Van Acker KJ, Simmonds HA, Cameron JS. Complete deficiency of adenine phosphoribosyltransferase: report of a family. *Adv Exp Med Biol* 1977;76A:295–305.
372. Paglia DE, Valentine WN, Brockway RA. Identification of thymidine nucleotidase and deoxyribonucleotidase activities among normal isozymes of 5'-nucleotidase in human erythrocytes. *Proc Natl Acad Sci U S A* 1984;81:588–592.
373. Paglia DE, et al. Pyrimidine nucleotidase deficiency with active dephosphorylation of dTMP: evidence for existence of thymidine nucleotidase in human erythrocytes. *Blood* 1983;62:1147–1149.
374. Swallow DM, et al. Analysis of human erythrocyte 5'-nucleotidases in healthy individuals and a patient deficient in pyrimidine 5'-nucleotidase. *Ann Hum Genet* 1983;47:19–23.
375. Vives-Corrons JL. Chronic non-spherocytic haemolytic anaemia due to congenital pyrimidine 5' nucleotidase deficiency: 25 years later. *Baillieres Best Pract Res Clin Haematol* 2000;13:103–118.
376. Ericson A, et al. Erythrocyte nucleotide pattern in two children in a Norwegian family with pyrimidine 5'-nucleotidase deficiency. *Clin Chim Acta* 1983;134:25–33.
377. Swanson MS, et al. <sup>31</sup>P NMR study of erythrocytes from a patient with hereditary pyrimidine-5'-nucleotidase deficiency. *Proc Natl Acad Sci U S A* 1983;80:169–172.
378. Valentine WN, et al. Studies on human erythrocyte nucleotide metabolism. II. Nonspherocytic hemolytic anemia, high red cell ATP, and ribosephosphate pyrophosphokinase (RPK, E.C.2.7.6.1) deficiency. *Blood* 1972;39:674–684.
379. Valentine WN, et al. Nonspherocytic haemolytic anaemia with increased red cell adenine nucleotides, glutathione and basophilic stippling and ribosephosphate pyrophosphokinase (RPK) deficiency: studies on two new kindreds. *Br J Haematol* 1973;24:157–167.
380. Ben-Bassat I, et al. A family with red cell pyrimidine 5'-nucleotidase deficiency. *Blood* 1976;47:919–922.
381. Paglia DE, Valentine WN. Hereditary and acquired defects in the pyrimidine nucleotidase of human erythrocytes. *Curr Top Hematol* 1980;3:75–109.
382. Beutler E, et al. Hemolytic anemia due to pyrimidine-5'-nucleotidase deficiency: report of eight cases in six families. *Blood* 1980;56:251–255.
383. Miwa S, et al. Three cases of hereditary hemolytic anemia with pyrimidine 5'-nucleotidase deficiency in a Japanese family. *Hum Genet* 1977;37:361–364.
384. Valentine WN, et al. Hereditary hemolytic anemia with human erythrocyte pyrimidine 5'-nucleotidase deficiency. *J Clin Invest* 1974;54:866–879.
385. Paglia DE, et al. Selective accumulation of cytosol CDP-choline as an isolated erythrocyte defect in chronic hemolysis. *Proc Natl Acad Sci U S A* 1983;80:3081–3085.
386. Swanson MS, et al. Identification of cytidine diphosphodiesterases in erythrocytes from a patient with pyrimidine nucleotidase deficiency. *Blood* 1984;63:665–670.
387. Tomoda A, et al. Hemolytic anemia in hereditary pyrimidine 5'-nucleotidase deficiency: nucleotide inhibition of G6PD and the pentose phosphate shunt. *Blood* 1982;60:1212–1218.
388. Rees DC, et al. Interaction of hemoglobin E and pyrimidine 5' nucleotidase deficiency. *Blood* 1996;88:2761–2767.
389. Paglia DE, Valentine WN, Dahlgren JG. Effects of low-level lead exposure on pyrimidine 5'-nucleotidase and other erythrocyte enzymes. Possible role of pyrimidine 5'-nucleotidase in the

pathogenesis of lead-induced anemia. *J Clin Invest* 1975;56:1164–1169.

390. Valentine WN, et al. Lead poisoning: association with hemolytic anemia, basophilic stippling, erythrocyte pyrimidine 5'-nucleotidase deficiency, and intraerythrocytic accumulation of pyrimidines. *J Clin Invest* 1976;58:926–932.

391. Lachant NA, Tomoda A, Tanaka KR. Inhibition of the pentose phosphate shunt by lead: a potential mechanism for hemolysis in lead poisoning. *Blood* 1984;63:518–524.

392. Paglia DE, Valentine WN. Red cell nucleotide abnormalities. *Prog Clin Biol Res* 1984;165:213–225.

393. Paglia DE, Valentine WN. Haemolytic anaemia associated with disorders of the purine and pyrimidine salvage pathways. *Clin Haematol* 1981;10:81–98.

394. Cowan MJ, Ammann AJ. Immunodeficiency syndromes associated with inherited metabolic disorders. *Clin Haematol* 1981;10:139–159.

395. Meuwissen HJ, Pollara B, Pickering RJ. Combined immunodeficiency disease associated with adenosine deaminase deficiency. Report on a workshop held in Albany, New York, October 1, 1973. *J Pediatr* 1975;86:169–181.

396. Valentine WN, et al. Hereditary hemolytic anemia with increased red cell adenosine deaminase (45- to 70-fold) and decreased adenosine triphosphate. *Science* 1977;195:783–785.

397. Miwa S, et al. A case of red-cell adenosine deaminase overproduction associated with hereditary hemolytic anemia found in Japan. *Am J Hematol* 1978;5:107–115.

398. Chottiner EG, et al. Erythrocyte adenosine deaminase overproduction in hereditary hemolytic anemia. *Blood* 1989;74:448–453.

399. Fujii H, et al. Overproduction of structurally normal enzyme in man: hereditary haemolytic anaemia with increased red cell adenosine deaminase activity. *Br J Haematol* 1982;51:427–430.

400. Fujii H, Miwa S, Suzuki K. Purification and properties of adenosine deaminase in normal and hereditary hemolytic anemia with increased red cell activity. *Hemoglobin* 1980;4:693–705.

401. Paglia D, Valentine WN, Tartaglia AP, et al. Perturbations in erythrocyte adenine nucleotide metabolism: a dominantly inherited hemolytic disorder with implications regarding normal mechanisms of adenine nucleotide preservation. *Blood* 1976;48:959.

402. Glader BE, Backer K, Diamond LK. Elevated erythrocyte adenosine deaminase activity in congenital hypoplastic anemia. *N Engl J Med* 1983;309:1486–1490.

403. Glader BE, Backer K. Elevated red cell adenosine deaminase activity: a marker of disordered erythropoiesis in Diamond-Blackfan anaemia and other haematologic diseases. *Br J Haematol* 1988;68:165–168.

404. Beutler E, et al. Metabolic compensation for profound erythrocyte adenylate kinase deficiency. A hereditary enzyme defect without hemolytic anemia. *J Clin Invest* 1983;72:648–655.

405. Matsuura S, et al. Human adenylate kinase deficiency associated with hemolytic anemia. A single base substitution affecting solubility and catalytic activity of the cytosolic adenylate kinase. *J Biol Chem* 1989;264:10148–10155.

406. Szeinberg A, et al. Hereditary deficiency of adenylate kinase in red blood cell. *Acta Haematol* 1969;42:111–126.

407. Boivin P, et al. (A new erythroenzymopathy: congenital non-spherocytic hemolytic anemia and hereditary erythrocytic adenylate kinase deficiency.) *Presse Med* 1971;79:215–218.

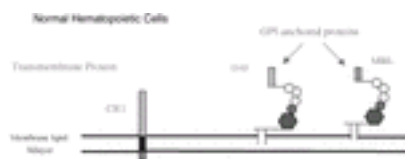
408. Miwa S, et al. Red cell adenylate kinase deficiency associated with hereditary nonspherocytic hemolytic anemia: clinical and biochemical studies. *Am J Hematol* 1983;14:325–333.

409. Lachant NA, et al. Hereditary erythrocyte adenylate kinase deficiency: a defect of multiple phosphotransferases? *Blood* 1991;77:2774–2784.
410. Toren A, et al. Congenital haemolytic anaemia associated with adenylate kinase deficiency. *Br J Haematol* 1994;87:376–380.
411. Quattieri A, et al. Severe erythrocyte adenylate kinase deficiency due to homozygous A?G substitution at codon 164 of human AK1 gene associated with chronic haemolytic anaemia. *Br J Haematol* 1997;99:770–776.
412. Bianchi P, et al. A case of complete adenylate kinase deficiency due to a nonsense mutation in AK-1 gene (Arg 107?Stop, CGA?TGA) associated with chronic haemolytic anaemia. *Br J Haematol* 1999;105:75–79.
413. Vives-Corrons JL, et al. Red cell adenylate kinase deficiency. Molecular study of three new mutations (118 G?A,190 G?A, and GAC deletion) associated with nonspherocytic hemolytic anemia. *Blood* 2003.

2004 Lippincott Williams & Wilkins  
John P. Greer, John Foerster, John N. Lukens  
George M. Rodgers, Frixos Paraskevas, Bertil Glader  
Wintrobe's Clinical Hematology

**COMPLEMENT SYSTEM**[Classic Pathway of Complement](#)[Alternative Pathway of Complement](#)**RECEPTORS FOR COMPLEMENT AND IMMUNOGLOBULIN G**[Complement Receptors](#)[Fc \$\gamma\$  Receptors](#)**MECHANISMS OF IMMUNE DESTRUCTION OF ERYTHROCYTES**[Destruction by Immunoglobulin M Antibodies](#)[Destruction by Immunoglobulin G Antibodies](#)[Role of Cytotoxic Cells in Immune Red Cell Destruction](#)**REFERENCES**

Immune destruction of erythrocytes is initiated by the binding of immunoglobulin (Ig) G or IgM antibodies to protein or carbohydrate antigens on the red cell surface. Erythrocytes come under attack by the immune system as a consequence of autoimmune, alloimmune, or isoimmune processes. IgG-sensitized erythrocytes can be destroyed directly (i.e., without complement activation) because cells of the reticuloendothelial system (tissue macrophages) express receptors that bind the Fc portion of the IgG molecule. In contrast, immune destruction of IgM-sensitized red cells is an indirect process that appears to depend entirely on complement activation because humans apparently lack specific receptors for the Fc portion of IgM. Complement mediates destruction of erythrocytes in two ways. First, cells can undergo direct complement-induced cytolysis. However, such immune-mediated intravascular hemolysis is rarely observed clinically because erythrocytes express membrane proteins that have evolved specifically to restrict complement-induced injury ( [Fig. 34.1](#)). Only when there is massive complement activation are the protective effects of the membrane regulatory proteins overwhelmed.



**Figure 34.1.** Complement regulatory proteins on normal erythrocytes. Although the primary function of red cell complement receptor (CR) 1 (CD35) is immune adherence mediated through binding of activation and degradation products of complement C3 and C4, it also has complement inhibitory activity. CR1 has decay-accelerating activity for both the classic and alternative pathways of complement, and it serves as a cofactor for enzymatic degradation of complement C3b and C4b by factor I. CR1 is an example of a transmembrane protein that has three domains: an ectoplasmic domain (rectangle with horizontal lines), a transmembrane domain (dark rectangle), and a cytoplasmic domain (rectangle below lipid bilayer). Decay-accelerating factor (DAF; CD55) is a glycosyl phosphatidylinositol (GPI)-anchored protein that inhibits the formation and stability of the C3 convertases of both the classic and the alternative pathways. Membrane inhibitor of reactive lysis (MIRL; CD59) is also GPI-anchored. It inhibits complement-mediated lysis by blocking the formation of the membrane attack complex of complement. In contrast to



transmembrane proteins like CR1, GPI-anchored proteins such as DAF (CD55) and MIRL (CD59) lack the cytoplasmic and transmembrane domains. This class of proteins is anchored to the cell by a GPI moiety consisting of phosphatidylinositol (dark hexagon), glucosamine (dark circle), and three mannose (light circles) molecules. The GPI moiety is linked to the COOH-terminus of the protein portion of the molecule by ethanol-amine. The GPI-anchored proteins are deficient in paroxysmal nocturnal hemoglobinuria (PNH), accounting for the abnormal sensitivity of erythrocytes of PNH to complement-mediated lysis.

The pathologic circumstances associated with major transfusion reactions and paroxysmal cold hemoglobinuria illustrate the stringent conditions required to induce direct complement-mediated intravascular hemolysis. Infusion of ABO-mismatched blood is invariably associated with intravascular hemolysis, with complement activation sufficient to mediate this process occurring because the following four conditions are present concomitantly: (a) the naturally occurring antibodies are present in high titer; (b) the antibodies are of the IgM type; (c) the carbohydrate antigens that are recognized by the antibodies are present in high density on the red cell membrane; (d) the antibodies are active at 37° C. Direct complement-mediated intravascular hemolysis is also observed in paroxysmal cold hemoglobinuria, but again, a set of exceptional circumstances is required to produce the intravascular hemolysis mediated in this case by an IgG antibody (the Donath-Landsteiner antibody). First, the antigens (most commonly, the carbohydrate moiety of the glycolipids that comprise the P blood group system) that are recognized by the Donath-Landsteiner antibody are present in high density on the red cell surface. Second, the unusual thermal properties of the Donath-Landsteiner antibody that result in fixation of both complement components C1 and C4 at cold temperatures greatly enhance the efficiency with which the remainder of the complement cascade is activated on subsequent warming to 37° C (1).

In contrast to paroxysmal cold hemoglobinuria, chronic cold agglutinin disease is less commonly associated with clinically significant intravascular hemolysis. Inasmuch as the antibodies of cold agglutinin disease are often present in very high titer, are of the IgM type, and recognize carbohydrate antigens that are present in high density on the erythrocyte membrane, this observation seems discrepant. However, the apparent discrepancy is explained by the thermal properties of the cold agglutinin antibody and its interactions with complement. Unlike the IgG Donath-Landsteiner antibody of paroxysmal cold hemoglobinuria that fixes both complement C1 and C4 at cold temperatures, the IgM antibodies of cold agglutinin disease fix only C1 (1). This difference reduces the efficiency with which the remainder of the complement cascade is activated when the blood is warmed to 37° C. Additionally, the thermal amplitude of most cold agglutinins is relatively low. Consequently, the antibody dissociates from the red cell surface at temperatures sufficiently high for efficient complement activation. Thus, the capacity of the IgM antibodies of cold agglutinin disease to activate complement is inadequate to overcome the protective effects of the membrane regulatory proteins (Fig. 34.1).

An uncommon disease further underscores the physiologic importance of erythrocyte membrane proteins that regulate complement. Paroxysmal nocturnal hemoglobinuria (PNH) is characterized by chronic complement-mediated intravascular hemolysis that occurs independent of antibody (see Chapter 37). In this case, the erythrocytes undergo spontaneous hemolysis mediated by the alternative pathway of complement because they lack two of the membrane regulatory proteins [decay-accelerating factor (DAF; CD55) and membrane inhibitor of reactive lysis (MIRL; CD59)] that normally restrict the functional activity of the complement system (Fig. 34.1).

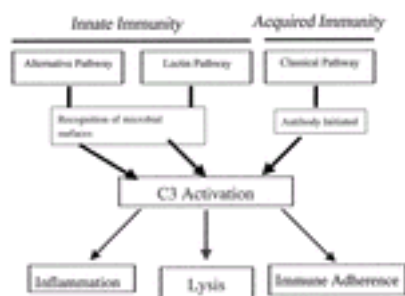
The second mechanism by which complement mediates destruction of erythrocytes is an indirect process that depends on complement activation and then on subsequent

recognition of both activation and degradation products of the third component of complement (C3) by specific receptors on reticuloendothelial cells. All IgM antibodies mediate extravascular, cell-dependent hemolysis via this mechanism; under some conditions, warm antibodies of the IgG type may also activate complement. In such cases, clearance of the IgG and C3 opsonized cells is greatly enhanced because the simultaneous engagement of both complement and Fc receptors augments the phagocytic process synergistically ( 2 ).

Under most clinical circumstances, immune destruction is an extravascular process that depends on recognition by specific receptors on reticuloendothelial cells of erythrocytes opsonized with IgG, complement, or both. To understand more completely the pathophysiology that underlies immune hemolysis, familiarity with the function of the complement system and the receptors for both the Fc portion of IgG and for the activation and degradation products of C3 is needed.

## COMPLEMENT SYSTEM

There are three distinct pathways that lead to C3 deposition and subsequent formation of the membrane attack complex of complement ( Fig. 34.2). The classic pathway is activated by antibody, whereas activation of the alternative pathway occurs independent of antibody. With the exception of PNH, complement-mediated destruction of erythrocytes is mediated by the classic pathway. The lectin pathway is activated by binding of a protein complex to specific carbohydrates expressed primarily by microbial organisms. The activation complex of the lectin pathway consists of both a recognition unit (mannose-binding lectin or L- or H-ficolin) and an activation unit [mannose-binding lectin-associated serine proteases 1, 2, and 3 (MASP-1, MASP-2, and MASP-3)]. Although the lectin pathway is not discussed in detail in this chapter because it has no apparent role in immune destruction of erythrocytes, it has been the subject of recent reviews by others ( 3 , 4 , 5 , 6 and 7 ).



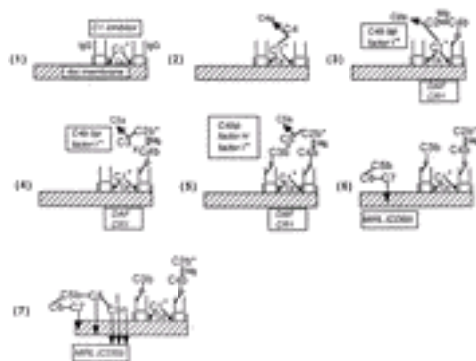
**Figure 34.2.** The complement system. Although there are three distinct pathways for complement activation, immune destruction of human erythrocytes is mediated by the classic pathway (with one exception). Direct lysis of human red blood cells by complement is unusual because of protection by the complement regulatory proteins ( Fig. 34.1). The reticuloendothelial system, through recognition of surface-bound IgG or activation and degradation products of complement C3 and C4, mediates destruction of erythrocytes in most cases of immune hemolytic anemia. Rarely (e.g., major transfusion reactions), complement activation is brisk enough so that clinical signs and symptoms of inflammation may be observed (mediated by C3a and C5a). The alternative pathway mediates immune lysis of paroxysmal nocturnal hemoglobinuria erythrocytes.

### Classic Pathway of Complement

The classic pathway is activated when the first component of complement (C1) binds to the Fc portion of an IgG or an IgM antibody that is affixed to an antigen on the red cell membrane surface. Antibodies of the IgA, IgD, and IgE classes lack the binding site for C1 and thus are unable to activate complement. Of the IgG subclasses, IgG3 binds C1 most efficiently, followed in order of efficiency by IgG1 and IgG2. IgG4 interacts poorly with C1 and appears to lack the capacity to activate the classic pathway (8).




C1 is actually composed of three subunits (C1q, C1r, and C1s). The stoichiometry is as follows: one unit of C1q, two units of C1r, and two units of C1s. The C1q component binds weakly to the C1r<sub>2</sub>C1s<sub>2</sub> tetramer, and the structural and functional integrity of the C1 complex is calcium dependent (9). The binding constant for this reaction ( $5 \times 10^7$  M<sup>-1</sup>) is such that approximately 80% of the C1q and C1r<sub>2</sub>C1s<sub>2</sub> subunits are combined as C1 molecules in the plasma (10, 11). C1q is the subunit of the complex that binds to the Fc portion of IgG or IgM. The ultrastructure of C1q is complex and distinctive (8, 12, 13). The molecule is composed of six globular heads extending from a collagenlike stem with the six stems joined together in a bunch (under electron microscopy, the side view of the molecule looks remarkably similar to a bouquet of tulips).

Each of the six globular heads of C1q has a binding site that is specific for a region in the Fc portion of the Ig molecule (8). Binding of a single head, however, is weak and lasts only a fraction of a second. Firm binding lasting several minutes requires the interaction of at least two of the heads (Fig. 34.3, part 1). Whereas each IgG molecule has two C1q binding sites (one in each of its two Fc domains), a single C1q molecule cannot bind firmly to a single IgG molecule because the binding sites in IgG are located on opposite sides of the Fc moiety. Inasmuch as the C1q molecule is relatively inflexible, two of its globular heads cannot engage both of the Fc binding sites of a single IgG molecule simultaneously.



**Figure 34.3.** Schematic representation of classic pathway activation. The details of the activation and regulation of the classic pathway are contained in the text. The lipid bilayer of the erythrocyte membrane is represented by (ZZZZ). Plasma inhibitors are enclosed in boxes above the lipid bilayer symbol. The symbol (\*) indicates enzymatic activity. The symbol (Ca) indicates that the integrity of the C1 complex is calcium dependent. The symbol (—●) indicates binding of one of the globular heads of C1q to an immunoglobulin molecule. The symbol (Mg) indicates that the binding of C2 to C4b is magnesium dependent. The symbol (C) indicates covalent bond. The symbol (e) indicates weak, transient binding. The symbol (st) indicates stable binding. A hair arrow (e) extending from an enzymatic component design substrate cleavage and indicates the released cleavage product. The wavy arrows (e) extending from C2, C4, and C2b indicate that an amphiphilic transition has occurred, resulting in integration of a portion of the complement component into the lipid bilayer. C2b indicates that multiple molecules of polymerized C3 are incorporated into the membrane attack complex. See text: C3b, C3b binding protein; C4, complement receptor; C2b, decay-accelerating factor; sMBL, membrane inhibitor of reactive lysis; sIC, red blood cell.

**Figure 34.3.** Schematic representation of classic pathway activation. The details of the activation and regulation of the classic pathway are contained in the text. The lipid bilayer of the erythrocyte membrane is represented by (ZZZZ). Plasma inhibitors are enclosed in boxes above the lipid bilayer symbol. The symbol (\*) indicates enzymatic activity. The symbol (Ca) indicates that the integrity of the C1 complex is calcium dependent. The symbol (—●) indicates binding of one of the globular heads of C1q to an immunoglobulin molecule. The symbol (Mg) indicates that the binding of C2 to C4b is magnesium

dependent. The (  ) symbol indicates a covalent bond between C3b or C4b and the immunoglobulin molecule. The symbol ( × ) indicates weak, transient binding. The symbol (  ) indicates stable binding. A bent arrow (  ) extending from an enzymatic component shows substrate cleavage and indicates the released cleavage product. The vertical arrows ( ? ) extending from C7, C8, and C9n indicate that an amphiphilic transition has occurred, resulting in integration of a portion of the complement component into the lipid bilayer. C9n indicates that multiple molecules of polymerized C9 are incorporated into the membrane attack complex. See text. C4bp, C4 binding protein; CR, complement receptor; DAF, decay-accelerating factor; MIRL, membrane inhibitor of reactive lysis; rbc, red blood cell.

For IgG to activate the classic pathway, at least two molecules must be bound to the erythrocyte in close proximity to each other (within 30 to 40 nm) ( [Fig. 34.3, part 1](#) ) ( [12](#), [13](#) and [14](#) ). This requirement means that the number of copies of antigen/cell is an important determinant of complement activation. In some cases, however, antigens that are present in relatively low numbers may be able to support complement activation if they are free to move within the plane of the membrane so that patches or clusters can form. The relatively low density of the Rh antigen, its even distribution over the entire membrane surface, and its inability to patch due to constraints imposed by its structure and interactions with other membrane constituents probably account for the lack of complement activation induced by anti-Rh antibodies ( [15](#), [16](#) ).

The efficiency with which IgG is able to activate the classic pathway is also enhanced when an immune reaction generates polyclonal antibodies that recognize different epitopes on the same antigen. Under these conditions, the stringent spacial requirements for C1q binding to Fc may be met when two or more molecules of IgG bind to a single antigenic structure.

In contrast to IgG, IgM is a highly efficient activator of the classic pathway. The pentameric structure of IgM means that five Fc moieties are present in the same molecule with at least three (and probably five) C1q binding sites available ( [17](#) ). Thus, a single molecule of IgM has the capacity to activate the classic pathway. However, the C1q binding sites are not exposed unless the IgM molecule assumes the “staple” form. To assume this configuration, at least two of the subunits of the IgM molecule must engage the cellular antigen ( [18](#) ). Thus, antigen density also has an impact on the capacity of IgM to activate complement. When free in plasma, IgM does not activate complement because it exists in a star-shaped, planar form. Under these conditions, the C1q binding sites are not exposed. Interaction with antigen causes the F(ab')<sub>2</sub> arms to bend so that they are at right angles to the central Fc core of the molecule (the staple configuration). This conformational change exposes the C1q binding sites, allowing complement activation to proceed.

Both C1r and C1s are serine proteases that exist in their native state as zymogens (inactive proenzymes). As noted above, the integrity of the C1r<sub>2</sub>C1s<sub>2</sub> complex is dependent on calcium ( [9](#) ), and the C1s molecules are located at either end of the linear tetramer with the two C1r molecules in the middle ( [9](#) ). The primary structure of C1r and C1s is very similar, suggesting that they arose by gene duplication. Enzymatic activity is expressed after proteolytic cleavage of the zymogens. Apparently, binding of C1q to Ig induces a conformational change in C1 that causes autoactivation of the two C1r molecules ( [19](#) ). The precise mechanism by which autoactivation occurs remains obscure; however, available evidence suggests that as each C1r molecule undergoes autoactivation, it cleaves its partner within the tetramer. By enzymatic cleavage, the two proteolytically activated C1r molecules subsequently activate their contiguous C1s

partners ( 8 ). Binding of C1 is rapid, but activation is a relatively slow process ( 19 ). This discrepancy appears to be due to the fact that not all C1 binding sites have the capacity to support activation of C1.

Binding of C1 to Ig is a crucial amplification step in the generation of the classic pathway cascade because activated C1s has the capacity to proteolytically cleave many molecules of C4 and C2. Because of its enormous destructive capacity elaborate safeguards for restricting the activity of complement have evolved. These checkpoints usually involve inhibition of the formation or activity of an enzymatic step in the pathway so that amplification is dampened. The first such complement regulatory factor is C1 inhibitor ( Fig. 34.3, part 1 ). This heavily glycosylated plasma protein (40% carbohydrate by weight) binds in a 1:1 stoichiometric relationship with activated C1r and C1s, forming an extremely stable (probably covalent) complex. Binding of C1 inhibitor causes activated C1r and C1s to dissociate from the C1 complex, leaving C1q bound to Ig ( 8 ). Because the rate of reaction of C1 inhibitor with activated C1r and C1s is so rapid, the half-life of activated C1 in the plasma is only 10 to 20 seconds ( 20 ). C1 inhibitor is a member of the superfamily of serine protease inhibitors (serpins), and it also has the capacity to block the activity of plasmin, kallikrein, factor XIa, and factor XIIa ( 15 ). Deficiency of C1 inhibitor underlies the clinical disorder angioedema, a disease that exists in both inherited and acquired forms ( 21 ).

The natural substrates for activated C1 are C4 and C2. Activated C1s cleaves C4 near the amino terminus of the  $\alpha$ -chain of this disulfide-linked heterotrimer ( Fig. 34.3, part 2 ) ( 22 ). The smaller cleavage fragment, designated C4a, is a weak anaphylatoxin ( 23 ). The larger fragment, C4b, contains an internal thioester bond that is exposed when C4 is cleaved by C1s ( 24 ). By acyl transfer, this thioester group located in the  $\alpha$ -chain can form either an ester or an imidoester bond with the Ig molecule or with an erythrocyte membrane glycoprotein (in particular, glycophorin A) ( 25, 26 ). The half-life of the activated C4 is extremely short (approximately 60  $\mu$ sec by analogy with nascent C3b, see below). During this period, the activated protein can diffuse approximately 40 nm. Thus, C4b is found in clusters around the Ig-C1 complex.

There are two C4 genes: C4A and C4B ( 27 ). The protein product of the two genes differs by only four amino acids, with the sequence variation being centered around the thioester reactive site ( 28 ). This difference appears to influence the type of bond that is formed between nascent C4b and its target surface and, in so doing, to account for the two- to fourfold greater hemolytic activity of C4B compared to C4A ( 29, 30 ). Studies have shown that C4B reacts more effectively with hydroxyl groups, forming ester bonds, whereas C4A displays a preference for amide bond formation because of preferential interaction with primary amino groups. Due to the relative abundance and accessibility of the carbohydrate moiety of erythrocytes, the opportunity for ester bond formation is greater than for amide bond formation. Consequently, C4B binds to erythrocytes approximately four times more efficiently than C4A. This quantitative difference in binding appears to account entirely for the greater hemolytic activity of C4B compared to C4A ( 29 ). Of additional interest is the observation that the Rodgers (Rg) and Chido (Ch) blood group phenotypes are determined by C4 genotype ( 31 ). With rare exception, individuals expressing only C4A (5% of the Caucasian population) are Rh<sup>+</sup>Ch<sup>-</sup>, whereas those expressing only C4B (2% of the population) are Rh<sup>-</sup>Ch<sup>+</sup>. Most of the Caucasian population (93%) expresses both C4A and C4B and is, therefore, Rh<sup>+</sup>Ch<sup>+</sup>. That the antigenic determinant is on the C4d portion of the molecule (the fragment containing the thioester reactive site) implies that some low-level activation of the classic pathway



occurs on erythrocytes under normal physiologic conditions.

The covalent attachment of C4b serves as the nidus for the formation of the C3 convertase of the classic pathway by providing a magnesium-dependent binding site for C2, a zymogen belonging to the family of serine proteases ( [Fig. 34.3, part 3](#) ) ( [32](#) ). C2 that is bound to C4b at a distance no greater than 60 nm from an Ig-activated C1 complex is cleaved by C1s into fragments of C2a and C2b. The C2b fragment remains bound and functions as the enzymatic subunit of the classic pathway C3 convertase. (Note that there is not universal agreement on the nomenclature of the C2 fragments. Many investigators continue to use the original nomenclature in which the enzymatic subunit of C2 was designated C2a.) No definite biologic function has been attributed to the nonenzymatic C2a peptide.

The activity of the C3 convertase of the classic pathway is regulated by its intrinsic instability and by both plasma and membrane proteins ( [Fig. 34.3, part 3](#) ). The plasma constituent, C4b-binding protein, restricts convertase activity by binding to C4b and inhibiting the subsequent binding of C2 or by accelerating the decay of formed C4b2b complexes, or both ( [33](#) , [34](#) and [35](#) ). C4b-binding protein also serves as a cofactor for the enzymatic degradation of C4b by the plasma serine protease, factor I ( [33](#) , [36](#) , [37](#) ). C4b-binding protein has an interesting structure in that it is composed of seven identical chains that are linked by disulfide bonds ( [38](#) ). Electron micrographs show a spiderlike structure consisting of seven elongated subunits (resembling tentacles) linked to a small central body ( [38](#) ). Approximately 50% of C4b-binding protein in plasma is complexed with protein S, the vitamin K-dependent protein C cofactor that plays a critical role in hemostasis ( [39](#) ).

The activity of the classic pathway C3 convertase (C4b2b) is also regulated by two erythrocyte membrane proteins: complement receptor type 1 (CR1; CD35) and DAF (CD55) ( [Fig. 34.3, part 3](#) ). CR1 regulates the convertase activity in much the same way as C4b-binding protein (i.e., it binds to C4b preventing formation of the complex, accelerates the decay of the C4b2b complex, and serves as a factor I cofactor) ( [40](#) , [41](#) and [42](#) ). In contrast, DAF lacks factor I cofactor activity, and it does not appear to block convertase formation. Rather, DAF (as its name suggests) restricts convertase activity by accelerating the decay of the C4b2b complex ( [43](#) , [44](#) ). Membrane cofactor protein (MCP; CD46) is another cellular protein that inhibits complement activation. As does CR1, MCP serves as a cofactor for the factor I-mediated cleavage of C4b (and C3b) ( [45](#) ). MCP, however, is not expressed by erythrocytes and, therefore, does not participate in regulation of immune hemolysis.

CR1 and DAF share a common structural motif consisting of cysteine-rich units of approximately 60 amino acids called *short consensus repeats* (SCRs). DAF contains four SCRs, whereas CR1 contains 30 SCR units. This structural feature is also shared by other complement proteins [factor H, C4b-binding protein, MCP (CD46), and complement receptor type 2 (CR2; CD21)]. All of these proteins interact with C3b, C4b, or both. The genes for these proteins have been localized to the long arm of chromosome 1 (band q32); together, this gene family is referred to as the *regulators of complement activation* ( [46](#) ). CR1 is a type I integral membrane protein, whereas DAF is anchored to the cell through a glycosyl phosphatidylinositol (GPI) moiety ( [Fig. 34.1](#) ). Like all GPI-anchored proteins, DAF is deficient on the erythrocytes from patients with PNH, and this deficiency accounts in part for the complement-mediated lysis that is the clinical hallmark of the disease (see [Chapter 37](#) ).

The classical pathway C5 convertase is formed when C3 in the fluid phase is cleaved into

C3a and C3b fragments by the C2b component of the C4b2b complex ( [Fig. 34.3, part 4](#)). The 77-amino acid C3a molecule that is liberated from the amino-terminal end of the  $\alpha$ -chain of C3 as a consequence of cleavage by C2b is an anaphylatoxin that is approximately tenfold more potent than C4a, but approximately 200-fold less potent than C5a ( [23](#), [47](#)). Recently, the molecular cloning of the receptor for C3a was reported ( [48](#), [49](#) ). Although the C3a receptor is structurally and functionally similar to the C5a receptor, the tissue distribution of the two anaphylatoxin receptors appears to be different. Whether the C3a receptor is also the receptor for C4a is under investigation. Like C4b, C3b contains an internal thioester bond that mediates the covalent attachment of the molecule to Ig or cell-surface constituents ( [Fig. 34.3, part 5](#)) ( [50](#), [51](#) and [52](#)). Thus, the C3b that becomes membrane bound is found in clusters around the C4b2b complex because the extremely short half-life of the binding site (approximately 60  $\mu$ sec) limits the distance that nascent C3b can diffuse before it becomes inactive ( [53](#)). Although only 10 to 15% of the C3b that is generated by C4b2b becomes cell bound, this step is nonetheless an important part of the amplification process because each convertase mediates the deposition of approximately 200 molecules of C3b ( [54](#)).

The same plasma and cellular proteins that control the activity of the C3 convertase ( [Fig. 34.3, part 5](#)) regulate the C5 convertase. In the case of the C5 convertase, CR1 also binds to C3b and serves as a cofactor for factor I-mediated degradation of C3b to iC3b and, subsequently, to C3dg ( [55](#), [56](#)). This latter C3 degradation fragment is the predominant form of C3 found on circulating erythrocytes in patients with immune hemolytic anemias involving complement activation (e.g., chronic cold agglutinin disease) ( [57](#)). In addition to CR1, the plasma protein factor H serves as a cofactor for factor I-mediated degradation of C3b to iC3b. Under physiologic conditions, however, factor H does not support the factor I-mediated cleavage of iC3b to C3c and C3dg ( [55](#)). Factor H, a single-chain glycoprotein consisting of 20 SCR units ( [58](#)), is an important regulator of the C3 and C5 convertases of the alternative pathway (see [Alternative Pathway of Complement](#)).

C2b is also the catalytic subunit of the classic pathway C5 convertase (C4b2b3b) ( [59](#)). In this case, cell-bound C3b serves as the attachment site for C5, thereby positioning it for enzymatic activation by C2b ( [Fig. 34.3, part 5](#)). Nascent C5b is generated when C2b cleaves a 74-amino acid peptide (C5a) from the amino-terminal portion of the  $\alpha$ -chain of C5 ( [60](#), [61](#)). In addition to being a potent anaphylatoxin, C5a is an important component of the immune process that mediates a variety of proinflammatory events through binding with a specific G protein-coupled receptor expressed on a variety of tissues ( [62](#)). Unlike C4b and C3b, C5b does not contain an internal thioester bond; thus, it does not bind covalently to the cell membrane ( [24](#)). Rather, C5b serves as the nidus for the formation of the membrane attack complex (MAC). The number of C5b molecules that are activated by the classic pathway C3 convertase is greatly constrained because only C5 that is bound to a C3b molecule that is in close proximity to a C4b2b complex can be cleaved. Thus, each C4b2b complex generates only two or three molecules of C5b. The functional half-life of C5b is approximately 2 minutes, and it appears to undergo irreversible inactivation while still bound to C3b ( [59](#)).

After the generation of C5b, no further enzymatic activity is involved in either the formation or the cytolytic activity of the MAC that consists of C5b, C6, C7, C8, and C9 (C5b-9). Components C6, C7, and C9 are single-chain polypeptides ( [63](#), [64](#), [65](#), [66](#) and [67](#)). As discussed above, C5b is a disulfide-linked heterodimer that is the product of a single gene. C8 consists of three nonidentical peptide chains ( [68](#)). The  $\alpha$ - and  $\beta$ -chains comprise a disulfide-linked unit that is noncovalently associated with the  $\beta$ -chain. Apparently, the three polypeptide chains that comprise C8 are the products of separate



genes ( [69](#) ). There are structural and antigenic similarities among four of the components (C6, C7, C8, and C9), and at the nucleotide level, modest homology is observed for C7, C8a, C8B, and C9 ( [53](#) ).

Formation of the MAC is initiated when nascent C5b (i.e., still complexed with C3b) binds specifically to C6, forming a stable, hydrophilic complex ( [70](#), [71](#) ). Binding to the C5b6 complex induces a conformational change in C7 that exposes a labile membrane-binding site and causes the molecule to undergo a hydrophilic–amphiphilic transition ( [72](#), [73](#) ). This process allows the trimolecular C5b67 complex to integrate into the lipid bilayer of the erythrocyte ( [Fig. 34.3, part 6](#) ). Once inserted into the cell, the complex is stable. Binding of C8 to the C5b67 complex is mediated through the  $\beta$ -chain that has a specific recognition site for C5b ( [74](#) ). Binding to C5b67 induces a conformational rearrangement that allows the  $\alpha$ -chain of C8 to insert into the hydrophobic core of the lipid bilayer and exposes a single binding site for C9. Binding to C8a within the C5b–8 complex ( [75](#) ) causes C9 to unfold. This conformational change exposes hydrophobic regions that allow the molecule to insert into the membrane ( [Fig. 34.3, part 7](#) ), exposing a binding site for an additional C9 molecule. Binding to C5b–9<sub>1</sub> causes the second C9 molecule to undergo the same conformational change as the first C9 molecule; in this way, multiple molecules of C9 become incorporated into the MAC (C5b–9<sub>n</sub>) ( [49](#) ). The C9 molecules undergo polymerization, and this process forms the ringlike structure that appears as the classic doughnut lesion visualized by electron microscopy ( [76](#), [77](#) ). Individual MACs are heterogeneous in size due to differences in C9 composition ( [78](#), [79](#) and [80](#) ). Thus, the stoichiometry of the MAC is C5b<sub>1</sub>, C6<sub>1</sub>, C7<sub>1</sub>, C8<sub>1</sub>, and C9<sub>n</sub>, where n ranges from 2 to 18 depending on the experimental conditions ( [53](#), [79](#), [80](#) ). On normal human erythrocytes that have undergone hemolysis, the average C8 to C9 ratio is 1:3, whereas on PNH erythrocytes that have undergone lysis, the average C8 to C9 ratio is 1:6 ( [81](#) ). These results indicate that MIRL (CD59), a GPI-anchored protein that is deficient in PNH, restricts the incorporation of C9 into the MAC.

Disruption of the integrity of the lipid bilayer of the erythrocyte by the MAC creates an osmotic gradient because small ions can traverse the damaged membrane, but large cytoplasmic components such as hemoglobin cannot. The consequent inflow of water causes the cell to expand rapidly. If membrane damage is sufficient, the cell ruptures, releasing hemoglobin into the plasma (a process called *colloid osmotic lysis*). The mechanism by which the MAC produces cell lysis is debated. According to the “leaky patch” hypothesis, insertion of the hydrophobic elements of the MAC causes local disruption of the integrity of the phospholipid bilayer ( [82](#) ). The proponents of the competing “pore” hypothesis argue that the polar surfaces of the MAC components aggregate, forming a hydrophilic channel through the membrane ( [83](#) ). Data in support of both hypotheses have been presented ( [82](#), [83](#) ), suggesting that both processes may be operative depending on the experimental conditions.

A number of plasma proteins, including S protein (vitronectin) ( [84](#) ), and apolipoproteins (particularly clusterin) have been shown to inhibit the activity of the MAC *in vitro* ( [70](#), [85](#), [86](#), [87](#) and [88](#) ). The importance of these plasma constituents in regulating the lytic actions of complement *in vivo*, however, has not been established unequivocally. Erythrocytes are protected from lytic action of the MAC by MIRL (CD59) ( [Fig. 34.3, part 7](#) ) ( [89](#), [90](#) ). This GPI-anchored protein ( [Fig. 34.1](#) ) inhibits MAC formation primarily by binding to C8, thereby restricting the subsequent binding and polymerization of C9 ( [91](#), [92](#) and [93](#) ). The importance of MIRL *in vivo* was made clear by a patient with an isolated deficiency of this complement regulatory protein ( [94](#) ). That patient had a syndrome characterized by

recurrent episodes of intravascular hemolysis that was clinically indistinguishable from PNH.

### Alternative Pathway of Complement

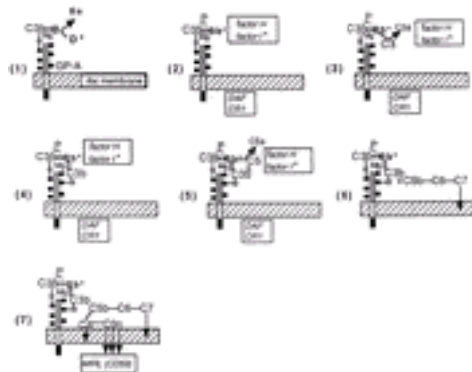
Activation of the classic pathway is highly specific in that antibody is required to initiate the process. Thus, the system is quiescent unless erythrocyte antigens become targets for immune attack as a consequence of some pathologic process, be it autoimmune, alloimmune, or isoimmune. Therefore, under normal physiologic conditions, host erythrocytes do not require protection against the classic pathway. In contrast, there is no specific initiating factor for the alternative pathway. Consequently, the alternative pathway does not discriminate between host and foreign cells. Rather, the burden of avoiding attack by the alternative pathway is borne directly by host cells that rely on membrane factors to restrict the activity of the system. Because they are continuously exposed to complement activation by the alternative pathway, erythrocytes have evolved specific cell-surface constituents (DAF, MIRL, and CR1) ( [Fig. 34.1](#) ) that protect them against complement-mediated destruction. That normal erythrocytes never undergo immune destruction mediated by the alternative pathway is a testament to the effectiveness of these two proteins. On the other hand, the chronic complement-mediated intravascular hemolysis that is characteristic of PNH is mediated by the alternative pathway. That PNH is a consequence of the deficiency of DAF and MIRL underscores the essential role that these proteins play in protecting normal erythrocytes from injury by the alternative pathway.

Inasmuch as antibody is not required for its activation, the alternative pathway functions as the first line of defense against bacterial infections in the nonimmune host ( [95](#) ). Thus, the alternative pathway, like the lectin pathway, is a component of the innate immune system ( [96](#) , [97](#) ). The alternative pathway is activated by certain microorganisms because the biochemical properties (e.g., the sialic acid content) of these potential pathogens favor the formation and stability of the C3 convertase. On alternative pathway activators, the binding of the catalytic subunit (factor B) of the C3 convertase is favored over the binding of the convertase inhibitory protein (factor H). Erythrocytes are exposed to the same plasma factors as invading organisms, and yet normal red cells are completely resistant to injury mediated by the alternative pathway. Thus, erythrocytes serve as the paradigm for understanding the elaborate mechanisms that have evolved to protect host cells against the untoward consequences of alternative pathway activation.

In plasma, the alternative pathway is in a state of continuous, low-grade activation. Thus, the system is primed for attack at all times. Activation of the alternative pathway is initiated by direct formation of the C3 convertase, consisting of hydrolyzed C3 and activated factor B ( [98](#) ). The activity of the system is kept at a low level because, in the plasma, the formation and stability of the amplification C3 convertase are tightly controlled by the endogenous regulatory protein, factor H. Nonetheless, some low-grade activation does occur because the internal thioester in native C3 is subject to spontaneous hydrolysis. Nascent (C3·H<sub>2</sub>O) undergoes a conformational change that transiently exposes a magnesium-dependent binding site for factor B ( [98](#) ). The catalytic subunit of the alternative pathway C3 convertase (Bb) is generated when factor B that is bound to (C3·H<sub>2</sub>O) is cleaved by factor D into Ba and Bb fragments ( [99](#) ). Factor D, a trace plasma protein, is a serine protease without a zymogen form (i.e., it is always functionally active) ( [53](#) ). Factor B is both structurally and functionally homologous to C2 of the classic pathway ( [27](#) ). Like C2, factor B is a serine protease that exists in its native state as a zymogen with enzymatic cleavage being required for activation ( [100](#) ). Further, activated C2 (C2b) and factor B (Bb) have the same natural substrates (i.e., C3 and C5). Although factor B and C2 share only modest (37%) amino acid sequence homology, the

genes that encode these two proteins are structurally similar and closely associated in the major histocompatibility complex region of chromosome 6. Together, these observations suggest that the C2 and factor B arose by gene duplication.

Activation of the alternative pathway on erythrocytes is initiated when native C3 binds to C3H<sub>2</sub>O:Bb. The subsequent enzymatic cleavage of C3a from native C3 induces a conformational change in the resulting C3b molecule such that the internal thioester becomes exposed. By acyl transfer, nascent C3b binds covalently to glycoprotein A, the major erythrocyte sialoglycoprotein (101). Although both ester and imidoester bonds can form, the majority of C3b on erythrocytes is bound via an ester bond to the carbohydrate moiety of glycoprotein A (101). The cell-surface C3 convertase is formed when factor B binds to C3b in a magnesium-dependent reaction. Factor B is activated by factor D (99), and the amplification C3 convertase (C3bBb) is stabilized by factor P (properdin) (102) (Fig. 34.4, part 1, Fig. 34.4, part 2, and Fig. 34.4, part 3).



**Figure 34.4.** Schematic representation of alternative pathway activation. The details of the activation and regulation of the alternative pathway are contained in the text. The lipid bilayer of the erythrocyte membrane is represented by (▨). Plasma inhibitors are enclosed in boxes above the lipid bilayer symbol, and membrane inhibitors are enclosed in boxes below the lipid bilayer symbol. The symbol (\*) indicates enzymatic activity. The symbol (Mg) indicates that the binding of C3b to factor B is magnesium dependent. The symbol (⌋) indicates a covalent bond between C3b and glycoprotein. The transmembrane (TM) and cytoplasmic (C) domains of glycoprotein A (GP-A) are represented schematically. The symbol (X) indicates that factor P stabilizes the C3bBb complex. A bent arrow (✓) extending from an enzymatic component shows substrate cleavage and indicates the released cleavage product. The vertical arrows (?) extending from C7, C8, and C9 indicate that an amphiphilic transition has occurred, resulting in integration of a portion of the complement into the lipid bilayer. C9n indicates that multiple molecules of polymerized C9 are incorporated into the membrane attack complex. See text. CR, complement receptor; DAF, decay-accelerating factor; MIRR, membrane inhibitor of reactive lysis; rbc, red blood cell.

**Figure 34.4.** Schematic representation of alternative pathway activation. The details of the activation and regulation of the alternative pathway are contained in the text. The lipid bilayer of the erythrocyte membrane is represented by (▨). Plasma inhibitors are enclosed in boxes above the lipid bilayer symbol, and membrane inhibitors are enclosed in boxes below the lipid bilayer symbol. The symbol (\*) indicates enzymatic activity. The symbol (Mg) indicates that the binding of C3b to factor B is magnesium dependent. The symbol (⌋) indicates a covalent bond between C3b and glycoprotein. The transmembrane (TM) and cytoplasmic (C) domains of glycoprotein A (GP-A) are represented schematically. The symbol (X) indicates that factor P stabilizes the C3bBb complex. A bent arrow (✓) extending from an enzymatic component shows substrate cleavage and indicates the released cleavage product. The vertical arrows (?) extending from C7, C8, and C9 indicate that an amphiphilic transition has occurred, resulting in integration of a portion of the complement into the lipid bilayer. C9n indicates that multiple molecules of polymerized C9 are incorporated into the membrane attack complex. See text. CR, complement receptor; DAF, decay-accelerating factor; MIRR, membrane inhibitor of reactive lysis; rbc, red blood cell.

Both plasma factors and membrane proteins control the formation and stability of the alternative pathway C3 convertase (Fig. 34.4, part 2 and Fig. 34.4, part 2). Factor H (103)

regulates the formation and stability of the convertase in the following three ways: First, by binding to C3b, it inhibits factor B binding; second, by binding to C3bBb, it displaces Bb from the complex; third, by binding to C3b, it acts as a cofactor for the enzymatic degradation of C3b to iC3b by factor I ( [55](#), [104](#), [105](#) ). DAF (CD55) is the erythrocyte membrane constituent that is primarily responsible for regulating the activity of the alternative pathway C3 convertase. It binds to the C3bBb complex causing the enzymatic subunit to dissociate ( [43](#) ). CR1 also controls C3 convertase activity. Using isolated complement components, purified CR1 has been shown to accelerate the decay of the alternative pathway C3 convertase *in vitro* ( [106](#) ). *In vivo*, however, it appears likely that erythrocyte CR1 functions primarily as a factor I cofactor rather than as a regulator of the C3 convertase because blocking CR1 function does not enhance alternative pathway C3 convertase activity when serum is used as the complement source ( [107](#) ). Further, available evidence suggests that CR1 exerts its activity intercellularly (binding to C3b on neighboring cells), whereas DAF functions as an intracellular regulator of the convertase (binding to C3bBb on the same cell) ( [108](#) ).

The C5 convertase of the alternative pathway consists of C3bBbC3b, with one of the C3b molecules acting as the binding site for Bb and the other molecule serving to position C5 for cleavage by Bb ( [109](#) ) ( [Fig. 34.4, part 4](#) and [Fig. 34.4, part 4](#) ). As is the case for the C3 convertase, the C5 convertase is stabilized by factor P, and the same plasma and membrane constituents that regulate the C3 convertase control the activity of the C5 convertase ( [Fig. 34.4, part 4](#) and [Fig. 34.4, part 4](#) ). Generation of C5b as a result of enzymatic cleavage of C5 by Bb releases C5a and initiates formation of the MAC ( [Fig. 34.4, part 6](#) and [Fig. 34.4, part 6](#) ) in a manner analogous to that described above for the classic pathway. The cytolytic activity of the MAC formed on erythrocytes by the alternative pathway is inhibited by MIRL (CD59) ( [Fig. 34.3, part 7](#) ).

## RECEPTORS FOR COMPLEMENT AND IMMUNOGLOBULIN G

That immune destruction of erythrocytes is rarely a consequence of complement-mediated intravascular hemolysis is a testament to the effectiveness of the membrane regulatory proteins DAF (CD55) and MIRL (CD59). In most cases of immune hemolytic anemia, erythrocyte destruction is an extravascular process that is mediated by cells of the reticuloendothelial system. Professional phagocytes that are found in the spleen and liver express receptors for the Fc portion of IgG and for activation (C3b) and degradation (iC3b) products of complement. Binding to these specific receptors (Fc $\gamma$ R, CR1, and CR3) stimulates phagocytosis of erythrocytes opsonized with IgG or complement, or both.

### Complement Receptors

Four classes of CRs have been recognized ( [Table 34.1](#) ). Two of these (CR1 and CR2) share a similar structural motif and belong to the regulators of complement activation superfamily ( [53](#) ). CR1 ( [42](#), [110](#), [111](#) ) and CR2 ( [112](#) ) recognize different ligands and have different patterns of tissue expression ( [Table 34.1](#) ). Because it is not expressed by tissue macrophages, CR2 does not participate in immune destruction of erythrocytes. The other two CRs (CR3 and CR4) belong to the integrin superfamily ( [113](#) ). They are heterodimers that have a unique  $\alpha$ -chain but share a common  $\beta$ -chain. Although their ligand binding specificity and tissue distribution show considerable overlap ( [Table 34.1](#) ), only CR3 has been shown unequivocally to participate in immune destruction of erythrocytes. The C3 activation and degradation products that are found on erythrocytes and the mechanisms involved in their generation are illustrated in [Figure. 34.5](#).

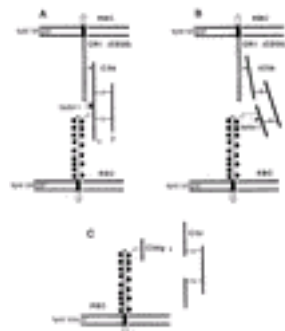
**TABLE 34.1. Characteristics of Complement Receptors (CRs)**

| Receptor         | Relative Molecular Mass (kd)                            | Complement Ligand                              | Cellular Distribution   | Functions  |
|------------------|---|--|---|--|
| CR1 (CD35)       | 210–330 (four allotypes); single-chain gp with ~30 SCRs | C3b (high affinity); C4b, iC3b (weak affinity) | RBCs; PMNs; Mo; Mf; B and some T lymphocytes; follicular dendritic cells; Langerhans cells; Kupffer cells | Regulates C3, C4, and C5 convertase of classic and alternative pathways of complement; factor I cofactor; RBC CR1, <sup>a</sup> phagocyte CR1 <sup>b</sup> |
| CR2 (CD21)       | 145; integral membrane gp with 15 SCRs                  | C3dg, C3d                                      | B lymphocytes; follicular dendritic cells   | Immune modulation; cellular receptor for the Epstein–Barr virus  |
| CR3 (CD11b/CD18) | 165 (CD11b), 95 (CD18); heterodimer                     | iC3b   | PMNs; Mo; Mf; NK cells; cytotoxic T cells   | Adherence and phagocytosis of opsonized RBCs   |
| CR4 (CD11c/CD18) | 150 (CD11c), 95 (CD18); heterodimer                     | iC3b   | PMNs; Mo; Mf; NK cells; cytotoxic T cells   | Undefined  |

gp, glycoprotein; Mo, monocyte; Mf, macrophage; NK, natural killer; PMN, polymorphonuclear neutrophil; RBC, red blood cell; SCR, short consensus repeat.

<sup>a</sup> RBC CR1 transports immune complexes to macrophages for clearance.

<sup>b</sup> Phagocyte CR1 promotes the adherence and phagocytosis of sensitized cells and immune complexes.



**Figure 34.5.** Schematic representation of the degradation of C3b on erythrocytes. **A:** Activated C3b forms a covalent bond (—) with one of the O-linked carbohydrate residues (•) of glyco-phorin A. Complement receptor (CR) 1 (CD35) on a neighboring erythrocyte binds (\*) C3b with high affinity. The ectoplasmic domain of CR1 is composed of a series of 30 short consensus repeats (SCRs) (□) consisting of approximately 60 amino acids each. The binding site for C3b has been localized to SCRs 15 to 18. C3b is composed of diisothiocyanate (iC3b) and 2-ethanolamine. The internal disulfide bond that mediates the covalent binding of activated C3b is located in the α-chain. Binding to CR1 provides the necessary cofactor activity for cleavage at two sites of the α-chain of the C3b by factor I, releasing a 1-342 fragment, thereby generating C3b. **B:** C3b undergoes a conformational change that both enables its binding to CR1 and exposes another factor I cleavage site in the α-chain. **C:** Cleavage of C3b by factor 1 leaves the C3b fragment covalently bound to glyco-phorin A and releases C3c into the plasma.

**Figure 34.5.** Schematic representation of the degradation of C3b on erythrocytes. **A:** Activated C3b forms a covalent bond (—) with one of the O-linked carbohydrate residues (•) of glyco-phorin A. Complement receptor (CR) 1 (CD35) on a neighboring erythrocyte binds (\*) C3b with high affinity. The ectoplasmic domain of CR1 is composed of a series of 30 short consensus repeats (SCRs) (□) consisting of approximately 60



amino acids each. The binding site for C3b has been localized to SCRs 15 to 18. C3b is composed of disulfide-linked (–S–)  $\alpha$ - and  $\beta$ -chains. The internal thioester bond that mediates the covalent binding of activated C3b is located in the  $\alpha$ -chain. Binding to CR1 provides the necessary cofactor activity for cleavage at two sites of the  $\alpha$ -chain of the C3b by factor I, releasing a 1.5-kd fragment, thereby generating iC3b. **B:** iC3b undergoes a conformational change that both weakens its binding to CR1 and exposes another factor I cleavage site in the  $\alpha$ -chain. **C:** Cleavage of iC3b by factor I leaves the C3dg fragment covalently bound to glycophorin A and releases C3c into the plasma.

**COMPLEMENT RECEPTOR 1** As discussed above, erythrocyte CR1 functions as a regulator of the C3 and C5 amplification convertases of both the classic and the alternative pathways. Along with factor H, it serves as a cofactor for factor I-mediated degradation of C3b to iC3b, and it is an essential cofactor for the subsequent conversion of iC3b to C3c and C3dg by factor I ( [Fig. 34.4](#)). Erythrocyte CR1 also appears to be critically important in the processing of immune complexes. Complement opsonized immune complexes bind with high affinity to erythrocyte CR1. The cell-bound complexes are transported to the liver, where they are removed as the erythrocytes traverse the hepatic circulation. In delivering the immune complexes, the red cells are neither trapped nor detained in the liver, although it appears that some erythrocyte CR1 is consumed during the process ( [114](#)). In addition to erythrocytes, a variety of tissues including professional phagocytes of the spleen and liver express CR1 ( [110](#), [115](#), [116](#) and [117](#)). Four different CR1 allotypes have been identified that vary in size from 250 to 160 kd ( [118](#), [119](#) and [120](#)). The gene frequency for the most common allotype (called *A* or *F*) is 0.82. The second most common allotype (called *B* or *S*) has a frequency of 0.18. The other two allotypes (called *C* and *D*) are rare. CR1 is comprised of 30 SCR units, and discrete binding sites for C3b and C4b have been identified. The binding site for C3b has been localized to SCRs 15 to 18, whereas the C4b binding is located within SCRs 1 to 4 ( [121](#), [122](#) and [123](#)). Erythrocytes bearing C3b bind specifically to CR1 on macrophages, but this interaction does not induce phagocytosis *in vitro* unless the macrophages have been stimulated ( [117](#)). In contrast, erythrocytes bearing C3b and even small amounts of IgG are avidly ingested by unstimulated monocytes ( [2](#)). Together, these observations suggest that an important role of CRs in immune clearance of opsonized erythrocytes is to mediate attachment to receptor-bearing cells of the reticuloendothelial system so that the phagocytic process that is induced through low-affinity ligation of Fc receptors by cell-bound IgG can be initiated. However, it is clear from *in vivo* studies that opsonization with complement alone is sufficient to produce rapid clearance of sensitized erythrocytes (see [Destruction by Immunoglobulin M Antibodies](#)). Reticuloendothelial cell CR1 may play a limited role in this process, as cell-bound C3b is very rapidly degraded to iC3b and then to C3dg ( [Fig. 34.5](#)). Whereas *in vitro* studies have shown that CR1 does bind iC3b, the affinity is much lower than for C3b ( [117](#)). Binding of erythrocyte C3dg to CR1 has not been observed. CR1 binds C4b, although the affinity is relatively low, and a high density of C4b is required ( [117](#)). However, based on the observation that C4b in combination with C3b (as would be found during classic pathway activation) enhances the interaction of complement-opsonized erythrocytes with cells expressing CR1, it is conceivable that C4b plays a minor role in immune destruction of erythrocytes. In support of this suggestion, C4b has been shown to function as an opsonin in C3-deficient patients ( [117](#)).

**COMPLEMENT RECEPTOR 2** The primary structure of CR2 (CD21) is similar to that of CR1 in that both proteins are single-chain polypeptides composed in large part of a series of SCRs (CR2 has 15 SCR units, whereas CR1 has 30 SCR units). The natural ligand for CR2 is C3dg; however, this receptor does not appear to participate in immune destruction of erythrocytes because studies have shown that erythrocytes from patients with chronic cold agglutinin disease bearing C3dg have a normal lifespan ( [57](#)). That CR2 is not expressed on phagocytic cells accounts for its lack of participation in the immune destruction of erythrocytes. CR2 is expressed on B lymphocytes, where it plays a pivotal

role in immune response ( [124](#)). CR2 is also the B-cell receptor for Epstein-Barr virus ( [112](#) ).

**COMPLEMENT RECEPTOR 3** Unlike CR1 and CR2, CR3 does not belong to the regulators of complement activation family; rather, it is a member of the integrin superfamily of proteins ( [113](#), [125](#)). CR3 is a heterodimer consisting of noncovalently linked  $\alpha$ - (CD11b) and  $\beta$ - (CD18) chains that are the products of different genes ( [125](#)). Phagocytic cells express CR3, and they bind erythrocytes bearing iC3b with high affinity. In the absence of stimulation, however, they do not ingest iC3b opsonized cells *in vitro* ( [126](#)). Nonetheless, it seems likely that CR3 plays a central role in immune destruction of opsonized erythrocytes. Not only is CR3 required for binding and ingestion of iC3b opsonized cells, but also both IgG- and C3b-dependent phagocytosis require the participation of CR3 ( [127](#), [128](#), [129](#) and [130](#)). There is no evidence that CR3 binds either C3b or C3dg. Thus, the conversion of iC3b to C3dg by the concert actions of factor I and CR1 may provide some protection of complement-opsonized erythrocytes because the ligand for CR3 is destroyed in the process ( [131](#)).

**COMPLEMENT RECEPTOR 4** Like CR3, CR4 (p150,95) is a member of the integrin superfamily ( [132](#)). It belongs to the  $\beta_2$  subgroup of integrins along with leukocyte function antigen-1 and CR3. These molecules share a common  $\beta$ -chain (CD18), but each has a unique  $\alpha$ -chain (CD11a for leukocyte function antigen-1, CD11b for CR3, and CD11c for CR4). An abnormality of the  $\beta$ -chain resulting in a deficiency of all three members of the CD11/CD18 family underlies the leukocyte adhesion deficiency syndrome. Patients with this rare inherited disease are usually identified within the first 2 years of life because of recurrent, often fatal bacterial infections ( [133](#)). *In vitro* studies have shown that CR4 on culture-derived macrophages binds both iC3b- and C3dg-bearing erythrocytes. Little is known about the function of CR4. Whereas tissue macrophages express a high number of CR4 molecules/cell, binding to CR4 on activated macrophages does not cause ingestion of complement-opsonized erythrocytes ( [117](#)). Thus, until more definitive data become available, the role of CR4 in the immune destruction of erythrocytes must be considered speculative.

## Fc $\gamma$ Receptors

Three distinct classes of Fc $\gamma$  receptors have been recognized ( [Table 34.2](#)); within each class, additional heterogeneity is observed ( [134](#), [135](#), [136](#) and [137](#)). In some cases, the heterogeneity is due simply to allelic polymorphisms, whereas in other cases, the different isoforms are the products of either alternative splicing or separate, highly homologous genes. The loci for the Fc $\gamma$  receptors are clustered on chromosome 1q23, supporting the hypothesis that these closely related proteins arose by gene duplication. Available evidence suggests that Fc $\gamma$ RI and Fc $\gamma$ RIIIa require an additional subunit (called  $\gamma$ ) for assembly and signaling ( [135](#)). Based on similarities in structural motifs, the Fc $\gamma$  receptors have been placed in the Ig superfamily. As their names suggest, these receptors bind to a region in the Fc portion of IgG. Their affinity for IgG1 and IgG3 is greater than for IgG2 and IgG4, and there is considerable overlap in the tissue distribution of the Fc $\gamma$  receptors. In particular, tissue macrophages express all three types, and each of the three receptors can mediate adherence and phagocytosis of IgG-opsonized particles. Thus, it appears likely that all three classes of Fc $\gamma$  receptors participate in immune destruction of erythrocytes. In addition to phagocytosis, Fc $\gamma$  receptors participate in a myriad of other inflammatory and immunomodulatory functions including antibody-dependent cell-mediated cytotoxicity (ADCC), mast cell degranulation, superoxide production, release of cytokines, and regulation of lymphocyte secretion and antibody production.

**TABLE 34.2. Characteristics of Fc $\gamma$  Receptors**



| Receptor                | Relative Molecular Mass (kd)   | Affinity for IgG                | Cellular Distribution   | Functions   |
|-------------------------|--|---------------------------------|---|---|
| Fc $\gamma$ RI (CD64)   | 72; integral membrane gp mediates  | High (1–3 $\times 10^{-8}$ L/M) | Mo; tissue Mf<br><br>PMNs   | Binds monomeric; interferon- $\gamma$ stimulated<br><br>ADCC and rosetting of IgG-coated RBCs; not essential for phagocytosis |
| Fc $\gamma$ RII (CDw32) | 40; integral membrane gp   | Low (2 $\times 10^{-5}$ L/M)    | Mo; tissue Mf; platelets; PMNs; B lymphocytes                                 | Binds aggregated IgG; mediates ADCC; weak mediator of rosetting; important for phagocytosis                                   |
| Fc $\gamma$ RIII (CD16) | 50–80; both integral membrane (Fc $\gamma$ RIIIa) and glycosyl phosphatidylinositol-anchored (Fc $\gamma$ RIIIb) forms | Low (5 $\times 10^{-5}$ L/M)    | PMNs (Fc $\gamma$ RIIIb); tissue Mf; natural killer cells (Fc $\gamma$ RIIIa) | Binds aggregated IgG; important for clearance of IgG-sensitized RBCs  |

ADCC, antibody-dependent cellular cytotoxicity; gp, glycoprotein; Ig, immunoglobulin; Mo, monocyte; Mf, macrophage; PMN, polymorphonuclear neutrophil; RBC, red blood cell.

**Fc $\gamma$  Receptor I** Fc $\gamma$ RI is distinctive because it is the only Fc $\gamma$  receptor for which the binding of monomeric IgG can be measured directly. Accordingly, Fc $\gamma$ RI is called the *high-affinity receptor* (Table 34.2). The isotype specificity of Fc $\gamma$ RI is as follows: IgG3 > IgG1 > IgG4 >>> IgG2 (136, 137). Fc $\gamma$ RI is expressed constitutively by monocytes and tissue macrophages but not by natural killer (NK) cells or by B or T lymphocytes. Neutrophil expression of Fc $\gamma$ RI requires stimulation with interferon- $\gamma$ , whereas monocyte expression can be enhanced eight- to tenfold by treatment with this cytokine. In addition to its capacity to mediate phagocytosis, Fc $\gamma$ RI also directs ADCC (136, 138). Congenital deficiency of Fc $\gamma$ RI has been reported in four members of a family (139). These individuals were healthy with no circulating immune complexes, no evidence of autoimmune pathology, and no increased susceptibility to infections. *In vitro* studies showed that monocytes from the affected subjects bound aggregated IgG and phagocytosed IgG-coated erythrocytes via Fc $\gamma$ RII. These observations provide clear evidence of redundancy of function, underscoring the critically important role that Fc $\gamma$  receptors play in host defense.

**Fc $\gamma$  RECEPTOR II** Three different genes encode at least six different Fc $\gamma$ RII transcripts (135, 137). This receptor has a low affinity for monomeric IgG; however, binding of immune complexes to Fc $\gamma$ RII can be readily demonstrated. Based on these observations, it appears likely that *in vivo* Fc $\gamma$ RII binds IgG that is clustered on opsonized particles. Fc $\gamma$ RII has the widest tissue distribution among the Fc $\gamma$  receptors, being constitutively expressed on all peripheral blood elements except NK cells and T lymphocytes (135). There is no evidence of enhancement of Fc $\gamma$ RII expression by cytokines, although neutrophil-directed ADCC is augmented by treatment with interferon- $\gamma$  (136). The isotype specificity of Fc $\gamma$ RII is as follows: IgG1 = IgG3 >>> IgG2, IgG4 (135). Like Fc $\gamma$ RI, Fc $\gamma$ RII has the capacity both to mediate phagocytosis and to direct ADCC (137). Humans with inherited deficiencies of Fc $\gamma$ RII have not been reported. Mice lacking Fc $\gamma$ RII have been

generated using homologous recombination (134). Studies using the mutant animals suggested that Fc $\gamma$ RII acts as a general negative regulator of the immune response.

**Fc $\gamma$  RECEPTOR III** Two forms of this receptor have been identified. In one case (Fc $\gamma$ RIIIa), the receptor is an integral protein (i.e., it has ectoplasmic, transmembrane, and cytoplasmic domains). In this case, the protein is anchored to the plasma membrane via the transmembrane domain that consists of a short stretch of hydrophobic amino acid residues (Fig. 34.1). In contrast to Fc $\gamma$ RIIIa, Fc $\gamma$ RIIIb is GPI-anchored. In this case, the protein has the same ectoplasmic domain as Fc $\gamma$ RIIIa, but the transmembrane and cytoplasmic domains are replaced by the GPI moiety that serves as the membrane anchor (Fig. 34.1). The two Fc $\gamma$ RIII are the products of separate, but highly homologous, genes. A single amino acid substitution at position 203 determines the nature of the anchor. Phe-203 is found in the transmembrane form (Fc $\gamma$ RIIIa), and Ser-203 is found in the GPI-anchored form (Fc $\gamma$ RIIIb) (135). Expression appears to be tissue specific with neutrophils expressing Fc $\gamma$ RIIIb exclusively and natural killer cells and macrophages expressing only Fc $\gamma$ RIIIa. Important functional differences have been reported between the two forms of Fc $\gamma$ RIII. Fc $\gamma$ RIIIa can mediate phagocytosis and direct ADCC, whereas Fc $\gamma$ RIIIb can direct ADCC of red cells, but it appears incapable of mediating phagocytosis (137, 138). Although there are conflicting data, some *in vitro* studies suggest that engagement of neutrophil Fc $\gamma$ RIIIb can trigger a respiratory burst (137). The physiologic role of Fc $\gamma$ RIIIb *in vivo* has not been clearly defined. Subjects with isolated deficiencies of Fc $\gamma$ RIIIb have been reported. One of the subjects had systemic lupus erythematosus (140), whereas two others were healthy without evidence of either immune complex disease or increased susceptibility to infection (141). Additionally, patients with PNH (who are deficient in neutrophil Fc $\gamma$ RIIIb) are not afflicted with immune complex disease. Polymorphisms affecting Fc $\gamma$ RIIIb are the basis of the biallelic NA antigen system of neutrophils (135). Like Fc $\gamma$ RII, Fc $\gamma$ RIII has an affinity for monomeric IgG that is too low to be measured directly. Indirect studies, however, have defined the isotype specificity as follows: IgG1 = IgG3 >>> IgG2, IgG4 (136, 137). *In vivo* studies suggest a critically important role for Fc $\gamma$ RIIIa in immune destruction of erythrocytes. Using the Fab fragment of a monoclonal antibody that blocks the function of Fc $\gamma$ RIIIa on the mononuclear phagocytic system of chimpanzees, Clarkson and colleagues (142) reported a dramatic inhibition of clearance of autologous erythrocytes bearing IgG. Those same investigators also presented *in vivo* evidence that monoclonal anti-Fc $\gamma$ RIII ameliorates destruction of platelets in patients with immune thrombocytopenic purpura (143). These findings complement other observations that have shown that antibody-coated erythrocytes and platelets are cleared primarily by macrophages in the red pulp of the spleen and that these cells express Fc $\gamma$ RIIIa in high density (136). Surprisingly, studies using targeted gene disruption showed that opsonization by murine peritoneal macrophages of sheep erythrocytes coated with murine IgG1 is mediated specifically by Fc $\gamma$ RIII (144). Whether this degree of specificity exists in humans remains to be determined. Additional studies showed that the Fc $\gamma$ RIII knock-out mice lacked IgG-mediated mast cell degranulation, were resistant to IgG-dependent passive cutaneous anaphylaxis, and exhibited an impaired Arthus reaction (144).

## MECHANISMS OF IMMUNE DESTRUCTION OF ERYTHROCYTES

### Destruction by Immunoglobulin M Antibodies

Inasmuch as receptors that are specific for the Fc portion of IgM do not exist, destruction of erythrocytes sensitized with IgM antibodies is mediated indirectly by the complement system. As discussed in detail above, complement mediates destruction in the following two ways: (a) directly by cytolysis, and (b) indirectly through interaction of cell-bound activation and degradation fragments of C3 with specific receptors on

reticuloendothelial cells, principally liver macrophages (Kupffer cells).

Because of its pentameric structure, IgM activates complement efficiently. High-titer IgM antibodies such as anti-A and anti-B can cause direct intravascular hemolysis by generating the cytolytic MAC of complement on the erythrocyte surface. If the antibody density is great enough, complement activation may be sufficiently robust to overwhelm the inhibitory activity of the complement regulatory proteins DAF (CD55) and MIRL (CD59). When  $^{51}\text{Cr}$ -labeled red cells are infused into ABO-incompatible subjects with relatively high concentrations of IgM antibodies, hemoglobinemia appears abruptly and is pronounced, reflecting the virtually instantaneous destruction of incompatible cells by complement-mediated lysis ( [145](#), [146](#) ). At least 80% of the hemoglobin contained in the injected cells appears in plasma, with peak levels being reached in less than 60 seconds.

However, in most clinical situations, IgM antierythrocyte antibodies are present in sublytic quantities. Under these conditions, DAF (CD55) and MIRL (CD59) are able to prevent direct cell lysis. Nonetheless, some C3b is deposited on the cell surface as a consequence of the IgM-induced complement activation, and interactions of C3b and iC3b with their specific receptors on liver macrophages (Kupffer cells) are ultimately responsible for the immune destruction of erythrocytes under sublytic conditions. Although ligation of erythrocyte-bound C3b to CR1 on Kupffer cells may mediate some of the clearance, interaction between erythrocyte-bound iC3b and macrophage CR3 is probably the principal mediator of extravascular destruction of complement-sensitized erythrocytes. Erythrocyte-bound C3b is rapidly degraded to iC3b because both plasma factor H and CR1 on neighboring erythrocytes can serve as a cofactor for the enzymatic conversion of C3b to iC3b ( [Fig. 34.5](#) ). The half-life of erythrocyte-bound iC3b is probably longer than that of C3b because, under physiologic conditions, only CR1 can provide the obligatory cofactor activity for conversion of iC3b to C3dg by factor I. Further, the affinity of CR1 for iC3b is much weaker than the affinity of CR1 for C3b ( [Fig. 34.5](#) ). It seems likely that clearance of the complement-sensitized erythrocytes is mediated by phagocytosis because the liver lacks the unique anatomy of the spleen and is thus unable to sequester cells (discussed more in Destruction by Immunoglobulin G Antibodies). *In vivo* studies have shown that when small quantities of ABO-incompatible  $^{51}\text{Cr}$ -labeled red cells are infused into subjects with normal levels of anti-A and anti-B isoagglutinins, one-half of the labeled erythrocytes are removed in just under 2 minutes, and surface counting shows rapid accumulation of radioactivity over the liver ( [145](#) ). That clearance of complement-opsonized cells is mediated by the liver explains why patients with cold agglutinin disease do not benefit from splenectomy. Once erythrocyte-bound iC3b has been converted to C3dg, the cells are no longer subject to immune destruction because the specific receptor for C3dg (CR2) is not expressed by phagocytic cells ( [Table 34.1](#) ). Thus, erythrocytes bearing C3dg only have a normal lifespan ( [23](#), [57](#) ).

### Destruction by Immunoglobulin G Antibodies

As discussed in detail above, IgG is a relatively ineffective initiator of activation of the classic pathway of complement because two antibody molecules bound in close proximity are required to support binding of C1q. Consequently, direct complement-mediated cytolysis of erythrocytes induced by IgG antibodies is unusual (an exception is the Donath-Landsteiner antibody of paroxysmal cold hemoglobinuria). In the absence of complement activation, IgG-sensitized erythrocytes are cleared primarily by the spleen. Two processes appear to be involved. First, binding to Fc receptors expressed by tissue macrophages in the red pulp of the spleen can mediate direct phagocytosis. Second, partial phagocytosis, in which a portion of the membrane is removed by the phagocytes, results in a decrease in the surface area to volume ratio. This process appears to be responsible for the production of spherocytes, the morphologic hallmark of immune hemolytic anemia. The loss of deformability that is a consequence of spherocyte

formation results in sequestration of the abnormal cells in the red pulp because they are too rigid to traverse the splenic cords into the sinuses. The trapped spherocytes are vulnerable to phagocytosis by professional phagocytes that are found in abundance in the splenic cords. Additionally, the lifespan of the sequestered cells is shortened by the unfavorable metabolic environment found in the splenic cords (a process called *splenic conditioning*). Once trapped, cell destruction appears to be complete within minutes.

When small volumes of  $^{51}\text{Cr}$ -tagged Rh0(D) red cells are injected into individuals with relatively high titers of IgG anti-Rh0 antibodies, the labeled erythrocytes are removed quickly from the circulation, and a concomitant increase of radioactivity is noted over the spleen and, to a smaller degree, over the liver ( [145](#), [147](#), [148](#) ). The half-life of these cells in the circulation is only a few minutes, and minimal amounts of hemoglobin appear in plasma, attesting to the predominantly extravascular destruction of erythrocytes sensitized with IgG antibodies. Even when larger volumes of Rh-incompatible red cells are given, the concentration of plasma free hemoglobin does not reach levels higher than those that would be derived from 12% of the total number of cells infused. Further, the amount of extracellular hemoglobin reaches a peak 1 hour after transfusion, suggesting that intravascular spillage occurs only when the mechanisms for removal of extravascularly released heme proteins have been saturated ( [145](#) ). The mechanism of hemoglobin release under these circumstances is obscure.

Extravascular splenic destruction of anti-Rh antibody-coated red cells occurs over a wide range of antibody concentrations ( [149](#) ). The speed of removal from the circulation appears to depend on the amount of antibody coating the red cells ( [149](#), [150](#) ). Antibody concentrations of 25  $\mu\text{g}/\text{ml}$  of red cells (corresponding to a titer of 1:64 or more) are required to bring about their clearance with a single passage through the spleen, the clearance half-time being approximately 20 minutes. Antibody concentrations of less than 5  $\mu\text{g}/\text{ml}$  of red cells and corresponding to titers of 1:8 or less may bring about the removal of red cells in a half-time of 60 to 100 minutes ( [149](#), [151](#) ). The liver clears red cells coated with IgG antibodies less efficiently than does the spleen. Even when erythrocytes are sensitized with as much as 40  $\mu\text{g}$  of antibody/ml of red cells, only approximately one-third are cleared by a single passage through the liver ( [149](#) ). Nevertheless, the liver plays a clinically significant role in the destruction of red cells. A rough correlation exists between the amount of antibody fixed to the red cell surface and the site of destruction (smaller amounts of antibody leading mainly to splenic sequestration and larger amounts of antibody leading to increased sequestration within the liver) ( [147](#), [150](#), [152](#) ).

The more rapid clearance of erythrocytes sensitized with a higher density of IgG antibodies and the shift in the clearance from the spleen to the liver are due to complement activation ( [149](#), [152](#) ). The presence of C3b, iC3b, or both acts synergistically with IgG to generate a potent phagocytic signal ( [2](#) ). *In vivo* studies involving complement-deficient subjects showed a reduced rate of clearance of IgG-sensitized red cells, although the sensitized cells were still cleared more rapidly than normal ( [152](#), [153](#) and [154](#) ). Together, these studies demonstrate that IgG alone can mediate red cell clearance, but the concomitant presence of cell-bound C3 fragments greatly enhances the rate of immune-mediated destruction.

That Fc receptors play a critical role in immune destruction *in vivo* is further demonstrated by the therapeutic approach to management of autoimmune hemolytic anemia (and immune thrombocytopenic purpura). Treatment with corticosteroids, intravenous IgG, anti-D, and splenectomy is aimed at reducing the capacity of reticuloendothelial cells to mediate immune clearance of IgG-sensitized cells ( [155](#) ). After

splenectomy, the rate of clearance of IgG-sensitized red cells is significantly decreased, whereas the rate of clearance of complement-sensitized cells is unchanged (156). IgG sensitization must be increased by approximately fourfold to produce an equal rate of clearance in splenectomized subjects compared to clearance in the same subjects before splenectomy. Under conditions of higher IgG sensitization, complement is activated, resulting in destruction of the opsonized cells by the liver in the postsplenectomy subjects. The most important features of red cell destruction by IgM and IgG antibodies are summarized in Table 34.3.

**TABLE 34.3. Red Cell Destruction by Immunoglobulin (Ig) M and IgG Antibodies**

| Antibody                   | Predominant Site of Red Blood Cell Destruction |       |        | Complement Dependency | Hemoglobinuria | Bilirubinemia | Specificity of Antiglobulin Test |
|----------------------------|--|-------|--------|-----------------------|----------------|---------------|----------------------------------|
|                            | Intravascular                                  | Liver | Spleen |                       |                |               |                                  |
| Low-titer IgM <sup>a</sup> | +  | +     | -      | +                     | ±              | +             | Anti-C                           |
| High-titer IgM             | +  | -     | -      | +                     | +              | +             | Anti-C                           |
| Low-titer IgG <sup>b</sup> | -  | -     | +      | -                     | -              | +             | Anti-IgG                         |
| High-titer IgG             | -  | ±     | +      | -                     | ±              | +             | Anti-IgG                         |

Anti-C, anti-complement.

<sup>a</sup> Anti-A or anti-B blood group antibodies are examples of IgM antibodies that can be present at low or high concentrations.

<sup>b</sup> Anti-Rho(D) is an example of an IgG antibody that can be present at low or high concentrations.

### Role of Cytotoxic Cells in Immune Red Cell Destruction

Although the primary mechanisms of extravascular red cell destruction are splenic sequestration and macrophage-mediated phagocytosis, direct cytotoxicity mediated by neutrophils, eosinophils, monocytes, and lymphocytes independent of phagocytosis has been demonstrated (157). This process (called ADCC) is dependent on engagement of Fc receptors on the effector cells by erythrocytes opsonized with IgG. All three classes of Fc $\gamma$  receptors can direct ADCC (138). Although the process is not dependent on complement, the presence of activation and degradation products of C3 on the target cell enhances ADCC mediated by lymphocytes (158). This situation is analogous to that observed for phagocytosis by monocytes, in which the concomitant engagement of Fc and CRs has a synergistic effect (2). Further, the susceptibility of individual erythrocytes to ADCC appears to be proportional to the total IgG available for interaction with effector



cells ( [159](#) ).

ADCC of nucleated cells by cytotoxic lymphocytes is a complex process that appears to involve effector systems that can kill cells by more than one mechanism ( [160](#) ). In the case of red cells, however, hemolysis induced by cytotoxic T lymphocytes and NK cells appears to be mediated by perforin ( [161](#) ). This 70-kd protein is found in the granules of cytolytic T cells and NK cells. When incubated with target cells, perforin binds to the membrane and undergoes a  $\text{Ca}^{2+}$ -dependent polymerization that forms a transmembrane channel. Consequently, the cells undergo colloid osmotic lysis in a manner analogous to that induced by complement. When viewed by electron microscopy, the membrane lesion induced by perforin is indistinguishable from the ringed "donut" lesion characteristic of complement-mediated lysis ( [161](#) ). In addition to functional similarities, perforin shows limited structural homology with MAC components. In contrast to the MAC-induced hemolysis, however, hemolysis mediated by perforin is not regulated by MIRL ( [162](#) ).

ADCC appears to function primarily as a mechanism for destroying tumor cells and cells infected with virus. The contribution ADCC makes to immune destruction of red cells has not been clearly defined. That an *in vitro* assay based on ADCC can be used to predict the severity of hemolytic disease of the newborn due to anti-D, however, suggests that the process may be pathophysiologically relevant ( [163](#) , [164](#) ).

## REFERENCES

1. Rosse WF. Autoimmune hemolytic anemia due to cold-reacting antibodies: paroxysmal cold hemoglobinuria. In: Rosse WF, ed. Clinical immunohematology: basic concepts and clinical applications. Boston: Blackwell Science, 1990:583-589.
2. Ehlenberger AG, Nussenzweig V. The role of membrane receptors for C3b and C3d in phagocytosis. J Exp Med 1977;145:357-371.
3. Fujita T. Evolution of the lectin-complement pathway and its role in innate immunity. Nat Rev Immunol 2002;2:346-353.
4. Gadjeva M, Thiel S, Jensenius JC. The mannan-binding-lectin pathway of the innate immune response. Curr Opin Immunol 2001;13:74-78.
5. Matsushita M, Fujita T. Ficolins and the lectin complement pathway. Immunol Rev 2001;180:78-85.
6. Matsushita M, Endo Y, Hamasaki N, Fujita T. Activation of the lectin complement pathway by ficolins. Int Immunopharmacol 2001;1:359-363.
7. Petersen SV, Thiel S, Jensenius JC. The mannan-binding lectin pathway of complement activation: biology and disease association. Mol Immunol 2001;38:133-149.
8. Cooper N. The classical complement pathway: activation and regulation of the first complement component. Adv Immunol 1985;37:151-216.
9. Ziccardi RJ. Nature of the metal ion requirement for assembly and function of the first component of human complement. J Biol Chem 1983;258:6187-6192.
10. Hughes-Jones NC, Gorick BD. The binding and activation of the C1r-C1s subunit of the first component of human complement. Mol Immunol 1982;19:1105-1112.
11. Siegel RC, Schumaker V. Measurement of the association constants of the complexes formed between intact C1q or pepsin-treated C1q stalks and the unactivated or activated C1r<sub>2</sub>C1s<sub>2</sub> tetramers. Mol Immunol 1983;20:53-66.

12. Porter RR, Reid KBM. The biochemistry of complement. *Nature (Lond)* 1978;275:699–704.
13. Reid KBM, Porter RR. Subunit composition and structure of subcomponent C1q of the first component of human complement. *Biochem J* 1976;155:19–23.
14. Rosse WF. Fixation of the first component of complement (C'1a) by human antibodies. *J Clin Invest* 1968;47:2430–2445.
15. Frank MM. Complement in the pathophysiology of human disease. *N Engl J Med* 1987;316:1525–1530.
16. Rosse WF. Mechanisms of immune destruction: complement and complement-dependent mechanisms. In: Rosse WF, ed. *Clinical immunohematology: basic concepts and clinical applications*. Boston: Blackwell Science, 1990:43–105.
17. Rosse WF, Rapp HJ, Borsos T. Structural characteristics of hemolytic antibodies as determined by the effects of ionizing radiation. *J Immunol* 1968;98:1190–1195.
18. Borsos T, Chapuis RM, Langone JJ. Distinction between fixation of C1 and the activation of complement by natural IgM antihapten antibody: effect of cell surface hapten density. *Mol Immunol* 1981;18:863–868.
19. Ziccardi RJ. Spontaneous activation of the first component of human complement (C1) by an intramolecular autocatalytic mechanism. *J Immunol* 1982;128:2500–2504.
20. Ziccardi RJ. Activation of the early components of the classical complement pathway under physiological conditions. *J Immunol* 1981;126:1769–1773.
21. Agostoni A, Cicardi M. Hereditary and acquired C1-inhibitor deficiency: biological and clinical characteristics in 235 patients. *Medicine* 1992;71:206–215.
22. Gigli I, von Zabern I, Porter RR. The isolation and structure of C4, the fourth component of human complement. *Biochem J* 1977;165:439–446.
23. Frank MM, Fries LF. The role of complement in inflammation and phagocytosis. *Immunol Today* 1991;12:322–326.
24. Law SK, Lichtenberg NA, Holcombe FH, Levine RP. Interaction between the labile binding sites of the fourth (C4) and fifth (C5) human complement proteins and erythrocyte cell membranes. *J Immunol* 1980;125:634–639.
25. Goers JWF, Porter RR. The assembly of early components of complement on antibody-antigen aggregates and on antibody-coated erythrocytes. *Biochem J* 1978;175:675–684.
26. Isenman DE, Young JR. Covalent binding properties of the C4A and C4B isotypes of the fourth component of human complement on several C1-bearing cell surfaces. *J Immunol* 1986;136:2542–2550.
27. Perlmutter DH, Colten HR. Structure and expression of complement genes. *Pharmacol Ther* 1987;34:247–270.
28. Belt KT, Carroll MC, Porter RR. The structural basis of the multiple forms of human complement component C4. *Cell* 1984;36:907–914.
29. Isenman DE, Young JR. The molecular basis for the difference in immune hemolysis activity of the Chido and Rodgers isotypes of human complement component C4. *J Immunol* 1984;132:3019–3027.
30. Law SKA, Dodds AW, Porter RR. A comparison of the properties of the two classes, C4A and C4B, of the human complement component C4. *EMBO J* 1984;3:1819–1823.
31. O'Neill GJ, Yang SY, Tegoli J, Berger R. Chido and Rodgers blood groups are distinct antigenic components of human complement C4. *Nature (Lond)* 1978;273:668–670.
32. Kerr MA, Porter RR. The purification and properties of the second component of human complement.



Biochem J 1978;171:99-107.

33. Fujita T, Tamura N. Interaction of C4-binding protein with cell-bound C4b: a quantitative analysis of binding and the role of C4-binding protein in proteolysis of cell-bound C4b. *J Exp Med* 1983;157:1239-1251.
34. Scharfstein J, Gerreira A, Gigli I, Nussenzweig V. Human C4-binding protein I. Isolation and characterization. *J Exp Med* 1978;148:207-222.
35. Ziccardi RJ, Dählback B, Müller-Eberhard HJ. Characterization of interaction of human C4b-binding protein with physiological ligands. *J Biol Chem* 1984;259:13674-13679.
36. Fearon DT. Purification of C3b inactivator and demonstration of its polypeptide chain structure. *J Immunol* 1977;119:1248-1252.
37. Fujita T, Nussenzweig V. The role of C4-binding protein and B1H in proteolysis of C4b and C3b. *J Exp Med* 1979;150:267-276.
38. Dahlbäck B SC, Müller-Eberhard HJs. Visualization of human C4b-binding protein and its complexes with vitamin K-dependent protein S and complement protein C4b. *Proc Natl Acad Sci U S A* 1983;80:3461-3465.
39. Dahlbäck B, Stenflo J. High molecular weight complex in human plasma between vitamin K-dependent protein S and complement component C4b-binding protein. *Proc Natl Acad Sci U S A* 1981;78:2512-2516.
40. Iida K, Nussenzweig V. Complement receptor is an inhibitor of the complement cascade. *J Exp Med* 1981;153:1138-1150.
41. Medof ME, Nussenzweig V. Control of the function of substrate-bound C4b-C3b by the complement receptor CR1. *J Exp Med* 1984;159:1669-1685.
42. Ross GD. Complement receptor type 1. *Curr Top Microbiol Immunol* 1992;178:31-44.
43. Nicholson-Weller A. Decay accelerating factor (CD55). *Curr Top Microbiol Immunol* 1992;178:7-30.
44. Nicholson-Weller A, Burge J, Fearon DT, et al. Isolation of a human erythrocyte membrane glycoprotein with decay-accelerating activity for C3 convertases of the complement system. *J Immunol* 1982;129:184-189.
45. Liszewski MK, Atkinson JP. Membrane cofactor protein. *Curr Top Microbiol Immunol* 1992;178:45-60.
46. Hourcade D, Holers VM, Atkinson JP. The regulators of complement activation (RCA) gene cluster. *Adv Immunol* 1989;45:45.
47. Hugli TE, Vallota EH, Müller-Eberhard HJ. Purification and partial characterization of human and porcine C3a anaphylatoxin. *J Biol Chem* 1975;250:1472-1478.
48. Ames RS, Li Y, Sarau HM, et al. Molecular cloning and characterization of the human anaphylatoxin C3a receptor. *J Biol Chem* 1996;271:20231-20234.
49. Grass T, Raffetseder U, Martin U, et al. Expression cloning of the human C3a anaphylatoxin receptor (C3aR) from differentiated U-937 cells. *Eur J Immunol* 1996;26:1944-1950.
50. Capel PJA, Groeneboer O, Grosveld G, Pondman KW. The binding of activated C3 to polysaccharides and immunoglobulins. *J Immunol* 1978;121:2566-2572.
51. Fries LF, Gaither TA, Hammer CH, Frank MM. C3b covalently bound to IgG demonstrates a reduced rate of inactivation by factors H and I. *J Exp Med* 1984;160:1640-1655.
52. Law SK, Lichtenberg NA, Levine RP. Evidence for an ester linkage between the labile binding site of C3b and receptive surfaces. *J Immunol* 1979;123:1388-1394.
53. Müller-Eberhard HJ. Molecular organization and function of the complement system. *Ann Rev*

Biochem 1988;57:321–347.

54. Müller-Eberhard HJ, Dalmasso AP, Calcott MA. The reaction mechanism of  $\beta$ 1c-globulin (C'3) in immune hemolysis. *J Exp Med* 1966;123:33–54.
55. Ross GD, Lambris JD, Cain JA, Newman SL. Generation of three different fragments of bound C3 with purified factor I or serum: I. Requirements for factor H vs. CR1 cofactor activity. *J Immunol* 1982;129:2051–2060.
56. Ross GD, Newman SL, Lambris JD, et al. Generation of three different fragments of bound C3 with purified factor I or serum: II. Location of binding sites in the C3 fragments for factors B and H, complement receptors, and bovine conglutinin. *J Exp Med* 1983;158:334–352.
57. Lachmann PJ, Voak D, Oldroyd RG, et al. Use of monoclonal anti-C3 antibodies to characterize the fragments of C3 that are found on erythrocytes. *Vox Sang* 1983;45:367–372.
58. Ripoche J, Day AJ, Harris TJR, Sim RB. The complete amino acid sequence of human complement factor H. *Biochem J* 1988;249:593–602.
59. Cooper NR, Müller-Eberhard HJ. The reaction mechanism of human C5 in immune hemolysis. *J Exp Med* 1970;132:775–793.
60. Fernandez HN, Hugli TE. Primary structural analysis of the polypeptide portion of human C5a anaphylatoxin: polypeptide sequence determination and assignment of the oligosaccharide attachment site in C5a. *J Biol Chem* 1978;253:6955–6964.
61. Gerard C, Hugli TE. Identification of classical anaphylatoxin as the des-Arg form of C5a molecule: evidence of a modulator role for the oligosaccharide unit in human des-Arg<sup>74</sup>-C5a. *Proc Natl Acad Sci U S A* 1981;78:1833–1837.
62. Gerard C, Gerard NP. C5a anaphylatoxin and its seven transmembrane-segment receptor. *Ann Rev Immunol* 1994;12:775–808.
63. Biesecker G, Müller-Eberhard HJ. The ninth component of human complement: purification and physicochemical characterization. *J Immunol* 1980;124:1291–1296.
64. Chakravarti DN, Chakravarti B, Parra CA, et al. Structural homology of complement protein C6 with other channel-forming proteins of complement. *Proc Natl Acad Sci U S A* 1989;86:2799–2803.
65. DiScipio RG, Gagnon J. Characterization of human components C6 and C7. *Biochem J* 1982;19:1425–1431.
66. DiScipio RG, Gehring MR, Podack ER, et al. Nucleotide sequence of cDNA and derived amino acid sequence of human complement component C9. *Proc Natl Acad Sci U S A* 1984;81:7298–7302.
67. Podack ER, Kolb WP, Esser AF, Müller-Eberhard HJ. Structural similarities between C6 and C7 of human complement. *J Immunol* 1979;123:1071–1077.
68. Steckel EW, York RG, Monahan JB, Sodetz JM. The eighth component of human complement: purification and physicochemical characterization of its unusual subunit structure. *J Biol Chem* 1980;255:11997–12005.
69. Ng SC, Rao AG, Howard OMZ, Sodetz JM. The eighth component of human complement: evidence that it is an oligomeric serum protein assembled from products of three different genes. *Biochemistry* 1987;26:5229–5233.
70. Podack ER, Kolb WP, Müller-Eberhard HJ. The C5b-6 complex: formation, isolation, and inhibition of its activity by lipoprotein and the S-protein of human serum. *J Immunol* 1978;120:1841–1848.
71. Yamamoto K, Gewurz H. The complex of C5b and C6: isolation, characterization, and identification of a modified form of C5b consisting of three polypeptide chains. *J Immunol* 1978;124:2008–2015.
72. DiScipio RG. Formation and structure of the C5b-7 complex of the lytic pathway of complement. *J*

Biol Chem 1992;267:17087–17094.

73. Preissner KT, Podack ER, Müller-Eberhard HJ. The membrane attack complex of complement: relation of C7 to the metastable membrane binding site of the intermediate complex C5b-7. *J Immunol* 1985;135:445–451.
74. Stewart JL, Kolb WP, Sodetz JM. Evidence that C5b recognizes and mediates C8 incorporation into the cytolytic complex of complement. *J Immunol* 1987;139:1960–1964.
75. Stewart JL, Sodetz JM. Analysis of the specific association of the eight and ninth components of human complement: identification of a direct role for the alpha subunit of C8. *Biochemistry* 1985;24:4598–4602.
76. Bhakdi S, Trandum-Jensen J. Molecular nature of the complement lesion. *Proc Natl Acad Sci U S A* 1978;75:5655–5659.
77. Borsos T, Dourmashkin RR, Humphrey JH. Lesions in erythrocyte membranes caused by immune hemolysis. *Nature (Lond)* 1964;202:251–254.
78. Bhakdi S, Bjerrum OJ, Bhakdi-Lehnen B, Trandum-Jensen J. Complement lysis: evidence for an amphiphilic nature of the terminal membrane C5b-9 complex of human complement. *J Immunol* 1978;121:2526–2532.
79. Bhakdi S, Trandum-Jensen J. On the cause and nature of C9-related heterogeneity of terminal complement complexes generated on target erythrocytes through the action of whole serum. *J Immunol* 1984;133:1453–1463.
80. Podack ER. Molecular composition of the tubular structure of the membrane attack complex of complement. *J Biol Chem* 1984;259:8641–8647.
81. Parker CJ, Wiedmer T, Sims PJ, Rosse WF. Characterization of the complement sensitivity of paroxysmal nocturnal hemoglobinuria erythrocytes. *J Clin Invest* 1985;75:2074–2084.
82. Esser AF. Big MAC attack: complement proteins cause leaky patches. *Immunol Today* 1991;12:316–318.
83. Bhakdi S, Trandum-Jensen J. Complement lysis: a hole is a hole. *Immunol Today* 1991;12:318–320.
84. Jenne D, Stanley KK. Molecular cloning of S-protein, a link between complement, coagulation and cell-substrate adhesion. *EMBO J* 1985;4:3153–3157.
85. Podack ER, Müller-Eberhard HJ. Binding of desoxycholate, phosphatidylcholine vesicles, lipoprotein and of the S-protein to complexes of terminal complement components. *J Immunol* 1978;121:1025–1030.
86. Rosenfeld SI, Packman CH, Leddy JP. Inhibition of the lytic action of cell-bound terminal complement components by human high density lipoproteins and apoproteins. *J Clin Invest* 1983;71:795–808.
87. Tschopp J, Chonn A, Hertig S, French LE. Clusterin, the human apolipoprotein and complement inhibitor, binds to complement C7, C8 $\beta$ , and B domain of C9. *J Immunol* 1993;151:2159–2165.
88. Tschopp J, Masson D, Schäfer S, et al. The heparin binding domain of S-protein/Vitronectin binds to complement components C7, C8, and C9 and perforin from cytolytic T-cells and inhibits their lytic activities. *Biochemistry* 1988;27:4103–4109.
89. Holguin MH, Fredrick LR, Bernshaw NJ, Parker CJ. Isolation and characterization of a protein from normal erythrocytes that inhibits reactive lysis of the erythrocytes of paroxysmal nocturnal hemoglobinuria. *J Clin Invest* 1989;84:7–17.
90. Holguin MH, Parker CJ. Membrane inhibitor of reactive lysis. *Curr Top Microbiol Immunol* 1992;178:61–85.
91. Lehto T, Meri S. Interactions of soluble CD59 with the terminal complement complexes: CD59 and C9

- compete for a nascent epitope on C8. *J Immunol* 1993;151:4941–4949.
92. Meri S, Morgan BP, Davies A, et al. Human protectin (CD59), an 18,000–20,000 MW complement lysis restricting factor, inhibits C5b–8 catalyzed insertion of C9 into lipid bilayers. *Immunology* 1990;71:1–9.
93. Rollins SA, Zhao J, Ninomiya H, Sims PJ. Inhibition of homologous complement by CD59 is mediated by a species-selective recognition conferred through binding to C8 within C5b–8 or C9 within C5b–9. *J Immunol* 1991;146:2345–2351.
94. Yamashina M, Ueda E, Kinoshita T, et al. Inherited complete deficiency of 20-kilodalton homologous restriction factor (CD59) as a cause of paroxysmal nocturnal hemoglobinuria. *N Engl J Med* 1990;323:1184–1189.
95. Fearon DT, Austen KF. The alternative pathway of complement—a system for host resistance to microbial infection. *N Engl J Med* 1980;303:259–263.
96. Medzhitov R, Janeway CA, Jr. Decoding the patterns of self and nonself by the innate immune system. *Science* 2002;296:298–300.
97. Hoffmann JA, Kafatos FC, Janeway CA, Ezekowitz RA. Phylogenetic perspectives in innate immunity. *Science* 1999;284:1313–1318.
98. Pangburn MK, Schreiber RD, Müller-Eberhard HJ. Formation of the initial C3 convertase of the alternative complement pathway: acquisition of C3b-like activities by spontaneous hydrolysis of the putative thioester in native C3. *J Exp Med* 1981;154:856–867.
99. Lesavre PH, Hugli TE, Esser AF, Müller-Eberhard HJ. The alternative pathway C3/C5 convertase: chemical basis of factor B activation. *J Immunol* 1979;123:529–534.
100. Kerr MA. Limited proteolysis of complement components C2 and factor B: structural analogy and limited sequence homology. *Biochem J* 1979;183:615–622.
101. Parker CJ, Soldato CM, Rosse WF. Abnormality of glycophorin-a on paroxysmal nocturnal hemoglobinuria erythrocytes. *J Clin Invest* 1984;73:1130–1143.
102. Fearon DT, Austen KF. Properdin: binding to C3b and stabilization of the C3b-dependent C3 convertase. *J Exp Med* 1975;142:856–863.
103. Whaley K, Ruddy S. Modulation of the alternative complement pathway by B1H globulin. *J Exp Med* 1976;144:1147–1163.
104. Law SK, Fearon DT, Levine RP. Action of the C3b-inactivator on the cell-bound C3b. *J Immunol* 1979;122:759–765.
105. Pangburn MK, Schreiber RD, Müller-Eberhard HJ. Human complement C3b inactivator: isolation, characterization and demonstration of an absolute requirement for the serum protein B1H for cleavage of C3b and C4b in solution. *J Exp Med* 1977;146:257–270.
106. Fearon DT. Regulation of the amplification C3 convertase of human complement by an inhibitory protein isolated from human erythrocyte membrane. *Proc Natl Acad Sci U S A* 1979;76:5867–5871.
107. Wilcox LA, Ezzell JL, Bernshaw NJ, Parker CJ. Molecular basis for the enhanced susceptibility of the erythrocytes of paroxysmal nocturnal hemoglobinuria to hemolysis in acidified serum. *Blood* 1991;78:820–829.
108. Medof ME, Kinoshita T, Nussenzweig V. Inhibition of complement activation on the surface of cells after incorporation of decay-accelerating factor (DAF) into their membranes. *J Exp Med* 1984;160:1558–1578.
109. Daha MR, Fearon DT, Austen KF. C3 requirements for formation of alternative pathway C5 convertase. *J Immunol* 1976;117:630–634.
110. Ross GD, Walport MJ, Hogg N. Receptors for IgG Fc and fixed C3. In: Asherson GL, Zembala M, eds.

Human monocytes. London: Academic Press, 1989:123–139.

111. Wong WW, Fearon DT. Complement ligand–receptor interactions that mediated biological responses. *Ann Rev Immunol* 1983;1:243–241.

112. Cooper NR, Moore MD, Nemerow GR. Immunobiology of CR2, the B lymphocyte receptor for Epstein–Barr virus and the C3d complement fragment. *Annu Rev Immunol* 1988;6:85–113.

113. Hynes RO. Integrins: a family of cell surface receptors. *Cell* 1987;48:549–554.

114. Ross GD, Yount WJ, Walport MJ, et al. Disease–associated loss of erythrocyte complement receptors (CR1, C3b receptors) in patients with systemic lupus erythematosus and other diseases involving autoantibodies and/or complement activation. *J Immunol* 1985;135:2005–2014.

115. Fearon DT. Identification of the membrane glycoprotein that is the C3b receptor of the human erythrocyte, polymorphonuclear leukocyte, B lymphocyte, and monocyte. *J Exp Med* 1980;152:20–30.

116. Fearon DT, Ahearn JM. Complement receptor type 1 (C3b/C4b receptor; CD35) and complement receptor type 2 (C3d/Epstein–Barr virus receptor; CD21). *Curr Top Microbiol Immunol* 1989;153:83–98.

117. Ross GD, Medof ME. Membrane complement receptors specific for bound fragments of C3. *Adv Immunol* 1985;37:217–267.

118. Dykman TR, Cole JL, Iida K, Atkinson JP. Polymorphism of human erythrocyte C3b/C4b receptor. *Proc Natl Acad Sci U S A* 1983;80:1698–1702.

119. Seya T, Holers VM, Atkinson JP. Purification and functional analysis of the polymorphic variants of the C3b/C4b receptor (CR1) and comparison with H, C4b–binding protein (C4bp), and decay accelerating factor (DAF). *J Immunol* 1985;135:2661–2667.

120. Wong WW, Wilson JG, Fearon DT. Genetic regulation of a structural polymorphism of human C3b receptor. *J Clin Invest* 1983;72:685–693.

121. Kalli KR, Hsu PH, Bartow TJ, et al. Mapping of the C3b–binding site of CR1 and construction of a (CR1)2–F(ab')<sub>2</sub> chimeric complement inhibitor. *J Exp Med* 1991;174:1451–1460.

122. Klickstein LB, Bartow TJ, Miletic V, et al. Identification of distinct C3b and C4b recognition sites in the human C3b/C4b receptor (CR1, CD35) by deletion mutagenesis. *J Exp Med* 1988;168:1699–1717.

123. Makrides SC, Scesney SM, Ford PJ, et al. Cell surface expression of the C3b/C4b receptor (CR1) protects Chinese hamster ovary cells from lysis by human complement. *J Biol Chem* 1992;267:24754–24761.

124. Dempsey PW, Allison MED, Akkaraju S, et al. C3d of complement as a molecular adjuvant: bridging innate and acquired immunity. *Science* 1996;271:348–350.

125. Arnaout MA. Structure and function of the leukocyte adhesion molecules CD11/CD18. *Blood* 1990;75:1037–1050.

126. Bianco C, Griffin FMJ, Silverstein SC. Studies of the macrophage complement receptor. Alteration of receptor function upon macrophage activation. *J Exp Med* 1975;141:1278–1291.

127. Arnaout MA, Todd RFI, Dana N, et al. Inhibition of phagocytosis of complement C3– or immunoglobulin G–coated particles and of C3bi binding by monoclonal antibodies to a monocyte granulocyte membrane glycoprotein (Mo1). *J Clin Invest* 1983;72:171–179.

128. Brown EJ. Complement receptors, adhesion, and phagocytosis. *Infect Agents Dis* 1992;2:63–70.

129. Graham IL, Gresham HD, Brown EJ. An immobile subset of plasma membrane CD11b/CD18 (Mac–1) is involved in phagocytosis of targets recognized by multiple receptors. *J Immunol* 1989;142:2352–2358.

130. Gresham HD, Graham IL, Anderson DC, Brown EJ. Leukocyte adhesion deficient (LAD) neutrophils fail to amplify phagocytic function in response to stimulation: evidence for CD11b/CD18–dependent and

- independent mechanisms of phagocytosis. *J Clin Invest* 1991;88:588-597.
131. Isenman DE. Conformational changes accompanying proteolytic cleavage of human complement protein C3b by the regulatory enzyme factor I and its cofactor H: spectroscopic and enzymological studies. *J Biol Chem* 1983;258:4238-4244.
132. Myones BL, Dalzell JG, Hogg N, Ross GD. Neutrophil and monocyte cell surface p150,95 has iC3b-receptor (CR4) activity resembling CR3. *J Clin Invest* 1988;82:640-651.
133. Arnaout MA, Pitt J, Cohen HJ, et al. Deficiency of a granulocyte-membrane glycoprotein (gp150) in a boy with recurrent bacterial infections. *N Engl J Med* 1982;306:693-699.
134. Ravetch JV. Fc receptors: rubor redux. *Cell* 1994;78:553-560.
135. Ravetch JV, Kinet JP. Fc receptors. *Annu Rev Immunol* 1991;9:457-492.
136. Unkless JC. Function and heterogeneity of human Fc receptors for immunoglobulin G. *J Clin Invest* 1989;83:355-361.
137. van de Winkel JGJ, Anderson CL. Biology of human immunoglobulin G Fc receptors. *J Leuk Biol* 1991;49:511-524.
138. Fanger MW, Shen L, Graziano RF, Guyre PM. Cytotoxicity mediated by human Fc receptors for IgG. *Immunol Today* 1989;10:92-99.
139. Ceuppens JL, Baroja ML, Van Vaeck F, Anderson CL. Defect in the membrane expression of high affinity 72-kD Fc $\gamma$  receptors on phagocytic cells in four healthy subjects. *J Clin Invest* 1988;82:571-578.
140. Clark MR, Liu L, Clarkson SB, et al. An abnormality of the gene that encodes neutrophil Fc receptor III in a patient with systemic lupus erythematosus. *J Clin Invest* 1990;86:341-346.
141. Huizinga TW, Kuijpers RW, Kleijer M, et al. Maternal genomic neutrophil FcRIII deficiency leading to neonatal isoimmune neutropenia. *Blood* 1990;76:1927-1932.
142. Clarkson SB, Kimberly RP, Valinsky JE, et al. Blockade of clearance of immune complexes by an anti-Fc gamma receptor monoclonal antibody. *J Exp Med* 1986;164:474-489.
143. Clarkson SB, Bussel JB, Kimberly RP, et al. Treatment of refractory immune thrombocytopenia with an anti-Fc gamma-receptor antibody. *N Engl J Med* 1986;314:1236-1239.
144. Hazenbos WL, Gessner JE, Hofhuis FM, et al. Impaired IgG-dependent anaphylaxis and Arthus reaction in Fc gamma RIII (CD16) deficient mice. *Immunity* 1996;5:181-188.
145. Jandl JH, Jones AR, Castle WB. Destruction of red cells by antibodies in man. I. Observations on the sequestration and lysis of red cells by immune mechanisms. *J Clin Invest* 1957;36:1428-1459.
146. Mollison PL, Hughes-Jones NC. Sites of removal of incompatible red cells from the circulation. *Vox Sang* 1958;4.
147. Christensen BE. The pattern of erythrocyte sequestration in immunohaemolysis. *Scand J Haematol* 1973;10:120-129.
148. Von Dem Borne AEG, Engelfriet CP, Reynierse E, et al. Autoimmune haemolytic anemia. VI. <sup>51</sup>Chromium survival studies in patients with different kinds of warm autoantibodies. *Clin Exp Immunol* 1973;13:561-571.
149. Mollison PL, Crome P, Hughes-Jones NC, Rochna E. Rate of removal from the circulation of red cells sensitized with different amounts of antibody. *Br J Haematol* 1965;11:461-470.
150. Logue G, Rosse WF. Immunologic mechanisms in autoimmune hemolytic disease. *Semin Hematol* 1976;13:277-289.
151. Cutbush M, Mollison PL. Relation between characteristics of blood group antibodies in vitro and

- associated patterns of red cell destruction in vivo. *Br J Haematol* 1958;4:115–137.
152. Frank MM, Schreiber AD, Atkinson JP. NIH conference. Pathophysiology of immune hemolytic anemia. *Ann Intern Med* 1977;87:210–222.
153. Schreiber AD, Frank MM. Role of antibody and complement in the immune clearance and destruction of erythrocytes I. In vivo effects of IgG and IgM complement-fixing sites. *J Clin Invest* 1972;51:575–582.
154. Schreiber AD, Frank MM. Role of antibody and complement in the immune clearance and destruction of erythrocytes II. Molecular nature of IgG and IgM complement-fixing sites and effects of their interactions with serum. *J Clin Invest* 1972;52:583–589.
155. Anderson DR, Kelton JG. Mechanisms of intravascular and extravascular cell destruction. In: Nance SJ, ed. *Immune destruction of red cells*. Arlington: American Association of Blood Banks, 1989:1–52.
156. Hosea SW, Brown EJ, Hamburger MI, Frank MM. Opsonic requirements for intravascular clearance after splenectomy. *N Engl J Med* 1981;304:245–250.
157. Greiss MA. Antibody-dependent cell-mediated cytotoxicity (ADCC) and red cell destruction. *Med Lab Sci* 1986;43:183–189.
158. Perlmann H, Perlmann P, Schrieber RD, Müller-Eberhard HJ. Interaction of target cell-bound C3bi and C3d with human lymphocyte receptors. Enhancement of antibody-mediated cellular cytotoxicity. *J Exp Med* 1981;153:1592–1603.
159. Rosse WF. Destruction mediated by immune adherence. In: Rosse WF, ed. *Clinical immunohematology: basic concepts and clinical applications*. Boston: Blackwell Science, 1990:107–141.
160. Martz E, Howell DM. CTL: virus control cells first and cytolytic cells second: DNA fragmentation, apoptosis and the prelytic halt hypothesis. *Immunol Today* 1989;10:79–86.
161. Podack E. Perforin: structure, function, and regulation. *Curr Top Microbiol Immunol* 1992;178:175–184.
162. Meri S, Morgan BP, Wing M, et al. Human protectin (CD59), an 18–20-kD homologous complement restriction factor, does not restrict perforin-mediated lysis. *J Exp Med* 1990;172:367–370.
163. Dooren MC, van Kamp IL, Kanhai HHH, et al. Evidence for the protective effect of maternal FcR-blocking IgG alloantibodies HLA-DR in Rh D-haemolytic disease of the newborn. *Vox Sang* 1993;65:55–58.
164. Urbaniak SJ, Greiss MA, Crawford RJ, Ferguson MJC. Prediction of the outcome of Rhesus haemolytic disease of the newborn: additional information using an ADCC assay. *Vox Sang* 1984;46:323–329.

2004 Lippincott Williams & Wilkins  
John P. Greer, John Foerster, John N. Lukens  
George M. Rodgers, Frixos Paraskevas, Bertil Glader  
Wintrobe's Clinical Hematology



CLASSIFICATIONETIOLOGY OF AUTOIMMUNE RESPONSEMechanisms of Immune Self-ToleranceInduction of Autoimmune DestructionSEROLOGIC INVESTIGATION OF ERYTHROCYTE AUTOANTIBODIESDirect Antiglobulin TestIndirect Antiglobulin TestSerologic Difficulties Secondary to the AutoantibodiesIMMUNE HEMOLYTIC ANEMIAS CAUSED BY COLD ACTIVE ANTIBODIESCold Agglutinin DiseaseParoxysmal Cold HemoglobinuriaIMMUNE HEMOLYTIC ANEMIAS CAUSED BY MIXED WARM AND COLD ACTIVE ANTIBODIESIMMUNE HEMOLYTIC ANEMIAS CAUSED BY WARM ACTIVE ANTIBODIESPrimary versus Secondary Autoimmune Hemolytic AnemiaDrug-Induced Immune Hemolytic AnemiaREFERENCES**CLASSIFICATION**

Autoimmune hemolytic anemia (AIHA) occurs when a patient produces pathologic antibodies that attach to and lead to the destruction of red blood cells (RBCs), causing anemia. For AIHA to be present, both pathogenic antibodies and associated erythrocyte consumption must occur. These syndromes can be most easily classified according to the characteristic temperature activity of the antibodies ([Table 35.1](#)). Cold active antibodies typically have little, if any, activity at body temperature but display increasing affinity for the RBC as the temperature approaches 0° C. Conversely, warm active antibodies have their greatest affinity at 37° C. Although notable exceptions occur, as a general rule, cold active antibodies are generally of the immunoglobulin (Ig) M type, fix complement, and may lead to immediate intravascular destruction of erythrocytes or their removal from the circulation by the liver. Warm antibodies are typically of the IgG variety, may or may not fix complement, and primarily lead to RBC loss by splenic removal of the sensitized cells. These mechanisms are detailed later in this chapter. Occasionally, a patient may have mixed cold and warm antibodies, which are particularly troublesome clinically as they usually cause severe RBC destruction and frequently respond poorly to therapy ([1](#)).

**TABLE 35.1. Classification of Immune Hemolytic Anemias**

|                              |
|------------------------------|
| Cold active antibodies       |
| Cold agglutinin disease      |
| Primary or idiopathic        |
| Secondary                    |
| Lymphoproliferative diseases |
| Autoimmune disorders         |
| Infections                   |
| <i>Mycoplasma pneumoniae</i> |

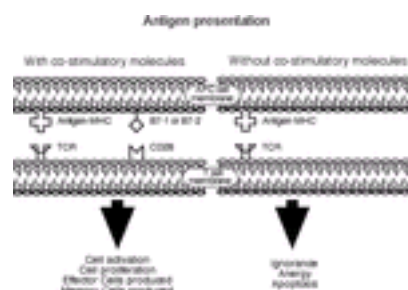


indicate the normal pathway of development. X indicates where these differentiation steps can be interrupted for self-reactive B cells as a consequence of encountering self-antigen. sIgM, surface immunoglobulin M. (Adapted from Schlomchik MJ. Mechanisms of immune self-tolerance and how they fail in autoimmune disease. In: Silberstein L, ed. Autoimmune disorders of blood. Bethesda, MD: American Association of Blood Banks, 1996:1-34.)

**CENTRAL TOLERANCE: FIRST CHANCE AT CONTROL** *Central tolerance* refers to control steps in place in the bone marrow or the thymus that prohibit the development and peripheral release of clones of B and T cells reactive to self-antigens (3). To prepare for the potential diversity of a world full of antigens, B cells rearrange Ig genes recombining segments V<sub>H</sub>, J, and D and V<sub>L</sub>, and T cells rearrange receptors (T-cell receptors) to recognize intruders and ensure their demise. As one might expect given the vast potential of recombinations possible, reactions with self-antigens can and do occur. If these cells are found to react strongly with antigens in early fetal life, the stimulation leads to apoptosis, thus removing the cell from the population, never to be seen again, in a negative selection process termed *clonal deletion* (4, 5). This was predicted by Owen in 1945 (6), who observed that dizygotic cattle twins that had exchanged blood and stem cells *in utero* were tolerant of the other's blood after birth. This concept has been proven with transgenic mice experiments that implanted Ig genes for specific antigens present in one strain of mouse and absent in another. Entire clones of B cells producing the transgene product are absent in the strain exhibiting the target antigen. Full production of antibody occurs in the strain not producing the antigen (7, 8). Exactly what happens to these B cells is not clear (4, 9). Strong interactions between antigen and immune cells in the bone marrow or thymus lead to the cells' early demise. However, weak interactions with a low-avidity antigen pose less of a threat to self and are kept in the repertoire in a positive-selection process to enhance the immune response against invaders (10). T cells express unique and specific receptors by recombining Va and Vβ or Vγ and Vδ gene segments (11). Macrophages and dendritic cells in the fetal thymus engulf and process outside material, such as RBCs, for presentation to thymocytes. T cells recognize antigens when randomly recombined receptors match a peptide sequence from an antigen presented in conjunction with major histocompatibility complex (MHC) class I/II molecules (12). MHC molecules are membrane glycoproteins on macrophages and dendritic cells required for T-cell recognition and processing of antigen peptides. T cells with the CD4<sup>+</sup> helper phenotype require MHC class II, and T cells that are CD8<sup>+</sup> suppressor cells recognize MHC class I (13, 14). T cells undergo a fate similar to deleted B-cell clones if their T-cell receptors bind with high affinity to peptide-presenting cells in the fetal thymus. More than 95% of thymocytes and lymphocytes are banished from the fetal population through cell death by apoptosis so that self-tolerance may be maintained throughout adult life (15). Another central control mechanism to prevent autoimmune disease is the inactivation, but not elimination, of cells designed to respond to self-antigens. This process, termed *clonal anergy*, produces B cells that have less surface Ig, have shorter half-lives in the peripheral circulation, and respond poorly to encountered antigen (7, 16). An equivalent process occurs in T-cell development, whereby T cells are incapable of responding appropriately to peptides presented (17). Central tolerance has significant limitations. Removal of any and all potential self-reactive cells is not only impossible but may also be undesirable. All of these control points must be balanced with the body's need to have a ready army to defend it against outside foes. A workable compromise is established with the elimination of the high-affinity responding cells only, leaving the weakly self-responding clones available for deployment against intruders. The sheer numbers of potential proteins to be encountered in the body make it unlikely that all potential self-reacting clones are effectively destroyed *in utero* (18). Also, many proteins, such as thyroglobulin, are tissue specific and never circulate, thus they are not available for presentation to immune cells in the thymus or bone marrow. Still other

immunogens, such as the I antigen on RBCs, are not expressed significantly until after birth, making fetal presentation an impossibility ( [19](#) ). Autoimmune diseases are frequently associated with a relative increase in CD5<sup>+</sup> B lymphocytes ( [20](#) ). This particular type of lymphocyte, also called a *B-1 cell*, is a population of B cells that arises from progenitors in the fetal peritoneal cavity. They develop in this relative sanctuary without exposure to antigens; therefore, no tolerance develops ( [21](#) ). They do not participate in the typical B-cell immune response but normally produce the low-affinity, “natural” IgM antibodies with broad reactivity to bacterial and blood group antigens ( [22](#) ). Perhaps partly because they may be less likely to encounter antigens during fetal life, CD5<sup>+</sup> B cells are overrepresented in autoimmune and malignant processes such as chronic lymphocytic leukemia (CLL) ( [23](#) ). They are also believed to play a role in regulating the immune system network. In CLL, the CD5<sup>+</sup> malignant clone is not typically the cell responsible for producing the pathologic RBC autoantibody but may participate in its induction ( [24](#), [25](#) ).

**PERIPHERAL TOLERANCE: BACKUP CONTROL MECHANISMS** There are many ways in which autoimmune populations may arise. That some cells escape the control mechanisms just described is well known. Realizing that many self-reactive immune cells evade early destruction, other mechanisms of restraining the immune response exist to provide further protection. For an immune response to occur as planned, the appropriate B cell must first encounter the antigen and process it for presentation to a T cell. Absence of circulating antigens in fetal life may continue after birth, and the cell is never stimulated to produce antibodies. This *clonal ignorance* may continue for as long as the antigen remains secluded in tissue or circulates in very small quantities. If an infectious or inflammatory process releases antigen into the circulation, a postinfectious autoimmune syndrome may result due to the exposure to this self-antigen. An example of this is the release of thyroglobulin after thyroiditis. Antithyroglobulin antibodies may result ( [26](#) ). Another important control in muting an antigen response is the need for the correctly matched B and T cells to be in the same place at the same time for optimal responses to occur ( [27](#) ). Chance may not favor the meeting of two different cell types of low concentration. Also, incomplete deletion of B cells in the bone marrow can be compensated somewhat by deletion of the corresponding clone of T cells needed to maximize the response. The appropriate stimulatory T cell for surviving clones of B cells simply may not exist or vice versa. Once the matched pair of T cell and B cell or other antigen-presenting cell encounters each other in the presence of the target antigen, activation still does not automatically take place. Co-stimulatory molecules (receptor/ligand pairs) must bind at the same time as the MHC/peptides bind to activate the respective cells ( [Fig. 35.2](#) ) ( [28](#) ). If the co-stimulatory molecules are not present, *anergy*, an unstable state of metabolic arrest that may lead to apoptosis, may result. This is yet another mechanism to retard or prevent antibody responses to self-antigens ( [10](#) ).



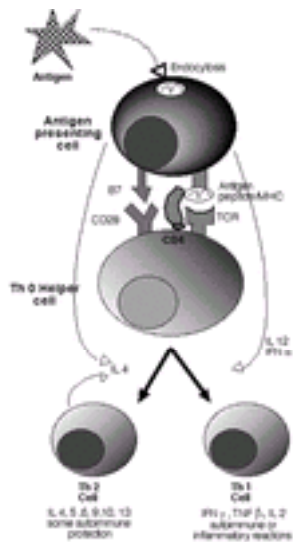
**Figure 35.2.** Activation of naïve T cells in the presence or absence of a co-stimulatory signal. Physiologic activation of naïve T cells requires two signals. The first signal is initiated by the binding of a peptide-major histocompatibility complex (MHC) complex to the T-cell-antigen receptor (TCR); the second is initiated by the binding of a co-stimulatory ligand (B7-1 or B7-2) to its receptor (CD28). Both the peptide-MHC complex and the co-stimulatory ligand are presented to the T cell by an

antigen-presenting cell (APC). Stimulation of naïve T cells through the TCR in the presence of a co-stimulatory signal leads to cell proliferation and the generation of effector cells and memory cells. In the absence of a co-stimulatory signal, activation of naïve T cells is nonproductive. In some cases, the T cell remains oblivious to stimulation of the TCR (ignorance). In other situations, activation of the TCR renders the lymphocyte refractory to further stimulation (anergy) or leads to its death (apoptosis). The precise outcome of T-cell stimulation in the absence of a co-stimulatory signal appears to depend on its state of activation and differentiation. (From Reiser H, Stadecker MJ. Costimulatory B7 molecules in the pathogenesis of infectious and autoimmune diseases. *N Engl J Med* 1996;335:1369–1377, with permission.)

When the offending agent is eradicated, B cells are still mutating their variable region genes randomly to produce high-affinity antibodies. Once again, the opportunity for the development of a self-reactive clone exists ( [29](#) ). There being no further need for legions of cells to fight the intruder, some cells are programmed for apoptosis after a certain amount of proliferation ( [30](#), [31](#) ). Those that survive may become memory B cells ( [32](#) ). Cells may die after receiving apoptotic death signals after binding of a receptor–ligand pair of genes called *Fas* (CD95) and *Fas ligand* ( *FasL* ). Activated B cells express *Fas*, and activated T cells express both *Fas* and *FasL* on their cell surfaces ( [33](#), [34](#) ). T cells may serve as assassins for unwanted stimulated cells, causing death by apoptosis. Evidence that this is true is supplied by the identification of mutations in the *Fas* gene that impair signal transduction and therefore impede subsequent apoptosis in patients with the rare Canale–Smith syndrome, an autoimmune lymphoproliferation of lymphoid hyperplasia, hemolytic anemia, and immune thrombocytopenia ( [35](#) ). Interleukin (IL)–2 also induces apoptosis. In fact, the absence of IL–2 or its high-affinity receptor is associated with AIHA. Overexpression of antiapoptotic molecules such as Bcl–2 can have a similar effect ( [36](#) ). These molecules not only control the proliferation of the immune response but also decrease the chance of autoimmune antibodies being produced by random mutation. Another receptor–ligand pair limiting the immune response is made up of CTLA4 ( cytotoxic T lymphocyte antigen 4 or CD152) and B7–1 (CD80) or B7–2 (CD86). Only activated T cells display the CTLA4 receptor, which, once bound to CD80/86 on an activated B cell, transmits a suicide signal, eventually destroying the T cell ( [37](#) ). Recall from [Figure 35.2](#) that these same B7 molecules activate the uninformed T cell through CD28. B7 molecules have a 100-fold greater affinity for CTLA4 than CD28, thus favoring control of the immune response, once activated ( [28](#) ). Therefore, B7s provide both positive and negative feedback for the immune response, depending on the receptor bound.

## Induction of Autoimmune Destruction

There are two types of T-helper cell responses, Th1 and Th2 ( [38](#) ). [Figure 35.3](#) depicts some of the conditions favoring the production of each and the consequences of each path. Th1 helper cells tend to favor autoimmune and allergic inflammatory tissue destruction. Th2 cells, in general, tend to protect against autoimmune disease. If Th1 cells predominate over Th2, autoimmune disease is more likely to result ( [36](#) ).



**Figure 35.3.** Immune response pathways. Antigen or autoantigen is engulfed by an antigen-presenting cell (dendritic cell, monocyte, macrophage, or B cell) and digested into peptides. These peptides are presented with major histocompatibility complex (MHC) type II molecules to an appropriate CD4 T cell (Th 0). This reaction is enhanced by CD4 interactions. Activation of the T cell proceeds if co-stimulatory molecules B7 bind to CD28 to produce the necessary signals. Depending on the prevailing cytokine influence, the cell develops into a Th 1 [interferon (IFN)- $\alpha$ , interleukin (IL)-12] or Th 2 (IL-4) cell. Th 1 cells and Th 2 cells release the cytokines listed, influencing the general reaction toward inflammation/autoimmunity (Th 1) or relative autoimmune protection (Th 2). TCR, T-cell receptor; TNF, tumor necrosis factor. (Redrawn from Mackay IR. Tolerance and autoimmunity. *BMJ* 2000;321:93-96; Reiser H, Stadecker MJ. Costimulatory B7 molecules in the pathogenesis of infectious and autoimmune diseases. *N Engl J Med* 1996;335:1369-1377; and Ring GH, Lakkis FG. Breakdown of self-tolerance and the pathogenesis of autoimmunity. *Semin Nephrol* 1999;19:25-33.)

Despite the controls previously discussed, the immune response may still proceed via other pathways of activation. Bacteria may activate lymphocytes even without co-stimulatory molecules by superantigens such as lipopolysaccharides. A very strong first activation signal may induce a cell to express its co-stimulatory molecules ( [39](#), [40](#) ). Infection and inflammation can lead to a nonspecific activation of lymphocytes ( [41](#) ). Antigen-presenting cells, such as macrophages and dendritic cells, may display these molecules and activate cells to start the response ( [42](#) ). Therefore, during infection or inflammation, self-reactive antibodies may be nonspecifically induced despite other control mechanisms.

**Genetic and Environmental Risk Factors** Despite all of the intense study of the immune system, the exact inciting event or trigger that produces an autoimmune syndrome remains illusive. Genetic factors clearly play a role, particularly the HLA genes. MHC genes determine which antigens are presented, thus potentially coding for a general susceptibility to autoimmune processes. The phenotype confers a predisposition, not a predestination, as most people do not develop disease ( [3](#) ). Studies with identical twins rarely display significant concordance ( [43](#) ). It is unknown where, in the many steps required to generate the immune response, these genes may exercise their influence, be it in the central tolerance stage or in curtailing a response already in progress. Clearly, more work needs to be done in this area. Environmental factors also have a very significant influence on the outcome. Infections can disrupt tolerance by exposing self-antigens through tissue necrosis. Their destructive inflammatory effects may break down vascular or cellular barriers that previously prevented access of those antigens to



the immune system. *Epitope spreading* is the subsequent autoimmune response to these formerly cryptic antigens. Infectious agents produce responses to many different peptide sequences in their antigen composition. *Molecular mimicry* results when organism epitopes cross-react with host antigens via shared sequences, producing tissue destruction ( [44](#) ). Our extensive pharmacopoeia can produce life-threatening hemolytic complications from induction of antibody to new immunogens consisting of drugs bound to tissues. Medications may produce generalized autoimmune syndromes such as procainamide-induced lupus ( [45](#) ). Once again, it is not known exactly how these agents incite pathologic antibodies.

## SEROLOGIC INVESTIGATION OF ERYTHROCYTE AUTOANTIBODIES

The demonstration of Igs or evidence of complement fixation and attachment to the surface of the cell supports the diagnosis of immune-mediated destruction of RBCs. *Ex vivo* and, occasionally, *in vivo* cells coated with IgM may spontaneously agglutinate as a result of the pentameric antibody's ability to cross-link cells. These have been called "complete" antibodies. In contrast are the IgG-coated cells, which do not typically agglutinate saline-suspended RBCs and are thus called "incomplete" antibodies.

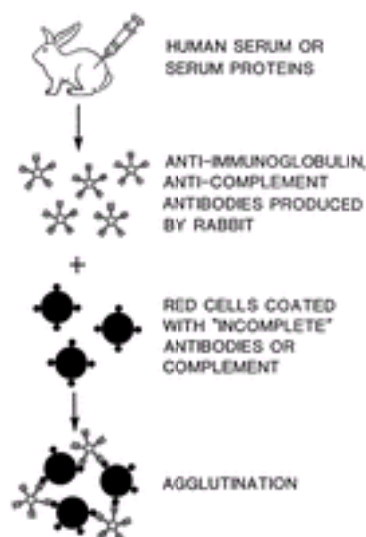
The explanation for this serologic difference lies in the physical properties of the RBCs and the involved antibody molecules. Erythrocytes have a strong net negative charge called the *zeta potentia*, produced by the sialoglycoprotein coat, such that approximately 18 nm is the shortest span between two cells. Factors other than negative charge may also play a role in the distance they keep. Water that is tightly bound to the surface of the cells may keep cells apart. IgM molecules with their large pentameric structure allow approximately 30-nm maximum distance between two binding sites and can therefore connect two cells. The smaller IgG can muster a span of only 12 nm between antigen recognition sites and thus usually cannot lead to agglutination alone ( [46](#) ). Some IgG antibodies can, indeed, agglutinate RBCs, such as in the anti-A, anti-B, and anti-M reactions. This reveals the influence on agglutination of the number of antigen sites per cell ( [47](#) ) and even how far the antigenic determinants project from the surface of the RBC. A and B oligosaccharides extend well beyond the lipid bilayer membrane ( [48](#) ). With their relative abundance, they are also close together on the cell surface, enhancing agglutination. Still, whereas the number of IgG molecules required to agglutinate RBCs has been measured at approximately 7000 to 20,000 per cell, the number of IgM necessary is only 25 to 50 per cell ( [49](#), [50](#) ). Other serologic tricks to enhance agglutination by IgG antibodies include treating the cells with enzymes to reduce the surface charge; centrifuging the mixtures; adding water-soluble polymers such as albumin, polyvinylpyrrolidone (PVP), or dextran; and adding plasma, the most significant constituent of which is fibrinogen ( [51](#) ). However, the most common way to enhance these reactions and determine the presence of immune system components on cells is through the direct antiglobulin test (DAT).

### Direct Antiglobulin Test

In 1908, Moreschi described antiglobulin reactions as an aid to RBC agglutination ( [52](#) ). This work went largely unnoticed until 1945 when the investigation of anti-RBC antibodies was revolutionized with the development of the antiglobulin test by Coombs, Mourant, and Race ( [53](#) ) and its application to diagnosing IgG coating of cells in hemolytic disease of the newborn in 1946 ( [54](#) ). Until this time, it was known that complete antibodies would produce spontaneous aggregation of RBCs without extra manipulation and that incomplete antibodies could not spontaneously agglutinate cells. The principle of the DAT or direct Coombs test is quite simple. To ascertain if the patient's cells are coated with



Ig, complement, or both, add antisera with reactivity to human Ig and/or complement molecules to the patient's RBC suspension, thus providing the necessary cross-link to elicit agglutination. [Figure 35.4](#) illustrates the principle of the test. An ethylenediaminetetraacetic acid-collected sample from the patient is used to prevent subsequent complement adherence to the RBC membrane *in vitro*. The test is performed by first washing the patient's cells to remove any nonspecifically attached proteins. Antiserum is added, and the mixture is centrifuged to enhance agglutination. Results are read by resuspending the cells gently and observing carefully for clumps. Magnifying mirrors or low-power microscopy aids in discerning weak reactions. Negative reactions are incubated at room temperature for 5 more minutes, spun, and read again, as this further promotes positive reactions in the presence of complement ([55](#)). Initial testing is done with polyspecific antisera, which contain anti-IgG, anti-C3d, and, occasionally, some anti-light chain activity. Monospecific reagents differentiate between IgG and C3d to further define the reaction pattern. Other monospecific antisera are available for C3b, C4b, C4d, and IgG heavy chain ([56](#)). Specific antiserum for IgM or IgA is rarely used as IgM is not usually found still attached to the cell surface and IgA, if found at all, is very rarely a cause of Ig coating by itself ([57](#), [58](#)). Monoclonal reagents have been licensed by the U.S. Food and Drug Administration, the most common of which is anti-C3d. It does not cross-react with any other complement components ([56](#)).



**Figure 35.4.** Direct antiglobulin test. Rabbits or goats are immunized with human serum or serum components. The resulting sera containing anti-?-globulin or anticomplement antibodies are then added to test samples of RBCs. If human ?-globulins, complement components, or both are bound to the cell surface, agglutination occurs. (From Foerster J. In: Lee G, et al., eds. Wintrobe's clinical hematology, 9th ed. Philadelphia: Lea & Febiger, 1993: [Chapter 40](#), with permission.)

A significant shortcoming of the original DAT methodology is its relative insensitivity. New technology has allowed much greater sensitivity in detecting Igs and complement on cells. The previously described tube method can detect approximately 150 to 200 molecules IgG per cell ([59](#)). Using PVP enhancement and an autoanalyzer, as few as 8 IgG molecules per cell would produce 5% agglutination. If bromelain was added with the PVP, 1 molecule per cell would produce 5% agglutination and 3 molecules could give 50% ([60](#)). Flow cytometry, enzyme-linked antiglobulin tests, radioimmunoassays using  $^{125}\text{I}$ -labeled anti-IgG or  $^{125}\text{I}$ -staphylococcal protein A, solid phase techniques using microtiter plates,

and gel testing have all produced acceptable results ( 51 ). However, only the tube test, solid phase test, and gel tests are in routine use in most laboratories. Gel tests have an advantage of producing stable results that can be read by another observer at a later time in case of questionable interpretations.

If the DAT is positive for antibody attached to the cell surface, this antibody is eluted from the cell with chemicals such as acid or xylene, and any binding specificities are further investigated with a reagent cell panel. Elutions are not typically performed on DAT specimens positive only for complement as these molecules would not be expected to have antigen-binding specificity. Occasionally, however, when antibody presence is suspected but perhaps in too low a concentration to be detected on the cells, eluates may show reactivity. Elution tends to produce a more concentrated antibody solution so that reactions are stronger. Once the antibody is in solution, indirect antiglobulin methodology may shed some light on the special characteristics of the antibody.

### Indirect Antiglobulin Test

Approximately 80% of patients with AIHA have autoantibodies in their serum as well as on their cells ( 61 ). They, as well as alloantibodies, are detected by the indirect antiglobulin test (IAT) or indirect Coombs test. This is more commonly referred to as the *antibody screen*. Unlike the DAT, which uses patient's *cells* with reagent serum, the IAT tests the patient's *serum* against reagent cells. Ig from the serum attaches to the reagent cells and is detected with antiglobulin sera, which cross-link the cells together and produce agglutination as in the DAT.

The precise antigen(s) to which the majority of warm autoantibodies attach is still a well-kept secret. Warm autoantibodies are typically panagglutinins, reacting with every cell in the diagnostic RBC panel. Many panagglutinins were believed to react with a basic determinant of the Rh antigen system, as they did not react with the very rare Rh<sub>null</sub> cells that have no Rh antigens on them ( 62 ). However, as more eluates are studied with a broader population of rare null phenotypes, it has been shown that, in addition to Rh, autoantibodies react to LW antigens, glyophorins A, B, C, and D, and very rarely, Kidd or Kell blood group system antigens ( 63 ). A small number of case reports exist describing AIHAs associated with ABO antigens ( 64 , 65 ).

### Serologic Difficulties Secondary to the Autoantibodies

ABO typing discrepancies are not common with warm autoantibodies but can be quite problematic with the spontaneous agglutination frequently seen with cold autoantibodies. Rh typing may pose a similar set of problems. Vigorous washing of the patient's cells and using prewarming techniques may permit accurate typing. Invalid results due to agglutination of all back-typing reactions with the patient's serum are not uncommon with cold autoantibodies ( 55 ). However, the cold autoantibody is rarely as strong as the naturally occurring isoagglutinins. For example, the patient's washed, prewarmed cells may type as A, but the warmed serum may give a weakly positive reaction with A<sub>1</sub> cells as well as the expected strong reaction to B cells. Cold autoadsorption of the serum, a technique similar to the autoadsorptions described below, may resolve the discrepancy. Using IgG antiglobulin serum or reducing and inactivating the IgM with dithiothreitol may eliminate the unwanted reactions but also may destroy the desired ones, especially if the IgG component of anti-A and anti-B is very weak, as might be seen in non-group O individuals. Interpretations must be made with caution ( 55 ).

The IAT is not critical to the diagnosis of AIHA, warm or cold, but an autoantibody in the

serum can become very problematic for the transfusion service if blood products will be required. Panagglutinins or spontaneous agglutination from cold antibodies masks the presence of any potential alloantibodies that may cause hemolytic transfusion reactions. These autoantibodies must be removed from the serum in ways that permit the alloantibodies to remain. If the patient has not recently been transfused, this may be accomplished by a procedure known as *autoadsorption* ( 55 ). The patient's own cells are treated with acid or enzymes to remove the autoantibody from the cells, and then the patient's serum is repeatedly mixed with these treated autologous cells until all autoantibody is removed. By definition, alloantibodies do not attach to autologous cells and should remain behind in the serum for identification in the usual manner with a diagnostic panel of reagent cells ( 56 ). The situation is more difficult if the patient has been recently transfused and has allogeneic cells circulating that may possess antigens that could potentially remove the very antibody to be identified. Alloadsorption of the patient's serum with three different types of RBC stroma, each carefully selected for absence of specific antigens, is performed. Antibodies to these specific, high-risk antigens are available for identification after removal of the panagglutinin, and the appropriate antigen-negative RBC unit can be selected for transfusion ( 55 ).

Cross-matching RBCs for a patient with circulating autoantibody is difficult. Once it has been determined that no unexpected alloantibodies are present, the laboratory chooses the ABO-compatible units available and releases them as "cross-match incompatible." As it is not possible to determine whether this incompatibility is due solely to the autoantibody, one should transfuse with caution. The physician is required by transfusion regulations to sign a form indicating awareness of the incompatibility and the urgent need for transfusion. It is not expected that these transfused cells will fare any more or less poorly than the patient's own. Rarely has a transfusion incited greater autoimmune activity and increased destruction of all circulating cells.

## IMMUNE HEMOLYTIC ANEMIAS CAUSED BY COLD ACTIVE ANTIBODIES

Cold active antibodies exhibit increased titer and RBC binding activity as the temperature approaches 0° C. Two different clinical syndromes are manifested from cold autoimmune antibodies. Cold agglutinin disease (CAD) is associated with IgM antibodies usually directed at the RBC I antigen. It typically occurs in adult patients and may be primary or secondary to another disease process, usually infectious. Paroxysmal cold hemoglobinuria (PCH) is caused by the so-called Donath-Landsteiner ( 66 ) antibody, an IgG hemolysin. With the decline in syphilis, PCH is uncommon and seen rarely outside the pediatric population. Both syndromes are much less common than warm AIHA and make up approximately 20% or less of AIHAs. [Table 35.2](#) summarizes the various types of cold autoantibodies.

**TABLE 35.2. Cold Autoantibodies**

|                          | Primary Cold Agglutinin Disease | Secondary Cold Autoantibodies | Paroxysmal Cold Hemoglobinuria         |
|--------------------------|---------------------------------|-------------------------------|--|
| Ig                       | IgM                             | IgM                           | IgG                                    |
| Clonality                | Monoclonal                      | Monoclonal/polyclonal         | Polyclonal                             |
| Direct antiglobulin test | C3                              | C3                            | C3                                     |
| Hemolysis                | Chronic, mild                   | Self-limited, mild to severe  | Episodic, self-limited; mild to severe |

Target red blood cell antigen I I, i P  
C3, complement third component; Ig, immunoglobulin.

---

## Cold Agglutinin Disease

Although Landsteiner first described cold agglutinins in 1903 (67), it was not until the late 1940s and early 1950s that the connection between cold autoantibodies and RBC destruction was made firmly. In the 1950s, Schubotho coined the term *CAD*, and the disorder became recognized as a separate entity from other acquired hemolytic processes (68). The pathologic IgM antibodies responsible are distinguished from naturally occurring cold autoantibodies by their titer and *thermal amplitude*, a term describing the range of temperatures over which the antibody is reactive. Natural cold autoantibodies occur in titers less than 1:64 measured at 4° C and have no activity at temperatures much higher than that. However, pathologic cold agglutinins typically have titers well over 1:1000 and may react at 28 to 31° C or even up to 37° C (57).

### PRIMARY VERSUS SECONDARY COLD AGGLUTININ DISEASE *Primary or idiopathic*

*CAD* is typically an affliction of older adults with a peak incidence around age 70 (68). Both sexes are affected, but women predominate (69). A monoclonal IgM ? (70) antibody is the usual culprit, and, as with other monoclonal gammopathies of unknown significance, B-cell neoplasms may eventually be diagnosed, but patients usually tolerate a relatively benign, waxing and waning hemolytic anemia. Patients with Waldenström macroglobulinemia or other B-cell neoplasms may produce monoclonal anti-RBC antibodies with cold reactivity. As in primary CAD, they are nearly always IgM ?. Another interesting characteristic of these B-cell clones is a distinctive karyotype of trisomy 3q11-q29 (71), trisomy 12 or 48,XX,+3,+12 found in 40% of patients. These chromosomal abnormalities have also been identified in patients with the chronic idiopathic variety. Further studies on the Ig and clonal cell populations revealed that the monoclonal cold agglutinins are produced by the (pre-) neoplastic B-cell clones (72, 73). This type of secondary cold agglutinin may be effectively treated with successful chemotherapeutic maneuvers directed at the neoplasm. Relapse of the tumor may be heralded by return of hemolysis. Other non-B-cell tumors reported in association with cold antibody formation include squamous carcinoma of the lung, metastatic adrenal adenocarcinoma, metastatic adenocarcinoma of the colon, basal cell carcinoma, and a mixed parotid tumor (74). Another scenario of secondary cold autoantibody hemolysis occurs in young adults after *Mycoplasma pneumoniae* infection or infectious mononucleosis. This is a transient process lasting a few weeks and seldom requires more than supportive care. These polyclonal IgM ? or ? Igs are self-limited but, in rare cases, may cause massive intravascular hemolysis and acute renal failure. See [Table 35.3](#) for other disease processes that have been associated with cold agglutinins.

### TABLE 35.3. Secondary Cold Agglutinin Disease

---

Neoplasms  
Waldenström macroglobulinemia  
Angioimmunoblastic lymphoma  
Other lymphomas  
Chronic lymphocytic leukemia  
Kaposi sarcoma  
Myeloma

Nonhematologic malignancy (rare)

Infections

*Mycoplasma pneumoniae*

Mononucleosis (Epstein–Barr virus)

Adenovirus

Cytomegalovirus

Encephalitis

Influenza viruses

Ornithosis

Rubella

Varicella

Human immunodeficiency virus

Mumps

Legionnaires disease

*Escherichia coli*

Subacute bacterial endocarditis

Listeriosis

Syphilis

Trypanosomiasis

Malaria

Other

Autoimmune diseases

Tropical eosinophilia

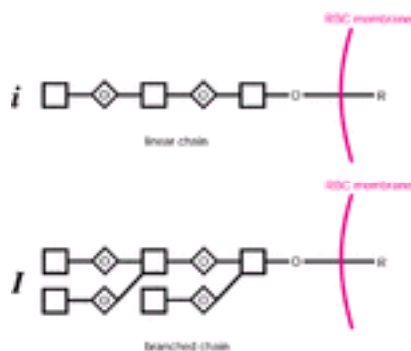
---

## CHARACTERISTICS OF THE ANTIBODY

**Immunochemistry and Origin** As stated earlier, nearly all cold agglutinins are IgM. A few reports of IgG or IgA agglutinins are recorded, and a mixed IgM–IgG has been seen in infectious mononucleosis and angioimmunoblastic lymphadenopathy (75). Those patients with non-IgM antibodies are more likely to have cold autoantibody hemolysis secondary to another disease and are less likely to display specificity for the I antigen (69, 76). Structural studies of cold agglutinins have focused on the variable regions or idiotypic determinants of the molecules. These are the regions that determine what antigen is bound by the antibody. Antiidiotypic antibodies and direct nucleotide sequencing of the rearranged Ig variable region genes have revealed significant cross-reactivity and homologies among cold autoantibodies with similar specificity (77, 78). For instance, the monoclonal antiidiotypic antibody 9G4 recognizes an idiotypic determinant present on the heavy chains of both anti-I and anti-i cold agglutinins and also on the neoplastic B cells secreting them (79). Further studies to ascertain the structural basis for this similarity revealed that essentially all pathologic anti-I and anti-i cold agglutinins are derived from a distinct subset of heavy-chain variable region genes called *V<sub>H</sub> 4 family genes*, specifically *V<sub>H</sub> 4-21* (80). It is interesting that harmless, naturally occurring anti-I/i antibodies may use *V<sub>H</sub> 4-21* but do not require this variable region heavy-chain gene. They may use *V<sub>H</sub> 3* gene segments as well (81). In an *in vitro* system, IgM autoantibodies with the *V<sub>H</sub> 4-21* heavy-chain variable region gene were produced and harvested from cell lines derived from a patient with Wiskott–Aldrich syndrome. They were found to react not only with the i antigen on RBCs but also with most pre-B cells in adult bone marrow and with a subpopulation of early B cells residing in the mantle zone of secondary follicles that constitutively coexpress the CD5 surface antigen. The investigators postulated that these gene products may play a role in B-cell development, differentiation, or both (82). Therefore, chronic CAD may represent a dysregulation of an early B-cell clone. The

initiating event for this exuberant expansion, however, is unknown. Unlike the heavy-chain genes, light-chain variable region genes are not quite so restricted. Anti-I autoantibodies appear to derive from the V $\lambda$ III gene family. The anti-i antibodies are not limited to V $\lambda$ III but use other V $\lambda$  genes as well (78).  $\lambda$ -Light chains also appear in anti-i antibodies (83). Thus, it seems that the fine antigen specificities are determined by the V $\lambda$  genes, and the more constant V $\mu$ 4-21 gene aids with the larger interaction with the I/i complex. The V $\mu$ 4-21 gene is also found in other antibodies, including rheumatoid factor autoantibodies and alloantibodies to other blood group antigens (84). The Ig gene regulation for anti-i/I antibodies may not differ greatly from that of normal antibody production. Common idiotypic determinants on these antibodies and the potential to create antiidiotypic antibodies may be an avenue of therapeutic application in the future as we learn more about their production (79).

**I/i Blood Group System Specificity** More than 90% of cold active antibodies have the I antigen as their target on the RBC, and the i antigen is the binding site for a significant portion of the remaining 10% (57). The I/i blood group system was defined when Wiener and colleagues tested the serum from a patient with CAD against more than 22,000 random blood samples (85). Five samples from that group, as well as the patient's own cells, were not agglutinated and thus labeled as "i" or "I-negative." A few years earlier, it was reported that high-titer cold agglutinins poorly agglutinate fetal cord blood cells (86, 87). Testing sera against adult RBCs and cord blood cells provides the basis for assessing specificity and the conclusion that nearly all are I-specific. This conclusion may not be entirely valid, as is discussed below. The I/i RBC antigen system is composed of repeating N-acetyllactosamine units linked to ceramide or to other membrane glycoproteins, band 3 and band 4.5 (48, 88). Evidence suggests that the major difference between the two is the presence of branching oligosaccharide chains in the I antigen. The i antigen is linear (Fig. 35.5). Antigen switching proceeds with development of the newborn. Only the i antigen is expressed in fetal life with gradual conversion to I from just before birth to approximately 18 months, when minimal amounts of i remain (89). This is due to the work of a branching enzyme, [B1?6]-N-acetylglucaminyl transferase (90). Rare adults express only the unbranched i<sub>adult</sub> antigen (91). The I/i determinants also serve as the nucleus for ABO. H substance, a precursor to ABO, is formed by substitution of the terminal Gal of the I structure with Fuca(1 and 2) (92). Understanding these structural similarities helps explain the combinations of specificity sometimes seen (e.g., IA, iH, IB, and so forth).



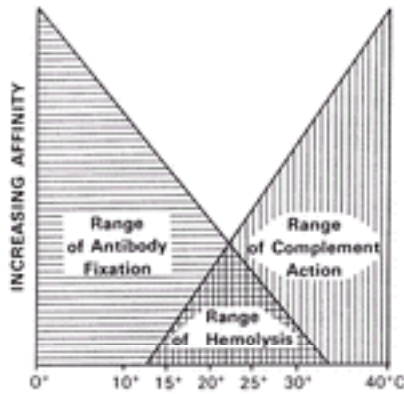
**Figure 35.5.** I/i blood group antigens. Structure of the I/i blood group system. R denotes ceramide or protein in the red blood cell (RBC) membrane. Open squares represent galactose. Circles in squares depict N-acetylglucosamine. The linear i antigen is converted to the branched chain I antigen by a "branching enzyme," [B1?6]-N-acetylglucaminyl transferase. (Adapted from Siegel DL, Silberstein LE. Red blood cell autoantibodies. In: Anderson KC, Ness PM, eds. Scientific basis of transfusion medicine. Philadelphia: WB Saunders, 1994:517-526.)



I and i antigens are expressed on other cells, including granulocytes, lymphocytes, macrophages, and platelets ( 93 ). On B lymphocytes, the antigens are carried on high-molecular-weight glycoproteins known as the *leukocyte common antigen* or *CD45*. T cells express I/i antigens on lower-molecular-weight sialoglycoproteins ( 94 ). The presence of these RBC antigens on lymphocytes, particularly on CD45, a protein tyrosine phosphatase involved in regulating lymphocyte activation and proliferation, raises questions about the role these antibodies may play in immune regulation. CD45 antigens may be abnormally expressed on cells in autoimmune disease, and antibodies to I/i antigens can be lymphocytotoxic ( 75, 95 ). Other uncommon but reported antigen targets include Pr, so labeled due to protease sensitivity of the antigen. The Pr determinants are O-glycosidically linked oligosaccharides of glycoporphins A or B ( 96 ). Anti-Pr cold agglutinins tend to be high titer, have a wide thermal range, and usually cause symptomatic anemia ( 92, 97 ). Other infrequent targets are Gd, Fl, Vo, Li, Sa, Lud, M, N, Me, Om, D, Sd<sup>x</sup>, and P in one case report ( 63, 69, 98 ). The fact that *M. pneumoniae* induces anti-I antibodies in the majority of patients is potentially related to the finding that sialylated I/i antigens serve as specific *Mycoplasma* receptors ( 99 ). This minor modification of antigen may incite autoantibodies. Another theory suggests that an I-like antigen appears on the organism itself, and cross-reacting antibodies form that lead to RBC lysis ( 100 ). Despite the high rate of antibody production, clinically significant hemolysis occurs in very few patients ( 101 ). The antibodies are usually IgM ? but can be ? ( 102 ). However, unlike chronic CAD, they are polyclonal ( 103 ). Infectious mononucleosis is also associated with CAD but to a much lesser degree than *Mycoplasma*. Estimates of 0.1 to 3.0% of patients with clinical hemolysis have been published ( 104, 105 ). However, anti-i is present in 8 to 69% of sera postinfection ( 106, 107 and 108 ). Therefore, the majority of patients' antibodies are asymptomatic. Anti-I activity is usually noted as well but not to the same degree. Also, anti-Pr and anti-N have been reported ( 109, 110 ). Both IgM and IgG antibodies as well as IgM rheumatoid-like factors reacting with IgG may act as cold agglutinins after infectious mononucleosis ( 111, 112 ). See [Table 35.3](#) for a list of other infectious diseases associated with cold agglutinins, most of which are anti-I, although anti-i has been seen in cytomegalovirus infections and in lymphomas ( 113 ).

**Functional Characteristics** Cold agglutinins attach to the RBC in the cooler peripheral circulation. As the blood proceeds back to the warmer central circulation, the antibody dissociates from the cell. Antibodies that attach, fix complement, and then dissociate are free to attack another unsuspecting erythrocyte and begin the process again ( 114 ). Complement fixation and activation, which are responsible for the destruction of the cells, prefer the warmer central temperatures. If the titer of the antibody is high enough and the thermal range of activity wide enough, there is adequate temperature overlap to produce maximum hemolysis at  $22 \pm 10^{\circ} \text{C}$  ( 68 ) ( [Fig. 35.6](#) ). Because of this diversity of temperature requirements for optimal activity of the antibody and complement, RBC destruction is usually not particularly severe with cold autoantibodies. Quite impressive exceptions occur, and these are typically the ones with high titers (<1:1000) or with activity up to  $37^{\circ} \text{C}$  even in the face of modest titers, as thermal amplitude is a better predictor of hemolysis than titer ( 75, 115 ). Cold agglutinins of high titer but narrower thermal amplitude may produce a clinical picture of bursts of hemolysis associated with exposure to cold. This can manifest as intermittent hemoglobinuria between quiescent periods ( 114 ).





**Figure 35.6.** Temperature ranges for cold agglutinin fixation and lytic complement action. (From Schubothe H. The cold hemagglutinin disease. *Semin Hematol* 1966;3:27–47, with permission.)

A frequent misconception about cold agglutinins is the assumption that they are cryoglobulins. These are two separate disease processes. Cold agglutinins are cryoprecipitable in up to one-third of those with anti-i specificity, but only rarely do anti-i antibodies precipitate in the cold (75). This confusion may result from the fact that both can cause agglutination in peripheral blood vessels perfusing cooler parts of the body, such as the fingertips and nose. Both may lead to cyanosis and Raynaud phenomenon. However, the cryoglobulins do not fix complement on the RBCs or cause hemolysis.

**CLINICAL MANIFESTATIONS** Mild, chronic hemolytic anemia with exacerbations in the winter is the general rule for CAD. Rarely does the hemoglobin drop below 70 g/L (116). Pallor and jaundice may occur if the rate of hemolysis is greater than the liver's ability to metabolize the bilirubin (69). Some patients have intermittent bursts of hemolysis associated with hemoglobinemia and hemoglobinuria on exposure to cold and may be forced to move to warmer climates to prevent attacks. Acrocyanosis can occur from agglutination of cells in the cooler vessels of the hands, ears, nose, and feet (57, 69). Digits become cold and stiff, painful, or numb and may turn purplish or limbs may manifest livedo reticularis, a mottled appearance. This is readily reversible on warming the affected area. Only rarely does actual gangrene of digits develop, and nearly all of these cases had an associated cryoglobulin (117). A minority of chronic CAD patients have mild splenomegaly or a slightly enlarged liver. Spleens may be larger or more frequently palpable in secondary cold agglutinins due to lymphoma or infectious mononucleosis (69). If hemolysis does occur after *Mycoplasma* infections, it begins when the patient is recovering from the pneumonia and titers for cold autoantibodies are at their peak. The process, even if severe, resolves spontaneously within 1 to 3 weeks (57). Hemolytic anemia after infectious mononucleosis may begin with the onset of illness or within the next 3 weeks (69). The self-limited, postinfectious CAD tends to affect younger patients, whereas the chronic idiopathic form is a disease of the elderly with peak incidence at approximately age 70 (68).

**LABORATORY FEATURES** Mild chronic anemia is the rule, but the hemoglobin may fall to 50 or 60 g/L, especially in the winter months in cold climates. The peripheral smear, if not from a prewarmed specimen spread on a warm slide, may show significant agglutination and clumping of cells under magnification. Agglutinates are frequently visible in the specimen tube and can be so pronounced as to give the appearance of a large clot. Dissolution with warming proves the clumped and clotted appearance to be due to a cold agglutinin instead of rouleaux or fibrin strands. Often, the first suspicion of a cold agglutinin comes from the hematology laboratory's failed attempt to obtain a meaningful RBC count and indices. The RBC count is artificially lowered and the mean corpuscular volume falsely elevated, producing an unbelievably high mean corpuscular hemoglobin concentration. The reticulocyte count is modestly elevated except in rare cases of concomitant marrow failure such as those due to parvovirus B19 infection (118).

Spherocytosis is not pronounced as in warm AIHA. Leukocyte and platelet counts are usually normal, but low levels of both have been reported as has leukocytosis ( 69 ). Bilirubin is mildly elevated and rarely more than 3 mg/dl. Lactate dehydrogenase may be increased, reflecting RBC destruction, and complement and haptoglobin can be low or absent. In brisk hemolysis, hemoglobinuria and hemoglobinemia are manifest. The DAT is positive with polyspecific and anticomplement antisera. As previously discussed, the IgM has dissociated and is not detectable. In extremely rare cases, the antibody involved is IgG or IgA either alone or in addition to IgM ( 57 , 69 ). Mixed warm and cold autoantibodies are not rare and are discussed later. Titers measured at 4° C may range from 1:1000 to 1:1,000,000, although typical values are between 1:1000 and 1:500,000. Much lower levels can be clinically significant if activity is measurable at 37° C. Postinfectious CAD titers are lower (<1:4000) than the chronic idiopathic or lymphoma-associated varieties. In patients with monoclonal IgM, evaluation of serum proteins frequently reveals an M spike, which serial observations show to be stable in the chronic idiopathic disease ( 119 ).

## MANAGEMENT

**Primary Cold Agglutinin Disease** Due to the mild, chronic nature of the anemia, the majority of patients need no specific therapy other than the general principle of avoiding temperatures below that at which their antibody shows activity. In some climates, this may necessitate a move closer to the equator. Somewhat extreme measures using an environmental suit to maintain temperature have been successful ( 120 ). For patients with more severe anemia and cardiovascular compromise, aggressive therapy is indicated.

**Immunosuppressive Therapy** Ideally, one would prefer a method that would suppress production of only the pathologic antibody. In the absence of that therapeutic advance, a common approach in treating symptomatic CAD is to use cyclophosphamide or chlorambucil. A minority of patients respond, but symptoms and transfusions can be avoided in those responders. Chlorambucil, beginning with 2 or 4 mg/day and increasing by 2 mg every 2 months until either a response is obtained or unacceptable myelotoxicity results, is one alternative. Twice-weekly blood counts plus reticulocyte count should be monitored for toxicity ( 57 , 121 ). Pulse therapy with cyclophosphamide at 250 mg/day and prednisone 100 mg/day for 4 days every 2 to 3 weeks, blood counts permitting, or a large-dose regimen of cyclophosphamide, 1000 mg, and methylprednisolone, 500 mg intravenously, may adequately control hemolysis ( 122 ).  $\alpha$ -Interferon has reportedly produced significant remissions ( 123 ). Rituximab, a chimeric human/murine monoclonal CD20 antibody, has been used with success in CAD in several case reports and series ( 124 , 125 , 126 , 127 and 128 ). These patients were refractory to other treatment regimens. Its proposed mechanism of action involves complement-dependent cytotoxicity, antibody-dependent cellular cytotoxicity, direct apoptotic effects, and inhibition of B-cell proliferation. *In vitro* evidence suggests that steroids may provide synergistic effects with rituximab ( 129 ). Doses used mimic the lymphoma treatment regimens of 375 mg/m<sup>2</sup> each week for 4 weeks. Some pediatric patients were successful with just two infusions ( 130 ). In a notoriously difficult to treat disease, it provides another option.

**Plasmapheresis** Given the fact that IgM has an intravascular distribution, it would seem logical that plasmapheresis or plasma exchange would provide rapid relief from hemolysis due to cold autoantibodies. Unfortunately, the results have been somewhat disappointing, in general ( 131 , 132 ). Removing the circulating antibody does not have any demonstrable effect on production of new antibodies by the clone of cells responsible. Therefore, improvements are very temporary. In patients with chronic CAD, plasmapheresis should probably be combined with immunosuppressive therapy in an attempt to decrease production ( 133 ). Successful use of plasmapheresis to temporarily decrease cold agglutinin titers, allowing safe coronary artery bypass surgery, has been reported ( 134 ). Other reports of successful cardiac surgery involving warm cardioplegia have circumvented the need for cold exposure and thus the risk of hemolysis ( 135 , 136 ).

**Blood Transfusion** Fortunately, most patients with CAD have such mild anemia that transfusion is not needed. It is best to avoid blood transfusion, if possible, in patients with

CAD. Patients with high-titer or wide thermal amplitude antibodies can pose extremely difficult serologic problems for the blood bank laboratory. Testing needs to be performed carefully at 37° C to minimize the effects of the cold agglutinin so that a search for alloantibodies may be properly performed ( 57 ). This still does not eliminate interference from some particularly pesky autoantibodies. Time-consuming and technically challenging cold autoadsorptions may be necessary to rule out the presence of underlying alloantibodies. Often, incompatible units are released due to residual agglutination from the cold autoantibody. Most cold agglutinins are directed at the I antigen, which is present on nearly all adult donor cells. Locating i<sub>adult</sub> cells is not practical due to their rarity.

Reports have documented i<sub>adult</sub> cells effectiveness and lack thereof ( 137 , 138 ). If transfusion is necessary to treat significant cardiovascular compromise, infusing the cells through an inline blood warmer at 37° C is the best method ( 139 ). Uncontrolled heating of RBC products is quite dangerous due to the damaging effects of excessive heat and should be avoided. If blood warmers are not available, transfusion may still be accomplished by the slow infusion of room temperature RBCs into a large vein while keeping the patient warm ( 57 , 69 ).

**Steroids** Unlike their effectiveness in treating warm AIHA, steroids have little or no place as monotherapy in the treatment of CAD. They have been part of multidrug regimens. The few reports of a response have been suspect in their serologic evaluations ( 140 ) or have required such high maintenance doses of prednisone that side effects of therapy were intolerable ( 141 ).

**Splenectomy** Given the fact that most RBC destruction occurs in the liver in CAD, it is no surprise that splenectomy has been essentially ineffective in treating CAD and is not advised. In a few, rare patients that have the unusual serologic characteristic of hemolysins reactive at 37° C as well as agglutinating activity at cooler temperatures, splenectomy may have some benefit ( 57 , 142 ).

**Secondary Cold Agglutinin Disease** Hemolysis from cold agglutinins associated with infection is of 2 to 3 weeks' duration, and therapy is typically not required. Given the transient nature of the antibody, even in the rare patient with significant hemolysis, supportive measures such as transfusion and plasmapheresis should suffice. Attempts to alter antibody production with immunosuppressives are generally not indicated. Patients with cold agglutinins and malignancies should have their treatment regimens directed at their underlying disease with the addition of supportive measures as the clinical situation dictates.

## Paroxysmal Cold Hemoglobinuria

PCH was the first hemolytic anemia to be described due to its dramatic presentation of intermittent attacks of pain, fever, and hemoglobinuria after exposure to the cold. The differentiation between hematuria and hemoglobinuria was made by Dressler in 1854 ( 143 ) in a patient who was probably a congenital syphilitic child. Further reports published in the 1860s ( 144 , 145 ) more fully described the attacks in relation to exposure to cold. In their classic 1904 paper, Donath and Landsteiner ( 66 ) described the antibody that now bears their names (D-L antibody), which produces the syndrome and the pathogenic mechanism behind it. It is a hemolysin that binds to the RBC at low temperatures and fixes complement. When the cells are warmed, they are destroyed by complement lysis. There are three clinical syndromes in which the D-L antibody occurs: (a) chronic PCH associated with late-stage or congenital syphilis, (b) acute transient PCH occurring after an infectious illness, and (c) chronic idiopathic PCH. Due to effective treatments for syphilis, the first type, which used to be the most common, is now extremely rare. Chronic idiopathic PCH has always been uncommon. The acute transient variety is believed to be one of the most common causes of acute hemolytic anemia of children (

[146](#), [147](#)).

## CHARACTERISTICS OF THE ANTIBODY

**Immunochemistry and Origin** Unlike cold agglutinins, antibodies that cause PCH are IgG and also, most likely, polyclonal ([148](#)). Originally described in patients with advanced or congenital syphilis, the antibody is not cross-reactive in syphilis serologic tests in patients with syphilis or in those who manifest the acute, transient variety of PCH ([149](#), [150](#)). PCH has been reported in more than one family member, suggesting a genetic predisposition ([69](#)). The origin or stimulus for antibody production is likely microorganism antigen(s) that induce antibodies that cross-react with the P blood group system ([151](#)). **P Antigen Specificity** Until 1963, the D-L antibody was believed to be “nonspecific” for RBCs in that it reacted with all erythrocytes. Specificity for the P antigen was shown by Levine, Celano, and Falkowski’s experiments with rare pp cells. They also showed failure of the antibody to react with P<sup>k</sup> cells. P<sub>1</sub> and P<sub>2</sub> cells were lysed by the D-L antibody ([152](#), [153](#)). Chemical studies of the P antigen have shown that it is a glycosphingolipid globoside ([154](#), [155](#)) quite similar to Forssman glycolipids present in many microorganisms. Indeed, the antibody can be inhibited by globoside and, to a lesser degree, by Forssman glycolipids ([151](#)).

**Functional Characteristics** The D-L IgG antibody is a potent hemolysin, causing significant RBC destruction even in low titers. The D-L antibody is classically described as a “biphasic” hemolysin. This is based on the test for the antibody originally described by Donath and Landsteiner whereby the patient’s serum is incubated with RBCs at 0 to 4° C and then warmed to 37° C to produce lysis. The antibody requires the cooler temperatures to bind to the RBC, but complement lysis does not proceed until the temperature is raised. For optimal lysis, complement C1 should be available when the antibody initially binds ([149](#), [150](#)). On warming, C4, C2, and the remainder of the complement cascade bind and disrupt the membrane producing lysis. Some D-L antibodies have a wider thermal amplitude and bind to the RBC at temperatures compatible with complement activity. These seem to be “monophasic” hemolysins in that cooling is not necessary to produce binding activity. At least one author believes that the distinction between biphasic and monophasic activity is unwarranted, representing only differences in thermal amplitude ([69](#)). Also, other cold active antibodies that vigorously fix complement may produce *in vitro* hemolysis biphasically but yet not have the distinguishing characteristics (IgG, anti-P specificity) that qualify them as true D-L antibodies.

**CLINICAL MANIFESTATIONS** The sudden onset of fever, back or leg pain, and hemoglobinuria after exposure to the cold are the hallmarks of PCH. Cold exposure may be only a few minutes, and symptoms may follow shortly or several hours later. Fever to 40° C is not unusual. Other symptoms may include pain or aching in the back, legs, or abdomen, cramps, headache, nausea, vomiting, and diarrhea. The first urine voided after the onset is dark red or even black and typically clears in a few hours. Rarely, it persists for a few days. The spleen may be palpable during an attack and shortly thereafter, and mild jaundice may appear ([69](#)). Vasomotor phenomena manifest as cold urticaria, tingling of hands and feet, cyanosis, and Raynaud phenomenon, and even gangrene has been reported ([156](#), [157](#)). Systemic symptoms may appear without the hemoglobinuria and vice versa. There does not appear to be any racial or gender predilection in PCH. Almost exclusively, children are affected by the acute transient syndrome ([57](#), [69](#)). An antecedent upper respiratory infection in children is usually identified, although the exact organism may not be discovered. Attacks have been associated with measles ([158](#)), measles vaccinations ([159](#)), mumps ([160](#)), *Mycoplasma pneumoniae* ([161](#)), influenza A, adenovirus, varicella ([162](#)), cytomegalovirus, *Haemophilus influenzae* ([163](#)), and infectious mononucleosis ([164](#)). These episodes are self-limited and not expected to recur in the

future. They can, however, be quite severe and even life-threatening without supportive care. Although PCH is uncommon, it may not be as rare as initial reports suggested. In series of all hemolytic anemias, the incidence has ranged from 1.7 to 10.0% ( 57, 105, 165 ). PCH may account for more than 40% of immune hemolytic anemias in children under 5 years of age ( 166 ). The original chronic PCH associated with syphilis has all but disappeared. It was characterized by relapsing episodes of hemoglobinuria with cold exposure. Treating the syphilis usually treated the PCH, although some patients' hemolysis did not respond to antiluetic therapy ( 69 ). The diagnosis of chronic PCH now should prompt an investigation for occult syphilis infection and, in its absence, should be considered the idiopathic variety. These cases are quite rare.

**LABORATORY FEATURES** Hematologic findings in PCH are typical for acute, severe intravascular hemolysis. Hemoglobins less than 50 g/L can be seen ( 158, 159, 163, 166 ). Spherocytes, nucleated RBCs, polychromatophilia, anisocytosis, poikilocytosis ( 57 ), and erythrophagocytosis by neutrophils ( 158, 166, 167 ) have been reported. The white blood cell count may be depressed very early in the attack but is usually normal or high. Platelet counts are usually normal. Reticulocytopenia is quite common early in the episode, but reticulocytosis appears in the recovery phase ( 69 ). Once haptoglobin is exhausted, hemoglobinuria results. The plasma is frequently red, reflecting the free hemoglobin. As in other instances of hemolysis, the lactate dehydrogenase and bilirubin (mostly unconjugated) are elevated. Complement levels are depressed. Urine tests are positive for hemoglobin and methemoglobin, giving it its dark red to almost black appearance. Occasionally, RBCs are found in the sediment, but the discoloration is primarily pigment. Rarely does the patient have renal insufficiency with elevated blood urea nitrogen and creatinine ( 168 ). Proteinuria may be detected, and hemosiderinuria is found in patients with the chronic variety. The Donath-Landsteiner test is a simple procedure involving incubating the patient's serum in melting ice with washed group O, P-positive RBCs and fresh normal serum as a source of complement. After 30 to 60 minutes, the tube is moved to 37° C for another incubation of similar duration. Lysis visible to the naked eye after the warm incubation is a positive test ( 55 ). Appropriate controls should be run simultaneously. Other serologic testing in the blood bank should reveal a positive DAT with anticomplement antisera. The anti-IgG DAT is rarely positive due to dissociation of the antibody from the cell at warmer temperatures. If the blood specimen is processed at cold temperatures, one can occasionally demonstrate IgG on the surface of the cells ( 57 ). The D-L antibody may be demonstrated using the IAT. The method of using an ice-cold saline wash to avoid elution of the antibody and then testing with monospecific antisera for IgG has been shown to be a very sensitive indicator for antibody presence ( 57 ). Differentiation between cold agglutinins and the D-L antibody can be made by careful characterization of the antibody involved, including specificity and Ig class. The classic age discrepancy and the rare occurrence of cold agglutinins in children may lend clinical support to the diagnosis.

**MANAGEMENT** Treatment of acute attacks is essentially supportive. Given the transient nature of the syndrome, little else is indicated. In severely anemic children, steroids are usually given, although their benefit has not been documented ( 160, 166 ). Blood transfusion may be safely accomplished with bank blood even though essentially all units are P antigen positive. Delaying a needed transfusion to locate the 1 unit of pp blood in 200,000 units ( 55 ) may put the patient in far more danger than transfusing readily available P units. Warming the patient and the blood is advisable. The hemoglobin rises the expected amount in most situations. In the rare patient in whom the hemoglobin does not rise, rare-donor files can locate pp or Tj(a-) units. When this pp antigen blood is available, transfusion results have been excellent ( 169 ). As with other immune hemolytic anemias, critical situations may be ameliorated by plasmapheresis ( 170 ). Chronic PCH is best treated by the avoidance of cold and rarely requires any other therapy. Patients that have documented syphilis should be treated for that, and most show resolution of the hemolytic attacks ( 171, 172 ).



## IMMUNE HEMOLYTIC ANEMIAS CAUSED BY MIXED WARM AND COLD ACTIVE ANTIBODIES

A significant number of patients with warm AIHA also have cold agglutinins in their serum. In fact, in one series, nearly 35% of these patients had low-titer cold agglutinins that caused agglutination of normal RBCs at 20° C ( [57](#) ). There was, however, no activity from the cold antibody at 30° C. Although the cold active antibody is abnormal in its thermal amplitude, it is not believed to play a role in RBC destruction. This is contrasted with the rare patient who, in addition to a warm antibody, has a cold active IgM antibody in high titer at 4° C and wide thermal amplitude with activity at 30° C or even 37° C. These cases satisfy the criteria for both warm autoimmune hemolysis and cold agglutinin syndrome. The clinical presentation of these patients with mixed warm and cold active antibodies is typically quite severe hemolysis without the characteristics of CAD, such as exacerbation with cold exposure or acral cyanosis ( [173](#) ). Many of these reported cases are idiopathic or have lymphoproliferative disorders. Other associations with systemic lupus erythematosus or viral infection have been reported ( [173](#) , [174](#) ). Concomitant immune thrombocytopenia has also been reported ( [173](#) ).

Laboratory investigations show a DAT positive for both IgG and complement in the vast majority. Eluates show the warm IgG panagglutinin without specificity. The cold agglutinin specificity is typically I, but i and Om have also been found ( [173](#) , [174](#) ). Hemoglobin values may be quite low (<50 g/L) ( [173](#) ). Transfusion is complicated by both autoantibodies and the increased difficulty of ruling out alloantibodies in their presence ( [55](#) ). Units are released cross-match incompatible as with any autoantibody present in the serum. However, their survival should not be expected to differ markedly from the patient's own cells.

Steroids are the mainstay of therapy as well as treatment of any underlying disease ( [173](#) , [175](#) ). Other immunosuppressives and splenectomy have also been used ( [176](#) ).

## IMMUNE HEMOLYTIC ANEMIAS CAUSED BY WARM ACTIVE ANTIBODIES

Autoantibodies with greatest activity at 37° C are responsible for the majority of patients with AIHA. Excluding drug-induced autoantibodies, approximately 70% of all AIHA patients have the warm antibody type ( [57](#) , [105](#) ). In general, these antibodies are IgG, may or may not fix complement, and destroy RBCs by extravascular hemolysis in the spleen. Exceptions occur as is discussed later. They may be secondary to an underlying disease, such as systemic lupus, lymphoproliferative or other neoplastic diseases, infections, or immune deficiency syndromes. In some cases, no underlying process is ever identified, and they are labeled *idiopathic*. Drugs may induce the production of warm active antibodies reacting with combinations of the medication and the RBC membrane, or, in the case of α-methyldopa, a true autoantibody that is not dependent on the presence of the drug.

### Primary versus Secondary Autoimmune Hemolytic Anemia

*Primary or idiopathic warm AIHA* accounts for less than half of the cases. It can occur in any age group, and females predominate in ratios of approximately 2:1 in most series ( [105](#) , [141](#) , [177](#) ). There is no racial predilection, but a genetic predisposition is suggested by the occurrence of more than one case of AIHA in one family ( [69](#) ). No blood group has been

consistently shown to be selectively affected. HLA-A1, -B7, and -B8 recur in the literature as being overrepresented in this population. However, not all series have reached this conclusion ( [178](#), [179](#), [180](#) and [181](#) ). The incidence of AIHA has been reported to be in the range of 1 per 75,000 to 2 per 100,000 ( [141](#), [182](#) ). This incidence rises some with age, but most of the increase is a reflection of the secondary hemolytic anemias as opposed to idiopathic. The immune system abnormality that leads to the production of the pathologic antibody in either primary or secondary hemolytic anemia is still not completely understood, as discussed earlier.

With an aggressive search and long follow-up, most patients with warm autoantibodies are found to have an underlying associated condition. Percentages of secondary disease have risen over the years from 22% to more than 80% ( [105](#), [141](#), [177](#), [183](#) ), probably reflecting more intensive investigation rather than a real change in the spectrum of disease. In Conley's review of warm autoimmune antibody cases, 19 of 33 that would have previously been labeled as idiopathic could be linked to an underlying immune-mediated disorder with careful history and follow-up ( [184](#) ). [Table 35.4](#) lists many diseases and other events that have been reported to occur with warm autoantibodies.

**TABLE 35.4. Diseases or Conditions That Have Been Associated with Warm Autoimmune Antibodies**

---

|   |
|---|
| Autoimmune disorders                      |
| Systemic lupus erythematosus              |
| Rheumatoid arthritis                      |
| Scleroderma                               |
| Ulcerative colitis                        |
| Antiphospholipid antibodies               |
| Chronic lymphocytic leukemia              |
| Acute myelocytic leukemia                 |
| Hodgkin disease                           |
| Non-Hodgkin lymphoma                      |
| Other lymphoproliferative disorders       |
| Multiple myeloma                          |
| Thymoma                                   |
| Waldenström macroglobulinemia             |
| Epstein-Barr virus infection              |
| Hepatitis C virus infection               |
| Diphtheria-pertussis-tetanus vaccinations |
| Ovarian dermoid cyst                      |
| Teratoma                                  |
| Kaposi sarcoma                            |
| Carcinoma                                 |
| Pregnancy                                 |
| Bone marrow transplantation               |
| Congenital immune deficiency states       |
| Hypogammaglobulinemia                     |
| Dysglobulinemia                           |
| Acquired immunodeficiency syndrome        |

---



Malignancy-associated AIHA has been an accepted phenomenon for quite some time. Lymphoproliferative disorders are the most commonly documented coexisting tumors, but others, such as ovarian dermoid cysts, teratomas, Kaposi sarcoma, and carcinomas, have been reported (185). The origin of these pathologic antibodies is uncertain. Mere coincidence is statistically unlikely but might account for a very few. A case report by Sthoeger et al. (186) supports the concept of the malignant cell as the source of the antierythrocyte antibody in that the monotypic heavy and light chains eluted from the RBCs were identical to those expressed on the surface of B-CLL clones. However, the vast majority of warm autoimmune antibodies associated with tumors are not monoclonal, but polyclonal. Another theory believed to explain the occurrence of both autoimmune disease and malignancy is a disruption of normal immune function surveillance that allows autoantibodies to form and neoplasia to proliferate (185). The aberrant immune system function secondary to effects of the tumor itself in B-CLL has been discussed earlier.

The association of AIHA with other nonmalignant diseases, frequently of immunologic origin, lends more support to theories of general immune system disturbance as an etiology. Human immunodeficiency virus infection (187, 188), thymic disorders (189, 190), and other immune deficiency states (191) can be associated with autoimmune hemolysis. In patients with ulcerative colitis and warm AIHA, colectomy has also successfully treated the hemolytic anemia (192). Systemic lupus erythematosus is frequently complicated by warm autoantibodies. Childhood viral illnesses are commonly associated with warm antibody RBC destruction. Other diseases may have less clear significance in their relation to the hemolysis.

#### CHARACTERISTICS OF THE ANTIBODY

**Immunochemistry and Origin** Compared to cold active antibodies, little is known or understood about the immunochemistry and origin of warm active antibodies. No cell line is available to provide a source of antibody for antigen-binding and structural studies. The target antigen(s) is unknown. It appears that most antibodies are IgG with a preponderance of IgG1 and, to a lesser extent, IgG3—the two subclasses most adept at fixing complement (193). The subtypes vary in their efficiency at causing hemolysis due to higher affinities of the macrophage Fc receptors for the IgG3 and IgG1 subclasses (194, 195). Various combinations of IgG subclasses may occur together. It is uncommon for IgA or IgM to occur in concert with IgG, and it is even more rare for them to occur singly (57, 58). Table 35.5 compares the serologic findings of the different types of immune hemolytic anemias.

**TABLE 35.5. Serologic Overview of Hemolytic Anemias**

|                          | Warm Autoimmune Hemolytic Anemia | Cold Agglutinin Disease | Mixed Warm and Cold Autoimmune Hemolytic Anemia | Paroxysmal Cold Hemoglobinuria  | x Drug-Induced Hemolytic Anemia  |
|--------------------------|----------------------------------|-------------------------|---|---------------------------------|----------------------------------|
| Percentage of cases      | 40–70%                           | 16–32%                  | 7–8%  | 32% in children; rare in adults | 12–18%                           |
| Direct antiglobulin test | IgG ± C3; rarely C3 alone        | C3                      | IgG ± C3  | C3                              | IgG or C3; occasionally IgG ± C3 |

|                         |   |               |                         |             |                               |
|-------------------------|---|---------------|-------------------------|-------------|-------------------------------|
| Ig                      | IgG,<br>occasionally<br>with IgA or IgM | IgM           | IgG, IgM                | IgG         | IgG                           |
| Eluate                  | IgG                                     | Nonreactive   | IgG                     | Nonreactive | IgG or<br>nonreactive         |
| Antibody<br>specificity | Panagglutinin;<br>rarely Rh or<br>other | I, i; rare Pr | Unclear; rare I, P<br>i |             | Rh-related;<br>drug-dependent |

C3, complement third component; Ig, immunoglobulin.

**Blood Group Specificity** Warm autoantibodies are described as *panagglutinins* in that they react with all the RBCs in the diagnostic panel. Many investigations of the specificity of antibodies to date have been serologic and thus rely on the existence of very rare antigen-negative cells to do the proper studies or on monoclonal antibodies to block particular epitopes. Expression of complementary DNA of Rh-related antigens and anion transporter band 3 in cell lines allowed investigation of antibody binding by flow cytometry (196). Of the reported specificities, Rh is by far the most common, appearing in 70%, due to reaction with all but the Rh<sub>null</sub> cell. Occasionally, the IAT identifies an antibody with relative Rh specificity for a particular Rh antigen such as e. It is extremely rare for antibodies of true specificity to occur in the absence of those of broader specificity. Thus, little is to be gained by transfusing antigen-negative blood to these patients. Indeed, intentionally giving RBCs possessing antigens foreign to the host may stimulate alloantibodies and further complicate the problem (197). Other blood group specificities that have been reported include Wright (Wr<sup>b</sup>), En<sup>a</sup>, Duffy (Fy<sup>b</sup>), Gerbich (Ge), Kidd (Jk<sup>a</sup>), Kell (K), Lutheran (Lu), LW, M, N, S, Pr, A, B, I<sup>T</sup>, Sc3, U, Vel, and Xg<sup>a</sup> (63, 69).

**CLINICAL MANIFESTATIONS** AIHA may present in all manners of severity from a clinically insignificant increase in RBC turnover to fatal fulminant hemolysis. Most patients present with an insidious onset of weakness, fatigue, dyspnea on exertion, and other symptoms of anemia (198). These gradual symptoms tend to accompany the idiopathic variety or those varieties that are secondary to malignancies or other autoimmune diseases. If the RBCs can survive in the circulation for approximately 2.5 days, a steady state may be reached with increased marrow production. Hemolysis rates greater than 20% per day may cause hypovolemic shock and death if not aggressively treated (199). The more aggressive, life-threatening end of the hemolytic spectrum tends to occur after viral infections, especially in children, and may produce prostration, shock, and death. Other signs and symptoms may include unexplained fever, abdominal pain, headache, anorexia, and confusion (198). In older patients with less cardiac reserve, angina may be an ominous symptom. Thrombophlebitis may also occur. Persons with concomitant antiphospholipid antibodies may be at higher risk for thromboembolic events (200). In those patients with hemolysis associated with other conditions, symptoms attributable to their underlying disease may predominate (Table 35.6). A careful history of any recent drug ingestion—prescription, over-the-counter, or illicit—should be obtained.

**TABLE 35.6. Most Common Presenting Signs and Symptoms in Patients with Autoimmune Hemolytic Anemia of the Warm Reactive Type**

| Symptom   | Frequency (%) |
|-----------|---------------|
| Weakness  | 88            |
| Dizziness | 50            |
| Fever     | 37            |
| Bleeding  | 10            |
| Dyspnea   | 9             |

| Cough                        | 6             |
|------------------------------|---------------|
| Weight loss                  | 5             |
| Gastrointestinal disturbance | 5             |
| Anorexia                     | 4             |
| Dark urine                   | 3             |
| Angina                       | 2             |
| Confusion                    | 2             |
| Sign                         | Frequency (%) |
| Splenomegaly                 | 82            |
| Hepatomegaly                 | 45            |
| Lymphadenopathy              | 34            |
| Jaundice                     | 21            |
| Thyromegaly                  | 10            |
| Edema                        | 6             |
| Cardiac failure              | 5             |
| Pallor                       | 4             |

Modified from Pirofsky B. Clinical aspects of autoimmune hemolytic anemia. *Semin Hematol* 1976;13:251–265.

If hemolysis is brisk, jaundice may be noticeable as well as mild splenomegaly, hepatomegaly, pallor, and edema. Rarely, hemoglobinemia and subsequent hemoglobinuria with dark or red urine may bring the patient to medical attention. Even among the idiopathic AIHAs, lymphadenopathy may occur in up to 25% (198). However, very large nodes or spleen should alert the clinician to the possibility of an underlying lymphoproliferative process requiring specific therapy. In only a very few patients with rampant hemolysis or, rarely, agglutination induced by the autoantibody will peripheral cyanosis occur. This is much more characteristic of CAD. The acute onset of hemolysis after an infectious episode may be severe but also tends to be short-lived (69). In contrast, the more insidious onset of the idiopathic or other secondary types may have a waxing and waning course for several years or follow the progression of the underlying disease.

**Pregnancy** Pregnancy may pose a special situation in AIHA. The rate of autoantibody formation in pregnant women has been reported at 1.0 per 50,000 as opposed to 0.2 per 50,000 in an age-comparable control population (201). Hemolysis tends to increase during the pregnancy and may remit after delivery of the infant. Hemoglobins below 50 g/L have been reported (202). Cases of recurring DAT-negative hemolytic anemia with pregnancy have been documented (203, 204). Infants born to mothers with hemolytic anemia may not suffer any hemolysis or may have a positive DAT and consequent RBC destruction from the passively acquired antibody. Even if difficulties are encountered initially, the infant should be expected to become normal in a few weeks to months as there is no ongoing production of antibodies (204, 205).

**Infancy and Childhood** AIHA in infancy and childhood can be quite different from that in adults. The disease onset is more likely to be sudden and severe. Cases in very young infants have been reported (206). It usually is preceded by a viral infection. There is a slight male predominance, and the prognosis is relatively good for a complete and lasting remission within several weeks of the onset. Most children respond well to steroids and rarely is splenectomy considered (69). A particular association of childhood vaccines and hemolytic anemia has been documented (207, 208). Children can have very severe Evans syndrome (209).

**Evans Syndrome** The concomitant presence of purpura or petechiae may herald a low

platelet count and indicate Evans syndrome, which was originally described in 1949 as immune thrombocytopenia and AIHA ( [210](#), [211](#) ). The thrombocytopenia may precede, occur concurrently with, or follow the AIHA ( [177](#) ). This is more common in children and is less likely to respond well to therapy ( [212](#), [213](#) ). Multiagent protocols have shown some success ( [214](#), [215](#) ). Severe cases have required stem cell transplantation ( [216](#) ), although standard treatment regimens recommended for AIHA alone are typically used first. These are discussed in more detail below.

**Immune Deficiency Syndromes** Since the 1960s, it has been noted that AIHA occurs in patients with congenital or acquired immune deficiency syndromes. These cases are characterized by variable hypogammaglobulinemia, recurrent infections, lymphopenia, and an assortment of other signs and symptoms, such as splenomegaly, thrombocytopenia, eczema, and more recently, acquired immunodeficiency syndrome ( [69](#), [188](#) ).

**Stem Cell Transplantation** Hemolytic anemia after stem cell transplantation has various etiologies. Mismatched ABO types produce hemolysis, which is sometimes quite significant until the transplanted marrow assumes primary residence and the host antibodies or cells are exhausted. Mixed chimerism can give rise to syndromes in which the host immune cells make antibodies to minor RBC antigens on RBCs produced by the transplanted stem cells. Autoimmune hemolysis complete with panagglutinin months after transplant is also possible. Serologic studies should provide the appropriate diagnosis ( [217](#) ). In addition, nonimmune, microangiopathic hemolysis associated with cyclosporine and other graft-versus-host preventatives is also well described ( [218](#) ).

**LABORATORY FEATURES** Hemoglobin and hematocrit values at presentation can vary from essentially normal in the compensated hemolyzing patient to extremely low in the rare patient with fulminant RBC destruction. The mean corpuscular volume is usually elevated, reflecting the young population of cells and perhaps a relative folate deficiency in those patients with chronic hemolysis and no replacement. Reticulocyte counts are usually elevated, sometimes remarkably so, but may be depressed early in the course ( [219](#) ). Reticulocytopenia may have myriad causes, including marrow shutdown from intervening infection, malignancy invasion, parvovirus B19 infection, or the possibility of the autoimmune antibody being directed at antigens in great concentration on the reticulocytes themselves ( [69](#), [220](#), [221](#) and [222](#) ). The bone marrow is usually hyperplastic even in the face of reticulocytopenia ( [219](#) ). The peripheral smear typically reflects the reticulocytosis with polychromatophilia and macrocytosis, as well as nucleated RBCs. Spontaneous agglutination is uncommon with warm autoantibodies but may occur if the cells are strongly sensitized with Ig. Variable amounts of microspherocytes are produced when the splenic sinusoidal macrophages bind and extract their pound of flesh from the RBC membrane. As the surface to volume ratio decreases with membrane loss, the cell assumes an increasingly spheric shape and becomes less malleable and less able to traverse the small capillaries ( [223](#) ). The presence of erythro-phagocytosis by monocytes, or rarely neutrophils, on the peripheral smear is an indication of AIHA ( [224](#) ). White blood cell counts are usually slightly elevated but may be depressed. Platelet counts typically are normal but may be low ( [141](#), [219](#) ). Leukopenia and thrombocytopenia may also be immune-mediated, as shown in some cases by the presence of antileukocyte and antiplatelet antibodies ( [225](#) ). Platelet dysfunction may occur as well ( [226](#) ). The serum bilirubin is elevated but is rarely above 5 mg/dl in the absence of concomitant liver disease, and the major fraction is unconjugated ( [227](#) ). Hemoglobinemia and depressed or absent haptoglobin can be seen in rapid hemolysis, even if it is extravascular. Urobilinogens are increased, and hemoglobinuria and hemosiderinuria may follow severe hemolysis. However, only very rarely has renal failure been reported ( [228](#) ). Stercobilinogens may turn the stool dark. Biologic false-positive syphilis tests are common, and other abnormal antibodies have been reported, including antithyroid antibodies, rheumatoid factors, and anticardiolipin antibodies. Serum Ig abnormalities have been reported with both elevations or depressed levels. No constant pattern has been

elucidated ( [229](#), [230](#) ). The hallmark of immune-mediated hemolytic anemia is the presence of Ig, complement, or both on the surface of the RBC. In over 95% of warm AIHA cases, the DAT is positive. Series vary in their DAT results. Between 20 and 66% have only IgG on the surface, 24 to 63% have IgG and C3, 7 to 14% have only C3, and 1 to 4% are DAT negative ( [57](#), [182](#), [231](#) ). Patients with systemic lupus erythematosus are particularly prone to positive tests for complement on the cells. IgG1 predominates, either alone or in combination with other subclasses, and IgG4 is uncommon. In rare cases of warm hemolysins, IgM antibodies that fix complement and are associated with severe, life-threatening hemolysis have been reported ( [232](#) ). It is even more uncommon for IgG antibodies to act as hemolysins ( [233](#) ). The severity of hemolysis is loosely correlated with the number of antibodies bound to the cell and the strength of the DAT ( [234](#), [235](#) ). However, other factors play a large role in the significance of the clinical picture, such as the subclass of Ig. There remain still other characteristics yet to be defined that explain why hemolysis occurs in DAT-negative patients, whereas other patients have globulins demonstrable on their cells without any significant increase in RBC turnover. If standard techniques do not produce a positive DAT, other, more sensitive techniques discussed earlier may be successful. Some patients with negative DATs may have hemolysis from low-affinity IgG antibodies that are inadvertently removed in the wash phase of the Coombs test ( [59](#) ). IgA-mediated hemolysis is an often cited and rarely found cause of a negative DAT. A large series found 124 patients who had IgA on their RBCs out of 5235 patients evaluated at an immunohematology referral center. Of the 124, only 6 had IgA as the sole Ig attached to the cell. All six also had complement detectable ( [58](#) ). The antibody screen reveals the presence of the panagglutinin in the serum in 80% of cases. Specificity for other antigens can be sought as described earlier but is difficult to accurately obtain without a large selection of rare, antigen-negative cells and is of marginal clinical benefit.

**MANAGEMENT** General principles of treatment are guided by the severity of hemolysis. Those patients with a positive DAT, mildly elevated reticulocyte count, and normal hematocrit should not be subjected to the possible side effects of steroid therapy. Folate deficiency can be avoided with daily supplements, which probably should be given to any patient with hemolysis. When the RBC lifespan shortens past the point of marrow compensation and anemia appears, intervention is indicated. Given the high proportion of secondary hemolytic anemias, a search for an underlying disorder ( [Table 35.4](#) ) that requires specific therapy, such as a lymphoproliferative disorder, is indicated. Treatment of the secondary disorder may also bring the AIHA under control. However, in some situations, each disorder must be addressed separately. Many treatment options exist for these patients, who can have vast differences in the severity of their disease ( [236](#), [237](#) and [238](#) ).

**Steroids** Glucocorticoids are the initial therapy of choice for warm AIHA. Doses that are likely to achieve the desired clinical result are 1.0 to 1.5 mg/kg or 40 mg/m<sup>2</sup> of body surface area/day of prednisone or its equivalent. Higher daily doses or high-dose pulsed therapy may be efficacious ( [237](#), [239](#) ). Response may not be evident for 3 or 4 days but should be noticeable by 7 days. Reticulocyte counts may increase, and the hemoglobin should rise 20 or 30 g/L/week. Once the hemoglobin reaches 100 g/L, weaning of the steroid can begin. The rate of decrease should parallel the response. Those who respond rapidly may have their dose reduced over 4 to 6 weeks to 20 mg prednisone/m<sup>2</sup>/day. Beyond this point, tapering should proceed more slowly over 3 to 4 months. Some even continue a low dose (e.g., 5 to 10 mg every other day) for prolonged periods thereafter to prevent relapse, although no data exist to fully support this practice. This schedule should be adjusted for the individual patient's response to the treatment and to any of the significant side effects that can result. The side effects, which include increased susceptibility to infection, hypertension, fluid retention, diabetes, myopathy, peptic ulceration, osteoporosis, and even reversible facial cosmetic changes, may be intolerable to some patients. Alternate-day steroid therapy decreases some of the side effects and may still be effective. Strong consideration should be given to concomitant prophylactic gastric acid control. Initial responses to steroids are generally excellent with more than



80% of patients having a prompt reduction in hemolysis. Only 7% in one series responded after 2 weeks, and even fewer responded after 3 weeks. Therefore, if there has been no improvement after 3 weeks of therapy, the patient can be considered a steroid treatment failure ( 141 ). Approximately 15 to 20% of patients have no response to steroids and need splenectomy or cytotoxic drugs. Recurrence of hemolysis after remission is usually gradual, especially if the steroids were weaned over a prolonged period. However, relapse will indeed occur in the vast majority of patients. Approximately 40 to 50% of patients require maintenance doses of prednisone, 5 to 20 mg/day ( 240 ). If the maintenance prednisone dose is greater than 15 mg/day, other measures should be considered. The DAT usually remains positive, although the strength of the reactions may decrease with clinical remission. Free autoantibody in the serum (positive IAT or antibody screen) may disappear, but the DAT remains positive in most patients ( 69 ). Complete and lasting remission rates from steroids alone are reported as 16 to 35% of patients ( 241 , 242 ). Even some of the long-term remission patients still have a positive DAT ( 241 ). How steroids control the hemolysis in these patients has been the subject of extensive investigation. There is good experimental evidence in animal models to support the claim of decreased antibody formation. Titers of autoantibody decrease, and gammaglobulin levels also fall ( 243 , 244 ). Another hypothesis for the rapid decrease in hemolysis after drug administration is alteration of the affinity of the antibody for the antigen ( 245 , 246 ). An understanding of the mechanism of this avidity change remains illusive. Probably the most immediate effect of steroids is to decrease the clearance of erythrocytes by the monocyte-macrophage system. Guinea pig studies have shown us that steroids are most effective in this when the cells are coated with IgG alone. Less effect is seen when complement appears with the IgG, and the least benefit is noted when complement and IgM are involved ( 247 ). This is in keeping with the clinical observations of little, if any, efficacy of steroids in CAD. The decreased clearance may be due to a drop in the number of Fc and C3 receptors on the surface of the macrophages ( 247 , 248 ).

**Transfusion** Despite the high rates of response to steroid therapy and the relative speed of their benefit, some patients present with critically low hemoglobins and associated symptoms that require immediate intervention. Transfusions should be avoided if at all possible due to the serologic difficulties encountered but never withheld from the patient in extremis. Keep in mind that the chief function of the transfusion is to temporize the patient until the steroids or other specific therapy has had time to work. Destruction of the transfused cells occurs at the same rate as that of autologous cells ( 249 ). Hematocrits may rise with transfusion or may continue to fall rapidly until the hemolytic process is under control ( 57 , 141 ). Only rarely does the autoantibody have true specificity for an identifiable antigen, justifying the transfusion of specific antigen-negative RBCs ( 250 ). ABO typing the patient's blood is usually not a problem with warm autoantibodies like it can be with cold agglutinins. However, some patients may have invalid ABO results with spontaneous agglutination or similar difficulties with Rh testing in albumin ( 139 ). If there is doubt about the accuracy of results, the antibody can be eluted from the cell and testing repeated ( 55 ). More problems arise during the antibody screen and cross-matching of donor units in those patients with free autoantibody in their serum that acts as a panagglutinin. In these patients, all cross-matches are incompatible, and units must be transfused with caution. In patients with panagglutinins in their serum, auto- and alloabsorption techniques can uncover alloantibodies induced from previous exposures to blood or pregnancy. An accurate transfusion history is vital for the complete evaluation of these blood samples. The incidence of alloantibodies has been variably reported from 14 ( 100 ) to 40% ( 251 ). Alloabsorption techniques may more accurately reflect the true incidence, as it is more likely to remove autoantibodies of mimicking specificities ( 252 ). Some advocate transfusing completely phenotypically matched cells if possible, but few laboratories have the capability or the blood inventory to do this ( 253 ). In the end, incompatible units are released and should be transfused slowly and under vigilant watch

for untoward reactions. *In vivo* compatibility testing with  $^{51}\text{Cr}$ -labeled RBCs is of little or no value in this situation ( 57 ). Given the fact that the patient who requires transfusion is nearly always profoundly anemic and in high-output heart failure, the most likely serious complication is dangerous fluid overload. These patients typically do not have the volume depletion of hemorrhagic shock and almost always require judicious diuretic use to maintain euolemia. Bovine hemoglobin solution given to a young patient with profound hemolysis and increasing reactions to standard RBC infusions was a successful temporizing measure until aggressive immunosuppressive therapies controlled the underlying hemolytic process ( 254 ).

**Splenectomy** Splenectomy is indicated in those surgical candidates who have not responded to prednisone, require prednisone doses greater than 10 to 20 mg/day to maintain remission, or have suffered intolerable side effects from prednisone therapy. The rationale for its effect is twofold. The spleen is the major site of RBC sequestration and destruction in warm AIHA due to IgG antibodies. Splenectomy has little effect on the clearance of IgM-coated cells and therefore would not be indicated in the unusual patient with a warm active IgM antibody. Recall that it is not an effective treatment for cold agglutinins either. The spleen is also believed to be a major producer of IgG antibodies. Removal of a source of autoantibody can decrease the titer and subsequent clearance. Some investigators report utility in determining the amount of cells removed by the spleen using  $^{51}\text{Cr}$ -tagged RBCs ( 255 , 256 ). However, others have not found it so useful ( 242 , 257 ), and still others argue that, in patients refractory to steroids and other therapies, splenectomy is the next option regardless of predictors of its success ( 57 ). Response rates to splenectomy vary. Indeed, published accounts range from virtually ineffective to near 100% success ( 57 , 258 ). Overall responses are probably around 60 to 75%, but many of these patients relapse or remain on steroids, albeit at lower, more tolerable doses ( 57 , 257 , 258 ). Likelihood of response to splenectomy may be higher in idiopathic hemolytic anemia than in secondary ( 259 ). The complications of splenectomy are those inherent in major abdominal surgery and also include subdiaphragmatic abscess, pulmonary embolism, and increased susceptibility to infections, especially in children ( 69 , 260 ). Appropriate vaccinations should be given preoperatively. Subsequent to splenectomy, patients should be given antibiotics promptly with any febrile illness. Morbidity and mortality rates of 5 to 10% are involved with splenectomy, but many believe that the complications of long-term steroid use rival these risks ( 258 ). Splenic irradiation may be a useful alternative in nonoperative candidates ( 261 ).

**Other Immunosuppressive Drugs** Antimitotic and antimetabolite drugs became available in the 1950s. These potent immunosuppressive drugs were used in AIHA and other autoimmune diseases in the hope that their immunosuppressive effect would be greater than their known bone marrow suppression. Early anecdotal success with nitrogen mustard ( 262 ) led to other therapeutic attempts with azathioprine and, later, cyclophosphamide. Azathioprine and other antimetabolites could effectively block the primary response to a purified protein antigen but had minimal effect on the secondary response ( 263 , 264 ). Despite this, many case reports document remissions in patients in whom other treatments had failed, including steroids and splenectomy ( 257 , 265 , 266 ). Cyclophosphamide is a very effective immunosuppressive agent that has the capacity to suppress the immune response when administered before, during, or after antigen presentation ( 267 ). This is particularly desirable for administration after the onset of immune hemolysis. Beneficial effects of cyclophosphamide therapy are reported in reviews ( 240 , 242 , 257 ). Great caution is advised with prescribing any myelotoxic drug. Blood counts should be followed closely. Other significant side effects from the antimetabolites and cyclophosphamide include hemorrhagic cystitis/bladder fibrosis, development of secondary malignancies, sterility, and alopecia ( 57 , 240 , 268 , 269 ). No properly controlled trial exists from which to draw conclusions, but the reviews and case reports suggest a response rate of approximately 40 to 60% in those patients who did not



respond to steroids and splenectomy ( [242](#), [257](#), [258](#)). Patients who are not operative candidates and have not responded to steroids may be given a trial of immunosuppressive drugs. A reasonable regimen might include azathioprine, 80 mg/m<sup>2</sup>/day, or cyclophosphamide, 60 mg/m<sup>2</sup>/day, concomitantly with prednisone, 40 mg/m<sup>2</sup>/day. Taper the prednisone over approximately 3 months and continue the cytotoxic agent for 6 months before reducing the dose gradually ( [240](#)). Bone marrow suppression may dictate minor dose adjustments. Rapid withdrawal has led to rebound immune response ( [270](#)). Alternatively, high-dose cyclophosphamide (50 mg/kg/day for 4 days) produced a complete remission in 66% of patients refractory to other therapies. Severe myelotoxicity and its attendant potential for complications are expected ( [271](#)). Rituximab is a chimeric human/murine monoclonal anti-CD20 antibody approved for use in lymphoma. Successful rituximab use in refractory warm AIHA has been documented in several case reports, although not as many as with CAD ( [272](#), [273](#), [274](#) and [275](#)). Regimens identical to the lymphoma treatment doses of 375 mg/m<sup>2</sup>/week for 4 weeks have produced remissions in some patients refractory to other therapeutic regimens. One series in refractory pediatric patients reported a response rate of 87%. Twenty-three percent of the responders relapsed, but subsequent courses of rituximab induced additional remissions ( [276](#)). Thus far, few side effects have been experienced by the patients reported, but be aware that severe reactions to the infusion, including fatalities, have been reported ( [277](#)). B-cell counts remain low for months after treatment, raising the risk of infections due to poor immune response ( [278](#)). To date, rituximab has been used in refractory patients. If remissions remain durable and potential side effects are believed to be less harmful than other treatments for warm AIHA, such as prolonged steroid use or splenectomy, its use may become more common. Mycophenolate mofetil, an inhibitor of inosine 5'-monophosphate dehydrogenase, is an immune suppressant first used in allograft rejection. It has been shown to induce complete or partial remission of hemolysis in case reports. Doses begin at 1 g/day and are then increased to 2 g/day. In cases of partial remission, reduction in doses of other immunosuppressives was possible without sacrificing efficacy. Long-term side effects of this relatively new medication are not fully established. Short-term side effects consist primarily of gastrointestinal intolerance and mild myelosuppression ( [279](#), [280](#)). Alemtuzumab (Campath-1H) is a humanized IgG monoclonal antibody targeted against the CD52 antigen found on lymphocytes and monocytes. The primary therapeutic result is through the profound depletion of T cells, particularly the CD4 population. In a pilot study of various types of autoimmune cytopenias, some response was demonstrated, including in AIHA and Evans syndrome patients. After a test dose of 1 mg, patients were given 10 mg/day for 10 days. Some patients were also given cyclosporine in follow-up, making the effect of the alemtuzumab alone difficult to interpret ( [281](#)). Cyclosporine A has been used successfully and unsuccessfully in refractory hemolytic anemia patients, like many of the other immunosuppressive medications previously described. Doses of 3 mg/kg/day with target serum levels of 200 to 400 ng/ml produced remissions ( [282](#)). It has also been used in combination with other remedies with some success, including danazol and prednisone ( [215](#), [283](#), [284](#)).

**Other Therapies** Intravenous Ig has not enjoyed the success in AIHA that it has in immune thrombocytopenia. Case reports of success ( [285](#), [286](#) and [287](#)) and failure ( [288](#), [289](#)) have appeared. Escalating the dose from the standard 0.4 g/kg/day for 5 days to 1.0 g/kg/day was helpful. In one refractory patient, weekly maintenance infusions of 800 mg/kg/week helped to control transfusion requirements ( [290](#)). The mechanism of action of intravenous Ig is not completely clear. Recent evidence suggests that intravenous Ig exerts inhibitory effects on dendritic cells by down-regulating co-stimulatory molecules, blocking maturation, and modifying their interactions with lipopolysaccharide and cytokines ( [291](#)). Other mechanisms include modulating expression and function of Fc receptors, interfering with the activation of complement, modulating immune response

through antiidiotype antibodies, and effects on B and T cells ( 292 ). Plasmapheresis has been used with limited success in attempts to remove the antibody ( 57 , 293 , 294 ). Given the large volume of distribution of IgG, it is not surprising that removal is difficult. However, in some patients in whom fulminant hemolysis proceeds unchecked, it may serve as a temporizing measure until other immunosuppressive therapies have time to take effect. Selective removal of IgG with staphylococcal protein A columns has also been reported with some benefit ( 295 ). Danazol, an androgen with minimal masculinizing effects, has had anecdotal success. It may inhibit binding of the antibody to the cell ( 296 ). Doses of 600 to 800 mg/day in conjunction with prednisone produced variable responses in 13 of 15 patients ( 297 ). Stem cell transplantation has now been described for many severe, life-threatening autoimmune syndromes, including hemolytic anemia and Evans syndrome. Sources of the stem cells have been autologous, HLA-matched sibling and cord blood ( 216 , 298 , 299 ). Relapses and the expected range of complications, including death, have occurred. As more refractory patients arise, stem cell reconstitution after high-dose immune suppressive regimens will no doubt expand. Anecdotal success has been reported with vinca-loaded platelets ( 300 , 301 ). Heparin, a drug well known to be anticomplementary, has offered temporary alleviation but only in those patients with a clearly complement-dependent mechanism ( 302 , 303 ). Thymectomy in infants has been followed by improvement in isolated cases of severe AIHA ( 105 , 304 ).

### Drug-Induced Immune Hemolytic Anemia

The first documented case of an immune-mediated, drug-induced cytopenia, reported in 1949, was thrombocytopenia secondary to allylisopropyl-acetylcarbamide (Sedormid) ingestion ( 305 ). In 1953, Snapper described a patient who suffered hemolysis after treatment with mephenytoin (Mesantoin) and recovered fully after discontinuation of the drug ( 306 ). In 1956, Harris' report of acute intravascular hemolysis in a patient treated for the second time with stibophen for schistosomiasis appeared ( 307 ). Agglutination of the patient's RBCs *in vitro* occurred only in the presence of the drug. After discontinuation of the drug, hemolysis resolved in a few weeks, and the DAT reverted to negative approximately 2 months later. Immune hemolysis produced by the interaction of drug, antibody, and RBC membrane is uncommon now that our pharmaceutical armamentarium has expanded to include other therapeutic options not prone to this complication. *a*-Methyldopa used to be responsible for the majority of drug-associated positive DATs and hemolytic anemia. High-dose penicillin (<10 million units/day) was also responsible for many cases of drug-induced hemolysis. With other effective antihypertensives and antibiotics now available, they are prescribed less frequently. Table 35.7 lists some medications associated with immune hemolysis, a positive DAT, or both.

**TABLE 35.7. Drugs Associated with Immune Hemolysis/Autoantibodies**

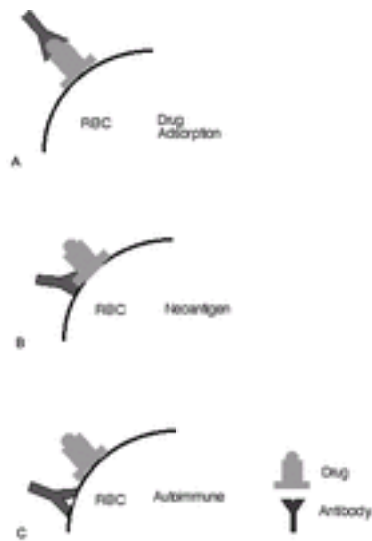
|                                     |                           |                               |
|-------------------------------------|---------------------------|-------------------------------|
| Acetaminophen                       | Doxepin                   | Oxaliplatin                   |
| Aminopyrine                         | “Ecstasy”                 | <i>p</i> -Aminosalicylic acid |
| Amphotericin B                      | Elliptinium acetate       | Penicillin G                  |
| Ampicillin                          | Erythromycin              | Phenacetin <sup>a</sup>       |
| Antazoline                          | Etodolac                  | Phenytoin                     |
| Apazone (azapropazone) <sup>a</sup> | Fenfluramine <sup>a</sup> | Podophyllotoxin               |
| Buthiazide (butazide)               | Fenoprofen                | Probenecid                    |
| Carbenicillin                       | Fludarabine <sup>a</sup>  | Procainamide <sup>a</sup>     |

|  |                             |                           |
|--|-----------------------------|---------------------------|
| Carbimazole <sup>a</sup>                             | Fluorescein                 | Propyphenazone            |
| Carboplatin  | 5-Fluorouracil              | Pyrimidon                 |
| Catergen <sup>a</sup>                                | Glafenine <sup>a</sup>      | Quinidine                 |
| Cefotaxime   | Hydralazine                 | Quinine                   |
| Cefotetan <sup>a</sup>                               | Hydrochlorothiazide         | Ranitidine                |
| Cefoxitin <sup>a</sup>                               | Ibuprofen <sup>a</sup>      | Rifampin (rifampicin)     |
| Ceftazidime  | Insulin                     | Sodium pentothal          |
| Ceftriaxone  | Interferon- $\alpha$        | Stibophen                 |
| Cephaloridine  | Intravenous contrast media  | Streptomycin <sup>a</sup> |
| Cephalothin  | Isoniazid                   | Sulfonamides              |
| Chaparral <sup>a</sup>                               | Latamoxef <sup>a</sup>      | Sulfonylurea derivative   |
| Chlorambucil   | Levodopa <sup>a</sup>       | Sulindac                  |
| Chlorinated hydrocarbons (insecticides) <sup>a</sup> | Mefenamic acid <sup>a</sup> | Suprofen                  |
| 2-Chlorodeoxyadenosine                               | Mefloquine                  | Suramin                   |
| Chlorpromazine <sup>a</sup>                          | Melphalan                   | Teniposide <sup>a</sup>   |
| Chlorpropamide                                       | 6-Mercaptopurine            | Tetracycline              |
| Cianidanol <sup>a</sup>                              | Mephenytoin                 | Thiazides                 |
| Ciprofloxacin  | Methadone                   | Thiopental                |
| Cisplatin  | Methicillin                 | Thioridazine              |
| Cladribine   | Methotrexate                | Tolbutamide               |
| Cyclofenil <sup>a</sup>                              | Methyldopa                  | Tolmetin <sup>a</sup>     |
| Diclofenac <sup>a</sup>                              | Nafcillin                   | Triamterene               |
| Diethylstilbestrol                                   | Nalidixic acid              | Trimellitic anhydride     |
| Diglycoaldehyde                                      | Nomifensine <sup>a</sup>    | Zomepirac                 |
| Dipyrrone  | Omeprazole                  |                           |

<sup>a</sup> Medications associated with the autoantibody mechanism as well as a drug-dependent (drug adsorption or neoantigen) type.

**MECHANISMS OF DRUG-ANTIBODY ATTACHMENT** Drugs may lead to *in vivo* hemolysis by a number of different mechanisms. Despite the fact that some of these require the presence of the drug, combining as a hapten with a protein or membrane component to form a neoantigen, they are still grouped most conveniently under the autoimmune heading. One subset of drugs, of which  $\alpha$ -methyldopa is the most prominent member, somehow produces an antibody indistinguishable from the previously described true autoimmune Igs. These drug-induced antibodies are not drug-dependent in the effector phase of RBC destruction but, curiously, do eventually resolve after discontinuation of the offending agent. The major mechanisms are (a) drug adsorption type, in which the antibody reacts with a drug tightly bound to the RBC membrane; (b) neoantigen type (also known as the *immune complex type*), in which the drug combines loosely with the RBC membrane, and the antibody reacts with a new antigenic site(s) created by the combination of drug and membrane; and (c) autoimmune type, which is indistinguishable from true AIHA without drug exposure ( Fig. 35.7). Some medications may produce hemolysis by more than one mechanism, and differentiating between them is not always possible. The nonimmunologic adsorption of proteins to the RBC membrane is also discussed. This produces a positive DAT but is not associated with increased RBC

destruction.



**Figure 35.7.** Based on a proposed theory of drug-induced antibody reactions. **A:** The antibody attaches only to the drug, which is tightly bound to the red blood cell (RBC) membrane (penicillin type). **B:** The antibody attaches to a neoantigen created by components of both the drug and the RBC membrane (quinidine/stibophen type). **C:** The antibody attaches mainly to the membrane, not requiring the presence of the drug (a-methyldopa type). (Adapted from Habbibi B. Drug induced red blood cell autoantibodies co-developed with drug specific antibodies causing haemolytic anaemias. *Br J Haematol* 1985;61:139–143.)

**Drug Adsorption Mechanism (Penicillin Type)** In this mechanism, the drug binds tightly to the RBC membrane and the antibody attaches to the drug without direct interaction with the erythrocyte. Antipenicillin antibody interacting with RBCs was first reported in a prospective transfusion recipient whose serum reacted with an entire panel of RBCs stored in penicillin as an antibacterial (308). Subsequently, reports appeared of patients receiving high-dose penicillin therapy who developed hemolytic anemia (309, 310 and 311). Penicillin binds to the RBC membrane covalently and can be demonstrated on the cell in most patients receiving high doses of the drug even in the absence of antibody (312). Attachment of only the drug does not harm the erythrocyte. However, when given in large doses (<10 million units/day), it can induce production of IgG antibody, which attaches to the membrane-bound drug, thus producing a positive DAT with anti-IgG sera (312). Eluates from these cells do not react with RBC panels, in stark contrast to the previously discussed true autoimmune antibodies, which display panagglutinin activity. The explanation lies in the fact that penicillin-induced antibodies are attached to the drug alone and not to membrane components of the erythrocyte. If reagent cell suspensions are first coated with penicillin, agglutination occurs with all cells, thus providing a diagnostic testing strategy when drug-induced hemolysis is suspected (57). Although penicillin may react with different proteins to form several haptenic groups, it is the benzylpenicilloyl determinant to which the majority of antibodies bind. Most sera contain IgM antibodies to benzylpenicilloyl, but these do not cause hemolysis. High-titered IgG anti-benzylpenicilloyl antibodies are responsible for the positive DAT and appear in approximately 3% of patients receiving high doses of the drug (313). The presence of a positive DAT is not cause for cessation of the drug. Only some of these patients develop hemolysis (57). Rare exceptions of complement fixation to the RBCs exist in patients on penicillin. These have been associated with IgG attachment, and the DAT is positive with both anti-IgG and anti-C3 sera (314, 315). RBC destruction in the drug adsorption mechanism of hemolysis is through sequestration by splenic macrophages of the IgG-coated cells (311, 316). Rarely, when associated with complement fixation, the cells

may be lysed ( 317 ). Anemia develops gradually over approximately 7 to 10 days but can be life-threatening if not recognized and the drug discontinued. Once the medication is stopped, the hemolysis resolves over the ensuing couple of weeks. However, the DAT may remain positive for several weeks. Of clinical importance is the observation that other signs of penicillin hypersensitivity, such as urticaria and airway reactivity, are usually absent ( 57 ). Other drugs can cause hemolysis by this mechanism. Cephalosporins have antigenic cross-reactivity with penicillin; hemolysis has been reported ( 318 , 319 , 320 , 321 and 322 ). Tetracycline ( 323 , 324 ), tolbutamide ( 325 ), and semisynthetic penicillins ( 326 , 327 ) are also in this category. Carbromal has been associated with a positive DAT but not hemolysis ( 328 ).

**Neoantigen Mechanism (Quinidine/Stibophen Type)** The neo-antigen mechanism is also known as the *immune complex* or *innocent bystander mechanism*, but these descriptors are now not adequate to explain the pathophysiology as currently understood. Old theory suggested that the drug formed an immune complex with the anti-drug antibody in the circulation, then attached nonspecifically to the RBC (the “innocent bystander”), and subsequently led to its destruction by activation of the complement cascade. This was supported by demonstration of low avidity of the drug for the RBC membrane and the presence of complement alone by the DAT ( 329 ). However, in studies in which the complex displayed a rare specificity for a particular alloantigen on the RBC, such as I or Rh, the antibody would not bind to cells lacking that particular antigen, even in the presence of the drug ( 330 , 331 ). This suggests that the interaction was, indeed, not nonspecific for an “innocent bystander” RBC but required a component of the erythrocyte membrane to bind to the antigen recognition site on the antibody. This concept is supported by careful studies of quinidine/quinine-induced thrombocytopenia that have shown that the culprit IgG binds to the platelet membrane via its Fab domain and not its Fc end to the platelet’s Fc receptor ( 332 , 333 ). This suggests that the antibody is specific for a combination antigen, or *neoantigen*, created by both the drug and the RBC. Investigations with rare antigen-negative cells revealed that these antibodies have specific sites on the RBC membrane to which they attach along with the drug ( 334 , 335 ). Other studies support this concept ( 336 , 337 , 338 , 339 and 340 ). It should be emphasized that this unique trimolecular complex applies to the effector phase of the process. It is presumed that the antibody is formed to the bound drug on the RBC membrane, although, in the face of the low avidity of this association, the mechanism is not understood. Both the drug adsorption mechanism and the neoantigen mechanism are truly drug-dependent in that the drug or its metabolite is required for RBC binding and destruction. The neoantigen mechanism differs from the drug adsorption mechanism in a few key areas. Unlike the penicillin model, these drugs bind very loosely to the RBC membrane. Only a small dose of the medication is required for hemolysis to occur as opposed to the very large doses of penicillin required. Hemolysis is usually sudden, severe, and accompanied by hemoglobi-nuria ( 2 ) instead of the subacute anemia typically seen with the drug adsorption type. Renal failure is a frequent occurrence in the neoantigen mechanism ( 341 , 342 ). The effector phase is mediated predominantly by complement fixation and subsequent intravascular cell lysis. Some sequestration of erythrocytes occurs in the splenic macrophages or the liver via complement receptors. The DAT is positive only for the presence of complement, and Ig, which may be IgM or IgG, is rarely still attached to the cell ( 57 ). Therefore, eluates are nonreactive primarily because there is no Ig to elute. *In vitro*, the patient’s serum reacts with RBCs only in the presence of the drug or a reactive metabolite ( 57 ). These drugs may also induce thrombocytopenia by similar mechanisms ( 332 , 333 ).

**Autoimmune Mechanism (a-Methyldopa Type)** Unlike the previous two mechanisms, which require the presence of the offending drug for antibody reaction with the RBC membrane, hemolysis induced by a-methyldopa is truly autoimmune in nature. Antibodies bind to erythrocyte membrane antigens in a manner indistinguishable from the sporadic AIHA discussed earlier. a-Methyldopa is responsible for the most cases and is the most



extensively studied ( 2 , 223 , 343 , 344 ). Other medications, such as levodopa ( 345 ) and procainamide ( 346 ), have also been documented to incite such a reaction. The DAT becomes positive in 8 to 36% of patients taking  $\alpha$ -methyldopa; the larger the daily dose, the more likely the positive Coombs test ( 344 , 347 ). The positive DAT is detected approximately 3 to 6 months into treatment, although some may require over 3 years of therapy ( 348 ). This delay is not shortened when patients with a history of a positive DAT on  $\alpha$ -methyldopa are rechallenged with the drug ( 2 ). Those patients without evidence of hemolysis may have variably reactive direct Coombs tests. However, those with overt RBC destruction typically have 2 to 4 or more reactions with anti-IgG sera ( 57 ). Anticomplement tests are usually negative. Some weakly positive anti-C3 DATs have been reported ( 57 ). Despite a high incidence of Ig coating of RBCs, only 0.8% of patients actually develop clinical hemolysis ( 2 ). Explanations of this phenomenon have been unsatisfactory. The amount of antibody on the RBC correlates poorly with *in vivo* hemolysis, and no threshold has ever been well established ( 105 , 349 ). In one series, only those patients who had IgM and C1q on their cells in addition to IgG developed hemolysis ( 350 ). Others contend that reticuloendothelial function is impaired in patients taking  $\alpha$ -methyldopa and that this may explain the low incidence of significant hemolysis ( 351 ). The characteristics of the IgG antibody eluted from the RBCs are strikingly similar to those in idiopathic warm AIHA. They are polyclonal ( 352 ) and bind as a panagglutinin to reagent cells even in the absence of the drug. As in warm AIHA, these antibodies have a predilection for Rh antigens at a very basic level, with some specific anti-c and anti-e documented ( 352 , 353 ). They react with the same ~34-kd, Rh-related polypeptide that idiopathic warm autoantibodies have been shown to bind ( 354 ). Other, much less common targets include Wr<sup>b</sup> ( 61 ), Jk<sup>a</sup> ( 355 ), and U ( 356 ). Because of their similar reactions and absence of requirement for the drug to be present, these antibodies would be indistinguishable from the spontaneously arising variety without the drug history. Indeed, it begs the question of whether other, as yet unidentified exposures incite the production of autoimmune RBC antibodies.  $\alpha$ -Methyldopa induces autoimmune RBC antibodies by an unknown mechanism. Early studies focused on the possibility of RBC binding, or alteration of RBC membrane proteins to enhance immunogenicity, or both. Several observations do not support these concepts. The kinetics of the antibody are inconsistent with those induced by immunogens. The DAT is positive months after initial exposure ( 2 ), and rechallenge does not produce an anamnestic response but the same delay in antibody production ( 357 ). The drug binds poorly, if at all, to the erythrocyte membrane ( 353 , 358 ). Alteration of the RBC membrane producing a positive DAT should persist for the life of the RBC and does not explain the rapid reversal to negative frequently seen when the drug is discontinued. Patients with the simultaneous development of drug-dependent and drug-induced autoantibodies with the same specificity suggest that there is interaction between the drug and the membrane ( 335 , 359 ). In immunologic theory of haptens binding to carrier proteins, the immune sera may contain antibodies to the hapten, to the carrier molecule, or to combined antigen sites on both. In the case of RBCs, the result could be antidrug antibodies (e.g., penicillin), RBC autoantibodies (e.g.,  $\alpha$ -methyldopa), or drug-dependent neoantigen antibodies (e.g., quinidine). Some investigators have proposed theories that  $\alpha$ -methyldopa alters the immune system directly by inhibiting suppressor T-cell function ( 360 ). However, other investigators could not reproduce these results ( 361 ). Work on procainamide, another drug known to induce autoantibodies to RBCs and other antigens, has produced additional hypotheses. It may combine with proteins to form neoantigens ( 362 , 363 ), induce T-cell autoreactivity ( 364 ), or act as an adjuvant for polyclonal activation of autoantibody clones ( 365 ). Many observations of immune system effects still have not elucidated the basic mechanism of autoantibody induction by these medications.

***Nonimmunologic Protein Adsorption Mechanism*** Proteins other than Igs may

nonspecifically attach to the RBC membrane and cause positive antiglobulin reactions. These do not cause increased RBC destruction and are of importance only because of the need to differentiate them from those of clinical significance. This is most commonly seen in patients on cephalosporins, which actually produce a positive DAT in approximately 3% of patients ( 366, 367 ). Many different types of proteins have been detected on the erythrocyte within a few days of instituting the medication, including fibrinogen, albumin, complement, Igs, a  $\gamma_2$ -macroglobulin, and others ( 367 ). Clinical distinction between this benign finding and other, potentially significant ones involves the demonstration of a nonreactive eluate with cephalosporin-treated cells and the absence or low titer of antidrug antibodies in the patient's serum ( 57 ). Adding to the confusion is the fact that cephalosporins may cause hemolysis by either the drug adsorption or the neoantigen mechanism. In the absence of hemolysis, a positive DAT is not a cause for discontinuing the medication. Table 35.8 summarizes the different proposed mechanisms of drug-RBC-antibody interactions.

**TABLE 35.8. Mechanisms of Drug-Induced Hemolysis or Positive Direct Antiglobulin Test**

|                                  | Drug Adsorption                          | Neoantigen                    | Autoimmune                              | Nonimmune Adsorption                                    |
|----------------------------------|--|-------------------------------|---|---|
| Prototype drug                   | Penicillin                               | Quinidine/stibophen           | a-Methyldopa                            | First generation cephalosporins                         |
| Role of drug                     | Cell-bound hapten                        | Antibody binds drug + RBC     | Induces drug-independent RBC antibody   | Modifies RBC membrane; adsorbs proteins nonspecifically |
| Typical direct antiglobulin test |  | Complement third component    | IgG                                     | Non-Ig  |
| Antibody reactions               | Reacts only with drug-coated cells       | Reacts only with drug present | Drug-independent panagglutinin          | No antibody present                                     |
| Typical clinical presentation    | Subacute onset; mild to severe hemolysis | Acute onset; severe hemolysis | Insidious onset; chronic mild hemolysis | No hemolysis  |

Ig, immunoglobulin; RBC, red blood cell.

**Multiple Mechanisms** Many medications have been implicated in producing hemolysis by more than one mechanism, sometimes simultaneously in the same patient. Those documented to have caused autoantibodies and drug-dependent antibodies are phenacetin ( 368 ), streptomycin ( 369 ), tolmetin ( 370 ), fenoprofen ( 371 ), suprofen ( 372 ), sulindac ( 373 ), and zomepirac ( 374 ). Nomifensine ( 375 ), diclofenac ( 376 ), teniposide ( 377 ), cianidanol ( 378 ), cefotetan ( 322 ), hydrochlorothiazide ( 379 ), cefoxitin, ceftriaxone ( 359 ), and cefotaxime ( 380 ) are also on this list. Penicillins may rarely react via the neoantigen mechanism ( 317 ), and quinidine ( 381 ) occasionally acts as a hapten. Triamterene ( 382 ) has been reported to use both mechanisms as well. Discontinuation of the medications leads to prompt resolution of the hemolysis in most cases.

**CLINICAL MANIFESTATIONS** The clinical features are similar to those found in idiopathic AIHA, including pallor, jaundice, and easy fatigability. Splenomegaly is not uncommon, but lymphadenopathy and hepatomegaly should not be attributed to



drug-related hemolysis ( [343](#) ). The severity of these symptoms depends on the rate of hemolysis, which is, in part, dependent on the mechanism involved. Those patients with the neoantigen mechanism are at the greatest risk for plummeting hemoglobins, hemoglobinuria, and renal failure ( [2](#), [341](#), [383](#) ). Cefotetan has been implicated in many severe hemolytic reactions ( [384](#), [385](#) and [386](#) ). Fatal reactions are rare but may occur ( [322](#), [387](#) ). The drug adsorption and autoimmune varieties are typically characterized by insidious onset of hemolysis over days to weeks. A careful medication history is necessary to evaluate the possibility of a culprit drug in all patients with AIHA.

**LABORATORY FEATURES** Just as with idiopathic AIHA, anemia with reticulocytosis and a positive DAT are the hallmarks of the condition. Elevated indirect bilirubin and lactate dehydrogenase are common findings. In rampant RBC destruction, hemoglobinemia and hemoglobinuria with elevated creatinine are manifest. Distinguishing between the mechanisms involved can be accomplished by the serologic results. One can differentiate the neoantigen mechanism from cold autoantibodies by the absence of high-titer cold agglutinins or D-L antibodies in the drug-induced cases. Drug-induced antibodies also do not react in the absence of the drug or a metabolite in IATs. Only a careful history and resolution of the hemolysis after discontinuation of the drug can separate the  $\alpha$ -methyl dopa variety from true autoimmune antibodies. The positive DAT may persist for a few weeks to months after stopping the medication responsible, especially with the autoimmune mechanism ( [57](#) ).

**MANAGEMENT** Take a careful drug history, including over-the-counter medications as well as illicit drugs. Discontinuing the implicated medication is usually all that is necessary in management of drug-induced hemolytic anemia. Problems may arise when a positive DAT occurs and uncertainty exists as to whether significant RBC destruction is occurring. As previously described, many medications may be associated with a positive Coombs test and yet not cause hemolysis. The drug need not be stopped in these patients. In the case of penicillin, in which very high doses are associated with significant reactions, merely decreasing the dose or adding another antibiotic may suffice to keep the patient out of danger. Substituting another penicillin in the face of hemolytic anemia is not advisable due to the cross-reactivity of the antibodies ( [57](#) ). In cases of brisk hemolysis associated with the neoantigen mechanism, stopping the offending agent can be life-saving. Prednisone therapy is rarely indicated, and its helpfulness is questionable ( [388](#) ). Transfusion can be accomplished, usually without difficulty in cross-matching as the antibodies in the drug adsorption and neoantigen mechanisms are drug-dependent. However, patients with the autoimmune mechanism may encounter the same difficulties as previously discussed in the warm AIHA section. It is important to keep in mind that the transfused cells may be destroyed at the same rate as the patient's cells if drug or active metabolites are still circulating. Prognosis is typically excellent for these patients after discontinuation of the drug. With the variety of choices of pharmaceuticals available, alternative therapies are nearly always available to treat the patient's original condition adequately.

## REFERENCES

1. Sokol RG, Hewitt S, Stamps BK. Autoimmune haemolysis. Mixed warm and cold antibody type. *Acta Haematol* 1983;69:266-274.
2. Worledge SM. Immune drug-induced hemolytic anemias. *Semin Hematol* 1969;6:181-200.
3. Shlomchik MJ. Mechanisms of immune self-tolerance and how they fail in autoimmune disease. In: Silberstein L, ed. *Autoimmune disorders of blood*. Bethesda, MD: American Association of Blood Banks, 1996:1-34.
4. Hartley SB, Cooke MP, Fulcher DA, et al. Elimination of self-reactive B lymphocytes proceeds in two stages: arrested development and cell death. *Cell* 1993;72:325-335.

5. Blackman M, Kappler J, Marrack P. The role of the T cell receptor in positive and negative selection of developing T cells. *Science* 1990;248:1335–1341.
6. Owen RD. Immunogenetic consequences of vascular anastomoses between bovine twins. *Science* 1945;102:400.
7. Goodnow CC, Crosbie J, Adelstein S, et al. Altered immunoglobulin expression and functional silencing of self-reactive B lymphocytes in transgenic mice. *Nature* 1988;334:676–682.
8. Nemazee DA, Burki K. Clonal deletion of B lymphocytes in a transgenic mouse bearing anti-MHC class-I antibody genes. *Nature* 1989;337:562–566.
9. Chen C, Nagy Z, Radic MZ, et al. The site and stage of anti-DNA B-cell deletion. *Nature* 1995;373:252–255.
10. Mackay IR. Tolerance and autoimmunity. *BMJ* 2000;321:93–96.
11. Weiss A. Structure and function of the T cell antigen receptor. *J Clin Invest* 1990;86:1015–1022.
12. Fisher AG, Goff LK, Lightstone L, et al. Problems in the physiology of class I and class II MHC molecules and of CD45. *Cold Spring Harb Symp Quant Biol* 1989;54:667–674.
13. Unanue ER, Allen PM. The basis for the immunoregulatory role of macrophages and other accessory cells. *Science* 1987;236:551–557.
14. Lorenz RG, Allen PM. Thymic cortical epithelial cells can present self-antigens in vivo. *Nature* 1989;337:560–562.
15. Sha WC, Nelson CA, Newberry RD, et al. Positive and negative selection of an antigen receptor on T cells in transgenic mice. *Nature* 1988;336:73–76.
16. Nossal GJV, Pike BL. Clonal anergy: persistence in tolerant mice of antigen-binding B lymphocytes incapable of responding to antigen or mitogen. *Proc Natl Acad Sci U S A* 1980;77:1602–1606.
17. Kisielow P, Swat W, Rocha B, et al. Induction of immunological unresponsiveness in vivo and in vitro by conventional and super-antigens in developing and mature T cells. *Immunol Rev* 1991;122:69–85.
18. Marrack P, Kappler J. The T cell receptor. *Science* 1987;238:1073–1079.
19. Marsh WL, Jenkins WJ. Anti-i: a new cold antibody. *Nature* 1960;188:173.
20. Kantor AB, Stall AM, Adams S, et al. Differential development of progenitor activity for the B cell lineages. *Proc Natl Acad Sci U S A* 1992;89:3320–3324.
21. Kantor AB. The development and repertoire of B-1 cells (CD5 B cells). *Immunol Today* 1991;12:389–391.
22. Kipps TJ. The CD5 B cell. *Adv Immunol* 1989;47:117–185.
23. Stall AM, Farinas MC, Tarlinton DM, et al. Ly-1 B-cell clones similar to human chronic lymphocytic leukemias routinely develop in older normal mice and young autoimmune (New Zealand Blank-related) animals. *Proc Natl Acad Sci U S A* 1988;85:7312–7316.
24. Murakami M, Tsubata T, Okamoto M, et al. Antigen-induced apoptotic death of Ly-1 B cells responsible for autoimmune disease in transgenic mice. *Nature* 1992;357:14–15.
25. UytdeHaag F, van der Heijden R, Osterhaus A. Maintenance of immunological memory: a role for CD5+ B cells? *Immunol Today* 1991;12:439–442.
26. Rose NR, Witebsky E. Studies on organ specificity. V. Changes in the thyroid glands of rabbits

- following acute inflammation with rabbit thyroid extracts. *J Immunol* 1956;26:417.
27. Glaman HN, Chaperon EA, Triplett RF. Thymus–marrow cell combinations. Synergism in antibody production. *Proc Soc Exp Biol Med* 1966;122:1167–1171.
  28. Reiser H, Stadecker MJ. Costimulatory B7 molecules in the pathogenesis of infectious and autoimmune diseases. *N Engl J Med* 1996;335:1369–1377.
  29. Diamond B, Scharff MD. Somatic mutation of the T15 heavy chain gives rise to an antibody with autoantibody specificity. *Proc Natl Acad Sci U S A* 1984;81:5841–5844.
  30. Shokat KM, Goodnow CC. Antigen–induced B–cell death and elimination during germinal–centre immune responses. *Nature* 1995;375:334–338.
  31. Ucker DS, Meyers J, Obermiller PS. Activation–driven T cell death. II. Quantitative differences alone distinguish stimuli triggering nontransformed T cell proliferation or death. *J Immunol* 1992;149:1583–1592.
  32. Gray D, Dullforce P, Jainandunsing S. Memory B cell development but not germinal center formation is impaired by in vivo blockade of CD40–CD40 ligand interaction. *J Exp Med* 1994;180:141–155.
  33. Daniel PT, Krammer PH. Activation induces sensitivity toward APO–1 (CD 95)–mediated apoptosis in human B cells. *J Immunol* 1994;152:5624–5632.
  34. Rouvier E, Luciani MF, Golstein P. Fas involvement in Ca(2+)–independent T cell–mediated cytotoxicity. *J Exp Med* 1993;177:195–220.
  35. Drappa J, Vaishnav AK, Sullivan KE, et al. Fas gene mutations in the Canale–Smith syndrome, an inherited lymphoproliferative disorder associated with autoimmunity. *N Engl J Med* 1996;335:1643–1649.
  36. Ring GH, Lakkis FG. Breakdown of self–tolerance and the pathogenesis of autoimmunity. *Semin Nephrol* 1999;19:25–33.
  37. Tivol EA, Borriello F, Schweitzer AN, et al. Loss of CTLA–4 leads to massive lymphoproliferation and fatal multiorgan tissue destruction, revealing a critical negative regulatory role of CTLA–4. *Immunity* 1995;3:541–547.
  38. Kawakami K, Parker DC. Differences between T helper–cell type I (T<sub>h</sub>1) and T<sub>h</sub>2 cell lines in signalling pathways for induction of contact–dependent T cell help. *Eur J Immunol* 1992;22:85–93.
  39. Freeman GJ, Freedman AS, Segil JM, et al. B7, a new member of the Ig superfamily with unique expression on activated and neoplastic B cells. *J Immunol* 1989;143:2714–2722.
  40. Lane P, Traunecker A, Hubele S, et al. Activated human T cells express a ligand for the human B cell–associated antigen CD–40 which participates in T cell–dependent activation of B lymphocyte. *Eur J Immunol* 1992;22:2573–2578.
  41. Barcy S, Wettendorff M, Leo O, et al. FcR cross–linking on monocytes results in impaired T cell stimulatory capacity. *Int Immunol* 1995;7:179–189.
  42. Inaba K, Witmer PM, Anaba M, et al. The tissue distribution of the B7–2 costimulator in mice: abundant expression on dendritic cells in situ and during maturation in vitro. *J Exp Med* 1994;180:1849–1860.
  43. Nepom BS, Nepom GT. Immunogenetics and the rheumatic diseases. In: Ruddy S, Sledge CB, eds. *Textbook of rheumatology*. Philadelphia: WB Saunders, 1993:89–107.
  44. Oldstone MBA. Molecular mimicry and immune–mediated diseases. *FASEB J* 1998;12:1255–1265.
  45. Salama A, Mueller–Eckhardt C. Immune–mediated blood cell dyscrasias related to drugs. *Semin Hematol* 1992;29:54–63.
  46. van Oss CJ, Absolom DR. Hemagglutination and the closest distance approach of normal,

neuraminidase, and papain-treated erythrocytes. *Vox Sang* 1983;47:250–256.

47. Leikola J, Pasanen VJ. Influence of antigen receptor density on agglutination of red blood cells. *Int Arch Allergy Appl Immunol* 1970;39:352–360.
48. Fukuda M, Fukuda MV, Hakomori S-I. Developmental change and genetic defect in the carbohydrate structure of band 3 glycoprotein of human erythrocyte membrane. *J Biol Chem* 1979;254:3700–3703.
49. Economidou J, Hughes-Jones NC, Gardner B. The functional activities of IgG and IgM anti-A and anti-B. *Immunology* 1967;13:227–234.
50. Greenbury CL, Moore D, Nunn LAC. Reaction of 7S and 19S components of immune rabbit antisera with human group A and AB red cells. *Immunology* 1963;6:421.
51. Mollison PL, Engelfriet CP, Contreras M. *Blood transfusion in clinical medicine*, 9th ed. Oxford: Blackwell Scientific Publications, 1993.
52. Moreschi C. Neue tatsachen über die blut körpenchenagglutination. *Zentralbl Bakt* 1908;46:49–51.
53. Coombs RRA, Mourant AE, Race RR. A new test for the detection of weak and “incomplete” Rh agglutinins. *Br J Exp Pathol* 1945;26:255–266.
54. Coombs RRA, Mourant AE, Race RR. In vivo isosensitization of red cells in babies with haemolytic disease. *Lancet* 1946;1:264–266.
55. Brecher ME, ed. *Technical manual*, 14th ed. Bethesda, MD: American Association of Blood Banks, 2002.
56. South SF. Use of the direct antiglobulin test in routine testing. In: Wallace M, Levitt J, eds. *Current applications and interpretations of the direct antiglobulin test*. Arlington, VA: American Association of Blood Banks, 1988:25–45.
57. Petz LD, Garratty G. *Acquired immune hemolytic anemias*. New York: Churchill Livingstone, 1980.
58. Sokol RJ, Booker DJ, Stamps R, et al. IgA red cell autoantibodies and autoimmune hemolysis. *Transfusion* 1997;37:175–181.
59. Garratty G. Novel mechanisms for immune destruction of circulating autologous cells. In: Silberstein L, ed. *Autoimmune disorders of blood*. Bethesda, MD: American Association of Blood Banks, 1996:79–114.
60. Burkhart P, Rosenfield RE, Hsu TC. Instrumental PVP-augmented antiglobulin tests I. Detection of allogeneic antibodies coating otherwise normal erythrocytes. *Vox Sang* 1974;26:289–304.
61. Issitt PD, Pavone BG, Goldfinger D, et al. Anti Wr<sup>b</sup> and other autoantibodies responsible for positive direct antiglobulin tests in 150 individuals. *Br J Haematol* 1976;34:5–18.
62. Weiner W, Vox GH. Serology of acquired hemolytic anemias. *Blood* 1963;22:606–613.
63. Garratty G. Target antigens for red-cell-bound autoantibodies. In: Nance SJ, ed. *Clinical and basic science aspects of immuno-hematology*. Arlington, VA: American Association of Blood Banks, 1991:33–72.
64. Szymanski IO, Roberts PL, Rosenfield RE. Anti-A autoantibody with severe intravascular hemolysis. *N Engl J Med* 1976;294:995–996.
65. Sokol RJ, Hewitt S, Booker DJ, et al. Patients with red cell autoantibodies: selection of blood for transfusion. *Clin Lab Haematol* 1988;10:257–264.
66. Donath J, Landsteiner K. Ueber paroxysmal Hämoglobinurie. *Münch Med Wschr* 1904;51:1590–1593.
67. Landsteiner K. Über Beziehungen zwischen dem Blutserum and den Körperzeller. *Munch Med Wochenschr* 1903;50:1812.

68. Schubotho H. The cold hemagglutinin disease. *Semin Hematol* 1966;3:27-47.
69. Dacie J. The auto-immune haemolytic anaemias, 3rd ed. Edinburgh: Churchill Livingstone, 1992.
70. Harboe M, et al. Exclusive occurrence of k chains in isolated cold haemagglutinins. 1965;2:259.
71. Michaux L, Dierlamm J, Wlodarska L, et al. Trisomy 3q11-q29 is recurrently observed in B-cell non-Hodgkin's lymphomas associated with cold agglutinin syndrome. *Ann Hematol* 1998;76:201-204.
72. Silberstein LE, Robertson GA, Harris AC, et al. Etiologic aspects of cold agglutinin disease: evidence for cytogenetically defined clones of lymphoid cells and the demonstration that an anti-Pr cold autoantibody is derived from a chromosomally aberrant B cell clone. *Blood* 1986;67:1705-1709.
73. Silberstein LE, Goldman J, Kant JA, et al. Comparative biochemical and genetic characterization of clonally related human B-cell lines secreting pathogenic anti-Pr<sub>2</sub> cold agglutinins. *Arch Biochem Biophys* 1988;264:244-252.
74. Wortman J, Rosse W, Logue G. Cold agglutinin autoimmune hemolytic anemia in nonhematologic malignancies. *Am J Hematol* 1979;6:275-283.
75. Pruzanski W, Shumak KH. Biologic activity of cold reactive autoantibodies. *N Engl J Med* 1977;297:538-542.
76. Roelcke D, Hack H, Kreft H, et al. IgA cold agglutinins recognize Pr and Sa antigens expressed on glycoporphins. *Transfusion* 1993;33:472-475.
77. Williams R, Kunkel H, Capra J. Antigenic specificities related to the cold agglutinin activity of gamma M globulins. *Science* 1968;161:379.
78. Silberstein LE, Jefferies LC, Goldman J, et al. Variable region gene analysis of pathologic human auto-antibodies to the related i and I red blood cell antigens. *Blood* 1991;73:2372-2386.
79. Stevenson F, Smith G, North J, et al. Identification of normal B-cell counterparts of neoplastic CLLs which secrete cold agglutinins of anti-I and anti-i specificity. *Br J Haematol* 1989;72:9-15.
80. Pascual V, Victor K, Spellerberg M, et al. V<sub>H</sub> restriction among human cold agglutinins. The V<sub>H</sub>4-21 gene segment is required to encode anti-I and anti-i specificities. *J Immunol* 1992;149:2337-2344.
81. Jefferies LC, Carchidi CM, Silberstein LE. Naturally occurring anti-i/I cold agglutinins may be encoded by different V<sub>H</sub>3 genes as well as the V<sub>H</sub>4.21 gene segment. *J Clin Invest* 1993;92:2821-2833.
82. Grillot-Courvalin C, Brouet JC, Piller F, et al. An anti-B cell autoantibody from Wiskott-Aldrich syndrome which recognizes i blood group specificity on normal human B cells. *Eur J Immunol* 1992;22:1781-1788.
83. Feizi T. Lambda chains in cold agglutinins. *Science* 1987;156:1111-1112.
84. Thompson KM, Sutherland J, Barden G, et al. Human monoclonal antibodies against blood group antigens preferentially express a V<sub>H</sub>4-21 variable region gene-associated epitope. *Scand J Immunol* 1991;34:509-518.
85. Wiener AS, Unger LG, Cohen L, et al. Type-specific cold auto-antibodies as a cause of acquired hemolytic anemia and hemolytic transfusion reactions: biologic test with bovine red cells. *Ann Intern Med* 1956;44:221-240.
86. Unger LJ, Wiener AS, Dolan D. Anémie auto-hémolytique chez un nouveau-né. *Rev Hémat* 1952;7:495-504.
87. Mortara M, Martinetti L. Su di un caso di anemia emolitica cronica con sindrome di Raynaud e crioagglutinazione. *G Clin Med* 1955;36:1791-1801.

88. Hakomori S. Blood group ABH and Ii antigens of human erythrocytes: chemistry, polymorphism, and their developmental change. *Semin Hematol* 1981;18:39–62.
89. Marsh WL. Anti-i: a cold antibody defining the Ii relationship in human red cells. *Br J Haematol* 1961;7:200–209.
90. Watanabe K, Hakomori S. Status of blood group carbohydrate chains in ontogenesis and oncogenesis. *J Exp Med* 1976;144:645–653.
91. Issitt PD. I blood group system and its relation to other blood group systems. *J Med Lab Tech* 1967;24:90–97.
92. Roelcke D. Cold agglutination. *Transfus Med Rev* 1989;3:140–166.
93. Siegel DL, Silberstein LE. Red blood cell autoantibodies. In: Anderson K, Ness P, ed. *Scientific basis of transfusion medicine implications for clinical practice*. Philadelphia: WB Saunders, 1994:517–526.
94. Childs RA, Feizi T. Differences in carbohydrate moieties of high molecular weight glycoproteins of human lymphocytes of T and B origins revealed by monoclonal autoantibodies with anti-I specificities. *Biochem Biophys Res Commun* 1981;102:1158–1164.
95. Yamashita Y, Imai Y, Osawa T. Poly[N-acetyllactosamine]-type sugar chain in CD45 antigens of abnormal T cells of Ipr mice are different from those of normal T cells and B cells. *Mol Immunol* 1989;26:905–913.
96. Ebert W, Fey J, Gärtner C, et al. Isolation and partial characterization of the Pr autoantigen determinants. *Mol Immunol* 1979;16:413–419.
97. König AL, Schabel A, Sugg U, et al. Autoimmune hemolytic anemia caused by IgG lambda-monotypic cold agglutinins of anti-Pr specificity after rubella infection. *Transfusion* 2001;41:488–492.
98. von dem Borne AE, Mol JJ, Joustra-Maas N, et al. Autoimmune haemolytic anaemia with monoclonal IgM(k) anti-P cold autohaemolysins. *Br J Haematol* 1982;50:345–350.
99. Loomes LM, Uemure K-I, Childs RA, et al. Erythrocyte receptors for *Mycoplasma pneumoniae* are sialylated oligosaccharides of Ii antigen type. *Nature* 1984;307:560–563.
100. Costea N, Yakulis V, Heller P. Inhibition of cold agglutinins (anti-I) by *M. pneumoniae* antigens. *Proc Soc Exp Biol Med* 1972;139:476–479.
101. Tanowitz HB, Robbins N, Leidich N. Hemolytic anemia: associated with severe *Mycoplasma pneumoniae* pneumonia. *N Y State J Med* 1978;78:2231–2232.
102. Jacobson LB, Longstreth GF, Edgington TS. Clinical and immunologic features of transient cold agglutinin hemolytic anemia. *Am J Med* 1973;54:514–521.
103. Feizi T, Schumacher M. Light chain homogeneity of post-infective cold agglutinins. *Clin Exp Immunol* 1968;3:923–929.
104. Hoagland RJ. *Infectious mononucleosis*. New York: Grune & Stratton, 1967.
105. Dacie JV, Worledge SM. Autoimmune hemolytic anemias. In: Brown EB, Moore CV, eds. *Progress in hematology VI*. New York: Grune & Stratton, 1969:82–120.
106. Jenkins WJ, Koster HG, Marsh WL, et al. Infectious mononucleosis: an unsuspected source of anti-i. *Br J Haematol* 1965;11:480–483.
107. Hossaini AA. Anti-i infectious mononucleosis. *Am J Clin Pathol* 1970;53:198–203.
108. Horwitz CA, Moulds J, Henle W, et al. Cold agglutinins in infectious mononucleosis and heterophil-antibody-negative mononucleosis-like syndromes. *Blood* 1977;50:195–200.

109. Brafield AJ. Glandular fever and cold agglutinins. *Lancet* 1966;ii:982.
110. Bowman HS, Marsh WL, Schumacher HR, et al. Auto anti-N immunohemolytic anemia in infectious mononucleosis. *Am J Clin Pathol* 1974;61:465-472.
111. Goldberg L, Barnett E. Mixed gG-gM cold agglutinin. *J Immunol* 1967;99:803-809.
112. Gronemeyer P, Chaplin H, Ghazarian V, et al. Hemolytic anemia complicating infectious mononucleosis due to the interaction of an IgG cold anti-i and an IgM cold rheumatoid factor. *Transfusion* 1981;21:715-718.
113. Horwitz CA, Skradski K, Reece E, et al. Haemolytic anaemia in previously healthy adult patients with CMV infections: report of two cases and an evaluation of subclinical haemolysis in CMV mononucleosis. *Scand J Haematol* 1984;33:35-42.
114. Evans RS, Turner E, Bingham M. Studies with radioiodinated cold agglutinins of ten patients. *Am J Med* 1965;38:378.
115. Rosse WF, Adams JP. The variability of hemolysis in the cold agglutinin syndrome. *Blood* 1980;56:409-416.
116. Evans RS, et al. Autoimmune hemolytic disease: observations of serological reactions and disease activity. *Ann N Y Acad Sci* 1965;124:422.
117. Ferriman DG, Dacie JV, Kelle KD, et al. The association of Raynaud's phenomena, chronic haemolytic anaemia, and the formation of cold antibodies. *Quart J Med N S* 1951;20:275-292.
118. Chitnavis VN, Patou G, Makar YF, et al. B19 parvovirus-induced red cell aplasia complicating acute cold antibody-mediated haemolytic anaemia. *Br J Haematol* 1990;76:433-434.
119. Harboe M, Torvick H. Protein abnormalities in the cold haemagglutinin syndrome. *Scand J Haematol* 1969;6:416-426.
120. Bartholomew JR, Bell WR, Shirey RS. Cold agglutinin hemolytic anemia: treatment with an environmental suit. *Ann Intern Med* 1987;106:243-244.
121. Hippe E, Jensen KB, Olesen H, et al. Chlorambucil treatment of patients with cold agglutinin syndrome. *Blood* 1970;35:68-72.
122. Foerster J. Autoimmune hemolytic anemias. In: Lee G, et al., eds. *Wintrobe's clinical hematology*, 9th ed. Philadelphia: Lea & Febiger, 1993:1170-1196.
123. Fest T, de Wazieres B, Lamy B, et al. Successful response to alpha-interferon 2b in a refractory IgM autoagglutinin-mediated hemolytic anemia. *Ann Hematol* 1994;69:147-149.
124. Lee EJ, Kueck B. Rituxan in the treatment of cold agglutinin disease. *Blood* 1998;92:3490-3491.
125. Bauduer F. Rituximab: a very efficient therapy in cold agglutinins and refractory autoimmune haemolytic anaemia associated with CD20-positive, low-grade non-Hodgkin's lymphoma. *Br J Haematol* 2001;112:1085-1086.
126. Zaja F, Iacona I, Masolini P, et al. B-cell depletion with rituximab as treatment for immune hemolytic anemia and chronic thrombocytopenia. *Haematologica* 2002;87:189-195.
127. Zaja F, Russo D, Fuga G, et al. Rituximab in a case of cold agglutinin disease. *Br J Haematol* 2001;115:232-233.
128. Berentsen S, Tjonnfjord GE, Brudevold R, et al. Favourable response to therapy with the anti-CD20 monoclonal antibody rituximab in primary chronic cold agglutinin disease. *Br J Haematol* 2001;115:79-83.
129. Rose AL, Smith BE, Maloney DG. Glucocorticoids and rituximab in vitro: synergistic direct



antiproliferative and apoptotic effects. *Blood* 2002;100:1765–1773.

130. Hongeng S, Tardtong P, Worapongpaiboon S, et al. Successful treatment of refractory autoimmune haemolytic anaemia in a post-unrelated bone marrow transplant paediatric patient with rituximab. *Bone Marrow Transplant* 2002;29:871–872.

131. Taft EG, Propp RP, Sullivan SA. Plasma exchange for cold agglutinin hemolytic anemia. *Transfusion* 1977;17:173–176.

132. Rodenhuis S, Maas A, Hazenberg CA, et al. Inefficacy of plasma exchange in cold agglutinin hemolytic anemia—a case study. *Vox Sang* 1985;49:20–25.

133. Nydegger UE, Kazatchkine MD, Miescher PA. Immunopathologic and clinical features of hemolytic anemia due to cold agglutinins. *Semin Hematol* 1991;28:66–77.

134. Zoppi M, Oppliger R, Althaus U, et al. Reduction of plasma cold agglutinin titers by means of plasmapheresis to prepare a patient for coronary bypass surgery. *Infusionstherapie und Transfusionsmedizin* 1993;20:19–22.

135. Innet LM, Lester JL 3rd, Tait N. Cold agglutinins: preoperative diagnosis leads to an uneventful perfusion. *Perfusion* 1995;10:343–345.

136. Agarwal SK, Ghosh PK, Gupta D. Cardiac surgery and cold-reactive proteins. *Ann Thorac Surg* 1995;60:1143–1150.

137. Woll JE, Smith CM, Nusbacher J. Treatment of acute cold agglutinin hemolytic anemia with transfusion of adult i RBCs. *JAMA* 1974;229:1779–1780.

138. Bell CA, Zwicker H, Sacks HJ. Autoimmune hemolytic anemia: routine serologic evaluation in a general hospital population. *Am J Clin Pathol* 1973;60:903–911.

139. Rosenfield RE, Jagathambal. Transfusion therapy for autoimmune hemolytic anemia. *Semin Hematol* 1976;13:311–321.

140. Schreiber AD, Herskovitz BS, Goldwein M. Low-titer cold-hemagglutinin disease. *New Engl J Med* 1977; 296:1490–1494.

141. Pirofsky B. Autoimmunization and the autoimmune hemolytic anemias. Baltimore: Williams & Wilkins, 1969.

142. Dacie JV. The auto-immune haemolytic anaemias, 2nd ed. London: J & A Churchill, Ltd., 1962.

143. Dressler D. Ein Fall von intermittirender Albuminurie und Chromaturie. *Virchows Arch Pathol Anat* 1854;6:264–266.

144. Dickinson WH. Notes on four cases of intermittent haematuria. *Lancet* 1865;i:568–569.

145. Hassall AH. On intermittent, or winter haematuria. *Lancet* 1865;ii:368–369.

146. Heddle NM. Acute paroxysmal cold hemoglobinuria. *Transfus Med Rev* 1989;3:219–229.

147. Göttsche B, Salama A, Mueller-Eckhardt C. Donath–Landsteiner autoimmune hemolytic anemia in children. A study of 22 cases. *Vox Sang* 1990;58:281–286.

148. Gelfand EW, Abramson N, Segel GB, et al. Buffy-coat observations and red cell antibodies in acquired hemolytic anemia. *New Engl J Med* 1971;284:1250–1252.

149. Hinz CB Jr, Picken ME, Lepow IH. Studies on immune human hemolysis. I. The kinetics of the Donath–Landsteiner reaction and the requirement for complement in the reaction. *J Exp Med* 1961;113:177–192.

150. Hinz CF Jr. Serologic and physicochemical characterization of Donath–Landsteiner antibodies from

six patients. *Blood* 1963;22:600–605.

151. Schwarting GA, Kundu SK, Marcus DM. Reaction of antibodies that cause paroxysmal cold hemoglobinuria (PCH) with globoside and Forssman glycosphingolipids. *Blood* 1979;53:186–192.

152. Levine P, Celano MJ, Falkowski F. The specificity of the antibody in paroxysmal cold hemoglobinuria. *Transfusion* 1963;3:278–280.

153. Levine P, Celano MJ, Falkowski F. The specificity of the antibody in paroxysmal cold hemoglobinuria (P.C.H.). *Ann N Y Acad Sci* 1966;124:456–461.

154. Naiki M, Marcus DM. Human erythrocyte P and P<sup>k</sup> blood group antigens: identification as glycosphingolipids. *Biochem Biophys Res Commun* 1974;60:1105–1111.

155. Naiki M, Marcus DM. An immunochemical study of the human blood group P<sub>1</sub>, P and P<sup>k</sup> glycosphingolipid antigens. *Biochemistry* 1975;14:4837–4841.

156. Harris KE, Lewis T, Vaughan JM. Haemoglobinuria and urticaria from cold occurring singly or in combination: observations referring especially to the mechanism of urticaria with some remarks on Raynaud's disease. *Heart* 1929;14:305–336.

157. Hunt JH. The Raynaud phenomena: a critical review. *Quart J Med* 1936;5:399–444.

158. O'Neill BJ, Marshall WC. Paroxysmal cold haemoglobinuria and measles. *Arch Dis Child* 1967;42:183–186.

159. Bunch DF, Schwarz DM, Bird GWG. Paroxysmal cold haemoglobinuria following measles immunization. *Arch Dis Child* 1972;47:299–300.

160. Colley EW. Paroxysmal cold haemoglobinuria after mumps. *BMJ* 1964;i:1552–1553.

161. Boccardi V, D'Annibali S, DiNatale G, et al. *Mycoplasma pneumoniae* infection complicated by paroxysmal cold hemoglobinuria with anti-P specificity of biphasic hemolysin. *Blut* 1977;34:211–214.

162. Sokol RJ, Hewitt S, Stamps BK. Autoimmune haemolysis in childhood and adolescence. *Acta Haematol (Basel)* 1984;72:245–257.

163. Wolach B, Heddle N, Barr RD, et al. Transient Donath–Landsteiner haemolytic anaemia. *Br J Haematol* 1981;48:425–434.

164. Wishart MM, Davey MG. Infectious mononucleosis complicated by acute haemolytic anaemia with a positive Donath–Landsteiner reaction. *J Clin Pathol* 1973;26:332–334.

165. van Loghem JJ, van der Hart M, Dorfmeier H. Serological studies in acquired hemolytic anemia. In: Sixth International Congress of the International Society of Hematology, 1958. Grune & Stratton, 1958.

166. Sokol RJ, Hewitt S, Stamps BK. Autoimmune haemolysis associated with Donath–Landsteiner antibodies. *Acta Haematol (Basel)* 1982;68:268–277.

167. Hernandez JA, Steane SM. Erythrophagocytosis by segmented neutrophils in paroxysmal cold hemoglobinuria. *Am J Clin Pathol* 1984;81:787–789.

168. Mohler DH, Farris BL, Pearre AA. Paroxysmal cold hemoglobinuria with acute renal failure. *Arch Intern Med* 1963;112:36–40.

169. Rausen AR, LeVine R, Hsu TCS, et al. Compatible transfusion therapy for paroxysmal cold hemoglobinuria. *Pediatrics* 1975;55:275–278.

170. Roy–Burman A, Glader BE. Resolution of severe Donath–Landsteiner autoimmune hemolytic anemia temporally associated with institution of plasmapheresis. *Crit Care Med* 2002;30:931–934.

171. Nabarro D. Congenital syphilis. London: Arnold, 1954.
172. Nelson MG, Nicholl B. Paroxysmal cold haemoglobinuria. *Ir J Med Sci, Sixth Series* 1960;410:49–57.
173. Shulman IA, Branch DR, Nelson JM, et al. Autoimmune hemolytic anemia with both cold and warm autoantibodies. *JAMA* 1985;253:1746–1748.
174. Kajii E, Miura Y, Ikemoto S. Characterization of autoantibodies in mixed-type autoimmune hemolytic anemia. *Vox Sang* 1991;60:45–52.
175. Freedman J, Lim FC, Musclove E, et al. Autoimmune hemolytic anemia with concurrence of warm and cold red cell autoantibodies and a warm hemolysin. *Transfusion* 1985;25:368–372.
176. Crookston JH. Hemolytic anemia with IgG and IgM autoantibodies and alloantibodies. *Arch Intern Med* 1975;135:1314–1315.
177. Dausset J, Colombani J. The serology and the prognosis of 128 cases of autoimmune hemolytic anemia. *Blood* 1959;14:1280–1301.
178. Da Costa JAG, White AG, Parker AC, et al. Increased incidence of HL-A1 and 8 in patients showing IgG or complement coating on their red cells. *J Clin Pathol* 1974;27:353–355.
179. Clauvel JP, Marcelli-Barge A, Gautier Coggia I, et al. HL-A antigens and idiopathic autoimmune hemolytic anemias. *Transplant Proc* 1974;6:447–448.
180. Abdel-Khalik A, Paton L, White AG, et al. Human leucocyte antigens A, B, C and DRW in idiopathic ‘warm’ autoimmune haemolytic anaemia. *BMJ* 1980;280:760–761.
181. Toolis F, Parker AC, White A, et al. Familial autoimmune haemolytic anaemia. *BMJ* 1977;1:1392.
182. Sokol R, Hewitt S, Stamps BK. Autoimmune haemolysis: an 18 year study of 865 cases referred to a regional transfusion centre. *Br Med J Clin Res Educ* 1981;282:2023–2027.
183. Dameshek W, Komninos ZD. The present status of treatment of autoimmune hemolytic anemia with ACTH and cortisone. 1956;11:648.
184. Conley CL. Immunologic precursors of autoimmune hematologic disorders. Autoimmune hemolytic observations with particular reference to their prognostic value. A survey of 57 cases. *Johns Hopkins Med J* 1981;149:101–109.
185. Dacie J. Secondary or symptomatic haemolytic anaemias, 3rd ed. Edinburgh: Churchill Livingstone, 1995.
186. Sthoeger ZM, Sthoeger D, Shtalrid M, et al. Mechanism of autoimmune hemolytic anemia in chronic lymphocytic leukemia. *Am J Hematol* 1993; 43:259–264.
187. Puppo F, Torresin A, Lotti G, et al. Autoimmune hemolytic anemia and human immunodeficiency virus (HIV) infection. *Ann Intern Med* 1989;109:249–250.
188. Telen M, Roberts KB, Bartlett JA. HIV-associated autoimmune hemolytic anemia: report of a case and review of the literature. *J Acquir Immune Defic Syndr* 1990;3:933–937.
189. Rubinstein I, et al. Autoimmune hemolytic anemia as the presenting manifestation of malignant thymoma. *Acta Haematol (Basel)* 1985;74:40–42.
190. Halperin IC, Minogue WF, Komninos ZD. Autoimmune hemolytic anemia and myasthenia gravis associated with thymoma. *N Engl J Med* 1966;275:663–664.
191. Rich KC, Arnold WJ, Palella T, et al. Cellular immune deficiency with autoimmune hemolytic anemia in purine nucleoside phosphorylase deficiency. *Am J Med* 1979;67:172–176.
192. Shashaty GG, Rath CE, Britt EJ. Autoimmune hemolytic anemia associated with ulcerative colitis.

Am J Hematol 1977;3:199–208.

193. Engelfriet CP, Overbeeke MA, von dem Borne AE. Autoimmune hemolytic anemia. *Semin Hematol* 1992;29:3–12.

194. Ravetch J, Kinet J-P. Fc receptors. *Annu Rev Immunol* 1991;9:457–492.

195. Anderson CL, Looney RJ. Human leukocyte IgG Fc receptors. *Immunol Today* 1986;7:264.

196. Iwamoto S, Kamesaki T, Oyamada T, et al. Reactivity of autoantibodies of autoimmune hemolytic anemia with recombinant rhesus blood group antigens or anion transporter band 3. *Am J Hematol* 2001;68:106–114.

197. Ley AB, Mayer K, Harris JP. Observations on a 'specific autoantibody'. In: 6th Congress International Society Blood Transfusions, 1956–1958. Boston: Karger, Basel, 1956:148–153.

198. Pirofsky B. Clinical aspects of autoimmune hemolytic anemia. *Semin Hematol* 1976;13:251–265.

199. Jandl JH. Immuno-hemolytic anemias. In: *Blood*, 2nd ed. Boston: Little, Brown and Company, 1996:421–471.

200. Pullarkat V, Ngo M, Iqbal S, et al. Detection of lupus anticoagulant identifies patients with autoimmune haemolytic anaemia at increased risk for venous thromboembolism. *Br J Haematol* 2002;118:1166–1169.

201. Sokol RJ, Hewitt S, Stamps B. Erythrocyte autoantibodies, autoimmune haemolysis and pregnancy. *Vox Sang* 1982;43:169–176.

202. Chaplin H Jr, Cohen R, Bloomberg G, et al. Pregnancy and idiopathic autoimmune haemolytic anaemia: a prospective study during 6 months gestation and 3 months post-partum. *Br J Haematol* 1973;24:219–229.

203. Hershko C, Berrebi A, Resnitzky P, et al. Relapsing haemolytic anaemia of pregnancy with negative antiglobulin reaction. *Scand J Haematol* 1976;16:135–140.

204. Starksen NF, Bell WE, Kickler TS. Unexplained hemolytic anemia associated with pregnancy. *Am J Obstet Gynecol* 1983;146:617–622.

205. Burt RL, Prichard RW. Acquired hemolytic anaemia in pregnancy: report of a case. *Obstet Gynecol* 1957;10:444–450.

206. Salama A, Mueller-Eckhardt C. Autoimmune haemolytic anaemia in childhood associated with non-complement binding IgM autoantibodies. *Br J Haematol* 1987;65:67–71.

207. Johnson ST, McFarland JG, Kelly KJ, et al. Transfusion support with RBCs from an Mk homozygote in a case of autoimmune hemolytic anemia following diphtheria-pertussis-tetanus vaccination. *Transfusion* 2002;42:567–571.

208. Downes KA, Domen RE, McCarron KF, et al. Acute autoimmune hemolytic anemia following DTP vaccination: report of a fatal case and review of the literature. *Clin Pediatr* 2001;40:355–358.

209. Muwakkit S, Rachid R, Bazarbachi A, et al. Treatment-resistant infantile Evans syndrome. *Pediatr Int* 2001;43:502–504.

210. Evans RS, Duane RT. Acquired hemolytic anaemia. I. The relation of antibody activity to activity of the disease. II. The significance of thrombocytopenia and leukopenia. *Blood* 1949;4:1196–1213.

211. Evans RS, Takahashi K, Duane RT, et al. Primary thrombocytopenic purpura and acquired hemolytic anaemia. Evidence for a common etiology. *Arch Intern Med* 1951;87:48–65.

212. Crosby WH, Rappaport H. Autoimmune hemolytic anaemia. I. Analysis of hematologic observations with particular reference to their prognostic value. A survey of 57 cases. *Blood* 1957;12:42–55.

213. Wang WC. Evans syndrome in childhood: pathophysiology, clinical course, and treatment. *Am J Pediatr Hematol Oncol* 1988;10:330–338.
214. Scaradavou A, Bussel J. Evans syndrome results of a pilot study utilizing a multiagent treatment protocol. *J Pediatr Hematol Oncol* 1995;17:290–295.
215. Ucar B, Akgun N, Aydogdu SD, et al. Treatment of refractory Evans' syndrome with cyclosporine and prednisone. *Pediatr Int* 1999;41:104–107.
216. Oyama Y, Papadopoulos EB, Miranda M, et al. Allogeneic stem cell transplantation for Evans syndrome. *Bone Marrow Transplant* 2001;28:903–905.
217. Sokol RJ, Stamps R, Booker DJ, et al. Posttransplant immune-mediated hemolysis. *Transfusion* 2002;42:198–204.
218. Paquette RL, Tran L, Landaw EM. Thrombotic microangiopathy following allogeneic bone marrow transplantation is associated with intensive graft-versus-host disease prophylaxis. *Bone Marrow Transplant* 1998;22:351–357.
219. Liesveld JL, Rowe JM, Lichtman MA. Variability of the erythropoietic response in autoimmune hemolytic anemia: analysis of 189 cases. *Blood* 1987;69:820–826.
220. Mangan KF, Besa EC, Shaddock RK, et al. Demonstration of two distinct antibodies in autoimmune hemolytic anemia with reticulocytopenia and red cell aplasia. *Exp Hematol* 1984;12:788–793.
221. Hauke G, Fauser AA, Weber S, et al. Reticulocytopenia in severe autoimmune hemolytic anemia (AIHA) of the warm antibody type. *Blut* 1983;46:321–327.
222. Lefrère J-J, Couroucé A-M, Bertrand Y, et al. Human parvovirus and aplastic crisis in chronic hemolytic anemias: a study of 24 observations. *Am J Hematol* 1986;23:271–275.
223. LoBuglio AF, Cotran RS, Jandl JH. Specific binding and sphering of gG-globulin-coated red cells by human monocytes and splenic macrophages. *Science* 1967;158:1582–1585.
224. Zinkham WH, Diamond LK. In vitro erythrophagocytosis in acquired hemolytic anemia. *Blood* 1952;7:592–601.
225. Fagiolo E. Platelet and leukocyte antibodies in autoimmune hemolytic anemia. *Acta Haematol (Basel)* 1976;56:97–106.
226. Russell NH, Keenan JP, Fraiss MA. Thrombocytopenia associated with autoimmune hemolytic anemia. *BMJ* 1978;2:604.
227. Tisdale WA, Klatskin G, Kinsella ED. Significance of the indirect-reacting fraction of serum bilirubin in hemolytic jaundice. *Am J Med* 1959;26:214–227.
228. Payne R, Spaet TH, Aggeler PM. An unusual antibody pattern in a case of idiopathic acquired hemolytic anemia. *J Lab Clin Med* 1955;46:245–254.
229. Kretschmer V, Mueller-Eckhardt C. Autoimmune hemolytic anemias. II. Immunoglobulins and b1-globulin in the serum with special regard to the immunochemical type of autoantibodies and the course of the disease. *Blut* 1972;25:159–168.
230. Mueller-Eckhardt C, Möhring F, Kretschmer V, et al. Reappraisal of the clinical and etiologic significance of immunoglobulin deviations in autoimmune hemolytic anemia ('warm type'). *Blut* 1977;34:39–47.
231. Chaplin H Jr. Clinical usefulness of specific antiglobulin reagents in autoimmune hemolytic anemias. *Prog Hematol* 1973;7:25–49.
232. Aragués C, Martí-n-Vega C, Massagué I, et al. 'Complete' warm hemolysins producing an

autoimmune hemolytic anemia. *Vox Sang* 1990;59:125–126.

233. Wolf MW, Roelcke D. Incomplete warm hemolysins. *Clin Immunol Immunopathol* 1989;51:68–76.

234. Lalezari P. Serologic profile in autoimmune hemolytic disease: pathophysiologic and clinical interpretations. *Semin Hematol* 1976;13:291–310.

235. Van der Meulen FW, de Bruin HG, Goosen PC, et al. Quantitative aspects of the destruction of red cells sensitized with IgG1 autoantibodies: an application of flow cytometry. *Br J Haematol* 1980;46:47–56.

236. Gehrs BC, Friedberg RC. Autoimmune hemolytic anemia. *Am J Hematol* 2002;69:258–271.

237. Petz LD. Treatment of autoimmune hemolytic anemias. *Curr Opin Hematol* 2001;8:411–416.

238. Dacie SJ. The immune haemolytic anaemias: a century of exciting progress in understanding. *Br J Haematol* 2001;114:770–785.

239. Meyer O, Stahl D, Beckhove P, et al. Pulsed high-dose dexamethasone in chronic autoimmune haemolytic anaemia of warm type. *Br J Haematol* 1997;98:860–862.

240. Murphy S, LoBuglio AF. Drug therapy in autoimmune hemolytic anemia. *Semin Hematol* 1976;13:323–334.

241. Allgood JW, Chaplin H. Idiopathic acquired autoimmune hemolytic anemia: a review of forty-seven cases treated from 1955 through 1965. *Am J Med* 1967;43:254–273.

242. Zupanska B, Sylwestrowicz T, Pawelski S. The results of prolonged treatment of autoimmune haemolytic anaemia. *Haematologia* 1981;14:425–433.

243. Casey TP, Howie JB. Autoimmune hemolytic anemia in NZB/BL mice treated with the corticosteroid drug betamethasone. *Blood* 1965;25:423–431.

244. Rosse WF. *Clinical immunohematology: basic concepts and clinical applications*. Boston: Blackwell Scientific Publications, 1990.

245. Rosse WF. Quantitative immunology of immune hemolytic anemia. II. The relationship of cell-bound antibody to hemolysis and the effect of treatment. *J Clin Invest* 1971;50:734–743.

246. Davidsohn I, Spurrier W. Immunohematological studies in hemolytic anemia. *JAMA* 1954;154:818–821.

247. Frank MM, Schreiber AD, Atkinson JP. NIH conference. Pathophysiology of immune hemolytic anemia. *Ann Intern Med* 1977;87:210–222.

248. Fries LF, Brickman M, Frank MM. Monocyte receptors for the Fc portion of IgG increase in number of autoimmune hemolytic anemia and other hemolytic states and are decreased by glucocorticoid therapy. *J Immunol* 1983;131:1240–1245.

249. Plapp F, Beck ML. Transfusion support in the management of immune hemolytic disorders. *Clin Haematol* 1984;13:167–183.

250. Mollison PL. Measurement of survival and destruction of red cells in haemolytic syndromes. *Br Med Bull* 1959;15:59–67.

251. Morel PA, Bergren MO, Frank BA. A simple method for the detection of alloantibody in the presence of warm autoantibody. *Transfusion* 1978;18:388(abst).

252. Issitt PD, Combs MR, Bumgarner DJ, et al. Studies of antibodies in the sera of patients who have made red cell autoantibodies. *Transfusion* 1996;36:481–486.

253. Shirey RS, Boyd JS, Parwani WS, et al. Prophylactic antigen-matched donor blood for patients with warm autoantibodies: an algorithm for transfusion management. *Transfusion* 2002;42:1435–1441.

254. Mullon J, Giacompe G, Clagett C, et al. Transfusions of polymerized bovine hemoglobin in a patient with severe autoimmune hemolytic anemia. *N Engl J Med* 2000;342:1638–1643.
255. Christensen BE. The pattern of erythrocyte sequestration in immunohaemolysis. *Scand J Haematol* 1973;10:120–129.
256. Goldberg A, Hutchison HE, MacDonald E. Radiochromium in the selection of patients with haemolytic anaemia for splenectomy. *Lancet* 1966;i:109–114.
257. Gibson J. Autoimmune hemolytic anemia: current concepts. *Aust N Z J Med* 1988;18:625–637.
258. Pirofsky B, Bardana EJ Jr. Autoimmune hemolytic anemia: II. Therapeutic aspects. *Ser Haematol* 1974;7:376–385.
259. Akpek G, McAneny D, Weintraub L. Comparative response to splenectomy in Coombs-positive autoimmune hemolytic anemia with or without associated disease. *Am J Hematol* 1999;61:98–102.
260. Heisel MA, Ortega JA. Factors influencing prognosis in childhood autoimmune hemolytic anemia. *Am J Pediatr Hematol Oncol* 1983;5:147–152.
261. Markus H, Forfar JC. Splenic irradiation in treating warm autoimmune haemolytic anaemia. *Br Med J Clin Res* 1986;293:839–840.
262. Dameshek W. Acquired hemolytic anemia: physiopathology with particular reference to autoimmunization and therapy. In: 3rd Congr Into Soc Hemat, 1950–1951. Cambridge: Grune & Stratton, 1950:120–133.
263. Schwartz R, Eisner A, Dameshek W. The effect of 6-mercaptopurine on primary and secondary immune responses. *J Clin Invest* 1959;38:1394–1403.
264. Schwartz R, J S, Dameshek W. Effect of 6-mercaptopurine on antibody production. *Proc Soc Exp Biol Med (N.Y.)* 1958;99:164–167.
265. Corley CC, Lessner HE, Larsen WE. Azathioprine therapy of ‘autoimmune’ disease. *Am J Med* 1966;41:404–412.
266. Worledge SM. Immune haemolytic anaemia (revised by NC Hughes-Jones and B Bain). In: Hardisty RM, Weatherall DJ, eds. *Blood and its disorders*. Oxford: Blackwell Scientific Publications, 1982:479–513.
267. Floersheim GL. A comparative study of the effects of anti-tumor and immunosuppressive drugs on antibody forming and erythropoietic cells. *Clin Exp Immunol* 1970;6:861–870.
268. Johnson WW, Meadows DC. Urinary bladder fibrosis and telangiectasia associated with long-term cyclophosphamide therapy. *N Engl J Med* 1971;284:290–294.
269. Kumar R, Biggart JD, McEvoy J, et al. Cyclophosphamide and reproductive function. *Lancet* 1972;1:1212–1214.
270. Cheema AR, Hersh EM. Patient survival after chemotherapy and its relationship to in vitro lymphocyte blastogenesis. *Cancer* 1971;28:851–855.
271. Moyo VM, Smith D, Brodsky I, et al. High-dose cyclophosphamide for refractory autoimmune hemolytic anemia. *Blood* 2002;100:704–706.
272. Ahrens N, Kingreen D, Seltsam A, et al. Treatment of refractory autoimmune haemolytic anaemia with anti-CD20 (rituximab). *Br J Haematol* 2001;114:244–245.
273. Quartier P, Brethon B, Philippet P, et al. Treatment of childhood autoimmune haemolytic anaemia with rituximab. *Lancet* 2001;358:1511–1513.
274. Perrotta S, Locatelli F, La Manna A, et al. Anti-CD20 monoclonal antibody (Rituximab) for life-threatening autoimmune haemolytic anaemia in a patient with systemic lupus erythematosus. *Br J*



Haematol 2002;116:465–467.

275. McMahon C, Babu L, Hodgson A, et al. Childhood refractory autoimmune haemolytic anaemia: is there a role for anti-CD20 therapy (rituximab)? *Br J Haematol* 2002;117:480–483.

276. Zecca M, Nobili B, Ramenghi U, et al. Rituximab for the treatment of refractory autoimmune hemolytic anemia in children. *Blood* 2003 ( *in press*).

277. Kunkel L, Wong A, Maneatis T, et al. Optimizing the use of rituximab for treatment of B-cell non-Hodgkin's lymphoma: a benefit-risk update. *Semin Oncol* 2000;27[Suppl 12]:53–61.

278. van der Kolk LE, Baars JW, Prins MH, et al. Rituximab treatment results in impaired secondary humoral immune responsiveness. *Blood* 2002;100:2257–2259.

279. Howard J, Hoffbrand AV, Prentice HG, et al. Mycophenolate mofetil for the treatment of refractory auto-immune haemolytic anaemia and auto-immune thrombocytopenia purpura. *Br J Haematol* 2002;117:712–715.

280. Zimmer-Molsberger B, Knauf W, Thiel E. Mycophenolate mofetil for severe autoimmune haemolytic anemia. *Lancet* 1997;350:1003–1004.

281. Willis F, Marsh JC, Bevan DH, et al. The effect of treatment with Campath-1H in patients with autoimmune cytopenias. *Br J Haematol* 2001;114:891–898.

282. Emilia G, Messori C, Longo G, et al. Long-term salvage treatment by cyclosporin in refractory autoimmune haematological disorders. *Br J Haematol* 1996;93:341–344.

283. Chemlal K, Wyplosz B, Grange MJ, et al. Salvage therapy and long-term remission with danazol and cyclosporine in refractory Evan's syndrome. *Am J Hematol* 1999;62:200.

284. Rackoff WR, Manno CS. Treatment of refractory Evans syndrome with alternate-day cyclosporine and prednisone. *Am J Pediatr Hematol Oncol* 1994;16:156–159.

285. Bussell JB, Cunningham-Rundles C, Abraham C. Intravenous treatment of autoimmune hemolytic anemia with very high dose gammaglobulin. *Vox Sang* 1986;51:264–269.

286. Leickly FE, Buckley RH. Successful treatment of auto-immune hemolytic anemia in common variable immunodeficiency with high-dose intravenous gamma globulin. *Am J Med* 1987;82:159–162.

287. Majer RV, Hyde RD. High-dose intravenous immunoglobulin in the treatment of autoimmune haemolytic anaemia. *Clin Lab Haematol* 1988;10:391–395.

288. Salama A, Mahn I, Neuzner J, et al. IgG therapy in autoimmune haemolytic anaemia of warm type. *Blut* 1984;48:391–392.

289. Weinblatt ME. Treatment of immune hemolytic anemia with gammaglobulin [Letter]. *J Pediatr* 1987;110:817.

290. Vandenberghe P, Zachee P, Verstraete S, et al. Successful control of refractory and life-threatening autoimmune hemolytic anemia with intravenous immunoglobulins in a man with the primary antiphospholipid syndrome. *Ann Hematol* 1996;73:253–256.

291. Bayry J, Lacroix-Desmazes S, Carbonneil C, et al. Inhibition of maturation and function of dendritic cells by intravenous immunoglobulin. *Blood* 2003;101:758–765.

292. Mackay IR, Rosen FS. Immunomodulation of autoimmune and inflammatory diseases with intravenous immune globulin. *N Engl J Med* 2001;345:747–755.

293. Anderson O, Taaning E, Rosenkvist J, et al. Autoimmune haemolytic anaemia treated with multiple transfusion, immunosuppressive therapy, plasma exchange, and desferrioxamine. *Acta Paediatr Scand* 1984;73:145–148.

294. Kutti J, Wadenvik H, Safai-Kutti S, et al. Successful treatment of refractory autoimmune haemolytic

anaemia by plasmapheresis. *Scand J Haematol* 1984;32:149–152.

295. Jaweed M, Nifong TP, Domen RE, et al. Durable response to combination therapy including staphylococcal protein A immunoabsorption in life-threatening refractory autoimmune hemolysis. *Transfusion* 2002;42:1217–1220.

296. Horstman LL, Jy W, Ahn YS. Danazol inhibits autoantibody binding to erythrocytes in vitro at physiological concentrations. *Clin Res* 1991;39:364A(abst).

297. Ahn YS, Harrington WJ, Mylvaganam R, et al. Danazol therapy for autoimmune hemolytic anemia. *Ann Intern Med* 1985;102:298–301.

298. Seeliger S, Baumann M, Mohr M, et al. Autologous peripheral blood stem cell transplantation and anti-B-cell directed immunotherapy for refractory auto-immune haemolytic anaemia. *Eur J Pediatr* 2001;160:492–496.

299. Raetz E, Beatty PG, Adams RH. Treatment of severe Evans syndrome with an allogeneic cord blood transplant. *Bone Marrow Transplant* 1997;20:427–429.

300. Gertz MA, Pettit RM, Alvaro A, et al. Vinblastine-loaded platelets for autoimmune hemolytic anemia. *Ann Intern Med* 1981;95:325–326.

301. Ahn YS, Harrington WJ, Byrnes JJ, et al. Treatment of autoimmune hemolytic anemia with Vinca-loaded platelets. *JAMA* 1983;249:2189–2194.

302. Hartman MM. Reversal of serologic reactions by heparin. Therapeutic implications. II. Idiopathic acquired hemolytic anemia. *Ann Allergy* 1964;22:313–320.

303. Rosenfield RE, Vitale B, Kochwa S. Immune mechanisms for destruction of erythrocytes in vivo. II. Heparinization for protection of lysin-sensitized erythrocytes. *Transfusion* 1967;7:261–264.

304. Karaklis A, Valaes T, Pantelakis SN, et al. Thymectomy in an infant with autoimmune haemolytic anaemia. *Lancet* 1964;ii:778–780.

305. Ackroyd JF. The pathogenesis of thrombocytopenic purpura due to hypersensitivity to Sedormid (allylisopropyl-acetylcarbamide). *Clin Sci* 1949;7:249.

306. Snapper I, Marks D, Schwartz L, et al. Hemolytic anemia secondary to Mesantoin. *Ann Intern Med* 1953;39:619.

307. Harris JW. Studies on the mechanism of a drug-induced hemolytic anemia. *J Lab Clin Med* 1956;47:760.

308. Ley AB, Harris JP, Brinkley M, et al. Circulating antibodies directed against penicillin. *Science* 1958;127:1118.

309. Strumia PV, Raymond FD. Acquired hemolytic anemia and antipenicillin antibody: case report and review of literature. *Arch Intern Med* 1962;109:603.

310. Petz LD, Fudenberg HH. Coombs-positive hemolytic anemia caused by penicillin administration. *N Engl J Med* 1966;274:171–178.

311. Swanson MA, Chanmougan D, Schwartz RS. Immuno-hemolytic anemia due to anti-penicillin antibodies. *N Engl J Med* 1966;274:178–181.

312. Levine BB, Redmond A. Immunochemical mechanisms of penicillin induced Coombs positivity and hemolytic anemia in man. *Int Arch Allergy Appl Immunol* 1967;31:594–606.

313. Petz LD. Immunologic cross-reactivity between penicillins and cephalosporins: a review. *J Infect Dis* 1978;137S:S74–S79.

314. Kerr RO, Caramone J, Dalmaso AP, et al. Two mechanisms of erythrocyte destruction in

penicillin-induced hemolytic anemia. *N Engl J Med* 1972;287:1322–1325.

315. Ries CA, Rosenbaum TJ, Garratty G, et al. Penicillin-induced immune hemolytic anemia. *JAMA* 1975;233:432–435.

316. Nesmith LW, Davis JW. Hemolytic anemia caused by penicillin. *JAMA* 1968;203:27–30.

317. Funicella T, Weinger RS, Moake JL, et al. Penicillin-induced immunohemolytic anemia associated with circulating immune complexes. *Am J Hematol* 1977;3:219–223.

318. Gralnick HR, Wright LD, McGinniss MH. Coombs' positive reactions associated with sodium cephalothin therapy. *JAMA* 1967;199:725–726.

319. Gralnick HR, McGinniss MH, Elton W, et al. Hemolytic anemia associated with cephalothin. *JAMA* 1971;217:1193–1197.

320. Branch DR, Berkowitz LR, Becker RL, et al. Extravascular hemolysis following the administration of cefamandole. *Am J Hematol* 1985;18:213–219.

321. Chambers LA, Donovan BA, Kruskall MS. Ceftazidime-induced hemolysis patient with drug-dependent antibodies reactive by immune complex and drug adsorption mechanisms. *Am J Clin Pathol* 1991;95:393–396.

322. Garratty G, Nance S, Lloyd M, et al. Fatal immune hemolytic anemia due to cefotetan. *Transfusion* 1992;32:269–271.

323. Simpson MB, Pryzbylik J, Innis B, et al. Hemolytic anemia after tetracycline therapy. *N Engl J Med* 1985;312:840–842.

324. Wenz B, Klein RL, Lalezari P. Tetracycline-induced immune hemolytic anemia. *Transfusion* 1974;14:265–269.

325. Malacarne P, Castaldi G, Bertusi M, et al. Tolbutamide-induced hemolytic anemia. *Diabetes* 1977;26:156–158.

326. Tuffs L, Manoharan A. Flucloxacillin-induced haemolytic anaemia. *Med J Aust* 1986;144:559–560.

327. Seldon MR, Bain B, Johnson CA, et al. Ticarcillin-induced immune haemolytic anaemia. *Scand J Haematol* 1982;28:459–460.

328. Stefanini M, Johnson NL. Positive antihuman globulin test in patients receiving carbromal. *Am J Med Sci* 1970;259:49–55.

329. Croft JD, Swisher SN, Gilliland BC, et al. Coombs'–test positivity induced by drugs. Mechanisms of immunologic reactions and red cell destruction. *Ann Intern Med* 1968;68:176–187.

330. Duran-Suarez JR, Marin-Vega C, Argelagues E, et al. Red cell I antigen as immune complex receptor in drug-induced hemolytic anemias. *Vox Sang* 1981;41:313–315.

331. Salama A, Mueller-Eckhardt C. Rh blood group-specific antibodies in immune hemolytic anemia induced by nomifensine. *Blood* 1986;68:1285–1288.

332. Christie DJ, Mullen PC, Aster RH. Fab-mediated binding of drug-dependent antibodies to platelets in quinidine- and quinine-induced thrombocytopenia. *J Clin Invest* 1985;75:310–314.

333. Smith ME, Reid DM, Jones CE, et al. Binding of quinine- and quinidine-dependent drug antibodies to platelets is mediated by the Fab domain of immunoglobulin G and is not Fc dependent. *J Clin Invest* 1987;79:912–917.

334. Habibi B, Bretagne Y. Blood group antigens may be the receptors for specific drug-antibody complexes reacting with red blood cells. *C R Acad Sci (Paris)* 1983;296:693–696.

335. Salama A, Mueller-Eckhardt C. On the mechanisms of sensitization and attachment of antibodies to

RBC in drug-induced immune hemolytic anemia. *Blood* 1987;69:1006-1010.

336. Habibi B, Basty R, Chodez S, et al. Thiopental-related immune hemolytic anemia and renal failure. *N Engl J Med* 1985;312:353-355.

337. Sandvei P, Nordhagen R, Michaelsen TE, et al. Fluorouracil (5-FU) induced acute immune haemolytic anaemia. *Br J Haematol* 1987;65:357-359.

338. Garratty G. Current viewpoints on mechanisms causing drug-induced immune hemolytic anemia and/or positive direct antiglobulin tests. *Immunohematology* 1989;5:97-106.

339. Petz LD. Drug-induced immune hemolytic anemia. In: Nance S, ed. *Immune destruction of red blood cells*. Arlington, VA: American Association of Blood Banks, 1989:53-75.

340. Mueller-Eckhardt C, Salama A. Drug-induced immune cytopenias: a unifying pathogenetic concept with special emphasis on the role of drug metabolites. *Transfus Med Rev* 1990;4:69-77.

341. Muirhead EE, Halden ER, Groves M. Drug-dependent Coombs' (antiglobulin) test and anemia. *Arch Intern Med* 1958;101:87.

342. Muirhead EF, Groves M, Guy R, et al. Acquired hemolytic anemia, exposures to insecticides and positive Coombs' test dependent on insecticide preparations. *Vox Sang* 1959;4:277.

343. Worledge SM, Carstairs KC, Dacie JV. Autoimmune haemolytic anaemia associated with alpha-methylidopa therapy. *Lancet* 1966;2:135-139.

344. Carstairs KC, Breckenridge A, Dollery CT, et al. Incidence of a positive direct Coombs' test in patients on alpha-methylidopa. *Lancet* 1966;2:133-135.

345. Territo MC, Peters RW, Tanaka KR. Autoimmune hemolytic anemia due to levodopa therapy. *JAMA* 1973;226:1347-1348.

346. Kleinman S, Nelson R, Smith L, et al. Positive direct antiglobulin tests and immune hemolytic anemia in patients receiving procainamide. *N Engl J Med* 1984;311:809-812.

347. Worledge SM. Autoantibody formation associated with methylidopa (Aldomet) therapy. *Br J Haematol* 1969;16:5-8.

348. Hunter E, Raik E, Gordon S, et al. Incidence of positive Coombs' test, LE cells and antinuclear factor in patients on alpha-methylidopa (Aldomet) therapy. *Med J Aust* 1971;2:810-812.

349. Garratty G, Nance SJ. Correlation between in vivo hemolysis and the amount of red cell-bound IgG measured by flow cytometry. *Transfusion* 1990;30:617-631.

350. Lalezari P, Louie JE, Fadlallah N. Serologic profile of alphas-methylidopa-induced hemolytic anemia: correlation between cell-bound IgM and hemolysis. *Blood* 1982;59:61-68.

351. Kelton JG. Impaired reticuloendothelial function in patients treated with methylidopa. *N Engl J Med* 1985;313:596-600.

352. Bakemeier RF, Leddy JP. Erythrocyte autoantibody associated with alpha-methylidopa: heterogeneity of structure and specificity. *Blood* 1968;32:1-14.

353. LoBuglio AF, Jandl JH. The nature of the alpha-methylidopa red-cell antibody. *N Engl J Med* 1967;276:658-665.

354. Leddy JP, Falany JL, Kissel GE, et al. Erythrocyte membrane proteins reactive with human (warm-reacting) anti-red cell autoantibodies. *J Clin Invest* 1993;91:1672-1680.

355. Patten E, Beck CE, Scholl C, et al. Autoimmune hemolytic anemia with anti-Jk<sup>a</sup> specificity in a patient taking Aldomet. *Transfusion* 1977;17:517-520.

356. Kessey EC, Pierce S, Beck ML, et al. Alpha-methylidopa-induced hemolytic anemia involving

autoantibody with U specificity. *Transfusion* 1973;13:360 (abst).

357. Breckenridge A, Dollery CT, Worledge SM, et al. Positive direct Coombs tests and antinuclear factor in patients treated with methyl dopa. *Lancet* 1967;2:1265-1267.

358. Green FA, Jung CY, Hui H. Modulation of alpha-methyl dopa and the erythrocyte membrane. *Clin Exp Immunol* 1980;40:554-560.

359. Arndt PA, Leger RM, Garratty G. Serology of antibodies to second- and third-generation cephalosporins associated with immune hemolytic anemia and/or positive direct antiglobulin tests. *Transfusion* 1999;39:1239-1246.

360. Kirtland HH III, Mohler DN, Horwitz DA. Methyl dopa inhibition of suppressor-lymphocyte function. *N Engl J Med* 1980;302:825-832.

361. Garratty G, Arndt P, Prince HE, et al. The effect of methyl dopa and procainamide on suppressor cell activity in relation to red cell autoantibody production. *Br J Haematol* 1993;84:310-315.

362. Blomgren SE, Condemi JJ, Vaughan JH. Procainamide-induced lupus erythematosus: clinical and laboratory observations. *Am J Med* 1972;52:238-348.

363. Gold EF, Ben-Efraim B, Faivisewitz A, et al. Experimental studies on the mechanism of induction of anti-nuclear antibodies by procainamide. *Clin Immunol Immunopathol* 1977;7:176-186.

364. Cornacchia E, Golbus J, Maybaum J, et al. Hydralazine and procainamide inhibit T cell DNA methylation and induce autoreactivity. *J Immunol* 1988;140:2197-2200.

365. Schoen RT, Trentham DE. Drug-induced lupus: an adjuvant disease? *Am J Med* 1981;71:5-8.

366. Abraham GN, Petz LD, Fudenberg HH. Immunohaematological cross-allergenicity between penicillin and cephalothin in humans. *Clin Exp Immunol* 1968;3:343-357.

367. Spath P, Garratty G, Petz LD. Studies on the immune response to penicillin and cephalothin in humans. II. Immunohematologic reactions to cephalothin administration. *J Immunol* 1971;107:860-869.

368. Hart MN, Mesara BW. Phenacetin antibody cross-reactive with autoimmune erythrocyte antibody. *Am J Clin Pathol* 1969;52:695-701.

369. Florendo NT, MacFarland D, Painter M, et al. Streptomycin-specific antibody coincident with a developing warm autoantibody. *Transfusion* 1980;20:662-668.

370. Squire JE, Mintz PD, Clark S. Tolmetin-induced hemolysis. *Transfusion* 1985;25:410-413.

371. Shirey RS, Morton SJ, Lawton KB, et al. Fenoprofen-induced immune hemolysis. Difficulties in diagnosis and complications in compatibility testing. *Am J Clin Pathol* 1988;89:410-414.

372. Van Dijk BA, Rico PB, Hoitsma A, et al. Immune hemolytic anemia associated with tolmetin and suprofen. *Transfusion* 1989;29:638-641.

373. Shirey RS, Kickler TS, Weigman FL, et al. Fatal immune hemolysis associated with sulindac. *Transfusion* 1987;27:515(abst).

374. Schulenberg BJ, Beck ML, Pierce SR, et al. Immune hemolysis associated with Zomax. *Transfusion* 1983;23:409(abst).

375. Salama A, Mueller-Eckhardt C. Two types of nomifensine-induced immune haemolytic anaemias: drug-dependent sensitization and/or autoimmunization. *Br J Haematol* 1986;64:613-620.

376. Salama A, Gottsche B, Mueller-Eckhardt C. Autoantibodies and drug- or metabolite-dependent antibodies in patients with diclofenac-induced immune haemolysis. *Br J Haematol* 1991;77:546-549.

377. Habibi B. Drug induced red blood cell autoantibodies co-developed with drug specific antibodies

causing haemolytic anaemias. *Br J Haematol* 1985;61:139–143.

378. Salama A, Mueller–Eckhardt C. Cianidanol and its metabolites bind tightly to red cells and are responsible for the production of auto– and/or drug–dependent antibodies against these cells. *Br J Haematol* 1987;66:263–266.

379. Garratty G, Houston M, Petz LD, et al. Acute immune intravascular hemolysis due to hydrochlorothiazide. *Am J Clin Pathol* 1981;76:73–78.

380. Shulman IA, Arndt PA, McGehee W, et al. Cefotaxime–induced immune hemolytic anemia due to antibodies reacting in vitro by more than one mechanism. *Transfusion* 1990;30:263–266.

381. Zeigler A, Shaddock RK, Winkelstein A, et al. Immune hemolytic anemia and thrombocytopenia secondary to quinidine–dependent red cell and platelet antibodies. *Blood* 1979;53:396–402.

382. Takahashi H, Tsukada T. Triamterene–induced immune haemolytic anaemia with acute intravascular haemolysis and acute renal failure. *Scand J Haematol* 1979;23:169–176.

383. MacGibbon BH, Loughridge LW, Hourihane DB, et al. Autoimmune haemolytic anaemia with acute renal failure due to phenacetin and p–aminosalicylic acid. *Lancet* 1960;1:7.

384. Garratty G, Leger RM, Arndt PA. Severe immune hemolytic anemia associated with prophylactic use of cefotetan in obstetric and gynecologic procedures. *Am J Obstet Gynecol* 1999;181:103–104.

385. Naylor CS, Steele L, Hsi R, et al. Cefotetan–induced hemolysis associated with antibiotic prophylaxis for cesarean delivery. *Am J Obstet Gynecol* 2000;182:1427–1428.

386. Ray EK, Warkentin TE, O'Hoski PL, et al. Delayed onset of life–threatening immune hemolysis after perioperative antimicrobial prophylaxis with cefotetan. *Can J Surg* 2000;43:461–462.

387. Garratty G, Postoway N, Schwellenbach J, et al. A fatal case of ceftriaxone (Rocephin)–induced hemolytic anemia associated with intravascular immune hemolysis. *Transfusion* 1991;31:176–179.

388. Petz LD. Drug–induced autoimmune hemolytic anemia. *Transfus Med Rev* 1993;7:242–254.

2004 Lippincott Williams & Wilkins  
John P. Greer, John Foerster, John N. Lukens  
George M. Rodgers, Frixos Paraskevas, Bertil Glader  
Wintrobe's Clinical Hematology

## Alloimmune Hemolytic Disease of the Fetus and Newborn

### [HISTORICAL BACKGROUND](#)

### [PATHOPHYSIOLOGY](#)

#### [Fetal-Maternal Hemorrhage](#)

#### [Maternal Alloimmunization to Blood Group Antigens](#)

#### [ABO Blood Group Isoagglutinins](#)

#### [Fetal and Neonatal Immune-Mediated Anemia](#)

#### [Neonatal Immune-Mediated Hyperbilirubinemia](#)

### [CLINICAL FEATURES](#)

### [LABORATORY EVALUATION](#)

#### [Maternal ABO/Rh Type and Antibody Screen](#)

#### [Serologic and Molecular Testing for Paternal/Fetal Blood Group Antigens](#)

#### [Maternal Red Cell Alloantibody Titers](#)

#### [Tests for Fetal-Maternal Hemorrhage](#)

#### [Noninvasive Fetal Monitoring](#)

#### [Amniotic Fluid Analysis](#)

#### [Fetal Blood Sampling](#)

#### [Laboratory Testing of Newborn Infants](#)

### [PREVENTION OF MATERNAL D ALLOIMMUNIZATION WITH RH IMMUNE GLOBULIN](#)

#### [Viral Safety Record](#)

#### [Dosage and Administration](#)

#### [International Clinical Practice Guidelines](#)

### [MANAGEMENT OF RED CELL ALLOIMMUNIZATION IN PREGNANCY](#)

#### [Amniocentesis versus Cordocentesis](#)

#### [Intrauterine Fetal Transfusion](#)

#### [Investigational Strategies](#)

### [TREATMENT OF THE NEWBORN INFANT](#)

#### [Phototherapy](#)

#### [Exchange Transfusion](#)

#### [Transfusion for Late-Onset Neonatal Anemia](#)

#### [Adjunctive and Experimental Treatment](#)

### [OUTCOME STUDIES](#)

### [CONCLUSION](#)

### [WEB SITES](#)

### [REFERENCES](#)

Alloimmune hemolytic disease of the fetus and newborn (HDF/N) results from the destruction of red cells by maternal immunoglobulin (Ig) G antibodies that gain access to the fetal circulation during gestation. The antibodies may be directed against Rhesus or other blood group antigens on fetal red cells, inherited from the father, that are not present on the mother's red cells. The outcome of immunized pregnancies varies drastically, ranging from asymptomatic infants demonstrating only laboratory evidence of maternal antibodies to fetal or perinatal death (1). Clinical manifestations of severe hemolytic disease before birth include profound fetal anemia, hepatosplenomegaly, generalized edema, massive ascites, and congestive heart failure. The accelerated destruction of fetal red cells elicits extramedullary hematopoiesis and release of nucleated and other immature red cells into the peripheral circulation (erythroblastosis fetalis). Ongoing hemolysis of red cells after birth results in neonatal hyperbilirubinemia



and may lead to kernicterus and permanent brain damage or death.

## HISTORICAL BACKGROUND

The twentieth century witnessed the identification of HDF/N as a clinical entity, the delineation of its underlying pathogenesis, and the introduction of an effective strategy for preventing its most common, severe form. Numerous case reports in the 1900s and earlier described stillborn, edematous infants with hydrops fetalis and anemic infants with prominent jaundice dying within days of birth. Not until 1932 were these phenomena unified on Occam's razor as manifestations of the same hematologic disease process when Diamond et al. described the interrelationship of neonatal anemia, jaundice, and edema as symptoms that occur in varying degrees and combinations in erythroblastosis fetalis ( [2](#) ).

The precise etiology of the disease remained obscure until seminal observations on blood group antigens and incompatibility in pregnancy were made in the 1940s. Landsteiner and Weiner first used immune sera raised in rabbits against red blood cells from Rhesus monkeys to agglutinate human red blood cells, thus discovering the Rhesus factor ( [3](#) ). This antigen, now known as the D antigen of the Rhesus blood group in humans, is present exclusively on red cells of Rh-positive individuals. In the year before this discovery, Levine and Stetson recognized that a woman could become immunized against paternally inherited red blood cell determinants during pregnancy ( [4](#) ). Using Landsteiner's anti-Rh antisera to investigate cases of erythroblastosis fetalis, Levine and colleagues subsequently demonstrated that 90% of the mothers were Rh-negative, and all the fathers and infants were Rh-positive ( [5](#) ). This statistical association as well as the presence of Rh agglutinins in the blood of mothers with affected infants supported their theory that alloimmunization and transplacental passage of these antibodies caused destruction of fetal red cells ( [5](#) ). The inciting stimulus for red cell alloimmunization in pregnancy, the passage of fetal red cells into the maternal circulation or fetal-maternal hemorrhage (FMH), was directly demonstrated by Chown in 1954 ( [6](#) ).

Methods to monitor alloimmunized pregnancies and to treat affected fetuses and infants were first introduced in the late 1940s. Neonatal exchange transfusion enabled simultaneous correction of the anemia and reduction of bilirubin concentration in affected infants ( [1](#), [7](#) ). In 1961, Liley described the relationship between the concentration of bilirubin in amniotic fluid and the degree of destruction of fetal red cells, providing a tool to assess the severity of intrauterine hemolytic disease ( [8](#) ). Two years later, Liley introduced the technique of intraperitoneal transfusion of anemic fetuses, which was used for more than 20 years before it was largely supplanted with intravascular transfusion techniques ( [9](#) ).

Primary prevention of D alloimmunization became possible with the advent of anti-D immune prophylaxis. The ability of passively transferred antibodies to effectively block active immunization to foreign antigens was first demonstrated by Von Dungern in 1900 ( [1](#) ). Experimental studies in the 1960s applied this approach to D alloimmunization, revealing that Rh-negative men could be protected if administered anti-D immune globulin (RhIG) before transfusion with Rh-positive red cells ( [10](#), [11](#) ). Between 1963 and 1968, clinical trials involving Rh-negative pregnant women demonstrated that administration of RhIG within 72 hours of delivery was successful in reducing the incidence of D alloimmunization from 7 to 15% to 1 to 2% ( [12](#), [13](#), [14](#), [15](#), [16](#) and [17](#) ). Metaanalysis of clinical trials of postpartum RhIG administration confirms a greater than 90% reduction in the alloimmunization rate among treated women compared to untreated women ( [Table 36.1](#) ) ( [17](#) ). The recognition that FMH occurring primarily in the third trimester contributed to

residual risk of alloimmunization during pregnancy led to the clinical observation that additional, antenatal RhIG prophylaxis could further reduce the risk of D alloimmunization to below 1% ( [18](#), [19](#)). Metaanalysis of two randomized controlled trials involving more than 4500 women confirms the effectiveness of antenatal administration of RhIG at 28 weeks and 32 weeks of pregnancy ( [Table 36.1](#)) ( [20](#), [21](#) and [22](#)).

**TABLE 36.1. Metaanalysis of Anti-D Immune Globulin (RhIG) Clinical Trials**

|   | Treatment         | Control           | Odds Ratio, 95% Confidence Interval |
|---|-------------------|-------------------|-------------------------------------|
| Postpartum RhIG (treatment) vs. no treatment (control)                  |                   |                   |                                     |
| Immunization after 6 mo (5 RCTs)  | 10/4756<br>(0.2%) | 204/2824<br>(7%)  | 0.08 (0.06, 0.11)                   |
| Immunization in a subsequent pregnancy (4 RCTs)                         | 11/682<br>(1.6%)  | 57/389<br>(14.6%) | 0.12 (0.70, 0.19)                   |
| Postpartum and antenatal RhIG (treatment) vs. postpartum RhIG (control) |                   |                   |                                     |
| Immunization in pregnancy after birth of Rh-positive infant (2 RCTs)    | 5/1112<br>(0.4%)  | 13/1185<br>(1.1%) | 0.44 (0.18, 1.12)                   |
| Immunization at 2–12 mo, primigravidae (1 RCT)                          | 0/362 (0)         | 4/360<br>(0.7%)   | 0.13 (0.02, 0.96)                   |

RCT, randomized controlled trial.

From Lee D, Rawlinson VI. Multicentre trial of antepartum low dose anti-D immunoglobulin. *Transfus Med* 1995;5:15–19; and Hensleigh PA. Preventing rhesus isoimmunization: antepartum Rh immune globulin prophylaxis versus a sensitive test for risk identification. *Am J Obstet Gynecol* 1983;146:749–755.

By 1971, the administration of RhIG to D-negative women after delivery of a D-positive infant and after abortion was recommended by the World Health Organization and rapidly came into widespread practice ( [23](#)). Recommendations for antenatal administration of RhIG were more controversial because of supply concerns and economic cost-benefit arguments but were introduced in Canada and the United States in 1979 to 1980 and in the United Kingdom in 1998 ( [24](#), [25](#), [26](#) and [27](#)). In the United States, the incidence of HDF/N due to anti-D decreased from 40.5 to 10.6 cases/10,000 total births between 1970 and 1986 ( [28](#), [29](#)). RhIG accounted for most of this improvement, but the trend toward smaller families and improved quality of perinatal care also contributed to the decline in the incidence of anti-D in pregnant women and related perinatal mortality, respectively ( [30](#)).

Despite all preventive efforts, HDF/N due to anti-D continues to occur at a low rate ( [29](#)). Failure to prevent maternal D alloimmunization is usually due to a failure to administer RhIG appropriately or, less commonly, to production of anti-D antibodies early in pregnancy before an antenatal dose of RhIG. No prophylactic measures are available to prevent sensitization to other blood group antigens in pregnancy, most notably Rhesus (c), Kell (K1), and Duffy (Fy<sup>a</sup>), and the corresponding maternal alloantibodies can cause severe HDF/N ( [31](#), [32](#) and [33](#)). Consequently, the ability to clinically manage such alloimmunized pregnancies and treat affected infants is still of paramount importance.

## PATHOPHYSIOLOGY

The risk of maternal alloimmunization to blood group antigens is influenced by the frequency of blood group alleles in the population and the volume of incompatible red cell exposure, as well as the immunogenicity of the offending red cell antigen and maternal immune responsiveness. The propensity of maternal red cell antibodies to cause HDF/N and the severity of the resultant condition are affected by the inherent characteristics of the red cell antibodies and the compensatory physiologic reaction to the anemia in the infant.

### Fetal–Maternal Hemorrhage

Although the fetal circulation is separated from the maternal circulation by placental membranes and fetal capillaries, blood cells pass between the fetal and maternal bloodstreams throughout gestation. FMH occurs in 3% of pregnancies in the first trimester, 12% in the second trimester, 45% in the third trimester, and 64 to 100% after delivery ( 34, 35 ). The total volume of fetal cells in the maternal circulation is usually small and does not exceed 0.1 to 0.25 ml in most cases ( 36 ). Large–volume FMH occurs less often, with more than 15 ml of fetal red cells (approximately 30 ml whole blood) detected at a rate of 1.6% after cesarean section or complicated vaginal delivery and 0.7% after spontaneous vaginal delivery ( 37 ). Invasive procedures, clinical maneuvers, or other traumatic events during pregnancy may also elicit sufficient FMH to induce or augment red cell alloantibody production in susceptible pregnant women ( Table 36.2 ) ( 38, 39 and 40 ).

**TABLE 36.2. Fetal–Maternal Hemorrhage and RhD Alloimmunization: Rates among Rh–Negative Women with D–Positive Infants, Who Do Not Receive Anti–D Immune Globulin**

|                            | Fetal–Maternal Hemorrhage (%) | Primary RhD Alloimmunization (%) |
|----------------------------|-------------------------------|----------------------------------|
| Pregnancy and delivery     |                               |                                  |
| Before 29 wk of gestation  | 3–12                          | 0.3–1.9                          |
| 35 wk to delivery          | 65–100                        | 7–15                             |
| Abortion                   |                               |                                  |
| Induced abortion           | 4–30                          | 4–5                              |
| Spontaneous abortion       | 3–12                          | 1.5–2.0                          |
| Threatened abortion        | 10                            | ND                               |
| Ectopic pregnancy          | 24                            | Case reports                     |
| Amniocentesis              | 7–15                          | 2–5                              |
| Cordocentesis              | 57                            | ND                               |
| Chorionic villous sampling | 14                            | 1–2                              |
| External cephalic version  | 2–28                          | ND                               |
| Abdominal trauma           | 28                            | Case reports                     |

ND, not determined.

From Huchet J, Dallemagne S, Huchet C, et al. The antepartum use of anti-D immunoglobulin in rhesus negative women. Parallel evaluation of fetal blood cells passing through the placenta. The results of a multicenter study carried out in the region of Paris. *J Gynecol Obstet Biol Reprod (Paris)* 1987;16:101–111; Medearis AL, Hensleigh PA, Parks DR, et al. Detection of fetal erythrocytes in maternal blood postpartum with the fluorescence-activated cell sorter. *Am J Obstet Gynecol* 1984;148: 290–295; Ness PM, Baldwin ML, Niebyl JR. Clinical high-risk designation does not predict excess fetal-maternal hemorrhage. *Am J Obstet Gynecol* 1987;156:154–158; American College of Obstetricians and Gynecologists. Prevention of RhD alloimmunization. Washington, DC: ACOG Practice Bulletin No. 4, May 1999; and Royal College of Obstetricians and Gynaecologists. Use of anti-D immunoglobulin for Rh prophylaxis guidelines, [www.rcog.org.uk/guidelines](http://www.rcog.org.uk/guidelines).

---

## Maternal Alloimmunization to Blood Group Antigens

The likelihood of a relevant blood group incompatibility occurring in pregnancy depends on the frequency of blood group alleles in the population ( 41 ). American Indians and Asians are almost all D-positive; consequently, D alloimmunization is extremely rare among these populations ( 41 ). In white and African-American populations in the United States, approximately 15% and 8%, respectively, are D-negative and lack a functional D gene on both chromosomes ( 41 ). Overall, incompatibility with respect to the D antigen occurs in approximately 10% of all pregnancies; among D-negative women, approximately 60 to 70% of pregnancies yield D-positive infants. Although virtually all pregnant women are exposed to fetal red cells with childbirth, alloimmunization to blood group antigens occurs in only a fraction of incompatible pregnancies. Approximately 1 in 6 multiparous D-negative women developed anti-D antibodies without RhIG prophylaxis in incompatible pregnancies. The risk of alloimmunization to the D antigen has been estimated for other obstetric interventions ( [Table 36.2](#) ) ( 38 , 39 and 40 ).

A primary determinant of the risk of red cell alloimmunization is the volume of incompatible red cell exposure. Less than 1 ml of D-positive, fetal red cells is sufficient to induce anti-D antibody formation in 0.3 to 1.9% of D-negative women before delivery, whereas transfusion of a unit of D-positive red cells (300 ml) immunizes approximately 70% of D-negative individuals ( 16 , 41 ). Host factors also influence the risk of red cell alloimmunization. Concomitant ABO and D incompatibility between the mother and fetus (e.g., a type O, D-negative mother with a type A, B, or AB, D-positive fetus) results in an almost ninefold reduction in the risk of alloimmunization to the D antigen in a first pregnancy ( 18 , 42 ). ABO incompatibility does not prevent a secondary immune response in a sensitized individual in subsequent pregnancies. The D antigen is one of the most potent immunogens among red cell antigens, but even after incompatible blood transfusion or multiple D-positive pregnancies, approximately 30% of D-negative individuals do not produce anti-D antibodies and are called *nonresponders* ( 41 ). Complex genetic factors regulate immune responses, and the basis of this variability to red cell immunization among individuals is not well understood.

The overall frequency of alloimmunization to clinically significant blood group antigens among women ranges from 0.04% to 0.3% ( 43 , 44 , 45 , 46 and 47 ). The variability in these rates may be due to geographic differences in blood group antigen expression, national blood transfusion practice, and higher order birth and abortion rates in the population, as well as the sensitivity of laboratory methods used in prenatal antibody screening ( 43 , 44 , 45 , 46 and 47 ). Anti-D is still among the most frequently detected antibodies in sensitized

pregnancies despite a precipitous decline in incidence after the introduction of RhIG prophylaxis ( [Table 36.3](#) ) ( [43](#), [44](#) ). In recent decades, other red cell alloantibodies have accounted for proportionately more cases of maternal alloimmunization and HDF/N. The K1 antigen surpassed the D antigen as the leading cause of alloimmunization among women in a recent series, occurring at a rate of 3.2 in 1000 compared to 2.7 in 1000 for anti-D ( [44](#) ). Women who develop anti-K1 antibodies in pregnancy often have a history of blood transfusion as the immunizing stimulus ( [48](#) ).

**TABLE 36.3. Red Cell Alloantibodies: Occurrence in Women and Association with Hemolytic Disease of the Fetus and Newborn (HDF/N)**

| Blood Group System                            | Antibody Incidence<br>(Number per 1000 Samples) |                   | Association with HDF/N  |
|---|---|-------------------|---|
|   | 1967 <sup>a</sup>                               | 1996 <sup>b</sup> |   |
| <b>Rhesus (Rh)</b>                            |   |                   |   |
| D   | 43.3  | 2.7               | Mild to severe HDF/N, hydrops fetalis   |
| C   | 0.1   | 0.7               | Mild to severe HDF/N, hydrops fetalis   |
| c   | 1.2   | 0.9               | Mild to severe HDF/N, hydrops fetalis   |
| E   | 1.3   | 2.0               | Mild to severe HDF/N, hydrops fetalis   |
| e   | 0.05  | 0                 | Mild to severe HDF/N, hydrops fetalis (rare)  |
| Other   |   |                   | Other Rh specificities in rare cases of moderate to severe fetal anemia: C <sup>w</sup> , C <sup>x</sup> , Go <sup>a</sup> , RH36 (Berrens, Be <sup>a</sup> ), RH37 (Evans), RH32 |
| <b>Kell</b>                                   |   |                   |   |
| K1  | 2.1   | 3.0               | Mild to severe HDF/N, hydrops fetalis   |
| K2  | 0   | 0.03              | Other Kell specificities in rare cases of moderate to severe fetal anemia: k [(Cellano; K2) (rare)], Js <sup>a</sup> , Js <sup>b</sup> , Ku                                       |
| Lewis (Le <sup>a</sup> , Le <sup>b</sup> )    | 2.2   | 3.0               | Not a cause of HDF/N  |
| <b>Duffy</b>                                  |   |                   |   |
| Fy <sup>a</sup>                               | 0.4   | 0.8               | Mild to severe HDF/N, hydrops fetalis   |
| Fy <sup>b</sup>                               | 0.02  | 0.03              | Not a cause of HDF; no or mild HDN  |
| <b>MNS</b>                                    |   |                   |   |
| M   | 0.7   | 0.5               | Rare cases of moderate to severe HDF  |
| N   | 0.1   | 0.03              | Not a cause of HDF; no or mild HDN  |
| S   | 0.2   | 0.1               | Rare cases of moderate to severe HDF  |
| Other   |   |                   | Other MNS specificities in rare cases of moderate to severe fetal anemia: s, U, Mt <sup>a</sup>   |
| Lutheran (Lu <sup>a</sup> , Lu <sup>b</sup> ) | 0.02  | 0.1               | No or mild HDF/N  |
| Ii  | 0.3   | 0.1               | Not a cause of HDF/N  |
| <b>Kidd</b>                                   |   |                   |   |
| Jk <sup>a</sup>                               | 0.2   | 0.2               | Mild to severe HDF/N  |

|                 |     |      |  |
|-----------------|-----|------|--|
| Jk <sup>b</sup> | 0   | 0    | Mild to severe HDF/N (rare)  |
| P (P1)          | 0.6 | 0.03 | Not a cause of HDF/N<br>Other P group specificities in rare cases of moderate to severe fetal anemia: PP <sub>1</sub> P <sub>k</sub>   |
| Other           | 0.3 | 0.03 | HLA (Bg <sup>a</sup> , Bg <sup>b</sup> , Bg <sup>c</sup> ): Not a cause of HDF/N<br>Other blood group specificities in rare cases of moderate to severe fetal anemia: Diego (Di <sup>a</sup> ), Cartwright (Yt <sup>a</sup> ), Biles (Bi), Radin (Rd), Wright (Wr <sup>a</sup> ) |

<sup>a</sup> From Polesky HF. Blood group antibodies in prenatal sera. *Minn Med* 1967;50:601–603.

<sup>b</sup> From Geifman–Holtzman O, Wojtowycz M, Kosmas E, et al. Female alloimmunization with antibodies known to cause hemolytic disease. *Obstet Gynecol* 1997;89:272–275.

### ABO Blood Group Isoagglutinins

ABO incompatibility occurs statistically in one of every five pregnancies. ABO isoagglutinins are present in the sera of all individuals whose red cells lack the corresponding antigen and are usually of the IgM class. High titers of IgG antibodies are more likely to occur in group O individuals than in group A or B individuals, and increased antibody production after antigenic stimulation can occur (<sup>32</sup>). Consequently, group O mothers with potent IgG anti–A, –B, or –A,B are at greatest risk of having affected infants. Among group A or B infants born to group O mothers, 30 to 50% have detectable maternal IgG antibody bound to their red cells compared to 5% among all infants (<sup>49</sup>). Because ABO IgG antibodies can occur without prior red cell exposure, they can result in HDN in a first pregnancy. However, ABO antigens are not fully developed on red cells at birth, and similar carbohydrate antigens occur on other tissues that effectively neutralize anti–A, anti–B, and anti–A,B antibodies to a large extent, thereby mitigating their effect. At birth, neonatal anemia due to ABO HDN is usually mild. Antibodies directed against other carbohydrate blood group antigens (Lewis, I, P) are naturally occurring IgM that are inconsequential in pregnancy because IgM is not transported across the placenta.

### Fetal and Neonatal Immune–Mediated Anemia

In contrast to antibodies against carbohydrate blood group antigens, antibodies against Rhesus, Kell, or other protein blood group antigens only rarely occur without exposure to incompatible red cells (<sup>41</sup>). IgM predominates in the primary immune response after the initial stimulus, and 4 weeks to 6 months may elapse before IgG is detected. Because FMH usually occurs late in the third trimester or at delivery, IgG antibodies against red cell alloantigens usually do not reach appreciable concentration to cause significant disease in a first pregnancy. In subsequent incompatible pregnancies, however, an anamnestic immune response after only minimal exposure to incompatible red cells rapidly produces IgG with enhanced avidity for target fetal red cells, translating to earlier onset and greater severity of hemolytic disease.

Maternal IgG red cell antibodies bind to their target red cells and cause Fc receptor–mediated extravascular destruction by splenic macrophages and other cytotoxic effector cells in the reticuloendothelial system. Progressive removal of portions of the red cell membrane by macrophages and other phagocytic cells in the spleen results in the



appearance of spherocytes in the peripheral circulation. The immunoglobulin subclasses IgG1 and IgG3 have greater affinity for Fc receptors on phagocytic cells than IgG2 and IgG4, which may account for their association with more severe hemolytic disease ( 41, 50 ). The concomitant presence of maternal anti-HLA and anti-D is associated with a mild course of HDF/N, possibly due to the competitive binding of the HLA antibodies to Fc receptors on cytotoxic effector cells ( 51 ).

Extravascular destruction of red cells often cannot account completely for the degree of fetal anemia due to anti-K1, unlike most cases of HDF due to anti-D and other red cell alloantibodies. Severe fetal anemia may occur with anti-K1 despite low maternal antibody titers and falsely reassuring concentrations of bilirubin in amniotic fluid ( 48, 52 ). In Kell-sensitized pregnancies, affected fetuses often have fewer reticulocytes and normoblasts in their peripheral circulation than infants with comparable anemia caused by anti-D, suggesting impaired production of red cells ( 53, 54 ). Anti-K1 was shown to specifically inhibit the growth of K1-positive erythroid progenitor cells *in vitro*, whereas anti-D exhibited no effect with D-positive precursors in the same assay ( 55 ). These observations support the dual action of maternal anti-Kell in eliciting both peripheral red cell destruction and erythropoietic suppression to produce fetal anemia.

Most cases of severe fetal anemia are caused by anti-D, anti-c, anti-K1, or rarely, anti-Fy<sup>a</sup> or other IgG red cell alloantibodies ( Table 36.3 ). Compensatory hematopoiesis in the bone marrow and extramedullary hematopoiesis primarily in the liver and spleen result in the release of nucleated red cells, reticulocytes, normoblasts, and other immature erythrocytes in the fetal circulation. Severely affected fetuses have marked hepatosplenomegaly due to the extramedullary hematopoiesis, which can lead to portal and umbilical venous obstruction, portal hypertension, and hepatocellular damage ( 1 ). Production of albumin and other plasma proteins by the liver is markedly impaired, and hypoproteinemia results. Severe anemia and hepatic dysfunction with hypoproteinemia and portal hypertension may also lead to the development of congestive heart failure. Hydrops fetalis describes the ultimate outcome of these physiologic insults, with the development of generalized edema (anasarca), massive ascites, and pleural and pericardial effusions. Although the pathogenesis of hydrops fetalis is not clearly defined, the extent of hepatic damage rather than the degree of anemia more consistently correlates with the severity of the condition ( 1 ).

### Neonatal Immune-Mediated Hyperbilirubinemia

Immune-mediated destruction of fetal red cells results in increased serum concentration of free heme, which is further metabolized to unconjugated (indirect) bilirubin. During gestation, unconjugated bilirubin and other metabolites are transported across the placenta and eliminated by the mother. When this connection is severed at birth, unconjugated bilirubin accumulates because infants have immature liver function and are not capable of efficiently metabolizing bilirubin.

Unconjugated bilirubin is transported in the plasma bound to albumin, but when its concentration exceeds the plasma-binding capacity or when it is displaced from carrier proteins, the lipophilic, free molecule can cross cell membranes and impair mitochondrial function to cause cell death. Preterm infants are at greater risk for developing bilirubin encephalopathy than are term infants because of the immaturity of their blood-brain barrier as well as their more pronounced hepatic deficiency. Bilirubin toxicity is potentiated by factors that displace bound bilirubin or otherwise increase circulating levels of unbound bilirubin, such as decreased albumin concentration, free heme molecules, acidosis, increased levels of free fatty acids, or drugs such as sulfonamides and sodium benzoate ( 1 ). Infants with severe unconjugated hyperbilirubinemia may



develop nerve deafness or the spectrum of kernicterus, leading to severe brain damage, mental retardation, spastic choreoathetosis, or, in many cases, death.

## CLINICAL FEATURES

The clinical spectrum of HDF/N ranges from the ominous, intrauterine development of hydrops fetalis to varying degrees of neonatal hyperbilirubinemia and anemia. Approximately one-half of infants with detectable maternal anti-D are unaffected or only mildly affected, whereas 30% have moderate disease in the neonatal period, and approximately 20% are severely affected *in utero* ( [Table 36.4](#) ) ( [1](#), [56](#) ). The onset of intrauterine disease occurs before 34 weeks' gestation in approximately one-half of the cohort of severely affected fetuses, or approximately 9% of affected pregnancies, overall ( [56](#) ). Similar trends are observed when anti-c, anti-Kell, and anti-Fy<sup>a</sup> are detected in pregnancy, in that many fetuses are unaffected, and most of the rest have only mild or moderate disease, but a small number manifests hydrops or severe anemia necessitating intrauterine transfusion ( [Table 36.4](#) ) ( [31](#), [32](#) and [33](#), [48](#), [56](#), [57](#) ). Maternal IgG antibodies with other specificities have been implicated in cases of severe fetal anemia or life-threatening HDN in rare cases ( [31](#), [32](#) and [33](#), [58](#), [59](#) ).

**TABLE 36.4. Clinical Series of Rhesus, Kell, and Duffy Alloantibodies in Pregnancy**

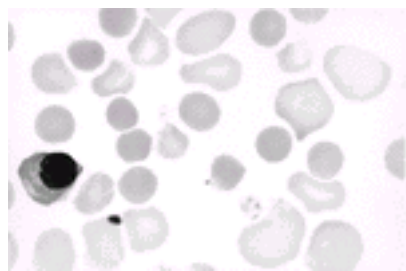
| Antibodies<br>(Number)          | Affected<br>Pregnancies <sup>a</sup><br>(Number) | Severity (% Affected Pregnancies Resulting<br>in Mild, Moderate, or Severe Disease) <sup>b</sup> |   |   | Reference |  |
|---------------------------------|--|--|---|---|-----------|--|
|                                 |  | None<br>or<br>Mild<br>(%)  | Mild-Moderate (e.g.,<br>Phototherapy<br>and/or Neonatal<br>Exchange<br>Transfusion) (%) | Severe (e.g.,<br>Intrauterine<br>Transfusion,<br>Hydrops, or<br>Perinatal Death)<br>(%) |           |  |
| <b>Rhesus</b>                   |  |  |   |   |           |  |
| D                               | 566  | 257  | 51  | 30  | 19        | <a href="#">1</a> , <a href="#">56</a> |
| c, cE                           | 302  | 164  | 70  | 23  | 7         | <a href="#">1</a>                      |
| E                               | 633  | 162  | 89  | 11  | —         | <a href="#">1</a>                      |
| C,                              | 193  | 50   | 86  | 14  | —         | <a href="#">1</a>                      |
| <b>Ce, C<sup>w</sup>,<br/>e</b> |  |  |   |   |           |  |
| Kell                            | 478  | 16   | 50  | 37  | 13        | <a href="#">1</a>                      |
| K1                              | 127  | 13   | 30  | 30  | 38        | <a href="#">48</a>                     |
| Duffy                           | 35   | 6  | 67  | 16  | 16        | <a href="#">1</a>                      |
| Fy <sup>a</sup>                 | 68   | 47   | 94  | 2   | 4         | <a href="#">57</a>                     |

<sup>a</sup> An affected pregnancy is one with maternal antibody and an antigen-positive, antigen-indeterminate, or direct antiglobulin test-positive fetus or infant.

<sup>b</sup> Definitions of disease severity and treatment thresholds may vary over time within a study period and among studies, but for purposes of comparison, severity of disease is classified in this table based on highest level of treatment performed.

Severely affected newborn infants demonstrate cord hemoglobin concentrations less than 12 g/dl and cord bilirubin concentrations greater than 5 mg/dl. If treatment is received before delivery, the course of hemolytic disease in the neonatal period may be relatively mild. These infants are at risk for developing late anemia several weeks after birth because intrauterine transfusion may suppress erythropoiesis and persistent circulating maternal alloantibody may cause ongoing hemolysis for 4 to 8 weeks. Infants with moderate disease have 12 to 14 g/dl hemoglobin in cord blood and 7 to 12 mg/dl hemoglobin in the first days of life. The bilirubin level in cord blood rarely exceeds 5 mg/dl, reflecting the prior clearance by the maternal liver *in utero*. After birth, however, jaundice may occur within the first 24 to 36 hours of life, earlier than the “physiologic jaundice” otherwise associated with immature liver function, and the bilirubin concentration peaks between 3 and 5 days of life. Mild HDN is characterized by cord hemoglobin of 14 g/dl or greater and only slightly increased bilirubin (<4 g/dl).

The most common cause of HDN currently is maternal ABO antibodies, although only a minority of infants with detectable maternal ABO antibodies have clinical signs of hemolysis. Exceedingly rare cases of fetal anemia due to ABO antibodies have been reported, but nonimmune hydrops superimposed on ABO incompatibility could not be excluded (1). Nonimmune hydrops fetalis may be caused by intrauterine infection, cardiac disease, or chromosomal disorders (Table 36.5). Because the neonatal anemia is usually mild, the compensatory hematopoietic activity in ABO HDN is not as pronounced as in HDN due to anti-D or anti-K1. Consequently, nucleated red cells and erythropoietic progenitors may be evident, but spherocytes predominate in the peripheral blood smear of infants with ABO HDN (Fig. 36.1). The failure to recognize hemolysis due to ABO blood group incompatibility or other risk factors for hyperbilirubinemia resulted in 90 cases of kernicterus in a 17-year period (60). This modern day tragedy underscores the importance of monitoring progressive jaundice in all infants.



**Figure 36.1.** ABO hemolytic disease of the newborn (HDN). Peripheral blood from an infant with ABO HDN, with numerous spherocytes, occasional nucleated red cells, anisocytosis, and polychromasia (Wright-Giemsa stain). See Color Plate. (©American Society for Clinical Pathology. Used with permission.)

#### TABLE 36.5. Differential Diagnosis

Hydrops fetalis (fetal edema, anemia)

Hemolytic disease of the fetus due to maternal anti-D, -c, -K1, -Fy<sup>a</sup>, or other blood group antibodies

Homozygous  $\alpha$ -thalassemia

Twin-to-twin or fetomaternal transfusion

High-output cardiac failure

- Congenital infection (e.g., parvovirus, cytomegalovirus, toxoplasmosis, syphilis)
- Genetic disorders (e.g., Turner syndrome, 45 XO)
- Idiopathic
- Neonatal hyperbilirubinemia (nonphysiologic)
  - Unconjugated (indirect) hyperbilirubinemia
    - Hemolysis
      - Hemolytic disease of the newborn due to maternal ABO isohemagglutinins, anti-D, or other blood group antibodies
      - Hereditary spherocytosis
      - Glucose-6-phosphate dehydrogenase deficiency, pyruvate kinase deficiency
      - $\alpha$ -Thalassemia
    - Extravascular blood loss/accumulation (e.g., cephalohematoma)
    - Genetic disorders (e.g., Crigler-Najjar syndrome; Gilbert syndrome)
    - Endocrine disease (e.g., hypothyroidism)
  - Conjugated (direct) hyperbilirubinemia
    - Infection, sepsis
    - Metabolic disorders (e.g., Dubin-Johnson syndrome, cystic fibrosis)
    - Anatomic abnormalities (e.g., biliary atresia)
    - Cholestasis from total parenteral nutrition or antibiotics (e.g., ceftriaxone)

---

## LABORATORY EVALUATION

All pregnant women should have their ABO/Rh type and antibody screen determined at the first visit to the obstetrician ( [61](#) ). These initial tests identify women as candidates for RhIG administration or for additional monitoring during pregnancy. After detection of clinically significant red cell alloantibodies, further testing may be required for evaluation of FMH, antenatal assessment of fetal anemia, and detection of neonatal anemia and hyperbilirubinemia. The principles of these laboratory tests and controversies surrounding their use are described below; specific practice recommendations for prevention and treatment of HDF/N are described in the subsequent sections [Prevention of Maternal D Alloimmunization with Rh Immune Globulin](#), [Management of Red Cell Alloimmunization in Pregnancy](#), and [Treatment of the Newborn Infant](#).

### Maternal ABO/Rh Type and Antibody Screen

The red cell ABO/Rh type is assigned in the forward group reaction by incubating the patient's red cells with IgM or IgG antibodies that cause their immediate and visible agglutination if they express the corresponding A, B, or D antigens. The reverse group identifies plasma reactivity due to ABO isoagglutinins and should confirm the forward, red cell typing reactions. The forward reaction for the D antigen may include an additional phase with antihuman globulin to enhance red cell agglutination and detect weak expression of the D antigen on the red cells.

Formerly known as *Du*, weak D phenotypes are due to quantitative or qualitative alterations in D antigen expression. Although weak D occurs in as much as 1 to 3% of the population, the risk of a weak D mother producing anti-D in pregnancy may be as low as 1 in 150,000 ( [24](#), [62](#) ). In these rare cases of maternal alloimmunization, the infants demonstrated only mild HDN, although a single fatal case has been documented ( [63](#) ). Acknowledging the rarity of alloimmunization and the propensity for mild disease in this clinical setting, the American Association of Blood Banks has made testing pregnant

women for weak D optional, and the American College of Obstetricians and Gynecologists (ACOG) recommends against administration of RhIG to weak D–positive women ( [38](#), [61](#) ).

The antibody screen detects maternal antibody in plasma by hemagglutination in an indirect antiglobulin test, which is also referred to as the *indirect Coombs test*. The reaction conditions should allow detection of clinically significant IgG alloantibodies that are reactive at 37° C in the antiglobulin phase. Conditions that permit identification of IgM antibodies are not required in the setting of obstetric testing, because IgM antibodies cannot cross the placenta. If IgM antibodies cause interference in the antibody screen, reducing agents such as dithiothreitol can be used to eliminate their reactivity in the assay and allow for specific detection of IgG antibodies. If the initial antibody screen is negative, the need to repeat testing at 28 weeks' gestation is currently debatable. Arguments for eliminating this testing include the extremely low probability that anti–D or other antibodies are formed during pregnancy ( [47](#), [64](#) ).

### Serologic and Molecular Testing for Paternal/Fetal Blood Group Antigens

If a potentially significant red cell alloantibody is detected in a pregnant woman, the blood type of the biologic father may be investigated to assess the risk of HDF/N. Three possibilities exist: The father lacks the antigen, and the fetus is not at risk; the father is heterozygous for the antigen, and the fetus may be at risk; the father is homozygous for the antigen, and the fetus is definitely at risk. To distinguish between the latter two possibilities, paternal D antigen zygosity may be deduced by serologic determination of the extended Rhesus phenotype (D, Cc, Ee) based on the prevalence of Rh haplotypes in different populations and the Rh type of previous children ( [65](#) ). Another indirect approach to determine paternal zygosity involves parallel quantitative amplification of *RHD*– and *RHCE*–specific sequence ( [66](#) ). The development of direct, D allele–specific molecular assays is complicated by the genetic diversity of the D locus and the variety of insertions, deletions, and missense and nonsense mutations in the *RHD* gene that can produce the D–negative phenotype. Recently, a molecular test to specifically detect the most prevalent D–negative allele in white populations, the complete *RHD* deletion, was developed ( [67](#) ). This approach may be amenable to routine use in most laboratories, but its clinical application will be limited until modification allows for detection of other common D–negative alleles in ethnically and racially heterogeneous donor populations. Determining the paternal genotype of other blood group determinants is more straightforward with the currently available allele–specific assays for other Rh (C/c; E/e), Kell (K1/K2), Duffy (Fy<sup>a</sup>/Fy<sup>b</sup>), Kidd (Jk<sup>a</sup>/Jk<sup>b</sup>), and other red cell loci ( [66](#) ).

For definitive prenatal diagnosis, the fetus's red cell type may be determined by serologic or molecular methods. Standard immunohematologic assays for blood typing can be performed on fetal blood obtained by cordocentesis ( [41](#) ). Alternatively, polymerase chain reaction–based molecular assays for D and other blood group antigens use fetal DNA isolated from amniotic fluid or fetal blood ( [66](#) ). Because these invasive sampling procedures are associated with the risk of fetal morbidity or mortality, the feasibility of isolating fetal cells or genetic material from the mother's venous blood is an area of active investigation. *RHD* sequences can be detected in the circulation of many D–negative pregnant women, even in the first trimester, but a failure rate as high as 30% currently limits the clinical use of this approach ( [68](#), [69](#) ).

### Maternal Red Cell Alloantibody Titers

If molecular testing suggests the fetus is at risk for HDF/N, or if molecular testing cannot be performed, determination of the maternal red cell alloantibody concentration may be

used as a screening test to guide further clinical management ( [70](#), [71](#) and [72](#) ). The concept of a “critical titer” of maternal antibody has been criticized based on the poor predictive accuracy for severe HDN ( [73](#), [74](#) ). However, critical titers are used not to predict the development of severe hemolytic disease after birth, but rather to predict its absence during gestation, because titers below “critical” thresholds are unlikely to require aggressive intervention *in utero*. In a classic study almost 50 years ago, Allen et al. followed 174 pregnancies with no history of affected fetuses or infants and with antibody titers of 1:32 or lower and reported 174 (96%) had live infants at 37 weeks’ gestation ( [70](#) ). The observation that significant intrauterine disease is unlikely to occur when the antiglobulin titer remains low has been substantiated in recent studies ( [71](#), [72](#) ). Recognizing that amniocentesis, cordocentesis, or both may cause fetal morbidity or mortality, most obstetricians and fetal–maternal specialists rely on maternal antibody titers as a screening test and do not perform these invasive procedures until the antibody level exceeds a critical titer or increases significantly in serial measurements ( [33](#), [61](#), [71](#), [72](#) ).

Antibody titers are determined with the indirect antiglobulin (Coombs) test by making several dilutions of maternal serum in saline, adding reagent red cells and anti-IgG, and observing for macroscopic agglutination in the tubes. The titer is reported as the reciprocal of the highest dilution at which this endpoint is observed; for example, agglutination with a serum dilution of 1:16 but not 1:32 would be reported as an antibody titer of 16. Alternatively, a 12–point scoring system that takes into account the strength of agglutination as well as the dilution factor may be a more specific indication of severe fetal anemia but is used less commonly than simple tube–titration in current practice ( [41](#), [72](#) ).

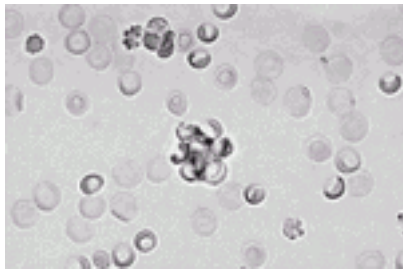
Because serial measurements of maternal antibody titer are necessary, an initial maternal sample should be frozen for comparison in subsequent titers determined with the same method, technique, and reagent red cells ( [61](#) ). A difference of greater than two dilutions or a score increase of more than ten should be considered a significant change in titer ( [61](#), [72](#) ). For anti–D, the critical titer is often considered 16 (range, 8 to 32) ( [61](#) ). Critical titers for antibodies other than anti–D have been suggested, based on cumulative clinical experience at a center or historical published data. Because severe fetal disease may be caused by lower titers of anti–K than anti–D, a lower critical threshold of eight has been recommended for Kell–sensitized pregnancies ( [33](#) ). In contrast, other antibodies are less likely than anti–D or anti–K to cause hemolytic disease at low titers, and higher thresholds have been proposed for anti–Fy<sup>a</sup> (titer, 64), anti–M (titer, 32 to 64), and anti–U (titer, 128) ( [33](#), [72](#) ). Anti–M often demonstrates IgG and IgM components that can be distinguished with the use of reducing agents in titration studies, and anti–M–sensitized pregnancies are managed on the basis of the titer of the IgG component ( [33](#) ).

Investigated as an alternative to maternal antibody titer, antibody functional assays, such as the monocyte monolayer assay, the antibody–dependent cellular cytotoxicity assay, and chemiluminescence test, examine the behavior of potentially significant red cell antibodies *in vitro* ( [74](#), [75](#) ). These assays evaluate the ability of the maternal IgG antibody to interact with target red cells and effector cells expressing Fc receptors, such as lymphocytes or monocytes, to cause adherence, phagocytosis, or cytotoxic lysis. The antibody–dependent cell–mediated cytotoxicity assay showed a higher specificity than maternal antibody titer for prediction of fetal disease and may be more useful in guiding decisions about invasive testing for D alloimmunization in pregnancy ( [75](#) ). Antibody functional assays, however, have not been as widely used in the United States as in Europe, primarily due to the fact that prenatal testing is not centralized in highly

specialized laboratories in the United States and the technical complexities of the tests precludes their use at most American centers ( 61 ).

### Tests for Fetal–Maternal Hemorrhage

An assessment of the volume of fetal cells in the peripheral circulation of a D–negative woman must be performed to determine the adequacy of the dose of administered RhIG after delivery of a D–positive infant and in other obstetric situations ( 38 , 39 and 40 , 76 ). A common approach to evaluating FMH is the rosette test to screen for the presence of fetal cells followed by the Kleihauer–Betke acid elution method to quantify the magnitude of the bleed. The rosette test is a modified antiglobulin reaction, based on detection of the fetal (D–positive) red cells in a maternal (D–negative) blood sample. On reaction with reagent anti–D Ig, fetal (D–positive) red cells form small clumps or rosettes around indicator D–positive red cells ( Fig. 36.2 ) ( 41 ). The presence of rosettes is a sensitive qualitative screen for FMH. A positive test is obtained in 75% of women with FMH of 2.5 ml of D–positive red cells (5 ml whole blood) and all women with FMH of 5 ml of D–positive red cells (10 ml whole blood) or more ( 76 , 77 ). If it is determined that an infant has the weak D phenotype, the rosette test is not reliable, and FMH should be evaluated with tests that do not rely on detection of the expression of the D antigen, such as the Kleihauer–Betke acid elution method ( 61 ). Rarely, maternal anti–D is present at such high concentration on the surface of fetal red cells that interaction with the reagent anti–D is blocked, and the rosette assay produces a false–negative result.

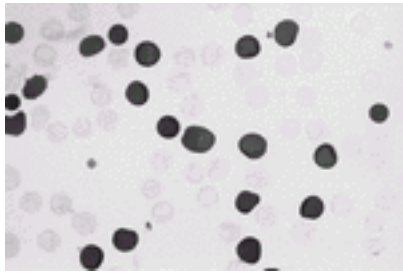


**Figure 36.2.** Rosette assay for fetal–maternal hemorrhage (FMH). D–positive red cells are identified in a background of D–negative red cells by the formation of rosettes in this screening test for FMH. There are two rosettes in this field—a large one in the center and a smaller one above it; unagglutinated red cells appear as refractile, biconcave (unstained) disks. See [Color Plate](#).

The Kleihauer–Betke acid elution method provides a quantitative estimate of the volume of FMH based on the different solubility properties of fetal hemoglobin (HbF) and adult hemoglobin (HbA). On a peripheral blood smear treated with an acidic solution and counterstained, red cells containing acid–soluble HbA appear as pale ghosts compared to the deeply stained red cells containing acid–resistant HbF ( Fig. 36.3 ). The Kleihauer–Betke test result is reported as the percentage of HbF–stained fetal cells present on the smear ( 76 ). The corresponding magnitude of FMH is calculated by multiplying the percentage of fetal cells, expressed as a fraction, by the maternal blood volume, which is 70 to 75 ml/kg or approximately 5000 ml for an average pregnant woman. For example, a Kleihauer–Betke result of 1.4% indicates the presence of 70 ml of fetal whole blood ( $0.014 \times 5000$  ml). The Kleihauer–Betke test is sensitive to bleeds between 0.01 and 0.06% or 0.2 to 1.0 ml, but samples containing at least 0.5% fetal cells are detected more reliably ( 76 , 78 ). Kleihauer–Betke results that exceed the total predicted fetal blood volume based on gestational age (i.e., 3 ml at 12 weeks; 30 ml at 20 weeks)



may reflect the inherent technical imprecision of the method or may reveal precedent maternal conditions associated with increases in HbF-containing red cells such as hereditary persistence of HbF. Notably, the levels of HbF often increase during pregnancy in as many as 25% of women ( [79](#) ). In addition to these false-positives, the Kleihauer-Betke test tends to overestimate the quantity of hemorrhage, resulting in administration of more RhIG than is necessary ( [78](#) ). This inherent potential for “overdosing” RhIG is not a problem from a medical standpoint given the safety record of the drug, but it is a concern to countries coping with RhIG shortages or those striving for the most cost-effective use of RhIG ( [40](#) ).



**Figure 36.3.** Kleihauer-Bethke acid elution for fetal hemoglobin (Hb). Cord blood was mixed with blood from a healthy adult to simulate fetal-maternal hemorrhage, and a Kleihauer-Bethke was performed. Red cells containing HbF are deeply stained red; red cells containing HbA appear as pale pink ghosts. See [Color Plate](#).

Alternative methods to quantify FMH include flow cytometry and the enzyme-linked antiglobulin test ( [80](#), [81](#) ). Most flow cytometric assays for FMH are based on detection of the D antigen on fetal red cells, but detection of HbF-containing fetal red cells is also possible ( [80](#) ). Flow cytometric methods are sensitive to FMH of 0.1% or 1.8 ml and can be used to detect events as rare as 1 fetal cell in 10,000 maternal cells ( [78](#) ). The enzyme-linked antiglobulin test is a modified enzyme-linked immunosorbent assay and detects D-positive red cells in a maternal D-negative background by successive incubations with anti-D, anti-IgG conjugated with the enzyme alkaline phosphatase, and an enzyme substrate ( [81](#) ). This test is sensitive to 0.25% or 3 ml FMH ( [41](#), [81](#) ). Both the enzyme-linked antiglobulin test and flow cytometry are reproducible and reliable but are not as commonly used in practice as the Kleihauer-Betke test for quantifying FMH.

### Noninvasive Fetal Monitoring

Fetal ultrasonography and Doppler studies of blood flow velocity in fetal vessels have been investigated as means to predict the severity of fetal anemia and guide the use of invasive methods in alloimmunized pregnancies. Images obtained with ultrasound are also used to guide needle placement during invasive procedures such as amniocentesis, cordocentesis, and intrauterine transfusion. Early sonographic signs of worsening fetal anemia include increases in the size of the fetal liver or spleen, an increase in placental thickness, the presence of effusions or polyhydramnios, visualization of both sides of the fetal bowel, and abnormalities of pulsed Doppler flow velocity waveforms in fetal vessels ( [82](#) ).

Variability in the use of ultrasound techniques and methodologic flaws in study design hamper systematic evaluation of the diagnostic accuracy of these tests in the clinical setting of HDF/N ( [82](#) ). Recent data support a role for measurement of the peak velocity

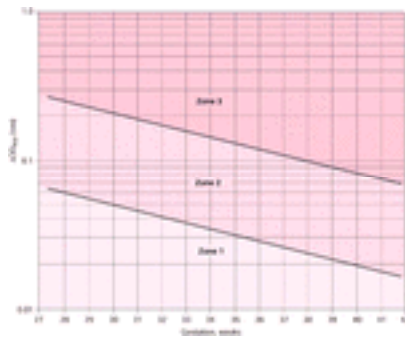


of systolic blood flow in the middle cerebral artery of the fetus by Doppler velocimetry in cases of maternal red cell alloimmunization, but the strength of the conclusions has been challenged ( [82](#), [83](#) ). In a study of 111 fetuses at risk for anemia due to maternal red cell antibodies, Mari et al. demonstrated an increased peak velocity in the middle cerebral artery of all 35 fetuses with moderate to severe anemia; however, 9 of 76 fetuses (12%) were falsely identified as being as severely affected. The high sensitivity (100%) supports the use of Doppler velocimetry of the middle cerebral artery to screen for moderate to severe fetal anemia; the high negative predictive value (100%) suggests that normal Doppler studies are reassuring in alloimmunized pregnancies. In contrast, Divakaran et al. reexamined the diagnostic accuracy in Mari's study in terms of likelihood ratios and concluded that Doppler velocimetry was only moderately informative for including or excluding HDF, although the study ranked the highest among the noninvasive tests reviewed ( [82](#) ).

In practice, ultrasonographic evaluation for fetal assessment is widely and variably used as an adjunct to the invasive tests used to monitor red cell alloimmunized pregnancies. Serial Doppler assessments of the middle cerebral artery are specifically advocated for managing K1-sensitized pregnancies because maternal antibody titers and amniotic fluid studies may be misleading ( [33](#) ). Additional study with a more standardized approach to ultrasound and Doppler studies may further validate their clinical usefulness in monitoring fetal anemia.

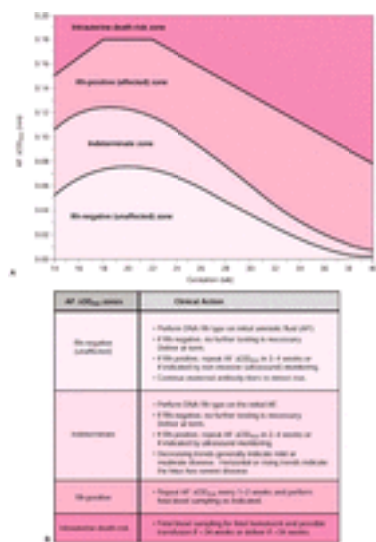
### Amniotic Fluid Analysis

Amniotic fluid analysis by spectrophotometry as introduced by Liley in 1961 is still a cornerstone of obstetric management of red cell alloimmunization in pregnancy ( [8](#) ). The principle of the test is based on the characteristic light absorbance by amniotic fluid between 365-nm and 535-nm wavelengths in unaffected pregnancies and the observed deviation from this linear baseline in alloimmunized pregnancies when bilirubin or other optically active compounds are present. An increase in optical density at 450 nm ( $OD_{450}$ ) relative to the normal baseline is proportional to the amount of bilirubin present in the amniotic fluid. Liley correlated the  $OD_{450}$  values to clinical outcomes in 101 Rhesus-sensitized pregnancies from 27 weeks' gestation to term, generating what is commonly referred to as the *Liley curve* ( [Fig. 36.4](#) ) ( [8](#) ). Values in the lowest zone of the Liley curve, zone I, are reassuring because these infants have only a 10% chance of needing treatment after birth ( [8](#) ). In contrast, readings in zone III predict severe hemolytic disease with the risk of impending hydrops and imminent fetal death (within 7 to 10 days) with 98% accuracy ( [8](#) ). The presence of contaminating meconium, blood, or the porphyrin-containing breakdown products of red cells interferes with the analysis in approximately 10% of cases but can be remedied with chloroform extraction of the amniotic fluid, reducing this rate to 1% ( [85](#), [86](#) ). Amniotic fluid analysis may also be affected by fetal conditions other than hemolytic disease, such as congenital hepatitis, and maternal diseases, such as sickle cell anemia.



**Figure 36.4.** Liley graph and management zones for alloimmunized pregnancies, based on amniotic fluid increase in optical density at 450 nm ( $\Delta OD_{450}$ ) determination. (From Liley AW. Liquor amnii analysis in management of pregnancy complicated by rhesus sensitization. *Am J Obstet Gynecol* 1961;82:1359–1370, with permission.)

In most cases, Liley’s method accurately reflects the severity of HDF due to anti-D after 27 weeks’ gestation. Although some investigators claim that extrapolating the curves for early time points in gestation can be used to manage alloimmunized pregnancies in the second trimester, others maintain that these “modified” Liley curves are unreliable ([84](#), [85](#), [86](#) and [87](#)). Queenan et al. directly evaluated amniotic fluid in 520 unaffected pregnancies from 14 to 40 weeks’ gestation and from 75 D-immunized pregnancies and developed four zones to guide management decisions in the second trimester ([Fig. 36.5](#)) ([88](#)). Analyzing the trends in the four zones was successfully used to manage pregnancies complicated by alloimmunization to the D antigen as well as the simultaneous presence of multiple blood group antibodies ([88](#), [89](#)). Spinnato et al., however, compared the Queenan curve to the modified Liley curve in 73 women sensitized to red blood cell antigens, using Liley data for treatment decisions ([85](#)). This group concluded that the Queenan approach overestimated risk and would have resulted in premature or unnecessary fetal blood sampling in nine cases ([85](#)). In contrast, Queenan and others have disputed the use of modified Liley curves in the second trimester, labeling this approach as an inappropriate or dangerous practice ([87](#), [90](#)). The controversy over appropriate management of second trimester alloimmunized pregnancies spurred development of management strategies that rely solely on fetal blood sampling that was, in turn, met with some controversy and still underlies considerable variation in current practice ([71](#), [91](#), [92](#)).



**Figure 36.5.** Queenan graph and clinical approach to D-alloimmunized pregnancies. **A:** Management zones proposed by Queenan et al. to monitor D alloimmunization in pregnancies, based on amniotic fluid (AF) increase in optical density at 450 nm (?OD<sub>450</sub>) determination. (From Queenan JT, Tomai TP, Ural SH, et al. Deviation in amniotic fluid optical density at a wavelength of 450 nm in Rh-immunized pregnancies from 14 to 40 weeks' gestation: a proposal for clinical management. *Am J Obstet Gynecol* 1993;168:1370–1376; Mosby Inc., with permission.) **B:** Clinical action for ?OD<sub>450</sub> zones. (From Queenan JT. Management of Rh-immunized pregnancies. *Prenatal Diagn* 1999;19:852–855; John Wiley & Sons Limited, with permission.)

## Fetal Blood Sampling

Fetal blood sampling (percutaneous umbilical blood sampling, cordocentesis) provides direct access to the fetal circulation for laboratory monitoring or blood transfusion ([93](#)). With ultrasound guidance, a needle (22- or 20-gauge spinal needle) can be introduced into an umbilical vessel as it enters the placenta or, rarely, at other points in its course. Fetal blood sampling permits direct measurement of HbF, hematocrit, reticulocyte count, and bilirubin, and normal values for these variables have been determined for fetuses from 15 weeks' gestational age onward. In addition, the fetal blood cells can be typed for the antigen in question, and, if positive, the presence of the corresponding maternal red cell antibody on the surface of fetal red cells can be assessed by the direct antiglobulin test.

The risk of fetal loss is generally greater with cordocentesis (1.0 to 2.7%) ([93](#), [94](#) and [95](#)) than amniocentesis (<1%) ([88](#)), but their comparative risk has not been systematically evaluated. As experience with these invasive procedures increases at an institution, the risk of procedure-related morbidity and mortality decreases. Both amniocentesis and cordocentesis may cause FMH with consequent increases in maternal antibody titers that could potentially accelerate the course of HDF ([96](#), [97](#)). Other complications of fetal blood sampling include fetal bradycardia, chorioamnionitis, placenta trauma, infection, cord hematoma, thrombosis, bleeding from the puncture site, and rupture of the membranes ([95](#)).

## Laboratory Testing of Newborn Infants

Infants born to women with potentially significant red cell antibodies or those demonstrating clinical signs of hemolytic disease despite a negative maternal antibody screen should have their ABO and D blood type determined and a direct antiglobulin test (DAT; direct Coombs test) performed at birth ([61](#)). Anti-A and anti-B are not detected in the antibody screen because the reagent red cells are type O but can be detected in an indirect antiglobulin test using reagent group A or B red cells. The DAT involves mixing cord red cells directly with antihuman globulin (anti-IgG) and observing for visible agglutination, which reveals the presence of maternal antibodies on the surface of the newborn infant's red cells ([41](#)). A negative DAT does not rule out the possibility of immune-mediated hemolytic anemia and may reflect a low surface concentration on fetal red cells or low avidity of the offending antibody under the reaction conditions. In many cases, maternal antibody may be concentrated by elution from the surface of the fetal cells, facilitating its detection. If HDN is still suspected in the absence of both ABO incompatibility and detectable maternal antibody, the maternal serum or an eluate prepared from the infant's red cells can be tested against the biologic father's red cells ([41](#)). This procedure may detect a maternal antibody directed against a low-incidence red cell antigen that has been associated with severe HDN in rare cases, such as anti-Wr<sup>a</sup> (Wright), but is not represented on most red cell panels used for antibody identification ([41](#)).

41, 61).

The American Association of Blood Banks does not countenance routine immunohematologic testing of infants in the absence of clinically significant maternal antibodies or without a clinical suspicion of HDN (61). Despite these recommendations, some institutions continue to perform ABO/D typing and DATs on all newborn infants; others perform selective testing for infants born to group O mothers. The latter strategy is intended to identify infants at risk of ABO HDN, whose hospital discharge may be planned at less than 24 hours, but it has been criticized because all newborn infants should be monitored for jaundice during the first weeks of life (61).

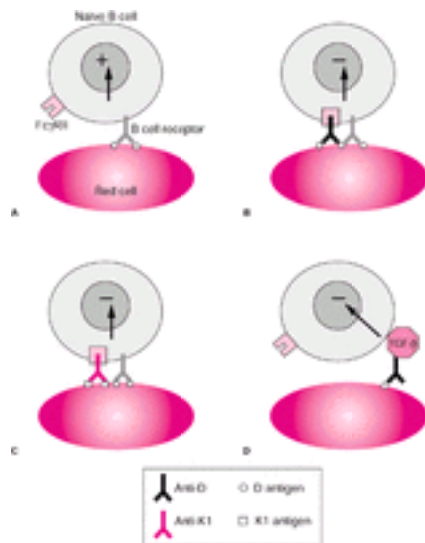
Jaundice is the visible manifestation of increased serum bilirubin concentration, and it becomes apparent when levels exceed 5 mg/dl. Laboratory detection of total, direct (conjugated), and indirect (unconjugated) bilirubin provides important diagnostic information regarding the cause of the jaundice (Table 36.5). In immune-mediated hemolytic disease, the total serum bilirubin concentration may be routinely assayed to guide clinical management, because it is almost entirely unconjugated (indirect) bilirubin. Under investigation are transcutaneous bilirubin measurements as well as measurements of unbound bilirubin, such as the bilirubin to albumin ratio, serum-free bilirubin, bilirubin reserve binding capacity, and bilirubin saturation index, and other signs of elevated bilirubin production such as the carboxyhemoglobin level and exhaled carbon monoxide levels (98). Further study is needed to determine the reliability of these tests in managing infants with immune-mediated hemolytic anemia.

## PREVENTION OF MATERNAL D ALLOIMMUNIZATION WITH RH IMMUNE GLOBULIN

RhIG prophylaxis is an international standard in obstetric care. Although the efficacy of RhIG in preventing alloimmunization to the D antigen is unequivocal, less clear are the mechanisms by which it inhibits the maternal immune response. Immune-mediated immunosuppression by passively transferred anti-D antibodies is not simply a matter of destruction of the D-positive red cells. This model was postulated initially because ABO-incompatible fetuses are partially protected from D alloimmunization, which suggests that ABO antibodies destroy fetal cells before the host reacts to them (42). RhIG, however, does not result in complete clearance of fetal red cells but is effective even though fetal red cells persist in the maternal circulation (99). Similarly, the theory that administered RhIG blocks the antigenic stimulus by coating D-positive red cells is not supported by the fact that immunosuppressive doses of RhIG bind only to a small fraction of the available antigen sites on red cells (99).

RhIG most likely prevents alloimmunization to the D antigen primarily through the activation of inhibitory intracellular signaling pathways, which ultimately blocks antibody production by the B cell (99). The pair of molecular interactions responsible for B-cell inhibition occur between the B-cell receptor (membrane IgG) and the D antigen on the red cell and between the B-cell Fc $\gamma$  receptor and the Fc portion of the bound anti-D on the red cell surface. In a primary immune response, naïve B cells are stimulated to produce antibody when B-cell receptors alone are activated by antigen (Fig. 36.6A). In the presence of RhIG, this signal is overridden, and apoptosis occurs when Fc receptors are simultaneously aggregated in the complex by their association with the red cell-bound anti-D antibodies (Fig. 36.6B). Memory B cells differ from naïve B cells in that they can be activated to produce antibody even in the presence of preexisting antibodies. Consequently, RhIG is not effective for preventing a secondary or anamnestic immune

response in a previously sensitized woman.



**Figure 36.6.** Mechanisms of anti-D immune globulin (RhIG) immune prophylaxis. **A:** Alloimmunization. Activation of naïve B cells in a D-negative individual occurs with exposure to D-positive red cells through interaction of the B-cell receptor (surface immunoglobulin) and D antigen. **B:** RhIG immune suppression. Inhibition of B cells is mediated by passively transferred anti-D (RhIG), which cross-links the B-cell receptor and Fc $\gamma$  receptor (Fc $\gamma$ RII). **C:** Specificity of immune suppression. Inhibition of B cells from a D-negative, K1-negative individual occurs despite exposure to D-positive, K1-positive red cells with the administration of anti-K1, in lieu of RhIG, through formation of the same receptor configuration as in (B) (i.e., cross-linking the Fc $\gamma$ RII receptor and B-cell receptor for the D antigen). **D:** Fc receptor-independent pathways for RhIG immune suppression. Inhibition or apoptosis of B cells may occur through interaction between the Fc portion of anti-D antibodies (RhIG) and immune complex formation on the surface of D-positive red cells. TGF, transforming growth factor.

Interestingly, immune suppression to the D antigen can be induced not only by anti-D but also by other passively transferred antibodies to a coexpressed blood group antigen, as long as the Fc $\gamma$  receptor is complexed with the B-cell receptor and the antigen ( [Fig. 36.6C](#)). This phenomenon of coinhibition was supported by the observation that passively administered anti-K1 IgG antibodies suppressed anti-D antibody formation in D-negative/K1-negative human subjects given D-positive/K1-positive red cells ( [100](#)). Finally, animal models of antibody-mediated immune suppression suggest the existence of Fc receptor-independent pathways ( [99](#)). For example, RhIG may bind and localize factors to the B cell that inhibit antibody production and induce apoptosis, such as transforming growth factor- $\beta$  ( [Fig. 36.6D](#)).

## Viral Safety Record

All commercially available RhIG products approved for clinical use are polyclonal anti-D preparations derived from the plasma of immunized human donors ( [Table 36.6](#)). Subsequent to the realization in the 1980s that human immunodeficiency virus (HIV) could be transmitted through blood product transfusion was the demonstration that the Cohn-Oncley fractionation process used for producing some of the RhIG formulations (e.g., RhoGAM) effectively partitioned and inactivated HIV. To further improve the safety of plasma derivatives, a serologic test to screen plasma donors for HIV was first

implemented in 1985; a serologic test for hepatitis C virus (HCV) was introduced in 1991; and nucleic acid testing for both HIV and HCV was added to the repertoire in 2000. As a further precaution, specific viral removal steps, such as size-exclusion filtration (RhoGAM), or viral inactivation methods, such as solvent-detergent treatment (WinRho), have been added to the manufacturing process ( [Table 36.6](#)). Despite these measures, every RhIG product derived from human plasma carries the warning that the potential for disease transmission has not been eliminated.

**TABLE 36.6. Anti-D Immune Globulin Products Available in the United States in 2000**

| Route of Administration/<br>Brand Name | Manufacturer   | Fractionation and Viral Inactivation  | Dose              | Coverage of D-Positive Red Cells (Whole Blood) | Labeled Indications  |
|--|--|---|-------------------|--|--|
| <b>IM</b>                              |  |   |                   |  |  |
| RhoGAM                                 | Ortho-Clinical Diagnostics, Raritan, NJ                                    | Cold alcohol fractionation; size-exclusion filtration <sup>a</sup>            | 300 µg (1500 IU)  | 15 ml (30 ml)                                  | Pregnancy/obstetric; D-incompatible transfusion                                  |
| MicRhoGAM                              |  |   | 50 µg (250 IU)    | 2.5 ml (5 ml)                                  |  |
| BayRho-D full dose                     | Bayer Biological, Elkhart, IN  | Cold ethanol fractionation; solvent-detergent and heat treatment <sup>b</sup> | 300 µg (1500 IU)  | 15 ml (30 ml)                                  | Pregnancy/obstetric; D-incompatible transfusion                                  |
| BayRho-D mini dose                     |  |   | 50 µg (250 IU)    | 2.5 ml (5 ml)                                  |  |
| <b>IV or IM</b>                        |  |   |                   |  |  |
| WinRho SDF                             | Cangene Corporation, Winnipeg, Canada; distributed by Nabi, Boca Raton, FL | Ion exchange chromatography; solvent-detergent and filtration <sup>c</sup>    | 120 µg (600 IU)   | 6 ml (12 ml)                                   | Pregnancy/obstetric; D-incompatible transfusion; immune thrombocytopenic purpura |
|  |  |   | 300 µg (1500 IU)  | 15 ml (30 ml)                                  |  |
|  |  |   | 1000 µg (5000 IU) | Not for obstetric use                          |  |

<sup>a</sup> Filtration reduces levels of enveloped (e.g., hepatitis C, hepatitis B, human immunodeficiency virus) and non-lipid-enveloped viruses (e.g., parvovirus, hepatitis A).



<sup>b</sup> Solvent-detergent and heat treatment removes and inactivates enveloped and nonenveloped viruses.

<sup>c</sup> Solvent-detergent treatment inactivates enveloped viruses, and filtration removes some non-lipid-enveloped viruses.

---

More than 500,000 doses of RhIG are given to an estimated 350,000 women each year, and no cases of hepatitis or HIV transmission attributed to RhIG have been documented in the United States ( [101](#), [102](#) ). In Ireland and the former East Germany, however, hepatitis C was transmitted to several hundred women by different batches of contaminated intravenous RhIG in the late 1970s, before the introduction of routine donor screening for anti-HCV antibodies in 1991 ( [103](#) ). In 1994, HCV RNA was also detected in batches of RhIG manufactured in Ireland between 1991 and 1994, and a single donor was implicated in contributing the infectious plasma to the pool ( [103](#) ). A large-scale retrospective investigation screened more than 19,000 recipients of anti-D in this time frame and identified 19 women with the same strain of HCV as the implicated donor ( [103](#) ).

HCV transmission was linked in 1993 and 1994 to two brands of intravenous Ig (IVIg) (Gammagard and Polygam), and these infections were the impetus for introducing viral inactivation steps for all plasma derivatives, including RhIG. No cases of viral transmission have been documented in the United States to any plasma derivative since 1995 ( [104](#) ). Another precautionary step recently taken in the United Kingdom is the importation of all source plasma for anti-D products from the United States, in light of a theoretical risk of transmission of variant Creutzfeld-Jacob disease from plasma collected in Europe ( [40](#) ). No cases of human variant Creutzfeld-Jacob disease transmission have been attributed to blood component transfusion or plasma derivative administration in any country to date. To lessen the reliance on human source plasma, monoclonal antibodies directed against D antigen epitopes have been developed with recombinant technology and compare favorably to RhIG in preventing D alloimmunization but are not commercially available ( [105](#) ).

## Dosage and Administration

The effective dose of RhIG to prevent sensitization, 20 µg/ml D-positive red cells, was determined experimentally by challenging D-negative male volunteers with incompatible blood ( [106](#) ). Dosage formulations of different preparations of RhIG are based on this conversion, with the “standard” 300 µg (1500 IU) sufficient to protect against FMH of 15 ml D-positive red cells (30 ml fetal whole blood) ( [Table 36.6](#) ) ( [76](#) ). The intravenous preparation (WinRho) is used more often for treating immune thrombocytopenia purpura than for preventing D alloimmunization, but it is effective for both indications. Dosage adjustments must be made for FMH that exceeds the volume covered by a dose of RhIG ( [41](#) ):

- Multiply the percentage of fetal cells in maternal circulation (expressed as a fraction) by the maternal blood volume (approximately 5000 ml) to determine the volume (ml) fetal whole blood in the maternal circulation [Kleihauer-Betke result of 1.4%: (0.014) (5000 ml) = 70 ml fetal whole blood].
- Divide by the volume of D-positive whole blood covered and round off by standard convention to determine required number of 300-µg vials of RhIG [70 ml fetal whole



blood  $\div$  30 ml whole blood per 300- $\mu$ g vial = 2.3 vials].

Given the inherent imprecision in calculating FMH with the Kleihauer–Betke test, some American authorities advocate administering one additional vial of RhIG than this calculated dose to ensure administration of sufficient RhIG ( [41](#), [76](#) ). For example, if the number of vials is calculated to be 2.3, round off to 2.0 vials, but administer 3.0 vials. If the number of vials is calculated to be 2.5, round off to 3.0 vials, but administer 4.0 vials ( [41](#) ).

RhIG is indicated for antenatal and postnatal prophylaxis as well as any clinical situation in which FMH is demonstrated or suspected in D–negative pregnant women. RhIG may also be administered to D–negative women of childbearing potential who inadvertently or unavoidably receive incompatible D–positive red blood cells or cellular components (e.g., platelets) prepared from D–positive whole blood in an attempt to prevent D alloimmunization ( [107](#) ). RhIG should *not* be administered to infants or to the following pregnant women ( [41](#), [76](#) ):

- A D–negative woman whose infant is D–negative
- Any D–positive woman, including women with weak/partial D phenotypes
- A D–negative woman known to be immunized to D

Although the appropriate dose of RhIG to administer was determined experimentally in red cell challenge experiments, the dosing interval of less than 72 hours after exposure was an arbitrary decision in early clinical trials but has been universally adopted. RhIG has been shown to be effective if administered 13 days, and possibly as late as 28 days, after exposure to D–positive red cells ( [108](#) ). Consequently, RhIG should be administered within 72 hours of potentially sensitizing events, but it should still be given if this interval is exceeded, as soon as the oversight is recognized. Depending on the administered dose and sensitivity of the laboratory tests, RhIG is detectable in maternal circulation for up to 6 months, with an average half–life of approximately 24 days. Cases of D alloimmunization in postdate pregnancies have been reported when delivery occurred more than 12 weeks after the antenatal dose of RhIG, although the residual circulating RhIG after the standard antenatal dose of 300  $\mu$ g should still protect against 1 to 2 ml of D–positive fetal red cells at 40 weeks ( [24](#) ).

Serious adverse reactions to RhIG are extremely rare but include anaphylaxis in IgA–deficient individuals. More commonly, mild to moderate discomfort may occur at the site of intramuscular injection. Products labeled only for intramuscular injection must not be given intravenously, because they may contain immune complexes that could activate circulating complement proteins and subsequently cause a systemic inflammatory response. The anti–D antibodies in RhIG preparations can cross the placenta and bind to fetal cells but do not cause significant hemolysis ( [109](#) ). Although the possible effects on infants were not consistently examined in previous clinical trials of RhIG, no short–term or long–term detriment to infants whose mothers received RhIG during pregnancy has been demonstrated ( [110](#) ).

### International Clinical Practice Guidelines

ACOG recommends an antenatal RhIG dose of 300  $\mu$ g at 28 weeks of gestation for nonsensitized, D–negative women and another 300  $\mu$ g after delivery of a D–positive infant, based primarily on data reviewed at the 1977 McMaster Conference revealing the high success rate associated with this regimen ( [Table 36.7](#) ) ( [16](#), [38](#) ). Current recommendations from the Royal College of Obstetricians and Gynaecologists (United

Kingdom) differ from those from ACOG in that antenatal prophylaxis is given as 100- $\mu$ g (500-IU) doses at both 28 weeks and 34 weeks of gestation, and another 100  $\mu$ g (500 IU) is given after delivery of a D-positive infant ( 39 ). Compared to the American strategy, the British approach achieves similar low rates of alloimmunization with less RhIG [300  $\mu$ g (1500 IU) vs. 600  $\mu$ g (3000 IU)] ( 39 , 40 ). This approach also avoids the risk of alloimmunization if delivery occurs more than 12 weeks after administration of the antenatal dose ( 24 ). A potential drawback, however, is the additional clinic visit required for the third injection at 34 weeks of gestation. Recommendations from Australian authorities diverge from current American and British guidelines in that antenatal prophylaxis is not currently recommended because of RhIG supply constraints in Australia ( 40 ).

**TABLE 36.7. Recommendations for Prophylactic Anti-D Immune Globulin (RhIG) Administration to D-Negative Women without Anti-D within 72 Hours of Delivery, Abortion, or Event**

|                                |  |
|--------------------------------|--|
| Antenatal                      | 300 $\mu$ g RhIG at 28 weeks' gestation unless father of baby is known to be D negative.   |
| Postpartum                     | 300 $\mu$ g RhIG after the delivery of a D-positive infant. American College of Obstetricians and Gynecologists acknowledges American Association of Blood Banks' recommendation for routine FMH screening in this situation to identify FMH >15 ml D-positive red cells requiring larger dose of RhIG.                          |
| Abortion                       | 50 $\mu$ g RhIG in the first trimester; 300 $\mu$ g RhIG after the first trimester; for induced or spontaneous abortion, ectopic pregnancy   |
| Potentially sensitizing events | 50 $\mu$ g RhIG in the first trimester; 300 $\mu$ g RhIG after the first trimester. This includes chorionic villus sampling, amniocentesis, and fetal blood sampling. RhIG should be considered in cases of threatened abortion, second- or third-trimester antenatal bleeding, external cephalic version, and abdominal trauma. |

FMH, fetal-maternal hemorrhage.

From American College of Obstetricians and Gynecologists. Prevention of RhD alloimmunization. Washington, DC: ACOG Practice Bulletin No. 4, May 1999.

All international medical authorities, however, emphasize the importance of recognizing potentially sensitizing events and appropriately administering RhIG after amniocentesis, chorionic villus sampling, percutaneous umbilical blood sampling, and obstetric complications, including abdominal trauma, manual removal of placenta, and antepartum vaginal bleeding ( [Table 36.2](#) ) ( 38 , 39 and 40 ). Smaller doses of anti-D immune globulin can be administered after first trimester events and procedures, because of the small total red cell mass of the fetus before 12 weeks' gestation. Consequently, ACOG recommends 50  $\mu$ g to protect against sensitization by 2.5 ml of red cells in the first trimester and the standard 300- $\mu$ g dose after 12 weeks.

Disconcertingly, the sensitization rate among D-negative women is higher than theoretically achievable rates, suggesting a failure to follow recommended prophylactic regimens ( 29 ). Although postpartum doses were almost always administered, anti-D immune globulin was less consistently administered after abortion (88 to 94%), antepartum hemorrhage (31%), and amniocentesis (14%) in a 1985 study ( 111 ). Deficiencies were noted as recently as 1994 in a series of more than 900 women in which RhIG administration

followed only 60% of invasive procedures or other events associated with FMH ( [112](#)). Ongoing vigilance in public health care is required to ensure effective use of RhIG given the potential severity of HDF/N due to D alloimmunization.

## MANAGEMENT OF RED CELL ALLOIMMUNIZATION IN PREGNANCY

If the antibody screen at the initial obstetric visit detects the presence of anti-D or other potentially clinically significant red cell alloantibodies, additional monitoring is necessary during the pregnancy, and prenatal intervention may be required. In general, the same principles of care provided for pregnant women with anti-D apply to those with other red cell alloantibodies reported to cause moderate to severe HDF, with some notable modifications for K1-sensitized pregnancies. Current American recommendations for the management of alloimmunization in pregnancy from ACOG and the American Association of Blood Banks are summarized in greater detail ( [61](#), [113](#)). For matters not addressed in these guidelines because of a lack of data or controversial findings in available studies, the opinions of current experts in the field based on their published interpretation of the available evidence or their clinical experience are presented ( [33](#), [71](#), [84](#), [91](#), [114](#)). Topics of debate have included the criteria used to identify the need for invasive fetal assessment, the timing of the first invasive procedure to assess the fetus's condition, the role of ultrasound, and the choice of invasive procedure and management protocol.

The obstetric history of an alloimmunized woman is extremely important in clinical management because the severity and onset of HDF/N are predictive of the course of disease in subsequent pregnancies. Antibody specificity is also taken into consideration; the presence of certain red cell antibodies are far more often implicated in cases of alloimmune fetal hydrops (e.g., anti-D, -c, -K, and -Fy<sup>a</sup>) than others (e.g., anti-E and anti-M) ( [33](#), [58](#)). Other IgG red cell antibodies have demonstrated the potential in rare cases to cause severe fetal anemia or life-threatening HDN ( [Table 36.3](#)), and still more IgG red cell antibodies have been reported to cause mild HDN. Although anecdotal reporting introduces bias toward the most severe cases, the previous behavior of non-D antibodies in sensitized pregnancies factors into monitoring and treatment decisions.

If paternal red cell typing reveals the fetus to be at risk for morbidity from these maternal red cell alloantibodies, prenatal diagnosis or further monitoring should be performed as necessary. The initial amniocentesis can be performed as early as 15 to 18 weeks' gestation for molecular diagnosis of blood group expression ( [114](#)). Alternatively, fetal blood sampling may be performed as early as 20 weeks to determine fetal blood groups and monitor hematologic parameters ( [33](#)). If the antigen is detected on fetal red cells or if testing is not performed, the maternal antibody titer should be determined at the first prenatal visit, at 18 to 20 weeks of gestation, and approximately every 2 to 4 weeks thereafter ( [61](#), [113](#)). If the antibody titer equals or exceeds titer deemed "critical" for increased risk of HDF, amniocentesis or percutaneous umbilical cord blood sampling should be planned. Antibody titers are not used to follow women whose prior pregnancies were affected by sensitization, such as those with a history of intrauterine transfusion, early delivery, or neonatal exchange transfusion ( [61](#), [113](#)). Similarly, once the decision has been made to use invasive measures to monitor a pregnancy, antibody titers are no longer indicated ( [61](#)).

Serial ultrasounds in an immunized pregnancy may reveal early signs of worsening fetal anemia or abnormalities of pulsed Doppler flow velocity waveforms, especially in K1-sensitized pregnancies ( [83](#)). Fetal evaluation in red cell alloimmunized pregnancies solely by ultrasound is currently not feasible, however, and ultrasound is usually used in

conjunction with amniocentesis, fetal blood sampling, or both.

### Amniocentesis versus Cordocentesis

A current pattern of practice in the United States is for the primary obstetrician to provide routine prenatal care to an alloimmunized pregnant woman and follow antibody titers, perform serial ultrasounds, and initiate amniotic fluid studies, if indicated, often in consultation with a fetal–maternal specialist. If the results suggest moderate or severe hemolytic disease in the fetus, the patient is usually referred to a specialty center for further management. Fetal blood sampling, although successfully used as a primary means of fetal surveillance in alloimmunized pregnancies, is often reserved for more aggressive management strategies for pregnant women at higher risk for severe hemolytic disease based on their previous obstetric history of affected infants.

In a first sensitized pregnancy, the initial invasive procedure is usually not necessary until 28 to 29 weeks if the titer is near the critical titer ( [61](#), [113](#)). For women with prior affected pregnancies, the timing of the initial procedure is determined by clinical history, being performed at least 4 to 8 weeks earlier than the prior gestational age at which significant morbidity occurred ( [113](#)). Amniocentesis can be performed at 18 to 20 weeks' gestation or earlier for patients with a history of a severely affected fetus.

Amniotic fluid  $\Delta OD_{450}$  measurements can be plotted on a Liley curve for pregnancies of at least 27 weeks' gestation ( [Fig. 36.4](#)) or on modified (extended) Liley curves for earlier time points in pregnancy, although the latter practice is controversial as previously discussed. The magnitude of the  $\Delta OD_{450}$  value and, more important, the trend in  $\Delta OD_{450}$  values with serial measurement guide treatment decisions ( [113](#)):

- Patients in zone I or low zone II are allowed to proceed to term.
- Patients in the middle of zone II can progress to 36 to 38 weeks of gestation in most cases.
- Patients in zone III or with a rising value in the upper part of zone II should be delivered or the fetus should receive intrauterine blood transfusion, depending on gestational age.

Unresolved is the question of the optimal frequency for repeated amniotic fluid sampling. In general, amniocentesis is repeated every 1 to 4 weeks if the  $\Delta OD_{450}$  reading falls in the middle of zone II and every 3 to 4 weeks if it has dropped into zone I. Declining values are reassuring but do not preclude hemolytic disease ( [113](#)).

The reliability of modified Liley curves, generated by extrapolating the values for gestational ages earlier than 27 weeks, has been supported by some ( [1](#), [86](#)) and contested by others ( [87](#), [90](#)). The alternative to modified Liley curves for the second trimester is the method developed by Queenan and colleagues ( [Fig. 36.5](#)) ( [84](#), [90](#)). If the  $\Delta OD_{450}$  values fall in the intermediate zones, the fetus's clinical condition may deteriorate, and intrauterine transfusion or delivery, depending on the gestational age, may be necessary ( [84](#), [90](#)).  $\Delta OD_{450}$  values or a trend into the uppermost zone put the fetus in jeopardy of dying *in utero*, prompting cordocentesis to evaluate the fetus. Although the zones predict fetal status, they do not correlate with the degree of fetal anemia; consequently, when cordocentesis is performed, the obstetric team must be prepared for the possibility of fetal transfusion.

Weiner and colleagues developed a management scheme based on fetal blood sampling

instead of amniotic fluid analysis, which offered the advantage of direct assessment of fetal hematologic parameters between 24 and 26 weeks' gestation or as early as 20 weeks' gestation, if clinically indicated ( [91](#), [92](#) ). With this surveillance scheme, repeat cordocentesis to guide treatment decisions is then based on gestational age, hematocrit, reticulocyte count, and a DAT of fetal red cells. Fetal bradycardia was the major risk of cordocentesis in this trial; no procedure-related deaths occurred after 272 diagnostic cordocenteses performed in 128 pregnancies, and only one patient had a twofold rise in antibody titer after the procedure ( [91](#), [92](#) ). This approach, however, requires an experienced and multidisciplinary team and should be limited to regional specialty referral centers with sufficient experience to achieve the highest level of safety.

## Intrauterine Fetal Transfusion

Intrauterine transfusion is performed to alleviate symptoms and extend gestation until the developing infant is mature enough to survive after delivery. Generally indicated if the fetal hematocrit falls below 25%, intrauterine transfusion can be given as early as 17 weeks' gestation by the intraperitoneal route and at approximately 20 weeks by the intravascular route ( [115](#) ). The only access before 17 weeks' gestation, the intracardiac route, is only an option in extreme circumstances, and most transfusions are given after 20 weeks by the intraperitoneal or intravascular routes ( [115](#) ).

Intraperitoneal transfusions are given by injecting blood into the abdominal cavity of the fetus, which is then absorbed into the fetal circulation by the subdiaphragmatic lymphatic system ( [115](#) ). The presence of ascites, however, interferes with absorption, limiting the benefit to the most severely affected infants. Intravascular transfusion directly into the fetus's circulation has largely supplanted the intraperitoneal method. The obvious advantage of the intravascular approach was the potential benefit offered to infants with hydrops and the ability to directly evaluate hematologic parameters after the transfusion ( [115](#), [116](#) and [117](#) ). A combined approach using both intravascular and intraperitoneal transfusion may produce more stable hematocrits and permit longer intervals between transfusions ( [116](#), [117](#) ).

The red cell volume to administer to a fetus during an intrauterine transfusion depends on the technique, the initial hematocrit, the target hematocrit, and the gestational age ( [41](#) ). For intraperitoneal transfusion, the volume of red cells is calculated by the following equation, which assumes the hematocrit of the donor red cell unit is approximately 75%: (gestational age in weeks – 20) × 10 ml ( [114](#) ). In a nonhydropic fetus, the rate of absorption is approximately 10 to 15% per 24 hours ( [114](#) ). Intravascular intrauterine transfusions are usually given as simple transfusions of small aliquots of red cells ranging in volume from 50 to 100 ml, and not as exchange transfusions, due to the technical complexity of the latter. Several equations have been developed to calculate the dose of red cells to transfuse for intravascular transfusion, including the following method ( [41](#), [118](#) ):

1. Calculate the fetoplacental volume (ml): ultrasound estimated fetal weight (g) × 0.14
2. Calculate the volume to transfuse (ml): fetoplacental volume × [(desired hematocrit – pretransfusion hematocrit) ÷ donor unit hematocrit]

The red cells used for intrauterine transfusion should be type O, D-negative, and antigen-negative if other clinically significant maternal alloantibodies are present, and they should be crossmatched against maternal serum. If antigen-negative red cells are needed but cannot be located, maternal red cells can be transfused to the infant if ABO/Rh



compatible and after reducing the amount of antibody-containing plasma ( [119](#) ). All red cell units for intrauterine transfusion should also be collected from cytomegalovirus (CMV)-seronegative donors or leukocyte-reduced to reduce the risk of CMV transmission, should lack hemoglobin S as a precaution against the potential for red cell sickling in hypoxic tissue beds, and should be gamma-irradiated to prevent transfusion-associated graft-versus-host disease ( [41](#) ).

Fetal blood is usually aspirated at the conclusion of intravascular transfusions to determine the final hematocrit and adequacy of the treatment. The goal of transfusions is usually to keep the fetal hematocrit around 27 to 30% ( [41](#), [114](#) ). Based on the association of increased umbilical cord venous pressure and mortality after transfusion, some authors recommend that in a severely anemic fetus, the final hematocrit after intravascular transfusion should not exceed a value of 25% or a fourfold increase from the pretransfusion value ( [120](#) ). Repeat transfusions are planned, based on an approximate 1% decline per day in hematocrit after intravascular transfusion ( [41](#) ). Brisk hemolysis of fetal cells with severe disease often necessitates a shorter interval between the first and second transfusion, usually 7 to 14 days, compared to subsequent transfusions, usually 21 to 28 days ( [114](#) ).

Complications of intrauterine transfusions in general include infection, premature rupture of membranes, premature labor, fetal hemorrhage, FMH resulting in increased maternal antibody titers and accelerated course of fetal hemolytic disease, and risks associated with allogeneic blood components including virus transmission and graft-versus-host disease ( [115](#) ). The risk of virus transmission with blood collected from repeat donors in the United States is currently estimated as 1 in 205,000 units for hepatitis B; 1 in 1,935,000 units for hepatitis C; and less than 1 in 2,135,000 units for HIV ( [121](#) ). The risk of physical injury during intrauterine transfusion, such as damage to fetal viscera with the intraperitoneal approach or umbilical cord damage with the intravascular approach, is minimized with the use of paralytic agents (i.e., vecuronium) to reduce fetal movement during intrauterine transfusions ( [114](#), [115](#) ). The procedure-related risk of fetal loss with intravascular transfusion is estimated as 4 to 9% ( [114](#) ). Complications of intravascular transfusion, not previously reported with intraperitoneal transfusion, include umbilical cord hematoma, fetal bradycardia, and porencephalic cysts ( [114](#), [115](#) ). The procedure-related risks of intrauterine transfusion must be weighed against the risks of preterm delivery and prematurity, and transfusions are rarely performed after completion of 34 gestational weeks ( [114](#) ).

## Investigational Strategies

Investigational strategies to prenatal treatment of HDF aim to modulate the maternal immune response and delay or avert the need for intrauterine transfusion by administering prenatal IVIg or performing therapeutic plasma exchange. Results with therapeutic plasma exchange in red cell alloimmunized pregnancies are variable, and in many cases, the maternal anti-D titer was not affected or rebounded to even higher levels after treatment ( [122](#) ). Prenatal intravenous IVIg administration, to either the mother or fetus, is not efficacious and is not recommended for routine use for management of HDF ( [123](#) ). For an alloimmunized woman with multiple fetal losses facing her reproduction options with a man heterozygous for the implicated blood group antigen, preimplantation diagnosis after *in vitro* fertilization may provide a means to identify antigen-negative embryos ( [124](#) ). Another investigational approach proposes to immunize these high-risk women against paternal HLA antigens before conception, citing the apparent mitigating effect of HLA antibodies on HDF/N caused by anti-D ( [51](#) ). Finally, research to selectively suppress the

maternal B cells that produce red cell alloantibodies is ongoing ( [114](#) ).

## TREATMENT OF THE NEWBORN INFANT

The therapeutic approach to anemia and jaundice after birth due to HDF/N depends on the gestational age at delivery, severity of disease, and other factors ( [98](#) ). Treatment of each affected infant must be individualized after a detailed history, physical examination, and laboratory investigation. An infant born with hydrops requires intensive and immediate supportive care. A thorough physical examination may reveal findings of pallor, tachycardia, and tachypnea, which reflect neonatal anemia. The infant must be monitored for worsening jaundice and neurologic findings of bilirubin toxicity. In contrast to “physiologic” jaundice developing on the second or third day of life, early jaundice appearing in the first 24 hours of life is always pathologic and may signify hemolysis. Initial laboratory assessment should include ABO/D blood typing and a direct antiglobulin test, as well as bilirubin measurement and a complete blood count for assessment of hemoglobin/hematocrit, reticulocyte count, and red cell morphology (polychromasia, spherocytes, and nucleated red cells). Early erythrocyte precursors and nucleated red blood cells may be prominent in the peripheral blood smear with hemolytic disease due to anti-D, whereas spherocytes predominate in ABO HDN. Serial tests of bilirubin concentration obtained every 4 to 8 hours are recommended to follow the rate of the rise in bilirubin and to determine the most appropriate form of treatment ( [98](#) ). Active hemolysis increases the concentration of unconjugated bilirubin; the concentration of conjugated bilirubin is usually normal or not greater than 0.5 mg/dl and should not be subtracted from the total bilirubin for treatment decisions. Conjugated bilirubin above the upper limit of the normal range in HDN may indicate mild cholestasis or “inspissated” bile ( [98](#) ).

Infants with jaundice due to immune-mediated hemolysis are generally considered at greater risk for bilirubin encephalopathy than infants with jaundice due to other causes, at any given serum unconjugated bilirubin concentration ( [98](#) ). Acid-base disturbances, asphyxia, free heme groups, and other byproducts of hemolysis may potentiate the toxic effects of bilirubin in infants with alloimmune hemolysis. Consequently, the trend in pediatric practice toward less aggressive intervention for hyperbilirubinemia in the otherwise healthy term newborn does not apply to infants with alloimmune hemolysis ( [98](#) ). Recommendations offered for management of hemolytic disease due to anti-D, however, may be applied to infants with anti-K1 or other potentially significant red cell antibodies ( [98](#) ).

### Phototherapy

Phototherapy is the first line of treatment for neonatal jaundice and often averts the need for an exchange transfusion in infants with HDN. Light exposure converts insoluble, unconjugated bilirubin into a water-soluble form, permitting more rapid excretion without conjugation through the bile or urine. Factors affecting optimal phototherapy include the dose of light, its spectral emission curve, the infant’s exposed surface area, the depth of penetration of the light, and characteristics of the infant’s skin and tissues. The effective wavelength of light for transcutaneous degradation of unconjugated bilirubin is in the 425– to 475-nm range, found at high irradiance in blue light ( [125](#) ). Conventional phototherapy uses banks of lights, whereas fiberoptic light systems contain optical fibers in a blanket or cummerbund-like band that is wrapped around the infant. The fiberoptic light systems expose greater surface area to light, are convenient to use, and are less disruptive to parent-child bonding than conventional phototherapy. Double phototherapy uses both fiberoptic and conventional phototherapy and lowers serum bilirubin faster than



conventional phototherapy alone ( [125](#) ).

Treatment must be tailored individually to infants who develop unconjugated hyperbilirubinemia within the first 24 hours of life. In general, phototherapy should be initiated in term infants if bilirubin increases by 0.5 mg/dl/hour or more, or if total bilirubin exceeds 10 mg/dl within the first 12 hours of life; 12 mg/dl within the first 18 hours of life; or 14 mg/dl within the first 24 hours of life ( [98](#) ). After 24 hours of life, phototherapy should be initiated at bilirubin thresholds that take into account the infant's birthweight and clinical condition ( [Table 36.8](#) ). Premature infants are treated earlier in the course of disease at lower bilirubin concentrations than term infants. Earlier initiation of therapy, at lower bilirubin concentrations, may also be clinically indicated in other scenarios as well; for example, infants who required extensive prenatal treatment may be started on optimal phototherapy after birth.

**TABLE 36.8. Treatment of Immune-Mediated Hemolytic Disease at 2 to 3 Days of Life <sup>a</sup>**

| Birth Weight (g) | Phototherapy Threshold (Bilirubin, mg/dl) | Exchange Threshold (Bilirubin, mg/dl) |
|------------------|---|---------------------------------------|
| ≥2500            | 15  | 18–20                                 |
| 2000–2499        | 10–13                                     | 15–17                                 |
| 1500–1999        | 7–8                                       | 13–15                                 |
| 1250–1499        | Immediate or 5–6                          | 12–13                                 |
| <1250            | Immediate or 4                            | 9–12                                  |

<sup>a</sup> Jaundice on the first day of life is always pathologic and requires individualized treatment decisions.

Adapted from Peterec SM. Management of neonatal Rh Disease. Clin Perinat Hematol 1995;22:561–592.

Adverse effects of phototherapy include increased insensible water loss, diarrhea, photosensitization, overheating, and hyperpigmentation. Because of the potential for retinal damage with phototherapy, protective eye devices must be used ( [125](#) ).

### Exchange Transfusion

Exchange transfusion is usually needed when phototherapy fails to adequately decrease bilirubin concentration or the initial serum bilirubin concentration places the infant at high risk for developing kernicterus. Current indications for exchange transfusion for HDN are debatable because recommendations often must be based on older studies before the development of effective phototherapy and prenatal interventions for fetal anemia. Historically, criteria for early exchange transfusion within 12 hours of birth are a cord bilirubin concentration exceeding 3 to 5 mg/dl for preterm infants and 5 to 7 mg/dl for term infants or a rate of rise of 0.5 mg/dl/hour or greater ( [98](#) ). A bilirubin level greater than 20 mg/dl despite phototherapy is generally cause for late exchange transfusion in term infants with hemolytic disease due to anti-D; the decision is triggered at lower bilirubin levels for preterm infants ( [Table 36.8](#) ).

If exchange transfusion is performed, a transfusion volume approximately twice the

infant's total blood volume ( $85 \text{ ml/kg} \times 2$  for a term infant;  $100 \text{ ml/kg} \times 2$  for a preterm infant) is administered incrementally while removing aliquots of the infant's blood over a period of 1 to 2 hours. The procedure either involves a push-pull method with a single vascular access or an isovolemic method that requires two catheters to allow for simultaneous withdrawal and infusion (1, 98). The umbilical artery is usually used for withdrawing blood, and the umbilical vein is usually used for infusion. The isovolemic method may be preferable because mean arterial pressure and cerebral blood volume may be more stable than during the single catheter push-pull method (98). An exchange of approximately two blood volumes removes approximately 85% of red cells but only approximately 45% of plasma bilirubin because the latter reequilibrates between intravascular and extravascular spaces. Consequently, infants with aggressive hemolytic disease may require more than one exchange transfusion before an acceptable bilirubin concentration is achieved.

Red cell units chosen for neonatal exchange transfusion should be O, Rh-negative, or ABO/Rh type-specific; should lack the blood group antigen implicated in hemolytic disease (e.g., ABO hemolytic disease requires the use of type O red cells); and should be compatible with maternal serum. Maternal serum or plasma is usually used in crossmatching red cells for infants because it contains the implicated antibody in high concentration and is available in large quantity. If a maternal sample is not available, the infant's plasma or serum can be used for compatibility testing; however, the concentration of circulating antibody may be low if most is bound to the infant's red cells. In this case, the bound antibody can be eluted from the surface of the infant's red cells, and the resulting eluate can be used for crossmatching. Rarely, HDN is due to an antibody to a high-incidence blood group antigen present in almost all persons, and no compatible units can be identified (41). In this case, maternal blood can be collected and washed to remove incompatible plasma for the infant.

Any blood component collected from biologic relatives must be irradiated as a precaution against transfusion-associated graft-versus-host disease, as well as blood components transfused to infants who received intrauterine transfusion or who are otherwise immunocompromised due to premature birth or severe primary immune deficiency. Because of the difficulty in identifying all high-risk newborn infants, many transfusion services provide gamma-irradiated blood for all infants until the age of 4, 6, or 12 months (126). Another common standard of practice is the use of either leukocyte-reduced cellular components or units selected from CMV-seronegative donors to reduce the risk of CMV transmission to newborn infants (126). Most blood banks also transfuse only units that lack hemoglobin S to infants to avoid the potential for hypoxia-induced sickling in a critically ill infant and fresh (<5 to 7 days old) or washed red cell units to avoid the risk of potassium-mediated cardiac toxicity with large transfusion volumes (41, 126). To prepare a two-blood volume exchange transfusion, red cells should be reconstituted with ABO-compatible plasma to the desired total volume and hematocrit. Albumin infusion before or during exchange in an effort to enhance bilirubin removal is controversial (98).

Morbidity and mortality among infants requiring exchange transfusion are usually due to the underlying disease and not the exchange transfusion procedure. In a study involving 331 exchanges given to 190 infants, there was only one death within 6 hours of an exchange transfusion—an infant who was critically ill before the procedure (127). Procedure-related reactions during exchange transfusion were noted in less than 10% of infants (22 of 328) and included transient, mild bradycardia (127). Other potential complications of neonatal exchange transfusion include hypervolemia and volume overload, cardiac toxicity due to citrate or hyperkalemia, air emboli or thrombosis in the umbilical vein, necrotizing enterocolitis, bleeding due to dilutional coagulopathy or thrombocytopenia, bacterial sepsis, or viral transmission, as previously described for fetal

blood component transfusion ( 1 ).

### Transfusion for Late-Onset Neonatal Anemia

Infants who respond to phototherapy alone or those who receive intrauterine transfusion may also require straight red cell transfusion between 2 to 10 weeks of life due to anemia developing as a result of low-grade hemolysis or erythropoietic suppression. Maternal antibody persists in the infant's circulation for approximately 6 weeks, and resultant hemolysis is usually associated with a marked reticulocytosis. In contrast, the late anemia associated with intrauterine transfusion is characterized by sustained suppression of erythropoiesis and decreased to absent reticulocytes and low erythropoietin concentrations ( 128 ). Erythropoietic suppression also occurs with anti-K1 and anti-D, irrespective of intrauterine transfusion ( 98 , 129 ). To counter this late hypoproliferative anemia, erythropoietin treatment resulted in increased reticulocyte count and hemoglobin concentration and avoided the need for transfusion in some infants with HDN ( 128 , 129 ).

Infants with circulating red cell antibodies should be closely monitored for at least 8 to 10 weeks to identify the development of late anemia. Hemoglobin concentrations below 7 to 10 g/dl have been proposed as transfusion "triggers." In general, the transfusion decision should be guided not only by the hemoglobin concentration and reticulocyte count but also, and most importantly, by the infant's condition, signs of lethargy, poor feeding, or failure to thrive.

### Adjunctive and Experimental Treatment

Whereas phototherapy and exchange transfusion effectively decrease bilirubin concentration in most infants with HDN, experimental strategies are aimed at blocking hemolysis and bilirubin production outright. High-dose IVIg may block binding of antibody-coated red cells to Fc receptors on cytotoxic cells, thereby preventing red cell destruction in the reticuloendothelial system ( 123 , 130 ). Based on available data, IVIg is not recommended for routine use but may be a reasonable adjunct to phototherapy for infants with severe immune-mediated hemolytic disease and should probably be given as early as possible in the clinical course ( 98 ).

*Metalloporphyrins* are heme analogs that block the rate-limiting enzyme, heme oxygenase, in the heme metabolic pathway. Sn-mesoporphyrin (SnMP) was used to treat two infants with severe immune-mediated hyperbilirubinemia after their parents refused exchange transfusion because of their religious convictions as Jehovah's Witnesses ( 131 ). In both cases, phototherapy failed to achieve adequate control, but SnMP effectively halted the progression of hyperbilirubinemia. Without such extenuating circumstances, however, the use of SnMP is not recommended ( 98 ). Other agents investigated as means to decrease serum bilirubin include phenobarbital, clofibrate, cholestyramine, agar, and charcoal ( 98 ). The clinical effectiveness and the potential toxicity of these various treatments require further study before they can be recommended for treatment of immune-mediated hemolytic disease.

## OUTCOME STUDIES

The survival rate among infants who required intrauterine transfusion varies with institution and experience, but infants without signs of hydrops have a relatively favorable prognosis. A survey of 16 institutions in the United States and Canada involving 1087 intrauterine intravascular transfusions given to 389 fetuses revealed a survival rate of 90%

for nonhydropic fetuses and 82% in cases of hydrops ( [114](#)). The degree of hydrops, and not merely its presence, is predictive of the outcome of alloimmunized pregnancies ( [132](#)). In 2001, Van Kamp et al. reported that 41 of 42 fetuses with mild hydrops (98%) survived, compared to only 21 of 55 fetuses with severe hydrops (55%) ( [132](#)). Hydrops can be reversed in 60 to 70% of fetuses after intrauterine transfusion, and almost all fetuses with resolved hydrops survived, whereas persistent hydrops was more often associated with an unfavorable outcome ( [114](#), [132](#)). The long-term neurodevelopmental outcome of infants successfully treated *in utero* with red cell transfusion compares favorably to other high-risk, very-low-birth-weight infants ( [133](#)). The majority of surviving infants who received intrauterine transfusion demonstrate normal development and neurologic function; less than 10% exhibit mild to severe developmental delays or cerebral palsy (spastic tetraparesis or hemiplegia) ( [133](#), [134](#) and [135](#)).

Recent outcome studies of infants with moderate and severe hemolytic disease in the neonatal period treated with current phototherapy modalities are not available, and uncertainties persist regarding the relationship between serum bilirubin levels and brain damage in both immune-mediated and nonimmune neonatal hyperbilirubinemia. In the early 1950s before effective treatment was available, approximately one-half of infants with bilirubin concentrations greater than 30 mg/dl developed kernicterus. An overall decrease in the incidence of kernicterus has been observed, but the neurologic or cognitive consequences of transient, severe hyperbilirubinemia due to alloimmune hemolysis have not been systematically studied ( [98](#)). The National Institute of Child Health and Human Development clinical trial of phototherapy for neonatal hyperbilirubinemia failed to demonstrate an association between intelligence quotient and maximum bilirubin, mean bilirubin, or duration of exposure to elevated bilirubin, although patients with immune-mediated hemolysis were not analyzed separately ( [136](#)).

## CONCLUSION

Alloimmune HDF/N caused by anti-D continues to occur at a low rate despite the availability of RhIG. When other red cell incompatibility occurs in pregnancy, no measures are available to prevent alloimmunization, and severe fetal disease may be caused by anti-c, anti-K1, or, rarely, anti-Fy<sup>a</sup> or other red cell alloantibodies. With improved techniques for prenatal and peri-natal management, the mortality rate attributed to HDF/N has decreased over the past decades, and survival rates for nonhydropic fetuses with alloimmune hemolysis currently approach 90%. In 1999 in the United States, only 16 infant deaths were attributed to alloimmune HDN—a number too low to calculate a statistically reliable mortality rate, according to the National Center for Health Statistics ( [137](#)). This estimate does not capture early intrauterine deaths, and some neonatal deaths may be attributed to other prevailing complications, but it is an accurate reflection of the current low burden of disease due to HDF/N because of the effectiveness of primary prevention and early treatment.

## WEB SITES

Agency for Healthcare Research and Quality (United States): [www.ahrq.gov](http://www.ahrq.gov)

American College of Obstetricians and Gynecologists (United States): [www.acog.org](http://www.acog.org)

National Guideline Clearinghouse (United States): [www.guideline.gov](http://www.guideline.gov)

National Health and Medical Research Council (Australia): [www.health.gov.au/nhmrc/](http://www.health.gov.au/nhmrc/)

National Institute of Child Health and Human Development (United States):  
[www.nichd.nih.gov/cochrane](http://www.nichd.nih.gov/cochrane)

Royal College of Obstetricians and Gynaecologists (United Kingdom): [www.rcog.org.uk](http://www.rcog.org.uk)

## REFERENCES

1. Bowman JM. Hemolytic disease of the newborn. In: Garratty G, ed. Immunobiology of transfusion medicine. New York: Marcel Dekker, 1994:553–595.
2. Diamond LK, Blackfan KD, Baty JM. Erythroblastosis fetalis and its association with universal edema of the fetus, icterus gravis neonatorum and anemia of the newborn. *J Pediatr* 1932;1:269–309.
3. Landsteiner K, Wiener AS. An agglutinable factor in human blood recognized by immune sera for rhesus blood. *Proc Soc Exp Biol Med* 1940;43:223.
4. Levine P, Stetson RE. An unusual case of intra-group agglutination. *J Am Med Assoc* 1939;113:126–127.
5. Levine P, Katzin EM, Burnham L. Isoimmunization in pregnancy: its possible bearing on the etiology of erythroblastosis fetalis. *J Am Med Assoc* 1941;116:825–827.
6. Chown B. Anemia from bleeding of the fetus into the mother's circulation. *Lancet* 1954;1:1213–1215.
7. Diamond LK, Allen FH, Jr., Thomas WO. Erythroblastosis fetalis. VII. Treatment with exchange transfusion. *N Engl J Med* 1951;244:39–49.
8. Liley AW. Liquor amnii analysis in the management of the pregnancy complicated by rhesus sensitization. *Am J Obstet Gynecol* 1961;82:1359–1370.
9. Liley AW. Intrauterine transfusion of foetus in haemolytic disease. *BMJ* 1963;2:1107–1109.
10. Clarke CA, Donohoe WTA, McConnell RB, et al. Further experimental studies in the prevention of Rh-haemolytic disease. *BMJ* 1963;1:979–984.
11. Freda VJ, Gorman JG, Pollack W. Successful prevention of experimental Rh sensitization in man with an anti-Rh gamma<sub>2</sub>-globulin antibody preparation: a preliminary report. *Transfusion* 1964;4:26–32.
12. Combined study. Prevention of Rh-haemolytic disease: results of the clinical trial. A combined study from centres in England and Baltimore. *BMJ* 1966;2:901–910.
13. Pollack W, Gorman JG, Freda VJ, et al. Results of clinical trials with RhoGAM in women. *Transfusion* 1968;8:151–153.
14. Chown B, Duff AM, James J, et al. Prevention of primary Rh immunization. First report of the Western Canadian Trial. *Can Med Assoc J* 1969;100:1021–1024.
15. Freda VJ, Gorman JG, Pollack W, et al. Prevention of Rh hemolytic disease—ten years' experience with Rh immune globulin. *N Engl J Med* 1975;292:1014–1016.
16. McMaster Conference on Prevention of Rh Immunization. 28–30 September 1977. *Vox Sang* 1979;36:50–64.
17. Crowther C, Middleton P. Anti-D administration after childbirth for preventing Rhesus alloimmunization. In: Sinclair J, Bracken M, Soll RF, Horbar JD, eds. Neonatal module of the Cochrane database of systematic reviews. Available in the Cochrane Library [database on disk and CD-ROM]. The Cochrane Collaboration, Issue 1; Oxford:2002. Updated quarterly. Available from BMJ Publishing Group,

London. [www.nichd.nih.gov/cochrane](http://www.nichd.nih.gov/cochrane).

18. Zipursky A. The universal prevention of Rh immunization. *Clin Obstet Gynecol* 1971;14:869–884.
19. Bowman JM, Chown B, Lewis M, Pollock JM. Rh isoimmunization during pregnancy: antenatal prophylaxis. *Can Med Assoc J* 1978;118:623–627.
20. Crowther C. Anti-D administration in pregnancy for preventing Rhesus alloimmunization. In: Sinclair J, Bracken M, Soll RF, Horbar JD, eds. Neonatal module of the Cochrane database of systematic reviews. Available in the Cochrane Library [database on disk and CD-ROM]. The Cochrane Collaboration, Issue 1; Oxford:2002. Updated quarterly. Available from BMJ Publishing Group, London. [www.nichd.nih.gov/cochrane](http://www.nichd.nih.gov/cochrane).
21. Huchet J, Dallemagne S, Huchet C, et al. The antepartum use of anti-D immunoglobulin in rhesus negative women. Parallel evaluation of fetal blood cells passing through the placenta. The results of a multicenter study carried out in the region of Paris. *J Gynecol Obstet Biol Reprod (Paris)* 1987;16:101–111.
22. Lee D, Rawlinson VI. Multicentre trial of antepartum low dose anti-D immunoglobulin. *Transfus Med* 1995;5:15–19.
23. Prevention of Rh sensitization: report of WHO Scientific group. WHO Technical Report Series 468, 1971.
24. Bowman JM. Controversies in Rh prophylaxis. Who needs Rh immune globulin and when should it be given? *Am J Obstet Gynecol* 1985;151:289–294.
25. Hensleigh PA. Preventing rhesus isoimmunization: antepartum Rh immune globulin prophylaxis versus a sensitive test for risk identification. *Am J Obstet Gynecol* 1983;146:749–755.
26. Tovey LA, Taverner JM. A case for the antenatal administration of anti-D immunoglobulin to primigravidae. *Lancet* 1981;878–881.
27. Statement from the consensus conference on anti-D prophylaxis 7 and 8 April 1997. The Royal College of Physicians of Edinburgh. Royal College of Obstetricians and Gynaecologists. *Vox Sang* 1998;74:127–128.
28. Centers for Disease Control. Rh hemolytic disease: Connecticut, United States, 1970–1979. *MMWR Morb Mortal Wkly Rep* 1981;30:13–15.
29. Chavez GF, Mulinare J, Edmonds LD. Epidemiology of Rh hemolytic disease of the newborn in the United States. *J Am Med Assoc* 1991;265:3270–3274.
30. Joseph KS, Kramer MS. The decline in Rh hemolytic disease: should Rh prophylaxis get all the credit? *Am J Public Health* 1998;88:209–215.
31. Weinstein L. Irregular antibodies causing hemolytic disease of the newborn: a continuing problem. *Clin Obstet Gynecol* 1982;25:321–332.
32. Vengelen-Tyler V. The serologic investigation of hemolytic disease of the newborn caused by antibodies other than anti-D. In: Garratty G, ed. *Hemolytic disease of the newborn*. Arlington: AABB, 1984:156–157.
33. Moise KJ. Non-anti-D antibodies in red-cell alloimmunization. *Eur J Obstet Gynecol Reprod Biol* 2000;92:75–81.
34. Bowman JM, Pollock JM, Penston LE. Fetomaternal transplacental hemorrhage during pregnancy and after delivery. *Vox Sang* 1986;51:117–121.
35. Medearis AL, Hensleigh PA, Parks DR, Herzenberg LA. Detection of fetal erythrocytes in maternal blood postpartum with the fluorescence-activated cell sorter. *Am J Obstet Gynecol* 1984;148:290–295.
36. Zipursky A, Isreals LG. The pathogenesis and prevention of Rh immunization. *Can Med Assoc J* 1967;97:1245–1257.



37. Ness PM, Baldwin ML, Niebyl JR. Clinical high-risk designation does not predict excess fetal-maternal hemorrhage. *Am J Obstet Gynecol* 1987;156:154-158.
38. Prevention of RhD alloimmunization. ACOG Practice Bulletin Number 4. Washington, DC: American College of Obstetricians and Gynecologists (ACOG), May 1999.
39. Royal College of Obstetricians and Gynaecologists. Use of anti-D immunoglobulin for Rh prophylaxis guidelines, [www.rcog.org.uk/guidelines](http://www.rcog.org.uk/guidelines).
40. National Health and Medical Research Council. Guidelines on the prophylactic use of Rh D immunoglobulin (anti-D) in obstetrics. Commonwealth of Australia, 1999.
41. Brecher ME, ed. Technical manual, 14th ed. Bethesda, MD: American Association of Blood Banks 2002.
42. Woodrow JC, Donohoe WTA. Rh immunization by pregnancy: results of a survey and their relevance to prophylactic therapy. *Brit Med J* 1968;4:139.
43. Geifman-Holtzman O, Wojtowycz M, Kosmas E, Artal R. Female alloimmunization with antibodies known to cause hemolytic disease. *Obstet Gynecol* 1997;89:272-275.
44. Polesky HF. Blood group antibodies in prenatal sera. *Minn Med* 1967;50:601-603.
45. Filbey D, Hanson U, Wesström G. The prevalence of red cell antibodies in pregnancy correlated to the outcome of the newborn: a 12 year study in central Sweden. *Acta Obstet Gynecol Scand* 1995;74:687-692.
46. Solola A, Sibai B, Mason JM. Irregular antibodies: an assessment of routine prenatal screening. *Obstet Gynecol* 1983;61:25-30.
47. Heddle NM, Klama L, Frassetto R, et al. A retrospective study to determine the risk of red cell alloimmunization and transfusion during pregnancy. *Transfusion* 1993;23:217-220.
48. Caine ME, Mueller-Heubach E. Kell sensitization in pregnancy. *Am J Obstet Gynecol* 1986;154:85-90.
49. Toy PT, Reid ME, Papenfus L, et al. Prevalence of ABO maternal-infant incompatibility in Asians, Blacks, Hispanics and Caucasians. *Vox Sang* 1988;54:181-183.
50. Contreras M, Garner SF, de Silva M. Prenatal testing to predict the severity of hemolytic disease of the fetus and newborn. *Curr Opin Hematol* 1996;3:480-484.
51. Neppert J, Witzleben-Schurholz E, Zupanska B, et al. High incidence of maternal HLA A, B and C antibodies associated with a mild course of haemolytic disease of the newborn. Group for the Study of Protective Maternal HLA Antibodies in the Clinical Course of HDN. *Eur J Haematol* 1999;63:120-125.
52. Bowman JM, Pollock JM, Manning FA, et al. Maternal Kell blood group alloimmunization. *Obstet Gynecol* 1992;79:239-244.
53. Vaughan JI, Manning M, Letsky EA, Nicolini U, et al. Erythropoietic suppression in fetal anemia because of Kell alloimmunization. *Am J Obstet Gynecol* 1994;171:247-252.
54. Weiner CP, Widness JA. Decreased fetal erythropoiesis and hemolysis in Kell hemolytic anemia. *Am J Obstet Gynecol* 1996;174:547-551.
55. Vaughan JI, Manning M, Warwick RM, et al. Inhibition of erythroid progenitor cells by anti-K antibodies in fetal alloimmune anemia. *N Engl J Med* 1998;338:798-803.
56. Bowman JM, Pollock JM. Rh immunization in Manitoba: progress in prevention and management. *Can Med Assoc J* 1983;129:343-345.
57. Weinstein L, Taylor ES. Hemolytic disease of the neonate secondary to anti-Fy<sup>a</sup>. *Am J Obstet*



Gynecol 1975;121:643-645.

58. De Young-Owens A, Kennedy M, Rose RL, et al. Anti-M isoimmunization: management anti-M isoimmunization: management and outcome at the Ohio State University from 1969 to 1995. *Obstet Gynecol* 1997;90:962-966.

59. Moran P, Robson SC, Reid MM. Anti-E in pregnancy. *Br J Obstet Gynecol* 2000;107:1436-1438.

60. Joint Commission on Accreditation of Healthcare Organizations. Kernicterus threatens healthy newborns. *Sentinel Event Alert* 2001;18:1-4.

61. Judd WJ. Practice guidelines for prenatal and perinatal immunohematology, revisited. *Transfusion* 2001;41:1445-1452.

62. Domen RE. Policies and procedures related to weak D phenotype testing and Rh immune globulin administration. *Arch Pathol Lab Med* 2000;124:1118-1121.

63. Lacey PA, Caskey CR, Werner DJ, Moulds JJ. Fatal hemolytic disease of the newborn due to anti-D in an Rh-positive Du variant mother. *Transfusion* 1983;23:91-94.

64. Rothenberg JM, Weirermiller B, Dirig K, et al. Is a third trimester antibody screen in Rh+ women necessary? *Am J Manag Care* 1999;5:1145-1150.

65. Kanter MH. Derivation of new mathematic formulas for determining whether a D-positive father is heterozygous or homozygous for the D antigen. *Am J Obstet Gynecol* 1992;166:61-63.

66. Avent ND, Finning KM, Martin PG, Soothill PW. Prenatal determination of fetal blood group status *Vox Sang* 2000;78:155-162.

67. Wagner FF, Flegel WA. RHD gene deletion occurred in the Rhesus box. *Blood* 2000;95:3662-3668.

68. Lo YMD, Hjelm NM, Fidler C, et al. Prenatal diagnosis of fetal RhD status by molecular analysis of maternal plasma. *N Engl J Med* 1998;339:1734-1738.

69. Bischoff FZ, Nguyen DD, Marquez-Do D, et al. Noninvasive determination of fetal RhD status using fetal DNA in maternal serum and PCR. *J Soc Gynecol Invest* 1999;6:64-69.

70. Allen LH, Diamond LK, Jones AR. Erythroblastosis fetalis: IX. Problems of stillbirth. *N Engl J Med* 1954;251:453-456.

71. Spinnato JA. Hemolytic disease of the fetus: a plea for restraint. *Obstet Gynecol* 1992;80:873-877.

72. Moise KJ, Perkins JT, Sosler DS, Brown SJ, et al. The predictive value of maternal serum testing for detection of fetal anemia in red blood cell alloimmunization. *Am J Obstet Gynecol* 1995;172:1003-1009.

73. Van Dijk BA, Dooren MC, Overbeeke MA. Red cell antibodies in pregnancy: there is no 'critical titre.' *Transfus Med* 1995;5:199-202.

74. Hadley AG, Kumpel BM, Leader KA, et al. Correlation of serologic, quantitative and cell-mediated functional assays of maternal alloantibodies with the severity of haemolytic disease of the newborn. *Br J Haematol* 1991;77:221-228.

75. Oepkes D, van Kamp IL, Simon MJG, et al. Clinical value of an antibody-dependent cell-mediated cytotoxicity assay in the management of Rh D alloimmunization. *Am J Obstet Gynecol* 2001;184:1015-1020.

76. Hartwell EA. Use of Rh immune globulin ASCP Practice Parameter. *Am J Clin Pathol* 1998;110:281-292.

77. Bayliss KM, Kueck BD, Johnson ST, et al. Detecting fetomaternal hemorrhage: a comparison of five methods. *Transfusion* 1991;31:303-307.

78. Sebring ES, Polesky HF. Comparison of fetomaternal hemorrhage detection methods and Rh immune

globulin usage. *Am J Clin Pathol* 1979;72:358–362.

79. Pembrey ME, Weatherall DJ, Clegg JB. Maternal synthesis of hemoglobin F in pregnancy. *Lancet* 1973;1:1350–1354.
80. Davis BH, Olsen S, Bigelow NC, Chen JC. Detection of fetal red cells in fetomaternal hemorrhage using a fetal hemoglobin monoclonal antibody by flow cytometry. *Transfusion* 1998;38:749–756.
81. Ness PM. The assessment of fetal–maternal hemorrhage by an enzyme–linked antiglobulin test for Rh immune globulin recipients. *Am J Obstet Gynecol* 1982;143:788–792.
82. Divakaran TG, Waugh J, Clark TJ, et al. Noninvasive techniques to detect fetal anemia due to red blood cell alloimmunization: a systematic review. *Obstet Gynecol* 2001;98:509–517.
83. Mari G, Deter RL, Carpenter RL, et al. Noninvasive diagnosis by Doppler ultrasonography of fetal anemia due to maternal red–cell alloimmunization. Collaborative Group for Doppler Assessment of the Blood Velocity in Anemic Fetuses. *N Engl J Med* 2000;342:9–14.
84. Queenan JT. Management of Rh–immunized pregnancies. *Prenat Diagn* 1999;19:852–855.
85. Spinnato JA, Clark AL, Ralston KK, et al. Hemolytic disease of the fetus: a comparison of the Queenan and extended Liley methods. *Obstet Gynecol* 1998;92:441–445.
86. Spinnato JA, Clark AL. Hemolytic disease of the fetus: a comparison of the Queenan and extended Liley methods. [Letter]. *Obstet Gynecol* 1999;93:162–163.
87. Nicolaides KH, Rodeck CH, Mibashan RS, Kemp JR. Have Liley charts outlived their usefulness? *Am J Obstet Gynecol* 1986;155:90–94.
88. Queenan JT, Tomai TP, Ural SH, King JC. Deviation in amniotic fluid optical density at a wavelength of 450 nm in Rh–immunized pregnancies from 14 to 40 weeks' gestation: a proposal for clinical management. *Am J Obstet Gynecol* 1993;168:1370–1376.
89. Spong CY, Porter AE, Queenan JT. Management of isoimmunization in the presence of multiple maternal antibodies. *Am J Obstet Gynecol* 2001;185:481–484.
90. Queenan JT, Eglinton GS, Tomai TP. Hemolytic disease of the fetus: a comparison of the Queenan and extended Liley methods. [Letter]. *Obstet Gynecol* 1999;93:162–163.
91. Weiner CP, Williamson RA, Wenstrom KD, et al. Management of fetal hemolytic disease by cordocentesis. I: prediction of fetal anemia. *Am J Obstet Gynecol* 1991;165:546–553.
92. Weiner CP, Williamson RA, Wenstrom, KD, et al. Management of fetal hemolytic disease by cordocentesis. II Outcome of treatment. *Am J Obstet Gynecol* 1991;165:1302–1307.
93. Daffos F, Capella–Povolsky M, Forstier F. Fetal blood sampling during pregnancy with use of a needle guided by ultrasound. A study of 606 consecutive cases. *Am J Obstet Gynecol* 1985;153:655–660.
94. Ghidini A, Spulveda W, Lockwood CJ, Romero R. Complications of fetal blood sampling. *Am J Obstet Gynecol* 1993;168:1339–1344.
95. Ludomirsky A. Intrauterine fetal blood sampling—a multicenter registry evaluation of 7462 procedures between 1987–1991. *Am J Obstet Gynecol* 1993;168:318.
96. Queenan JT, Adams DW. Amniocentesis for prenatal diagnosis of erythroblastosis fetalis. *Obstet Gynecol* 1965;25:302–307.
97. Bowman JM, Pollock JM, Peterson LE, et al. Fetomaternal hemorrhage following funipuncture: increase in severity of maternal red–cell alloimmunization. *Obstet Gynecol* 1994;84:839–843.
98. Peterec SM. Management of Neonatal Rh Disease. *Clin Perinat Hematol* 1995;22:561–592.
99. Kumpel BM, Elson CJ. Mechanism of anti–D mediated immune suppression—a paradox awaiting

resolution? *Trends Immunol* 2001;22:26–31.

100. Woodrow JC, Clarke CA, Donohoe WTA, et al. Mechanism of Rh prophylaxis: an experimental study on specificity of suppression. *BMJ* 1975;2:57–59.

101. CDC: lack of transmission of human immunodeficiency virus through Rho(D) immune globulin (human). *MMWR Morb Mortal Wkly Rep* 1987;36:728–729.

102. Wantanabe KK, Busch MP, Schreiber GB, Zuck TF. Evaluation of the safety of Rh immunoglobulin by monitoring viral markers among Rh-negative female blood donors. *Vox Sang* 2000;78:1–6.

103. Smith DB, Lawlor E, Power J, et al. A second outbreak of hepatitis C virus infection from anti-D immunoglobulin in Ireland. *Vox Sang* 1999;76:175–180.

104. CDC: Outbreak of hepatitis C associated with intravenous immunoglobulin administration—United States, October 1993–June 1994. *MMWR Morb Mortal Wkly Rep* 1994;43:505–509.

105. Kumpel BM, Goodrick J, Pamphilon DH, et al. Human Rh D monoclonal antibodies (BRAD-3 and BRAD-5) cause accelerated clearance of Rh D+ red blood cells and suppression of Rh D immunization in Rh D- volunteers. *Blood* 1995;86:1701–1709.

106. Pollack W, Ascari W, Kochesky RJ, et al. Studies on Rh prophylaxis. 1. Relationship between doses of anti-Rh and size of antigenic stimulus. *Transfusion* 1971;11:333–339.

107. Anderson B, Shad AT, Gootenberg JE, Sandler SG. Successful prevention of post-transfusion Rh alloimmunization by intravenous Rho(D) immune globulin (WinRhoSD). *Am J Hematol* 1999;60:245–247.

108. Samson D, Mollison PL. Effect on primary Rh immunization of delayed administration of anti-Rh. *Immunology* 1975;28:349–357.

109. Maayan-Metzger A, Schwartz T, Sulkes J, Merlob P. Maternal anti-D prophylaxis during pregnancy does not cause neonatal haemolysis. *Arch Dis Child Fetal Neonatal Ed* 2001;84(1):F60–62.

110. Thornton JG, Page C, Foote G, et al. Efficacy and long term effects of antenatal prophylaxis with anti-D immunoglobulin. *BMJ* 1989;298:1671–1673.

111. Huchcroft S, Gunton P, Bowen T. Compliance with postpartum Rh isoimmunization prophylaxis in Alberta. *Can Med Assoc J* 1985;133:871–875.

112. Howard HL, Marlew VJ, McFadyen IR, Clarke CA. Preventing Rhesus D haemolytic disease of the newborn by giving anti-D immunoglobulin: are the guidelines being adequately followed? *Br J Obstet Gynaecol* 1997;104:37–41.

113. Management of isoimmunization in pregnancy. ACOG Educational Bulletin Number 227. Washington, DC: American College of Obstetricians and Gynecologists (ACOG), August, 1996.

114. Moise KJ. Changing trends in the management of red blood cell alloimmunization in pregnancy. *Arch Pathol Lab Med* 1994;118:421–428.

115. Abdalla MGK, Beattie B, Alirevic Z. Intrauterine transfusion techniques in fetuses with Rhesus incompatibility. (Protocol) In: Sinclair J, Bracken M, Soll RF, Horbar JD, eds. Neonatal module of the Cochrane database of systematic reviews. Available in the Cochrane Library [database on disk and CD-ROM]. The Cochrane Collaboration, Issue 1; Oxford:2002. Updated quarterly. Available from BMJ Publishing Group, London. [www.nichd.nih.gov/cochrane](http://www.nichd.nih.gov/cochrane).

116. Moise KJ, Carpenter RJ, Kirshon B, et al. Comparison of four types of intrauterine transfusion: effect on fetal hematocrit. *Fetal Ther* 1989;4:126–137.

117. Nicolini U, Kochenour NK, Greco P, et al. When to perform the next intra-uterine transfusion in patient with Rh allo-immunization: combined intravascular and intraperitoneal transfusion allows longer intervals. *Fetal Ther* 1989;4:14–20.

118. Giannina G, Moise KJ, Dorman K. A simple method to estimate volume for fetal intravascular

transfusion. *Fetal Diagn Ther* 1998;13:94–97.

119. Gonsoulin WJ, Moise KJ, Jr., Milam JD, et al. Serial maternal blood donations for intrauterine transfusion. *Obstet Gynecol* 1990;75:158–162.

120. Radunovic N, Lockwood CJ, Alvarez M, et al. The severely anemic and hydropic isoimmune fetus: changes in fetal hematocrit associated with intrauterine death. *Obstet Gynecol* 1992;79:390–393.

121. Dodd RY, Notari EP, Stramer SL. Current prevalence and incidence of infectious disease markers and estimated window-period risk in the American Red Cross blood donor population. *Transfusion* 2002;42:975–979.

122. Grima KM. Therapeutic apheresis in hematological and oncological diseases. *J Clin Apher* 2000;15:42.

123. University HealthSystem Consortium. Technology assessment: intravenous immunoglobulin preparations. Oak Brook, IL: University HealthSystem Consortium, 2001:25–30.

124. Van den Veyver IB, Chong SS, Cota J, et al. Single-cell analysis for the RhD blood type for use in preimplantation diagnosis in the prevention of severe hemolytic disease of the newborn. *Am J Obstet Gynecol* 1995;172:533–540.

125. Mills JF, Tudehope D. Fiberoptic phototherapy for neonatal jaundice. In: Sinclair J, Bracken M, Soll RF, Horbar JD, eds. Neonatal module of the Cochrane database of systematic reviews. Available in the Cochrane Library [database on disk and CD-ROM]. The Cochrane Collaboration, Issue 1; Oxford:2002. Updated quarterly. Available from BMJ Publishing Group, London. [www.nichd.nih.gov/cochrane](http://www.nichd.nih.gov/cochrane).

126. Strauss RG. Data-driven blood banking practices for neonatal RBC transfusion. *Transfusion* 2000;40:1528–1540.

127. Keenan WJ, Novak KK, Sutherland JM, et al. Morbidity and mortality associated with exchange transfusion. *Pediatrics* 1985;75:417–441.

128. Scaradavou A, Inglis S, Peterson P, et al. Suppression of erythropoiesis by intrauterine transfusion in hemolytic disease of the newborn: use of erythropoietin to treat the late anemia. *J Pediatr* 1993;123:279–284.

129. Dhodapkar KM, Blei F. Treatment of hemolytic disease of the newborn caused by anti-Kell antibody with recombinant erythropoietin. *J Pediatr Hematol Oncol* 2001;23:69–70.

130. Rubo J, Albrecht K, Lasch P, et al. High-dose intravenous immune globulin therapy for hyperbilirubinemia caused by Rh hemolytic disease. *J Pediatr* 1992;121:93–97.

131. Kappas A, Drummond GS, Munson DP, Marshall JR. Sn-Mesoporphyrin interdiction of severe hyperbilirubinemia in Jehovah's Witness newborns as an alternative to exchange transfusion. *Pediatrics* 2001;108:1374–1377.

132. van Kamp IL, Klumper FJCM, Bakkum RSLA, et al. The severity of immune fetal hydrops is predictive of fetal outcome after intrauterine treatment. *Am J Obstet Gynecol* 2001;185:668–673.

133. Janssens HM, de Haan MJJ, van Kamp IL, et al. Outcome for children treated with fetal intravascular transfusions because of severe blood group antagonism. *J Pediatr* 1997;131:373–380.

134. Doyle LW, Kelley EA, Rickards AL, et al. Sensorineural outcome at 2 years for survivors of erythroblastosis treated with fetal intravascular transfusions. *Obstet Gynecol* 1993;81:931–935.

135. Hudon L, Moise KJ, Hegemier SE, et al. Long-term neurodevelopmental outcome after intrauterine transfusion for the treatment for fetal hemolytic disease. *Am J Obstet Gynecol* 1998;179:858–863.

136. Scheidt PC, Graubard BI, Nelson KB, et al. Intelligence at six years in relation to neonatal bilirubin level: follow-up of the National Institute of Child Health and Human Development clinical trial of phototherapy. *Pediatrics* 1991;87:797.

137. Hoyert DL, Arias E, Smith BL, et al. Deaths: final data for 1999. *National vital statistics reports*; vol

49 no 8. Hyattsville, MD: National Center for Health Statistics, 2001. [www.cdc.gov/nchs](http://www.cdc.gov/nchs).

2004 Lippincott Williams & Wilkins  
John P. Greer, John Foerster, John N. Lukens  
George M. Rodgers, Frixos Paraskevas, Bertil Glader  
Wintrobe's Clinical Hematology

**ETIOLOGY AND PATHOGENESIS**

[Sensitivity to Complement-Mediated Lysis..](#)  
[Erythrocyte Membrane Protein Deficiencies..](#)  
[Molecular Basis of Paroxysmal Nocturnal Hemoglobinuria..](#)  
[Clonal Dominance.](#)  
[Aplastic Anemia and Paroxysmal Nocturnal Hemoglobinuria..](#)  
[Leukocytes and Platelets.](#)  
[Hematopoietic Stem Cells.](#)

**CLINICAL MANIFESTATIONS**

[Hemoglobinuria.](#)  
[Episodic Hemolysis.](#)  
[Marrow Hypoplasia.](#)  
[Thrombotic Disease.](#)  
[Renal Abnormalities.](#)  
[Dysphagia.](#)  
[Infections.](#)  
[Physical Examination.](#)

**LABORATORY FINDINGS**

[Blood.](#)  
[Plasma.](#)  
[Urine.](#)  
[Bone Marrow.](#)  
[Cytogenetic Studies.](#)  
[Diagnostic Tests.](#)

**DIFFERENTIAL DIAGNOSIS****TREATMENT**

[Bone Marrow Transplantation.](#)  
[Hormones and Steroids and Immunosuppressive Therapy..](#)  
[Transfusions.](#)  
[Iron.](#)  
[Prevention and Treatment of Thrombosis..](#)  
[Pregnancy and Paroxysmal Nocturnal Hemoglobinuria..](#)  
[Other Measures.](#)

**DISEASE COURSE AND PROGNOSIS****REFERENCES**

Paroxysmal nocturnal hemoglobinuria (PNH) is closely associated with aplastic anemia. The syndrome arises as a consequence of expansion of a mutant hematopoietic stem cell that has a conditional growth or survival advantage in the setting of a specific type of bone marrow injury (putatively immune). It is a rare, acquired disorder that is insidious in onset and chronic in course. It is characterized, in the classic case, by attacks of intravascular hemolysis and hemoglobinuria that occur chiefly at night while the patient is asleep. Consequently, the patient becomes alarmed the following morning by the startling abnormal appearance of the first voided urine. In many patients, however, the classic pattern is absent at diagnosis. These patients manifest chronic, low-grade intravascular hemolysis punctuated by occasional episodes of hemoglobinuria, usually in association with infection or unusual stress. Thrombocytopenia, leukopenia, or both and recurrent venous thrombosis involving unusual sites (particularly abdominal) are other notable

clinical characteristics of PNH.

The history of PNH has been recently reviewed ([1](#)). Strübing published a remarkable paper on PNH in 1882, clearly recognizing the uniqueness of the disease and providing laboratory support for his prescient hypothesis on the etiology of nocturnal hemoglobinuria. Marchiafava and Nazari (1911) and Micheli (1931) subsequently chronicled the clinical characteristics of the disease (in some older literature, PNH is called *Marchiafava–Micheli syndrome*). By 1953, at least 162 cases had been collected ([2](#)). Undoubtedly, many cases go undiagnosed because the classic signs and symptoms may be absent. Often, several years elapse between the onset of clinical symptoms and the correct diagnosis because this uncommon disease frequently presents without its most widely recognized symptom (i.e., hemoglobinuria that is most apparent in the morning) ([3](#)).

It can be argued that the term *paroxysmal nocturnal hemoglobinuria* is imprecise because it describes only one feature of the illness—a feature, moreover, that is found in only one-fourth of affected individuals at presentation. Nonetheless, the term has been established through long usage and, consequently, has become incorporated as a part of the essence of the disease.

## ETIOLOGY AND PATHOGENESIS

### Sensitivity to Complement–Mediated Lysis

The chronic intravascular hemolysis that is the clinical hallmark of PNH is due to the abnormal sensitivity of the erythrocytes to complement–mediated lysis. From 1937 to 1939, Ham and Ham and Dingle made the seminal observations that connected the hemolysis to complement ([4](#), [5](#) and [6](#)). Those studies demonstrated that the abnormal cells are hemolyzed when incubated in acidified serum and that the hemolysis is complement dependent. The lysis of the defective cells in acidified serum (a process that activates the alternative pathway of complement) became the standard technique for the diagnosis of PNH, and appropriately, the assay is called the *Ham test*. Approximately 10 years after the studies of Ham and Dingle, cross–transfusion studies confirmed that hemolysis in PNH results from an intrinsic abnormality of the red cell ([7](#)). In those studies, Dacie reported that normal erythrocytes survive normally in patients with PNH, whereas the lifespan of PNH erythrocytes is shortened both in the patient and in a normal recipient. Not all PNH red cells are equally sensitive to complement–mediated lysis (see below), however, and cohorts of relatively long–lived and very short–lived cells can be distinguished in red cell survival studies ([8](#)). Moreover, the proportions of complement–sensitive and complement–insensitive cells vary greatly among patients. The percentage of abnormal cells remains remarkably stable in most patients although there are clearly exceptions to this rule. Generally, the percentage of markedly complement–sensitive cells correlates with the clinical course of each patient with respect to the hemolytic component of the disease (see below).

A defining feature of PNH is phenotypic mosaicism based on sensitivity of the erythrocytes to complement–mediated lysis. This remarkable characteristic was clearly elucidated by Rosse and Dacie in 1966 ([9](#)), and Rosse further refined the analysis in 1973 ([10](#)). Using an *in vitro* test that quantitates the sensitivity of erythrocytes to complement–mediated lysis (the complement lysis sensitivity assay), three phenotypes of PNH erythrocytes were identified ([Table 37.1](#); [Fig. 37.1](#) and [Fig. 37.2](#)). One of the phenotypes (designated PNH I) was characterized by normal or near–normal sensitivity to complement, whereas another phenotype (designated PNH III) was 15 to 25 times more susceptible to lysis. A third phenotype (PNH II) was of intermediate sensitivity,



approximately 3 to 5 times more susceptible than normal cells. Most patients have a mixture of type I and type III cells, but mosaics of type I, type II, and type III, as well as type I and type II, are also observed.

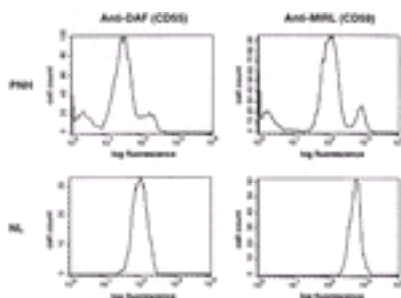
**TABLE 37.1. Paroxysmal Nocturnal Hemoglobinuria (PNH) Phenotypes**

| Phenotypic Designation | Complement Sensitivity <sup>a</sup>     | GPI-AP Expression by Flow Cytometry <sup>b</sup> | Type of PIG-A Mutation  |
|------------------------|---|--|---|
| PNH I                  | Normal                                  | Normal   | None  |
| PNH II                 | Moderately sensitive (3–5 times normal) | Dim positive                                     | Missense (partial PIG-A inactivation)   |
| PNH III                | Markedly sensitive (15–25 times normal) | Negative   | Nonsense, frameshifts, deletions, insertions (complete inactivation of PIG-A) |

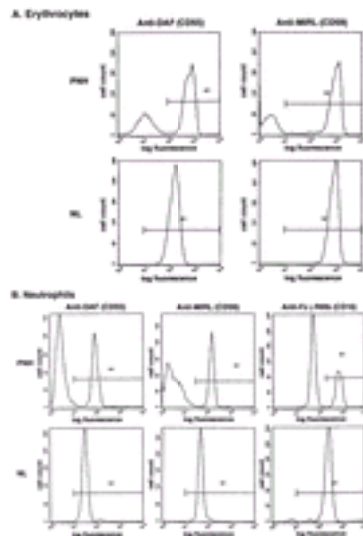
GPI-AP, glycosyl phosphatidylinositol-anchored protein.

<sup>a</sup> Based on the complement lysis sensitivity assay of Rosse and Dacie.

<sup>b</sup> Based on flow cytometric analysis of GPI-AP expression of erythrocytes.



**Figure 37.1.** Phenotypic mosaicism in paroxysmal nocturnal hemoglobinuria (PNH). Erythrocytes from a patient with PNH and from a normal volunteer donor (NL) were analyzed by flow cytometry using anti-decay accelerating factor (anti-DAF) (CD55) and anti-membrane inhibitor of reactive lysis (anti-MIRL) (CD59) as primary antibodies. The histogram of the erythrocytes from the normal donor shows uniformly positive staining with both antibodies. In contrast, the patient's histogram (PNH) suggests three discrete populations of cells (a negative population, a population with partial expression, and a population with normal expression). Statistic analysis of the three groups of cells from the patient showed that the negative population contributed 14% to the total, the intermediate population contributed 75%, and the normal population contributed 11%. (From Parker CJ. Molecular basis of paroxysmal nocturnal hemoglobinuria. *Stem Cells* 1996;14:396–411, with permission.)



**Figure 37.2.** Analysis of glycosyl phosphatidylinositol–anchored proteins (GPI–APs) on erythrocytes (A) and neutrophils (B) from a patient with paroxysmal nocturnal hemoglobinuria (PNH). Erythrocytes and isolated neutrophils from a patient with PNH and from a normal volunteer donor (NL) were analyzed by flow cytometry using anti–decay accelerating factor (anti–DAF) (CD55), anti–membrane inhibitor of reactive lysis (anti–MIRL) (CD59), or anti–Fc $\gamma$ RIIIb (CD16b) (neutrophils only) as primary antibodies. The histograms of the cells from the normal donor show uniformly positive staining with both antibodies. In contrast, the patient’s histograms (PNH) demonstrate two discrete populations of cells. In the case of the erythrocytes (A), 30% of the cells are negative for DAF and MIRL expression, and 70% show normal expression. In the case of the neutrophils (B), 65% are negative for DAF and MIRL expression. The same population of cells shows abnormal expression of Fc $\gamma$ RIIIb, but the deficiency is partial rather than absolute. Together, these results demonstrate three characteristic features of PNH: (a) The hematopoietic cells are a mosaic of normal and GPI–AP–deficient cells; (b) the proportion of abnormal neutrophils is greater than the proportion of abnormal erythrocytes; and (c) the deficiency of Fc $\gamma$ RIIIb is partial rather than absolute.

As noted above, the proportion of complement–sensitive and –insensitive cells varies greatly among patients. For example, the erythrocytes of one patient may be comprised of 10% PNH III cells and 90% PNH I cells, whereas another patient may have 75% PNH III cells and 25% PNH I cells. The intensity of the hemolytic component of the disease is related to the size of the PNH III population ([11](#)). As a rule, visibly apparent hemoglobinuria is absent or mild when PNH III erythrocytes (the most complement–sensitive cells) constitute less than 20% of the red cell population. Episodes of gross hemoglobinuria occur when the PNH III population ranges from 20 to 50% of the population, and constant hemoglobinuria is associated with greater than 50% PNH III cells. PNH II cells (the erythrocytes of intermediate sensitivity to complement), even when present in high proportions, are associated with minimal or no hemoglobinuria. The proportion of abnormal cells is greater in the marrow than in the blood and, among circulating cells, is greatest in young cell populations, especially in reticulocytes ([8](#), [9](#), [12](#), [13](#)). Erythrokinetic studies have shown that the complement–sensitive population does not gain recruits from the complement–insensitive population ([8](#)). The proportions of sensitive and insensitive cells usually remain stable for long periods, but population shifts may be observed during the course of the disease, and in some patients, the abnormal clone(s) remit spontaneously ([14](#), [15](#)).

PNH is not an immune–mediated hemolytic anemia that arises as a consequence of the development of autoantibodies. Rather, failure to regulate alternative pathway of

complement activation on the erythrocyte surface underlies the hemolysis of PNH. Under physiologic conditions, the alternative pathway is in a state of continuous, low-grade activation. Normal erythrocytes are not hemolyzed as a result of this low-grade alternative pathway activation because specific cell-surface proteins have evolved that inhibit the activity of complement. In contrast, PNH erythrocytes are deficient in the two most important membrane regulators of complement; consequently, they are subject to chronic, spontaneous hemolysis *in vivo*. Failure to inhibit alternative pathway activation has a profound effect on red cell survival, as studies have shown that the half-life of complement-sensitive PNH cells is only 6 days ( [8](#) ).

Rosse and colleagues reported the first clear evidence of the nature of the aberrant interactions of PNH erythrocytes with complement in 1973 and 1974 ( [16](#), [17](#) ). Those investigators showed that when complement is activated *in vitro* by either the classic or the alternative pathway, PNH erythrocytes bind much greater amounts of activated C3 than normal erythrocytes. The difference in C3 deposition was particularly striking when acidified serum was used to activate the alternative pathway. Subsequent studies showed that PNH red cells lacked the capacity to regulate the formation and stability of the amplification C3 convertases of complement ( [18](#), [19](#) ), thus accounting for the greater binding of activated C3. A second defect was suggested by experiments demonstrating that PNH erythrocytes also failed to regulate the activity of the cytolytic membrane attack complex of complement ( [20](#), [21](#) and [22](#) ). Collectively, these observations indicated that PNH erythrocytes had two complement regulatory defects: one that affected regulation of the C3 convertases and a second that affected regulation of the membrane attack complex.

## Erythrocyte Membrane Protein Deficiencies

**ACETYLCHOLINESTERASE** Although Beck and Valentine reported in 1951 that neutrophils from patients with PNH were deficient in leukocyte alkaline phosphatase ( [23](#) ), the first erythrocyte membrane protein that was found to be deficient in PNH was acetylcholinesterase ( [24](#) ). In 1959, Auditore and Hartmann ( [24](#) ) presented evidence that the extent of the acetylcholinesterase deficiency correlated with the severity of the hemolysis. More detailed studies by others ( [25](#) ) showed that PNH I red cells had a relatively normal amount of acetylcholinesterase, whereas PNH III erythrocytes were profoundly deficient. Although the deficiency of acetylcholinesterase plays no role in the abnormal susceptibility of PNH red cells to complement-mediated lysis, the observations that the red cells lack acetylcholinesterase and that the neutrophils lack alkaline phosphatase ultimately provided important insights into the fundamental defect that underlies PNH.

**DECAY ACCELERATING FACTOR (CD55)** In 1983, two groups reported that PNH erythrocytes were deficient in decay accelerating factor (DAF, CD55) ( [26](#), [27](#) ). DAF, first identified by Hoffman ( [28](#), [29](#) ) in 1969 and subsequently purified by Nicholson-Weller and colleagues in 1982 ( [30](#) ), is a 70-kd protein that inhibits the formation and stability of the C3 convertases of complement ( [31](#) ). Thus, the absence of DAF provided a plausible explanation for the greater binding of activated C3 to PNH erythrocytes. Detailed studies, however, demonstrated that DAF does not regulate the activity of the membrane attack complex of complement ( [32](#), [33](#) ). Those results implied that PNH erythrocytes were deficient in a second complement regulatory protein that was functionally distinct from DAF.

**MEMBRANE INHIBITOR OF REACTIVE LYSIS (CD59)** In 1989, Holguin et al. ( [34](#) ) reported the isolation from normal erythrocytes of an 18-kd protein called *membrane inhibitor of reactive lysis* (MIRL, CD59) that protected PNH III red cells against complement-mediated lysis. As anticipated, PNH cells were found to be deficient in MIRL

([29](#)), and additional studies by those investigators and others demonstrated that MIRL inhibits complement-mediated lysis by blocking the assembly of the membrane attack complex ([29](#), [35](#), [36](#) and [37](#)). By comparing expression of DAF and MIRL on PNH I, PNH II, and PNH III erythrocytes, the functional basis of the different complement sensitivity phenotypes was defined ([34](#)). Those studies showed that PNH III cells are completely deficient in DAF and MIRL, whereas PNH II cells are partially deficient in the two complement regulatory proteins, and PNH I cells have normal expression. Thus, the variability in sensitivity to lysis among the different phenotypes is explained by quantitative differences in expression of DAF and MIRL ([38](#)). Additional experiments demonstrated that the combined deficiency of DAF and MIRL was sufficient to explain the enhanced susceptibility of PNH erythrocytes to hemolysis in acidified serum ([39](#)). Of the two complement regulatory proteins, MIRL is more important than DAF in protecting cells from complement-mediated lysis *in vivo*. Antigens of the Cromer-related blood group complex are located on DAF, and rare cases of a null phenotype called *Inab* have been reported ([40](#)). Like PNH cells, *Inab* erythrocytes are deficient in DAF, but unlike PNH erythrocytes, MIRL expression is normal on *Inab* red cells ([41](#)). Although *Inab* erythrocytes bind more activated C3 when exposed to acidified serum ([41](#)), they undergo little or no hemolysis ([41](#), [42](#) and [43](#)). Furthermore, subjects with the *Inab* phenotype have no known hematologic abnormalities, and in particular, they have no clinical evidence of hemolysis ([40](#), [42](#)). These observations show that isolated deficiency of DAF does not produce the PNH syndrome. In contrast, a patient with an inherited, isolated deficiency of MIRL (CD59) had a syndrome that was indistinguishable from PNH ([44](#), [45](#)). Clinically, the patient experienced recurrent episodes of hemoglobinuria, suggesting that MIRL is essential for protecting erythrocytes against complement-mediated lysis *in vivo*. Recurrent thromboembolic events were also observed in this patient. The patient had normal DAF expression ([45](#)), but *in vitro*, his cells were susceptible to hemolysis in acidified serum, implying that MIRL deficiency accounts primarily for the positive Ham test in PNH ([39](#)). Together, these observations indicate that the PNH phenotype is primarily a manifestation of MIRL deficiency although it is the *combined* deficiency of DAF and MIRL that results in the marked abnormal susceptibility of the red cells of PNH to complement-mediated lysis.

#### **BASIS OF THE PROTEIN DEFICIENCIES IN PAROXYSMAL NOCTURNAL**

**HEMOGLOBINURIA** If only DAF or only MIRL were deficient in PNH, it would have been logical to hypothesize that the disease was due to mutations affecting the gene that encodes the particular protein. That PNH cells were deficient in multiple proteins (MIRL, DAF, and acetylcholinesterase on red cells and leukocyte alkaline phosphatase on neutrophils), however, eliminated the possibility that the gene for each protein was mutant. Rather, a more plausible hypothesis was that the PNH defect involved a posttranslational modification common to all of the proteins that are deficient in PNH. In 1984, Medof and colleagues ([46](#)) reported that isolated DAF spontaneously reincorporated into erythrocyte membranes. This property of DAF had actually been appreciated by Hoffman in 1969 ([28](#), [47](#)). Working with the butanol-saturated aqueous phase of a crude extract prepared from normal human erythrocyte stroma, he showed that the sample contained a factor capable of inhibiting complement-mediated lysis by accelerating the decay of the C3 convertase. He further showed that this substance (that he called *decay accelerating factor of stroma*) had the capacity to reincorporate into red cells and remain functionally active. In 1980, Low and Zilversmit ([48](#)) demonstrated that alkaline phosphatase that had been solubilized from cells by butanol extraction exhibited the capacity to bind to phospholipid vesicles. In this case, the incorporation was thought to be due to the attachment of a phosphatidylinositol moiety to the enzyme. Subsequent experiments demonstrated that isolated acetylcholinesterase also spontaneously reincorporated into cell membranes ([49](#), [50](#) and [51](#)). Previous studies ([48](#), [52](#)) had shown that alkaline phosphatase, acetylcholinesterase, and 5'-ectonucleotidase (another protein

that is deficient in PNH) were released from the cell surface by treatment with phosphatidylinositol-specific phospholipase C. The cumulative work of a number of investigators showed that both the capacity to reincorporate into membranes and the susceptibility to cleavage by phosphatidylinositol-specific phospholipase C were characteristic of a group of amphipathic membrane proteins that shared the common structural feature of being anchored to the cell surface through a glycosyl phosphatidylinositol (GPI) moiety ( 53 , 54 , 55 , 56 and 57 ). The structural link between DAF and acetylcholinesterase, alkaline phosphatase, and 5'-ectonucleotidase was made in 1986 by Davitz et al. ( 58 ) and Medof et al. ( 59 ) when those investigators presented evidence that DAF is a GPI-anchored protein (GPI-AP). Subsequent studies confirmed that MIRL is also a GPI-AP ( 60 ). The results of those studies suggested the following paradigm: *All proteins that are deficient in PNH are GPI anchored, and all GPI-APs that are expressed by hematopoietic cells are deficient in PNH.* All data to date are consistent with this postulate. GPI-APs are functionally diverse. In addition to the complement regulatory proteins [DAF (CD55) and MIRL (CD59)] and enzymes [acetylcholinesterase, alkaline phosphatase, and 5'-ectonucleotidase (CD73)] discussed above, proteins with receptor, adhesion, and immune modulatory function [e.g., Fc $\gamma$ RIIIb (CD16b), urokinase receptor (CD87), endotoxin binding protein receptor (CD14), and lymphocyte function-associated antigen-3 (CD58)] are also GPI anchored. Further, a number of proteins whose function is unknown are GPI anchored ( 53 , 54 , 55 , 56 and 57 , 61 ). To date, more than 80 eukaryotic proteins have been shown to be GPI anchored, and approximately 30 of these are found in humans. Currently, the list of proteins that are deficient in PNH numbers 18 ( Table 37.2 ). This number is less than the total number of GPI-anchored human proteins because PNH is an acquired disease that affects only hematopoietic cells. Thus, GPI-APs that are present on somatic tissues other than hematopoietic cells are expressed normally in patients with PNH. Although PNH cells lack a number of functionally diverse membrane constituents, the only pathologic component of the disease that is unequivocally causally related to GPI-AP deficiency is the abnormal susceptibility of the erythrocytes to complement-mediated lysis.

**TABLE 37.2. Glycosyl Phosphatidylinositol-Anchored Proteins Deficient in Paroxysmal Nocturnal Hemoglobinuria**

|   |                                     |
|---|-------------------------------------|
| Leukocyte alkaline phosphatase                  | 5'-ectonucleotidase (CD73)          |
| Acetylcholinesterase                            | Urokinase receptor (CDw52)          |
| Decay accelerating factor (CD55)                | JMH-bearing protein<br>CD66c        |
| Membrane inhibitor of reactive lysis (CD59)     | p50-80<br>CD24                      |
| Fc $\gamma$ RIIIb (CD16b)                       | CD48                                |
| Lymphocyte function-associated antigen 3 (CD58) | CD67                                |
| CD14  | Folate receptor                     |
|   | Cellular prion protein <sup>a</sup> |

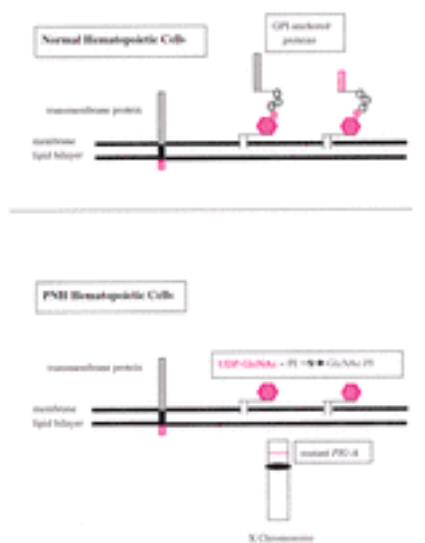
<sup>a</sup> Deficient on resting platelets, but putative transmembrane form expressed on activated platelets.

### Molecular Basis of Paroxysmal Nocturnal Hemoglobinuria

The observation that, based on sensitivity to complement, the peripheral blood of PNH patients is a mosaic comprised of both normal and abnormal cells suggested that the abnormal cells were the progeny of a mutant clone and that they coexisted with the

progeny of residual normal stem cells. Further, that PNH is an acquired rather than an inherited disease implied that the abnormal clone arises as a consequence of a somatic mutation. In 1970, Oni et al. (62) analyzed glucose-6-phosphate dehydrogenase isoforms in both the complement-sensitive and the complement-insensitive erythrocytes of a female PNH patient who was heterozygous at the glucose-6-phosphate dehydrogenase locus. The complement-insensitive cells expressed both glucose-6-phosphate dehydrogenase isoforms, indicating a polyclonal origin for this cohort. In contrast, the complement-sensitive cells expressed only one isoform, a finding consistent with monoclonality. These studies provided the first experimental evidence in support of the clonal hypothesis of PNH. In 1969, Aster and Enright (63) reported that a portion of both the platelet and granulocyte populations from patients with PNH was abnormally sensitive to complement-mediated cytolysis. This publication represented another watershed event in the understanding of the origins of PNH because it indicated that the mutation arose in a primitive hematopoietic stem cell that has the capacity to differentiate along myeloid lines. Subsequent studies showed that monocytes are also affected (64), and, in some patients, affected lymphocytes were demonstrated (65). Together with the observation that all proteins that are deficient in PNH are GPI anchored, these studies suggested that PNH arises as a result of a somatic mutation affecting a pluripotent hematopoietic stem cell and that the gene that is mutant is essential for the normal biosynthesis of the GPI anchor.

The GPI anchor is a complex structure (61, 66). Based on complementation analysis of GPI anchor-deficient mutant cell lines, at least eight proteins are essential for assembly of the GPI moiety (61, 66). Hypothetically, the PNH phenotype would result if any of these proteins were nonfunctional because if the GPI anchor is not synthesized, GPI-APs are not expressed. Accordingly, it seemed probable that PNH would be found to be heterogeneous at the molecular level, as mutations affecting any one of several genes that encode elements critical for GPI anchor assembly would produce the disease phenotype. In 1992 (67) and 1993 (68), however, two groups published the surprising finding that GPI protein-deficient lymphocyte cell lines derived from different patients with PNH all belonged to the same complementation class. Additional experiments confirmed that the PNH cell lines had the same biochemical defect as the complementation class A mutants. Like the class A mutants, the PNH cell lines failed to synthesize *N*-acetylglucosaminyl-phosphatidylinositol (GlcNAc-PI), the first intermediate in the pathway of GPI anchor assembly (61) (Fig. 37.3).





**Figure 37.3.** Paroxysmal nocturnal hemoglobinuria (PNH) defect. Transmembrane proteins have three domains: an ectoplasmic domain (rectangle with horizontal lines), a transmembrane domain (gray rectangle), and a cytoplasmic domain (red rectangle). In contrast, glycosyl phosphatidylinositol (GPI)-anchored proteins lack the cytoplasmic and transmembrane domains. This class of proteins is anchored to the cell by a GPI moiety consisting of phosphatidylinositol (red hexagon), glucosamine (light red circle), and three mannose (gray circles) molecules. The GPI moiety is linked to the COOH-terminus of the protein portion of the molecule by ethanolamine. The *PIG-A* gene product is essential for the transfer of the nucleotide sugar uridine diphosphate-*N*-acetylglucosamine (UDP-GlcNAc) to phosphatidylinositol (PI) to form GlcNAc-PI, the first intermediate in the synthesis of the GPI anchor. *PIG-A* is located on the X chromosome. Hematopoietic cells in PNH are deficient in all proteins that are GPI anchored because a somatic mutation in a hematopoietic stem cell partially or completely inactivates the *PIG-A* gene product. Consequently, the GPI moiety is not synthesized. (Modified from Parker CJ. Molecular basis of paroxysmal nocturnal hemoglobinuria. *Stem Cells* 1996;14:396-411.)

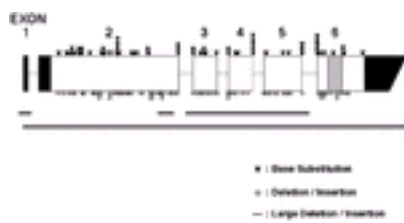
A gene that restores normal expression of GPI-APs in the complementation class A PNH cell lines was identified by Kinoshita and colleagues in 1993 ([69](#), [70](#)). As predicted by the studies cited above, the gene, called *PIG-A* (for phosphatidylinositol glycan class A), encodes a protein that is essential for the normal synthesis of GlcNAc-PI ([69](#)). Subsequently, Takeda et al. ([70](#)) showed that *PIG-A* complements the deficient expression of GPI-APs in PNH lymphoblastoid cell lines and that those cell lines harbored somatic mutations in *PIG-A*. Together, those studies defined both the biochemical and the molecular bases of the deficiency of GPI-APs in PNH ([Fig. 37.3](#)).

Additionally, Takeda and colleagues observed that a heterozygous mutation was sufficient to produce the PNH phenotype ([70](#)). As presaged by the studies of Hyman et al. ([71](#)), the dominant expression of the somatic mutation was explained when *PIG-A* was mapped to chromosome Xp22.1 (i.e., the *PIG-A* gene is located on the short arm of the X chromosome in humans). As males have a single X chromosome, any functionally significant mutation affecting *PIG-A* is expressed. Females are functionally haploid due to X inactivation. Thus, somatic mutations in *PIG-A* appear dominant when they occur on the active X chromosome. To date, somatic mutations affecting *PIG-A* account for the PNH phenotype in all patients in whom the genetic basis has been identified ([61](#), [72](#), [73](#)). *PIG-A* mutations have not been identified in all patients studied, but this apparent discrepancy is probably a technical artifact rather than a true difference in etiology. The chromosomal location of *PIG-A* provides the most logical explanation for the uniformity of the molecular defect in PNH. This interpretation supposes that all other genes that are essential for synthesis of the GPI moiety are autosomal, a supposition supported by available data ([61](#), [74](#)). However, until a case of PNH is shown to involve mutation of a gene required for GPI-AP synthesis other than *PIG-A*, this supposition remains unproved.

Analysis of *PIG-A* has revealed that the same mutation can be identified in isolated neutrophils, monocytes, and lymphocytes from individual patients with PNH ([70](#), [75](#)), confirming that the disease involves the hematopoietic stem cell. Of 174 *PIG-A* mutations that have been identified in affected cells of 146 patients with PNH, only three large deletions have been observed ([72](#), [76](#)) ([Fig. 37.4](#)). The remainder consists of nucleotide substitutions of the missense or nonsense types, or small deletions or insertions. The mutations are distributed randomly over the entire coding region and at splice junctions. At least 19 mutations have been observed to occur in more than one patient ([72](#)) ([Fig. 37.4](#)). Absence of repetitive mutations indicates that *PIG-A* lacks hot spots. That most of the mutations completely inactivate *PIG-A* function has suggested to some that complete deficiency of GPI-AP (the PNH III phenotype) may be advantageous relative to partial



deficiency (the PNH II phenotype) (77). Arguing against this interpretation, however, is the observation that in some patients with both PNH II and PNH III cells, the PNH II cells dominate hematopoiesis (75). This finding is more consistent with the hypothesis that relative clonal dominance is determined not by the type of *PIG-A* mutation but by the intrinsic proliferative or survival properties of the affected stem cells (78). Further, in some PNH patients, two separate clones with distinct mutations that completely inactivate *PIG-A* can be identified, but the contribution to hematopoiesis of the two affected clones may be quantitatively very different (14, 75, 79, 80). Thus, the *PIG-A* mutation may provide the conditional survival advantage, but other intrinsic factors may determine the proliferative properties of a particular clone. These proposed other factors may include stochastic epigenetic events or additional genetic abnormalities resulting from mutation affecting genes that regulate cellular proliferation or apoptosis (81).

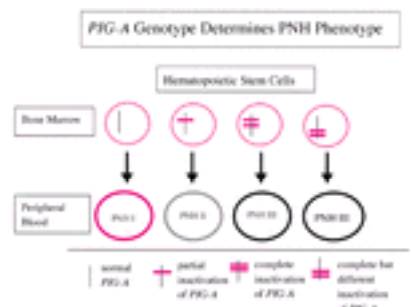


**Figure 37.4.** Hypothetical etiology of paroxysmal nocturnal hemoglobinuria. Diagram of the human *PIG-A* gene and the locations of somatic mutations reported in patients with paroxysmal nocturnal hemoglobinuria. The boxes represent exons within the *PIG-A* gene, and the blackened areas denote noncoding regions. Lines connecting the exons represent introns. The hatched region within exon 6 indicates the putative *PIG-A* transmembrane domain. Single nucleotide substitutions are indicated above the gene as inverted triangles, whereas small nucleotide deletions and insertions are identified beneath the gene by diamonds. Large DNA deletions and insertions are denoted by horizontal lines below the gene. &#x25b2; base substitution; ?, deletion/insertion; ■, large deletion/insertion. (From Nishimura J, Murakami Y, Kinoshita T. Paroxysmal nocturnal hemoglobinuria: an acquired genetic disease. *Am J Hematol* 1999;62:175–182, with permission of Wiley–Liss.)

An uncommon *PIG-A* sequence variant (C–55–T) has been identified in patients with PNH and in unaffected parents and normal volunteers (72, 77, 82, 83). In some cases, inheritance has been demonstrated (72, 82). This missense mutation results in replacement of tryptophan with arginine at amino acid position 19. This change in primary structure has no obvious effect on expression of GPI–AP (82). Thus, C–55–T appears to represent a silent polymorphism. Although unproved, finding C–55–T in 5 of approximately 100 PNH patients (72) suggests that this sequence variant may be in linkage disequilibrium with PNH. If so, it would suggest that *PIG-A* plays a direct role in the etiology of PNH.

Studies of *PIG-A* mutations have also provided insights into the molecular basis of the phenotypic mosaicism of PNH (75). Cloned lymphocyte cell lines were established from the peripheral blood of a patient whose erythrocytes were a mixture of PNH I, PNH II, and PNH III cells (Fig. 37.1). Based on expression of GPI–APs, lymphocyte clones with four different phenotypes were observed. Analysis of clones with normal expression of GPI–AP revealed no somatic *PIG-A* mutations. In contrast, among the three phenotypically distinct lymphocyte clones with abnormal GPI–AP expression, four discrete *PIG-A* mutations were identified. In the lymphocyte clones with the PNH II phenotype, a missense mutation that changed a highly conserved amino acid was found. This finding

suggests that cells with partial expression of GPI-APs (PNH II) are derived from stem cells with mutations that incompletely inactivate *PIG-A*. In the case of the lymphocyte clones with the PNH III phenotype, three separate mutations were identified, each of which was expected to inactivate completely the *PIG-A* gene product. Collectively, these experiments demonstrate that the phenotypic mosaicism that is characteristic of PNH is a consequence of genotypic mosaicism. Further, because any mutation that completely inactivates *PIG-A* results in PNH III cells, phenotypically identical cells can have different *PIG-A* genotypes ( [Fig. 37.5](#)).



**Figure 37.5.** Schematic representation of the molecular basis of phenotypic mosaicism in paroxysmal nocturnal hemoglobinuria (PNH). Cells with normal expression of glycosyl phosphatidylinositol-anchored protein (the PNH I phenotype) are derived from stem cells with normal *PIG-A*. In patients with heterogeneous expression of glycosyl phosphatidylinositol-anchored protein, more than one abnormal clone is present, and the progeny of some of the abnormal clones are phenotypically different because the *PIG-A* genotype is different. For example, PNH II cells are the progeny of stem cells with mutations that incompletely inactivate the *PIG-A* protein, whereas PNH III cells are progeny of stem cells with mutations that completely inactivate *PIG-A*. Inasmuch as any mutation that completely inactivates *PIG-A* produces PNH III cells, phenotypically identical cells can have different genotypes. (Modified from Parker CJ. Molecular basis of paroxysmal nocturnal hemoglobinuria. *Stem Cells* 1996;14:396-411.)

Studies of the pattern of X chromosomal inactivation indicated that, in the female patient with four different *PIG-A* mutations, the abnormal clones were not derived from a common ancestor ([75](#)). Further, that each of the mutations was discrete demonstrated that the mutational events occurred independently rather than by clonal evolution. These results demonstrate that PNH is not strictly a clonal myelopathy and have important implications for the origins of the disease ([75](#), [78](#), [84](#), [85](#)).

Three studies ([86](#), [87](#) and [88](#)) have suggested that mutational frequency is increased in PNH, although the magnitude of the difference varied considerably among the three studies. Although abnormally high mutational frequency is a plausible explanation for the presence of multiple *PIG-A* mutant clones ([75](#), [84](#), [85](#)), it does not explain clonal dominance.

### Clonal Dominance

Despite the progress that has been made in determining the basis of the abnormal sensitivity of the erythrocytes to complement-mediated lysis and the global absence of GPI-APs from hematopoietic cells, an issue that is fundamental to a more complete understanding of PNH remains unresolved. For PNH to become clinically evident, the hematopoietic stem cells bearing the mutant *PIG-A* must expand so that progeny

sufficient to produce symptoms and signs of the disease are generated. In many instances, GPI-AP-deficient (GPI-AP<sup>-</sup>) cells dominate hematopoiesis in patients with PNH, suggesting that the mutant stem cell has either a greater proliferative capacity or a survival advantage relative to GPI-AP-sufficient (GPI-AP<sup>+</sup>) stem cells. That *PIG-A* mutations are necessary for the development of PNH is incontrovertible. At issue is whether *PIG-A* mutations are both necessary *and* sufficient to account for the PNH syndrome and whether the *PIG-A* mutation provides an absolute or a conditional growth/survival advantage.

That PNH is not strictly a monoclonal disease ( [75](#), [84](#), [85](#) ) suggests that the *PIG-A* mutation may not invest the mutant stem cells with an absolute growth advantage. Thus, PNH appears to differ from monoclonal hematopoietic stem cell disorders such as chronic myelogenous leukemia in which the t(9;21) that generates the fusion protein bcr-abl is sufficient to account for the proliferative advantage of the mutant cell. Further, the proportion of GPI-AP<sup>-</sup> to GPI-AP<sup>+</sup> cells varies greatly among patients, and the ratio tends to remain fixed over long periods of observations. Thus, PNH does not behave as a monoclonal disease with a malignant phenotype (e.g., acute leukemia) in which all normal hematopoiesis is progressively displaced as a consequence of the uncontrolled proliferation of a transformed clone.

An additional feature that suggests that the *PIG-A* mutation results in a conditional rather than an absolute growth advantage is the fact that the gene product is apparently a glycosyl transferase ( [61](#), [72](#) ). Thus, a role for *PIG-A* in the regulation of cell growth is not apparent. In contrast, the mutations that produce most hematopoietic malignancies affect expression of protooncogenes that have an obvious impact on signal transduction, regulation of transcription, or control of cellular proliferation or apoptosis. Further arguing against an intrinsic growth/survival advantage are the results of studies using gene targeting ( [89](#) ), in which evidence of outgrowth of *PIG-A* mutant hematopoietic cells has not been observed in transgenic mice (discussed in more detail below).

The oligoclonal nature of PNH ( [75](#), [84](#), [85](#) ) suggests that stem cells with mutant *PIG-A* dominate hematopoiesis because of a powerful selection process that is most likely based on phenotype. According to this hypothesis ( [84](#), [90](#), [91](#) and [92](#) ), stem cells with mutant *PIG-A* have an advantage because of some pathologic process (putatively immune) that involves a GPI-AP. For example, an autoimmune process could arise in which the target antigen is a GPI-AP expressed on hematopoietic stem cells. Under those circumstances, *PIG-A* mutant stem cells (lacking GPI-AP) would escape immune-mediated destruction because they lack the target antigen.

Support for the hypothesis that immune attack against a specific GPI-AP exerts selective pressure sufficient to cause the emergence of a population of GPI-AP<sup>-</sup> cells was provided by clinical observations in patients with chronic lymphocytic leukemia treated with anti-CD52 (the CAMPATH-1 antigen, a GPI-AP) ( [93](#) ). Some of those patients developed a population of GPI-AP<sup>-</sup> peripheral blood lymphocytes and monocytes. Analysis of *PIG-A* from cloned GPI-AP<sup>-</sup> T lymphocytes of one of these patients showed a nonsense mutation ( [93](#) ), demonstrating that a mutation involving *PIG-A* rather than the gene that encodes CD52 produced the population of cells with the selective advantage. This situation is not entirely analogous to PNH, however, because antibodies against a GPI-AP have not been demonstrated. Further, if immune selection underlies the pathophysiology of PNH, it is most likely a cellular rather than a humoral process.

Nonimmune mechanisms could also provide a basis for selection of *PIG-A* mutant stem

cells—for example, if a GPI-AP functions as a receptor for a factor that functions as a negative regulator of hematopoiesis. Under these circumstances, GPI-AP<sup>-</sup> stem cells would have a growth advantage because they lack the receptor for the inhibitor.

Another important unresolved issue is the role of the GPI anchor in the development of PNH. Clearly, deficiency of GPI-AP accounts for most of the pathology associated with PNH. But is the clonal expansion of GPI-AP<sup>-</sup> stem cells the consequence of failure to synthesize the GPI moiety per se, or is it due to the absence of a particular protein that just happens to be GPI anchored? In addressing this question, one must attempt to separate the function of a particular protein from the function of the GPI moiety ( [94](#), [95](#) ). It is also important to consider that the GPI anchor may serve different functions on different proteins. Despite the progress that has been made in defining the structure of the GPI anchor, much less is known about its functional properties. Besides its most obvious role of providing a mechanism for membrane attachment of proteins, the GPI moiety may influence the release of proteins from the cell surface, the lateral mobility of the protein within the plane of the membrane, and the sorting of proteins in polarized epithelial cells ( [94](#), [95](#) ). Additionally, more than a dozen GPI-APs have been implicated in cellular activation and signaling through interactions with tyrosine kinases ( [94](#), [95](#), [96](#) and [97](#) ). GPI molecules that are not attached to protein (free GPIs) have been identified on the outer surface of cells ( [98](#) ). The significance of free GPIs is unknown, but they may have important biologic functions that influence cell proliferation. Thus, it is conceivable that the clonal expansion observed in PNH is due to the absence of a GPI-dependent signaling mechanism that regulates cell growth.

Although it is plausible to suggest that failure to synthesize the anchor per se underlies the development of PNH, it seems more likely that the global deficiency of GPI-AP is an epiphenomenon. Hematopoietic cells express a relatively large number of functionally diverse GPI-APs ( [Table 37.2](#) ). Thus, absence of all GPI-AP is probably not required for the clonal expansion of the mutant stem cells. Rather, the selective advantage may be dependent on the absence of a single protein that is GPI anchored, and the reason for the global deficiency of GPI-AP is that *PIG-A* is located on the X chromosome. According to this supposition, an autosomal gene encodes the GPI-AP that is conditionally detrimental (e.g., an antigen targeted for immune destruction or a receptor for a negative growth regulator). Inasmuch as two alleles rather than one must be mutated, the probability of inactivating an autosomal gene through somatic mutagenesis is remote compared to the probability of inactivating an X-linked gene. Therefore, stem cells with a deficiency of the detrimental GPI-AP are most likely to arise as a consequence of *PIG-A* mutations (as was the case discussed above in which patients with chronic lymphocytic leukemia were treated with CAMPATH-1H). Assuming that the GPI-AP complement regulatory proteins are not the targets of the underlying pathologic process, the hemolytic anemia that is the clinical hallmark of PNH may represent an epiphenomenon related to the chromosomal location of *PIG-A*.

Although a compelling case can be made in support of the paradigm that the *PIG-A* mutation bestows a conditional growth advantage on the affected stem cell, the hypothesis that the mutant stem cells have an absolute growth or survival advantage must also be strongly considered. Data that both support and challenge this hypothesis can be found.

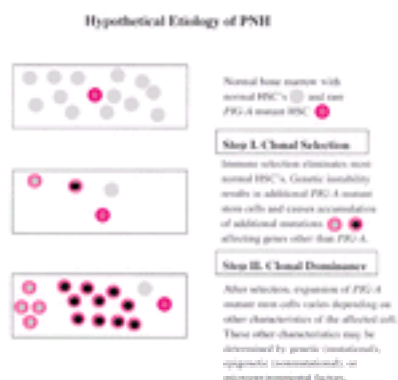
In support of the hypothesis are the studies of Iwamoto et al. ( [99](#) ). Using a model in which human bone marrow cells were transplanted into sublethally irradiated severe combined immunodeficiency mice, the investigators presented data suggesting that GPI-AP<sup>-</sup> stem cells have a growth advantage compared to GPI-AP<sup>+</sup> stem cells from either PNH patients or normal donors. Inasmuch as the only obvious variable in this model

is whether the transplanted cells are GPI-AP<sup>+</sup> or GPI-AP<sup>-</sup>, these results suggest that the growth advantage of the GPI-AP<sup>-</sup> stem cells relative to the GPI-AP<sup>+</sup> stem cells is an unconditional, intrinsic property of the mutant stem cells.

Brodsky and colleagues (100) presented data showing that *PIG-A* mutant cells are relatively resistant to apoptosis. Sensitivity to apoptosis was restored when the mutant cells were transfected with a *PIG-A*-containing expression vector. Others have also observed resistance to apoptosis in cells derived from patients with PNH (101, 102). Those authors, however, concluded that resistance to apoptosis was a property of cells isolated from patients with bone marrow failure syndromes (e.g., aplastic anemia and myelodysplasia) and was not specific for *PIG-A* mutant cells. More recently, Chen et al. (103) reported that GPI-AP<sup>-</sup> stem cells from patients with PNH have a growth advantage *in vitro* compared to their GPI-AP<sup>+</sup> counterparts. Interestingly, the proliferative properties of GPI-AP<sup>-</sup> cells were similar to those of stem cells isolated from normal volunteer donors. Interpretation of these studies is ambiguous, however. The findings could be explained by a difference in the intrinsic properties of the cells. Alternatively, the GPI-AP<sup>+</sup> cells could have been more severely damaged *in vivo* by the pathologic process that underlies PNH, resulting in diminished growth and survival in the *in vitro* studies.

The most compelling argument against an intrinsic growth or survival advantage for *PIG-A* mutant cells is made by the results of studies using transgenic mice (89). By using homologous recombination, Kawagoe et al. (104) disrupted *Pig-a* (the murine homolog of *PIG-A*). Only mice with a low degree of chimerism survived. Among those animals, the percentage of GPI-AP<sup>-</sup> erythrocytes ranged from approximately 1 to 5%. During 10 months of observation, the ratio of GPI-AP<sup>-</sup> to GPI-AP<sup>+</sup> peripheral blood cells did not increase. Studies by others using conditional knock-out technology have confirmed these observations (89).

In summary, the basis of the clonal dominance in PNH is enigmatic. Indirect evidence, however, supports the concept that *PIG-A* mutant, GPI-AP<sup>-</sup> stem cells emerge because they have a conditional growth or survival advantage. A cellular immune process most likely exerts the selective pressure. Thus, principles of darwinian evolution may apply to development of PNH. The extent of expansion of a particular mutant clone and the dominance of one *PIG-A* mutant clone in the presence of other *PIG-A* mutants may be mediated by secondary events (genetic or epigenetic) that influence cellular proliferation (Fig. 37.6).



**Figure 37.6.** Model of how paroxysmal nocturnal hemoglobinuria (PNH) arises. Step I is



clonal selection. According to this model, the *PIG-A* mutant, glycosyl phosphatidylinositol-anchored protein (GPI-AP)-deficient stem cells have a growth or survival advantage in the setting of a specific type of marrow injury. The close connection between PNH and aplastic anemia suggests that immune-mediated injury provides the selection pressure. Putatively, absence of one or more GPI-APs is advantageous in this setting. Step II is clonal dominance. Patients with PNH often have more than one mutant hematopoietic stem cell (HSC) that is active. The contribution of the *PIG-A* mutant clones to hematopoiesis varies greatly, however. This observation suggests that factors in addition to the *PIG-A* mutation influence the proliferative properties of stem cells that survive the injury-mediated selection process. Remarkably, a single clone can maintain normal (or near-normal) hematopoiesis for more than a decade without malignant transformation.

## Aplastic Anemia and Paroxysmal Nocturnal Hemoglobinuria

Patients with PNH can be divided into the following two groups: those without a history of aplastic anemia (primary or hemolytic PNH) and those with a history of aplastic anemia who subsequently develop PNH (aplastic anemia/PNH). An association between aplastic anemia and PNH has been recognized at least since 1961 ([105](#)), and numerous subsequent studies have confirmed the association ([106](#), [107](#), [108](#), [109](#), [110](#), [111](#), [112](#), [113](#), [114](#), [115](#), [116](#), [117](#), [118](#) and [119](#)). The probability that two rare diseases could occur together so frequently by chance is negligible. Thus, there is a pathophysiologic link between PNH and aplastic anemia.

Recently, Hillmen et al. ([15](#)) reported that 23 of 80 PNH patients (29%) had a history of aplastic anemia, and in a series of 220 French patients with PNH, Socié and colleagues identified 65 (30%) in whom the diagnosis of aplastic anemia preceded that of PNH ([120](#)). The latter group of investigators also found that 10% of PNH patients with no history of aplastic anemia developed pancytopenia during the period of observation covered by the study (median follow-up of 2 years). The estimated cumulative incidence of pancytopenia was 8.2% [ $\pm 2.4\%$ , standard error (SE)] at 2 years and 14.2% ( $\pm 3.3\%$ , SE) at 4 years ([120](#)). This incidence appears to be somewhat higher than that observed in the study reported by Hillmen et al. in which 5 of 80 (6%) patients with PNH subsequently developed aplasia ([15](#)).

On the other hand, the proportion of patients with aplastic anemia who subsequently develop PNH varies widely among studies, in part, because the criteria for diagnosis of PNH are not uniform. In some cases, a positive Ham test or sucrose lysis test was required for diagnosis, and in other cases, identification by flow cytometry of a population of peripheral blood cells with GPI-AP deficiency was used to classify patients. A recent study reported that PNH cells were found in the bone marrow in 89% of 115 patients with aplastic anemia at some point during the course of their illness ([121](#)). Two other studies reported 38% (11 of 29 patients) ([115](#)) and 32% (12 of 37 patients) ([110](#)) for the portion of patients with aplastic anemia treated with immunosuppression who developed laboratory evidence of PNH during the course of their disease. In that study, 23% of patients had clinical signs and symptoms of PNH. Thus, in most patients with aplastic anemia, evidence of PNH is subclinical or transient. These results suggest that the selective pressure that favors *PIG-A* mutant cells occurs frequently in the setting of aplastic anemia but that the clinical syndrome occurs at a significantly lower frequency. The simplest interpretation of these observations is that factors in addition to *PIG-A* mutation contribute to the development of clinical signs and symptoms of PNH by determining the extent to which the *PIG-A* mutant stem cells expand. As discussed in the section [Clonal Dominance](#),

these factors could be genetic, epigenetic, or microenvironmental.

The time between the diagnosis of aplastic anemia and the development of PNH varies from a few months to several years. In the series reported by Socié et al. ([120](#)), the median time between diagnosis of aplastic anemia and laboratory evidence of PNH was 3.1 years (range, 0.17 to 15.0 years). Using an assay with the capacity to detect 0.004% GPI-AP<sup>-</sup> erythrocytes, Mukhina et al. reported that 61% of patients with aplastic anemia had detectable PNH cells before therapy ([112](#)). None of these patients, however, would have had GPI-AP<sup>-</sup> cells detected by conventional flow cytometry. Therefore, the selection of *PIG-A* mutant stem cells appears to occur early in the course of aplastic anemia. Expansion of the mutant clones occurs later and, thus, may be influenced directly or indirectly by therapy. Although many patients with aplastic anemia who develop PNH are treated with immunosuppressive therapy (e.g., antithymocyte globulin and cyclosporin) at the time the aplastic anemia is diagnosed, there is no direct evidence that immunosuppression causes PNH. Patients with aplastic anemia who respond to androgens appear equally likely to develop PNH ([120](#)). Thus, marrow recovery per se may account for the expansion of progeny of the *PIG-A* mutant stem cell clones.

The basis of the relationship between PNH and aplastic anemia is speculative. Most patients with PNH have some evidence of bone marrow failure (e.g., thrombocytopenia, leukopenia, or both) during the course of their disease ([15](#), [120](#)). Thus, bone marrow injury may be essential for the development of PNH. Currently, there is no evidence that the types of *PIG-A* mutations that occur in aplastic anemia/PNH are different from those observed in primary PNH ([83](#)). Further, a distinction between primary PNH and aplastic anemia/PNH may be artificial, as the underlying pathophysiologic process could be the same. According to this hypothesis, in primary or hemolytic PNH, the aplastic or hypoplastic component is subclinical with the recovery phase being spontaneous.

### Leukocytes and Platelets

Deficiency of GPI-AP on neutrophils, monocytes, platelets, and lymphocytes has been demonstrated ([64](#), [65](#), [122](#), [123](#), [124](#), [125](#) and [126](#)), and identical *PIG-A* mutations have been identified in neutrophils, monocytes, and lymphocytes from the same patient ([70](#), [75](#)). Together, these studies indicate that the somatic mutation that gives rise to PNH affects a hematopoietic stem cell. Most PNH patients have pancytopenia or either neutropenia or thrombocytopenia in combination with anemia at some point during the course of their illness ([15](#), [120](#), [127](#)). The neutropenia and thrombocytopenia, however, are due to abnormal hematopoiesis rather than to increased peripheral, complement-mediated destruction, as *in vivo* studies have demonstrated normal survival of neutrophils and platelets in patients with PNH ([122](#), [128](#)). That absence of GPI-anchored complement regulatory proteins from PNH neutrophils and platelets does not affect their survival implies that these cell types (unlike erythrocytes) have additional mechanisms that protect them from complement-mediated destruction *in vivo*.

*In vitro* studies have reportedly shown functional abnormalities of PNH leukocytes and platelets ([128](#), [129](#), [130](#), [131](#) and [132](#)). Further, deficiency of some of the GPI-AP from PNH leukocytes and platelets would seem to have important functional consequences (e.g., deficiency of Fc $\gamma$ RIIIb from neutrophils, deficiency of urokinase-type plasminogen activator receptor from monocytes and neutrophils, deficiency of lymphocyte function-associated antigen-3 from lymphocytes, deficiency of the folate receptor from hematopoietic stem cells) ([Table 37.2](#)). However, evidence that deficiency of GPI-AP other than erythrocyte DAF and MIRL contributes to the pathophysiologic manifestations of PNH is largely conjectural. At least in some cases, functional redundancy appears to



account for the lack of untoward consequences associated with GPI-AP deficiency ( 133 ).

## Hematopoietic Stem Cells

The PNH defect can be demonstrated in erythroid and granulocytic precursors grown *in vitro* (i.e., colony-forming unit erythroid, burst-forming unit erythroid, and colony-forming unit granulocyte-macrophage) ( 134 ). Two populations of colonies can be identified in such studies, and they differ from one another in complement sensitivity and expression of acetylcholinesterase ( 135 ). These latter observations support the concept of a clonal process originating from a mutant hematopoietic stem cell.

Cytogenetic studies on hematopoietic cells of patients with PNH have yielded mixed results. The issue is complicated because patients with aplastic anemia can have karyotypic abnormalities ( 136 ). Recently, Araten and colleagues reported karyotypic abnormalities in 11 of 46 (24%) PNH patients examined in a retrospective study ( 137 ). In seven of these patients, there was evidence of clonal regression, and none of the patients developed excess of blasts or transformed into acute leukemia. These findings suggest that karyotypic abnormalities in PNH do not predict progression into a malignant phenotype. Nonrandom chromosomal abnormalities specific for PNH have not been identified, arguing against clonal evolution as a common process in PNH.

Uncommonly (~1%), patients with PNH develop acute leukemia ( 15 , 120 ). In some cases, the leukemic clone arises from the PNH clone because the blasts are GPI-AP deficient ( 138 ). Similar observations have been made in myelodysplasia arising in the setting of PNH ( 139 ). However, in other cases, PNH cells disappear after the onset of the leukemia ( 140 ) or myelodysplasia ( 141 ). Although transformation into acute leukemia or other clonal myelopathies is uncommon in PNH, the incidence is probably higher than in the general population. Thus, an element of genetic instability may be associated with PNH or the process that underlies PNH ( 87 ).

## CLINICAL MANIFESTATIONS

PNH usually begins insidiously, with the abrupt onset of clinically apparent hemoglobinuria being the presenting symptom in approximately 25% of cases ( 3 ). The course is chronic with a generally stable clinical pattern in a given individual. The illness ranges in severity from a mild, clinically benign process to a chronically debilitating, potentially lethal disease. The diagnosis is made most frequently in the fourth to fifth decades of life ( 15 , 120 ), but PNH is also encountered in childhood ( 13 ) and in old age [age range, 16 to 75 years ( 15 ) and 6 to 82 years ( 120 ) in two large series]. Both genders are affected, with perhaps a slight female predominance ( 120 ), and PNH has been described in many racial groups but principally in whites and Asians ( 80 , 106 , 142 , 143 ). The disease has no familial tendency. Inherited cases due to global deficiency of GPI-AP have not been reported, suggesting that germline mutations of *PIG-A* are incompatible with life. This hypothesis is supported by the lack of success in producing a homozygous or hemizygous knock-out mouse using targeted mutation of *Pig-a* ( 104 ). A patient with an inherited deficiency of MIRL (CD59) had a syndrome that was clinically indistinguishable from PNH, but other GPI-APs were expressed normally by that patient ( 45 ).

Most commonly, patients initially report weakness, yellowish discoloration of the skin (jaundice), and other symptoms of chronic hemolysis, but (as noted earlier in this section) a history of hemoglobinuria is part of the initial presentation in only approximately 25% of

patients ( [Table 37.3](#)). Because PNH frequently is not considered in such patients, the correct diagnosis is often delayed by months to years.

**TABLE 37.3. Presenting Features in 80 Patients with Paroxysmal Nocturnal Hemoglobinuria**

| Signs and Symptoms             | Number of Patients (%) |
|--------------------------------|------------------------|
| Symptoms of anemia             | 20 (35)                |
| Hemoglobinuria                 | 21 (26)                |
| Hemorrhagic signs and symptoms | 14 (18)                |
| Aplastic anemia                | 10 (13)                |
| Gastrointestinal symptoms      | 8 (10)                 |
| Hemolytic anemia and jaundice  | 7 (9)                  |
| Iron deficiency anemia         | 5 (6)                  |
| Thrombosis or embolism         | 5 (6)                  |
| Infections                     | 4 (5)                  |
| Neurologic signs and symptoms  | 3 (4)                  |

From Dacie JV, Lewis SM. Paroxysmal nocturnal haemoglobinuria: clinical manifestations, haematology, and nature of the disease. *Ser Haematol* 1972;5:3–23, with permission.

## Hemoglobinuria

Although most patients (80%) have episodes of hemoglobinuria some time during their illness ( [15](#)), this classic symptom is reported as part of the initial evaluation in only one-fourth of all patients ( [Table 37.3](#)). Nocturnal hemoglobinuria appears to result from an increase in the rate of hemolysis that occurs during sleep. It is not related to time of day, however, because the pattern can be reversed if the patient is kept awake at night and allowed to sleep during the day. In patients with nocturnal hemoglobinuria, the urine is usually darkly discolored in the morning and clears during the day. When hemolysis is intense, however, hemoglobinuria may persist throughout the day.

The cause of the nocturnal exacerbation is poorly understood. Retention of CO<sub>2</sub> causing a slight fall in plasma pH that is sufficient to activate the alternative pathway of complement is a possible explanation ( [4](#), [5](#)), but this hypothesis has been challenged ( [2](#)).

## Episodic Hemolysis

In addition to the sleep-related pattern, most patients experience irregular but recurrent exacerbations of hemolysis and hemoglobinuria. Paroxysms may be precipitated by a wide variety of events, including infections (even minor ones), surgery, transfusions, iron supplementation, vaccinations, and menstruation. Attacks of hemoglobinuria are unrelated to cold exposure, thus distinguishing PNH clinically from paroxysmal cold hemoglobinuria.

Mild hemolytic episodes often pass without significant symptoms, but more severe attacks may be associated with substernal, lumbar, or abdominal pain together with drowsiness, general malaise, fever, and headaches. The abdominal pain may be colicky and may last for 1 to 2 days. The abdomen may be tender, especially in the left upper quadrant, with guarding and rebound tenderness. The back pain resembles that noted in

patients with other types of intravascular hemolysis and is most severe in the lumbar region. Headaches may be excruciating and sometimes last for days.

### **Marrow Hypoplasia**

Because many patients with aplastic anemia/PNH have only a small proportion of complement-sensitive cells ([112](#)), few of the changes usually associated with hemolytic anemia are obvious. Thus, the aplastic anemia/PNH syndrome is probably underdiagnosed. Clinicians need to maintain a high degree of suspicion, and any evidence of hemolysis (e.g., elevated serum lactate dehydrogenase) in a patient with aplastic anemia warrants evaluation for PNH. In one series of 80 European patients with PNH, aplastic anemia was the first diagnosis in 23 cases (29%) ([3](#), [15](#)); the same was true for 26 of 85 patients (31%) from Thailand ([142](#)) and 65 of 220 French patients (30%) ([120](#)). In some instances, the diagnosis of hemolysis is made first, and pancytopenia develops subsequently ([3](#), [15](#), [120](#), [142](#)). Although speculative, the basis of the relationship between aplastic anemia and PNH is discussed in the section [Aplastic Anemia and Paroxysmal Nocturnal Hemoglobinuria](#).

### **Thrombotic Disease**

PNH is associated with a striking predisposition to intravascular thromboses, especially within the venous circulation ([15](#), [120](#), [144](#)). Intraabdominal veins are the most common sites of thrombosis in patients with PNH. Cerebral vein thrombosis and superficial dermal vein thrombosis also appear to be represented disproportionately. Thrombotic disease accounts for approximately 50% of all deaths in patients with PNH. Fatal thromboses usually involve the portal system or the brain.

Recurrent abdominal pain is the dominant clinical manifestation in some patients with PNH ([Table 37.3](#)). The cause of the pain is often obscure but may be severe enough to be confused with an acute abdomen warranting emergency surgery. The possibility that a thrombosis in the portal or mesenteric veins is the cause of the pain should be considered in this setting. Both transient intestinal ischemia and intestinal infarction are other possible causes.

Hepatic venous thrombosis (Budd–Chiari syndrome) is a serious, potentially fatal complication of PNH ([145](#), [146](#)). In various series, 15 to 30% of patients with PNH had hepatic venous thrombosis, and it might be even more common because affected individuals can be asymptomatic when the disease is in its early stage ([147](#)). The clinical manifestations include nausea, abdominal pain, variable degrees of ascites, variceal bleeding, and signs of liver failure. Often, the liver increases abruptly in size, but hepatomegaly is not always noted. Three pathophysiologic stages of hepatic venous thrombosis have been defined ([147](#)). In the early or mildest stage, only venules or small hepatic veins are involved. Patients may be asymptomatic; therefore, the condition may go unrecognized. Mild, easily controlled ascites is detected in some patients. In the second stage, larger hepatic veins are partially occluded. Ascites is noted in most patients with such abnormalities. Some individuals develop variceal bleeding, and a few become jaundiced. The third or advanced stage is characterized by complete occlusion of large hepatic veins. Ascites is almost always present, jaundice is common, and variceal bleeding occurs in a few patients. This stage is often fatal.

An increase in the level of serum lactate dehydrogenase, alanine aminotransferase, and aspartate aminotransferase may be an early clue to the presence of hepatic vein thrombosis. Plasma concentration of conjugated bilirubin also may increase, but other biochemical tests of liver function are of limited value. Ultrasonography probably is the

most effective, noninvasive method for early detection of hepatic vein thrombosis ( [148](#) ). Serial computed tomography scans also are of value. Radioactive isotope scanning demonstrates patchy uptake in most of the liver, except for a normal-functioning, hypertrophied caudate lobe, which is spared because of its separate venous drainage ( [146](#) ). Hepatic venography can provide definitive information, but this procedure carries more risk than noninvasive techniques. Biopsy may demonstrate congestion and liver cell loss, but the procedure is hazardous and not always of diagnostic value.

Small-vessel thromboses may cause severe and refractory headaches, or they presage progressive cerebrovascular thrombosis ( [149](#) ). Isotopic brain scanning and electroencephalography usually are of little help in monitoring PNH patients with headaches.

The etiology of the thrombophilia associated with PNH is speculative ( [144](#) ). A link between thrombosis and GPI-AP deficiency has been suggested ( [132](#), [150](#) ). However, the lack of an association between thrombosis and the portion of GPI-AP deficiency implies that additional factors contribute to the thrombophilia of PNH. Risk factors for thrombosis in PNH have not been identified, and the frequency of mutations in factor V Leiden is not abnormally high among tested patients ( [151](#) ).

### **Renal Abnormalities**

Both acute and chronic renal insufficiency occur in patients with PNH ( [152](#) ). Acute renal insufficiency is associated with hemoglobinuric crises and may resolve without residual damage. In one series of 19 patients with PNH, however, 12 individuals had reduced values for creatinine clearance, whereas their underlying disease was stable. Furthermore, at least three of these patients had progressive renal insufficiency. Patients with PNH may also have hematuria, proteinuria, hypertension, an inability to concentrate urine, or some combination of these abnormalities. The kidneys usually are enlarged when examined radiographically. The renal abnormalities probably result from repeated thrombotic episodes involving small venules.

### **Dysphagia**

When closely questioned, many patients with PNH report painful or difficult swallowing. The symptom is often worse in the morning and appears to be exacerbated during hemolytic episodes. Studies of peristalsis have shown that the esophageal contractions that occur in this setting have nine to ten times the normal force. The pathogenesis of these esophageal symptoms is speculative. Inasmuch as hemoglobin binds nitric oxide, it has been proposed that the plasma free hemoglobin that is a consequence of the chronic intravascular hemolysis characteristic of PNH acts as a sump for nitric oxide. Esophageal (and intestinal spasm) may ensue due to consumption by plasma free hemoglobin of the smooth muscle-relaxing activity of nitric oxide.

### **Infections**

Infectious diseases are common and may be attributable in part to leukopenia, to treatment with corticosteroids, or, possibly, to functional defects in leukocytes. Even mild infections may constitute a serious hazard because they may precipitate a hemolytic or an aplastic crisis.

### **Physical Examination**

Findings may include pallor and jaundice. Moderate splenomegaly is usual, and mild to moderate hepatomegaly is sometimes found. The association of splenomegaly with “aplastic anemia” is often a clue to the real nature of the disease (i.e., PNH/aplastic anemia). Physical examination is otherwise unrevealing.

## LABORATORY FINDINGS

### Blood

Essentially all patients are anemic, and in many, the anemia is severe. The red cells are usually macrocytic, but size range varies considerably among patients. Occasionally, when urinary iron loss has been considerable, the red cells may appear hypochromic and microcytic. Spherocytes and other abnormal red cell shapes are not seen, but, occasionally, red cell fragments may be observed. When present, these fragments may indicate a complicating intravascular coagulopathy. In addition to polychromatophilia, normoblasts (nucleated red blood cells) may be found in the peripheral blood film. Relative reticulocytosis may be marked, but the absolute reticulocyte count is often lower than that found in association with other hemolytic disorders at comparable degrees of anemia. This discrepancy reflects underlying marrow dysfunction that is invariably a component of the disease. The osmotic and mechanical fragility of the erythrocytes is normal, and the reaction to the direct antiglobulin (Coombs) test is negative.

Leukopenia is often detected and may be marked ([120](#)). The leukopenia is a consequence of abnormal hematopoiesis, although a shift from the circulating to the marginated granulocyte pool may be a contributing factor ([128](#)). The neutrophil alkaline phosphatase (a GPI-AP) content is low or absent. Functional leukocyte defects have been demonstrated, but their clinical relevance is conjectural.

Thrombocytopenia of moderate to severe degree is common ([120](#)), but platelet lifespan and function generally are normal ([122](#)). Bleeding due to severe thrombocytopenia contributes significantly to the morbidity and mortality of the disease ([3](#), [120](#)).

### Plasma

The plasma may be golden brown, reflecting the presence of increased levels of unconjugated bilirubin, hemoglobin, and methemalbumin. Predictably, serum haptoglobin levels are low, and lactate dehydrogenase concentration is usually markedly elevated, reflecting chronic intravascular hemolysis.

### Urine

When the rate of blood destruction is increased, the urine contains increased amounts of urobilinogen. In addition, intravascular hemolysis leads to the depletion of serum haptoglobin, which results in the continuous presence of hemoglobin in the glomerular filtrate in the kidney. The cells of the proximal convoluted tubules that become heavily laden with iron reabsorb much of the hemoglobin. The excretion of this iron in the form of granules gives rise to hemosiderinuria. In addition, spectroscopic examination may reveal variable amounts of free hemoglobin. The continuous loss of relatively large amounts of iron in the urine may produce iron deficiency. Average daily losses of up to 15.9 mg have been observed, and as many as 3.6 mg of iron excreted in 24 hours have been demonstrated, even in the absence of hemoglobinuria. Albumin has been detected in the urine immediately before and after an episode of hemoglobinuria, and long-term study of

PNH patients has shown an unexpected high incidence of functional renal abnormalities, such as hematuria, hyposthenuria, tubular malfunction, and declining creatinine clearance ( [152](#) ).

## Bone Marrow

Normoblastic hyperplasia is the characteristic finding. As many as 50% of the nucleated cells may be normoblasts; megaloblastic changes are evident only occasionally. The absence of morphologic changes consistent with megaloblastic anemia suggests that deficiency of the GPI-anchored form of the folate receptor ( [Table 37.2](#) ) does not result in abnormalities in folate metabolism that are clinically significant. The number of megakaryocytes may be decreased. When pancytopenia is evident, hypoplastic marrow may be observed, although in many patients, pancytopenia is associated with cellular marrow, a feature that is more consistent with a myelodysplastic process.

## Cytogenetic Studies

Although karyotypic abnormalities have been reported in PNH, nonrandom chromosomal aberrations specific for PNH have not been identified ( [137](#) ). Apparently, the presence of karyotypically abnormal bone marrow cells is not a negative prognostic factor in PNH as it is in myelodysplasia ( [137](#) ).

## Diagnostic Tests

Until recently, the diagnosis of PNH was based on the results of special tests that exploited the abnormal sensitivity of PNH red cells to lysis by complement. Among the available assays, the Ham test (acidified serum lysis) and the sucrose lysis (sugar water) test ( [153](#) , [154](#) ) were most commonly used for the clinical diagnosis of PNH. Although these tests are sensitive and specific when properly performed and relatively simple in both theory and practice, their accuracy is strongly operator dependent. Thus, in the hands of an inexperienced technician, results are not always reliable. This problem is compounded by the fact that the tests are usually performed on a sporadic basis in most clinical laboratories because the diagnosis of PNH is entertained relatively uncommonly.

The recognition that the deficiency of GPI-AP underlies PNH has resulted in the development of a simple, reliable method for diagnosing the disease ( [113](#) , [123](#) , [124](#) , [126](#) , [155](#) ). By analyzing the expression of GPI-AP on hematopoietic cells using monoclonal antibodies and flow cytometry, the abnormal cells can be readily identified ( [Fig. 37.1](#) and [Fig. 37.2](#) ). The simplest method is to analyze the expression of MIRL (CD59) on erythrocytes. Because it is normally present in relatively high density, red cells with either complete or partial deficiency of MIRL are easily distinguished from normal ( [Fig. 37.1](#) and [Fig. 37.2A](#) ). Thus, PNH I (normal expression), PNH II (partial expression), and PNH III (negative expression) erythrocytes can be identified by analyzing the flow cytometry histogram ( [Fig. 37.1](#) and [Fig. 37.2A](#), [Table 37.1](#) ). Analysis of erythrocyte DAF (CD55) expression is also informative. Because erythrocytes express approximately six- to eightfold less DAF than MIRL, however, separation into discrete populations may be less obvious when anti-DAF is used as the primary antibody. By using both antibodies, the diagnosis can be confirmed ( [Fig. 37.1](#) and [Fig. 37.2A](#) ).

Expression of GPI-AP on other hematopoietic cells, such as granulocytes, can also be used to diagnose PNH, but, with rare exception ( [113](#) ), this approach offers no advantage over analysis of red cells. To the contrary, analysis of GPI-AP on granulocytes is technically more challenging than on erythrocytes ( [123](#) ). Further, granulocyte expression



must be analyzed immediately after the blood sample is obtained, whereas erythrocytes can be analyzed 1 to 2 weeks after the blood is obtained if the sample is properly stored at 4° C.

GPI-AP<sup>-</sup> populations that comprise more than 1% of the red cells can be identified by standard flow cytometry ( [123](#) ). Concern that recent red cell transfusion might result in a false-negative result seems unfounded. Because the assay is so sensitive and because the proportion of GPI-AP<sup>-</sup> cells is greater in the reticulocyte population than in the peripheral blood as a whole ( [12](#) , [156](#) ), massive transfusion that both replaces essentially all of the patient's blood volume and completely suppresses hematopoiesis would be required to produce a false-negative result. Transfusion has an impact on the percentage of GPI-AP<sup>-</sup> cells that are observed, but the possibility that the diagnosis would be obscured seems remote. Likewise, the possibility that a recent hemolytic episode would result in a false-negative result because all the abnormal cells are destroyed is negligible. Clearly, when documenting the proportion of affected cells and determining the precise phenotype, the analysis is best done when the patient has not been recently transfused, as well as when the patient is not experiencing a hemolytic crisis related to infection or some other cause.

Recently, Brodsky and colleagues developed a very sensitive assay for PNH by exploiting the properties of the bacterial toxin aerolysin ( [112](#) , [157](#) , [158](#) ). This channel-forming protein binds to the GPI anchor. Thus, PNH cells are selectively spared from the lytic effects of the toxin because they lack the GPI anchor. In samples containing a mixture of GPI-AP<sup>+</sup> and GPI-AP<sup>-</sup> cells, treating with the toxin can eliminate the GPI-AP<sup>+</sup> cells, and any residual GPI-AP<sup>-</sup> cells can be detected by flow cytometry. Using this method, as few as 0.004% GPI-AP<sup>-</sup> cells could be identified ( [112](#) ). This assay may be particularly valuable in identifying patients with aplastic anemia and myelodysplasia who have a very small portion of GPI-AP<sup>-</sup> cells, especially if finding such a population has prognostic or therapeutic significance.

Analysis of the expression of GPI-AP on erythrocytes is also a highly specific test for PNH. There is no other disease in which the erythrocytes are a mosaic of both GPI-AP<sup>+</sup> and GPI-AP<sup>-</sup> cells. Patients with isolated deficiency of either DAF [the Inab phenotype ( [159](#) )] or MIRL ( [45](#) ) are identified by this method (assuming that anti-DAF and anti-MIRL antibodies are used). Such patients are extremely rare, however, and their flow cytometry histograms are readily distinguishable from those of patients with PNH because 100% of the cells are abnormal and expression of only one GPI-AP is deficient.

## DIFFERENTIAL DIAGNOSIS

The diagnosis of PNH must be considered in any patient who has the following: (a) signs of intravascular hemolysis of undefined cause, especially in the presence of hemoglobinuria, and a high serum lactate dehydrogenase; (b) pancytopenia in association with hemolysis, whether or not the marrow is cellular; (c) persistent, poorly explained iron deficiency, when accompanied by hemolysis; (d) evidence of recurrent venous thrombosis, especially intraabdominal events; and (e) unexplained recurrent bouts of abdominal pain, low backache, or headache in the presence of chronic hemolysis.

It is difficult to overemphasize the importance of documenting evidence of hemolysis before proceeding with tests more specific for PNH. As discussed in the section [Hemoglobinuria](#), a history of hemoglobinuria (nocturnal or otherwise) is not part of the



initial clinical presentation in approximately three-fourths of patients with PNH ( [Table 37.3](#) ). With rare exception, however, laboratory evidence of hemolysis is a constant feature of the disease. Quantitation of serum lactate dehydrogenase is particularly informative because intravascular hemolysis results in markedly elevated values. If lactate dehydrogenase levels are difficult to interpret because of other comorbid conditions (e.g., liver disease), alternative evidence for hemolysis should be sought (e.g., low serum haptoglobin, urine hemosiderin). Without evidence of hemolysis, more specific tests for PNH are generally unwarranted. PNH must be differentiated from antibody-mediated hemolytic anemias, especially paroxysmal cold hemoglobinuria and the cold agglutinin syndrome, and from HEMPAS ( *hereditary erythroblastic multinuclearity with positive acidified serum* ). The mechanism that underlies the abnormal susceptibility of HEMPAS erythrocytes to acidified serum lysis is different from that of PNH ( [160](#) ). By using flow cytometry, there is no difficulty distinguishing PNH from other hemolytic diseases because deficiency of GPI-AP affecting a portion of the erythrocytes is diagnostic of PNH.

## TREATMENT

With the exception of marrow transplantation, no definitive therapy is available. Rigid guidelines for management are inappropriate because of the highly variable clinical course. Some patients have only a moderate degree of anemia with minimal hemoglobinuria, and in such patients, “he prescribes best who prescribes least.” Other patients have severe anemia punctuated by hemolytic crises, thromboses, and infection; in such patients, treatment is warranted, but response is often unsatisfactory.

### Bone Marrow Transplantation

Allogeneic bone marrow transplantation (BMT) has been used in the treatment of severe PNH for more than 25 years ( [161](#) , [162](#) , [163](#) and [164](#) ). Presumably, the abnormal stem cells are destroyed by the conditioning regimen, and the marrow is repopulated with normal donor cells. The transplant process may also have immune modulatory activity that contributes to the efficacy of the treatment. Although allogeneic BMT is potentially curative, the benefits must be weighed against the significant morbidity and mortality associated with the procedure. The experience of the International Bone Marrow Transplant Registry was recently reviewed ( [164](#) ). A total of 57 patients were included in this study, with 48 receiving HLA-identical sibling transplants. The 2-year probability of survival for this group was 56%. Only one of seven patients who underwent unrelated donor transplant was alive after 5 years of follow-up. Recently, successful treatment of a patient with PNH using nonmyeloablative stem cell transplantation has been reported ( [165](#) ).

Although BMT has been used primarily to treat patients with PNH/aplastic anemia, consideration should be given to this form of therapy in patients with PNH who have thrombosis at presentation, as this group has only a 40% survival rate at 4 years ( [120](#) ). Progression to pancytopenia is also a risk factor that negatively affects survival ( [120](#) ), as do the development of myelodysplastic syndrome or acute leukemia, age older than 55 years at diagnosis, and thrombocytopenia at diagnosis ( [Table 37.4](#) ). Surprisingly, however, a history of aplastic anemia has been reported to favorably influence survival in a multivariate analysis ( [Table 37.4](#) ) ( [120](#) ). That some patients with PNH undergo spontaneous remission must also be taken into account when deciding on the appropriateness of allogeneic BMT as treatment for PNH ( [15](#) ).

**TABLE 37.4. Risk Factors Affecting Survival**

| Factor   | Relative Risk of Disease-Related Mortality (95% Confidence Interval) | $p$ Value |
|--|--|-----------|
| Development of thrombosis                                      | 10.2 (6.0–17.0)  | <.0001    |
| Progression to pancytopenia                                    | 5.5 (2.8–11.0)   | <.0001    |
| Myelodysplastic disease or acute leukemia                      | 19.1 (7.3–50.0)  | <.001     |
| Age >55 yr   | 4.0 (2.4–6.9)  | <.0001    |
| More than one treatment  | 2.1 (1.3–3.6)  | <.003     |
| Thrombocytopenia at diagnosis                                  | 2.2 (1.3–3.8)  | <.003     |
| Aplastic anemia antedating paroxysmal nocturnal hemoglobinuria | 0.32 (0.14–0.72)   | <.023     |

Modified from Socié G, Mary JY, de Gramont A, et al. Paroxysmal nocturnal haemoglobinuria: long-term follow-up and prognostic factors. *Lancet* 1996;348:573–577.

In the unusual circumstance in which the patient has a syngeneic twin, BMT is the most appropriate therapy for severe PNH because absence of graft-versus-host disease greatly reduces transplant-associated morbidity and mortality. Syngeneic transplantation without preconditioning has been unsuccessful generally because abnormal hematopoiesis usually returns, suggesting that the residual *PIG-A* mutant stem cells have a survival or proliferative advantage relative to the transplanted GPI-AP<sup>+</sup> cells ([79](#)). This same phenomenon may limit the efficacy of gene therapy ([166](#)), as transducing *PIG-A* mutant stem cells with normal *PIG-A* would hypothetically eliminate their conditional growth or survival advantage. An attractive alternative approach to gene therapy would take advantage of the fact that the hematopoietic stem cells of patients with PNH are a mosaic. Conceivably, the GPI-AP<sup>+</sup> cells can be selected and used for marrow rescue after myeloablation. The success of this approach depends on developing a method for separating uniformly and efficiently the GPI-AP<sup>+</sup> population from the GPI-AP<sup>-</sup> population and acquiring GPI-AP<sup>+</sup> stem cells sufficient to repopulate the ablated marrow. Fluorescence-activated cell sorting may be useful for this purpose, as CD34<sup>+</sup>, CD38<sup>-</sup> hematopoietic stem cells express both CD55 and CD59 ([167](#)).

### Hormones and Steroids and Immunosuppressive Therapy

Androgenic steroids and prednisone have been used in the treatment of PNH with some success. As a rule, androgens appear to be most effective in cases with prominent marrow hypoplasia, whereas prednisone is most useful in patients with overt hemolysis ([168](#)).

Approximately 50% of patients appear to respond to androgen therapy with an increase in their hemoglobin level or a reduction in transfusion requirement; however, attempting to identify the responders in advance is problematic. Furthermore, the side effects of androgen therapy can be substantial, ranging from virilizing effects in women and acne in both sexes to serious liver disease, including peliosis hepatitis and hepatocellular carcinoma. Although neither of the last two complications have been reported to occur in androgen-treated patients with PNH, some investigators suggest androgens might

predispose patients to an insidious form of hepatic vein thrombosis ( [168](#) ). These considerations make prudent the institution of androgen therapy for 6 to 8 weeks with discontinuation if no clear response is observed. Oral preparations, such as fluoxymesterone (5 to 30 mg/day) or oxymetholone (10 to 50 mg/day), have been used most commonly. Because of fewer adverse effects, danazol is an attractive alternative to anabolic steroids. More recently, immunosuppressive therapy has been used to treat PNH patients with clinically significant bi- or trilineage cytopenias (discussed below). Initial results are encouraging, suggesting that this approach may represent an improvement over androgen therapy.

The value of using prednisone in treating the hemolysis of PNH is controversial. For prednisone to be effective in this setting, it must be given in relatively high doses (1 mg/kg), putting patients at risk for significant adverse effects. Toxicity seems to be least with an alternate day regimen, using doses of 15 to 40 mg every other day. In one series, 12 of 18 patients improved significantly with such therapy ( [168](#) ). Higher doses given daily can be administered for up to 7 days to treat hemolytic crises. The response is usually rapid (often within 12 hours), but the mode of action of adrenal steroids in PNH is speculative.

Responses to immunosuppressive therapy with cyclosporin and antithymocyte globulin have been reported ( [169](#), [170](#) and [171](#) ). This approach to management has been used primarily for patients with the aplastic anemia/PNH syndrome. Use of high-dose cyclophosphamide (Cytosan) for treatment of PNH and the aplastic anemia/PNH is under investigation ( [172](#) ).

## Transfusions

Blood transfusions may be required for treatment of anemia. The recommendation that the blood is given in the form of saline-washed or frozen-thawed, deglycerolized red cells to avert a hemolytic episode has been questioned ( [173](#), [174](#) ). Transfused red cells survive normally in patients with PNH, and transfusion to near-normal hemoglobin levels can produce short-lived remissions. Such remissions may result from a temporary decrease in the production of abnormal cells with a consequent reduction of hemolysis and other disease-associated phenomena.

## Iron

Iron deficiency eventually develops in most patients, sometimes even after repeated transfusion ( [175](#) ). The amount of iron lost should be replaced. Most patients tolerate oral iron therapy well, but hemolytic episodes have been precipitated by such treatment ( [176](#) ). This phenomenon probably results from the outpouring of a cohort of young erythrocytes of which a larger proportion is more complement-sensitive than those in the older, antecedent population ( [168](#) ). If hemoglobinuria after iron therapy is troublesome, hematopoiesis can be suppressed by a brief period of transfusion during which iron stores are replenished. Alternatively, a short course of high doses of prednisone given during the early phases of iron replacement therapy may ameliorate the hemolytic exacerbation.

## Prevention and Treatment of Thrombosis

A recent review of 13 retrospective studies of PNH in nonpregnant patients revealed considerable variation in the reported rate of thromboembolic disease; however, overall 14.4% (95.0% confidence interval of 7.6 to 25.5) of the patients included in these studies were affected ( [177](#) ). Thromboembolic complications of PNH appear to be more common

among patients from Western countries, with intraabdominal (hepatic and mesenteric veins) and cerebral veins being the most common involved sites. Nine of these studies described cause of death, with 22% of the mortality due to venous thrombosis (higher among Westerners).

Clinicians should be particularly alert for thrombotic disease in patients with indwelling catheters, after surgical procedures, during prolonged sedentary periods, and during the puerperium (see section [Pregnancy and Paroxysmal Nocturnal Hemoglobinuria](#)). Female patients should avoid the use of oral contraceptives because these agents increase the risk of serious thrombotic disease.

Anticoagulation is required for the treatment of venous thrombosis (including cerebral vein thrombosis) associated with PNH, with thrombolytic therapy being advocated for extensive acute or life-threatening hepatic vein thrombosis (see below). Mild to moderate thrombocytopenia (platelet count between 50,000 and 100,000 per  $\mu\text{l}$ ) is not a contraindication to anticoagulation; however, platelet transfusion may be required for patients with counts less than 50,000 per  $\mu\text{l}$ . Occasional episodes of hemolysis coincident with the administration of heparin have been reported ([168](#)), and this phenomenon has been attributed to activation of the alternative pathway of complement by heparin. This complication is rare, however, and concern for exacerbation of hemolysis by heparin should not deter its use in standard pharmacologic doses in situations in which anticoagulation is warranted. Once adequately anticoagulated with heparin, warfarin (Coumadin) therapy should be initiated with a goal of maintaining the international normalized ratio between 2.0 and 3.0. Although data on recurrence rates have not been generated, patients with PNH who experience a thromboembolic episode probably warrant life-long anticoagulation.

For hepatic vein thrombosis, prompt treatment with heparin or thrombolytic agents is recommended ([146](#), [178](#)). Even with heparin therapy, extensive hepatic vein thrombosis is associated with a poor prognosis ([149](#), [178](#)). Experience with thrombolytic therapy in this setting is limited, but success has been reported with the use of streptokinase, urokinase, and tissue plasminogen activator ([178](#), [179](#)). A PNH patient with chronic hepatic vein thrombosis markedly improved after BMT ([180](#)).

In the study of Socié et al. ([120](#)), 30% of French patients experienced an episode of thrombosis within 8 years of the diagnosis of PNH, and based on Kaplan-Meier estimates, approximately 50% of patients were predicted to have this complication by 15 years. Because of the relatively high incidence of thrombosis (particularly among Westerners) and its associated morbidity and mortality, an argument can be made for prophylactic anticoagulation in patients without contraindications such as severe thrombocytopenia ([15](#), [181](#)). A nonrandomized study with a relatively short follow-up period suggested a significant reduction in thrombotic events when PNH patients with at least 50% GPI-AP<sup>-</sup> granulocytes received prophylactic anticoagulation with warfarin (Coumadin) ([181](#)). The benefits of prophylactic anticoagulation, however, must be weighed against potential adverse effects of long-term anticoagulation. Patients at risk for cerebral vein thrombosis and portal/hepatic vein thrombosis would likely derive the greatest benefit from prophylactic anticoagulation. A method for identifying that small subgroup of patients, however, has not been developed.

### **Pregnancy and Paroxysmal Nocturnal Hemoglobinuria**

It is clear that pregnancy is hazardous in PNH ([182](#), [183](#) and [184](#)). It is also clear that patients with PNH can have successful, uncomplicated pregnancies ([184](#), [185](#), [186](#) and [187](#)).

De Gramont and colleagues ([184](#)) reported that approximately one-third of 38 pregnancies observed in 28 patients with PNH were uncomplicated and that life-threatening complications in mothers are uncommon. Complications experienced by mothers in that series were mainly hemorrhage and acute hemolysis. However, 45% of the pregnancies resulted in either spontaneous miscarriage or elective termination. Other studies ([182](#)) have reported a maternal mortality of approximately 6% with the major complications being related to thrombosis (particularly Budd-Chiari syndrome). Fetal wastage and prematurity were also reported to be relatively common. Based on a review of 20 published reports that described the outcome of 33 pregnant women with PNH, Ray and colleagues ([177](#)) calculated an all-cause maternal mortality rate of 20.8% (95.0% confidence intervals of 7.3 to 39.0). Approximately one-half of all infants were delivered preterm. Three deaths were reported among 34 live births (perinatal mortality of 8.8%, with 95% confidence intervals of 1.9 to 23.7).

When possible, patients with PNH who are contemplating pregnancy should be counseled about the potential for both maternal and fetal complications. The care of a pregnant patient with PNH requires the combined expertise of an experienced hematologist and an obstetrician who specializes in the management of high-risk pregnancies.

Unless there is an absolute contraindication, patients should receive therapeutic doses of subcutaneous heparin during pregnancy. Anticoagulation should be initiated during the first trimester and continued 4 to 6 weeks postpartum ([177](#)). As patients are often thrombocytopenic, platelet counts should be monitored regularly while on heparin. Patients should undergo hepatic ultrasound monthly to monitor the patency of hepatic veins.

### **Other Measures**

As with other types of chronic hemolysis, supplemental folate (1 mg/day) is indicated for patients with PNH.

Splenectomy should be considered in patients with splenomegaly and clinically significant cytopenias with a cellular marrow, as such treatment may ameliorate the cytopenias. Anecdotal reports of amelioration of hemolysis after splenectomy have appeared, but evidence-based guidelines for splenectomy in the management of PNH are not available.

Currently available are a wide variety of reagents that are specific inhibitors of complement ([188](#)). For example, a recombinant, soluble form of complement receptor type 1 is currently undergoing clinical trials for treatment of a variety of complement-mediated diseases. This protein is a potent inhibitor of both the classic and the alternative pathways of complement, and a modified form that inhibits only the alternative pathway has been developed. Conceivably, soluble complement receptor type 1 could be used to treat acute hemolytic episodes. Clinical studies designed to test the efficacy of complement inhibitors in the treatment of PNH, however, have not been initiated.

Because they are GPI anchored, isolated DAF and MIRL have the capacity to reincorporate into cells. Thus, theoretically, expression of DAF and MIRL on PNH erythrocytes could be supplemented by infusion of the recombinant proteins. The feasibility of this therapeutic approach appears limited, however, because plasma apolipoproteins bind the hydrophobic GPI anchor moiety of the proteins, preventing incorporation into cells ([46](#)). Molecular derivatization of soluble DAF and MIRL offers the potential of circumventing this problem.

Inasmuch as *PIG-A* mutations are necessary for the development of PNH, correction of the underlying defect by gene therapy is another hypothetical possibility. The results of BMT in the treatment of PNH suggest that for gene therapy to be successful, *PIG-A* mutant stem cells need to be ablated, as the GPI-AP<sup>-</sup> stem cells appear to have a relative proliferative or survival advantage ( [79](#) ).

## DISEASE COURSE AND PROGNOSIS

PNH is a chronic disease with a median survival of 10 to 15 years ( [15](#) , [120](#) ). Approximately 25% of patients survive for 25 years or longer after diagnosis ( [15](#) ). The major causes of morbidity and mortality are thrombosis, bleeding, and infections. The latter two complications are due to thrombocytopenia and neutropenia, respectively, which are consequences of the abnormal hematopoiesis that underlies this stem cell disorder.

In some PNH patients, the severity of the illness lessens with time, and (in one series) approximately one-third of patients who survived 10 years experienced a spontaneous clinical remission ( [15](#) ). These cases suggest that, in time, the abnormal clone(s) can gradually lose its relative proliferative or survival advantage. That the disease spontaneously remits in a significant number of instances provides a basis for hope for both patient and physician. Additionally, this feature of the disease should enter into management decisions, particularly when the patient is a candidate for allogeneic BMT ( [15](#) ).

The development of other clonal myelopathies, including myelodysplastic disease and acute leukemia, adversely affects prognosis ( [120](#) ). The incidence of acute leukemia in association with PNH appears to be in the range of 1.0% ( [120](#) ), although higher [7.7% in a study of Japanese patients ( [189](#) )] and lower [0 of 80 patients in a study from England ( [15](#) )] incidences have been reported. The rate of myelodysplastic disease in association with PNH is in the range of 5% ( [120](#) ). Other clonal myelopathies that have been reported in association with PNH include myelofibrosis, chronic lymphocytic leukemia, chronic myelocytic leukemia, polycythemia vera, and erythroleukemia. In some instances, the clonal myelopathy arises in the PNH clone ( [138](#) , [139](#) ), whereas in other instances, it arises in a GPI-AP<sup>+</sup> clone ( [140](#) , [141](#) ). The association of PNH with other stem cell disorders, particularly myelodysplasia and acute leukemia, suggests that genetic instability is a component of the disease ( [87](#) ). This process may be a consequence of the as yet undefined bone marrow injury that underlies PNH.

## REFERENCES

1. Parker CJ. Historical aspects of paroxysmal nocturnal haemoglobinuria: "defining the disease." Br J Haematol 2002;117:3-22.
2. Crosby WH. Paroxysmal nocturnal hemoglobinuria: plasma factors of the hemolytic system. Blood 1953;8:444-458.
3. Dacie JV, Lewis SM. Paroxysmal nocturnal haemoglobinuria: clinical manifestations, haematology, and nature of the disease. Ser Haematol 1972;5:3-23.
4. Ham TH. Chronic hemolytic anemia with paroxysmal nocturnal hemoglobinuria. A study of the mechanism of hemolysis to acid-base equilibrium. N Engl J Med 1937;217:915-917.
5. Ham TH. Studies on destruction of red blood cells. I. Chronic hemolytic anemia with paroxysmal



nocturnal hemoglobinuria: an investigation of the mechanism of hemolysis with observations of five cases. *Arch Intern Med* 1939;64:1271–1305.

6. Ham TH, Dingle JH. Studies on the destruction of red blood cells. II. Chronic hemolytic anemia with paroxysmal nocturnal hemoglobinuria: certain immunological aspects of the hemolytic mechanism with special reference to serum complement. *J Clin Invest* 1939;18:657–672.

7. Dacie JV. Diagnosis and mechanism of hemolysis in chronic hemolytic anemia with nocturnal hemoglobinuria. *Blood* 1949;4:1183–1195.

8. Rosse WF. The life-span of complement-sensitive and -insensitive red cells in paroxysmal nocturnal hemoglobinuria. *Blood* 1971;37:556–562.

9. Rosse WF, Dacie JV. Immune lysis of normal human and paroxysmal nocturnal hemoglobinuria (PNH) red blood cells. I. The sensitivity of PNH red cells to lysis by complement and specific antibody. *J Clin Invest* 1966;45:736–748.

10. Rosse WF. Variations in the red cells in paroxysmal nocturnal haemoglobinuria. *Br J Haematol* 1973;24:327–342.

11. Rosse WF. Paroxysmal nocturnal hemoglobinuria—present status and future prospects. *West J Med* 1980;132:219–228.

12. Iwamoto N, Kawaguchi T, Nagakura S, et al. Markedly high population of affected reticulocytes negative for decay-accelerating factor and CD59 in paroxysmal nocturnal hemoglobinuria. *Blood* 1995;85:2228–2232.

13. Ware RE, Hall SE, Rosse WF. Paroxysmal nocturnal hemoglobinuria with onset in childhood and adolescence. *N Engl J Med* 1991;325:991–996.

14. Nishimura Ji J, Hirota T, Kanakura Y, et al. Long-term support of hematopoiesis by a single stem cell clone in patients with paroxysmal nocturnal hemoglobinuria. *Blood* 2002;99:2748–2751.

15. Hillmen P, Lewis SM, Bessler M, et al. Natural history of paroxysmal nocturnal hemoglobinuria. *N Engl J Med* 1995;333:1253–1258.

16. Logue GL, Rosse WF, Adams JP. Mechanisms of immune lysis of red blood cells in vitro. I. Paroxysmal nocturnal hemoglobinuria cells. *J Clin Invest* 1973;52:1129–1137.

17. Rosse WF, Logue GL, Adams J, Crookston JH. Mechanisms of immune lysis of the red cells in hereditary erythroblastic multinuclearity with a positive acidified serum test and paroxysmal nocturnal hemoglobinuria. *J Clin Invest* 1974;53:31–43.

18. Pangburn MK, Schreiber RD, Trombold JS, Muller-Eberhard HJ. Paroxysmal nocturnal hemoglobinuria: deficiency in factor H-like functions of the abnormal erythrocytes. *J Exp Med* 1983;157:1971–1980.

19. Parker CJ, Baker PJ, Rosse WF. Increased enzymatic activity of the alternative pathway convertase when bound to the erythrocytes of paroxysmal nocturnal hemoglobinuria. *J Clin Invest* 1982;69:337–346.

20. Packman CH, Rosenfeld SI, Jenkins DE, Jr, et al. Complement lysis of human erythrocytes. Differing susceptibility of two types of paroxysmal nocturnal hemoglobinuria cells to C5b-9. *J Clin Invest* 1979;64:428–433.

21. Parker CJ, Wiedmer T, Sims PJ, Rosse WF. Characterization of the complement sensitivity of paroxysmal nocturnal hemoglobinuria erythrocytes. *J Clin Invest* 1985;75:2074–2084.

22. Rouault TA, Rosse WF, Bell S, Shelburne J. Differences in the terminal steps of complement lysis of normal and paroxysmal nocturnal hemoglobinuria red cells. *Blood* 1978;51:325–330.

23. Beck WS, Valentine WN. Biochemical studies on leucocytes. II. Phosphatase activity in chronic lymphatic leukemia, acute leukemia, and miscellaneous hematologic conditions. *J Lab Clin Med* 1951;38:245–253.

24. Auditore JV, Hartmann RC. Paroxysmal nocturnal hemoglobinuria II. Erythrocyte acetylcholinesterase



defect. *Am J Med* 1959;27:401–410.

25. Kunstling TR, Rosse WF. Erythrocyte acetylcholinesterase deficiency in paroxysmal nocturnal hemoglobinuria (PNH). A comparison of the complement-sensitive and insensitive populations. *Blood* 1969;33:607–616.
26. Nicholson-Weller A, March JP, Rosenfeld SI, Austen KF. Affected erythrocytes of patients with paroxysmal nocturnal hemoglobinuria are deficient in the complement regulatory protein, decay accelerating factor. *Proc Natl Acad Sci U S A* 1983;80:5066–5070.
27. Pangburn MK, Schreiber RD, Muller-Eberhard HJ. Deficiency of an erythrocyte membrane protein with complement regulatory activity in paroxysmal nocturnal hemoglobinuria. *Proc Natl Acad Sci U S A* 1983;80:5430–5434.
28. Hoffmann EM. Inhibition of complement by a substrate isolated from human erythrocytes: I. Extraction from human erythrocyte stroma. *Immunochemistry* 1969;6:391–403.
29. Holguin MH, Fredrick LR, Bernshaw NJ, et al. Isolation and characterization of a membrane protein from normal human erythrocytes that inhibits reactive lysis of the erythrocytes of paroxysmal nocturnal hemoglobinuria. *J Clin Invest* 1989;84:7–17.
30. Nicholson-Weller A, Burge J, Fearon DT, et al. Isolation of a human erythrocyte membrane glycoprotein with decay-accelerating activity for C3 convertases of the complement system. *J Immunol* 1982;129:184–189.
31. Nicholson-Weller A. Decay accelerating factor (CD55). *Curr Top Microbiol Immunol* 1992;178:7–30.
32. Medof ME, Gottlieb A, Kinoshita T, et al. Relationship between decay accelerating factor deficiency, diminished acetylcholinesterase activity, and defective terminal complement pathway restriction in paroxysmal nocturnal hemoglobinuria erythrocytes. *J Clin Invest* 1987;80:165–174.
33. Shin ML, Hansch G, Hu VW, Nicholson-Weller A. Membrane factors responsible for homologous species restriction of complement-mediated lysis: evidence for a factor other than DAF operating at the stage of C8 and C9. *J Immunol* 1986;136:1777–1782.
34. Holguin MH, Wilcox LA, Bernshaw NJ, et al. Relationship between the membrane inhibitor of reactive lysis and the erythrocyte phenotypes of paroxysmal nocturnal hemoglobinuria. *J Clin Invest* 1989;84:1387–1394.
35. Lehto T, Meri S. Interactions of soluble CD59 with the terminal complement complexes. CD59 and C9 compete for a nascent epitope on C8. *J Immunol* 1993;151:4941–4949.
36. Meri S, Morgan BP, Davies A, et al. Human protectin (CD59), an 18,000–20,000 MW complement lysis restricting factor, inhibits C5b-8 catalyzed insertion of C9 into lipid bilayers. *Immunology* 1990;71:1–9.
37. Rollins SA, Zhao J, Ninomiya H, Sims PJ. Inhibition of homologous complement by CD59 is mediated by a species-selective recognition conferred through binding to C8 within C5b-8 or C9 within C5b-9. *J Immunol* 1991;146:2345–2351.
38. Holguin MH, Parker CJ. Membrane inhibitor of reactive lysis. *Curr Top Microbiol Immunol* 1992;178:61–85.
39. Wilcox LA, Ezzell JL, Bernshaw NJ, Parker CJ. Molecular basis of the enhanced susceptibility of the erythrocytes of paroxysmal nocturnal hemoglobinuria to hemolysis in acidified serum. *Blood* 1991;78:820–829.
40. Telen MJ, Hall SE, Green AM, et al. Identification of human erythrocyte blood group antigens on decay-accelerating factor (DAF) and an erythrocyte phenotype negative for DAF. *J Exp Med* 1988;167:1993–1998.
41. Holguin MH, Martin CB, Bernshaw NJ, Parker CJ. Analysis of the effects of activation of the alternative pathway of complement on erythrocytes with an isolated deficiency of decay accelerating factor. *J Immunol* 1992;148:498–502.

42. Merry AH, Rawlinson VI, Uchikawa M, et al. Studies on the sensitivity to complement-mediated lysis of erythrocytes (Inab phenotype) with a deficiency of DAF (decay accelerating factor). *Br J Haematol* 1989;73:248–253.
43. Telen MJ, Green AM. The Inab phenotype: characterization of the membrane protein and complement regulatory defect. *Blood* 1989;74:437–441.
44. Motoyama N, Okada N, Yamashina M, Okada H. Paroxysmal nocturnal hemoglobinuria due to hereditary nucleotide deletion in the HRF20 (CD59) gene. *Eur J Immunol* 1992;22:2669–2673.
45. Yamashina M, Ueda E, Kinoshita T, et al. Inherited complete deficiency of 20-kilodalton homologous restriction factor (CD59) as a cause of paroxysmal nocturnal hemoglobinuria. *N Engl J Med* 1990;323:1184–1189.
46. Medof ME, Kinoshita T, Nussenzweig V. Inhibition of complement activation on the surface of cells after incorporation of decay-accelerating factor (DAF) into their membranes. *J Exp Med* 1984;160:1558–1578.
47. Hoffmann EM. Inhibition of complement by a substance isolated from human erythrocytes. II. Studies on the site and mechanism of action. *Immunochemistry* 1969;6:405–419.
48. Low MG, Zilversmit DB. Role of phosphatidylinositol in attachment of alkaline phosphatase to membranes. *Biochemistry* 1980;19:3913–3918.
49. Dutta-Choudhury TA, Rosenberry TL. Human erythrocyte acetylcholinesterase is an amphipathic protein whose short membrane-binding domain is removed by papain digestion. *J Biol Chem* 1984;259:5653–5660.
50. Futerman AH, Fiorini RM, Roth E, et al. Physicochemical behaviour and structural characteristics of membrane-bound acetylcholinesterase from *Torpedo electric organ*. Effect of phosphatidylinositol-specific phospholipase C. *Biochem J* 1985;226:369–377.
51. Roberts WL, Rosenberry TL. Identification of covalently attached fatty acids in the hydrophobic membrane-binding domain of human erythrocyte acetylcholinesterase. *Biochem Biophys Res Commun* 1985;133:621–627.
52. Taguchi R, Ikezawa H. Phosphatidyl inositol-specific phospholipase C from *Clostridium novyi* type A. *Arch Biochem Biophys* 1978;186:196–201.
53. Cross GA. Glycolipid anchoring of plasma membrane proteins. *Annu Rev Cell Biol* 1990;6:1–39.
54. Ferguson MA, Williams AF. Cell-surface anchoring of proteins via glycosyl-phosphatidylinositol structures. *Annu Rev Biochem* 1988;57:285–320.
55. Low MG. Glycosyl-phosphatidylinositol: a versatile anchor for cell surface proteins. *FASEB J* 1989;3:1600–1608.
56. Low MG, Saltiel AR. Structural and functional roles of glycosyl-phosphatidylinositol in membranes. *Science* 1988;239:268–275.
57. McConville MJ, Ferguson MA. The structure, biosynthesis and function of glycosylated phosphatidylinositols in the parasitic protozoa and higher eukaryotes. *Biochem J* 1993;294:305–324.
58. Davitz MA, Low MG, Nussenzweig V. Release of decay-accelerating factor (DAF) from the cell membrane by phosphatidylinositol-specific phospholipase C (PIPLC). Selective modification of a complement regulatory protein. *J Exp Med* 1986;163:1150–1161.
59. Medof ME, Walter EI, Roberts WL, et al. Decay accelerating factor of complement is anchored to cells by a C-terminal glycolipid. *Biochemistry* 1986;25:6740–6747.
60. Holguin MH, Wilcox LA, Bernshaw NJ, et al. Erythrocyte membrane inhibitor of reactive lysis: effects of phosphatidylinositol-specific phospholipase C on the isolated and cell-associated protein. *Blood*

1990;75:284–289.

61. Kinoshita T, Inoue N, Takeda J. Defective glycosyl phosphatidylinositol anchor synthesis and paroxysmal nocturnal hemoglobinuria. *Adv Immunol* 1995;60:57–103.
62. Oni SB, Osunkoya BO, Luzzatto L. Paroxysmal nocturnal hemoglobinuria: evidence for monoclonal origin of abnormal red cells. *Blood* 1970;36:145–152.
63. Aster RH, Enright SE. A platelet and granulocyte membrane defect in paroxysmal nocturnal hemoglobinuria: usefulness for the detection of platelet antibodies. *J Clin Invest* 1969;48:1199–1210.
64. Nicholson–Weller A, Spicer DB, Austen KF. Deficiency of the complement regulatory protein, “decay–accelerating factor,” on membranes of granulocytes, monocytes, and platelets in paroxysmal nocturnal hemoglobinuria. *N Engl J Med* 1985;312:1091–1097.
65. Kinoshita T, Medof ME, Silber R, Nussenzweig V. Distribution of decay–accelerating factor in the peripheral blood of normal individuals and patients with paroxysmal nocturnal hemoglobinuria. *J Exp Med* 1985;162:75–92.
66. Rosse WF. The glycolipid anchor of membrane surface proteins. *Semin Hematol* 1993;30:219–231.
67. Armstrong C, Schubert J, Ueda E, et al. Affected paroxysmal nocturnal hemoglobinuria T lymphocytes harbor a common defect in assembly of N–acetyl–D–glucosamine inositol phospholipid corresponding to that in class A Thy–1– murine lymphoma mutants. *J Biol Chem* 1992;267:25347–25351.
68. Takahashi M, Takeda J, Hirose S, et al. Deficient biosynthesis of N–acetylglucosaminyl–phosphatidylinositol, the first intermediate of glycosyl phosphatidylinositol anchor biosynthesis, in cell lines established from patients with paroxysmal nocturnal hemoglobinuria. *J Exp Med* 1993;177:517–521.
69. Miyata T, Takeda J, Iida Y, et al. The cloning of PIG–A, a component in the early step of GPI–anchor biosynthesis. *Science* 1993;259:1318–1320.
70. Takeda J, Miyata T, Kawagoe K, et al. Deficiency of the GPI anchor caused by a somatic mutation of the PIG–A gene in paroxysmal nocturnal hemoglobinuria. *Cell* 1993;73:703–711.
71. Hyman R, Cunningham K, Stallings V. Evidence for a genetic basis for the Class A Thy–1–defect. *Immunogenetics* 1980;10:261–271.
72. Luzzatto L, Nafa K. Genetics of PNH. In: Young NS, Moss J, eds. *Paroxysmal nocturnal hemoglobinuria and the glycosylphosphatidylinositol–linked proteins*. San Diego: Academic Press, 2000:21–47.
73. Rosse WF, Ware RE. The molecular basis of paroxysmal nocturnal hemoglobinuria. *Blood* 1995;86:3277–3286.
74. Ware RE, Howard TA, Kamitani T, et al. Chromosomal assignment of genes involved in glycosylphosphatidylinositol anchor biosynthesis: implications for the pathogenesis of paroxysmal nocturnal hemoglobinuria. *Blood* 1994;83:3753–3757.
75. Endo M, Ware RE, Vreeke TM, et al. Molecular basis of the heterogeneity of expression of glycosyl phosphatidylinositol anchored proteins in paroxysmal nocturnal hemoglobinuria. *Blood* 1996;87:2546–2557.
76. Nishimura J, Murakami Y, Kinoshita T. Paroxysmal nocturnal hemoglobinuria: an acquired genetic disease. *Am J Hematol* 1999;62:175–182.
77. Nafa K, Mason PJ, Hillmen P, et al. Mutations in the PIG–A gene causing paroxysmal nocturnal hemoglobinuria are mainly of the frameshift type. *Blood* 1995;86:4650–4655.
78. Parker CJ. Molecular basis of paroxysmal nocturnal hemoglobinuria. *Stem Cells* 1996;14:396–411.
79. Endo M, Beatty PG, Vreeke TM, et al. Syngeneic bone marrow transplantation without conditioning in a patient with paroxysmal nocturnal hemoglobinuria: *in vivo* evidence that the mutant stem cells have a

survival advantage. *Blood* 1996;88:742–750.

80. Yamada N, Miyata T, Maeda K, et al. Somatic mutations of the PIG-A gene found in Japanese patients with paroxysmal nocturnal hemoglobinuria. *Blood* 1995;85:885–892.

81. Inoue N, Izui T, Kuwayama M, et al. HMGI-C, a candidate protein involved in clonal expansion of PNH Cells. *Blood* 2001;98:221a.

82. Endo M, Ware RE, Vreeke TM, et al. Identification and characterization of an inherited mutation of PIG-A in a patient with paroxysmal nocturnal haemoglobinuria. *Br J Haematol* 1996;93:590–593.

83. Nagarajan S, Brodsky RA, Young NS, Medof ME. Genetic defects underlying paroxysmal nocturnal hemoglobinuria that arises out of aplastic anemia. *Blood* 1995;86:4656–4661.

84. Bessler M, Mason P, Hillmen P, Luzzatto L. Somatic mutations and cellular selection in paroxysmal nocturnal haemoglobinuria. *Lancet* 1994;343:951–953.

85. Nishimura J, Inoue N, Wada H, et al. A patient with paroxysmal nocturnal hemoglobinuria bearing four independent PIG-A mutant clones. *Blood* 1997;89:3470–3476.

86. Hattori H, Machii T, Ueda E, et al. Increased frequency of somatic mutations at glycoporphin A loci in patients with aplastic anaemia, myelodysplastic syndrome and paroxysmal nocturnal haemoglobinuria. *Br J Haematol* 1997;98:384–391.

87. Horikawa K, Kawaguchi T, Ishihara S, et al. Frequent detection of T cells with mutations of the hypoxanthine-guanine phosphoribosyl transferase gene in patients with paroxysmal nocturnal hemoglobinuria. *Blood* 2002;99:24–29.

88. Purow DB, Howard TA, Marcus SJ, et al. Genetic instability and the etiology of somatic PIG-A mutations in paroxysmal nocturnal hemoglobinuria. *Blood Cells Mol Dis* 1999;25:81–91.

89. Kinoshita T, Bessler M, Takeda J. Animal models of PNH. In: Young NS, Moss J, eds. *Paroxysmal nocturnal hemoglobinuria and the glycosylphosphatidylinositol-linked proteins*. San Diego: Academic Press, 2000:139–158.

90. Dunn DE, Liu JM, Young NS. Bone marrow failure in PNH. In: Young NS, Moss J, eds. *Paroxysmal nocturnal hemoglobinuria and the glycosylphosphatidylinositol-linked proteins*. San Diego: Academic Press, 2000:113–138.

91. Bessler M, Hillmen P. Somatic mutation and clonal selection in the pathogenesis and in the control of paroxysmal nocturnal hemoglobinuria. *Semin Hematol* 1998;35:149–167.

92. Luzzatto L, Bessler M, Rotoli B. Somatic mutations in paroxysmal nocturnal hemoglobinuria: a blessing in disguise? *Cell* 1997;88:1–4.

93. Hertenstein B, Wagner B, Bunjes D, et al. Emergence of CD52-, phosphatidylinositolglycan-anchor-deficient T lymphocytes after in vivo application of Campath-1H for refractory B-cell non-Hodgkin lymphoma. *Blood* 1995;86:1487–1492.

94. Lublin DM. Glycosyl-phosphatidylinositol anchoring of membrane proteins. *Curr Top Microbiol Immunol* 1992;178:141–162.

95. Okazaki I, Moss J. The function of GPI-anchored proteins. In: Young NS, Moss J, eds. *Paroxysmal nocturnal hemoglobinuria and the glycosylphosphatidylinositol-linked proteins*. San Diego: Academic Press, 2000:159–178.

96. Robinson PJ. Phosphatidylinositol membrane anchors and T-cell activation. *Immunol Today* 1991;12:35–41.

97. Stefanova I, Horejsi V, Ansotegui IJ, et al. GPI-anchored cell-surface molecules complexed to protein tyrosine kinases. *Science* 1991;254:1016–1019.

98. Singh N, Liang LN, Tykocinski ML, Tartakoff AM. A novel class of cell surface glycolipids of

- mammalian cells. Free glycosyl phosphatidylinositols. *J Biol Chem* 1996;271:12879–12884.
99. Iwamoto N, Kawaguchi T, Horikawa K, et al. Preferential hematopoiesis by paroxysmal nocturnal hemoglobinuria clone engrafted in SCID mice. *Blood* 1996;87:4944–4948.
100. Brodsky RA, Vala MS, Barber JP, et al. Resistance to apoptosis caused by PIG-A gene mutations in paroxysmal nocturnal hemoglobinuria. *Proc Natl Acad Sci U S A* 1997;94:8756–8760.
101. Horikawa K, Nakakuma H, Kawaguchi T, et al. Apoptosis resistance of blood cells from patients with paroxysmal nocturnal hemoglobinuria, aplastic anemia, and myelodysplastic syndrome. *Blood* 1997;90:2716–2722.
102. Ware RE, Nishimura J, Moody MA, et al. The PIG-A mutation and absence of glycosylphosphatidylinositol-linked proteins do not confer resistance to apoptosis in paroxysmal nocturnal hemoglobinuria. *Blood* 1998;92:2541–2550.
103. Chen R, Nagarajan S, Prince GM, et al. Impaired growth and elevated fas receptor expression in PIGA(+) stem cells in primary paroxysmal nocturnal hemoglobinuria. *J Clin Invest* 2000;106:689–696.
104. Kawagoe K, Kitamura D, Okabe M, et al. Glycosylphosphatidylinositol-anchor-deficient mice: implications for clonal dominance of mutant cells in paroxysmal nocturnal hemoglobinuria. *Blood* 1996;87:3600–3606.
105. Dacie JV, Lewis SM. Paroxysmal nocturnal haemoglobinuria: variation in clinical severity and association with bone-marrow hypoplasia. *Br J Haematol* 1961;7:442–457.
106. Azenishi Y, Ueda E, Machii T, et al. CD59-deficient blood cells and PIG-A gene abnormalities in Japanese patients with aplastic anaemia. *Br J Haematol* 1999;104:523–529.
107. Ben-Bassat I, Brok-Simoni F, Ramot B. Complement-sensitive red cells in aplastic anemia. *Blood* 1975;46:357–361.
108. de Planque MM, Bacigalupo A, Wursch A, et al. Long-term follow-up of severe aplastic anaemia patients treated with antithymocyte globulin. Severe Aplastic Anaemia Working Party of the European Cooperative Group for Bone Marrow Transplantation (EBMT). *Br J Haematol* 1989;73:121–126.
109. Doney K, Pepe M, Storb R, et al. Immunosuppressive therapy of aplastic anemia: results of a prospective, randomized trial of antithymocyte globulin (ATG), methylprednisolone, and oxymetholone to ATG, very high-dose methylprednisolone, and oxymetholone. *Blood* 1992;79:2566–2571.
110. Griscelli-Bennaceur A, Gluckman E, Scrobohaci ML, et al. Aplastic anemia and paroxysmal nocturnal hemoglobinuria: search for a pathogenetic link. *Blood* 1995;85:1354–1363.
111. Lewis SM, Dacie JV. The aplastic anaemia-paroxysmal nocturnal haemoglobinuria syndrome. *Br J Haematol* 1967;13:236–251.
112. Mukhina GL, Buckley JT, Barber JP, et al. Multilineage glycosylphosphatidylinositol anchor-deficient haematopoiesis in untreated aplastic anaemia. *Br J Haematol* 2001;115:476–482.
113. Nakakuma H, Nagakura S, Iwamoto N, et al. Paroxysmal nocturnal hemoglobinuria clone in bone marrow of patients with pancytopenia. *Blood* 1995;85:1371–1376.
114. Schrezenmeier H, Marin P, Raghavachar A, et al. Relapse of aplastic anaemia after immunosuppressive treatment: a report from the European Bone Marrow Transplantation Group SAA Working Party. *Br J Haematol* 1993;85:371–377.
115. Schubert J, Vogt HG, Zielinska-Skowronek M, et al. Development of the glycosylphosphatidylinositol-anchoring defect characteristic for paroxysmal nocturnal hemoglobinuria in patients with aplastic anemia. *Blood* 1994;83:2323–2328.
116. Tichelli A, Gratwohl A, Nissen C, et al. Morphology in patients with severe aplastic anemia treated with antilymphocyte globulin. *Blood* 1992;80:337–345.
117. Tichelli A, Gratwohl A, Nissen C, Speck B. Late clonal complications in severe aplastic anemia. *Leuk*

Lymphoma 1994;12:167–175.

118. Tichelli A, Gratwohl A, Wursch A, et al. Late haematological complications in severe aplastic anaemia. *Br J Haematol* 1988;69:413–418.

119. Tooze JA, Marsh JC, Gordon-Smith EC. Clonal evolution of aplastic anaemia to myelodysplasia/acute myeloid leukaemia and paroxysmal nocturnal haemoglobinuria. *Leuk Lymphoma* 1999;33:231–241.

120. Socié G, Mary JY, de Gramont A, et al. Paroxysmal nocturnal haemoglobinuria: long-term follow-up and prognostic factors. *French Society of Haematology. Lancet* 1996;348:573–577.

121. Nissen C, Tichelli A, Gratwohl A, et al. High incidence of transiently appearing complement-sensitive bone marrow precursor cells in patients with severe aplastic anemia—a possible role of high endogenous IL-2 in their suppression. *Acta Haematol* 1999;101:165–172.

122. Devine DV, Siegel RS, Rosse WF. Interactions of the platelets in paroxysmal nocturnal hemoglobinuria with complement. Relationship to defects in the regulation of complement and to platelet survival in vivo. *J Clin Invest* 1987;79:131–137.

123. Hall SE, Rosse WF. The use of monoclonal antibodies and flow cytometry in the diagnosis of paroxysmal nocturnal hemoglobinuria. *Blood* 1996;87:5332–5340.

124. Schubert J, Alvarado M, Uciechowski P, et al. Diagnosis of paroxysmal nocturnal haemoglobinuria using immunophenotyping of peripheral blood cells. *Br J Haematol* 1991;79:487–492.

125. Tseng JE, Hall SE, Howard TA, Ware RE. Phenotypic and functional analysis of lymphocytes in paroxysmal nocturnal hemoglobinuria. *Am J Hematol* 1995;50:244–253.

126. van der Schoot CE, Huizinga TW, van 't Veer-Korthof ET, et al. Deficiency of glycosyl-phosphatidylinositol-linked membrane glycoproteins of leukocytes in paroxysmal nocturnal hemoglobinuria, description of a new diagnostic cytofluorometric assay. *Blood* 1990;76:1853–1859.

127. Rosse WF. Paroxysmal nocturnal hemoglobinuria. In: Rosse WF, ed. *Clinical immunohematology: basic concepts and clinical applications*. Boston: Blackwell Science, 1990:593–684.

128. Brubaker LH, Essig LJ, Mengel CE. Neutrophil life span in paroxysmal nocturnal hemoglobinuria. *Blood* 1977;50:657–662.

129. Craddock PR, Fehr J, Jacob HS. Complement-mediated granulocyte dysfunction in paroxysmal nocturnal hemoglobinuria. *Blood* 1976;47:931–939.

130. Dixon RH, Rosse WF. Mechanism of complement-mediated activation of human blood platelets in vitro: comparison of normal and paroxysmal nocturnal hemoglobinuria platelets. *J Clin Invest* 1977;59:360–368.

131. Schubert J, Uciechowski P, Zielinska-Skowronek M, et al. Differences in activation of normal and glycosylphosphatidylinositol-negative lymphocytes derived from patients with paroxysmal nocturnal hemoglobinuria. *J Immunol* 1992;148:3814–3819.

132. Wiedmer T, Hall SE, Ortel TL, et al. Complement-induced vesiculation and exposure of membrane prothrombinase sites in platelets of paroxysmal nocturnal hemoglobinuria. *Blood* 1993;82:1192–1196.

133. Hundt M, Schubert J, de Haas M, et al. The loss of Fc gamma RIIIb in paroxysmal nocturnal hemoglobinuria is functionally replaced by Fc gamma RII. *Blood* 1994;83:3574–3580.

134. Dessypris EN, Clark DA, McKee LC, Jr., Krantz SB. Increased sensitivity to complement or erythroid and myeloid progenitors in paroxysmal nocturnal hemoglobinuria. *N Engl J Med* 1983;309:690–693.

135. Rotoli B, Robledo R, Scarpato N, Luzzatto L. Two populations of erythroid cell progenitors in paroxysmal nocturnal hemoglobinuria. *Blood* 1984;64:847–851.

136. Maciejewski JP, Risitano A, Sloand EM, et al. Distinct clinical outcomes for cytogenetic abnormalities

evolving from aplastic anemia. *Blood* 2002;99:3129–3135.

137. Araten DJ, Swirsky D, Karadimitris A, et al. Cytogenetic and morphological abnormalities in paroxysmal nocturnal haemoglobinuria. *Br J Haematol* 2001;115:360–368.

138. Devine DV, Gluck WL, Rosse WF, Weinberg JB. Acute myeloblastic leukemia in paroxysmal nocturnal hemoglobinuria. Evidence of evolution from the abnormal paroxysmal nocturnal hemoglobinuria clone. *J Clin Invest* 1987;79:314–317.

139. Longo L, Bessler M, Beris P, et al. Myelodysplasia in a patient with pre-existing paroxysmal nocturnal haemoglobinuria: a clonal disease originating from within a clonal disease. *Br J Haematol* 1994;87:401–403.

140. Krause JR. Paroxysmal nocturnal hemoglobinuria and acute non-lymphocytic leukemia. A report of three cases exhibiting different cytologic types. *Cancer* 1983;51:2078–2082.

141. van Kamp H, Smit JW, van den Berg E, et al. Myelodysplasia following paroxysmal nocturnal haemoglobinuria: evidence for the emergence of a separate clone. *Br J Haematol* 1994;87:399–400.

142. Kruatrachue M, Wasi P, Na-Nakorn S. Paroxysmal nocturnal haemoglobinuria in Thailand with special reference to its association with aplastic anaemia. *Br J Haematol* 1978;39:267–276.

143. Pramoonjago P, Wanachiwanawin W, Chinprasertsak S, et al. Somatic mutations of PIG-A in Thai patients with paroxysmal nocturnal hemoglobinuria. *Blood* 1995;86:1736–1739.

144. Sloand EM, Young NS. Thrombotic complications in PNH. In: Young NS, Moss J, eds. *Paroxysmal nocturnal hemoglobinuria and the glycosylphosphatidylinositol-linked proteins*. San Diego: Academic Press, 2000:101–112.

145. Hartmann RC, Luther AB, Jenkins DE, Jr., et al. Fulminant hepatic venous thrombosis (Budd-Chiari syndrome) in paroxysmal nocturnal hemoglobinuria: definition of a medical emergency. *Johns Hopkins Med J* 1980;146:247–254.

146. Leibowitz AI, Hartmann RC. The Budd-Chiari syndrome and paroxysmal nocturnal haemoglobinuria. *Br J Haematol* 1981;48:1–6.

147. Valla D, Dhumeaux D, Babany G, et al. Hepatic vein thrombosis in paroxysmal nocturnal hemoglobinuria. A spectrum from asymptomatic occlusion of hepatic venules to fatal Budd-Chiari syndrome. *Gastroenterology* 1987;93:569–575.

148. Birgens HS, Hancke S, Rosenklint A, Hansen NE. Ultrasonic demonstration of clinical and subclinical hepatic venous thrombosis in paroxysmal nocturnal haemoglobinuria. *Br J Haematol* 1986;64:737–743.

149. Peytremann R, Rhodes RS, Hartmann RC. Thrombosis in paroxysmal nocturnal hemoglobinuria (PNH) with particular reference to progressive, diffuse hepatic venous thrombosis. *Ser Haematol* 1972;5:115–136.

150. Ploug M, Plesner T, Ronne E, et al. The receptor for urokinase-type plasminogen activator is deficient on peripheral blood leukocytes in patients with paroxysmal nocturnal hemoglobinuria. *Blood* 1992;79:1447–1455.

151. Nafa K, Bessler M, Mason P, et al. Factor V Leiden mutation investigated by amplification created restriction enzyme site (ACRES) in PNH patients with and without thrombosis. *Haematologica* 1996;81:540–542.

152. Clark DA, Butler SA, Braren V, et al. The kidneys in paroxysmal nocturnal hemoglobinuria. *Blood* 1981;57:83–89.

153. Hartmann RC, Jenkins DE. The “sugar-water” test for paroxysmal nocturnal hemoglobinuria. *N Engl J Med* 1966;275:155–157.

154. Hartmann RC, Jenkins DE, Jr., Arnold AB. Diagnostic specificity of sucrose hemolysis test for paroxysmal nocturnal hemoglobinuria. *Blood* 1970;35:462–475.

155. Hillmen P, Hows JM, Luzzatto L. Two distinct patterns of glycosylphosphatidylinositol (GPI) linked protein deficiency in the red cells of patients with paroxysmal nocturnal haemoglobinuria. *Br J Haematol*



1992;80:399–405.

156. Ware RE, Rosse WF, Hall SE. Immunophenotypic analysis of reticulocytes in paroxysmal nocturnal hemoglobinuria. *Blood* 1995;86:1586–1589.

157. Brodsky RA, Mukhina GL, Li S, et al. Improved detection and characterization of paroxysmal nocturnal hemoglobinuria using fluorescent aerolysin. *Am J Clin Pathol* 2000;114:459–466.

158. Brodsky RA, Mukhina GL, Nelson KL, et al. Resistance of paroxysmal nocturnal hemoglobinuria cells to the glycosylphosphatidylinositol-binding toxin aerolysin. *Blood* 1999;93:1749–1756.

159. Daniels G. Cromer-related antigens–blood group determinants on decay accelerating factor. *Vox Sang* 1989;56:205–211.

160. Tomita A, Parker CJ. Aberrant regulation of complement by the erythrocytes of hereditary erythroblastic multinuclearity with a positive acidified serum lysis test (HEMPAS). *Blood* 1994;83:250–259.

161. Antin JH, Ginsburg D, Smith BR, et al. Bone marrow transplantation for paroxysmal nocturnal hemoglobinuria: eradication of the PNH clone and documentation of complete lymphohematopoietic engraftment. *Blood* 1985;66:1247–1250.

162. Kawahara K, Witherspoon RP, Storb R. Marrow transplantation for paroxysmal nocturnal hemoglobinuria. *Am J Hematol* 1992;39:283–288.

163. Raiola AM, Van Lint MT, Lamparelli T, et al. Bone marrow transplantation for paroxysmal nocturnal hemoglobinuria. *Haematologica* 2000;85:59–62.

164. Saso R, Marsh J, Cevreska L, et al. Bone marrow transplants for paroxysmal nocturnal haemoglobinuria. *Br J Haematol* 1999;104:392–396.

165. Suenaga K, Kanda Y, Niiya H, et al. Successful application of nonmyeloablative transplantation for paroxysmal nocturnal hemoglobinuria. *Exp Hematol* 2001;29:639–642.

166. Nishimura J, Phillips KL, Ware RE, et al. Efficient retrovirus-mediated PIG-A gene transfer and stable restoration of GPI-anchored protein expression in cells with the PNH phenotype. *Blood* 2001;97:3004–3010.

167. Prince GM, Nguyen M, Lazarus HM, et al. Peripheral blood harvest of unaffected CD34+ CD38- hematopoietic precursors in paroxysmal nocturnal hemoglobinuria. *Blood* 1995;86:3381–3386.

168. Rosse WF. Treatment of paroxysmal nocturnal hemoglobinuria. *Blood* 1982;60:20–23.

169. Schubert J, Scholz C, Geissler RG, et al. G-CSF and cyclosporin induce an increase of normal cells in hypoplastic paroxysmal nocturnal hemoglobinuria. *Ann Hematol* 1997;74:225–230.

170. Stoppa AM, Vey N, Sainty D, et al. Correction of aplastic anaemia complicating paroxysmal nocturnal haemoglobinuria: absence of eradication of the PNH clone and dependence of response on cyclosporin A administration. *Br J Haematol* 1996;93:42–44.

171. van Kamp H, van Imhoff GW, de Wolf JT, et al. The effect of cyclosporine on haematological parameters in patients with paroxysmal nocturnal haemoglobinuria. *Br J Haematol* 1995;89:79–82.

172. Brodsky RA, Sensenbrenner LL, Smith BD, et al. Durable treatment-free remission after high-dose cyclophosphamide therapy for previously untreated severe aplastic anemia. *Ann Intern Med* 2001;135:477–483.

173. Brecher ME, Taswell HF. Paroxysmal nocturnal hemoglobinuria and the transfusion of washed red cells: a myth revisited. *Transfusion* 1989;29:681–685.

174. Rosse WF. Transfusion in paroxysmal nocturnal hemoglobinuria: to wash or not to wash. *Transfusion* 1989;29:663–664.

175. Hartmann RC, Kolhouse JF. Viewpoints on the management of paroxysmal nocturnal hemoglobinuria

(PNH). *Ser Haematol* 1972;5:42–60.

176. Hartmann RC, Jenkins DE, Jr., McKee LC, Heyszel RM. Paroxysmal nocturnal hemoglobinuria: clinical and laboratory studies relating to iron metabolism and therapy with androgen and iron. *Medicine (Baltimore)* 1966;45:331–363.

177. Ray JG, Burows RF, Ginsberg JS, Burrows EA. Paroxysmal nocturnal hemoglobinuria and the risk of venous thrombosis: review and recommendations for management of the pregnant and nonpregnant patient. *Haemostasis* 2000;30:103–117.

178. McMullin MF, Hillmen P, Jackson J, et al. Tissue plasminogen activator for hepatic vein thrombosis in paroxysmal nocturnal haemoglobinuria. *J Intern Med* 1994;235:85–89.

179. Sholar PW, Bell WR. Thrombolytic therapy for inferior vena cava thrombosis in paroxysmal nocturnal hemoglobinuria. *Ann Intern Med* 1985;103:539–541.

180. Graham ML, Rosse WF, Halperin EC, et al. Resolution of Budd–Chiari syndrome following bone marrow transplantation for paroxysmal nocturnal haemoglobinuria. *Br J Haematol* 1996;92:707–710.

181. Hall C, Richards S, Hillmen P. Primary prophylaxis with warfarin prevents thrombosis in paroxysmal nocturnal haemoglobinuria (PNH). *Blood* 2001;98:220a.

182. Bais J, Pel M, von dem Borne A, van der Lelie H. Pregnancy and paroxysmal nocturnal hemoglobinuria. *Eur J Obstet Gynecol Reprod Biol* 1994;53:211–214.

183. Bais JM, Pel M. Late maternal mortality due to paroxysmal nocturnal hemoglobinuria and pregnancy. *Eur J Obstet Gynecol Reprod Biol* 1995;58:211.

184. De Gramont A, Krulik M, Debray J. Paroxysmal nocturnal haemoglobinuria and pregnancy. *Lancet* 1987;1:868.

185. Beresford CH, Gudex DJ, Symmans WA. Paroxysmal nocturnal haemoglobinuria and pregnancy. *Lancet* 1986;2:1396–1397.

186. Jacobs P, Wood L. Paroxysmal nocturnal haemoglobinuria and pregnancy. *Lancet* 1986;2:1099.

187. Svigos JM, Norman J. Paroxysmal nocturnal haemoglobinuria and pregnancy. *Aust N Z J Obstet Gynaecol* 1994;34:104–106.

188. Sahu A, Lambris JD. Complement inhibitors: a resurgent concept in anti-inflammatory therapeutics. *Immunopharmacology* 2000;49:133–148.

189. Fujioka S, Takayoshi T. Prognostic features of paroxysmal nocturnal hemoglobinuria in Japan. *Acta Haematol Japan* 1989;52:1386–1394.

2004 Lippincott Williams & Wilkins  
John P. Greer, John Foerster, John N. Lukens  
George M. Rodgers, Frixos Paraskevas, Bertil Glader  
Wintrobe's Clinical Hematology

**HEMOLYSIS DUE TO INFECTION**[Malaria](#)[Babesiosis](#)[Trypanosomiasis](#)[Visceral Leishmaniasis \(Kala Azar\)](#)[Bartonellosis](#)[Clostridial Sepsis](#)[Other Bacterial Infections](#)**HEMOLYSIS DUE TO DRUGS AND CHEMICALS**[Oxidant Drugs and Chemicals](#)[Arsine Exposure](#)[Copper Toxicity](#)[Lead Toxicity](#)[Water](#)**HEMOLYSIS DUE TO VENOMS**[Spider Bites](#)[Snakebites](#)[Bee Stings](#)**HEMOLYSIS DUE TO THERMAL INJURY**[Burns](#)[Heated Fluids and Blood](#)**FRAGMENTATION HEMOLYSIS**[Cardiac and Large Vessel Abnormalities](#)[Small Vessel Disease \(Microangiopathic Hemolytic Anemia\)](#)[Thrombotic Thrombocytopenic Purpura](#)[Hemolytic Uremic Syndrome](#)[Thrombotic Microangiopathy Due to Other Disorders](#)[Hemolysis and Thrombotic Microangiopathy Associated with Pregnancy](#)**HEMOLYSIS DUE TO MALIGNANT HYPERTENSION****HEMOLYSIS DUE TO DISSEMINATED INTRAVASCULAR COAGULATION****HEMOLYSIS DUE TO IMMUNE DISORDERS**[Giant Hemangiomas and Hemangioendotheliomas](#)[March Hemoglobinuria](#)**OTHER ACQUIRED CAUSES OF HEMOLYSIS**[Hypersplenism](#)[Liver Disease](#)[Renal Disease](#)[Hypophosphatemia](#)[Posttransfusion Syndrome](#)**ACKNOWLEDGMENTS****REFERENCES**

Hemolysis occurs when red blood cells (RBCs) are exposed to a variety of infectious agents, chemicals, or physical stresses. In some cases, these effects are antibody mediated (see [Chapter 35](#) and [Chapter 36](#)). In others, such as in patients with glucose-6-phosphate dehydrogenase (G6PD) deficiency (see [Chapter 33](#)) or in those with unstable hemoglobins (see [Chapter 41](#)), there is an underlying propensity of the RBCs to be more susceptible to injury. In still other cases, such as paroxysmal nocturnal hemoglobinuria (PNH), hemolysis occurs as a consequence of an acquired clonal abnormality in the RBC membrane (see [Chapter 37](#)). Last, hemolytic anemia also occurs

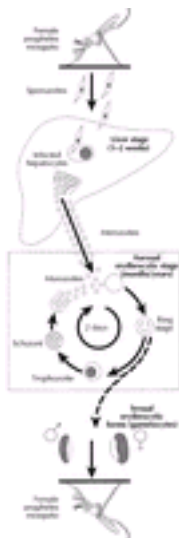
when otherwise normal RBCs are injured directly by infectious agents, chemicals, thermal injury, mechanical stresses, or altered metabolites. These disorders are the focus of this chapter.

## HEMOLYSIS DUE TO INFECTION

A variety of infectious processes can lead to hemolytic destruction of normal RBCs. In some cases, such as in *Mycoplasma pneumoniae* infection or with infections related to paroxysmal cold hemoglobinuria, hemolysis is related to antibody-mediated cell destruction (see [Chapter 35](#)). With the infections described in this section, hemolysis is largely the result of direct nonimmune effects on erythrocytes. Some of the infections discussed here are not major problems in North America or Europe; however, to the extent that there is significant international travel to and from endemic areas, recognition of these infections is important for medical personnel worldwide.

### Malaria

Malaria is an acute, chronic, or recurrent febrile disease caused in humans by four species of *Plasmodia*: *P. vivax*, *P. falciparum*, *P. malariae*, and *P. ovale*. Infections with *P. falciparum* are the major form of malaria in Africa and Southeast Asia, whereas *P. vivax* is most common in Central America and India. These protozoan microorganisms are capable of parasitizing erythrocytes and other body tissues. Malaria is spread by female mosquitoes of the genus *Anopheles* ([Fig. 38.1](#)). The sexual phase of the *Plasmodium* life cycle takes place within the mosquito. The semitropical and tropical endemic distribution of malaria corresponds to the distribution of the vector.

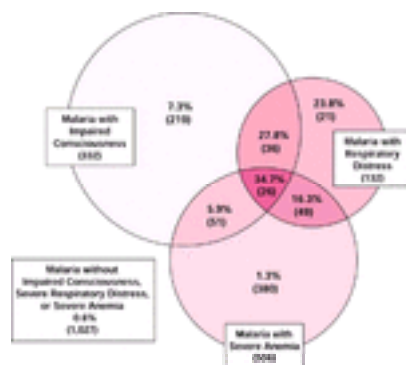


**Figure 38.1.** Life cycle of malarial parasite. (From Weatherall DJ, Kwiatkowski D. Hematologic manifestations of systemic diseases in children of the developing world. In: Nathan D, Orkin S, eds. Hematology of infancy and childhood. Philadelphia: W.B. Saunders, 1998:1893–1914.)

On a worldwide basis, malaria is the most prevalent of all serious diseases; 300 to 500 million people are affected at any given time, and 1.5 to 2.7 million die each year ([1](#)). Ninety percent of the deaths are in African children ([2](#)). Malaria has not been endemic in the United States since the 1940s, but approximately 1000 cases have been reported

each year since 1985, and there has been a steady increase in the number of cases reported annually ( 3 ). Malaria can also be transmitted by blood transfusions ( 4 ) or by the sharing of needles among intravenous drug abusers ( 5 ).

**CLINICAL MANIFESTATIONS** After the initial exposure to malaria some patients are completely asymptomatic, while others have nonspecific flulike symptoms that mimic a viral illness ( 6 ). Classically, the most prominent clinical manifestations are recurrent paroxysms of chills and fever with temperatures as high as 105° to 106° F (40.5° to 41° C) associated with malaise, headache, vomiting, and other systemic symptoms. The paroxysms tend to recur regularly every 36 to 72 hours. They are most prominent with *P. malariae* infections and much less with *P. falciparum*. Splenomegaly is noted in approximately one-half of patients during early stages of disease ( 6 ) and becomes more common later. Jaundice and hepatomegaly may develop in later stages of the illness. Of the various malaria species, *P. falciparum* infection causes the most morbidity and mortality. In the acute stage it can be associated with increasing parasitemia, hypotension, malignant hyperthermia, and death. In addition, *P. falciparum* malaria is associated with cerebral, pulmonary, and renal complications ( 7 ). The overall mortality from a study of more than 1800 children with malaria in Kenya was 3.5%, and in 84% of cases death occurred within 24 hours of admission ( 8 ). The most important prognostic factors for death were impaired consciousness and respiratory distress ( Fig. 38.2 ). Severe anemia alone did not affect prognosis ( 2 , 8 ).

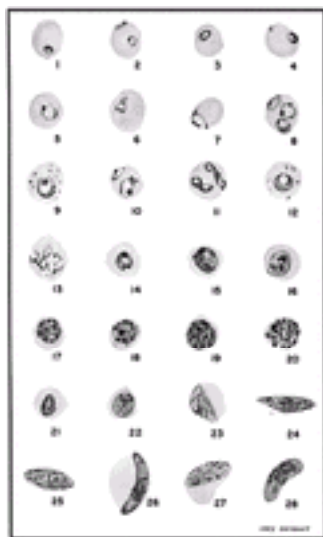


**Figure 38.2.** Prevalence, overlap, and mortality for major clinical subgroups of severe malaria in 1809 African children. In 1027 of these children, malaria was present without signs of impaired consciousness, respiratory distress, or severe anemia. In a subset of all children presenting with malaria (782 patients; approximately 40% of total) there was evidence of severe anemia (hemoglobin <5 g/dl), severe respiratory distress, impaired consciousness, and/or some combination of these clinical findings. Almost all deaths occurred in the children who presented with combinations of these clinical abnormalities. Total numbers of patients are given in parentheses. Mortality is given as a percentage. [Modified from Marsh K, Forster D, Waruiru C, et al. Indicators of life-threatening malaria in African children. *N Engl J Med* 1995;332(21):1399–1404.]

Anemia is common in malaria ( 9 , 10 and 11 ). It is particularly characteristic of *P. falciparum* malaria because of the greater extent of RBC parasitization with this species. With uncomplicated *P. falciparum* malaria, moderately severe anemia is seen in approximately 20% of previously healthy patients during or after the first infection ( 12 ). Complete eradication of malaria parasites from the blood may take months to years, particularly in areas of high transmission, and immunity to malaria is slowly acquired. In tropical areas, anemia tends to be most prevalent and most severe in children from 1 to 5 years of age ( 13 ), whereas only moderate anemia is usually noted in adolescents and adults. Leukocyte numbers may be normal, but patients often have leukopenia. Thrombocytopenia has been observed in approximately two-thirds of patients with *P. falciparum* malaria ( 7 , 13 ),

frequently associated with splenomegaly (<sup>14</sup>). The most serious hematologic complication of malaria is acute intravascular hemolytic anemia (blackwater fever), which occurs as a rare event in the course of infection by *P. falciparum*. The clinical manifestations are fulminating, the intravascular hemolysis being associated with prostration, vomiting, chills, and fever. Hemoglobinemia, hemoglobinuria, and hyperbilirubinemia are consistent features, and in the most severe episodes, acute oliguric renal failure supervenes.

**PATHOGENESIS** After a bite from the female *Anopheles* mosquito, sporozoites introduced into the circulation go to the liver parenchyma where they proliferate into thousands of merozoites ( Fig. 38.1). The duration of this liver development stage varies between species. The infected hepatocytes next release merozoites into the bloodstream, where they invade erythrocytes. The ability of various *Plasmodia* to infect RBCs is related to their attachment to specific membrane receptors. Of the species that infect humans, *P. vivax* and *P. ovale* invade only reticulocytes. *P. malariae* invades mature RBCs, and *P. falciparum* invades erythrocytes of all ages. As a result, the proportion of cells parasitized in *P. vivax* malaria rarely exceeds 1%, whereas as many as 50% of cells may be affected in *P. falciparum* malaria. It is of interest that *P. vivax* invades only Duffy blood group-positive RBCs (<sup>15</sup>); in West Africa, where the Duffy antigen is missing on RBCs, *P. vivax* malaria is nonexistent. *P. falciparum* apparently has two receptors: one that binds to sialic acid groups on the erythrocyte membrane protein glycophorin and another that binds to a trypsin-sensitive, nonsialated ligand (<sup>16</sup>, <sup>17</sup> and <sup>18</sup>). Further development of the parasite within RBCs is along one of two pathways: asexual or sexual differentiation ( Fig. 38.3). Sexual forms, or *gametocytes*, continue their development within mosquitoes. The asexual differentiation of parasites in RBCs proceeds from young ring forms through trophozoites to produce schizonts containing six to thirty-two merozoites ( Fig. 38.3). In the process, parasites use 25 to 75% of the hemoglobin of the cell (<sup>19</sup>). The intraerythrocytic phase lasts 24 to 72 hours, depending on the species. The schizonts then lyse, the cell ruptures, and the merozoites are released to invade other cells, thereby continuing the erythrocyte cycle. The simultaneous rupture of billions of schizonts from RBCs is associated with the classic paroxysms of malarial fever.



**Figure 38.3.** *Plasmodium falciparum*. 1: Very young ring form trophozoite. 2: Double infection of single cell with young trophozoites, one a marginal form, the other a signet-ring form. 3, 4: Young trophozoites showing double chromatin dots. 5-7: Developing trophozoites. 8: Three medium trophozoites in one cell. 9: Trophozoite showing pigment in a cell containing Maurer spots. 10, 11: Two trophozoites in each of two cells, showing variation of forms that parasites may assume. 12: Almost-mature trophozoite showing haze of pigment throughout cytoplasm. 14: Mature trophozoite, showing clumped pigment. 15: Parasite in the process of initial chromatin division. 16-19: Various phases of the development of the schizont. 20: Mature schizont. 21-24: Successive forms in the development of the gametocyte, usually not found in the

circulation. **25:** Immature macrogametocyte. **26:** Mature macrogametocyte. **27:** Immature microgametocyte. **28:** Mature microgametocyte. See [Color Plate](#). (From Wilcox A. Manual for the microscopical diagnosis of malaria in man. National Institutes of Health Bulletin No. 180, with permission.)

Erythrocytes parasitized by certain strains of *P. falciparum* develop electron-dense knobs that mediate the attachment of the infected RBCs to venules ([20](#), [21](#)). Such sequestration of parasite-infected RBCs creates an obstruction to tissue perfusion. In addition, the sequestration in venules prevents parasitized cells from entering the splenic circulation, thereby evading destruction and allowing further merozoite development; this phenomenon may be a factor in the rapid development of anemia in severe infections ([22](#)). The anemia in malaria is due to a combination of factors that include parasite-mediated RBC destruction, splenic removal of infected RBCs, and decreased RBC production ([Table 38.1](#)). Hemoglobin digestion and cell disruption by the parasite is clearly the major cause of hemolysis ([9](#), [10](#), [23](#)).

**TABLE 38.1. Factors Contributing to Anemia in Malaria**

---

Accelerated RBC destruction

Direct parasite destruction of RBCs ([9](#), [10](#), [23](#))

Decreased deformability of parasitized RBC and destruction by splenic macrophages ([24](#), [25](#), [26](#) and [27](#))

Macrophage-mediated destruction of parasitized RBCs in marrow and liver sinusoids ([30](#))

Destruction of nonparasitized cells by immune mechanisms ([33](#))

Destruction of nonparasitized cells by hypersplenism and hyperactive macrophages ([27](#))

Hapten (quinine)-induced intravascular hemolysis (blackwater fever) ([42](#), [43](#) and [44](#))

Decreased RBC production

Bone marrow suppression due to inflammatory cytokines ([10](#), [32](#), [35](#), [36](#), [37](#) and [38](#))

Inadequate erythropoietin production ([39](#), [40](#))

Dyserythropoiesis ([11](#), [34](#), [35](#))

Modified from Menendez C, Fleming AF, et al. Malaria-related anaemia. *Parasitol Today* 2000;16(11):469-476.

---

The role of the spleen in RBC destruction is related to the decreased deformability of RBCs infected with plasmodia ([24](#), [25](#) and [26](#)), erythrocyte retention in the red pulp, prolonged exposure to splenic macrophages, and removal of parasitized cells or “pitting” of the parasite, with consequent damage to the cell ([27](#), [28](#) and [29](#)). A similar process of macrophage-mediated destruction of parasitized RBCs occurs in the marrow sinusoids ([30](#)). Moreover, normal nonparasitized RBCs have a shorter survival in malaria, presumably a consequence of hypersplenism and hyperactive macrophages ([31](#)). Even after complete clearance of the parasites, hemolysis may persist for 4 to 5 weeks ([32](#)). A complement-mediated process may be responsible in part, and often the direct antiglobulin test is positive ([33](#)). Dyserythropoiesis with characteristic morphologic findings in red cell precursors also occurs in malaria. It is thought that this contributes to the slow recovery seen after a single malarial attack, and also to the persistence of anemia in individuals with chronic parasitemia ([11](#), [34](#), [35](#)). Anemia often persists for weeks after treatment of malaria and results in part from relative marrow failure, as occurs in association with other forms of infection (see [Chapter 47](#)) ([10](#), [32](#)). Tumor necrosis factor and other cytokine mediators of the anemia of chronic disorders are increased in patients



with severe *P. falciparum* malaria ( [36](#), [37](#) and [38](#)). Serum erythropoietin levels also are inadequate ( [39](#), [40](#)). The percentage of reticulocytes tends to be low during active infection and increases transiently after effective treatment. In *P. vivax* malaria, however, the low reticulocyte count may be explained in part by the increased affinity of the organism for reticulocytes ( [41](#)). The pathogenesis of acute intravascular hemolysis (blackwater fever) remains uncertain, and currently this complication is less commonly seen, although it still occurs ( [42](#)). Blackwater fever does not reflect an unusual degree of parasitemia. Often, the acute intravascular hemolysis appears to be precipitated by quinine ingestion ( [43](#), [44](#)), and quinine may act as a hapten, becoming antigenic after interacting with the RBC. Cases involving untreated individuals also have been reported, however ( [7](#)). Some episodes thought to represent blackwater fever may have resulted from the use of primaquine-like drugs in G6PD-deficient people. Certain inherited RBC disorders appear to confer resistance to malaria, by inhibiting parasitic invasion or by slowing intracellular growth. It is thought that these phenomena may contribute to increased prevalence of such inherited diseases because of their effects on survival (i.e., balanced polymorphism). These disorders include sickle cell trait ( [45](#), [46](#) and [47](#)), G6PD deficiency ( [48](#), [49](#), [50](#) and [51](#)), thalassemia ( [52](#), [53](#)), hemoglobin E variants ( [54](#)), hemoglobin C variants ( [55](#)), ovalocytosis of the Melanesian (Malayan) type ( [56](#)), and lack of the Duffy blood group antigen ( [15](#)).

**DIAGNOSIS** Diagnosis of malaria in the United States is often delayed because it is not suspected ( [6](#), [57](#)). Such delays are dangerous because the early mortality rate from *P. falciparum* malaria approaches 10%, and these deaths can be prevented with adequate treatment. Malaria should be considered in the differential diagnosis of any febrile patient returning from an endemic zone. Diagnosis traditionally has required identification of parasites on the blood smear ( [Fig. 38.3](#)). The parasites can be recognized on ordinary Wright-stained smears, but the chances for detection and identification of species are enhanced by the use of thick smears. Single negative smears do not exclude the disease with certainty in patients with low-grade infections. Parasites may be detected in blood during any phase of the illness, but the chances of detection are greatest during afebrile periods. *P. falciparum* disease is distinguished from that caused by other strains by heavy parasitemia involving all ages of erythrocytes and by the lack of trophozoites and schizonts; usually, only ring forms and the distinctive, banana-shaped gametocytes are apparent ( [Fig. 38.3](#)). Simple test strips that take 10 to 15 minutes are available for diagnosis of malaria from a drop of finger-stick blood. The sensitivity of these tests is probably as good as microscopy ( [58](#), [59](#) and [60](#)). Test strips are available to detect *P. falciparum* only or *P. falciparum* as well as other *P.* species. It is important to distinguish *P. falciparum* malaria from other malaria species because of therapeutic considerations, and only *P. falciparum* infection has the potential for being rapidly fatal ( [7](#)).

**MANAGEMENT** Therapeutic considerations for malaria include supportive medical care for anemia and other complications. Chemoprophylaxis should be recommended to all people traveling to an endemic area ( [61](#), [62](#)). Because of the spread of drug-resistant strains of *P. falciparum*, however, no single regimen is completely effective. Knowledge of the characteristics of the malaria strains in the sites to be visited is essential. Because of changes in drug resistance and the development of new agents, before recommending a regimen to a prospective traveler, physicians should become familiar with current guidelines from the U.S. Centers for Disease Control and Prevention ( <http://www.cdc.gov/travel/malinfo.htm>).

## Babesiosis

Infection by tick-borne protozoans of the genus *Babesia* is rare in humans ( [63](#), [64](#), [65](#) and [66](#)). The infection has been reported in Nantucket and other islands off the northeastern U.S. shore, as well as in neighboring coastal areas of New England. It also is found in north

central states, Washington, and California (63). Recently, cases of babesiosis have been described in Europe, and almost all have occurred in asplenic individuals (65). In the United States, *Babesia microti* is the causative agent, whereas *B. divergens* is the species identified in Europe, and the later cases are usually more severe (66). Babesiosis also can be transmitted by blood transfusion (65, 67).

Babesiosis is characterized by an acute febrile illness and hemolytic anemia, very similar to malaria. In most cases it is a mild self-limited disorder that goes undiagnosed, and thus not reported. It is likely the true incidence of babesiosis in healthy hosts is under-recognized. However, in asplenic individuals it can produce serious, often fatal illness with hemolytic anemia, renal failure, or pulmonary edema (65, 66, 68).

Laboratory features include hemoglobinuria, hyperbilirubinemia, normocytic anemia, thrombocytopenia, and sometimes leukopenia (66). *B. microti* and *B. divergens* can be seen in RBCs on the peripheral blood smear, and this can be confused with malaria (66). Serologic antibody tests and polymerase chain reaction-based assays are available to aid in diagnosis (66).

In most mild cases of babesiosis no treatment is necessary. In some more severe cases, clindamycin and quinine are useful (66), and, rarely, RBC exchange transfusions have successfully been used (66, 69).

### Trypanosomiasis

Moderate to severe hemolytic anemia is a regular feature of African trypanosomiasis (sleeping sickness) (70, 71 and 72). This often-fatal illness is caused by *Trypanosoma brucei gambiense* or *T. brucei rhodesiense*. The diseases induced by the two subspecies are similar, except that *T. brucei gambiense* infection follows a more chronic course. The organisms are transmitted to humans and domestic animals by the bite of the tsetse fly.

Normocytic anemia with reticulocytosis is prominent. RBC survival is shortened, and autoagglutination of erythrocytes with accelerated erythrocyte sedimentation characteristically is observed. The results of the direct antiglobulin (Coombs) test may be positive. Erythrophagocytosis by macrophages is seen throughout the reticuloendothelial system (73).

The toxic effects of the parasite and immunologic mechanisms are implicated in the destruction of RBCs. The intensity of the hemolytic anemia may fluctuate with the degree of parasitemia. Transient hepatosplenomegaly and decreased serum complement levels accompany the episodes. Marrow failure often supervenes during the terminal phases of the illness. Diagnosis depends on serologic tests or demonstration of the parasite in the blood.

### Visceral Leishmaniasis (Kala Azar)

*Leishmaniasis* is an infection caused by intracellular protozoan parasites transmitted by sand flies. There are three main forms of leishmania infections in humans: cutaneous, mucocutaneous, and visceral. The major hematologic problems occur with the visceral infection (kala azar) and involve the lymph nodes, liver, spleen, and bone marrow. The disorder is caused by *Leishmania donovani*, and is found throughout Asia and Africa, affecting individuals of all ages. A variant parasite, *L. donovani infantum*, is the form that causes kala azar in southern Europe and North Africa, and primarily affects young children

and infants. Visceral leishmaniasis mainly occurs in local endemic areas; however, it may be contracted on short-term visits, and it is being recognized in the United Kingdom after return from Mediterranean holidays ( [74](#) ).

After an incubation period of 1 to 3 months, there is the insidious onset of fever, sweating, malaise, and anorexia, but these acute symptoms gradually abate. Next, hepatosplenomegaly gradually evolves, and this stage of illness is associated with anemia, neutropenia, and thrombocytopenia. In young children with acute visceral leishmaniasis, particularly in Mediterranean populations, the clinical and hematologic features may be more aggressive with a rapid onset of severe hemolytic anemia ( [75](#) ).

The bone marrow is hyperplastic with dyserythropoietic changes, and diagnosis can usually be made by finding macrophages containing intracellular parasites (Leishman–Donovan bodies). The overall hematologic picture is typical of hypersplenism. RBC survival studies indicate that hemolysis is the major cause of anemia in leishmaniasis ( [75](#), [76](#) ).

In most cases, there is no evidence of immune hemolysis, although immunoglobulin (Ig) G and complement occasionally are found on the RBCs. Similar to what is seen in malaria, nonsensitized RBCs are destroyed by macrophages recruited to the spleen and liver as part of the inflammatory response to the parasite.

### **Bartonellosis**

A severe, acute hemolytic anemia is produced in humans by *Bartonella bacilliformis*, a flagellated bacillus ( [77](#) ). The infection is limited to South America, particularly in the Andean valleys of Peru, Ecuador, and Colombia, at elevations of 500 to 3000 m ( [78](#), [79](#), [80](#) and [81](#) ). The bacillus is transmitted by the sand fly (*Phlebotomus*) and probably by other arthropods. After a 2- to 3-week incubation period, the acute phase of the illness, known as *Oroya fever*, begins. It is marked by malaise, headache, muscle pains, remittent fever, chills, and rapid onset of severe anemia. The disease has existed in Peru since pre-Inca times ( [82](#) ). The highest rates of infection are in children ( [78](#), [81](#) ).

The findings in the blood are characteristic of acute extravascular blood destruction ( [83](#), [84](#) ). As viewed in Wright- or Giemsa-stained blood smears, numerous *Bartonella* organisms are apparent in the erythrocyte ( [83](#) ). The organisms are rod-shaped (1 to 2  $\mu$ m in length and 0.2 to 0.5  $\mu$ m in width) or round (0.3 to 1.0  $\mu$ m in diameter).

*Bartonella* infection can be controlled with chloramphenicol and other antibiotics. Depending on the reported study, up to 35% of affected patients are transfused with RBCs ( [78](#) ), and in cases that do not receive treatment, the fatality rate may be 60 to 80% ( [78](#) ).

In patients who recover from the acute phase, a quiescent period ensues during which the organisms disappear from the blood. A chronic, eruptive stage follows, *verruca peruviana*, a benign condition characterized by hemangioma-like lesions of the skin but without hematologic manifestations ( [84](#) ). *Oroya fever* and *verruca peruviana* constitute the two phases of Carrion disease, named after Daniel Carrion, the medical student who lost his life while investigating its cause ( [85](#) ).

## Clostridial Sepsis

*Clostridium perfringens* septicemia occurs after septic abortion ( 77, 86 ) or in association with a diseased biliary tree, traumatic wound infections, cancer, leukemia, endocarditis, gastrointestinal arteriovenous malformations, or necrotizing enterocolitis of newborns ( 87, 88, 89 and 90 ). Sometimes no underlying disease is identified ( 91, 92 ). Profound, often-fatal hemolytic anemia is a regular feature of clostridial sepsis ( 93 ). Signs of intravascular RBC destruction are prominent, and many microspherocytes are found in the blood. The hemolysis can be rapid and massive, with hematocrit values falling to very low levels in a matter of hours ( 91, 92, 94 ). Hemolysis is thought to result from the elaboration of a clostridial toxin, a phospholipase that attacks erythrocyte membrane lipids to form highly lytic lysolecithins ( 95, 96 ). The diagnosis should be suspected when fever, jaundice, and intravascular hemolysis occur together in a patient with a history of previous gastrointestinal or genitourinary surgery, a recent wound, cancer, or other disease. Clostridial infections respond to antibiotic therapy, but to affect outcome, treatment must be started quickly, usually before culture results are available ( 97 ).

## Other Bacterial Infections

Acute hemolytic anemia with bacterial infection is common, especially in childhood, and has been reported with streptococcal, staphylococcal, or pneumococcal septicemia or endocarditis ( 98, 99, 100, 101 and 102 ). Intravascular hemolysis with hemoglobinuria has been observed in patients with cholera ( 103 ) and with typhoid fever ( 104 ). *Escherichia coli* O157 gastroenteritis can cause the hemolytic-uremic syndrome (HUS) (see below), but can also bring about hemolytic anemia with no renal involvement or RBC fragmentation ( 105 ). Severe hemolytic anemia is observed occasionally in patients with military tuberculosis ( 100, 106 ). Certain spirochetal infections are occasionally associated with hemolytic anemia, including relapsing fever caused by *Borrelia recurrentis* ( 107 ), and leptospirosis (Weil syndrome) ( 108 ).

The pathogenesis of hemolysis in most cases cited previously is uncertain. In some it is thought that anemia is due to direct action of the infectious agent or its products on erythrocytes. Adsorption of microbial antigens to RBCs has been detected by immunofluorescent techniques ( 109 ), and this phenomenon may lead to phagocytosis or complement-mediated erythrocyte destruction. The capsular polysaccharide of *Haemophilus influenzae* type b, polyribosyl ribitol phosphate, is released from growing organisms during human infection and can be found in body fluids including RBCs. It has been proposed that the hemolytic anemia that occurs during *H. influenzae* type b infection may owe to absorption of polyribosyl ribitol phosphate to RBCs and immune destruction of sensitized erythrocytes ( 110 ).

In other cases, serious bacterial infections are associated with disseminated intravascular coagulation (DIC) and a microangiopathic hemolytic anemia. Also, as discussed previously, *C. perfringens* may release phospholipases that can lead to RBC membrane injury and cell destruction. Other bacteria release neuraminidase, an enzyme that cleaves RBC sialic acid residues, thereby exposing a cryptic “T-antigen” ( 111 ). These “T-activated” RBCs can react with anti-T IgM antibodies present in most human adult plasma, thereby resulting in RBC agglutination and possible hemolysis *in vivo* ( 111 ). The main bacteria that release neuraminidase are *C. perfringens* and *Streptococcus pneumoniae*; however,

*Bacteroides*, *E. coli*, *Actinomyces*, and *Vibrio cholera* also have been implicated.

## HEMOLYSIS DUE TO DRUGS AND CHEMICALS

Many drugs and chemicals injure normal RBCs to cause hemolytic anemia. Some of the more common occurrences are summarized in this section.

### Oxidant Drugs and Chemicals

Certain chemical agents can bring about the oxidative denaturation of hemoglobin, leading to the sequential formation of methemoglobin, sulfhemoglobin, and Heinz bodies (see [Chapter 8](#)). In some cases, the chemical itself acts as an oxidizing agent; more often, however, it interacts with oxygen to form free radicals or peroxides. These free radicals or peroxides, if produced in quantities too great to be detoxified by the glutathione-dependent reduction system, denature hemoglobin and damage other cellular structures. Individuals deficient in RBC G6PD or other components of glutathione-dependent detoxification processes (see [Chapter 33](#)) are particularly sensitive to the hemolytic effects of oxidant compounds ([Table 38.2](#)). However, some of these agents are powerful enough to overcome the defense mechanisms of normal erythrocytes, and can cause hemolysis when given to healthy subjects in higher than usual doses or if renal failure leads to unusually high blood levels.

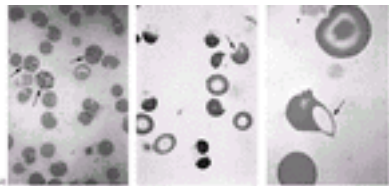
**TABLE 38.2. Drugs and Chemicals That Cause Hemolytic Anemia in Patients with Normal Erythrocytes**

|  |  |
|--|--|
| Sulfonamides ( <a href="#">112</a> , <a href="#">460</a> , <a href="#">461</a> and <a href="#">462</a> )                   | Aniline ( <a href="#">476</a> )  |
| Sulfones ( <a href="#">460</a> , <a href="#">463</a> , <a href="#">464</a> , <a href="#">465</a> and <a href="#">466</a> ) | Phenylsemicarbazide ( <a href="#">477</a> )                                    |
| Phenazopyridine (Pyridium) ( <a href="#">112</a> , <a href="#">113</a> , <a href="#">467</a> )                             | Phenylhydrazine ( <a href="#">478</a> , <a href="#">479</a> )                  |
|  | Chlorates ( <a href="#">480</a> , <a href="#">481</a> )                        |
| Nitrofurantoin (Furadantin) ( <a href="#">460</a> )  | Nitrates ( <a href="#">482</a> , <a href="#">483</a> and <a href="#">484</a> ) |
| Phenacetin ( <a href="#">468</a> , <a href="#">469</a> )   | Oxygen ( <a href="#">485</a> , <a href="#">486</a> )                           |
| Phenol ( <a href="#">108</a> )   | Hydroxylamine ( <a href="#">487</a> )  |
| Cresol (Lysol, penetrating oil) ( <a href="#">114</a> , <a href="#">470</a> , <a href="#">471</a> )                        | Methylene blue (in infants) ( <a href="#">488</a> )                            |
|  | Hematin ( <a href="#">489</a> )  |
| Naphthalene (mothballs) ( <a href="#">460</a> , <a href="#">472</a> , <a href="#">473</a> and <a href="#">474</a> )        | Pentachlorophenol ( <a href="#">490</a> )                                      |
|  | Cisplatin ( <a href="#">491</a> )  |
| Nitrobenzene ( <a href="#">475</a> )   |  |

Some of the agents that can induce hemolytic anemia in apparently normal subjects are listed in [Table 38.2](#). Many of these are derivatives of aromatic organic compounds.

Hemolytic anemia caused by oxidant drugs varies considerably in severity. Usually, the anemia is noted within 1 to 2 weeks after drug therapy is initiated, with laboratory findings of low hemoglobin, reticulocytosis, hyperbilirubinemia, low serum haptoglobin, and erythroid hyperplasia of the bone marrow. In some cases, hemoglobinemia and hemoglobinuria may be apparent. Cyanosis with methemoglobinemia or sulfhemoglobinemia is sometimes noted. The hemolytic process usually disappears within 1 to 3 weeks after use of the offending drug has been discontinued.

Morphologic findings characteristic of hemolytic anemia caused by oxidant drugs and chemicals include the following: Heinz bodies (seen with brilliant cresyl blue supravital stains of blood during hemolytic episodes) ( [Fig. 38.4A](#)); “bite cells” (seen in routine Wright–stained blood smear) as erythrocytes that look as if a semicircular bite has been taken from one edge ( [Fig. 38.4B](#)) ( [112](#), [113](#)); and hemighosts ( [114](#)) or eccentrocytes ( [115](#)), erythrocytes that look as if the hemoglobin has shifted to one side of the cell, leaving the other side clear ( [Fig. 38.4C](#)). These hemighosts also are referred to as *blister cells* and may appear to contain a large vacuole. These RBCs contain a coagulum of hemoglobin that has separated from the membrane, often leaving an unstained non–hemoglobin–containing cell membrane ( [116](#)). Hemighosts appear only when hemolysis is brisk ( [112](#), [114](#)), and probably indicate a particularly severe degree of oxidant damage. All of these morphologic alterations are a consequence of the oxidative assault on hemoglobin.



**Figure 38.4.** Morphologic findings characteristic of hemolytic anemia caused by oxidant drugs and chemicals. **A:** Heinz bodies (arrows) (seen with brilliant cresyl blue supravital stains of blood during hemolytic episodes). **B:** “Bite cells” (seen in routine Wright–stained blood smear) as erythrocytes that look as if a semicircular bite has been taken from one edge (arrow). **C:** “Blister cells” or hemighosts (seen in routine Wright–stained blood smear) appear as if hemoglobin has shifted to one side of the cell, leaving the other side clear. These blister RBCs contain a coagulum of hemoglobin that has separated from the membrane, leaving an unstained non–hemoglobin–containing cell membrane (arrow) ( [116](#)). ( **C** courtesy of Dr. Lawrence Naiman, M.D.) See [Color Plate](#).

## Arsine Exposure

Arsine ( $\text{AsH}_3$ ) is the most acutely toxic form of arsenic. It is a colorless, nonirritating, highly toxic gas that is produced by the action of water on a metallic arsenide. Arsine poisoning is associated most often with the use of acids in refining, extracting, or otherwise processing crude metals that contain arsenic as an impurity ( [117](#), [118](#)). Such industrial processes as galvanizing, soldering, etching, and lead plating can expose workers to this noxious gas ( [119](#)). Arsine is also used in the transistor industry to stabilize silicon, and leakage from cylinders in which the gas is transported can lead to accidental poisoning ( [120](#)).

Manifestations of poisoning appear 2 to 24 hours after exposure and include abdominal pain, nausea, and vomiting, the passage of dark–red urine, jaundice, anemia, reticulocytosis, leukocytosis, and other signs of acute hemolytic anemia. Hemoglobinemia and hemoglobinuria are found, and acute, oliguric renal failure often ensues. The antiglobulin test result is negative. The mortality rate can approach 20% ( [121](#)). The mechanism of RBC injury is not known for certain. Interactions between arsine and oxyhemoglobin may be involved ( [122](#)). Also, arsine–induced membrane injury with altered



ion transport has been proposed ( [123](#) , [124](#) ).

The treatment of choice for acute toxicity is exchange transfusion to remove the arsenic-containing erythrocytes and to restore the blood hemoglobin levels ( [119](#) ).

## Copper Toxicity

Hemolytic episodes due to copper toxicity have been noted in humans after accidental exposure to toxic amounts of copper sulfate ( [125](#) , [126](#) and [127](#) ). Moreover, copper has been implicated in hemolytic episodes after hemodialysis due to faulty copper tubing and increased levels of the metal in dialysis fluid ( [128](#) , [129](#) ).

When inorganic copper enters the blood in large amounts, much of it accumulates in RBCs ( [130](#) , [131](#) ). Within RBCs it may damage the cell membrane, accelerate oxidation of hemoglobin, and inactivate enzymes of the pentose-phosphate and glycolytic pathways. Which of these abnormalities is responsible for shortened RBC survival is not known.

The release of inorganic copper into the circulation accounts for the occurrence of hemolytic anemia in Wilson disease (hepatolenticular degeneration) ( [132](#) , [133](#) , [134](#) , [135](#) , [136](#) , [137](#) , [138](#) and [139](#) ). This inherited illness, characterized by a lifelong tendency to accumulate copper, is due to a deficiency of ceruloplasmin the copper transport protein ( [140](#) ). It usually becomes symptomatic in the teens or early twenties, when copper concentration in the liver or nervous system reaches toxic levels ( [141](#) ). Hemolytic anemia can be associated with the early stages of Wilson disease ( [142](#) ) and occasionally may be the first manifestation of the disorder ( [138](#) , [139](#) , [143](#) , [144](#) and [145](#) ), or it may be associated with hepatic decompensation ( [135](#) ). However, it may appear late in the course of the disease if therapy with penicillamine is discontinued ( [132](#) , [133](#) ). The hemolytic episodes in Wilson disease usually are transient and self-limited, but they may be severe and recurrent. When they occur with hepatic decompensation, death from liver failure often follows ( [135](#) ).

The true incidence of this copper-induced hemolysis in Wilson disease is not known, and there are estimates of 2 to 50% ( [144](#) , [145](#) and [146](#) ). Laboratory test findings include the usual signs of hemolytic anemia. Treatment of this complication may require plasma exchange transfusion ( [147](#) ).

## Lead Toxicity

Risk factors for lead toxicity are related to occupational hazards in adults and environmental exposure in children ( [148](#) ). Occupational hazards include the manufacturing of batteries, paint or pigments, mining, and smelting; the primary route of assimilation is by inhalation. Environmental exposures in children occur by ingestion of lead from ceramics, paint, gasoline, water from lead pipes, or having a parent who works in a high-lead environment. Recently, there have been reports of herbal-associated lead poisoning from Asia ( [149](#) ).

Acute toxicity occurs when lead accidentally gets into a food or water source. Such acute poisoning leads to lead encephalopathy (headache, confusion, stupor, coma, and seizures), and in addition there is abdominal colic, hypertension, and hemolytic anemia. Chronic exposure over time also is associated with a variety of neurologic,



gastrointestinal, reproductive, and hematologic complications.

The peripheral smear shows extensive coarse basophilic stippling and reticulocytosis. RBC morphology is not otherwise characteristic. The diagnosis of lead-related hemolysis can be made from the history of lead exposure, the physical finding of the gingival lead sulfide line, and from the coarse basophilic stippling of RBCs. The diagnosis is confirmed by measuring of blood and urine lead levels.

Lead inhibits two steps in heme synthesis: delta-aminolevulinic acid dehydratase and heme synthetase (or ferrochelatase). The latter enzyme catalyzes the insertion of iron into protoporphyrin IX to form heme. The lead-induced inhibition of ferrochelatase is responsible for the increase in free erythrocyte protoporphyrin seen in this disorder, and also the basis of a simple screening test for lead toxicity.

The explanation for hemolysis in acute lead toxicity is not known for sure, but it is intriguing that the basophilic stippling seen in acute lead poisoning is similar to that found in hereditary deficiency of the enzyme pyrimidine 5'-nucleotidase (P5'N) (see [Chapter 33](#)). In the enzyme-deficient cells, intracellular aggregates form as a consequence of impaired ribosomal degradation; these aggregates appear as basophilic stippling on Wright-stained peripheral blood smears. Of interest, the P5'N enzyme is readily inactivated by heavy metals such as lead, and it has been proposed that the basophilic stippling in lead poisoning is secondary to acquired P5'N deficiency ([150](#), [151](#) and [152](#)). As blood lead levels approach 200 µg/dl packed RBCs, P5'N activity decreases to levels comparable to those associated with the homozygous deficiency state, intracellular pyrimidine nucleotides accumulate, and basophilic stippling can be demonstrated ([151](#), [153](#)).

## Water

There are anecdotal reports of hemolysis after inadvertent injection of water and other hypotonic fluids. Hemoglobinuria, renal failure, and death were observed in association with transurethral resection of the prostate when distilled water was used for irrigation. Apparently, the water entered the bloodstream by way of the lymphatic and venous channels opened during the operation ([154](#)). Hemolysis also has been noted in survivors of near-drowning in fresh water ([155](#)). The entry of more than 0.6 L of water into the circulation produces hemoglobinemia and hemoglobinuria as a result of osmotic hemolysis.

## HEMOLYSIS DUE TO VENOMS

### Spider Bites

Certain spider bites produce severe, necrotic, gangrenous lesions (“necrotic arachnidism”) that are sometimes associated with hemolytic anemia or DIC, and occasionally renal failure ([156](#), [157](#), [158](#), [159](#) and [160](#)). In South America and the southwestern part of the United States, the spiders implicated are the brown recluse spider (*Loxosceles reclusa*) and other *Loxosceles* species ([160](#), [161](#)). In the northwestern United States, a similar picture follows the bite of the hobo spider, *Tegenaria agrestis* ([162](#), [163](#) and [164](#)).

The initially painless *Loxosceles* bite develops into a painful, edematous, necrotic lesion that may progress to an extensive, slowly healing, gangrenous process, necrotic arachnidism ([161](#), [165](#), [166](#)). In a few patients, systemic manifestations, including intravascular hemolytic anemia, develop within several hours to 5 days later.

Hemoglobinuria and severe anemia are characteristic findings; spherocytes, basophilic stippling, and leukocytosis are found in the blood. Thrombocytopenia also has been observed, sometimes associated with diffuse intravascular coagulation ( [167](#) ). In some cases, RBCs are coated with complement and the results of the direct antiglobulin test are positive ( [166](#) , [168](#) ). Most often, the hemolytic episode subsides spontaneously in approximately 1 week, but occasionally severe reactions occur with renal failure and death.

Pathogenesis of this syndrome is beginning to be understood. The venom primarily attacks endothelium and secondarily activates granulocytes with adhesion and discharge of their granular contents ( [169](#) ). Granulocytes are required for the necrotic process to ensue. The spider venom also causes complement-dependent intravascular hemolysis associated with cleavage of glycophorin from the RBC membrane ( [165](#) , [168](#) , [170](#) ). These events occur because *Loxosceles* venom contains sphingomyelinase activity that activates a membrane-bound metalloproteinase ( [171](#) , [172](#) and [173](#) ).

Treatment is largely supportive. An antivenom to *Loxosceles* toxin has been produced, but is not commercially available ( [166](#) ).

## Snakebites

Snakebites are a significant health problem worldwide, especially in parts of Asia where thousands of people die annually ( [174](#) ). The composition of snake venom varies considerably between species, between the same species living in different geographic locations, and in the same snake at different times of the year. Most venoms contain a mixture of active ingredients ( [175](#) , [176](#) ). The problems resulting from snake venoms include neurotoxicity, myotoxicity, renal failure, edema, bleeding due to activation of clotting proteins, and intravascular hemolysis. Hemolysis is seen after envenomation with most poisonous snakes including cobras ( [177](#) , [178](#) ), Australian king brown snakes ( [179](#) ), the Tunisian saw-scaled (carpet) viper ( [180](#) ), U.S. rattlesnakes ( [181](#) ), habu snakes ( [182](#) ), and most significantly in the several species of Russell viper ( *Daboia russelli* ) found throughout India and the rest of Asia ( [174](#) , [175](#) and [176](#) , [183](#) ). Much of the information regarding the pathophysiology of envenomation comes from studies of the Russell viper in Asia ( [176](#) ).

The clinical presentation of intravascular hemolysis from snakebites can be acute and fulminant, associated with few clinical or laboratory findings, or the effects can be delayed for a few hours to days. Hemoglobinemia and hemoglobinuria are present, the severity of which varies with the degree of envenomation and species of snake. The main venom component responsible for hemolysis is thought to be phospholipase A<sub>2</sub>, which has direct toxicity for many tissues including the RBC membrane ( [176](#) , [184](#) ). Venom from the habu snake has additional actions in that it activates complement and cleaves CD55 and CD59 from the RBC membrane, thus leaving the RBC susceptible to complement-induced lysis ( [182](#) ).

## Bee Stings

Africanized honeybees ( *Apis mellifera* ) are a problem in Brazil ( [185](#) ), where these bees were accidentally released 40 years ago. However, they also are now appearing as far north as the southwestern United States ( [186](#) ). These bees are aggressive, and their

attacks are usually massive ( [187](#) ).

The effects of bee stings can be immediate or delayed. “Immediate” reactions are related to anaphylaxis. “Delayed” reactions refer to patients who are asymptomatic after massive bee envenomation, but 12 to 24 hours later, have evidence of hemolysis, DIC, thrombocytopenia, rhabdomyolysis, liver dysfunction, or renal failure ( [186](#) , [188](#) ). The delayed effects are related to the degree of envenomation, and it is thought that problems in an adult occur after 100 to 500 stings, whereas as few as 30 to 50 stings can be problematic in a child ( [189](#) ). In one instance, a 3-year-old child stung 200 to 300 times by honeybees died after the development of intravascular hemolysis and oliguric renal failure ( [190](#) ). The venom contains melittin and phospholipase A<sub>2</sub>, which together disrupt the RBC membrane and cause hemolysis ( [187](#) ). Hemolytic reactions to bee stings appear to be rare. Renal failure is a much more significant problem than hemolytic anemia.

## HEMOLYSIS DUE TO THERMAL INJURY

### Burns

Acute hemolytic anemia has been observed after extensive thermal burns ( [191](#) , [192](#) and [193](#) ). Signs of intravascular hemolysis are associated with schistocytes, spherocytes, and echinocytes in the blood, along with increased osmotic and mechanical fragility of the erythrocytes ( [192](#) , [194](#) ). The severity of the reaction is related to the area of body surface affected. In one series, hemoglobinuria was found in 11 of 14 patients who were moderately to severely burned, with more than 15% of the body surface involved in most cases ( [192](#) ). In another series, hemolysis was apparent in patients with third-degree burns affecting more than 20% of the body surface ( [195](#) ).

Hemolysis occurs during the first 24 to 48 hours after the burn ( [194](#) ), and as much as 30% of the circulating RBC mass may be destroyed in this 2-day period ( [196](#) ). After the acute hemolytic episode, anemia develops and may last for many weeks ( [191](#) ), although signs of hemolysis disappear. This later stage of the anemia of thermal injury is probably a form of the anemia of chronic disease (see [Chapter 47](#)) ( [197](#) , [198](#) and [199](#) ).

The acute hemolytic reaction in burned patients results from the direct effects of heat on erythrocytes. When RBCs are heated to temperatures greater than 47° C, irreversible morphologic and functional abnormalities occur, the severity of which is related to the temperature and the duration of exposure ( [200](#) , [201](#) ). The major alterations are fragmentation of the cells and the development of spherocytes, accompanied by an increase in osmotic and mechanical fragility. These changes result from irreversible denaturation of the cytoskeletal protein spectrin ( [202](#) , [203](#) and [204](#) ). Mildly heat-damaged erythrocytes are removed predominantly by the spleen, and with greater degrees of damage, the RBCs also are destroyed in the liver ( [201](#) , [205](#) ).

### Heated Fluids and Blood

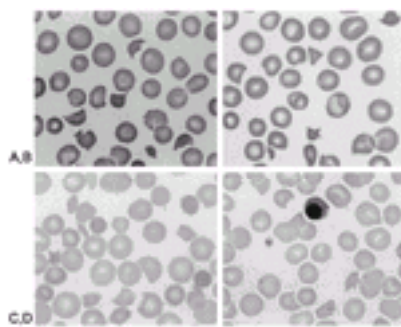
Overheating of biologic fluids is another clinical circumstance resulting in thermal RBC damage. One reported example of this was the overheating of dialysis solution due to failure of thermostatic controls on the hemodialysis equipment ( [206](#) ). It also is recognized that direct microwave warming of blood before transfusion can damage RBCs and cause hemolytic anemia after infusion ( [207](#) , [208](#) , [209](#) and [210](#) ). Similarly, the heating of intravenous

tubing has resulted in hemolysis ( 211 ). In one interesting report, intravascular hemolysis was noted in a child after two separate RBC transfusions. In both cases, the hemolysis occurred after the patient's mother had warmed a wet towel in a microwave oven for the purpose of decreasing the painful cold sensation of the blood transfusion ( 212 ).

It is noteworthy that the current use of U.S. Food and Drug Administration–approved inline blood warmers equipped with thermometers and alarms, and close adherence to the manufacturer's specific directions, should provide a safety level that prevents the accidental overheating of blood.

## FRAGMENTATION HEMOLYSIS

When RBCs are subjected to excessive physical trauma, they may undergo premature fragmentation and intravascular hemolysis, thereby resulting in hemoglobinemia, hemoglobinuria, and hemosiderinuria. The hallmark of this type of hemolysis is the fragmented RBC or schistocyte, and these cells take the form of crescents, helmets, triangles, and/or microspherocytes ( Fig. 38.5 ). Hemolytic anemias resulting from RBC fragmentation are associated with abnormalities of the heart and great vessels, diseases of small vessels, DIC, and hypertension ( Table 38.3 ). In most of these conditions hemolysis is one of many clinical findings, although not usually the major problem.



**Figure 38.5.** Schistocytes in patients with thrombotic thrombocytopenic purpura (A), disseminated intravascular coagulation (B), aortic valve replacement (C), and hemolytic uremic syndrome (D). See [Color Plate](#).

**TABLE 38.3. Causes of Red Cell Fragmentation**

|   |
|---|
| Associated with abnormalities of the heart and great vessels            |
| Synthetic valvular prostheses   |
| Valve homografts  |
| Valve xenografts and xenobioprosthesis                                  |
| Autograft valvoplasties   |
| Ruptured chordae tendineae  |
| Intracardiac patch repairs  |
| Unoperated valve disease (especially aortic stenosis)                   |
| Coarctation of the aorta  |
| Associated with small vessel disease: microangiopathic hemolytic anemia |
| TTP   |
| HUS   |
| HUS– /TTP–related disorders   |

- Disseminated carcinoma
- Chemotherapy/drugs
- Transplant-associated microangiopathy
- Pregnancy and postpartum period
  - HELLP syndrome
  - TTP/HUS
- Malignant hypertension
- Disseminated intravascular coagulation
- Immune mechanisms
  - Lupus erythematosus
  - Acute glomerulonephritis
  - Scleroderma
  - Wegener granulomatosis
- Hemangiomas
  - Giant hemangioma (Kasabach–Merritt syndrome)
  - Hemangioendothelioma of the liver
  - Plexiform lesions in pulmonary hypertension
- March hemoglobinuria

HELLP, hemolysis (*H*), elevated liver (*EL*) enzymes, and low platelet (*LP*) counts; HUS, hemolytic uremic syndrome; TTP, thrombotic thrombocytopenic purpura.

---

## Cardiac and Large Vessel Abnormalities

**ETIOLOGY** Soon after the advent of open-heart surgery it became apparent that the postoperative course of some patients was complicated by the development of anemia of varying severity. The discovery of fragmented RBCs as a characteristic feature of this type of anemia was made in 1961, when Sayed et al. described these morphologic alterations in a patient who developed severe and persistent intravascular hemolysis after repair of an ostium primum defect with Teflon ( [213](#) ). It now is well recognized that fragmented erythrocytes with intravascular hemolysis are commonly associated with a wide variety of structural defects of the heart or great vessels ( [Table 38.3](#) ). Surgically inserted prosthetic devices furnish the most striking examples of RBC fragmentation. These devices include valves of the ball-and-basket variety ( [214](#), [215](#), [216](#) and [217](#) ), disk-type prostheses ( [218](#) ), Teflon leaflets, and synthetic valves made of Dacron cloth impregnated with rubber ( [219](#) ), as well as valve homografts ( [215](#) ) and autograft valvoplasties ( [220](#), [221](#) ). Most of the valve prostheses associated with hemolytic disease are of the aortic variety ( [214](#), [219](#), [220](#), [222](#) ), but cases of hemolysis caused by mitral valve replacement ( [216](#), [217](#), [223](#), [224](#), [225](#), [226](#) and [227](#) ), unsuccessful mitral valvoplasties ( [228](#), [229](#) ), and repair of ruptured chordae tendinae ( [230](#) ) also have been reported. The use of bioprosthesis has reduced the risk of hemolysis greatly, although RBC fragmentation still occurs after the insertion of porcine xenografts or bioprosthesis constructed from bovine tissues ( [224](#), [231](#), [232](#), [233](#), [234](#), [235](#) and [236](#) ). In these patients, hemolysis usually is associated with a paravalvular leak ( [232](#) ), a torn cusp ( [233](#) ), or other manifestations of valvular dysfunction ( [231](#) ), including infective endocarditis or calcification ( [237](#) ). Intracardiac patch repairs of various types also may lead to intravascular hemolysis ( [213](#), [238](#), [239](#) ); typical cases involve patients with Teflon patches used in the repair of ostium primum defects. Last, although RBC fragmentation is associated most strikingly with intracardiac surgical procedures, intravascular hemolysis occurs in many patients with valvular heart disease

who have not had surgery ( [240](#), [241](#), [242](#) and [243](#) ). Most often, this RBC fragmentation is noted in patients suffering from severe aortic valve disease, especially aortic stenosis; occasionally, however, patients with mitral valve involvement are affected. Intravascular hemolysis also has been reported in patients with a ruptured aneurysm of the sinus of Valsalva ( [244](#) ), coarctation of the aorta ( [245](#), [246](#) ), coarctation with a bicuspid aortic valve ( [246](#) ), and a ventricular septal defect in conjunction with a patent ductus arteriosus ( [247](#) ). The hemolysis accompanying valvular heart disease that has not been treated surgically is usually minor and rarely severe.

**INCIDENCE** Clinically significant hemolytic disease is reported in 5 to 25% of patients with various types of valvular prostheses ( [214](#), [221](#), [248](#) ), usually involving replacement of defective aortic valves, and in approximately 5% of patients with Teflon repairs of ostium primum defects ( [190](#) ). The incidence of clinically detectable hemolysis in patients with mitral valve prostheses is considerably lower. When more sensitive techniques are used to detect RBC destruction, such as RBC survival studies ( [240](#), [242](#), [249](#) ), or haptoglobin levels ( [243](#), [250](#), [251](#) and [252](#) ), most patients with aortic valvular prostheses have evidence of mild intravascular hemolysis ( [221](#), [240](#), [242](#), [249](#), [252](#) ). The incidence of intravascular hemolysis in patients with aortic valve disease who have not undergone surgical treatment ranges from 5% to more than 60% when patients are studied with erythrocyte <sup>51</sup>Cr survival techniques ( [221](#), [240](#), [242](#), [249](#), [252](#), [253](#) ) or by assessing haptoglobin levels ( [243](#), [252](#) ). Undoubtedly, the severity of the valvular disease is an important variable.

**PATHOGENESIS** Several mechanisms may account for the intravascular nature of the hemolysis and the appearance of the characteristic fragmented cells. Direct mechanical trauma, for instance by the closure of prosthetic valves, has been postulated; it is known also to occur in other conditions, such as march hemoglobinuria ( [254](#) ). However, it is unlikely that valve closure itself is responsible for RBC fragmentation because many patients with prosthetic valves do not have clinically significant hemolysis. It also is unlikely that the presence of prosthetic materials per se contributes to RBC fragmentation ( [214](#), [255](#) ), although Teflon that is not covered by endothelium ( [213](#), [239](#) ) has been found at reoperation in some patients. In all likelihood, therefore, hemolysis and the lack of endothelialization depend on the presence of a third factor, such as turbulence. The most common feature in recorded cases of hemolysis occurring after the insertion of prosthetic devices is the existence of some form of hemodynamic defect, such as regurgitation through or around valvular prostheses ( [214](#), [226](#), [232](#) ) or mitral insufficiency after Teflon patch repair of atrioventricular canal defects ( [238](#) ). Extreme turbulence is a common factor in all of these patients, and can easily generate shearing stress greater than 3000 dynes/cm<sup>2</sup> ( [217](#), [256](#), [257](#) ), leading to mechanical hemolysis *in vitro* ( [258](#) ) and *in vivo*, such as in the presence of regurgitant defects between the aorta and the left ventricle, when the lumen of the aortic prosthesis is small relative to the stroke volume or when the ball of a ball valve is large relative to the diameter of the aorta. A positive direct antiglobulin test is observed occasionally in patients with prosthetic valves ( [259](#), [260](#) and [261](#) ) and also in patients with severe aortic valve disease in the absence of surgical intervention ( [262](#) ). It is possible that mechanical damage may expose subsurface antigens, which then elicit the production of autoantibodies.

**CLINICAL MANIFESTATIONS** No distinctive clinical features are noted, with the exception of those related to preexistent heart disease or cardiac surgery. The development of hemolysis sometimes coincides with severe deterioration of cardiac function because of the tear of a valve cusp or the loosening of valve attachments. When the hemolysis is clinically significant, jaundice often is obvious, but hemoglobinuria may not be detectable by the naked eye.

**LABORATORY FINDINGS** The blood findings of these patients vary widely, depending on the severity of hemolytic process. The hemoglobin level may be normal if hemolysis is compensated, or it may be extremely low. Most cells are normocytic and normochromic, but there also are variable numbers of fragmented erythrocytes, and these are identical



to the schistocytes seen in patients with microangiopathic hemolytic anemia ( [Fig. 38.5](#)). The number of fragmented cells apparent in the blood smear directly reflects the severity of the hemolytic process ( [263](#)). In patients with long-standing hemolysis iron stores may be depleted because of hemoglobinuria and hemosiderinuria, and the RBCs may appear hypochromic due to iron deficiency. Hemosiderinuria is present in many patients when hemoglobinuria is not detectable. The serum bilirubin level is slightly or moderately raised. Serum haptoglobin is reduced or absent. Lactate dehydrogenase levels, especially isoenzyme LDH1, usually are elevated. The reaction to the antiglobulin test is usually, but not always, negative.

**TREATMENT** A marked degree of anemia and elevation of lactate dehydrogenase isoenzymes often indicate wear or malfunction of a valvular prosthesis ( [216](#), [263](#) ), and under these circumstances, prompt surgical intervention and valve replacement are usually indicated. Only occasionally does the condition causing hemolysis improve spontaneously ( [220](#)). Because the severity of the hemolytic process increases with physical activity ( [264](#) ), bed rest is mandatory during acute exacerbations. When iron deficiency has developed because of prolonged hemosiderinuria, iron therapy is indicated. Erythropoietin has been used as a substitute for blood transfusion ( [265](#) ).

### Small Vessel Disease (Microangiopathic Hemolytic Anemia)

In 1952, Symmers introduced the term *microangiopathic hemolytic anemia* to describe a clinical syndrome now commonly called *thrombotic thrombocytopenic purpura* (TTP) ( [266](#) ). Brain, Dacie, and Hourihane subsequently popularized the term ( [267](#) ), and it is now used to designate any hemolytic anemia related to RBC fragmentation occurring in association with small vessel disease ( [Table 38.2](#)). The term *thrombotic microangiopathy* also is used to describe syndromes characterized by hemolytic anemia with RBC fragmentation, thrombocytopenia, and thrombotic lesions in small blood vessels ( [268](#) ).

TTP and HUS are similar disorders included in this category. They share many laboratory and clinical features, and the clinical distinction between TTP and HUS is not always clear. In addition, there are also TTP-/HUS-related conditions seen with pregnancy, cancer, drug therapy, tissue transplantation, and other disorders ( [Table 38.3](#) ).

### Thrombotic Thrombocytopenic Purpura

TTP, also known as *Moschcowitz disease*, is an uncommon but serious disorder of young adults characterized by hemolytic anemia secondary to RBC fragmentation; thrombocytopenia; and evidence of central nervous system dysfunction, renal failure, and fever. This disorder is discussed in detail elsewhere in this text (see [Chapter 54](#)). Most laboratory and clinical manifestations are attributable directly to microvascular thrombotic lesions that characterize this disease.

The pathophysiology of TTP is related to the interaction of von Willebrand factor (vWF), platelets and endothelial cells. vWF multimers are produced within megakaryocytes and endothelial cells and stored within the  $\alpha$ -granules of platelets and the Weibel-Palade bodies of endothelial cells (see [Chapter 19](#) and [Chapter 22](#)). The intracellular forms of vWF are much larger than the normal vWF multimers in plasma, and they are referred to as *ultra-large vWF* (ULvWF) *multimers*. These ULvWF multimers in endothelial cells are secreted to the subendothelium and to the vascular lumen. The ULvWF forms that reach the subendothelium become part of a matrix that can cause aggregation of platelets when the endothelial barrier is disrupted and the matrix is exposed to flowing blood. In contrast, the ULvWF multimers secreted into the lumen are cleaved into smaller forms before release into the plasma. This is accomplished on the endothelial cell surface by a metalloproteinase enzyme known as ADAMTS 13 ( *A* disintegrin and metalloproteinase



with thrombospondin-1-like domains) ( [269](#) , [270](#) ). ADAMTS 13 is made in hepatocytes, and its regulatory gene is located on chromosome 9q34 ( [271](#) , [272](#) ).

An important physical property of ULvWF multimers is a high binding affinity for platelet gpIb-IX and gpIIb-IIIa complexes ( [273](#) ). Under conditions in which ULvWF multimers are exposed to blood, this affinity for platelets can lead to platelet activation and formation of platelet thrombi. In TTP, there is decreased metalloproteinase activity with impaired cleavage of ULvWF multimers as they are secreted by endothelial cells ( [272](#) , [274](#) , [275](#) ). As a consequence of this, the uncleaved ULvWF multimers on the endothelial surface cause adhesion of platelets, further platelet aggregation, and formation of microvascular thrombi in many organs. Characteristically these thrombi contain platelet aggregates and vWF antigen, with little or no fibrin or evidence of endothelial cell damage ( [276](#) ). The reduced metalloproteinase activity can occur as an acquired abnormality due to inhibitors or autoantibodies against the enzyme ( [277](#) ). Alternatively, it can occur as an inherited disease due to mutations of the ADAMTS gene ( [278](#) ). (See [Chapter 54](#) for a more extensive discussion.)

The microangiopathic hemolytic anemia in TTP presumably is a consequence of RBCs flowing in turbulent parts of the microcirculation that are partially occluded by platelet-rich thrombi. The serum lactic dehydrogenase level is markedly elevated, a consequence of tissue necrosis, not necessarily RBC destruction ( [279](#) ).

## Hemolytic Uremic Syndrome

The term *hemolytic uremic syndrome* (HUS) was first used by Gasser et al. in 1955 to describe the association of acute intravascular hemolytic anemia and renal failure in infants and young children ( [280](#) ). Since then, several thousand patients have been reported, and the clinical features of the disease and its pathogenesis are now well established ( [275](#) , [281](#) , [282](#) , [283](#) , [284](#) , [285](#) , [286](#) , and [287](#) ). The defining features of HUS are renal microangiopathy involving small arterioles and glomerular capillaries, microangiopathic hemolytic anemia, and platelet destruction leading to variable degrees of thrombocytopenia. HUS has been classified as epidemic (prodromal) or sporadic (nonprodromal, also called *atypical HUS*). The epidemic form of HUS is most common and is associated by an enteritis prodrome, whereas the sporadic form of HUS is not preceded by enteritis ( [288](#) , [289](#) ). The sporadic form of HUS is not common in children. It has a worse prognosis, is more likely to relapse, and may be associated with a family history of HUS. It has been associated with a variety of drugs, cancer, and transplantation (see later).

Epidemic HUS occurs predominantly in otherwise healthy children younger than 5 years. It is preceded by bloody diarrhea caused by various *E. coli* serotypes or *Shigella dysenteriae* serotype I ( [288](#) , [289](#) ). The offending organisms share the capacity to produce similar forms of powerful exotoxins, the prototype of which is the Shiga toxin (Stx) produced by *S. dysenteriae* and encoded in its DNA ( [285](#) , [290](#) ). Because of the effect of these toxins on kidney Vero cell lines, these toxins are also called *verotoxins* and the pathogenic O157:H7 coliforms are called verotoxin-producing *E. coli* (VTEC) ( [284](#) ).

Enterohemorrhagic *E. coli* has a bovine reservoir and generally is transmitted by undercooked meat, unpasteurized milk, or food and water contaminated by bovine feces ( [286](#) , [291](#) , [292](#) ). Epidemic HUS occurs predominantly in the first 2 years of life ( [293](#) , [294](#) ), with a marked decline thereafter; only occasionally does the disease affect older teenagers or young adults. Infections caused by *S. dysenteriae* and other organisms presumably

account for the epidemics of HUS described in Argentina ( [295](#) ) and elsewhere ( [282](#) , [296](#) ).

**PATHOGENESIS** The central feature of HUS is vascular endothelial damage in the glomerular capillaries, renal arterioles, and, to a lesser extent, other vessels ( [285](#) , [297](#) ). This injury is known to be a direct consequence of Stx ( [298](#) ). Stx and Shiga-like toxins consist of a single 32-kd catalytic A subunit and five 7.7-kd B binding subunits ( [284](#) , [285](#) , [299](#) ). The B subunit binds with high affinity to a glycosphingolipid on cell membranes, globotriosyl ceramide (Gb3), which functions as the predominant membrane receptor for Stx on endothelial and other target cells ( [285](#) , [299](#) ). Once Stx is bound to the cell, the A subunit is internalized by endocytosis and, after proteolysis, a smaller fragment binds to 60S ribosomal subunits ( [284](#) , [285](#) ) and inhibits protein synthesis, and cell death ensues ( [285](#) , [296](#) , [299](#) ). In epidemic HUS, enteropathogenic bacteria enter intestinal mucosa cells and the Stx damage the underlying tissue and vasculature, thereby causing bloody diarrhea. Stx next enter the bloodstream, where they directly bind and activate platelets ( [300](#) ). They also bind to neutrophils, monocytes, and the RBC P<sub>1</sub> antigen ( [301](#) ), and travel to targets in the glomerular endothelial cells, mesangial cells, and glomerular and tubular epithelial cells ( [285](#) , [296](#) , [299](#) ). In conjunction with various cytokines Stx injure and kill renal glomerular and tubular epithelial cells ( [275](#) ). Stx-induced endothelial cell injury leads to increased expression of ULvWF multimers on the luminal surface. As a result, platelets are activated and thrombi form on the endothelial surface ( [275](#) ). In contrast to TTP, ADAMTS 13 activity is not decreased in HUS ( [302](#) , [303](#) and [304](#) ). The Stx-induced death of endothelial cells also exposes subendothelial matrix, leading to further platelet aggregation. Moreover, in HUS there is activation of clotting and fibrinolysis as evidenced by increased levels of thrombin activation markers (e.g., thrombin-antithrombin complexes, prothrombin fragment 1+2) and increased D-dimer levels ( [305](#) , [306](#) and [307](#) ). In contrast to TTP, the thrombi in HUS contain mainly platelets and fibrin with much less vWF ( [304](#) ). Capillary and arteriolar lumina are narrowed by swollen endothelial cells, thrombi, and the effect of vasoactive substances released by platelets and endothelial cells ( [299](#) ). All of the aforementioned factors contribute to impaired renal function ( [299](#) ). The anemia in HUS is mainly attributed to RBC damage by fibrin and platelets deposited on the damaged endothelium, with the subsequent sequestration of damaged cells within the spleen and the liver ( [308](#) , [309](#) and [310](#) ).

**CLINICAL MANIFESTATIONS** The most common antecedent symptoms include vomiting and bloody diarrhea. The onset of hemolysis and renal failure may be dramatic, with sudden pallor, abdominal pain, vomiting, and the appearance of dark-red or nearly black urine. These manifestations quickly give way to oliguria and, in many patients, total anuria. Neurologic manifestations may include drowsiness, convulsions, and transient pareses ( [311](#) , [312](#) and [313](#) ). The presence of these neurologic signs is what sometimes confuses the clinical presentations of TTP and HUS. Sporadic forms of HUS may occur in children and adults and account for 5 to 10% of all cases ( [314](#) ). In contrast to the classic epidemic form, sporadically affected children tend not to have VTEC infections, and their family contacts have no concurrent illness ( [314](#) ). A majority of these patients need dialysis, and the morbidity and mortality rate at 1 year is very high ( [314](#) , [315](#) , [316](#) and [317](#) ). Sporadic forms of HUS in adults are also associated with a poor prognosis unless the disease trigger is transient, as occurs in enterohemorrhagic *E. coli* infections ( [318](#) ).

**LABORATORY FINDINGS** The anemia often is severe and may be accompanied by moderate polymorphonuclear leukocytosis. The blood smear findings are distinctive: many fragmented erythrocytes, burr cells, some microspherocytes, and a number of polychromatophilic cells representing reticulocytes. The direct and indirect antiglobulin tests usually are negative. Thrombocytopenia may be severe, but is not a constant finding. Hemoglobinemia may be marked and correlates with the degree of anemia and the

severity of the morphologic changes. Serum haptoglobin levels are low or absent. The bilirubin levels usually are mildly elevated, but rarely exceed 2 to 3 mg/dl. The blood urea nitrogen and serum creatinine levels may be high. The urine usually contains hemoglobin and hemosiderin in addition to large quantities of other proteins, especially albumin. Microscopically, RBCs, white cells, and casts are seen. The prothrombin time and partial thromboplastin time usually are normal or minimally prolonged; fibrin breakdown products may be elevated and D-dimers present ( [319](#), [320](#), and [321](#) ). Overall, both coagulation and fibrinolysis are activated in HUS ( [305](#), [306](#), and [307](#) ). It is estimated that approximately 90% of North American and European children with HUS have some evidence of VTEC infection, and that the serotype O157:H7 can be demonstrated in many cases by culture and/or the detection of free verotoxin in the feces ( [284](#), [322](#), [323](#) ). In addition, IgM antibodies against the O157 lipopolysaccharide sometimes are present ( [322](#) ).

**TREATMENT AND PROGNOSIS** Children with anuria of less than 24 hours' duration usually require only careful monitoring of fluid and electrolyte balance, control of blood pressure, and correction of acidosis ( [282](#), [324](#) ). Unless anemia is severe, transfusion of packed RBCs should be given sparingly to prevent volume overload. When children are more severely affected, peritoneal dialysis or hemodialysis may be required; the usual indications include fluid overload unresponsive to diuretics, a rapidly rising creatinine value, anuria for more than 24 hours, severe electrolyte imbalance, and serious clinical signs of uremia, such as seizures ( [324](#) ). Early and careful management of the acute renal failure, control of hypertension, and the judicious use of packed RBC transfusions appears to constitute the safest and most effective approach to the management of HUS in children ( [297](#) ). Platelet transfusions rarely are needed because bleeding manifestations are uncommon, and theoretically platelet transfusions could make the disease worse by accelerating thrombus formation. There are no good data to support the use of heparin, antiplatelet drugs, corticosteroids, or intravenous immunoglobulin. Currently, the overall mortality in children with epidemic HUS is 3 to 5% ( [283](#), [325](#), [326](#), and [327](#) ). It is the most common cause of acute renal failure in U.S. children ( [327](#) ). Approximately 50% of children require dialysis, and 5% of surviving children have long-term renal impairment ( [328](#) ). In adults, the management plan is similar to that proposed for children. However, because of the excellent results achieved in the treatment of TTP, therapy with fresh frozen plasma or plasmapheresis is recommended by some ( [329](#), [330](#), [331](#), and [332](#) ). Platelet transfusions, on the other hand, may have an adverse effect on the patient's clinical course ( [333](#) ). Renal impairment often is more severe in adults than in children.

### Thrombotic Microangiopathy Due to Other Disorders

Patients with thrombotic microangiopathy (i.e., sporadic or atypical HUS) caused by other diseases such as cancer, the use of cytotoxic agents, autoimmune disorders, or immune deficiency disorders, and patients who have had bone marrow transplantation (BMT) tend to do poorly ( [318](#), [334](#) ).

**DISSEMINATED CARCINOMA** A microangiopathic hemolytic anemia occasionally is observed in patients with disseminated malignant disease ( [335](#), [336](#) ). The onset of hemolysis may be abrupt and severe, often requiring several units of transfused blood daily to maintain a safe hemoglobin level ( [335](#) ). Reticulocytosis is almost always present, but may be less than expected because of associated marrow suppression from myelophthisis or chronic disease ( [337](#) ). Thrombocytopenia is usually present ( [335](#), [338](#) ), and in many cases, patients also have documented laboratory evidence of DIC. Most, but not all, tumors are adenocarcinomas, with gastric cancer being the most common ( [309](#), [336](#), [339](#), [340](#) ). A most striking finding is the extensive involvement of blood vessels, especially within the pulmonary bed ( [309](#), [335](#), [337](#) ). It has been proposed that the intimal proliferation

in these vessels elevates pulmonary arterial pressure sufficiently to magnify the shearing force on RBCs and platelets passing through these abnormal pulmonary vessels, thereby producing fragmentation ( 335 ). The RBC fragmentation in cancer patients often is attributed to RBC shearing on fibrin strands produced by intravascular coagulation ( 309 , 335 ); however, microangiopathic hemolysis can occur in the absence of DIC ( 335 , 337 ). In some patients with microangiopathic hemolysis and cancer there is evidence of ULvWF multimers in plasma, along with decreased metalloproteinase activity ( 341 ). However, in other similar patients with microangiopathic hemolysis and cancer there is no evidence of ADAMTS 13 deficiency ( 209 ). Once microangiopathic hemolysis is seen, the overall prognosis is poor, with observed survival periods of only a few weeks ( 335 , 342 ).

**CHEMOTHERAPY-INDUCED DISEASE** An HUS/TTP syndrome less commonly may follow treatment with certain antineoplastic agents and other drugs. In one review, most were attributed to mitomycin C use, often given in combination with other drugs such as doxorubicin and 5-fluorouracil ( 338 , 343 , 344 and 345 ). Tamoxifen, given in conjunction with mitomycin, also has been shown to increase significantly the risk of developing thrombotic microangiopathy ( 346 ). Less commonly, the syndrome is observed with other drugs: carboplatin ( 347 , 348 ), occasionally after daunorubicin in combination with cytosine arabinoside ( 348 ), and 1-(2-chlorethyl)-3-(4-methylcyclohexyl)-1-nitrosourea ( 349 ). Immunosuppressive drugs such as tacrolimus (FK506) ( 350 , 351 ) and cyclosporine A (CsA) ( 352 , 353 and 354 ) have been associated with microangiopathic hemolysis. A similar clinical picture also was noted in two people with chronic myelogenous leukemia receiving interferon- $\alpha$  ( 355 ). The syndrome described here is characterized by microangiopathic hemolytic anemia, thrombocytopenia, renal failure, and hypertension ( 338 ). Severe dyspnea and hypoxemia caused by noncardiogenic pulmonary edema is considered characteristic of chemotherapy-related HUS ( 342 ). These complications, as well as the hypertension, can be aggravated by administered blood transfusions. Most patients with cancer who develop this syndrome are in clinical remission ( 338 ) or have recently experienced significant regression of their tumors in response to chemotherapy ( 356 ). It is postulated that the primary pathogenetic mechanism involves direct drug-induced damage to the renal endothelium, with subsequent activation of the clotting system at sites of injury and the ultimate deposition of fibrin ( 338 , 357 ). The onset of microangiopathy usually occurs a few weeks after the last dose of chemotherapy, the median time being 12 months from the beginning of therapy. The laboratory findings are typical of moderate microangiopathic hemolytic anemia, with evidence of intravascular hemolysis, schistocytes on the peripheral blood smear, moderate reticulocytosis, and decreased plasma haptoglobin levels. Generally, there is no evidence of DIC; the serum creatinine level is usually elevated; and urinalysis reveals hematuria, proteinuria, and occasional hyaline or granular casts ( 338 ). The prognosis in patients with chemotherapy-related HUS is poor; approximately 70% of patients succumb to the complications of the syndrome within a few weeks of onset ( 358 ). Deaths that occur early in the disease course usually are related to renal or pulmonary failure ( 338 ). Among patients who survive for a longer period, the hemolytic process and thrombocytopenia may abate, but the renal failure usually persists ( 355 ). A few patients experience complete recovery without relapse ( 338 , 355 , 359 , 360 ). Plasmapheresis reportedly improves the hematologic abnormalities, but has little if any effect on renal failure in most cases ( 361 ).

**TRANSPLANT-ASSOCIATED MICROANGIOPATHY** A thrombotic microangiopathy syndrome similar to that associated with HUS/TTP has been shown to occur in recipients of solid organ ( 268 , 362 ) and bone marrow transplants ( 363 , 364 and 365 ), both autologous and allogeneic. Analysis of 96 patients who developed HUS or TTP after BMT identified a number of factors that appeared to be associated with the appearance of thrombotic microangiopathy: 91% of patients had received total body irradiation, and nearly all had

received cyclophosphamide ( 363 ), although the latter is common to most transplant programs and the significance of its contribution to the development of the syndrome is therefore unclear. CsA appeared to have an exacerbating effect, and a reduction in the dose of this drug often led to the resolution of the syndrome ( 363 ). Clinically, a fulminant, rapidly fatal disease, severe renal impairment, seizures, and significant microangiopathic hemolytic anemia and thrombocytopenia may develop ( 365 ). Graft-versus-host disease, infection, and intensive pretransplant conditioning may be aggravating factors. In some patients, CsA may precipitate microangiopathic hemolytic anemia with nephrotoxicity ( 366 , 367 ) or microangiopathic hemolytic anemia with neurotoxicity similar to that described in association with TTP ( 365 ). Microthrombi are found, especially in the kidney. The fulminant, multifactorial form of the transplant-associated disease is difficult to treat with measures usually applied to patients with TTP, including plasma exchange ( 365 , 368 ). Antiplatelet drugs and heparin are of no benefit ( 365 ). Plasma exchange may be of benefit in some patients with conditioning-associated HUS. Cyclosporin-associated nephrotoxicity and neurotoxicity usually respond to a reduction or cessation of CsA therapy ( 365 ).

### Hemolysis and Thrombotic Microangiopathy Associated with Pregnancy

Three major microangiopathic disorders associated with pregnancy are the HELLP syndrome [hemolysis (*H*), elevated liver (*EL*) enzymes, and low platelet (*LP*) counts], TTP of pregnancy, and postpartum HUS ( Table 38.4 ). It is necessary to distinguish these disorders because they have different prognoses and treatments. TTP and HUS occur much less frequently than HELLP.

**TABLE 38.4. Major Clinical Characteristics of HELLP Syndrome, TTP, and HUS**

| Clinical Features            | HELLP Syndrome       | TTP           | HUS        |
|------------------------------|----------------------|---------------|------------|
| Target organ/system involved | Liver                | Neurologic    | Renal      |
| Gestational age              | 2nd to 3rd trimester | 2nd trimester | Postpartum |
| Platelets                    | Decreased            | Decreased     | Decreased  |
| PT/PTT                       | Normal               | Normal        | Normal     |
| Hemolysis                    | Present              | Present       | Present    |
| Fibrinogen                   | Normal               | Normal        | Normal     |
| Creatinine                   | Normal/increased     | Increased     | Increased  |
| Liver enzymes                | Increased            | Normal        | Normal     |

HELLP, hemolysis (*H*), elevated liver (*EL*) enzymes, and low platelet (*LP*) counts; HUS, hemolytic uremic syndrome; PT, prothrombin time; PTT, partial thromboplastin time; TTP, thrombotic thrombocytopenic purpura.

Modified from Saphier CJ, Repke JT. Hemolysis, elevated liver enzymes, and low platelets (HELLP) syndrome: a review of diagnosis and management. *Semin Peri-natol* 1998;22(2):118–133.

**HELLP SYNDROME** Preeclampsia is characterized by gestational hypertension and proteinuria or pathologic edema; eclampsia is complicated by the additional occurrence of seizures ( 369 , 370 ). Preeclampsia and eclampsia are systemic diseases involving the kidney, liver, heart, and central nervous system ( 370 ). Hematologic complications have been recognized for some time and include microangiopathic hemolytic anemia with



characteristic fragmented RBCs in the peripheral blood, thrombocytopenia, and well-defined abnormalities of the coagulation system ( 370 ). This subset of patients with severe preeclampsia/eclampsia are considered to have HELLP syndrome, characterized by hemolysis (*H*), elevated liver (*EL*) enzymes, and low platelet (*LP*) counts ( 300 , 369 , 371 , 372 , 373 , 374 , 375 , 376 and 377 ). It is thought that RBC fragmentation and thrombocytopenia associated with HELLP are a result of a number of interrelated, largely mechanical factors, including endothelial damage, vasoconstriction coupled with hypertension, and the deposition of fibrin in injured vessels. Women with preeclampsia can have evidence of chronic intravascular coagulation syndrome ( 378 ) with a shortened platelet lifespan ( 379 , 380 ), an increased rate of factor VIII consumption ( 381 ), a decline in plasma antithrombin III activity ( 382 , 383 ), and fibrin deposition within the kidney ( 384 ) and the liver ( 385 ). Women with preeclampsia also have higher circulating levels of endothelin, one of the most potent vasoconstrictors produced by the vascular endothelium ( 386 , 387 ); when endothelin is injected into rabbits, they develop vasospasm and HELLP ( 388 ). Preeclampsia also has an imbalance of placental prostacyclin and thromboxane production ( 389 ), with a decrease in the production of the vasodilator prostacyclin in comparison to the vasoconstrictor thromboxane A<sub>2</sub> ( 373 , 389 ). HELLP syndrome reportedly occurs in 20% of women with severe preeclampsia and 10% of women with eclampsia ( 374 ). The median gestational age at presentation is 32 to 34 weeks, with a range of 24 to 39 weeks ( 372 , 375 ). Clinical findings at presentation include malaise, right upper quadrant tenderness, hypertension, and edema. Most women with HELLP syndrome are not anemic at presentation, although they may drop their hemoglobin out of proportion to the volume of blood lost at delivery ( 372 ). Laboratory features include elevated liver enzymes (i.e., ALT and AST), thrombocytopenia with less than 100,000/ $\mu$ l in most patients, and evidence of compensated hemolysis. The latter is probably the most specific abnormality associated with HELLP syndrome, but sometimes difficult to detect. The peripheral blood smear usually reveals schistocytes and there also may be burr cells and polychromatophilia ( 372 ). In one study, however, schistocytes were seen in only a small fraction of patients and it was proposed that the fragmented cells may have been removed by the spleen ( 390 ). Hemoglobinemia and hemoglobinuria occur in less than 10% of cases. The one consistent abnormality noted in women with HELLP syndrome is a decreased serum haptoglobin in virtually all patients, and this is considered to be the most sensitive test to detect this RBC abnormality when only a few schistocytes are present on smear ( 390 ). The management of preeclampsia with HELLP syndrome is a matter of some obstetric debate, and is beyond the scope of this chapter. In general, the issues relate to immediate delivery or close observation, and these in turn are governed by maternal clinical status and fetal gestational age ( 375 , 377 ). The most common approach is to deliver the fetus as soon as possible or, if it is likely that there is fetal lung immaturity because of gestational age, steroids are administered to the mother for 2 to 3 days, and then the infant is delivered. It is intriguing that a small, but significant fraction of women (30% in one study) spontaneously improves without more aggressive intervention ( 391 ). In contrast to TTP, there currently are no data indicating a role for plasmapheresis. One of the most serious complications is hepatic rupture, with 50% maternal and 60 to 70% fetal mortality. Other complications include DIC, renal failure, pulmonary edema, and placental abruption ( 376 ). Overall, maternal mortality ranges from 0 to 4% in different series ( 375 ). Hematologic and chemical abnormalities resolve within a few days of delivery. Neonatal mortality ranges from 5 to 20% ( 375 , 376 ), and this is more a reflection more of fetal age rather than any specific complication of maternal HELLP issues.

### **PREGNANCY-ASSOCIATED THROMBOTIC THROMBOCYTOPENIC PURPURA AND HEMOLYTIC UREMIC SYNDROME**

In most reported studies of thrombotic microangiopathy with pregnancy, TTP and HUS have been distinguished on the basis of the predominant symptomatology, neurologic or renal. TTP most commonly occurs

antepartum, with a significant majority of cases presenting before 24 weeks' gestation. Postpartum TTP is very rare (392). HUS, on the other hand, typically occurs after a normal delivery and a symptom-free interval, and is characterized by acute-onset renal failure and microangiopathic hemolytic anemia (377, 378). Hypertension is almost always found. A small fraction (10 to 15%) of HUS and TTP patients have signs of preeclampsia. Sometimes TTP/HUS is not correctly diagnosed until the patient, thought to have preeclampsia, has an atypical prolonged recovery in the postpartum period (393). Laboratory results show the expected hemolytic anemia with many RBC fragments. Severe thrombocytopenia usually is present. Fibrin breakdown products are often increased, but the findings of other coagulation studies usually are normal (378). In postpartum HUS azotemia is the rule, but is rare in TTP. In an extensive case review, the overall maternal mortality was 44%. The rate was reduced to 0% with plasma therapy, but was 68% if plasma therapy was not instituted (378, 394, 395). The pregnancy should not be terminated because this does not cure the disease, and the fetus may survive with successful therapy.

## HEMOLYSIS DUE TO MALIGNANT HYPERTENSION

An association between RBC fragmentation and malignant hypertension was first recorded in 1954, and has since been confirmed in many other studies (396, 397). The pathogenesis of microangiopathic hemolytic anemia in malignant hypertension is attributed to the presence of fibrinoid necrosis within the arterioles (267), which in turn appears to depend on the presence of hypertension.

Experimental animal models have been useful in studying the role of hypertension in producing RBC fragmentation. Rats given desoxycorticosterone and having a high salt intake develop malignant hypertension with widespread degenerative vascular lesions and, coincidentally, hemolytic anemia characterized by RBC fragmentation (398). Closely analogous to the human counterpart of this syndrome, the most anemic animals are those with the most severe vascular lesions. Fibrin and platelet deposits may be apparent within the lumen of some blood vessels, but they do not play a predominant role in RBC fragmentation. The striking finding on electron microscopic analysis of arterioles is the close juxtaposition of erythrocytes to endothelial cells, the apparent molding of projections of endothelial cells around the erythrocytes, and the partial penetration of the endothelium by erythrocytes. RBC fragmentation is the result of shearing stress from the force of arterial blood as it moves past RBCs that are attached to endothelial projections or that have partially penetrated the endothelium.

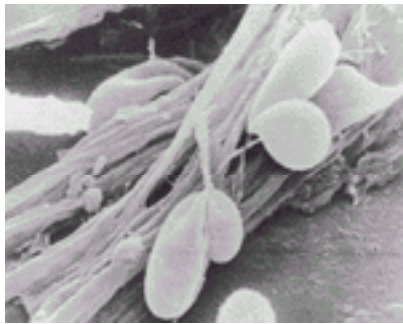
## HEMOLYSIS DUE TO DISSEMINATED INTRAVASCULAR COAGULATION

Microangiopathic hemolytic anemia is associated with a variety of disorders characterized by DIC, including sepsis (399, 400), purpura fulminans (401), heat stroke (402), and abruptio placentae (403) (see Chapter 60). In all of these clinical conditions, RBC fragmentation is thought to result from the deposition of fibrin within the microvasculature. Hemolysis often is not severe, however, and may not contribute significantly to the morbidity of the disease. As the underlying disease comes under control with appropriate therapy, RBC fragmentation also ceases.

The generation of RBC fragmentation with DIC is supported by classical experimental animal data. When intravascular coagulation is induced in rabbits by the infusion of endotoxin (267) or thrombin (404), the onset of RBC fragmentation and hemoglobinemia is closely linked to the development of renal glomerular thrombosis. These findings indicate a link between the deposition of platelet and fibrin thrombi and RBC fragmentation; this is



supported by histologic studies that associate hemolysis with a loose fibrin network to which RBCs adhere ( [310](#) ). From *in vitro* experiments it has been observed that when RBCs are forced through a loose fibrin clot within a slide chamber, they attach to fine fibrin threads and fold around these razor-sharp strands ( [Fig. 38.6](#) ) ( [405](#) ). As other cells flow past the attached RBCs, they cause their release or their fragmentation, often with resealing of the membrane, and thus the formation of RBC fragments. Similar results are obtained when nylon or glass fibers are used in artificial circuits ( [405](#) ).



**Figure 38.6.** Scanning electron micrograph. Red blood cells are “clotheslined” over fine fibrin strands ( *in vitro* model). Other cells, moving past these trapped erythrocytes, may cause their fragmentation. Thicker fibrin strands in background do not cause this injury. (From Bull BS, Kuhn IH. The production of schistocytes by fibrin strands. *Blood* 1970;35:104, with permission.)

## HEMOLYSIS DUE TO IMMUNE DISORDERS

Microangiopathic hemolytic anemia may be a feature of diseases in which the microvasculature is damaged by immune mechanisms. Connective tissue diseases characterized by vasculitis, which occasionally leads to RBC fragmentation, include lupus erythematosus ( [406](#) ) and perhaps rheumatoid arthritis, Sjögren syndrome, and polyarteritis nodosa ( [268](#) ). RBC fragmentation also has been observed in association with polymyositis ( [268](#) ), scleroderma ( [407](#) ), Wegener granulomatosis ( [408](#) , [409](#) ), and giant-cell arteritis ( [410](#) ).

Circulating immune complexes trigger the coagulation cascade ( [308](#) ), leading to fibrin deposition, which in turn stimulates the proliferation of endothelial cells. Fibrin deposition and endothelial changes, including immune complex-mediated damage of endothelial cells, are probably responsible for the RBC fragmentation that occurs in disorders characterized by the presence of circulating immune complexes. Such complexes, together with RBC fragmentation, have been found in patients with a variety of disorders, including TTP, subacute bacterial endocarditis ( [411](#) ), and glomerulonephritis ( [412](#) , [413](#) ). The significance of this association is unclear, however, because immune complexes are found commonly in patients with some of these conditions ( [414](#) ), whereas RBC fragmentation and other manifestations of thrombotic microangiopathy are much less common.

### Giant Hemangiomas and Hemangioendotheliomas

Microangiopathic hemolytic anemia has been identified in patients with giant hemangiomas ( [415](#) , [416](#) and [417](#) ) and in patients with hemangioendotheliomas of the liver ( [418](#) , [419](#) ). Microangiopathic hemolytic anemia also has been described in the blue rubber-bleb nevus syndrome, a rare disorder characterized by subcutaneous and gastrointestinal

hemangiomas ( [420](#) ). It is thought that local coagulation in the abnormal blood vessels plays a role in RBC fragmentation ( [415](#) ). Therapeutic resolution of the hemangioma cures the microangiopathic hemolytic anemia and consumption coagulopathy ( [416](#) ). Antifibrinolytic therapy with ε-aminocaproic acid has caused several hemangiomas to thrombose and to stabilize the hematocrit in one reported case ( [421](#) ).

## March Hemoglobinuria

*March hemoglobinuria* is an unusual hemolytic disorder in which transient hemoglobinemia and hemoglobinuria develop in susceptible individuals after strenuous exercise that involves forceful contact of the body with a hard surface. Although RBC fragmentation is not always evident, the condition carries all the hallmarks of acute intravascular hemolysis, which presumably results from the mechanical disruption of circulating RBCs. Few cases have been reported since Fleischer described the first case in 1881 ( [254](#) ). Clinically inapparent hemoglobinemia may be more common.

With rare exception ( [422](#) ), march hemoglobinuria primarily affects young males ( [254](#) ). Hemoglobinuria is precipitated by prolonged marches or competitive running, but the syndrome has also been noted in conga drum players ( [423](#) , [424](#) ) and people participating in karate exercises ( [425](#) ). Passage of red or dark urine after physical exertion is often the only complaint. Occasionally, symptoms include nausea; vague abdominal, back, or thigh pain; and a burning feeling in the soles of the feet. Hemoglobinuria characteristically occurs immediately after exercise and lasts for only a few hours. March hemoglobinuria most commonly affects athletes at the beginning of a running career or on resumption of road training ( [254](#) ).

Laboratory studies reveal the hallmarks of intravascular hemolysis: hemoglobinemia and a decreased value of serum haptoglobin. Significant anemia is uncommon. The bilirubin concentration rarely exceeds 2 mg/dl. Serum lactic dehydrogenase levels may be elevated ( [422](#) , [426](#) ). The urine contains hemoglobin; after recurrences, it also may contain hemosiderin. Long-distance runners may develop iron deficiency attributable to hemosiderinuria ( [426](#) ).

Hemoglobinuria can be prevented by the use of shoes with thicker and more resilient soles than those usually worn. Thus, one postulation was that susceptible individuals destroy RBCs in the soles of their feet while running ( [254](#) ). Confirmation came from the ingenious experiments of Davidson, who inserted polyvinyl tubes containing blood into the running shoes of susceptible individuals and showed that these runners destroyed their own and the control blood at approximately the same rate, and to a greater degree than control subjects running on the same surface.

Whether hemolysis is entirely attributable to the type of exercise and the style of running or whether other factors make the RBCs of some people particularly susceptible to hemolysis is not clear. In three patients with march hemoglobinuria, a well-defined and similar membrane protein abnormality was identified by means of sodium dodecyl sulfate-polyacrylamide gel electrophoresis ( [427](#) ). In each case, differences from the normal pattern were readily apparent in the low-molecular-weight regions, and these changes were not evident in patients with other hemolytic anemias. In another unique report, intravascular hemolysis was noted in an individual while swimming, generally not considered to be a contact sport ( [428](#) ). Of interest, this individual also had an intrinsic RBC membrane disorder, hereditary xerocytosis, characterized by dehydrated RBCs (see [Chapter 33](#) ). The RBCs of this patient manifested increased sensitivity to shear stress *in*

*vitro*; this was most pronounced in the dehydrated cells, and partially corrected when the cells were rehydrated. The significance of the aforementioned observations is unknown. It is possible that hemolysis occurring with shear stress in some cases may be associated with underlying RBC abnormalities.

No specific therapy is usually needed for individuals with march hemoglobinuria. Attacks may be prevented by wearing shoes with more resilient soles and by changing to a less traumatic running style.

## OTHER ACQUIRED CAUSES OF HEMOLYSIS

Hemolytic anemia also is seen in association with a number of nonhematologic systemic disorders, and in most cases there are several etiologies to the anemia.

### Hypersplenism

Normal functions of the spleen include the monitoring and processing of “old” and “damaged” RBCs. These culling and pitting functions are executed by macrophages that line reticuloendothelial sinuses of the spleen, and also the liver and bone marrow (see [Chapter 70](#)). Macrophages have receptors that recognize immunoglobulin and complement molecules on the RBC surface, and possibly receptors that detect alterations in the outer portion of the phospholipid bilayer. The spleen is considered to be the most stringent of the reticuloendothelial filters, and this is aided by the slow rate of blood flow through the splenic red pulp.

Broadly defined, the term *hypersplenism* refers to sequestration and/or destruction of blood cells occurring in an enlarged spleen, associated with peripheral anemia and/or neutropenia and/or thrombocytopenia. In experimental animals with splenomegaly induced by methylcellulose injections, there is accelerated destruction of normal erythrocytes ([429](#)). Also, in humans, it is generally held that splenomegaly from any cause can be associated with increased filtering, extended macrophage attack, and increased erythrocyte destruction ([430](#)). Rarely does hypersplenism cause significant hemolysis. However, under conditions in which macrophages are activated there may be increased RBC destruction, and this may explain the accelerated hemolysis commonly seen with infections, in particular with malaria ([27](#)).

Massive splenomegaly often is associated with an increased plasma volume, and in these cases the low hemoglobin or hematocrit gives a falsely low estimate of the true RBC mass.

### Liver Disease

Anemia in liver disease has many causes, including hemolysis (see [Chapter 47](#)). One component of this shortened RBC survival relates to portal hypertension and associated splenomegaly. However, the hemolysis occurring under these conditions is usually mild, with varying degrees of a compensatory increase in RBC production.

Another cause of hemolysis in liver disease is associated with the formation of “spur cells,” a variant form of acanthocytes. In patients with liver disease, abnormalities in lipid metabolism result in RBCs becoming selectively loaded with excess cholesterol. The cholesterol-loaded RBCs have impaired ability to repair peroxidized membrane lipids ([431](#)), and thus they undergo oxidative damage. As a consequence, they become rigid, nondeformable, and are rapidly cleared by the reticuloendothelial system, in particular the

spleen ( [432](#) , [433](#) ) (see [Chapter 47](#)).

Attempts to correct portal hypertension have used angiographic techniques to create a communication between the intrahepatic portal vein and the hepatic vein. The placement of these transjugular intrahepatic portosystemic shunts avoids the anesthetic and surgical risks of other shunting procedures; however, some 10% of patients develop mild intravascular hemolysis ( [434](#) ). The hemolysis usually is self-limited and rarely requires intervention.

## Renal Disease

Hemolytic anemia and renal failure occur together as discussed in the section on [thrombotic microangiopathy](#). Anemia also is a frequent complication of primary renal disease, the most common cause being impaired erythropoietin production (see [Chapter 47](#)). However, in some cases there also is a hemolytic component ( [435](#) , [436](#) ), thought to be a consequence of uremia. Classic cross-transfusion studies from several years ago demonstrated that normal erythrocytes have a shortened survival in uremic patients while RBCs from uremic patients survive normally when transfused into healthy control individuals ( [437](#) , [438](#) ). RBC survival is decreased in proportion to the blood urea nitrogen concentration ( [439](#) ), and it improves significantly after intensive hemodialysis ( [440](#) ). The exact uremic metabolite responsible for RBC injury is not known.

The specific uremia-induced RBC injury that causes shortened RBC survival also is not defined. It has been suggested that oxidative stresses and impaired membrane fluidity may be involved ( [441](#) ). Of interest, it also has been observed that uremic RBCs have increased expression of phosphatidylserine on the outer membrane surface, and incubation of normal RBC in uremic plasma also induces increased expression of phosphatidylserine on the outer cell surface ( [442](#) , [443](#) ). These observations are important because it is now thought that one mechanism for macrophage recognition of damaged RBC may be the loss of phospholipid asymmetry across the membrane, particularly the appearance of phosphatidylserine on the external side of the membrane ( [444](#) , [445](#) ).

Nowadays, with aggressive dialysis programs and the regular use of erythropoietin, hemolytic anemia associated with uremia is uncommon. However, there are reports that complications of hemodialysis itself can cause hemolytic anemia. This has been attributed to the presence of chloramines (i.e., oxidant compounds used as bactericidal agents in urban water supplies) ( [446](#) ), formaldehyde in a water filtration system ( [447](#) ), overheated dialysate ( [206](#) ), and contaminants in the dialysates such as nitrates ( [448](#) ) or copper ( [128](#) , [129](#) ). In addition, mechanical-induced hemolysis due to kinking in the arterial blood line has been reported ( [449](#) ).

## Hypophosphatemia

Severe hypophosphatemia can occur in patients undergoing prolonged antacid therapy, in those receiving intravenous hyperalimentation without phosphorus supplementation, in debilitated and starved people, and in alcoholics. In addition to confusion, weakness, anorexia, malaise, paresthesias, and electroencephalographic and electromyographic changes, hypophosphatemia also has been noted to cause hemolytic anemia ( [450](#) , [451](#) , [452](#) , [453](#) , [454](#) , [455](#) and [456](#) ). The anemia is characterized by reticulocytosis and microspherocytosis seen on the peripheral smear ( [451](#) ). In affected individuals, the serum phosphorus concentration invariably is very low. When measured, the concentrations of intracellular phosphorylated compounds also are reduced and glycolysis is thought to be

inhibited. In particular, RBC adenosine triphosphate is decreased, cell deformability is reduced, and RBC survival is shortened ( 451 ). Therapy with parenterally administered phosphate corrects the hypophosphatemia and all RBC abnormalities.

## Postperfusion Syndrome

Cardiopulmonary bypass sometimes is associated with several adverse reactions, including acute intravascular hemolysis, leukopenia, a hemostatic deficit, and nonspecific systemic inflammatory reactions, collectively referred to as the *postperfusion syndrome*. This systemic dysfunction may result in acute respiratory distress syndrome and shock.

After cardiopulmonary bypass intravascular hemolysis can occur with hemoglobinemia, and, at the same time, lysed RBC ghosts can be found in the plasma. The mechanism of hemolysis associated with this syndrome was thought to be due to mechanical factors during surgery ( 457 ). However, it now is recognized that complement is activated during the procedure ( 458 ) and the terminal C5b-9 complement complexes are deposited on erythrocytes and polymorphonuclear neutrophilic leukocytes ( 459 ). In one interesting study using lysed erythrocyte membranes recovered from blood of patients at the end of bypass surgery, C5b-9 components were identified on the RBC ghosts but not on intact erythrocytes. Moreover, the appearance of ghosts carrying C5b-9 neoantigens always coincided with hemolysis ( 459 ). Thus, it now is thought that complement activation occurs as blood flows through the oxygenator, and the resultant deposition of C5b-9 on RBCs leads to immediate intravascular hemolysis. The same reactions presumably lead to granulocyte activation and sequestration in the lungs ( 458 ).

The hemolytic process is transient. Hematologic treatment is directed toward RBC support as needed until spontaneous resolution occurs.

## ACKNOWLEDGMENTS

The authors wish to acknowledge G. Richard Lee, M.D., and John Foerster, M.D., for the excellent previous chapters on acquired hemolytic anemias and fragmentation syndromes in the Tenth Edition of Wintrobe's *Clinical Hematology*. These earlier contributions provided a template for the current chapter in this, the Eleventh Edition.

## REFERENCES

1. World malaria situation in 1993. *Wkly Epidemiol Rec* 1996;71:17-32.
2. Taylor TE, Molyneux ME. Something new out of Africa. *N Engl J Med* 1995;332:1441-1442.
3. Jerrard DA, et al. Malaria: a rising incidence in the United States. *J Emerg Med* 2002;23:23-33.
4. Mungai M, et al. Transfusion-transmitted malaria in the United States from 1963 through 1999. *N Engl J Med* 2001;344:1973-1978.
5. Friedmann CT, et al. A malaria epidemic among heroin users. *Am J Trop Med Hyg* 1973;22:302-307.
6. Kean BH, Reilly PC Jr. Malaria—the mime. Recent lessons from a group of civilian travellers. *Am J Med* 1976;61:159-164.
7. Fitzgerald FT. Malaria: a modern dilemma. *West J Med* 1982;136:220-226.
8. Marsh K, et al. Indicators of life-threatening malaria in African children. *N Engl J Med*

1995;332:1399–1404.

9. Conrad ME. Pathophysiology of malaria. Hematologic observations in human and animal studies. *Ann Intern Med* 1969;70:134–141.
10. Menendez C, Fleming AF, Alonso PL. Malaria-related anaemia. *Parasitol Today* 2000;16:469–476.
11. Abdalla S, et al. The anaemia of falciparum malaria. *Br J Haematol* 1980;46:171–183.
12. Caulfield C. Renal and hematologic complication of acute falciparum malaria in Vietnam. *Bull N Y Acad Med* 1969;45:1043.
13. Perrin LH, Mackey LJ, Miescher PA. The hematology of malaria in man. *Semin Hematol* 1982;19:70–82.
14. Niazi GA. Haematological aspect of malaria in a population based hospital, Saudi Arabia. *J Egypt Soc Parasitol* 1995;25:787–793.
15. Miller LH, et al. The resistance factor to *Plasmodium vivax* in blacks. The Duffy-blood-group genotype, FyFy. *N Engl J Med* 1976;295:302–304.
16. Hadley TJ, et al. *Falciparum* malaria parasites invade erythrocytes that lack glycophorin A and B (MkMk). Strain differences indicate receptor heterogeneity and two pathways for invasion. *J Clin Invest* 1987;80:1190–1193.
17. Mitchell GH, et al. Invasion of erythrocytes by *Plasmodium falciparum* malaria parasites: evidence for receptor heterogeneity and two receptors. *Blood* 1986;67:1519–1521.
18. Pasvol G, et al. Glycophorin as a possible receptor for *Plasmodium falciparum*. *Lancet* 1982;2:947–950.
19. Goldberg DE. Hemoglobin degradation in *Plasmodium*-infected red blood cells. *Semin Cell Biol* 1993;4:355–361.
20. Gritzmacher CA, Reese RT. Reversal of knob formation on *Plasmodium falciparum*-infected erythrocytes. *Science* 1984;226:65–67.
21. Wyler DJ. Malaria—resurgence, resistance, and research. (First of two parts). *N Engl J Med* 1983;308:875–878.
22. Davis TM, et al. Erythrocyte sequestration and anemia in severe *falciparum* malaria. Analysis of acute changes in venous hematocrit using a simple mathematical model. *J Clin Invest* 1990;86:793–800.
23. Phillips RE, Pasvol G. Anaemia of *Plasmodium falciparum* malaria. *Baillieres Clin Haematol* 1992;5:315–330.
24. Miller LH, Usami S, Chien S. Alteration in the rheologic properties of *Plasmodium knowlesi*-infected red cells. A possible mechanism for capillary obstruction. *J Clin Invest* 1971;50:1451–1455.
25. Cranston HA, et al. *Plasmodium falciparum* maturation abolishes physiologic red cell deformability. *Science* 1984;223:400–403.
26. Dondorp AM, et al. Abnormal blood flow and red blood cell deformability in severe malaria. *Parasitol Today* 2000;16:228–232.
27. Looareesuwan S, et al. Dynamic alteration in splenic function during acute falciparum malaria. *N Engl J Med* 1987;317:675–679.
28. Schnitzer B, et al. An ultrastructural study of the red pulp of the spleen in malaria. *Blood* 1973;41:207–218.
29. Wyler DJ, Quinn TC, Chen LT. Relationship of alterations in splenic clearance function and microcirculation to host defense in acute rodent malaria. *J Clin Invest* 1981;67:1400–1404.
30. Wickramasinghe SN, et al. The bone marrow in human cerebral malaria: parasite sequestration within

sinusoids. Br J Haematol 1987;66:295–306.

31. Looareesuwan S, et al. Reduced erythrocyte survival following clearance of malarial parasitaemia in Thai patients. Br J Haematol 1987;67:473–478.
32. Woodruff AW, Ansdell VE, Pettitt LE. Cause of anaemia in malaria. Lancet 1979;1:1055–1057.
33. Abdalla S, Weatherall DJ. The direct antiglobulin test in *falciparum* malaria. Br J Haematol 1982;51:415–425.
34. Wickramasinghe SN, et al. Dyserythropoiesis and ineffective erythropoiesis in *Plasmodium vivax* malaria. Br J Haematol 1989;72:91–99.
35. Clark IA, Chaudhri G. Tumour necrosis factor may contribute to the anaemia of malaria by causing dyserythropoiesis and erythrophagocytosis. Br J Haematol 1988;70:99–103.
36. Wenisch C, et al. Elevated serum levels of IL-10 and IFN- $\gamma$  in patients with acute *Plasmodium falciparum* malaria. Clin Immunol Immunopathol 1995;74:115–117.
37. Grau GE, et al. Tumor necrosis factor and disease severity in children with *falciparum* malaria. N Engl J Med 1989;320:1586–1591.
38. Kern P, et al. Elevated tumor necrosis factor alpha and interleukin-6 serum levels as markers for complicated *Plasmodium falciparum* malaria. Am J Med 1989;87:139–143.
39. Burgmann H, et al. Serum levels of erythropoietin in acute *Plasmodium falciparum* malaria. Am J Trop Med Hyg 1996;54:280–283.
40. el Hassan AM, et al. Decreased erythropoietin response in *Plasmodium falciparum* malaria-associated anaemia. Eur J Haematol 1997;59:299–304.
41. Vryonis G. Observations on the parasitization of erythrocytes in *Plasmodium vivax*, with special reference to reticulocytes. Am J Hyg 1939;30:41.
42. Van den Ende J, et al. Recurrence of blackwater fever: triggering of relapses by different antimalarials. Trop Med Int Health 1998;3:632–639.
43. Fernan Nunez M. Blackwater fever: a clinical review of fifty two cases. Ann Intern Med 1936;9:1203.
44. Blackie W. Blackwater fever. Clin Proc 1944;3:272.
45. Roth EF Jr, et al. Sickling rates of human AS red cells infected in vitro with *Plasmodium falciparum* malaria. Science 1978;202:650–652.
46. Friedman MJ. Erythrocytic mechanism of sickle cell resistance to malaria. Proc Natl Acad Sci U S A 1978;75:1994–1997.
47. Motulsky AG. Frequency of sickling disorders in U.S. blacks. N Engl J Med 1973;288:31–33.
48. Luzatto L. Genetics of red cells and susceptibility to malaria. Blood 1979;54:961.
49. Roth EF Jr, et al. The effect of X chromosome inactivation on the inhibition of *Plasmodium falciparum* malaria growth by glucose-6-phosphate-dehydrogenase-deficient red cells. Blood 1983;62:866–868.
50. Roth EF Jr, et al. Ribose metabolism and nucleic acid synthesis in normal and glucose-6-phosphate dehydrogenase-deficient human erythrocytes infected with *Plasmodium falciparum*. J Clin Invest 1986;77:1129–1135.
51. Nagel RL, Roth EF Jr. Malaria and red cell genetic defects. Blood 1989;74:1213–1221.
52. Ifediba TC, et al. *Plasmodium falciparum* in vitro: diminished growth in hemoglobin H disease



erythrocytes. *Blood* 1985;65:452–455.

53. Udomsangpetch R, et al. Alteration in cytoadherence and rosetting of *Plasmodium falciparum*-infected thalassemic red blood cells. *Blood* 1993;82: 3752–3759.

54. Nagel RL, et al. Impairment of the growth of *Plasmodium falciparum* in HbEE erythrocytes. *J Clin Invest* 1981;68:303–305.

55. Freedman M, Roth EF, Roth RL, et al. The role of hemoglobins C, S and NBalt in the inhibition of malaria parasite development in vitro. *Am J Trop Med Hyg* 1979;777.

56. Mohandas N, et al. Rigid membranes of Malayan ovalocytes: a likely genetic barrier against malaria. *Blood* 1984;63:1385–1392.

57. Kyriacou DN, et al. Emergency department presentation and misdiagnosis of imported *falciparum* malaria. *Ann Emerg Med* 1996;27:696–699.

58. Beadle C, et al. Diagnosis of malaria by detection of *Plasmodium falciparum* HRP-2 antigen with a rapid dipstick antigen-capture assay. *Lancet* 1994;343:564–568.

59. Mills CD, et al. Evaluation of a rapid and inexpensive dipstick assay for the diagnosis of *Plasmodium falciparum* malaria. *Bull World Health Organ* 1999;77:553–559.

60. Richardson DC, et al. Evaluation of the Makromed dipstick assay versus PCR for diagnosis of *Plasmodium falciparum* malaria in returned travelers. *J Clin Microbiol* 2002;40:4528–4530.

61. White NJ. The treatment of malaria. *N Engl J Med* 1996;335:800–806.

62. Wyler DJ. Malaria chemoprophylaxis for the traveler. *N Engl J Med* 1993;329:31–37.

63. Jerant AF, Arline AD. Babesiosis in California. *West J Med* 1993;158:622–625.

64. Filbin MR, et al. Babesiosis. *J Emerg Med* 2001;20:21–24.

65. Gorenflot A, et al. Human babesiosis. *Ann Trop Med Parasitol* 1998;92:489–501.

66. Homer MJ, et al. Babesiosis. *Clin Microbiol Rev* 2000;13:451–469.

67. Grabowski EF, et al. Babesiosis transmitted by a transfusion of frozen-thawed blood. *Ann Intern Med* 1982;96:466–467.

68. Bredt AB, Weinstein WM, Cohen S. Treatment of babesiosis in asplenic patients. *JAMA* 1981;245:1938–1939.

69. Evenson DA, et al. Therapeutic apheresis for babesiosis. *J Clin Apheresis* 1998;13:32–36.

70. Wery M, et al. Hematologic manifestations, diagnosis, and immunopathology of African trypanosomiasis. *Semin Hematol* 1982;19:83–92.

71. Rickman WJ, Cox HW. Association of autoantibodies with anemia, splenomegaly, and glomerulonephritis in experimental African trypanosomiasis. *J Parasitol* 1979;65:65–73.

72. Woodruff AW, et al. Anaemia in African trypanosomiasis and ‘big spleen disease’ in Uganda. *Trans R Soc Trop Med Hyg* 1973;67:329–337.

73. Fleming AF. Haematological manifestations of malaria and other parasitic diseases. *Clin Haematol* 1981;10:983–1011.

74. Weatherall DJ, Kwiatkowski D. Hematologic manifestations of systemic diseases in children of the developing world. In: Nathan D, Orkin S, eds. *Hematology of infancy and childhood*. Philadelphia: WB Saunders, 1998:1893–1914.

75. Li Volti S, Fischer F, Musumeci S. Hematological and serological aspects of Mediterranean kala-azar in infancy and childhood. *Acta Trop* 1980;37:351–365.
76. Woodruff AW, et al. The anaemia of kala-azar. *Br J Haematol* 1972;22:319–329.
77. Weinman D. Infectious anemias due to *Bartonella* and related red cell parasites. *Bull N Y Acad Med* 1946;22:647.
78. Ellis BA, et al. An outbreak of acute bartonellosis (Oroya fever) in the Urubamba region of Peru, 1998. *Am J Trop Med Hyg* 1999;61:344–349.
79. Gray GC, et al. An epidemic of Oroya fever in the Peruvian Andes. *Am J Trop Med Hyg* 1990;42:215–221.
80. Cooper P, et al. An outbreak of bartonellosis in Zamora Chinchipe Province in Ecuador. *Trans R Soc Trop Med Hyg* 1997;91:544–546.
81. Chamberlin J, et al. Epidemiology of endemic *Bartonella bacilliformis*: a prospective cohort study in a Peruvian mountain valley community. *J Infect Dis* 2002;186:983–990.
82. Schultz MG. A history of bartonellosis (Carrion's disease). *Am J Trop Med Hyg* 1968;17:503–515.
83. Reynafarje C, Ramos J. The hemolytic anemia of human bartonellosis. *Blood* 1961;17:562.
84. Ricketts W. *Bartonella bacilliformis* anemia (Oroya fever). *Blood* 1948;3:1025.
85. Schultz MG. Daniel Carrion's experiment. *N Engl J Med* 1968;278:1323–1326.
86. Suzuki A, Yamada A, Maruyama H. [A case of acute hemolytic anemia due to *Clostridium perfringens* A septicemia]. *Rinsho Ketsueki* 1972;13:850–854.
87. Boggs D, et al. Clostridial gas gangrene and septicemia in four patients with leukemia. *N Engl J Med* 1958;259:1255.
88. Terebelo HR, McCue RL, Lenneville MS. Implication of plasma free hemoglobin in massive clostridial hemolysis. *JAMA* 1982;248:2028–2029.
89. Warren S, Schreiber JR, Epstein MF. Necrotizing enterocolitis and hemolysis associated with *Clostridium perfringens*. *Am J Dis Child* 1984;138:686–688.
90. Wynne JW, Armstrong D. Clostridial septicemia. *Cancer* 1972;29:215–221.
91. Meyerhoff A, et al. Fatal clostridial sepsis in a previously healthy woman. *Clin Infect Dis* 1995;20:1066–1067.
92. Gutierrez A, et al. Fatal intravascular hemolysis in a patient with *Clostridium perfringens* septicemia. *Clin Infect Dis* 1995;20:1064–1065.
93. Singer AJ, et al. *Clostridium perfringens* septicemia with massive hemolysis in a patient with Hodgkin's lymphoma. *Am J Emerg Med* 1997;15:152–154.
94. Tsai IK, et al. *Clostridium perfringens* septicemia with massive hemolysis. *Scand J Infect Dis* 1989;21:467–471.
95. Ikezawa H, Murata R. Comparative kinetics of hemolysis of mammalian erythrocytes by *Clostridium perfringens* alpha-toxin (phospholipase C). *J Biochem* 1964;55:217.
96. Hubl W, et al. Investigation of the pathogenesis of massive hemolysis in a case of *Clostridium perfringens* septicemia. *Ann Hematol* 1993;67:145–147.
97. Batge B, et al. Clostridial sepsis with massive intravascular hemolysis: rapid diagnosis and successful

treatment. Intensive Care Med 1992;18:488–490.

98. Brown G. The pathogenesis of secondary anemias. Can Med Assoc J 1951;62:472.
99. Daland G, et al. Hematologic observation in bacterial endocarditis, especially the prevalence of histocytes and the elevation and variation of the white cell count in blood from the ear lobe. J Lab Clin Med 1956;48:827.
100. Jandl J, et al. Hypersplenism due to infection. A study of 5 cases manifesting hemolytic anemia. N Engl J Med 1961;264:1043.
101. Mollison P. The survival of transfused erythrocytes, with special reference to cases of acquired hemolytic anemia. Clin Sci 1947;6:137.
102. Inada T, Shirono K, Tsuda H. Hemolytic anemia in a patient with subacute bacterial endocarditis due to *Streptococcus sanguis*. Acta Haematol 1995;94:95–97.
103. De S, et al. Intravascular haemolysis in cholera. Lancet 1954;1:807.
104. Retief F, Hofmeyr NG. Acute hemolytic anemia as a complication of typhoid fever. S Afr Med J 1965;39:93.
105. Pennings CM, et al. Haemolytic anaemia in association with *Escherichia coli* O157 infection in two sisters. Eur J Pediatr 1994;153:656–658.
106. Lindeboom G. Rare form of symptomatic hemolytic anemia. Acta Haematol (Basel) 1950;4:343.
107. Banwell J, Kibukamusoke JW. Haemolytic anemia and relapsing fever. East Afr Med J 1963;40:124.
108. Trowbridge AA, et al. Hemolytic anemia associated with leptospirosis. Morphologic and lipid studies. Am J Clin Pathol 1981;76:493–798.
109. Seitz RC, et al. The acute infection-associated hemolytic anemia of childhood: immunofluorescent detection of microbial antigens altering the erythrocyte membrane. Ann Hematol 1993;67:191–196.
110. Shurin SB, et al. Pathophysiology of hemolysis in infections with *Haemophilus influenzae* type b. J Clin Invest 1986;77:1340–1348.
111. Ramasethu J, Luban N. T activation. Br J Haematol 2001;112:259–263.
112. Ward PC, Schwartz BS, White JG. Heinz-body anemia: “bite cell” variant—a light and electron microscopic study. Am J Hematol 1983;15:135–146.
113. Greenberg MS. Heinz body hemolytic anemia. “Bite cells”—a clue to diagnosis. Arch Intern Med 1976;136:153–155.
114. Chan TK, Chan WC, Weed RI. Erythrocyte hemighosts: a hallmark of severe oxidative injury in vivo. Br J Haematol 1982;50:575–582.
115. Ham TH, et al. Physical properties of red cells as related to effects in vivo. IV. Oxidant drugs producing abnormal intracellular concentration of hemoglobin (eccentrocytes) with a rigid-red-cell hemolytic syndrome. J Lab Clin Med 1973;82:898–910.
116. Arese P, De Flora A. Pathophysiology of hemolysis in glucose-6-phosphate dehydrogenase deficiency. Semin Hematol 1990;27:1–40.
117. Fowler BA, Weissberg JB. Arsine poisoning. N Engl J Med 1974;291:1171–1174.
118. Jenkins G. Arsine poisoning. BMJ 1965;2:78.
119. Romeo L, et al. Acute arsine intoxication as a consequence of metal burnishing operations. Am J Ind

Med 1997;32:211–216.

120. Kleinfeld MJ. Arsine poisoning. *J Occup Med* 1980;22:820–821.
121. Buchanan W. Toxicity of arsenic compounds. Amsterdam: Elsevier, 1962.
122. Hatlelid KM, Brailsford C, Carter DE. Reactions of arsine with hemoglobin. *J Toxicol Environ Health* 1996;47:145–457.
123. Rael LT, Ayala-Fierro F, Carter DE. The effects of sulfur, thiol, and thiol inhibitor compounds on arsine-induced toxicity in the human erythrocyte membrane. *Toxicol Sci* 2000;55:468–477.
124. Winski SL, et al. Sequence of toxic events in arsine-induced hemolysis in vitro: implications for the mechanism of toxicity in human erythrocytes. *Fundam Appl Toxicol* 1997;38:123–128.
125. Chuttani HK, et al. Acute copper sulfate poisoning. *Am J Med* 1965;39:849–854.
126. Fairbanks VF. Copper sulfate-induced hemolytic anemia. Inhibition of glucose-6-phosphate dehydrogenase and other possible etiologic mechanisms. *Arch Intern Med* 1967;120:428–432.
127. Sontz E, Schwieger J. The “green water” syndrome: copper-induced hemolysis and subsequent acute renal failure as consequence of a religious ritual. *Am J Med* 1995;98:311–315.
128. Klein WJ Jr, Metz EN, Price AR. Acute copper intoxication. A hazard of hemodialysis. *Arch Intern Med* 1972;129:578–582.
129. Manzler AD, Schreiner AW. Copper-induced acute hemolytic anemia. A new complication of hemodialysis. *Ann Intern Med* 1970;73:409–412.
130. Oski FA. Chickee, the copper. *Ann Intern Med* 1970;73:485–486.
131. Metz EN, Sagone AL Jr. The effect of copper on the erythrocyte hexose monophosphate shunt pathway. *J Lab Clin Med* 1972;80:405–413.
132. Deiss A, Lee GL, Cartwright GE. Hemolytic anemia in Wilson’s disease. *Ann Intern Med* 1970;73:413–418.
133. Forman SJ, et al. Hemolytic anemia in Wilson disease: clinical findings and biochemical mechanisms. *Am J Hematol* 1980;9:269–275.
134. Robitaille GA, et al. Hemolytic anemia in Wilson’s disease. A report of three cases with transient increase in hemoglobin A2. *JAMA* 1977;237:2402–2403.
135. Roche-Sicot J, Benhamou JP. Acute intravascular hemolysis and acute liver failure associated as a first manifestation of Wilson’s disease. *Ann Intern Med* 1977;86:301–303.
136. Shimon I, et al. Hemolytic episode in a patient with Wilson’s disease treated with zinc. *Isr J Med Sci* 1993;29:646–647.
137. Zandman-Goddard G, et al. Acute varicella infection heralding Wilsonian crisis. *J Clin Gastroenterol* 1994;18:265–266.
138. Dabrowska E, et al. Acute haemolytic syndrome and liver failure as the first manifestations of Wilson’s disease. *Med Sci Monit* 2001;7:246–251.
139. Michel M, et al. [Hemolytic anemia disclosing Wilson’s disease. Report of 2 cases]. *Rev Med Interne* 2001;22:280–283.
140. Loudianos G, Gitlin JD. Wilson’s disease. *Semin Liver Dis* 2000;20:353–364.
141. Williams D, Lee GR. Hepatolenticular degeneration (Wilson’s disease). In: Powell L, ed. *Metals and the*

liver. New York: Marcel Dekker, 1978.

142. Deiss A, et al. Long-term therapy of Wilson's disease. *Ann Intern Med* 1971;75:57-65.
143. Buchanan GR. Acute hemolytic anemia as a presenting manifestation of Wilson disease. *J Pediatr* 1975;86:245-247.
144. Hoagland H, Goldstein NP. Hematologic (cytopenic) manifestations of Wilson's disease. *Mayo Clin Proc* 1978;53:498.
145. Walshe J. Wilson's disease. The presenting symptoms. *Arch Dis Child* 1962;37:253.
146. Nazer H, Ede RJ, Mowat AP, et al. Wilson's disease in childhood: variability of clinical presentation. *Clin Pediatr* 1983;22:755.
147. Matsumura A, Hiraishi H, Terano A. Plasma exchange for hemolytic crisis in Wilson disease. *Ann Intern Med* 1999;131:866.
148. Landrigan J, Todd AC. Lead poisoning. *West J Med* 1994;161:153-159.
149. Ibrahim AS, Latif AH. Adult lead poisoning from a herbal medicine. *Saudi Med J* 2002;23:591-593.
150. Paglia DE, Valentine WN, Dahlgren JG. Effects of low-level lead exposure on pyrimidine 5'-nucleotidase and other erythrocyte enzymes. Possible role of pyrimidine 5'-nucleotidase in the pathogenesis of lead-induced anemia. *J Clin Invest* 1975;56:1164-1169.
151. Valentine WN, et al. Lead poisoning: association with hemolytic anemia, basophilic stippling, erythrocyte pyrimidine 5'-nucleotidase deficiency, and intraerythrocytic accumulation of pyrimidines. *J Clin Invest* 1976;58:926-932.
152. Paglia DE, Valentine WN. Characteristics of a pyrimidine-specific 5'-nucleotidase in human erythrocytes. *J Biol Chem* 1975;250:7973-7979.
153. Paglia DE, et al. Pyrimidine nucleotidase deficiency with active dephosphorylation of dTMP: evidence for existence of thymidine nucleotidase in human erythrocytes. *Blood* 1983;62:1147-1149.
154. Landsteiner E, Finch CA. Hemoglobinemia accompanying transurethral resection of the prostate. *N Engl J Med* 1947;237:310.
155. Rath C. Drowning hemoglobinuria. *Blood* 1953;8:1099.
156. Ginsburg CM, Weinberg AG. Hemolytic anemia and multiorgan failure associated with localized cutaneous lesion. *J Pediatr* 1988;112:496-499.
157. Sezerino UM, et al. A clinical and epidemiological study of *Loxosceles* spider envenoming in Santa Catarina, Brazil. *Trans R Soc Trop Med Hyg* 1998;92:546-548.
158. Futrell JM. Loxoscelism. *Am J Med Sci* 1992;304:261-267.
159. Bey TA, et al. *Loxosceles arizonica* bite associated with shock. *Ann Emerg Med* 1997;30:701-703.
160. Murray LM, Seger DL. Hemolytic anemia following a presumptive brown recluse spider bite. *J Toxicol Clin Toxicol* 1994;32:451-456.
161. Nance W. Hemolytic anemia of necrotic arachnidism. *Am J Med* 1961;31:801.
162. From the Centers for Disease Control and Prevention. Necrotic arachnidism—Pacific Northwest, 1988-1996. *MMWR Morb Mortal Wkly Rep* 1996;45:433-436.
163. From the Centers for Disease Control and Prevention. Necrotic arachnidism—Pacific Northwest, 1988-1996. *JAMA* 1996;275:1870-1871.

164. Fisher RG, et al. Necrotic arachnidism. *West J Med* 1994;160:570–572.
165. Foil LD, Norment BR. Envenomation by *Loxosceles reclusa*. *J Med Entomol* 1979;16:18–25.
166. Leung LK, Davis R. Life-threatening hemolysis following a brown recluse spider bite. *J Tenn Med Assoc* 1995;88:396–397.
167. Wasserman GS, Siegel C. Loxoscelism (brown recluse spider bites): a review of the literature. *Clin Toxicol* 1979;14:353–358.
168. Eichner ER. Spider bite hemolytic anemia: positive Coombs' test, erythrophagocytosis, and leukoerythroblastic smear. *Am J Clin Pathol* 1984;81:683–687.
169. Patel KD, et al. The necrotic venom of the brown recluse spider induces dysregulated endothelial cell-dependent neutrophil activation. Differential induction of GM-CSF, IL-8, and E-selectin expression. *J Clin Invest* 1994;94:631–642.
170. Tambourgi DV, et al. Incorporation of a 35-kilodalton purified protein from *Loxosceles intermedia* spider venom transforms human erythrocytes into activators of autologous complement alternative pathway. *J Immunol* 1995;155:4459–4466.
171. Tambourgi DV, et al. Mechanism of induction of complement susceptibility of erythrocytes by spider and bacterial sphingomyelinases. *Immunology* 2002;107:93–101.
172. Tambourgi DV, et al. *Loxosceles intermedia* spider envenomation induces activation of an endogenous metalloproteinase, resulting in cleavage of glycophorins from the erythrocyte surface and facilitating complement-mediated lysis. *Blood* 2000;95:683–691.
173. Van Den Berg CW, et al. *Loxosceles* spider venom induces metalloproteinase mediated cleavage of MCP/CD46 and MHC I and induces protection against C-mediated lysis. *Immunology* 2002;107:102–110.
174. Warrell DA. Snake venoms in science and clinical medicine. 1. Russell's viper: biology, venom and treatment of bites. *Trans R Soc Trop Med Hyg* 1989;83:732–740.
175. Hung DZ, et al. Russell's viper snakebite in Taiwan: differences from other Asian countries. *Toxicon* 2002;40:1291–1298.
176. Mukherje AK, Ghosal SK, Maity CR. Some biochemical properties of Russell's viper (*Daboia russellii*) venom from Eastern India: correlation with clinico-pathological manifestation in Russell's viper bite. *Toxicon* 2000;38:163–175.
177. Reid H. Cobra bites. *BMJ* 1964;2:540.
178. Perkash A, Sarup BM. Red cell abnormalities after snake bite. *J Trop Med Hyg* 1972;75:85–90.
179. Campbell CH. Myotoxic paralysis and hemolytic anemia due to king brown snake bite. *Aust N Z J Med* 1984;14:169.
180. Gillissen A, et al. Neurotoxicity, haemostatic disturbances and haemolytic anaemia after a bite by a Tunisian saw-scaled or carpet viper (*Echis 'pyramidum' -complex*): failure of antivenom treatment. *Toxicon* 1994;32:937–944.
181. Gibly RL, et al. Intravascular hemolysis associated with North American crotalid envenomation. *J Toxicol Clin Toxicol* 1998;36:337–343.
182. Yamamoto C, et al. *Trimeresurus flavoviridis* (habu snake) venom induces human erythrocyte lysis through enzymatic lipolysis, complement activation and decreased membrane expression of CD55 and CD59. *Pharmacol Toxicol* 2001;89:188–194.
183. Phillips RE, et al. Paralysis, rhabdomyolysis and haemolysis caused by bites of Russell's viper (*Vipera russelli pulchella*) in Sri Lanka: failure of Indian (Haffkine) antivenom. *Q J Med* 1988;68:691–715.

184. Condrea E, et al. Susceptibility of erythrocytes of various animal species to the hemolytic and phospholipid splitting action of snake venom. *Biochim Biophys Acta* 1964;84:365.
185. Franca FO, et al. Severe and fatal mass attacks by 'killer' bees (Africanized honey bees— *Apis mellifera scutellata*) in Brazil: clinicopathological studies with measurement of serum venom concentrations. *Q J Med* 1994;87:269–282.
186. Kolecki P. Delayed toxic reaction following massive bee envenomation. *Ann Emerg Med* 1999;33:114–116.
187. Munoz–Arizpe R, et al. Africanized bee stings and pathogenesis of acute renal failure. *Nephron* 1992;61:478.
188. Vetter RS, Visscher K, Camazine S. Mass envenomations by honey bees and wasps. *West J Med* 1999;170:223–227.
189. Bresolin NL, et al. Acute renal failure following massive attack by Africanized bee stings. *Pediatr Nephrol* 2002;17:625–627.
190. Dacie J. The haemolytic anemias, congenital and acquired, vol. III, 2nd ed. New York: Grune & Stratton, 1967.
191. Moore F. The anemia of thermal burns. *Ann Surg* 1946;124:811.
192. Shen S, et al. Mechanism and complications of hemoglobinuria in patients with thermal burns: spherocytosis and increased osmotic fragility of red blood cells. *N Engl J Med* 1943;229:701.
193. Lawrence C, Atac B. Hematologic changes in massive burn injury. *Crit Care Med* 1992;20:1284–1288.
194. Topley E. The usefulness of counting "heat affected" red cells as a guide to the risk of the later disappearance of red cells after burns. *J Clin Pathol* 1961;14:295.
195. James GI. The anemia of thermal injury. *J Clin Invest* 1951;30:181.
196. Davies J, Topley E. The disappearance of red cells in patients with burns. *Clin Sci* 1956;15:135.
197. Andes WA, et al. The erythropoietin response to the anemia of thermal injury. *J Lab Clin Med* 1976;88:584–592.
198. Robinson H, et al. The role of erythropoietin in the anemia of thermal injury. *Ann Surg* 1973;178:565–572.
199. Wallner SF, et al. The anemia of thermal injury: studies of erythropoiesis in vitro. *J Trauma* 1982;22:774–780.
200. Ham T, et al. Studies on the destruction of red blood cells. IV. Thermal injury. *Blood* 1948;3:373.
201. Kimber R, Lander H. The effect of heat on human red cell morphology, fragility and subsequent survival in vivo. *J Lab Clin Med* 1964;64:922.
202. Rakow AL, Hochmuth RM. Effect of heat treatment on the elasticity of human erythrocyte membrane. *Biophys J* 1975;15:1095–1100.
203. Brandts JF, et al. Calorimetric studies of the structural transitions of the human erythrocyte membrane. The involvement of spectrin in the A transition. *Biochemistry* 1977;16:3450–3454.
204. Jacob HS. Editorial: Tightening red-cell membranes. *N Engl J Med* 1976;294:1234–1235.
205. Wagner H, et al. The removal of erythrocytes from the circulation. *Arch Intern Med* 1962;110:90.
206. Lynn KL, Boots MA, Mitchell TR. Haemolytic anaemia caused by overheated dialysate. *BMJ*



1979;1:306–307.

207. Phillips WA, Pottenger LA, DeWald RL. Extracorporeal hemolysis in orthopedic patients. Report of two cases. *Clin Orthop* 1989;241–244.
208. McCullough J, et al. Iatrogenic hemolysis: a complication of blood warmed by a microwave device. *Anesth Analg* 1972;51:102–106.
209. Forman RB, et al. Presence of ADAMTS13 activity in a patient with metastatic cancer and thrombotic microangiopathy. *Acta Haematol* 2003;109:150–152.
210. Staples J, Griner F. Extracorporeal hemolysis of blood in a microwave blood warmer. *N Engl J Med* 1971;285:317–319.
211. Opitz JC, et al. Hemolysis of blood in intravenous tubing caused by heat. *J Pediatr* 1988;112:111–113.
212. Wu N, et al. Microwave heat-induced hemolysis. *Clin Pediatr* 1985;24:645.
213. Sayed H, et al. Hemolytic anemia of mechanical origin after open heart surgery. *Thorax* 1961;16:356.
214. Marsh GW, Lewis SM. Cardiac haemolytic anaemia. *Semin Hematol* 1969;6:133–149.
215. Roeser WH, Powell LW, O'Brien MF. Hemolysis after heterograft and prosthetic valve replacement. *Am Heart J* 1970;79:281–283.
216. Clark RE, et al. Late clinical problems with Beall model 103 and 104 mitral valve prostheses: hemolysis and valve wear. *Ann Thorac Surg* 1976;21:475–482.
217. Garcia MJ, et al. Mechanisms of hemolysis with mitral prosthetic regurgitation. Study using transesophageal echocardiography and fluid dynamic simulation. *J Am Coll Cardiol* 1996;27:399–406.
218. Walinski P, et al. Hemolytic anemia with a Cross Jones prosthesis. *Am J Med Sci* 1967;254:832.
219. De Cesare W, et al. Hemolytic anemia of mechanical origin with aortic valve prostheses. *N Engl J Med* 1965;272:1045.
220. Dave KS, et al. Chronic hemolysis following fascia lata and Starr–Edwards aortic valve replacement. *Circulation* 1972;46:240–249.
221. Straub W, Rothlin M. [Severe traumatic hemolysis and endocarditis in fascia aortic valvuloplasty. Correction with ball valve.] *Dtsch Med Wochenschr* 1969;94:2212–2214.
222. Lund O. Late chronic hemolysis after valve replacement for aortic stenosis. Relation to residual hypertrophy and impaired left ventricular function. *Angiology* 1990;41:836–847.
223. Hashimoto K, et al. Valvular (external hinge) leakage of the CarboMedics mitral valve. *J Thorac Cardiovasc Surg* 1996;111:277–278.
224. Reddy SB, et al. Hemolytic anemia following insertion of Ionescu–Shiley mitral valve bioprosthesis. *Can Med Assoc J* 1984;131:1469–1470.
225. Smith RE, Berg D. Occult paravalvular leak in a clinically normal St. Jude's mitral valve presenting with life-threatening microangiopathic hemolytic anemia. *J Cardiovasc Surg (Torino)* 1991;32:56–58.
226. Weiss GB, et al. Traumatic cardiac hemolytic anemia: a late complication of a Starr–Edwards mitral valve prosthesis. *Arch Intern Med* 1979;139:374–375.
227. Barmada H, Starr A. Clinical hemolysis with the St. Jude heart valve without paravalvular leak. *Med Prog Technol* 1994;20:191–194.
228. O'Regan S, Newman AJ. Cardiac hemolytic anemia resolving after second mitral annuloplasty. *Can*

Med Assoc J 1976;115:419-420.

229. Ziperovich S, Paley HW. Severe mechanical hemolytic anemia due to valvular heart disease without prosthesis. *Ann Intern Med* 1966;65:342.

230. Gupta SC, Suryaprasad AG. Mechanical hemolytic anemia after repair of ruptured chordae tendineae of mitral valve apparatus. *Angiology* 1979;30:776-779.

231. Enzenauer RJ, Berenberg JL, Cassell PF Jr. Microangiopathic hemolytic anemia as the initial manifestation of porcine valve failure. *South Med J* 1990;83:912-917.

232. Rao KR, et al. Erythrocyte survival in patients with porcine xenograft aortic and mitral valves. *South Med J* 1982;75:296-297.

233. Schaer DH, Cheng TO, Aaron BL. Hemolytic anemia and acute mitral regurgitation caused by a torn cusp of a porcine mitral prosthetic valve 7 years after its implantation. *Am Heart J* 1987;113:404-406.

234. Terada Y, et al. The hole in the valve: presentation with haemolytic anaemia. *Med J Aust* 1994;161:674.

235. Chan DK, Cheung GY. A case of bioprosthetic mitral valve dysfunction presenting as haemolytic anaemia. *Aust N Z J Med* 1995;25:543.

236. Mecozzi G, et al. Intravascular hemolysis in patients with new-generation prosthetic heart valves: a prospective study. *J Thorac Cardiovasc Surg* 2002;123:550-556.

237. Weesner KM, et al. Intravascular hemolysis associated with porcine mitral valve calcification in children. *Am J Cardiol* 1981;47:1286-1288.

238. Sigler A, et al. Severe intravascular hemolysis following surgical repair of endocardial cushion defects. *Am J Med* 1963;35:467.

239. Verdon T, et al. Hemolytic anemia following open heart repair of ostium primum defects. *N Engl J Med* 1963;269:444.

240. Brodeur M, et al. Hemolytic anemia and valvular heart disease. *N Engl J Med* 1965;272:104.

241. Dupont B, Wennevold A. Mechanical hemolytic anemia in unoperated aortic valve disease. *Acta Med Scand* 1968;184:353-357.

242. Grosse-Brockhoff F, Gehrman G. Mechanical hemolysis in patients with valvular heart disease and valve prosthesis. *Am Heart J* 1967;74:137-139.

243. Veneziale CM, et al. Hypohaptoglobinemia and valvular heart disease: association with hemolysis after insertion of valvular prostheses and in cases in which operation had not been performed. *Mayo Clin Proc* 1966;41:657-662.

244. Ellman L, Knox-Macauley H. Traumatic hemolysis with rupture of aneurysm of sinus of Valsalva. *Arch Intern Med* 1970;126:1019-1021.

245. Ravenel SD, Johnson JD, Sigler AT. Intravascular hemolysis associated with coarctation of the aorta. *J Pediatr* 1969;75:67-73.

246. Westphal RG, Azen EA. Macroangiopathic hemolytic anemia due to congenital cardiovascular anomalies. *JAMA* 1971;216:1477-1478.

247. Daubeney PE, Milne AE, Salmon AP. Hemolytic anemia: an unusual presentation of congenital heart disease. *Arch Pediatr Adolesc Med* 1996;150:109-111.

248. Kloster F, et al. Medical problems in mitral and multiple valve replacement. *Prog Cardiovasc Dis* 1965;7:504.

249. Yacoub MH, Keeling DH. Chronic haemolysis following insertion of ball valve prostheses. *Br Heart J*

1968;30:676-678.

250. Bell RE, Petuoglu S, Fraser RS. Chronic haemolysis occurring in patients following cardiac surgery. *Br Heart J* 1967;29:327-332.
251. Anderson M, et al. Chronic hemolysis in patients with ball valve prosthesis. *J Thorac Cardiovasc Surg* 1965;50:501.
252. Cullhead I. Serum haptoglobin in cases with Starr Edwards ball valve prostheses. *Acta Med Scand* 1967;181:321.
253. Miller S, et al. Intravascular hemolysis in a patient with valvular heart disease. *Ann Intern Med* 1966;65:210.
254. Davidson RJ. March or exertional haemoglobinuria. *Semin Hematol* 1969;6:150-161.
255. Neill C. Postoperative hemolytic anemia in endocardial cushion defects. *Circulation* 1964;30:801.
256. Hasenkam JM, et al. Turbulent stress measurements downstream of six mechanical aortic valves in a pulsatile flow model. *J Biomech* 1988;21:631-645.
257. Yoganathan A, et al. In vitro velocity and turbulence measurements in the vicinity of three new mechanical valve prostheses. *J Thorac Cardiovasc Surg* 1988;95:929.
258. Nevaril CG, et al. Erythrocyte damage and destruction induced by shearing stress. *J Lab Clin Med* 1968;71:784-790.
259. Hjelm M, et al. Transient autoantibody formation in a case of open heart surgery with no signs of increased red cell destruction. *Vox Sang* 1964;9:505.
260. Pirofsky B, et al. Hemolytic anemia complicating aortic valve surgery. *N Engl J Med* 1965;272:235.
261. Pirofsky B. Aortic valve surgery and autoimmune hemolytic anemia. *Am Heart J* 1965;70:426.
262. Westring D. Aortic valve disease and hemolytic anemia. *Ann Intern Med* 1966;65:203.
263. Ducrou W, et al. Traumatic haemolysis after heart valve replacement: a comparison of haematological investigations. *Aust N Z J Med* 1972;2:118-123.
264. Sears D, Crosby WH. Intravascular hemolysis due to intracardiac prosthetic devices. *Am J Med* 1965;39:341.
265. Gitler B. Treatment of hemolytic anemia due to red blood cell fragmentation using recombinant human erythropoietin. *JAMA* 1995;274:300-301.
266. Symmers W. Thrombotic microangiopathic hemolytic anemia. *BMJ* 1952;2:897.
267. Brain M, et al. Microangiopathic hemolytic anemia: the possible role of vascular lesions in pathogenesis. *Br J Haematol* 1962;8:358.
268. Kwaan HC. Miscellaneous secondary thrombotic microangiopathy. *Semin Hematol* 1987;24:141-147.
269. Furlan M, Robles R, Lamie B. Partial purification and characterization of a protease from human plasma cleaving von Willebrand factor to fragments produced by in vivo proteolysis. *Blood* 1996;87:4223-4234.
270. Fujikawa K, et al. Purification of human von Willebrand factor-cleaving protease and its identification as a new member of the metalloproteinase family. *Blood* 2001;98:1662-1666.
271. Gerritsen HE, et al. Partial amino acid sequence of purified von Willebrand factor-cleaving protease. *Blood* 2001;98:1654-1661.

272. Furlan M, Lammle B. Von Willebrand factor in thrombotic thrombocytopenic purpura. *Thromb Haemost* 1999;82:592–600.
273. Moake JL, et al. Involvement of large plasma von Willebrand factor (vWF) multimers and unusually large vWF forms derived from endothelial cells in shear stress-induced platelet aggregation. *J Clin Invest* 1986;78:1456–1461.
274. Furlan M, et al. Von Willebrand factor-cleaving protease in thrombotic thrombocytopenic purpura and the hemolytic-uremic syndrome. *N Engl J Med* 1998;339:1578–1584.
275. Moake JL. Thrombotic microangiopathies. *N Engl J Med* 2002;347:589–600.
276. Asada Y, et al. Immunohistochemistry of vascular lesion in thrombotic thrombocytopenic purpura, with special reference to factor VIII related antigen. *Thromb Res* 1985;38:469–479.
277. Tsai HM, Lian EC. Antibodies to von Willebrand factor-cleaving protease in acute thrombotic thrombocytopenic purpura. *N Engl J Med* 1998;339:1585–1594.
278. Levy GG, et al. Mutations in a member of the ADAMTS gene family cause thrombotic thrombocytopenic purpura. *Nature* 2001;413:488–494.
279. Cohen JA, Brecher ME, Bandarenko N. Cellular source of serum lactate dehydrogenase elevation in patients with thrombotic thrombocytopenic purpura. *J Clin Apheresis* 1998;13:16–19.
280. Gasser W, et al. Hämolytisch urämische syndrome: Bilaterale Nierenridennekrosen bei akuten erworbenen hämolytischen Anämien. *Schweiz Med Wochenschr* 1955;85:905.
281. Gianantonio C, et al. The hemolytic-uremic syndrome. *J Pediatr* 1968;72:757.
282. Kaplan BS, Proesmans W. The hemolytic uremic syndrome of childhood and its variants. *Semin Hematol* 1987;24:148–160.
283. Martin DL, et al. The epidemiology and clinical aspects of the hemolytic uremic syndrome in Minnesota. *N Engl J Med* 1990;323:1161–1167.
284. Remuzzi G, Ruggenti. The hemolytic uremic syndrome. *Kidney Int* 1995;48:2–19.
285. Moake JL. Haemolytic-uraemic syndrome: basic science. *Lancet* 1994;343:393–397.
286. Pickering LK, Obrig TG, Stapleton FB. Hemolytic-uremic syndrome and enterohemorrhagic *Escherichia coli*. *Pediatr Infect Dis J* 1994;13:459–476.
287. Moake JL. Thrombotic thrombocytopenic purpura and the hemolytic uremic syndrome. *Arch Pathol Lab Med* 2002;126:1430–1433.
288. Drummond KN. Hemolytic uremic syndrome—then and now. *N Engl J Med* 1985;312:116–118.
289. Neild G. The haemolytic uraemic syndrome: a review. *Q J Med* 1987;63:367–376.
290. O'Brien AD, Holmes RK. Shiga and Shiga-like toxins. *Microbiol Rev* 1987;51:206–220.
291. Dorn CR, Angrick EJ. Serotype O157:H7 *Escherichia coli* from bovine and meat sources. *J Clin Microbiol* 1991;29:1225–1231.
292. Keene WE, et al. A swimming-associated outbreak of hemorrhagic colitis caused by *Escherichia coli* O157:H7 and *Shigella sonnei*. *N Engl J Med* 1994;331:579–584.
293. Levin M, et al. Inhibitor of prostacyclin production in sporadic haemolytic uraemic syndrome. *Arch Dis Child* 1983;58:703–708.

294. Brain MC. Hemolytic-uraemic syndrome. *Lancet* 1968;2:1394.
295. Gianantonio CA, et al. The hemolytic-uremic syndrome. *Nephron* 1973;11:174-192.
296. Levin M, Walters MD, Barratt TM. Hemolytic uremic syndrome. *Adv Pediatr Infect Dis* 1989;4:51-81.
297. Kaplan BS, Drummond KN. The hemolytic-uremic syndrome is a syndrome. *N Engl J Med* 1978;298:964-966.
298. Ray PE, Liu XH. Pathogenesis of Shiga toxin-induced hemolytic uremic syndrome. *Pediatr Nephrol* 2001;16:823-839.
299. Kaplan BS, Cleary TG, Obrig TG. Recent advances in understanding the pathogenesis of the hemolytic uremic syndromes. *Pediatr Nephrol* 1990;4:276-283.
300. Karpman D, et al. Platelet activation by Shiga toxin and circulatory factors as a pathogenetic mechanism in the hemolytic uremic syndrome. *Blood* 2001;97:3100-3108.
301. Taylor CM, et al. The expression of blood group P1 in post-enteropathic haemolytic uraemic syndrome. *Pediatr Nephrol* 1990;4:59-61.
302. Furlan M, Lammle B. Deficiency of von Willebrand factor-cleaving protease in familial and acquired thrombotic thrombocytopenic purpura. *Baillieres Clin Haematol* 1998;11:509-514.
303. Veyradier A, et al. Specific von Willebrand factor-cleaving protease in thrombotic microangiopathies: a study of 111 cases. *Blood* 2001;98:1765-1772.
304. Tsai HM, et al. von Willebrand factor and von Willebrand factor-cleaving metalloprotease activity in *Escherichia coli* O157:H7-associated hemolytic uremic syndrome. *Pediatr Res* 2001;49:653-659.
305. Van Geet C, et al. Activation of both coagulation and fibrinolysis in childhood hemolytic uremic syndrome. *Kidney Int* 1998;54:1324-1330.
306. Nevard CH, et al. Activation of coagulation and fibrinolysis in childhood diarrhoea-associated haemolytic uraemic syndrome. *Thromb Haemost* 1997;78:1450-1455.
307. Chandler WL, et al. Prothrombotic coagulation abnormalities preceding the hemolytic-uremic syndrome. *N Engl J Med* 2002;346:23-32.
308. Bull BS, Kuhn IN. The production of schistocytes by fibrin strands (a scanning electron microscope study). *Blood* 1970;35:104-111.
309. Brain MC, et al. Microangiopathic haemolytic anaemia and mucin-forming adenocarcinoma. *Br J Haematol* 1970;18:183-193.
310. Rubenberg ML, et al. Microangiopathic haemolytic anaemia: the experimental production of haemolysis and red-cell fragmentation by defibrination in vivo. *Br J Haematol* 1968;14:627-642.
311. Kaplan BSD, Thomson, de Chadarevian JP. The hemolytic uremic syndrome. *Pediatr Clin North Am* 1976;23:761-777.
312. Bale JF Jr, Brasher C, Siegler RL. CNS manifestations of the hemolytic-uremic syndrome. Relationship to metabolic alterations and prognosis. *Am J Dis Child* 1980;134:869-872.
313. Bos AP, Donckerwolcke RA, van Vught AJ. The hemolytic-uremic syndrome: prognostic significance of neurological abnormalities. *Helv Paediatr Acta* 1985;40:381-389.
314. Hall SM, Glickman M. The British Paediatric Surveillance Unit. *Arch Dis Child* 1988;63:344-346.
315. Kaplan BS. Hemolytic uremic syndrome with recurrent episodes: an important subset. *Clin Nephrol*

1977;8:495-498.

316. Milford D. The hemolytic uremic syndromes in the United Kingdom. In: Kaplan B, Trompeter R, Moake J, eds. Hemolytic uremic syndrome and thrombotic thrombocytopenic purpura. New York: Marcel Dekker, 1992:39-59.

317. Fitzpatrick M, et al. Atypical Hemolytic Uremic Syndrome. In: Kaplan B, Trompeter R, Moake J, eds. Hemolytic uremic syndrome and thrombotic thrombocytopenic purpura. New York: Marcel Dekker, 1992:163-178.

318. Melnyk AM, Solez K, Kjellstrand CM. Adult hemolytic-uremic syndrome. A review of 37 cases. Arch Intern Med 1995;155:2077-2084.

319. Lanzkowsky, McCrory W. Disseminated intravascular coagulation as a possible factor in the pathogenesis of thrombotic microangiopathy (hemolytic-uremic syndrome). J Pediatr 1967;70:460-462.

320. Piel C, Phibbs R. The hemolytic uremic syndrome. Pediatr Clin North Am 1966;13:295.

321. Willoughby ML, et al. Coagulation studies in haemolytic uraemic syndrome. Arch Dis Child 1972;47:766-771.

322. Bitzan M, et al. High incidence of serum antibodies to *Escherichia coli* O157 lipopolysaccharide in children with hemolytic-uremic syndrome. J Pediatr 1991;119:380-385.

323. Martin JN Jr, et al. Plasma exchange for preeclampsia. I. Postpartum use for persistently severe preeclampsia-eclampsia with HELLP syndrome. Am J Obstet Gynecol 1990;162:126-137.

324. Goldstein MH, et al. Hemolytic-uremic syndrome. Nephron 1979;23:263-272.

325. Boyce TG, Swerdlow DL, Griffin M. *Escherichia coli* O157:H7 and the hemolytic-uremic syndrome. N Engl J Med 1995;333:364-368.

326. Elliott MA, Nichols WL. Thrombotic thrombocytopenic purpura and hemolytic uremic syndrome. Mayo Clin Proc 2001;76:1154-1162.

327. Andreoli SP. The pathophysiology of the hemolytic uremic syndrome. Curr Opin Nephrol Hypertens 1999;8:459-464.

328. Siegler RL, et al. A 20-year population-based study of postdiarrheal hemolytic uremic syndrome in Utah. Pediatrics 1994;94:35-40.

329. Hayward CP, et al. Treatment outcomes in patients with adult thrombotic thrombocytopenic purpura-hemolytic uremic syndrome. Arch Intern Med 1994;154:982-987.

330. Sheth KJ, et al. Reversal of central nervous system involvement in hemolytic uremic syndrome by use of plasma exchanges. Clin Pediatr (Phila) 1987;26:651-656.

331. Ruggenti P, et al. Thrombotic thrombocytopenic purpura: evidence that infusion rather than removal of plasma induces remission of the disease. Am J Kidney Dis 1993;21:314-318.

332. Dundas S, et al. Effectiveness of therapeutic plasma exchange in the 1996 Lanarkshire *Escherichia coli* O157:H7 outbreak. Lancet 1999;354:1327-1330.

333. Gordon LI, Kwaan HC, Rossi EC. Deleterious effects of platelet transfusions and recovery thrombocytosis in patients with thrombotic microangiopathy. Semin Hematol 1987;24:194-201.

334. Schieppati A, et al. Renal function at hospital admission as a prognostic factor in adult hemolytic uremic syndrome. The Italian Registry of Haemolytic Uremic Syndrome. J Am Soc Nephrol 1992;2:1640-1644.

335. Antman KH, et al. Microangiopathic hemolytic anemia and cancer: a review. Medicine (Baltimore) 1979;58:377-384.

336. Gordon LI, Kwaan HC. Thrombotic microangiopathy manifesting as thrombotic thrombocytopenic purpura/hemolytic uremic syndrome in the cancer patient. *Semin Thromb Hemost* 1999;25:217-221.
337. Lohrmann HP, et al. Microangiopathic hemolytic anemia in metastatic carcinoma. Report of eight cases. *Ann Intern Med* 1973;79:368-375.
338. Murgu AJ. Thrombotic microangiopathy in the cancer patient including those induced by chemotherapeutic agents. *Semin Hematol* 1987;24:161-177.
339. Rauch AE, et al. RBC fragmentation and thymoma. *Arch Intern Med* 1984;144:1280-1282.
340. Blau A, Kaplinsky N. Microangiopathic haemolytic anaemia associated with recurrent pulmonary emboli and benign pelvic tumours. *Postgrad Med J* 1982;58:362-363.
341. Blot E, et al. Cancer-related thrombotic microangiopathy secondary to Von Wil-lebrand factor-cleaving protease deficiency. *Thromb Res* 2002;106:127-130.
342. Lesesne JB, et al. Cancer-associated hemolytic-uremic syndrome: analysis of 85 cases from a national registry. *J Clin Oncol* 1989;7:781-789.
343. Gardner G, Mesler D, Gitelman HJ. Hemolytic uremic syndrome following cisplatin, bleomycin, and vincristine chemotherapy: a report of a case and a review of the literature. *Ren Fail* 1989;11:133-137.
344. Canpolat C, Pearson P, Jaffe N. Cisplatin-associated hemolytic uremic syndrome. *Cancer* 1994;74:3059-3062.
345. Weinblatt ME, et al. Hemolytic uremic syndrome associated with cisplatin therapy. *Am J Pediatr Hematol Oncol* 1987;9:295-298.
346. Montes A, et al. A toxic interaction between mitomycin C and tamoxifen causing the haemolytic uraemic syndrome. *Eur J Cancer* 1993;29A:1854-1857.
347. Walker RW, et al. Carboplatin-associated thrombotic microangiopathic hemolytic anemia. *Cancer* 1989;64:1017-1020.
348. Byrnes JJ, et al. Thrombotic thrombocytopenic purpura subsequent to acute myelogenous leukemia chemotherapy. *Am J Hematol* 1986;21:299-304.
349. Laffay DL, et al. Chronic glomerular microangiopathy and metastatic carcinoma. *Hum Pathol* 1979;10:433-438.
350. Mach-Pascual S, Samii K, Beris P. Microangiopathic hemolytic anemia complicating FK506 (tacrolimus) therapy. *Am J Hematol* 1996;52:310-312.
351. Shitrit D, et al. Tacrolimus-induced hemolytic uremic syndrome case presentation in a lung transplant recipient. *Transplant Proc* 2003;35:627-628.
352. Silva VA, et al. Plasma exchange and vincristine in the treatment of hemolytic uremic syndrome/thrombotic thrombocytopenic purpura associated with bone marrow transplantation. *J Clin Apheresis* 1991;6:16-20.
353. Powles RL, et al. Cyclosporin A to prevent graft-versus-host disease in man after allogeneic bone-marrow transplantation. *Lancet* 1980;1:327-329.
354. Bonser RS, et al. Cyclosporin-induced haemolytic uraemic syndrome in liver allograft recipient. *Lancet* 1984;2:1337.
355. Ohashi N, et al. Withdrawal of interferon-alpha results in prompt resolution of thrombocytopenia and hemolysis but not renal failure in hemolytic uremic syndrome caused by interferon-alpha. *Am J Kidney Dis* 2003;41:E10.
356. Cantrell JE Jr, Phillips TM, Schein PS. Carcinoma-associated hemolytic-uremic syndrome: a



complication of mitomycin C chemotherapy. *J Clin Oncol* 1985;3:723–734.

357. Doll DC, Weiss RB. Hemolytic anemia associated with antineoplastic agents. *Cancer Treat Rep* 1985;69:777–782.

358. Sheldon R, Slaughter D. A syndrome of microangiopathic hemolytic anemia, renal impairment, and pulmonary edema in chemotherapy-treated patients with adenocarcinoma. *Cancer* 1986;58:1428–1436.

359. Zimmerman SE, et al. Gastric carcinoma and thrombotic thrombocytopenic purpura: association with plasma immune complex concentrations. *BMJ (Clin Res Ed)* 1982;284:1432–1434.

360. Grem JL, Merritt JA, Carbone PP. Treatment of mitomycin-associated microangiopathic hemolytic anemia with vincristine. *Arch Intern Med* 1986;146:566–568.

361. Doll DC, Yarbro JW. Vascular toxicity associated with antineoplastic agents. *Semin Oncol* 1992;19:580–596.

362. Agarwal A, et al. Recurrent hemolytic uremic syndrome in an adult renal allograft recipient: current concepts and management. *J Am Soc Nephrol* 1995;6:1160–1169.

363. Byrnes JJ, Moake JL. Thrombotic thrombocytopenic purpura and the haemolytic-uraemic syndrome: evolving concepts of pathogenesis and therapy. *Clin Haematol* 1986;15:413–442.

364. Rabinowe SN, et al. Hemolytic-uremic syndrome following bone marrow transplantation in adults for hematologic malignancies. *Blood* 1991;77:1837–1844.

365. Pettitt AR, Clark RE. Thrombotic microangiopathy following bone marrow transplantation. *Bone Marrow Transplant* 1994;14:495–504.

366. Atkinson K, et al. Cyclosporin A associated nephrotoxicity in the first 100 days after allogeneic bone marrow transplantation: three distinct syndromes. *Br J Haematol* 1983;54:59–67.

367. Bonsib SM, et al. Recurrent thrombotic microangiopathy in a renal allograft. Case report and review of the literature. *Am J Med* 1985;79:520–527.

368. Byrnes JJ, Hussein AM. Thrombotic microangiopathic syndromes after bone marrow transplantation. *Cancer Invest* 1996;14:151–157.

369. Cunningham FG, Lindheimer MD. Hypertension in pregnancy. *N Engl J Med* 1992;326:927–932.

370. Weiner CP. The clinical spectrum of preeclampsia. *Am J Kidney Dis* 1987;9:312–316.

371. Oian P, Maltau JM, Abyholm T. HELLP syndrome—a serious complication of hypertension in pregnancy. *Acta Obstet Gynecol Scand* 1984;63:727–729.

372. Weinstein L. Syndrome of hemolysis, elevated liver enzymes, and low platelet count: a severe consequence of hypertension in pregnancy. *Am J Obstet Gynecol* 1982;142:159–167.

373. Sibai BM, Kustermann L, Velasco J. Current understanding of severe preeclampsia, pregnancy-associated hemolytic uremic syndrome, thrombotic thrombocytopenic purpura, hemolysis, elevated liver enzymes, and low platelet syndrome, and postpartum acute renal failure: different clinical syndromes or just different names? *Curr Opin Nephrol Hypertens* 1994;3:436–445.

374. Sibai BM, et al. Maternal morbidity and mortality in 442 pregnancies with hemolysis, elevated liver enzymes, and low platelets (HELLP syndrome). *Am J Obstet Gynecol* 1993;169:1000–1006.

375. Curtin WM, Weinstein L. A review of HELLP syndrome. *J Perinatol* 1999;19:138–143.

376. Rath W, Faridi A, Dudenhausen JW. HELLP syndrome. *J Perinat Med* 2000;28:249–260.

377. Saphier CJ, Repke JT. Hemolysis, elevated liver enzymes, and low platelets (HELLP) syndrome: a review of diagnosis and management. *Semin Perinatol* 1998;22:118–133.

378. Weiner CP. Thrombotic microangiopathy in pregnancy and the postpartum period. *Semin Hematol* 1987;24:119-129.
379. Inglis TC, et al. Haemostatic and rheological changes in normal pregnancy and pre-eclampsia. *Br J Haematol* 1982;50:461-465.
380. Rakoczi I, et al. Platelet life-span in normal pregnancy and pre-eclampsia as determined by a non-radioisotope technique. *Thromb Res* 1979;15:553-556.
381. Redman CW, et al. Factor-VIII consumption in pre-eclampsia. *Lancet* 1977;2:1249-1252.
382. Weiner CP, et al. Antithrombin III activity in women with hypertension during pregnancy. *Obstet Gynecol* 1985;65:301-306.
383. Weiner CP, Brandt J. Plasma antithrombin III activity: an aid in the diagnosis of preeclampsia-eclampsia. *Am J Obstet Gynecol* 1982;142:275-281.
384. Vassalli P, McCluskey R. The coagulation process and glomerular disease. *Am J Med* 1965;39:179.
385. Arias F, Mancilla-Jimenez R. Hepatic fibrinogen deposits in pre-eclampsia. Immunofluorescent evidence. *N Engl J Med* 1976;295:578-582.
386. Kraayenbrink AA, et al. Endothelial vasoactive mediators in preeclampsia. *Am J Obstet Gynecol* 1993;169:160-165.
387. Nova A, et al. Maternal plasma level of endothelin is increased in preeclampsia. *Am J Obstet Gynecol* 1991;165:724-727.
388. Halim A, et al. HELLP syndrome-like biochemical parameters obtained with endothelin-1 injections in rabbits. *Gynecol Obstet Invest* 1993;35:193-198.
389. Walsh SW. Preeclampsia: an imbalance in placental prostacyclin and thromboxane production. *Am J Obstet Gynecol* 1985;152:335-340.
390. Wilke G, et al. Haptoglobin as a sensitive marker of hemolysis in HELLP-syndrome. *Int J Gynaecol Obstet* 1992;39:29-34.
391. van Pampus MG, et al. Maternal and perinatal outcome after expectant management of the HELLP syndrome compared with pre-eclampsia without HELLP syndrome. *Eur J Obstet Gynecol Reprod Biol* 1998;76:31-36.
392. Helou J, et al. Postpartum thrombotic thrombocytopenic purpura: report of a case and review of the literature. *Obstet Gynecol Surv* 1994;49:785-789.
393. Egerman RS, et al. Thrombotic thrombocytopenic purpura and hemolytic uremic syndrome in pregnancy: review of 11 cases. *Am J Obstet Gynecol* 1996;175:950-956.
394. Ezra Y, Rose M, Eldor A. Therapy and prevention of thrombotic thrombocytopenic purpura during pregnancy: a clinical study of 16 pregnancies. *Am J Hematol* 1996;51:1-6.
395. Rose M, Rowe JM, Eldor A. The changing course of thrombotic thrombocytopenic purpura and modern therapy. *Blood Rev* 1993;7:94-103.
396. Baker LR, Sevitt LH, Wrong OM. Vascular lesions in malignant hypertension. *Lancet* 1969;2:593.
397. Capelli JP, Wesson GL Jr, Erslev AV. Malignant hypertension and red cell fragmentation syndrome. Report of a case. *Ann Intern Med* 1966;64:128-136.
398. Venkatachalam MA, Jones DB, Nelson DA. Microangiopathic hemolytic anemia in rats with malignant hypertension. *Blood* 1968;32:278-291.
399. Rosner F, Rubenberg ML. Erythrocyte fragmentation in consumption coagulopathy. *N Engl J Med*

1969;280:219–220.

400. Rubenberg ML, et al. Intravascular coagulation in a case of *Clostridium perfringens* septicaemia: treatment by exchange transfusion and heparin. *BMJ* 1967;4:271–274.

401. Hollingsworth JH, Mohler DN. Microangiopathic hemolytic anemia caused by purpura fulminans. *Ann Intern Med* 1968;68:1310–1314.

402. Stefanini M, Spicer DD. Hemostatic breakdown, fibrinolysis, and acquired hemolytic anemia in a patient with fatal heatstroke: pathogenetic mechanisms. *Am J Clin Pathol* 1971;55:180–186.

403. Brain MC, et al. Treatment of patients with microangiopathic haemolytic anaemia with heparin. *Br J Haematol* 1968;15:603–621.

404. Brain MC, Esterly JR, Beck EA. Intravascular haemolysis with experimentally produced vascular thrombi. *Br J Haematol* 1967;13:868–891.

405. Bull BS, et al. Microangiopathic haemolytic anaemia: mechanisms of red-cell fragmentation: in vitro studies. *Br J Haematol* 1968;14:643–652.

406. Neshet G, et al. Thrombotic microangiographic hemolytic anemia in systemic lupus erythematosus. *Semin Arthritis Rheum* 1994;24:165–172.

407. Salyer WR, Salyer DC, Heptinstall RH. Scleroderma and microangiopathic hemolytic anemia. *Ann Intern Med* 1973;78:895–897.

408. Crummy CS, Perlin E, Moquin RB. Microangiopathic hemolytic anemia in Wegener's granulomatosis. *Am J Med* 1971;51:544–548.

409. Jordan JM, Manning M, Allen NB. Multiple unusual manifestations of Wegener's granulomatosis: breast mass, microangiopathic hemolytic anemia, consumptive coagulopathy, and low erythrocyte sedimentation rate. *Arthritis Rheum* 1986;29:1527–1531.

410. Zauber NP, Echikson AB. Giant cell arteritis and microangiopathic hemolytic anemia. *Am J Med* 1982;73:928–930.

411. Bayer AS, et al. Thrombotic thrombocytopenic purpura-like syndrome associated with infective endocarditis. A possible immune complex disorder. *JAMA* 1977;238:408–410.

412. Medani CR, Pearl PL, Hall-Craggs M. Acute renal failure, hemolytic anemia, and thrombocytopenia in poststreptococcal glomerulonephritis. *South Med J* 1987;80:370–373.

413. Michael AF Jr, et al. Acute poststreptococcal glomerulonephritis: immune deposit disease. *J Clin Invest* 1966;45:237–248.

414. Kauffman RE. The clinical interpretation and application of drug concentration data. *Pediatr Clin North Am* 1981;28:35–45.

415. Inceman S, Tangun Y. Chronic defibrination syndrome due to a giant hemangioma associated with microangiopathic hemolytic anemia. *Am J Med* 1969;46:997–1002.

416. Shimizu M, et al. Hepatic giant cavernous hemangioma with microangiopathic hemolytic anemia and consumption coagulopathy. *Am J Gastroenterol* 1990;85:1411–1413.

417. Propp RP, Scharfman WB. Hemangioma-thrombocytopenia syndrome associated with microangiopathic hemolytic anemia. *Blood* 1966;28:623–633.

418. Alpert LI, Benisch B. Hemangioendothelioma of the liver associated with microangiopathic hemolytic anemia. Report of four cases. *Am J Med* 1970;48:624–628.

419. Yohannan MD, Abdulla AM, Patel PJ. Neonatal hepatic haemangioendothelioma: presentation with jaundice and microangiopathic haemolytic anaemia. *Eur J Pediatr* 1990;149:804–805.

420. Hofhuis WJ, et al. Blue rubber-bleb naevus syndrome: report of a case with consumption coagulopathy complicated by manifest thrombosis. *Eur J Pediatr* 1990;149:526-528.
421. Ortel TL, et al. Antifibrinolytic therapy in the management of the Kasabach Merritt syndrome. *Am J Hematol* 1988;29:44-48.
422. Hornbostel H, et al. [Recent information on march hemoglobinuria]. *Dtsch Med Wochenschr* 1970;95:458-461.
423. Kaden WS. Traumatic haemoglobinuria in conga-drum players. *Lancet* 1970;760:1341-1342.
424. Caro XJ, et al. Traumatic hemoglobinuria associated with conga drumming. *West J Med* 1975;123:141-144.
425. Streeton JA. Traumatic haemoglobinuria caused by karate exercises. *Lancet* 1967;2:191-192.
426. Buckman MT. Gastrointestinal bleeding in long-distance runners. *Ann Intern Med* 1984;101:127-128.
427. Banga JP, et al. An erythrocyte membrane-protein anomaly in march haemoglobinuria. *Lancet* 1979;2:1048-1049.
428. Platt OS, Lux SE, Nathan DG. Exercise-induced hemolysis in xerocytosis. Erythrocyte dehydration and shear sensitivity. *J Clin Invest* 1981;68:631-638.
429. Brabec V, Sebestik V. Blood volume changes in "hypersplenic" rats. *Haematologia (Budap)* 1975;9:97-102.
430. Rosse WF. The spleen as a filter. *N Engl J Med* 1987;317:704-706.
431. Allen DW, Manning N. Cholesterol-loading of membranes of normal erythrocytes inhibits phospholipid repair and arachidonoyl-CoA: 1-palmitoyl-sn-glycero-3-phosphocholine acyl transferase. A model of spur cell anemia. *Blood* 1996;87:3489-3493.
432. Cooper RA, Kimball DB, Durocher JR. Role of the spleen in membrane conditioning and hemolysis of spur cells in liver disease. *N Engl J Med* 1974;290:1279-1284.
433. Cooper RA. Hemolytic syndromes and red cell membrane abnormalities in liver disease. *Semin Hematol* 1980;17:103-112.
434. Sanyal AJ, et al. The hematologic consequences of transjugular intrahepatic portosystemic shunts. *Hepatology* 1996;23:32-39.
435. Eschbach JW Jr, et al. Erythropoiesis in patients with renal failure undergoing chronic dialysis. *N Engl J Med* 1967;276:653-658.
436. Bonomini M, Sirolli V. Uremic toxicity and anemia. *J Nephrol* 2003;16:21-28.
437. Loge J, Lange R, Moore C. Characterization of the anemia associated with chronic renal insufficiency. *Am J Med* 1958;24:4-18.
438. Kaye M. The anemia associated with renal disease. *J Lab Clin Med* 1958;52:83-100.
439. Shaw AB. Haemolysis in chronic renal failure. *BMJ* 1967;2:213-216.
440. Koch KM, et al. Anemia of the regular hemodialysis patient and its treatment. *Nephron* 1974;12:405-419.
441. Caimi G. Erythrocyte peroxide metabolism, plasma lipid pattern and hemorheological profile in chronic renal failure. *J Nephrol* 2002;15:104-108.
442. Bonomini M, et al. Increased erythrocyte phosphatidylserine exposure in chronic renal failure. *J Am*

Soc Nephrol 1999;10:1982-1990.

443. Bonomini M, et al. Involvement of phosphatidylserine exposure in the recognition and phagocytosis of uremic erythrocytes. *Am J Kidney Dis* 2001;37:807-814.

444. Connor J, Pak CC, Schroit AJ. Exposure of phosphatidylserine in the outer leaflet of human red blood cells. Relationship to cell density, cell age, and clearance by mononuclear cells. *J Biol Chem* 1994;269:2399-2404.

445. McEvoy L, Williamson P, Schlegel RA. Membrane phospholipid asymmetry as a determinant of erythrocyte recognition by macrophages. *Proc Natl Acad Sci U S A* 1986;83:3311-3315.

446. Eaton JW, et al. Chlorinated urban water: a cause of dialysis-induced hemolytic anemia. *Science* 1973;181:463-464.

447. Orringer EP, Mattern WD. Formaldehyde-induced hemolysis during chronic hemodialysis. *N Engl J Med* 1976;294:1416-1420.

448. Carlson DJ, Shapiro FL. Methemoglobinemia from well water nitrates: a complication of home dialysis. *Ann Intern Med* 1970;73:757-759.

449. Sweet SJ, et al. Hemolytic reactions mechanically induced by kinked hemodialysis lines. *Am J Kidney Dis* 1996;27:262-266.

450. Adams KF, et al. The effect of copper on erythrocyte deformability: a possible mechanism of hemolysis in acute copper intoxication. *Biochim Biophys Acta* 1979;550:279-287.

451. Jacob HS, Amsden T. Acute hemolytic anemia with rigid red cells in hypophosphatemia. *N Engl J Med* 1971;285:1446-1450.

452. Klock JC, Williams HE, Mentzer WC. Hemolytic anemia and somatic cell dysfunction in severe hypophosphatemia. *Arch Intern Med* 1974;134:360-364.

453. Melvin JD, Watts RG. Severe hypophosphatemia: a rare cause of intravascular hemolysis. *Am J Hematol* 2002;69:223-224.

454. Shilo S, Werner D, Hershko C. Acute hemolytic anemia caused by severe hypophosphatemia in diabetic ketoacidosis. *Acta Haematol* 1985;73:55-57.

455. Altuntas Y, et al. Rhabdomyolysis and severe haemolytic anaemia, hepatic dysfunction and intestinal osteopathy due to hypophosphataemia in a patient after Billroth II gastrectomy. *Eur J Gastroenterol Hepatol* 2002;14:555-557.

456. Kaiser U, Barth N. Haemolytic anaemia in a patient with anorexia nervosa. *Acta Haematol* 2001;106:133-135.

457. Andersen MN, Kuchiba K. Blood trauma produced by pump oxygenators: a comparative study of five different units. *J Thorac Cardiovasc Surg* 1969;57:238-244.

458. Chenoweth DE, et al. Complement activation during cardiopulmonary bypass: evidence for generation of C3a and C5a anaphylatoxins. *N Engl J Med* 1981;304:497-503.

459. Salama A, et al. Deposition of terminal C5b-9 complement complexes on erythrocytes and leukocytes during cardiopulmonary bypass. *N Engl J Med* 1988;318:408-414.

460. Beutler E. Drug induced blood dyscrasias. III. Hemolytic anemia. *JAMA* 1964;189:143.

461. Goodacre RL, et al. Hemolytic anemia in patients receiving sulfasalazine. *Digestion* 1978;17:503-508.

462. Hayes D, Felts JH. Sulfonamide methemoglobinemia and hemolytic anemia during renal failure. *Am J Med Sci* 1964;247:552.

463. Mayer K, Ley AB. Hemolysis of red cells due to sulfone. *Ann Intern Med* 1970;72:711-714.
464. Sanders SW, et al. Hemolytic anemia induced by dapsone transmitted through breast milk. *Ann Intern Med* 1982;96:465-466.
465. Scott GL, Rasbridge MR. The in vitro action of dapsone and its derivatives on normal and G6PD-deficient red cells. *Br J Haematol* 1973;24:307-317.
466. Jollow DJ, Bradshaw TP, McMillan DC. Dapsone-induced hemolytic anemia. *Drug Metab Rev* 1995;27:107-124.
467. Nathan DM, Siegel AJ, Bunn HF. Acute methemoglobinemia and hemolytic anemia with phenazopyridine: possible relation to acute renal failure. *Arch Intern Med* 1977;137:1636-1638.
468. Davidson RJ. Phenacetin-induced haemolytic anaemia. *J Clin Pathol* 1971;24:537-541.
469. Millar J, Peloquin R, De Leeuw NK. Phenacetin-induced hemolytic anemia. *Can Med Assoc J* 1972;106:770-775.
470. Chan TK, Mak LW, Ng RP. Methemoglobinemia, Heinz bodies, and acute massive intravascular hemolysis in Lysol poisoning. *Blood* 1971;38:739-744.
471. Cote MA, Lyonnais J, Leblond PF. Acute Heinz-body anemia due to severe cresol poisoning: successful treatment with erythrocytapheresis. *Can Med Assoc J* 1984;130:1319-1322.
472. Dawson J, et al. Acute hemolytic anemia in the newborn infant due to naphthalene poisoning. *Blood* 1958;13:1113.
473. Todisco V, Lamour J, Finberg L. Hemolysis from exposure to naphthalene mothballs. *N Engl J Med* 1991;325:1660-1661.
474. Zuelzer W, Apt L. Acute hemolytic anemia due to naphthalene poisoning: a clinical and experimental study. *JAMA* 1949;141:185.
475. Nabarro J. A case of acute mononitrobenzine poisoning. *BMJ* 1948;1:929.
476. Lubash G, et al. Acute aniline poisoning treated by hemodialysis. *Arch Intern Med* 1964;114:530.
477. de Leeuw N, et al. Drug induced hemolytic anemia. *Ann Intern Med* 1963;58:592.
478. Azen E, Schilling RF. Role of the spleen in acetylphenylhydrazine anemia in rats. *J Lab Clin Med* 1963;62:59.
479. Itano HA, Hosokawa K, Hirota K. Induction of haemolytic anaemia by substituted phenylhydrazines. *Br J Haematol* 1976;32:99-104.
480. Davies P. Potassium chlorate poisoning with oliguria treated by the Bull regime. *Lancet* 1956;1:612.
481. Jackson R, et al. Sodium chlorate poisoning complicated by acute renal failure. *Lancet* 1961;2:1381.
482. Bogart L, Bonsignore J, Carvalho A. Massive hemolysis following inhalation of volatile nitrites. *Am J Hematol* 1986;22:327-329.
483. Romeril KR, Concannon AJ. Heinz body haemolytic anaemia after sniffing volatile nitrites. *Med J Aust* 1981;1:302-303.
484. Beaupre SR, Schiffman FJ. Rush hemolysis. A 'bite-cell' hemolytic anemia associated with volatile liquid nitrite use. *Arch Fam Med* 1994;3:545-548.
485. Larkin EC, Williams WT, Ulvedal F. Human hematologic responses to 4 hr of isobaric hyperoxic

exposure (100 per cent oxygen at 760 mm Hg). *J Appl Physiol* 1973;34:417-421.

486. Mengel C, Kann HE Jr, Heyman A, et al. Effects of in vivo hyperoxia on erythrocytes. II. Hemolysis in a human after exposure to oxygen under high pressure. *Blood* 1965;25:822.

487. Martin H, et al. Hamolytische Anämie durch Inhalation von Hydrozylaminen. *Klin Wochenschr* 1964;42:725.

488. Sills MR, Zinkham WH. Methylene blue-induced Heinz body hemolytic anemia. *Arch Pediatr Adolesc Med* 1994;148:306-310.

489. Petersen JM, Pierach CA. Hematin-induced hemolysis in acute porphyria. *Ann Intern Med* 1984;101:877-878.

490. Hassan AB, Seligmann H, Bassan HM. Intravascular haemolysis induced by pentachlorophenol. *BMJ (Clin Res Ed)* 1985;291:21-22.

491. Maloisel F, et al. Platin salts-induced hemolytic anemia: cisplatin- and the first case of carboplatin-induced hemolysis. *Anticancer Drugs* 1995;6:324-326.

2004 Lippincott Williams & Wilkins  
John P. Greer, John Foerster, John N. Lukens  
George M. Rodgers, Frixos Paraskevas, Bertil Glader  
Wintrobe's Clinical Hematology



HISTORYNOMENCLATURECLASSIFICATIONPREVALENCE AND GEOGRAPHIC DISTRIBUTIONGENETIC MECHANISMS AND MOLECULAR PATHOLOGYOrganization and Structure of Globin GenesGenetic Basis of Abnormal HemoglobinsPatterns of InheritanceHemoglobin Patterns Associated with Various Genetic CombinationsPATHOPHYSIOLOGYHEMOGLOBIN C DISORDERSHemoglobin C TraitHemoglobin C DiseaseHemoglobin SC DiseaseHemoglobin C Korie-Bu DiseaseHEMOGLOBIN D DISORDERSHemoglobin D TraitHemoglobin D DiseaseHemoglobin SD DiseaseHEMOGLOBIN E DISORDERSHemoglobin E TraitHemoglobin E DiseaseRELEVANT WEB SITESREFERENCES

Inherited abnormalities of hemoglobin synthesis may be divided into two groups: those characterized by structurally abnormal hemoglobin variants and those in which one or more of the normal polypeptide chains of hemoglobin are synthesized at a reduced rate. The term *hemoglobinopathy* is used to designate the former disorders, and the term *thalassemia* is associated with the latter. The hemoglobinopathies may be divided further into functionally distinctive groups. Many are functionally normal and, therefore, clinically silent. Some form polymers [hemoglobin (Hb) S] or crystals (Hb C), giving rise to hemolytic disease (see [Chapter 40](#)). Others are unstable, producing either intermittent or chronic hemolysis (see [Chapter 41](#)). Structural changes that increase the affinity of hemoglobin for oxygen are characterized by erythrocytosis (see [Chapter 50](#)), whereas those with decreased oxygen affinity are associated with cyanosis (see [Chapter 49](#)). Mutations that maintain hemoglobin iron in the ferric state are responsible for methemoglobinemia (see [Chapter 49](#)). A few structural variants remain that are characterized by a thalassemic phenotype rather than by one of the syndromes associated with hemoglobinopathies. Most of the latter variants are thought to arise from a single mutation that simultaneously produces a structural and a quantitative defect in globin chain synthesis. Some may involve two mutations within a single gene—one responsible for a structural defect and the other for a biosynthetic defect. These thalassemic hemoglobinopathies are discussed in [Chapter 42](#), the focus of which is on thalassemias. This chapter provides a broad introduction to the abnormal hemoglobins, with an emphasis on population genetics, molecular pathology, and pathophysiology. In addition, the clinical consequences of some of the more prevalent hemoglobin disorders are discussed (those involving Hb C, Hb D, and Hb E). Hb S and the sickling disorders are

discussed in [Chapter 40](#).

## HISTORY

The story of the events leading to an understanding of the hemoglobinopathies and thalassemia provides a fascinating picture that illustrates the value of the pursuit of knowledge for its own sake. It reveals the fruits that can be gained if curiosity is aroused and an answer sought to questions that may at the time seem to be of no practical importance, as well as the progress that can be made when the right question is put to a “prepared mind.”

In 1910, James B. Herrick reported “peculiar, elongated, sickle-shaped red corpuscles” in “a case of severe anemia” in a black student ([1](#)). He described the clinical manifestations in his patient in considerable detail. The sickle cells, he thought, were freakish poikilocytes, and, with considerable prescience, he suggested that they were a manifestation of a peculiar chemical or physical condition. Emmel, in 1917, observed the transformation of the biconcave red cell to the sickle form *in vitro* ([2](#)). He also noted that sickling occurred both in persons with severe anemia and in others who were apparently healthy, thus recognizing both sickle cell anemia and sickle cell trait.

The comprehensive studies of Hahn and Gillespie in 1927 delineated the conditions affecting sickle cell formation *in vitro*, including pH, temperature, fixatives, tonicity, and others ([3](#)). Perhaps their most important observations were the observation that exclusion of oxygen was a prerequisite for sickling and the recognition that sickling was reversed on reexposure to the gas. They postulated that similar effects of oxygen could occur *in vivo*, with hypoxia leading to cellular distortion and consequent hemolysis. Later, Hahn applied the term *sickle cell trait* to the asymptomatic condition associated with *in vitro* sickling. He performed studies in families and concluded that the trait was inherited as a dominant character.

Paralleling these events was the report of Cooley and Lee, in 1925, who separated from the complex of disorders of infancy and childhood that had been known as *Von Jaksch anemia* a syndrome characterized by chronic, progressive anemia beginning early in life, with pronounced peripheral blood erythroblastosis, characteristic facies, splenomegaly, and a familial incidence ([4](#)). The observation that these patients were of Mediterranean background led to the introduction of the name *thalassemia*, derived from the Greek word for *sea*. The parents of these children, however, were not examined. At this time and in the following years, descriptions appeared in the Italian literature of a milder disorder, encountered in adults as well as in children, that was marked by morphologic abnormalities in the red cells and decreased red cell osmotic fragility (microelliptopoikilocytic anemia, *malattia di Rietti-Greppi-Michel*). In 1938, Caminopetros noted that the parents of a child suffering from severe thalassemia had diminished red cell osmotic fragility ([5](#)), but the relationship between Cooley anemia and the Rietti-Greppi-Micheli syndrome remained obscure.

Curiosity regarding the significance of basophilic stippling of the red cells of several adult patients with minor ailments led to the description in 1940 by Wintrobe and his associates of what they considered to be a mild form of Cooley anemia ([6](#)). These investigators also showed that the manifestations of this disorder were present in both parents of a child with classic Cooley anemia. Subsequent genetic studies established that Cooley anemia is the homozygous or doubly heterozygous state for an autosomal gene; the patients described by Rietti and by Wintrobe and their co-workers represented the heterozygous

state ( 7 ).

In 1940, the sickling phenomenon was reinvestigated by Sherman ( 8 ), who confirmed the observations of Hahn and Gillespie regarding reversibility and the importance of oxygen. Sherman also found that the cells in sickle cell disease were birefringent, an observation that aroused curiosity but remained unexplained for nearly a decade. Then, in a casual conversation, the birefringence was called to the attention of the physical chemist Linus Pauling ( 9 ), who immediately deduced that the phenomenon was the manifestation of an abnormal hemoglobin molecule. With Itano, he demonstrated an electrophoretically abnormal hemoglobin in sickle cell anemia ( 10 ), thus introducing the concept of molecular disease.

In the same year that Pauling made his discovery, Neel established that sickle cell trait was the heterozygous and sickle cell anemia the homozygous state for the same gene ( 11 ). With the demonstration by Ingram of a difference in the amino acid sequence in one small part of the polypeptide chains of sickle cell hemoglobin ( 12 ), the science of molecular biology took root. The contributions of Perutz, Lehmann, and many others have resulted in an expansion of knowledge to a degree unforeseen even in the 1950s, let alone when Herrick wrote about his patient with a peculiar anemia.

## NOMENCLATURE

When newly discovered hemoglobins were first reported, they were designated by letters of the alphabet. Normal adult hemoglobin and fetal hemoglobin were called *Hb A* and *Hb F*, respectively. When sickle cell hemoglobin was discovered, some individuals called it *Hb E*, but soon the letter *S* was assigned to it, and, to avoid confusion, no other hemoglobin was designated *E*. Hemoglobins associated with methemoglobinemia were given the letter *M*. Other hemoglobins were assigned letters in alphabetic order. By the time the letter *G* was reached, the inability of this system to provide sufficient designations was apparent. Furthermore, structurally different hemoglobins occasionally had been given the same letter. In 1960, a new system of nomenclature was adopted, and the letters *A* and *Z* through *Z* were unassigned ( 13 ). Solitary letter designations are used only for the normal hemoglobins *A* and *F* and for the abnormal hemoglobins *C*, *E*, *S*, and *H*. Letters, however, may be used as part of a more complete common name.

Abnormal hemoglobins are now assigned both a common name and a scientific designation. The common name is selected by the discoverer. It usually represents a geographic area, such as a city, district, province, or hospital, and may be the native region of the propositus or the place of discovery. Capital letters are sometimes retained to indicate a special property of the hemoglobin variant. Thus, the designation *Hb G Copenhagen* indicates a hemoglobin discovered in Copenhagen with the same electrophoretic mobility as that of other hemoglobins *G*. Similarly, *Hb M Boston* indicates a variant that, like other *M* hemoglobins, tends to form methemoglobin.

Recommended scientific designations indicate the variant chain, both the sequential and helical number of the aberrant amino acid, and the nature of the substitution. Thus,  $\beta_6(\text{A3})\text{Glu}\rightarrow\text{Val}$ , the scientific designation for *Hb S*, indicates that the substitution of valine (*Val*) for glutamic acid (*Glu*) has occurred at amino acid number 6, the third amino acid in the  $\alpha$  helix, in the  $\beta$ -chain. In the case of hemoglobins with two substitutions, both are indicated; thus, *Hb C Harlem* is designated  $\beta(\text{A3})\text{Glu}\rightarrow\text{Val}; 73(\text{E17})\text{Asp}\rightarrow\text{Asn}$ .

Amino acid deletions are indicated by the symbol 0; thus,  $\beta_{23}(\text{B5})\text{Val}\rightarrow 0$ , the designation for *Hb Freiburg*, indicates the deletion of valine at position 23 in the  $\beta$ -chain. Less

commonly, the word *missing* is used to indicate deletions; thus,  $\beta 56-59(D7-E3)$  missing, the designation for Hb Tochigi, indicates the deletion of four amino acids in the  $\beta$ -chain.

Various designations have been used for fusion hemoglobins. The current convention identifies the portions of the chains that are fused insofar as they are known. Hemoglobin Lepore-Boston is shown as  $d(1-87) \beta(116-146)$ . The fusion occurs somewhere between amino acids 88 and 115. The first 87 amino acids come from the d-chain, and the last 32 come from the  $\beta$ -chain.

Variants with elongated chains are indicated by the use of a plus sign followed by the number of added amino acids. For example, Hb Tak can be designated  $\beta^+ 11C$ , indicating that 11 amino acids have been added to the C-terminal of the normal  $\beta$ -chain. When the elongation is accompanied by altered amino acids, they are shown in parentheses, as in Hb Constant Spring, which is designated  $\alpha^+ 31C(142 \text{ Gln})$ , or Hb Wayne, which is designated  $\alpha(139-141 \text{ Asn Thr Val}) + 5C$ .

## CLASSIFICATION

A catalog of human hemoglobin variants was maintained until 1998 by Dr. Titus H.J. Huisman (14). After his death, this syllabus was converted to an electronic database, which is expanded and revised on an ongoing basis (15). It is accessible on the World Wide Web at <http://globin.cse.psu.edu>. As of 2002, the database included no fewer than 850 unique hemoglobin variants. Of these, 44 were associated with a thalassemic phenotype (thalassemic hemoglobinopathies). These are discussed in Chapter 42.

The hemoglobin variants can be classified on the basis of functional characteristics or structural abnormalities. The functional properties of hemoglobin variants are discussed in the section Pathophysiology. Structural alterations include single and double amino acid substitutions; amino acid deletions, insertions, and both deletions and insertions; additions; and fusion chains formed from two different polypeptide chains (Table 39.1).

**TABLE 39.1. Summary of the Molecular Abnormalities of Hemoglobin Variants**

|                                | Number of Variants |                |         |         | Total |
|--------------------------------|--------------------|----------------|---------|---------|-------|
|                                | $\alpha$ -Chain    | $\beta$ -Chain | d-Chain | ?-Chain |       |
| Single amino acid substitution | 253                | 405            | 34      | 67      | 759   |
| Two amino acid substitutions   | 1                  | 23             | 0       | 5       | 29    |
| Deletions                      | 9                  | 12             | 0       | 0       | 21    |
| Insertions                     | 5                  | 2              | 0       | 0       | 7     |
| Deletions and insertions       | 0                  | 11             | 0       | 0       | 11    |
| Extended chains                | 9                  | 9              | 0       | 0       | 18    |
| Fusions                        | 0                  | 9              | 8       | 1       | 18    |
| Totals <sup>a</sup>            | 277                | 471            | 42      | 73      | 863   |

<sup>a</sup> The total number of hemoglobin variants (854) is 9 less than the sum of the first four columns because each of the nine fusion hemoglobins is recorded in two columns.

Most abnormal hemoglobins differ from normal hemoglobin in the substitution of a single amino acid for another. In Hb S, for example, valine replaces glutamic acid in the sixth position from the *N*-terminal of the  $\beta$ -globin chain. Many other examples of this kind have been discovered. More than 600 hemoglobin variants characterized by a single amino acid substitution have been recognized and characterized ( [14](#), [15](#) ). Of these variants, more than 200 involve the  $\alpha$ -chain, nearly 400 involve the  $\beta$ -chain, more than 30 involve the  $\delta$ -chain, and more than 70 involve the  $\epsilon$ -chain ( [Table 39.1](#) ). The paucity of  $\alpha$ -chain variants as compared with  $\beta$ -chain defects is explained by duplication of the  $\alpha$ -globin genes. Individuals homozygous for  $\alpha$ -chain variants have two normally functioning  $\alpha$  genes and are therefore likely to be protected from clinical expression of the abnormal hemoglobin, whereas homozygotes for  $\beta$ -chain variants are unable to synthesize Hb A. Thus, mutations affecting the  $\beta$  gene are detected during the investigation of disease, whereas most of those involving the  $\alpha$  gene escape recognition, except in the course of population surveys. Likewise, structural alterations of the  $\delta$ - and  $\epsilon$ -chains are unlikely to produce signs or symptoms that would warrant diagnostic evaluation. Two exceptions are the  $\epsilon$ -chain substitutions in Hb F Poole and Hb FM Osaka. The former renders the hemoglobin molecule sufficiently unstable to produce hemolytic disease in fetal and early postnatal life ( [16](#) ), and the latter is responsible for neonatal cyanosis ( [17](#) ).

Other abnormal hemoglobins are characterized by more complex structural alterations. Two amino acid substitutions have been detected in 24 hemoglobin variants ( [Table 39.2](#) ). Many of the  $\beta$ -globin variants with two amino acid substitutions are unstable and therefore associated with hemolytic anemia of varying severity. Of particular interest are six variants in which one of the two point substitutions is identical to that in Hb S ( $\beta_6$  Glu $\rightarrow$ Val). Not surprisingly, these variants possess sickling properties. Two variants include the substitution found in Hb C ( $\beta_6$  Glu $\rightarrow$ Lys), and another two variants include the substitution found in Hb E ( $\beta_{26}$  Glu $\rightarrow$ Lys).

**TABLE 39.2. Hemoglobins Characterized by Two Amino Acid Substitutions in the Same Globin Chain**

| Common Name      | Scientific Designation   |
|------------------|--|
| J-Singapore      | $\alpha_{78}$ (EF7) Asn $\rightarrow$ Asp; $\alpha_{79}$ (EF8) Ala $\rightarrow$ Gly |
| S-Antilles       | $\beta_6$ (A3) Glu $\rightarrow$ Val; $\beta_{23}$ (B5) Val $\rightarrow$ Ile        |
| C-Ziguinchor     | $\beta_6$ (A3) Glu $\rightarrow$ Val; $\beta_{58}$ (E2) Pro $\rightarrow$ Arg        |
| C-Harlem         | $\beta_6$ (A3) Glu $\rightarrow$ Val; $\beta_{73}$ (E17) Asp $\rightarrow$ Asu       |
| S-Providence     | $\beta_6$ (A3) Glu $\rightarrow$ Val; $\beta_{82}$ (EF6) Lys $\rightarrow$ Asp       |
| S-Oman           | $\beta_6$ (A3) Glu $\rightarrow$ Val; $\beta_{121}$ (GH4) Glu $\rightarrow$ Lys      |
| S-Travis         | $\beta_6$ (A3) Glu $\rightarrow$ Val; $\beta_{142}$ (H20) Ala $\rightarrow$ Val      |
| C-Rothchild      | $\beta_6$ (A3) Glu $\rightarrow$ Lys; $\beta_{37}$ (C3) Trp $\rightarrow$ Arg        |
| Arlington Park   | $\beta_6$ (A3) Glu $\rightarrow$ Lys; $\beta_{95}$ (FG2) Lys $\rightarrow$ Glu       |
| D-Agri           | $\beta_9$ (A6) Ser $\rightarrow$ Tyr; $\beta_{121}$ (GH4) Glu $\rightarrow$ Gln      |
| O-Tibesti        | $\beta_{11}$ (A8) Val $\rightarrow$ Ile; $\beta_{121}$ (GH4) Glu $\rightarrow$ Lys   |
| Corbeil          | $\beta_{26}$ (B8) Glu $\rightarrow$ Lys; $\beta_{104}$ (G6) Arg $\rightarrow$ Thr    |
| T-Cambodia       | $\beta_{26}$ (B8) Glu $\rightarrow$ Lys; $\beta_{121}$ (GH4) Glu $\rightarrow$ Gln   |
| Medicine Lake    | $\beta_{32}$ (B14) Leu $\rightarrow$ Glu; $\beta_{98}$ (FG5) Val $\rightarrow$ Met   |
| Grenoble         | $\beta_{51}$ (D2) Pro $\rightarrow$ Ser; $\beta_{52}$ (D3) Asp $\rightarrow$ Asn     |
| Poissy           | $\beta_{56}$ (D7) Gly $\rightarrow$ Arg; $\beta_{86}$ (F2) Ala $\rightarrow$ Pro     |
| Casablanca       | $\beta_{65}$ (E9) Lys $\rightarrow$ Met; $\beta_{122}$ (GH5) Phe $\rightarrow$ Leu   |
| Atlanta-Coventry | $\beta_{75}$ (E19) Leu $\rightarrow$ Pro; $\beta_{141}$ (H19) Leu $\rightarrow$ 0    |

|                |                                      |
|----------------|--------------------------------------|
| Villeparisis   | β77(EF1) His?Tyr; β80(EF4) Asn?Ser   |
| Duino          | β92(F8) His?Pro; β104(G6) Arg?Ser    |
| Cleveland      | β93(F9) Cys?Arg; β121(GH4) Gln?Glu   |
| Fannin–Lubbock | β111(G13) Val?Leu; β119(GH2) Gly?Asp |
| Masuda         | β114(G16) Leu?Met; β119(GH2) Gly?Asp |
| Nijkerk        | β138(H16) Ala?0; β139(H17) Asn?Tyr   |

Shortened polypeptide chains result from the loss of one or more amino acid residues. Most involve the β-globin chain. The clinical phenotype is that of mild anemia when no more than one or two amino acids are deleted, whereas more extensive deletions are responsible for unstable hemoglobin disease ( [Chapter 41](#)). Hb Higashitochigi (β24 or 25 Gly?0) is characterized by both hemolytic anemia and methemoglobinemia ( [18](#)). Hemoglobin variants characterized by the loss of one or more amino acids are listed in [Table 39.3](#). In all but nine, the deletions involve the β-chain. The loss of one to five amino acids renders these variants unstable. Other variants are characterized by the insertion of one or more amino acids ( [Table 39.4](#)). These hemoglobins, also, are unstable.

**TABLE 39.3. Hemoglobins Characterized by Simple Amino Acid Deletions**

| Common Name    | Scientific Designation  |
|----------------|---|
| Boyle Heights  | α6 (A4) Asp?0   |
| Heraklion      | α37 (C2) Pro?0  |
| Taybe          | α38 or 39 (C3 or 4) Thr?0   |
| J–Bishra       | α51–58 (CE 9–E7) Gly–Ser–Ala–Glu–Val–Lys–Gly–His?0<br>(or) α52–59 (E1–E8) Ser–Ala–Gln–Val–Lys–Gly–His–Gly?0 |
| Clinic         | α61 (E10) Lys?0   |
| Aghia Sophia   | α62 (E11) Val?0   |
| Watts          | α74 or 75 (EF3 or EF4) Asp?0  |
| Lleida         | α112 (G19) His?Glu; α113–116 (GH1–GH4) Leu–Pro–Ala–Glu?0  |
| Natal          | α140 (HC2)–α141(HC3) Tyr–Arg?0  |
| Leiden         | β6 or 7 (A3–4) Glu?0  |
| Lyon           | β17–18 (A14–15) Lys–Val?0   |
| Freiburg       | β23 (B5) Val?0  |
| Higashitochigi | β24 or 25 (B6 or 7) Gly?0   |
| Bruxelles      | β41 or 42 (C7 or CD1) Phe?0   |
| Niteroi        | β42–44 (CD1–3) Phe–Glu–Ser?0<br>(or) β43–45 (CD2–4) Glu–Ser–Phe?0   |
| Tochigi        | β56–59 (D7–E3) Gly–Asn–Pro–Lys?0  |
| Saint Antoine  | β74–75 (E18–19) Gly–Leu?0   |
| Vicksburg      | β75 (E19) Leu?0   |
| Tours          | β87 (F3) Thr?0  |
| Gun Hill       | β91–95 (F7–FG2) Leu–His–Cys–Asp–Lys?0   |
| Coventry       | β141 (H19) Leu?0  |



**TABLE 39.4. Hemoglobins Characterized by Amino Acid Insertions**

| Common Name       | Scientific Designation                                    |
|-------------------|---|
| Catonsville       | $\alpha^+$ Glu between codons 37 and 38                   |
| Neuilly-sur-Marne | $\alpha^+$ Ser-Asp-Leu between codons 86 and 87           |
| Phnom Penh        | $\alpha^+$ Ile between codons 117 and 118                 |
| Zaire             | $\alpha^+$ His-Leu-Pro-Ala-Glu between codons 116 and 117 |
| Grady (Dakar)     | $\alpha^+$ Glu-Phe-Thr between codons 118 and 119         |
| Fairfax           | $\beta^+$ Glu-Leu-His-Cys-Asp between codons 94 and 95    |
| Koriyama          | $\beta^+$ Leu-His-Cys-Asp-Lys between codons 95 and 96    |

Elongation of  $\alpha$ -globin chains beyond the expected 141 amino acids and of  $\beta$ -globin chains beyond 146 amino acids occurs with mutations affecting the initiator or terminator codons of the  $\alpha$ - and  $\beta$ -globin genes ( [Table 39.5](#)). Hb Thionville, Hb Doha, Hb South Florida, and Hb Marseille (also designated *Hb Long Islana*) are characterized by point mutations involving the NH<sub>2</sub> terminal valine of the  $\alpha$ - or  $\beta$ -globin chain or the histidine residue in the second position of the  $\beta$ -chain. These substitutions prevent the initiator methionyl residue from being cleaved from the polypeptide chain, elongating the chain by one amino acid. In Hb Constant Spring, Hb Icaria, Hb Koya Dora, Hb Seal Rock, and Hb Paské, 31 additional amino acids are added to the C-terminus of the  $\alpha$ -globin chain. The  $\alpha$ -globin gene frameshift mutation in Hb Wayne replaces lysine at position 139 with asparagine and extends the  $\alpha$ -chain by five amino acid residues to an inphase terminator codon. Base mutations extend the  $\beta$ -globin chain 11 additional amino acids in Hb Cranston, and 10 additional amino acids in Hb Saverne. Insertions in the midportions of the  $\alpha$ - and  $\beta$ -globin genes are responsible for extending the corresponding polypeptide chains by one to five amino acid residues in Hb Catonsville, Hb Neuilly-sur-Marne, Hb Phnom Penh, Hb Zaire, Hb Grady (also designated *Hb Dakar*), Hb Fairfax, and Hb Koriyama ( [Table 39.4](#)).

**TABLE 39.5. Hemoglobins Characterized by Extended Chains**

| Common Name  | Scientific Designation   |
|--|--|
| <i>N</i> -terminal extensions due to mutations that prevent cleavage of the initiator methionine residue |  |
| Thionville   | $\alpha^1(\text{NA } 1)$ Val?Glu   |
| Doha   | $\beta^1(\text{NA } 1)$ Val?Glu  |
| South Florida  | $\beta^1(\text{NA } 1)$ Val?Met  |
| Marseille  | $\beta^2(\text{NA } 2)$ His?Pro  |
| <i>C</i> -terminal extensions due to mutations affecting the terminator codon                            |  |
| Pak Num Po   | $\alpha^{132(+T)}$ ;<br>(132)Cys-Glu-His-Arg-Ala-Asp-Leu-Gln-Ile-Pro-Leu-Ser-Trp-Ser-Leu-Gly-Gly-His-<br>$\alpha$ -Ser-Cys-Pro-Leu-Gly-Leu-Pro-Pro-Ala-Pro-Pro-Pro-Leu-Pro-Ala-Pro-Val-Pro-<br>o-Trp-Ser-Leu-Asn-Lys-(175)Val-COOH |
| Wayne  | $\alpha^{139(-A)}$ ; (139)Asn-Thr-Val-Lys-Leu-Glu-Pro-(146)Arg-COOH  |
| Zurich-Altstetten  | $\alpha^{142}$ , Stop?His  |
| Constant Spring  | $\alpha^{142}$ , Stop?Gln;<br>(142)Gln-Ala-Gly-Ala-Ser-Val-Ala-Val-Pro-Pro-Ala-Arg-Trp-Ala-Ser-Gln-Arg-Ala-<br>u-Leu-Pro-Ser-Leu-His-Arg-Pro-Phe-Leu-Lal-Phe-(172)Glu-COOH   |



|           |   |
|-----------|---|
| Icaria    | a142, Stop?Lys;<br>(142)Lys-Ala-Gly-Ala-Ser-Val-Ala-Val-Pro-Pro-Ala-Arg-Trp-Ala-Ser-Gln-Arg-Ala-Leu-Pro-Ser-Leu-His-Arg-Pro-Phe-Leu-Val-Phe-(172)Glu-COOH   |
| Koya Dora | a142, Stop?Ser;<br>(142)Ser-Ala-Gly-Ala-Ser-Val-Ala-Val-Pro-Pro-Ala-Arg-Ala-Ser-Gln-Arg-Ala-Leu-Pro-Ser-Leu-His-Arg-Pro-Phe-Leu-Val-Phe-(172)Glu-COOH   |
| Seal Rock | a142, Stop?Glu;<br>(142)Glu-Ala-Gly-Ala-Ser-Val-Ala-Val-Pro-Pro-Ala-Arg-Trp-Ala-Ser-Gln-Arg-Ala-Leu-Pro-Ser-Leu-His-Arg-Pro-Phe-Leu-Val-Phe-(172)Glu-COOH   |
| Paské     | a142, Stop?Tyr;<br>(142)Tyr-Ala-Gly-Ala-Ser-Val-Ala-Val-Pro-Pro-Ala-Arg-Trp-Ala-Ser-Gln-Arg-Ala-Leu-Pro-Ser-Leu-His-Arg-Pro-Phe-Leu-Val-Phe-(172)Glu-COOH   |
| Manhattan | B109, (-G);<br>(109)Cys-Trp-Ser-Val-Cys-Trp-Pro-Ile-Thr-Leu-Ala-Lys-Asn-Ser-Pro-His-Gln-Arg-Leu-Pro-Ile-Arg-Lys-Trp-Trp-Leu-Val-Trp-Leu-Met-Pro-Trp-Pro-Thr-Ser-Ile-Thr-Lys-Leu-Ala-Phe-Leu-Leu-Ser-Asn-Phe-(156)Tyr-COOH |
| Makabe    | B123 (-A);<br>(123)Pro-His-Gln-Cys-Arg-Leu-Pro-Ile-Arg-Lys-Trp-Trp-Leu-Val-Trp-Leu-Met-Pro-Trp-Pro-Thr-Ser-Ile-Thr-Lys-Leu-Ala-Phe-Leu-Leu-Ser-Asn-Phe-(156)Tyr-COOH  |
| Vercelli  | B126 (-T);<br>(126)Gly-Arg-Leu-Pro-Ile-Arg-Lys-Trp-Trp-Leu-Val-Trp-Leu-Met-Pro-Trp-Pro-Thr-Ser-Ile-Thr-Lys-Leu-Ala-Phe-Leu-Leu-Ser-Asn-Phe-(156)Tyr-COOH  |
| Saverne   | B143, (-A);<br>(143)Pro-Ser-Ile-Thr-Lys-Leu-Ala-Phe-Leu-Leu-Ser-Asn-Phe-(156)Tyr-COOH   |
| Cranston  | B145, (+CT);<br>(145)Ser-Ile-Thr-Lys-Leu-Ala-Phe-Leu-Leu-Ser-Asn-Phe-(157)Tyr-COOH  |
| Tak       | B147, (+AC); (147)Thr-Lys-Leu-Ala-Phe-Leu-Leu-Ser-Asn-Phe-(157)Tyr-COOH   |

Fusion hemoglobins are those containing a globin chain formed from parts of two different polypeptide chains ( [Table 39.6](#)). Thus, the non- $\alpha$ -chains in Hbs Lepore-Hollandia, Lepore-Baltimore, and Lepore-Boston (also known as *Hb Lepore-Washington*) are formed from the  $N$ -terminal portion of the  $d$ -chain and the  $C$ -terminal portion of the  $\beta$ -chain. “Anti-Lepore” hemoglobins (see [Chapter 42](#)) (i.e., those with a  $\beta$ -  $N$ -terminal and a  $d$ -  $C$ -terminal) have also been described: Hbs Miyada, P Nilotic, P Congo, and P India. Hb Lincoln Park is identical to Hb P Nilotic except for the deletion of a single amino acid in the  $d$  portion of the hybrid chain. The non- $\alpha$ -chain in Hb Kenya is composed of  $\beta$ -chain sequences in the  $N$ -terminal portion and  $\beta$ -chain sequences in the  $C$ -terminal portion ( [19](#) ). In Hb Parchman, the non- $\alpha$ -chain is a hybrid of three different portions of the  $d$ - and  $\beta$ -chains:  $d$  sequences in the  $N$ -terminal portion,  $\beta$  sequences in the midportion, and  $d$  sequences in the  $C$ -terminal portion ( [20](#) ).

**TABLE 39.6. Fusion Hemoglobins**

| Common Name                    | Scientific Designation   |
|--------------------------------|--------------------------|
| Lepore-Hollandia               | $d(1-22) \beta(50-146)$  |
| Lepore-Baltimore               | $d(1-50) \beta(86-146)$  |
| Lepore-Boston (or -Washington) | $d(1-87) \beta(116-146)$ |
| Miyada                         | $\beta(1-12) d(22-146)$  |
| P Nilotic                      | $\beta(1-22) d(50-146)$  |

|          |                                 |
|----------|---------------------------------|
| P Congo  | β(1-22) d(116-146)              |
| P India  | β(1-87) d(116-147)              |
| Parchman | d(1-12) β(22-50) d(86-146)      |
| Kenya    | A <sup>?</sup> (1-80) β(87-146) |

---

Some structural changes in globin chains result from posttranslational modifications. Deamination of asparagine to aspartic acid occurs when asparagine is substituted for another amino acid that is adjacent to a histidine residue or when histidine is introduced adjacent to a normally present asparagine ([21](#)). When this occurs, two abnormal hemoglobins may be detected by electrophoresis or high-performance liquid chromatography—one containing the encoded asparagine and the other containing aspartic acid. In Hb Wayne, for example, a reading frameshift causes the substitution of asparagine for lysine at position 139 of the α-globin chain, leading to the retention of an additional five amino acids until a new terminator codon is encountered ([Table 39.5](#)). Partial deamination of the substituted asparagine produces two Hb Wayne peptides, one containing asparagine and the other containing aspartic acid at position 139 ([22](#), [23](#)). Posttranslation oxidation was shown to modify the apparent structure of Hb Coventry. This variant was initially thought to involve two amino acid substitutions in the β-globin chain, a substitution of proline for leucine at β75, and the deletion of leucine at β141. Subsequent sequencing of the gene identified the expected mutation in the codon for β75 but, surprisingly, found an intact codon for β141 ([24](#)). This apparent paradox was explained by the oxidation of β141 leucine to hydroxyleucine, which is not detected by amino acid analysis ([25](#)). It is postulated that the β75 mutation, lying within the heme pocket, predisposes to the generation of activated oxygen species that then oxidize some of the β141 leucine residues. Hb Bristol, also, undergoes posttranslational modification. Methionine, which is substituted for valine at β67, is converted to aspartate after transcription ([26](#)).

## PREVALENCE AND GEOGRAPHIC DISTRIBUTION

The frequency of the abnormal hemoglobins varies considerably with geographic location and racial group. Four hemoglobin variants, Hb S, Hb C, Hb E, and Hb D Punjab, each affects millions worldwide.

Hemoglobin S is found in equatorial Africa in a broad zone extending from coast to coast ([Fig. 39.1](#)) ([27](#)). The highest incidence occurs in the eastern part of the continent, where 40 to 50% of the members of some tribes are affected. A prevalence rate of 10 to 20% is common throughout other parts of the zone, but considerable variation exists from one tribe to another.



**Figure 39.1.** Geographic distribution of hemoglobin (Hb) S, Hb C, Hb E, Hb D Punjab, and  $\alpha$ - and  $\beta$ -thalassemia. (Specially prepared by Dr. Hermann Lehmann.)

The Hb S gene is found also in non-African populations. A prevalence as high as 25% has been reported in southern Turkey, in Saudi Arabia, especially in the oasis areas of Qatif and Al Hasa, in Israeli Arabs, and in southern India. Hemoglobin S is also found along the northern Mediterranean shore, especially in Sicily, Cyprus, and Greece, where as many as 32% of the inhabitants of certain villages are affected. Isolated cases of sickle cell disease in white Americans also have been reported ( [28](#), [29](#) ).

Results of studies of DNA polymorphisms linked to the  $\beta^S$  gene suggest that Hb S arose from three independent mutations in tropical Africa ( [30](#) ). All three haplotypes are associated with the  $\beta^S$  gene in black Americans and Jamaicans ( [31](#), [32](#) ), whereas only the haplotypes encountered in West Africa are prevalent among North Africans, Greeks, and Italians ( [31](#), [33](#) ). A different pattern of polymorphisms associated with the  $\beta^S$  gene in Saudi Arabia and India suggests that the Asian gene may have arisen from an independent mutation ( [34](#), [35](#) ).

In the United States, the prevalence of sickle cell trait among blacks is approximately 8% ( [Table 39.7](#) ), although the rate varies in different parts of the country. A lower incidence is found in the north, possibly because of greater racial mixture, whereas in such isolated populations as the Gullahs of South Carolina, the prevalence of Hb S approaches 20%. The frequency of the gene among blacks in Central and South America and in the West Indies is similar to that in North America.

**TABLE 39.7. Prevalence of Hemoglobinopathies and Thalassemia among Blacks**

| Disorder                                    | Prevalence (Subjects/100,000 Population) |
|---|--|
| Heterozygous states                         |  |
| $\alpha$ -Thalassemia <sup>+</sup> (silent) | 24,000                                   |
| Sickle cell trait                           | 8600                                     |
| Hb C trait                                  | 2400                                     |
| $\beta$ -Thalassemia minor                  | 1400                                     |
| HPFH trait                                  | 100                                      |
| Others                                      | 300 <sup>a</sup>                         |
| Homozygous disorders                        |  |
| $\alpha$ -Thalassemia minor                 | 5700                                     |
| Sickle cell anemia                          | 141                                      |
| $\beta$ -Thalassemia major                  | 20                                       |

|                                    |        |
|------------------------------------|--------|
| Hb C disease                       | 21     |
| Doubly heterozygous disorders      |        |
| Hb SC disease                      | 132    |
| Hb S/ $\beta$ -thalassemia disease | 60     |
| Hb C/ $\beta$ -thalassemia disease | 13     |
| Hb S/HPFH                          | 29     |
| Hb C/HPFH                          | 7      |
| Hb S/other Hb variants             | 4      |
| Hb C/other Hb variants             | 2      |
| All variant Hbs                    | 12,000 |
| All Hb S syndromes                 | 9000   |
| All Hb C syndromes                 | 2500   |

Hb, hemoglobin; HPFH, hereditary persistence of fetal hemoglobin.

NOTE: Prevalence figures are based on data culled from population surveys reported in references [42](#), [43](#) and [44](#).

<sup>a</sup> Figure is approximate. Of the 249,000 persons screened for variant hemoglobins, 164 kindreds were detected. However, the existence of kindreds biases the numbers because family members have an incentive to participate in screening. The most common were Hb G Philadelphia (47 kindreds), Hb N Baltimore (12), Hb D Punjab (9), and Hb O Arab (9).

Compared with Hb S, Hb C is found in a smaller and more sharply demarcated geographic zone in western Africa ( [Fig. 39.1](#)). The greatest prevalence is in northern Ghana, where 28% of the population harbors the gene. The frequency declines sharply to the south, east, and west. Within Nigeria, the River Niger seems to have been a barrier to eastward spread. Nearly 3% of blacks have the Hb C gene ( [Table 39.6](#)).

Hemoglobin E is most prevalent in Southeast Asia, affecting more than 50% of the population in eastern Thailand (Surin Province) and from 20 to 45% in other parts of Thailand and in Cambodia, Laos, and Burma. A somewhat lower prevalence, 3 to 8%, is found in Vietnam. Altogether, an estimated 30 million people may carry hemoglobin E ( [36](#)). From the mainland, the gene spreads southward to parts of Indonesia, but the incidence is low in India to the west and in China to the northeast. With the resettlement of many Southeast Asians in the United States, the Hb E syndromes assumed significance in North America as well.

Hemoglobin D Punjab is found in greatest frequency (2%) among the Sikhs of the Punjab in India ( [Fig. 39.1](#)) as well as in nearby Gujerat (1%) and in Iran. It has also been found in blacks (0.4% in North Carolina) ( [37](#)), sporadically in whites throughout the world, and in American Indians.

The high rates of occurrence of the more prevalent hemoglobin variants as well as thalassemia and glucose-6-phosphate dehydrogenase deficiency suggest that the deleterious effects of the homozygous states of these disorders are counterbalanced by the selective advantage they provide to heterozygous individuals (“balanced polymorphism”). By this mechanism, the gene frequency increases in the population despite the adverse effects on survival of homozygous individuals, because the heterozygote is more “fit” than a normal subject. Most of the studies of this phenomenon have focused on the role of malaria, especially *Plasmodium falciparum* malaria, as the selecting agent and on the possible resistance to malaria offered by subjects

heterozygous for the aforementioned disorders.

The “malaria hypothesis” is best established with respect to Hb S. The geographic distribution of *P. falciparum* malaria and of Hb S coincides remarkably. Furthermore, subjects with sickle cell trait have a lower rate of parasitization of the blood, even when they are deliberately inoculated with the parasite, and the mortality rate from cerebral malaria is lower in children with the trait than in those without Hb S ( [38](#) ). The mechanism of malarial resistance has not been established, but the most likely hypothesis holds that parasitization of cells induces sickling, which is followed by destruction of sickled cells and their parasites by macrophages ( [39](#) ). Indeed, the sickling phenomenon itself can kill and lyse parasites within the cells ( [40](#) ).

Most other hemoglobin variants are rare. Many have been reported in a single individual or in a single family. Occasionally, in isolated populations, a minor variant may attain considerable prevalence; for example, Hb J Tongariki was found to affect nearly 10% of the population on an island in the Pacific. In a survey of 8000 Europeans (5000 Danish, 3000 British), only 11 were found to have an electrophoretically identifiable abnormal hemoglobin ( [41](#) ).

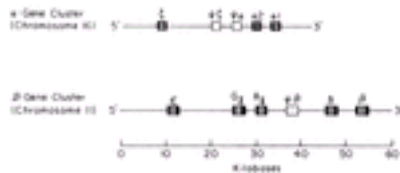
As might be expected, the prevalence of hemoglobin variants in the United States is a function of the ethnicity of the population sampled. Approximately 12% of blacks have a hemoglobin variant ( [Table 39.7](#) ). Hb S is found alone or in combination with other hemoglobins in 8.5%, and Hb C is found alone or in combination with other hemoglobins in 2.5%. Hb G Philadelphia is the third most common hemoglobin variant among blacks. At least 19 other variants, affecting 117 kindreds, were found in a survey of 249,000 blacks in Alabama ( [42](#) ).

Both  $\alpha$ -thalassemia and  $\beta$ -thalassemia also are prevalent among blacks. In gene mapping studies, approximately 27% of blacks lack a single  $\alpha$ -globin gene (silent carrier state) and approximately 2% lack two of the four  $\alpha$ -globin genes ( $\alpha$ -thalassemia minor).  $\beta$ -Thalassemia minor affects approximately 1.4% of this population ( [43](#) ).

## GENETIC MECHANISMS AND MOLECULAR PATHOLOGY

### Organization and Structure of Globin Genes

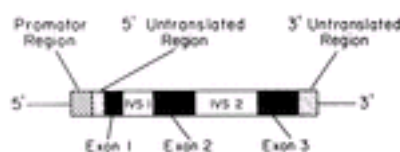
A discussion of the molecular pathology of abnormal hemoglobins assumes an understanding of the organization and structure of the globin genes ( [44](#) , [45](#) and [46](#) ). These genes occur in clusters, the  $\alpha$ - and  $\alpha$ -like genes on the short arm of chromosome 16, and the  $\beta$ - and  $\beta$ -like genes on the short arm of chromosome 11 ( [Fig. 39.2](#) ). The  $\alpha$ -like cluster extends over a 40-kilobase (kb) range, and the  $\beta$ -like cluster extends over a 60-kb range. In the  $\alpha$  gene cluster, two  $\alpha$ -globin structural genes  $\alpha 1$  and  $\alpha 2$  are located at the 3' end of the complex. The nucleotide sequences of the coding portions of these two genes are identical. Minor differences in sequences in the second intron have been detected. Upstream, or 5' from the expressed  $\alpha$  genes, is a pseudo- $\alpha$  gene (?), a DNA sequence closely resembling the  $\alpha$  genes but having a mutation that renders it nonfunctional. Further upstream are two embryonic  $\alpha$ -like genes (? genes), one of which is not expressed.



**Figure 39.2.** Organization of the human globin gene clusters on chromosomes 16 and 11. Solid areas within genes indicate coding sequences; open areas indicate intervening sequences. Each cluster includes pseudogenes ( $\alpha^1$ ,  $\alpha^2$ , and  $\alpha^3$ ) that have sequence homology to functional genes but include mutations that prevent their expression.

The  $\beta$  gene complex comprises six genes arranged in the following 5' to 3' order: a single embryonic gene ( $\epsilon$ ), two fetal genes ( $\gamma^G$  and  $\gamma^A$ ), a pseudo- $\beta$  gene ( $\delta$ ), the  $\delta$  gene, and the  $\beta$  gene. The polypeptide chains produced by the two  $\gamma$  genes differ only in the amino acid at position 136: glycine in  $\gamma^G$  and alanine in  $\gamma^A$ . Because of extensive homology between them, the  $\delta$  and  $\beta$  genes are thought to have arisen from duplication of a single gene. Subsequent mutations in the regulatory region of the  $\delta$  gene have rendered it functionally insignificant. In both gene clusters, genes are arranged on the chromosome in the order in which they are expressed during embryonic, fetal, and postnatal development. The nucleotide sequences of each of these genes and of intragenic DNA have been determined (47).

All of the functional globin genes share a common general structure, consisting of three exons and two introns. A schematic representation of globin gene structure is provided in Figure 39.3. Although not translated, DNA sequences that are 5' as well as those that are 3' to the gene are important for gene expression. The promoter region consists of approximately 100 base pairs immediately preceding the point at which transcription begins (cap site). Three short sequences within this region bind RNA polymerase, which catalyzes messenger RNA (mRNA) synthesis. Two sequences (referred to as the *TATA box* and the *CAT box*) are particularly important for the initiation of gene transcription. Mutations involving these sequences reduce enzyme binding, thereby limiting mRNA transcription. The region downstream from the third exon contains a sequence (AATAAA) that signals the termination of gene transcription. This region is thought to trigger an enzymatic process that cuts mRNA at the appropriate point and releases it for further processing.



**Figure 39.3.** Structure of the globin genes. Each of the human globin genes contains three coding blocks (exons) that are separated by two introns, or intervening sequences. In the  $\beta$ -globin gene, exon 1 encodes for amino acids 1 through 30, exon 2 encodes for amino acids 31 through 104, and exon 3 encodes for amino acids 105 through 146. Shaded regions indicate 5' and 3' transcribed but untranslated regions. The promoter region contains approximately 100 base pairs, some of which are necessary for the initiation of transcription.

The primary mRNA transcript includes copies of the entire genomic DNA sequence, including both exons and introns. Before this pre-mRNA is transported to the cytoplasm, it is processed by capping of the 5' end, splicing to remove sequences transcribed from



introns, and polyadenylation of the 3' end. The last step appears to be important for the nuclear-to-cytoplasmic transport of the finished product as well as for stability of mRNA in the cytoplasm. Splicing involves the formation of loops in pre-mRNA, such that the downstream ends of exons (donor sites) approximate the upstream ends of the next exons (receptor sites). The intron sequences are then enzymatically excised, and the donor and acceptor sites of exons are sealed. Donor sites are identified by the nucleotides GT at the 5' end of introns, and acceptor sites are identified by AG at the 3' end. In addition to these dinucleotides, certain preferred nucleotide sequences adjacent to them are required for accurate and efficient splicing. These sequences are referred to as *consensus sites*. Mutations involving splice junctions and consensus sites result in abnormal splicing and therefore in abnormal mRNAs.

## Genetic Basis of Abnormal Hemoglobins

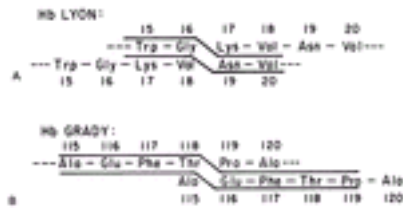
**POINT MUTATIONS** Approximately 90% of hemoglobin variants are due to point mutations (i.e., the substitution of a single DNA nucleotide base for another). This mutation alters the genetic code, often in such a way that an amino acid change occurs in the resulting globin. When the amino acid substitutions in the reported human hemoglobin variants have been examined in relation to the genetic code, almost all such variants have been explainable by a change in only one of the three bases coding for each amino acid. The mutation responsible for the Glu $\rightarrow$ Val substitution in Hb S, for example, is GUG $\rightarrow$ GAG. As a rule, substitutions that require a change in more than one base have not been observed. For example, the substitution Asp $\rightarrow$ Lys does not occur because neither of the codons for aspartic acid (GAC, GAU) can change to a codon for lysine (AAA, AAG) without altering two bases. Only one possible exception to the one-base change rule has been noted. In Hb M Milwaukee, the change at  $\beta$ 67 is Val $\rightarrow$ Glu; in Hb Bristol, it is  $\beta$ 67 Val $\rightarrow$ Asp. None of the known valine codons (GUU, GUC, GUA, and GUG) can change to both a glutamic acid codon (GAA, GAG) and an aspartic acid codon (GAU, GAC) by means of one-base changes. Sequence analysis has shown that the usual Val codon at  $\beta$ 67 is GUG. Thus, either Hb Bristol represents a two-base change or the  $\beta$ 67 codon has normal variants. DNA nucleotide substitutions have been described for 113 of the 141 codons that determine the sequence of amino acids in the  $\alpha$ -globin chain and for 143 of the 146 codons for the  $\beta$ -globin chain. As many as 13 different mutations involving the same codon have been documented. Most codons with multiple substitutions encode contact sites between the  $\alpha$ - and  $\beta$ -globin chains or between globin and the heme moiety. The mutation rate of single bases in the globin genes is estimated to be 1 in 104 individuals per generation. The *de novo* mutation rate for all  $\beta$ -chain variants is calculated to be  $7.4 \times 10^{-9} \pm 9$  per  $\beta$  gene nucleotide per generation ([48](#)). Two types of point mutations have been defined. A *transition* is a substitution of a pyrimidine for another pyrimidine or a purine for another purine. A *transversion* is a substitution of a purine for a pyrimidine or vice versa. The amino acid changes produced by transversions tend to result in more radical alterations in protein structure than those occurring with transitions. If mutations occurred at random, twice as many transversions as transitions would be observed. The number of human hemoglobin variants resulting from transitions, however, is approximately equal to that resulting from transversions. If only substitutions affecting the molecular surface are tabulated, the expected 2:1 ratio is found, but changes in the molecular core are produced only rarely by transversion. Purine transitions are more common than pyrimidine transitions, and the most common of all point substitutions is adenine $\rightarrow$ guanine in DNA (guanine $\rightarrow$ adenine in RNA). The reasons for the nonrandom nature of these genetic defects are not entirely clear. Hemoglobins with elongated globin chains also arose from point mutations ([49](#)). Termination of polypeptide chain synthesis during translation occurs when a stop codon is reached. In the  $\alpha$ -chain, this codon, UAA, is in position 142 (i.e., after the codon for the amino acid normally in the C-terminal position). Five hemoglobins have been detected with 31 amino acids added to the C-terminal of the  $\alpha$ -chain ([Table 39.5](#)). In all of these hemoglobins, an amino acid that probably arose from the stop codon by means of a one-base mutation (UAA $\rightarrow$ CAA, Gln;



UAA?AAA, Lys; UAA?GAA, Gln; and UAA?UCA, Ser) appears at position 142. A different mechanism is responsible for  $\beta$ -chain elongation in Hb Marseille (also designated *Hb Long Islana*), Hb South Florida ( 50 ), and Hb Doha ( 51 ). The latter two are characterized by point substitutions at the first position of the  $\beta$ -chain; Hb Marseille is characterized by a point substitution at the second position. In each case, the substitution prevents the removal of the initiator methionine during translation, thus extending the N-terminus by one residue.

**NUCLEOTIDE DELETIONS AND INSERTIONS** Deletion or insertion of one or two nucleotide bases changes the grouping and therefore the meaning of codons downstream from the mutation. The result is a frameshift error, so called because of a shift in the reading frame produced by the mutation. Most frameshift mutations result in the thalassemia phenotype, because the globin chains they produce are nonfunctional. Frameshift mutations occurring at the end of the coding portion of globin genes permit the synthesis of viable globin chains, however, and result in structurally abnormal hemoglobins. Such is the case with Hb Wayne, in which a nucleotide deletion in codon 139 changes the termination signal, permitting the translation of an additional five amino acids ( 49 ). Similarly, Hb Cranston and Hb Tak have elongated chains, probably resulting from the insertion of two bases (AG in codon 145 in Hb Cranston and AC in codon 147 in Hb Tak). The frameshift mutation responsible for Hb Saverne results from deletion of the second base in the codon at position 143. Hb Grady results from an internal frameshift mutation ( 52 ). Because only three residues are inserted in tandem, a viable globin chain is produced. The nucleotide deletions in Hb Birmingham and Hb Galicia result in the loss of four and two amino acids, respectively, from the  $\beta$ -chain ( 53 ). In addition, one amino acid residue is inserted, encoded by a hybrid codon created by the nucleotide deletions.

**CROSSOVERS** Crossing-over between homologous chromosomes also has the potential for generating abnormal hemoglobins. Normal crossovers that occur at identical loci on the chromosome pairs are called *homologous* or *equal crossovers*. Such a crossover in an individual carrying genes for Hb S ( $\beta 6$  Val) and Hb Korle-Bu ( $\beta 73$  Asn) on separate chromosomes is a way to form the gene for Hb C Harlem, carrying both substitutions on the same chromosome ( 54 ). Other hemoglobins with two abnormal amino acids may have developed in this way. In addition to Hb C Harlem, three others, Hb C Ziguinchor, Hb Arlington Park, and Hb S Travis, are formed from the combination of the common  $\beta 6$  Glu?Val mutation found in Hb S with another mutation elsewhere in the  $\beta$ -chain. An alternative hypothesis for the development of such hemoglobins is that they simply represent a second point mutation in a subject already carrying the gene for Hb S. Unequal homologous crossing-over (chromosomal mutation) has the potential for producing more extensive changes in structural genes, such as deletion of a portion of the gene, as well as an addition to it or a fusion of genes at the crossover sites. The hemoglobins with single or multiple deletions probably arose in this way because a minimum of three nucleotide bases must have been deleted. In Hb Lyon, for example, an unequal crossover resulted in deletion of amino acids 17 and 18 ( Fig. 39.4 ) ( 55 ). Presumably, sufficient homology between nucleotide bases exists in certain regions of the chromosome to allow a slight misalignment during crossover. For example, if the DNA segments of two chromosomes are misaligned in the manner necessary to produce the deletion in Hb Lyon, as many as 12 of 18 nucleotide bases in the crossover region can be identical as compared with the random chance identity of only 25% ( 55 ). Similarly, correspondence of nine bases has been identified in the crossover producing Hb Gun Hill. The fact that Hb Gun Hill and Hb Leiden appear to have arisen by spontaneous mutation more than once lends support to the idea that such areas of near identity exist and make unequal crossing-over possible.



**Figure 39.4.** Unequal crossovers producing deletions or elongations of globin chains. **A:** Slight misalignment of codons for amino acids 15 through 20 in the  $\beta$ -chain allows a crossover that eliminates amino acids 17 and 18, forming Hb Lyon. **B:** A similar misalignment, allowing a crossover, in which amino acids 116, 117, and 118 are duplicated to form Hb Grady. The crossover, of course, occurs in the DNA coding for the amino acids shown rather than in the globin chains themselves.

Unequal crossovers may also add amino acids to the chain, as in the case of Hb Grady ( [Fig. 39.4](#)) ( [49](#)). In this hemoglobin, the sequence of three amino acids at a116–118, Glu–Phe–Thr, is repeated, resulting in an  $\alpha$ -chain elongated by three amino acids. A greater degree of misalignment allows crossing-over between different genes, which results in fusion genes. The Lepore and anti-Lepore hemoglobins must have arisen from unequal crossovers in which the  $\beta$  and  $\delta$  genes were in alignment (see [Chapter 42](#)). Similarly, Hb Kenya results from a crossover between the  $\beta$  and ? genes. Other genetic mechanisms resulting in thalassemias and the formation of the tetrameric hemoglobins are discussed in [Chapter 42](#).

### Patterns of Inheritance

All genes for abnormal  $\beta$ -chain variants are alleles (i.e., genes that occupy the same genetic locus). Furthermore, the genes producing  $\beta$ -thalassemias and hereditary persistence of hemoglobin F are allelic with those producing the  $\beta$ -chain structural variants. Similarly, the genes producing  $\alpha$ -chain structural abnormalities and the  $\alpha$ -thalassemias are alleles. As would be expected from the different chromosomal location, however,  $\alpha$ - and  $\beta$ -chain abnormalities are not alleles, nor are they linked ( [56](#)).

The abnormal hemoglobin diseases are inherited in a fashion sometimes referred to as *autosomal codominant*. If the properties of the hemoglobin are such that symptoms are produced in the heterozygous state, as in unstable hemoglobin disease, then the pattern of inheritance of the “disease” is that of an autosomal-dominant trait. If, on the other hand, only the homozygous condition is symptomatic, as in sickle cell anemia, a recessive inheritance pattern is observed, and the heterozygous state is called the “trait.” Whether symptomatic or not, the heterozygous state is detectable by means of hemoglobin analysis.

A patient carrying two different abnormal hemoglobin genes is referred to as *doubly heterozygous*. The inheritance pattern in such situations may take one of two forms, depending on whether the two genes are alleles or nonalleles (i.e., whether they affect the same or different polypeptide chains) ( [Table 39.8](#)). For example, children of a man doubly heterozygous for Hbs S and C, both of which are  $\beta$ -chain defects and therefore allelic, can inherit only one of these genes. All children, therefore, will be heterozygous for either Hb S or Hb C, but none will be normal, and none will be doubly heterozygous. Nonallelic inheritance, when one gene affects the  $\alpha$ -chain and one affects the  $\beta$ -chain, is quite different. In such pedigrees, children of the doubly heterozygous patient may be normal, or they may inherit either or both abnormal genes.

**TABLE 39.8.** Allelic and Nonallelic Inheritance Patterns in Doubly Heterozygous

## Individuals

| Patient   | Spouse | Expected Proportion of Children |                             |                     |
|---|--------|---------------------------------|-----------------------------|---------------------|
|   |        | Normal                          | Heterozygous                | Doubly Heterozygous |
| Two genes affecting the same chain (allelic) (e.g., Hbs S and C)                              | Normal | 0                               | 100% (50% S, 50% C)         | 0                   |
| Two genes affecting different chains (nonallelic) (e.g., Hb S, Hopkins II)<br>Hb, hemoglobin. | Normal | 25%                             | 50% (25% S, 25% Hopkins II) | 25%                 |

Because of their close linkage,  $\delta$ -chain abnormalities tend to be inherited with a  $\beta$ -chain abnormality on the same chromosome (cis), but if on opposite chromosomes (trans), they are not inherited together.

## Hemoglobin Patterns Associated with Various Genetic Combinations

**$\beta$ -CHAIN VARIANTS** The homozygous state has been described for Hbs S, C, D Punjab, D Iran, E, and O Arab, as well as for several variants not associated with any clinical or hematologic abnormality. The variant hemoglobin comprises the major hemoglobin fraction, Hb A is absent, and the proportion of Hbs A<sub>2</sub> and F may be increased slightly. In the heterozygous state for  $\beta$ -chain variants, Hb A predominates, and the abnormal hemoglobin constitutes less than one-half of the total. On average, 38% of the hemoglobin is abnormal, but values range from 35 to 50%. To some extent, variability in the relative amount of the variant hemoglobin can be attributed to the multiplicity of techniques used in the quantitation of hemoglobin fractions. That more fundamental differences are involved is apparent from failure noted when using consistent techniques in a single laboratory to provide more uniform results (57). A few variants, such as Hbs Lepore, Vicksburg, and North Shore, are synthesized at a slower rate than Hb A and, as a result, produce a thalassemia phenotype. Other variants are preferentially degraded because of instability. More commonly, the relative amount of the variant hemoglobin is decreased by iron or folate deficiency or by  $\alpha$ -thalassemia (58, 59). Because  $\beta^A$ -chains appear to have a greater affinity for  $\alpha$ -chains than variant  $\beta$ -chains, relatively more Hb A is synthesized when the availability of  $\alpha$ -chains is limited (59). For this reason, a trimodal distribution of the relative amount of Hb S is observed in sickle cell trait, corresponding with the presence of four, three, or two  $\alpha$ -globin genes (60). Finally, variability in the rate of subunit assembly related to differences in electrostatic interactions may also contribute to differences in the relative proportion of variant hemoglobins (61).

**$\alpha$ -CHAIN VARIANTS** The expected hemoglobin pattern in subjects with  $\alpha$ -chain abnormalities is complicated by the reduplication of the  $\alpha$  gene. In theory, one, two, three, or four genes may be affected, corresponding to abnormal hemoglobin proportions of approximately 25%, 50%, 75%, and 100%, respectively. Furthermore, interaction with  $\alpha$ -thalassemia is frequent enough to make the interpretation even more complex. A state similar to the "homozygous" state described for  $\beta$ -chain variants has been reported for Hb J Tongariki (62), Hb G Philadelphia (63), and Hb Q (64); in each, the variant hemoglobin comprises the major hemoglobin fraction, and Hb A is absent. This hemoglobin pattern is explained by the fact that the  $\alpha$  gene mutation has occurred on a chromosome with only a single  $\alpha$ -globin gene. Affected individuals are, in fact, doubly heterozygous for  $\alpha$ -thalassemia and an  $\alpha$ -chain structural variant (see Chapter 42). The clinical phenotype is similar to that of Hb H disease (64). In most instances,  $\alpha$ -chain variants probably have occurred in patients with only one of the four  $\alpha$  genes affected. As a result, the

proportion of abnormal hemoglobin averages only 23%. Wide variation in the relative concentration of  $\alpha$ -chain mutants results from differences in expression of the  $\alpha_1$ - and  $\alpha_2$ -globin genes. Mutations affecting the  $\alpha_2$  gene are expressed at two- to threefold higher levels than those involving the  $\alpha_1$ -globin gene. Because Hb F and A<sub>2</sub> contain  $\alpha$ -chains, these minor hemoglobin fractions are also affected when there is a mutant  $\alpha$ -chain. Thus, in infants, as many as six hemoglobins may be detected: Hb A, Hb A<sub>2</sub>, and Hb F, along with three corresponding abnormal hemoglobins containing the mutant  $\alpha$ -chain (65).

**DOUBLE HETEROZYGOTES** The hemoglobin pattern in doubly heterozygous individuals depends on whether the two abnormal genes are alleles. When they are allelic, as in Hb SC disease, no hemoglobin A is produced. The two abnormal hemoglobins are found in the circulation in approximately equal amounts, and in addition, some compensatory increase in Hb F may be noted. In nonallelic double heterozygotes, four variants of adult hemoglobin circulate. Such individuals can synthesize  $\alpha^{A-}$ ,  $\alpha^{X-}$ ,  $\beta^{A-}$ , and  $\beta^{Y-}$  chains (X and Y superscripts indicate the mutant chains) to form four hemoglobins: Hb A, Hb X, Hb Y, and Hb XY.

## PATHOPHYSIOLOGY

The construction by Perutz and co-workers of a three-dimensional model of the hemoglobin molecule made it possible to visualize the effects of amino acid substitution on molecular function (66). The Perutz model demonstrates that the water-free, molecular core is stabilized by nonpolar interactions of the van der Waals type. Amino acids with polar side chains are completely excluded from the interior and are found only on the molecular surface, where they interact with water, rendering the molecule soluble. The heme group is covalently bound at the F8 histidine but also forms approximately 60 contacts with nonpolar amino acids in the heme crevice, thereby contributing to the stability of the tertiary structure. This nonpolar environment makes possible the association of heme iron with oxygen without significant methemoglobin formation. The contacts between the four polypeptide chains in each molecule were also evaluated from the model; two kinds were identified. The larger contact, called  $\alpha_1\beta_1$ , is formed from nonpolar interactions among 34 amino acids; the smaller contact,  $\alpha_1\beta_2$ , involves only 19 amino acids. With oxygenation, the  $\alpha_1\beta_2$  contact undergoes significant alteration, a movement of approximately 0.7 nm (7.0 Å) taking place, producing so-called heme-heme or subunit interaction.

The C-terminal portions of the globin chains are also important in oxygen binding. When oxygen is added to the molecule, the spin state of iron is altered, and the subsequent molecular changes result in the expulsion of the penultimate tyrosine residue from its pocket between the F and H helices (67).

On the basis of this general background, one can understand the effects of substitution at certain molecular sites, and one can make a functional classification of the abnormal hemoglobins (Table 39.9). Substitutions at the molecular surface usually are innocuous because they are not likely to affect tertiary structure, heme function, or subunit interaction. Indeed, most of the functionally normal hemoglobin variants are characterized by substitutions at surface positions. Many of them have been discovered by hemoglobin electrophoresis in population screening studies and result, therefore, from substitutions that change the net charge of the molecule. Some surface substitutions result in hemoglobin molecules that tend to polymerize or aggregate. Such mutations likely create a site on the molecular surface that can interact with a complementary site on an adjacent molecule. The aggregating hemoglobins, of which Hb S is the prototype, tend to crystallize or polymerize intracellularly with consequent distortion of cell shape, reduced cell deformability, hemolysis, and impaired microvascular circulation.

**TABLE 39.9. Functional Classification of Abnormal Hemoglobins**

| Functional Abnormality              | Location of Substitution                        | Clinical Abnormality                   | Example   |
|-------------------------------------|---|--|---|
| None                                | Surface   | None                                   | Hb G Philadelphia                                 |
| Aggregation with reduced solubility | Surface   | Hemolytic anemia (homozygous)          | Hb S ( <a href="#">Chapter 40</a> )               |
| Unstable                            | Internal, nonpolar residues                     | Hemolytic anemia (heterozygous)        | Hb Köln ( <a href="#">Chapter 41</a> )            |
| Increased oxygen affinity           | $\alpha^1\beta^2$ Contact or $\beta$ C-terminal | Erythrocytosis                         | Hb Chesapeake ( <a href="#">Chapter 50</a> )      |
| Decreased oxygen affinity           | Near heme and $\alpha^1\beta^2$ contact         | Cyanosis                               | Hb Kansas ( <a href="#">Chapter 49</a> )          |
| Methemoglobinemia                   | Proximal (F8) or distal (E7) histidine          | Cyanosis                               | Hb M ( <a href="#">Chapter 49</a> )               |
| $\alpha$ -Thalassemia phenotype     | Variable  | Hemolytic anemia (doubly heterozygous) | Hb Constant Spring ( <a href="#">Chapter 42</a> ) |
| $\beta$ -Thalassemia phenotype      | Variable  | Hemolytic anemia (doubly heterozygous) | Hb Lepore ( <a href="#">Chapter 42</a> )          |
| Hb, hemoglobin.                     |   |  |   |

Several hemoglobin variants exhibit structural instability (see [Chapter 41](#)). These hemoglobins have a tendency to precipitate intracellularly, forming inclusion bodies and causing shortened cell survival. Most unstable hemoglobins result from neutral (unchanged) substitutions, affecting internal, nonpolar residues. Many of these substitutions affect residues that contact the heme group; thus, heme-globin bonding is reduced, water may gain access to the heme pocket, and heme may drop out of the molecule. Heme-free normal globin and partially heme-free hemoglobin are, themselves, unstable. Some unstable hemoglobins are characterized by a marked change in conformation of the entire molecule, especially those hemoglobins with deletions (e.g., Hb Gun Hill) and those in which proline has been inserted into a helical segment, a change that disrupts or bends the helix [e.g., Hb Bibba,  $\alpha 136$  (H19) Leu $\rightarrow$ Pro]. The van der Waals forces on which structural stability depends are greatly affected by molecular dimensions; therefore, the altered dimensions of the substituted amino acid can have far-reaching consequences. The insertion of a charged amino acid into the nonpolar core is likely to have devastating effects on stability unless the charge can be stabilized by internal salt formation, as in Hb Wien, or the charged group can be accommodated on the molecular surface, as in hemoglobins Sögn, Riverdale-Bronx, Shepherds Bush, and Ann Arbor.

Many hemoglobins exhibit increased oxygen affinity, which may be of sufficient magnitude to cause erythrocytosis (see [Chapter 50](#)). Most of the substitutions producing this abnormality occupy an  $\alpha^1\beta^2$  contact point, where they impair subunit (heme-heme) interaction. Some have been near the C-terminus of the  $\beta$ -chain, where they interfere with the alkaline Bohr effect, with 2,3-diphosphoglycerate binding, or with the formation of salt bridges that tend to stabilize hemoglobin in the low oxygen affinity (T) state.

Decreased oxygen affinity has been described in many variants, some of which also are unstable (see [Chapter 49](#)). In some of these variants, of which Hb Kansas is the



best-studied example, the abnormality is severe enough to produce cyanosis. In many others, the abnormality is detected only in the laboratory. The substitution in Hb Kansas [B102 (G4) Asn→Thr] occurs at a residue that forms part of the  $\alpha_1\beta_2$  contact and that also contacts the heme group. The B102 Asn residue normally forms a hydrogen bond with  $\alpha 94$  Asp when hemoglobin is oxygenated. This bond tends to stabilize the high-affinity (R) form of hemoglobin. Another hemoglobin with a substitution at the same site, Hb Beth Israel (B102 Asn→Ser), shares many of the properties of Hb Kansas.

A proclivity to methemoglobin formation is created by substitution of a tyrosine for either the proximal (F8: $\alpha 87$ ,  $\beta 92$ ) or distal (E7: $\alpha 58$ ,  $\beta 63$ ) histidine residue (see [Chapter 49](#)). These substitutions allow an ionic bond to form between heme iron and the phenolic oxygen of tyrosine, thereby stabilizing iron in the nonfunctional, ferric state. In Hb M Milwaukee [ $\beta 67$  (E11) Val→Glu], a similar ionic bond forms with the glutamic carboxyl group. Such heme groups cannot bind oxygen, and affected patients have methemoglobinemia and cyanosis.

Some unstable hemoglobins also have a tendency to form methemoglobin, but they lack some of the clinical, electrophoretic, and spectral properties characteristic of the other hemoglobins M; these hemoglobins include Hbs St. Louis, Freiburg, and I Toulouse.

Several different mechanisms limit the synthesis of structurally abnormal globin chains, thereby producing a thalassemia phenotype (see [Chapter 42](#)). The synthesis of hybrid globin chains is roughly intermediate between that of normal  $\beta$ - and  $\delta$ -chains (in the case of the Lepore hemoglobins) or that of normal  $\beta$ - and  $\gamma$ -chains (for Hb Kenya). The mRNA generated by chain terminator mutations is less stable than normal mRNA, again upsetting the balance between  $\alpha$ - and  $\beta$ -globin synthesis. Thus, some of the hemoglobins containing elongated  $\alpha$ -chains (Hb Constant Spring, Hb Icaria, Hb Seal Rock, and Hb Koya Dora) are characterized by the  $\alpha$ -thalassemia clinical phenotype, and Hb Tak, containing an elongated  $\beta$ -chain, is characterized by the  $\beta$ -thalassemia phenotype. Mutations activating cryptic splice sites limit normal mRNA synthesis by competing with normal splice sites. The  $\beta$ -thalassemia phenotype associated with Hb E and Hb Knossos is explained by such mutations. Finally, the thalassemia phenotype may result from instability of the variant globin chain. Such is the case for the  $\beta$ -chains of Hb Indianapolis and the  $\alpha$ -chains of Hb Quong Sze, Hb Suan-Dok, and Hb Petah Tikva.

## HEMOGLOBIN C DISORDERS

In Hb C, lysine replaces glutamic acid in the sixth position of the  $\beta$ -chain. The positive charge resulting from this substitution gives the variant a slow electrophoretic mobility at both an acid and an alkaline pH. Although Hb C cannot be separated from Hb A<sub>2</sub> by electrophoretic techniques, separation is possible with the use of column chromatography. This variant appears to have originated on the west coast of Africa ([68](#)) where the carrier rate is as high as 25%. Although less convincing than for Hb S, the distribution of Hb C in Africa suggests that it also may have conferred a survival advantage in areas endemic for malaria. Among the Dogon of West Africa, where the gene frequency of Hb C is high and that of Hb S is low, cerebral malaria and other forms of severe malaria are uncommon in those having Hb C ([69](#)). Although not providing full protection against malaria, Hb C appears to minimize the risk of severe infection. These clinical observations are supported by *in vitro* studies that demonstrate the inability of Hb CC red cells to release merozoites by cell lysis at the appropriate stage of parasite development ([70](#)). The heterozygous state is noted in 2 to 3% of blacks, and homozygous Hb C disease affects approximately 1 in 5000 ([Table 39.7](#)) ([42](#), [45](#)). As with Hb S, Hb C has been identified in individuals with no known African ancestry ([71](#)). The  $\beta^C$  gene can be identified in fetal DNA by using restriction fragment length polymorphisms ([72](#)) and by sequence-specific

oligonucleotide probes ( [73](#) ).

## Hemoglobin C Trait

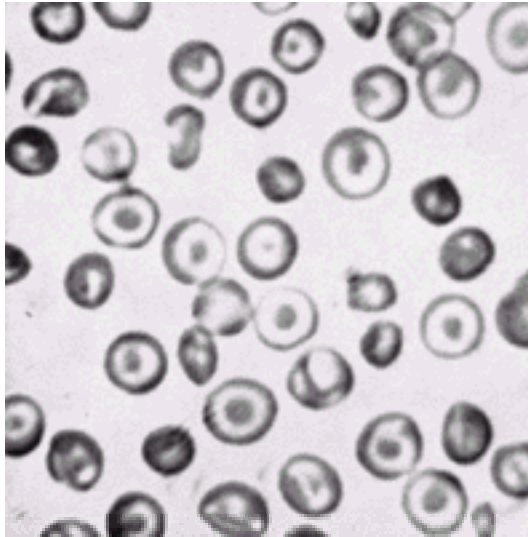
The heterozygous state for Hb C (Hb AC) is clinically silent. Although the hemoglobin concentration is within the broad range of normal, the mean for groups of subjects is clearly low. The red cell mass and red cell survival also may be decreased ( [74](#) ). Reticulocyte numbers, however, are not increased. The physiologic basis for the apparent failure of appropriate erythropoietic response to shortened cell survival is probably similar to that operative in Hb CC disease. The peripheral blood smear contains moderate numbers (5 to 30%) of target cells. By electrophoretic analysis, 30 to 40% of the hemoglobin is Hb C, and 50 to 60% is Hb A; Hb A<sub>2</sub> (separated chromatographically) is increased slightly. The relative amount of Hb C with coexistent  $\alpha$ -thalassemia is less, reflecting the higher affinity of  $\beta^A$ - compared with  $\beta^C$ -globin for limited amounts of  $\alpha$ -globin during hemoglobin assembly ( [75](#) ). Hb C trait has no adverse consequences for individuals with pernicious anemia, glucose-6-phosphate dehydrogenase deficiency, or hereditary elliptocytosis.

## Hemoglobin C Disease

Hemoglobin C disease (Hb CC) is a mild disorder that characteristically is detected through newborn hemoglobinopathy screening programs or during the investigation of an unrelated medical problem ( [76](#) ). Growth and development are appropriate, and pregnancy and surgery are well tolerated. Mild intermittent abdominal discomfort, arthralgia, and headaches are noted in some reports, but their relationship to the hemoglobinopathy, if any, is far from clear. The spleen is enlarged in many affected individuals, and spontaneous rupture of the organ has been reported ( [77](#) ). Spleen function is unaffected, however, and unusual infectious problems are not observed. As with other hemolytic disorders, cholelithiasis occurs with increased frequency.

Anemia is mild to moderate in severity ( [78](#) ). The mean packed cell volume is 33%; individual values often fall within the normal range. Reticulocyte counts are elevated only slightly (2 to 6%). Erythrocyte morphology is strikingly abnormal, with microcytosis, target cells (=90%), occasional spherocytes, and cells distorted by what appear to be crystals of hemoglobin ( [Fig. 39.5](#) ) ( [79](#) , [80](#) ). The intracellular crystallization of Hb C is potentiated by the overnight incubation of red cells in 3% sodium chloride. Target cells appear more plump and smaller in diameter than those seen in individuals with liver disease, although their resistance to osmotic lysis is similar to that of other target cells ( [79](#) ). A smaller population of osmotically fragile cells (spherocytes) is also present. Red blood cell survival is shortened with evidence of splenic sequestration. Plasma iron turnover and incorporation of iron into red cells are increased. Considering the relative indolence of the hemolytic process, it is surprising that anemia is not fully compensated by a greater erythropoietic effort. This apparent inconsistency is explained by an increase in the oxygen half-saturation pressure of hemoglobin of Hb CC erythrocytes, which, in turn, is explained by an intracellular pH lower than that of normal cells ( [81](#) ). The right-shifted oxygen dissociation curve of whole blood permits normal tissue oxygenation in spite of a smaller-than-normal red blood cell mass. The mechanism responsible for the decrease in intraerythrocytic pH is not known.





**Figure 39.5.** Photomicrograph of stained smear from a patient with homozygous hemoglobin C disease. Note the prominence of target cells.

Shortened red cell survival probably is related to the decreased solubility of deoxy-Hb C, a consequence of electrostatic interactions between positively charged  $\beta$ -6 amino groups and negatively charged groups on adjacent molecules ([79](#)). When suspended in hypertonic medium, Hb CC cells form intracellular crystals, a process that begins along the membrane ([82](#)) and is enhanced by deoxygenation ([79](#)). Intracellular aggregates of hemoglobin limit cell deformability by increasing internal viscosity ([83](#)), thereby predisposing to fragmentation, spherocyte formation, and splenic sequestration. Although calcium flux and cytosolic calcium levels are normal, the total calcium content of Hb CC red cells is increased ([84](#)).

Diagnosis rests on the electrophoretic or chromatographic analysis of hemoglobin. The major fraction is Hb C, Hb A is absent, and Hb F is slightly increased. Relatively more Hb F (to 22%) is present in individuals having coexistent Hb CC disease and  $\alpha$ -thalassemia ([85](#)). Therapy is neither available nor needed.

### Hemoglobin SC Disease

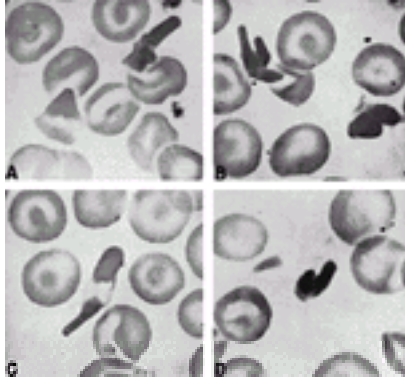
The sickling disorder known as *hemoglobin SC disease* results from the inheritance of an Hb S gene from one parent and an Hb C gene from the other. Red cells contain approximately equal amounts of the two hemoglobins. Hb A is absent, and Hb F is normal or slightly increased. The disorder occurs with an approximate frequency of 1 in 833 births among blacks and 1 in 1400 births in Jamaica. In Ghana, Hb SC disease is as prevalent as sickle cell anemia, and in some regions, it affects as many as 25% of the population.

The clinical and laboratory features of Hb SC disease cannot be explained by copolymerization of Hb C with Hb S ([86](#)). The solubility of mixtures of deoxy-Hb S and Hb C is no different from that of mixtures of Hb S and Hb A ([87](#)). Differences in the sickling properties of sickle trait cells and Hb SC cells are related to two factors: a higher proportion of Hb S and a higher concentration of hemoglobin in Hb SC cells compared with Hb AS cells ([86](#), [88](#)). The 10 to 15% greater proportion of Hb S in Hb SC cells is the result of differences in rates of subunit assembly, which, in turn, are determined by the net surface charges of  $\beta^A$ ,  $\beta^S$ , and  $\beta^C$  ([88](#)). The higher mean corpuscular hemoglobin

concentration of Hb SC cells relates to the opening of normally dormant membrane channels that allow the loss of potassium and water ( [89](#) ). The shrunken, dehydrated cells of Hb SC disease may be classified morphologically as xerocytes ( [90](#) ).

**CLINICAL FEATURES** The clinical manifestations of Hb SC disease are similar to, but less severe than, those of sickle cell anemia. Growth, development, and sexual maturation are normal. Symptoms in the first year are rare, and one-fourth of affected individuals remain asymptomatic throughout the first decade of life ( [91](#) ). The most common symptom is episodic abdominal or skeletal pain, qualitatively similar to that caused by vasoocclusive events in sickle cell anemia. Moderate enlargement of the spleen is present in approximately two-thirds of children and often persists into adult life. Spleen perfusion is intact, however, and as a result, symptomatic splenic infarction ( [92](#), [93](#) and [94](#) ) and acute splenic sequestration ( [95](#) ) may occur in adults as well as in children. Despite preservation of splenic perfusion, spleen function as assessed by quantitation of intraerythrocytic inclusions (“pits”) is compromised. “Pit counts” are intermediate between normal and those associated with sickle cell anemia. Loss of spleen function is more gradual and occurs at a later age than in sickle cell anemia. Probably because of altered spleen function, the frequency of infections is increased. Fatal pneumococcal septicemia, although well documented ( [96](#) ), is less of a risk than is noted in sickle cell anemia ( [97](#) ). In contrast to the infectious complications of sickle cell anemia, those of Hb SC disease are characteristically associated with a primary focus, tend not to recur, and respond promptly to therapy ( [98](#), [99](#) ). *Streptococcus pneumoniae* and *Haemophilus influenzae* are the most frequent bacterial isolates, and the respiratory tract is the most common focus. The incidence of bacteremia drops abruptly after 2 years of age, a contrasting pattern to sickle cell anemia, in which incidence rates decline gradually between 2 and 6 years of age. Central nervous system deficits ( [100](#) ), proptosis resulting from infarction of the orbital bones ( [101](#) ), asymptomatic hematuria, ankle ulceration, priapism, and other complications of sickling are reported but infrequent events. Because of the frequency with which they occur, three complications of Hb SC disease deserve special comment. Proliferative retinopathy is more common and more severe than in sickle cell anemia. Retinal vascular disease has been noted in most Jamaicans with Hb SC disease, and retinitis proliferans affects one-third of this population. Progressive loss of vision may have its onset early in the second decade. Aseptic necrosis of the femoral heads is also seen with greater frequency than in association with sickle cell anemia. An acute chest syndrome, attributed to fat emboli after bone marrow infarction, occurs most commonly during the final months of pregnancy ( [102](#), [103](#) ). The exaggerated vulnerability of individuals with Hb SC disease to these complications is thought to be a function of the higher viscosity of the blood relative to that in sickle cell anemia. The primary determinant of blood viscosity is the concentration of erythrocytes with sickling properties. Moderately severe complications of *in vivo* sickling occur in Hb SC Harlem disease ( [104](#) ) and in the Hb SC/ $\alpha$ -thalassemia syndrome ( [105](#) ). Combined Hb SC disease and hereditary spherocytosis were documented as the cause of recurrent splenic sequestration crises ( [106](#) ).

**LABORATORY FEATURES** Anemia is mild or nonexistent, with only 10% of individuals with Hb SC disease having a hemoglobin concentration less than 10 g per dl ( [107](#), [108](#) ). The mean corpuscular volume may be decreased, and the mean corpuscular hemoglobin concentration may be increased owing to cellular dehydration ( [90](#) ). Reticulocytes are modestly increased in number. Blood films contain as many as 50% target cells. Although sickled cells are seen rarely, cells containing hemoglobin “crystals” are noted regularly ( [80](#) ). These hyperchromic, shrunken cells are distorted into pyramidal or elongated contours by condensed aggregates of hemoglobin ( [Fig. 39.6](#) ).



**Figure 39.6.** Photomicrographs of stained blood smears of patients with hemoglobin (Hb) SC disease. Dark, blunt protuberances and other distortions are produced by condensation of Hb crystals. In frame C, the red cell is elongated, and the Hb is concentrated at each end, leaving an Hb-free central area. (From Diggs LW, Bell A. Intraerythrocytic crystals in sickle cell-hemoglobin C disease. *Blood* 1965;25:218-223. Copyright American Society of Hematology, with permission.)

### Hemoglobin C Korle-Bu Disease

The doubly heterozygous state for Hb C and Hb Korle-Bu also has been described ([109](#)). At 6 months of age, the propositus' hemolysate contained 55% Hb Korle-Bu, 39% Hb C, and 6% Hb F. The moderately severe hemolytic anemia was characterized morphologically by microcytosis and target cells. Anemia was attributed to the acceleration of Hb C crystal formation by Hb Korle-Bu.

## HEMOGLOBIN D DISORDERS

Hemoglobin D has an electrophoretic mobility identical to that of Hb S at pH 8.6. It is distinguished from Hb S by its normal solubility, an electrophoretic mobility on agar gel at an acid pH that differs from that of Hb S, and its failure to produce sickling ([110](#)). The electrophoretic and solubility properties of Hb G are so similar to those of Hb D that the two generally are not differentiated. At least 11  $\beta$ -chain variants and 6  $\alpha$ -chain variants have the electrophoretic and solubility characteristics of Hb D and Hb G. Hb D Punjab (also known as *Hb D Los Angeles*) is by far the most common of the Hb D variants, occurring in 1 to 3% of western Indian populations and in small numbers in European communities having colonial ties with India. In North America, the most prevalent variant is Hb G Philadelphia, an  $\alpha$ -chain abnormality seen primarily in blacks.

### Hemoglobin D Trait

The heterozygous state (Hb AD) is associated with no clinical, hematologic, or physiologic abnormality. Persons with Hb AD usually are identified in screening programs for Hb S. Unless a test for sickling is performed, the condition is mistaken for sickle cell trait.

### Hemoglobin D Disease

Homozygous Hb D disease (Hb DD) is characterized by a mild microcytic anemia, poikilocytosis, minimal hemolysis, and mild to moderate splenomegaly ([110](#), [111](#)). Hemoglobin electrophoresis shows 95% Hb D and normal amounts of Hb F and Hb A<sub>2</sub>. This disorder is easily confused with the doubly heterozygous state for Hb D and B

<sup>0</sup>-thalassemia, in which microcytes and target cells also are prominent ( [112](#) ). The two disorders may be differentiated on the basis of red cell indices, levels of Hb A<sub>2</sub> and F, and family studies.

### Hemoglobin SD Disease

Of the 16 variants fulfilling the electrophoretic and solubility criteria for Hb D or Hb G, at least 9 have been recognized in association with Hb S ( [113](#) , [114](#) ). With but one exception, the doubly heterozygous states for Hb S and Hb D or Hb G are clinically silent. Hemoglobin D Punjab interacts with Hb S to produce mild hemolytic anemia and symptoms that mimic those of mild sickle cell anemia. The Hb SD Punjab syndrome was first detected in a white man whose case had been previously reported as one of sickle cell anemia. Subsequently, Hb SD Punjab disease was recognized in a number of subjects, with most of African origin ( [115](#) ). In each of these subjects, the clinical and hematologic features were those of mild sickle cell anemia.

## HEMOGLOBIN E DISORDERS

Hemoglobin E (β26 Glu→Lys) is the most common hemoglobin variant in Southeast Asia and the second most prevalent hemoglobin variant worldwide ( [116](#) ). Of the estimated 30 million persons with Hb E, more than 80% live on the Southeast Asian mainland. Hb E is particularly prevalent at the borders shared by Thailand, Laos, and Cambodia. Its high frequency is attributed to its mild thalassemia phenotype, which may impart positive selection in areas where malaria is endemic. Three chromosome backgrounds containing the β<sup>E</sup> gene have been detected, suggesting multiple origins of the β<sup>E</sup> mutation ( [117](#) ). This theory is supported by the rare occurrence of Hb E in Europeans ( [118](#) ). Spread of the variant to North America resulted from the Indochinese resettlement program in the late 1970s ( [119](#) ). The incidence of Hb E in refugee children settling in the United States is approximately 19% for those from Cambodia and Laos and 1% for those from Vietnam ( [120](#) ). The electrophoretic mobility of Hb E is similar to, although slightly faster than, Hb C at pH 8.6. It can be differentiated from Hb C by performing agar gel electrophoresis at an acid pH and by its instability on exposure to oxidants ( [121](#) ).

The Hb E syndromes are associated with red cell microcytosis and hypochromia. The doubly heterozygous state for Hb E and β-thalassemia is characterized clinically by thalassemia major (see [Chapter 42](#) ), a situation different from other compound heterozygous states for structural β-chain variants and β-thalassemia. The thalassemic phenotype of the β<sup>E</sup> gene is the result of the activation of a cryptic donor splice site by the codon 26 nucleotide mutation ( [122](#) ). The new splice site competes with the normal donor site at the beginning of the first intron, thereby reducing β<sup>E</sup>-mRNA generation ( [123](#) , [124](#) ). Decreased synthesis may be compounded by β<sup>E</sup>-mRNA instability ( [125](#) , [126](#) ).

### Hemoglobin E Trait

The heterozygous state (Hb AE), although clinically silent, is associated with microcytosis (mean corpuscular volume, 65 fl), slight erythrocytosis, and target erythrocytes ( [120](#) ). No anemia or reticulocytosis is noted. Hemoglobin electrophoresis reveals 20 to 35% Hb E, less than the relative amount of Hbs S, C, and D usually found in individuals heterozygous for these variants. The relative proportion of Hb E is reduced further by coexistent

α-thalassemia and iron deficiency ( [126](#) ).

## Hemoglobin E Disease

Homozygosity for Hb E (Hb EE) is characterized by prominent microcytosis (mean corpuscular volume, 55 to 65 fl) and significant morphologic alterations (target cells, leptocytosis) but little or no anemia or reticulocytosis. No physical abnormalities are noted other than possible slight splenomegaly ( [120](#) , [127](#) ). Hb E accounts for 85 to 95% of the hemoglobin; Hb F is normal or is increased only slightly. Red cell hypochromia is due to defective β<sup>E</sup>-globin synthesis resulting from β<sup>E</sup>-mRNA instability ( [128](#) ). Red cell survival is reduced slightly, and osmotic fragility is decreased. Shortened cell survival may result, in part, from instability of Hb E, a property attributed to the tendency for β<sup>E</sup>-dimers to dissociate into monomers, thereby exposing reactive SH groups ( [121](#) ).

## RELEVANT WEB SITES

<http://globin.cse.psu.edu>: This site contains a comprehensive and current database of the known human hemoglobin variants and thalassemia mutations.

<http://www.umass.edu/microbio/chime/hemoglob>: This site includes a tutorial on hemoglobin structure, including that of sickle hemoglobin.

<http://www.urmc.rochester.edu/Genetics/hemobroc.htm>: This site provides information on a wide variety of hemoglobin variants and offers informative brochures in both Adobe PDF file format and HTML.

<http://www.chime.ucl.ac.uk/APoGI>: This is a source for information on carrier detection and counseling, prepared by geneticists at the University College of London.

<http://www.rhofed.com/sickle/>: This is the web site for the Comprehensive Sickle Cell Centers, with links to several of the National Institutes of Health-designated Comprehensive Sickle Cell Centers.

## REFERENCES

1. Herrick JB. Peculiar elongated and sickle-shaped red corpuscles in a case of severe anemia. Arch Intern Med 1910;6:517-521.
2. Emmel VE. A study of the erythrocytes in a case of severe anemia with elongated and sickle-shaped red blood corpuscles. Arch Intern Med 1917;20:586-598.
3. Hahn EV, Gillespie EB. Sickle cell anemia. Arch Intern Med 1927;39:233.
4. Cooley TB, Lee P. Series of cases of splenomegaly in children with anemia and peculiar bone change. Trans Am Pediatr Soc 1925;37:29.
5. Caminopetros J. Recherches sur L'anemie erythroblastique infantile, des peuples de la Mediterranee orientale. Ann Med 1938;43:27-61.
6. Wintrobe MM, Matthews E, Pollack R, et al. A familial hematopoietic disorder in Italian adolescents and adults resembling Mediterranean disease (thalassemia). JAMA 1940;114:1530-1538.
7. Valentine WN, Neel JV. Hematologic and genetic study of the transmission of thalassemia. Arch Intern

Med 1944;74:185–196.

8. Sherman IJ. The sickling phenomenon, with special reference to the differentiation of sickle cell anemia from the sickle cell trait. *Johns Hopkins Med J* 1940;67:309–324.
9. Wintrobe MM. Anemia, serendipity and science. *JAMA* 1969;210:318–321.
10. Pauling L, Itano HA, Singer SJ, et al. Sickle cell anemia, a molecular disease. *Science* 1949;110:543–548.
11. Neel JV. The inheritance of sickle cell anemia. *Science* 1949;110:64–66.
12. Ingram VM. A specific difference between the globins of normal human and sickle cell anemia hemoglobins. *Nature* 1956;178:792–794.
13. Editorial Board. Recommendations for nomenclature of hemoglobins. *Hemoglobin* 1979;3:1–11.
14. Huisman THJ, Carver MFH, Efremov GD. A syllabus of human hemoglobin variants, 2nd ed. 1998. Augusta: Sickle Cell Anemia Foundation of Augusta, Georgia, 1998.
15. Chui DHK, Hardison R, Riemer C, et al. An electronic database of human hemoglobin variants on the world wide web. *Blood* 1998;91:2643–2644.
16. Lee–Potter JP, Deacon–Smith RA, Simpkins MJ, et al. A new cause of haemolytic anaemia in the newborn. A description of an unstable fetal haemoglobin: F Poole,  $\alpha_2^G \beta_2$  130 tryptophan  $\rightarrow$  glycine. *J Clin Pathol* 1975;28:317–320.
17. Hayashi A, Fujita T, Fujimura M, et al. A new abnormal fetal hemoglobin: Hb FM–Osaka ( $\alpha_2 \beta_2$  63 His  $\rightarrow$  Tyr). *Hemoglobin* 1980;4:447–448.
18. Fugisawa K, Yamashiro Y, Hattori Y, et al. Hb Higashitochigi (Hb HT) [ $\beta$ 24 (B6) or  $\beta$ 25 (B7) glycine deleted]: a new unstable hemoglobin expressing cyanosis. *Hemoglobin* 1993;17:467–473.
19. Ojwang PJ, Nakatsuji T, Gardiner MB, et al. Gene deletion as the molecular basis for the Kenya– $\beta^G$ –HPFH condition. *Hemoglobin* 1983;7:115–123.
20. Adams JG, Morrison WT, Steinberg MH, et al. Hemoglobin Parchman: double crossover within a single human gene. *Science* 1982;218:291–293.
21. Wright HT. Sequence and structure determinants of nonenzymatic deamination of asparagine and glutamine residues. *Protein Eng* 1991;4:283–294.
22. Seid–Akhaven M, Winter WP, Abramson R, et al. Hemoglobin Wayne: a frameshift mutation detected in human hemoglobin alpha chains. *Proc Natl Acad Sci U S A* 1976;73:882–886.
23. Huisman THJ, Headlee MG, Wilson JB, et al. Hb Wayne the frameshift variant with extended  $\alpha$  chains observed in a Caucasian family from Alabama. *Hemoglobin* 1984;8:1–15.
24. George PM, Myles T, Willaimson D, et al. A family with haemolytic anaemia and three  $\beta$ –globins: the deletion in Atlanta–Coventry ( $\beta$ 75 Leu  $\rightarrow$  Pro, 141 Leu deleted) is not present at nucleotide level. *Br J Haematol* 1992;81:93–98.
25. Brennan SO, Shaw J, Allen J, et al.  $\beta$ 141 Leu is not deleted in the unstable hemoglobin Atlanta–Coventry but is replaced by a novel amino acid of mass 129 daltons. *Br J Haematol* 1992;81:99–103.
26. Rees DC, Rochette J, Schofield C, et al. A novel silent posttranslational mechanism converts methionine to aspartate in hemoglobin Bristol ( $\beta$ 67 [E 11] Val–Met  $\rightarrow$  Asp). *Blood* 1996;88:341–348.
27. Livingstone FB. Abnormal hemoglobins in human populations. A summary and interpretation. Chicago: Aldine, 1967.

28. Campbell JJ, Oski FA. Sick cell anemia in an American white boy of Greek ancestry. *Am J Dis Child* 1977;131:186–188.
29. Noronha PH, Honig GR. Sick cell anemia in two white American children: essential laboratory criteria for diagnosis. *Pediatrics* 1979;63:242–246.
30. Pagnier J, Mears JG, Dunda–Belkhodja O, et al. Evidence for the multicentric origin of the sickle cell hemoglobin gene in Africa. *Proc Natl Acad Sci U S A* 1984;81:1771–1773.
31. Antonarakis SE, Boehm CD, Sergent GR, et al. Origin of the  $\beta^S$ -globin gene in blacks: the contribution of the recurrent mutation or gene conversion or both. *Proc Natl Acad Sci U S A* 1984;81:853–856.
32. Wainscoat JS, Bell JI, Thein SL, et al. Multiple origins of the sickle mutation: evidence from beta S globin gene cluster polymorphisms. *Mol Biol Med* 1983;1:191–197.
33. Mears JG, Beldjord C, Benabadji M, et al. The sickle gene polymorphism in North Africa. *Blood* 1981;58:599–601.
34. Kan YW, Dozy AM. Polymorphism of DNA sequence adjacent to the human  $\beta$ -globin structural gene; its relation to the sickle mutation. *Proc Natl Acad Sci U S A* 1978;75:5631–5635.
35. Kan YW, Dozy AM. Evolution of the hemoglobin S and C genes in world populations. *Science* 1980;209:388–391.
36. Flatz G. Hemoglobin E: distribution and population dynamics. *Humangenetik* 1967;3:189–234.
37. Chernoff AI. The hemoglobin D syndromes. *Blood* 1958;8:116–127.
38. Motulsky AG. Hereditary red cell traits and malaria. *Am J Trop Med Hyg* 1964;13:147–158.
39. Roth EF, Friedman M, Ueda Y, et al. Sickling rates of human AS red cells infected in vitro with *Plasmodium falciparum* malaria. *Science* 1978;202:650–652.
40. Friedman MJ. Erythrocytic mechanism of sickle cell resistance to malaria. *Proc Natl Acad Sci U S A* 1978;75:1994–1997.
41. Sick K, Beale D, Irvine D, et al. Haemoglobin G Copenhagen and haemoglobin J Cambridge. Two new beta-chain variants of haemoglobin A. *Biochim Biophys Acta* 1967;140:231–242.
42. Schneider RG, Hightower B, Hosty TS, et al. Abnormal hemoglobins in a quarter million people. *Blood* 1976;48:629–637.
43. Pierce HI, Kurachi S, Sofroniadou K, et al. Frequencies of thalassemia in American blacks. *Blood* 1977;49:981–986.
44. Motulsky AG. Frequency of sickling disorders in U.S. blacks. *N Engl J Med* 1973;288:31–33.
45. Steinberg MH, Forget BG, Higgs DR, et al. Disorders of hemoglobin: genetics, pathophysiology, and clinical management. Cambridge: Cambridge University Press, 2001.
46. Honig GR, Adams JG. Human hemoglobin genetics. New York: Springer–Verlag New York, 1986.
47. Collins FS, Weissman SM The molecular genetics of human hemoglobin. *Prog Nucleic Acid Res Mol Biol* 1984;31:315–462.
48. Stamatoyannopoulos G, Nute PE. Cases of unstable hemoglobin and methemoglobin produced by de novo mutation. *Hemoglobin* 1984;8:85–95.
49. Bunn HF. Mutant hemoglobins having elongated chains. *Hemoglobin* 1978;2:1–28.



50. Boissel JP, Kasper TJ, Shah SC, et al. Amino-terminal processing of proteins: hemoglobin South Florida, a variant with retention of initiator methionine and N alpha-acetylation. *Proc Natl Acad Sci U S A* 1985;82:8448-8452.
51. Kamel K, el-Najjar A, Webber BB, et al. Hb Doha or a  $\alpha_2\beta_2$  [X-N-Met-1(NA1)Val?Glu]; a new  $\beta$ -chain abnormal hemoglobin observed in a Qatari female. *Biochim Biophys Acta* 1985;831:257-260.
52. Huisman TH, Wilson JB, Gravely M, et al. Hemoglobin Grady: the first example of a variant with elongated chains due to an insertion of residues. *Proc Natl Acad Sci U SA* 1974;71:3270-3273.
53. Wilson JB, Webber BB, Hu H, et al. Hemoglobin Birmingham and hemoglobin Galicia: two unstable  $\beta$ -chain variants characterized by small deletions and insertions. *Blood* 1990;75:1883-1887.
54. Konotey-Ahulu FI, Gallo E, Lehmann H, et al. Haemoglobin Korle-Bu ( $\beta$ 73 aspartic acid replaced by asparagine) showing one of the two amino acid substitutions of haemoglobin C Harlem. *J Med Genet* 1968;5:107-111.
55. Cohen-Solal M, Blouquit Y, Garel MC, et al. Haemoglobin Lyon ( $\beta$  17-18 (A 14-15) Lys-Val ? O). Determination by sequenator analysis. *Biochim Biophys Acta* 1974;351:306-316.
56. Wong SC, Huisman TH. Further evidence for non-linkage of the Hb  $\alpha$  and Hb  $\beta$  structural loci in man. *Clin Chim Acta* 1972;38:473-474.
57. Huisman TH. Percentages of abnormal hemoglobins in adults with a heterozygosity for an  $\alpha$ -chain and/or a  $\beta$ -chain variant. *Am J Hematol* 198;14:393-404.
58. Steinberg MH, Embury SH. Alpha-thalassemia in blacks: genetic and clinical aspects and interactions with the sickle hemoglobin gene. *Blood* 1986;68:985-990.
59. Liebhaber SA, Cash FE, Cornfield DB. Evidence for posttranslational control of Hb C synthesis in an individual with Hb C trait and  $\alpha$ -thalassemia. *Blood* 1988;71:502-504.
60. Huisman TH. Trimodality in the percentages of  $\beta$  chain variants in heterozygotes: the effect of the number of active Hb  $\alpha$  structural loci. *Hemoglobin* 1977;1:349-382.
61. Bunn HF. Subunit assembly of hemoglobin: an important determinant of hematologic phenotype. *Blood* 1987;69:1-6.
62. Abramson RK, Rucknagel DL, Shreffler DC, et al. Homozygous Hb J Tongariki: evidence for only one  $\alpha$ -chain structural locus in Melanesians. *Science* 1970;169:194-196.
63. Rieder RF, Woodbury DH, Rucknagel DL. The interaction of  $\alpha$ -thalassaemia and haemoglobin G Philadelphia. *Br J Haematol* 1976;32:159-165.
64. Lie-Injo LE, Dozy AM, Kan YW, et al. The  $\alpha$ -globin gene adjacent to the gene for HbQ- $\alpha$  74 Asp?His is deleted, but not that adjacent to the gene for HbG- $\alpha$  30 Glu?Gln; three-fourths of the  $\alpha$ -globin genes are deleted in HbQ- $\alpha$ -thalassemia. *Blood* 1979;54:1407-1416.
65. Weatherall DJ, Boyer SH. Evidence for the genetic identity of alpha chain determinants in hemoglobins A, A<sub>2</sub> and F. *Bull Johns Hopkins Hosp* 1962;110:8-22.
66. Perutz MF, Lehmann H. Molecular pathology of human haemoglobin. *Nature* 1968;219:902-909.
67. Perutz MF. Stereochemistry of cooperative effects in haemoglobin. *Nature* 1970;228:726-739.
68. Kan YW, Dozy AM. Evolution of the hemoglobin S and C genes in world populations. *Science* 1980;209:388-391.
69. Agarwal A, Guindo A, Cissoko Y, et al. Hemoglobin C associated with protection from severe malaria in the Dogon of Mali, a West African population with a low prevalence of hemoglobin S. *Blood*

2000;96:2358–2363.

70. Olson JA, Nagel RL. Synchronized cultures of *P falciparum* in abnormal red cells: the mechanism of the inhibition of growth in HbCC cells. *Blood* 1986;67:997–1001.
71. Galbraith PA, Green PT. Hemoglobin C disease in an Anglo–Saxon family. *Am J Med* 1960;28:969–972.
72. Orkin SH, Kazazian HH Jr, Antonarakis SE, et al. Linkage of  $\beta$ -thalassaemia mutations and  $\beta$ -globin gene polymorphisms with DNA polymorphisms in human  $\beta$ -globin gene cluster. *Nature* 1982;296:627–631.
73. Studencki AB, Conner BJ, Impraim CC, et al. Discrimination among the human  $\beta^A$ ,  $\beta^S$ , and  $\beta^C$ -globin genes using allele-specific oligonucleotide hybridization probes. *Am J Hum Genet* 1985;37:42–51.
74. Prindle KH Jr, McCurdy PR. Red cell lifespan in hemoglobin C disorders (with special reference to hemoglobin C trait). *Blood* 1970;36:14–19.
75. Liebhaber SA, Cash FE, Cornfield DB. Evidence for posttranslational control of Hb C synthesis in an individual with Hb C trait and  $\alpha$ -thalassemia. *Blood* 1988;71:502–504.
76. Olson JF, Ware RE, Schultz WH, et al. Hemoglobin C disease in infancy and childhood. *J Pediatr* 1994;125:745–747.
77. Lipshutz M, McQueen DA, Rosner F. Spontaneous rupture of the spleen in homozygous hemoglobin C disease. *JAMA* 1977;237:792–793.
78. Redetzki JE, Bickers JN, Samuels MS. Homozygous hemoglobin C disease: clinical review of fifteen patients. *South Med J* 1968;61:238–242.
79. Charache S, Conley CL, Waugh DF, et al. Pathogenesis of hemolytic anemia in homozygous hemoglobin C disease. *J Clin Invest* 1967;46:1795–1811.
80. Diggs LW, Bell A. Intraerythrocytic hemoglobin crystals in sickle cell–hemoglobin C disease. *Blood* 1965;25:218–223.
81. Murphy JR. Hemoglobin CC erythrocytes: decreased intracellular pH and decreased  $O_2$  affinity–anemia. *Semin Hematol* 1976;13:177–180.
82. Lessin LS, Jensen WN, Ponder E. Molecular mechanism of hemolytic anemia in homozygous hemoglobin C disease. Electron microscopic study by the freeze–etching technique. *J Exp Med* 1969;130:443–466.
83. Mohandas N, Clark MR, Jacobs MS, et al. Analysis of factors regulating erythrocyte deformability. *J Clin Invest* 1980;66:563–573.
84. Rhoda MD, Galacteros F, Beuzard Y, et al.  $Ca^{2+}$  permeability and cytosolic  $Ca^{2+}$  concentration are not impaired in  $\beta$ -thalassemic and hemoglobin C erythrocytes. *Blood* 1987;70:804–808.
85. Steinberg MH. Haemoglobin C/ $\alpha$  thalassaemia: haematological and biosynthetic studies. *Br J Haematol* 1975;30:337–342.
86. Bunn HF, Noguchi CT, Hofrichter J, et al. Molecular and cellular pathogenesis of hemoglobin SC disease. *Proc Natl Acad Sci U S A* 1982;79:7527–7531.
87. Bookchin RM, Balazs T. Ionic strength dependence of the polymer solubilities of deoxyhemoglobin S + C and S + A mixtures. *Blood* 1986;67:887–892.
88. Bunn HF. Subunit assembly of hemoglobin: an important determinant of hematologic phenotype. *Blood* 1987;69:1–6.
89. Fabry ME, Kaul DK, Raventos–Suarez C, et al. SC erythrocytes have an abnormally high intracellular hemoglobin concentration. Pathophysiological consequences. *J Clin Invest* 1982;70:1315–1319.

90. Ballas SK, Larner J, Smith ED, et al. The xerocytosis of Hb SC disease. *Blood* 1987;69:124–130.
91. Williams S, Maude GH, Serjeant GR. Clinical presentation of sickle cell–hemoglobin C disease. *J Pediatr* 1986;109:586–589.
92. Chu JY, Niederman LG. Splenic sequestration syndrome in sickle/hemoglobin C disease at low altitude. *J Pediatr* 1977;91:350–351.
93. Geola F, Kukreja SC, Schade SG. Splenic sequestration with sickle cell–C disease. *Arch Intern Med* 1978;138:307–308.
94. Yeung KY, Lessin LS. Splenic infarction in sickle cell–hemoglobin C disease. Demonstration by selective splenic arteriogram and scintillation scan. *Arch Intern Med* 1976;136:905–991.
95. Githens JH, Gross GP, Eife RF, et al. Splenic sequestration syndrome at mountain altitudes in sickle/hemoglobin C disease. *J Pediatr* 1977;90:203–206.
96. Chilcote RR, Dampier C. Overwhelming pneumococcal septicemia in a patient with HbSC disease and splenic dysfunction. *J Pediatr* 1984;104:734–736.
97. Barrett–Connor E. Infection and sickle cell–C disease. *Am J Med Sci* 1971;262:162–169.
98. Buchanan GR, Smith SJ, Holtkamp CA, et al. Bacterial infection and splenic reticuloendothelial function in children with hemoglobin SC disease. *Pediatrics* 1983;72:93–98.
99. Topley JM, Cupidore L, Vaidya S, et al. Pneumococcal and other infections in children with sickle–cell hemoglobin C (SC) disease. *J Pediatr* 1982;101:176–179.
100. Ali SK, Wilimas J, Goff J. Choreiform activity in hemoglobin SC disease. *J Pediatr* 1978;93:106.
101. Seeler RA. Exophthalmos in hemoglobin SC disease. *J Pediatr* 1983;102:90–91.
102. Chmel H, Bertles JF. Hemoglobin S/C disease in a pregnant woman with crisis and fat embolization syndrome. *Am J Med* 1975;58:563–566.
103. Davey RJ, Esposito DJ, Jacobson RJ, et al. Partial exchange transfusion as treatment for hemoglobin SC disease in pregnancy. *Arch Intern Med* 1978;138:937–939.
104. Moo–Penn W, Bechtel K, Jue D, et al. The presence of hemoglobin S and C Harlem in an individual in the United States. *Blood* 1975;46:363–367.
105. Honig GR, Gunay U, Mason RG, et al. Sickle cell syndromes. I. Hemoglobin SC–a thalassemia. *Pediatr Res* 1976;10:613–620.
106. Warkentin TE, Barr RD, Ali MA, et al. Recurrent acute splenic sequestration crisis due to interacting genetic defects: hemoglobin SC disease and hereditary spherocytosis. *Blood* 1990;75:266–270.
107. Movitt ER, Mangum JF, Porter ER. Sickle cell–hemoglobin C disease. Quantitative determination of iron kinetics and hemoglobin synthesis. *Blood* 1963;21:535–545.
108. Stevens MC, Maude GH, Beckford M, et al. Haematological change in sickle cell–haemoglobin C disease and in sickle cell– $\beta$ –thalassaemia: a cohort study from birth. *Br J Haematol* 1985;60:279–292.
109. Nagel RL, Lin MJ, Witkowska HE, et al. Compound heterozygosity for hemoglobin C and Korle–Bu: moderate microcytic hemolytic anemia and acceleration of crystal formation. *Blood* 1993;82:1907–1912.
110. Chernoff AI. The hemoglobin D syndromes. *Blood* 1958;13:116–127.
111. Thornburg CD, Zimmerman SA, Schultz WH, et al. An infant with homozygous hemoglobin D–Iran. *J Pediatr Hematol Oncol* 2001;23:67–68.

112. Rohe RA, Sharma V, Ranney HM. Hemoglobin D Iran a  $\beta$ <sup>E</sup> 22 Glu?Gln in association with thalassemia. *Blood* 1973;42:455-462.
113. Schneider RG, Ueda S, Alperin JB, et al. Hemoglobin D Los Angeles in two Caucasian families: hemoglobin SD disease and hemoglobin D thalassemia. *Blood* 1968;32:250-259.
114. McCurdy PR, Lorkin PA, Casey R, et al. Hemoglobin S-G (S-D) syndrome. *Am J Med* 1974;57:665-670.
115. Ringelmann B, Lewis RA, Lorkin PA, et al. Sickle cell hemoglobin D Punjab disease: S from Ghana and D from England. *Acta Haematol (Basel)* 1967;38:324-331.
116. Rees DC, Styles L, Vichinsky EP, et al. The hemoglobin E syndromes. *Ann N Y Acad Sci* 1998;850:334-343.
117. Antonarakis SE, Orkin SH, Kazazian HH Jr, et al. Evidence for multiple origins of the  $\beta$ <sup>E</sup>-globin gene in Southeast Asia. *Proc Natl Acad Sci U S A* 1982;79:6608-6611.
118. Kazazian HH Jr, Waber PG, Boehm CD, et al. Hemoglobin E in Europeans: further evidence for multiple origins of the  $\beta$ <sup>E</sup>-globin gene. *Am J Hum Genet* 1984;36:212-217.
119. Fairbanks VF, Gilchrist GS, Brimhall B, et al. Hemoglobin E trait reexamined: a cause of microcytosis and erythrocytosis. *Blood* 1979;53:109-115.
120. Hurst D, Tittle B, Kleman KM, et al. Anemia and hemoglobinopathies in Southeast Asian refugee children. *J Pediatr* 1983;102:692-697.
121. Frischer H, Bowman J. Hemoglobin E, an oxidatively unstable mutation. *J Lab Clin Med* 1975;85:531-539.
122. Orkin SH, Kazazian HH Jr, Antonarakis SE, et al. Abnormal RNA processing due to the exon mutation of  $\beta$ <sup>E</sup>-globin gene. *Nature* 1982;300:768-769.
123. Benz EJ Jr, Berman BW, Tonkonow BL, et al. Molecular analysis of the  $\beta$ -thalassemia phenotype associated with inheritance of hemoglobin E ( $\alpha_2\beta_2$ <sup>26</sup>Glu?Lys). *J Clin Invest* 1981;68:118-126.
124. Traeger J, Wood WG, Clegg JB, et al. Defective synthesis of HbE is due to reduced levels of  $\beta$ <sup>E</sup> mRNA. *Nature* 1980;288:497-499.
125. Traeger J, Winichagoon P, Wood WG. Instability of  $\beta$ <sup>E</sup>-messenger RNA during erythroid cell maturation in hemoglobin E homozygotes. *J Clin Invest* 1982;69:1050-1053.
126. Wasi P, Sookanek M, Pootrakul S, et al. Haemoglobin E and alpha-thalassaemia. *Br Med J* 1967;4:29-32.
127. Fairbanks VF, Oliveros R, Brandabur JH, et al. Homozygous hemoglobin E mimics  $\beta$ -thalassemia minor without anemia or hemolysis: hematologic, functional, and biosynthetic studies of first North American cases. *Am J Hematol* 1980;8:109-121.
128. Traeger J, Winichagoon P, Wood WG. Instability of  $\beta$ <sup>E</sup>-messenger RNA during erythroid cell maturation in hemoglobin E homozygotes. *J Clin Invest* 1982;69:1050-1053.

2004 Lippincott Williams & Wilkins  
John P. Greer, John Foerster, John N. Lukens  
George M. Rodgers, Frixos Paraskevas, Bertil Glader  
Wintrobe's Clinical Hematology

HEMOGLOBIN S: PREVALENCE AND GEOGRAPHIC DISTRIBUTIONPATHOPHYSIOLOGYMolecular Basis of SicklingCellular PathologyPathogenesis of HemolysisPathogenesis of VasocclusionSICKLE CELL ANEMIA (HEMOGLOBIN SS)Clinical FeaturesPrognosisLaboratory FeaturesDiagnosisTreatmentSICKLE CELL TRAITClinical FeaturesDiagnosisScreening ProgramsOTHER SICKLING SYNDROMESHemoglobin SC DiseaseHemoglobin S-β-ThalassemiaHemoglobin S/Hereditary Persistence of Fetal HemoglobinHemoglobin SE DiseaseHemoglobin SD DiseaseHemoglobin SO-Arab DiseaseREFERENCES

This chapter discusses hemoglobin (Hb) variants that cause alterations in erythrocyte morphology and rheology. Three recent texts offer extensive information and indicate the rapid expansion of information about sickle cell disease (<sup>1</sup>, <sup>2</sup> and <sup>3</sup>). Because of their prevalence and worldwide distribution, the disorders resulting from sickle Hb (Hb S) are of enormous clinical importance. Sickle cell anemia alone is the most common heritable hematologic disease affecting humans.

Long before they were recognized in the Western hemisphere, sickling disorders were known in Africa by onomatopoeic names denoting the recurrent, unrelenting, and painful nature of the crises (<sup>4</sup>, <sup>5</sup>). Although in one Ghanaian family, symptoms of sickle cell anemia could be traced to the year 1670 (<sup>6</sup>), disorders of Hb synthesis went unrecognized by the scientific community until 1910, when Herrick, a Chicago cardiologist, recorded observations made during investigation of anemia in a 20-year-old West Indian student (<sup>7</sup>). The fascinating account of the events that followed and of the individuals who contributed to the still unfolding story of sickle cell anemia is presented in detail by Conley (<sup>8</sup>). Herrick's report led not only to the recognition of hundreds of abnormalities of Hb synthesis, but also to a series of remarkable scientific advances involving protein chemistry, cell biology, physiology, and genetics. In 1949, Linus Pauling and collaborators demonstrated for the first time that an abnormal protein could be causally linked to a disease (<sup>9</sup>). A historical review of all of the major developments in the current

understanding of sickle cell disease has recently been published by Sergeant ( [10](#) ).

The genetic basis for Hb synthesis is discussed in [Chapter 5](#) and [Chapter 39](#). Each major hemoglobinopathy occurs in both a heterozygous and a homozygous form. In the heterozygous state, red cells contain both normal adult Hb (Hb A) and the variant Hb. Because they rarely have phenotypic expressions of clinical significance, heterozygotes are said to have the trait for that abnormality, for example, sickle cell trait. In the homozygous state, Hb A is totally lacking, and clinical manifestations are of variable severity; individuals so affected have sickle cell anemia. In addition, disease may result from the combination of two variant hemoglobins or from a variant Hb and an interacting thalassemia gene. These doubly heterozygous states are designated by both aberrant gene products, such as Hb SC disease, Hb S/ $\beta$ -thalassemia. The term *sickle cell disease* is used in a generic sense to refer to all of the sickling syndromes.

## HEMOGLOBIN S: PREVALENCE AND GEOGRAPHIC DISTRIBUTION

Hb S, so called because of the sickle shape it imparts to deoxygenated red cells, is responsible for a wide spectrum of disorders that vary with respect to degree of anemia, frequency of crises, extent of organ injury, and duration of survival. Some of the sickling syndromes lack significant pathologic potential, but they are easily confused with clinically aggressive disorders on the basis of laboratory evaluation; consequently, precision in diagnosis is essential both to proper clinical management and to meaningful genetic counseling.

The highest prevalence of Hb S is in tropical Africa and among blacks in countries that participated in the slave trade. It occurs with lower frequency in the Mediterranean basin, Saudi Arabia, and parts of India. Results of studies of DNA polymorphisms linked to the  $\beta^S$  gene suggest that it arose from three independent mutations in tropical Africa ( [Fig. 40.1](#) ) ( [11](#), [12](#) ). The most common  $\beta^S$  chromosome is found in Benin (neighboring Nigeria) and central West Africa. A second haplotype is prevalent in Senegal and the African West Coast, and a third haplotype is seen in the Central African Republic (Bantu-speaking Africa). The same three haplotypes are associated with the  $\beta^S$  gene in black Americans and Jamaicans ( [13](#) ). The Hb S gene in the Eastern Province of Saudi Arabia and in Central India is associated with a different DNA structure not encountered in Africa and probably represents a fourth independent occurrence of the sickle cell mutation ( [12](#) ). Only the Benin and Senegal haplotypes are prevalent among North Africans, Greeks, and Italians, suggesting that the  $\beta^S$  mutation spread to the Mediterranean basin from West Africa ( [13](#), [14](#) ). In some parts of Africa, as much as 45% of the population has sickle cell trait. In the United States ( [15](#), [16](#) and [17](#) ), Latin America, and the Caribbean ( [2](#), [18](#) ), approximately 8% of blacks carry the sickle gene. In the United States, the expected incidence of sickle cell anemia (Hb SS) at birth is 1 in 625. The validity of this estimate is borne out by prospective studies of the Hb phenotypes of black infants at birth ( [19](#), [20](#) ). Taking into account increased mortality, approximately 70,000 cases of sickle cell disease would be expected among black Americans in the United States.



**Figure 40.1.** Geographic dispersion of  $\beta^S$ -globin gene haplotypes. (From Ragusa A, Lombardo M, Sortino G, et al. Beta S gene in Sicily is in linkage disequilibrium with the Benin haplotype: implications for gene flow. *Am J Hematol* 1988;27:139–141, with permission.)

Before this century, most individuals with sickle cell anemia died before the age of reproduction. Without selective advantage to Hb S trait, the sickle gene would have been eliminated. The most widely accepted theory to account for the remarkable stability of the sickle gene in Africa is that of balanced polymorphism ( 21, 22 ). Recognition that sickle cell trait has its highest prevalence in areas hyperendemic for malaria suggested that Hb S afforded selective protection against lethal forms of malaria. Although there is a great deal of clinical evidence to support this concept ( 21 ), the mechanism affording selective advantage remains conjectural. Preferential sickling of parasitized cells has been observed in the blood of children with sickle cell trait and malaria ( 23, 24 ). Selective removal of sickled cells from the circulation probably reduces the degree of parasitemia and substantially limits the infectious process.

## PATHOPHYSIOLOGY

The sickle mutation substitutes thymine for adenine in the sixth codon of the  $\beta$  gene (GAG→GTG), thereby encoding valine instead of glutamine in the sixth position of the  $\beta$ -chain. This ostensibly minor change in structure is responsible for profound changes in molecular stability and solubility. The tendency of deoxygenated Hb S to undergo polymerization underlies the innumerable expressions of the sickling syndromes ( 25 ).

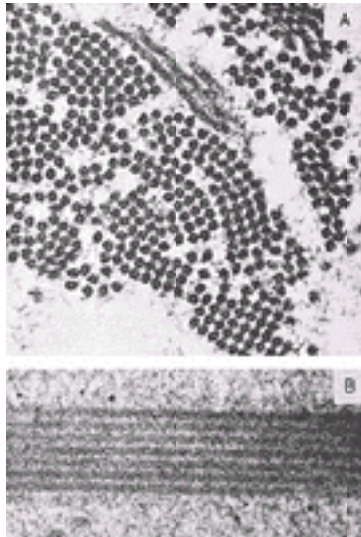
### Molecular Basis of Sickling

An abundance of information indicates that the distortion of cells containing Hb S is the result of Hb polymerization ( 26 ). Cell-free solutions of Hb S undergo a pronounced decrease in solubility and an increase in viscosity when deoxygenated ( 27 ). Deoxy Hb S polymers in the cell exist in a spectrum of forms from scattered individual fibers to highly ordered fiber aggregates that essentially fill the cell and distort it into the classic sickle shape or other elongated forms. It is the presence of polymer that causes the reversible, oxygen-linked changes in the rheologic properties of the sickle erythrocyte that characterizes the disease. On oxygenation, these polymers dissolve or “melt,” and the sickle erythrocyte loses most of those pathologic properties caused by the presence of polymer ( 25 ). If the concentration of Hb S in such solutions or in the red cell approaches 30 g/dl, a semisolid gel forms.

**STRUCTURE OF HEMOGLOBIN S POLYMER** The structure of the deoxygenated Hb S polymer has been deduced from studies involving the use of electron microscopy ( [Fig. 40.2](#) ) ( 28, 29 ) and x-ray diffraction ( 29, 30 ). The polymerized Hb fiber is a helical structure



with 14 Hb tetramers in each layer; these form a central core of four strands and an outer sheath of ten additional strands with a diameter of approximately 21 nm ( [29](#), [31](#), [32](#)). The points of contact between molecules along the longitudinal axis of the chains and laterally between chains have been determined by x-ray diffraction ( [33](#)) and by the gelling characteristics of mixtures of deoxy Hb S and variant ( [27](#), [34](#), [35](#)) or hybrid ( [36](#)) hemoglobins. Only one of the two  $\beta^6$  Val residues appears to participate in the intermolecular contact; it fits into a hydrophobic pocket formed by a  $\beta^{85}$  Phe and a  $\beta^{88}$  Leu residue on a  $\beta$ -chain of a nearby Hb S tetramer ( [37](#)). Bonds between contact points include both hydrophobic ( [38](#)) and electrostatic ( [27](#)) forces.



**Figure 40.2.** Electron photomicrographs of cell-free pellets of deoxy hemoglobin (Hb S). **A:** Transverse section through fibers of polymerized Hb S ( $\times 97,000$ ). **B:** Longitudinal section through same ( $\times 102,000$ ). (From Finch JT, Perutz MF, Bertles JF, et al. Structure of sickled erythrocytes and of sickle-cell hemoglobin fibers. Proc Natl Acad Sci U S A 1973;70:718, with permission.)

**PHYSIOLOGIC DETERMINANTS OF POLYMERIZATION** The equilibrium of Hb S between its liquid and solid phases is determined by four variables: oxygen tension, Hb S concentration, temperature, and hemoglobins other than Hb S.

**Oxygen** The most important physiologic determinant of Hb S gelation is oxygen. Polymerization occurs only with deoxygenation. Ligated states of the molecule (oxy, met, and carbonmonoxy Hb S) do not aggregate and, in fact, are excluded from the polymer ( [37](#), [39](#)). With deoxygenation, the oxygen affinity of Hb S falls ( [40](#)), thereby stabilizing the deoxy state. The effects of 2,3-diphosphoglycerate and pH on gelation are mediated primarily through their influence on the oxygen affinity of Hb. An increase in 2,3-diphosphoglycerate decreases the affinity of Hb S for oxygen and enhances gelation ( [41](#)). Likewise, a decrease in pH decreases oxygen affinity via the Bohr effect, thereby increasing the amount of deoxy Hb S at any given oxygen tension.

**Hemoglobin S Concentration** There is a positive correlation between Hb S concentration and gelation ( [39](#)). Under standard laboratory conditions, gelation occurs as the concentration of deoxy Hb S is raised above 20.8 g/dl ( [42](#)). Because the mean Hb concentration of the red cell is normally greater than 30 g/dl, intracellular gelation of Hb S is a predictable consequence of deoxygenation. The concentration dependence of sickling provides the basis for both the minimum gelling concentration assay ( [39](#)) and equilibrium solubility assays ( [43](#)).

**Temperature** Gels of deoxy Hb S dissolve when cooled below a critical temperature. Because the temperatures required for melting are well below the physiologic range, the significance of this phenomenon is limited to the laboratory study of gelation. The gradual

heating of cold, concentrated solutions of deoxy Hb S permits study of the kinetics of polymerization ( [44](#), [45](#) ).

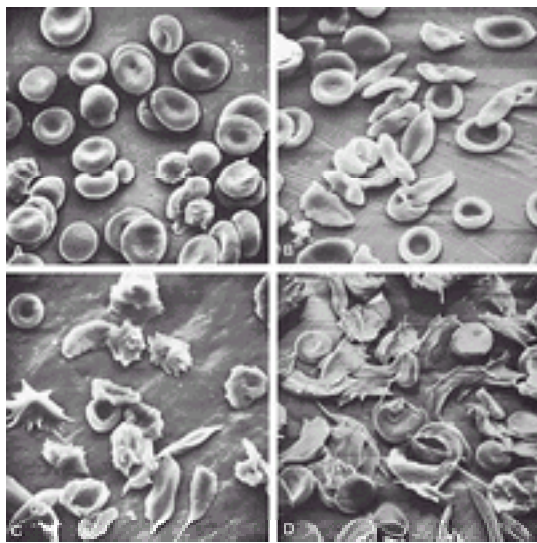
**Other Hemoglobins** The influence of other hemoglobins on Hb S polymerization is variable. Both Hb A and Hb F have an inhibitory effect on gelation ( [46](#) ). When deoxygenated, these hemoglobins enter the sickle polymer less readily than does deoxy Hb S, thereby retarding gelation by a dilutional effect ( [27](#) ). Because there are 20 surface amino acid differences between  $\beta^{S-}$  and  $\alpha$ -chains and only a single residue difference between  $\beta^{S-}$  and  $\beta^A$ -chains, it is not surprising that Hb F is excluded from Hb S polymers to a greater extent than Hb A. Differences in the relative amounts of the G $\alpha$  and A $\alpha$  fractions of Hb F do not affect the polymerization of mixtures of Hb F and Hb S ( [46](#) ). Other hemoglobins interfere with polymer formation less well. By measuring the minimum gelling concentration of various mixtures of hemoglobins, the extent of interaction can be quantitated. Deoxy Hb S molecules copolymerize most effectively with other Hb S molecules and, in decreasing order, with Hb C, D, O Arab, A, J, and F ( [34](#), [39](#), [47](#) ). These *in vitro* observations predict the clinical severity of disorders involving these variants ( [48](#) ). In contrast, the doubly heterozygous state for Hb S and hereditary persistence of fetal Hb (HPFH), in which red cells contain approximately 70% Hb S and 30% Hb F, is not associated with clinical disease ( [49](#), [50](#), [51](#) and [52](#) ). It is now possible to correlate the estimated level of polymerization with clinical severity in untreated patients ( [53](#) ). It is also possible to estimate how much inhibition of polymerization would result from therapeutic interventions such as altering Hb S solubility, which might be accomplished by modifying polymer structure, lowering mean corpuscular Hb concentration (MCHC), or elevating the fraction of Hb F ( [54](#) ). Analysis of Hb S polymerization allows the design of new therapies and enhances interpretation of the pathophysiology of the various sickle cell syndromes ( [25](#) ).

**KINETICS OF SICKLING** Sickling is not an instantaneous phenomenon. Analysis of the kinetics of sickling suggests that molecular polymerization occurs in stages. The delay period between deoxygenation and polymerization is attributed to nucleation processes, in which Hb S tetramers form small aggregates without modification of internal viscosity. When these aggregates reach a critical mass, a rapid addition of free Hb units occurs to form fibers that then undergo alignment to form a tactoid ( [55](#), [56](#) ). A red cell spends approximately 1 to 2 seconds in the arterial circulation and 1 second in the microcirculation; it then requires approximately 15 seconds to return to the lungs ( [57](#) ). Thus, if the delay time is longer than 15 seconds, the cell can return to the lungs and be reoxygenated before any significant polymerization has begun. If the delay time is between 1 and 15 seconds, gelation occurs while the cell is in the venous circulation. Sickling in the large veins does not produce vasoocclusion, but the cell membrane may be damaged, resulting in a loss of water and a shorter delay time in subsequent trips through the circulation. If the delay time is less than approximately 1 second, gelation can occur while the cell is in one of the narrow vessels of the microcirculation. Because the cell is much less deformable, it may not be able to “squeeze” through and may become transiently or permanently stuck ( [57](#) ). Under physiologic conditions, the delay between complete deoxygenation and erythrocyte sickling is approximately 2 seconds, but it is strongly influenced by changes in Hb concentration, the presence of hemoglobins other than Hb S, temperature, pH, and 2,3-diphosphoglycerate ( [44](#), [58](#) ). Of particular clinical significance is the MCHC. Small increments in deoxyhemoglobin concentration (e.g., those that occur with loss of cell water) profoundly shorten the delay time ( [55](#), [59](#) ), thereby potentiating sickling.

## Cellular Pathology

Red cells containing Hb S acquire the sickle-shape deformity on deoxygenation because

of the intracellular polymerization of Hb. This phenomenon may be monitored directly with light or scanning electron microscopy ( Fig. 40.3) ( 26, 60 ) and indirectly by measuring changes in viscosity or filterability ( 61 ). Electron micrographs demonstrate filaments in parallel array, some of which extend into the protuberances of sickled cells ( 62, 63 ). The membrane is secondarily involved by repeated or prolonged sickling. Irreparable damage to membrane structures obviates resumption of the normal disc shape despite solubilization of intracellular polymers and thus produces the irreversibly sickled cell (ISC) ( 64 ). Both Hb polymerization and membrane injury contribute to the pathophysiology of the sickling syndromes.



**Figure 40.3.** Erythrocytes from a patient with sickle cell anemia examined with scanning electron microscopy. **A:** Oxygenated blood. Red cells appear normal except for one microspherocyte. Three leukocytes are evident in the field. **B:** Oxygenated irreversibly sickled cells are smooth in texture and outline but are ovoid or boatlike in shape. **C:** Partial deoxygenation causes the cells to assume bizarre shapes with spikes, spicules, and filaments that protrude from the cells. **D:** More complete deoxygenation causes the cells to assume sickled shapes with longitudinal surface striations.

**RED CELL SICKLING** Deoxygenation is associated with a continuum of cellular changes. Hb polymers rapidly expand to command large domains that distort cells into elongated crescents. Long, thin filaments extend from the body of cells exposed to prolonged deoxygenation. When quantitated by  $^{13}\text{C}$  nuclear magnetic resonance spectroscopy, polymerized Hb S can be detected in significant amounts, even in morphologically normal cells maintained at oxygen saturations in excess of 95%. This observation is attributed to the nonideal nature of Hb solutions, in which a high concentration of oxy Hb S crowds deoxy Hb S molecules out of solution ( 65 ). Only with deoxygenation is the growth of polymers sufficient to cause cellular distortion ( 66 ). The presence of polymerized Hb at arterial oxygen saturations suggests that abnormal rheology is not restricted to the capillary and venous side of the circulation. Because cellular flexibility is governed by the amount and alignment of intracellular polymer, some cells with polymer but no deformation may have difficulty in traversing the constriction of precapillary arterioles ( 65 ). The sickling of erythrocytes containing Hb S is induced by the same physicochemical perturbations as those responsible for the gelation of Hb S solutions. Arterial blood, having a high oxygen saturation, contains fewer sickle cells than blood collected from various sites in the venous circulation ( 67 ). The oxygen affinity of blood from subjects with sickle cell anemia is abnormally sensitive to pH fluctuations in the physiologic range.

A decrease in pH from 7.4 to 7.2 is attended by twice the normal decrement in oxygen affinity and a corresponding excess of deoxygenated Hb ( 68, 69 ). The pathophysiologic significance of the increased Bohr effect is underscored by the observation that the intracellular pH of fresh blood from subjects with sickle cell anemia is approximately 0.15 pH unit lower than that of normal blood ( 70 ). Predictably, sickling is potentiated by increasing the intracellular concentration of Hb S ( 68 ). Red cells containing relatively more Hb F sickle less readily ( 47, 71 ) and survive longer than cells containing little Hb F. Some of these predisposing factors are interrelated. In contrast to normal red cells, cells containing Hb S become more dense when deoxygenated, particularly at reduced pH ( 72 ).

**MEMBRANE ALTERATIONS** Red cell sickling is associated with reversible membrane changes. With repeated cycles of sickling and unsickling, aberrations in membrane function and structure become increasingly pronounced, culminating in fixation of the membrane in the sickled configuration ( 73 ).

**Reversibly and Irreversibly Sickled Cells** When sickled, red cells leak  $K^+$  and gain  $Na^+$ , a phenomenon previously ascribed to partial failure of the  $Na^+$ ,  $K^+$ -adenosine triphosphatase (ATPase) pump ( 74, 75 ). Because the net flux of  $Na^+$  and  $K^+$  is approximately equal in reversibly sickled cells, no change occurs in intracellular hydration or Hb concentration ( 76, 77 ). The intracellular concentration of  $Ca^{2+}$  is increased during sickling, owing in part to increased membrane permeability for  $Ca^{2+}$  and possibly in part to impairment of the ATPase-dependent  $Ca^{2+}$  pump ( 78, 79 ). From 5 to 50% of cells from individuals with sickle cell anemia are ISCs, permanently stabilized in their abnormal crescent or oval shape ( 80, 81 ). These cells fail to assume a normal shape even with vigorous reoxygenation. Their low mean cell volume (MCV) and high MCHC reflect a shrunken, dehydrated state. They may be quantitated morphologically or indirectly by measurements of deformability or density ( 82 ). The number of ISCs is relatively constant for a given individual, but it varies considerably from person to person ( 83 ). Results of cohort labeling studies of reticulocytes suggest that ISCs are formed shortly after release from the marrow and thereafter are rapidly removed from the circulation ( 80 ). ISCs contain substantially less Hb F than reversibly sickled cells ( 80, 84 ), and their endowment of Hb F appears to be the primary determinant of irreversible sickling. The physicochemical basis for irreversible membrane alterations has been the focus of intense research ( 79, 85, 86 ). The importance of membrane protein alterations is apparent from the demonstration that Hb-free ISC ghosts and membrane skeletons prepared from ISC ghosts retain the sickled shape ( 87 ). Fixation of membrane skeletons in a sickled form is thought to result from abnormal interactions between cytoskeletal proteins rather than from cross-linking phenomena. A functional abnormality in ankyrin is suggested by inefficient binding of normal spectrin by the ankyrin of inside-out vesicles prepared from sickle red cells; a reduced ability of protein 3 to bind ankyrin has also been found ( 88 ). Oxidation of membrane protein thiol has been proposed to explain increased microvesiculation of sickle red cells during thermal stress ( 89 ). In the ISC, the quantity of membrane lipids is decreased consistent with membrane loss, probably as a result of vesiculation ( 90, 91 ). The normal phospholipid organization of the red cell membrane is asymmetric and involves a dynamic equilibrium: Phosphatidyl choline and sphingomyelin predominate in the outer monolayer, and phosphatidyl ethanolamine and phosphatidyl serine (PS) are primary in the inner monolayer. On deoxygenation of Hb S, polymerization leads to mechanical stress on the membrane as well as uncoupling of the bilayer from the membrane skeleton. Ultimately, membrane lipid organization is altered, resulting in negatively charged PS on the red cell surface. This phospholipid may initiate blood clotting by enhancing the conversion by prothrombinase of prothrombin to thrombin as suggested by the findings of increased plasma levels of fragment 1.2 in the circulation ( 92, 93 ). Vesicles that are lost from the red cell membrane may also contribute significant



exposure of PS on their surfaces ( [91](#) ). Sickle red cells contain and spontaneously generate increased amounts of malonyldialdehyde ( [94](#) , [95](#) ). This by-product of lipid peroxidation is of particular interest in that it has the potential to form cross-links between proteins, aminophospholipids, or both ( [94](#) , [96](#) ).

**Dehydration** The ISC exhibits several perturbations in cation homeostasis, related at least in part to physical distortion of the cation permeability barriers by bundles of Hb S polymers ( [97](#) ). The amount of intracellular  $\text{Ca}^{2+}$  is increased as much as fourfold ( [98](#) , [99](#) and [100](#) ). Two pathways play a major role in formation of dense cells: the  $\text{Ca}^{2+}$ -activated  $\text{K}^+$  channel (Gardos pathway) and the K-Cl cotransport channel. The transient increase in free  $\text{Ca}^{2+}$  induced by red cell deoxygenation leads to activation of the Gardos pathway and subsequent activation of K-Cl cotransport with further  $\text{K}^+$  loss. In ISCs, unlike reversibly sickled cells,  $\text{K}^+$  loss exceeds  $\text{Na}^+$  gain, and there is overall loss of cell water and increased concentration of intracellular Hb. These changes cannot be attributed to metabolic exhaustion because the level of adenosine triphosphate (ATP) is normal or increased ( [101](#) ), and Na-K and Ca-ATPase activities also are increased ( [100](#) ). Although total cellular  $\text{Ca}^{2+}$  is increased, it is compartmentalized in cytoplasmic vesicles, resulting in normal levels of free cytoplasmic  $\text{Ca}^{2+}$  and prevention of dysfunction of the inner membrane ( [102](#) , [103](#) and [104](#) ). The mechanisms of sickle red cell dehydration and potential therapeutic strategies for its prevention have been reviewed in three recent articles ( [105](#) , [106](#) and [107](#) ). The rate of dehydration of sickle cells is uneven, and those destined to become ISCs dehydrate by a fast-track process ( [108](#) , [109](#) ). Reversible permeability pathways for  $\text{Na}^+$  ,  $\text{K}^+$  ,  $\text{Mg}^{2+}$  , and  $\text{Ca}^{2+}$  , sometimes referred to as the *sickling-induced pathway*, are the result of ionic shifts affecting cell hydration; the direct effect on  $\text{Ca}^{2+}$  permeabilization activates the Gardos channel, which triggers the loss of KCl and water and is associated with red cell acidification ( [106](#) ). In reticulocytes and young red cells with high expression of K-Cl cotransporter, acidification results in further KCl loss, further acidification, and K-Cl cotransport stimulation. The combined activity of the Gardos channel and K-Cl cotransport leads to rapid dehydration of a relatively young subpopulation of sickle cells, many with the characteristics of ISCs ( [106](#) ). The antimycotic agent clotrimazole is an inhibitor of the  $\text{Ca}^{2+}$ -activated  $\text{K}^+$  channel and prevents dehydration of sickle cells *in vitro* and *in vivo* ( [110](#) ). Red cell magnesium is abnormally reduced in sickle erythrocytes, and increasing cell magnesium produces a marked decrease in the activity of K-Cl cotransport ( [107](#) ). A study carried out in ten adult patients with Hb SS demonstrated that a 4-week course of oral magnesium supplementation (using magnesium pidolate) resulted in increased red cell  $\text{Mg}^{2+}$  and  $\text{K}^+$  concentrations, a reduction in K-Cl cotransport activity, and a decrease in the number of dense SS erythrocytes ( [111](#) ). A subsequent study on 20 patients with Hb SS disease involved the administration of magnesium pidolate for 6 months ( [112](#) ). In this unblinded study, a reduction in the number of pain crises was noted during the period of magnesium supplementation. In both of the above studies, a significant decrease in red cell density was noted. This inhibition of the Gardos channel is mediated by metabolites without the imidazole ring ( [107](#) ). Recently, an analog of clotrimazole with greater potency and fewer side effects has been shown to prevent dehydration of red cells in a transgenic sickle mouse model ( [113](#) ). Still another approach to prevention of red cell dehydration has been to inhibit chloride conductance with a reversible anion conductance inhibitor ( [114](#) ). The sickling-induced permeability pathway may be affected by transport inhibitors, including dipyrindamole at pharmacologic levels ( [115](#) ). Regulation of the K-Cl cotransport activity involves phosphorylation and dephosphorylation reactions in membrane-bound serine/threonine kinases and phosphatases ( [107](#) ). Transferrin receptor-positive

reticulocytes, which have a very low content of Hb F, have much greater K-Cl cotransport activity and may reach a state of intermediate dehydration. Subsequent dehydration is mediated by Hb S polymerization, sickling, and activation of the Gardos channel ( [116](#), [117](#) ).

**Adhesion** Sickle red cells demonstrate abnormal adherence to vascular endothelium ( [118](#), [119](#) ), monocytes ( [120](#) ), macrophages ( [95](#) ), and model lipid membranes ( [121](#) ). Compared with normal red cells, sickle cells are two to ten times more adherent to bovine ( [121](#), [122](#) ) and human ( [118](#), [123](#) ) endothelial cells. This property of sickle blood is imparted by deformable sickle cells rather than by ISCs ( [119](#), [122](#), [124](#) ), perhaps because rigid cells are unable to form multiple surface contacts with endothelial cells. The importance of this observation in regard to the pathophysiology of vasoocclusive events is suggested by the demonstration that red cell deformability has a strong positive correlation with the frequency and severity of pain crises ( [125](#), [126](#) ). Individuals who generate a relatively greater number of ISCs have decreased red cell deformability and milder disease compared with those whose red cells are more deformable. Presumably, rigid ISCs are unable to enter capillaries or to adhere tenaciously to capillary endothelium, whereas deformable sickle cells enter capillaries readily, adhere to the endothelium, and compromise blood flow. When examined under dynamic conditions, red cell adherence is noted primarily at sites of turbulence rather than where flow is laminar ( [127](#) ). Several mechanisms for increased adherence have been proposed ( [128](#) ). The repellent force of the red cell is thought to reside in negatively charged sialic acid residues that are homogeneously distributed over the surface of the membrane. The distribution of negative charges on membranes of sickle red cells is patchy and interrupted ( [118](#) ), creating surface areas that may have an electrostatic attraction for other cells. Alternatively, abnormal adherence may be a derivative of cellular dehydration. Dehydration of normal red cells induces an abnormality of negative charge distribution similar to that of sickle red cells ( [129](#) ). Excessive autooxidation of sickle red cells is yet another possible mechanism for increased adherence. Induction of excessive free radical generation in normal red cells is associated with increased adherence under conditions that allow the influx of calcium ( [130](#) ). Conditions and factors that promote the expression of adhesion receptors by endothelial cells include hypoxia, thrombin, tissue necrosis factor, platelet-activated factor, and interleukin-1 ( [131](#) ). These conditions/factors also cause increased adhesion of sickle cells to endothelium *in vitro*. Thrombospondin may be an important plasma adhesogen because of its ability to bridge CD36 expressed on sickle stress reticulocytes ( [132](#), [133](#) ). Thrombospondin-mediated adherence occurs under flow conditions with both microvascular and large-vessel endothelial cell assays. Thrombospondin levels are elevated in sickle cell patients during crisis ( [134](#), [135](#) ), perhaps as a result of platelet activation. Fibronectin may link endothelial receptors with the fibronectin receptor  $\alpha_4\beta_1$  (very late antigen-4) expressed on sickle reticulocytes ( [136](#), [137](#) ). Ultralarge forms of von Willebrand factor are postulated to promote adherence through nonreceptor mechanisms such as by binding with co-clustered hemichrome-band 3 aggregates on sickle membranes ( [132](#), [138](#), [139](#) ). It is possible that different mechanisms predominate under various circumstances or in different parts of the circulation. Coagulopathy might cause thrombospondin release and precipitate vasoocclusion in microvessels, and dehydration-induced vasopressin elevation might stimulate von Willebrand factor release and precipitate vasoocclusion in large postcapillary venules. The increased sickle cell adherence to injured endothelium, the role of platelet and leukocyte receptors, and the possible stimulation of nitric oxide (NO) production by adherent red cells all require further evaluation. Recently, circulating activated endothelial cells have been assayed using immunohistochemical examination of buffy coat smears with anti-endothelial cell antibodies ( [140](#) ). Patients with sickle cell anemia who had acute painful episodes had higher levels of circulating endothelial cells than patients with no recent events, who, in turn, had higher levels than controls. Circulating endothelial cells

were predominantly microvascular (CD36<sup>+</sup>) and expressed markers of endothelial cell activation [intercellular adhesion molecule-1, vascular cell adhesion molecule (VCAM)-1, E-selectin, and P-selectin]. This study suggested that vascular endothelium is activated in patients with sickle cell anemia and that adhesion proteins on the cells may have a role in the vascular pathology. Using an animal model that uses the *ex vivo* rat mesocecum venules and human sickle cells, two monoclonal antibodies were demonstrated to inhibit interactions between sickle cells and endothelial cells by blocking ligand binding to integrin  $\alpha_v\beta_3$ , a molecule that binds to several adhesion proteins, including von Willebrand factor and thrombospondin (131). P-selectin may also mediate SS red cell adhesion to endothelial cells *in vitro* (141). Macrophages have an increased affinity for sickle red cells. Excess immunoglobulin (Ig) G is found on the surface of sickle red cells, which are ingested by macrophages as readily as are red cells giving a positive antiglobulin test (95, 142). Increased phagocytosis is inhibited partially by blockade of macrophage Fc receptors with human IgG or its Fc fragment. A possible recognition signal is co-clustering of denatured Hb with band 3, which is followed by accumulation of IgG and complement, leading to recognition by macrophage receptors (143, 144). Both erythrophagocytosis and increased cell-associated IgG are more evident with ISCs than with less dense sickle cells. A common mechanism likely underlies many of the membrane lesions. Because of the multiplicity of effects that calcium accumulation may have on cellular properties, several pathways have been suggested for the putative influence of calcium on ISC formation (77, 145, 146). Hemichromes (ferric derivatives resulting from oxidative Hb denaturation) co-cluster with band 3 and Ig on the membranes of sickle cells (147). Free heme and nonheme iron such as free iron are also on the membrane surface. The pathologic deposition of iron on the membrane catalyzes the formation of highly reactive hydroxyl radicals and promotes oxidative reactions (148). A particularly comprehensive hypothesis argues that excessive red cell autooxidation initiates a cascade of interrelated events causing cytoskeletal dysfunction, perturbation of the lipid bilayer, and disruption of normal mechanisms for cation hemostasis (96, 149, 150 and 151). The hypothesis is based in part on the observation that sickle cells spontaneously generate twice as much superoxide, peroxide, and hydroxyl radicals as normal cells (151). Excessive free radical generation is explained in part by membrane-bound heme (149, 152), nonheme iron (153), and the release of heme from denatured Hb S (150, 154). It may be potentiated by impaired *in vitro* antioxidant defense, as manifested by decreased levels of vitamin E in both plasma and red cells (155, 156). Although exposure of normal red cells to oxidants produces many of the membrane lesions responsible for ISC formation, it is not clear that free radical generation by sickle cells exceeds the capacity of their protective mechanisms.

**RHEOLOGY OF SICKLE CELLS** The clinical features of sickle cell anemia are directly or indirectly related to increased blood viscosity. The viscosity of plasma in sickle cell anemia is slightly higher than that of plasma from normal subjects as a result of higher total protein concentration in plasma (157). However, the viscosity of oxygenated sickle blood is lower than that of normal blood at all shear rates, mainly as a result of lower hematocrit values (157, 158). The viscosity of a sickle blood sample increases with decreased oxygen saturation, primarily because of reduced cellular deformability (157, 159). When the cell concentration of sickle blood is raised *in vitro* to 45%, viscosity becomes higher than that of normal blood. The extent to which membrane rigidity (61, 160, 161), Hb polymerization (162), and increased intracellular Hb concentration (80, 158) contributes to altered blood flow depends in part on the method used to study the rheologic and mechanical properties of sickle red cells. Reduction in the cellular deformability of oxygenated sickle red cells has been demonstrated by increased viscosity of sickle blood (viscometry) (158), decreased filtration of dilute cell suspensions through narrow pores (61, 163), decreased ability of cells to undergo deformation in shear fields (ektacytometry) (



[145](#), [164](#)), and increased aspiration pressures needed to induce entry of cells into micropipettes ([160](#), [165](#), [166](#)). Cellular dehydration, as well as the resulting increase in cytoplasmic viscosity, is a major determinant of abnormal rheologic behavior of oxygenated sickled red cells ([145](#)). Sickled red cell membranes demonstrate extensional rigidity and persistent deformation as documented by videomicrographs of micropipette aspiration ([160](#), [165](#)). The rheologic properties of oxygenated sickle cells are strongly influenced by the state of cell hydration and the increased propensity for oxidative damage to the membrane ([145](#), [165](#), [167](#), [168](#)). The already compromised deformability of oxygenated sickle cells is dramatically reduced further after deoxygenation. Both static extensional rigidity and dynamic (time-dependent) rigidity increase by orders of magnitude after deoxygenation ([169](#), [170](#) and [171](#)). Under conditions of high shear stress, increased internal viscosity appears to determine the rheologic behavior of ISCs, whereas at low shear rates, membrane rigidity assumes greater significance ([172](#)). Under physiologic conditions, increased viscosity results primarily from cellular dehydration. The poor deformability of ISCs, as measured by ektacytometry, can be rectified by osmotically hydrating them to a normal MCHC ([73](#), [145](#)). The membrane rigidity of oxygenated sickle cells also can be returned to a normal level by replacing Hb S with Hb A, suggesting that the interaction of Hb S with the cell membrane is an important determinant of cellular rigidity ([173](#)). Peripheral vascular resistance is increased in proportion to ISC numbers, the extent of ISC deoxygenation, and ISC density ([174](#)). The microvascular response to rheologically abnormal cells has been studied by measuring cutaneous blood flow with a laser Doppler velocimeter ([175](#)). This technique demonstrates local, large-amplitude rhythmic variations in resting blood flow, suggesting that microvascular flow is somehow synchronized at the precapillary level in large domains of small vessels. One may infer that the terminal arteriole or precapillary sphincter is the initial site of blood flow impedance rather than the capillary or vein, where deoxygenation is greatest. This concept is supported by the demonstration that red cells are entrapped on the arterial side of capillaries in the retina ([176](#)) and nail folds ([177](#)) of patients with sickle cell disease and in the microcirculation of laboratory animals given human sickle red cells ([178](#)). This concept is also consistent with the view that the rheologic properties of red cells containing Hb S polymers at arterial oxygen saturation are sufficient to influence microvascular perfusion before any change in red cell morphology is apparent ([65](#)). Laser Doppler velocimetry has been used to examine microcirculatory cutaneous blood flow in Hb SS patients ([179](#)). Impairments of microcirculatory fluxes resulting from a vasodilated state combined with abnormal vasoreactivity resembled those in patients with chronic venous insufficiency and may contribute to the pathogenesis of chronic leg ulcers. The functional significance of the impaired flow properties of sickle red cells was convincingly demonstrated by measuring exercise tolerance before and after partial exchange transfusion. By increasing the relative number of cells containing Hb A without increasing the total Hb concentration, exercise capacity improved significantly ([180](#)).

## Pathogenesis of Hemolysis

Intravascular hemolysis results from the lysis of complement-sensitive red cells ([181](#)) and Hb lost during sickling- or shear-induced membrane fragmentation ([26](#), [182](#), [183](#)). Extravascular hemolysis may occur by two mechanisms: monocyte and macrophage recognition and phagocytosis of red cells that have undergone sickling- or oxidation-induced membrane changes ([95](#), [184](#), [185](#)) and physical entrapment of rheologically compromised red cells ([174](#), [186](#)). Sickling- and oxidation-induced membrane changes promote cell dehydration and clustering of membrane protein band 3. This leads to accumulation of IgG and complement on the sickle cell surface ([187](#), [188](#)). In addition,

ability to inactivate surface complement (189). Monocyte and these dense cells is the dominant mechanism for. However, these cells are also abnormally sensitive to extravascular hemolysis (189). Increased susceptibility to fragmentation has been documented *in vitro* and in sickle cell exercise (183), another component of intravascular

relationship to the rate of hemolysis. Of greatest number of ISCs (83). The extent of Hb polymer formation, and the relative proportion of Hb fractions, also correlates with hemolysis (190, 191). Of particular interest is the relationship of adherence of sickle cells to macrophages (95, 192).

n

Development of sickle cell vasoocclusion include Hb S deformability, sickle blood viscosity, the fraction of dense cells, adherence, endothelial cell activation, hemostatic activation, interaction with white blood cells and platelets, local and regional hemodynamic factors (193). A hypothetical interrelationship of vasoocclusion is shown in Figure 40.4. It is possible that the interrelationship varies over time and anatomic site and among patients. For heterogeneity of endothelial cells from large vessel and there are organ-to-organ differences in microvascular structure. It is possible that different mechanisms are likely to prevail as different circumstances (193). For example, during sickle cell blood cell interactions with endothelium could be a different circumstances, platelet activation might result in an increased level. Clinical dehydration might lead to an increased release of these events might trigger red cell adherence to vascular obstruction.

**Figure 40.4.** Interrelationships of risk factors for vasoocclusion. RBC, red blood cell; WBC, white blood cell. (From Embury SH, et al. Pathogenesis of vasoocclusion. In: Embury SH, Hebbel RP, Mohandas N, et al., eds. Sickle cell disease: basic principles and clinical practice. New York: Raven Press, 1994, with permission.)

Because of their higher Hb S concentration, the most dense cells are least deformable and are at greatest risk for intracellular polymerization (145). Obstruction by these cells

develops at the arteriolar–capillary junctions in model systems ( [194](#), [196](#), [197](#) ). The role of dense cells may be to create a logjam behind an obstruction rather than to initiate the vascular plug. The proportion of dense cells increases immediately before an acute pain crisis and falls during the first few days afterwards ( [198](#), [199](#) and [200](#) ). Initiation of vasoocclusion by adherent cells may explain the fractional reduction in the least dense, most adherent cells during the initial stages of a vasoocclusive pain crisis. This is consistent with the frequency of painful events correlating with better red cell deformability ( [125](#), [171](#) ) rather than poorer deformability as might be expected.

The abnormal interaction between sickle cells and vascular endothelium may be of greater relevance for vasoocclusive events than are alterations in red cell morphology or viscosity. Although endothelial adherence does not correlate with standard hematologic measurements, it correlates significantly with the severity of pain crises ( [201](#) ). Likewise, patients with clinically less severe sickling disorders, such as Hb SC disease, tend to have less adherent red cells ( [202](#) ). When red cells from patients with sickle cell anemia are suspended in autologous plasma, however, dramatic increases in adherence are noted at the onset of vasoocclusive events ( [202](#), [203](#) ). Both plasma fibrinogen ( [202](#), [204](#) ) and fibronectin ( [204](#) ) have been implicated as factors modulating adherence. These findings from *in vitro* studies complement the clinical observation of a temporal relationship between infections and pain crises ( [205](#) ) and the demonstration of increased plasma fibrinogen levels during vasoocclusive crises ( [202](#), [206](#) ). Red cell adherence is also augmented by hyperosmolar conditions and by endothelial injury ( [202](#) ). Together, these observations suggest that alterations in the environment of the red cell predispose to vasoocclusion by amplifying the abnormal attraction of sickle red cells to vascular endothelium.

Sickled red cells may adversely affect local regulation of vascular tone. Normal endothelial cell–derived vasoactive factors include prostacyclins and NO (vasodilators) and endothelin–1 and platelet–derived growth factor– $\beta$  (vasoconstrictors). These agents act on vascular smooth muscle cells and inhibit or stimulate platelet aggregation and adhesion. Vascular tone is also modulated by local oxygen tension and shear forces. Free radicals, especially superoxide, may cause vasoconstriction, possibly by interfering with NO–induced vasodilation ( [207](#) ). An abnormal state of vasodilation and low vascular resistance in subjects with sickle cell disease occurs during steady–state periods, but during crisis states, there is a decrease in the levels of vasodilator substances like the prostacyclins and an increase in vasoconstrictor substances including endothelin and prostaglandins (PGs). This shift in the balance of vascular tone toward vasoconstriction results in slowing of vascular flow, further obstruction, and more profound deoxygenation of sickled red cells ( [208](#) ). NO is the major endothelium–derived relaxing factor in normal physiology. It plays a central role in vascular homeostasis by maintaining vasomotor tone, limiting ischemia–reperfusion injury, and modulating endothelial proliferation ( [209](#) ). Plasma levels of the NO metabolites nitrite and nitrate and plasma arginine levels are depressed in sickle cell patients during vasoocclusive crisis and the acute chest syndrome (ACS) ( [210](#), [211](#) ). Basal and stimulated NO production and responses to exogenous NO may be significantly reduced in adult men (but not women) with sickle cell disease, consistent with a protective effect of ovarian–produced estrogen on endothelial function in sickle cell disease ( [209](#) ). NO has been linked to transcriptional control of fetal Hb, suggesting that it may contribute to the increased fetal Hb level seen in women ( [212](#) ). In patients with sickle cell disease, elevated levels of plasma Hb cause destruction of NO and limit its bioavailability ( [213](#) ) and its ability to cause vasodilatation ( [214](#) ). Increased plasma Hb concentrations during vasoocclusive crisis and ACS ( [215](#) ) lead to increased scavenging of NO. Basal endothelial NO production and pharmacologic NO treatment reduce VCAM–1

gene transcription ( [216](#) ); conversely, diminished endothelial NO bioavailability and increased NO destruction are associated with increased plasma VCAM-1 levels ( [217](#) ). Thus, NO appears to play a critical compensatory role in maintaining endothelial homeostasis ( [209](#) ). L-arginine is an orally available dietary supplement that produces NO-dependent increased blood flow and reduced pulmonary artery pressure in patients with pulmonary hypertension. Arginine levels are low in sickle cell patients with vasoocclusive crisis and ACS, providing a rationale for arginine therapy in these conditions ( [210](#) , [218](#) ). Several potentially beneficial effects of NO require further investigation in sickle cell disease including prevention of red cell dehydration by inhibition of the Gardos channel ( [219](#) ) and a function in hydroxyurea or arginine-butyrates-induced expression of fetal Hb ( [212](#) , [220](#) ).

Adhesion of red cells to endothelial cells alters vascular flow as described above. Specific ligands that may mediate adhesion of sickled red cells to endothelium include von Willebrand factor, thrombospondin, fibrinogen, fibronectin, laminin, and vitronectin ( [221](#) , [222](#) , [223](#) and [224](#) ). Factors that act as vasoconstrictors, such as free radicals, PGs (PGI<sub>2</sub> and PGD<sub>2</sub>), and endothelin-1, may enhance adhesion of sickled red cells to the endothelium. Infection or tissue inflammation may exacerbate erythrocyte adhesion through inflammatory cytokines such as tumor necrosis factor ( [225](#) ).

Alterations in the number and function of white blood cells may contribute to vasoocclusive events ( [226](#) , [227](#) ). Alterations in chemotaxis and adhesion and increased stickiness of neutrophil membranes also have been observed in crisis states ( [228](#) , [229](#) ). Leukocytes may interfere with microvascular flow by lodging in the capillary entrance or adhering to venous or capillary endothelium ( [230](#) , [231](#) ). Increased white blood cell counts in patients with sickle cell disease have been associated with increased mortality ( [232](#) ) and silent infarcts in the brain ( [233](#) ). The beneficial effect of hydroxyurea in the Multi-Center Study of Hydroxyurea has been associated with its effect in reducing leukocyte counts ( [234](#) ). Data from the Cooperative Study of Sickle Cell Disease (CSSCD) show that increased baseline white blood cell counts in infants are a predictive factor for severe manifestations of sickle cell disease in later childhood ( [235](#) ). Furthermore, acute infection, possibly because of the attendant leukocytosis, is thought to be a triggering mechanism for vasoocclusive pain events in many cases. In addition, four separate reports have linked the administration of a myeloid colony-stimulating factor (granulocyte colony-stimulating factor or granulocyte-macrophage colony-stimulating factor) to the initiation of severe or even fatal sickle cell crisis ( [236](#) , [237](#) , [238](#) and [239](#) ). Recently, an experimental *in vivo* model using blood flow in the cremasteric muscle of sickle cell mice has indicated that leukocytes that are adherent to the vessel wall can directly contribute to vascular occlusion by means of their interaction with sickle red cells; inhibition of leukocyte adhesion by targeted disruption of P- and E-selectin expression can prevent vasoocclusion ( [240](#) ). A multistep pathogenesis of vasoocclusion based on white cell involvement has been proposed in which the following take place: (a) endothelial activation in postcapillary venules; (b) recruitment of adherent leukocytes to the endothelium; (c) interactions of sickle erythrocytes with adherent leukocytes; and (d) vascular clogging by white blood cell/sickle red blood cell aggregates resulting in ischemia, further activation of the endothelium, and so forth ( [241](#) ). It is also possible that platelets participate in the process through the formation of platelet-Hb SS red cell aggregates ( [242](#) ). However, a recent study in which thrombin generation was correlated with exposure of either erythrocyte or platelet PS on the cell surface noted a correlation of markers of thrombin generation (prothrombin fragment F1.2) and fibrin dissolution (D-dimers and plasmin complexes) only with red cell PS ( [243](#) ). Leukocytes may cause further tissue damage by

release of inflammatory mediators and oxygen radicals. Endothelium adhesion molecules such as E-selectin, VCAM-1, and intercellular adhesion molecule-1 mediate leukocyte recruitment and promote an inflammatory response, as may the release of heme from red cell lysis ( 244 ). In sickle cell transgenic mice, induction of hypoxia followed by reoxygenation enhances peroxide production and increases leukocyte recruitment ( 245 ). Elevation of multiple circulating cytokines, including tumor necrosis factor- $\alpha$ , interleukin-1, granulocyte-macrophage colony-stimulating factor, and endothelin-1, occurs in sickle disease ( 246 , 247 , 248 and 249 ). The inhibitor nuclear factor- $\kappa$ B was shown in the sickle cell mouse model to reduce the expression of intercellular adhesion molecule-1 and VCAM-1 and on circulating endothelial cells of patients with sickle cell disease ( 250 ). It has been postulated that sickle cell disease leads to a proinflammatory state and that the inflammatory response is enhanced in both the sickle cell mouse model and patients ( 241 ).

Consistent alterations in platelet numbers and function have invited speculation regarding the possible involvement of platelets in vasoocclusive events. Abnormalities include increased platelet counts, increased platelet volume ( 251 ), decreased platelet survival ( 252 ), and decreased platelet aggregation ( 253 ). The latter has been attributed to a refractory state resulting from *in vivo* platelet activation. In support of this interpretation is the demonstration that plasma  $\beta$ -thromboglobulin, a measure of release activity from platelet  $\alpha$ -granules, is elevated in the steady state and increases further during vasoocclusive crises ( 254 ). Elevated urinary levels of thromboxane metabolites and depressed platelet thrombospondin content provide evidence for platelet activation in steady-state sickle cell patients ( 255 , 256 ). The levels of the contact factors (factor XII, prekallikrein, and high-molecular-weight kinogen) are low and decrease further during crises ( 257 ). The coagulation inhibitors protein C and free protein S are reduced in steady-state sickle cell disease ( 258 , 259 ); antithrombin III activity levels have been variable, but increased thrombin-antithrombin III complexes and plasma factor VII levels indicate increased tissue factor activity during the steady state ( 260 ). Plasma prostacyclin activity, thought to be generated from vessel wall PG, is increased ( 261 ). The level of fibrin D-dimer, a breakdown fragment of cross-linked fibrin, increases during vasoocclusive crises and returns to normal after crisis resolution ( 262 ). Whether these alterations in hemostasis and fibrinolysis are of pathogenic significance or are simply epiphenomena remains to be determined.

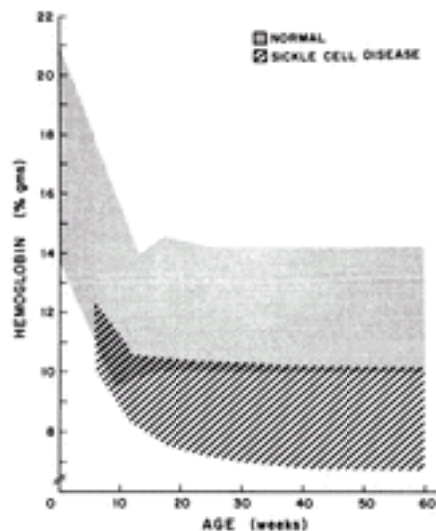
## SICKLE CELL ANEMIA (HEMOGLOBIN SS)

### Clinical Features

Although disease attributed to Hb S has been observed in early infancy ( 263 ), affected individuals characteristically are without symptoms until the second half of the first year of life ( 264 ). The lack of clinical expression of the Hb SS genotype during fetal and early postnatal life is explained by the production of a sufficient quantity of Hb F to limit clinically important sickling. Because erythrocytes contain increasing amounts of Hb S and proportionally decreasing amounts of Hb F, the conditions for sickling under physiologic conditions gradually are met. Prospective studies of affected infants followed from birth indicate a close temporal relationship between the postnatal decline in Hb F and evolution of anemia ( 265 , 266 , 267 , 268 and 269 ). Mild hemolytic anemia is apparent by 10 to 12 weeks of age ( 266 , 270 ) ( Fig. 40.5 ). Splenomegaly is first noted after 6 months of age. The first vasoocclusive episode is experienced between 6 and 12 months of age by approximately one-half the subjects ( 266 ), before 6 years of age by the majority ( 265 ), but



not until late childhood or adult life by a few. Dactylitis and ACS have the highest incidence during the first year of life ( [269](#) ); dactylitis is a common presenting symptom ( [268](#) ). Loss of function of the spleen has been documented as early as 5 months of age ( [266](#), [271](#) ), and death from overwhelming infection is clearly an increased risk before 12 months of age ( [265](#), [268](#) ).



**Figure 40.5.** Hemoglobin concentration as a function of age in infants with sickle cell anemia. (From O'Brien RT, McIntosh S, Aspnes GT, et al. Prospective study of sickle cell anemia in infancy. *J Pediatr* 1976;89:205, with permission.)

The clinical features of sickle cell anemia result more from the vasoocclusive consequences of sickle cells than from the anemia itself. These features may be divided into those that characteristically are acute and episodic and those that are chronic and often progressive. The multiinstitutional CSSCD generated prospective information regarding the “natural history” of sickle cell disease in a group of more than 3500 patients, some of whom were followed for almost two decades.

### ACUTE EVENTS: CHARACTERISTICS, MANAGEMENT, PREVENTION

**Vasoocclusive Events** The term *sickle cell crisis* was introduced to describe a recurring attack of pain involving the skeleton, chest, abdomen, or all three ( [205](#) ). Using the term in a broader sense, vasoocclusive “crises” comprise a variety of syndromes that are typically recurrent and potentially catastrophic. Clinical manifestations are sudden in onset and are directly attributable to obstruction of the microcirculation by intravascular sickling. Modest exacerbation of anemia and increased leukocytosis are common. Infections often precede vasoocclusive episodes in children, suggesting that fever, dehydration, and acidosis may be contributing factors. In adults, a triggering event is not often identified, but in a Jamaican series, painful crises developed most often between 3:00 p.m. and midnight. Perceived precipitating factors included skin cooling, emotional stress, physical exertion, and pregnancy ( [272](#) ). No seasonal variation in the frequency of crises has been noted ( [273](#) ).

**Hand-Foot Syndrome** The initial episode in young children often involves the small bones of the hands and feet (the hand-foot syndrome). By 2 years of age, nearly 50% of Jamaican children and 25% of American children with sickle cell anemia have experienced at least one episode of dactylitis ( [269](#), [274](#) ). Typically, the dorsa of the hands and feet are swollen, nonerythematous, and exquisitely painful. Fever and leukocytosis are common.

Radiographic changes are limited initially to soft-tissue swelling; cortical thinning and destruction of metacarpals, metatarsals, and phalanges appear 2 to 3 weeks after the onset of symptoms. Dactylitis is sudden in onset and usually lasts 1 or 2 weeks. It may recur on one or more occasions until the patient is approximately 3 years of age ( [274](#), [275](#) ).

**Painful Crises** Typically, after the first few years of age, interruption of blood flow occurs in the larger bones of the extremities, spine, rib cage, and periarticular structures, producing painful crises of the bones and joints ( [4](#), [205](#), [276](#), [277](#) ). The sinusoidal circulation of the bone marrow provides an ideal vascular bed for the sickling phenomenon. In the CSSCD, epidemiologic features of pain crises were analyzed in a large group of patients with sickle cell disease ( [278](#) ). The average rate of pain was 0.8 episode/patient-year in Hb SS, 1.0 episode/patient-year in Hb S $\beta^0$ -thalassemia, and 0.4 episode/patient-year in Hb SC disease and Hb S $\beta^+$ -thalassemia. However, the rate varied widely from patient to patient: 39% of patients with sickle cell anemia had no episodes of pain, but 1% had more than six episodes/year. Five percent of Hb SS patients accounted for almost one-third of all the episodes. The pain rate increased moderately from childhood to the third decade of life. Recently, a higher rate of pain crises has been associated with low nocturnal oxygen saturation detected by continuous monitoring during sleep ( [279](#) ). Pain resulting from ischemia of the bone marrow is gnawing and progressive in severity. The most frequent sites of involvement are the humerus, tibia, and femur ( [276](#) ). Involvement of facial bones is less common but is well documented. The swelling associated with infarction of the orbital bone may be sufficient to produce proptosis and ophthalmoplegia ( [280](#) ). Swelling of the elbows or knees may mimic rheumatic fever or septic arthritis ( [281](#) ). Infarcts involving deep bones and joints are not associated with detectable swelling, erythema, or surface temperature change. Laboratory findings, too, are inconstant and nonspecific. The radiographic features of bone infarction and periostitis usually do not appear until after the resolution of symptoms. Increased signal with T2-weighted images are seen by magnetic resonance imaging (MRI) in approximately one-third of pain crises ( [282](#) ).

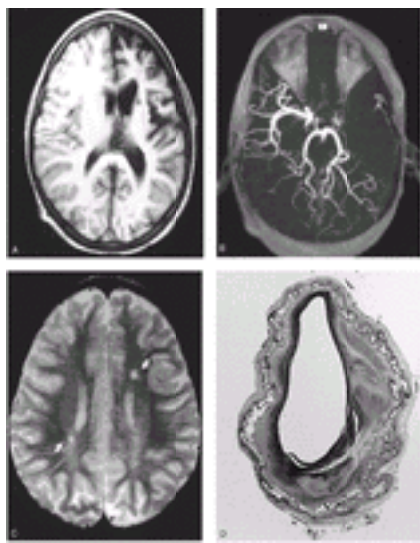
Discrete areas of decreased localization of  $^{99}\text{Tc}$ -sulfur colloid identify areas of decreased marrow blood flow, and  $^{85}\text{Sr}$  or  $^{99}\text{Tc}$ -phosphate localizes the increased osteoblastic activity that occurs with healing ( [283](#), [284](#) and [285](#) ). Although radionuclide bone and bone marrow scans theoretically enable differentiation of bone infarcts from osteomyelitis, in practice they are of limited value ( [276](#) ). Unlike osteomyelitis, bone infarcts are associated with no more than a low-grade fever and little or no left shift in the leukocyte differential. As a cause of bone pain, infarction is more than 50 times as common as osteomyelitis ( [276](#) ). Abdominal pain crises are attributed to small infarcts of the mesentery and abdominal viscera and are characterized by severe abdominal pain and signs of peritoneal irritation. Persistence of bowel sounds differentiates pain crises from acute intraabdominal disorders requiring surgical intervention. Diagnosis is facilitated by prior experience with the patient, because the pattern of pain tends to repeat itself from crisis to crisis. Atypical clinical or laboratory features should suggest one of several complications to which patients with sickle cell anemia are especially susceptible such as ACS, urinary tract infection, or cholecystitis. On average, painful crises persist for 4 or 5 days, although protracted episodes may last for weeks. Data from the CSSCD indicate that an increased frequency of painful events is associated with a high hematocrit and a low fetal Hb level ( [278](#) ). No additional influence on pain rate results from concurrent  $\alpha$ -thalassemia among patients with sickle cell anemia who are older than 20 years of age. Adults with high rates of pain episodes tend to die earlier than those with low rates ( [278](#) ). Of potential therapeutic significance, it was noted in the CSSCD that even when the level of Hb F is low, a small increase is associated with an ameliorating effect on the pain rate and may ultimately improve survival. No specific form of therapy has proven effective for vasoocclusive crises. None of the many medications and manipulations that have been touted as beneficial have withstood critical scrutiny. Low-molecular-weight dextran,



phenothiazines, antifibrinolytic agents, bicarbonate and other alkalis, and urea solutions, when evaluated in controlled clinical studies, were found to be without apparent effect on vasoocclusive crises ( [286](#), [287](#), [288](#), [289](#), [290](#), [291](#), and [292](#) ). Other therapeutic strategies, although not subjected to randomized clinical trials, have enjoyed only fleeting popularity. These strategies include carbonic anhydrase inhibitors ( [293](#) ), vasodilators ( [294](#) ), anticoagulants, progesterone ( [295](#) ), testosterone ( [296](#) ), papaverine ( [297](#) ), antithyroid drugs ( [298](#) ), and hyperbaric oxygen ( [299](#), [300](#) ). Pentoxifylline, an agent that increases red blood cell deformability and inhibits platelet aggregation, may be beneficial for treatment of a pain crisis; clinical studies have been poor methodologically ( [301](#) ). Similarly, early reports on the use of cetiedil, a smooth muscle relaxant that inhibits sickling and cell dehydration through inhibition of the Gardos channel, suggested a reduction in duration of painful crises ( [302](#), [303](#) ), but they have not been substantiated by further trials. Poloxamer-188, a monionic surfactant compound, reduced total analgesic use, but a phase III trial demonstrated only a slight shortening of the duration of pain crises ( [304](#) ). The duration and severity of pain crises are notoriously variable, and the natural course is one of spontaneous improvement. Consequently, uncontrolled reports of effective therapies must be viewed with skepticism, especially if the proposed treatment entails an element of risk. The cornerstones of present day therapy are fluids and analgesics. The volume of fluids administered should be sufficient to abolish any deficit, correct hypertonicity, and fully compensate for ongoing losses imposed by fever, hyposthenuria, vomiting, or diarrhea. Because urinary sodium losses are increased during crises, maintenance sodium requirements also are exaggerated ( [305](#) ). Precipitants of the crisis should be sought and eliminated. Infection, a common precipitating cause in children, may require antibiotic therapy. Acidosis is corrected readily with intravenous administration of sodium bicarbonate. Oxygen therapy in the absence of documented hypoxemia is without benefit and triggers an increase in the number of ISCs when discontinued ( [306](#) ). Control of pain requires the liberal use of analgesics ( [307](#), [308](#) ), but narcotic addiction is unlikely as long as the use of analgesics is closely monitored. Recently, benefit from adjunctive therapy with a short course of high-dose corticosteroid (methylprednisolone) ( [309](#) ) or a long-acting nonsteroidal antiinflammatory drug (e.g., ketorolac) ( [310](#) ) has been reported. The use of patient-controlled analgesia, which enables patients to inject themselves with limited boluses of intravenous morphine or meperidine, has been beneficial for some and provides an element of self-control in pain management ( [311](#), [312](#) ). Patient-controlled analgesia also allows individualization of narcotic dosing, which may be valuable in view of the wide variability in morphine pharmacokinetics ( [313](#) ) and the rare fatality from narcotic overdose ( [314](#) ). Self-hypnosis has been used successfully for pain control in selected subjects ( [315](#) ). Blood transfusions do not modify the course of an established crisis and are not without risk. Because fever and back pain are common features of pain crises, transfusion reactions may escape early recognition ( [316](#) ).

**Central Nervous System Events** Stroke is a catastrophic complication of sickle cell anemia that affects 6 to 17% of children and young adults ( [317](#), [318](#), [319](#) and [320](#) ). Two major syndromes are observed: One results from occlusion of major cerebral vessels and primarily affects children from 2 to 15 years of age (mean, 6 to 7 years) ( [318](#), [319](#) ); the other results from intracerebral or subarachnoid hemorrhage and affects older children and adults ( [318](#), [320](#), [321](#) ). The risk of stroke appears to be increased in patients with Hb F levels less than 8% ( [322](#), [323](#) ) and in patients with siblings who have had strokes ( [322](#) ). Data from the CSSCD, in which approximately 4000 patients were followed for an average of 5 years, indicated that infarctive stroke was most frequent in children and older adults with Hb SS, whereas hemorrhagic stroke had the highest incidence in patients 20 to 29 years of age ( [325](#) ). The mortality rate was 26% after hemorrhagic stroke and 0% after infarctive stroke. Risk factors for infarctive stroke included prior transient ischemic attack, low steady-state Hb concentration, frequent or recent episodes of ACS, and

elevated systolic blood pressure. The pathogenesis of cerebral vascular disease is incompletely understood ( Fig. 40.6). In approximately 80% of cases, cerebral arteriograms performed on children who have had strokes demonstrate occlusion or stenosis of one or more of the major cerebral arteries ( 318 , 324 , 326 ), sometimes with a telangiectatic network of collateral vessels producing a moyamoya (“puff of smoke”) pattern ( 327 ). Pathologically, vascular narrowing results from segmental proliferation and fragmentation of the intima. The internal elastic lamina may show degenerative changes, and the media may be disrupted by fibrosis and hemorrhage. Occlusion is the result of progressive proliferation of vascular smooth muscle, superimposed thrombosis, or an embolus ( 328 , 329 ). Adherence of sickle red cells to the endothelium of vessel walls may be an additional mechanism ( 322 ). Aneurysms can be demonstrated in some patients who have sustained intracranial hemorrhage ( 318 ) and may be observed as an incidental finding in children with cerebral vasooclusive disease ( 322 ). Presumably, these aneurysms result from progressive damage to the intima at sites of weakened vessel walls.



**Figure 40.6.** Vasoocclusive effects in the central nervous system. **A:** T1-weighted magnetic resonance imaging (MRI) in a 6-year-old girl with hemoglobin (Hb) SS and a history of stroke. There is extensive atrophy involving the distributions of the left anterior and middle cerebral arteries with compensatory enlargement of the left lateral ventricle. **B:** Magnetic resonance angiography in same patient showing occlusion of left middle cerebral artery and diminished flow through both anterior cerebral arteries. **C:** T2-weighted sagittal MRI in a 4-year-old boy with “silent infarcts.” Small areas of leukomalacia are seen in deep white matter in frontal and parietal areas ( *arrows*). **D:** Pathologic section of internal carotid artery showing fibrinous thrombus with parallel layers of fibrin deposited on intimal surfaces and atrophic media. (Courtesy of Dr. JJ Jenkins, St. Jude Children’s Research Hospital.)

Clinically, strokes are characterized by the abrupt onset of hemiparesis, aphasia, seizures, sensory deficits, and altered consciousness, occurring singly or together. The patient may make a full recovery, but incomplete resolution of neurologic deficits is the rule. Although the findings may be negative early in the course of infarction, MRI permits noninvasive visualization of focal damage. Individuals with cerebral vessels that appear normal on magnetic resonance angiography and who have no evidence of brain infarction on MRI are rarely encountered after symptoms and signs indicative of a cerebrovascular accident. It is not certain if these patients also require transfusion therapy. A recent study indicated that patients with moyamoya were more than twice as likely to incur subsequent stroke or transient ischemic attack despite treatment with chronic transfusions ( 330 ). Strokes tend to be repetitive because of the progressive nature of cerebral vascular disease. Unless patients begin a long-term transfusion program, they are at risk for recurrent

cerebral infarctions with progressive neurologic deterioration. Chronic transfusion therapy designed to maintain the level of Hb S below 30% slows or arrests the progression of arterial abnormalities and reduces the risk of recurrent strokes (within 36 months) from approximately 70 to 90% to 10 to 20% ( [318](#), [322](#) ). Interruption or termination of treatment, even after 8 years of chronic transfusion, is associated with a stroke recurrence rate similar to that of untransfused patients ( [331](#), [332](#) and [333](#) ), suggesting that transfusion therapy for secondary stroke prophylaxis should be continued indefinitely. However, reduction of the intensity of chronic transfusion to allow pretransfusion Hb S levels to reach 50% appears safe after the first few years of prophylaxis ( [334](#), [335](#) ). Recently, the risk of recurrent stroke in patients who received blood transfusion therapy for at least 5 years was analyzed in relationship to antecedent medical events (e.g., hypertension, ACS, fever) that may have led to the cerebrovascular accident ( [336](#) ). Although 22% had a second stroke despite long-term transfusion, patients who had a possible etiology for their initial stroke had much less risk of recurrence. Many chronically transfused children have transfusions discontinued when they reach adulthood. None of the nine adult patients who stopped transfusion after a median of 6 years suffered recurrent stroke ( [337](#) ). Hydroxyurea may be an alternative to blood transfusion for the prevention of recurrent stroke in patients who cannot tolerate continued chronic transfusion (or the need for chronic iron chelation), and associated phlebotomy may be of additional benefit ( [338](#), [339](#) ). Transcranial Doppler ultrasonography (TCD) is a noninvasive technique in which cerebral artery blood flow velocity is measured in the distal internal carotid and proximal middle and anterior cerebral arteries. Markedly increased flow velocity is often an indicator of vascular stenosis and has been associated with a greatly increased risk of cerebral infarction within a 3-year period ( [340](#) ). In a recent multicenter phase III trial, patients with confirmed abnormally elevated TCD velocity were randomized to receive chronic transfusion versus standard care ( [341](#) ). Subsequent stroke occurred in 1/63 patients randomized to transfusion and in 11/67 randomized to standard therapy, a significant difference that has prompted routine TCD screening in many pediatric sickle cell centers. Rare neurologic complications include infarction of the spinal cord ( [319](#) ) and brain stem ( [342](#) ) as well as cord compression by extramedullary masses of erythropoietic tissue ( [343](#) ).

**Acute Chest Syndrome** Characterized by fever, tachypnea, chest pain, increased leukocytosis, and pulmonary infiltrates, pulmonary events are a frequent cause of morbidity and mortality in patients with sickle cell anemia. Because it may be impossible to determine the relative importance of vascular occlusion and infection in the process in any given patient, the term *acute chest syndrome* has been applied. Infection tends to predominate in children and infarction in adults, but the two processes are often interrelated and concurrent ( [344](#) ). Impaired access of oxygen to infected segments of the lung likely enhances local sickling with resulting focal microvascular thrombotic disease. Data from the CSSCD indicate that patients with Hb SS have an incidence of ACS of approximately 13/100 patient-years; the rate is highest in children 2 to 4 years of age (25/100 patient-years) and decreases gradually with increasing age to that seen in adults (9/100 patient-years) ( [345](#) ). A higher ACS rate is associated with a higher rate of mortality from all causes ( [349](#) ). The risk of ACS is associated with a lower fetal Hb level and a higher steady-state hematocrit and leukocyte count. Before the availability of pneumococcal vaccines and the widespread use of penicillin prophylaxis, pulmonary events in children typically were the result of bacterial infection ( [346](#), [347](#) ). *Streptococcus pneumoniae* was the most common causative organism. Infiltrates often affected multiple lobes, and resolution was slower than in the general population ( [346](#), [348](#) ). Identified infectious agents have included *Mycoplasma pneumoniae* ( [349](#) ), *Chlamydia* ( [350](#) ), parvovirus B19 ( [351](#) ), and respiratory viruses. The National Acute Chest Syndrome Study Group reported causes and outcomes based on analysis of 671 episodes of ACS ( [352](#) ). Nearly one-half the patients were initially admitted for another reason, mainly pain. The mean length of hospitalization was 10.5 days; 13% required mechanical ventilation, and 3%

died. Patients who were 20 years of age or older had a more severe course. A specific cause of ACS was identified in 38% of all episodes and 70% in episodes with complete data ( Table 40.1 and Table 40.2) ( 353 ). The most common specific causes were pulmonary fat embolism, chlamydia, mycoplasma, miscellaneous viruses, and bacterial infections due to coagulase-positive *Staphylococcus aureus* and *S. pneumoniae*. Treatment with transfusion and bronchodilators improved oxygenation, although older patients often progressed to respiratory failure. In adults, an infectious basis for lobar consolidation is established less often than in children, and antibiotic therapy is without apparent effect on the duration or severity of symptoms ( 354 , 355 ). *In situ* vasooclusion owing to erythrocyte stasis appears to be the more common primary event.

**TABLE 40.1. Causes of Acute Chest Syndrome**

| Cause                                   | Number of Episodes (N = 670) | Percentage | Age at Episode of Acute Chest Syndrome |                    |                  |
|---|------------------------------|------------|--|--------------------|------------------|
|   |                              |            | 0–9 yr (N = 329)                       | 10–19 yr (N = 188) | ≥20 yr (N = 153) |
| Fat embolism, with or without infection | 59                           | 8.8        | 24                                     | 16                 | 19               |
| Chlamydia                               | 48                           | 7.2        | 19                                     | 15                 | 14               |
| Mycoplasma                              | 44                           | 6.6        | 29                                     | 7                  | 8                |
| Virus                                   | 43                           | 6.4        | 36                                     | 5                  | 2                |
| Bacteria                                | 30                           | 4.5        | 13                                     | 5                  | 12               |
| Mixed infections                        | 25                           | 3.7        | 16                                     | 6                  | 3                |
| Legionella                              | 4                            | 0.6        | 3                                      | 0                  | 1                |
| Miscellaneous infections                | 3                            | 0.4        | 0                                      | 3                  | 0                |
| Infarction                              | 108                          | 16.1       | 50                                     | 43                 | 15               |
| Unknown                                 | 306                          | 45.7       | 139                                    | 88                 | 79               |

Modified from Vichinsky EP, Neumayr LD, Earles AN, et al. Causes and outcomes of the acute chest syndrome in sickle cell disease. National Acute Chest Syndrome Study Group. *New Engl J Med* 2000;342:1855–1865.

**TABLE 40.2. Most Common Pathogens Isolated in 671 Episodes of Acute Chest Syndrome**

| Pathogen  | Number of Episodes |
|---|--------------------|
| <i>Chlamydia pneumoniae</i>                     | 71                 |
| <i>Mycoplasma pneumoniae</i>                    | 51                 |
| Respiratory syncytial virus                     | 26                 |
| Coagulase-positive <i>Staphylococcus aureus</i> | 12                 |
| <i>Streptococcus pneumoniae</i>                 | 11                 |
| <i>Mycoplasma hominis</i>                       | 10                 |
| Parvovirus                                      | 10                 |
| Rhinovirus                                      | 8                  |
| Parainfluenza virus                             | 6                  |
| <i>Haemophilus influenzae</i>                   | 5                  |

Modified from Vichinsky EP, Neumayr LD, Earles AN, et al. Causes and outcomes of the acute chest syndrome in sickle cell disease. National Acute Chest Syndrome Study Group. *New Engl J Med* 2000;342:1855–1865.

---

Hematologically, ACS is characterized by a sudden drop in Hb concentration and an increase in the number of platelets and leukocytes ( 356 ). Rib infarcts are a primary cause of ACS when bone pain is followed by soft-tissue reaction, pleuritis, splinting, hypoventilation, atelectasis, and the typical radiologic picture ( 357 ). Lung crises may result from embolization of fat from infarcted bone marrow (pulmonary fat emboli) ( 358 , 359 and 360 ) or deep vein thrombi ( 361 ). Occlusion of major pulmonary vessels is a recognized cause of sudden death ( 362 ). Pulmonary fat emboli are found more commonly than previously appreciated when a diagnosis is sought by fat staining of pulmonary macrophages obtained by bronchoalveolar lavage ( 360 ). Fat emboli are associated with bone pain, chest pain, neurologic symptoms, acute decreases in Hb level and platelet count, and prolonged hospitalization. Recently, secretory phospholipase A<sub>2</sub>, an inflammatory mediator that liberates free fatty acids and may be responsible for acute lung injury, was found to be dramatically elevated in sickle cell patients before the diagnosis of ACS ( 363 ). Incentive spirometry with the use of maximal inspirations every 2 hours has been shown to prevent ACS in patients with sickle cell disease who were hospitalized with chest or back pain ( 364 ). Because the relative importance of infection and infarction is difficult to ascertain, broad-spectrum parenteral antibiotics should be provided for children with fever, chest pain, and pulmonary infiltrates. If mycoplasma infection is an endemic problem, coverage should include a macrolide antibiotic. Of utmost importance is the correction of hypoxemia. If the arterial PO<sub>2</sub> value is less than 75 mm Hg or the O<sub>2</sub> saturation by pulse oximetry is significantly below baseline, the clinician should consider prompt simple ( 365 ) or partial exchange transfusion ( 307 , 355 ). Recently, intravenous dexamethasone was shown to result in a shorter hospital stay and reduced need for blood transfusion and oxygen when compared to placebo in children with ACS ( 366 ). However, there appeared to be a high risk of readmission to the hospital after dexamethasone was discontinued. The role of NO and Hb in the regulation of hypoxic pulmonary vasoconstriction and possible treatment with NO inhalation or arginine (a precursor to NO) are currently being explored ( 367 ).

**Priapism** The incidence of priapism in patients with sickle cell disease has been reported to be between 5% and 45% ( 368 ); it has a bimodal distribution of age of onset with peaks at 5 to 13 years of age and 21 to 29 years of age ( 369 ). It may be initiated during the normal erections of rapid eye movement sleep and may be associated with physiologic dehydration and hypoventilation, which results in metabolic acidosis followed by increases in sickling and stagnation of blood within the penile sinusoids or the corpora cavernosum. Although usually self-limited and of relatively short duration, priapism is often recurrent and may become chronic. "Stuttering" priapism refers to multiple episodes, each less than 3 hours in duration, which occur several times a week. Usually, these do not require medical intervention. Typically, priapism results from engorgement of the paired cavernosal bodies with sparing of the glands and corpus spongiosum (bicorporal). However, tricorporal priapism may occur, especially in postpubertal patients, and is associated with a poor prognosis ( 370 ). Although it occurs with approximately equal frequency in prepubertal and postpubertal males, priapism is more difficult to manage in the latter group ( 371 , 372 and 373 ). Numerous ISCs and clots are found in the distended sinuses when needle aspiration or incisional drainage is performed ( 374 ). The repetitive trapping of cells in the corpora cavernosa, with or without surgical intervention, may lead to fibrosis of the septa and impotence ( 375 ). Penile blood gas measurements and technetium-99 penile scintigraphy scans ( 373 ) have been used to define intracorporeal hemodynamics and to guide therapy. However, these modalities are not readily available, and a more conventional approach to treatment is necessary. Of particular concern is an increased rate of impotence reported in sickle cell patients whose attacks lasted more



than 24 hours ( [376](#), [377](#) ). As with other complications resulting from the sludging of sickled erythrocytes, aggressive hydration and adequate analgesia are of primary importance and should be pursued within the first few hours of symptoms. If no response is seen within 12 to 24 hours, partial exchange transfusion to lower the Hb S level to less than 30% should be performed; this is occasionally sufficient ( [378](#) ). If no resolution occurs within another 12 to 24 hours, corporal aspiration and irrigation with saline are indicated through such means as a Winter procedure ( [379](#) ), in which a fistula between the glans penis and the corpora cavernosa is created using a biopsy needle. If this is unsuccessful, creation of a cavernosa spongiosum shunt ( [380](#) ) or a venous bypass may be considered. Prevention of recurrent priapism has been accomplished in some patients with chronic transfusion, particularly through exchange transfusion ( [368](#) ).  $\alpha$ -Adrenergic agonists are thought to increase the contractile state of the trabecular/arterial meshwork and facilitate venous outflow from the corpora ( [368](#) ). Agents including etilefrine pseudoephedrine and phenylephrine may be administered either orally or by intracavernous injection ( [381](#), [382](#) ). Another approach has been the administration of diethylstilbestrol ( [383](#) ), the gonadotropin-releasing hormone analog leuprolide acetate ( [384](#) ), and low-dose antiandrogens ( [385](#) ). Despite either conservative or aggressive treatment, more than 25% of patients have some degree of impotence ( [372](#), [373](#), [386](#) ) and may be candidates for a penile prosthesis after 6 to 12 months ( [387](#) ). A recently described association of sickle cell disease, priapism, exchange transfusion, and neurologic events, including seizures and obtundation, is also of concern ( [388](#), [389](#) ).

**Hematologic Crises** Hematologic crises, characterized by sudden exaggeration of anemia, are pathogenetically and temporally unrelated to vasoocclusive crises. If unrecognized or untreated, the decrease in Hb concentration may be so precipitous and severe as to cause heart failure and death within hours.

**Aplastic Crises** These events are the most common of the hematologic complications. The pathogenesis and course of aplastic crises in sickle cell anemia are similar to those of other chronic hemolytic states. Several characteristics are indicative of an infectious basis: The crises are characteristically preceded by or associated with febrile illnesses; several members of families with congenital hemolytic anemia may have concurrent aplasia ( [390](#) ); recurrence of crisis within the same individual is not observed ( [391](#) ); and most aplastic episodes occur during childhood ( [392](#), [393](#) ). Results of recent epidemiologic studies clearly implicate human parvovirus B19 as the cause for almost all aplastic crises ( [391](#), [392](#), [394](#), [395](#), [396](#) and [397](#) ). Aplasia is the result of direct cytotoxicity of the parvovirus to erythroid precursors, especially colony-forming units, erythroid ( [398](#), [399](#) ). Susceptible hospital workers exposed to patients with aplastic crises are at high risk of contracting nosocomial erythema infectiosum ( [400](#) ). Because infection during the midtrimester of pregnancy may result in hydrops fetalis and stillbirth, isolation precautions are a necessity if an aplastic crisis is suspected ( [401](#) ). In the early phase of an aplastic crisis, peripheral blood reticulocytes and bone marrow normoblasts disappear or are greatly reduced in number. Because red cell survival in Hb SS is no more than 10 to 20 days ( [402](#) ), cessation of erythropoiesis is followed by a rapid decrease in Hb concentration. The process is self-limited, however; within 10 days, red cell production resumes spontaneously, and large numbers of reticulocytes and nucleated erythrocytes appear in the peripheral blood. Thereafter, the Hb concentration returns to its precrisis level. Often, the patient is first seen early in the recovery phase, when differentiation from a hemolytic crisis may be difficult. Although leukocytes and platelets are usually normal, all marrow elements may be affected ( [403](#) ). Treatment consists of supportive care with red cell transfusion when necessary.

**Splenic Sequestration** This event is characterized by sudden trapping of blood in the spleen. A splenic sequestration crisis is defined by a decrease in the steady-state Hb concentration of at least 2 g/dl, evidence of compensatory marrow erythropoiesis, and an

acutely enlarging spleen (404). This complication occurs in infants and young children whose spleens are chronically enlarged before autoinfarction and fibrosis. Although splenic sequestration has been documented in infants as young as 3 and 4 months of age (405, 406), it is observed most commonly during the second 6 months of life and is a less frequent finding after 2 years of age (404). Children experiencing splenic sequestration may have an earlier onset of splenomegaly and a lower level of Hb F at 6 months of age (267, 406). Crises often are associated with respiratory tract infections (404, 406) or, rarely, with parvovirus B19 in conjunction with an aplastic crisis (407). The already enlarged spleen rapidly increases in size at the expense of blood volume; hypovolemic shock and death may occur within hours (408, 409). The sole pertinent postmortem finding is engorgement of splenic sinusoids with sickled cells (374). Individuals who survive have a tendency for recurrent episodes until 5 or 6 years of age, by which time sufficient fibrosis of the spleen has occurred to limit its expansion. The long-term management of patients with splenic sequestration has not been well defined. Chronic transfusion is of limited benefit in preventing reoccurrence of splenic sequestration (410). In a large series of Jamaican Hb SS patients with recurrent splenic sequestration or chronic hypersplenism, splenectomy did not increase the risk of death or bacteremic illness (411). Although encountered less frequently, sudden trapping of blood in the liver (hepatic sequestration crisis) also occurs (412, 413 and 414).

**Hemolytic Crises (Hyperhemolytic Crises)** Such crises result from a sudden acceleration of the hemolytic process. They have been described in association with hereditary spherocytosis (415) and mycoplasma infection (349). Although approximately 10% of black male patients with sickle cell anemia have the unstable A variant of glucose-6-phosphate dehydrogenase (416, 417); they have no more severe anemia and no greater frequency of acute hemolytic episodes than those with normal levels of glucose-6-phosphate dehydrogenase, even when challenged with oxidant drugs and infections (418). This finding is explained by the young mean age of sickle red blood cells. Increased lipid peroxidation of sickle red cells by reactive oxygen species derived from activated neutrophils is another possible mechanism for infection-associated hemolytic crises (419).

**Megaloblastic Crises** These crises result from the sudden arrest of erythropoiesis by folate depletion (420, 421). Chronic erythroid hyperplasia imposes a drain on folate reserves, and biochemical evidence of mild folate deficiency can be demonstrated with high frequency in subjects with sickle cell anemia (422). Megaloblastic crises likely occur when food consumption is interrupted by illness or alcoholism or when the folate requirement is augmented by rapid growth or pregnancy. The inverse relationship between plasma homocysteine concentration and folate status has led to a series of recent reports describing homocysteine levels and the possible need for folate supplementation. However, both elevated homocysteine levels (423, 424) and normal homocysteine levels have been reported (425, 426). Currently, folic acid deficiency, as a cause of exaggerated anemia in sickle cell disease, appears to be extremely rare in the United States. Nevertheless, it is common practice to prescribe prophylactic folic acid (1 mg/day) to patients with sickle cell disease.

**Infections** Overwhelming infection may be the presenting manifestation of sickle cell anemia in early childhood. Acute infection is one of the most common causes of hospitalization and previously was the most frequent cause of death, particularly during the first 3 years of life. *S. pneumoniae* is the usual infecting organism; the blood and spinal fluid are the major sites of infection (427, 428 and 429). The incidence of invasive infection with *S. pneumoniae* previously was approximately 7/100 patient-years in children with sickle cell anemia younger than 5 years of age; this rate was 30 to 100 times that which would be expected in a healthy population of this age (429, 430). More than 70% of meningitis in children with sickle cell anemia resulted from *S. pneumoniae* (431). The mortality rate of pneumococcal sepsis was as high as 35%, but the widespread



improvement in parental education and aggressive management of the febrile child have greatly improved the likelihood of surviving a septic event ( 432 ). Furthermore, penicillin prophylaxis and pneumococcal vaccines have substantially lowered the risk of invasive pneumococcal infection. A major threat to continued success in prevention and management of *S. pneumoniae* invasive infection is the emergence of antibiotic-resistant pneumococcal organisms over the past 15 years. A recent report cited 16 cases of intermediate or high resistance to penicillin among *S. pneumoniae* causing sepsis in children with sickle cell anemia in the United States ( 433 ); many of the organisms were also resistant to extended-spectrum cephalosporins and other antibiotics. After 5 years of age, the incidence of life-threatening infections decreases substantially. Gram-negative bacteria replace *S. pneumoniae* as the major offenders ( 347 , 429 , 434 , 435 ). In contrast to infections in young children, those in older children and adults generally have an identifiable source or focus (e.g., *Escherichia coli* associated with urinary tract infection) ( 347 , 429 , 431 ). Osteomyelitis, often involving multiple sites, occurs with increased frequency at all ages. The increased risk of osteomyelitis may stem from tissue ischemia and infarction associated with pain crises; these provide a potential nidus for infection in the long bones ( Fig. 40.7 ). Although more than 80% of hematogenous osteomyelitis in the general population is caused by staphylococcus, most cases of osteomyelitis occurring in individuals with sickle cell anemia are caused by *Salmonella* ( 436 , 437 , 438 and 439 ). Serum antibody levels against *Salmonella* antigens are normal, but microinfarcts of the intestinal mucosa may predispose to invasive infections ( 440 , 441 ). Documentation of *Salmonella* in a patient with sickle cell anemia strongly suggests the diagnosis of osteomyelitis. Staphylococcal bone infection, clinically indistinguishable from *Salmonella* infection, also occurs with increased frequency in sickle cell disease ( 347 , 442 , 443 ).



**Figure 40.7.** Pathogenesis of infection in sickle cell disease. Ig, immunoglobulin. (Modified from Wang WC. Sickle cell disease. In: Patrick C, ed. Infections in immunocompromised infants and children. New York: Churchill Livingstone, 1992.)

Human parvovirus B19 has been noted to produce sequelae other than aplastic crises in patients with sickle cell disease. In a series from Jamaica, seven patients developed glomerulonephritis with proteinuria and symptoms of nephrotic syndrome within 7 days after an aplastic crisis ( 444 ). Renal failure appears to be a common consequence of this complication. Parvovirus may also result in severe pulmonary problems ( 444 ) and in cerebrovascular complications, including hemiplegia, encephalitis, and seizures ( 445 ). The pathophysiologic basis for increased susceptibility to aggressive infection relates in large part to the loss of spleen function ( Fig. 40.7 ) ( 446 , 447 ). During the first few years of life, recurrent perivascular hemorrhage and infarction reduce the spleen to a small siderofibrotic vestige ( 448 ). Despite the frequent occurrence of splenomegaly in the first few years, spleen function often is impaired by 6 to 12 months of age ( 266 ). Howell-Jolly bodies and “pits” (depressions in the red blood cell membrane) are seen in peripheral blood erythrocytes ( 271 , 449 , 450 and 451 ), and radiolabeled sulfur colloid is not cleared by the spleen ( 452 ). Spleen function is temporarily restored by transfusion therapy in early life, suggesting that functional asplenia is a consequence of altered perfusion imposed by intrasplenic sickling ( 453 ). In the absence of spleen function, bloodborne particulate

antigens fail to elicit an expected antigenic response ( 454 ), and challenge with *S. pneumoniae* is not followed by an appropriate generation of pneumococcal opsonins ( 455 ). Spleen function is necessary for effective host response to *S. pneumoniae* in the absence of preformed antibodies; in the presence of antibody, organisms are trapped effectively at extrasplenic sites. Because the acquisition of pneumococcal antibodies occurs with advancing age, young children without spleen function fare less well than older children and adults. However, responses to conjugated *Haemophilus influenzae* vaccine in young infants with sickle cell anemia ( 456 ) and an experimental conjugated pneumococcal vaccine in 2- to 5-year-olds have been appropriate ( 456 , 457 ). Other mechanisms may contribute to the vulnerability of children with sickle cell disease to infectious crises. Serum IgM levels are decreased ( 458 ). The alternative pathway for complement activation has been described as defective ( 459 , 460 ) or normal ( 461 ). Alterations of B- and T-lymphocyte number and function and of the function of neutrophils and monocytes are of uncertain significance ( 462 , 463 , 464 and 465 ).

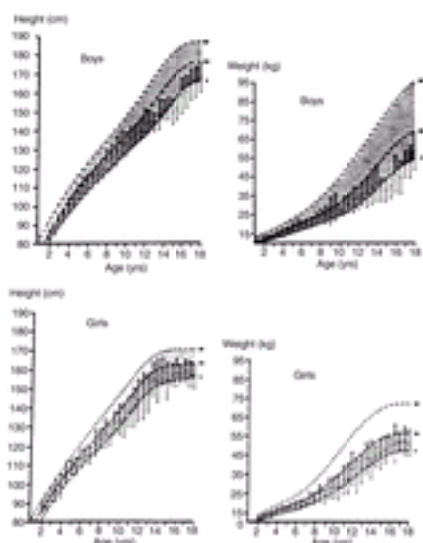
**Prevention of Infection** Over the past 15 years, penicillin prophylaxis has emerged as a success story in the management of sickle cell disease. Two controlled trials, one in Jamaica and the other organized by the National Institutes of Health, led to the widespread acceptance of penicillin prophylaxis as standard therapy ( 466 , 467 ). In the latter trial, twice-daily oral penicillin V resulted in an 84% reduction in the incidence of pneumococcal bacteremia in infants younger than 36 months of age. Current recommendations are to initiate penicillin prophylaxis by 3 months of age and to continue it at least until 5 years of age in children with Hb SS or Hb S<sup>0</sup>-thalassemia. A multiinstitutional controlled trial found no further advantage of penicillin in the prevention of invasive pneumococcal infection in children older than 5 years of age ( 468 ). The use of prophylaxis in young children with Hb SC disease or sickle B<sup>+</sup>-thalassemia is controversial ( 469 ), but many centers maintain all children with sickle cell disease on penicillin until 5 years of age. Of concern has been the question of whether prophylaxis might increase the risk of penicillin-resistant pneumococcal organisms. Its usage reduces nasopharyngeal colonization with *S. pneumoniae*, but an unequivocal effect on the development of antibiotic resistance has not been described ( 470 , 471 and 472 ). However, the pneumococcal serotypes that are most prevalent in the community and most highly virulent (types 6A, 14, 19, and 23F) are least immunogenic ( 466 , 473 , 474 and 475 ). Although the immunologic response of children 2 years of age and older to polysaccharide-conjugated pneumococcal vaccine is comparable to that of the general population ( 476 , 477 ), antibody titers fall more rapidly than in adults. It is recommended that all children with sickle cell anemia receive a primary immunization with the 23-valent polysaccharide vaccine at 2 years of age and a booster immunization 3 to 5 years later ( 478 ). However, the vaccine is ineffective in children younger than 2 years of age, and at all ages, it fails to establish reliable protection against some of the serotypes included in the vaccine (e.g., types 6A, 19F) ( 466 , 479 ). The seven-valent protein-conjugated pneumococcal vaccine, which is immunogenic in the first few months of life, became available for general pediatric use in 2000. Protein-conjugated pneumococcal vaccine (which includes serotypes 4, 6B, 9V, 14, 18C, 19F, and 23F) administered at 2, 4, and 6 months of age produced adequate antibody concentrations in the same range as those achieved among infants without sickle cell disease ( 480 , 481 ). In addition, significant rises were seen in antibody concentration to all seven protein-conjugated pneumococcal vaccine serotypes after the administration of polysaccharide-conjugated pneumococcal vaccine at 24 months of age. The conjugated *H. influenzae* type B vaccine induces protective antibody levels in young infants with sickle cell anemia ( 456 , 482 ) and has virtually eliminated invasive *H. influenzae* infection in this population. The influenza virus vaccine ( 483 ) and hepatitis B vaccine ( 484 ) offer further protection.

**Management of Fever** Any fever greater than 38.5° C in a child with sickle cell anemia

must be considered a medical emergency because of the potential risk of overwhelming pneumococcal sepsis, especially during the high-risk period between 6 months and 3 years of age (432). This risk remains significant despite the efficacy of penicillin prophylaxis. Previously, routine hospitalization of every febrile patient with sickle cell anemia was standard management to deliver intravenous antibiotic coverage until blood cultures were demonstrated to be negative. More recently, in certain centers, the majority of febrile patients have been managed in the emergency department and the outpatient setting if they do not have high-risk characteristics (e.g., toxic appearance, very high fever, serious localized infection, exceptionally high or low white blood cell count, a history of invasive infection, or inadequate capacity for close follow-up) (485, 486 and 487). These children may be managed with prompt assessment in the emergency department, rapid administration of ceftriaxone, observation for several hours, and close outpatient follow-up.

### CHRONIC ORGAN DAMAGE

**Growth and Development** The sickling syndromes profoundly affect growth and development. Growth curves for the height, weight, and sexual development of children with sickle cell anemia have been constructed to permit the identification of individuals whose growth delay is greater than what can be accounted for by the hemoglobinopathy (Fig. 40.8) (488, 489). Although normal at birth, the heights and weights of children with sickle cell anemia are significantly delayed by 2 years of age (488, 489, 490, 491 and 492). The growth curves maintain a relatively normal configuration but deviate progressively from the normal curves. Increases in velocity of adolescent height and weight growth occur later, and the magnitude of the growth spurt is substantially less than in healthy children. Puberty also is delayed. Menarche occurs 2 to 3 years later than in the general population (median age, 14.0 to 15.5 years) (493, 494), and Tanner stage V is not achieved until the median ages of 17.3 and 17.6 years for girls and boys, respectively (488). As in normal subjects, progression through Tanner stages is orderly and appropriate for bone age (494), and the age of menarche correlates closely with age and weight (488). By adulthood, both men and women with sickle cell disease appear to acquire normal or near-normal heights, but their mean weights are still lower than those of controls (488). Investigations in small numbers of subjects show that growth hormone, thyroid hormone, adrenocorticotrophic hormone and cortisol levels, and pituitary responses to growth hormone-releasing factor are normal (495). Transient hypogonadism may occur in adolescence. The normal relationship of puberty and growth pattern seen in most patients suggests that the delay in skeletal maturation represents constitutional delay rather than gonadal or pituitary failure (488). Former descriptions of the adult with sickle cell anemia as thin, asthenic, long-limbed, short-trunked, and sexually immature are now recognized as misleading.

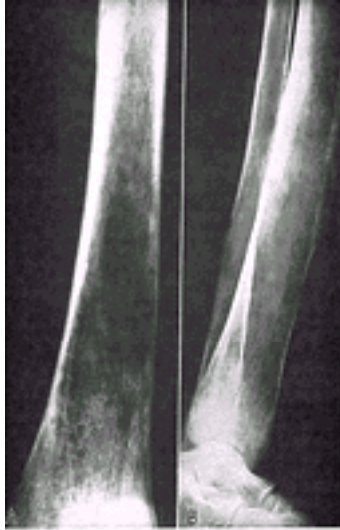


**Figure 40.8.** Height and weight (mean,  $\pm 1$  standard deviation) of American boys and girls with sickle cell anemia compared with National Center for Health Statistics growth percentiles. (From Phebus CK, Gloninger MF, Maciak BJ. Growth patterns by age and sex in children with sickle cell disease. *J Pediatr* 1984;105:28, with permission.)

Low weight appears to be the most critical variable influencing differences in physical maturation among the sickling syndromes (488). The basis for delay in weight gain is not fully understood, although it has been hypothesized that chronic hemolysis leads to a state of high protein turnover and increased basal metabolic requirements (496). Several recent reports have confirmed that resting energy expenditure measured by indirect calorimetry is 15 to 20% greater in Hb SS patients (497, 498 and 499). Increased whole body protein breakdown and protein synthesis (497) may be related to increased bone turnover (500). Prepubertal children with sickle cell disease do not compensate for their higher resting energy expenditure by increasing their energy intake, measured by weighing all food consumed during a 3-day period (501). Furthermore, caloric intake is significantly decreased at the time of an admission for acute illness, contributing to an overall energy deficit (502). When body composition of children and adolescents with sickle cell disease was measured by bioelectrical impedance analysis, male subjects had significantly lower fat-free mass and body fat compared with controls (503). Response to nasogastric dietary supplementation has been reported (504). Other studies have suggested increased requirements for zinc, folate, riboflavin, vitamin B<sub>6</sub>, ascorbate, and the fat-soluble vitamins A and E, but consistent correlations between deficiencies and growth retardation have not been established (498, 505, 506 and 507). A relationship between zinc deficiency and hypogonadism in adults with sickle cell anemia has been suggested (508), and zinc supplements may promote adolescent growth (509). Recently, defective growth hormone secretion, decreased insulinlike growth factor-1, and partial resistance to growth hormone in short children with sickle cell disease were reported (510). Hematocrit and fetal Hb levels are related to total insulinlike growth factor-1 and insulinlike growth factor binding protein in patients with sickle cell anemia, suggesting that delayed growth may be linked to intrinsic factors of the disease (511).

**Bones and Joints** In addition to the acute episodes of skeletal pain described previously, chronic and progressive destruction of the bones and joints may take place in the absence of clearly defined episodes of pain. The most prominent changes evolve slowly from the cumulative effect of recurrent, small episodes of ischemia or infarction within the spongiosa of bone. Radiographs of the long bones of adults show a mottled, strandlike increase in density randomly distributed within the medullary region (Fig. 40.9). These irregular areas of increased density are produced by new bone laid down on devitalized trabeculae (512, 513). Increased signal is seen with T2-weighted MRI images of infarcted areas (282). Because the bone is weakened during the early stages of repair, weight-bearing may collapse the femoral head, producing osteonecrosis with the clinical and radiologic features of Legg-Calvé-Perthes disease (514). Osteonecrosis of the femoral and humeral heads affects patients with all the genotypes of sickle cell disease but occurs most often in those with Hb SS and  $\alpha$ -thalassemia (4.5 cases/100 patient-years) (515). The overall prevalence of osteonecrosis of the hip in persons with sickle cell disease older than 5 years of age is approximately 10% (515); the prevalence of osteonecrosis of the humeral head is approximately one-half as much (516). Typically, the pain from osteonecrosis of the hip begins insidiously, is brought on by walking or quick movements, and is localized to the groin or buttock. After several months, radiographs may show areas of increased density mixed with areas of increased lucency, followed by the appearance of a "crescent sign," segmental collapse, molding of the femoral head, loss of joint space, involvement of the acetabulum, and complete degeneration of the joint. When osteonecrosis occurs in the femoral capital epiphysis before closure, healing

with minimal destruction may occur. However, long-term follow-up shows that in the majority of cases, the hip is painful and permanently damaged ( 517 ). Because weight-bearing is not required of the shoulder joint, the prognosis of osteonecrosis of the humeral head is substantially better. Only approximately 20% of patients have pain or limited range of movement at the time of diagnosis ( 516 ), but functional abnormalities of the shoulder may be a long-term consequence in adults ( 518 ).



**Figure 40.9.** Sickle cell anemia. **A:** Femur. The cortex is thinned, and the normal bony architecture is disturbed. Adjoining small areas of translucency are areas of sclerosis. **B:** Tibia and fibula. Marked thinning of the cortex of the bones as well as periosteal reaction and disarrangement of the trabeculae. The latter changes and the extensive coarseness of the cortical layers suggest the bone is involved from within.

Avoidance of weight-bearing in the early phases of bone necrosis may permit sufficient repair to preserve reasonable joint function. More often, however, the deformity is progressively crippling. Total hip replacement is usually recommended for the painful hip in stages III or IV or for restoration of joint movement, if this is desired. However, the prognosis for hip replacement has been suboptimal with a 30% chance that arthroplasty will require revision within 4 to 5 years ( 519 , 520 ). For stage I and II osteonecrosis, core decompression, in which a core of cancellous bone approximately 8 mm in diameter is removed from the neck and head of the femur through an incision in the lateral cortex, has been of benefit ( 521 ), but this approach has not yet been proven superior to avoidance of weight-bearing. In a multicenter study, the perioperative complication rate of orthopedic surgery was 67%, including excessive intraoperative blood loss, postoperative ACS, and transfusion reactions ( 522 ). Another characteristic bone change develops in the vertebral column of some individuals during the second decade of life. Recurrent infarcts of the main vertebral arteries lead to ischemic damage of the central portion of the vertebral body growth plates. Because the outer portion of the plates is supplied by numerous apophyseal arteries, vertebral growth is irregular, producing a “fish-mouth” deformity in which symmetric cuplike depressions are confined to the central three-fifths of the vertebral plates ( 437 , 523 ). Other skeletal changes result from expansion of medullary cavities owing to long-standing erythroid hyperplasia. Radiographs of the skull show a thickening of the diploë and thinning of the outer table of the calvaria in the frontal and parietal regions. Gnathopathy (prominent maxillary overbite) may result from overgrowth of maxillary bone ( 4 ) and frequently leads to significant malocclusion ( 524 ). Joints may be affected by avascular necrosis of adjacent bone ( 525 ). The joint effusion, pain, fever, and leukocytosis accompanying such infarcts make differentiation from septic arthritis difficult. Numerous neutrophils and sickled erythrocytes are found in the joint



fluid ( [281](#) , [526](#) ). Less commonly, joint disease is related to infection ( [527](#) , [528](#) ), gout ( [529](#) ), or synovial hemosiderosis. Adults may have deformities of the hands and feet with shortening of the digits, apparently the remote sequelae of dactylitis during early childhood ( [530](#) ).

**Central Nervous System** As expected, children with a history of overt stroke have significant cognitive impairment, reduced language function, and problems in adjustment ( [531](#) ). Several reports in the past two decades have identified deficits in global and specific neuropsychological functioning in school-aged children with sickle cell disease when compared with their siblings or healthy children ( [532](#) , [533](#) , [534](#) and [535](#) ). Diminished performance has been noted in the areas of visual-motor integration, attention and concentration, arithmetic, memory, and reading. Routine MRI of the central nervous system performed prospectively in children between the ages of 6 and 14 years as part of the CSSCD disclosed a 17% prevalence of “silent infarcts” (areas of increased signal intensity primarily in deep white matter or watershed areas of the cerebral cortex) in children with Hb SS and no history of stroke ( [536](#) ). Data from the CSSCD gathered over a 10-year period of follow-up of school-aged children with Hb SS indicated that those with silent infarct had significantly lower scores for math and reading achievement, full-scale intelligence quotient (IQ), verbal IQ, and performance IQ, when compared with normal MRI findings ( [537](#) ). However, even in children with normal MRI findings, the scores for verbal IQ and math achievement declined with increasing age ( [537](#) ). A metaanalysis of 17 reports of cognitive functioning in children concluded that sickle cell disease is associated with detrimental effects even in the absence of cerebral infarction. Direct effects of sickle cell disease on brain function or the indirect effects of a chronic illness may be important ( [538](#) ). A multiinstitutional study from France in which children with sickle cell disease were compared to sibling controls reported impaired cognitive function in patients both with a history of stroke and with silent infarcts. In addition, hematocrits less than 20% and platelet count greater than  $500 \times 10^9/L$  were independent risk factors for cognitive deficiency ( [539](#) ). Patients with frontal lobe infarction differed from their peers in measures of attention, executive function, and memory ( [540](#) , [541](#) ). In another recent study, children with silent infarcts had twice the rate of school difficulties as those without infarcts, including poor *educational attainment*, defined as repeating a grade in school because of lack of educational progress, a requirement for special educational services, or both ( [542](#) ). Recent data from the CSSCD have shown that children with silent infarcts had an increased incidence of new stroke and new or more extensive silent infarcts ( [543](#) ) and that silent infarcts were the strongest independent predictor of stroke ( [544](#) ). Data from the Stroke Prevention Trial in Sickle Cell Anemia (STOP) of transfusion therapy in patients with abnormal TCD velocities indicated that those who had silent infarcts as well as abnormal velocities were at higher risk for developing a new silent infarct or stroke than those whose MRI showed no abnormality ( [544](#) ). However, a comparison of patients who were on both the CSSCD and STOP studies indicated that those who had abnormal TCDs did not have an unusually high frequency of MRI abnormality; conversely, those who had silent infarcts did not have an unusually high frequency of abnormal TCD velocities, suggesting that those findings represent different aspects of the pathophysiology of the brain in children with sickle cell disease ( [545](#) ). The role of magnetic resonance angiography and diffusion- and perfusion-weighted MRI requires further evaluation at this time. However, diffusion-weighted imaging may be particularly sensitive to identify newly occurring stroke, and perfusion-weighted imaging abnormalities appear to be highly associated with neurologic symptoms ( [546](#) ). In general, increased stroke risk may be related to both environmental factors (e.g., hypoxia and inflammation) and genetic factors (e.g., mutations resulting in thrombogenesis) ( [547](#) ).

**Cardiovascular System** The cardiovascular system is stressed by chronic anemia, recurrent small pulmonary artery occlusions, and myocardial hemosiderosis ( [548](#) ). Autopsies have revealed that right and left ventricular dilation is common in both children

and adults ( 549 ). Left ventricular hypertrophy may result from systemic hypertension secondary to chronic renal failure; right ventricular hypertrophy is associated with pulmonary thromboses and cor pulmonale. Echocardiography, performed on adult sickle cell patients from the CSSCD in their baseline state, has shown striking left atrial and biventricular enlargement, normal shortening fraction, prolonged ejection time, and increased stroke volume ( 550 ). In general, there is an absence of atherosclerotic heart disease, although one study reported myocardial infarction and fibrosis in 17% ( 551 ). Adults with sickle cell disease may present with clinical signs of acute myocardial infarction in the absence of atherosclerosis or coronary occlusion, but this is uncommon ( 552 , 553 and 554 ). In children, rare cases of myocardial infarction and transient ventricular dysfunction have been reported ( 555 , 556 ), and myocardial perfusion abnormality measured by thallium-201 single-photon emission computed tomography may be relatively frequent ( 557 , 558 ). Congestive heart failure generally does not occur in the absence of extracardiac complications of sickle cell disease ( 550 ). However, physical performance is severely compromised; adults are usually unable to exceed 50% of expected work capacity ( 559 , 560 ), and children and adolescents have 60 to 70% work capacities ( 561 , 562 and 563 ). This is the result of a high cardiac output at rest and an inability to increase output adequately under stress as demonstrated by abnormalities of systolic (ejection) and diastolic (filling) function. Cardiac enlargement, particularly an increase in left ventricular dimensions and mass, results from an increase in cardiac output imposed by chronic anemia and has its onset in early childhood ( 564 ). The typical physical examination in sickle cell disease reveals cardiomegaly, a hyperdynamic precordium, and a grade II–III systolic ejection murmur with wide radiation. An ejection click from pulmonary artery dilatation and an S3 or apical diastolic rumble also may be heard. Other factors may compound the cardiac embarrassment resulting from anemia. The shunting of blood through infarcted, nonaerated segments of the lung compromises arterial oxygen saturation, and sludging of sickled erythrocytes in small pulmonary arteries may result in pulmonary hypertension. Myocardial hemosiderosis, the consequence of long-standing transfusion therapy, may be responsible for intractable heart failure.

**Pulmonary System** Chronic pulmonary disease, presumably related to recurring episodes of infarction and infection, is characterized by a decrease in the radiolucency of the lungs and by moderate to severe impairment of pulmonary function. Typically, the vital capacity and total lung capacity are reduced ( 565 , 566 ), and gas mixing and exchange are compromised. Less often, obstructive lung disease is noted. Blood is shunted through poorly aerated or collapsed segments of the lung, creating a disparity between ventilation and perfusion. The resulting reduction in the functional pulmonary vascular tree is responsible for a decrease in arterial oxygen tension (70 to 90 mm Hg) and desaturation of arterial blood ( 567 ). The availability of noninvasive monitoring of arterial oxygen saturation through transcutaneous pulse oximetry has led to more careful assessment of oxygenation in sickle cell patients hospitalized for ACS and painful crises ( 568 ). Hb oxygen saturation is lower in children with Hb SS compared with those with Hb SC and in those with a history of ACS ( 568 ). Children with acute pulmonary illness have an oxygen saturation level that is below their baseline state and generally less than 96% ( 568 ). Oxygen saturation measured by pulse oximetry has been compared with arterial cooximeter blood gas measurements. Pulse oximetry may underestimate true arterial saturation, but pulse oximetry values correlate positively with Hb and fetal Hb levels in patients with Hb SS ( 569 , 570 , 571 , 572 and 573 ). Evidence of pulmonary hypertension has been increasingly recognized in the echocardiograms of patients with sickle cell disease and is now considered to be a major cause of morbidity and mortality ( 574 , 575 and 576 ). In one study, the median survival for patients with pulmonary hypertension was only 26 months, and pulmonary artery pressure had a significant inverse relationship with survival ( 575 ). The role of NO in the pathophysiology and treatment of pulmonary hypertension is currently being explored. The use of hydroxyurea for these patients also has been



recommended ( 577 ). In children with sickle cell disease, obstructive restrictive defects and airway hyperreactivity are particular problems and have been associated with responsiveness to bronchodilators ( 578 , 579 ).

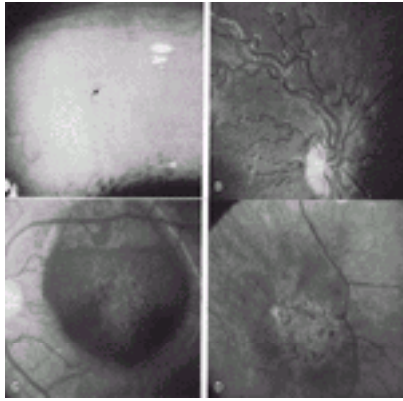
**Hepatobiliary and Gastrointestinal Systems** Liver enlargement is present by 1 year of age and persists to a moderate degree throughout life. Analysis of histologic sections reveals distention of sinusoids with sickled cells, Kupffer cell erythrophagocytosis, and varying degrees of periportal fibrosis and hemosiderin pigment ( 580 , 581 ). Sickle cell disease may be associated with disturbances in hepatic function ( 581 , 582 ). In adult life, diffuse nodular cirrhosis may occur ( 583 ). Acute enlargement of the liver, such as may occur with sequestration of sickle cells, subcapsular infarction, or hepatic vein thrombosis ( 584 ), is associated with tenderness or right upper quadrant pain. Intrahepatic infarcts may be complicated by abscess formation. In addition, hepatic function as assessed by lidocaine metabolism is impaired in patients with sickle cell disease, suggesting caution when using hepatically metabolized medication in these patients ( 585 ). It is not unusual for hyperbilirubinemia to punctuate the course of sickle cell anemia. These episodes may result from intercurrent infectious hepatitis, intrahepatic sickling (hepatic crisis, "sickle hepatopathy"), or choledocholithiasis. It has been suggested that coexistent glucose-6-phosphate dehydrogenase deficiency may be a contributing factor ( 586 ). The clinical picture of acute viral hepatitis is similar to that seen in non-sickle cell patients except for the remarkable elevation of serum bilirubin concentration (which may reach 100 mg/dl) ( 587 , 588 ). Hepatitis A virus may be a frequent cause of acute icteric hepatitis in endemic areas and may result in fulminant hepatic failure and death ( 589 ). Hepatitis B surface antigen has been found in 6 to 14% of patients in limited studies ( 590 , 591 ). However, most sickle cell patients respond normally to hepatitis B vaccine ( 484 ), although surface antibody titers after immunization should be measured to identify those who do not convert and require booster injections ( 592 ). Evidence of prior hepatitis C virus infection has been found in 21% of sickle cell anemia patients in Philadelphia ( 593 ), 10% in Brooklyn ( 594 ), 2% of previously transfused sickle cell patients in Jamaica ( 595 ), and 18% in Saudi Arabia ( 591 ). Liver biopsies may show progression to chronic active hepatitis and cirrhosis. Since the advent of screening of transfused blood for hepatitis C, new cases of this infection have become extremely rare. Orthotopic liver transplantation has been used in a patient with liver failure due to cirrhosis ( 596 ). The histologic consequences of intrahepatic sickling include impaction of hepatic sinusoids with sickled erythrocytes, patchy areas of hepatocellular necrosis, engorgement of Kupffer cells, and bile stasis ( 580 , 597 , 598 ). In children, manifestations of sickle hepatopathy are mild and transient. These include right upper quadrant pain, hepatomegaly, fever and leukocytosis, mild elevation of serum transaminase levels, and moderate to marked elevation of serum bilirubin and alkaline phosphatase levels ( 599 ). Although the course in children is benign and symptoms usually resolve in 1 to 3 weeks, progression to fulminant hepatic failure, generalized bleeding, and death are much more frequent in adults ( 590 ) and are occasionally seen in adolescents ( 600 , 601 and 602 ). Prompt exchange transfusion and, occasionally, chronic transfusion have been the only effective therapies in these patients ( 600 , 601 , 602 and 603 ). Liver transplantation has been attempted in at least one patient ( 604 ). Because of a sustained increase in heme catabolism, the frequency of pigmentary gallstones in sickle cell disease is high. These stones, which may be either radiolucent or radiopaque, have been documented in children younger than 5 years of age ( 605 , 606 and 607 ). The incidence of gallstones increases with age, from 12% in the 2- to 4-year-old age group to 42% in the 15- to 18-year-old age group and 60% in adults ( 608 ). In Jamaica, the prevalence of gallstones was 53% at 23 years of age in Hb SS and 20% in Hb SC ( 609 ). When ultrasonography is used routinely, the finding of gallbladder sludge with or without concurrent stones is common ( 610 ); even if not present initially, patients with sludge

eventually develop stones. Genetic variations in the uridine diphosphate–glucuronosyltransferase 1a promoter significantly influence serum bilirubin levels and the development of symptomatic cholelithiasis in children with sickle cell anemia ( 611 ). Not more than 10 to 15% of patients have symptoms that can be attributed to the biliary tract ( 605 , 612 ). Occasionally, they are able to distinguish the pain of choledocholithiasis from that of abdominal vasoocclusive crises. Elective cholecystectomy may be followed by a dramatic decrease in the frequency of abdominal crises ( 605 , 606 ). Laparoscopic cholecystectomy has replaced open cholecystectomy in many centers because it results in shorter hospitalization and decreased postoperative pain and other complications ( 613 , 614 , 615 and 616 ). Although duodenal ulcer disease has been reported in patients with sickle cell anemia ( 617 , 618 ), there is no clear evidence that it is more common than in the general population. Gastric acid output is not increased in patients with duodenal ulcers ( 617 , 619 ). Severe ischemic colitis has been reported in two patients ( 620 , 621 ), and pancreatitis has been a rare problem in sickle cell disease ( 622 ).

**Kidneys** A variety of defects in renal function have been described ( 623 ), and a number of histologic alterations have been noted ( 624 , 625 ). Even in the absence of clinically apparent renal disease, small cortical infarcts of varying ages are evident ( 626 ), hemosiderin is deposited in the epithelium of proximal convoluted tubules, glomerular arterioles are dilated and congested, glomerular surface area relative to kidney size is increased ( 625 ), and varying degrees of juxtamedullary glomerular hypertrophy and sclerosis are seen ( 624 ). Symmetric enlargement of the kidneys is a regular feature, and distortion of the collecting system has been a common finding on intravenous pyelograms ( 627 ). Frank papillary necrosis may occur. Hyposthenuria ( 628 , 629 ) and a limited capacity for hydrogen ion excretion ( 630 , 631 and 632 ) are present after 6 or 12 months of age. Hyposthenuria is corrected temporarily with red cell transfusions until up to 15 years, but not thereafter ( 628 , 633 ). Disruption of the countercurrent multiplication system owing to sludging of sickle cells in the more hypertonic portions of the renal medulla has been proposed as the mechanism responsible for the concentrating defect ( 628 ). The demonstrated obliteration of a portion of the vasa rectae is in keeping with this hypothesis ( 627 ). An alternative mechanism involving decreased perfusion and progressive destruction of structures in the renal papillae has been proposed ( 623 ). Presumably, because of the large fluid consumption necessitated by the renal concentrating defect, most patients experience enuresis ( 634 ). Enuretic sickle cell patients have nocturnal urine osmolality equivalent to that of nonenuretic patients but may respond to desmopressin ( 635 , 636 ). Urinary acidification is abnormal in sickle cell patients probably resulting from an incomplete form of distal tubular acidosis attributable to diminished ability of the collecting duct to maintain hydrogen ion gradient ( 631 , 632 ). Impaired potassium excretion by the kidney and subsequent hyperkalemia, increased phosphate reabsorption, and increased uric acid clearance have also been described ( 637 , 638 and 639 ). Hematuria is common and may be both brisk and prolonged. Bleeding may originate in one kidney or both, or it may take place in an alternating fashion. The most common lesion is an ulcer in the renal pelvis at the site of a papillary infarct ( 640 , 641 and 642 ). The possibility that painless hematuria may be the result of poststreptococcal glomerulonephritis ( 643 ), renal medullary carcinoma ( 644 ), or other disorders unrelated to the hemoglobinopathy should not be overlooked. Idiopathic hematuria rarely requires more than symptomatic treatment. The risk of clotting within the collecting system is best minimized with a high fluid intake. Rarely, protracted blood loss necessitates iron supplementation. Although there is no controlled study of its use, e-aminocaproic acid is said to shorten the duration of hematuria in both sickle cell anemia and sickle trait patients ( 645 , 646 and 647 ). Its use, however, is attended by a risk of ureteral obstruction resulting from blood clots. Unrelenting, brisk hematuria is best managed with a course of transfusion therapy

designed to maintain the Hb S concentration below 40%. The nephrotic syndrome is an infrequent but well-documented complication of sickle cell anemia that occurs in adolescents and adults. The syndrome may be associated with hypertension, hematuria, and progressive renal insufficiency culminating in renal failure ( 648 , 649 ). Pathologic lesions include glomerular enlargement and focal segmental glomerulosclerosis ( 624 , 625 , 648 , 650 , 651 ). In more advanced disease, a lesion that resembles membranoproliferative glomerulopathy has been described ( 652 ); immune complex nephropathy has also been reported ( 653 ). Glomerular enlargement is probably secondary to the increased glomerular filtration rate and effective renal plasma flow that are found in children but that decline to subnormal levels with increasing age or from adverse effects of nonsteroidal antiinflammatory agents ( 654 , 655 ). In adults with glomerulopathy and end-stage renal disease, the mortality rate was 40% ( 655 ). Microalbuminuria occurs in 46% of children between the ages of 10 to 18 years ( 656 ) and is directly related to age and degree of anemia ( 652 ). Approximately one-fourth of adult sickle cell patients have at least 1+ proteinuria, and 7% have serum creatinine concentrations above the normal range ( 651 ). Administration of enalapril, an angiotensin-converting enzyme inhibitor, reduces proteinuria, suggesting that glomerular capillary hypertension may be a pathogenic factor in sickle cell nephropathy ( 657 ). The overall incidence of hypertension in patients with Hb SS is 2 to 6%, compared with a published incidence of 28% for the black population in the United States ( 658 ). Recent data from the CSSCD confirmed that individuals with sickle cell disease have a significantly lower blood pressure than the general population, but hypertension is still a risk factor for stroke and increased mortality ( 659 ). Intermittent hypertension occurring during sickle cell crises and associated with transient elevation of plasma renin activity has been attributed to the reversible sludging of red cells in the small vessels of the kidney ( 660 ). Renal failure, which occurs in approximately 4% of patients with sickle cell anemia at a median age of onset of 23 years ( 661 ), is a significant cause of mortality in adults ( 232 ). The preazotemic manifestations of hypertension, proteinuria, and increasingly severe anemia predict end-stage renal failure with an average survival (despite dialysis) of 4 years after diagnosis ( 661 ). Management of renal failure is the same as that for renal insufficiency owing to other causes. Both hemodialysis ( 649 ) and peritoneal dialysis, when used in conjunction with a transfusion program, are efficacious in transiently correcting uremic complications. Erythropoietin is of value in correcting the worsened anemia associated with renal failure ( 662 ). The role of renal transplantation has not been well established because of limited numbers of patients and posttransplant problems of increased pain crises, graft thrombosis, and recurrence of sickle nephropathy ( 663 ). A report from the North American Pediatric Transplant Cooperative Society described nine patients with end-stage sickle cell nephropathy for whom graft survival was 71% at 2 years after transplant ( 664 ). In another recent report, 82 patients with end-stage sickle cell nephropathy received renal allografts ( 665 ). The short-term result was similar to that seen with other causes of end-stage renal disease, but the long-term outcome was diminished. Pharmacologic doses of exogenous erythropoietin have been effective in correcting anemia, but higher hematocrits have been associated with increased pain crises ( 666 ). Recently, a patient with intrahepatic cholestasis and renal failure was successfully transplanted with a combination of liver and kidney ( 667 ), but a combined bone marrow/renal transplant, which would be theoretically advantageous, has not been reported.

**Eyes** A variety of ocular lesions result from occlusion of the small vessels of the eye by sickled erythrocytes ( Fig. 40.10 ). The prominence of end arterioles within the retina renders this tissue especially vulnerable to irreversible injury after vascular occlusion.



**Figure 40.10.** Ocular abnormalities in sickle cell anemia. **A:** “Comma” vascular sign: superficial conjunctival vessel that contains densely packed sickled cells ( *arrow*). **B:** Widened veins and tortuous large vessels of the retina. **C:** Large preretinal hemorrhage of approximately 2 weeks’ duration. There is partial resorption and exposure of a darkened area that was the probable site of intraretinal hemorrhage. **D:** Old pigmented chorioretinal scar. See [Color Plate](#). (Photographs by Professor Mansour Armaly, The George Washington University Medical Center.)

Sludging of blood in conjunctival vessels is responsible for the so-called conjunctival sign ( [668](#), [669](#) ), which consists of dark red, comma-shaped or corkscrew-shaped vascular fragments that appear to be isolated from other vessels. The anomalous segments are seen most often in that part of the temporal bulbar conjunctiva covered by the lower lid. A direct relationship between the prominence of these saccular segments and the number of ISCs on blood smears has been noted ( [176](#), [670](#) ). Vasocclusive disease of the retina is responsible for both nonproliferative and proliferative (neovascular) changes ( [671](#), [672](#) and [673](#) ). The former consist of “salmon patches,” produced by small intraretinal hemorrhages; iridescent spots, representing collections of iron-loaded retinal macrophages; and schisis cavities, left after resorption of blood. Hemorrhages that break into the potential space between the sensory retina and pigment epithelium stimulate pigment production and migration, giving rise to black, disc-shaped scars known as *black sunbursts*. Proliferative changes begin with the formation of arteriovenous anastomoses, followed by the development of vascular fronds resembling sea fans ( [674](#) ). Immunohistochemical techniques have been used to demonstrate the association of vascular endothelial growth factor and fibroblast growth factor with sea fan formation ( [675](#) ). Vessels grow anteriorly toward the preequatorial, ischemic portion of the retina. Inspection of sea fans with ultraviolet light after the intravenous injection of fluorescein usually reveals small leaks into the vitreous. Major hemorrhages from sea fans that extend into the visual axis can generate visual symptoms. More often, however, they are confined to the peripheral portions of the retina and go undetected except by ophthalmoscopy. With time, repeated vitreous hemorrhages cause vitreous degeneration and vitreoretinal traction, which in turn produces retinal holes, tears, and detachment. Although these changes may culminate in loss of vision, they do so less often in association with Hb SS than in association with Hb SC disease ( [674](#), [676](#), [677](#) and [678](#) ). No correlation has been found between retinopathy and age, sex, systemic complications, and various hematologic parameters except Hb F level, which is higher in less affected patients ( [677](#) ). Proliferative retinal disease may be arrested satisfactorily by using xenon arc or argon laser photocoagulation or cryocoagulation ( [176](#) ). These procedures not only seal off the feeder vessels of neovascular patches and coagulate vascular leaks, but also promote the absorption of intraretinal and subretinal fluid by producing chorioretinal adhesions. Vitreous hemorrhages can be removed by pars plana vitrectomy followed by photocoagulation. Retinal detachment is treated by using standard surgical techniques, taking special precaution to avoid anterior segment ischemia. An additional ocular complication of sickle cell disease is hyphema. Bleeding into the anterior chamber leads to trapping of sickled

red cells, mechanical obstruction of the outflow apparatus, compromised circulation of the aqueous humor, and increased intraocular pressure, which may result in sudden blindness ( 678 , 679 ). This complication, which also can occur with sickle cell trait red cells, may be effectively managed by lowering intraocular pressure through anterior chamber paracentesis. Mild edema of the eyelids is frequently seen in association with vasoocclusive pain crises, but more significant sickle “orbitopathy” has been described in approximately 20 patients ( 281 , 680 , 681 ). A vasoocclusive process in the marrow space around the orbit may result in frontal headache, fever, eyelid edema, and orbital compression. Subperiosteal hematomas are common and appear to result from bone marrow infarction. Although supportive care is usually adequate, the presence of optic nerve dysfunction or unusually large hematomas may require surgical evacuation to prevent loss of vision ( 680 ).

**Leg Ulcers** Breakdown of the skin over the malleoli and distal portions of the legs is a recurring problem during adult life ( Fig. 40.11 ). Stasis of blood in the small vessels supplying these areas may interfere with the healing of minor traumatic abrasions. Venous incompetence detected by Doppler ultrasonography was more frequent in Jamaican patients with Hb SS than in controls and was highly associated with leg ulcers ( 682 ). These were observed in 2.5% of sickle cell patients over 10 years of age in North America ( 683 ), but they affect as many as 75% of adults with sickle cell anemia who live in tropical areas ( 684 ). A number of other risk factors have been identified. Ulcers are common in patients with Hb SS but quite rare in those with Hb SC disease or Hb S  $\beta^+$ -thalassemia ( 683 ). The presence of  $\alpha$ -thalassemia with either three or two  $\alpha$ -globin genes reduces the incidence of ulcers. They are more common in men than in women and in those older than 20 years of age. There is a positive correlation with a low steady-state Hb concentration and with a low level of Hb F ( 683 ).



**Figure 40.11.** Chronic leg ulcers in a patient with sickle cell anemia. (Courtesy of AF Jonas, Jr.)

The ulcers typically form a shallow depression with a smooth and slightly elevated margin; often, they have a surrounding area of edema ( 374 ). There may be exudation, crusting, and granulation at the base. Secondary infection of the ulcer with undermining of the edges and progressive extension are common. Single or multiple bacterial organisms may be cultured from the lesions and may contribute to their refractoriness. Healing leaves a thinned, depigmented epithelium often surrounded by areas of hyperpigmentation and hyperkeratosis. This fragile epithelium is likely to break down with minimal trauma or edema, leading to recurrence rates greater than 70% ( 685 ). Healing of leg and ankle ulcerations is facilitated by bed rest, elevation of the affected extremities, wet-to-dry dressings, and eradication of documented wound infections with systemically administered antibiotics. When acute inflammation has subsided, occlusive zinc oxide-impregnated gel boots (Unna boots) are applied, and partial ambulation is permitted. In refractory or progressive cases, the healing process may be enhanced if the level of Hb S is maintained below 40% with transfusions. Split-thickness skin grafting may be necessary ( 686 ). Zinc deficiency has been invoked to explain slow tissue healing ( 687 ), and oral zinc therapy



may hasten healing in some patients ( 688 ). A number of alternative approaches have also been described in recent years. Topical oxygen using a local tent to envelop an ulcer can be used on an outpatient basis ( 689 ). Erythropoietin and hydroxyurea may improve healing by increasing fetal or total (or both) Hb levels ( 690 , 691 ). The use of collagen matrix dressings (RGD peptide matrix) in a controlled collaborative trial resulted in greater ulcer closure ( 692 ). Antithrombin III in combination with subcutaneous heparin ( 693 ) and pentoxifylline ( 694 ) have also yielded anecdotal benefit.

**Pregnancy** ( 695 ) poses potentially serious problems for the woman with sickle cell anemia, as well as for the fetus and neonate. In the absence of medical supervision, the mortality for mother and infant is as high as 20% and 50%, respectively ( 696 ). With optimal care, mortality and morbidity are reduced substantially ( 697 , 698 ), even in difficult settings in Africa ( 699 ). The jeopardy imposed by pregnancy is explained in part by marginal health status before conception and in part by the sinusoidal circulation of the placenta, whereby a high degree of oxygen extraction provides an excellent milieu for sickling, stasis, and infarction ( 374 ). Although life-threatening complications generally are not encountered until the third trimester, an increased incidence of pyelonephritis, hematuria, and thrombophlebitis is noted throughout pregnancy ( 698 ). Anemia is more severe and may be compounded by folate deficiency. During late pregnancy and the postpartum period, major infarctions may involve the lungs, kidneys, or brain. Toxemia, heart failure, and postpartum puerperal endometritis occur with greater frequency in women with sickle cell anemia than in the general population ( 697 , 698 , 700 , 701 and 702 ). The risk to the fetus is no less serious, with an overall survival rate of only approximately 58% compared with 87% in the general population. Fetal wastage results from a combination of abortion and stillbirth ( 698 , 700 ). The incidence of congenital malformations or susceptibility to complications is comparable to that shared by all preterm infants ( 697 ). Striking hyperbilirubinemia of cord blood owing to a reversal of the usual maternal-fetal bilirubin gradient has been observed ( 696 ). Infants born to women with sickle cell anemia are at greater risk of preterm birth, low birth weight, being small for gestational age, and neonatal jaundice ( 701 ). Infants small for their gestational age are two and one-half times more likely than in the general population ( 701 ); 21% of infants in a recent CSSCD report were small for their gestational age ( 702 ). Possible etiologic factors are severe maternal anemia; frequent episodes of vasoocclusion leading to hypoperfusion and hypoxia of the placenta; increased risks of abruptio placentae, placenta previa, and toxemia of pregnancy; diminished maternal nutrition; and increased narcotic use in the mother. Preeclampsia and acute anemic events were risk factors identified by the CSSCD ( 702 ). The increased risk of preterm labor and prematurity may be caused by similar factors including anemia, abruptio placentae, placenta previa, toxemia, and narcotic use, as well as increased urinary tract infection and chorioamnionitis. A high maternal Hb F level may have an ameliorating effect on perinatal mortality ( 703 ). The efficacy and safety of various methods of contraception have not been investigated systematically in women with sickle cell disease. Despite a theoretical possibility of enhancing thrombotic risk, low-estrogen-dose birth control pills are sometimes recommended. Recent studies in Nigeria and Brazil found no adverse effects from the progestational contraceptive implant and a possible improvement in fetal Hb level ( 704 , 705 ). An association of pain crises and menstrual periods seen in 37% of women suggests the use of a continuous combined contraceptive pill regimen or Depo-Provera to induce amenorrhea in severe cases ( 706 ).

## Prognosis

Prognostic expectations for persons with sickle cell anemia have undergone dramatic change as a result of early diagnosis, patient education, and therapeutic intervention. In a

retrospective review of autopsy cases from the United States in 1972, 20 to 30% were younger than 5 years of age at the time of death ( 374 ). The median age at death was 14 years, and survival beyond 40 years of age was unusual. In a 1976 report of a screening program involving the use of cord blood, 31% of children diagnosed at birth died before 15 years of age at a mean age of 2 years ( 707 ). The disproportionate number of reported deaths occurring in early childhood was the result of overwhelming bacterial infections and splenic sequestration crises ( 265 , 708 ).

Newborn screening for sickle cell disease and greater awareness of the unique needs of affected infants and children are effecting a change in prognosis ( 709 , 710 ). The simple adoption of a standardized protocol for the management of febrile illnesses reduced the mortality in children with sickle cell anemia 0 to 5 years of age from 3.2/100 patient-years to 1.4/100 patient-years ( 432 ). In 1989, the CSSCD documented an 85% survival rate at 20 years of age ( 711 ). In that study, peak incidence of death (mostly resulting from infections) occurred between 1 and 3 years of age. Cerebrovascular accidents and traumatic events exceeded infections as a cause of death in the second decade of life. Mortality data for young children with Hb SS born in the early 1990s in three large states with newborn hemoglobinopathy screening indicated that 1% died as a result of sickle cell disease-related causes during the first 3 years of life ( 712 ). In another retrospective review, mortality rates of black children with sickle cell disease decreased by 40 to 50% between 1968 and 1992 ( 713 ).

In a report from the CSSCD ( 232 ), causes of death for 209 adult patients who died during the study were analyzed. Among adults with Hb SS, the median age at death was 42 years for males and 48 years for females. However, among those with Hb SC disease, the median age at death was 60 years for males and 68 years for females. Only 18% of deaths occurred in patients with chronic organ failure; of these, 58% had chronic renal failure, 29% had chronic congestive failure, and 23% had chronic debilitating stroke. One-third of the deaths occurred in the context of hospitalization for an acute painful episode, ACS, or stroke, which was predominantly hemorrhagic. Six percent died with infection, 6% had perioperative deaths, and 6% died from trauma. Miscellaneous causes included cancer, gastrointestinal bleeding, and fulminant hepatic failure. In approximately 23%, the exact cause of death was unknown. Statistical modeling revealed that in patients with sickle cell anemia, ACS, renal failure, seizures, baseline white cell count above 15,000/mm<sup>3</sup>, and a low level of fetal Hb were associated with an increased risk of early death. Early mortality was highest among patients whose disease was symptomatic. It was concluded that a high level of fetal Hb is probably a reliable childhood forecaster of improved adult life expectancy.

**DETERMINANTS OF SEVERITY** Extensive data from the CSSCD highlighting frequency/incidence and risk factors for various complications of sickle cell disease have been published. Because of the large number of patients involved and the efforts to avoid patient selection bias, these data represent the most ambitious attempt to describe the natural history of sickle cell disease to date. A large, carefully followed cohort of sickle cell patients from Jamaica described in numerous publications and a textbook provides another major source of data for prognostic analysis ( 2 ). Sickle cell anemia is remarkably variable in its clinical expression, even among affected members of the same family. Whereas many individuals have recurrent, severe complications, others enjoy a relatively benign, virtually symptom-free course ( 714 ). The calculated extent of polymer formation is purported to correlate with the clinical severity of different sickling syndromes ( 194 ). Occasionally, patients with apparently mild sickle cell anemia are found on further study to be doubly heterozygous for Hb S and another Hb variant having the same electrophoretic mobility as Hb S or to be heterozygous for both Hb S and HPFH. That

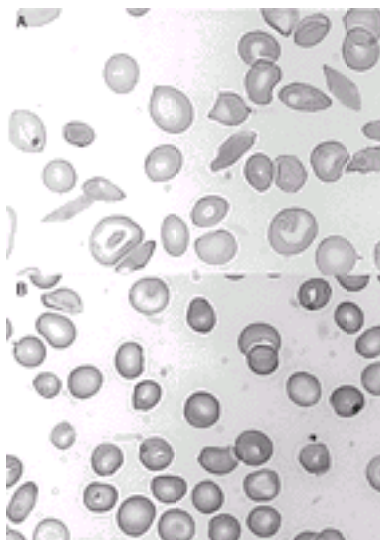


clinical heterogeneity is related to genetic variables is suggested by the tendency for differences in disease severity to follow selected geographic and ethnic lines. In the eastern oases of Saudi Arabia, for example, sickle cell anemia is clinically benign ( [715](#), [716](#), [717](#) and [718](#) ), whereas in western Saudi Arabia, it is comparable in severity to that seen in black Americans ( [719](#) ). At least four important modulators of hematologic and clinical severity have been identified: Hb F level, the presence of  $\alpha$ -thalassemia, the  $\beta$ -globin gene cluster haplotype, and gender ( [720](#), [721](#), [722](#), [723](#) and [724](#) ). Because Hb F is excluded from the Hb S polymer, individuals with relatively greater amounts of Hb F should have less severe disease than those with less Hb F. The level of Hb F in patients with sickle cell anemia is determined by the number of red cells containing Hb F (F cells), the Hb F concentration within F cells, and the survival of F cells ( [725](#) ). The proportion of reticulocytes containing Hb F is relatively constant over time, but it varies greatly among affected individuals (2 to 50%). Other confounding factors in studies to determine the prognostic significance of Hb F include the variability in techniques used to measure fetal Hb and the fact that Hb F levels in sickle cell patients gradually decline over a long period of childhood and do not reach equilibrium until 12 years of age ( [726](#) ). The expression of high levels of Hb F and F reticulocytes may be inherited as an autosomal-dominant characteristic ( [727](#), [728](#) ). Five factors have been shown to influence the 20-fold variation of fetal Hb in sickle cell anemia: age, sex,  $\alpha$ -globin gene number,  $\beta$ -globin haplotype, and the F-cell production locus. In the eastern province of Saudi Arabia ( [715](#), [729](#) ) and in Kuwait ( [730](#) ), Iran ( [731](#) ), India ( [718](#) ), and the West Indies ( [732](#) ), mild disease is associated with Hb F levels of 15 to 30%. Levels of Hb F influence the age at which symptoms develop ( [268](#) ) and partially determine the risk of splenic sequestration crisis ( [267](#), [406](#) ), stroke ( [322](#), [324](#) ), ACS ( [345](#) ), leg ulcers ( [683](#) ), pain crises ( [278](#) ), loss of spleen function ( [271](#) ), and mortality ( [662](#) ). Among patients of West African ancestry, higher levels of Hb F are associated with an improvement in hematologic features ( [274](#), [733](#) ), but an improvement in measures of clinical severity related to increased Hb F has been difficult to establish. One study concluded that Hb F levels substantially lower than 20% conferred minimal benefit on disease severity, indicating a threshold effect ( [734](#) ). However, evidence from the CSSCD indicates that even when the fetal Hb level is low, small increments in the level may have an ameliorating effect on the pain rate and may ultimately improve survival ( [278](#) ). The limited capacity of Hb F levels to predict disease severity, however, does not negate the importance of Hb F production. Hb F levels are determined not only by synthetic rates but also by the extent to which F cells are enriched by differential cell survival. Thus, high levels of Hb F may reflect increased synthesis, resulting in mild disease, or greater amplification through accelerated destruction of cells containing no Hb F, a manifestation of more severe disease ( [725](#) ). Co-inheritance of sickle cell anemia and  $\alpha$ -thalassemia is not an unusual event. Nearly 30% of black Americans have a single  $\alpha$ -gene deletion, and in approximately 2%, deletion of two of the four  $\alpha$ -globin genes has been found. Hematologic studies provide support for the clinical relevance of  $\alpha$ -thalassemia. Subjects with sickle cell anemia and  $\alpha$ -thalassemia have a higher Hb concentration, lower MCV and MCHC, fewer ISCs, a lower reticulocyte count, lower serum bilirubin concentration, and relatively more Hb A<sub>2</sub> than subjects without concurrent  $\alpha$ -thalassemia ( [125](#), [735](#), [736](#), [737](#), [738](#) and [739](#) ). The  $\alpha$ -gene deletion also is associated with improved cell deformability ( [740](#) ), a decreased fraction of dense cells ( [740](#), [741](#) ), protection against cation leak ( [742](#) ), and improved red cell survival ( [743](#) ). There is relatively little effect of  $\alpha$ -thalassemia on Hb F levels ( [736](#), [737](#) ), although in patients with the Senegal haplotype, Hb F levels are higher ( [716](#) ). The mechanism responsible for these differences in hematologic status is probably mediated by a decrease in the MCHC, because the extent and the rate of Hb S polymerization are highly dependent on the cellular concentration of Hb S. Early reports indicated that the frequency of  $\alpha$ -thalassemia increases progressively with the age of patients with sickle cell anemia ( [744](#), [745](#) ).

However, a subsequent larger study demonstrated that coexistent  $\alpha$ -thalassemia is associated with a diminished mortality risk in patients older than 20 years of age ( [232](#) ). The rheologic benefits of more deformable  $\alpha$ -thalassemic sickle cells are offset by rheologic impairment associated with the greater viscosity of a higher hematocrit induced by  $\alpha$ -thalassemia ( [746](#) ). Thus,  $\alpha$ -thalassemia is associated with more frequent vasoocclusive pain crises by virtue of its effect on hematocrit ( [278](#) ). Osteonecrosis and perhaps sickle retinopathy occur more often in sickle cell subjects with coexistent  $\alpha$ -thalassemia ( [515](#), [516](#), [739](#), [747](#), [748](#) and [749](#) ). On the other hand, the incidence of stroke is lower in subjects with sickle cell anemia and  $\alpha$ -thalassemia ( [750](#) ). Sickle cell trait is also influenced by  $\alpha$ -thalassemia. Subjects with lower fractional content of Hb S associated with  $\alpha$ -thalassemia have less severely impaired urinary-concentrating ability ( [751](#), [752](#) ). Genetic factors that modulate the phenotype of sickle cell disease are now known to be associated with polymorphic sites within the  $\beta$ -globin-like gene cluster. These are identifiable by restriction fragment length polymorphisms and are referred to as  $\beta$ -globin gene haplotypes ( [753](#) ). The haplotypes are characteristic of different populations; most patients with sickle cell anemia in the United States have the Benin haplotype, with fewer having the Bantu (Central African Republic) and Senegal types. The origin of these genes in malarial regions of Africa is shown in [Figure 40.1](#) ( [11](#), [754](#), [755](#) ). In Mediterranean populations, the  $\beta^S$  gene is usually associated with a Benin haplotype, whereas the haplotype found in Eastern Saudi Arabia and parts of India resembles but is distinct from that of Senegal. The Senegal haplotype is associated with higher levels of Hb F ( [716](#), [755](#), [756](#) and [757](#) ) and with fewer hospitalizations and painful episodes ( [758](#), [759](#) ). By contrast, the Bantu haplotype has been associated with the highest incidence of organ damage, particularly renal failure ( [661](#) ). More recently, fetal Hb levels in sickle cell patients and normal individuals have been found to be partially controlled by an X-linked gene located at Xp22.2 called the *F-cell production locus* ( [723](#) ). Female gender increases the expression of Hb F both in patients with sickle cell anemia and in normal individuals ( [723](#) ). Multiple regression analysis in one study showed that the F-cell production locus was the strongest predictor of Hb F level, although approximately one-half of the variation was not accounted for ( [724](#) ). When  $\beta$ -globin haplotype and gender were considered together, the Hb F level in female patients of all haplotype groupings was higher than that in male patients, with the highest level occurring in female patients with one Senegal haplotype chromosome (Hb F, 12.8%) ( [760](#) ). Thus, gender and  $\beta$ -globin gene cluster haplotype interact in the modulation of Hb F and Hb level in sickle cell anemia. In Jamaica, high levels of Hb F (and a normal  $\alpha$ -globin gene complement) have been associated with a benign disease, which occurred in 15% of patients ( [761](#) ). A recent report from the GSSCD involved a cohort of 392 infants with Hb SS or Hb SB<sup>0</sup>-thalassemia who were followed for an average of 10 years beginning at younger than 6 months of age. Eighteen percent had an adverse outcome, defined as death, stroke, frequent pain, or recurrent ACS ( [234](#) ). Three statistically significant predictors of an adverse outcome could be identified at 2 years of age: Hb level less than 7 g/dl, leukocytosis in the absence of infection, and an episode of dactylitis before 1 year of age. Although these are easily identifiable manifestations of sickle cell disease, other investigators did not confirm this finding ( [762](#) ). Sickle cell disease should no longer be considered a single gene disorder ( [763](#) ) because a number of epistatic and pleiotropic genes have been defined ( [764](#), [765](#) ). Microchip array technology and high throughput sequencing may be used in the future to identify expressed genes that predict clinical outcome, and recently, single nucleotide polymorphisms have been used to identify alleles of VCAM-1 associated with protection from stroke ( [766](#) ).

## Laboratory Features

**RED BLOOD CELLS** In sickle cell anemia, a moderately severe normocytic, normochromic anemia manifests by 3 months of age ( [270](#) ) and persists throughout life ( [266](#) ). The average Hb concentration is 8.0 g/dl, with a range from approximately 6.0 to 10.0 g/dl. Mean Hb levels vary with gender and with age; they are higher in adult men compared with women and higher in males between the ages of 20 and 39 years ( [767](#) ). In adults with Hb SS, the mean MCV is approximately 90 fl, and the mean MCHC is approximately 34.0 g/dl ( [767](#) ). The MCV and MCHC are substantially lower (mean, 72 fl and 32.5 g/dl, respectively) in patients with concurrent  $\alpha$ -thalassemia minor ( $-\alpha/-\alpha$  genotype) ( [735](#) , [736](#) , [737](#) and [738](#) ) and in children with incidental iron deficiency ( [768](#) ). The MCV in males with sickle cell anemia is below that for females in almost all age groups ( [769](#) ); this may reflect the higher Hb F concentration seen in female patients. Modern automated blood cell counters (based on aperture and impedance or light scatter techniques) may result in overestimation of the MCV and underestimation of the MCHC ( [756](#) , [770](#) ) because of the inability of dehydrated, dense sickled red cells to deform like normal cells as they pass through the narrow counter aperture. However, the use of two-angle light scattering technology permits accurate measurement of MCV and MCHC and generation of histograms of these properties ( [771](#) ). This allows routine quantitation of the percentage of dense, dehydrated red cells, which enhances the monitoring of therapeutic interventions. Blood smears contain variable numbers of sickled forms, target cells, cigar-shaped cells, and ovalocytes ( [Fig. 40.12](#) ). The great variety of sickle cells is best appreciated by scanning electron microscopy ( [Fig. 40.2](#) ). The morphologic features of accelerated erythropoiesis, which include polychromatophilia, basophilic stippling, and normoblastosis, are prominent. The mean reticulocyte count is approximately 10%, with a range of 4 to 24% ( [767](#) ). Howell-Jolly bodies and Pappenheimer bodies reflect functional asplenia. Numerous pits in red cell membranes, also a feature of the asplenic state, require phase interference contrast microscopy for visualization ( [271](#) , [450](#) ). With transmission electron microscopy, dense aggregates of Hb can be seen adjacent to red cell membranes ( [772](#) ).



**Figure 40.12.** Blood smears of patients with hemoglobin (Hb) SS and Hb SC disease. **A:** Red blood cell morphology in sickle cell anemia is characterized by sickled forms (dense elongated cells with pointed ends), target cells, ovalocytes, and polychromatophilia. **B:** Hb SC disease is characterized by target cells, relatively few sickled forms, and a small proportion of cells that contain dark, blunt protuberances (hemoglobin “crystals”). See

## Color Plate.

Erythrokinetic studies performed in the steady state indicate a four- to fivefold increase in red cell production and erythron iron turnover and a comparable shortening of red cell survival. The curves of cell survival obtained with  $^3\text{H}$ - or  $^{32}\text{P}$ -labeled diisopropylfluorophosphate indicate a random rather than a senescent mode of cell destruction ( [402](#), [773](#), [774](#) ). This pattern of cell loss is explained by the lack of dependence of ISC formation on cell age ( [83](#) ). Chronic hemolysis, some of which is intravascular, is responsible for an increase in endogenous carbon monoxide generation and for elevated serum levels of unconjugated bilirubin and heme proteins ( [215](#) ). The serum haptoglobin level is decreased. Serum immunoreactive erythropoietin levels are lower than those noted in association with other anemias of comparable severity ( [775](#) ).

**WHITE BLOOD CELLS** The white blood cell count is consistently elevated owing to an increase in the number of mature granulocytes. The mean leukocyte count under steady-state conditions is  $12$  to  $15 \times 10^9/\text{L}$ , with a range of  $6$  to  $20 \times 10^9/\text{L}$  ( [769](#) ). This increase is explained to a large extent by a shift of granulocytes from the marginated to the circulating compartments (see [Chapter 10](#)) ( [226](#) ). Both total and segmented leukocyte numbers increase during vasoocclusive crises and infections, but only with bacterial infections does a consistent increase occur in nonsegmented neutrophils, often to levels above  $1 \times 10^9/\text{L}$  ( [227](#) ).

**PLATELETS AND COAGULATION** The platelet count is increased (mean, approximately  $440 \times 10^9/\text{L}$ ), reflecting reduced or absent splenic sequestration ( [251](#), [769](#), [776](#) ). Totals of both platelets and megathrombocytes decrease during vasoocclusive crises ( [251](#), [252](#) ). Platelet aggregation is decreased, the likely result of *in vivo* platelet activation ( [253](#), [777](#) ). The plasma  $\beta$ -thromboglobulin level is elevated ( [254](#) ). The contact factors are decreased ( [257](#) ), whereas factor VIII activity, fibrinogen concentration, and fibrinolytic activity are increased ( [778](#), [779](#) and [780](#) ). Some of these alterations likely reflect vascular endothelial damage inflicted by the sickling process and not primary perturbations responsible for crises.

**OTHER LABORATORY TESTS** The sedimentation rate is consistently low, even in the presence of anemia, hyperfibrinogenemia, and active inflammation, because of the failure of sickle cells to undergo rouleaux formation. The serum lactate dehydrogenase level, which is increased in the steady state because of hemolysis, increases further during vasoocclusive episodes ( [781](#) ). The level of serum alkaline phosphatase also increases during symptomatic crises ( [782](#) ).

## Diagnosis

The diagnosis of sickle cell anemia rests on the electrophoretic or chromatographic separation of hemoglobins in hemolysates prepared from peripheral blood. The predominant Hb is S; Hb F is present in varying concentrations; and Hb A2 is normal. There is no Hb A. Electrophoresis using cellulose acetate and an alkaline buffer is rapid, inexpensive, and effective in the separation of normal hemoglobins from common variants. Whole blood, blood specimens dried on filter paper, or Hb solutions may be used ( [783](#) ). However, several relatively rare Hb variants have an electrophoretic mobility identical to that of Hb S on cellulose acetate. Because most of these variants do not copolymerize with Hb S on deoxygenation, the doubly heterozygous states are seldom associated with the clinical and hematologic features of sickling. The interaction of Hb S with  $\beta^0$ -thalassemia also gives an electrophoretic pattern that is indistinguishable from that of homozygous sickle cell anemia. In general, the appropriate diagnosis can be made by taking into consideration associated hematologic data ( [Table 40.3](#) ). However, detailed family studies, Hb separation by isoelectric focusing or high-performance liquid

chromatography (HPLC), globin-chain electrophoresis or structural analysis of Hb (by protein chemistry, mass spectrometry or sequencing of polymerase chain reaction (PCR)-amplified DNA) may be required to characterize accurately the genotypic basis for a sickling disorder.

**TABLE 40.3. Differential Diagnosis of Electrophoretic Pattern of Hemoglobin (Hb) SS at pH 8.6**

| Diagnosis                                       | Symptoms | Anemia             | Red Blood Cell Morphology                     | Distinguishing Features   |
|---|----------|--------------------|---|---|
| Sickle cell anemia (Hb SS)                      | Present  | Moderate or severe | ISCs, target cells                            | —   |
| Hb S/ $\beta$ <sup>0</sup> -thalassemia disease | Present  | Moderate or severe | ISCs, target cells, hypochromia, microcytosis | Hb A <sub>2</sub> increased; mean cell volume and mean corpuscular Hb concentration decreased |
| Hb S/hereditary persistence of fetal Hb         | Absent   | Absent             | Target cells                                  | Hb F evenly distributed in erythrocytes   |
| Hb S/D-Punjab disease                           | Present  | Moderate           | ISCs, target cells                            | Hb S and D separable on citrate agar at acid pH   |

ISC, irreversibly sickled cell.

A variety of simple tests permit detection of Hb S. The sickling phenomenon can be induced by sealing a drop of blood under a coverslip to exclude oxygen or by adding agents that induce chemical deoxygenation, such as 2% sodium meta-bisulfite or sodium dithionite (784). The decreased solubility of deoxy Hb S forms the basis for tests in which blood is added to a buffered solution of a reducing agent such as sodium dithionite. Hb S is insoluble and precipitates in solution, rendering it turbid, whereas solutions containing hemoglobins other than Hb S remain clear (785). Hyperglobulinemia and other sickling hemoglobins may cause false-positive results (786, 787); false-negatives may result from the addition of an inadequate number of red cells. Neither the sickle cell preparation nor solubility tests differentiate sickle cell anemia from sickle cell trait or detect Hb variants that interact with Hb S. Thus, they should never be used as a primary screening test. Their principal value has been as an adjunct to electrophoretic identification of Hb S.

Quantitation of Hb A<sub>2</sub> is performed by minicolumn chromatography or HPLC. Quantitation of Hb F can be carried out by alkali denaturation, HPLC, or radioimmunoassay (788, 789 and 790). The distribution of Hb F in red cells may be analyzed by its resistance to acid elution (791) or, more precisely, by Hb F-specific antibodies that measure the number of “F cells” (792).

Although the diagnosis of Hb SC disease is straightforward, that of Hb S $\beta$ -thalassemia may sometimes be problematic. In Hb S $\beta$ <sup>+</sup>-thalassemia, there is a preponderance of Hb S, with Hb A comprising 5 to 30% of the total. This must be distinguished from sickle cell trait in which Hb A exceeds Hb S and from the presence of Hb A resulting from red blood cell transfusions within the previous 3 to 4 months. Hb S $\beta$ <sup>0</sup>-thalassemia produces an electrophoretic pattern that is visually indistinguishable from that of sickle cell anemia,



but a diagnosis can often be made by the presence of an elevated Hb A<sub>2</sub> level and a decreased MCV. However, because sickle cell anemia with coincident  $\alpha$ -thalassemia also has a phenotype with reduced MCV and elevated Hb A<sub>2</sub>, family or DNA-based studies may be necessary to make this distinction.

**NEONATAL DIAGNOSIS** The first statewide newborn hemoglobinopathy screening program was initiated in New York in 1975 (793), but the impetus for universal screening came from the demonstration that early diagnosis and comprehensive care could reduce morbidity and mortality in infants with sickle cell anemia, particularly through the prevention of pneumococcal sepsis with penicillin prophylaxis (467). A National Institutes of Health Consensus Conference concluded that every child should be screened early for sickle cell disease (794), leading to statewide newborn screening programs in at least 41 states (795). Universal rather than targeted screening is necessary to insure that all with disease are identified and none are discriminated against or stigmatized (794). In California, it was shown that 58 nonblack infants with sickle cell disease would not have been diagnosed over a 4-year period if screening were confined to blacks (796). In 1990, more than 3.4 million newborns were tested, and approximately 2800 with clinically significant Hb variants were detected (795). Most programs use dried blood spots on filter paper because Hb testing can easily be integrated into existing metabolic programs with established methods of sample collection, specimen processing, data management, and quality control (797). A comparison of liquid cord blood and heel puncture blood on filter paper showed that both systems were subject to a small error rate, primarily involving carrier phenotypes, but that cord blood testing was more prone to lead to inconclusive results and noncompliance in sample collection (798). Isoelectric focusing and HPLC have replaced cellulose acetate electrophoresis in most screening programs (798, 799). The primary goal of newborn screening for sickle syndromes is reduction of morbidity and mortality by identifying affected infants at birth, initiating prophylactic penicillin early, and providing ongoing care by knowledgeable health professionals (797). The number of early deaths avoided has been estimated at 0.6 to 1.2/100 births (800). All cases of suspected disease still must be confirmed with a separate sample from the infant because clerical errors may be encountered (798). A common problem is the need to establish a mechanism for educating and counseling parents of carriers detected by testing at birth (794). Using public health and state genetic program resources, it is possible to provide parents with individual counseling, education, and extended family testing (801). Prenatal education for expectant mothers, which includes information about newborn sickle cell screening, significantly increases the follow-up rate for infants with sickle cell trait and contributes to a greater retention of information (802). Each of the above techniques allows the detection of minor Hb components in the presence of large amounts of Hb F. The pattern in infants destined to develop sickle cell anemia comprises Hb F, a relatively small amount of Hb S, and no Hb A. Neonates doubly heterozygous for Hb S and  $\beta^0$ -thalassemia and for Hb S and HPFH have a Hb separation pattern indistinguishable from that for Hb SS. They may be differentiated by hemoglobinopathy testing of the parents or by repeat testing of the infant at a later age. Another potential pitfall is misdiagnosis of Hb S $\beta^+$ -thalassemia by incorrect identification of an FS or FAS (sickle cell trait) pattern rather than the correct FSA pattern (803). Molecular genetic analysis using PCR-based techniques may provide reliable confirmatory testing (e.g., for distinguishing Hb S $\beta^0$ -thalassemia from Hb SS) (804, 805). The combination of isoelectric focusing and HPLC also is an effective strategy for dramatically reducing the risk of errors (806).

**PRENATAL DIAGNOSIS** The clinical application of recombinant DNA techniques to the prenatal diagnosis of sickle cell anemia permits a high level of diagnostic accuracy with

relatively little risk to the fetus ( [807](#), [808](#) and [809](#) ). Guidelines for the ethical application of prenatal diagnosis have been developed ( [810](#), [811](#) ), and the use of routinely incorporating screening and counseling into the early prenatal care of populations at risk has been demonstrated ( [812](#) ). Initially, prenatal diagnosis required fetal blood sampling. More recently developed assays permit the use of DNA prepared from amniotic fluid cells obtained at 15 to 20 weeks' gestation or from a biopsy of chorionic villi obtained at 10 to 12 weeks' gestation. The latter technique is an outpatient procedure that involves passing a catheter through the cervix with ultrasonographic guidance ( [813](#), [814](#) ). It provides earlier diagnostic information, thereby permitting termination of pregnancy in the first trimester, when it is simpler, safe, and less psychologically stressful. The least invasive method of prenatal diagnosis uses fetal cells from the maternal circulation isolated by a variety of techniques such as multiparameter flow cytometry ( [815](#) ). A recent experimental technique uses preimplantation diagnosis ( [816](#), [817](#) ): *In vitro* fertilization is performed, and an unaffected embryo is implanted into the uterus. Recently, the first unaffected pregnancy resulting from identification of an unaffected embryo using *in vitro* fertilization and preimplantation genetic diagnosis was reported ( [818](#) ). Although prenatal diagnosis of fetuses conceived by couples at risk of having children with sickle cell disease is widely accepted in some countries ( [819](#) ), use of this technology has been infrequently requested by couples at risk in the United States. Several strategies have been successfully used for the analysis of fetal DNA. Methods that involve the use of restriction fragment length polymorphisms are indirect and suitable only for those cases in which the parents at risk can be shown to carry the appropriate linked polymorphism ( [820](#) ). The most widely used approach is based on the fact that the DNA mutation in the  $\beta^S$  gene is itself a cleavage site for the restriction enzyme Mst II ( [821](#), [822](#) ), which cleaves DNA at the normal sixth codon and, therefore, generates abnormally long DNA fragments with base mutations involving this codon. Synthetic oligonucleotides that are specific for the  $\beta^S$  nucleotide substitution also permit direct, rapid, and sensitive detection of the  $\beta^S$  gene ( [823](#), [824](#) ). The use of the PCR to amplify  $\beta$ -globin sequences enzymatically before restriction enzyme or oligonucleotide analysis greatly increases the sensitivity and speed of the procedure, making it possible to provide genetic diagnoses within a few hours ( [824](#), [825](#) ). The dot-blot method of allele-specific hybridization uses fixation of PCR-amplified target  $\beta$ -globin DNA to filters and hybridization of the filters with labeled probes complementary to  $\beta^A$  and  $\beta^S$  sequences ( [826](#) ); the reverse dot-blot method allows screening for multiple mutations simultaneously with a single hybridization ( [827](#) ). Prenatal screening of single-gene disorders from maternal blood is possible using cell-free fetal DNA obtained from maternal plasma ( [828](#) ).

## Treatment

Several recent review articles reflect the rapid pace of development of feasible and effective treatment options for patients with sickle cell disease ( [829](#), [830](#), [831](#), [832](#), [833](#), [834](#) and [835](#) ). In addition to prophylactic measures aimed at preventing specific complications of sickle cell disease, three treatment options have been increasingly used for overall management: chronic transfusion, hydroxyurea, and stem cell transplantation. Gene therapy remains a future goal.

**PREVENTIVE MEASURES** Until a safe and widely applicable mechanism for the prevention of intravascular sickling is found, a high priority must be placed on the prevention of complications. Because vasoocclusive crises are precipitated by infection, fever, dehydration, acidosis ( [269](#) ), hypoxemia, and cold exposure ( [598](#) ), measures to prevent or remedy these conditions assume importance. Optimal hydration is essential,



especially during febrile illnesses. In estimating fluid requirements, the hyposthenuria of sickle cell anemia, as well as increased insensible losses, must be considered. Because the liberal use of salicylates imposes an acid load, acetaminophen is probably the preferred antipyretic. Sudden transition to high altitude and exposure to situations likely to cause chilling should be avoided. The high risk of overwhelming pneumococcal disease in children mandates the use of penicillin prophylaxis and pneumococcal vaccination. Preventive measures and early medical intervention for febrile illnesses substantially decrease the incidence of meningitis and reduce mortality ( 427 ).

**BLOOD TRANSFUSION** One of the most effective therapeutic measures presently available is the transfusion of normal red cells ( 836 , 837 ). However, because of the complications of transfusion therapy, it is reserved for selected complications, such as severe anemia, progressive or recurrent organ damage, surgery, and certain severe acute vasoocclusive events ( 836 , 837 ). Transfusion therapy facilitates improved blood and tissue oxygenation, reduces the propensity for sickling by diluting host cells, and temporarily suppresses the production of red cells containing Hb S. With chronic transfusion support, splenic involution and fibrosis are reversed in some patients ( 838 , 839 ). The viscosity of deoxygenated sickle cell blood is disproportionately reduced by the addition of normal red cells. A mixture of one-fourth Hb A cells and three-fourths Hb S cells reduces the viscosity of deoxygenated blood by 50% ( 162 ). Accordingly, the relative number of Hb S-containing cells needs to be reduced only to approximately 40% to prevent most clinically significant vasoocclusive events ( 840 ). Replacement of patient cells with donor cells is readily accomplished by a limited exchange transfusion, in which patient blood is removed before or during packed cell transfusion ( 779 , 841 , 842 and 843 ). Repeated partial exchange transfusion, which can be performed through erythrocytapheresis, greatly reduces the net gain of iron ( 844 , 845 ). However, the long-term central venous access, which is often required, may be associated with an unusually high rate of catheter infection, thrombosis, and premature removal of the central line ( 846 , 847 ). Repeated simple transfusions are probably equally effective in terminating the consequences of *in vivo* sickling ( 848 ). Packed red cell transfusions at 3- to 4-week intervals generally are sufficient to maintain the relative number of donor cells in the circulation above 70%, but Hb S is more easily suppressed in some patients than others ( 849 ). Furthermore, chronic transfusion may result in recurrent splenomegaly and the additional problem of hypersplenism ( 850 ). Although effective in circumventing the numerous complications of sickle cell anemia ( 851 , 852 ), chronic transfusion therapy is limited by logistic and toxicologic considerations. The requisite commitment of personnel and blood resources is considerable, and the risks of hepatitis, alloimmunization, and hemosiderosis are cumulative and potentially life-limiting. Of individuals with sickle cell anemia, 18 to 36% become alloimmunized, considerably more than with other forms of anemia ( 853 , 854 ). The greater risk of alloimmunization in sickle cell anemia is primarily a result of racial differences between the blood donor and recipient populations. The development of multiple antibodies is a relatively common problem ( 854 ); antibodies against C, E, and Kell (K) antigens account for most of the alloantibodies. The use of racially matched and selected minor blood group antigen-matched blood for chronically transfused patients with sickle cell disease has been recommended to prevent alloimmunization ( 854 , 855 and 856 ). Hemolytic transfusion reactions are associated with as many as 3% of transfusions. Most occur several days after the transfusion and are accompanied by a falling hematocrit, hemoglobinuria, increased jaundice, and, frequently, a pain episode ( 316 , 857 ). In some cases, a delayed hemolytic transfusion reaction may lead to a fall in Hb level to a level lower than before transfusion, with a life-threatening or fatal outcome resulting from attempts to provide further transfusions ( 856 ). Iron overload has been an inevitable result if chronic transfusion is not performed by partial exchange methodology, such as erythrocytapheresis. The severity of iron overload commonly has been monitored with serum ferritin concentration, and there is a strong *inpatient* correlation between ferritin

levels and volumes transfused ( [858](#) ). However, there is wide *interpatient* variability, indicating a need to assess iron stores directly by liver biopsy to determine the necessity for iron chelation with deferoxamine ( [858](#), [859](#) ).

**Anemia** Anemia with Hb levels as low as 5 g/dl generally is well tolerated and requires no therapy. During hematologic crises, however, the Hb concentration may fall precipitously, requiring rapid correction. An aplastic crisis caused by parvovirus infection often requires a single packed red cell transfusion before erythropoiesis eventually returns. A severe splenic sequestration crisis may require an immediate transfusion to restore blood volume and oxygen-carrying capacity. If the patient does not have an elective splenectomy, chronic transfusion therapy to maintain splenic function has been used as an alternative. However, recurrences of sequestration have occurred despite transfusion ( [410](#) ). The experimental use of polymerized bovine Hb in adult patients and polymerized human Hb along with erythropoietin in a sickle cell patient with multiple red cell antibodies has been described ( [860](#), [861](#) ), but overall evidence of the efficacy and safety of this approach is lacking.

**Progressive Organ Damage** The risks and expense of a long-term transfusion program are justified if progressive or recurrent vasoocclusive events threaten major organ function ( [862](#) ). Chronic transfusion therapy minimizes the risk of recurrent or progressive neurologic deterioration in children who have had a stroke ( [322](#), [332](#), [863](#) ). Progressive retinopathy, sickle cell renal disease, and cardiac decompensation may also be arrested with repeated transfusions. Short-term transfusion therapy may be of benefit for a variety of complications, including ACS pain events, priapism, protracted hematuria, and chronic skin ulcerations ( [852](#) ).

**Surgery** Anesthesia, surgery, and postsurgical convalescence expose patients to the formidable consequences of hypoventilation, hypotension, cooling, dehydration, acidosis, and immobilization. Although recommendations regarding the preparation of patients for surgery have varied, simple transfusions before elective procedures ( [848](#), [864](#) ) and partial exchange transfusions before emergency surgery ( [307](#), [842](#) ) have been used. The CSSCD noted a perioperative mortality rate over a 10-year period of 1.1% ( [865](#) ). A large multicenter prospective trial compared the rates of perioperative complications among patients randomly assigned to receive either an aggressive transfusion regimen (to decrease the Hb S level to <30%) or a conservative regimen (to increase the Hb level to 10 g/dl) ( [866](#) ). Perioperative complications, including ACS, were similar in the two groups except for transfusion-associated complications, which were more common in the aggressively treated group. With good perioperative management, it is unnecessary to markedly reduce the Hb S level before surgery ( [866](#) ).

**Pregnancy** Like women who are hematologically normal, women with sickle cell anemia experience a decrease in Hb concentration during pregnancy as a consequence of hemodilution. In general, however, the minor aggravation of anemia is without symptomatic consequence, and no therapy is indicated. However, the final weeks of pregnancy are often complicated by vasoocclusive events that may have devastating consequences for both mother and fetus. In an attempt to prevent progressive placental infarction and premature delivery, some authors advocate the use of transfusion therapy during the third trimester ( [702](#), [867](#) ). In the only randomized study of its effectiveness, however, prophylactic transfusion therapy did not have a favorable impact on maternal morbidity (other than a reduction in the number of pain crises) or fetal wastage ( [868](#) ).

## NEW APPROACHES TO THERAPY

**Activation of Hemoglobin F Synthesis** Reversal of ontogeny with reinstatement of Hb F synthesis ( [869](#) ) is a long-standing objective that appears increasingly attainable. This therapeutic strategy is based on the observation that clinical expression of the sickle gene is prevented by Hb F synthesis in the perinatal period, as well as throughout life in individuals with HPFH. Initial attempts to augment  $\beta$ -globin synthesis were based on the observation that DNA in the vicinity of a wide variety of expressed genes is undermethylated relative to the DNA flanking inactive genes ( [870](#), [871](#) ). 5-Azacytidine, a

cytidine analog that blocks DNA methylation, reactivated dormant genes in cultured cells and increased Hb F synthesis in anemic baboons ( [872](#) ). When given to patients with severe sickle cell anemia, 5-azacytidine caused a four- to sixfold increase in net  $\beta$ -globin synthesis, a marked increase in the proportion of reticulocytes containing Hb F (F reticulocytes), and a precipitous decrease in the number of ISCs and dense red cells ( [873](#), [874](#) ). Because of the known carcinogenic potential of 5-azacytidine, alternative stimulants of fetal Hb were sought. Hydroxyurea, a cytotoxic drug having no known effect on DNA methylation, also increases Hb F production in anemic primates ( [875](#) ) and in patients with severe sickle cell anemia ( [876](#), [877](#) ). Hydroxyurea preferentially arrests the development of the more mature erythroid precursors, perhaps resulting in the recruitment of earlier erythroid progenitors with a greater capacity for Hb F synthesis ( [878](#) ). Alternatively, hydroxyurea may have a direct effect on “reprogramming” globin synthesis by early erythroid progenitors, a suggestion that is supported by the fact that the increase in F-reticulocyte numbers that follows hydroxyurea administration occurs sooner (within 2 to 3 days) than would be expected if the effect represented recovery from bone marrow suppression ( [876](#), [877](#), [879](#) ). Alterations in the physical properties of red cells produced under the influence of 5-azacytidine and hydroxyurea appear to be out of proportion to modest changes in the level of Hb F. This disparity is attributed in part to reduced  $\beta$  S-globin synthesis and in part to increased formation of  $\alpha_2\beta^S$  tetramers, which do not participate in polymer formation ( [880](#) ). Patients taking hydroxyurea consistently develop macrocytosis, which may occur before any change in Hb F takes place. They also show a rapid correction toward normal of red cell density distribution and improved whole blood viscosity. The density profile is characterized by the disappearance of two red cell populations: the densest, most dehydrated, ISC-enriched fraction and the least dense, most hydrated cells ( [691](#) ). The least dense cells tend to adhere most tenaciously to the endothelium, and the most dense cells are the least deformable. It is possible that these changes in red cell density distribution may be unrelated to the increased Hb F induced by hydroxyurea therapy ( [881](#) ). Recently, it has been demonstrated that hydroxyurea therapy is associated with the intravascular and intraerythrocytic generation of NO and that this might have a role in the induction of fetal Hb and, possibly, in clinical response that precedes the improvement in fetal Hb level ( [882](#), [883](#) and [884](#) ). In 1995, a double-blind multiinstitutional trial of hydroxyurea versus placebo in approximately 300 adults with moderate to severe sickle cell disease was concluded with convincing evidence of clinical benefit from the drug ( [220](#) ). Patients treated with hydroxyurea had approximately 50% lower rates of pain crises, ACS, hospitalization, and transfusion. There was wide variability in drug tolerance and clinical response, but the primary toxicity and dose-limiting factor was mild neutropenia. Because of the favorable outcome in the majority of treated patients, hydroxyurea has become widely used in the treatment of adult patients who experience frequent vasoocclusive crises ( [885](#) ). However, a report of severe complications of sickle cell disease (ACS, fatal cerebral hemorrhage) in two young adults who were on long-term hydroxyurea treatment indicates that the drug may not reverse preexisting pathology ( [886](#) ). Studies in pediatric patients are more limited, but several recent studies, including a multicenter phase I-II trial, indicate that school-aged children treated with hydroxyurea have increases in fetal Hb, Hb concentration, and MCV similar to those of adults and suggest that clinical benefit and toxicity may also be similar ( [887](#), [888](#), [889](#), [890](#) and [891](#) ). Recent studies in children 6 to 24 months of age (at onset of treatment) and 2 to 5 years of age have not indicated unusual toxicity from hydroxyurea ( [892](#), [893](#) ). The capacity of this treatment for prevention or reversal of organ dysfunction remains to be determined, but a return of splenic function has occurred in a few patients treated with hydroxyurea ( [886](#), [888](#), [893](#), [894](#) ). The drug has led to weight gain and improved exercise performance in adults ( [895](#) ) and growth in children ( [896](#) ). Recent pilot trials have suggested that hydroxyurea with or without concurrent phlebotomy may be substituted

for chronic transfusion in the prevention of recurrent stroke ( 339 , 897 ). Although caution about the long-term carcinogenic and teratogenic potential of hydroxyurea needs to be exercised, to date there is no evidence that the drug leads to an increased cancer risk or to congenital anomalies in offspring of women who inadvertently became pregnant while taking hydroxyurea ( 898 , 899 and 900 ). Prediction of fetal Hb response in patients with sickle cell disease receiving hydroxyurea has been difficult ( 901 ), but a recent analysis of the multicenter phase I-II trials has indicated that baseline Hb F and Hb concentrations, maximum tolerated dose, compliance, and therapy-related changes in blood count had predictive value ( 902 ). Increased levels of Hb F during stress erythropoiesis result from premature maturation of early erythroid progenitor cells under the influence of high concentrations of erythropoietin ( 903 ). In patients with sickle cell anemia, doses of erythropoietin above 1000 units/kg were shown to increase Hb F levels modestly ( 904 , 905 ). Erythropoietin given in combination with hydroxyurea did not show any additional effect on Hb F production ( 906 ), but another trial in which hydroxyurea was alternated with erythropoietin and supplemental iron did result in a significant further increase in Hb F level ( 907 ).  $\alpha$ -Aminobutyric acid, a fatty acid metabolite in maternal serum, was found to be the likely cause of the delayed  $\alpha$ - to  $\beta$ -globin switch in infants of mothers with poorly controlled diabetes ( 908 ). Subsequently, parenteral infusions of butyrate were shown to augment Hb F production in primates ( 909 , 910 ). Short courses of intravenous arginine butyrate administered to children with sickle cell anemia were associated with increases in F reticulocytes and relative rates of  $\alpha$ -globin synthesis ( 911 ), but administration of the drug over a 10-week period did not demonstrate a hematologic response ( 912 ). Subsequently, intermittent or pulse dosing of butyrate for 4 days at a time resulted in a sustained increase in Hb F in most patients ( 913 ). Oral sodium phenylbutyrate has also been shown to increase fetal Hb levels ( 914 ). The mechanism of action of butyrate compounds is unknown; it has been postulated that they interfere with transcriptional silencing factors and interact with promotor sequences located near the  $\alpha$ -globin gene ( 913 , 915 ). The antiepileptic drug valproic acid also has been reported to stimulate Hb F ( 916 ), as has the azacytidine analog 5-aza-2'-deoxycytidine (decitabine) ( 917 ).

**Antisickling Agents Acting on Hemoglobin or Membrane** The definition of the molecular basis of sickling has stimulated an intense search for chemical agents that block Hb polymerization or preserve membrane integrity ( 918 , 919 ). Many agents that inhibit *in vitro* sickling have been identified. Some have appeared promising in initial clinical trials only to be shown ineffective in properly controlled studies. Based on the mechanism of action, these inhibitors of sickling can be grouped into two broad categories. The first category includes compounds that bind Hb S either irreversibly (covalent agents) or reversibly (noncovalent agents). The second category consists of compounds that act on the red cell membrane rather than on Hb. Covalent agents act at different sites of the globin chain to decrease deoxy Hb S gelation, to increase the affinity of Hb for oxygen, or both. Noncovalent agents decrease Hb S gelation by interference with hydrophobic bonds between Hb tetramers. However, *in vitro* behavior does not necessarily predict *in vivo* effectiveness. Inhibition of sickling by an increase in the oxygen affinity of Hb, for example, may be offset *in vivo* by increased blood viscosity imposed by an expanded red cell mass. Of the covalent agents, cyanate has an antisickling effect mediated primarily by an increase in oxygen affinity ( 920 ). Short-term treatment with cyanate prolongs red cell survival but has little or no effect on the frequency of vasoocclusive crises, and it has unacceptable neurologic toxicity ( 921 , 922 ). The extracorporeal treatment of red cells with cyanate avoids systemic toxicity but is time consuming and costly ( 923 ). Of the noncovalent inhibitors, only urea has been evaluated clinically. Although it disrupts intermolecular hydrophobic bonds at molar concentrations ( 924 ), urea is ineffective at concentrations obtainable *in vivo* ( 925 ). Poloxamer-188, also known as RheothRx, is a nonionic copolymer emulsifying agent that may counteract the tendency of sickle cells to



adhere to endothelium by decreasing the interaction between red cells and fibrinogen ( [926](#), [927](#) ).

**Reduction of Red Cell Hemoglobin Concentration** Therapy designed to reduce the MCHC is based on the fact that small decrements in the MCHC significantly delay the rate of deoxy Hb S polymerization and inhibit red cell sickling. The delay time of gelation of deoxy Hb S is inversely proportional to the thirtieth power of Hb S concentration ( [45](#) ). Anecdotal accounts of patients with a low MCHC on the basis of iron deficiency led to the suggestion that symptomatic crises were fewer ( [928](#) ) and red cell survival was longer ( [929](#) ). One approach to reduction of the MCHC used the long-acting antidiuretic hormone desmopressin, salt restriction, and water loading. When combined, these measures induced sufficient hyponatremia and osmotic swelling of red cells to reduce the MCHC by 2 to 3 g/dl ( [930](#) ), but clinical testing uncovered problems related to poor compliance, fluctuating levels of serum sodium, neurologic complications, and lack of efficacy ( [931](#), [932](#) ). The Ca<sup>2+</sup>-activated K<sup>+</sup> channel (Gardos channel) contributes to the deleterious dehydration of sickle cells. One of the membrane-active agents, cetedil, appears to inhibit sickling by inducing red cell swelling and decreasing the MCHC as a result of inhibiting the Gardos pathway and increasing passive Na<sup>+</sup> influx more than K<sup>+</sup> efflux. In a placebo-controlled study, cetedil appeared to shorten the duration of pain crises but had no effect on the total analgesic requirement ( [303](#) ). Clotrimazole and other imidazole antimycotics also prevent sickle cell dehydration by inhibiting the Gardos pathway ( [110](#) ). In a small group of sickle cell patients, clotrimazole resulted in reduced red cell dehydration, increased cell potassium content, and increased Hb levels ( [933](#) ), but analogs of the drug may be less toxic. Because the K-Cl cotransporter is a major determinant of sickle cell dehydration and is inhibited by increasing red cell magnesium, phase I and II trials of oral magnesium pidolate in adult sickle cell patients have been conducted ( [111](#), [112](#) ). Biologic effects included a reduction in red cell MCHC and K-Cl cotransport activity and an absence of clinical toxicity except for mild diarrhea. The combination approach of oral hydroxyurea and magnesium treatment has been suggested because the two agents have differing mechanisms of action and different toxicities, and because hydroxyurea by itself may induce magnesium loss ( [934](#) ).

**Bone Marrow (Stem Cell) Transplantation** Bone marrow transplantation has the potential to normalize Hb synthesis in patients with sickle cell anemia. The first transplant was performed in a child with both sickle cell anemia and acute myeloblastic leukemia in 1984; bone marrow from an HLA-identical sibling abolished both diseases ( [935](#) ). Subsequent transplant experience has been reported from Belgium, France, and the United States ( [936](#), [937](#) and [938](#) ). The majority of donors have been HLA-identical relatives, and pretransplant conditioning regimens have generally consisted of busulfan and cyclophosphamide with or without antithymocyte globulin. In the updated American multiinstitutional study ( [938](#) ), 50 children younger than 16 years of age received HLA-identical marrow allografts because of a history of stroke, recurrent ACS, or recurrent pain crises. Kaplan-Meier probabilities of survival and event-free survival at a median follow-up of 58 months were 94% and 84%, respectively. Lung function was stable in almost all patients; among patients with prior central nervous system vasculopathy who had engraftment, stabilization of cerebral vascular disease was documented by MRI and magnetic resonance angiography. An adverse effect of busulfan conditioning was seen in five of seven evaluable females. Because four of the first seven patients enrolled had neurologic events ( [939](#) ), including two episodes of intracranial hemorrhage, anticonvulsant prophylaxis with dilantin was initiated before transplantation, hypertension was strictly controlled, and platelet counts were maintained above 50,000/mm<sup>3</sup>. Among 50 patients transplanted in Belgium, overall and event-free survival were 93% and 85%, respectively, but the group transplanted early in the course of their condition (before developing clinical complications) had better overall and disease-free survival ( [936](#) ). The availability and the relative success of bone

marrow transplantation worldwide have raised a number of social and ethical questions about its use. For example, how severe must sickle cell disease be to justify a transplant-associated mortality rate of 5 to 10%? In the United States, only 6% of patients with sickle cell anemia met the criteria for transplantation specified in the study protocol; furthermore, a survey of children with sickle cell anemia in the San Francisco area estimated that only 18% would have sibling donors (940). Although these criteria would result in approximately 1% of American children with sickle cell anemia being eligible for transplantation, criteria used in Belgium were based on the poor prognosis of children with sickle cell disease who were returning to a setting of limited medical care in central Africa (936). Another point of view has been that transplantation is warranted in virtually all patients for whom a suitable donor is available (941), particularly before organ dysfunction and transfusion exposure occur. Recently, it has been noted that the transplant enrollment criteria parallel those of studies using hydroxyurea treatment (942). When these two modalities are compared, transplantation offers a definitive cure for sickle cell anemia but a significant risk of mortality, whereas hydroxyurea offers amelioration of the clinical symptoms with short-term complications that appear to be reversible and small. When transplantation and periodic prophylactic blood transfusion were compared in a hypothetical intention-to-treat analysis for sickle cell patients at high risk for ischemic stroke, the number of quality-adjusted life years experienced by both populations was essentially identical (943). Another significant issue is the cost of treatment; in the early 1990s, allogeneic bone marrow transplantation in the United States cost \$150,000 to \$200,000 (944, 945), but the annual cost for the care of a child with stroke requiring chronic transfusion therapy and chelation was approximately \$32,000 (946). Other approaches to transplantation are rapidly being developed. Cord blood stem cells harvested from HLA-identical newborn sibs, as well as unrelated donors, have been successfully transplanted (947, 948). Directed donor banking of cord blood of a sibling of a child who has a disorder treatable by stem cell transplantation has been shown to be feasible and has made possible cord blood allografts that were successful in 16 of 17 cases (949). Another approach is based on the observation that when stable mixed chimerism is established after stem cell transplant, even a minority of donor cells with a selective advantage may overcome a genetic defect. In an analysis of 50 patients with successful allografts from the multiinstitutional sickle cell trial, five had chimerism with a relatively low proportion of donor cells (range, 11 to 74%). These five patients had normal Hb levels and much lower Hb S fractions than the proportion of donor chimerism, suggesting that donor erythroid progenitors or erythrocytes had a survival advantage over recipient sickle cell counterparts (950). Because these five patients were also clinically asymptomatic, this observation suggested that full-donor chimerism is not necessary to cure nonmalignant disorders, and reduced intensity regimens that allow mixed chimerism may be effective (950, 951). Stem cell transplantation after reduced intensity conditioning in an adult patient with severe complications of sickle cell disease has been reported (952).

## SICKLE CELL TRAIT

Sickle cell trait, the heterozygous state for the Hb S gene, is present in approximately 8% of black Americans and in as many as 30% of some African populations. The red cells of such individuals contain both Hb A and Hb S, but there is always more Hb A than Hb S (27).

### Clinical Features

Sickle cell trait rarely is associated with clinical or hematologic manifestations of significance. Individuals have no anemia, and red cell morphology is normal. Growth and

development proceed normally ( 953 ), infections occur with no greater frequency than in the general population, and no increased frequency of bone and joint disease is observed ( 954 ). A prospective study of pregnant women with sickle cell trait documented an overall incidence of complications and a distribution of birth weights similar to those of a control group ( 955 ). Life expectancy and overall mortality rate for persons with sickle cell trait are the same as for the general population ( 956 ). The prevalence of the trait among professional football players is the same as that in the black population, suggesting that it imposes no limitation in physical capabilities ( 957 ). Nevertheless, most of the complications associated with sickle cell anemia have been described in individuals with sickle cell trait. In most such reports, the presence of Hb S was likely an incidental finding, unrelated to the observed deficit.

Most reports of sudden death in soldiers and athletes undergoing strenuous physical conditioning lack pertinent information concerning the relative amounts of Hb A and Hb S and the presence of potential but undetected underlying illness ( 958 , 959 ). Nevertheless, a comprehensive analysis of sudden unexplained deaths among more than 2 million recruits undergoing basic training in the U.S. Armed Forces demonstrated a small but convincing increase of such deaths in association with sickle cell trait ( 960 ). Because the risk under even the most adverse circumstances is low (1 in 3200 in the Armed Forces study), it is important that the millions of black individuals with sickle cell trait not be labeled as sick.

Other complications of the trait are well documented but relatively rare: hematuria, urinary tract infection, and splenic infarction. The former generally is transient and probably is related to poor perfusion of the renal papillae ( 623 , 645 , 961 , 962 ). Frank renal papillary necrosis has been described ( 641 ). Urine-concentrating ability also is impaired, although renal acidification is normal ( 963 ). A Jamaican study of older adult women showed an increased frequency of bacteriuria in those with sickle cell trait ( 964 ). During pregnancy, women with sickle cell trait have increases in bacteriuria and pyelonephritis ( 965 ). There are numerous reports of splenic infarction in individuals with sickle cell trait who are exposed to altitudes of 10,000 feet or more in unpressurized aircraft, but this has not been reported in commercial flights, in which cabin pressure is equivalent to approximately 8000 feet ( 966 ). Individuals with sickle cell trait, especially whites, have suffered splenic infarction at mountain altitudes ( 967 ). Most individuals with sickle cell trait, however, tolerate simulated high altitude with impunity ( 968 ).

## Diagnosis

Sickle cell trait is characterized by an electrophoretic pattern containing both Hb A and Hb S, with more Hb A than Hb S. The interaction of  $\alpha$ -thalassemia with sickle cell trait is responsible for a trimodal distribution of Hb S with means of approximately 41%, 35%, and 28%, corresponding to the aa/aa, -a/aa, and -a/-a genotypes, respectively ( 739 , 969 , 970 ). The positive correlation between the proportion of Hb S and the output of a genes indicates the greater affinity of  $\beta^A$ -chains than of  $\beta^S$ -chains for  $\alpha$ -chains in the formation of Hb tetramers. Excess  $\beta^S$ -chains presumably are destroyed by proteolysis ( 971 ). The relative amount of Hb S is also decreased by iron ( 972 ) and folate ( 973 ) deficiencies.

## Screening Programs

There are two possible reasons to screen groups for the presence of sickle cell trait: (a) to inform affected persons of health risks and (b) to provide information that might affect



an individual's reproductive decisions. Most hemoglobinopathy screening is now done to identify sickle cell disease in neonates. Therefore, identification of sickle cell trait occurs at a time when counseling of the affected individual obviously is impossible. Counseling of family members of newborns with sickle cell trait may be of value but is only performed sporadically in most states.

The technique chosen for screening should be genetically diagnostic and should clearly differentiate between sickle cell trait and those disorders of Hb having implications for health. Both conventional Hb electrophoresis ( 974 ) and thin-layer isoelectric focusing on acrylamide gel ( 975 ) have been adapted satisfactorily to mass screening. Because solubility tests do not detect  $\beta$ -thalassemia trait, Hb C, and other Hb variants that interact with Hb S to cause disease, they should not be used for screening.

## OTHER SICKLING SYNDROMES

Several of the doubly heterozygous states for Hb S and a second disorder of Hb synthesis are characterized by clinical and hematologic aberrations that to some extent mimic the features of sickle cell anemia. The clinically significant disorders resulting from double heterozygosity for Hb S and a second Hb variant are considered forms of sickle cell disease.

### Hemoglobin SC Disease

The sickling disorder known as *hemoglobin SC* disease results from the inheritance of an Hb S gene from one parent and an Hb C gene from the other parent. Red cells contain approximately equal amounts of the two hemoglobins. Hb A is absent, and Hb F is normal or slightly increased. The disorder occurs with an approximate frequency of 1 in 1100 births among black Americans ( 793 ) and 1 in 1400 births in Jamaica ( 744 ). In Ghana, the presumed site of origin of the Hb C mutation ( 976 ), Hb SC disease is as prevalent as sickle cell anemia, and in some regions, it affects as many as 25% of the population ( 4 ).

The clinical and laboratory features of Hb SC disease cannot be explained by copolymerization of Hb C with Hb S ( 977 ). The solubility of mixtures of deoxy Hb S and Hb C is no different from that of mixtures of Hb S and Hb A ( 978 ). Differences in the sickling properties of sickle trait cells and Hb SC cells are related to two factors: a higher proportion of Hb S and a higher concentration of Hb in Hb SC cells compared with Hb AS cells ( 977 , 979 ). The 10 to 15% greater proportion of Hb S in Hb SC cells is the result of differences in rates of subunit assembly, which, in turn, are determined by the net surface charges of  $\beta^A$ ,  $\beta^S$ , and  $\beta^C$  ( 979 ). The higher MCHC of Hb SC cells relates to the opening of normally dormant membrane channels that allow the loss of  $K^+$  and water ( 980 ).

**CLINICAL FEATURES** The clinical manifestations of Hb SC disease are similar to, but less severe than, those of sickle cell anemia ( 2 , 6 , 981 ). Growth and sexual development are delayed compared to normal children, but less so than in children with sickle cell anemia ( 488 ). Symptoms in the first year are rare, and one-fourth of affected individuals remain asymptomatic throughout the first decade of life ( 744 , 982 ). The most common symptom is episodic abdominal or skeletal pain, qualitatively similar to that caused by vasoocclusive events in sickle cell anemia. The average number of painful episodes/year for Hb SC patients is approximately one-half that for persons with sickle cell anemia (0.4 vs. 0.8 episodes/year) ( 278 ). Moderate enlargement of the spleen is present in

approximately two-thirds of children and often persists into adult life. Spleen perfusion is intact, however, and as a result, symptomatic splenic infarction ( 983 , 984 and 985 ) and acute splenic sequestration ( 986 ) may occur in adults as well as in children. Loss of spleen function is more gradual and occurs at a later age than occurs in sickle cell anemia ( 271 , 450 ). The frequency of infections of patients with Hb SC disease is increased, but fatal pneumococcal septicemia, although well documented ( 987 ), is less of a risk than is noted in sickle cell anemia ( 988 ). In contrast to the infectious complications of sickle cell anemia, those of Hb SC disease are characteristically associated with a primary focus, tend not to recur, and respond promptly to therapy ( 989 , 990 ). *S. pneumoniae* is the most common bacterial isolate, and the respiratory tract is the most common focus ( 989 , 990 and 991 ). The incidence of bacteremia drops abruptly after 2 years of age, a contrasting pattern to sickle cell anemia, in which the incidence declines gradually between 2 and 6 years of age ( 429 ). Because bacteremia rarely progresses to septicemia and a fatal outcome in young children with Hb SC disease, prophylactic penicillin is thought to be unnecessary by some investigators ( 469 ). However, fatal pneumococcal septicemia has been reported in a series of seven children, six of whom were older than 3 years of age ( 992 ). Central nervous system deficits ( 993 ), asymptomatic hematuria, ankle ulceration, priapism, and other complications of sickling occur with Hb SC disease but are infrequent events. In the United States, the median lifespan for male and female Hb SC patients is 60 and 68 years of age, respectively ( 232 ). Because of the frequency with which they occur, certain complications of Hb SC disease deserve special comment. Proliferative retinopathy is more common and more severe than in sickle cell anemia ( 176 , 674 ). Progressive loss of vision may have its onset early in the second decade, and patients should be encouraged to have an annual ophthalmologic examination after reaching adolescence. Aseptic necrosis of the femoral head has been reported to have a greater frequency in Hb SC disease than in Hb SS, but a recent report indicates that the age-adjusted prevalence is lower ( 515 ). ACS, attributed to fat emboli after bone marrow infarction, occurs most commonly during the final months of pregnancy ( 994 , 995 and 996 ) in women with Hb SC. The exaggerated vulnerability of individuals with Hb SC disease to certain complications is thought to be a function of the higher viscosity of the blood relative to that in sickle cell anemia. Two recent analyses of adults with Hb SC disease ( 997 , 998 ) have reemphasized the common clinical features of pain crises, avascular necrosis of the hip, proliferative sickle retinopathy, and splenic infarction/sequestration. In one series, it was noted that comorbidity of obesity, hypertension, and type 2 diabetes mellitus were common ( 998 ). In the other, decreased morbidity was noted in patients who had concurrent  $\alpha$ -thalassemia 2 ( 997 ). Moderately severe complications of *in vivo* sickling occur in Hb SC-Harlem disease ( 999 ) and in the Hb SC/ $\alpha$ -thalassemia syndrome ( 1000 ). Combined Hb SC disease and hereditary spherocytosis was documented as the cause of recurrent splenic sequestration crises ( 1001 ).

**LABORATORY FEATURES** Anemia is mild or nonexistent; 75% of children 2 to 15 years of age have a hematocrit between 28 and 38, and 75% of adults have a hematocrit between 28 and 42 (with males having higher levels than females) ( 1002 ). Compared with Hb SS, the MCV may be decreased (10 to 15 fl lower), and the MCHC may be increased owing to cellular dehydration ( 1002 , 1003 ). Reticulocytes are modestly increased in number. Blood films contain as many as 50% target cells. Although sickled cells are relatively rare, cells containing Hb “crystals” are noted regularly ( 1004 ). These hyperchromic, shrunken cells are distorted into pyramidal or elongated contours by condensed aggregates of Hb ( Fig. 40.12 ). The white blood cell count and leukocyte differential are normal ( 227 ).

**TREATMENT** Unlike the extensive investigations of the use of hydroxyurea in adults and children with Hb SS, data in patients with Hb SC disease are lacking. One study involving six adult Hb SC disease patients noted that hydroxyurea resulted in an increase in

hematocrit and MCV, improved cell hydration, and no significant difference in Hb F level ( [1005](#) ). In a study of six severely affected children with Hb SC disease, MCV and Hb F increased, and patients improved clinically, but Hb concentration did not change after hydroxyurea treatment ( [1006](#) ). A randomized trial is necessary to determine if hydroxyurea or other drugs that may affect red cell density are of benefit.

### Hemoglobin S-β-Thalassemia

The doubly heterozygous condition of Hb S and β-thalassemia is designated as Sβ<sup>0</sup>-thalassemia if there is no β-globin synthesis from the affected allele and Sβ<sup>+</sup>-thalassemia if β-globin synthesis is present but reduced. The clinical manifestations are quite variable, and patients may be nearly asymptomatic or have problems similar to those occurring in the worst cases of sickle cell anemia ( [1007](#) ). In general, Hb Sβ<sup>0</sup>-thalassemia resembles Hb SS in severity, and Hb Sβ<sup>+</sup>-thalassemia is somewhat milder than Hb SC disease. Patients with Hb Sβ<sup>0</sup>-thalassemia have a slightly higher Hb level, an increased Hb A<sub>2</sub> level (4 to 6%), and a smaller MCV (65 to 75 fl) than those with Hb SS. Hb Sβ<sup>+</sup>-thalassemia patients have a higher Hb level and lower reticulocyte count than those with Hb Sβ<sup>0</sup>-thalassemia ( [1007](#), [1008](#) ). In children with Hb Sβ<sup>0</sup>-thalassemia, splenic dysfunction measured by pit cell counts occurs within the first year of life, but only 20% of those with Hb Sβ<sup>+</sup>-thalassemia have elevated pit counts by 20 years of age ( [451](#) ). Patients with Hb Sβ-thalassemia, unlike those with sickle cell anemia, often have splenomegaly beyond the first few years of childhood. The use of hydroxyurea in patients with Hb Sβ-thalassemia has been reported to be effective in a small series from Greece ( [1009](#) ) and Sicily ( [1010](#) ). (The interaction of Hb S with thalassemia mutations is discussed further in [Chapter 42](#).)

### Hemoglobin S/Hereditary Persistence of Fetal Hemoglobin

In HPFH, Hb F levels are elevated relative to the patient's age. Deletional mutations typically involve large segments of DNA and result in a pancellular distribution of Hb F. Approximately 1:1000 African-Americans carry the deletion HPFH gene. Nondeletion mutations result in more variable levels of Hb F (4 to 30%) and heterocellular or pancellular distribution. The doubly heterozygous condition for Hb S and HPFH results in a heterogeneous disorder that is generally extremely mild and associated with a pancellular distribution of Hb F, normal blood counts, microcytosis, target cells, and 20 to 30% Hb F ( [2](#), [51](#), [52](#) ). Overall, there is approximately 1 case of Hb S/HPFH for every 100 cases of Hb SS, but it is important to identify this condition because of its extremely good prognosis.

### Hemoglobin SE Disease

Hb E is characterized by the substitution of lysine for glutamic acid at position 26 of the β-chain and results in a mild β-thalassemia phenotype. Because of the increase in the Asian population in the United States, the doubly heterozygous condition of Hb SE is now occasionally seen. Patients with Hb SE may have mild anemia and microcytosis along with approximately 30% Hb E, but blood smears look relatively normal (except for target cells), and patients are usually asymptomatic ( [52](#), [1011](#) ).

### Hemoglobin SD Disease

Of the 16 variants fulfilling the electrophoretic and solubility criteria for Hb D or Hb G, at least nine have been recognized in association with Hb S ([1012](#)). With one exception, the doubly heterozygous states for Hb S and Hb D or Hb G are clinically silent. Hb D–Punjab (Hb D–Los Angeles) interacts with Hb S to produce mild hemolytic anemia and symptoms that mimic those of mild sickle cell anemia. The Hb SD–Punjab syndrome was first detected in a Caucasian man ([1013](#)) whose case had been previously reported as an instance of sickle cell anemia in the white race ([1014](#)). Subsequently, Hb SD–Punjab disease was recognized in a number of subjects, most of African origin ([1015](#), [1016](#), [1017](#), [1018](#) and [1019](#)). In each of these subjects, the clinical and hematologic features were those of mild sickle cell anemia.

### Hemoglobin SO–Arab Disease

Hb O–Arab interacts strongly with Hb S *in vitro*. As would be predicted, the doubly heterozygous state is clinically and hematologically indistinguishable from sickle cell anemia ([34](#), [1020](#), [1021](#), [1022](#), [1023](#) and [1024](#)). Functional asplenia occurs at an early age and is followed by progressive splenic infarction. The disorder is differentiated readily from Hb SC disease, with which it is confused on electrophoretic grounds, by the greater prominence of symptoms, the severity of the anemia, and the presence of numerous ISCs on blood smears ([1023](#)).

### REFERENCES

1. Embury SH, Hebbel RP, Steinberg MH, Mohandas N. Sickle cell disease: basic principles and clinical practice. New York: Raven Press, 1994.
2. Serjeant GR. Sickle cell disease, 2nd ed. New York: Oxford University Press, 1992.
3. Mankad VN, Moore RB, eds. Sickle cell disease: Pathophysiology, diagnosis, and management. Westport: Praeger, 1992.
4. Konotey–Ahulu FID. The effect of environment on sickle cell disease in West Africa. In: Abramson H, Bertles JF, Wethers DL, eds. Sickle cell disease: Diagnosis, management, education, and research. St. Louis: Mosby, 1973:20–38.
5. Edelstein SJ. The sickled cell: From myths to molecules. Cambridge: Harvard University Press, 1986.
6. Konotey–Ahulu FI. The sickle cell diseases. Clinical manifestations including the “sickle crisis.” *Arch Intern Med* 1974;133(4):611–619.
7. Herrick JB. Peculiar elongated and sickle-shaped red blood corpuscles in a case of severe anemia. 1910. *Yale J Biol Med* 2001;74(3):179–184.
8. Conley CL. Sickle cell anemia–The first molecular disease. In: Wintrobe MM, ed. *Blood, pure and eloquent*. New York: McGraw–Hill, 1979:319–371.
9. Strasser BJ. Linus Pauling’s “molecular diseases”: between history and memory. *Am J Med Genet* 2002;115(2):83–93.
10. Serjeant GR. The emerging understanding of sickle cell disease. *Br J Haematol* 2001;112(1):3–18.
11. Pagnier J, Mears JG, Dunda–Belkhodja O, et al. Evidence for the multicentric origin of the sickle cell hemoglobin gene in Africa. *Proc Natl Acad Sci U S A* 1984;81(6):1771–1773.
12. Serjeant GR. The geography of sickle cell disease: Opportunities for understanding its diversity. *Ann*

Saudi Med 1994;14:237–246.

13. Antonarakis SE, Boehm CD, Serjeant GR, et al. Origin of the beta S-globin gene in blacks: the contribution of recurrent mutation or gene conversion or both. *Proc Natl Acad Sci U S A* 1984;81(3):853–856.
14. Mears JG, Beldjord C, Benabadji M, et al. The sickle gene polymorphism in North Africa. *Blood* 1981;58(3):599–601.
15. Motulsky AG. Frequency of sickling disorders in U.S. blacks. *N Engl J Med* 1973;288(1):31–33.
16. Uddin DE, Dickson LG, Brodine CE. Screening of military recruits for hemoglobin variants. *JAMA* 1974;227(12):1405–1407.
17. Schneider RG, Hightower B, Hosty TS, et al. Abnormal hemoglobins in a quarter million people. *Blood* 1976;48(5):629–637.
18. Neel JV. Sickle cell disease: a worldwide problem. In: Abramson H, Bertles JF, Wethers DL, eds. *Sickle cell disease: diagnosis, management, education, and research*. St. Louis: Mosby, 1973.
19. Pearson HA, O'Brien RT, McIntosh S, et al. Routine screening of umbilical cord blood for sickle cell diseases. *JAMA* 1974;227(4):420–421.
20. Powars D, Schroeder WA, White L. Rapid diagnosis of sickle cell disease at birth by microcolumn chromatography. *Pediatrics* 1975;55(5):630–635.
21. Allison AC. Protection afforded by sickle cell trait against subtertian malarial infection. *BMJ* 1954;1:290.
22. Luzzatto L. Genetics of red cells and susceptibility to malaria. *Blood* 1979;54(5):961–976.
23. Luzzatto L, Nwachuku-Jarrett ES, Reddy S. Increased sickling of parasitized erythrocytes as mechanism of resistance against malaria in the sickle-cell trait. *Lancet* 1970;1(7642):319–321.
24. Nagel RL, Roth EF, Jr. Malaria and red cell genetic defects. *Blood* 1989;74(4):1213–1221.
25. Schechter AN, Noguchi CT. Sickle hemoglobin polymer: structure–function correlates. In: Embury SH, Hebbel RP, Mohandas N, Steinberg MH, eds. *Sickle cell disease: basic principles and clinical practice*. New York: Raven Press, 1994:33–51.
26. Harris JW, Brewster HH, Ham TH, Castle WB. Studies on the destruction of red blood cells. X. The biophysics and biology of sickle cell disease. *Arch Intern Med* 1956;97:145–168.
27. Bookchin RM, Nagel RL. Molecular interactions of sickling hemoglobin. In: Abramson H, Bertles JF, Wethers DL, eds. *Sickle cell disease: diagnosis, management, education, and research*. St. Louis: Mosby, 1973:140–154.
28. Finch JT, Perutz MF, Bertles JF, Dobler J. Structure of sickled erythrocytes and of sickle-cell hemoglobin fibers. *Proc Natl Acad Sci U S A* 1973;70(3):718–722.
29. Dykes G, Crepeau RH, Edelstein SJ. Three-dimensional reconstruction of the fibers of sickle cell haemoglobin. *Nature* 1978;272(5653):506–510.
30. Russu IM, Ho C. A proton nuclear magnetic resonance investigation of histidyl residues in sickle hemoglobin. *Biochemistry* 1982;21(20):5044–5051.
- 30a. Magdoff-Fairchild B, Swerdlow PH, Bertles JF. Intermolecular organization of deoxygenated sickle haemoglobin determined by x-ray diffraction. *Nature* 1972;239(5369):217–219.
31. Wellem's TE, Josephs R. Crystallization of deoxyhemoglobin S by fiber alignment and fusion. *J Mol Biol* 1979;135(3):651–674.
32. Edelstein SJ. Molecular architecture of the fibers of sickle (SS) hemoglobin. *Am J Pediatr Hematol*

Oncol 1983;5(4):386–389.

33. Wishner BC, Ward KB, Lattman EE, Love WE. Crystal structure of sickle-cell deoxyhemoglobin at 5 Å resolution. *J Mol Biol* 1975;98(1):179–194.
34. Milner PF, Miller C, Grey R, et al. Hemoglobin O Arab in four negro families and its interaction with hemoglobin S and hemoglobin C. *N Engl J Med* 1970;283(26):1417–1425.
35. Bookchin RM, Nagel RL, Ranney HM. The effect of beta 73 Asn on the interactions of sickling hemoglobins. *Biochim Biophys Acta* 1970;221(2):373–375.
36. Benesch RE, Yung S, Benesch R, et al. Alpha-Chain contacts in the polymerisation of sickle haemoglobin. *Nature* 1976;260(5548):219–221.
37. Bookchin RM, Nagel RL. Ligand-induced conformational dependence of hemoglobin in sickling interactions. *J Mol Biol* 1971;60(2):263–270.
38. Murayama M. Molecular mechanism of red cell “sickling”. *Science* 1966;153(732):145–149.
39. Singer K, Singer L. Studies on abnormal hemoglobins. VIII. The gelling phenomenon of sickle hemoglobin: Its biological and diagnostic significance. *Blood* 1953;8:1008.
40. May A, Huehns ER. The concentration dependence of the oxygen affinity of haemoglobin S. *Br J Haematol* 1975;30(3):317–335.
41. Briehl RW, Ewert S. Effects of pH, 2,3-diphosphoglycerate and salts on gelation of sickle cell deoxyhemoglobin. *J Mol Biol* 1973;80(3):445–458.
42. Hofrichter J, Ross PD, Eaton WA. Supersaturation in sickle cell hemoglobin solutions. *Proc Natl Acad Sci U S A* 1976;73(9):3035–3039.
43. Bertles JF, Rabinowitz R, Dobler J. Hemoglobin interaction: modification of solid phase composition in the sickling phenomenon. *Science* 1970;169(943):375–377.
44. Harris JW, Bensusan HB. The kinetics of the sol-gel transformation of deoxyhemoglobin S by continuous monitoring of viscosity. *J Lab Clin Med* 1975;86(4):564–575.
45. Eaton WA, Hofrichter J, Ross PD. Editorial: Delay time of gelation: a possible determinant of clinical severity in sickle cell disease. *Blood* 1976;47(4):621–627.
46. Adachi K, Kim J, Asakura T, Schwartz E. Characterization of two types of fetal hemoglobin: alpha 2G gamma 2 and alpha 2A gamma. *Blood* 1990;75(10):2070–2075.
47. Charache S, Conley CL. Rate of sickling of red cells during deoxygenation of blood from persons with various sickling disorders. *Blood* 1964;24:25.
48. Bookchin RM, Nagel RL. Interactions between human hemoglobins: sickling and related phenomena. *Semin Hematol* 1974;11(4):577–595.
49. Conley CL. Hereditary persistence of fetal hemoglobin: A study of 79 affected persons in 15 Negro families in Baltimore. *Blood* 1963;21:261.
50. Reed LJ, Bradley TB, Ranney HM. The effect on amelioration of anemia of the synthesis of fetal hemoglobin in sickle cell anemia. *Blood* 1965;25:37–48.
51. Murray N, Serjeant BE, Serjeant GR. Sickle cell-hereditary persistence of fetal haemoglobin and its differentiation from other sickle cell syndromes. *Br J Haematol* 1988;69(1):89–92.
52. Kinney TR, Ware RE. Compound heterozygous states. In: Embury SH, Hebbel RP, Mohandas N, Steinberg MH, eds. *Sickle cell disease: basic principles and clinical practice*. New York: Raven Press, 1994:437–451.
53. Noguchi CT, Rodgers GP, Schechter AN. Intracellular polymerization. Disease severity and therapeutic

predictions. *Ann N Y Acad Sci* 1989;565:75–82.

54. Noguchi CT, Rodgers GP, Serjeant G, Schechter AN. Levels of fetal hemoglobin necessary for treatment of sickle cell disease. *N Engl J Med* 1988;318(2):96–99.

55. Wenger GD, Balcerzak SP. Viscometric and spectrophotometric measurements of hemoglobin S polymerization kinetics. *Blood* 1984;63(4):897–903.

56. Hofrichter J. Kinetics of sickle hemoglobin polymerization. III. Nucleation rates determined from stochastic fluctuations in polymerization progress curves. *J Mol Biol* 1986;189(3):553–571.

57. Eaton WA, Hofrichter J. Sickle hemoglobin polymerization. In: Embury SH, Hebbel RP, Mohandas N, Steinberg MH, eds. *Sickle cell disease: basic principles and clinical practice*. New York: Raven Press, 1994:53–87.

58. Zarkowsky HS, Hochmuth RM. Sickling times of individual erythrocytes at zero  $P_{O_2}$ . *J Clin Invest* 1975;56(4):1023–1034.

59. Hofrichter J, Ross PD, Eaton WA. Kinetics and mechanism of deoxyhemoglobin S gelation: a new approach to understanding sickle cell disease. *Proc Natl Acad Sci U S A* 1974;71(12):4864–4868.

60. Padilla F, Bromberg PA, Jensen WN. The sickle–unsickle cycle: a cause of cell fragmentation leading to permanently deformed cells. *Blood* 1973;41(5):653–660.

61. Usami S, Chien S, Bertles JF. Deformability of sickle cells as studied by microsieving. *J Lab Clin Med* 1975;86(2):274–279.

62. Jensen WN, Lessin LS. Membrane alterations associated with hemoglobinopathies. *Semin Hematol* 1970;7(4):409–426.

63. White JG. Ultrastructural features of erythrocyte and hemoglobin sickling. *Arch Intern Med* 1974;133(4):545–562.

64. Shen SC, Fleming EM, Castle WB. Studies on the destruction of red blood cells. V. Irreversibly sickled erythrocytes: Their experimental production in vitro. *Blood* 1949;4:498–504.

65. Noguchi CT, Schechter AN. The intracellular polymerization of sickle hemoglobin and its relevance to sickle cell disease. *Blood* 1981;58(6):1057–1068.

66. Noguchi CT, Torchia DA, Schechter AN. Determination of deoxyhemoglobin S polymer in sickle erythrocytes upon deoxygenation. *Proc Natl Acad Sci U S A* 1980;77(9):5487–5491.

67. Serjeant GR, Petch MC, Serjeant BE. The in vivo sickle phenomenon: a reappraisal. *J Lab Clin Med* 1973;81(6):850–856.

68. Bookchin RM, Balazs T, Landau LC. Determinants of red cell sickling. Effects of varying pH and of increasing intracellular hemoglobin concentration by osmotic shrinkage. *J Lab Clin Med* 1976;87(4):597–616.

69. Ueda Y, Nagel RL, Bookchin RM. An increased Bohr effect in sickle cell anemia. *Blood* 1979;53(3):472–480.

70. Lam YF, Lin AK, Ho C. A phosphorus-31 nuclear magnetic resonance investigation of intracellular environment in human normal and sickle cell blood. *Blood* 1979;54(1):196–209.

71. Bertles JF. *Multiple hemoglobins in cells: Significance and genetic control*. St. Louis: Mosby, 1973.

72. Fabry ME, Nagel RL. The effect of deoxygenation on red cell density: significance for the pathophysiology of sickle cell anemia. *Blood* 1982;60(6):1370–1377.

73. Nash GB, Johnson CS, Meiselman HJ. Rheologic impairment of sickle RBCs induced by repetitive cycles of deoxygenation–reoxygenation. *Blood* 1988;72(2):539–545.

74. Tosteson DC, Shea E, Darling RC. Potassium and sodium of red blood cells in sickle cell anemia. *J*



Clin Invest 1952;31:406–411.

75. Clark MR, Morrison CE, Shohet SB. Monovalent cation transport in irreversibly sickled cells. *J Clin Invest* 1978;62(2):329–337.

76. Fales FW. Water distribution in blood during sickling of erythrocytes. *Blood* 1978;51(4):703–709.

77. Glader BE, Nathan DG. Cation permeability alterations during sickling: relationship to cation composition and cellular hydration of irreversibly sickled cells. *Blood* 1978;51(5):983–989.

78. Anderson DR, Davis JL, Carraway KL. Calcium-promoted changes of the human erythrocyte membrane. Involvement of spectrin, transglutaminase, and a membrane-bound protease. *J Biol Chem* 1977;252(19):6617–6623.

79. Palek J. Red cell membrane injury in sickle cell anaemia. *Br J Haematol* 1977;35(1):1–9.

80. Bertles JF, Milner PF. Irreversibly sickled erythrocytes: a consequence of the heterogeneous distribution of hemoglobin types in sickle-cell anemia. *J Clin Invest* 1968;47(8):1731–1741.

81. Smith CM, Krivit W, White JG. The irreversibly sickled cell. *Am J Pediatr Hematol Oncol* 1982;4(3):307–315.

82. Clark MR, Mohandas N, Embury SH, Lubin BH. A simple laboratory alternative to irreversibly sickled cell (ISC) counts. *Blood* 1982;60(3):659–662.

83. Serjeant GR, Serjeant BE, Milner PF. The irreversibly sickled cell; a determinant of haemolysis in sickle cell anaemia. *Br J Haematol* 1969;17(6):527–533.

84. Serjeant GR, Serjeant BE, Desai P, et al. The determinants of irreversibly sickled cells in homozygous sickle cell disease. *Br J Haematol* 1978;40(3):431–438.

85. Eaton JW, Jacob HS, White JG. Membrane abnormalities of irreversibly sickled cells. *Semin Hematol* 1979;16(1):52–64.

86. Bookchin RM, Lew VL. Red cell membrane abnormalities in sickle cell anemia. *Prog Hematol* 1983;13:1–23.

87. Lux SE, John KM, Karnovsky MJ. Irreversible deformation of the spectrin-actin lattice in irreversibly sickled cells. *J Clin Invest* 1976;58(4):955–963.

88. Platt OS, Falcone JF. Membrane protein interactions in sickle red blood cells: evidence of abnormal protein 3 function. *Blood* 1995;86(5):1992–1998.

89. Rank BH, Moyer NL, Hebbel RP. Vesiculation of sickle erythrocytes during thermal stress. *Blood* 1988;72:1060.

90. Westerman MP, Diloy-Puray M, Streczyn M. Membrane components in the red cells of patients with sickle cell anemia. Relationship to cell aging and to irreversibility of sickling. *Biochim Biophys Acta* 1979;557(1):149–155.

91. Allan D, Raval P. Some morphological consequences of uncoupling the lipid bilayer from the plasma membrane skeleton in intact erythrocytes. *Biomed Biochim Acta* 1983;42(11–12):S11–S16.

92. Zwaal RFA, Bevers EM, Rosing J. Phospholipids in the clotting process. In: Nigel HE, Exuer T, Hughes GRV, Asherson RA, eds. *Phospholipid-binding antibodies*. Boston: CRC Press, 1991:31–59.

93. Kuypers FA, Yee M, Vichinsky E, Lubin BH. Activation of the prothrombinase complex in sickle cell anemia. *Blood* 1992;80:75.

94. Das SK, Nair RC. Superoxide dismutase, glutathione peroxidase, catalase and lipid peroxidation of normal and sickled erythrocytes. *Br J Haematol* 1980;44(1):87–92.

95. Hebbel RP, Miller WJ. Phagocytosis of sickle erythrocytes: immunologic and oxidative determinants of

hemolytic anemia. *Blood* 1984;64(3):733–741.

96. Jain SK, Shohet SB. A novel phospholipid in irreversibly sickled cells: evidence for in vivo peroxidative membrane damage in sickle cell disease. *Blood* 1984;63(2):362–367.

97. Mohandas N, Rossi ME, Clark MR. Association between morphologic distortion of sickle cells and deoxygenation-induced cation permeability increase. *Blood* 1986;68(2):450–454.

98. Eaton JW, Skelton TD, Swofford HS, et al. Elevated erythrocyte calcium in sickle cell disease. *Nature* 1973;246(5428):105–106.

99. Palek J, Thomae M, Ozog D. Red cell calcium content and transmembrane calcium movements in sickle cell anemia. *J Lab Clin Med* 1977;89(6):1365–1374.

100. Luthra MG, Sears DA. Increased  $Ca^{++}$ ,  $Mg^{++}$ , and  $Na^{++}$   $K^{+}$  ATPase activities in erythrocytes of sickle cell anemia. *Blood* 1982;60(6):1332–1336.

101. Clark MR, Unger RC, Shohet SB. Monovalent cation composition and ATP and lipid content of irreversibly sickled cells. *Blood* 1978;51(6):1169–1178.

102. Lew VL, Hockaday A, Sepulveda MI, et al. Compartmentalization of sickle-cell calcium in endocytic inside-out vesicles. *Nature* 1985;315(6020):586–589.

103. Rubin E, Schlegel RA, Williamson P. Endocytosis in sickle erythrocytes: a mechanism for elevated intracellular  $Ca^{2+}$  levels. *J Cell Physiol* 1986;126(1):53–59.

104. Rhoda MD, Apovo M, Beuzard Y, Giraud F.  $Ca^{2+}$  permeability in deoxygenated sickle cells. *Blood* 1990;75(12):2453–2458.

105. Giordano PC, Hartevelde CL. Chromatographic measurements of hemoglobin A2 in blood samples containing sickle hemoglobin. *Ann Clin Lab Sci* 2000;30(4):430–431.

106. Bookchin RM, Lew VL. Sickle red cell dehydration: mechanisms and interventions. *Curr Opin Hematol* 2002;9(2):107–110.

107. Brugnara C. Therapeutic strategies for prevention of sickle cell dehydration. *Blood Cells Mol Dis* 2001;27(1):71–80.

108. Lew VL, Freeman CJ, Ortiz OE, Bookchin RM. A mathematical model of the volume, pH, and ion content regulation in reticulocytes. Application to the pathophysiology of sickle cell dehydration. *J Clin Invest* 1991;87(1):100–112.

109. Bookchin RM, Ortiz OE, Lew VL. Evidence for a direct reticulocyte origin of dense red cells in sickle cell anemia. *J Clin Invest* 1991;87(1):113–124.

110. Brugnara C, De Franceschi L, Alper SL. Inhibition of  $Ca^{2+}$ -dependent  $K^{+}$  transport and cell dehydration in sickle erythrocytes by clotrimazole and other imidazole derivatives. *J Clin Invest* 1993;92(1):520–526.

111. De Franceschi L, Bachir D, Galacteros F, et al. Oral magnesium supplements reduce erythrocyte dehydration in patients with sickle cell disease. *J Clin Invest* 1997;100(7):1847–1852.

112. De Franceschi L, Bachir D, Galacteros F, et al. Oral magnesium pirolate: effects of long-term administration in patients with sickle cell disease. *Br J Haematol* 2000;108(2):284–289.

113. Stocker JW, De Franceschi L, McNaughton-Smith G, et al. A novel Gardos channel inhibitor, ICA-17043, prevents red blood cell dehydration in vitro and in a mouse model (SAD) of sickle cell disease. *Blood* 2000;96:486a.

114. Bennekou P, De Franceschi L, Pedersen O, et al. Treatment with NS3623, a novel  $Cl^{-}$  conductance blocker, ameliorates erythrocyte dehydration in transgenic SAD mice: a possible new therapeutic approach for sickle cell disease. *Blood* 2001;97(5):1451–1457.

115. Joiner CH, Jiang M, Claussen WJ, et al. Dipyridamole inhibits sickling-induced cation fluxes in sickle red blood cells. *Blood* 2001;97(12):3976–3983.
116. Franco RS, Palascak M, Thompson H, Joiner CH. KCl cotransport activity in light versus dense transferrin receptor-positive sickle reticulocytes. *J Clin Invest* 1995;95(6):2573–2580.
117. Franco RS, Thompson H, Palascak M, Joiner CH. The formation of transferrin receptor-positive sickle reticulocytes with intermediate density is not determined by fetal hemoglobin content. *Blood* 1997;90(8):3195–3203.
118. Hebbel RP, Yamada O, Moldow CF, et al. Abnormal adherence of sickle erythrocytes to cultured vascular endothelium: possible mechanism for microvascular occlusion in sickle cell disease. *J Clin Invest* 1980;65(1):154–160.
119. Mohandas N, Evans E. Adherence of sickle erythrocytes to vascular endothelial cells: requirement for both cell membrane changes and plasma factors. *Blood* 1984;64(1):282–287.
120. Schwartz RS, Schroit AJ, Tanaka Y, et al. Increased adherence of sickle erythrocytes to peripheral blood monocytes is correlated with an increased content of outer leaflet aminophospholipids. *Blood* 1983;62:61a.
121. Hoover R, Rubin R, Wise G, Warren R. Adhesion of normal and sickle erythrocytes to endothelial monolayer cultures. *Blood* 1979;54(4):872–876.
122. Mohandas N, Evans E. Sickle erythrocyte adherence to vascular endothelium. Morphologic correlates and the requirement for divalent cations and collagen-binding plasma proteins. *J Clin Invest* 1985;76(4):1605–1612.
123. Kucukcelebi A, Barmatoski SP, Barnhart MI. Interactions between vessel wall and perfused sickled erythrocytes: preliminary observations. *Scan Electron Microsc* 1980;(3):243–248.
124. Barabino GA, McIntire LV, Eskin SG, et al. Endothelial cell interactions with sickle cell, sickle trait, mechanically injured, and normal erythrocytes under controlled flow. *Blood* 1987;70(1):152–157.
125. Ballas SK, Lerner J, Smith ED, et al. Rheologic predictors of the severity of the painful sickle cell crisis. *Blood* 1988;72(4):1216–1223.
126. Lande WM, Andrews DL, Clark MR, et al. The incidence of painful crisis in homozygous sickle cell disease: correlation with red cell deformability. *Blood* 1988;72(6):2056–2059.
127. Burns ER, Wilkinson WH, Nagel RL. Adherence properties of sickle erythrocytes in dynamic flow systems. *J Lab Clin Med* 1985;105(6):673–678.
128. Hebbel RP, Schwartz RS, Mohandas N. The adhesive sickle erythrocyte: cause and consequence of abnormal interactions with endothelium, monocytes/macrophages and model membranes. *Clin Haematol* 1985;14(1):141–161.
129. Marikovsky Y, Khodadad JK, Weinstein RS. Influence of red cell shape on surface charge topography. *Exp Cell Res* 1978;116(1):191–197.
130. Hebbel RP. Erythrocyte autoxidation and the membrane abnormalities of sickle red cells. *Prog Clin Biol Res* 1984;159:219–225.
131. Hebbel RP. Blockade of adhesion of sickle cells to endothelium by monoclonal antibodies. *N Engl J Med* 2000;342(25):1910–1912.
132. Sugihara K, Sugihara T, Mohandas N, Hebbel RP. Thrombospondin mediates adherence of CD36+ sickle reticulocytes to endothelial cells. *Blood* 1992;80(10):2634–2642.
133. Brittain HA, Eckman JR, Swerlick RA, et al. Thrombospondin from activated platelets promotes sickle erythrocyte adherence to human microvascular endothelium under physiologic flow: a potential role

for platelet activation in sickle cell vaso-occlusion. *Blood* 1993;81(8):2137-2143.

134. Sugihara K, Sugihara T, Mohandas N, et al. Thrombospondin at pathophysiologic levels mediates adherence of CD36-positive sickle reticulocytes to endothelium cells. *Blood* 1992;80[Suppl]:344a.

135. Musso R, Alessi M, Assisi A, et al. Thrombospondin plasma levels in beta thalassemia sickle cell disease. *Blood* 1992;80[Suppl]:391a.

136. Joneckis CC, Ackley RL, Orringer EP, et al. Integrin alpha 4 beta 1 and glycoprotein IV (CD36) are expressed on circulating reticulocytes in sickle cell anemia. *Blood* 1993;82(12):3548-3555.

137. Swerlick RA, Eckman JR, Kumar A, et al. Alpha 4 beta 1-integrin expression on sickle reticulocytes: vascular cell adhesion molecule-1-dependent binding to endothelium. *Blood* 1993;82(6):1891-1899.

138. Wick TM, Moake JL, Udden MM, et al. Unusually large von Willebrand factor multimers increase adhesion of sickle erythrocytes to human endothelial cells under controlled flow. *J Clin Invest* 1987;80(3):905-910.

139. Brittain HA, Eckman JR, Wick TM. Sickle erythrocyte adhesion to large vessel and microvascular endothelium under physiologic flow is qualitatively different. *J Lab Clin Med* 1992;120(4):538-545.

140. Solovey A, Lin Y, Browne P, et al. Circulating activated endothelial cells in sickle cell anemia. *N Engl J Med* 1997;337(22):1584-1590.

141. Matsui NM, Borsig L, Rosen SD, et al. P-selectin mediates the adhesion of sickle erythrocytes to the endothelium. *Blood* 2001;98(6):1955-1962.

142. Petz LD, Yam P, Wilkinson L, et al. Increased IgG molecules bound to the surface of red blood cells of patients with sickle cell anemia. *Blood* 1984;64(1):301-304.

143. Turrini F, Arese P, Yuan J, Low PS. Clustering of integral membrane proteins of the human erythrocyte membrane stimulates autologous IgG binding, complement deposition, and phagocytosis. *J Biol Chem* 1991;266(35):23611-23617.

144. Lutz HU. Naturally occurring anti-band 3 antibodies. *Transfus Med Rev* 1992;6(3):201-211.

145. Clark MR, Mohandas N, Shohet SB. Deformability of oxygenated irreversibly sickled cells. *J Clin Invest* 1980;65(1):189-196.

146. Jain SK, Shohet SB. Calcium potentiates the peroxidation of erythrocyte membrane lipids. *Biochim Biophys Acta* 1981;642(1):46-54.

147. Kannan R, Labotka R, Low PS. Isolation and characterization of the hemichrome-stabilized membrane protein aggregates from sickle erythrocytes. Major site of autologous antibody binding. *J Biol Chem* 1988;263(27):13766-13773.

148. Repka T, Hebbel RP. Hydroxyl radical formation by sickle erythrocyte membranes: role of pathologic iron deposits and cytoplasmic reducing agents. *Blood* 1991;78(10):2753-2758.

149. Hebbel RP. Auto-oxidation and a membrane-associated "Fenton reagent": a possible explanation for development of membrane lesions in sickle erythrocytes. *Clin Haematol* 1985;14(1):129-140.

150. Hebbel RP. The sickle erythrocyte in double jeopardy: autoxidation and iron decompartmentalization. *Semin Hematol* 1990;27(1):51-69.

151. Hebbel RP, Eaton JW, Balasingam M, Steinberg MH. Spontaneous oxygen radical generation by sickle erythrocytes. *J Clin Invest* 1982;70(6):1253-1259.

152. Kuross SA, Rank BH, Hebbel RP. Excess heme in sickle erythrocyte inside-out membranes: possible role in thiol oxidation. *Blood* 1988;71(4):876-882.

153. Kuross SA, Hebbel RP. Nonheme iron in sickle erythrocyte membranes: association with

phospholipids and potential role in lipid peroxidation. *Blood* 1988;72(4):1278–1285.

154. Liu SC, Zhai S, Palek J. Detection of heme release during hemoglobin S denaturation. *Blood* 1988;71(6):1755–1758.

155. Natta CL, Machlin LJ, Brin M. A decrease in irreversibly sickled erythrocytes in sickle cell anemia patients given vitamin E. *Am J Clin Nutr* 1980;33(5):968–971.

156. Chiu D, Vichinsky E, Yee M, et al. Peroxidation, vitamin E, and sickle-cell anemia. *Ann N Y Acad Sci* 1982;393:323–335.

157. Chien S, King RG, Kaperonis AA, Usami S. Viscoelastic properties of sickle cells and hemoglobin. *Blood Cells* 1982;8(1):53–64.

158. Chien S, Usami S, Bertles JF. Abnormal rheology of oxygenated blood in sickle cell anemia. *J Clin Invest* 1970;49(4):623–634.

159. Danish EH, Harris JW. Viscosity studies of deoxyhemoglobin S: evidence for formation of microaggregates during the lag phase. *J Lab Clin Med* 1983;101(4):515–526.

160. Nash GB, Johnson CS, Meiselman HJ. Mechanical properties of oxygenated red blood cells in sickle cell (HbSS) disease. *Blood* 1984;63(1):73–82.

161. Messmann R, Gannon S, Sarnaik S, Johnson RM. Mechanical properties of sickle cell membranes. *Blood* 1990;75(8):1711–1717.

162. Murphy JR, Wengard M, Brereton W. Rheological studies of Hb SS blood: influence of hematocrit, hypertonicity, separation of cells, deoxygenation, and mixture with normal cells. *J Lab Clin Med* 1976;87(3):475–486.

163. Schmalzer EA, Manning RS, Chien S. Filtration of sickle cells: recruitment into a rigid fraction as a function of density and oxygen tension. *J Lab Clin Med* 1989;113(6):727–734.

164. Bessis M, Mohandas N. Laser diffraction patterns of sickle cells in shear fields. *Blood Cells* 1977;3:229–239.

165. Evans E, Mohandas N, Leung A. Static and dynamic rigidities of normal and sickle erythrocytes. Major influence of cell hemoglobin concentration. *J Clin Invest* 1984;73(2):477–488.

166. Havell TC, Hillman D, Lessin LS. Deformability characteristics of sickle cells by microelastimetry. *Am J Hematol* 1978;4(1):9–16.

167. Clark MR. Mean corpuscular hemoglobin concentration and cell deformability. *Ann N Y Acad Sci* 1989;565:284–294.

168. Hebbel RP, Leung A, Mohandas N. Oxidation-induced changes in microrheologic properties of the red blood cell membrane. *Blood* 1990;76(5):1015–1020.

169. Itoh T, Chien S, Usami S. Deformability measurements on individual sickle cells using a new system with pO<sub>2</sub> and temperature control. *Blood* 1992;79(8):2141–2147.

170. Mackie LH, Hochmuth RM. The influence of oxygen tension, temperature, and hemoglobin concentration on the rheologic properties of sickle erythrocytes. *Blood* 1990;76(6):1256–1261.

171. Nash GB, Johnson CS, Meiselman HJ. Influence of oxygen tension on the viscoelastic behavior of red blood cells in sickle cell disease. *Blood* 1986;67(1):110–118.

172. Schmid-Schonbein H. Continuous viscous deformation of red blood cells in flow and their disturbance in sickle cell disease. *Blood Cells* 1982;8(1):29–51.

173. Evans EA, Mohandas N. Membrane-associated sickle hemoglobin: a major determinant of sickle erythrocyte rigidity. *Blood* 1987;70(5):1443–1449.

174. Kaul DK, Fabry ME, Windisch P, et al. Erythrocytes in sickle cell anemia are heterogeneous in their rheological and hemodynamic characteristics. *J Clin Invest* 1983;72(1):22–31.
175. Rodgers GP, Schechter AN, Noguchi CT, et al. Periodic microcirculatory flow in patients with sickle cell disease. *N Engl J Med* 1984;311:1534–1538.
176. Nagpal KC, Goldberg MF, Rabb MF. Ocular manifestations of sickle hemoglobinopathies. *Surv Ophthalmol* 1977;21(5):391–411.
177. Chien S, Lipowsky HH. Capillary circulation in sickle cell anemia. *Int J Microcirc Clin Exp* 1984;3:493.
178. Lipowsky HH, Usami S, Chien S. Human SS red cell rheological behavior in the microcirculation of cremaster muscle. *Blood Cells* 1982;8(1):113–126.
179. Tharaux PL, Girot R, Kanfer A, et al. Cutaneous microvascular blood flow and reactivity in patients with homozygous sickle cell anaemia. *Eur J Haematol* 2002;68(6):327–331.
180. Miller DM, Winslow RM, Klein HG, et al. Improved exercise performance after exchange transfusion in subjects with sickle cell anemia. *Blood* 1980;56(6):1127–1131.
181. Test ST, Kleman K, Lubin B. Characterization of the complement sensitivity of density-fractionated sickle cells. *Blood* 1991;78[Suppl]:202a.
182. Allan D, Limbrick AR, Thomas P, Westerman MP. Release of spectrin-free spicules on reoxygenation of sickled erythrocytes. *Nature* 1982;295(5850):612–613.
183. Platt OS. Exercise-induced hemolysis in sickle cell anemia: shear sensitivity and erythrocyte dehydration. *Blood* 1982;59(5):1055–1060.
184. Galili U, Clark MR, Shohet SB. Excessive binding of natural anti-alpha-galactosyl immunoglobulin G to sickle erythrocytes may contribute to extravascular cell destruction. *J Clin Invest* 1986;77(1):27–33.
185. Green GA, Kalra VK. Sickling-induced binding of immunoglobulin to sickle erythrocytes. *Blood* 1988;71(3):636–639.
186. Kaul DK, Fabry ME, Nagel RL. Vaso-occlusion by sickle cells: evidence for selective trapping of dense red cells. *Blood* 1986;68(5):1162–1166.
187. Waugh SM, Willardson BM, Kannan R, Labotka RJ, Low PS. Heinz bodies induce clustering of band 3, glycophorin, and ankyrin in sickle cell erythrocytes. *J Clin Invest* 1986;78(5):1155–1160.
188. Schluter K, Drenckhahn D. Co-clustering of denatured hemoglobin with band 3: its role in binding of autoantibodies against band 3 to abnormal and aged erythrocytes. *Proc Natl Acad Sci U S A* 1986;83(16):6137–6141.
189. Test ST, Woolworth VS. Defective regulation of complement by the sickle erythrocyte: evidence for a defect in control of membrane attack complex formation. *Blood* 1994;83(3):842–852.
190. Noguchi CT, Schechter AN. Non-uniformity of intracellular polymer formation in sickle erythrocytes: possible correlation with severity of hemolytic anemia. *Annu Rev Biophys Chem* 1985;4:239.
191. Brittenham GM, Schechter AN, Noguchi CT. Hemoglobin S polymerization: primary determinant of the hemolytic and clinical severity of the sickling syndromes. *Blood* 1985;65(1):183–189.
192. Miller WJ, Hebbel RP. Erythrophagocytosis as a determinant of hemolytic rate in sickle disease. *Prog Clin Biol Res* 1984;165:85–92.
193. Embury SH, Hebbel RP, Steinberg MH, Mohandas N. Pathogenesis of vasoocclusion. In: Embury SH, Hebbel RP, Mohandas N, Steinberg MH, eds. *Sickle cell disease: basic principles and clinical practice*. New York: Raven Press, 1994:311–326.
194. Kurantsin-Mills J, Klug PP, Lessin LS. Vaso-occlusion in sickle cell disease: pathophysiology of the

microvascular circulation. *Am J Pediatr Hematol Oncol* 1988;10(4):357–372.

195. Wiedman MP. Architecture. In: Renkin EM, Michel CC, Geiger SR, eds. *Handbook of physiology*. Bethesda: American Physiology Society, 1993:11–40.

196. Kaul DK, Fabry ME, Nagel RL. Microvascular sites and characteristics of sickle cell adhesion to vascular endothelium in shear flow conditions: pathophysiological implications. *Proc Natl Acad Sci U S A* 1989;86(9):3356–3360.

197. Kaul DK, Fabry ME, Nagel RL. Erythrocytic and vascular factors influencing the microcirculatory behavior of blood in sickle cell anemia. *Ann N Y Acad Sci* 1989;565:316–326.

198. Fabry ME, Benjamin L, Lawrence C, Nagel RL. An objective sign in painful crisis in sickle cell anemia: the concomitant reduction of high density red cells. *Blood* 1984;64(2):559–563.

199. Akinola NO, Stevens SM, Franklin IM, et al. Rheological changes in the prodromal and established phases of sickle cell vaso-occlusive crisis. *Br J Haematol* 1992;81(4):598–602.

200. Ballas SK, Mohandas N, Cremens J, et al. Contribution of reticulocytes and mature erythrocytes to cellular dehydration in various sickle cell syndromes. *Blood* 1992;80[Suppl 1]:9a.

201. Hebbel RP, Boogaerts MA, Eaton JW, Steinberg MH. Erythrocyte adherence to endothelium in sickle-cell anemia. A possible determinant of disease severity. *N Engl J Med* 1980;302 (18):992–995.

202. Hebbel RP, Moldow CF, Steinberg MH. Modulation of erythrocyte-endothelial interactions and the vasoocclusive severity of sickling disorders. *Blood* 1981;58(5):947–952.

203. Smith BD, La Celle PL. Erythrocyte-endothelial cell adherence in sickle cell disorders. *Blood* 1986;68(5):1050–1054.

204. Wautier JL, Pintigny D, Wautier MP, et al. Fibrinogen, a modulator of erythrocyte adhesion to vascular endothelium. *J Lab Clin Med* 1983;101(6):911–920.

205. Diggs LW. Sickle cell crises. *Am J Clin Pathol* 1965;44:1.

206. Richardson SG, Matthews KB, Stuart J, et al. Serial changes in coagulation and viscosity during sickle-cell crisis. *Br J Haematol* 1979;41(1):95–103.

207. Rubanyi GM. Vascular effects of oxygen-derived free radicals. *Free Radic Biol Med* 1988;4(2):107–120.

208. Faller DV. Vascular modulation. In: Embury SH, Hebbel RP, Mohandas N, Steinberg MH, eds. *Sickle cell disease: basic principles and clinical practice*. New York: Raven Press, 1994: 235–246.

209. Reiter CD, Gladwin MT. An emerging role for nitric oxide in sickle cell disease vascular homeostasis and therapy. *Curr Opin Hematol* 2003;10(2):99–107.

210. Morris CR, Kuypers FA, Larkin S, et al. Patterns of arginine and nitric oxide in patients with sickle cell disease with vaso-occlusive crisis and acute chest syndrome. *J Pediatr Hematol Oncol* 2000;22(6):515–520.

211. Stuart MJ, Setty BN. Sickle cell acute chest syndrome: pathogenesis and rationale for treatment. *Blood* 1999;94(5):1555–1560.

212. Ikuta T, Ausenda S, Cappellini MD. Mechanism for fetal globin gene expression: role of the soluble guanylate cyclase-cGMP-dependent protein kinase pathway. *Proc Natl Acad Sci U S A* 2001;98(4):1847–1852.

213. Reiter CD, Wang X, Tanus-Santos JE, et al. Cell-free hemoglobin limits nitric oxide bioavailability in sickle-cell disease. *Nat Med* 2002;8(12):1383–1389.

214. Pohl U, Lamontagne D. Impaired tissue perfusion after inhibition of endothelium-derived nitric oxide.



Basic Res Cardiol 1991;86[Suppl 2]:97–105.

215. Naumann HN, Diggs LW, Barreras L, Williams BJ. Plasma hemoglobin and hemoglobin fractions in sickle cell crisis. *Am J Clin Pathol* 1971;56(2):137–147.
216. De Caterina R, Libby P, Peng HB, et al. Nitric oxide decreases cytokine-induced endothelial activation. Nitric oxide selectively reduces endothelial expression of adhesion molecules and proinflammatory cytokines. *J Clin Invest* 1995;96(1):60–68.
217. Gladwin MT, Schechter AN, Ognibene FP, et al. Divergent nitric oxide bioavailability in men and women with sickle cell disease. *Circulation* 2003;107(2):271–278.
218. Morris CR, Kuypers FA, Larkin S, et al. Arginine therapy: a novel strategy to induce nitric oxide production in sickle cell disease. *Br J Haematol* 2000;111(2):498–500.
219. Romero JR, Suzuka SM, Nagel RL, Fabry ME. Arginine supplementation of sickle transgenic mice reduces red cell density and Gardos channel activity. *Blood* 2002;99(4):1103–1108.
220. Charache S, Terrin ML, Moore RD, et al. Effect of hydroxyurea on the frequency of painful crises in sickle cell anemia. Investigators of the Multicenter Study of Hydroxyurea in Sickle Cell Anemia. *N Engl J Med* 1995;332(20):1317–1322.
221. Mohandas N, Evans E. Rheological and adherence properties of sickle cells. Potential contribution to hematologic manifestations of the disease. *Ann N Y Acad Sci* 1989;565:327–337.
222. Rock EP, Roth EF, Jr, Rojas-Corona RR, et al. Thrombospondin mediates the cytoadherence of *Plasmodium falciparum*-infected red cells to vascular endothelium in shear flow conditions. *Blood* 1988;71(1):71–75.
223. Giltay JC, van Mourik JA. Structure and function of endothelial cell integrins. *Haemostasis* 1988;18(4–6):376–389.
224. Ginsburg V, Roberts DD. Glycoconjugates and cell adhesion: the adhesive proteins laminin, thrombospondin, and von Willebrand's factor bind specifically to sulfated glycolipids. *Biochimie* 1988;70(11):1651–1659.
225. Vordermeier S, Singh S, Biggerstaff J, et al. Red blood cells from patients with sickle cell disease exhibit an increased adherence to cultured endothelium pretreated with tumour necrosis factor (TNF). *Br J Haematol* 1992;81(4):591–597.
226. Boggs DR, Hyde F, Srodes C. An unusual pattern of neutrophil kinetics in sickle cell anemia. *Blood* 1973;41(1):59–65.
227. Buchanan GR, Glader BE. Leukocyte counts in children with sickle cell disease. Comparative values in the steady state, vaso-occlusive crisis, and bacterial infection. *Am J Dis Child* 1978;132(4):396–398.
228. Akenzua GI, Amienheme OR. Inhibitor of in vitro neutrophil migration in sera of children with homozygous sickle cell gene during pain crisis. *Br J Haematol* 1981;47(3):345–352.
229. Boghossian SH, Wright G, Webster AD, Segal AW. Investigations of host defense in patients with sickle cell disease. *Br J Haematol* 1985;59(3):523–531.
230. Bagge U, Amundson B, Lauritzen C. White blood cell deformability and plugging of skeletal muscle capillaries in hemorrhagic shock. *Acta Physiol Scand* 1980;108(2):159–163.
231. Ginis I, Mentzer SJ, Faller DV. Oxygen tension regulates neutrophil adhesion to human endothelial cells via an LFA-1-dependent mechanism. *J Cell Physiol* 1993;157(3):569–578.
232. Platt OS, Brambilla DJ, Rosse WF, et al. Mortality in sickle cell disease. Life expectancy and risk factors for early death. *N Engl J Med* 1994;330(23):1639–1644.
233. Kinney TR, Sleeper LA, Wang WC, et al. Silent cerebral infarcts in sickle cell anemia: a risk factor

analysis. The Cooperative Study of Sickle Cell Disease. *Pediatrics* 1999;103(3):640–645.

234. Charache S, Barton FB, Moore RD, et al. Hydroxyurea and sickle cell anemia. Clinical utility of a myelosuppressive “switching” agent. The Multicenter Study of Hydroxyurea in Sickle Cell Anemia. *Medicine (Baltimore)* 1996;75(6):300–326.

235. Miller ST, Sleeper LA, Pegelow CH, et al. Prediction of adverse outcomes in children with sickle cell disease. *N Engl J Med* 2000;342(2):83–89.

236. Pieters RC, Rojer RA, Saleh AW, et al. Molgramostim to treat SS-sickle cell leg ulcers. *Lancet* 1995;345(8948):528.

237. Abboud M, Laver J, Blau CA. Granulocytosis causing sickle-cell crisis. *Lancet* 1998;351(9107):959.

238. Adler BK, Salzman DE, Carabasi MH, et al. Fatal sickle cell crisis after granulocyte colony-stimulating factor administration. *Blood* 2001;97(10):3313–3314.

239. Grigg AP. Granulocyte colony-stimulating factor-induced sickle cell crisis and multiorgan dysfunction in a patient with compound heterozygous sickle cell/beta+ thalassemia. *Blood* 2001;97(12):3998–3999.

240. Turhan A, Weiss LA, Mohandas N, et al. Primary role for adherent leukocytes in sickle cell vascular occlusion: a new paradigm. *Proc Natl Acad Sci U S A* 2002;99(5):3047–3051.

241. Frenette PS. Sickle cell vaso-occlusion: multistep and multicellular paradigm. *Curr Opin Hematol* 2002;9(2):101–106.

242. Wun T, Paglieroni T, Field CL, et al. Platelet-erythrocyte adhesion in sickle cell disease. *J Invest Med* 1999;47(3):121–127.

243. Setty BN, Rao AK, Stuart MJ. Thrombophilia in sickle cell disease: the red cell connection. *Blood* 2001;98(12):3228–3233.

244. Wagener FA, Eggert A, Boerman OC, et al. Heme is a potent inducer of inflammation in mice and is counteracted by heme oxygenase. *Blood* 2001;98(6):1802–1811.

245. Kaul DK, Hebbel RP. Hypoxia/reoxygenation causes inflammatory response in transgenic sickle mice but not in normal mice. *J Clin Invest* 2000;106(3):411–420.

246. Francis RB, Jr., Haywood LJ. Elevated immunoreactive tumor necrosis factor and interleukin-1 in sickle cell disease. *J Natl Med Assoc* 1992;84(7):611–615.

247. Malave I, Perdomo Y, Escalona E, et al. Levels of tumor necrosis factor alpha/cachectin (TNF alpha) in sera from patients with sickle cell disease. *Acta Haematol* 1993;90(4):172–176.

248. Croizat H. Circulating cytokines in sickle cell patients during steady state. *Br J Haematol* 1994;87(3):592–597.

249. Graido-Gonzalez E, Doherty JC, Bergreen EW, et al. Plasma endothelin-1, cytokine, and prostaglandin E2 levels in sickle cell disease and acute vaso-occlusive sickle crisis. *Blood* 1998;92(7):2551–2555.

250. Solovey AA, Solovey AN, Harkness J, Hebbel RP. Modulation of endothelial cell activation in sickle cell disease: a pilot study. *Blood* 2001;97(7):1937–1941.

251. Freedman ML, Karpatkin S. Elevated platelet count and megathrombocyte number in sickle cell anemia. *Blood* 1975;46(4):579–582.

252. Haut MJ, Cowan DH, Harris JW. Platelet function and survival in sickle cell disease. *J Lab Clin Med* 1973;82(1):44–53.

253. Mehta P, Mehta J. Abnormalities of platelet aggregation in sickle cell disease. *J Pediatr* 1980;96(2):209–213.

254. Mehta P. Significance of plasma beta-thromboglobulin values in patients with sickle cell disease. *J Pediatr* 1980;97(6):941-944.
255. Kurantsin-Mills J, Ibe BO, Natta CL, et al. Elevated urinary levels of thromboxane and prostacyclin metabolites in sickle cell disease reflects activated platelets in the circulation. *Br J Haematol* 1994;87(3):580-585.
256. Browne PV, Mosher DF, Steinberg MH, Hebbel RP. Disturbance of plasma and platelet thrombospondin levels in sickle cell disease. *Am J Hematol* 1996;51(4):296-301.
257. Gordon EM, Klein BL, Berman BW, et al. Reduction of contact factors in sickle cell disease. *J Pediatr* 1985;106(3):427-430.
258. Karayalcin G, Lanzkowsky P. Plasma protein C levels in children with sickle cell disease. *Am J Pediatr Hematol Oncol* 1989;11(3):320-323.
259. Francis RB, Jr. Protein S deficiency in sickle cell anemia. *J Lab Clin Med* 1988;111(5):571-576.
260. Kurantsin-Mills J, Ofosu FA, Safa TK, et al. Plasma factor VII and thrombin-antithrombin III levels indicate increased tissue factor activity in sickle cell patients. *Br J Haematol* 1992;81(4):539-544.
261. Mehta P, Albiol L. Prostacyclin and platelet aggregation in sickle cell disease. *Pediatrics* 1982;70(3):354-359.
262. Devine DV, Kinney TR, Thomas PF, et al. Fragment D-dimer levels: an objective marker of vaso-occlusive crisis and other complications of sickle cell disease. *Blood* 1986;68(1):317-319.
263. Hegyi T, Delphin ES, Bank A, et al. Sickle cell anemia in the newborn. *Pediatrics* 1977;60(2):213-216.
264. Pearson HA. Sickle cell anemia: Clinical management during the early years of life. In: Abramson H, Bertles JF, Wethers DL, eds. *Sickle cell disease: Diagnosis, management, education, and research*. St. Louis: Mosby, 1973.
265. Powars DR. Natural history of sickle cell disease—the first ten years. *Semin Hematol* 1975;12(3):267-285.
266. O'Brien RT, McIntosh S, Aspnes GT, Pearson HA. Prospective study of sickle cell anemia in infancy. *J Pediatr* 1976;89(2):205-210.
267. Stevens MC, Hayes RJ, Vaidya S, Serjeant GR. Fetal hemoglobin and clinical severity of homozygous sickle cell disease in early childhood. *J Pediatr* 1981;98(1):37-41.
268. Bainbridge R, Higgs DR, Maude GH, Serjeant GR. Clinical presentation of homozygous sickle cell disease. *J Pediatr* 1985;106(6):881-885.
269. Gill FM, Sleeper LA, Weiner SJ, et al. Clinical events in the first decade in a cohort of infants with sickle cell disease. Cooperative Study of Sickle Cell Disease. *Blood* 1995;86(2):776-783.
270. Brown AK, Sleeper LA, Miller ST, et al. Reference values and hematologic changes from birth to 5 years in patients with sickle cell disease. Cooperative Study of Sickle Cell Disease. *Arch Pediatr Adolesc Med* 1994;148(8):796-804.
271. Pearson HA, McIntosh S, Ritchey AK, et al. Developmental aspects of splenic function in sickle cell diseases. *Blood* 1979;53(3):358-365.
272. Serjeant GR, Geulaer CD, Lethbridge R, et al. The painful crisis of homozygous sickle cell disease: clinical features. *Br J Haematol* 1994;87(3):586-591.
273. Diggs LW, Flowers E. Sickle cell anemia in the home environment. Observations on the natural history of the disease in Tennessee children. *Clin Pediatr (Phila)* 1971;10(12):697-700.
274. Stevens MC, Padwick M, Serjeant GR. Observations on the natural history of dactylitis in

homozygous sickle cell disease. *Clin Pediatr (Phila)* 1981;20(5):311–317.

275. Watson RJ, Burko H, Megas H, Robinson M. The hand-foot syndrome in sickle cell disease in young children. *Pediatrics* 1963;31:975.

276. Keeley K, Buchanan GR. Acute infarction of long bones in children with sickle cell anemia. *J Pediatr* 1982;101(2):170–175.

277. Milner PF, Brown M. Bone marrow infarction in sickle cell anemia: correlation with hematologic profiles. *Blood* 1982;60(6):1411–1419.

278. Platt OS, Thorington BD, Brambilla DJ, et al. Pain in sickle cell disease. Rates and risk factors. *N Engl J Med* 1991;325(1):11–16.

279. Hargrave DR, Wade A, Evans JP, et al. Nocturnal oxygen saturation and painful sickle cell crises in children. *Blood* 2003;101(3):846–848.

280. Blank JP, Gill FM. Orbital infarction in sickle cell disease. *Pediatrics* 1981;67(6):879–881.

281. Schumacher HR, Andrews R, McLaughlin G. Arthropathy in sickle-cell disease. *Ann Intern Med* 1973;78(2):203–211.

282. Mankad VN, Williams JP, Harpen MD, et al. Magnetic resonance imaging of bone marrow in sickle cell disease: clinical, hematologic, and pathologic correlations. *Blood* 1990;75(1):274–283.

283. Hammel CF, DeNardo SJ, DeNardo GL, Lewis JP. Bone marrow and bone mineral scintigraphic studies in sickle cell disease. *Br J Haematol* 1973;25(5):593–598.

284. Lutzker LG, Alavi A. Bone and marrow imaging in sickle cell disease: diagnosis of infarction. *Semin Nucl Med* 1976;6(1):83–93.

285. Rao S, Solomon N, Miller S, Dunn E. Scintigraphic differentiation of bone infarction from osteomyelitis in children with sickle cell disease. *J Pediatr* 1985;107(5):685–688.

286. Schwartz E, McElfresh AE. Treatment of painful crises of sickle cell disease. *J Pediatr* 1964;64:132.

287. Oski F, Viner ED, Puruggan H, McElfresh AE. Low molecular weight dextran in sickle cell crisis. *JAMA* 1965;191:43.

288. Pearson HA, Noyes WD. Failure of phenothiazines in sickle cell anemia. *JAMA* 1967;199(1):33–34.

289. Oski F, Call FL, Lessen L. Failure of promazine HCl to prevent the painful episodes in sickle cell anemia. *J Pediatr* 1968;73(2):265–266.

290. Mann JR, Deeble TJ, Breeze GR, Stuart J. Ancrod in sickle-cell crisis. *Lancet* 1972;1(7757):934–937.

291. Opio E, Barnes PM. Intravenous urea in treatment of bone-pain crises of sickle-cell disease. A double-blind trial. *Lancet* 1972;2(7769):160–162.

292. Clinical trials of therapy for sickle cell vaso-occlusive crises. Cooperative urea trials group. *JAMA* 1974;228(9):1120–1124.

293. Finney RAJ, Hatch FE, Jr. Effect of carbonic anhydrase inhibitor (Dichlorphenamide) on sickle cell anemia. *Am J Med Sci* 1965;250:154.

294. Smith E, et al. Sickle cell anemia crisis: Report on seven patients treated with Priscoline. *J Pediatr* 1953;43:655.

295. Isaacs WA, Effiong CE, Ayeni O. Steroid treatment in the prevention of painful episodes in sickle-cell disease. *Lancet* 1972;1(7750):570–571.

296. Lundh B, Gardner FH. The haematological response to androgens in sickle cell anaemia. *Scand J*

Haematol 1970;7(5):389-397.

297. Diggs LW, Williams DL. Treatment of painful sickle cell crises with papaverine: Preliminary report. *South Med J* 1963;56:472.

298. Seward CW, Eaton JW, Chaplin H, Jr. Artificially induced thyroid suppression in sickle cell disease. *Blood* 1972;40(6):905-913.

299. Laszlo J, Obenour W, Jr., Saltzman HA. Effects of hyperbaric oxygenation on sickle syndromes. *South Med J* 1969;62(4):453-456.

300. Reynolds JD. Painful sickle cell crisis. Successful treatment with hyperbaric oxygen therapy. *JAMA* 1971;216(12):1977-1978.

301. Sherer JT, Glover PH. Pentoxifylline for sickle-cell disease. *Ann Pharmacother* 2000;34(9):1070-1074.

302. Cabannes R, Sangare A, Cho YW. Acute painful sickle-cell crises in children. A double blind, placebo-controlled evaluation of efficacy and safety of cetiedil. *Clin Trials* 1983;20:207-217.

303. Benjamin LJ, Berkowitz LR, Orringer E, et al. A collaborative, double-blind randomized study of cetiedil citrate in sickle cell crisis. *Blood* 1986;67(5):1442-1447.

304. Orringer EP, Casella JF, Ataga KI, et al. Purified poloxamer 188 for treatment of acute vaso-occlusive crisis of sickle cell disease: A randomized controlled trial. *JAMA* 2001;286(17):2099-2106.

305. Radel EG, Kochen JA, Finberg L. Hyponatremia in sickle cell disease. A renal salt-losing state. *J Pediatr* 1976;88(5):800-805.

306. Embury SH, Garcia JF, Mohandas N, et al. Effects of oxygen inhalation on endogenous erythropoietin kinetics, erythropoiesis, and properties of blood cells in sickle-cell anemia. *N Engl J Med* 1984;311(5):291-295.

307. Charache S. Treatment of sickle cell anemia. *Annu Rev Med* 1981;32:195-206.

308. Vichinsky EP, Johnson R, Lubin BH. Multidisciplinary approach to pain management in sickle cell disease. *Am J Pediatr Hematol Oncol* 1982;4(3):328-333.

309. Griffin TC, McIntire D, Buchanan GR. High-dose intravenous methylprednisolone therapy for pain in children and adolescents with sickle cell disease. *N Engl J Med* 1994;330(11):733-737.

310. Daghistani D, Schoenike S, Vasconcellos E, et al. A pilot study comparing parental ketorolac to morphine for the control of vaso-occlusive (VOC) pain in sickle cell anemia (SCA). *Pediatr Res* 1996;910.

311. McPherson E, Perlin E, Finke H, et al. Patient-controlled analgesia in patients with sickle cell vaso-occlusive crisis. *Am J Med Sci* 1990;299(1):10-12.

312. Shapiro BS, Cohen DE, Howe CJ. Patient-controlled analgesia for sickle-cell-related pain. *J Pain Symptom Manage* 1993;8(1):22-28.

313. Dampier CD, Setty BN, Logan J, et al. Intravenous morphine pharmacokinetics in pediatric patients with sickle cell disease. *J Pediatr* 1995;126(3):461-467.

314. Gerber N, Apseloff G. Death from a morphine infusion during a sickle cell crisis. *J Pediatr* 1993;123(2):322-325.

315. Zeltzer L, Dash J, Holland JP. Hypnotically induced pain control in sickle cell anemia. *Pediatrics* 1979;64(4):533-536.

316. Diamond WJ, Brown FL, Jr., Bitterman P, et al. Delayed hemolytic transfusion reaction presenting as sickle-cell crisis. *Ann Intern Med* 1980;93(2):231-234.

317. Portnoy BA, Herion JC. Neurological manifestations in sickle-cell disease, with a review of the

literature and emphasis on the prevalence of hemiplegia. *Ann Intern Med* 1972;76(4):643–652.

318. Powars D, Wilson B, Imbus C, et al. The natural history of stroke in sickle cell disease. *Am J Med* 1978;65(3):461–471.

319. Sarnaik SA, Lusher JM. Neurological complications of sickle cell anemia. *Am J Pediatr Hematol Oncol* 1982;4(4):386–394.

320. Falter ML, Sutton AL, Robinson MG. Massive intracranial hemorrhage in sickle-cell anemia. *Am J Dis Child* 1973;125(3):415–416.

321. Van Hoff J, Ritchey AK, Shaywitz BA. Intracranial hemorrhage in children with sickle cell disease. *Am J Dis Child* 1985;139(11):1120–1123.

322. Russell MO, Goldberg HI, Hodson A, et al. Effect of transfusion therapy on arteriographic abnormalities and on recurrence of stroke in sickle cell disease. *Blood* 1984;63(1):162–169.

323. Powars DR, Schroeder WA, Weiss JN, et al. Lack of influence of fetal hemoglobin levels or erythrocyte indices on the severity of sickle cell anemia. *J Clin Invest* 1980;65(3):732–740.

324. Stockman JA, Nigro MA, Mishkin MM, Oski FA. Occlusion of large cerebral vessels in sickle-cell anemia. *N Engl J Med* 1972;287(17):846–849.

325. Ohene-Frempong K, Weiner SJ, Sleeper LA, et al. Cerebrovascular accidents in sickle cell disease: rates and risk factors. *Blood* 1998;91(1):288–294.

326. Gerald B, Sebes JI, Langston JW. Cerebral infarction secondary to sickle cell disease: arteriographic findings. *AJR Am J Roentgenol* 1980;134(6):1209–1212.

327. Seeler RA, Royal JE, Powe L, Goldberg HR. Moyamoya in children with sickle cell anemia and cerebrovascular occlusion. *J Pediatr* 1978;93(5):808–810.

328. Boros L, Thomas C, Weiner WJ. Large cerebral vessel disease in sickle cell anaemia. *J Neurol Neurosurg Psychiatry* 1976;39(12):1236–1239.

329. Tuohy AM, McKie V, Mancini EA, Adams RJ. Internal carotid artery occlusion in a child with sickle cell disease: case report and immunohistochemical study. *J Pediatr Hematol Oncol* 1997;19(5):455–458.

330. Dobson SR, Holden KR, Nietert PJ, et al. Moyamoya syndrome in childhood sickle cell disease: a predictive factor for recurrent cerebrovascular events. *Blood* 2002;99(9):3144–3150.

331. Wilimas J, Goff JR, Anderson HR, Jr., et al. Efficacy of transfusion therapy for one to two years in patients with sickle cell disease and cerebrovascular accidents. *J Pediatr* 1980;96(2):205–208.

332. Buchanan GR, Bowman WP, Smith SJ. Recurrent cerebral ischemia during hypertransfusion therapy in sickle cell anemia. *J Pediatr* 1983;103(6):921–923.

333. Wang WC, Kovnar EH, Tonkin IL, et al. High risk of recurrent stroke after discontinuance of five to twelve years of transfusion therapy in patients with sickle cell disease. *J Pediatr* 1991;118(3):377–382.

334. Miller ST, Jensen D, Rao SP. Less intensive long-term transfusion therapy for sickle cell anemia and cerebrovascular accident. *J Pediatr* 1992;120(1):54–57.

335. Cohen AR, Martin MB, Silber JH, et al. A modified transfusion program for prevention of stroke in sickle cell disease. *Blood* 1992;79(7):1657–1661.

336. Scothorn DJ, Price C, Schwartz D, et al. Risk of recurrent stroke in children with sickle cell disease receiving blood transfusion therapy for at least five years after initial stroke. *J Pediatr* 2002;140(3):348–354.

337. Rana S, Houston PE, Surana N, et al. Discontinuation of long-term transfusion therapy in patients with sickle cell disease and stroke. *J Pediatr* 1997;131(5):757–760.

338. Ware RE, Steinberg MH, Kinney TR. Hydroxyurea: an alternative to transfusion therapy for stroke in

- sickle cell anemia. *Am J Hematol* 1995;50(2):140–143.
339. Ware RE, Zimmerman SA, Schultz WH. Hydroxyurea as an alternative to blood transfusions for the prevention of recurrent stroke in children with sickle cell disease. *Blood* 1999;94(9):3022–3026.
340. Adams R, McKie V, Nichols F, et al. The use of transcranial ultrasonography to predict stroke in sickle cell disease. *N Engl J Med* 1992;326(9):605–610.
341. Adams RJ, McKie VC, Hsu L, et al. Prevention of a first stroke by transfusions in children with sickle cell anemia and abnormal results on transcranial Doppler ultrasonography. *N Engl J Med* 1998;339(1):5–11.
342. Arnow PM, Panwalker A, Garvin JS, Rodriguez–Erdmann F. Aspirin, hyperventilation, and cerebellar infarction in sickle cell disease. *Arch Intern Med* 1978;138(1):148–149.
343. Ammoumi AA, Sher JH, Schmelka D. Spinal cord compression by extramedullary hemopoietic tissue in sickle cell anemia. Case report. *J Neurosurg* 1975;43(4):483–485.
344. Barrett–Connor E. Pneumonia and pulmonary infarction in sickle cell anemia. *JAMA* 1973;224(7):997–1000.
345. Castro O, Brambilla DJ, Thorington B, et al. The acute chest syndrome in sickle cell disease: incidence and risk factors. The Cooperative Study of Sickle Cell Disease. *Blood* 1994;84(2):643–649.
346. Barrett–Connor E. Acute pulmonary disease and sickle cell anemia. *Am Rev Respir Dis* 1971;104(2):159–165.
347. Barrett–Connor E. Bacterial infection and sickle cell anemia. An analysis of 250 infections in 166 patients and a review of the literature. *Medicine (Baltimore)* 1971;50(2):97–112.
348. Petch MC, Serjeant GR. Clinical features of pulmonary lesions in sickle–cell anaemia. *BMJ* 1970;3(713):31.
349. Shulman ST, Bartlett J, Clyde WA, Jr, Ayoub EM. The unusual severity of mycoplasmal pneumonia in children with sickle–cell disease. *N Engl J Med* 1972;287(4):164–167.
350. Miller ST, Hammerschlag MR, Chirgwin K, et al. Role of *Chlamydia pneumoniae* in acute chest syndrome of sickle cell disease. *J Pediatr* 1991;118(1):30–33.
351. Lowenthal EA, Wells A, Emanuel PD, et al. Sickle cell acute chest syndrome associated with parvovirus B19 infection: Case series and review. *Am J Hematol* 1996;51:207–213.
352. Vichinsky EP, Neumayr LD, Earles AN, et al. Causes and outcomes of the acute chest syndrome in sickle cell disease. National Acute Chest Syndrome Study Group. *N Engl J Med* 2000;342(25):1855–1865.
353. Sprinkle RH, Cole T, Smith S, Buchanan GR. Acute chest syndrome in children with sickle cell disease. A retrospective analysis of 100 hospitalized cases. *Am J Pediatr Hematol Oncol* 1986;8(2):105–110.
354. Charache S, Scott JC, Charache P. “Acute chest syndrome” in adults with sickle cell anemia. Microbiology, treatment, and prevention. *Arch Intern Med* 1979;139(1):67–69.
355. Davies SC, Luce PJ, Win AA, et al. Acute chest syndrome in sickle–cell disease. *Lancet* 1984;1(8367):36–38.
356. Poncz M, Greenberg J, Gill FM, Cohen A. Hematologic changes during acute chest syndrome in sickle cell disease. *Am J Pediatr Hematol Oncol* 1985;7(1):96–99.
357. Rucknagel DL, Kalinyak KA, Gelfand MJ. Rib infarcts and acute chest syndrome in sickle cell diseases. *Lancet* 1991;337(8745):831–833.
358. Oppenheimer EH, Esterly JR. Pulmonary changes in sickle cell disease. *Am Rev Respir Dis* 1971;103(6):858–859.
359. Haupt HM, Moore GW, Bauer TW, Hutchins GM. The lung in sickle cell disease. *Chest*



1982;81(3):332-337.

360. Vichinsky E, Williams R, Das M, et al. Pulmonary fat embolism: a distinct cause of severe acute chest syndrome in sickle cell anemia. *Blood* 1994;83(11):3107-3112.

361. Bromberg PA, Jensen WN. Arterial oxygen unsaturation in sickle cell disease. *Am Rev Respir Dis* 1967;96(3):400-407.

362. Heath D, Thompson IM. Bronchopulmonary anastomoses in sickle-cell anaemia. *Thorax* 1969;24(2):232-238.

363. Styles LA, Schalkwijk CG, Aarsman AJ, et al. Phospholipase A2 levels in acute chest syndrome of sickle cell disease. *Blood* 1996;87(6):2573-2578.

364. Bellet PS, Kalinyak KA, Shukla R, et al. Incentive spirometry to prevent acute pulmonary complications in sickle cell diseases. *N Engl J Med* 1995;333(11):699-703.

365. Mallouh Asha M. Beneficial effect of blood transfusion in children with sickle cell chest syndrome. *Am J Dis Child* 1998;142:178.

366. Bernini JC, Rogers ZR, Sandler ES, et al. Beneficial effect of intravenous dexamethasone in children with mild to moderately severe acute chest syndrome complicating sickle cell disease. *Blood* 1998;92(9):3082-3089.

367. Gladwin MT, Schechter AN, Shelhamer JH, Ognibene FP. The acute chest syndrome in sickle cell disease. Possible role of nitric oxide in its pathophysiology and treatment. *Am J Respir Crit Care Med* 1999;159(5 Pt 1):1368-1376.

368. Bruno D, Wigfall DR, Zimmerman SA, et al. Genitourinary complications of sickle cell disease. *J Urol* 2001;166(3):803-811.

369. Hamre MR, Harmon EP, Kirkpatrick DV, et al. Priapism as a complication of sickle cell disease. *J Urol* 1991;145(1):1-5.

370. Sharpsteen JR, Jr., Powars D, Johnson C, et al. Multisystem damage associated with tricipital priapism in sickle cell disease. *Am J Med* 1993;94(3):289-295.

371. Rothfeld SH, Mazor D. Priapism in children: a complication of sickle cell disease. *J Urol* 1971;105(2):307-308.

372. Karayalcin G, Imran M, Rosner F. Priapism in sickle cell disease: report of five cases. *Am J Med Sci* 1972;264(4):289-293.

373. Miller ST, Rao SP, Dunn EK, Glassberg KI. Priapism in children with sickle cell disease. *J Urol* 1995;154(2 Pt 2):844-847.

374. Diggs LW. Anatomic lesions in sickle disease. In: Abramson H, Bertles JF, Wethers DL, eds. *Sickle cell disease: Diagnosis, management, education, and research*. St. Louis: Mosby, 1973:189-229.

375. Snyder GB, Wilson CA. Surgical management of priapism and its sequelae in sickle cell disease. *South Med J* 1966;59(12):1393-1396.

376. Emond AM, Holman R, Hayes RJ, Serjeant GR. Priapism and impotence in homozygous sickle cell disease. *Arch Intern Med* 1980;140(11):1434-1437.

377. Burnett AL, Allen RP, Tempany CM, et al. Evaluation of erectile function in men with sickle cell disease. *Urology* 1995;45(4):657-663.

378. Seeler RA. Intensive transfusion therapy for priapism in boys with sickle cell anemia. *J Urol* 1973;110(3):360-363.

379. Winter CC. Priapism cured by creation of fistulas between glans penis and corpora cavernosa. *J Urol*

1978;119(2):227-228.

380. Quackels R. Cure of a patient suffering from priapism by cavernospongiosal anastomosis. *Acta Urol Belg* 1964;32:5-7.

381. Okpala I, Westerdale N, Jegede T, Cheung B. Etilefrine for the prevention of priapism in adult sickle cell disease. *Br J Haematol* 2002;118(3):918-921.

382. Gbadoe AD, Atakouma Y, Kusiaku K, Assimadi JK. Management of sickle cell priapism with etilefrine. *Arch Dis Child* 2001;85(1):52-53.

383. Gbadoe AD, Assimadi JK, Segbena YA. Short period of administration of diethylstilbestrol in stuttering priapism in sickle cell anemia. *Am J Hematol* 2002;69(4):297-298.

384. Levine LA, Guss SP. Gonadotropin-releasing hormone analogues in the treatment of sickle cell anemia-associated priapism. *J Urol* 1993;150(2 Pt 1):475-477.

385. Dahm P, Rao DS, Donatucci CF. Antiandrogens in the treatment of priapism. *Urology* 2002;59(1):138.

386. Fowler JE, Jr., Koshy M, Strub M, Chinn SK. Priapism associated with the sickle cell hemoglobinopathies: prevalence, natural history and sequelae. *J Urol* 1991;145(1):65-68.

387. Bertram RA, Carson CC III, Webster GD. Implantation of penile prostheses in patients impotent after priapism. *Urology* 1985;26(4):325-327.

388. Rackoff WR, Ohene-Frempong K, Month S, et al. Neurologic events after partial exchange transfusion for priapism in sickle cell disease. *J Pediatr* 1992;120(6):882-885.

389. Siegel JF, Rich MA, Brock WA. Association of sickle cell disease, priapism, exchange transfusion, and neurological events: ASPEN syndrome. *J Urol* 1993;150(5 Pt 1):1480-1482.

390. Leiken SL. The aplastic crises of sickle cell disease. Occurrence in several members of a family. *Am J Dis Child* 1957;93:128.

391. Pattison JR, Jones SE, Hodgson J, et al. Parvovirus infections and hypoplastic crisis in sickle-cell anaemia. *Lancet* 1981;1(8221):664-665.

392. Serjeant GR, Topley JM, Mason K, et al. Outbreak of aplastic crises in sickle cell anaemia associated with parvovirus-like agent. *Lancet* 1981;2(8247):595-597.

393. Rao KR, Patel AR, Anderson MJ, et al. Infection with parvovirus-like virus and aplastic crisis in chronic hemolytic anemia. *Ann Intern Med* 1983;98(6):930-932.

394. Blacklock HA, Mortimer PP. Aplastic crisis and other effects of the human parvovirus infection. *Clin Haematol* 1984;13(3):679-691.

395. Saarinen UM, Chorba TL, Tattersall P, et al. Human parvovirus B19-induced epidemic acute red cell aplasia in patients with hereditary hemolytic anemia. *Blood* 1986;67(5):1411-1417.

396. Gowda N, Rao SP, Cohen B, et al. Human parvovirus infection in patients with sickle cell disease with and without hypoplastic crisis. *J Pediatr* 1987;110(1):81-84.

397. Young N. Hematologic and hematopoietic consequences of B19 parvovirus infection. *Semin Hematol* 1988;25(2):159-172.

398. Mortimer PP, Humphries RK, Moore JG, et al. A human parvovirus-like virus inhibits haematopoietic colony formation in vitro. *Nature* 1983;302(5907):426-429.

399. Young NS, Mortimer PP, Moore JG, Humphries RK. Characterization of a virus that causes transient aplastic crisis. *J Clin Invest* 1984;73(1):224-230.

400. Bell LM, Naides SJ, Stoffman P, et al. Human parvovirus B19 infection among hospital staff members

after contact with infected patients. *N Engl J Med* 1989;321(8):485-491.

401. Anand A, Gray ES, Brown T, et al. Human parvovirus infection in pregnancy and hydrops fetalis. *N Engl J Med* 1987;316(4):183-186.

402. McCurdy PR. 32-DFP and 51-Cr for measurement of red cell life span in abnormal hemoglobin syndromes. *Blood* 1969;33(2):214-224.

403. Kim KY, Karayalcin G, Rosner F, Aballi A. Pancytopenia in a patient with sickle cell anemia. *Am J Dis Child* 1975;129(10):1195-1196.

404. Topley JM, Rogers DW, Stevens MC, Serjeant GR. Acute splenic sequestration and hypersplenism in the first five years in homozygous sickle cell disease. *Arch Dis Child* 1981;56(10):765-769.

405. Walterspiel JN, Rutledge JC, Bartlett BL. Fatal acute splenic sequestration at 4 months of age. *Pediatrics* 1984;73(4):507-508.

406. Emond AM, Collis R, Darvill D, et al. Acute splenic sequestration in homozygous sickle cell disease: natural history and management. *J Pediatr* 1985;107(2):201-206.

407. Mallouh AA, Qudah A. Acute splenic sequestration together with aplastic crisis caused by human parvovirus B19 in patients with sickle cell disease. *J Pediatr* 1993;122(4):593-595.

408. Jenkins ME, Scott RB, Baird RL. Studies in sickle cell anemia. XVI. Sudden death during sickle cell anemia crises in young children. *J Pediatr* 1960;56:30-38.

409. Seeler RA, Shwiaki MZ. Acute splenic sequestration crises (ASSC) in young children with sickle cell anemia. Clinical observations in 20 episodes in 14 children. *Clin Pediatr (Phila)* 1972;11(12):701-704.

410. Kinney TR, Ware RE, Schultz WH, Filston HC. Long-term management of splenic sequestration in children with sickle cell disease. *J Pediatr* 1990;117(2 Pt 1):194-199.

411. Wright JG, Hambleton IR, Thomas PW, et al. Postsplenectomy course in homozygous sickle cell disease. *J Pediatr* 1999;134(3):304-309.

412. Hatton CS, Bunch C, Weatherall DJ. Hepatic sequestration in sickle cell anaemia. *BMJ (Clin Res Ed)* 1985;290(6470):744-745.

413. Gutteridge C, Newland AC, Sequeira J. Hepatic sequestration in sickle cell anemia. *BMJ (Clin Res Ed)* 1985;290(6476):1214-1215.

414. Hernandez P, Dorticos E, Espinosa E, et al. Clinical features of hepatic sequestration in sickle cell anaemia. *Haematologia (Budap)* 1989;22(3):169-174.

415. Maurer HS, Vida LN, Honig GR. Homozygous sickle cell disease with coexistent hereditary spherocytosis in three siblings. *J Pediatr* 1972;80(2):235-242.

416. Steinberg MH, Dreiling BJ. Glucose-6-phosphate dehydrogenase deficiency in sickle-cell anemia. A study in adults. *Ann Intern Med* 1974;80(2): 217-220.

417. Bienzle U, Sodeinde O, Effiong CE, Luzzatto L. Glucose 6-phosphate dehydrogenase deficiency and sickle cell anemia: frequency and features of the association in an African community. *Blood* 1975;46(4):591-597.

418. Steinberg MH, West MS, Gallagher D, Mentzer W. Effects of glucose-6-phosphate dehydrogenase deficiency upon sickle cell anemia. *Blood* 1988;71(3):748-752.

419. Claster S, Chiu DT, Quintanilha A, Lubin B. Neutrophils mediate lipid peroxidation in human red cells. *Blood* 1984;64(5):1079-1084.

420. Alperin JB. Folic acid deficiency complicating sickle cell anemia. A study on the response to titrated doses of folic acid. *Arch Intern Med* 1967;120(3):298-306.

421. Lopez R, Shimizu N, Cooperman JM. Recurrent folic acid deficiency in sickle cell disease. *Am J Dis Child* 1973;125(4):544-548.
422. Pearson HA. Folic acid studies in sickle cell anemia. *J Lab Clin Med* 1964;64:913.
423. van der Dijs FP, Schnog JJ, Brouwer DA, et al. Elevated homocysteine levels indicate suboptimal folate status in pediatric sickle cell patients. *Am J Hematol* 1998;59(3):192-198.
424. van der Dijs FP, Fokkema MR, Dijck-Brouwer DA, et al. Optimization of folic acid, vitamin B(12), and vitamin B(6) supplements in pediatric patients with sickle cell disease. *Am J Hematol* 2002;69(4):239-246.
425. Rodriguez-Cortes HM, Griener JC, Hyland K, et al. Plasma homocysteine levels and folate status in children with sickle cell anemia. *J Pediatr Hematol Oncol* 1999;21(3):219-223.
426. Balasa VV, Gruppo RA, Gartside PS, Kalinyak KA. Correlation of the C677T MTHFR genotype with homocysteine levels in children with sickle cell disease. *J Pediatr Hematol Oncol* 1999;21(5):397-400.
427. Seeler RA, Metzger W, Mufson MA. *Diplococcus pneumoniae* infections in children with sickle cell anemia. *Am J Dis Child* 1972;123(1):8-10.
428. Landesman SH, Rao SP, Ahonkhai VI. Infections in children with sickle cell anemia. Special reference to pneumococcal and salmonella infections. *Am J Pediatr Hematol Oncol* 1982;4(4):407-418.
429. Zarkowsky HS, Gallagher D, Gill FM, et al. Bacteremia in sickle hemoglobinopathies. *J Pediatr* 1986;109(4):579-585.
430. Wong WY, Overturf GD, Powars DR. Infection caused by *Streptococcus pneumoniae* in children with sickle cell disease: epidemiology, immunologic mechanisms, prophylaxis, and vaccination. *Clin Infect Dis* 1992;14(5):1124-1136.
431. Overturf GD, Powars D, Baraff LJ. Bacterial meningitis and septicemia in sickle cell disease. *Am J Dis Child* 1977;131(7):784-787.
432. Powars D, Overturf G, Weiss J, et al. Pneumococcal septicemia in children with sickle cell anemia. Changing trend of survival. *JAMA* 1981;245(18):1839-1842.
433. Wang WC, Wong WY, Rogers ZR, et al. Antibiotic-resistant pneumococcal infection in children with sickle cell disease in the United States. *J Pediatr Hematol Oncol* 1996;18(2):140-144.
434. Evans HE, Sampath AC, Douglass F, Baki A. *Shigella* bacteremia in a patient with sickle cell anemia. *Am J Dis Child* 1972;123(3):238-239.
435. Robinson MG, Halpern C. Infections, *Escherichia coli*, and sickle cell anemia. *JAMA* 1974;230(8):1145-1148.
436. Hook EW, Campbell CG, Weens HS, Cooper GR. Salmonella osteomyelitis in patients with sickle cell anemia. *N Engl J Med* 1957;257:403-407.
437. Diggs LW. Bone and joint lesions in sickle-cell disease. *Clin Orthop* 1967;52:119-143.
438. Constant E, Green RL, Wagner DK. Salmonella osteomyelitis of both hands and the hand-foot syndrome. *Arch Surg* 1971;102(2):148-151.
439. Givner LB, Luddy RE, Schwartz AD. Etiology of osteomyelitis in patients with major sickle hemoglobinopathies. *J Pediatr* 1981;99(3):411-413.
440. Hand WL, King NL. Serum opsonization of salmonella in sickle cell anemia. *Am J Med* 1978;64(3):388-395.
441. Mallouh AA, Salamah MM. Pattern of bacterial infections in homozygous sickle cell disease. A report from Saudi Arabia. *Am J Dis Child* 1985;139(8):820-822.

442. Engh CA, Hughes JL, Abrams RC, Bowerman JW. Osteomyelitis in the patient with sickle-cell disease. *J Bone Joint Surg Am* 1971;53(1):1-15.
443. Syrogiannopoulos GA, McCracken GH, Jr., Nelson JD. Osteoarticular infections in children with sickle cell disease. *Pediatrics* 1986;78(6):1090-1096.
444. Wierenga KJ, Pattison JR, Brink N, et al. Glomerulonephritis after human parvovirus infection in homozygous sickle-cell disease. *Lancet* 1995;346(8973):475-476.
445. Wierenga KJ, Serjeant BE, Serjeant GR. Cerebrovascular complications and parvovirus infection in homozygous sickle cell disease. *J Pediatr* 2001;139(3):438-442.
446. Johnston RB, Jr. Increased susceptibility to infection in sickle cell disease: review of its occurrence and possible causes. *South Med J* 1974;67(11):1342-1348.
447. Falter ML, Robinson MG, Kim OS, et al. Splenic function and infection in sickle cell anemia. *Acta Haematol* 1973;50(3):154-161.
448. Diggs LW. Siderofibrosis of the spleen in sickle cell anemia. *JAMA* 1939;112:695.
449. Casper JT, Koethe S, Rodey GE, Thatcher LG. A new method for studying splenic reticuloendothelial dysfunction in sickle cell disease patients and its clinical application: a brief report. *Blood* 1976;47(2):183-188.
450. Sills RH, Oski FA. RBC surface pits in the sickle hemoglobinopathies. *Am J Dis Child* 1979;133(5):526-527.
451. Pearson HA, Gallagher D, Chilcote R, et al. Developmental pattern of splenic dysfunction in sickle cell disorders. *Pediatrics* 1985;76(3):392-397.
452. Pearson HA, Spencer RP, Cornelius EA. Functional asplenia in sickle-cell anemia. *N Engl J Med* 1969;281(17):923-926.
453. Pearson HA, Cornelius EA, Schwartz AD, et al. Transfusion-reversible functional asplenia in young children with sickle-cell anemia. *N Engl J Med* 1970;283(7):334-337.
454. Schwartz AD, Pearson HA. Impaired antibody response to intravenous immunization in sickle cell anemia. *Pediatr Res* 1972;6(2):145-149.
455. Schulkind ML, et al. Effect of antibody upon clearance of 125I-labeled pneumococci by the spleen and liver. *Pediatr Res* 1967;1:178.
456. Gigliotti F, Feldman S, Wang WC, et al. Immunization of young infants with sickle cell disease with a *Haemophilus influenzae* type b saccharide-diphtheria CRM197 protein conjugate vaccine. *J Pediatr* 1989;114(6):1006-1010.
457. Sarnaik S, Kaplan J, Schiffman G, et al. Studies on *Pneumococcus* vaccine alone or mixed with DTP and on *Pneumococcus* type 6B and *Haemophilus influenzae* type b capsular polysaccharide-tetanus toxoid conjugates in two- to five-year-old children with sickle cell anemia. *Pediatr Infect Dis J* 1990;9(3):181-186.
458. Gavrilis P, Rothenberg SP, Guy R. Correlation of low serum IgM levels with absence of functional splenic tissue in sickle cell disease syndromes. *Am J Med* 1974;57(4):542-545.
459. Johnston RB, Jr., Newman SL, Struth AG. An abnormality of the alternate pathway of complement activation in sickle-cell disease. *N Engl J Med* 1973;288(16):803-808.
460. Corry JM, Polhill RB, Jr., Edmonds SR, Johnston RB, Jr. Activity of the alternative complement pathway after splenectomy: comparison to activity in sickle cell disease and hypogammaglobulinemia. *J Pediatr* 1979;95(6):964-969.
461. Bjornson AB, Lobel JS. Direct evidence that decreased serum opsonization of *Streptococcus pneumoniae* via the alternative complement pathway in sickle cell disease is related to antibody deficiency.

J Clin Invest 1987;79(2):388–398.

462. Wang W, Herrod H, Presbury G, Wilimas J. Lymphocyte phenotype and function in chronically transfused children with sickle cell disease. *Am J Hematol* 1985;20(1):31–40.
463. Boghossian SH, Nash G, Dormandy J, Bevan DH. Abnormal neutrophil adhesion in sickle cell anaemia and crisis: relationship to blood rheology. *Br J Haematol* 1991;78(3):437–441.
464. Strauss RG, Johnston RB, Jr., Asbrock T, et al. Neutrophil oxidative metabolism in sickle cell disease. *J Pediatr* 1976;89(3):391–394.
465. Kaplan SS, Nardi M. Impairment of leukocyte function during sickle cell crisis. *J Reticuloendothel Soc* 1977;22(5):499–506.
466. John AB, Ramlal A, Jackson H, et al. Prevention of pneumococcal infection in children with homozygous sickle cell disease. *BMJ (Clin Res Ed)* 1984;288(6430):1567–1570.
467. Gaston MH, Verter JI, Woods G, et al. Prophylaxis with oral penicillin in children with sickle cell anemia. A randomized trial. *N Engl J Med* 1986;314(25):1593–1599.
468. Falletta JM, Woods GM, Verter JI, et al. Discontinuing penicillin prophylaxis in children with sickle cell anemia. Prophylactic Penicillin Study II. *J Pediatr* 1995;127(5):685–690.
469. Rogers ZR, Buchanan GR. Bacteremia in children with sickle hemoglobin C disease and sickle beta (+)-thalassemia: is prophylactic penicillin necessary? *J Pediatr* 1995;127(3):348–354.
470. Steele RW, Warrier R, Unkel PJ, et al. Colonization with antibiotic-resistant *Streptococcus pneumoniae* in children with sickle cell disease. *J Pediatr* 1996;128(4):531–535.
471. Daw NC, Wilimas JA, Wang WC, et al. Nasopharyngeal carriage of penicillin-resistant *Streptococcus pneumoniae* in children with sickle cell disease. *Pediatrics* 1997;99(4):E7.
472. Woods G, Wang W, Jorgensen J, Waclawiw M. PROPS II Investigators of the Ancillary Nasopharyngeal Culture Study. Influences of penicillin prophylaxis in children with sickle cell disease on the antimicrobial susceptibility of *S. pneumoniae*. 20th Annual Meeting National Sickle Cell Disease Program: 1995.
473. Ahonkhai VI, Landesman SH, Fikrig SM, et al. Failure of pneumococcal vaccine in children with sickle-cell disease. *N Engl J Med* 1979;301(1):26–27.
474. Kaplan J, Frost H, Sarnaik S, Schiffman G. Type-specific antibodies in children with sickle cell anemia given polyvalent pneumococcal vaccine. *J Pediatr* 1982;100(3):404–406.
475. Bruyn GA, Zegers BJ, van Furth R. Mechanisms of host defense against infection with *Streptococcus pneumoniae*. *Clin Infect Dis* 1992;14(1):251–262.
476. Overturf GD, Rigau-Perez JG, Selzer J, et al. Pneumococcal polysaccharide immunization of children with sickle cell disease. I. Clinical reactions to immunization and relationship to preimmunization antibody. *Am J Pediatr Hematol Oncol* 1982;4(1):19–23.
477. Chudwin DS, Wara DW, Matthay KK, et al. Increased serum opsonic activity and antibody concentration in patients with sickle cell disease after pneumococcal polysaccharide immunization. *J Pediatr* 1983;102(1):51–54.
478. Ammann AJ. Current status of pneumococcal polysaccharide immunization in patients with sickle cell disease or impaired splenic function. *Am J Pediatr Hematol Oncol* 1982;4(3):301–306.
479. Weintrub PS, Schiffman G, Addiego JE, Jr., et al. Long-term follow-up and booster immunization with polyvalent pneumococcal polysaccharide in patients with sickle cell anemia. *J Pediatr* 1984;105(2):261–263.
480. O'Brien KL, Swift AJ, Winkelstein JA, et al. Safety and immunogenicity of heptavalent pneumococcal vaccine conjugated to CRM(197) among infants with sickle cell disease. *Pneumococcal Conjugate Vaccine*

Study Group. *Pediatrics* 2000;106(5):965–972.

481. Nowak–Wegrzyn A, Winkelstein JA, Swift AJ, Lederman HM. Serum opsonic activity in infants with sickle–cell disease immunized with pneumococcal polysaccharide protein conjugate vaccine. The Pneumococcal Conjugate Vaccine Study Group. *Clin Diagn Lab Immunol* 2000;7(5):788–793.
482. Rubin LG, Voulalas D, Carmody L. Immunization of children with sickle cell disease with *Haemophilus influenzae* type b polysaccharide vaccine. *Pediatrics* 1989;84(3):509–513.
483. Steinberg E, Overturf GD, Portnoy B, et al. Serologic and clinical response of children with sickle cell disease to bivalent influenza A split virus vaccine. *J Pediatr* 1978;92(5):823–825.
484. Sarnaik SA, Merline JR, Bond S. Immunogenicity of hepatitis B vaccine in children with sickle cell anemia. *J Pediatr* 1988;112(3):429–430.
485. Rogers ZR, Morrison RA, Vedro DA, Buchanan GR. Outpatient management of febrile illness in infants and young children with sickle cell anemia. *J Pediatr* 1990;117(5):736–739.
486. Wilimas JA, Flynn PM, Harris S, et al. A randomized study of outpatient treatment with ceftriaxone for selected febrile children with sickle cell disease. *N Engl J Med* 1993;329(7):472–476.
487. Williams LL, Wilimas JA, Harris SC, et al. Outpatient therapy with ceftriaxone and oral cefixime for selected febrile children with sickle cell disease. *J Pediatr Hematol Oncol* 1996;18(3):257–261.
488. Platt OS, Rosenstock W, Espeland MA. Influence of sickle hemoglobinopathies on growth and development. *N Engl J Med* 1984;311(1):7–12.
489. Phebus CK, Gloninger MF, Maciak BJ. Growth patterns by age and sex in children with sickle cell disease. *J Pediatr* 1984;105(1):28–33.
490. Kramer MS, Rooks Y, Washington LA, Pearson HA. Pre– and postnatal growth and development in sickle cell anemia. *J Pediatr* 1980;96(5):857–860.
491. Stevens MC, Hayes RJ, Serjeant GR. Body shape in young children with homozygous sickle cell disease. *Pediatrics* 1983;71(4):610–614.
492. Stevens MC, Maude GH, Cupidore L, et al. Prepubertal growth and skeletal maturation in children with sickle cell disease. *Pediatrics* 1986;78(1):124–132.
493. Jimenez CT, Scott RB, Henry WL, et al. Studies in sickle cell anemia. XXVI. The effects of homozygous sickle cell disease on the onset of menarche, pregnancy, fertility, pubescent changes, and body growth in Negro subjects. *Am J Dis Child* 1966;111(5):497–504.
494. Luban NL, Leikin SL, August GA. Growth and development in sickle cell anemia. Preliminary report. *Am J Pediatr Hematol Oncol* 1982;4(1):61–65.
495. Landefeld CS, Schambelan M, Kaplan SL, Embury SH. Clomiphene–responsive hypogonadism in sickle cell anemia. *Ann Intern Med* 1983;99(4):480–483.
496. Borel MJ, Buchowski MS, Turner EA, et al. Alterations in basal nutrient metabolism increase resting energy expenditure in sickle cell disease. *Am J Physiol* 1998;274(2 Pt 1):E357–E364.
497. Barden EM, Zemel BS, Kawchak DA, et al. Total and resting energy expenditure in children with sickle cell disease. *J Pediatr* 2000;136(1):73–79.
498. Kopp–Hoolihan LE, van Loan MD, Mentzer WC, Heyman MB. Elevated resting energy expenditure in adolescents with sickle cell anemia. *J Am Diet Assoc* 1999;99(2):195–199.
499. Buchowski MS, de la Fuente FA, Flakoll PJ, et al. Increased bone turnover is associated with protein and energy metabolism in adolescents with sickle cell anemia. *Am J Physiol Endocrinol Metab* 2001;280(3):E518–E527.
500. Singhal A, Parker S, Linsell L, Serjeant G. Energy intake and resting metabolic rate in preschool



Jamaican children with homozygous sickle cell disease. *Am J Clin Nutr* 2002;75(6):1093–1097.

501. Fung EB, Malinauskas BM, Kawchak DA, et al. Energy expenditure and intake in children with sickle cell disease during acute illness. *Clin Nutr* 2001;20(2):131–138.

502. VanderJagt DJ, Harmatz P, Scott-Emuakpor AB, et al. Bioelectrical impedance analysis of the body composition of children and adolescents with sickle cell disease. *J Pediatr* 2002;140(6):681–687.

503. Gray NT, Bartlett JM, Kolasa KM, et al. Nutritional status and dietary intake of children with sickle cell anemia. *Am J Pediatr Hematol Oncol* 1992;14(1):57–61.

504. Heyman MB, Vichinsky E, Katz R, et al. Growth retardation in sickle-cell disease treated by nutritional support. *Lancet* 1985;1(8434):903–906.

505. Nelson MC, Zemel BS, Kawchak DA, et al. Vitamin b6 status of children with sickle cell disease. *J Pediatr Hematol Oncol* 2002;24(6):463–469.

506. Westerman MP, Zhang Y, McConnell JP, et al. Ascorbate levels in red blood cells and urine in patients with sickle cell anemia. *Am J Hematol* 2000;65(2):174–175.

507. Gee BE, Platt OS. Growth and development. In: Embury SH, Hebbel RP, Mohandas N, Steinberg MH, eds. *Sickle cell disease: basic principles and clinical practice*. New York: Raven Press, 1994:589–597.

508. Prasad AS, Abbasi AA, Rabbani P, DuMouchelle E. Effect of zinc supplementation on serum testosterone level in adult male sickle cell anemia subjects. *Am J Hematol* 1981;10(2):119–127.

509. Soliman AT, el Banna N, alSalmi I, et al. Growth hormone secretion and circulating insulin-like growth factor-I (IGF-I) and IGF binding protein-3 concentrations in children with sickle cell disease. *Metabolism* 1997;46(11):1241–1245.

510. Luporini SM, Bendit I, Manhani R, et al. Growth hormone and insulin-like growth factor I axis and growth of children with different sickle cell anemia haplotypes. *J Pediatr Hematol Oncol* 2001;23(6):357–363.

511. Abshire TC, English JL, Githens JH, Hambidge M. Zinc status in children and young adults with sickle cell disease. *Am J Dis Child* 1988;142(12):1356–1359.

512. Reynolds J. Radiologic manifestations of sickle cell hemoglobinopathy. *JAMA* 1977;238(3):247–250.

513. Bohrer SP. *Bone ischaemia and infarction in sickle cell disease*. St. Louis: Green, 1981.

514. Chung SM, Ralston EL. Necrosis of the femoral head associated with sickle-cell anemia and its genetic variants. A review of the literature and study of thirteen cases. *J Bone Joint Surg Am* 1969;51(1):33–58.

515. Milner PF, Kraus AP, Sebes JI, et al. Sickle cell disease as a cause of osteonecrosis of the femoral head. *N Engl J Med* 1991;325(21):1476–1481.

516. Milner PF, Kraus AP, Sebes JI, et al. Osteonecrosis of the humeral head in sickle cell disease. *Clin Orthop* 1993;(289):136–143.

517. Hernigou P, Allain J, Bachir D, Galacteros F. Abnormalities of the adult shoulder due to sickle cell osteonecrosis during childhood. *Rev Rhum Engl Ed* 1998;65(1):27–32.

518. Hernigou P, Galacteros F, Bachir D, Goutallier D. Deformities of the hip in adults who have sickle-cell disease and had avascular necrosis in childhood. A natural history of fifty-two patients. *J Bone Joint Surg Am* 1991;73(1):81–92.

519. Hanker GJ, Amstutz HC. Osteonecrosis of the hip in the sickle-cell diseases. Treatment and complications. *J Bone Joint Surg Am* 1988;70(4):499–506.

520. Clarke HJ, Jinnah RH, Brooker AF, Michaelson JD. Total replacement of the hip for avascular necrosis in sickle cell disease. *J Bone Joint Surg Br* 1989;71(3):465–470.

521. Vichinsky EP, Neumayr LD, Haberkern C, et al. The perioperative complication rate of orthopedic surgery in sickle cell disease: report of the National Sickle Cell Surgery Study Group. *Am J Hematol* 1999;62(3):129–138.
522. Styles LA, Vichinsky EP. Core decompression in avascular necrosis of the hip in sickle-cell disease. *Am J Hematol* 1996;52(2):103–107.
523. Oredugba FA, Savage KO. Anthropometric finding in Nigerian children with sickle cell disease. *Pediatr Dent* 2002;24(4):321–325.
524. Reynolds J. A re-evaluation of the “fish vertebra” sign in sickle cell hemoglobinopathy. *Am J Roentgenol Radium Ther Nucl Med* 1966;97(3):693–707.
525. Alavi A, Schumacher HR, Dorwart B, Kuhl DE. Bone marrow scan evaluation of arthropathy in sickle cell disorders. *Arch Intern Med* 1976;136(4):436–440.
526. Goldberg MA. Sickle cell arthropathy: analysis of synovial fluid in sickle cell anemia with joint effusion. *South Med J* 1973;66(8):956–958.
527. Palmer DW. Septic arthritis in sickle-cell thalassemia. Pathophysiology of impaired response to infection. *Arthritis Rheum* 1975;18(4):339–345.
528. Palmer DW, Ellman MH. Septic arthritis and Reiter’s syndrome in sickle cell disorders: case reports and implications for management. *South Med J* 1976;69(7):902–904.
529. Ball GV, Sorensen LB. The pathogenesis of hyperuricemia and gout in sickle cell anemia. *Arthritis Rheum* 1970;13(6):846–848.
530. Serjeant GR, Ashcroft MT. Delayed skeletal maturation in sickle cell anemia in Jamaica. *Johns Hopkins Med J* 1973;132(2):95–102.
531. Hariman LM, Griffith ER, Hurtig AL, Keehn MT. Functional outcomes of children with sickle-cell disease affected by stroke. *Arch Phys Med Rehabil* 1991;72(7):498–502.
532. Fowler MG, Whitt JK, Lallinger RR, et al. Neuropsychologic and academic functioning of children with sickle cell anemia. *J Dev Behav Pediatr* 1988;9(4):213–220.
533. Swift AV, Cohen MJ, Hynd GW, et al. Neuropsychologic impairment in children with sickle cell anemia. *Pediatrics* 1989;84(6):1077–1085.
534. Wasserman AL, Wilimas JA, Fairclough DL, et al. Subtle neuropsychological deficits in children with sickle cell disease. *Am J Pediatr Hematol Oncol* 1991;13(1):14–20.
535. Knight S, Singhal A, Thomas P, Serjeant G. Factors associated with lowered intelligence in homozygous sickle cell disease. *Arch Dis Child* 1995;73(4):316–320.
536. Wang W, Enos L, Gallagher D, et al. Neuropsychologic performance in school-aged children with sickle cell disease: a report from the Cooperative Study of Sickle Cell Disease. *J Pediatr* 2001;139(3):391–397.
537. Schatz J, Finke RL, Kellett JM, Kramer JH. Cognitive functioning in children with sickle cell disease: a meta-analysis. *J Pediatr Psychol* 2002;27(8):739–748.
538. Bernaudin F, Verlhac S, Freard F, et al. Multicenter prospective study of children with sickle cell disease: radiographic and psychometric correlation. *J Child Neurol* 2000;15(5):333–343.
539. Watkins KE, Hewes DK, Connelly A, et al. Cognitive deficits associated with frontal-lobe infarction in children with sickle cell disease. *Dev Med Child Neurol* 1998;40(8):536–543.
540. Brown RT, Davis PC, Lambert R, et al. Neurocognitive functioning and magnetic resonance imaging in children with sickle cell disease. *J Pediatr Psychol* 2000;25(7):503–513.

541. Schatz J, Brown RT, Pascual JM, et al. Poor school and cognitive functioning with silent cerebral infarcts and sickle cell disease. *Neurology* 2001;56(8):1109–1111.
542. Pegelow CH, Macklin EA, Moser FG, et al. Longitudinal changes in brain magnetic resonance imaging findings in children with sickle cell disease. *Blood* 2002;99(8):3014–3018.
543. Miller ST, Macklin EA, Pegelow CH, et al. Silent infarction as a risk factor for overt stroke in children with sickle cell anemia: a report from the Cooperative Study of Sickle Cell Disease. *J Pediatr* 2001;139(3):385–390.
544. Wang WC, Gallagher DM, Pegelow CH, et al. Multicenter comparison of magnetic resonance imaging and transcranial Doppler ultrasonography in the evaluation of the central nervous system in children with sickle cell disease. *J Pediatr Hematol Oncol* 2000;22(4):335–339.
545. Kirkham FJ, Calamante F, Bynevelt M, et al. Perfusion magnetic resonance abnormalities in patients with sickle cell disease. *Ann Neurol* 2001;49(4):477–485.
546. Prengler M, Pavlakis SG, Prohovnik I, Adams RJ. Sickle cell disease: the neurological complications. *Ann Neurol* 2002;51(5):543–552.
547. Armstrong FD, Thompson RJ, Jr., Wang W, et al. Cognitive functioning and brain magnetic resonance imaging in children with sickle cell disease. *Neuropsychology Committee of the Cooperative Study of Sickle Cell Disease. Pediatrics* 1996;97(6 Pt 1):864–870.
548. Lindsay J, Jr., Meshel JC, Patterson RH. The cardiovascular manifestations of sickle cell disease. *Arch Intern Med* 1974;133(4):643–651.
549. Gerry JL, Bulkley BH, Hutchins GM. Clinicopathologic analysis of cardiac dysfunction in 52 patients with sickle cell anemia. *Am J Cardiol* 1978;42(2):211–216.
550. Covitz W, Espeland M, Gallagher D, et al. The heart in sickle cell anemia. The Cooperative Study of Sickle Cell Disease (CSSCD). *Chest* 1995;108(5):1214–1219.
551. Martin C, Cobb C, Johnson C. Cardiovascular pathology in sickle cell disease. *J Am Coll Cardiol* 1983;1:723.
552. Martin CR, Cobb C, Tatter D, et al. Acute myocardial infarction in sickle cell anemia. *Arch Intern Med* 1983;143(4):830–831.
553. Barrett O, Jr., Saunders DE, Jr., McFarland DE, Humphries JO. Myocardial infarction in sickle cell anemia. *Am J Hematol* 1984;16(2):139–147.
554. Johnson WH, Jr., McCrary RB, Mankad VN. Transient left ventricular dysfunction in childhood sickle cell disease. *Pediatr Cardiol* 1999;20(3):221–223.
555. Deymann AJ, Goertz KK. Myocardial infarction and transient ventricular dysfunction in an adolescent with sickle cell disease. *Pediatrics* 2003;111(2):E183–E187.
556. Acar P, Sebahoun S, de Pontual L, Maunoury C. Myocardial perfusion in children with sickle cell anaemia. *Pediatr Radiol* 2000;30(5):352–354.
557. Maunoury C, Acar P, de Montalembert M, Sidi D. Myocardial perfusion in children with sickle cell disease. *Am J Cardiol* 2003;91(3):374–376.
558. Norris S, Johnson CS, Haywood LJ. Sickle cell anemia: does myocardial ischemia occur during crisis? *J Natl Med Assoc* 1991;83(3):209–213.
559. Callahan LA, Woods KF, Mensah GA, et al. Cardiopulmonary responses to exercise in women with sickle cell anemia. *Am J Respir Crit Care Med* 2002;165(9):1309–1316.
560. Brown J, Geer M, Covitz W, et al. Electrocardiographic responses to exercise in sickle cell anemia.

In: Doyle EG, Engle MA, Gersony WM, eds. Pediatric cardiology. New York: Springer-Verlag, 1986:1111-1116.

561. Alpert BS, Gilman PA, Strong WB, et al. Hemodynamic and ECG responses to exercise in children with sickle cell anemia. *Am J Dis Child* 1981;135(4):362-366.
562. Covitz W, Eubig C, Balfour IC, et al. Exercise-induced cardiac dysfunction in sickle cell anemia. A radionuclide study. *Am J Cardiol* 1983;51(3):570-575.
563. Batra AS, Acherman RJ, Wong WY, et al. Cardiac abnormalities in children with sickle cell anemia. *Am J Hematol* 2002;70(4):306-312.
564. Sellers BB, Jr. Intermittent hypertension during sickle cell crisis. *J Pediatr* 1978;92(6):941-943.
565. Femi-Pearse D, Gazioglu KM, Yu PN. Pulmonary function studies in sickle cell disease. *J Appl Physiol* 1970;28(5):574-577.
566. Miller GJ, Serjeant GR. An assessment of lung volumes and gas transfer in sickle-cell anaemia. *Thorax* 1971;26(3):309-315.
567. Bromberg PA. The lung in sickle cell disease. *Arch Intern Med* 1974;133:652.
568. Pianosi P, Charge TD, Esseltine DW, Coates AL. Pulse oximetry in sickle cell disease. *Arch Dis Child* 1993;68(6):735-738.
569. Comber JT, Lopez BL. Evaluation of pulse oximetry in sickle cell anemia patients presenting to the emergency department in acute vasoocclusive crisis. *Am J Emerg Med* 1996;14(1):16-18.
570. Blaisdell CJ, Goodman S, Clark K, et al. Pulse oximetry is a poor predictor of hypoxemia in stable children with sickle cell disease. *Arch Pediatr Adolesc Med* 2000;154(9):900-903.
571. Fitzgerald RK, Johnson A. Pulse oximetry in sickle cell anemia. *Crit Care Med* 2001;29(9):1803-1806.
572. Homi J, Levee L, Higgs D, et al. Pulse oximetry in a cohort study of sickle cell disease. *Clin Lab Haematol* 1997;19(1):17-22.
573. Sutton LL, Castro O, Cross DJ, et al. Pulmonary hypertension in sickle cell disease. *Am J Cardiol* 1994;74(6):626-628.
574. Castro O, Hoque M, Brown BD. Pulmonary hypertension in sickle cell disease: cardiac catheterization results and survival. *Blood* 2003;101(4):1257-1261.
575. Haque AK, Gokhale S, Rampy BA, et al. Pulmonary hypertension in sickle cell hemoglobinopathy: a clinicopathologic study of 20 cases. *Hum Pathol* 2002;33(10):1037-1043.
576. Minter KR, Gladwin MT. Pulmonary complications of sickle cell anemia. A need for increased recognition, treatment, and research. *Am J Respir Crit Care Med* 2001;164(11):2016-2019.
577. Leong MA, Dampier C, Varlotta L, Allen JL. Airway hyperreactivity in children with sickle cell disease. *J Pediatr* 1997;131(2):278-283.
578. Koumbourlis AC, Zar HJ, Hurlet-Jensen A, Goldberg MR. Prevalence and reversibility of lower airway obstruction in children with sickle cell disease. *J Pediatr* 2001;138(2):188-192.
579. Rackoff WR, Kunkel N, Silber JH, et al. Pulse oximetry and factors associated with hemoglobin oxygen desaturation in children with sickle cell disease. *Blood* 1993;81(12):3422-3427.
580. Song J. Pathology of sickle cell disease. Springfield: Charles C. Thomas, 1971.
581. Johnson CS, Omata M, Tong MJ, et al. Liver involvement in sickle cell disease. *Medicine (Baltimore)* 1985;64(5):349-356.
582. Hilkovitz G, Jacobson A. Hepatic dysfunction and abnormalities of serum proteins and serum

enzymes in sickle cell anemia. *J Lab Clin Med* 1961;57:856.

583. Bogoch A, Casselman WGB, Margolies MP, Bockus HL. Liver disease in sickle cell anemia. *Am J Med* 1955;19(4):583-609.

584. Gremse DA, Fillingim E, Hoff CJ, et al. Hepatic function as assessed by lidocaine metabolism in sickle cell disease. *J Pediatr* 1998;132(6):989-993.

585. Sty JR. Ultrasonography: hepatic vein thrombosis in sickle cell anemia. *Am J Pediatr Hematol Oncol* 1982;4(2):213-215.

586. Smits HL, Oski FA, Brody JI. The hemolytic crisis of sickle cell disease: the role of glucose-6-phosphate dehydrogenase deficiency. *J Pediatr* 1969;74(4): 544-551.

587. Barrett-Connor E. Sickle cell disease and viral hepatitis. *Ann Intern Med* 1968;69(3):517-527.

588. Hargrove MD, Jr. Marked increase in serum bilirubin in sickle cell anemia. A report of 6 patients. *Am J Dig Dis* 1970;15(5):437-442.

589. Yohannan MD, Arif M, Ramia S. Etiology of icteric hepatitis and fulminant hepatic failure in children and the possible predisposition to hepatic failure by sickle cell disease. *Acta Paediatr Scand* 1990;79(2):201-205.

590. Sheehy TW. Sickle cell hepatopathy. *South Med J* 1977;70(5):533-538.

591. al Fawaz I, Ramia S. Decline in hepatitis B infection in sickle cell anaemia and beta thalassaemia major. *Arch Dis Child* 1993;69(5):594-596.

592. Hord J, Windsor B, Koehler M, et al. Diminished antibody response to hepatitis B immunization in children with sickle cell disease. *J Pediatr Hematol Oncol* 2002;24(7):548-549.

593. DeVault KR, Friedman LS, Westerberg S, et al. Hepatitis C in sickle cell anemia. *J Clin Gastroenterol* 1994;18(3):206-209.

594. Hasan MF, Marsh F, Posner G, et al. Chronic hepatitis C in patients with sickle cell disease. *Am J Gastroenterol* 1996;91(6):1204-1206.

595. King SD, Dodd RY, Haynes G, et al. Prevalence of antibodies to hepatitis C virus and other markers in Jamaica. *West Indian Med J* 1995;44(2):55-57.

596. Kindscher JD, Laurin J, Delcore R, Forster J. Liver transplantation in a patient with sickle cell anemia. *Transplantation* 1995;60(7):762-764.

597. Green TW, Conley CL, Berthrong M. Liver in sickle cell anemia. *Bull Johns Hopkins Hosp* 1953;92(2):99-127.

598. Rosenblate HJ, Eisenstein R, Holmes AW. The liver in sickle cell anemia. A clinical-pathologic study. *Arch Pathol* 1970;90(3):235-245.

599. Buchanan GR, Glader BE. Benign course of extreme hyperbilirubinemia in sickle cell anemia: analysis of six cases. *J Pediatr* 1977;91(1):21-24.

600. Stephan JL, Merpit-Gonon E, Richard O, et al. Fulminant liver failure in a 12-year-old girl with sickle cell anaemia: favourable outcome after exchange transfusions. *Eur J Pediatr* 1995;154(6):469-471.

601. O'Callaghan A, O'Brien SG, Ninkovic M, et al. Chronic intrahepatic cholestasis in sickle cell disease requiring exchange transfusion. *Gut* 1995;37(1):144-147.

602. Shao SH, Orringer EP. Sickle cell intrahepatic cholestasis: approach to a difficult problem. *Am J Gastroenterol* 1995;90(11):2048-2050.

603. Sheehy TW, Law DE, Wade BH. Exchange transfusion for sickle cell intrahepatic cholestasis. *Arch*

Intern Med 1980;140(10):1364–1366.

604. Emre S, Kitibayashi K, Schwartz ME, et al. Liver transplantation in a patient with acute liver failure due to sickle cell intrahepatic cholestasis. *Transplantation* 2000;69(4):675–676.
605. Barrett-Connor E. Cholelithiasis in sickle cell anemia. *Am J Med* 1968;45(6):889–898.
606. Karayalcin G, Hassani N, Abrams M, Lanzkowsky P. Cholelithiasis in children with sickle cell disease. *Am J Dis Child* 1979;133(3):306–307.
607. Lachman BS, Lazerson J, Starshak RJ, et al. The prevalence of cholelithiasis in sickle cell disease as diagnosed by ultrasound and cholecystography. *Pediatrics* 1979;64(5):601–603.
608. Sarnaik S, Slovis TL, Corbett DP, et al. Incidence of cholelithiasis in sickle cell anemia using the ultrasonic gray-scale technique. *J Pediatr* 1980;96(6):1005–1008.
609. Walker TM, Hambleton IR, Serjeant GR. Gallstones in sickle cell disease: observations from The Jamaican Cohort study. *J Pediatr* 2000;136(1):80–85.
610. Winter SS, Kinney TR, Ware RE. Gallbladder sludge in children with sickle cell disease. *J Pediatr* 1994;125(5 Pt 1):747–749.
611. Passon RG, Howard TA, Zimmerman SA, et al. Influence of bilirubin uridine diphosphate–glucuronosyltransferase 1A promoter polymorphisms on serum bilirubin levels and cholelithiasis in children with sickle cell anemia. *J Pediatr Hematol Oncol* 2001;23(7):448–451.
612. Cameron JL, Maddrey WC, Zuidema GD. Biliary tract disease in sickle cell anemia: surgical considerations. *Ann Surg* 1971;174(4):702–710.
613. Ware RE, Kinney TR, Casey JR, et al. Laparoscopic cholecystectomy in young patients with sickle hemoglobinopathies. *J Pediatr* 1992;120(1):58–61.
614. Al Mulhim AS, Al Mulhim FM, Al Suwaiygh AA. The role of laparoscopic cholecystectomy in the management of acute cholecystitis in patients with sickle cell disease. *Am J Surg* 2002;183(6):668–672.
615. Haberkern CM, Neumayr LD, Orringer EP, et al. Cholecystectomy in sickle cell anemia patients: perioperative outcome of 364 cases from the National Preoperative Transfusion Study. Preoperative Transfusion in Sickle Cell Disease Study Group. *Blood* 1997;89(5):1533–1542.
616. Tagge EP, Othersen HB, Jr., Jackson SM, et al. Impact of laparoscopic cholecystectomy on the management of cholelithiasis in children with sickle cell disease. *J Pediatr Surg* 1994;29(2):209–212.
617. Serjeant GR, May H, Patrick A, Slifer ED. Duodenal ulceration in sickle cell anaemia. *Trans R Soc Trop Med Hyg* 1973;67(1):59–63.
618. Rao S, Royal JE, Conrad HA, Jr., Harris V, Ahuja J. Duodenal ulcer in sickle cell anemia. *J Pediatr Gastroenterol Nutr* 1990;10(1):117–120.
619. Lee MG, Thirumalai CH, Terry SI, Serjeant GR. Endoscopic and gastric acid studies in homozygous sickle cell disease and upper abdominal pain. *Gut* 1989;30(5):569–572.
620. Karim A, Ahmed S, Rossoff LJ, et al. Fulminant ischemic colitis with atypical clinical features complicating sickle cell disease. *Postgrad Med J* 2002;78(920):370–372.
621. Moukarzel AA, Rajaram M, Sundeep A, et al. Sickle cell anemia: severe ischemic colitis responding to conservative management. *Clin Pediatr (Phila)* 2000;39(4):241–243.
622. Kumar A, Posner G, Marsh F, et al. Acute pancreatitis in sickle cell crisis. *J Natl Med Assoc* 1989;81(1):91–92.
623. Buckalew VM, Jr., Someren A. Renal manifestations of sickle cell disease. *Arch Intern Med* 1974;133(4):660–669.

624. Bernstein J, Whitten CF. A historical appraisal of the kidney in sickle cell anemia. *Arch Pathol Lab Med* 1960;70:407.
625. Eifenbein IB, Patchefsky A, Schwartz W, Weinstein AG. Pathology of the glomerulus in sickle cell anemia with and without nephrotic syndrome. *Am J Pathol* 1974;77(3):357-374.
626. Kimmelstiel P. Vascular occlusion and ischemic infarction in sickle cell disease. *Am J Med Sci* 1948;216:11.
627. Khademi M, Marquis JR. Renal angiography in sickle-cell disease. A preliminary report correlating the angiographic and urographic changes in sickle-cell nephropathy. *Radiology* 1973;107(1):41-46.
628. Keitel HG. Hyposthenuria in sickle cell anemia. A reversible renal defect. *J Clin Invest* 1956;35:998.
629. Perillie P, Epstein FH. Sickling phenomenon produced by hypertonic solutions: A possible explanation for the hyposthenuria of sicklemia. *J Clin Invest* 1963;42:570.
630. Hatch FE, Culbertson JW, Diggs LW. Nature of the renal concentrating defect in sickle cell disease. *J Clin Invest* 1967;46(3):336-345.
631. Ho PK, Alleyne GA. Defect in urinary acidification in adults with sickle-cell anaemia. *Lancet* 1968;2(7575):954-955.
632. Goossens JP, Stadius van Eps LW, Schouten H, Giterson AL. Incomplete renal tubular acidosis in sickle cell disease. *Clin Chim Acta* 1972;41:149-156.
633. Stadius van Eps LW, Schouten H, Haar Romeny-Wachter CC, Porte-Wijsman LW. The relation between age and renal concentrating capacity in sickle cell disease and hemoglobin C disease. *Clin Chim Acta* 1970;27(3):501-511.
634. Suster G, Oski FA. Enuresis in sickle cell anemia. *Am J Dis Child* 1967;113(3):311.
635. Figueroa TE, Benaim E, Griggs ST, Hvizdala EV. Enuresis in sickle cell disease. *J Urol* 1995;153(6):1987-1989.
636. Readett DR, Morris J, Serjeant GR. Determinants of nocturnal enuresis in homozygous sickle cell disease. *Arch Dis Child* 1990;65(6):615-618.
637. DeFronzo RA, Taufield PA, Black H, et al. Impaired renal tubular potassium secretion in sickle cell disease. *Ann Intern Med* 1979;90(3):310-316.
638. de Jong PE, de Jong-van den Berg LT, Stadius van Eps LW. The tubular reabsorption of phosphate in sickle-cell nephropathy. *Clin Sci Mol Med* 1978;55(5):429-434.
639. Diamond HS, Meisel A, Sharon E, et al. Hyperuricosuria and increased tubular secretion of urate in sickle cell anemia. *Am J Med* 1975;59(6):796-802.
640. Mostofi FK, Bruegge CFV, Diggs LW. Lesions in kidneys removed for unilateral hematuria in SC disease. *Arch Pathol* 1957;63(4):336-351.
641. Harrow BR, Sloane JA, Liebman NC. Roentgenologic demonstration of renal papillary necrosis in sickle-cell trait. *N Engl J Med* 1963;268(18):969-976.
642. Allen TD. Sickle cell disease and hematuria: A report of 29 cases. *J Urol* 1964;91:177.
643. Susmano S, Lewy JE. Sickle cell disease and acute glomerulonephritis. *Am J Dis Child* 1969;118(4):615-618.
644. Davis CJ, Jr., Mostofi FK, Sesterhenn IA. Renal medullary carcinoma. The seventh sickle cell nephropathy. *Am J Surg Pathol* 1995;19(1):1-11.
645. Bennett MA, Heslop RW, Meynell MJ. Massive haematuria associated with sickle-cell trait. *BMJ*



1967;1(541):677-679.

646. Bilinsky RT, Kandel GL, Rabiner SF. Epsilon aminocaproic acid therapy of hematuria due to heterozygous sickle cell diseases. *J Urol* 1969;102(1):93-95.
647. Black WD, Hatch FE, Acchiardo S. Aminocaproic acid in prolonged hematuria of patients with sickle cell anemia. *Arch Intern Med* 1976;136(6):678-681.
648. Walker BR, Alexander F, Birdsall TR, Warren RL. Glomerular lesions in sickle cell nephropathy. *JAMA* 1971;215(3):437-440.
649. Friedman EA, Rao TK, Sprung CL, et al. Uremia in sickle-cell anemia treated by maintenance hemodialysis. *N Engl J Med* 1974;291(9):431-435.
650. Bhatena DB, Sondheimer JH. The glomerulopathy of homozygous sickle hemoglobin (SS) disease: morphology and pathogenesis. *J Am Soc Nephrol* 1991;1(11):1241-1252.
651. Falk RJ, Scheinman J, Phillips G, et al. Prevalence and pathologic features of sickle cell nephropathy and response to inhibition of angiotensin-converting enzyme. *N Engl J Med* 1992;326(14):910-915.
652. Bakir AA, Hathiwala SC, Ainsworth TE, et al. Prognosis of the nephrotic syndrome in sickle cell nephropathy. A retrospective study. *Am J Nephrol* 1987;7(2):110-115.
653. Strauss J, Pardo V, Koss MN, et al. Nephropathy associated with sickle cell anemia: an autologous immune complex nephritis. I. Studies on nature of glomerular-bound antibody and antigen identification in a patient with sickle cell disease and immune deposit glomerulonephritis. *Am J Med* 1975;58(3):382-387.
654. Hatch FE, Jr., Azar SH, Ainsworth TE, et al. Renal circulatory studies in young adults with sickle cell anemia. *J Lab Clin Med* 1970;76(4):632-640.
655. Allon M, Lawson L, Eckman JR, et al. Effects of nonsteroidal antiinflammatory drugs on renal function in sickle cell anemia. *Kidney Int* 1988;34(4):500-506.
656. Dharnidharka VR, Dabbagh S, Atiyeh B, et al. Prevalence of microalbuminuria in children with sickle cell disease. *Pediatr Nephrol* 1998;12(6):475-478.
657. McBurney PG, Hanevold CD, Hernandez CM, et al. Risk factors for microalbuminuria in children with sickle cell anemia. *J Pediatr Hematol Oncol* 2002;24(6):473-477.
658. van Eps LW, De Long P. Sickle cell disease. In: Schrier R, Gottschalk C, eds. *Diseases of the kidney*. Boston: Little, Brown and Company, 1997:561.
659. Pegelow CH, Colangelo L, Steinberg M, et al. Natural history of blood pressure in sickle cell disease: risks for stroke and death associated with relative hypertension in sickle cell anemia. *Am J Med* 1997;102(2):171-177.
660. Alpert BS, Dover EV, Strong WB, Covitz W. Longitudinal exercise hemodynamics in children with sickle cell anemia. *Am J Dis Child* 1984;138(11):1021-1024.
661. Powars DR, Elliott-Mills DD, Chan L, et al. Chronic renal failure in sickle cell disease: risk factors, clinical course, and mortality. *Ann Intern Med* 1991;115(8):614-620.
662. Steinberg MH. Erythropoietin for anemia of renal failure in sickle cell disease. *N Engl J Med* 1991;324(19):1369-1370.
663. Montgomery R, Zibari G, Hill GS, Ratner LE. Renal transplantation in patients with sickle cell nephropathy. *Transplantation* 1994;58(5):618-620.
664. Warady BA, Sullivan EK. Renal transplantation in children with sickle cell disease: a report of the North American Pediatric Renal Transplant Cooperative Study (NAPRTCS). *Pediatr Transplant* 1998;2(2):130-133.
665. Ojo AO, Govaerts TC, Schumder RL, et al. Renal transplantation in end-stage sickle cell

nephropathy. *Transplantation* 1999;67(2):291–295.

666. Breen CP, Macdougall IC. Improvement of erythropoietin-resistant anaemia after renal transplantation in patients with homozygous sickle-cell disease. *Nephrol Dial Transplant* 1998;13(11):2949–2952.

667. Ross AS, Graeme-Cook F, Cosimi AB, Chung RT. Combined liver and kidney transplantation in a patient with sickle cell disease. *Transplantation* 2002;73(4):605–608.

668. Paton D. The conjunctival sign of sickle cell disease. Further observations. *Arch Ophthalmol* 1967;68:627.

669. Fink AI. Vascular fine structure changes in the bulbar conjunctiva associated with sickle cell disease. *Am J Ophthalmol* 1970;69(4):563–572.

670. Serjeant GR, Serjeant BE, Condon PI. The conjunctival sign in sickle cell anemia. A relationship with irreversibly sickled cells. *JAMA* 1972;219(11):1428–1431.

671. Condon PI, Serjeant GR. Ocular findings in homozygous sickle cell anemia in Jamaica. *Am J Ophthalmol* 1972;73(4):533–543.

672. Armaly MF. Ocular manifestations in sickle cell disease. *Arch Intern Med* 1974;133(4):670–679.

673. Goldberg MF. Retinal vaso-occlusion in sickling hemoglobinopathies. *Birth Defects Orig Artic Ser* 1976;12(3):475–515.

674. Goldberg MF. Natural history of untreated proliferative sickle retinopathy. *Arch Ophthalmol* 1971;85(4):428–437.

675. Cao J, Mathews MK, McLeod DS, et al. Angiogenic factors in human proliferative sickle cell retinopathy. *Br J Ophthalmol* 1999;83(7):838–846.

676. Condon PI, Serjeant GR. Ocular findings in hemoglobin SC disease in Jamaica. *Am J Ophthalmol* 1972;74(5):921–931.

677. Kent D, Arya R, Aclimandos WA, et al. Screening for ophthalmic manifestations of sickle cell disease in the United Kingdom. *Eye* 1994;8(Pt 6):618–622.

678. Goldberg MF. Sickled erythrocytes, hyphema, and secondary glaucoma: V. The effect of vitamin C on erythrocyte sickling in aqueous humor. *Ophthalmic Surg* 1979;10(4):70–77.

678a. Penman AD, Talbot JF, Chuang EL, et al. New classification of peripheral retinal vascular changes in sickle cell disease. *Br J Ophthalmol* 1994;78(9):681–689.

679. Deutsch TA, Weinreb RN, Goldberg MF. Indications for surgical management of hyphema in patients with sickle cell trait. *Arch Ophthalmol* 1984;102(4):566–569.

680. Curran EL, Fleming JC, Rice K, Wang WC. Orbital compression syndrome in sickle cell disease. *Ophthalmology* 1997;104(10):1610–1615.

681. Garty I, Koren A, Garzosi H. Frontal and orbital bone infarctions causing periorbital swelling in patients with sickle cell anemia. *Arch Ophthalmol* 1984;102(10):1486–1488.

682. Clare A, FitzHenley M, Harris J, et al. Chronic leg ulceration in homozygous sickle cell disease: the role of venous incompetence. *Br J Haematol* 2002;119(2):567–571.

683. Koshy M, Entsuah R, Koranda A, et al. Leg ulcers in patients with sickle cell disease. *Blood* 1989;74(4):1403–1408.

684. Serjeant GR. Leg ulceration in sickle cell anemia. *Arch Intern Med* 1974;133(4):690–694.

685. Akinyanju O, Akinsete I. Leg ulceration in sickle cell disease in Nigeria. *Trop Geogr Med*

1979;31(1):87-91.

686. Wolfort FG, Krizek TJ. Skin ulceration in sickle cell anemia. *Plast Reconstr Surg* 1969;43(1):71-77.

687. Hallbook T, Lanner E. Serum-zinc and healing of venous leg ulcers. *Lancet* 1972;2(7781):780-782.

688. Serjeant GR, Galloway RE, Gueri MC. Oral zinc sulphate in sickle-cell ulcers. *Lancet* 1970;2(7679):891-892.

689. Heng MC, Pilgrim JP, Beck FW. A simplified hyperbaric oxygen technique for leg ulcers. *Arch Dermatol* 1984;120(5):640-645.

690. al Momen AK. Recombinant human erythropoietin induced rapid healing of a chronic leg ulcer in a patient with sickle cell disease. *Acta Haematol* 1991;86(1):46-48.

691. Charache S, Dover GJ, Moore RD, et al. Hydroxyurea: effects on hemoglobin F production in patients with sickle cell anemia. *Blood* 1992;79(10):2555-2565.

692. Wethers DL, Ramirez GM, Koshy M, et al. Accelerated healing of chronic sickle-cell leg ulcers treated with RGD peptide matrix. RGD Study Group. *Blood* 1994;84(6):1775-1779.

693. Cacciola E, Giustolisi R, Musso R, et al. Antithrombin III concentrate for treatment of chronic leg ulcers in sickle cell-beta thalassemia: a pilot study. *Ann Intern Med* 1989;111(6):534-536.

694. Frost ML, Treadwell P. Treatment of sickle cell leg ulcers with pentoxifylline. *Int J Dermatol* 1990;29(5):375-376.

695. Charache S, Niebyl JR. Pregnancy in sickle cell disease. *Clin Haematol* 1985;14(3):729-746.

696. Pritchard JA, Scott DE, Whalley PH, et al. The effects of maternal sickle cell hemoglobinopathies and sickle cell trait on reproductive performance. *Am J Obstet Gynecol* 1973;117(5):662-670.

697. Perkins RP. Inherited disorders of hemoglobin synthesis and pregnancy. *Am J Obstet Gynecol* 1971;111(1):120-159.

698. Horger EO III. Sickle cell and sickle cell-hemoglobin C disease during pregnancy. *Obstet Gynecol* 1972;39(6):873-879.

699. Rahimy MC, Gangbo A, Adjou R, et al. Effect of active prenatal management on pregnancy outcome in sickle cell disease in an African setting. *Blood* 2000;96(5):1685-1689.

700. Hendrickse JP, Watson-Williams EJ. The influence of hemoglobinopathies on reproduction. *Am J Obstet Gynecol* 1966;94(5):739-748.

701. Brown AK, Sleeper LA, Pegelow CH, et al. The influence of infant and maternal sickle cell disease on birth outcome and neonatal course. *Arch Pediatr Adolesc Med* 1994;148(11):1156-1162.

702. Smith JA, Espeland M, Bellevue R, et al. Pregnancy in sickle cell disease: experience of the Cooperative Study of Sickle Cell Disease. *Obstet Gynecol* 1996;87(2):199-204.

703. Morris JS, Dunn DT, Poddar D, Serjeant GR. Haematological risk factors for pregnancy outcome in Jamaican women with homozygous sickle cell disease. *Br J Obstet Gynaecol* 1994;101(9):770-773.

704. Nascimento ML, Ladipo OA, Coutinho EM. Noregestrol acetate contraceptive implant use by women with sickle cell disease. *Clin Pharmacol Ther* 1998;64(4):433-438.

705. Ladipo OA, Falusi AG, Feldblum PJ, et al. Norplant use by women with sickle cell disease. *Int J Gynaecol Obstet* 1993;41(1):85-87.

706. Yoong WC, Tuck SM. Menstrual pattern in women with sickle cell anaemia and its association with sickling crises. *J Obstet Gynaecol* 2002;22(4):399-401.

707. Gilman PA, McFarlane JM, Huisman THJ. Natural history of sickle cell anemia: Reevaluation of a 15

year cord blood testing program. *Pediatr Res* 1976;10:452:376.

708. Seeler RA. Deaths in children with sickle cell anemia. A clinical analysis of 19 fatal instances in Chicago. *Clin Pediatr (Phila)* 1972;11(11):634-637.

709. Vichinsky E, et al. Newborn screening for sickle cell disease: Effect on mortality. *Pediatrics* 1988;81:749.

710. Githens JH, Lane PA, McCurdy RS, et al. Newborn screening for hemoglobinopathies in Colorado. The first 10 years. *Am J Dis Child* 1990;144(4):466-470.

711. Mortality among children with sickle cell disease identified by newborn screening during 1990-1994—California, Illinois, and New York. *MMWR Morb Mortal Wkly Rep* 1998;47(9):169-172.

712. Davis H, Schoendorf KC, Gergen PJ, Moore RM, Jr. National trends in the mortality of children with sickle cell disease, 1968 through 1992. *Am J Public Health* 1997;87(8):1317-1322.

713. Leikin SL, Gallagher D, Kinney TR, et al. Mortality in children and adolescents with sickle cell disease. Cooperative Study of Sickle Cell Disease. *Pediatrics* 1989;84(3):500-508.

714. Steinberg MH, Hebbel RP. Clinical diversity of sickle cell anemia: genetic and cellular modulation of disease severity. *Am J Hematol* 1983;14(4):405-416.

715. Pembrey ME, Wood WG, Weatherall DJ, Perrine RP. Fetal haemoglobin production and the sickle gene in the oases of eastern Saudi Arabia. *Br J Haematol* 1978;40(3):415-429.

716. Schroeder WA, Powars DR, Kay LM, et al. Beta-cluster haplotypes, alpha-gene status, and hematological data from SS, SC, and S-beta-thalassemia patients in southern California. *Hemoglobin* 1989;13(4):325-353.

716a. Perrine RP, Pembrey ME, John P, et al. Natural history of sickle cell anemia in Saudi Arabs. A study of 270 subjects. *Ann Intern Med* 1978;88(1):1-6.

717. Al Awamy B, Wilson WA, Pearson HA. Splenic function in sickle cell disease in the eastern province of Saudi Arabia. *J Pediatr* 1984;104(5):714-717.

718. el Mouzan MI, Al Awamy BH, al Torki MT. Clinical features of sickle cell disease in eastern Saudi Arab children. *Am J Pediatr Hematol Oncol* 1990;12(1):51-55.

719. Acquaye JK, Omer A, Ganeshaguru K, et al. Non-benign sickle cell anaemia in western Saudi Arabia. *Br J Haematol* 1985;60(1):99-108.

720. Steinberg MH, Hsu H, Nagel RL, et al. Gender and haplotype effects upon hematological manifestations of adult sickle cell anemia. *Am J Hematol* 1995;48(3):175-181.

721. Nagel RL. Sickle cell anemia is a multigene disease: sickle painful crises, a case in point. *Am J Hematol* 1993;42(1):96-101.

722. Powars DR, Meiselman HJ, Fisher TC, et al. Beta-S gene cluster haplotypes modulate hematologic and hemorheologic expression in sickle cell anemia. Use in predicting clinical severity. *Am J Pediatr Hematol Oncol* 1994;16(1):55-61.

723. Dover GJ, Smith KD, Chang YC, et al. Fetal hemoglobin levels in sickle cell disease and normal individuals are partially controlled by an X-linked gene located at Xp22.2. *Blood* 1992;80(3):816-824.

724. Chang YC, Smith KD, Moore RD, et al. An analysis of fetal hemoglobin variation in sickle cell disease: the relative contributions of the X-linked factor, beta-globin haplotypes, alpha-globin gene number, gender, and age. *Blood* 1995;85(4):1111-1117.

725. Dover GJ, Boyer SH, Charache S, Heintzelman K. Individual variation in the production and survival of F cells in sickle-cell disease. *N Engl J Med* 1978;299(26):1428-1435.

726. Lessin L, Muenz L, Makris N, et al. Intracellular sickle cell polymer fraction and SS disease severity:

an analysis for the Cooperative Study of Sickle Cell Disease database. *Blood* 1991;78:368a.

727. Milner PF, Leibfarth JD, Ford J, et al. Increased HbF in sickle cell anemia is determined by a factor linked to the beta S gene from one parent. *Blood* 1984;63(1):64-72.

728. Boyer SH, Dover GJ, Serjeant GR, et al. Production of F cells in sickle cell anemia: regulation by a genetic locus or loci separate from the beta-globin gene cluster. *Blood* 1984;64(5):1053-1058.

729. Miller BA, Salameh M, Ahmed M, et al. Analysis of hemoglobin F production in Saudi Arabian families with sickle cell anemia. *Blood* 1987;70(3):716-720.

730. Ali SA. Milder variant of sickle-cell disease in Arabs in Kuwait associated with unusually high level of foetal haemoglobin. *Br J Haematol* 1970;19(5):613-619.

731. Haghshenass M, Ismail-Beigi F, Clegg JB, Weatherall DJ. Mild sickle-cell anaemia in Iran associated with high levels of fetal haemoglobin. *J Med Genet* 1977;14(3):168-171.

732. Kar BC, Satapathy RK, Kulozik AE, et al. Sickle cell disease in Orissa State, India. *Lancet* 1986;2(8517):1198-1201.

733. Serjeant GR. Fetal haemoglobin in homozygous sickle cell disease. *Clin Haematol* 1975;4(1):109-122.

734. Powars DR, Weiss JN, Chan LS, Schroeder WA. Is there a threshold level of fetal hemoglobin that ameliorates morbidity in sickle cell anemia? *Blood* 1984;63(4):921-926.

735. Embury SH, Dozy AM, Miller J, et al. Concurrent sickle cell anemia and alpha-thalassemia: effect on severity of anemia. *N Engl J Med* 1982;306(5):270-274.

736. Higgs DR, Aldridge BE, Lamb J, et al. The interaction of alpha-thalassemia and homozygous sickle-cell disease. *N Engl J Med* 1982;306(24):1441-1446.

737. Steinberg MH, Rosenstock W, Coleman MB, et al. Effects of thalassemia and microcytosis on the hematologic and vasoocclusive severity of sickle cell anemia. *Blood* 1984;63(6):1353-1360.

738. Stevens MC, Maude GH, Beckford M, et al. Alpha thalassemia and the hematology of homozygous sickle cell disease in childhood. *Blood* 1986;67(2):411-414.

739. Steinberg MH, Embury SH. Alpha-thalassemia in blacks: genetic and clinical aspects and interactions with the sickle hemoglobin gene. *Blood* 1986;68(5):985-990.

740. Embury SH, Clark MR, Monroy G, Mohandas N. Concurrent sickle cell anemia and alpha-thalassemia. Effect on pathological properties of sickle erythrocytes. *J Clin Invest* 1984;73(1):116-123.

741. Fabry ME, Mears JG, Patel P, et al. Dense cells in sickle cell anemia: the effects of gene interaction. *Blood* 1984;64(5):1042-1046.

742. Embury SH, Backer K, Glader BE. Monovalent cation changes in sickle erythrocytes: a direct reflection of alpha-globin gene number. *J Lab Clin Med* 1985;106(1):75-79.

743. De Ceulaer K, Higgs DR, Weatherall DJ, et al. Alpha-thalassemia reduces the hemolytic rate in homozygous sickle-cell disease. *N Engl J Med* 1983;309(3):189-190.

744. Serjeant GR, Richards R, Barbor PR, Milner PF. Relatively benign sickle-cell anaemia in 60 patients aged over 30 in the West Indies. *BMJ* 1968;3(610):86-91.

745. Mears JG, Lachman HM, Labie D, Nagel RL. Alpha-thalassemia is related to prolonged survival in sickle cell anemia. *Blood* 1983;62(2):286-290.

746. Serjeant BE, Mason KP, Kenny MW, et al. Effect of alpha thalassaemia on the rheology of homozygous sickle cell disease. *Br J Haematol* 1983;55(3):479-486.

747. Hawker H, Neilson H, Hayes RJ, Serjeant GR. Haematological factors associated with avascular

necrosis of the femoral head in homozygous sickle cell disease. *Br J Haematol* 1982;50(1):29–34.

748. Hayes RJ, Condon PI, Serjeant GR. Haematological factors associated with proliferative retinopathy in homozygous sickle cell disease. *Br J Ophthalmol* 1981;65(1):29–35.

749. Fox PD, Higgs DR, Serjeant GR. Influence of alpha thalassaemia on the retinopathy of homozygous sickle cell disease. *Br J Ophthalmol* 1993;77(2):89–90.

750. Program of the 18th Annual Sickle Cell Meeting, ed. Concomitant beta thalassemia reduces the odds of stroke in Hgb SS disease. Philadelphia: 1993.

751. Kennedy AP, Walsh DA, Nicholson R, et al. Influence of HbS levels upon the hematological and clinical characteristics of sickle cell trait. *Am J Hematol* 1986;22(1):51–54.

752. Gupta AK, Kirchner KA, Nicholson R, et al. Effects of alpha-thalassemia and sickle polymerization tendency on the urine-concentrating defect of individuals with sickle cell trait. *J Clin Invest* 1991;88(6):1963–1968.

753. Young N, Mortimer P. Viruses and bone marrow failure. *Blood* 1984;63(4):729–737.

753a. Orkin SH, Kazazian HH, Jr., Antonarakis SE, et al. Linkage of beta-thalassaemia mutations and beta-globin gene polymorphisms with DNA polymorphisms in human beta-globin gene cluster. *Nature* 1982;296(5858):627–631.

754. Wainscoat JS, Bell JI, Thein SL, et al. Multiple origins of the sickle mutation: evidence from beta S globin gene cluster polymorphisms. *Mol Biol Med* 1983;1(2):191–197.

755. Nagel RL, Fabry ME, Pagnier J, et al. Hematologically and genetically distinct forms of sickle cell anemia in Africa. The Senegal type and the Benin type. *N Engl J Med* 1985;312(14):880–884.

756. Nagel RL, Erlingsson S, Fabry ME, et al. The Senegal DNA haplotype is associated with the amelioration of anemia in African-American sickle cell anemia patients. *Blood* 1991;77(6):1371–1375.

757. Rieder RF, Safaya S, Gillette P, et al. Effect of beta-globin gene cluster haplotype on the hematological and clinical features of sickle cell anemia. *Am J Hematol* 1991;36(3):184–189.

758. Powars DR. Sickle cell anemia: beta S-gene-cluster haplotypes as prognostic indicators of vital organ failure. *Semin Hematol* 1991;28(3):202–208.

759. Powars DR. Beta S-gene-cluster haplotypes in sickle cell anemia. Clinical and hematologic features. *Hematol Oncol Clin North Am* 1991;5(3):475–493.

760. Adams JG, Benjamin L, Fryd S, et al. Gender and haplotype effects upon hematological and clinical manifestations of sickle cell anemia. *Clin Res* 1992;40:378a.

761. Thomas PW, Higgs DR, Serjeant GR. Benign clinical course in homozygous sickle cell disease: a search for predictors. *J Clin Epidemiol* 1997;50(2):121–126.

762. Quinn CT, Buchanan GR. Predictors of outcome in sickle cell disease. *J Pediatr Hematol Oncol* 2002;24(4):244–245.

763. Chui DH, Dover GJ. Sickle cell disease: no longer a single gene disorder. *Curr Opin Pediatr* 2001;13(1):22–27.

764. Nagel RL. Pleiotropic and epistatic effects in sickle cell anemia. *Curr Opin Hematol* 2001;8(2):105–110.

765. Steinberg MH, Rodgers GP. Pathophysiology of sickle cell disease: role of cellular and genetic modifiers. *Semin Hematol* 2001;38(4):299–306.

766. Taylor JG, Tang DC, Savage SA, et al. Variants in the VCAM1 gene and risk for symptomatic stroke in sickle cell disease. *Blood* 2002;100(13):4303–4309.

767. Hayes RJ, Beckford M, Grandison Y, et al. The haematology of steady state homozygous sickle cell disease: frequency distributions, variation with age and sex, longitudinal observations. *Br J Haematol* 1985;59(2):369-382.
768. Vichinsky E, et al. The diagnosis of iron deficiency anemia in sickle cell disease. *Blood* 1981;58:963.
769. West MS, Wethers D, Smith J, Steinberg M. Laboratory profile of sickle cell disease: a cross-sectional analysis. The Cooperative Study of Sickle Cell Disease. *J Clin Epidemiol* 1992;45(8):893-909.
770. Marvel JS, Sutera SP, Krogstad DJ, et al. Accurate determination of mean cell volume by isotope dilution in erythrocyte populations with variable deformability. *Blood Cells* 1991;17(3):497-512.
771. Mohandas N, Johnson A, Wyatt J, et al. Automated quantitation of cell density distribution and hyperdense cell fraction in RBC disorders. *Blood* 1989;74(1):442-447.
772. Schneider RG, Takeda I, Gustavson LP, Alperin JB. Intraerythrocytic precipitations of haemoglobins S and C. *Nat New Biol* 1972;235(55):88-90.
773. Milner PF, Charache S. Effect of carbamylation with varying concentrations of cyanate (NCO) or carbamyl phosphate (CP) on red cell destruction in sickle cell anemia (HbSS). *Blood* 1972;40:928.
774. Bensinger TA, Gillette PN. Hemolysis in sickle cell disease. *Arch Intern Med* 1974;133(4):624-631.
775. Sherwood JB, Goldwasser E, Chilcote R, et al. Sickle cell anemia patients have low erythropoietin levels for their degree of anemia. *Blood* 1986;67(1):46-49.
776. Schwartz AD. The splenic platelet reservoir in sickle cell anemia. *Blood* 1972;40(5):678-683.
777. Stuart MJ, Stockman JA, Oski FA. Abnormalities of platelet aggregation in the vaso-occlusive crisis of sickle-cell anemia. *J Pediatr* 1974;85(5):629-632.
778. Abildgaard CF, Simone JV, Schulman I. Factor-8 (antihaemophilic factor) activity in sickle-cell anaemia. *Br J Haematol* 1967;13(1):19-27.
779. Rickles FR, O'Leary DS. Role of coagulation system in pathophysiology of sickle cell disease. *Arch Intern Med* 1974;133(4):635-641.
780. Leslie J, Langler D, Serjeant GR, et al. Coagulation changes during the steady state in homozygous sickle-cell disease in Jamaica. *Br J Haematol* 1975;30(2):159-166.
781. White JM, Billimoria F, Muller MA, et al. Serum-alpha-hydroxybutyrate dehydrogenase levels in sickle-cell disease and sickle-cell crisis. *Lancet* 1978;1(8063):532-533.
782. Brody JI, Ryan WN, Haidar MA. Serum alkaline phosphatase isoenzymes in sickle cell anemia. *JAMA* 1975;232(7):738-741.
783. Garrick MD, Dembure P, Guthrie R. Sickle-cell anemia and other hemoglobinopathies. Procedures and strategy for screening employing spots of blood on filter paper as specimens. *N Engl J Med* 1973;288(24):1265-1268.
784. Schneider RG, Alperin JB, Lehmann H. Sickling tests. Pitfalls in performance and interpretation. *JAMA* 1967;202(5):419-421.
785. Itano HA. Solubility of naturally occurring mixtures of human hemoglobin. *Arch Biochem Biophys* 1953;47:148.
786. Canning DM, Huntsman RG. An assessment of Sickledex as an alternative to the sickling test. *J Clin Pathol* 1970;23(8):736-737.
787. Fairbanks VF, Petitt RM. Sickledex tests with unstable hemoglobin disorders. *JAMA* 1972;220(1):128.



788. Wilson JB, Headlee ME, Huisman TH. A new high-performance liquid chromatographic procedure for the separation and quantitation of various hemoglobin variants in adults and newborn babies. *J Lab Clin Med* 1983;102(2):174-186.
789. Singer K, Chernoff AI, Singer L. Studies of abnormal hemoglobins. I. Their demonstration in sickle cell anemia and other hematologic disorders by means of alkali denaturation. *Blood* 1951;6:413-428.
790. Chudwin DS, Rucknagel DL. Immunological quantification of hemoglobins F and A2. *Clin Chim Acta* 1974;50:413-419.
791. Betke K, Fleihauer EF. Fetaler und bleibender blutfarbstoff in erythrozyten und erythroblasten von menschlichen feten adn neuborenen. *Blut* 1958;4:241-248.
792. Dover GJ, Boyer SH. Quantitation of hemoglobins within individual red cells: asynchronous biosynthesis of fetal and adult hemoglobin during erythroid maturation in normal subjects. *Blood* 1980;56(6):1082-1091.
793. Grover R, Wethers D, Shahidi S, et al. Evaluation of the expanded newborn screening program in New York City. *Pediatrics* 1978;61(5):740-749.
794. Consensus conference. Newborn screening for sickle cell disease and other hemoglobinopathies. *JAMA* 1987;258 (9):1205-1209.
795. The Council of Regional Networks for Genetic Services (CORN). Newborn screening report: 1990. Maternal and Child Health Program, United States Department of Health and Human Services. 54-63:1992.
796. Shafer FE, Lorey F, Cunningham GC, et al. Newborn screening for sickle cell disease: 4 years of experience from California's newborn screening program. *J Pediatr Hematol Oncol* 1996;18(1):36-41.
797. Eckman JR. Neonatal screening. In: Embury SH, Hebbel RP, Mohandas N, Steinberg MH, eds. *Sickle cell disease: basic principles and clinical practice*. New York: Raven Press, 1994:309-315.
798. Papadea C, Eckman JR, Kuehnert RS, Platt AF. Comparison of liquid and dried blood for neonatal hemoglobinopathy screening: laboratory and programmatic issues. *Pediatrics* 1994;93(3):427-432.
799. Galacteros F, Kleman K, Caburi-Martin J, et al. Cord blood screening for hemoglobin abnormalities by thin layer isoelectric focusing. *Blood* 1980;56(6):1068-1071.
800. Karnon J, Zeuner D, Ades AE, et al. The effects of neonatal screening for sickle cell disorders on lifetime treatment costs and early deaths avoided: a modelling approach. *J Public Health Med* 2000;22(4):500-511.
801. Day SW, Brunson GE, Wang WC. Successful newborn sickle cell trait counseling program using health department nurses. *Pediatr Nurs* 1997;23(6):557-561.
802. Yang YM, Andrews S, Peterson R, et al. Prenatal sickle cell screening education effect on the follow-up rates of infants with sickle cell trait. *Patient Educ Couns* 2000;39(2-3):185-189.
803. Strickland DK, Ware RE, Kinney TR. Pitfalls in newborn hemoglobinopathy screening: failure to detect beta (+)-thalassemia. *J Pediatr* 1995;127(2):304-308.
804. Zhang YH, McCabe LL, Wilborn M, et al. Application of molecular genetics in public health: improved follow-up in a neonatal hemoglobinopathy screening program. *Biochem Med Metab Biol* 1994;52(1):27-35.
805. Old JM. Screening and genetic diagnosis of haemoglobin disorders. *Blood Rev* 2003;17(1):43-53.
806. Ducrocq R, Pascaud O, Bevier A, et al. Strategy linking several analytical methods of neonatal screening for sickle cell disease. *J Med Screen* 2001;8(1):8-14.
807. Alter BP. Prenatal diagnosis of hemoglobinopathies: development of methods for study of fetal red cells and fibroblasts. *Am J Pediatr Hematol Oncol* 1983;5(4):378-385.

808. Alter BP. Advances in the prenatal diagnosis of hematologic diseases. *Blood* 1984;64(2):329–340.
809. Benz EJ, Jr. Molecular genetics of the sickling syndromes: evolution of new strategies for improved diagnosis. *Am J Pediatr Hematol Oncol* 1984;6(1):59–66.
810. Powledge TM, Fletcher J. Guidelines for the ethical, social, and legal issues in prenatal diagnosis: A report from the Genetics Research Group of the Hastings Center, Institute of Society, Ethics and the Life Sciences. *N Engl J Med* 1979;300:168.
811. Murray RF, Jr., Chamberlain N, Fletcher J, et al. Special considerations for minority participation in prenatal diagnosis. *JAMA* 1980;243(12):1254–1256.
812. Rucknagel DL. A decade of screening in the hemoglobinopathies: is a national program to prevent sickle cell anemia possible? *Am J Pediatr Hematol Oncol* 1983;5(4):373–377.
813. Goossens M, Dumez Y, Kaplan L, et al. Prenatal diagnosis of sickle-cell anemia in the first trimester of pregnancy. *N Engl J Med* 1983;309(14):831–833.
814. Rhoads GG, Jackson LG, Schlesselman SE, et al. The safety and efficacy of chorionic villus sampling for early prenatal diagnosis of cytogenetic abnormalities. *N Engl J Med* 1989;320(10):609–617.
815. Price JO, Elias S, Wachtel SS, et al. Prenatal diagnosis with fetal cells isolated from maternal blood by multiparameter flow cytometry. *Am J Obstet Gynecol* 1991;165(6 Pt 1):1731–1737.
816. Varawalla NY, Dokras A, Old JM, et al. An approach to preimplantation diagnosis of beta-thalassaemia. *Prenat Diagn* 1991;11(10):775–785.
817. Goldberg JD, Martin MC, Lebo RV, Pedersen RA. Preimplantation diagnosis. *West J Med* 1993;159(3):301–307.
818. Xu K, Shi ZM, Veeck LL, et al. First unaffected pregnancy using preimplantation genetic diagnosis for sickle cell anemia. *JAMA* 1999;281(18):1701–1706.
819. Dorticos-Balea A, Martin-Ruiz M, Hechevarria-Fernandez P, et al. Reproductive behaviour of couples at risk for sickle cell disease in Cuba: a follow-up study. *Prenat Diagn* 1997;17(8):737–742.
820. Boehm CD, Antonarakis SE, Phillips JA III. Prenatal diagnosis using DNA polymorphisms. Report on 95 pregnancies at risk for sickle-cell disease or beta-thalassemia. *N Engl J Med* 1983;308(18):1054–1058.
821. Chang JC, Kan YW. A sensitive new prenatal test for sickle-cell anemia. *N Engl J Med* 1982;307(1):30–32.
822. Orkin SH, Little PF, Kazazian HH, Jr., Boehm CD. Improved detection of the sickle mutation by DNA analysis: application to prenatal diagnosis. *N Engl J Med* 1982;307(1):32–36.
823. Conner BJ, Reyes AA, Morin C, et al. Detection of sickle cell beta S-globin allele by hybridization with synthetic oligonucleotides. *Proc Natl Acad Sci U S A* 1983;80(1):278–282.
824. Saiki RK, Chang CA, Levenson CH, et al. Diagnosis of sickle cell anemia and beta-thalassemia with enzymatically amplified DNA and nonradioactive allele-specific oligonucleotide probes. *N Engl J Med* 1988;319(9):537–541.
825. Embury SH, Scharf SJ, Saiki RK, et al. Rapid prenatal diagnosis of sickle cell anemia by a new method of DNA analysis. *N Engl J Med* 1987;316(11):656–661.
826. Saiki RK, Bugawan TL, Horn GT, et al. Analysis of enzymatically amplified beta-globin and HLA-DQ alpha DNA with allele-specific oligonucleotide probes. *Nature* 1986;324(6093):163–166.
827. Saiki RK, Walsh PS, Levenson CH, Erlich HA. Genetic analysis of amplified DNA with immobilized sequence-specific oligonucleotide probes. *Proc Natl Acad Sci U S A* 1989;86:6230–6234.
828. Sekizawa A, Saito H. Prenatal screening of single-gene disorders from maternal blood. *Am J*

Pharmacogenomics 2001;1(2):111–117.

829. Steinberg MH. Management of sickle cell disease. *N Engl J Med* 1999;340(13):1021–1030.
830. Castro O. Management of sickle cell disease: recent advances and controversies. *Br J Haematol* 1999;107(1):2–11.
831. Ballas SK. Sickle cell disease: current clinical management. *Semin Hematol* 2001;38(4):307–314.
832. Vichinsky E. New therapies in sickle cell disease. *Lancet* 2002;360(9333):629.
833. Steinberg MH, Brugnara C. Pathophysiological-based approaches to treatment of sickle cell disease. *Annu Rev Med* 2003;54:89–112. Epub 2001 Dec 03. Review.
834. Amrolia PJ, Almeida A, Halsey C, et al. Therapeutic challenges in childhood sickle cell disease Part 1: current and future treatment options. *Br J Haematol* 2003;120(5):725–736.
835. Amrolia PJ, Almeida A, Davies SC, Roberts IA. Therapeutic challenges in childhood sickle cell disease Part 2: a problem-orientated approach. *Br J Haematol* 2003;120(5):737–743.
836. Wayne AS, Keyv SV, Nathan DG. Transfusion management of sickle cell disease. *Blood* 1993;81(5):1109–1123.
837. Vichinsky E. Transfusion therapy. In: Embury SH, Hebbel RP, Mohandas N, Steinberg MH, eds. *Sickle cell disease: basic principles and clinical practice*. New York: Raven Press Ltd, 1994:781–798.
838. Buchanan GR, McKie V, Jackson EA, et al. Splenic phagocytic function in children with sickle cell anemia receiving long-term hypertransfusion therapy. *J Pediatr* 1989;115(4):568–572.
839. Ozkaynak MF, Ortega JA. Reversibility of anatomical and functional asplenia by chronic transfusion in a child with sickle cell anemia. *Am J Pediatr Hematol Oncol* 1989;11(4):445–446.
840. Anderson R, Cassell M, Mullinax GL, Chaplin H. Effect of normal cells on viscosity of sickle cell blood. *Arch Intern Med J* 1963;111(3):286–294.
841. Sommer A, Kontras SB, Craenen JM. Partial exchange transfusion in sickle cell anemia complicated by heart disease. *JAMA* 1971;215(3):483–484.
842. Lanzkowsky P, Shende A, Karayalcin G, et al. Partial exchange transfusion in sickle cell anemia. Use in children with serious complications. *Am J Dis Child* 1978;132(12):1206–1208.
843. Klein HG, Garner RJ, Miller DM, et al. Automated partial exchange transfusion in sickle cell anemia. *Transfusion* 1980;20(5):578–584.
844. Kim HC, Dugan NP, Silber JH, et al. Erythrocytapheresis therapy to reduce iron overload in chronically transfused patients with sickle cell disease. *Blood* 1994;83(4):1136–1142.
845. Adams DM, Schultz WH, Ware RE, Kinney TR. Erythrocytapheresis can reduce iron overload and prevent the need for chelation therapy in chronically transfused pediatric patients. *J Pediatr Hematol Oncol* 1996;18(1):46–50.
846. Jeng MR, Feusner J, Skibola C, Vichinsky E. Central venous catheter complications in sickle cell disease. *Am J Hematol* 2002;69(2):103–108.
847. Abdul-Rauf A, Gauderer M, Chiarucci K, Berman B. Long-term central venous access in patients with sickle cell disease. Incidence of thrombotic and infectious complications. *J Pediatr Hematol Oncol* 1995;17(4):342–345.
848. Janik JS, Seeler RA. Surgical procedures in children with sickle hemoglobinopathy. *J Pediatr* 1977;91:505.
849. Zinkham WH, Seidler AJ, Kickler TS. Variable degrees of suppression of hemoglobin S synthesis in

- subjects with hemoglobin SS disease on a long-term transfusion regimen. *J Pediatr* 1994;124(2):215-219.
850. Cohen AR, Buchanan GR, Martin M, Ohene-Frempong K. Increased blood requirements during long-term transfusion therapy for sickle cell disease. *J Pediatr* 1991;118(3):405-407.
851. Charache S. The treatment of sickle cell anemia. *Arch Intern Med* 1974;133(4):698-705.
852. Telen MJ. Principles and problems of transfusion in sickle cell disease. *Semin Hematol* 2001;38(4):315-323.
853. Rosse WF, Gallagher D, Kinney TR, et al. Transfusion and alloimmunization in sickle cell disease. The Cooperative Study of Sickle Cell Disease. *Blood* 1990;76(7):1431-1437.
854. Vichinsky EP, Earles A, Johnson RA, et al. Alloimmunization in sickle cell anemia and transfusion of racially unmatched blood. *N Engl J Med* 1990;322(23):1617-1621.
855. Tahhan HR, Holbrook CT, Braddy LR, et al. Antigen-matched donor blood in the transfusion management of patients with sickle cell disease. *Transfusion* 1994;34(7):562-569.
856. Ness PM. To match or not to match: the question for chronically transfused patients with sickle cell anemia. *Transfusion* 1994;34(7):558-560.
857. Petz LD, Calhoun L, Shulman IA, et al. The sickle cell hemolytic transfusion reaction syndrome. *Transfusion* 1997;37(4):382-392.
858. Files B, Brambilla D, Kutlar A, et al. Longitudinal changes in ferritin during chronic transfusion: a report from the Stroke Prevention Trial in Sickle Cell Anemia (STOP). *J Pediatr Hematol Oncol* 2002;24(4):284-290.
859. Harmatz P, Butensky E, Quirolo K, et al. Severity of iron overload in patients with sickle cell disease receiving chronic red blood cell transfusion therapy. *Blood* 2000;96(1):76-79.
860. Gonzalez P, Hackney AC, Jones S, et al. A phase I/II study of polymerized bovine hemoglobin in adult patients with sickle cell disease not in crisis at the time of study. *J Invest Med* 1997;45(5):258-264.
861. Stroncek DF, Rainer T, Sharon V, et al. Sickle Hb polymerization in RBC components from donors with sickle cell trait prevents effective WBC reduction by filtration. *Transfusion* 2002;42(11):1466-1472.
862. Milner PF. Chronic transfusion regimens in sickle cell disease. *Prog Clin Biol Res* 1982;98:97-107.
863. Pegelow CH, Adams RJ, McKie V, et al. Risk of recurrent stroke in patients with sickle cell disease treated with erythrocyte transfusions. *J Pediatr* 1995;126(6):896-899.
864. Spigelman A, Warden MJ. Surgery in patients with sickle cell disease. *Arch Surg* 1972;104(6):761-764.
865. Koshy M, Weiner SJ, Miller ST, et al. Surgery and anesthesia in sickle cell disease. Cooperative Study of Sickle Cell Diseases. *Blood* 1995;86(10):3676-3684.
866. Vichinsky EP, Haberkern CM, Neumayr L, et al. A comparison of conservative and aggressive transfusion regimens in the perioperative management of sickle cell disease. The Preoperative Transfusion in Sickle Cell Disease Study Group. *N Engl J Med* 1995;333(4):206-213.
867. Cunningham FG, Pritchard JA, Mason R, Chase G. Prophylactic transfusions of normal red blood cells during pregnancies complicated by sickle cell hemoglobinopathies. *Am J Obstet Gynecol* 1979;135(7):994-1003.
868. Koshy M, Burd L, Wallace D, et al. Prophylactic red-cell transfusions in pregnant patients with sickle cell disease. A randomized cooperative study. *N Engl J Med* 1988;319(22):1447-1452.
869. Atweh GF, Schechter AN. Pharmacologic induction of fetal hemoglobin: raising the therapeutic bar in sickle cell disease. *Curr Opin Hematol* 2001;8(2):123-130.

870. Felsenfeld G, McGhee J. Methylation and gene control. *Nature* 1982;296(5858):602–603.
871. Busslinger M, Hurst J, Flavell RA. DNA methylation and the regulation of globin gene expression. *Cell* 1983;34(1):197–206.
872. DeSimone J, Heller P, Hall L, Zwiers D. 5-Azacytidine stimulates fetal hemoglobin synthesis in anemic baboons. *Proc Natl Acad Sci U S A* 1982;79(14): 4428–4431.
873. Charache S, Dover G, Smith K, et al. Treatment of sickle cell anemia with 5-azacytidine results in increased fetal hemoglobin production and is associated with nonrandom hypomethylation of DNA around the gamma-delta-beta-globin gene complex. *Proc Natl Acad Sci U S A* 1983;80(15):4842–4846.
874. Ley TJ, DeSimone J, Noguchi CT, et al. 5-Azacytidine increases gamma-globin synthesis and reduces the proportion of dense cells in patients with sickle cell anemia. *Blood* 1983;62(2):370–380.
875. Letvin NL, Linch DC, Beardsley GP, et al. Augmentation of fetal-hemoglobin production in anemic monkeys by hydroxyurea. *N Engl J Med* 1984;310(14):869–873.
876. Platt OS, Orkin SH, Dover G, et al. Hydroxyurea enhances fetal hemoglobin production in sickle cell anemia. *J Clin Invest* 1984;74(2):652–656.
877. Veith R, Galanello R, Papayannopoulou T, Stamatoyannopoulos G. Stimulation of F-cell production in patients with sickle-cell anemia treated with cytarabine or hydroxyurea. *N Engl J Med* 1985;313(25):1571–1575.
878. Torrealba-de Ron A, et al. Perturbations in the erythroid marrow progenitor cell pools may play a role in the augmentation of Hb F by 5-azacytidine. *N Engl J Med* 1984;63:201.
879. Humphries RK, Dover G, Young NS, et al. 5-Azacytidine acts directly on both erythroid precursors and progenitors to increase production of fetal hemoglobin. *J Clin Invest* 1985;75(2):547–557.
880. Sunshine HR, Hofrichter J, Ferrone FA, Eaton WA. Oxygen binding by sickle cell hemoglobin polymers. *J Mol Biol* 1982;158(2):251–273.
881. Orringer EP, Parker JC. Hydroxyurea and sickle cell disease. *Hematol Pathol* 1992;6(4):171–178.
882. Gladwin MT, Shelhamer JH, Ognibene FP, et al. Nitric oxide donor properties of hydroxyurea in patients with sickle cell disease. *Br J Haematol* 2002;116(2):436–444.
883. Huang J, Hadimani SB, Rupon JW, et al. Iron nitrosyl hemoglobin formation from the reactions of hemoglobin and hydroxyurea. *Biochemistry* 2002;41(7):2466–2474.
884. Glover RE, Ivy ED, Orringer EP, et al. Detection of nitrosyl hemoglobin in venous blood in the treatment of sickle cell anemia with hydroxyurea. *Mol Pharmacol* 1999;55(6):1006–1010.
885. Ferguson RP, Arun A, Carter C, et al. Hydroxyurea treatment of sickle cell anemia in hospital-based practices. *Am J Hematol* 2002;70(4):326–328.
886. Vichinsky EP, Lubin BH. A cautionary note regarding hydroxyurea in sickle cell disease. *Blood* 1994;83(4):1124–1128.
887. de Montalembert M, Belloy M, Bernaudin F, et al. Three-year follow-up of hydroxyurea treatment in severely ill children with sickle cell disease. The French Study Group on Sickle Cell Disease. *J Pediatr Hematol Oncol* 1997;19(4):313–318.
888. Kinney TR, Helms RW, O'Branski EE, et al. Safety of hydroxyurea in children with sickle cell anemia: results of the HUG-KIDS study, a phase I/II trial. Pediatric Hydroxyurea Group. *Blood* 1999;94(5):1550–1554.
889. Scott JP, Hillery CA, Brown ER, et al. Hydroxyurea therapy in children severely affected with sickle cell disease. *J Pediatr* 1996;128(6):820–828.

890. Ferster A, Vermeylen C, Cornu G, et al. Hydroxyurea for treatment of severe sickle cell anemia: a pediatric clinical trial. *Blood* 1996;88(6):1960–1964.
891. Jayabose S, Tugal O, Sandoval C, et al. Clinical and hematologic effects of hydroxyurea in children with sickle cell anemia. *J Pediatr* 1996;129(4):559–565.
892. Hoppe C, Vichinsky E, Quirolo K, et al. Use of hydroxyurea in children ages 2 to 5 years with sickle cell disease. *J Pediatr Hematol Oncol* 2000;22(4):330–334.
893. Wang WC, Wynn LW, Rogers ZR, et al. A two-year pilot trial of hydroxyurea in very young children with sickle-cell anemia. *J Pediatr* 2001;139(6):790–796.
894. Claster S, Vichinsky E. First report of reversal of organ dysfunction in sickle cell anemia by the use of hydroxyurea: splenic regeneration. *Blood* 1996;88(6):1951–1953.
895. Hackney AC, Hezier W, Gullledge TP, et al. Effects of hydroxyurea administration on the body weight, body composition and exercise performance of patients with sickle-cell anaemia. *Clin Sci (Lond)* 1997;92(5):481–486.
896. Wang WC, Helms RW, Lynn HS, et al. Effect of hydroxyurea on growth in children with sickle cell anemia: results of the HUG-KIDS Study. *J Pediatr* 2002;140(2):225–229.
897. Sumoza A, de Bisotti R, Sumoza D, Fairbanks V. Hydroxyurea (HU) for prevention of recurrent stroke in sickle cell anemia (SCA). *Am J Hematol* 2002;71(3):161–165.
898. de Montalembert M, Begue P, Bernaudin F, et al. Preliminary report of a toxicity study of hydroxyurea in sickle cell disease. French Study Group on Sickle Cell Disease. *Arch Dis Child* 1999;81(5):437–439.
899. Diav-Citrin O, Hunnisett L, Sher GD, Koren G. Hydroxyurea use during pregnancy: a case report in sickle cell disease and review of the literature. *Am J Hematol* 1999;60(2):148–150.
900. Byrd DC, Pitts SR, Alexander CK. Hydroxyurea in two pregnant women with sickle cell anemia. *Pharmacotherapy* 1999;19(12):1459–1462.
901. Valafar H, Valafar F, Darvill A, et al. Predicting the effectiveness of hydroxyurea in individual sickle cell anemia patients. *Artif Intell Med* 2000;18(2):133–148.
902. Ware RE, Eggleston B, Redding-Lallinger R, et al. Predictors of fetal hemoglobin response in children with sickle cell anemia receiving hydroxyurea therapy. *Blood* 2002;99:10–14.
903. Papayannopoulou T, Brice M, Stamatoyannopoulos G. Hemoglobin F synthesis in vitro: evidence for control at the level of primitive erythroid stem cells. *Proc Natl Acad Sci U S A* 1977;74(7):2923–2927.
904. al Khatti A, Umemura T, Clow J, et al. Erythropoietin stimulates F-reticulocyte formation in sickle cell anemia. *Trans Assoc Am Physicians* 1988;101:54–61.
905. Nagel RL, Vichinsky E, Shah M, et al. F reticulocyte response in sickle cell anemia treated with recombinant human erythropoietin: a double-blind study. *Blood* 1993;81(1):9–14.
906. Goldberg MA, Brugnara C, Dover GJ, et al. Treatment of sickle cell anemia with hydroxyurea and erythropoietin. *N Engl J Med* 1990;323(6):366–372.
907. Rodgers GP, Dover GJ, Uyesaka N, et al. Augmentation by erythropoietin of the fetal-hemoglobin response to hydroxyurea in sickle cell disease. *N Engl J Med* 1993;328(2):73–80.
908. Perrine SP, Greene MF, Faller DV. Delay in the fetal globin switch in infants of diabetic mothers. *N Engl J Med* 1985;312(6):334–338.
909. McDonagh KT, Dover GJ, Donahue RE, et al. Hydroxyurea-induced HbF production in anemic primates: augmentation by erythropoietin, hematopoietic growth factors, and sodium butyrate. *Exp Hematol*

1992;20(10):1156-1164.

910. Blau CA, Constantoulakis P, Shaw CM, Stamatoyannopoulos G. Fetal hemoglobin induction with butyric acid: efficacy and toxicity. *Blood* 1993;81(2):529-537.

911. Perrine SP, Ginder GD, Faller DV, et al. A short-term trial of butyrate to stimulate fetal-globin-gene expression in the beta-globin disorders. *N Engl J Med* 1993;328(2):81-86.

912. Sher GD, Ginder GD, Little J, et al. Extended therapy with intravenous arginine butyrate in patients with beta-hemoglobinopathies. *N Engl J Med* 1995;332(24):1606-1610.

913. Pace BS, Chen YR, Thompson A, Goodman SR. Butyrate-inducible elements in the human gamma-globin promoter. *Exp Hematol* 2000;28(3):283-293.

914. Resar LM, Segal JB, Fitzpatrick LK, et al. Induction of fetal hemoglobin synthesis in children with sickle cell anemia on low-dose oral sodium phenylbutyrate therapy. *J Pediatr Hematol Oncol* 2002;24(9):737-741.

915. McDonagh KT, Nienhuis AW. Induction of the human gamma globin gene promoter in K562 cells by sodium butyrate: Reversal repression by CCAAT displacement protein. *Blood* 1991;78:225a.

916. Collins AF, Dover GJ, Luban NL. Increased fetal hemoglobin production in patients receiving valproic acid for epilepsy. *Blood* 1994;84(5):1690-1691.

917. DeSimone J, Koshy M, Dorn L, et al. Maintenance of elevated fetal hemoglobin levels by decitabine during dose interval treatment of sickle cell anemia. *Blood* 2002;99(11):3905-3908.

918. Mentzer WC, Jr. Inhibitors of sickling. *Am J Pediatr Hematol Oncol* 1982;4(3):320-327.

919. Chang H, Ewert SM, Bookchin RM, Nagel RL. Comparative evaluation of fifteen anti-sickling agents. *Blood* 1983;61(4):693-704.

920. Diederich D. Relationship between the oxygen affinity and in vitro sickling propensity of carbamylated sickle erythrocytes. *Biochem Biophys Res Commun* 1972;46(3):1255-1261.

921. Peterson CM, Tsairis P, Onishi A, et al. Sodium cyanate induced polyneuropathy in patients with sickle-cell disease. *Ann Intern Med* 1974;81(2):152-158.

922. Harkness DR, Roth S. Clinical evaluation of cyanate in sickle cell anemia. *Prog Hematol* 1975;9:157.

923. Diederich DA, et al. Hematologic and clinical responses in patients with sickle cell anemia after chronic extracorporeal red cell carbamylation. *J Clin Invest* 1976;58:642.

924. Elbaum D, et al. Molecular and cellular effects of antisickling concentrations of alkylureas. *Blood* 1976;48:273.

925. Segal GB, et al. The effects of urea and cyanate on sickling in vitro. *N Engl J Med* 1972;287:59.

926. Smith CM, Hebbel RP, Tukey DP, et al. Pluronic F-68 reduces the endothelial adherence and improves the rheology of liganded sickle erythrocytes. *Blood* 1987;69(6):1631-1636.

927. Carr ME, Jr., Powers PL, Jones MR. Effects of poloxamer 188 on the assembly, structure and dissolution of fibrin clots. *Thromb Haemost* 1991;66(5):565-568.

928. Haddy TB, Castro O. Overt iron deficiency in sickle cell disease. *Arch Intern Med* 1982;142(9):1621-1624.

929. Castro O, Haddy TB. Improved survival of iron-deficient patients with sickle erythrocytes. *N Engl J Med* 1983;308(9):527.

930. Rosa RM, Bierer BE, Thomas R, et al. A study of induced hyponatremia in the prevention and treatment of sickle-cell crisis. *N Engl J Med* 1980;303(20):1138-1143.



931. Charache S, Walker WG. Failure of desmopressin to lower serum sodium or prevent crisis in patients with sickle cell anemia. *Blood* 1981;58(5):892-896.
932. Leary M, Abramson N. Induced hyponatremia for sickle-cell anemia. *N Engl J Med* 1981;304(14):844-845.
933. Brugnara C, Gee B, Armsby CC, et al. Therapy with oral clotrimazole induces inhibition of the Gardos channel and reduction of erythrocyte dehydration in patients with sickle cell disease. *J Clin Invest* 1996;97(5):1227-1234.
934. Altura RA, Wang WC, Wynn L, et al. Hydroxyurea therapy associated with declining serum levels of magnesium in children with sickle cell anemia. *J Pediatr* 2002;140(5):565-569.
935. Johnson FL, Look AT, Gockerman J, et al. Bone-marrow transplantation in a patient with sickle-cell anemia. *N Engl J Med* 1984;311(12):780-783.
936. Vermynen C, Cornu G, Philippe M, et al. Bone marrow transplantation in sickle cell anaemia. *Arch Dis Child* 1991;66(10):1195-1198.
937. Bernaudin F, Souillet G, Vannier JP, et al. Bone marrow transplantation (BMT) in 14 children with severe sickle cell disease (SCD): the French experience. *GEGMO. Bone Marrow Transplant* 1993;12[Suppl 1]:118-121.
938. Walters MC, Patience M, Leisenring W, et al. Bone marrow transplantation for sickle cell disease. *N Engl J Med* 1996;335(6):369-376.
939. Walters MC, Sullivan KM, Bernaudin F, et al. Neurologic complications after allogeneic marrow transplantation for sickle cell anemia. *Blood* 1995;85(4):879-884.
940. Mentzer WC, Heller S, Pearle PR, et al. Availability of related donors for bone marrow transplantation in sickle cell anemia. *Am J Pediatr Hematol Oncol* 1994;16(1):27-29.
941. Piomelli S. Bone marrow transplantation in sickle cell diseases: a plea for a rational approach. *Bone Marrow Transplant* 1992;10[Suppl 1]:58-61.
942. Platt OS, Guinan EC. Bone marrow transplantation in sickle cell anemia—the dilemma of choice. *N Engl J Med* 1996;335(6):426-428.
943. Nietert PJ, Abboud MR, Silverstein MD, Jackson SM. Bone marrow transplantation versus periodic prophylactic blood transfusion in sickle cell patients at high risk of ischemic stroke: a decision analysis. *Blood* 2000;95(10):3057-3064.
944. Kirkpatrick DV, Barrios NJ, Humbert JH. Bone marrow transplantation for sickle cell anemia. *Semin Hematol* 1991;28:240-243.
945. Ballas SK. Bone-marrow transplantation in sickle-cell anaemia: why so few so late? *Lancet* 1992;340(8829):1226.
946. Nagel RL. The dilemma of marrow transplantation in sickle cell anemia. *Semin Hematol* 1991;28(3):233-234.
947. Gore L, Lane PA, Quinones RR, Giller RH. Successful cord blood transplantation for sickle cell anemia from a sibling who is human leukocyte antigen-identical: implications for comprehensive care. *J Pediatr Hematol Oncol* 2000;22(5):437-440.
948. Brichard B, Vermynen C, Ninane J, Cornu G. Persistence of fetal hemoglobin production after successful transplantation of cord blood stem cells in a patient with sickle cell anemia. *J Pediatr* 1996;128(2):241-243.
949. Reed W, Smith R, Dekovic F, et al. Comprehensive banking of sibling donor cord blood for children with malignant and nonmalignant disease. *Blood* 2003;101(1):351-357.

950. Walters MC, Patience M, Leisenring W, et al. Stable mixed hematopoietic chimerism after bone marrow transplantation for sickle cell anemia. *Biol Blood Marrow Transplant* 2001;7(12):665-673.
951. Gaziev J, Lucarelli G. Stem cell transplantation for hemoglobinopathies. *Curr Opin Pediatr* 2003;15(1):24-31.
952. Schleuning M, Stoetzer O, Waterhouse C, et al. Hematopoietic stem cell transplantation after reduced-intensity conditioning as treatment of sickle cell disease. *Exp Hematol* 2002;30(1):7-10.
953. Kramer MS, Rooks Y, Pearson HA. Growth and development in children with sickle-cell trait. A prospective study of matched pairs. *N Engl J Med* 1978;299(13):686-689.
954. Dorwart BB, Goldbert MA, Schumacher HR, Alavi A. Absence of increased frequency of bone and joint disease with hemoglobin AS and AC. *Ann Intern Med* 1977;86(1):66-67.
955. Blattner P, Dar H, Nitowsky HM. Pregnancy outcome in women with sickle cell trait. *JAMA* 1977;238(13):1392-1394.
956. Heller P, Moneer Y. Clinical problems: The usual and unusual. In: Abramson H, Bertles JR, Wethers DL, eds. *Sickle cell disease: Diagnosis, management, education, and research*. St. Louis: Mosby, 1973.
957. Murphy JR. Sickle cell hemoglobin (Hb AS) in black football players. *JAMA* 1973;225(8):981-982.
958. Jones SR, Binder RA, Donowho EM, Jr. Sudden death in sickle-cell trait. *N Engl J Med* 1970;282(6):323-325.
959. Cooper MR, Toole JF. Sickle-cell trait: benign or malignant?. *Ann Intern Med* 1972;77(6):997-998.
960. Kark JA, Posey DM, Schumacher HR, Ruehle CJ. Sickle-cell trait as a risk factor for sudden death in physical training. *N Engl J Med* 1987;317(13):781-787.
961. Goodwin WE, et al. Hematuria and sickle cell disease: Unexplained, gross unilateral renal hematuria in Negroes coincident with the blood sickling trait. *J Urol* 1950;63:79.
962. Heller P, Best WR, Nelson RB, Becktel J. Clinical implications of sickle-cell trait and glucose-6-phosphate dehydrogenase deficiency in hospitalized black male patients. *N Engl J Med* 1979;300(18):1001-1005.
963. Oster JR, Lee SM, Lespier LE, et al. Renal acidification in sickle cell trait. *Arch Intern Med* 1976;136(1):30-35.
964. Ashcroft MT, Miall WE, Milner PF. A comparison between the characteristics of Jamaican adults with normal hemoglobin and those with sickle cell trait. *Am J Epidemiol* 1969;90(3):236-243.
965. Baill IC, Witter FR. Sickle trait and its association with birthweight and urinary tract infections in pregnancy. *Int J Gynaecol Obstet* 1990;33(1):19-21.
966. Sears DA. The morbidity of sickle cell trait: a review of the literature. *Am J Med* 1978;64(6):1021-1036.
967. Lane PA, Githens JH. Splenic syndrome at mountain altitudes in sickle cell trait. Its occurrence in nonblack persons. *JAMA* 1985;253(15):2251-2254.
968. McKenzie JM. Vocational options for those with sickle cell trait: questions about hypoxemia and the industrial environment. *Am J Pediatr Hematol Oncol* 1982;4(2):172-178.
969. Huisman TH. Trimodality in the percentages of beta chain variants in heterozygotes: the effect of the number of active Hbalpha structural loci. *Hemoglobin* 1977;1(4):349-382.
970. Embury SH, Dozy AM. Correlation of a-globulin genotype with hematologic parameters in sickle cell trait. *Blood* 1979;54:53a.

971. Shaeffer JR, Kleve LJ, DeSimone J. beta S Chain turnover in reticulocytes of sickle trait individuals with high or low concentrations of haemoglobin S. *Br J Haematol* 1976;32(3):365-372.
972. Levere RD, Lichtman HC, Levine J. Effect of iron deficiency anaemia on the metabolism of the heterogenic haemoglobins in sickle cell trait. *Nature* 1964;202(493):499-501.
973. Heller P, Yakulis VJ, Epstein RB, Friedland S. Variation in the amount of hemoglobin S in a patient with sickle cell trait and megaloblastic anemia. *Blood* 1963;21(4):479.
974. Barnes MG, Komarmy L, Novack AH. A comprehensive screening program for hemoglobinopathies. *JAMA* 1972;219(6):701-705.
975. Basset P, Beuzard Y, Garel MC, Rosa J. Isoelectric focusing of human hemoglobin: its application to screening, to the characterization of 70 variants, and to the study of modified fractions of normal hemoglobins. *Blood* 1978;51(5):971-982.
976. Eddington GM, Laing WN. Relationships between haemoglobin C and S and malaria in Ghana. *BMJ* 1957;2:143-145.
977. Bunn HF, Noguchi CT, Hofrichter J, et al. Molecular and cellular pathogenesis of hemoglobin SC disease. *Proc Natl Acad Sci U S A* 1982;79(23):7527-7531.
978. Bookchin RM, Balazs T. Ionic strength dependence of the polymer solubilities of deoxyhemoglobin S + C and S + A mixtures. *Blood* 1986;67(4):887-892.
979. Bunn HF. Subunit assembly of hemoglobin: an important determinant of hematologic phenotype. *Blood* 1987;69(1):1-6.
980. Fabry ME, Kaul DK, Raventos-Suarez C, et al. SC erythrocytes have an abnormally high intracellular hemoglobin concentration. Pathophysiological consequences. *J Clin Invest* 1982;70(6):1315-1319.
981. River GL, Robbins AB, Schwartz SO. SC Hemoglobin: A clinical study. *Blood* 1961;18(4):385-416.
982. Williams S, Maude GH, Serjeant GR. Clinical presentation of sickle cell-hemoglobin C disease. *J Pediatr* 1986;109(4):586-589.
983. Yeung KY, Lessin LS. Splenic infarction in sickle cell-hemoglobin C disease. Demonstration by selective splenic arteriogram and scintillation scan. *Arch Intern Med* 1976;136(8):905-911.
984. Chu JY, Niederman LG. Splenic sequestration syndrome in sickle/hemoglobin C disease at low altitude. *J Pediatr* 1977;91(2):350-351.
985. Geola F, Kukreja SC, Schade SG. Splenic sequestration with sickle cell-C disease. *Arch Intern Med* 1978;138(2):307-308.
986. Githens JH, Gross GP, Eife RF, Wallner SF. Splenic sequestration syndrome at mountain altitudes in sickle/hemoglobin C disease. *J Pediatr* 1977;90(2):203-206.
987. Chilcote RR, Dampier C. Overwhelming pneumococcal septicemia in a patient with HbSC disease and splenic dysfunction. *J Pediatr* 1984;104(5):734-736.
988. Barrett-Connor E. Infection and sickle cell-C disease. *Am J Med Sci* 1971;262(3):162-169.
989. Topley JM, Cupidore L, Vaidya S, et al. Pneumococcal and other infections in children with sickle-cell hemoglobin C (SC) disease. *J Pediatr* 1982;101(2):176-179.
990. Buchanan GR, Smith SJ, Holtkamp CA, Fuseler JP. Bacterial infection and splenic reticuloendothelial function in children with hemoglobin SC disease. *Pediatrics* 1983;72(1):93-98.
991. Chusid MJ, Lachman BS, Lazerson J. Severe mycoplasma pneumonia and vesicular eruption in SC hemoglobinopathy. *J Pediatr* 1978;93(3):449-451.

992. Lane PA, Rogers ZR, Woods GM, et al. Fatal pneumococcal septicemia in hemoglobin SC disease. *J Pediatr* 1994;124(6):859–862.
993. Ali SK, Wilimas J, Goff J. Choreiform activity in hemoglobin SC disease. *J Pediatr* 1978;93(6):1062.
994. Fullerton WT, Hendrickse JP, de V, Watson–Williams EJ. Haemoglobin SC disease in pregnancy. In: Jonxis JHP, ed. *Abnormal haemoglobins in Africa*. Oxford: Blackwell Science, 1965:411–433.
995. Chmel H, Bertles JF. Hemoglobin S/C disease in a pregnant woman with crisis and fat embolization syndrome. *Am J Med* 1975;58(4):563–566.
996. Davey RJ, Esposito DJ, Jacobson RJ, Corn M. Partial exchange transfusion as treatment for hemoglobin SC disease in pregnancy. *Arch Intern Med* 1978;138(6):937–939.
997. Powars DR, Hiti A, Ramicone E, et al. Outcome in hemoglobin SC disease: a four–decade observational study of clinical, hematologic, and genetic factors. *Am J Hematol* 2002;70(3):206–215.
998. Koduri PR, Agbemadzo B, Nathan S. Hemoglobin S–C disease revisited: clinical study of 106 adults. *Am J Hematol* 2001;68(4):298–300.
999. Moo–Penn W, Bechtel K, Jue D, et al. The presence of hemoglobin S and C Harlem in an individual in the United States. *Blood* 1975;46(3):363–367.
1000. Honig GR, Gunay U, Mason RG, et al. Sick cell syndromes. I. Hemoglobin SC–alpha–thalassemia. *Pediatr Res* 1976;10(6):613–620.
1001. Warkentin TE, Barr RD, Ali MA, Mohandas N. Recurrent acute splenic sequestration crisis due to interacting genetic defects: hemoglobin SC disease and hereditary spherocytosis. *Blood* 1990;75(1):266–270.
1002. West MS, Wethers D, Smith J, Steinberg M. Laboratory profile of sickle cell disease: a cross–sectional analysis. The Cooperative Study of Sickle Cell Disease. *J Clin Epidemiol* 1992;45(8):893–909.
1003. Ballas SK, Lerner J, Smith ED, et al. The xerocytosis of Hb SC disease. *Blood* 1987;69(1):124–130.
1004. Diggs LW, Bell A. Intraerythrocytic hemoglobin crystals in sickle cell hemoglobin C disease. *Blood* 1965;25:218.
1005. Steinberg MH, Nagel RL, Brugnara C. Cellular effects of hydroxyurea in Hb SC disease. *Br J Haematol* 1997;98(4):838–844.
1006. Miller MK, Zimmerman SA, Schultz WH, Ware RE. Hydroxyurea therapy for pediatric patients with hemoglobin SC disease. *J Pediatr Hematol Oncol* 2001;23(5):306–308.
1007. Serjeant GR, Ashcroft MT, Serjeant BE, Milner PF. The clinical features of sickle–cell–thalassaemia in Jamaica. *Br J Haematol* 1973;24(1):19–30.
1008. Stevens MC, Maude GH, Beckford M, et al. Haematological change in sickle cell–haemoglobin C disease and in sickle cell–beta thalassaemia: a cohort study from birth. *Br J Haematol* 1985;60(2):279–292.
1009. Loukopoulos D, Voskaridou E, Kalotychou V, et al. Reduction of the clinical severity of sickle cell/beta–thalassemia with hydroxyurea: the experience of a single center in Greece. *Blood Cells Mol Dis* 2000;26(5):453–466.
1010. Rigano P, Rodgers GP, Renda D, et al. Clinical and hematological responses to hydroxyurea in Sicilian patients with Hb S/beta–thalassemia. *Hemoglobin* 2001;25(1):9–17.
1011. Rey KS, Unger CA, Rao SP, Miller ST. Sickle cell–hemoglobin E disease: clinical findings and implications. *J Pediatr* 1991;119(6):949–951.
1012. McCurdy PR, Lorkin PA, Casey R, et al. Hemoglobin S–G (S–D) syndrome. *Am J Med*

1974;57(4):665-670.

1013. Sturgeon P, Itano HA, Bergreu WR. Clinical manifestations of hemoglobin-S with hemoglobin-D. The interaction of hemoglobin-S with hemoglobin-D. *Blood* 1955;10:389.

1014. Cooke JV, Mack JK. Sickle-cell anemia in a white American family. *J Pediatr* 1934;5:601.

1015. Smith EW, Conley CL. Sickle cell hemoglobin D disease. *Ann Intern Med* 1959;50:94.

1016. McCurdy PR. Clinical and physiologic studies in a Negro with sickle cell hemoglobin D disease. *N Engl J Med* 1960;262:961.

1017. Cawein MJ, Lappat EJ, Brangle RW, Farley CH. Hemoglobin S-D disease. *Ann Intern Med* 1966;64(1):62-70.

1018. Ringelhann B, Lewis RA, Lorkin PA, et al. Sickle cell hemoglobin D Punjab disease: S from Ghana and D from England. *Acta Haematol (Basel)* 1967;38(5):324-331.

1019. Schneider RG, Ueda S, Alperin JB, et al. Hemoglobin D Los Angeles in two Caucasian families: hemoglobin SD disease and hemoglobin D thalassemia. *Blood* 1968;32(2):250-259.

1020. Ramot B, Fisher S, Remez D, et al. Hemoglobin O in an Arab family. Sickle cell hemoglobin O trait. *BMJ* 1960;2:1262-1264.

1021. Ibrahim SA, Mustafa D. Sickle-cell haemoglobin O disease in a Sudanese family. *BMJ* 1967;3:715.

1022. Javid J. Hemoglobin SO Arabia disease in a black American. *Am J Med Sci* 1973;265:266.

1023. Charache S, et al. Hemoglobin SC, SS/G Philadelphia and SO Arab disease: diagnostic importance of an integrative analysis of clinical, hematologic, and electrophoretic findings. *Am J Med* 1977;63:439.

1024. Maeda K, et al. Hemoglobin SO Arab and hemoglobin CO Arab diseases. *Am J Pediatr Hematol Oncol* 1983;5:127.

2004 Lippincott Williams & Wilkins  
John P. Greer, John Foerster, John N. Lukens  
George M. Rodgers, Frixos Paraskevas, Bertil Glader  
Wintrobe's Clinical Hematology

[PREVALENCE](#)  
[MOLECULAR PATHOLOGY AND PATHOPHYSIOLOGY](#)  
[CLINICAL FEATURES](#)  
[HEMATOLOGIC FEATURES](#)  
[DIAGNOSIS](#)  
[TREATMENT](#)  
[WEB SITES](#)  
[REFERENCES](#)

In 1890, Heinz described the staining characteristics of the red cell inclusions that now bear his name. For the next 60 years, *Heinz bodies* were considered to be solely a manifestation of exposure to various kinds of toxins. Their relation to primaquine-induced hemolytic anemia was established in the 1950s (see [Chapter 34](#)). In 1952, Cathie described a patient with severe congenital hemolytic anemia in which similar inclusions were found in the absence of toxic exposure ([1](#)). This congenital form of Heinz-body anemia was more fully delineated by Lange and Akeroyd ([2](#)) and by Schmid et al. ([3](#)), who reported similar cases and, in addition, noted brown pigment in the urine. The patients described by Schmid et al., being father and son, provided evidence for the genetic basis of the disease.

The first suggestion that an abnormal hemoglobin (Hb) might be implicated in the pathogenesis was made by Scott and co-workers, who found an electrophoretically abnormal Hb component in a patient with congenital Heinz-body hemolytic anemia ([4](#)). Their suggestion was supported by the discovery that Hb Zürich was associated with an inclusion-body hemolytic anemia, although only after exposure to sulfonamides ([5](#)). The discovery of Hb Köln and the determination of its molecular abnormality constituted final proof that congenital Heinz-body hemolytic anemia was a hemoglobinopathy ([6](#)). Other unstable Hbs—Hb Genova ([7](#)), Hb Sydney ([8](#)), and Hb Hammersmith ([9](#))—were soon found to produce a similar picture. Hb Bristol ([10](#)) was detected in Cathie's original patient, and the family described by Scott et al. was shown to have Hb Santa Ana.

Characterization of the amino acid substitutions in these and other unstable Hbs paved the way for present concepts of the structure-function relationships of Hb variants. More than 200 unstable Hbs have now been identified ([11](#), [12](#)), and a clearer picture of the spectrum of disease they produce has emerged. Fewer than one-half of the unstable variants are of clinical significance, however. Initially, those that were attended by anemia were referred to as *congenital Heinz-body hemolytic anemia*. These disorders are more properly designated *unstable Hb disease*.

## PREVALENCE

Despite the large number of unstable variants, unstable Hb disease is rare. By far the most common of the unstable variants is Hb Köln, which has a worldwide distribution ([6](#), [13](#), [14](#), [15](#), [16](#), [17](#), and [18](#)). The independent occurrence of this variant in so many apparently unrelated individuals suggests that the Hb Köln mutation is located at a methylated CpG

dinucleotide sequence of the  $\beta$ -globin gene that can act as a “hotspot” for mutation through the deamination of the methylcytosine nucleotide to form thymine ( [19](#)). Hb Hammersmith has been reported in cases from China and Japan as well as from the United Kingdom ( [20](#)). Most unstable variants have been demonstrated only in single individuals or within single kindreds ( [21](#)).

Unstable Hb disease is expressed fully in the heterozygous state. Thus, the inheritance pattern is autosomal dominant. Rarely, the homozygous state has been reported. Such was the case with a Pakistani child whose parents, both of whom had Hb Bushwick, were first cousins ( [22](#)). Whereas family members who were heterozygous for the variant Hb had a compensated hemolytic disorder, the homozygous child had chronic anemia due to hemolysis and ineffective erythropoiesis. There were severe exacerbations of anemia during febrile illnesses. The apparent spontaneous mutation rate among affected heterozygotes is high. From a compilation of apparent *de novo* mutations, the mutation rate for unstable variants has been calculated to be  $5.9 \times 10^{-9}$  per  $\beta$ -gene nucleotide per generation ( [23](#)). Of interest is the fact that most variants resulting from apparent *de novo* mutations are characterized by severe hemolysis. The rarity of symptomatic unstable Hb disease suggests that individuals with severe hemolysis are less likely to reproduce than those with mild disease.

## MOLECULAR PATHOLOGY AND PATHOPHYSIOLOGY

The mutations responsible for the unstable Hbs produce major conformational changes. The most common causes of instability are amino acid substitutions that alter the steric configuration of the heme pocket or the site of  $\alpha\beta$ -dimer binding. Other variants are made unstable by substitutions that disrupt the  $\alpha$  helix of globin or by the insertion of polar amino acids in the interior of the Hb molecule. Each of these mutations eventually leads to an unfolding of the affected globin chain and subsequent denaturation and precipitation ( [11](#), [24](#)). Mutations also can be responsible for posttranslational changes that affect either the variant amino acid or nonmutated residues that are exposed by conformational changes of the molecule ( [25](#)).

The most common and most extensively studied of the mutations responsible for Hb instability are those producing defective heme binding. Loss of stability of the heme-globin linkage is caused by amino acid substitutions in the vicinity of the heme pocket. Variants with a substitution at the proximal histidine of the heme pocket are unable to bind heme. These include Hb Istanbul, Hb Mozhaisk, and Hb Newcastle. Amino acid substitutions involving the distal histidine residue (such as occurs in Hb Zürich and Hb Bictre) open the heme pocket, exposing heme iron to exogenous compounds (e.g., the sulfanilamides) from which it is normally protected ( [26](#)). Substitution of polar for nonpolar residues in or near the heme pocket (Hb Bristol, Hb Böras, Hb Olmsted, and Hb Shepherds Bush) allows water to enter the normally hydrophobic heme pocket, thereby loosening the heme-globin linkage and rendering heme susceptible to oxidation. Hb Bristol is of particular interest in that DNA sequencing data and protein analysis of the Hb are discordant. Whereas the base substitution in DNA predicts a valine to methionine change at  $\beta 67$ , protein analysis of the variant Hb demonstrates a substitution of aspartate for valine. This seeming paradox is explained by the posttranslational oxidation of translated methionine to aspartate ( [25](#)).

Other substitutions in the heme pocket (those producing Hb Köln and Hb Hammersmith) directly disrupt heme binding ( [27](#)). In each of these variants, heme dissociates from the abnormal chain, resulting in a partially heme-deficient molecule  $\alpha_2 \text{heme} \beta^o_2$  ( [28](#)).



Reversible, then irreversible hemichrome formation in the normal chains follows with subsequent denaturation of the molecule. Precipitates of these Hbs tend to be pale, and the pattern found during electrophoresis is characterized by multiple bands unless hemin is added ( [29](#) ). It is with these variants that dipyrroluria is seen; an observation suggesting that freed heme is converted to dipyrroles rather than to bilirubin.

Some of the amino acid substitutions involving interchain contact sites weaken dimer and tetramer association. Mutations affecting the  $\alpha_1\beta_1$  interphase [Hb Khartoum, Hb Philly, Hb Stanmore ( [30](#) ), and Hb Tacoma] tend to be more unstable than those affecting the  $\alpha_1\beta_2$  contact sites. Isolated globin chains and  $\alpha\beta$ -dimers are vulnerable to oxidation and hemichrome formation ( [31](#) ). Hemichrome formation is followed by precipitation of Hb and isolated globin chains without loss of heme ( [32](#) ).

Disruption of the  $\alpha$  helix is caused by mutations substituting proline for another amino acid in all but the first three and final positions of the helix. Disruption of the  $\alpha$  helix, in turn, markedly affects tertiary structure and molecular stability. Mutations that interfere with  $\alpha$ -helix formation include Hb Atlanta, Hb Bibba, Hb Casper, Hb Duarte, Hb Genova, Hb Madrid, Hb Perth, Hb Sabine, and Hb Santa Ana. To the extent that these substitutions involve the heme pocket, they also produce abnormal heme binding.

The folding of normal globin chains ensures that charged amino acids are on the surface of the Hb molecule in contact with cell water, whereas nonpolar residues are on the interior of the molecule, interacting hydrophobically to stabilize it. This organization is disrupted by the insertion of polar residues into the interior of the molecule. In some Hb variants, such substitutions permit water to enter the molecule, thereby altering tertiary structure. In others, the substituted polar residue is forced to the surface of the molecule, again distorting molecular structure. Variants characterized by internal polar substitutions include Hb Ann Arbor, Hb B $\ddot{o}$ ras, Hb Olmsted, and Hb Riverdale-Bronx.

Shortened red cell survival is mediated by two processes: Heinz body formation and oxidant damage to membrane lipids and proteins ( [33](#) ). The sequence of events involved in the oxidative conversion of Hb to hemichromes and the precipitation of hemichromes to form Heinz bodies is outlined in [Chapter 32](#). In addition to denatured globin and hemichromes, Heinz bodies derived from some unstable variants (Hb K $\ddot{o}$ ln) contain fluorescent breakdown products of heme ( [34](#) ). They attach to red cell membranes by hydrophobic bonds ( [29](#) ), limiting cellular deformability and increasing membrane permeability. Heinz bodies are removed selectively by the spleen, a phenomenon that contributes directly to the hemolytic process and also leaves damaged cells with reduced viability.

The role of membrane oxidant damage unrelated to Heinz body formation is less well characterized ( [33](#) ). Red cells containing Hb K $\ddot{o}$ ln are unusually susceptible to lipid peroxidation ( [35](#) ). In addition, membranes prepared from the red cells of patients with Hb K $\ddot{o}$ ln disease who have had splenectomies contain aggregates composed of disulfide-linked spectrin, band 3, and globin as well as high-molecular-weight complexes composed in part of denatured spectrin ( [35](#), [36](#) ). As would be expected, the deformability of cells containing membrane aggregates is limited. The treatment of normal red cell membranes with malondialdehyde, a product of lipid peroxidation, reproduces the protein cross-linking seen in unstable Hb K $\ddot{o}$ ln cells ( [37](#) ). Oxidative injury of membranes is attributed to superoxide and other reactive oxygen radicals generated in excessive quantities by a physicochemically altered heme moiety ( [38](#), [39](#) ). The importance of these membrane changes for cell survival is suggested by the fact that they cannot be

demonstrated in patients with Hb Köln disease whose spleens are intact (35). This concept of splenic removal of oxidant-injured cells is further supported by an animal model involving the use of red cells with diamide-induced membrane aggregates (40).

The relative proportion of unstable Hb in heterozygotes generally is considerably less than that of stable variants. The unstable  $\beta$ -chain variants constitute less than 30% of the total Hb, and the unstable  $\alpha$ -chain variants often constitute less than 20%. Although the findings from studies of the synthetic rates of unstable Hbs are difficult to interpret, most evidence suggests that synthesis is appropriate for gene dose (24). Low levels of unstable Hbs are most likely explained by posttranslational loss of mutant globin chains. The initial explanation was that this loss occurs through protein denaturation and the selective removal of Heinz bodies. If so, however, the level of the variant Hb should correlate with disease severity, and such is not the case. Although associated with severe hemolysis, Hb Bristol (10) and Hb Hammersmith (9) constitute 30 to 37% of the Hb in circulating red cells, whereas Hb Christchurch (41) and Hb Köln (18) are characterized by less severe disease and a relative Hb level of only 12 to 22%. A more likely explanation is that the low levels of unstable Hbs result from proteolysis of abnormal globin chains before their incorporation into Hb tetramers. This concept relates the amount of unstable Hb in mature cells to conformationally abnormal globin chains, and the severity of hemolysis to conformationally abnormal Hb tetramers. Highly unstable globin variants disrupt the balance between  $\alpha$ - and  $\beta$ -chains, producing a thalassemia phenotype (11, 42). An extreme example is Hb Indianapolis, which is so unstable that it can be detected only as newly synthesized protein in reticulocytes and bone marrow normoblasts (43).

## CLINICAL FEATURES

The unstable Hbs give rise to a broad spectrum of hemolytic syndromes (11, 44). They can be classified on the basis of the severity of symptoms with which they are associated (Table 41.1). Some variants causing severe hemolytic disease are expressed clinically in the first year of life. These include Hb Bibba, Hb Bristol, Hb Castilla, Hb Hammersmith, Hb Indianapolis, Hb Nottingham, Hb Olmsted, Hb Perth, Hb Sabine, Hb Savannah, and Hb Yokohama. Except for Hb Bibba, which is an  $\alpha$ -chain variant, signs and symptoms of hemolysis evolve gradually as fetal Hb (HbF) synthesis is phased out. The Hb concentration is less than 7 g/dl, and the reticulocyte count may exceed 30%. Some reported values for reticulocytes may be factitiously high in that cells containing inclusion bodies may be mistaken for reticulocytes (24). Splenectomy fails to confer clinical benefit. Except for Hb Bibba and Hb Indianapolis, the variants producing severe disease appear to have arisen as *de novo* mutations.

**TABLE 41.1. Response of the Clinically Significant Unstable Hemoglobins to Splenectomy**

| <b>Chronic Hemolytic Anemia without Response to Splenectomy</b> |                            |           |
|---|----------------------------|-----------|
| Bibba   | Indianapolis               | Sabine    |
| Bristol   | Nottingham                 | Savannah  |
| Castilla  | Olmsted                    | Yokohama  |
| Hammersmith/ Chiba  | Perth/Abraham Lincoln/Kobe |           |
| <b>Chronic Hemolytic Anemia with Response to Splenectomy</b>    |                            |           |
| Ann Arbor   | Köln/San Francisco/Ube-1   | St. Louis |

|                      |                |               |
|----------------------|----------------|---------------|
| Böras                |                | Torino        |
| Casper/Southampton   | Mizuho         | Volga/Drenthe |
| Christchurch         | Newcastle      | Wien          |
| Genova/Hyogo         | Santa Ana      |               |
| Istanbul/St. Etienne | Shepherds Bush |               |

---

### Episodic Hemolytic “Crises”

---

|                                |                             |                 |
|--------------------------------|-----------------------------|-----------------|
| Aldorf                         | Hazebrouck                  | Peterborough    |
| Atlanta                        | Hirosaki                    | Philly          |
| Baylor                         | Hope                        | Port Philip     |
| Belfast                        | I Toulouse                  | Riverdale–Bronx |
| Birmingham                     | Imi                         | Saitama         |
| Bryn Mawr/Buenos Aires         | J Calabria/J Bari/J Cosenza | Seal Rock       |
|                                |                             | Seattle         |
| Bucuresti/Louisville           | Leiden                      | Setif           |
| Burke                          | Lufkin                      | Shuangfeng      |
| Bushwick                       | Lyon                        | St. Antoine     |
| Caribbean                      | Mequon                      | Suan Dok        |
| Duarte                         | Moabit                      | Sydney          |
| F Poole                        | Mozhaisk                    | Tochigi         |
| Freiburg                       | Nagoya                      | Tottori         |
| Galicia                        | Niteroi                     | Tours           |
| Gun Hill                       | North Shore                 | Toyoake         |
| Hasharon/Sealy/Sinai/L Ferrara | Pasadena                    | Tübingen        |
|                                | Petah Tikya                 | Zürich          |

---

Other variants give rise to moderately severe hemolytic disease that is benefitted by splenectomy ( [Table 41.1](#)). Detection of the disorder is often delayed until late childhood or adolescence. Intermittent jaundice, splenomegaly, hemolytic crisis, or symptoms related to cholelithiasis are the usual presenting manifestations. In approximately one-half of cases, a family history of hemolytic disease can be elicited. Before splenectomy, the Hb concentration averages approximately 9 g/dl (range, 7 to 12 g/dl), with 4 to 20% reticulocytes. After splenectomy, anemia is corrected but reticulocytosis persists.

Many unstable Hb variants produce mild hemolytic disease. In the steady state, anemia is mild or absent, and the reticulocyte count ranges between 4 and 10%. Splenomegaly may or may not be present. Most patients with mild disease are first seen during a hemolytic crisis.

More than one-half of the unstable Hb variants are associated with no hematologic abnormality. Most of these variants were detected through screening programs and therefore are characterized by an abnormal electrophoretic pattern. They are of no clinical significance.

Although most differences in clinical phenotypes are explained by the multiplicity of unstable variants, variation in the clinical and hematologic expression of individual unstable Hbs also has been noted ( [45](#)). Investigation of the basis for intrafamilial variation in drug-related hemolysis in Hb Zürich disease led to the surprising recognition that tobacco smoking has an ameliorating effect on the hemolytic process ( [46](#), [47](#)). This effect

is explained by a 65-fold increase in the affinity of Hb Zürich for carbon monoxide ( [26](#) ). This ligand stabilizes the Hb molecule, protecting it from denaturing influences. As a result, the rates of *in vitro* Heinz body formation and isopropanol-induced precipitation of Hb Zürich vary inversely with carboxyhemoglobin levels ( [46](#) , [47](#) ).

Hemolytic crises characteristically occur during febrile illnesses. Oxidants generated by phagocytic cells involved with microbial killing have been implicated in Hb oxidation ( [33](#) ). In addition, fever itself may be responsible for hemichrome formation and precipitation of unstable methemoglobins ( [48](#) ). The formation of Heinz bodies has been demonstrated for cells containing Hb Christchurch, Hb Köln, and Hb Volga when incubated at 40° C *in vitro* ( [49](#) ). Less frequently, hemolytic crises can be attributed to drugs given for febrile illnesses. Drug-induced hemolytic anemia has been demonstrated in patients with Hb Zürich ( [5](#) ), Hb Torino ( [50](#) ), Hb Peterborough ( [51](#) ), Hb Bushwick ( [52](#) ), Hb Shepherds Bush ( [53](#) ), Hb Hasharon ( [54](#) ), and Hb Leiden ( [55](#) ). Sulfonamides are the usual offending agents. Phenazopyridine, a urinary tract analgesic, also has been incriminated ( [46](#) ). Nitrates in drinking water are believed to have aggravated the severity of hemolysis in a patient with Hb Perth ( [56](#) ). Drug sensitivity is not a feature of Hb Köln ( [57](#) ) or Hb Sögn ( [58](#) ) diseases. With most other variants, drug sensitivity has not been assessed.

For many of the unstable variants, the clinical symptoms of anemia correlate poorly with the Hb concentration, principally because of differences in the affinity of variant Hbs for oxygen. Although individuals with Hb Caribbean, Hb Hope, and Hb Seattle maintain Hb levels of approximately 10 g/dl, they have no symptoms and no signs of hemolysis. Anemia is likely related to the low oxygen affinity of these Hb variants, permitting more efficient tissue oxygenation ( [59](#) ). Other unstable variants are characterized by increased oxygen affinity and little or no anemia, despite chronic hemolysis. Patients having such variants may be thought of as “physiologically anemic” despite normal blood Hb levels ( [60](#) ). They are unusually susceptible to tissue hypoxia if they develop diseases that further impair oxygen delivery. Erythrocytosis may be observed after splenectomy ( [13](#) ). The importance of oxygen affinity for patient management is well illustrated by the clinical consequences of Hb Hammersmith ( [9](#) ) and Hb Nottingham ( [61](#) ), both Hbs associated with severe hemolysis. The original patient with Hb Hammersmith, a low-affinity Hb, experienced normal growth and development despite a Hb concentration of 6 to 7 g/dl; whereas the patient with Hb Nottingham, a high-affinity Hb, had anemia of comparable severity but manifested evidence of marrow expansion and a transfusion requirement.

Some of the unstable Hb disorders are associated with the intermittent passage of dark urine, varying from brown to almost black. The pigment is believed to be a dipyrrole related to the mesobilifuscin group and derived from heme released during Heinz body formation ( [62](#) ). In general, the degree of discoloration is related to the intensity of hemolysis, although intermittent pigmenturia without clear relation to other signs of hemolysis may be noted ( [14](#) ). Some unstable Hbs, including Hb Philly, Hb Riverdale-Bronx, Hb Sydney, and Hb Sabine, retain heme during Heinz body formation and therefore are not associated with pigmenturia.

Dusky cyanosis has been described in patients with unstable Hbs that predispose to methemoglobin formation. These variants include Hb Freiburg, Hb St. Louis, Hb I Toulouse, and Hb Tübingen. Clinical cyanosis may be observed in persons with other variants as well. Approximately one-third of patients are said to be cyanotic, perhaps because of hemichromes or other abnormal heme pigments ( [63](#) ).

One example of a symptomatic unstable HbF has been described ( [64](#) ). HbF Poole

produced hemolytic anemia and hyperbilirubinemia in the newborn period. As HbF was replaced by adult Hb (HbA), hemolysis disappeared and the hematologic status returned to normal.

## HEMATOLOGIC FEATURES

As noted previously, anemia, if present, is variable in severity and by itself is a poor index of the severity of hemolysis. Red blood cell indices are normal or indicative of hypochromia. The mean corpuscular Hb concentration may be as low as 25 g/dl, the result of heme loss from the unstable Hb or of Hb loss through Heinz body formation. Red cell morphology is characterized by polychromatophilia, anisopoikilocytosis, stippling, and (possibly) hypochromia. With severe disease and during hemolytic crises, microspherocytes and fragmented cells may be observed. Many of the latter appear to have had “a bite taken from them.” These “bite cells” are thought to result from the phagocytosis of Heinz bodies during passage of the cell through the spleen. Moderate thrombocytopenia, possibly due to splenic sequestration, may occur.

Heinz bodies in circulating red cells usually are found only after splenectomy or during an acute hemolytic episode. Under such circumstances, more than 50% of the cells typically contain one large, spherical inclusion when stained with methyl violet or brilliant cresyl blue. Rhodanile blue may offer some advantages over the classic stains (48, 65). Because it has no redox activity, it merely stains rather than induces Heinz bodies. It also is more satisfactory as a stain for permanent mounting and storage of preparations. Heinz bodies seen in unstable Hb disease differ from those associated with toxic exposures in that they are larger and are found in reticulocytes as well as in older cells. The inclusions consist mainly of denatured globin, although other cellular constituents, including porphyrins and nucleic acids, may be adsorbed nonspecifically.

Hb electrophoresis may or may not reveal the abnormality. Hb Köln migrates more slowly than HbA when routine methods are used. Other variants migrate more slowly or faster than HbA or may be inseparable from it. Electrophoretic behavior cannot be predicted from the change in charge induced by the amino acid substitution; the altered tertiary structure exposes some groups normally hidden and conceals others, thereby changing the overall surface charge.

In a number of instances, an inhomogenous streak trailing behind HbA has been described, presumably the result of heme loss occurring during electrophoresis. In such circumstances, a more discrete band may be seen if electrophoresis is performed at 10° C (14) or if excess hemin is added (32).

The amount of abnormal Hb varies considerably. Unstable  $\beta$ -chain variants average approximately 25% of the total Hb, whereas  $\alpha$ -chain variants average 12%. Only when associated with thalassemia does the amount of an unstable Hb exceed 50%. Hb Duarte (66) and Hb Köln (67) each constitute 100% of the Hb in individuals who are doubly heterozygous for these Hb variants and  $\beta^0$ -thalassemia. The abnormal Hb constitutes less than 2% of the total in the case of Hb Bushwick and Hb Bryn Mawr, and one Hb, Hb Indianapolis, is present in such small amounts that it is undetectable by usual methods (43).

With  $\beta$ -chain unstable Hbs, free  $\alpha$ -chains may be found by electrophoresis; these typically have even slower anodal mobility than HbA<sub>2</sub>. In addition, heme-depleted unstable Hb ( $\alpha_2$  heme $\beta^0_2$ ) may be found, usually migrating just in front of HbA<sub>2</sub>. HbA<sub>2</sub> proportions may be increased to as high as 5% in association with unstable  $\beta$ -chain variants, and HbF

levels may be increased to as much as 10 to 12%.

Red blood cell survival ranges from a mean lifespan of 6 days in severe disease to one of 20 to 35 days in mild disease ( [68](#) ). Because rates of chromium binding and elution from some Hb variants are undoubtedly different from those for HbA, DF <sup>32</sup>P is the preferred red cell label. At least for Hb Köln and Hb Hammersmith, however, chromium and DF <sup>32</sup>P techniques for measuring cell survival give equivalent results ( [68](#) ).

## DIAGNOSIS

Both the heat denaturation test and the isopropanol precipitation test reliably detect most unstable Hbs. Because they constitute less than 2% of the total Hb, Hb Bryn Mawr and Hb Indianapolis are not identified by the heat denaturation test. With the quantitative heat denaturation procedure, 8 to 45% of the Hb is precipitated as compared with less than 1 to 2% of normal Hb. In Hb Köln disease, 10 to 15% of the Hb is precipitated. With some variants, modification of incubation time and temperature may be required.

Because of its simplicity and sensitivity, the isopropanol test is probably the preferred screening procedure. False-positive results are common, however, especially if the specimen has been stored or if HbF levels are greater than 4% ( [69](#) ). The addition of potassium cyanide greatly reduces the number of false-positive results, and the effects of storage are minimized if specimens are stored as whole blood at a temperature of 4° C rather than as hemolysates.

Electrophoresis may be helpful in characterizing an unstable Hb, although as noted previously, many variants have a normal electrophoretic pattern. The intense fluorescence of cells containing Hb Köln, measured by a hematofluorometer or spectrofluorometer, provides a convenient method for screening patients for this variant ( [34](#) ). Precise identification of the abnormal Hb requires peptide analysis. For the clinical hematologist, however, this information may not be necessary, because clinical management generally does not require knowledge of the specific variant.

Synthetic oligonucleotide probes for the nucleotide mutation (G?A) associated with Hb Köln provide a sensitive technique for both the pre- and postnatal diagnosis of Hb Köln disease ( [70](#) ).

## TREATMENT

Management is dictated by the severity of hemolysis. Patients with mild disease require little or no therapy, except during hemolytic crises. They should be cautioned against the use of sulfonamides and other oxidant drugs listed in [Chapter 34](#) as causing hemolysis in glucose-6-phosphate dehydrogenase deficiency, unless they have a variant (Hb Köln, Hb Sögn) that is not drug sensitive. They should also be apprised of the potential for febrile illnesses to trigger hemolytic crises. To the extent that intercurrent illnesses compromise nutrition, folic acid should be taken prophylactically. Red cell transfusion may be required for symptomatic crises.

Severe unstable Hb disease may require intermittent or chronic transfusion therapy. Because many of the substitutions producing Hb instability also modify the affinity of the molecule for oxygen, the decision to transfuse should be based on patient tolerance of anemia rather than on the Hb concentration alone. Splenectomy reduces or obviates a transfusion requirement in some of the unstable Hb diseases. An informed decision



regarding splenectomy is facilitated by precise identification of the variant. Many of the clinically expressed unstable Hbs are classified with respect to response to splenectomy in [Table 41.1](#). However, the best responses tend to occur in patients with only moderately severe disease, whereas those with the most severe illness tend not to benefit from this procedure. Exceptions to this generalization, however, have been noted. Patients with Hb Casper have severe disease yet respond to splenectomy ([71](#)), and patients with Hb Sabine have moderate disease yet do not improve with the operation. Presumably, splenectomy fails to be beneficial when the most severely damaged erythrocytes are removed as readily by macrophages in the liver as in the spleen. Overwhelming pneumococcal septicemia occurred after splenectomy in a 6-year-old boy with Hb Hammersmith ([44](#)), and fatal thromboembolic disease was noted in two splenectomized patients with Hb Duarte ([66](#)). A potentially pertinent fact is that both of the latter patients had postsplenectomy erythrocytosis. These experiences underscore the importance of delaying splenectomy until after the first decade of life, if possible, and of avoiding the procedure in persons with high-affinity Hbs, if possible.

## WEB SITES

<http://globin.cse.psu.edu/globin/html>

<http://www.chime.ucl.ac.uk/APoGI>

<http://www.umass.edu/microbio/chime/hemoglob>

## REFERENCES

1. Cathie LAB. Apparent idiopathic Heinz body anemia. *Great Ormond St J* 1952;3:43-49.
2. Lange RD, Akeroyd JH. Congenital hemolytic anemia with abnormal pigment metabolism and red cell inclusion bodies: a new clinical syndrome. *Blood* 1958;13:950-958.
3. Schmid R, Brecher G, Clemens T. Familial hemolytic anemia with erythrocyte inclusion bodies and a defect in pigment metabolism. *Blood* 1959;14:991-1002.
4. Scott JL, Haut A, Cartwright GE, et al. Congenital hemolytic disease associated with red cell inclusion bodies, abnormal pigment metabolism and an electrophoretic hemoglobin abnormality. *Blood* 1960;16:1239-1252.
5. Frick PG, Hitzig WH, Betke K. Hemoglobin Zürich. *Blood* 1962;20:261-271.
6. Carrell RW, Lehmann H, Hutchison HE, et al. Haemoglobin Köln (B98 valine?methionine): an unstable protein causing inclusion body anemia. *Nature* 1966;210:915-916.
7. Sansone G, Carrell RW, Lehmann H. Haemoglobin Genova: B28 (B10) leucine?proline. *Nature* 1967;214:877-879.
8. Carrell RW, Lehmann H, Lorkin PA, et al. Haemoglobin Sydney. *Nature* 1967;215:626-628.
9. Dacie JV, Shinton NK, Gaffney PJ, et al. Haemoglobin Hammersmith. *Nature* 1967;216:663-665.
10. Steadman JH, Yates A, Huehns ER. Idiopathic Heinz body anemia: Hb Bristol (B67 [E11] Val?Asp). *Br J Haematol* 1970;18:435-446.
11. Williamson D. The unstable haemoglobins. *Blood Rev* 1993;7:146-163.
12. Huisman THJ, Carver MFH, Efremov GD. *A syllabus of hemoglobin variants*, 2nd ed. Augusta, GA:



Sickle Cell Anemia Foundation, 1998.

13. Egan EL, Fairbanks VF. Postsplenectomy erythrocytosis in hemoglobin Köln disease. *N Engl J Med* 1973;288:929–931.
14. Fairbanks VF, Opfell RW, Burgert EO Jr. Three families with unstable hemoglobinopathies (Köln, Olmsted and Santa Ana) causing hemolytic anemia with inclusion bodies and pigmenturia. *Am J Med* 1969;46:344–359.
15. Jackson JM, Way BJ, Woodliff HK. A West Australian family with a haemolytic disorder associated with haemoglobin Köln. *Br J Haematol* 1967;13:474–481.
16. Eng LL, Lopez CG, Eapen JS, et al. Unstable haemoglobin Köln disease in members of a Malay family. *J Med Genet* 1972;9:340–343.
17. Ohba Y, Miyaji T, Shibata S. Identical substitution in Hb Ube-I and Hb Köln. *Nat New Biol* 1973;243:205–207.
18. Vaughan-Jones R, Grimes AJ, Carrell RW, et al. Köln haemoglobinopathy. Further data and a comparison with other hereditary Heinz body anaemias. *Br J Haematol* 1967;13:394–408.
19. Perutz MF. Frequency of abnormal human haemoglobins caused by C?T transitions in CpG dinucleotides. *J Mol Biol* 1990;213:203–206.
20. Rahbar S, Bennetts GA, Ettinger LJ. Hemoglobin Hammersmith as the cause of severe hemolytic anemia in a Chinese girl. *Am J Pediatr Hematol Oncol* 1986;8:13–17.
21. Ohba Y. Unstable hemoglobins. *Hemoglobin* 1990;14:353–388.
22. Srivastava P, Kaeda JS, Roper D, et al. Severe hemolytic anemia associated with the homozygous state for an unstable hemoglobin variant (Hb Bushwick). *Blood* 1995;86:1977–1982.
23. Stamatoyannopoulos G, Nute PE. Cases of unstable hemoglobin and methemoglobin produced by *de novo* mutation. *Hemoglobin* 1984;8:85–95.
24. Steinberg MH, Forget BG, Higgs DR, et al., eds. Disorders of hemoglobin: genetics, pathophysiology, and clinical management. Cambridge, UK: Cambridge University Press, 2001.
25. Rees DC, Rochette J. A novel posttranslational mechanism converts methionine to aspartate in Hemoglobin Bristol (B67 [E11] Val-Met?Asp). *Blood* 1996;88:341–348.
26. Tucker PW, Phillips SEV, Perutz MF, et al. Structure of hemoglobins Zürich [His E7 (63) B?Arg] and Sydney [Val E 11 (67) B?Ala] and role of the distal residues in ligand binding. *Proc Natl Acad Sci U S A* 1978;75:1076–1084.
27. Smith ML, Hjortsberg K, Romeo PH, et al. Mutant hemoglobin stability depends upon location and nature of single point mutation. *FEBS Lett* 1984;169:147–150.
28. Jacob HS, Winterhalter KH. The role of hemoglobin heme loss in Heinz body formation. *J Clin Invest* 1970;49:2008–2013.
29. Winterbourn CC, Carrell RW. The attachment of Heinz bodies to the red cell membrane. *Br J Haematol* 1973;25:585–592.
30. Como PF, Wylie BR, Trent RJ, et al. A new unstable and low oxygen affinity hemoglobin variant: Hb Stanmore (B111[G13]Val?Ala). *Hemoglobin* 1991;15:53–65.
31. Rachmilewitz EA. Denaturation of the normal and abnormal hemoglobin molecule. *Semin Hematol* 1974;11:441–452.
32. Winterbourn CC, Carrell RW. Studies of hemoglobin denaturation and Heinz body formation in the unstable hemoglobins. *J Clin Invest* 1974;54:678–686.

33. Winterbourn CC. Oxidative denaturation in congenital hemolytic anemias: the unstable hemoglobins. *Semin Hematol* 1990;27:41–50.
34. Eisinger J, Flores J, Tyson JA, et al. Fluorescent cytoplasm and Heinz bodies of hemoglobin Köln erythrocytes: evidence for intracellular heme catabolism. *Blood* 1985;65:886–894.
35. Flynn TP, Allen DW, Johnson GJ, et al. Oxidant damage of the lipids and proteins of the erythrocyte membrane in unstable hemoglobin disease. *J Clin Invest* 1983;71:1215–1222.
36. Alloisio N, Jaccoud D, Michelson D, et al. Alterations of red cell membrane proteins and hemoglobin under natural and experimental oxidant stress. *Biochim Biophys Acta* 1982;691:300–308.
37. Allen DW, Burgoyne CF, Groat JD, et al. Comparison of hemoglobin Köln erythrocyte membranes with malondialdehyde-reacted normal erythrocyte membranes. *Blood* 1984;64:1263–1269.
38. Carrell RW, Winterbourn CC, Rachmilewitz EA. Activated oxygen and haemolysis. *Br J Haematol* 1975;30:259–264.
39. Misra HP, Fridovich I. The generation of superoxide radical during the autoxidation of hemoglobin. *J Biol Chem* 1972;247:6960–6962.
40. Johnson GJ, Allen DW, Flynn TP, et al. Decreased survival *in vivo* of diamide-incubated dog erythrocytes. A model of oxidant-induced hemolysis. *J Clin Invest* 1980;66:955–961.
41. Carrell RW, Owen MC. A new approach to haemoglobin variant: identification of hemoglobin Christchurch B71 (E15) phenylalanine→serine. *Biochim Biophys Acta* 1971;236:507–511.
42. Steinberg MH, Adams JG. Thalassemic hemoglobinopathies. *Am J Pathol* 1983;113:396–409.
43. Adams JG, Boxer LA, Baehner RL, et al. Hemoglobin Indianapolis (B112[G14] arginine). An unstable B-chain variant producing the phenotype of severe β-thalassemia. *J Clin Invest* 1979;63:931–938.
44. White JM. The unstable haemoglobin disorders. *Clin Haematol* 1974;3:333.
45. Carrell RW, Lehmann H. The unstable haemoglobin haemolytic anaemias. *Semin Hematol* 1969;6:116–132.
46. Virshup DM, Zinkham WH, Sirota RL, et al. Unique sensitivity of Hb Zürich to oxidative injury by phenazopyridine. Reversal of the effects by elevating carboxyhemoglobin levels *in vivo* and *in vitro*. *Am J Hematol* 1983;14:315–324.
47. Zinkham WH, Houtchens RA, Caughey WS. Relation between variations in the phenotypic expression of an unstable hemoglobin disorder (hemoglobin Zürich) and carboxyhemoglobin levels. *Am J Med* 1983;74:23–29.
48. Zinkham WH, Liljestrand JD, Dixon SM, et al. Observations on the rate and mechanism of hemolysis in individuals with Hb Zürich: II. Thermal denaturation of hemoglobin as a cause of anemia during fever. *Johns Hopkins Med J* 1979;144:109–116.
49. Winterbourn CC, Williamson D, Vissers MC, et al. Unstable haemoglobin haemolytic crises: contributions of pyrexia and neutrophil oxidants. *Br J Haematol* 1981;49:111–116.
50. Prato V, Gallo E, Ricco G, et al. Haemolytic anaemia due to haemoglobin Torino. *Br J Haematol* 1970;19:105–115.
51. King MAR, Wiltshire BG, Lehmann H, et al. An unstable hemoglobin with reduced oxygen affinity: Hemoglobin Peterborough. *Br J Haematol* 1972;22:125–131.
52. Rieder RF, Wolf DJ, Clegg JB, et al. Rapid postsynthetic destruction of unstable hemoglobin Bushwick. *Nature* 1975;254:725–727.
53. White JM, Brian MC, Lorkin PA, et al. Mild “unstable hemoglobin hemolytic anaemia” caused by

hemoglobin Shepherd's Bush. *Nature* 1970;225:939-941.

54. Adams JG, Heller P, Abramson RK, et al. Sulfonamide-induced hemolytic anemia and hemoglobin Hasharon. *Arch Intern Med* 1977;137:1449-1451.

55. DeJong WW, Went LN, Bernini LF. Hemoglobin Leiden: deletion of  $\beta$ -6 or 7 glutamic acid. *Nature* 1968;220:788-790.

56. Grove SS, Jenkins T, Kamuzora HL, et al. Congenital Heinz body hemolytic anemia due to haemoglobin Perth in a Nama child seemingly aggravated by the high nitrate content of the water supply. *Acta Haematol (Basel)* 1977;57:143-151.

57. Miller DR, Weed RI, Stamatoyannopoulos G, et al. Hemoglobin Köln disease occurring as a fresh mutation. Erythrocyte metabolism and survival. *Blood* 1971;38:71-80.

58. Monn E, Bjark P. Hb Sögn ( $\beta$ 14 arg). Haematological and genetical studies. *Scand J Haematol* 1970;7:455-459.

59. Stamatoyannopoulos G, Parer JT, Finch CA. Physiologic implications of a hemoglobin with decreased oxygen affinity (hemoglobin Seattle). *N Engl J Med* 1969;281:916-919.

60. Woodson RD, Heywood JD, Lefant C. Oxygen transport in hemoglobin Köln. Effect of increased oxygen affinity in absence of compensatory erythrocytosis. *Arch Intern Med* 1974;134:711-715.

61. Gordon-Smith EC, Dacie JV, Blecher TE, et al. Haemoglobin Nottingham,  $\beta$ 98 (FG5) Val<sup>98</sup>Gly: a new unstable haemoglobin producing severe haemolysis. *Proc R Soc Med* 1973;66:507-508.

62. Goldstein GW, Hammaker L, Schmid R. The catabolism of Heinz bodies: an experimental model demonstrating conversion to non-bilirubin catabolites. *Blood* 1968;31:388-395.

63. White JM. The unstable hemoglobins. *Br Med Bull* 1976;32:219-222.

64. Lee-Potter JP, Deacon-Smith RA, Simpkins MJ, et al. A new cause of haemolytic anaemia in the newborn. *J Clin Pathol* 1975;28:317-323.

65. Simpson CF, Carlisle JW, Mallard L, et al. Rhodanile blue: a rapid and selective stain for Heinz bodies. *Stain Technol* 1970;45:221-223.

66. Beutler E, Lang A, Lehmann H. Hemoglobin Duarte ( $\alpha_2\beta_2$  <sup>62</sup>[E6] Ala<sup>62</sup>Pro): a new unstable hemoglobin with increased oxygen affinity. *Blood* 1974;43:527-535.

67. Galacteros F, Loukopoulos D, Fessas P, et al. Hemoglobin Köln occurring in association with a  $\beta^0$ -thalassemia: hematologic and functional consequences. *Blood* 1989;74:496-500.

68. Bentley SA, Lewis SM, White JM. Red cell survival studies in patients with unstable hemoglobin disorders. *Br J Haematol* 1974;26:85-92.

69. Brosious EM, Morrison BY, Schmidt RM. Effects of hemoglobin F levels, KCN, and storage on the isopropanol test for unstable hemoglobins. *Am J Clin Pathol* 1976;66:878-882.

70. Horst J, Oehme R, Kohne E. Hemoglobin Köln: direct analysis of the gene mutation by synthetic DNA probes. *Blood* 1986;68:1175-1177.

71. Koler RD, Jones RT, Bigley RH, et al. Hemoglobin Casper  $\beta$ 106 (G8) Leu<sup>106</sup>Pro, a contemporary mutation. *Am J Med* 1973;55:549-555.

2004 Lippincott Williams & Wilkins  
John P. Greer, John Foerster, John N. Lukens  
George M. Rodgers, Frixos Paraskevas, Bertil Glader  
Wintrobe's Clinical Hematology

## Thalassemias and Related Disorders: Quantitative Disorders of Hemoglobin Synthesis

### PREVALENCE AND GEOGRAPHIC DISTRIBUTION

Role of Malaria

### GENETIC MECHANISMS AND MOLECULAR PATHOLOGY

$\alpha$ -Thalassemia

$\beta$ -Thalassemia

Hereditary Persistence of Fetal Hemoglobin

### PATHOPHYSIOLOGY

$\beta$ -Thalassemia

$\alpha$ -Thalassemia

### GENOTYPE-PHENOTYPE CORRELATION

### CLINICAL AND LABORATORY FEATURES

$\alpha$ -Thalassemia: Clinical Forms

$\alpha$ -Thalassemia Associated with Structural Variants

$\beta$ -Thalassemia Major

Thalassemia Minor

Thalassemia Intermedia

### WEB SITES

### REFERENCES

The thalassemias are a group of congenital anemias that have in common deficient synthesis of one or more of the globin subunits of the normal human hemoglobins (Hbs). The primary feature is a quantitative one, but it is now clear that some of the thalassemias derive from structural hemoglobin variants leading to the production of an unstable globin chain. Therefore, a rigid differentiation from the qualitative changes of hemoglobin structure that characterize the hemoglobinopathies is no longer appropriate. According to the chain whose synthesis is impaired, the thalassemias are designated  $\alpha$ -,  $\beta$ -,  $\delta$ -,  $\epsilon$ -,  $\delta\beta$ -, or  $\epsilon\delta\beta$ -thalassemia. These subgroups have in common imbalanced globin synthesis, with the consequence that the globin produced in excess is responsible for ineffective erythropoiesis and peripheral destruction of red cells. In the last few years, the application of recombinant DNA technology has permitted the understanding of the basic aspects of gene structure and function and the characterization of the molecular basis for deficient globin synthesis. The thalassemias result from the interaction of a large number of different molecular defects.

## PREVALENCE AND GEOGRAPHIC DISTRIBUTION

Thalassemia is considered the most common genetic disorder worldwide. It occurs with a particularly high frequency in a broad belt extending from the Mediterranean basin through the Middle East, Indian subcontinent, Burma and Southeast Asia, and Melanesia and islands of the Pacific. According to recent data collected through the Hereditary Disease Program of the World Health Organization and based on local surveys and reports by visiting experts, the carriers of hemoglobin disorders in the world are estimated to be 269 million (1). The only countries where a thalassemia register is maintained for surveillance

purposes are Iran and Oman ( [2](#), [3](#) ).

Disease caused by  $\alpha$ -thalassemia is encountered commonly in Southeast Asia and China and sporadically in India, Kuwait, the Middle East, Greece, Italy, and Northern Europe ( [4](#), [5](#), [6](#), [7](#), [8](#), [9](#), [10](#), [11](#), [12](#), [13](#), [14](#) and [15](#) ). In the eastern oases of Saudi Arabia, more than 50% of the population appears to have a clinically silent form of  $\alpha$ -thalassemia, and HbH disease is recognized with increasing frequency ( [16](#), [17](#) and [18](#) ). In a random population sample, the gene frequency of deletion-type  $\alpha$ -thalassemia-2 ( $-\alpha$ ) was 0.18 in Sardinians and 0.07 in Greek Cypriots; the occurrence of nondeletion  $\alpha$ -thalassemia is estimated to be one-third that of the deletion type ( [19](#), [20](#) and [21](#) ). In black Americans,  $\alpha$ -thalassemia is relatively common, but it is rarely of clinical significance ( [22](#), [23](#) ). Three percent of black infants born in Philadelphia were found to have the electrophoretic and hematologic characteristics, and 5.7% of black military recruits had the  $\beta$ - to  $\alpha$ -chain synthetic ratio of heterozygous  $\alpha$ -thalassemia ( [24](#), [25](#) ). Of 211 healthy black Americans in whom the  $\alpha$ -globin genotype was characterized, 27.5% lacked a single  $\alpha$ -globin gene, and 1.9% lacked two of the four  $\alpha$ -globin genes ( [26](#) ). With the resettlement of nearly 2 million refugees from Cambodia, Laos, and Vietnam in the 1970s and 1980s, symptomatic  $\alpha$ -thalassemia syndromes assumed increasing clinical significance in North America and Europe ( [27](#) ).

Approximately 3% of the world's population (150 million people) carry  $\beta$ -thalassemia genes. In Europe, they are particularly prevalent in inhabitants of Italy and Greece. In Italy, the highest prevalence of the carrier state in descending order has been found in Sardinia (13%), the delta region of the Po River near Ferrara (8%), and Sicily (5.9%, with an almost equal distribution over the entire island) ( [28](#), [29](#) and [30](#) ). In Greece, the prevalence varies considerably, ranging from less than 5% to nearly 15% in the southern and central areas ( [31](#), [32](#) ). In Cyprus, one individual in seven is a carrier of  $\beta$ -thalassemia, and 1 individual in 1000 is currently homozygous ( [1](#) ). In Sardinia, the incidence of homozygous  $\beta$ -thalassemia was 1:250 live births in the absence of preventive measures ( [28](#) ) and is now 1:4000. There are an estimated 3500 individuals with thalassemia major in Greece and 6500 in Italy ( [33](#) ).  $\beta$ -Thalassemia is encountered less often in the northern and western parts of Africa. In the Maghreb (African countries opening on the Mediterranean), frequencies vary from 3% in Algeria to 7% in Morocco and Libya ( [34](#), [35](#) and [36](#) ). In Egypt, thalassemia represents a serious health problem, with a predicted 1000 new patients born each year ( [37](#), [38](#) ). In Turkey, the frequency varies from 0.8 to 10.8% ( [39](#) ). It has been described in high frequencies (10 to 20%) in Indian and Kurdish Jews ( [40](#), [41](#) ). In Arabs, it averages 2% ( [17](#), [42](#) ). Few data are available for Pakistan ( [43](#) ). In Indians, frequencies between 3.5 and 14.9% have been reported ( [44](#), [45](#) and [46](#) ). In North America, thalassemia used to affect mainly individuals of Mediterranean origin and African-Americans but is, at present, most frequently observed in Asians ( [23](#), [47](#) ). In fact, increases in Asian immigration and births in the United States, particularly in California, have led to a prevalence rate of HbE/ $\beta$ -thalassemia among Southeast Asians of approximately 1 in 2200 ( [48](#) ). In one survey of healthy black men, heterozygous  $\beta$ -thalassemia was documented in 1.4% ( [25](#) ).  $\beta$ -Thalassemia in Jamaica may have its origin in both the African and Oriental immigrant population ( [49](#) ). In sporadic cases,  $\beta$ -thalassemia has been noted in North Europeans with no apparent Mediterranean or Oriental ancestry ( [36](#) ). Although well documented in natives of Southeast Asia and southern China,  $\beta$ -thalassemia is far less prevalent in these regions than  $\alpha$ -thalassemia ( [5](#), [50](#), [51](#) and [52](#) ). HbE, the hallmark of Southeast Asia, is most frequently found at the border of Thailand, Laos, and Cambodia, where the frequencies may reach 50 to 60%. The average frequency of HbE is 13%. In Great Britain, which is today a multiethnic society due to substantial migration from Cyprus, the Indian subcontinent, Southeast Asia, and the Middle East, it is

estimated that 0.37/1000 fetuses have a major hemoglobin disorder, 20% being thalassemias and 80% being sickle cell disease. A formal patient register was also recently established in Great Britain in 1997 (53). At the end of 1999, 807 patients with thalassemia major were alive and residing in the United Kingdom, most of whom were of Pakistani or Cypriot origin (2). Detailed information on the frequency of thalassemia in different world regions can be found in Weatherall and Clegg and Angastanotis and Modell (1, 36).

## Role of Malaria

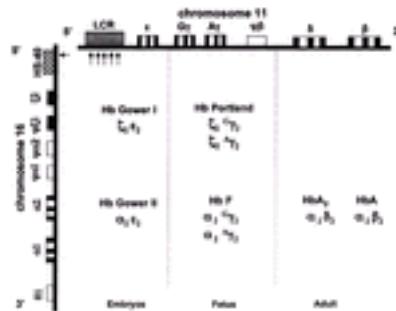
In the first description from Italy of children affected by thalassemia, Maccanti observed that all the patients came from malarial areas, and, 20 years later, Vezzoso noted that the distribution of Cooley anemia in Italy coincided with that of malaria (54, 55). The hypothesis that malaria had an influence in maintaining the high prevalence of hemoglobinopathies in the world was first suggested in 1948 by Haldane, who also proposed that the small red cells of the carriers of thalassemia could be more resistant to the malaria parasites (56). A few years earlier, Neel and Valentine had calculated that, in the absence of some kind of selective pressure, the mutation rate for thalassemia had to be in the order of 1 in 2500 (47). Carcassi and Siniscalco in Sardinia obtained suggestive epidemiologic data on the distribution of thalassemia and malaria, but their results were not confirmed in other populations (57, 58). Molecular biology studies helped to clarify at least some aspects of the problem. In fact, they revealed the very high number of  $\beta$ -thalassemia mutations that are, for the most part, regionally specific and the association of particular mutations with specific  $\beta$ -globin gene haplotypes. The regional specificity of mutations suggests local processes for their elevation to high frequencies, whereas the close association with specific haplotypes suggests a recent cause. These observations point to the conclusion that the selective pressure of malaria has amplified the  $\beta$ -thalassemia genes to high frequency so recently that migration, recombination, or genetic drift could not have had sufficient time to bring them into spatial or genetic equilibrium with their background (59).

The mechanism by which the thalassemia heterozygote could be protected from malaria is still not clear. Several studies have demonstrated reduced red cell invasion by malaria parasites in the severe forms of thalassemia, but the results in the heterozygous states for  $\alpha$ - and  $\beta$ -thalassemia have been contradictory (60, 61, 62, 63, 64, 65, 66 and 67). A provocative study performed in newborns with  $\alpha$ -thalassemia revealed an increased susceptibility to infection by *Plasmodium vivax*, a less severe form of malaria, and suggested that this could confer permanent cross-species protection against *Plasmodium falciparum* (68). Both parasites preferentially invade young circulating red cells, and early infection in a period of life when maternal antibodies are still present could protect from later severe disease. Also, some form of immunologic mechanism could be involved in protecting carriers of thalassemia from malaria and, possibly, from other diseases as well (69, 70 and 71).

## GENETIC MECHANISMS AND MOLECULAR PATHOLOGY

Synthesis of hemoglobin, the molecule used for oxygen transport, is directed by two gene clusters: the  $\alpha$  locus, which contains the embryonic  $\zeta$  gene and the two adult  $\alpha$  genes, and the  $\beta$  cluster, which contains the embryonic  $\epsilon$ , the fetal  $\gamma^G$  and  $\gamma^A$ , and the adult  $\delta$  and  $\beta$  genes (Fig. 42.1). Different hemoglobins are produced during development, and two globin gene switches take place: the embryonic to fetal switch ( $\epsilon$  to  $\zeta$  and  $\zeta$  to  $\alpha$ ), which starts very early in pregnancy and is completed at 10 weeks of gestation, and the fetal to adult

switch ( $\zeta$  to  $\beta$ ), which occurs during the perinatal period (72). The globin gene switches, besides the changes in hemoglobin composition, come with changes in other morphologic and biochemical characteristics of the erythropoietic cell line, including the shift from the nucleated megaloblast to macrocyte and to the definitive normocyte, the shift in the site of erythropoiesis from the yolk sac to liver, spleen, and bone marrow, and changes in the membrane antigenic profile and in the red cell glycolytic activity (72).



**Figure 42.1.**  $\alpha$ - and  $\beta$ -globin gene cluster and hemoglobins (Hbs) produced during development. HS, hypersensitive site; LCR, locus control region.

The globin genes are relatively small and are composed of three exons, coding for functional domains of the hemoglobin, and two intervening sequences (introns) (73). The different globin gene expression during development is controlled through the action of transcription factors and regulatory elements (promoter, enhancers, and silencers) that flank each globin gene and of more remote sequences important for the regulation of all the loci.

The promoter of each globin gene contains sequences that act as binding sites for erythroid-restricted or ubiquitously expressed transcription factors responsible for tissue-specific and developmental-specific regulation of the globin genes. Particularly relevant promoter sequences are the TATA box, situated 30 base pairs (bp) upstream of the initiation site, and the CAAT and the CACCC boxes at approximately -70 and -110 bp from the initiation site, respectively. Among the transcription factors, some have been studied in detail for their role in the regulation of globin gene expression. GATA-1 is the first of a family of DNA-binding proteins, whose binding sites are present in one or more copies in almost all of the regulatory elements of the globin genes (74). Nuclear factor-erythroid 2 and erythroid Kruppel-like factor are transcription factors involved in the expression of the  $\beta$ -globin gene (75, 76 and 77).

Like other genes, globin genes possess a series of motifs critical for their expression: the CAP site, which indicates the start of transcription; the AGT initiation codon, which is the signal for starting translation in mRNA; the donor and acceptor splice sites, which are involved in the processing (splicing) of mRNA; the termination codon, which interrupts translation; and the polyadenylation signal, which is crucial for the addition of a poly (A) tail to the mRNA. Essentially, the process of globin gene expression consists of the following steps: (a) the transcription of DNA into a primary mRNA transcript; (b) the processing of the primary mRNA, involving modifications at both its 5' (capping) and 3' ends (polyadenylation), together with the removal of the introns and joining of the exons (splicing) to produce mature mRNA, the final template for protein synthesis; and (c) the translation of mRNA in the globin protein. Transcription and RNA processing occur in the



nucleus, whereas translation occurs in the cytoplasm ( [36](#), [78](#) ).

Thalassemia syndromes result from a large number of molecular defects that alter the expression of one or more of the globin genes.

### **$\alpha$ -Thalassemia**

The  $\alpha$ -globin genes are duplicated and located in the telomeric region of chromosome 16 (16p13.3) in a cluster containing an embryonic  $\alpha$ -like gene ( $\alpha_2$ ) and three pseudogenes ( $\alpha_1$ ,  $\alpha_1$ , and  $\alpha_2$ ) ( [Fig. 42.1](#) ) ( [79](#) ). A gene ( $\alpha$ ) with unknown function—but whose mRNA can be found through all stages of development—is part of the  $\alpha$  cluster. Several regions of the cluster contain tandem arrays of short GC-rich sequences (minisatellites), identified as hypervariable regions, and many Alu-family repeats ( [80](#), [81](#), [82](#) and [83](#) ). The  $\alpha$  complex is arranged in the order in which it is expressed during development: 5' $\alpha_2$ ..... $\alpha_2$ - $\alpha_1$ . There is a very high homology between  $\alpha_2$  and  $\alpha_1$  genes; they only differ in the IVS-2 (two base substitutions and a 7-bp insertion/deletion) and in the 3' noncoding region [18 base substitutions and a single-base deletion in the 3' untranslated region (UTR)] ( [84](#), [85](#) and [86](#) ). This remarkable homology has been maintained during evolution through repeated rounds of gene conversion ( [81](#), [84](#), [85](#) and [86](#) ). The embryonic  $\alpha$  gene shows only 58% homology with the  $\alpha$  genes in the coding region.

The level of transcription of the two  $\alpha$  genes differs: The  $\alpha_2$  gene encodes two to three times more  $\alpha$ -globin than  $\alpha_1$  ( [87](#), [88](#), [89](#) and [90](#) ). This would imply that the globin structural variants of the  $\alpha_2$  gene should represent approximately 35% of the total hemoglobin, whereas the  $\alpha_1$ -globin mutants approximately 15%. However, contrasting results have been reported on this point. Shakin and Liebhaber have reported identical translation profiles of  $\alpha_2$ - and  $\alpha_1$ -mRNA and higher percentages of  $\alpha_2$ -globin variants (24 to 40% as compared to 11 to 23% for  $\alpha_1$ -globin variants) ( [91](#) ).

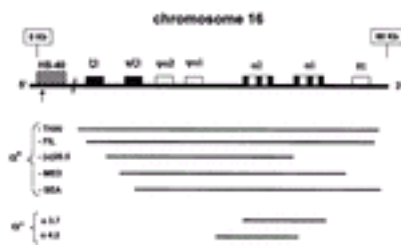
Molchanova et al. confirmed the average ratio of 2.6 to 1.0, observed for  $\alpha_2$ - and  $\alpha_1$ -mRNA, but they reported an average percentage of the abnormal hemoglobin in heterozygotes with  $\alpha_2$  mutations (23.5%) to be only slightly higher than that in heterozygotes with  $\alpha_1$  mutations (19.7%), suggesting a less efficient translation of a  $\alpha_2$ -mRNA ( [92](#) ). It should be pointed out that, besides the rate of transcription and efficiency of translation, other factors, such as stability of the variant, affinity of the variant for  $\beta$ -chains, and the number of active  $\alpha$  genes, may influence the final level of the abnormal hemoglobin. The issue of different expression of the two  $\alpha$  genes is important not only for the  $\alpha$ -globin structural variants, but also for the pathophysiology of the deletional and nondeletional forms of  $\alpha$ -thalassemia.

The expression of the  $\alpha$ -globin genes is regulated by the sequences in and around the structural genes and by a region located 40 kb upstream from the  $\alpha$  cluster ( [93](#) ). This region, defined as hypersensitive site (HS)-40, contains an erythroid-specific DNAase I HS and a 350-bp core element with multiple binding sites for transacting factors (nuclear factor-erythroid 2, GATA-1), several CACCC motifs, and a YY1 transcription factor binding site. The importance of HS-40 as a regulatory element is suggested by the presence of rare deletions of this region that produce  $\alpha$ -thalassemia, although both  $\alpha$  genes on the chromosome are intact.

Normal individuals have usually four  $\alpha$ -globin genes, but as a result of unequal genetic

exchange, some may have five or six  $\alpha$  genes, while still being phenotypically normal (94, 95 and 96). Multiple arrangements with three to six  $\gamma$ -like embryonic genes have also been reported (97, 98).

**DELETION  $\alpha$ -THALASSEMIA**  $\alpha$ -Thalassemia is caused most frequently by deletions of DNA that involve one or both  $\alpha$ -globin genes. The  $\alpha$ -globin genes are embedded within two highly homologous regions extending for approximately 4 kb, whose sequence homology has been maintained by gene conversion and unequal crossover events (79, 99). Three homologous subsegments (X, Y, and Z) separated by nonhomologous elements have been defined. Reciprocal recombination between Z boxes, which are 3.7 kb apart, and between X boxes, which are 4.2 kb apart, gives rise to chromosomes with only one  $\alpha$  gene. These  $\alpha$ -thalassemia determinants, which are the most common, are referred to as  $-\alpha$  3.7-kb rightward deletion and  $-\alpha$  4.2-kb leftward deletion, respectively (Fig. 42.2) (100). Based on the exact location within the Z box where the crossover took place, the  $-\alpha$  3.7-kb deletion is further subdivided into  $-\alpha$  3.7 I,  $-\alpha$  3.7 II, and  $-\alpha$  3.7 III (81).



**Figure 42.2.** Most common deletional  $\alpha$ -thalassemia defects. HS, hypersensitive site.

Besides the deletion  $\alpha$ -thalassemia determinants, the nonreciprocal crossover produces chromosomes with three  $\alpha$ -globin genes:  $aaa$  anti-3.7 and  $aaa$  anti-4.2 (94, 101, 102). More complex recombination events result in chromosomes with four  $\alpha$  genes ( $aaaa$  anti-3.7 and  $aaaa$  anti-4.2) (102). In addition to the common  $-\alpha$  3.7-kb and  $-\alpha$  4.2-kb deletions, three rare deletion determinants that produce  $\alpha$ -thalassemia have been reported. One removes a segment of 3.5 kb containing the whole  $\alpha_1$  gene and its flanking DNA ( $-\alpha$  3.5); a second removes the 5' end of the  $\alpha_2$  gene, the  $\alpha_1$  gene, and its flanking region [ $\alpha(a)5.3$ ]; and the third, described in a Chinese patient with HbH disease, deletes a region containing the  $\alpha_1$  gene (9, 103, 104). The result of a single  $\alpha$ -globin gene deletion is a reduced production of  $\alpha$ -chains from the affected chromosome ( $\alpha^+$ -thalassemia). Measurements of  $\alpha$ -globin mRNA in patients with  $-\alpha$  4.2 determinants suggest that there is a compensatory increase in expression of the remaining  $\alpha_1$  gene, whereas in the chromosome with  $-\alpha$  3.7 deletion, the remaining  $\alpha$  gene is expressed roughly halfway between a normal  $\alpha_2$  and  $\alpha_1$  gene (105, 106). These differences in expression most likely are a consequence of changes in the rate of transcription, due to the new combinations of flanking sequences, to the modification in chromatin structure resulting from the deletion, or to variation in the interaction with the HS-40 regulatory element (107, 108). Deletions that remove all or part of the  $\alpha$ -globin gene cluster, including both  $\alpha$  genes (entirely or in part) and sometimes the embryonic  $\gamma_2$  gene, result in  $\alpha^0$ -thalassemia. The extent of the deletions, completely removing both  $\alpha$ -globin genes, is from 100 kb to more than 250 kb; sometimes, other flanking genes, such as a DNA repair enzyme, a protein disulfide isomerase, and several anonymous housekeeping genes, are removed (Fig. 42.2) (108). However, interestingly, in subjects with these large deletions, the only phenotypical manifestation is  $\alpha$ -thalassemia. Several molecular mechanisms (illegitimate recombination, reciprocal translocation, truncation of chromosome 16) have been described as responsible for these large deletions (82, 83). Two deletions [ $-(\alpha)^{5.2}$  and  $-(\alpha)^{20.5}$ ] remove the  $\alpha_2$ -globin gene and partially remove the  $\alpha_1$ -globin gene: The affected chromosome

produces no  $\alpha$ -chains (13, 109).  $\alpha^0$ -Thalassemia may also result from deletions of the  $\alpha$ -globin regulatory element HS-40. Twelve different deletions of variable extent, all involving HS-40 but leaving both  $\alpha$  genes intact, have been reported [for references see Higgs et al. (108)]. The associated phenotype is the  $\alpha^0$ -thalassemia phenotype.

**NONDELETION  $\alpha$ -THALASSEMIA** Single nucleotide mutations or oligonucleotide deletions/insertions in regions critical for  $\alpha$ -globin gene expression produce  $\alpha$ -thalassemia. Nondeletional types of  $\alpha$ -thalassemia are much less common than deletional  $\alpha$ -thalassemia, except the Constant Spring mutation, which is quite common in Southeast Asia. Several molecular mechanisms (mutations affecting RNA splicing, the poly (A) addition signal, the initiation mRNA translation, chain termination mutations, in-frame deletions, and frameshift and nonsense mutations) and 41 well-defined types of nondeletion  $\alpha$ -thalassemia have been described [for references see Higgs et al. (108)]. The majority of nondeletional mutants so far reported occur in the  $\alpha_2$  gene and, as expected, have a more severe effect on  $\alpha$ -globin gene expression. Hb Constant Spring ( $\alpha$  142 TAA $\rightarrow$ CAA, Stop $\rightarrow$ Glu) is the most common of the nine potential chain termination mutants, which change the stop codon to one amino acid, allowing mRNA translation to continue to the next in-phase stop codon located within the polyadenylation signal. The result of this class of mutation is the production of a very low amount (approximately 1%) of an  $\alpha$ -chain variant elongated by 31 amino acids. It has been suggested that the reason for the reduced production of the elongated variants is the instability of the mRNA due to disruption of the 3' UTR (110). Other extended  $\alpha$ -chain variants are Hb Icaria ( $\alpha$  142 Lys), Koya Dora ( $\alpha$  142 Ser), Seal Rock ( $\alpha$  142 Glu), and Paksé ( $\alpha$  142 Tyr). Heterozygotes for  $\alpha$ -globin elongated chain, besides the presence of the hemoglobin variant, have the phenotype of  $\alpha$ -thalassemia. Mutations of  $\alpha$ -globin genes, which result in the production of highly unstable globin variants such as Hb Heraklion ( $\alpha$  137 Pro $\rightarrow$ ?) and Hb Agrinio ( $\alpha$  29 Leu $\rightarrow$ Pro) and are unable to assemble in stable tetramers and are thus rapidly degraded, are associated with the phenotype of  $\alpha$ -thalassemia (111, 112).

## $\beta$ -Thalassemia

The  $\beta$ -globin gene is located in the short arm of chromosome 11 in a region containing the  $\delta$  gene, the embryonic  $\epsilon$  gene, the fetal  $\gamma^G$  and  $\gamma^A$  genes, and the pseudogene  $\beta_1$  (Fig. 42.1) (113). The five functional globin genes are arranged in the order of their developmental expression. The complete sequencing of the  $\beta$ -globin gene complex has shown interspersed repetitive sequences [microsatellite repeats of (CA) $_n$ , an (ATTTT) $_n$  repeat, Alu I and Kpn I families of repeat DNA sequences], which may play a role in the generation of the deletions of the  $\beta$  cluster. The region also contains many polymorphic base substitutions, which produce restriction fragment length polymorphisms, combined in a restricted number of haplotypes in linkage disequilibrium with  $\beta$ -thalassemia mutations (114). Haplotype analysis provides information relevant for population genetics of the hemoglobinopathies. Similar to the  $\alpha$ -like globin genes, variations in the number of  $\beta$  cluster genes, mostly involving the  $\gamma$  genes (which may be present in one to five copies), have been reported (115, 116). Like the  $\alpha$  genes,  $\beta$ -globin genes are subject to a very complex regulatory mechanism, acting at the level of single genes as well as of the entire  $\beta$  cluster.

The appropriate expression of the different  $\beta$ -like globin genes in erythroid tissues during development depends on a major regulatory region named the *locus control region* (LCR), located 5 to 25 kb upstream from the  $\epsilon$ -globin gene (117). Five DNAase HSs have been described in the region, and each HS contains one or more binding motifs for erythroid-specific transcriptional activator (GATA-1 and nuclear factor-erythroid 2) and for ubiquitous DNA-binding proteins (72, 118). The importance of LCR for the control of the  $\beta$ -like globin gene expression has also been suggested by a series of naturally

occurring deletions that totally or partially remove the HS sites and result in the inactivation of the intact downstream  $\beta$ -globin gene ( [119](#), [120](#) ).

$\beta$ -Thalassemia mutations result in either a complete absence of  $\beta$ -globin chains ( $\beta^0$ -thalassemia) or a largely variable reduction of  $\beta$ -globin output ( $\beta^+$ -thalassemia). More than 200 different mutations producing  $\beta$ -thalassemia have been so far described; the large majority are point mutations in functionally important sequences of the  $\beta$ -globin gene, whereas in contrast to  $\alpha$ -thalassemia, gene deletion is a rare cause of  $\beta$ -thalassemia ( [Table 42.1](#) ). A complete updated list of  $\beta$ -thalassemia mutations has been published and is also available through the globin gene server web site (noted at chapter's conclusion in the section [Web Sites](#) ( [121](#), [122](#) ) ).

**TABLE 42.1. Mutations Causing  $\beta$ -Thalassemia**

|                                      | Phenotype         | Number of Mutations |
|--------------------------------------|-------------------|---------------------|
| Transcriptional mutants              |                   |                     |
| Promoter                             | Silent            | 2                   |
|                                      | Mild              | 5                   |
|                                      | $\beta^+$         | 12                  |
| 5'-UTR                               | Silent            | 4                   |
|                                      | Mild              | 1                   |
|                                      | $\beta^+$         | 1                   |
| RNA processing                       |                   |                     |
| Splice junction                      | $\beta^0$         | 24                  |
| Consensus splice sites               | Silent            | 1                   |
|                                      | $\beta^0$         | 1                   |
|                                      | Mild              | 1                   |
|                                      | $\beta^+$         | 8                   |
| Cryptic splice sites in introns      | $\beta^0/\beta^+$ | 1                   |
|                                      | $\beta^0$         | 1                   |
|                                      | $\beta^+$         | 3                   |
| Cryptic splice sites in exons        | Mild              | 2                   |
|                                      | $\beta^+$         | 3                   |
| 3'-UTR RNA cleavage: poly (A) signal | Mild              | 4                   |
|                                      | $\beta^+$         | 2                   |
| Others                               | Silent            | 1                   |
|                                      | Mild              | 1                   |
|                                      | $\beta^+$         | 1                   |
| RNA translation                      |                   |                     |
| Initial codon                        | $\beta^0$         | 7                   |
| Nonsense codon                       | $\beta^0$         | 14                  |
| Frameshift                           | $\beta^0$         | 64                  |
| Deletions                            | $\beta^0$         | 17                  |

### Dominant $\beta$ -thalassemias

|                                       |           |    |
|---------------------------------------|-----------|----|
| Missense mutations                    | $\beta^0$ | 8  |
| Deletion or insertion of intact codon | $\beta^0$ | 7  |
| Nonsense mutations                    | $\beta^0$ | 2  |
| Frameshift or aberrant splicing       | $\beta^0$ | 14 |

UTR, untranslated region.

---

**NONDELETION  $\beta$ -THALASSEMIA** Point mutations resulting in  $\beta$ -thalassemia are single nucleotide substitutions or oligonucleotide insertions/deletions that affect the  $\beta$  gene expression by a variety of mechanisms ( [Table 42.1](#)).

#### **Transcription Mutations**

**Promoter Mutations** Several mutations have been described in or around the conserved motifs in the 5'-flanking sequence of  $\beta$ -globin genes (TATA box and the proximal and distal CACCC box). They reduce binding of RNA polymerase, thereby reducing the rate of mRNA transcription to 20 to 30% of normal. They result in a moderate decrease of

$\beta$ -globin chain output ( $\beta^+$ -thalassemia) and, hence, in a mild phenotype. One mutation, C?T at position -101 to the  $\beta$ -globin gene (distal CACCC box), is unusually mild and associated with a silent phenotype in carriers and in a very mild thalassemia intermedia clinical picture in genetic compounds with severe  $\beta$ -thalassemia mutations ( [123](#) , [124](#) ). The promoter mutations -28 A?G and -29 A?G are relatively common in Chinese and black populations, whereas -87 C?G and the silent -101 C?T have been described in Mediterraneans. No mutations of the CCAAT box have been identified so far.

**5' Untranslated Region Mutations** Several mutations (single-base substitution and minor deletions) have been reported in this 50-nucleotide region; all have a mild effect on gene transcription. Heterozygotes have normal or borderline red cell indices and HbA<sub>2</sub>, and compound heterozygotes, with severe  $\beta$ -thalassemia alleles, usually have a mild phenotype. The only homozygous state for a mutation at  $\beta$ -globin gene mRNA cap site (Cap + 1 A?C) shows hematologic values of a thalassemia trait ( [125](#) ).

**Mutations Affecting mRNA Processing** RNA processing essentially consists of the removal of intervening sequences and the splicing of the coding regions to produce functional mRNA. The precision of this process relies on critical sequences present at intron/exon boundaries: the invariant dinucleotides -GT- at the 5' (donor) and -AG- at the 3' (acceptor) splice junctions and the flanking sequences (consensus sequences) that are rather well conserved ( [126](#) ).

**Splice Junction and Consensus Sequence Mutations** Mutations of the invariants 5'-GT- and 3'-AG- dinucleotides completely abolish normal splicing and result in  $\beta^0$ -thalassemia. Twenty-four base substitutions or short deletions involving the invariant dinucleotides have been identified. Other cryptic splice sites present elsewhere in precursor mRNA are used for alternative splicing, but the misspliced mRNA cannot be translated into functional  $\beta$ -globin ( [127](#) , [128](#) ). The efficiency of normal splicing may be decreased by mutations within the consensus sequences immediately adjacent to the splice junctions. The reduction of  $\beta$ -globin production is quite variable, and the resulting phenotypes range from mild to severe. For example, the mutations at position 5 of IVS-1 (G?C, G?T, G?A) produce a consistent reduction of  $\beta$ -globin synthesis and, hence, a severe  $\beta^+$ -thalassemia phenotype, whereas the IVS-1-6 T?C mutation (Portuguese mutation), quite common in the Mediterranean, only mildly affects normal splicing and results in a mild thalassemia intermedia clinical picture ( [129](#) ). Even in the consensus sequence mutations, abnormal alternative splicing using neighboring cryptic sites may occur ( [127](#) ).

**Cryptic Site Mutations in Introns and Exons** Along introns and exons, there are sequences similar to those found at the intron/exon boundaries, which normally are not used for splicing ("cryptic" splice sites). A number of nucleotide substitutions involving

these sequences transform a cryptic site into a legitimate one. This new splice signal competes with the normal consensus sequence for splicing and, in some cases, is used preferentially (up to 90% in the IVS-1-110 G?A substitution and almost 100% in the IVS-1-116 T?G substitution), resulting in a severe  $\beta^{-}$  or  $\beta^0$ -thalassemia phenotype ( [130](#), [131](#) ). Two cryptic splice site mutations in IVS-1 and four in IVS-2 have been described. In the exons, three cryptic splice sites can be activated by nucleotide substitution: one at codon 10 (C?A), a second at codon 19 (A?G), and a third, by mutation, at codons 24 (T?A), 26 (G?A), or 27 (G?T). The nucleotide substitutions partially activate the cryptic splice sites, resulting in both normally and abnormally spliced  $\beta$ -mRNA. The cd 24 T?A mutation is translationally silent and associated with a severe  $\beta^{-}$ -thalassemia ( [132](#) ). Mutations at codons 19, 26, and 27 result in the production of abnormal hemoglobins [cd 19, Hb Malay (Asn?Ser); cd 26, HbE (Glu?Lys); cd 27, Hb Knossos (Ala?Ser)] and are associated with a mild or silent phenotype because of the preferential use of the normal splice sites ( [127](#), [133](#), [134](#) and [135](#) ).

***Poly (A) and Other 3' Untranslated Region Mutants*** Downstream of the mRNA terminal codon, there is a highly conserved AAUAAA sequence, which represents a signal for the cleavage and polyadenylation reaction, as a part of the RNA transcript processing. Because polyadenylation is important in determining the stability of mRNA, mutations at the AAUAAA sequence affect the efficiency of translation, resulting in  $\beta^{-}$ -thalassemia of variable, but usually mild, severity. Four nucleotide substitutions and two oligonucleotide deletions (of two and five bases), involving the polyadenylation signal, have been described. Other mutations in the 3' UTR (+1480 C?G) also produce  $\beta^{-}$  silent-thalassemia.

***Mutations Affecting mRNA Translation*** A large group of mutations alter the different steps of mRNA translation. Three categories of mRNA translation mutations can be identified: initiation codon mutations, nonsense mutations, and frameshift mutations.

***Initiation Codon Mutations*** The initiator codon ATG, which encodes for methionine, is a critical signal for starting translation. Seven different point mutations of the initiation codon have been reported as causes of  $\beta^0$ -thalassemia.

***Nonsense Mutations*** Single nucleotide substitutions may change a codon for a given amino acid to one of the three possible chain termination codons: TAA, TAG, or TGA. The result is a premature interruption of mRNA translation, with absence of  $\beta$ -globin production ( $\beta^0$ -thalassemia). A very low level of  $\beta$ -mRNA has been detected in affected erythroid cell mutations in exons 1 and 2 as a consequence of rapid degradation of the mutant  $\beta$ -mRNA ( [136](#), [137](#) ). This process is referred to as *nonsense-mediated decay* and may be a mechanism to eliminate mRNAs encoding truncated polypeptides with potential harmful effects for the erythroid cell ( [138](#), [139](#) and [140](#) ). Nonsense mutations in exon 3 are associated with  $\beta$ -mRNA levels comparable with normal levels. The protective process does not occur, and mutant  $\beta$ -mRNA is probably translated to produce the abnormal globin (see section [Hyperunstable Globins](#)) ( [141](#) ). The most common nonsense mutation in the Mediterranean population, particularly in Sardinians in whom it accounts for more than 95% of  $\beta$ -thalassemia, is the C?T base substitution at codon 39, whereas the nonsense mutation at codon 17 A?T shows a high frequency in the Chinese and Thai populations ( [142](#), [143](#) ).

***Frameshift Mutations*** Insertion or deletion of one or a few nucleotides (other than three or multiples of three) alters the reading frame of the encoded mRNA starting at the site of the mutation. The new reading frame usually results in a novel abnormal amino acid sequence and in a premature termination further downstream. The mutant globin chain is rapidly degraded, and the final result is a  $\beta^0$ -thalassemia. The frameshift resulting from a single base deletion at codon 6 (-A) is relatively common in Mediterranean populations, whereas the -4-nucleotide deletion at codon 41 and 42 is particularly common in Chinese and Asian Indian populations ( [144](#), [145](#) ). The position of the premature termination (in exon 1, 2, or 3) caused by the frameshift mutation affects the mutant mRNA level and



processing as previously reported for nonsense mutations.

**β-GLOBIN GENE DELETIONS** Several deletions, affecting only the β-globin gene and ranging in size from 290 bp to approximately 67 kb, have been reported. Only one, the 619-bp deletion, removing the 3' end of the β-globin gene, is relatively common in the Sind and Punjab population of India and Pakistan (146). All the others are extremely rare and have in common the deletion of the promoter region and at least part of the β-globin gene. The phenotype is that of β<sup>0</sup>-thalassemia with unusually high levels of HbA<sub>2</sub> and HbF in heterozygotes. This is probably the result of the removal of competition for the upstream LCR, thus allowing an increased interaction between LCR and the γ and δ gene *in cis*, with a consequently more efficient expression of these genes (147). Other deletions causing β-thalassemia remove either the whole β-globin cluster or the LCR. Total deletions of β cluster result in lack of any globin production and, hence, in (e<sup>G?</sup>-A<sup>?</sup>δβ)<sup>0</sup>-thalassemia (148, 149 and 150). Three deletions, removing totally or partially the LCR but leaving the β gene (120, 151, 152). These deletions confirm importance of the LCR for the control of expression of the β-globin genes.

**β-THALASSEMIA HEMOGLOBINOPATHIES** This group includes some structurally abnormal hemoglobins associated with a thalassemia phenotype. They can be classified according to the molecular mechanism.

**dβ Hybrid Genes** Unequal crossing over between the homologous δ- and β-globin genes results in the formation of hybrid dβ and βδ genes, referred to as *Lepore* and *anti-Lepore* genes. The Lepore hemoglobins contain the N-terminal amino acid sequence of the normal δ-chain and the C-terminal sequence of the normal β-chain; depending on the point of transition from δ to β sequence, three different variants of Hb Lepore have been described: Boston or Washington (δ 87/β IVS-2-8), Baltimore (δ 68/β 84), and Hollandia (δ 22/β IVS-1-16) (153, 154, 155 and 156). The rate of production of the Lepore hemoglobins (approximately 10% in the carriers) likely depends on the structure of the hybrid gene, which has the promoter of the δ gene (this would explain the lower Hb Lepore amount as compared to normal HbA), and the IVS-2 of the β gene that probably contains an enhancer (this would explain the higher level of Hb Lepore as compared with HbA<sub>2</sub>). Moreover, the relative instability of the Lepore mRNA may be responsible for the low level of synthesis. Nonhomologous crossing over between the β and δ genes also results in the production of a hybrid βδ gene in a chromosome containing also the normal β and δ genes. These anti-Lepore genes produce approximately 15 to 20% of the abnormal hemoglobin. Based on the position of the fusion point, several anti-Lepore hemoglobins have been identified (Hb Miyada, P Congo, P Nilotic, and Hb Lincoln Park, which has, in addition, a valine residue deleted at position 137), and carriers have normal hemoglobin levels and normal red cell indices. A similar nonhomologous crossing over involving the A<sup>?</sup>- and β-globin gene produces an abnormal hybrid chain, which contains γ and β sequences (Hb Kenya). Restriction enzyme analysis in these patients showed a deletion of approximately 22.5 kb and the loss of sequences extending from exon 2 of the A<sup>?</sup> gene to exon 2 of the β gene (157).

**Activation of Cryptic Splice Sites** This group, including the HbE, Hb Malay, and Hb Knossos, has been previously described.

**Hyperunstable Globins** A singular group of β-globin gene mutants are characterized by amino acid substitutions, additions, or deletions in the β-globin chain associated with a thalassemic phenotype in the heterozygous state. For this reason, these forms are also referred to as *dominantly inherited β-thalassemia*. The molecular lesions include missense mutations, small deletions resulting in the loss of intact codons, or frameshift mutations producing elongated or truncated β-globin chains. Most of these mutations are located in the exon 3 (158, 159). In contrast to the typical recessively inherited forms of β-thalassemia, which lead to a reduced synthesis of normal β-globin chains, this group of mutations results in the production of β-globin variants that are extremely unstable. These hyperunstable globins fail to form functional tetramers and precipitate in the erythroid precursors, leading to ineffective erythropoiesis, which is exacerbated by the



concomitant relative excess of  $\alpha$ -chains ( [159](#) ). Most patients present with the clinical phenotype of thalassemia intermedia; a few have the phenotype of thalassemia trait, and some may even have a severe anemia requiring red blood cell (RBC) transfusions. Laboratory findings consist of varying degrees of hypochromic microcytic anemia, increased HbA<sub>2</sub>, and an imbalanced  $\alpha$ - to  $\beta$ -globin synthesis ratio. In most of the cases, the hemoglobin variant cannot be detected in the peripheral blood.

**Unknown Mechanism** In 1981, Adams et al. reported a patient with 8% of an abnormal hemoglobin (Hb Vicksburg  $\beta$  75 Leu?) and the phenotype of thalassemia intermedia ( [160](#) ). The reason for the thalassemia intermedia phenotype associated with Hb Vicksburg has not yet been defined. The original patient has been reexamined; despite the use of the new technologies of DNA analysis, the predicted Hb Vicksburg deletion was not present ( [161](#) ). Moreover, even the Hb variant was not detected on two occasions, whereas HbA<sub>2</sub>, absent at the beginning, has now been found. DNA analysis showed that the patient was a compound heterozygote for the  $-88$  C?T  $\beta$ <sup>+</sup> allele and the IVS-2-849 A?G mutation that causes  $\beta$ <sup>0</sup>-thalassemia ( [161](#) ). It has been proposed that Hb Vicksburg arose as a stem cell mutation on the  $\beta$ <sup>+</sup>-thalassemia chromosome. The variable hemoglobin composition at different ages suggests that over time there were at least two clones of erythroid progenitors contributing to erythropoiesis ( [161](#) ). A phenotype of mild heterozygous  $\beta$ -thalassemia with microcytosis and increased levels of HbA<sub>2</sub> has been reported in patients with two hemoglobin variants: Hb North Shore ( $\beta$  134 Val?Glu) and Hb Woolwich ( $\beta$  132 Lys?Glu) ( [162](#), [163](#) ). In both cases, a mild deficit of  $\beta$ -globin chain synthesis has been reported. DNA analysis of these patients has not been performed, and the mechanism responsible for the thalassemic phenotype remains unknown.

**d-THALASSEMIA** Several mutations of the d-globin gene that result in reduced (d<sup>+</sup>-thalassemia) or absent (d<sup>0</sup>-thalassemia) production of d-globin chains have been described. These conditions do not have clinical relevance, but the coinheritance with  $\beta$ -thalassemia mutations may create problems in  $\beta$ -carrier identification, because the HbA<sub>2</sub> may be normal or borderline. The classes of mutations are similar to those responsible for  $\beta$ -thalassemia. Some d-thalassemia mutations have been described *in cis* to  $\beta$ -thalassemia. The d<sup>+</sup>27 C?T, fairly common in the Mediterranean, has been reported *in cis* to  $\beta$ <sup>+</sup>IVS-2-745 C?G,  $\beta$ <sup>0</sup>39 C?T, and  $\beta$ <sup>+</sup> 27 G?T (Hb Knossos) ( [164](#), [165](#) and [166](#) ). Even the Corfu deletion (-7.2 kb) has been reported with, isolated to, or associated with the  $\beta$ <sup>+</sup>IVS-1-5 G?A mutation ( [167](#), [168](#) ).

**d $\beta$ -THALASSEMIA** d $\beta$ -Thalassemia includes a group of disorders characterized by reduced or absent production of both d- and  $\beta$ -globin chains and by a variable increase in  $\gamma$ -chain synthesis that only partially balances the d- and  $\beta$ -chain deficiency. The most common molecular mechanism consists of deletions of variable extent of the  $\beta$ -like globin cluster, which involve the d- and  $\beta$ -globin genes. Based on the presence of one (G $\gamma$ -) or both (G $\gamma$ - and A $\gamma$ -) globin genes and, hence, on the residual synthesis of only G $\gamma$ - or both G $\gamma$ - and A $\gamma$ -globin chains, two groups of d $\beta$ <sup>0</sup>-thalassemia have been identified: G $\gamma$ (A $\gamma$ d $\beta$ )<sup>0</sup>- and G $\gamma$ A $\gamma$ (d $\beta$ <sup>0</sup>)-thalassemia. In [Table 42.2](#), the different varieties with the size of the deletion are summarized ( [169](#), [170](#), [171](#), [172](#), [173](#), [174](#), [175](#), [176](#), [177](#), [178](#), [179](#), [180](#), [181](#), [182](#), [183](#), [184](#), [185](#), [186](#), [187](#), [188](#) and [189](#) ). Some have been described in single or a few families, whereas others, such as the Sicilian, the Spanish G $\gamma$ A $\gamma$ (d $\beta$ <sup>0</sup>), and the black G $\gamma$ (A $\gamma$ d $\beta$ )<sup>0</sup>, are more common. Homozygotes have been reported as well. For some deletions, the 3' breakpoint has not been defined. The majority of the deletions that result in d $\beta$ -thalassemia are due to illegitimate recombination. Similar but more complex mechanisms have been invoked to explain other d $\beta$ <sup>0</sup>-thalassemias such as Macedonian/Turkish G $\gamma$ A $\gamma$ (d $\beta$ )<sup>0</sup>-thalassemia, which is characterized by a double deletion/inversion rearrangement ( [170](#), [173](#) ). The reasons for the increased expression of the  $\gamma$  genes in (d $\beta$ )<sup>0</sup>-thalassemia and the

difference with hereditary persistence of fetal hemoglobin (HPFH) have not been defined. Juxtaposition to the globin genes of new sequences as a result of the deletion, removal of intergene sequences critical for control of  $\gamma$ -globin gene expression, and the altered spatial relationship between the LCR and the genes of the  $\beta$  cluster with changes in LCR/globin gene promoter interaction and competition have been postulated to explain the up-regulation of the  $\gamma$ -globin genes and the phenotypic differences between (d $\beta$ )-thalassemia and deletion HPFH. It is possible that a combination of the above mechanisms plays a role and that a balance between regulatory sequences, with positive or negative effects on the  $\gamma$  gene expression, may finally determine the amount of HbF in the red cells.

**TABLE 42.2. Mutations Responsible for Deletional and Nondeletional d $\beta$ -Thalassemia**

|   | Deletion Size<br>(kb)                   | Reference                                  |
|---|---|--|
| <b>Deletional</b>                           |   |  |
| G?A? (d $\beta$ ) <sup>0</sup> -thalassemia |   |  |
| Mediterranean                               | 13.378                                  | <a href="#">Bernards et al., 1979</a>      |
| SE Asian                                    | 12.584                                  | <a href="#">Craig et al., 1994</a>         |
| Eastern European                            | 9.124                                   | <a href="#">Palena et al., 1994</a>        |
| Black                                       | 11.767                                  | <a href="#">Anagnou et al., 1985</a>       |
| Macedonian/Turkish                          | 11.465                                  | <a href="#">Kulozik et al., 1992</a>       |
| Macedonian/Turkish                          | 1.593                                   | <a href="#">Kulozik et al., 1992</a>       |
| Indian                                      | 32.621                                  | <a href="#">Mishima et al., 1989</a>       |
| Spanish                                     | 114                                     | <a href="#">Ottolenghi et al., 1982</a>    |
| Japanese                                    | >130                                    | <a href="#">Matsunaga et al., 1985</a>     |
| Turkish                                     | ~30                                     | <a href="#">Öner et al., 1996</a>          |
| G? (A?d $\beta$ ) <sup>0</sup> -thalassemia |   |  |
| Black                                       | 35.807                                  | <a href="#">Henthorn et al., 1985</a>      |
| Chinese                                     | ~100                                    | <a href="#">Jones et al., 1981b</a>        |
| Indian                                      | 0.834                                   | <a href="#">Jones et al., 1981a</a>        |
| Indian                                      | 7.460                                   | <a href="#">Jones et al., 1981a</a>        |
| Italian                                     | ~52                                     | <a href="#">De Angioletti et al., 1997</a> |
| Belgian                                     | 50                                      | <a href="#">Losekoot et al., 1991</a>      |
| Yunnanese                                   | ~88                                     | <a href="#">Zhang et al., 1993</a>         |
| German                                      | ~52                                     | <a href="#">Anagnou et al., 1988</a>       |
| Turkish                                     | 36.213                                  | <a href="#">Fritsch et al., 1979</a>       |
| SE Asian                                    | ~101                                    | <a href="#">Trent et al., 1984</a>         |
| Malaysian 2                                 | >40                                     | <a href="#">George et al., 1986</a>        |
| <b>Nondeletional</b>                        |   |  |
| Sardinian                                   | A?-196 C?T/ $\beta$ <sup>0</sup> 39 C?T | <a href="#">Pirastu et al., 1984</a>       |
| Chinese                                     | Not defined                             | <a href="#">Zeng et al., 1985</a>          |
| SE, southeast.                              |   |  |

Corfu d $\beta$ -thalassemia is characterized by a deletion of 7.2 kb, which removes the d gene associated with the  $\beta$  IVS 1-5 G?A mutation ([190](#)). Carriers for this mutation have the unusual hematologic phenotype of heterozygous  $\beta$ -thalassemia with normal levels of HbA<sub>2</sub>, whereas homozygotes have relatively high levels of HbF and a mild clinical phenotype ([167](#)). The 7.2-kb deletion has been reported isolated as a deletion form of d-thalassemia

not associated with increased HbF (168). Two varieties of nondeletion (d $\beta$ -) thalassemia have also been described. One, relatively common in Sardinia, is of the (d $\beta$ )<sup>0</sup> type and presents two mutations *in cis*: the common  $\beta$ <sup>0</sup> 39 C?T nonsense mutation and a point mutation at position -196 in the A? gene promoter, which is responsible for the Italian/Chinese nondeletion A? HPFH (188). The other, reported in two Chinese families and characterized by decreased expression of the  $\beta$ -globin gene and increased expression of both G?- and A?-globin genes [(d $\beta$ )<sup>+</sup>-thalassemia], showed no deletion in the  $\beta$ -globin cluster (189). In one of these families, the -29 A?G mutation in the promoter of the  $\beta$  gene (a mild  $\beta$ <sup>+</sup> allele) and a nonpolymorphic C?T substitution in the 3 A? enhancer have been identified (191, 192).

### Hereditary Persistence of Fetal Hemoglobin

HPFH is characterized by the presence of increased levels of HbF in the adult life in the absence of relevant hematologic abnormalities. The amount of HbF is quite variable, ranging in the carriers from 2.0 to 30%; this variability reflects a marked molecular heterogeneity. Both deletion and nondeletion defects have been identified. The deletions resulting in HPFH, listed in Table 42.3, extend from 13 kb (HPFH-5 or Sicilian HPFH) to approximately 106 kb (HPFH-1 or black HPFH) (193, 194). They remove d- and  $\beta$ -globin genes but spare both G? and A? genes. As in (d $\beta$ )<sup>0</sup>-thalassemia, the most common mechanism producing deletions is an illegitimate recombination followed by unequal crossing over.

**TABLE 42.3. Mutations Responsible for Hereditary Persistence of Fetal Hemoglobin (HPFH)**

|                                     | Deletion Size (kb) | Reference                  |
|-------------------------------------|--------------------|----------------------------|
| <b>Deletional</b>                   |                    |                            |
| ? $\beta$ Fusion                    |                    |                            |
| Hb Kenya                            | 22.675             | Huisman et al., 1972       |
| G?A? (d $\beta$ ) <sup>0</sup> HPFH |                    |                            |
| Black                               | ~106               | Fritsch et al., 1979       |
| Ghanaian                            | ~105               | Bernards and Flavell, 1980 |
| Indian                              | ~48.5              | Wainscoat et al., 1984     |
| Italian                             | ~40                | Saglio et al., 1986        |
| Sicilian                            | 12.910             | Camaschella et al., 1990   |
| Southeast Asian                     | ~28                | Dimovski et al., 1994      |
| <b>Nondeletional</b>                |                    |                            |
| G? mutations                        |                    |                            |
| Black                               | -202 C?G           | Collins et al., 1984       |
| Tunisian                            | -200 +C            | Pissard et al., 1996       |
| Black/Sardinian/British             | -175 T?C           | Surrey et al., 1988        |
| Japanese                            | -114 C?T           | Fucheroen et al., 1990     |
| Australian                          | -114 C?G           | Motum et al., 1994         |
| A? mutations                        |                    |                            |
| Black                               | -202 C?T           | Hattori et al., 1986       |
| British                             | -198 T?C           | Yang et al., 1988          |

|                    |                  |   |
|--------------------|------------------|---|
| Italian/Chinese    | -196 C?T         | <a href="#">Giglioni et al., 1984</a>               |
| Brazilian          | -195 C?G         | <a href="#">Costa et al., 1990</a>                  |
| Black              | -175 T?C         | <a href="#">Stoming et al., 1989</a>                |
| Greek/Black        | -117 G?A         | <a href="#">Fessas and Stamatoyannopoulos, 1964</a> |
| Black <sup>a</sup> | -114 to -102 del | <a href="#">Gilman et al., 1988b</a>                |
| Georgia            | -114 C?T         | <a href="#">Öner et al., 1991</a>                   |

<sup>a</sup> Only described in combination with hemoglobin S.

Nondeletion HPFH usually is the result of mutations in the promoter regions of  $G\gamma$  and  $A\gamma$  genes ( [Table 42.3](#)) ( [195](#), [196](#), [197](#), [198](#), [199](#), [200](#), [201](#), [202](#), [203](#), [204](#), [205](#), [206](#), [207](#), [208](#), [209](#), [210](#), [211](#), [212](#) and [213](#) ). Most of these mutations are single nucleotide substitutions in, or very close to, the conserved sequences that bind various regulatory transcription factors. As a consequence, there are changes in the binding of repressor or activator proteins that may modify the balance of the competition between the promoter and LCR, ultimately resulting in increased HbF synthesis in adult life ( [214](#) ).

In some families, mostly with interacting  $\beta$ -thalassemia or sickle cell anemia, it has been shown that HPFH may segregate unlinked to the  $\beta$ -globin cluster ( [215](#), [216](#), [217](#), [218](#) and [219](#) ). Several patterns of inheritance have been identified: autosomal-dominant, X-linked, and autosomal-recessive. The locus for the X-linked form seems to reside at Xp22.2-22.3 ( [220](#) ). Craig et al., by using polymorphic markers covering the whole genome to study a single very large family, localized a putative locus for HPFH at 6q22.3-q24 ( [219](#) ). The putative loci may affect the HbF levels coding for trans-acting factors that bind within the  $\beta$  gene cluster and directly act on gene expression or may alter the kinetics of erythropoiesis, mimicking the increased HbF observed in stress erythropoiesis ( [214](#) ).

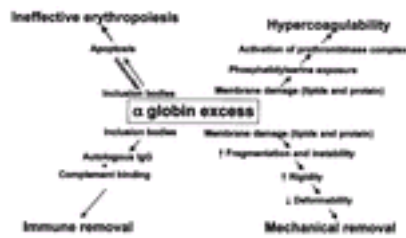
## PATHOPHYSIOLOGY

The pathophysiology of thalassemia syndromes is complex and encompasses intracellular processes as well as their consequences for the organism as a whole. An appreciation for the pathophysiology of the thalassemias is essential for understanding the differences in clinical expression of  $\alpha$ - and  $\beta$ -thalassemia, the high variability of clinical phenotypes, and the principles of treatment.

### $\beta$ -Thalassemia

The basic defect in  $\beta$ -thalassemia is a reduced or absent production of  $\beta$ -globin chains with relative excess of  $\alpha$ -chains. The direct consequences are a net decrease in the hemoglobin production and an imbalance of globin chain synthesis. The former is more evident in carriers, leading to a reduction of mean cell hemoglobin (MCH) and mean cell volume (MCV), and is of minor clinical significance. The latter has dramatic effects on the red cell precursors, resulting in their premature destruction in the bone marrow and extramedullary sites. This process is referred to as *ineffective erythropoiesis* and is the hallmark of  $\beta$ -thalassemia. Using ferrokinetic analysis, it has been shown that in  $\beta$ -thalassemia patients, only 15% of  $^{59}\text{Fe}$  is incorporated in circulating erythrocytes, indicating that ineffective erythropoiesis could account for as much as 60 to 75% of total erythropoiesis ( [221](#), [222](#) ). Hemolysis of the erythrocytes containing inclusions that reach

peripheral blood is a minor cause of anemia, particularly in thalassemia major ( [Fig. 42.3](#)).



**Figure 42.3.** Pathophysiology of  $\beta$ -thalassemia. Ig, immunoglobulin.

The excess  $\alpha$ -chains may, in minor amounts, combine with residual  $\beta$ - and  $\delta$ -chains to undergo proteolysis or, in large part, become associated with the erythroid precursors and red cell membrane with deleterious effects on erythroid maturation and survival. Therefore, the main determinant of the clinical severity is the extent of the relative excess of  $\alpha$ -chains in red cell precursors and, hence, the degree of  $\alpha$ /non- $\alpha$  gene imbalance. In 1966, Fessas et al. described the presence of inclusion bodies in erythroblasts of thalassemic patients, suggesting that they were precipitated  $\alpha$ -chains ( [223](#) ). The composition of inclusion bodies in  $\beta$ -thalassemia, completely consisting of precipitated  $\alpha$ -chains, has been recently confirmed by immunoelectron microscopy ( [224](#) ). Oxidation of excess  $\alpha$ -chains results in the formation of hemichromes, whose basic structure consists of the covalent binding of distal histidine E7 to the sixth coordination site of the heme iron ( [225](#) ). Irreversible hemichromes and denatured  $\alpha$ -chains precipitate as inclusion bodies early during differentiation and throughout erythroid maturation ( [226](#) ).  $\alpha$ -Chain precipitation in the red cell membrane causes structural and functional alterations with changes in deformability, stability, and red cell hydration ( [222](#), [227](#), [228](#) ). Isolated red cell membranes from  $\beta$ -thalassemia intermedia, particularly from splenectomized patients, are rigid and unstable. Protein 4.1, a major component of the cytoskeleton, undergoes partial oxidation in  $\beta$ -thalassemia, resulting in its defective capability to mediate the formation of the spectrin-protein 4.1-actin complex, which is critical to maintain cytoskeleton stability ( [229](#), [230](#) ). *In vitro* experiments, using purified  $\alpha$ -chains released within normal RBCs, support the role of aggregated  $\alpha$ -chains in causing red cell membrane rigidity ( [231](#) ). A further consequence of the membrane-bound hemichromes is their association with the cytoplasmic domain of protein band 3, creating a neoantigen that is subjected to opsonization with autologous immunoglobulin G and complement and immune removal of the cell by macrophages ( [232](#), [233](#) ). RBCs in  $\beta$ -thalassemia lose  $K^+$ , store  $Ca^{++}$ , and are dehydrated, resulting in altered deformability ( [222](#) ). Besides oxidation, free  $\alpha$ -chains are subjected to degradation, resulting in the formation of denatured  $\alpha$ -globin protein, heme, and free iron. These degradation products play a role in damaging erythroid precursors and red cell membranes. The effect of precipitated  $\alpha$ -globin on the structure and function of red cell membrane has been discussed above. Free iron, via the "Fenton reaction," generates reactive oxygen species, which cause lipid and protein peroxidation with consequent damage to red cell membranes and intracellular organelles ( [234](#), [235](#) ). High levels of iron, closely associated with denatured hemoglobin, have been found in the membrane of  $\beta$ -thalassemic red cells ( [236](#) ). *In vitro* and *in vivo* (in humans and animals) experiments have shown that the oral iron chelator deferoxamine, which may enter the cells, is able to remove free iron from thalassemic red cells, resulting in an improvement of red cell survival ( [237](#), [238](#) and [239](#) ). These results confirm the role of free iron in damaging red cell membrane structure. Also, heme and its oxidized form hemin produce oxidative damage to the different components

of the red cell membrane with consequent structural and functional alterations ( [227](#), [240](#), [241](#) ).

These alterations of erythroid precursors result in an enhanced rate of apoptosis ( [242](#) ). Apoptosis contributes significantly to ineffective erythropoiesis and occurs primarily at the polychromatophilic erythroblast stage ( [243](#) ). There is wide variability of apoptosis in the different forms of thalassemia, and erythroid expansion seems to be important in determining the extent of apoptosis ( [244](#), [245](#) ). It is not clear how  $\alpha$ -globin precipitation causes apoptosis, but the apoptotic control and ineffective erythropoiesis are under active investigation ( [246](#), [247](#) and [248](#) ).

Ineffective erythropoiesis and anemia have several consequences. The first response to anemia is an increased production of erythropoietin, causing a marked erythroid hyperplasia, which may range between 10 to 30 times normal ( [221](#) ). Anemia may produce cardiac enlargement and, sometimes, severe cardiac failure. Erythroid expansion produces skeletal deformities, osteoporosis, and, occasionally, extramedullary masses, and it contributes to splenomegaly. Untreated or undertreated individuals with thalassemia major have retarded growth as a result of anemia and an excessive metabolic burden imposed by erythroid expansion. Environmental factors such as poor nutrition and infections may contribute to growth failure. The high vascularization of expanded marrow results in an increase in plasma volume that, associated with splenomegaly, aggravates the anemia. Ineffective erythropoiesis is associated with increased iron absorption that further contributes to the iron burden imposed by blood transfusions ( [249](#) ). Iron overload damages several organs, including the myocardium, liver, and endocrine glands. Removal of the abnormal RBCs by the reticuloendothelial elements of the spleen results in splenomegaly and hypersplenism, which, when severe, may exacerbate anemia and cause thrombocytopenia and neutropenia.

A further consequence of the RBC membrane damage is the loss of the normal asymmetric distribution and increased surface exposure of the procoagulants, negatively charged phospholipids phosphatidylserine and phosphatidylethanolamine. The anionic phospholipids increase thrombin generation, which leads to activation of platelets and endothelial cells ( [250](#), [251](#) and [252](#) ). Evidence of *in vivo* platelet activation is supported by kinetic studies using platelets labeled with indium-111 oxine that have shown a significant reduction of mean platelet lifespan in patients with thalassemia major and intermedia ( [253](#) ). Further evidence of the chronic platelet activation has been provided by the increased urinary levels of metabolites of thromboxane A<sub>2</sub> and prostacyclin ( [254](#) ). Decreased levels of naturally occurring anticoagulants, such as protein C and protein S, and elevated plasma levels of thrombin-antithrombin III complex have been reported ( [255](#), [256](#) ). It has also been shown that adherence of thalassemic red cells to endothelial cells is markedly enhanced as compared to that of normal red cells, and elevated levels of endothelial adhesion proteins (intracellular adhesion molecule-1, E-selectin, vascular cell adhesion molecule-1, von Willebrand factor) in the serum and plasma of thalassemic patients have been described ( [257](#), [258](#) ). Activated monocytes and granulocytes, found in patients with thalassemia, could contribute to the endothelial damage and the hypercoagulable state ( [259](#), [260](#) ).

### **$\alpha$ -Thalassemia**

As in the case of  $\beta$ -thalassemia, the primary defect of  $\alpha$ -thalassemia is the imbalance of globin biosynthesis, with excess of  $\beta$ -,  $\delta$ -, or both globin chains. Unlike  $\alpha$ -chains, which are highly unstable and unable to form soluble tetramers, excess  $\delta$ -chains in fetal life and



$\beta$ -chains in extrauterine life associate to form partially soluble  $\beta_4$  tetramers (Hb Bart) and  $\beta_4$  tetramers (HbH), respectively ( [261](#), [262](#) ). These excess non- $\alpha$ -chains damage mostly mature red cells and, to a lesser extent, erythroid precursors, leading mainly to hemolysis and minimally to ineffective erythropoiesis. The different characteristics of the excess chains in  $\alpha$ -thalassemia are of great importance in determining its pathophysiology, but also the functional properties of HbH and Hb Bart and the number of  $\alpha$  genes contribute to the different severity of  $\alpha$ -thalassemia as compared to  $\beta$ -thalassemia syndromes.

RBCs in  $\alpha$ -thalassemia are rigid, as in  $\beta$ -thalassemia, but, unlike  $\beta$ -thalassemia, they are hyperhydrated and have red cell membranes that are hyperstable. The reason for hyperhydration has not been clearly defined, but it is likely a consequence of the effect of  $\beta$ -chain excess on the KCl cotransporter system. Membrane skeletal-bound  $\beta$ -globins become partially oxidized with consequent membrane damage ( [230](#) ). *In vitro* studies have shown that entrapment of  $\beta$ -chains in normal red cells does not result in any significant change in membrane protein function or thiol concentrations; rather, it produces changes in red cell deformability, as reported *in vivo* in patients with HbH disease ( [228](#), [263](#), [264](#) ). Interaction of excess  $\beta$ -globin with the cytoplasmic domain of protein band 3 is abnormal in erythrocytes of patients with HbH disease, because  $\beta_4$  tetramers tend to adhere tightly to protein band 3 ( [229](#), [265](#) ).

$\beta$ -Globin tetramers precipitate as the red cells age, forming inclusions. These inclusions can be induced by vital stains, such as brilliant cresyl blue or new methylene blue, and are more common in splenectomized patients ( [266](#), [267](#) ). Studies using monoclonal antibodies have shown that red cell inclusions in HbH disease are composed of  $\beta$ -globin ( [224](#) ). Membrane-bound inclusion bodies perturb the flow velocity during transit through the spleen capillaries, ultimately resulting in mechanical trapping and macrophagic phagocytosis ( [268](#) ). Hemolysis is the main pathophysiologic mechanism of HbH disease, but ineffective erythropoiesis is a component even if moderate. This has been suggested by morphologic and ferrokinetic studies and by the analysis of plasma levels of transferrin receptor ( [244](#), [269](#), [270](#) and [271](#) ). Excess  $\beta$ -chains accumulate and precipitate not only in older red cells, but also in marrow erythroid precursors in which they may cause some intramedullary cell death.  $\beta_4$  Inclusion bodies alter the normal membrane phospholipid bilayer, exposing phosphatidylserine, which represents a signal for the development of apoptosis and red cell removal by the macrophages in the spleen and other reticuloendothelial organs ( [272](#), [273](#) ). Programmed cell death is moderately increased in patients with HbH disease ( [244](#) ). Red cell membrane deformability and stability are even more affected in patients with HbH/Hb Constant Spring ( [274](#) ). As compared with patients with HbH disease, those with HbH/Hb<sup>CS</sup> have a higher amount of HbH and a higher percentage of erythrocytes with inclusion bodies and translocated phosphatidylserine ( [267](#), [272](#), [275](#) ). These differences may account for the greater hematologic severity of HbH/Hb<sup>CS</sup> disease.  $\beta$ -Globin tetramers (Hb Bart) are much less prone than  $\beta$ -globin tetramers to precipitate and form inclusions ( [276](#) ).

Besides the characteristics of excess  $\beta$ - and  $\beta$ -globin chains discussed above, other functionally abnormal properties are important in determining the pathophysiology of  $\alpha$ -thalassemia. HbH and, even more so, Hb Bart have a very high oxygen affinity and show no heme-heme interaction or Bohr effect, hence severely reducing their oxygen-carrying capacity ( [277](#), [278](#) ).



## GENOTYPE-PHENOTYPE CORRELATION

The recent progress in molecular biology and the wide availability of methods for DNA analysis have allowed for the definition of globin gene defects in thalassemia syndromes and the understanding of the mechanisms of globin gene regulation and expression and have partially elucidated the relationship between genotype and phenotype. This knowledge is helpful in clinical practice for planning the management of the patients and in genetic counseling for the prediction of phenotype from genotype in couples at risk.

The differentiation between thalassemia major and intermedia is essential for design of the appropriate treatment. The prediction of a mild phenotype may avoid unnecessary transfusions and their complications, whereas the diagnosis of thalassemia major allows an early start of the transfusion program, thus preventing hypersplenism and the red cell sensitization often associated with a delayed start of red cell administration ( [279](#) ).

As reported earlier in this chapter, in  $\beta$ -thalassemia, the globin chain imbalance is the main determinant of clinical severity. Therefore, the presence of factors able to reduce the globin chain imbalance results in a milder form of thalassemia. These factors are the coinheritation of  $\alpha$ -thalassemia or of genetic determinants that increase  $\gamma$ -chain production and the presence of silent or mild  $\beta$ -thalassemia alleles associated with a high residual output of  $\beta$ -globin.

Examples of these alleles are the silent -101 C>T and the mild IVS-1-6 T>C mutation in Mediterraneans and the -29 A>G in Africans. Deletion and nondeletion HPFH mutations, associated with a high HbF level in carriers, when in genetic compounds with severe  $\beta$ -thalassemia alleles, result in mild thalassemia intermedia. The effect of  $\alpha$ -thalassemia determinants in ameliorating the disease severity is less consistent, but the coinheritation of the deletion of two  $\alpha$ -globin genes with homozygous  $\beta^+$ -thalassemia, and sometimes even with  $\beta^0$ -thalassemia, produces the clinical picture of thalassemia intermedia ( [36](#) , [280](#) , [281](#) ). However, because each genetic combination is associated with a wide range of clinical outcomes, the definition of the  $\alpha$ -globin genotype in each single patient may not have an absolute value in the prediction of the clinical picture.

The precise definition of the phenotype from the genotype is helpful also in genetic counseling because it may prevent the necessity for prenatal diagnosis in cases of expected very mild thalassemia intermedia in the fetus. Prenatal diagnosis in at-risk couples in whom the -101 C>T mutation is present should not be considered, and the same applies to the coinheritation of the triple  $\alpha$  gene arrangement or of the HPFH mutations associated with high levels of HbF. The ameliorating effect that results from the presence of mild  $\beta$ -thalassemia alleles is less constant. The mild  $\beta$ -thalassemia allele IVS-1-6 T>C, common in Mediterraneans, shows remarkable phenotypic diversity in some populations, such as the Jewish population ( [282](#) ).

In conclusion, despite the progress made in molecular genetics, the accurate prediction of phenotype from the genotype is still not perfect, but a careful analysis of clinical, hematologic, genetic, and molecular data of patient and parents may allow a reasonable aptitude for treatment and for genetic counseling in many cases.

HbH disease has a wide phenotypic diversity. Studies that have correlated hematologic and clinical findings with  $\alpha$ -globin genotypes indicate that HbH patients with nondeletion  $\alpha$ -thalassemia defects have a more severe clinical expression ( [283](#) , [284](#) , [285](#) and [286](#) ).

As reported above, the wide range of phenotypic manifestations of thalassemia results from the heterogeneity of primary mutation and from the coinheritance of other globin gene-associated determinants that may ameliorate or worsen the disease severity (287). However, other known or unknown genetic determinants may modify the clinical expression of the thalassemia syndromes. Several secondary genetic modifiers have been identified in the recent years. The presence of (TA)<sub>7</sub> polymorphism in the promoter region of the uridine diphosphate-glucuronosyltransferase gene, which, in the homozygous state, is associated with the Gilbert syndrome, is a risk factor for the development of cholelithiasis in thalassemia major and intermedia patients and in patients with HbE/ $\beta$ -thalassemia (288, 289). Other candidate genes for modification of the thalassemia phenotype are the apolipoprotein E  $\epsilon$ 4 allele, which seems to be a genetic risk factor for left ventricular failure in homozygous  $\beta$ -thalassemia (290). Less consistent data have been reported for genes involved in iron metabolism (C282Y and H63D HFE gene mutations), probably because their effect on iron overload is hidden as a result of treatment (i.e., secondary iron overload from red cell transfusion and iron chelation) (291, 292 and 293).

## CLINICAL AND LABORATORY FEATURES

### $\alpha$ -Thalassemia: Clinical Forms

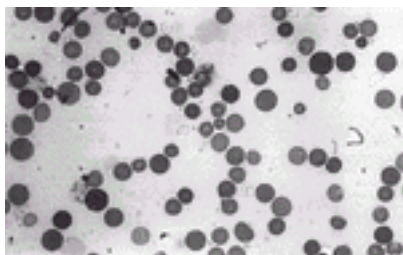
Despite the large number of  $\alpha$ -thalassemia alleles (approximately 50 associated with  $\alpha^+$ -thalassemia and 40 associated with  $\alpha^0$ -thalassemia), only four hematologic and clinical conditions of increasing severity are recognized: silent carrier,  $\alpha$ -thalassemia trait, HbH disease, and Hb Bart hydrops fetalis.

**SILENT CARRIER** This condition results from the presence of a single  $\alpha$ -globin gene defect associated with the 3.7- or 4.2-kb deletion ( $-\alpha/aa$ ). This genotype is characterized in the newborn period by a very mild increased percentage (1 to 2%) of Hb Bart, a tetramer of four  $\gamma$ -globin chains ( $\gamma_4$ ). However, failure to demonstrate Hb Bart in cord blood does not exclude the silent carrier state (294, 295). Among black Americans, the incidence of the silent carrier state determined by gene mapping is approximately 27%, yet Hb Bart is detected in only 12% of cord samples. Similar trends have been found in Mediterranean and Saudi Arabian populations (83, 295). Adult individuals with three functional  $\alpha$  genes may have a completely silent phenotype (normal RBC indices) or present with a moderate thalassemia-like hematologic picture (reduced MCV and MCH and very mild anemia) with normal HbA<sub>2</sub> and HbF. Analysis of globin chain synthesis in peripheral blood reticulocytes displays a reduced  $\alpha$  to  $\beta$  ratio in the range of 0.8 to 0.9. Infants with the  $-\alpha^{4.2}$  deletion, which removes the  $\alpha_2$  gene, have a more severe phenotype than children with the  $-\alpha^{3.7}$  deletion, which deletes most of the less productive  $\alpha_1$  gene, resulting in a hybrid gene consisting of the 5' part of the  $\alpha_2$  gene linked to the 3' part of the  $\alpha_1$  gene (105, 296). However, with increasing age, the two genotypic forms become phenotypically indistinguishable, presumably due to up-regulation of  $\alpha$ -globin production by the  $\alpha_1$  gene in subjects with the  $-\alpha^{4.2}$  deletion (106, 296, 297).

**$\alpha$ -THALASSEMIA TRAIT** This disorder is characterized in the newborn by higher levels of Hb Bart (5 to 6%) and in the adult by thalassemia-like red cell indices, normal HbA<sub>2</sub> and HbF, and a reduced  $\alpha$ - to  $\beta$ -globin chain synthesis ratio in the range of 0.7 to 0.8. Subjects with two residual functional  $\alpha$  genes, either *in cis* on the same chromosome ( $-\alpha/aa$  or  $\alpha^0$ -thalassemia carriers) or *in trans* in opposite chromosomes ( $-\alpha/-\alpha$ ,

homozygous  $\alpha^+$ -thalassemia), clearly show the  $\alpha$ -thalassemia carrier state. Carriers of nondeletion defects have quite variable hematologic phenotypes ranging from the  $\alpha$ -thalassemia trait to the silent carrier state. Double heterozygotes for  $-\alpha/$  and nondeletion  $\alpha$ -thalassemia [ $-\alpha/(\alpha\alpha)^T$ ] and homozygotes for nondeletion defects [ $(\alpha\alpha)^T/(\alpha\alpha)^T$ ] have the typical phenotype of the  $\alpha$ -thalassemia carrier state. However, homozygotes for some nondeletional forms of  $\alpha$ -thalassemia may have a mild HbH disease (298). Homozygotes for Hb Constant Spring, the most common nondeletion defect in the Oriental population, have a clinical syndrome similar to that of HbH disease (299). The  $\alpha$ -thalassemia carrier state should be differentiated from iron deficiency and from  $\delta$ - and  $\beta$ -thalassemia interaction (see section [Carrier Detection](#)). This differentiation has important practical consequences.

**HEMOGLOBIN H DISEASE** HbH disease is common in Southeast Asia and relatively frequent in Mediterranean countries and parts of the Middle East, but it occurs rarely in populations of African descent. This clinical condition results from the presence of only one functional  $\alpha$  gene, usually as a consequence of the compound heterozygous state for  $\alpha^0$ -thalassemia/ $\alpha^+$ -thalassemia ( $-/-\alpha$  or  $-/\alpha^T$ ). As a consequence of the relative excess of  $\beta$ -chains, individuals with HbH disease produce a variable amount of this abnormal hemoglobin, a tetramer of  $\beta$ -globin chains ( $\beta_4$ ). HbH is unstable and precipitates inside red cells and, to some extent, in erythroid precursors, causing membrane damage and premature erythrocyte destruction. As reported above, both hemolysis and ineffective erythropoiesis contribute to anemia in HbH disease, but the predominant mechanism is hemolysis. HbH has a much higher oxygen affinity than HbA; this may worsen the severity of symptoms produced by anemia (300). In the neonatal period, subjects with the HbH disease genotype have consistently elevated Hb Bart (approximately 25%) that may still be detected in small amounts in some adults. The syndrome of HbH disease shows considerable variability in clinical and hematologic severity. The majority of patients have minor disability; few are severely affected, requiring regular blood transfusions; and rare cases have been described with the hydrops fetalis clinical picture (36, 285, 301, 302). The most relevant features are microcytic and hypochromic hemolytic anemia, hepatosplenomegaly, jaundice, and moderate thalassemia-like skeletal modifications. The hemoglobin concentration is usually in the range of 7 to 10 g/dl, and the MCV varies with age (approximately 58 fl in childhood and approximately 64 fl in adulthood), whereas the MCH is approximately 18 pg irrespective of age. Reticulocytes range between 5 and 10%, and the  $\alpha$ - to  $\beta$ -globin chain synthesis ratio is markedly reduced, in the order of 0.20 to 0.60. Hemoglobin electrophoresis at alkaline pH shows a fast moving band (HbH) ranging from 1 to 40%. On occasion, HbH may not be detected due to low levels and loss because of instability in preparation of the hemolysate. The most sensitive method for detection of HbH consists of the incubation of peripheral blood cells for 1 to 2 hours at 37° C in the presence of supravital dyes (brilliant cresyl blue or methyl violet), which induce precipitation of the abnormal hemoglobin as inclusion bodies, easily recognizable by the microscope (Fig. 42.4). Determination of the  $\alpha$ -globin genotype may be useful for prognosis of HbH disease, being that the nondeletion forms are more severe than the deletion forms.



**Figure 42.4.** Hemoglobin H inclusion bodies. See [Color Plate](#).

Anemia is accentuated during pregnancy and may worsen quite dramatically as a

consequence of increased hemolysis with infections and after administration of oxidant drugs ( 266 , 285 ). A variable spleen enlargement is almost always present, whereas liver enlargement is less common. A mild phenotype of HbH disease may result from the homozygous state for nondeletional  $\alpha$ -thalassemia, even if the phenotype in some cases is closer to that of the homozygous state for a  $^{+}$ -thalassemia, although the degree of anemia and hypochromia may be more severe ( 303 ). In particular, homozygotes for the elongated  $\alpha$ -chain variant Hb Constant Spring are asymptomatic but show mild pallor and jaundice with liver and spleen enlargement in approximately 50% of the cases ( 36 , 299 , 304 ). The hemoglobin level ranges from 9 to 11 g/dl, and the MCV tends to be normal ( $88 \pm 6$  fl), whereas the MCH is slightly reduced ( $26 \pm 3$  pg). The peripheral blood contains HbA<sub>2</sub>, HbA, Hb Constant Spring, and traces of Hb Bart rather than HbH ( 36 ). The severity of HbH disease shows a good correlation with the degree of  $\alpha$ -chain deficiency. Thus, the more severe phenotypes are associated with interactions involving nondeletion  $\alpha$ -thalassemia defects that affect the dominant  $\alpha_2$  gene, including ( $-/\alpha^{\text{Constant Spring}}\alpha$ ), ( $-/\alpha^{\text{NcoI}}\alpha$ ), and ( $-/\alpha^{\text{HphI}}\alpha$ ) ( 283 , 284 , 302 ). Few patients with HbH disease resulting from the interaction of a  $^{+}$ -thalassemia ( $-a$ ) with the deletion of the HS-40 regulatory region have been reported [for references see Higgs ( 108 )]. A very few cases of unusual severe HbH disease associated with hydrops fetalis due to coinheritance of a  $^0$ - and a  $^{+}$ -thalassemia have been described ( 305 , 306 and 307 ). In four cases, the a  $^{+}$ -thalassemia alleles were mutations of the  $\alpha_2$  gene associated with hyperunstable  $\alpha$ -globin variants. In the other patients, the molecular mechanism was less clear. In these families, prenatal diagnosis may be indicated. Subjects with HbH disease may develop complications including hypersplenism, leg ulcers, and gallstones. Hypersplenism has been reported in 10% of Thai patients but seems to be rare elsewhere ( 308 ). Iron overload is not common and has been reported only in older patients and as a result of repeated blood transfusions ( 36 , 309 ). In general, patients with HbH disease do not need any treatment. Some clinicians recommend folic acid supplementation as for other hemolytic anemias. Patients should be advised to avoid oxidant drugs because of the risk of hemolytic crisis. Occasional blood transfusions may be required when the hemoglobin level suddenly drops. Pregnant women need careful monitoring of hemoglobin levels. Splenectomy may be indicated in the presence of hypersplenism, but the potential complication of venous thrombosis, reported in some patients with HbH disease after splenectomy, should be considered ( 310 , 311 ).

**HEMOGLOBIN BART HYDROPS FETALIS SYNDROME** Hb Bart hydrops fetalis syndrome is the most severe  $\alpha$ -thalassemia clinical condition, often associated with the absent function of all four  $\alpha$ -globin genes (homozygous  $\alpha^0$ -thalassemia or  $-/-$ ). A few cases of hydrops fetalis have been reported in infants with very low levels of  $\alpha$ -chain synthesis, resulting from interaction of common  $\alpha^0$ -thalassemia determinants with uncharacterized nondeletion defects ( 305 , 306 and 307 ). Hb Bart hydrops fetalis syndrome is relatively common in Southeast Asia; however, in Mediterranean populations, it is relatively rare due to the low frequency of  $\alpha^0$ -thalassemia ( 36 , 312 , 313 ). Due to the extreme rarity of the  $-/aa$  genotype, this disorder rarely, if ever, affects infants of African descent. A fetus homozygous for a  $\alpha^0$ -thalassemia produces mainly Hb Bart ( $?_4$ ), which is functionally useless for oxygen transport, and survival to late pregnancy is due to the presence of small amounts of embryonic hemoglobins Portland 1 ( $?_2?_2$ ) and Portland 2 ( $?_2\beta_2$ ). This condition is usually not compatible with postnatal life, and affected fetuses are either stillborn or die soon after birth ( 314 ). The clinical features of this syndrome are those of a very severe anemia (Hb level range, 3 to 8 g/dl), with marked hepatosplenomegaly, generalized edema, signs of cardiac failure, and extensive extramedullary erythropoiesis ( 36 , 315 ). Other congenital abnormalities, particularly of the skeletal, cardiovascular, and urogenital system, have been reported. Complications during pregnancy are common and

include severe and mild preeclampsia, polyhydramnios or oligohydramnios, and antepartum hemorrhage. Postpartum complications include placenta retention, eclampsia, hemorrhage, anemia, and sepsis. At present, there is no effective treatment. Early treatment with intrauterine transfusions or *in utero* hematopoietic stem cell transplantation has been unsuccessfully attempted and also may not be justified in view of the unknown future risks for normal development ( [276](#) , [316](#) , [317](#) , [318](#) and [319](#) ). Given the severity of this syndrome and the potential for maternal obstetric complications, early termination of at-risk pregnancies is recommended.

**UNUSUAL FORMS OF  $\alpha$ -THALASSEMIA** There are two unusual forms of  $\alpha$ -thalassemia: acquired HbH disease associated with myelodysplasia and  $\alpha$ -thalassemia associated with mental retardation syndrome.

***$\alpha$ -Thalassemia/Myelodysplasia Syndromes*** Patients with myelodysplasia may rarely develop an unusual form of HbH disease characterized by the presence of classic HbH inclusion bodies in RBCs, often detectable levels of HbH (1 to 57%), and a severe microcytic and hypochromic anemia with anisopoikilocytosis ( [320](#) ). The  $\alpha$ - to  $\beta$ -globin mRNA ratio is reduced (0.06:0.50), as is the  $\alpha$ - to  $\beta$ -globin chain synthesis ratio (0.28) ( [321](#) ). The molecular basis of this form of  $\alpha$ -thalassemia has not been defined. Structural analysis of the  $\alpha$ -globin genes and of their flanking regions has revealed no abnormalities in such patients ( [321](#) , [322](#) ). It seems possible that the  $\alpha$  genes are down-regulated by a mutation in trans-acting genes that normally controls a gene expression.

***$\alpha$ -Thalassemia and Mental Retardation Syndromes*** There are two different syndromes in which  $\alpha$ -thalassemia is associated with mental retardation ( [108](#) , [323](#) , [324](#) ). The first is characterized by relatively mild mental retardation and a variety of facial and skeletal abnormalities. These subjects have extended (1 to 2 megabases) deletions resulting from rearrangements of the short arm of chromosome 16. The deletions remove both  $\alpha$ -globin genes and other known and unknown genes. Two common patterns of  $\alpha$ -thalassemia have been described: One is characterized by parents with normal  $\alpha$ -globin genotype ( $aa/aa$ ) and an affected offspring with the phenotype of severe  $\alpha$ -thalassemia trait (genotype  $-/aa$ ); in the other, one parent has the phenotype of mild thalassemia trait, and the child has the phenotype of HbH disease. This condition is called a  *$\alpha$ -thalassemia mental retardation-16 syndrome*. The second group of patients has a complex phenotype characterized by severe mental retardation, quite uniform clinical features, similar facial appearance, genital abnormalities, other developmental abnormalities, and defective  $\alpha$ -globin synthesis, resulting in a relatively mild form of HbH disease. No structural changes of the  $\alpha$  cluster or 16p chromosome have been found in these patients, and the transmission is X-linked. Recently, it has been shown that this syndrome is associated with mutations in an X-encoded gene, the XH2 gene, a member of the DNA helicase family ( [325](#) , [326](#) , [327](#) and [328](#) ). Mutations in this gene down-regulate the expression of the  $\alpha$ -globin genes and of other unidentified genes producing the complex phenotype. This condition is referred to as a  *$\alpha$ -thalassemia mental retardation-X syndrome*.

### **$\alpha$ -Thalassemia Associated with Structural Variants**

A number of syndromes result from the interaction of  $\alpha$ -thalassemia genes with those producing structurally abnormal hemoglobins. In some disorders, thalassemia genes that otherwise would have gone unnoticed are given clinical expression by the variant hemoglobin; in others, the relative amount of the variant hemoglobin is altered by the thalassemia gene. Features common to all of these syndromes are red cell hypochromia and microcytosis, in addition to the presence of a hemoglobin variant.

Some of the mutations causing  $\alpha$ -chain structural variants appear to have occurred in chromosomes with only a single  $\alpha$ -globin gene. Thus, HbQ/ $\alpha^0$ -thalassemia has a clinical phenotype similar to that of HbH disease ( [329](#) ). Affected subjects synthesize no HbA. This disorder has been described in individuals from Thailand, China, Iran, and India ( [330](#) ,



[331](#), [332](#), [333](#) and [334](#)). The mutation responsible for HbG Philadelphia sometimes occurs on a chromosome with a single  $\alpha$ -globin gene and other times on a chromosome containing both  $\alpha$  genes. This variant is encountered primarily in black individuals ([335](#)). In persons with a normal  $\alpha$ -globin gene on the same chromosome containing the HbG mutation, HbG-Philadelphia/ $\alpha^0$ -thalassemia ( $\alpha^G \alpha^-$ ) is characterized clinically by  $\alpha$ -thalassemia minor, whereas in individuals with no normal  $\alpha$  gene *cis* to the  $\alpha^G$  gene ( $-\alpha^G/-$ ), the doubly heterozygous state resembles HbH disease clinically. The variant hemoglobin constitutes approximately 40% of the total concentration of hemoglobin in the former situation and more than 90% in the latter ([36](#)). HbI/ $\alpha$ -thalassemia has been reported in a black patient ([336](#)). That the gene for HbI is not linked *in cis* with an  $\alpha$ -thalassemia gene is indicated by the presence of 30% HbA. The combination of  $\alpha$ -thalassemia with  $\beta$ -chain variants is associated with a decrease in the relative amount of the variant hemoglobin and a clinical picture similar to that of the heterozygous state for the structural variant ([36](#)). The lower than usual percentage of the variant hemoglobin is attributed to the preferential binding of  $\alpha$ -chains with  $\beta A$ -chains. The  $\beta$ -chain variants noted in association with  $\alpha$ -thalassemia include HbS, HbC, HbE, and HbJ Bangkok ([36](#)).

The interaction of  $\alpha$ -thalassemia and HbS trait produces a trimodal distribution in the relative amount of HbS. Individuals with a full complement of  $\alpha$ -globin genes have more than 35% HbS, compared with 28 to 35% in those with the ( $-\alpha/aa$ ) genotype, 25 to 30% in those with the ( $-\alpha/-a$ ) genotype, and no more than 20% in those with the rare ( $-/-a$ ) genotype ([337](#), [338](#)). Reductions in MCV and MCH are also observed.  $\alpha$ -Thalassemia modifies some of the hematologic consequences of homozygous sickle cell anemia. Subjects with the ( $-\alpha/-a$ ) genotype have a higher hemoglobin concentration, lower red cell indices, fewer irreversibly sickled cells, a lower reticulocyte count, and lower serum bilirubin levels than subjects without concurrent  $\alpha$ -thalassemia ([9](#), [339](#), [340](#)). The ameliorating effect of  $\alpha$ -thalassemia is probably mediated by a decreased red cell concentration of HbS.  $\alpha$ -Thalassemia fails, however, to temper significantly the clinical expression of sickle cell anemia.

### **$\beta$ -Thalassemia Major**

The designations commonly used to describe the  $\beta$ -thalassemia syndromes are based on clinical severity. The most severe form is defined  $\beta$ -thalassemia major and is characterized by transfusion-dependent anemia. *Thalassemia intermedia* is the term used to designate a form of anemia that, independent of the genotype, does not require transfusion. *Thalassemia minor* indicates the heterozygous state that is usually asymptomatic. *Thalassemia minima* was used in the Italian literature to indicate a carrier in whom no hematologic or clinical symptoms were recognizable, but the term should probably be abandoned. Some authors use the term *thalassemia minima* to indicate the condition of silent carrier.

**HISTORY** Initial descriptions of thalassemia appeared as *anemia splenica infantum*, a term that undoubtedly included several conditions, often not well distinguished from one another. Syphilis was considered a possible cause, as were tuberculosis and leishmaniasis. Affected children appeared normal at birth and grew normally until the second half of the first year, when they were noticed to become pale and to develop an enormous abdomen, containing a spleen that could extend from a few centimeters below the left costal margin to the iliac crest and below. At this time in the disease course, the patients liked to be left alone and to lie down “in a monotonous morbid state” ([54](#)). Bone deformities, especially of the skull, soon appeared, giving the children a distinctive “mongolian” appearance ([341](#), [342](#) and [343](#)). The disease was often present in more than one sibling, or, more frequently, other siblings had previously died of the same disease. The first

systematic descriptions of what was to be identified as thalassemia major came from Drs. Cooley and Lee, who observed the disease in Italian and Greek children, and from Dr. Maccanti, a pediatrician from Ferrara, Italy, who also noted that the children often came from malarial areas near the Po river ( 341 ). Anemia, leukocytosis, and normoblastemia were present. Both groups unsuccessfully tried the entire armamentarium of therapies then available, as well as blood transfusions ( 54 , 342 ). The futility of the latter is not surprising, considering the very limited blood matching available at the time and the already enormous size of the spleen at presentation. Splenectomy and roentgen irradiation of the spleen were also performed without benefit. All children died shortly after presentation. At about the same time, Rietti, also from Ferrara, reported three adult patients, two of whom were father and son, who presented with “primitive hemolytic jaundice” associated with decreased osmotic fragility ( 344 ). Anemia, microcytosis, anisocytosis, and basophilic stippling were noted. The syndrome was probably a form of thalassemia intermedia, and for a long time, the eponymic title of *Rietti-Greppi-Michel* was used. In 1932, in consideration of the Mediterranean origin of the patients affected by Cooley anemia, Whipple and Bradford proposed the name *thalassemia*, from the Greek word *thalassa*, meaning sea ( 345 ). Subsequently, the severe and the mild form of thalassemia were designated *thalassemia major* and *minor*, respectively ( 346 ). However, the lack of communication between the two sides of the Atlantic delayed further characterization of the disorders ( 347 , 348 ). In 1940, Wintrobe reported the presence of a familial hemopoietic disorder in adolescents and adults of Italian origin, while in Italy between 1943 and 1947, Silvestroni and Bianco defined the hematologic, clinical, and epidemiologic characteristics of thalassemia minor and its relationship with thalassemia major ( 349 ). A detailed report of contributions can be found in a recent, comprehensive book on thalassemia by Ida Bianco Silvestroni ( 350 ). The picture was further clarified by the identification of HbA<sub>2</sub> and its increase in the parents of patients affected by thalassemia major ( 351 , 352 ). The patients, on the other hand, were found to be completely devoid of HbA and to have, in addition to HbA<sub>2</sub>, only an alkali-resistant variant usually found in the newborn—HbF ( 353 ). Erythrokinetic studies documented extensive ineffective erythropoiesis ( 354 ). Between 1956 and 1961, the chemical structure of hemoglobin was defined, and soon the complete sequences of globin chains were clarified ( 355 , 356 ). The introduction of techniques for assessment of globin chain synthesis confirmed the suggestion that thalassemia resulted from defective production of adult hemoglobin ( 357 ). The contributions of molecular biology continue to clarify aspects of this disease.

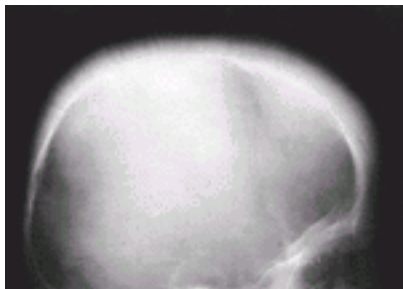
**CLINICAL FEATURES** The clinical picture of  $\beta$ -thalassemia major includes features that are due to the disease itself, as well as others that represent the consequences of therapy and are, in a sense, iatrogenic.

**Anemia** Symptoms of the disease usually appear in the first year of life, as the synthesis of  $\beta$ -chains is down-regulated. In an ethnically composite population of transfusion-dependent children diagnosed in the United Kingdom, the mean age at presentation was reported to be 6 months; in a study from Greece, the age was 13.1 months, ranging from 2 to 36 months ( 358 , 359 ). In Sardinia, the disease was recognized at approximately 8 months of age in patients with transfusion-dependent thalassemia but at 2 years of age in non-transfusion-dependent children ( 28 ). The age at diagnosis is influenced by the molecular defect and by the degree of suspicion of the treating physician. Pallor is usually the first sign, accompanied by splenomegaly of various severity, fever, and failure to thrive.

**Bone Deformities** Untransfused or poorly transfused patients develop typical bone abnormalities that are due to extremely increased erythropoiesis, with consequent expansion of the bone marrow to 15 to 30 times normal ( 341 , 342 , 360 ). The skull is large and deformed by frontal and posterior bossing with the diploë increased in thickness to several times normal. The outer and inner tables are thin, and the trabeculae are arranged in vertical striations, resulting in a “hair-on-end” appearance. A peculiar, stratified



appearance of the skull has been reported ( Fig. 42.5) ( 361 ). The zygomatic bones are prominent, the base of the nose appears to be depressed, and pneumatization of the sinuses is delayed. Overgrowth of the maxilla produces severe malocclusion, with a rodentlike appearance ( 362 ). Metatarsal and metacarpal bones are the first to expand as a consequence of increased erythropoiesis ( Fig. 42.6 ). The measurement of the size of the metacarpal bones has been proposed as an indicator of time for initiating transfusion therapy ( 363 ). The ribs are broad, often with a “rib-within-rib” appearance, and the vertebral bodies are square. The trabeculation of the medullary space gives the bones a mosaic pattern. Shortening of long bones is frequent as a result of premature fusion of the humeral and femoral epiphyseal lines ( 364 , 365 ). Extramedullary erythropoiesis gives rise to masses that protrude from bones where red marrow persists ( 366 ). Overgrowth from the vertebral bodies has been reported to cause cord compression and paraparesis ( 365 ). Ear impairment due to extramedullary marrow growing in the middle ear and progressive visual loss caused by compressive optic neuropathy have been reported ( 367 , 368 ). This kind of picture is more often present in patients with thalassemia intermedia, in whom transfusions are avoided at the price of intense autologous marrow hyperactivity. Improvement in the radiologic appearance of bone in patients who have had the benefit of transfusion therapy from early age is striking. However, bone lesions of a different nature may be observed as a consequence of excessive deferoxamine (DFO) therapy.



**Figure 42.5.** X-ray of the skull. In the frontal area, the bone has a lamellated structure, parallel to the inner table of the diploe. In the parietal area, erythroid hyperplasia has perforated the outer table, producing a characteristic “hair-on-end” appearance. (Courtesy of Dr. C. Orzincolo.)



**Figure 42.6.** Mosaic pattern produced by trabeculation in the bones of the hand of a patient with thalassemia major. Note the rectangular contour of the metacarpals.

**Osteoporosis** Reduced bone mineral density and consequent susceptibility to fractures have been observed in thalassemia patients and, in recent years, have been the subject of intense research. Mineral density is usually investigated with dual-energy x-ray absorptiometry at the spinal (L1 to L4) and femoral neck level. *Osteoporosis* is defined as a decrease in bone mineral density greater than or equal to 2.5 standard deviations (SD) below the young adult mean value, whereas a decrease between -1.0 and -2.5 SD is defined as *osteopenia* (369). Osteoporosis in thalassemia has been found to affect 51% of the patients, with an additional 45% affected by osteopenia. Male sex, lack of spontaneous puberty, and diabetes seem to represent significant risk factors, whereas transfusion history, chelation, and erythropoietic activity do not (370). Analysis of genetic polymorphisms for the collagen type I gene, vitamin D, estrogen, and calcitonin receptors has given conflicting results (371, 372). Bone formation, as evidenced by the levels of serum alkaline phosphatase and osteocalcin, does not appear to be impaired, whereas an increase in bone resorption, evaluated by means of the measurement of the urinary N-terminal peptides of collagen type I, has been demonstrated (373). Fractures, often secondary to mild or moderate trauma, are more frequent than in the general population (374, 375). Bone pain of varying severity is a common complaint among adult patients, and it has been attributed to expanded bone marrow with consequent pressure on the cortical bone (376). Magnetic resonance imaging (MRI) in these cases shows reappearance of hypercellular areas in bones previously replaced by fatty marrow. Reduced and irregular mineralization of the bone has been found using microradiography and x-ray in thalassemic patients with and without clinically evident bone abnormalities (377). Therapy should include sex hormone replacement therapy, regular exercise, and a diet rich in calcium and vitamin D. Treatment with bisphosphonates has been tried with encouraging preliminary results (378, 379). Parathormone is another promising alternative (380).

**Cholelithiasis** Gallstones have been reported in 4 to 23% of patients with thalassemia (381, 382). The large variability may be related to differences in transfusion practices and consequent variations in ineffective erythropoiesis and hemolysis, to the time of splenectomy, and, probably more importantly, to the associated presence of the (TA)<sub>7</sub> promoter mutation of the uridine diphosphate-glucuronosyltransferase gene, which is associated with Gilbert syndrome (288). Ultrasonography of the gallbladder should be checked regularly. If stones are present at the time of splenectomy, cholecystectomy should be performed at the same time. Prophylactic cholecystectomy has been proposed, but it is probably unnecessary for well-transfused patients, especially in view of data suggesting an increased risk of intestinal cancer after cholecystectomy (383). It could be considered for patients with persistently elevated indirect bilirubin or for patients who are known to be homozygous for the Gilbert mutation.

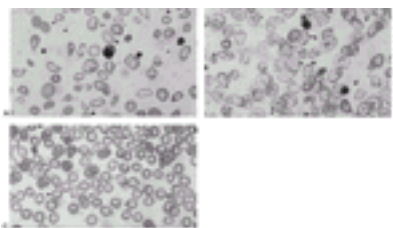
**Thrombotic Complications** In recent years, there have been numerous reports of thromboembolic complications in thalassemia. In a multicenter study, the frequency of thromboembolic events was found to be 4% in patients with thalassemia major and 10% in patients with thalassemia intermedia (384). Other groups have reported similar prevalences (385). A chronic hypercoagulable state has been observed even in childhood (256). It has been demonstrated that procoagulant phospholipids are exposed on the surface of the red cells and that platelets and the hemostatic system are activated in thalassemia major and intermedia. In addition, vascular endothelial cell injury has been proposed as a possible pathogenetic mechanism (257, 386). Concomitant prothrombotic conditions are frequently present in thalassemia patients after the first decade of life: insulin-dependent diabetes, estrogen therapy, atrial fibrillation, and postsplenectomy thrombocytosis, among others. A thorough review of the literature on the mechanisms of the hypercoagulable state present in thalassemia has been recently published (252). Prophylactic measures have been proposed (385).

**Pseudoxanthoma Elasticum** The development of clinical and histopathologic manifestations of a diffuse elastic tissue defect, resembling inherited pseudoxanthoma

elasticum, has been encountered with a notable frequency in patients with  $\beta$ -thalassemia. This clinical syndrome, consisting of skin, ocular, and vascular manifestations, has a variable severity and is age dependent, with an onset usually after the second decade of life ( 387 ). The defect is believed to be acquired, but its progression seems to be similar to that of the inherited form ( 388 ).

**Secondary Gout** Hyperuricemia is not unusual in thalassemia patients, but gouty arthritis has been rarely reported ( 389 ).

**LABORATORY FINDINGS AND DIAGNOSIS** Laboratory data at presentation are characterized by HbF levels ranging from 10 to 100% and HbA<sub>2</sub> levels that may be normal or increased to 5 to 7%, with HbA constituting the remainder. HbF is heterogeneously distributed among red cells. The reticulocyte count is low, usually below 1%. MCV is typically 60 to 70 fl, and MCH is 12 to 18 pg/cell. In the peripheral blood smear, a great variation in size and shape of the erythrocytes is always evident. Together with large and pale target cells, microcytes, tear drop cells, and nucleated red cells are present ( Fig. 42.7 ). The hemoglobin composition varies according to genotype. Homozygotes for  $\beta^0$ -thalassemia mutations have HbF and HbA<sub>2</sub> but no HbA, whereas homozygotes for  $\beta^+$ -thalassemia mutations and  $\beta^0/\beta^+$  genetic compounds have HbA, HbA<sub>2</sub>, and a variable, but always significantly elevated, amount of HbF (10 to 90%). HbA<sub>2</sub> in homozygous  $\beta$ -thalassemia may be normal or increased and so of no diagnostic value. Hemoglobin separation is accomplished by a number of different methods, including electrophoresis at alkaline or acidic pH, isoelectric focusing, and high-performance liquid chromatography ( 36 ). In transfused patients, diagnosis can be made by globin chain synthesis analysis from peripheral blood reticulocytes, which shows a severe a/non-a imbalance (usually >2), or by  $\beta$ -globin gene analysis to identify the DNA mutations ( 36 , 390 , 391 , 392 and 393 ).



**Figure 42.7.** Peripheral blood smears in  $\beta$ -thalassemia major (A) and intermedia (B) and in heterozygous  $\beta$ -thalassemia (C). See [Color Plate](#).

## THERAPY

**Blood Transfusion** For many years after the description of thalassemia major as a clinical entity, therapy was limited to blood transfusion, generally reserved for those with incapacitating symptoms. By today's standards, transfusion therapy was inadequate, failing to arrest progressive hepatosplenomegaly and skeletal changes. In the 1960s, the superiority of regular and methodically repeated transfusions was recognized, first by Orsini in France, and later by Wolman in Philadelphia, and Piomelli in New York, who started a program of chronic transfusion directed at maintaining a baseline hemoglobin level sufficient to eliminate hypoxia ( 394 , 395 , 396 and 397 ). It was calculated that the amount of iron administered to maintain an Hb of 9.5 g/dl was only 50% greater than that resulting from maintaining a baseline hemoglobin of 6 g/dl. Further, the additional iron intake could be counterbalanced in part by reduction of intestinal iron absorption. This regimen, designed to maintain the hemoglobin above 9.5 to 10 g/dl, was termed *hypertransfusion*. Complete bone marrow suppression, however, is seldom obtained at these hemoglobin levels; therefore, some bone remodeling and expansion of the blood volume persist. To completely correct the effects of anemia, Propper launched what was called a "supertransfusion" regimen, in which the pretransfusion packed cell volume was maintained above 35% ( 398 ). This approach was based on the hypothesis that the amount of blood needed to maintain a higher baseline would be no greater because of a reduction

in blood volume. Experience has shown, however, that patients maintained at a higher baseline hemoglobin level require a larger amount of blood and, therefore, accumulate more iron ( 399 , 400 and 401 ). In a study of patients kept at a pretransfusion hemoglobin level between 9 and 10 g/dl, the erythroid marrow activity, evaluated through the measurement of serum transferrin receptor, did not exceed two to three times normal levels ( 401 ). Therefore, as a consequence of these more recent studies, the majority of centers choose to transfuse at an Hb level of 9 to 10 g/dl ( 402 ). To reduce the volume transfused and to avoid the administration of foreign proteins, packed RBCs must be transfused. In addition, to avoid transfusion reactions resulting from the development of antibodies to white blood cells, the blood product should be rendered leukocyte-free. In the United States, this goal was achieved using frozen blood. This was expensive, however, and required 15% more blood than when using standard packed RBCs ( 403 ). At present, leukocyte depletion is achieved by filtering donor blood. Transfusion reactions were found to complicate 1% of the transfusional events in 17% of the patients reported by the Cooley Care Programme ( 404 ). Alloimmunization against red cells varies between 4 and 23%, the lower percentages being found in patients who received blood matched for the ABO, Rhesus, and Kell systems from their first transfusion ( 279 ). Extended red cell antigen typing, including at least the Rh antigens, Duffy, Kidd, and Kell, is recommended before the patient is started on a transfusion regimen. Transfusion of young red cells (neocytes) obtained by centrifugation has been proposed in the attempt to reduce the total blood requirement, but the results obtained were not sufficient to justify increased cost and the exposure to a larger number of donors ( 398 , 405 , 406 ). In general, the amount transfused should not exceed 15 to 20 ml/kg/day, at a maximum rate of 5 ml/kg/hour, to avoid rapid increase of blood volume. Rarely, if ever, do more than two units need to be transfused at a time. In the case of patients with cardiac problems, smaller volumes at a slower rate (no more than 2 ml/kg/hour) should be administered. When cardiac failure or severe anemia is present, the administration of diuretics before transfusion is advisable. The recommended interval between transfusions is usually 2 to 3 weeks, rarely longer.

**Complications of Transfusion** Although blood transfusions are lifesavers for thalassemia patients, who no longer die of anemia, they are also responsible for the main afflictions now complicating the course of the disease: chronic viral infections and hemosiderosis.

**INFECTIONS** The risk of transfusion-transmitted viral infection is well known. The hepatotropic viruses include hepatitis B virus (HBV), hepatitis C virus (HCV), and hepatitis G virus. The prevalence of infection with these viruses in multitransfused patients is very different in different parts of the world, and it is directly related to their frequency in that population. In 1992, serologic evidence of previous HBV infection was found in 19% of French and in 34% of Italian patients but in 56 to 66% of Indian patients ( 407 , 408 and 409 ). The risk of chronic hepatitis is approximately 5% ( 410 ). A DNA recombinant vaccine for HBV is available and should be administered to all patients who have not yet been infected. HCV infection is widely diffused among thalassemia patients who were transfused before 1989, when systematic screening of blood units was begun ( 411 ). Recent data from the Cooley Care Cooperative Group have reported the presence of HCV antibodies in 85% of multitransfused Italian patients, whereas 23% of patients tested positive in 1990 in the United Kingdom, 34% in France, and 21% in India ( 407 , 412 , 413 ). In the United States, one-third of the transfusion-dependent thalassemia patients were found to have antibodies against HCV. Of these, one-third were RNA positive ( 414 ). In Italy between 1994 and 1999, the residual risk of transfusion-transmitted infections associated with window period donations has been calculated to be 2.5/million donations for human immunodeficiency virus (HIV), 15.8/million donations for HBV, and 4.5/million for HCV ( 415 ). HCV hepatitis becomes chronic in 70 to 80% of infected individuals ( 416 ). HCV-RNA may be detected in patients' serum, and liver histology shows signs of chronic inflammation, fibrosis, and even cirrhosis. The risk of liver fibrosis is highest in patients with HCV infection and elevated iron load ( 417 ). It has been calculated that 20% of HCV chronically infected patients develop cirrhosis within 10 years and that their risk of

developing hepatocellular carcinoma is increased ( 418, 419 ). Transaminase levels typically fluctuate between normal and slightly elevated values, with a good correlation being demonstrated between transaminase levels and viral load measured by quantitative polymerase chain reaction (PCR) ( 410 ). Treatment with interferon- $\alpha$  is effective in inducing sustained viral clearance in 25 to 30% of thalassemia patients ( 28, 420 ). Young age, a histologic picture of chronic active hepatitis, and low liver iron content appear to correlate with a better prognosis ( 28, 421 ). Patients who do not respond to interferon treatment or relapse after cessation of therapy may benefit from ribavirin in combination with interferon ( 422, 423 ). The recently identified member of the Flaviviridae hepatitis G virus, common among multitransfused patients, seems to carry a low risk of chronic liver disease even in long-term follow-up ( 424, 425 ). Cytomegalovirus is notoriously widely diffused in most populations and can be transmitted by blood transfusion. A European collaborative study revealed a positive cytomegalovirus immunoglobulin G test in two-thirds of the thalassemia patients examined ( 407 ). The same study found the disquieting presence of human T-cell leukemia virus type-1 antibodies in a few patients from Sicily. HIV infection was acquired almost exclusively before the systematic screening of blood donation. In 1987, the prevalence of HIV in thalassemia patients from 13 European or Mediterranean countries was found to be 1.56%. Two years later, no HIV seroconversion was observed in the same areas when a total of 2972 patients affected by thalassemia who had received 96,518 blood units were examined ( 426 ). Malaria can be transmitted by transfusions in endemic areas ( 427 ).

**HEMOSIDEROSIS** In patients who undergo transfusion therapy for several years, the accumulation of iron, if untreated, causes considerable morbidity and, ultimately, leads to death. Because each unit of blood contains approximately 200 mg of iron, a patient who receives 25 to 30 units of blood/year, in the absence of chelation, accumulates more than 70 g of iron by the third decade of life ( 428 ). In addition to the iron administered through blood transfusions, a hyperactive bone marrow favors increased intestinal iron absorption that contributes, although marginally, to the total body load ( 429 ). Excessive intracellular iron may damage the cell by several mechanisms. In patients who have fully saturated transferrin, a significant fraction of the total iron in plasma circulates in the form of low-molecular-weight complexes not bound to transferrin ( 430, 431 ). Although the exact mechanism of tissue damage remains unclear, iron-induced peroxidative injury to the phospholipids of lysosomes and mitochondria, produced by free hydroxyl radicals, is probably the most important pathogenetic factor ( 432 ). During chelation, non-transferrin bound iron (NTBI) decreases to normal levels; because desferrioxamine causes a dose-related inhibition of iron-dependent lipid peroxidation, a simple method for measuring NTBI, based on the use of a probe fluorescein DFO, termed *desferrioxamine-chelatable iron*, has been devised ( 433, 434 and 435 ). Ascorbic acid at suboptimal concentration is a prooxidant and enhances the catalytic effect of iron in free radical formation. Excessive iron stores lead to depletion of substances that defend against free radical attack (i.e., ascorbic acid, which is oxidized to oxalate, and vitamin E) ( 436, 437 and 438 ). This, in turn, causes sequestration of the iron in the reticuloendothelial system, somehow protecting tissues from siderosis ( 439 ). In fact, the amount of iron deposited in parenchymal tissues seems to be more dangerous than iron deposited in the reticuloendothelial system. The presence of the genetic hemochromatosis mutations does not seem to influence the degree of iron overload and its consequences in regularly transfused and chelated patients with thalassemia major ( 291 ).

**Assessment of Iron Stores** The iron status of multitransfused patients can be inferred by several methods. The use of two or more parameters usually provides a good approximation of the total amount of iron accumulated. Serum iron is always elevated. Transferrin saturation correlates reasonably well with serum ferritin, and before the discovery of the HFE gene mutation, it was used to identify patients with genetic hemochromatosis ( 440, 441 ). After only a few years of transfusion, however, transferrin is



usually completely saturated, even in well-chelated patients. Serum ferritin has, in general, been found to correlate well with iron stores, as measured by phlebotomy and liver iron, either measured directly by liver biopsy or by magnetic susceptometry ( 442, 443, 444 and 445 ). In one study, however, the 95% prediction intervals in hepatic iron concentrations for a given plasma ferritin were so broad as to make plasma ferritin a poor predictor of body iron burden ( 446 ). Several variables can interfere with the reliability of ferritin as a marker of iron overload. Being an acute phase reactant, ferritin is increased in chronic disease, malignancy, and inflammatory disorders. A ferritin concentration of 4000 µg/L is considered the maximum level of physiologic synthesis, whereas higher values would represent the release of intracellular ferritin from damaged cells ( 447 ). Ascorbic acid deficiency can lead to decreased synthesis and release of ferritin. This can, therefore, lead to ferritin levels that are only mildly elevated, even in the presence of massive iron stores ( 439, 448 ). Conversely, patients with active liver disease may have high serum ferritin that does not mirror the body iron load. Lack of correlation between serum ferritin and directly measured liver iron in transfusion-dependent thalassemia patients with chronic hepatitis has been demonstrated ( 449 ). Despite all this, serial measurements of serum ferritin remain a reliable means, as well as the easiest one, to evaluate iron overload and efficacy of chelation therapy. The measurement of iron excretion over 24 hours after an intramuscular injection of 500 mg of desferrioxamine was, in the past, largely used to establish the time to start chelation therapy or to evaluate the iron burden. Unfortunately, the correlation between urinary excretion and body iron is not very good, as many factors, including the dose of chelator administered and vitamin C status, influence iron excretion ( 450 ). None of these methods provide an estimate of iron accumulation in the various organs, as its distribution is usually not homogeneous. At present, the most accurate way of estimating the iron burden is by direct measurement of iron concentration in the liver. Needle biopsy specimens of 1 mg dry weight are adequate ( 451 ). The measurement is performed by atomic absorption spectrometry on ashed or lyophilized samples and correlates well with the total amount of blood transfused and with the extent of hepatic fibrosis ( 452 ). It has been demonstrated through post-bone marrow transplantation (BMT) phlebotomies that total body iron stores (in mg/kg of body weight) is equivalent to 10.6 times the hepatic iron concentration (in mg/g of liver, dry weight). In the absence of cirrhosis, the correlation is linear up to a body iron burden of 250 mg/kg ( 417 ). Noninvasive alternative methods include computed tomography, nuclear MRI, and magnetic susceptometry ( 453, 454 ). MRI, which has the advantage of avoiding radiation exposure to the patient, has been used by several authors to demonstrate the presence of iron in the pituitary gland, the pancreas, the liver, and even the heart ( 455, 456 and 457 ). A good correlation between the amount of liver iron evaluated with MRI and liver iron measured in biopsy samples has been found, although the presence of fibrosis makes estimates of hepatic iron, derived from MRI, not completely reliable ( 458, 459 ). Liver to muscle signal intensity ratio on spin-echo T1-weighted images was recently found to be of value for estimating liver iron content ( 460 ). A recent study has demonstrated the value of a new so-called T2-star technique in the evaluation of myocardial and liver iron ( 461 ). Hopefully, in the not-too-distant future, standardization of the methods will provide a precious tool for obtaining reproducible results. Magnetic susceptometry is based on the magnetic response of ferritin and hemosiderin iron in the liver ( 442, 462, 463 and 464 ). The equipment necessary for this measurement [ superconducting quantum interference device (SQUID)] is so far available only in two sites in the United States and one in Italy.

### ***Clinical Manifestations of Iron Overload***

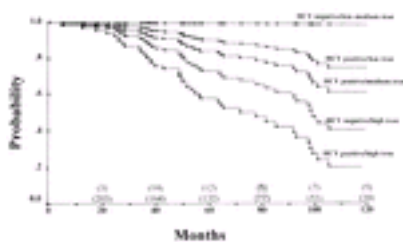
**HEART** Although the cardiac complications of thalassemia are multifactorial, the role of iron in the development of cardiac dysfunction is of paramount importance. In the absence of chelation, subclinical dysfunction has its onset in the second decade of life, or when approximately 20 g of iron have been accumulated. Subsequently, cardiomegaly and left ventricular deterioration progress to congestive heart failure. Arrhythmias are a cause

of sudden death (465). The classic picture of end-stage iron-induced cardiomyopathy is a combination of left ventricular diastolic dysfunction, pulmonary hypertension, and right ventricular dilatation (466, 467). Myocardial iron toxicity is attributed to free radical damage, and the role of NTBI has been demonstrated both *in vitro* and in the experimental animal (468). When iron is taken up by the heart fibers, protective antioxidant enzymes decrease, free radical production increases, and cardiac dysfunction ensues. In a series of patients followed prospectively, the frequency of cardiac failure was significantly lower in patients chelated from early childhood. In a study of 97 patients born before 1976 who were treated with regular transfusions and chelation, the prognosis for survival without cardiac disease was best for those in whom fewer than 33% of the serum ferritin values exceeded 2500 ng/ml (469, 470). Nevertheless, heart disease, including cardiac failure, arrhythmias, myocarditis, pericarditis, and myocardial infarction, is the leading cause of death in thalassemia major, accounting for 71% of the deaths (471). The measurement of cardiac iron is not easily obtainable. Endomyocardial biopsies, performed in small series of patients with primary or secondary iron overload, revealed an uneven iron distribution in different biopsy fragments from the same patient and a poor correlation between endomyocardial iron grade and liver iron (472, 473 and 474). In other studies of endomyocardial biopsies, good correlation was found between iron loading and the degree of cardiac fibrosis and between cardiac fibrosis and electrophysiologic disturbances (472, 475). A poor correlation between myocardial and liver iron was documented with MRI (461). Traditional diagnostic tools (i.e., electrocardiography, 24-hour tracings, echocardiography, nuclear studies), although routinely used, are not predictive of subsequent cardiac dysfunction (466). The prognosis for patients with heart failure has always been poor. Recently, however, the 5-year survival rate after the onset of heart failure was reported to be 48% (476). In the prechelation era, acute episodes of sterile pericarditis were seen in approximately one-half of the patients with massive iron overload but are now quite uncommon (477). Impaired cardiac function due to iron deposition may be compounded by coexistent anemia (478). Viral infections and pulmonary hypertension have also been suggested as possible concomitant causes (467, 479, 480). Management of cardiac complications in patients with thalassemia major has been described in detail (481). In asymptomatic thalassemia patients with normal myocardial mass, diastolic dysfunction has been found to be an early event, even while the systolic function is only mild impaired. There are no universally accepted treatments for diastolic abnormalities (466). The effect of the angiotensin-converting enzyme inhibitor enalapril was recently reported in asymptomatic or minimally symptomatic patients with left ventricular dysfunction resulting from  $\beta$ -thalassemia major. Echocardiographically, significant improvement in systolic and diastolic function was demonstrated (482). Whether this will have an impact on long-term prognosis and survival remains to be demonstrated. The treatment of arrhythmias is difficult, and the risk of proarrhythmic effects of antiarrhythmic drugs is high. Once electrolyte imbalances have been corrected and the metabolic homeostasis has been monitored, the help of a cardiac electrophysiologist is often necessary. Heart transplantation has been attempted with variable results (483, 484, 485 and 486).

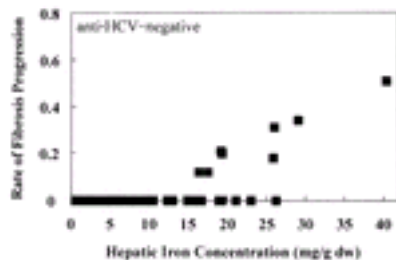
**LIVER** Studies in dogs have shown the liver to be the site of earliest iron deposition. Parenchymal siderosis is present from the very early stages of iron loading and progresses to fibrosis and cirrhosis (487). In transfusion-dependent thalassemia, fibrosis of the liver correlates directly with age, number of units transfused, and liver iron concentration (488). The degree of liver fibrosis is best evaluated by the Ishak score (489). In a study of patients with genetic hemochromatosis, mean hepatic iron concentration in the absence of liver fibrosis was  $13 \pm 6$  mg/g dry weight, whereas it was  $18 \pm 9$  mg/g when fibrosis was present (490). Accordingly, in a group of patients followed after BMT for an average of 100 months, no progression of fibrosis was noted in HCV-negative patients when the iron concentration in the liver was below 16 mg/kg. If HCV infection



was present, no threshold for iron could be established ( [Fig. 42.8](#) and [Fig. 42.9](#) ) ( [417](#) ). Iron depletion by venesection after BMT has produced regression of cirrhosis in iron overloaded patients, some of whom were HCV positive ( [491](#) ). Chelation therapy has been found to be effective in improving liver fibrosis in a proportion of transfusion-dependent patients ( [Fig. 42.10](#) ) ( [492](#) , [493](#) ). Viral infections contribute to liver damage, and HCV is believed to account for more than 90% of cases of transfusion-associated hepatitis in most Western countries. Iron influences the natural history of hepatitis C and the response of chronic hepatitis C to treatment. The mechanisms responsible for the effects of iron are not clear, but emerging data suggest that the cellular location of iron within the liver lobule and the subsequent effects on immune function are likely to be critical determinants for these effects ( [494](#) ). A larger iron load is present in patients with chronic hepatitis, probably as a consequence of an inflammation-dependent iron deposition ( [449](#) ). Cirrhosis of the liver, attributed to the combination of transfusional and alimentary iron, is observed at necropsy in almost 50% of the patients ( [495](#) , [496](#) ).



**Figure 42.8.** Probability of fibrosis progression-free survival according to iron concentration and hepatitis C virus (HCV) status. (Reprinted from Angelucci E, Muretto P, Nicolucci A, et al. Effects of iron overload and hepatitis C virus positivity in determining progression of liver fibrosis in thalassemia following bone marrow transplantation. *Blood* 2002;100:19. The American Society of Hematology, with permission.)



**Figure 42.9.** Rate of fibrosis progression in hepatitis C virus (HCV)-negative patients according to hepatic iron concentration. Rate of fibrosis progression was determined by dividing the difference between the final fibrosis score and initial fibrosis score by years of follow-up. In the absence of HCV infection, no patient with hepatic iron content lower than 16 mg/g dry weight showed fibrosis progression. (Reprinted from Angelucci E, Muretto P, Nicolucci A, et al. Effects of iron overload and hepatitis C virus positivity in determining progression of liver fibrosis in thalassemia following bone marrow transplantation. *Blood* 2002;100:19. The American Society of Hematology, with permission.)



**Figure 42.10.** Liver biopsies before (A) and after (B) bone marrow transplantation demonstrating reversal of liver cirrhosis. See [Color Plate](#). (From Muretto P, Angelucci E,

Lucarelli G. Reversibility of cirrhosis in patients cured of thalassemia by bone marrow transplantation. *Ann Intern Med* 2002;136:669, with permission.)

Liver biopsy represents a precious tool to assess both histology and liver iron concentration. However, it has been suggested, on the basis of autoptic measurements recently confirmed by the MRI technique, that the distribution of iron within the liver is not uniform ( 497 , 498 ). However, these results were based on autoptic measurements that could be influenced by the presence of large amounts of heme iron. Hepatocellular carcinoma is the primary cause of death in patients with genetic hemochromatosis in whom cirrhosis is present at diagnosis, and it frequently complicates the course of cirrhosis due to chronic HCV and HBV hepatitis ( 419 , 499 , 500 and 501 ). Despite the numerous risk factors present in multitransfused patients, only one case so far has been reported in thalassemia, possibly because death occurs before the development of the tumor ( 502 ).

**ENDOCRINE GLANDS** Iron deposition can damage also the endocrine glands, either directly or through the hypothalamic–pituitary axis. **PUBERTAL DELAY.** Lack of sexual maturation is very common, affecting, in 1997, 55% of patients older than 15 years of age ( 471 ). The data are very similar to those collected 15 years earlier, when 67% of males and 38% of females between 12 and 18 years of age had no signs of pubertal maturation, suggesting little, if any, improvement in pubertal development in adolescents treated with transfusion and chelation from an earlier age ( 503 ). Similar percentages have been published elsewhere ( 504 ). Conversely, Bronsiegel–Weintrob found in a younger group of female patients that beginning chelation before 10 years of age helped to attain normal sexual maturation ( 505 ). Secondary amenorrhea has been reported in 10 to 20% of the girls who had developed normally ( 503 , 506 ). A proportion of sexually mature men go on to develop impotence. Hypogonadism is hypogonadotropic in origin and is probably due to the free radical oxidative damage caused by iron deposition in the anterior pituitary, in the hypothalamus, or both. Damage to the gonads can sometimes be demonstrated ( 507 ). Replacement therapy consists of conjugated estrogens and progesterone for females and testosterone enanthate for males ( 359 ). Hormone replacement, in addition to inducing secondary sexual characteristics, enhances height velocity, contributes to the prevention of osteoporosis, and has enormous psychological benefits ( 378 ). Fertility is normal in female patients with normal menstrual function, or it can be induced with gonadotropin or follicle–stimulating hormone in those without menses ( 508 , 509 ). Oligospermia and astheno–spermia have been reported in more than 50% of men with thalassemia ( 510 ). Gonadotropin treatment, using human chorionic gonadotropin plus human follicle–stimulating hormone or gonadotropin–releasing hormone, is given to stimulate spermatogenesis and induce fertility ( 511 ). **PREGNANCY.** Hundreds of pregnancies have now taken place, and severe obstetric complications have been quite rare ( 508 , 512 , 513 and 514 ). During pregnancy, anemia should be avoided to protect the fetus from hypoxia (maintaining hemoglobin >10 g/dl), and desferrioxamine or deferiprone should be discontinued because of concerns regarding teratogenicity ( 515 , 516 ). However, more than 40 cases have been reported in which desferrioxamine was given in various periods of gestation without evidence of a teratogenic effect ( 517 ). Preexisting cardiomyopathy, expanded plasma volume, increase of the cardiac output, increasing iron deposits in the absence of chelation, and reduced glucose tolerance all pose potential threats to maternal health in the course of pregnancy. Death from cardiac failure has been reported ( 508 , 518 ). Delivery has been performed by elective cesarean section in approximately one–half of the cases reported. Genetic counseling is mandatory before conception. **GROWTH RETARDATION.** Stunted growth is common in thalassemia and is not correlated with transfusion regimens or iron chelation ( 519 ). It has been attributed to the disease itself, to delayed puberty, to iron overload, and to desferrioxamine toxicity ( 520 ). Sitting height is also reduced as a consequence of spinal growth abnormalities. Eight percent of boys 7 to

8 years of age who had been adequately treated were found to be below the third percentile for height. The percentage grew to 12% of boys and 15% of girls 20 to 29 years of age, one-half of whom had spontaneously completed puberty ( 521 ). The prevalence of short stature was 29% when other endocrinopathies were present, marking an improvement in comparison to data reported in 1982, when 52% of males and 39% of females older than 14 years of age were below the third percentile for height ( 503 ). Growth hormone deficiency can be detected in 20% of patients, and circulating insulinlike growth factor-1 and insulinlike growth factor-binding protein-3 are low in patients with short stature but increase after the insulinlike growth factor generation test, suggesting intact insulinlike growth factor-1 generation by the liver ( 521 , 522 and 523 ). Treatment with recombinant human growth hormone improves height velocity, but patients remain below their target height ( 521 , 524 ). In one report, long-acting androgens administered for 1 year were found to significantly improve growth ( 521 , 525 ).

**HYPOTHYROIDISM.** Hypothyroidism is not uncommon, having been reported in 5.6% to 17.0% of patients ( 379 , 526 ). The majority of patients have subclinical or mild forms, whereas approximately one-third have overt disease. No difference in the mean level of serum ferritin concentration was found between patients with or without hypothyroidism ( 471 ).

**HYPOPARATHYROIDISM.** Hypoparathyroidism is reported to affect 3% to 7% of patients, and it is attributed to iron deposition in the parathyroids ( 28 , 527 ). Males seem to be affected more often than females. Extreme hypocalcemia is a frequent late event. Early detection requires periodic estimation of calcium homeostasis. Serum calcium levels below 8 mg/dl (2 mmol/L), phosphorus above 7 mg/dl (2.6 mmol/L), and low 1,25-dihydroxyvitamin D are suggestive of hypoparathyroidism. Symptoms are usually mild and include paresthesias, muscle pain, and, when severe, tetany and even convulsions ( 359 ). A decrease of parathyroid hormone levels in the absence of symptoms has been reported in more than 12% of the patients examined ( 528 ).

**ADRENAL DYSFUNCTION.** No adrenal insufficiency has been reported ( 526 , 529 ).

**DIABETES MELLITUS.** In 1992, 4.2% of 2535 transfusion-dependent patients were affected by diabetes ( 526 ). However, the reported prevalence of insulin-dependent diabetes and of impaired glucose tolerance is variable, and it has changed in recent years, probably as a result of chelation therapy ( 530 , 531 ). Pathologically, iron deposition resulting in excess collagen deposition in the pancreas and defective microcirculation can be demonstrated ( 532 ). Age at initiation of transfusion therapy, liver iron load measured by the SQUID, poor compliance with chelation, and male sex were found to be significant factors in the development of diabetes, whereas serum ferritin level was not ( 531 , 533 , 534 ). It has been suggested that liver damage could contribute to the impairment of islet cell function ( 535 ). Diabetes developing in thalassemic patients differs from the usual form in that there is no association with HLA haplotypes, and islet cell antibodies are negative ( 531 ). Ketoacidosis is said to be uncommon, and retinopathy develops in one-fourth of patients, a frequency that is approximately one-half that of age- and sex-matched diabetic controls without thalassemia ( 359 , 536 ). Insulin resistance and increased insulin secretion are thought to antedate the development of overt diabetes ( 533 , 537 ). Impaired glucose tolerance is often responsive to oral hypoglycemic drugs. Intensive chelation may reverse glucose intolerance and postpone the onset of insulin-dependent diabetes ( 538 ). Insulin therapy needs to be closely monitored, as glucose control is often difficult.

**EXOCRINE GLANDS** Reduced serum levels of chymotrypsin have been described in patients with thalassemia and have been attributed to hemosiderosis of the pancreatic acinar tissue ( 539 ). Low values of lipase and trypsin were also found in a small group of patients in whom ultrasonography showed increased echogenicity of the pancreas ( 540 ). Sicca syndrome, xerostomia, and xerophthalmia, also attributed to iron overload, have been reported in a patient with genetic hemochromatosis and in one with thalassemia ( 541 , 542 ). However, it is now known that HCV can also cause sicca syndrome; therefore, the relation of these symptoms to iron overload is not certain.

**EYE** It has been known for a long time that retinal pigmentary changes may complicate hemochromatosis. Accordingly, retinal hyperpigmentation detected in a group of thalassemia patients was attributed to iron overload. Also reported were abnormal electroretinographic potentials, similar to those observed in experimental siderosis bulbi ( 543 , 544 ). Their severity was directly correlated with iron overload. Most eye problems in patients with thalassemia major, however, are a consequence of desferrioxamine toxicity and are discussed later.

**PULMONARY INSUFFICIENCY** Pulmonary problems, mainly due to ventilatory restrictive impairment, have been reported in patients with thalassemia major, and iron deposition in the respiratory system has been proposed as the likely cause. In a recent study, however, no correlation was found between restrictive impairment and iron deposition in the respiratory system evaluated by MRI ( 545 ). Pulmonary hypertension seems to be more frequent after splenectomy and in patients with thalassemia intermedia.

**Chelation** To prevent hemosiderosis, iron administered as blood must be chelated and excreted. Iron balance is obtained when the daily excretion is sufficient to eliminate the iron introduced by transfusion. This amount approximates, in most patients, 0.5 mg/kg. The two main sources of chelatable iron are (a) the intracellular labile pool, derived from lysosomal catabolism of ferritin and from transferrin and NTBI, and (b) the iron derived from red cell catabolism in macrophages ( 546 , 547 and 548 ). The first contributes chiefly to the hepatocellular load and is excreted as fecal iron, whereas the second is the major source of urinary iron. Ferric iron has six coordination sites, which need to be chelated completely if generation of harmful free radicals is to be prevented. Two chelators are presently in use: DFO, which, being hexadentate, forms stable iron-chelate complexes using a single molecule, and deferiprone, which, being bidentate, requires three molecules to coordinate all six sites and tends to dissociate from iron at low concentrations.

**Deferoxamine B** DFO, a trihydroxamic acid produced by *Streptomyces pilosus*, was first used for the treatment of transfusional hemosiderosis in 1962 ( 549 ). Because of its large molecular weight, it is not efficiently absorbed from the gut, and it cannot, therefore, be administered orally. Initially, the drug was given by intramuscular injection, but, due to the drug's short half-life and the finite chelatable iron pool available at any given time, negative iron balance was not obtained ( 550 ). In a fundamental study performed in the United Kingdom, it was found that patients treated with DFO had, after 7 years, lower ferritin levels and lower liver iron concentration than those not chelated ( 550 , 551 and 552 ). However, it was only with the administration of prolonged parenteral infusions, intravenous at first and then subcutaneous, that negative iron balance was achieved ( 549 , 553 , 554 , 555 and 556 ). Today, DFO is most frequently administered subcutaneously by means of a portable, battery-operated pump, starting at a dose ranging between 20 and 60 mg/kg/day over 8 to 12 hours at night. The dose can then be adjusted according to ferritin levels and urinary iron excretion. Decreasing growth velocity should be an indication to lower the dose of the chelator. Pharmacokinetic studies have shown that a plateau is reached within 4 and 8 hours after starting the infusion and that plasma levels fall rapidly thereafter ( 557 ). NTBI is efficiently bound by DFO, so that the effects of free radical formation and lipid peroxidation are prevented ( 558 ). The efficacy of DFO in reducing the iron burden and in improving organ function and survival has been repeatedly demonstrated ( 469 , 471 , 530 , 559 , 560 ). To avoid severe effects on growth and bone metabolism, DFO should not be started before a significant amount of chelatable iron is present. It is usually advised that chelation be started when ferritin levels reach 1000 ng/ml, or after 10 to 15 units of blood have been given ( 561 , 562 ). These recommendations have been corroborated by a study in which serial liver biopsies were performed after inception of transfusion therapy ( 563 ). The mean liver iron concentration after 1.3 years was found to be 8.5 mg/g, slightly above the limit of 7.0 mg/g that is considered compatible with a normal life expectancy in patients with idiopathic hemochromatosis ( 564 ). The adequacy of therapy is monitored by serial measurements of serum ferritin and by direct quantification of liver iron when necessary. The main limitation of the drug is the

requirement for parenteral administration. Compliance with DFO, therefore, is often erratic, especially during the teenage years. In patients who have accumulated a large iron burden and who show signs of cardiac involvement, continuous intravenous infusion through implantable venous access ports should be considered ( 565, 566 ). Improvement of cardiac performance can usually be demonstrated even before the total iron load is significantly reduced, probably as a result of binding of toxic NTBI ( 566 ). As shown in heart cell culture studies, DFO removes iron directly from iron-loaded heart cells, inhibits lipid peroxidation, and reverses the abnormalities in cellular contractility and rhythmicity induced by iron ( 567, 568 ). The dose of DFO should never exceed 100 mg/kg/day. This dose, to be administered only in the presence of symptoms of severe iron overload and in the attempt to improve cardiac function, should be infused slowly, preferably over 24 hours. At these dosages, an acute, often lethal, pulmonary infiltration syndrome can occur ( 569, 570 ). The principal catheter-related complications are infection and thromboembolism, reported in one study to occur at a rate of 1.15 and 0.48/1000 catheter days, respectively ( 566 ). The administration of DFO by twice daily subcutaneous bolus injection has been demonstrated to induce the same urinary iron excretion as the slow, pump-mediated infusion and to be well accepted, especially by older patients ( 571, 572 and 573 ).

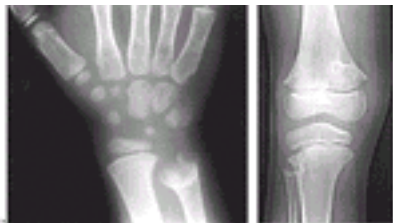
**DEFEROXAMINE B TOXICITY** The most common side effects of DFO are represented by local reactions with redness and soreness at the site of infusion. Inflammation, necrosis, and even ulceration can be caused by the intradermal insertion of the needle. If the reaction persists after appropriate needle placement in the subcutaneous tissue, hydrocortisone (5 to 10 mg) can be added in the syringe. The direct and rapid injection of DFO in a vessel can cause brief episodes of nausea, hypotension, and collapse. Systemic allergic reactions and, occasionally, anaphylaxis require desensitization or change of chelator ( 574, 575 ). Retinal and optic nerve disturbances, manifesting as loss of central vision, night blindness, and amaurosis, were reported in patients treated with high-dose DFO ( 576, 577 ). These disturbances are reversible on discontinuation of therapy, and resumption of treatment is well tolerated. High-frequency sensorineural hearing loss is observed in a large percentage of patients during intensive DFO therapy. The defect is correlated with the total monthly dose of DFO received, and it is more frequent in younger patients with low serum ferritin levels ( 578 ). Auditory toxicity can be often prevented by keeping a therapeutic index devised for that purpose [mean daily dose of DFO (mg/kg) divided by the serum ferritin ( $\mu\text{g/L}$ )] below 0.025 ( 579 ). The hearing defect should be detected early, performing an audiogram at least yearly, or whenever symptoms, even subtle, are reported. Significant improvement has been observed after reduction of the DFO dose in patients with a mild defect, whereas only little benefit has been gained by those severely affected ( 580 ). Stunted growth and ricketslike bone abnormalities have been described when treatment was initiated early, at a dosage higher than 40 mg/kg, or when the iron burden was not severe ( 520, 561, 581, 582 ). Sitting height is more often affected than standing height, as a consequence of vertebral growth retardation or flatness of vertebral bodies ( Fig. 42.11 ). Cupping of the ulnar, radial, and tibial metaphyses, which are poorly ossified and with irregular sclerotic margins, can be demonstrated radiographically and, when more advanced, can produce severe deformity of knees and elbows ( Fig. 42.12 ). Reduction of the DFO dose is sufficient to reestablish normal growth velocity, but orthopedic surgery has sometimes been required for correction of advanced varus and valgus deformities of the knees ( 582, 583 ). Pulmonary toxicity has been observed in patients treated intensively with “rescue” doses of DFO (10 to 20 mg kg/hour) ( 569, 570 ). Renal failure has also been reported in this context ( 584, 585 ). Infection with *Yersinia enterocolitica* is a well-known complication of hemosiderosis. The presence of DFO in plasma and tissues further fosters the growth of the organism that uses the drug as a siderophore ( 586 ). Fever and gastrointestinal symptoms are an indication to temporarily discontinue DFO. Antibiotic therapy is indicated, as *Yersinia*



infection can be severe and even life-threatening ( [587](#) ).



**Figure 42.11.** Antero-posterior (A) and lateral (B) views of the lumbar spine of a 15-year-old with thalassemia major, demonstrating flat vertebral bodies due to desferrioxamine.



**Figure 42.12.** A: Desferrioxamine toxicity. The growth plate of the distal ulna is wide, and the metaphysis exhibits a cuplike deformity with sclerotic and irregular borders. B: A similar picture is present in the metaphyses of the femur and fibula. (Courtesy of Dr. C. Orzincolo.)

**Deferiprone** Deferiprone (L1) is a member of the family of the hydroxypyridin-4-one chelators that have been intensively studied during the past two decades to find an orally active alternative to DFO for the treatment of transfusional iron overload. Because each molecule provides two coordination sites, three molecules of deferiprone are required to fully bind iron. The iron-chelate complex that is formed has a lower stability than that of DFO. Deferiprone is easily absorbed from the gut and a peak concentration is reached in the plasma 45 minutes after ingestion ( [588](#) , [589](#) ). The sources of chelatable iron are both parenchymal and reticuloendothelial cells. In addition, iron is mobilized from transferrin, lactoferrin, and hemosiderin. Most iron is excreted in urine, whereas fecal excretion ranges between 5 and 20%. A dose of 75 mg/kg/day has been shown to induce urinary iron excretion equivalent to that achieved with 40 mg/kg/day of DFO ( [466](#) ). Greater excretion can be obtained with a dose of 100 mg/kg/day, but it is believed that more toxic effects occur at this dose ( [590](#) ). A metaanalytic review of nine clinical trials, including 129 iron-overloaded patients, concluded that deferiprone is effective in achieving negative iron balance and reducing the body iron burden in hemosiderotic patients ( [591](#) ). A decrease in NTBI was demonstrated in a small series of patients in whom the decrease of ferritin had not been statistically significant ( [592](#) ). No effect of ascorbate has been found on iron excretion in response to deferiprone. Deferiprone has been licensed for clinical use in India and Europe. The recommended dosage is 75 mg/kg/day in three divided doses given 1 hour before meals. In a randomized trial comparing the efficacy of desferrioxamine and deferiprone, no difference between the two groups in reduction of liver and heart iron content was found after 1 year by magnetic resonance ( [593](#) ). Recent studies have explored the effectiveness of combining deferiprone and DFO therapy ( [594](#) ). Results have usually demonstrated an additive effect of combination therapy, suggesting that the two drugs access different pools of iron ( [594](#) ).

Deferiprone, being able to pass through membranes, could “shuttle” tissue iron to DFO in the bloodstream and then be reused ( 595 ). If this is the case, combination therapy could provide better therapeutic strategies for iron-overloaded patients.

**DEFERIPRONE TOXICITY** The main adverse effects observed with deferiprone are agranulocytosis, reported in 0.5 to 2.0% of patients exposed to the drug, and neutropenia, reported in 4% ( 596 , 597 ). The dose that these patients were receiving ranged from 50 to 105 mg/kg, and the interval from inception of therapy to appearance of the complication ranged between 6 weeks and 21 months ( 590 , 598 , 599 and 600 ). Rechallenge with the drug has invariably produced relapse of the agranulocytosis and is contraindicated ( 590 ). In a prospective multicenter study, the incidence of agranulocytosis was found to be 0.6/100 patient-years, whereas that of neutropenia was 5.4/100 patient-years. Neutropenia occurred more frequently in nonsplenectomized patients ( 601 ). No deaths were reported as a consequence of low neutrophil counts. Other unwanted effects include nausea or anorexia, zinc deficiency, and fluctuation in liver enzymes, more commonly found in patients with hepatitis ( 602 ). Arthropathy, particularly of the knees, occurs in 6 to 39% of patients, and it appears to be more frequent in patients who have more severe iron overload ( 596 , 601 , 603 ). It has been hypothesized that the formation of 1:1 or 1:2 deferiprone-iron complexes can induce inflammatory changes, possibly mediated by free radicals. Progressive liver fibrosis was reported in 5 out of 14 patients treated with deferiprone for over 2 years ( 604 ). More recently, however, a large multicenter study, involving 56 patients over 3.5 years, whose liver biopsies were evaluated in blinded fashion, did not confirm an effect of deferiprone on hepatic fibrosis ( 605 ).

**Vitamin Supplementation** Hemosiderotic patients are often found to be ascorbate deficient, and a case of frank scurvy has been reported ( 436 , 439 , 448 ). DFO-induced iron excretion is enhanced by ascorbic acid supplementation due to the expansion of the chelatable iron pool to which DFO has access ( 554 ). However, ascorbate, a natural reducing agent, accelerates iron-induced lipid peroxidation in biologic systems at low concentrations, and it has been shown to alter the function of rat myocardial cells in culture ( 437 , 568 ). In addition, echocardiographic observations suggest it may potentiate cardiotoxicity ( 606 ). Vitamin C supplementation is therefore recommended only in patients not affected by cardiomyopathy, who have unsatisfactory iron excretion and demonstrated ascorbate deficiency. When necessary, 50 mg/day of ascorbate in children younger than 10 years of age and 100 mg/day thereafter should be sufficient. Vitamin C should be given when DFO infusion is already under way.  $\alpha$ -Tocopherol, a lipid-soluble antioxidant, is able to interrupt the membrane lipid peroxidation process ( 568 ). Supplementation with vitamin E is therefore often suggested, but data demonstrating its efficacy are lacking. Folic acid deficiency was reported in early studies and, more recently, from Thailand ( 607 , 608 ). Folate supplementation is advised for patients with a hyperactive bone marrow, such as those with thalassemia intermedia, and during pregnancy. Zinc has been found to be low in patients with thalassemia major, even though these patients have a normal zinc-binding capacity. Zinc-binding capacity is generally increased in nutritional zinc deficiency ( 609 , 610 ). Desferrioxamine and deferiprone could, at least in some cases, be responsible for this finding.

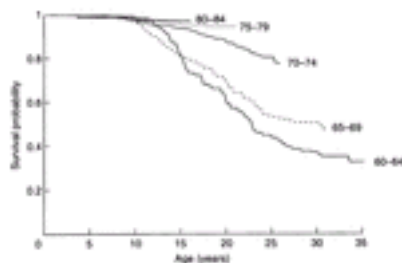
**Splenectomy** Splenectomy together with blood transfusions for many years represented the mainstay of therapy in thalassemia. It was often performed shortly after diagnosis because the spleen soon reached an enormous size and caused profound neutropenia and thrombocytopenia. The introduction of regular transfusions has significantly delayed the appearance of splenomegaly, so that splenectomy is now postponed until the second decade of life or later. Rational criteria for splenectomy were first proposed by Modell ( 611 ). She suggested that surgery should be performed when the transfusion requirement exceeds 50% above that of the average of the splenectomized population. In practice, this occurs when more than 200 to 250 ml/kg/year of pure red cells are required to maintain a pretransfusional Hb of 9.0 to 9.5 g/dl. Splenectomy reduces the transfusion requirement



to approximately 150 ml/kg/year, with some variation from patient to patient, and the effect has been demonstrated to be long lasting (612). The use of technetium-99 sulfur colloid or technetium-99 RBC uptake to assess the need for splenectomy has not proven to be of great practical use. Laparoscopic splenectomy, when available, avoids the disfiguring scar created by laparotomy, reduces the hospital stay, and does not have a higher financial cost (613). Risks associated with splenectomy include increased susceptibility to infections with encapsulated bacteria and an increase in thromboembolic events. In addition, increased frequency of pulmonary hypertension has recently been reported (311, 614, 615, 616, 617, 618, and 619). The role of splenectomy in worsening iron overload is controversial. The problem of postsplenectomy sepsis with encapsulated organisms has been recognized for many years (611, 620, 621 and 622). These infections are often abrupt in onset and rapidly fatal. Overwhelming postsplenectomy sepsis results from the removal of a major site of antibody production (in particular, the splenic marginal zone) and, possibly, the long-term decrease of T-cell subsets of functional relevance for primary immune responses (623, 624). The most frequently responsible bacteria are *Streptococcus pneumoniae*, *Haemophilus influenzae*, and *Neisseria meningitidis*, but cases have been reported in which *Escherichia coli* and *Staphylococcus aureus* were the causative agents. Malaria and babesiosis can be particularly severe after splenectomy (625). *Capnocytophaga canimorsus*, a gram-negative rod present as a commensal organism in the saliva of cats and dogs, has also caused severe infections in asplenic and splenectomized individuals (626). The risk of severe infections is greatest in younger children and in the first years after splenectomy, but it never disappears. It has been suggested that thalassemia patients are exposed to a higher risk than other nonimmunodeficient patients splenectomized for different causes (627). From a review of the literature, Singer found that 25% of patients undergoing splenectomy for thalassemia developed postsplenectomy sepsis (628). Later, however, in Thai patients, the frequency was found to be 4%, with a mortality of 89% (629). Guidelines for the prevention of postsplenectomy infections were published by the British Committee for Standards in Haematology in 1996 and include antibiotic prophylaxis, with penicillin, amoxicillin, or erythromycin, for the first 2 years after surgery and for children until 16 years of age (630). The Committee also recommended early antibiotic treatment for fever and malaise, as well as antipneumococcal immunization to be given 2 weeks before the procedure, or as soon as possible after it. A second dose should be repeated after 5 years. The recently developed 7-valent conjugated antipneumococcal vaccine should be administered in young children. Immunization against *H. influenzae* is also recommended (631). The antimeningococcal vaccine presently in use, giving only short-lasting protection, should be administered only during epidemics in small communities. At present, however, a protein-conjugate vaccine producing longer immunologic memory is available for the prevention of infection due to meningococcus type C (632). The efficacy of antipneumococcal immunization in conjunction with early antibiotic therapy has been demonstrated in children, but infection by serotypes not included in the vaccine or poorly immunogenic has been reported (633, 634). Compliance with penicillin prophylaxis can be a problem and requires continuous reinforcement (635, 636). The risk, already increased, of thrombotic events can be exacerbated by splenectomy (252, 384). Thrombocytosis, due at least in part to the presence in the circulation of platelets previously marginated in the spleen, develops in 75% of splenectomized patients; in 15%, it reaches 1 million/mm<sup>3</sup> or more, peaking between 8 days and 4 months after surgery (637, 638). The value of low-dose aspirin for patients with high platelet counts has not been demonstrated. A correlation between splenectomy and pulmonary hypertension has been suggested on the basis of a high prevalence of asplenia among patients with unexplained pulmonary hypertension and has been confirmed by case series reports (616, 618, 619). Recurrent lung thromboembolism could be responsible for the phenomenon. In an attempt to avoid these complications of splenectomy, several alternative approaches have been proposed with

mixed results. Partial splenectomy and partial dearterialization of the spleen have been reported to have an immediate beneficial effect but are of short duration ( 639 ). Partial embolization of the spleen has been successfully performed with long-lasting results, but it has sometimes led to complications ( 428 , 640 , 641 ). It has the advantage of not requiring general anesthesia and not leaving a scar. The theory that a residual portion of spleen protects the patient from infections and thrombotic events is tempting but still unproven. It has been hypothesized that the spleen could represent a reservoir for transfused iron and that splenectomy would, therefore, expose the patient to the risk of more massive siderosis of the liver ( 642 ). However, the iron content of the spleen, at splenectomy, is low, amounting to no more than one-fifth to one-tenth of the liver iron content ( 643 ). In addition, no difference has been observed in extent of liver fibrosis between splenectomized and nonsplenectomized patients ( 644 ).

**PROGNOSIS WITH CONVENTIONAL THERAPY** Thalassemia used to be a rapidly fatal disease, but prognosis is constantly improving. Between 1949 and 1957, only 9% of patients in Ferrara reached 6 years of age, and at the end of the 1970s, one-half of the Italian patients died before 12 years of age ( 350 ). Today, at least in developed countries, most patients reach the age of employment and marriage ( 560 ). A review of patients followed between 1960 and 1976 at Cornell Medical Center reported a median survival of 17.1 years for patients who were conventionally transfused and not chelated, whereas those who were hypertransfused and well chelated had a median survival of 31.0 years ( 645 ). A large cooperative study involving 1146 uniformly treated patients showed a probability of survival at age 20 of 89% for patients born in the years 1970 to 1974 and 96% for those born between 1975 and 1979. Eighty-two percent of the patients of the cohort 1970 to 1974 were alive at 25 years of age ( 471 ). The importance of good chelation in improving life expectancy has been repeatedly demonstrated ( Fig. 42.13 ) ( 470 , 645 ).

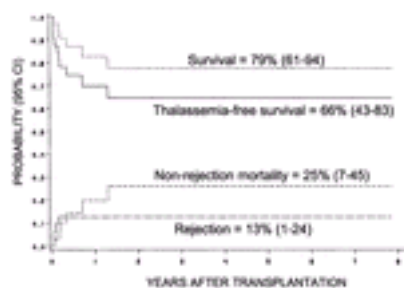


**Figure 42.13.** Survival probability as of January 1996 of thalassemic patients born in Italy between 1960 and 1984. (Prepared by C. Borgna-Pignatti. Reprinted from Weatherall DJ, Clegg JB. *The thalassemia syndromes*, 4th ed. London: Blackwell Science Ltd, 2002:639, with permission.)

Complications are still frequent and, together with the burden of therapy, compromise quality of life. Studies of the effects of the illness on psychosocial adjustment report contradictory results. According to a survey from Greece, 42% of the patients examined had psychiatric problems, whereas other authors demonstrate that thalassemic adults have normal psychologic development and better social adjustment and self-esteem than their normal peers ( 646 , 647 and 648 ). Cultural and economic variables probably influence the acceptance of the chronic problems of thalassemia ( 649 ). Psychologic support seems appropriate as an adjunct in treating thalassemia, a chronic disease with a considerable role for self-management. However, no randomized controlled trials assessing the effectiveness of specific psychologic interventions have so far been performed ( 650 ).

**BONE MARROW TRANSPLANTATION** BMT is an accepted approach to the treatment of thalassemia major and, at this time, the only curative one. The first transplant for thalassemia was performed in Seattle in 1981 ( 651 ). The patient is now a completely

normal young man. Nearly 2000 patients have since been transplanted worldwide. The majority had thalassemia major; a few had thalassemia intermedia, HbE/ $\beta$ -thalassemia, or HbH disease. Most donors have been chosen among HLA-identical siblings. The conditioning regimen has, in general, included busulfan, 14 mg/kg, and cyclophosphamide, 200 mg/kg. Prophylaxis against graft-versus-host disease (GVHD) has more often been performed with cyclosporine A alone or in combination with methotrexate. High-risk patients were reported to benefit from a conditioning regimen containing a lower dose of cyclophosphamide, with or without the addition of antilymphocyte globulin (652). The largest experience has been reported by Lucarelli and his group, who suggest that patients be stratified by risk group based on the presence or absence of portal fibrosis, hepatomegaly, and regular chelation (653, 654, 655 and 656). The lowest risk group is comprised of patients who have been regularly chelated and who have not had liver fibrosis or hepatomegaly. Patients poorly chelated, with hepatomegaly and portal fibrosis, are believed to have the highest risk, whereas the intermediate risk group includes patients with one or two risk factors. According to this classification, age in itself does not influence prognosis. The reported event-free survival probability is 90% in class 1 patients, 81% in class 2, and only 54% in class 3. Similar data (overall survival, 88%; disease-free survival, 80%) were reported in a review of 80 patients transplanted in Europe, Asia, and South America (657). From the United States, the reported probability of survival was 80%, with disease-free survival of 57% and rejection in 24% of the patients (658). Several reports of transplants for thalassemia are being published from countries where the disease is common and conventional therapy is not always available (659, 660 and 661). The results reported are as good as those from Western countries, and the procedure has proven to be cost effective. When partially mismatched siblings or parents, phenotypically identical parents, and other relatives were used as marrow donors, sustained engraftment was obtained in only 45% of patients, with a probability of graft failure or rejection of 55% (662). For patients who do not have a genotypically identical donor, selection of matched unrelated donors, using modern molecular typing techniques, has been shown to improve prognosis (Fig. 42.14) (663). Patients of all ages have been grafted, including several adults (652, 664). The Pesaro group's experience with 86 patients from 17 to 32 years of age includes probabilities of survival, event-free survival, and rejection of 65%, 63%, and 3%, respectively (652). Sixteen percent developed chronic GVHD. Rejection can appear in different patterns (665). The patients can have no take, develop aplasia, or, more often, have autologous reconstitution of the thalassemic marrow after engraftment. Approximately two-thirds of rejections were observed within the first 100 days after transplant. Second transplants have been performed in those who have rejected their graft. Approximately one-half of the patients survive the second transplant, and one-third reach sustained engraftment. Transient engraftment and autologous reconstitution have been reported in a substantial number of patients from Thailand (666). In general, these patients had multiple risk factors, including inadequate transfusion therapy, little or no chelation, hepatosplenomegaly, very active erythropoiesis, and iron-induced organ damage. The most common transplant-related cause of death is infection, especially in patients who remain aplastic after graft rejection. A few splenectomized patients have died after transplant of overwhelming sepsis.



**Figure 42.14.** Survival of patients from all risk classes treated with bone marrow

transplantation from an unrelated identical donor. (Reprinted from La Nasa G, Giardini C, Argioli F, et al. Unrelated donor bone marrow transplantation for thalassemia: the effect of extended haplotypes. *Blood* 2002;99:4354. The American Society of Hematology, with permission.)

Persistent mixed chimerism has been observed in 11% of patients ( [667](#), [668](#) ). Despite the presence of large numbers of residual host cells, these patients no longer required RBC transfusions, producing levels of HbA ranging from 8.3 to 14.7 g/dl. The mechanisms underlying this apparent state of immunologic tolerance or education are not clear. However, these observations may be useful in defining optimal strategies for gene therapy, *in utero* hematopoietic stem cell transplantation, and adoption of less toxic conditioning regimens. The feasibility of “minitransplants” is being explored.

#### ***Side Effects of Bone Marrow Transplantation***

***Chronic Graft–Versus–Host Disease*** Between 6% and 24% of the patients surviving with a functioning graft for at least 150 days developed moderate or severe chronic GVHD ( [658](#), [669](#) ). This complication, a multiorgan disorder with features of an autoimmune disorder, is of particular concern for a procedure that is offered for quality of life considerations rather than as therapy for a disorder with impending death.

***Growth, Development, and Fertility*** Short stature is a frequent complication of transplantation. There appears to be a good correlation between age at the time of transplant and final adult height. In one study, patients who were transplanted before 7 years of age reached their genetic target for height, whereas those who were older did not ( [670](#) ). This is in contrast with most studies of children transplanted for hematologic malignancies that have demonstrated that the younger the patient was at the time of BMT, the greater was the loss in height. Probably, the deleterious effects on growth of iron overload and desferrioxamine toxicity are greater than the effects of pretransplant conditioning ( [671](#) ). Clinical and hormonal evidence of gonadal dysfunction is frequent in patients transplanted during childhood or in the prepubertal period, and normal puberty occurs in only 40% of them. There is no correlation between pubertal maturation and age at BMT or serum ferritin levels ( [672](#) ). Sterility from pretransplant conditioning is also a potential complication. Nevertheless, successful conception and the delivery of healthy infants have been observed in several individuals after BMT in childhood ( [673](#) ) (Angelucci E, Borgna–Pignatti C, *personal communication*, November 6, 2002).

***Malignancies*** A few solid tumors and several cases of early and late non–Hodgkin lymphoma have been observed in patients transplanted for thalassemia ( [674](#), [675](#), [676](#) and [677](#) ).

***Iron Depletion*** After BMT, ferritin increases, reaching a peak around the third month after the procedure, probably as a consequence of bone marrow aplasia and a shift of iron to the storage compartment. Thereafter, ferritin usually returns to pretransplant levels. In the absence of chelation therapy, liver iron concentration remains high, and hepatic fibrosis, often present before transplantation, can progress to cirrhosis. Therefore, phlebotomy is indicated for patients with high ferritin levels, high liver iron concentration, or both. In one study, bimonthly venesections starting at least 18 months after grafting succeeded in decreasing the median ferritin level from 2587 to 417 µg/L and median liver iron concentration from 20.8 to 4.2 mg/g of dry tissue. Also, serum transaminases decreased significantly ( [678](#) ). Monthly erythrocytaphereses are equally effective. This technique has the advantage of saving plasma and mononucleated cells, but it is more costly and time consuming ( [679](#) ). Cirrhosis of the liver has been shown to be reversible after iron depletion by phlebotomy ( [491](#) ). Desferrioxamine can be used to reduce the iron burden in patients who are anemic after transplantation or who have difficult venous access ( [680](#) ). Chelation should not be started until well after transplantation, because desferrioxamine has been reported to interfere with grafting.

***Cord Blood Transplantation*** Related cord blood transplantation for hemoglobinopathies appears to have a probability of success comparable to that offered by BMT and, in addition to avoiding general anesthesia for the donor, is associated with lower risks of

transplant-related mortality, chronic GVHD, and transmission of viral infections. The main disadvantage is represented by the longer time necessary to reach safe platelet and neutrophil counts. The first successful transplantation of cord blood stem cells in a patient with thalassemia was reported in 1995 from Thailand (681). Subsequently, numerous cord blood transplants have been performed (666, 682). In some cases, combined cord blood and bone marrow cells have been infused (683). A recent review of 44 cord blood transplants performed in ten countries between 1994 and 2001, in patients having a median age of 5 years (range, 1 to 20 years), reported a survival rate of 100% and an event-free survival of 79%. Forty-one donors were HLA-identical siblings, whereas three were mismatched for one antigen. The risk of chronic GVHD was 6% (684).

***In Utero Transplantation*** Early in gestation, the fetus is immunoincompetent and, therefore, unable to reject allogeneic cells. Several attempts at *in utero* stem cell transplantation have been made (685). None of those performed for thalassemia has, so far, been successful. In conclusion, BMT offers a chance for cure when an HLA-compatible donor is available. The availability of a donor is related to the size of the sibship, the frequency of certain haplotypes, and the degree of inbreeding in a particular population. In Italy, approximately 30% of patients have an HLA-identical donor (686). It is now clear that patients in good general condition and who are well chelated have the highest disease-free survival after BMT (687). However, these patients have a good prognosis also with conventional therapy. For older patients in whom hemosiderosis has already produced organ damage, both treatment modalities carry a high risk of death. The high initial cost of bone marrow or cord blood transplantation is easily compensated by the high prices of conventional treatment. In countries where the blood supply is not safe and chelation is not readily available, stem cell transplantation may represent the only opportunity for survival.

**HEMOGLOBIN F REACTIVATION** For patients with homozygous  $\beta$ -thalassemia, an increased  $\gamma$ -globin chain production would result in a more balanced  $\alpha$ - to non- $\alpha$ -globin ratio and an amelioration of disease severity.  $\gamma$ -Chains neutralize the harmful excess of  $\alpha$ -chains and allow a better survival of erythroid precursors in the bone marrow and of the red cells in the peripheral blood. Effective procedures to enhance red cell production could reduce or even eliminate the need for transfusions and would represent a major advance in the treatment of homozygous  $\beta$ -thalassemia. To this aim, trials with chemotherapeutic agents known to increase  $\gamma$ -chain production *in vitro* and in animals have been conducted in thalassemia patients. 5-Azacytidine is a cytidine analog that, when incorporated into newly synthesized DNA, leads to extensive demethylation and to reactivation of  $\gamma$ -globin synthesis (688). 5-Azacytidine was the first drug shown to enhance  $\gamma$ -globin synthesis in patients with  $\beta$ -thalassemia (689). Small clinical trials have been conducted with 5-azacytidine with some apparent clinical benefit, but its use is limited because of concern about its carcinogenic risk (690, 691). An analog of 5-azacytidine, 5-aza-2'-deoxycytidine, which may have fewer adverse effects than the parent drug, is being evaluated in patients with sickle cell anemia (692). At present, these drugs are considered investigational. The effect of 5-azacytidine on HbF synthesis may be mediated also by its cytotoxic properties. Like other antimetabolites, 5-azacytidine preferentially kills dividing cells, permitting the emergence of primitive erythroid progenitors more highly committed to HbF synthesis (693). Therefore, other cell cycle-specific agents, including hydroxyurea (HU), cytarabine, and vinblastine, have been used with the aim of increasing HbF production (694, 695 and 696). The largest experience has been reported with HU, which has been given with many different regimens and doses, alone or in combination with other drugs including erythropoietin. Only in some patients with thalassemia intermedia has there been a modest effect on hemoglobin concentration and HbF (697, 698 and 699). HU has been used effectively in thalassemia intermedia also to reduce the size of extramedullary erythropoietic masses when these compress vital organs or tissues (700, 701 and 702). In conclusion, the efficacy of HU to increase the hemoglobin level in thalassemia is still controversial, and more controlled and expanded



trials are warranted. Butyrate and its analogs have been used to induce HbF production in hemoglobinopathies with variable responses (703, 704). Therefore, their use remains experimental and cannot be recommended outside of clinical trials. Several studies have been performed with recombinant human erythropoietin, mainly on patients with  $\beta$ -thalassemia intermedia, but the results have been inconsistent (705, 706 and 707). Combinations of HbF inducers, erythropoietin, and other cytokines have been proposed to increase HbF production in an additive or synergistic manner, but these combinations also must be considered investigational (708).

**GENE THERAPY** The  $\beta$ -thalassemias were among the first diseases to be considered for gene therapy. In principle, the tissue to be corrected (i.e., the bone marrow) can be removed, treated, and reinfused into the patient. Moreover, the gene and the molecular lesions responsible for the disease are well known. Therefore, genetically based strategies, aimed at inserting a normal copy of the human  $\beta$ -globin gene along with key regulatory sequences into autologous hematopoietic stem cells, represent a feasible alternative to BMT for curative intent. However, this approach has been impeded over the last decade by challenging obstacles, including the isolation and the biology of the optimal target cell (i.e., the pluripotent self-renewing hematopoietic stem cell), a safe and efficient method of transduction, and a stable and effective transgene expression (709). Encouraging reports of the successful transfer of a human  $\beta$ -globin gene into the hematopoietic stem cells of mice, using an oncoretroviral vector, appeared in 1988 (710, 711). However, the level of expression was too low (<1% of mouse  $\beta$ -globin) for a potential therapeutic effect. Recent studies using murine models support the clinical impression that sustained and regulated transgene expression in the range of 10 to 20% of the level of the endogenous globin is required for a therapeutic benefit (712, 713). The discovery that the nuclease HSs of the  $\beta$ -LCR possess powerful erythroid-specific enhancer activity led to the hope that inclusion in the transgene of relatively small (<1 kb) "core" HS fragments might significantly increase its level of expression. Regrettably, inclusion of HS core elements in retroviral vectors caused genetic instability of the vector genome, with frequent rearrangements and low titers of viral producer cell clones (714, 715). Other major barriers to efficient gene transfer into stem cells are related to low levels of viral receptors on the stem cells of large animal species and the low frequency of cycling stem cells in the bone marrow. To overcome these problems, several strategies have been attempted, such as the use of cytokine-mobilized peripheral blood cells as targets for gene transfer, of different envelope proteins ("pseudotyping") for vector particles, and of alternative vector systems (adeno-associated virus, lentiviral vectors) (716, 717, 718, 719, 720 and 721). Recent advances in vector construction have overcome this and other problems that limit both gene transfer efficiency and regulation of transgene expression (722). Using a lentiviral vector termed TNS9, May et al. (2000) recently succeeded in stably transmitting a vector harboring a large  $\beta$ -globin gene fragment, including the promoter, from position -618 and the intragenic and 3' enhancers, combined with specific segments spanning the HS2, HS3, and HS4 regions of the human  $\beta$ -globin LCR (723, 724, 725 and 726). The human  $\beta$ -globin expression in transduced hematopoietic stem cells of  $\beta$ -thalassemic heterozygous mice reached high and sustained levels of expression (17 to 24% of total hemoglobin) (723). Long-term (up to 40 weeks) synthesis of chimeric hemoglobin (murine  $\alpha_2$ :human  $\beta_2^A$ ) has been achieved in mice with  $\beta$ -thalassemia intermedia after engraftment with bone marrow cells transduced with the same lentiviral vector encoding the human  $\beta$ -globin gene (727). Ineffective and extramedullary erythropoiesis regressed, and hepatic iron accumulation was markedly decreased. Similar results have been obtained in mouse sickle cell disease models (728). Experiments in large animals are needed for a full understanding of the real value of these new therapies. Moreover, the promising results with recombinant lentiviruses might have therapeutic applications once safety concerns are fully addressed.

## Thalassemia Minor

**CLINICAL FEATURES** The classic heterozygous carrier of  $\beta$ -thalassemia is usually asymptomatic. The diagnosis is made through evaluation of a positive family history or during population screening. Several series have been published on the clinical and hematologic features of people with thalassemia minor (729, 730, 731 and 732). Anemia is mild or absent. In pregnancy, however, anemia may be more severe than in normal women (733, 734). Folate supplementation at the dose of 5 mg daily is recommended (735, 736). Iron absorption is increased, and frank iron overload has been reported. Inappropriate administration of iron has been proposed as a possible cause in some of the patients (737). In addition, it has been observed that the  $\beta$ -thalassemia trait aggravates hemochromatosis in individuals homozygous for the mutations C282Y and H63D, favoring higher rates of iron accumulation and the possible development of iron-related complications (738). On the other hand, the H63D mutation has been reported to increase iron overload in  $\beta$ -thalassemia carriers (739). Iron deficiency anemia occurs less frequently in children heterozygous for  $\beta$ -thalassemia as compared to normal controls, but its clinical expression, at similar levels of iron depletion, is more severe. The hemoglobin nadir at the end of the first trimester of life is also deeper and more prolonged in carriers of the trait (740). Serum bilirubin levels present considerable variation. Homozygosity for the mutation typical of Gilbert syndrome is one of the factors determining hyperbilirubinemia in these individuals (741). Increased risk of gallstones has also been observed in women with  $\beta$ -thalassemia trait as compared to controls (742). Data from Sicily suggest that heterozygotes for  $\beta$ -thalassemia have a longer life expectancy (743). Men have a lower risk of myocardial infarction than the general population (744). A partially improved cardiovascular risk profile has been observed with respect to a low packed cell volume and low low-density lipoprotein cholesterol and apolipoprotein B in carriers of  $\beta$ -thalassemia (745). The low-density lipoprotein-lowering effect of the thalassemia trait is evident even in patients with familial hypercholesterolemia (746).

**LABORATORY FEATURES** The mean hemoglobin concentration in affected Italian men and women is 12.7 and 10.9 g/dl, respectively; in Greek men, 13.9 g/dl; and in Oriental men and women, 12.1 and 10.8 g/dl, respectively (731, 732, 736, 747). A slightly lower hemoglobin concentration was noted in Jamaicans with heterozygous  $\beta^0$ -thalassemia (11.3 g/dl) compared with those having heterozygous  $\beta^+$ -thalassemia (12.5 g/dl) (748). Hemoglobin is less markedly decreased in Africans than in Mediterraneans (748, 749). The red cell count is elevated, and the MCV and MCH values are reduced. The mean cell hemoglobin concentration is normal or only slightly decreased. In one series of 244 cases of  $\beta^0$ -thalassemia carriers, the MCV was  $67 \pm 4.6$  fl (mean,  $\pm 1$  SD), the MCH was  $22.4 \pm 1.6$  pg, and the mean cell hemoglobin concentration was  $32.9 \pm 0.8$  g/dl RBCs (732). The degree of reduction in the MCV is directly related to the degree of reduction in  $\beta$ -globin production (750). The MCVs produced by  $\beta^0$  mutations are lower than those produced by  $\beta^+$ -mutations (751). Heterozygotes for mild  $\beta$ -thalassemia mutations, as a group, have higher MCV and MCH as compared to the severe  $\beta^0$  and  $\beta^+$  alleles. Microcytosis and hypochromia, associated with variation in size and shape of the erythrocytes, are commonly observed in the peripheral blood smear. Basophilic stippling is frequently found in heterozygous individuals from the Mediterranean, but not in Africans or Orientals (730, 752). Reticulocytes are generally increased to twice the normal numbers and have been found to correlate with the hemoglobin level (730, 731). In children, the MCV is lower than in the adults and normally increases with age; in thalassemia carriers,



the correlation with age is less evident (753). The evolution of hematologic parameters in children at various ages is summarized in Table 42.4 (754). Free erythrocyte protoporphyrin is normal or slightly increased. Osmotic fragility is decreased. Red cell survival, measured by  $^{51}\text{Cr}$ , shows mild ineffective erythropoiesis rather than peripheral hemolysis (755). HbA<sub>2</sub> is elevated in heterozygous carriers of  $\beta$ -thalassemia in all the ethnic groups studied. The values range from 3.5 to 7.0% with a mean of 5% (36). This increase appears to be determined by an increased output of  $\delta$ -chains from both loci *in cis* and *in trans* to the thalassemia gene. HbF is increased in one-half of the patients, but the values observed are in general in the range of 1 to 3%. The distribution within the red cells is usually heterogeneous (756, 757). A minority of carriers show unusually high levels of HbA<sub>2</sub> (>6.5%) associated with a variable increase of HbF. The molecular basis for these forms is large deletions of the  $\beta$ -globin gene that remove its 5' promoter region. Globin chain synthesis analysis in heterozygous  $\beta$ -thalassemia shows variable imbalance correlated to the severity of  $\beta$ -globin chain defect (36). The physiologic decline of HbF in the first weeks of life is slower in  $\beta$ -thalassemia heterozygotes (Table 42.4).

**TABLE 42.4. Main Hematologic Parameters of  $\beta$ -Thalassemia Carriers According to Age**

| Age          | Hb (g/dl)  | Mean Cell Volume (fl) | HbA <sub>2</sub> (%) | HbF (%)     |
|--------------|------------|-----------------------|----------------------|-------------|
| At birth     | 18.3 ± 2.3 | 99 ± 8                | 0.5 ± 0.2            | 73.8 ± 10.1 |
| 4 mo         | 10.1 ± 1.1 | 70 ± 6                | 3.2 ± 0.7            | 27.0 ± 10.5 |
| 7 mo         | 10.5 ± 0.8 | 59 ± 4                | 4.8 ± 0.7            | 8.2 ± 4.0   |
| 9–10 mo      | 11.1 ± 0.9 | 59 ± 2                | 5.1 ± 0.5            | 4.4 ± 2.1   |
| 2 yr         | 11.2 ± 0.9 | 58 ± 2                | 4.8 ± 0.4            | 4.1 ± 2.1   |
| 2–6 yr       | 10.7 ± 1.0 | 61 ± 4                | 5.3 ± 0.6            | nd          |
| 6–12 yr      | 11.0 ± 1.0 | 62 ± 5                | 5.2 ± 0.6            | nd          |
| Adult male   | 13.3 ± 0.8 | 67 ± 6                | 5.0 ± 0.5            | 1.0 ± 0.5   |
| Adult female | 11.8 ± 0.9 | 66 ± 4                | 5.0 ± 0.5            | 0.9 ± 0.6   |

Hb, hemoglobin; nd, not determined.

**ATYPICAL CARRIERS** The typical phenotype of  $\beta$ -thalassemia trait, essentially characterized by reduced MCV and MCH and increased HbA<sub>2</sub>, may be modified by several genetic and acquired factors causing problems in carrier identification (Table 42.5). The coinheritance of heterozygous  $\beta$ -thalassemia with homozygous  $\alpha^+$ -thalassemia ( $-a/-a$ ) or heterozygous  $\alpha^0$ -thalassemia ( $-/aa$ ) has a substantial effect on MCV and MCH, which may fall within normal ranges (Fig. 42.15) (758). However, the HbA<sub>2</sub> in these double heterozygotes remains in the carrier range, thus allowing their identification. Atypical carriers with reduced MCV and MCH and normal or borderline HbA<sub>2</sub> include double heterozygotes for  $\delta$ - and  $\beta$ -thalassemia and carriers of some mild mutation, such as the -87 C?G, the -29 A?G, and IVS-1-6 T?C (Table 42.6). The differential diagnosis includes iron deficiency and  $\alpha$ -thalassemia trait. Specific tests and, sometimes, family studies allow correct identification (759, 760).



**Figure 42.15.** Effect of coinheritance of different  $\alpha$ -thalassemia alleles in  $\beta$ -thalassemia carriers. Hb, hemoglobin; MCV, mean cell volume.

**TABLE 42.5. Genotype and Phenotype of Atypical  $\beta$ -Thalassemia Carriers**

| Phenotype   | Genotype  |
|---|---|
| Normal MCV and MCH  | Coinheritance of $\alpha$ -thalassemia  |
| Borderline/normal HbA <sub>2</sub>                        | Some mild $\beta$ -thalassemia alleles  |
|   | Coinheritance of $\delta$ -thalassemia  |
|   | e $\beta$ -Thalassemia  |
|   | Corfu $\delta\beta$ -thalassemia  |
| Normal MCV, MCH, and HbA <sub>2</sub><br>(silent carrier) | Very mild/silent alleles  |
|   | Triplicated $\alpha$ -globin gene   |
| Significant clinical phenotype                            | Coinheritance of $\alpha$ -globin gene defects: triple $\alpha$ locus<br>and HbH disease genotype (-/- $\alpha$ ) |
|   | Hyperunstable globins   |

Hb, hemoglobin; MCH, mean cell hemoglobin; MCV, mean cell volume.

**TABLE 42.6. Most Common Silent and Mild  $\beta$ -Thalassemia Mutations**

|                             |
|-----------------------------|
| Silent                      |
| -101 C?T                    |
| -92 C?T                     |
| IVS-2-844 C?G               |
| 5'-UTR mutants              |
| 3'-UTR mutants              |
| Mild                        |
| Transcriptional mutants     |
| Proximal CACCC box          |
| -88 C?T                     |
| -87 C?G                     |
| TATA box                    |
| -30 T?A                     |
| -29 A?G                     |
| Alternative splicing site   |
| cd 19 A?C                   |
| cd 24 T?A                   |
| cd 27 G?T                   |
| Consensus splicing sequence |
| IVS-1-6 T?C                 |
| Poly A site                 |
| AACCCC                      |
| AATGAA                      |

cd, codon; UTR, untranslated region.

A third group of atypical  $\beta$ -thalassemia carriers is represented by heterozygotes for very mild or silent  $\beta$ -thalassemia mutations ( [Table 42.6](#)). As a result of minimal deficiency of  $\beta$ -globin production, these carriers have normal MCV and MCH and normal or borderline

HbA<sub>2</sub> ( 759, 761 ). The  $\alpha$ - to  $\beta$ -globin chain synthesis ratio is normal or slightly higher than 1, confirming that these mutations cause only a very mild reduction in the expression of  $\beta$ -globin gene. In this group also, the carriers of the triple  $\alpha$ -globin gene arrangement (aaa/aa), which for the excess of  $\alpha$ -globin chain produced may be considered as a very mild  $\beta$ -thalassemia allele, should be included ( 96, 761 ). Identification of these silent carriers is usually retrospective in parents of patients with mild thalassemia intermedia. An extreme, although rare, instance of complex thalassemia gene combination that may lead to an almost silent phenotype is the coinheritance of  $\alpha$ -, d-, and  $\beta$ -thalassemia ( 762 ). Acquired factors able to modify the typical phenotype of  $\beta$ -thalassemia trait are iron deficiency and folate deficiency ( 763 ). When severe, iron deficiency may decrease the high HbA<sub>2</sub> levels typical of heterozygous  $\beta$ -thalassemia, and folate deficiency may increase the MCV to normal values. When these deficiencies are present, other tests, such as DNA analysis to identify the  $\beta$ -globin gene mutation or retesting after correction of the anemia, may be necessary for diagnosis.

### **d $\beta$ -THALASSEMIA AND HEREDITARY PERSISTENCE OF FETAL HEMOGLOBIN**

**CARRIERS** d $\beta$ <sup>0</sup>-Thalassemia carriers have RBC changes milder than those observed in  $\beta$ -thalassemia trait. Overall, MCV and MCH are approximately 70 fl and 24 pg, respectively. HbA<sub>2</sub> is normal or reduced, and HbF is increased (5 to 20%) and heterogeneously distributed among red cells. The degree of globin chain imbalance is mild ( $\alpha$ - to non- $\alpha$  ratio approximately 1.5). Heterozygotes for deletional HPFH are characterized mostly by normal MCV, MCH, and HbA<sub>2</sub>. Only in some cases is there a mild reduction of red cell indices and HbA<sub>2</sub>. HbF ranges from 15 to 30% with pancellular distribution.  $\alpha$ -/Non- $\alpha$ -globin synthesis is normal or mildly unbalanced ( 214 ). Nondeletional HPFH heterozygotes have red cell indices, HbA<sub>2</sub>, and  $\alpha$ - to non- $\alpha$  ratios similar to those of deletional HPFH carriers, whereas mean HbF levels vary from 2.5 to 27.0% ( 214 ).

### **CARRIER DETECTION**

***$\beta$ -Thalassemia and d $\beta$ -Thalassemia*** Carrier detection methods should be able to identify typical and atypical heterozygous  $\beta$ -thalassemia as well as d $\beta$ -thalassemia and the hemoglobin variants, such as HbS and HbE, which interact with  $\beta$ -thalassemia to produce clinically significant syndromes. As compared to most genetic diseases, carrier detection in hemoglobinopathies is relatively easy because it may be achieved through hematologic examination rather than DNA analysis. However, DNA analysis is needed for prenatal diagnosis. Basic hematology methods for carrier detection consist of RBC indices determination and hemoglobin pattern analysis. More specialized tests and eventually DNA analysis are required in some cases for definitive diagnosis. High-pressure liquid chromatography (HPLC) provides effective separation of hemoglobins, gives an accurate quantitation of HbA<sub>2</sub> and HbF, and detects the large majority of Hb variants ( 764, 765 ). Alternatively, cellulose acetate electrophoresis or isoelectric focusing can be used for detecting Hb variants, but quantitation of HbA<sub>2</sub> and HbF should be performed by microchromatography and alkali denaturation, respectively. Elution of HbA<sub>2</sub> and HbF bands after electrophoresis is an accurate, but time-consuming, method. Appropriate tests for iron status determination and globin chain synthesis analysis are supplementary hematologic methods useful in carrier detection procedures. Family studies may be helpful in some atypical cases, particularly in genetic compounds for two different alleles. Carrier detection procedure should be designed so as not to miss any carrier or couple at risk. Based on the frequency and heterogeneity of thalassemia types present in a population, appropriate screening programs are set out. The most used flow chart for Mediterranean populations is provided in [Figure 42.16](#) ( 759 ). In addition to MCV and MCH, the first set of tests includes HbA<sub>2</sub> quantitation to avoid missing double heterozygotes for  $\alpha$ - and  $\beta$ -thalassemia with normal MCV and MCH. Globin chain synthesis analysis is performed to differentiate  $\alpha$ -thalassemia trait from d- +  $\beta$ -thalassemia or mild  $\beta$ -thalassemia alleles. With this flow chart, only the truly silent  $\beta$ -thalassemia carrier and the triple  $\alpha$ -globin gene arrangement may be missed. In populations with low frequency of thalassemia, the



carrier's ethnic origin. It is advisable for any diagnostic laboratory to have at least two alternative methods for detecting mutations.

**TABLE 42.7.  $\beta$ -Thalassemia Mutations Occurring in Specific Populations with High Frequency**

| Population        | Alleles   |
|-------------------|---|
| African-Americans | -88 C?T<br>-29 A?G  |
| Italians          | IVS-1-1 G?A<br>IVS-1-6 T?C<br>IVS-1-110 G?A<br>cd 39 C?T  |
| Greek             | IVS-2-745 C?G<br>IVS-1-1 G?A<br>IVS-1-6 T?C<br>IVS-1-110 G?A<br>cd 39 C?T   |
| Indian            | IVS-2-745 C?G<br>cd 8/9 +G<br>IVS-1-1 G?T<br>IVS-1-5 G?C<br>cd 41/42-TTCT   |
| Thai              | 619-base pair deletion<br>-28 A?G<br>cd 17 A?T<br>cd 19 A?G<br>IVS-1-1 G?T<br>IVS-1-5 G?C<br>cd 41/42-TTCT<br>IVS-2-645 C?T |
| Chinese           | -28 A?G<br>cd 17 A?T<br>cd 41/42-TTCT<br>IVS-2-645 C?T  |
| Middle East       | cd 8 -AA<br>cd 8/9 +G<br>IVS-1-5 G?C<br>cd 39 C?T<br>cd 44 -C<br>IVS-2-1 G?A  |
| Israeli           | -28 A?G<br>IVS-1-110 G?A<br>cd 39 C?T<br>cd 44 -C<br>IVS-2-1 G?A  |
| North African     | cd 6 -A<br>IVS-1-1 G?A<br>IVS-1-110 G?A<br>cd 39 C?T  |

cd, codon.

---

***a*-Thalassemia** *a*-Thalassemia carriers are more difficult to identify than  $\beta$ - or  $\delta\beta$ -thalassemia carriers because they do not have typical changes in HbA<sub>2</sub> or HbF levels. MCV and MCH are always reduced in carriers of  $-a/-a$  and  $-/aa$  genotypes, whereas  $-a/aa$  carriers often have a normal or, sometimes, a mild reduction of MCV and MCH values. The hemoglobin pattern in adult *a*-thalassemia carriers is normal, although as a group, they have slightly lower levels of HbA<sub>2</sub>. In the newborn, the electrophoretic detection of Hb Bart ( $\gamma_4$ ), a fast-moving band, is useful for the diagnosis of

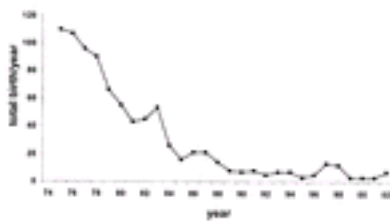
*a*-thalassemia trait.  $a^+$ -Thalassemia carriers usually show up to 3% of Hb Bart, and  $a^0$ -thalassemia carriers ( $-/aa$ ) and  $a^+$ -thalassemia homozygotes ( $-a/-a$ ) may have 3 to 8%. However, in some carriers, Hb Bart may be not detected ( 294, 295). A simple test for detecting *a*-thalassemia carriers is the incubation of the peripheral blood with brilliant cresyl blue; the smear examination may show rare RBCs with HbH inclusion bodies, although their absence does not exclude *a*-thalassemia carrier status ( 295). Globin chain synthesis analysis is used to identify *a*-thalassemia carriers that show an  $a$  to  $\beta$  ratio lower than 0.9. This test is helpful in the presence of microcytosis with normal HbA<sub>2</sub> to differentiate the *a*-thalassemia trait from the  $\delta$ -thalassemia- $\beta$ -thalassemia interaction. Definitive diagnosis of *a*-thalassemia carriers can also be achieved with DNA analysis of the *a*-globin genes. The methods used depend on the type of mutations expected in each population and are divided into those that detect deletions (i.e., gap-PCR and, sometimes, Southern blotting) and those that detect point mutations [i.e., nondeletion *a*-thalassemia (direct detection by restriction enzyme analysis, allele-specific oligonucleotide hybridization, denaturing gradient gel electrophoresis, and DNA sequencing)] ( 768, 769, 770, 771 and 772). The  $a^0$ -thalassemia phenotype can be detected with an anti- $\gamma$ -globin monoclonal antibody, because small amounts of embryonic  $\gamma$ -globin are produced in adult life by chromosomes lacking both *a*-globin genes ( 773). Detection of  $a^0$ -thalassemia carriers is important for prevention of Hb Bart hydrops fetalis syndrome, for which prenatal diagnosis is always indicated. HbH disease is not considered to be among those hemoglobinopathies targeted for prevention.

***Hemoglobin E*** The diagnosis of heterozygous HbE is based on the hemoglobin pattern analysis by electrophoresis or HPLC separation. At alkaline pH (8.4), HbE moves in the same position as HbA<sub>2</sub> and can be distinguished by its high concentration, usually 25 to 30%. HbE has the same elution time as HbA<sub>2</sub> on HPLC ( 774). Lower proportions of HbE in carriers indicate the presence of coinheritance *a*-thalassemia or of iron deficiency anemia. The blue dye dichlorophenolindophenol can be used as a screening test for HbE, which dissociates and precipitates at the bottom of the tube on incubation at 37° C ( 775).

**PRENATAL DIAGNOSIS** The availability of prenatal diagnosis added a new option to couples at risk for a major hemoglobinopathy, leading to a significant change in the effectiveness of screening and counseling in hemoglobinopathy prevention ( 776). Prenatal diagnosis of both *a*- and  $\beta$ -thalassemia was carried out for the first time in the 1970s using globin chain synthesis analysis in fetal blood, obtained by fetoscopy or placental aspiration around the nineteenth week of gestation ( 777). The advent of DNA analysis and the introduction of chorionic villi sampling resulted in a notable improvement in prenatal diagnosis because it could be performed within the first trimester of pregnancy, generally at 10 to 12 weeks of gestation ( 778, 779). Fetal DNA can be obtained also from amniocytes at 15 to 17 weeks of pregnancy. Chorionic villi sampling is carried out transcervically or transabdominally. The reported risk of fetal loss with this procedure ranges from 0.5 to 4.5% ( 780, 781 and 782). However, in experienced hands, the fetal loss rate appears to be 0.5 to 1.0%, similar to natural wastage for pregnancies of this duration (



782, 783). After sampling, fetal DNA analysis is performed by the PCR-based methods mentioned for carrier detection procedures. In general, the mutation to be detected in the fetus is first identified in the parents. The results of DNA analysis are very accurate, but misdiagnosis may occur for several reasons (failure to amplify the target DNA fragment, mispaternity, maternal contamination, and sample exchange). However, the risk of misdiagnosis can be significantly reduced using a number of precautionary measures, such as fetal DNA analysis for selected polymorphic markers (759, 784, 785). Fetal cells, known to be present in the maternal circulation, represent an attractive, noninvasive approach to prenatal diagnosis (786). Fetal cells, immunologically isolated for their low purity, can only be used for the prenatal diagnosis of  $\beta$ -thalassemia in women whose partners carry a different mutation (787). Recently, this problem has been overcome by the development of a technique able to isolate single fetal erythroblasts from maternal blood by microscopic micromanipulation, making possible the analysis of both fetal genes in a single cell (788, 789). However, this procedure is associated with several technical and biologic problems, and it is not widely applicable. The discovery of free fetal DNA in maternal plasma provided the basis for developing another method for noninvasive prenatal diagnosis (790). However, because free maternal DNA is also present, the application to prenatal diagnosis of thalassemias would be possible only to exclude paternally derived pathologic alleles different from the mother's mutation. The advent of DNA amplification has made it possible to define the genotype of a single cell biopsied from cleaving embryos (preimplantation diagnosis) and to analyze the polar body obtained during the maturation of the oocyte (preconceptional diagnosis) (791, 792). These procedures avoid the need to terminate affected pregnancies and permit the transfer of only healthy embryos established from *in vitro* fertilization. Successful experiences in many couples with this approach have been reported in hemoglobinopathies (793, 794 and 795). However, preimplantation genetic diagnosis is a technically challenging, intensive procedure, which requires the close collaboration of a team of specialists. To date, programs for  $\beta$ -thalassemia prevention based on carrier screening, genetic counseling, and prenatal diagnosis are ongoing in several areas at risk in Mediterranean countries, with a marked decline in the incidence of thalassemia major (Fig. 42.17) (33, 796, 797). Effective preventive programs have also been established in countries such as the United Kingdom, where thalassemia is a rare disorder that affects diverse minority ethnic groups. Special attention should be given in these programs to the different religious and social issues and to the different aptitude toward prenatal diagnosis of the various ethnic minorities (798).



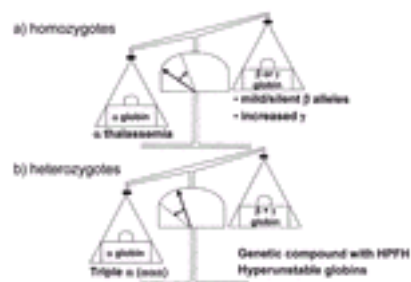
**Figure 42.17.** Fall in the birth rate of infants with homozygous  $\beta$ -thalassemia in Sardinia. (Reprinted from Cao A, Rosatelli C, Galanello R. In: Variation of the human genome. Control of beta-thalassaemia by carrier screening, genetic counselling and prenatal diagnosis: the Sardinian experience. Ciba Found Symp 1996;197:137, Wiley, with permission.)

## Thalassemia Intermedia

**GENETIC DETERMINANTS** The remarkable clinical diversity of thalassemia intermedia is related to the great variety of genotypes. Thalassemia intermedia most commonly is



associated with homozygous or compound heterozygous state for two  $\beta$ -thalassemia alleles ( [36](#), [280](#), [799](#) ). However, several patients with this mild clinical picture have only a single  $\beta$ -globin gene affected and are considered heterozygotes for  $\beta$ -thalassemia. It has been clearly established that the severity of  $\beta$ -thalassemias is related to the degree of globin chain imbalance. Therefore, in homozygous  $\beta$ -thalassemia, any inherited or acquired factor able to reduce the degree of globin imbalance may produce milder clinical forms ( [Fig. 42.18](#) ). On the other hand, in simple  $\beta$ -thalassemia heterozygotes, the worsening of globin chain imbalance may turn the asymptomatic carrier state into a significant clinical phenotype.



**Figure 42.18.** Mechanisms of  $\beta$ -thalassemia intermedia. **A:** Reduced globin chain imbalance. **B:** Increased globin chain imbalance. HPFH, hereditary persistence of fetal hemoglobin.

Homozygotes or compound heterozygotes for mild  $\beta$ -thalassemia mutations, characterized by a residual high  $\beta$ -globin chain production, usually have thalassemia intermedia. Examples are the homozygous state for -29 A?G in black patients and the IVS-1-6 T?C in Mediterranean patients ( [129](#), [800](#), [801](#) ). Compound heterozygotes for a mild and a severe mutation may cover a remarkably broad clinical spectrum of severity ( [281](#), [282](#) ). This variability can be related to the presence of  $\alpha$ -thalassemia or of genetic determinants able to increase  $\beta$ -chain production ( [281](#) ). Few homozygotes for silent mutations have been reported (i.e.,  $\beta$  CAP +1 A?C, IVS-2-844 C?G); they have the hematologic and clinical characteristics of  $\beta$ -thalassemia trait ( [125](#), [802](#) ). Compound heterozygotes for a silent and a severe mutation usually have very mild thalassemia intermedia, but exceptions with a severe phenotype have been reported ( [124](#), [282](#), [761](#), [803](#), [804](#), [805](#) and [806](#) ). Coinheritance of  $\alpha$ -thalassemia with homozygous  $\beta$ -thalassemia leads to a reduction in the excess of  $\alpha$ -chains ( [Fig. 42.18](#) ). Interacting  $\alpha$ -thalassemia has been reported in patients with  $\beta$ -thalassemia intermedia from the Mediterranean and Southeast Asia ( [807](#), [808](#), [809](#) and [810](#) ). However, the ameliorating effect depends both on the type of coinherited  $\alpha$ -thalassemia (the presence of two  $\alpha$  genes deleted being more effective) and on the severity of the  $\beta$ -thalassemia allele ( $\alpha$ -thalassemia being less effective in ameliorating the homozygous  $\beta^0$ -thalassemia). Genetic determinants maintaining a high  $\beta$ -chain synthesis after birth result in a reduction of the  $\alpha$ -/non- $\alpha$ -chain imbalance, thus producing a mild phenotype when coinherited with homozygous severe  $\beta$ -thalassemia. Moreover, a high  $\beta$ -chain synthesis produces a net increase in total hemoglobin synthesis. Several genetic determinants associated with a high  $\beta$ -chain output have been identified, including  $\beta$ -thalassemia defects with intrinsic propensity to increase  $\beta$ -chain production (d $\beta$ -thalassemia, some deletions causing  $\beta^0$ -thalassemia, Hb Lepore) and independent genetic determinants, such as mutations in the  $G\beta$ - or  $A\beta$ -promoter associated with  $\beta$ -thalassemia mutations ( [280](#), [811](#) ). The most common is -158 C?T G? promoter substitution, which is in linkage disequilibrium with several  $\beta^0$ -thalassemia mutations [cd 6 (-A), cd 8 (-AA), IVS-2-1 G?A] ( [280](#), [811](#), [812](#) ). This mutation leads to enhanced  $\beta$ -chain production under conditions of erythropoietic stress and partially compensates for the absence of  $\beta$ -chain synthesis with consequent amelioration of the  $\alpha$ -/non- $\alpha$  imbalance and of the clinical phenotype. The -158 G? C?T substitution has been found occasionally

in patients with  $\beta^+$  IVS-1-6 T?C and with the severe  $\beta^0$  39 C?T mutation ( [813](#) ). Other genetic determinants increasing  $\beta$ -chain production unlinked to the  $\beta$ -globin cluster have been mapped on chromosome 6q and Xp ( [219](#) , [220](#) ). However, in many patients with thalassemia intermedia and homozygotes or compound heterozygotes for severe  $\beta$ -thalassemia mutations, even of the  $\beta^0$  type, the inherited modifying factors able to ameliorate the clinical features are yet unknown. Several patients with thalassemia intermedia have only a single  $\beta$ -globin gene affected—they are simple  $\beta$ -thalassemia heterozygotes. The worsening of globin chain imbalance in most of these cases results from the coinheritance of one or two extra  $\alpha$ -globin genes due to the heterozygous or homozygous state for the triplicated  $\alpha$  gene complex (aaa/aa or aaa/aaa) ( [96](#) , [814](#) , [815](#) ). The compound heterozygosity for severe  $\beta$ -thalassemia with both deletion and nondeletion pancellular HPFH results in a mild thalassemia intermedia phenotype. As reported above, hyperunstable hemoglobins are a group of hemoglobin variants able to produce the clinical picture of thalassemia intermedia of variable severity when present in heterozygous state ( [158](#) ). Compound heterozygosity for  $\beta$ -thalassemia and some structural  $\beta$ -chain variants (HbD-Los Angeles  $\beta$  121 Glu?Gln, HbC  $\beta$  6 Glu?Lys, HbO-Arab  $\beta$  121 Glu?Lys) may produce thalassemia intermedia as a result of globin chain imbalance in combination with the modified structural and functional characteristics of the variant ( [816](#) ). Finally, several patients heterozygote for  $\beta$ -thalassemia with the typical thalassemia intermedia clinical picture have been reported in whom extensive analysis of  $\beta$ - and  $\alpha$ -globin gene cluster and family studies fail to identify any other associated molecular defect ( [817](#) , [818](#) ). Recently, a new protein has been identified that binds to  $\alpha$ -globin, preventing its precipitation ( [819](#) ). This protein belongs to the group of molecular chaperones and is referred to as a  *$\alpha$ -hemoglobin-stabilizing protein*. Transgenic mice, lacking functional  $\alpha$ -hemoglobin-stabilizing protein, showed RBC changes consistent with damage caused by excess  $\alpha$ -chains. Unexplained cases of thalassemia intermedia in  $\beta$ -thalassemia heterozygotes might result from mutations in  $\alpha$ -hemoglobin-stabilizing protein that would cause the  $\alpha$ -chain excess to be more detrimental ( [819](#) , [820](#) ).

**CLINICAL FEATURES** The term *thalassemia intermedia* designates a non-transfusion-dependent thalassemia phenotype. The disorder is heterogeneous, and severity is variable. Conventionally, the condition is considered non-transfusion-dependent if hemoglobin is spontaneously maintained at or above 7.0 to 7.5 f/dl. Age at presentation seems to represent a good indicator of future transfusion independence. In fact, Modell and Berdoukas reported that only 11% of patients with thalassemia intermedia presented in the first year of life, 30% presented in the second year, and 59% presented later in life ( [358](#) ). Cao et al., describing a group of 34 patients with thalassemia due to  $\beta^0$  homozygosity, observed that those who became transfusion dependent were diagnosed at a mean age of  $8.5 \pm 1.8$  months, whereas those who remained transfusion independent were diagnosed at  $17.4 \pm 11.8$  months ( [821](#) ). From the experience of many, however, it appears that a steady-state hemoglobin value is reached only several years after diagnosis. In the truly transfusion-independent forms of thalassemia intermedia, anemia of various degree and mild jaundice are present, whereas growth and development remain normal. The spleen is palpable from the beginning in the majority of the patients, and its size increases with time. Hypersplenism is frequently heralded by decreasing hemoglobin levels. Thrombocytopenia and neutropenia may then ensue. Bone abnormalities are common and include frontal bossing, prominence of the zygomatic bones, depression of the base of the nose, shortening of long bones, excessive thinning of cortices, and dilatation of the medullary cavities, as described for thalassemia major. Fractures due to minor trauma are also signs of medullary overgrowth. Bone and joint pains are not infrequent. The skeletal abnormalities are a consequence of increased erythropoiesis and, when severe, indicate that marrow activity is excessive and that transfusion is required. Osteoporosis, an emerging problem in thalassemia major, has been reported also in thalassemia intermedia ( [822](#) ). Extramedullary erythropoiesis is frequent in thalassemia intermedia and can produce all sorts of bizarre symptoms ( [823](#) , [824](#) , [825](#) and [826](#) ).

). In a series of adult patients subjected to computed tomography scan, 65% were found to have ectopic erythropoiesis ( [827](#) ). A review of radiologic characteristics and MRI findings of extramedullary hemopoiesis has recently been reported ( [828](#) , [829](#) , [830](#) and [831](#) ). Spinal cord compression causing paraparesis and cauda equina syndrome are not rare and require urgent treatment. Transfusion is effective, but regression of the extramedullary masses is slow ( [832](#) , [833](#) ). More rapid results can be obtained by x-ray therapy or with the administration of HU ( [701](#) , [832](#) , [834](#) , [835](#) ). Iron loading in patients who receive no or few transfusions is mainly a consequence of increased iron absorption from the digestive tract. An increase in ferritin levels with age has been observed, but rarely untransfused patients with thalassemia intermedia accumulate large amounts of iron before 20 years of age ( [836](#) , [837](#) , [838](#) and [839](#) ). In a study of 20 patients with thalassemia intermedia, it was found that 62% of the variation in serum ferritin was explained by age and by changes in soluble transferrin receptor, a reliable measure of erythropoiesis ( [840](#) ). An aggravating effect of splenectomy on hemosiderosis has been suggested ( [841](#) , [842](#) ). Endocrine function is usually normal, although diabetes mellitus has frequently been reported ( [535](#) , [824](#) , [843](#) ). Puberty is normal or delayed, but fertility is usually preserved ( [513](#) ). Miscarriages seem to be more frequent than in the normal population, especially if severe anemia is present ( [844](#) ). Leg ulcers, appearing above the medial malleolus, are a common and distressing problem that has been attributed to the hypoxia caused by anemia and to the abnormal rheology of the thalassaemic red cells ( [845](#) , [846](#) ). Treatment is often unsatisfactory. It includes pressure dressing, skin grafting, blood transfusion, HU, arginine butyrate, granulocyte colony-stimulating factor, and platelet growth factor ( [847](#) , [848](#) , [849](#) and [850](#) ).

**Thromboembolic Disease** A hypercoagulable state has been described in patients with thalassemia major and intermedia ( [252](#) ). In an Italian multicenter study, the prevalence of thromboembolic events was found to be 9.6% in patients with thalassemia intermedia as compared to 4.0% in patients with thalassemia major ( [384](#) ). In a recent study, Cappellini et al. reported a high prevalence (29%) of thromboembolic events in splenectomized patients with thalassemia intermedia ( [851](#) ). These authors found high plasma levels of markers of coagulation and fibrinolysis activation and hypothesized that the abnormal red cells and erythroid precursors of patients affected by thalassemia intermedia act as activated platelets in thrombin generation. Thrombosis of the portal vein after splenectomy has been described ( [852](#) ). Heparin therapy followed by long-term oral anticoagulants is indicated after significant thrombotic episodes. Gallstones are a frequent complication, especially in patients homozygous for the Gilbert promoter mutation ( [853](#) ). Folic acid deficiency can be present, and it can be at the basis of intervening severe anemia ( [358](#) , [824](#) , [843](#) ). Regular folate supplementation should be administered.

**Cardiac Disease** Limited data were available on the cardiac function of patients with thalassemia intermedia until recently when a large multicenter study from Greece described a worrisome picture ( [854](#) ). One hundred and ten patients having a mean age of  $32.5 \pm 11.4$  years with a mean hemoglobin of  $9.1 \pm 1.1$  g/dl and ferritin levels of  $1657 \pm 1477$  ng/ml were included in the study. Overall, 5.4% of the patients had congestive heart failure, and 8.0% had a history of acute pericarditis. In addition, pulmonary hypertension developed in 59% of the patients, making it the leading cause of cardiac failure. A smaller study of left ventricular function by two-dimensional and M-mode echocardiography in 24 asymptomatic young adults affected by  $\beta$ -thalassemia intermedia demonstrated significant increases in left ventricular volumes, left ventricular mass, and cardiac index, more pronounced than those found in patients affected by thalassemia major ( [855](#) ).

**TRANSFUSION THERAPY** When assessing the need for a transfusion program, in addition to the level of hemoglobin, the general condition must be considered, particularly with respect to growth, skeletal deformities, and size of the spleen. Only if the patient's well-being and activity are preserved, at not too high a cost in terms of medullary and extramedullary hyperplasia, can transfusion be withheld. Thalassemia intermedia, by

definition, does not require transfusion therapy except in special circumstances that include infections, hypersplenism, periods of rapid growth, and pregnancy. Aplastic crises complicating the course of thalassemia intermedia (as well as of all other conditions characterized by shortened red cell life) are typically due to parvovirus B19 infection. Small epidemics have been reported ( 856 ). Reticulocytes disappear from the circulation, and typical giant and bizarre pronormoblasts appear in the marrow ( 857 ). Sometimes, transient pancytopenia is present ( 858 ). The crisis typically lasts 1 to 2 weeks, but anemia may be severe enough to require blood transfusion. The development of cardiac disease is also an indication to begin transfusions. Sometimes, adults who have maintained acceptable hemoglobin levels for 20 or more years develop transfusion dependency. The need for transfusion must be evaluated carefully because the risk of alloimmunization and autoimmunization is high in thalassemia patients who have not been transfused in the first years of life. A Greek study reported a frequency of alloimmunization of 20.9% versus 47.5% when patients transfused before and after 3 years of age were compared ( 279 ). Also, Asian patients seem to be more prone to this complication, both when transfused from different ethnic donors and from donors of the same ethnicity ( 859 , 860 ). When immunization develops, anemia can be life-threatening, but transfusing only aggravates the problem. Immunosuppressive therapy is not always successful. Remission of the hemolytic process has been reported with HU, and one patient has undergone allogeneic BMT from an HLA-matched unrelated donor ( 851 , 861 ). Hypersplenism is an almost inevitable complication of thalassemia intermedia, leading to transfusion dependency that is usually reversed by splenectomy. HU therapy in patients with thalassemia intermedia may increase total HbF levels and improve their sense of well-being. Good results have been reported with different protocols at doses varying between 3.0 to 10.0 mg/kg/day and 1.5 g/day ( 862 , 863 ). Therefore, a trial of HU for thalassemia intermedia patients in whom chronic transfusion therapy is being contemplated is indicated.

**IRON OVERLOAD** Bone marrow hyperactivity stimulates iron absorption from the gut; however, as mentioned, accumulation of large amounts of iron is an uncommon event in untransfused children with thalassemia intermedia ( 836 , 837 ). Blood transfusions, however, even when occasional, can contribute to iron overload so that some way of eliminating the excess iron becomes necessary. Subcutaneous desferrioxamine by continuous infusion remains the first choice, accompanied by careful assessment of iron stores and regular monitoring for toxicity ( 572 , 573 ). Reduction in tissue iron stores and normalization of serum ferritin concentration have also been reported with the use of deferiprone ( 456 ). Phlebotomy could be an option for patients with sufficiently high hemoglobin levels ( 824 , 864 ).

## WEB SITES

<http://globin.cse.psu.edu>

[www.geneclinics.org](http://www.geneclinics.org)

[www.thalassaemia.org.cy/](http://www.thalassaemia.org.cy/)

## REFERENCES

1. Angastiniotis M, Modell B. Global epidemiology of hemoglobin disorders. *Ann N Y Acad Sci* 1998;850:251-269.
2. Modell B, Khan M, Darlison M, et al. A national register for surveillance of inherited disorders: beta thalassaemia in the United Kingdom. *Bull World Health Organ* 2001;79:1006-1013.

3. Rajab A, Patton MA. Major factors determining the frequencies of hemoglobinopathies in Oman. *Am J Med Genet* 1997;71:240–242.
4. Lopez CG, Lie-Injo LE. Alpha-Thalassaemia in newborns in West Malaysia. *Hum Hered* 1971;21:185–191.
5. Wasi P, Na-Nakorn S, Pootrakul S, et al. Alpha- and beta-thalassemia in Thailand. *Ann N Y Acad Sci* 1969;165:60–82.
6. Lin KS, et al. Haemoglobin H disease: among Chinese residents of Taiwan. *Acta Haematol* 1965;33:178.
7. Zaino EC, Tien YY. Hemoglobinopathy and thalassemia in China. *N Engl J Med* 1981;305:766.
8. Chouhan DM, Sharma RS, Parekh JG. Alpha-thalassaemia in India. *J Indian Med Assoc* 1970;54:364–367.
9. Kulozik AE, Kar BC, Serjeant GR, et al. The molecular basis of alpha thalassemia in India: its interaction with the sickle cell gene. *Blood* 1988;71:467–472.
10. Ali SA. Haemoglobin H disease in Arabs in Kuwait. *J Clin Pathol* 1969;22:226–228.
11. McNeil JR. Family studies of alpha-thalassemia and hemoglobin H disease in eastern Saudi Arabia. *J Med Assoc Thai* 1971;54:153–166.
12. Zaizov R, Matoth Y. Thalassemia in Yemenite and Iraqi Jews. *Isr J Med Sci* 1972;8:11–17.
13. Nicholls RD, Higgs DR, Clegg JB, Weatherall DJ. Alpha zero-thalassemia due to recombination between the alpha 1-globin gene and an AluI repeat. *Blood* 1985;65:1434–1438.
14. Alessio L, Sulis E, Pabis A, Mannucci MP. Unusual pattern of inheritance of haemoglobin-H disease. Family study and reports of a case. *Scand J Haematol* 1968;5:454–457.
15. Hedenberg F, et al. Haemoglobin H and inclusion Body anaemia in a Swedish family. *Acta Paediatr Scand* 1958;47:652.
16. Pembrey ME, Weatherall DJ, Clegg JB, et al. Haemoglobin Bart's in Saudi Arabia. *Br J Haematol* 1975;29:221–234.
17. Munchi N, De Silva V, While IM. The frequencies of HbS a and B-thalassemia in Saudi Arabia preliminary national values. *Saudi Med J* 1989;10:62–65.
18. Pressley L, Higgs DR, Clegg JB, et al. A new genetic basis for hemoglobin-H disease. *N Engl J Med* 1980;303:1383–1388.
19. Pirastu M, Lee KY, Dozy AM, et al. Alpha-thalassemia in two Mediterranean populations. *Blood* 1982;60:509–512.
20. Cao A, Galanello R, Furbetta M, et al. Thalassaemia types and their incidence in Sardinia. *J Med Genet* 1978;15:443–447.
21. Kan YW, Dozy AM, Stamatoyannopoulos G, et al. Molecular basis of hemoglobin-H disease in the Mediterranean population. *Blood* 1979;54:1434–1438.
22. McCurdy PR. Thalassemia in Negroes. *Arch Intern Med* 1967;119:86–91.
23. Weatherall DJ. Abnormal haemoglobins in the neonatal period and their relationship to thalassaemia. *Br J Haematol* 1963;9:265.
24. Friedman SH, et al. a-Thalassemia in Negro infants. *Pediatr Res* 1974;8:955.
25. Pierce HI, Kurachi S, Sofroniadou K, Stamatoyannopoulos G. Frequencies of thalassemia in American

blacks. *Blood* 1977;49:981–986.

26. Dozy AM, Kan YW, Embury SH, et al. alpha-Globin gene organization in blacks precludes the severe form of alpha-thalassaemia. *Nature* 1979;280:605–607.

27. Anderson HM, Ranney HM. Southeast Asian immigrants: the new thalassemiias in Americans. *Semin Hematol* 1990;27:239–246.

28. Cao A, Galanello R, Rosatelli MC, et al. Clinical experience of management of thalassaemia: the Sardinian experience. *Semin Hematol* 1996;1:66–75.

29. Barrai I, Rosito A, Cappellozza G, et al. Beta-thalassaemia in the Po Delta: selection, geography, and population structure. *Am J Hum Genet* 1984;36:1121–1134.

30. Schiliro G, Di Gregorio F, Samperi P, et al. Genetic heterogeneity of beta-thalassaemia in southeast Sicily. *Am J Hematol* 1995;48:5–11.

31. Malamos B, Fessas P, Stamatoyannopoulos G. Types of thalassaemia-trait carriers as revealed by a study in their incidence in Greece. *Br J Haematol* 1962;8:5.

32. Stamatoyannopoulos G, Fessas P. Thalassaemia, glucose-6-phosphate dehydrogenase deficiency, sickling and malarial endemicity in Greece. *BMJ* 1964;1:875.

33. Loukopoulos D. Current status of thalassaemia and the sickle cell syndromes in Greece. *Semin Hematol* 1996;33:76–86.

34. Labie D, Bennani C, Beldjord C. Beta-thalassaemia in Algeria. *Ann N Y Acad Sci* 1990;612:43–54.

35. Grozdea I, Benegmos J, Levéque M. Hémoglobines anormales chez les maladies marocains cancéreux. *Acta Haematol* 1966;35:53–57.

36. Weatherall DJ, Clegg JB. *The Thalassaemia Syndromes*. Oxford: Blackwell Science, 2001.

37. Novelletto A, Hafez M, Deidda G, et al. Molecular characterization of beta-thalassaemia mutations in Egypt. *Hum Genet* 1990;85:272–274.

38. Hussein IR, Temtamy SA, el-Beshlawy A, et al. Molecular characterization of beta-thalassaemia in Egyptians. *Hum Mutat* 1993;2:48–52.

39. Aksoy M, Kutlar A, Kutlar F, et al. Survey on haemoglobin variants, beta thalassaemia, glucose-6-phosphate dehydrogenase deficiency, and haptoglobin types in Turks from western Thrace. *J Med Genet* 1985;22:288–290.

40. Horowitz A, Cohen T, Goldschmidt E, Levene C. Thalassaemia types among Kurdish Jews in Israel. *Br J Haematol* 1966;12:555–568.

41. Ramot B, Abrahamov A, Frayer Z, et al. The incidence and types of thalassaemia-trait carriers in Israel. *Br J Haematol* 1964;10:155.

42. White JM, Byrne M, Richards R, et al. Red cell genetic abnormalities in Peninsular Arabs: sickle haemoglobin, G6PD deficiency, and alpha and beta thalassaemia. *J Med Genet* 1986;23:245–251.

43. Hashmi JA, Farzana F. Thalassaemia trait, abnormal haemoglobins, and raised fetal haemoglobin in Karachi. *Lancet* 1976;1:206.

44. Chatterjea JB. Haemoglobinopathies, glucose-6-phosphate dehydrogenase deficiency and allied problems in the Indian subcontinent. *Bull World Health Organ* 1966;35:837.

45. Labie D, et al. On the existence of different abnormalities of hemoglobin in a population of Southern India. *Nouv Rev Fr Hematol* 1961;1:562.

46. Mehta BC, Dave VB, Joshi SR, et al. Study of hematological and genetical characteristics of Cutchhi

Bhanushali community. *Indian J Med Res* 1972;60:305–311.

47. Neel JV, Valentine WN. Further studies on the genetics of thalassaemia. *Genetics* 1947;32:38.

48. Lorey F. Asian immigration and public health in California: thalassaemia in newborns in California. *J Pediatr Hematol Oncol* 2000;22:564–546.

49. Ahern E, Herbert R, McIver C, et al. Beta-thalassaemia of clinical significance in adult Jamaican Negroes. *Br J Haematol* 1975;30:197–213.

50. Wickramasinghe SN, Bush V. Observations on the ultrastructure of erythropoietic cells and reticulum cells in the bone marrow of patients with homozygous beta-thalassaemia. *Br J Haematol* 1975;30:395–399.

51. Flatz G, Pik C, Sringam S. Haemoglobin E and  $\beta$ -thalassaemia: their distribution in Thailand. *Ann Hum Genet* 1965;29:151–170.

52. Minnich V, Na-Nakorn S, Chongchareonsuk S, et al. Mediterranean anemia: a study of 32 cases in Thailand. *Blood* 1954;9:1.

53. Modell B, Khan M, Darlison M, et al. A national register for surveillance of inherited disorders: beta thalassaemia in the United Kingdom. *Bull World Health Organ* 2001;79:1006–1013.

54. Maccanti A. Contributo alla conoscenza dell'anemia splenica infantile a tipo familiare. *Rivista di Clinica Pediatrica* 1928;26:620–640.

55. Vezzoso, B. Influenza della malaria sulla mortalità infantile per anemia con speciale riguardo al morbo di Cooley. *Riv Malarial* 1946;XXV:61.

56. Haldane JBS. The rate of mutation of human genes. *Proc. VIII Int. Cong. Genet. Hereditas* 1949;35:267.

57. Carcassi V, Ceppellini R, Pitzus F. Frequenza della talassemia in quattro popolazioni sarde e suoi rapporti con la distribuzione dei gruppi sanguigni e della malaria. *Boll 1st Sieroter Mil* 1957;36:206.

58. Siniscalco M, Bernini L, Filippi G, et al. Population genetics of haemoglobin variants, thalassaemia and glucose-6-phosphate dehydrogenase deficiency, with particular reference to the malaria hypothesis. *Bull World Health Organ* 1966;34:379–393.

59. Fullerton SM, Harding RM, Boyce AJ, Clegg JB. Molecular and population genetic analysis of allelic sequence diversity at the human beta-globin locus. *Proc Natl Acad Sci U S A* 1994;91:1805–1809.

60. Bunyaratvej A, Butthep P, Sae-Ung N, et al. Reduced deformability of thalassaemic erythrocytes and erythrocytes with abnormal hemoglobins and relation with susceptibility to *Plasmodium falciparum* invasion. *Blood* 1992;79:2460–2463.

61. Nagel RL, Raventos-Suarez C, Fabry ME, et al. Impairment of the growth of *Plasmodium falciparum* in HbEE erythrocytes. *J Clin Invest* 1981;68:303–305.

62. Udomsangpetch R, Sueblinvong T, Pattanapanyasat K, et al. Alteration in cytoadherence and resetting of *Plasmodium falciparum*-infected thalassaemic red blood cells. *Blood* 1993;82:3752–3759.

63. Yuthavong Y, Butthep P, Bunyaratvej A, et al. Impaired parasite growth and increased susceptibility to phagocytosis of *Plasmodium falciparum* infected alpha-thalassaemia or hemoglobin Constant Spring red blood cells. *Am J Clin Pathol* 1988;89:521–525.

64. Luzzi GA, Pasvol G. Cytoadherence of *Plasmodium falciparum*-infected alpha-thalassaemic red cells. *Ann Trop Med Parasitol* 1990;84:413–414.

65. Pasvol G, Weatherall DJ, Wilson RJ. Effects of foetal haemoglobin on susceptibility of red cells to *Plasmodium falciparum*. *Nature* 1977;270:171–173.

66. Ifediba TC, Stern A, Ibrahim A, et al. *Plasmodium falciparum* in vitro: diminished growth in hemoglobin



H disease erythrocytes. *Blood* 1985;65:452–455.

67. Senok AC, Li K, Nelson EA, et al. Invasion and growth of *Plasmodium falciparum* is inhibited in fractionated thalassemic erythrocytes. *Trans Roy Soc Trop Med Hyg* 1997;91:138–143.

68. Williams TN, Maitland K, Bennett S, et al. High incidence of malaria in alpha-thalassaemic children. *Nature* 1996;383:522–525.

69. Luzzi GA, Merry AH, Newbold CI, et al. Surface antigen expression on *Plasmodium falciparum*-infected erythrocytes is modified in alpha- and beta-thalassemia. *J Exp Med* 1991;173:785–791.

70. Carlson J, Nash GB, Gabutti V, et al. Natural protection against severe *Plasmodium falciparum* malaria due to impaired rosette formation. *Blood* 1994;84:3909–3914.

71. Allen SJ, O'Donnell A, Alexander ND, et al. alpha+-Thalassemia protects children against disease caused by other infections as well as malaria. *Proc Natl Acad Sci U S A* 1997;94:14736–14741.

72. Stamatoyannopoulos G, Grosveld F. Hemoglobin switching. In: Stamatoyannopoulos G, Majeurs P, Perlmutter R, Varmus H, eds. *The molecular basis of blood disease*, 3rd ed. Philadelphia: WB Saunders, 2001:135–182.

73. Go M. Correlation of DNA exonic regions with protein structural units in haemoglobin. *Nature* 1981;291:90–92.

74. Orkin SH. GATA-binding transcription factors in hematopoietic cells. *Blood* 1992;80:575–581.

75. Ney PA, Sorrentino BP, Lowrey CH, et al. Inducibility of the HS II enhancer depends on binding of an erythroid specific nuclear protein. *Nucleic Acids Res* 1990;18:6011–6017.

76. Miller IJ, Bieker JJ. A novel, erythroid cell-specific murine transcription factor that binds to the CACCC element and is related to the Kruppel family of nuclear proteins. *Mol Cell Biol* 1993;13:2776–2786.

77. Feng WC, Southwood CM, Bieker JJ. Analyses of beta-thalassemia mutant DNA interactions with erythroid Kruppel-like factor (EKLF), an erythroid cell-specific transcription factor. *J Biol Chem* 1994;269:1493–1500.

78. Forget BG. Molecular genetics of the human globin genes. In: Steinberg MH, Forget BG, Higgs DR, Nagel RL, eds. *Disorders of haemoglobin*. Cambridge: Cambridge University Press, 2001:117–130.

79. Lauer J, Shen C-Kj, Maniatis T. The chromosomal arrangement of human alpha-like globin genes: sequence homology and alpha-globin gene deletions. *Cell* 1980;20:119–130.

80. Higgs DR, Goodbourn SEY, Wainscoat JS, et al. Highly variable regions of DNA flank the Human alpha-globin genes. *Nucleic Acids Res* 1981;9:4213–4224.

81. Higgs DR, Hill AVS, Bowden DK, et al. Independent recombination events between the duplicated human alpha-globin genes: implications for their concerted evolution. *Nucleic Acids Res* 1984;12:6965–6977.

82. Nicholls RD, Fischel-Ghodsian N, Higgs DR. Recombination at the human alpha-globin gene cluster: sequences features and topological constraints. *Cell* 1987;49:369–378.

83. Higgs DR, Vickers MA, Wilkie AO, et al. A review of the molecular genetics of the human alpha-globin gene cluster. *Blood* 1989;73:1081–1104.

84. Liebhaber SA, Goosens M, Kan YW. Cloning and complete nucleotide sequence of human 5' alpha-globin gene. *Proc Natl Acad Sci U S A* 1980;77: 7054–7058.

85. Michelson AM, Orkin SH. The 3' untranslated regions of the duplicated human alpha-globin genes are unexpectedly divergent. *Cell* 1980;22:371–377.

86. Liebhaber SA, Goosens M, Kan YW. Homology and concerted evolution at the alpha1- and alpha2 loci of human alpha-globin. *Nature* 1981;290:26–29.

87. Liebhaber SA, Kan YW. Differentiation of the mRNA transcripts origination from alpha1- and alpha 2 globin loci in normals and alpha-thalassemics. *J Clin Invest* 1981;68:439-446.
88. Orkin SH, Goff SC. The duplicated human alpha-globin genes: their relative expression as measured by RNA analysts. *Cell* 1981;24:345-351.
89. Liebhaber SA, Cash FE, Ballas SK. Human a-globin gene expression. The dominant role of the a2-locus in mRNA and protein synthesis. *J Biol Chem* 1986;261:15327-15333.
90. Molchanova TP, Huisman THJ. The importance of the 3' untranslated region for the expression of the a-globin genes. *Hemoglobin* 1996;20:41-54.
91. Shakin SH, Liebhaber SA. Translational profiles of a1-, a2-, and B-globin messenger ribonucleic acids in human reticulocytes. *J Clin Invest* 1986;78:1125-1129.
92. Molchanova TP, Pobedinskaya DD, Huisman THJ. The differences in quantities of a2- and a1-globin gene variants in heterozygotes. *Br J Haematol* 1994;88:300-306.
93. Higgs DR, Wood WG, Jarman AP, et al. A major positive regulatory region located far upstream of the human a-globin gene locus. *Genes Dev* 1990;4:1588-1601.
94. Higgs DR, Old JM, Pressley L, et al. A novel a-globin gene arrangement in man. *Nature* 1980;284:632-635.
95. Gu YC, Landman H, Huisman THJ. Two different quadruplicated a-globin arrangements. *Br J Haematol* 1987;66:245-250.
96. Galanello R, Ruggeri R, Paglietti E, et al. A family with segregating triplicated a-globin loci and B-thalassemia. *Blood* 1983;62:1035-1040.
97. Winichagoon P, Higgs DR, Goodbourn SEY, et al. Multiple arrangements of the human embryonic ?-globin genes. *Nucleic Acids Res* 1982;10:5853-5868.
98. Felice AE, Cleek MP, Marino EM, et al. Different ?-globin gene deletions among black Americans. *Hum Genet* 1986;73:221-224.
99. Michelson AM, Orkin SH. Boundaries of gene conversion within the duplicated human a-globin genes. Concerted evolution by segmental recombination. *J Biol Chem* 1983;258:15245-15254.
100. Embury SH, Miller JA, Dozy AM, et al. Two different molecular organizations account for the single a-globin gene of the a-thalassemia-2 genotype. *J Clin Invest* 1980;66:1319-1325.
101. Goossens M, Dozy AM, Embury Sh, et al. Triplicated a-globin loci in humans. *Proc Natl Acad Sci U S A* 1980;77:518-521.
102. Trent RJ, Higgs DR, Clegg JB, et al. A new triplicated a-globin gene arrangement in man. *Br J Haematol* 1981;49:149-152.
103. Lacerra G, Fioretti G, De Angioletti M, et al. (a)a<sup>5.3</sup>: A novel a<sup>+</sup>-thalassemia deletion with the break-points in the a2-globin gene and in close proximity to an Alu family repeat between the ?a2- and ?a1-globin genes. *Blood* 1991;78:2740-2746.
104. Zhao JB, Zhao L, Fei YJ, et al. A novel a-thalassemia-2 (-2.7 kb) observed in a Chinese patient with HbH disease. *Am J Haematol* 1991;38:248-249.
105. Bowden DK, Hill AV, Higgs DR, et al. Different hematologic phenotypes are associated with the leftward (-alpha 4.2) and rightward (-alpha 3.7) alpha<sup>+</sup>-thalassemia deletions. *J Clin Invest* 1987;79:39-43.
106. Liebhaber SA, Cash FE, Main DM. Compensatory increase in a1-globin gene expression in individuals heterozygous for the a-thalassemia-2 deletion. *J Clin Invest* 1985;76:1057-1064.
107. Proudfoot NJ. Transcriptional interference and termination between duplicated a-globin gene

constructs suggest a novel mechanism for gene regulation. *Nature* 1986;322:562–565.

108. Higgs DR. Molecular mechanisms of alpha thalassemia. In: Steinberg MH, Forget PG, Higgs DR, Nagel RL, eds. *Disorders of hemoglobin: genetics pathophysiology, and clinical management*. Cambridge: Cambridge University Press, 2001:405–430.

109. Pressley L, Higgs DR, Aldridge B, et al. Characterization of a new alpha thalassemia 1 defect due to a partial deletion of the alpha globin gene complex. *Nucleic Acids Res* 1980;8:4889–4898.

110. Hunt DM, Higgs DR, Winichagoon P, et al. Haemoglobin Constant Spring has an unstable alpha chain messenger RNA. *Br J Haematol* 1982;51:405–413.

111. Traeger-Synodinos J, Metaxotou-Mavromati A, Kanavakis E, et al. An alpha-thalassemic hemoglobinopathy: homozygosity for the HB Agrinio alpha 2-globin chain variant. *Hemoglobin* 1998;22:209–215.

112. Traeger-Synodinos J, Papassotiriou I, Metaxotou-Mavromati A, et al. Distinct phenotypic expression associated with a new hyperunstable alpha globin variant (Hb heraklion, alpha1cd37(C2)Pro>O): comparison to other alpha-thalassemic hemoglobinopathies. *Blood Cells Mol Dis* 2000;26:276–284.

113. Fritsch EF, Lawn RM, Maniatis T. Molecular cloning and characterization of the human beta-like globin gene cluster. *Cell* 1980;19:959–972.

114. Antonarakis SE, Boehm CD, Giardina PJ, et al. Non random association of polymorphic restriction sites in the beta-globin gene cluster. *Proc Natl Acad Sci U S A* 1982;79:137–141.

115. Fei YJ, Kultar F, Harris HF, et al. A search for anomalies in  $\alpha$ ,  $\beta$ , and  $\delta$  globin gene arrangements in normal Black, Italian, Turkish and Spanish newborns. *Hemoglobin* 1989;13:45–65.

116. Huisman TH, Kultar F, Gu LH. Gamma chain abnormalities and gamma-globin gene rearrangements in newborn babies of various populations. *Hemoglobin* 1991;15:349–379.

117. Forrester WC, Thompson C, Elder JT, et al. A developmentally stable chromatin structure in the human  $\beta$ -globin gene cluster. *Proc Natl Acad Sci U S A* 1986;83:1359–1363.

118. Talbot D, Grosveld F. The 5'HS2 of the globin locus control enhances transcription through the interaction of a multimeric complex binding at two functionally distinct NF-E2 binding sites. *EMBO J* 1991;10:1391–1398.

119. Van der Ploeg LH, Konings A, Oort M, et al.  $\beta$ -Thalassaemia studies showing that deletion of the  $\delta$ - and  $\epsilon$ -genes influences  $\beta$ -globin gene expression in man. *Nature* 1980;283:637–642.

120. Curtin P, Pirastu M, Kan YM, et al. A distant gene deletion affects  $\beta$ -globin gene function in an atypical  $\delta\beta$ -thalassaemia. *J Clin Invest* 1985;76:1554–1558.

121. Huisman THJ, Carver MFH, Baysal E. *A Syllabus of Thalassemia Mutation*. Augusta: The Sickle Cell Anemia Foundation, 1997:309.

122. Hardison R, Riemer C, Chui DHK, et al. Electronic access to sequence alignment, experimental results and Hum Mutats as an aid to studying globin gene regulation. *Genomics* 1998;47:429–437.

123. Gonzales-Redondo JM, Stoming TA, Kultar F, et al. A C>T substitution at nt-101 in a conserved DNA sequence of the promoter region of the  $\beta$ -globin gene is associated with “silent”  $\beta$ -thalassemia. *Blood* 1989;73:1705–1711.

124. Maragoudaki E, Kanavakis E, Traeger-Synodinos J, et al. Molecular, haematological and clinical studies of the -101 C>T substitution of the beta-globin gene promoter in 25 beta-thalassaemia intermedia patients and 45 heterozygotes. *Br J Haematol* 1999;107:699–706.

125. Wong C, Dowling CE, Saiki RK, et al. Characterization of  $\beta$ -thalassemic mutations using direct genomic sequencing of amplified single copy DNA. *Nature* 1987;330:384–386.

126. Mount SM. A catalogue of splice junction sequences. *Nucleic Acids Res* 1982;1:459–472.
127. Treisman R, Orkin SH, Maniatis T. Specific transcription and RNA splicing defects in five cloned  $\beta$ -thalassaemia genes. *Nature* 1983;302:591–596.
128. Cheng TE, Orkin SH, Antonarakis SE, et al.  $\beta$  Thalassemia in Chinese: use of in vivo RNA analysis and oligonucleotide hybridization in systematic characterization of molecular defects. *Proc Natl Acad Sci U S A* 1984;81:2821–2825.
129. Tamagnini GP, Lopes MC, Castanheira ME, et al.  $\beta^{++}$  thalassaemia-Portuguese type: clinical, haematological and molecular studies of a newly defined form of  $\beta$  thalassaemia. *Br J Haematol* 1983;54:189–200.
130. Spritz RA, Jagadeeswaran P, Choudary PV, et al. Base substitution in an intervening sequence of a  $\beta^{++}$  thalassaemic human globin gene. *Proc Natl Acad Sci U S A* 1981;78:2455–2459.
131. Metherall JE, Collins FS, Pan J, et al.  $\beta$  zero-Thalassemia caused by a base substitution that creates an alternative splice acceptor site in an intron. *EMBO J* 1986;5:2551–2557.
132. Goldsmith ME, Humphries RK, Ley T, et al. Silent substitution in  $\beta^{++}$  thalassaemia gene activating a cryptic splice site in  $\beta$ -globin RNA coding sequence. *Proc Natl Acad Sci U S A* 1983;80:2318–2322.
133. Orkin SH, Kazazian HHJ, Antonarakis SE, et al. Abnormal RNA processing due to the exon mutation of  $\beta^{E-}$  globin gene. *Nature* 1982;300:768–769.
134. Orkin SH, Antonarakis S, Loukopoulos D. Abnormal processing of  $\beta^{Knossos}$  RNA. *Blood* 1984;64:311–313.
135. Yang KG, Kultar F, George E, et al. Molecular characterization of  $\beta$ -globin gene mutations in Malay patients with Hb E-  $\beta$ -thalassaemia and thalassaemia major. *Br J Haematol* 1989;72:73–80.
136. Baserga SJ, Benz EJ, Jr. Nonsense mutations in the human  $\beta$ -globin gene affect mRNA metabolism. *Proc Natl Acad Sci U S A* 1988;85:2056–2060.
137. Nagy E, Maquat LE. A rule for termination-codon position within intron-containing genes: when nonsense affects RNA abundance. *Trends Biol Sci* 1998;23:198–199.
138. Sachs AB. Messenger RNA degradation in eukaryotes. *Cell* 1993;74:413–421.
139. Zhang J, Sun X, Qian Y, et al. Intron function in the nonsense-mediated decay of  $\beta$ -globin mRNA: indications that pre-mRNA splicing in the nucleus can influence mRNA translation in the cytoplasm. *RNA* 1998;4:801–815.
140. Maquat LE. When cells stop making sense: effects of nonsense codons on RNA metabolism in vertebrate cells. *RNA* 1995;1:453–465.
141. Hall GW, Thein SL. Nonsense codon mutations in the terminal exon of the  $\beta$ -globin gene are not associated with a reduction in  $\beta$ -mRNA accumulation: a mechanism for the phenotype of dominant  $\beta$ -thalassaemia. *Blood* 1994;83:2031–2037.
142. Cao A, Rosatelli C, Pirastu M, et al. Thalassemias in Sardinia: molecular pathology, phenotype-genotype correlation and prevention. *Am J Pediatr Hematol Oncol* 1991;13:179–188.
143. Liang R, Liang S, Jiang NH, et al. Alpha and beta thalassaemia among Chinese children in Guangxi Province, P.R. China: molecular and haematological characterization. *Br J Haematol* 1994;86:351–354.
144. Chang JC, Alberti A, Kann YW. A  $\beta$ -Thalassemia lesion abolishes the same Mst II site as the sickle mutation. *Nucleic Acids Res* 1983;11:7789–7794.
145. Kimura A, Matsunaga E, Takihara Y, et al. Structural analysis of a  $\beta$ -Thalassemia gene found in

Taiwan. *J Biol Chem* 1983;58:2748–2749.

146. Thein SL, Old JM, Wainscoat JS, et al. Population and genetic studies suggest a single origin for the Indian deletion  $\beta$  thalassemia. *Br J Haematol* 1984;57:271–278.

147. Popovich BW, Rosenblatt DS, Kendall AG, et al. Molecular characterization of an atypical  $\beta$ -thalassemia caused by a large deletion in the 5'  $\beta$ -globin gene region. *Am J Hum Genet* 1986;39:797–810.

148. Orkin SH, Goff SC, Nathan DG. Heterogeneity of DNA deletion in  $\delta\beta$ -thalassemia. *J Clin Invest* 1981;67:878–884.

149. Pirastu M, Kan YW, Lin CC, et al. Hemolytic disease of the newborn caused by a new deletion of the entire  $\beta$ -globin cluster. *J Clin Invest* 1983;72:602–609.

150. Diaz-Chico JC, Huang JH, Juncic D, et al. Two new large deletions resulting in e $\delta\beta$ -thalassemia. *Acta Haematol* 1988;80:79–84.

151. Taramelli R, Kioussis D, Vanin E, et al.  $\delta\beta$ -Thalassaemias 1 and 2 are the result of a 100 kbp deletion in the human  $\beta$ -globin cluster. *Nucleic Acids Res* 1986;14:7017–7029.

152. Driscoll MC, Dobkin CS, Alter BP.  $\delta\beta$ -Thalassaemia due to a de novo mutation deleting the 5'  $\beta$ -globin gene activation-region hypersensitive sites. *Proc Natl Acad Sci U S A* 1989;86:7470–7474.

153. Baglioni C. The fusion of two peptide chains in hemoglobin Lepore and its interpretation as a genetic deletion. *Proc Natl Acad Sci U S A* 1962;48:1880.

154. Baird B, Driscoll C, Schreiner H, et al. A nucleotide change at a splice junction in the human  $\beta$ -globin gene is associated with  $\beta$  0-thalassemia. *Proc Natl Acad Sci U S A* 1981;78:4218–4221.

155. Miranda SR, Figueiredo MS, Kerbauy J, et al. Hb Lepore<sub>Baltimore</sub> (d50 Ser B83 Ala) identified by DNA analysis in a Brazilian family. *Acta Haematol* 1994;91:7–9.

156. Waye JS, Eng B, Coleman MB, et al. d $\beta$ -Thalassaemia in an African-American: identification of the deletion endpoints and PCR-based diagnosis. *Hemoglobin* 1994;18:389–399.

157. Ojwang PJ, Nakatsuji T, Gardiner MB, et al. Gene deletion as the molecular basis for the Kenya-<sup>G</sup> $\delta$ HPFH condition. *Hemoglobin* 1983;7:115–123.

158. Thein SL, Hesketh C, Taylor P, et al. Molecular basis for dominantly inherited inclusion body beta-thalassemia. *Proc Natl Acad Sci U S A* 1990;87:3924–3928.

159. Thein SL. Structural variants with a  $\beta$ -thalassemia phenotype. In: Steinberg MH, Forget BG, Higgs DR, Nagel RL, eds. *Disorders of hemoglobin: genetics, pathophysiology, and clinical management*. Cambridge: Cambridge University Press, 2001:342–355.

160. Adams JG, Steinberg MH, Newman MV, et al. Beta-Thalassemia present in cis to a new beta-chain structural variant, Hb Vicksburg [ $\beta$  75 (E19)Leu leads to O]. *Proc Natl Acad Sci U S A* 1981;78:469–473.

161. Adams JG, Hardy CL, Steinberg MH. Disappearance of the protein of a somatic mutation: a possible example of stem cell inactivation. *Am J Physiol* 1991;261:C448–C454.

162. Lang A, Lehmann H, King-Lewis PA. Hb K Woolwich the cause of a thalassaemia. *Nature* 1974;249:467–469.

163. Smith CM, Hedlund B, Cich JA, et al. Hemoglobin North Shore: a variant hemoglobin associated with the phenotype of beta-thalassemia. *Blood* 1983;61:378–383.

164. Pirastu M, Ristaldi MS, Loudianos G, et al. Molecular analysis of atypical  $\beta$ -thalassemia heterozygotes. *Ann N Y Acad Sci* 1990;612:90–97.

165. Oggiano L, Guiso L, Frogheri L, et al. A novel Mediterranean delta; $\beta$ -thalassemia' determinant

containing the d+27 and  $\beta$  (0)39 point mutations in cis. *Am J Hematol* 1994;45:81–84.

166. Loudianos G, Cao A, Pirastu M, et al. Molecular basis of the d thalassemia in cis to hemoglobin Knossos variant. *Blood* 1991;77:2087–2088.

167. Traeger–Synodinos J, Tzetis M, Kanavakis E, et al. The Corfu d $\beta$  thalassemia mutation in Greece: haematological phenotype and prevalence. *Br J Haematol* 1991;79:302–305.

168. Galanello R, Melis MA, Podda A, et al. Deletion d–thalassemia: the 7.2 kb deletion of Corfu d $\beta$ –thalassemia in a non– $\beta$ –thalassemia chromosome. *Blood* 1990;75:1747–1749.

169. Bernards R, Kooter JM, and Flavell RA. Physical mapping of the globin gene deletion in (d $\beta$ (0)) thalassemia. *Gene* 1979;6:265–280.

170. Craig JE, Barnetson RA, Prior J, et al. Rapid detection of deletions causing d $\beta$  thalassemia and hereditary persistence of fetal hemoglobin by enzymatic amplification. *Blood* 1994;83:1673–1682.

171. Palena A, Blau A, Stamatoyannopoulos G, Anagnou NP. Eastern European (d $\beta$ )zero–thalassemia: molecular characterization of a novel 9.1 kb deletion resulting in high levels of fetal hemoglobin in the adult. *Blood* 1994;83:3738–3745.

172. Anagnou NP, Papayannopoulou T, Stamatoyannopoulos G, Nienhuis AW. Structurally diverse molecular deletions in the  $\beta$ –globin gene cluster exhibit an identical phenotype on interaction with the  $\beta$ <sup>s</sup>–gene. *Blood* 1985;65:1245–1251.

173. Kulozik AE, Bellan–Koch A, Kohne E, et al. A deletion/inversion rearrangement of the  $\beta$ –globin gene cluster in a Turkish family with d $\beta$  zero–thalassemia intermedia. *Blood* 1992;79:2455–2459.

174. Mishima N, Landman H, Huisman THJ, Gilman JG. The DNA deletion in an Indian d $\beta$ –thalassemia begins one kilobase from the A $\gamma$ –globin gene and ends in an L1 repetitive sequence. *Br J Haematol* 1989;73:375–379.

175. Ottolenghi S, Giglioli B, Taramelli R, et al. Molecular comparison of d $\beta$ –thalassemia and hereditary persistence of fetal hemoglobin DNAs: evidence of a regulatory area? *Proc Natl Acad Sci U S A* 1982;79:2347–2351.

176. Matsunaga E, Kimura A, Yamada H, et al. A novel deletion in d $\beta$ –thalassemia found in Japan. *Biochem Biophys Res Commun* 1985;126:185–191.

177. Öner R, Öner C, Erdem G, et al. A novel (d $\beta$ ) zero–thalassemia due to an approximately 30–kb deletion observed in a Turkish family. *Acta Haematol* 1996;96:232–236.

178. Henthorn PS, Smithies O, Nakatsuji T. (A $\gamma$ d $\beta$ ) zero–thalassemia in blacks easy due to deletion of 34 kbp of DNA. *Br J Haematol* 1985;59:343–356.

179. Jones RW, Old JM, Trent RJ, et al. Restriction mapping of a new deletion responsible for G $\gamma$ (d $\beta$ ) zero–thalassemia. *Nucleic Acids Res* 1981;9:6813–6825.

180. Jones RW, Old JM, Trent RJ, et al. Major rearrangement in the Human  $\beta$ –globin gene cluster. *Nature* 1981;291:39–44.

181. De Angioletti M, Lacer G, Carestia C. Breakpoint characterization of the Italian (A $\gamma$ d $\beta$ )<sup>o</sup> thalassemia showing 3' Breakpoint clustering with those of Indian HPFH and Belgian (A $\gamma$ d $\beta$ )<sup>o</sup> thalassemia. 8th International Conference on Thalassemia, Malta 1997:146.

182. Losekoot M, Fodde R, Gerritsen EJA, et al. Interaction of two different disorders in the  $\beta$ –globin gene cluster associated with an increased hemoglobin F production: a novel deletion type of G $\gamma$ (A $\gamma$ d $\beta$ ) zero–thalassemia and a d<sup>o</sup> –hereditary persistence of fetal hemoglobin determinant. *Blood* 1991;77:861–867.

183. Zhang JW, Song WF, Zhao YJ, et al. Molecular characterization of a novel form of (A $\gamma$ d $\beta$ )<sup>o</sup> thalassemia deletion in a Chinese family. *Blood* 1993;81:1624–1629.

184. Anagnou NP, Papayannopoulou T, Stamatoyannopoulos G, Nienhuis AW. Molecular characterization of a novel form of (A?dB)<sup>o</sup> thalassemia deletion with 3' Breakpoint close to those of HPFH-3 and HPFH-4: insights for a common regulatory mechanism. *Nucleic Acids Res* 1988;16:6057-6066.
185. Fritsch EF, Lawn RM, Maniatis T. Characterization of deletions which affect the expression of fetal globin genes in man. *Nature* 1979;291:598-603.
186. Trent RJ, Jones RW, Clegg JB, et al. (A?dB)<sup>o</sup> thalassemia. Similarity of phenotype in four different molecular defects, including one newly described. *Br J Haematol* 1984;57:279-289.
187. George E, Faridah K, Trent RJ, et al. Homozygosity for a new type of G?(A?dB) zero-thalassemia in a Malaysian male. *Hemoglobin* 1986;10:353-363.
188. Pirastu M, Kan YM, Galanello R, et al. Multiple mutations produce delta beta 0 thalassemia in Sardinia. *Science* 1984;223:929-930.
189. Zeng YT, Huang SZ, Chen B, et al. Hereditary persistence of fetal hemoglobin or (delta beta) 0-thalassemia: three types observed in South-Chinese families. *Blood* 1985;66:1430-1435.
190. Kulozik AE, Yarwood N, Jones RW. The Corfu dB<sup>o</sup> thalassemia: a small deletion acts at a distance to selectively abolish  $\beta$ -globin gene expression. *Blood* 1988;71:457-462.
191. Atweh GF, Zhu XX, Brickner HE, et al. The beta-globin gene on the Chinese delta beta-thalassemia chromosome carries a promoter mutation. *Blood* 1987;70:1470-1474.
192. Balta G, Brickner HE, Takegawa S, et al. Increased expression of the G gamma globin genes associated with a mutation in the A gamma enhancer. *Blood* 1994;83:3727-3737.
193. Camaschella C, Serra A, Gottardi E, et al. A new hereditary persistence of fetal hemoglobin deletion has the breakpoint within the 3'  $\beta$ -globin gene enhancer. *Blood* 1990;75:1000-1005.
194. Collins FS, Cole JL, Lockwood WK, et al. The deletion in both common types of hereditary persistence of fetal hemoglobin is approximately 105 kilo bases. *Blood* 1987;70:1797-1803.
195. Huisman THJ, Wrihstone RN, Wilson JB, et al. Hemoglobin Kenya, the product of fusion of ? and  $\beta$  polypeptide chains. *Arch Biochem Biophys* 1972;153:850-853.
196. Fritsch EF, Lawn RM, Maniatis T. Characterization of deletions which affect the expression of fetal globin genes in man. *Nature* 1979;291:598-603.
197. Bernards R, Flavell RA. Physical mapping of the globin gene deletion in hereditary persistence of foetal haemoglobin. *Nucleic Acids Res* 1980;8:1521-1534.
198. Wainscoat JS, Thein SL, Wood WG. A novel deletion in the  $\beta$  globin gene complex. *Ann N Y Acad Sci* 1984;445:20-27.
199. Saglio G, Camaschella C, Serra A, et al. Italian type of deletional hereditary persistence of fetal hemoglobin. *Blood* 1986;68:646-651.
200. Dimovski AJ, Divoky V, Adeline AD, et al. A novel deletion of approximately 27 kb including the  $\beta$ -globin gene and the locus control region 3'HS-1 regulatory sequence:  $\beta$  zero-thalassemia or hereditary persistence of fetal hemoglobin? *Blood* 1994;83:822-827.
201. Collins FS, Stoeckert CJ, Serjeant GR, et al. G? $\beta$ <sup>+</sup> hereditary persistence of fetal hemoglobin: cosmid cloning and identification of a specific mutation 5' to the G? gene. *Proc Natl Acad Sci U S A* 1984;81:4894-4898.
202. Pissard S, M'rad A, Beuzard Y, Roméo PH. A new type of hereditary persistence of fetal haemoglobin (HPFH): (HPFH) Tunisia  $\beta$ <sup>+</sup>(<sup>+</sup>C-200) G?. *Br J Haematol* 1996;95:67-72.
203. Surrey S, Delgrosso K, Palladi P, Schwartz E. A single-base change at position -175 in the



- 5'-flanking region of the  $G\gamma$  globin gene from a black with  $G\gamma\beta^+$  HPFH. *Blood* 1988;71:807-810.
204. Fucheroen S, Schimizu K, Fukumaki Y. A novel C-T transition within the distal CCAAT motif of the  $G\gamma$  globin gene in the Japanese HPFH: implication of factor binding in elevated fetal globin expression. *Nucleic Acids Res* 1990;18:5142-5253.
205. Motum P, Deng ZM, Huong L, Trent RJ. The Australian type of nondeletional  $G\gamma$ -HPFH has a C?G substitution at nucleotide -114 of the  $G\gamma$  gene. *Br J Haematol* 1994;86:219-221.
206. Hattori Y, Kutlar F, Mosley CJ, et al. Association of the level of  $G\gamma$  chain in the fetal hemoglobin of normal adults with specific haplotypes. *Hemoglobin* 1986;10:185-204.
207. Yang KG, Stoming TA, Fei YJ, et al. Identification of base substitutions in the promoter regions of the  $A\gamma$ - and  $G\gamma$  globin genes in  $A\gamma$ -(or  $G\gamma$ )  $\beta^+$  HPFH heterozygotes using the DNA-amplification-synthetic oligonucleotide procedure. *Blood* 1988;71:1414-1417.
208. Giglioni B, Casini C, Mantovani R, et al. A molecular study of a family with Greek hereditary persistence of fetal hemoglobin and  $\beta$ -thalassemia. *EMBO J* 1984;3:2641-2645.
209. Costa FF, Zago MA, Cheng G, et al. The Brazilian type of nondeletional  $A\gamma$ -fetal hemoglobin has C?G substitution at nucleotide -195 of the  $A\gamma$ -globin gene. *Blood* 1990;75:1896-1897.
210. Stoming TA, Stoming GS, Lanclos KD, et al. An  $A\gamma$ -type of non-deletional hereditary persistence of fetal hemoglobin with a T?C mutation at position -175 to the cap site of the  $A\gamma$  globin gene. *Blood* 1989;73:329-333.
211. Fessas P, Stamatoyannopoulos G. Hereditary persistence of fetal hemoglobin in Greece: a study and a comparison. *Blood* 1964;24:223-240.
212. Gilman JG, Mishima N, Wen XJ, et al. Distal CCAAT box deletion in the  $A\gamma$  globin gene of two black adolescents with elevated fetal  $A\gamma$  globin. *Nucleic Acids Res* 1988;16:10635-10642.
213. á-ner R, Kutlar F, GU LH, Huisman THJ. The Georgia type nondeletional hereditary persistence of fetal hemoglobin has a C? T mutation at nucleotide-114 of the  $A\gamma$  globin gene. *Blood* 1991;77:1124-1128.
214. Wood WG. Hereditary persistence of fetal hemoglobin and  $\delta\beta$  thalassemia. In: Steinberg MH, Forget B, Higgs DR, Nagel RL, eds. *Disorders of hemoglobin: genetics, pathophysiology, and clinical management*. Cambridge: Cambridge University Press, 2001:356-388.
215. Gianni AM, Bregni M, Cappellini MD. A gene controlling fetal hemoglobin expression in adults is not linked to the non- $\alpha$  globin cluster. *EMBO J* 1983;2:921-925.
216. Martinez G, Novelletto A, Di Rienzo A, et al. A case of hereditary persistence of fetal hemoglobin caused by a gene not the  $\beta$ -globin cluster. *Hum Genet* 1989;82:335-337.
217. Thein SL, Weatherall DJ. A non-deletion hereditary persistence of fetal hemoglobin (HPFH) determinant not linked to the  $\beta$ -globin gene complex. In: Stamatoyannopoulos G, Nierhuis AW, eds. *Hemoglobin switching: cellular and molecular mechanism*. New York: Alan R Liss, 1989:97-111.
218. Seltzer WK, Abshire TC, Lane PA, et al. Molecular genetic studies in black families with sickle cell anemia and unusually high levels of fetal hemoglobin. *Hemoglobin* 1992;16:363-377.
219. Craig JE, Rochette J, Fisher CA, et al. Dissecting the loci controlling fetal haemoglobin production on chromosomes 11p and 6q by the regressive approach. *Nat Genet* 1996;12:58-64.
220. Dover GJ, Smith KD, Chang YC, et al. Fetal hemoglobin levels in sickle cell disease and normal individuals are partially controlled by an X-linked gene located at Xp22.2. *Blood* 1992;80:816-824.
221. Finch CA, Deubelbeiss K, Cook JD, et al. *Ferrokinesis in man*. Baltimore: Medicine, 1970.
222. Rachmilewitz EA, Schrier SL. Pathophysiology of  $\beta$  thalassemia. In: Steinberg MH, Forget BG, Higgs

DR, Nagel RL, eds. Disorders of hemoglobin: genetics, pathophysiology, and clinical management. Cambridge: Cambridge University Press, 2001:233–251.

223. Fessas P, Loukopoulos D, Kaltsoya A. Peptide analysis of the inclusions of erythroid cells in  $\beta$ -thalassemia. *Biochim Biophys Acta* 1966;124:430–432.
224. Wickramasinghe SN, Lee MJ, Furukawa T, et al. Composition of the intra-erythroblastic precipitates in thalassemia and congenital dyserythropoietic anemia (CDA): identification of a new type of CDA with intra-erythroblastic precipitates not reacting with monoclonal antibodies to  $\alpha$ - and  $\beta$ -globin chains. *Br J Haematol* 1996;93:576–585.
225. Rachmilewitz EA. Denaturation of the normal and abnormal hemoglobin molecule. *Haematology* 1974;11:248–250.
226. Polliack A, Yataganas X, Rachmilewitz EA. Ultra-structure of the inclusion bodies and nuclear abnormalities in  $\beta$ -thalassemia erythroblasts. *Ann N Y Acad Sci* 1974;32:261–282.
227. Rachmilewitz EA, Shinar E, Shalev O, et al. Erythrocyte membrane alterations in beta-thalassaemia. *Clin Haematol* 1985;14:163–182.
228. Schrier SL, Rachmilewitz EA, Mohandas N. Cellular and membrane properties of  $\alpha$  and  $\beta$  thalassemia erythrocytes are different: implication for differences in clinical manifestations. *Blood* 1989;74:2194–2202.
229. Shinar E, Rachmilewitz EA, Lux SE. Differing erythrocyte membrane skeletal protein defects in  $\alpha$  and  $\beta$  thalassemia. *J Clin Invest* 1989;83:404–410.
230. Advani R, Sorenson S, Shinar E, et al. Characterization and comparison of the red blood cell membrane damage in severe human  $\alpha$ - and  $\beta$ -thalassemia. *Blood* 1992;79:1058–1063.
231. Scott MD, Rouyer-Fessard P, Ba Ms, et al.  $\alpha$ - and  $\beta$ -Haemoglobin chain induced changes in normal erythrocyte deformability. Comparison to  $\beta$ -thalassemia intermedia and Hb H disease. *Br J Haematol* 1992;80:519–526.
232. Yuan J, Kannan R, Shinar E, et al. Isolation, characterization and immunoprecipitation studies of immune complexes from membranes of  $\beta$ -thalassemic erythrocytes. *Blood* 1992;79:3007–3013.
233. Mannu F, Arese P, Cappellini MD, et al. Role of hemichrome binding to erythrocyte membrane in the generation of band -3 alterations in  $\beta$  thalassemia intermedia erythrocyte. *Blood* 1995;86:2014–2020.
234. Hebbel RP. Auto-oxidation and a membrane associated “Fenton Reagent”: a possible explanation for development of membrane lesions in sickle erythrocytes. *Clin Haematol* 1985;14:129–140.
235. Grinberg LN, Rachmilewitz EA, Kitrossky N, et al. Hydroxyl radical generation in  $\beta$  thalassemia red blood cells. *Free Radic Biol Med* 1995;18:611–615.
236. Repka T, Shalev O, Reddy R, et al. Nonrandom association of free iron with membranes of sickle and  $\beta$  thalassaemic erythrocytes. *Blood* 1993;82:3204–3210.
237. Shalev O, Repka T, Goldfarb A, et al. Deferiprone (L1) chelates pathologic iron deposits from membranes of intact thalassaemic and sickle red blood cells both in vitro and in vivo. *Blood* 1995;86:2008–2013.
238. Browne PV, Shalev O, Kuypers FA, et al. Removal of erythrocyte membrane iron in vivo ameliorates the pathobiology of murine thalassemia. *J Clin Invest* 1997;100:1459–1464.
239. De Franceschi L, Shalev O, Piga A, et al. Deferiprone therapy in homozygous human  $\beta$  thalassemia removes erythrocytes membrane free iron and reduces KCl cotransport activity. *J Lab Clin Med* 1999;133:64–69.
240. Avissar N, Inbal A, Rabizadeh E, et al. Interaction of spectrin with hemin disaggregates spectrin associations. *Biochem Int* 1984;8:113–120.
241. Chiu DA, Lubin B. Oxidative hemoglobin denaturation and red blood cells destruction: the effect of

heme on red cell membranes. *Semin Hematol* 1989;26:128-135.

242. Yuan J, Angelucci E, Lucarelli G, et al. Accelerated programmed cell death (apoptosis) in erythroid precursors of patients with severe beta-thalassemia (Cooley's anemia). *Blood* 1993;82:374-377.

243. Mathias LA, Fisher TC, Zeng L, et al. Ineffective erythropoiesis in  $\beta$ -thalassemia major is due to apoptosis at the polychromatophilic normoblast stage. *Exp Hematol* 2000;28:1343-1353.

244. Pootrakul P, Sirankapracha P, Hhemsorach S, et al. A correlation of erythrokinetics, ineffective erythropoiesis, and erythroid precursor apoptosis in Thai patients with thalassemia. *Blood* 2000;96:2606-2612.

245. Centis F, Tabellini L, Lucarelli G, et al. The importance of erythroid expansion in determining the extent of apoptosis in erythroid precursors in patients with  $\beta$ -thalassemia major. *Blood* 2000;96:3624-3629.

246. DeMaria R, Testa U, Lucchetti L, et al. Apoptotic role of Fas/Fas ligand in the regulation of erythropoiesis. *Blood* 1999;93:796-803.

247. Zermati Y, Garrido C, Amsellem S, et al. Caspase activation is required for terminal erythroid differentiation. *J Exp Med* 2001;193:247-254.

248. Schrier SL. Pathophysiology of thalassemia. *Curr Opin Hematol* 2002;9:123-126.

249. Pootrakul P, Kitcharoen K, Yansukon P, et al. The effect of erythroid hyperplasia on iron balance. *Blood* 1988;71:1124-1129.

250. Borenstain-Ben Yashar V, Barenholoz Y, Hy-Am E, et al. Phosphatidylserine in the outer leaflet of red blood cells from beta-thalassemia patients may explain the chronic hypercoagulable state and thrombotic episodes. *Am J Hematol* 1993;44:63-65.

251. Helley D, Eldor A, Girot R, et al. Comparison of the procoagulant activity of red blood cells from patients with homozygous sickle cell disease and  $\beta$ -thalassemia. *Thromb Haemost* 1996;76:322-327.

252. Eldor A, Rachmilewitz EA. The hypercoagulable state in thalassemia. *Blood* 2002;99:36-43.

253. Eldor A, Krausz Y, Atlan H, et al. Platelet survival in patients with beta-thalassemia. *Am J Hematol* 1989;32:94-99.

254. Eldor A, Lellouche F, Goldfarb A, et al. In vivo platelet activation in beta-thalassemia major reflected by increased platelet-thromboxane urinary metabolites. *Blood* 1991;77:1749-1753.

255. Musumeci S, Leonardi S, Di Dio R, et al. Protein C and antithrombin III in polytransfused thalassaemic patients. *Acta Haematol* 1987;77:30-33.

256. Eldor A, Durst R, Hy-Am E, et al. A chronic hypercoagulable state in patients with beta-thalassaemia major is already present in childhood. *Br J Haematol* 1999;107:739-746.

257. Butthep P, Bunyaratvej A, Funahara Y, et al. Alterations in vascular endothelial cell-related plasma proteins in thalassaemic patients and their correlation with clinical symptoms. *Thromb Haemost* 1995;74:1045-1049.

258. Hovav T, Goldfarb A, Artmann G, et al. Enhanced adherence of  $\beta$  thalassemia erythrocytes to endothelial cells. *Br J Haematol* 1999;106:178-181.

259. Deo SS, Merchant SM, Kapadia AC. Elevated polymorphonuclear phagocytic function in thalassemia patients by chemiluminescence. *Indian J Pediatr* 1994;61:395-399.

260. Wiener E, Wanachiwanawin W, Chinprasertsuk S, et al. Increased serum levels of macrophage colony-stimulating factor (M-CSF) in alpha- and beta-thalassemia syndromes: correlation with anaemia and monocyte activation. *Eur J Haematol* 1996;57:364-369.

261. Gabuzda TG. Hemoglobin H and the red cell. *Blood* 1966;27:568-579.

262. Lehmann H. Different types of alpha-thalassemia and significance of haemoglobin Bart's in neonates. *Lancet* 1970;11:78-80.
263. Scott MD, Rouyer-Fessard P, Lubin BH, et al. Entrapment of purified  $\alpha$ -hemoglobin chains in normal erythrocytes: a model for  $\beta$ -thalassemia. *J Biol Chem* 1990;265:17953-17959.
264. Shalev O, Shinar E, Lux SE. Isolated  $\beta$ -globin chains reproduce, in normal red cell membranes, the defective binding of spectrin to  $\alpha$ -thalassemic membranes. *Br J Haematol* 1996;94:273-278.
265. Shinar E, Rachmilewitz EA. Hemoglobinopathies and red cell membrane function. *Baillieres Clin Haematol* 1993;6:357-369.
266. Rigas DA, Koler RD. Decreased erythrocyte survival in hemoglobin H disease as a result of the abnormal properties of hemoglobin H: the benefit of splenectomy. *Blood* 1961;18:1-17.
267. Bunyaratavej A, Sahaphong S, Bhamarapravati N, et al. Different patterns of intraerythrocytic inclusion body distribution in the two types of haemoglobin H disease. *Acta Haematol* 1983;69:314-318.
268. Liebhaber SA, Schrier SL. Pathophysiology of a thalassemia. In: Steinberg MH, Forget BG, Higgs DR, Nagel RL, eds. *Disorders of hemoglobin: genetics, pathophysiology, and clinical management*. Cambridge: Cambridge University Press, 2001:391-404.
269. Pearson HA, McFarland W. Erythrokinetics in thalassemia. Studies in Lepore trait and hemoglobin H disease in Sardinians. *Br J Haematol* 1962;46:507.
270. Wickramasinghe SN, Hughes M, Fucharoen S, et al. The fate of excess  $\alpha$  globin chains within erythropoietic cells in  $\alpha$ -thalassemia 2 trait,  $\alpha$ -thalassemia 1 trait, haemoglobin H disease and haemoglobin Q-H disease. An electron microscope study. *Br J Haematol* 1984;56:473-482.
271. Papassotiriou I, Traeger-Synodinos J, Kanavakis E, et al. Erythroid marrow activity and hemoglobin H levels in hemoglobin H disease. *J Pediatr Hematol Oncol* 1998;20:539-544.
272. Kuypers FA, Yuan J, Lewis RA. Membrane phospholipid asymmetry in human thalassemia. *Blood* 1998;91:3044-3051.
273. Naito M, Nagashima K, Massima T, et al. Phosphatidylserine externalization is a downstream event of interleukin-1 $\beta$ -converting enzyme family protease activation during apoptosis. *Blood* 1997;89:2060-2066.
274. Schrier SL, Bunyaratvej A, Khuhapinant A, et al. The usual pathobiology of hemoglobin Constant Spring red blood cells. *Blood* 1997;89:1762-1769.
275. Winichagoon P, Adirojanon P, Wasi P. Levels of haemoglobin H and proportions of red cells with inclusion bodies in the two types of haemoglobin H disease. *Br J Haematol* 1980;46:507-509.
276. Chui DH, Waye JS. Hydrops fetalis caused by  $\alpha$ -thalassemia: an emerging health care problem. *Blood* 1998;91:2213-2222.
277. Benesch RE, Ranney HM, Benesch R, et al. The chemistry of the Bohr effect II. Some properties of hemoglobin H. *J Biol Chem* 1961;36:2926-2932.
278. Horton BF, Thompson RP, Dpzy AM, et al. Inhomogeneity of hemoglobin. VI: the minor hemoglobin components of cord blood. *Blood* 1962;20:302.
279. Spanos T, Karageorga M, Ladis V, et al. Red cell alloantibodies in patients with thalassemia. *Vox Sang* 1990;58:50-55.
280. Galanello R, Cao A. Relationship between genotype and phenotype. Thalassemia intermedia. *Ann N Y Acad Sci* 1998;9:325-333.
281. Ho PJ, Hall GW, Luo LY, et al. Beta-thalassemia intermedia: is it possible consistently to predict phenotype from genotype? *Br J Haematol* 1998;100:70-78.

282. Rund D, Oron-Karni V, Filon D, et al. Genetic analysis of  $\beta$ -thalassemia intermedia in Israel: diversity of mechanisms and unpredictability of phenotype. *Am J Haematol* 1997;54:16-22.
283. Galanello R, Pirastu M, Melis MA, et al. Phenotype-genotype correlation in haemoglobin H disease in childhood. *J Med Genet* 1983;20:425-429.
284. Fucharoen S, Winichagoon P, Pootrakul P, et al. Differences between two types of Hb H disease, alpha-thalassemia 1/alpha-thalassemia 2 and alpha-thalassemia 1/Hb Constant Spring. *Birth Defects Orig Artic Ser* 1987;23:309-315.
285. Galanello R, Aru B, Dessì C, et al. Hb H disease in Sardinia: molecular, haematological and clinical aspects. *Acta Haematol* 1992;88:1-6.
286. Kanavakis E, Papassotiriou I, Karagiorga M, et al. Phenotypic and molecular diversity of haemoglobin H disease: a Greek experience. *Br J Haematol* 2000;111:915-923.
287. Weatherall DJ. Single gene disorders or complex traits: lessons from the thalassaemias and other monogenic disease. *BMJ* 2000;321:1117-1120.
288. Galanello R, Piras S, Barella S, et al. Cholelithiasis and Gilbert's syndrome in homozygous  $\beta$ -thalassemia. *Br J Haematol* 2001;115:926-928.
289. Premawardhena A, Fisher CA, Fathiu F, et al. Genetic determinants of jaundice and gallstones in haemoglobin E beta thalassaemia. *Lancet* 2001;16:1945-1946.
290. Economou-Petersen E, Aessopos A, Kladi A, et al. Apolipoprotein E e4 allele as a genetic risk factor for left ventricular failure in homozygous  $\beta$ -thalassemia. *Blood* 1998;92:3455-3459.
291. Borgna-Pignatti C, Solinas A, Bombieri C, et al. The haemochromatosis mutations do not modify the clinical picture of thalassaemia major in patients regularly transfused and chelated. *Br J Haematol* 1998;103:813-816.
292. Longo F, Zecchina G, Sbaiz L, et al. The influence of hemochromatosis mutations on iron overload of thalassaemia major. *Haematologica* 1999;84:799-803.
293. Rees DC, Singh BM, Luo LY, et al. Nontransfusional iron overload in thalassaemia. *Ann N Y Acad Sci* 1998;850:490-494.
294. Higgs DR, Lamb J, Aldridge BE, et al. Inadequacy of Hb Bart's as an indicator of alpha thalassaemia. *Br J Haematol* 1982;51:177-178.
295. Galanello R, Maccioni L, Ruggeri R, et al. a Thalassaemia in Sardinian newborns. *Br J Haematol* 1984;58:361-368.
296. Ganczakowski M, Bowden DK, Maitland K, et al. Thalassaemia in Vanuatu, south-west Pacific: frequency and haematological phenotypes of young children. *Br J Haematol* 1995;89:485-495.
297. Williams TN, Maitland K, Ganczakowski M, et al. Red blood cell phenotypes in the alpha + thalassaemias from early childhood to maturity. *Br J Haematol* 1996;95:266-272.
298. Galanello R, Monne MI, Paderi L, et al. Homozygous non-deletion alpha 2 globin gene mutation (initiation codon mutation): clinical and haematological phenotype. *Br J Haematol* 1991;79:117-119.
299. Pootrakul P, Winichagoon P, Fucharoen S, et al. Homozygous haemoglobin Constant Spring: a need for revision of concept. *Hum Genet* 1981;59:250-255.
300. Benesch RE, Ranney HM, Benesch R, et al. The chemistry of the Bohr effect. II. Some properties of hemoglobin H. *J Biol Chem* 1961;236:2926-2929.
301. Wasi P. Hemoglobinopathies in Southeast Asia. In: Bowman JE, ed. *Distribution and evolution of hemoglobin and globin loci*. New York: Elsevier Science, 1983:179-208.

302. Kattamis C, Tzotzos S, Kanavakis E, et al. Correlation of clinical phenotype to genotype in haemoglobin H disease. *Lancet* 1988;1:442-444.
303. Paglietti E, Galanello R, Moi P, et al. Molecular pathology of haemoglobin H disease in Sardinians. *Br J Haematol* 1986;63:485-496.
304. Lie-Injo LE, Ganesan J, Lopez CG. The clinical, haematological and biochemical expression of hemoglobin Constant Spring and its distribution. In: Schmidt RM, ed. *Abnormal haemoglobins and thalassaemia-diagnostic aspects*. New York: Academic Press, 1975:275.
305. Chan V, Chan TK, Liang ST, et al. Hydrops fetalis due to an unusual form of HbH disease. *Blood* 1985;66:224-228.
306. Ko T, Hsieh FJ, Hsu PM, et al. Molecular characterization of severe  $\alpha$ -thalassemias causing hydrops fetalis in Taiwan. *Am J Med Genet* 1991;39:317-320.
307. Lorey F, Charoenkwan P, Witkowska HE, et al. Hb H hydrops foetalis syndrome: a case report and review of literature. *Br J Haematol* 2001;115:72-78.
308. Wasi P, Na-Nakorn S, Pootrakul S. The alpha thalassaemias. *Clin Haematol* 1974;3:383-410.
309. Galanello R, Melis MA, Paglietti E, et al. Serum ferritin levels in hemoglobin H disease. *Acta Haematol* 1983;69:56-58.
310. Tso Sc, Chan Tk, Todd D. Venous thrombosis in haemoglobin H disease after splenectomy. *Aust N Z J Med* 1982;12:635-638.
311. Sonakul D, Fucharoen S. Pulmonary thromboembolism in thalassemic patients. *Southeast Asian J Trop Med Public Health* 1992;23:25-28.
312. Kattamis C, Metaxotou-Mavromati A, Tsiarta E, et al. Haemoglobin Bart's hydrops syndrome in Greece. *BMJ* 1980;281:268-270.
313. Galanello R, Sanna MA, Maccioni L, et al. Fetal hydrops in Sardinia: implications for genetic counseling. *Clin Genet* 1990;38:327-331.
314. Weatherall DJ, Clegg JB, Boon WH. The haemoglobin constitution of infants with the haemoglobin Bart's hydrops fetalis syndrome. *Br J Haematol* 1970;18:357-362.
315. Pootrakul S, Wasi P, Na-Nakorn S. Haemoglobin Bart's hydrops foetalis in Thailand. *Ann Hum Genet* 1967;30:293-311.
316. Diukman R, Golbus MS. In utero stem cell therapy. *J Reprod Med* 1992;37:515-520.
317. Carr S, Rubin L, Dixon D, et al. Intrauterine therapy for homozygous alpha-thalassaemia. *Obstet Gynecol* 1995;85:876-879.
318. Westgren M, Rindgen O, Eik-Nes S, et al. Lack of evidence of permanent engraftment after in utero fetal stem cell transplantation in congenital hemoglobinopathies. *Transplantation* 1996;61:1176-1179.
319. Naqvi A, Wayne JS, Morrow R, et al. Normal development of an infant with homozygous  $\alpha$  thalassaemia. *Blood* 1997;90:132.
320. Higgs DR, Bowden DK. Clinical and laboratory features of the  $\alpha$  thalassaemia syndromes. In: Steinberg MH, Forget BG, Higgs DR, Nagel R, eds. *Disorders of hemoglobin: genetics, pathophysiology and clinical management*. Cambridge: Cambridge University Press, 2001:431-469.
321. Higgs DR, Wood WG, Barton C, et al. Clinical features and molecular analysis of acquired HbH disease. *Am J Med* 1983;75:181-191.
322. Craddock CF. Normal and abnormal regulation of human  $\alpha$  globin expression. D. Phil., University of

Oxford, 1994.

323. Wilkie AOM, Buckle VJ, Harris PC, et al. Clinical features and molecular analysis of the  $\alpha$  thalassemia /mental retardation syndromes. I. Cases due to deletions involving chromosome band 16 p 13.3. *Am J Hum Genet* 1990;46:1112–1126.
324. Wilkie AOM, Zeitlin HC, Lindenbaum RH, et al. Clinical features and molecular analysis of the  $\alpha$  thalassemia /mental retardation syndromes. II. Cases without detectable abnormality of the  $\alpha$  globin complex. *Am J Hum Genet* 1990;46:1127–1140.
325. Gibbons RJ, Suthers GK, Wilkie AO, et al. X-linked  $\alpha$ -thalassemia/mental retardation (ATR-X) syndrome: localization to Xq12–q21.31 by X inactivation and linkage analysis. *Am J Hum Genet* 1992;51:1136–1149.
326. Gibbons RJ, Brueton L, Buckle VJ, et al. Clinical and hematologic aspects of the X-linked  $\alpha$ -thalassemia/mental retardation syndrome (ATR-X). *Am J Med Genet* 1995;55:288–299.
327. Picketts DJ, Higgs DR, Bachoo S, et al. ATRX encodes a novel member of the SNF2 family of proteins: mutations point to a common mechanism underlying the ATR-X syndrome. *Hum Mol Genet* 1996;5:1899–1907.
328. Gibbons RJ, Higgs DR. The Alpha Thalassemia/mental retardation syndromes. In: Steinberg MH, Forget BG, Higgs DR, Nagel R, eds. *Disorders of hemoglobin: genetics, pathophysiology and clinical management*. Cambridge: Cambridge University Press, 2001:470–488.
329. Lie-Injo LE, et al. The  $\alpha$ -globin gene adjacent to the gene for HbQ- $\alpha$  74 asp? His is deleted, but not that adjacent to the gene for HbG- $\alpha$  glu?gln; three-fourths of the  $\alpha$ -globin genes are deleted in HbQ- $\alpha$ -thalassemia. *Blood* 1979;54:1407–1416.
330. Dormandy KM, et al. Haemoglobin Q- $\alpha$ -thalassaemia. *BMJ* 1961;1:1582.
331. Lorkin PA, et al. Two haemoglobins Q,  $\alpha$ 74 (EF3) and  $\alpha$ 75 (EF4) aspartic acid ?histidine. *Br J Haematol* 1970;19:117–125.
332. Lie-Injo LE, et al. Further cases of Hb Q-h disease (Hb Q- $\alpha$  thalassemia). *Blood* 1966;28:830.
333. Vella F, Wells RHC, Ager JAM, et al. A haemoglobinopathy involving haemoglobin H and a new (Q) haemoglobin. *Br Med J* 1958;i:752.
334. Sukumaran PK, Merchant SM, Desai MP, et al. Hemoglobin Q India ( $\alpha$ 64[E13] aspartic acid?histidine) associated with  $\beta$ -thalassemia observed in three Sindhi families. *J Med Genet* 1972;9:436.
335. Rieder RF, Woodbury DH, Rucknagel DL. The interaction of  $\alpha$ -thalassemia and haemoglobin G Philadelphia. *Br J Haematol* 1976;32:159.
336. Atwater J, et al. Sickling of erythrocytes in a patient with thalassemia-hemoglobin-I disease. *N Engl J Med* 1960;263:1215.
337. Felice AE, Cleek MP, McKie K, et al. The rare  $\alpha$ -thalassemia-1 of blacks is a  $\alpha$ -thalassemia -1 associated with deletion of all  $\alpha$ - and  $\alpha$ -globin genes. *Blood* 1984;63:1253.
338. Matthay KK, et al. Modification of hemoglobin H disease by sickle trait. *J Clin Invest* 1979;64:1024.
339. Embury SH, et al. Concurrent sickle-cell anemia and  $\alpha$ -thalassemia: effect on severity. *N Engl J Med* 1982;306:270.
340. Higgs DR, et al. The interaction of  $\alpha$ -thalassemia and homozygous sickle-cell disease. *N Engl J Med* 1982;306:1441.
341. Cooley TB, Lee P. A series of cases of splenomegaly in children with anemia and peculiar bone changes. *Trans Am Pediatr Soc* 1925;37:29–34.



342. Cooley TB, Lee P. Erythroblastic anemia: additional comments. *Am J Dis Child* 1932;43:705.
343. Cooley TB, Witwer ER, et al. Anemia in children with splenomegaly and peculiar changes in the bones. Report of cases. *Am J Dis Child* 1927;34:347.
344. Rietti F. Sugli itteri emolitici primitivi. Comunicazione all'Accademia delle Scienze Naturali di Ferrara, Serie II, vol. II (1924–1925).
345. Whipple Gh, Bradford WL. Racial and familial anemia of children. *Am J Dis Child* 1932;44:336.
346. Velentine WN, Neel JV. Hematologic and genetic study of the transmission of thalassemia. *Arch Intern Med* 1944;74:185.
347. Ravenna F, Canella C. Una forma nuova di grave anemia infantile associata ad osteoporosi diffusa. *Policlinico* 1934;41:807–814.
348. Caminopetros J. L'anémie Erythroblastique. Monographies. Acad d'Athènes 1937;6:3.
349. Wintrobe MM, Mathews E, et al. A familial hemopoietic disorder in Italian adolescents and adults resembling Mediterranean disease (Thalassemia). *JAMA* 1940;114:1530.
350. Bianco Silvestroni I. Le talassemie. Un problema medico–sociale: ieri e oggi. Ist. Ital. Di Medicina Sociale Ed. Roma, 1998.
351. Kunkel HG, Wallenius G. New Hemoglobin in normal adult blood. *Science* 1955;122:288.
352. Silvestroni E, Bianco I, Modiano G. Sul valore discriminante dell'Hb A2 tra soggetti normali e microcitemici. *Il Prog Med* 1957;13:772.
353. Vecchio F. Sulla resistenza della emoglobina alla denaturazione alcalina in alcune sindromi emopatiche. *Pediatria* 1946;54:545.
354. Sturgeon P, Finch CA. Erythrokinetics in Cooley Anaemia. *Blood* 1957;12:64.
355. Perutz MF, Rossman MG, Cullis AF, et al. Structure of haemoglobin. *Nature* 1960;185:416.
356. Perutz MF, Kendrew JC, Watson HC. Structure and function of haemoglobin. II. Some relations between polypeptide chain configuration and amino acid sequence. *J Mol Biol* 1965;13:669.
357. Weatherall DJ, Clegg JB, Naughton MA. Globin synthesis in thalassemia: an in vitro study. *Nature* 1965;208:1061–1065.
358. Modell CB, Berdoukas VA. The clinical approach to thalassaemia. New York: Grune & Stratton, 1984.
359. Kattamis CA, Kattamis AC. Management of thalassemyas: growth and development, hormone substitution, vitamin supplementation, and vaccination. *Semin Hematol* 1995;32:269–279.
360. Castagnari G. Intorno ad una particolare sindrome osteopatica diffusa in un caso di anemia eritroblastica dell'infanzia. *Boll Sci Med (Bologna)* 1933;1:399.
361. Orzincolo C, Castaldi G, Scutellari PN, Franceschini F. The “lamellated” skull in beta-thalassaemia. *Skeletal Radiol* 1989;18:373–376.
362. Logothetis J, Economidou J, Constantoulakis M, et al. Cephalofacial deformities in thalassemia major (Cooley's anemia). A correlative study among 138 cases. *Am J Dis Child* 1971;121:300–306.
363. Sbyrakis S, Karagiorga-Lagana M, Voskaki I, et al. A simple index for initiating transfusion treatment in thalassaemia intermedia. *Br J Haematol* 1987;67:479–484.
364. Wonke B. Bone disease in  $\beta$ -thalassaemia major. *Br J Haematol* 1998;103:897–901.

365. Colavita N, Orazi C, Danza SM, et al. Premature epiphyseal fusion and extramedullary hematopoiesis in thalassemia. *Skeletal Radiol* 1987;16:533–538.
366. Elbers H, vd Stadt J, Wagenaar SS. Tumor-stimulating thoracic extramedullary hematopoiesis. *Ann Thorac Surg* 1980;30:584–587.
367. Sheikh A, Kameswaran M, Okafor BC, al-Saigh AA. Otological manifestations of thalassaemia intermedia: evidence of temporal bone involvement and report of a unique cholesteatoma-like lesion. *J Laryngol Otol* 1992;106:316–321.
368. Aarabi B, Haghshenas M, Rakeii V. Visual failure caused by suprasellar extramedullary hematopoiesis in beta thalassemia: case report. *Neurosurgery* 1998;42:922–925.
369. World Health Organization Study Group. Assessment of fracture risk and its application to screening for postmenopausal osteoporosis. WHO Technical Report Series, 843.
370. Jensen CE, Tuck SM, Agnew JE, et al. High prevalence of low bone mass in thalassaemia major. *Br J Haematol* 1998;103:911–915.
371. Wonke B, Jensen C, Hanslip JJ, et al. Genetic and acquired predisposing factors and treatment of osteoporosis in thalassaemia major. *J Pediatr Endocrinol Metab* 1998;11[Suppl 3]:795–780.
372. Perrotta S, Cappellini MD, Bertoldo F, et al. Osteoporosis in beta-thalassaemia major patients: analysis of the genetic background. *Br J Haematol* 2000;111:461–466.
373. Voskaridou E, Kyrtsionis MC, Terpos E, et al. Bone resorption is increased in young adults with thalassaemia major. *Br J Haematol* 2001;112:36–41.
374. Ruggiero L, De Sanctis V. Multicentre study on prevalence of fractures in transfusion-dependent thalassaemic patients. *J Pediatr Endocrinol Metab* 1998;11[Suppl 3]:773–778.
375. Michelson J, Cohen A. Incidence and treatment of fractures in thalassemia. *J Orthop Trauma* 1988;2:29–32.
376. Angastiniotis M, Pavlides N, Aristidou K, et al. Bone pain in thalassaemia: assessment of DEXA and MRI findings. *J Pediatr Endocrinol Metab* 1998;11[Suppl 3]:779–784.
377. De Sanctis V, Savarino L, Stea S, et al. Microstructural analysis of severe bone lesions in seven thalassaemic patients treated with deferoxamine. *Calcif Tissue Int* 2000;67:128–133.
378. Lasco A, Morabito N, Gaudio A, et al. Effects of hormonal replacement therapy on bone metabolism in young adults with beta-thalassemia major. *Osteoporos Int* 2001;12:570–575.
379. Wonke B. Clinical management of beta-thalassemia major. *Semin Hematol* 2001;38:350–359.
380. Seeman E, Delmas PD. Reconstructing the skeleton with intermittent parathyroid hormone. *Trends Endocrinol Metab* 2001;12:281–283.
381. Borgna-Pignatti C, De Stefano P, Panjo D, et al. Cholelithiasis in children with thalassemia major. An ultrasonographic study. *Pediatrics* 1981;99:243–244.
382. Dewey KW, Grossman H, Canale VC. Cholelithiasis in thalassemia major. *Radiology* 1970;96:385–388.
383. Feretis CB, Legakis NC, Apostolidis NS, et al. Prophylactic cholecystectomy during splenectomy for beta thalassemia homozygous in Greece. *Surg Gynecol Obstet* 1985;160:9–12.
384. Borgna-Pignatti C, Carnelli V, Caruso V, et al. Thromboembolic events in beta thalassemia major: an Italian multicenter study. *Acta Haematol* 1998;99:76–79.
385. Moratelli S, De Sanctis V, Gemmati D, et al. Thrombotic risk in thalassaemic patients. *J Pediatr Endocrinol Metab* 1998;11[Suppl 3]:915–921.

386. Borenstain-Ben Yashar V, Barenholz Y, Hy-Am E, et al. Phosphatidylserine in the outer leaflet of red blood cells from beta-thalassemia patients may explain the chronic hypercoagulable state and thrombotic episodes. *Am J Hematol* 1993;44:63-65.
387. Aessopos A, Farmakis D, Loukopoulos D. Elastic tissue abnormalities resembling pseudoxanthoma elasticum in beta thalassemia and the sickling syndromes. *Blood* 2002;99:30-35.
388. Cianciulli P, Sorrentino F, Maffei L, et al. Cardiovascular involvement in thalassemic patients with PXE-like skin lesions. A long term follow up study. *Eur J Clin Invest* 2002;32:700-706.
389. Paik CH, Alavi I, Dunea G, Weiner L. Thalassemia and gouty arthritis. *JAMA* 1970;213:296-297.
390. Sanbrook J, Fritsh EF, Moniatis T. Molecular cloning: a laboratory manual. Cold Spring Harbor: Cold Spring Harbor Laboratory Press, 1989.
391. Molecular biology: current innovations and future trends. Griffin AM, Griffin HG, eds. Norfolk: Horizon Scientific Press, 1995.
392. Old JM. DNA-based diagnosis of the hemoglobin disorders. In: Steinberg MH, Forget BG, Higgs DR, Nagel RL, eds. Disorders of hemoglobin: genetics, pathophysiology, and clinical management. Cambridge: Cambridge University Press, 2001:941-957.
393. Xiao W, Oefner PJ. Denaturing high-performance liquid chromatography: a review. *Hum Mutat* 2001;17:439-474.
394. Orsini A, Boyer G. La talassemia a Marsiglia; dati sulla frequenza ed osservazioni su alcuni aspetti clinici terapeutici ed assistenziali. Il problema sociale della microcitemia e del Morbo di Cooley. Rome, 1961.
395. Wolman LJ. Transfusion therapy in Cooley's anemia. Growth and health as related to long range hemoglobin level. *Ann N Y Acad Sci* 1964;119:736.
396. Wolman LJ, Ortolani M. Some clinical features of Cooley's anemia patients as related to transfusion schedules. *Ann N Y Acad Sci* 1969;105:407-414.
397. Piomelli S, Danoff SJ, Becker MH, et al. Prevention of bone malformations and cardiomegaly in Cooley's anemia by early hypertransfusion regimen. *Ann N Y Acad Sci* 1969;165:427-436.
398. Propper RD, Button LN, Nathan DG. New approaches to the transfusion management of thalassemia. *Blood* 1980;55:55-60.
399. Gabutti V, Piga A, Nicola P, et al. Haemoglobin levels and blood requirement in thalassaemia. *Arch Dis Child* 1982;57:156-158.
400. Piomelli S. Management of Cooley's anemia. *Baillieres Clin Haematol* 1993;6:287-298.
401. Cazzola M, Borgna-Pignatti C, Locatelli F, et al. A moderate transfusion regimen may reduce iron loading in beta-thalassemia major without producing excessive expansion of erythropoiesis. *Transfusion* 1997;37:135-140.
402. Thalassaemia International Federation. Guidelines for the clinical management of thalassemia. 2000.
403. Piomelli S, Karpatkin MH, Arzarian M, et al. Hypertransfusion regimen in patients with Cooley's anemia. *Ann N Y Acad Sci* 1974;232:186-192.
404. Rebulli P, Modell B. Transfusion requirements and effects in patients with thalassaemia major. Cooley care programme. *Lancet* 1991;337:277-280.
405. Cohen AR, Schmidt JM, Martin MB, et al. Clinical trial of young red cell transfusions. *J Pediatr* 1984;104:865-868.
406. Marcus RE, Wonke B, Bantock HM. A prospective trial of young red cells in 48 patients with

transfusion-dependent thalassaemia. *Br J Haematol* 1985;60:153-159.

407. de Montalembert M, Costagliola DG, Lefrere JJ, et al. Prevalence of markers for human immunodeficiency virus types 1 and 2, human T-lymphotropic virus type I, cytomegalovirus, and hepatitis B and C virus in multiply transfused thalassemia patients. The French Study Group on Thalassaemia. *Transfusion* 1992;32:509-512.

408. Jaiswal SP, Chitnis DS, Jain AK, et al. Prevalence of hepatitis viruses among multi-transfused homogenous thalassaemia patients. *Hepato Res* 2001;1:247-253.

409. Williams TN, Wonke B, Donohue SM. A study of hepatitis B and C prevalence and liver function in multiply transfused thalassemics and their parents. *Indian Pediatr* 1992;29:1119-1124.

410. de Montalembert M, Girot R, Mattlinger B, Lefrere JJ. Transfusion-dependent thalassemia: viral complications (epidemiology and follow-up). *Semin Hematol* 1995;32:280-287.

411. Kuo G, Choo QL, Alter HJ, et al. An assay for circulating antibodies to a major etiologic virus of human non-A, non-B hepatitis. *Science* 1989;244:362-364.

412. Prati D, Zanella A, Farma E, et al. A multicenter prospective study on the risk of acquiring liver disease in anti-hepatitis C virus negative patients affected from homozygous beta-thalassemia. *Blood* 1998;92:3460-3464.

413. Wonke B, Hoffbrand AV, Brown D, et al. Antibody to hepatitis C virus in multiply transfused patients with thalassaemia major. *J Clin Pathol* 1990;43:638-640.

414. Neufeld EJ, Macklin EA, Cohen AR for the Thalassemia Clinical Research Network. Age-related complications of thalassemia in North America. *Blood* 2002;100:120A.

415. Tosti ME, Solinas S, Prati D, et al. An estimate of the current risk of transmitting blood-borne infections through blood transfusion in Italy. *Br J Haematol* 2002;117:215-219.

416. Prati D. Benefits and complications of regular blood transfusion in patients with beta-thalassaemia major. *Vox Sang* 2000;79:129-137.

417. Angelucci E, Muretto P, Nicolucci A, et al. Effects of iron overload and HCV positivity in determining progression of liver fibrosis in thalassemia following bone marrow transplantation. *Blood* 2002;100:17-21.

418. Alter HJ. To C or not to C. There are the questions. *Blood* 1995;85:1681-1695.

419. Resnick RH, Koff R. Hepatitis C-related hepatocellular carcinoma. Prevalence and significance. *Arch Intern Med* 1993;153:1672-1677.

420. Donohue SM, Wonke B, Hoffbrand AV, et al. Alpha interferon in the treatment of chronic hepatitis C virus in multiply transfused patients with thalassaemia major. *Br J Haematol* 1993;83:491-497.

421. Rowntree C, Telfer PT, Wonke B, et al. Long-term follow up of alpha interferon therapy for chronic hepatitis C infection in thalassaemic patients. *Br J Haematol* 1995;199[Suppl 1]:55.

422. Telfer PT, Garson JA, Whitby K, et al. Combination therapy with interferon alpha and ribavirin for chronic hepatitis C virus infection in thalassaemic patients. *Br J Haematol* 1997;98:850-855.

423. Li CK, Chan PK, Ling SC, Ha SY. Interferon and ribavirin as frontline treatment for chronic hepatitis C infection in thalassaemia major. *Br J Haematol* 2002;117:755-758.

424. Kondili LA, Chionne P, Dettori S, et al. GB virus C/hepatitis G virus exposure in Italian pediatric and young adult thalassaemic patients. *Infection* 2001;29:219-221.

425. Sampietro M, Corbetta N, Cerino M, et al. Prevalence and clinical significance of hepatitis G virus infection in adult beta-thalassaemia major patients. *Br J Haematol* 1997;97:904-907.

426. Lefrere JJ, Girot R. Risk of HIV infection in polytransfused thalassaemia patients. *Lancet* 1989;2:813.

427. Choudhury NY, Dubey ML, Jolly JG, et al. Post-transfusion malaria in thalassaemia patients. *Blut* 1990;61:314-316.
428. Piomelli S. The management of patients with Cooley's anemia: transfusions and splenectomy. *Semin Hematol* 1995;32:262-268.
429. de Alarcon PA, Donovan ME, Forbes GB, et al. Iron absorption in the thalassemia syndromes and its inhibition by tea. *N Engl J Med* 1979;300:5-8.
430. Hershko C, Graham G, Bates GW, Rachmilewitz EA. Non-specific serum iron in thalassaemia: an abnormal serum iron fraction of potential toxicity. *Br J Haematol* 1978;40:255-263.
431. Ahmed NK, Hanna M, Wang W. Nontransferrin-bound serum iron in thalassemia and sickle cell patients. *Int J Biochem* 1986;18:953-956.
432. Bacon BR, Britton RS. The pathology of hepatic iron overload: a free radical-mediated process? *Hepatology* 1990;11:127-137.
433. Wang WC, Ahmed N, Hanna M. Non-transferrin-bound iron in long-term transfusion in children with congenital anemias. *J Pediatr* 1986;108:552-557.
434. Braugher JM, Chase RL, Pregoner JF. Stimulation and inhibition of iron-dependent lipid peroxidation by desferrioxamine. *Biochem Biophys Res Commun* 1988;153:933-938.
435. Breuer W, Ermers MJ, Pootrakul P, et al. Desferrioxamine-chelatable iron, a component of serum non-transferrin-bound iron, used for assessing chelation therapy. *Blood* 2001;97:792-798.
436. Tagliabue A, Turconi G, Allegrini M, et al. Ascorbic acid status in thalassemia major. *Hematologica* 1984;69:542-548.
437. Link G, Pinson A, Kahane I, Hershko C. Iron loading modifies the fatty acid composition of cultured rat myocardial cells and liposomal vesicles: effect of ascorbate and alpha-tocopherol on myocardial lipid peroxidation. *J Lab Clin Med* 1989;114:243-249.
438. Rachmilewitz EA, Shoket SB, Lubin BH, et al. Lipid membrane peroxidation in beta thalassemia major. *Blood* 1976;47:495-505.
439. Cohen A, Cohen IJ, Schwartz E. Scurvy and altered iron stores in thalassemia major. *N Engl J Med* 1981;304:158-160.
440. Lipschitz DA, Cook JD, Finch CA. A clinical evaluation of serum ferritin as an index of iron stores. *N Engl J Med* 1974;290:1213-1216.
441. Dadone MM, Kushner JP, Edwards CQ, et al. Hereditary hemochromatosis. Analysis of laboratory expression of the disease by genotype in 18 pedigrees. *Am J Clin Pathol* 1982;78:196-207.
442. Angelucci E, Muretto P, Lucarelli G, et al. Phlebotomy to reduce iron overload in patients cured of thalassemia by bone marrow transplantation. *Blood* 1997;90:994-998.
443. Letsky EA, Miller F, Worwood M, Flynn DM. Serum ferritin in children with thalassaemia regularly transfused. *J Clin Pathol* 1974;27:652-655.
444. Cazzola M, Borgna Pignatti C, De Stefano P, et al. Internal distribution of excess iron and sources of serum ferritin in patients with thalassaemia. *Scand J Haematol* 1983;30:289-296.
445. Brittenham GM, Cohen AR, McLaren CE, et al. Hepatic iron stores and plasma ferritin concentration in patients with sickle cell anemia and thalassemia major. *Am J Hematol* 1993;42:81-85.
446. Olivieri NF, Brittenham GM, Matsui D, et al. Iron-chelation therapy with oral deferiprone in patients with thalassemia major. *N Engl J Med* 1995;332:918-922.
447. Worwood M, Cragg SJ, Jacobs A, et al. Binding of serum ferritin to concanavalin A: patients with

- homozygous beta thalassaemia and transfusional iron overload. *Br J Haematol* 1980;46:409–416.
448. Chapman RWG, Hussain MAM, Gorman A, et al. Effect of ascorbic acid deficiency on serum ferritin concentration in patients with beta-thalassaemia. *J Clin Pathol* 1982;35:487–491.
449. De Virgiliis S, Cornacchia G, Sanna G, et al. Chronic liver disease in transfusion-dependent thalassaemia: liver iron quantitation and distribution. *Acta Haematol* 1981;65:32–39.
450. Pippard M. Desferrioxamine induced iron excretion in humans. *Baillieres Clin Hematol* 1989;2:323–343.
451. Angelucci E, Brittenham GM, McLaren CE, et al. Hepatic iron concentration and total body iron stores in thalassaemia major. *N Engl J Med* 2000;343:327–331.
452. Walker RJ, Miller JPG, Dymolk JW, et al. Relationship of hepatic iron concentration to histochemical grading and to total chelatable body iron in conditions associated with iron overload. *Gut* 1977;132:1011.
453. Olivieri NF, Grisaru D, Daneman A, et al. Computed tomography scanning of the liver to determine efficacy of iron chelation therapy in thalassaemia major. *J Pediatr* 1989;114:427–430.
454. Houang MT, Arozana X, Skalicka A, et al. Correlation between computed tomographic values and liver iron content in thalassaemia major with iron overload. *Lancet* 1979;1:1322–1323.
455. Berkovitch M, Bistrizter T, Milone SD, et al. Iron deposition in the anterior pituitary in homozygous beta-thalassaemia: MRI evaluation and correlation with gonadal function. *J Pediatr Endocrinol Metab* 2000;13:179–184.
456. Olivieri NF, Koren G, Matsui D, et al. Reduction of tissue iron stores and normalization of serum ferritin during treatment with the oral iron chelator L1 in thalassaemia intermedia. *Blood* 1992;79:2741–2748.
457. Bonetti MG, Castriota-Scanderbeg A, Criconia GM, et al. Hepatic iron overload in thalassaemic patients: proposal and validation of an MRI method of assessment. *Pediatr Radiol* 1996;26:650–656.
458. Chezmar JL, Nelson RC, Malko JA, Bernardino ME. Hepatic iron overload: diagnosis and quantification by noninvasive imaging. *Gastrointest Radiol* 1990;15:27–31.
459. Angelucci E, Giovagnoni A, Valeri G, et al. Limitations of magnetic resonance imaging in measurement of hepatic iron. *Blood* 1997;90:4736–4742.
460. Chan YL, Li CK, Lam CW, et al. Liver iron estimation in beta-thalassaemia: comparison of MR biochemical assay and histological grading. *Clin Radiol* 2001;56:911–916.
461. Anderson LJ, Holden S, Davis B, et al. Cardiovascular T2-star (T2\*) magnetic resonance for the early diagnosis of myocardial iron overload. *Eur Heart J* 2001;22:2171–2179.
462. Brittenham GM, Farrel DE, Harris JW, et al. Magnetic-Susceptibility measurement of human iron stores. *N Engl J Med* 1982;307:1671–1675.
463. Fisher R, Engelhardt R, Nielsen P, et al. Liver iron quantification in the diagnosis and therapy control of iron overload patients. *Biomagnetism Clinical Aspects* 1992;585–588.
464. Fischer R, Tiemann CD, Engelhardt R, et al. Assessment of iron stores in children with transfusion siderosis by biomagnetic liver susceptometry. *Am J Hematol* 1999;60:289–299.
465. Ehlers KH, Levin AR, Markenson AL, et al. Longitudinal study of cardiac function in thalassaemia major. *Ann N Y Acad Sci* 1980;344:397–404.
466. Jessup M, Manno CS. Diagnosis and management of iron-induced heart disease in Cooley's anemia. *Ann N Y Acad Sci* 1998;850:242–250.
467. Grisaru D, Rachmilewitz EA, Mosseri M, et al. Cardiopulmonary assessment in beta-thalassaemia major. *Chest* 1990;98:1138–1142.

468. Link G, Athias P, Grynberg A, et al. Effect of iron loading on transmembrane potential, contraction, and automaticity of rat ventricular muscle cells in culture. *J Lab Clin Med* 1989;113:103-111.
469. Zurlo MG, DeStefano P, Borgna-Pignatti C, et al. Survival and causes of death in thalassemia major. *Lancet* 1989;2:27-30.
470. Olivieri NF, Nathan DG, MacMillan JH, et al. Survival in medically treated patients with homozygous beta-thalassemia. *N Engl J Med* 1994;331:574-578.
471. Borgna-Pignatti C, Rugolotto S, De Stefano P, et al. Survival and disease complications in thalassemia major. *Ann N Y Acad Sci* 1998;850:227-230.
472. Short EM, Winkle RA, Billingham ME. Myocardial involvement in idiopathic hemochromatosis. Morphologic and clinical improvement following venesection. *Am J Med* 1981;70:1275-1279.
473. Barosi G, Arbustini E, Gavazzi A, et al. Myocardial iron grading by endomyocardial biopsy. A clinicopathologic study on iron overloaded patients. *Eur J Haematol* 1989;42:382-388.
474. Fitchett DH, Coltart DJ, Littler WA, et al. Cardiac involvement in secondary haemochromatosis: a catheter biopsy study and analysis of myocardium. *Cardiovasc Res* 1980;14:719-724.
475. Lombardo T, Tamburino C, Bartoloni G, et al. Cardiac iron overload in thalassemic patients: an endomyocardial biopsy study. *Ann Hematol* 1995;71:135-161.
476. Kremastinos DT, Tsetsos GA, Tsiapras DP, et al. Heart failure in beta thalassemia: a 5-year follow-up study. *Am J Med* 2001;111:349-354.
477. Stanfield JB. Acute benign pericarditis in thalassemia major. *Proc R Soc Med* 1962;55:236.
478. Bahl VK, Malhotra OP, Kumar D, et al. Noninvasive assessment of systolic and diastolic left ventricular function in patients with chronic severe anemia: a combined M-mode, two-dimensional, and Doppler echocardiographic study. *Am Heart J* 1992;124:1516-1523.
479. Kremastinos DT, Tiniakos G, Theodorakis GN, et al. Myocarditis in beta-thalassemia major. A cause of heart failure. *Circulation* 1996;91:66-71.
480. Aessopos A, Stamatelos G, Skoumas V, et al. Pulmonary hypertension and right heart failure in patients with beta-thalassemia intermedia. *Chest* 1995;107:50-53.
481. Vecchio C, Derchi G. Management of cardiac complications in patients with thalassemia major. *Semin Hematol* 1995;32:288-296.
482. Karvounis HI, Zaglavara TA, Parharidis GE, et al. An angiotensin-converting enzyme inhibitor improves left ventricular systolic and diastolic function in transfusion-dependent patients with beta-thalassemia major. *Am Heart J* 2001;141:281.
483. Olivieri NF, Liu PP, Sher GD, et al. Successful combined cardiac and liver transplantation in an adult with homozygous beta-thalassemia. *N Engl J Med* 1994;330:1125-1128.
484. Detry O, Defechereux T, Honore P, et al. Combined liver and heart transplantation in a patient with thalassemia major. *Rev Med Liege* 1997;52:532-534.
485. Koerner MM, Tenderich G, Minami K, et al. Heart transplantation for end-stage heart failure caused by iron overload. *Br J Haematol* 1997;97:293-296.
486. Perrimond H, Michel G, Orsini A, et al. First report of a cardiac transplantation in a patient with thalassaemia major. *Br J Haematol* 1991;78:467.
487. Lisboa PE. Experimental hepatic cirrhosis in dogs caused by chronic massive iron overload. *Gut* 1971;12:363-368.
488. O'Brien RT. Iron overload: clinical and pathologic aspects in pediatrics. *Semin Hematol*



1977;14:115-125.

489. Ishak KG, Baptista A, Bianchi L, et al. Histological grading and staging of chronic hepatitis. *J Hepatol* 1995;22:696-699.
490. Loreal O, Deugnier Y, Moirand R, et al. Liver fibrosis in genetic hemochromatosis. Respective roles of iron and non-iron related factors in 127 homozygous patients. *J Hepatol* 1992;16:122-127.
491. Muretto P, Angelucci E, Lucarelli G. Reversibility of cirrhosis in patients cured of thalassemia by bone marrow transplantation. *Ann Intern Med* 2002;136:667-672.
492. Maurer HS, Lloyd-Still JD, Ingrisano C, et al. A prospective evaluation of iron chelation therapy in children with severe beta-thalassemia. A six-year study. *Am J Dis Child* 1988;142:287-292.
493. Aldouri MA, Wonke B, Hoffbrand AV, et al. Iron state and hepatic disease in patients with thalassaemia major, treated with long term subcutaneous desferrioxamine. *J Clin Pathol* 1987;40:1353-1359.
494. Olynyk JK. Hepatitis C and iron. *Keio J Med* 1999;48:124-131.
495. Ellis JT, Schulman I, Smith CH. Generalized siderosis with fibrosis of liver and pancreas in Cooley's (Mediterranean) anemia; with observations on the pathogenesis of the siderosis and fibrosis. *Am J Pathol* 1954;30:287.
496. Witzleben CL, Wyatt JP. The effect of long-survival on the pathology of thalassaemia major. *J Pathol Bact* 1961;82:1.
497. Ambu R, Crisponi G, Sciot R, et al. Uneven hepatic iron and phosphorus distribution in beta-thalassemia. *J Hepatol* 1995;23:544-549.
498. Clark PR, St Pierre TG. Quantitative mapping of transverse relativity ( $1/T(2)$ ) in hepatic iron overload: a single spin-echo imaging methodology. *Magn Reson Imaging* 2000;18:431-438.
499. Niederau C, Fischer R, Sonnenberg A, et al. Survival and causes of death in cirrhotic and in noncirrhotic patients with primary hemochromatosis. *N Engl J Med* 1985;313:1256-1262.
500. Fracanzani A, Conte D, Fraquelli M, et al. Increased cancer risk in a cohort of 230 patients with hereditary hemochromatosis in comparison to matched control patients with non-iron-related chronic liver disease. *Hepatology* 2001;33:647-651.
501. Beasley RP. Hepatitis B virus. The major etiology of hepatocellular carcinoma. *Cancer* 1988;61:1942-1956.
502. Borgna-Pignatti C, De Stefano P, Sessa F, Avato F. Hepatocellular carcinoma in thalassemia major. *Med Pediatr Oncol* 1986;14:327-328.
503. Borgna-Pignatti C, De Stefano P, Zonta L, et al. Growth and sexual maturation in thalassemia major. *J Pediatr* 1985;106:150-155.
504. De Sanctis V, Pintor C, Gamberini MR, et al. Multicenter study on prevalence of endocrine complications in thalassaemia major. *Clin Endocrinol* 1995;42:581-586.
505. Bronsiegel-Weintrob N, Olivieri NF, Tyler B, et al. Effect of age at the start of iron chelation therapy on gonadal function in beta-thalassemia major. *N Engl J Med* 1990;323:713-719.
506. Kattamis CA, Kattamis AC. Management of thalassemias: growth and development, hormone substitution, vitamin supplementation, and vaccination. *Semin Hematol* 1995;32:269-279.
507. Canale VC, Steinherz P, New M, Erlandson M. Endocrine function in thalassemia major. *Ann N Y Acad Sci* 1974;232:333-345.
508. Skordis N, Christou S, Koliou M, et al. Fertility in female patients with thalassemia. *J Pediatr Endocrinol Metab* 1998;11[Suppl 3]:935-943.

509. Negri P, De Sanctis V, Grechi E, et al. Preliminary observations about assisted reproduction in thalassaemia. *J Pediatr Endocrinol Metab* 1998;11[Suppl 3]:929-933.
510. De Sanctis V, Katz M, Wonke B, et al. Semen parameters in patients with homozygous B-thalassemia. *Infertility* 1989;12:167.
511. Cisternino M, Manzoni SM, Coslovich E, Autelli M. Hormonal replacement therapy with HCG and HU-FSH in thalassaemic patients affected by hypogonadotropic hypogonadism. *J Pediatr Endocrinol Metab* 1998;11[Suppl 3]:885-890.
512. Tampakoudis P, Tsatalas C, Mamopoulos M, et al. Transfusion-dependent homozygous beta-thalassaemia major: successful pregnancy in five cases. *Eur J Obstet Gynecol Reprod Biol* 1997;74:127-131.
513. Karagiorga-Lagana M. Fertility in thalassemia: the Greek experience. *J Pediatr Endocrinol Metab* 1998;11[Suppl 3]:945-951.
514. Savona-Ventura C, Bonello F. Beta-thalassemia syndromes and pregnancy. *Obstet Gynecol Surv* 1994;49:129-137.
515. Naef RW III, Morrison JC. Transfusion therapy in pregnancy. *Clin Obstet Gynecol* 1995;38:547-557.
516. Voskaridou E, Konstantopoulos K, Kyriakou D, Loukopoulos D. Deferoxamine treatment during early pregnancy: absence of teratogenicity in two cases. *Haematologica* 1993;78:183-184.
517. Singer ST, Vichinsky EP. Deferoxamine treatment during pregnancy: is it harmful? *Am J Hematol* 1999;60:24-26.
518. Tuck SM, Jensen CE, Wonke B, Yardumian A. Pregnancy management and outcomes in women with thalassaemia major. *J Pediatr Endocrinol Metab* 1998;11[Suppl 3]:923-928.
519. De Sanctis V, Katz M, Vullo C, et al. Effect of different treatment regimes on linear growth and final height in beta-thalassaemia major. *Clin Endocrinol* 1994;40:791-798.
520. Piga A, Luzzatto L, Capalbo P, et al. High-dose desferrioxamine as a cause of growth failure in thalassaemic patients. *Eur J Haematol* 1988;40:380-381.
521. Theodoridis C, Ladis V, Papatheodorou A, et al. Growth and management of short stature in thalassaemia major. *J Pediatr Endocrinol Metab* 1998;11[Suppl 3]:835-844.
522. Roth C, Pekrun A, Bartz M, et al. Short stature and failure of pubertal development in thalassaemia major: evidence for hypothalamic neurosecretory dysfunction of growth hormone secretion and defective pituitary gonadotropin secretion. *Eur J Pediatr* 1997;156:777-783.
523. Low LCK, Wang Q. Gonadotropin independent precocious puberty. *J Pediatr Endocrinol Metab* 1998;11:497-507.
524. Cavallo L, Gurrado R, Zecchino C, et al. Short-term therapy with recombinant growth hormone in polytransfused thalassaemia major patients with growth deficiency. *J Pediatr Endocrinol Metab* 1998;11[Suppl 3]:845-849.
525. Katz M, De Sanctis V, Vullo C, et al. Pharmacokinetics of sex steroids in patients with beta thalassaemia major. *J Clin Pathol* 1993;46:660-664.
526. De Sanctis V, Pintor C, Aliquò MC, et al. Prevalence of endocrine complications in patients with beta-thalassemia major: an Italian Multicenter Study. In: Pintor C, Muller EE, Loche S, eds. *New advances in pediatric endocrinology*. Milano: Pythagora Press and Berlin-Heidelberg: Springer-Verlag, 1992:127-133.
527. De Sanctis V, Vullo C, Bagni B, et al. Hypoparathyroidism in beta-thalassemia major. Clinical and laboratory observations in 24 patients. *Acta Haematol* 1992;88:105-108.
528. Pratico G, Di Gregorio F, Caltabiano L, et al. Calcium phosphate metabolism in thalassemia. *Pediatr*

Med Chir 1998;20:265–268.

529. Sklar CA, Lew LQ, Yoon DJ, et al. Adrenal function in thalassemia major following long-term treatment with multiple transfusions and chelation therapy. Evidence for dissociation of cortisol and adrenal androgen secretion. *Am J Dis Child* 1987;141:327–330.

530. Brittenham GM, Griffith PM, Nienhuis AW, et al. Efficacy of deferoxamine in preventing complications of iron overload in patients with thalassemia major. *N Engl J Med* 1994;331:567–573.

531. Gamberini MR, Fortini M, Gilli G, et al. Epidemiology and chelation therapy effects on glucose homeostasis in thalassaemic patients. *J Pediatr Endocrinol Metab* 1998;11[Suppl 3]:867–869.

532. Iancu TC. Biological and ultrastructural aspects of iron overload. An overview. *New York: Hemisphere*, 1990:251–295.

533. Merkel PA, Simonson DC, Amiel SA, et al. Insulin resistance and hyperinsulinemia in patients with thalassemia major treated by hypertransfusion. *N Engl J Med* 1988;318:809–814.

534. Borgna-Pignatti C, Piga A, Rugolotto S, et al. Survival and disease complications in thalassemia major. *Bone Marrow Transplant* 1997;19[Suppl 2]:227–231.

535. De Sanctis V, D'Ascola G, Wonke B. The development of diabetes mellitus and chronic liver disease in long term chelated beta-thalassaemic patients. *Postgrad Med J* 1986;62:831–836.

536. Incorvaia C, Parmeggiani F, Mingrone G, et al. Prevalence of retinopathy in diabetic thalassaemic patients. *J Pediatr Endocrinol Metab* 1998;11[Suppl 3]:879–883.

537. Cavallo-Perin P, Pacini G, Cerutti F, et al. Insulin resistance and hyperinsulinemia in homozygous beta-thalassemia. *Metabolism* 1995;44:281–286.

538. Ladis V, Theodorides C, Palamidou F, et al. Glucose disturbances and regulation with glibenclamide in thalassemia. *J Pediatr Endocrinol Metab* 1998;11:871–878.

539. Hussain MAM, Dandona P, Fedail SS, et al. Serum immunoreactive trypsin in beta-thalassemia major. *J Clin Pathol* 1981;45:970–971.

540. Gullo L, Corcioni E, Brancati C, et al. Morphologic and functional evaluation of the exocrine pancreas in beta-thalassemia. *Pancreas* 1993;8:176–180.

541. Blandford RL, Dowdle JR, Stephens MR, Walker DM. Sicca syndrome associated with idiopathic haemochromatosis. *Br Med J* 1979;1:1323.

542. Borgna-Pignatti C, Cammareri V, De Stefano P, Magrini U. The sicca syndrome in thalassaemia major. *Br Med J* 1984;288:668–669.

543. Arden GB, Wonke B, Kennedy C, Huehns ER. Ocular changes in patients undergoing long-term desferrioxamine treatment. *Br J Ophthalmol* 1984;68:873–877.

544. Gelmi C, Borgna-Pignatti C, Franchin S, et al. Electroretinographic and visual-evoked potential abnormalities in patients with beta-thalassemia major. *Ophthalmologica* 1988;196:29–34.

545. Dimopoulou I, Kremastinos DT, Maris TG, et al. Respiratory function in patients with thalassaemia and iron overload. *Eur Respir J* 1999;13:602–605.

546. Hershko C, Grady R, Cerami A. Mechanism of desferrioxamine-induced iron extraction in the hypertransfused rat: definition of two alternative pathways of iron mobilization. *J Lab Clin Med* 1978;92:144–157.

547. Hershko C, Rachmilewitz E. Mechanism of desferrioxamine induced iron excretion in thalassaemia. *Br J Haematol* 1979;42:125–132.

548. Pippard M, Johnson D, Callender S, et al. Ferrioxamine excretion in iron loaded man. *Blood*

1982;60:288-294.

549. Sephton-Smith R. Iron excretion in thalassaemia major after administration of chelating agents. *Br Med J* 1962;2:1577.
550. Barry M, Flynn DM, Letsky EA, Risdon RA. Long term chelation therapy in thalassaemia: effect on liver iron concentration, liver histology and clinical progress. *BMJ* 1974;2:16-20.
551. Letsky EA, Flynn DM, Barry M. The effect of treatment with long-term chelating agents on iron overload in thalassaemia. *Br J Haematol* 1973;25:285.
552. Letsky EA. A controlled trial of long-term chelation therapy in homozygous beta-thalassaemia. *Birth Defects Orig Artic Ser* 1976;12:31-41.
553. Propper RL, Cooper B, Rufo RR, et al. Continuous subcutaneous administration of deferoxamine in patients with iron overload. *N Engl J Med* 1977;297:418.
554. Hussain MAM, Flynn DM, Green N, Hoffbrand AV. Effect of dose, time, and ascorbate on iron excretion after subcutaneous desferrioxamine. *Lancet* 1977;1:977-979.
555. Pippard MJ, Callender ST, Weatherall DJ. Intensive iron-chelation therapy with desferrioxamine in iron-loading anaemias. *Clin Sci Mol Med* 1978;54:99-106.
556. Pippard MJ, Letsky EA, Callender ST, Weatherall DJ. Prevention of iron loading in transfusion-dependent thalassaemia. *Lancet* 1978;1:1178-1181.
557. Porter JB, Aheysinghe RD, Marshall L, et al. Kinetics of removal and reappearance of non-transferrin-bound plasma iron with deferoxamine therapy. *Blood* 1996;88:705-713.
558. Breuer W, Ronson A, Slotki IN, et al. The assessment of serum nontransferrin-bound iron in chelation therapy and iron supplementation. *Blood* 2000;95:2975-2982.
559. Cohen A, Martin M, Schwartz E. Depletion of excessive liver iron stores with desferrioxamine. *Br J Haematol* 1984;58:369-373.
560. Modell B, Khan M, Darlison M. Survival in beta-thalassaemia major in the UK: data from the UK Thalassaemia Register. *Lancet* 2000;355:2051-2052.
561. Rodda CP, Reid ED, Johnson S, et al. Short stature in homozygous-thalassaemia is due to disproportionate truncal shortening. *Clin Endocrinol* 1995;42:587-592.
562. Olivieri NF, Brittenham GM. Iron-chelating therapy and the treatment of thalassaemia. *Blood* 1997;89:739-761.
563. Saxon BR, Brittenham GM, Nisbet Brown, et al. Liver biopsy is safe and provides quantitative guidelines for initiation of chelating therapy in children with thalassaemia major. *Blood* 1997;90:130a.
564. Cartwright GE, Edwards CQ, Kravitz K, et al. Hereditary hemochromatosis. Phenotypic expression of the disease. *N Engl J Med* 1979;301:175-179.
565. Cohen AR, Mizanin J, Schwartz E. Rapid removal of excessive iron with daily, high-dose intravenous chelation therapy. *J Pediatr* 1989;115:151-155.
566. Davis BA, Porter JB. Long-term outcome of continuous 24-hour deferoxamine infusion via indwelling intravenous catheters in high-risk beta-thalassaemia. *Blood* 2000;95:1229-1236.
567. Link G, Pinson A, Hershko C. Heart cells in culture: a model of myocardial iron overload and chelation. *J Lab Clin Med* 1985;106:147-153.
568. Hershko C, Link G, Pinson A. Modification of iron uptake and lipid peroxidation by hypoxia, ascorbic acid, and alpha-tocopherol in iron-loaded rat myocardial cell cultures. *J Lab Clin Med* 1987;110:355-361.
569. Freedman MH, Olivieri NF, Grisaru D, et al. Pulmonary syndrome in patients receiving intravenous

deferoxamine infusions. *Am J Dis Child* 1990;144:565-569.

570. Castriota Scanderbeg A, Izzi GC, Butturini A, Benaglia G. Pulmonary syndrome and intravenous high-dose desferrioxamine. *Lancet* 1990;336:1511.

571. Borgna-Pignatti C, Cohen A. Evaluation of a new method of administration of the iron chelating agent deferoxamine. *J Pediatr* 1997;130:86.

572. Borgna-Pignatti C, Franchini M, Gandini G, et al. Subcutaneous bolus injection of deferoxamine in adult patients affected by onco-hematologic diseases and iron overload. *Haematologica* 1998;83:788.

573. Franchini M, Gandini G, de Gironcoli M, et al. Safety and efficacy of subcutaneous bolus injection of deferoxamine in adult patients with iron overload. *Blood* 2000;95:2776.

574. Cianciulli P, Sorrentino F, Maffei L, Amadori S. Continuous low-dose subcutaneous desferrioxamine (DFO) to prevent allergic manifestations in patients with iron overload. *Ann Hematol* 1996;73:279-281.

575. Bosquet J, Navarro M, Robert G, et al. Rapid desensitization for desferrioxamine anaphylactoid reaction. *Lancet* 1983;2:859.

576. Davies SC, Marcus RE, Hungerford JL, et al. Ocular toxicity of high-dose intravenous desferrioxamine. *Lancet* 1983;2:181-184.

577. Borgna-Pignatti C, De Stefano P, Broglia AM. Visual loss in patient on high-dose subcutaneous desferrioxamine. *Lancet* 1984;1:681.

578. Olivieri NF, Buncic JR, Chew E, et al. Visual and auditory neurotoxicity in patients receiving subcutaneous deferoxamine infusions. *N Engl J Med* 1986;314:869-873.

579. Porter JB, Jaswon MS, Huehns ER, et al. Desferrioxamine ototoxicity: evaluation of risk factors in thalassaemic patients and guidelines for safe dosage. *Br J Haematol* 1989;73:403-409.

580. Gallant T, Boyden MH, Gallant LA, et al. Serial studies of auditory neurotoxicity in patients receiving deferoxamine therapy. *Am J Med* 1987;83:1085-1090.

581. DeVirgilis S, Congia M, Frau F, et al. Deferoxamine-induced growth retardation in patients with thalassemia major. *J Pediatr* 1988;113:661-669.

582. Olivieri NF, Koren G, Harris J, et al. Growth failure and bony changes induced by deferoxamine. *Am J Pediatr Hematol Oncol* 1992;14:48-56.

583. De Sanctis V, Pinamonti A, Di Palma A, et al. Growth and development in thalassaemia major patients with severe bone lesions due to desferrioxamine. *Eur J Paediatr* 1996;155:368.

584. Koren G, Bentur Y, Strong D, et al. Acute changes in renal function associated with deferoxamine therapy. *Am J Dis Child* 1989;143:1077-1080.

585. Koren G, Kochavi-Atiya Y, Bentur Y, Olivieri NF. The effects of subcutaneous deferoxamine administration on renal function in thalassemia major. *Int J Haematol* 1991;54:371-375.

586. Robins-Browne RM, Prpic JK. Effects of iron and desferrioxamine in infections with *Yersinia enterocolitica*. *Infect Immunol* 1985;47:774-779.

587. Gallant T, Freedman MH, Vellend H, Francombe WH. *Yersinia* sepsis in patients with iron overload treated with deferoxamine. *N Engl J Med* 1986;314:1643.

588. al-Refaie FN, Sheppard LN, Nortey P, et al. Pharmacokinetics of the oral iron chelator deferiprone (L1) in patients with iron overload. *Br J Haematol* 1995;89:403-408.

589. Kontoghiorghes GJ, Goddard JG, Bartlett AN, Sheppard L. Pharmacokinetic studies in humans with the oral iron chelator 1,2-dimethyl-3-hydroxypyrid-4-one. *Clin Pharmacol Ther* 1990;48:255-261.

590. Hoffbrand AV. Oral iron chelators. *Semin Hematol* 1996;33:1-8.
591. Addis A, Loebstein R, Koren G, Einarson TR. Meta-analytic review of the clinical effectiveness of oral deferiprone (L1). *Eur J Clin Pharmacol* 1999;55:1-6.
592. al-Refaie FN, Wickens DG, Wonke B, et al. Serum non-transferrin-bound iron in beta-thalassaemia major patients treated with desferrioxamine and L1. *Br J Haematol* 1992;82:431-436.
593. Maggio A, D'Amico G, Morabito A, et al. Deferiprone versus deferoxamine in patients with thalassemia major: a randomized clinical trial. *Blood Cells Mol Dis* 2002;28:196-208.
594. Wonke B, Wright C, Hoffbrand AV. Combined therapy with deferiprone and desferrioxamine. *Br J Haematol* 1998;103:361-364.
595. Link G, Konijn AM, Breuer W, et al. Exploring the "iron shuttle" hypothesis in chelation therapy: effects of combined deferoxamine and deferiprone treatment in hypertransfused rats with labeled iron stores and in iron-loaded rat heart cells in culture. *J Lab Clin Med* 2000;138:130-138.
596. al-Refaie FN, Wonke B, Hoffbrand AV, et al. Efficacy and possible adverse effects of the oral iron chelator 1,2-dimethyl-3-hydroxypyrid-4-one (L1) in thalassemia major. *Blood* 1992;80:593-599.
597. al-Refaie FN, Hershko C, Hoffbrand AV, et al. Results of long-term deferiprone (L1) therapy: a report by the International Study Group on Oral Iron Chelators. *Br J Haematol* 1995;91:224-229.
598. Hoffbrand AV, Bartlett AN, Veys PP, et al. Agranulocytosis and thrombocytopenia in patient with Blackfan-Diamond anaemia during oral chelator trial [letter]. *Lancet* 1989;2:457.
599. Goudsmit R, Kersten MJ. Long term treatment of transfusion hemosiderosis with the oral chelator L1. *Drugs Today* 1992;28:133.
600. al-Refaie FN, Wonke B, Hoffbrand AV. Deferiprone-associated myelotoxicity. *Eur J Haematol* 1994;53:298-301.
601. Cohen AR, Galanello R, Piga A, et al. Safety profile of the oral iron chelator deferiprone: a multicenter study. *Br J Haematol* 2000;108:305-312.
602. al-Refaie FN, Wonke B, Wickens DG, et al. Zinc concentration in patients with iron overload receiving oral iron chelator 1,2-dimethyl-3-hydroxypyrid-4-one or desferrioxamine. *J Clin Pathol* 1994;47:657-660.
603. Agarwal MB, Gupte SS, Viswanathan C, et al. Long term assessment of efficacy and safety of L1, an oral iron chelator in transfusion dependent thalassaemia. *Br J Haematol* 1992;82:460-466.
604. Olivieri NF, Brittenham GM, McLaren CE, et al. Long-term safety and effectiveness of iron-chelation therapy with deferiprone for thalassemia major. *N Engl J Med* 1998;339:417-423.
605. Wanless IR, Sweeney G, Dhillon AP, et al. Lack of progressive hepatic fibrosis during long term therapy with deferiprone in subjects with transfusion-dependent beta-thalassemia. *Blood* 2002;100:1566-1569.
606. Nienhuis AW. Vitamin C and iron. *N Engl J Med* 1981;304:170-171.
607. Vatanavicharn S, Anuvatanakulchai M, Na-nakorn S, Wasi P. Serum erythrocyte folate levels in thalassemia patients. *J Med Assoc Thailand* 1978;61:56.
608. Vatanavicharn S, Anuvatanakulchai M, Na-Nakorn S, Wasi P. Serum erythrocyte folate levels in thalassaemic patients in Thailand. *Scand J Haematol* 1979;22:241-245.
609. Arcasoy A, Canata D, Sinav B, et al. Serum zinc levels and zinc binding capacity in thalassemia. *J Trace Elem Med Biol* 2001;15:85-87.
610. Silprasert A, Laokuldilok T, Kulapongs P. Zinc deficiency in beta thalassaemic children. *Birth Defects*

1998;23:473.

611. Modell B. Total management of thalassaemia major. *Arch Dis Child* 1977;52:489–500.
612. Cohen A, Gayer R, Mizanin J. Long-term effect of splenectomy on transfusion requirements in thalassemia major. *Am J Hematol* 1989;30:254–256.
613. Luks FI, Logan J, Breuer CK, et al. Cost-effectiveness of laparoscopy in children. *Arch Pediatr Adolesc Med* 1999;153:965–968.
614. Rich S, Dantzker DR, Ayres SM, et al. Primary pulmonary hypertension. A national prospective study. *Ann Intern Med* 1987;107:216–223.
615. Rubin LJ. Primary pulmonary hypertension. *N Engl J Med* 1997;336:111–117.
616. Hoepfer MM, Niedermeyer J, Hoffmeyer F, et al. Pulmonary hypertension after splenectomy? *Ann Intern Med* 1999;130:506–509.
617. Sumiyoshi A, Thakerngpol K, Sonakul D. Pulmonary microthromboemboli in thalassaemic cases. *Southeast Asian J Trop Med Public Health* 1992;23[Suppl 2]:29–31.
618. Du ZD, Roguin N, Milgram E, Saab K, Koren A. Pulmonary hypertension in patients with thalassemia major. *Am Heart J* 1997;134:532–537.
619. Derchi G, Fonti A, Forni GL, et al. Pulmonary hypertension in patients with thalassemia major. *Am Heart J* 1999;138:384.
620. Smith CH, Erlandson ME, Stern G, Hilgartner MW. Postsplenectomy infection in Cooley's anemia. An appraisal of the problem in this and other blood disorders, with consideration of prophylaxis. *N Engl J Med* 1962;266:737.
621. Smith CH, Erlandson ME, Stern G, Hilgartner H. Postsplenectomy infection in Cooley's anemia. *Ann N Y Acad Sci* 1964;119:748.
622. Erikson WD, Burget EO, Lynn HB. The hazard of infection following splenectomy in children. *Am J Dis Child* 1968;116:1.
623. Martin F, Oliver AM, Kearney JF. Marginal zone and B1 B cells unite in the early response against T-independent blood-borne particulate antigens. *Immunity* 2001;14:617–629.
624. Wolf HM, Eibl MM, Georgi E, Samstag A, et al. Long-term decrease of CD4+CD45RA+ T cells and impaired primary immune response after post-traumatic splenectomy. *Br J Haematol* 1999;107:55–68.
625. Looareesuwan S, Suntharasamai P, Webster HK, Ho M. Malaria in splenectomized patients: report of four cases and review. *Clin Infect Dis* 1993;16:361–366.
626. Yu RK, Shepherd LE, Rapson DA. Capnocytophaga canimorsus, a potential emerging microorganism in splenectomized patients. *Br J Haematol* 2000;109:679.
627. Hansen K, Singer DB. Asplenic-hyposplenic overwhelming sepsis: postsplenectomy sepsis revisited. *Pediatr Dev Pathol* 2001;4:105–121.
628. Singer DB. Postsplenectomy sepsis. *Perspect Pediatr Pathol* 1973;1:285–311.
629. Issaragrisil S, Wanachiwanawin W, Bhuripanyo K, et al. Infection in thalassemia: a retrospective study of 1,018 patients with beta-thalassemia/Hb E disease. *Birth Defects Orig Artic Ser* 1987;23:505–511.
630. Working Party of the British Committee for Standards in Haematology Clinical Haematology Task Force. Guidelines for the prevention and treatment of infection in patients with an absent or dysfunctional spleen. *BMJ* 1996;312:430–434.
631. Li Volti S, Sciotto A, Fisichella M, et al. Immune responses to administration of a vaccine against



- Haemophilus influenzae type B in splenectomized and non-splenectomized patients. *J Infect* 1999;39:38-41.
632. Balmer P, Miller E. Meningococcal disease: how to prevent and how to manage. *Curr Opin Infect Dis* 2002;15:275-281.
633. Konradsen HB, Henrichsen J. Pneumococcal infections in splenectomized children are preventable. *Acta Paediatr Scand* 1991;80:423-427.
634. Broome CV, Facklam RR, Fraser DW. Pneumococcal disease after pneumococcal vaccination: an alternative method to estimate the efficacy of pneumococcal vaccine. *N Engl J Med* 1980;303:549-552.
635. Borgna-Pignatti C, De Stefano P, Barone F, Concia E. Penicillin compliance in splenectomized thalassaemics. *Eur J Pediatr* 1984;142:83-85.
636. Buchanan GR, Siegel JD, Smith SJ, DePasse BM. Oral penicillin prophylaxis in children with impaired splenic function: a study of compliance. *Pediatrics* 1982;70:926-930.
637. Slater PP, Sherlock EC. Splenectomy, thrombocytosis and venous thrombosis. *Ann Surg* 1957;23:549-554.
638. Hathirat P, Mahaphan W, Chuansumrit A, et al. Platelet counts in thalassaemic children before and after splenectomy. *Southeast Asian J Trop Med Public Health* 1993;24:213-215.
639. de Montalembert M, Girot R, Revillon Y, et al. Partial splenectomy in homozygous beta thalassaemia. *Arch Dis Child* 1990;65:304-307.
640. Politis C, Spigos DG, Georgiopoulou P, et al. Partial splenic embolization for hypersplenism of thalassaemia major: five-year follow up. *Br Med J Clin Res Ed* 1987;294:665-667.
641. Pinca A, Di Palma A, Soriani S, et al. Effectiveness of partial splenic embolization as treatment for hypersplenism in thalassaemia major. *Eur J Haematol* 1992;49:49-52.
642. Okon E, Levij IS, Rachmilewitz EA. Splenectomy, iron overload and liver cirrhosis in beta-thalassaemia major. *Acta Haematol* 1976;56:142-150.
643. Borgna-Pignatti C, De Stefano P, Bongo IG, et al. Spleen iron content is low in thalassaemia. *Am J Pediatr Hematol Oncol* 1984;6:340-343.
644. Risdon RA, Barry M, Flynn DM. Transfusional iron overload: the relationship between tissue iron concentration and hepatic fibrosis in thalassaemia. *J Pathol* 1975;116:83-95.
645. Ehlers KH, Giardina PJ, Lesser ML, et al. Prolonged survival in patients with beta-thalassaemia major treated with deferoxamine. *J Pediatr* 1991;118:540-545.
646. Tsiantis J. Family reactions and relationships in thalassaemia. *Ann N Y Acad Sci* 1990;612:451-461.
647. Di Palma A, Vullo C, Zani B, Facchini A. Psychosocial integration of adolescents and young adults with thalassaemia major. *Ann N Y Acad Sci* 1998;850:355-360.
648. Politis C, Di Palma A, Fisfis M, et al. Social integration of the older thalassaemic patient. *Arch Dis Child* 1990;65:984-986.
649. Tsiantis J, Dragonas T, Richardson C, et al. Psychosocial problems and adjustment of children with beta-thalassaemia and their families. *Eur Child Adolesc Psychiatry* 1996;5:193-203.
650. Anie KA, Massaglia P. Psychological therapies for thalassaemia. *Cochrane Database Syst Rev* 2001;(3):CD002890.
651. Thomas ED, Buckner CD, Sanders JE, et al. Marrow transplantation for thalassaemia. *Lancet* 1982;ii:227-229.
652. Lucarelli G, Giardini C, Baronciani D. Bone marrow transplantation in thalassaemia. *Semin Hematol*

1995;32:297-303.

653. Lucarelli G, Clift RA, Galimberti M, et al. Bone marrow transplantation in adult thalassemic patients. *Blood* 1999;93:1164-1167.
654. Lucarelli G, Clift RA, Galimberti M, et al. Marrow transplantation for patients with thalassemia: results in class 3 patients. *Blood* 1996;87:2082-2088.
655. Lucarelli G, Andreani M, Angelucci E. The cure of the thalassemia with bone marrow transplantation. *Bone Marrow Transplant* 2001;28[Suppl 1]:S11-13.
656. Lucarelli G, Galimberti M, Polchi P, et al. Bone marrow transplantation in patients with thalassemia. *N Engl J Med* 1990;322:417-421.
657. Borgna-Pignatti C. Bone marrow transplantation for the haemoglobinopathies. In: Barrett J, Treleaven JG, eds. *Bone marrow transplantation in practice*. London: Churchill Livingstone, 1992:151-159.
658. Clift RA, Johnson FL. Marrow transplants for thalassemia. The USA experience. *Bone Marrow Transplant* 1997;19:57-59.
659. Chandy M, Srivastava A, Dennison D, et al. Allogeneic bone marrow transplantation in the developing world: experience from a center in India. *Bone Marrow Transplant* 2001;27:785-790.
660. Khojasteh NH, Zakernia M, Ramzi M, Haghshenas M. Bone marrow transplantation for hematological disorders—Shiraz experience. *Indian J Pediatr* 2002;69:31-32.
661. Shing MMK, Yuen PMP, Li CK, et al. A more immunosuppressive pre-transplant conditioning may be required for Chinese patients with thalassemia. *Bone Marrow Transplant* 1996;17:907-910.
662. Gaziev D, Galimberti M, Lucarelli G, et al. Bone marrow transplantation from alternative donors for thalassemia: HLA-phenotypically identical relative and HLA-nonidentical sibling or parent transplants. *Bone Marrow Transplant* 2000;25:815-821.
663. La Nasa G, Giardini C, Argioli F, et al. Unrelated donor bone marrow transplantation for thalassemia: the effect of extended haplotypes. *Blood* 2002;99:4350-4356.
664. Di Bartolomeo P, Di Girolamo G, Olioso P, et al. The Pescara experience of allogeneic bone marrow transplantation in thalassemia. *Bone Marrow Transplant* 1997;19:48-53.
665. Galimberti M, Andreani M, Lucarelli G, et al. Patterns of graft rejection after bone marrow transplantation in thalassemia. *Prog Clin Biol Res* 1989;309:223-229.
666. Issaragrisil S, Suvatte V, Visuthisakchai S, et al. Bone marrow and cord blood stem cell transplantation for thalassemia in Thailand. *Bone Marrow Transplant* 1997;19[Suppl 2].
667. Andreani M, Manna M, Lucarelli G, et al. Persistence of mixed chimerism in patients transplanted for the treatment of thalassemia. *Blood* 1996;87:3494-3499.
668. Andreani M, Nesci S, Lucarelli G, et al. Long-term survival of ex-thalassemic patients with persistent mixed chimerism after bone marrow transplantation. *Bone Marrow Transplant* 2000;25:401-404.
669. Galimberti M, Angelucci E, Baronciani D, et al. Bone marrow transplantation in thalassemia. The experience of Pesaro. *Bone Marrow Transplantation* 1997;19[Suppl 2].
670. De Simone M, Verrotti A, Iughetti L, et al. Final height of thalassemic patients who underwent bone marrow transplantation during childhood. *Bone Marrow Transplant* 2001;28:201-205.
671. Cohen A, Rovelli A, Bakker B, et al. Final height of patients who underwent bone marrow transplantation for hematological disorders during childhood: a study by the Working Party for Late Effects-EBMT. *Blood* 1999;93:4109-4115.
672. De Sanctis V, Galimberti M, Lucarelli G, et al. Pubertal development in thalassaemic patients after

- allogenic bone marrow transplantation. *Eur J Pediatr* 1993;152:993–997.
673. Borgna-Pignatti C, Marradi P, Rugolotto S, Marcolongo A. Successful pregnancy after bone marrow transplantation for thalassemia. *Bone Marrow Transplant* 1996;18:235–236.
674. Erer B, Angelucci E, Muretto P, et al. Kaposi's sarcoma after allogeneic bone marrow transplantation. *Bone Marrow Transplant* 1997;19:629–631.
675. Baronciani D, Angelucci E, Polchi P, et al. An unusual marrow transplant complication: cardiac myxoma. *Bone Marrow Transplant* 1998;21:825–827.
676. Polchi P, Lucarelli G, Galimberti M, Moretti L. Cyclosporin in children. *Prog Clin Biol Res* 1989;309:333–348.
677. Argioli F, Sanna MA, Cossu F, et al. Bone marrow transplant in thalassemia. The experience of Cagliari. *Bone Marrow Transplant* 1997;19:65–67.
678. Angelucci E, Ripalti M, Baronciani D, et al. Phlebotomy to reduce iron overload in patients cured of thalassemia by marrow transplantation. *Bone Marrow Transplant* 1997;19[Suppl 2].
679. Piga A, Longo F, Garofalo F, et al. Iron overload after bone marrow transplantation in thalassemia. *Blood* 1995;86[Suppl 1]:1592.
680. Giardini C, Galimberti M, Lucarelli G, et al. Desferrioxamine therapy accelerates clearance of iron deposits after bone marrow transplantation for thalassaemia. *Br J Haematol* 1995;89:868–873.
681. Issaragrisil S, Visuthisakchai S, Suvatte V, et al. Brief report: transplantation of cord-blood stem cells into a patient with severe thalassemia. *N Engl J Med* 1995;332:367–369.
682. Li CK, Shing MK, Chik KW, et al. Stem cell transplant for thalassemia patients in Hong Kong. *Bone Marrow Transplant* 1997;19[Suppl 2].
683. Miniero R, Vai S, Nesi F, et al. Fetal hemoglobin synthesis after combined cord blood and bone marrow transplantation from a sibling heterozygous for beta-thalassemia in a child with Cooley's anemia. *Bone Marrow Transplant* 1997;19[Suppl 2].
684. Locatelli F, Vanderson R, Reed W. Related umbilical cord blood transplant in patients with thalassemia and sickle cell disease. *Blood* 2003;101:2137–2141.
685. Flake AW, Roncarolo MG, Puck J, et al. Treatment of x-linked severe combined immunodeficiency by in utero transplantation of paternal bone marrow. *N Engl J Med* 1996;335:1806–1810.
686. Delfini C, Donati M, Marchionni D, et al. HLA compatibility for patients with thalassemia: implications for bone marrow transplantation. *Int J Cell Cloning* 1986;4:274–278.
687. Lucarelli G, Galimberti M, Polchi P, et al. Marrow transplantation in patients with thalassemia responsive to iron chelation therapy. *N Engl J Med* 1993;329:840–844.
688. DeSimone J, Heller P, Hall L, et al. 5-Azacytidine stimulates fetal hemoglobin (Hb F) synthesis in anemic baboons. *Proc Natl Acad Sci U S A* 1982;79:4428–4431.
689. Ley TJ, DeSimone J, Anagnou NP, et al. 5-Azacytidine selectively increases  $\beta$ -globin synthesis in a patient with  $\beta^+$ -thalassemia. *N Engl J Med* 1982;307: 1469–1475.
690. Carr BL, Reilly JG, Smith SS, et al. The tumorigenicity of 5-azacytidine in the male Fischer rat. *Carcinogenesis* 1984;5:1583–1590.
691. Hsiao WL, Gattoni-Celli S, Weinstein IB. Effect of 5-azacytidine on the progressive nature of cell transformation. *Mol Cell Biol* 1985;5:1800–1803.
692. Koshy M, Dorn L, Bressier L, et al. 2-Deoxy 5-azacytidine and fetal hemoglobin induction in sickle cell anemia. *Blood* 2000;96:2379–2384.

693. Torrealba-de Ron AT, Papayannopoulou T, Knapp MS, et al. Perturbations in the erythroid marrow progenitor cell pools may play a role in the augmentation of Hb F by 5-azacytidine. *Blood* 1984;63:201-210.
694. Olivieri NF. Reactivation of fetal hemoglobin in patients with  $\beta$ -thalassemia. *Semin Hematol* 1996;33:24-42.
695. Atweh GF, Loukopoulos D. Pharmacological induction of fetal hemoglobin in sickle cell disease and  $\beta$ -thalassemia. *Semin Hematol* 2001;38:367-373.
696. Steinberg MH, Griffin P, Rodgers MD. Pharmacologic modulation of fetal hemoglobin. *Medicine* 2001;80:328-344.
697. Hajjar FM, Pearson HA. Pharmacologic treatment of thalassemia intermedia with hydroxyurea. *J. Pediatr* 1994;125:490-492.
698. Fucharoen S, Siriranarkul N, Winichagoon P, et al. Hydroxyurea increases hemoglobin F levels and improves the effectiveness of erythropoiesis in  $\beta$  thalassemia hemoglobin E disease. *Blood* 1996;87:887-892.
699. Zeng YT, Huang SZ, Ren ZR, et al. Hydroxyurea therapy in  $\beta$  thalassemia intermedia: improvement in haematological parameters due to enhanced  $\beta$ -globin synthesis. *Br J Haematol* 1995;90:557-563.
700. Kostantopoulos K, Vagiopoulos G, Kantouni R, et al. A case of spinal cord compression by extramedullary haemopoiesis in a thalassaemic patient: a putative role for hydroxyurea. *Ann N Y Acad Sci* 1992;9:120-128.
701. Saxon BR, Rees D, Olivieri NF. Regression of extramedullary haemopoiesis and augmentation of fetal haemoglobin concentration during hydroxyurea therapy in beta thalassaemia. *Br J Haematol* 1998;101:416-419.
702. Rigano P, Rodgers GP, Renda D, et al. Clinical and hematological responses to hydroxyurea in Sicilian patients with Hb S/beta-thalassemia. *Hemoglobin* 2001;25:9-17.
703. Perrine SP, Ginder GD, Faller DV, et al. A short-term trial of butyrate to stimulate fetal-globin-gene expression in the  $\beta$ -globin disorders. *N Engl J Med* 1993;328:81-86.
704. Sher GD, Ginder GD, Little J, et al. Extended therapy with intravenous arginine butyrate in patients with  $\beta$ -hemoglobinopathies. *N Engl J Med* 1995;332:1606-1610.
705. Rachmilewitz EA, Goldfarb A, Dover G. Administration of erythropoietin to patients with  $\beta$  thalassemia intermedia: a preliminary trial. *Blood* 1991;78: 1145-1147.
706. Olivieri NF, Sheridan B, Freedman M, et al. Trial of recombinant human erythropoietin in thalassemia intermedia. *Blood* 1992;80:3258-3260.
707. Bourantas K, Economou G, Georgiou J. Administration of high doses of recombinant human erythropoietin to patients with beta-thalassemia intermedia: a preliminary trial. *Eur J Haematol* 1997;58:22-25.
708. Rachmilewitz EA, Aker M. The role of recombinant human erythropoietin in the treatment of thalassemia. *Ann N Y Acad Sci* 1998;850:129-138.
709. Sorrentino BP, Niehuis AW. Prospects for gene therapy of sickle cell disease and thalassemia. In: Steinberg MH, Forget BG, Higgs DR, Nagel RL, eds. *Disorders of hemoglobin: genetics, pathophysiology, and clinical management*. Cambridge: Cambridge University Press, 2001:1084-1118.
710. Dzierzak E, Papayannopoulou T, Mulligan RC. Lineage-specific expression of a human beta-globin gene in murine bone marrow transplant recipients reconstituted with retrovirus-transduced stem cells. *Nature* 1988;331:35-41.
711. Karlsson S, Bodine DM, Perry L, et al. Expression of the human beta-globin gene following retroviral-mediated transfer into multipotential hematopoietic progenitors of mice. *Proc Natl Acad Sci U S*

A 1988;85:6062–6066.

712. Persons DA, Nienhuis AW. Gene therapy for the hemoglobin disorders: past, present and future. *Proc Natl Acad Sci U S A* 2000;97:5022–5024.

713. Blouin MJ, Beauchemin H, Wright A, et al. Genetic correction of sickle cell disease: insights using transgenic mouse models. *Nat Med* 2000;6:177–182.

714. Novak U, Harris EA, Forrester W, et al. High-level beta-globin expression after retroviral transfer of locus activation region-containing human beta-globin gene derivatives into murine erythroleukemia cells. *Proc Natl Acad Sci U S A* 1990;87:3386–3390.

715. Chang JC, Liu D, Kan YW. A 36-base-pair core sequence of locus control region enhances retrovirally human beta-globin gene expression. *Proc Natl Acad Sci U S A* 1992;89:3107–3110.

716. Bodine DM, Seidel NE, Gale MS, et al. Efficient retrovirus transduction of mouse pluripotent hematopoietic stem cells mobilized into the peripheral blood by treatment with granulocyte colony-stimulating factor and stem cell factor. *Blood* 1994;84:1482–1491.

717. Horwitz ME, Malech HL, Anderson SM, et al. Granulocyte colony-stimulating factor mobilized peripheral blood stem cells enter into G<sub>0</sub> of the cell cycle and express higher levels of amphotropic retrovirus receptor mRNA. *Exp Hematol* 1999;27:1160–1167.

718. Glimm H, Eaves CJ. Direct evidence for multiple self-renewal divisions of human in vivo repopulating hematopoietic cells in short-term culture. *Blood* 1999;94:2161–2168.

719. Bauer TR, Jr., Miller AD, Hichstein DD. Improved transfer of the leukocyte integrin CD18 subunit into hematopoietic cell lines by using retroviral vectors having a gibbon ape leukemia virus envelope. *Blood* 1995;86:2379–2387.

720. Yang Y, Vanin EF, Whitt MA, et al. Inducible, high-level production of infectious murine leukemia retroviral vector particles pseudotyped with vesicular stomatitis virus G envelope protein. *Hum Gene Ther* 1995;6:1203–1213.

721. Kelly PF, Vandergriff JV, Nathwani A, et al. Highly efficient gene transfer into human NOD/SCID repopulating cells by oncoretroviral vector particles pseudotyped with the feline endogenous retrovirus (RD114) envelope protein. *Blood* 2000;96:1206–1214.

722. Tisdale J, Sadelain M. Toward gene therapy for disorders of globin synthesis. *Semin Hematol* 2001;38:382–392.

723. May C, Rivella S, Callegari J, et al. Therapeutic hemoglobin synthesis in beta-thalassemic mice expressing lentivirus-encoded human beta-globin. *Nature* 2000;406:82–86.

724. Trudel M, Costantini F. A 3' enhancer contributes to the stage-specific expression of the human beta-globin gene. *Genes Dev* 1987;1:954–961.

725. Grosveld F. Activation by locus control regions? *Curr Opin Genet Dev* 1999;9:152–157.

726. Engel JD, Tanimoto K. Looping, linking, and chromatin activity: new insights into beta-globin locus regulation. *Cell* 2000;100:499–502.

727. May C, Rivella S, Chadburn A, et al. Successful treatment of murine  $\beta$ -thalassemia intermedia by transfer of the human  $\beta$ -globin gene. *Blood* 2002;99:1902–1908.

728. Pawliuk R, Westerman KA, Fabry ME, et al. Correction of sickle cell disease in transgenic mouse models by gene therapy. *Science* 2001;294:2368–2371.

729. Gardikas C. Modes of presentation of thalassaemia minor. *Acta Haematol* 1968;40:34–36.

730. Pootrakul P, Wasi P, Na-Nakorn S. Haematological data in 312 cases of beta-thalassaemia trait in Thailand. *Br J Haematol* 1973;24:703–712.

731. Mazza U, Saglio G, Cappio FC, et al. Clinical and haematological data in 254 cases of beta-thalassaemia trait in Italy. *Br J Haematol* 1976;33:91-99.
732. Galanello R, Melis MA, Ruggeri R, et al. Beta 0 thalassaemia trait in Sardinia. *Hemoglobin* 1979;3:33-46.
733. Cooley JR, Kitay DZ. Heterozygous beta-thalassaemia in pregnancy. *J Reprod Med* 1984;29:141-142.
734. White JM, Richards R, Byrne M, et al. Thalassaemia trait and pregnancy. *J Clin Pathol* 1985;38:810-817.
735. Leung CF, Lao TT, Chang AM. Effect of folate supplement on pregnant women with beta-thalassaemia minor. *Eur J Obstet Gynecol Reprod Biol* 1989;33:209-213.
736. Castaldi G, Zavagli G, Ambroso G, et al. Anaemia in beta-thalassaemic carriers. *Br Med J* 1974;1:518.
737. Van der Weyden MB, Fong H, Hallam LJ, Harrison C. Red cell ferritin and iron overload in heterozygous beta-thalassaemia. *Am J Hematol* 1989;30:201-205.
738. Piperno A, Mariani R, Arosio C, et al. Haemochromatosis in patients with beta-thalassaemia trait. *Br J Haematol* 2000;111:908-914.
739. Melis MA, Cau M, Deidda F, et al. H63D mutation in the HFE gene increases iron overload in beta-thalassaemia carriers. *Haematologica* 2002;87:242-245.
740. Galanello R, Turco MP, Barella S, et al. Iron stores and iron deficiency anemia in children heterozygous for beta-thalassaemia. *Haematologica* 1990;75:319-322.
741. Galanello R, Perseu L, Melis MA, et al. Hyperbilirubinemia in heterozygous beta-thalassaemia is related to co-inherited Gilbert's syndrome. *Br J Haematol* 1997;99:433-436.
742. Borgna Pignatti C, De Stefano P, Bongo IG, et al. Cholelithiasis in thalassaemia minor: an epidemiological study on Italian women. *Ital J Gastroenterol* 1983;15:228-230.
743. Schiliro G, Li Volti S, Marino S, et al. Increase with age in the prevalence of beta-thalassaemia trait among Sicilians. *N Engl J Med* 1989;321:762.
744. Gallerani M, Scapoli C, Cicognani I, et al. Thalassaemia trait and myocardial infarction: low infarction incidence in male subjects confirmed. *J Intern Med* 1991;230:109-111.
745. Maioli M, Vigna GB, Tonolo G, et al. Plasma lipoprotein composition, apolipoprotein(a) concentration and isoforms in beta-thalassaemia. *Atherosclerosis* 1997;131:127-133.
746. Deiana L, Garuti R, Pes GM, et al. Influence of beta(0)-thalassaemia on the phenotypic expression of heterozygous familial hypercholesterolemia: a study of patients with familial hypercholesterolemia from Sardinia. *Arterioscler Thromb Vasc Biol* 2000;20:236-243.
747. Livingstone FB. *Abnormal hemoglobins in human populations*. Chicago: Aldine, 1967.
748. Millard DP, Mason K, Serjeant BA, Serjeant GR. Comparison of haematological features of the  $\beta^0$  and  $\beta^+$  traits in Jamaican Negroes. *Br J Haematol* 1977;36:161.
749. Charache S, Conley CL, Doebelin TD, Bartalos M. Thalassaemia in Black Americans. *Ann N Y Acad Sci* 1974;232:125.
750. Rund D, Filon D, Strauss N, et al. Mean corpuscular volume of heterozygotes for beta-thalassaemia correlates with the severity of mutations. *Blood* 1992;79:238-243.
751. Rosatelli C, Leoni GB, Tuveri T, et al. Heterozygous beta-thalassaemia: relationship between the hematological phenotype and the type of beta-thalassaemia mutation. *Am J Hematol* 1992;39:1-4.

752. Weatherall DJ. Biochemical phenotypes of thalassemia in the American Negro populations. *Ann N Y Acad Sci* 1964;119:450.
753. Borgna-Pignatti C, Zonta L, Bongo I, et al. Red blood cell indices in adults and children with heterozygous beta thalassemia. *Haematologica* 1983;68:149.
754. Galanello R, Melis MA, Ruggeri R, Cao A. Prospective study of red blood cell indices, hemoglobin A<sub>2</sub>, and hemoglobin F in infants heterozygous for beta-thalassemia. *J Pediatr* 1981;99:105-108.
755. Pippard MJ, Wainscoat JS. Erythrokinetics and iron status in heterozygous beta thalassaemia, and the effect of interaction with alpha thalassaemia. *Br J Haematol* 1987;66:123.
756. Shepherd MK, et al. Semiquantitative estimation of the distribution of fetal hemoglobin in red cell populations. *Bull Johns Hopkins Hosp* 1962;11:293.
757. Wood WG, Stamatoyannopoulos G, Lim G, Nute PE. F-cells in the adult: normal values and levels in individuals with hereditary and acquired elevations of HbF. *Blood* 1975;46:671.
758. Melis MA, Pirastu M, Galanello R, et al. Phenotype effect of heterozygous  $\alpha$  and  $\beta$ -thalassaemia interaction. *Blood* 1983;62:226-229.
759. Cao A, Rosatelli C, Galanello R. Prenatal diagnosis and screening of the haemoglobinopathies. *Baillieres Clin Haematol* 1998;11:215-218.
760. Galanello R, Barella S, Ideo A, et al. Genotype of subjects with borderline HbA<sub>2</sub>: implication for  $\beta$ -thalassemia carrier screening. *Am J Hematol* 1994;46:79-81.
761. Bianco I, Cappabianca MP, Foglietta E, et al. Silent thalassemias: genotypes and phenotypes. *Haematologica* 1997;82:257-258.
762. Galanello R, Paglietti E, Addis M, et al. Pitfalls in genetic counseling for  $\beta$  thalassemia: an individual with 4 different thalassemia mutations. *Clin Genet* 1988;33:151-155.
763. Galanello R, Ruggeri R, Addis M, et al. Hemoglobin A<sub>2</sub> in iron deficiency  $\beta$ -thalassaemia heterozygotes. *Hemoglobin* 1981;5:613-618.
764. Galanello R, Barella S, Gasperini D, et al. Evaluation of an automatic HPLC analyser for thalassemia and haemoglobin variants screening. *J Auto Chem* 1995;17:73-76.
765. Gwendolyn M, Higgins C, Higgins T. Laboratory investigation of hemoglobinopathies and thalassemias: review and update. *Clin Chem* 2000;46:1284-1290.
766. Kattamis C, Efremov G, Pootrakul S. Effectiveness of one tube osmotic fragility screening  $\beta$ -thalassemia trait. *J Med Genet* 1981;18:266-270.
767. D'Onofrio G, Zini G, Ricerca BM, et al. Automated measurement of red blood cell microcytosis and hypochromia in iron deficiency and  $\beta$ -thalassemia trait. *Arch Pathol Lab Med* 1992;116:84-89.
768. Hall GW, Thein SL, Newland AC, et al. A base substitution (T>C) in codon 29 of the  $\alpha$ 2 globin gene causes a thalassaemia. *Br J Haematol* 1993;85:546-552.
769. Hartveld KL, Heister AJ, Giordano PC, et al. Rapid detection of point mutations and polymorphisms of the  $\alpha$ -globin genes by DGGE and SSCA. *Hum Mutat* 1996;7:114-122.
770. Galanello R, Sollaino C, Paglietti E, et al.  $\alpha$ -Thalassemia carrier identification by DNA analysis in the screening for thalassemia. *Am J Hematol* 1998;59:273-278.
771. Liu YT, Old JM, Miles K, et al. Rapid detection of  $\alpha$ -thalassemia deletions and  $\alpha$ -globin gene triplication by multiplex polymerase reaction. *Br J Haematol* 2000;108:295-299.
772. Chong SS, Boehm CD, Higgs DR, et al. Single tube multiplex-PCR screen for common deletional



determinants of  $\alpha$ -thalassemia. *Blood* 2000;95:360–361.

773. Luo HY, Clarke BJ, Gaudie J, et al. A novel monoclonal antibody based diagnostic test for alpha-thalassemia-1 carriers due to the (-SEA/) deletion. *Blood* 1988;72:1589–1594.

774. Fucharoen S, Winichagoon P, Thonglairoam V.  $\beta$ -Thalassemia associated with  $\alpha$ -thalassemia on Thailand. *Hemoglobin* 1988;12:581–592.

775. Frischer H, Bowman J. Hemoglobin E, an oxidatively unstable mutation. *J Lab Clin Med* 1975;85:531–539.

776. Cao A, Galanello R, Saba L, et al.  $\beta$ -Thalassemias: molecular diagnosis, carrier screening and prevention. A review for clinicians. *J Am Med Assoc* 1997;278:11273–11277.

777. Kan YW, Golbus MS, Klein P, et al. Successful application of prenatal diagnosis in a pregnancy at risk for homozygous beta-thalassemia. *N Engl J Med* 1975;292:1096–1099.

778. Hogge WA, Schonberg SA, Golbus MS. Chorionic villus sampling: experience of the first 1000 cases. *Am J Obstet Gynecol* 1986;154:1249–1252.

779. Cao A, Cossu P, Monni G, et al. Chorionic villus sampling and acceptance rate of prenatal diagnosis. *Prenat Diagn* 1987;7:531–533.

780. Monni G, Ibba RM, Lai R, et al. Early transabdominal chorionic villus sampling in couples at high genetic risk. *Am J Obstet Gynecol* 1993;168:170–173.

781. Brambati B, Tului L, Cislighi C, et al. First 10,000 chorionic villous samplings performed on singleton pregnancies by a single operator. *Prenat Diagn* 1998;18:255–266.

782. Jauniaux Pahal GS, Rodeck C. What invasive procedure to use in early pregnancy. *Baillieres Best Pract Res Clin Obstet Gynecol* 2000;14:651–662.

783. Kuliev A, Modell B, Jackson L, et al. Risk evaluation of CVS. *Prenat Diagn* 1993;13:197–209.

784. Decorte R, Cuppens H, Marynen P. Rapid detection of hypervariable regions by the polymerase chain technique. *DNA Cell Biol* 1991;9:461–469.

785. Old J, Petrou M, Varnavides L, et al. Accuracy of prenatal diagnosis for haemoglobin disorders in the UK: 25 years' experience. *Prenat Diagn* 2000;20: 986–991.

786. Pertl B, Bianchi DW. First trimester prenatal diagnosis: fetal cells in the maternal circulation. *Semin Perinatol* 1999;23:393–402.

787. Camaschella C, Alfarano A, Gottardi E, et al. Prenatal diagnosis of fetal hemoglobin Lepore-Boston disease on maternal peripheral blood. *Blood* 1990;75:2102–2106.

788. Cheung MC, Goldberg JD, Kann YW. Prenatal diagnosis of sickle cell anemia and thalassemia by analysis of fetal cells in maternal blood. *Nat Genet* 1996;14:264–268.

789. Ikawa K, Yamafuji K, Ukita T, et al. Fetal DNA diagnosis from maternal blood: PEP-TaqMan PCR analysis of a single nucleated erythrocyte (NRBC). *Ann N Y Acad Sci* 2001;945:153–155.

790. Lo YM. Fetal DNA in maternal plasma. *Ann N Y Acad Sci* 2000;906:141–147.

791. Monk M, Holding C. Amplification of a  $\beta$ -haemoglobin sequence in individual human oocytes and polar bodies. *Lancet* 1990;325:985–988.

792. Handyside AM, Lesko JG, Tarin JJ, et al. Birth of a normal girl after in vitro fertilization and preimplantation diagnostic testing for cystic fibrosis. *N Engl J Med* 1992;327:905–909.

793. Kuliev A, Rechitsy S, Verlinsky O, et al. Preimplantation diagnosis of thalassaemias. *J Assoc Reprod Genet* 1998;15:219–225.

794. Palmer GA, Traeger-Synodinos J, Davies S, et al. Pregnancies following blastocyst stage transfer in PGD cycles at risk for  $\beta$ -thalassaemic haemoglobinopathies. *Hum Reprod* 2002;17:25-31.
795. Kanavakis E, Traeger-Synodinos J. Preimplantation genetic diagnosis in clinical practice. *J Med Genet* 2002;39:6-11.
796. Angastiniotis M, Modell B, Boulinzhenkov V. Prevention and control of haemoglobinopathies. *Bull World Health Organ* 1995;73:375-386.
797. Cao A, Rosatelli C, Galanello R. Control of  $\beta$ -thalassemia by carrier screening, genetic counseling and prenatal diagnosis: the Sardinian experience. In *Variation of the Human Genome, Ciba Found Symp* 1996;197:137-151.
798. Modell B, Petrou M, Layton M, et al. Audit of prenatal diagnosis for haemoglobin disorders in the United Kingdom: the first 20 years. *BMJ* 1997;315:779-784.
799. Wainscoat JS, Thein SL, Weatherall DJ. Thalassemia intermedia. *Blood* 1987;1:273-279.
800. Gonzalez-Redondo JM, Stoming TA, Lanclos KD, et al. Clinical and genetic heterogeneity in black patients with homozygous beta-thalassemia from the southeastern United States. *Blood* 1988;72:1007-1014.
801. Safaya S, Rieder RF, Dowling CE, et al. Homozygous beta-thalassemia without anemia. *Blood* 1989;73:324-328.
802. Rosatelli C, Pischedda A, Meloni A, et al. Homozygous  $\beta$ -thalassaemia resulting in the  $\beta$ -thalassemia carrier state phenotype. *Br J Haematol* 1994;88:562-565.
803. Ristaldi MS, Murru S, Loudianos G, et al. The C-T substitution in the distal CAAA box of the  $\beta$ -globin gene promoter is a common cause of silent  $\beta$ -thalassemia in the Italian population. *Br J Haematol* 1990;74:480-486.
804. Jankovic L, Dimovski AJ, Kollia P, et al. A C-G mutation at nt position 6 3' to the terminating codon may be the cause of a silent  $\beta$ -thalassemia. *Int J Hematol* 1991;54:289-293.
805. Bianco I, Cappabianca MP, Foglietta E, et al. Silent thalassemias: genotypes and phenotypes. *Haematologica* 1997;82:269-280.
806. Maragoudaki E, Vrettou C, Kanavakis E, et al. Molecular, haematological and clinical studies of a silent  $\beta$ -gene C?G mutation at 6 bp 3' to the termination codon (+1480 C?G) in twelve Greek families. *Br J Haematol* 1998;103:45-51.
807. Wainscoat JS, Kanavakis E, Wood WG, et al. Thalassemia intermedia in Cyprus—the interaction of  $\alpha$ - and  $\beta$ -thalassemia. *Br J Haematol* 1983;53:411-416.
808. Winichagoon P, Fucharoen S, Weatherall DJ, et al. Concomitant inheritance of  $\alpha$ -thalassemia and  $\beta^0$ -thalassemia/HbE. *Am J Hematol* 1985;20:217-222.
809. Thein SL, Hesketh C, Wallas RB, et al. The molecular basis of thalassaemia major and thalassemia intermedia in Asian Indians: application to prenatal diagnosis. *Br J Haematol* 1988;70:225-231.
810. Galanello R, Dessì E, Melis MA, et al. Molecular analysis of  $\beta^0$ -thalassemia intermedia in Sardinia. *Blood* 1989;74:823-827.
811. Cao A, Moi P. Genetic modifying factors in  $\beta$ -thalassemia. *Clin Chem Lab Med* 2000;38:123-132.
812. Gilman JG, Huisman THJ. DNA sequence variation associated with elevated fetal G-globin production. *Blood* 1985;66:783-787.
813. Efremov DG, Dimovski AJ, Baysal E, et al. Possible factors influencing the haemoglobin and fetal haemoglobin levels in patients with beta-thalassaemia due to a homozygosity for the IVS-I-6 (T?C)

mutation. *Br J Haematol* 1994;86:824–830.

814. Camaschella C, Bertero MT, Serra A, et al. A benign form of thalassaemia intermedia may be determined by the interaction of triplicated alpha locus and heterozygous beta-thalassaemia. *Br J Haematol* 1987;66:103–107.

815. Traeger-Synodinos J, Kanavakis E, Vrettou C, et al. The triplicated alpha-globin gene locus in beta-thalassaemia heterozygotes: clinical, haematological, biosynthetic and molecular studies. *Br J Haematol* 1996;95:467–471.

816. Huisman TH. Silent beta-thalassaemia and thalassaemia intermedia. *Haematologica* 1990;75:1–8.

817. Gasperini D, Perseu L, Melis MA, et al. Heterozygous beta-thalassaemia with thalassaemia intermedia phenotype. *Am J Hematol* 1998;57:43–47.

818. Ho PJ, Hall GW, Watt S, et al. Unusually severe heterozygous beta-thalassaemia: evidence for an interacting gene affecting globin translation. *Blood* 1998;92:3428–3435.

819. Kihm AJ, Kong Y, Hong W, et al. An abundant erythroid protein that stabilizes free alpha-haemoglobin. *Nature* 2002;417:758–763.

820. Luzzatto L, Notaro R. Haemoglobin's chaperone. *Nature* 2002;417:703–705.

821. Cao A. Diagnosis of beta-thalassaemia intermedia at presentation. *Birth Defects Orig Artic Ser* 1988;23:219–226.

822. Dresner Pollack R, Rachmilewitz E, Blumenfeld A, et al. Bone mineral metabolism in adults with beta-thalassaemia major and intermedia. *Br J Haematol* 2000;111:902–907.

823. Genovese MG, Neretto G, Poti A, Benincasa A. A case of mediastinal extramedullary hemopoiesis (MEH) in a patient with intermediate thalassaemia. *Minerva Med* 1979;70:981–986.

824. Pippard MJ, Rajagopalan B, Callender ST, Weatherall DJ. Iron loading, chronic anaemia, and erythroid hyperplasia as determinants of the clinical features of  $\beta$ -thalassaemia intermedia. In: Weatherall DJ, Fiorelli G, Gorini S, eds. *Advance in red blood cell biology*. New York: Raven Press, 1982:103.

825. Yu YC, Kao EL, Chou SH, et al. Intrathoracic extramedullary hematopoiesis simulating posterior mediastinal mass—report of a case in patient with beta-thalassaemia intermedia. *Gaoxiong Yi Xue Ke Xue Za Zhi* 1991;7:43–48.

826. Mancuso P, Zingale A, Basile L, et al. Cauda equina compression syndrome in a patient affected by thalassaemia intermedia: complete regression with blood transfusion therapy. *Childs Nerv Syst* 1993;9:440–441.

827. Dore F, Cianciulli P, Rovasio S, et al. Incidence and clinical study of ectopic erythropoiesis in adult patients with thalassaemia intermedia. *Ann Ital Med Int* 1992;7:137–140.

828. Alam R, Padmanabhan K, Rao H. Paravertebral mass in a patient with thalassaemia intermedia. *Chest* 1997;112:265–267.

829. Papavasiliou C, Gouliamos A, Vlahos L, et al. CT and MRI of symptomatic spinal involvement by extramedullary haemopoiesis. *Clin Radiol* 1990;42:91–92.

830. Chourmouzi D, Pistevou-Gompaki K, Plataniotis G, et al. MRI findings of extramedullary haemopoiesis. *Eur Radiol* 2001;11:1803–1806.

831. Wong Y, Chen F, Tai KS, et al. Imaging features of focal intrahepatic extramedullary haematopoiesis. *Br J Radiol* 1999;72:906–910.

832. Issaragrisil S, Piankigagum A, Wasi P. Spinal cord compression in thalassaemia. Report of 12 cases and recommendations for treatment. *Arch Intern Med* 1981;141:1033–1036.

833. Aliberti B, Patrikiou A, Terentiou A, et al. Spinal cord compression due to extramedullary

- haematopoiesis in two patients with thalassaemia: complete regression with blood transfusion therapy. *J Neurol* 2001;248:18–22.
834. Cianciulli P, di Toritto TC, Sorrentino F, et al. Hydroxyurea therapy in paraparesis and cauda equina syndrome due to extramedullary haematopoiesis in thalassaemia: improvement of clinical and haematological parameters. *Eur J Haematol* 2000;64:426–429.
835. Rigano P, Manfre L, La Galla R, et al. Clinical and hematological response to hydroxyurea in a patient with Hb Lepore/beta-thalassemia. *Hemoglobin* 1997;21:219–226.
836. Gumruk F, Gurgey A, Duru F, Altay C. Reevaluation of iron absorption and serum ferritin in beta-thalassemia intermedia. *Pediatr Hematol Oncol* 1992;9:359–363.
837. Pippard MJ, Callender ST, Warner GT, Weatherall DJ. Iron absorption and loading in beta-thalassaemia intermedia. *Lancet* 1979;2:819–821.
838. Cossu P, Toccafondi C, Vardeu F, et al. Iron overload and desferrioxamine chelation therapy in beta-thalassemia intermedia. *Eur J Pediatr* 1981;137:267.
839. Buonanno G, Valente A, Gonnella F, et al. Serum ferritin in beta-thalassaemia intermedia. *Scand J Haematol* 1984;32:83–87.
840. Cazzola M, Beguin Y, Bergamaschi G, et al. Soluble transferrin receptor as a potential determinant of iron loading in congenital anaemias due to ineffective erythropoiesis. *Br J Haematol* 1999;10:752–755.
841. Pootrakul P, Vongmasa V, La-onpanich P, Wasi P. Serum ferritin levels in thalassemias and the effect of splenectomy. *Acta Haematol* 1981;66:244–250.
842. Fiorelli G, Fargion S, Piperno A, et al. Iron metabolism in thalassemia intermedia. *Haematologica* 1990;75:89–95.
843. Erlandson ME, Brilliant R, Smith CH. Comparison of sixty-six patients with thalassemia major and thirteen patients with thalassemia intermedia: including evaluations of growth, development, maturation and prognosis. *Ann N Y Acad Sci* 1964;119:727–734.
844. Afifi AM. High transfusion regime in the management of reproductive wastage and maternal complications of pregnancy in thalassaemia major. *Acta Haematol* 1974;52:331–335.
845. Gimmon Z, Wexler MR, Rachmilewitz EA. Juvenile leg ulceration in beta-thalassemia major and intermedia. *Plast Reconstr Surg* 1982;69:320–325.
846. Camaschella C, Cappellini MD. Thalassemia intermedia. *Haematologica* 1995;80:58–68.
847. Sher GD, Olivieri NF. Rapid healing of chronic leg ulcers during arginine butyrate therapy in patients with sickle cell disease and thalassemia. *Blood* 1994;84:2378–2380.
848. Gilsanz F, Escalante F, Auray C, Olbes AG. Treatment of leg ulcers in beta-thalassaemia intermedia: use of platelet-derived wound healing factors from the patient's own platelets. *Br J Haematol* 2001;115:710.
849. Edmonds M, Bates M, Doxford M, et al. New treatments in ulcer healing and wound infection. *Diabetes Metab Res Rev* 2000;16[Suppl 1]:S51–54.
850. Josifova D, Gatt G, Aquilina A, et al. Treatment of leg ulcers with platelet-derived wound healing factor (PDWHFS) in a patient with beta thalassaemia intermedia. *Br J Haematol* 2001;112:527–529.
851. Cappellini MD, Robbiolo L, Bottasso BM, et al. Venous thromboembolism and hypercoagulability in splenectomized patients with thalassaemia intermedia. *Br J Haematol* 2000;111:467–473.
852. Skarsgard E, Doski J, Jaksic T, et al. Thrombosis of the portal venous system after splenectomy for pediatric hematologic disease. *J Pediatr Surg* 1993;28:1109–1112.
853. Galanello R, Piras S, Barella S, et al. Cholelithiasis and Gilbert's syndrome in homozygous

beta-thalassaemia. *Br J Haematol* 2001;115:926–928.

854. Aessopos A, Farmakis D, Karagiorga M, et al. Cardiac involvement in thalassemia intermedia: a multicenter study. *Blood* 2001;97:3411–3416.

855. Vaccari M, Crepaz R, Fortini M, et al. Left ventricular remodeling, systolic function, and diastolic function in young adults with beta-thalassemia intermedia: a Doppler echocardiography study. *Chest* 2002;122:506–512.

856. Serjeant GR, Topley LM, Mason K, et al. Outbreak of aplastic crises in sickle cell anaemia associated with parvovirus-like agent. *Lancet* 1981;2:595–597.

857. Kurtzman G, Young N. Virus-associated bone marrow failure. *Baillieres Clin Haematol* 1989;2:51–67.

858. Yarali N, Duru F, Sipahi T, et al. Parvovirus B19 infection reminiscent of myelodysplastic syndrome in three children with chronic hemolytic anemia. *Pediatr Hematol Oncol* 2000;17:475–482

859. Singer ST, Wu V, Mignacca R, et al. Alloimmunization and erythrocyte autoimmunization in transfusion-dependent thalassemia patients of predominantly Asian descent. *Blood* 2000;96:3369–3373.

860. Ho HK, Ha SY, Lam CK, et al. Alloimmunization in Hong Kong southern Chinese transfusion-dependent thalassemia patients. *Blood* 2001;97:3999–4000.

861. De Stefano P, Zecca M, Giorgiani G, et al. Resolution of immune haemolytic anaemia with allogeneic bone marrow transplantation after an unsuccessful autograft. *Br J Haematol* 1999;106:1063–1064.

862. Hoppe C, Vichinsky E, Lewis B, et al. Hydroxyurea and sodium phenylbutyrate therapy in thalassemia intermedia. *Am J Hematol* 1999;62:221–227.

863. Loukopoulos D, Voskaridou E, Stamoulakatou A, et al. Hydroxyurea therapy in thalassemia. *Ann N Y Acad Sci* 1998;850:120–128.

864. Camba L. Phlebotomy in beta-thalassemia intermedia and secondary hemosiderosis. *Haematologica* 2000;85(E-letters):E05.

2004 Lippincott Williams & Wilkins  
John P. Greer, John Foerster, John N. Lukens  
George M. Rodgers, Frixos Paraskevas, Bertil Glader  
Wintrobe's Clinical Hematology

## Megaloblastic Anemias: Disorders of Impaired DNA Synthesis

### HISTORICAL BACKGROUND

### NORMAL PHYSIOLOGY AND PATHOPHYSIOLOGY

#### Biochemistry and Metabolism

#### Normal Folate Physiology

#### Normal Cobalamin Physiology

### CLINICAL AND LABORATORY FEATURES

#### Megaloblastic Anemia in Cobalamin and Folate Deficiency

#### Neurologic Dysfunction

#### Other Clinical and Laboratory Manifestations

#### Laboratory Evaluation

### SPECIFIC DISORDERS CAUSING DEFICIENCY

#### Causes of Cobalamin Deficiency

#### Causes of Folate Deficiency

#### Causes of Megaloblastic Anemia Other Than Cobalamin or Folate Deficiency

#### Laboratory Diagnosis of the Causes of Deficiency

### MANAGEMENT

#### Reversal of Presenting Symptoms

#### Dose, Route, Duration, and Toxicity of Vitamin Replacement

#### Assurance of Response

#### Managing Underlying Disorders Causing the Deficiency

#### Patient Education

#### Preventive and Other Use of Supplements

### REFERENCES

## HISTORICAL BACKGROUND

The story of megaloblastic anemia, its causes, and how they were decoded is a wonderfully instructive chapter of medicine. The random advances of clinical observation set the stage for a series of insightful clinical investigations that dramatically converted a dreaded “pernicious” condition into one that is now easily treated.

A puzzling illness with idiopathic anemia, debilitation, languor, and, finally, torpor and death was described by Addison ( <sup>1</sup> ) in 1849. Although possibly similar cases were reported earlier and Addison believed the anemia to be related to adrenal dysfunction, this is generally taken as the first description of pernicious anemia, a colorful, apt name coined by Biermer ( <sup>2</sup> ). Neuropathy was noted by Osler and Gardner in 1877, and the association with myelopathy was made by Lichtheim 10 years later. In 1880, Ehrlich ( <sup>3</sup> ) identified megaloblasts and proposed them as the precursors of the “giant blood corpuscles” described in the peripheral blood by Hayem ( <sup>4</sup> ). The white cell changes were not established until the 1920s.

The clinical breakthrough occurred in 1926 when Minot and Murphy ( <sup>5</sup> ), using the then new technique of reticulocyte assessment, showed that the disease could be reversed and held in abeyance by eating prodigious amounts of liver; for this, they shared the Nobel

Prize. Three years later, Castle (6), building on earlier descriptions of achylia gastrica, demonstrated that gastric juice contains an “intrinsic factor” (IF) that combines with an “extrinsic factor” in meat and allows it to be absorbed. Several decades later, the extrinsic factor, vitamin B<sub>12</sub>, was synthesized by biochemists at two drug companies (7, 8), and its structure was demonstrated by Hodgkin (9), who was awarded a Nobel Prize for her crystallographic work.

Studies by Wills (10), who treated macrocytic anemia with yeast, and by many others defined the need for folate, which was isolated and characterized by 1948 (11). The ability of nutritional folate deficiency to cause megaloblastic anemia was proven in a notable self-experiment by Herbert (12). The stories of these and other discoveries are available in several highly readable books and articles (13, 14, 15 and 16).

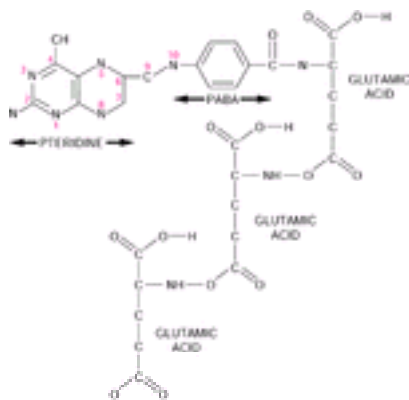
Cure is so simple now that the once deadly diseases are considered domesticated. Although that development is a gratifying contrast with the past, the potential for clinical neglect has emerged (17, 18 and 19), even as major metabolic and molecular advances continue. With increasingly finer and more accessible biochemical tools, the boundaries of insufficiency are expanding in efforts to define optimal health in addition to treating disease. Still, unsolved questions persist.

## NORMAL PHYSIOLOGY AND PATHOPHYSIOLOGY

Megaloblastic anemia is, most often, a product of folic acid or cobalamin (vitamin B<sub>12</sub>) deficiency. The two vitamins are closely interrelated metabolically, and their disorders are sometimes difficult to differentiate. However, the vitamins, the disorders responsible for their deficiencies, and the approaches to their diagnosis and treatment are very distinct. Folic acid and cobalamin are discussed separately throughout this chapter, reflecting the clinical necessity of always differentiating between the two.

### Biochemistry and Metabolism

**FOLATE** Folate, or pteroylglutamate, consists of a pteridine ring, paraminobenzoate, and one or more glutamate side chains (Fig. 43.1). Polyglutamated folates, with three or more  $\gamma$ -carboxyl-linked glutamate residues, predominate intracellularly; they are better retained in cells than are monoglutamated forms, which traverse cell membranes more easily (20). The polyglutamated forms are more effective participants in enzymatic reactions, as reviewed elsewhere (21), although 5-methyltetrahydrofolate (methylTHF), the major folate in the body, tends to be a poor substrate for polyglutamation.

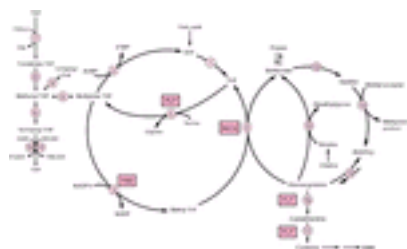


**Figure 43.1.** Folate structure. The constituents are, from left to right, pteridine and



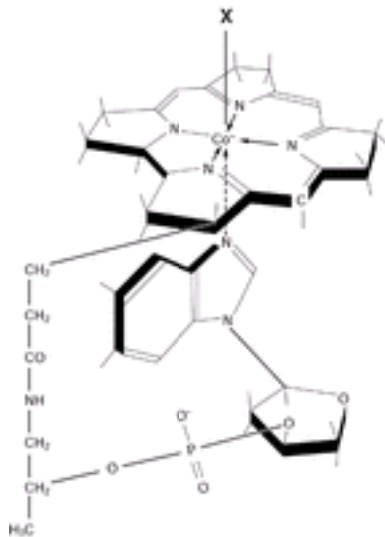
*p*-aminobenzoic acid (PABA), which together make up the pteroyl moiety, and one or more glutamates that are attached by  $\gamma$ -carboxyl linkage (in this diagram, three glutamates are linked). Metabolic activity requires reduction to tetrahydrofolate at positions 5, 6, 7, and 8. Various one-carbon moieties are attached to the nitrogen at positions 5 (5-methyl, 5-formyl, or 5-formimino) or 10 (10-formyl), or bridging 5 and 10 (5,10-methylene or 5,10-methenyl). Each folate takes part in specific reactions by transferring, accepting, or transforming its one-carbon moiety.

Folates, when reduced to the tetrahydrofolate (THF) form, function as one-carbon group donors and acceptors. THFs with one-carbon moieties of varying oxidation states attach to select enzymes and serve as active substrates in cytoplasmic or mitochondrial one-carbon group transfers involving amino acids ( Fig. 43.2; reactions 4, 5, and 7), purines (reactions 10 and 11), and pyrimidines (reaction 2). Folate is also indirectly linked to DNA methylation by contributing to *S*-adenosylmethionine (AdoMet) availability for methylation of DNA cytosine ( Fig. 43.2; reaction 13). Cellular folate metabolism and its compartments are reviewed elsewhere ( [22](#), [23](#) ).



**Figure 43.2.** Folate metabolism ( *left* ) and its linkage with cobalamin ( *center* ) to homocysteine and methionine metabolism ( *right* ). Vitamin cofactors are highlighted in boxes. Not all bidirectional reactions are noted as such. The enzymes for the reactions include the following: (1, dihydrofolate (DHF) reductase; (2, thymidylate synthase; (3, methylene tetrahydrofolate (THF) reductase; (4, methionine synthase (maintained by a reductive system mediated by methionine synthase reductase); (5, serine hydroxymethyltransferase; (6, two reactions mediated by two enzymes' activities of one protein (methylene THF dehydrogenase and methenyl THF cyclohydrolase); (7, glutamate formiminotransferase; (8, formimino THF cyclodeaminase; (9, methenyl THF synthase; (10) glycinamide ribonucleotide (GAR) transformylase; (11, 5(4)-aminoimidazole-4(5)carboxamide ribonucleotide (AICAR) transformylase; (12, methionine adenosyltransferase; (13, various *S*-adenosylmethionine (AdoMet)-dependent methyltransferases; (14) *S*-adenosylhomocysteine (AdoHcy) hydrolase (kinetics usually favor synthesis of AdoHcy); (15, betaine:homocysteine methyltransferase; (16, cystathionine  $\beta$ -synthase; (17, cystathionine  $\gamma$ -lyase. dTMP, deoxythymidine monophosphate; dUMP, deoxyuridine monophosphate; FAD, flavin adenine dinucleotide (riboflavin); FAICAR, formylAICAR; FGAR, formylGAR; FIGLU, formiminoglutamic acid; Glu, glutamic acid; MeCbl, methylcobalamin; PLP, pyridoxal 5'-phosphate.

**COBALAMIN** *Cobalamin*, a member of the corrin family, is a planar tetrapyrrole with a central cobalt atom and a nucleotide (5,6-dimethylbenzimidazole) below and a variable prosthetic moiety above the plane ( Fig. 43.3 ). Specific cobalamins are named according to that prosthetic moiety. A methyl moiety gives rise to methylcobalamin, which predominates in plasma and cytoplasm, and 5'-deoxyadenosyl gives rise to adenosylcobalamin, which predominates intramitochondrially. *Vitamin B*<sub>12</sub>, often used as a general name for cobalamin, was the name given to cyanocobalamin ( [7](#) ); the latter is a stable pharmacologic preparation but must be converted to other forms for metabolic utilization. Noncobalamin corrinoids, often with structural deletions, are present in nature but cannot be used by humans. Some of these analogs can nevertheless be bound by the widely distributed cobalamin-binding protein transcobalamin (TC) I ( [24](#), [25](#) ) and are found in blood and tissues ( [26](#) ).



**Figure 43.3.** Cobalamin structure. Attached to the central cobalt atom of the corrin tetrapyrrole and to one of the pyrrole rings is the  $\alpha$ -ligand, the 5,6-dimethylbenzimidazole nucleotide, extending below the corrin's plane. The  $\beta$ -ligand (marked as X in the diagram) above the plane can be any one of several moieties, such as methyl, 5'-deoxyadenosyl, hydroxyl, or cyanide.

To be active, cobalamin requires reduction of its naturally oxidized, trivalent cobalt [cob(III)alamin] or the divalent cob(II)alamin. Reduced cob(I)alamin has two known roles in humans. Attached to methionine synthase, it accepts the methyl group from 5-methylTHF as methylcobalamin and transfers it to homocysteine ( [Fig. 43.2](#); reaction 4). Cobalamin activity for this reaction is maintained by methionine synthase reductase ( [27](#) ) and requires AdoMet. In its second role, reduced mitochondrial cobalamin accepts 5'-deoxyadenosyl from adenosine triphosphate and binds to methylmalonyl coenzyme A (CoA) mutase. That enzyme mediates an intramolecular rearrangement of L-methylmalonyl CoA to succinyl CoA in propionate metabolism ( [28](#) ). Cobalamin deficiency has a major impact on folate, homocysteine, and methionine metabolism by impairing the methionine synthase reaction. Considerable evidence supports the concept that cobalamin deficiency thereby traps methylTHF, which has no alternative metabolic role or route ( [29](#) , [30](#) ). Feedback mechanisms activate methyleneTHF reductase ( [Fig. 43.2](#); reaction 3) in a vain effort to mobilize methylTHF for methionine synthesis but only end up diverting even more methyleneTHF from its other roles and into the trap. A general paralysis of folate metabolism ensues as THF and other active forms of folate decrease. An alternative proposal to the trap hypothesis emphasizes that the failure of methionine synthesis ultimately leads to formate "starvation" ( [31](#) ), with depletion of formylTHF, methenylTHF, and methyleneTHF.

**HOMOCYSTEINE AND METHIONINE** Folate and cobalamin are intertwined with the metabolism of homocysteine and methionine, as discussed. The adenosine triphosphate-dependent conversion of methionine to AdoMet ( [Fig. 43.2](#); reaction 12) serves several important functions. AdoMet helps regulate the metabolism of folate and disposition of homocysteine by inhibiting methyleneTHF reductase (reaction 3), as well as betaine hydroxymethyltransferase [an alternate remethylator of homocysteine (reaction 15) in liver and perhaps kidney and lens], and by activating cystathionine  $\beta$ -synthase (reaction 16) ( [32](#) ). Even more important, AdoMet is the critical methyl donor for most cellular methylation reactions affecting proteins, nucleic acids, histones, phospholipids, and neurotransmitters—all mediated by various methyltransferases (reaction 13) ( [33](#) ). For example, DNA hypomethylation, which has been associated with neoplasia, can result from AdoMet deficiency. In the methylation reactions, S-adenosylhomocysteine (AdoHcy) is formed. AdoHcy, which in excess inhibits the methylation activity of AdoMet, can be hydrolyzed to homocysteine; under normal conditions, however, the direction of this

reaction favors AdoHcy synthesis (reaction 14). An alternate fate of homocysteine is its transsulfuration to cystathionine and then to cysteine; both of these steps require pyridoxal 5'-phosphate (reactions 16 and 17). This is the major catabolic pathway of homocysteine, which is toxic to cells in concentrations normal for other amino acids. The pathway also produces glutathione, an important reducing agent. Thus, homocysteine has important ultimate influence on redox activity as well as synthesis of important thiols.

## Normal Folate Physiology

**NUTRITIONAL CHARACTERISTICS** Folate, named for green leafy vegetables, is found in nearly all classes of foods. Organ meats (e.g., liver and kidney) and yeast are particularly rich, although not frequently eaten, sources. More common sources are other meats, nuts, beans, orange juice, dairy products, grains, and cereals. However, folate is labile, and large losses occur with some cooking processes and some foods (<sup>34</sup>), especially when water is used that is then discarded (<sup>12</sup>). Fortification of the American food supply with 140 µg folic acid/100 g in grain and cereal products was begun in 1998 to lower the risk of neural tube defect births (<sup>35</sup>). Many food producers have exceeded that amount, thus increasing the average folate intake by an estimated 190 µg/day (<sup>36</sup>). An independent but parallel development has been the growing use of vitamin supplements in Western societies, especially the United States. However, folate intake is often marginal or low in developing countries. The Institute of Medicine (<sup>37</sup>) has revised earlier recommendations for folate intake that had been based on the replacement of daily losses and prevention of evidence of deficiency. The new recommendations also take into account folate bioavailability, which is highest for synthetic folic acid. Food folate tends to be polyglutamated and requires conversion to monoglutamate for optimal absorption, making it less bioavailable than folic acid. Recommended daily intake is therefore expressed in dietary folate equivalents, in which 0.5 µg of synthetic folic acid delivers the dietary equivalent of 1 µg of food folate. The recommended dietary folate equivalent intake is 400 µg daily for adults, 600 µg for pregnant women, 500 µg for lactating women, and lesser amounts scaled for age for children. Women of reproductive age are advised to take 400 µg synthetic folic acid as an additional supplement for prevention of neural tube defect births.

## PHYSIOLOGIC CYCLE OF ASSIMILATION

**Folate Absorption** The absorption of folate combines specific, saturable, carrier-mediated processes that tend to predominate in the upper small intestine and nonsaturable ones that predominate in the ileum (<sup>38</sup>). Luminal binding proteins appear not to be involved. The saturable process allows absorption of all forms of folate, usually after polyglutamated forms are hydrolyzed to monoglutamated ones by glutamate carboxypeptidase, a zinc-dependent enzyme with a pH optimum of 5.5 in the jejunal brush borders. Saturable absorption is mediated largely by the reduced folate carrier (RFC) that has high affinity for reduced folates and is in the brush border membrane of the more mature intestinal cells (<sup>39, 40</sup>). Conversion to methylTHF tends to occur in the intestinal cell, which then exports it into the blood via carrier-mediated basolateral membrane transport. Folate appears in the blood soon after ingestion, with peak levels at 1 hour. The nonsaturable process allows the absorption of large, linearly proportional fractions of the folate presented to the ileum. The mechanism assumes a dominant role whenever more than 200 µg of folate, which exceeds the capacity of the jejunal process, is ingested. Such absorption probably explains why oral folic acid is effective even when the specific jejunal mechanisms fail in some malabsorptive disorders. The monoglutamic folic acid also does not require hydrolysis and often enters the bloodstream both as a monoglutamate and unreduced.

**Folate Binders and Receptors** The roles of many of the specific and nonspecific folate binders, which do not appear to be required as facilitators of cellular uptake of folate, are incompletely understood. Specific binding proteins in the blood bind only a small fraction of circulating folate. Secretions, especially milk, also contain specific binding protein

whose role is unclear but may withhold folate from bacteria. The previously mentioned RFC is a 58-kd protein whose complementary DNA (cDNA) has been cloned and the gene for which is on chromosome 21q22. RFC transports reduced folates into cells; it also transports the antifolate, methotrexate. RFC participates in folate uptake not only in intestinal cells but also in the brain, liver, and heart. Specific, partially homologous folate receptors, folate receptor- $\alpha$  (FR- $\alpha$ ) and FR- $\beta$ , are found in epithelial cells, hematopoietic cells, renal tubular cells, and placenta ( [39](#), [40](#) and [41](#) ). Their cDNAs have been cloned, and four related genes and pseudogenes have been localized to chromosome 11q13. These receptors are covalently linked to glycosylphosphatidyl inositol anchors on the membrane, bind and internalize methylTHF by endocytosis via clathrin-coated pits, and are recycled ( [42](#), [43](#) ). The roles of the folate receptor isoforms, which have slightly different affinities for folates, are not known. Folate receptors may also have potential roles in chemotherapy because of their expression in malignant cells and involvement in the uptake of antifolates as well as folates. FR- $\alpha$  also serves as a cofactor for entry of Marburg and Ebola viruses into cells ( [44](#) ). Some folate receptor is found intracellularly, and some circulating folate-binding proteins appear to derive from folate receptor. The subject of folate binders and receptors has been reviewed ( [39](#), [40](#) ).

**Folate Transport and Cellular Utilization** Dietary folate and reabsorbed biliary folate enter the bloodstream and are rapidly cleared to tissues ( [45](#) ). The flux probably explains why serum folate declines within 3 weeks when intake is reduced ( [12](#) ). Most circulating folate is methylTHF. It is bound nonspecifically and with low affinity to proteins such as albumin, approximately one-third circulates unbound, and a tiny fraction is bound specifically by cell membrane-derived folate-binding protein ( [46](#) ). None of the circulating proteins play any obvious role in cell uptake of folates. Cellular uptake of monoglutamated folate occurs via either folate receptor or RFC in the cell membrane, the details varying among different cell types and conditions ( [39](#), [40](#) ). Passive diffusion also occurs. Inside the cell, folates are rapidly polyglutamated by cytosolic polyglutamate synthetase, which permits their retention and promotes attachment to enzymes. The folate is transported by poorly understood saturable mechanisms into organelles; 35% of intracellular folate is in mitochondria. The distribution and roles of intracellular folates have been reviewed ( [23](#) ).

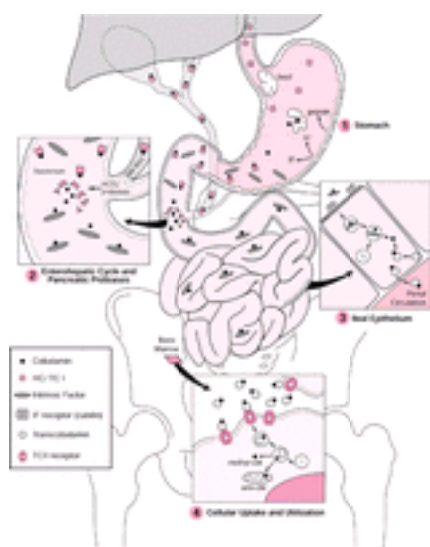
**Folate Stores and Turnover** Extrapolations from a depletion study suggest that body stores of folate can be depleted in a few months to levels that do not support normal hematopoiesis ( [12](#) ). However, specific numbers are scarce, and the rate of depletion is unlikely to be linear. Old data suggest that normal liver folate content exceeds 7.5 mg ( [47](#) ). The liver concentrates much of the body's folate and is a major site of one-carbon metabolism. Several folate pools exist, with different turnover rates ranging up to 100 days ( [48](#) ); the exchange among them is not well defined. Enterohepatic recycling occurs on a large scale ( [45](#) ). Approximately 200  $\mu$ g of folate is excreted fecally every day. However, in addition to reflecting loss of body folate via sloughed intestinal cells and nonreabsorbed biliary folate, part of that does not really involve the body folate economy because it is unabsorbed food folate and folate synthesized by intestinal bacteria ( [48](#) ). Folate is also filtered in the glomerulus and reabsorbed and conserved in the tubules by a carrier-mediated process, but some is secreted by tubular cells as well. Oxidatively degraded folate ( [49](#) ) is also lost, primarily in urine. The relative proportions of urinary and fecal avenues of loss are unclear.

## Normal Cobalamin Physiology

**NUTRITIONAL CHARACTERISTICS** Humans obtain cobalamin third-hand, either by eating animals that have ingested the bacteria that synthesize cobalamin or by eating animal produce, such as milk, cheese, or eggs. The more prodigious bacteria ingestors, such as ruminants and oysters, are rich sources. Plants do not contain cobalamin. Bioavailability varies with different foods. Cereals, fortified with cobalamin, and dairy

products appear to be more effectively assimilated than are meats (50). Cobalamin supplement use, usually as part of a multivitamin, has grown (51, 52 and 53). The daily requirement of cobalamin has been increased recently to 2.4 µg in adults (54) and is predicated on normal absorption. A survey in 1995 indicated that typical daily intake of cobalamin in the United States is 4.0 to 6.2 µg (55). An informative comparison is that this is only 1% of the amount of folate required daily, even though body stores of the two vitamins are nearly equal.

**PHYSIOLOGIC CYCLE OF ASSIMILATION** Intestinal absorption and cellular uptake by tissues (Fig. 43.4) are designed to internalize and concentrate available cobalamin while excluding possibly harmful nonfunctional analogs. The process is tightly regulated by a complex system of binding proteins and specific receptors (56). Excess cobalamin above the limits of the capacity of IF is poorly absorbed (57), unlike free folic acid. IF mediates the absorption of more than 75% of a small cobalamin load in a meal or supplement but can accommodate little more than a total of 1 to 2 µg at a time (47).



**Figure 43.4.** Assimilation and utilization of cobalamin. ado-cbl, adenosylcobalamin; HC/TC I, haptocorrin/transcobalamin I; IF, intrinsic factor; methyl-cbl, methylcobalamin. (From Carmel R. Cobalamin deficiency. In: Carmel R, Jacobsen DW, eds. Homocysteine in health and disease. Cambridge, UK: Cambridge University Press, 2001:289–305, with permission.)

**Cobalamin-Binding Proteins** Three proteins with nonoverlapping roles bind cobalamin (56, 58, 59) (Table 43.1). IF and TC II (sometimes called simply *TC*) each have specific cell membrane receptors, via which they transport cobalamin into cells by endocytosis. They have different distributions in the body. Parietal cell-derived IF is localized to the gut, whereas TC II, which is synthesized by endothelial, ileal, and other cells (60, 61 and 62), is found in plasma and other fluids. IF is highly specific for cobalamin and does not bind nonfunctional analogs (24). The structures of both proteins have been elucidated and their cDNA sequenced (63, 64). The two genes show considerable homology (64, 65) but are localized to different chromosomes: 11q12–q13 for IF and 22q11.2–qter for TC II (63, 66). A single-nucleotide polymorphism of the TC II gene has been identified (67), but its functional effect is unclear. Levels of TC II in plasma tend to rise in inflammatory and other disorders, suggesting an acute phase reactant character (58, 68, 69), but holo-TC II (TC II that is carrying cobalamin) is also cleared quickly from the plasma (70).

**TABLE 43.1. Cobalamin-Binding Proteins**

| Intrinsic Factor | TC II | Haptocorrin; TC I |
|------------------|-------|-------------------|
|------------------|-------|-------------------|



|                                  |                            |   |  |
|----------------------------------|----------------------------|---|--|
| Cbl-related role                 | Promotes ileal uptake      | Promotes cell uptake                                  | Unknown (carries Cbl in blood; initial binder of Cbl in stomach) |
| Cbl binding                      | Highly specific            | Intermediate specificity                              | Also binds nonfunctional analogs                                 |
| Receptors                        | Cubilin (ileal epithelium) | All cells   | None identified <sup>a</sup>                                     |
| Cell of origin                   | Gastric parietal cell      | Endothelial cell; fibroblast; ileal cell; ?hepatocyte | Neutrophil; exocrine epithelium                                  |
| Distribution                     | Gastrointestinal tract     | Plasma, cerebrospinal fluid, semen                    | Plasma, secretions   |
| Protein structure                | 48-kd glycoprotein         | 43-kd peptide chain                                   | 66-kd glycoprotein   |
| Consequence of binder deficiency | Cbl malabsorption          | Severe cellular Cbl deficiency                        | Low serum Cbl level without Cbl deficiency                       |

Cbl, cobalamin; TC, transcobalamin.

<sup>a</sup> Nonspecific clearance of desialylated TC I by asialoglycoprotein receptors may occur in the liver.

Modified from Carmel R. Cobalamin deficiency. In: Carmel R, Jacobsen DW, eds. Homocysteine in health and disease. Cambridge, UK: Cambridge University Press, 2001:289–305.

Haptocorrin (HC) or TC I (also called *R binder* and *cobalophilin*; HC/TC I is the abbreviation used here) refers to a family of immunologically identical glycoproteins ( [58](#) ). They vary in carbohydrate residues, however, which gives them slightly different physicochemical characteristics and has led to probably unjustified distinctions between TC I and “TC III” subsets in the blood. The HC/TC I gene, found on chromosome 11p11.11–q11, has limited homology to IF and TC II ( [65](#), [71](#) ). HC/TC I is synthesized in specific granules of late myeloid precursors ( [72](#) ) and probably in exocrine gland epithelium. The concentration in plasma approaches that of TC II, but HC/TC I predominates in secretions, such as saliva, bile, and breast milk ( [58](#) ). Although its binding of cobalamin is avid and most circulating cobalamin is carried by it, the role of HC/TC I in cobalamin metabolism is unknown. HC/TC I-cobalamin is cleared nonspecifically by hepatic receptors for asialoglycoprotein ( [73](#) ). Several minor, unrelated cobalamin-binding proteins have also been described in plasma, but their roles are unknown ( [58](#), [74](#) ).

**Cobalamin Absorption** Cobalamin is released from binding proteins in food by pepsin at an acid pH in the stomach and is then bound by salivary HC/TC I ( [Fig. 43.4](#); panel 1). In the duodenum, pancreatic secretions neutralize the pH and provide proteases that degrade HC/TC I ( [75](#) ). The released cobalamin, including biliary cobalamin ( [25](#) ), becomes available for binding to IF (panel 2). The IF-cobalamin complex later attaches to cubilin receptors for IF in the ileum (panel 3). Cubilin is a 460-kd glycoprotein that lacks a transmembrane domain but is internalized by association with the 600-kd transmembrane protein, megalin ( [76](#) ). As reviewed elsewhere ( [77](#) ), cubilin and megalin are widely expressed, especially in renal tubules and yolk sac, which have heavy endocytotic traffic. After endocytosis ( [56](#) ), the cubilin-IF-cobalamin complex is split. The cobalamin binds to TC II, and the holo-TC II exits basolaterally from the ileal cell. The emergence of cobalamin into the bloodstream occurs several hours after its ingestion.

**Plasma Transport and Cellular Utilization** After passing from portal blood to the liver, some of the cobalamin is internalized by hepatocytes via TC II receptors; as a result, the holo-TC II fraction is smaller in hepatic vein and peripheral blood than in portal blood ( [25](#),

<sup>78</sup>). Clearance of holo-TC II to tissues continues in the systemic circulation, much of it occurring in the kidney, which is rich in cobalamin. Proximal renal tubules are rich in TC II receptors, one of which appears to be megalin (<sup>79</sup>). Because of the continuous uptake by tissues, the half-life of holo-TC II is brief, estimated at 90 minutes (<sup>70</sup>). The HC/TC I-cobalamin complex is not taken up by tissues and circulates with a half life of 9 to 10 days (<sup>70</sup>). Therefore, 70% or more of cobalamin in the plasma is attached to HC/TC I (<sup>78</sup>, <sup>80</sup>, <sup>81</sup> and <sup>82</sup>), but this varies widely in different conditions (<sup>78</sup>). Endocytosis of holo-TC II occurs via specific receptors for TC II ( Fig. 43.4; panel 4), although there may be more than one class of receptors (<sup>56</sup>, <sup>79</sup>). After lysosomal degradation of TC II, cobalamin is released to the cytoplasm for attachment to methionine synthase and conversion to methylcobalamin. Cobalamin also enters mitochondria and is converted to adenosylcobalamin. The cellular uptake of holo-TC II has been reviewed (<sup>83</sup>).

**Body Stores and Turnover** The total body content of cobalamin approximates 2.5 mg in adults (<sup>84</sup>) and is well conserved. Only approximately 1 µg is lost daily. Some of the loss is by biliary excretion, although most biliary cobalamin is reabsorbed via the IF mechanism (<sup>25</sup>). A small amount escapes renal tubular reabsorption and is lost in urine. The body stores to daily requirement ratio approximates 1000:1, taking into account the recommended excess intake to accommodate the restricted absorption.

## CLINICAL AND LABORATORY FEATURES

The hematologic consequences are identical in folate and cobalamin deficiency. Similarities also exist in other clinical expressions of the two vitamin deficiencies, with the notable exception of neurologic dysfunction. Some clinical variance is influenced by the ways in which the deficiencies arise. Folate deficiency has a rapid evolution, measured in weeks or months; its broad dietary origins and association with other deficiencies and with alcohol abuse can also make attribution of some reported findings to the folate deficiency uncertain. Cobalamin deficiency, on the other hand, has a slow onset often measured in years but tends to be a purer deficiency state because of the usual specificity of cobalamin malabsorption.

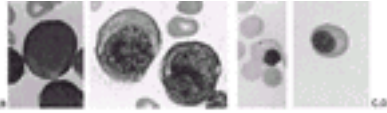
### Megaloblastic Anemia in Cobalamin and Folate Deficiency

**BIOCHEMISTRY** MethyleneTHF is needed for the methylation of deoxyuridylate to deoxythymidylate ( Fig. 43.2; reaction 2). Deficiency of folate compromises this reaction directly, and deficiency of cobalamin does so indirectly, as described earlier. However, impaired *de novo* thymidylate synthesis only partially explains megaloblastic anemia. Observations in nonanemic patients with cobalamin deficiency (<sup>85</sup>, <sup>86</sup>, <sup>87</sup> and <sup>88</sup>) and animal models (<sup>89</sup>) show that thymidylate synthase impairment need not lead to anemia. Other DNA processes become defective (<sup>90</sup>). Excess uracil from deoxyuridylate is misincorporated into DNA in place of thymine (<sup>91</sup>, <sup>92</sup>). Active excision repair produces many single-strand breaks. However, when excision coincides at opposing DNA strand sites, double-stranded breaks result, and this DNA damage may explain the nuclear defects of megaloblastic anemia. The end result appears to be an arrest at various stages of interphase in hematopoietic precursors (<sup>93</sup>). The role of apoptosis is controversial (<sup>93</sup>, <sup>94</sup> and <sup>95</sup>). It is noteworthy that an identical anemia is seen in patients with hereditary thiamine-responsive megaloblastic anemia and with antipurine drugs, neither of which reflects cobalamin or folate deficiency.

**HEMATOPATHOLOGY** Megaloblastic anemia is a panmyelosis, even though the terminology suggests a disorder limited to red cells and erythroid hyperplasia is prominent in the bone marrow. Indeed, the immature appearance of megaloblastic nuclei and occasionally intense myeloid proliferation in the marrow have led to a misdiagnosis of



leukemia in rare cases ([96](#)). The morphologic hallmark is nuclear–cytoplasmic dissociation, which is best appreciated in precursor cells in the bone marrow aspirate ([Fig. 43.5](#)). Megaloblastic nuclei are larger than in comparable normoblastic cells, and nuclear chromatin appears abnormally dispersed due to its retarded condensation. Random chromosomal abnormalities are seen, including centromere spreading ([97](#)), but nonrandom changes may also occur ([98](#), [99](#)). Cytoplasmic maturation and appearance are unremarkable.



**Figure 43.5.** Normal and megaloblastic precursor cells in the bone marrow. **A:** Pronormoblast. **B:** Megaloblastic equivalent of cell in **A**. **C:** Late normoblast. **D:** Megaloblastic equivalent of cell in **C**. See [Color Plate](#). (From Lee RG, Foerster J, Lukens J, et al., eds. *Wintrobe’s clinical hematology*, 10th ed. Philadelphia: Lippincott Williams & Wilkins, 1999: 913, with permission.)

Giant band cells and metamyelocytes with unusually large and often misshapen nuclei are typically seen. Neutrophils with hypersegmented nuclei are characteristic in the blood ([Fig. 43.6](#)), although they do not arise from the giant metamyelocytes ([90](#)). The mechanism of hypersegmentation is unknown as is the explanation for its persistence in the blood for a week or longer after therapy ([100](#)). Although platelets are often functionally impaired ([101](#), [102](#)), megakaryocytes do not show definable morphologic changes. Neither do lymphocytes, although biochemical and functional changes have been reported ([103](#)).



**Figure 43.6.** Normal peripheral blood cells compared with megaloblastic cells. Normal red blood cells (**A**); macroovalocytic red blood cells with poikilocytosis (**B**); and a normal neutrophil with a larger, hypersegmented one below it (**C**). See [Color Plate](#). (From Lee RG, Foerster J, Lukens J, et al., eds. *Wintrobe’s clinical hematology*, 10th ed. Philadelphia: Lippincott Williams & Wilkins, 1999: 910, 1895, with permission.)

Macrocytosis of red blood cells ([Fig. 43.6](#)) occurs early in the peripheral blood and increases progressively. Individual macrocytes appear first, followed by a gradual rise in mean corpuscular volume (MCV) that eventually crosses the line into abnormality ( $>97$  fl), long before the hemoglobin and packed cell volume levels fall ([12](#)). In the case of cobalamin deficiency, with its slow progression, macrocytosis precedes anemia by months ([17](#), [18](#)). Macroovalocytes are especially characteristic of megaloblastic anemia but are not specific ([104](#)). Early megaloblastic changes in the bone marrow precede the macrocytosis ([12](#), [105](#)) but tend to be mild and are easily missed. As anemia advances, poikilocytosis becomes more pronounced with teardrop cells. Eventually, nucleated red cells, Howell–Jolly bodies, and even Cabot rings appear in the blood. Receding macrocytosis has been reported in very severe anemia, presumably caused by increasing poikilocytosis and fragmentation ([106](#)). As anemia progresses, iron levels, sideroblast counts, and the ferritin content of erythroid precursors and macrophages increase ([47](#), [107](#)). Neutrophils develop hypersegmented nuclei very early in the course ([12](#), [108](#)). As megaloblastic anemia progresses, neutropenia may develop and, in severe cases, can be striking. This is even more true of thrombocytopenia. As reviewed elsewhere ([47](#), [90](#), [93](#)), the functional pathophysiology of megaloblastic anemia is ineffective hematopoiesis in all three hematopoietic cell lines. Many of the precursor cells are arrested at various stages in interphase but continue to mature. When the process is advanced, most of the

precursors within the hypercellular bone marrow die and are phagocytosed. Whether early cell death is primarily apoptotic or not is controversial ( [93](#), [109](#), [110](#) ) and may depend on the model studied. Reticulocytosis does not occur. Advanced anemia also has a poorly understood component of intravascular hemolysis, and survival is short for normal red cells transfused into cobalamin-deficient patients ( [111](#) ). Low serum glutathione has been reported as the most significant metabolic predictor of anemia in cobalamin deficiency ( [112](#) ). Abnormalities of erythrocyte membrane proteins, including spectrin, have also been described ( [113](#) ). The evolution of hematologic changes has been detailed elsewhere ( [47](#) ). With progressive anemia also come hyper-volemia, cardiovascular symptoms, pallor combined with hyperbilirubinemia that gives a classic lemon yellow skin color, and even retinal hemorrhages and, on occasion, pseudotumor cerebri. Erythropoietin levels correlate with severity of anemia, but variations can be wide ( [114](#) ).

## Neurologic Dysfunction

### COBALAMIN DEFICIENCY

**Pathophysiology** Demyelination with subsequent axonal disruption and gliosis can affect all parts of the central nervous system. Peripheral nerves, however, tend to show axonal degeneration without demyelination ( [115](#), [116](#) ). The classic myelopathic syndrome is subacute combined degeneration, in which posterior and lateral column damage predominates; dorsal, pyramidal, and spinocerebellar tracts are affected. The earliest changes are in the cervical or thoracic spine and can be detected by magnetic resonance imaging ( [Fig. 43.7](#) ). Larger, more heavily myelinated fibers tend to be affected most often ( [117](#) ).

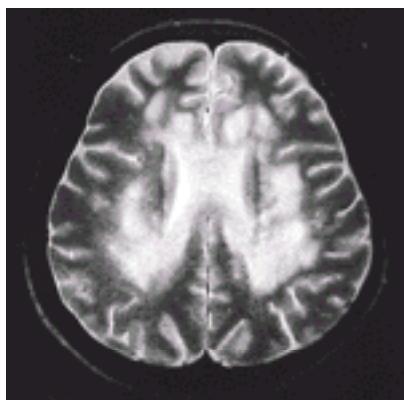


**Figure 43.7.** Magnetic resonance imaging (T2 weighted) of a sagittal section of the cervical spine of a man with pernicious anemia and severe myelopathy. Note the posterior localization of the high signal intensity lesion (arrow). (From Lerner AJ, Zeman AZ, Allen CMC, et al. MRI appearances in subacute combined degeneration of the spinal cord due to vitamin B<sub>12</sub> deficiency. *J Neurol Neurosurg Psychiatry* 1997;62:99–101, with permission.)

The biochemical mechanisms are unknown, however. Because neurologic involvement is much more prominent in cobalamin deficiency than in folate deficiency, suspicion fell first on the role of adenosylcobalamin in propionate metabolism, with possible consequences to fatty acids in myelin. Most evidence, reviewed elsewhere ( [118](#), [119](#) ), now points to methio-nine synthase impairment and its effects on methionine metabolism instead. Animal data suggested that methionine ameliorates cobalamin deficiency-induced

neurologic dysfunction; preliminary cerebrospinal fluid studies in humans described low AdoMet levels; and high AdoHcy to AdoMet ratios suggested inhibition of AdoMet's methylation activity by AdoHcy. A comparison of serum metabolite levels in patients with pernicious anemia suggests an even more complex picture ( [112](#) ). Unexpectedly, AdoMet levels were higher in neurologically impaired patients than in neurologically intact patients. Higher cysteine levels in neurologically affected patients were the most significant of the many differences found in both the transsulfuration and remethylation pathways of homocysteine metabolism. Moreover, neurologically impaired patients had significantly higher serum folate levels than those without neurologic problems ( [112](#) , [120](#) , [121](#) ). It is unclear if these changes represent cause or effect.

**Clinical Features** The frequency of neurologic involvement in cobalamin deficiency is not known. Often regarded as a later development than anemia, neurologic changes can precede anemia ( [122](#) , [123](#) and [124](#) ). Anemia may be absent in as many as 28% of cases of neurologic dysfunction ( [123](#) ). However, very mild hematologic changes are often found with careful search. Interestingly, the presence and severity of neurologic and hematologic expressions of cobalamin deficiency tend to be inversely related to each other in patients ( [120](#) , [124](#) ). Moreover, patients in whom one manifestation predominates tend to reexpress it if cobalamin deficiency relapses ( [124](#) , [125](#) and [126](#) ). Neuromyelopathic symptoms are the most common neurologic features of cobalamin deficiency ( [117](#) , [124](#) , [127](#) , [128](#) and [129](#) ). Sensory findings include position sense disturbance and dysesthesia; pyramidal tract signs include spasticity and the Babinski reflex; neuropathy is exemplified by loss of tendon reflexes; and gait disturbances are common signs of advanced involvement. A general symmetricalness of manifestations is a hallmark. Neuropathy, which is usually sensory but can be sensorimotor ( [130](#) ), and posterior column damage are often hard to differentiate clinically ( [124](#) , [127](#) , [131](#) ). Sometimes, the reversal of neuropathy early in therapy unmasks myelopathic findings, which may be mistaken for deterioration. The earliest manifestations are loss of vibratory sense in the feet and numbness, tingling, and loss of fine sensation. Others include loss of proprioception and, depending on the balance between myelopathy and neuropathy, hyperactive or diminished deep tendon reflexes. Involvement ascends up the legs, and, eventually, hands are affected as well. Muscle weakness and tenderness may be seen but are unexplained. Ataxia, spasticity, gait disturbances, positive Babinski reflex, impotence, and loss of bladder and bowel control are found in advanced cases. Cerebral symptoms, notably cognitive and emotional changes, can be severe ( [123](#) , [124](#) ), or they can be so mild as to be recognized only in retrospect after therapeutic improvement. As with myelopathy, demyelinating changes in the brain can be detected by magnetic resonance imaging ( [132](#) ) ( [Fig. 43.8](#) ). Chronic dementias, such as Alzheimer disease, appear unrelated to cobalamin deficiency and do not improve with cobalamin therapy ( [133](#) ), even though cobalamin levels are low in 10 to 20% of affected patients ( [87](#) , [134](#) , [135](#) ). In young children, developmental delay, lethargy, cerebral atrophy, and seizures may occur.



**Figure 43.8.** Magnetic resonance imaging (T2 weighted) of the brain in a woman with

pernicious anemia and cognitive dysfunction. Large confluent and focal areas of increased signal intensities are seen, predominating around the ventricles. The changes improved after therapy. (From Stojisavljevic N, Levic Z, Drulovic J, et al. A 44-month clinical-brain MRI follow-up in a patient with B<sub>12</sub> deficiency. *Neurology* 1997;49:878-881, with permission.)

Other manifestations include visual changes ( [124](#), [136](#) ), optic neuritis, which predominates in men ( [124](#) ), disturbances of smell or taste, and autonomic dysfunction ( [115](#), [137](#) ). Classic motor dysfunction is rare, other than that caused by spasticity and proprioceptive loss, although abnormal central motor conduction times have been described ( [130](#) ). At early or late stages, demyelination can be documented by magnetic resonance imaging ( [130](#), [132](#), [138](#), [139](#) ) ( [Fig. 43.7](#) and [Fig. 43.8](#) ) and functional changes by electrophysiologic tests of evoked potentials, nerve conduction, and electroencephalography ( [130](#), [140](#), [141](#), [142](#) and [143](#) ). Changes and their reversal were first identified electrophysiologically in the asymptomatic, preclinical deficiency state in some studies ( [88](#), [133](#), [144](#) ) but not others ( [145](#) ). Unlike anemia, neurologic dysfunction does not always respond to cobalamin therapy. Poor response is not always predictable but tends to be associated with more extensive involvement and longer duration before treatment begins ( [127](#), [128](#) ). Mistaken folate therapy has also been tied to this problem sometimes. The reason is presumed to be the delayed recognition of cobalamin deficiency that can result when its anemia responds to folate. The folate therapy thus allows neurologic abnormalities to appear, progress, and, in occasional reports ( [146](#) ), perhaps even to accelerate. Although folate should never be given alone to cobalamin-deficient patients, the events it sets in motion are more ambiguous than usually assumed: transient neurologic responses to folate actually occur in some cases ( [147](#) ), and hematologic improvement is usually neither complete nor long lived ( [146](#), [147](#) ).

**FOLATE DEFICIENCY** Neurologic dysfunction has been reported infrequently in adults with folate deficiency ( [148](#), [149](#), [150](#) and [151](#) ) and is rarely as severe as in cobalamin deficiency. Although myelopathy has been reported ( [151](#) ), mild mental changes, such as forgetfulness and irritability, and mild neuropathy have been better accepted. A causative association with depression is controversial ( [152](#), [153](#) ). As noted earlier, attribution of neurologic changes to folate deficiency must be cautious until alternative explanations such as alcohol or thiamine deficiency have been considered. Nevertheless, children with inborn errors of folate metabolism often have severe myelopathy and brain dysfunction ( [154](#), [155](#), [156](#) and [157](#) ). The explanations for these neurologic differences between folate and cobalamin deficiency and between acquired and hereditary disorders are unknown.

## Other Clinical and Laboratory Manifestations

**MISCELLANEOUS CLINICAL FINDINGS** Atrophy of tongue papillae is common with cobalamin deficiency and sometimes gives rise to a beefy red tongue that may or may not be symptomatic ( [47](#), [158](#) ). Aphthous stomatitis and oral soreness can be prominent in some patients, including some without anemia. However, oral and tongue changes occur with other deficiency states also. The glossitis of cobalamin deficiency does not respond to folate ( [159](#) ). Mucosal changes occur everywhere ( [47](#) ). Megaloblastic changes have been shown in buccal epithelium, cervical cells, and intestinal villi ( [160](#), [161](#) and [162](#) ). Reversible intestinal absorptive defects affecting various nutrients and substances have also been described ( [162](#), [163](#) and [164](#) ). Reversible weight loss of uncertain cause ( [165](#) ) and anorexia occur in pernicious anemia, presumably as a result of cobalamin deficiency. Reversible signs of impaired osteoblastic activity are common in cobalamin deficiency ( [166](#) ), but studies of bone density and fractures have not shown consistent clinical findings.

Reversible splenomegaly and fever have been reported ( [47](#) ) but should be attributed to cobalamin deficiency only after exclusion of other explanations. Sporadic, reversible cases of infertility have been described. Reversible darkening of nails and skin and change of hair color are sometimes seen in blacks, south Asians, and Latin-Americans with cobalamin or folate deficiency ( [167](#), [168](#) and [169](#) ).

**MISCELLANEOUS LABORATORY ABNORMALITIES** Platelet function is sometimes impaired, and rebound hyperfunction may occur transiently after therapy ( [101](#), [102](#) ). Neutrophil dysfunction has been variable ( [170](#) ). Neutrophil myeloperoxidase and platelet monoamine oxidase contents are increased ( [171](#), [172](#) ). Cobalamin deficiency also produces reversible changes in blood analytes that, unlike lactate dehydrogenase, bilirubin, and iron-related changes, are not directly related to the anemia: Serum alkaline phosphatase is often decreased ( [166](#) ); cholesterol falls, whereas triglyceride and free fatty acid levels rise ( [47](#), [173](#) ); immunoglobulin levels sometimes decline ( [174](#), [175](#) ); and hemoglobin A<sub>2</sub> levels tend to rise slightly ( [176](#), [177](#) ). Occasional patients with sickle cell trait have shown striking changes in hemoglobin S and F levels when folate deficient ( [178](#), [179](#) ).

**ASYMPTOMATIC (SUBCLINICAL) DEFICIENCY** Sensitive metabolic tests have permitted recognition and better understanding of the early stages of vitamin deficiency.

***Subclinical Cobalamin Deficiency*** Many patients and healthy people have low cobalamin levels but are asymptomatic and have normal blood counts. The low cobalamin levels had been thought artifactual, but, as reviewed elsewhere ( [180](#), [181](#) ), mild cellular cobalamin insufficiency exists in 60 to 70% of such people ( [88](#), [182](#), [183](#) and [184](#) ) and is reversible with cobalamin therapy ( [185](#) ). Such asymptomatic people are said to have subclinical deficiency, although some may also have electrophysiologic abnormalities that improve with therapy ( [133](#), [144](#) ). The number has grown further with the documentation of abnormal homocysteine and methylmalonic acid (MMA) levels in some asymptomatic people with low-normal cobalamin levels ( [182](#) ). This massive influx has revolutionized the concept of cobalamin deficiency but also introduced quandaries about cobalamin levels. It is important to remember that 30 to 40% of people with low cobalamin levels (<250 ng/L) and nearly 70% of those with low-normal levels (250 to 350 ng/L) are metabolically normal. A small proportion of people with subclinical deficiency have early pernicious anemia ( [186](#) ). They, and others with malabsorption of free cobalamin identifiable by the Schilling test, can be expected to progress to clinical deficiency eventually. However, the course in the many remaining cases is unknown. An older and limited study reported that they remain free of symptoms and anemia for at least 10 years, even though their cobalamin levels remain low ( [187](#) ). The elderly are at increased risk for both clinically expressed and subclinical cobalamin deficiency ( [180](#), [188](#), [189](#) ). Most studies estimate that approximately 10% of the elderly are affected. The frequency of low cobalamin levels increases from 8% of 65- to 75-year-old people to 20% of those 80 years of age or older, whereas low folate levels are found in only 1% of both those age subgroups ( [190](#) ).

***Subclinical Folate Deficiency*** Subclinical folate deficiency and its mechanisms have been less explicitly defined than subclinical cobalamin deficiency. The reasons include the fact that folate status is regulated largely by dietary intake variations ( [191](#) ) and thus fluctuates more readily. The question has also been subsumed by a focus on the hyperhomocysteinemia that is its identifying metabolic feature. The chief importance of subclinical folate deficiency may reside in its potential influence on the several issues that are discussed next.

***Vitamin Status as Risk Factor*** Folate supplementation reduces a woman's risk of having a child with a neural tube defect ( [192](#), [193](#) ) but must be taken at conception because the neural tube closes at approximately day 18. Doses of 400 µg are effective, with 4 mg recommended for women with risk factors such as a history of previous neural tube defects or anticonvulsant use. Because many women are unaware of their pregnancy in its first few weeks and because compliance with advised supplementation is always



spotty, all grain and cereal foods are now fortified with folic acid. The debate continues about potential side effects of the increased folate intake on the elderly and others with unrecognized cobalamin deficiency ( [194](#), [195](#) ). The explanation for the preventive effect of folic acid is unknown, almost certainly variable, and often multifactorial. Neural tube defects are rarely due to acquired folate deficiency. It is likely that genetic susceptibilities to abnormal metabolism of folate, cobalamin, or homocysteine (or all three) underlie the risk. Epidemiologic data have suggested possible associations with folate status in other birth defects also ( [196](#) ). Altered folate status may increase the risk of cancer in some people. Proposed mechanisms include folate's direct role in thymidylate synthesis and indirect role in generating AdoMet, which is needed for DNA methylation ( [197](#), [198](#) ). The data are inconsistent, but the most suggestive evidence has been associated with colon cancer ( [199](#) ). Interestingly, men with mildly impaired activity of methyleneTHF reductase due to the common 677C>T mutation of its gene have a diminished risk for colon cancer ( [200](#) ). Cervical atypia may also be increased in women with limited folate status, perhaps especially those with papillomavirus infection ( [201](#) ).

**HYPERHOMOCYSTEINEMIA** Extrapolation from inborn errors of homocysteine metabolism suggested that severe hyperhomocysteinemia is associated with severe thrombotic manifestations ( [202](#) ). Considerable epidemiologic data, reviewed elsewhere ( [203](#) ), indicate that even mild elevations of homocysteine carry increased risks for coronary, cerebral, and peripheral vascular complications. Mild homocysteine elevations are often reversible by folate, cobalamin, and sometimes vitamin B<sub>6</sub> ( [204](#) ), even if evidence of vitamin deficiency is absent, which suggests pharmacologic or epigenetic effects in many cases. As a result, folate or multivitamins are often prescribed to bring homocysteine levels down. Closer scrutiny showed that the associations were less firm in prospective, rigorously designed studies than in retrospective or less rigorous ones ( [203](#), [205](#), [206](#) and [207](#) ). The results of large interventional trials of lowering homocysteine levels are not available yet, but a decreased risk of postangioplasty restenosis was found in a small, randomized supplementation study ( [208](#) ). As mentioned earlier, mild hyperhomocysteinemia is also associated with neural tube defects, other birth defects, and fetal loss ( [196](#) ). The mechanisms underlying these associations and the benefits of lowering homocysteine levels remain unclear. A role for homocysteine in cognitive dysfunction in the elderly, independent of cobalamin, has also been proposed ( [209](#) ) but may reflect increased cerebrovascular events ( [210](#) ).

## Laboratory Evaluation

Laboratory evaluation has two separate targets. The diagnostic hematologic, metabolic, and clinical chemistry changes in the laboratory assessment of cobalamin and folate deficiency are discussed next. Laboratory testing for the conditions and diseases that cause the vitamin deficiencies are discussed in Laboratory Diagnosis of the Causes of Deficiency.

**HEMATOLOGIC ASSESSMENT** The classic blood count findings in cobalamin deficiency are anemia, a high MCV and mean corpuscular hemoglobin (MCH), and, in more advanced cases, thrombocytopenia and neutropenia. In folate deficiency, the findings may be admixed with those of coexisting problems such as alcohol abuse. Patients are often identifiable at an early stage in which they have only MCV and MCH elevation; indeed, sometimes they can be identified with an MCV and MCH that are higher than their previous levels but still within the reference range (e.g., an MCV of 90 fl replacing one of 85 fl). An early anisocytosis as new macrocytic cells begin to emerge is occasionally detectable by an elevated red cell distribution width, but a high red cell distribution width is not invariable ( [211](#) ). This slow progression can precede anemia by many months in cobalamin deficiency but only by a few weeks in folate deficiency. Red cell counts fall

before hemoglobin and packed cell volume levels. Megaloblastic anemia is not the only cause of macrocytic anemia, however, or even the most common ( [Table 43.2](#)). A recent study found 63.6% of MCV values greater than 100 fl in one hospital to be due to chemotherapy, antiretroviral therapy, or alcohol abuse ( [104](#)). Cobalamin and folate deficiencies accounted for only 6.3% of the high values but accounted for most MCV values above 110 fl. Experience may vary in other hospitals and in outpatients. A survey of MCV values above 90 fl in a pediatric center found no cases of cobalamin or folate deficiency ( [212](#)), but it was not clear how carefully those diagnoses were sought.

**TABLE 43.2. Causes of Macrocytosis, Defined as Mean Corpuscular Volume (MCV) Greater Than 97 fl** [a](#)

| Causes  | Likelihood of Severe Macrocytosis (MCV >110 fl) |
|---|---|
| Megaloblastic anemia                                  |   |
| Cobalamin or folate deficiency                        | High  |
| Other metabolic disorders (e.g., thiamine responsive) | High  |
| Cytotoxic drugs                                       | High  |
| Immunosuppressive drugs                               | High  |
| Alcohol   |   |
| Without liver disease                                 | Low   |
| With liver disease                                    | High  |
| Drugs   |   |
| Antiviral drugs                                       | High  |
| Anticonvulsant drugs                                  | Low   |
| Disorders of red cell production                      |   |
| Aplastic anemia; pure red cell aplasia                | High  |
| Myelodysplastic syndromes                             | High  |
| Myeloproliferative disease; leukemia                  | Low   |
| Sideroblastic anemia (hereditary or acquired)         | Low   |
| Reticulocytosis                                       |   |
| Hemolytic anemia                                      | High  |
| Nonhematologic disease                                |   |
| Liver disease (alcohol unrelated)                     | High  |
| Hypothyroidism  | Low   |
| Physiologic   |   |
| Red cells are enlarged in the first 4 wk of life      | Low   |
| Idiopathic  |   |
| Pregnancy   | Low   |
| Chronic lung disease, smoking                         | Low   |
| Cancer  | Low   |
| Multiple myeloma                                      | Low   |
| Artifact of electronic cell sizing                    |   |
| Cold agglutinins                                      | High  |
| Severe hyperglycemia                                  | High  |
| Hyponatremia  | ?   |
| Stored blood  | ?   |
| Warm antibody to red blood cells                      | ?   |



<sup>a</sup> Macrocytosis can also be diagnosed when an MCV is not yet >97 fl but is higher than usual for the patient. The second column in the table also estimates how often macrocytosis can be severe (>110 fl).

---

Reticulocyte counts never rise and may fall slightly. The serum lactate dehydrogenase and indirect bilirubin levels begin to rise only as anemia advances, usually when the hemoglobin falls below 10 g/dl (47). The laboratory signs of ineffective erythropoiesis and hemolysis include not only lactate dehydrogenase levels that can eventually reach thousands of units/L and hyperbilirubinemia but also high serum transferrin receptor (213), iron, ferritin, nontransferrin bound iron (214), and methemalbumin levels (215) and low serum haptoglobin levels (215). As anemia progresses, platelet and neutrophil counts start to decline and can become very low in severe megaloblastic anemia. The pancytopenia can ultimately mimic aplastic anemia, which is also usually macrocytic but does not feature the hyperbilirubinemia and lactate dehydrogenase elevation. Most of the variability in the hematologic picture is dictated by the stage at which the patient is discovered (47). However, other influences also affect the pattern. Patients with coexisting iron deficiency display dimorphic red cell patterns. They and patients with thalassemia may have normal or low MCV, which fall further when vitamin therapy is given (216). Iron deficiency sometimes blunts the erythroid megaloblastic changes themselves, both morphologically and by deoxyuridine suppression testing (217, 218). Iron studies in untreated megaloblastic anemia often do not reveal the coexisting iron deficiency (47). Because those marrow and blood markers of iron status uniformly fall sharply within 24 to 48 hours of vitamin therapy, it may be advisable to wait several days after that for the tests to stabilize and reflect the patient's true iron status. Hypersegmentation of neutrophil nuclei is a constant feature but is variably defined (47). The most serviceable criteria are finding one or more neutrophils with six or more nuclear lobes or showing that at least 4 to 5% of neutrophils have five lobes. Calculating lobe averages is considered the gold standard but cannot rely on published reference ranges because interobserver variation is great. Hypersegmentation often precedes anemia (12, 108), but it is not found in subclinical deficiency (219). The finding is also not specific for cobalamin or folate deficiency. Hypersegmented neutrophils are found in patients receiving chemotherapeutic drugs such as 5-fluorouracil or hydroxyurea, some patients receiving steroid therapy for immune thrombocytopenic purpura (220), rare patients with myelofibrosis or chronic myelogenous leukemia, and, perhaps, as a benign hereditary condition. Whether hypersegmentation is caused by iron deficiency or reflects a coexisting folate deficiency in such cases is controversial (221, 222). A higher normal neutrophil segmentation has been reported in blacks than in whites (219). The above events mark most patients with megaloblastic anemia. Nevertheless, not every cobalamin-deficient patient expresses the same level of anemia for his or her level of deficiency. Many patients with severe deficiency have surprisingly mild anemia or even lack it. The explanations for blunted anemia are not always apparent, although there is a tendency for an inverse association of anemia with neurologic dysfunction (122, 123).

**LABORATORY ASSESSMENT OF DEFICIENCY** Cobalamin and folate levels can be measured in serum and in cells. The original methods were microbiologic, exploiting the vitamin requirements of various microorganisms and including differential bacterial sensitivity to specific forms of folate (47). Although rarely used today, microbiologic assays provided the basis for our understanding of cobalamin levels (223, 224) and remain the gold standard. They were replaced by radiodilution binding assays, which are now giving way to automated, chemiluminescence-based immunoassays. Technical ease has improved, but each methodologic changeover has been accompanied by diminishing documentation and validation (225, 226). Metabolic tests are available to augment and

clarify the vitamin levels, as summarized in [Table 43.3](#) and reviewed elsewhere ([225](#)). However, these are not necessary in many cases, and no single test is conclusive for either cobalamin or folate deficiency. The metabolic tests are essential in the diagnosis of inborn errors of metabolism, however, in which vitamin levels are often normal. They are also useful in monitoring response of deficiency to therapy when necessary. Unlike vitamin levels, which rise instantly whether vitamin therapy was beneficial or not, metabolite levels do not change in the first few days, thus allowing delayed reassessment of the suspected diagnosis in early posttreatment specimens. More important, metabolite levels do not improve at all unless the therapy was effective.

**TABLE 43.3. Biochemical Tests for the Diagnosis and Differentiation of Cobalamin and Folate Deficiencies**

| Test                                       | Deficiency of         |                       | Ability to Discriminate between the Two Deficiencies |
|--|-----------------------|-----------------------|--|
|  | Cobalamin             | Folate                |  |
| Serum cobalamin <sup>a</sup>               | ?                     | N or ?                | Fair to good   |
| Serum folate <sup>a</sup>                  | N or ?                | ?                     | Very good  |
| Red cell folate <sup>a</sup>               | ? or N                | ?                     | Poor   |
| Serum methylmalonic acid <sup>a</sup>      | ?                     | N                     | Very good  |
| Serum 2-methyl citric acid <sup>b</sup>    | ?                     | N                     | Good   |
| Plasma homocysteine <sup>a</sup>           | ?                     | ?                     | Poor   |
| Plasma cystathionine <sup>b</sup>          | ?                     | ?                     | Poor   |
| Deoxyuridine suppression test <sup>b</sup> | Abnormal <sup>c</sup> | Abnormal <sup>c</sup> | Very good <sup>c</sup>                               |

?, increased; ?, decreased; N, normal result.

<sup>a</sup> Test is available in clinical laboratories.

<sup>b</sup> Test is limited to research laboratories.

<sup>c</sup> The diagnostic discriminatory power arises from including testing with various vitamin additives *in vitro*. Folate-deficient cells show normal results after exposure to any form of folate (folic acid, methyltetrahydrofolate, formyltetrahydrofolate, and so forth) but not to cobalamin. Cobalamin-deficient cells respond to cobalamin and those forms of folate that bypass the methyltetrahydrofolate trap, such as folic acid or formyltetrahydrofolate; they do not respond to methyltetrahydrofolate.

Modified from Zittoun J, Zittoun R. Modern clinical testing strategies in cobalamin and folate deficiency. *Semin Hematol* 1999;36:35-46.

**Cobalamin Levels** In cobalamin deficiency, serum cobalamin levels fall below the generally accepted cutpoint of 200 to 250 ng/L. (Note that publications often express values in pmol/L; 1 ng = 0.738 pmol.) The lower the level, the more likely is clinically noteworthy deficiency with symptoms and signs to exist ([223](#), [224](#)). However, not every level below 100 ng/L represents deficiency, whereas some patients with obvious deficiency have only mildly decreased cobalamin levels. Levels of 100 to 200 ng/L were reported in 27% of patients with pernicious anemia and levels of 200 to 250 ng/L in another 9% ([122](#)). Therefore, despite the poor positive predictive value of serum cobalamin levels when the clinical picture is not taken into account ([227](#)), all subnormal levels in patients suspected of deficiency require attention. As mentioned earlier, occasional patients with cobalamin

deficiency, including a few with frank symptoms and signs of deficiency, have normal serum cobalamin levels for unknown reasons ( [182](#), [228](#), [229](#) ). Metabolic abnormalities compatible with deficiency are found in 30 to 35% of healthy elderly people with cobalamin levels of 250 to 350 ng/L, as summarized elsewhere ( [230](#) ). Raising the serum cobalamin cutpoint for deficiency to 350 ng/L has been suggested so as to encompass those cases ( [51](#) ). The controversy centers on the trade-off between identifying that 30 to 35% subset, consisting mostly of asymptomatic people with subclinical deficiency, and mislabeling as deficient the other 65 to 70% who are not deficient at all ( [180](#), [181](#) ). Moreover, neither abnormal homocysteine nor abnormal MMA levels alone are incontrovertible proof of deficiency, especially in patients whose cobalamin levels are normal. Causes of low cobalamin levels, including falsely low levels, are listed in [Table 43.4](#). Serum cobalamin levels frequently fall in folate deficiency, becoming subnormal in approximately 10% of cases, and recover after folate therapy ( [47](#) ); such cases must be differentiated from combined deficiency of both vitamins. Cobalamin levels also decline as pregnancy progresses and can reach levels below 100 ng/L, recovering within days after delivery. Low levels occur in 35% of women in the third trimester ( [231](#) ). The explanation is unknown, and metabolic studies do not demonstrate evidence of deficiency ( [231](#), [232](#) ). Low cobalamin levels without evidence of deficiency also occur in patients with human immunodeficiency virus (HIV) infection ( [233](#), [234](#) and [235](#) ), multiple sclerosis ( [236](#) ), and multiple myeloma ( [237](#) ). Diagnostic dilemmas may be especially acute in HIV infection and multiple sclerosis, in which neurologic defects often resemble those of cobalamin deficiency.

**TABLE 43.4. Causes of Low Serum Cobalamin Levels**

Most common causes (in approximate descending order of frequency)

Inappropriately high reference range <sup>a</sup>

Subclinical (biochemical) cobalamin deficiency

Latent pernicious anemia or other malabsorptive disorders uncovered at early, presymptomatic stage

Atrophic gastritis

Strict vegetarianism

Other (e.g., elderly with causes not listed above)

Idiopathic

Clinical (symptomatic or anemic, or both) cobalamin deficiency

Pregnancy (second or third trimester)

Mild haptocorrin/transcobalamin I deficiency

Laboratory error or artifact

Other causes of undetermined or low frequency

Folate deficiency

Severe haptocorrin/transcobalamin I deficiency

Human immunodeficiency virus infection <sup>a</sup>

Anticonvulsant therapy <sup>a</sup>

Multiple myeloma <sup>a</sup>

Multiple sclerosis

Hairy cell leukemia

Aplastic anemia

Myelodysplasia

Paroxysmal nocturnal hemoglobinuria

Gaucher disease

## Oral contraceptive use

<sup>a</sup> Evidence of true cobalamin deficiency or malabsorption has been found in only some cases in these categories.

---

Elevated cobalamin levels are more common than low levels in clinical practice ( 82 ). The most frequently identified association was renal failure ( 82 ), although low levels have also been reported in patients undergoing chronic high-flux hemodialysis ( 238 ). Cobalamin therapy must always be considered as a cause of high cobalamin levels. Consistent but infrequent causes include chronic myelogenous leukemia and acute promyelocytic leukemia, both accompanied by markedly increased HC/TC I levels ( 58 ). Patients with chronic myelogenous leukemia and coexisting pernicious anemia have falsely normal cobalamin levels ( 239 ). Other associations of high cobalamin and HC/TC I levels include some cases of metastatic cancer, often with leukemoid reactions or hepatic involvement, and hepatoma ( 58 ). Spontaneous or therapy-acquired autoantibody to TC II is a rare cause of elevated cobalamin levels ( 74 , 240 , 241 ). Cobalamin levels, like HC/TC I and TC II levels, tend to be higher in blacks than in whites ( 242 ).

**Serum Folate** The traditional definition of folate deficiency, derived from patients with megaloblastic anemia, is a serum folate level below 2.5 µg/L. (Note that publications often express folate in nmol/L; 1 µg = 2.266 nmol.) However, studies in the elderly suggest that homocysteine levels tend to rise in those whose serum folate falls below 4.8 µg/L ( 191 ) or 6.5 µg/L ( 243 ). Homocysteine also tends to improve when folate is given to people with folate levels up to 4.5 or 5.0 µg/L ( 244 ). These findings justify viewing serum folate levels between 2.5 and 5.0 µg/L with suspicion, at least in the elderly. Due to folate instability, levels fall within a few days of sample storage, especially if ascorbate is not added to protect against oxidative damage. Serum folate levels tend to rise with cobalamin deficiency and are high in approximately 30% of cases ( 47 ). The most common cause of elevated levels is the use of folate supplements, however. Artificially high levels also occur in hemolyzed blood samples because red cell folate is released into plasma.

**Red Blood Cell Folate** MethylTHF (60.4%) and formylTHF (26.3%) are the major folates in red cells ( 245 ). Red cell folate is viewed as a truer indicator of tissue folate than are serum levels, which fluctuate with changes in folate intake. Levels below 160 µg/L red blood cells are usually considered low ( 246 ), but the reference range varies widely among laboratories and methods. Red cell folate results do not distinguish between folate and cobalamin deficiencies; 63% of patients with cobalamin deficiency have low levels ( 246 ). This finding is thought to reflect the limited intracellular retention of the increased but less easily polyglutamated methylTHF. Because early cells are richer in folate than older cells, red cell folate levels are higher, and therefore unreliable, in states of intense reticulocytosis such as hemolytic anemia ( 246 ). Transfusion invalidates red cell folate measurement. Red cell folate, much of it bound to hemoglobin ( 247 ), is also slightly higher in deoxygenated than oxygenated cells ( 248 ). The several clinical sources of error, along with methodologic difficulties, have led some to downgrade the usefulness of red cell folate determination ( 249 ).

**Plasma Homocysteine** In the past decade, precise measurement of low concentrations of homocysteine has become possible with high-performance liquid chromatography and other techniques. These methods measure “total” homocysteine, which consists of reduced homocysteine and its oxidized forms, homocystine and mixed disulfides. Measuring levels after oral loading with methionine is occasionally useful, especially when vitamin B<sub>6</sub> deficiency is suspected ( 250 ). Because of methodologic, subject recruitment and conceptual differences, no universally agreed reference range exists. Age and sex further influence normal levels ( 251 ). Levels above 12 to 14 nmol/L in women and 14 to

15 in men are generally regarded as elevated. It is essential to use plasma rather than serum and to separate plasma from blood cells within an hour to avoid artificial elevation of homocysteine levels. Because homocysteine and creatinine levels correlate even in patients without renal failure, serum creatinine should be measured whenever a high homocysteine level is found. Homocysteine rises, often very markedly, with either folate or cobalamin deficiency. Although this lack of discrimination limits its diagnostic usefulness, a normal result can help exclude deficiency. Homocysteine levels are elevated in more than 95% of patients with clinically expressed cobalamin deficiency, but sensitivity is only 86% in clinical folate deficiency ( [252](#) ). The levels fall several days after appropriate treatment of either vitamin deficiency and become normal within a week, but they do not budge if the wrong vitamin is used ( [228](#) , [253](#) ). As reviewed elsewhere ( [254](#) ), homocysteine levels rise in many other acquired and genetic conditions ( [Table 43.5](#) ). This further reduces the specificity of elevated levels, despite the observation that folate and cobalamin status accounts for 63 to 66% of the risk for elevated homocysteine levels in the healthy population ( [251](#) ). Folate intake and serum creatinine levels are major determinants of homocysteine status in population surveys ( [251](#) ). Cobalamin levels, but not intake, assume increased significance in the elderly ( [191](#) , [251](#) ). Cystathionine, a product of homocysteine transsulfuration, also rises in cobalamin and folate deficiency but has little clinical application.

**TABLE 43.5. Causes of Elevated Homocysteine Levels**

| Causes   | Degree of Homocysteine Elevation <sup>a</sup> |
|--|---|
| Vitamin deficiency   |   |
| Cobalamin deficiency   | Mild to severe                                |
| Folate deficiency  | Mild to severe                                |
| Vitamin B <sub>6</sub> deficiency                                      | Mild <sup>b</sup>                             |
| Riboflavin deficiency  | Mild  |
| Disease  |   |
| Renal failure  | Mild to moderate                              |
| Posttransplantation  | Mild to moderate                              |
| Hypothyroidism   | Mild <sup>c</sup>                             |
| Acute lymphocytic leukemia   | Mild  |
| Psoriasis  | Mild  |
| Drugs and toxins   |   |
| Alcohol abuse  | Mild to severe                                |
| Methotrexate and other antifols  | Mild to severe                                |
| Trimethoprim; levodopa   | Mild  |
| Fenofibrate  | Mild <sup>c</sup>                             |
| Cyclosporine A   | Mild  |
| Drugs affecting vitamin B <sub>6</sub> (e.g., isoniazid)               | Mild <sup>b</sup>                             |
| Nitrous oxide toxicity   | Mild to severe                                |
| Genetic disorders  |   |
| Cystathionine β-synthase deficiency                                    |   |
| Homozygous state   | Severe  |
| Heterozygous state   | Mild <sup>b</sup>                             |
| Hereditary disorders of cobalamin metabolism, transport, or absorption | Mild to severe                                |

|   |                   |
|---|-------------------|
| Hereditary disorders of folate metabolism, transport, or absorption                       | Mild to severe    |
| Methylene tetrahydrofolate reductase polymorphisms (homozygous C677T or A1298C mutations) | Mild <sup>d</sup> |
| Physiologic and lifestyle factors <sup>e</sup>  |                   |
| Male sex  | Mild              |
| Aging   | Mild              |
| Coffee drinking   | Mild              |
| Smoking   | Mild              |
| Artifact  |                   |
| Use of serum; delay in centrifugation   | Mild              |

<sup>a</sup> Homocysteine elevations are categorized arbitrarily as mild (15–25 μmol/L), moderate (25–50 μmol/L), and severe (>50 μmol/L).

<sup>b</sup> Often inapparent unless postmethionine–loading measurement is done.

<sup>c</sup> Homocysteine elevation may be due to change in creatinine level.

<sup>d</sup> Often inapparent unless folate status is compromised.

<sup>e</sup> In these categories, it is not known if other influences are responsible for the differences attributed to the factors.

**Methylmalonic Acid** MMA, a product of accumulated D–methylmalonyl CoA, increases in serum and urine with cobalamin deficiency but not folate deficiency. MMA is therefore a more specific test for cobalamin deficiency than homocysteine. With the advent of sensitive methods ( [253](#), [255](#) ), serum MMA was shown to be elevated in 98.4% of patients with symptomatic cobalamin deficiency ( [252](#) ). Definitions of the reference range are almost as uncertain as with homocysteine. Serum levels are now considered elevated above 280 nmol/L (0.28 μmol/L), but much of the literature has been based on considerably higher cutpoints. MMA levels often exceed 1000 nmol/L in symptomatic cobalamin deficiency, with milder elevations in subclinical deficiency. The levels fall several days after cobalamin therapy and become normal within a week ( [228](#), [253](#) ); folate therapy has no effect. MMA levels rise in renal failure, making it useful to measure serum creatinine in any patient with elevated MMA. Some high levels are unexplained, including those in occasional folate–deficient patients, and have often been attributed to volume contraction ( [252](#) ), but other explanations seem possible ( [256](#) ). The observation that MMA levels fall after antibiotic therapy ( [228](#) ) also suggests bacterial causes for MMA elevation. High MMA levels occur in many newborns ( [257](#), [258](#) ); it is unknown if the elevations reflect hepatic immaturity or transient cobalamin insufficiency. Urine MMA assay ( [255](#), [259](#) ) is less widely used. Serum 2–methylcitric acid also rises with impaired propionate metabolism in cobalamin deficiency but has little clinical use.

**Deoxyuridine Suppression Test** The ability of deoxyuridine, added *in vitro* to bone marrow cells in short–term culture, to suppress the normal incorporation of thymidine into DNA ( [260](#) ) was developed into a test of cobalamin and folate deficiency ( [261](#) ). Its mechanism as a reflection of impaired thymidylate synthase has been questioned ( [262](#) ). Nevertheless, the test appears at least as sensitive for cobalamin deficiency as homocysteine or MMA assay ( [263](#) ) and served to first define subclinical cobalamin deficiency ( [87](#), [88](#), [185](#) ). Cobalamin and folate deficiencies can usually be differentiated by incubation of cell aliquots with different vitamins *in vitro* ( [261](#), [264](#) ). However, the procedure is labor intensive and requires bone marrow aspiration, and tests using lymphocytes are unreliable ( [265](#) ).



**Other Tests** Formal diagnostic trials of reticulocyte response to a small dose of either folic acid or cobalamin ( [266](#) ) are no longer needed. Nevertheless, evaluation of the clinical response is an important part of management. Because most circulating cobalamin is carried by HC/TC I and is thus unavailable for cell uptake, measuring holo-TC II is a theoretically attractive diagnostic tool ( [267](#) ). However, the interpretation and clinical value of the results are unproved ( [268](#) , [269](#) ).

## SPECIFIC DISORDERS CAUSING DEFICIENCY

Diagnostic evaluation requires that the condition responsible for the deficiency is identified. This process helps confirm the diagnosis of deficiency, ascertains the prognosis, and is invaluable for management. The underlying cause also determines the rate at which cobalamin deficiency progresses or relapses. A metabolic or cellular block produces deficiency within days, weeks, or at most a few months, whereas deficiency is delayed for several years when IF-mediated absorption is disrupted and even longer if dietary insufficiency is the cause. These approximate time scales are modified if limited body stores or other compromises coexist.

### Causes of Cobalamin Deficiency

The disorders follow the cobalamin assimilation and utilization sequence illustrated in [Figure 43.4](#).

### DIETARY INSUFFICIENCY

**Adults** The circumscribed dietary source for cobalamin and the huge body stores to daily loss ratio protect most adults from becoming frankly deficient on a purely dietary basis. Malnutrition lasting a few weeks or months does not produce cobalamin deficiency, nor does old age or alcohol abuse lead to dietary insufficiency. The only adults at risk are long-term, strict vegetarians, especially vegans who also avoid eggs and dairy products. A study of vegetarian women showed their cobalamin intake was  $1.68 \pm 1.60 \mu\text{g/day}$ , one-half that of nonvegetarian controls ( [270](#) ). Minimal changes of MCV have been noted in surveys of vegetarians ( [271](#) , [272](#) ), but macrocytic anemia is uncommon. Even long-standing dietary restriction rarely leads to megaloblastic anemia or myelopathy, which tend to be accompanied by MMA levels exceeding  $1000 \text{ nmol/L}$  ( [273](#) ). Consideration of coexisting causes, such as malabsorption, is warranted in patients with symptoms ( [274](#) , [275](#) ). Most often, vegetarians are found only to have mildly low cobalamin levels and mildly elevated MMA and homocysteine levels ( [276](#) , [277](#) and [278](#) ).

**Children** The consequences of dietary restriction are often more serious in children, who must simultaneously undergo neurologic development and expansion of cobalamin stores. Children in macrobiotic communities have persistent metabolic abnormalities ( [279](#) ), and perhaps impaired cognitive performance ( [280](#) ), even years after starting cobalamin supplementation. Diets restricted because of phenylketonuria may also lead to cobalamin deficiency ( [281](#) ). The consequences are sometimes catastrophic for babies born to and breast-fed by mothers who are strict vegetarians or have undiagnosed pernicious anemia ( [167](#) , [282](#) , [283](#) ). Indeed, maternal deficiency is the most common cause of cobalamin deficiency in childhood ( [284](#) ). It is very instructive of the cobalamin differences between adults and children that the mothers are themselves mildly deficient and asymptomatic, whereas the children have severe neurologic and developmental abnormalities. Involuntary movements and tremors are also common and may increase just after therapy is begun ( [285](#) ). Long-term neurologic deficits may persist ( [286](#) ). Dietary and second-hand cobalamin deficiency may have substantive roles in growth and developmental retardation ( [284](#) , [287](#) ).

### MALABSORPTION



**Pernicious Anemia** The central defect of pernicious anemia, as well as its defining characteristic, is not the anemia but the malabsorption of cobalamin due to the loss of IF. Although atrophic gastritis is universal in Addisonian pernicious anemia, it differs from the much more common, nonpernicious anemia form of gastritis in which IF secretion persists long after acid secretion ceases ( 288 ). In 90% of cases of pernicious anemia, the gastric atrophy affects the fundus but spares the antrum, which is often hypertrophic. The disease, with its loss of parietal cells that synthesize IF, appears autoimmune in nature. The gastric and immune aspects of pernicious anemia have been reviewed ( 47 , 289 , 290 ). Antibodies to gastric antigens are found in 85% of cases, more often directed against the parietal cell but more telling when directed against IF; the gastric histology suggests an inflammatory disorder; cell-mediated immune abnormalities have been suggested; steroid therapy sometimes restores IF secretion; and other immune disorders often coexist. No consistent association with HLA subtypes has been found, but lymphocytotoxic antibodies and CD4 cells are increased ( 291 , 292 and 293 ). Gastritis was subdivided presumptively into types A and B ( 294 ). Type A gastritis is characterized by the presence of parietal cell antibody and sparing of the antrum; although the less common form in the general population, it is found in 80 to 90% of patients with pernicious anemia. Type B gastritis is a pangastritis without antibodies. It predominates in the general population but is found in only a minority of patients with pernicious anemia; it is now known that type B gastritis usually results from *Helicobacter pylori* infection. *H. pylori* infection is infrequent in patients with pernicious anemia ( 295 ). Pernicious anemia appears to have a familial predisposition ( 296 , 297 ). Relatives of affected patients have increased frequencies of atrophic gastritis, antibodies to parietal cells, and thyroid disease ( 296 ). Pernicious anemia occurs most often in people older than 60 years of age ( 47 ), although the gastritis begins many years earlier ( 298 ). A survey of the elderly in Los Angeles found that 1.9% had unrecognized pernicious anemia ( 186 ). Older surveys in Scandinavia found the prevalence to be 0.13 to 0.2% among all ages ( 47 ). Women are affected almost 50% more often than men in most surveys ( 47 , 299 ). Although most common in northern Europeans, pernicious anemia occurs throughout the world ( 47 , 186 , 242 , 299 , 300 , 301 , 302 and 303 ). Indeed, the frequency in African-Americans approaches that in American whites ( 186 ). The reason why black women develop the disease more often before 50 years of age than do whites and have antibody to IF more often is unknown ( 299 ); a similar but less significant trend was found in American Hispanics ( 242 , 302 ). Nevertheless, even in whites, approximately 10% of cases occur at a young age, sometimes in childhood or adolescence ( 47 ). Called *juvenile pernicious anemia* in children, it is accompanied by especially high rates of antibodies, immune endocrinopathy, and a positive family history. Similar characteristics were noted in young and middle-aged patients in Denmark ( 297 ). Pernicious anemia carries many disease-specific associations and prognostic implications, besides causing relentless cobalamin deficiency. The most serious one is an increased risk for two gastric tumors, both predominating in the fundus. Gastric carcinoid is found in 7% of patients but metastasizes in only 20% of them ( 289 , 304 , 305 ). The increased risk for gastric carcinoma has been widely noted ( 47 , 289 , 306 , 307 and 308 ), although some reports disagree ( 309 , 310 ). A prospective endoscopic study reported a 4.1% incidence ( 307 ). Most experts recommend endoscopy at the time of diagnosis in every patient with pernicious anemia ( 311 ), but routine examinations thereafter are not advised. Other gastroenterologic associations with pernicious anemia include bacterial contamination of the stomach and upper small bowel, perhaps due to achlorhydria ( 312 ), and gall bladder disease ( 313 ). Iron deficiency is seen in 21% of patients at diagnosis and in another 23% later ( 314 ). An independent cause of iron deficiency is not always found, suggesting that iron malabsorption due to gastritis may play a role. Approximately 10% of patients develop clinical or latent thyroid disease, most often hypothyroidism ( 315 ). Other immune

disorders associated with pernicious anemia include vitiligo, hypoparathyroidism, hypoadrenalism, and myasthenia gravis ( 47 ). A noteworthy syndrome occurs in patients with agammaglobulinemia or common variable immunodeficiency ( 316 ); the patients are young, have type B gastritis, often have bacterial overgrowth, and are at very high risk for gastric cancer. Associations with pernicious anemia have also been suggested for immune thrombocytopenia, immune hemolytic anemia, transient red cell aplasia, diabetes mellitus, biliary cirrhosis, and renal tubular acidosis ( 47 , 317 , 318 , 319 , 320 and 321 ). Links have also been suggested with myelodysplasia, leukemia, chronic myelogenous leukemia, and other myeloproliferative diseases ( 239 , 308 , 322 , 323 and 324 ). An increased rate of tuberculosis was reported in Asian Indians and Chinese ( 301 , 303 ) but has not been described in Westerners.

**Hereditary Intrinsic Factor Deficiency** Also called *congenital pernicious anemia*, this autosomal-recessive disorder is characterized by absence of gastric IF ( 157 , 325 ). Nonfunctional ( 326 ) and unstable IF ( 327 ) have also been reported. Gastric status is otherwise normal, although basal hypochlorhydria sometimes occurs ( 325 ). Hereditary HC/TC I deficiency coexisted in one patient ( 328 ). Hereditary IF deficiency usually presents with anemia, myelopathy, and, occasionally, developmental delay in the first few years of life. Infrequently, diagnosis is delayed until adolescence or later ( 325 ).

**Food-Cobalamin Malabsorption** It was recognized in 1973 that the existing tests of cobalamin absorption, such as the Schilling test, failed to identify defects in the release of food-bound cobalamin because they used free, crystalline cyanocobalamin in the test dose ( 329 ). Tests using a variety of food vehicles showed that many patients did not absorb food-bound cobalamin while absorbing free cobalamin normally, as reviewed elsewhere ( 330 ). Most prominent among these were patients with gastric surgery or with gastritis but intact IF secretion. Patients taking acid-suppressive drugs, such as omeprazole, also malabsorb food-cobalamin ( 331 , 332 ), but cobalamin deficiency has been rare thus far. The crux of food-cobalamin malabsorption appears to be the loss of pepsin and the loss of acid secretion needed for optimal pepsin activity ( 333 ) ( Fig. 43.4; panel 1). However, the gastric defect is more heterogeneous than suspected, and not all patients have severe gastritis and achlorhydria ( 334 ). An association also exists with *H. pylori* infection, but there are many exceptions ( 335 ). Malabsorption improves with antibiotic therapy sometimes; improvement was accompanied by disappearance of *H. pylori* in one study ( 334 ), but anaerobic bacteria were suspected in another ( 336 ). Food-cobalamin malabsorption is found in 30 to 40% of people with low cobalamin levels. It is usually associated with subclinical cobalamin deficiency and less often with severe deficiency ( 88 , 330 , 337 , 338 ) but also occurs in 10 to 15% of people with normal cobalamin status ( 330 ). Progression to pernicious anemia with loss of IF has been reported in several patients ( 275 , 337 ).

**Gastric Surgery** Subtotal gastrectomy is associated with eventual cobalamin deficiency in 15 to 30% of patients ( 339 , 340 ). Some patients develop severe deficiency with megaloblastic anemia and neuropsychiatric problems. However, absorption of free cobalamin (Schilling test) is usually normal ( 341 ), and most patients have only low cobalamin levels and food-cobalamin malabsorption ( 329 ). Iron deficiency and folate malabsorption may be seen ( 342 , 343 ). Food-cobalamin malabsorption and mild cobalamin deficiency also complicate other gastric procedures, such as those performed to promote weight loss ( 344 , 345 and 346 ).

**Pancreatic Insufficiency** Pancreatic proteases and bicarbonate degrade HC/TC I and release its cobalamin for transfer to IF ( 75 ). One-half of patients with chronic pancreatic insufficiency have abnormal Schilling test results, requiring exogenous pancreatic extract for correction. Nevertheless, cobalamin deficiency is rarely seen, perhaps because malabsorption must continue without treatment for several years before deficiency

develops.

**Bacterial Overgrowth of the Small Bowel** As reviewed elsewhere ( [347](#) ), bacteria take up cobalamin and may compete with IF for it. Large enough numbers of bacteria in the upper small bowel may accumulate in structural abnormalities (e.g., fistulas, strictures, large diverticula) or motility disorders (e.g., autonomic dysfunction in diabetes). Cobalamin deficiency is sometimes the only obvious clinical manifestation. Folate deficiency does not occur. Antibiotics reverse the malabsorption, but relapse occurs if the cause of bacterial overgrowth is not corrected.

**Parasitic Infestation** The classic parasite associated with cobalamin deficiency is *Diphyllobothrium latum*, which infests freshwater fish ( [348](#) ). The tapeworms in the upper small intestine compete avidly for cobalamin. Most patients are asymptomatic, but cobalamin levels are often low ( [349](#) ). It is uncertain whether the worm load or coexisting disorders determine the extent of deficiency. Affected patients often have atrophic gastritis also. The infection is rare in the United States. *Giardia lamblia* has been associated with cobalamin malabsorption in a few cases, particularly children or immunocompromised patients. It is unclear if the association is a causal one. Low cobalamin levels have been reported in heavy *Strongyloides stercoralis* infection. Malabsorption in parasitic infections has been reviewed ( [348](#) ).

**Gastrinoma** The Zollinger–Ellison syndrome has been associated with cobalamin malabsorption. The basis appears to be the low pH in the intestine ( [350](#) ). Ileal uptake of the IF–cobalamin complex requires a neutral pH.

**Ileal Diseases** Acquired diseases involving enough of the ileum impair IF receptor–mediated absorption of cobalamin ( [Fig. 43.4](#); panel 3). Diagnosis requires the Schilling test, which shows malabsorption that is not corrected by oral IF, and it is followed by diagnostic pursuit of the specific disease. Tropical sprue is endemic in many regions, such as the Caribbean and South Asia, but manifestations may also appear long after a person has emigrated. Cobalamin deficiency, occurring in chronic cases, is sometimes the sole clinical finding ( [351](#) , [352](#) ). Some patients have folate deficiency instead, especially early in the course, or have both deficiencies. As in all malabsorptive diseases, other nutrients are also at risk. Cobalamin malabsorption can also occur in inflammatory bowel disease and occasionally in celiac disease ( [353](#) ). Ileal malabsorption has been associated with acquired immunodeficiency syndrome in some studies but does not explain most of the low cobalamin levels. Few HIV–infected patients have metabolic evidence of deficiency, and the low cobalamin levels may reflect low HC/TC I levels ( [233](#) , [234](#) and [235](#) ). Ileal resection may lead to cobalamin malabsorption. Jejunioileal bypass for obesity also creates long–term malabsorption ( [354](#) , [355](#) ). Creation of an ileal reservoir for the ureters in bladder cancer has been associated with cobalamin malabsorption and deficiency ( [356](#) , [357](#) ). The risk in all ileal surgery appears proportional to the length of affected ileum. Radiation therapy involving the ileum sometimes causes cobalamin malabsorption.

**Imlerslund–Gräsbeck Syndrome (Megaloblastic Anemia Type 1)** Selective malabsorption of cobalamin due to heterogeneous genetic defects affecting ileal IF receptor function has been described worldwide. Two mutations of the cubilin gene have been identified in Finnish families only ( [358](#) , [359](#) ). The malabsorption is limited to cobalamin and usually produces clinical signs of deficiency in the first few years of life ( [360](#) , [361](#) ). Diagnosis is occasionally delayed. The disorder is often accompanied by mild proteinuria because the cubilin receptor for IF is also distributed in renal tubular cells, where it takes up other proteins also ( [76](#) ). The proteinuria is not reversed by cobalamin therapy ( [362](#) ).

**Drugs, Toxins, and Related Toxicities** Many drugs and toxins interfere with cobalamin absorption, usually by unknown mechanisms ( [363](#) , [364](#) and [365](#) ). Known agents include alcohol, colchicine, metformin, neomycin, cholestyramine, paraaminosalicylic acid, and slow–release potassium. The true list of offending drugs is probably longer, but cobalamin deficiency rarely occurs with any of them. Exposure must be constant for several years to deplete cobalamin stores, and few drugs fulfill that criterion. Cobalamin deficiency itself

impairs ileal absorption of cobalamin and other substances ( [163](#), [164](#) ), which has been attributed to megaloblastic changes in the gut ( [160](#) ).

**TRANSPORT AND CELLULAR DEFECTS** Most disorders of cobalamin transport and utilization are genetic in origin and usually affect children. [Table 43.6](#) summarizes the hereditary disorders. Serum cobalamin levels are almost invariably normal.

**TABLE 43.6. Hereditary Disorders of Cobalamin (Cbl) and Cobalamin-Related Metabolism**

| Disorder                       | Defect                            | Cbl | Homocysteine | Methylmalonic Acid | Megaloblastic Anemia | Myeloneuropathy  |
|--------------------------------|-----------------------------------|-----|--------------|--------------------|----------------------|------------------|
| Congenital pernicious anemia   | IF synthesis                      | ?   | ?            | ?                  | Yes                  | Often            |
| Imerslund-Gräsbeck             | IF receptor defect                | ?   | ?            | ?                  | Yes                  | Often            |
| TC II deficiency               | TC II synthesis                   | N   | ?            | N-?                | Yes                  | Occasionally     |
| HC/TC I deficiency             | HC/TC I synthesis                 | ?   | N            | N                  | No                   | No               |
| <i>CblA</i> defect             | Mitochondrial reduction of Cbl    | N   | N            | ?                  | No                   | No <sup>a</sup>  |
| <i>CblB</i> defect             | Cob(I)alamin adenosyl transferase | N   | N            | ?                  | No                   | No <sup>a</sup>  |
| <i>CblC</i> defect             | ?Cytoplasmic reduction of Cbl     | N   | ?            | ?                  | Yes                  | Yes <sup>b</sup> |
| <i>CblD</i> defect             | ?Cytoplasmic reduction of Cbl     | N   | ?            | ?                  | Mild <sup>c</sup>    | No? <sup>d</sup> |
| <i>CblE</i> defect             | Methionine synthase reductase     | N   | ?            | N                  | Yes                  | Yes <sup>e</sup> |
| <i>CblF</i> defect             | Cbl transfer from lysosome?       | N   | ?            | ?                  | Mild                 | No <sup>f</sup>  |
| <i>CblG</i> defect             | Methionine synthase               | N   | ?            | N                  | Yes                  | Yes <sup>e</sup> |
| <i>CblH</i> defect             | Mitochondrial reduction of Cbl    | N   | N            | ?                  | No                   | No <sup>a</sup>  |
| <i>Mut</i> <sup>0</sup> defect | MM-CoA mutase (absent)            | N   | N            | ?                  | No                   | No <sup>a</sup>  |
| <i>Mut</i> defect              | MM-CoA mutase (decreased)         | N   | N            | ?                  | No                   | No <sup>a</sup>  |

?, increased; ↓, decreased; Abnl, abnormal; HC, haptocorrin; IF, intrinsic factor; MM-CoA, methylmalonyl-CoA; TC, transcobalamin.

<sup>a</sup> Patients have hypotonia, lethargy, failure to thrive, vomiting, and acidosis.

<sup>b</sup> Patients also have lethargy, poor feeding, seizures, microcephaly, developmental delay, and retinopathy.

<sup>c</sup> Overt megaloblastic anemia did not develop (only mild macrocytosis) in the two brothers, but deoxyuride suppression test showed cobalamin deficiency in marrow cells.

<sup>d</sup> The two brothers had mental slowness and behavioral abnormalities.

<sup>e</sup> Patients also have developmental delay, cerebral atrophy, seizures, and hypotonia.

<sup>f</sup> Patients have growth retardation and poor feeding.

---

**Nitrous Oxide Toxicity** Nitrous oxide oxidizes cob(I)alamin, irreversibly inactivating the methionine synthase to which the cobalamin is bound ( 366 ). Because exposure during dental and surgical procedures is brief and enzyme is regenerated quickly, clinical problems do not occur despite mild metabolic abnormalities lasting a few days ( 367 , 368 and 369 ). There are two exceptions to the benign consequences. One is repetitive exposure ( 370 ), such as recreational abuse of the gas. The other is when someone with unrecognized preexisting cobalamin deficiency undergoes routine intraoperative exposure to nitrous oxide ( 371 , 372 , 373 , 374 and 375 ). Both situations lead to megaloblastic anemia, but neuropsychiatric dysfunction is especially prominent ( 366 ). Like nitrous oxide, nitric oxide reacts with cobalamin and inhibits methionine synthase ( 376 , 377 ), but its clinical impact is unknown.

**Cbl Mutations** Inborn errors affecting intracellular cobalamin metabolism, designated *cb*, mutations and differentiated by complementation studies, are summarized in Table 43.6. All the *cb* disorders call for cobalamin therapy, but responses vary. The methylmalonic acidurias ( *cb/A*, *B*, and *H* defects) affect adenosylcobalamin, which is needed in the methylmalonyl CoA mutase reaction. The *cb/E* defect involves the adenosyltransferase needed for adenosylcobalamin synthesis, whereas mitochondrial reduction of cobalamin appears to be defective in *cb/A* and *cb/H* ( 157 ). These disorders cause lethargy, vomiting, dehydration, failure to thrive, hypotonia, and acidosis but do not produce megaloblastic anemia ( 378 ). Presentation is in the first months of life, but the course and response to cobalamin may vary. The methylmalonic acidurias also include disorders arising from noncobalamin defects in the mutase enzyme itself: *mut*<sup>o</sup>, characterized by enzyme deficiency, and *mut*<sup>-</sup>, with abnormal enzyme. These disorders do not respond to cobalamin therapy and are mentioned here for differential diagnosis purposes only. Clinical manifestations may be absent or resemble those of cobalamin-related methylmalonic acidurias. The *cb/C*, *cb/D*, and *cb/F* mutations involve unidentified cellular processes that affect both methylcobalamin and adenosylcobalamin and are characterized by hyperhomocysteinemia and methylmalonic aciduria. Megaloblastic anemia is prominent in *cb/C*, often with a microangiopathic and thrombocytopenic process resembling the hemolytic-uremic syndrome ( 379 ), but megaloblastic anemia is muted in *cb/D* and *cb/F* defects ( 85 ). The course of the child with *cb/C* defect is often severe, marked by neurologic dysfunction, acidosis, perimacular degeneration, and thromboses, and has a poor prognosis ( 380 ). The two brothers with *cb/D* mutation had mild neuropsychiatric problems, minimal megaloblastic anemia, and venous thromboses ( 85 ). Variable presentations are seen in the *cb/F* defect ( 381 , 382 and 383 ). The *cb/E* defect results from methionine synthase reductase deficiency, and the *cb/G* defect results from methionine synthase deficiency. Thus, hyperhomocysteinemia occurs in both, but adenosylcobalamin



activity and MMA levels are normal. Megaloblastic anemia and prominent neurologic problems occur, usually in the first few years of life ( [384](#) ), although one patient was not diagnosed until adulthood ( [385](#) ). Therapy is generally effective, although the neurologic problems are difficult to reverse unless treated early.

***Transcobalamin II Deficiency*** Deficiency of TC II impairs delivery of cobalamin to cells, although some cobalamin enters cells by unknown, presumably nonspecific means. The undelivered HC/TC I-bound cobalamin continues to circulate; serum cobalamin levels are normal, with only rare exceptions ( [386](#) ). The children typically have megaloblastic anemia and failure to thrive in the first year of life. Neurologic dysfunction is less frequent but can occur later in the course, especially when the diagnosis is delayed and folate is used ( [387](#) ). Some children also have infections suggesting immune hypofunction ( [388](#) ). Because of the role of TC II in transporting absorbed cobalamin, most children have abnormal Schilling test results. The diagnosis rests on TC II assay, preferably immunoassay of total TC II ( [386](#) ). Several mutations of the TC II gene have been identified ( [389](#) , [390](#) ).

Nonfunctional TC II has also been described ( [391](#) ). The disorder responds clinically to frequent cobalamin injections. Eventual oral therapy has been used in some cases, but severe complications have also been attributed to undertreatment ( [392](#) ).

***Haptocorrin (Transcobalamin I) Deficiency*** This disorder is marked by low serum cobalamin levels, because most circulating cobalamin is carried by HC/TC I. Cellular deficiency, metabolic dysfunction, and megaloblastic anemia do not result ( [393](#) , [394](#) ). HC/TC I deficiency is typically diagnosed accidentally in adults who are investigated for a low cobalamin level, which causes diagnostic confusion with cobalamin deficiency. A few patients have had atypical neurologic dysfunction that was not cobalamin responsive ( [393](#) , [395](#) ). The diagnosis requires demonstration of absent HC/TC I in serum and secretions, such as saliva. A combined deficiency of HC/TC I and lactoferrin, both of which are synthesized in specific granules of myeloid cells and in exocrine gland epithelium, was demonstrated in one family ( [395](#) ); there was no predisposition to infection. Another patient had coexisting HC/TC I and IF deficiencies ( [328](#) ). A milder HC/TC I deficiency, perhaps the heterozygous state of the severe deficiency ( [395](#) ), has been identified in approximately 15% of all patients with low cobalamin levels, all of them asymptomatic ( [396](#) ). In these patients, plasma HC/TC I is decreased but not absent; saliva HC/TC I content is normal.

**INCREASED REQUIREMENTS** High demand for cobalamin in hypermetabolic and increased cell turnover states has been proposed, but its clinical relevance is undefined. Refractoriness to erythropoietin therapy was reported in a patient found to have cobalamin deficiency, but no evidence of cobalamin depletion was detected in 30 other patients receiving erythropoietin while on hemodialysis ( [397](#) ).

## **Causes of Folate Deficiency**

Folate deficiency is often multifactorial. Limited intake may not be able to compensate for increased folate demand, or a drug that mildly inhibits folate metabolism can convert borderline folate intake into frank deficiency. In addition, a diet that is insufficient in folate is typically insufficient for other nutrients also. That being said, it also must be noted that the landscape of folate deficiency has changed dramatically as a result of food fortification and supplement use. The incidence of deficiency has decreased sharply in the United States. A large clinical laboratory reported that the incidence of subnormal folate levels declined from 1.3% to 0.3% of submitted samples between 1994 and 1998 ( [398](#) ). The literature on folate status in Americans was reviewed in 1995 ( [399](#) ), but the applicability of pre-1997 data today is open to question. Nevertheless, subpopulations remain at risk. These include premature infants, adolescents, young women, and some ethnic groups, such as blacks and Mexican-Americans ( [184](#) , [400](#) , [401](#) ). The prevalence of deficiency in the

elderly has declined, however ( 402 ).

**DIETARY INSUFFICIENCY** The small ratio of body stores to daily requirement and the lability of food folates make it possible to become folate deficient after several weeks or months of poor intake. As mentioned, the likelihood of deficiency is enhanced when other causes coexist. By far, the most common of these is alcohol abuse ( 403 ), especially when involving hard liquor, which contains little folate.

**Children** Delivery of maternal folate to the fetus is efficient, so folate deficiency is rare at birth ( 284 ). Folate levels decline thereafter, and problems might arise in some children in whom growth demands and limited diet combine. Premature infants have especially high requirements ( 404 ). The availability of folate from milk is limited. Deficiency can appear in babies whose diet depends heavily on milk and who do not receive folate-fortified foods or supplements. Folate deficiency can also occur in restricted diets, such as those given to patients with phenylketonuria.

### **MALABSORPTION**

**Intestinal Malabsorption** In tropical sprue, folate deficiency appears early and is often seen in the setting of marked gastrointestinal symptoms and other absorptive defects ( 351 , 352 ). The intestinal lesion itself often remits with folate therapy, although antibiotic therapy tends to produce more durable remission. Celiac disease also causes folate malabsorption and deficiency in some patients ( 405 ). Inflammatory bowel disease, such as Crohn's disease, which involves ileum most prominently, produces folate deficiency less often ( 406 ). Folate malabsorption has been described in patients with dermatitis herpetiformis.

**Other Malabsorptive Mechanisms** Patients with pancreatic insufficiency have diminished folate absorption when oral pancreatic replacement therapy is given ( 407 ), perhaps because of its pH-buffering effect. Folate absorption is diminished in the presence of endogenous or iatrogenic achlorhydria and in gas-tropathy ( 343 , 408 , 409 , 410 and 411 ), although it is not clear how often deficiency results ( 410 ).

**DRUGS AND TOXINS** Alcohol abuse is a major contributor to folate deficiency ( 403 ) and should be suspected even when other causes of deficiency are found. The risk is highest in alcoholics who eat poorly, but alcohol also has direct effects on folate metabolism and transport. The latter include interruption of the enterohepatic recycling of hepatic methylTHF, direct toxicity to enterocytes, formation of aldehyde adducts, and increased degradation of folates ( 412 , 413 , 414 and 415 ). Drug effects on folate status have been reviewed ( 416 ). Sulfasalazine interferes with folate absorption and perhaps with folate-related enzymes ( 417 ). Hydantoins, and to a lesser extent other anticonvulsants, have been associated with macrocytosis and low folate levels, but megaloblastic anemia is uncommon ( 47 ). The mechanisms remain unclear. Valproic acid inhibits mitochondrial folate metabolism and has fetal effects ( 418 ). Antifols, such as methotrexate, inhibit dihydrofolate binding to its reductase and thus limit the availability of metabolically active THF. Their effect can be bypassed by administering reduced folates such as 5-formylTHF (leucovorin). Trimetho-prim-sulfamethoxazole and pyrimethamine are potent inhibitors of bacterial dihydrofolate reductase but weak inhibitors of the human enzyme. They have been reported to cause megaloblastic anemia but appear to do so especially in patients with other limitations of folate status ( 419 ). Oral contraceptive use has been associated with diminished serum folate levels, but deficiency has not been clearly documented ( 420 ). Cellular depletion of folate has been proposed as an interactive risk factor for cervical dysplasia, especially in women who have papillomavirus infection or use oral contraceptives, or both ( 421 ).

### **INBORN ERRORS OF TRANSPORT AND METABOLISM**

**Methylene Tetrahydrofolate Reductase Deficiency** Homozygous deficiency of this enzyme ( Fig. 43.2; reaction 3) produces severe neurologic dysfunction, including myelopathy,



developmental delay, seizures, and microcephaly ( [157](#) ). Thrombosis may also occur. Symptoms usually arise in the first year, but mild cases may be diagnosed in adulthood. Anemia does not develop because methyleneTHF remains available for thymidylate synthesis (reaction 2). The serum folate level is low because methyleneTHF cannot be converted to methylTHF, the main circulating form of folate. The diagnosis is made by measuring enzyme activity in fibroblasts or leukocytes, which correlates with disease severity ( [422](#) ). Many mutations of the reductase gene have been identified ( [157](#) ). Early treatment, which includes betaine, is essential ( [423](#) ).

**Hereditary Folate Malabsorption** Hereditary folate malabsorption is a rare disorder that is characterized by impaired transport of all folate forms across the intestinal mucosa and the choroid plexus. Transport in other cells and tissues appears adequate. Low serum folate levels, megaloblastic anemia, and severe neurologic dysfunction, including seizures, appear in the first few months of life ( [154](#) , [155](#) and [156](#) ). Diarrhea, failure to thrive, and oral ulcers also occur. Intensive parenteral and even intrathecal therapy is required, but cerebrospinal fluid folate levels are difficult to maintain.

**Miscellaneous Disorders** A rare, poorly understood familial syndrome of aplastic anemia and defective cellular uptake of folate has been described ( [424](#) ). Hereditary formiminoglutamic aciduria has been associated with deficiency of glutamate formiminotransferase or cyclodeaminase deficiency, or both ( [Fig. 43.2](#); reactions 7 and 8), but it is unclear that clinical dysfunction results ( [284](#) ).

**Enzyme Polymorphisms** Two common single nucleotide polymorphisms in the gene for methyleneTHF reductase, 677C>T and 1298A>C, produce mildly diminished enzyme activity ( [425](#) ). No symptoms result, but mild hyperhomocysteinemia is seen if folate levels are diminished or borderline.

#### INCREASED DEMAND OR INCREASED LOSSES

**Increased Demand for Folate** Fetal needs divert maternal folate via placental receptors. Other settings for increased demand for folate are lactation, chronic hemolytic anemia, and perhaps psoriasis and myeloproliferative diseases. Evidence exists for stress on folate metabolism ( [37](#) , [426](#) , [427](#) and [428](#) ). Folate deficiency may result when dietary intake cannot compensate adequately or disorders such as alcohol abuse or malabsorption supervene. Therefore, folic acid is often given routinely to pregnant women and patients with chronic hemolysis. Nevertheless, the only prospective, randomized trial of supplementation in sickle cell anemia did not show any clinical benefits ( [429](#) ). Routinely supplemented patients have developed unrecognized pernicious anemia with neurologic deterioration ( [430](#) ).

**Increased Folate Loss** Folate is lost during dialysis, and supplements are now used in chronic dialysis. As reviewed elsewhere ( [431](#) ), increased folate catabolism and loss have been proposed with alcohol abuse, anticonvulsants, and oral contraceptives.

**Acute Folate Deficiency** A syndrome of acute deficiency, megaloblastic changes in bone marrow (but not peripheral blood), and pancytopenia was described in severely ill patients in intensive care units ( [432](#) , [433](#) ). Folate levels are normal. The mechanism, and even the entity itself, is unclear because the patients have many illnesses and receive many drugs.

#### Causes of Megaloblastic Anemia Other Than Cobalamin or Folate Deficiency

**THIAMINE-RESPONSIVE MEGALOBLASTIC ANEMIA** A rare familial syndrome of megaloblastic anemia, diabetes mellitus, and sensorineural deafness has been described in the first few years of life ( [434](#) , [435](#) ). The megaloblastic anemia and diabetes improve at least partially with thiamine therapy. Neither folate nor cobalamin have any known role. Several mutations of the thiamine transporter-1 gene have been found ( [436](#) , [437](#) and [438](#) ), but the patients have no signs of thiamine deficiency.

**HEREDITARY OROTIC ACIDURIA** Megaloblastic anemia unrelated to folate or cobalamin accompanies developmental delay and orotic acid crystalluria in affected patients ( [439](#) ).

There is clinical heterogeneity, with most cases occurring in the first few years of life. Some patients also have congenital malformations and immune deficiency. The biochemical lesion usually involves defects in orotate phosphoribosyltransferase and orotidine 5'-monophosphate decarboxylase. Treatment is with oral uridine.

**MISCELLANEOUS CAUSES** Chemotherapeutic agents that affect nucleoprotein synthesis, such as hydroxyurea and 5-fluorouracil, cause megaloblastic anemia. More easily distinguishable from megaloblastic anemia are the bizarre nuclear changes in arsenic toxicity. Myelodysplastic syndromes occasionally feature nuclear characteristics that resemble megaloblastic change, but hyposegmentation of neutrophil nuclei ("pseudo-Pelger-Huet") is more common than hypersegmentation. Erythroleukemia and some cases of acute myelogenous leukemia also show megaloblastic-like nuclear changes in erythroid precursors.

## Laboratory Diagnosis of the Causes of Deficiency

**COBALAMIN DEFICIENCY** Absorption is the first target of diagnostic evaluation because 95% or more of cases of frank cobalamin deficiency in adults arise from gastrointestinal problems (440). The situation has been modified by the growing, often accidental identification of patients with subclinical deficiency, which is less often associated with malabsorption and much less so with malabsorption of free cobalamin (180, 181). The diagnostic approach is somewhat modified in children, depending on the child's age and other issues. Maternal cobalamin status must be part of the evaluation of very young children. Inborn errors of metabolism tend to present clinically in early childhood but should be considered at any age.

**Tests of Free Cobalamin Absorption** The classic absorption test is the Schilling test, which measures the urinary excretion of an oral dose of  $^{57}\text{Co}$ -labeled crystalline ("free") cyanocobalamin that approximates the amount ingested in a meal (441). The patient is tested in the fasted state, at least 3 days removed from a cobalamin injection. To minimize diversion of the absorbed cobalamin to TC II and tissues, the patient is given 1000  $\mu\text{g}$  cyanocobalamin intramuscularly within 2 hours after the oral dose. All urine is collected for 24 hours because the peak of excretion varies. If excreted radioactivity is subnormal, usually defined as less than 8% of the oral dose, then the test is repeated a few days later with an oral dose of IF. Correction of an abnormal result by this maneuver is diagnostic for the absence of IF (i.e., pernicious anemia). If the result remains abnormal, the problem resides in the intestine. However, 40% of patients with pernicious anemia may have abnormal results with IF until they have been treated with cobalamin for several weeks (163, 164). Further modifications can be applied to identify bacterial overgrowth in the gut (antibiotic treatment before retesting) or pancreatic insufficiency (incorporating pancreatic extract into the test), when appropriate. The Schilling test's drawbacks are its requirement for normal renal function and complete collection of urine, its inconvenience, and the exposure to radioisotope. It is also subject to occasional unexplained false results. Because the procedure treats the patient with cobalamin, any studies requiring the untreated state must be done beforehand. Various modifications of the Schilling test have been tried. The most popular has been the simultaneous testing of absorption with and without IF, using a commercial double-isotope kit. Besides its greater convenience, the test sometimes allows interpretation of results even if urine collection is incomplete. However, the test is also subject to errors, especially the frequently false normal result in patients with pernicious anemia caused by isotope exchange. Isotopic tests of absorption are becoming less available, in part because of economic and technical considerations. This may create a serious gap in the diagnosis of cobalamin malabsorption, which has been abetted by misperceptions that identifying malabsorption is clinically unimportant.

**Food-Bound Cobalamin Absorption Test** Impaired release of ingested cobalamin from its binding to food proteins (329, 330) is not recognized by the Schilling test, which provides the free cobalamin as the test substance. Several test models were developed, using egg, egg yolk, or chicken serum as the vehicle in a procedure otherwise identical to the

Schilling test ( 330 ). However, the tests are not available commercially. Blood tests of gastric status are unreliable as surrogate diagnostic markers ( 335 ).

**Gastric Autoantibodies** Testing serum for antibody to IF permits the diagnosis of pernicious anemia in some cases without having to resort to the Schilling test. Two antibodies to IF have been identified. Blocking or type I antibody, which attaches to the cobalamin-binding site of IF, is found slightly more often. It is also tested more easily than the type II antibody, which is detected as a complex with IF. Antibody to IF is found in 50 to 70% of patients with pernicious anemia, with somewhat higher frequencies if more sensitive assays are used ( 442 , 443 and 444 ). Some subpopulations of patients have higher rates; IF antibody is present in more than 90% of black women, for example. Despite its limited sensitivity, the antibody is very useful because only rare patients without pernicious anemia have it ( 445 , 446 ). Modern data on specificity are not available, but it probably exceeds 95%. However, samples obtained within a day or two after cobalamin injection produce false-positive results ( 447 ). Parietal cell antibody is directed to the membrane H<sup>+</sup>K<sup>+</sup> adenosine triphosphatase pump subunits preexisting in cytoplasmic tubulovesicles ( 290 , 448 , 449 ). The antibody occurs in 80 to 90% of patients with pernicious anemia. However, its diagnostic value is limited because it is specific for immune gastritis ( 450 ), not for pernicious anemia. Moreover, the antibody is found less frequently than IF antibody in young patients ( 443 ) and in blacks, Latin-Americans, and Hong Kong Chinese ( 303 , 443 ). The antibody also tends to disappear with time, unlike IF antibody ( 451 ).

**Blood Tests of Gastric Atrophy** Serum gastrin levels are elevated in 80 to 90% of patients with pernicious anemia ( 452 ), reflecting the patients' gastric achlorhydria and frequent antral hypertrophy ( 289 , 294 ). Gastrin levels tend to be very high, often in the thousands, particularly in women ( 443 , 452 ). However, hypergastrinemia has many causes, such as atrophic gastritis without pernicious anemia or with the use of omeprazole. Serum gastrin levels are often mildly elevated in patients with food-cobalamin malabsorption but overlap with control values, which renders them unreliable as a test for this condition ( 335 ). Serum pepsinogens I (or A) and II (or C) also reflect gastric status. Pepsinogen I, derived from fundic chief cells, is usually decreased in pernicious anemia, whereas pepsinogen II, which derives from fundus and antrum, is normal or elevated because of antral sparing in most patients with pernicious anemia ( 453 ). A low pepsinogen I to II ratio or low pepsinogen I level, or both, may be the most sensitive blood tests for pernicious anemia ( 452 ) but have limited specificity.

**Direct Gastric Tests** Measuring IF content in stimulated gastric juice is considered the best test for pernicious anemia, but IF assay is not widely available. IF fragments are detectable in urine ( 454 ), but assay problems bar its clinical application ( 455 ). Measuring gastric acid secretion has diagnostic value only in that the presence of acid in stimulated gastric juice rules out Addisonian pernicious anemia.

**Tests of Ileal Function** Ileal cobalamin malabsorption is demonstrable only with the Schilling test. The specific disease is identified by the relevant gastroenterologic methods.

**Cobalamin-Binding Proteins** Serum TC II levels are measured in children with unexplained cobalamin deficiency who have normal cobalamin levels. Measuring HC/TC I levels is useful in patients with unexplained low cobalamin levels who are asymptomatic or have equivocal symptoms ( 396 ). The radioimmunoassays for HC/TC I and TC II are not widely available. Measurement of unsaturated cobalamin-binding capacity is done in some commercial laboratories but is informative only if the individual TCs are separated and if the patient is not receiving cobalamin by injection. Measurement of TCs is sometimes also helpful in explaining high cobalamin levels (e.g., by identifying HC/TC I elevation in chronic myelogenous leukemia, acute promyelocytic leukemia, cancer, and other disorders) ( 58 ).

**FOLATE DEFICIENCY** Because dietary insufficiency, alcohol abuse, drug effects, and high utilization states are frequent contributors to folate deficiency, a careful history is usually the most effective diagnostic test. Malabsorption must be considered when history or

other findings suggest it and whenever no dietary cause is apparent. Tests for folate absorption are not in common use. Therefore, the diagnosis of malabsorption rests on general gastroenterologic procedures, such as measuring absorption of other substances, radiographic tests, blood tests for intestinal disorders such as celiac disease, and intestinal biopsies. Acquired causes predominate in children also. Dietary deficiency may occur in specific settings and are often aggravated by the high demands created by growth and development. Hereditary disorders are rare.

## MANAGEMENT

Management of cobalamin and folate deficiencies extends beyond giving the patient the right vitamin and can be complex. It is often subject to patient noncompliance ( [125](#) ) and physician error. Management goals are to reverse symptoms; to select the appropriate dose, route, and duration of vitamin replacement; to assure that the vitamin deficiency was identified properly and that the patient responded appropriately; to identify the underlying disorder that caused the deficiency and treat it directly, if possible; to define the prognosis and manage the complications of the underlying disorder; and to provide patient education.

### Reversal of Presenting Symptoms

**COURSE** Megaloblastic anemia reverses quickly with the correct vitamin therapy. The patient begins to feel better within a day, before anemia improves. Reticulocytes begin to appear in 2 to 3 days. Ineffective hematopoiesis is replaced by effective hematopoiesis, as lactate dehydrogenase and bilirubin decline while serum transferrin receptor levels rise transiently. Maturation of erythroid precursors becomes more normoblastic. Although neutrophil hypersegmentation persists for 2 weeks or more ( [100](#) ), the white blood cell and platelet counts rise in the first week if they were originally decreased. Peak reticulocytosis occurs at 7 to 10 days, and the hemoglobin level begins to rise. As normocytic cells replace macrocytic ones, the MCV declines. The blood count becomes completely normal before 8 weeks have elapsed. In most cases, neurologic improvement also becomes noticeable in the first few weeks of cobalamin therapy and continues more slowly for several months.

**MONITORING THE RESPONSE** Homocysteine and MMA levels begin to fall within a few days of therapy and can be used to monitor response ( [456](#) , [457](#) ); monitoring vitamin levels has little value. If needed, adequacy of reticulocyte response can be assessed best at the end of the first week. However, it is always useful to determine completeness of response after 8 weeks, when the blood count should be completely normal. An incomplete hematologic response at either time point usually indicates a coexisting cause of anemia; most often, that cause is iron deficiency, which may have been masked before the patient's megaloblastic anemia was treated. A poor response can also indicate that the original diagnosis was incorrect. The extent of neurologic improvement cannot be predicted with full confidence. In general, the likelihood of full reversal after cobalamin therapy is inversely related to the duration of symptoms before therapy was started and to the extensiveness of the dysfunction. Whatever reversal can be expected is usually completed by 6 months, but, occasionally, improvement continues over a year or more. Progression of symptoms despite therapy rules out cobalamin deficiency as its cause.

**BLOOD TRANSFUSION** Patients with megaloblastic anemia tend to compensate for even severe anemia surprisingly well ( [458](#) ) and usually can be managed supportively until therapy takes effect. The temptation to transfuse should be resisted unless worrisome symptoms or signs require immediate intervention. If transfusion is used, care must be taken to avoid aggravating the patient's volume overload.

### Dose, Route, Duration, and Toxicity of Vitamin Replacement

Using both folate and cobalamin regardless of the deficiency has unclear benefits and can muddy continuing evaluation and patients' understanding of their condition.

**COBALAMIN DEFICIENCY** Immediate reversal of megaloblastic anemia or neurologic dysfunction is achieved most reliably with intramuscular cobalamin. A series of 1000- $\mu$ g injections is often given during the first few weeks. Because nonspecific absorption of cobalamin is very limited, many details of subsequent therapy depend on whether the IF mechanism is intact. When absorption is normal, oral cobalamin can be used. Normal intake is mimicked by using 2  $\mu$ g twice a day, which does not exceed IF capacity, but one daily dose is also effective and more practical. If free cobalamin cannot be absorbed, as in pernicious anemia, the classic regimen calls for 100 to 1000  $\mu$ g given intramuscularly once a month. Although most of the dose is excreted rapidly in the urine, the total amount retained is higher with higher doses. Occasional patients seem to require more frequent injections for unexplained reasons. Oral therapy has been resurrected as a suitable alternative in the past decade; however, the most detailed study included many patients who did not have malabsorption ( 459 ), and not all studies report consistently optimal clinical responses ( 460 ). Daily oral doses of 1000  $\mu$ g must be taken. The advantages of oral therapy are its lower cost and avoidance of injections. These must be weighed against the need to take that dose every day, often for life, the need to monitor periodically because so much depends on daily compliance, which may not be as good in daily medical practice as in study volunteers, and the still incompletely proved equivalence of neurologic improvement after oral and parenteral cobalamin. Because of the quicker relapse when oral therapy is discontinued ( 126 ), replenishing stores by injection before embarking on oral maintenance may be advisable. The optimal treatment of patients with malabsorption that is limited to food-bound cobalamin, such as patients with atrophic gastritis or gastric surgery, is unclear. Oral 6- $\mu$ g doses are not always effective ( 344 , 345 and 346 ), and daily doses of 25 to 50  $\mu$ g or more have been recommended ( 461 , 462 and 463 ). Because gastric status is not always known, the higher doses may be advisable in all cases, especially in elderly patients. Treatment of hereditary disorders must be tailored individually because expression and severity vary even in the same disorder. Because of the need to overcome transport and enzymatic blocks, the frequently poor prognosis, and developmental concerns in children, therapy tends to be parenteral, frequent, and with doses of at least 1000  $\mu$ g. Constant monitoring is required until the patient has been stabilized. Cobalamin replacement must continue for as long as the underlying cause persists. Cyanocobalamin use predominates in the United States, but hydroxocobalamin is more physiologic and has better retention ( 464 ). The only described side effects of cobalamin are occasional allergic reactions, often to the preservative, and formation of anti-TC II antibodies in some patients treated with depot preparations of hydroxocobalamin ( 240 ). Earlier reports of frequent sudden death during treatment of severe pernicious anemia, hypothesized to result from the transient hypokalemia that accompanies the early hematologic response to therapy, have not been borne out ( 465 ). A report that viral load correlates with serum cobalamin levels in hepatitis C-infected patients raised the possibility that cobalamin influences viral replication in the human host ( 466 ). However, cobalamin also appears to inhibit HIV integrase ( 467 ).

**FOLATE DEFICIENCY** Oral synthetic folic acid is cheap and stable, and doses of 1 mg suffice in most patients. As noted earlier, it is better absorbed than food folate by patients with malabsorptive disorders because several effective pathways of specific and nonspecific folate absorption operate throughout the small intestine. Monitoring the response can determine if higher doses or parenteral administration are needed. Treatment of children with inborn errors of folate metabolism calls for larger doses, often given parenterally, and may require specialized regimens. Leucovorin (5-formylTHF) is needed only in patients unable to reduce folic acid, such as those using drugs that inhibit



dihydrofolate reductase. Indications for methylTHF therapy are unclear. Therapy is often continued until body stores are repleted, which can be done within a month. The need to continue therapy beyond that is guided by the underlying disorder, its persistence or likelihood of recurrence, and the patient's dietary, medical, and social details. Toxicity of folic acid is minimal ( [468](#) ). Seizure disorders have worsened in some patients receiving large doses intravenously ( [469](#) ). Massive doses have caused renal failure in rats, presumably due to precipitation in the tubules. By far, the most important risk of folate therapy, however, is its administration to someone with untreated cobalamin deficiency; this was documented in 13% of cobalamin-deficient patients in one survey ( [19](#) ). The anemia of cobalamin deficiency usually responds at least partially to folate, although relapse occurs eventually ( [146](#) , [147](#) ). In the meantime, unchecked neurologic progression can occur. Related concerns have been raised in the debate about the increased intake of folic acid, much of it by the elderly, as a result of food fortification and supplement use ( [470](#) ).

### **Assurance of Response**

The diagnosis of deficiency is often made with varying degrees of certainty. The less compelling the original evidence, the greater is the value of monitoring therapeutic response. The time landmarks of improvement of clinical manifestations and the preference for metabolic over serum vitamin determinations have been mentioned.

### **Managing Underlying Disorders Causing the Deficiency**

The argument that testing for causes is wasteful because cobalamin deficiency is usually due to pernicious anemia is not sound. Only 70% of megaloblastic anemias due to cobalamin deficiency were caused by pernicious anemia ( [440](#) ); the remainder included treatable intestinal diseases, such as sprue and bacterial overgrowth that would have been missed without diagnostic assessment. Yet, even establishing the diagnosis of irreversible diseases has benefits. Proving that a patient has pernicious anemia allows the physician to recommend endoscopy to screen for cancer, to be vigilant for early signs of hypothyroidism, and to be confident in recommending lifelong cobalamin therapy.

Folate deficiency often has underlying causes with implications as important for the patient as the deficiency itself. Dietary correction, intervention for alcoholism, and readjustment of medications are some of the potential benefits.

### **Patient Education**

Pernicious anemia is a prototype of the ideal medical encounter, a disease with potentially disastrous consequences that is easily treatable without risk. Yet, relapse due to discontinued therapy is distressingly common ( [125](#) ), and patient education is critical to preventing this. Patient noncompliance occurs in other serious but treatable diseases, such as Hodgkin disease and tuberculosis. In many of those diseases, therapy has considerable toxicity and inconvenience. Just the opposite may be operative in pernicious anemia; a byproduct of its simple therapy may be a complacent attitude to "vitamin problems" ( [471](#) , [472](#) ).

### **Preventive and Other Use of Supplements**

Nonmedical vitamin use is widespread in the United States, especially in certain subpopulations, such as women, the elderly, and affluent whites. The result has been eradication of folate deficiency as a common clinical problem. Most over-the-counter

preparations do not exceed 400 µg of folic acid, which is effectively absorbed. There is concern that intake of more than 1 mg may increase the risk of neurologic complications if cobalamin deficiency is present, although the selection of that cutpoint is imprecise because most reports of adverse effects of folate therapy in cobalamin deficiency involved doses many times higher.

Most multivitamin preparations contain 6 µg of cyanocobalamin, but many contain up to 25 µg or more. Although serum cobalamin levels tend to be higher in supplement users than in nonusers, a subset of supplement users nevertheless continues to have metabolic evidence of cobalamin deficiency ( [52](#), [462](#) ), in some cases even despite supplements of 100 µg ( [461](#), [463](#) ). It seems likely that mild absorptive limitations or other factors sometimes impair responsiveness, and these need to be better defined.

## REFERENCES

1. Addison T. Anaemia—disease of the supra-renal capsules. *London Med Gaz* 1849;43:517–518.
2. Biermer A. Über eine form von progressiver perniciöser anämie. *Schweiz Arzte* 1872;2:15.
3. Ehrlich P. Über regeneration und degeneration rother blutscheiben bei anämien. *Berlin Klin Wschr* 1880;17(28):405.
4. Hayem G. Des degrés d'anémie. *Bul Mém Soc Méd Hôp Paris* 1877;14:155–166.
5. Minot GR, Murphy WP. Treatment of pernicious anemia by a special diet. *JAMA* 1926;87:470–476.
6. Castle WB. Observations on the etiologic relationship of achylia gastrica to pernicious anemia. I. The effect of the administration to patients with pernicious anemia of the contents of the normal human stomach recovered after the ingestion of beef muscle. *Am J Med Sci* 1929;178:748–764.
7. Rickes EL, Brink NG, Koniuszy FR, et al. Crystalline vitamin B<sub>12</sub>. *Science* 1948;107:396–397.
8. Smith EL, Parker LFJ. Purification of anti-pernicious anaemia factor. *Biochem J* 1948;43:viii–ix.
9. Hodgkin DC, Kamper J, Mackay M, et al. Structure of vitamin B<sub>12</sub>. *Nature* 1956;178:64–66.
10. Wills L. Treatment of “pernicious anaemia of pregnancy” and “tropical anaemia,” with special reference to yeast extract as curative agent. *BMJ* 1931;1:1059–1064.
11. Jukes TH, Stokstad TLR. Pteroylglutamic acid and related compounds. *Physiol Rev* 1948;28:51–106.
12. Herbert V. Experimental nutritional folate deficiency in man. *Trans Assoc Am Physicians* 1962;75:307–320.
13. Kass L. *Pernicious anemia*. Philadelphia: WB Saunders, 1976.
14. Wintrobe MM. *Blood, pure and eloquent: a story of discovery, of people, and of ideas*. New York: McGraw-Hill, 1980.
15. Chanarin I. A history of pernicious anemia. *Br J Haematol* 2000;111:407–415.
16. Hoffbrand AV, Weir DG. The history of folic acid. *Br J Haematol* 2001;113:579–589.
17. Hall CA. The nondiagnosis of pernicious anemia. *Ann Intern Med* 1965;63:951–954.
18. Carmel R. Macrocytosis, mild anemia and delay in diagnosis of pernicious anemia. *Arch Intern Med* 1979;139:47–50.



19. Carmel R, Karnaze DS. Physician response to low serum cobalamin levels. *Arch Intern Med* 1986;146:1161–1165.
20. Moran RG. Roles of folylpoly- $\gamma$ -glutamate synthetase in therapeutics with tetrahydrofolate antimetabolites: an overview. *Semin Oncol* 1999;26[Suppl 6]:24–32.
21. Shane B. Folate chemistry and metabolism. In: Bailey LB, ed. *Folate in health and disease*. New York: Marcel Dekker, 1995:1–22.
22. Wagner C. Biochemical role of folate in cellular metabolism. In: Bailey LB, ed. *Folate in health and disease*. New York: Marcel Dekker, 1995:23–42.
23. Cook RJ. Folate metabolism. In: Carmel R, Jacobsen DW, eds. *Homocysteine in health and disease*. Cambridge: Cambridge University Press, 2001:113–134.
24. Kolhouse JF, Kondo H, Allen NC, et al. Cobalamin analogues are present in human plasma and can mask cobalamin deficiency because current radioisotope dilution assays are not specific for true cobalamin. *N Engl J Med* 1978;299:785–792.
25. el Khoity S, Guéant JL, Bressler L, et al. Portal and biliary phases of enterohepatic circulation of corrinoids in humans. *Gastroenterology* 1991;101:1399–1408.
26. Kondo H, Kolhouse JF, Allen RH. Presence of cobalamin analogues in animal tissues. *Proc Natl Acad Sci U S A* 1980;77:817–821.
27. Leclerc D, Wilson A, Dumas R, et al. Cloning and mapping of a cDNA for methionine synthase reductase, a flavoprotein defective in patients with homocystinuria. *Proc Natl Acad Sci U S A* 1998;95:3059–3064.
28. Fenton WA, Hack AM, Helfgott D, et al. Biogenesis of the mitochondrial enzyme methylmalonyl-CoA mutase: synthesis and processing of a precursor in a cell-free system and in cultured cells. *J Biol Chem* 1984;259:6616–6621.
29. Noronha JM, Silverman M. On folic acid, vitamin B<sub>12</sub>, methionine und formiminoglutamic acid metabolism. In: Heinrich HC, ed. *Vitamin B<sub>12</sub> and intrinsic factor 2. Europäisches Symposium*. Stuttgart: Enke, 1962:728–736.
30. Herbert V, Zalusky R. Interrelations of vitamin B<sub>12</sub> and folic acid metabolism: folic acid clearance studies. *J Clin Invest* 1962;41:1263–1276.
31. Chanarin I, Deacon R, Lumb M, et al. Cobalamin and folate: recent developments. *J Clin Pathol* 1992;45:277–283.
32. Finkelstein J. Homocysteine: a history in progress. *Nutr Rev* 2000;58:193–204.
33. Clarke S, Banfield K. S-Adenosylmethionine-dependent methyltransferases. In: Carmel R, Jacobsen DW, eds. *Homocysteine in health and disease*. Cambridge: Cambridge University Press, 2001:65–80.
34. McKillop DJ, Pentieva K, Daly D, et al. The effect of different cooking methods on folate retention in various foods that are major contributors to folate intake in the UK diet. *Br J Nutr* 2002;88:681–688.
35. Food standards: amendment of the standards of identity for enriched grain products to require addition of folic acid. *Federal Register* 1996;61:8781–8797.
36. Choukmenowitch SF, Selhub J, Wilson PWF, et al. Folic acid intake from fortification in United States exceeds predictions. *J Nutr* 2002;132:2792–2798.
37. Panel on folate, other B vitamins, and choline; Institute of Medicine. *Folate*. In: *Dietary reference intakes: Thiamin, riboflavin, niacin, vitamin B<sub>6</sub>, folate, vitamin B<sub>12</sub>, pantothenic acid, biotin, and choline*. Washington, DC: National Academy of Sciences, 1998:196–305.

38. Rosenberg IH, Selhub J. Intestinal absorption of folates. In: Blakley R, Whitehead V, eds. *Folates and pterins*. New York: John Wiley and Sons, 1986:147–176.
39. Antony AC. Folate receptors. *Annu Rev Nutr* 1996;16:501–521.
40. Sirotnak FM, Tolner B. Carrier-mediated membrane transport of folates in mammalian cells. *Annu Rev Nutr* 1999;19:91–122.
41. Maziarz KM, Monaco HL, Shen F, et al. Complete mapping of divergent amino acids responsible for differential ligand binding of folate receptors a and B. *J Biol Chem* 1999;274:11086–11091.
42. Luhrs CA, Slomiany BL. A human membrane-associated folate binding protein is anchored by a glycosyl phosphatidylinositol tail. *J Biol Chem* 1989;264:21446–21449.
43. Rijnboutt S, Jansen G, Posthuma G, et al. Endocytosis of GPI-linked membrane folate receptor-a. *J Cell Biol* 1996;132:35–47.
44. Chan SY, Empig CJ, Welte FJ, et al. Folate receptor-a is a cofactor for cellular entry by Marburg and Ebola viruses. *Cell* 2001;106:117–126.
45. Steinberg SE, Campbell CL, Hillman RS. Kinetics of the normal folate enterohepatic cycle. *J Clin Invest* 1979;64:83–88.
46. Kane MA, Elwood PC, Portillo RM, et al. The interrelationship of the soluble and membrane-associated folate-binding proteins in human KB cells. *J Biol Chem* 1986;261:15625–15631.
47. Chanarin I. *The megaloblastic anaemias*, 2nd ed. Oxford: Blackwell Science, 1979.
48. Stites TE, Bailey LB, Scott KC, et al. Kinetic modeling of folate metabolism through the use of chronic administration of deuterium-labeled folic acid in men. *Am J Clin Nutr* 1997;65:53–60.
49. Reed LS, Archer MC. Oxidation of tetrahydrofolic acid by air. *J Agric Food Chem* 1980;28:801–805.
50. Tucker KL, Rich S, Rosenberg I, et al. Plasma vitamin B-12 concentrations relate to intake source in the Framingham Offspring Study. *Am J Clin Nutr* 2000;71:514–522.
51. Lindenbaum J, Rosenberg IH, Wilson PWF, et al. Prevalence of cobalamin deficiency in the Framingham elderly population. *Am J Clin Nutr* 1994;60:2–11.
52. Howard JM, Azen C, Jacobsen DW, et al. Dietary intake of cobalamin in elderly people who have abnormal serum cobalamin, methylmalonic acid and homocysteine levels. *Eur J Clin Nutr* 1998;52:582–587.
53. Tucker KL, Rich S, Rosenberg I, et al. Plasma vitamin B-12 concentrations relate to intake source in the Framingham Offspring study. *Am J Clin Nutr* 2000;71:514–522.
54. Panel on folate, other B vitamins, and choline; Institute of Medicine. Folate. In: *Dietary reference intakes: thiamin, riboflavin, niacin, vitamin B<sub>6</sub>, folate, vitamin B<sub>12</sub>, pantothenic acid, biotin, and choline*. Washington, DC: National Academy of Sciences, 1998:306–356.
55. Life Sciences Research Office. *Third Report on Nutrition Monitoring in the United States*, vol. 2. Washington DC: US Government Printing Office, 1996.
56. Seetharam B. Receptor-mediated endocytosis of cobalamin (vitamin B12). *Annu Rev Nutr* 1999;19:173–195.
57. Berlin H, Berlin R, Brante G. Oral treatment of pernicious anaemia with high doses of vitamin B<sub>12</sub> without intrinsic factor. *Acta Med Scand* 1968;184:247–258.
58. Carmel R. Cobalamin-binding proteins in man. In: Silber R, Gordon AS, LoBue J, Muggia FM, eds. *Contemporary hematology-oncology*, vol 2. New York: Plenum Publishing, 1981:79–129.

59. Rothenberg SP, Quadros EV, Regec A. Transcobalamin II. In: Banerjee, ed. Chemistry and biochemistry of B<sub>12</sub>. New York: Wiley-Interscience, 1999:441-473.
60. Quadros EV, Rothenberg SP, Jaffe EA. Endothelial cells from human umbilical vein secrete functional transcobalamin II. *Am J Physiol* 1989;256:C296-C303.
61. Carmel R, Neely SM, Francis RB, Jr. Human umbilical vein endothelial cells secrete transcobalamin II. *Blood* 1990;75:251-254.
62. Quadros EV, Regec AL, Khan KMF, et al. Transcobalamin II synthesized in the intestinal villi facilitates transfer of cobalamin to the portal blood. *Am J Physiol* 1999;277:G161-G166.
63. Hewitt JE, Gordon MM, Taggart RT, et al. Human gastric intrinsic factor: characterization of cDNA and genomic clones and localization to human chromosome 11. *Genomics* 1991;10:432-440.
64. Platica O, Janeczko R, Quadros EV, et al. The cDNA sequence and the deduced amino acid sequence of human transcobalamin II show homology with rat intrinsic factor and human transcobalamin I. *J Biol Chem* 1991;266:7860-7863.
65. Li N, Seetharam S, Seetharam B. Genomic structure of human transcobalamin II: comparison to human intrinsic factor and transcobalamin I. *Biochem Biophys Res Commun* 1995;208:756-764.
66. Eiberg H, Moller N, Mohr J, et al. Linkage of transcobalamin II (TC2) to the P blood group system and assignment to chromosome 22. *Clin Genet* 1986;29:354-359.
67. Namour F, Olivier J-L, Abdelmouttaleb I, et al. Transcobalamin codon 259 polymorphism in HT-29 and Caco-2 cells and in Caucasians: relation to transcobalamin and homocysteine concentration in blood. *Blood* 2001;97:1092-1098.
68. Carmel R, Hollander D. Extreme elevation of transcobalamin II levels in multiple myeloma and other disorders. *Blood* 1978;51:1057-1063.
69. Fräter-Schröder M, Hitzig WH, Grob PJ, et al. Increased unsaturated transcobalamin II in active autoimmune disease. *Lancet* 1978;2:238-239.
70. Hom BL. Plasma turnover of <sup>57</sup>cobalt-vitamin B<sub>12</sub> bound to transcobalamin I and II. *Scand J Haematol* 1967;4:321-332.
71. Johnston J, Yang-Feng T, Berliner N. Genomic structure and mapping of the chromosomal gene for transcobalamin I (*TCN1*): comparison to human intrinsic factor. *Genomics* 1992;12:459-464.
72. Cowland JB, Borregaard N. The individual regulation of granule protein mRNA levels during neutrophil maturation explains the heterogeneity of neutrophil granules. *J Leukoc Biol* 1999;66:989-995.
73. Burger RL, Schneider RJ, Mehlman CS, et al. Human plasma R-type vitamin B<sub>12</sub> binding proteins. II. The role of transcobalamin I, transcobalamin III and the normal granulocyte vitamin B<sub>12</sub>-binding protein in the plasma transport of vitamin B<sub>12</sub>. *J Biol Chem* 1975;250:7707-7713.
74. Carmel R. Large vitamin B<sub>12</sub>-binding proteins and complexes in human serum. In: Zagalak B, Friedrich W, eds. Vitamin B<sub>12</sub>. Proceedings of the third European symposium on vitamin B<sub>12</sub> and intrinsic factor. Berlin: Walter de Gruyter, 1979:777-790.
75. Allen RH, Seetharam B, Podell E, et al. Effect of proteolytic enzymes on the binding of cobalamin to R protein and intrinsic factor. In vitro evidence that a failure to partially degrade R protein is responsible for cobalamin malabsorption in pancreatic insufficiency. *J Clin Invest* 1978;61:47-54.
76. Moestrup SK, Kozyraki R, Kristiansen M, et al. The intrinsic factor-vitamin B<sub>12</sub> receptor and target of teratogenic antibodies is a megalin-binding peripheral membrane protein with homology to developmental proteins. *J Biol Chem* 1998;273:5235-5242.
77. Moestrup SK, Verroust PJ. Megalin- and cubilin-mediated endocytosis of protein-bound vitamins,

lipids, and hormones in polarized epithelia. *Annu Rev Nutr* 2001;21:407–428.

78. Carmel R. The distribution of endogenous cobalamin among cobalamin-binding proteins in the blood in normal and abnormal states. *Am J Clin Nutr* 1985;41:713–719.

79. Birn H, Willnow TE, Nielsen R, et al. Megalin is essential for renal proximal tubule reabsorption and accumulation of transcobalamin-B<sub>12</sub>. *Am J Physiol* 2002;282:F408–F416.

80. Hall CA. The carriers of native vitamin B<sub>12</sub> in normal human serum. *Clin Sci Mol Med* 1977;53:453–457.

81. Hall CA. Transcobalamins I and II as natural transport proteins of vitamin B<sub>12</sub>. *J Clin Invest* 1975;56:1125–1131.

82. Carmel R, Vasireddy H, Aurangzeb I, et al. High serum cobalamin levels in the clinical setting: clinical associations and holo-transcobalamin changes. *Clin Lab Haematol* 2001;23:365–371.

83. Seetharam B, Bose S, Li N. Cellular import of cobalamin (vitamin B-12). *J Nutr* 1999;129:1761–1764.

84. Adams JF, Tankel HI, MacEwan F. Estimation of the total body vitamin B<sub>12</sub> in the live subject. *Clin Sci* 1970;39:107–113.

85. Carmel R, Goodman SI. Abnormal deoxyuridine suppression test in congenital methylmalonic aciduria-homocystinuria without megaloblastic anemia: divergent biochemical and morphological bone marrow manifestations of disordered cobalamin metabolism in man. *Blood* 1982;59:306–311.

86. Carmel R, Karnaze DS. The deoxyuridine suppression test identifies subtle cobalamin deficiency in patients without typical megaloblastic anemia. *JAMA* 1985;253:1284–1287.

87. Karnaze DS, Carmel R. Low serum cobalamin levels in primary degenerative dementia: Do some patients harbor atypical cobalamin deficiency states? *Arch Intern Med* 1987;147:429–431.

88. Carmel R, Sinow RM, Karnaze DS. Atypical cobalamin deficiency: subtle biochemical evidence of deficiency is commonly demonstrable in patients without megaloblastic anemia and is often associated with protein-bound cobalamin malabsorption. *J Lab Clin Med* 1987;109:454–463.

89. Goodman AM, Harris JW. Studies in B<sub>12</sub>-deficient monkeys with combined system disease. I. B12-deficient patterns in bone marrow deoxyuridine suppression tests without morphologic or functional abnormalities. *J Lab Clin Med* 1980;96:722–733.

90. Wickramasinghe SN. The wide spectrum and unresolved issues of megaloblastic anemia. *Semin Hematol* 1999;36:3–18.

91. Luzzatto L, Falusi AO, Joju EA. Uracil in DNA in megaloblastic anaemia. *N Engl J Med* 1981;305:1156–1157.

92. Blount BC, Mack MM, Wehr CM, et al. Folate deficiency causes uracil misincorporation into human DNA and chromosome breakage: implications for cancer and neuronal damage. *Proc Natl Acad Sci U S A* 1997;94:3290–3295.

93. Wickramasinghe SN. Morphology, biology, and biochemistry of cobalamin- and folate-deficient bone marrow cells. *Baillieres Clin Haematol* 1995;8:441–459.

94. Ingram CF, Davidoff AN, Marais E, et al. Evaluation of DNA analysis for evidence of apoptosis in megaloblastic anaemia. *Br J Haematol* 1997;96:576–583.

95. Koury M, Price J, Hicks G. Apoptosis in megaloblastic anemia occurs during DNA synthesis by a p53-independent, nucleoside-reversible mechanism. *Blood* 2000;96:3249–3255.

96. Levine PH, Hamstra RD. Megaloblastic anemia of pregnancy simulating acute leukemia. *Ann Intern Med* 1969;71:1141–1147.

97. Keller R, Lindstrand K, Norden A. Chromosome studies in megaloblastic anaemia before and after treatment. *Scand J Haematol* 1971;8:309–320.
98. Chintagumpala MM, Dreyer ZE, Steuber CP, et al. Pancytopenia with chromosomal fragility: vitamin B<sub>12</sub> deficiency. *J Pediatr Hematol Oncol* 1996;18:166–170.
99. Wollman MR, Panchansky L, Shekhter–Levin S. Transient 7q– in association with megaloblastic anemia due to dietary folate and B<sub>12</sub> deficiency. *J Pediatr Hematol Oncol* 1996;18:162–165.
100. Nath BJ, Lindenbaum J. Persistence of neutrophil hypersegmentation during recovery from megaloblastic granulopoiesis. *Ann Intern Med* 1979;90:757–760.
101. Levine PH. A qualitative platelet defect in severe vitamin B<sub>12</sub> deficiency. Response, hyperresponse, and thrombosis after vitamin B<sub>12</sub> therapy. *Ann Intern Med* 1973;78:533–539.
102. Ingeberg S, Stoffersen E. Platelet dysfunction in patients with vitamin B<sub>12</sub> deficiency. *Acta Haematol* 1979;61:75–79.
103. Tamura J, Kubota K, Murakami H, et al. Immunomodulation by vitamin B<sub>12</sub>: augmentation of CD8<sup>+</sup> T lymphocytes and natural killer (NK) cell activity in vitamin B<sub>12</sub>–deficient patients by methyl–B12 treatment. *Clin Exp Immunol* 1999;116:28–32.
104. Savage DG, Ogundipe A, Allen RH, et al. Etiology and diagnostic evaluation of macrocytosis. *Am J Med Sci* 2000;319:343–352.
105. Eichner ER, Pierce HJ, Hillman RS. Folate balance in dietary–induced megaloblastic anemia. *N Engl J Med* 1971;284:933–938.
106. Prentice AG, Evans IL. Megaloblastic anaemia with normal mean cell volume. *Lancet* 1979;1:606–607.
107. Hodgetts J, Peters SW, Hoy TG, et al. The ferritin content of normoblasts and megaloblasts from human bone marrow. *Clin Sci* 1986;70:47–51.
108. Lindenbaum J, Nath BJ. Megaloblastic anemia and neutrophil hypersegmentation. *Br J Haematol* 1980;44:511–513.
109. Koury MJ, Horne DW. Apoptosis mediates and thymidine prevents erythroblast destruction in folate deficiency anemia. *Proc Natl Acad Sci U S A* 1994;91:4067–4071.
110. Ingram CF, Davidoff AN, Marais E, et al. Evaluation of DNA analysis for evidence of apoptosis in megaloblastic anaemia. *Br J Haematol* 1997;96:576–583.
111. Hamilton HE, Sheets RF, DeGowin EL. Studies with inagglutinable erythrocyte counts. VII. Further investigation of the hemolytic mechanism in untreated pernicious anemia and the demonstration of a hemolytic property in the plasma. *J Lab Clin Med* 1958;51:942–955.
112. Carmel R, Melnyk S, James SJ. Cobalamin deficiency with and without neurologic abnormalities: differences in homocysteine and methionine metabolism. *Blood* 2003;101:3302–3308.
113. Ballas SK. Abnormal erythrocyte membrane protein pattern in severe megaloblastic anemia. *J Clin Invest* 1978;61:1097–1101.
114. Carmel R, MacPhee RD, Jr. Erythropoietin levels in cobalamin deficiency: comparison of anemic and nonanemic, subtly deficient patients. *Eur J Haematol* 1992;48:159–162.
115. McCombe PA, McLeod JG. The peripheral neuropathy of vitamin B<sub>12</sub> deficiency. *J Neurol Sci* 1984;66:117–126.
116. Tomoda H, Shibasaki H, Hirata I, et al. Central vs peripheral nerve conduction. Before and after

treatment of subacute combined degeneration. *Arch Neurol* 1988;45:526–529.

117. Pant SS, Asbury AK, Richardson EP, Jr. The myelopathy of pernicious anemia. A neurological reappraisal. *Acta Neurol Scand* 1968;44[Suppl 35]:1–36.
118. Metz J. Cobalamin deficiency and the pathogenesis of nervous system disease. *Annu Rev Nutr* 1992;12:59–79.
119. Weir D, Scott J. The biochemical basis of the neuropathy in cobalamin deficiency. *Baillieres Clin Haematol* 1995;8:479–497.
120. Waters AH, Mollin DL. Observations on the metabolism of folic acid in pernicious anaemia. *Br J Haematol* 1963;9:319–327.
121. Magnus EM. Whole blood folate values in pernicious anaemia: relation to treatment. *Eur J Haematol* 1987;39:39–43.
122. Carmel R. Pernicious anemia: the expected findings of very low serum cobalamin levels, anemia and macrocytosis are often lacking. *Arch Intern Med* 1988;148:1712–1714.
123. Lindenbaum J, Heaton EB, Savage DG, et al. Neuropsychiatric disorders caused by cobalamin deficiency in the absence of anemia or macrocytosis. *N Engl J Med* 1988;318:1720–1728.
124. Heaton EB, Savage DG, Brust JC, et al. Neurologic aspects of cobalamin deficiency. *Medicine* 1991;70:229–245.
125. Savage D, Lindenbaum J. Relapses after interruption of cyanocobalamin therapy in patients with pernicious anemia. *Am J Med* 1983;74:765–772.
126. Magnus EM. Cobalamin and unsaturated transcobalamin values in pernicious anaemia: relation to treatment. *Scand J Haematol* 1986;36:457–465.
127. Rundles RW. Prognosis in the neurologic manifestations of pernicious anemia. *Blood* 1946;1:209–219.
128. Ungley CC. Subacute combined degeneration of the cord. *Brain* 1949;72:382–427.
129. Victor M, Lear AA. Subacute combined degeneration of spinal cord. Current concepts of the disease process. Value of serum vitamin B<sub>12</sub> determinations in clarifying some of the common clinical problems. *Am J Med* 1956;20:896–911.
130. Hemmer B, Glocker FX, Schumacher M, et al. Subacute combined degeneration: clinical, electrophysiological, and magnetic resonance imaging findings. *J Neurol Neurosurg Psychiatry* 1998;65:822–827.
131. Steiner I, Kidron D, Soffer D, et al. Sensory peripheral neuropathy of vitamin B<sub>12</sub> deficiency: a primary demyelinating disease? *J Neurol* 1988;235:163–164.
132. Stojavljevic N, Levic Z, Drulovic J, et al. A 44-month clinical–brain MRI follow-up in a patient with B<sub>12</sub> deficiency. *Neurology* 1997;49:878–881.
133. Carmel R, Gott PS, Waters CH, et al. The frequently low cobalamin levels in dementia usually signify treatable metabolic, neurologic and electrophysiologic abnormalities. *Eur J Haematol* 1995;54:245–253.
134. Cole M, Prchal J. Low serum vitamin B<sub>12</sub> in Alzheimer-type dementia. *Age Ageing* 1984;13:101–105.
135. Levitt A, Karlinsky H. Folate, vitamin B<sub>12</sub> and cognitive impairment in patients with Alzheimer's disease. *Acta Psychiatr Scand* 1992;86:301–305.
136. Adams P, Chalmers T, Foulds W, et al. Megaloblastic anaemia and vision. *Lancet* 1967;1:229–231.
137. White WB, Reik L, Jr., Cutlip DE. Pernicious anemia seen initially as orthostatic hypotension. *Arch*

Intern Med 1981;141:1543–1544.

138. Lerner AJ, Zeman AZ, Allen CMC, et al. MRI appearances in subacute combined degeneration of the spinal cord due to vitamin B<sub>12</sub> deficiency. *J Neurol Neurosurg Psychiatry* 1997;62:99–101.

139. Bassi SS, Bulundwe KK, Greeff GP, et al. MRI of the spinal cord in myelopathy complicating vitamin B<sub>12</sub> deficiency: two additional cases and a review of the literature. *Neuroradiol* 1999;41:271–274.

140. Wallace P, Westmoreland B. The electroencephalogram in pernicious anemia. *Mayo Clin Proc* 1976;51:281–285.

141. Troncoso J, Mancall EL, Schatz N. Visual evoked responses in pernicious anemia. *Arch Neurol* 1979;36:168–169.

142. Zegers de Beyl D, Delecluse F, Verbanck P, et al. Somatosensory conduction in vitamin B<sub>12</sub> deficiency. *Electroencephalogr Clin Neurophysiol* 1988;69:313–318.

143. Fine EJ, Soria E, Paroski MW, et al. The neurophysiological profile of vitamin B<sub>12</sub> deficiency. *Muscle Nerve* 1990;13:158–164.

144. Karnaze DS, Carmel R. Neurological and evoked potential abnormalities in subtle cobalamin deficiency states, including those without anemia and with normal absorption of free cobalamin. *Arch Neurol* 1990;47:1008–1012.

145. Gilois C, Wierzbicki A, Hirani N, et al. The hematological and electrophysiological effects of cobalamin. Deficiency secondary to vegetarian diets. *Ann N Y Acad Sci* 1992;669:345–348.

146. Ross JF, Belding H, Paegel BL. The development and progression of subacute combined degeneration of the spinal cord in patients with pernicious anemia treated with synthetic pteroylglutamic (folic) acid. *Blood* 1948;3:68–90.

147. Schwartz SO, Kaplan SR, Armstrong BE. The long-term evaluation of folic acid in the treatment of pernicious anemia. *J Lab Clin Med* 1950;35:894–898.

148. Reynolds EH, Rothfeld P, Pincus J. Neurological disease associated with folate deficiency. *BMJ* 1973;2:398–400.

149. Manzoor M, Runcie J. Folate responsive neuropathy: reports of ten cases. *BMJ* 1976;1:1176–1178.

150. Shorvon SD, Carney MWP, Chanarin I, et al. The neuropsychiatry of megaloblastic anaemia. *BMJ* 1980;281:1036–1038.

151. Lever EG, Elwes RDC, Williams A, et al. Subacute combined degeneration of the cord due to folate deficiency: response to methyl folate treatment. *J Neurol Neurosurg Psychiatry* 1986;49:1203–1207.

152. Alpert J, Fava M. Nutrition and depression: the role of folate. *Nutr Rev* 1997;55:145–149.

153. Penninx BWJH, Guralnik JM, Ferrucci L, et al. Vitamin B<sub>12</sub> deficiency and depression in physically disabled older women: epidemiologic evidence from the Women's Health and Aging Study. *Am J Psychiatry* 2000;157:715–721.

154. Urbach J, Abrahamov A, Grossowicz N. Congenital isolated folic acid malabsorption. *Arch Dis Child* 1987;62:78–80.

155. Steinschneider M, Sherbany A, Pavlakis S, et al. Congenital folate malabsorption: reversible clinical and neurophysiologic abnormalities. *Neurology* 1990;40:1315.

156. Zittoun J. Congenital errors of folate metabolism. *Baillieres Clin Haematol* 1995;8:603–616.

157. Rosenblatt D, Fenton W. Inherited disorders of folate and cobalamin metabolism. In: Scriver C, Beaudet A, Sly W, Valle D, eds. *The metabolic and molecular bases of inherited disease*, 8th ed. New York:



McGraw-Hill, 2001:3897-3933.

158. Hjorting-Hansen E, Bertram U. Oral aspects of pernicious anaemia. *Br Dent J* 1968;125:266-270.
159. Wagley PF. Neurologic disturbances with folic acid therapy. *N Engl J Med* 1948;238:11-15.
160. Foroozan P, Trier J. Mucosa of the small intestine in pernicious anemia. *N Engl J Med* 1967;277:554-559.
161. Berg N, Dahlqvist A, Lindberg T, et al. Morphology, dipeptidases and disaccharidases of small intestinal mucosa in vitamin B<sub>12</sub> and folic acid deficiency. *Scand J Haematol* 1972;9:167-173.
162. Titenko-Holland N, Jacob RA, Shang N, et al. Micronuclei in lymphocytes and exfoliated buccal cells of postmenopausal women with dietary changes in folate. *Mutat Res* 1998;417:101-114.
163. Carmel R, Herbert V. Correctable intestinal defect of vitamin B<sub>12</sub> absorption in pernicious anemia. *Ann Intern Med* 1967;67:1201-1207.
164. Lindenbaum J, Pezzimenti J, Shea N. Small-intestinal function in vitamin B<sub>12</sub> deficiency. *Ann Intern Med* 1974;80:326-331.
165. Seaton DA, Goldberg A. Weight-loss in pernicious anaemia. *Lancet* 1960;1:1002-1004.
166. Carmel R, Lau KHW, Baylink DJ, et al. Cobalamin and osteoblast-specific proteins. *N Engl J Med* 1988;319:70-75.
167. Jadhav M, Webb JKG, Vaishnava S, et al. Vitamin B<sub>12</sub> deficiency in Indian infants: a clinical syndrome. *Lancet* 1962;2:903-907.
168. Gough KR, Read AE, McCarthy CF, et al. Megaloblastic anaemia due to nutritional deficiency of folic acid. *QJM* 1963;32:243-257.
169. Carmel R. Hair and fingernail changes in acquired and congenital pernicious anemia. *Arch Intern Med* 1985;145:484-485.
170. Hamrell MR, Hochstein P, Carmel R. Leukocyte hexose monophosphate shunt activity during phagocytosis in vitamin B<sub>12</sub> and folic acid deficiencies. *Am J Clin Nutr* 1979;32:2265-2268.
171. Gulley ML, Bentley SA, Ross DW. Neutrophil myeloperoxidase measurement uncovers masked megaloblastic anemia. *Blood* 1990;76:1004-1007.
172. Glover V. Platelet monoamine oxidase activity in megaloblastic anaemia. *J Clin Pathol* 1980;33:963-965.
173. Wallentin L, Berlin R, Vikrot O. Studies on plasma lipid and phospholipid composition in pernicious anemia before and after specific treatment. *Acta Med Scand* 1977;201:161-165.
174. Kafetz K. Immunoglobulin deficiency responding to vitamin B<sub>12</sub> in two elderly patients with megaloblastic anaemia. *Postgrad Med J* 1985;61:1065-1066.
175. Wright PE, Sears DA. Hypogammaglobulinemia and pernicious anemia. *Southern Med J* 1987;80:243-246.
176. Alperin J, Dow P, Petteway M. Hemoglobin A<sub>2</sub> levels in health and various hematologic disorders. *Am J Clin Pathol* 1977;67:219-226.
177. Henshaw L, Tizzard J, Booth K, et al. Haemoglobin A<sub>2</sub> levels in vitamin B<sub>12</sub> and folate deficiency. *J Clin Pathol* 1978;31:960-962.
178. Heller P, Yakulis V, Epstein R, et al. Variation in the amount of hemoglobin S in a patient with sickle

cell trait and megaloblastic anemia. *Blood* 1983;21:479-483.

179. Grode H, Laszlo J. Sickle cell trait, refractory anemia, and nutritional anemia with variable expression of A and S hemoglobin. *Ann Intern Med* 1966;65:321-324.

180. Carmel R. Cobalamin, the stomach and aging. *Am J Clin Nutr* 1997;66:750-759.

181. Carmel R. Current concepts in cobalamin deficiency. *Annu Rev Med* 2000;51:357-375.

182. Pennypacker LC, Allen RH, Kelly JP, et al. High prevalence of cobalamin deficiency in elderly outpatients. *J Am Geriatr Soc* 1992;40:1197-1204.

183. Metz J, Bell AH, Flicker L, et al. The significance of subnormal vitamin B<sub>12</sub> concentration in older people: a case control study. *J Am Geriatr Soc* 1996;44:1355-1361.

184. Carmel R, Green R, Jacobsen DW, et al. Serum cobalamin, homocysteine and methylmalonic acid concentrations in a multiethnic elderly population: ethnic and sex differences in cobalamin and metabolite abnormalities. *Am J Clin Nutr* 1999;70:904-910.

185. Carmel R. Reversal by cobalamin therapy of minimal defects in the deoxyuridine suppression test in patients without anemia: further evidence for a subtle metabolic cobalamin deficiency. *J Lab Clin Med* 1992;119:240-244.

186. Carmel R. Prevalence of undiagnosed pernicious anemia in the elderly. *Arch Intern Med* 1996;156:1097-1100.

187. Waters WE, Withey JL, Kilpatrick GS, et al. Serum vitamin B<sub>12</sub> concentrations in the general population: a ten-year follow-up. *Br J Haematol* 1971;20:521-526.

188. Nilsson-Ehle H. Age-related changes in cobalamin (vitamin B<sub>12</sub>) handling. Implications for therapy. *Drugs Aging* 1998;12:277-292.

189. Baik HW, Russell RM. Vitamin B<sub>12</sub> deficiency in the elderly. *Annu Rev Nutr* 1999;19:357-377.

190. Herrmann W, Quast S, Ullrich M, et al. Hyperhomocystinemia in high-aged subjects: relation of B-vitamins, folic acid, renal function, and the methylenetetrahydrofolate reductase mutation. *Atherosclerosis* 1999;144:91-101.

191. Selhub J, Jacques PF, Wilson PWF, et al. Vitamin status and intake as primary determinants of homocystinemia in an elderly population. *JAMA* 1993;270:2693-2698.

192. MRC Vitamin Study Research Group. Prevention of neural tube defects: results of the MRC Vitamin Study. *Lancet* 1991;338:131-137.

193. Czeizel AE, Dudas I. Prevention of the first occurrence of neural tube defects by periconceptional vitamin supplementation. *N Engl J Med* 1992;327:1832-1835.

194. Dickinson CJ. Does folic acid harm people with vitamin B<sub>12</sub> deficiency? *QJM* 1995;88:357-364.

195. Rothenberg SP. Increasing the dietary intake of folate: pro and con. *Semin Hematol* 1999;36:65-74.

196. Eskes TKAB. Homocysteine and human reproduction. In: Carmel R, Jacobsen DW, eds. *Homocysteine in health and disease*. Cambridge: Cambridge University Press, 2001:451-465.

197. Choi SW, Mason JB. Folate and carcinogenesis: an integrated scheme. *J Nutr* 2000;130:129-132.

198. Duthie SJ, Narayanan S, Brand GM, et al. Impact of folate deficiency on DNA stability. *J Nutr* 2002;132:2444S-2449S.

199. Mason JB. Diet, folate, and colon cancer. *Curr Opin Gastroenterol* 2002;18:229-234.

200. Ma J, Stampfer MJ, Giovanucci E, et al. Methylene tetrahydrofolate reductase polymorphism, dietary interactions, and risk of colorectal cancer. *Cancer Res* 1997;57:1098–1102.
201. Butterworth CE, Jr., Hatch KD, Macaluso M, et al. Folate deficiency and cervical dysplasia. *JAMA* 1992;267:528–533.
202. McKully KS. Vascular pathology of homocysteinemia: implications for the pathogenesis of arteriosclerosis. *Am J Pathol* 1969;56:111–128.
203. Verhoef P, Stampfer M. Epidemiology of vascular and thrombotic associations. In: Carmel R, Jacobsen DW, eds. *Homocysteine in health and disease*. Cambridge: Cambridge University Press, 2001:357–370.
204. Homocysteine Lowering Trialists' Collaboration. Lowering blood homocysteine with folic-acid based supplements: meta-analysis of randomised trials. *BMJ* 1998;316:894–898.
205. Danesh J, Lewington S. Plasma homocysteine and coronary heart disease: systematic review of published epidemiological studies. *J Cardiovasc Risk* 1998;5:229–232.
206. Eikelboom JW, Lonn E, Genest J, Jr., et al. Homocyst(e)ine and cardiovascular disease: a critical review of the epidemiologic evidence. *Ann Intern Med* 1999;131:363–375.
207. Ford ES, Smith SJ, Stroup DF, et al. Homocyst(e)ine and cardiovascular disease: a systematic review of the evidence with special emphasis on case-control studies and nested case-control studies. *Int J Epidemiol* 2002;31:59–70.
208. Schnyder G, Roffi M, Pin R, et al. Decreased rate of coronary restenosis after lowering of plasma homocysteine levels. *N Engl J Med* 2001;345:1593–1600.
209. Clarke R, Smith AD, Jobst KA, et al. Folate, vitamin B<sub>12</sub>, and serum total homocysteine levels in confirmed Alzheimer disease. *Arch Neurol* 1998;55:1449–1455.
210. Miller JW, Green R, Mungas DM, et al. Homocysteine, vitamin B<sub>6</sub>, and vascular disease in AD patients. *Neurology* 2002;58:1471–1475.
211. Saxena S, Weiner JM, Carmel R. Red cell distribution width in untreated pernicious anemia. *Am J Clin Pathol* 1988;89:660–663.
212. Pappo AS, Fields BW, Buchanan GR. Etiology of red blood cell macrocytosis during childhood: impact of new diseases and therapies. *Pediatrics* 1992;89:1063–1067.
213. Carmel R, Skikne BS. Serum transferrin receptor in the megaloblastic anemia of cobalamin deficiency. *Eur J Haematol* 1992;49:246–250.
214. Gafter-Gvili A, Prokocimer M, Breuer W, et al. Increased non-transferrin-bound serum iron in megaloblastic anaemia. *Acta Haematol* 2002;108:53–54.
215. Nyman M. Haptoglobin in pernicious anemia. *Scand J Clin Lab Invest* 1957;9:168–169.
216. Green R, Kuhl W, Jacobson R, et al. Masking of macrocytosis by alpha-thalassemia in blacks with pernicious anemia. *N Engl J Med* 1982;307:1322–1325.
217. Spivak J. Masked megaloblastic anemia. *Arch Intern Med* 1982;142:2111–2114.
218. van der Weyden M, Rother M, Firkin B. Megaloblastic maturation masked by iron deficiency: a biochemical basis. *Br J Haematol* 1972;22:299–307.
219. Carmel R, Green R, Jacobsen DW, et al. Neutrophil nuclear segmentation in mild cobalamin deficiency: relation to metabolic tests of cobalamin status and observations on ethnic differences in neutrophil segmentation. *Am J Clin Pathol* 1996;106:57–63.

220. Eichacker P, Lawrence C. Steroid-induced hypersegmentation in neutrophils. *Am J Hematol* 1985;18:41-45.
221. Das KC, Herbert V, Colman N, et al. Unmasking covert folate deficiency in iron-deficient subjects with neutrophil hypersegmentation: dU suppression tests on lymphocytes and bone marrow. *Br J Haematol* 1978;39:357-375.
222. Westerman DA, Evans D, Metz J. Neutrophil hypersegmentation in iron deficiency anaemia: a case-control study. *Br J Haematol* 1999;107:512-515.
223. Adams J, Boddy K, Douglas A. Interrelation of serum vitamin B<sub>12</sub>, total body vitamin B<sub>12</sub>, peripheral blood morphology and the nature of erythropoiesis. *Br J Haematol* 1972;23:297-305.
224. Mollin DL, Anderson BB, Burman JF. The serum vitamin B<sub>12</sub> level: its assay and significance. *Clin Haematol* 1976;5:521-546.
225. Zittoun J, Zittoun R. Modern clinical testing strategies in cobalamin and folate deficiency. *Semin Hematol* 1999;36:35-46.
226. Carmel R, Brar S, Agrawal A, et al. Failure of assay to identify low cobalamin concentrations. *Clin Chem* 2000;46:2017-2018.
227. Matchar DB, McCrory DC, Millington DS, et al. Performance of the serum cobalamin assay for diagnosis of cobalamin deficiency. *Am J Med Sci* 1994;308:276-283.
228. Lindenbaum J, Savage DG, Stabler SP, et al. Diagnosis of cobalamin deficiency. II. Relative sensitivities of serum cobalamin, methylmalonic acid, and total homocysteine concentrations. *Am J Hematol* 1990;34:99-107.
229. Metz J, Bell AH, Flicker L, et al. The significance of subnormal serum vitamin B<sub>12</sub> concentration in older people: a case control study. *J Am Geriatr Soc* 1996;44:1355-1361.
230. Carmel R. Cobalamin deficiency. In: Carmel R, Jacobsen DW, eds. *Homocysteine in health and disease*. Cambridge: Cambridge University Press, 2001:289-305.
231. Koebnick C, Heins UA, Dagnelie PC, et al. Longitudinal concentrations of vitamin B<sub>12</sub> and B<sub>12</sub>-binding proteins during uncomplicated pregnancy. *Clin Chem* 2002;48:928-933.
232. Metz J, McGrath K, Bennett M, et al. Biochemical indices of vitamin B<sub>12</sub> nutrition in pregnant patients with subnormal serum vitamin B<sub>12</sub> levels. *Am J Hematol* 1995;48:251-255.
233. Burkes RL, Cohen H, Krailo M, et al. Low serum cobalamin levels occur frequently in the acquired immune deficiency syndrome and related disorders. *Eur J Haematol* 1987;38:141-147.
234. Remacha AF, Cadafalch J. Cobalamin deficiency in patients infected with the human immunodeficiency virus. *Semin Hematol* 1999;36:75-87.
235. Remacha AF, Cadafalch J, Sardá P, et al. Vitamin B-12 metabolism in HIV- infected patients in the age of highly active antiretroviral therapy: role of homocysteine in assessing vitamin B-12 status. *Am J Clin Nutr* 2003;77:420-424.
236. Goodkin DE, Jacobsen DW, Galvez N, et al. Serum cobalamin deficiency is uncommon in multiple sclerosis. *Arch Neurol* 1994;51:1110-1114.
237. Hansen O, Drivsholm A, Hippe E. Vitamin B<sub>12</sub> metabolism in myelomatosis. *Scand J Haematol* 1977;18:395-402.
238. Chandna SM, Tattersall JE, Nevett GE, et al. Low serum vitamin B<sub>12</sub> levels in chronic high-flux haemodialysis patients. *Nephron* 1997;75:259-263.

239. Corcino JJ, Zalusky R, Greenberg M, et al. Coexistence of pernicious anaemia and chronic myeloid leukaemia: an experiment of nature involving vitamin B<sub>12</sub> metabolism. *Br J Haematol* 1971;20:511–520.
240. Skouby A, Hippe E, Olesen H. Antibody to transcobalamin II and B<sub>12</sub> binding capacity in patients treated with hydroxocobalamin. *Blood* 1971;38:769–774.
241. Carmel R, Tatsis B, Baril L. Circulating antibody to transcobalamin II causing retention of vitamin B<sub>12</sub> in the blood. *Blood* 1977;49:987–1000.
242. Carmel R. Ethnic and racial factors in cobalamin metabolism and its disorders. *Semin Hematol* 1999;36:88–100.
243. Lewis CA, Pancharuniti N, Sauberlich HE. Plasma folate adequacy as determined by homocysteine level. *Ann N Y Acad Sci* 1992;669:360–362.
244. Brouwer DAJ, Welten HTME, Reijngoud DJ, et al. Plasma folic acid cutoff value derived from its relationship with homocyst(e)ine. *Clin Chem* 1998;44:1545–1550.
245. Lucock M, Yates Z. Measurement of red blood cell methylfolate. *Lancet* 2002;360:1021–1022.
246. Hoffbrand AV, Newcombe BFA, Mollin DL. Method of assay of red cell folate activity and the value of the assay as a test for folate deficiency. *J Clin Pathol* 1966;19:17–28.
247. Benesch R, Kwong S, Benesch R, et al. The binding of foyl- and antifolypolyglutamates to hemoglobin. *J Biol Chem* 1985;260:14653–14658.
248. Nelson NL, Klausner JS, Branda RF. Oxygenation alters red cell folate levels. *Br J Haematol* 1983;55:235–242.
249. Jaffe JP, Schilling RF. Erythrocyte folate levels: a clinical study. *Am J Hematol* 1991;36:116–121.
250. Silberberg J, Dudman N. Methionine loading. In: Carmel R, Jacobsen DW, eds. *Homocysteine in health and disease*. Cambridge: Cambridge University Press 2001:212–219.
251. Selhub J, Jacques PF, Rosenberg IH, et al. Serum total homocysteine concentrations in the Third National Health and Nutrition Examination Survey (1991–1994): population reference ranges and contribution of vitamin status to high serum concentrations. *Ann Intern Med* 1999;131:331–339.
252. Savage DG, Lindenbaum J, Stabler SP, et al. Sensitivity of serum methylmalonic acid and total homocysteine determinations for diagnosing cobalamin and folate deficiencies. *Am J Med* 1994;96:239–246.
253. Allen RH, Stabler SP, Savage DG, et al. Diagnosis of cobalamin deficiency. I. Usefulness of serum methylmalonic acid and total homocysteine concentrations. *Am J Hematol* 1990;34:90–98.
254. Schneede J, Refsum H, Ueland PM. Biological and environmental determinants of plasma homocysteine. *Semin Thromb Hemost* 2000;26:263–279.
255. Matchar DB, Feussner JR, Millington DS, et al. Isotope-dilution assay for urinary methylmalonic acid in the diagnosis of vitamin B<sub>12</sub> deficiency. A prospective clinical evaluation. *Ann Intern Med* 1987;106:707–710.
256. Giorgio AJ, Trowbridge M, Boone AW, et al. Methylmalonic aciduria without vitamin B12 deficiency in an adult sibship. *N Engl J Med* 1976;295:310–313.
257. Sniderman LC, Lambert M, Giguère R, et al. Outcome of individuals with low-moderate methylmalonic aciduria detected through a neonatal screening program. *J Pediatr* 1999;134:675–680.
258. Monsen ALB, Ueland PM, Vollset SE, et al. Determinants of cobalamin status in newborns. *Pediatrics* 2001;108:624–630.
259. Specker BL, Miller D, Norman EJ, et al. Increased urinary methylmalonic acid excretion in breast-fed

infants of vegetarian mothers and identification of an acceptable dietary source of vitamin B-12. *Am J Clin Nutr* 1988;47:89-92.

260. Killmann SA. Effect of deoxyuridine on incorporation of tritiated thymidine: difference between normoblasts and megaloblasts. *Acta Med Scand* 1964;175:483-488.

261. Metz J, Kelly A, Swett VC, et al. Deranged DNA synthesis by bone marrow from vitamin B<sub>12</sub>-deficient humans. *Br J Haematol* 1968;14:575-592.

262. Pelliniemi TT, Beck WS. Biochemical mechanisms in the Killmann experiment: critique of the deoxyuridine suppression test. *J Clin Invest* 1980;65:449-460.

263. Carmel R, Rasmussen K, Jacobsen DW, et al. Comparison of the deoxyuridine suppression test with serum levels of methylmalonic acid and homocysteine in mild cobalamin deficiency. *Br J Haematol* 1996;93:311-318.

264. Wickramasinghe S. The deoxyuridine suppression test: biochemical basis and diagnostic applications. *Blood Rev* 1988;2:168-177.

265. Mathews JH, Wickramasinghe SN. The deoxyuridine suppression test performed on phytohaemagglutinin-stimulated peripheral blood cells fails to reflect in vivo vitamin B<sub>12</sub> or folate deficiency. *Eur J Haematol* 1988;40:174-180.

266. Hansen HA, Weinfeld A. Metabolic effects and diagnostic value of small doses of folic acid and B12 in megaloblastic anemias. *Acta Med Scand* 1962;172:427-443.

267. Lindemans J, Schoester M, van Kapel J. Application of a simple immunoabsorption assay for the measurement of saturated and unsaturated transcobalamin II and R-binders. *Clin Chim Acta* 1983;132:53-61.

268. Wickramasinghe SN, Ratnayaka ID. Limited value of serum holo-transcobalamin II measurements in the differential diagnosis of macrocytosis. *J Clin Pathol* 1996;49:755-758.

269. Carmel R. On measuring and interpreting holotranscobalamin (holotranscobalamin II). *Clin Chem* 2002;48:407-409.

270. Barry SI, Broughton TM. Relative weight, weight loss efforts and nutrient intakes among health-conscious vegetarian, past vegetarian and nonvegetarian women ages 18 to 50. *J Am Coll Nutr* 2000;19:781-788.

271. Sanders TAB, Ellis FR, Dickerson JWT. Haematological studies on vegans. *Br J Nutr* 1978;40:9-15.

272. Haddad EH, Berk LS, Kettering JD, et al. Dietary intake and biochemical, hematologic, and immune status of vegans compared with nonvegetarians. *Am J Clin Nutr* 1999;70[Suppl]:586S-593S.

273. Kwok T, Cheng G, Woo J, et al. Independent effect of vitamin B<sub>12</sub> deficiency on hematological status in older Chinese vegetarian women. *Am J Hematol* 2002;70:186-190.

274. Schloesser LL, Schilling RF. Vitamin B12 absorption studies in a vegetarian with megaloblastic anemia. *Am J Clin Nutr* 1963;12:70-74.

275. Carmel R. Subtle cobalamin malabsorption in a vegan patient: evolution into classical pernicious anemia with anti-intrinsic factor antibody. *Arch Intern Med* 1982;142:2206-2207.

276. Refsum H, Yajnik CS, Gadkari M, et al. Hyperhomocysteinemia and elevated methylmalonic acid indicate a high prevalence of cobalamin deficiency in Asian Indians. *Am J Clin Nutr* 2001;74:233-241.

277. Carmel R, Mallidi PV, Vinarskiy S, et al. Hyperhomocysteinemia and cobalamin deficiency in young Asian Indians in the United States. *Am J Hematol* 2002;70:107-114.

278. Obeid R, Geisel J, Schorr H, et al. The impact of vegetarianism on some haematological parameters.

Eur J Haematol 2002;69:275–279.

279. van Dusseldorp M, Schneede J, Refsum H, et al. Risk of persistent cobalamin deficiency in adolescents fed a macrobiotic diet in early life. *Am J Clin Nutr* 1999;69:664–671.
280. Louwman MWJ, van Dusseldorp M, van den Vijver FJR, et al. Signs of impaired cognitive function in adolescents with marginal cobalamin status. *Am J Clin Nutr* 2000;72:762–769.
281. Hanley WB, Feigenbaum AS, Clarke JT, et al. Vitamin B<sub>12</sub> deficiency in adolescents and young adults with phenylketonuria. *Eur J Pediatr* 1996;155[Suppl 1]:S145–S147.
282. Higginbottom MC, Sweetman L, Nyhan WL. A syndrome of methylmalonic aciduria, homocystinuria, megaloblastic anemia and neurologic abnormalities in a vitamin B<sub>12</sub>-deficient breast-fed infant of a strict vegetarian. *N Engl J Med* 1978;299:317–323.
283. Monagle PT, Tauro GP. Infantile megaloblastosis secondary to maternal vitamin B<sub>12</sub> deficiency. *Clin Lab Haematol* 1997;19:23–25.
284. Rosenblatt DS, Whitehead VM. Cobalamin and folate deficiency: acquired and hereditary disorders in children. *Semin Hematol* 1999;36:19–34.
285. Grattan-Smith PJ, Wilcken B, Procopis PG, et al. The neurological syndrome of infantile cobalamin deficiency: developmental regression and involuntary movements. *Movement Disorders* 1997;12:39–46.
286. Graham SM, Arvela OM, Wise GA. Long-term neurologic consequences of nutritional vitamin B<sub>12</sub> deficiency. *J Pediatr* 1992;121:710–714.
287. Dagnelie PC, van Staveren WA, Hautvast GA. Stunting and nutrient deficiencies in children on alternative diets. *Acta Paediatr Scand* 1991;374[Suppl]:111–118.
288. Poliner IJ, Spiro HM. The independent secretion of acid, pepsin, and “intrinsic factor” by the human stomach. *Gastroenterology* 1958;34:196–209.
289. Carmel R. Pernicious anemia: definitions, expressions, and the long-term consequences of atrophic gastritis. In: Holt PR, Russell RM, eds. *Chronic gastritis and hypochlorhydria in the elderly*. Boca Raton: CRC Press, 1993:99–114.
290. Toh B-H, van Driel IR, Gleeson PA. Pernicious anemia. *N Engl J Med* 1997;337:1441–1448.
291. Carmel R, Ozturk G, Johnson CS, et al. Profiles of black and Latin-American patients having pernicious anemia: HLA antigens, lymphocytotoxic antibody, anti-parietal cell antibody, serum gastrin levels and ABO blood groups. *Am J Clin Pathol* 1981;75:291–296.
292. Carmel R, Boone D, Parker JW. Lymphocyte surface phenotypes in pernicious anemia. *Dig Dis Sci* 1987;32:846–850.
293. Vargas JA, Alvarez-Mon M, Manzano L, et al. Natural killer cell activity in patients with pernicious anemia. *Dig Dis Sci* 1995;40:1538–1541.
294. Strickland RG, Mackay IR. A reappraisal of the nature and significance of atrophic gastritis. *Am J Dig Dis* 1973;18:426–440.
295. Fong TL, Dooley CP, Dehesa M, et al. *Helicobacter pylori* infection in pernicious anemia: a prospective controlled study. *Gastroenterology* 1991;100:328–332.
296. Whittingham S, Ungar B, Mackay IR, et al. The genetic factors in pernicious anaemia. A family study in patients with gastritis. *Lancet* 1969;1:951–954.
297. Hippe E, Birger Jensen K. Hereditary factors in pernicious anemia and their relation to serum-immunoglobulin levels and age at diagnosis. *Lancet* 1969;2:721–722.
298. Irvine WJ, Cullen DR, Mawhinney H. Natural history of autoimmune achlorhydric atrophic gastritis. *A*



1–15 year follow-up study. *Lancet* 1974;2:482–485.

299. Carmel R, Johnson CS. Racial patterns in pernicious anemia: early age of onset and increased frequency of intrinsic factor antibody in black women. *N Engl J Med* 1978;298:647–650.

300. Sievers ML, Metzger AL, Goldberg LS, et al. Pernicious anemia in Southwestern American Indians. *Blood* 1973;41:309–317.

301. Chanarin I, Malkowska V, O'Hea AM, et al. Megaloblastic anaemia in a vegetarian Hindu community. *Lancet* 1985;2:1168–1172.

302. Carmel R, Johnson CS, Weiner JM. Pernicious anemia in Latin Americans is not a disease of the elderly. *Arch Intern Med* 1987;147:1995–1996.

303. Au WY, Hui CH, Chan LC, et al. Clinicopathological features of megaloblastic anaemia in Hong Kong: a study of 84 Chinese patients. *Clin Lab Haematol* 1998;20:217–219.

304. Sjoblom SM, Sipponen P, Miettinen M, et al. Gastroscopic screening for gastric carcinoids and carcinoma in pernicious anemia. *Endoscopy* 1988;20:52–56.

305. Gilligan CJ, Lawton GP, Tang LH, et al. Gastric carcinoid tumors: the biology and therapy of an enigmatic and controversial lesion. *Am J Gastroenterol* 1995;90:338–352.

306. Elsborg L, Mosbech J. Pernicious anaemia as a risk factor in gastric cancer. *Acta Med Scand* 1979;206:315–318.

307. Borch K. Epidemiologic, clinicopathologic and economic aspects of gastroscopy screening of patients with pernicious anemia. *Scand J Gastroenterol* 1986;21:21–30.

308. Hsing AW, Hansson LE, McLaughlin JK, et al. Pernicious anemia and subsequent cancer: a population-based cohort study. *Cancer* 1993;71:745–750.

309. Eriksson S, Clase L, Moquist-Olsson I. Pernicious anemia as a risk factor in gastric cancer. The extent of the problem. *Acta Med Scand* 1981;210:481–484.

310. Schafer LW, Larson DE, Melton LJ III, et al. Risk of development of gastric carcinoma in patients with pernicious anemia: a population-based study in Rochester, Minnesota. *Mayo Clin Proc* 1985;60:444–448.

311. Kokkola A, Sjoblom SM, Haapianien R, et al. The risk of gastric carcinoma and carcinoid tumours in patients with pernicious anaemia. *Scand J Gastroenterol* 1998;33:88–92.

312. Stockbruegger RW, Cotton PB, Menon GG, et al. Pernicious anaemia, intragastric bacterial overgrowth, and possible consequences. *Scand J Gastroenterol* 1984;19:355–364.

313. Aydogdu I, Sari R, Ulu R, et al. The frequency of gallbladder stones in patients with pernicious anemia. *J Surg Res* 2001;101:120–123.

314. Carmel R, Weiner JM, Johnson CS. Iron deficiency occurs frequently in patients with pernicious anemia. *JAMA* 1987;257:1081–1083.

315. Carmel R, Spencer CA. Clinical and subclinical thyroid disorders associated with pernicious anemia. Observations on abnormal thyroid-stimulating hormone levels and on a possible association of blood group O with hyperthyroidism. *Arch Intern Med* 1982;142:1465–1469.

316. Twomey JJ, Jordan PH, Jarrold T, et al. The syndrome of immunoglobulin deficiency and pernicious anemia: a study of ten cases. *Am J Med* 1969;47:340–350.

317. Pezzimenti J, Lindenbaum J. Megaloblastic anemia associated with erythroid hypoplasia. *Am J Med* 1972;53:748–754.

318. Chanarin I, Loewi G, Tavill AS, et al. Defect of renal tubular acidification with antibody to loop of

Henle. *Lancet* 1974;2:317–318.

319. Rabinowitz AP, Sacks Y, Carmel R. Autoimmune cytopenias in pernicious anemia: a report of four cases and review of the literature. *Eur J Haematol* 1990;44:18–23.

320. Dan K, Ito T, Nomura T. Pure red cell aplasia following pernicious anemia. *Am J Hematol* 1990;33:148–150.

321. Takahashi T, Honma T, Ishizuka K, et al. A female with asymptomatic biliary cirrhosis associated with pernicious anemia. *J Gastroenterol Hepatol* 2001;16:1420–1424.

322. Blackburn EK, Callender ST, Dacie JV, et al. Possible association between pernicious anaemia and leukaemia: a prospective study of 1625 patients with a note on the very high incidence of stomach cancer. *Int J Cancer* 1968;3:163–170.

323. Brinton JA, Gridley G, Hrubec Z, et al. Cancer risk following pernicious anaemia. *Br J Cancer* 1989;59:810–813.

324. Drabick JJ, Davis BJ, Byrd JC. Concurrent pernicious anemia and myelodysplastic syndrome. *Ann Hematol* 2001;80:243–245.

325. Carmel R. Gastric juice in congenital pernicious anemia contains no immunoreactive intrinsic factor molecule: study of three kindreds with variable ages at presentation, including a patient first diagnosed in adulthood. *Am J Hum Genet* 1983;35:67–77.

326. Katz M, Lee SK, Cooper BA. Vitamin B<sub>12</sub> malabsorption due to a biologically inert intrinsic factor. *N Engl J Med* 1972;287:425–429.

327. Yang YM, Ducos R, Rosenberg AJ, et al. Cobalamin malabsorption in three siblings due to an abnormal intrinsic factor that is markedly susceptible to acid and proteolysis. *J Clin Invest* 1985;76:2057–2065.

328. Zittoun J, Léger J, Marquet J, et al. Combined congenital deficiencies of intrinsic factor and R binder. *Blood* 1988;72:940–943.

329. Doscherholmen A, Swaim WR. Impaired assimilation of egg Co<sup>57</sup> vitamin B<sub>12</sub> in patients with hypochlorhydria and achlorhydria and after gastric resection. *Gastroenterology* 1973;64:913–919.

330. Carmel R. Malabsorption of food cobalamin. *Baillieres Clin Haematol* 1995;8:639–655.

331. Marcuard SP, Albarnaz L, Khazanie PG. Omeprazole therapy causes malabsorption of cyanocobalamin (vitamin B<sub>12</sub>). *Ann Intern Med* 1994;120:211–215.

332. Schenk BE, Festen HPM, Kuipers EJ, et al. Effect of short- and long-term treatment with omeprazole on the absorption and serum levels of cobalamin. *Aliment Pharmacol Ther* 1996;10:541–545.

333. del Corral A, Carmel R. Transfer of cobalamin from the cobalamin-binding protein of egg yolk to R binder of human saliva and gastric juice. *Gastroenterology* 1990;98:1460–1466.

334. Cohen H, Weinstein WM, Carmel R. The heterogeneity of gastric histology and function in food cobalamin malabsorption: absence of atrophic gastritis and achlorhydria in some patients with severe malabsorption. *Gut* 2000;47:638–645.

335. Carmel R, Aurangzeb I, Qian D. Associations of food-cobalamin malabsorption with ethnic origin, age, *Helicobacter pylori* infection, and serum markers of gastritis. *Am J Gastroenterology* 2001;96:63–70.

336. Suter PM, Golner BB, Goldin BR, et al. Reversal of protein-bound vitamin B<sub>12</sub> malabsorption with antibiotics in atrophic gastritis. *Gastroenterology* 1991;101:1039–1045.

337. Dawson DW, Sawers AH, Sharma RK. Malabsorption of protein bound vitamin B<sub>12</sub>. *BMJ* 1984;288:675–678.

338. Jones BP, Broomhead AF, Kwan YL, et al. Incidence and clinical significance of protein-bound vitamin B12 malabsorption. *Eur J Haematol* 1987;38:131-136.
339. Rygvold O. Hypovitaminosis B<sub>12</sub> following partial gastrectomy by the Billroth II method. *Scand J Gastroenterol* 1974;9[Suppl 29]:57-64.
340. Sumner AE, Chin MM, Abraham JL, et al. Elevated methylmalonic acid and total homocysteine levels show high prevalence of vitamin B<sub>12</sub> deficiency after gastric surgery. *Ann Intern Med* 1996;124:469-476.
341. Mahmud K, Ripley D, Doscherholmen A. Vitamin B<sub>12</sub> absorption tests. Their unreliability in postgastrectomy states. *JAMA* 1971;216:1167-1171.
342. Hines JD, Hoffbrand AV, Mollin DL. The hematologic complications following partial gastrectomy. A study of 292 patients. *Am J Med* 1967;43:555-569.
343. Elsborg L. Malabsorption of folic acid following partial gastrectomy. *Scand J Gastroenterol* 1974;9:271-274.
344. Schilling RF, Gohdes PN, Hardie GH. Vitamin B<sub>12</sub> deficiency after gastric bypass surgery for obesity. *Ann Intern Med* 1984;101:501-502.
345. Provenzale D, Reinhold RB, Golner B, et al. Evidence for diminished B<sub>12</sub> absorption after gastric bypass: oral supplementation does not prevent low plasma B<sub>12</sub> levels in bypass patients. *J Am Coll Nutr* 1992;11:29-35.
346. Rhode BM, Arseneau P, Cooper BA, et al. Vitamin B-12 deficiency after gastric surgery for obesity. *Am J Clin Nutr* 1996;63:103-109.
347. King CE, Toskes PP. Small intestine bacterial overgrowth. *Gastroenterology* 1979;76:1035-1055.
348. Brasitus TA. Parasites and malabsorption. *Am J Med* 1979;67:1058-1065.
349. Editorial. Anaemia and the fish tapeworm. *Lancet* 1977;1:292.
350. Shimoda S, Saunders D, Rubin C. The Zollinger-Ellison syndrome with steatorrhea. II. The mechanism of fat and vitamin B12 malabsorption. *Gastroenterology* 1968;55:705-723.
351. Baker SJ. Idiopathic small intestinal disease in the tropics. *Crit Rev Trop Med* 1982;1:197-245.
352. Haghghi P, Wolf PL. Tropical sprue and subclinical enteropathy: a vision for the nineties. *Crit Rev Clin Lab Sci* 1997;34:313-341.
353. Fausa O. Vitamin B<sub>12</sub> absorption in intestinal diseases. (Coeliac disease, dermatitis herpetiformis, ulcerative colitis, Crohn's disease, jejunioileal shunting). *Scand J Gastroenterol* 1974;9[Suppl]:75-79.
354. Hocking M, Duerson M, O'Leary J, et al. Jejunioileal bypass for morbid obesity. Late follow-up in 100 cases. *N Engl J Med* 1983;308:995-999.
355. Rasmussen I, Enblad P, Arosenius KE. Jejunioileal bypass for morbid obesity. Report of a series with long-term results. *Acta Chir Scand* 1989;155:401-407.
356. Nilsson L, Myrvold H, Swolin B, et al. Vitamin B<sub>12</sub> in plasma in patients with continent ileostomy and long observation time. *Scand J Gastroenterol* 1984;19:369-374.
357. Pannek J, Haupt G, Schulze H, et al. Influence of continent ileal urinary diversion on vitamin B<sub>12</sub> absorption. *J Urol* 1996;155:1206-1208.
358. Aminoff M, Carter JE, Chadwick RB, et al. Mutations in *CUBN*, encoding the intrinsic factor-vitamin

- B<sub>12</sub> receptor, cubilin, cause hereditary megaloblastic anaemia 1. *Nat Genet* 1999;21:309–313.
359. Kristiansen M, Aminoff M, Jacobsen C, et al. Cubilin P1297L mutation associated with hereditary megaloblastic anemia 1 causes impaired recognition of intrinsic factor–vitamin B<sub>12</sub> by cubilin. *Blood* 2000;96:405–409.
360. Imerslund O. Idiopathic chronic megaloblastic anemia in children. *Acta Paediatr* 1960;49[Suppl]:1–115.
361. Gräsbeck R, Gordin RKI, Kantero I, et al. Selective vitamin B<sub>12</sub> malabsorption and proteinuria in young people. A syndrome. *Acta Med Scand* 1960;167:289–296.
362. Broch H, Imerslund O, Monn E, et al. Imerslund–Gräsbeck anemia: a long–term follow–up study. *Acta Paediatr Scand* 1984;73:248–253.
363. Tomkin G, Hadden D, Weaver J, et al. Vitamin B–12 status of patients on long–term metformin therapy. *BMJ* 1971;2:685–687.
364. Longstreth G, Newcomer A. Drug–induced malabsorption. *Mayo Clin Proc* 1975;50:284–293.
365. Adams J, Clark J, Ireland J, et al. Malabsorption of vitamin B<sub>12</sub> and intrinsic factor secretion during biguanide therapy. *Diabetologia* 1983;24:16–18.
366. Guttormsen AB, Refsum H, Ueland PM. The interaction between nitrous oxide and cobalamin. Biochemical effects and clinical consequences. *Acta Anaesthesiol Scand* 1994;38:753–756.
367. Ermens AAM, Refsum H, Ruprecht J, et al. Monitoring cobalamin inactivation during nitrous oxide anesthesia by determination of homocysteine and folate in plasma and urine. *Clin Pharmacol Ther* 1991;49:385–393.
368. Carmel R, Rabinowitz AP, Mazumder A. Metabolic evidence of cobalamin deficiency in bone marrow cells harvested for transplantation from donors given nitrous oxide. *Eur J Haematol* 1993;50:228–233.
369. Badner NH, Drader K, Freeman D, et al. The use of intraoperative nitrous oxide leads to postoperative increases in plasma homocysteine. *Anesth Analg* 1998;87:711–713.
370. Layzer RB, Fishman RA, Schafer JA. Neuropathy following abuse of nitrous oxide. *Neurology* 1978;28:504–506.
371. Schilling RF. Is nitrous oxide a dangerous anesthetic for vitamin B<sub>12</sub>–deficient subjects? *JAMA* 1986;255:1605–1606.
372. Flippo TS, Holder WD. Neurologic degeneration associated with nitrous oxide anesthesia in patients with vitamin B<sub>12</sub> deficiency. *Arch Surg* 1993;128:1391–1395.
373. Kinsella LJ, Green R. “Anesthesia paresthetica:” nitrous oxide–induced cobalamin deficiency. *Neurology* 1995;45:1608–1610.
374. Rosener M, Dichgans J. Severe combined degeneration of the spinal cord after nitrous oxide anesthesia in a vegetarian. *J Neurol Neurosurg Psychiatry* 1996;60:354.
375. Sesso RMCC, Iunes Y, Melo ACP. Myeloneuropathy following nitrous oxide anesthesia in a patient with macrocytic anaemia. *Neuroradiology* 1999;41:588–590.
376. Brouwer M, Chamulitrat W, Ferruzzi G, et al. Nitric oxide interactions with cobalamin: biochemical and functional consequences. *Blood* 1996;88:1857–1864.
377. Danishpajoo IO, Gudi T, Chen Y, et al. Nitric oxide inhibits methionine synthase activity in vivo and disrupts carbon flow through the folate pathway. *J Biol Chem* 2001;276:27296–27303.
378. Matsui SM, Mahoney MJ, Rosenberg LE. The natural history of the inherited methylmalonic

acidemias. *N Engl J Med* 1983;308:857–861.

379. Geraghty MT, Perlman EJ, Martin LS, et al. Cobalamin C defect associated with hemolytic–uremic syndrome. *J Pediatr* 1992;120:934–937.

380. Rosenblatt DS, Aspler AL, Shevell MI, et al. Clinical heterogeneity and prognosis in combined methylmalonic aciduria and homocystinuria (*cb/C*). *J Inherit Metab Dis* 1997;20:528–538.

381. Rosenblatt DS, Laframboise R, Pichette J, et al. New disorder of vitamin B<sub>12</sub> metabolism (cobalamin F) presenting as methylmalonic aciduria. *Pediatrics* 1986;78:51–54.

382. Shih VE, Axel SM, Tewksbury JC, et al. Defective lysosomal release of vitamin B<sub>12</sub> (*cb/F*) a hereditary metabolic disorder associated with sudden death. *Am J Med Genet* 1989;33:555–563.

383. MacDonald MR, Wiltse HE, Bever JL, et al. Clinical heterogeneity in two patients with *cb/F* disease. *Am J Hum Genet* 1992;51:A353.

384. Watkins D, Rosenblatt DS. Functional methionine synthase deficiency (*cb/E* and *cb/G*): clinical and biochemical heterogeneity. *Am J Med Genet* 1989;34:427–434.

385. Carmel R, Watkins D, Goodman SI, et al. A hereditary defect of cobalamin metabolism (*cb/G* mutation) presenting as a neurologic disorder in adulthood. *N Engl J Med* 1988;318:1738–1741.

386. Carmel R, Ravindranath Y. Congenital transcobalamin II deficiency presenting atypically with a low serum cobalamin level: studies demonstrating the coexistence of a circulating transcobalamin I (R binder) complex. *Blood* 1984;63:598–605.

387. Hall CA. The neurologic aspects of transcobalamin II deficiency. *Br J Haematol* 1992;80:117–120.

388. Hitzig WH, Fráter–Schröder M, Seger R. Immunodeficiency due to transcobalamin II deficiency. In: *Enzyme defects and immune dysfunction*. Ciba Foundation Series 68: Excerpta Medica, 1979:77–91.

389. Li N, Rosenblatt DS, Kamen BA, et al. Identification of two mutant alleles of transcobalamin II in an affected family. *Hum Mol Genet* 1994;3:1835–1840.

390. Li N, Rosenblatt DS, Seetharam B. Nonsense mutations in human transcobalamin II deficiency. *Biochem Biophys Res Commun* 1994;204:1111–1118.

391. Haurani F, Hall CA, Rubin R. Megaloblastic anemia as a result of an abnormal transcobalamin II (Cardeza). *J Clin Invest* 1979;64:1253–1259.

392. Monagle PT, Tauro GP. Long term follow–up of patients with transcobalamin II deficiency. *Arch Dis Child* 1995;72:237–238.

393. Carmel R, Herbert V. Deficiency of vitamin B<sub>12</sub>–binding alpha globulin in two brothers. *Blood* 1969;33:1–12.

394. Carmel R. R binder deficiency: a clinically benign cause of cobalamin pseudo–deficiency. *JAMA* 1983;250:1886–1890.

395. Lin JC, Borregaard N, Liebman HA, et al. Deficiency of the specific granule proteins, R binder/transcobalamin I and lactoferrin, in plasma and saliva: a new disorder. *Am J Med Genet* 2001;100:145–151.

396. Carmel R. Mild transcobalamin I (haptocorrin) deficiency and low serum cobalamin concentrations. *Clin Chem* 2003;49:1367–1374.

397. Zachee P, Chew SL, Daelemans R, et al. Erythropoietin resistance due to vitamin B<sub>12</sub> deficiency. Case report and retrospective analysis of B<sub>12</sub> levels after erythropoietin treatment. *Am J Nephrol* 1992;12:188–191.

398. Lawrence JM, Petitti DB, Watkins M, et al. Trends in serum folate after food fortification. *Lancet*

1999;354:915–916.

399. Sauberlich HE. Folate status of US population groups. In: Bailey LB, ed. *Folate in health and disease*. New York: Marcel Dekker, 1995:171–193.

400. Ford ES, Bowman BA. Serum and red blood cell folate concentrations, race, and education: findings from the third National Health and Nutrition Examination Survey. *Am J Clin Nutr* 1999;69:476–481.

401. Stabler SP, Allen RH, Fried LP, et al. Racial differences in prevalence of cobalamin and folate deficiencies in disabled elderly women. *Am J Clin Nutr* 1999;70:911–919.

402. Jacques PF, Selhub J, Bostom AG, et al. The effect of folic acid fortification on plasma folate and total homocysteine concentrations. *N Engl J Med* 1999;340:1449–1454.

403. Lindenbaum J, Roman MJ. Nutritional anemia in alcoholism. *Am J Clin Nutr* 1980;33:2727–2735.

404. Worthington–White DA, Behnke M, Gross S. Premature infants require additional folate and vitamin B–12 to reduce the severity of the anemia of prematurity. *Am J Clin Nutr* 1994;60:930–935.

405. Hallert C, Tobiasson P, Walan A. Serum folate determinations in tracing adult coeliacs. *Scand J Gastroenterol* 1981;16:263–267.

406. Elsborg L, Larsen L. Folate deficiency in chronic inflammatory bowel disease. *Scand J Gastroenterol* 1979;14:1019–1024.

407. Russell RM, Dutta S, Oaks E, et al. Impairment of folic acid absorption by oral pancreatic extracts. *Dig Dis Sci* 1980;25:369–373.

408. MacKenzie JF, Russell RI. The effect of pH on folic acid absorption in man. *Clin Sci Mol Med* 1976;51:363–365.

409. Belaiche J, Matuchansky C, Zittoun J, et al. “Folate-losing gastropathy” and intestinal folate absorption in patients with Menetrier’s disease (giant hypertrophic gastritis). *Am J Dig Dis* 1978;23:143–147.

410. Russell RM, Krasinski SD, Samloff IM, et al. Folic acid malabsorption in atrophic gastritis: possible compensation by bacterial folate synthesis. *Gastroenterology* 1986;91:1476–1482.

411. Russell RM, Golner BB, Krasinski SD, et al. Effect of antacid and H<sub>2</sub> receptor antagonists on the intestinal absorption of folic acid. *J Lab Clin Med* 1988;112:458–463.

412. Steinberg S, Campbell C, Hillman R. The toxic effects of alcohol on folate metabolism. *Clin Toxicol* 1980;17:407–411.

413. Halsted CH. Folate deficiency in alcoholism. *Am J Clin Nutr* 1980;33:2736–2740.

414. Guynn R, Labaume L, Henkin J. Equilibrium constants under physiologic conditions for the condensation of acetaldehyde with tetrahydrofolic acid. *Arch Biochem Biophys* 1982;217:181–190.

415. Shaw S, Jayatilleke E, Herbert V, et al. Cleavage of folates during ethanol metabolism. Role of acetaldehyde/xanthine oxidase-generated superoxide. *Biochem J* 1989;257:277–280.

416. Lambie D, Johnson R. Drugs and folate metabolism. *Drugs* 1985;30:145–155.

417. Selhub J, Dhar J, Rosenberg IH. Inhibition of folate enzymes by sulfasalazine. *J Clin Invest* 1978;61:221–224.

418. Wegner C, Nau H. Alteration of embryonic folate metabolism by valproic acid during organogenesis: implications for mechanism of teratogenesis. *Neurology* 1992;42[Suppl 5]:17–24.

419. Kobrinsky L, Ramsay N. Acute megaloblastic anemia induced by high-dose trimethoprim-sulfamethoxazole. *Ann Intern Med* 1981;94:780–781.

420. Ross C, Stone M, Reagan J, et al. Lack of influence of oral contraceptives on serum folate, hematologic values, and uterine cervical cytology. *Semin Hematol* 1976;13:233–238.
421. Butterworth CE, Hatch KD, Macalusa M, et al. Folate deficiency and cervical dysplasia. *JAMA* 1992;267:528–533.
422. Rosenblatt DS, Cooper BA, Lue-Shing S, et al. Folate distribution in cultured human cells. Studies on 5,10-CH<sub>2</sub>-H<sub>4</sub>PteGlu reductase deficiency. *J Clin Invest* 1979;63:1019–1025.
423. Ronge E, Kjellman B. Long term treatment with betaine in methylenetetrahydrofolate reductase deficiency. *Arch Dis Child* 1996;74:239–241.
424. Branda RF, Moldow CF, MacArthur JR, et al. Folate-induced remission in aplastic anemia with familial defect of cellular folate uptake. *N Engl J Med* 1978;298:469–475.
425. Rozen R. Polymorphisms of folate and cobalamin metabolism. In: Carmel R, Jacobsen DW, eds. *Homocysteine in health and disease*. Cambridge: Cambridge University Press 2001:259–269.
426. Lindenbaum J. Folic acid requirement in situations of increased need. In: *Folic acid. Biochemistry and physiology in relation to the human nutrition requirement*. (Food and Nutrition Board, National Research Council.) Washington, DC: National Academy of Sciences, 1977:256–276.
427. McPartlin J, Halligan A, Scott JM, et al. Accelerated folate breakdown in pregnancy. *Lancet* 1993;341:148–149.
428. Mackey AD, Picciano MF. Maternal folate status during extended lactation and the effect of supplemental folic acid. *Am J Clin Nutr* 1999;69:285–292.
429. Rabb L, Grandison Y, Mason K, et al. A trial of folate supplementation in children with homozygous sickle cell disease. *Br J Haematol* 1983;54:589–594.
430. Dhar M, Bellevue R, Carmel R. Pernicious anemia with neuropsychiatric dysfunction in a patient with sickle cell anemia treated with folate supplementation. *N Engl J Med* 2003;348:2204–2207.
431. Suh JR, Herbig AK, Stover PJ. New perspectives on folate catabolism. *Annu Rev Nutr* 2001;21:255–282.
432. Beard M, Hatipov C, Hamer J. Acute onset of folate deficiency in patients under intensive care. *Crit Care Med* 1980;8:500–503.
433. Amos R, Amess J, Hinds C, et al. Incidence and pathogenesis of acute megaloblastic bone-marrow change in patients receiving intensive care. *Lancet* 1982;2:835–839.
434. Rogers LE, Porter FS, Sidbury JBJ. Thiamine-responsive megaloblastic anemia. *J Pediatr* 1969;74:494–504.
435. Haworth C, Evans DIK, Mitra J, et al. Thiamine responsive anaemia: a study of two further cases. *Br J Haematol* 1982;50:549–561.
436. Labay V, Raz T, Baron D, et al. Mutations in *SLC19A2* cause thiamine-responsive megaloblastic anaemia associated with diabetes mellitus and deafness. *Nat Genet* 1999;22:300–304.
437. Fleming J, Tartaglioni E, Schorderet D, et al. The gene mutated in thiamine-responsive anaemia with diabetes and deafness (TRMA) encodes a functional thiamine transporter. *Nat Genet* 1999;22:305–308.
438. Diaz G, Banikazemi M, Oishi K, et al. Mutations in a new gene encoding a thiamine transporter cause thiamine-responsive megaloblastic anaemia syndrome. *Nat Genet* 1999;22:309–312.
439. Webster D, Becroft D, van Gennip AH, et al. Hereditary orotic aciduria and other disorders of pyrimidine metabolism. In: Scriver C, Beaudet A, Valle D, et al., eds. *Metabolic and molecular bases of inherited disease*, 8th ed. New York: McGraw-Hill, 2001:2663–2702.



440. Lindenbaum J. Aspects of vitamin B<sub>12</sub> and folate metabolism in malabsorption syndromes. *Am J Med* 1979;67:1037–1048.
441. Schilling RF. Intrinsic factor studies. II. The effect of gastric juice on the urinary excretion of radioactivity after the oral administration of radioactive vitamin B<sub>12</sub>. *J Lab Clin Med* 1953;42:860–866.
442. Nimo RE, Carmel R. Increased sensitivity of detection of the blocking (type I) anti-intrinsic factor antibody. *Am J Clin Pathol* 1987;88:729–733.
443. Carmel R. Reassessment of the relative prevalences of antibodies to gastric parietal cell and to intrinsic factor in patients with pernicious anaemia: influence of patient age and race. *Clin Exp Immunol* 1992;89:74–77.
444. Waters HM, Dawson DW, Howarth JE, et al. High incidence of type II autoantibodies in pernicious anaemia. *J Clin Pathol* 1993;46:45–47.
445. Rose M, Chanarin I, Doniach D, et al. Intrinsic factor antibodies in the absence of pernicious anaemia. 3–7-year follow-up. *Lancet* 1970;2:9–13.
446. Conn D. Intrinsic factor antibodies in relation to disease. *Med Lab Sci* 1986;43:220–224.
447. Muckerheide M, Wolfman J, Rohde D, et al. Studies on a radioassay for intrinsic factor antibody: comparison of methods and false positive results due to elevated serum B<sub>12</sub> levels. *Am J Clin Pathol* 1984;82:300–304.
448. Karlsson FA, Burman P, Loof L, et al. Major parietal cell antigen in autoimmune gastritis with pernicious anemia is the acid-producing H<sup>+</sup>K<sup>+</sup>-adenosine triphosphatase of the stomach. *J Clin Invest* 1988;81:475–479.
449. Callaghan JM, Khan MA, Alderuccio F, et al.  $\alpha$  and  $\beta$  Subunits of the gastric H<sup>+</sup>/K<sup>+</sup>-ATPase are concordantly targeted by parietal cell autoantibodies associated with autoimmune gastritis. *Autoimmunity* 1993;16:289–295.
450. Kaye M. Immunological aspects of gastritis and pernicious anaemia. *Baillieres Clin Gastroenterol* 1987;1:487–506.
451. Davidson RJL, Atrah HI, Sewell HF. Longitudinal study of circulating gastric antibodies in pernicious anaemia. *J Clin Pathol* 1989;42:1092–1095.
452. Carmel R. Pepsinogens and other serum markers in pernicious anemia. *Am J Clin Pathol* 1988;90:442–446.
453. Samloff IM, Varis K, Ihmaki T, et al. Relationships among serum pepsinogen I, serum pepsinogen II, and gastric mucosal histology. A study in relatives of patients with pernicious anemia. *Gastroenterology* 1982;83:204–209.
454. Gräsbeck R, Wahlstedt V, Kouvonen I. Radioimmunoassay of urinary intrinsic factor. *Lancet* 1982;1:1330–1332.
455. Waters HM, Dawson DW. An enzyme immunoassay for intrinsic factor in urine. *Clin Lab Haematol* 1999;21:169–172.
456. Stabler SP, Marcell PD, Podell ER, et al. Assay of methylmalonic acid in the serum of patients with cobalamin deficiency using capillary gas chromatography mass spectrometry. *J Clin Invest* 1986;77:1606–1612.
457. Stabler SP, Marcell PD, Podell ER, et al. Elevation of total homocysteine in the serum of patients with cobalamin and folate deficiency detected by capillary gas chromatography–mass spectrometry. *J Clin Invest* 1988;81:466–474.
458. Carmel R, Shulman IA. Blood transfusion in medically treatable chronic anemia: pernicious anemia as

a model for transfusion overuse. *Arch Pathol Lab Med* 1989;113:995–997.

459. Kuzminski AM, Del Giacco EJ, Allen RH, et al. Effective treatment of cobalamin deficiency with oral cobalamin. *Blood* 1998;92:1191–1198.

460. Kondo H. Haematological effects of oral cobalamin preparations on patients with megaloblastic anaemia. *Acta Haematol* 1998;99:200–205.

461. Seal EC, Metz J, Flicker L, et al. A randomized double-blind, placebo-controlled study of oral vitamin B12 supplementation in older patients with subnormal or borderline serum vitamin B12 concentrations. *J Am Geriatr Soc* 2002;50:146–151.

462. Garcia A, Paris-Pombo A, Evans L, et al. Is low-dose oral cobalamin enough to normalize cobalamin function in older people? *J Am Geriatr Soc* 2002;50:1401–1404.

463. Rajan S, Wallace JI, Brodtkin KI, et al. Response of elevated methylmalonic acid to three doses levels of oral cobalamin in older adults. *J Am Geriatr Soc* 2002;50:1789–1795.

464. Skouby AP. Hydroxocobalamin for initial and long-term therapy for vitamin B<sub>12</sub> deficiency. *Acta Med Scand* 1987;221:399–402.

465. Carmel R. Treatment of severe pernicious anemia: no association with sudden death. *Am J Clin Nutr* 1988;48:1443–1444.

466. Lott WB, Takyar SS, Tuppen J, et al. Vitamin B<sub>12</sub> and hepatitis C: molecular biology and human pathology. *Proc Natl Acad Sci U S A* 2001;98:4916–4921.

467. Weinberg JB, Shugars DC, Sherman PA, et al. Cobalamin inhibition of HIV-1 integrase and integration of HIV-1 DNA into cellular DNA. *Biochem Biophys Res Commun* 1998;246:393–397.

468. Butterworth CE, Jr., Tamura T. Folic acid safety and toxicity: a brief review. *Am J Clin Nutr* 1989;50:353–358.

469. Ch'ien LT, Krumdieck CL, Scott CW, Jr., et al. Harmful effect of megadoses of vitamins: electroencephalogram abnormalities and seizures induced by intravenous folate in drug-treated epileptics. *Am J Clin Nutr* 1975;28:51–58.

470. Mills JL. Fortification of foods with folic acid—how much is enough? *N Engl J Med* 2000;342:1442–1445.

471. Fraser RC, Cathcart M, Seivewright H. Audit of the use of vitamin B<sub>12</sub> in general practice. *BMJ* 1983;287:729–731.

472. Taylor MP. Response to paper “Audit of the use of vitamin B<sub>12</sub> in general practice.” *BMJ* 1984;288:1275.

2004 Lippincott Williams & Wilkins  
John P. Greer, John Foerster, John N. Lukens  
George M. Rodgers, Frixos Paraskevas, Bertil Glader  
Wintrobe's Clinical Hematology

## ACQUIRED APLASTIC ANEMIA

[Historical Background](#)

[Epidemiology](#)

[Clinical Causal Associations](#)

[Pathophysiology](#)

[Clinical Features](#)

[Laboratory](#)

[Treatment](#)

[Supportive Care of Bone Marrow Failure Patients](#)

## INHERITED APLASTIC ANEMIA SYNDROMES

[Fanconi Anemia](#)

[Dyskeratosis Congenita](#)

[WEB SITES](#)

[REFERENCES](#)

## ACQUIRED APLASTIC ANEMIA

### Historical Background

The first known reported case of aplastic anemia was in 1888 when Ehrlich (<sup>1</sup>) described a young woman with bleeding, fever, and severe anemia. Her bone marrow at autopsy was found to be largely devoid of blood-forming elements. The term *aplastic anemia* was introduced by Vaquez and Aubertin in discussions of the Society of the Hospital of Paris in 1904 (<sup>2</sup>). The word *aplastic* is derived from the Greek *a* and *plastic* meaning “without form.” Despite the potentially misleading term *anemia*, patients with aplastic anemia fail to form blood cells of all three lineages. This combination of decreased or absent bone marrow precursor cells and peripheral cytopenias characterizes aplastic anemia.

The paucity at presentation of the organ of interest, the bone marrow, poses a formidable obstacle to investigations into the pathophysiology of aplastic anemia. Nonetheless, ongoing studies continue to yield significant progress in the understanding of the biology and treatment of aplastic anemia.

Aplastic anemia may be acquired or inherited. The causes are numerous, and the clinical histories are diverse. The distinction between inherited and acquired aplastic anemia syndromes carries profound treatment implications, and each entity is discussed separately in this chapter.

### Epidemiology

A large, prospective study conducted in Europe and Israel between 1980 and 1984 that required stringent case definition and pathologic confirmation reported an annual incidence of aplastic anemia of 2 new cases per 1 million population per year (<sup>3</sup>). Aplastic

anemia occurs much more commonly in the Far East than in the West ( 4 ). This geographic variation likely stems from environmental rather than genetic risk factors, because the Japanese population in Hawaii manifests similar rates of aplastic anemia as other Americans ( 5 ). Studies have not been able to attribute the increased risk of aplastic anemia in the Far East to specific agents, such as chloramphenicol, widely used in Asia ( 6 , 7 ).

The incidence of acquired aplastic anemia varies bimodally with age, with one peak between ages 15 to 25 years and another peak at older than 60 years of age ( 8 , 9 ). Aplastic anemia occurs with equal frequency in both genders ( 6 ).

### Clinical Causal Associations

The cause of aplastic anemia is generally difficult to determine in an individual patient. In the vast majority of cases, no causal etiology can be found. Attributions of causality in the literature must be interpreted with caution, as often multiple risk factors can be uncovered for any given patient. The clinical prognosis and management are generally related more to the severity of the disease than to the underlying cause.

**IONIZING RADIATION** Aplastic anemia has been reported after exposure to ionizing radiation due to nuclear bomb explosion, radioactive fallout, and medical or occupational exposure. Bone marrow cells are affected by both high-energy gamma rays as well as by absorbed lower-energy alpha particles. Acute radiation exposure in large doses leads to dose-related depressed marrow function. Bone marrow hypoplasia is observed at total body exposures between 1.0 and 2.5 Gy. LD<sub>50</sub> due to marrow failure is observed at a dose of 4.5 Gy, and 100% mortality is observed in the range of 10 Gy ( 10 ). Chronic radiation-induced aplasia is also dose dependent, and radiation exposures greater than 4.4 Gy are associated with the development of aplasia ( 11 ). Nuclear reactor accidents, malfunctioning medical equipment, and accidental industrial exposures have resulted in a wide range of injuries, including marrow aplasia. Thermal burns and gastrointestinal toxicity pose early management problems and contribute greatly to mortality in such accidents. The use of the radioactive compound thorium dioxide as a diagnostic aid in the form of Thorotrast was associated many years later with the development of aplastic anemia and leukemia ( 12 ). Acute radium poisoning, such as that affecting radium dial workers, is accompanied by striking changes in the blood. A high incidence of leukemia and cancer has been observed in people exposed to ionizing radiation, and aplastic anemia has been reported in a few survivors ( 13 ). The effects of continuous internal irradiation were described many years ago in radium dial workers ( 14 ). In these people, injured by the ingestion of radium through the habit of wetting their brushes by mouth, severe macrocytic anemia with megaloblasts in the circulating blood, leukopenia, and relative lymphocytosis developed. The bone marrow showed primitive red cells and leukocytic hyperplasia, as well as numerous megakaryocytes. In some of the affected workers, death occurred as late as 4 to 6 years after they left their occupation. Hyperplastic marrow and macrocytic anemia have also been noted in human beings and animals subjected only to external roentgen radiation ( 15 , 16 ). The practice of making regular blood counts in people occupationally exposed to radiation yields little to justify it ( 17 ). Degrees of radiation exposure 20 times greater than the maximal permissible dose may produce a real drop in neutrophils or lymphocytes, and serious aplastic anemia has been observed to occur without a preceding decrease in blood counts. Regular physical measurement of the doses received by the use of film badges and other methods is a more practical procedure in most situations.

**DRUGS AND CHEMICALS** [Table 44.1](#) lists many of the drugs and chemicals associated with an increased risk of aplastic anemia. Of note, many drugs and toxins have been

implicated by circumstantial evidence and may represent confounding factors associated with other, unrecognized, primary etiologies. For example, if an individual develops an infection and is treated with an antibiotic and an analgesic and then is subsequently found to have pancytopenia, it is impossible to determine whether this is secondary to the infection, the pharmacologic exposures, a synergistic interaction of disease and treatment, or is unrelated. Thus, although the listed agents warrant judicious use, they are by no means prohibited if the clinical indications for their use in a specific patient are strong. Even drugs that carry increased risks of marrow failure account for only a minority of cases ( 3 ).

**TABLE 44.1. Drugs and Chemicals Associated with Aplastic Anemia**

---

Agents that regularly produce marrow depression as major toxicity in commonly used doses or normal exposures

Cytotoxic drugs used in cancer chemotherapy

Benzene (less often benzene-containing chemicals)

Agents probably associated with aplastic anemia but with a relatively low probability relative to their use

Chloramphenicol

Insecticides

Antiprotozoals: quinacrine and chloroquine

Nonsteroidal antiinflammatory drugs: phenylbutazone, indomethacin, ibuprofen, sulindac, and aspirin

Anticonvulsants: hydantoins, carbamazepine, phenacemide

Gold (and possibly other heavy metals such as arsenic, bismuth, mercury)

Sulfonamides as a class: some antibiotics, antithyroid drugs (e.g., methimazole, methylthiouracil, and propylthiouracil), antidiabetes drugs (e.g., tolbutamide and chlorpropamide), carbonic anhydrase inhibitors (e.g., acetazolamide and methazolamide)

D-Penicillamine

Estrogens (in pregnancy and in high doses in animals)

Agents more rarely associated with aplastic anemia

Antibiotics: streptomycin, tetracycline, methicillin, mebendazole, sulfonamides, trimethoprim/sulfamethoxazole, flucytosine

Antihistamines: cimetidine, ranitidine, chlorpheniramine

Sedatives and tranquilizers: chlorpromazine, prochlorperazine, piperacetazine, chlordiazepoxide, meprobamate, methyprylon

Allopurinol (may potentiate marrow suppression by cytotoxic drugs)

Methyldopa

Quinidine

Lithium

Guanidine

Potassium perchlorate

Thiocyanate

Carbimazole

---

From Shimamura A, Young NS. Acquired bone marrow failure syndromes. In: Handin RI, Lux SE, Stossel TP, eds. *Blood: principles and practice of hematology*, 2nd ed. Philadelphia: Lippincott, Williams & Wilkins, 2002, with permission.

---

The mechanisms whereby drugs might cause aplastic anemia are diverse. Some drugs, such as certain chemotherapeutic agents, may be directly cytotoxic to bone marrow precursor cells. In most cases, however, drug-related aplasia is idiosyncratic and occurs

unpredictably in a minority of individuals. A genetic predisposition has been suggested for some cases of idiosyncratic drug-induced aplasia.

***Benzene and Its Derivatives*** Benzene has been known as a cause of fatal aplastic anemia since a description in 1897 of four cases in workers in a bicycle-tire factory ( [18](#) ).

Benzene (C<sub>6</sub>H<sub>6</sub>) is a hydrocarbon byproduct of the manufacture of coke. Benzene is used as a solvent for rubber, gum, resins, fats, and alkaloids and in the manufacture of drugs, dyes, and explosives. It has been used in many industries, including the manufacture of artificial leather, natural leather products, enamels, rubber, waterproof fabrics, lacquers, shellac, paint removers, batteries, and bronzing, silvering, and gilding liquids; in electroplating, lithography, photography, dry cleaning, and feather preparation; and in the airplane, linoleum, and celluloid industries. Certain petroleum fractions contain significant quantities of benzene and often are used to clean machinery parts or to remove grease from the hands. Benzene is volatile and consequently is readily absorbed by inhalation in badly ventilated rooms; it is poorly absorbed through the skin ( [19](#) ). In industrialized countries, exposure limits have been established, but higher levels are common in the manufacturing sector of developing nations. Even though industrial exposure appears to be declining, benzene remains an important cause of hematopoietic damage. Benzene is found in gasoline, automobile emissions, and cigarette smoke, and a concern of possible benzene exposure in the general population has been raised as the result of surveys using sensitive assays of urinary metabolites of benzene ( [20](#) ). Great variations are noted in susceptibility to benzene poisoning ( [18](#) ). Evidence of poisoning may appear in a few weeks or only after many years of exposure, or it may not be discovered until the onset of infection, long after exposure has ceased. The classic picture of leukopenia, thrombocytopenia, and severe anemia represents only the severe and fatal spectrum of poisoning by benzene. Among exposed workers, the most common abnormalities reported were anemia (48%), thrombocytopenia (33%), and leukopenia (15%) ( [18](#), [21](#) ). Other manifestations of poisoning are lymphocytopenia, increased reticulocyte counts, eosinophilia, immature marrow elements in the circulating blood, leukocytosis, and pseudo-Pelger-Huet cells ( [18](#), [22](#) ). Evidence of increased blood destruction also has been reported. In one survey, serum bilirubin values were elevated in one-third of the subjects ( [23](#) ). Like the blood abnormalities, which may be of the regenerative or the hemolytic type instead of aplastic, the bone marrow may be hyperplastic rather than acellular.

Extramedullary hematopoiesis has been observed ( [18](#) ), and the complete picture of myeloid leukemia has been described in a few patients ( [24](#) ). More often, when extramedullary hematopoiesis has been present, splenomegaly and a blood picture of myelophthytic anemia have been found.

***Chloramphenicol*** A review of chloramphenicol-associated aplastic anemia can be found in reference [25](#). An analysis of 408 cases of chloramphenicol-associated, nonneoplastic depression of one or more blood cell types reported to the registry concluded that people of all ages are affected, with a broad age spectrum ranging from 25 to 65 years old for adults and a childhood peak ( [26](#) ). In 75% of the patients reported, all three blood cell types were depressed, and marrow hypoplasia was found. No clear relationship could be established between the development of the dyscrasia and previous exposure to the drug, the dose used, or continuous versus intermittent administration. In 50% of the subjects, evidence of reaction appeared within 38 days of the last dose, in 22% during therapy, and in 10% after 130 days. The overall mortality rate was approximately 50%, with one-half the number of deaths occurring within 50 days of the reaction. The pathogenesis of chloramphenicol-associated blood dyscrasia is unclear despite extensive research efforts. Two types of reactions have been described: a reversible suppression of erythropoiesis ( [27](#) ) and an irreversible aplasia ( [28](#), [29](#) ). Reversible bone marrow suppression primarily involving erythropoiesis occurs in approximately 50% of patients to whom chloramphenicol is given in large doses. In such cases, the marrow is not characterized by hypoplasia, and abnormal sideroblasts have been seen in the marrow of some patients. A striking finding in the bone marrow is vacuolization of the nucleus and cytoplasm of the erythroblasts and,

less often, the granulocytes ( [30](#) ). These toxic effects usually are observed between 11 and 18 days after initiation of antibiotic therapy. If the drug is withdrawn at this point, the reaction is reversible. Severe and often irreversible bone marrow aplasia, often resulting in death, does not manifest any clear clinical or pathogenic relationship to the reversible form of erythropoietic suppression. Individual susceptibility appears more likely. Because in most cases aplastic anemia becomes evident only after drug use has been discontinued and a long period of aplasia follows, some type of damage that lingers long after the last traces of drug have disappeared must be considered. No evidence exists to indicate that monitoring the effects of chloramphenicol by repeated blood counts reduces the incidence of chloramphenicol-associated aplastic anemia.

**VIRUSES** Patients with bacterial or viral infections frequently develop moderate pancytopenia. Cases of aplastic anemia have been reported in the context of a number of diverse viruses (reviewed in reference [9](#) ). As in the prior example, such patients receive multiple medications, confounding the etiologic factor for the pancytopenia. Furthermore, in some cases, it is unclear whether the infection came before or after the pancytopenia. Several models have been proposed for the mechanism by which viruses induce bone marrow aplasia. Viruses may be directly cytotoxic to bone marrow cells. Alternatively, viral infection of bone marrow progenitor cells may stimulate an immune response against those cells through activation of cytotoxic lymphocytes, cell-surface expression of viral proteins, or shared epitopes leading to an autoimmune reaction. Infection of bone marrow stromal cells has also been postulated to compromise the bone marrow microenvironment and result in diminished hematopoiesis. Acute hepatitis has been associated with the subsequent development of aplastic anemia (reviewed in reference [31](#) ). Antecedent hepatitis has been noted in 2 to 5% of aplastic anemia cases occurring in the West. The converse is less common; less than 0.07% of total pediatric hepatitis cases have been followed by the development of aplastic anemia, and less than 2% of the non-A, non-B hepatitis cases. The association appears to be much higher in patients undergoing liver transplant for hepatic failure after non-A, non-B hepatitis: 28% or 9 of 32 patients in one series. Post-hepatitis aplastic anemia has not been consistently associated with any of the known hepatitis viruses. The clinical features of aplastic anemia after hepatitis have been described. Bone marrow suppression generally occurs during convalescence approximately 2 months after the acute hepatitis episode. Untreated hepatitis-associated aplastic anemia has a particularly poor prognosis. In one early series of 174 cases, more than 90% of patients died within 1 year of diagnosis, and the average duration of survival was only 11 weeks from onset of pancytopenia ( [31](#) ). These patients may respond to antithymocyte globulin (ATG) ( [32](#) , [33](#) and [34](#) ) or benefit from early bone marrow transplantation (BMT) ( [35](#) , [36](#) and [37](#) ). Acute infectious mononucleosis caused by Epstein-Barr virus (EBV) can be accompanied by aplastic anemia, albeit rarely. One study found immunologic and molecular evidence of EBV in the bone marrow cells of six aplastic anemia patients ( [38](#) ). Serologic evidence of recent infection or reactivation was documented in all six patients, but only two had a previous clinical history of typical infectious mononucleosis, suggesting that the virus may be involved more frequently than recognized from the history alone ( [38](#) , [39](#) ). Patients with aplastic anemia and herpes simplex infections may respond to acyclovir therapy ( [40](#) , [41](#) ). Suppressor T-cell activation may mediate EBV-associated bone marrow failure ( [42](#) ). One patient with EBV-associated aplastic anemia responded to ATG ( [43](#) ). Although cytomegalovirus (CMV) infection generally produces only mild clinical symptoms, it may be associated with bone marrow failure, particularly in immunosuppressed patients. In immunodeficient mouse models, CMV infection prevented bone marrow reconstitution in a manner that could be reversed by the presence of cytotoxic CD8<sup>+</sup> cells ( [44](#) , [45](#) ). CMV inhibition of hematopoiesis may occur through primary infection of bone marrow precursor cells, bone marrow stromal cells, or through reversal of the T helper/T suppressor ratio. Although the pancytopenias associated with human immunodeficiency virus (HIV) infection are generally associated with cellular but dysplastic marrow, aplastic anemia may also occur ( [46](#) ). Concomitant



infections and myelosuppressive drug therapies can also contribute to marrow hypocellularity in this patient population ( 47, 48 ). Cytopenias in acquired immunodeficiency syndrome patients may also stem from immune destruction or from retroviral infection of bone marrow precursor cells ( 49, 50 ). Recent *in vitro* studies indicate that neither HIV-1 nor HIV-2 infects human CD34<sup>+</sup> bone marrow cells ( 51 ).

**PAROXYSMAL NOCTURNAL HEMOGLOBINURIA** Paroxysmal nocturnal hemoglobinuria (PNH) is characterized by the clinical triad of intravascular hemolysis, venous thrombosis, and bone marrow failure ( Chapter 37 ). The increased sensitivity of erythrocytes to complement is due to an inability to inactivate complement on the cell surface. PNH was found to affect diverse membrane proteins sharing a common structural feature: the glycosylphosphatidylinositol (GPI) anchor linking these proteins to the cell membrane. GPI covalently binds to specific carboxyl terminal protein sequences and attaches them to cell membrane phosphatidylinositol residues. The genetic defect in PNH was found to reside in the X-linked PIG-A (phosphatidylinositol glycan class A) gene whose product functions in an early step in GPI anchor formation. The PNH defect can be detected by the absence of GPI-anchored cell-surface proteins in flow cytometry. Approximately 20 to 50% of patients presenting with aplastic anemia manifest the PNH cell phenotype on their granulocytes and erythrocytes by this assay ( 52, 53 ). Detection of the PNH phenotype is more sensitive by flow cytometric analysis than by sucrose hemolysis or acid lysis tests because flow cytometry can detect smaller numbers of abnormal cells and is not affected by prior red cell transfusion if neutrophils are assayed. Aerolysin-based assays may allow detection of even smaller PNH clonal populations. Because the toxin aerolysin must bind to the GPI anchor before forming transmembrane channels that lead to cell lysis, PNH cells do not bind aerolysin and are unaffected by concentrations that lyse normal cells. In one series, PNH clones were detected in 61% (14 of 23) of aplastic anemia patients using the aerolysin-based assays but in only 4% (1 of 23) of these patients by flow cytometry ( 54 ). The PNH defect may also appear during the course of otherwise typical aplastic anemia. Aplastic anemia-PNH patients can respond to immunosuppressive therapy. Studies of hematopoiesis in PNH patients have not detected any selective proliferative advantage of the GPI-anchored protein-deficient hematopoietic clones ( 55 ). Severe combined immunodeficiency mice infused with bone marrow from PNH patients showed preferential engraftment with the PNH clones ( 56 ). An *in vitro* study comparing proliferation of PIG-A(-) and PIG-A(+) CD34 cells from PNH patients found a selective growth deficiency in the PIG-A(+) cell population rather than an advantage for the PIG-A mutant cells ( 57 ). Fas expression was elevated on the wild type compared with the GPI-deficient cells, suggesting increased resistance to apoptosis as one potential mechanism for these findings. Expansion of the PNH clone has been proposed to be the result of escape from an immune-mediated bone marrow suppressive process ( 58 ). Another possibility is that the abnormal PNH clone itself might trigger an aberrant immune response, culminating in immune-mediated bone marrow failure ( 59, 60 ). In support of an immune disorder underlying PNH, abnormal T-cell clonal expansions were noted in PNH patients, as compared with multitransfused hemoglobinopathy patients or age-matched healthy controls ( 61 ). Arguing against the model of PNH as a form of escape from immune-mediated bone marrow failure is the observation that PNH clone size did not show any consistent change as a result of immunosuppression or relapse. A third possibility is that PNH represents a primary stem cell abnormality. The role of immune, proliferative, and survival mechanisms in marrow aplasia continues to be investigated ( 62 ).

## Pathophysiology

**HEMATOPOIETIC STEM CELLS** Low numbers of bone marrow hematopoietic progenitor cells have been consistently reported in aplastic anemia. The long-term-culture-initiating cell, which serves as a surrogate measure of hematopoietic stem cells, is markedly

reduced in aplastic anemia patients ( [63](#), [64](#) ). CD34<sup>+</sup> cell numbers are also greatly diminished ( [65](#), [66](#) ). Several lines of evidence support the hypothesis that abnormalities in the hematopoietic stem cell compartment may contribute to the development of aplastic anemia. Stem cell infusion from an identical twin donor without prior conditioning of the recipient is curative in approximately 50% of cases ( [67](#) ). These results are consistent with a primary underlying stem cell deficiency and argue against disorders of the bone marrow microenvironment or global immune dysfunction as the only causes of stem cell destruction, at least in a subset of patients. Although the requirement for prior conditioning in approximately 50% of BMTs between syngeneic twins has been interpreted to indicate an underlying immune process targeted on bone marrow cells, it is also possible that such conditioning is necessary to ablate an abnormal bone marrow precursor with suppressive rather than proliferative qualities. Low stem cell numbers persist even after hematologic recovery with immunosuppressive therapy ( [68](#) ). Blood cell parameters, such as macrocytosis, do not return to normal after medical therapy in many cases. The increased incidence of late clonal disorders, such as myelodysplasias (MDSs) or acute leukemia, also suggests an underlying stem cell defect. Ball et al. ( [69](#) ) reported significant telomere shortening in the leukocytes of aplastic anemia patients. Because telomeres play an important role in maintaining stable chromosome ends and preventing chromosomal rearrangements, it is possible that chromosomal instability may contribute to progressive marrow aplasia. A second study reported relatively normal telomere lengths in patients who responded to immunosuppression, whereas untreated or unresponsive patients showed significant telomere shortening ( [70](#) ). Whether telomere shortening represents a primary versus a secondary event in the genesis of aplastic anemia remains to be ascertained.

**HEMATOPOIETIC STROMA AND GROWTH FACTORS** Inability of the bone marrow stroma to support hematopoiesis has been proposed as a potential mechanism underlying aplastic anemia ( [11](#) ). Abnormal adipocyte proliferation, based on morphologic characteristics of fatty marrow in patients and controls, has even been proposed as the primary lesion in aplastic anemia ( [71](#) ). Animal models of stromal cell defects resulting in bone marrow failure have been reported. For example, bone marrow failure due to a stromal defect occurs in the Sl/Sl<sup>d</sup> mouse. In this disorder, a genetic defect of the Sl<sup>d</sup> allele results in an anemia that is not corrected by stem cell infusion but is cured by splenic transplantation. The product of the Sl allele is stem cell factor, the ligand for the c-kit receptor ( [72](#), [73](#) and [74](#) ). The presence of normal stem cells in Sl/Sl<sup>d</sup> mice is shown by the ability of their spleen or bone marrow to cure W/W<sup>v</sup> animals carrying a mutation in the gene for c-kit. Parallel results occur in long-term bone marrow cultures: Stroma of Sl/Sl<sup>d</sup> animals does not support hematopoiesis by W/W<sup>v</sup> cells, whereas W/W<sup>v</sup> stroma supports hematopoiesis from Sl/Sl<sup>d</sup> mice ( [75](#) ). Evidence to date fails to support a clear role for bone marrow stromal cell defects in the pathogenesis of aplastic anemia. Direct evidence for a microenvironmental defect in aplastic patients has not been found in biochemical analysis of the composition of fat cells ( [76](#) ) or in ultrastructural studies of marrow microvasculature ( [77](#) ). After marrow transplantation, most stromal cell elements remain of host origin ( [78](#) ) and adequately support the donor's stem cells. Bone marrow stromal cells derived from aplastic anemia patients can support hematopoiesis of normal CD34<sup>+</sup> cells in culture, whereas CD34<sup>+</sup> cells derived from aplastic anemia patients failed to grow on normal stromal control cells ( [79](#), [80](#) ). Hematopoietic growth factor production and plasma levels are usually elevated rather than decreased in aplastic anemia patients (reviewed in reference [81](#) ). Circulating levels of erythropoietin, granulocyte colony-stimulating factor (G-CSF) and granulocyte-macrophage colony-stimulating factor (GM-CSF), thrombopoietin, and flt-3 ligand are elevated in patients with aplastic anemia. Stem cell factor levels have been reported to be low to normal. Levels of interleukin-1 (IL-1), produced by monocytes, are low in aplastic anemia. Therapeutic trials with these

factors have not been consistently successful and have generally resulted in partial rather than complete hematologic improvement ( [82](#) ), casting doubt on the pathophysiologic significance of these factor deficiencies.

**IMMUNE SUPPRESSION OF HEMATOPOIESIS** Aplasia often responds to treatment with antilymphocyte globulin/ATG (ALG/ATG) and/or cyclosporin A (CYA). This response to treatment regimens that suppress immune function has fueled current theories of immune-mediated bone marrow suppression as the mechanism underlying aplastic anemia. The antilymphocyte preparations contain heterogeneous mixtures of antibodies and are clearly immunosuppressive as well as generally cytotoxic. They lead to rapid lymphopenia during and immediately after treatment, and reduced levels of lymphocytes persist for months. Cyclosporin exerts inhibitory effects on T cells and on transcription of genes for cytokines, including IL-2 and  $\gamma$ -interferon ( [83](#) ). Nonetheless, the attribution of immune dysregulation as causal in aplastic anemia based on therapy must be tempered with caution because ATG and cyclosporin exert multiple effects in addition to immunosuppression. ATG is a complex mixture of diverse antibodies directed against a wide range of antigens, including signal transduction and adhesion molecules ( [84](#) ). The active component(s) of ATG in aplastic anemia has yet to be identified. Therapies with mixtures of monoclonal antibodies specific for human T cells have not been very effective in clinical trials to date (reviewed in reference [85](#) ). Furthermore, ATG can increase colony growth in normal, MDS, and aplastic anemia CD34<sup>+</sup> bone marrow cells in culture ( [86](#) ). ATG treatment also reduces the expression of Fas-Ag on aplastic anemia bone marrow CD34<sup>+</sup> cells ( [87](#) ). As cyclosporine is thought to be more specifically immunosuppressive than ATG, its efficacy has been cited as further evidence for T-cell mediation in the pathophysiology of aplastic anemia; however, cyclosporine therapy also has a multitude of additional effects. Recent studies reporting ATG ( [88](#) ) or cyclosporin ( [89](#) ) to be effective in the treatment of MDS suggest either that these agents act on the bone marrow in addition to modulating immune function or an immune mechanism underlying MDS ( [90](#) ). A role for immune dysregulation is supported by several studies of T-cell characteristics in aplastic anemia. T cells were first implicated by *in vitro* studies of an aplastic patient's bone marrow in mixing and depletion experiments. Hematopoietic colony formation occurred only after physical separation of myeloid cells from lymphocytes; colony formation was improved by addition of antilymphocyte serum, and the patient's bone marrow cells inhibited normal bone marrow colony formation. In several larger series, inhibition was detected in most ( [91](#), [92](#) ) or at least some patients ( [93](#), [94](#) ). In contrast, other studies reported that only a minority of cases showed cellular suppression of hematopoiesis ( [95](#), [96](#) ), and others found no evidence of inhibitory cells ( [97](#) ). Suppressor cell activity has shown variable responses to therapy ( [92](#), [98](#), [99](#) ). Because many of these studies were performed in pretreated or transfused patients, lymphocyte function could arguably also represent a secondary phenomenon. Use of T-cell depletion was proposed to distinguish the transfusion effect; marrow burst-forming unit erythrocyte-derived colony formation was increased by this maneuver in 8 of 32 patients ( [100](#) ). Studies of heavily transfused patients with diverse hematologic diseases as controls ( [91](#), [101](#) ) or using the T-cell depletion assay continued to support a role for immune-mediated bone marrow suppression in some patients ( [92](#), [93](#) ). Analysis of cell-surface phenotypes further suggests an immune-mediated pathogenesis for aplastic anemia. Lymphocytes with immunoglobulin G receptors and T $\gamma$ <sup>+</sup>-activated cytotoxic lymphocytes were reported in aplastic but not in normal bone marrow ( [102](#) ). Cell clones of this phenotype have been isolated from patients, and *in vitro* they overproduce inhibitory cytokines and inhibit hematopoiesis ( [103](#), [104](#) and [105](#) ). Altered T-helper and T-cytotoxic cell profiles have been reported in patients with aplastic anemia ( [106](#), [107](#) and [108](#) ). Identification of a T-cell clone showing HLA-DRB1 0405-restricted cytotoxicity for hematopoietic cells was seen in one patient with aplastic anemia ( [109](#) ). Studies of V $\beta$  T-cell receptors have not found any

general restriction of T-cell clonality or of dominant lymphocyte clones ( [110](#)). Skewing of the CDR3 (complementarity-determining region 3) of the V<sub>β</sub> region of the T-cell receptor, suggestive of clonal predominance, has been noted in a small group of cyclosporin-dependent patients ( [111](#)). Furthermore, analysis of the CDR3 region of CD4 cells derived from five patients with aplastic anemia and an HLA-DR2 haplotype showed a high frequency of clones bearing identical CDR3 DNA sequences that were not found in normal controls ( [112](#)). Skewing of the CDR3 V<sub>β</sub> size distribution was increased in newly diagnosed aplastic anemia patients, as compared with age-matched healthy controls or multiply transfused control patients; however, the degree of V<sub>β</sub> skewing showed either no change after ATG treatment or increased after CYA treatment, calling into question the etiologic significance of this correlation ( [113](#)). It remains to be determined whether these oligoclonal T-cell expansions represent either a cause or an effect of the aplastic bone marrow process.

## Clinical Features

The presenting symptoms of aplastic anemia generally reflect the underlying anemia, neutropenia, or thrombocytopenia. Bleeding or bruising secondary to thrombocytopenia is common and typically presents as easy bruising and petechiae, usually over dependent surfaces, bleeding gums, and epistaxis. In a study of 22 aplastic anemia patients, the most common oral manifestations were petechiae and spontaneous gingival bleeding ( [114](#)). Heavy menstrual flow or menorrhagia is common in menstruating women. In classic cases of PNH, dark red urine is reported, but visible bleeding from the genitourinary and gastrointestinal tracts is otherwise rare on presentation in patients with aplastic anemia. Major hemorrhage from any organ can occur in aplastic anemia but is usually not seen until late in the course of the disease and is generally associated with infections (especially invasive fungi), drug therapy (e.g., ulcerogenic corticosteroids), or traumatic therapeutic procedures (e.g., intravenous line placements). Patients also present with nonspecific symptoms of fatigue, lack of energy, shortness of breath, or even angina secondary to anemia, although its gradual onset allows physiologic compensation even at alarmingly low hematocrits. Young children may present with poor feeding, lack of interest in playing, or excessive sleep. Patients can also present with a fever in the setting of neutropenia. Most patients appear clinically well on initial presentation.

A careful history should be obtained regarding exposures to drugs or chemicals or any preceding infections. Any family history of blood diseases, early onset cancers, or congenital anomalies should be ascertained to assess for a potential inherited bone marrow failure syndrome.

The physical examination is generally unremarkable except for bruising and petechiae, as noted above. Hepatosplenomegaly and lymphadenopathy are usually absent. The presence of short stature; congenital anomalies, such as abnormal thumbs or forearms; café au lait spots; rashes; or nail abnormalities suggests a possible underlying inherited bone marrow failure disorder such as Fanconi anemia (FA) or dyskeratosis congenita (DKC) (see sections [Fanconi Anemia](#) and [Dyskeratosis Congenita](#)).

## Laboratory

**PERIPHERAL BLOOD** Peripheral blood cytopenias and bone marrow hypocellularity constitute the key diagnostic features of aplastic anemia. The severity of aplastic anemia was classified by Camitta et al. ( [115](#)) in an effort to make possible the comparison of diverse groups of patients and different therapeutic approaches. Diagnosis of severe aplastic anemia requires that the patient have at least two of the following: a granulocyte count below 500/μl, a platelet count below 20,000/μl, and an absolute reticulocyte count

=  $40 \times 10^9$ /L. In addition, the bone marrow biopsy must contain less than 25% of the normal cellularity. Very severe aplastic anemia is further defined by a granulocyte count  $<200/\mu\text{l}$  (116). Mild or moderate aplastic anemia is distinguished from the severe form by the presence of mild or moderate cytopenias and more variable, but still deficient, bone marrow cellularity. These distinctions are more than semantic; they are critical for the prediction of outcome and the choice of therapy. The workup of the patient with peripheral blood pancytopenia should be focused on eliminating diagnoses for which alternative curative therapies are available or for which treatments for aplastic anemia would be inappropriate. Although a complete workup is important, it also behooves the clinician to draw the minimal volume of blood necessary, particularly from small pediatric patients. Table 44.2 lists the differential diagnosis of pancytopenia. *Pancytopenia* is a descriptive term referring to a reduction in all three blood cell lineages: erythrocytes, leukocytes, and platelets. Pancytopenia can result from diverse mechanisms. For example, pancytopenia can be associated with a decrease in hematopoietic cell production in the bone marrow secondary to toxins, medications, or infections. In such cases, the bone marrow appears hypoplastic. Replacement of normal marrow by malignant cells, granulomas, or storage cells points to other etiologies for pancytopenia. In other situations, the marrow may appear normocellular or even hypercellular. Such a marrow might be seen in cases of ineffective hematopoiesis, formation of defective cells that are rapidly removed from the circulation, peripheral sequestration of normal cells in a hypertrophied or overactive reticuloendothelial system, or immune-mediated destruction.

**TABLE 44.2. Differential Diagnosis of Pancytopenia**

---

Hypocellular bone marrow

Acquired aplastic anemia

Inherited bone marrow failure syndrome (e.g., Fanconi anemia, dyskeratosis congenita, amegakaryocytic thrombocytopenia, and Shwachman–Diamond syndrome)

Hypoplastic myelodysplastic syndrome

Virus-associated aplastic anemia

Cellular bone marrow

Primary bone marrow disease

Malignant/clonal

Myelodysplasia

Myelofibrosis

Paroxysmal nocturnal hemoglobinuria

Acute myelogenous leukemia

Acute lymphoblastic leukemia

Hemophagocytic lymphohistiocytosis

Osteopetrosis

Secondary to systemic disease

Metastatic solid tumors

Autoimmune

Systemic lupus erythematosus

Sjögren syndrome

Nutritional/toxic

Vitamin B<sub>12</sub> deficiency

Folate deficiency

Alcoholism

Infections

Overwhelming infection/sepsis

Virus

Brucellosis



Ehrlichiosis  
Mycobacteria  
Storage disease  
Gaucher  
Niemann–Pick  
Sarcoidosis  
Anatomic  
Hypersplenism

---

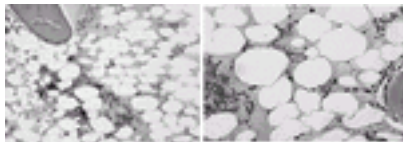
A suggested laboratory evaluation for aplastic anemia is outlined in [Table 44.3](#). The red cell morphology is normal other than the frequent finding of macrocytosis. Fetal hemoglobin concentration and erythrocyte i antigen expression may be increased. The absolute reticulocyte count is low. Neutrophils may show toxic granulations. Decreases in monocyte and lymphocyte counts are variably seen. Platelet size is most often normal. Folate and vitamin B<sub>12</sub> levels are normal. Erythropoietin levels are usually increased. Serum transaminase elevation, if present, suggests hepatitis-associated aplastic anemia. Elevated serum creatinine points to underlying renal disease. Because aplastic anemia can be the first presenting symptom of FA, chromosome breakage studies should be performed in all patients (see [Fanconi Anemia](#)). Peripheral blood should be sent for flow cytometry tests to rule out PNH. Once the diagnosis of aplastic anemia is confirmed, HLA typing should be performed on all patients and potential related donors (e.g., siblings and parents).

**TABLE 44.3. Laboratory Evaluation for Aplastic Anemia**

| Test   | Rationale  |
|--|--|
| Complete blood cell count and differential   | Define severity of aplasia   |
| Morphology   | Define abnormal cells (e.g., blasts or storage cells)  |
|  | Vitamin B <sub>12</sub> deficiency   |
| Reticulocyte count   | Define severity  |
|  | Differentiate production vs. destruction   |
| Bone marrow biopsy   | To assess cellularity  |
|  | To assess architecture (e.g., granuloma, fibrosis, hemophagocytosis, and infiltrative or metastatic disease) |
| Bone marrow aspirate   |  |
| Morphology   | Malignant vs. benign disease   |
|  | Storage disease  |
|  | Hemophagocytosis   |
|  | Congenital disorder  |
| Cytogenetics   | Myelodysplasia   |
| Culture  | Infectious agent (e.g., tuberculosis or virus)   |
| Other  | DNA/antigen-based viral tests  |
| Peripheral blood studies   |  |
| Aspartate aminotransferase, alanine aminotransferase, ?-glutamyltransferase, bilirubin | To evaluate for hepatitis  |
| Blood urea nitrogen, creatinine  | To assess for chronic renal failure  |

|  |  |
|--|--|
| Serologic testing  | To evaluate for human immunodeficiency virus, Epstein–Barr virus, hepatitis, other virus |
| Ham test/fluorescence-activated cell sorter              | To evaluate for paroxysmal nocturnal hemoglobinuria                                      |
| Chromosomal breakage studies (diepoxybutane/mitomycin C) | To assess for fanconi anemia   |
| Autoimmune disease evaluation                            | Evidence of collagen vascular disease  |
| Histocompatibility testing                               | To establish potential transplant donor pool   |

**BONE MARROW** Both a bone marrow aspirate to assess cell morphology, and a bone marrow biopsy to assess cellularity and architecture are required for diagnosis ( [Fig. 44.1](#)). Biopsy point counting (determination of numbers of cells in small grids) is the most accurate method of determining cellularity, but visual estimation is more frequently used ( [117](#)). The lower limit of normal marrow cellularity decreases with age, but in the typical adult, it is approximately 30%. Although aplastic anemia patients have decreased myeloid cellularity by definition, significant residual cellularity is present in some patients because of lymphocytosis. A few patients may manifest patchy areas of hematopoiesis ( [118](#)). Cellularity often diminishes rapidly, and a discordant relationship between cellularity and peripheral blood findings should prompt a repeat evaluation after a short interval.



**Figure 44.1.** Aplastic anemia bone marrow histology. A bone marrow biopsy obtained from a child with aplastic anemia shows the characteristic hypocellularity. Note the abundance of fat. The few cellular elements are comprised primarily of lymphocytes. See [Color Plate](#).

Individual cell morphology is best appreciated on Wright–Giemsa stain of the aspirate smear. The predominant cells usually are lymphocytes. Increased numbers of mast cells can also be associated with bone marrow failure. Dyserythropoiesis is common, with the “megaloblastoid” features of macrocytosis and some nuclear–cytoplasmic maturation asynchrony. An increase in myeloblast count is not seen in patients with aplastic anemia and may herald the evolution of leukemia from pancytopenia ( [119](#)). The biopsy usually shows almost complete replacement of the marrow with fat. Reticulin stains do not show increased marrow fibrosis. The presence of ring sideroblasts in iron-stained marrow should point to alternative diagnoses such as MDS. Intramedullary granulomas suggest other infectious or autoimmune diagnoses. Bone marrow cytogenetics are typically normal for patients initially presenting with aplastic anemia. In contrast, cytogenetic abnormalities are frequently found in myelodysplastic bone marrows and may be helpful in distinguishing aplastic anemia from hypoplastic MDS. The subsequent development of clonal cytogenetic abnormalities represents a serious complication of aplastic anemia and is discussed in the section [Complications of Immunosuppressive Therapy](#).

## Treatment

Severe aplastic anemia is a medical emergency and warrants an expeditious workup and prompt institution of treatment. The management of patients with aplastic anemia entails both corrective treatment of the bone marrow failure and the institution of aggressive supportive care.

**HEMATOPOIETIC STEM CELL TRANSPLANT** The earliest successful treatments for



aplastic anemia involved BMT ( 120, 121 ). As noted above, stem cell transplant (SCT) between identical twins in the absence of any conditioning regimen is curative in approximately 50% of cases. A recent study showed that long-term survival for identical twin transplants was highest using an algorithm of initial transplant without conditioning followed by a subsequent transplant with conditioning for any patients failing to engraft with the first transplant ( 67 ). None of the patients who failed the first transplant died before receiving a second transplant, and mortality was similar to that of patients who received conditioning upfront. In the absence of an identical twin donor, conditioning for transplant is necessary, although less intensive than that used for most other diseases. **Allogeneic Donors** Outcomes for several large studies of HLA-matched allogeneic SCT are summarized in Table 44.4. The improvement in survival rates over time has been attributed in large part to improvements in graft-versus-host disease (GVHD) prevention and graft rejection rates ( 122 ). From the most recent data reported to the International Bone Marrow Transplant Registry (IBMTR), among 1699 patients receiving HLA-identical sibling transplants for aplastic anemia between 1991 and 1997, the 5-year probabilities of survival (95% confidence intervals) by age were: up to 20 years of age, 75% ± 3%; between 21 to 39 years of age, 68% ± 4%; older than 40 years of age, 35% ± 18%. Survival data from single centers showed more variability but overlapped with the 95% confidence intervals reported by the IBMTR ( 123 ). Patient age, duration of aplasia before transplant, prior transfusion history, and clinical status all affected survival rates. Survival after SCT was not affected by severity of aplasia.

**TABLE 44.4. Allogeneic Stem Cell Transplant for Aplastic Anemia**

| Study (Reference)         | Survival (%)   | Chronic Graft-Versus-Host Disease (%) | Rejection/Failure (%) |
|---------------------------|----------------|---------------------------------------|-----------------------|
| Gluckman et al. ( 336 )   | 68 + 10 (5 yr) | 35                                    | 3                     |
| Champlin et al. ( 337 )   | 78 ± 10 (5 yr) | 12                                    | 17                    |
| May et al. ( 338 )        | 79 ± 8         | 0                                     | 29                    |
| Storb et al. ( 132, 339 ) | 89 (8 yr)      | 34                                    | 5                     |
| Passweg et al. ( 122 )    | 66 ± 6 (5 yr)  | 32                                    | 16                    |
| Reiter et al. ( 340 )     | 95 (15 yr)     | 53                                    | 0                     |

An unexpectedly high rate of engraftment failure was noted early on ( 124, 125 ) even in syngeneic transplants with ( 126 ) or without ( 127 ) conditioning. Graft rejection rates have been increased in aplastic patients undergoing SCT, compared to those with leukemia. The more intensive conditioning regimens used to eradicate malignant disease may also more effectively ablate the host immune system. Mixed hematologic chimerism occurs commonly after transplantation in aplastic anemia, and persistence of donor lymphocytes is highly associated with graft rejection (30% vs. 5% in complete chimeras) ( 128 ). Increased intensity of pretransplant conditioning regimens has been accompanied by significant decreases in graft rejection ( 116, 129 ). The rate of successful second transplants in response to graft rejection has also improved ( 129 ). Transfusion sensitization poses a significant risk for graft failure. In general, risk of graft rejection increases with higher numbers of units transfused, although this relationship does not appear strictly linear. In the IBMTR analysis, untransfused patients had a risk of rejection of approximately 5%, heavily transfused patients (more than 40 units) had a risk of more than 25%, and patients who received 1 to 40 units had an intermediate risk of approximately 15% ( 130 ). In the

Seattle retrospective analysis, increased graft rejection was observed in patients who had received more than 10 units of erythrocytes or 40 or more units of platelets ( [131](#) ). Studies of allogeneic transplantation of multiply transfused patients with severe aplastic anemia using a conditioning regimen combining cyclophosphamide with ATG ( [132](#) ) reported sustained engraftment in 96% of patients and 88% survival with a median follow-up time of 6 years ( [133](#) ). Increased survival in patients without transfusions could also reflect the influence of other variables, especially the absence of hemorrhage and infection in the patient who receives a transplant soon after diagnosis ( [134](#) ). Nonetheless, a plateau of graft rejection in the range of 5 to 10% persists. Improvements in stem cell engraftment accompanying intensification of conditioning regimens are counterbalanced by increased risks of GVHD and other end-organ toxicity syndromes. The IBMTR compared the efficacy over time of 1305 HLA-identical sibling BMTs performed between 1976 and 1992 and found that changes in GVHD prophylaxis accounted for much of the improvement in 5-year survival. Mortality from severe GVHD has not improved substantially over time, although the proportion of patients developing severe GVHD has declined ( [135](#) ).

**Alternative Donors** Approximately 70% of aplastic anemia patients do not have histocompatible sibling donors. Alternative potential donors include phenotypically matched relatives, partially matched (mismatched) relatives, and histocompatible but unrelated volunteers. Haplotype sharing between parents occasionally has allowed successful transplantation between phenotypically matched (but genotypically mismatched) family members. Survival after alternative donor transplants, although improving, has continued to be significantly lower than that achieved with matched HLA-identical sibling transplants for aplastic anemia (reviewed in reference [136](#) ). Transplantation with matched unrelated or mismatched donors is discussed in [Chapter 25](#). Retrospective analysis of patients undergoing unrelated donor transplant in the 1990s has resulted in disease-free survival rates of 56% at 5 years and confirms prior suggestions that earlier transplantation results in better outcomes ( [137](#) ). Also, age younger than 20 years again was associated with better outcomes. Umbilical cord blood has been used successfully as a source of hematopoietic stem cells for unrelated, often mismatched, transplantation ( [138](#), [139](#), [140](#), [141](#), and [142](#) ).

## IMMUNOSUPPRESSIVE THERAPY

**Antilymphocyte Sera** ATG or ALG, particularly in combination with additional agents, is an effective therapy for many aplastic anemia patients who do not receive SCTs. This has been particularly important for older patients who may not be candidates for SCT. Both horse ATG (ATGAM, Upjohn, Kalamazoo, MI) and rabbit ATG (Thymoglobulin, SangStat Medical Corp., Fremont, CA) are approved for use in the United States. ATG is derived from animals immunized with normal human thymocytes, whereas the immunogen for ALG is human thoracic duct lymphocytes. Studies have shown superior response rates in patients treated with ATG/ALG as compared with androgens (70% vs. 18%) as well as superior 1-year survival rates (76% vs. 22%) ( [143](#) ). A randomized trial also reported higher response rates to ATG as compared with supportive care only ( [144](#) ). However, variability in patient populations, differences in the definition of hematologic response, differences in the time at which a response is measured, and duplication of case material in the literature make an overall response rate to ATG difficult to approximate. Specific criteria used to measure improvement in aplastic anemia can include independence of need for transfusions (which may be subjective and does not measure neutrophil improvement), improvement in blood counts (which are altered by transfusion and affected by error at the low range of reticulocyte and platelet determinations), and clinical assessments of improvement ( [145](#) ). Although the average time to improvement in neutrophil number (the only objective measure unaffected by transfusion) is 1 to 2 months ( [145](#) ) and to transfusion independence is approximately 2 to 3 months ( [146](#), [147](#) ), continued improvement without further therapy commonly occurs beyond 3 months. A small fraction of patients are late responders, with responses observed as far out as 9 months ( [147](#) ).

ATG-induced remission rates vary between studies from a low of approximately 24% in severe disease ( 146 ) to high rates of approximately 85% ( 148 , 149 ). The true rate likely lies in the mid-range of 40 to 60%. Variations in ATG or ALG lots do not appear to account for differences in clinical response ( 150 ). In contrast to SCT, the likelihood of response to ALG has been correlated with disease severity ( 151 ), with the lowest responses in patients with absolute neutrophil counts less than 200/ $\mu$ l ( 152 ). Atgam is often given to a total dose of 100 to 160 mg/kg divided over 4 to 10 days. A comparison of ATG administered over 10 days versus 28 days showed no statistical difference in response rates ( 32 ). Lower frequency and severity of serum sickness is associated with shorter courses of ATG/ALG. The heterologous horse serum proteins trigger an immune response, leading to rapid clearance of ATG with resultant compromise of any benefit of prolonged administration of ATG ( 153 ). Patients who fail to respond within 2 to 3 months after the initial round of ATG/ALG may respond after a repeated course of treatment, with reported response rates varying from 22 to 64% ( 154 ). The three major side effects associated with antilymphocyte serum treatment are immediate allergic reactions, serum sickness, and transient blood count depression. Fever, rigors, and urticaria are common on the first day or two of therapy and respond to antihistamines, steroids, and meperidine. Anaphylaxis is rare but can occur. Patients treated with a second course of ATG of the same animal species have not shown any significant increase in side effects, although the side effects were seen sooner during the subsequent administration ( 154 ). Serum sickness, caused by the patient's antibody response to the horse/rabbit proteins, is a common occurrence. Serum sickness usually begins 5 to 11 days after the first dose of horse/rabbit immunoglobulin. Although the symptoms are generally brief, they can persist for weeks. Clinical manifestations are variable and include symptoms of fever, malaise, a cutaneous maculopapular rash, arthralgia, and myalgia. Gastrointestinal and neurologic symptoms may also be seen. A serpiginous rash on the volardorsal border of the hands and feet is an early pathognomonic sign. Urinalysis and creatinine clearance may be transiently abnormal, but frank renal failure is uncommon. In severe cases, rhabdomyolysis and myocarditis may be seen. There is no correlation between hematologic recovery and serum sickness ( 155 ). Corticosteroids are usually administered in moderate doses (1 mg/kg of prednisone or methylprednisolone) during the first 2 weeks to minimize the symptoms of serum sickness. In addition to lymphocytes, ATG reacts with cell-surface antigens on granulocytes, platelets, and red cells, and decreased blood cell counts are common during the immediate period of ATG use. No direct comparisons between ATG and ALG, or even between ATG preparations derived from horses versus rabbits for the treatment of aplastic anemia, are available. A comparison between horse versus rabbit ATG on *in vitro* T-cell priming effects showed similar levels of tumor necrosis factor- $\alpha$ , interferon- $\gamma$ , and GM-CSF in T-cell supernatants as well as similar effects of T-cell supernatants on colony formation. It is important to be aware that ATG/ALG consists of crude mixtures of antibodies against a myriad of targets and that their active components have yet to be identified. Monoclonal antibodies directed against T cells have not been effective in the treatment of aplastic anemia either as single agents or in combination. Thus, it remains to be demonstrated whether the lymphocytotoxic and immunosuppressive effects of ATG/ALG are responsible for their therapeutic effects. Pleiotropic effects of ATG/ALG have been identified. ATG can increase colony growth of cultured bone marrow cells ( 86 ) and reduce the expression of Fas-Ag on aplastic anemia bone marrow CD34<sup>+</sup> cells ( 87 ). ATG also includes antibodies against a variety of signal transduction and cell adhesion molecules ( 84 ). In a mouse model, ATG increased circulating levels of colony-stimulating activity ( 156 ). ATG also binds directly to bone marrow precursor ( 157 ) and progenitor ( 158 ) cells. In the absence of complement-mediated lysis, ATG/ALG can also stimulate lymphocyte function ( 159 , 160 ). **Cyclosporin** CYA is an effective immunosuppressive drug that has been successfully used to treat many autoimmune diseases ( 161 ). Although it has highly specific inhibitory effects on T-lymphocyte function, the mechanism of action responsible for its therapeutic effect

in aplastic anemia has yet to be conclusively demonstrated. CYA inhibits inducible gene transcription and affects production of IL-2 and  $\gamma$ -interferon but not colony-stimulating factors. Cytotoxic T-cell activation of IL-2 receptors in response to lectins and alloantigens is prevented by cyclosporine. Multiple studies of aplastic anemia patients report responses to CYA ( [162](#), [163](#) ), although the success rates were highly variable ( [164](#), [165](#) ). A cooperative group study comparing patients with severe aplastic anemia randomly assigned to receive either ALG or CYA as initial therapy found equivalent remission rates and survival in the two groups ( [166](#), [167](#) ). As with ATG, clinical response cannot be predicted by *in vitro* tests. For many patients, remissions have been sustained even after discontinuation of CYA, although some patients relapse once CYA is discontinued. A proportion of patients who relapse respond to a second course of treatment. Some patients are unable to be weaned off CYA and require maintenance CYA treatment ( [165](#) ). Oral cyclosporin is generally administered twice daily at a dose that maintains blood trough levels between 100 and 250 ng/ml, as measured by radioimmunoassay ( [161](#) ). Hematologic responses can take weeks to months, and an initial trial period of 3 to 6 months is generally recommended. Periodic measurements of blood levels of CYA are necessary to ensure adequate immunosuppression and to avoid toxicity. Variability in cyclosporine metabolism, especially in children, may require serum levels to be determined frequently for dose adjustments ( [168](#) ). Cyclosporine toxicities include hypertension, azotemia, hirsutism, and gingival hypertrophy. Increasing serum creatinine levels are an indication to lower the dose ( [161](#) ). Chronic, irreversible nephrotoxicity can occur with long-term exposure. Cyclosporine, especially in combination with other agents, results in temporary immunodeficiency and new susceptibility to opportunistic infections.

**Combination Immunosuppressive Therapy** A striking increase in the response rate to immunosuppression was achieved using combination therapy with ALG and CYA: an 85% hematologic remission rate at 6 months, compared with 50% in those treated with ALG alone ( [169](#) ). Furthermore, CYA appeared to increase the tempo and extent of the responses. Subsequent trials have supported the improved effect of combined treatment with response rates of approximately 70 to 80% and 5-year survival rates of 90% in responders. Intensive immunosuppressive therapy has particularly improved the results in patient populations generally refractory to ALG or ATG alone such as patients with very severe disease or children ( [170](#) ). A study enrolling both children and adults observed response rates of 67% at 43 months and a 5-year survival of 86% in those responding to treatment ( [171](#) ). The Gruppo Italiano Trapianti di Midollo Osseo/European Group for Blood and Marrow Transplantation study of 100 patients with severe aplastic anemia, including children (median age, 16 years) treated with ALG, CYA, prednisolone, and G-CSF, found trilineage hematopoietic responses in 77% after one or more courses of ALG ( [172](#) ). ATG is typically given over a 4-day course followed by a 6- to 12-month course of cyclosporin. When cyclosporin is discontinued, blood counts should be closely monitored. Some patients require continuous cyclosporin, and they should be maintained on the lowest effective dose. A review of ongoing trials revealed that 14 to 29% of initial responders have required continuous treatment ( [171](#) ). The reoccurrence of frank pancytopenia generally requires a second course of ATG followed by full-dose cyclosporin. Patients treated with immunosuppressive therapy often continue to have subnormal counts, although levels are functionally adequate. Thus, the goal of treatment is to maintain blood counts in a range that is adequate to minimize the risks of bleeding and infection and to prevent excessive fatigue. The addition of high-dose methylprednisolone to ALG has been associated with high response rates in some trials ( [148](#), [149](#) ) but not in other studies ( [173](#) ). Survival was the same for low- and high-dose methylprednisolone ( [152](#) ). A retrospective analysis of published series failed to find any advantage for the high-dose regimen ( [174](#) ). Because very high doses of corticosteroids can be associated with serious toxicity, this regimen is not currently recommended as first-line therapy.

**Relapse** Relapse is common after immunosuppressive therapy, with a 1993 report



estimating relapse risk at 35% at 14 years ( [175](#) ). An ongoing National Institutes of Health trial noted a higher relapse rate, with an apparent plateau at 64% between 7 and 10 years, possibly an offsetting result of the higher initial response rates noted with cyclosporine-containing combination regimens ( [171](#) ). Disease severity, age, sex, and etiology were not predictive of relapse. A short interval to response after initiation of therapy and a long interval from diagnosis to treatment correlated with an increased risk of relapse ( [175](#) ). The definition of relapse varies between studies and physicians and can range from a decrease below a specified blood count(s) or the development of symptomatic cytopenia(s). Relapse has not significantly compromised survival in those patients who continue to respond to additional courses of immunosuppression. Tichelli et al. ( [154](#) ) studied the efficacy of repeated treatment with ALG for patients with severe aplastic anemia who either failed to respond to an initial course of ALG or who experienced hematologic relapse. Transfusion independence was achieved in 63% of patients, and survival probability was 52% ± 8% at 10 years. No differences were noted between patients retreated for nonresponse versus relapse. No increases in acute toxicity were noted with additional courses of ALG, although the timing of serum sickness tended to occur earlier after repeat ALG administration.

***Complications of Immunosuppressive Therapy*** Patients treated for aplastic anemia with immunosuppressive therapy have an increased risk of developing clonal hematopoietic disorders (reviewed in references [176](#) and [177](#) ). This increased malignant risk does not appear to be due to any direct carcinogenic effect of the immunosuppressive medications but likely arises from either the persistent alterations in immune surveillance or the continued presence of the underlying abnormal marrow. In an analysis of 860 patients treated with immunosuppression, there were 11 cases of MDS, 15 cases of acute leukemia, seven cases of solid tumors, and one case of non-Hodgkin lymphoma ( [178](#) ). Of 748 patients treated with transplantation, nine malignancies were reported: two acute leukemias and seven solid tumors. The cumulative incidence of developing a malignant tumor at 10 years was 18.8% after immunosuppression and 3.1% after transplantation. A recent series of 122 National Institutes of Health patients treated with immunosuppression reported a 33% risk of developing a clonal hematopoietic disorder at 10 years ( [9](#) ). A cohort of 30 aplastic anemia patients who developed clonal bone marrow abnormalities was followed prospectively ( [179](#) ). Abnormalities of chromosome 7 were seen in 40% of cases, and these accounted for most of the deaths related to leukemic transformation. The 23% of patients with trisomy 8 did not develop leukemias and had an excellent prognosis. The cytogenetic abnormalities were transient in only two patients, both of whom had manifested only 20 to 25% cytogenetically abnormal metaphases at the time the clonality was noted.

### **IMMUNOSUPPRESSION VERSUS BONE MARROW TRANSPLANTATION**

Immunosuppressive therapy and BMT are both effective therapies for aplastic anemia. For the 25% of patients for whom a suitable HLA-identical sibling donor is available, the decision to treat with immunosuppression versus HLA-identical sibling SCT is based on a consideration of risks and benefits that vary depending primarily on patient age and neutrophil count. Both short-term and long-term efficacy and side effects for each treatment must be carefully weighed. BMT is more expensive and riskier in the short term, but it is capable of permanently restoring normal hematopoiesis. Immunosuppression is cheaper, much less toxic, but more often results in partial remission ( [174](#) ) or in gradual recovery ( [180](#) ) rather than prompt reconstitution of entirely normal blood counts. As discussed above, late complications after immunosuppressive therapy include relapse and the development of late clonal hematologic disorders and malignancies in surviving patients. Immunosuppressive drugs have also been associated with end-organ toxicities such as cataracts, avascular necrosis, or renal failure. BMT is also not without its late problems. A small number of transplant patients may show late graft loss ( [181](#) ). Chronic thrombocytopenia occurred in 23% of patients who underwent transplants for diverse hematologic diseases ( [182](#) ). Acute leukemia has been reported to occur shortly after BMT

for aplastic anemia ( 183 ). Moreover, the conditioning drugs and radiation of the transplantation procedure produce their own delayed complications, including pulmonary disease, endocrine dysfunction and infertility, leukoencephalopathy, cataracts, and secondary malignancies ( 181 , 184 ). A recent European Group for Blood and Marrow Transplantation study in adult patients from ages 20 and older showed that response to immunosuppression (62% at 12 months) was independent of age, but mortality increased with increasing age ( 185 ). Studies comparing BMT and immunosuppression in children have generally significantly favored SCT. A comparison of immunosuppression versus BMT in patients stratified by age and neutrophil count showed superior failure-free survival with BMT for children regardless of their neutrophil count ( 186 ). The advantage of BMT increased with increasing follow-up time, most likely due to the ongoing risks of late relapse and evolution to MDS and leukemia in the immunosuppression group. Children have a lower mortality with SCT, and a longer posttreatment life expectancy places them at higher risk for late complications of immunosuppressive therapy than older adults. Thus, it has been recommended to treat young patients (= 10 years) with HLA-identical sibling SCT when a suitable donor is available. Patients younger than 40 years of age with neutrophil counts <300/ $\mu$ l also did better with BMT. Patients older than 40 years of age generally did better with immunosuppressive therapy. No clear advantage was apparent for either therapeutic option in patients between the ages of 20 and 40 years with neutrophil counts >300/ $\mu$ l. Studies comparing SCT to immunosuppressive therapy for the treatment of aplastic anemia are summarized in [Table 44.5](#).

**TABLE 44.5. Stem Cell Transplant vs. Immunosuppressive Therapy for Aplastic Anemia**

| Study (Reference)          | Survival (%)         |                           |              |
|----------------------------|----------------------|---------------------------|--------------|
|                            | Stem Cell Transplant | Immunosuppressive Therapy | $\rho$ Value |
| Speck et al. ( 147 )       | 44                   | 69                        | NS           |
| Bayever et al. ( 341 )     | 72                   | 45                        | NS           |
| Bacigalupo et al. ( 116 )  | 63                   | 61                        | NS           |
| Halperin et al. ( 342 )    | 79                   | 25                        | ?            |
| Locasciulli et al. ( 343 ) | 63                   | 48                        | .002         |
| Speck et al. ( 344 )       | 50                   | 71                        | NS           |
| Paquette et al. ( 345 )    | 72                   | 45                        | NS           |
| Lawlor et al. ( 346 )      | 75                   | 92                        | NS           |
| Doney et al. ( 347 )       | 69                   | 38                        | <.001        |
| Fuhrer et al. ( 348 )      | 84                   | 87                        | NS           |
| Kojima et al. ( 349 )      | 97                   | 55                        | <.001        |

NS, not statistically significant.

It is important to note that many studies of long-term outcomes were performed before the development of current immunosuppressive regimens containing both ATG and cyclosporin. Any differential long-term effects of these more intensive immunosuppressive regimens remains to be ascertained.

**ANDROGENS** Androgens no longer have a primary role in the management of aplastic anemia and are generally reserved for patients who have failed immunosuppressive therapy. In the past, early reports of responses to androgens ( 187 , 188 ) were not supported by subsequent studies that found low rates of remission and no improvement in survival ( 189 , 190 and 191 ). When the effects of androgens are compared in patients with severe and moderate aplastic anemia, the response rate (8% vs. 56%) ( 192 ) and subsequent survival (20% vs. 58%) ( 193 ) have generally been lower in those patients with

severe disease. Selection bias for patients with moderate or chronic disease who could tolerate and survive a 3-month+ treatment regimen may account for a significant fraction of patient responses reported in many of the early studies. The greatest response to androgens is seen in the hematocrit, although improvements in granulocytes and in platelets may also occur ( [193](#) , [194](#) ). Three to 6 months of treatment may be required before an adequate response is seen. Androgen therapy has multiple side effects such as virilization, hirsutism and acne, fluid retention, and psychological alterations. Hepatotoxicity can occur with all preparations but is less frequent with parenteral preparations ( [195](#) ). Liver function test abnormalities are usually reversible when androgens are discontinued, but the rare syndrome peliosis hepatis has been associated with androgen therapy ( [196](#) ). Children can tolerate high doses of androgens for more than a year without lasting effects on growth or maturation ( [197](#) ). The mechanism of action has been reviewed extensively by Gardner and Besa ( [198](#) ). Androgens have a wide variety of biologic effects ( [199](#) , [200](#) ), including several actions on hematopoiesis ( [201](#) , [202](#) and [203](#) ). The effect of androgens on stimulating erythropoietin production by the kidney is unlikely to be important in aplastic patients, who produce abundant amounts of erythropoietin. Androgens have direct effects on hematopoietic cells. Androgens also have diverse, generally suppressive effects on the immune system ( [201](#) ).

**HEMATOPOIETIC GROWTH FACTORS** Although patients with aplastic anemia do not have a deficiency of most hematopoietic growth factors (see [Hematopoietic Stroma and Growth Factors](#)), it was hypothesized that supraphysiologic levels might stimulate hematopoiesis of one or more cell lines (reviewed in reference [82](#) ). Trials of GM-CSF ( [204](#) , [205](#) and [206](#) ), G-CSF ( [207](#) , [208](#) ), IL-3 ( [209](#) , [210](#) ), IL-1 ( [211](#) ), IL-6 ( [212](#) ), SCF ( [213](#) ), and IL-11 ( [214](#) ) in aplastic anemia have been reported. Although the total number of patients treated in these protocols is not large, these studies do not support the use of growth factors as primary treatment for aplastic anemia. No consistent benefit in terms of response rate or survival after the adjunctive use of growth factors in immunosuppressive regimens has been observed. A recent pediatric prospective, randomized trial of G-CSF for aplastic anemia patients with neutrophil counts greater than 200/ $\mu$ l found no difference in the incidence of fever or infection with or without G-CSF ( [215](#) ). A few refractory patients have had responses to single or combined growth factors. A major concern with G-CSF treatment of aplastic anemia patients is the potential risk of promoting the development or propagation of a dysplastic or malignant clone (reviewed in reference [216](#) ). A retrospective study of children with severe acquired aplastic anemia in Japan found that 11 out of a total of 167 patients developed MDS/acute myeloid leukemia (AML). Ten of the 11 cases showed monosomy 7. All 11 cases had received combination therapy with cyclosporin and G-CSF ( [217](#) ). It has been difficult to distinguish whether growth factor treatment is causally related to MDS/AML or whether MDS/AML develops in those patients selected for growth factor therapy because of the severity of the underlying bone marrow premalignant state. A recent study comparing 144 aplastic anemia patients on immunosuppressive therapy with or without G-CSF found that the risk of developing MDS/AML was similar between the two groups ( [218](#) ). In eight aplastic anemia patients who had developed MDS/AML, no mutations were detected in the cytoplasmic domain of the G-CSF receptor ( [219](#) ). Toxicities of recombinant human growth factors vary. G-CSF and GM-CSF are associated with flulike symptoms, bone pain, and splenomegaly. Symptoms of “cytokine flu”—fever, rash, hives, headache, and myalgia—are common but do respond to acetaminophen or resolve with the passage of time. Bone pain may be a symptom of increased marrow activity, although this is more commonly seen with G-CSF. At higher doses, the severity of symptoms increases, and there may be evidence of visceral engorgement and fluid retention. The toxic effects of IL-3 are similar, usually including fever, chills, and headache. Hypotension is the dose-limiting toxicity of IL-1. Anaphylactic responses have been associated with the use of SCF, also known as *mast cell factor*.

**OTHER THERAPIES** New therapeutic regimens aimed at improving rates of hematologic



response and minimizing acute and long-term complications of therapy are under investigation ( [85](#) ). Administration of high doses of cyclophosphamide is an effective nonmyeloablative immunosuppressive therapy. An early study of treatment with this drug without transplant indicated a complete response in seven of ten patients treated with 45 mg/kg per day for 4 days ( [220](#) ). A subsequent phase III prospective, randomized trial compared high-dose cyclophosphamide plus cyclosporin to ATG plus cyclosporin as first-line therapy ( [221](#) ). The trial was terminated prematurely due to invasive fungal infections and three early deaths in the cyclophosphamide group (none in the ATG group). Responses at 6 months follow-up were seen in 6 of 13 (46%) patients treated with cyclophosphamide versus 9 of 12 (75%) patients treated with ATG. Other immunosuppressive agents currently under investigation include an anti-IL-2 receptor monoclonal antibody (Daclizumab), mycophenolate mofetil (MMF; Cell-Cept), FK506, and rapamycin.

### Supportive Care of Bone Marrow Failure Patients

To avoid sensitization of the aplastic anemia patient, blood product support should be used sparingly, and donors should never be from the patient's family. All blood products should be leukofiltered and irradiated.

**THROMBOCYTOPENIA** Platelet (and red cell) support has probably had the greatest impact on survival in bone marrow failure by greatly reducing the mortality from bleeding. Few studies of platelet therapy in bone marrow failure patients are available, and treatment has generally been extrapolated from studies in acute leukemia patients. Significant characteristics of the bone marrow failure patients, such as the chronicity of the cytopenias, the absence of intensive chemotherapy, and differences in immune system function, dictate caution in applying studies of leukemia patients to this population. Platelets can be obtained from several individual units of blood or by plateletpheresis from a single donor. One platelet unit from a single unit of blood contains at least  $5.5 \times 10^{10}$  platelets, whereas a single donor apheresis pack contains  $3$  to  $6 \times 10^{11}$  platelets. Because the donor exposure is markedly diminished using apheresis platelets, the risk of allosensitization and of blood-borne infection transmission would, in theory, be lower using this approach. Although a recent multiinstitutional, randomized, blinded study in patients receiving induction chemotherapy for acute myeloid leukemia found similar low rates of allosensitization between patients receiving leukoreduced apheresis platelets or pooled platelet concentrates ( [222](#) ), the intensive immunosuppressive effects of induction chemotherapy compromises the generalizability of these findings to other immunocompetent bone marrow failure states. Refractoriness to platelet transfusions can be a devastating consequence of allosensitization, and management once this occurs is difficult ( [223](#) , [224](#) ). Nonimmune causes of platelet refractoriness should also be considered and include disseminated intravascular coagulation, amphotericin B treatment, antibiotics, splenomegaly, ongoing bleeding, and fever. The main role of prophylactic platelet support is reduction of the risk of intracranial hemorrhage, which is a rare but devastating event. Intracranial hemorrhage must be considered in thrombocytopenic patients presenting with headache, particularly when accompanied by additional symptoms of increased intracranial pressure, such as vomiting, or focal neurologic signs. Evaluation of such patients typically includes neuroradiologic imaging studies to assess for an intracranial bleed. Of note, in the setting of anemia, blood may generate a less intense signal on computed tomography scan, rendering acute bleeds more difficult to detect, and magnetic resonance imaging scans may be advantageous in certain cases. Although it is generally accepted that prophylactic platelet transfusions can reduce the risk of hemorrhage, the guidelines for such treatments remain an area of controversy ( [225](#) ). Multicenter, randomized trials in newly diagnosed AML patients found no significant difference in risk of major bleeding between patients randomized to receive

prophylactic platelet transfusions at threshold platelet counts of 20,000/ $\mu$ l versus 10,000/ $\mu$ l ( [226](#), [227](#) ). Use of the lower platelet threshold significantly reduced platelet use. Patients with fevers, active bleeding, or invasive procedures were transfused at platelet counts between 10,000 and 20,000/ $\mu$ l. Platelet transfusions at platelet counts below 5000 to 10,000/ $\mu$ l in stable outpatients with chronic severe aplastic anemia were feasible and safe in a recent study ( [228](#) ). This decision should be individualized for each patient, taking into consideration whether the patient has manifested a tendency to bleed reproducibly at any given platelet level. Chronic platelet transfusions for aplastic anemia are not used as frequently as they are in leukemia, and they are usually given when there are symptoms of bleeding or if the patient is at increased bleeding risk (e.g., toddlers learning to walk, patients with hypertension while on cyclosporin, and patients with fever and infection).

Other measures to reduce bleeding include maintenance of good dental hygiene ( [229](#) ), use of a soft toothbrush, stool softeners, and avoidance of trauma. Drugs that may interfere with platelet function, such as aspirin or nonsteroidal antiinflammatory drugs, should be avoided. Antifibrinolytic agents, such as aminocaproic acid, may decrease bleeding, particularly from the gums and nasal mucosa ( [230](#), [231](#) ). Management of menstrual prophylaxis should be initiated as appropriate for the degree of thrombocytopenia.

**ANEMIA** Red cells should be provided as clinically indicated. When possible, extended panel red cell antigen typing to minimize the risk of allosensitization seems reasonable, although studies to support the efficacy of this approach are currently lacking. Chronic anemia can be well tolerated, particularly in children. Anemia in the setting of concurrent thrombocytopenia is a potentially dangerous combination, and the threshold for transfusion may be higher in this situation. Long-term transfusions lead to iron overload, with accumulation in critical organs. Permanent damage to heart, liver, and endocrine glands can be prevented by iron chelation therapy ( [232](#) ). This may be difficult in thrombocytopenic patients, who may not tolerate subcutaneous infusions. Guidelines for the institution of iron chelation therapy in bone marrow failure patients are based on those established for thalassemia patients who are undergoing accelerated, albeit ineffective, erythropoiesis and often have concomitant increases in iron absorption. Total red blood cell volumes transfused, particularly for infants and small children, as well as total body iron status as reflected in serum ferritin and liver iron levels must be carefully monitored.

**INFECTIONS** There are few reported studies of infection management in bone marrow failure patients ( [233](#), [234](#) ), and therapy is based largely on studies in cancer patients. Important differences from cancer patients should be noted. Whereas severe granulocytopenia may last for years, the cellular immune functions of aplastic anemia patients (before SCT or immunosuppressive therapy) remain intact. In addition, mucositis with subsequent compromise of mucosal barriers that can accompany chemotherapy is absent. Neutropenia (and perhaps monocytopenia) increases the risk of bacterial infection in aplastic anemia. Because neutropenia precludes the development of an inflammatory response, signs and symptoms of infection can be deceptively minimal. Bacterial infections may involve gram-negative bacilli, such as *Escherichia coli*, *Klebsiella pneumoniae*, and *Pseudomonas aeruginosa*, as well as gram-positive cocci such as *Staphylococcus aureus*, *Staphylococcus epidermidis*, and streptococci.

Immunosuppression due to preparation for BMT or as primary therapy for aplastic anemia may lead to unusual bacterial, fungal, viral, and protozoan infections. Treatment regimens are changing rapidly as new generations of treatments are developed and are beyond the scope of this chapter. The use of prophylactic antibiotics has no demonstrated role in the otherwise well patient with aplastic anemia. Although specific studies of the bone marrow failure population are lacking, patients undergoing immunosuppressive therapy should receive prophylaxis for *Pneumocystis carinii*. In the context of fever and neutropenia, complete evaluation and cultures of all possible sites should generally be followed by the administration of broad-spectrum parenteral antibiotics until the fever abates and all cultures are negative. Fungal infections occur with increased frequency in patients who have received repeated or extended courses of antibiotics; candidiasis and, especially, aspergillosis, which lead to sinusitis, lung disease, or disseminated infection, were frequent

causes of death in a retrospective study of aplastic anemia patients between 1978 to 1990 ( [233](#) ). Antecedent or concurrent administration of steroids is expected to increase this risk. Aggressive initiation of amphotericin B treatment is indicated in the persistently febrile patient who is unresponsive to antibiotics or in the appropriate clinical setting.

## INHERITED APLASTIC ANEMIA SYNDROMES

### Fanconi Anemia

**HISTORICAL BACKGROUND** FA is an inherited syndrome with a variable clinical presentation that includes congenital anomalies, progressive pancytopenia, and cancer susceptibility. Guido Fanconi reported a familial syndrome of pancytopenia and congenital physical abnormalities in 1927 ( [235](#), [236](#) ). The diagnostic hallmark of FA is increased chromosomal breakage in response to DNA-damaging agents such as mitomycin C (MMC) or diepoxybutane (DEB). Remarkable advances in the last few years have elucidated a biochemical pathway that is disrupted in FA cells and carry potential implications for the diagnosis and treatment of FA patients.

**EPIDEMIOLOGY** FA follows an autosomal-recessive pattern of inheritance ( [237](#), [238](#) ). FA is found with similar frequencies in both genders and has no known ethnic restriction. The heterozygote carrier state has been estimated at 1 in 300 in the United States and in Europe ( [237](#) ) but may be higher in South Africa ( [239](#) ). The mean age at diagnosis is generally reported to be between 7 to 9 years, with 75% of cases diagnosed between the ages of 4 and 14 years; however, FA has been diagnosed in neonates as well as in adults in their 40s ( [240](#) ).

**CLINICAL FEATURES** FA should be considered in patients with congenital anomalies, aplastic anemia, or a family history of bone marrow failure or cancer susceptibility. The International Fanconi Anemia Registry analysis of 370 patients found that nearly 40% had no reported physical findings ( [241](#) ). Aplastic anemia or malignancy may be the presenting sign of the underlying diagnosis of FA in the absence of physical anomalies or prior family history. The manifestations of FA can vary between affected members of the same family, suggesting that additional genetic or environmental factors likely influence the disease course. A wide range of congenital anomalies has been reported in FA patients (reviewed in reference [240](#)) ( [Table 44.6](#) ). Skin pigmentary changes, short stature, and upper limb and thumb abnormalities are the most common manifestations associated with FA, although these characterize some of the other inherited bone marrow failure syndromes as well. Abnormalities of the skeletal, ocular, renal, genital, aural, gastrointestinal, cardiac, and central nervous systems have also been reported.

**TABLE 44.6. Physical Findings Associated with Fanconi Anemia**

---

|  |
|--|
| Skeletal   |
| Short stature  |
| Radial anomalies (e.g., thumbs, hands, and forearms)             |
| Microcephaly   |
| Hip and spine anomalies  |
| Skin   |
| Hyperpigmentation (e.g., café au lait spots)                     |
| Hypopigmentation (e.g., vitiligo)                                |
| Genitourinary  |
| Renal anomalies  |
| Hypogonadism   |
| Craniofacial   |
| Ophthalmic anomalies (e.g., microphthalmia and epicanthal folds) |

Otic anomalies (e.g., external and internal ear anomalies and deafness)  
Gastrointestinal malformations  
Cardiac malformations

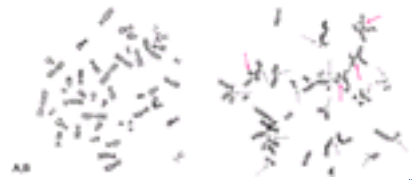
---

The hematologic complications of FA typically present within the first decade of life, most often as moderate single or bilineage cytopenia. Patients with FA have an increased risk of developing MDS or AML. The overall incidence of MDS is estimated at 5%, and the incidence of AML is estimated at 10% ( [242](#) ). The cumulative risk of developing MDS or AML increases with increasing age, with an actuarial risk of 52% by 40 years of age ( [243](#) ). Patients with FA are also at increased risk of developing solid tumors, particularly squamous cell carcinomas of the head and neck, skin, gastrointestinal tract, and genital tract ( [242](#) ). All patients, and perhaps particularly those receiving androgen treatment, are at increased risk of liver tumors. The majority of tumors associated with FA develop in patients in their second or third decade of life. These malignancies may be difficult to treat because patients with FA are sensitive to chemotherapy and radiation. Regular and frequent surveillance for cancers is particularly important in this population and is discussed further in the section [Supportive Care](#). Growth hormone deficiency has been observed in some FA patients ( [244](#) ), and treatment with growth hormone improved growth in a subset of these patients ( [245](#) ). Additional endocrine disorders associated with FA include hypothyroidism with or without thyroid hormone-binding globulin deficiency, abnormal glucose tolerance, and diabetes mellitus ( [244](#) ).

**DIFFERENTIAL DIAGNOSIS** FA is the most common known genetic cause of aplastic anemia and one of the most common genetic causes of hematologic malignancy. Cells derived from patients with other chromosomal breakage syndromes or syndromes with similar constitutional findings, such as Bloom syndrome or ataxia-telangiectasia, may also exhibit high rates of spontaneous chromosomal breakage; however, only FA cells exhibit increased chromosomal breakage in response to DEB.

**LABORATORY** Cell morphology on peripheral blood smear is typically unremarkable except for red cell macrocytosis and mild anisocytosis, although these are variably present. Thrombocytopenia or leukopenia typically precede anemia. Pancytopenia generally worsens over time. Erythrocyte macrocytosis and increased hemoglobin F levels may be present even in the absence of cytopenias. Bone marrow biopsy findings vary from normal cellularity to frank aplasia. Morphologic examination of the bone marrow aspirate may show dysplastic features, with nuclear-cytoplasmic maturation dysynchrony. Dyserthropoiesis with multinucleate forms or nuclear fragmentation may be seen. Bone marrow aspirates should be sent for cytogenetic analysis, as FA patients are at high risk for malignant transformation. The diagnosis of FA is based on the demonstration of increased chromosomal breakage in the presence of DNA cross-linking agents such as MMC or DEB ( [246](#) , [247](#) ) ( [Fig. 44.2](#) ). DEB is preferred in some centers because it is associated with less variability in chromosomal breakage among normal controls. The chromosomal breakage test is usually performed on metaphase spreads of peripheral blood lymphocytes treated with MMC or DEB. A total of 50 cells in metaphase are analyzed for chromosomal breakage, including the formation of radials—a hallmark of this disease. Results are compared to a normal and a positive control that have been run in parallel. Results are reported as aberrations per cell and the number of cells with radial forms. Increased spontaneous chromosomal breakage may be observed in some FA patients; nonetheless, the rate of breakage is markedly enhanced by exposure to MMC or DEB regardless of patient phenotype or severity of disease. Chromosomal breakage in response to MMC/DEB can also be assessed in fetal cells obtained by amniocentesis or chorionic villus sampling for prenatal diagnosis ( [248](#) , [249](#) ). If the disease-causing mutation is known for a given family, these assays can be used for preimplantation genetic diagnosis ( [250](#) ). FA patient cells also exhibit cell cycle abnormalities, with G<sub>2</sub> phase prolongation and arrest by flow cytometry ( [251](#) , [252](#) ). Studies comparing results of DEB

chromosomal breakage with cell cycle analyses of patients referred for FA testing showed close correlation between the results of these two tests ( [253](#) ). Constitutive elevation of serum alpha-fetoprotein has been reported in FA patients ( [254](#) ), although variations in alpha-fetoprotein levels determined by different methodologies and the lack of specificity has limited the diagnostic utility of this test so far ( [255](#) ). FA heterozygous carriers cannot be reliably detected by cytogenetic testing for chromosomal breakage.



**Figure 44.2.** Chromosomal breakage in Fanconi anemia. Peripheral blood lymphocytes from a Fanconi anemia patient were cultured without (A) or with (B) mitomycin C. The black arrows indicate chromosomal breaks. The red arrows indicate radial chromosomal fusions characteristic of Fanconi anemia. (Courtesy of Lisa A. Moreau, Dana Farber Cancer Institute, Boston, MA.)

Somatic reversion to wild type has been observed in a subset of lymphocytes from some FA patients. Increased chromosomal breakage may only be seen in a subpopulation of lymphocytes in such patients. The reversion to normal cellular phenotype has been attributed to recombination or gene conversion events leading to selective advantage of the reverted lymphocytes ( [256](#) , [257](#) ), although somatic reversion has also been reported in earlier hematopoietic lineages ( [258](#) ). Patients with a high degree of wild-type lymphocyte mosaicism may be difficult to diagnose. In such cases with a high degree of suspicion for FA, the MMC/DEB test should be performed on skin fibroblasts derived from a punch biopsy because somatic mosaicism has not been observed in fibroblasts.

**PATHOPHYSIOLOGY** Several mechanisms for the underlying defect in FA have been postulated, and data are available to support each theory. Models of the FA biochemical pathway have emerged from molecular studies of the cloned FA gene products. At least eight different FA complementation groups (A, B, C, D1, D2, E, F, G) have been identified, and the corresponding genes have been identified ( [259](#) , [260](#) ) ( [Table 44.7](#) ). The proteins FANCA, FANCC, FANCD2, FANCE, FANCF, and FANCG do not share homology to known proteins, and their function is not known. The gene for Fanconi subtype D1, and possibly also subtype B, is the previously identified tumor suppressor gene, BRCA2 ( [260](#) ). These complementation groups were first identified through cell fusion studies looking for correction of MMC sensitivity ( [261](#) ). Subtyping analysis has been facilitated by the use of retroviral vectors to introduce different wild-type Fanconi complementary DNAs to assess for correction of MMC sensitivity in cultured patient cells ( [262](#) , [263](#) ). The most common FA subtype is FA-A (60 to 70%), followed by FA-C (10%), and FA-G (10%). The other FA subtypes are rare. The mutations associated with FA are highly variable.

**TABLE 44.7. Complementation Groups of Fanconi Anemia (FA)**

| Subtype    | FA Patients (Estimated) | Chromosome Location | Protein Products (kd) |
|------------|-------------------------|---------------------|-----------------------|
| A          | 70%                     | 16q24.3             | 163                   |
| B (BRCA2?) | Rare                    | (13q12.3?)          | (380?)                |
| C          | 10%                     | 9q22.3              | 63                    |
| D1/BRCA2   | Rare                    | 13q12.3             | 380                   |
| D2         | Rare                    | 3p25.3              | 155,162               |
| E          | Rare                    | 6p21-22             | 60                    |
| F          | Rare                    | 11p15               | 42                    |
| G          | 10%                     | 9p13                | 68(XRCC9)             |



A model ( [Fig. 44.3](#) ) has emerged whereby DNA damage by agents, such as MMC, ionizing radiation, or ultraviolet radiation, leads to activation of the Fanconi proteins A, B, C, E, F, and G to culminate in the covalent attachment of a ubiquitin protein (monoubiquitination) to FANCD2 ( [264](#) ). After monoubiquitination, FANCD2 colocalizes in nuclear foci with BRCA1, a known cancer susceptibility gene implicated in DNA repair. Additional DNA repair proteins, such as rad 51, MRE11, and NBS1, also localize in BRCA1-containing foci ( [265](#), [266](#) ) to further implicate FANCD2 in DNA repair. Monoubiquitination of FANCD2 is required for MMC resistance and is dependent on the functional integrity of the upstream Fanconi proteins. FANCD2 monoubiquitination remains intact in bone marrow failure syndromes other than FA ( [267](#) ). The role of FANCD2 monoubiquitination is a subject of intensive investigation. FANCD2 monoubiquitination can be assessed on a Western blot and serves as a potentially useful biochemical diagnostic screen for FA.



**Figure 44.3.** Model of the Fanconi anemia biochemical pathway. After activation by DNA damage, the upstream Fanconi proteins A, B/BRCA2, C, E, F, and G function coordinately to culminate in monoubiquitination of the Fanconi D2 protein. Monoubiquitinated FANCD2 interacts with the tumor suppressor BRCA1 protein and translocates to discrete nuclear foci together with additional DNA repair proteins. The Fanconi D1/BRCA2 protein is not required for FANCD2 monoubiquitination.

Elucidation of the Fanconi biochemical pathway in turn led to the identification of interactions between the Fanconi proteins and other known tumor suppressor pathways. These findings provide biochemical support for a role of the Fanconi pathway in tumorigenesis. FANCD2 was subsequently shown to be phosphorylated at a serine residue at amino acid position 222 ( [268](#) ). FANCD2 serine 222 phosphorylation is dependent on ATM kinase and is required for the cell cycle S-phase checkpoint in response to radiation ( [268](#) ). ATM function is disrupted in the chromosomal instability syndrome ataxia-telangiectasia. Thus, FANCD2 links two DNA repair pathways, the Fanconi pathway and the ataxia-telangiectasia pathway. Dysfunction of the Fanconi pathway or the ATM pathway is associated with increased cancer susceptibility. The Fanconi biochemical pathway was further implicated in DNA repair by the identification of the gene for FANCD1, and possibly also FANCB, as the tumor suppressor gene, BRCA2 ( [260](#) ). Given the compelling biochemical data linking the Fanconi pathway to other known DNA repair pathways functioning in tumor suppression, the question of whether asymptomatic FA heterozygotes carry an increased risk of developing malignancies is a subject of active investigation. Previous studies of cancer risk in FA heterozygotes by Swift et al. ( [269](#), [270](#) ) were performed before the development of diagnostic tests for FA, and the diagnosis of the study population is not clear because other syndromes may also manifest with low blood counts and congenital anomalies. In addition to a nuclear role in DNA repair, numerous studies suggest additional potential functions for the FA proteins. FA cells are sensitive to many different extracellular apoptotic signal, such as  $\gamma$ -interferon, tumor necrosis factor- $\alpha$ , and double-stranded RNA ( [271](#), [272](#), [273](#) and [274](#) ). Furthermore, Fanconi proteins, such as FANCC, may have additional roles in other signaling pathways ( [275](#) ).

Studies also suggest a role for the FA proteins in mediating oxidative stress ([276](#), [277](#)). DEB, a clastogen to which Fanconi cells are especially susceptible, can cause oxidative DNA damage. FA cells can exhibit increased susceptibility to oxidative damage, and reactive oxygen species can damage DNA and can lead to DNA cross-links and double-stranded breaks.

**SUPPORTIVE CARE** The guidelines discussed above for supportive care of the aplastic anemia patient also are generally applicable to FA patients with marrow failure. Choice of therapies should be guided by an understanding of the underlying pathophysiology and after careful consideration of concomitant treatments. Cancer surveillance and education play an important role in the management of FA patients. Physicians should counsel patients regarding established behavioral and environmental risk factors associated with increased cancer risk. Because FA patients have a defect in DNA repair, imaging studies should minimize exposure to ionizing radiation. For example, when clinically indicated, it is reasonable to use magnetic resonance imaging scans rather than computed tomography scans for FA patients. Complete blood cell counts to monitor for MDS or leukemia are recommended. Given the increased risk of MDS and leukemias in bone marrow failure patients, annual bone marrow aspirates and biopsies with cytogenetic analysis are recommended. For patients on androgen therapy, regular physical examinations for liver size, liver ultrasound for masses or abnormalities every 6 to 12 months, and frequent liver enzyme tests are recommended. Annual examinations for leukoplakia or other signs of squamous cell carcinoma of the oral cavity and oropharynx by an otolaryngologist are important for patients with FA, DKC, and those FA patients previously treated with BMT. Annual endoscopy can be considered in older FA and DKC patients. Regular dental examinations are important both for maintenance of oral hygiene and for detecting leukoplakia. Patients should be evaluated immediately for symptoms of pain in the mouth or throat, difficulty swallowing, changes in voice, anorexia, or weight loss. Suspicious lesions should be biopsied immediately because early surgical excision is the mainstay of cancer therapy in FA patients. Annual gynecologic examinations, including Pap smears and human papillomavirus examination, are recommended at puberty or after the age of 16 years. Counseling regarding sexual activity should be provided as this possesses an increased risk for neutropenic and thrombocytopenic patients. Barrier methods of contraception may be particularly pertinent for the FA patients who are already at risk for cervical and vulvar malignancies. Regular breast examinations are also recommended, although it is not clear what role mammography should play in cancer screening of these patients. Regular endocrinology evaluations are important, particularly in the pediatric population if the patient exhibits poor growth or delayed puberty. Gastrointestinal symptoms may present in FA patients, necessitating prompt referral to a gastroenterologist.

**TREATMENT** Hematopoietic SCT is the only curative therapy for the hematologic manifestations of FA. Because patients with FA are exquisitely sensitive to the toxicity of the usual chemotherapy and radiation regimens used in preparation for BMT, reduced doses are typically used. An appropriate conditioning regimen combined with use of a matched sibling donor has resulted in survivorship in 65 to 80% of patients ([278](#), [279](#) and [280](#)). The long-term effects of transplantation, both with respect to immune suppression and end-organ toxicity, in this population remain unclear. Some patients have experienced post-SCT malignancies, especially squamous cell carcinomas of the head and neck. Risk factors for posttransplant malignancies have included the use of radiation and chronic GVHD. In an attempt to reduce the long-term risk for malignancies, clinical trials replacing radiation with fludarabine and ATG are in progress. Initial results show engraftment rates comparable to those with radiation-containing regimens. Long-term outcomes on malignancy risk remain to be determined. Global effects of SCT on growth, endocrine disturbance, and other end-organ function are poorly characterized. Alternative donor SCT has been limited by high rates of graft failure and toxicities from the more rigorous conditioning regimens required for these transplants ([281](#), [282](#)). Encouraging preliminary results have been reported in studies investigating the addition of fludarabine to the conditioning regimens, including either total body irradiation or busulfan. Improvements in engraftment and GVHD have been seen with fludarabine-conditioning regimens; however,



fatal opportunistic infections remain a major source of mortality. Multiple other therapies are also available to FA patients. Androgens can improve the blood counts in approximately 50% of patients with FA. Suggested treatment guidelines have been proposed by a consensus committee of the Fanconi Anemia Research Foundation, though these guidelines must be individualized for each patient and undergo continuous modification as new data emerge. The suggestion of the committee is to consider an allogeneic SCT or androgen therapy if the hemoglobin falls below 8 g/dl, if anemia is symptomatic, if the platelet count falls below 30,000/mm<sup>3</sup>, or the neutrophil count falls below 500/mm<sup>3</sup>. The earliest and most frequent response to androgens is seen in red cells, with reticulocytosis and increase in hemoglobin generally occurring within the first 1 to 2 months of treatment. Responses in the white blood cell count and platelet count are variable and may not be seen until 6 to 12 months of therapy. Resistance to therapy often develops over time (generally years). A common androgen regimen consists of oxymetholone, 2 to 5 mg/kg/day given orally. Androgen doses may be slowly tapered to the minimal effective dose with careful monitoring of the blood counts. Side effects of androgen administration include liver toxicity such as elevated liver enzymes, cholestasis, peliosis hepatis, and increased propensity to develop hepatic tumors. Other side effects of androgens include acne, oily skin, enlarged penis/clitoris, hoarseness/voice deepening, hair growth or hair loss, behavioral changes, hot flashes, breast enlargement or tenderness, amenorrhea, fluid retention, and secondary hypertension. Hematopoietic growth factors, such as G-CSF or GM-CSF, have been shown to improve the neutrophil count in the majority of treated patients ([283](#), [284](#)). In a few patients, platelet or red cell counts have also improved after treatment with G-CSF ([284](#)). Growth factor treatment is generally not recommended for patients with MDS and is generally avoided for those with a clonal cytogenetic abnormality of the bone marrow, although there are no available data that address these issues. It is reasonable to perform a bone marrow aspirate and biopsy before the initiation of growth factor therapy and monitor regularly throughout therapy. Results of a gene therapy trial for FA-C patients have been reported ([285](#)). Three FA-C patients underwent three to four cycles of retroviral transduction of G-CSF-mobilized peripheral blood CD34<sup>+</sup> mononuclear cells, whereas a fourth patient received a single infusion of transduced cells. The transduced wild-type FANCC gene was detected in peripheral blood and bone marrow mononuclear cells in association with increased hematopoietic colony growth *in vitro*. Transient improvement in bone marrow cellularity accompanied these findings, and two patients experienced a transient improvement in blood counts, suggesting that correction of the underlying FANCC gene defect may be sufficient to improve hematopoietic function. However, these findings were transient, indicating that hematopoietic stem cell transduction had not been achieved.

## Dyskeratosis Congenita

DKC is an inherited disorder characterized by abnormalities of skin pigmentation, nail dystrophy, and leukoplakia. X-linked-recessive, autosomal-dominant, and autosomal-recessive inheritance patterns have been reported. Patients exhibit a predisposition to bone marrow failure, malignancy, and pulmonary dysfunction.

**CLINICAL FEATURES** A comprehensive study of the clinical features associated with DKC was undertaken by the DKC registry established in 1995 ([286](#)). By 1999, the registry included 92 families from 20 countries. There were 148 DKC patients of whom 127 were male and 21 were female. Twenty-five families showed an X-linked-recessive pattern of inheritance, whereas 51 families had sporadic affected males. Sixteen families included one or more affected females representing both autosomal-dominant and autosomal-recessive forms of the disease. The severity of the clinical phenotype can vary widely in affected members of the same family. In addition to the classic triad of skin, nail, and oral findings, a variety of other clinical features have been described in patients with DKC ([Table 44.8](#)). The range of physical findings in female patients is similar to

those reported in male patients, though the phenotype in females is highly variable ( 286 ). Most of the somatic abnormalities are not present early in life but develop progressively with age. The skin rash is typically reticular and mottled in appearance and may be localized or widespread. The classic triad of abnormal skin pigmentation, nail dystrophy, and leukoplakia generally appears between the ages of 5 and 10 years, with a median age of onset between 6 and 8 years (range, 0.5 to 26.0 years) ( 286 ). Both the tempo of symptom progression as well as symptom severity are highly variable between patients. For example, nail dystrophy can range from minimal nail irregularities to progressive atrophy and even complete nail loss.

**TABLE 44.8. Clinical Features Associated with Dyskeratosis Congenita**

|                                      |   |
|--------------------------------------|---|
| Skin pigmentary abnormalities        | Hyperhidrosis                           |
| Nail dystrophy                       | Malignancy                              |
| Bone marrow failure                  | Intrauterine growth retardation         |
| Leukoplakia                          | Gastrointestinal disorders              |
| Epiphora                             | Ataxia                                  |
| Cognitive/developmental delay        | Hypogonadism/undescended testes         |
| Pulmonary disease                    | Microcephaly                            |
| Short stature                        | Urethral stricture/phimosis             |
| Dental caries/tooth loss             | Osteoporosis/aseptic necrosis/scoliosis |
| Esophageal stricture                 |   |
| Hair loss/gray hair/sparse eyelashes | Deafness                                |

From Dokal I. Dyskeratosis congenita in all its forms. *Br J Haematol* 2000;110:768–779, with permission.

Peripheral cytopenias of at least one lineage developed in 85.5% of patients, and two or more peripheral lineages were affected in the majority of registry patients. The median age of onset of pancytopenia was 8 years, with 50% developing pancytopenia younger than the age of 10 years ( 286 ). The bone marrow is typically hypocellular, though cellularity may be normal or even increased early in the disease. Bone marrow failure or its associated complications accounted for the majority of deaths (67%). Approximately 20% of patients develop pulmonary disease with reduced diffusion capacity and/or restrictive pulmonary disease ( 286 , 287 and 288 ). Pulmonary complications account for nearly 10% of deaths ( 286 ). Postmortem studies reveal pulmonary fibrosis and abnormalities in the pulmonary microvasculature. Similarly, a high incidence of early and late fatal BMT-associated pulmonary complications has also been reported in DKC patients ( 289 ). Immunologic abnormalities, including low or high immunoglobulins, reduced numbers of B or T cells, and reduced stimulation by phytohemagglutinin, have been described in some DKC patients ( 286 , 290 ). Opportunistic infections, such as *P. carinii* pneumonia, have been reported ( 291 , 292 ). Malignancies were noted in 13 out of 148 patients (8.8%) in the DKC registry ( 286 ). Malignancies developed in older patients, generally after the second decade of life. It is possible that a higher incidence of malignancies might have been observed had not many patients succumbed to aplastic anemia at an earlier age. An increased incidence of MDS and acute myeloid leukemia has also been observed ( 286 ). Eight cases of carcinomas were reported in patients aged 20 to 56 years.

**DIFFERENTIAL DIAGNOSIS** Although DKC shares many clinical features with FA (e.g., aplastic anemia, oral leukoplakia, and cancer predisposition), cells from DKC patients do not manifest increased chromosomal breakage in response to MMC or DEB ( 309 ). Literature reports differ over whether cells from DKC patient cells exhibit increased

chromosomal breakage in response to other agents ( 310 , 311 , 312 , 313 and 314 ). Because DKC patients may develop aplastic anemia in the first decade of life before the manifestation of skin or nail abnormalities, they may be misdiagnosed as having severe aplastic anemia. With the identification of two of the genes involved in DKC, DNA sequence analysis of skin fibroblasts or buccal swabs will be useful in directly identifying DKC.

**LABORATORY FINDINGS** In addition to peripheral cytopenias, red cell macrocytosis and elevated fetal hemoglobin may be seen in patients with DKC ( 315 ). As noted above, immunologic abnormalities have also been described in some patients ( 286 , 290 ). Primary DKC skin fibroblasts grow slowly in culture and exhibit abnormal morphology. X-chromosome inactivation patterns in female obligate carriers showed complete skewing, consistent with a growth or survival disadvantage for cells expressing only the defective X-chromosome allele ( 316 , 317 and 318 ). Spontaneous unbalanced chromosomal translocations have been observed ( 306 , 319 ).

**PATHOPHYSIOLOGY** Reduced hematopoietic progenitor cell colonies have been described for all three hematopoietic lineages, compared with controls ( 293 , 294 , 295 and 296 ). DKC patients show a reduction in the proliferative capacity of myeloid progenitors, as measured by secondary colony formation after replating ( 297 ). Bone marrow cells from DKC patients show poor growth in long-term bone marrow culture assays. The defect is intrinsic to the hematopoietic stem cells because DKC stromal cells are able to support hematopoietic cells from normal controls, whereas DKC hematopoietic cells grow poorly on normal control stroma ( 296 ). The X-linked-recessive form of DKC was linked to Xq28, and the gene was identified by positional cloning and named *DKC1* ( 298 ). *DKC1* encodes a ubiquitously expressed protein, dyskerin, that exhibits strong homology to two previously characterized proteins: *Saccharomyces cerevisiae* Cbf5p ( 299 , 300 ) and rat NAP57 ( 301 ). Like Cbf5p and NAP57, dyskerin is localized primarily in the nucleolus and shares some homology with RNA pseudouridine synthases. Pseudouridine synthases together with small nucleolar RNAs isomerize uridine bases in ribosomal RNAs (rRNAs) to pseudouridine. In the absence of Cbf5p, yeast rRNA processing is defective ( 300 ). The hypothesis that dyskerin mutations might lead to misprocessing of rRNA and defective ribosomal function is not supported by studies of pseudouridylation or rRNA processing in affected cells ( 302 ). It was subsequently shown that dyskerin interacts with human telomerase as well as with other small nucleolar RNAs ( 303 ). Telomere length is abnormally short, and levels of human telomerase RNA and of telomerase activity are reduced in cells from X-linked DKC patients with two different dyskerin point mutations ( 302 ). Because dyskerin mutations described to date consist of missense mutations or small deletions, it is possible that these result in partial loss of telomerase function and that null mutations might be lethal. In further support of a telomerase defect in DKC, the mutations responsible for the autosomal-dominant form of DKC in three affected families were found to reside in human telomerase RNA itself ( 304 ). *Telomerase* is an enzyme that adds DNA sequences to the ends of chromosomes (the telomeres) to prevent loss of terminal repeats during DNA replication (reviewed in reference 305 ). Telomeres are important for the prevention of chromosomal fusions and rearrangements. Spontaneous unbalanced chromosomal rearrangements have been described in fibroblasts and bone marrow cells from DKC patients ( 306 ). Telomerase consists of a catalytic reverse transcriptase component as well as an RNA component. Although telomerase activity is abundant early in development, it is later detectable only in a subset of tissues, including the progenitor cells of the hematopoietic system, the basal layer of the epidermis, intestinal cells, and hair follicles. These tissues mirror those most severely affected in DKC patients. Telomere loss has also been implicated in contributing to the process of aging, and DKC may represent a form of premature aging of tissues with a high replicative requirement ( 307 , 308 ). With the identification of two of the genes responsible for DKC, a relationship between the genotype and phenotype of extended kindreds can be

established. It is possible that the full syndrome of DKC might represent only the most severe form of the disease and that previously unrecognized milder forms exhibiting only isolated symptoms might also exist.

**SUPPORTIVE CARE** Supportive care for DKC patients is similar to that outlined for aplastic anemia and FA patients. In addition, annual pulmonary function testing is recommended. Regular endocrinology visits are particularly important as DKC patients are at increased risk of osteoporosis, and their diet, vitamin D, and parathyroid hormone levels and calcium status should be monitored.

**TREATMENT** The only curative treatment for bone marrow failure in DKC remains allogeneic SCT ( [289](#), [320](#), [321](#), [322](#), [323](#), [324](#), [325](#), and [326](#) ). Although long-term survivors have been reported, early and late fatal pulmonary and vascular complications after SCT remain a significant problem ( [289](#), [320](#), [323](#), [324](#), [327](#) ). The avoidance of drugs associated with pulmonary toxicity and the use of radiation-sparing conditioning regimens may provide useful avenues for future study. DKC may be mistaken for chronic GVHD in patients transplanted for aplastic anemia ( [328](#), [329](#) ). Improvement in peripheral blood counts has been described in response to oxymetholone ( [330](#) ). Improved neutrophil counts in response to GM-CSF ( [331](#), [332](#) ) or G-CSF ( [333](#), [334](#) ) have been reported. Combined treatment with G-CSF and erythropoietin led to improved neutrophil and red cell counts in one case report ( [335](#) ).

## WEB SITES

Aplastic Anemia and MDS International Foundation, Inc.: [www.aplastic.org](http://www.aplastic.org)

Fanconi Anemia Research Fund: [www.fanconi.org](http://www.fanconi.org)

Fanconi Anemia Mutation Database: [www.rockefeller.edu/fanconi/mutate](http://www.rockefeller.edu/fanconi/mutate)

## REFERENCES

1. Ehrlich P. Uber einen Fall von Anamie mit Bemerkungen uber regenerative Veranderungen des Knochenmarks. *Charite-Annalen* 1888;13:300.
2. Vaquez M, Aubertin C. L'anemie pernicieuse d'apres les conceptions actuelles. *Bull Mem Soc Med Hop Paris* 1904;21:288.
3. Kaufman D, Kelly J, et al. The drug etiology of agranulocytosis and aplastic anemia. New York: Oxford University Press, 1991:259.
4. Issaragrisil S, Sriratanasatavorn C, Piankijagum A, et al. Incidence of aplastic anemia in Bangkok. The Aplastic Anemia Study Group. *Blood* 1991;77:2166-2168.
5. Aoki K, Fujiki N, Shimizu H, Ohno Y. Geographic and ethnic differences of aplastic anemia in humans. In: Najean Y, ed. *Medullary aplasia*, vol 79. New York: Masson, 1980.
6. Szklo M, Sensenbrenner L, Markowitz J, et al. Incidence of aplastic anemia in metropolitan Baltimore: a population-based study. *Blood* 1985;66:115-119.
7. Issaragrisil S, Kaufman DW, Anderson T, et al. Low drug attributability of aplastic anemia in Thailand. The Aplastic Anemia Study Group. *Blood* 1997;89:4034-4039.
8. Davies SM, Walker DJ. Aplastic anaemia in the Northern Region 1971-1978 and follow-up of long term survivors. *Clin Lab Haematol* 1986;8:307-313.
9. Young N. Acquired aplastic anemia. In: NS Y, ed. *Bone marrow failure syndromes*. Philadelphia: WB

Saunders, 2000:1–46.

10. Metler FJ, Moseley RJ. Medical effects of ionizing radiation. New York: Grune & Stratton, 1985:1–185.
11. Knospe WH, Crosby WH. Aplastic anaemia: a disorder of the bone–marrow sinusoidal microcirculation rather than stem–cell failure? *Lancet* 1971;1:20–22.
12. Duane G. Aplastic anemia fourteen years following administration of thorotrast. *Am J Med* 1957;23:499.
13. Kirshbaum JD, Matsuo T, Sato K, et al. A study of aplastic anemia in an autopsy series with special reference to atomic bomb survivors in Hiroshima and Nagasaki. *Blood* 1971;38:17–26.
14. Martland H. Occupational poisoning in manufacture of luminous watch dials. *JAMA* 1929;92:466.
15. Dunlap C. Effects of radiation on the blood and the hemopoietic tissues including the spleen, the thymus, and the lymph nodes. *Arch Pathol Lab Med* 1942;34:562.
16. Jacobson L. The hematologic effects of ionizing radiations. *Radiology* 1949;52:371.
17. Mole RH. Risks from chronic radiation and their haematological control. *J Clin Pathol* 1954;7:267.
18. Bowditch M, Elkins H. Chronic exposure to benzene (benzol). I. The industrial aspects. *J Ind Hyg Toxicol* 1939;21:321.
19. Gerade HW. Toxicology and biochemistry of aromatic hydrocarbons. New York: Elsevier Science, 1960.
20. Johnson ES, Lucier G. Perspectives in risk assessment impact of recent reports on benzene. *Am J Ind Med* 1992;21:749–757.
21. Goldwater L. Disturbances in the blood following exposure to benzol. *J Lab Clin Med* 1941;26:957.
22. Aksoy M, Koray D, Akgun T, et al. Haematological effects of chronic benzene poisoning in 217 workers. *Br J Ind Med* 1971;28:296.
23. Greenburg L. Benzene (benzol) poisoning in the rotogravure printing industry in New York City. *J Ind Hyg Toxicol* 1939;21:395.
24. Erf L, Rhoads C. The hematological effects of benzene (benzol) poisoning. *J Ind Hyg Toxicol* 1939;21:421.
25. Yunis AA. Chloramphenicol–induced bone marrow suppression. *Semin Hematol* 1973;10:225–234.
26. Nagao T, Mauer AM. Concordance for drug–induced aplastic anemia in identical twins. *N Engl J Med* 1969;281:7–11.
27. Gussoff BD, Lee SL. Chloramphenicol–induced hematopoietic depression: a controlled comparison with tetracycline. *Am J Med Sci* 1966;251:8–15.
28. Lewis C, Putnam L, Hendricks FD, et al. Chloramphenicol (Chloromycetin) in relation to blood dyscrasias with observations on other drugs: a special study. *Antibiot Chemother* 1952;2:601.
29. Welch H, Lewis C, Kerlan I. Blood dyscrasias: a nationwide survey. *Antibiot Chemother* 1954;4:607.
30. Rosenbach L, Caviles A, Mitus W. Chloramphenicol toxicity: reversible vacuolization of erythroid cells. *N Engl J Med* 1960;263:724.
31. Hagler L, Pastore RA, Bergin JJ, Wrench MR. Aplastic anemia following viral hepatitis: report of two fatal cases and literature review. *Medicine* 1975;54:139–164.
32. Young N, Griffith P, Brittain E, et al. A multicenter trial of antithymocyte globulin in aplastic anemia

and related diseases. *Blood* 1988;72:1861–1869.

33. Tzakis AG, Arditì M, Whittington PF, et al. Aplastic anemia complicating orthotopic liver transplantation for non-A, non-B hepatitis. *N Engl J Med* 1988;319:393–396.

34. Brown KE, Tisdale J, Barrett AJ, et al. Hepatitis-associated aplastic anemia. *N Engl J Med* 1997;336:1059–1064.

35. Camitta BM, Nathan DG, Forman EN, et al. Posthepatic severe aplastic anemia—an indication for early bone marrow transplantation. *Blood* 1974;43:473–483.

36. Kojima S, Matsuyama K, Kodera Y. Bone marrow transplantation for hepatitis-associated aplastic anemia. *Acta Haematol* 1988;79:7–11.

37. Witherspoon R, Storb R, Shulman H, et al. Marrow transplantation in hepatitis-associated aplastic anemia. *Am J Hematol* 1984;17:269.

38. Baranski B, Armstrong G, Truman JT, et al. Epstein-Barr virus in the bone marrow of patients with aplastic anemia. *Ann Intern Med* 1988;109:695–704.

39. Ahronheim GA, Auger F, Joncas JH, et al. Primary infection by Epstein-Barr virus presenting as aplastic anemia. *N Engl J Med* 1983;309:313–314.

40. Bacigalupo A, Frassoni F, Van Lint MT. Acyclovir for the treatment of severe aplastic anemia. *N Engl J Med* 1984;310:1606–1607.

41. Gomez-Almaguer D, Marfil-Rivera J, Kudish-Wersh A. Acyclovir in the treatment of aplastic anemia. *Am J Hematol* 1988;29:172–173.

42. Tosato G, Magrath I, Koski I, et al. Activation of suppressor T cells during Epstein-Barr-virus-induced infectious mononucleosis. *N Engl J Med* 1979;301:1133–1137.

43. Shadduck RK, Winkelstein A, Zeigler Z, et al. Aplastic anemia following infectious mononucleosis: possible immune etiology. *Exp Hematol* 1979;7:264–271.

44. Mutter W, Reddehase MJ, Busch FW, et al. Failure in generating hemopoietic stem cells is the primary cause of death from cytomegalovirus disease in the immunocompromised host. *J Exp Med* 1988;167:1645–1658.

45. Reddehase MJ, Mutter W, Munch K, et al. CD8-positive T lymphocytes specific for murine cytomegalovirus immediate-early antigens mediate protective immunity. *J Virol* 1987;61:3102–3108.

46. Spivak JL, Bender BS, Quinn TC. Hematologic abnormalities in the acquired immune deficiency syndrome. *Am J Med* 1984;77:224–228.

47. Treacy M, Lai L, Costello C, Clark A. Peripheral blood and bone marrow abnormalities in patients with HIV related disease. *Br J Haematol* 1987;65:289–294.

48. Zon LI, Arkin C, Groopman JE. Haematologic manifestations of the human immune deficiency virus (HIV). *Br J Haematol* 1987;66:251–256.

49. Zucker-Franklin D, Cao YZ. Megakaryocytes of human immunodeficiency virus-infected individuals express viral RNA. *Proc Natl Acad Sci U S A* 1989;86:5595–5599.

50. Donahue RE, Johnson MM, Zon LI, et al. Suppression of in vitro haematopoiesis following human immunodeficiency virus infection. *Nature* 1987;326:200–203.

51. Weichold F, Zella D, Barabidkaja O, et al. Neither human immunodeficiency virus-1 (HIV-1) nor HIV-2 infects most-primitive human hematopoietic stem cells as assessed in long-term bone marrow cultures. *Blood* 1998;92:907–915.

52. Van der Schoot C, Huizinga T, van't Veer-Korthof E, et al. Deficiency of gly-cosyl-phosphatidylinositol-linked membrane glycoproteins of leukocytes in paroxysmal nocturnal

hemoglobinuria, description of a new diagnostic cytofluorometric assay. *Blood* 1990;76:1853–1859.

53. Schubert J, Alvarado M, Uciechowski P, et al. Diagnosis of paroxysmal nocturnal haemoglobinuria using immunophenotyping of peripheral blood cells. *Br J Haematol* 1991;79:487–492.
54. Mukhina GL, Buckley JT, Barber JP, et al. Multilineage glycosylphosphatidylinositol anchor-deficient haematopoiesis in untreated aplastic anaemia. *Br J Haematol* 2001;115:476–482.
55. Maciejewski J, Sloand E, Sato T, et al. Impaired hematopoiesis in paroxysmal nocturnal hemoglobinuria/aplastic anemia is not associated with a selective proliferative defect in the glycosylphosphatidylinositol-anchored protein-deficient clone. *Blood* 1997;89:1173–1181.
56. Iwamoto N, Kawaguchi T, Horikawa K, et al. Preferential hematopoiesis by paroxysmal nocturnal hemoglobinuria clone engrafted in SCID mice. *Blood* 1996;87:4944–4948.
57. Chen R, Nagarajan S, Prince GM, et al. Impaired growth and elevated fas receptor expression in PIGA(+) stem cells in primary paroxysmal nocturnal hemoglobinuria. *J Clin Invest* 2000;106:689–696.
58. Luzzatto L, Bessler M, Rotoli B. Somatic mutations in paroxysmal nocturnal hemoglobinuria: a blessing in disguise? *Cell* 1997;88:1–4.
59. Young N, Maciejewski J. Genetic and environmental effects in paroxysmal nocturnal hemoglobinuria: this little PIG-A goes “Why? Why? Why?” *J Clin Invest* 2000;106:637–641.
60. Maciejewski J, Follmann D, Rivera C, et al. Increased frequency of HLA-DR2 in patients with paroxysmal nocturnal hemoglobinuria and PNH/aplastic anemia syndrome. *Ann Intern Med* 2001 ( *in press*).
61. Karadimitris A, Manavalan JS, Thaler HT, et al. Abnormal T-cell repertoire is consistent with immune process underlying the pathogenesis of paroxysmal nocturnal hemoglobinuria. *Blood* 2000;96:2613–2620.
62. Hillmen P, Richards SJ. Implications of recent insights into the pathophysiology of paroxysmal nocturnal haemoglobinuria. *Br J Haematol* 2000;108:470–479.
63. Schrezenmeier H, Gerok M, Heimpel H. Assessment of frequency of hematopoietic stem cells in aplastic anemia by limiting dilution type long term marrow culture. *Exp Hematol* 1992;20:806.
64. Maciejewski JP, Selleri C, Sato T, et al. A severe and consistent deficit in marrow and circulating primitive hematopoietic cells (long-term culture-initiating cells) in acquired aplastic anemia. *Blood* 1996;88:1983–1991.
65. Maciejewski JP, Anderson S, Katevas P, Young NS. Phenotypic and functional analysis of bone marrow progenitor cell compartment in bone marrow failure. *Br J Haematol* 1994;87:227–234.
66. Scopes J, Bagnara M, Gordon-Smith EC, et al. Haemopoietic progenitor cells are reduced in aplastic anaemia. *Br J Haematol* 1994;86:427–430.
67. Hinterberger W, Rowlings PA, Hinterberger-Fischer M, et al. Results of transplanting bone marrow from genetically identical twins into patients with aplastic anemia. *Ann Intern Med* 1997;126:116–122.
68. Maciejewski JP, Kim S, Sloand E, et al. Sustained long-term hematologic recovery despite a marked quantitative defect in the stem cell compartment of patients with aplastic anemia after immunosuppressive therapy. *Am J Hematol* 2000;65:123–131.
69. Ball SE, Gibson FM, Rizzo S, et al. Progressive telomere shortening in aplastic anemia. *Blood* 1998;91:3582–3592.
70. Brummendorf TH, Maciejewski JP, Mak J, et al. Telomere length in leukocyte subpopulations of patients with aplastic anemia. *Blood* 2001;97:895–900.
71. Islam A. Do bone marrow fat cells or their precursors have a pathogenic role in idiopathic aplastic anaemia? *Med Hypotheses* 1988;25:209.
72. Huang E, Nocka K, Beier DR, et al. The hematopoietic growth factor KL is encoded by the Sl locus



and is the ligand of the c-kit receptor, the gene product of the W locus. *Cell* 1990;63:225-233.

73. Zsebo KM, Williams DA, Geissler EN, et al. Stem cell factor is encoded at the Sl locus of the mouse and is the ligand for the c-kit tyrosine kinase receptor. *Cell* 1990;63:213-224.
74. Flanagan JG, Leder P. The kit ligand: a cell surface molecule altered in steel mutant fibroblasts. *Cell* 1990;63:185-194.
75. Dexter TM, Moore MA. In vitro duplication and "cure" of haemopoietic defects in genetically anaemic mice. *Nature* 1977;269:412-414.
76. Malik F, Gordon MY, Goldman JM, Gordon-Smith EC. Comparisons of the composition of fat cells obtained from the marrow of normal individuals or of subjects with aplastic anemia and from bone marrow cultures. *Exp Hematol* 1984;12:191-197.
77. Samsom JP, Hulstaert CE, Molenaar I, Nieweg HO. Fine structure of the bone marrow sinusoidal wall in idiopathic and drug-induced panmyelopathy. *Acta Haematol* 1972;48:218-226.
78. Athanasou NA, Quinn J, Brenner MK, et al. Origin of marrow stromal cells and haemopoietic chimaerism following bone marrow transplantation determined by in situ hybridisation. *Br J Cancer* 1990;61:385-389.
79. Marsh JC, Chang J, Testa NG, et al. In vitro assessment of marrow 'stem cell' and stromal cell function in aplastic anaemia. *Br J Haematol* 1991;78:258-267.
80. Novitzky N, Jacobs P. Immunosuppressive therapy in bone marrow aplasia: the stroma functions normally to support hematopoiesis. *Exp Hematol* 1995;23:1472-1477.
81. Kojima S. Hematopoietic growth factors and marrow stroma in aplastic anemia. *Int J Hematol* 1998;68:19-28.
82. Marsh JC. Hematopoietic growth factors in the pathogenesis and for the treatment of aplastic anemia. *Semin Hematol* 2000;37:81-90.
83. Bickel M, Tsuda H, Amstad P, et al. Differential regulation of colony-stimulating factors and interleukin 2 production by cyclosporin A. *Proc Natl Acad Sci U S A* 1987;84:3274-3277.
84. Rebellato LM, Gross U, Verbanac KM, Thomas JM. A comprehensive definition of the major antibody specificities in polyclonal rabbit antithymocyte globulin. *Transplantation* 1994;57:685-694.
85. Tisdale JF, Dunn DE, Maciejewski J. Cyclophosphamide and other new agents for the treatment of severe aplastic anemia. *Semin Hematol* 2000;37:102-109.
86. Killick SB, Marsh JC, Gordon-Smith EC, et al. Effects of antithymocyte globulin on bone marrow CD34+ cells in aplastic anaemia and myelodysplasia. *Br J Haematol* 2000;108:582-591.
87. Killick SB, Cox CV, Marsh JC, et al. Mechanisms of bone marrow progenitor cell apoptosis in aplastic anaemia and the effect of anti-thymocyte globulin: examination of the role of the Fas-Fas-L interaction. *Br J Haematol* 2000;111:1164-1169.
88. Molldrem JJ, Caples M, Mavroudis D, et al. Antithymocyte globulin for patients with myelodysplastic syndrome. *Br J Haematol* 1997;99:699-705.
89. Jonasova A, Neuwirtova R, Germak J, et al. Cyclosporin A therapy in hypoplastic MDS patients and certain refractory anaemias without hypoplastic bone marrow. *Br J Haematol* 1998;100:304-309.
90. Young NS, Barrett AJ. Immune modulation of myelodysplasia: rationale and therapy. In: Bennett JM, ed. *The myelodysplastic syndromes: pathobiology and clinical management*, vol ( *in press*). New York: Marcel Dekker, 2001.
91. Hoffman R, Zanjani ED, Lutton JD, et al. Suppression of erythroid-colony formation by lymphocytes from patients with aplastic anemia. *N Engl J Med* 1977;296:10-13.

92. Nissen C, Cornu P, Gratwohl A, Speck B. Peripheral blood cells from patients with aplastic anaemia in partial remission suppress growth of their own bone marrow precursors in culture. *Br J Haematol* 1980;45:233-243.
93. Bacigalupo A, Podesta M, Van Lint MT, et al. Severe aplastic anaemia: correlation of in vitro test with clinical response to immunosuppression in 20 patients. *Br J Haematol* 1981;47:423-432.
94. Takaku F, Suda T, Mizoguchi H, et al. Effect of peripheral blood mononuclear cells from aplastic anemia patients on the granulocyte-macrophage and erythroid colony formation in samples from normal human bone marrow in vitro—a cooperative work. *Blood* 1980;55:937-943.
95. Abdou NI, Verdirame JD, Amare M, Abdou NL. Heterogeneity of pathogenetic mechanisms in aplastic anemia. Efficacy of therapy based on in-vitro results. *Ann Intern Med* 1981;95:43-50.
96. Nagasawa T, Abe T, Hanada T. Inhibitory effects of T cells on in vitro granulopoiesis, erythropoiesis, and immunoglobulin production in patients with aplastic anaemia. *Scand J Haematol* 1982;28:389-398.
97. Sullivan R, Quesenberry PJ, Parkman R, et al. Aplastic anemia: lack of inhibitory effect of bone marrow lymphocytes on in vitro granulopoiesis. *Blood* 1980;56:625-632.
98. Hanada T, Aoki Y, Ninomiya H, Abe T. T cell-mediated inhibition of haematopoiesis in aplastic anaemia: serial assay of inhibitory activities of T cells to autologous CFU-E during immunosuppressive therapy. *Br J Haematol* 1986;63:69-74.
99. Bacigalupo A, Podesta M, Raffo MR, et al. Lack of in vitro colony (CFUC) formation and myelosuppressive activity in patients with severe aplastic anemia after autologous hematologic reconstitution. *Exp Hematol* 1980;8:795-801.
100. Torok-Storb BJ, Sieff C, Storb R, et al. In vitro tests for distinguishing possible immune-mediated aplastic anemia from transfusion-induced sensitization. *Blood* 1980;55:211-215.
101. Kagan WA, Ascensao JA, Pahwa RN, et al. Aplastic anemia: presence in human bone marrow of cells that suppress myelopoiesis. *Proc Natl Acad Sci U S A* 1976;73:2890-2894.
102. Koller U, Hinterberger W, Gschwandter L, et al. Identification of activated T cells and the suppressor/inducer subset in patients suffering from severe aplastic anemia. *Blut* 1989;58:21-26.
103. Herrmann F, Griffin JD, Meuer SG, Meyer zum Buschenfelde KH. Establishment of an interleukin 2-dependent T cell line derived from a patient with severe aplastic anemia, which inhibits in vitro hematopoiesis. *J Immunol* 1986;136:1629-1634.
104. Tong J, Bacigalupo A, Piaggio G, et al. In vitro response of T cells from aplastic anemia patients to antilymphocyte globulin and phytohemagglutinin: colony-stimulating activity and lymphokine production. *Exp Hematol* 1991;19:312-326.
105. Nakao S, Takamatsu H, Yachie A, et al. Establishment of a CD4+ T cell clone recognizing autologous hematopoietic progenitor cells from a patient with immune-mediated aplastic anemia. *Exp Hematol* 1995;23:433-438.
106. Zoumbos NC, Ferris WO, Hsu SM, et al. Analysis of lymphocyte subsets in patients with aplastic anaemia. *Br J Haematol* 1984;58:95-105.
107. Ruiz-Arguelles GJ, Katzmman JA, Greipp PR, et al. Lymphocyte subsets in patients with aplastic anemia. *Am J Hematol* 1984;16:267-275.
108. Tsuda H, Yamasaki H. Type I and type II T-cell profiles in aplastic anemia and refractory anemia. *Am J Hematol* 2000;64:271-274.
109. Nakao S, Takami A, Takamatsu H, et al. Isolation of a T-cell clone showing HLA-DRB1\*0405-restricted cytotoxicity for hematopoietic cells in a patient with aplastic anemia. *Blood* 1997;89:3691-3699.
110. Manz CY, Dietrich PY, Schnuriger V, et al. T-cell receptor beta chain variability in bone marrow and

peripheral blood in severe acquired aplastic anemia. *Blood Cells Mol Dis* 1997;23:110–122.

111. Zeng W, Nakao S, Takamatsu H, et al. Characterization of T-cell repertoire of the bone marrow in immune-mediated aplastic anemia: evidence for the involvement of antigen-driven T-cell response in cyclosporine-dependent aplastic anemia. *Blood* 1999;93:3008–3016.

112. Zeng W, Maciejewski J, Chen G, Young N. Limited heterogeneity of T-cell receptor BV usage in aplastic anemia. *J Clin Invest* 2001 ( *in press*).

113. Kook H, Risitano AM, Zeng W, et al. Changes in T-cell receptor VB repertoire in aplastic anemia: effects of different immunosuppressive regimens. *Blood* 2002;99:3668–3675.

114. Lasser SD, Camitta BM, Needleman HL. Dental management of patients undergoing bone marrow transplantation for aplastic anemia. *Oral Surg* 1989;43:181.

115. Camitta BM, Thomas ED, Nathan DG, et al. Severe aplastic anemia: a prospective study of the effect of early marrow transplantation on acute mortality. *Blood* 1976;48:63–70.

116. Bacigalupo A, Hows J, Gluckman E, et al. Bone marrow transplantation (BMT) versus immunosuppression for the treatment of severe aplastic anaemia (SAA): a report of the EBMT SAA working party. *Br J Haematol* 1988;70:177–182.

117. Fong TP, Okafor LA, Schmitz TH, et al. An evaluation of cellularity in various types of bone marrow specimens. *Am J Clin Pathol* 1979;72:812–816.

118. Kansu E, Erslev AJ. Aplastic anaemia with ‘hot pockets.’ *Scand J Haematol* 1976;17:326–334.

119. Clemmesen L, Hansen MM, Mortensen L, et al. The applicability of simple blood and bone marrow variables in prediction of acute leukaemia in patients with acquired bi- or pancytopenia. *Scand J Haematol* 1981;27:193–200.

120. Osgood EE, Mathews TJ. Aplastic anemia treated with daily transfusions and intravenous marrow: case report. *Ann Intern Med* 1939;13:357.

121. Pillow RP, Epstein RB, Buckner CD, et al. Treatment of bone-marrow failure by isogeneic marrow infusion. *N Engl J Med* 1966;275:94–97.

122. Passweg JR, Socie G, Hinterberger W, et al. Bone marrow transplantation for severe aplastic anemia: has outcome improved? *Blood* 1997;90:858–864.

123. Horowitz MM. Current status of allogeneic bone marrow transplantation in acquired aplastic anemia. *Semin Hematol* 2000;37:30–42.

124. Storb R, Prentice RL, Thomas ED. Marrow transplantation for treatment of aplastic anemia. An analysis of factors associated with graft rejection. *N Engl J Med* 1977;296:61–66.

125. van Bekkum DW, Bergan JJ, et al. Bone marrow transplantation from donors with aplastic anemia. *JAMA* 1976;236:1131.

126. Appelbaum FR, Cheever MA, Fefer A, et al. Recurrence of aplastic anemia following cyclophosphamide and syngeneic bone marrow transplantation: evidence for two mechanisms of graft failure. *Blood* 1985;65:553–556.

127. Champlin RE, Feig SA, Sparkes RS, Galen RP. Bone marrow transplantation from identical twins in the treatment of aplastic anaemia: implication for the pathogenesis of the disease. *Br J Haematol* 1984;56:455–463.

128. Hill RS, Petersen FB, Storb R, et al. Mixed hematologic chimerism after allogeneic marrow transplantation for severe aplastic anemia is associated with a higher risk of graft rejection and a lessened incidence of acute graft-versus-host disease. *Blood* 1986;67:811–816.

129. Stucki A, Leisenring W, Sandmaier BM, et al. Decreased rejection and improved survival of first and second marrow transplants for severe aplastic anemia (a 26-year retrospective analysis). *Blood*

1998;92:2742–2749.

130. Champlin RE, Horowitz MM, van Bekkum DW, et al. Graft failure following bone marrow transplantation for severe aplastic anemia: risk factors and treatment results. *Blood* 1989;73:606–613.
131. Deeg HJ, Self S, Storb R, et al. Decreased incidence of marrow graft rejection in patients with severe aplastic anemia: changing impact of risk factors. *Blood* 1986;68:1363–1368.
132. Storb R, Etzioni R, Anasetti C, et al. Cyclophosphamide combined with antithymocyte globulin in preparation for allogeneic marrow transplants in patients with aplastic anemia. *Blood* 1994;84:941–949.
133. Storb R, Blume KG, O'Donnell MR, et al. Cyclophosphamide and antithymocyte globulin to condition patients with aplastic anemia for allogeneic marrow transplantations: the experience in four centers. *Biol Blood Marrow Transplant* 2001;7:39–44.
134. Bacigalupo A, Chaple M, Hows J, et al. Treatment of aplastic anaemia (AA) with antilymphocyte globulin (ALG) and methylprednisolone (MPred) with or without androgens: a randomized trial from the EBMT SAA working party. *Br J Haematol* 1993;83:145–151.
135. Deeg HJ, Leisenring W, Storb R, et al. Long-term outcome after marrow transplantation for severe aplastic anemia. *Blood* 1998;91:3637–3645.
136. Margolis DA, Cammita BM. Hematopoietic stem cell transplantation for severe aplastic anemia. *Curr Opin Hematol* 1998;5:441–444.
137. Kojima S, Matsuyama T, Kato S, et al. Outcome of 154 patients with severe aplastic anemia who received transplants from unrelated donors: the Japan Marrow Donor Program. *Blood* 2002;100:799–803.
138. Gluckman E, Broxmeyer HE, Auerbach AD, et al. Hematopoietic reconstitution in a patient with Fanconi's anemia by means of umbilical-cord blood from an HLA-identical sibling. *N Engl J Med* 1989;321:1174–1178.
139. Wagner JE, Kernan NA, Steinbuch M, et al. Allogeneic sibling umbilical-cord-blood transplantation in children with malignant and non-malignant disease. *Lancet* 1995;346:214–219.
140. Kurtzberg J, Laughlin M, Graham ML, et al. Placental blood as a source of hematopoietic stem cells for transplantation into unrelated recipients. *N Engl J Med* 1996;335:157–166.
141. Wagner JE, Rosenthal J, Sweetman R, et al. Successful transplantation of HLA-matched and HLA-mismatched umbilical cord blood from unrelated donors: analysis of engraftment and acute graft-versus-host disease. *Blood* 1996;88:795–802.
142. Rubinstein P, Carrier C, Scaradavou A, et al. Outcomes among 562 recipients of placental-blood transplants from unrelated donors. *N Engl J Med* 1998;339:1565–1577.
143. Camitta B, O'Reilly RJ, Sensenbrenner L, et al. Antithoracic duct lymphocyte globulin therapy of severe aplastic anemia. *Blood* 1983;62:883–888.
144. Champlin R, Ho W, Gale RP. Antithymocyte globulin treatment in patients with aplastic anemia: a prospective randomized trial. *N Engl J Med* 1983;308:113–118.
145. Young N, Griffith P, Brittain E, et al. A multicenter trial of antithymocyte globulin in aplastic anemia and related diseases. *Blood* 1988;72:1861–1869.
146. Fairhead SM, Chipping PM, Gordon-Smith EC. Treatment of aplastic anaemia with antilymphocyte globulin (ALG). *Br J Haematol* 1983;55:7–16.
147. Speck B, Gratwohl A, Nissen C, et al. Treatment of severe aplastic anaemia with antilymphocyte globulin or bone-marrow transplantation. *BMJ (Clin Res Ed)* 1981;282:860–863.
148. Young N, Speck B. Antithymocyte and antilymphocyte globulins: clinical trials and mechanism of action. In: Young NS, Levine A, Humphries RK, eds. *Aplastic anemia: stem cell biology and advances in*

treatment, vol 221. New York: Alan R Liss, 1984.

149. Hinterberger-Fischer M, Hinterberger W, Hockern P, et al. Treatment of severe aplastic anemia with combined immunosuppression (antithymocyte globulin and high-dose methylprednisolone). *Acta Haematol* 1986;76:196-201.

150. Raefsky EL, Gascon P, Gratwohl A, et al. Biological and immunological characterization of ATG and ALG. *Blood* 1986;68:712-719.

151. Marsh JC, Hows JM, Bryett KA, et al. Survival after antilymphocyte globulin therapy for aplastic anemia depends on disease severity. *Blood* 1987;70:1046-1052.

152. Bacigalupo A. Treatment of severe aplastic anaemia. In: Hinton K TB, ed. *Clinical haematology*, vol 19. Long, Bailliere Tindall, 1989.

153. Satoh PS DJ, Flwming WF, et al. Horse IgG, anti-horse IgG, and circulating immune complexes in the plasma of renal transplant patients receiving ATGAM. Upjohn Technical Report, 1979.

154. Tichelli A, Passweg J, Nissen C, et al. Repeated treatment with horse antilymphocyte globulin for severe aplastic anaemia. *Br J Haematol* 1998;100:393-400.

155. Bielory L, Gascon P, Lawley TJ, et al. Serum sickness and haematopoietic recovery with antithymocyte globulin in bone marrow failure patients. *Br J Haematol* 1986;63:729-736.

156. Mookerjee BK, Azzolina L, Poultar L. Interaction of anti-thymocyte serum with hematopoietic stem cells. I. Effects in vitro and in vivo. *J Immunol* 1974;112:822-829.

157. Greco B, Bielory L, Stephany D, et al. Antithymocyte globulin reacts with many normal human cell types. *Blood* 1983;62:1047-1054.

158. Barrett AJ, Longhurst P, Rosengurt N, et al. Crossreaction of antilymphocyte globulin with human granulocyte colony-forming cells. *J Clin Pathol* 1978;31:129-135.

159. Zoumbos NC, Gascon P, Djeu JY, Young NS. Interferon is a mediator of hematopoietic suppression in aplastic anemia in vitro and possibly in vivo. *Proc Natl Acad Sci U S A* 1985;82:188-192.

160. Barbano GC, Schenone A, Roncella S, et al. Anti-lymphocyte globulin stimulates normal human T cells to proliferate and to release lymphokines in vitro. A study at the clonal level. *Blood* 1988;72:956-963.

161. Kahan BD. Cyclosporine. *N Engl J Med* 1989;321:1725-1738.

162. Wisloff F, Godal HC. Cyclosporine in refractory severe aplastic anemia. *N Engl J Med* 1985;312:1193.

163. Werner EJ, Stout RD, Valdez LP, Harris RE. Immunosuppressive therapy versus bone marrow transplantation for children with aplastic anemia. *Pediatrics* 1989;83:61-65.

164. Totterman TH, Hoglund M, Bengtsson M, et al. Treatment of pure red-cell aplasia and aplastic anaemia with ciclosporin: long-term clinical effects. *Eur J Haematol* 1989;42:126-133.

165. Leonard EM, Raefsky E, Griffith P, et al. Cyclosporine therapy of aplastic anaemia, congenital and acquired red cell aplasia. *Br J Haematol* 1989;72:278-284.

166. Gluckman EEH, Devergie A. Comparison of cyclosporine A (CyA) and horse antithymocyte globulin (H.ATG) for treatment of severe aplastic anemia. *Blood* 1988;72[Suppl 1]:42a.

167. Esperou H, Devergie A, Lehn P, et al. A randomized study comparing ciclosporin A and antithymocyte globulin for treatment of severe aplastic anemia. *Nouv Rev Fr Hematol* 1989;31:65-68.

168. Kahan BD. Individualization of cyclosporine therapy using pharmacokinetic and pharmacodynamic parameters. *Transplantation* 1985;40:457-476.

169. Speck B, Gratwohl A, Nissen C, et al. Treatment of severe aplastic anemia. *Exp Hematol*

1986;14:126–132.

170. Rosenfeld SJ, Kimball J, Vining D, Young NS. Intensive immunosuppression with antithymocyte globulin and cyclosporine as treatment for severe acquired aplastic anemia. *Blood* 1995;85:3058–3065.
171. Frickhofen N, Rosenfeld SJ. Immunosuppressive treatment of aplastic anemia with antithymocyte globulin and cyclosporine. *Semin Hematol* 2000;37:56–68.
172. Bacigalupo A, Bruno B, Saracco P, et al. Antilymphocyte globulin, cyclosporine, prednisolone, and granulocyte colony-stimulating factor for severe aplastic anemia: an update of the GITMO/EBMT study on 100 patients. European Group for Blood and Marrow Transplantation (EBMT) Working Party on Severe Aplastic Anemia and the Gruppo Italiano Trapianti di Midollo Osseo (GITMO). *Blood* 2000;95:1931–1934.
173. Doney K, Storb R, Buckner CD, et al. Treatment of aplastic anemia with antithymocyte globulin, high-dose corticosteroids, and androgens. *Exp Hematol* 1987;15:239–242.
174. Bussel A, Dumont J, Schenmetzler C, et al. Long-term complete autologous reconstitution following cyclophosphamide and allogeneic marrow infusion in a case of severe aplastic anemia. *Nouv Rev Fr Hematol* 1985;27:15–18.
175. Schrezenmeier H, Marin P, Raghavachar A, et al. Relapse of aplastic anaemia after immunosuppressive treatment: a report from the European Bone Marrow Transplantation Group SAA Working Party. *Br J Haematol* 1993;85:371–377.
176. Tooze JA, Marsh JC, Gordon-Smith EC. Clonal evolution of aplastic anaemia to myelodysplasia/acute myeloid leukaemia and paroxysmal nocturnal haemoglobinuria. *Leuk Lymphoma* 1999;33:231–241.
177. Socie G, Rosenfeld S, Frickhofen N, et al. Late clonal diseases of treated aplastic anemia. *Semin Hematol* 2000;37:91–101.
178. Socie G, Henry-Amar M, Bacigalupo A, et al. Malignant tumors occurring after treatment of aplastic anemia. European Bone Marrow Transplantation–Severe Aplastic Anaemia Working Party. *N Engl J Med* 1993;329:1152–1157.
179. Maciejewski JP, Risitano AM, Sloand EM, et al. Distinct clinical outcomes for cytogenetic abnormalities evolving from aplastic anemia. *Blood* 2002;99:3129–3135.
180. de Planque MMBA, Würsch A, et al. Long-term follow-up of severe aplastic anaemia patients treated with antithymocyte globulin. *Br J Haematol* 1989;73:121.
181. Deeg HJ, Storb R, Thomas ED. Bone marrow transplantation: a review of delayed complications. *Br J Haematol* 1984;57:185–208.
182. First LR, Smith BR, Lipton J, et al. Isolated thrombocytopenia after allogeneic bone marrow transplantation: existence of transient and chronic thrombocytopenic syndromes. *Blood* 1985;65:368–374.
183. Hughes RT, Milligan DW, Smith GM, et al. A second bone marrow transplant for acute myeloid leukaemia after transplantation for aplastic anaemia. *Br J Haematol* 1988;68:391.
184. Kolb HJ, Socie G, Duell T, et al. Malignant neoplasms in long-term survivors of bone marrow transplantation. Late Effects Working Party of the European Cooperative Group for Blood and Marrow Transplantation and the European Late Effect Project Group. *Ann Intern Med* 1999;131:738–744.
185. Tichelli A, Socie G, Henry-Amar M, et al. Effectiveness of immunosuppressive therapy in older patients with aplastic anemia. European Group for Blood and Marrow Transplantation Severe Aplastic Anaemia Working Party. *Ann Intern Med* 1999;130:193–201.
186. Bacigalupo A, Brand R, Oneto R, et al. Treatment of acquired severe aplastic anemia: bone marrow transplantation compared with immunosuppressive therapy—The European Group for Blood and Marrow Transplantation experience. *Semin Hematol* 2000;37:69–80.
187. Shahidi N, Diamond L. Testosterone-induced remission in aplastic anemia of both acquired and

- congenital types. Further observations in 24 cases. *N Engl J Med* 1961;264:953.
188. Li FP, Alter BP, Nathan DG. The mortality of acquired aplastic anemia in children. *Blood* 1972;40:153-162.
189. Alexanian R, Nadell J, Alfrey C. Oxymetholone treatment for the anemia of bone marrow failure. *Blood* 1972;40:353-365.
190. Branda RF, Amsden TW, Jacob HS. Randomized study of nandrolone therapy for anemias due to bone marrow failure. *Arch Intern Med* 1977;137:65-69.
191. Camitta BM, Thomas ED, Nathan DG, et al. A prospective study of androgens and bone marrow transplantation for treatment of severe aplastic anemia. *Blood* 1979;53:504-514.
192. Pizzuto J, Conte G, Sinco A, et al. Use of androgens in acquired aplastic anaemia. Relation of response to etiology and severity. *Acta Haematol* 1980;64:18-24.
193. Najean Y. Long-term follow-up in patients with aplastic anemia. A study of 137 androgen-treated patients surviving more than two years. Joint Group for the Study of Aplastic and Refractory Anemias. *Am J Med* 1981;71:543-551.
194. Shahidi NTDL. Testosterone-induced remission in aplastic anemia of both acquired and congenital types: further observations in 24 cases. *N Engl J Med* 1961;264:953.
195. Peking AGR, Najean Y, Le Joly JM. Liver damage during androgenic anabolic therapy. In: Najean Y, ed. *Medullary aplasia*. New York: Masson, 1980:189.
196. McGiven AR. Peliosis hepatitis: case report and review of pathogenesis. *J Pathol* 1970;101:283-285.
197. Bourliere BNY. Influence of long-term androgen therapy on growth: an analysis of 18 cases of aplastic anemia in children. *Pediatr Forum* 1987;141:718.
198. Gardner FH, Besa EC. Physiologic mechanisms and the hematopoietic effects of the androstanes and their derivatives. *Curr Top Hematol* 1983;4:123-195.
199. Mooradian AD, Morley JE, Korenman SG. Biological actions of androgens. *Endocr Rev* 1987;8:1-28.
200. Minguell JJ, Sierralta WD. Molecular mechanism of action of the male sex hormones. *J Endocrinol* 1975;65:287-315.
201. Gardner FH. Androgen therapy of aplastic anaemia. *Clin Haematol* 1978;7:571-585.
202. Adamson JW. Pharmacological stimulation of marrow function. *Clin Haematol* 1978;7:555-569.
203. Naets JP, Wittek M. The mechanism of action of androgens on erythropoiesis. *Ann N Y Acad Sci* 1968;149:366-376.
204. Champlin RE, Nimer SD, Ireland P, et al. Treatment of refractory aplastic anemia with recombinant human granulocyte-macrophage-colony-stimulating factor. *Blood* 1989;73:694-699.
205. Vadhan-Raj S, Buescher S, Broxmeyer HE, et al. Stimulation of myelopoiesis in patients with aplastic anemia by recombinant human granulocyte-macrophage colony-stimulating factor. *N Engl J Med* 1988;319:1628-1634.
206. Nissen C, Tichelli A, Gratwohl A, et al. Failure of recombinant human granulocyte-macrophage colony-stimulating factor therapy in aplastic anemia patients with very severe neutropenia. *Blood* 1988;72:2045-2047.
207. Kojima S, Matsuyama T. Stimulation of granulopoiesis by high-dose recombinant human granulocyte colony-stimulating factor in children with aplastic anemia and very severe neutropenia. *Blood* 1994;83:1474-1478.
208. Sonoda Y, Ohno Y, Fujii H, et al. Multilineage response in aplastic anemia patients following



long-term administration of filgrastim (recombinant human granulocyte colony stimulating factor). *Stem Cells* 1993;11:543-554.

209. Nimer SD, Paquette RL, Ireland P, et al. A phase I/II study of interleukin-3 in patients with aplastic anemia and myelodysplasia. *Exp Hematol* 1994;22:875-880.

210. Bargetzi MJ, Gluckman E, Tichelli A, et al. Recombinant human interleukin-3 in refractory severe aplastic anaemia: a phase I/II trial. *Br J Haematol* 1995;91:306-312.

211. Nemunaitis J, Ross M, Meisenberg B, et al. Phase I study of recombinant human interleukin-1 beta (rhIL-1 beta) in patients with bone marrow failure. *Bone Marrow Transplant* 1994;14:583-588.

212. Schrezenmeier H, Marsh JC, Stromeyer P, et al. A phase I/II trial of recombinant human interleukin-6 in patients with aplastic anaemia. *Br J Haematol* 1995;90:283-292.

213. Kurzrock R, Paquette R, Gratwohl A, et al. Use of stem cell factor (Stemgen, SCF) and filgrastim (G-CSF) in aplastic anemia patients who have failed ATG/ALG therapy. *Blood* 1997;90[Suppl 1]:173.

214. Kurzrock R, Cortes J, Thomas DA, et al. Pilot study of low-dose interleukin-11 in patients with bone marrow failure. *J Clin Oncol* 2001;19:4165-4172.

215. Kojima S, Hibi S, Kosaka Y, et al. Immunosuppressive therapy using antithymocyte globulin, cyclosporine, and danazol with or without human granulocyte colony-stimulating factor in children with acquired aplastic anemia. *Blood* 2000;96:2049-2054.

216. Lehrnbecher T, Welte K. Haematopoietic growth factors in children with neutropenia. *Br J Haematol* 2002;116:28-56.

217. Ohara A, Kojima S, Hamajima N, et al. Myelodysplastic syndrome and acute myelogenous leukemia as a late clonal complication in children with acquired aplastic anemia. *Blood* 1997;90:1009-1013.

218. Locasciulli A, Arcese W, Locatelli F, et al. Treatment of aplastic anaemia with granulocyte-colony stimulating factor and risk of malignancy. Italian Aplastic Anaemia Study Group. *Lancet* 2001;357:43-44.

219. Kudo K, Nagai H, Numata S, et al. Absence of mutations in the granulocyte colony-stimulating factor (G-CSF) receptor gene in patients with myelodysplastic syndrome/acute myeloblastic leukaemia occurring after treatment of aplastic anaemia with G-CSF. *Br J Haematol* 2000;111:656-658.

220. Brodsky RA, Sensenbrenner LL, Jones RJ. Complete remission in severe aplastic anemia after high-dose cyclophosphamide without bone marrow transplantation. *Blood* 1996;87:491-494.

221. Tisdale JF, Dunn DE, Geller N, et al. High-dose cyclophosphamide in severe aplastic anaemia: a randomised trial. *Lancet* 2000;356:1554-1559.

222. Group TTtRAtPS. Leukocyte reduction and ultraviolet B irradiation of platelets to prevent alloimmunization and refractoriness to platelet transfusions. *N Engl J Med* 1997;337:1861-1869.

223. Benson K, Fields K, Hiemenz J, et al. The platelet-refractory bone marrow transplant patient: prophylaxis and treatment of bleeding. *Semin Oncol* 1993;20:102-109.

224. McFarland JG. Alloimmunization and platelet transfusion. *Semin Hematol* 1996;33:315-328.

225. Cahill MR, Lilleyman JS. The rational use of platelet transfusions in children. *Semin Thromb Hemost* 1998;24:567-575.

226. Rebulli P, Finazzi G, Marangoni F, et al. The threshold for prophylactic platelet transfusions in adults with acute myeloid leukemia. *N Engl J Med* 1997;337:1870-1875.

227. Wandt H, Frank MM, Ehninger G, et al. Safety and cost effectiveness of a  $10 \times 10^9/L$  trigger for prophylactic platelet transfusions compared with the traditional  $20 \times 10^9/L$  trigger: a prospective comparative trial in 105 patients with acute myeloid leukemia. *Blood* 1998;91:3601-3606.

228. Sagmeister M, Oec L, Gmur J. A restrictive platelet transfusion policy allowing long-term support of

outpatients with severe aplastic anemia. *Blood* 1999;93:3124–3126.

229. Valdez IH, Patton LL. Aplastic anemia: current concepts and dental management. *Special Care Dentist* 1990;10:185–189.

230. Bartholomew JR, Salgia R, Bell WR. Control of bleeding in patients with immune and nonimmune thrombocytopenia with aminocaproic acid. *Arch Intern Med* 1989;149:1959–1961.

231. Garewal HS, Durie BG. Anti-fibrinolytic therapy with aminocaproic acid for the control of bleeding in thrombocytopenic patients. *Scand J Haematol* 1985;35:497–500.

232. Brittenham GM, Griffith PM, Nienhuis AW, et al. Efficacy of deferoxamine in preventing complications of iron overload in patients with thalassemia major. *N Engl J Med* 1994;331:567–573.

233. Weinberger M, Elattar I, Marshall D, et al. Patterns of infection in patients with aplastic anemia and the emergence of *Aspergillus* as a major cause of death. *Medicine* 1992;71:24–43.

234. Keidan AJ, Tsatalas C, Cohen J, et al. Infective complications of aplastic anaemia. *Br J Haematol* 1986;63:503–508.

235. Fanconi G. Familiare infantile perniziosaartige Anämie (pernizioses Blutbild und Konstitution). *Z Kinderheilkunde* 1927;117:257.

236. Fanconi G. Familial constitutional panmyelocytopeny, Fanconi's anemia (FA). I. Clinical aspects. *Semin Hematol* 1967;4:233–240.

237. Schroeder TM, Tilgen D, Kruger J, Vogel F. Formal genetics of Fanconi's anaemia in the genetics of neoplasia. *Nature* 1976;230:370–373.

238. Rogatko A, Auerbach AD. Segregation analysis with uncertain ascertainment: application to Fanconi anemia. *Am J Hum Genet* 1988;42:889.

239. Rosendorff J, Bernstein R, Macdougall L, Jenkins T. Fanconi anemia; another disease of unusually high prevalence in the Afrikaans population of South Africa. *Am J Med Genet* 1987;2:793–797.

240. Alter BP, Young N. The bone marrow failure syndromes. In: DG N, SH O, eds. *Nathan and Oski's hematology of infancy and childhood*, 5th ed. Philadelphia: WB Saunders, 1998:237–335.

241. Giampietro PF, Adler-Brecher B, Verlander PC, et al. The need for more accurate and timely diagnosis in Fanconi anemia. A report from the international Fanconi Anemia Registry. *Pediatrics* 1993;91:1116–1120.

242. Alter BP. Fanconi's anemia and malignancies. *Am J Hematol* 1996;53:99–110.

243. Butturini A, Gale RP, Verlander PC, et al. Hematologic abnormalities in Fanconi anemia. An International Fanconi Anemia Registry study. *Blood* 1994;84:1650–1655.

244. Wajnrajch MPGJ, Huma Z, Popovic J, et al. Evaluation of growth and hormonal status in patients referred to the International Fanconi Anemia Registry. *Pediatrics* 2001;107:744–754.

245. Dupuis-Girod S, Gluckman E, Souberbielle JC, Brauner R. Growth hormone deficiency caused by pituitary stalk interruption in Fanconi's anemia. *J Pediatr* 2001;138:129–133.

246. Sasaki MS, Tonomura A. A high susceptibility of Fanconi's anemia to chromosome breakage by DNA cross linking agents. *Cancer Res* 1973;33:1829–1836.

247. Auerbach AD, Wolman SR. Susceptibility of Fanconi's anemia fibroblasts to chromosome damage by carcinogens. *Nature* 1976;261:494–496.

248. Auerbach AD, Adler B, Chaganti RSK. Prenatal and postnatal diagnosis and carrier detection of Fanconi anemia by a cytogenetic method. *Pediatrics* 1981;67:128.

249. Auerbach AD, Alter BP. Prenatal and postnatal diagnosis of aplastic anemia. In: Alter BP, ed.

Methods in hematology: perinatal hematology. Edinburgh, UK: Churchill-Livingstone, 1989:225.

250. Verlinsky Y, Rechitsky S, Schoolcraft W, et al. Preimplantation diagnosis for Fanconi anemia combined with HLA matching. *JAMA* 2001;285:3130-3133.
251. Kubbies M, Schindler D, Hoehn H, et al. Endogenous blockage and delay of the chromosome cycle despite normal recruitment and growth phase explain poor proliferation and frequent endomitosis in Fanconi Anemia Cells. *Am J Hum Genet* 1985;37:1022-1030.
252. Dutrillaux B, Aurias A, Dutrillaux AM, et al. The cell cycle of lymphocytes in Fanconi anemia. *Hum Genet* 1982;62:327.
253. Seyschab H, Schindler D, Friedl R, et al. Simultaneous measurement, using flow cytometry, of radiosensitivity and defective mitogen response in ataxia telangiectasia and related syndromes. *Eur J Pediatr* 1992;151:756-760.
254. Cassinat B, Guardiola P, Chevret S, et al. Constitutive elevation of serum alpha-fetoprotein in Fanconi anemia. *Blood* 2000;96:859-863.
255. Cassinat B, Darsin D, Guardiola P, et al. Intermethod discordance for alpha-fetoprotein measurements in Fanconi anemia. *Clin Chem* 2001;47:1405-1409.
256. Lo Ten Foe JR, Kwee ML, Roimans MA, et al. Somatic mosaicism in Fanconi anemia: molecular basis and clinical significance. *Eur J Hum Genet* 1997;5:137-148.
257. Waisfisz Q, Morgan NV, Savino M, et al. Spontaneous functional correction of homozygous Fanconi Anaemia alleles reveals novel mechanistic basis for reverse mosaicism. *Nat Genet* 1999;22:379-383.
258. Gregory JJ Jr, Wagner JE, Verlander PC, et al. Somatic mosaicism in Fanconi anemia: evidence of genotypic reversion in lymphohematopoietic stem cells. *Proc Natl Acad Sci U S A* 2001;98:2532-2537.
259. Joenje H, Patel KJ. The emerging genetic and molecular basis of Fanconi anaemia. *Nat Rev Genet* 2001;2:446-459.
260. Howlett NG, Taniguchi T, Olson S, et al. Biallelic inactivation of BRCA2 in Fanconi anemia. *Science* 2002;297:606-609.
261. Duckworth-Rysiecki G, Cornish K, Clarke CA, Buchwald M. Identification of two complementation groups in Fanconi Anemia. *Som Cell Mol Genet* 1985;11:35-41.
262. Pulsipher M, Kupfer GM, Naf D, et al. Subtyping analysis of Fanconi anemia by immunoblotting and retroviral gene transfer. *Mol Med* 1998;4:468-479.
263. Hanenberg H, Batish SD, Pollok KE, et al. Phenotypic correction of primary Fanconi anemia T cells with retroviral vectors as a diagnostic tool. *Exp Hematol* 2002;30:410.
264. Garcia-Higuera I, Taniguchi T, Ganesan S, et al. Interaction of the Fanconi anemia proteins and BRCA1 in a common pathway. *Mol Cell* 2001;7:249-262.
265. Scully R, Chen J, Plug A, et al. Association of BRCA1 with Rad51 in Mitotic and Meiotic Cells. *Cell* 1997;88:265-275.
266. Paull TT, Rogakou EP, Yamazaki V, et al. A critical role for histone H2AX in recruitment of repair factors to nuclear foci after DNA damage. *Curr Biol* 2000;10:886-895.
267. Shimamura A, Montes De Oca R, Svenson JL, et al. A novel diagnostic screen for defects in the Fanconi anemia pathway. *Blood* 2002 ( *in press*).
268. Taniguchi T, Garcia-Higuera I, Xu B, et al. Convergence of the Fanconi anemia and ataxia telangiectasia signaling pathways. *Cell* 2002;109:459-472.
269. Swift M. Fanconi's anaemia in the genetics of neoplasia. *Nature* 1971;230:370-373.

270. Swift M, Caldwell RJ, Chase C. Reassessment of cancer predisposition of Fanconi anemia heterozygotes. *J Natl Cancer Inst* 1980;65:863–867.
271. Cumming RC, Liu JM, Youssoufian H, Buchwald M. Suppression of apoptosis in hematopoietic factor-dependent progenitor cell lines by expression of the FAC gene. *Blood* 1996;88:4558–4567.
272. Rathbun R, Christianson T, Faulkner G, et al. Interferon-gamma-induced apoptotic responses of Fanconi anemia group C hematopoietic progenitor cells involve caspase 8-dependent activation of caspase 3 family members. *Blood* 2000;96:4204–4211.
273. Fagerlie SR, Diaz J, Christianson T, et al. Functional correction of FA-C cells with FANCC suppresses the expression of interferon gamma-inducible genes. *Blood* 2001;97:3017–3024.
274. Pang Q, Keeble W, Christianson TA, et al. FANCC interacts with hsp70 to protect hematopoietic cells from IFN-gamma/TNF-mediated cytotoxicity. *EMBO J*. 2001;20:4478–4489.
275. Pang Q, Christianson TA, Keeble W, et al. The Fanconi anemia complementation group C gene product: structural evidence of multifunctionality. *Blood* 2001;98:1392–1401.
276. Cumming RC, Lightfoot J, Beard K, et al. Fanconi anemia group C protein prevents apoptosis in hematopoietic cells through redox regulation of GSTP1. *Nat Med* 2001;7:814–20.
277. Pagano G. Mitomycin C and diepoxybutane action mechanisms and FANCC protein functions: further insights into the role for oxidative stress in Fanconi's anaemia phenotype. *Carcinogenesis* 2000;21:1067–1068.
278. Gluckman E, Auerbach AD, Horowitz MM, et al. Bone marrow transplantation for Fanconi Anemia. *Blood* 1995;86:2856–2862.
279. Kohli-Kumar M, Morris C, Delaat C, et al. Bone marrow transplantation in Fanconi anemia using matched sibling donors. *Blood* 1994;84:2050–2054.
280. Dufour C, Rondelli R, Locatelli F, et al. Stem cell transplantation from HLA-matched related donor for Fanconi's anaemia: a retrospective review of the multicentric Italian experience on behalf of AIEOP-GITMO. *Br J Haematol* 2001;112:796–805.
281. Guardiola P, Pasquini R, Dokal I, et al. Outcome of 69 allogeneic stem cell transplantations for Fanconi anemia using HLA-matched unrelated donors: a study on behalf of the European Group for Blood and Marrow Transplantation. *Blood* 2000;95:422–429.
282. Macmillan ML, Auerbach AD, Davies SM, et al. Haematopoietic cell transplantation in patients with Fanconi anaemia using alternate donors: results of a total body irradiation dose escalation trial. *Br J Haematol* 2000;109:121–129.
283. Guinan EC, Lopez KD, Huhn RD, et al. Evaluation of granulocyte-macrophage colony-stimulating factor for treatment of pancytopenia in children with Fanconi anemia. *J Pediatr* 1994;124:144.
284. Rackoff WROA, Robinson CA, Cooper RJ, et al. Prolonged administration of granulocyte colony-stimulating factor (filgrastim) to patients with Fanconi anemia: a pilot study. *Blood* 1996;88:1588–1593.
285. Liu JM, Kim S, Read EJ, et al. Engraftment of hematopoietic progenitor cells transduced with the Fanconi anemia group C gene (FANCC). *Hum Genet Ther* 1999;10:2337–2346.
286. Dokal I. Dyskeratosis congenita in all its forms. *Br J Haematol* 2000;110:768–779.
287. Paul SR, Perez-Atayde A, Williams DA. Interstitial pulmonary disease associated with dyskeratosis congenita. *Am J Pediatr Hematol Oncol* 1992;14:89–92.
288. Verra F, Kouzan S, Saiag P, et al. Bronchoalveolar disease in dyskeratosis congenita. *Eur Respir J* 1992;5:497–499.

289. Rocha V, Devergi A, Socie G, et al. Unusual complications after bone marrow transplantation for dyskeratosis congenita. *Br J Haematol* 1998;103:243–248.
290. Solder B, Weiss M, Jager A, Belohradsky BH. Dyskeratosis congenita: multisystem disorder with special consideration of immunologic aspects. *Clin Pediatr* 1998;19:32–38.
291. Wiedemann HP, McGuire J, Dwyer JM, et al. Progressive immune failure in dyskeratosis congenita. Report of an adult in whom *Pneumocystis carinii* and fatal disseminated candidiasis developed. *Arch Intern Med* 1984;144:397–399.
292. Rose C, Kern WV. Another case of *Pneumocystis carinii* pneumonia in a patient with dyskeratosis congenita (Zinsser–Cole–Engman syndrome). *Clin Infect Dis* 1992;15:1056–1057.
293. Colvin BT, Baker H, Hibbin JA, et al. Haemopoietic progenitor cells in dyskeratosis congenita. *Br J Haematol* 1984;56:513–515.
294. Friedland M, Lutton JD, Spitzer R, Levere RD. Dyskeratosis congenita with hypoplastic anemia: a stem cell defect. *Am J Hematol* 1985;20:85–87.
295. Alter BP, Knoblock ME, He L, et al. Effect of stem cell factor on in vitro erythropoiesis in patients with bone marrow failure syndromes. *Blood* 1992;80:3000–3008.
296. Marsh JCW, Will AJ, Hows JM, et al. “Stem Cell” origin of the hematopoietic defect in dyskeratosis congenita. *Blood* 1992;79:3138–3144.
297. Marley SB, Lewis JL, Davidson RJ, et al. Evidence for a continuous decline in haemopoietic cell function from birth: application to evaluating bone marrow failure in children. *Br J Haematol* 1999;106:162–166.
298. Heiss NS, Knight SW, Vulliamy TJ, et al. X-linked dyskeratosis congenita is caused by mutations in a highly conserved gene with putative nucleolar functions. *Nat Genet* 1998;19:32–38.
299. Jiang W, Middleton K, Yoon HJ, et al. An essential yeast protein, Cbf5p, binds in vitro to centromeres and microtubules. *Mol Cell Biol* 1993;13:4884–4893.
300. Cadwell C, Yoon HJ, Zebrarjadian Y, Carbon J. The yeast nucleolar protein, Cbf5p is involved in rRNA biosynthesis and interacts genetically with the RNA polymerase I transcription factor RRN3. *Mol Cell Biol* 1997;17:6175–6183.
301. Meier UT, Blobel G. NAP57, a mammalian nucleolar protein with a putative homologue in yeast and bacteria. *J Cell Biol* 1994;127:1505–1514.
302. Mitchell JR, Wood E, Collins K. A telomerase component is defective in the human disease dyskeratosis congenita. *Nature* 1999;402:551–555.
303. Mitchell JR, Cheng J, Collins K. A box H/ACA small nucleolar RNA-like domain at the human telomerase RNA 3' end. *Mol Cell Biol* 1999;19:567–576.
304. Vulliamy T, Marrone A, Goldman F, et al. The RNA component of telomerase is mutated in autosomal dominant dyskeratosis congenita. *Nature* 2001;413:432–435.
305. Collins K, Mitchell JR. Telomerase in the human organism. *Oncogene* 2002;21:564–579.
306. Dokal I, Bungey J, Williamson P, et al. Dyskeratosis Congenita fibroblasts are abnormal and have unbalanced chromosomal rearrangements. *Blood* 1992;80:3090–3096.
307. Marciniak RA, Johnson FB, Guarente L. Dyskeratosis congenita, telomeres, and human aging. *Trends Genet* 2000;16:193–195.
308. Shay JW, Wright WE. Mutant dyskenin ends relationship with telomerase. *Science* 1999;286:2284–2285.

309. Coulthard S, Chase A, Pickard J, et al. Chromosome breakage analysis in dyskeratosis congenita peripheral blood lymphocytes. *Br J Haematol* 1998;102:1162–1164.
310. Pai GS, Yan Y, DeBauche DM, et al. Bleomycin hypersensitivity in dyskeratosis congenita fibroblasts, lymphocytes and transformed lymphoblasts. *Cytogenet Cell Genet* 1989;52:186–189.
311. DeBauche DM, Pai GS, Stanley WS. Enhanced G2 chromatid radiosensitivity in dyskeratosis congenita fibroblasts. *Am J Hum Genet* 1990;46:350–357.
312. Ning Y, Yongshan Y, Pai GS, Gross AJ. Heterozygote detection through bleomycin-induced G2 chromatid breakage in dyskeratosis congenita families. *Cancer Genet Cytogenet* 1992;60:31–34.
313. Sirinavin C, Trowbridge AA. Dyskeratosis congenita: clinical features and genetic aspects: report of a family and review of the literature. *J Med Genet* 1975;12:339–354.
314. Drachtman RA, Alter BP. Dyskeratosis congenita: clinical and genetic heterogeneity: Report of a new case and review of the literature. *Am J Pediatr Hematol Oncol* 1992;14:297–304.
315. Reichel M, Grix A, Isseroff R. Dyskeratosis congenita associated with elevated fetal hemoglobin, X-linked ocular albinism, and juvenile-onset diabetes mellitus. *Pediatr Dermatol* 1992;9:103–106.
316. Devriendt K, Matthijs G, Legius E, et al. Skewed X-chromosome inactivation in female carriers of dyskeratosis congenita. *Am J Hum Genet* 1997;60:581–587.
317. Ferraris AM, Forni GL, Mangeini R, Gaetani GF. Nonrandom X-chromosome inactivation in hematopoietic cells from carriers of dyskeratosis congenita. *Am J Hum Genet* 1997;61:458–461.
318. Vulliamy TJ, Knight SW, Dokal I, Mason PJ. Skewed X-inactivation in carriers of X-linked dyskeratosis congenita. *Blood* 1997;90:2213–2216.
319. Scappaticci S, Fraccaro M, Cerimele D. Chromosomal abnormalities in dyskeratosis congenita. *Am J Med Genet* 1989;34:609–610.
320. Berthou C, Devergi A, D'Agay MF, et al. Late vascular complications after bone marrow transplantation for dyskeratosis congenita. *Br J Haematol* 1991;79:335–336.
321. Phillips RJ, Judge M, Webb D, Harper JI. Dyskeratosis congenita: delay in diagnosis and successful treatment of pancytopenia by bone marrow transplantation. *Br J Dermatol* 1992;127:278–280.
322. Forni GL, Melevendi C, Fappelli S, Rasore-Quartino A. Dyskeratosis congenita: unusual presenting features within a kindred. *Pediatr Hematol Oncol* 1993;10:145–149.
323. Langston AA, Sanders JE, Deeg HJ, et al. Allogeneic marrow transplantation for aplastic anaemia associated with dyskeratosis congenita. *Br J Haematol* 1996;92:758–765.
324. Knight S, Vulliamy T, Coppelstone A, et al. Dyskeratosis congenita (DC) registry: identification of new features of DC. *Br J Haematol* 1998;103:990–996.
325. Lau YL, Ha SY, Chan DF, et al. Bone marrow transplant for dyskeratosis congenita. *Br J Haematol* 1999;105:571.
326. Ghavamzadeh A, Alimoghadam K, Nasseri P, et al. Correction of bone marrow failure in dyskeratosis congenita by bone marrow transplantation. *Bone Marrow Transplant* 1999;23:299–301.
327. Yabe M, Yabe H, Hattori K, et al. Fatal interstitial pulmonary disease in a patient with DC after allogeneic bone marrow transplantation. *Bone Marrow Transplant* 1997;19:389–392.
328. Ling NS, Fenske NA, Julius RL, et al. Dyskeratosis congenita in a girl simulating chronic graft-versus-host disease. *Arch Dermatol* 1985;121:1424–1428.
329. Ivker RA, Woosley J, Resnick SD. Dyskeratosis congenita or chronic graft-versus-host disease? A diagnostic dilemma in a child eight years after bone marrow transplantation for aplastic anemia. *Pediatr*

Dermatol 1993;10:362-365.

330. Smith CM, Ramsay NKC, Branda RF, et al. Response to androgens in the constitutional aplastic anemia of dyskeratosis congenita. *Pediatr Res* 1979;13:441.
331. Russo CL, Glader BE, Israel RJ, Galasso F. Treatment of neutropenia associated with dyskeratosis congenita with granulocyte-macrophage colony-stimulating factor. *Lancet* 1990;336:751-752.
332. Putterman C, Safadi R, Zolotogoora J, et al. Treatment of the hematological manifestations of dyskeratosis congenita. *Ann Hematol* 1993;66:209-212.
333. Pritchard SL, Junker AK. Positive response to granulocyte colony-stimulating factor in dyskeratosis congenita before matched unrelated bone marrow transplantation. *Am J Pediatr Hematol Oncol* 1994;16:186-187.
334. Oehler L, Reiter E, Friedl J, et al. Effective stimulation of neutropoiesis with rh G-CSF in dyskeratosis congenita: a case report. *Ann Hematol* 1994;69:325-327.
335. Alter BP, Gardner EH, Hall RE. Treatment of dyskeratosis congenita with granulocyte macrophage colony-stimulating factor and erythropoietin. *Br J Haematol* 1997;97:309-311.
336. Gluckman E, Socie G, Devergie A, et al. Bone marrow transplantation in 107 patients with severe aplastic anemia using cyclophosphamide and thoraco-abdominal irradiation for conditioning: long-term follow-up. *Blood* 1991;78:2451-2455.
337. Champlin RE, Ho WG, Nimer SD, et al. Bone marrow transplantation for severe aplastic anemia. Effect of a preparative regimen of cyclophosphamide-low-dose total-lymphoid irradiation and posttransplant cyclosporine-methotrexate therapy. *Transplantation* 1990;49:720-724.
338. May WS, Sensenbrenner LL, Burns WH, et al. BMT for severe aplastic anemia using cyclosporine. *Bone Marrow Transplant* 1993;11:459-464.
339. Storb R, Leisenring W, Anasetti C, et al. Long-term follow-up of allogeneic marrow transplants in patients with aplastic anemia conditioned by cyclophosphamide combined with antithymocyte globulin. *Blood* 1997;89:3890-3891.
340. Reiter E, Keil F, Brugger S, et al. Excellent long-term survival after allogeneic marrow transplantation in patients with severe aplastic anemia. *Bone Marrow Transplant* 1997;19:1191-1196.
341. Bayever E, Champlin R, Ho W, et al. Comparison between bone marrow transplantation and antithymocyte globulin in treatment of young patients with severe aplastic anemia. *J Pediatr* 1984;105:920-925.
342. Halperin DS, Grisaru D, Freedman MH, Saunders EF. Severe acquired aplastic anemia in children: 11-year experience with bone marrow transplantation and immunosuppressive therapy. *Am J Pediatr Hematol Oncol* 1989;11:304-309.
343. Locasciulli A, van't Veer L, Bacigalupo A, et al. Treatment with marrow transplantation or immunosuppression of childhood acquired severe aplastic anemia: a report from the EBMT SAA Working Party. *Bone Marrow Transplant* 1990;6:211-217.
344. Speck B, Tichelli A, Grathwohl A, et al. Treatment of severe aplastic anemia: a 12-year follow-up of patients after bone marrow transplantation or after therapy with antilymphocyte globulin. In: Shahidi T, ed. *Aplastic anemia and other bone marrow failure syndromes*. New York: Springer-Verlag, 1990:96.
345. Paquette RL, Tebyani N, Frane M, et al. Long-term outcome of aplastic anemia in adults treated with antithymocyte globulin: comparison with bone marrow transplantation. *Blood* 1995;85:283-290.
346. Lawlor ER, Anderson RA, Davis JH, et al. Immunosuppressive therapy: a potential alternative to bone marrow transplantation as initial therapy for acquired severe aplastic anemia in childhood? [see comments]. *J Pediatr Hematol Oncol* 1997;19:115-123.
347. Doney K, Leisenring W, Storb R, Appelbaum FR. Primary treatment of acquired aplastic anemia: outcomes with bone marrow transplantation and immunosuppressive therapy. *Seattle Bone Marrow*



Transplant Team. *Ann Intern Med* 1997;126:107–115.

348. Fuhrer M, Burdach S, Ebell W, et al. Relapse and clonal disease in children with aplastic anemia (AA) after immunosuppressive therapy (IST): the SAA 94 experience. German/Austrian Pediatric Aplastic Anemia Working Group. *Klinische Padiatrie* 1998;210:173–179.

349. Kojima S, Horibe K, Inaba J, et al. Long-term outcome of acquired aplastic anaemia in children: comparison between immunosuppressive therapy and bone marrow transplantation. *Br J Haematol* 2000;111:321–328.

2004 Lippincott Williams & Wilkins  
John P. Greer, John Foerster, John N. Lukens  
George M. Rodgers, Frixos Paraskevas, Bertil Glader  
Wintrobe's Clinical Hematology

[ADULT PURE RED CELL APLASIA](#)[Etiology and Pathogenesis](#)[Clinical Manifestations](#)[Laboratory Evaluation](#)[Differential Diagnosis](#)[Treatment](#)[Prognosis](#)[RED CELL APLASIA IN CHILDREN](#)[Transient Erythroblastopenia of Childhood](#)[Diamond–Blackfan Anemia](#)[REFERENCES](#)

## ADULT PURE RED CELL APLASIA

*Pure red cell aplasia* (PRCA) is a syndrome characterized by normochromic normocytic anemia, reticulocytopenia (reticulocyte count <1%), and almost a complete absence of erythroblasts from the bone marrow (erythroblasts <0.5%) ([1](#)). PRCA is a rare disorder that affects any age group and both males and females equally.

In contrast to aplastic anemia, in which the aplasia involves all three cell lines, in PRCA, the aplasia is selective for the erythroid cell line, resulting in severe anemia with normal leukocyte and platelet counts. This disorder was described for the first time in 1922 ([2](#)) and later appeared in the literature under different names, including *pure aplastic anemia*, *erythrophthisis*, *chronic hypoplastic anemia*, *aplastic crisis*, *erythroblastopenia*, *erythrogenesis imperfecta*, *Blackfan–Diamond syndrome*, *pure red cell agenesis*, and *primary red cell anemia* ([1](#)). Today, the term *PRCA* is used to describe this disorder in adults, whereas the terms *Diamond–Blackfan anemia* (DBA) and *transient erythroblastopenia of childhood* (TEC) are used for the congenital and acquired forms that occur in infants and children.

### Etiology and Pathogenesis

PRCA is an acquired anemia that may be primary or secondary to a variety of neoplastic, autoimmune, or infectious diseases ([1](#), [2](#), [3](#), [4](#), [5](#), [6](#), [7](#), [8](#), [9](#), [10](#), [11](#), [12](#), [13](#), [14](#), [15](#), [16](#), [17](#), [18](#), [19](#), [20](#), [21](#), [22](#), [23](#), [24](#), [25](#), [26](#), [27](#), [28](#), [29](#), [30](#), [31](#), [32](#), [33](#), [34](#), [35](#), [36](#), [37](#), [38](#), [39](#), [40](#), [41](#), [42](#), [43](#), [44](#), [45](#), [46](#), [47](#), [48](#), [49](#), [50](#), [51](#), [52](#), [53](#), [54](#), [55](#), [56](#), [57](#), [58](#), [59](#), [60](#), [61](#), [62](#), [63](#), [64](#), [65](#), [66](#), [67](#), [68](#), [69](#), [70](#), [71](#), [72](#), [73](#), [74](#), [75](#), [76](#), [77](#), [78](#), [79](#), [80](#), [81](#), [82](#), [83](#), [84](#), [85](#), [86](#), [87](#), [88](#), [89](#), [90](#), [91](#), [92](#), [93](#), [94](#), [95](#), [96](#), [97](#), [98](#), [99](#), and [100](#)) ([Table 45.1](#)).

### TABLE 45.1. Classification of Pure Red Cell Aplasia

Congenital hypoplastic anemia (Diamond–Blackfan syndrome) ([3](#))

## Acquired pure red cell aplasia

### Primary

Autoimmune (includes transient erythroblastopenia of childhood)

Preleukemic

Idiopathic

### Secondary, associated with

Thymoma ( [1](#), [4](#), [5](#) )

### Hematologic malignancies

Chronic lymphocytic leukemia

B-cell type ( [1](#), [6](#), [7](#) and [8](#) )

T-cell type ( [1](#), [9](#), [10](#) and [11](#) )

Large granular lymphocyte leukemia ( [1](#), [12](#) )

Hodgkin disease ( [13](#), [14](#), [15](#) and [16](#) )

Non-Hodgkin lymphomas ( [17](#), [18](#), [19](#), [20](#) and [21](#) )

Multiple myeloma ( [22](#), [23](#) )

Waldenström macroglobulinemia ( [24](#) )

Chronic myelocytic leukemia ( [25](#), [26](#) and [27](#) )

Myelofibrosis with myeloid metaplasia ( [1](#), [27](#), [28](#) and [29](#) )

Essential thrombocythemia ( [30](#) )

Acute lymphoblastic leukemia ( [31](#), [32](#) and [33](#) )

### Solid tumors

Carcinoma of the stomach ( [34](#) )

Adenocarcinoma of the breast ( [35](#), [36](#) )

Adenocarcinoma of the bile duct ( [37](#) )

Squamous cell carcinoma of the lung ( [38](#), [39](#) and [40](#) )

Epidermoid carcinoma of the skin ( [41](#) )

Carcinoma of the thyroid ( [42](#) )

Renal cell carcinoma ( [43](#) )

Carcinoma of unknown primary site ( [44](#) )

Kaposi sarcoma ( [6](#), [45](#), [46](#) )

### Infections

Human B19 parvovirus ( [47](#), [48](#), [49](#), [50](#), [51](#), [52](#), [53](#), [54](#), [55](#), [56](#) and [57](#) )

Human immunodeficiency virus ( [58](#), [59](#) )

T-cell leukemia-lymphoma virus ( [60](#) )

Infectious mononucleosis ( [61](#), [62](#), [63](#) and [64](#) )

Viral hepatitis ( [65](#), [66](#) and [67](#) )

Mumps ( [1](#), [68](#), [69](#) )

Cytomegalovirus ( [70](#) )

Atypical pneumonia ( [1](#), [68](#), [69](#) )

Meningococemia ( [1](#), [68](#), [69](#) )

Staphylococemia ( [1](#), [68](#), [69](#) )

Leishmaniasis ( [70](#), [71](#) and [72](#) )

Chronic hemolytic anemias ( [1](#), [47](#), [48](#), [49](#), [50](#), [51](#), [52](#), [53](#), [54](#), [55](#), [56](#) and [57](#) )

### Collagen vascular diseases

Systemic lupus erythematosus ( [73](#), [74](#) )

Rheumatoid arthritis ( [75](#), [76](#) )

Mixed connective tissue disease ( [77](#) )

Sjögren syndrome ( [78](#), [79](#) )

Drugs and chemicals (see [Table 45.2](#))

Pregnancy ( [80](#), [81](#), [82](#) and [83](#) )

Severe renal failure ( [84](#) )

Severe nutritional deficiencies ( [85](#), [86](#), [87](#) and [88](#) )

Miscellaneous

Post-ABO-incompatible bone marrow transplantation ( [89](#), [90](#) )

Angioimmunoblastic lymphadenopathy ( [91](#), [92](#) )

Autoimmune multiple endocrine gland insufficiency ( [93](#), [94](#) )

Autoimmune hypothyroidism ( [95](#), [96](#) )

Autoimmune chronic hepatitis ( [97](#), [98](#) )

Anti-EPO antibodies after treatment with EPO ( [99](#), [100](#) )

EPO, erythropoietin.

---

Primary acquired PRCA affects individuals of any age in the absence of any underlying disorder. It may run an acute and usually self-limited course or may persist chronically as a form of refractory anemia. In children, this condition is referred to as *TEC*, which is usually of limited duration ( [1](#), [69](#), [70](#), [101](#), [102](#) ). In contrast, the acute form of primary PRCA is very rare in adults, and the chronic form of this disorder predominates. Acute PRCA in adults escapes diagnosis because acute arrest of erythropoiesis of short duration does not lead to symptoms of anemia due to the long lifespan of the red cells. Many cases of PRCA have been shown to have an immune pathogenesis and are classified as autoimmune. However, there are cases in which no immune pathogenic mechanism can be established by *in vitro* assays, and these are classified as idiopathic. Failure to demonstrate an immune mechanism does not exclude an immune pathogenesis because the outcome of treatment seems to be the same in autoimmune and idiopathic cases ( [1](#) ). A small percentage of cases of idiopathic PRCA, usually refractory to treatment, may evolve into acute leukemia, and these cases are classified as preleukemic or myelodysplastic ( [1](#), [103](#) ).

PRCA may develop as a hematologic complication in the course of a variety of diseases. Of these, thymic neoplasms were the first to be associated with erythroid aplasia ( [1](#), [5](#), [6](#) ). The incidence of PRCA among patients with thymoma was initially estimated to be as high as 15%; however, in more recent series, the incidence was found to be close to 4% ( [1](#), [5](#) ). The presence of a thymoma among patients presenting with PRCA was initially reported to be as high as 50%, but in more recent series, it was estimated to be close to 9% ( [1](#), [5](#), [6](#), [104](#) ). PRCA may precede the development of thymoma, coexist with thymoma, or even develop years after the surgical removal of a thymoma.

Various hematologic malignancies have been associated with severe erythroid aplasia ( [7](#), [8](#), [9](#), [10](#), [11](#), [12](#), [13](#), [14](#), [15](#), [16](#), [17](#), [18](#), [19](#), [20](#), [21](#), [22](#), [23](#), [24](#), [25](#), [26](#), [27](#), [28](#), [29](#), [30](#), [31](#), [32](#) and [33](#) ) with chronic lymphocytic leukemia (CLL) of B-cell or T-cell type, or of the large granular lymphocyte (LGL) type, being the most frequent ( [6](#), [12](#) ). The incidence of severe erythroid aplasia among patients with CLL may be as high as 6%, with many cases missed because severe normochromic anemia and reticulocytopenia are frequent manifestations of advanced stage CLL and are usually attributed to the myelophthistic process in the marrow. The development of erythroid aplasia may depend on the stage of CLL ( [104](#) ); however, it does not affect its prognosis and, in the majority of cases, does not seem to be related to previous cytotoxic chemotherapy ( [1](#), [6](#) ). PRCA has also been described in association with Hodgkin and non-Hodgkin lymphomas ( [13](#), [14](#), [15](#), [16](#), [17](#), [18](#), [19](#), [20](#) and [21](#) ),

multiple myeloma, Waldenström macroglobulinemia ( [22](#), [23](#) and [24](#) ), chronic myelocytic leukemia, idiopathic myelofibrosis, essential thrombocythemia ( [25](#), [26](#), [27](#), [28](#), [29](#) and [30](#) ), and acute lymphoblastic leukemia ( [31](#), [32](#) and [33](#) ).

PRCA may develop in the course of a variety of nonhematopoietic, nonthymic neoplasms ( [34](#), [35](#), [36](#), [37](#), [38](#), [39](#), [40](#), [41](#), [42](#), [43](#), [44](#), [45](#) and [46](#) ). Considering the frequency of reports of PRCA associated with solid tumors and the high incidence of malignant neoplasms, it becomes clear that such an association is very rare. On the other hand, it may be that PRCA is underdiagnosed in patients with advanced cancer, in whom anemia is such a frequent finding that bone marrow examination is not routinely performed. In both hematopoietic malignancies and solid tumors, PRCA may appear before or after the diagnosis of malignancy and follows a chronic course independent of the evolution of the underlying disease ( [1](#) ). In those cases in which a real association exists, successful treatment of the underlying malignant disease leads to remission of PRCA.

Acute, self-limited PRCA may develop in the course of various infections ( [47](#), [48](#), [49](#), [50](#), [51](#), [52](#), [53](#), [54](#), [55](#), [56](#), [57](#), [58](#), [59](#), [60](#), [61](#), [62](#), [63](#), [64](#), [65](#), [66](#), [67](#), [68](#), [69](#), [70](#), [71](#) and [72](#) ). Human B19 parvovirus is responsible for the aplastic crisis seen in children and young adults with chronic hemolytic anemia ( [47](#), [48](#), [49](#), [50](#), [51](#), [52](#), [53](#), [54](#), [55](#), [56](#) and [57](#) ) and for chronic PRCA in immunocompromised patients (e.g., with acquired immune deficiency syndrome, posttransplantation, on chemotherapy, or on immunosuppressive treatment) ( [56](#), [57](#), [58](#) and [59](#) ). Viral hepatitis and infectious mononucleosis are two other viral infections that have been reported many times in association with PRCA ( [61](#), [62](#), [63](#), [64](#), [65](#), [66](#) and [67](#) ). In general, PRCA remits with treatment or with the resolution of the underlying infection.

It is not surprising that PRCA is a hematologic complication of various autoimmune diseases, including collagen vascular diseases such as systemic lupus erythematosus ( [73](#), [74](#) ), rheumatoid arthritis ( [75](#), [76](#) ), mixed connective tissue disease ( [77](#) ), and Sjögren syndrome ( [78](#), [79](#) ), and autoimmune hemolytic anemia ( [1](#) ), multiple endocrine gland insufficiency ( [93](#), [94](#) ), autoimmune hypothyroidism ( [95](#), [96](#) ), ulcerative colitis ( [97](#) ), autoimmune hepatitis ( [97](#), [98](#) ), angioimmunoblastic lymphadenopathy ( [91](#), [92](#) ), post-ABO-incompatible bone marrow transplantation ( [89](#), [90](#) ), and in very rare cases of patients with end-stage renal disease or other conditions treated with recombinant erythropoietin who develop antibodies to the hormone ( [99](#), [100](#) ). In many of these autoimmune conditions, PRCA may be the first manifestation of the underlying disease.

An ever-increasing number of drugs and chemicals have been reported as causes of PRCA ( [106](#), [107](#), [108](#), [109](#), [110](#), [111](#), [112](#), [113](#), [114](#), [115](#), [116](#), [117](#), [118](#), [119](#), [120](#), [121](#), [122](#), [123](#) and [124](#) ) ( [Table 45.2](#) ). Drug-induced PRCA is usually an acute form of erythroblastopenia that remits soon after discontinuation of the drug or cessation of exposure to the chemical. It may appear after the first exposure to the drug or a significant time after drug exposure begins. In most instances, the association of a drug with PRCA is circumstantial and is based on the evidence that PRCA remits after discontinuation of the drug ( [1](#), [107](#) ). Diphenylhydantoin, azathioprine, chlorpropamide, and isoniazid have been repeatedly implicated as causes of PRCA, and, in certain instances, their association to PRCA has been proven by recurrence of anemia on reinstatement of therapy ( [1](#) ).

**TABLE 45.2. Drugs and Chemicals Associated with Pure Red Cell Aplasia**

---

|                      |                                      |
|----------------------|--------------------------------------|
| Allopurinol          | Leuprolide                           |
| a-Methyldopa         | Linezolid                            |
| Aminopyrine          | Maloprim (dapsone and pyrimethamine) |
| Anagryne             |                                      |
| Arsphenamine         | Mepacrine                            |
| Azathioprine         | Methazolamide                        |
| Benzene hexachloride | Mycophenolate mofetil                |
| Calomel              | D-Penicillamine                      |
| Carbamazepine        | Penicillin                           |
| Cephalothin          | Pentachlorophenol                    |
| Chenopodium          | Phenobarbital                        |
| Chloramphenicol      | Phenylbutazone                       |
| Chlormadinone        | Procainamide                         |
| Chlorpropamide       | Rifampicin                           |
| Cladribine           | Salicylazosulfapyridine              |
| Cotrimoxazole        | Santonin                             |
| Diphenylhydantoin    | Sodium dipropylacetate               |
| Estrogens            | Sodium valproate                     |
| Fenbufen             | Sulfasalazine                        |
| Fenoprofen           | Sulfathiazole                        |
| FK506                | Sulfobromophthalein sodium           |
| Fludarabine          | Sulindac                             |
| Gold                 | Tacrolimus                           |
| Halothane            | Thiamphenicol                        |
| Interferon- $\alpha$ | Tolbutamide                          |
| Isoniazid            | Zidovudine                           |
| Lamivudine           |                                      |

---

Pregnancy has been associated with PRCA that usually remits after delivery ([80](#), [81](#), [82](#) and [83](#)). Development of PRCA during pregnancy does not necessarily predict recurrence of the disease in subsequent pregnancies. In a unique case, PRCA developed in three successive pregnancies in the same individual, and two of the fetuses were born with hydrops fetalis and found to have erythroid aplasia on autopsy, whereas the third fetus was treated with intrauterine red cell transfusions and was born with red cell aplasia that remitted after 3 months ([83](#)).

In rare cases, PRCA has been associated with renal failure ([84](#)), severe malnutrition such as marasmus and kwashiorkor ([85](#)), and riboflavin ([85](#), [125](#)) B<sub>12</sub> ([86](#), [87](#) and [88](#)), and folic acid deficiency ([86](#)).

The failure of erythropoiesis in red cell aplasia is characterized by absence of mature erythroid precursor cells despite the presence in the bone marrow of normal or nearly normal numbers of erythroid progenitor cells. The failure of the erythroid progenitors to mature, differentiate, and give rise to erythroblasts may be due to an intrinsic defect in these cells, to the presence of humoral or cellular inhibitors of erythropoiesis, or to an abnormal bone marrow microenvironment. Different mechanisms seem to operate in each of the various forms of PRCA.

**PRIMARY ACQUIRED PURE RED CELL APLASIA** In primary acquired PRCA and TEC, multiple studies have indicated that the arrest of erythropoiesis is caused by the presence of an erythropoietic inhibitor in the patient's plasma. Early studies in mice have shown that injection of PRCA patients' plasma leads to a significant suppression of *in vivo* erythropoiesis as measured by <sup>59</sup>Fe incorporation into newly formed red cells ( [1](#), [126](#), [127](#), [128](#) and [129](#) ). Evaluation of the response of a patient's marrow cells to erythropoietin by measuring heme synthesis *in vitro* shows that, in the presence of normal plasma, PRCA marrow responds normally to erythropoietin, but in the presence of the patient's autologous plasma, a significant decline in heme synthesis is observed. This suggests the presence of an inhibitor acting on erythroid cells in the patient's plasma ( [130](#), [131](#) ). In approximately 60% of cases, patients' marrow cells respond to erythropoietin in a normal way by increasing the rate of heme synthesis by two- to ninefold, and in approximately 40% of cases, an inhibitor of erythropoiesis can be detected in the plasma. This inhibitor has been localized to the immunoglobulin (Ig) G fraction, and it disappears from the plasma after remission of PRCA ( [130](#), [131](#), [132](#) and [133](#) ). The stage of erythropoiesis at which the arrest occurs has been studied by assaying PRCA marrow cells in semisolid media for erythroid progenitors. Despite a conspicuous absence of erythroblasts from the PRCA marrow, normal numbers of early [burst-forming unit, erythroid (BFU-E)] and late [colony-forming unit, erythroid (CFU-E)] erythroid progenitors can be detected in at least 60% of patients, indicating that the arrest occurs at any level between CFU-E and basophilic erythroblasts. In the remaining patients, the erythroid cell compartment is affected at a stage earlier than the CFU-E, so that the CFU-E and/or BFU-E marrow pools are significantly reduced ( [1](#), [27](#), [134](#), [135](#) ). The presence of normal numbers of erythroid progenitors has been associated with a favorable outcome of immunosuppressive therapy ( [27](#), [135](#) ). The patient's serum IgG inhibits maturation and differentiation of erythroid progenitors into erythroblasts *in vitro*. The inhibition is dose dependent and is no longer present in the IgG fraction of a patient's plasma collected after remission. The inhibitory effect of the IgG is specific to erythroid cells because no effect on myeloid progenitor cell growth has been detected ( [134](#), [135](#), [136](#) and [137](#) ). The mode of action of the PRCA IgG inhibitor of erythropoiesis has been investigated in a number of cases of primary PRCA as well as in cases of TEC. In some cases, the IgG seems to be cytotoxic to CFU-E in the presence of complement; in others, its inhibitory activity is independent of the presence of complement, but IgG's presence is continuously required during the 7-day period of maturation of CFU-E to erythroblasts ( [1](#), [136](#), [137](#) ). In another cohort of patients, the IgG is cytotoxic to mature recognizable erythroblasts ( [132](#), [138](#), [139](#), [140](#) and [141](#) ), and, in rare cases, the inhibitory IgG has the properties of an antierythropoietin antibody ( [100](#), [142](#), [143](#) and [144](#) ). In the majority of cases, the target for the IgG antibody is an erythroid cell at a stage of differentiation between BFU-E and mature erythroblast. The nature of the molecule(s) on the erythroid cell membrane with which the PRCA IgG inhibitor interacts has not yet been defined.

## **SECONDARY PURE RED CELL APLASIA**

***Thymoma and Red Cell Aplasia*** Many studies have shown the presence of an inhibitor of erythroid cell development in the plasma of patients with thymoma and PRCA ( [1](#), [14](#), [45](#), [126](#), [127](#) and [128](#) ); however, these studies were performed on either mice *in vivo* or allogeneic human marrow cells *in vitro*, and the significance of these findings is unknown because the possibility of detection of heterophile antibodies or antibodies developed from alloimmunization secondary to multiple red cell transfusions cannot be excluded ( [1](#) ). A possible role for T-cell-mediated suppression of erythropoiesis has been suggested by more recent studies ( [145](#), [146](#) and [147](#) ). The exact incidence of antibody- or T-cell-induced erythropoietic arrest in PRCA associated with thymoma remains unknown.

***Chronic Lymphocytic Leukemia and Red Cell Aplasia*** In B-cell CLL, the frequency of PRCA is 6%, and in T-cell CLL and in LGL types, it may be even higher ( [6](#), [7](#), [8](#), [9](#), [10](#), [11](#) and [12](#) ). All attempts to detect an inhibitor in the plasma of these patients have provided



negative results ( [1](#), [7](#), [9](#), [148](#) ). Various studies have demonstrated that, in T-cell CLL (including the LGL type), the T lymphocytes are responsible for the suppression of erythropoiesis ( [9](#), [10](#) and [11](#), [60](#) ). The suppression is mediated by direct cell-to-cell interaction, mainly between a subset of T cells expressing receptors for the gamma chain of IgG (T $\gamma$  cells) and erythroid progenitors, and it is HLA-DR restricted ( [11](#) ). The suppression is selective for the erythroid cells and is not detectable after remission of the PRCA ( [10](#), [11](#) ). Similar findings have been reported in B-cell CLL in which there seems to be a progressive increase of T $\gamma$  cells in the marrow. These T $\gamma$  cells suppress erythropoiesis and cause red cell aplasia when they reach a critical concentration ( [7](#), [105](#), [148](#), [149](#) ). More recently, clonal expansion of LGLs of the gamma/delta type expressing killer cell inhibitory receptors for class I HLA antigens has been shown to be responsible for lysis of erythroblasts, which is most likely related to the declining density and eventual disappearance of HLA-I antigens in late marrow erythroid cells. The role of killer cell inhibitory receptors in the pathogenesis of PRCA in large granular lymphocytosis remains unclear because such receptors are frequently detectable in large granular lymphocytosis CLL cases without PRCA ( [150](#), [151](#) ).

***Viral Infections and Red Cell Aplasia*** Human B19 parvovirus, the cause of erythema infectiosum (fifth disease), is responsible for the acute PRCA (aplastic crisis) in children and young adults with chronic hemolytic anemias ( [47](#), [48](#), [49](#), [50](#), [51](#), [52](#), [53](#), [54](#), [55](#) and [56](#) ) and for the chronic PRCA in immunocompromised patients ( [56](#), [57](#), [152](#), [153](#), [154](#) and [155](#) ). Human B19 parvovirus infection is not associated with TEC, which affects hematologically normal children ( [49](#), [156](#), [157](#) ). This DNA virus infects erythroid cells by binding to the P antigen on erythroid cell membrane ( [158](#) ), is cytotoxic to erythroid progenitors, and inhibits preferentially normal CFU-E growth and development, whereas it has no significant effects on myeloid cells ( [49](#), [50](#) ). The cytotoxic effects of the virus on erythroid cells *in vitro* can be blocked by antibodies to the virus ( [49](#) ). In normal individuals, infection by B19 parvovirus does not lead to symptomatic anemia because the arrest of erythropoiesis is transient and the survival of the red cells is normal. However, in the presence of hemolysis, even transient arrest of erythropoiesis leads to acute and precipitous decline of the hemoglobin concentration, resulting in clinically symptomatic anemia. Erythropoiesis is restored usually within 10 to 15 days with development of immunity to the virus and elimination of the viral infection. In immunocompromised patients unable to clear the virus, the infection with B19 parvovirus becomes chronic, and the arrest of erythropoiesis persists for as long as the infection is active, leading to a chronic form of PRCA ( [56](#), [57](#), [152](#), [153](#), [154](#), [155](#) and [156](#) ). Administration of high-dose, pooled, human IgG provides adequate amounts of specific antibodies to eliminate the chronic infection, thus allowing the restoration of erythropoiesis. In view of the primary therapeutic role of human IgG in chronic parvovirus infection, all immunocompromised patients with PRCA should be tested for evidence of active parvovirus infection. Studies on the pathogenesis of PRCA in the course of viral hepatitis, infectious mononucleosis, and human T-cell leukemia virus type 1 infection have suggested that the suppression of erythropoiesis is mediated by cytotoxic T lymphocytes ( [60](#), [64](#), [67](#) ).

***Autoimmune Hemolytic Anemia and Red Cell Aplasia*** Antibodies directed against red cells may in certain cases attack the erythroid precursors, the progenitors leading to erythroid aplasia, or both ( [159](#) ). Such a mechanism was confirmed in two cases of autoimmune hemolytic anemia and PRCA in which the IgG antibody eluted from the red cells inhibited *in vitro* normal and autologous CFU-E growth ( [1](#), [73](#) ). In another two cases, two separate autoantibodies, one directed against the erythrocytes and another inhibiting autologous CFU-E growth *in vitro*, were detected ( [160](#), [161](#) ).

***Collagen Vascular Diseases and Red Cell Aplasia*** A serum IgG inhibitor of autologous erythroid progenitor cell growth *in vitro* has been demonstrated in a case of systemic lupus erythematosus and in a case of rheumatoid arthritis ( [74](#), [75](#) ).

***Drug-Induced Red Cell Aplasia*** Limited numbers of studies have addressed the

pathogenesis of drug-induced PRCA. A serum IgG inhibitor was detected in a case of diphenylhydantoin-induced PRCA that inhibited erythroid, but not myeloid, cell growth *in vitro* in the presence, but not in the absence, of subtherapeutic concentrations of diphenylhydantoin. Diphenylhydantoin alone in the same concentration had no effect on autologous erythroid progenitor cell growth *in vitro* ( [106](#) ). A similar mechanism was shown in a case of rifampicin-induced PRCA ( [161](#) , [162](#) ). In both cases, the plasma inhibitor disappeared from the patients' plasma after remission of PRCA. However, studies performed in cases of isoniazid- and procainamide-induced PRCA failed to demonstrate a similar mechanism ( [110](#) , [112](#) , [163](#) ). It seems that various drugs can cause erythroid aplasia through different mechanisms. Studies on direct drug effects on erythroid cell growth *in vitro* should be interpreted with caution because a large number of drugs may affect hematopoietic colony formation *in vitro* in a nonspecific way.

## Clinical Manifestations

Adult patients present with symptoms of anemia that may be quite severe at the time of diagnosis. Complete arrest of erythropoiesis leads to the decline of red cell count by approximately 1% per day, so the development of anemia is slow and progressive, allowing for physiologic compensatory changes. Physical examination in primary PRCA is usually negative except for pallor and signs of anemia. Hepatosplenomegaly and lymphadenopathy are not findings consistent with primary PRCA. In secondary cases, physical findings related to the underlying disease may be present. Patients with chronic red cell aplasia who have been supported with red cell transfusions may develop chronic hepatitis or transfusion-acquired hemosiderosis with physical findings secondary to iron overload.

## Laboratory Evaluation

In acquired PRCA, the erythrocytes are normochromic and normocytic. There is a complete absence of polychromatophilic red cells on the smear, and the reticulocyte count is between 0 and 1%. A reticulocyte count greater than 2% should raise serious doubt about the correctness of the diagnosis. The white cell count and the differential count are normal. Occasionally, mild leukopenia, lymphocytosis, or eosinophilia may be present. The platelet count is usually normal. Mild thrombocytopenia of 100,000 to 150,000 platelets per  $\mu\text{l}$  is occasionally seen, and a number of patients may have a thrombocytosis reactive to anemia.

The hallmark of PRCA is the absence of erythroblasts from an otherwise normal marrow. The cellularity of the marrow is normal or slightly increased. High cellularity with elimination of fat spaces should lead away from the diagnosis of PRCA. In typical cases, the erythroblasts are either totally absent or constitute less than 1% on the marrow differential count. In a small number of cases, a few proerythroblasts, basophilic erythroblasts, or both may be seen, not exceeding 5% of the differential count ( [1](#) , [101](#) , [144](#) , [159](#) ). The presence of a small number of proerythroblasts with vacuolated cytoplasm and pseudopodia formation may raise the suspicion of an active B19 parvovirus infection or of severe malnutrition ( [50](#) , [85](#) ).

In certain cases, a period of ineffective erythropoiesis characterized by erythroid hyperplasia with maturation arrest at the stage of proerythroblasts or basophilic erythroblasts in the marrow and reticulocytopenia in the blood may precede the development of PRCA, develop during the course of PRCA, or develop after partial response to treatment and before the return of erythropoiesis to normal ( [164](#) , [165](#) and [166](#) ). Although this picture is not diagnostic of PRCA, it is a phase within the natural course of this disease, and, in the absence of any bone marrow karyotypic abnormality or dysplastic features in any one of the three marrow cell lines, it should raise the suspicion of

developing PRCA. Under these circumstances, the marrow should be reevaluated at a later time, or the patient should be treated for PRCA.

The myeloid cells and the megakaryocytes in the marrow are normal and exhibit full maturation. An increased number of lymphocytes on marrow smear or an increased number of lymphoid aggregates in marrow biopsy and a mild increase in plasma cells, eosinophils, or mast cells may be seen (1). Iron stores are increased and normally distributed, but during recovery or the phase of ineffective erythropoiesis, a few ring sideroblasts may be seen (1).

Cytogenetic studies on marrow cells in PRCA reveal a normal karyotype with the exception of preleukemic/myelodysplastic cases, in which chromosomal abnormalities may be detected (13, 102, 148). An abnormal karyotype carries a poor prognosis regarding response to treatment and may be a harbinger of leukemic transformation (12, 103, 133). Vitamin B<sub>12</sub>, folic acid, ferritin, serum iron, and saturation of transferrin are normal or elevated. Serum erythropoietin levels are increased in proportion to the severity of the anemia (132, 139). Ferrokinetic studies show a prolonged clearance of <sup>59</sup>Fe, no accumulation of iron in the sacral bone, and almost undetectable incorporation into red cells—findings consistent with an almost complete arrest of erythropoiesis. Ferrokinetic parameters return to normal after full hematologic recovery except in adult patients in partial remission, in whom ineffective erythropoiesis may be present (166). Bone marrow imaging by the use of <sup>59</sup>Fe or <sup>111</sup>In shows little or no uptake, which returns to normal on remission. In both children and adults with PRCA, <sup>51</sup>Cr red cell survival is mildly shortened to a degree that is inadequate to explain the severity of the anemia (164, 166, 167). Patients refractory to treatment who are supported by regular red cell transfusions may develop a significant hemolytic component after alloimmunization or development of hypersplenism (1).

Various abnormalities of the immune system have been reported in patients with chronic PRCA (1), including hypogam-maglobulinemia, monoclonal gammopathies, pyroproteins, decreased complement, antinuclear antibodies, decreased or increased B cells, and impaired phytohemagglutinin-induced lymphocyte cytotoxicity (1, 139, 168, 169, 170 and 171). More recently, the presence of lymphocytes with  $\alpha$  or  $\delta$  T-cell receptor gene rearrangement has been described in a number of patients (172, 173, 174, 175 and 176); however, it is not yet clear whether these were cases associated with T-cell CLL or lymphoproliferative syndrome, which frequently have very subtle morphologic abnormalities (12), or cases of primary acquired PRCA.

## Differential Diagnosis

The peripheral blood smear is examined first for the presence of red cells with abnormal morphology, monocytosis, shift to the left, bilobed granulocytes, and lymphocytosis with increase of LGLs. The clinical history may provide evidence for the presence of a disease with which PRCA may be associated. If symptoms are present suggesting an autoimmune disorder, appropriate testing is performed to confirm or rule out such a possibility. In all patients diagnosed with primary acquired PRCA, computed tomography of the chest is obtained to rule out the presence of thymoma. In patients considered to be potentially immunocompromised, active B19 parvovirus infection should be excluded by obtaining IgM and IgG antibody titers for B19 parvovirus or by polymerase chain reaction.

PRCA in adults can be easily diagnosed when isolated anemia with normal white cell and platelet counts is associated with a marrow of normal cellularity in which there is an

almost complete absence of erythroblasts but normal myeloid cells and megakaryocytes. It can be easily differentiated from aplastic anemia, in which pancytopenia is present and the marrow cellularity is severely decreased with hypoplasia or aplasia of all three cell lines. High or low cellularity on bone marrow biopsy, presence of a small number of erythroblastic islands, and focal infiltration by lymphoid or immature cells are considered findings against the diagnosis of primary acquired PRCA. If there is a suspicion of a B- or T-cell lymphoid malignancy (B, T, or LGL CLL), the blood is submitted for immunophenotyping of lymphocytes by flow cytometry or for T-cell receptor gene rearrangement. The LGL type of CLL may be difficult to diagnose in its early phases when PRCA is the only predominant hematologic abnormality. The presence of a small number of large, vacuolated proerythroblasts frequently indicates active infection by B19 parvovirus. The most frequent hematologic disorder from which PRCA must be differentiated is refractory anemia or myelodysplastic syndromes.

In myelodysplastic syndromes presenting with isolated anemia, the reticulocyte count is rarely less than 1%, the red cells tend to be slightly macrocytic, and features of dysplasia of white cells may exist. Careful examination of the blood smear may reveal the presence of monocytosis, Pelger-Huët anomaly, or both. In addition, the marrow is hypercellular with dysplastic myelopoiesis, a shift of the myeloid cells to the left with an increase of blasts, and mononuclear megakaryocytes. Erythroblasts may be present in small numbers, but only rarely are they absent or less than 5%, and they usually exhibit megaloblastoid features. Cytogenetic abnormalities are frequent, and their presence is helpful in differentiating preleukemic or myelodysplastic erythroid hypoplasia from primary autoimmune PRCA ( [1](#), [13](#), [102](#), [148](#) ).

## Treatment

After the diagnosis is confirmed by bone marrow examination, all drugs should be discontinued, and any infection should be treated appropriately. An active or recent B19 parvovirus infection should be treated by administration of normal pooled serum IgG that provides specific antibodies that can clear the viral infection and allow the recovery of erythropoiesis ( [55](#), [56](#), [152](#), [153](#), [154](#), [155](#) and [156](#) ). B<sub>12</sub> or folate deficiency should be treated. In the presence of a malignant tumor, appropriate treatment should be instituted. PRCA associated with drugs or infection usually remits within 1 to 3 weeks after elimination of the responsible drug or treatment of the infection ( [1](#) ).

In the presence of a thymoma, thymectomy should be performed before the initiation of any immunosuppressive treatment. In 30 to 40% of patients with thymoma, erythropoiesis returns to normal within 4 to 8 weeks after thymectomy ( [4](#), [5](#), [177](#) ). Patients not responding to thymectomy should be treated as having primary acquired PRCA. Removal of the thymoma seems to increase the effectiveness of immunosuppressive therapy ( [5](#) ). Chemotherapy, radiation, or both ( [177](#), [178](#) ) may benefit patients with severe contraindications for surgery or with malignant thymomas. Thymectomy in the absence of thymoma is not recommended ( [1](#) ).

For primary or secondary PRCA not responding to treatment of the underlying disease, the therapeutic plan should focus on sequential use of various immunosuppressive therapies until remission is obtained. Corticosteroids are the immunosuppressive drugs of choice and should be tried before any other form of immunosuppressive treatment. Prednisone is given orally at a dose of 1 mg/kg/day until remission is induced. In approximately 40% of patients, remission usually occurs within 4 weeks, so continuation of a trial with prednisone longer than 12 weeks is not recommended ( [133](#), [179](#) ). The effect of treatment can be assessed by weekly reticulocyte count and measurement of hemoglobin concentration. A rising reticulocyte count, stabilization of the hematocrit, or both are the

first laboratory findings indicating response to treatment. Once the hematocrit reaches a level of 35%, the dose of prednisone can be tapered very slowly, and the drug can eventually be discontinued, preferably after 3 to 4 months. Rapid tapering of prednisone may lead to recurrence of anemia. A number of responders may be prednisone dependent, requiring small doses of the drug to maintain a normal hematocrit ( [179](#), [180](#) and [181](#) ). The patient's dependence of the response on low-dose prednisone can be assessed during the period of slow tapering, and the minimum dose required can be easily determined.

If the patient does not respond to prednisone within 2 to 3 months, the dose should be rapidly decreased to 20 to 30 mg daily, because responses seen after this period of treatment are extremely rare ( [179](#) ). Patients who do not respond to prednisone should be treated with an alternate immunosuppressive agent, such as cyclophosphamide or azathioprine, cyclosporine (CsA), antithymocyte  $\gamma$ -globulin (ATG), high-dose  $\gamma$ -globulin, humanized anti-CD20, or anti-CD52 (Campath-1H) monoclonal antibodies. No data exist favoring one type of treatment over another. The physician should take into consideration any coexisting disease, the age of the patient, the potential short- and long-term side effects, and the cost of treatment. The advantage of cytotoxic agents is their low cost, but they have long-term potential leukemogenic and carcinogenic effects ( [182](#), [183](#), [184](#) and [185](#) ). CsA therapy is more expensive and requires monitoring of the renal function, but it seems that the average time to induce remission is shorter than with cytotoxic drugs. In most cases, ATG administration requires hospitalization that increases its cost significantly, but it lacks the leukemogenic potential of cytostatic agents. High-dose intravenous  $\gamma$ -globulin is an expensive form of therapy but is without significant side effects. Experience with monoclonal antibodies is thus far limited.

Cyclophosphamide or azathioprine is given alone or, preferably, with small doses of prednisone, which seems to increase the effectiveness of treatment. The initial dose is 50 mg by mouth daily. If the white blood and platelet counts allow, it is increased by 50 mg weekly or biweekly to a maximum of 150 mg daily until remission occurs or bone marrow suppression develops. The mean time to response is approximately 11 to 12 weeks, with a broad range of 2 to 26 weeks and an overall response rate of 40 to 60% ( [1](#), [12](#), [132](#), [133](#), [179](#), [186](#), [187](#) ). If response occurs, the dose of prednisone is tapered, and then the dose of cytostatic agent is progressively decreased and eventually discontinued. If bone marrow toxicity develops, the drug is discontinued and the marrow is allowed to recover. If after 3 months of treatment, no response or marrow toxicity is seen, the dose can be increased progressively (by 50 mg biweekly) to the maximum tolerable or 250 mg daily under close monitoring of the blood counts. If reticulocytosis or stabilization of the hematocrit is noticed, the dose is gradually reduced. If the absolute neutrophil count decreases to below 1000 per  $\mu$ l or the platelet count drops below 100,000 per  $\mu$ l, the cytotoxic drug is discontinued. In a number of patients, a reticulocytosis is seen with the return of granulocytes and platelets to normal, followed by a return of erythropoiesis to normal. If no response occurs, another type of immunosuppressive treatment should be initiated.

CsA is given at a dose of 10 to 12 mg/kg daily in two divided doses, preferably with 20 to 30 mg of prednisone daily, under monitoring of renal function until remission occurs, usually within an average time of 2 to 4 weeks. A response to CsA is seen in 65 to 80% of patients who receive this drug as a second- or third-line treatment ( [1](#), [12](#), [137](#), [188](#), [189](#), [190](#), [191](#), [192](#), [193](#) and [194](#) ). After remission, the dose of prednisone is tapered, followed by tapering of the dose of CsA. If no remission occurs after 3 to 4 months of treatment with CsA, the drug should be discontinued, and an alternate mode of immunosuppression should be instituted.

ATG is used in patients who have not responded to other means of immunosuppression. It is given intravenously as an infusion at a dose of 20 mg of horse IgG per kg of body



weight daily for 7 days, preferably in combination with 20 to 30 mg of prednisone orally per day that is rapidly tapered within 2 to 3 weeks after completion of ATG therapy. The overall response rate to ATG seems to be around 50% ( [12](#), [45](#), [133](#), [195](#), [196](#) and [197](#) ).

High-dose intravenous  $\gamma$ -globulin is the treatment of choice for immunosuppressed patients with PRCA that may be caused by the B19 parvovirus ( [55](#), [56](#), [152](#), [153](#), [154](#), [155](#) and [156](#) ). Responses have been reported, however, in nonimmunosuppressed patients with primary or secondary PRCA ( [8](#), [198](#), [199](#) ).

Humanized monoclonal antibodies directed against specific epitopes on lymphocytes, such as anti-CD20 (rituximab) or anti-CD52 (Campath-1H) have recently been used successfully in the treatment of primary or secondary PRCA refractory to other therapies. The experience with these agents in PRCA is, thus far, limited, and the overall response to such a treatment is unknown ( [200](#), [201](#), [202](#), [203](#) and [204](#) ).

Plasmapheresis is considered in patients who have not responded to any of the above immunosuppressive therapies ( [139](#), [206](#), [207](#), [208](#) and [209](#) ). It is performed at least three times weekly for a minimum of 2 to 3 weeks, and occasionally much longer, until a response is noted. Because IgG is distributed in both intravascular and extravascular space, plasmapheresis should be performed intensively and for a long period of time before any response is seen.

Splenectomy is considered as a final therapeutic maneuver in patients whose disease is refractory to all other forms of treatment. Responses to splenectomy have been reported in approximately 17% of such recalcitrant cases within the first 2 to 3 postoperative months ( [1](#), [69](#), [159](#), [210](#) ). Nonresponders to splenectomy should receive another trial of immunosuppression following the same approach as for initial therapy of PRCA. A number of refractory cases have been reported to respond to immunosuppressive therapy after splenectomy ( [69](#), [124](#), [159](#), [210](#), [211](#) and [212](#) ). Sequential, prolonged immunosuppressive therapy should be administered carefully because, although it induces remission in two-thirds of patients, it is associated with a high frequency of infections, occurring in 30% of cases ( [179](#) ).

Patients unresponsive to all forms of treatment should be maintained on regular red cell transfusions. They usually require approximately 1 unit of packed red cells per week. Due to the frequency of red cell transfusions, after a period of time, they develop iron overload, which has detrimental effects on various organs. Thus, in this patient population, institution of iron chelation by deferoxamine should be considered within the first 6 months after the disease is declared refractory to treatment ( [1](#), [213](#) ).

Evaluation of the effectiveness of immunosuppressive treatment of PRCA is very difficult because of the infrequency of the disease and its unpredictable clinical course, with spontaneous remissions occurring in approximately 5 to 10% of cases of primary PRCA within 4 months to 14 years after the diagnosis ( [1](#), [132](#), [133](#), [179](#) ). In addition, there is no clinical or laboratory criterion to differentiate between chronic and acute disease other than observation. A number of cases treated immediately after diagnosis may represent acute and self-limited PRCA secondary to a viral infection or drugs that the patient did not mention. Comparative studies between different immunosuppressive modalities are not available. [Table 45.3](#) summarizes the experience with various forms of treatment in 133 patients at three different institutions.

**TABLE 45.3. Response of Pure Red Cell Aplasia (PRCA) to Various Immunosuppressive Therapies**

| Study  | Dessypris ( <a href="#">1</a> ) | Lacy et al. ( <a href="#">12</a> ) | Charles et al. ( <a href="#">135</a> ) | Total        |
|--|---------------------------------|------------------------------------|--|--------------|
| Patients (no.)   | 49                              | 47                                 | 37                                     | 133          |
| Primary PRCA   | 32                              | 25                                 | 18                                     | 75           |
| Secondary PRCA   | 17                              | 22                                 | 19                                     | 58           |
| Therapy (no. patients responding/no. patients treated) |                                 |                                    |  |              |
| Corticosteroids  | 18/41                           | 9/29                               | 9/36                                   | 36/106 (34%) |
| Cytotoxic agents <sup>a</sup>                          | 24/54                           | 14/29                              | 8/27                                   | 46/110 (42%) |
| Antithymocyte $\gamma$ -globulin                       | 2/6                             | 0/1                                | 8/12                                   | 10/19 (53%)  |
| Cyclosporine   | 3/4                             | 4/5                                | 2/3                                    | 9/12 (75%)   |
| Intravenous immunoglobulin G                           | —                               | 1/2                                | 2/8                                    | 3/10 (30%)   |
| Plasmapheresis   | —                               | —                                  | 0/2                                    | —            |
| Splenectomy  | 4/23                            | 0/1                                | 0/1                                    | 4/25 (16%)   |
| Multiple treatments                                    | 35/49                           | 28/47                              | 28/37                                  | 91/133 (68%) |

NOTE: Many patients did not respond to treatment or suffered relapses, so one patient may be included in more than one treatment modality.

<sup>a</sup> Including cyclophosphamide, azathioprine, or methotrexate given alone or in combination with prednisone.

## Prognosis

Sequential immunosuppressive therapy leads to a remission in approximately 68% of patients. Approximately 5 to 10% of patients may remit spontaneously. Relapses are not uncommon, and in one study, 80% of patients relapsed during the 24 months after remission ([179](#)). However, relapses are treated as successfully as the initial disease ([133](#), [179](#)). A number of patients may require low-dose maintenance immunosuppressive therapy, which, if deemed necessary, should be continued for 1 to 2 years ([1](#), [179](#)). Even after repeated relapses, approximately 60% of patients become transfusion-independent for many years. The median survival of patients with primary acquired PRCA has been estimated to be approximately 14 years ([179](#)). Overall, patients with bone marrow cytogenetic abnormalities or low growth of erythroid progenitor cells *in vitro* have a much worse prognosis due to very low or no response to immunosuppressive agents, and in these patients, the persistent use of sequential immunosuppressive therapies is not indicated ([1](#), [12](#), [27](#), [179](#)). Evolution of PRCA into aplastic anemia has been described but is exceedingly rare ([5](#), [214](#)). Approximately 3 to 5% of patients with refractory disease develop acute nonlymphocytic leukemia ([1](#), [103](#), [179](#)). The prognosis of patients with secondary PRCA depends on the nature of their primary disease.

## RED CELL APLASIA IN CHILDREN



The two major causes of red cell aplasia in children are TEC and DBA.

### Transient Erythroblastopenia of Childhood

TEC, a self-limited red cell aplasia, must be considered and ruled out when the diagnosis of DBA is considered lest unnecessary treatment and parental and patient anxiety ensue. The disorder presents in previously well children lacking the physical stigmata of DBA, often follows a viral illness, and resolves spontaneously. Before the report of Cherrick and colleagues ( 214a), TEC was believed to be restricted to red cells. These authors, however, identified neutropenia in 64% of 50 consecutive patients evaluated prospectively over an 8-year period at a single institution. In the majority of cases studied, TEC was caused, as described earlier in the chapter, by an erythroid-restricted IgG ( 136). This observation suggests that neutropenia may arise as a nonspecific effect of a particular viral infection. Table 45.4 provides a useful guide to differentiating DBA from TEC. However, neither disorder is uniformly restricted to red cells, not all DBA patients have physical anomalies, there is significant age overlap, fetal red cell characteristics are not observed in all patients with DBA (especially at diagnosis), and TEC red cells in recovery will exhibit fetal-like erythropoiesis. TEC is described in more detail below in the sections [Differential Diagnosis](#) and [Treatment](#).

**TABLE 45.4. Differential Diagnosis of Diamond-Blackfan Anemia (DBA) versus Transient Erythroblastopenia of Childhood (TEC)**

|  | DBA   | TEC             |
|--|---|-----------------|
| Pure red cell aplasia                    | Present   | Present         |
| Age                                      | Younger than 1 yr   | Older than 1 yr |
| Inheritance                              | Sporadic and dominant or possibly recessive inheritance; mutation analysis available for DBA1 (RPS19) | Not inherited   |
| Congenital anomalies                     | Present   | Absent          |
| Mean corpuscular volume                  | Elevated  | Normal          |
| Fetal hemoglobin                         | Elevated  | Normal          |
| Red blood cell antigen                   | Present   | Absent          |
| Erythrocyte adenosine deaminase activity | Elevated  | Normal          |

NOTE: All red blood cell characteristics except adenosine deaminase activity are helpful only when tested in a reticulocytopenic child. During recovery from TEC, a transient wave of fetallike erythropoiesis may be detected.

### Diamond-Blackfan Anemia

DBA, first recognized as a discrete clinical entity in 1938 ( 3), is a rare aregenerative anemia of childhood. The accepted diagnostic criteria are (a) normochromic, usually macrocytic, and occasionally normocytic anemia developing in early childhood; (b) reticulocytopenia; (c) normocellular bone marrow with selective deficiency of erythroid

precursors; (d) normal or only slightly decreased granulocyte count; and (e) normal or slightly increased platelet count. DBA is frequently associated with a variety of somatic malformations and, rarely, with developmental delay. The majority of patients (over 80%) respond to corticosteroids with an improvement in or complete remission of their anemia ( [215](#) , [216](#) and [217](#) ). However, prolonged corticosteroid treatment has been problematic for many patients with DBA ( [216](#) ). Since the first description of this syndrome over 60 years ago, a number of theories have been put forth regarding its etiology. The myriad explanations have included humoral ( [217](#) ) or cellular ( [218](#) , [219](#) ) suppression of erythropoiesis, a microenvironmental defect ( [220](#) ), a block in the erythroid maturation pathway ( [221](#) ), accessory cell failure ( [222](#) ), and an intrinsic progenitor cell defect ( [223](#) , [224](#) and [225](#) ). Recent data suggest that there is a defective pathway from the multipotent bone marrow progenitor to the mature CFU-E through terminal differentiation to the proerythroblast and beyond ( [224](#) , [225](#) ), in which an intrinsic defect in erythroid progenitors and precursors render them highly sensitive to death by apoptosis ( [226](#) , [227](#) ).

**ETIOLOGY AND PATHOGENESIS** Normal erythropoiesis is dependent on the interaction between erythroid progenitors, accessory cells, and the bone marrow stroma ( [228](#) ). Thus, the erythroid failure in DBA could potentially arise from an absence of one of these elements or from failure of any one of the elements to act or respond appropriately. Studies performed over the past decade suggested multiple etiologies for this condition. Some early investigators described a marrow microenvironmental defect ( [220](#) ) or implicated accessory cell dysfunction ( [227](#) ). Others seemingly found evidence that the red cell failure in DBA was due to the presence of cytotoxic or autoreactive T cells ( [218](#) , [219](#) ) or humoral inhibitors of erythropoiesis ( [217](#) ). These findings have not been substantiated in the vast majority of patients ( [221](#) , [223](#) , [224](#) and [225](#) , [229](#) , [230](#) and [231](#) ). It is now accepted that DBA results from an intrinsic progenitor defect ( [221](#) , [223](#) , [224](#) and [225](#) , [231](#) , [232](#) and [233](#) ). Freedman et al. ( [223](#) ) first suggested that some patients had decreased numbers of CFU-E, whereas studies by Nathan et al. ( [221](#) ), using chronically affected, multiply-transfused or steroid-dependent patients, suggested a block in maturation between the earliest committed multipotent myeloid progenitor and the immature BFU-E. In addition, these investigators found that the progenitors expressed in culture were relatively insensitive to erythropoietin. Chan et al. ( [232](#) , [233](#) ) reiterated the concept of progenitor hyporesponsiveness to erythropoietin and suggested that this abnormality could be corrected, in part, by the addition of glucocorticoids *in vitro*, implying a relationship between clinical response to corticosteroids and *in vitro* progenitor response. A series of studies by Lipton and colleagues confirmed these observations. In these studies, some patients expressed normal or nearly normal numbers of BFU-E-derived colonies but had decreased numbers of CFU-E-derived colonies in the presence of exogenous cytokines and erythropoietin, whereas other patients demonstrated normal numbers of, albeit small and poorly differentiated, colonies from both progenitors ( [224](#) ). These data suggested that DBA is a heterogeneous disorder in which erythropoiesis may be blocked at different stages of erythroid differentiation. This observation was later confirmed in studies by McGuckin and colleagues ( [234](#) ). Additional studies from this group and others clearly demonstrate that DBA is due to an intrinsic disorder of the erythroid progenitor, which involves its inability to respond normally to inducer(s) of erythroid proliferation and differentiation ( [225](#) ), resulting in accelerated apoptosis ( [226](#) ), and that the effect could be ameliorated by corticosteroids ( [227](#) ). These findings were not associated with any abnormalities in erythropoietin or its receptor in any of the DBA patients studied ( [235](#) , [236](#) ). In addition, the defect is likely not confined to erythroid cell differentiation. A mildly decreased leukocyte count and the development of pancytopenia, bone marrow hypoplasia, and reduced clonogenic cell output in long-term

culture-initiating cell assays ( [237](#) ) as well as hypogammaglobulinemia and T-cell abnormalities ( [222](#) , [238](#) ) support this contention. Furthermore, recent studies show that, in addition to erythroid progenitors, a defect in colony-forming unit granulocyte-monocyte can be found in a subset of patients ( [234](#) ). These *in vitro* studies are consistent with the observation of neutropenia and even aplastic anemia in some DBA patients. The responses of erythroid cell growth and differentiation to a variety of cytokines in addition to erythropoietin, such as stem cell factor and interleukin-3, have been evaluated with no abnormalities of the cytokines or their receptors being identified ( [239](#) , [240](#) , [241](#) , [242](#) and [243](#) ). The first DBA gene, DBA1, has been cloned and is identified as *RPS19*, a gene that encodes for a ribosomal protein located at chromosome 19q13.2 ( [244](#) , [245](#) ). Our knowledge of the activity of RPS19, other than that it is an integral part of the ribosomal machinery, is limited. However, this observation firmly establishes DBA as an intrinsic progenitor cell disorder. The genetics of DBA are discussed in more detail below.

**CLINICAL PRESENTATION** DBA usually presents in infancy. Severe anemia is recognized at birth in 25% of patients, with 65% diagnosed by 6 months of age and 90% within the first year of life ( [246](#) ). DBA presenting as hydrops fetalis has been reported ( [247](#) ). Rarely, the disease may present in older children and adults ( [246](#) , [248](#) ). The incidence in men equals that in women. The majority of cases are reported in whites, but the disorder has been reported in virtually all ethnic groups ( [246](#) ). An unusually high proportion of mothers of patients have a prior history of fetal loss, either by miscarriage or stillbirth ( [246](#) ). Other parental problems include premature low birth weight and small for gestational age babies ( [246](#) ). Josephs in 1936 ( [249](#) ) and Diamond and Blackfan in 1938 ( [3](#) ) were the first to describe red cell failure in infants. The variety of descriptive names for what is now preferably called *DBA* includes *congenital pure red cell hypoplastic anemia* (the name preferred by Dr. Diamond), *congenital red cell aregenerative anemia*, *erythrogenesis imperfecta*, *chronic erythroblastopenia*, *primary red cell aplasia*, and *Josephs–Diamond–Blackfan anemia* ( [215](#) , [246](#) ) and reflects the historic lack of a precise clinical definition as well as the uncertainty regarding the pathophysiology of the disorder. The diagnostic criteria for DBA reflect the careful clinical analysis performed by Diamond and colleagues ( [215](#) ) and, more recently, by Alter ( [246](#) , [250](#) , [251](#) ). For an exhaustive compilation of the clinical syndrome of DBA that is beyond the scope of this chapter, interested readers are referred to Young and Alter ( [251](#) ). The Diamond–Blackfan Anemia Registry of North America (DBAR), a database of over 350 patients, was established in 1993 and has been described in detail ( [216](#) ). The DBAR has provided important information regarding the epidemiology and biology of DBA ( [252](#) , [253](#) , [254](#) and [255](#) ). The male to female ratio of cases is 1:1.04. The median age at presentation is 8 weeks with a median age at diagnosis of 12 weeks. More than 90% of the reported cases presented by 1 year of age. The mainstays of therapy, as described below, remain red cell transfusions and corticosteroids. Physical anomalies, excluding short stature, are found in nearly 50% of patients. The constellation of physical findings in the 47% of affected patients with typical hematologic manifestations includes a high percentage of craniofacial anomalies (50%) and upper limb and hand abnormalities, in particular thumbs (38%), as well as genitourinary (39%) and cardiac abnormalities (30%). [Table 45.5](#) enumerates the congenital anomalies collected in a series by Alter ( [256](#) ). Thus, efforts to define genotype–phenotype correlations on the basis of any particular physical findings will require careful mutation analysis as the “DBA genes” are cloned ( [257](#) , [258](#) ). The relationship of abnormal thumbs to hematopoietic failure in DBA as well as Fanconi anemia ( [258](#) ) and the radial abnormalities in patients with thrombocytopenia and absent radii (TAR syndrome) are particularly fascinating ( [259](#) ). [Figure 45.1](#) illustrates typical thumb abnormalities in a patient with DBA. Despite the detailed cataloging of these anomalies, their relationship to the pathogenesis of DBA and other syndromes remains obscure. An understanding of these observations awaits a more complete understanding of the function of the proteins mutated in these disorders.



**Figure 45.1.** Typical displaced and “trigger” thumbs in a patient with Diamond–Blackfan anemia.

**TABLE 45.5. Physical Abnormalities in Patients with Diamond–Blackfan Anemia**

|  |                           |
|--|---------------------------|
| Low birth weight   | Neck                      |
| Short stature, no steroids                               | Short                     |
| Head and face  | Webbed                    |
| “Cathie” facies  | Thumb                     |
| Other facies   | Triphalangeal             |
| Small head   | Duplicated or bifid       |
| Large head   | Subluxed                  |
| Jaw and mouth  | Hypoplastic               |
| Small jaw alone  | Renal                     |
| Small jaw and cleft palate (e.g., Pierre Robin syndrome) | Dysplastic                |
|  | Absent                    |
|  | Horseshoe                 |
| Cleft palate alone                                       | Duplicated ureters        |
| Cleft palate and lip                                     | Caliectasis               |
| Cleft lip alone  | Congenital heart disease  |
| Macroglossia   | Ventricular septal defect |
| Flat nasal bridge  | Atrial septal defect      |
| Abnormal ears  | Coarctation of aorta      |
| Abnormal eyes  | Other                     |
| Hypertelorism  | Mental retardation        |
| Epicanthal folds   | Hypogonadism              |
| Ptosis   | Asplenia                  |
| Strabismus   |                           |
| Blue sclerae   |                           |
| Congenital cataracts                                     |                           |
| Microphthalmia   |                           |
| Glaucoma   |                           |

Modified from Alter BP. The bone marrow failure syndromes. In: Nathan DG, Oski FA, eds. Hematology of infancy and childhood, 3rd ed. Philadelphia: WB Saunders, 1987:159.

**LABORATORY EVALUATION** As previously described, DBA is characterized by severe anemia, with hemoglobins in typical patients ranging from 2.8 to 8.5 g per dl ([224](#)). There is a marked reticulocytopenia, frequently as low as zero. There are usually no significant abnormalities in other cell lines. Occasionally, there is mild neutropenia ([215](#), [246](#), [256](#)) or

thrombocytopenia ( [260](#) ). However, thrombocytosis in the range of 400,000 to 700,000 is more common ( [215](#), [246](#), [256](#), [260](#) ). There is no evidence of platelet dysfunction ( [260](#) ). Although originally described as a normochromic, normocytic anemia, macrocytosis was noted in approximately 30% of cases reviewed by Alter ( [246](#) ) when data at presentation was available. The percentage of patients with macrocytosis increases with the age of the patients as the disease becomes chronic and the normal red cell mean corpuscular volume (MCV) decreases. Indeed, the persistence of “fetallike” red cells with macrocytosis, i antigen, an increased fetal hemoglobin (HbF), and red cell glycolytic and hexose–monophosphate shunt enzyme activities characteristic of fetal cells is a consistent finding. The HbF is typical of fetal cells ( [246](#), [261](#) ) with an elevated glycine to alanine ratio at position 136 of the gamma chain (Gly:1<sup>136</sup>). Of note is that the fetallike characteristics are not concordant; cells with high HbF are not necessarily those with the i antigen. Although red cells contain significant HbF, as determined by hemoglobin electrophoresis, the distribution is uneven as evaluated by the Kleihauer–Betke method. Alter points out that red cells contain both HbF and adult hemoglobin and that the “re–expression of fetal erythropoiesis is thus incomplete, and not clonal” ( [246](#) ). Although glycolytic and hexose–monophosphate shunt enzymes have a fetal pattern, erythrocyte adenosine deaminase (eADA), a purine salvage pathway enzyme, is increased in activity in DBA patients but not in fetal or cord blood erythrocytes ( [262](#) ). When compared to controls with normal eADA activity obtained from normals, cord blood, patients with hemolytic anemia, Fanconi anemia, and those with steroid–dependent nephrosis, as well as virtually all patients with TEC, approximately 85% of the patients with typical DBA have an elevated eADA activity ( [262](#), [263](#) and [264](#) ). In some DBA patients with normal eADA activity, there is markedly elevated orotidine decarboxylase activity ( [263](#), [265](#) ). Although abnormalities in purine or pyrimidine biosynthesis are consistent findings in most DBA patients, this observation has not yet been helpful in understanding the pathophysiology of DBA. Red cells of some patients with acute leukemia, adult–type chronic myelogenous leukemia, myeloproliferative disorder with Down syndrome, dyskeratosis congenita with pancytopenia, and megaloblastic anemia were also found to have increased eADA activity ( [264](#) ). This may suggest an association of elevated eADA activity with abnormal progenitor function consistent with the concept that DBA is the consequence of an intrinsic progenitor cell defect. Also of interest is the observation that W/W<sup>v</sup> and S1/S1<sup>d</sup> mice with genetically determined red cell failure have elevated erythrocyte nucleoside deaminase activity ( [266](#) ). Further advances in this area must await a detailed understanding of the biochemistry of hematopoiesis. However, from a practical perspective, eADA activity determinations provide a reasonably useful means for distinguishing approximately 85% of DBA from TEC (see [Differential Diagnosis](#)). To date, none of the described abnormalities is linked to a specific pathophysiology, and they have no predictive value in distinguishing steroid responders from nonresponder patients. Vitamin B<sub>12</sub>, folate, serum iron, and transferrin saturation are elevated or normal in patients with DBA ( [215](#), [263](#) ). Erythropoietin levels seem to reflect the degree of anemia or may be elevated for the degree of anemia and remain elevated even in steroid–responsive patients ( [215](#), [246](#) ). Approximately one–third of patients evaluated by Alter had hypogammaglobulinemia consistent with the finding of *in vitro* immunologic abnormalities in some DBA patients ( [222](#), [246](#), [267](#) ). Examination of the bone marrow biopsy and aspirate usually reveals normal cellularity with a paucity of erythroid precursors. Myeloid and megakaryocyte lineages appear normal. Myeloid to erythroid ratios at diagnosis are usually around 10:1 and, with time, may become as high as 100:1 ( [215](#) ). This progression of erythroid failure (with time) seems to parallel the more severe abnormalities in *in vitro* progenitor differentiation observed in older chronically affected patients as compared to those newly diagnosed ( [225](#) ). The heterogeneity of the disorder is reflected in the marrow. In one series of nine patients, all had marked erythroid hypoplasia: Four had virtually no erythroid precursors, two had erythroid maturation up to the polychromatophilic or



orthochromatic normoblast stage, and three had a maturation arrest at the proerythroblast stage with 2 to 7% of the total nucleated cells being proerythroblasts ( [224](#) ). In Alter's review, 28 of 29 DBA patients had erythroid hypoplasia ( [256](#) ). One had erythroid hyperplasia with a maturation arrest. Several of Alter's patients had normal numbers of proerythroblasts but no differentiation beyond that stage. In a series of patients from Bernard et al., 90% had erythroid hypoplasia, 5% had normal erythroid precursors, and 5% had erythroid hyperplasia ( [268](#) ). Although all patients have a profound reticulocytopenia, the erythroid arrest in DBA has been demonstrated, by progenitor assays or morphologically, to occur at all stages of maturation from the multipotent myeloid progenitor to the late normoblast. These and other observations ( [237](#) ) suggest that the defect may become more profound with age and that the arrest of erythropoiesis moves to an earlier stage as patients get older. This is, however, somewhat confounding in light of the presence of spontaneous remissions ( [216](#) ). Imaging studies are useful to help delineate congenital abnormalities that may be present in patients with DBA. Skeletal surveys are not usually warranted, but selected radiographs may define suspected bony anomalies. Abdominal and cardiac ultrasonography may detect or diagnose suspected and perhaps significant renal or cardiac anomalies.

**GENETICS** Alter originally estimated that there is more than one affected family member in approximately 10% of the cases ( [256](#) ). Data from the DBAR reveal comparable information ( [216](#) ). Early case reports are representative of the genetics of DBA. In these families, there are reports of affected same- and opposite-sex siblings ( [257](#), [269](#), [270](#) and [271](#) ), including identical twins ( [272](#) ) and maternal or paternal half-siblings ( [273](#), [274](#), [275](#) and [276](#) ). There are also instances of parental transmission ( [275](#), [277](#), [278](#) and [279](#) ). Striking evidence of autosomal-dominant inheritance is illustrated in one case report of DBA in a male infant who had an affected mother and maternal grandfather ( [280](#) ). In support of an autosomal-recessive mode, parental consanguinity has been observed ( [281](#), [282](#) ). Thus, there was early evidence for both autosomal-recessive and -dominant modes of inheritance. The genetics of DBA were more firmly established when, in 1997, after studying a patient with a 19:X translocation, Gustavsson and colleagues ( [244](#), [245](#), [283](#) ) used linkage analysis to show that DBA mapped to chromosome 19q13.2. That observation led to the cloning of a gene that encodes a ribosomal protein, RPS19, the function of which remains unclear. Studies have shown that the RPS19 or DBA1 mutation accounts for only approximately 20 to 25% of familial as well as sporadic cases. More recently, Gazda et al. used linkage to suggest the presence of a second locus, DBA2 at 8p23-22, in approximately 40% of cases studied ( [255](#) ). As a significant minority of cases linked to neither 19q nor 8p, it is clear that additional DBA genes exist. These data indicate that the majority of familial cases are of dominant inheritance, with sporadic cases representing new dominant mutations. Within the identified pedigrees, there is marked heterogeneity in the expression of the DBA phenotype. This heterogeneity exists for both the hematologic and nonhematologic manifestations of DBA. Thus, the DBA phenotype appears to be the result of complex interactions between DBA and non-DBA genes. A family with discordant hematologic manifestations, including a nonhematologically affected phenotype and discordance of craniofacial anomalies in affected family members, has been reported ( [284](#) ). The incidence of genetically determined cases is no doubt underestimated due to the apparent variable penetrance of the autosomal-dominant cases, in which an elevated HbF, MCV, or eADA activity may be the only abnormality in a parent or sibling of a child with typical DBA ( [215](#), [245](#), [251](#), [260](#), [261](#) and [262](#), [266](#) ). Indeed, in the case described, the mothers of affected cousins had none of these hematologic abnormalities ( [234](#) ). Therefore, pending the availability of a molecular diagnosis for all DBA genotypes, families of affected individuals should be evaluated to determine HbF levels, MCV, and eADA activity. A number of cases currently believed to be sporadic or autosomal recessive in nature will no doubt be recategorized. The absence of a phenotype is a particularly distressing finding, as the use of such potential hematopoietic

stem cell transplantation (HSCT) donors with such a “silent phenotype” may result in transplant failure ([285](#)). The vast majority of DBA patients have a normal karyotype, but the few reported abnormal cases, two of which involve chromosome 1, are of interest ([286](#), [287](#)). These findings have not been corroborated in other patients using more modern banding techniques, but in light of recent discoveries, these will no doubt be revisited.

**DIFFERENTIAL DIAGNOSIS** The differential diagnosis of DBA includes the normochromic normocytic (or macrocytic) anemias that present from birth through the first year of life. These anemias are pathophysiologically distinct from the majority of PRCA cases seen in adults, which are frequently associated with an underlying disorder. [Table 45.4](#) describes the differential diagnosis of red cell aplasia, with TEC representing the vast majority of cases of autoimmune red cell aplasia in children. The differential almost always consists of DBA versus TEC. For example, the association of PRCA with thymoma, as described in adults, has not been described in infancy, although it has been observed in a 5-year-old girl ([288](#)). A careful history, physical examination, and examination of the peripheral blood smear can usually rule out hemorrhage, myelosuppression due to infection, renal failure, infiltrative disease, severe protein malnutrition, or drug-related red cell failure, as well as the aplastic crisis of a chronic hemolytic anemia (such as sickle cell anemia or hereditary spherocytosis). Because folate deficiency is prevented as a cause of the hypoplastic crises associated with chronic hemolytic anemia by prophylactic administration of the vitamin, acquired hypoplastic anemia in these patients is now most frequently a consequence of human parvovirus B19 infection. Evidence of human parvovirus B19 infection (see the section [Viral Infections and Red Cell Aplasia](#)) has been found in patients with a variety of sickle cell syndromes, hereditary spherocytosis, pyruvate kinase deficiency, and thalassemia after an aplastic crisis ([47](#), [48](#), [49](#), [50](#), [51](#), [52](#), [53](#) and [54](#)). Red cell aplasia in otherwise normal neonates (resulting in fetal hydrops) and in a patient on treatment for acute lymphoblastic leukemia has also been described, apparently due to parvovirus infection ([289](#)). Chronic red cell aplasia due to parvovirus B19 after 10 years of transfusion-dependent anemia has been eradicated by the use of intravenous Ig ([55](#)). Thus, parvovirus infection should be ruled out in all atypical instances of red cell failure in children. This can best be accomplished by polymerase chain reaction analysis, as IgM and IgG antibody evidence are lacking in the presence of significant immunodeficiency (see [Viral Infections and Red Cell Aplasia](#)). A bone marrow examination revealing red cell aplasia or severe hypoplasia with no abnormalities in myeloid or megakaryocyte lineages and no evidence of infiltrative disease or congenital dyserythropoietic anemia in an infant or young child suggests either DBA or TEC. [Table 45.4](#) outlines the important features that distinguish TEC, a temporary suppression of erythropoiesis that frequently follows a viral infection, from DBA. There is a moderate to severe anemia with reticulocytopenia. TEC is not familial, and there are no associated anomalies. The age of onset is usually a bit older than for congenital PRCA. One key point in differentiating between DBA and TEC is the presence of fetal characteristics in the erythrocytes of many patients with DBA (see [Laboratory Evaluation](#)). As previously described, these characteristics include an elevated MCV for age, elevated levels of HbF and i antigen, and a fetal erythrocyte glycolytic and hexose-monophosphate shunt enzyme pattern ([290](#)). These fetal characteristics are probably the consequence of “stress erythropoiesis” associated with chronic DBA. The presence of “fetallike” cells is much less reliable in differentiating DBA from TEC in very young infants, in whom red cells normally possess fetal characteristics. Thus, as more children with TEC who are younger than 1 year of age are being described, the differential diagnosis is becoming more difficult. In addition, adolescents with TEC have been reported ([291](#)). Even in typical DBA, only 30% of patients will have “fetallike” erythrocytes at diagnosis. In addition, the recovery from TEC is characterized by “stress erythropoiesis giving rise to erythrocytes with fetal characteristics” ([292](#)). Making a diagnosis of TEC retrospectively after a long course of corticosteroids subjects the child to needless toxicity. As previously described, recent studies by Glader and co-workers ([262](#), [263](#) and [264](#)) have demonstrated that elevated eADA activity can be used to distinguish DBA from TEC. However, many patients are transfused before consideration of the



diagnosis, making an accurate eADA activity determination impossible. A molecular diagnosis can be made by mutation analysis in approximately 25% of patients mutated at DBA1 (RPS19). Based on the differences listed in [Table 45.4](#), a high index of suspicion of TEC should prompt avoidance of steroids, minimal red cell transfusions, and alleviation of parental concern.

**TREATMENT** If the diagnosis of DBA versus TEC is in doubt, and the patient has symptomatic anemia, they should be only modestly transfused to a hemoglobin level of 7 to 8 g per dl so that erythropoiesis is not suppressed, delaying recovery in those patients who have TEC. In 1951, corticosteroid treatment in the form of adrenocorticotrophic hormone was first shown to be effective in DBA ([293](#), [294](#)). The current approach is to start all patients on prednisone, 2 mg/kg/day orally in three to four divided doses. A reticulocyte response usually occurs within 1 to 2 weeks. If there is no response within 2 weeks, the dose may be increased to 3 mg/kg/day. The clinical response to prednisone is variable. Data from the DBAR reveal that 82% of patients were initially responsive to corticosteroids, 16% were nonresponsive, and 1.6% were never treated with steroids ([216](#)). At the time of the analysis, only 44% of patients were using corticosteroids. Steroid-related side effects were observed in most patients, at least transiently, with 40%, 12%, and nearly 7% manifesting cushingoid features, pathologic fractures, and cataracts, respectively. Thirty-six percent of the patients were receiving red cell transfusions. Some patients respond rapidly and can be tapered off prednisone, remaining in remission for extended periods of time; others respond but require continued therapy, with erythropoiesis ceasing rapidly if steroids are discontinued. Thus, the ability of responders to achieve an effective every-other-day dose schedule is variable. Of the transfused patients, 32% were never steroid-responsive, 17% became steroid-refractory, and 49% could not be weaned to an acceptable dose. A small number never received steroids or were transfused for unspecified reasons. Some patients may be tapered off steroids even after many years. Indeed, the actuarial likelihood of remission is 20% by age 25 years, with 77% entering remission during the first decade of life. Patients appear to remit equally from steroid and transfusion therapy. Almost 75% of these patients have what appears to be a sustained remission. Although high-dose corticosteroid pulses may evoke an erythroid response in some patients ([295](#), [296](#)), the potential side effects, the need for repeat pulses, and the failure of this modality in subsequent studies ([297](#)) have limited its utility. Likewise, trials of CsA, despite anecdotal reports in DBA, have not been particularly encouraging ([298](#)). Furthermore, the potential toxicity of this agent makes it less preferable than red cell transfusions for those patients who cannot be weaned to an acceptable corticosteroid dose. In some patients who do not respond to prednisone, there may be a response when oxymetholone (2.0 to 5.0 mg/kg/day) is added ([215](#), [256](#)). However, most clinicians do not advocate the use of androgens in infants and young children. If there is no response within 1 month, prednisone is discontinued in favor of transfusion and chelation regimens following the established guidelines (see [Chapter 42](#)). These patients may receive periodic prednisone trials because they may respond at a later date. For patients who respond to steroids, their hemoglobin levels are followed until a level of 10 gm per dl is achieved. The steroid dose is then tapered until the patient is on the smallest possible alternate-day dose. A Monday-Wednesday-Friday dose schedule is usually effective and easier to comply with than a strict every-other-day regimen. The dosage in a Monday-Wednesday-Friday schedule may range from a few milligrams, even in adolescents, to as much as 40 to 50 mg. Another approach uses 1 week of daily prednisone during a 3-week to monthly cycle ([299](#)). This regimen may reduce side effects, such as growth retardation, but some patients may not maintain a desirable hemoglobin level. Arbitrary discontinuation of therapy should be discouraged because reestablishment of erythropoiesis after discontinuation of an effective every-other-day course of prednisone requires reinstatement of the original daily dose. For patients who are steroid-refractory or in whom the dose cannot be tapered to an alternate-day regimen and who thus require high daily doses that cause toxicity, chronic transfusion is instituted. Data from the DBAR and accumulated international experience demonstrate that more patients than originally anticipated have significant steroid-related side effects

even on a low-dose every-other-day schedule. These occur in addition to pathologic fractures and cataracts, include poor growth, osteoporosis, and osteonecrosis, and may require the discontinuation of corticosteroids in favor of chronic transfusion therapy. There are virtually no pediatric disorders for which corticosteroids are initiated in infancy and may be continued into adulthood. Thus, many experienced clinicians are foregoing steroid treatment in favor of chronic red cell transfusions during infancy. Patients must be carefully monitored and steroid therapy discontinued when morbid side effects ensue. As preparative regimens and infection control have improved and graft-versus-host disease has become more amenable to treatment and prevention, reducing morbidity and mortality, HSCT has been used in DBA patients with good results. The first successful transplant for DBA was performed by August and colleagues in 1976 (300). In a 1998 review of stem cell transplantation in DBA by Alter that analyzed 35 of the 37 cases reported to date in the literature, the actuarial survival for predominantly allogeneic HLA-matched donor transplants was 66% (301). Two more recent studies suggest that the actuarial survival is in the range of 90% for matched related HSCT in young, otherwise healthy patients (254, 302). On the other hand, the still substantial risks associated with alternative donor bone marrow transplantation favor transfusion and chelation in those patients unable to achieve an every-other-day steroid schedule. Modern chelation regimens seem to be very effective in reducing the consequences of iron overload in chronically transfused patients, but the long-term results of these programs are not currently known. This uncertainty and the other risks of transfusion (i.e., sensitization and infection) make the decision regarding bone marrow transplantation (when a suitable alternative donor exists) versus chelation therapy for DBA patients who are steroid-refractory or steroid-intolerant one that must be individualized and constantly reevaluated. Studies indicate that recombinant human interleukin-3 may increase the *in vitro* clonogenicity of DBA progenitors when unfractionated cell preparations are cultured (303). The mixed response and, ultimately, the toxicity of interleukin-3, the most promising of the cytokines, have precluded its use in DBA (304, 305, 306, 307, 308, 309, 310 and 311).

**PROGNOSIS** Due to advances in therapy, the published mortality rates are not particularly helpful for determining the prognosis of patients diagnosed today (251). Deaths due to infection in splenectomized patients with DBA are now dramatically reduced through the use of pneumococcal and *Haemophilus influenzae* vaccines, prophylactic penicillin, and careful follow-up and management. In addition, splenectomy is only performed for hypersplenism and an increased transfusion requirement, not as specific therapy for DBA. Modern chelation schemes seem to be able to dramatically postpone, if not eliminate, clinically significant transfusion-related hemosiderosis. There have been 23 deaths recorded by the DBAR as of the last published report: one from severe aplastic anemia, two from *Pneumocystis carinii* pneumonia, one from varicella pneumonia, one from *Pseudomonas* pneumonia and sepsis, two from complications of iron overload, one from cardiac tamponade secondary to a vascular access device complication, six from malignancy, and nine from HSCT complications (216). Thus, cancer and complications of alternative donor HSCT are the leading causes of death in DBA. Although the major indication for HSCT was steroid nonresponsiveness or intolerance resulting in transfusion dependence, two of the cases recorded by the DBAR were those of patients who were transplanted (one by the HLA-matched related HSCT and one by alternative donor HSCT) for the indication of severe aplastic anemia. The overall actuarial survival rates at approximately 40 years of age are 77.9% ± 5.6%, 100% for those with sustained remissions, 87.4% ± 6.9% for corticosteroid-maintainable patients, and 57.5% ± 12.9% for transfusion-dependent patients. There is a trend toward increased survival in patients with sustained remission and a statistically significant survival advantage for steroid-maintainable patients compared to transfusion-dependent patients. With regard to cancer, 29 cases of cancer in DBA patients have been reported in the literature (252). There appears to be no doubt that DBA is a syndrome predisposing to cancer. Both hematopoietic and nonhematopoietic malignancies have been documented. An analysis

from the DBAR was performed in an effort to determine the cancer risk in DBA patients. Seven of 354 registered patients had malignancies. Four had osteogenic sarcoma, one had myelodysplastic syndrome, one had colon cancer, and one a soft-tissue sarcoma ( [216](#), [252](#) ). Three additional patients, who were not registered in the DBAR but were DBA-affected relatives of registered patients with documented DBA, were identified. Of these, there was one case each of colon cancer, melanoma, and myelodysplasia. Young age at presentation is a feature of DBA-associated osteogenic sarcoma and perhaps other malignancies. These observations strongly support the need for a genotypic analysis of patients with DBA-associated cancer and their families.

**FUTURE DIRECTIONS** Advances in cellular and molecular biology have begun to increase our understanding of the pathophysiology of DBA. DBA has been shown to be the consequence of an intrinsic progenitor cell defect. One of the genes responsible for the disease has been cloned, and genetic linkage analysis supports the existence of at least two other genes. Careful clinical investigation has defined the syndrome, and the study of the cellular biology of the disorder has borrowed from and contributed to the understanding of the mechanism of hematopoietic progenitor cell differentiation. Using the DBAR, important epidemiologic, clinical, and laboratory observations have been made with regard to the clinical presentation and inheritance of DBA. The database has yielded other important observations on the genetics of congenital malformations in DBA, the therapeutic outcomes including the efficacy of HSCT, and the recognition of DBA as a cancer-predisposing syndrome. In particular, the DBAR has provided the essential substrate of multiple well-characterized families for gene discovery ( [216](#) ). The final description of DBA at the molecular level would be a most extraordinary tribute to Dr. Louis Diamond, whose career spanned over 60 years and who has been a teacher to many and an inspiration to the rest ( [250](#) ).

## REFERENCES

1. Dessypris EN. Pure red cell aplasia. Baltimore: The Johns Hopkins University Press, 1988.
2. Kaznelson P. Zur entstehung der blutplattchen. Verh Dtsch Ges Inn Med 1922;34:557.
3. Diamond LK, Blackfan KD. Hypoplastic anemia. Am J Dis Child 1938;56:464.
4. Jacobs EM, Hutter RV, Pool JL, Ley AB. Benign thymoma and selective erythroid aplasia of the bone marrow. Cancer 1959;12:47.
5. Hirst E, Robertson TI. The syndrome of thymoma and erythroblastopenic anemia: a review of 56 cases including 3 case reports. Medicine 1967;46:225.
6. Chikkappa G, Zarrali MH, Tsan MF. Pure red cell aplasia in patients with chronic lymphocytic leukemia. Medicine 1986;65:339.
7. Mangan KF, Chikkappa G, Farley PC. T-gamma (T?) cells suppress growth of erythroid colony forming units in vitro in the pure red cell aplasia of B-cell chronic lymphocytic leukemia. J Clin Invest 1982;70:1148.
8. Clauvel JP, Vainchenker W, Herrera A, et al. Treatment of pure red cell aplasia by high-dose intravenous immunoglobulins. Br J Haematol 1983;55:380.
9. Hoffman R, Kopel S, Hsu SD, et al. T cell chronic lymphocytic leukemia: presence in bone marrow and peripheral blood of cells that suppress erythropoiesis in vitro. Blood 1978;52:255.
10. Nagasawa T, Abe T, Nakagawa T. Pure red cell aplasia and hypogammaglobulinemia associated with T?-cell chronic lymphocytic leukemia. Blood 1981;57:1025.
11. Lipton JM, Nadler LM, Canellos GP, et al. Evidence for genetic restriction in the suppression of erythropoiesis by a unique subset of T-lymphocytes in man. J Clin Invest 1983;72:694.
12. Lacy MG, Kurtin PJ, Tefferi A. Pure red cell aplasia: association with large granular lymphocyte

leukemia and the prognostic value of cytogenetic abnormalities. *Blood* 1996;87:3000.

13. Bove JR. Combined erythroid hypoplasia and symptomatic hemolytic anemia. *N Engl J Med* 1956;255:135.
14. Field EO, Caughi MN, Blackett NM, Smithers DW. Marrow suppressing factors in the blood in pure red cell aplasia, thymoma and Hodgkin's disease. *Br J Haematol* 1968;15:101.
15. Guerra L, Najman A, Homberg JC, et al. Auto-anticorps multiples au cours d'une maladie de Hodgkin: interpretation d'une erythroblastopenie. *Nouv Rev Fr Hematol* 1969;9:601.
16. Morgan E, Pang KM, Goldwasser E. Hodgkin's disease and red cell aplasia. *Am J Hematol* 1978;5:71.
17. Jepson JH, Vas M. Decreased in vivo and in vitro erythropoiesis induced by plasma of ten patients with thymoma, lymphosarcoma or idiopathic erythroblastopenia. *Cancer Res* 1974;34:1325.
18. Hunt FA, Lander CM. Successful use of combination chemotherapy in pure red cell aplasia associated with malignant lymphoma of histiocytic type. *Aust N Z J Med* 1975;5:469.
19. Prasad AS, Tranchida L, Palutke M, Ponlik DM. Red cell hypoplasia and monoclonal gammopathy in a patient with lymphoproliferative disorder. *Am J Med Sci* 1976;271:355.
20. Lee CH, Firkin FC, Grace CS, Rozenberg MC. Pure red cell aplasia: a report of three cases with studies on circulating toxic factors against erythroid precursors. *Aust N Z J Med* 1978;8:75.
21. Carloss HW, Saab GA, Tavassoli M. Pure red cell aplasia and lymphoma. *JAMA* 1979;242:67.
22. Gilbert EF, Harley JB, Anido V, et al. Thymoma, plasma cell myeloma, red cell aplasia and malabsorption syndrome. *Am J Med* 1968;44:820.
23. Orchard J, Myint H, Hamblin TJ. A patient with myeloma who still has pure red cell aplasia despite the most intensive immune modulation. *Leuk Res* 1997;21:353.
24. Masauzi N, Tanaka J, Watanabe M, et al. Primary Waldenström's macroglobulinemia associated with pure red cell aplasia in which T s/c lymphocytes inhibiting erythroid precursors were detected. *Rinsho Ketsueki* 1993;34:355.
25. Kitahara M. Pure RBC aplasia associated with chronic granulocytic leukemia. *JAMA* 1978;240:376.
26. Dessypris EN, McKee LC, Metzantonakis C, et al. Red cell aplasia and chronic granulocytic leukemia. *Br J Haematol* 1981;48:217.
27. Lacombe C, Casadevall N, Muller O, Varet B. Erythroid progenitors in adult chronic pure red cell aplasia: relationship of in vitro erythroid colonies to therapeutic response. *Blood* 1984;64:71.
28. Bentley SA, Murray KH, Lewis SM, Roberts PD. Erythroid hypoplasia in myelofibrosis: a feature associated with blastic transformation. *Br J Haematol* 1977;36:41.
29. Barosi G, Baraldi A, Gazzola M, et al. Red cell aplasia in myelofibrosis with myeloid metaplasia: a distinct functional and clinical entity. *Cancer* 1983;52:1290.
30. Sarode R, Bambery SR, Marwaha N, et al. Pure red cell aplasia associated with essential thrombocythemia. *Indian J Cancer* 1990;27:138.
31. deAlarcon PA, Miller ML, Stuart MJ. Erythroid hypoplasia: an unusual presentation of childhood acute lymphoblastic leukemia. *Am J Dis Child* 1978;132:763.
32. Imamura N, Kuramoto A, Morimoto T, Ihara A. Pure red cell aplasia associated with acute lymphoblastic leukemia of pre-T cell origin. *Med J Aust* 1986;144:724.
33. Sallan SE, Buchanan GR. Selective erythroid aplasia during therapy for acute lymphoblastic leukemia. *Pediatrics* 1977;59:895.

34. Gajwani B, Zinner EN. Pure red cell aplasia associated with adenocarcinoma of stomach. *N Y State J Med* 1976;76:2177.
35. Slater LM, Schlutz MJ, Armentrout SA. Remission of pure red cell aplasia associated with non thymic malignancy. *Cancer* 1979;44:1879.
36. Clarkson BC, Prockop DJ. A regenerative anemia associated with benign thymoma. *N Engl J Med* 1958;259:253.
37. Lee CH, Clark AR, Thorpe ME, et al. Bile duct adenocarcinoma with Leser–Trelat sign and pure red blood cell aplasia. *Cancer* 1980;46:1657.
38. Entwistle CC, Fentem PH, Jacobs A. Red cell aplasia with carcinoma of the bronchus. *Br Med J* 1964;2:1504.
39. Brafield AJ, Verbov J. A case of thrombocythemia with red cell aplasia. *Postgrad Med J* 1966;42:525.
40. Tsai SY, Levin WC. Chronic erythrocytic hypoplasia in adults: review of literature and report of a case. *Am J Med* 1957;22:322.
41. Guthrie TH, Thornton RM. Pure red cell aplasia obscured by a diagnosis of carcinoma. *South Med J* 1983;76:532.
42. Iannuci A, Perini A, Pizzolo G. Acquired pure red cell aplasia associated with thyroid carcinoma: a case report. *Acta Haematol* 1983;69:62.
43. Maekawa K, Shibata J, Nakagawa S, et al. Pure red cell aplasia associated with renal cell carcinoma. *Nippon Naika Gakkai Zasshi* 1989;78:1002.
44. Mitchell ABS, Pinn G, Pegrum GD. Pure red cell aplasia and carcinoma. *Blood* 1971;37:594.
45. Marmont A, Peschle C, Sanguinetti M, Condorelli M. Pure red cell aplasia: response of three patients to cyclophosphamide and/or antilymphocyte globulin (ALG) and demonstration of two types of serum IgG inhibitors to erythropoiesis. *Blood* 1975;45:247.
46. Shimm DS, Logue GL, Rohlfing MB, Gaede JT. Primary amyloidosis, pure red cell aplasia and Kaposi's sarcoma in a single patient. *Cancer* 1979;44:1501.
47. Anderson MJ, Davis LR, Hodgson J, et al. Occurrence of infection with a parvovirus-like agent in children with sickle cell anemia during a two-year period. *J Clin Pathol* 1982;35:744.
48. Young NS, Harrison M, Mortimer PP, et al. Direct demonstration of the human parvovirus in erythroid progenitor cells infected in vitro. *J Clin Invest* 1984;74:2024.
49. Young NS, Mortimer PP. Viruses and bone marrow failure. *Blood* 1984;63: 729.
50. Young NS, Mortimer PP, Moore JG, Humphries RK. Characterization of a virus that causes transient aplastic crisis. *J Clin Invest* 1984;73:224.
51. Duncan JR, Potter CB, Cappelini MD, et al. Aplastic crisis due to parvovirus infection in pyruvate kinase deficiency. *Lancet* 1983;2:14.
52. Kelleher JF, Luban NL, Mortimer PP, Kamimura T. Human serum "Parvovirus": a specific cause of aplastic crisis in children with hereditary spherocytosis. *J Pediatr* 1983;102:720.
53. Pattison JR, Jones SE, Hodgson J, et al. Parvovirus infections and hypoplastic crisis in sickle cell anemia. *Lancet* 1981;1:664.
54. Serjeant GR, Mason K, Topley JM, et al. Outbreak of aplastic crises in sickle cell anemia associated with parvovirus-like agent. *Lancet* 1981;2:595.
55. Kurtzman G, Frickhofen N, Kimball J, et al. Pure red-cell aplasia of 10 years' duration due to

- persistent parvovirus B19 infection and its care with immunoglobulin therapy. *N Engl J Med* 1989;321:519.
56. Frickhofen N, Abkowitz JL, Safford M, et al. Persistent B19 parvovirus infection in patients infected with human immunodeficiency virus-1: a treatable cause of anemia in AIDS. *Ann Intern Med* 1990;113:926.
57. Rao KRP, Patel AR, Anderson MJ, et al. Infection with parvovirus-like virus and aplastic crisis in chronic hemolytic anemia. *Ann Intern Med* 1983;98:930.
58. Berner YN, Berrebi A, Green L, et al. Erythroblastopenia in acquired immunodeficiency syndrome (AIDS). *Acta Haematol* 1983;70:273.
59. Drevonoulas JG, Gogas HJ, Lazanas MC, et al. Zidovudine-responsive pure red cell aplasia as initial manifestation of HIV infection. *AIDS* 1993;7:290.
60. Levitt LJ, Reyes GR, Moonka DK, et al. Human T cell leukemia virus-1 associated T-suppressor cell inhibition of erythropoiesis in a patient with pure red cell aplasia and chronic T?-lymphoproliferative disease. *J Clin Invest* 1988;81:538.
61. Reference deleted.
62. Purtilo DT, Zerkowicz L, Harada S, et al. Delayed onset of infectious mononucleosis associated with acquired agammaglobulinemia and red cell aplasia. *Ann Intern Med* 1984;101:180.
63. Chernoff AI, Josephson AM. Acute erythroblastopenia in sickle cell anemia and infectious mononucleosis. *Am J Dis Child* 1951;82:310.
64. Socinski MA, Ershler WB, Tosato G, Blaese RM. Pure red blood cell aplasia associated with chronic Epstein-Barr virus infection: evidence for T-cell-mediated suppression of erythroid colony-forming units. *J Lab Clin Med* 1984;104:995.
65. Bruyn GA, Schelfhout LJ. Transient syndrome of inappropriate antidiuretic hormone secretion in a patient with infectious mononucleosis and pure red cell aplasia. *Neth J Med* 1986;29:167.
66. Sears DA, George JN, Gold MS. Transient red blood cell aplasia in association with viral hepatitis. *Arch Intern Med* 1974;135:1585.
67. Wilson HA, McLaren GD, Dworken HJ, Tebbi K. Transient pure red cell aplasia: cell-mediated suppression of erythropoiesis associated with hepatitis. *Ann Intern Med* 1980;92:196.
68. Ide T, Sata M, Nouno R, et al. Clinical evaluation of four cases of acute viral hepatitis complicated by pure red cell aplasia. *Am J Gastroenterol* 1994;89:257.
69. Krantz SB, Zaentz SD. Pure red cell aplasia. In: Gordon AS, Silber R, LoBue J, eds. *The year in hematology*. New York: Plenum Publishing, 1977:153.
70. Krantz SB, Dessypris EN. Pure red cell aplasia. In: Golde DW, Takaku F, eds. *Hematopoietic stem cells*. New York: Marcel Dekker Inc, 1985:229.
71. Sao H, Yoshikawa H, Akao Y, et al. An adult case of acute erythroblastopenia. *Rinsho Ketsueki* 1982;23:1453.
72. Solano C, Gomez-Reino F, Fernandez-Ranada JM. Pure red cell aplasia in kala-azar. *Acta Haematol* 1984;72:205.
73. Meyer RJ, Hoffman R, Zanjani ED. Autoimmune hemolytic anemia and periodic pure red cell aplasia in systemic lupus erythematosus. *Am J Med* 1978;65:342.
74. Cavalcant J, Shadduck RK, Winkelstein A, et al. Red cell hypoplasia and increased bone marrow reticulin in systemic lupus erythematosus: reversal with corticosteroid therapy. *Am J Hematol* 1978;5:253.
75. Dessypris EN, Baer MR, Sergent JS, Krantz SB. Rheumatoid arthritis and pure red cell aplasia. *Ann Intern Med* 1984;100:202.

76. Rodrigues JF, Harth M, Barr RM. Pure red cell aplasia in rheumatoid arthritis. *J Rheumatol* 1988;15:1159.
77. Julkunen H, Jantti J, Pettersson T. Pure red cell aplasia in mixed connective tissue disease. *J Rheumatol* 1989;16:1385.
78. Giordano N, Senesi M, Battisti E, et al. Sjögren's syndrome and pure red cell aplasia. *Clin Exp Rheumatol* 1996;14:344.
79. Ramakrishna R, Chaudhuri K, Sturgess A, et al. Hematological manifestations of primary Sjögren's syndrome: a clinicopathological study. *QJM* 1992;83:547.
80. Aggio MC, Zunini C. Reversible pure red cell aplasia in pregnancy. *N Engl J Med* 1977;297:221.
81. Miyoshi I, Hikita T, Koi B, Kimura I. Reversible pure red cell aplasia in pregnancy. *N Engl J Med* 1978;299:777.
82. Lehman G, Alcock J. Reversible pure red cell hypoplasia in pregnancy. *JAMA* 1982;247:1170.
83. Oie BK, Hertel J, Seip M, Friis-Hansen B. Hydrops foetalis in three infants of a mother with acquired chronic pure red cell aplasia: transitory red cell aplasia in one of the infants. *Scand J Haematol* 1984;33:466.
84. Pasternack A, Wahlberg P. Bone marrow in acute renal failure. *Acta Med Scand* 1967;181:505.
85. Foy H, Kondi A, MacDougall L. Pure red cell aplasia in marasmus and kwashiorkor treated with riboflavin. *Br Med J* 1961;1:937.
86. Chanarin I. Investigation and management of megaloblastic anemia. *Clin Haematol* 1976;5:747.
87. Hotchkiss DJ Jr. Pure red cell aplasia following pernicious anemia. In: *Proceedings of the Eighth International Congress of Haematology*. Munich: JF Lehmann, 1970:133.
88. Dan K, Ito T, Nomura T. Pure red cell aplasia following pernicious anemia. *Am J Hematol* 1990;33:148.
89. Gmur JP, Burger J, Schaffner A, et al. Pure red cell aplasia of long duration complicating major ABO-incompatible bone marrow transplantation. *Blood* 1990;75:290.
90. Bar BM, Van Dijk BA, Schlanttenberg A, et al. Erythrocyte repopulation after major ABO incompatible transplantation with lymphocyte depleted bone marrow. *Bone Marrow Transplant* 1995;16:793.
91. Mannoji M, Shimoda M, Koresawa S, et al. A case of angioimmunoblastic lymphadenopathy with dysproteinemia associated with autoimmune hemolytic anemia and pure red cell aplasia with special references to its pathogenesis. *Rinsho Ketsueki* 1981;22:1751.
92. al-Hilali MA, Joyner MV. Pure red cell aplasia secondary to angioimmunoblastic lymphadenopathy. *J R Soc Med* 1983;76:894.
93. Mandell M, Etzioni A, Teodor R, et al. Pure red cell hypoplasia associated with polyglandular autoimmune syndrome type I. *Isr J Med* 1989;25:138.
94. Myers TJ, Bower FB, Hild DH. Pure red cell aplasia and the syndrome of multiple endocrine gland insufficiency. *Am J Med Sci* 1980;280:29.
95. Gill PJ, Amare M, Larsen WE. Pure red cell aplasia: three cases responding to immunosuppression. *Am J Med Sci* 1977;273:213.
96. Francis DA. Pure red cell aplasia: association with systemic lupus erythematosus and primary autoimmune hypothyroidism. *Br Med J* 1982;284:85.
97. Fox RM, Firkin RC. Sequential pure red cell and megakaryocyte aplasia associated with chronic liver



disease and ulcerative colitis. *Am J Hematol* 1978;4:79.

98. Trinchet JC, Lacombe C, Islam S, et al. Association of autoimmune chronic active hepatitis and acquired erythroblastopenia cured by cyclophosphamide. *Gastroenterol Clin Biol* 1986;10:841.

99. Prabhakar SS, Muhlfelder T. Antibodies to recombinant human erythropoietin causing pure red cell aplasia. *Clin Nephrol* 1997;47:331.

100. Casadevall N, Nataf J, Viron B, et al. Pure red cell aplasia and anti-erythropoietin antibodies in patients treated with recombinant erythropoietin. *N Engl J Med* 2002;346:469.

101. Dessypris EN. The biology of pure red cell aplasia. *Semin Hematol* 1991;28:275.

102. Wranne L. Transient erythroblastopenia in infancy and childhood. *Scand J Haematol* 1970;7:76.

103. Dessypris EN, Fogo A, Russell M, et al. Studies on pure red cell aplasia. X. Association with acute leukemia and significance of bone marrow karyotype abnormalities. *Blood* 1980;56:421.

104. DiGiacomo J, Furst SW, Nixon DD. Primary acquired red cell aplasia in the adult. *Mt Sinai J Med* 1966;33:382.

105. Mangan KF, D'Alessandro L. Hypoplastic anemia in B-cell chronic lymphocytic leukemia: evolution of T-cell mediated suppression of erythropoiesis in early stage and late stage disease. *Blood* 1985;66:533.

106. Dessypris EN, Redline S, Harris JW, Krantz SB. Diphenylhydantoin-induced pure red cell aplasia. *Blood* 1985;65:789.

107. Geary CG. Drug-related red cell aplasia. *Br Med J* 1978;1:51.

108. Reid G, Patterson AC. Pure red-cell aplasia after gold treatment. *Br Med J* 1977;2:1457.

109. Jurgenson JC, Abraham JP, Hardy WW. Erythroid aplasia after halothane hepatitis: report of a case. *Am J Dig Dis* 1970;15:577.

110. Hoffman R, McPhedram P, Benz EJ, Duffy TP. Isoniazid-induced pure red cell aplasia. *Am J Med Sci* 1983;286:2.

111. Lewis CR, Manoharan A. Pure red cell hypoplasia secondary to isoniazid. *Postgrad Med J* 1987;63:309.

112. Agudelo CA, Wise CM, Lyles MF. Pure red cell aplasia in procainamide induced systemic lupus erythematosus. Report and review of the literature. *J Rheumatol* 1988;15:1431.

113. MacDougall-Lorna G. Pure red cell aplasia associated with sodium valproate therapy. *JAMA* 1982;247:53.

114. Dunn AM, Kerr GD. Pure red cell aplasia associated with sulphasalazine. *Lancet* 1981;2:1288.

115. Antilla PM, Välimäki M, Pentikäinen PJ. Pure-red-cell aplasia associated with sulphasalazine but not 5-aminosalicylic acid. *Lancet* 1985;2:1006.

116. Strauss AM. Erythrocyte aplasia following sulfathiazole. *Am J Clin Pathol* 1943;13:249.

117. Sanz MA, Martinez JA, Gomis F, Garcia-Borras JJ. Sulindac-induced bone marrow toxicity. *Lancet* 1980;2:802.

118. Arbeiter K, Greenbaum L, Balzar E, et al. Reproducible erythroid aplasia caused by mycophenolate mofetil. *Pediatr Nephrol* 2000;14:195.

119. Hirri HM, Green PJ. Pure red cell aplasia in a patient with chronic granulocytic leukemia treated with interferon-alpha. *Clin Lab Haematol* 2000;22:53.

120. Maeda H, Arai Y, Aoki Y, et al. Leuprolide causes pure red cell aplasia. *J Urol* 1998;160:501.
121. Misra S, Moore TB, Aments ME, et al. Red cell aplasia in children on tacrolimus after liver transplantation. *Transplantation* 1998;65:575.
122. Robak T, Kasznicki M, Blonski JZ, et al. Pure red cell aplasia with chronic lymphocytic leukemia treated with cladribine. *Br J Haematol* 2001;112:1083.
123. Majluf-Cruz A, Luna-Castanos G, Trevino-Perez S, et al. Lamivudine-induced pure red cell aplasia. *Am J Hematol* 2000;65:189.
124. Monson T, Schichman SA, Zent CS. Linezolid-induced pure red blood cell aplasia. *Clin Infect Dis* 2002;35:E29.
125. Foy H, Kondi A. A case of true red cell aplastic anemia successfully treated with riboflavin. *J Pathol* 1953;65:559.
126. Jepson JH, Vas M. Decreased in vitro and in vivo erythropoiesis induced by plasma of ten patients with thymoma, lymphosarcoma or idiopathic erythroblastopenia. *Cancer Res* 1974;34:1325.
127. Jepson JH, Lowenstein L. Inhibition of erythropoiesis by a factor present in the plasma of patients with erythroblastopenia. *Blood* 1966;27:425.
128. al-Mondhiry H, Zanjani ED, Spivack M, et al. Pure red cell aplasia and thymoma: loss of serum inhibitor of erythropoiesis following thymectomy. *Blood* 1971;38:576.
129. Zalusky R, Zanjani ED, Gidari AS, Ross J. Site of action of a serum inhibitor of erythropoiesis. *J Lab Clin Med* 1973;81:867.
130. Krantz SB, Kao V. Studies on red cell aplasia. I. Demonstration of a plasma inhibitor to heme synthesis and an antibody to erythroblast nuclei. *Proc Natl Acad Sci U S A* 1967;58:493.
131. Krantz SB, Kao V. Studies on red cell aplasia. II. Report of a second patient with an antibody to erythroblast nuclei and a remission after immunosuppressive therapy. *Blood* 1969;34:1.
132. Krantz SB, Dessypris EN. The role of antibody in pure red cell aplasia. In: Levine AS, ed. *Proceedings of Conference on Aplastic Anemia: A Stem Cell Disease*. NIH publication 81-1008, 1981:157.
133. Peschle C, Marmont A, Perugini S, et al. Physiopathology and therapy of adult pure red cell aplasia: a cooperative study. In: Hibino S, ed. *Aplastic anemia*. Baltimore: University Park Press, 1978:285.
134. Katz JL, Hoffman R, Ritchey AK, Dainiak N. The proliferative capacity of pure red cell aplasia bone marrow cells. *Yale J Biol Med* 1981;54:89.
135. Charles RJ, Sabo KM, Kidd PG, Abkowitz JL. The pathophysiology of pure red cell aplasia: implications for therapy. *Blood* 1996;87:4831.
136. Dessypris EN, Krantz SB, Roloff JS, Lukens JN. Mode of action of the IgG inhibitor of erythropoiesis in transient erythroblastopenia of childhood. *Blood* 1982;59:114.
137. Messner HA, Fauser AA, Curtis JE, Dotten D. Control of antibody-mediated pure red cell aplasia by plasmapheresis. *N Engl J Med* 1981;304:1334.
138. Lowenberg B, Ghio R. An assay for serum cytotoxicity against erythroid precursor cells in pure red cell aplasia. *Biomedicine* 1977;27:285.
139. Krantz SB. Pure red cell aplasia. *N Engl J Med* 1974;291:345.
140. Krantz SB, Moore WH, Zaentz SD. Studies on red cell aplasia. V. Presence of erythroblast cytotoxicity in  $\gamma$ -globulin fraction of plasma. *J Clin Invest* 1973;52:324.
141. Zaentz SD, Luna JA, Baker AS, Krantz SB. Detection of cytotoxic antibody to erythroblasts. *J Lab*

Clin Med 1977;89:851.

142. Jepson JH, Lowenstein L. Panhypoplasia of the bone marrow. I. Demonstration of a plasma factor with anti-erythropoietin-like activity. *Can Med Assoc J* 1968;99:99.
143. Peschle C, Marmont AM, Marone G, et al. Pure red cell aplasia: studies on an IgG serum inhibitor neutralizing erythropoietin. *Br J Haematol* 1975;30:411.
144. Casadevall N, Dupuy E, Molho-Sabatier P, et al. Autoantibodies against erythropoietin in a patient with pure red cell aplasia. *N Engl J Med* 1996;334:630.
145. Mangan KF, Volkin R, Winkelstein A. Autoreactive erythroid progenitor T suppressor cells in the pure red cell aplasia associated with thymoma and panhypogammaglobulinemia. *Am J Hematol* 1986;23:167.
146. Masuda M, Arai Y, Okamura T, Mizoguchi H. Pure red cell aplasia with thymoma: evidence of T-cell clonal disorder. *Am J Hematol* 1997;54:324.
147. Soler J, Estivill X, Ayats R, et al. Chronic T cell lymphocytosis associated with pure red cell aplasia, thymoma and hypogammaglobulinemia. *Br J Haematol* 1985;61:582.
148. Mangan KF, Chikkappa G, Scharfman WB, Desforges JF. Evidence for reduced erythroid burst promoting function of T lymphocytes in the pure red cell aplasia of chronic lymphocytic leukemia. *Exp Hematol* 1981;9:489.
149. Abkowitz JL, Kadin ME, Powell JS, Adamson JW. Pure red cell aplasia: lymphocyte inhibition of erythropoiesis. *Br J Haematol* 1986;63:59.
150. Handgrentiger R, Geiselhart A, Moris A, et al. Pure red cell aplasia with clonal expansion of granular lymphocytes expressing killer-cell inhibitory receptors. *N Engl J Med* 1999;340:278.
151. Casado LF, Granados E, Algara P, et al. High expression of the ILT2 (LIR-1) inhibitory receptor for major histocompatibility complex class I molecules on clonal expansions of T-large granular lymphocytes in asymptomatic patients. *Haematologica* 2001;86:457.
152. Kurtzman GJ, Ozawa K, Cohen B, et al. Chronic bone marrow failure due to persistent B19 parvovirus infection. *N Engl J Med* 1987;317:287.
153. Kurtzman GJ, Meyers P, Cohen B, et al. Persistent B19 parvovirus infection as a cause of severe chronic anaemia in children with acute lymphocytic leukaemia. *Lancet* 1988;2:1159.
154. Weiland HT, Salimans MM, Fibbe WE, et al. Prolonged parvovirus B19 infection with severe anaemia in a bone marrow transplant recipient [Letter]. *Br J Haematol* 1989;71:300.
155. Griffin TC, Squires JE, Timmons CF, Buchanen GR. Chronic human parvovirus B19-induced erythroid hypoplasia as the indirect manifestation of human immunodeficiency virus infection. *J Pediatr* 1991;118:899.
156. Frickhofen N, Chen ZJ, Youngs NS, et al. Parvovirus B19 as a cause of acquired chronic pure red cell aplasia. *Br J Haematol* 1994;87:818.
157. Rogers BB, Rogers ZR, Timmons CF. Polymerase chain reaction amplification of archival material for parvovirus B19 in children with transient erythroblastopenia of childhood. *Pediatr Pathol Lab Med* 1996;16:471.
158. Brown KE, Anderson SM, Young NS. Erythrocyte P antigen: cellular receptor for B19 parvovirus. *Science* 1993;262:114.
159. Eisenmann G, Dameshek W. Splenectomy for pure red cell hypoplastic aregenerative anemia associated with autoimmune hemolytic disease: report of a case. *N Engl J Med* 1954;251:1044.
160. Mangan KF, Besa EC, Shadduck RK, et al. Demonstration of two distinct antibodies in autoimmune hemolytic anemia with reticulocytopenia and red cell aplasia. *Exp Hematol* 1984;12:788.
161. Taniguchi S, Shibuya T, Morioka E, et al. Demonstration of three distinct immunological disorders on

erythropoiesis in a patient with pure red cell aplasia and autoimmune haemolytic anaemia associated with thymoma. *Br J Haematol* 1988;68:473.

162. Mariette X, Mitjavila MT, Moulinie JP, et al. Rifampicin-induced pure red cell aplasia. *Am J Med* 1989;87:459.

163. Giannone L, Kugler JW, Krantz SB. Pure red cell aplasia associated with administration of sustained release procainamide. *Arch Int Med* 1987;147:1179.

164. Beard MJE, Krantz SB, Johnson SAN, et al. Pure red cell aplasia. *QJM* 1978; 187:339.

165. Keefer MJ, Solanki DL. Dyserythropoiesis and erythroblast-phagocytosis preceding pure red cell aplasia. *Am J Hematol* 1988;27:132.

166. Wibulyachainunt S, Price P, Brill AB, Krantz SB. Studies on red cell aplasia. IX. Ferrokinetics during remission of the disease. *Am J Hematol* 1978;4:233.

167. Schmid JR, Kiely JM, Pease GL, Hargraves MM. Acquired pure red cell agenesis: report of 16 cases and review of the literature. *Acta Haematol* 1963;30:255.

168. Rogers BH, Manligod JR, Blazek WV. Thymoma associated with pancytopenia and hypo-gammaglobulinemia: report of a case and review of the literature. *Am J Med* 1968;44:154.

169. Krantz SB. Studies on red cell aplasia. III. Treatment with horse antihuman thymocyte gamma globulin. *Blood* 1972;39:347.

170. Barnes RD. Refractory anemia with thymoma. *Lancet* 1966;2:1464.

171. Holborow EJ, Asherson GL, Johnson GD, et al. Anti-nuclear factor and other antibodies in blood and liver disease. *BMJ* 1963;1:656.

172. Frøland SS, Wisloff F, Stavem P. Abnormal lymphocyte populations in pure red cell aplasia. *Scand J Haematol* 1976;17:241.

173. Sivakumaran M, Bhavnani M, Stewart A, et al. Is pure red cell aplasia a clonal disorder? *Clin Lab Haematol* 1993;15:1.

174. Handa SI, Schofield KP, Sivakumaran M, et al. Pure red cell aplasia associated with malignant thymoma, myasthenia gravis, polyclonal large granular lymphocytosis and clonal thymic T cell expansion. *J Clin Pathol* 1994;47:676.

175. Maung ZT, Norden J, Middleton PG, et al. Pure red cell aplasia: further evidence of T cell clonal disorder. *Br J Haematol* 1994;87:189.

176. Nezu M, Kawano E, Ishii H, et al. Pure red cell aplasia requiring cytotoxic chemotherapy: presence of clonal T-lymphocytes without characteristics of chronic lymphocytic leukemia. *Am J Hematol* 1996;53:145.

177. Masaoka A, Hashimoto T, Shibata K, et al. Thymomas associated with pure red cell aplasia: histology and follow up studies. *Cancer* 1989;64:1872.

178. Weide LG, Ulbright TM, Loehrer PG, et al. Thymic carcinoma, a distinct clinical entity responsive to chemotherapy. *Cancer* 1993;71:1219.

179. Clark DA, Dessypris EN, Krantz SB. Studies on pure red cell aplasia. XI. Results of immunosuppressive treatment of 37 patients. *Blood* 1984;63:227.

180. Zaentz SD, Krantz SB, Brown EB. Studies on pure red cell aplasia. VIII. Maintenance therapy with immunosuppressive drugs. *Br J Haematol* 1976;32:47.

181. Finkel HE, Kimber RJ, Dameshek W. Corticosteroid responsive acquired pure red cell aplasia in adults. *Am J Med* 1967;43:771.

182. Greene MH, Boice JD Jr, Greer BE. Acute nonlymphocytic leukemia after therapy with alkylating

- agents for ovarian cancer. A study of five randomized clinical trials. *N Engl J Med* 1982;307:1416.
183. Berk PD, Goldberg JD, Donovan PD, et al. Therapeutic recommendations in polycythemia vera based on polycythemia vera study group protocols. *Semin Hematol* 1986;23:132.
184. Fairley FK, Barrie JU, Johnson W. Sterility and testicular atrophy related to cyclophosphamide therapy. *Lancet* 1972;1:568.
185. Alexandre J, Levy V, Hunault M, et al. Bladder neoplasms and cyclophosphamide. A propos of 3 cases and review of the literature. *Bull Cancer* 1996;83:945.
186. Bottiger LE, Rausing A. Pure red cell anemia: immunosuppressive treatment. *Ann Intern Med* 1972;76:593.
187. Vilan J, Rhyner K, Ganzoni A. Immunosuppressive treatment of pure red cell aplasia. *Lancet* 1971;2:51.
188. Tötterman TH, Nisell J, Killander A, et al. Successful treatment of pure red cell aplasia with cyclosporin. *Lancet* 1984;2:693.
189. Debusscher L, Paridaeus R, Stryckmans P. Cyclosporine for pure red cell aplasia. *Blood* 1985;65:249.
190. Williams DL, Mageed ASA, Findley H, Ragab AH. Cyclosporine in the treatment of red cell aplasia. *Am J Pediatr Hematol Oncol* 1987;9:314.
191. Finelli C, Bandini G, Ricci P. Cyclosporin A in idiopathic and CLL-associated pure red cell aplasia. *Haematologica* 1987;72:537.
192. Chikkappa G, Pasquale D, Phillips PG, et al. Cyclosporin-A for the treatment of pure red cell aplasia in a patient with chronic lymphocytic leukemia. *Am J Hematol* 1987;26:179.
193. Tötterman TH, Bengtsson M. Treatment of pure red cell aplasia with cyclosporin: suppression of activated T suppressor/cytotoxic and NK-like cells in marrow and blood correlates with haematological response. *Eur J Haematol* 1988;41:204.
194. Means RT Jr, Dessypris EN, Krantz SB. Treatment of refractory pure red cell aplasia with cyclosporine A: disappearance of IgG inhibitor associated with clinical response. *Br J Haematol* 1991;78:114.
195. Abkowitz JL, Powell JS, Nakamura JM, et al. Pure red cell aplasia: response to therapy with anti-thymocyte globulin. *Am J Hematol* 1986;23:363.
196. Hocking W, Champlin R, Mitsuyasu R. Transient response of pure red cell aplasia to anti-thymocyte globulin in a patient with T-cell chronic lymphocyte leukemia. *Am J Hematol* 1987;24:284.
197. Etzioni A, Atias D, Pollack S, et al. Complete recovery of pure red cell aplasia by intramuscular gammaglobulin therapy in a child with hypoparathyroidism. *Am J Hematol* 1986;22:409.
198. Katakhar SB. Pure red cell aplasia: response to intravenous immunoglobulin, a blocking antibody. *Arch Intern Med* 1986;146:2288.
199. McGuire WA, Yang HH, Bruno E, et al. Treatment of antibody-mediated pure red cell aplasia with high-dose intravenous gammaglobulin therapy. *N Engl J Med* 1987;317:1004.
200. Zecca M, De Stefano P, Nobili P, et al. Anti-CD20 monoclonal antibody for the treatment of severe, immune-mediated, pure red cell aplasia and hemolytic anemia. *Blood* 2001;97:3995.
201. Marsh DF, Bevan DH, Killick SB, et al. The effect of treatment with Campath-1H in patients with autoimmune cytopenias. *Br J Haematol* 2001;114:891.
202. Battle M, Rivera JM, Oriol A, et al. Successful response to rituximab in a patient with pure red cell aplasia complicating chronic lymphocytic leukemia. *Br J Haematol* 2002;118:1192.
203. Auner HW, Wolfer A, Beham-Schmid C, et al. Restoration of erythropoiesis by rituximab in an adult

patient with primary acquired pure red cell aplasia refractory to conventional treatment. *Br J Haematol* 2002;116:727.

204. Ghazal H. Successful treatment of pure red cell aplasia with rituximab in patients with chronic lymphocytic leukemia. *Br J Haematol* 2002;99:1092.

205. Reference deleted.

206. Marinone G, Mombelloni P, Marini G, et al. Bone marrow erythroblastic recovery after plasmapheresis in acquired pure red cell anemia: case report. *Haematologica* 1981;66:796.

207. Young NS, Klein HG, Griffith P, Nienhuis AW. A trial of immunotherapy in aplastic anemia and pure red cell aplasia. *J Clin Apheresis* 1983;1:95.

208. Khelif A, Van HV, Tremis JP, et al. Remission of acquired pure red cell aplasia following plasma exchanges. *Scand J Haematol* 1985;34:13.

209. Freund LG, Hippe E, Strandgaard S, et al. Complete remission in pure red cell aplasia after plasmapheresis. *Scand J Haematol* 1985;35:315.

210. Krantz SB. Studies on red cell aplasia. IV. Treatment with immunosuppressive drugs. In: Gordon AS, Condorelli M, Peschle C, eds. *Regulation of erythropoiesis*. Rome: Il Ponte, 1972:312.

211. Zaentz SD, Krantz SB, Sears DA. Studies on pure red cell aplasia. VII. Presence of proerythroblasts and response to splenectomy: a case report. *Blood* 1975;46:261.

212. Safdar SH, Krantz SB, Brown EB. Successful immunosuppressive treatment of erythroid aplasia appearing after thymectomy. *Br J Haematol* 1970;19:435.

213. Propper RD, Cooper B, Rufo RR, et al. Continuous subcutaneous administration of deferoxamine in patients with iron overload. *N Engl J Med* 1977;297:418.

214. MacMahon JN, Egan EL. Aplastic anemia in a patient with pure red cell aplasia. *Ir J Med Sci* 1980;149:212.

214a. Cherrick I, Karayalcin G, Lanzkowsky P. Transient erythroblastopenia of childhood. Prospective study of fifty patients. *Am J Pediatr Hematol Oncol* 1994;16:320.

215. Diamond LD, Wang WC, Alter BP. Congenital hypoplastic anemia. *Adv Pediatr* 1976;22:349.

216. Vlachos A, Klein GW, Lipton JM. The Diamond-Blackfan Anemia Registry: tool for investigating the epidemiology and biology of Diamond-Blackfan anemia. *J Pediatr Hematol Oncol* 2001;23:377.

217. Ortega JA, Shore NA, Dukes PP, Hammond D. Congenital hypoplastic anemia: inhibition of erythropoiesis by sera from patients with congenital hypoplastic anemia. *Blood* 1975;45:83.

218. Hoffman R, Zanjani ED, Vila J, et al. Diamond-Blackfan Syndrome: lymphocyte mediated suppression of erythropoiesis. *Science* 1976;193:899.

219. Sawada K, Koyonagawa Y, Sakamura S, et al. Diamond-Blackfan Syndrome: a possible role of cellular factors for erythropoietic suppression. *Scand J Haematol* 1985;35:158.

220. Ershler WB, Ross J, Finlay JL, Shahidi NT. Bone marrow microenvironmental defect in congenital hypoplastic anemia. *N Engl J Med* 1980;302:1321.

221. Nathan DG, Clarke BJ, Hillman DG, et al. Erythroid precursors in congenital hypoplastic (Diamond-Blackfan) anemia. *J Clin Invest* 1978;61:489.

222. Finlay JL, Shahidi NT, Horowitz S, et al. Lymphocyte dysfunction in congenital hypoplastic anemia. *J Clin Invest* 1982;70:619.

223. Freedman MH, Amato D, Saunders EF. Erythroid colony growth in congenital hypoplastic anemia. *J*

Clin Invest 1976;57:673.

224. Lipton JM, Kudisch M, Gross R, Nathan DG. Defective erythroid progenitor differentiation system in congenital hypoplastic (Diamond-Blackfan) anemia. *Blood* 1986;67:962.

225. Tsai P, Arkin S, Lipton JM. An intrinsic progenitor defect in Diamond-Blackfan anemia. *Br J Haematol* 1989;73:112.

226. Perdahl EB, Naprstek BL, Wallace WC, Lipton JM. Erythroid failure in Diamond-Blackfan anemia is characterized by apoptosis. *Blood* 1994;83:645.

227. Ball S, Yaw O-A, Orfali K. Steroids directly enhance and accelerate erythroid maturation in Diamond-Blackfan anemia: results of 2-phase liquid erythroid cultures. *Blood* 2001;98:897a(abst).

228. Lipton JM, Nathan DG. Cell-cell interactions in the regulation of erythropoiesis. *Br J Haematol* 1983;53:361.

229. Geller G, Krivit N, Zalusky R. Lack of erythropoietic inhibitory effect from patients with congenital pure red cell aplasia. *J Pediatr* 1975;86:198.

230. Freedman MH, Saunders EF. Diamond-Blackfan Syndrome: evidence against cell mediated erythropoietic suppression. *Blood* 1978;51:1125.

231. Nathan DG, Hillman DG, Chess L, et al. Normal erythropoietic helper T-cells in congenital hypoplastic anemia. *N Engl J Med* 1978;298:1049.

232. Chan HSL, Saunders EF, Freedman MH. Diamond-Blackfan Syndrome I. Erythropoiesis in prednisone responsive and resistant disease. *Pediatr Res* 1978;16:474.

233. Chan HSL, Saunders EF, Freedman MH. Diamond-Blackfan Syndrome II. In vitro corticosteroid effect on erythropoiesis. *Pediatr Res* 1982;16:477.

234. McGuckin CP, Ball SE, Gordon-Smith EC. Diamond-Blackfan anaemia: three patterns of in vitro response to haemopoietic growth factors. *Br J Haematol* 1995;89:457.

235. Bagnara GP, Zauli G, Vitale L, et al. In vitro growth and regulation of bone marrow enriched CD34+ hematopoietic progenitors in Diamond-Blackfan anemia. *Blood* 1991;78:2203.

236. Dianzani I, Garelli E, Dompe C, et al. Mutations in the erythropoietin receptor are not a common cause of Diamond-Blackfan anemia. *Blood* 1996;87:2568.

237. Giri N, Kang E, Tisdale JF, et al. Clinical and laboratory evidence for a trilineage haematopoietic defect in patients with refractory Diamond-Blackfan anaemia. *Br J Haematol* 2000;108:167.

238. van Diemen PC, Maasdam D, Darroudi F, Natarajan AT. X-ray sensitivity of lymphocytes of aplastic and Diamond-Blackfan anemia patients as detected by conventional cytogenetic and chromosome painting techniques. *Mutat Res* 1997;373:225.

239. Abkowitz JL, Sabo KM, Nakamoto B, et al. Diamond-Blackfan anemia: in vitro response on erythroid progenitors to the ligand for c-kit. *Blood* 1991;78:2198.

240. Sieff CA, Yokoyama CT, Zsebo KM, et al. The production of steel factor mRNA in Diamond Blackfan anaemia long-term cultures and interactions of steel factor with erythropoietin and interleukin-3. *Br J Haematol* 1992;82:640.

241. Spritz RA, Freedman MH. Lack of mutations of the MFG and KIT genes in Diamond-Blackfan anemia. *Blood* 1993;81:3165.

242. Scopes J, Daly S, Ball SE, et al. The effect of human flt-3 ligand on committed progenitor cell production from normal, aplastic anaemia and Diamond-Blackfan anaemia bone marrow. *Br J Haematol* 1995;91:544.

243. McGuckin CP, Uhr MR, Liu WM, Gordon-Smith EC. The use of recombinant SCF protein for rapid



determination of c-kit expression in normal and abnormal erythropoiesis. *Eur J Haematol* 1996;57:72.

244. Gustavsson P, Willig TN, van Haeringen A, et al. Diamond-Blackfan anaemia: genetic homogeneity for a gene on chromosome 19q13 restricted to 1.8 Mb. *Nat Genet* 1997;16:368.

245. Draptchinskaia N, Gustavsson P, Anderson B, et al. The gene encoding ribosomal protein S19 gene is mutated in Diamond-Blackfan anemia. *Nat Genet* 1999;21:169.

246. Alter BP. Childhood red cell aplasia. *Am J Pediatr Hematol Oncol* 1980;2:121.

247. Scimeca PG, Weinblatt ME, Slepowitz G, et al. Diamond-Blackfan syndrome: an unusual cause of hydrops fetalis. *Am J Pediatr Hematol Oncol* 1988;10:241.

248. Balban EP, Buchanan GR, Graham M, Frenkel EP. Diamond-Blackfan syndrome in adult patients. *Am J Med* 1985;78:533.

249. Josephs HW. Anemia of infancy and early childhood. *Medicine* 1936;15:307.

250. Alter BP. Modern review of congenital hypoplastic anemia. *J Pediatr Hematol Oncol* 2001;23:383.

251. Young NS, Alter BP. *Aplastic anemia acquired and inherited*. Philadelphia: WB Saunders, 1994.

252. Lipton JM, Federman N, Khabbaze Y, et al. Osteogenic sarcoma associated with Diamond-Blackfan anemia: a report from the Diamond Blackfan Anemia Registry. *J Pediatr Hematol Oncol* 2001;23:377.

253. Vlachos A, Boonyasai R, Abramson J, et al. Data from the Diamond Blackfan Anemia Registry suggest a reevaluation of current treatment practices. *Pediatr Res* 1998;43:804(abst).

254. Vlachos A, Federman N, Reyes-Haley C, et al. Hematopoietic stem cell transplantation for Diamond-Blackfan anemia: a report from the Diamond Blackfan Anemia Registry. *Bone Marrow Transplant* 2001;27:381.

255. Gazda H, Lipton JM, Willig TN, et al. Evidence for linkage of familial Diamond-Blackfan anemia to chromosome 8p23.3-p22 and for non-19q non 8p disease. *Blood* 2001;97:2145.

256. Alter BP. The bone marrow failure syndromes. In: Nathan DG, Oski FA, eds. *Hematology of infancy and childhood*, 3rd ed. Philadelphia: WB Saunders, 1987:159.

257. Aase JM, Smith DW. Congenital anemia and triphalangeal thumbs: a new syndrome. *J Pediatr* 1969;74:471.

258. Alter BP. Thumbs and anemia. *Pediatrics* 1978;62:613.

259. Hedberg VA, Lipton JM. Thrombocytopenia with absent radii: a review of 100 cases. *Am J Pediatr Hematol Oncol* 1988;10:51.

260. Buchanan GR, Alter BP, Holtkamp CA, Walsh EG. Platelet number and function in Diamond-Blackfan anemia. *Pediatrics* 1981;68:238.

261. Schroeder WA, Huisman THJ, Brown AD, et al. Postnatal changes in the chemical heterogeneity of human fetal hemoglobin. *Pediatr Res* 1971;9:493.

262. Glader BE, Backer K. Comparative activity of erythrocyte adenosine deaminase activity in congenital hypoplastic anemia. *N Engl J Med* 1983;309:1486.

263. Glader BE, Backer K. Comparative activity of erythrocyte adenosine deaminase and orotidine decarboxylase in Diamond-Blackfan anemia. *Am J Hematol* 1986;23:135.

264. Glader BE, Backer K. Elevated red cell adenosine deaminase activity: a marker of disordered erythropoiesis in Diamond-Blackfan anemia and other haematologic diseases. *Br J Haematol* 1988;68:165.

265. Zielke HR, Ozand PT, Luddy RE, et al. Elevation of pyrimidine enzyme activities in the RBC of

- patients with congenital hypoplastic anemia and their parents. *Br J Haematol* 1979;42:381.
266. Harrison DE, Malathi VG, Silber R. Elevated erythrocyte erythrocyte nucleoside deaminase levels in genetically anemic W/W<sup>v</sup> and Sl/Sl<sup>d</sup> mice. *Blood Cells* 1975;1:605.
267. Brookfield EG, Singh P. Congenital hypoplastic anemia associated with hypogammaglobulinemia. *J Pediatr* 1974;85:529.
268. Bernard J, Seligmann M, Chassigneux J, Dresch. Anemie de Blackfan–Diamond. *Nouv Rev Fr Hematol* 1962;2:721.
269. Gordon RR, Varadi S. Congenital hypoplastic anaemia (pure red-cell anaemia) with periodic erythroblastopenia. *Lancet* 1962;I:296.
270. Sensenbrenner JA. Congenital hypoplastic anemia of Blackfan and Diamond in sibs. In: Bergsma D, ed. *The clinical delineation of birth defects, part XIV, Blood*. Baltimore: Williams & Wilkins, 1972:166.
271. Starling KA, Fernbach DJ. Hypoplastic anemia. *J Pediatr* 1973;82:735.
272. Waterkote GW, McElfresh AE. Congenital pure red-cell hypoplasia in identical twins. *Pediatrics* 1974;54:646.
273. Forare SA. Pure red-cell anemia in step-siblings. *Acta Paediatr* 1963;52:159.
274. Altman AC, Gross S. Severe congenital hypoplastic anemia: transmission from a healthy female to opposite sex step-siblings. *Am J Pediatr Hematol Oncol* 1983;5:99.
275. Mott MG, Apley J, Raper AB. Congenital (erythroid) hypoplastic anaemia: modified expression in males. *Arch Dis Child* 1969;44:757.
276. Hunter RE, Hakami N. The occurrence of congenital hypoplastic anemia in half-brothers. *J Pediatr* 1972;81:346.
277. Hamilton PJ, Dawson AA, Galloway WH. Congenital erythroid hypoplastic anaemia in mother and daughter. *Arch Dis Child* 1974;49:71.
278. Michelson AD. Inheritance of Diamond–Blackfan anaemia. *Med J Aust* 1982;2:409.
279. Lawton JWM, Aldrich JE, Turner TL. Congenital erythroid hypoplastic anaemia: autosomal dominant transmission. *Scand J Haematol* 1974;13:276.
280. Gray PH. Pure red-cell aplasia: occurrence in three generations. *Med J Aust* 1982;1:519.
281. Diamond LK, Allen DM, Magill FB. Congenital (erythroid) hypoplastic anemia. *Am J Dis Child* 1961;102:403.
282. Tada K, Kudo T, Nakagawa I, et al. Anemie congenitale hypoplastique. *Arch Fr Pediatr* 1958;15:183.
283. Gustavsson P, Skeppner G, Johansson B, et al. Diamond–Blackfan anaemia in a girl with a de novo balanced reciprocal X:19 translocation. *J Med Genet* 1997;34:779.
284. Gripp KW, McDonald–McGinn DM, La Rossa D, et al. Bilateral microtia and cleft palate in cousins with Diamond–Blackfan anemia. *Am J Med Genet* 2001;101:268.
285. Orfali KA, Wynn RF, Stevens R, et al. Failure of red cell production following allogeneic BMT for Diamond–Blackfan anaemia (DBA) illustrates functional significance of high erythrocyte adenosine deaminase (eADA) activity in the donor. *Blood* 1999;94:414a(abstract).
286. Tartaglia AP, Propp S, Amarose AP, et al. Chromosome abnormality and hypocalcemia in congenital erythroid hypoplasia (Blackfan–Diamond syndrome). *Am J Med* 1966;41:990.
287. Heyn R, Kurczynski E, Schmickel R. The association of Blackfan–Diamond syndrome, physical

abnormalities, and an abnormality of chromosome 1. *J Pediatr* 1974;85:531.

288. Talerman A, Maigo A. Thymoma associated with aregenerative and aplastic anemia in a five year old child. *Cancer* 1968;21:1212.

289. Von Horn DK, Mortimer PP, Young N, Hanson GR. Human parvovirus-associated red cell aplasia in the absence of underlying hemolytic anemia. *Am J Pediatr Hematol Oncol* 1986;8:235.

290. Wang WC, Mentzer WC. Differentiation of transient erythroblastopenia of childhood from congenital hypoplastic anemia. *J Pediatr* 1976;88:784.

291. Zwerdling T, Finlay J, Glader BE. Transient erythroblastopenia of adolescence. *Clin Pediatr* 1986;25:563.

292. Link MP, Alter BP. Fetal-like erythropoiesis during recovery from transient erythroblastopenia of childhood (TEC). *Pediatr Res* 1981;15:1036.

293. Hill JM, Hunter RB. ACTH therapy in refractory anemias. In: Monte JR, ed. *Proceedings of the Second Clinical ACTH Conference, Vol. II*. New York: Blakeston, 1987:181.

294. Gasser C. Aplastische anemie (chronische erythroblastophthise) und cortison. *Schweiz Med Wochenschr* 1951;81:1241.

295. Ozsoylu S. High-dose intravenous corticosteroid for a patient with Diamond-Blackfan syndrome refractory to classical prednisone treatment. *Acta Haematol* 1984;71:207.

296. Ozsoylu S. High-dose intravenous corticosteroid treatment for patients with Diamond-Blackfan syndrome resistant or refractory to conventional treatment *Am J Pediatr Hematol Oncol* 1988;10:217.

297. Buchanan GR. Oral megadose methylprednisolone therapy for refractory Diamond-Blackfan anemia. International Diamond-Blackfan Anemia Study Group. *J Pediatr Hematol Oncol* 2001;23:353.

298. Leonard EM, Raefsky E, Griffith P, et al. Cyclosporin therapy of aplastic anaemia congenital and acquired red cell aplasia. *Br J Haematol* 1989;72:278.

299. Sjolín S, Wranne L. Treatment of congenital hypoplastic anaemia with prednisone. *Scand J Haematol* 1970;7:63.

300. August CS, King E, Githens JH, et al. Establishment of erythropoiesis following bone marrow transplantation in a patient with congenital hypoplastic anemia (Diamond-Blackfan Syndrome). *Blood* 1976;48:491.

301. Alter BP. Bone marrow transplant in Diamond-Blackfan anemia [Letter]. *Bone Marrow Transplant* 1998;21:965.

302. Willig T-N, Niemeyer C, Leblanc T, et al. Identification of new prognosis factors from the clinical and epidemiologic analysis of a registry of 229 Diamond-Blackfan anemia patients. *Pediatr Res* 1999;46:553.

303. Halperin DS, Estrov Z, Freedman MH. Diamond-Blackfan anemia: promotion of marrow erythropoiesis *in vitro* by recombinant interleukin-3. *Blood* 1989;73:1168.

304. Dunbar CE, Smith DA, Kimball J, et al. Treatment of Diamond-Blackfan anaemia with haematopoietic growth factors, granulocyte-macrophage colony stimulating factor and interleukin 3: sustained remissions following IL-3. *Br J Haematol* 1991;79:316.

305. Sieff C, Guinan E. In vitro enhancement of erythropoiesis by steel factor in Diamond-Blackfan anemia and treatment of congenital cytopenias with recombinant interleukin3/granulocyte macrophage colony stimulating factor. *Stem Cells* 1993;11[Suppl2]:113.

306. Gillio AP, Faulkner LB, Alter BP, et al. Treatment of Diamond-Blackfan anemia with recombinant interleukin-3. *Blood* 1993;82:744.

307. Bastion Y, Bordigoni P, Debre M, et al. Sustained response after recombinant interleukin-3 on

Diamond-Blackfan anemia. *Blood* 1994;83:617.

308. Olivieri NF, Feig S, Valentino L, et al. Failure of recombinant interleukin-3 in Diamond-Blackfan anemia. *Blood* 1994;83:2444.

309. Bastion Y, Campos L, Roubi N, et al. IL-3 increases marrow and peripheral blood precursors in chronic pure red cell aplasia presenting in childhood. *Br J Haematol* 1995;83:413.

310. Ball SE, Tchernia G, Wranne L, et al. Is there a role for interleukin-3 in Diamond Blackfan anaemia? Results of a European multicentre study. *Br J Haematol* 1995;91:313.

311. McGuckin CP, Uhr MR, Ball SE, et al. In vitro progenitor analysis in a Diamond-Blackfan anemia patient who responded once but not twice to interleukin3 therapy using short-term and long-term cultures and c-kit analysis. *Br J Haematol* 1996;93:319.

2004 Lippincott Williams & Wilkins  
John P. Greer, John Foerster, John N. Lukens  
George M. Rodgers, Frixos Paraskevas, Bertil Glader  
Wintrobe's Clinical Hematology

[OVERVIEW OF CONGENITAL DYSERYTHROPOIETIC ANEMIA](#)  
[CONGENITAL DYSERYTHROPOIETIC ANEMIA TYPE II \(HEMPAS\)](#)  
[Pathogenesis](#)  
[Clinical Description and Hematologic Findings](#)  
[CONGENITAL DYSERYTHROPOIETIC ANEMIA TYPE I](#)  
[CONGENITAL DYSERYTHROPOIETIC ANEMIA TYPE III](#)  
[OTHER VARIANTS](#)  
[DIAGNOSIS OF CONGENITAL DYSERYTHROPOIETIC ANEMIA](#)  
[REFERENCES](#)

## OVERVIEW OF CONGENITAL DYSERYTHROPOIETIC ANEMIA

The *congenital dyserythropoietic anemias* (CDAs) are a group of genetic disorders characterized by ineffective erythropoiesis and dyserythropoiesis ([1](#), [2](#)). *Ineffective erythropoiesis* is a kinetic term indicating increased marrow erythroid activity, intramedullary red cell destruction, and decreased release of red blood cells (RBCs) into the circulation. *Dyserythropoiesis* is a descriptive term indicating the presence of morphologically abnormal erythroblasts with multinuclearity, karyorrhexis, or megaloblastic changes. Overt abnormalities in other hematopoietic lineages are uncommon in CDA and have only been reported in association with a few cases ([3](#), [4](#)).

Three major types of CDA have been distinguished on the basis of morphologic and serologic classification ([5](#), [6](#) and [7](#)). These have been designated CDA types I, II, and III. In aggregate, a few hundred cases have been described in the literature, and CDA II accounts for approximately two-thirds of all cases reported. A significant number of additional cases have been published that do not fit precisely into the established classification scheme ([8](#), [9](#) and [10](#)). Whether some of these represent distinct entities or represent variants on the three major types is controversial.

The abnormalities associated with all three types of CDA are intrinsic to the erythroid stem cell and are not due to a defect in the cell environment. *In vitro* cultures of erythroid precursors from each of the CDAs reveal the typical morphologic abnormalities seen *in vivo* ([11](#)). In addition, such studies have revealed that even in a given individual the morphologic manifestations of the disorder may be variable, with a single progenitor cell producing both morphologically normal and abnormal progeny ([12](#)). The chromosomal locations of the genes for CDA I, II, and III have now been mapped ([13](#), [14](#) and [15](#)). The eventual identification of the actual genes responsible for these disorders should provide insight into normal RBC development.

Clinically, the degree of anemia encountered in the CDAs varies considerably. It may range from a mild to moderate anemia that is only discovered or diagnosed later in life to a severe anemia apparent in infancy, occasionally associated with hydrops fetalis and requiring antenatal intrauterine red cell transfusions ([16](#), [17](#), [18](#), [19](#) and [20](#)). Morphologically, the anemia is generally mildly macrocytic in CDA I and is normocytic to mildly macrocytic in CDA II and CDA III. In all of the disorders, the bone marrow findings are consistent with

ineffective erythropoiesis: There is erythroid hyperplasia along with morphologically abnormal precursors. An elevation in serum lactate dehydrogenase and indirect bilirubin levels may be observed. Iron absorption and transport are increased, but the use of iron in erythropoiesis is decreased. Thus, patients with CDAs may develop secondary hemochromatosis, although in some cases, a component of intravascular hemolysis has been reported to prevent this complication or even cause iron deficiency ( [21](#) ).

## CONGENITAL DYSERYTHROPOIETIC ANEMIA TYPE II (HEMPAS)

Type II CDA was first categorized as such by Heimpe and Wendt in 1968 ( [1](#) ). It is the most common clinical type of CDA, and more than 150 patients have been described ( [22](#) ). The mode of inheritance is autosomal recessive, and the CDAN2 gene has been localized to a 5-cM interval on chromosome 20q11.2 ( [14](#) ). This CDA is distinguished by the fact that it can be defined by accompanying serologic abnormalities.

When tested against a panel of acidified sera (pH 6.8) from normal individuals, approximately 30% of the normal sera lyse CDA II red cells. Unlike the situation in paroxysmal nocturnal hemoglobinuria (PNH), there is very rarely lysis of the patient's red cells by his or her own serum under this condition. In addition, CDA II cells do not lyse in isotonic sucrose, as is the case in PNH. The lysis in acidified heterologous sera is due to a naturally occurring immunoglobulin M antibody against a unique antigenic determinant on the cells that binds complement. The combination of the morphologic abnormalities and the above pathognomonic serologic finding led Crookston et al. to propose the acronym for CDA II: HEMPAS ( *h*ereditary *e*rythroblastic *m*ultinuclearity with *p*ositive *a*cidified serum test) ( [2](#) ).

An additional serologic finding in CDA II is that the red cells of patients have increased expression of the fetal i antigen and are, therefore, strongly agglutinated by both anti-i and anti-I sera ( [23](#) ). This is in distinction to other conditions, such as Diamond-Blackfan anemia and sickle cell anemia, in which both antigens may be present but expressed on different erythrocytes, reflecting that a fraction of RBCs are a product of fetal-like erythropoiesis.

### Pathogenesis

As might be hinted by the defining serologic abnormalities, the underlying genetic defect in CDA II leads to defective enzymatic glycosylation of membrane proteins ( [24](#) ). Normally, a series of enzymatic steps leads to the synthesis of lactosaminoglycans that constitute the carbohydrate moieties of proteins such as band 3 and glycophorin A. Erythrocytes from patients with CDA II contain partially glycosylated proteins with a different structure than normal ( [25](#), [26](#) ). In particular, the abnormal band 3 protein (easily detectable by sodium dodecyl sulfate-polyacrylamide gel electrophoresis analysis) is particularly hydrophobic and tends to cluster, causing disruption of the cytoskeleton ( [27](#) ). Such disruption may in part account for the abnormal membrane architecture that is observed in this disorder. In addition, the unused polylactosamines that would normally be conjugated to protein accumulate as glycolipids and may be involved in formation of the antigenic determinant (the HEMPAS antigen) on the surface of cells that leads to complement-mediated lysis with heterologous sera ( [28](#) ). Abnormal glycosylation also leads to persistence of the i antigen on the red cell surface.

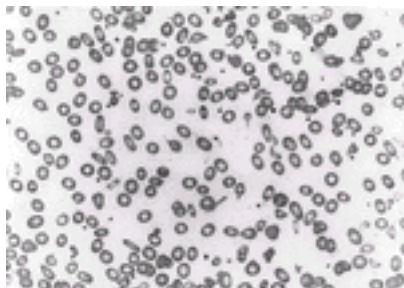
Initially, abnormalities in two Golgi enzymes were implicated in the pathogenesis of CDA II: *N*-acetylglucosaminyl-transferase II and  $\alpha$ -mannosidase II ( [29](#), [30](#) ). In fact, an

$\alpha$ -mannosidase II knock-out mouse reproduces a phenotype similar to CDA II ( [31](#)). However, further familial studies have excluded linkage of CDA II to the *N*-acetyl-glucosaminotransferase and  $\alpha$ -mannosidase II genes ( [32](#)). Eventual cloning of the CDAN2 gene may reveal that it plays a more fundamental role in glycosylation, and a variety of mutations in this single gene may explain the phenotypic heterogeneity observed ( [33](#)).

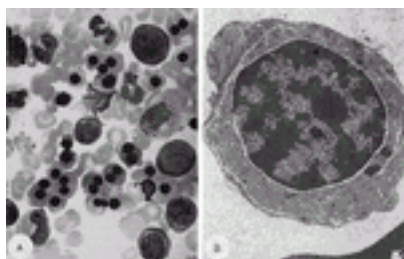
### Clinical Description and Hematologic Findings

CDA II presents as a normocytic anemia with evidence of ineffective erythropoiesis and premature peripheral RBC destruction, including jaundice and hepatosplenomegaly. In very mild cases, the anemia may be so mild as to remain undiscovered until late in adult life. However, in the majority of patients, the hemoglobin level is less than 11 g/dl, and in 10 to 25% of patients, it is severe enough to require regular transfusions ( [16](#)). As in other disorders in which ineffective erythropoiesis is a prominent feature, abnormal facies and extramedullary hematopoiesis may occur, particularly in severely affected individuals ( [34](#), [35](#)). Cholelithiasis and secondary hemochromatosis are complications frequently associated with CDA II. In fact, iron overload may be the presenting manifestation in some cases ( [36](#)).

The abnormalities observed on the peripheral blood smear include anisocytosis, poikilocytosis, and basophilic stippling ( [Fig. 46.1](#)). Phase contrast microscopy of red cell ghosts demonstrates irregular regions of thickened membrane ( [Fig. 46.2](#)). These regions of apparent doubling of the plasma membrane in a continuous or discontinuous fashion are derived from endoplasmic reticulum ( [37](#)).



**Figure 46.1.** Blood smear from a patient with congenital dyserythropoietic anemia type II (hereditary erythroblastic multinuclearity with positive acidified serum test) ( $\times 600$ ). (Courtesy of SM Lewis, London.)



**Figure 46.2.** A: Binucleate cells in late normoblasts of patient with congenital dyserythropoietic anemia (CDA) type II. B: Electron micrograph, CDA II. Note doubling of plasma membrane. (Courtesy of SM Lewis, London.)



Bone marrow examination reveals marked erythroid hyperplasia. Precursors appear normal until after the basophilic erythroblast stage, after which point up to 30% of erythroblasts contain two nuclei ( [Fig. 46.2](#)). Each of the nuclei contains a normal DNA content, but DNA synthesis in the binucleate cells is markedly reduced or absent. In addition, ineffective erythropoiesis in the marrow may be accompanied by erythrophagocytosis and Gaucher-like histiocytes in some individuals ( [38](#)). Megaloblastic changes are generally not observed.

CDA II often follows an indolent course. However, transfusion-dependent individuals may benefit from splenectomy ( [16](#)). Whether exogenous administration of erythropoietin would be of benefit in this disorder has yet to be formally studied. In one case, allogeneic bone marrow transplant was reported to be curative ( [39](#)). Most important, patients should be monitored closely for secondary hemochromatosis, which can occur even in the absence of regular transfusion therapy ( [21](#)). Iron chelation therapy may be indicated, or alternatively, phlebotomy may be considered in patients with mild anemia.

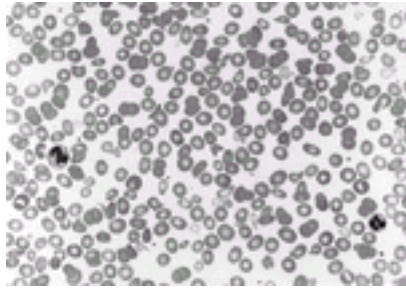
## CONGENITAL DYSERYTHROPOIETIC ANEMIA TYPE I

CDA I is the second most common of these disorders, with nearly 100 cases reported in the literature. The mode of inheritance is autosomal recessive, and the CDAN1 gene has been localized to a 0.5-cM interval on chromosome 15, 15q15.1–15.3 ( [13](#)). In contrast to CDA II, there is no defining serologic abnormality (the acidified serum lysis test is negative), and the diagnosis currently is made on a morphologic basis.

Little is known about the exact nature of the pathogenesis of CDA I. It has been suggested that there is an abnormality of nucleoprotein synthesis leading to abnormal mitosis, and it has been suggested that abnormal nuclear histones may be responsible ( [40](#), [41](#)). Alternatively, other investigators have suggested a plasma membrane defect, and abnormalities in plasma membrane proteins have recently been described ( [42](#)).

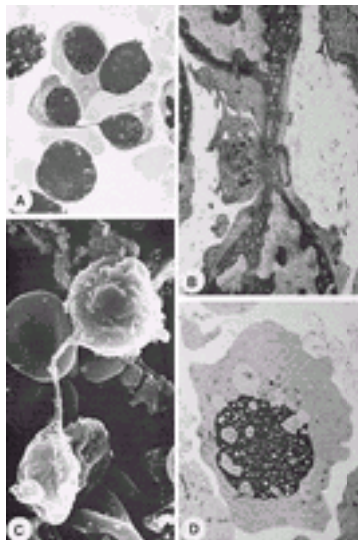
Studies on the natural history of CDA I have been facilitated in part by a clustering of cases in several Israeli Bedouin families ( [20](#), [43](#), [44](#)). The anemia varies from mild to severe, with the most severe cases presenting in infancy and the milder cases presenting in adolescence or later in life. Jaundice and splenomegaly are common physical findings. In addition, skeletal abnormalities, such as distal limb malformations, have been reported in association with CDA I ( [45](#)).

The anemia is usually macrocytic with a mean corpuscular volume of 90 to 115 fl. Anisocytosis, poikilocytosis, basophilic stippling, and Cabot rings are features of the peripheral blood smear, regardless of whether a splenectomy has been performed ( [Fig. 46.3](#)). Lactate dehydrogenase and bilirubin levels may be elevated, reflecting ineffective erythropoiesis. Although increased hemoglobin A2 levels have been reported, other evidence for thalassemia is absent ( [46](#)).



**Figure 46.3.** Blood smear from a patient with congenital dyserythropoietic anemia type I ( $\times 600$ ). (Courtesy of SM Lewis, London.)

The most prominent defining features of CDA I are in the bone marrow. The nuclear chromatin is spongy and has a megaloblastic appearance. Thin, Feulgen test-positive intranuclear chromatin bridges between erythroblasts may be observed in a minority of cells ( [Fig. 46.4A](#), [Fig. 46.4B](#) and [Fig. 46.4C](#)). Electron microscopy of erythroblasts reveals unevenly condensed nuclear chromatin that has a spongy appearance ( [47](#)). Some nuclei may have a characteristic Swiss cheese appearance ( [Fig. 46.4D](#)) with electron-lucent areas with cytoplasmic components that seem to be located within the nucleus. Studies have demonstrated that marked invagination and evagination of the nuclear envelope are responsible for this phenomenon rather than abnormally located cytoplasmic components ( [48](#)).



**Figure 46.4.** Morphologic studies of congenital dyserythropoietic anemia (CDA) type I. **A–C:** An intranuclear chromatin bridge in CDA type I. **A:** With light microscopy. **B:** With transmission electron microscopy. **C:** With scanning electron microscopy. **D:** Abnormal nucleus in CDA type I with Swiss cheese appearance and nuclear invagination. (Courtesy of E Conde, Santander, Spain.)

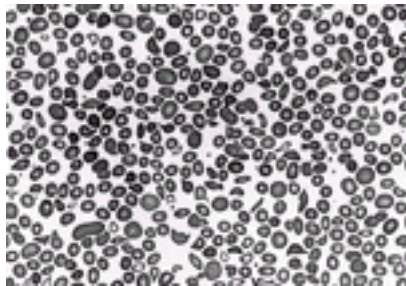
CDA I often follows an indolent course, although some patients require periodic red cell transfusions. From the limited reports to date, the benefit of splenectomy in this disorder is not clear, although this procedure may be considered in transfusion-dependent patients ( [18](#)). Erythropoietin administration has been examined in CDA I and does not appear to be effective in the management of this disorder ( [49](#)). More recently, on the basis of the fortuitous observation that treatment of a CDA I patient with hepatitis C with

interferon- $\alpha$ 2a led to hematologic improvement, a few additional patients, including a severely affected infant, have been treated with this therapy and have also experienced hematologic improvement ( [50](#), [51](#) ). This suggests that interferon- $\alpha$ 2a may have a role in management. As for CDA II, careful monitoring for secondary hemochromatosis is important, and effective treatment of a CDA I patient with deferoxamine has been reported ( [52](#) ).

### CONGENITAL DYSERYTHROPOIETIC ANEMIA TYPE III

CDA III was likely the first of the CDAs to be described. In 1951, Wolfe and von Hofe described familial erythroid multinuclearity, which was also reported in 1962 by Bergström and Jacobsson as hereditary benign erythroreticulosis ( [53](#), [54](#) ). Approximately 50 patients with this disorder have been reported in the literature, and most of these have been members of a single large Swedish family. Although the mode of inheritance of sporadic cases has yet to be determined, the inheritance pattern in the Swedish family is autosomal dominant. Linkage analysis reveals that the CDAN3 gene is localized to an 11-cM interval on chromosome 15, 15q21-q25 ( [15](#) ). Little is known about the pathogenesis of CDA III, although minor alterations in the glycosylation of band 3 of erythrocytes similar to those seen in CDA II have been reported ( [55](#) ). The diagnosis of CDA III is currently made on a morphologic basis. Although the red cells may be agglutinated by both anti-i and anti-I sera, the acidified serum lysis test is negative with heterologous sera.

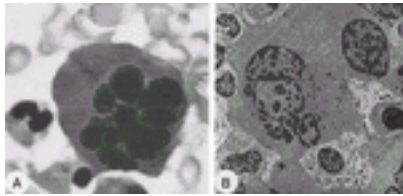
The macrocytic anemia is generally of mild to moderate severity, and a few large erythrocytes may be seen on peripheral blood smear ( [Fig. 46.5](#) ). Individuals may experience periods of fatigue and jaundice and episodes of intravascular hemolysis. Hemosiderinuria may be present.



**Figure 46.5.** Blood smear from a patient with congenital dyserythropoietic anemia type III ( $\times 600$ ). (Courtesy of SM Lewis, London.)

Bone marrow examination is remarkable for the finding of marked multinuclearity, with as many as 12 nuclei per cell, which occurs in giant erythrocyte precursors that may reach 50 to 60  $\mu\text{m}$  in diameter ( [Fig. 46.6A](#) ). As many as 30% of the erythroblasts may be multinucleated, and their DNA content is highly variable ( [56](#) ). Electron microscopy reveals a variety of features that are similar to CDA I, but CDA III is distinguished by the lack of spongy-appearing chromatin and the preservation of the nuclear envelope ( [Fig. 46.6B](#) ). Time-lapse phase contrast microscopy has demonstrated that the erythroblasts grow to the size at which division is expected but do not divide ( [57](#) ). In doing so, they also acquire morphologic abnormalities. Abnormalities in megakaryocytes have been reported in two cases of CDA III ( [4](#) ). An association of CDA III with monoclonal gammopathy, macular degeneration, and angioid streaks has also been reported ( [58](#) ). Management of CDA III is

supportive.



**Figure 46.6.** A: Gigantoblast in congenital dyserythropoietic anemia (CDA) type III. B: Multiple nuclear abnormalities in CDA type III evident by electron microscopic analysis. (Courtesy of Prof. Dr. R Goudsmit, Amsterdam.)

## OTHER VARIANTS

Numerous cases of CDA are reported in the literature that could not be classified into one of the three major types. A proposed category of CDA IV used to describe cases with features of CDA II, but a negative acidified serum lysis test with heterologous sera is controversial. Some of these cases may simply represent CDA II in which an insufficiently large panel of heterologous sera was used initially. Examples exist in the literature of cases that have been classified as CDA II when retested ([59](#), [60](#)). Aside from these, there are a number of reports of CDA with atypical features, as well as others that presented with severe manifestations such as hydrops fetalis ([8](#), [9](#), [61](#)). Whether these reports represent distinct syndromes or more severe variants of the known CDAs is unknown.

## DIAGNOSIS OF CONGENITAL DYSERYTHROPOIETIC ANEMIA

CDA should be suspected in any individual with a chronic anemia that manifests as ineffective erythropoiesis, as well as in individuals with evidence of secondary hemochromatosis. Review of previous complete blood counts may be helpful in determining whether the anemia is congenital, although in some individuals, the anemia is so mild that it goes undetected until late in adulthood.

Bone marrow examination is usually the most helpful procedure in making the diagnosis of a CDA. The finding of erythroid hyperplasia and dyserythropoiesis, along with other signs specific to each of the CDAs, is apparent. However, some care must be taken to thoughtfully rule out other disorders on the differential diagnosis that can have a somewhat similar appearance, including vitamin B<sub>12</sub> or folate deficiency,  $\beta$ -thalassemia, sideroblastic anemias, and myelodysplasia.

Serologic studies, such as the acidified serum lysis test with heterologous serum and electron microscopy of bone marrow, are useful for the categorization of the CDA. If CDA II is suspected, a reasonably large panel of normal sera (=30 samples) should be used in the acidified serum lysis test before deciding that the test is negative. The acidified serum lysis test, also known as the *Ham test*, has been the classic test used to diagnose PNH. Nowadays, however, flow cytometry to look for the presence of CD55 and CD59 has replaced this test for establishing the diagnosis of PNH and has led to decreased availability of the acidified serum lysis test in clinical laboratories. This may present a problem in evaluating patients for CDA. Such limited availability of specialized testing may necessitate referral of clinical specimens to academic centers with an interest in these disorders.

## REFERENCES

1. Heimpel H, Wendt F. Congenital dyserythropoietic anemia with karyorrhexis and multinuclearity of erythroblasts. *Helv Med Acta* 1968;34:103.
2. Crookston JH, et al. Hereditary erythroblastic multinuclearity associated with a positive acidified serum test: a type of congenital dyserythropoietic anaemia. *Br J Haematol* 1969;17:11.
3. Hirose M, Taguchi Y, Makimoto A, et al. New variant of congenital dyserythropoietic anemia with trilineage myelodysplasia. *Acta Haematol* 1995;94:102-104.
4. Wickramasinghe SN, Wahlin A, Anstee D, et al. Observations on two members of the Swedish family with congenital dyserythropoietic anaemia, type III. *Eur J Haematol* 1993;50:213-221.
5. Delauney J, Iolascon A. The congenital dyserythropoietic anaemias. *Baillieres Clin Haematol* 1999;12:691-705.
6. Marks PW, Mitus AJ. Congenital dyserythropoietic anemias. *Am J Hematol* 1996;51:55-63.
7. Wickramasinghe SN. Congenital dyserythropoietic anemias. *Curr Opin Hematol* 2000;7:71-78.
8. Benjamin JT, Rosse WF, Daldorf FG, McMillan CW. Congenital dyserythropoietic anemia type IV. *J Pediatr* 1975;87:210.
9. Boogaerts MA, Verwighen RL. Variants of congenital dyserythropoietic anemia: an update. *Haematologica* 1982;15:212.
10. Wickramasinghe SN, Lee MJ, Furukawa T, et al. Composition of the intra-erythroblastic precipitates in thalassemia and congenital dyserythropoietic anaemia (CDA): identification of a new type of CDA with intra-erythroblastic precipitates not reacting with monoclonal antibodies to alpha- and beta-globulin chains. *Br J Haematol* 1996;93:576-585.
11. Florensa L, Woessner S, Besses C, et al. Congenital dyserythropoietic anemia type II: morphological characterization of the erythroid colonies (BFU-E) from the bone marrow and peripheral blood of two patients. *Ann Hematol* 1994;69:57-59.
12. Vainchecker W, Guichard J, Bouguet J, Breton-Gorius J. Congenital dyserythropoietic anaemia type I: absence of clonal expression in the nuclear abnormalities of cultured erythroblasts. *Br J Haematol* 1980;46:33.
13. Tamary H, Shalmon L, Shalev H, et al. Localization of the gene for congenital dyserythropoietic anemia type I to a 1 cM interval on chromosome 15q 15.1-15.3. *Am J Hum Genet* 1998;62:1062-1069.
14. Gasparini P, Miraglia del Guidice E, Delauney J, et al. Localization of the congenital dyserythropoietic anemia II locus to chromosome 20q11.2 by genomewide search. *Am J Hum Genet* 1997;61:1112-1116.
15. Lind L, Sandstrom H, Wahlin A, et al. Localization of the gene for congenital dyserythropoietic anemia type III, CDAN3, to chromosome 15q21-q25. *Hum Mol Genet* 1995;4:109-112.
16. Iolascon A, Delaunay J, Wickramasinghe SN, et al. Natural history of congenital dyserythropoietic anemia type II. *Blood* 2001;98:1258-1260.
17. Maldonado JE, Taswell HF. Type I dyserythropoietic anemia in an elderly patient. *Blood* 1974;44:495.
18. Shalev H, Kapleushnik Y, Haeskelzon L, et al. Clinical and laboratory manifestations of congenital dyserythropoietic anemia type I in young adults. *Eur J Haematol* 2002;68:170-174.
19. Remacha A, Badell I, Pujol-Moix N, et al. Hydrops fetalis-associated congenital dyserythropoietic anemia treated with intrauterine transfusions and bone marrow transplantation. *Blood* 2002;100:356-358.
20. Shalev H, Tamary H, Shaft D, et al. Neonatal manifestations of congenital dyserythropoietic anaemia

type I. *J Pediatr* 1997;131:95–97.

21. Halpern Z, Rahmani R, Levo Y. Severe hemochromatosis: the predominant clinical manifestation of congenital dyserythropoietic anemia type 2. *Acta Haematol* 1985;74:178–180.
22. Punt K, Borst-Eilers E, Nijessen JG. Congenital dyserythropoietic anaemia, type II (HEMPAS). In: Lewis SM, Verwilgen, eds. *Dyserythropoiesis*. London: Academic Press, 1977:71.
23. Lewis SM, Grammaticos P, Dacie JV. Lysis by anti-I in dyserythropoietic anaemias: role of increased uptake of antibody. *Br J Haematol* 1970;465–474.
24. Fukuda MN. HEMPAS. Hereditary erythroblastic multinuclearity with positive acidified serum lysis test. *Biochim Biophys Acta* 1999;1455:231–239.
25. Fukuda MN, Papayannopoulou T, Gordon-Smith EC, et al. Defect in glycosylation of erythrocyte membrane proteins in congenital dyserythropoietic anaemia type II (HEMPAS). *Br J Haematol* 1984;56:55–68.
26. Zdebska E, Anselstetter V, Pacuska, et al. Glycolipids and glycopeptides of red cell membranes in congenital dyserythropoietic anaemia type II. *Br J Haematol* 1987;66:385–391.
27. Fukuda MN, Klier G, Yu J, Scartezzini P. Anomalous clustering of underglycosylated band 3 in erythrocytes and their precursor cells in congenital dyserythropoietic anemia type II. *Blood* 1986;68:521–529.
28. Verwilghen RL. Congenital dyserythropoietic anaemia type II (HEMPAS). In: *Congenital disorders of erythropoiesis (Ciba Symposium)*. Verwilghen RL, ed. Congenital dyserythropoietic anaemia type II (HEMPAS). Amsterdam: Elsevier Science, 1976:151.
29. Fukuda MN, Dell A, Scartezzini P. Primary defect of congenital dyserythropoietic anemia type II. Failure in glycosylation of erythrocyte lactosaminoglycan proteins caused by lowered N-acetylglucosaminyltransferase II. *J Biol Chem* 1987;262:7195–7206.
30. Fukuda MN, Masri KA, Dell A, et al. Incomplete synthesis of N-glycans in congenital dyserythropoietic anemia type II caused by a defect in the gene encoding alpha-mannosidase II. *Proc Natl Acad Sci U S A* 1990;87:7443–7447.
31. Chui D, Oh-Eda M, Liao YF, et al. Alpha-mannosidase-II deficiency results in dyserythropoiesis and unveils an alternate pathway in oligosaccharide biosynthesis. *Cell* 1997;90:157–167.
32. Iolascon A, Miraglia del Giudice E, Perrotta S, et al. Exclusion of three candidate genes as determinants of congenital dyserythropoietic anemia type II (CDA-II). *Blood* 1997;90:4197–4200.
33. Iolascon A, De Mattia D, Perotta S, et al. Genetic heterogeneity of congenital dyserythropoietic anemia type II. *Blood* 1998;92:2593–2594.
34. Hines GL. Paravertebral extramedullary hematopoiesis (as a posterior mediastinal tumor) associated with congenital dyserythropoietic anemia [Letter]. *J Thorac Cardiovasc Surg* 1993;106:760.
35. Lugassy G, Michaeli J, Harats N, et al. Paravertebral extramedullary hematopoiesis associated with improvement of anemia in congenital dyserythropoietic anemia type II. *Am J Hematol* 1986;22:295–300.
36. Greiner TC, Burns CP, Dick FR, et al. Congenital dyserythropoietic anemia type II diagnosed in a 69-year-old patient with iron overload. *Am J Clin Pathol* 1992;98:522–525.
37. Alloisio N, Texier P, Denoroy L, Berger C, et al. The cisternae decorating the red blood cell membrane in congenital dyserythropoietic anemia (type II) originate from the endoplasmic reticulum. *Blood* 1996;87:4433–4439.
38. Van Dorpe A, Broeckeaert-van Orshoven A, Desmet V, Verwilgen RL. Gaucher-like cells and congenital dyserythropoietic anemia, type II (HEMPAS). *Br J Haematol* 1973;25:165–170.
39. Iolascon A, Sabato V, de Mattia D, Locatelli F. Bone marrow transplantation in a case of severe, type

II congenital dyserythropoietic anaemia (CDA II) Bone Marrow Transplant 2001;27:213–215

40. Meurat G, Tschan P, Schluter G, et al. DNA-, histone, RNA-, hemoglobin-content and DNA-synthesis in erythroblasts in a case of congenital dyserythropoietic anemia type I. *Blut* 1972;23:32–41.
41. Wickramasinghe SN, Pippard MJ. Studies of erythroblast function in congenital dyserythropoietic anaemia, type I: evidence of impaired DNA, RNA and protein synthesis and unbalanced globin chain synthesis in ultrastructurally abnormal cells. *J Clin Pathol* 1986;39:881–890.
42. Zdebska E, Golaszewska E, Fabijanska-Mitek J, et al. Glycoconjugate abnormalities in patients with congenital dyserythropoietic anaemia type I, II and III. *Br J Haematol* 2001;114:907–913.
43. Tamary H, Shalev H, Luria D, et al. Clinical features and studies of erythropoiesis in Israeli Bedouins with congenital dyserythropoietic anemia type I. *Blood* 1996;87:1763–1770.
44. Shalev H, Kapleushnik Y, Haeskelzon L, et al. Clinical and laboratory manifestations of congenital dyserythropoietic anemia type I in young adults. *Eur J Haematol* 2002;68:1704.
45. Sabry MA, Zaki M, al Awadi SA, et al. Non-haematological traits associated with congenital dyserythropoietic anaemia type 1: a new entity emerging. *Clin Dymorphol* 1997;6:205–212.
46. Heimpel H. Congenital dyserythropoietic anemia type I: clinical and experimental aspects. In: *Congenital disorders of erythropoiesis (Ciba Symposium)*. Amsterdam: Elsevier Science, 1976:35.
47. Conde E, Mazo E, Baro J, et al. Transmission and scanning electron microscopy study on congenital dyserythropoietic anemia type I. *Acta Haematol* 1983;70:243–249.
48. Hiraoka A, Kanayama Y, Yonezawa T, et al. Congenital dyserythropoietic anemia type I: a freeze fracture and thin section electron microscopy study. *Blut* 1983;46:329–338.
49. Tamary H, Shalev H, Pinsk V, et al. No response to erythropoietin therapy in patients with congenital dyserythropoietic anemia type I. *Pediatr Hematol Oncol* 1999;16:165–168.
50. Shamseddine A, Taher A, Jaafar H, et al. Interferon alpha is an effective pharmacologic therapy for congenital dyserythropoietic anaemia type 1. *Eur J Haematol* 2000;65:207–209.
51. Perez N, Dommergues M, Zupan V, et al. Severe congenital dyserythropoietic anaemia type I: prenatal management, transfusion support and alpha-interferon therapy. *Br J Haematol* 2000;100:420–423.
52. Smithson WA, Perrault J. Use of subcutaneous deferoxamine in a child with hemochromatosis associated with congenital dyserythropoietic anemia, type I. *Mayo Clin Proc* 1982;57:322–325.
53. Wolfe JA, von Hofe FH. Familial erythroid multinuclearity. *Blood* 1951;6:1274–1283.
54. Bergström I, Jacobsson L. Hereditary benign erythroreticulosis. *Blood* 1962;19:296–303.
55. Wickramasinghe SN, Wahlin A, Anstee D, et al. Observations on two members of the Swedish family with congenital dyserythropoietic anaemia, type III. *Eur J Haematol* 1993;50:213–221.
56. Goudsmit R, Beckers D, De Bruijne JI, et al. Congenital dyserythropoietic anaemia, type III. *Br J Haematol* 1972;23:97–105.
57. Furukawa T, Inoue H, Sugita K, et al. Long-term cinemicrography of erythroblasts from a patient with congenital dyserythropoietic anemia type III: direct observation of dysplastic erythroblast formation *Blood Cells* 1993;19:493–508.
58. Sanstrom H, Wahlin A, Eriksson M, et al. Angioid streaks are part of a familial syndrome of congenital dyserythropoietic anaemia (CDA III). *Br J Haematol* 1997;98:845–849.
59. Seip M, Skrede S, Bjerve K, et al. A case of variant congenital dyserythropoietic anemia revisited. *Scand J Haematol* 1982;28:278–280.
60. Seip M, Skrede S, Bjerve K, et al. Congenital dyserythropoietic anaemia with features of both type I



and type II. Scand J Haematol 1975;15:272-286.

61. Carter C, Darbyshire PJ, Wickramasinghe SN. A congenital dyserythropoietic anemia variant presenting as hydrops fetalis [Letter]. Br J Haematol 1989; 72:289-290.

2004 Lippincott Williams & Wilkins  
John P. Greer, John Foerster, John N. Lukens  
George M. Rodgers, Frixos Paraskevas, Bertil Glader  
Wintrobe's Clinical Hematology

## Anemias Secondary to Chronic Disease and Systemic Disorders

### ANEMIA OF CHRONIC DISEASE

#### Associated Syndromes

#### Clinical and Laboratory Description

#### Anemia

#### Other Biochemical Findings

#### Kinetic Characteristics

#### Pathogenesis

#### Cytokines

#### Shortened Erythrocyte Survival

#### Impaired Marrow Response

#### Abnormal Iron Metabolism

#### Anemia in Patients with Cancer

#### Diagnosis

#### Treatment

### ANEMIA OF CHRONIC RENAL INSUFFICIENCY

#### Clinical Description

#### Laboratory Findings

#### Pathogenesis

#### Management and Course

### ANEMIA IN CIRRHOSIS AND OTHER LIVER DISEASES

#### Prevalence and Clinical Manifestations

#### Hematologic Findings

#### Pathogenesis

### ANEMIAS ASSOCIATED WITH ENDOCRINE DISORDERS

#### Hypothyroidism

#### Hyperthyroidism

#### Adrenal Insufficiency

#### Androgen Deficiency

#### Hypopituitarism

#### Hyperparathyroidism

#### Anorexia Nervosa

### REFERENCES

## ANEMIA OF CHRONIC DISEASE

The anemia that is often observed in patients with infectious, inflammatory, or neoplastic diseases that persist for more than 1 or 2 months is called *anemia of chronic disease*. The characteristic feature of this syndrome is the occurrence of hypoferrremia in the presence of ample reticuloendothelial iron stores. Anemia of chronic disease is defined by the presence of this unique combination of findings (<sup>1</sup>, <sup>2</sup> and <sup>3</sup>). As so defined, the syndrome does not include anemias caused by marrow replacement, blood loss, hemolysis, renal insufficiency, hepatic disease, or endocrinopathy, even when these disorders are chronic. These other syndromes are discussed in the sections [Anemia of Chronic Renal Insufficiency](#), [Anemia in Cirrhosis and Other Liver Diseases](#), and [Anemias Associated with](#)

## Endocrine Disorders.

As the discussion above suggests, the designation *anemia of chronic disease* is far from perfect ( [4](#) ). The most commonly proposed alternative, *anemia of inflammation* ( [4](#) ), also has significant deficiencies, and the more pathophysiologically correct term *cytokine-mediated anemia* ( [5](#) ) is not commonly used. Highly specific descriptive designations, such as *anemia of defective iron reuse* ( [6](#) ), *hypoferremic anemia with reticuloendothelial siderosis*, and *thesauric hypoferremic anemia* ( [7](#) ), are also rarely used.

### Associated Syndromes

Anemia of chronic disease is extremely common and, overall, is probably more common than any anemia syndrome other than blood loss with consequent iron deficiency. Cash and Sears evaluated all the anemic individuals admitted to the medical service of a busy municipal hospital during two 2-month periods in 1985 to 1986 ( [8](#) ). After patients with active bleeding, hemolysis, or known hematologic malignancy were excluded, 52% of anemic patients met laboratory criteria for anemia of chronic disease ( [8](#) ). The syndrome is also observed in 27% of outpatients with rheumatoid arthritis ( [9](#) ) and in 58% of new admissions to inpatient rheumatology units ( [10](#) ). Clinical disorders commonly associated with anemia of chronic disease are listed in [Table 47.1](#). However, it should be remembered that 40% of patients in the series reported by Cash and Sears lacked one of the traditional chronic associated disorders ( [8](#) ). Approximately one-third of this latter group had renal insufficiency, in which pathophysiologic mechanisms implicated in anemia of chronic disease are active ( [28](#) ).

**TABLE 47.1. Conditions Associated with Anemia of Chronic Disease**

---

|  |
|--|
| Chronic infections ( <a href="#">8</a> , <a href="#">13</a> )  |
| Pulmonary infections: abscesses, emphysema, tuberculosis, pneumonia  |
| Subacute bacterial endocarditis  |
| Pelvic inflammatory disease  |
| Osteomyelitis  |
| Chronic urinary tract infections   |
| Chronic fungal disease   |
| Meningitis   |
| Human immunodeficiency virus   |
| Chronic, noninfectious inflammations   |
| Rheumatoid arthritis ( <a href="#">14</a> , <a href="#">15</a> , <a href="#">16</a> and <a href="#">17</a> ) |
| Rheumatic fever ( <a href="#">18</a> )   |
| Systemic lupus erythematosus ( <a href="#">19</a> )  |
| Severe trauma ( <a href="#">20</a> )   |
| Thermal injury ( <a href="#">21</a> )  |
| Vasculitis   |
| Malignant diseases ( <a href="#">22</a> , <a href="#">23</a> , <a href="#">24</a> and <a href="#">25</a> )   |
| Carcinoma  |
| Hodgkin disease  |
| Lymphosarcoma  |
| Leukemia   |
| Multiple myeloma   |

## Miscellaneous

- Alcoholic liver disease
- Congestive heart failure
- Thrombophlebitis
- Ischemic heart disease

## Idiopathic

---

## Clinical and Laboratory Description

Because this type of anemia occurs in association with so many diseases, the clinical manifestations necessarily vary widely. Usually, the signs and symptoms of the underlying disorder overshadow those of the anemia, but on rare occasions, reduction of the hemoglobin level provides the first evidence of the existence of the primary condition. This situation may be observed particularly in difficult-to-diagnose clinical syndromes, such as temporal arteritis ( [29](#) ).

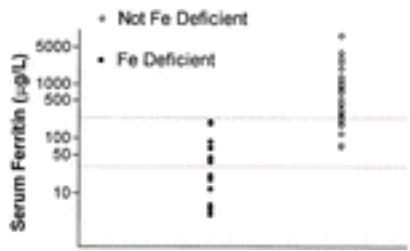
## Anemia

**DEVELOPMENT AND SEVERITY** Typically, anemia develops during the first 1 to 2 months of illness and thereafter does not progress ( [2](#) ). The hematocrit usually is maintained between 0.25 and 0.40 ( [2](#), [11](#), [30](#) ), but significantly lower values are observed in 20 to 30% of patients ( [8](#), [9](#) ). The hemoglobin concentration and hematocrit generally provide an accurate reflection of the extent to which the circulating red cell mass is reduced, although in certain cases, expansion of the total blood volume would mean that the reduction in red cell mass is less than the hemoglobin or hematocrit indicates ( [11](#) ). This is particularly likely in syndromes associated with increased levels of interleukin (IL)-6. IL-6 produces a dilutional anemia: Expansion of the plasma volume results in a reduced hematocrit or hemoglobin concentration without changes in the circulating red cell mass ( [31](#) ). A general correlation exists between the degree of anemia and the severity of the underlying disease ( [2](#) ). For example, infections accompanied by pronounced fever, chills, and suppuration are associated with more severe anemia than those with fewer systemic manifestations ( [32](#) ). In infected wounds, the degree of anemia is related to the number of organisms present ( [32](#) ). Correlation has also been observed between the severity of the anemia and the activity of rheumatoid arthritis, judged by fever, severity of joint swelling and inflammation, and the erythrocyte sedimentation rate ( [16](#), [33](#) ). In patients with malignant disease, anemia is more severe when metastases are widespread than when the disease is localized; however, the development of anemia does not require neoplastic invasion of the bone marrow ( [27](#), [34](#) ). Typically, the percentage of reticulocytes is normal or reduced ( [2](#) ), although on rare occasions, it may be slightly increased ( [32](#) ).

**MORPHOLOGIC FEATURES** The erythrocytes usually are normocytic and normochromic; however, hypochromia and microcytosis may be observed. In older series, microcytosis [mean corpuscular volume (MCV) <80 fl] was observed in 2 to 8% of patients with anemia of chronic disease ( [16](#), [35](#), [36](#) ); however, other more recent studies report a frequency of 20 to 40% ( [8](#), [30](#) ). Hypochromia (mean corpuscular hemoglobin concentration, 26 to 32 g/dl) is more common than microcytosis. In various series, hypochromia was observed in 23 to 50% of patients with chronic infection, 50 to 100% of patients with rheumatoid arthritis, and 44 to 64% of patients with cancer ( [2](#), [30](#) ). Overall, it is observed in 40 to 70%

of patients with the anemia of chronic disease ( [8](#), [9](#), [16](#), [35](#), [36](#) ). Hypochromia may be observed even though the hematocrit remains within normal limits ( [12](#) ). Microcytosis in anemia of chronic disease is usually not as striking as that commonly associated with iron deficiency anemia; values for MCV below 72 fl are rare ( [2](#), [30](#) ). Another distinction from iron deficiency is that hypochromia typically precedes microcytosis in anemia of chronic disease but typically follows the development of microcytosis in iron deficiency ( [2](#) ). Slight anisocytosis and poikilocytosis may be detected, but such changes tend to be less prominent than in iron-deficient subjects. Routine examination of the blood smear rarely reveals specific morphologic abnormalities. The width of the erythrocyte size distribution curve (red cell distribution width) is typically elevated to a moderate degree.

**IRON METABOLISM** Characteristically, serum iron concentration is decreased, total iron-binding capacity (or serum transferrin concentration) is reduced, and transferrin saturation is subnormal ( [2](#), [36](#) ). In patients with infection, hypoferrremia develops early in the course of the illness, often within 24 hours, and is observed even in acute, self-limited febrile diseases or after experimentally induced fever in humans or animals ( [7](#), [11](#), [37](#), [38](#) ). When the infection is of short duration, the serum iron returns to normal, and anemia does not develop; in prolonged illnesses, the serum iron level remains low as long as the disease is active. When the disorder subsides, anemia often is relieved before the serum iron level returns to normal. The degree of hypoferrremia is related to the severity of the underlying illness ( [15](#), [16](#), [36](#) ). In bone marrow aspirates stained for iron, the number of sideroblasts is reduced to 5 to 20% of the total quantity of normoblasts (normal, 30 to 50%). In contrast, the amount of hemosiderin within macrophages usually is increased; exceptions probably represent cases complicated by iron deficiency ( [2](#) ). Serum ferritin levels are useful indicators of iron status in patients without underlying chronic disorders. In patients with anemia of chronic disease, however, the serum ferritin level indicative of adequate reticuloendothelial iron stores requires upward adjustment. Serum ferritin values usually increase in patients with inflammatory diseases ( [39](#) ), and extreme elevations of serum ferritin may be a nonspecific indicator of significant underlying disease ( [40](#) ). When iron deficiency coexists, the serum ferritin level falls but may not reach values as low as those found in uncomplicated iron deficiency. Values of 60 to 100 µg/L previously suggested as the appropriate lower limit of normal for serum ferritin in chronic inflammation are almost certainly too low ( [41](#), [42](#) and [43](#) ). In a recent single institution experience, all patients with serum ferritin levels below 30 µg/L were iron deficient by marrow examination, as were the majority of hospitalized patients with serum ferritin levels 30 to 100 µg/L and approximately one-third of hospitalized patients with serum ferritin levels between 100 and 200 µg/L ( [Fig. 47.1](#) ) ( [44](#) ). Combining the serum ferritin level with other parameters, such as erythrocyte sedimentation rate and C-reactive protein, did not improve its predictive value ( [45](#) ), although it has been suggested that the combination of serum ferritin with red cell ferritin may be more predictive ( [46](#) ). The recognition of iron deficiency in patients with chronic inflammatory states is not a trivial issue: Iron deficiency contributes to anemia in up to 27% of anemic rheumatoid arthritis patients ( [9](#) ) and probably accounts for periodic reports of successful treatment of “the anemia of chronic disease” with iron preparations ( [47](#) ). A patient with chronic inflammatory disease and a serum ferritin less than 30 µg/L is certainly iron deficient, and a patient with a serum ferritin greater than 200 µg/L is certainly not iron deficient; in other circumstances, certainty can be provided only by examination of a Prussian blue-stained marrow specimen. An elevated serum concentration of soluble transferrin receptors (sTfR) may be able to identify iron-deficient individuals with normal serum ferritin concentrations ( [48](#) ).



**Figure 47.1.** Comparison of serum ferritin levels from iron-deficient and non-iron-deficient patients as identified by bone marrow examination during 1994 to 1995 at the University of Cincinnati Medical Center. Dashed lines indicate the range of normal for the laboratory.

### Other Biochemical Findings

The concentration of free protoporphyrin in the erythrocytes (FEP) tends to be elevated in patients with anemia of chronic disease ( [11](#), [49](#), [50](#)). However, FEP increases more slowly in anemia of chronic disorders than it does in iron deficiency, and it does not become clearly abnormal until significant anemia has developed. It is a test that separates groups of patients with anemia of chronic disease from groups of patients with iron deficiency, but it is not particularly useful in the evaluation of individuals.

A variety of other biochemical changes often are detected in patients with chronic diseases. Many of these changes reflect alteration of levels of particular plasma proteins, often called *acute phase reactants* ( [51](#), [52](#), [53](#), [54](#) and [55](#)). The concentrations of certain plasma proteins, such as fibrinogen, ceruloplasmin, haptoglobin, C-reactive protein, orosomucoid, C3, and amyloid A protein, increase ( [56](#), [57](#) and [58](#)), whereas the concentrations of albumin and transferrin characteristically decrease ( [59](#)). The increase in ceruloplasmin accounts for the increase in serum copper levels often noted in association with chronic diseases ( [2](#), [11](#)). An elevated fibrinogen level is probably the most important factor in the increased sedimentation rate ( [60](#)).

Patients with chronic illness develop accelerated protein catabolism and negative nitrogen balance associated with muscle proteolysis ( [61](#), [62](#) and [63](#)). Over time, this phenomenon can result in muscle wasting, increased urea excretion, weight loss, and growth impairment in children. However, protein catabolism generates amino acids that can be used by the patient as alternative energy sources or to supply substrates for biosynthetic processes related to host response. In this context, it is perhaps relevant that elevated serum levels of tumor necrosis factor (TNF), a cytokine implicated in the pathogenesis of anemia of chronic disease, are noted in patients with significant malnutrition ( [64](#), [65](#)).

### Kinetic Characteristics

Erythrocyte survival is modestly but significantly reduced in patients with anemia of chronic disease. In two studies comparing red cell survival in anemic patients with rheumatoid arthritis to red cell survival in normal individuals, the mean red cell survivals noted were 81 days versus 98 days and 90 days versus 114 days, respectively ( [14](#), [62](#)). In a similar study comparing red cell survivals in ten anemic patients with a variety of chronic inflammatory states to ten normal individuals, the mean values observed were 80 days versus 88 days, respectively ( [63](#)). The usual manifestations of increased blood destruction, such as increases in serum bilirubin values and urobilinogen excretion, are

not typically observed ( [2](#), [64](#) ).

There is little evidence of a compensatory erythropoietic response to this reduction in red cell survival. The reticulocyte count usually is normal or decreased, and little or no erythroid hyperplasia of the marrow is observed. The pathogenetic significance of these findings is discussed in the following section. Kinetic data indicate that anemia develops because the bone marrow fails to increase red cell production sufficiently to compensate for a mild decrease in the lifespan of the red cells ( [2](#), [7](#), [63](#) ). Ferrokinetic studies involving patients with chronic infections ( [65](#), [66](#) ), rheumatoid arthritis ( [67](#) ), and various malignant diseases ( [26](#), [27](#), [33](#) ) reveal that the rate of disappearance of iron from the plasma is rapid, the plasma iron transport rate is normal or slightly increased, the uptake of iron into erythrocytes and the amount of iron turning over through red cells daily are normal or increased, and the fraction of red cells renewed daily is increased ( [2](#) ). When techniques that allow the division of marrow iron turnover (a measure of total erythropoiesis) into red cell iron turnover and ineffective iron turnover were used, marrow iron turnover was normal in patients with anemia of chronic disease ( [14](#), [62](#), [63](#), [68](#) ). Ineffective iron turnover was also normal, or even less than normal, indicating a lack of ineffective erythropoiesis ( [14](#) ). In iron-deficient subjects, ineffective iron turnover is increased, perhaps because of greater stimulation of the marrow.

## Pathogenesis

Efforts to clarify the pathogenesis of anemia of chronic disease have focused on three principal abnormalities: shortened erythrocyte survival, impaired marrow response, and disturbance in iron metabolism. The modest shortening of the erythrocyte survival creates an increased demand for red cell production on the marrow. Normally, the marrow could easily accommodate this demand, but in the setting of anemia of chronic disease, the marrow is unable to respond fully because of a combination of a blunted erythropoietin response, an inadequate progenitor response to erythropoietin, and limited iron availability.

## Cytokines

Anemia of chronic disease is one manifestation of the systemic response to immunologic or inflammatory stress, which results in the production of various cytokines ( [3](#), [69](#) ): The ability to trigger this cytokine response appears to be the common pathogenetic factor shared by the various conditions associated with this anemia syndrome. The central role of these molecules suggests that anemia of chronic disease may be best understood as a cytokine-mediated process ( [5](#) ). The cytokines most often implicated in the pathogenesis of the anemia of chronic disease are TNF ( [70](#), [71](#) and [72](#) ), IL-1 ( [73](#), [74](#) ), and the interferons ( [75](#), [76](#) and [77](#) ), concentrations of which have been reported to be increased in the serum or plasma of patients with disorders associated with anemia of chronic disease ( [75](#), [77](#), [78](#), [79](#) and [80](#) ). Therapeutic administration of TNF or interferon may induce anemia ( [81](#), [82](#) ). IL-6, another cytokine implicated in the inflammatory and immune response ( [83](#), [84](#) ), is a special case. Although increased serum IL-6 is observed in anemic patients with rheumatoid arthritis ( [85](#) ), IL-6 does not suppress erythropoiesis but rather is associated with increased plasma volume; the anemia is therefore dilutional ( [31](#) ). The association of IL-6 with hepatocyte activation may thus explain the dilutional component of the anemia observed in liver disease ( [86](#), [87](#) and [88](#) ).



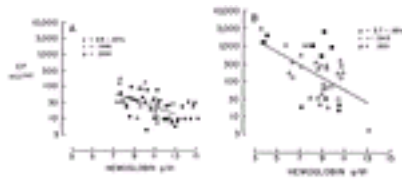
## Shortened Erythrocyte Survival

The rate of survival of cells from patients with arthritis, when transfused into normal subjects, is normal, and the survival of red cells from normal individuals in the circulation of patients with arthritis is less than the normal rate ( [2](#), [35](#) ). Therefore, shortened red cell survival in patients with chronic inflammatory disorders is attributed to an extracorporeal mechanism ( [15](#) ). IL-1 levels and shortened red cell survival are correlated in anemic patients with rheumatoid arthritis ( [89](#) ), and mice that become anemic after exposure to TNF *in vivo* also exhibit a shortened red cell survival ( [90](#) ). The precise mechanism by which this shortened red cell survival is produced remains unclear. Peroxynitrite, derived from the reaction of the cytokine second messenger nitric oxide ( [91](#) ) and superoxide, may contribute to red cell rigidity and thus to decreased survival ( [92](#) ). Neocytolysis, a selective hemolysis of newly formed erythrocytes induced by activated macrophages ( [93](#), [94](#) ), may also play a role in the abnormal red cell survival observed in anemia of chronic disease.

## Impaired Marrow Response

Normal bone marrow, capable of a six- to eightfold increase in the red cell production rate, should easily compensate for such a modest reduction in erythrocyte survival. Its failure to do so in anemia of chronic disease suggests that impaired production capacity is of fundamental importance in the pathogenesis of this condition. The possible defects in erythropoiesis fall into three categories: inappropriately low erythropoietin secretion, diminished marrow response to erythropoietin, and iron-limited erythropoiesis.

An inverse relationship between serum or plasma erythropoietin levels and hemoglobin normally exists: As the hemoglobin decreases, the erythropoietin level rises ( [95](#) ). A similar inverse relationship between hemoglobin and erythropoietin level exists in anemic individuals with rheumatoid arthritis, cancer, and human immunodeficiency virus infection ( [96](#), [97](#), [98](#) and [99](#) ); however, for any given anemic patient in these disease categories, the erythropoietin level was lower than that found in equally anemic individuals with iron deficiency, indicating that the erythropoietin response to anemia was blunted ( [Fig. 47.2](#) ). This impaired erythropoietin response is cytokine-mediated. IL-1, TNF- $\alpha$ , and transforming growth factor- $\beta$  inhibit production of erythropoietin by various hepatoma cell lines and by isolated perfused rat kidneys *in vitro* ( [100](#), [101](#) ). This effect occurs at the messenger RNA level ( [100](#) ). It has been proposed that this inadequate erythropoietin secretion is adaptive; that is, it reflects reduced tissue oxygen use so that normal oxygenation is maintained despite reduced hemoglobin levels. One colorful description of this process is that the "hematologic thermostat has been turned down a bit" ( [7](#) ), perhaps to allow diversion of substrates normally used in erythropoiesis to more immediately critical activities. A model that supports this explanation is the "euthyroid sick syndrome," in which serum triiodothyronine levels are reduced without evidence of clinical hypothyroidism because of decreased conversion of thyroxine to triiodothyronine in peripheral tissues ( [102](#), [103](#) and [104](#) ). These findings provide a basis for reduced oxygen consumption at the tissue level. However, changes that ordinarily signify erythrocyte adaptation to tissue hypoxia such as increased erythrocyte 2,3-diphosphoglycerate levels are observed in anemia of chronic disease ( [105](#) ). Hemoglobin oxygen affinity is also slightly decreased in these patients but overlaps the range observed in normal subjects ( [105](#) ).



**Figure 47.2.** Relationship between the logarithm of serum immunoreactive erythropoietin (EP) and the hemoglobin concentration in 54 patients with rheumatoid arthritis (A) and in 41 anemic patients without rheumatoid arthritis (B). In (A), anemic patients with deficient or replete marrow iron stores are indicated by open triangles and solid triangles, respectively. In (B), the 25 patients with simple iron deficiency anemia are indicated by open triangles. The nine patients with anemia and an associated malignancy or chronic inflammatory disease are indicated by circles—solid for those who were iron replete and open for those who had concomitant iron deficiency. (From Baer AN, Dessypris EN, Goldwasser E, et al. Blunted erythropoietin response to anaemia in rheumatoid arthritis. *Br J Haematol* 1987;66:559–564, with permission.)

Although the erythropoietin levels of patients with anemia of chronic disease are lower than those observed in equally anemic iron-deficient individuals, they are still higher than are observed in normal individuals who are not anemic. This implies that inhibition of erythropoietin production cannot entirely account for the impaired erythropoiesis associated with anemia of chronic disease, and that the erythroid progenitors themselves exhibit an abnormal response to erythropoietin. Studies of anemic cancer patients support this concept ( [106](#) , [107](#) ).

TNF, IL-1, and interferon have all been reported to inhibit erythropoiesis *in vivo* and *in vitro* ( [80](#) , [82](#) , [108](#) , [109](#) , [110](#) , [111](#) , [112](#) , [113](#) , [114](#) , [115](#) and [116](#) ). TNF inhibits *in vitro* colony formation by human erythroid colony-forming units (CFU-E) indirectly, through soluble factors released from marrow accessory cells in response to TNF. The identity of the required accessory cells is unknown at present; cell-mixing studies imply that it is neither a lymphocyte nor a monocyte ( [117](#) ). Inhibition of CFU-E colony formation by TNF was ablated by neutralizing antibodies to interferon- $\beta$ , which itself has direct inhibitory effects; however, insufficient quantities of interferon- $\beta$  were produced in response to TNF to entirely account for the inhibition observed ( [118](#) ). The inhibitory effect of rhIL-1 on human CFU-E colony formation was also indirect and dependent on marrow accessory cells; however, the responsible accessory cells in this case were T lymphocytes, and the mediator was interferon- $\gamma$ , which also exhibits a direct inhibitory effect on human CFU-E ( [119](#) ). Although interferon- $\alpha$  and interferon- $\beta$  share a common receptor, interferon- $\alpha$  does not exert a direct inhibitory effect on human CFU-E colony formation. Instead, its effect is mediated through an unidentified soluble factor released by T lymphocytes ( [120](#) ). The inhibitory effects of interferon- $\alpha$  and interferon- $\beta$  exhibit synergy with interferon- $\gamma$  ( [120](#) ). An important point to consider in reviewing the various models for cytokine effects on erythropoiesis is that none of the systems described operates in isolation *in vivo*. Thus, TNF induces IL-1 production by macrophages, IL-1 induces interferon- $\gamma$  production by T lymphocytes, and interferon- $\gamma$  can exhibit positive or negative feedback on production of IL-1 and TNF.

Treatment with recombinant human erythropoietin can correct anemia of chronic disease in many cases. Inhibition of *in vitro* erythroid colony formation by interferon- $\gamma$ , but not interferon- $\alpha$  and interferon- $\beta$ , can be corrected by exposure to high concentrations of erythropoietin ( [120](#) , [121](#) ).

## Abnormal Iron Metabolism

It has been proposed that lack of iron for erythropoiesis contributes to the inadequate marrow response in anemia of chronic disease. Evidence of a functional iron deficiency in this syndrome includes erythrocyte microcytosis, increased FEP ( [11](#), [50](#) ), reduced transferrin saturation ( [36](#) ), and decreased marrow sideroblasts ( [36](#) ).

Ferrokinetic studies have proved confusing. It has been reported that erythroid iron turnover correlated with serum iron levels, permitting a conclusion that marrow proliferation was limited by availability of iron in anemia of chronic disease ( [106](#) ). Other studies found no correlation between marrow iron turnover and serum iron concentration ( [14](#), [62](#), [63](#), [122](#) ).

The major contributor to hypoferrremia in patients with anemia of chronic disease is probably a shift of iron from a transferrin-bound, available state to a ferritin-incorporated storage state. Iron absorption appears to be normal, but iron tends to remain in the mucosal cell and in hepatocytes ( [123](#), [124](#) ). Macrophages, the major site from which iron is obtained for erythropoiesis, also exhibit increased iron storage. Macrophage iron becomes available for erythropoiesis through two mobilization pathways: a rapid pathway, associated with almost immediate return of the iron retrieved from senescent red cells, and a slower pathway, consisting of iron mobilized from storage ( [125](#), [126](#) ). In anemia of chronic disease, the slower pathway predominates, and iron tends to accumulate. This phenomenon probably explains previous studies that demonstrated defective reuse of erythrocyte iron in patients with inflammatory conditions and in animal models of such conditions ( [127](#), [128](#) and [129](#) ).

Apo-ferritin is normally synthesized in response to increased intracellular iron concentration ( [130](#) ). One possibility is that, like acute phase proteins, excess apo-ferritin is made in inflammatory and malignant conditions, and the surplus binds a larger than usual amount of iron entering the cell ( [131](#), [132](#) ). In effect, such a mechanism would divert iron from the rapid to the slow pathway of iron release. Studies of cytokine effects on iron mobilization support this hypothesis. A correlation between the immune activation marker neopterin and increasing ferritin levels in patients with malignancies has been demonstrated, implying that immune activation can alter iron metabolism ( [133](#) ). Rodents injected with recombinant TNF developed a hypoferrremic anemia associated with impaired storage iron release and incorporation into erythrocytes ( [90](#), [134](#) ). It has also been reported that IL-1 increases translation of ferritin messenger RNA and that this additional ferritin could act as a trap for iron that might otherwise be available for erythropoiesis ( [135](#) ). Nitric oxide, which is a common mediator of cytokine effects, has similar effects on ferritin expression ( [136](#), [137](#) ).

The lactoferrin hypothesis ( [138](#) ) is another approach to explaining iron abnormalities in anemia of chronic disease. *Lactoferrin* is a transferrin-like protein found in neutrophil-specific granules ( [139](#), [140](#) ). It is released from the neutrophil during phagocytosis or stimulation by IL-1 ( [141](#) ). At low pH, lactoferrin binds iron more avidly than does transferrin ( [142](#) ). Lactoferrin-bound iron is not immediately available for erythropoiesis ( [143](#) ); rather, it binds to specific receptors on macrophages (particularly in the liver and spleen) and is endocytosed and subsequently incorporated into ferritin ( [23](#), [144](#) ). Thus, lactoferrin transfers iron from its transferrin-bound, circulating state to a

storage state, from which it cannot be rapidly mobilized ( [138](#) ). Definitive experimental confirmation of the lactoferrin hypothesis is not available. One group of investigators found that reducing the available lactoferrin by inducing neutropenia in rats blunted the hypoferremic response to IL-1 ( [145](#) ), but another group found that administration of recombinant IL-1 induced hypoferremia in mice, even in the face of severe neutropenia ( [146](#) ).

Hepcidin, an acute-phase reactant antimicrobial protein produced in the liver, appears to be a key regulator of iron storage and transport and has been proposed as a mediator of the anemia of chronic disease ( [146a](#), [146b](#) and [146c](#) ). Urinary hepcidin excretion is strongly correlated with serum ferritin concentration and is markedly elevated in patients with the anemia of inflammation (defined as anemia with a characteristic clinical setting and an elevated serum ferritin) compared to iron deficient patients ( [146c](#) ). Serum hepcidin concentration is also strongly correlated with serum ferritin concentration, but does not differ when iron deficient patients are compared to those with the anemia of chronic disease (defined as hypoferremia with adequate iron stores) ( [146d](#) ). The apparent discrepancy most likely reflects the different definitions used.

In addition to decreased availability of iron, erythroid progenitors may also be unable to fully use the iron available to them. Erythroblasts from anemic patients with rheumatoid arthritis express fewer surface TfR than do erythroblasts from normal individuals. These TfR also exhibit lower binding affinity for transferrin ( [147](#) ). Furthermore, acute phase reactants, such as  $\alpha_1$ -antitrypsin, impair transferrin binding to erythroblasts and also inhibit transferrin internalization ( [148](#) ). Recombinant human erythropoietin appears to induce a greater level of TfR expression on erythroid cells ( [149](#) ). Circulating sTfR in anemia of chronic disease are most likely of nonerythroid origin ( [150](#) ).

[Figure 47.3](#) summarizes the pathogenetic mechanisms involved in anemia of chronic disease and the role of cytokines in this syndrome ( [151](#) ).



**Figure 47.3.** Schematic diagram representing cytokine effects in the pathogenesis of anemia of chronic disease. Positive regulatory effects are represented by solid lines, and negative regulatory effects are represented by broken lines. IFN, interferon; IL-1, interleukin 1; TNF, tumor necrosis factor. (Modified from Means RT Jr, Krantz SB. Progress in understanding the pathogenesis of the anemia of chronic disease. *Blood* 1992;80:1639-1647.)

## Anemia in Patients with Cancer

Much of the anemia commonly observed in patients with cancer can be attributed to the mechanisms involved in the anemia of chronic disease; however, certain processes unique to malignancy may also contribute. Erythroid precursors may be displaced from marrow by metastatic tumor ( [152](#) ), tumor-induced fibrosis ( [153](#) ), or tumor-associated marrow

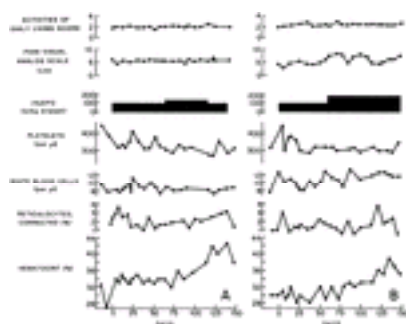
necrosis ( 154 ). The treatment of cancer can also produce or exacerbate anemia by a variety of mechanisms, including impaired erythropoietin production ( 155 ) and cytotoxic effects of therapy on erythroid progenitors ( 156 ).

## Diagnosis

Recent studies suggest that diagnosis of anemia of moderate degree, as is commonly observed in anemia of chronic disease, is often missed ( 157 ). Anemia of chronic disease should be considered in anemic patients with associated inflammatory, infectious, or neoplastic states. As described in [Table 47.1](#) ( 8 ), not all cases are associated with a classic chronic disease, but virtually all cases are associated with states of cytokine or immune activation. The diagnosis is confirmed by demonstrating hypoferrremia with adequate reticuloendothelial iron stores in a patient with an appropriate clinical syndrome. Typically, the serum transferrin is either low or low normal. The major differential diagnosis is iron deficiency anemia. This is not a trivial distinction. The diagnosis of iron deficiency mandates identification of a source of blood loss. Incorrectly labeling a patient with anemia of chronic disease as iron deficient exposes that patient to intrusive and expensive (although fairly safe) diagnostic procedures and to ineffective therapy. Mislabeling an iron-deficient patient as having anemia of chronic disease may result in failure to diagnose an underlying gastrointestinal malignancy at a curable stage and in failure to offer inexpensive and effective therapy. The diagnosis of iron deficiency is discussed in detail in [Chapter 28](#) and in the section [Abnormal Iron Metabolism](#).

## Treatment

The focus of therapy should be on the underlying disorder. The anemia itself is rarely an important clinical problem. Thus, direct approaches to correction of the anemia are rarely necessary. Less than 30% of patients have hematocrits sufficiently low to necessitate transfusion, and assessment of the symptomatic state should always be considered before administration of blood products. Recombinant erythropoietin is effective and safe but expensive ( [Fig. 47.4](#) ) ( 158 , 159 and 160 ). Because most patients were not symptomatic from their anemia, symptomatic benefit was rarely reported in the initial studies ( 158 , 159 ). Subsequent studies using more sophisticated evaluation instruments have reported increased quality of life in anemic patients with rheumatoid arthritis ( 161 ) or cancer ( 162 ) treated with erythropoietin, suggesting that more frequent use may be indicated in anemia of chronic disease. It can also be used for patients who wish to donate blood for autologous transfusion at elective surgery but are too anemic to do so ( 163 ) or to permit autologous blood donation by a patient with anemia of chronic disease and multiple alloantibodies ( 164 ).



**Figure 47.4.** Response to therapy with recombinant human erythropoietin (rHuEPO), as

observed in changes in hematocrit value, reticulocyte count, white blood cell count, arthritis-associated pain, and activities of daily living scores in patient 1 (A) and patient 2 (B). (Reproduced from Means RT, Olsen NJ, Krantz SB, et al. Treatment of the anemia of rheumatoid arthritis with recombinant human erythropoietin: clinical and in vitro studies. *Arthritis Rheum* 1989;32:638–642, with permission.)

It is debated whether or not to routinely administer iron to patients receiving erythropoietin therapy. It is this author's practice to do so. In one study of anemic patients with rheumatoid arthritis, the concurrent use of iron supplementation was a powerful predictor of response to erythropoietin ( [165](#) ); however, many of the patients in this study may have been iron deficient. Although there are reports of correction of anemia of chronic disease by intravenous iron without erythropoietin ( [47](#), [166](#) ), normalization of hemoglobin was only described in patients who were clearly iron deficient ( [47](#) ). Iron therapy by itself is likely to be useful only in patients who have concurrent iron deficiency ( [9](#) ), and then only for the component of anemia caused by iron deficiency. There is no convincing evidence that iron alone corrects anemia of chronic disease per se.

*Darbepoetin* (also called *novel erythropoiesis stimulating protein*) is an erythropoietin analog with modified glycosylation permitting a longer half-life. It has been shown to be effective in anemic patients with cancer (whether receiving chemotherapy or not) and in a cytokine-mediated anemia animal model ( [167](#), [168](#) ). The optimal dosing schedule is not yet established.

## ANEMIA OF CHRONIC RENAL INSUFFICIENCY

Anemia is an almost invariable manifestation of chronic renal failure, often contributing substantially to the morbidity of the condition. It may be considered as typical of the disease as azotemia ( [169](#) ). In the era before the availability of recombinant human erythropoietin, 98% of patients on hemodialysis were anemic ( [170](#) ); even now, 28% of dialysis patients have hematocrit values less than 0.30 ( [171](#) ). The term *anemia of chronic renal insufficiency* refers to that anemia resulting directly from failure of the endocrine and filtering functions of the kidney. The kidney is the major source of erythropoietin, and the ability to secrete this hormone is lost as the kidney fails. In addition, renal failure is associated with other pathologic processes, including some that may inhibit erythropoiesis and others that may shorten erythrocyte survival. Lack of sufficient erythropoietin is by far the most important of these anemia-causing factors; consequently, the hypoproliferative features of the anemia tend to predominate ( [172](#) ).

In clinical settings associated with chronic renal failure, additional factors may also contribute to the development of anemia, but these should be considered complications rather than fundamental components of the anemia of renal insufficiency itself. In the presence of infection or inflammation, anemia of chronic disease is likely to be observed. Iron deficiency anemia (see [Chapter 35](#)) may develop because of blood loss from the gastrointestinal tract or (less frequently) hematuria or from retention of blood in the hemodialysis apparatus tubing ( [172](#), [173](#) ). The megaloblastic anemia of folate deficiency also may occur in patients on dialysis ( [174](#), [175](#) ) but is otherwise uncommon ( [176](#) ). Certain types of renal disease, including the hemolytic-uremic syndrome or thrombotic thrombocytopenic purpura, are associated with microangiopathic hemolytic anemia (see [Chapter 54](#)). Finally, aluminum intoxication can cause microcytic anemia in dialysis



patients ( [177](#) ).

## Clinical Description

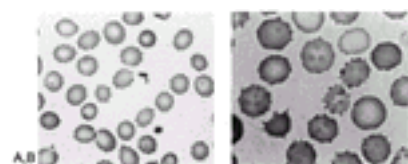
Chronic renal failure occurs during the final stages of several renal diseases. As a rule, the nature of the underlying disease bears little relation to the degree of anemia, although anemia may be less severe in patients with hypertensive renal disease ( [178](#) ) and is considerably less severe in patients with polycystic disease ( [179](#) , [180](#) ). In one series, the mean hematocrit in 12 subjects with polycystic disease was 0.297 as compared with 0.212 in 24 subjects with other types of chronic renal failure ( [179](#) ). Apparently, the erythropoietin-secreting function of the kidney is preserved in polycystic disease—even when filtering function is lost ( [180](#) , [181](#) ). Erythropoietic activity can be found in the cystic fluid and may arise from single interstitial cells juxtaposed to proximal tubular cysts ( [180](#) ).

In most instances, the patient seeks medical attention because of symptoms related to the underlying renal disease, and anemia is an incidental finding. Occasionally, however, the renal symptoms are so subtle and so slowly progressive that the patient cites only symptoms of pallor, exertional dyspnea, or other signs of the cardiovascular adjustment to anemia. The severity of the anemia bears a rough relationship to the degree of renal insufficiency. Anemia is not routinely observed until the creatinine clearance falls below 40 ml/minute, which corresponds roughly to a serum creatinine of 2.0 to 2.5 mg/ml in an average-sized adult. At creatinine clearance rates below that, a statistically significant correlation between creatinine clearance and hematocrit has been reported ( [181](#) , [182](#) ). However, the variation in the results of these studies is so great that one cannot reliably predict the hemoglobin level in an individual patient on the basis of renal function.

## Laboratory Findings

Anemia tends to become more severe as renal failure worsens, but in most patients, the hematocrit ultimately stabilizes between 0.15 and 0.30 ( [2](#) ). Because regulation of body water and electrolyte balance is impaired in renal disease, the apparent degree of anemia may be exaggerated or minimized by alterations in plasma volume.

The erythrocytes usually are normocytic and normochromic, but slight macrocytosis is occasionally observed ( [184](#) ). The majority of red cells appear normal on blood smears. Occasionally, however, “burr” cells ( [Fig. 47.5](#) ) are observed along with some triangular, helmet-shaped, or fragmented cells. The reticulocyte count often is within normal limits ( [185](#) ), but it may be moderately increased ( [184](#) , [186](#) ). In one study, the numbers of reticulocytes were normal when the blood urea nitrogen (BUN) value was less than 130 mg/dl; at higher BUN levels, however, their number often was increased ( [187](#) ). The highest values (average, 6%) were observed with extreme azotemia (BUN, 300 to 350 mg/dl).



**Figure 47.5.** **A:** Crenated cells in renal disease ( $\times 1500$ ). **B:** Burr cells in renal disease ( $\times 3000$ ). See [Color Plate](#).



The leukocyte count typically is normal, but slight neutrophilic leukocytosis may be observed. In one series, the leukocyte count averaged  $10.7 \times 10^9/L$  (185). The platelet count is either normal or slightly increased (185), but platelet function may be severely impaired, resulting in defective hemostasis (see Chapter 58).

The bone marrow tends to be moderately hypercellular, and slight erythroid hyperplasia may be observed. The myeloid to erythroid ratio averaged 2.5:1.0 in one study (185). Erythroid maturation appears morphologically normal. In some instances, especially when renal failure is relatively acute, hypoplasia of erythroid elements is noted (188, 189).

The serum bilirubin level was within normal limits in all of the 26 patients in one series (184). The hemolytic index, a measure of urobilinogen excretion in relation to total circulating hemoglobin, was increased in approximately 40% of patients evaluated (184, 190).

Values for serum iron vary considerably in renal disease (184, 190). As a rule, the value is normal when renal impairment is mild. With more severe disease, some investigators observe a decrease in serum iron levels (191), whereas others note hyperferremia (190, 192). Whether a characteristic disturbance of serum iron concentration is associated with “uncomplicated” renal failure remains to be determined. One group of investigators has reported that the gastrointestinal absorption of iron is reduced in patients with chronic renal failure (193). Other researchers, using a different method, found iron absorption was related to disturbances in iron balance and was unrelated to the degree of anemia, the rate of erythropoiesis, or the degree of azotemia (194). FEP may be normal or moderately increased (184), but the increased values seem to occur only in patients with hypoferremia (195). The erythrocyte lactate dehydrogenase level is within normal limits (196).

The glycosylated fraction ( $A_{1c}$ ) of hemoglobin (the best known component of which is hemoglobin  $A_{1c}$ ) tends to increase in chronic renal failure. In uremic patients who have not undergone dialysis, the hemoglobin  $A_{1c}$  value averaged 10.8% of the total hemoglobin as compared with 7.1% in nonuremic individuals (197). In uremic patients treated with dialysis, the value averaged 8.8%. The increase is thought to result from carbamylation of the hemoglobin molecule by urea-derived cyanate; it can be detected by using column chromatography but not by using certain chemical methods designed for hemoglobin  $A_{1c}$ . The magnitude of the increase usually correlates with the average value for BUN over the preceding 2 to 3 months. The increase in the  $A_{1c}$  fraction may continue after successful renal transplantation has brought the azotemia under control; in this case, the increase might reflect disturbed carbohydrate metabolism (198) and probably reflects hemoglobin  $A_{1c}$ .

## Pathogenesis

It has been known for many years that there are three factors involved in the pathogenesis of anemia of chronic renal failure. These factors are erythropoietin deficiency, suppression of marrow erythropoiesis, and shortened red cell survival (199, 200 and 201). When anemia is severe, ferrokinetic studies typically demonstrate that the plasma iron transport rate is normal, but red cell iron utilization and erythrocyte iron

turnover are decreased ( [172](#), [184](#) ). With milder degrees of anemia, ferrokinetic measurements tend to be near normal. In anemic patients, however, such “normal” values indicate an insufficient marrow response to the stimulus of anemia. The success of recombinant erythropoietin in the treatment of anemia of renal failure has caused the other two factors to receive short shrift in recent years.

As renal function deteriorates, renal erythropoietin secretion decreases ( [183](#), [202](#) ). Measured erythropoietin values may be lower than normal, higher than normal, or normal ( [182](#), [183](#), [202](#), [203](#) ). However, it is important to remember that even the “increased” erythropoietin concentrations observed in this syndrome are still strikingly low for the degree of anemia ( [204](#) ). Overall, the usual relationship between erythropoietin and hemoglobin concentrations is lost, indicating a loss of customary feedback mechanisms ( [181](#) ). Some capacity to induce erythropoietin secretion is preserved, however, because even the very low levels of erythropoietin secretion in renal disease change in response to hemorrhage or transfusion ( [205](#) ). Certain extrarenal sources of erythropoietic hormone account for some of the activity found in serum, especially that found in anephric subjects ( [204](#), [206](#) ). This extrarenal erythropoietin secretion does not, however, appear to increase sufficiently in response to anemia to compensate for deficiencies at the renal source ( [207](#) ). Elegant studies in sheep ( [208](#) ) and subsequent confirmatory studies in patients ( [209](#), [210](#) ) have established the primacy of erythropoietin deficiency in the pathogenesis of anemia of chronic renal failure.

There is also a significant body of data suggesting that the inadequate marrow response to anemia is not solely due to erythropoietin deficiency. The observation that the rate of erythropoiesis improved in patients treated with dialysis even though erythropoietin levels were unchanged ( [186](#), [211](#) ) suggested that retained uremic toxins depress erythropoiesis directly. This field of research has been quite confusing, because not all investigators have been able to confirm the presence of inhibitors or to demonstrate their specificity. Several groups of investigators have shown that plasma from uremic patients can depress heme synthesis ( [212](#) ) or inhibit growth of erythroid colonies *in vitro*, or both ( [213](#), [214](#), [215](#) and [216](#) ). The polyamine spermine and other molecules that accumulate in renal failure have been proposed as candidates ( [214](#), [215](#), [217](#), [218](#) and [219](#) ). Inhibitors of multipotential stem cell (colony-forming unit granulocyte-erythroid-macrophage-megakaryocyte) growth have also been detected in uremic plasma ( [220](#) ), but they are of uncertain pathophysiologic importance ( [214](#) ). Parathyroid hormone, associated with secondary hyperparathyroidism in renal failure patients, may also contribute to marrow suppression ( [221](#) ). The hematocrit increases in approximately one-half of the patients with renal failure who undergo parathyroidectomy, although only to a modest degree ( [222](#), [223](#) and [224](#) ). Some, but not all, investigators suggest that levels of parathyroid hormone similar to those found in the serum of uremic patients depress the growth of erythroid colonies *in vitro* ( [221](#), [225](#), [226](#) and [227](#) ). Hyperparathyroidism may also exert its effects by causing marrow fibrosis ( [222](#), [224](#) ).

In recent studies, Allen and colleagues have demonstrated that inhibition of erythroid colony formation by uremic serum can be abrogated by neutralizing antibodies to TNF and interferon- $\gamma$  ( [28](#) ). These data suggest that cytokine-mediated anemia mechanisms typically associated with anemia of chronic disease may be active in renal failure ( [228](#) ). It is also possible that the excellent response of anemia of renal failure to erythropoietin does not indicate a lack of contributing inhibitors but rather reflects the ability of erythropoietin to overcome an inhibitor, as has been reported for interferon- $\gamma$  ( [120](#) ).

A third pathogenetic factor is hemolysis. Erythrocyte survival, although often within normal limits, may be slightly to moderately reduced ( [229](#) ). Depending on the evaluation technique used, 20 to 70% of uremic patients show shortened red cell survival ( [169](#), [184](#), [186](#), [191](#) ). The extent to which red cell survival is decreased is somewhat related to the degree of azotemia ( [172](#) ). Cross-transfusion studies suggest that the hemolytic factor, when present, is extracorporeal. Survival of normal cells transfused into patients is shortened, whereas patients' cells survive normally in normal recipients ( [169](#), [184](#), [191](#) ). Less commonly, shortened survival of uremic patients' cells is observed even in normal subjects ( [191](#) ). In some patients, splenic sequestration of red cells may be a contributory factor ( [230](#) ).

The hemolytic factor(s) is presumed to be a toxic substance (or substances) normally excreted or metabolized by the kidney. Guanidine and its derivatives appear to be a subset of the many retained metabolites that adversely affect erythrocyte survival ( [231](#), [232](#) ). The hypothetical factor(s) is apparently not dialyzable ( [199](#) ). Peroxidation of membrane lipids by free radicals may also contribute to the shortened survival observed ( [233](#) ).

In approximately 20% of uremic patients not treated with dialysis, the red cell pentose phosphate pathway is impaired as a result of a poorly defined substance in the plasma ( [234](#), [235](#) ). This defect is best detected by using the ascorbate-cyanide test; other tests of pentose phosphate pathway function may yield normal results ( [236](#) ). Administration of glutathione returns the ascorbate-cyanide test to normal ( [233](#) ). Oxidant drugs, such as primaquine or sulfonamides, produce a Heinz body hemolytic anemia in patients with the pentose phosphate pathway defect. Even in the absence of drug exposure, Heinz bodies may be observed in the red cells of uremic patients if they have undergone splenectomy ( [234](#) ). Contamination of dialysate water by chloramines, which inhibit phosphoglyceromutase and thus cause accumulation of glycolytic intermediates, may worsen this defect ( [235](#), [237](#) ).

Cation transport may be impaired in uremic red cells: The defect reverts toward normal after dialysis ( [238](#), [239](#) ). When sensitive measures are used, nearly all patients can be shown to have such an abnormality ( [239](#) ); in those most severely affected, the erythrocyte sodium concentration is increased ( [238](#) ). Considerable disagreement surrounds the nature of the defect, with various investigators reporting abnormalities in cation pump site number or function ( [238](#), [239](#) ) and others reporting the presence (or absence) of soluble, dialyzable inhibitors of pump function ( [240](#), [241](#) and [242](#) ).

Evidence of impaired erythrocyte glycolysis has been found in uremic patients ( [243](#) ); however, in most studies, the overall glycolytic rate is increased ( [244](#), [245](#) ), probably because of the elevation in plasma levels of inorganic phosphorus ( [244](#) ). The increase in the glycolytic rate probably accounts for the observed increase in red cell adenosine triphosphate levels ( [244](#), [245](#) ). Hemoglobin oxygen affinity is reduced ( [246](#) ), presumably because of increased erythrocyte adenosine triphosphate and 2,3-DPG levels. Such abnormalities would not be expected to cause reduced red cell survival.

Neocytolysis, the selective hemolysis of newly formed red cells, has been reported after erythropoietin withdrawal in dialysis patients and may contribute to shortened red cell

survival in dialysis patients ( [93](#) ).

## Management and Course

**RECOMBINANT ERYTHROPOIETIN** Recombinant human erythropoietin has been available for treatment of anemia of renal disease since 1989 and has revolutionized the approach to this disorder. Therapy with this agent is safe and effective, and it substantially improves quality of life and cognitive function ( [247](#), [248](#) ). It is the treatment of choice for anemia in renal insufficiency, being effective in patients receiving peritoneal or hemodialysis ( [209](#), [210](#), [249](#) ). It is equally efficacious in anemia due to renal insufficiency not sufficiently advanced to require dialysis, but in which the creatinine clearance is less than 40 ml/minute or the serum creatinine is greater than 2.5 mg/ml ( [182](#), [183](#), [250](#), [251](#) ). Erythropoietin can be administered intravenously or subcutaneously: The latter route may allow lower total weekly doses ( [252](#) ). Although erythropoietin was originally given three times weekly (to coincide with dialysis schedules), single weekly doses are similarly efficacious if the total weekly dose is increased appropriately ( [253](#) ). A standard starting dose would be 150 U/kg/week, given as a single or divided dose. Higher doses generally result in faster correction of anemia; target hemoglobin is typically attained within 6 to 8 weeks ( [249](#) ). Iron supplementation is necessary, particularly in patients on hemodialysis (discussed in section [Dialysis](#) ). The target hemoglobin/hematocrit range is usually 12 g/dl/0.360; some data suggest that higher levels may have an adverse clinical impact ( [254](#) ).

**Side Effects/Adverse Reactions** As noted earlier, erythropoietin is generally safe. When used for anemia in renal disease, increased blood pressure is an important complication, experienced by up to 35% of patients ( [255](#), [256](#) ). Occasionally, the hypertension is abrupt and severe with encephalopathy and seizures ( [257](#) ). The occurrence of hypertension appears to be more closely related to the rate of increase in the blood hemoglobin level than the dose of recombinant erythropoietin ( [258](#) ). It tends to be a transient phenomenon confined to the first 3 to 6 months of treatment. The pathogenesis is incompletely understood and probably multifactorial ( [258](#) ). Because heart rate, stroke volume, and cardiac output decrease as anemia is corrected, an increase in peripheral vascular resistance may be responsible. Daytime vasoconstriction may be a consequence of reduced plasma volume ( [255](#) ). Left ventricular hypertrophy, an important predictor of cardiac morbidity and mortality in renal patients, tends to decrease by approximately 18% within a year of correction of anemia; this beneficial effect may be diminished by hypertension ( [256](#) ). However, erythropoietin can also contribute to hypertension through direct vasopressor effects, which appear most active in renal insufficiency ( [259](#), [260](#) ). In early studies, prolonged or less effective dialysis ( [261](#), [262](#) ) and increased thrombotic events were thought to be problems associated with erythropoietin treatment, but these concerns were not borne out in a large study ( [249](#) ). Anaphylaxis in response to erythropoietin has been described but is extremely rare ( [263](#) ).

**Erythropoietin Resistance** As mentioned earlier, more than one-fourth of hemodialysis patients have a hematocrit less than 0.30. The failure of patients to respond optimally to erythropoietin therapy or a requirement for unusually high doses is referred to as *erythropoietin resistance*. The possible causes of erythropoietin resistance are listed in [Table 47.2](#).

**TABLE 47.2. Causes of Erythropoietin Resistance**

---

|   |
|---|
| Iron deficiency   |
| Blood loss (in dialysis apparatus, gastrointestinal, genitourinary) |
| Insufficient iron supplementation                                   |

- Concurrent cytokine activation
  - Infection
  - Inflammation
  - Neoplasm
- Insufficient dialysis intensity
- Aluminum toxicity
- Secondary hyperparathyroidism
- Folate deficiency
- Angiotensin-converting enzyme inhibitors
- Renal allograft failure
- Antierythropoietin antibody-mediated resistance
  - Pure red cell aplasia
  - Other
- Splenomegaly

---

Iron deficiency is the most common cause ( [264](#), [265](#) ). Loss of blood in the dialysis apparatus is an important source of iron depletion ( [266](#) ). Most patients require iron supplementation at some time during their course ( [267](#) ). In general, those with serum ferritin levels below 100 to 200 µg/L or with transferrin saturation values less than 20 to 25% ( [265](#), [268](#), [269](#) ) require iron supplementation, but such values may not appear until resistance to recombinant erythropoietin becomes apparent. In another study, patients with serum ferritin values between 100 and 400 µg/ml were as likely to respond to iron replacement as those with serum ferritin less than 100 µg/ml ( [270](#) ). Other investigators found that a low MCV, but not a low serum ferritin, predicted response to iron replacement ( [271](#) ). The best early predictors of erythropoietin response are serum TfRs and serum fibrinogen ( [272](#) ). Response rate approaches 100% when both are low and 29% when both are high, reflecting both the patient's iron status and the presence or absence of inflammation. Some authors recommend routine oral iron supplementation for all patients. However, oral iron administration can be limited by intolerance, so that compliance is relatively poor ( [267](#) ). Consequently, intravenous iron replacement, particularly with iron dextran, is recommended for dialysis patients ( [273](#), [274](#) ). Studies comparing oral versus intravenous iron supplementation generally find that the intravenous replacement group achieves higher hemoglobin levels with less erythropoietin use ( [271](#), [275](#) ). Inadequate hemodialysis is associated with erythropoietin resistance ( [276](#) ). As a general rule, the intensity of dialysis must be sufficient to reduce the BUN by 65% or more to ensure optimal erythropoietin response. Such factors as the frequency and duration of dialysis and characteristics of the dialyzer may need to be adjusted to achieve this goal ( [277](#) ). Mortality is also reduced by attention to dialysis intensity. Rates of reimbursement for dialysis in the United States have discouraged optimal intensity, with the result that mortality is higher there than in Western Europe and Japan. As discussed earlier, secondary hyperparathyroidism often accompanies renal failure, and the associated marrow fibrosis may contribute to the anemia ( [221](#), [222](#), [224](#) ) and to erythropoietin resistance. Treatment with vitamin D<sub>3</sub> can decrease recombinant erythropoietin requirements and improve hemoglobin values ( [278](#) ). Aluminum toxicity may also occur ( [177](#) ) and tends to respond to chelation therapy ( [279](#) ). If erythropoietin resistance is associated with an increased MCV, folate supplementation is warranted ( [174](#) ). Serum folate levels may not be helpful in this situation. In some cases, iron replacement may unmask folate deficiency in dialysis patients ( [271](#) ). Associated infections or inflammatory states, as in anemia of chronic disease, may provoke cytokine-mediated anemia mechanisms. In addition, there are a number of minor etiologies of erythropoietin



resistance. The use of angiotensin-converting enzyme inhibitors in renal failure patients (particularly those undergoing transplantation) may exacerbate erythropoietin resistance ( [280](#), [281](#) ). Splenomegaly may create a requirement for higher erythropoietin dosing: This is resolved by splenectomy ( [230](#) ). Infrequent cases of erythropoietin resistance due to antierythropoietin antibodies, including production of pure red cell aplasia, have been reported ( [282](#), [283](#) ).

***Darbepoetin (Novel Erythropoiesis Stimulating Protein)*** The long-acting erythropoietin analog darbepoetin (novel erythropoiesis stimulating protein) appears to be safe and effective in the anemia of renal failure ( [284](#) ). The recommended starting dose is 0.45 µg/kg/week.

**RENAL REPLACEMENT THERAPY** Renal replacement approaches (transplantation and dialysis) aim to restore or substitute for lost renal function. As such, they may have some effects on anemia associated with renal failure.

***Renal Transplantation*** In many ways, renal transplantation is the most complete and satisfactory treatment for renal insufficiency. With a successful graft, the hematologic response is often striking. Anemia is usually corrected over an 8- to 10-week period ( [285](#), [286](#) and [287](#) ). For the most part, the improvement results from erythropoietin secretion by the grafted kidney. Two peaks of erythropoietin secretion have been documented: an early peak, in which serum erythropoietin levels increase approximately ninefold and then return to normal after approximately 7 days, and a second smaller, more sustained increase in erythropoietin levels, which begins on approximately day 8 and is accompanied by reticulocytosis and a gradual increase in hemoglobin levels. Erythropoietin values return to normal when the hematocrit reaches 0.32. The early peak is seen only in patients with delayed graft function and is not associated with hematologic improvement ( [285](#), [287](#) ). The second peak is associated with recovery of the graft excretory function and is presumed to be the important factor in the hematologic response. Approximately 80% of patients experience an increase in blood hemoglobin concentration after renal allograft ( [286](#) ). Failure to respond usually can be explained on the basis of hemorrhage, vigorous immunosuppression, or graft rejection. The rejection phenomenon often is accompanied transiently by increased erythropoietin levels ( [288](#), [289](#) ), but this is followed by a profound reduction in erythropoietin levels and reticulocyte counts ( [290](#) ). Improvement in erythropoiesis occurs earlier when cyclosporin is used for immunosuppression rather than with antilymphocyte globulin. With the latter, the reticulocyte peak is delayed approximately 2 days. Cyclosporin immunosuppression, however, may be associated with slower correction of the anemia ( [290](#) ). In approximately 20% of transplant patients, erythrocytosis follows correction of the anemia ( [285](#) ). This complication is discussed in [Chapter 49](#) and can sometimes be avoided by pretransplant use of erythropoietin ( [290](#) ).

***Dialysis*** Most patients with end-stage renal disease are maintained on dialysis. As a modality for managing anemia, dialysis has been essentially eclipsed by the availability of erythropoietin and is primarily of interest because the mild increment observed in hemoglobin concentration provides circumstantial evidence for the role of circulating inhibitors. Red cell production increases slightly in patients on hemodialysis, with attendant small increases in hematocrit and decreases in transfusion requirement ( [291](#) ). As a general rule, anemia is less severe in patients receiving peritoneal dialysis, with consequently lower erythropoietin and transfusion requirements ( [292](#), [293](#), [294](#), [295](#), [296](#) and [297](#) ). Increments in hemoglobin in the absence of erythropoietin are gradual and of modest extent: They are accompanied by an increase in red cell mass and a reduction in plasma volume ( [295](#) ). The reasons for the beneficial effects of peritoneal dialysis on erythropoiesis are not firmly established. An increase in erythropoietin production has been reported ( [294](#) ), whereas other data suggest that removal of inhibitors in the “middle molecule” range (500 to 1500 daltons) is the important mechanism ( [298](#) ). In the erythropoietin era, the importance of other treatments for anemia of renal disease, such as androgens or the use of transfusion only, has become of primarily historical interest.

Certainly, the risks of bloodborne infections and of iron overload are significantly increased by the use of transfusion ( [291](#) ).

## ANEMIA IN CIRRHOSIS AND OTHER LIVER DISEASES

Some degree of anemia is commonly observed in patients with liver disease. Although it has been studied most extensively in patients with alcohol-induced cirrhosis (Laënnec cirrhosis), changes in red cell morphology and other contributors to anemia have been observed in various other liver diseases, including biliary cirrhosis ( [299](#) ), hemochromatosis ( [88](#) ), postnecrotic cirrhosis, and acute hepatitis ( [300](#) ). When the term *anemia of liver disease* is used, it refers to the mild to moderate anemia associated with liver disease in the absence of any complicating factors such as blood loss, marrow suppression by exogenous agents, or nutritional deficiency. This syndrome apparently results from a combination of intravascular dilution due to hypervolemia, shortened red cell survival, and impaired ability of the marrow to respond optimally to the anemia. In addition, some patients develop a severe hemolytic anemia associated with morphologically abnormal erythrocytes (spur cells). Hemolytic anemia associated with Wilson disease is discussed in [Chapter 38](#).

The anemia actually observed in patients with liver disease reflects both the “uncomplicated” anemia discussed above and the consequences of factors extrinsic to the liver itself. Alcohol abusers can develop a characteristic sideroblastic anemia, often accompanied by impaired folate metabolism or overt folate deficiency (see [Chapter 43](#)), or may have direct suppression of hematopoiesis by alcohol ( [301](#) ). Individuals with cirrhosis of any etiology are at increased risk for hemorrhage. Blood loss occurs in 24 to 70% of patients with alcoholic cirrhosis ( [88](#) ). The upper gastrointestinal tract is the major site of bleeding, but loss of blood from the nose, hemorrhoids, and uterus often occurs in association with coagulopathy of hepatic origins.

### Prevalence and Clinical Manifestations

Approximately 75% of patients with chronic liver disease develop anemia as defined by a reduction in the hematocrit or hemoglobin level ( [87](#), [88](#), [302](#) ). The whole blood volume in liver disease (especially cirrhosis) averages 10 to 15% greater than normal; thus, hemodilution tends to exaggerate the prevalence and degree of anemia ( [87](#), [88](#), [303](#) ). For the same reason, the hematocrit may be decreased despite a normal red cell mass. The majority of cirrhotic patients are described as anemic, but in only 30 to 40% is the red cell mass reduced ( [87](#), [303](#) ). Patients with more severe liver disease and bleeding tend to have reduced red cell mass ( [88](#) ). The magnitude of the hypervolemia in cirrhosis appears to be related to the degree of portal hypertension, but not to the presence or absence of ascites ( [Table 47.3](#) ).

**TABLE 47.3. Changes in Blood Volume in Patients with Cirrhosis**

| Measurement                | Normal Subjects | Patients with Cirrhosis |              |
|----------------------------|-----------------|-------------------------|--------------|
|                            |                 | Without Ascites         | With Ascites |
| Hematocrit                 | 0.42            | 0.35                    | 0.34         |
| Red cell mass (ml/kg)      | 23              | 20                      | 19           |
| Plasma volume (ml/kg)      | 42              | 57                      | 55           |
| Whole blood volume (ml/kg) | 65              | 74                      | 74           |



NOTE: Values are means of 24 normal subjects, 63 patients with cirrhosis and no ascites, and 34 patients with cirrhosis and ascites. All groups included approximately twice as many men as women.

Data from Lieberman FL, Reynolds TB. Plasma volume in cirrhosis of the liver. J Clin Invest 1967;46:1297–1308, with permission.

---

The anemia is usually mild to moderate. In cirrhotic patients, the hemoglobin level averages around 12 g/dl or the hematocrit around 0.36 ( 88 , 303 ). The hemoglobin level rarely falls below 10 g/dl in the absence of bleeding or severe hemolysis. Approximately 5% of liver disease patients, all of whom have relatively severe hepatocellular disease, develop spur cell hemolytic anemia and hemoglobin concentrations less than 10 g/dl ( 304 ). Spur cell anemia may be seen chronically with cirrhosis, or it may develop rapidly in association with fulminant hepatic failure. Morphologic and hemolytic abnormalities may resolve or diminish if liver function improves. Spur cell anemia can also occur in infants with cholestatic liver disease ( 305 ).

Episodic hemolysis can occur in association with alcoholic liver disease even before cirrhosis ( 306 , 307 ). These episodes are typically related to binge drinking, are usually mild to moderate in severity, and tend to resolve in 2 to 4 weeks if the patient abstains. Splenomegaly is not a major finding in these patients. When accompanied by jaundice and hyperlipidemia, the condition is known as *Zieve syndrome* ( 308 , 309 ). It is unclear whether this transient form of hemolysis in liver disease is a syndrome of discrete and characteristic pathogenesis or simply a coincident constellation of abnormalities to which patients with liver disease are prone anyway. The clinical diagnosis of hemolysis in alcoholic liver disease is problematic in any event, because interruption of alcohol intake is frequently accompanied by reticulocytosis, and liver disease of any etiology may be associated with jaundice.

### Hematologic Findings

More often than not, anemia of liver disease is mildly macrocytic: The MCV rarely exceeds 115 fl in the absence of megaloblastic changes in the bone marrow ( 86 , 87 ). When macrocytosis (particularly with very elevated MCVs) is found in patients with liver disease, complicating folate deficiency or stimulated erythropoiesis must be suspected, but such findings may not explain the macrocytosis observed in patients with milder forms of the disease ( 310 ). The reported proportion of patients with liver disease who have increased MCV varies from 33 to 65% ( 88 , 302 , 311 , 312 ). Even more common is “thin” macrocytosis—an increase in mean cell diameter with a normal mean cell volume. In one study of 222 patients with various kinds of liver disease, the mean cell diameter was increased in 137 (62%) ( 313 ). The patients were classified into three groups: thin macrocytosis (81 patients), target macrocytosis (39 patients), and thick macrocytosis (17 patients). The MCV was increased only in the last group. In a sense, thin macrocytes and target macrocytes are the mirror image of the microspherocytes observed in autoimmune hemolysis. The latter result from a decreased membrane pulled more tightly over a constant volume; the former result from a membrane that is more abundant.

The reticulocyte count often is increased, but this depends on the point in the natural history of disease at which it is measured. In one series, the mean reticulocyte percent of all anemic cirrhotic patients was only 2.8 ( 87 ). However, erythropoiesis can be transiently

After acute alcohol withdrawal, reticulocyte percentages in the blood are commonly elevated (301, 311, 314). Sustained reticulocytosis of 15% or more suggests chronic hemolysis, hemorrhage, spur cell anemia, or other complicating

conditions. Increased diameters are evident on blood smear (Fig. 47.6). The appearance is related to the thinness of the cell membrane and low hemoglobin concentration. These morphologic changes are associated with resistance to hemolysis in osmotic fragility tests (313, 315). In liver disease, anemia supervenes, characteristic acanthocytes—erythrocytes with irregular, thin membrane projections—are evident. The acanthocytes are distinguishable from the distorted erythrocytes found in patients with sickle cell anemia. Acanthocytes are sometimes observed in association with the anemia associated with acute fatty liver disease (316), but they are distinguishable because they display no evidence of hemolysis (307).

**Figure 47.6.** Macrocytes and target cells in liver disease (× 1500). See [Color Plate](#).

Approximately 50% of patients with cirrhosis have mild thrombocytopenia, but values less than  $50 \times 10^9/L$  are uncommon (87, 302). A variety of leukocyte abnormalities may be observed; in a study of 25 patients, 16 had lymphopenia, 4 had neutropenia, and 12 had neutrophilia (302). Severe pancytopenia associated with splenomegaly in liver disease (Banti syndrome) is discussed in the following section.

Bone marrow cellularity is normal or increased (88, 302, 312). Often, erythroid hyperplasia is observed. Red cell precursors at times have been described as *macronormoblasts*, a term that implies their size is increased, but their nuclear chromatin appears normal (302, 312, 317). Frank megaloblastosis is seen in less than 20% of patients.

## Pathogenesis

**SHORTENED ERYTHROCYTE SURVIVAL** Red cell survival is decreased in approximately two-thirds of patients with alcoholic liver disease. The precise extent to which this occurs varies depending on the technique used to measure survival, but it is usually of only moderate degree (87, 88, 300). Shorter survival tends to be observed in more anemic patients. When indirect bilirubinemia is observed in a liver disease patient (elevated total bilirubin with >70% indirect), erythrocyte survival is particularly likely to be reduced (319). Erythrocyte survival also was significantly shortened in patients with biliary cirrhosis (299).

), obstructive jaundice, and infectious hepatitis ( [300](#), [319](#) ), even in the absence of anemia. The mechanism for the observed decrease in red cell lifespan is not fully understood; it is most probably multifactorial. Results of cross-transfusion studies demonstrate improved survival when patients' cells are transfused to normal recipients, suggesting that the hemolytic mechanism is extracorporeal (i.e., not intrinsic to the erythrocyte) ( [318](#) ). Congestive splenomegaly and splenic sequestration are major suspects in this category ( [88](#), [306](#), [311](#), [320](#), [321](#) ), although it cannot always be demonstrated ( [88](#) ). In a few patients, correction of the hemolytic process was noted after splenectomy ( [322](#) ). Abnormal erythrocyte metabolism is a possible intracorporeal factor leading to reduced erythrocyte survival in liver disease. Activity of the methylene blue-stimulated pentose phosphate shunt is decreased, with consequent glutathione instability and a tendency to form Heinz bodies ( [323](#), [324](#) ). This metabolic abnormality renders the cell sensitive to oxidant hemolysis, but whether this form of hemolysis is an important mechanism of shortened erythrocyte survival in liver disease is uncertain, because a comparable shunt defect in most patients with glucose-6-phosphate dehydrogenase deficiency does not lead to hemolysis unless oxidant drugs are encountered. However, oxidant drugs can produce hemolysis in liver disease, as when patients with hepatitis C are treated with ribavirin ( [325](#) ). Another metabolic abnormality encountered occasionally in liver disease is hypophosphatemia, with reduced erythrocyte adenosine triphosphate levels and consequent hemolysis ( [326](#) ). Characteristic alterations in red cell membrane lipids are found in patients with hepatitis, cirrhosis, and obstructive jaundice and may also be another contributor to shortened red cell survival ( [306](#), [315](#), [327](#), [328](#) and [329](#) ). In the usual uncomplicated case, a 25 to 50% increase in both cholesterol and lecithin is noted in the membrane. These changes result in an increased cell-surface area associated with the target cells or thin macrocytes that are so characteristic of liver disease. The loss of sialic acid from the red cell surface may contribute to impaired viability of the cell ( [330](#) ). Bile duct obstruction leads to an increase in the activity of neuraminidases, enzymes that remove sialic acid. However, it is not proven that such abnormalities shorten red cell survival ( [306](#) ). In spur cell hemolytic anemia, the erythrocyte membrane accumulates excess cholesterol without a corresponding increase in lecithin, resulting in the characteristic morphologic abnormality. This change is accompanied by pronounced reduction in erythrocyte survival, probably because the distorted cells are less deformable than normal and thus become trapped by splenic macrophages. Passage through the spleen causes loss of cell surface with transformation of echinocytes to acanthocytes ( [320](#), [331](#) ), but in fact, the spleen is not required for development of spur cells ( [332](#) ). Splenectomy may ameliorate severe hemolysis ( [320](#) ). The mechanism whereby the red cell lipid pattern becomes altered is not well understood. One possible factor is an alteration in the cholesterol to phospholipid ratio in high-density plasma lipoproteins, because mature erythrocytes are unable to synthesize lipids and depend largely on plasma lipids for replenishment ( [333](#) ). In addition, the process of red cell phospholipid repair appears to be defective in spur cell anemia ( [334](#) ). Phospholipid biosynthesis is inhibited and therefore cannot compensate for the increased membrane cholesterol characteristic of liver disease. Other potential contributors to altered erythrocyte membrane lipids in liver disease are changes in plasma lecithin-cholesterol acyltransferase activity, retention of lytic bile acids ( [306](#) ), and an increase in the intrinsic proteolytic activity of the membrane ( [335](#) ). Zieve syndrome has been mentioned in the section [Prevalence and Clinical Manifestations](#). It has been proposed that the transient hemolytic anemia in this syndrome is caused by the lytic action of certain plasma lipids ( [308](#) ). However, hypertriglyceridemia by itself does not cause hemolysis ( [329](#), [336](#) ); erythrocyte lipids in these patients are similar to those described in patients with only a modest hemolytic component ( [329](#) ); and hemolytic anemia may occur in patients with acute fatty liver disease even if plasma triglyceride levels are not increased ( [307](#) ).

Alcohol-induced vitamin E deficiency with decreased polyunsaturated fatty acids in membrane lipids may play a role in some patients (336); similar findings have been reported in vitamin E-deficient children (337).

**ERYTHROPOIESIS** In addition to the shortened erythrocyte survival, the marrow response to the anemia in patients with liver disease may be inadequate. Plasma iron turnover, red cell iron utilization, and erythrocyte iron turnover were normal or reduced in the majority of patients in one series, whereas these parameters were increased two- to threefold in another (88, 338). The presence or absence of complications may explain such discrepancies. Alcohol, in particular, depresses erythropoiesis, and if the patient is studied before the effects of alcohol ingestion subside, marrow function appears depressed (314). Serum from cirrhotic patients can suppress hematopoietic colony formation *in vitro* (339), and cytokines implicated in inhibition of erythropoiesis have been found to be increased in patients with liver disease (340). Dyserythropoiesis with morphologic abnormalities and intramedullary hemolysis has also been reported in severe liver disease (341). It has been suggested that extrarenal erythropoietin by the liver is abnormal in patients with liver disease, but in fact, the expected inverse relationship between hemoglobin and erythropoietin production has been found to be preserved in liver disease and to result in levels appropriate for the degree of anemia (342, 343).

## ANEMIAS ASSOCIATED WITH ENDOCRINE DISORDERS

A mild to moderate anemia commonly accompanies disorders affecting the thyroid, adrenals, parathyroids, gonads, or pituitary. It is usually not associated with symptomatology (other than that associated with the underlying endocrinopathy) and in fact may reflect a physiologically appropriate hemoglobin concentration because the hormone deficiency often results in reduced oxygen requirements. The anemia is therefore “adaptive” (344). In consultative hematology practice, these individuals present as referrals for evaluation of moderate anemia with normal iron, B<sub>12</sub>, and folate studies, generally with a question from the referring doctor of whether marrow examination is required. The endocrine disorder is typically undiagnosed at time of referral.

### Hypothyroidism

Anemia is observed in 21 to 60% of hypothyroid patients and is more common in hypothyroid men than in hypothyroid women (345). The anemia observed may be normocytic and normochromic, hypochromic and microcytic, or macrocytic. The last category comprises roughly one-third of anemic patients in most reported series; the frequency of the other two morphologic types varies considerably in different reports (Table 47.4; 344, 346, 347, 348, and 349).

**TABLE 47.4. Incidence of Various Types of Anemia Morphologies in Patients with Myxedema**

| Type of Anemia           | Reference 348 (%) | Reference 345 (%) |
|--------------------------|-------------------|-------------------|
| Normocytic, normochromic | 4                 | 13.5              |
| Hypochromic, microcytic  | 14                | 4.5               |
| Macrocytic               | 13                | 8                 |
| All anemias              | 31                | 26                |

The uncomplicated anemia of hypothyroidism is either normocytic or slightly macrocytic, as is suggested by the predominance of these findings in most series ( 345, 347, 348 ). Hypochromic microcytic anemia found in association with hypothyroidism should be considered iron deficiency until proven otherwise ( 344, 345, 348 ). Biochemical markers of iron deficiency are present: The anemia responds (at least in part) to iron therapy, even if thyroid hormone is not administered, but does not typically respond to thyroid hormone without iron ( 345 ). Iron deficiency in hypothyroidism may be normocytic, so an important step is to determine the serum iron, transferrin, and ferritin concentrations. Hypothyroid individuals are more likely to become iron deficient because of predisposition to menorrhagia ( 349 ) and achlorhydria ( 348 ) and because thyroid hormone itself may be essential for normal iron absorption ( 345 ). Severely macrocytic anemia usually results from complicating deficiency of vitamin B<sub>12</sub> ( 348 ) or folate ( 347 ).

When patients with iron, folate, or vitamin B<sub>12</sub> deficiency are excluded, the remaining individuals should be considered to have so-called uncomplicated anemia of hypothyroidism, which is a manifestation of the hormone deficiency itself ( 347, 348 ). All or nearly all children with anemia and hypothyroidism have the uncomplicated form of the syndrome ( 350 ). Anemia usually affects children whose height is below the third percentile. The anemia usually is mild, with the hematocrit rarely falling below 0.35. The plasma volume often is decreased, which tends to make the reduction in hematocrit less than might be expected for a given decrease in red cell mass ( 348, 351 ). The degree of anemia is related to both the severity and the duration of the hypothyroidism ( 352 ). The hematocrit declines for as long as 6 months after thyroidectomy in previously euthyroid subjects, even though the basal metabolic rate remains at a stable reduced level.

The MCV may be increased in hypothyroid patients, even in the absence of anemia ( 345 ). Anisocytosis, poikilocytosis, and other red cell morphologic abnormalities are uncommon, but acanthocytes are apparent in approximately 20% of patients ( 344 ). Usually, the leukocyte and platelet counts are within the normal range, although both may be slightly reduced ( 352 ). The bone marrow may be mildly hypoplastic, but the myeloid to erythroid ratio is not significantly altered ( 353, 354 ). Hemoglobin A<sub>2</sub> levels are reduced slightly ( 355 ).

**PATHOGENESIS** The anemia of hypothyroidism results from decreased red cell production. Erythrocyte survival is normal or even slightly prolonged in humans ( 348, 356 ), but plasma iron transport and erythrocyte iron turnover rates are reduced, indicating subnormal red cell production ( 192, 356 ). As noted earlier, the anemia of hypothyroidism is considered “adaptive”—that is, a physiologic adjustment to the reduced needs of the organism for oxygen ( 344 ). Erythropoietin secretion is reduced in hypothyroid patients ( 357 ), and 2,3-DPG levels are not increased ( 358 ) as occurs in most anemias and hypoxic states. Thyroid hormones can enhance erythropoiesis *in vitro* and presumably *in vivo* as well ( 359 ). The observation that the noncalorigenic d-isomer of triiodothyronine can stimulate erythropoiesis without altering oxygen consumption has been cited as evidence of a hormonal effect that is not oxygen dependent ( 360 ). The response of anemia of hypothyroidism to thyroid hormone is gradual. No striking reticulocytosis occurs, and the hematocrit returns to a normal value only gradually over approximately a 6-month period (range, 3 to 12 months) ( 345, 348 ). The MCV almost always decreases, regardless of its initial value or the presence or degree of anemia, and stabilizes after 4 to 6 months or more ( 345 ).

## Hyperthyroidism

A mild anemia with no other apparent etiology occurs in 10 to 25% of patients with hyperthyroidism ( [361](#), [362](#) ). Anemia is primarily observed in individuals with severe or prolonged hyperthyroidism ( [362](#) ). More typically, the hemoglobin value falls somewhat but remains within normal limits ( [361](#) ). The anemia of hyperthyroidism is in many ways the mirror image of that observed in hypothyroidism. MCV is either normal or modestly decreased and, consistent with the comparison to hypothyroidism, may be decreased even in the absence of anemia ( [361](#) ). Hemoglobin A<sub>2</sub> levels are slightly increased but not as much as in thalassemia ( [355](#) ). Both the anemia and the microcytosis are corrected when the hyperthyroidism is successfully treated; on average, the hemoglobin increases 0.5 g/dl, and the MCV increases 6 fl.

The pathogenesis of anemia and microcytosis of hyperthyroidism is not well understood. Plasma volume may be increased, suggesting dilution ( [351](#) ). Erythropoiesis usually is accelerated but ineffective ( [362](#), [363](#) ). Some (but not all) investigators report increased levels of erythrocyte 2,3-DPG ( [358](#), [364](#), [365](#) ). Such a change would reduce oxygen affinity and improve oxygen delivery, thereby compensating for the reduced hemoglobin level. Increased plasma erythropoietin levels have been reported ( [366](#) )—the opposite of what has been described for hypothyroidism.

## Adrenal Insufficiency

Although anemia (in the sense of a decreased red cell mass) is common and probably nearly universal in adrenal insufficiency, it may be masked by the dehydration characteristic of this syndrome ( [367](#), [368](#) ). In a series of patients with untreated Addison disease, the average blood hemoglobin level was 13.2 g/dl (range, 9.4 to 18.0 g/dl) ( [369](#) ). The red cells were normocytic and normochromic. After institution of hormone replacement, the average hemoglobin fell to 10.7 g/dl and the hematocrit from 0.42 to 0.33, presumably reflecting the expansion of plasma volume associated with clinical improvement. Later in the course of the disease, reticulocytosis and a return to normal hemoglobin levels occurred ( [369](#) ). Pernicious anemia is observed in 3 to 16% of cases of nontuberculous adrenal insufficiency and may complicate 13% of adrenal insufficiency cases associated with the polyglandular autoimmune syndrome type I ( [370](#), [371](#) ).

## Androgen Deficiency

After puberty, values for the hematocrit, blood hemoglobin concentration, and red cell count average approximately 10 to 13% higher in men than in women (see [Appendix A](#)). In castrated men, these values fall to within the normal female range ( [372](#), [373](#) ). This is almost certainly due to a difference in erythropoietin production ( [374](#) ), although the relationship between hemoglobin and erythropoietin concentration does not differ between the sexes. After the sixth decade, male hemoglobin values fall back toward those observed in women ( [375](#) ). The anemia in these patients is corrected by androgen replacement.

The differences in red cell parameters between the sexes are accounted for chiefly by the stimulating effect of androgens on erythropoiesis. In addition, some observers suggest that estrogens exert a suppressive effect. Thus, castration of male rats precipitates a decrease in hemoglobin, whereas castration of female rats brings about an increase ( [376](#) ),



377 and 378). The administration of androgens to castrated males restores male values for hemoglobin concentration. Androgens can also stimulate erythropoiesis in normal subjects (see Chapter 50). In normal men, testosterone enanthate induced an average red cell mass increase of 1.7 to 2.3 (379). The increase in hematocrit was of smaller magnitude (from 0.456 to 0.494), probably because the plasma volume also increased. Androgens act by increasing renal synthesis of erythropoietin (372, 380). Estrogens produce anemia when given in large amounts to rats (381, 382). It has been suggested that this effect results from suppression of hepatic synthesis of erythropoietin, but it may also simply represent opposition to androgen effects in general.

## Hypopituitarism

Moderately severe anemia is a well-recognized feature of pituitary insufficiency, regardless of cause. In an extensive review of cases of Simmonds disease in the first half of the twentieth century, the average blood hemoglobin concentration was approximately 10 g/dl, with similar values reported in patients with hypopituitarism that arose from neoplasms (383, 384 and 385). Anemia is also evident in prepubertal pituitary dwarfs but tends to be underappreciated because of contracted plasma volume (386, 387). The anemia usually is normocytic and normochromic, and the red cells appear normal morphologically. In some patients, slight hypochromia or macrocytosis has been observed (384, 388); however, complicating deficiencies of iron or folate were not excluded. Results of kinetic studies demonstrate reduced red cell production (386, 389).

The anemia of hypopituitarism results chiefly from deficiencies of the hormones of target glands controlled by the pituitary, especially the thyroid and adrenal hormones, but also from deficiency of androgens. In addition, lack of other pituitary factors, such as growth hormone (386, 387, 390), prolactin (391), or factors characterized less clearly (392), may be of importance. The interrelations of these various hormones have been studied experimentally in animals, especially the rat. In this species, hypophysectomy results in a moderately severe, slightly hypochromic and microcytic anemia (390, 393) associated with a pronounced decrease in erythroid elements in the bone marrow (394). No hemolysis has been reported. Combined adrenalectomy and thyroidectomy results in an anemia that is similar, but not identical, to that noted after hypophysectomy (390, 395).

As suggested for the anemia of hypothyroidism, panhypopituitarism probably produces its effects on erythropoiesis chiefly by reducing tissue oxygen consumption (390). The organism reacts to this decreased need for oxygen by secreting less erythropoietin, and the red cell mass diminishes until a new equilibrium between oxygen supply and demand is established. This hypothesis is supported by the observations that (a) tissue oxygen consumption is low in the hypophysectomized rat, even if the red cell mass is restored to normal levels (390); (b) once equilibrium is established, the marrow of the hypophysectomized animal responds to hypoxia, bleeding, or cobalt administration (390, 396); (c) correlation between oxygen consumption and rate of erythropoiesis is apparent in hypophysectomized animals given thyroxine or 2,4-dinitrophenol (391); and (d) erythrocyte 2,3-DPG levels, which increase when tissue oxygen delivery is compromised, are normal in patients with panhypopituitarism (387).

Treatment with a combination of thyroxine, cortisone, and growth hormone corrects both the anemia and the marrow hypoplasia (390) and is more effective than any single hormone by itself. In one reported case of panhypopituitarism secondary to craniopharyngioma, anemia persisted and progressed despite replacement hormone



therapy. Administration of recombinant human erythropoietin (6000 IU/day) was followed by correction of the anemia, with the blood hemoglobin level rising from 6 g/dl to normal over a 3-month period ( [397](#) ).

## Hyperparathyroidism

Secondary hyperparathyroidism as a contributor to anemia of renal failure has been discussed earlier. Anemia is a rare complication of primary hyperparathyroidism ( [398](#) ). At one institution, 17 of 332 patients (5.1%) with primary hyperparathyroidism were anemic, with hematocrit values ranging from 0.23 to 0.37 ( [399](#) ). None had leukopenia or thrombocytopenia. The anemia was normocytic and normochromic, and no reticulocytosis was evident. Five patients had bone marrow examinations. Four of these patients had 25% or more of their marrow replaced by fibrosis. Anemic patients appeared to have relatively severe hyperparathyroidism as judged by the presence of bone cysts, subperiosteal bone resorption, and particularly high values for serum calcium, alkaline phosphatase, and parathyroid hormone. The hematocrit increased in all seven patients who underwent parathyroidectomy; in six patients, it became normal ( [399](#) ).

The cause of the anemia in these patients remains obscure. Although renal failure and gastrointestinal bleeding occur in association with hyperparathyroidism, they could not be implicated as an etiologic factor in this group of anemic patients, nor was incidental iron deficiency evident. Some authors conclude that parathyroid hormone decreases proliferation of erythroid precursors in culture ( [221](#) ). Marrow fibrosis may also be a result of excess hormone levels ( [222](#) , [224](#) ). Myelofibrosis is a common finding in bone marrow biopsy specimens, but the usual morphologic signs of myelophthisis are lacking ( [398](#) ).

When hyperparathyroidism is secondary to renal disease, it is difficult to ascertain the relative importance of the hormone excess versus the erythropoietin deficit characteristic of renal failure as a contributor to the observed anemia. Of note, however, is that medical treatment of hyperparathyroidism with vitamin D<sub>3</sub> can bring about improvement in anemia and decreased requirement for erythropoietin in some patients ( [278](#) ).

## Anorexia Nervosa

Anemia is observed in as many as 84% of patients with anorexia nervosa admitted to the hospital ( [400](#) , [401](#) ). A moderate degree of leukopenia or thrombocytopenia may also be observed. The peripheral blood smear shows a striking campsite process, and bone marrow examination shows gelatinous transformation with necrosis, as well as decreased cellularity in most cases ( [400](#) , [401](#) and [402](#) ). These are essentially the findings observed in starvation, and they return to normal with improved nutrition ( [400](#) , [401](#) ).

## REFERENCES

1. Bentley DP. Anaemia and chronic disease. Clin Haematol 1982;11:465.
2. Cartwright GE. The anemia of chronic disorders. Semin Hematol 1966;3:351.
3. Lee GR. The anemia of chronic disease. Semin Hematol 1983;20:61.
4. Schilling RF. Anemia of chronic disease: a misnomer (editorial). Ann Intern Med 1991;115:572.
5. Means RT. Pathogenesis of the anemia of chronic disease: a cytokine-mediated anemia. Stem Cells

1995;13:32–37.

6. Haurani FI, Green D. Primary defective iron reutilization. *Am J Med* 1967;42:151.
7. Cartwright GE, Lee GR. The anaemia of chronic disorders. *Br J Haematol* 1971;21:147.
8. Cash JM, Sears DA. The anemia of chronic disease: spectrum of associated diseases in a series of unselected hospitalized patients. *Am J Med* 1989;87: 638.
9. Baer AN, Dessypris EN, Krantz SB. The pathogenesis of anemia in rheumatoid arthritis: a clinical and laboratory analysis. *Semin Arthritis Rheum* 1990;14:209–223.
10. Miller RK, Altz-Smith M. Usefulness of serum ferritin in detecting iron deficiency in rheumatoid arthritis (RA) (letter). *Arthritis Rheum* 1982;25:S114.
11. Cartwright GE, Wintrobe MM. The anemia of infection. *Adv Intern Med* 1952;5:165.
12. Kyllonen KEJ. Observations concerning the blood volume, red cells and erythropoiesis in patients with lung cancer. *Ann Chir Gynaecol [Suppl]* 1961;101:1.
13. Schiavone DJ, Rubbo SD. Anaemia associated with *Haemophilus influenzae* meningitis. *Lancet* 1953;2:696.
14. Cavill I, Bentley DP. Erythropoiesis in the anaemia of rheumatoid arthritis. *Br J Haematol* 1982;50:583.
15. Freireich EJ, et al. Radioactive iron metabolism and erythrocyte survival studies of the mechanism of the anemia associated with rheumatoid arthritis. *J Clin Invest* 1957;36:1043.
16. Jeffrey MR. Some observations on anemia in rheumatoid arthritis. *Blood* 1953;8:502.
17. Strandberg O. Anemia in rheumatoid arthritis. *Acta Med Scand [Suppl]* 1966;454:1.
18. Hubbard JP, McKee MH. Anemia of rheumatic fever. *J Pediatr* 1939;14:66.
19. Dubois EL, Tuffanelli DL. Disseminated lupus erythematosus. New York: McGraw-Hill, 1966.
20. Gelin LE. Studies in anemia of injury. *Acta Chir Scand [Suppl]* 1956;210:1.
21. Andes WA, Rogers PW, Beason JW, et al. The erythropoietin response to the anemia of thermal injury. *J Lab Clin Med* 1976;88:584.
22. Bauer FK, et al. Red cell survival in primary and metastatic cancer. *Am J Med Sci* 1967;254:842.
23. Friedell GH. Anaemia in cancer. *Lancet* 1965;1:356.
24. Griffin AC, et al. Serum iron levels in patients with malignant disease. *Proc Soc Exp Biol Med* 1965;118:741.
25. Haurani FI, Young K, Tocantins LM. Reutilization of iron in anemia complicating malignant neoplasms. *Blood* 1963;22:73.
26. Hyman GA. Anemia in malignant neoplastic disease. *J Chron Dis* 1963;16:645.
27. Miller A, Chodos RB, Emerson CP, et al. Studies of the anemia and iron metabolism in cancer. *J Clin Invest* 1956;35:1248.
28. Allen DA, Breen C, Yaqoob MM, et al. Inhibition of CFU-E colony formation in uremic patients with inflammatory disease: role of IFN- $\gamma$  and TNF- $\alpha$ . *J Invest Med* 1999;47:204–211.
29. Healey LA, Wilske KR. Presentation of occult giant cell arteritis. *Arthritis Rheum* 1980;23:641–643.
30. Chernow B, Wallner SF. Is the anemia of chronic disorders normocytic–normochromic? *Milit Med*

1978;143:345.

31. Atkins MB, Kappler K, Mier JW, et al. Interleukin-6-associated anemia: determination of the underlying mechanism. *Blood* 1995;86:1288-1291.
32. James GW, Purnell OJ, Evans EI, et al. Studies on prolonged suppurative infection in man. *J Lab Clin Med* 1948;33:1607-1623.
33. Eastgate JA, Wood NC, DiGiovine FS, et al. Correlation of plasma interleukin-1 levels with disease activity in rheumatoid arthritis. *Lancet* 1988;2:706-709.
34. Hyman GA, Harvey JE. The pathogenesis of anemia in patients with carcinoma. *Am J Med* 1955;19:350.
35. Alexander WRM, Richmond J, Roy LMH, et al. Nature of anemia in rheumatoid arthritis. II. Survival of transfused erythrocytes in patients with rheumatoid arthritis. *Ann Rheum Dis* 1956;15:12.
36. Bainton DF, Finch CA. The diagnosis of iron deficiency anemia. *Am J Med* 1964;37:62.
37. Elin RJ, Wolff SM, Finch CA. Effect of induced fever on serum iron and ferritin concentrations in man. *Blood* 1977;49:147-153.
38. Kampschmidt RF, Upchurch HF, Johnson HL. Iron transport after injection of endotoxin in rats. *Am J Physiol* 1965;208:68.
39. Lipschitz DA, Cook JD, Finch CA. A clinical evaluation of serum ferritin as an index of iron stores. *N Engl J Med* 1974;290:1213.
40. Lee MH, Means RT. Extremely elevated serum ferritin levels in a university hospital: associated diseases and clinical significance. *Am J Med* 1995;98:566-571.
41. Hansen NE. The anaemia of chronic disorders. A bag of unsolved questions. *Scand J Haematol* 1983;31:397.
42. Hansen TM, et al. Serum ferritin and the assessment of iron deficiency in rheumatoid arthritis. *Scand J Rheumatol* 1983;12:353.
43. Witte DL. Can serum ferritin be effectively interpreted in the presence of the acute phase response? *Clin Chem* 1991;37:484-485.
44. North M, Dallalio G, Donath AS, et al. Serum transferrin receptor levels in patients undergoing evaluation of iron stores: correlation with other parameters, and observed versus predicted results. *Clin Lab Haematol* 1997;19:93-97.
45. Kurer SB, Seifert B, Michel B, et al. Prediction of iron deficiency in chronic inflammatory rheumatic disease anaemia. *Br J Haematol* 1995;91:820-826.
46. Balaban EP, Sheehan RG, Demian SE, et al. Evaluation of bone marrow iron stores in anemia associated with chronic disease: a comparative study of serum and red cell ferritin. *Am J Hematol* 1993;42:177-181.
47. Auerbach M, Witt D, Toler W, et al. Clinical use of the total dose intravenous infusion of iron dextran. *J Lab Clin Med* 1988;111:566-570.
48. Means RT, Allen J, Sears DA, et al. Serum soluble transferrin receptor and the prediction of marrow aspirate results in a heterogeneous group of patients. *Clin Lab Haematol* 1999;21:161-167.
49. Marsh WL, Koenig HM. The laboratory evaluation of microcytic red blood cells. *CRC Crit Rev Clin Lab Sci* 1982;16:195.
50. Marsh WL Jr, Nelson DP, Koenig HM. Free erythrocyte protoporphyrin (FEP). II. The FEP test is clinically useful in classifying microcytic RBC disorders in adults. *Am J Clin Pathol* 1983;79:661.

51. Dinarello CA. Interleukin-1 and the pathogenesis of the acute-phase response. *N Engl J Med* 1984;311:1413.
52. Kushner I. The phenomenon of the acute phase response. *Ann N Y Acad Sci* 1982;389:39.
53. Bronstein DL. Leukocytic pyrogen: a major mediator of the acute phase reaction. *Ann N Y Acad Sci* 1982;389:323.
54. Morley JJ, Kushner I. Serum C-reactive protein levels in disease. *Ann N Y Acad Sci* 1982;389:406.
55. Lebreton JP, et al. Serum concentration of human alpha-2 HS glycoprotein during the inflammatory process. *J Clin Invest* 1979;64:1118.
56. Kushner I. The acute phase reactants and the erythrocyte sedimentation rate. In: Kelley WN et al., eds. *Textbook of rheumatology*. Philadelphia: WB Saunders, 1981.
57. Baracos V, Rodemann HP, Dinarello CA, et al. Stimulation of muscle protein degradation and prostaglandin E-2 release by leukocytic pyrogen (interleukin-1). *N Engl J Med* 1983;308:553.
58. Beisel WR. Mediators of fever and muscle proteolysis (editorial). *N Engl J Med* 1983;308:586.
59. Clowes GHA Jr, George BC, Vilee CA Jr, et al. Muscle proteolysis induced by a circulating peptide in patients with sepsis or trauma. *N Engl J Med* 1983;308:544.
60. Means RT, Mendenhall CL, Worden BD, et al. Erythropoietin and cytokine levels in the anemia of severe alcoholic liver disease. *Alcohol Clin Exp Res* 1996;20:355-358.
61. Dekaris D, Sabioncello A, Mazuran R, et al. Multiple changes of immunologic parameters in prisoners of war. Assessments after release from a camp in Manjaca, Bosnia. *JAMA* 1993;270:595-599.
62. Dinant HJ, deMaat CEM. Erythropoiesis and mean red-cell lifespan in normal subjects and in patients with the anaemia of active rheumatoid arthritis. *Br J Haematol* 1978;39:437.
63. Cavill I, Ricketts C, Napier JAF. Erythropoiesis in the anaemia of chronic disease. *Scand J Haematol* 1977;19:509.
64. Saifi MF, Vaughan JM. The anemia associated with infection. *J Pathol* 1944;56:189.
65. Bush JA, Ashenbrucker H, Cartwright GE, et al. The anemia of infection. The kinetics of iron metabolism in the anemia associated with chronic infection. *J Clin Invest* 1956;35:89.
66. Haurani FI, Burke W, Martinez EJ. Defective reutilization of iron in the anemia of inflammation. *J Lab Clin Med* 1965;65:560.
67. Dower SK, Urdal DL. The interleukin-1 receptor. *Immunol Today* 1987;8:46.
68. Ricketts C, Jacobs A, Cavill I. Ferrokinetics and erythropoiesis in man: the measurement of effective erythropoiesis, ineffective erythropoiesis and red cell lifespan using 59-Fe. *Br J Haematol* 1975;31:65.
69. Mackaness GB. The monocyte in cellular immunity. *Semin Hematol* 1970;7:172.
70. Beutler B, Cerami A. Cachectin: more than a tumor necrosis factor. *N Engl J Med* 1987;316:379.
71. Brenner MK. Annotation: tumor necrosis factor. *Br J Haematol* 1988;69:149-152.
72. Tracey KJ, Vlassara H, Cerami A. Cachectin/tumor necrosis factor. *Lancet* 1988;1:1122-1125.
73. Durum SK, Schmidt JA, Oppenheim JJ. Interleukin 1: an immunological perspective. *Ann Rev Immunol* 1985;3:263-287.

74. Dinarello CA. Interleukin 1 and its biologically related cytokines. *Adv Immunol* 1989;44:153.
75. Hooks JJ, Moutsopoulos HM, Geis SA, et al. Immune interferon in the circulation of patients with autoimmune disease. *N Engl J Med* 1979;301:5–8.
76. Murray HW. Interferon-gamma, the activated macrophage, and host defense against microbial challenge. *Ann Intern Med* 1988;108:595–608.
77. Vilcek J, Gray PW, Rinderknecht E, et al. Interferon  $\gamma$ : a lymphokine for all seasons. *Lymphokines* 1985;11:1–32.
78. Balkwill F, Burke F, Talbot D, et al. Evidence for tumor necrosis factor/cachectin production in cancer. *Lancet* 1987;2:1229–1232.
79. Mauritz NJ, Holmdahl R, Jonsson R, et al. Treatment with gamma-interferon triggers the onset of collagen arthritis in mice. *Arthritis Rheum* 1988;31:1297–1303.
80. Maury CPJ, Andersson LC, Teppo A-M, et al. Mechanism of anaemia in rheumatoid arthritis: demonstration of raised interleukin 1 $\beta$  concentration in anaemic patients and of interleukin 1 mediated suppression of normal erythropoiesis and proliferation of human erythroleukemia (HEL) cells in vitro. *Ann Rheum Dis* 1988;47:972–978.
81. Blick M, et al. Phase I study of recombinant tumor necrosis factor in cancer patients. *Cancer Res* 1987;47:2986.
82. Vadhan-Raj S, Al-Katib A, Bhulla R, et al. Phase I trial of recombinant interferon gamma in cancer patients. *J Clin Oncol* 1986;4:137–146.
83. Billiau A, et al. Interleukin 6, a ubiquitous cytokine with paracrine as well as endocrine functions. In: Fradelizi D, Bertoglio J, eds. *Lymphokine receptor interactions*. London: John Libby Eurotext Ltd., 1989.
84. Kishimoto T. The biology of interleukin 6. *Blood* 1989;74:1.
85. Vreugdenhil G, Lowenberg B, van Eijk HG, et al. Anaemia of chronic disease in rheumatoid arthritis: raised serum interleukin-6 (IL-6) levels and the effects of IL-6 and anti-IL-6 on in vitro erythropoiesis. *Rheumatol Int* 1990;10:127–130.
86. Hill DB, Marsano L, Cohen D, et al. Increased plasma interleukin-6 concentrations in alcoholic hepatitis. *J Lab Clin Med* 1992;119:547–552.
87. Sheehy TW, Berman A. The anemia of cirrhosis. *J Lab Clin Med* 1960;56:72–82.
88. Kimber C, Deller DJ, Ibbotson RN, et al. The mechanism of anemia in chronic liver disease. *QJM* 1965;133:33–64.
89. Rogers J, Durmowicz G, Kasschau K, et al. A motif within the 5' non-coding regions of acute phase mRNA mediates control of ferritin translation by IL-1 $\beta$  and may contribute to the anemia of chronic disease (abstract). *Blood* 1991;78(Suppl 1):361a.
90. Moldawer LL, Marano MA, Wei H, et al. Cachectin/tumor necrosis factor alters red blood cell kinetics and induces anemia in vivo. *FASEB J* 1989;3:1637–1643.
91. Eiserich JP, Hristova M, Cross CE, et al. Formation of nitric oxide-derived inflammatory oxidants by myeloperoxidase in neutrophils. *Nature* 1998;391:393–397.
92. Deliconstantinos G, Villitou V, Stavrides JC, et al. Nitric oxide and peroxynitrite production by human erythrocytes: a causative factor of toxic anemia in breast cancer patients. *Anticancer Res* 1995;15:1435–1446.
93. Rice L, Alfrey CP, Driscoll T, et al. Neocytolysis contributes to the anemia of renal disease. *Am J Kidney Dis* 1999;33:59–62.

94. Trial J, Rice L, Alfrey CP. Erythropoietin withdrawal alters interactions between young red blood cells, splenic endothelial cells, and macrophages: an in vitro model of neocytolysis. *J Invest Med* 2001;49:335–345.
95. Erslev AJ, Wilson J, Caro J. Erythropoietin titers in anemic, nonuremic patients. *J Lab Clin Med* 1987;109:429–433.
96. Baer AN, Dessypris EN, Goldwasser E, et al. Blunted erythropoietin response to anaemia in rheumatoid arthritis. *Br J Haematol* 1987;66:559–564.
97. Hochberg MC, Arnold CM, Hogans BB, et al. Serum immunoreactive erythropoietin in rheumatoid arthritis: impaired response to anemia. *Arthritis Rheum* 1988;31:1318–1321.
98. Spivak JL, Barnes DC, Fuchs E, et al. Serum immunoreactive erythropoietin in HIV-infected patients. *JAMA* 1989;261:3104–3107.
99. Miller CB, Jones RJ, Piantadosi S, et al. Decreased erythropoietin response in patients with the anemia of cancer. *N Engl J Med* 1990;322:1689–1692.
100. Faquin WC, Schneider TJ, Goldberg MA. Effect of inflammatory cytokines on hypoxia-induced erythropoietin production. *Blood* 1992;79:1987.
101. Jelkmann W, Pagel H, Wolff M, et al. Monokines inhibiting erythropoietin production in human hepatoma cultures and in isolated perfused rat kidneys. *Life Sci* 1991;50:301–308.
102. Chopra IJ, Hershman JM, Pardridge WM, et al. Thyroid function in nonthyroidal illnesses. *Ann Intern Med* 1983;98:946.
103. Erslev AJ, Caro J. Pathophysiology of erythropoietin. In: Dunn CDR, ed. *Current concepts in erythropoiesis*. Chichester: Wiley, 1983.
104. Wartofsky L, Burman KD. Alterations in thyroid function in patients with systemic illness: the “euthyroid sick syndrome.” *Endocr Rev* 1982;3:164.
105. Douglas SW, Adamson JW. The anemia of chronic disorders: studies of marrow regulation and iron metabolism. *Blood* 1975;45:55.
106. Dowlati A, R'zik S, Fillet G, et al. Anemia of lung cancer is due to impaired erythroid marrow response to erythropoietin stimulation as well as relative inadequacy of erythropoietin production. *Br J Haematol* 1997;97:297–299.
107. Carazza F, Beguin Y, Bergmann P, et al. Anemia in children is associated with decreased erythropoietic activity and not with inadequate erythropoietin production. *Blood* 1998;92:1793–1798.
108. Johnson CS, Chang M-J, Furmanski P. In vivo hematopoietic effects of tumor necrosis factor- $\alpha$  in normal and erythroleukemic mice: characterization and therapeutic applications. *Blood* 1988;72:1875.
109. Johnson CS, et al. In vivo hematopoietic effects of recombinant interleukin-1 $\alpha$  in mice. *Blood* 1989;73:678.
110. Johnson RA, et al. Chronic exposure to tumor necrosis factor in vivo preferentially inhibits erythropoiesis in nude mice. *Blood* 1989;74:130.
111. Mamus SW, Beck-Schroeder SK, Zanjani ED. Suppression of normal human erythropoiesis by gamma interferon in vitro: role of monocytes and T-lymphocytes. *J Clin Invest* 1985;75:1496–1503.
112. Maury CPJ. Anaemia in rheumatoid arthritis: role of cytokines. *Scand J Rheumatol* 1987;18:3–5.
113. Raefsky EL, Plataniias LC, Zoumbos NC, et al. Studies of interferon as a regulator of hematopoietic cell proliferation. *J Immunol* 1985;135:2507–2512.
114. Roodman GD, Bird A, Hutzler D, et al. Tumor necrosis factor- $\alpha$  and hematopoietic progenitors: effects of tumor necrosis factor on the growth of erythroid progenitors CFU-E and BFU-E and the

- hematopoietic cell lines K562, HL60, HEL cells. *Exp Hematol* 1987;15:928-935.
115. Sugimoto M, Wakabayashi Y, Hirose S-I, et al. Immunological aspects of the anemia of rheumatoid arthritis. *Am J Hematol* 1987;25:1-11.
116. Tracey KJ, Wei H, Nanogue KR, et al. Cachectin/tumor necrosis factor induces cachexia, anemia, and inflammation. *J Exp Med* 1988;167:1211-1227.
117. Means RT, Dessypris EN, Krantz SB. Inhibition of human colony-forming-unit erythroid by tumor necrosis factor requires accessory cells. *J Clin Invest* 1990;86:538.
118. Means RT, Krantz SB. Inhibition of human erythroid colony-forming units by tumor necrosis factor requires beta interferon. *J Clin Invest* 1993;91:416-419.
119. Means RT, Dessypris EN, Krantz SB. Inhibition of human erythroid colony-forming units by interleukin-1 is mediated by gamma interferon. *J Cell Physiol* 1992;150:59-64.
120. Means RT, Krantz SB. Inhibition of human erythroid colony-forming units by interferons  $\alpha$  and  $\beta$ : differing mechanisms despite shared receptor. *Exp Hematol* 1996;24:204-208.
121. Means RT, Krantz SB. Inhibition of human erythroid colony forming units by gamma interferon can be corrected by recombinant human erythropoietin. *Blood* 1991;78:2564-2567.
122. Al-Ismail S, et al. Erythropoiesis in Hodgkin's disease. *Br J Cancer* 1979;40:365.
123. Hershko C, Cook JD, Finch CA. Storage iron kinetics. VI. The effect of inflammation on iron exchange in the rat. *Br J Haematol* 1974;28:67.
124. Schade SG. Normal incorporation of oral iron into intestinal ferritin in inflammation. *Proc Soc Exp Biol Med* 1972;139:620.
125. Fillet G, Cook JD, Finch CA. Storage iron kinetics. VII. A biologic model for reticuloendothelial iron transport. *J Clin Invest* 1974;53:1527.
126. Lynch SR, et al. Iron and the reticuloendothelial system. In: Jacobs A, Worwood M, eds. *Iron in biochemistry and medicine*. New York: Academic Press, 1974.
127. Esparza I, Brock JH. Release of iron by resident and stimulated mouse peritoneal macrophages following ingestion and degradation of transferrin-antitransferrin immune complexes. *Br J Haematol* 1981;49:603.
128. Freireich EJ, Miller A, Emerson CP, et al. The effect of inflammation on the utilization of erythrocyte and transferrin-bound radioiron for red cell production. *Blood* 1957;12:972.
129. Noyes WD, Bothwell TH, Finch CA. The role of the reticuloendothelial cell in iron metabolism. *Br J Haematol* 1960;6:43.
130. Harrison PM. Ferritin: an iron storage molecule. *Semin Hematol* 1977;14:55.
131. Konijn AM, Hershko C. Ferritin synthesis in inflammation. I. Pathogenesis of impaired iron release. *Br J Haematol* 1977;37:7.
132. Konijn AM, Carmel N, Levy R, et al. Ferritin synthesis in inflammation. II. Mechanism of increased ferritin synthesis. *Br J Haematol* 1981;49:361.
133. Denz H, Fuchs D, Huber P, et al. Association between serum neopterin and ferritin in patients with haematologic neoplasias. *Pteridines* 1990;2:120-124.
134. Alvarez-Hernandez X, Liceaga J, McKay IC, et al. Induction of hypoferremia and modulation of macrophage iron metabolism by tumor necrosis factor. *Lab Invest* 1989;61:319-322.
135. Rogers J, Lacroix L, Durmowicz G, et al. The role of cytokines in the regulation of ferritin expression.



Adv Exp Med Biol 1994;356:127–132.

136. Domachowske JB, Rafferty SP, Singhania N, et al. Nitric oxide alters the expression of gamma-globin, H-ferritin, and transferrin receptor in human K562 cells at the posttranscriptional level. *Blood* 1996;88:2980–2988.
137. Recalcati S, Taramelli D, Conte D, et al. Nitric oxide-mediated induction of ferritin synthesis in J774 macrophages by inflammatory cytokines: role of selective iron regulatory protein-2 downregulation. *Blood* 1998;91:1059–1066.
138. Van Snick JL, Masson PL, Heremans JF. The involvement of lactoferrin in the hyposideremia of acute inflammation. *J Exp Med* 1974;140:1068.
139. Bennett RM, Kokocinski T. Lactoferrin content of peripheral blood cells. *Br J Haematol* 1978;39:509.
140. Lash JA, et al. Plasma lactoferrin reflects granulocyte activation in vivo. *Blood* 1983;61:885.
141. Klempner MS, Dinarello CA, Gallin JJ. Human leukocyte pyrogen induces release of specific granule contents from human neutrophils. *J Clin Invest* 1978;61:1330.
142. Ainscough EW, et al. Studies on human lactoferrin by electron paramagnetic resonance, fluorescence and resonance Raman spectroscopy. *Biochemistry* 1980;19:4072.
143. Brock JH, Esparza I. Failure of reticulocytes to take up iron from lactoferrin saturated by various methods. *Br J Haematol* 1979;42:481.
144. Birgens HS, Hansen NE, Karle H, et al. Receptor binding of lactoferrin by human monocytes. *Br J Haematol* 1983;54:383.
145. Goldblum SE, et al. Interleukin 1-induced depression of iron and zinc: role of granulocytes and lactoferrin. *Am J Physiol (Endocrinol Metab)* 1987;15:E27.
146. Gordeuk VR, et al. Interleukin 1 administration in mice produces hypoferrremia despite neutropenia. *J Clin Invest* 1988;82:1934.
- 146a. Weinstein DA, Roy CN, Fleming MD, et al. Inappropriate expression of hepcidin is associated with iron refractory anemia: implications for the anemia of chronic disease. *Blood* 2002;100:3776–3781.
- 146b. Fleming RE, Sly WS. Hepcidin: a putative iron-regulatory hormone relevant to hereditary hemochromatosis and the anemia of chronic disease. *Proc Natl Acad Sci U S A* 2001;98:8160–8162.
- 146c. Nemeth E, Valore EV, Territo M, et al. Hepcidin, a putative mediator of anemia of inflammation, is a type II acute phase protein. *Blood* 2003;101:2461–2463.
- 146d. Dallalio G, Fleury T, Means RT. Serum hepcidin in clinical specimens. *Br J Haematol* 2003;122:1–5.
147. Feelders RA, Vreugdenhil G, van Dijk JP, et al. Decreased affinity and number of transferrin receptors on erythroblasts in the anemia of rheumatoid arthritis. *Am J Hematol* 1993;43:200–204.
148. Graziadei I, Gaggl S, Kaserbacher R, et al. The acute phase protein  $\alpha$ -1-antitrypsin inhibits growth and proliferation of human early erythroid progenitor cells (burst-forming units-erythroid) and of human erythroleukemic cells (K562) in vitro by interfering with transferrin iron uptake. *Blood* 1994;83:260–268.
149. Weiss G, Houston T, Kastner S, et al. Regulation of cellular iron metabolism by erythropoietin: activation of iron-regulatory protein and upregulation of transferrin receptor expression on erythroid cells. *Blood* 1997;89:680–687.
150. Shinzaki H, Torimoto Y, Nishimura J, et al. Distinct property of soluble transferrin receptors in anemia of chronic disease and chronic hepatitis. *Blood* 2001;98(Suppl):14(abst).
151. Means RT, Krantz SB. Progress in understanding the pathogenesis of the anemia of chronic disease. *Blood* 1992;80:1639–1647.

152. Bezwoda WR, Lewis D, Livini N. Bone marrow involvement in anaplastic small cell lung cancer. Diagnosis, hematologic features, and prognostic implications. *Cancer* 1986;58:1762-1765.
153. Jacobs SC. Spread of prostate cancer to bone. *Urology* 1983;21:337-344.
154. Norgard MJ, Carpenter JT Jr, Conrad ME. Bone marrow necrosis and degeneration. *Arch Intern Med* 1979;139:905-911.
155. Schapira L, Antin JH, Ransil BJ, et al. Serum erythropoietin levels in patients receiving intensive chemotherapy and radiotherapy. *Blood* 1990;76:2354-2359.
156. Gastineau DA, Hoaglund HC. Hematologic effects of chemotherapy. *Semin Oncol* 1992;19:543-550.
157. Self KG, Conrady MM, Eichner ER. Failure to diagnose anemia in medical inpatients. Is the traditional diagnosis of anemia a dying art? *Am J Med* 1986;81:786-790.
158. Means RT, Olsen NJ, Krantz SB, et al. Treatment of the anemia of rheumatoid arthritis with recombinant human erythropoietin: clinical and in vitro studies. *Arthritis Rheum* 1989;32:638-642.
159. Pincus T, Olsen NJ, Russell IJ, et al. Multicenter study of recombinant human erythropoietin in correction of anemia in rheumatoid arthritis. *Am J Med* 1990;89:161-168.
160. Gudbjornsson B, Hallgren R, Wide L, et al. Response of anemia in rheumatoid arthritis to treatment with subcutaneous recombinant human erythropoietin. *Ann Rheum Dis* 1992;51:747-752.
161. Peeters HR, Jongen-Lavrencic M, Bakker CH, et al. Recombinant human erythropoietin improves health-related quality of life in patients with rheumatoid arthritis and anaemia of chronic disease; utility measures correlate strongly with disease activity measures. *Rheumatol Int* 1999;18:201-206.
162. Quirt I, Robeson C, Lau CY, et al. Epoetin alfa therapy increases hemoglobin levels and improves quality of life in patients with cancer-related anemia who are not receiving chemotherapy and patients with anemia who are receiving chemotherapy. *J Clin Oncol* 2001;19:4126-4134.
163. Means RT. Clinical application of recombinant human erythropoietin in the anemia of chronic disease. *Hematol Oncol Clin North Am* 1994;8:933-944.
164. Thompson FL, Powers JS, Graber SE, et al. Use of recombinant human erythropoietin to enhance autologous blood donation in a patient with multiple red cell allo-antibodies and the anemia of chronic disease. *Am J Med* 1991;90:398-400.
165. Nordstrom D, Lindroth Y, Marsal L, et al. Availability of iron and degree of inflammation modifies the response to recombinant human erythropoietin when treating anemia of chronic disease in patients with rheumatoid arthritis. *Rheumatol Int* 1997;17:67-73.
166. Martini A, Ravelli A, Di FG, et al. Intravenous iron therapy for severe anaemia in systemic-onset juvenile chronic arthritis. *Lancet* 1994;344:1052-1054.
167. Smith RE, Jaiyesima IA, Meza LA, et al. Novel erythropoiesis stimulating protein (NESP) for the treatment of the anemia of chronic disease associated with cancer. *Br J Cancer* 2001;84(Suppl 1):24-30.
168. Coccia MA, Cooke K, Stoney G, et al. Novel erythropoiesis stimulating protein (darbepoetin alfa) alleviates anemia associated with chronic inflammatory disease in a rodent model. *Exp Hematol* 2001;10:1201-1209.
169. Desforges JF. Anemia in uremia. *Arch Intern Med* 1970;126:808-811.
170. Charles G, Lundin AP, Delano BG, et al. Absence of anemia in maintenance hemodialysis. *Int J Artif Organs* 1981;4:277-279.
171. End Stage Renal Disease Core Indicators Project. 1997 Annual Report. Baltimore, MD: US Department of Health and Human Services/Health Care Financing Administration, 1997.

172. Adamson JW, Eschbach JW, Finch CA. The kidney and erythropoiesis. *Am J Med* 1968;44:725-733.
173. Carter RA, et al. Iron metabolism in the anaemia of chronic renal failure. *BMJ* 1969;3:206.
174. Hampers CL, Streiff R, Natan DG, et al. Megaloblastic hematopoiesis in uremia and in patients on long term dialysis. *N Engl J Med* 1967;276:551-554.
175. Pronai W, Riegler Keil M, et al. Folic acid supplementation improves erythropoietin response. *Nephron* 1995;71:395-400.
176. Paine CJ, et al. Folic acid binding protein and folate balance in uremia. *Arch Intern Med* 1976;136:756.
177. Touam M, Martinez F, Lacour B, et al. Aluminum induced reversible microcytic anemia in chronic renal failure: clinical and experimental studies. *Clin Nephrol* 1983;19:295-298.
178. Hilden M, Hilden T. Haemoglobin level and renal function in patients with and without hypertension. *Acta Med Scand* 1968;183:183.
179. Chandra M, et al. Serum immunoreactive erythropoietin levels in patients with polycystic disease as compared with other hemodialysis patients. *Nephron* 1985;39:26.
180. Eckardt K-U, et al. Erythropoietin in polycystic kidneys. *J Clin Invest* 1989;84:1160.
181. Pavlovic-Kentera V, Clemons GK, Djukanovic L, et al. Erythropoietin and anemia in chronic renal failure. *Exp Hematol* 1987;15:785.
182. de Klerk G, Wilmink JM, Rosengarten PCJ, et al. Serum erythropoietin (ESF) titers in anemia of chronic renal failure. *J Lab Clin Med* 1982;100:720-734.
183. Radtke HW, Claussner A, Erbes PM, et al. Serum erythropoietin concentration in chronic renal failure: relationship to degree of anemia and excretory renal function. *Blood* 1979;54:877-884.
184. Loge JP, Lange RD, Moore CV. Characterization of the anemia associated with chronic renal insufficiency. *Am J Med* 1958;24:4-18.
185. Callen IR, Limarzi LR. Blood and bone marrow studies in renal disease. *Am J Clin Pathol* 1950;20:3-23.
186. Kurtides ES, et al. Effect of hemodialysis on erythrokinetics in anemia of uremia. *J Lab Clin Med* 1964;63:469.
187. Shaw AB, Scholes MC. Reticulocytosis in renal failure. *Lancet* 1967;1:799-802.
188. Morgan T, et al. The management of the anaemia of patients on chronic haemodialysis. *Med J Aust* 1972;1:848-852.
189. Pasternack A, Wahlberg P. Bone marrow in acute renal failure. *Acta Med Scand* 1967;181:505.
190. Eklund SG, Johansson SV, Strandberg O. Anemia in uremia. Hemolysis evaluated by common methods and application of the bilirubin turnover method. *Acta Med Scand* 1971;190:435-443.
191. Kaye M. The anemia associated with renal disease. *J Lab Clin Med* 1958;52:83.
192. Finch CA, et al. Ferrokinetics in man. *Medicine* 1970;49:17.
193. Boddy K, et al. Iron metabolism in patients with chronic renal failure. *Clin Sci* 1970;39:115.
194. Eschbach JW, Cook JD, Finch CA. Iron absorption in chronic renal disease. *Clin Sci* 1970;38:191-196.
195. London GM, et al. Free erythrocyte protoporphyrin level and nerve conduction velocity in end-stage

renal disease. *BMJ* 1975;4:324.

196. Melissinos K, et al. LDH activity of red cells in chronic renal failure. *Clin Chim Acta* 1972;40:165.
197. Fluckiger R, et al. Hemoglobin carbamylation in uremia. *N Engl J Med* 1981;304:823.
198. Zawada ET, et al. Hemoglobin A<sub>1c</sub> in renal transplant recipients. *Arch Intern Med* 1985;145:82.
199. Eschbach JW, Adamson JW. Anemia of end-stage renal disease. *Kidney Int* 1985;28:1.
200. Fisher J. Mechanism of the anemia of chronic renal failure. *Nephron* 1980;25:106.
201. Sexauer CL, Matson JR. Anemia of chronic renal failure. *Ann Clin Lab Sci* 1981;11:484.
202. McGonigle RJS, Wallin JD, Shaddock RK, et al. Erythropoietin deficiency and inhibition of erythropoiesis in renal insufficiency. *Kidney Int* 1984;25:437.
203. Garcia JF, Ebbe SN, Hollander L. Radioimmunoassay of erythropoietin circulating levels in normal and polycythemic human beings. *J Lab Clin Med* 1982;99:624.
204. Caro JS, et al. Erythropoietin levels in uremic nephric and anephric patients. *J Lab Clin Med* 1979;93:449.
205. Walle AJ, et al. Erythropoietin-hematocrit feedback circuit in the anemia of end-stage renal disease. *Kidney Int* 1987;31:1205.
206. Naets JP, Wittek M. Erythropoiesis in anephric man. *Lancet* 1968;1:941.
207. Zucker S, et al. Erythropoiesis in chronic renal disease. *J Lab Clin Med* 1976;88:528.
208. Eschbach JW, Mladenovic J, Garcia JF, et al. The anemia of chronic renal failure in sheep: response to erythropoietin-rich plasma in vivo. *J Clin Invest* 1984;74:434-441.
209. Eschbach JW, Kelly MR, Haley NR, et al. Treatment of the anemia of progressive renal failure with recombinant human erythropoietin. *N Engl J Med* 1989;321:158-163.
210. Winearls CG, Oliver DO, Pippard MJ, et al. Effect of human erythropoietin derived from recombinant DNA on the anaemia of patients maintained by chronic haemodialysis. *Lancet* 1986;2:1175-1178.
211. Mann DL, et al. Erythropoietin assay and ferrokinetic measurements in anaemic uremic patients. *JAMA* 1965;194:153.
212. Wallner SF, Vantrien RM. The anemia of chronic renal failure. *J Lab Clin Med* 1980;96:67.
213. Freedman MH, Cattran DC, Saunders EF. Anemia of chronic renal failure: inhibition of erythropoiesis by uremic serum. *Nephron* 1983;35:15.
214. Hotta T, et al. Selective inhibition of erythropoiesis by sera from patients with chronic renal failure. *Proc Soc Exp Biol Med* 1987;186:47.
215. Radtke HW, Rege AB, LaMarche MB, et al. Identification of spermine as an inhibitor of erythropoiesis in patients with chronic renal failure. *J Clin Invest* 1981;67:1623-1629.
216. Wallner SF, Vantrien RM, Kurnick JE, et al. The effect of serum from patients with chronic renal failure on erythroid colony growth in vitro. *J Lab Clin Med* 1978;92:370.
217. Spragg BP, Bentley DP, Coles GA. Anaemia of chronic renal failure. Polyamines are not raised in uraemic serum. *Nephron* 1984;38:65.
218. Wallner SF, Vantrien RM. The anemia of chronic renal failure: studies of the effect of organic solvent extraction of serum. *J Lab Clin Med* 1978;92:363.

219. Gutman RA, Huang AT. Inhibitor of marrow thymidine incorporation from sera of patients with uremia. *Kidney Int* 1980;18:715.
220. Delwiche F, Segal GM, Eschbach JW, et al. Hematopoietic inhibitors in chronic renal failure: lack of in vitro specificity. *Kidney Int* 1986;29:641.
221. Potasman I, Better OS. The role of secondary hyperparathyroidism in the anemia of chronic renal failure. *Nephron* 1983;33:229.
222. Barbour GL. Effect of parathyroidectomy on anemia in chronic renal failure. *Arch Intern Med* 1979;139:889.
223. Podjarny E, et al. Is anemia of chronic renal failure related to secondary hyperparathyroidism? *Arch Intern Med* 1981;141:453.
224. Zingraff J, et al. Anemia and secondary hyperparathyroidism. *Arch Intern Med* 1978;138:1650.
225. Meytes D, et al. Effect of parathyroid hormone on erythropoiesis. *J Clin Invest* 1981;67:1263.
226. Delwiche F, et al. High levels of the circulating form of parathyroid hormone do not inhibit in vitro erythropoiesis. *J Lab Clin Med* 1983;102:613.
227. McGonigle RJS, et al. Potential role of parathyroid hormone as an inhibitor of erythropoiesis in the anemia of renal failure. *J Lab Clin Med* 1984;104:1016.
228. Means RT. Commentary: An anemia of chronic disease, after all? *J Invest Med* 1999;47:203.
229. Shaw AB. Hemolysis in chronic renal failure. *BMJ* 1967;2:213.
230. Hartley LCJ, et al. Splenectomy for anaemia in patients on regular hemodialysis. *Lancet* 1971;2:1343.
231. Giovannetti S, Balestri L, Barsotti G. Methylguanidine in uremia. *Arch Intern Med* 1973;131:709.
232. Giovannetti S, Cioni L, Balestri L, et al. Evidence that guanidines and some related compounds cause haemolysis in chronic uremia. *Clin Sci* 1968;34:141.
233. Zachee P, Ferrant A, Daelemans R, et al. Reduced glutathione for the treatment of anemia during hemodialysis: a preliminary communication. *Nephron* 1995;71:343-349.
234. Rosenmund A, et al. Oxidative injury to erythrocytes, cell rigidity and splenic hemolysis in hemodialyzed uremic patients. *Ann Intern Med* 1975;82:460.
235. Yawata Y, et al. Abnormal red cell metabolism causing hemolysis in uremia. *Ann Intern Med* 1973.
236. Monti M. Microcalorimetric measurements of heat production in erythrocytes of patients with chronic uraemia. *Scand J Haematol* 1977;18:154.
237. Eaton JW, et al. Chlorinated urban water: a cause of dialysis-induced hemolytic anemia. *Science* 1973;181:463.
238. Cheng J-T, Kahn T, Kaji DM. Mechanism of alteration of sodium potassium pump of erythrocytes from patients with chronic renal failure. *J Clin Invest* 1984;74:1811.
239. Izumo H, Izumo S, DeLuise M, et al. Erythrocyte Na,K pump in uremia. Acute correction of a transport defect by hemodialysis. *J Clin Invest* 1984;74:581.
240. Gault MH, Vasdev SC, Longrich LL. Endogenous digoxin-like substance(s) and combined hepatic and renal failure. *Ann Intern Med* 1984;101:567.
241. Graves SW, Brown B, Valdes R Jr. An endogenous digoxin-like substance in patients with renal

impairment. *Ann Intern Med* 1983;99:604.

242. Heazlewood VJ, Heazlewood RL, Jellett LB. An endogenous digoxin-like substance and renal failure (letter). *Ann Intern Med* 1984;100:618.

243. Morgan JM, Morgan RE. Study of the effect of uremic metabolism on erythrocyte glycolysis. *Metabolism* 1964;13:629.

244. Lichtman MA, Miller DR. Erythrocyte glycolysis, 2,3-diphosphoglycerate and adenosine triphosphate concentration in uremic subjects: relationship to extracellular phosphate concentration. *J Lab Clin Med* 1970;76:267.

245. Wallas CH. Metabolic studies on red cells from patients with chronic renal disease on haemodialysis. *Br J Haematol* 1974;26:71; 1974;27:145.

246. Mitchell TR, Pegrum GD. The oxygen affinity of haemoglobin in chronic renal failure. *Br J Haematol* 1971;21:463.

247. Temple RM, Deary IJ, Winney RJ. Recombinant erythropoietin improves cognitive function in patients maintained on chronic ambulatory peritoneal dialysis. *Nephrol Dial Transplant* 1995;10:1733-1738.

248. Mayer G, Thum J, Cada EM, et al. Working capacity is increased following recombinant human erythropoietin treatment. *Kidney Int* 1988;34:525-528.

249. Eschbach JW, et al. Recombinant human erythropoietin in anemic patients with end-stage renal disease. *Ann Intern Med* 1989;111:992.

250. Valderrabano F, Madias NE, Schena FP, et al. Erythropoietin in chronic renal failure. *Kidney Int* 1996;50:1373-1391.

251. Branger B, Vecina F, Zabadani B, et al. Subcutaneous erythropoietin administration in predialysis patients: a single centre prospective study. *Nephrol Dial Transplant* 1995;10(Suppl 6):36-39.

252. Kaufman JS, Reda DJ, Fye CL, et al. Subcutaneous compared with intravenous epoetin in patients receiving hemodialysis. *N Engl J Med* 1998;339:578-583.

253. Lago M, Perez-Garcia R, De VMSG, et al. Efficiency of once-weekly subcutaneous administration of recombinant human erythropoietin versus three times a week administration in hemodialysis patients. *Nephron* 1996;72:723-724.

254. Besarab A, Bolton WK, Browne JK, et al. The effects of normal as compared to low hematocrit values in patients with cardiac disease who are receiving hemodialysis and epoetin. *N Engl J Med* 1998;339:347-354.

255. Jones MA, Kingswood JC, Dallyn PE, et al. Changes in diurnal blood pressure variation and red cell and plasma volumes in patients with renal failure who develop erythropoietin-induced hypertension. *Clin Nephrol* 1995;44:193-200.

256. Radermacher J, Koch KM. Treatment of renal anemia by erythropoietin substitution. The effects on the cardiovascular system. *Clin Nephrol* 1995;44(Suppl 1):S56-S60.

257. Beccary M. Seizures in dialysis patients with recombinant erythropoietin. Review of the literature and guidelines for prevention. *Int J Artif Organs* 1994;17:5-13.

258. Kokot F, Wiecek A. Arterial hypertension in uraemic patients treated with erythropoietin [editorial]. *Nephron* 1995;71:127-132.

259. Vaziri ND, Zhou XJ, Smith J, et al. In vivo and in vitro pressor effects of erythropoietin in rats. *Am J Physiol* 1995;268:F838-F845.

260. Hand MF, Haynes WG, Johnstone HA, et al. Erythropoietin enhances vascular responsiveness to norepinephrine in renal failure. *Kidney Int* 1995;48:806-813.

261. Ahmad R, Hand M, Erslev A. Recombinant erythropoietin for the anemia of chronic renal failure (letter). *N Engl J Med* 1987;317:169.
262. Walczyk MH, et al. Correction of the anemia of end-stage renal disease with recombinant human erythropoietin (letter). *N Engl J Med* 1987;317:249.
263. Garcia JE, Senent C, Pascual C, et al. Anaphylactic reaction to recombinant human erythropoietin. *Nephron* 1993;65:636–637.
264. Van Wyck DB, Stivelman JC, Ruiz, et al. Iron status in patients receiving erythropoietin for dialysis associated anemia. *Kidney Int* 1989;35:712–716.
265. Tarng DC, et al. Iron metabolism indices for early prediction of the response and resistance to erythropoietin therapy in maintenance hemodialysis patients. *Am J Nephrol* 1995;15:230–237.
266. Curtis JR, et al. Maintenance haemodialysis. *QJM* 1969;38:49.
267. Wingard RL, et al. Efficacy of oral iron therapy in patients receiving recombinant human erythropoietin. *Am J Kidney Dis* 1995;25:433–439.
268. Kalantar-Zadeh K, et al. Diagnosis of iron deficiency anemia in renal failure patients during the post-erythropoietin era. *Am J Kidney Dis* 1995;26:292–299.
269. Phelps KR. Diagnosis of iron deficiency in dialysis patients [letter]. *Am J Kidney Dis* 1996;27:762–764.
270. Silva J, Andrade S, Ventura H, et al. Iron supplementation in haemodialysis—practical clinical guidelines. *Nephrol Dial Transplant* 1998;13:2572–2577.
271. Pollak VE, Lorch JA, Means RT. Unanticipated favorable effects of correcting iron deficiency in chronic hemodialysis patients. *J Invest Med* 2001;49:173–183.
272. Beguin Y, Loo M, R'Zik S, et al. Early prediction of response to recombinant human erythropoietin in patients with the anemia of renal failure by serum transferrin receptor and fibrinogen. *Blood* 1993;82:2010–2016.
273. Drueke TB, Barany P, Cazzola M, et al. Management of iron deficiency in renal anemia: guidelines for the optimal therapeutic approach in erythropoietin-treated patients. *Clin Nephrol* 1997;48:1–8.
274. Macdougall IC. Strategies for iron supplementation: oral versus intravenous. *Kidney Int* 1999;69:S61–S66.
275. Fishbane S, et al. Reduction in recombinant human erythropoietin doses by the use of chronic intravenous iron supplementation. *Am J Kidney Dis* 1995;26:41–46.
276. Ifudu O, Feldman J, Friedman EA. The intensity of hemodialysis and the response to erythropoietin in patients with end-stage renal disease. *N Engl J Med* 1996;334:420–425.
277. Klahr S. Anemia, dialysis, and dollars (Editorial). *N Engl J Med* 1996;334:461–463.
278. Argiles A, et al. Medical treatment of severe hyperparathyroidism and its influence on anaemia in end-stage renal failure. *Nephrol Dial Transplant* 1994;9:1809–1812.
279. Goch J, Birgegard G, Danielson BG, et al. Treatment of erythropoietin-resistant anaemia with desferrioxamine in patients on haemofiltration. *Eur J Haematol* 1995;55:73–77.
280. Gossmann J, et al. Anemia in renal transplant recipients caused by concomitant therapy with azathioprine and angiotensin-converting enzyme inhibitors. *Transplantation* 1993;56:585–589.
281. Sizeland PC, Bailey RR, Lynn KL, et al. Anemia and angiotensin-converting enzyme inhibition in renal transplant recipients. *J Cardiovasc Pharmacol* 1990;16(Suppl 7):S117–S119.



282. Peces R, De la Torre M, Alcazar R, et al. Antibodies against recombinant human erythropoietin in a patient with erythropoietin-resistant anemia. *N Engl J Med* 1996;335:523-524.
283. Casedevall N, Nataf J, Viron B, et al. Pure red cell aplasia and antierythropoietin antibodies in patients treated with recombinant erythropoietin. *N Engl J Med* 2002;346:469-475.
284. Locatelli F, Olivares J, Walker R, et al. Novel erythropoiesis stimulating protein for treatment of anemia in chronic renal insufficiency. *Kidney Int* 2001;60:741-744.
285. Kessler M. Erythropoietin and erythropoiesis in renal transplantation. *Nephrol Dial Transplant* 1995;10(Suppl 6):114-116.
286. Hoffman GC. Human erythropoiesis following kidney transplantation. *Ann N Y Acad Sci* 1968;149:504.
287. Abbrecht PH, Greene JA Jr. Serum erythropoietin after renal homotransplantation. *Ann Intern Med* 1966;65:908.
288. Sun CH, et al. Serum erythropoietin levels after renal transplantation. *N Engl J Med* 1989;321:151.
289. Murphy GP, et al. Erythropoietin activity in anephric or renal allotransplanted man. *Ann Surg* 1969;170:581.
290. Besarab A, Caro J, Jarrell BE, et al. Dynamics of erythropoiesis following renal transplantation. *Kidney Int* 1987;32:526-536.
291. Eschbach JW, Funk D, Adamson J, et al. Erythropoiesis in patients with renal failure undergoing chronic dialysis. *N Engl J Med* 1967;276:653-658.
292. House AA, Pham B, Page DE. Transfusion and recombinant human erythropoietin requirements differ between dialysis modalities. *Nephrol Dial Transplant* 1998;13:1763-1769.
293. Friedman EA. Critical appraisal of continuous ambulatory peritoneal dialysis. *Annu Rev Med* 1984;35:233.
294. Chandra M, et al. Role of erythropoietin in the reversal of anemia of renal failure with continuous ambulatory peritoneal dialysis. *Nephron* 1987;46:312.
295. De Paepe MBJ, Schelstraete KHG, Ringoir SMG, et al. Influence of continuous ambulatory peritoneal dialysis on the anemia of end-stage renal disease. *Kidney Int* 1983;23:744.
296. Steiner RW. Characteristics of the hematocrit response to continuous ambulatory peritoneal dialysis. *Arch Intern Med* 1984;144:728.
297. Zappacosta AF, Caro J, Erslev A. Normalization of hematocrit in patients with end-stage renal disease on continuous ambulatory peritoneal dialysis. *Am J Med* 1982;72:53.
298. McGonigle RJS, Husserl F, Wallin DJ, et al. Hemodialysis and continuous ambulatory peritoneal dialysis effects on erythropoiesis in renal failure. *Kidney Int* 1984;25:430.
299. Hume R, et al. Red cell survival in biliary cirrhosis. *J Clin Pathol* 1970;23:397.
300. Pitcher CS, Williams R. Reduced red cell survival in jaundice and its relation to glutathione metabolism. *Clin Sci* 1963;24:239.
301. Eichner ER. The hematologic disorders of alcoholism. *Am J Med* 1973;54:621-630.
302. Berman L, Axelrod AR, Horan TN, et al. The blood and bone marrow in patients with cirrhosis of the liver. *Blood* 1949;4:511.
303. Lieberman FL, Reynolds TB. Plasma volume in cirrhosis of the liver. *J Clin Invest* 1967;46:1297-1308.

304. Wallner SF, Vantrien RM. Evidence that inhibition of erythropoiesis is important in the anemia of chronic renal failure. *J Lab Clin Med* 1981;97:170.
305. Cynamon HA, Isenberg JN, Gustavson LP, et al. Erythrocyte lipid alterations in pediatric cholestatic liver disease: spur cell anemia of infancy. *J Pediatr Gastroenterol Nutr* 1985;4:542.
306. Cooper RA. Hemolytic syndromes and red cell membrane abnormalities in liver disease. *Semin Hematol* 1980;17:103.
307. Wisloff F, Boman D. Haemolytic anaemia in alcohol abuse. *Acta Med Scand* 1979;205:237.
308. Zieve L. Jaundice, hyperlipemia and hemolytic anemia: a heretofore unrecognized syndrome associated with alcoholic fatty liver and cirrhosis. *Ann Intern Med* 1958;48:471.
309. Martin JC, Ross A, Watson D, et al. A case of Zieve's syndrome presenting with myalgia: not to be confused with polymyalgia rheumatica [letter]. *Br J Rheumatol* 1996;35:495-496.
310. Unger KW, Johnson D Jr. Red blood cell mean corpuscular volume: a potential indicator of alcohol usage in a working population. *Am J Med Sci* 1974;267:281.
311. Jandl J, et al. The anemia of liver disease. *J Clin Invest* 1955;34:390;1956;35:842.
312. Kumar S, et al. The macrocytosis in cirrhosis of the liver. *Acta Haematol (Basel)* 1966;35:30.
313. Bingham J. The macrocytosis of liver disease. *Blood* 1959;14:694.
314. Straus DJ. Hematologic aspects of alcoholism. *Semin Hematol* 1973;10:183.
315. Neerhout RC. Abnormalities of erythrocyte stromal lipids in hepatic disease. *J Lab Clin Med* 1968;71:438; *J Pediatr* 1968;73:364.
316. Douglass CC, Twomey JT. Transient stomatocytosis with hemolysis: a previously unrecognized complication of alcoholism. *Ann Intern Med* 1970;72:159.
317. Nunnally RM, Levine I. Macronormoblastic hyperplasia of the bone marrow in hepatic cirrhosis. *Am J Med* 1961;30:972.
318. Katz R, et al. Red cell survival estimated by radioactive chromium in hepatobiliary disease. *Gastroenterology* 1964;46:399.
319. Felsher BF, et al. Indirect reacting bilirubinemia in cirrhosis: its relation to red cell survival. *Am J Dig Dis* 1968;13:598.
320. Cooper RA, Kimball DB, Durocher JR. Role of the spleen in membrane conditioning and hemolysis of spur cells in liver disease. *N Engl J Med* 1974;290:1279.
321. Subhiyah BW, Al-Hindawi AY. Red cell survival and splenic accumulation of radiochromium in liver cirrhosis with splenomegaly. *Br J Haematol* 1967;13:773.
322. Levey AS. The improving prognosis after kidney transplantation. *Arch Intern Med* 1984;144:2382.
323. Smith JR, Kay NE, Gottlieb AJ, et al. Abnormal erythrocyte metabolism in hepatic disease. *Am J Hematol* 1979;6:313.
324. Smith JR, Kay NE, Gottlieb AJ, et al. Abnormal erythrocyte metabolism in hepatic disease. *Blood* 1975;46:955.
325. Van Vlierbergh H, Delange JR, DeVos M, et al. Factors influencing ribavirin-induced hemolysis. *J Hepatol* 2001;34:911-916.
326. Wolf PL, Koett J. Hemolytic anemia in hepatic disease with decreased erythrocyte adenosine

triphosphate. *Am J Clin Pathol* 1980;73:785.

327. Cooper RA. Lipids of the red cell membrane: normal composition and variability in disease. *Semin Hematol* 1970;7:296.

328. Cooper RA, Jandl JH. Bile salts and cholesterol in the pathogenesis of target cells in obstructive jaundice. *J Clin Invest* 1968;47:809–822.

329. Shohet SB. Hemolysis and changes in erythrocyte membrane lipids. *N Engl J Med* 1972;286:577.

330. Powell LW, LaMont JT, Isselbacher KJ. Haemolysis in experimental cholestasis: possible role of erythrocyte sialic acid. *Gut* 1974;15:794.

331. Shohet SB. “Acanthocytogenesis”—Or how the red cell won its spurs (editorial). *N Engl J Med* 1974;290:1316.

332. Greenberg MS, Choi ESK. Case report: Post-splenectomy spur cell hemolytic anemia. *Am J Med Sci* 1975;269:277.

333. Owen JS, McIntyre N. Erythrocyte lipid composition and sodium transport in human liver disease. *Biochim Biophys Acta* 1978;510:168–176.

334. Allen DW, Manning N. Abnormal phospholipid metabolism in spur cell anemia: decreased fatty acid incorporation into phosphatidylethanolamine and increased incorporation into acylcarnitine in spur cell anemia erythrocytes. *Blood* 1994;84:1283–1287.

335. Olivieri O, Guarini P, Negri M, et al. Increased proteolytic activity of erythrocyte membrane in spur cell anemia. *Br J Haematol* 1988;70:483.

336. Goebel KM, Goebel FD, Schubotz R, et al. Red cell metabolic and membrane features in haemolytic anaemia of alcoholic liver disease (Zieves' syndrome). *Br J Haematol* 1977;35:573.

337. Fernández-Zamorano A, Arnalich F, Codoceo R, et al. Hemolytic anemia and susceptibility to hydrogen peroxide hemolysis in children with vitamin E deficiency and chronic liver disease. *J Med* 1988;19:317–334.

338. Boivin P, et al. L'anemie des cirrhoses. Frequence et mecanisme. *Nouv Rev Fr Hematol* 1961;1:3.

339. Ohki I, Dan K, Kuriya S, et al. A study on the mechanism of anemia and leukopenia in liver cirrhosis. *Jpn J Med* 1988;27:155–159.

340. Tilg H, Wilmer A, Vogel W, et al. Serum levels of cytokines in chronic liver diseases. *Gastroenterology* 1992;103:264–274.

341. Hadnagy C, Laszlo GA. Acquired dyserythropoiesis in liver disease (letter). *Br J Haematol* 1991;78:283.

342. Pirisi M, Fabris C, Falletti E, et al. Evidence for a multifactorial control of serum erythropoietin concentration in liver disease. *Clin Chim Acta* 1993;219:47–55.

343. Means RT, Mendenhall CL, Worden BD, et al. Erythropoietin and cytokine levels in the anemia of severe alcoholic liver disease. *Alcohol Clin Exp Res* 1996;20:355–358.

344. Bomford R. Anemia in myxoedema. *QJM* 1938;7:495.

345. Horton L, et al. The haematology of hypothyroidism. *QJM* 1976;45:101.

346. Green ST, Ng J-P. Hypothyroidism and anaemia. *Biomed Pharmacother* 1986;40:326.

347. Hines JD, et al. Megaloblastic anemia secondary to folate deficiency associated with hypothyroidism. *Ann Intern Med* 1968;68:792.

348. Tudhope GR, Wilson GM. Anaemia in hypothyroidism. *QJM* 1960;29:513.
349. Goldsmith RE. The menstrual pattern in thyroid disease. *J Clin Endocrinol Metab* 1952;12:846.
350. Chu J-Y, et al. Anemia in children and adolescents with hypothyroidism. *Clin Pediatr (Phila)* 1981;20:696.
351. Muldowney FP, et al. The total red cell mass in thyrotoxicosis and myxoedema. *Clin Sci* 1957;16:309.
352. Stern B, Altschule MD. Hematologic studies in hypothyroidism following total thyroidectomy. *J Clin Invest* 1936;15:633.
353. Axelrod AR, Berman L. The bone marrow in hyperthyroidism and hypothyroidism. *Blood* 1951;6:436.
354. Jones RM. Human sternal bone marrow in hyperthyroid and myxedematous states. *Am J Med Sci* 1940;200:211.
355. Kuhn JM, et al. Influence of thyroid status on hemoglobin A<sub>2</sub> expression. *J Clin Endocrinol Metab* 1983;57:344.
356. Kiely JM, et al. Erythrokinetics in myxedema. *Ann Intern Med* 1967;67:533.
357. Nakao K, et al. Anemia due to hypothyroidism. *Isr J Med Sci* 1965;1:742.
358. Zaroulis CG, et al. Red cell 2,3-diphosphoglycerate and oxygen affinity of hemoglobin in patients with thyroid disorders. *Blood* 1978;52:181.
359. Golde DW, Bersch N, Chopra IJ, et al. Thyroid hormones stimulate erythropoiesis in vitro. *Br J Haematol* 1977;37:173-177.
360. Meineke HA, Crafts RC. Evidence for a non-calorigenic effect of thyroxin on erythropoiesis as judged by radioiron utilization. *Proc Soc Exp Biol Med* 1964;117:520.
361. Nightingale S, Vitek PJ, Himsworth RL. The haematology of hyperthyroidism. *QJM* 1978;185:35.
362. Rivlin RS, Wagner HN. Anemia in hyperthyroidism. *Ann Intern Med* 1969;79:507.
363. Donati RM, et al. Ferrokinetics in hyperthyroidism. *Ann Intern Med* 1965;63:945.
364. Miller WW, et al. Oxygen releasing factor in hyperthyroidism. *JAMA* 1970;211:1824.
365. Snyder LM, Reddy WJ. Thyroid hormone control of erythrocyte 2,3-diphosphoglyceric acid concentrations. *Science* 1970;169:879.
366. Das KC, et al. Erythropoiesis and erythropoietin in hypo- and hyperthyroidism. *J Clin Endocrinol Metab* 1975;40:211.
367. Franco-Saenz R. Diseases of the adrenal cortex. In: Mulrow PG, ed. *The adrenal gland*. New York: Elsevier, 1986.
368. Bethune JE. The diagnosis and treatment of adrenal insufficiency. In: DeGroot LJ, ed. *Endocrinology*, 2nd ed. Philadelphia: WB Saunders, 1989.
369. Irvine WJ, Stewart AG, Scart L. A clinical and immunological study of adrenocortical insufficiency (Addison's disease). *Clin Exp Immunol* 1967;1:31.
370. Neufeld M, Maclaren NK, Blizzard RM. Two types of autoimmune Addison's disease associated with different polyglandular autoimmune (PGA) syndromes. *Medicine* 1981;60:355.

371. Baez-Villasenor J, et al. The blood picture in Addison's disease. *Blood* 1948;3:769.
372. Alexanian R. Erythropoietin and erythropoiesis in anemic man following androgens. *Blood* 1969;33:564-572.
373. McCullagh EP, Jones TR. Effect of androgens on the blood count of men. *J Clin Endocrinol* 1942;2:243.
374. Krantz SB, Jacobson LO. Erythropoietin and the regulation of erythropoiesis. Chicago: University of Chicago, 1970.
375. Hawkins VW, Speck E, Leonard VG. Variation of the hemoglobin level with sex and age. *Blood* 1954;9:999.
376. Crafts RC. Effect of hypophysectomy, castration and testosterone propionate on hemopoiesis in the adult male rat. *Endocrinology* 1946;39:401.
377. Gimzell CA, Sjostrand T. The effect of the gonads on the total amount of haemoglobin and blood volume in rats. *Acta Endocrinol (Copenh)* 1956;21:86.
378. Steinglass P, et al. Effect of castration and sex hormones on blood of the rat. *Proc Soc Exp Biol Med* 1941;48:169.
379. Gardner FH, et al. The erythrocythemetic effects of androgens. *Br J Haematol* 1968;14:611.
380. Gordon AS, et al. The renal erythropoietic factor. Relation to sex steroid hormone effects in erythropoiesis. *Proc Soc Exp Biol Med* 1968;129:871; *Endocrinology* 1966;78:325; *Nature* 1965;206:270.
381. Dukes PP, Goldwasser E. Inhibition of erythropoiesis by estrogens. *Endocrinology* 1961;69:21.
382. Piliero SJ, et al. The interrelationships of the endocrine and erythropoietic systems in the rat with special reference to the mechanism of action of estradiol and testosterone. *Ann N Y Acad Sci* 1968;149:336.
383. Escamilla RF, Lasser H. Simmonds' disease. *J Clin Endocrinol* 1942;2:65.
384. Daughaday WD, et al. The effect of endocrinopathies on the blood. *Blood* 1948;3:1342.
385. Grieg HBW, et al. Anemia in hypopituitarism. *S Afr J Lab Clin Med* 1956;22: 52.
386. Jepson JH, McGarry EE. Hemopoiesis in pituitary dwarfs treated with human growth hormone and testosterone. *Blood* 1972;39:238-248.
387. Rodriguez JM, Shahidi NT. Erythrocyte 2,3-diphosphoglycerate in adaptive red cell volume deficiency. *N Engl J Med* 1971;285:479.
388. Summers VK. The anaemia of hypopituitarism. *BMJ* 1952;1:787-790.
389. Degrossi OJ, et al. Erythrokinetic studies in the anemia of thyroid and pituitary insufficiency. In: R Pitt-Rivers, ed. *Advances in thyroid research*. New York: Pergamon Press, 1961:410.
390. Crafts RD, Meinecke HA. Influence of the pituitary on hemopoiesis. *Am J Clin Nutr* 1957;5:453; *Ann N Y Acad Sci* 1959;77:501; *Proc Soc Exp Biol Med* 1959;102:121.
391. Jepson JH, Lowenstein L. Effect of prolactin on erythropoiesis in the mouse. *Blood* 1964;24:726.
392. Lindemann R, Trygstad O, Halvorsen S. Pituitary control of erythropoiesis. *Scand J Haematol* 1969;6:77-86.
393. Berlin NI, Van Dyke DC, Siri WE, et al. The effect of hypophysectomy on the total circulating red cell

volume of the rat. *Endocrinology* 1950;47:429.

394. Bozzini CE. Decrease in the number of erythrocytic elements in the blood forming tissues as the cause of anemia in hypophysectomized rats. *Endocrinology* 1965;77:977.

395. Contopoulos AN, et al. A comparison of the anemia produced by hypophysectomy with that resulting from combined thyroidectomy, adrenalectomy and gonadectomy. *Endocrinology* 1954;55:509.

396. Fisher JW, Crook JJ. Influence of several hormones on erythropoiesis and oxygen consumption in the hypophysectomized rat. *Blood* 1962;19:557.

397. Nomiya J, Shinohara K, Inoue H. Improvement of anemia by recombinant erythropoietin in a patient with postoperative hypopituitarism [letter]. *Am J Hematol* 1994;47:249.

398. Mallette LE. Anemia in hypercalcemic hyperparathyroidism: renewed interest in an old observation. *Arch Intern Med* 1977;137:572.

399. Boxer M, Ellman L, Geller R, et al. Anemia in primary hyperparathyroidism. *Arch Intern Med* 1977;137:588-590.

400. Smith RRL, Spivak JL. Marrow cell necrosis in anorexia nervosa and involuntary starvation. *Br J Haematol* 1985;60:525-530.

401. Mant MJ, Faragher BS. The haematology of anorexia nervosa. *Br J Haematol* 1972;23:737-749.

402. Amrein P, Freidman R, Kosinski K, et al. Hematologic changes in anorexia nervosa. *JAMA* 1979;241:2190-2191.

2004 Lippincott Williams & Wilkins  
John P. Greer, John Foerster, John N. Lukens  
George M. Rodgers, Frixos Paraskevas, Bertil Glader  
Wintrobe's Clinical Hematology

## Anemias Unique to Pregnancy and the Perinatal Period

### ANEMIAS UNIQUE TO PREGNANT WOMEN

[Physiologic Anemia of Pregnancy](#)

[Erythropoietin Biology in the Mother and Fetus](#)

[Iron Deficiency during Pregnancy](#)

[Deficiency of Folate and Other Nutrients during Pregnancy](#)

[Maternal Anemia Associated with Prenatal Infections](#)

[Pregnancy-Induced Hemolytic Anemia](#)

[Postpartum Anemia](#)

### ANEMIA IN THE FETUS AND NEONATE

[Normal Erythrocyte Values during Human Fetal Development](#)

[Fetal and Neonatal Erythrocyte Membrane and Metabolism](#)

[Fetal and Neonatal Anemia due to Hemolysis](#)

[Fetal and Neonatal Anemia due to Hemorrhage](#)

[Fetal and Neonatal Anemia due to Congenital Infection](#)

[Anemia of Prematurity and Other Hypoproliferative Disorders](#)

### REFERENCES

The hematocrit, the hemoglobin concentration, and the erythrocyte count all assess the same basic biologic variable. *Anemia* refers to a pathologic reduction in this variable, to the point where oxygen demands of tissues are not adequately met. However, none of these three laboratory tests actually assess whether oxygen demands of tissues are being adequately met. Therefore, as a practical matter, anemia is generally defined by a hematocrit, hemoglobin concentration, or erythrocyte count below a lower limit of "normal." The precise definition of which values are normal, and therefore which values signify anemia, becomes somewhat complex for a pregnant woman, a fetus, and for a neonate, because the normal values for hematocrit, hemoglobin concentration, and erythrocyte count vary considerably during pregnancy and with fetal and neonatal age.

## ANEMIAS UNIQUE TO PREGNANT WOMEN

### Physiologic Anemia of Pregnancy

Expansion of the plasma volume is the cause of the physiologic anemia of pregnancy ( [Table 48.1](#) ). Expanding the plasma volume reduces the hematocrit, the blood hemoglobin concentration, and the circulating erythrocyte count but does not reduce the absolute amounts of hemoglobin or number of erythrocytes in the entire circulation. The mechanisms underlying these changes are obscure. It has been speculated that the physiologic anemia of pregnancy serves the purpose of reducing maternal blood viscosity, thereby enhancing placental perfusion and facilitating oxygen and nutrient delivery to the fetus. Beginning approximately the sixth week of pregnancy, the plasma volume increases disproportionately to the red cell mass. It generally reaches a maximum value at approximately 24 weeks' gestation ( [1](#) ) but can continue increasing until as late as the 37th week ( [2](#) ). At its peak, the plasma volume is about 40% higher among pregnant women than among nonpregnant women ( [3](#) , [4](#) ). A reduction in the hematocrit, hemoglobin



concentration, and circulating erythrocyte count are usually evident by the seventh to eighth week of pregnancy ([1](#), [4](#), [5](#)), and the reduction continues until the 16th to 22nd week when a new equilibrium is established ([3](#), [6](#)). It has been suggested that a hemoglobin concentration less than 11 g/dl in the late first trimester and less than 10 g/dl in the second and third trimesters are lower limits below which a cause other than the physiologic anemia of pregnancy should be sought. Similar values were reported by Milman et al., studying only iron replete women, where the lowest hemoglobin values in pregnant women were 11.0 g/dl in the first trimester and 10.5 g/dl in the second and third trimesters ([7](#)).

**TABLE 48.1. Features of the Physiologic Anemia of Pregnancy**

---

|   |
|---|
| Plasma volume begins to increase during 6th week of pregnancy   |
| No significant increase in erythrocyte production during the 1st trimester  |
| Dilutional anemia is first apparent by 7th to 8th week  |
| Increase in erythrocyte production apparent during 2nd trimester  |
| Lowest hemoglobin explainable by dilutional effect (the physiologic anemia of pregnancy) is 11 g/dl in 1st trimester; 10 g/dl in 2nd and 3rd trimesters                 |
| Physiologic anemia of pregnancy is normochromic, normocytic, does not worsen during the 3rd trimester, and does not require additional evaluation or specific treatment |

---

During pregnancy, a 15 to 25% increase in the red cell mass generally occurs but is masked by the dilutional effect of the increase in plasma volume ([2](#), [3](#), [5](#)). A greater increase in red cell mass generally occurs if iron supplements are taken ([8](#)). Results of ferrokinetic studies demonstrated accelerated erythropoiesis during pregnancy, supporting the concept of an increase in red cell mass ([9](#), [10](#)). Choi and Pai investigated erythropoiesis during pregnancy among 342 women by examining reticulocyte subpopulations using flow cytometry and also by measuring serum transferrin receptor concentrations ([11](#)). They found no differences between prepregnancy and those during the first and second trimesters. However, during the third trimester of pregnancy, reticulocyte maturity index and serum transferrin receptor concentrations increased twofold. After delivery these values decreased, falling to nonpregnant values about 5 weeks after delivery. They concluded that maternal erythropoiesis increases late in gestation and returns to normal by about 1 month after delivery.

Maternal plasma volume generally decreases during the final weeks of pregnancy, and consequently the hematocrit, hemoglobin, and circulating erythrocyte count increase ([12](#), [13](#)). Measurements of plasma volume made during late pregnancy with the patient supine, as contrasted to the decubitus position, have been criticized because of variable effects of interference with the circulation imposed by the gravid uterus ([2](#)). With this potential pitfall in mind, conflicting reports regarding changes in plasma volume near term may represent only variations within the error of measurement or random occurrences ([5](#), [12](#), [13](#)). The maternal blood volume generally returns to prepregnancy levels within 1 to 3 weeks after delivery ([14](#), [15](#), [16](#) and [17](#)), in part reflecting blood loss at delivery ([10](#)).

### Erythropoietin Biology in the Mother and Fetus

Much remains to be learned about maternal/fetal erythropoietin biology. It is clear that

erythropoietin acts as a physiologic stimulator of maternal erythropoiesis during pregnancy, but erythropoietin also has nonerythropoietic actions in the fetus. The increase in maternal erythropoiesis during the third trimester is preceded by an increase in serum erythropoietin concentrations, presumably on the basis of reduced oxygen delivery to maternal renal tissues during the late second and early third trimesters ( 18 ). Similarly, serum erythropoietin concentrations are elevated in fetuses with anemia, and correlate with hypoxemia ( 19 ).

Erythropoietin has certain critical nonerythropoietic effects during human fetal development ( Table 48.2 ) ( 20 ). It is an important growth and development factor for intestinal villi ( 20 , 21 and 22 ). It also plays a role in fetal central nervous system (CNS) development ( 23 ). Erythropoietin is a constituent of amniotic fluid, in concentrations of 25 to 40 mU/ml. A normal human fetus swallows 200 to 300 ml of amniotic fluid per kilogram body weight per day, and thus swallows 10 to 15 U of erythropoietin/kg/day ( 20 , 21 ). In humans, erythropoietin does not cross the placenta from maternal to fetal circulations, thus the source of the erythropoietin in amniotic fluid is not the maternal circulation. In the second and third trimesters, amniotic fluid is largely derived from fetal urine, with minor constituents from fetal tracheal effluent and the placenta and fetal membranes. However, erythropoietin in amniotic fluid does not appear to come from fetal urine. The fetal kidney makes little erythropoietin before delivery, and the first-voided urine of neonates has no detectable erythropoietin ( 24 ). Studies using *in situ* hybridization and immunohistochemistry indicate that the source of erythropoietin in amniotic fluid is largely maternal: from mesenchymal and endothelial cells in the deciduae and from the amnion ( 21 ).

**TABLE 48.2. Actions of Erythropoietin in the Human Fetus**

| Site of Erythropoietin Production               | Mechanism of Erythropoietin Delivery to Target Cells | Actions at Target Cells         |
|---|--|---------------------------------|
| Hepatocyte/hepatic macrophages                  | Paracrine  | Erythropoiesis/angiogenesis     |
| Glia  | Paracrine  | Neural migration                |
| Glia  | Paracrine  | Neural protection from hypoxia  |
| Decidua and amniotic membranes (amniotic fluid) | Swallowed by fetus                                   | Small bowel villous development |
| Mammary epithelia (breast milk)                 | Swallowed by neonate                                 | Small bowel villous development |

Erythropoietin is also present in human colostrum and breast milk in concentrations of 10 to 20 mU/ml; essentially the same as in amniotic fluid ( 25 ). Erythropoietin concentrations in mother's milk do not correlate with erythropoietin concentrations in her blood ( 25 ). In fact, over the first weeks of lactation, maternal serum erythropoietin concentrations fall, whereas milk erythropoietin concentrations increase, reaching the highest concentrations in women breast-feeding for a year or more. The source of erythropoietin in breast milk appears to be mammary gland epithelium ( 25 ).

Erythropoietin in human amniotic fluid, colostrum, and breast milk is relatively protected from proteolytic digestion in the fetal and neonatal gastrointestinal tract ( [25](#) ). However, rather than being absorbed into the blood, the erythropoietin swallowed by the fetus from amniotic fluid and by the neonate from colostrum and breast milk binds to erythropoietin receptors on the luminal surface of villous enterocytes, where it serves as a growth and development factor. Indeed, experimental animals artificially fed formulas devoid of erythropoietin have retarded villous development, a condition that can be treated by enteral recombinant erythropoietin and is blocked by antierythropoietin antibody ( [21](#) ).

Erythropoietin is produced by cells in the developing CNS and is present in relatively high concentrations in fetal cerebrospinal fluid (CSF) ( [26](#) , [27](#) ). Among newborn infants, the highest concentrations of erythropoietin in the CSF are seen in the most premature neonates, and by several years of age, CSF erythropoietin concentrations are generally below 1 mU/ml ( [26](#) ). Erythropoietin receptors are expressed on human fetal neurons ( [28](#) , [29](#) , [30](#) and [31](#) ). It has been speculated that erythropoietin in the CNS is a natural neuroprotectant from hypoxia. CNS erythropoietin production increases rapidly during hypoxia, and when erythropoietin binds to receptors on neurons, antiapoptotic activity is induced. Cell culture systems and whole animal models illustrate a marked neuroprotective effect of erythropoietin ( [32](#) ). The clinical utility of recombinant erythropoietin as a neuroprotectant is a topic of current studies.

The liver is the primary site of erythropoietin production in the fetus. The kidney does not become the primary site until after birth, probably by several months of age. In the human fetus, the kidney produces about 5% of the total erythropoietin during midgestation ( [33](#) ). The developmental mechanisms regulating the switch in erythropoietin production from the liver to the kidney are not completely known but may involve developmental expression of transcription activators such as hypoxia inducible factor and hepatic nuclear factor 4 ( [34](#) ), or developmental methylation of promoter and enhancer regions around the gene. Alternatively, the switch might involve the GATA transcription factors, particularly GATA-2 and GATA-3, which are negative regulators of erythropoietin gene transcription. Studies are ongoing to determine the biologic mechanisms involved in erythropoietin gene expression during fetal and neonatal development.

### **Iron Deficiency during Pregnancy**

The physiologic anemia of pregnancy is normochromic and normocytic. Therefore, if a pregnant woman has a microcytic hypochromic anemia, nonphysiologic causes must be considered. Iron deficiency is common in pregnancy and is certainly the most common cause of nonphysiologic anemia during pregnancy ( [8](#) ). It is particularly common in lower economic groups ( [35](#) ). The prevalence of iron deficiency ranges from 16 to 55% in pregnant women during the third trimester.

In a Cochrane review, Milman et al observed that among fertile women, 20% have iron reserves of less than 500 mg, which is stated as the required minimum during pregnancy; 40% have iron stores of 100 to 500 mg, and 40% have undetectable iron stores ( [36](#) ). The demand for absorbed iron increases from 0.8 mg/day in early pregnancy to 7.5 mg/day in late pregnancy. An iron supplement of 65 mg/day beginning at or before 20 weeks' gestation generally is adequate to prevent iron deficiency during pregnancy.

The fetus acts as an effective parasite for the nutrients required for hemoglobin synthesis. Thus, the hemoglobin concentration of infants born to mothers with severe iron

deficiency anemia is normal ( [37](#), [38](#), [39](#), [40](#), [41](#) and [42](#) ), and the serum iron, transferrin saturation, and serum ferritin levels are unrelated to maternal iron status ( [39](#), [40](#), [43](#), [44](#) and [45](#) ).

Iron balance in pregnancy is discussed in [Chapter 28](#). Limited iron reserves before pregnancy are common ( [35](#), [46](#) ), and the additional iron requirements of pregnancy impose a negative iron balance unless supplemental iron is provided ( [8](#) ).

Pregnant women who are iron deficient sometimes experience unique manifestations. There is evidence that the risks of premature delivery, low birth weight, and infant death are increased by severe iron deficiency. However, it is difficult to distinguish the effects of the iron deficiency itself from the conditions that produced the deficiency. A large case-control study from Venezuela indicated that maternal iron deficiency was associated with increased odds of premature delivery [odds ratio (OR), 1.70; 95% confidence interval (CI), 1.18 to 2.57] ( [47](#) ). However, when Mahomed reviewed 20 trials evaluating the issue of iron supplementation in pregnancy for the Cochrane database, he concluded that iron supplementation during pregnancy resulted in a substantial reduction in women with anemia (a hemoglobin below 10 g/dl late in pregnancy) but had no detectable effect on maternal or fetal outcome ( [48](#) ). Thus, whether maternal iron deficiency adversely influences pregnancy is controversial. In fact, it is not entirely clear whether maternal iron deficiency reduces the fetal iron supply. Harthoorn-Lasthuizen et al found no significant differences in iron status of neonates born to iron-deficient versus iron-sufficient women and concluded that the fetal iron supply is not negatively influenced by iron deficiency in the mother ( [49](#) ). In contrast, Turgeon O'Brien et al reviewed medical records of 202 pregnant women to examine the association of low and high ferritin levels and anemia with pregnancy outcome ( [50](#) ). They observed an inverse relationship between first trimester anemia and birth weight, but they observed no relationship in the second and third trimesters. They suggested that maternal iron deficiency in early pregnancy was associated with poor fetal weight gain but that maternal iron deficiency later in pregnancy was not.

Sifakis et al sought to determine whether recombinant erythropoietin administration, combined with parenteral iron, was an effective treatment for moderate and severe iron deficiency anemia during pregnancy ( [51](#) ). They studied 26 pregnant women with evidence of iron deficiency and with a hemoglobin less than 8.5 g/dl despite at least 8 weeks of iron supplementation. They administered recombinant erythropoietin, 150 U/kg SC three times/week plus 100 mg parenteral iron daily for 4 weeks. Nineteen (73%) of the women responded with a hemoglobin increase of less than 3 g/dl within 4 weeks. However, seven (27%) had no response.

During iron deficiency, the placenta becomes hypertrophied, a possible cause of maternal hypertension. A special type of pica, namely, ingestion of baking powder, can lead to symptoms suggesting preeclampsia ( [52](#) ).

The usual criteria for diagnosing iron deficiency are valid during pregnancy (see [Chapter 28](#)), including a reduced mean corpuscular volume (MCV), a reduced serum transferrin saturation to less than 16%, and a reduced serum ferritin concentration. Measurement of serum transferrin receptors may be useful in complicated situations in which inflammatory disease makes the serum ferritin value less reliable ( [53](#) ). Interpretation of serum iron values can be complicated during pregnancy: Even in apparently iron-replete women, serum iron levels progressively decline, and values for serum total iron-binding capacity and free erythrocyte protoporphyrin increase ( [8](#), [54](#) ), findings that usually indicate iron

deficiency.

Dietary supplementation with 78 mg of elemental ferrous iron daily during pregnancy increased the hematocrit, hemoglobin concentration, and red cell mass, the red cell mass rising to nearly twice that found in similar, apparently healthy women not supplemented ( [8](#) ). At term, the mean hemoglobin concentration averaged 12.4 g/dl in those who received the supplement and 10.9 g/dl in those who did not. In Bantu women, whose diet is habitually high in iron, a significant change in serum iron does not occur, and iron deficiency anemia does not develop during pregnancy ( [55](#) ). Some have recommended that all pregnant women receive iron supplements beginning at 18 to 20 weeks' gestation in doses ranging from 30 to 60 mg/day ( [35](#) ). The recommendation of the U.S. Institute of Medicine is that iron supplementation be provided selectively to those with a serum ferritin level less than 20 ng/dl in the first and second trimester and that all pregnant women receive a supplement of 30 mg/day in the third trimester.

For treatment of established iron deficiency, the oral regimen described in [Chapter 28](#) should be used. Constipation may be an especially problematic side effect in pregnant women; therefore, gradual increases in dose until fully therapeutic levels are achieved, along with emphasis on taking medication with meals are particularly important precautions. Rarely, parenteral treatment may be necessary.

### **Deficiency of Folate and Other Nutrients during Pregnancy**

Macrocytic anemia of pregnancy is often megaloblastic and in most cases results from deficiency of folic acid ( [56](#), [57](#), [58](#) and [59](#) ). Megaloblastic anemia during pregnancy begins most often in either the third trimester or shortly after delivery ( [60](#) ). Folate requirements increase during pregnancy, and the diets of many pregnant patients are insufficient to meet the increased need ( [61](#), [62](#) ). Although folate deficiency occurs most often in economically deprived patients, this consequence of inadequate eating habits is not confined to the poor ( [60](#), [61](#), [62](#) and [63](#) ). Particularly in pregnant adolescents, the diet may provide an inadequate source of folate, regardless of the economic class ( [62](#) ). In uncomplicated pregnancies, the gastrointestinal absorption of dietary folate (polyglutamate) and of folic acid (monoglutamate) is normal ( [64](#) ). Folate deficiency during pregnancy is relatively common, although its frequency depends on the population studied. The prevalence varies from 1 to 50% of pregnant patients ( [58](#), [60](#), [63](#), [65](#) ). In North America, the prevalence is 1 to 4% ( [66](#) ). Not all patients in whom the serum concentration of folate is low develop megaloblastic anemia. Of those who do, often the serum folate concentration was low earlier in pregnancy ( [60](#) ).

Pregnant women often have no symptoms with folate deficiency anemia and are found to have blood hemoglobin levels of 6 to 9 g/dl in the third trimester or postpartum. Folate deficiency is clearly associated with fetal neural tube defects and cleft palate, but these defects are established very early in fetal development, long before maternal megaloblastic anemia is detected ( [66](#) ). The association between low serum folate during the first trimester of pregnancy and fetal neural tube defects has been known for over 25 years ( [67](#) ). Randomized, double-blind, controlled clinical trials, indicating that prenatal folate administration reduces neural-tube defects, date back 20 years ( [68](#) ). Lumley reviewed this issue for the Cochrane database, examining four trials involving 6425 women treated with folate or placebo ( [69](#) ). Preconceptional folate supplementation reduced the incidence of neural tube defects to a relative risk of 0.28 (95% CI, 0.13 to 0.58). Folate did not increase miscarriage, ectopic pregnancy, or still birth. Multivitamins without folate did not prevent neural tube defects, and adding multivitamins to folate did

not produce additional preventive effects. Thompson et al. reported an unexpected but significant reduction in childhood acute lymphoblastic leukemia (ALL) among offspring of women supplemented with folate during pregnancy (70). They performed a case-control study of 83 children with ALL and 166 controls. Mothers who reported taking the combination of iron and folate during pregnancy had a risk of ALL in their child of 0.37 (95% CI, 0.21 to 0.65). For iron alone, the OR was 0.75 (0.37 to 1.51). This protective effect requires validation and mechanistic investigation.

An association between bacteriuria and folate deficiency was noted in pregnant patients. In experimental systems, infection may induce folate-deficient megaloblastic anemia. Malabsorption (see [Chapter 43](#)) may be associated with megaloblastic anemia of pregnancy, even in nontropical areas (55).

Rarely, folate-deficient pregnant patients develop erythroblastopenia and bone marrow changes closely simulating acute leukemia. In one case, the findings suggesting leukemia were so convincing that 6-mercaptopurine was prescribed for 4 months (71). With full awareness of the confusion between these diagnoses and the application of current tools for diagnosing leukemia, this difficulty should be avoided.

Megaloblastic anemia during pregnancy, as in the nonpregnant patient, is suggested by an increased MCV with oval macrocytes and hypersegmented granulocytes on blood smear, but a bone marrow examination can be done if doubt exists. Folate deficiency must be distinguished from vitamin B<sub>12</sub> deficiency. The latter is rare in pregnancy, and the distinction can often be made on clinical grounds, especially on the basis of a careful nutritional history.

Folate is transported across the placenta against a concentration gradient. Infants born to mothers with the megaloblastic anemia of pregnancy have no anemia and no biochemical evidence of folate deficiency (43, 72). The concentration of vitamin B<sub>12</sub> also is two to three times higher in cord blood than in maternal blood (73). Nevertheless, this nutritional advantage is insufficient to protect the infant if the mother is vitamin B<sub>12</sub> deficient and if the sole source of nutrition is the mother's milk. Megaloblastic anemia accompanied by irreversible neurologic damage has been documented in breast-fed infants of vegetarian mothers (74, 75) and in breast-fed infants of mothers with subclinical pernicious anemia (76, 77).

Dietary supplementation with approximately 0.3 mg of folic acid daily during pregnancy reduces the occurrence of megaloblastic anemia to approximately 0.7% of all pregnant women (59, 78, 79), whereas a supplement of only 0.1 to 0.2 mg/day is not adequate to maintain serum folic acid concentration at normal levels (80, 81). A supplement of 0.45 mg/day results in supranormal values for serum folate (79, 81), but, even with this amount of supplementation, megaloblastic anemia may occur in a pregnant patient in whom the course is complicated by urinary tract infection or hemolysis hemorrhage (79). Nevertheless, because true pernicious anemia caused by a lack of intrinsic factor and vitamin B<sub>12</sub> does occur in pregnant patients (82), the considerations regarding masking of pernicious anemia with folate doses of 0.40 mg/day or more, apply ([Chapter 43](#)). Accordingly, daily supplements of 0.4 mg of folic acid, but not more, are generally prescribed for most pregnant women. In high-risk patients, such as those with disorders or chronic hemolytic anemia, the supplement may be increased to 1 mg/day (66).

For established deficiencies, the regimen described in [Chapter 43](#) should be followed. If the possibility of vitamin B<sub>12</sub> deficiency cannot be excluded, vitamin B<sub>12</sub> injections



should be added to the regimen.

Zinc deficiency has been associated in some studies with fetal growth restriction, congenital abnormalities, and neurodevelopmental delay. Iodine deficiency during pregnancy is very uncommon in developed countries but can result in fetal wastage, preterm delivery, and neonatal hypothyroidism. Deficiency of magnesium, selenium, copper, and calcium have also been associated with complications of pregnancy and fetal development ( [83](#) ). In a study in Nepal, vitamin A supplementation reduced maternal mortality ( [84](#) ). It was suggested that vitamin A influenced the synthesis of erythropoietin. To determine whether daily vitamin A supplementation increased plasma erythropoietin concentrations in humans, a randomized, double-blind, controlled clinical trial was performed in 203 women in Malawi, Africa, using a daily vitamin A dose of 3000 µg (retinol equivalent), iron (30 mg), and folate (400 µg) versus iron and folate without vitamin A. There were no differences in any parameter between vitamin A and control mothers or neonates. Thus, vitamin A supplementations did not appear to have any benefit in this population. In contrast, Burns et al. quantified vitamin A levels in plasma of 449 women enrolled in a multicenter cohort study of mother to infant transmission of human immunodeficiency virus (HIV) type 1 ( [85](#) ). Women with low vitamin A levels before the third trimester were more likely to deliver infants of low birth weight (OR, 4.58; 95% CI, 1.57 to 13.40).

### **Maternal Anemia Associated with Prenatal Infections**

Most clinically significant infections of the fetus are viral or protozoal, but generally these conditions result in minimal evidence of infection in the mother. Specifically, women carrying a fetus infected with cytomegalovirus, toxoplasmosis, rubella, herpes simplex, or parvovirus B19 generally have no anemia related to the infection. However, certain infectious diseases during pregnancy do result in maternal anemia. For example, intestinal helminth infections, common in certain parts of the world, produce or exacerbate iron deficiency during pregnancy, resulting in anemia. Nurdia et al reported that 70% of 442 pregnant women from Central Java, Indonesia, had either *Trichuris trichiura*, *Necator americanus*, or *Ascaris lumbricoides* detected during pregnancy ( [86](#) ). They observed a significant negative association between hookworm infection and serum ferritin in the first trimester and suggested that anthelmintic therapy should be given to infected women before conception as a means of improving their iron status. Similarly, Torlesse and Hodges reported that anthelmintics were useful in Sierra Leone, reducing the decline in hemoglobin concentration during pregnancy by more than 6.5 g/L ( [87](#) ).

Syphilis generally does not result in maternal anemia. Mavrov and Goubenko, from the Ukraine, reported on 155 pregnant women with syphilis. They observed that 78% of the women remained asymptomatic throughout pregnancy, although placental and fetal/neonatal pathology were found in about half of cases ( [88](#) ).

Malaria can cause maternal and fetal anemia ( [89](#) ). The anemia is mild in most neonates with malaria, but with a marked placental accumulation of parasites, intrauterine growth retardation can be significant ( [90](#) ). Steketee et al reviewed studies between 1985 and 2000 and summarized the risk neonatal anemia, low birth weight, and infant mortality associated with maternal malaria ( [91](#) ). Indeed, maternal malaria was associated with substantial risks for anemia (population attributable risk, 3 to 15% increased), low birth weight (8 to 14% increased risk), and infant mortality (3 to 8% increased risk). They estimated that each year 75,000 to 200,000 infant deaths are associated with maternal malaria.



HIV-1 infection during pregnancy remains a major world-wide medical issue ( [92](#) ). The rate of maternal to fetal HIV transmission can be markedly reduced by complying with protocols of antiretroviral treatment during pregnancy and labor, coupled with postpartum treatment of neonates ( [93](#) ). Maternal HIV infection does not cause significant fetal anemia. However, progressive anemia develops in neonates after vertical HIV transmission. Before routine antiretroviral therapy of HIV-exposed neonates, Galli et al observed a progressive anemia among 22 neonates with perinatal HIV infection ( [94](#) ). Beginning in the second month of life, hemoglobin concentrations, hematocrits, and circulating erythrocyte counts were lower in infected than in uninfected infants born to HIV-infected mothers. They reported that anemia at 2 months of age was a good predictor of those neonates born to HIV-positive women who acquired vertical HIV transmission.

Some fraction of the anemia observed among neonates delivered to HIV-positive women can be ascribed to the antiretroviral treatment. Zidovudine has a more pronounced suppressive effect on erythroid progenitors of fetal origin than it does on progenitors of maternal origin, possibly due to the more rapid cycling rate of fetal progenitors ( [95](#) ). This is consistent with the findings of zidovudine toxicity among nonhuman primates ( *Macaca nemestrina* ) treated with zidovudine throughout pregnancy, where the infants at birth were mildly anemic ( [96](#) ). The *in vitro* experiments and the animal studies support clinical reports, such as those of Ferrazin et al., who reported that zidovudine given to pregnant women leads to a mild macrocytic anemia in neonates, resolving by 2 months of life ( [97](#) ). Silverman et al found similar results from a six-centered treatment trial of 39 HIV-infected pregnant women ( [98](#) ). In that study, zidovudine was instituted at a mean of 13 weeks' gestation with lamivudine added in 85% of cases at a mean of 17.6 weeks. No changes in maternal hematocrit, hemoglobin, or erythrocyte count were observed. However, anemia in the neonatal period (hematocrit <0.50 L/L) was seen in 62% of the 40 neonates, with no children needing transfusions. Mild anemia, sometimes slightly macrocytic, among neonates delivered after maternal zidovudine treatment was also reported from U.S. centers by Sperling et al ( [99](#) ), and from a European collaborative study ( [100](#) ).

### Pregnancy-Induced Hemolytic Anemia

Diverse hemolytic anemias can occur in pregnant women just as well as in nonpregnant women. In fact, pregnancy can exacerbate underlying autoimmune hemolytic anemia ( [101](#) ). Thus, hemolytic anemia is not particularly uncommon in obstetric practice. However, a rare entity has been described (approximately 25 cases reported), in which an idiopathic hemolytic anemia occurs during pregnancy, resolves completely after pregnancy, and recurs during subsequent pregnancy ( [Table 48.3](#) ). The pathogenesis of this anemia is not known. Terms for the condition include *idiopathic autoimmune hemolytic anemia of pregnancy*, *unexplained hemolytic anemia associated with pregnancy*, and *pregnancy-induced hemolytic anemia*. The condition is not homogeneous. In the cases reported by Ng et al from Kuala Lumpur ( [102](#) ) and Benraad et al from The Netherlands ( [103](#) ), women had immunoglobulin G warm antibodies and were successfully treated with glucocorticoids. In contrast, the majority of cases have no identifiable immune mechanisms and have a variable response to glucocorticoids ( [104](#), [105](#), [106](#), [107](#), [108](#), [109](#), [110](#), [111](#) and [112](#) ).

**TABLE 48.3. Features of Idiopathic Pregnancy-Induced Hemolytic Anemia**

---

No identifiable mechanism

Anemia becomes apparent in the 3rd trimester

Remits completely within 2 mo of delivery

Generally recurs in subsequent pregnancies

Anemia is usually severe, even life-threatening

Corticosteroids and intravenous immunoglobulin sometimes helpful

Erythrocyte transfusions mainstay treatment for severe anemia

Donor cells have a shortened survival

Neonates generally have transient, nonsevere hemolysis

---

This pregnancy-induced hemolytic anemia becomes apparent in the third trimester of pregnancy and in most cases remits completely within 2 months of delivery, sometimes taking as long as 4 or 5 months. The anemia is usually very severe, even life-threatening to mother and fetus. Corticosteroids and intravenous immunoglobulin (IVIg) have been reported to be successful in some cases, but many of the women have been treated with repeated packed erythrocyte transfusions. Generally, the transfused donor cells have a shortened survival. Neonates born to women with pregnancy-induced hemolytic anemia generally have transient hemolysis, lasting 1 to 2 months; severe jaundice requiring neonatal exchange transfusion has not been reported.

In cases of autoimmune hemolytic anemia during pregnancy, whether idiopathic or of an identified variety, the degree of hemolysis is generally more severe in the mother than that in the fetus ([113](#)). However, therapy that ameliorates the maternal disease (such as corticosteroids or IVIg) often does not protect the fetus. This is in contrast to autoimmune thrombocytopenia during pregnancy, in which maternal and fetal platelet counts are likely to be concordant.

### Postpartum Anemia

Postpartum anemia is common, particularly among low-income women. Studying nearly 60,000 women who were enrolled in the Special Supplemental Nutrition Program for Women, Infants, and Children, Bodnar et al reported an overall incidence of postpartum anemia of 27% ([114](#)). However, rates reached 48% among non-Hispanic black women. Prenatal anemia was the best predictor of postpartum anemia. Maternal obesity, multiple births, and formula feeding also predicted postpartum anemia.

Peripartum hemorrhage is an obvious and common cause of postpartum anemia. An estimated blood loss at delivery in excess of 500 ml is claimed to be a good predictor of postpartum anemia ([115](#)). Unsuccessful vacuum extraction can cause peripartum hemorrhage and subsequent postpartum maternal anemia. Shoham-Vardi et al. evaluated over 2100 cases of delivery by vacuum extraction in Israel between 1990 and 1998 ([116](#)) and reported that 5.4% of all deliveries were complicated by unsuccessful extraction, with a subsequent cesarean section. Postpartum anemia was much more common in the women following unsuccessful vacuum extraction than in those in whom cesarean sections were not preceded by attempts at vacuum extraction. Maternal blood loss during and after the unsuccessful vacuum extraction procedures was suggested as the cause.

Hemorrhage occurring a week or more after delivery, so-called secondary postpartum hemorrhage, has a high morbidity rate. Hoveyda and MacKenzie analyzed 132 consecutive women presenting with secondary postpartum hemorrhage over a 3-year period at

Barrett Maternity Hospital, Northampton, United Kingdom (117). They observed this complication in just under 1% of women and found that that most presented in the second week after delivery. Histories of either primary postpartum hemorrhage or manual removal of the placenta were the only significant risk factors identified. Eighty-four percent of these women were rehospitalized, 63% required surgery, and 17% received blood transfusions.

Peripartum hemolysis is another cause of postpartum anemia. Hemolytic reactions have been described in women receiving second- and third-generation cephalosporins, such as cefotetan, administered prophylactically for caesarian section (118). Garratty et al noted that 10 of 35 cases of cefotetan-induced hemolytic anemia occurred in patients who had received cefotetan prophylactically for obstetric and gynecologic procedures (119).

Several studies have tested the effect of recombinant erythropoietin administration for treating postpartum anemia (120, 121, 122, 123 and 124). As shown in Table 48.4, the studies suggest efficacy, with a reduction in postpartum transfusions. These conclusions require verification by randomized, placebo-controlled trials appropriately powered to detect a significant difference in postpartum transfusions.

**TABLE 48.4. Reports of Recombinant Erythropoietin (rEpo) Administration to Women with Postpartum Anemia**

| Author (Reference No.) | Year | Country     | Design   | Number Subjects                         | Results   | Adverse Effects |
|------------------------|------|-------------|--|---|---|-----------------|
| Huch (120)             | 1992 | Switzerland | Randomized, not placebo controlled. 4000 U IV × 1, then SC for 4 d.  | 37 rEpo treated; 37 controls            | Treated = higher reticulocytes, hemoglobin, and hematocrit by day 5                         | None            |
| Zimmermann (121, 122)  | 1994 | Switzerland | Randomized into 4 groups: 1) 150 U SC × 2 d; 2) 150 U IV × 2 d; 3) 300 U SC × 1 d; 4) 300 U IV × 1 d.              | 95 subjects: 1) 26; 2) 25; 3) 22; 4) 22 | No difference between groups  | None            |
| Meyer (123)            | 1995 | Switzerland | “Blues Questionnaire” of women receiving vs. not receiving postpartum rEpo.  | 71 rEpo treated; 274 controls           | Anemia on postpartum day 5 correlates with “blues,” but rEpo treatment does not reduce this | None            |
| Breymann               | 1996 | Switzerland | Randomized into 3 groups; 1) rEpo 300 U/kg × 1 SC + iron; 2) 300 U/kg × 1 IV + iron vs. rEpo + iron; 3) iron only. | 90 (30/group)                           | Combination of rEpo + iron was more effective than iron alone in treating postpartum anemia | None            |

|            |                  |  |                              |   |      |
|------------|------------------|--|------------------------------|---|------|
| Makrydimas | 1998 Greece      | Not randomized, not placebo controlled. rEpo SC + oral iron vs. iron alone for 15 d.       | 10 rEpo treated; 10 controls | No transfusions in rEpo group vs. 2 in control group          | None |
| Malinova   | 1999 Bulgaria    | Not controlled. rEpo SC + oral iron × 5 d.   | 5                            | Higher reticulocytes, blood pressure                          | None |
| Breymann   | 2000 Switzerland | Randomized, 3 groups (treated 4 d): 1) rEpo + IV iron; 2) placebo + IV iron; 3) oral iron. | 60                           | Higher reticulocytes and hemoglobin in rEpo than other groups | None |

## ANEMIA IN THE FETUS AND NEONATE

### Normal Erythrocyte Values during Human Fetal Development

The erythron at birth reflects the relative hypoxic nature of the fetal environment. Bone marrow cavities are fully used by the erythroid marrow, and circulating red cells have all the features associated with stress erythropoiesis: increased variation in size and shape, macrocytosis, and shortened survival. Many of the characteristics of the erythron at birth are related to the disproportionate number of young cells.

Marrow cellularity in the fetus approaches 100%, and all cell lines are represented by 30 weeks' gestation. Because the available marrow space is fully cellular, the fetus and newborn infant have no marrow reserve on which to call. This limitation undoubtedly contributes to the persistence of hepatic and splenic erythropoiesis in congenital hemolytic anemias. Erythroid precursors account for 30 to 65% and myeloid cells 45 to 75% of nucleated marrow cells at birth ([125](#)). The myeloid to erythroid ratio at birth is approximately 1.5:1. Marrow cellularity decreases after birth, attaining a density that is normal for adults by 1 to 3 months ([125](#)). Initially, this decrease in cellularity results from a rapid decline in red cell precursors. At 1 week of age, erythroid elements account for only 8 to 12% of nucleated cells, and the myeloid to erythroid ratio exceeds 6:1. The normal adult proportion of myeloid to erythroid precursors is not established until the third month. Both the percentage and absolute number of lymphocytes increase during the first 2 months, so that by 3 months of age, they constitute nearly 50% of marrow nucleated cells. Differential counts of bone marrow aspirates from preterm infants are the same as those for term infants ([126](#)).

Normal values for the hemoglobin concentration and packed cell volumes ([Table 48.5](#)) are influenced strongly by the site of blood sampling. Perfusion of small vessels in the infant's extremities is poor, resulting in increased transudation of fluid and hemoconcentration. Consequently, the hemoglobin concentration and packed cell volume of capillary blood are 5 to 10% higher than those of venous blood ([127](#)). The difference between capillary and venous values is greatest at birth but disappears by 3 months of age. The discrepancy is greatest in preterm infants and in those with hypotension, hypovolemia, and acidosis ([128](#)). Differences can be minimized but not fully resolved by warming the extremity before sampling, obtaining freely flowing blood, and discarding the first few drops. The interpretation of serial observations necessitates the consistent use of one site of blood

sampling.

**TABLE 48.5. Normal Mean Values Relative to the Erythron for Term Infants during the First Week**

|                   | Cord Blood | Day 1 | Day 3 | Day 7 |
|-------------------|------------|-------|-------|-------|
| Hb (g/dl)         | 16.8       | 19    | 18.5  | 17.0  |
| PCV (L/L)         | 53.0       | 58    | 55.0  | 54.0  |
| MCV (fl)          | 106.0      | 107   | 99.0  | 98.0  |
| MCH (pg)          | 34.0       | 35    | 33.0  | 33.0  |
| MCHC (g/dl)       | 31.7       | 32    | 33.0  | 33.0  |
| Reticulocytes (%) | 5.3        | 4     | 3.0   | 0.5   |
| Normoblasts (%)   | 500.0      | 200   | 0.5   | 0.0   |

Hb, hemoglobin; MCH, mean corpuscular hemoglobin; MCHC, mean corpuscular hemoglobin concentration; MCV, mean corpuscular volume; PCV, packed cell volume.

The normal mean value for hemoglobin concentration in blood obtained from the umbilical vein is 16.8 g/dl, with CI 95% limits of 13.7 and 20.1 g/dl ( [129](#)). Hemoglobin values from the umbilical artery are approximately 0.5 g/dl higher. The packed cell volume of umbilical venous blood averages 0.53 L/L, with CI 95% limits of 0.47 to 0.57 L/L ( [129](#)). Hemoglobin concentration and the packed cell volume increase during the first hours to mean levels of 18.4 g/dl and 58%, respectively ( [127](#)). This increase is attributed in part to a shift of fluid from the intravascular compartment but also, more important, to the transfusion of red cells from placenta via umbilical vessels at the time of birth ( [130](#)). After the first day, the packed cell volume slowly decreases, reaching levels seen in cord blood by 7 days ( [131](#)). A drop in the concentration of hemoglobin below the cord blood concentration during the first week of life is indicative of either hemorrhage or hemolysis. The MCV at birth is 106.4 fl (standard deviation  $\pm$  5.7 fl) ( [132](#)). Values of 94 fl or less are seen in infants with  $\alpha$ -thalassemia trait or iron deficiency. Iron deficiency can result from *in utero* hemorrhage, as is seen with chronic fetomaternal hemorrhage (FMH) or twin-to-twin transfusion syndrome (TTS).

The mean corpuscular hemoglobin is increased at birth, with values ranging from 33.5 to 41.4 pg. The mean corpuscular hemoglobin concentration is within the normal adult range but can be slightly elevated in the presence of increased numbers of spherocytes, commonly seen on newborn peripheral smears.

Reticulocytosis and normoblastosis reflect the accelerated nature of erythropoiesis. The mean number of reticulocytes at birth is approximately 5.3%, with a range of 4 to 7% ( [133](#)). Reticulocytes remain elevated for the first 1 to 3 days of life, dropping abruptly to 0 to 1% by day 7. Nucleated red cells are seen regularly on blood smears during the first day of life. When quantified, they constitute about 0.1% of the red cell population (500 normoblasts/mm<sup>3</sup>) ( [134](#)). Normoblasts are cleared rapidly from the circulation during the first 3 days of life.

Red cell morphology is characterized by macrocytosis and poikilocytosis. Target cells and

irregularly shaped cells are particularly prominent. A high proportion of stomatocytes is noted when viewed by phase contrast microscopy ( [135](#)). Decreased splenic function compared to adults results in increased number of siderocytes (3.16% vs. normal male adult mean of 0.09%) ( [136](#)). Differential staining of red cells for fetal hemoglobin (HbF) provides a nice demonstration of the switch in hemoglobin synthesis that precedes birth: The younger macrocytes contain a minimal amount of HbF, whereas the smaller, older cells are rich in HbF ( [137](#)).

Differences in hematologic values for preterm and term infants reflect the dynamic nature of the erythron in late fetal development ( [138](#)). The hemoglobin concentration rises slowly from approximately 14.5 g/dl at 28 weeks' gestation to 15.0 g/dl at 34 weeks to 16.8 g/dl at 40 weeks ( [129](#)). The relationship between cord hemoglobin concentration and duration of pregnancy is linear for normal weight for date infants. The MCV is higher in preterm infants than in term infants. In one group of preterm infants with an average birthweight of 1300 g, the average MCV on the first day of life was 115 fl, 8 fl above the mean for term infants ( [139](#)).

Reticulocyte counts in preterm infants are slightly higher, averaging 6 to 10%. Nucleated red cells number 1000 to 1500/mm<sup>3</sup>. There is an inverse relationship between numbers of nucleated red cells and gestational age. As in the term infant, normoblasts are cleared rapidly from the circulation during the first postnatal days, although a few may still be observed in small preterm infants as late as 7 days. Variations in red cell size and shape are somewhat greater than those observed in term infants, and cytoplasmic vacuoles are evident in nearly one-half of all cells when viewed by using interference-contrast microscopy. Red cell survival is considerably shorter than in term infants. For infants who undergo exchange transfusion or multiple transfusions, both erythropoietin concentrations and reticulocyte counts are lower at any given hemoglobin concentration ( [140](#)). It is often assumed that oxygen delivery is decreased in newborns because of the presence of a high-affinity hemoglobin. In fact, a leftward shift in the hemoglobin-oxygen dissociation curve due to high levels of HbF might actually better maintain oxygen delivery during episodes of severe hypoxemia.

Precise quantification of red cell survival is made difficult by the disproportionate number of young cells at birth and by a higher rate of chromium elution from HbF compared with HbA ( [141](#)). Nevertheless, data from most studies indicate a substantially shorter rate of red cell survival in neonates relative to that in children and adults, regardless of the techniques used. The life span of red cells from term infants is estimated to be 60 to 80 days with use of the <sup>51</sup>Cr method ( [142](#)) and 45 to 70 days when using methods involving <sup>59</sup>Fe ( [142](#)). Fetal studies using [<sup>14</sup>C]cyanate-labeled red cells in sheep revealed an average red cell life span of 63.6 ± 5.8 days ( [143](#)). The mean red cell life span increased linearly from 35 to 107 days as the fetal age increased from 97 days (midgestation) to 136 days (term).

Cells of the newborn have a similarly short survival in normal, compatible adults ( [144](#)), indicating that factors intrinsic to the newborn red cell are responsible. This conclusion gains further support by the demonstration that adult red cells survive normally in newborn recipients ( [145](#)). The life span frequency function is not parametrically distributed, in that most cells are destroyed before the mean survival is reached. Shortened red cell survival as well as demands imposed by an expanding red cell mass account for erythropoietic rates at birth that are three to five times greater than those of normal adults.



The abrupt transition from the relative hypoxia of the uterus to an oxygen-rich environment triggers responses that have a profound effect on erythropoiesis. During the first 2 months of life, the infant experiences both the highest and lowest hemoglobin concentrations occurring at any time in development. Although quite variable, erythropoietin levels at birth usually are well above the normal adult range. Erythropoietin levels fall in the immediate postnatal period, with a half-life of no more than 4 hours:  $2.6 \pm 0.5$  hours in infants with polycythemia and  $3.7 \pm 0.9$  hours in infants of the preeclampsia group ( [146](#) ). By 24 hours, the erythropoietin value is below the normal adult range, where it remains throughout the first month of life. The decrease in erythropoietin is followed by a decline in the number of bone marrow precursors ( [125](#), [147](#) ) and a fall in the reticulocyte count.

The combination of shortened cell survival, decreased production, and growth-related expansion of the blood volume is responsible for a progressive fall of the hemoglobin concentration to a mean of approximately 11 g/dl at 2 months of age ( [148](#) ). The lower range of normal for infants of this age is approximately 9 g/dl. This nadir is called *physiologic anemia*, in that it is not associated with apparent distress and is not prevented with nutritional supplements. Stabilization of the hemoglobin concentration is heralded by an increase in reticulocytes at 4 to 8 weeks ( [147](#) ). Thereafter, the hemoglobin concentration rises to a mean level of 12.5 g/dl, where it remains throughout infancy and early childhood ( [149](#) ).

The placenta and umbilical cord contain 75 to 125 ml of blood at term, or approximately one-fourth to one-third of the fetal blood volume. Umbilical arteries constrict shortly after birth, but the umbilical vein remains dilated, and blood flows in the direction of gravity. Infants held below the level of the placenta can receive half of the placental blood volume (30 to 50 ml) in 1 minute. Conversely, infants held above the placenta can lose 20 to 30 ml of blood back into the placenta per minute ( [150](#) ). The blood volume of infants with early cord clamping averages 72 ml/kg, whereas the volume of infants with delayed cord clamping averages 93 ml/kg. Linderkamp et al. compared postnatal alterations in blood viscosity, hematocrit, plasma viscosity, red cell aggregation, and red cell deformability in the first 5 days of postnatal life in full-term neonates with early (less than 10 seconds) and late (3 minutes) cord clamping ( [151](#) ). The residual placental blood volume decreased from  $52 \pm 8$  ml/kg of neonatal body weight after early cord clamping to  $15 \pm 4$  ml/kg after late cord clamping. The neonatal blood volume was 50% higher in the late cord-clamped infants than in the early cord-clamped infants. Intrauterine asphyxia appears to have little effect on blood volume, whereas intrapartum asphyxia and nuchal cords are associated with a reduced blood volume ( [152](#) ).

Preterm infants have slightly larger blood volumes (89 to 105 ml/kg) owing to an increased plasma volume. At 30 weeks' gestation, half of the approximately 120 ml/kg total blood volume of the fetoplacental circulation is in the fetus ( [149](#) ). Preterm infants commonly experience rapid cord clamping, resulting in a decreased blood volume. Postnatally, blood volume decreases rapidly, so that by 1 to 2 months of age, it approximates the normal adult volume of 77 ml/kg.

### **Fetal and Neonatal Erythrocyte Membrane and Metabolism**

The different morphologic variants seen by using phase contrast microscopy suggest that the red cell membrane of the newborn differs from that of the adult. Protein patterns obtained with two-dimensional polyacrylamide gel electrophoresis isoelectric focusing show only minor variations from patterns obtained with adult cells ( [153](#) ). Although



$\alpha$ -spectrin is extracted less easily from neonatal red cell ghosts ( [154](#) ), the percentage of spectrin dimers and the spectrin tryptic peptide pattern are the same as in adult cells ( [155](#) ). An increase in the amount of immunoreactive myosin in the red cell membrane has been observed ( [156](#) ).

The quantity and distribution of lipids in neonatal red cells differ in several respects from adult red cells. Total values of lipid, phospholipid, and cholesterol are increased out of proportion to the surface area of newborn red cells ( [157](#), [158](#) ). Neonatal cells also exhibit increased endocytosis in response to membrane-active agents, suggesting that the membranes of neonatal cells are less stable and are capable of greater reorganization ( [158](#) ). The distribution of phospholipid is altered, with an increased level of sphingomyelin and a decreased amount of phosphatidylcholine. Phosphatidylinositol values may also be increased ( [159](#) ). Unsaturated fatty acids are diminished in concentration, producing a relative increase in saturated fatty acids. These changes appear not to affect membrane viscosity ( [158](#) ).

Antigen expression differs from that of adult cells. The A, B, S, and Lutheran antigens are present in decreased amounts ( [160](#) ). Replacement of the i antigen with its adult counterpart I requires its conversion from a linear polylectosamine to a branched polylectosamine ( [161](#) ). Reduced A and B antigenicity may result in part from decreased branching and increased stimulation of glycoproteins on neonatal red cells ( [162](#) ).

The number of membrane receptors for digoxin is 2.5 times that in adult red cells ( [163](#) ). The red cell to plasma ratio of digoxin in infants on maintenance digoxin therapy is three times that of adults. Sequestration of digoxin by red cell receptors undoubtedly contributes to the greater digoxin tolerance of infants. An increase in insulin receptors is explained by the young mean age of newborn red cells and by their larger surface area ( [164](#) ).

Red cell deformability and viscoelastic properties are normal ( [165](#) ). Nevertheless, the passage of newborn red cells through small pore filters is impaired. This difficulty probably results from the greater size and therefore the greater minimal cylindrical diameter of neonatal red cells ( [165](#) ). One theory is that this property of neonatal cells may restrict their passage through the spleen, thereby contributing to their shortened life span.

In addition to distinctive membrane and hemoglobin characteristics, neonatal red cells also exhibit metabolic characteristics that differ from those of adult red cells ( [Table 48.6](#) ) ( [129](#), [141](#), [157](#), [166](#), [167](#) ). To some extent, differences are explained by the young mean age of red cells at birth. The increase in activity of many of the glycolytic enzymes is comparable in magnitude to that observed in high-reticulocyte adult blood ( [168](#), [169](#) ). Increased glycolytic enzyme activity, in turn, is responsible for increased consumption of glucose and galactose and increased levels of adenosine triphosphate (ATP) ( [170](#) ). Glucose consumption, although increased, may be less than that observed in age-matched cells from adults ( [171](#) ).

#### **TABLE 48.6. Metabolic Characteristics of Neonatal Red Blood Cells**

---

Metabolic characteristics explained by young mean cell age  
Increased enzyme activity

- Hexokinase
- Aldolase
- Triosephosphate isomerase
- Phosphoglycerate mutase
- Pyruvate kinase
- Lactate dehydrogenase
- Glucose-6-phosphate dehydrogenase
- 6-Phosphogluconate dehydrogenase
- Glutathione reductase
- Glyoxalase I and II
- Galactokinase
- Galactose-1-phosphate uridyl transferase
- Increased glucose and galactose consumption
- Increased levels of ATP
- Metabolic characteristics distinctive for neonatal red cells
  - Embden-Meyerhof pathway
    - Increased activity of phosphoglycerate kinase, enolase, glucose phosphate isomerase, and glyceraldehyde-3-phosphate dehydrogenase
    - Decreased activity of phosphofructokinase
    - 2,3-Diphosphoglycerate instability
  - Pentose phosphate pathway and glutathione metabolism
    - Decreased glutathione peroxidase and glutathione synthetase
    - Glutathione instability
  - ATP and phosphate metabolism
    - ATP instability
    - Decreased phosphate uptake, slower incorporation of phosphate into ATP and 2,3-diphosphoglycerate
  - Nonglycolytic enzymes
    - Decreased enzyme activity
    - Carbonic anhydrase
    - Catalase
    - Cholinesterase
    - Adenylate kinase
    - Phosphoribosyl transferase
    - Cytochrome *b*<sub>5</sub> reductase

ATP, adenosine triphosphate.

---

Certain characteristics of neonatal red cells reflect fundamental metabolic differences. The activities of four enzymes in the Embden-Meyerhof pathway—phosphoglycerate kinase, enolase, glucose phosphate isomerase, and glyceraldehyde-3-phosphate dehydrogenase—are increased out of proportion to cell age ( [169](#), [170](#), [172](#) ). The activity of phosphofructokinase, a rate-controlling enzyme in glycolysis, is only 40 to 70% of that in adult red cells of comparable age ( [169](#), [170](#), [172](#) ). Low levels of phosphofructokinase may produce a block in glycolysis, resulting in the accumulation of glucose-6-phosphate and fructose-6-phosphate and a decrease in the amounts of 2,3-diphosphoglycerate (2,3-DPG) and phosphoenolpyruvate ( [173](#) ). Decreased activity of phosphofructokinase is probably explained by accelerated decay of a less stable fetal isoenzyme ( [174](#) ). Neonatal

red cells contain a homotetramer of liver-type phosphofructokinase subunits rather than the heterotetramer of liver and muscle subunits present in adult cells ( 175 ). Differences in the relative proportions of isoenzymes have also been described for hexokinase and enolase ( 176 ). The concentration of 2,3-DPG falls rapidly during short periods of incubation ( 170 ), apparently because of accelerated breakdown. Preterm infants have lower 2,3-DPG concentrations than term infants. These concentrations gradually increase with gestation ( 177 , 178 ). Concentrations can be increased with the use of erythropoietin, thereby shifting the oxygen dissociation curve to the right ( 179 ).

The activities of two key enzymes of the pentose phosphate pathway, glucose-6-phosphate dehydrogenase and 6-phosphogluconate dehydrogenase, are increased by virtue of a young mean red cell age ( 169 , 170 ). The response of the pentose phosphate pathway to oxidant stimuli is normal, and the level of reduced glutathione is equal to or greater than that found in adults ( 171 ). Yet newborn cells exhibit glutathione instability, increased Heinz body formation, and a propensity to increased methemoglobin generation, all indicative of greater susceptibility to oxidant-induced injury ( 157 , 168 ). The basis for this oxidant vulnerability is not known. Although red cells of the newborn infant have low levels of activities of both glutathione peroxidase ( 180 ) and glutathione synthetase ( 181 ), no apparent relationship exists between these deficiencies and oxidant vulnerability ( 182 ). Other factors that have been implicated in attempts to explain metabolic differences include deficient catalase activity, decreased numbers of membrane sulfhydryl groups ( 183 ), greater residual membrane hemoglobin ( 184 ), and other plasma factors ( 185 , 186 ). Studies evaluating the antioxidant capacity of preterm red cells and plasma from infants with respiratory distress syndrome reported no difference in activity between sick and well preterm infants, and antioxidant activity appeared intact. The study did not provide convincing evidence of oxidative damage and diminished antioxidant defenses in preterm infants with neonatal respiratory distress syndrome ( 187 ).

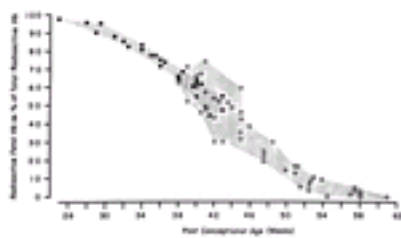
Although elevated at birth, the red cell ATP level falls rapidly during short periods of incubation. The uptake of labeled orthophosphate by cord blood cells is slower than that by adult cells, resulting in delayed incorporation of phosphate into ATP and 2,3-DPG ( 188 ). This disturbance in energy metabolism has been held responsible for accelerated potassium loss during incubation. Neonatal erythrocytes have increased rates of endocytosis compared to adult erythrocytes; these rates gradually decrease to adult levels with prolonged incubation ( 189 ). In septic neonates, ATP concentration in red blood cells was significantly lower than in neonates with respiratory distress syndrome and controls, whereas the 2,3-DPG concentration was increased ( 190 ).

The activity of a number of nonglycolytic enzymes also is different in neonatal red cells. Carbonic anhydrase ( 188 ), catalase ( 191 ), acetylcholinesterase ( 192 ), adenylate kinase ( 192 ), hypoxanthine-guanine-phosphoribosyl transferase ( 193 ), and cytochrome *b*<sub>5</sub> reductase ( 194 ) are all less active than in adult red cells. Differences in carbonic anhydrase activity have been exploited by using this enzyme to lyse selectively any contaminating maternal cells from samples of mixed fetal and maternal cells obtained for the prenatal diagnosis of hemoglobinopathies ( 195 ). Reduced activity of cytochrome *b*<sub>5</sub> reductase, the enzyme responsible for methemoglobin reduction, contributes to the infant's vulnerability to methemoglobinemia. This enzyme exists in both soluble and membrane-bound forms. The membrane-bound form is the precursor enzyme that is posttranslationally processed to a smaller, soluble form, probably by a calmodulin-dependent endogenous protease ( 196 ). Neonatal red cells have membrane-bound cytochrome *b*<sub>5</sub> reductase activity comparable to that of adult cells but

are limited in their ability to convert membrane-bound enzyme to the soluble form.

Cord blood contains three types of hemoglobin: HbF ( $\alpha_2, \gamma_2$ ), HbA ( $\alpha_2, \beta_2$ ), and HbA2 ( $\alpha_2, \delta_2$ ). HbF constitutes the major fraction (50 to 85%) (5). Because of this, hemoglobinopathies involving  $\beta$ -chain synthesis, such as sickle cell disease and  $\beta$ -thalassemia, do not present in the neonatal period. The G- $\gamma$  to A- $\gamma$  ratio at birth is approximately 3:1, in contrast to a ratio of 2:3 in adults (197, 198). HbA accounts for 15 to 40% of the hemoglobin. HbA2 is present in only trace amounts (mean, 0.3%) at birth (199), but it increases slowly after birth, reaching the normal adult level (2 to 3%) by 5 months of age. Relative to values in adults, that of free erythrocyte protoporphyrin is high at birth and remains elevated through the first 6 months of age (200).

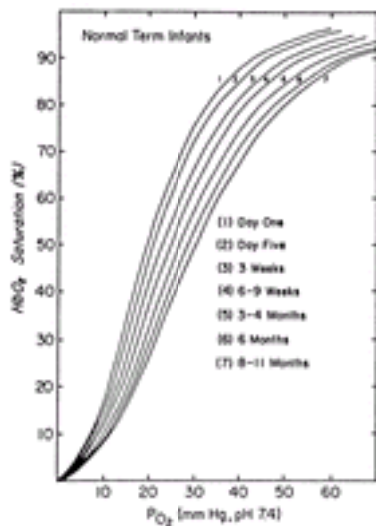
The level of HbF at birth is influenced by a number of variables, the most significant of which is gestational age. Premature infants have more HbF and postmature infants less (Fig. 48.1) (201). Neonates who have survived chronic intrauterine hypoxia, such as occurs with maternal heart and lung disease, have higher levels of HbF (202). Hemolytic disease is associated with lower levels of HbF. This association does not result from a difference in the synthetic ratios of  $\beta$ - and  $\delta$ -globin chains (203), but rather relates to a younger population of red cells produced late in fetal life (204). The switch from  $\gamma$ -chain synthesis to  $\beta$ -chain synthesis is insensitive to environmental variables and appears to be developmentally programmed. Neither intrauterine transfusion nor neonatal exchange transfusion affects the synthetic rates of  $\beta$ - and  $\delta$ -chains (202). Studies quantifying the specific gamma globin messenger RNAs (mRNAs) report that (G)gamma globin mRNA to total gamma globin mRNAs remains around 66% until the 44 week of postconceptual age, when a change in the (G)gamma and (A)gamma globin mRNA proportions occurred. Immature red cells of adults have a range of (G)gamma globin mRNA to total gamma globin mRNAs varying from 20 to 74% (205). Lower levels of HbF are associated with trisomy 21 (206); higher levels are associated with trisomy 13 (207).



**Figure 48.1.** Decline in fetal hemoglobin (Hb) synthesis as a function of gestational age. Solid dots cord blood samples from preterm infants; open circles samples from infants considered to have been delivered at term. (From Bard H. The postnatal decline of hemoglobin F synthesis in normal full-term infants. *J Clin Invest* 1975;55:395, with permission.)

HbF has an affinity for oxygen that is greater than that of HbA (208). The oxygen tension at which the hemoglobin of cord blood is 50% saturated is 19 to 21 mm Hg, 6 to 8 mm Hg lower than that of normal adult blood. This shift to the left of the hemoglobin-oxygen dissociation curve results from poor binding of 2,3-DPG by HbF (209). The position of the oxygen dissociation curve is determined by both the percentage of HbA and the red cell content of 2,3-DPG (210). As the relative proportion of HbA increases, the oxygen dissociation curve shifts by approximately 4 to 6 months of age to a position that is

normal for the adult ( [Fig. 48.2](#)). The increased oxygen affinity of HbF confers a physiologic advantage to the fetus in facilitating the transfer of oxygen from mother to fetus. Postnatally, however, it imposes a potential hazard in that oxygen unloading is constrained.



**Figure 48.2.** Oxygen dissociation curves of blood from term infants at different ages. The  $P_{50}$  at birth is  $19.4 \pm 1.8$  mm Hg; by 11 months of age,  $P_{50}$  is  $30.3 \pm 0.7$ . Hb, hemoglobin. (From Oski FA, Delivoria-Papadopoulos M. The red cell, 2,3-diphosphoglycerate, and tissue oxygen release. *J Pediatr* 1970;77:941, with permission.)

HbF is resistant to alkali denaturation, a property that is the basis for its chemical quantitation ( [211](#)). Unlike HbA, HbF is not eluted from fixed blood smears immersed in an acid buffer ( [212](#)). This property permits the differential staining of HbF and HbA, a technique used widely to study the distribution of HbF in red cells and to detect fetal cells in the maternal circulation.

### Fetal and Neonatal Anemia due to Hemolysis

Hemolytic anemia in neonates is generally associated with serum bilirubin levels above 10 mg/dl. The exaggerated bilirubin response to shortened red cell survival reflects the unique nature of bilirubin metabolism in the newborn period ( [213](#)). During intrauterine life, bilirubin is cleared effectively by the placenta and is metabolized by the maternal liver ( [214](#)). As a result, fetal hemolytic disease never presents as jaundice at birth, and the bilirubin concentration of cord blood is normal or is elevated only modestly. After birth, however, the products of heme catabolism must be processed by the liver. The neonatal liver is limited in its ability to metabolize bilirubin efficiently, in part because of a deficiency of the cytoplasmic acceptor protein ligandin ( [215](#)), and in part because of decreased activity of uridine diphosphoglucuronyl transferase ( [216](#)). As a result, hepatic binding and transport are compromised, conjugation of bilirubin is limited, and biliary excretion is reduced.

Causes of hemolytic disease in the newborn are noted in [Table 48.7](#). Worldwide, isoimmunization caused by maternal-fetal blood group incompatibility is the most common

cause of hemolytic anemia. The pathophysiology, diagnosis, prevention, and treatment of erythroblastosis fetalis are discussed in [Chapter 36](#). Descriptions of the neonatal expressions of hemolysis resulting from congenital defects of the red cell are provided in subsequent chapters: hereditary spherocytosis, hereditary elliptocytosis, and hereditary pyropoikilocytosis in [Chapter 32](#); pyruvate kinase deficiency and glucose-6-phosphate dehydrogenase deficiency in [Chapter 33](#); and hemoglobin H disease in [Chapter 42](#).

**TABLE 48.7. Causes of Hemolytic Disease in Newborns**

---

Immune-mediated

- Rh incompatibility (anti-D antibody)
- ABO, c, C, e, E, G incompatibility
- Minor blood group incompatibility:
  - Fya (Duffy), Kell group, Jka, MNS, Vw
- Drug-induced (penicillin,  $\alpha$ -methyldopa, cephalosporins)
- Maternal autoimmune hemolytic anemia

Congenital erythrocyte enzyme defects

- Glucose-6-phosphate dehydrogenase deficiency
- Pyruvate kinase deficiency
- Hexokinase deficiency
- Glucose phosphate isomerase deficiency
- Pyrimidine 5' nucleotidase deficiency

Hereditary erythrocyte membrane disorders

- Spherocytosis
- Elliptocytosis
- Stomatocytosis
- Pyropoikilocytosis
- Other membrane disorders

Infection

- Bacterial sepsis (*Escherichia coli*, group B streptococcus)
- Parvovirus B19 (can present with hydrops fetalis)
- Congenital syphilis
- Congenital malaria
- Congenital TORCH infections (*toxoplasmosis*, *rubella*, *cytomegalovirus*, disseminated herpes)
- Other congenital viral infections

Hemoglobin defects

- $\alpha$ -thalassemia syndromes
- ?-thalassemia syndromes
- $\alpha$ - and ?-chain structural anomalies

Macro- and microangiopathic hemolysis

- Cavernous hemangiomas
- Arteriovenous malformations
- Renal artery stenosis or thrombosis
- Other large vessel thrombi
- Severe coarctation of the aorta
- Severe valvular stenoses

Other causes

- Disseminated intravascular coagulation



Hypothyroidism  
Galactosemia  
Lysosomal storage diseases  
Prolonged metabolic acidosis from metabolic disease (amino acid and organic acid disorders)

---

Antigens in the ABO, MN, Rh, Kell, Duffy, and Vel systems are well developed on fetal red cells during early intrauterine life ( [217](#) ). They are present in the fifth to seventh gestational week and remain constant through the remainder of intrauterine development. Other antigens, such as the Lutheran and XgA systems, develop more slowly but are present at birth, unlike Lewis antigens, which develop after birth. By 2 years of age, red cell and plasma antigens have developed a pattern that is seen throughout the remainder of life ( [218](#) ).

Although A and B antigens are present early *in utero*, A and B isoagglutinin production occurs later during the second and third trimester ( [219](#) ). By 30 to 34 weeks' gestation, about one-half of all fetuses have some measurable anti-A or anti-B antibodies. The fetal production of such antibodies is not related to maternal blood type, rather, intrauterine exposure to gram-negative organisms whose antigens are chemically related to those of blood groups A and B act as a potent stimulus for antibody development.

Isoimmunization due to Rh or ABO incompatibility is the most common cause of hemolytic disease in the newborn period. ABO incompatibility represents a spectrum of hemolytic disease in newborns.

To determine the frequency of red blood cell antigen alloimmunization that is capable of causing hemolytic disease, a study group in Syracuse, New York, identified 452 women who had a positive antibody screen during a 30-month screening period ( [221](#) ). The frequencies of specific alloimmunization were: anti-D, 18.4%; anti-E, 14%; anti-c, 5.8%; anti-C, 4.7%; Kell group, 22%; anti-MNS, 4.7%; anti-Fya (Duffy), 5.4%; and anti-Jka, 1.5%. The study group concluded that anti-D was still a common antibody, despite the use of RHo (D) immune globulin (Rhogam).

Rhesus and Kell antigen status can be determined by DNA studies, and molecular biology techniques, such as polymerase chain reaction, have been used recently to determine fetal blood type. These methods may represent an advance in the clinical management of alloimmunization in the future ( [222](#) ).

Anti-Kell anemic fetuses have lower reticulocyte counts and total serum bilirubin levels than comparable anti-D anemic fetuses ( [223](#) ). The level of hemolysis caused by anti-Kell antibodies is less than that caused by anti-D antibodies, but fetal erythropoiesis is blunted. It appears that Kell sensitization results in both suppression of fetal erythropoiesis and hemolysis. Vaughan and co-workers evaluated the effects of anti-Kell antibodies on erythroid progenitors ( [224](#) ). The growth of Kell-positive erythroid progenitor cells from cord blood was markedly inhibited by anti-Kell antibodies in a dose-dependent fashion. Anti-D antibodies had no effect on erythroid progenitor growth. They concluded that anti-Kell antibodies cause fetal anemia by suppressing erythropoiesis at the level of erythroid progenitors. Fetuses with anti-Kell hemolytic anemia may therefore benefit from fetal blood sampling rather than amniotic fluid analysis, which might underestimate the



degree of anemia ( [223](#) ).

Extremely high titers of anti-C antibody have been associated with neonatal hemolytic disease ( [225](#) ). However, routine screening of titers is not warranted, because antibody titers do not accurately reflect the severity of hemolytic disease ( [226](#) ). Blood type is sufficient to screen for possible anti-D antibody.

### Fetal and Neonatal Anemia due to Hemorrhage

Hemorrhage can occur at any time during the prenatal, perinatal, and postnatal periods ( [Table 48.8](#) ).

**TABLE 48.8. Causes of Hemorrhage in the Fetus and Neonate**

---

#### Prenatal

- Chronic and/or acute twin-to-twin transfusion syndrome
- Chronic and/or acute fetal-maternal hemorrhage
- Hemorrhage into amniotic fluid after periumbilical blood sampling
- Traumatic amniocentesis
- Maternal trauma
- Trauma after external cephalic version

#### Perinatal

- Placental abruption
- Placenta previa
- Vasa previa
- Trauma or incision of placenta during cesarean section
- Ruptured normal or abnormal (varices, aneurysms, hematoma) umbilical cord
- Placental hematoma
- Velamentous insertion of the cord
- Nuchal cord

#### Postnatal

- Subgaleal hemorrhage
  - Cephalohematoma
  - Hemorrhage associated with disseminated intravascular coagulation/sepsis
  - Intraventricular/intracranial hemorrhage (prematurity, trauma, isoimmune thrombocytopenia)
  - Organ trauma (liver, spleen, adrenal, renal, gonadal)
  - Pulmonary hemorrhage
  - Iatrogenic blood loss (phlebotomy, central line accidents)
- 

**PRENATAL HEMORRHAGE** Maternal and fetal circulating cells may cross the placental barrier at varying times during the pregnancy. Fetal red cells can be found in the maternal circulation before delivery, as evidenced by studies of maternal blood group immunization. Approximately 50 to 75% of pregnancies are associated with some degree of FMH. This event is uncommon in the first trimester. Approximately 1 pregnancy in 400 is associated with a fetal transplacental bleed of 30 ml or greater, and approximately 1 pregnancy in 2000 is associated with a potential fetal transplacental hemorrhage of 100 ml or more ( [227](#) ). More commonly, the volume of fetal blood transferred into the maternal circulation is

relatively small, usually on the order of 0.01 to 0.10 ml. The overall risk of Rh immunization occurring with FMH in an Rh-incompatible pregnancy is 16% if the fetus is Rh positive and ABO compatible with its mother. This risk decreases to 1.5% if the fetus is Rh positive but ABO incompatible, due to the destruction of ABO incompatible cells early during transfer. Fetal transfer of cells to the mother occurs during abortions as well (approximately a 2% incidence of such transfer with spontaneous abortion and a 4 to 5% rate if induced) ( [228](#) ). The Kleihauer Betke stain of maternal blood evaluates the acid elution of hemoglobin from red cells ( [212](#) ). HbF resists acid elution to a greater degree than adult hemoglobin. Maternal cells appear clear (termed *ghost cells*), whereas the contaminating fetal cells appear pink. Results from mothers with increased HbF synthesis (i.e., sickle cell disease, thalassemia, and hereditary persistence of HbF) are not reliable; in these cases, other measures should be taken to detect FMH. Diagnosis of FMH may also be difficult to detect when the mother and infant are ABO incompatible, because fetal cells are rapidly cleared from the maternal circulation by maternal anti-A or anti-B antibodies. Severe FMH occurs in 1 in 1000 deliveries and has been associated with decreased fetal movements and a fetal sinusoidal heart rate pattern ( [229](#) ). Giacoia reviewed these variables to determine if they correlated with the severity of FMH ( [230](#) ). Fetal movements for a period ranging between 24 hours and 7 days were absent in 17 of 134 cases evaluated. In this group, six infants survived, five were stillborn, and five died in the neonatal period. A sinusoidal heart rate pattern was reported in 21 cases, and was associated with decreased fetal movement in 40% of the cases. No significant difference was found between the cases with a FMH of less than 200 ml and those less than 200 ml. Decreased neonatal blood volumes are associated with a maternal history of vaginal bleeding, placenta previa or abruption, nonelective cesarean section, and deliveries associated with cord compression ( [231](#) ). Significant FMH has been described following trauma ( [232](#) ), and fetal hemorrhage into the placenta has been associated with placental chorioangioma ( [233](#) ). Infants need rapid evaluation and treatment if a significant hemorrhage is suspected. The infant with massive hemorrhage presents with pallor and tachypnea but generally with minimal to no oxygen requirement. Hemoglobin concentrations can be extremely low at birth, between 4 and 6 g/dl. A significant metabolic acidosis is often present as a result of poor perfusion. Other causes of pallor in the newborn period do occur and can be ruled out once the infant is stable. Infants with asphyxia and infants with chronic anemia due to hemolysis can also present with pallor. These diagnoses can be distinguished from acute hemorrhage based on differences in clinical signs and symptoms. The clinical picture with chronic blood loss is usually mild, and infants respond to conservative therapy with iron alone. Asphyxiated infants will be pale, floppy, and may have poor peripheral circulation. The hemoglobin will be stable, but may decrease if disseminated intravascular coagulation (DIC) and internal bleeding occur. TTS is a complication of monochorionic twin gestations, occurring in 5 to 30% of these pregnancies ( [234](#) ). TTS involves placental anastomoses, which allow transfer of blood from one twin to the other. The perinatal mortality rate can be as high as 70 to 100%, depending on severity and timing of presentation. Approximately 70% of monozygous twin pregnancies have monochorionic placentas ( [235](#) ). Although vascular anastomoses are present in almost all instances of monochorionic placentas, not all of those develop TTS. Acute TTS generally results in twins of similar size but with hemoglobin concentrations that vary by more than 5 g/dl ( [236](#) ). In chronic TTS, the donor twin becomes progressively anemic and growth retarded, whereas the recipient twin becomes polycythemic, macrosomic, and sometimes hypertensive. Both infants can develop hydrops fetalis; the donor twin becomes hydropic from profound anemia, whereas the recipient twin becomes hydropic from congestive heart failure and hypervolemia. The donor twin often has low amniotic fluid volumes, whereas the recipient twin has increased amniotic fluid, due to significant differences in blood volume, renal blood flow, and urine output. Chronic TTS can be diagnosed by serial prenatal ultrasounds measuring cardiomegaly, discordant amniotic fluid production, and fetal growth discrepancy of >20%. Percutaneous umbilical blood sampling can determine if hemoglobin concentration

differences of greater than 5 gm/dl exist between the two fetuses ( [236](#) ). After birth, the donor twin may require transfusions and can also experience neutropenia, hydrops from severe anemia, growth retardation, congestive heart failure, and hypoglycemia. The recipient twin is often the sicker of the two. Problems include hypertrophic cardiomyopathy, congestive heart failure, polycythemia, hyperviscosity, respiratory difficulties, hypocalcemia, and hypoglycemia. Neurologic evaluation and imaging are imperative because the risk of antenatally acquired neurologic cerebral lesions is 20 to 30% in both twins ( [236](#) ). The incidence of neurologic morbidity following the intrauterine death of one of the fetuses averages 20 to 25%. Morbidities include multiple cerebral infarctions, hypoperfusion syndromes from hypotension, and periventricular leukomalacia. Long-term neurologic follow-up is indicated for all TTS survivors. Treatment for TTS consists of close monitoring and reduction amniocenteses to decrease uterine stretch and prolong the pregnancy. The average survival rates with serial reduction amniocenteses range from 40 to 70% ( [237](#) ). Selective feticide of the hydropic twin has also resulted in the survival of the healthier twin in some studies ( [238](#) ). Treatment *in utero* has occurred during some pregnancies using laser surgery to ablate bridging vessels, resulting in improved survival rates up to around 50%, with approximately 70% of the pregnancies having at least one survivor ( [239](#), [240](#) ). However, the survival rate without morbidity in the surviving twin is approximately 50% ( [241](#) ). Supski et al. performed a metaanalysis of 140 cases to correlate types of treatment with outcome ( [242](#) ). They found no differences in outcome between amnioreduction, fetoscopy, septostomy, or close observation. Although the number of cases was small, the results of the analysis showed that a definitive form of treatment has not been established for severe TTS.

**PERINATAL HEMORRHAGE** Obstetric complications, such as placenta previa, placental abruption, incision or tearing of the placenta during cesarean section, and cord evulsion of normal or abnormal umbilical cords, can result in significant neonatal blood loss. Newborns may also undergo significant blood loss back into the placenta, termed a *fetoplacental hemorrhage*. Finally, placental anomalies, such as a multilobed placenta and placental chorioangiomas, may be a source of hemorrhage during the perinatal period ( [233](#) ). Placental abruption involves premature separation of the placenta from the uterus and occurs in 3 to 6 per 1000 live births. Prolonged rupture of the membranes, severe fetal growth restriction, chorioamnionitis, hypertension (before pregnancy and pregnancy-induced), cigarette smoking, advanced maternal age, and male fetal gender are potential risk factors for placental abruption ( [243](#) ). The incidence of abruption increases with lower gestational age. Mortality ranges from 0.8 to 2.0 per thousand births ( [244](#) ), or 15 to 20% of the deliveries in which significant abruption occurs. Women with a history of a previous cesarean birth and increased parity are at increased risk of having a pregnancy complicated by placenta previa ( [245](#) ), a condition where part or all of the placenta overlies the cervical os. Cigarette smoking is associated with a 2.6- to 4.4-fold increased risk of placenta previa ( [246](#) ). Prenatal diagnosis of vasa previa (anomalous vessels overlying the internal os of the cervix) can be made with transvaginal color Doppler, and should be suspected in any case of antepartum or intrapartum hemorrhage. Although uncommon (1 in 3000 deliveries), the perinatal death rate is high, ranging from 33 to 100% when undetected before delivery. Infants are often stillborn ( [247](#) ). Infants born after placental abruption may be anemic but may also present with signs of hypoxia. In these infants, it is important to monitor changes in hematocrit and neurologic signs. Infants born to mothers with placenta previa can also be anemic. The need for postnatal transfusions in the infants is generally associated with the volume of maternal hemorrhage. The infant's hemoglobin should be measured at birth and again at 12 to 24 hours whenever there is evidence of placental abruption, placenta previa, or unusual vaginal bleeding. A Kleihauer Betke stain can be performed on maternal blood to determine if fetal hemorrhage occurred. Monitoring mothers with a history of second or third trimester bleeding with Doppler flow ultrasound may detect placental abnormalities and thereby decrease the incidence of anemia and fetal loss in newborns ( [247](#) ). Cord rupture due to excess traction

on a shortened or abnormal umbilical cord usually occurs on the fetal side. Cord aneurysms, varices, and cysts can all lead to formation of a weakened cord. Cord infections (funisitis) can also weaken the cord and increase the risk of rupture. Infants born precipitously may be at increased risk for hemorrhage due to a ruptured cord. Hematomas of the cord occur infrequently (1 in 5000 to 6000 deliveries) but can also be a cause of fetal blood loss, and may be associated with significant perinatal mortality. Intrauterine death may occur due to compression of the umbilical vein and arteries by the hematoma. Cord hematomas can result from trauma due to percutaneous umbilical blood sampling and can also be associated with a high maternal  $\alpha$ -fetoprotein. Hematomas of the cord can be accurately diagnosed *in utero* by ultrasound and differentiated from other lesions of the placenta and cord ( [248](#) ). The lesion can be associated with poor fetal growth and FMH. Subamniotic hematomas can occur when chorionic vessels rupture near the cord insertion. Most subamniotic hematomas are the result of excessive traction on a normal or shortened umbilical cord and are not noted until after delivery. Velamentous insertion of the umbilical cord occurs when the umbilical cord enters the membranes distant from the placenta and is present in approximately 0.5 to 2.0% of pregnancies ( [249](#) ). Blood vessels left unprotected by Wharton jelly are more likely to tear. Rupture of anomalous vessels in the absence of traction or trauma can occur even if the cord itself attaches centrally or paracentrally. The fetal mortality remains very high in this condition, often because detection by routine ultrasound is rare. Eddleman and co-workers noted that targeted sonographic examination of the placental site of umbilical cord insertion could reveal abnormal placental cord insertions. However, distinguishing the specific type of abnormal insertion would likely require the use of color Doppler imaging ( [250](#) ).

**POSTNATAL HEMORRHAGE** Blood loss into the placenta is one of the most common etiologies for a low birth hematocrit in a neonate. Of the 120 ml/kg of blood in the fetoplacental unit, a large residual volume remains in the placenta, and blood continues to flow in the direction of gravity after birth. Fetoplacental hemorrhage occurs when the infant is held above the placenta after birth. In addition, infants can lose 10 to 20% of their total blood volume when born with a tight nuchal cord that allows blood to be pumped through umbilical arteries while constricting flow through the umbilical vein ( [251](#) ). Blood loss into the subgaleal space can occur during difficult deliveries requiring vacuum or forceps assistance, such as face presentation, occiput posterior presentations, and shoulder dystocias. Subgaleal hematomas are potentially life-threatening events and must be recognized as early as possible to prevent significant morbidity or mortality. The hematomas occur when emissary or “bridging” veins are torn, allowing blood to accumulate in the large potential space between the galea aponeurotica (the epicranial aponeurosis) and the periosteum of the skull. The subgaleal space extends from the orbital ridge to the base of the skull and can accommodate an infant’s entire blood volume (>85 ml/kg of blood). Subgaleal hematomas may form because of preexisting risk factors (such as coagulopathy or asphyxia), but vacuum extraction itself is a risk factor for the development of subgaleal bleeding. The diagnosis should be considered in the presence of a ballotable fluid collection in dependent regions of the infant’s head, coupled with signs of hypovolemia ( [252](#) ). Treatment requires restoration of blood volume and control of bleeding. Exsanguination due to subgaleal hemorrhage has been reported; the mortality is high if the hemorrhage goes unrecognized. A rule of thumb for estimating the volume of blood lost is: 38 ml of blood has been lost for every 1 cm increase in head circumference that occurs ( [253](#) ). Of 134 infants undergoing vacuum extraction, 28 had scalp trauma, and only one infant had subgaleal, subdural, and subarachnoid hemorrhage ( [254](#) ). The duration of vacuum application is thought to be the best predictor of scalp injury, followed by duration of second stage of labor and paramedian cup placement. Of those infants with reported subgaleal hemorrhages, 80 to 90% had some history of vacuum or instrument-assisted delivery ( [255](#) ). It is important to remember that a cesarean delivery does not preclude the use of vacuum or forceps, and significant hemorrhage can still occur via this route of delivery. Therefore, limiting the frequency and duration of vacuum assistance in high-risk infants may decrease the incidence of subgaleal hematomas. Anemia appearing after the first 24 hours of life in a nonjaundiced infant may result from

occult hemorrhage. In addition to birth trauma causing visible hemorrhages, such as a cephalohematoma, internal hemorrhage can occur. Breech deliveries may be associated with renal, adrenal, or splenic hemorrhage into the retroperitoneal space. Delivery of macrosomic infants, such as infants born to diabetic mothers, may also result in organ damage and hemorrhage. Infants with overwhelming sepsis may develop DIC and bleed into soft tissue and organs, such as liver, adrenal glands, and lungs. In addition to causing anemia, adrenal hemorrhage may result in circulatory collapse due to the loss of organ function. The incidence of adrenal hemorrhage is 1.7 per 1000 births ( [256](#) ). Adrenal hemorrhage can also affect surrounding organs. Intestinal obstruction and kidney dysfunction have been reported in infants with adrenal hemorrhage ( [257](#) ). Diagnosis can be made using ultrasonography, during which calcifications or cystic masses are noted. Adrenal hemorrhage can be distinguished from renal vein thrombosis (RVT) by ultrasound, in that RVT generally results in a solid mass. Occasionally, both entities may coexist in the same patient ( [258](#) ). Infants with RVT may have gross or microscopic hematuria and may go on to develop renal failure and hypertension. Infectious etiologies resulting in DIC and hemorrhage are also a cause of adrenal hemorrhage. Mostoufizadeh and colleagues reported five cases of echovirus type 11 diagnosed in neonates born in the Boston area during a single season ( [259](#) ). Four of the mothers experienced symptomatic gastroenteritis late in the third trimester of pregnancy. Affected infants experienced jaundice, hepatosplenomegaly, hypotonia, and progressive hepatic failure. At autopsy, investigators found massive hepatic and adrenal hemorrhage and necrosis, with evidence of a consumptive coagulopathy. Echovirus type 11 was isolated from various sites before and after death. The newborn liver is very prone to iatrogenic rupture, resulting in a high morbidity and mortality ( [260](#) ). Infants may appear asymptomatic until the liver ruptures and hemoperitoneum occurs. This can occur in both term and preterm infants ( [261](#) ) and has been associated with chest compressions during cardiopulmonary resuscitation. Surgical intervention involving vascular tamponade has been reported to save some infants; however, the mortality remains high ( [262](#) ). Splenic rupture can result from birth trauma or as a result of distention caused by extramedullary hematopoiesis, such as that seen in erythroblastosis fetalis. Abdominal distension and discoloration, scrotal swelling, and pallor are clinical signs of splenic rupture; these signs may also be seen with adrenal hemorrhage or hepatic rupture ( [261](#) ). Other rare causes of hemorrhage in the newborn include hemangiomas of the gastrointestinal tract ( [263](#) ), vascular malformations of the skin, and hemorrhage into soft tumors, such as giant sacrococcygeal teratomas. Occult intraabdominal hemorrhage can occur with fetal ovarian cysts, which are usually benign and resolve spontaneously. One case of fetal anemia was diagnosed by a spontaneous hemorrhage into a fetal ovarian cyst and was managed by intrauterine blood transfusions ( [264](#) ).

### **Fetal and Neonatal Anemia due to Congenital Infection**

Neonatal sepsis due to group B streptococcus, *Escherichia coli*, and other perinatal organisms may result in hemolysis, DIC, and hemorrhage. Infants are often jaundiced and have hepatosplenomegaly, although the degree of hyperbilirubinemia does not always reflect the degree of anemia. Infants may have an elevated direct bilirubin as well, possibly due to infectious involvement with the liver. Bacteria, such as *E. coli*, produce hemolytic endotoxins, which result in increased red cell destruction, often associated with a microangiopathic process ( [265](#) ).

Congenital viral infections due to cytomegalovirus, toxoplasmosis, rubella, and herpes simplex may also be associated with a hemolytic anemia. Congenital syphilis may present with hemolytic anemia despite negative testing in the mother. Initial maternal screening for syphilis may be negative despite overwhelming infection, a condition termed the *prozone effect* ( [266](#) ). This occurs when a higher than optimal amount of antibody in the



tested sera prevents the flocculation reaction seen in positive reagin test results. Serum dilution is necessary to make the correct diagnosis. In cases of nonimmune hydrops, nontreponemal testing should be repeated using serum dilutions to prevent a missed diagnosis of syphilis in women with negative syphilis serologic results.

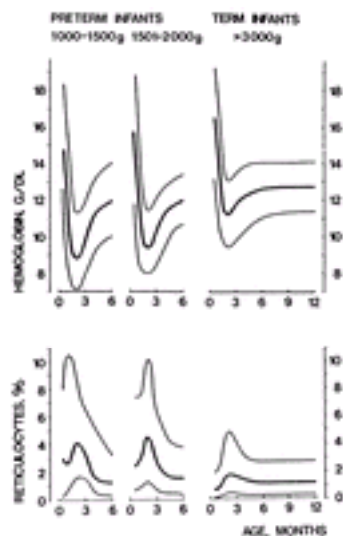
Fetal and neonatal infection with parvovirus B19 can cause severe anemia, hydrops, and fetal demise ( [267](#), [268](#) ). The infant generally presents with a hypoplastic anemia ( [269](#) ), but hemolysis can occur as well. The virus replicates in erythroid progenitor cells and shuts down erythropoiesis, resulting in red cell aplasia. *In utero* transfusions for hydropic fetuses have been investigated but are not successful in all patients. Treatment with IVIG during aplastic crises leads to resolution of the anemia.

Other infections associated with neonatal anemia include malaria and HIV. Congenital malaria may occur in areas, such as New York City ( [270](#) ), where imported cases of malaria are increasing. Congenital HIV infection can be asymptomatic in newborns. Infants born to mothers on zidovudine may have a hypoplastic anemia due to side effects of the drug ( [97](#) ).

### **Anemia of Prematurity and Other Hypoproliferative Disorders**

Impaired erythrocyte production can result from a variety of reasons. Lack of an appropriate or sufficient marrow environment for growth (as seen in osteopetrosis) can cause decreased red cell production. Lack of specific substrates or their carriers (e.g., iron, folate, vitamin B<sub>12</sub>, or transcobalamin II deficiency) can lead to deficient production. Lack of specific growth factors stimulating erythropoiesis (e.g., decreased erythropoietin production or abnormalities in Epo receptors) can also lead to hypoproliferative anemia, such as the anemia of prematurity.

**ANEMIA OF PREMATURITY** In preterm infants, adaptive mechanisms to the extrauterine environment are incomplete. Erythropoietin concentrations in anemic preterm infants are still significantly lower than those found in adults, given the degree of their anemia ( [140](#) ). This normocytic, normochromic anemia, termed the *anemia of prematurity*, commonly affects infants at less than or equal to 32 weeks' gestation. The anemia of prematurity is not responsive to the addition of iron, folate, or vitamin E. Some infants may be asymptomatic, whereas others demonstrate signs of anemia that are alleviated by transfusion. These signs traditionally include tachycardia, increased episodes of apnea and bradycardia, poor weight gain, an increased oxygen requirement, and elevated serum lactate concentrations that decrease following transfusion. Infants with the anemia of prematurity have a decreased ability to increase serum erythropoietin concentrations, despite diminished available oxygen to tissues ( [271](#) ) and the appearance of signs of anemia. However, erythroid progenitors are highly sensitive to erythropoietin ( [272](#), [273](#) ), and concentrations of other erythropoietic growth factors appear to be normal ( [274](#) ) ( [Figure 48.3](#) ).



**Figure 48.3.** Hemoglobin concentration and reticulocyte counts in preterm and term infants. Curves describe median values and 95% confidence limits for infants of three different weight categories. (From Dallman PR. Anemia of prematurity. *Annu Rev Med* 1981;32:143, with permission.)

The molecular and cellular mechanisms responsible for the anemia of prematurity remain undefined. Some explanations include the transition from fetal to adult hemoglobin, shortened erythrocyte survival, and hemodilution associated with a rapidly increasing body mass ( [144](#), [275](#) ). It is unknown whether preterm infants rely on erythropoietin produced by the liver (the source of erythropoietin *in utero*), or that produced by the kidney, or a combination of the two. Regardless of the mechanism responsible for the anemia of prematurity, exogenous erythropoietin administered to preterm infants activates erythropoiesis ( [276](#) ). A review of studies evaluating the use of erythropoietin to prevent and treat the anemia of prematurity reveals a positive effect on decreasing transfusion requirements in preterm infants ( [277](#) ).

**OTHER HYPOPROLIFERATIVE ANEMIAS** With the exception of the anemia of prematurity, anemia in the newborn period is rarely the result of impaired red cell production ( [Table 48.9](#) ). Although classified as a congenital anemia, the Diamond–Blackfan syndrome characteristically is not recognized until after 2 to 3 months of age. However, it is estimated that 10 to 25% of affected infants have a mild anemia at birth ( [278](#) ). Rarely, hydrops fetalis has been reported in conjunction with this syndrome. This disorder is discussed in [Chapter 45](#). Aase syndrome, another congenital hypoplastic anemia syndrome involving marrow and skeletal anomalies ( [279](#) ), is likely a variant of Diamond–Blackfan syndrome. Congenital dyserythropoietic anemia is a rare disorder marked by ineffective erythropoiesis, megaloblastic anemia, and characteristic abnormalities of the nuclear membrane and cytoplasm seen on electron microscopy. This disorder is reviewed in [Chapter 46](#).

**TABLE 48.9. Syndromes Associated with Anemia**

| Genetic Syndrome               | Phenotypic Features  | Genotypic Features |
|--------------------------------|--|--------------------|
| Adenosine deaminase deficiency | Autoimmune hemolytic anemia, reduced erythrocyte adenosine deaminase activity. | AR, 20q13.11       |



|  |   |  |
|--|---|--|
| Congenital dyserythropoietic anemias                                   | Type I (rare): megaloblastoid erythroid hyperplasia and nuclear chromatin bridges between nuclei; type II (most common): “hereditary erythroblastic multinuclearity, positive acidified serum (HEMPAS) test, increased lysis to anti-i; type III: erythroblastic multinuclearity (“gigantoblasts”), macrocytosis. | Type I: 15q15.1–q15.3; type II: 20q11.2; type III: 15q21   |
| Diamond–Blackfan syndrome  | Steroid–responsive hypoplastic anemia, often macrocytic after 5 mo of age.  | AR; sporadic mutations and AD inheritance described; 19q13.2, 8p23.3–p22   |
| Dyskeratosis congenita   | Hypoproliferative anemia usually presenting between 5 to 15 yr of age.  | X–linked recessive, locus on Xq28; some cases with AD inheritance  |
| Fanconi pancytopenia   | Steroid–responsive hypoplastic anemia, reticulocytopenia, some macrocytic RBCs, shortened RBC lifespan. Cells are hypersensitive to DNA cross–linking agents.   | AR, multiple genes: complementation; group A: 16q24.3; B:; C: 9q22.3; D2: 3p25.3; E: 6p22–p21; F: 11p15; G: 9p13 |
| Osler hemorrhagictelangiectasia syndrome                               | Hemorrhagic anemia.   | AD, 9q34.1   |
| Osteopetrosis  | Hypoplastic anemia from marrow compression; extramedullary erythropoiesis.  | AR: 16p13, 11q13.4–q13.5; AD: 1p21; lethal: reduced osteoclasts  |
| Pearson syndrome   | Hypoplastic sideroblastic anemia, marrow cell vacuolization.  | Pleioplasmatic rearrangement of mitochondrial DNA; X–linked or AR  |
| Peutz–Jeghers syndrome   | Iron deficiency anemia from chronic blood loss.   | AD, 19p13.3  |
| X–linked a–thalassemia/mental retardation (ATR–X and ATR–16) syndromes | ATR–X: hypochromic, microcytic anemia; mild form of hemoglobin H disease ATR–16: more significant hemoglobin H disease and anemia are present.  | ATR–X: X–linked recessive, Xq13.3; ATR–16: 16p13.3, deletions of a–globin locus                                  |

AD, autosomal dominant; AR, autosomal recessive; RBC, red blood cell.

Fanconi pancytopenia is an autosomal–recessive disorder characterized by marrow failure and congenital anomalies, including abnormalities in skin pigmentation, gastrointestinal anomalies, renal anomalies, and upper limb anomalies ([280](#)). Approximately one–third of patients have no obvious congenital anomalies, and anemia is less common than thrombocytopenia and leukopenia. Five genetic phenotypes of Fanconi pancytopenia have been reported, and two of the genes have been cloned ([281](#)). Cells are hypersensitive to DNA cross–linking agents such as diepoxybutane and mitomycin C. The diepoxybutane test represents a sensitive and specific diagnostic test. Most patients with Fanconi anemia present in early childhood, but newborns have been reported, usually when

obvious congenital anomalies are present ( [282](#) ). Patients generally have an androgen-responsive hypoplastic anemia, reticulocytopenia, and macrocytic erythrocytes on the peripheral smear. Erythropoietin concentrations are usually elevated, and HbF production is increased. A significant percentage of patients develop myelodysplastic syndrome or acute myelogenous leukemia later in life. Treatment of Fanconi pancytopenia includes androgen therapy, and, in many cases, bone marrow transplantation has been successful ( [Chapter 44](#) ). Osteopetrosis is a rare autosomal-recessive disorder characterized by defects in osteoclastic function, resulting in a decreased bone marrow space. Developmental delay, ocular involvement, and neurodegenerative findings occur in association with hypoplastic anemia, although patients may also present with hemolytic anemia. Longitudinal studies in the United States and Europe have shown variability in outcome, although survival rates beyond 5 to 6 years are less than 30% ( [283](#) , [284](#) ). Patients presenting with early hematologic and visual impairment had an even shorter life expectancy. Limited treatment options for this disorder include marrow transplantation and administration of calcitriol and interferon- $\gamma$  ( [284](#) ). Pearson marrow-pancreas syndrome is a disorder involving the hematopoietic system, exocrine pancreas, liver, and kidneys ( [285](#) ). Patients present in infancy with macrocytic anemia, which is sometimes associated with neutropenia and thrombocytopenia. Marrows have normal cellularity, but abnormalities including vacuolization of erythroid and myeloid precursors, hemosiderosis, and ringed sideroblasts are present. The disorder appears to involve defects in oxidative phosphorylation due to mitochondrial DNA abnormalities ( [286](#) , [287](#) ). The anemia is unresponsive to pyridoxine supplementation. Bone marrow transplantation has not been reported in these patients, and the disorder is considered fatal.

## REFERENCES

1. Lund CJ, Donovan JC. Blood volume during pregnancy. *Am J Obstet Gynecol* 1967;98:393.
2. Mani S, Duffy TP. Anemia of pregnancy. *Clin Perinatol* 1995;22:593.
3. Chesley LC. Plasma and red cell volumes during pregnancy. *Am J Obstet Gynecol* 1972;12:440.
4. Low JA, et al. Blood volume adjustments in the normal obstetric patient with particular reference to the third trimester of pregnancy. *Am J Obstet Gynecol* 1965;91:356.
5. Adair FL, et al. Anemia in pregnancy. *Am J Obstet Gynecol* 1939;32:560.
6. Pritchard JA. Changes in blood volume during pregnancy and delivery. *Anesthesiology* 1965;26:393.
7. Milman N, Byg KE, Agger AO. Hemoglobin and erythrocyte indices during normal pregnancy and postpartum in 206 women with and without iron supplementation. *Acta Obstet Gynecol Scand* 2000;79:89.
8. de Leeuw NKM, et al. Iron deficiency and hydremia in normal pregnancy. *Medicine* 1966;45:291.
9. Pritchard JA, Adams RH. Erythrocyte production and destruction during pregnancy. *Am J Obstet Gynecol* 1960;79:750; 1962;84:1271.
10. Pritchard JA, et al. Blood volume changes in pregnancy and puerperium. II. Red blood cell loss and changes in apparent blood volume during and following vaginal delivery, caesarean section, and caesarean section and total hysterectomy. *Am J Obstet Gynecol* 1962;84:1271.
11. Choi JW, Pai SH. Changes in erythropoiesis with gestational age during pregnancy. *Ann Hematol* 2001;80:26.
12. McLennan CE. Plasma volume late in pregnancy. *Am J Obstet Gynecol* 1950;59:662.
13. McLennan CE, Thouin LG. Blood volume in pregnancy. A critical review and preliminary report of

results with a new technique. *Am J Obstet Gynecol* 1948;55:189.

14. Verel D, et al. Blood volume changes in pregnancy and the puerperium. *Clin Sci* 1956;15:1.
15. Caton WL, et al. Plasma volume and extravascular fluid volume during pregnancy and puerperium. *Am J Obstet Gynecol* 1951;61:1207.
16. Gemzell CA, et al. Blood volume and total amount of haemoglobin in normal pregnancy and the puerperium. *Acta Obstet Gynecol Scand* 1954;33:289.
17. Lund CJ, Sisson TRC. Blood volume and anemia of mother and baby. *Am J Obstet Gynecol* 1958;76:1013.
18. Milman N, Graudal N, Nielson OJ, Agger AO. Serum erythropoietin during normal pregnancy: relationship to hemoglobin and iron status markers and impact of iron supplementation in a longitudinal, placebo-controlled study on 118 women. *Int J Hematol* 1997;66:159.
19. Bajoria R, Ward S, Saoranna SR. Erythropoietin in monochorionic twin pregnancies in relation to twin-twin transfusion syndrome. *Hum Reprod* 2001;16:574.
20. Juul SE. Nonerythropoietic roles of erythropoietin in the fetus and neonate. *Clin Perinatol* 2000;27:527.
21. Juul SE, Ledbetter DJ, Joyce AE, et al. Erythropoietin acts as a trophic factor in neonatal rat intestine. *GUT* 2001;49:182.
22. Ledbetter DJ, Jul SE. Necrotizing enterocolitis and hematopoietic cytokines. *Clin Perinatol* 2000;27:697.
23. Dame C, Juul SE, Christensen RD. The biology of erythropoietin in the central nervous system and its neurotrophic and neuroprotective potential. *Biol Neonate* 2001;79:228.
24. Juul SE, Zhao Y, Dame JB, et al. Origin and fate of erythropoietin in human milk. *Pediatr Res* 2000;48:600.
25. Kling PJ, Sullivan TM, Roberts RA, et al. Human milk as a potential enteral source of erythropoietin. *Pediatr Res* 1998;43:216.
26. Juul SJ, Li Y, Christensen RD. Erythropoietin is present in the cerebrospinal fluid of neonates. *J Pediatr* 1997;130:428.
27. Juul SE, Stallings SA, Christensen RD. Erythropoietin in the cerebrospinal fluid of neonates who sustained CNS. *Pediatr Res* 1999;46:543.
28. Li Y, Juul SE, Morris-Winman JA, et al. Erythropoietin receptors are expressed in the central nervous system of mid-trimester human fetuses. *Pediatr Res* 1996;40:376.
29. Juul SJ, Li Y, Anderson DK, Christensen RD. Erythropoietin and erythropoietin receptor in the developing human central nervous system. *Pediatr Res* 1998;43:40.
30. Juul SE, Yachnis AT, Christensen RD. Tissue distribution of erythropoietin and erythropoietin receptor in the developing human fetus. *Early Hum Dev* 1998;52:235.
31. Juul SE, Yachnis AT, Rojiani AM, Christensen RD. Immunohistochemical localization of erythropoietin and its receptor in the developing human brain. *Pediatr Dev Pathol* 1999;2:142.
32. Cerami A. Beyond erythropoiesis: novel applications for recombinant human erythropoietin. *Semin Hemotol* 2001;38[Suppl 7]:33.
33. Ohls RK. Erythropoietin and hypoxia inducible factor-1 expression in the mid-trimester human fetus. *Acta Pediatr* 2002;91[SupplA38]:27.

34. Ohls RK. The use of erythropoietin in neonates. *Clin Perinatol* 2000;3:681–696.
35. Schwartz WJ III, Thurnau GR. Iron deficiency anemia in pregnancy. *Clin Obstet Gynecol* 1995;38:443.
36. Milman N, Bergholt T, Byg KE, et al. Iron status and iron balance during pregnancy. A critical reappraisal of iron supplementation. *Acta Obstet Gynecol Scand* 1999;78:749.
37. Hanshaw JB, Dugeon JA. *Viral diseases of the fetus and newborn*. Philadelphia: WB Saunders, 1978.
38. Lukens JN. Neonatal haematological abnormalities associated with maternal disease. *Clin Haematol* 1978;7:155.
39. Lanzkowsky P. The influence of maternal iron-deficiency anemia on the hemoglobin of the infant. *Arch Dis Child* 1961;36:205.
40. Murray MJ, et al. The effect of iron status of Nigerian mothers on that of their infants at birth and 6 months, and on the concentration of iron in breast milk. *Br J Nutr* 1978;39:627.
41. Shott RJ, Andrews BF. Iron status of a medical high-risk population at delivery. *Am J Dis Child* 1972;124:369.
42. Woodruff CW, Bridgeforth EB. Relationship between the hemogram of the infant and that of the mother during pregnancy. *Pediatrics* 1953;12:681.
43. Pritchard JA, et al. Infants of mothers with megaloblastic anemia due to folate deficiency. *JAMA* 1970;211:1982.
44. Van Eijk HG, et al. Serum ferritin and iron stores during pregnancy. *Clin Chim Acta* 1978;83:81.
45. Worwood M. Ferritin in human tissues and serum. *Clin Haematol* 1982;11:275.
46. Pritchard JA, Mason RA. Iron stores of normal adults and replenishment with oral iron therapy. *JAMA* 1964;190:897.
47. Marti A, Pena-Martí G, Muñoz S, et al. Association between prematurity and maternal anemia in Venezuelan pregnant women during third trimester at labor. *Arch Latinoam Nutr* 2001;51:44.
48. Mahomed K. Iron supplementation in pregnancy. *Cochrane Database Syst Rev* 2000;CD 000117.
49. Harthoorn-Lasthuizen EJ, Lindemans J, Langenhuisen MM. Does iron-deficient erythropoiesis in pregnancy influence fetal iron supply? *Acta Obstet Gynecol Scand* 2001;80:392.
50. Turgeon O'Brien H, Santure M, Maziade J. The association of low and high ferritin levels and anemia with pregnancy outcome. *Can J Diet Pract Res* 2000;61:121.
51. Sifakis S, Angelakis E, Vardaki E, et al. Erythropoietin in the treatment of iron deficiency anemia during pregnancy. *Gynecol Obstet Invest* 2001;51:150.
52. Burton JR, Riely CA, Sibai BM. Baking powder pica mimicking preeclampsia. *Am J Obstet Gynecol* 1992;167:98.
53. Akesson A, Bjellerup P, Berglund M, et al. Serum transferrin receptor: a specific marker of iron deficiency in pregnancy. *Am J Clin Nutr* 1998;68:1241.
54. Dagg JH, et al. Value of erythrocyte protoporphyrin in the diagnosis of latent iron deficiency (sideropenia). *Br J Haematol* 1966;12:326.
55. Gerritsen T, Walker ARP. The effect of habitually high iron intake on certain blood values in pregnant Bantu women. *J Clin Invest* 1954;33:23.
56. Giles C. An account of 335 cases of megaloblastic anaemia of pregnancy and the puerperium. *J Clin*

Pathol 1966;19:1.

57. Lawrence C, Klipstein FA. Megaloblastic anemia of pregnancy in New York City. *Ann Intern Med* 1967;66:25.
58. Lowenstein L, et al. The incidence and prevention of folate deficiency in a pregnant clinical population. *Can Med Assoc J* 1966;95:797.
59. Streiff RR, Little AB. Folic acid deficiency in pregnancy. *N Engl J Med* 1967;276:776.
60. Rae PG, Robb PM. Megaloblastic anaemia of pregnancy, a clinical and laboratory study with particular reference to the total and labile serum folate levels. *J Clin Pathol* 1970;23:379.
61. Chanarin I, et al. Normal dietary folate, iron, and protein intake with particular reference to pregnancy. *Br Med J* 1968;2:394.
62. Daniel WA, et al. Obstetric and fetal complications in folate-deficient adolescent girls. *Am J Obstet Gynecol* 1971;111:233.
63. Cooper BA, et al. The case for folic acid supplements during pregnancy. *Am J Clin Nutr* 1970;23:848.
64. McLean FW, et al. Folic acid absorption in pregnancy: comparison of pteroylpolyglutamate and pteroylmonoglutamate. *Blood* 1970;36:628.
65. Iyengar L. Folic acid requirements of Indian pregnant women. *Am J Obstet Gynecol* 1971;111:13.
66. Campbell BA. Megaloblastic anemia in pregnancy. *Clin Obstet Gynecol* 1995;38:455.
67. Smithells RW, Sheppard S, Schorah CJ. Vitamin deficiencies and neural tube defects. *Arch Dis Child* 1976;51(12):944.
68. Laurence KM, James N, Miller MH, et al. Double-blind randomized controlled trial of folate treatment before conception to prevent recurrence of neural-tube defects. *Br Med J* 1981;282(6275):1509-1511.
69. Lumley J, Watson L, Watson M, Bower C. Periconceptional supplementation with folate and/or multivitamins for preventing neural tube defects (Cochrane Review). *Cochrane Database Syst Rev* 2001;3:CD001056.
70. Thompson JR, Gerald PF, Willoughby ML, Armstrong BK. Maternal folate supplementation in pregnancy and protection against acute lymphoblastic leukaemia in childhood: a case-control study. *Lancet* 2001;358:1935.
71. Levine PH, Hamstra RD. Megaloblastic anemia of pregnancy simulating acute leukemia. *Ann Intern Med* 1969;71:1141.
72. Grossowicz N, et al. The effect of anemia on the concentration of folate derivatives in paired fetal-maternal blood. *Isr J Med Sci* 1966;2:510.
73. Rappazzo ME, et al. The content of vitamin B12 in adult and foetal tissue: a comparative study. *Br J Haematol* 1970;18:425.
74. Higgenbottom MC, et al. A syndrome of methylmalonic aciduria, homocystinuria, megaloblastic anemia, and neurological abnormalities in a vitamin B12-deficient breast-fed infant of a strict vegetarian. *N Engl J Med* 1978;299:317.
75. Jadhav M, et al. Vitamin B12 deficiency in Indian infants. *Lancet* 1962;2:903.
76. Johnson PR, Roloff JS. Vitamin B12 deficiency in an infant strictly breast-fed by a mother with latent pernicious anemia. *J Pediatr* 1982;100:917.
77. Lampkin BC, et al. Megaloblastic anemia of infancy secondary to maternal pernicious anemia. *N Engl J Med* 1966;274:1168.

78. Lyengar L. Folic acid requirements of Indian pregnant women. *Am J Obstet Gynecol* 1971;111:13.
79. Willoughby MLN. An investigation of folic acid requirements in pregnancy. II. *Br J Haematol* 1967;13:503.
80. Alperin JB, et al. Studies of folic acid requirements in megaloblastic anemia of pregnancy. *Arch Intern Med* 1966;117:681.
81. Willoughby MLN, Jewell FJ. Investigation of folic acid requirements in pregnancy. *BMJ* 1966;2:1568.
82. Martin JD, et al. Serum folate and vitamin B12 levels in pregnancy with particular reference to uterine bleeding and bacteriuria. *Br J Obstet Gynaecol* 1967;74:697.
83. Black RE. Micronutrients in pregnancy. *Br J Nutr* 2001;85[Suppl 2]:S193–197.
84. Sembra RD, Jimwenda N, Taha TE, et al. Impact of vitamin A supplementation on anaemia and plasma erythropoietin concentrations in pregnant women: a controlled clinical trial. *Eur J Haematol* 2001;66:389.
85. Burns DN, FitzGerald G, Semba R, et al. Vitamin A deficiency and other nutritional indices during pregnancy in human immunodeficiency virus infection: prevalence, clinical correlates, and outcome. Women and Infants Transmission Study Group. *Clin Infect Dis* 1999;29:328.
86. Nurdia DS, Sumarni S, Suyoko, et al. Impact of intestinal helminth infection on anemia and iron status during pregnancy: a community based study in Indonesia. *Southeast Asian J Trop Med Public Health* 2001;32:14.
87. Torlesse H, Hodges M. Anthelmintic treatment and haemoglobin concentrations during pregnancy. *Lancet* 2000;356:1083.
88. Mavrov GI, Goubenko TV. Clinical and epidemiological features of syphilis in pregnant women: the course and outcome of pregnancy. *Gynecol Obstet Invest* 2001;52:114.
89. Ghosh S, et al. Clinical and hematologic peculiarities of malaria in infancy. A study of 40 infants. *Clin Pediatr* 1978;17:369.
90. Thompson DM, et al. Congenital malaria: a rare cause of splenomegaly and anemia in an American infant. *Pediatrics* 1977;60:209.
91. Steketee RW, Mahlen BL, Parise ME, Mendez C. The burden of malaria in pregnancy in malaria-endemic areas. *Am J Trop Med Hyg* 2001;64:S28.
92. Wilfert, CM, Ammann A, Bayer R, et al. Science, ethics, and the future of research into maternal infant transmission of HIV-1: consensus statement. *Lancet North Am Ed* 1999;353:832–835.
93. Connor EM, Sperling RS, Gleber R, et al. Reduction of maternal-infant transmission of human immunodeficiency virus type 1 with zidovudine treatment. Pediatric AIDS Clinical Trials Group Protocol 076 Study Group. *N Engl J Med* 1994;331:1173.
94. Galli L, de Martino M, Rossi ME, et al. Hemochrome parameters during the first two years of life in children with perinatal HIV-1 infection. *Pediatr AIDS HIV Infect* 1995;6:340.
95. Shah MM, Christensen RD. Effects of perinatal zidovudine on hematopoiesis: a comparison of effects of progenitors from human fetuses versus mothers. *AIDS* 1996;10:1239.
96. Ha JC, Nosbisch E, Abkowitz JL, et al. Fetal, infant, and maternal toxicity of zidovudine (azidothymidine) administered throughout pregnancy in *Macaca nemestrina*. *J Acquir Immune Defic Syndr Hum Retroviro* 1998;18:27.
97. Ferrazin A, De Maria A, Gotta C, et al. Zidovudine therapy of HIV-1 infection during pregnancy: assessment of the effect on the newborns. *J Acquir Immune Defic Syndr* 1993;6:376.
98. Silverman NS, Watts DH, Hitti J, et al. initial multicenter experience with double nucleoside therapy

for human immunodeficiency virus infection during pregnancy. *Infect Dis Obstet Gynecol* 1998;6:237.

99. Sperling RS, Shapiro DE, McSherry GD, et al. Safety of the maternal–infant zidovudine regimen utilized in the Pediatric AIDS Clinical Trial Group 076 Study. *AIDS* 1998;12:1805.

100. HIV–infected pregnant women and vertical transmission in Europe since 1986. European collaborative study. *AIDS* 2001;15:761.

101. Sacks DA, Platt LD, Johnson CS. Autoimmune hemolytic disease during pregnancy. *Am J Obstet Gynecol* 1981;140:942.

102. Ng SC, Wong KK, Raman S, Bosco J. Autoimmune haemolytic anemia in pregnancy: a case report. *Eur J Obstet Gynecol Reprod Biol* 1990;37:83.

103. Benraad CE, Scheerder HA, Overbeeke MA. Autoimmune haemolytic anaemia during pregnancy. *Eur J Obstet Gynecol Reprod Biol* 1994;55:209.

104. Craig GA, Turner RL. A case of symptomatic hemolytic anemia in pregnancy. *BMJ* 1995;1:1003.

105. Jankelowitz T, Eckerling B, Joshua H. A case of acquired hemolytic anemia associated with pregnancy. *S Afr Med J* 1960;34:911.

106. Gilliland BC, Baxter E, Evans RS. Red cell antibodies in acquired hemolytic anemia with negative antiglobulin test. *N Engl J Med* 1971;285:252.

107. Hershko C, Berrebi A, Resnitzky P, Eldor A. Relapsing hemolytic anemia of pregnancy with negative antiglobulin reaction. *Scand J Haematol* 1976;16:135.

108. Goodal BC, Ho–Yen DO, Clark DM, et al. Hemolytic anemia of pregnancy. *Scand J Haematol* 1979;22:185.

109. Starksen NF, Bell WR, Kickler TX. Unexplained hemolytic anemia associated with pregnancy. *Am J Obstet Gynecol* 1983;146:617.

110. Bjornsson S, Brennand JE, Calder AA, et al. Unexplained hemolytic anemia in successive pregnancies with negative direct antiglobulin test and response to high dose IV IG. *Br J Obstet Gynaecol* 1994;101:75.

111. Tsai YC, Chang JM, Chang JC, et al. Idiopathic autoimmune hemolytic anemia during pregnancy. *J Formos Med Assoc* 1994;93:328.

112. Kumar R, Advani AR, Sharan J, et al. Pregnancy induced hemolytic anemia: an unexplained entity. *Ann Hematol* 2001;80:623.

113. Sachs DA, et al. Autoimmune hemolytic disease during pregnancy. *Am J Obstet Gynecol* 1981;140:942.

114. Bodnar LM, Scanlon KS, Freedman DS, et al. High prevalence of postpartum anemia among low–income women in the United States. *Am J Obstet Gynecol* 2001;185:438.

115. Swaim LS, Perriatt S, Andres RL, et al. Clinical utility of routine postpartum hemoglobin determinations. *Am J Perinatol* 1999;16:333.

116. Shoham–Vardi SE, Silberstein T, Hallak M, et al. Failed vacuum extraction. Maternal risk factors and pregnancy outcome. *J Reprod Med* 2001;46:819.

117. Hoveyda F, MacKenzie IZ. Secondary postpartum haemorrhage: incidence, morbidity and current management. *BJOG* 2001;108:927.

118. Naylor CS, Steele L, His R, et al. Cefotetan–induced hemolysis associated with antibiotic prophylaxis for cesarean delivery. *Am J Obstet Gynecol* 2000;182:1427.

119. Garratty G, Leger RM, Arndt PA. Severe immune hemolytic anemia associated with prophylactic use



of cefotetan in obstetric and gynecologic procedures. *Am J Obstet Gynecol* 1999;181:103.

120. Huch A, Eichhorn KH, Danko J, et al. Recombinant human erythropoietin in the treatment of postpartum anemia. *Obstet Gynecol* 1992;80:127.

121. Zimmermann R, Breyman C, Huch R, Huch A. rHuEpo in the treatment of postpartum anemia: subcutaneous versus intravenous administration. *Clin Invest* 1994;72:S25.

122. Zimmermann R, Breyman C, Richter C, et al. rhEpo treatment of postpartum anemia. *J Perinat Med* 1995;23:111.

123. Meyer JW, Eichhorn KH, Vetter K, et al. Does recombinant human erythropoietin not only treat anemia but reduce postpartum (emotional) distress as well? *J Perinat Med* 1995;23:99.

124. Mayrydimas G, Lolis D, Lialios G, et al. Recombinant human erythropoietin treatment of postpartum anemia. Preliminary results. *Eur J Obstet Gynecol Reprod Biol* 1998;82:27.

125. Gairdner D, et al. Blood formation in infancy. I. The normal bone marrow. II. Normal erythropoiesis. *Arch Dis Child* 1952;27:128.

126. Gairdner D, et al. Blood formation in infancy. IV. The early anaemias of prematurity. *Arch Dis Child* 1955;30:203.

127. Oettinger L, Mills WB. Simultaneous capillary and venous hemoglobin determinations in newborn infant. *J Pediatr* 1949;35:362.

128. Linderkamp O, et al. Capillary-venous hematocrit differences in newborn infants. *Eur J Pediatr* 1977;127(1):9.

129. Christensen RD. Hematologic problems of the neonate, 1st ed. Philadelphia: WB Saunders, 2000.

130. Lanzkowsky P. Effects of early and late clamping of umbilical cord on infant's hemoglobin level. *BMJ* 1960;2:1777.

131. Gaitti RA. Hematocrit values of capillary blood in the newborn. *J Pediatr* 1967;70:117.

132. Schmaier AH, Mauer HM. Alpha-thalassemia screening in neonates by mean corpuscular volume and mean corpuscular hemoglobin concentration. *J Pediatr* 1973;83:794.

133. Zinkham WH. Peripheral blood and bilirubin values in normal full-term primaquine-sensitive Negro infants. *Pediatrics* 1963;31:983.

134. Lippman HS. Morphologic and quantitative study of blood corpuscles in newborn period. *Am J Dis Child* 1924;27:473.

135. Zipursky A, et al. The erythrocyte differential count in newborn infants. *Am J Pediatr Hematol Oncol* 1983;5:45.

136. Kurth D, et al. Circulating siderocytes in human subjects. *Blood* 1969;34:754.

137. Komazawa M, et al. The relation of red cell size to fetal hemoglobin concentration in the term infant. *J Pediatr* 1974;85:114.

138. Zaizov R, Matoth Y. Red cell values on the first postnatal day as a function of gestational age. *Am J Hematol* 1976;1:276.

139. Stockman JA, Oski FA. RBC values in low-birth-weight infants during the first seven weeks of life. *Am J Dis Child* 1980;134:945.

140. Stockman JA, Garcia JF, Oski FA. The anemia of prematurity: factors governing the erythropoietin response. *N Engl J Med* 1977;296:647-650.

141. Pearson HA, Vertrees KM. Site of binding to chromium-51 by hemoglobin. *Nature* 1961;189:1019.
142. Pearson HA. Life-span of the fetal red blood cell. *J Pediatr* 1967;70:166-171.
143. Brace RA, Langendorfer C, Song TB, Mock DM. Red blood cell life span in the ovine fetus. *Am J Physiol Regul Integr Comp Physiol* 2000;279(4):R1196-1204.
144. Bratteby LE, et al. Studies on erythrokinetics in infancy. XII. Survival in adult recipients of cord blood red cells labeled in vitro with diisopropyl fluorophosphate (DF32P). *Acta Paediatr Scand* 1968;57:305.
145. Mollison PL. The survival of transfused erythrocytes in hemolytic disease of the newborn. *Arch Dis Child* 1943;18:161.
146. Ruth V, Widness JA, Clemons G, Raivio JO. Postnatal changes in serum immunoreactive erythropoietin in relation to hypoxia before and after birth. *J Pediatr* 1990;116(6):950-954.
147. Kling PJ, Schmidt RL, Roberts RA, et al. Serum erythropoietin levels during infancy: associations with erythropoiesis. *J Pediatr* 1996;128(6):791-796.
148. Saarinen VM, Siimes MA. Developmental changes in red blood cell counts and indices of infants after exclusion of iron deficiency by laboratory criteria and continuous iron supplementation. *J Pediatr* 1978;92:412.
149. Oski FA. The erythrocyte and its disorders. In: Oski FA, Nathan DG, eds. *Hematology of infancy and childhood*. Philadelphia: WB Saunders, 1993:18-43.
150. Oh W, Lind J. Venous and capillary hematocrit in newborn infants and placental transfusion. *Acta Paediatr Scand* 1966;55:38.
151. Linderkamp O, Nelle M, Kraus M, Zilow EP. The effect of early and late cord-clamping on blood viscosity and other hemorheological parameters in full-term neonates. *Acta Paediatr* 1992;81:745-750.
152. Linderkamp O, et al. The effect of intra-partum and intra-uterine asphyxia on placental transfusions in premature and full-term infants. *Eur J Pediatr* 1978;127(2):91.
153. Rosenblum BB. Two-dimensional gel electrophoresis of erythrocyte membrane proteins. *Prog Clin Biol Res* 1981;56:251.
154. Landaw SA, et al. Evidence for a tightly linked spectrin lattice in red blood cells of newborn man. *Pediatr Res* 1981;16:208A.
155. Lawler J, et al. Molecular defect of spectrin in a subset of patients with hereditary elliptocytosis. Alterations in the subunit domain involved in spectrin self-association. *J Clin Invest* 1984;73:1688.
156. Matovcik LM, et al. Myosin in adult and neonatal human erythrocyte membranes. *Blood* 1986;67:1668.
157. Jain SK. The neonatal erythrocyte and its oxidative susceptibility. *Semin Hematol* 1989;26:286.
158. Neerhout RC. Erythrocyte lipids in infants with low birth weights. *Pediatr Res* 1971;5:101.
159. Kehry M, et al. Fluidity in the membrane of adult and neonatal erythrocytes. *Science* 1977;195:486.
160. Marsh WL. Erythrocyte blood groups in humans. In: Nathan DG, Oski FA, eds. *Hematology of infancy and childhood*, 3rd ed. Philadelphia: WB Saunders, 1987.
161. Fukuda M, Fukuda MN. Changes in cell surface glycoproteins and carbohydrate structures during development and differentiation of human erythroid cells. *J Cell Biochem* 1981;17:313.
162. Fukuda MN, Levery SB. Glycolipids of fetal, newborn, and adult erythrocytes. *Biochemistry* 1983;22:5034.

163. Kearin M, et al. Digoxin "receptors" in neonates: an explanation of less sensitivity to digoxin than in adults. *Clin Pharmacol Ther* 1980;28:346.
164. Polychronakos C, et al. The role of cell age in the difference in insulin binding between adult and cord erythrocytes. *J Clin Endocrinol Metab* 1982;55:290.
165. Linderkamp O, et al. Deformability and intrinsic material properties of neonatal red blood cells. *Blood* 1986;67:1244.
166. Matthay KK, Mentzer WC. Erythrocyte enzymopathies in the newborn. *Clin Haematol* 1981;10:31.
167. Oski FA, Komazawa M. Metabolism of the erythrocytes of the newborn infant. *Semin Hematol* 1975;12:49.
168. Konrad PN, et al. Enzymatic activities and glutathione content of erythrocytes in the newborn: comparison with red cells of older normal subjects and those with comparable reticulocytosis. *Acta Haematol (Basel)* 1972;48:193.
169. Travis SF, et al. Red cell metabolic alterations in postnatal life in term infants: Glycolytic enzymes and glucose-6-phosphate dehydrogenase. *Pediatr Res* 1980;14:1349.
170. Lachhein L, et al. Der Verbrauch an glucose, galactose, ribose und inosin von erwachsenen-und nabelschnur-erythrocyten. *Klin Wochenschr* 1961;39:875.
171. Oski FA, Smith C. Red cell metabolism in the premature infant. III. Apparent inappropriate glucose consumption for cell age. *Pediatrics* 1968;41:473.
172. Gahr M, et al. Fetal properties in red blood cells of newborn infants. *Pediatr Res* 1979;13:1231.
173. Travis SF, et al. Red cell metabolic alterations in intermediates and adenosine triphosphate. *Pediatr Res* 1981;15:34.
174. Travis SF, Garvin JH. In vivo lability of red cell phosphofructokinase in term infants. The possible molecular basis of the relative PFK deficiency in neonatal red cells. *Pediatr Res* 1977;11:1159.
175. Vora S, Poimelli S. Fetal isozyme of phosphofructokinase in newborn erythrocytes. *Pediatr Res* 1977;11:483.
176. Gahr M. Isoelectric focusing of hexokinase and glucose-6-phosphate dehydrogenase isoenzymes in erythrocytes of newborn infants and adults. *Br J Haematol* 1980;4:529.
177. Scopesi F, Canini S, Mazzella M, et al. 2,3 diphosphoglycerate in preterm newborns. *Acta Biomed Ateneo Parmense* 2000;71[Suppl 1]:621-626.
178. Barretto OC, Nonoyama K, Deutsch AD, Ramos JL. Physiological red cell, 2,3-diphosphoglycerate increase by the sixth hour after birth. *J Perinat Med* 1995;23(5):365-369.
179. Soubasi V, Kremenopoulos G, Tsantali C, et al. Use of erythropoietin and its effects on blood lactate and 2, 3-diphosphoglycerate in premature neonates. *Biol Neonate* 2000;78(4):281-287.
180. Whaun JM, Oski FA. Relation of red cell glutathione peroxidase to neonatal jaundice. *J Pediatr* 1970;76:555.
181. Minnick F, et al. Erythrocyte glutathione synthesis in the neonate. *Biol Neonate* 1974;24:128.
182. Glader BE, Conrad MD. Decreased glutathione peroxidase in neonatal erythrocytes. Lack of relation to hydrogen peroxide metabolism. *Pediatr Res* 1972;6:900.
183. Schroter W, Bodemann H. Experimentally induced cation leaks of the red cell membrane. *Biol Neonate* 1970;15:291.
184. Tillman W, et al. The formation of Heinz bodies in ghosts of human erythrocytes of adults and

newborn infants. *Klin Wochenschr* 1973;51:201.

185. Schroter W, Tillman W. Heinz body susceptibility of red cells and exchange transfusion. *Acta Haematol (Basel)* 1973;49:74.
186. Stockman JA, et al. Diminished antioxidant activity of newborn plasma. *Pediatr Res* 1981;15:684.
187. van Zoeren-Grobbe D, Lindeman JH, Houdkamp E, et al. Markers of oxidative stress and antioxidant activity in plasma and erythrocytes in neonatal respiratory distress syndrome. *Acta Paediatr* 1997;86(12):1356-1362.
188. Stevenson SS. Carbonic anhydrase in newborn infants. *J Clin Invest* 1943;22:403.
189. Colin FC, Schrier SL. Spontaneous endocytosis in human neonatal and adult red blood cells: comparison to drug-induced endocytosis and to receptor-mediated endocytosis *J Hematol* 1991;37(1):34-40.
190. Kalan G, Derganc M, Primocic J. Phosphate metabolism in red blood cells of critically ill neonates. *Pflugers Arch* 2000;440[5 Suppl]:R109-111.
191. Jones PEH, McCance RA. Enzyme activities in the blood of infants and adults. *Biochem J* 1949;45:464.
192. Rudolph N. Adenylate kinase in red cells of newborn infants. Program, Society for Pediatric Research. Atlantic City, New Jersey. May 3, 1969:160.
193. Muller MM, Wagenbichler P. Activity of the salvage-pathway in erythrocytes of newborn infants, children, and adults. *Adv Exp Med Biol* 1977;76A:129.
194. Ross JD. Deficient activity of DPNH-dependent methemoglobin diaphorase in cord blood erythrocytes. *Blood* 1963;21:51.
195. Boyer SH, et al. Enrichment of the erythrocytes of fetal origin from adult-fetal blood mixtures via selective hemolysis of adult blood cells: an aid to antenatal diagnosis of hemoglobinopathies. *Blood* 1976;47:883.
196. Choury D, et al. Endogenous proteolysis of membrane-bound red cell cytochrome-b5 reductase in adults and newborns: its possible relevance to the generation of soluble "methemoglobin reductase." *Blood* 1983;61:894.
197. Alter BP. The G- $\gamma$ :A- $\gamma$  composition of fetal hemoglobin in fetuses and newborns. *Blood* 1979;54:1158.
198. Jensen M, et al. The developmental change in the G- $\gamma$  and A- $\gamma$ -globin proportions in hemoglobin F. *Eur J Pediatr* 1982;138:311.
199. Karaklis A, Fessas P. The normal minor components of human foetal haemoglobin. *Acta Haematol (Basel)* 1963;29:267.
200. Paes B, et al. Developmental changes in red cell creatine and free erythrocyte protoporphyrin in healthy full-term infants during the first 6 months of life. *J Pediatr* 1986;108:732.
201. Cotter J, Prystowsky H. Fetal blood studies. XIX. Adult and fetal hemoglobin levels of human fetal blood in term pregnancy and in prolonged pregnancy. *Am J Obstet Gynecol* 1963;22:745.
202. Bard H, et al. The relative rates of synthesis of hemoglobins A and F in immature red cells of newborn infants. *Pediatrics* 1970;45:766.
203. Bard H. Etudes preliminaire de la synthese des hemoglobines foetales et adultes chez le premature. *Union Med Can* 1971;100:1097.
204. Oppe TE, Fraser ID. Foetal haemoglobin in haemolytic disease of the newborn. *Arch Dis Child* 1961;36:507.

205. Bard H, Peri KG, Gagnon C. Changes in the G gamma- and A gamma-globin mRNA components of fetal hemoglobin during human development. *Biol Neonate* 2001;80(1):26-29.
206. Wilson MG, et al. Postnatal changes of hemoglobin F and A2 in infants with Down's syndrome. *Pediatrics* 1968;42:349.
207. Bard H. Postnatal fetal and adult hemoglobin synthesis in D-1 trisomy syndrome. *Blood* 1972;40:523.
208. Darling RC, et al. Some properties of human fetal and maternal blood. *J Clin Invest* 1941;20:739.
209. Bauer C, et al. Different effects of 2,3-diphosphoglycerate and adenosine triphosphate on oxygen affinity of adult and fetal human hemoglobin. *Life Sci* 1968;7:1339.
210. Delivoria-Papadopoulos M, et al. Postnatal changes in oxygen transport of term, premature, and sick infants: the role of red cell 2,3-diphosphoglycerate and adult hemoglobin. *Pediatr Res* 1971;5:235.
211. Brinkman R, Jonxis JHP. Alkaline resistance and spreading velocity of foetal and adult types of mammalian hemoglobin. *J Physiol (Lond)* 1936;88:162.
212. Kleihauer E, et al. Demonstration von fetalem hamoglobin in den erythrocyten eines blutausstrichs. *Klin Wochenschr* 1957;35:637.
213. Odell GB. Neonatal Hyperbilirubinemia. New York: Grune & Stratton, 1980.
214. Shenker S, et al. Bilirubin metabolism in the fetus. *J Clin Invest* 1964;43:32.
215. Levi AJ, et al. Deficiency of hepatic organic anion-binding protein, impaired organic anion uptake by liver and "physiologic" jaundice in newborn monkeys. *N Engl J Med* 1970;283:1136.
216. Gartner LM, et al. Development of bilirubin transport and metabolism in the newborn rhesus monkey. *J Pediatr* 1977;90:513.
217. Toivanen B, Hirvonen T. Iso- and heteroagglutinins in human fetal and neonatal sera. *Scand J Haematol* 1969;6:42.
218. Marsh WL, Allen FH. Erythrocyte blood groups in humans. In: Nathan DG, Oski FA, eds. *Hematology of infancy and childhood*, 3rd ed. Philadelphia: WB Saunders, 1987:1497-1521.
219. Thomaidis T, et al. Natural isohemagglutinin production by the fetus. *J Pediatr* 1969;74:39.
220. Zipursky A, Pollock J, Neeland P, et al. The transplacental passage of foetal red blood cells and the pathogenesis of Rh immunisation during pregnancy. *Lancet* 1963;2:489.
221. Geifman-Holtzman O, Wojtowycz M, Kosmos E, et al. Female alloimmunization with antibodies known to cause hemolytic disease. *Obstet Gynecol* 1997;89:272-275.
222. Lipitz S, Many A, Mitrani-Rosenbaum S, et al. Obstetric outcome after RhD and Kell testing. *Hum Reprod* 1998;13(6):1472-1475.
223. Weiner CP, Widness JA. Decreased fetal erythropoiesis and hemolysis in Kell hemolytic anemia. *Am J Obstet Gynecol* 1996;174:547-551.
224. Vaughan JI, Manning M, Warwick RM, et al. Inhibition of erythroid progenitor cells by anti-Kell antibodies in fetal alloimmune anemia. *N Engl J Med* 1998;338(12):798-803.
225. Kozlowski CL, Lee D, Shwe KH, et al. Quantification of anti-c in haemolytic disease of the newborn. *Transfus Med* 1995;5(1):37-42.
226. van Dijk BA, Dooren MC, Overbeeke MA. Red cell antibodies in pregnancy: there is no "critical titre." *Transfus Med* 1995;5(3):199-202.

227. Scott JR, Warenski JC. Tests to detect and quantitate fetal maternal bleeding. *Clin Obstet Gynecol* 1982;25:277.
228. Bowman JM. Maternal blood group immunization. In: Eden RD, Boehm FH, eds. *Assessment and care of the fetus. Physiologic, clinical and medicolegal principles*. Norwalk: Appleton & Lange, 1989:749-772.
229. Kosasa TS, Ebesugawa I, Nakayama RT, et al. Massive fetomaternal hemorrhage preceded by decreased fetal movement and a nonreactive fetal heart rate pattern. *Obstet Gynecol* 1993;82:711-714.
230. Giacoia GP. Severe fetomaternal hemorrhage: a review. *Obstet Gynecol Surv* 1997;52(6):372-380.
231. Faxelius G, Raye J, Gutberlet R, et al. Red cell volume measurements and acute blood loss in high-risk newborn infants. *J Pediatr* 1977;90:273-281.
232. Rose PG, Strohm PL, Zuspan FP. Fetomaternal hemorrhage following trauma. *Am J Obstet Gynecol* 1985;153(8):844-847.
233. Stiller AG, Skafish PR. Placental chorioangioma: a rare cause of fetomaternal transfusion with maternal hemolysis and fetal distress. *Obstet Gynecol* 1986;67(2):296-298.
234. Lopriore E, Vandenbussche FP, Tiersma ES, et al. Twin-to-twin transfusion syndrome: new perspectives. *J Pediatr* 1995;127:675-680.
235. Benirschke K. Accurate recording of twin placenta. *Obstet Gynecol* 1961;18:334.
236. Tan KL, Tan R, Tan SH, et al. The twin transfusion syndrome. Clinical observations on 35 affected pairs. *Clin Pediatr* 1979;18:111.
237. Dennis LG, Winkler CL. Twin-to-twin transfusion syndrome: aggressive therapeutic amniocentesis. *Am J Obstet Gynecol* 1997;177(2):342-347.
238. Dommergues M, Mandelbrot L, Delezoide AL, et al. Twin-to-twin transfusion syndrome: selective feticide by embolization of the hydropic fetus. *Fetal Diagn Ther* 1995;10(1):26-31.
239. De Lia JE, Kuhlmann RS, Harstad TW, et al. Fetoscopic laser ablation of placental vessels in severe previable twin-twin transfusion syndrome. *Am J Obstet Gynecol* 1995;172(4 Pt 1):1202-1208.
240. Ville Y, Hyett J, Hecher K, et al. Preliminary experience with endoscopic laser surgery for severe twin-twin transfusion syndrome. *N Engl J Med*. 1995;332(4):224-227.
241. van Heteren CF, Nijhuis JG, Semmekrot BA, et al. Risk for surviving twin after fetal death of co-twin in twin-twin transfusion syndrome. *Obstet Gynecol* 1998;92(2):215-219.
242. Supski DW, Gurushanthaiah K, Chasen S. The effect of treatment of twin-twin transfusion syndrome on the diagnosis-to-delivery interval. *Twin Res* 2002;5(1):1-4.
243. Kramer MS, Usher RH, Pollack R, et al. Etiologic determinants of abruptio placentae. *Obstet Gynecol* 1997;89(2):221-226.
244. Rasmussen S, Irgens LM, Bergsjø P, et al. Perinatal mortality and case fatality after placental abruption in Norway 1967-1991. *Acta Obstet Gynecol Scand* 1996;75(3):229-234.
245. McMahon MJ, Li R, Schenck AP, et al. Previous cesarean birth. A risk factor for placenta previa? *J Reprod Med* 1997;42(7):409-412.
246. Chelmos D, Andrew DE, Baker ER. Maternal cigarette smoking and placenta previa. *Obstet Gynecol* 1996;87(5 Pt 1):703-706.
247. Chen KH, Konchak P. Use of transvaginal color Doppler ultrasound to diagnose vasa previa. *J Am Osteopath Assoc* 1998;98(2):116-117.
248. Deans A, Jauniaux E. Prenatal diagnosis and outcome of subamniotic hematomas. *Ultrasound Obstet*

Gynecol 1998;11:319–323.

249. Benirschke K. Obstetrically important lesions of the umbilical cord. *J Reprod Med* 1994;39(4):262–272.
250. Eddleman KA, Lockwood CJ, Berkowitz GS, et al. Clinical significance and sonographic diagnosis of velamentous umbilical cord insertion. *Am J Perinatol* 1992;9(2):123–126.
251. Cashore WJ, Usher RH. Hypovolemia resulting from a tight nuchal cord at birth. *Pediatr Res* 1973;7:399.
252. Benaron DA. Subgaleal hematoma causing hypovolemic shock during delivery after failed vacuum extraction: a case report. *J Perinatol* 1993;13(3):228–231.
253. Robinson RJ, Rossiter MA. Massive subaponeurotic haemorrhage in babies of African origin. *Arch Dis Child* 1968;43:684.
254. Teng FY, Sayre JW. Vacuum extraction: does duration predict scalp injury? *Obstet Gynecol* 1997;89(2):281–285.
255. Chadwick LM, Pemberton PJ, Kurinczuk JJ. Neonatal subgaleal haematoma: associated risk factors, complications and outcome. *J Paediatr Child Health* 1996;32(3):228–232.
256. Felc Z. Ultrasound in screening for neonatal adrenal hemorrhage. *Am J Perinatol* 1995;12(5):363–366.
257. Pinto E, Guignard JP. Renal masses in the neonate. *Biol Neonate* 1995;68(3):175–184.
258. Levine C. Intestinal obstruction in a neonate with adrenal hemorrhage and renal vein thrombosis. *Pediatr Radiol* 1989;19(6 and 7):477–478.
259. Mostoufizadeh M, Lack EE, Gang DL, et al. Postmortem manifestations of echovirus 11 sepsis in five newborn infants. *Hum Pathol* 1983;14(9):818–823.
260. Davies MR. Iatrogenic hepatic rupture in the newborn and its management by pack tamponade. *J Pediatr Surg* 1997;32(10):1414–1419.
261. Emma F, Smith J, Moerman PH. Subcapsular hemorrhage of the liver and hemoperitoneum in premature infants: report of 4 cases. *Eur J Obstet Gynecol Reprod Biol* 1992 21;44(2):161–164.
262. Miele V, Galluzzo M, Patti G, et al. Scrotal hematoma due to neonatal adrenal hemorrhage: the value of ultrasonography in avoiding unnecessary surgery. *Pediatr Radiol* 1997;27(8):672–674.
263. Nagaya M, Kato J, Niimi N, et al. Isolated cavernous hemangioma of the stomach in a neonate. *J Pediatr Surg* 1998;33(4):653–654.
264. Abolmakarem H, Tharmaratnum S, Thilaganathan B. Fetal Anemia as a consequence of hemorrhage into an ovarian cyst. *Ultrasound Obstet Gynecol* 2001;17:527–528.
265. Cleary TG, Lopez EL. The shiga-like toxin-producing *Escherichia coli* and hemolytic uremic syndrome. *Pediatr Infect Dis J* 1989;8:720–724.
266. Berkowitz K, Baxi L, Fox HE. False-negative syphilis screening: the prozone phenomenon, nonimmune hydrops, and diagnosis of syphilis during pregnancy. *Am J Obstet Gynecol* 1990;163(3):975–977.
267. Vogel H, Kornman M, Ledet SC, et al. Congenital parvovirus infection. *Pediatr Pathol Lab Med* 1997;17(6):903–912.
268. Sheikh AU, Ernest JM, O’Shea M. Long-term outcome in fetal hydrops from parvovirus B19 infection. *Am J Obstet Gynecol* 1992;167(2):337–341.
269. Brown KE, Young NS. Parvovirus B19 infection and hematopoiesis. *Blood Rev* 1995;9(3):176–182.
270. McNeely DF, Chu A, Lowe S, et al. Malaria surveillance in New York City: 1991–1996. *Int J Infect Dis*



1998;2:132–136.

271. Brown MS, Garcia JF, Phibbs RH, et al. Decreased response of plasma immunoreactive erythropoietin to “available oxygen” in anemia of prematurity. *J Pediatr* 1984;105:793–798.
272. Shannon KM, Naylor GS, Torkildson JC, et al. Circulating erythroid progenitors in the anemia of prematurity. *N Engl J Med* 1987;31:728–733.
273. Rhondeau SM, Christensen RD, Ross MP, et al. Responsiveness to recombinant human erythropoietin of marrow erythroid progenitors from infants with the “anemia of prematurity.” *J Pediatr* 1988;112:935–940.
274. Ohls RK, Liechty KW, Turner MC, et al. Erythroid “burst promoting activity” in the serum of patients with the anemia of prematurity. *J Pediatr* 1990;116:786–789.
275. Delivoria-Papadopoulos M, Roncevic NP, Oski FA. Postnatal changes in oxygen transport of term, preterm and sick infants: the role of red cell 2,3 diphosphoglycerate in adult hemoglobin. *Pediatr Res* 1971;5:235.
276. Ohls RK. Erythropoietin treatment in extremely low birth weight infants: blood in versus blood out. *J Pediatr* 2002;140:3–6.
277. Ohls RK. Human recombinant erythropoietin in the prevention and treatment of anemia of prematurity. *Paediatr Drugs* 2002;4:111–121.
278. Tamary H, Shalmon L, Shalev H, et al. Localization of the gene for congenital dyserythropoietic anemia type I to a <1-cM interval on chromosome 15q15.1–15.3. *Am J Hum Genet* 1998;62(5):1062–1069.
279. Aase JM, Smith DW. Congenital anemia and triphalangeal thumbs: a new syndrome. *J Pediatr* 1969;74(3):471–474.
280. Alter BP. Fanconi’s anaemia and its variability. *Br J Haematol* 1993;85(1):9–14.
281. D’Andrea AD, Grompe M. Molecular biology of Fanconi anemia: implications for diagnosis and therapy. *Blood* 1997;90(5):1725–1736.
282. Perel Y, Butenandt O, Carrere A, et al. Oesophageal atresia, VACTERL association: fanconi’s anaemia related spectrum of anomalies. *Arch Dis Child* 1998;78(4):375–376.
283. Charles JM, Key LL. Developmental spectrum of children with congenital osteopetrosis. *J Pediatr* 1998;132(2):371–374.
284. Gerritsen EJ, Vossen JM, Fasth A, et al. Bone marrow transplantation for autosomal recessive osteopetrosis. A report from the Working Party on Inborn Errors of the European Bone Marrow Transplantation Group. *J Pediatr* 1994;125(6 Pt 1):896–902.
285. Pearson HA, Lobel JS, Kocoshis SA, et al. A new syndrome of refractory sideroblastic anemia with vacuolization of marrow precursors and exocrine pancreatic dysfunction. *J Pediatr* 1979;95(6):976–984.
286. Toth T, Bokay J, Szonyi L, et al. Detection of mtDNA deletion in Pearson syndrome by two independent PCR assays from Guthrie card. *Clin Genet* 1998;53(3):210–213.
287. Rotig A, Cormier V, Blanche S, et al. Pearson’s marrow-pancreas syndrome. A multisystem mitochondrial disorder in infancy. *J Clin Invest* 1990;86(5):1601–1608.

2004 Lippincott Williams & Wilkins  
John P. Greer, John Foerster, John N. Lukens  
George M. Rodgers, Frixos Paraskevas, Bertil Glader  
Wintrobe’s Clinical Hematology

## Hemoglobins Associated with Cyanosis: Methemoglobinemia and Low-Affinity Hemoglobins

### [CYANOSIS](#)

### [METHEMOGLOBINEMIA](#)

#### [Acquired \(Toxic\) Methemoglobinemia](#)

#### [Hereditary Methemoglobinemia](#)

### [LOW-AFFINITY HEMOGLOBINS](#)

### [REFERENCES](#)

This chapter is concerned with disorders of hemoglobin (Hb) characterized by cyanosis. These conditions are associated with decreased arterial oxygen saturation in the absence of pulmonary or cardiac disease. The most common of these relatively rare causes of cyanosis is methemoglobinemia. Accumulation of methemoglobin in the red cell occurs when the rate of heme oxidation is increased (*acquired methemoglobinemia*), when methemoglobin reduction is limited by deficient reducing capacity [*nicotinamide adenine dinucleotide (reduced form) (NADH)-cytochrome b<sub>5</sub> reductase deficiency*], or when a structural abnormality in the globin moiety stabilizes Hb in the oxidized state (*HbM disorders*). Cyanosis unrelated to methemoglobinemia is also characteristic of the Hb variants that have a low affinity for oxygen.

## CYANOSIS

The term *cyanosis* refers to a bluish discoloration of the skin and mucous membranes resulting from excessive amounts of reduced Hb. It is usually most marked in the lips, nail beds, ears, and malar eminences. As a rule, cyanosis becomes apparent when the mean capillary concentration of reduced Hb exceeds 5 g/dl. It is the absolute rather than the relative amount of reduced Hb, however, that is important in producing cyanosis. For this reason, if the same proportion of Hb is reduced, cyanosis will be more evident when the total Hb level is high, as in polycythemia, and less evident if there is an associated anemia. In contrast to reduced Hb, methemoglobin produces detectable cyanosis at concentrations as low as 2.0 g/dl.

Long-standing cyanosis dating from birth and unaccompanied by obvious cardiac and pulmonary disease was first reported by Francois in 1845 (<sup>1</sup>). Although it was appreciated that cyanosis could be induced by "blood poisons," not until 1891 did Dittrich (<sup>1</sup>) emphasize that methemoglobinemia tended to disappear spontaneously without any alteration in the concentration of circulating erythrocytes, thereby suggesting the existence of a reducing mechanism in erythrocytes. At the turn of the century, a new concept was introduced—that of "autotoxic enterogenous cyanosis," a disorder attributed to the formation of intracellular methemoglobin or sulfhemoglobin by toxic substances, possibly of bacterial origin absorbed from the gastrointestinal tract. Ultimately, it was recognized that met-hemoglobinemia could be observed in the absence of exposure to drugs, chemicals, or gastrointestinal disease. In 1948, a hereditary form of methemoglobinemia was described, and not long thereafter, the abnormality in the globin moiety of infected individuals was described (<sup>2</sup>). Subsequently, Scott and Hoskins (<sup>3</sup>) noted a high incidence of hereditary methemoglobinemia in Alaskan Eskimos and Native

Americans, and Scott with Griffith, in the following year, reported the absence of an enzyme, later called ( *NADH*)- *cytochrome b<sub>5</sub> reductase* ( *diaphorase*), in the erythrocytes of those affected.

“Enterogenous cyanosis” is no longer considered to be an entity. Cases reported as such can best be explained by exposure to chemicals or drugs capable of increasing the rate of Hb oxidation. It remains possible, however, that erythrocytes are made more susceptible to the action of oxidant drugs by products of bacterial overgrowth in the intestinal tract ( [4](#), [5](#) ).

## METHEMOGLOBINEMIA

*Methemoglobin* is an oxidation product of Hb in which the sixth coordination position of ferric iron is bound to a water molecule (acid form, having absorption peaks at 631 and 500 nm) or to a hydroxyl group (alkaline form, having absorption peaks at 575 and 540 nm). Acid methemoglobin is the predominant species at physiologic pH. Methemoglobin is produced at a slow, predictable rate *in vivo* by the escape of an electron from heme to released oxygen. After loss of an electron, binding of oxygen by the oxidized (ferric) heme cannot occur unless an electron is regained by means of reducing mechanisms within the cell. Because the capacity of red cells to reduce oxidized heme exceeds the spontaneous rate of heme oxidation by several hundredfold, less than 1% of the total Hb is normally in the ferric or methemoglobin form. The most important pathway of methemoglobin reduction uses *NADH*-cytochrome *b<sub>5</sub>* reductase for the transfer of an electron from *NADH* to heme. The reaction appears to proceed in two steps: (a) enzymatic reduction of cytochrome *b<sub>5</sub>*, followed by (b) nonenzymatic transfer of an electron from reduced cytochrome *b<sub>5</sub>* to methemoglobin ( [Fig. 49.1](#) ). Another mechanism for methemoglobin reduction involves the direct transfer of electrons from ascorbic acid and glutathione to heme. The nicotinamide adenine dinucleotide phosphate (*NADPH*)-dependent methemoglobin reductase (dehydrogenase) lacks an endogenous electron acceptor and therefore is physiologically inert. It can be “activated,” however, by an exogenous electron acceptor, such as methylene blue or riboflavin ( [6](#) ). The *NADPH*-dependent enzyme reduces methylene blue to leukomethylene blue, which rapidly reduces methemoglobin nonenzymatically ( [Fig. 49.1](#) ).



**Figure 49.1.** Metabolic pathways for the reduction of methemoglobin (MetHb) to hemoglobin (Hb). **A:** Nicotinamide adenine dinucleotide (reduced form) (*NADH*)-dependent cytochrome *b<sub>5</sub>* reductase pathway. **B:** Nicotinamide adenine dinucleotide phosphate (*NADPH*)-dependent dehydrogenase pathway. The latter pathway requires an exogenous electron acceptor, such as methylene blue. *NAD*, nicotinamide adenine dinucleotide; *NADP*, nicotinamide adenine dinucleotide phosphate.

### Acquired (Toxic) Methemoglobinemia

Various chemical compounds used in the home or in industry and several therapeutic agents are capable of increasing the rate of heme oxidation 100- to 1000-fold, thereby overwhelming the capacity of erythrocytes to maintain Hb in the reduced state. Infants are especially vulnerable. To some extent, the vulnerability of infants can be attributed to a greater susceptibility of fetal Hb (HbF) to oxidation compared with that of adult Hb (HbA). Of probably greater significance is reduced capacity for methemoglobin reduction during the first months of life (7). In the red cells of adults, NADH-cytochrome *b*<sub>5</sub> reductase is approximately equally distributed between a soluble form and a form tightly bound to the inner surface of the membrane (8). The membrane-bound enzyme is believed to be the primary gene product. It is posttranslationally processed, probably by a calmodulin-dependent protease, to a smaller, soluble form. Although membrane-bound enzyme activity in neonatal red cells is the same as that of adult cells, that of the soluble enzyme is 50% less (9). The relative deficiency of the soluble form of the enzyme appears to be related to impairment of the proteolytic processing of the membrane precursor. The ability of cells of infants to solubilize membrane-bound enzyme increases with age, reaching adult capacity by 6 months of age.

**PATHOGENESIS** A number of substances are capable of oxidizing Hb directly and do so *in vitro* (Table 49.1). These include nitrites, nitrates, chlorates, and quinones. The mechanism of Hb oxidation by most of these substances is not well defined. Nitrates, when ingested, are reduced to nitrites in the intestinal tract. Poisoning, sometimes fatal, is observed in infants given well water high in nitrates or powdered milk reconstituted with water containing nitrates (10, 11). Nitrate-contaminated well water used in dialysis equipment has also been incriminated as a cause of methemoglobinemia in patients receiving home dialysis treatment (12). Nitrates may be absorbed from burn sites after the topical application of bismuth subnitrate or ammonium, potassium, or silver nitrate (13). Foods high in nitrates or accidentally contaminated with nitrites are a well-recognized cause of met-hemoglobinemia (14, 15, 16 and 17), as is the direct administration of nitrite as a folk remedy (18). The use of butyl and isobutyl nitrate, substances used by the gay community and drug abusers, can cause potentially fatal methemoglobinemia (19).

**TABLE 49.1. Agents Implicated in Acquired Methemoglobinemia**

|   |                         |                               |
|---|-------------------------|-------------------------------|
| Direct oxidants                           | Indirect agents         | Aminobenzenes                 |
| Therapeutic agents                        | Sulfonamides            | Aminophenol                   |
| Amyl nitrite                              | Dapsone                 | Benzocaine                    |
| Ethyl nitrite                             | Sulfamethizole          | Lidocaine                     |
| Sodium nitrite                            | Sulfanilamide           | Nitrobenzene                  |
| Ammonium nitrate                          | Sulfapyridine           | Nitroethane                   |
| Silver nitrate                            | Sulfathiazole           | Nitrofurans                   |
| Bismuth subnitrate                        | Prontosil               | Nitrotoluenes                 |
| Nitroglycerin                             | Aniline dyes            | Phenacetin                    |
| Quinones                                  | Diaper-marking ink      | Phenazopyridine<br>(Pyridium) |
| Domestic and industrial agents            | Dyed blankets           | Phenylenediamine              |
| Well water high in nitrates               | Laundry markings        | Prilocaine                    |
| Food high in nitrates                     | Freshly dyed shoes      | Primaquine                    |
| Nitrous gases (arc welders, silo fillers) | Red wax crayons         | Procaine                      |
| Corning extract                           | Miscellaneous compounds | Resorcin                      |

|                                  |                       |                 |
|----------------------------------|-----------------------|-----------------|
| Butyl nitrite (“room odorizers”) | Acetanilid            | Toluenediamine  |
| Potassium chlorate               | Acetylphenylhydrazine | Trinitrotoluene |

An indirect effect is postulated for certain aromatic amino and nitro compounds, including acetanilid (Bromo-Seltzer), phenacetin (APC, Empirin, Anacin, Stanback), sulfonamides, phenazopyridine (Pyridium) ( 20 ), and aniline dyes. Because most of these agents do not produce methemoglobin *in vitro*, active intermediate compounds are presumed responsible. The ingestion of deodorant containing naphthalene and aniline ( 21 ) or red wax crayons containing p-nitroaniline ( 22 ); contact with marking ink ( 23 ), dyed blankets, or laundry marks on diapers ( 24 ); and benzocaine ( 25 ), prilocaine, resorcinol ( 26 ), aniline dyes, nitrobenzene ( 27 ), or other aromatic compounds absorbed orally, rectally, or percutaneously have led to methemoglobinemia. Exposure to such compounds industrially also has been reported to produce methemoglobinemia. Exposure to naphthalene has been associated with met-hemoglobinemia in glucose-6-phosphate dehydrogenase (G6PD)-deficient infants, and malaria prophylaxis has been reported as provoking methemoglobinemia in unsuspected heterozygotes deficient in NADH-cytochrome *b*<sub>5</sub> reductase. Dapsone given for the prophylaxis and treatment of *Pneumocystis carinii* pneumonia in immunocompromised patients is a well-documented cause for methemoglobin ( 28 , 29 , 30 , 31 and 32 ). Cimetidine is reported to ameliorate the degree of methemoglobinemia in patients for whom dapsone therapy is essential ( 33 ). Methemoglobinemia that follows the ingestion of nitroethane artificial fingernail remover may be delayed and recurrent ( 34 ). The inhalation of nitric oxide as premedication for endoscopy or for the treatment of pulmonary edema has been implicated as a cause of severe methemoglobinemia ( 35 , 36 ). Endogenous overproduction of nitric oxide may be responsible for methemoglobinemia in children with septic shock ( 37 ). Transient methemoglobinemia unassociated with apparent oxidant or drug exposure has been described in young infants with gastroenteritis and metabolic acidosis ( 38 , 39 and 40 ). Methemoglobin levels as high as 67% have been observed. Some infants have had transient organic aciduria ( 41 ). The basis for met-hemoglobinemia in sick infants is likely multifactorial, involving enteric colonization by nitrate-generating bacteria and accelerated autooxidation of oxyhemoglobin by acidosis and hyperchloremia ( 42 ) as well as limited capacity for methemoglobin reduction. Colonic inflammatory changes induced by cow milk or soy-milk protein appear to be operative in some infants with diarrhea-associated methemoglobinemia ( 43 ). The rapidity of methemoglobin production depends on several factors: (a) the extent and rate of entry of the compound into the circulation and erythrocytes, (b) the metabolism of the offending chemical compounds within the body, (c) the extent to which the compound is converted to intermediates with either increased or decreased oxidizing potential, (d) the excretion of the compound, and (e) the rate at which erythrocytes reduce methemoglobin to Hb. Thus, the effect of nitrite introduced intravenously is expended within 1 hour, whereas the peak effect of nitrobenzene is not reached until 12 to 15 hours after exposure ( 44 ). The extent to which these factors are influential in different persons may vary, and this variation may explain why some seem to be more likely to develop methemoglobinemia than others.

**CLINICAL FEATURES** Symptoms vary in intensity, but they often are mild or absent altogether. Concentrations of 10 to 25% methemoglobin, although producing cyanosis, are tolerated without ill effects; at 35 to 40%, slight exertional dyspnea and headaches, as well as fatigue, tachycardia, and dizziness, may be experienced. Lethargy and stupor may appear with concentrations of approximately 60%; the lethal concentration for adults probably is greater than 70%. With the exception of infants, methemoglobin concentrations rarely approach lethal levels. Toxic methemoglobinemia may be associated with hemolytic anemia caused by the precipitation of Hb to form Heinz bodies ( 20 ). Signs of toxicity in patients with acquired methemoglobinemia are greater than would be expected from a

comparable decrement in the red cell mass. This observation is explained by the tendency of oxidized heme to increase the oxygen affinity of the remaining functional heme groups in the Hb tetramer ( 45 ). As a result, tissue hypoxia resulting from loss of the oxygen-carrying capacity of blood is compounded by less efficient unloading of oxygen from Hb.

**TREATMENT** In the absence of symptoms, simple avoidance of the offending oxidant is sufficient to permit conversion of methemoglobin to Hb by physiologic mechanisms. Patients who are symptomatic or in whom a rapid increase in methemoglobin concentration has occurred are best given methylene blue intravenously. As noted previously, this substance is an effective electron donor for NADPH-methemoglobin reductase. In the presence of this enzyme and NADPH, methylene blue is rapidly reduced to leukomethylene blue, which in turn reduces methemoglobin nonenzymatically ( Fig. 49.1 ). The initial dose is 1 mg/kg body weight in a 1-g/dl solution given over 5 minutes. Twice this amount is used for symptomatic infants. A second dose of 2 mg/kg body weight may be given if cyanosis has not cleared within 1 hour. Cumulative doses in excess of 7 mg/kg cause dyspnea, precordial pain, restlessness, apprehension, a sense of oppression, fibrillar tremors, persisting cyanosis, and hemolytic anemia ( 46 ). In patients with more than 70% methemoglobin, automated red cell exchange has been used to achieve a rapid restoration of red cell oxygenation ( 47 ). Reduction of methylene blue to leukomethylene blue requires an intact pentose phosphate pathway for regeneration of NADPH. Consequently, methylene blue has no effect on methemoglobin levels in patients with G6PD deficiency. Because of its oxidant properties, methylene blue may trigger hemolytic episodes in G6PD-deficient individuals ( 48 ). Such subjects are best managed with exchange transfusions to restore reduced Hb ( 49 ). Because of the slow rate at which it reduces methemoglobin, ascorbic acid has no place in the treatment of toxic methemoglobinemia.

### Hereditary Methemoglobinemia

In contrast to acquired methemoglobinemia, the hereditary forms are rare. An autosomal-recessive mode of transmission characterizes familial methemoglobinemia due to NADH-cytochrome *b*<sub>5</sub> reductase deficiency, and an autosomal-dominant mode is characteristic of the Hb variants that stabilize iron in the oxidized state. Congenital deficiency of NADPH-cytochrome *b*<sub>5</sub> reductase is not associated with methemoglobinemia ( 50 ).

### NICOTINAMIDE ADENINE DINUCLEOTIDE (REDUCED FORM)-CYTOCHROME *b*<sub>5</sub> REDUCTASE (NICOTINAMIDE ADENINE DINUCLEOTIDE-METHEMOGLOBIN

REDUCTASE, DIAPHORASE) DEFICIENCY ( 51 ) Hereditary methemoglobinemia responsive to the administration of methylene blue or ascorbic acid was described initially in cases involving persons of European extraction. After the demonstration that these individuals were deficient in NADH-dependent cytochrome *b*<sub>5</sub> reductase, a near-global distribution of the disorder was recognized. Congenital deficiency of NADH-cytochrome *b*<sub>5</sub> reductase has been recognized as the cause of methemoglobinemia among Navajo and Alaskan Indians ( 9 ), Cubans, Puerto Ricans ( 52 ), North Africans, Arabs ( 53 ), Hindu, Chinese ( 54 , 55 ), Japanese ( 56 ), Siberians, and blacks ( 57 , 58 ). Most reports are descriptions of sibships derived from inbred populations. Most affected subjects are homozygous for a rare, functionally abnormal allele of the enzyme ( 57 ), although double heterozygosity for two different variants is well documented ( 59 , 60 ). The carrier or heterozygous state is characterized by intermediate levels of enzyme activity together with a greater than normal susceptibility to methemoglobin formation after exposure to oxidant drugs and chemicals ( 61 ). Two clinically distinct syndromes are recognized. They are due to deficient activity of two different forms of the enzyme. Type I



NADH-cytochrome  $b_5$  reductase deficiency is characterized by isolated methemoglobinemia and enzyme deficiency limited to red cells. Type II NADH-cytochrome  $b_5$  reductase deficiency is characterized by mental retardation, spasticity, microcephaly, and growth retardation (62, 63). The enzyme defect is generalized and involves both soluble and membrane-bound forms of the enzyme. The membrane-bound enzyme, which is localized in the endoplasmic reticulum of all somatic cells, participates in the destruction and elongation of fatty acids as well as in cholesterol synthesis and drug metabolism. Multiple variants of NADH-cytochrome  $b_5$  reductase activity have been identified by electrophoretic, functional, and immunologic techniques (54, 55, 58, 64, 65). At least 14 different mutations have been described in families with type I enzyme deficiency, and 11 different mutations in families with type II disease (55, 62, 65). In addition, several electrophoretically distinct variants with normal catalytic activity have been described. The overall prevalence of these clinically silent variants is approximately 1 in 100 (66). The mutants responsible for type I enzyme deficiency have relatively normal enzyme activity but are unstable (58, 67), whereas the type II mutant enzymes have deficient catalytic efficiency (68, 69 and 70). Variants with distinctive physical and functional properties include Boston slow (64, 71), Duarte (71), Princeton (71), Gaza (53), Beni Messous, La Tronche, Grenoble, Puerto Rico (52, 71), and  $m_s$  (60). Deficient enzyme activity is the result of exaggerated enzyme lability in at least some of the variants (Boston slow, Puerto Rico, Beni Messous, and La Tronche). Consequently, the distribution of methemoglobin is heterogeneous in peripheral blood cells, being greatest in the older, more dense population (52, 59). The sole clinical expression of erythrocyte enzyme deficiency is cyanosis, often dating from birth, in the absence of associated signs or symptoms. No digital clubbing or evidence of cardiopulmonary disease is apparent. Pregnancies are not compromised, and life expectancy is normal. Affected individuals are "more blue than sick." The contrast is especially striking if cyanosis is pronounced. The hue may be slate-gray, gray-brown, or violet. Cyanosis is apparent over the entire body, but it is particularly noticeable in the lips, the mucous membranes of the mouth, the tongue, the palate, the nose, over the cheekbones, on the ears, and in the nail beds. Erythrocytosis, if present, is mild. A variant of unusual severity was described in patients from the Yakut region of Siberia, where erythrocytosis (red cell count as high as  $7.0 \times 10^{12}/L$ ), reticulocytosis, and hyperbilirubinemia are associated features (72). Hereditary deficiency of NADH-cytochrome  $b_5$  reductase involving all cells is phenotypically similar to the disorder caused by isolated red cell enzyme deficiency except for associated mental retardation, spasticity, opisthotonos, microcephaly, and growth retardation (63, 73). Evidence of neurologic disease is apparent by 2 to 3 months of age, and death may occur as early as 1 year of age. Because cytochrome  $b_5$  reductase plays an important role in lipid metabolism by brain microsomes, the neurologic disorder presumably is a consequence of defective myelin production. Untreated individuals generally maintain levels of met-hemo-globin between 15 and 30%. Most of the methemoglobin is segregated in older cells. Oxidation of one heme group in the Hb tetramer increases the oxygen affinity of the remaining ferrohemes (45). As a result, the oxygen dissociation curve may be shifted slightly to the left, and mild compensatory erythrocytosis may be noted (54). Red cell survival is normal (72). Screening tests for the detection of deficient red cell NADH-cytochrome  $b_5$  reductase have been described. One requires the addition of nitrited blood to a reaction mixture freshly prepared from stable stock reagents (74). It is based on disappearance of fluorescence because of NADH consumption, a principle used in the detection of other red cell enzyme deficiencies. Another screening test takes advantage of the brown color that results from the addition of ferricyanide to blood and its failure to change to red when NADH is added (75). Assay of enzyme is required for confirmation of the diagnosis (76). Measurement of enzyme activity in amniotic fluid cells has been used to identify affected fetuses in families with type II cytochrome  $b_5$



reductase deficiency ( 77 ). Treatment is rarely necessary except for cosmetic purposes. Methylene blue in oral daily doses of 100 to 300 mg and ascorbic acid (500 mg daily) are usually sufficient to maintain the methemoglobin level below 10% in both type I and type II NADH-dependent cytochrome *b*<sub>5</sub> reductase deficiency. When used for protracted periods, methylene blue may cause urinary tract irritation, and ascorbic acid may induce renal stones due to hyperoxaluria ( 78 ). Riboflavin in daily oral doses of 20 to 60 mg may be as effective as ascorbic acid ( 79 ). Methemoglobin is reduced after the intravenous injection of methylene blue (1 mg/kg). Thereafter, it increases gradually, reaching pretreatment levels after 10 to 14 days.

**CYTOCHROME *b*<sub>5</sub> DEFICIENCY** Congenital deficiency of cytochrome *b*<sub>5</sub> was implicated as the cause of life-long methemoglobinemia in a Yemenite Jew ( 80 ). Although red cell cytochrome *b*<sub>5</sub> reductase activity was normal, red cells and red cell hemolysates failed to reduce methemoglobin normally. The addition of the purified reductase was without effect, whereas the addition of cytochrome *b*<sub>5</sub> normalized methemoglobin reduction. This case illustrates the importance of the cofactor cytochrome *b*<sub>5</sub> for methemoglobin reduction *in vivo*. Elevated levels of methemoglobin (15 to 19%) were effectively reduced with methylene blue.

**HEMOGLOBIN M DISORDERS** Hbs designated *M* are characterized by amino acid substitutions that create an abnormal environment for the heme residue, displacing the equilibrium toward the oxidized (ferric) state. Familial cyanosis having an autosomal-dominant inheritance pattern was recognized in Japan as early as 1800. This condition, originally described as *hereditary nigremia*, was restricted to the Iwate district of Honshu. The Hb variant now known to be responsible for this disorder is referred to as *HbM Iwate*. In recent years, HbM variants have been recognized in a variety of ethnic groups in North America, Europe, and Africa. Seven HbM variants have been identified and characterized ( Table 49.2 ). In six of the seven, tyrosine is substituted for histidine in the heme pocket of the globin chain. The affected moiety is the proximal  $\alpha$ -chain histidine (E7) in HbM Boston, the distal  $\alpha$ -chain histidine (F8) in HbM Iwate ( 81 ), the proximal  $\beta$ -chain histidine (E7) in HbM Saskatoon, the distal  $\beta$ -chain histidine (F8) in HbM Hyde Park ( 82 ), the proximal  $G\gamma$ -chain histidine (E7) in HbF M Osaka ( 83 ), and the distal  $G\gamma$ -chain histidine (F8) in HbF M Fort Ripley ( 84 ). In each of these variants, the phenolic group of tyrosine forms covalent bonds with heme iron, thus stabilizing iron in the oxidized form ( 81 , 85 ). The substitution in HbM Milwaukee ( $\beta$ 67 Val $\rightarrow$ Glu) also involves the heme pocket. The carboxylic group of the substituted glutamate is of sufficient length to form a bond with iron ( 86 , 87 ). Other Hb variants, such as Hb St. Louis ( 88 ), also oxidize abnormally rapidly. Because of their instability, however, they are characterized by hemolytic anemia (see Chapter 41) rather than by methemoglobinemia. The oxygen affinity of HbM Boston, HbM Iwate, and HbM Milwaukee is decreased, and that of Hb Saskatoon and Hb Hyde Park is normal ( 82 , 85 ). The  $\alpha$ -chain variants have nearly absent Bohr effect in contrast to preserved Bohr effect in the  $\beta$ -chain variants.

**TABLE 49.2. Hemoglobin (Hb) M Disorders**

| Hb                         | Substitution                          | Oxygen Affinity | Bohr Effect |
|----------------------------|---------------------------------------|-----------------|-------------|
| HbM Boston <sup>a</sup>    | $\alpha$ 58(E7)His $\rightarrow$ Tyr  | Decreased       | Decreased   |
| HbM Iwate <sup>b</sup>     | $\alpha$ 87(F8)His $\rightarrow$ Tyr  | Decreased       | Decreased   |
| HbM Saskatoon <sup>c</sup> | $\beta$ 63(E7)His $\rightarrow$ Tyr   | Normal          | Normal      |
| HbM Hyde Park <sup>d</sup> | $\beta$ 92(F8)His $\rightarrow$ Tyr   | Normal          | Normal      |
| HbM Milwaukee              | $\beta$ 67(E11)Val $\rightarrow$ Glu  | Decreased       | Normal      |
| HbFM Osaka                 | $G\gamma$ 63(E7)His $\rightarrow$ Tyr | Unknown         | Unknown     |
| HbFM Fort Ripley           | $G\gamma$ 92(F8)His $\rightarrow$ Tyr | Unknown         | Unknown     |

<sup>a</sup> HbM Boston is identical to HbM Kiskunhalas and HbM Osaka.

<sup>b</sup> HbM Iwate is identical to HbM Kankakee and HbM Oldenburg.

<sup>c</sup> HbM Saskatoon is identical to HbM Arhus, HbM Chicago, HbM Emory, HbM Erlangen, HbM Hida, HbM Kurume, and HbM Radom.

<sup>d</sup> HbM Hyde Park is identical to HbM Akita.

---

Clinically, the HbM disorders are characterized by cyanosis without dyspnea, clubbing, or other signs or symptoms of disease. Individuals with HbM Boston and HbM Iwate are cyanotic from birth, because the  $\alpha$ -chains of HbF are also affected by the mutation. Cyanosis is not apparent in infants with the  $\beta$ -chain variants until they are 3 to 6 months of age. The two  $\alpha$ -chain variants are characterized by transient cyanosis in the first weeks of life (83, 84). The cyanosis resulting from methemoglobinemia may be compounded by Hb desaturation in variants associated with low oxygen affinity. Mild hemolytic anemia has been observed in some individuals with  $\beta$ -chain variants (85, 89, 90). Methemoglobin is distributed uniformly among peripheral blood erythrocytes. HbM can be distinguished from other forms of methemoglobinemia by the spectroscopic examination of an acid methemoglobin hemolysate. Instead of the normal absorption maxima at 502 and 632 nm, wavelengths lower than 632 nm are found. In addition, slight variations in the absorption spectra permit differentiation of the HbM variants. The M Hbs can also be identified by electrophoresis under appropriate conditions, which include an agar gel medium and a neutral pH. HbA is the major component, and HbM accounts for 15 to 30% of the total pigment in the  $\alpha$ -chain HbM disorders and for 40 to 50% in the  $\beta$ -chain HbM variants. The homozygous state for the M Hbs is presumably incompatible with fetal survival. Treatment is neither indicated nor possible. Methemoglobin levels are unaffected by methylene blue or ascorbic acid. The most important reason for confirming the diagnosis is the avoidance of unnecessary restrictions on activity and inappropriate diagnostic pursuits.

## LOW-AFFINITY HEMOGLOBINS

The stable Hb variants that have reduced affinity for oxygen are listed in [Table 49.3](#). Unstable mutants that exhibit a low oxygen affinity are characterized by hemolytic anemia rather than by cyanosis; these are discussed in [Chapter 41](#).

**TABLE 49.3. Low-Affinity Hemoglobin Variants**

| Hemoglobin  | Substitution            | Bohr Effect |
|-------------|-------------------------|-------------|
| Kansas      | $\beta$ 102(G4)Asn?Thr  | Normal      |
| Beth Israel | $\beta$ 102(G4)Asn?Ser  | Normal      |
| Yoshizuka   | $\beta$ 108(G10)Asn?Asp | —           |
| Agenogi     | $\beta$ 90(F6)Glu?Lys   | —           |
| Titusville  | $\alpha$ 94(G1)Asp?Asn  | Decreased   |

Low-affinity Hbs have in common a right shift of the oxygen dissociation curve. At any given oxygen tension, the Hb is less saturated with oxygen than HbA. If the shift is of

sufficient magnitude, arterial desaturation results in clinically apparent cyanosis ([91](#), [92](#)). The amino acid substitution in both Hb Kansas and Hb Beth Israel involves the B102 residue, which is at the  $\alpha_1\beta_2$  interface of the Hb molecule. The substituted amino acid prevents the formation of a stabilized bond between  $\alpha_1$  and  $\beta_2$  in the oxyhemoglobin or R (relaxed) conformation ([93](#)). Destabilization of oxyhemoglobin is sufficient to increase the partial pressure at which whole blood is half saturated from a normal value of 26 mm Hg to 70 mm Hg in Hb Kansas and 88 mm Hg in Hb Beth Israel ([92](#)). The mutation at B108 in Hb Yoshizuka involves the  $\alpha_1\beta_1$  contact, disrupting the overall conformation of Hb to favor the deoxyhemoglobin or T (tense) state. The exact mechanisms responsible for the low oxygen affinity of Hb Agenogi, Hb Yoshizuka, and Hb Titusville ([94](#)) are not as well defined.

Both Hb Kansas and Hb Beth Israel are characterized clinically by cyanosis unassociated with symptoms or apparent exercise intolerance. Arterial blood is approximately 50% saturated with oxygen despite normal oxygen tension. The inheritance pattern for most of the Hb variants with altered oxygen affinity is autosomal dominant. Hb Beth Israel, however, appears to have arisen as a spontaneous mutation ([92](#)). Tissue oxygenation is normal, and, as a result, erythrocytosis does not occur. Mild anemia, noted in many individuals with low-affinity Hbs, is related to improved oxygen delivery, hemolysis, or both.

Unexplained cyanosis in association with normal arterial oxygen tension should prompt a search for a low-affinity Hb. Most, but not all, variants are detected by starch gel electrophoresis at an alkaline pH. Hb Kansas, Hb Beth Israel, and Hb Agenogi move slightly more slowly, and Hb Yoshizuka slightly faster than HbA.

## REFERENCES

1. Jaffé ER. Hereditary methemoglobinemias associated with abnormalities in the metabolism of erythrocytes. *Am J Med* 1966;41:786–798.
2. Singer K. Hereditary hemolytic disorders associated with abnormal hemoglobins. *Am J Med* 1955;18:633–652.
3. Scott EM, Hoskins DD. Hereditary methemoglobinemia in Alaskan Eskimos and Indians. *Blood* 1958;13:795–802.
4. Rossi EC, Bryant GT, Schilling RF, et al. Remission of chronic methemoglobinemia following neomycin therapy. *Am J Med* 1966;40:440–447.
5. Westphal RG, Azen EA. Experimental enterogenous cyanosis and anaemia. *Br J Haematol* 1972;22:609–616.
6. Kaplan JC, Chirouze M. Therapy of recessive congenital methaemoglobinaemia by oral riboflavine. *Lancet* 1978;2:1043–1044.
7. Ross JD. Deficient activity of DPNH-dependent methemoglobinemia diaphorase in cord blood erythrocytes. *Blood* 1963;21:51–62.
8. Choury D, Leroux A, Kaplan JC. Membrane-bound cytochrome b5 reductase (methemoglobin reductase) in human erythrocytes. *J Clin Invest* 1981;67:149–155.
9. Choury D, Reghis A, Pichard AL, et al. Endogenous proteolysis of membrane-bound red cell cytochrome b5 reductase in adults and newborns: its possible relevance to the generation of soluble “methemoglobin reductase.” *Blood* 1983;61:894–898.
10. Bucklin R, Myint MK. Fatal methemoglobinemia due to well water nitrates. *Ann Intern Med*

1960;52:703–705.

11. Marcus H, Joffe JR. Nitrate methemoglobinemia. *N Engl J Med* 1949;240:599.
12. Carlson DJ, Shapiro FL. Methemoglobinemia from well water nitrates: a complication of home dialysis. *Ann Intern Med* 1970;73:757–759.
13. Cushing AH, Smith S. Methemoglobinemia with silver nitrate therapy of a burn. *J Pediatr* 1967;74:613–615.
14. Roueché B. *Eleven blue men*. Boston: Little Brown & Co., 1947.
15. Singley TL III. Secondary methemoglobinemia due to the adulteration of fish with sodium nitrite. *Ann Intern Med* 1963;57:800–803.
16. Askew GL, Finelli L, Genese CA, et al. An outbreak of methemoglobinemia in New Jersey in 1992. *Pediatrics* 1994;94:381–384.
17. Sanchez-Echaniz J, Benito-Fernandez J, Mintegui-Raso S. Methemoglobinemia and consumption of vegetables in infants. *Pediatrics* 2001;107:1024–1028.
18. Chilcote RR, Williams B, Wolff LJ, et al. Sudden death in an infant from methemoglobinemia after administration of “sweet spirits of nitre.” *Pediatrics* 1977;59:280–282.
19. Shessler R, Dixon D, Allen Y, et al. Fatal methemoglobinemia from butyl nitrite ingestion. *Ann Intern Med* 1980;92:131–132.
20. Nathan DM, Siegel AJ, Bunn HF. Acute methemoglobinemia and hemolytic anemia with phenazopyridine: possible relation to acute renal failure. *Arch Intern Med* 1977;137:1636–1638.
21. Banning A, Harley JD, O’Gorman Hughes DW, et al. Prolonged methaemoglobinaemia after eating a toy-shaped deodorant. *Med J Aust* 1965;2:922–925.
22. Rieders F, Brieger H. Mechanism of poisoning from wax crayons. *JAMA* 1953;151:1490.
23. Howarth BE. Epidemic of aniline methaemoglobinaemia in newborn babies. *Lancet* 1951;1:934–935.
24. Fisch RO, Berglund EB, Bridge AG, et al. Methemoglobinemia in a hospital nursery. A search for a causative factor. *JAMA* 1964;185:760–763.
25. Sherman JM, Smith K. Methemoglobinemia owing to rectal-probe lubrication. *Am J Dis Child* 1979;133:439–440.
26. Griffin JP. Methemoglobinemia. *Adv Drug React Toxicol* 1997;16:46–53.
27. Mallouh AA, Sarette WO. Methemoglobinemia induced by topical hair oil. *Ann Saudi Med* 1993;13:78–88.
28. Reiter WM, Cimoch PJ. Dapsone-induced methemoglobinemia in a patient with *P. carinii* pneumonia and AIDS. *N Engl J Med* 1987;317:1740.
29. Mandrell BN, McCormick JN. Dapsone-induced methemoglobinemia in pediatric oncology patients. *J Pediatr Oncol Nurs* 2001;18:224–228.
30. Sin DD, Shafran SD. Dapsone- and primiquine-induced methemoglobinemia in HIV-infected individuals. *J Acquir Immune Defic Syndr Hum Retrovirol* 1996;12:477–481.
31. Valentovic MA, Rogers BA, Meadows MK, et al. Characterization of methemoglobin formation induced by 3,5 dichloroaniline, 4-amino-2,6-dichlorophenol and 3,5-dichlorophenylhydroxyamine. *Toxicology* 1997;118:23–36.

32. Ward KE, McCarthy MW. Dapsone-induced methemoglobinemia. *Ann Pharmacother* 1998;32:549-553.
33. Coleman MD, Coleman NA. Drug induced methemoglobinemia. Treatment issues. *Drug Saf* 1996;14:394-405.
34. Osterhoudt KC, Wiley CC, Dudley R, et al. Rebound severe methemoglobinemia from ingestion of a nitroethane artificial fingernail remover. *J Pediatr* 1995;126:819-821.
35. Brown CM, Levy SA, Sussan PW. Methemoglobinemia: life-threatening complication of endoscopy premedication. *Am J Gastroenterol* 1994;89:1108-1109.
36. Hovenga S, Koenders ME, van der Werf TS, et al. Methemoglobinemia after inhalation of nitric oxide for treatment of hydrochlorothiazide-induced pulmonary edema. *Lancet* 1996;348:1035-1036.
37. Krafte-Jacobs B, Brill R, Szabo C, et al. Circulating methemoglobin and nitrite/nitrate concentrations as indicators of nitric oxide overproduction in critically ill children with septic shock. *Crit Care Med* 1997;25:1588-1593.
38. Smith MA, Shah NR, Lobel JS, et al. Methemoglobinemia and hemolytic anemia associated with *Campylobacter jejuni* enteritis. *Am J Pediatr Hematol Oncol* 1988;10:35-38.
39. Yano SS, Danish EH, Hsia YE. Transient methemoglobinemia with acidosis in infants. *J Pediatr* 1982;100:415-417.
40. Hanukoglu A, Danon PN. Endogenous methemoglobinemia associated with diarrheal disease infancy. *J Pediatr Gastroenterol Nutr* 1996;23:1-7.
41. Kay MA, O'Brien W, Kessler B, et al. Transient organic aciduria and met-hemoglobinemia with acute gastroenteritis. *Pediatrics* 1990;85:589-592.
42. Lanir A, Borochowitz Z, Kaplan T. Transient methemoglobinemia with acidosis and hyperchloremia in infants. *Am J Pediatr Hematol Oncol* 1986;8:353-355.
43. Murray KF, Christie DL. Dietary protein intolerance in infants with transient methemoglobinemia and diarrhea. *Pediatrics* 1993;122:90-92.
44. Cox WW, Wendel WB. Normal rate of reduction of hemoglobin in dogs. *J Biol Chem* 1942;143:331-340.
45. Darling RC, Roughton FJW. The effect of methemoglobinemia on the equilibrium between oxygen and hemoglobin. *Am J Physiol* 1942;137:56-68.
46. Goluboff N, Sheaton R. Methylene blue-induced cyanosis and acute hemolytic anemia complicating the treatment of methemoglobinemia. *J Pediatr* 1961;58:86-89.
47. Golden PJ, Weinstein R. Treatment of high-risk, refractory acquired met-hemoglobinemia with automated red cell exchange. *J Clin Apheresis* 1998;13:28-31.
48. Rosen PJ, Johnson C, McGhee WG, et al. Failure of methylene blue treatment in toxic methemoglobinemia. Association with glucose-6-phosphate dehydrogenase deficiency. *Ann Intern Med* 1971;75:83-86.
49. Hibbard BZ, Koenig HM, Lightsey AL, et al. Severe methemoglobinemia in an infant with glucose-6-phosphate dehydrogenase deficiency. *J Pediatr* 1978;93:816-818.
50. Sass MD, Caruso CJ, Farhangi M. TPNH-methemoglobin reductase deficiency: a new red-cell enzyme defect. *J Lab Clin Med* 1967;70:760-767.
51. Jaffé ER, Hultquist DE. Cytochrome b5 reductase deficiency and enzymopenic hereditary methemoglobinemia. In: Scriver CR, Beaudet AL, Sly WS, et al., eds. *The metabolic and molecular basis of inherited disease*, 7th ed. New York: McGraw-Hill, 1995:2267.
52. Schwartz JM, Friedman SA, Schreiber ZA, et al. Unstable variant of NADH-methemoglobin reductase

in Puerto Ricans with hereditary methemoglobinemia. *J Clin Invest* 1972;51:1594–1601.

53. Gotlieb A, Nordan UZ, Hegesh E. An enzyme variation in a case of congenital methemoglobinemia. *Isr J Med Sci* 1973;9:909–913.

54. Jaffé ER, Hsieh H-S. DPNH-methemoglobin reductase deficiency and hereditary methemoglobinemia. *Semin Hematol* 1971;8:417–437.

55. Wang Y, Wu Y-S, Zhen P-Z, et al. A novel mutation in the NADH-cytochrome b5 reductase gene of a Chinese patient with regressive congenital methemoglobinemia. *Blood* 2000;95:3250–3255.

56. Kitao T, Sugita Y, Yoneyama Y, et al. Methemoglobin reductase (cytochrome b5 reductase) deficiency in congenital methemoglobinemia. *Blood* 1974;44:879–884.

57. Prchal JT, Borgese N, Moore MR, et al. Congenital methemoglobinemia due to methemoglobin reductase deficiency in two unrelated American black families. *Am J Med* 1990;89:516–522.

58. Jenkins MM, Prchal TJ. A novel mutation found in the 3' domain of NADH-cytochrome b5 reductase in an African-American family with type I congenital methemoglobinemia. *Blood* 1996;87:2993–2999.

59. Feig SA, Nathan DG, Gerald PS, et al. Congenital methemoglobinemia: the result of age-dependent decay of methemoglobin reductase. *Blood* 1972;39:407–414.

60. West CA. A study of the inheritance and properties of an electrophoretic variant of NADH-methemoglobin reductase associated with congenital methemoglobinemia. *Br J Haematol* 1972;23:343–349.

61. Cohen RJ, Sachs JR, Wickerf DJ, et al. Methemoglobinemia provoked by malarial chemoprophylaxis in Vietnam. *N Engl J Med* 1968;279:1127–1131.

62. Kobayashi Y, Fukumaki Y, Yubisui T, et al. Serine-proline replacement at residue 127 of NADH-cytochrome b5 reductase causes hereditary methemoglobinemia, generalized type. *Blood* 1990;75:1408–1413.

63. Leroux A, Junien C, Kaplan J, et al. Generalized deficiency of cytochrome b5 reductase in congenital methaemoglobinemia with mental retardation. *Nature* 1975;258:619–620.

64. Bloom GE, Zarkowsky HS. Heterogeneity of the enzymatic defect in congenital methemoglobinemia. *N Engl J Med* 1969;281:919–922.

65. Dekker J, Eppink MHM, van Zwieten R, et al. Seven new mutations in the nicotinamide adenine dinucleotide reduced-cytochrome b5 reductase gene leading to methemoglobinemia type I. *Blood* 2001;97:1106–1114.

66. Hopkinson DA, Corney G, Cook PJ, et al. Genetically determined electrophoretic variants of human red cell NADH diaphorase. *Ann Hum Genet* 1970;34:1–10.

67. Shirabe K, Yubisui T, Borgese N, et al. Enzymatic instability of NADH-cytochrome b5 reductase as a cause of hereditary methemoglobinemia type I (red cell type). *J Biol Chem* 1992;267:20416–20421.

68. Vieira LM, Kaplan J-C, Kahn A, et al. Four new mutations in NADH-cytochrome b5 reductase gene from patients with recessive congenital methemoglobinemia type II. *Blood* 1995;85:2254–2262.

69. Yuibisui T, Shirabe K, Takeshita M, et al. Structural role of serine 127 in the NADH-binding site of human NADH-cytochrome b5 reductase. *J Biol Chem* 1991;266:66–70.

70. Shirabe K, Fujimoto Y, Yubisui T, et al. An in-frame deletion of codon 298 of NADH-cytochrome b5 reductase gene in hereditary methemoglobinemia type II (generalized type). A functional implication for the role of the COOH-terminal region of the enzyme. *J Biol Chem* 1994;269:5952–5957.

71. Hsieh H-S, Jaffé ER. Electrophoretic and functional variants of NADH-methemoglobin reductase in hereditary methemoglobinemia. *J Clin Invest* 1971;50:196–202.

72. Jaffé ER. Methemoglobinemia. *Clin Haematol* 1981;10:99–122.
73. Tanishima K, Tanimoto K, Tomoda A, et al. Hereditary methemoglobinemia due to cytochrome b5 reductase deficiency in blood cells without associated neurologic and mental disorders. *Blood* 1985;66:1288–1291.
74. Kaplan JC, Nicolas AM, Hanzlickova-Leroux A, et al. A simple spot screening test for fast detection of red cell NADH-diaphorase deficiency. *Blood* 1970;36:330–333.
75. Rogers LE. Rapid method for detection of erythrocyte NADH-methemoglobin reductase deficiency. *Am J Clin Pathol* 1972;57:186–187.
76. Hegesh E, Calmanivici N, Avron M. New method for determining ferrihemoglobin reductase (NADH-methemoglobin reductase) in erythrocytes. *J Lab Clin Med* 1968;72:339–344.
77. Junien C, Leroux A, LOSTANLEN D, et al. Prenatal diagnosis of congenital enzymopenic methaemoglobinaemia with mental retardation due to generalized cytochrome b5 reductase deficiency. *Prenat Diagn* 1981;1:17–24.
78. Tiselius HG, Almgard LE. The diurnal urinary excretion of oxalate and the effect of pyridoxine and ascorbate on oxalate excretion. *Eur Urol* 1977;3:41–46.
79. Matsuki T, Yubisui T, Tomoda A. Acceleration of methaemoglobin reduction by riboflavin in human erythrocytes. *Br J Haematol* 1978;39:523–528.
80. Hegesh E, Hegesh J, Kaftory A. Congenital methemoglobinemia with a deficiency of cytochrome b5. *N Engl J Med* 1986;314:757–761.
81. Hayashi N, Motokawa Y, Kikuchi G. Studies on relationship between structure and function of hemoglobin M Iwate. *J Biol Chem* 1966;241:79–84.
82. Ranney HM, Nagel RL, Heller P, et al. Oxygen equilibrium of hemoglobin M-Hyde Park. *Biochim Biophys Acta* 1968;160:112–115.
83. Hayashi A, Fujita T, Fujimura M, et al. A new abnormal fetal hemoglobin, Hb FM Osaka (α<sup>2</sup>?<sup>2</sup>His?Tyr). *Hemoglobin* 1980;4:447–448.
84. Priest JR, Watterson J, Jones RT, et al. Mutant fetal hemoglobin causing cyanosis in a newborn. *Pediatrics* 1989;83:734–736.
85. Pulsinelli PD, Perutz MF, Nagel RL. Structure of hemoglobin M Boston, a variant with a five-coordinated ferric heme. *Proc Natl Acad Sci U S A* 1973;70:3870–3874.
86. Lindstrom TR, Ho C, Pisciotta AV. Nuclear magnetic resonance studies of haemoglobin M Milwaukee. *Nat New Biol* 1972;237:263–264.
87. Perutz MF, Pulsinelli PD, Ranney HM. Structure and subunit interaction of haemoglobin M Milwaukee. *Nat New Biol* 1972;237:259–263.
88. Thillet J, Cohen-Solal M, Seligmann M, et al. Functional and physicochemical studies of hemoglobin St. Louis B28 (B10) Leu?Gln. *J Clin Invest* 1976;58:1098–1106.
89. Josephson AM, Weinstein HG, Yakulis VJ, et al. A new variant of hemoglobin M disease: hemoglobin M Chicago. *J Lab Clin Med* 1962;59:918–925.
90. Pisciotta AV, Ebbe SN, Hing JE. Clinical and laboratory features of two variants of methemoglobin M disease. *J Lab Clin Med* 1959;54:73–87.
91. Nagel RL, Bookchin RM. Human hemoglobin mutants with abnormal oxygen binding. *Semin Hematol* 1974;11:385–403.
92. Nagel RL, Lynfield J, Johnson J, et al. Hemoglobin Beth Israel: a mutant causing clinically apparent



cyanosis. N Engl J Med 1976;295:125–130.

93. Bonaventura J, Riggs A. Hemoglobin Kansas, a human hemoglobin with a neutral amino acid substitution and an abnormal oxygen equilibrium. J Biol Chem 1968;243:980–991.

94. Schneider RG, Atkins RJ, Hosty TS, et al. Haemoglobin Titusville:  $\alpha 94$  Asp $\rightarrow$ Asn: a new haemoglobin with lowered affinity for oxygen. Biochim Biophys Acta 1975;400:365–373.

2004 Lippincott Williams & Wilkins  
John P. Greer, John Foerster, John N. Lukens  
George M. Rodgers, Frixos Paraskevas, Bertil Glader  
Wintrobe's Clinical Hematology

DEFINITIONS AND TERMINOLOGYPATHOLOGIC PHYSIOLOGYBlood Viscosity and Oxygen TransportCLASSIFICATION AND APPROACH TO THE PATIENT WITH ERYTHROCYTOSISRELATIVE POLYCYTHEMIAPOLYCYTHEMIA (ABSOLUTE ERYTHROCYTOSIS)Primary PolycythemiaSecondary Polycythemia [Physiologically Appropriate (Hypoxic)]Secondary Polycythemia [Physiologically Inappropriate (Normoxic)]Idiopathic PolycythemiaREFERENCES**DEFINITIONS AND TERMINOLOGY**

The terms *polycythemia* and *erythrocytosis* are often used as if they are interchangeable; in fact, they describe related but distinct findings that usually, but not always, coexist. *Polycythemia* (“many cells”) describes an increase in the total quantity or volume (mass) of red blood cells in the body without any implication regarding leukocytes or platelets. An increase in the *concentration* of erythrocytes, however, whether measured as number of cells, hemoglobin (Hb), or packed cell volume (hematocrit), is more correctly designated *erythrocytosis*. Erythrocytosis may be the result of an increase in the red cell volume or mass (polycythemia; also called *absolute erythrocytosis*) or the result of a reduced plasma volume (called *relative* or *spurious* polycythemia or erythrocytosis), which produces an increase in red cell concentration that does not reflect an increase in the quantity of red cells in the body.

Despite the precision with which these terms are defined, opportunities for confusion abound. *Polycythemia vera* (also called *polycythemia rubra vera*) is a myeloproliferative disorder associated with trilineage marrow hyperplasia and characterized by an increased red cell mass, usually in association with leukocytosis and thrombocytosis. The outdated term *erythremia* refers to this disease (see [Chapter 85](#)). Some patients who do not have this myeloproliferative disease are described as having polycythemia vera simply because they have an elevated red cell mass [i.e., their polycythemia is “true” (“vera”)]. Such errors are frequently encountered in consultative practice.

**PATHOLOGIC PHYSIOLOGY**

Red cell survival in polycythemic states is typically normal, implying that increased red cell mass reflects increased erythropoiesis. As the red cell mass rises, the total blood volume typically increases: The variability of changes in plasma volume means that the degree of increase is unpredictable (<sup>1</sup>).

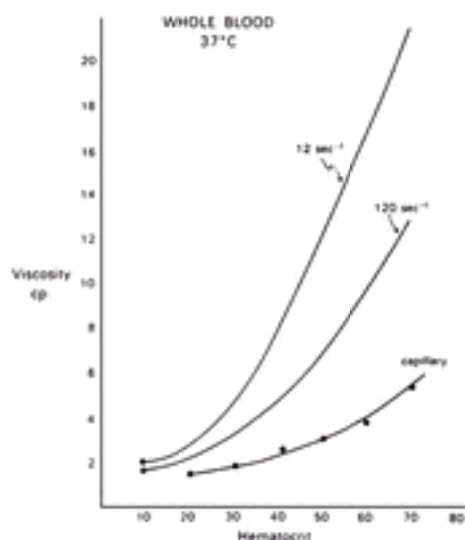
The clinical manifestations of erythrocytosis are related in part to the disorder responsible for erythrocytosis [e.g., thrombosis in patients with polycythemia vera (<sup>2</sup>), hypertension in relative polycythemia (<sup>3</sup>), and so on]. In addition, the increased blood volume and increased blood viscosity that occur in association with polycythemia

themselves produce certain symptoms and signs; these are related to the degree of the increase and the resulting effects on blood flow and oxygen transport (4). Thus, the “ruddy cyanosis” seen in patients with polycythemia vera is a consequence of dilatation of cutaneous vessels by expanded blood volume and sluggish local circulation caused by increased blood viscosity (5, 6). Headache, dizziness, tinnitus, a full feeling in the head, and a bleeding tendency may develop in patients with erythrocytosis and expanded blood volume regardless of the basic cause (7). These symptoms usually are relieved by normalization of the hematocrit.

## Blood Viscosity and Oxygen Transport

Viscosity is an intrinsic characteristic of a liquid and represents the tendency of that liquid to resist changes in shape. The viscosity of blood is a result of the interaction of several factors, including the red cell concentration [referred to in this section as the *volume of packed red cells* (VPRC)], the physical characteristics (deformability, aggregability, and size) of red cells, the plasma volume, plasma proteins, platelet count, and leukocyte number and character (8). As discussed below, the blood viscosity affects the oxygen content and delivery. This section focuses primarily on the contribution of red cell concentration to viscosity and oxygen transport; more complete discussions are available elsewhere (8).

The rate of flow of a liquid through a tube of fixed length is directly related to the pressure gradient across that length of tube and to the radius raised to the fourth power ( $r^4$ ) and inversely related to the viscosity of that liquid (Poiseuille law) (9, 10). Determinations of the effects of erythrocytosis on blood viscosity were largely made by determining the flow rate of venous blood through an 18-gauge needle under known pressure and thus calculating viscosity (9). The values thus determined are only an approximation. Poiseuille law is strictly applicable only to fluids that maintain constant viscosity under differing flow rates; this is not the case with blood (Fig. 50.1) (6, 10). As the velocity of flow (indicated by the shear rate) increases, the viscosity at any given VPRC decreases (10). Other factors that interact with the VPRC to contribute to viscosity are the mean erythrocyte corpuscular volume (MCV) and mean corpuscular Hb (MCH) (11, 12 and 13). At any given VPRC, decreased MCV or MCH (or both) is associated with increased viscosity, especially at low flow rates (12, 13). This is a clinically significant observation, because iron deficiency with a normal Hb or hematocrit is a common endpoint of the treatment of polycythemia by phlebotomy.



**Figure 50.1.** Relation of volume of packed red cells (hematocrit) to blood viscosity in centipoise (cp) as measured in a capillary viscosimeter compared with that calculated for shear rates of  $120 \text{ sec}^{-1}$  (ascending aorta) and  $12 \text{ sec}^{-1}$  (medium arteriole). (From Wells RE Jr, Merrill EW. The variability of blood viscosity. *Am J Med* 1961;31:505, with permission.)

It is noted above that the model for determining blood viscosity represents a somewhat artificial system: Calculated values probably exceed those existing *in vivo* ([10](#)). However, studies of cerebral blood flow in patients with erythrocytosis of various etiologies have demonstrated the clinical effects of an elevated hematocrit on *in vivo* blood flow ([14](#), [15](#), [16](#) and [17](#)). Cerebral blood flow in patients with erythrocytosis due to an elevated red cell mass ([14](#)), due to reduced plasma volume ([16](#), [17](#)), or of unknown etiology ([15](#)) was significantly reduced compared to controls ([Table 50.1](#)). Hematocrit reduction, either by venesection ([14](#), [15](#), [16](#) and [17](#)) or by volume expansion ([17](#)), improved cerebral blood flow.

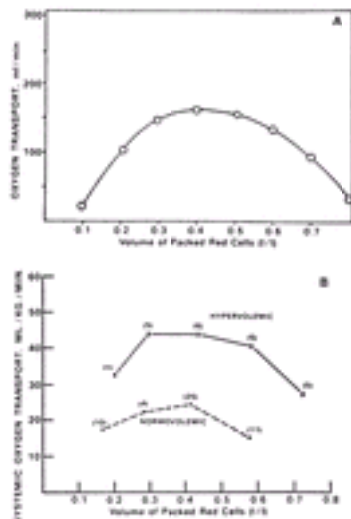
**TABLE 50.1. Effect of Erythrocytosis on Cerebral Blood Flow (CBF)**

| Etiology of Erythrocytosis (No. Patients)              | Reference          | CBF (ml/100 g/min) | Percent Normal CBF |
|--|--------------------|--------------------|--------------------|
| Polycythemia ( <a href="#">16</a> )                    | <a href="#">14</a> | $37.9 \pm 11.2$    | $54.8 \pm 16.2$    |
| Mixed ( <a href="#">38</a> )                           | <a href="#">15</a> | $41.4 \pm 10.5$    | $63.6 \pm 16.2$    |
| Relative polycythemia                                  | <a href="#">16</a> |                    |                    |
| High-normal red blood cell mass ( <a href="#">21</a> ) |                    | $45.8 \pm 10.9$    | $66.8 \pm 15.9$    |
| Low plasma volume ( <a href="#">18</a> )               |                    | $48.8 \pm 12.9$    | $71.1 \pm 18.8$    |
| Relative polycythemia ( <a href="#">5</a> )            | <a href="#">17</a> | $40.7 \pm 5.4$     | $59.9 \pm 7.8$     |

NOTE: Values expressed as mean  $\pm$  standard deviation.

The determination of blood viscosity values at different VPRC allows the estimation of blood flow rates under different conditions. As Poiseuille law predicts (and the data in [Table 50.1](#) imply), blood flow decreases linearly with increasing viscosity ([18](#)). The rate of oxygen transport can then be calculated from the blood flow rate and oxygen content. At

a given vessel size and pressure gradient, the predicted relation of oxygen transport to VPRC is expressed by an arch-shaped curve ( [Fig. 50.2A](#)) ( [9](#), [18](#), [19](#)). At low VPRC, the reduced Hb content of blood translates into reduced oxygen content. At elevated VPRC (>0.5 to 0.6), increased viscosity reduces oxygen transport despite increased blood oxygen content. Optimal oxygen transport would be predicted to occur in the normal hematocrit range ( [18](#), [19](#), [20](#) and [21](#)). Experiments in normovolemic dogs ( [Fig. 50.2B](#), dashed line) support this prediction ( [19](#)).



**Figure 50.2.** Arterial oxygen transport at different volumes of packed red cells and thus different viscosity values. **A:** Values in curve were calculated from blood viscosity values as measured by Pirofsky ( [9](#)). **B:** Systemic oxygen transport as calculated from cardiac output measured in normo-volemic and hypervolemic dogs. (From Murray JF, Gold P, Johnson BL Jr. The circulatory effects of hematocrit variations in normovolemic and hypovolemic dogs. *J Clin Invest* 1963;42:1150–1159, with permission.)

The differences in oxygen transport observed between normovolemic and hypervolemic dogs at different VPRC ( [Fig. 50.2B](#)) reflect the probable situation occurring in patients with erythrocytosis due to an expanded red cell mass (polycythemia). In polycythemia, the associated hypervolemia permits an oxygen transport curve that is similar to that of normovolemic patients but which is elevated and shifted to the right ( [19](#), [22](#)). Therefore, in patients with tissue hypoxia, polycythemia is beneficial because it leads to hypervolemia and increases oxygen transport (compare oxygen transport at VPRC 0.6 on the hypervolemic and normovolemic curves in [Fig. 50.2B](#)). In contrast, in patients who have a normal or decreased total blood volume (as in relative or spurious polycythemia), erythrocytosis has an adverse effect on oxygen transport.

**RELATION TO TREATMENT OF POLYCYTHEMIA** The considerations noted above are of interest in understanding not only the pathophysiology of the different etiologies of erythrocytosis but also their treatment. Patients with polycythemia vera have no need for increased tissue oxygen transport. In some areas where fixed vessel diameter (from arteriosclerosis) limits increased blood flow, however, the additional impeding effect of increased blood viscosity may limit oxygen transport and result in local tissue ischemia. Phlebotomy can bring about a significant clinical benefit (see [Chapter 93](#)). When treating by phlebotomy, however, blood volume should not be reduced too greatly at any one bleeding, especially in patients with known symptoms of cardiovascular disease (angina pectoris, transient ischemic attacks). This is particularly true early in the course of

therapy, when hematocrit (and consequently viscosity) is highest ( [23](#) ). Rather, time should be allowed for hemodilution to occur between phlebotomies; in emergencies, the blood volume should be maintained by infusing saline or some other plasma expander ( [24](#) ). A concern is that the patient not suddenly be shifted from the hypervolemic, erythrocytosis–beneficial curve to the normo–volemic, erythrocytosis–adverse curve. Another concern is that a sudden fall in blood volume from any cause, such as dehydration or acute hemorrhage, may result in local ischemia because increased cardiac output cannot compensate immediately for the effects of high viscosity. In patients with congestive heart failure, the need for reduction of blood viscosity may be urgent, because the ability to increase cardiac output to compensate for the increased blood viscosity has been compromised. The oxygen–Hb dissociation curve is shifted to the right in such patients ( [25](#) ). In contrast to polycythemia vera, patients with polycythemia due to tissue hypoxia may benefit from increased VPRC. Reduced arterial oxygen saturation means that blood oxygen transport is less efficient at particular Hb or hematocrit levels. Therefore, the curves for oxygen transport would be shifted closer to the origin than those noted in situations in which Hb oxygenation is normal ( [Fig. 50.2B](#) ). In the presence of decreased arterial oxygen saturation, tissue hypoxia may persist even when erythrocytosis is marked. The main advantage to decreasing blood viscosity and blood volume in hypoxic (secondary) polycythemia is to decrease the cardiac workload. One would predict that in such situations an increase in tissue oxygen transport and clinical improvement should result from phlebotomy; results show that this is the case ( [26](#) ). Again, especially early in the course, phlebotomy with preservation of an expanded blood volume may be beneficial ( [23](#), [24](#) ). To achieve the best balance between increased cardiac work and decreased tissue hypoxia in patients with hypoxemic erythrocytosis, some authors suggest that the hematocrit be maintained between 0.50 and 0.55 ( [24](#), [26](#) ); however, the subjective symptomatology of the patient is usually the best guide ( [18](#) ).

## CLASSIFICATION AND APPROACH TO THE PATIENT WITH ERYTHROCYTOSIS

As stated previously, erythrocytosis (an increase in red cell *concentration*) may result from decreased plasma volume or from *polycythemia*, which is an increase in the absolute quantity of red cells or red cell mass. The various forms of erythrocytosis are listed in [Table 50.2](#). They are classified according to red cell mass (relative erythrocytosis or polycythemia vs. actual polycythemia). Polycythemia, in turn, is divided into primary polycythemia ( *polycythemia vera* and *familial primary polycythemia* ) and polycythemia driven by erythropoietin production ( *secondary polycythemia* ). The secondary polycythemic syndromes are divided into those that represent a response to tissue hypoxia (physiologically appropriate) and those driven by erythropoietin not produced in response to tissue hypoxia (physiologically inappropriate).

**TABLE 50.2. Classification of Erythrocytosis**

---

|  |
|--|
| Relative erythrocytosis or polycythemia (pseudoerythrocytosis) |
| Hemoconcentration  |
| Spurious polycythemia (Gaisböck syndrome)                      |
| Polycythemia (absolute erythrocytosis)                         |
| Primary polycythemia   |
| Polycythemia vera  |
| Primary familial polycythemia                                  |
| Secondary polycythemia   |

Secondary to decreased tissue oxygenation (physiologically appropriate polycythemia or hypoxic erythrocytosis)

High-altitude erythrocytosis (Monge disease)

Pulmonary disease

Chronic cor pulmonale

Ayerza syndrome

Cyanotic congenital heart disease

Hypoventilation syndromes

Primary alveolar hypoventilation

Pickwickian syndrome, Ondine curse

Positional desaturation

Sleep apnea

Abnormal hemoglobins

Inherited

Acquired: drugs and chemicals, carboxyhemoglobin

Familial polycythemia

Secondary to aberrant erythropoietin production or response (physiologically inappropriate polycythemia)

Tumors, cysts, hemangiomas, and so forth

Androgen abuse

Erythropoietin abuse

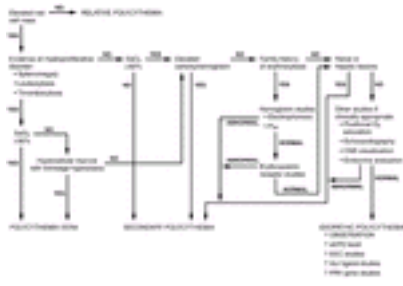
Familial polycythemia

Idiopathic polycythemia

---

An approach to the evaluation of the patient with erythrocytosis is outlined in [Figure 50.3](#). Although polycythemia can usually be differentiated from relative erythrocytosis on clinical grounds (as described below), the measurement of red cell mass and blood volume is recommended as the initial step in evaluation. Normal values are presented in [Table 50.3](#), but considerable variation exists from one subject to another in red cell, plasma, and total blood volume, even when expressed as milliliters per kilogram (ml/kg) body weight. This variation results, in part, from differences in body fat content ([27](#), [28](#), [29](#), [30](#) and [31](#)); blood volume is more closely related to lean body mass ([29](#)) than to weight or surface area. It has been proposed that a red cell mass of at least 125% of that predicted should be considered as indicating polycythemia ([32](#)). It is a common practice to measure either plasma volume or red cell volume and, from one of these determinations, to calculate total blood volume on the basis of the relative amounts as indicated by a hematocrit determination. In the view of most ([33](#), [34](#) and [35](#)), but not all ([11](#)), investigators, this practice is associated with an increased chance of error; measuring red cell mass and plasma volume separately is preferable. It must be emphasized that blood volume measurements do not differentiate between secondary polycythemia and polycythemia vera; they are useful only in distinguishing absolute from relative erythrocytosis. In men with a hematocrit greater than 60% or women with a hematocrit greater than 55%, there is reported to be greater than 99% likelihood that the red cell mass is elevated ([36](#)); although this is probably correct, it should be remembered that in certain circumstances of severe hemoconcentration [e.g., in the systemic capillary leak syndrome ([37](#))], hematocrits in this range may be observed in patients with a normal red cell mass. Such patients typically exhibit physical findings suggestive of severe intravascular volume depletion and redistribution of intravascular volume.





**Figure 50.3.** Approach to patients with erythrocytosis. CNS, central nervous system; EEC, endogenous erythroid colonies; SaO<sub>2</sub>, arterial oxygen saturation; sEPO, serum erythropoietin.

**TABLE 50.3. Normal Values for Red Blood Cell, Plasma, and Total Blood Volume (ml/kg  $\pm$  1 Standard Deviation <sup>a</sup>)**

|                          | No. | Red Blood Cells | Plasma         | Total Blood Volume |
|--------------------------|-----|-----------------|----------------|--------------------|
| <b>Women</b>             |     |                 |                |                    |
| Sea level                |     |                 |                |                    |
| Wennesland, et al. ( 30) | 97  | 25.4 $\pm$ 2.6  | 36.8 $\pm$ 3.7 | —                  |
| Huff and Feller ( 27)    | 20  | 24.4 $\pm$ 2.6  | 34.8 $\pm$ 3.2 | 58.9 $\pm$ 4.9     |
| <b>Men</b>               |     |                 |                |                    |
| Sea level                |     |                 |                |                    |
| Wennesland, et al. ( 30) | 199 | 28.3 $\pm$ 2.8  | 34.4 $\pm$ 4.0 | —                  |
| Huff and Feller ( 27)    | 42  | 28.3 $\pm$ 4.1  | 33.5 $\pm$ 5.2 | 61.5 $\pm$ 8.6     |
| Weil, et al. ( 39)       | 16  | 27.1 $\pm$ 3.7  | 33.0 $\pm$ 5.3 | 60.0 $\pm$ 8.6     |
| 1600 m <sup>b</sup>      |     |                 |                |                    |
| Weil, et al. ( 39)       | 19  | 26.8 $\pm$ 3.2  | 31.9 $\pm$ 3.6 | 58.7 $\pm$ 5.8     |
| 3100 m <sup>b</sup>      |     |                 |                |                    |
| Weil, et al. ( 39)       | 39  | 31.8 $\pm$ 6.7  | 35.2 $\pm$ 5.3 | 66.8 $\pm$ 8.5     |

<sup>a</sup> Red blood cell volume measured by <sup>51</sup>Cr method. Other values calculated without correction for trapped plasma.

<sup>b</sup> Only values of which we are aware at altitudes significantly above sea level. They may be somewhat low for unknown reasons; the packed cell volumes at 1600 m were the same as at sea level, a finding that contradicts our own large experience.

The goal of the approach outlined in [Figure 50.3](#) is initially to distinguish spurious (relative) polycythemia from actual polycythemia; then to distinguish polycythemia vera from secondary polycythemia and primary proliferative polycythemia; to rule out other primary polycythemia; and finally to identify the etiology of secondary polycythemia. The characteristics of polycythemia vera are outlined in [Chapter 85](#); the other polycythemic syndromes are discussed below. A certain number of patients are not readily classified as having either polycythemia vera or secondary polycythemia. These patients fall into a category called (for want of a more physiologic term) *idiopathic polycythemia* and appear to represent a heterogeneous group of disorders (see below).

Two tests that do not appear in the routine evaluation of erythrocytosis described in [Figure 50.3](#) are the serum erythropoietin level and the formation of erythroid colonies *in vitro* in the absence of added erythropoietin [“endogenous erythroid colonies” (EEC)]. The role of serum erythropoietin levels in the evaluation of erythrocytosis has been well evaluated in a number of studies ([Table 50.4](#)) ([38](#), [39](#) and [40](#)). Although mean serum erythropoietin concentration in the subset of patients with polycythemia vera is significantly lower than that observed in secondary polycythemia, there is considerable overlap, making it less useful for individual cases. This would be expected physiologically. A patient with secondary polycythemia due to tissue hypoxia would have an elevated serum erythropoietin level until the hematocrit was sufficiently high to adequately oxygenate tissue; then the erythropoietin concentration would be expected to decrease. The intermittent nature of detection of an elevated serum erythropoietin concentration in secondary polycythemia has been described ([41](#)), as has the failure of serum erythropoietin concentrations to predict clinical course in idiopathic erythrocytosis ([42](#)). Studies have been reported demonstrating that polycythemia vera and secondary polycythemia can be distinguished based on the serum erythropoietin response to phlebotomy: After phlebotomy, serum erythropoietin levels increase in secondary polycythemia but remain stable in polycythemia vera ([43](#)). Methods for detecting low serum erythropoietin concentrations are probably not sufficiently sensitive that a low serum erythropoietin can be considered as ruling out secondary polycythemia ([44](#)).

**TABLE 50.4. Serum Erythropoietin Levels in Erythrocytosis**

|                        | Mean Serum Erythropoietin Concentration (U/L) |                    |                    |
|------------------------|---|--------------------|--------------------|
| Normal                 | 6.7 (3.3–13.5)                                | 15 ± 4             | 25 (18–35)         |
| Polycythemia vera      | 2.1 ± 1.0                                     | 17 ± 8             | 16 (8–22)          |
| Secondary polycythemia | 121.7 ± 242.0                                 | 94 ± 101           | 30 (14–23)         |
| Relative polycythemia  | 7.0 ± 2.5                                     | —                  | 23 (17–39)         |
| Reference              | <a href="#">38</a>                            | <a href="#">40</a> | <a href="#">39</a> |

NOTE: Values expressed as mean ± standard deviation or as mean (range).

EEC are described as a hallmark of myeloproliferative disorders ([45](#), [46](#)); however, they do not absolutely distinguish polycythemia vera and secondary polycythemia nor are they observed in all polycythemia vera patients. EEC corresponding to erythroid burst-forming units were observed in 12 of 17 polycythemia vera patients, 3 of 11 secondary polycythemics, 1 of 6 relative polycythemics, and 1 of 11 normal individuals in one series ([47](#)). EEC corresponding to erythroid colony-forming units (CFU-E) have also been described and represented of total CFU-E in polycythemia vera patients, 3.6 ± 2.8% of total CFU-E in secondary polycythemics and patients with elevated endogenous erythropoietin levels, and 0.2 ± 0.3% of total CFU-E in normal persons ([48](#)). Flow cytometry-based techniques for detecting EEC have been described that may make this diagnostic technique (now primarily available through research laboratories) available on a more routine basis ([49](#)).

Soluble transferrin receptors are typically elevated in all forms of polycythemia and thus do not distinguish polycythemia vera and secondary polycythemia ([50](#)).

## RELATIVE POLYCYTHEMIA

Lowered fluid intake, marked loss of body fluids, or a combination of both causes a decrease in plasma volume and may produce a relative erythrocytosis. The decrease in plasma volume may result from any cause of intravascular fluid loss, insensible fluid loss, persistent vomiting, severe diarrhea, copious sweating, postoperative complications, or shift of fluid into the extravascular space (“third-spacing”) (37, 51, 52) or may be an effect of high altitude (53). In severe burns, plasma loss leads to hemoconcentration.

Chronic relative polycythemia or erythrocytosis has been variously referred to as *Gaisböck syndrome* (48, 54), “stress” erythrocytosis (3), *benign polycythemia* (52), *benign erythrocytosis* (55), *spurious polycythemia* (56, 57), *pseudopolycythemia* (58), and *apparent polycythemia* (59). The last three terms are the most accurate: In the absence of an elevated red cell mass, there is no polycythemia. In one series of 215 patients referred with a diagnosis of polycythemia vera (60), 18 (8.3%) were believed to have chronic relative erythrocytosis, possibly caused by “stress” (3). Patients with relative polycythemia or erythrocytosis are typically male; the mean age at diagnosis is less than is seen in patients with polycythemia vera (59). Obesity is typically described as an associated feature (3), although not all studies support this association (61). Other features reported to be strongly associated with relative polycythemia are hypertension and smoking (59, 61, 62); associations with alcohol abuse and renal disease are occasionally reported (59, 60). It is probable that this syndrome is not a true clinical entity (57, 63). The red cell mass values generally accepted as normal at sea level, or at any given altitude, represent the mean  $\pm$  2 standard deviations. Thus, on the basis of the normal frequency distribution curve for this physiologic parameter, the values in 2.5% of the population are above this range. The individuals in this group should not be regarded as necessarily abnormal (63).

The optimal management of relative polycythemia is unknown. As noted previously, phlebotomy increases cerebral blood flow even in patients with relative polycythemia; whether it is of symptomatic benefit is less clear (16, 17). It should probably be avoided. Theoretic arguments can be made that contracting the blood volume further in these patients who already are normovolemic or slightly hypovolemic may impair tissue perfusion. Satisfactory control of hematocrit can be obtained in at least two-thirds of patients by reduction of excess weight, improved hypertension control, avoidance of diuretics, and reduction if not cessation of smoking (61). Potentially leukemogenic cytoreductive therapy, such as radioactive phosphorus or oral chemotherapeutic agents, is probably never indicated.

## POLYCYTHEMIA (ABSOLUTE ERYTHROCYTOSIS)

### Primary Polycythemia

**POLYCYTHEMIA VERA** Polycythemia vera is discussed in [Chapter 85](#).

**PRIMARY FAMILIAL POLYCYTHEMIA (“CHUVASH POLYCYTHEMIA”)** *Familial erythrocytosis* or *polycythemia* is a term used to describe instances in which two or more members of a family have polycythemia, do not have polycythemia vera, and have no identifiable “secondary” causes (62, 64). This finding can result from a constellation of pathophysiologic mechanisms, including abnormalities of oxygen-Hb interaction, or idiopathic constitutive erythropoietin secretion. These syndromes are discussed under

etiologies of secondary polycythemia, below. *Primary familial polycythemia* is a term used to describe a syndrome observed in families with abnormalities of the erythropoietin receptor, resulting in hypersensitivity to erythropoietin and consequent erythrocytosis ( [65](#) , [66](#) and [67](#) ). This particular autosomal-dominant trait does not necessarily confer an adverse prognosis early in life: The propositus of the first such family described was an Olympic gold medallist in cross-country skiing ( [65](#) ). However, these individuals are at increased risk for thrombotic and vascular mortality later on ( [68](#) , [69](#) ). A variant of this syndrome occurs with high frequency among the people of the Chuvashia region of the former Soviet Union. These individuals appear to have a mutation in the oxygen-sensing pathway regulating erythropoietin production and also in the response of erythroid progenitors to erythropoietin ( [70](#) , [71](#) and [72](#) ).

## Secondary Polycythemia [Physiologically Appropriate (Hypoxic)]

Insufficient oxygen supply to the tissues may result from any of the following, alone or in combination: (a) decreased ambient oxygen pressure (e.g., high altitude); (b) pulmonary diffusion or mixing abnormalities; (c) right-to-left cardiopulmonary shunts, as in cyanotic congenital heart disease; (d) hypoventilation; or (e) altered oxygen-carrying affinity of Hb. In all of these disorders, insufficient tissue oxygenation leads to increased erythropoietin production and a consequent increase in red cell mass (see [Chapter 7](#) ).

**HIGH-ALTITUDE ERYTHROCYTOSIS** In 1890, Viault showed that erythrocytosis develops during sojourn at high altitude ( [73](#) ). He found erythrocyte counts of  $7.5$  to  $8.0 \times 10^{12}$  cells/L not only in natives of the Peruvian Andes working in a mine at an altitude of 4392 m above sea level, but also in himself and in a traveling companion, although his blood count in Lima (160 m above sea level) had been normal. On a Mt. Everest expedition, researchers demonstrated that red cell volume and values of total Hb rose progressively as higher altitudes were attained; at 19,000 feet (5800 m), mean values were 49% above those at sea level. The increase in total blood volume was partially masked by reductions in plasma volume ( [74](#) ). Recent investigations of the control of erythropoiesis at high altitudes indicate that a sharp increase in erythropoietin production occurs within the first week of high-altitude exposure and is associated with mobilization of iron stores and evidence of iron-deficient erythropoiesis ( [75](#) ). Mechanisms of adaptation to living at high altitude apparently are multiple and differ between ethnic groups ( [76](#) , [77](#) ). The rapid ascent to high altitude is accompanied by symptoms of fatigue, dizziness, pulsating headache, anorexia, nausea, vomiting, insomnia, and irritability—a syndrome well known to mountain climbers and residents of high altitudes and referred to as *acute mountain sickness* ( [78](#) , [79](#) and [80](#) ). The symptoms first appear some 4 to 6 hours after reaching a high altitude but may be delayed for as many as 96 hours, suggesting that the pathogenesis represents more than simple hypoxia. The incidence is greatest in younger persons, in those flying to high altitude, or in those who climb fast and spend few nights acclimatizing. Gender, the weight of the load carried, and recent respiratory infection do not appear to affect the incidence ( [81](#) ). Severity is greatest in the young and correlates with the speed of ascent and the altitude reached ( [81](#) ). Thus, all persons develop symptoms if they are suddenly transported from sea level to 15,000 feet (4570 m) or higher, whereas a few develop symptoms at 8000 to 10,000 feet (2400 to 3000 m) ( [74](#) ). After 4 to 8 days, acclimatization usually occurs, and symptoms remit spontaneously ( [78](#) , [81](#) ). In some individuals, however, symptoms may progress to cerebral confusion, coma, and even death related to pulmonary edema unless the subject is returned to low altitude ( [79](#) , [82](#) ). The pathogenesis of acute mountain sickness may involve hypoxia and subsequent excessive secretion of antidiuretic hormone and adrenal steroids with resulting fluid retention, increased blood volume, and finally cerebral edema, pulmonary

congestion, or both ( [79](#), [83](#)). The incidence and severity of symptoms can be considerably reduced by administering diuretics, such as acetazolamide or furosemide ( [79](#), [80](#) and [81](#)). The administration of dexamethasone has also proven effective in the prevention and treatment of this disorder ( [84](#)). The events associated with acclimatization after arrival at high altitude are not understood completely but probably include the following: An increase in erythrocyte 2,3-diphosphoglycerate (DPG) levels and a shift to the right in the oxygen-Hb dissociation curve, thus allowing better tissue delivery of oxygen despite decreased arterial oxygen saturation ( [77](#), [82](#), [85](#)). The increase in 2,3-DPG appears to compensate for the left shift in the curve that results from the initial hypocapnia and increase in arterial pH ( [79](#), [82](#)). Increased erythropoietin production with subsequent increase in iron mobilization (discussed above), reticulocytosis ( [86](#)), and increase in red cell mass and blood volume. Correction of the initial excessive antidiuretic hormone and adrenal steroid secretion and return to the normal diurnal variation of plasma steroid levels ( [79](#)). The final result is a new equilibrium at decreased oxygen saturation and carbon dioxide tension with increases in alveolar ventilation, respiratory frequency, and red cell mass ( [78](#), [84](#)). These manifestations of acclimatization are quickly lost on descent to sea level, even after many years of residence at high altitude. At an altitude of 15,000 feet, well-acclimated individuals had hematocrit values of approximately 0.60 and, although cyanotic, had no significant limitations of physical activity ( [87](#)). This physiologic state is accomplished by hematologic adjustments and alterations in ventilatory rate, the diffusing capacity of the lungs, and the anatomic relation of capillaries to muscles ( [76](#)), as well as increased levels of myoglobin ( [76](#)) and altered enzymes within the muscle cell ( [88](#)). Cardiac output remains normal despite the increase in blood viscosity imposed by polycythemia. In some individuals, however, after a few or many years of good adaptation, excessive erythrocytosis develops, and arterial oxygen saturation may fall to as low as 60% (normal, 81%). An incapacitating illness characterized by alveolar hypoventilation develops. This entity is known as *chronic mountain sickness* or *Monge disease* ( [88](#)). Diminished mental acuity, headaches, dyspnea, fatigue, reduced physical fitness, nausea, vomiting, diminution of visual acuity, dizziness, tinnitus, vague or even excruciating pains in the extremities, paresthesias, and cough are characteristic symptoms. If the condition advances, symptoms include incessant dyspnea, aphonia, profound lethargy, and even coma. The face is bluish violet or almost black, the eyelids are edematous and bluish, the sclerae are intensely colored by distended capillaries, the tongue is thick, the hands are enlarged and turgid, the fingers are clubbed, and dependent edema may be observed. The thorax is more barrel shaped than in healthy inhabitants of the same region and altitude. Hypotension is often present. The spleen and the liver are infrequently enlarged, unless cardiac failure ensues. Erythrocytosis is more marked than in normal residents of high altitudes, with VPRC up to 0.84 L/L and Hb values as high as 28.0 g/dl. MCV is normal or slightly increased, and the mean corpuscular Hb concentration (MCHC) is normal ( [87](#)). Normal reticulocyte and leukocyte counts are usually observed ( [88](#), [89](#)). Hyperbilirubinemia owing to unconjugated bilirubin may be pronounced. Red cell turnover is greater in these individuals than in normal residents of high altitudes ( [90](#)). Platelet counts usually are normal or high, yet epistaxis is common, and hemoptysis, bleeding of the gums, and purpura may occur. Red cell volume is greatly increased (88 to 95 ml/kg body weight) ( [90](#)). Affected individuals usually are in the fourth to sixth decade of life. Remissions and relapses are described. Ascent to still higher altitudes aggravates symptoms, whereas descent to sea level relieves them. Cardiac impairment does not appear until late in the disease course, and death occurs more often from hemorrhage, pulmonary tuberculosis, or bronchopneumonia than from cardiac insufficiency. At first, the disease was considered a distinct entity. It has been suggested that the disease is an exaggeration of the process of acclimatization and aging, because patients with chronic mountain sickness had Hb concentrations within the normally distributed values for large groups of native residents. Support for this suggestion comes from the observation that



chronic lung disease increases the likelihood of chronic mountain sickness (91). Chronic mountain sickness has not been reported to occur in natives of the Himalayas (92, 93). This may reflect in part occupational differences, namely mining, and a consequently high incidence of chronic lung disease in the Andes as compared with the pastoral occupation of the Sherpas. Differentiation of chronic mountain sickness from other causes of hypoxic polycythemia should not be difficult. Cases of congenital or acquired cyanotic heart disease can be distinguished by the cardiac findings. Polycythemia vera is not altered by increased ambient oxygen tension, whereas in Monge disease, descent to sea level produces complete relief of symptoms, together with a pronounced reduction in the blood volume and restoration of normal blood counts (87). Medroxyprogesterone also produces clinical and laboratory improvement, apparently by decreasing the frequency of periods of sleep apnea and accompanying arterial oxygen desaturation (94, 95).

**PULMONARY DISEASE** A variety of diseases, such as chronic obstructive pulmonary disease, diffuse pulmonary infiltrates (fibrous or granulomatous), kyphoscoliosis, and multiple pulmonary emboli, lead to erythrocytosis as the result of inadequate oxygenation of the blood circulating through the lungs. Not all patients with lung disease and decreased arterial oxygen saturation, however, have elevated Hb or hematocrit levels (96, 97), and only in approximately 50% is an increase in red cell mass noted (98). The reason for this suboptimal response to hypoxia is not clear, but it does not appear to result from a decrease in erythropoietin production or the presence of chronic infection (96, 97 and 98). When polycythemia occurs, it usually is associated with increased MCV, reduced MCHC (99), and normal MCH (96) values. The red cell changes have been attributed to increased water uptake by the cell, which in turn may result from carbon dioxide retention (96). It has been suggested that carbon dioxide retention may inhibit the marrow response, but no confirmatory evidence is available (96). If polycythemia is present, it is corrected by chronic oxygen administration (100). Cavernous hemangiomas of the lung may be associated with erythrocytosis (101). Pulmonary arteriovenous fistulae should be suspected when a murmur is heard in a lung field in association with erythrocytosis, cyanosis, and other symptoms suggestive of a pulmonary disorder (102, 103 and 104).

**Chronic Cor Pulmonale** The clinical picture of chronic cor pulmonale varies, but oxygen deficiency with arterial desaturation and elevated pulmonary artery pressure are of central importance (105, 106). Polycythemia with its associated increase in blood viscosity and volume appears to be the physiologic price of a compensatory mechanism progressively extended to the point at which it is more injurious than beneficial (107). As in less severe pulmonary disease, the MCV of the red cells tends to be elevated, whereas the MCHC generally is decreased (108).

**Ayerza syndrome (Primary Pulmonary Hypertension)** Ayerza syndrome, characterized clinically by slowly developing asthma, bronchitis, dyspnea, and cyanosis ("black cardiacs") with associated polycythemia, was described by Ayerza in 1901. The syndrome probably represents right-sided heart failure consequent to primary pulmonary hypertension (109, 110 and 111).

**CYANOTIC HEART DISEASE** Red cell counts of  $7.0$  to  $8.5 \times 10^{12}/L$  are common in persons with congenital heart disease; counts as high as  $10.0$  to  $13.9 \times 10^{12}/L$  have been reported (112). Polycythemia occurs in patients with a partial shunt of the blood from the pulmonary circuit. The most common defects producing such polycythemia are pulmonary stenosis (usually with defective ventricular or atrial septum, patent foramen ovale, or patent ductus arteriosus), persistent truncus arteriosus, complete transposition of the great vessels, and the tetralogy of Fallot (pulmonary stenosis, defective ventricular septum, dextroposition of the aorta, right ventricular hypertrophy). Individuals with such defects exhibit evidence of disturbed cardiorespiratory function, marked cyanosis, clubbing of the fingers and toes, and sometimes stunted growth. The total plasma volume may be reduced to below normal levels, but the increase in the size of the red cell mass

is so great that the total blood volume usually is higher than normal ( [113](#), [114](#) ). Erythroid hyperplasia is observed in the marrow ( [112](#), [115](#) ). The general consensus is that low oxygen tension resulting from shunting of unoxygenated blood through or around the lungs with consequent desaturation of the arterial blood stimulates erythropoietin production. The arterial oxygen saturation often is as low as 30 to 35%. With successful operative intervention, this value may be significantly corrected, with resolution of polycythemia.

**ACQUIRED HEART DISEASE** In acquired heart disease, such erythrocytosis as may develop is of minor degree and is correlated to some extent with the degree of cardiopulmonary decompensation. Polycythemia is reportedly accompanied by evidence of intensified erythropoiesis in the bone marrow, an increase in red cell mass, and some macrocytosis ( [116](#) ).

**HYPOVENTILATION SYNDROMES** Polycythemia is found occasionally in patients who exhibit no evidence of pulmonary disease or cardiovascular shunts. The primary defect in at least some of this group appears to be an inadequate ventilatory drive from the respiratory center in the brain ( [105](#), [117](#) ). Such a defect has been reported in patients with the *Pickwickian syndrome*, so called because of the description of Joe, the hypersomnolent fat boy, in Dickens's *The Pickwick Papers* ( [118](#) ). In the setting of extreme obesity, these patients exhibit somnolence, cyanosis, and hypercapnia and may develop periodic respiration, ultimately with right ventricular failure. Voluntary hyperventilation alleviates the hypercapnia, and in many patients, loss of weight restores normal alveolar ventilation and reverses the syndrome ( [105](#) ). Alveolar hypoventilation and erythrocytosis, however, do not develop in all obese individuals; it appears that only in the presence of an insensitive respiratory center does a massive panniculus limit respiratory function and result in alveolar hypoventilation, hypoxemia, and hypercapnia ( [119](#) ). In some patients, the decreased ventilatory drive is of unknown cause or is a result of idiopathic disease of the medullary respiratory center (Ondine curse) ( [117](#), [120](#) ); other etiologies include bulbar poliomyelitis, vascular thrombosis, or previous encephalitis ( [105](#), [117](#) ). In any case, the consequent hypoxemia results in elevated levels of erythropoietin and erythrocytosis, with hematocrits reported as high as 0.75 ( [121](#) ). Medroxyprogesterone acetate has been reported to be an effective treatment for the Pickwickian syndrome ( [122](#) ). Patients with polycythemia and positional arterial oxygen desaturation have also been reported ( [123](#) ). Whether this results from alveolar hypoventilation while supine or from shunting through an arteriovenous malformation while upright ( [124](#) ) is unclear. Obstructive sleep apnea has been associated with polycythemia (presumably due to episodic erythropoietin secretion during apneic episodes) in some ( [125](#) ) but not all ( [126](#) ) reports.

### **ABNORMAL HEMOGLOBINS**

**Inherited Abnormalities of Hemoglobin** Certain mutant Hbs are characterized by increased oxygen, and patients who carry such Hbs tend to develop erythrocytosis ( [127](#), [128](#), [129](#), [130](#) and [131](#) ). Oxygen-Hb dissociation curves are shifted dramatically to the left in individuals carrying these abnormal Hbs. The degree of left shift can be quantified by determining the P<sub>50</sub> (i.e., the oxygen pressure at which Hb is half-saturated). The normal value in whole blood is 23 to 29 mm Hg at standard pH, temperature, CO<sub>2</sub> content, and barometric pressure. The whole-blood P<sub>50</sub> is almost invariably decreased in patients with a high-affinity Hb; most values fall between 9 and 21 mm Hg. In a few instances, the P<sub>50</sub> has been normal, or nearly so, in whole blood (e.g., HbG Norfolk), necessitating the measurement of the oxygen dissociation curve of the purified Hb to demonstrate the defect. The most important physiologic consequence of increased oxygen affinity is that release of oxygen is impaired at partial pressure of oxygen values normally found in tissues. Uptake of oxygen in the lungs is enhanced, but this effect is relatively unimportant, because normal Hb is nearly completely saturated in the lungs under the usual physiologic circumstances. As previously noted, however, the increased affinity may confer some advantages when environmental oxygen is low, such as at high altitudes. The first described high-affinity Hb, Hb Chesapeake, was reported in 1966 ( [132](#) ). By 2000,



more than 115 high-affinity Hbs had been characterized. Most result from amino acid substitutions in the  $\beta$ -chain. Some unstable Hbs (see [Chapter 41](#)) and M Hbs (see [Chapter 49](#)) also have increased affinity for oxygen but do not cause erythrocytosis. Most of the high-affinity Hb variants associated with erythrocytosis are found in single subjects or in small family clusters. However, studies of the few large kindreds available suggest that the inheritance pattern is autosomal-dominant ([132](#), [133](#)). No apparent predilections for any racial group or geographic area have been observed. The severity of reported erythrocytosis varies considerably. With some of the variants (particularly those involving the  $\alpha$ -chain), the associated blood Hb levels were within normal limits. In other variants (e.g., Hb British Columbia), the abnormality in oxygen binding was relatively mild and was demonstrable only by careful laboratory studies. In most patients, a mild, stable erythrocytosis (Hb, 17 to 20 g/dl) is found. The finding of erythrocytosis is often incidental. Patients may have noticed that their complexions are ruddy, but they usually have no other symptoms, and the clinical course is benign. Somewhat more severe erythrocytosis has been noted with a few variants: Hb Vanderbilt, Hb Malmö, Hb Wood, Hb Kempsey, Hb Yakima, Hb Heathrow, Hb Little Rock, Hb Syracuse, Hb Osler, and Hb Villaverde. Many of these patients were symptomatic, but some complained of the nonspecific symptoms of expanded blood volume and erythrocytosis: headaches, dizziness, a feeling of "fullness" in the head, and fatigue. Leukocyte and platelet counts were rarely abnormal ([131](#)). Individuals with high-affinity Hbs are not at a disadvantage under hypoxic conditions. They tolerate ascent to high altitudes as well as or better than normal subjects and thus appear to be preadapted to hypoxic stresses. Under such conditions, the enhanced oxygen loading seems more important than the impaired delivery. Similarly, exercise tolerance appears unimpaired ([134](#)). There is no evidence that oxygen delivery to the heart is defective in patients with high-affinity Hbs. Although myocardial infarctions and other findings of atherosclerotic cardiovascular disease are reported in these patients, it is unclear whether this is an actual association or simply reflects the high frequency of atherosclerosis in the general population ([135](#), [136](#), [137](#) and [138](#)). High-affinity Hbs appear to exert no adverse effects on fetal development *in utero*. Theoretically, oxygen delivery to a developing, noncarrier fetus might be impaired when the mother is a carrier, because the normal differential in oxygen affinity between fetal and adult Hb (which is in favor of the developing fetus) would be narrowed. However, only in the family with Hb Yakima was there a suggestion that spontaneous abortions occurred at an increased rate ([139](#)). In contrast, normal pregnancy outcomes were recorded for mothers carrying the severe high-affinity variants Hb Bethesda, Hb Osler, and Hb Little Rock ([140](#), [141](#)). Evidently, maternal and fetal polycythemia and increased uterine and fetal blood flow compensate for the theoretic deficit in placental oxygen transport. There are no data addressing whether carrier fetuses have a developmental advantage over noncarriers born to these mothers; however, in dizygotic twins born to a mother with Hb Osler, the carrier twin developed more fully than the noncarrier as measured by the ponderal index (weight/length<sup>3</sup>) ([140](#)). It has been suggested that the homozygous state for high-affinity Hbs would be incompatible with life because of insufficient oxygen release to tissue. This may be true; however, at least four patients with abnormal Hb levels approximating those that would be observed in homozygotes have been described with no apparent ill effects [Hb Abruzzo ([142](#)), Hb Crete ([143](#)), and Hb Headlington ([144](#))]. The unusually high proportion of abnormal Hb was clearly due to concurrent  $\beta$ -thalassemia in two cases ([144](#)) and probably in the others as well. Routine electrophoresis at alkaline pH on cellulose acetate detects approximately one-half of the stable high-affinity Hbs. An additional 10 to 15% can be detected by electrophoresis on citrate agar at acidic pH, and a further 10% are detectable by isoelectric focusing. This leaves 20 to 25% electrophoretically silent. The detection of an abnormal Hb in these circumstances requires determination of  $P_{50}$  under conditions controlled for pH and DPG concentration. The steps used to identify Hbs with altered oxygen affinity have been outlined ([129](#)). Some high-affinity Hbs interfere with detection of glycosylated Hb and lead to falsely

elevated HbA<sub>1c</sub> levels in diabetics (145). Most patients fully compensate for the reduced tissue oxygen delivery by developing erythrocytosis. Levels of serum erythropoietin and erythrocyte 2,3-DPG are typically normal, indicating that compensation is complete. It may be assumed that a new homeostatic equilibrium has been achieved by the mechanism reviewed in the discussion on erythropoietin levels in the classification of polycythemia.

The situation is precisely analogous (146). No treatment is indicated for most patients with high-affinity Hbs. Their erythrocytosis is a compensation for a physiologic state and should be regarded as “normal for them.” In the rare patient with erythrocytosis and associated symptoms, phlebotomy may be used, but caution must be used to avoid lowering the hematocrit to a point at which oxygen delivery is impaired. A reasonable approach is probably to phlebotomize the individual patient to the highest hematocrit at which he or she is no longer symptomatic rather than to a specific number (129, 134, 136, 147). Certainly, reducing blood Hb concentrations to normal levels would be undesirable. Under no circumstances should cytoreductive agents be used for treatment. A partial listing of high-affinity Hbs associated with erythrocytosis is shown in Table 50.5.

**TABLE 50.5. A Selection of Stable Hemoglobins with Increased Oxygen Affinity**

| Name               | Reference          | Structure        | Molecular Abnormality         | Amount (%)      | Electrophoresis | P Bohr 50 |
|--------------------|--------------------|------------------|-------------------------------|-----------------|-----------------|-----------|
| Milledgeville      | 148                | a44(CD2)Pro?Leu  | a <sub>1</sub> β <sub>2</sub> | 15              | NS <sup>b</sup> | 11.0 N    |
| Fort de France     | 128, 149           | a45(CD3)His?Arg  | ?Heme                         | 20              | 8.6s            | 27.5 N    |
| G-Norfolk          | 150                | a85(F6)Asp?Asn   | ?                             | 20              | 8.6s            | 30.0 N    |
| Chesapeake         | 132                | a92(FG4)Arg?Leu  | a <sub>1</sub> β <sub>2</sub> | 23              | 8.6f            | 19.0 N    |
| Denmark Hill       | 135                | a95(G2)Pro?Ala   | a <sub>1</sub> β <sub>2</sub> | 19              | 8.6s            | D D       |
| Nunobiki           | 151                | a141(HC3)Arg?Cys | Salt bridge                   | 13              | IF              | D D       |
| Rouen              | 152                | a140(HC2)Ty?His  | ?                             | 19              | IF              | 12.1 D    |
| Okayama            | 153                | β2(HA2)His?Glu   | 2,3-DPG                       | 47              | IF              | 23.0—     |
| Olympia            | 154                | β20(B2)Val?Met   | ?                             | 40              | NS              | 19.0 N    |
| Pitie-Saltpetriere | 155                | β34(B16)Val?Phe  | a <sub>1</sub> β <sub>1</sub> | 37              | IF              | 17.0—     |
| Hirose             | 140, 148, 156, 180 | β37(C3)Ty?Ser    | a <sub>1</sub> β <sub>2</sub> | 41              | 8.6s            | — D       |
| Great Lakes        | 157                | β68(E12)Leu?His  | Heme                          | 39              | NS              | 16.0 D    |
| Olomouc            | 158                | β86(E2)Ala?Asp   | ?                             | 47              | 8.6f            | 12.0?D    |
| Rahere             | 159                | β82(EF6)Lys?Thr  | 2,3-DPG                       | 50              | 6.2f            | 18.0 N    |
| Creteil            | 147, 160           | β89(F5)Ser?Asn   | ?                             | —               | IF              | 18.0 D    |
| Vanderbilt         | 161                | β89(F5)Ser?Arg   | ?                             | —               | 8.8s            | 14.5—     |
| Barcelona          | 162                | β94(FG1)Asp?His  | Salt bridge                   | 37              | 8.6s            | 21.0 D    |
| Malmö              | 163                | β97(FG4)His?Gln  | a <sub>1</sub> β <sub>2</sub> | 50              | IF              | 14.0 N    |
| Wood               | 164                | β97(FG4)His?Leu  | a <sub>1</sub> β <sub>2</sub> | 50              | IF              | 9.0 N     |
| Kempsey            | 165, 166           | β99(G1)Asp?Asn   | a <sub>1</sub> β <sub>2</sub> | 48              | 8.6s            | — D       |
| Yakima             | 139, 167           | β99(G1)Asp?His   | a <sub>1</sub> β <sub>2</sub> | 38              | 8.6s            | 12.0 N    |
| Ypsilanti          | 168                | β99(G1)Asp?Tyr   | a <sub>1</sub> β <sub>2</sub> | 50              | 8.6s            | 17.0—     |
| Brigham            | 138                | β100(G2)Pro?Leu  | a <sub>1</sub> β <sub>2</sub> | 50              | NS              | 20.0 N    |
| New Mexico         | 169                | β100(G2)Pro?Arg  | a <sub>1</sub> β <sub>2</sub> | 54              | 8.5s            | D D       |
| British Columbia   | 170                | β101(G3)Glu?Lys  | a <sub>1</sub> β <sub>2</sub> | —               | —               | 23.0 N    |
| Heathrow           | 171                | β103(G5)Phe?Leu  | ?Heme                         | 50              | NS              | 10.0 N    |
| Crete              | 143                | β129(H7)Ala?Pro  | a <sub>1</sub> β <sub>1</sub> | 85 <sup>c</sup> | 8.6s            | 11.0 D    |

|               |  |                   |   |                 |      |   |       |
|---------------|--|-------------------|---|-----------------|------|---|-------|
| Abruzzo       | <a href="#">142</a>  | β143(H21)His?Arg  | 2,3-DPG   | 95 <sup>c</sup> | 9.0s | D | N     |
| Little Rock   | <a href="#">172</a> , <a href="#">173</a>                            | β143(H21)His?Gln  | 2,3-DPG   | 50              | 6.2f | D | N     |
| Syracuse      | <a href="#">174</a>  | β143(H21)His?Pro  | 2,3-DPG   | 40              | IF   |   | 11.0D |
| Mito          | <a href="#">175</a>  | β144(HC1)Lys?Glu  | Salt bridge   | 42              | IF   | D | D     |
| Osler         | <a href="#">176</a> , <a href="#">177</a>                            | β145(HC2)Tyr?Asp  | a <sub>1</sub> β <sub>2</sub>                       | 28              | 8.6f |   | 13.0D |
| McKees Rocks  | <a href="#">178</a>  | β145(HC2)Tyr?Stop | a <sub>1</sub> β <sub>2</sub>                       | 46              | 6.0f |   | 10.0D |
| Hiroshima     | <a href="#">179</a>  | β146(HC3)His?Asp  | Salt bridge,<br>Bohr, a <sub>1</sub> β <sub>2</sub> | 50              | 8.6f |   | 5.0 D |
| Cowtown       | <a href="#">180</a> , <a href="#">181</a><br>and <a href="#">182</a> | β145(HC3)His?Leu  | Salt bridge,<br>Bohr a <sub>1</sub> β <sub>2</sub>  | 40              | 6.0f |   | 19.0D |
| Headlington   | <a href="#">144</a>  | β72(E16)Ser?Arg   | ?   | 83 <sup>c</sup> | 8.6s |   | 8.8 N |
| Gambara       | <a href="#">183</a>  | β82(EF6)Lys?Glu   | ?   | 52              | f    |   | 19.3D |
| Villaverde    | <a href="#">184</a>  | β89(F5)Ser?Thr    | ?   | —               | NS   |   | 1.3 D |
| Saint Nazaire | <a href="#">185</a>  | β130(G5)Phe?Ile   | ?   | —               | IF   |   | 9.0 N |

D, decreased; DPG, diphosphoglycerate; f, migrating faster than hemoglobin A; IF, demonstrable only by isoelectric focusing; N, normal; NS, not separable; s, migrating slower than hemoglobin A. NOTE: Variants are grouped by α-chain and β-chain abnormalities. Within each group, they are listed in order of the position in the polypeptide chain at which amino acid substitution has occurred. See [Chapter 35](#) for an explanation of the notation for structure.

<sup>a</sup> Hill *n* is a measure of subunit interaction. Normal range, 27 to 31.

<sup>b</sup> Value for pH at which separation was detected.

<sup>c</sup> High values probably occurring in individuals with coexisting thalassemia.

**Molecular Pathology** Most of the changes in the oxygen affinity of Hb can be accounted for by effects on the equilibrium between a low-affinity molecular configuration, designated T, and a high-affinity configuration, designated R (see [Chapter 7](#)). Normally, the Hb molecule shifts from T to R as oxygen is bound, accounting for the phenomenon of subunit interaction. The usual measure of subunit interaction is the value *n* in Hill's equation. With no subunit interaction, *n* is 1.0; the value for HbA is 2.7 to 3.1. Most high oxygen-affinity variants are characterized by a reduced value for *n*; 16 of the 29 variants in [Table 50.5](#) with reported *n* values are 1.5 or less. Biphasic Hill plots are observed when Hbs of different oxygen affinities are mixed. The high oxygen-affinity variants result from molecular alterations that either stabilize the R form or destabilize the T form. The most common known sites for amino acid substitutions involve the a<sub>1</sub>β<sub>2</sub> interface, which destabilize the T form. Substitutions at 2,3-DPG binding sites or at residues involving intrachain salt bridges also destabilize the T form. In contrast, certain Hbs result from amino acid substitutions that stabilize the R form, such as Hb Little Rock ([172](#)), Hb Chesapeake ([186](#)), and Hb Creteil ([159](#)). The mechanisms by which several other substitutions produce altered oxygen affinity are unclear.

**Acquired Abnormalities of Hemoglobin** Moderate elevations of carboxyhemoglobin in erythrocytes shift the oxygen dissociation curve. In heavy smokers, carboxyhemoglobin concentration may reach sufficiently high levels (4.0 to 6.8%) to produce polycythemia ([187](#)). In the older literature, polycythemia in association with phosphorus poisoning has been described, although it may have been merely relative erythrocytosis resulting from acute liver damage. Although certain drugs and chemicals (e.g., nitrites, nitrates, aniline dyes, sulfonamides, and nitrobenzene) produce toxic levels of methemoglobin, sulfhemoglobin, or both in the blood of even normal persons ([188](#), [189](#), [190](#) and [191](#)), erythrocytosis apparently has not been described in patients with toxic methemoglobinemia.

**FAMILIAL POLYCYTHEMIA (PHYSIOLOGICALLY APPROPRIATE)** Familial defects in

2,3-DPG metabolism [e.g., DPG mutase deficiency ( [192](#) ) or elevated erythrocyte adenosine triphosphate ( [193](#) )], which would have the effect of shifting the oxygen dissociation curve, provide other physiologically appropriate (tissue hypoxia) reasons for polycythemia.

### Secondary Polycythemia [Physiologically Inappropriate (Normoxic)]

**ABERRANT ERYTHROPOIETIN SECRETION** Erythrocytosis has been described in association with a variety of neoplasms, cysts, vascular abnormalities, and endocrinologic disorders. In the syndromes discussed in the preceding section, erythrocytosis was secondary (i.e., driven by increased erythropoietin); however, this erythropoietin secretion and the consequent erythrocytosis were physiologic responses to tissue hypoxia. In this section, disorders in which erythropoietin-driven erythrocytosis bears no relation to physiologic requirements are reviewed ( [Table 50.6](#) ).

**TABLE 50.6. Disorders Associated with Normoxic Secondary Polycythemia**

|                                    |   |
|------------------------------------|---|
| Renal disease                      | Other neoplasms                                     |
| Renal cell carcinoma               | Uterine leiomyomata                                 |
| Renal sarcoma <sup>a</sup>         | Uterine fibroid tumors <sup>a</sup>                 |
| Renal adenoma <sup>a</sup>         | Cutaneous leiomyomata <sup>a</sup>                  |
| Renal hemangioma <sup>a</sup>      | Meningioma <sup>a</sup>                             |
| Wilms tumor <sup>a</sup>           | Placental trophoblastic tumors <sup>a</sup>         |
| Solitary renal cysts               | Chronic lymphocytic leukemia <sup>a</sup>           |
| Polycystic kidney disease          | Systemic amyloidosis <sup>a</sup>                   |
| Hydronephrosis                     | Atrial myxoma <sup>a</sup>                          |
| Horseshoe kidney <sup>a</sup>      | Endocrine disorders                                 |
| Renal artery stenosis <sup>a</sup> | Cushing syndrome                                    |
| Postrenal transplantation          | Primary aldosteronism                               |
| Hepatic disease                    | Virilizing ovarian tumors                           |
| Hepatocellular carcinoma           | Bartter syndrome <sup>a</sup>                       |
| Hepatic hamartoma <sup>a</sup>     | Pheochromocytoma <sup>a</sup>                       |
| Hepatic metastases <sup>a</sup>    | Other   |
| Hepatic angiosarcoma <sup>a</sup>  | Human immunodeficiency virus infection <sup>a</sup> |
| Hepatic angioma <sup>a</sup>       |   |
| Viral hepatitis <sup>a</sup>       |   |
| Vascular cerebellar tumors         |   |

<sup>a</sup> Polycythemia infrequently reported.

**Renal Disorders** *Renal cell carcinoma* (hypernephroma) is one of the disorders most frequently associated with erythrocytosis. Erythrocytosis is observed in 0.9 to 1.6% of patients with renal cell carcinoma (approximately one-fourth as frequent a finding as anemia) ( [194](#) ). Elevated serum erythropoietin levels, however, are observed in more than 60% of patients ( [195](#) ). Erythrocytosis also has been reported in patients with renal sarcoma, hemangioma, adenoma ( [196](#) ), Wilms tumor ( [197](#) ), renal cysts, hydronephrosis ( [198](#) )

, [199](#)), horseshoe kidney ([199](#)), and polycystic kidneys ([196](#)). Renal artery stenosis has also been reported in association with erythrocytosis ([200](#)). Erythrocytosis in renal cell carcinoma is attributed to constitutive erythropoietin production by the tumor. Erythropoietin messenger RNA can be demonstrated in renal carcinoma cells ([201](#)). It is assumed that this is also the mechanism by which other parenchymal renal diseases produce erythrocytosis. Hydronephrosis and anatomic abnormalities probably produce erythrocytosis by increasing pressure on erythropoietin-producing cells in the renal parenchyma ([202](#)). Significant and measurable concentrations of erythropoietin (sometimes >100 mU/ml) can be detected in fluid aspirated from renal cysts associated with polycythemia. Production of erythropoietin in renal cell carcinoma is said to predict a good response to therapy ([203](#)). Management of erythrocytosis in these patients should be directed at treatment of the responsible renal lesion with phlebotomy as an adjunct, when necessary. Erythrocytosis is also observed in patients after renal transplantation ([204](#)). This phenomenon is associated with elevated serum erythropoietin; the source of erythropoietin is presumed to be the transplant recipient's native kidneys ([205](#), [206](#)). Effective therapeutic modalities include phlebotomy, angiotensin-converting enzyme inhibitors, and theophylline ([207](#), [208](#) and [209](#)).

**Liver Diseases** During fetal development, the liver contributes to erythropoietin production ([Chapter 6](#)); hepatic disease, like renal disease, may be associated with erythropoietin production and polycythemia. Erythrocytosis has been identified in persons with hepatocellular carcinoma with incidence 2.5 to 10.0% ([210](#), [211](#), [212](#) and [213](#)). When measured, red cell mass has been shown to be increased ([211](#)), and elevated serum erythropoietin levels have also been described ([213](#)). As with renal cell carcinoma, erythropoietin production by the tumor has been demonstrated ([214](#), [215](#) and [216](#)).

Remission of erythrocytosis may be observed after successful tumor treatment ([215](#), [216](#)). Erythrocytosis has also been reported with hepatic hamartomas and tumors metastatic to liver ([196](#)), as well as hepatic angiomas ([217](#)) and hemangiosarcomas ([218](#)). Polycythemia has been reported in the early stages of viral hepatitis ([219](#), [220](#)). Cirrhosis is occasionally listed in texts as associated with erythrocytosis, but this apparently does not occur except in the setting of another disease, such as cirrhosis with hepatocellular carcinoma.

**Cerebellar Vascular Tumors** The association of erythrocytosis with vascular tumors of the cerebellum is well established ([196](#), [221](#)). Elevated serum erythropoietin levels and tumor production of erythropoietin have been demonstrated ([222](#), [223](#)). Correction of erythrocytosis may be observed after effective therapy and erythrocytosis may return with recurrence of the tumor ([196](#)).

**Leiomyoma and Fibroid Tumors of the Uterus** Several cases in which large leiomyomas and fibroid tumors of the uterus were associated with erythrocytosis have been reported ([224](#), [225](#)). Erythrocytosis tends to subside after effective therapy and is also associated with production of erythropoietin by tumor ([226](#), [227](#)). Cutaneous leiomyomata have also been associated with erythrocytosis ([228](#)).

**Other Neoplasms** Rare instances of erythrocytosis in association with a variety of other tumors have been reported, but some of these associations may be coincidental ([196](#)). However, erythropoietin synthesis by tumor cells has been clearly demonstrated in a patient with meningioma ([229](#)). Erythrocytosis has also been reported in rare patients with chronic lymphocytic leukemia ([230](#)), systemic amyloidosis ([231](#)), placental trophoblastic tumors ([232](#)), and atrial myxomas ([233](#)).

**Endocrinologic and Other Disorders** Erythrocytosis has been reported in association with a number of endocrinologic disorders, including Cushing syndrome, primary aldosteronism ([234](#)), virilizing ovarian tumors ([235](#)), Bartter syndrome ([236](#)), and pheochromocytoma ([237](#)). In the latter disorder, tumor erythropoietin production has been reported ([237](#)). There have been a number of reports describing small numbers of patients with human



immunodeficiency virus infection and polycythemia ( [238](#), [239](#), [240](#), [241](#), [242](#) and [243](#)). It is unclear if there is an actual pathophysiologic association or if this is coincidental.

**DRUG-INDUCED ERYTHROCYTOSIS** Anabolic and androgenic steroids may be abused by both recreational and professional athletes for purposes of improving performance ( [244](#), [245](#)). A consequence of androgen administration, either medicinal or extralegal, may be erythrocytosis ( [246](#)). In some cases, the degree of erythrocytosis may be severe. Recombinant human erythropoietin has also been abused by athletes (particularly those in endurance sports) to increase the red cell mass and thus oxygen-carrying capacity ( [244](#), [247](#), [248](#)). As indicated earlier, this may backfire if the athlete becomes hypovolemic as a result of exertion. Cases of surreptitious erythropoietin self-administration resulting in accelerated hypertension and unstable angina have been reported ( [249](#)). A perceived advantage of erythropoietin over androgens for this purpose is the inability to distinguish endogenous from exogenous erythropoietin as well as the lack of hepatic toxicity. More recently developed techniques that allow discrimination between exogenous recombinant erythropoietin and endogenous erythropoietin may make this practice less frequent ( [250](#)). **FAMILIAL POLYCYTHEMIA (PHYSIOLOGICALLY INAPPROPRIATE)** Kindreds that exhibit an autosomal-recessive erythrocytosis associated with increased erythropoietin production have been described ( [251](#)).

### Idiopathic Polycythemia

The term *idiopathic polycythemia* (or *erythrocytosis*) refers to patients who have an elevated red cell mass of unknown etiology after appropriate investigation. It would include most of the patients formerly categorized as “benign erythrocytosis.” The existence of this group, which is estimated to contain 20 to 30% of patients evaluated for polycythemia ( [125](#)), essentially represents a failure to correctly categorize all polycythemic patients.

Of 25 patients reported in one series, 12 were found to have elevated erythropoietin levels and were therefore assumed to represent patients with secondary polycythemia; these patients tended to be younger than the patients with normal erythropoietin levels ( [123](#)). Progenitor culture studies were not helpful in subcategorizing the group in this particular study ( [123](#)). Some studies have reported endogenous colony-formation studies to be useful and serum erythropoietin levels not helpful ( [42](#)), whereas others have reported the opposite ( [252](#)).

Kiladjian and colleagues treated 39 patients with idiopathic erythrocytosis with pipbroman and compared their clinical course to 140 concurrently treated polycythemia vera patients ( [253](#)). The risk of leukemia, thrombosis, and myelofibrosis was the same in the two groups. This study confirms that the idiopathic erythrocytosis group contains a certain number of polycythemia vera patients; however, it does not provide a way to identify individuals who do not have a myeloproliferative disorder and therefore should not be exposed to leukemogenic agents ( [253](#)).

Because this category probably represents a mixed bag, including early polycythemia vera, mild secondary polycythemia, and normal individuals at the higher end of the bell-shaped curve for red cell mass ( [61](#)), a cautious approach is warranted. Observation may be the most reasonable intervention; this may be the patient subset in whom otherwise low-yield studies, such as erythropoietin levels, and erythroid progenitor studies are likely to be useful.

## REFERENCES

1. Hüber H et al. The influence of anemia, polycythemia and splenomegaly on the relationship between venous hematocrit and red cell volume. *Br J Haematol* 1964;10:567.
2. Schwarz TH, Hogan LA, Edean ED, et al. Thromboembolic complications of polycythemia: polycythemia vera versus smoker's polycythemia. *J Vasc Surg* 1993;17:518.
3. Lawrence JH, Berlin NI. Relative polycythemia—the polycythemia of stress. *Yale J Biol Med* 1952;24:498.
4. Finch CA, Lenfant C. Oxygen transport in man. *N Engl J Med* 1972;286:407.
5. Cobb LA et al. Circulatory effects of chronic hypervolemia in polycythemia. *J Clin Invest* 1960;38:1722.
6. Dintenfass L. A preliminary outline of the blood high viscosity syndromes. *Arch Intern Med* 1966;118:427.
7. Monge CM, Monge CC. High altitude disease, mechanism and management. Springfield, IL: Charles C Thomas, 1966.
8. Chien S, Gallick S. Rheology in normal individuals and polycythemia vera. In: Wasserman LR, Berk PD, Berlin NI, eds. *Polycythemia vera and the myeloproliferative disorders*. Philadelphia: WB Saunders, 1995:114.
9. Pirofsky B. The determination of blood viscosity in man by a method based on Poiseuille's law. *J Clin Invest* 1953;32:292.
10. Wells RE Jr, Merrill EW. The variability of blood viscosity. *Am J Med* 1961;31:505.
11. Stone HO, Thompson HK Jr, Schmidt-Nielsen K. Influence of erythrocytes on blood viscosity. *Am J Physiol* 1968;214:913.
12. Milligan DW, MacNamee R, Roberts BE, et al. The influence of iron-deficient indices on whole blood viscosity in polycythaemia. *Br J Haematol* 1982;50:467.
13. Hutton RD. The effect of iron deficiency on whole blood viscosity in polycythaemic patients. *Br J Haematol* 1979;43:191.
14. Thomas DJ, Marshall J, Ross Russell RW, et al. Cerebral blood-flow in polycythemia. *Lancet* 1977;2:161.
15. Thomas DJ, Marshall J, Ross Russell RW, et al. Effect of haematocrit on cerebral blood-flow in man. *Lancet* 1977;2:941.
16. Humphrey PRD, Marshall J, Ross Russell RW, et al. Cerebral blood-flow and viscosity in relative polycythaemia. *Lancet* 1979;2:873.
17. Humphrey PRD, Michael J, Pearson TC. Management of relative polycythaemia: studies of cerebral blood flow and viscosity. *Br J Haematol* 1980;46:427.
18. Castle WB, Jandl JH. Blood viscosity and blood volume: opposing influences upon oxygen transport in polycythemia. *Semin Hematol* 1966;3:193.
19. Murray JF et al. The circulatory effects of hematocrit variations in normo-volemic and hypervolemic dogs. *J Clin Invest* 1963;42:1150.
20. Anderson CB, Gray FD. The circulatory and ventilatory effects of normo-volemic polycythemia. *Yale J Biol Med* 1962;35:233.
21. Richardson TQ, Guyton AC. Effects of polycythemia and anemia on cardiac output and other



circulatory factors. *Am J Physiol* 1959;197:1167.

22. Thorling EB, Erslev AJ. The "tissue" tension of oxygen and its relation to hematocrit and erythropoiesis. *Blood* 1968;31:332.
23. Kiraly JF, Feldmann JE, Wheby MS. Hazards of phlebotomy in polycythemic patients with cardiovascular disease. *JAMA* 1976;236:2080.
24. Harrison BDW, Stokes TC. Secondary polycythaemia: its causes, effects and treatment. *Br J Dis Chest* 1982;76:313.
25. Metcalfe J, Dhindsa DS, Edwards MJ. Decreased affinity of blood for oxygen in patients with low output congestive heart failure. *Circ Res* 1969;24:47.
26. Chetty KG, Brown SE, Light RL. Improved exercise tolerance of the polycythemic lung patient following phlebotomy. *Am J Med* 1983;74:415.
27. Huff RL, Feller DO. Relation of circulating red cell volume to body density and obesity. *J Clin Invest* 1956;35:1.
28. Hyde RD, Jones NF. Red-cell volume and total body water. *Br J Haematol* 1962;8:283.
29. Nathan DG. Comments on the interpretation of measurement of total red cell volume in the diagnosis of polycythemia vera. *Semin Hematol* 1966;3:216.
30. Wennesland R et al. Red cell, plasma and blood volume in healthy men measured by radiochromium (Cr51) cell tagging and hematocrit. *J Clin Invest* 1959;38:1065.
31. McMullin MF, Percy MJ. Erythropoietin receptor and hematological disease. *Am J Hematol* 1999;60:55.
32. Pearson TC, Messinezy M. The diagnostic criteria of polycythemia rubra vera. *Leuk Lymphoma* 1996;22[Suppl 1]:87.
33. Berson SA, Yalow RS. The use of K42 or P32 labeled erythrocytes and I131 tagged human serum albumin in simultaneous blood volume determinations. *J Clin Invest* 1952;31:572.
34. Blum AS, Zbar MJ. Relative polycythemia. *Arch Intern Med* 1959;104:385.
35. Valentine WN. UCLA Interdepartmental Conference: polycythemia, erythrocytosis and erythremia. *Ann Intern Med* 1968;69:587.
36. Djulbegovic B, Hadley T, Joseph G. A new algorithm for the diagnosis of polycythemia. *Am Fam Physician* 1991;44:113.
37. Droder RM, Kyle RA, Griep PR. Control of systemic capillary leak syndrome with aminophylline and terbutaline. *Am J Med* 1992;92:523.
38. Birgegard G, Wide L. Serum erythropoietin in the diagnosis of polycythemia and after phlebotomy treatment. *Br J Haematol* 1992;81:603.
39. Cotes PM, Dorie CJ, Yin JA, et al. Determination of serum immunoreactive erythropoietin in the investigation of erythrocytosis. *N Engl J Med* 1986;315:283.
40. Koeffler HP, Goldwassser E. Erythropoietin radioimmunoassay in evaluating patients with polycythemia. *Ann Intern Med* 1981;94:44.
41. Remacha AF, Montserrat I, Santamaria A, et al. A follow-up study. *Haematologia* 1997;82:406.
42. Shih LY, Lee CT, Ou YC. Prediction of clinical course in patients with idiopathic erythrocytosis by endogenous erythroid colony assay but not by serum erythropoietin levels. *Exp Hematol* 1997;25:288.
43. Weil JV, Jamieson G, Brown DW, et al. The red cell mass. Arterial oxygen relationship in normal man.

J Clin Invest 1968;47:1627.

44. Lindstedt G, Lundberg PA. Are current methods of measurement of erythropoietin (EPO) in human plasma or serum adequate for the diagnosis of polycythaemia vera and the assessment of EPO deficiency? Scand J Clin Lab Invest 1998;58:441.

45. Reid CDL. The significance of endogenous erythroid colonies in haematological disorders. Blood Rev 1987;1:133.

46. Shih LY, Lee CT. Identification of masked polycythemia vera from patients with idiopathic marked thrombocytosis by endogenous erythroid colony assay. Blood 1994;83:744.

47. Westwood N, Dudley JM, Sawyer B, et al. Primary polycythaemia: diagnosis by non-conventional positive criteria. Eur J Haematol 1993;51:228.

48. Means RT, Krantz SB, Sawyer ST, et al. Erythropoietin receptors in polycythemia vera. J Clin Invest 1989;84:1340.

49. Manor D, Rachmilewitz EA, Fibach E. Improved method for diagnosis of polycythemia vera based on flow cytometric analysis of autonomous growth of erythroid precursors in liquid culture. Am J Hematol 1997;54:47.

50. Manteiga R, Remacha AF, Sarda MP, et al. Serum transferrin receptor in polycythemia. Haematologia 1998;83:958.

51. Harrop GA Jr, Wintrobe MM. Polycythemia. In: Downey H, ed. Handbook of hematology, volume 4. New York: Paul B Hoeber Inc., 1938.

52. Hassell RP, Conley CL. Benign polycythemia: Gaisböck's syndrome. Arch Intern Med 1964;114:734.

53. Lawrence JH et al. A physiological study in the Peruvian Andes. Acta Med Scand 1952;142:117.

54. Gaisböck F. Die Polyzythämie. Ergeb Inn Med Kinderheilkd 1922;21:210.

55. Modan B, Modan M. Benign erythrocytosis. Br J Haematol 1968;14:375.

56. Weinreb NJ, Shih CF. Spurious polycythemia. Semin Hematol 1975;12:397.

57. Brown SM, Gilbert HS, Krauss S, et al. Spurious (relative) polycythemia: a nonexistent disease. Am J Med 1971;50:200.

58. Kaung DT, Peterson RE. "Relative polycythemia" or "pseudopolycythemia." Arch Intern Med 1962;110:456.

59. Messinezy M, Pearson TC. Apparent polycythaemia: diagnosis, pathogenesis and management. Eur J Haematol 1993;51:125.

60. Lawrence JH et al. The nature and treatment of polycythemia. Medicine 1953;32:323.

61. Messinezy M, Pearson TC. A retrospective study of apparent and relative polycythaemia: associated factors and early outcome. Clin Lab Haematol 1990;12:121.

62. Emery AC Jr, Whitcomb WH, Frohlich ED. "Stress" polycythemia and hypertension. JAMA 1974;229:159.

63. Fessel WJ. Odd men out. Arch Intern Med 1965;115:736.

64. Adamson JW. Familial polycythemia. Semin Hematol 1975;12:383.

65. Juvonen E, Ikkala E, Fyhrquist F, et al. Autosomal dominant erythrocytosis is caused by increased sensitivity to erythropoietin. Blood 1991;78:3066.

66. de la Chapelle A, Sistonen P, Lehaslaiho H, et al. Familial erythrocytosis genetically linked to erythropoietin receptor gene. *Lancet* 1993;1:82.
67. de la Chapelle A, Traskelin AL, Juvonen E. Truncated erythropoietin receptor causes dominantly inherited benign human erythrocytosis. *Proc Natl Acad Sci U S A* 1993;90:4495.
68. Gordeuk VR, Sergueeva AI, Miasnikova GY, et al. High mortality due to thrombosis and cerebral hemorrhage in Chuvash polycythemia. *Blood* 2001;98[Suppl]:935a(abst).
69. Sokol L, Kralovics R, Hubbell G, et al. A novel erythropoietin receptor mutation associated with primary familial polycythemia and severe cardiovascular and peripheral vascular disease. *Blood* 2001;98[Suppl]:937a(abst).
70. Sokol L, Luhovy M, Guan Y, et al. Primary familial polycythemia: a frameshift mutation in the erythropoietin receptor gene and increased sensitivity of erythroid progenitors to erythropoietin. *Blood* 1995;86:15.
71. Ang SO, Chen H, Stockton DW, et al. Von Hippel-Lindau protein, Chuvash polycythemia, and oxygen sensing. *Blood* 2001;98[Suppl]:3115a(abst).
72. Sergeeva A, Gordeuk VR, Tokarev YN, et al. Congenital polycythemia in Chuvashia. *Blood* 1997;89:2148.
73. Viault F. Sur l'augmentation considerable du nombre des globules rouges dans le sang chez les habitants des hautes plateaux de l'Amerique du Sud. *C R Acad Sci [III]* 1890;111:917.
74. Pugh LGCE. Muscular exercise on Mount Everest. *J Physiol* 1958;141:233.
75. Richalet JP, Souberbille JC, Antezana AM, et al. Control of erythropoiesis in humans during prolonged exposure to the altitude of 6542 m. *Am J Physiol* 1994;266:R756-R764.
76. Frisancho AR. Functional adaptation to high altitude hypoxia. *Science* 1975;187:313.
77. Morpurgo G, Battaglia P, Berani L, et al. Higher Bohr effect in Indian natives of Peruvian highlands as compared with Europeans. *Nature* 1970;227:387.
78. Hecht HH. A sea level view of altitude problems. *Am J Med* 1971;50:703.
79. Sutton J. Acute mountain sickness. An historical review, with some experiences from the Peruvian Andes. *Med J Aust* 1971;2:243.
80. Singh I, Ichana PK, Srivastava M, et al. Acute mountain sickness. *N Engl J Med* 1969;280:175.
81. Hackett PH, Rennie D. The incidence, importance, and prophylaxis of acute mountain sickness. *Lancet* 1976;2:1149.
82. Fitch RF. Mountain sickness. A cerebral form. *Ann Intern Med* 1964;60:871.
83. Milledge JS, Catley DM. Angiotensin converting enzyme response to hypoxia in man: its role in altitude acclimatization. *Clin Sci* 1984;67:453.
84. Levine BD, Yashimiura K, Kobayashi T, et al. Dexamethasone in the treatment of acute mountain sickness. *N Engl J Med* 1989;321:1707.
85. Lenfant C, Torrance J, English E, et al. Effect of altitude on oxygen binding by hemoglobin and on organic phosphate levels. *J Clin Invest* 1968;47:2652.
86. Faura J, Ramos J, Reynardie C, et al. Effect of altitude on erythropoiesis. *Blood* 1969;33:668.
87. Hurtado A. Chronic mountain sickness. *Ann Intern Med* 1960;53:247.

88. Monge C, Whittenbury J. Chronic mountain sickness. *Johns Hopkins Med J* 1976;139:87.
89. Monge C. High altitude disease. *Arch Intern Med* 1937;59:32.
90. Merino C. Studies on blood formation and destruction in the polycythemia of high altitude. *Blood* 1950;5:1.
91. Leon-Velvarde F, Arreugi A, Vargas M, et al. Chronic mountain sickness and chronic lower respiratory tract disorders. *Chest* 1994;106:151.
92. Porter R, Knight J, eds. High altitude physiology: cardiac and respiratory aspects. Ciba Found Symp, 1971.
93. Eaton JW, Skelton TD, Berger E. Survival at extreme altitude: protective effect of increased hemoglobin-oxygen affinity. *Science* 1974;183:743.
94. Kryger M, Weil J, Grover R. Chronic mountain polycythemia: a disorder of the regulation of breathing during sleep? *Chest* 1978;73[Suppl]:303.
95. Block AJ, Boynensen PG, Wynne JW, et al. Sleep apnea, hypopnea and oxygen desaturation in normal subjects, a strong male predominance. *N Engl J Med* 1979;300:513.
96. Freedman BJ, Penington DG. Erythrocytosis in emphysema. *Br J Haematol* 1963;9:425.
97. Gallo RC, Fraimow W, Cathcart RT, et al. Erythropoietic response in chronic pulmonary disease. *Arch Intern Med* 1964;113:559.
98. Murray JF. Classification of polycythemic disorders with comments on the diagnostic value of arterial oxygen analysis. *Ann Intern Med* 1966;64:892.
99. Rapin M et al. La polyglobulie de l'insuffisance respiratoire chronique. *Nouv Rev Fr Haematol* 1961;1:479.
100. Chamberlain DA, Millard FJC. The treatment of polycythaemia secondary to hypoxic lung disease by continuous oxygen administration. *QJM* 1963;32:341.
101. Rodes CB. Cavernous hemangiomas of the lung with secondary polycythemia. *JAMA* 1938;110:1914.
102. Hutchison DC, Supra RP, Sumerling MD, et al. Cirrhosis, cyanosis and polycythaemia: multiple pulmonary arteriovenous anastomoses. *Am J Med* 1968;45:139.
103. Lindskog GE et al. Pulmonary arteriovenous aneurysm. *Ann Surg* 1950;132:591.
104. Yater WM et al. Pulmonary arteriovenous fistula (varix). *JAMA* 1949;141:581.
105. Fishman AP. Chronic cor pulmonale. *QJM* 1966;35:261.
106. Hecht HH. Heart failure and lung disease. *Circulation* 1956;14:265.
107. Fishman AP et al. Polycythemia. *Am J Med* 1958;24:132.
108. Grant JL et al. Red cell changes in chronic pulmonary insufficiency. *J Clin Invest* 1958;37:1166.
109. Leopold SS. The etiology of pulmonary arteriosclerosis. *Am J Med Sci* 1950;219:152.
110. Porto J. Analyse pathogénique de la cardiopathie noire. *J Suisse Méd* 1948;78:913.
111. Warthin AS. A case of Ayerza's disease. *Osler Memorial* 1919;2:1042.

112. Todtenhaupt W. Kongenitaler Herzfehler und Erythrocytose. *Dtsch Arch Klin Med* 1927;154:79.
113. Prader A et al. Blutuntersuchungen beim morbus Coeruleus. *Helv Paediatr Acta* 1949;4:267.
114. Váerel D. Blood volume changes in cyanotic congenital heart disease and polycythemia rubra vera. *Circulation* 1961;23:749.
115. Weber FP. *Polycythaemia, erythrocytosis and erythraemia (Vaquez–Osler disease)*. London: Lewis, 1921.
116. Hedlund S. Studies on erythropoiesis and total red cell volume in congestive heart failure. *Acta Med Scand* 1953;146[Suppl 284]:ss.
117. Mellins RB, Balfour HH, Turino GM, et al. Failure of automatic control of ventilation (Ondine's curse). *Medicine* 1970;49:487.
118. Burwell CS, Robin EP, Whaley RD, et al. Extreme obesity associated with alveolar hypoventilation—a Pickwickian syndrome. *Am J Med* 1956;21:811.
119. Fishman AP, Goldring RM, Turino GM. General alveolar hypoventilation: a syndrome of respiratory and cardiac failure in patients with normal lungs. *QJM* 1966;35:261.
120. Tsitouris G, Fertakis A. Alveolar hypoventilation due to respiratory center dysfunction of unknown cause. *Am J Med* 1965;39:173.
121. Fraser RS et al. Hypoventilation, cyanosis and polycythemia in a thin man. *Can Med Assoc J* 1963;89:1178.
122. Sutton FD, Zwillich CW, Greagh CE, et al. Progesterone for outpatient treatment of Pickwickian syndrome. *Ann Intern Med* 1975;83:476.
123. Messinezy M, Sawyer B, Westwood NB, et al. Idiopathic erythrocytosis—additional new study techniques suggest a heterogenous group. *Eur J Haematol* 1994;53:163.
124. Seward JB, Hayes DL, Smith HC, et al. Platypnea–orthodeoxia: clinical profile, diagnostic workup, management, and report of seven cases. *Mayo Clin Proc* 1984;59:221.
125. Moore–Gillon JC, Treacher DF, Gaminara EJ, et al. Intermittent hypoxia in patients with unexplained polycythemia. *BMJ* 1986;293:588.
126. Hoffstein V, Herridge M, Mateika S, et al. Hematocrit levels in sleep apnea. *Chest* 1994;106:787.
127. Bunn HF, Forget BG. *Hemoglobin: molecular, genetic, and clinical aspects*. Philadelphia: WB Saunders, 1986.
128. Charache S. Haemoglobins with altered oxygen affinity. *Clin Haematol* 1974;3:357.
129. Stamatoyannopoulos G, Bellingham AJ, Lenfant C, Finch CA. Abnormal hemoglobins with high and low oxygen affinity. *Annu Rev Med* 1971;22:221.
130. Stephens AD. Polycythemia and high affinity haemoglobins. *Br J Haematol* 1977;36:153.
131. Prchal JT, Sokol L. Benign erythrocytosis and other familial and congenital polycythemia. *Eur J Haematol* 1996;57:263.
132. Charache S, Weatherall DJ, Clegg JB. Polycythemia associated with a hemoglobinopathy. *J Clin Invest* 1966;45:813.
133. Berglund S. Erythrocytosis associated with haemoglobin Malmo, accompanied by pulmonary changes, occurring in the same family. *Scand J Haematol* 1972;9:355.

134. Charache S, Weatherall DJ, Clegg JBL. Variability of the homeostatic response to altered P<sub>50</sub>. *Blood* 1978;52:1156.
135. Wiltshire BG, Clark KG, Lorkin PA, Lehmann H. Haemoglobin Denmark Hill alpha 95 (G2) Pro<sup>→</sup>Ala. A variant with unusual electrophoretic and oxygen-binding properties. *Biochim Biophys Acta* 1972;278:459.
136. Boyer SH, Charache S, Fairbanks VF, et al. Hemoglobin Malmo, beta-97 (FG-4) histidine<sup>→</sup>glutamine: a cause of polycythemia. *J Clin Invest* 1972;51:666.
137. Fujita S. Oxygen equilibrium characteristics of abnormal hemoglobins: Hirose (beta 37 Ser), L Ferrara (alpha 47 Gly), Broussais (alpha 90 Asn), and Dhofar (beta 58 Arg). *J Clin Invest* 1972;51:2520.
138. Lokich JJ, Moloney WC, Bunn HF, et al. Hemoglobin variant associated with familial erythrocytosis. *J Clin Invest* 1973;52:2060.
139. Jones RT, Osgood EE, Brimhall B, Koler RD. Hemoglobin Yakina: I. Clinical and biochemical studies. *J Clin Invest* 1967;46:1840.
140. Charache S, Catalano P, Burns S, et al. Pregnancy in carriers of high-affinity hemoglobins. *Blood* 1985;65:713.
141. Francina A, Lacombe C, Baklouti F, et al. A new case of Hb Little Rock, a high affinity variant. Study during pregnancy. *Hemoglobin* 1987;11:113.
142. Tentori L, Carta Sorcini M, Buccella C. Hemoglobin Abruzzo: beta 143 (H21) His<sup>→</sup>Arg. *Clin Chim Acta* 1972;38:258.
143. Maniatis A, Bousios T, Nagel RL, et al. Hemoglobin Crete (beta 129 Ala<sup>→</sup>Pro): a new high affinity variant interacting with beta-zero and delta-beta-zero thalassemia. *Blood* 1979;54:54.
144. Rochette J, Barnetson R, Kiger L, et al. Association of a novel high affinity haemoglobin variant with delta beta thalassemia. *Br J Haematol* 1994;86:118.
145. Elder GE, Lappin TR, Horne AB, et al. Hemoglobin Old Dominion/Burton-upon-Trent, beta 143 (H21) His<sup>→</sup>Tyr, codon 143 CAC<sup>→</sup>TAC—a variant with altered oxygen affinity that compromises measurement of glycated hemoglobin in diabetes mellitus: structure, function, and DNA sequence. *Mayo Clin Proc* 1998;73:321.
146. Adamson JW, Parer JT, Stamatoyannopoulos G. Erythrocytosis associated with hemoglobin Rainer: oxygen equilibria and marrow regulation. *J Clin Invest* 1969;48:1376.
147. Poyart C, Bursaux E, Teisseire B, et al. Hemoglobin Creteil: oxygen transport by erythrocytes. *Ann Intern Med* 1978;88:758.
148. Honig GR, Vida LN, Shamsuddin M, et al. Hemoglobin Milledgeville (alpha 44(CD2) Pro<sup>→</sup>Leu). A new variant with increased oxygen affinity. *Biochim Biophys Acta* 1980;626:424.
149. Braconnier F, Gacon G, Thillet J, et al. Hemoglobin Fort de France, alpha 45 (CD3) His<sup>→</sup>Arg, a new variant with increased oxygen affinity. *Biochim Biophys Acta* 1977;493:228.
150. Lorkin PA, Huntsman RG, Ager JA, et al. Haemoglobin G-Norfolk: alpha 85 (F6) Asp<sup>→</sup>Asn. *Biochim Biophys Acta* 1975;379:22.
151. Shimasaki S. A new hemoglobin variant, hemoglobin Nunobiki. Notable influence of the carboxy-terminal cysteine upon various physicochemical characteristics of the hemoglobin. *J Clin Invest* 1985;75:695.
152. Wajzman H, Jister J, Marden M, et al. Hemoglobin Rouen (alpha-140(HC2)Tyr<sup>→</sup>His): alteration of alpha-chain C-terminal region and moderate increase in oxygen affinity. *Biochim Biophys Acta* 1992;1180:53.
153. Harano T, Harano K, Shibata S, et al. Hemoglobin Okayama [beta[2](NA2) His<sup>→</sup>Glu]: a new 'silent'

- hemoglobin variant with substituted amino acid residue at the 2,3 DPG binding site. FEBS Lett 1983;156:20.
154. Stamatoyannopoulos G, Nute PE, Adamson JW, et al. Hemoglobin Olympia (beta 20 valine?methionine): an electrophoretically silent variant associated with high oxygen affinity and erythrocytosis. J Clin Invest 1973;52:342.
155. Blouquit Y, Braconnier F, Cohen-Solal M, et al. Hemoglobin Pitie-Saltpetriere beta 34(B16)Val?Phe. A new high oxygen affinity variant associated with familial erythrocytosis. Biochim Biophys Acta 1980;624:473.
156. Yamaoka K. Hemoglobin Hirose: beta 37 (C3) tryptophan?serine. Blood 1971;38:730.
157. Rahbar S, Winkler K, Louis J, et al. Hemoglobin Great Lakes (beta 68[E12] Leucine?Histidine): a new high-affinity hemoglobin. Blood 1981;58:813.
158. Indrak K, Wiedermann BF, Batek F, et al. Hb Olomouc, a new high oxygen affinity variant. Hemoglobin 1987;11:151.
159. Lorkin PA, Stephens AD, Beard ME, et al. Haemoglobin Rahere (Beta 82 Lys?Thr): a new high affinity haemoglobin associated with decreased 2,3-diphosphoglycerate binding and relative polycythaemia. BMJ 1975;4:200.
160. Thillet J et al. Hemoglobin Creteil beta 89 (F5) Ser?Asn: high affinity variant of hemoglobin frozen in a quaternary R structure. J Mol Med 1976;1:135.
161. Paniker NV, Lin KT, Krantz SB, et al. Haemoglobin Vanderbilt (beta 89 Ser?Arg): a new haemoglobin with high oxygen affinity and compensatory erythrocytosis. Br J Haematol 1978;39:249.
162. Wajcman H, Bascompte JLA, Labie D. Structural and functional studies of hemoglobin Barcelona (beta 94 Asp(FG1)?His). Consequences of altering an important intrachain salt bridge involved in the alkaline Bohr effect. J Mol Biol 1982;156:185.
163. Gacon G, Wajcman H, Labie D, et al. Structural and functional study of Hb Nancy beta 145(HC2)Tyr?Asp, a high oxygen affinity hemoglobin. FEBS Lett 1975;56:39.
164. Taketa F, Huang YP, Libnock JA, Dessel BH. Hemoglobin Wood beta 97 (FG4) His?Leu. A new high-oxygen-affinity hemoglobin associated with familial erythrocytosis. Biochim Biophys Acta 1975;400:348.
165. Bunn HF et al. Functional properties of hemoglobin Kempsey. J Biol Chem 1974;249:7402.
166. Reed CS et al. Erythrocytosis secondary to increased oxygen affinity of a mutant hemoglobin, hemoglobin Kempsey. Blood 1968;31:623.
167. Novy MJ et al. Hemoglobin Yakima: II. High blood oxygen affinity associated with compensatory erythrocytosis and normal hemodynamics. J Clin Invest 1967;46:1848.
168. Glynn KP et al. Familial erythrocytosis. A description of three families, one with hemoglobin Ypsilanti. Ann Intern Med 1968;69:769.
169. Moo-Penn WF et al. Hemoglobin New Mexico. A variant hemoglobin associated with erythrocytosis. Biochim Biophys Acta 1985;832:192.
170. Jones RT et al. Hemoglobin British Columbia (beta 101 (G3) Glu?Lys). A new variant with high oxygen affinity. Hemoglobin 1976;1:171.
171. White JM et al. Familial polycythaemia caused by a new haemoglobin variant Hb Heathrow, beta 103 (G5) phenylalanine?leucine. BMJ 1973;3:665.
172. Perutz MF. Haemoglobin Little Rock. Stereochemical interpretation of high oxygen affinity. Nature 1973;243:180.
173. Bromberg PA et al. Hemoglobin Little Rock (beta 143?Gln; H21). A high affinity variant with unique



properties. *Nature* 1973;243:177.

174. Jensen M et al. Hemoglobin Syracuse (beta 143 (H21) His<sup>?</sup>Pro), a new high-affinity variant detected by special electrophoretic methods. *J Clin Invest* 1975;55:469.

175. Harano K et al. A new hemoglobin variant, Hb Mito, with increased oxygen affinity. *FEBS Lett* 1985;192:75.

176. Charache S et al. Polycythemia produced by hemoglobin Osler (beta 145(HC2) Tyr<sup>?</sup>Asp). *Johns Hopkins Med J* 1975;136:132.

177. Kleckner HB et al. Hemoglobin Fort Gordon or beta 145 Try<sup>?</sup>Asp, a new high-oxygen-affinity hemoglobin variant. *Biochim Biophys Acta* 1975;400:343.

178. Winslow RM et al. Hemoglobin McKees Rocks (beta 145<sup>?</sup>term). A human "nonsense" mutation leading to a shortened beta-chain. *J Clin Invest* 1976;57:772.

179. Hamilton HB et al. Hemoglobin Hiroshima (beta 143 Histidine<sup>?</sup>Aspartic acid): a newly identified fast moving beta chain variant associated with increased oxygen affinity and compensatory erythremia. *J Clin Invest* 1969;48:525.

180. Perutz MF, Fermi G, Shih T-B. Structure of deoxyhemoglobin Cowtown [beta His HC3 (146) Leu]: origin of the alkaline Bohr effect and electrostatic interaction in hemoglobin. *Proc Natl Acad Sci U S A* 1984;81:4781.

181. Schneider RG et al. Hemoglobin Cowtown (beta 146 HC3 His<sup>?</sup>Leu). A mutant with high oxygen affinity and erythrocytosis. *Am J Clin Pathol* 1979;72:1028.

182. Shih T-B et al. Involvement of His HC3 (146) beta in the Bohr effect of human hemoglobin. Studies of native and n-ethylmaleimide-treated hemoglobin A and hemoglobin Cowtown. *J Biol Chem* 1984;259:967.

183. Ivaldi G, Scime-Degani V, David O, et al. A new fast-moving variant causing erythrocytosis and mild hemolysis: Hb Gambara [beta 82(EF6)Lys<sup>?</sup>Glu]. *Hemoglobin* 1997;21:345.

184. Wajcman H, Kister J, Promée D, et al. Hb Vilaverde [B89(F5)Ser<sup>?</sup>Thr]: the structural modification of an intrasubunit contact is responsible for a high oxygen affinity. *Biochim Biophys Acta* 1993;1225:89.

185. Wajcman H, Kister J, M'Rad A, et al. Hb Sainte Nazaire (B103[G5]Phe<sup>?</sup>Ile): a new example of polycythemia due to a hemoglobin variant with increased oxygen affinity. *Am J Hematol* 1993;44:16.

186. Bunn HF. Dissociation of haemoglobin Chesapeake into subunits. *Nature* 1970;227:839.

187. Smith JR, Landau SA. Smokers' polycythemia. *N Engl J Med* 1978;298:612.

188. Bodansky O. Methemoglobinemia and methemoglobin-producing compounds. *Pharmacol Rev* 1951;3:144.

189. Cohen RJ, Sachs JR, Wicker PJ, et al. Methemoglobinemia provoked by malarial chemoprophylaxis in Vietnam. *N Engl J Med* 1968;279:1127.

190. Finch CA. Methemoglobinemia and sulfhemoglobinemia. *N Engl J Med* 1948;239:470.

191. Kiese M. The biochemical production of ferrihemoglobin-forming derivatives from aromatic amines and mechanisms of ferrihemoglobin formation. *Pharmacol Rev* 1966;18:1091.

192. Cartier P, Labie D, Leroux TP, et al. Déficit familial en diphospho-glycérate-mutase: étude hématologique et biochimique. *Nouv Rev Fr Hématol* 1972;12:269.

193. Zürcher C, Loos JA, Prins HK. Hereditary high ATP content of human erythrocytes. *Folia Haem Leipzig* 1965;83:366.

194. Lasli ME, Vugrin D. Paraneoplastic syndromes in hypernephroma. *Semin Nephrol* 1987;7:123.

195. Sufrin G, Mirand EA, Moore RH, et al. Hormones in renal cancer. *J Urol* 1977;117:433.
196. Thorling EB. Paraneoplastic erythrocytosis and inappropriate erythropoietin production. *Scand J Haematol Suppl* 1972;17:1.
197. Souid AK, Dubansky AS, Richman P, et al. Polycythemia: a review article and case report of erythrocytosis secondary to Wilm's tumor. *Ped Hematol Oncol* 1993;10:215.
198. Hirsch I, Leiter E. Hydronephrosis and polycythemia. *Urology* 1983;21:345-350.
199. Bailey RR, Shand BI, Walker RJ. Reversible erythrocytosis in a patient with a hydronephrotic horseshoe kidney. *Nephron* 1995;70:104.
200. Maezawa M, Takaku F, Muta Y, et al. A case of intrarenal artery stenosis associated with erythrocytosis. *Scand J Haematol* 1978;21:278.
201. Shiramizu M, Katsuoka Y, Grodberg J, et al. Constitutive expression of erythropoietin by human renal adenocarcinoma cells in vivo and in vitro. *Exp Cell Res* 1994;215:249.
202. Mitus WJ, Galbraith JP, Gollikeri M. Experimental renal erythrocytosis. *Blood* 1964;24:343.
203. Janik JE, Sznol M, Urba WJ, et al. Erythropoietin production. A potential marker for interleukin-2/interferon-responsive tumors. *Cancer* 1993;72:2656.
204. Wickre CG, Baer GM, Womg J. Postrenal transplant erythrocytosis: a review of 53 patients. *Kidney Int* 1983;23:731.
205. Chan PC, Wei DC, Tam SC, et al. Post-transplant-erythrocytosis: role of erythropoietin and male sex hormones. *Nephrol Dial Transpl* 1992;7:137.
206. Martino R, Oliver A, Ballarin JM, et al. Postrenal transplant erythrocytosis: further evidence implicating erythropoietin production by the native kidney. *Ann Hematol* 1994;68:201.
207. Barenbrook M, Spieker C, Rahn KH, et al. Therapeutic efficiency of phlebotomy in posttransplantation hypertension associated with erythrocytosis. *Clin Nephrol* 1993;40:241.
208. Torregosa JV, Campistol JM, Montesinos M, et al. Efficacy of captopril on posttransplant erythrocytosis. Long term followup. *Transplantation* 1994;58:311.
209. Ilan Y, Dranitzki-Elhallel M, Rubinger D, et al. Erythrocytosis after renal transplantation. The response to theophylline treatment. *Transplantation* 1994;57:661.
210. Davidson CS. Hepatocellular carcinoma and erythrocytosis. *Semin Hematol* 1976;13:115.
211. McFadzean AJS et al. Polycythemia in primary carcinoma of the liver. *Blood* 1958;13:427.
212. Brownstein MH, Ballard HS. Hepatoma associated with erythrocytosis. *Am J Med* 1966;40:204.
213. Hwang SJ, Lee SD, Wu JC, et al. Clinical evaluation of erythrocytosis in patients with hepatocellular carcinoma. *Chung Hua i Hsueh Tsa Chih* 1994;53:262.
214. Okazaki N, Ozaki H, Arima M, et al. Hepatocellular carcinoma associated with erythrocytosis. A nine year survival after successful chemotherapy and left lateral hepatectomy. *Acta Hepato-Gastroenterol* 1979;36:248.
215. Muta H, Funakoshi A, Baba T, et al. Gene expression of erythropoietin in hepatocellular carcinoma. *Intern Med* 1994;33:427.
216. Sakisaka S, Watanabe M, Tateshi H, et al. Erythropoietin production in hepatocellular carcinoma associated with erythrocytosis: immunohistochemical evidence. *Hepatology* 1993;18:1357.

217. Taillan B, Sanderson F, Fuzibet JG, et al. Association polyglobulie angiome hepaticue. Mise en evidence d'une activite "erythropoietine-like." *Presse Med* 1990;19:1319.
218. Rothman SA, Savage RA, Paul P. Erythropoietin dependent erythrocytosis associated with hepatic angiosarcoma. *J Surg Oncol* 1982;20:105.
219. Capron JP, Chivrac D, Lorriaux A. Erythrocytose moderee a la phase initiale de l'hepatite virale. *Nouv Presse Med* 1975;4:2951.
220. Bank H, Passwell J. Absolute erythrocytosis in early infectious hepatitis. *Med Chir Digest* 1974;3:321.
221. Hennessy TG, Stern WE, Herrick SE. Cerebellar hemangioblastoma: erythropoietic activity by radioiron assay. *J Nucl Med* 1967;8:601.
222. Linstedt G, Lundberg PA, Norrby A, et al. Hormone conference at Sahlgren's University Hospital: polycythemia and inappropriately high serum erythropoietin levels in a 62 year-old man. *Clin Chem* 1994;40:2093.
223. Tachibana O, Yamashita T, Yamashita J, et al. Immunohistochemical study of basic fibroblast growth factor and erythropoietin in cerebellar hemangioblastomas. *Noshuyo Bori* 1994;11:169.
224. Wrigley PF, Malpus JS, Turnbull AC, et al. Secondary polycythaemia due to uterine fibromyoma producing erythropoietin. *Br J Haematol* 1971;21:551.
225. Takkar D, Kumar A. Polycythemia associated with uterine fibroid. *Indian J Med Sci* 1994;48:144.
226. Naets JP, Wittek M, Delwiche F, et al. Polycythaemia and erythropoietin producing uterine fibromyoma. *Scand J Haematol* 1977;19:75.
227. Ossias AL, Zanjani ED, Zalusky R, et al. Case report: studies on the mechanism of erythrocytosis associated with a uterine fibromyoma. *Br J Haematol* 1973;25:179.
228. Venencie PY, Pissant A, Boffa GA, et al. Multiple cutaneous leiomyomata and erythrocytosis with demonstration of erythropoietic activity in the cutaneous leiomyomata. *Br J Dermatol* 1982;107:483.
229. Bruneval P, Sassy C, Mayeux P, et al. Erythropoietin synthesis by tumor cells in a case of meningioma associated with erythrocytosis. *Blood* 1993;81:1593.
230. Ballard HS, Kouri Y. The association of erythrocytosis and chronic lymphocytic leukemia. *Cancer* 1992;70:2431.
231. Nagawasa T, Yanagisawa H, Hasegawa Y, et al. Polycythemia associated with systemic amyloidosis: elevated levels of hemopoietic factors and cytokines. *Am J Hematol* 1993;43:57.
232. Brewer CA, Adelson MD, Elder RC. Erythrocytosis associated with a placental trophoblastic tumor. *Obstet Gynecol* 1992;79:846.
233. Siggillino JJ et al. Myxoma of the right atrium with polycythemia. *Arch Intern Med* 1963;111:178.
234. Mann DL, Gallagher NJ, Donati RM. Erythrocytosis and primary aldosteronism. *Ann Intern Med* 1967;66:335.
235. Muechler EK. Testosterone-producing ovarian tumor associated with erythrocytosis, hyperuricemia, and recurrent deep vein thrombosis. *Am J Obstet Gynecol* 1977;129:467.
236. Erkelens DW, Stadius Van Eps LW. Bartter's syndrome and erythrocytosis. *Am J Med* 1973;55:711.
237. Drenou B, LeTulzo Y, Caulet-Maugendre S, et al. Pheochromocytoma and secondary erythrocytosis: role of tumor erythropoietin secretion. *Nouv Rev Fran Hematol* 1995;37:197.
238. Koduri PR, Sherer R, Teter C. Polycythemia in patients infected with human immunodeficiency

virus-1. *Am J Hematol* 2000;64:80.

239. Caminal Montero L, Trapiella Martinez L, Gonzalez Marroquin A, et al. Polycythemia in a patient with HIV. *Rev Clin Espanola* 1997;197:383.

240. Edwards TB, Nelson RP, Ballester OF, et al. Polycythemia as a complication of human immunodeficiency virus infection. *South Med J* 1993;86:686.

241. Kennedy CA, Griffith HS, Mathisen GE. Erythrocytosis after zidovudine for AIDS. *Ann Intern Med* 1991;114:250.

242. Willocks L, Ludlam CA, Welsby PD. Polycythaemia and HIV infection. *Lancet* 1990;336:812.

243. Battan R, Ottaviano P, Porcelli M, et al. Polycythaemia in patient with AIDS. *Lancet* 1990;335:1342.

244. Wagner JC. The abuse of drugs to enhance athletic performance. *Am J Hosp Pharm* 1989;46:2059.

245. Lukas SE. Current perspectives on anabolic-androgenic steroid abuse. *Trends Pharm Sci* 1993;14:61.

246. Shahidi NT. Androgens and erythropoiesis. *N Engl J Med* 1973;289:72.

247. Scott WC. The abuse of erythropoietin to enhance athletic performance (letter). *JAMA* 1990;264:1660.

248. Garceau R, Audran M, Baynes RD, et al. Erythropoietin abuse in athletes (letter). *Nature* 1996;380:113.

249. Brown KR, Carter Jr. W, Lombardi GE. Recombinant erythropoietin overdose. *Am J Emer Med* 1993;11:619.

250. Skibell V, Nissen-Lie G, Toorjeson P. Sugar profiling proves that human serum erythropoietin differs from recombinant human erythropoietin. *Blood* 2001;98:3626.

251. Adamson JW, Stamatoyannopoulos G, Kontras S, et al. Recessive familial erythrocytosis: aspects of marrow regulation in two families. *Blood* 1973;41:641.

252. Shih LY, Lee CT, See LC, et al. In vitro culture growth of erythroid progenitors and serum erythropoietin assay in the differential diagnosis of polycythaemia. *Eur J Clin Invest* 1998;28:569-576

253. Kiladjian J-J, Dubernet E, Bruno F, et al. Idiopathic erythrocytosis: long term outcome of 39 patients treated with pipobroman in a prospective study (abstract). *Blood* 2001;98[Suppl]:2643a.

2004 Lippincott Williams & Wilkins  
John P. Greer, John Foerster, John N. Lukens  
George M. Rodgers, Frixos Paraskevas, Bertil Glader  
Wintrobe's Clinical Hematology

[CLINICAL EVALUATION OF THE BLEEDING PATIENT](#)  
[MANIFESTATIONS OF DISORDERED HEMOSTASIS](#)  
[Bleeding into Skin and Soft Tissues](#)  
[Hemarthrosis](#)  
[Traumatic Bleeding](#)  
[Miscellaneous Bleeding Manifestations](#)  
[CLINICAL FEATURES OF INHERITED BLEEDING DISORDERS](#)  
[Age at Onset: Bleeding in the Neonate](#)  
[Family History](#)  
[CLINICAL FEATURES OF ACQUIRED BLEEDING DISORDERS](#)  
[Drug History](#)  
[LABORATORY METHODS FOR STUDY OF HEMOSTASIS AND BLOOD COAGULATION](#)  
[Tests of Vascular and Platelet Phases](#)  
[Tests of Coagulation Phase](#)  
[Tests for Fibrin \(Fibrinogen\)–Degradation Products and D–Dimer](#)  
[Tests for Factor XIII Activity](#)  
[Tests for Fibrinolysis](#)  
[Bioassays for Coagulation Factors](#)  
[Tests for Inhibitors of Coagulation](#)  
[Tests for Physiologic Inhibitors of Coagulation](#)  
[Automated Coagulation Methods](#)  
[Chromogenic and Fluorometric Techniques](#)  
[INITIAL LABORATORY EVALUATION](#)  
[Primary Screening Tests](#)  
[CONFIRMATORY TESTS](#)  
[Thrombocytopenia](#)  
[von Willebrand Disease](#)  
[Qualitative Platelet Disorders](#)  
[Disorders of the Intrinsic Pathway of Coagulation](#)  
[Disorders of the Common Pathway of Coagulation](#)  
[Disorders of the Extrinsic Pathway of Coagulation](#)  
[Disorders in Which Results of Primary Screening Tests Are Normal](#)  
[PREOPERATIVE HEMOSTASIS EVALUATION](#)  
[EVALUATION OF THE NEONATE](#)  
[REFERENCES](#)

Except for that which occurs during menstruation, spontaneous bleeding is abnormal. Surprisingly, little blood is lost, even after large injuries, because of the efficiency with which vascular integrity is normally maintained and the rapidity with which it is restored after injury. In general, these phenomena reflect the functional effectiveness of normal hemostasis (see [Chapter 19](#), [Chapter 20](#), [Chapter 21](#) and [Chapter 22](#)). It must be recognized, however, that the adequacy of hemostasis is only relative, and despite the presence of normal vessels, platelets, and coagulation factors, bleeding can occur as the result of localized pathologic processes.

The 11 chapters in Part V deal with disorders that result from abnormalities of the hemostatic process. [Chapter 51](#) is a summary of the diagnostic approach to these disorders and includes a brief discussion of laboratory methods for their study. In subsequent chapters, individual disorders are considered in six categories:

thrombocytopenia ( [Chapter 52](#), [Chapter 53](#), [Chapter 54](#) and [Chapter 55](#)), bleeding disorders caused by vascular abnormalities ( [Chapter 56](#)), thrombocytosis ( [Chapter 57](#)), disorders of platelet function ( [Chapter 58](#)), inherited coagulation disorders ( [Chapter 59](#)), and acquired coagulation disorders ( [Chapter 60](#)). The pathophysiology of thrombosis and the principles of antithrombotic therapy are summarized in [Chapter 61](#).

## CLINICAL EVALUATION OF THE BLEEDING PATIENT

A careful evaluation of the patient presenting with a bleeding disorder can often provide valuable clues as to whether the abnormality resides in the vessels, platelets, or the process of blood coagulation; a carefully obtained history can usually establish whether the disorder is inherited or acquired; and the physical examination may reveal findings such as the characteristic skin lesions of hereditary hemorrhagic telangiectasia, which alone may provide the diagnosis of a previously perplexing bleeding problem. Results of the clinical evaluation should lead to a rational and efficient laboratory investigation. If laboratory studies are to be used to maximal advantage in terms of time and expense, they should supplement and not supersede a careful review of the history and the physical examination.

It is important to ask specific questions about bleeding because people with normal hemostasis may believe they bleed excessively ( [1](#)). Certain questions may discriminate between those with normal and abnormal hemostasis, including whether excessive bleeding occurs after tooth extraction or small cuts, whether spontaneous bruising or muscle bleeding occurs, or whether the patient has ever been transfused or treated with blood products ( [1](#)).

## MANIFESTATIONS OF DISORDERED HEMOSTASIS

Certain signs and symptoms are virtually diagnostic of disordered hemostasis. They can be divided arbitrarily into two groups: those seen more often in disorders of blood coagulation and those most commonly noted in disorders of the vessels and platelets. The latter group is often called *purpuric disorders* because cutaneous and mucosal bleeding usually are prominent. The clinical findings that are most valuable in distinguishing between these two broad categories are summarized in [Table 51.1](#). Although these criteria are relative, they provide valuable clues to the probable diagnosis if they are applied to the predominant clinical features in a given patient.

**TABLE 51.1. Clinical Distinction between Disorders of Vessels and Platelets and Disorders of Blood Coagulation**

| Finding                                      | Disorders of Coagulation           | Disorders of Platelets or Vessels          |
|--|------------------------------------|--|
| Petechiae                                    | Rare                               | Characteristic                             |
| Deep dissecting hematomas                    | Characteristic                     | Rare                                       |
| Superficial ecchymoses                       | Common; usually large and solitary | Characteristic; usually small and multiple |
| Hemarthrosis                                 | Characteristic                     | Rare                                       |
| Delayed bleeding                             | Common                             | Rare                                       |
| Bleeding from superficial cuts and scratches | Minimal                            | Persistent; often profuse                  |

|                         |   |  |
|-------------------------|---|--|
| Sex of patient          | 80–90% of inherited forms occur only in male patients | Relatively more common in females  |
| Positive family history | Common  | Rare (except von Willebrand disease and hereditary hemorrhagic telangiectasia) |

---

### Bleeding into Skin and Soft Tissues

Petechiae are characteristic of an abnormality of the vessels or the platelets, such as thrombocytopenia, and are exceedingly rare in the coagulation disorders. These lesions are small capillary hemorrhages ranging from the size of a pinhead to much larger ( [Fig. 51.1](#)). They characteristically develop and regress in crops and are most conspicuous in areas of increased venous pressure, such as the dependent parts of the body and areas subjected to pressure or constriction from girdles or stockings. In patients with scurvy, petechiae may be distributed around hair follicles in the “saddle area” of the thighs and buttocks (see [Fig. 56.6](#)). Petechiae must be distinguished from small telangiectasias and angiomas. Vascular structures such as telangiectasias or angiomas blanch with pressure, whereas petechiae do not.



**Figure 51.1.** Diffuse petechial rash induced by a tourniquet in a patient with chronic idiopathic thrombocytopenic purpura (platelet count =  $40 \times 10^9/L$ ).

In the purpuric disorders, petechiae commonly are associated with multiple superficial ecchymoses, which usually develop without perceptible trauma but seldom spread into deeper tissues. Small isolated ecchymoses are commonly noted in apparently normal women, especially on the legs, and in small children.

Although large superficial ecchymoses may be seen in association with the coagulation disorders, the most characteristic lesion is the large spreading hematoma ( [Fig. 51.2](#)). Such hematomas may arise spontaneously or after trivial trauma and often spread to involve an entire limb by dissecting within muscles and deep fascial spaces, often with minimal discoloration of the overlying skin.

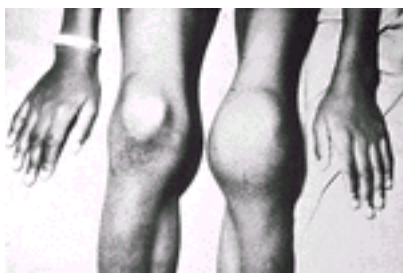




**Figure 51.2.** Large dissecting hematoma of thigh in a patient with hemophilia A. The lesion resulted from a slight bump to the inguinal area and spread to involve the entire thigh. See [Color Plate](#). (Courtesy of Dr. John Lukens.)

### Hemarthrosis

Hemorrhage into synovial joints is virtually diagnostic of a severe inherited coagulation disorder, most commonly hemophilia A or hemophilia B, and is rare in disorders of the vessels and platelets or in acquired coagulation disorders. This disabling problem often develops with pain and swelling as chief symptoms but without discoloration or other external evidence of bleeding ([Fig. 51.3](#)). Subperiosteal hemorrhages in children with scurvy and swollen painful joints that may develop in some patients with allergic purpura occasionally may be confused with hemarthrosis.



**Figure 51.3.** Acute hemarthrosis and its sequelae in a patient with hemophilia B. Note the periarticular swelling in the left leg and the marked atrophy of the thigh muscles as a result of recurrent hemarthrosis. (Courtesy of Dr. John Lukens.)

### Traumatic Bleeding

The unavoidable traumas of daily life and even minor surgical procedures are a greater challenge to hemostasis than any test yet developed in the laboratory. In contrast to “spontaneous” bleeding manifestations, bleeding after trauma in a person with a hemorrhagic diathesis differs in a quantitative way from that which would normally be expected in terms of the amount, duration, and magnitude of the inciting trauma. Such

variables are extremely difficult to assess accurately by taking the patient's history. The amount of blood lost may be exaggerated by the patient. The need for transfusions and the number administered may serve as a rough guide. The patient's statement concerning the duration of bleeding is more reliable. Detailed inquiry as to past injuries and operations must be made because the patient is likely to forget procedures or injuries that were uncomplicated and to dwell on those in which bleeding was a problem. Whether reoperation was required for prolonged bleeding after tooth extraction or other minor surgical procedures may be helpful in identifying a patient with abnormal hemostasis.

In individuals with a coagulation disorder, the onset of bleeding after trauma often is delayed. For example, bleeding after a tooth extraction may stop completely, only to recur in a matter of hours and to persist despite the use of styptics, vasoconstrictors, and packing. The temporary hemostatic adequacy of the platelet plug despite defective blood coagulation may explain this phenomenon of delayed bleeding, as well as the fact that patients with coagulation disorders seldom bleed abnormally from small superficial cuts such as razor nicks. In contrast, posttraumatic or postoperative surgical bleeding in thrombocytopenic patients usually is immediate in onset, as a rule responds to local measures, and rarely is as rapid or voluminous as that encountered in patients with coagulation disorders. However, it may persist for hours or days after surprisingly small injuries.

Valuable information often is obtained from a careful review of dental procedures, because most patients have had one or more teeth extracted at some time during their lives. Inquiry should clarify whether the extractions were single or multiple, the size and location of the tooth or teeth, any treatment given, and the amount, if any, of direct operative trauma. The amount of bleeding normally encountered varies greatly, but as a rough guide, uncomplicated extraction of a single molar tooth may result in brisk bleeding for up to 1 hour and slight oozing for up to 2 days in normal persons (<sup>2</sup>). Typically, bleeding is more profuse from upper than from lower sockets and is more extensive after extraction of molar teeth, particularly impacted third molars, than after removal of other teeth. In patients with inherited coagulation disorders, the shedding of deciduous teeth often is uncomplicated.

The response to trauma is an excellent screening test for the presence of an inherited hemorrhagic disorder, and a history of surgical procedures or significant injury without abnormal bleeding is equally good evidence against the presence of such a disorder. The removal of molar teeth is a major challenge to hemostasis, as is a tonsillectomy, and it is a rare hemophiliac, however mildly affected, who can withstand these procedures without excessive bleeding.

### **Miscellaneous Bleeding Manifestations**

Despite the fact that structural causes for bleeding (such as polyps, varices, and tumors) are commonly seen in patients with hematuria, hematemesis, and melena, bleeding from these sites may also be associated with both purpuric and coagulation disorders. Severe menorrhagia may be the sole symptom of women with von Willebrand disease (vWD), mild thrombocytopenia, or autosomally inherited coagulation disorders. Recurrent gastrointestinal bleeding or epistaxis in the absence of other bleeding manifestations is common in hereditary hemorrhagic telangiectasia. A coagulation disorder or a disorder of platelet function should be considered if protracted hematuria is the only symptom.

Bleeding into serous cavities and internal fascial spaces often occurs in patients with inherited coagulation disorders and may create serious diagnostic problems. In hemophilia, retroperitoneal hemorrhage or bleeding into the psoas sheath may mimic appendicitis, and hemorrhage into the bowel wall may be confused with intestinal obstruction. Signs and

symptoms simulating a variety of acute intraabdominal disorders also may be seen in association with allergic purpura. Bleeding into the central nervous system may complicate thrombocytopenia and may occur after minor trauma in patients with coagulation disorders. Multiple small retinal hemorrhages are common in patients with thrombocytopenia and other purpuric disorders but are uncommon in those with inherited coagulation disorders; large hematomas of the orbit may be seen in the latter group. The coexistence of bleeding and thromboembolic phenomena or bleeding from previously intact venipuncture sites is suggestive of diffuse intravascular coagulation (DIC). Protracted wound healing, wound dehiscence, and abnormal scar formation have been described in inherited afibrinogenemia, the dysfibrinogenemias, and in factor XIII deficiency (3). Hemoptysis rarely is associated with hemorrhagic disorders.

## CLINICAL FEATURES OF INHERITED BLEEDING DISORDERS

An inherited bleeding disorder is suggested by the onset of bleeding symptoms in infancy and childhood, a positive family history (particularly if it reveals a consistent genetic pattern), and laboratory evidence of a single or isolated abnormality, most commonly the deficiency or aberrance of a single coagulation factor.

### Age at Onset: Bleeding in the Neonate

Birth and the neonatal period provide unique challenges to the hemostatic mechanism (4), and bleeding during the first month of life often is the first evidence of an inherited disorder of hemostasis. Small cephalohematomas and petechiae are common in the newborn as a result of the trauma of delivery. Large cephalohematomas that progressively increase in size may result from hemophilia but are more common in association with acquired bleeding disorders such as hemorrhagic disease of the newborn (see [Chapter 60](#)). Bleeding from the umbilical stump and after circumcision is common in the acquired coagulation disorders, and it also occurs in the inherited coagulation disorders (5) with the exception of hypofibrinogenemia, dysfibrinogenemia, and factor XIII deficiency. The onset of bleeding from the umbilical cord may be delayed in these latter disorders. In the evaluation of bleeding in the neonate, the clinician should remember that hematochezia and hematemesis may originate from swallowed blood of maternal origin. Simple tests to distinguish such maternal blood from fetal blood have been described (5).

Many infants with inherited coagulation disorders do not bleed significantly in the neonatal period. Less than one-third of patients with hemophilia A and B and only 10% of those with other inherited coagulation disorders have hemorrhagic symptoms during the first week of life. In such patients, the disorder may become clinically silent for a time. Hematomas may first be seen only when the child becomes active. Hemarthrosis commonly does not develop until a child is 3 or 4 years of age.

A mild inherited hemorrhagic disorder may be difficult to distinguish from the insidious onset of an acquired defect. Patients with mild inherited coagulation disorders may enter adult life before characteristic bleeding manifestations occur. These patients and those with some forms of inherited thrombocytopenia and disordered platelet function often describe a history of posttraumatic bruising and hematoma formation that they have come to accept as normal. In hereditary hemorrhagic telangiectasia, the lesions become more prominent with advancing age and may not be symptomatic until middle age. Similarly, in patients with Ehlers-Danlos syndrome, bleeding may not be a problem until adult life.

### Family History

The family history is of great importance in the evaluation of bleeding disorders. In disorders inherited as autosomal-dominant traits with characteristic symptoms and high penetrance, such as hereditary hemorrhagic telangiectasia, an accurate pedigree spanning several generations can often be obtained. The presence of typical bleeding manifestations in male siblings and maternal uncles is virtually diagnostic of X-linked recessive inheritance, which characterizes hemophilia A and hemophilia B. In such X-linked traits, the family history also may be helpful in a negative sense—that is, it may clearly exclude the disorder in certain offspring, such as the sons of a known hemophiliac. Details of the various genetic patterns that may be encountered are discussed in the chapters that deal with these conditions.

The limitations of the family history, however, are greater than is commonly realized. Hearsay history is difficult to evaluate, and it is often impossible to assess the significance of easy bruising or to differentiate between manifestations of a generalized bleeding disorder and more common localized lesions, such as peptic ulcer and uterine leiomyomas. In affected families, a bewildering variety of unrelated symptoms is often attributed to bleeding. A negative family history is of no value in excluding an inherited coagulation disorder in an individual patient. As many as 30 to 40% of patients with hemophilia A have a negative family history (6). The family history usually is negative in the autosomal-recessive traits, and consanguinity, which is commonly present in these kindreds, is notoriously difficult to document or exclude.

## CLINICAL FEATURES OF ACQUIRED BLEEDING DISORDERS

Generalized bleeding may be a prominent feature of a wide variety of acquired disorders that encompass virtually the entire field of medicine. Bleeding manifestations usually are less severe than in the inherited forms, and the clinical picture often is dominated by evidence of the underlying disorder rather than by bleeding alone. In the neonate, for example, DIC usually is associated with significant complications such as sepsis, hypoxia, acidosis, or problems related to prematurity. The physician should suspect sepsis or occult thrombosis in any sick neonate with unexplained thrombocytopenia (5). Multiple hemostatic defects commonly are present in patients with acquired hemorrhagic diseases, which often include thrombocytopenia and significant coagulation abnormalities. In contrast, a single abnormality usually is found in patients with inherited hemorrhagic disorders.

In general, the emphasis of the study of the acquired bleeding disorders should be on the patient, not on the laboratory. A thorough history and the physical examination often reveal the cause of thrombocytopenia, such as a drug or acute leukemia. In most vascular disorders, including senile purpura, allergic purpura, scurvy, and amyloidosis, the history and physical examination are of primary diagnostic importance, and the laboratory has little to offer.

### Drug History

The importance of exhaustive interrogation regarding drug use and chemical exposure cannot be overemphasized. The list of drugs associated with thrombocytopenia (see [Table 53.5](#)) or vascular purpura grows longer each year. Less common but more serious is drug-induced aplastic anemia, which may present initially with bleeding (see [Chapter 44](#)). Many commonly used drugs (see [Table 58.4](#)), notably aspirin, impair platelet function and produce abnormal findings on laboratory tests that often lead to expensive and unnecessary additional laboratory studies. The same drugs may provoke bleeding when

administered to patients with preexisting hemostatic defects such as hemophilia A.

Drug ingestion also may produce coagulation abnormalities, and drugs that potentiate or antagonize the anticoagulant effects of coumarin derivatives may lead to bleeding or erratic laboratory control. The surreptitious ingestion of such agents is not uncommon.

Results of various coagulation tests may be abnormal in a surprisingly large percentage of hospitalized patients because of heparin that is administered therapeutically or is used in small amounts to maintain the patency of indwelling venous catheters, venous pressure lines, arteriovenous shunts, and various pumps and infusion machines. The partial thromboplastin time (PTT), in particular, may be greatly prolonged in patients who have received even a minute amount of this anticoagulant. Such coagulation abnormalities often are confused with DIC, inhibitors of factor VIII, and other serious coagulation disorders, and they commonly lead to repeated, often detailed, and usually useless coagulation studies. A thorough bedside inventory often is required to find out that heparin is indeed responsible. Prolongation of the thrombin time associated with a normal reptilase time or direct assay of heparin provides laboratory evidence of heparin contamination.

## LABORATORY METHODS FOR STUDY OF HEMOSTASIS AND BLOOD COAGULATION

No single test is suitable for the laboratory evaluation of the overall process of hemostasis and blood coagulation, but methods of varying complexity and use are available for assessing various components and functions individually. The emphasis of the following discussion is on methods that are simple and widely available in most laboratories. The interpretation of the most commonly used tests and the range of values obtained in normal subjects with representative techniques are summarized in [Table 51.2](#). Definitive methods usually require a specially equipped laboratory and trained personnel, and are discussed here from a general standpoint only. Additional comments concerning the use and limitations of the various methods are included in chapters dealing with individual disorders. For details concerning such definitive methods, the reader is referred to more comprehensive works devoted entirely to this subject ([7](#)).

**TABLE 51.2. Interpretation of Common Tests of Hemostasis and Blood Coagulation**

| Test   | Normal Range <sup>a</sup> ( $\pm 2$ SD) and Reference | Common Causes of Abnormalities  |
|--|---|---|
| Platelet count                                       |   |   |
| Phase microscopy                                     | 140,000–440,000/ $\mu$ l                              | Thrombocytopenia, thrombocytosis  |
| Automated  | 177,000–406,000/ $\mu$ l                              |   |
| Partial thromboplastin time (activated) <sup>b</sup> | 26–37 sec; ( <a href="#">51</a> ) <sup>c</sup>        | Deficiencies or inhibitors of prekallikrein; high-molecular-weight kininogen; factors XII, XI, IX, VIII, X, and V; prothrombin or fibrinogen; lupus inhibitors; heparin |
| Prothrombin time <sup>b</sup>                        | 12.0–15.5 sec; ( <a href="#">62</a> ) <sup>c</sup>    | Deficiencies or inhibitors of factors VII, X, and V; prothrombin or fibrinogen; dysfibrinogenemia; lupus inhibitors; heparin  |

|                                  |                      |  |
|----------------------------------|----------------------|--|
| Thrombin time <sup>b</sup>       | 18–22 sec; ( 7)      | Afibrinogenemia, dysfibrinogenemia, hypofibrinogenemia, and hyperfibrinogenemia; inhibitors of thrombin (heparin) or fibrin polymerization (fibrin degradation products, paraproteins) |
| Fibrinogen assay <sup>b</sup>    | 150–430 mg/dl; ( 68) | Afibrinogenemia, dysfibrinogenemia, and hypofibrinogenemia; inhibitors of thrombin or fibrin polymerization  |
| Factor VIII assay <sup>b</sup>   | 50–150 U/dl; ( 7)    | Hemophilia A and von Willebrand disease; acquired antibodies to factor VIII  |
| Fibrin degradation product assay | 0–5 µg/ml; ( 77)     | Disseminated intravascular coagulation; fibrinogenolysis; thrombolytic drugs, liver disease; dysfibrinogenemia   |

<sup>a</sup> Normal range in the University of Utah coagulation laboratory.

<sup>b</sup> Tests affected by heparin.

<sup>c</sup> Significant variations depending on reagents and technique.

---

## Tests of Vascular and Platelet Phases

**BLEEDING TIME** Hemostasis in a small superficial wound, such as that produced when measuring the bleeding time, depends on the rate at which a stable platelet plug is formed and, thus, provides a measure of the efficiency of the vascular and platelet phases. However, it does not discriminate between vascular defects, thrombocytopenia, and platelet dysfunction. The bleeding time leaves much to be desired in terms of reproducibility because no two skin areas are exactly the same and it is impossible to produce a truly standard wound ( 8). Older studies using the bleeding time test supported the view that this test might be helpful in predicting bleeding in individual patients ( 9). More recent studies suggest that a bleeding time result is determined not only by platelet number and function, but also by hematocrit ( 10), certain components of the coagulation mechanism ( 11, 12), skin quality ( 13), and technique ( 14). A careful analysis of this literature indicates that there is no correlation between a skin template bleeding time and certain visceral bleeding times ( 14, 15), and that no correlation exists between preoperative bleeding time results and surgical blood loss or transfusion requirements ( 16). A clinical outcomes study reported that discontinuation of the bleeding time in a major academic medical center had no detectable adverse clinical impact ( 17). A position paper of the College of American Pathologists and the American Society of Clinical Pathologists concluded that the bleeding time was not effective as a screening test, and that a normal bleeding time does not exclude a bleeding disorder ( 18). Patients thought to have a platelet-type bleeding disorder based on their personal or family history (or both) should be evaluated for vWD and the inherited qualitative platelet disorders using assays discussed in the section [Platelet Function Assays](#). Newer assays that may be useful in screening patients for platelet dysfunction are also discussed in the section [New Assays of Platelet Function](#).

**PLATELET ENUMERATION** Platelets are considerably more difficult to count than erythrocytes or leukocytes. This difficulty is to be expected in view of the small size of these cells and their tendency to adhere to foreign surfaces and to aggregate when activated. In general, techniques for platelet counting may be classified into three groups: hemacytometer or direct methods, in which whole blood is diluted and the platelets are counted in much the same way as leukocytes or erythrocytes; semiautomated methods, in which the number of platelets in plasma prepared by sedimentation or centrifugation is

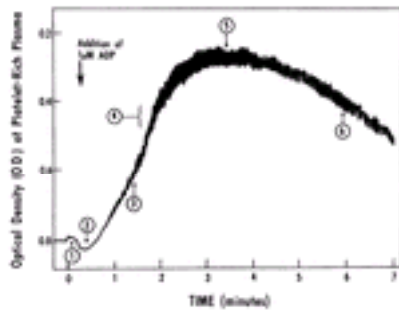


determined in an electronic particle counter; and fully automated electronic methods. Virtually identical values for the normal range of the platelet count have been obtained with modern methods, as summarized in [Table 51.2](#). An estimate of platelet numbers in a well-prepared blood smear by an experienced observer is a valuable check on the platelet count as determined by any method. In general, when a blood smear is examined at 100× power, each platelet seen/field represents approximately 10,000 platelets × 10<sup>9</sup>/L. Consequently, a normal blood smear should demonstrate, on average, at least 14 platelets/high-power field. Instruments for totally automated platelet counting are widely used. Details of automated cell counters are discussed in [Chapter 1](#). When automated methods are used, various nontechnical factors may produce falsely low platelet counts ([19](#)). These factors include platelet agglutinins ([20](#)), abnormal amounts of plasma proteins in various paraproteinemias, previous contact of platelets with foreign surfaces such as dialysis membranes ([21](#)), giant platelets, platelet satellitism ([22](#)), lipemia ([23](#)), and ethylenediaminetetraacetic acid-induced platelet clumping ([24](#)), a phenomenon that may produce platelet clumps of sufficient size to artifactually increase the leukocyte count ([25](#)). Spuriously high platelet counts may result from the presence of microspherocytes ([26](#)), fragments of leukemic cells ([27](#)), and Pappenheimer bodies ([28](#)). Special technical modifications and the use of careful manual counting methods may be required to eliminate these artifacts and to obtain accurate platelet counts.

**PLATELET VOLUME MEASUREMENTS** The widespread availability of particle counters in the clinical laboratory now permits the accurate measurement of platelet volume on a routine basis. Mean platelet volume (MPV) is increased in disorders associated with accelerated platelet turnover as the result of large numbers of megathrombocytes ([29](#)) or in patients with Bernard-Soulier syndrome. Normal or decreased values for MPV usually are obtained in patients with disorders associated with deficient platelet production, in some patients with sepsis ([30](#)), and in people with certain big-spleen syndromes ([31](#)). Some authors suggest that increased MPV provides evidence of accelerated platelet production and may be interpreted in the same way as the reticulocyte count. The method is difficult to standardize, however, and when determined on routinely collected specimens by automated counters, it is affected by numerous variables pertaining to specimen collection, anticoagulant, temperature, and duration of storage ([32](#)). In view of these problems and the difficulty in interpreting platelet size heterogeneity under normal and abnormal conditions ([33](#)), these measurements should be interpreted with caution. Nevertheless, this method is potentially valuable, and estimates of MPV are obtained with currently available instruments at essentially no additional cost. The presence of microcytic platelets in patients with some inherited thrombocytopenias such as Wiskott-Aldrich syndrome is reliably reflected by MPV measurements. On the other hand, giant platelets associated with Bernard-Soulier syndrome may be counted as leukocytes or erythrocytes and may not be reflected in the MPV.

**PLATELET FUNCTION ASSAYS** Since the 1960s, platelet aggregation using platelet-rich plasma has been the standard method to assess platelet function. This method uses aggregometers, which are modified nephelometers that permit measurement of changes in optical density of a platelet suspension under conditions of constant temperature and continuous agitation ([Fig. 51.4](#); also see [Fig. 58.3](#)). Most instruments measure a combination of light scatter and absorption. Instruments have been developed that permit both nephelometric and photometric measurements and the simultaneous measurement of aggregation and nucleotide release ([34](#)).





**Figure 51.4.** The interpretation of aggregometer tracings. Tracing of platelet aggregation produced by a low concentration of adenosine diphosphate (ADP), illustrating normal changes in optical density (OD)—that is, ( 1) a slight decrease caused by dilution with aggregating agent; ( 2) a transient increase caused by initial platelet swelling or shape change; ( 3) a rapid progressive decrease as platelet aggregates form, the size of which is roughly proportional to the amplitude of the oscillations in the tracing ( 4). The OD then reaches a nadir ( 5) from which maximal aggregation as a percentage of the initial OD may be calculated as follows: maximal aggregation (%) =  $\text{OD at } T_0 - \text{minimum OD} / \text{OD at } T_0$ . After this ( 6), a slow increase in OD caused by disaggregation occurs under some conditions.

Platelet aggregation usually is studied in suspensions of citrated platelet-rich plasma, in which the size and dimensions of the stirring bar, variations in plasma citrate concentration attributable to variations in hematocrit, the pH, and the nature of the buffers are important variables. Platelet suspensions usually are prepared by differential centrifugation, but methods that use albumin density-gradient centrifugation and gel filtration have also been described ( 35). Although harvesting platelets from the blood of thrombocytopenic patients is difficult, testing such platelets in the aggregometer is reproducible in suspensions containing as few as 50,000 platelets/ $\mu\text{l}$ . Methods for the study of platelet aggregation in whole blood ( 36, 37) also have been described. Interphased computer systems have been developed for calculating and expressing platelet function data ( 38). Adaptation of microplate technology to platelet aggregation has been reported, permitting more samples to be more rapidly analyzed ( 39). Adenosine diphosphate (ADP) in concentrations of 5  $\mu\text{mol/L}$  or higher produces platelet aggregation directly that is independent of the release of platelet-contained ADP ( 40). Various other aggregating agents act mainly by inducing the release reaction, such as a suspension of connective tissue particles (collagen), epinephrine and norepinephrine, and thrombin. With epinephrine (5  $\mu\text{mol/L}$ ), a weak primary aggregating effect usually can be clearly distinguished from the subsequent release reaction, which produces a secondary wave of aggregation. Such primary and secondary waves of aggregation also may be seen with carefully titrated amounts of ADP (0.2 to 1.5  $\mu\text{mol/L}$ ) ( 40). *Ristocetin* is an antibiotic that induces platelet agglutination (platelet metabolic activity not required) in the presence of von Willebrand factor (vWF). Patients deficient in vWF (vWD) or in the receptor for vWF (Bernard-Soulier syndrome) have an abnormal ristocetin response. Ristocetin is tested in concentrations of 0.6 to 1.2 mg/ml; the lower concentrations are helpful in identifying specific variants of vWD, type IIB and platelet-type vWD (see [Chapter 58](#) and [Chapter 59](#)). The release reaction is measured only indirectly by routine aggregometry—that is, the aggregation associated with the release of ADP from the platelets (release-induced aggregation or secondary aggregation). Methods for the quantitation of various substances released from platelets have been described. For example, the amounts of ADP or serotonin released/unit of time serve as indices of dense body release ( 41); the amount of various hydrolytic enzymes or platelet factor 4 released is a measure of the extent of  $\alpha$ -granule release ( 42). Sensitive methods have been developed for the determination of platelet-derived substances in plasma that may serve as markers of intravascular platelet activation ( 43), including platelet factor 4,  $\beta$ -thromboglobulin, stable

prostaglandins (6-keto prostaglandin F<sub>1</sub>α and thromboxane A<sub>2</sub>), and leukotrienes (43). These measurements may have diagnostic value in thromboembolic disorders and syndromes characterized by intravascular platelet aggregation.

**Clot Retraction** Clot retraction usually is deficient when the platelet count is below 50,000/μl and in a rare disorder of platelet function (Glanzmann thrombasthenia) (44). It is normal in most other disorders of platelet function. Qualitative estimates of clot retraction can be made by incubating a tube of clotted blood, in which retraction normally is apparent within 2 hours. This test is primarily of historical interest; Glanzmann thrombasthenia is typically diagnosed using platelet aggregation methods or flow cytometry.

**New Assays of Platelet Function** Recently appreciated limitations of the bleeding time test have led to the development of newer assays to evaluate platelet function (45). Some of these are point-of-care tests. The clinical use and predictive value of these tests to identify patients with hemostatic disorders remain to be established. One assay, the platelet function analyzer (PFA-100), has been investigated for several years, and many published reports using this assay are available. In this method, citrated blood samples are exposed to high shear rates in a capillary flowing through an aperture within a membrane coated with collagen and either ADP or epinephrine (46). The closure time to hemostatic plug formation within the aperture is the endpoint of the test. A large study using the PFA-100 found that prolonged closure times could be attributed to specific quantitative or qualitative abnormalities in platelet function or vWF (or both) in 93% of patients tested (47). It was suggested that optimal use of the PFA-100 in evaluation of hemostasis would use an algorithmic approach, evaluating not only PFA-100 closure times, but also a complete blood count, blood smear, and assays for vWD and platelet aggregation to further evaluate abnormal closure times (47).

## Tests of Coagulation Phase

It is doubtful whether any of the innumerable minor technical variations that have found their way into methods for the study of blood coagulation have significantly improved the specificity or reproducibility of the commonly used tests. Because of the lack of standardization of techniques and reagents, however, the normal range of almost every test varies depending on the technique used, and the physician must be aware of the normal range for the specific method used in a particular laboratory.

In general, meticulous performance of coagulation tests is more important than the exact technique chosen. Blood samples obtained by traumatic venipunctures or from indwelling catheters often are inadequate for coagulation studies (48). A poorly collected blood sample is a far more common cause of inaccurate results than is technical error. Confusion and delay usually result when coagulation tests are performed on inadequate specimens.

With the exception of testing for fibrin degradation products (FDPs), all coagulation tests are performed on citrated plasma, most commonly obtained using blue-top Vacutainer tubes. These tubes contain either 3.2% or 3.8% buffered sodium citrate and a vacuum that pulls in nine parts of blood to one part citrate. The International Society for Thrombosis and Haemostasis recommends the routine use of 3.2% sodium citrate. A pool of freshly frozen citrated plasma from several normal donors is a suitable control for screening procedures in most laboratories. Lyophilized control plasma and borderline abnormal control plasmas are available commercially to standardize coagulation assays and to provide reference standards.

The citrate ion does not enter the erythrocyte. Consequently, the plasma citrate concentration is abnormally high when blood with a high hematocrit is collected in usual

gulant. This may produce artifactual prolongation of coagulation, such as the PTT (49). To obtain interpretable tubes containing citrate concentrations appropriate for the or citrate must be added to the control plasma so the hat of the patient's plasma.

**TIME** The PTT is a simple test of the intrinsic and ion. When a mixture of plasma and a phospholipid platelet forms at a normal rate only if the factors involved in the , high-molecular-weight kininogen, and factors XII, XI, IX, athway (factors X and V, prothrombin, and fibrinogen) are [ig. 51.5](#)). Platelet substitutes of various kinds may be used, brain (50) and other crude cephalin fractions as well as in). In the PTT, such platelet substitutes are provided in cted by the number of platelets remaining in the plasma ntiphospholipid antibodies). Platelet substitutes are only er, and they are incapable of activating the extrinsic lete tissue thromboplastin (tissue factor). Thus, the PTT y and is unaffected by deficiency of factor VII. The PTT deficiency, screen for the lupus anticoagulant, and monitor

**Figure 51.5.** The interpretation of common screening tests of blood coagulation. Coagulation factors are indicated within arrow-shaped blocks, which represent the major pathways of coagulation. Screening tests are indicated at the side of these blocks in relation to pathways and coagulation factors measured by each. HMWK, high-molecular-weight kininogen; PL, phospholipid; Pre-K, prekallikrein.

The PTT is somewhat more sensitive to deficiencies of factors VIII and IX than to deficiencies of factors XI and XII or factors involved in the common pathway (51, 52), but with most techniques, the test usually yields abnormal results if the plasma level of any of the essential factors is below 15 to 30% of the normal value. The PTT thus detects some mild coagulation disorders. However, the ability to detect mild factor deficiency is reagent dependent, and certain PTT reagents may not detect factor deficiency as low as 5 to 10% (53). As is the case with all one-stage tests, the PTT may be shortened by high levels of a single factor, most commonly factor VIII. Thus, a short PTT may signify any of the various hypercoagulable states (see [Chapter 61](#)), and high levels of any of the factors involved in the intrinsic or common pathways of coagulation may mask deficiencies of other factors (54). In the original method, contact activation was provided by the glass tube, but the addition of activators, such as ellagic acid, or particulate silicates, such as Celite or kaolin, provides more optimal and standardized contact activation and represents a significant improvement over the original nonactivated test (55, 56). The activated PTT (aPTT) is the routine assay currently used to evaluate intrinsic coagulation. The aPTT of plasma deficient in prekallikrein (Fletcher factor) is abnormal when it is determined by standard methods using particulate activators such as Celite or

kaolin ( 57 ). This abnormality is minimized or abolished by protracted contact activation [15 minutes ( 58 )], as compared with 2 to 3 minutes used in the standard technique. The aPTT may yield normal results in prekallikrein deficiency when soluble activators such as ellagic acid are used ( 58 ). Because of physiologic abnormalities in the contact phase of the intrinsic pathway, the aPTT often is prolonged in normal newborn infants when it is performed with particulate activators. These abnormalities are abolished when preformed activation product is used as the activator ( 59 ). Prolonged aPTT values that are observed in healthy children are not due to a single deficiency or inhibitor to a coagulation protein, but rather from the combination of mild decreases of several coagulation proteins ( 60 ). Whereas increased PTT values may suggest a bleeding disorder, shortened PTT values have been found to be independent predictors of an increased risk of death, thrombosis, bleeding, and morbidity ( 61 ). The use of the aPTT in the control of heparin therapy and in detection of the lupus anticoagulant is discussed in [Chapter 61](#) and [Chapter 60](#), respectively.

**PROTHROMBIN TIME** The production of fibrin by means of the extrinsic and common pathways ( [Fig. 51.5](#) ) requires tissue factor and factor VII, in addition to factors X and V, prothrombin, and fibrinogen. These pathways are measured by the prothrombin time (PT) ( 62 ), in which plasma is recalcified in the presence of excess tissue factor. This test does not require contact activation and bypasses the intrinsic pathway and the factors involved therein. Because tissue thromboplastins contain phospholipids that act as platelet substitutes, the test is unaffected by platelet numbers. Of the five coagulation factors measured by the PT (factors V, VII, and X, prothrombin, and fibrinogen), three (prothrombin and factors VII and X) are vitamin K-dependent and are depressed by coumarinlike drugs. As a result, the PT is the test used most widely for controlling oral anticoagulant therapy. The PT usually is prolonged if the plasma levels of any of the requisite factors are below 10% of normal, and it is more sensitive to deficiencies of factors VII and X than to deficiencies of fibrinogen and prothrombin. The PT also is prolonged by inhibitors of any of the essential factors and by heparin, but it is less sensitive to the anticoagulant action of heparin than is the aPTT. Various modified techniques and thromboplastins ( 63 ), including recombinant human thromboplastins ( 64 ), have been developed to improve the use of the PT in the control of coumarin anticoagulant therapy (see [Chapter 61](#) ). The expression of the PT as a percentage of normal may be misleading and is not recommended because the dilution curves used to arrive at this figure often have little quantitative meaning ( 65 ). Use of the international normalized ratio in monitoring oral anticoagulation therapy is the recommended format (discussed in [Chapter 61](#) ). The PT performed with bovine brain thromboplastin is abnormal in patients with certain genetic variants of factor IX deficiency but is normal in patients with the more common form of this disorder. The venom of Russell viper contains an enzyme that initiates coagulation by the direct activation of factor X and does not require factor VII. The one-stage “prothrombin time” performed with this venom (the Stypven time) thus distinguishes between deficiency of factor VII and deficiency of factor X ( [Fig. 51.5](#) ).

**THROMBOPLASTIN GENERATION TEST** The thromboplastin generation test is important for historical reasons. This two-stage test measures the amount and rate of prothrombinase formation by way of the intrinsic pathway ( 66 ). The thromboplastin generation test has been supplanted by specific factor assays in most coagulation laboratories.

**ASSAY OF PLASMA FIBRINOGEN** Several accurate methods are available for the quantitative assay of plasma fibrinogen, a measurement of great clinical importance that should be available in all laboratories. Fibrinogen may be converted into fibrin, which is quantitated by gravimetric, nephelometric ( 67 ), or chemical ( 68 ) methods. An immunologic ( 69 ) method has also been described. Kinetic techniques based on the thrombin time, however, are simple to perform, and they have been widely adopted ( 70 ). Both gravimetric methods and those based on the thrombin time underestimate fibrinogen in the presence

of high concentrations of FDPs; technical modifications designed to avoid these problems have been proposed ( 71 ). Some nephelometric methods appear to be minimally affected by FDP. Modified methods that eliminate interference by heparin ( 72 ), as well as automated techniques, have been described. Marked differences in fibrinogen levels obtained by gravimetric and immunologic methods and those obtained by functional techniques are found in patients with the inherited dysfibrinogenemias. Reference values to identify patients with dysfibrinogenemia have been reported ( 73 ).

**THROMBIN TIME AND RELATED TECHNIQUES** When thrombin is added to plasma, the time required for clot formation is a measure of the rate at which fibrin forms ( Fig. 51.5 ). This test (thrombin time) yields abnormal results when the fibrinogen level is below 70 to 100 mg/dl, but it is unaffected by the levels of any of the other coagulation factors ( 74 ); it is greatly prolonged by heparin. The thrombin time may also be prolonged by a qualitatively abnormal fibrinogen, elevated levels of fibrin (fibrinogen)–degradation products, certain paraproteins, and hyperfibrinogenemia. The thrombin time and modifications thereof are technically simple, can be performed quickly, and are valuable, particularly in the diagnosis of DIC. The reptilase clotting time is similar to the thrombin time in principle, but coagulation induced by this enzyme, which is prepared from snake venom, is unaffected by the presence of heparin.

### Tests for Fibrin (Fibrinogen)–Degradation Products and D–Dimer

Fibrin (fibrinogen)–degradation products (FDPs) are protein fragments of varying sizes that result from the proteolytic action of plasmin on fibrin or fibrinogen (see Chapter 21 ) ( 75 ). Plasma levels of these fragments are commonly increased in association with DIC and fibrinogenolysis, disorders in which their presence is of considerable diagnostic significance. Quantitative assays for FDP are based on several principles, such as staphylococcal clumping ( 76 ), the agglutination of latex particles coated with antifibrinogen antibody ( 77 ), immunodiffusion ( 78 ), and red cell hemagglutination inhibition ( 79 ). Serum containing rheumatoid factor ( 80 ) or residual fibrinogen may yield false–positive results in some assays. Reagents needed for most of these methods are available commercially.

None of the aforementioned methods distinguishes between fibrin degradation products and fibrinogen degradation products; to make this distinction, measurement of the DD–dimer or even more sophisticated methods are required ( 81 ). Extremely sensitive methods for the measurement of fibrinopeptides and specific FDP, such as the DD–dimer ( 82 ), DDE–trimer, or B– $\beta$  15–42–related peptide, are useful as indices of DIC and as markers of subtle activation of coagulation *in vivo* (see Chapter 60 ).

Unpolymerized fibrin monomer is commonly present in the blood of patients with DIC. Various techniques (paracoagulation techniques) for demonstrating such monomers have been described; these range from the ethanol gelation test ( 83 ) and modifications thereof ( 84 ), which are insensitive, to various protamine gelation techniques ( 85 ), which are highly sensitive but nonspecific. Cryofibrinogen, which may be demonstrated in some cases of DIC, also may signify the presence of fibrin monomers. All of these assays to diagnose DIC have been supplanted by the D–dimer test ( 82 ). The use of D–dimer tests to exclude venous thromboembolism is discussed in Chapter 61 .

### Tests for Factor XIII Activity

The principle of the factor XIII screening test is that clots cross–linked by factor XIII resist denaturation by high concentrations of urea or acid. Deficiency of factor XIII results



in premature clot lysis (<sup>3</sup>). Patient plasma is recalcified to induce a clot; the clot is then suspended in 5 mol/L urea (or 1% monochloroacetic acid) for 24 hours. Clot stability is visually examined after 24 hours of incubation. Because this assay is a screening test, abnormal results should be repeated and confirmed using a quantitative factor XIII method, such as measuring factor XIII-dependent incorporation of labeled amines into substances such as fibrinogen or casein (<sup>86</sup>).

## Tests for Fibrinolysis

The plasma euglobulin fraction contains plasminogen activators and fibrinogen. Most of the major antiplasmins are removed in the pseudoglobulin supernatant fluid. The rate of lysis of a fibrin clot prepared from the euglobulin fraction (the euglobulin clot lysis time) thus provides a measure of fibrinolysis in the absence of major inhibitors and is a measure of the activity of plasminogen activators (<sup>87</sup>). This test has been adapted to allow measurement of endothelial cell plasminogen activators released *in vivo* after vascular occlusion (<sup>88</sup>).

Tests for fibrinogenolysis and assays for individual components of the fibrinolytic enzyme system, including plasminogen (<sup>89</sup>), free plasmin (<sup>90</sup>), and antiplasmins, are available. Routine coagulation assays for plasminogen activators and plasminogen activator inhibitors typically involve enzyme-linked immunosorbent assay methods (<sup>91</sup>, <sup>92</sup>). These tests are most useful in evaluating patients with recurrent thrombosis who may have abnormal fibrinolysis. Blood collection methods, timing, processing, and determination of assay-specific reference ranges are critically important in accurate evaluation of fibrinolysis parameters (<sup>91</sup>, <sup>92</sup> and <sup>93</sup>).

Moderate concentrations of ε-aminocaproic acid ( $4 \times 10^{-4}$  mol/L) inhibit plasminogen activators but not free plasmin. Thus, a shortened euglobulin lysis time in the presence of such concentrations of ε-aminocaproic acid indicates the presence of free plasmin, as in association with fibrinogenolysis (see [Chapter 60](#)). Fibrinolysis in heated fibrin plates also measures free plasmin (<sup>94</sup>) because plasminogen activators are thermolabile.

The rate of whole blood clot lysis is a gross measurement of fibrinolysis, and its determination requires only the incubation and observation of a blood clot, such as one of the samples obtained for a clotting time. If rapid, whole blood clot lysis may be of diagnostic significance; otherwise, the time required for lysis, which normally is more than 24 hours, is usually too long to be of diagnostic help. Neither the euglobulin clot lysis time nor the whole blood clot lysis time is interpretable in the presence of severe hypofibrinogenemia. The results of both tests may be normal, despite the presence of plasminogen activators, as the result of plasminogen depletion. The whole blood and euglobulin clot lysis times have been supplanted by specific assays of fibrinolytic components, as discussed earlier in this section.

## Bioassays for Coagulation Factors

Bioassays for coagulation factors are usually based on the familiar screening tests, such as the PT and aPTT. In principle, the extent to which an unknown sample corrects the abnormality in plasma with a known deficiency is assumed to be proportional to the content of the deficient factor in the sample.

The results of coagulation assays may be expressed in terms of units, which equal the amount of a given factor that is present in 1 ml of normal pooled or reference plasma. Alternatively, plasma levels of various factors may be expressed as a percentage of

normal. Thus, plasma levels of various coagulation factors typically range from 50 to 150 U/dl, or 50 to 150% of normal.

One-stage methods for factors VIII and IX, which are based on the aPTT and use substrate plasma from patients with severe inherited deficiencies (<1% of normal) of these factors, have proved satisfactory in most laboratories and are somewhat simpler to perform than comparable two-stage methods. However, two-stage methods are more specific than one-stage methods, particularly in patients with intravascular coagulation and liver disease ( [95](#) ), presumably because the two-stage methods are less affected by the presence of activated coagulation factors or traces of thrombin that increase the activity of factors V and VIII. Plasmas deficient in specific factors are available commercially. Modifications that do not depend on natural substrates have been developed, including techniques for the assay of prothrombin ( [96](#) ); factors V ( [97](#) ), VII, and X combined ( [65](#) ); and factors VIII ( [98](#) ), IX ( [99](#) ), X ( [100](#) ), and XI ( [101](#) ). Details of coagulation assay methodology have been reported ( [102](#) ).

### Tests for Inhibitors of Coagulation

Abnormalities in any test of coagulation, if caused by deficiency of an essential factor, are corrected by the addition of small amounts of normal plasma. If the abnormality is caused by the presence of one of the various inhibitors of coagulation rather than a deficiency of an essential factor, the opposite is true: Small amounts of the patient's plasma impair coagulation in normal samples. These tests are called *mixing studies* or *inhibitor screens*. This phenomenon is the essence of all screening tests for inhibitors, most of which are based on one-stage coagulation techniques, such as the PT and aPTT ( [103](#) ). The presence of heparin may be confirmed in various ways, including use of thrombin time and reptilase time assays, correction by protamine sulfate, or direct assays for activity of heparin or low-molecular-weight heparin ( [102](#) ).

### Tests for Physiologic Inhibitors of Coagulation

Several methods have been described for the assay of physiologic inhibitors of coagulation ( [104](#) ), such as antithrombin III (now referred to as *antithrombin*) ( [105](#) , [106](#) ), heparin cofactor II, protein C ( [104](#) , [107](#) ), and protein S ( [108](#) , [109](#) ). Both immunologic and functional assays are available for many of these components ( [104](#) ). Quantitative assays of such physiologic inhibitors may yield valuable information in patients with certain thromboembolic disorders (see [Chapter 61](#) ).

### Automated Coagulation Methods

Numerous instruments are available to detect automatically the endpoint of blood coagulation ( [110](#) ). These devices operate on a variety of principles: mechanical detection of the onset of fibrin formation, photometric recording of clot opacity, or the rate of fibrin polymerization. Such instruments are helpful in the performance of one-stage screening tests, such as the PT and aPTT ( [111](#) ), especially if a large number of tests must be done daily. The automated methods are not inherently more precise than those performed manually ( [112](#) ).

Totally automated methods for performing coagulation tests are widely used. The discrete clinical analyzer (ACA, DuPont, Wilmington, DE) has been adapted to measure fibrinogen ( [113](#) ), antithrombin ( [114](#) ), and plasminogen. This instrument is particularly convenient when a single assay is needed, in an emergency, or after regular laboratory hours. Automated



instrument platforms have been developed to perform a large variety of coagulation methods with significant cost savings, permitting more laboratories to do comprehensive coagulation testing ( [115](#) ).

The *thromboelastograph*, an instrument that demonstrates changes occurring during blood coagulation and fibrinolysis, has been used by some investigators. Different coagulograms are described in association with various bleeding disorders and hypercoagulable states ( [116](#) , [117](#) ). However, this is not a commonly used method to diagnose coagulation abnormalities in most laboratories. Its primary use is as a point-of-care instrument in the surgical setting ( [45](#) ).

The activated clotting time (ACT) is a whole blood clotting assay now primarily used as a point-of-care test. The ACT measures the clotting time for a whole blood sample after addition of particulate (contact) activators such as kaolin or Celite; thus, this assay measures the intrinsic pathway of coagulation. The ACT is mostly used to monitor anticoagulation in the setting of cardio-pulmonary bypass, cardiac catheterization, or dialysis. The ACT is preferable to the aPTT in certain settings that require high-dose heparin, such as cardiopulmonary bypass ( [118](#) ).

Other point-of-care coagulation instruments are being used in the setting of outpatient or home-based oral anticoagulation monitoring. Numerous studies have found that these instruments are at least as effective in providing safe and efficacious anticoagulation as is provided by physicians with standard laboratory anticoagulation testing ( [119](#) ). This topic is discussed further in [Chapter 61](#).

## Chromogenic and Fluorometric Techniques

Artificial peptides release chromogenic substances or fluorophores when they are enzymatically cleaved ( [120](#) , [121](#) ). The hydrolysis of such peptides by activated coagulation factors provides a novel means for assessing various coagulation reactions ( [122](#) , [123](#) ). Such chromogenic and fluorometric techniques have been developed for the assay of prothrombin and factors VII, IX, and X ( [124](#) ); antithrombin ( [125](#) ); a  $\alpha_2$ -antiplasmin; heparin; urokinase ( [126](#) ); kallikrein ( [127](#) ); plasmin; and other components of the fibrinolytic enzyme system ( [128](#) ). Assays also have been developed for coagulants that do not have enzymatic activity, such as cellulose sandwich fluoroimmunoassays for vWF antigen ( [129](#) ) and solid-phase front-surface fluorescence detection methods for factors VIIIc and IX ( [130](#) ). These methods appear to be intrinsically more precise and may be less time consuming than traditional coagulation methods, and instruments specifically designed for their performance are available. Chromogenic and fluorometric assays are expensive, however, and at present are used mainly in research and in large reference coagulation laboratories.

## INITIAL LABORATORY EVALUATION

### Primary Screening Tests

The initial laboratory study of the bleeding patient should be guided by the information obtained from the clinical evaluation. In many cases, however, the routine use of a small battery of screening tests has merit because it usually saves time, and the results direct the course of further study. It is generally agreed that the most essential information usually can be obtained from the three tests summarized in [Table 51.3](#), which in view of

their availability, simplicity, and low cost, are well suited to serve as primary screening tests. The platelet count provides the most reliable and reproducible test of primary hemostasis. The aPTT measures all of the coagulation factors involved in the intrinsic and common pathways ( Fig. 51.5) and generally is accepted as the best single screening test for disorders of blood coagulation. When supplemented with the PT, which assesses the extrinsic as well as the common pathway, the abnormality usually can be localized to one of the three pathways and the factors involved therein ( Fig. 51.5 and Table 51.3). The results of these three tests thus provide a presumptive diagnosis, which can then be clarified further by the confirmatory methods summarized in the next section. The bleeding time test has been omitted from this evaluation because of its nonspecificity in the general clinical setting ( 14, 17). The definitive laboratory diagnosis of individual bleeding disorders is discussed in Chapter 52, Chapter 53, Chapter 54, Chapter 55, Chapter 56, Chapter 57, Chapter 58, Chapter 59 and Chapter 60.

**TABLE 51.3. Profiles of Hemostasis Screening Tests in Patients with Bleeding Disorders**

| Prothrombin Time | Activated Partial Thromboplastin Time | Platelet Count | Differential Diagnosis   |
|------------------|---------------------------------------|----------------|--|
| ?                | —                                     | —              | Common<br>Acquired factor VII deficiency (early liver disease; early vitamin K deficiency; early warfarin therapy)<br>Rare<br>Factor VII inhibitor; dysfibrinogenemia; some cases of DIC; inherited factor VII deficiency; certain factor X variants |
| —                | ?                                     | —              | Common<br>Deficiency or inhibitor of factors VIII, IX, or XI; vWD; heparin<br>Rare<br>Lupus inhibitor with qualitative platelet defect; certain factor X variants  |
| ?                | ?                                     | —              | Common<br>Vitamin K deficiency; liver disease; warfarin; heparin<br>Rare<br>Deficiency or inhibitor of factors X or V, prothrombin, or fibrinogen; lupus inhibitor with hypoprothrombinemia; DIC; dysfibrinogenemia; primary fibrinolysis            |
| ?                | ?                                     | ?              | Common<br>DIC; liver disease<br>Rare<br>Heparin therapy with associated thrombocytopenia   |
| —                | —                                     | ?              | Common<br>Increased platelet destruction; decreased platelet production; hypersplenism; hemodilution<br>Rare   |

|   |   |   |  |
|---|---|---|--|
|   |   |   | Certain inherited platelet disorders<br>(Wiskott–Aldrich syndrome, Bernard–Soulier syndrome)   |
| — | — | ? | Myeloproliferative disorders   |
| — | — | — | Common<br>Mild vWD; acquired qualitative platelet disorders (uremia)   |
|   |   |   | Rare<br>Inherited qualitative platelet disorders; vascular disorders; fibrinolytic disorders; factor XIII deficiency; autoerythrocyte sensitization; dysfibrinogenemia; mild factor deficiency (VIII, IX, XI); disorders of platelet procoagulant activity |

?, increased; ?, decreased; —, normal; DIC, disseminated intravascular coagulation; vWD, von Willebrand disease.

NOTE: The differential diagnosis of bleeding disorders suggested by results of the prothrombin time, partial thromboplastin time, and platelet count is listed for each profile. This table includes the differential diagnosis of hemostasis screening test results in patients with a history of bleeding. Consideration of patients with abnormal coagulation tests and negative bleeding histories is not included in this table.

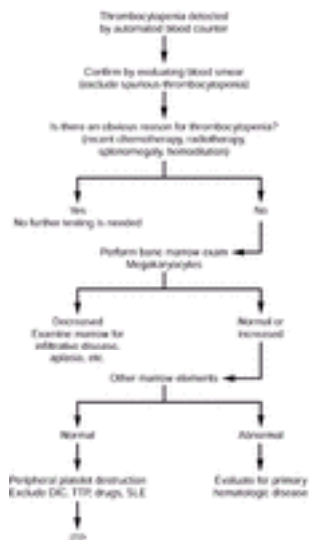
Modified from Rodgers GM. Common clinical bleeding disorders. In: Boldt DH, ed. Update on hemostasis. New York: Churchill Livingstone, 1990:75–120.

It is important to realize that patients with mild bleeding disorders (factor VIII, IX, or XI deficiency) may have normal aPTT values because most aPTT reagents do not detect mild deficiency states (factor levels of 20 to 30%) ([53](#)). Consequently, if the clinical suspicion is high, specific factor assays for these disorders should be performed, even if the initial evaluation suggested in [Table 51.3](#) is not productive.

## CONFIRMATORY TESTS

### Thrombocytopenia

Thrombocytopenia (see [Chapter 52](#)), like anemia, is a symptom, not a diagnosis. It is the most common of the acquired bleeding disorders. Additional laboratory tests usually are not indicated merely to confirm the presence of thrombocytopenia ([Table 51.3](#)) but are helpful in establishing the mechanism for thrombocytopenia. It is useful, however, to examine the thrombocytopenic patient's blood smear to exclude pseudothrombocytopenia that may be seen in a small number of patients ([19](#), [20](#)). The differential diagnosis of thrombocytopenia is discussed at length in [Chapter 52](#), [Chapter 53](#), [Chapter 54](#) and [Chapter 55](#). One approach to evaluating thrombocytopenia is shown in [Figure 51.6](#).



**Figure 51.6.** An approach for evaluation of thrombocytopenia. The necessity to do a bone marrow examination in the evaluation of idiopathic thrombocytopenic purpura (ITP) is controversial. DIC, disseminated intravascular coagulation; SLE, systemic lupus erythematosus; TTP, thrombotic thrombocytopenic purpura. (From Kjeldsberg C, ed. Practical diagnosis of hematologic disorders, 3rd ed. Chicago: ASCP Press, 2000:743, with permission.)

### von Willebrand Disease

This disorder is the result of an abnormality in primary hemostasis combined with mild to moderate deficiency of factor VIIIc (see [Chapter 59](#)). In the classic case, the results of screening tests reveal a normal platelet count and a prolonged aPTT ([Table 51.3](#)). In many patients, however, the aPTT may be normal. Furthermore, the results of all of the laboratory tests tend to fluctuate from time to time ([131](#)). If the clinical suspicion is high, initial laboratory studies directed at excluding vWD should be performed, because vWD is more common than the inherited disorders of platelet function ([Fig. 51.7](#)). Useful tests include bioassay of factor VIII (VIIIc), immunoassay of vWF antigen, and measurement of ristocetin cofactor activity. In many cases, the diagnosis of vWD requires repeated testing.



**Figure 51.7.** Laboratory diagnosis of von Willebrand disease (vWD) and platelet dysfunction. The initial evaluation reveals mucocutaneous bleeding symptoms in a patient with a normal platelet count (*block in bold*). In vWD, the partial thromboplastin time also may be prolonged because of deficiency of factor VIIIc. Additional tests (*blocks*) and a suggested sequence for their performance are indicated as a flow diagram. Some patients with vWD may have normal assays for factor VIIIc, von Willebrand factor (vWF) Ag, and ristocetin cofactor activity. These patients may be diagnosed by abnormal ristocetin-induced platelet agglutination when aggregation studies are performed or by multimeric analysis of vWF. For patients with normal studies for vWD and platelet

dysfunction who are strongly suspected of having an inherited disorder, von Willebrand studies should be repeated.

A more recently available test to evaluate patients for vWD is multimeric analysis of vWF. Patient plasma is separated by agarose electrophoresis, and vWF is identified by immunologic methods. The patient's multimeric pattern is compared to that of normal plasma. A more detailed description of this test is given in [Chapter 59](#).

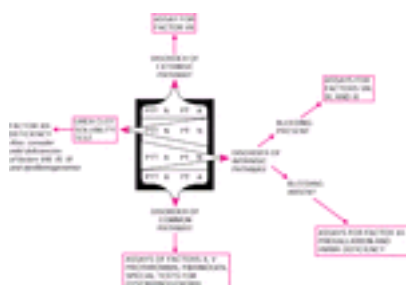
### Qualitative Platelet Disorders

Symptoms of mucocutaneous bleeding in the presence of a normal number of platelets and normal results of coagulation tests ( [Table 51.3](#)) are presumptive evidence of a disorder of platelet function (see [Chapter 58](#)). Inherited forms are uncommon, but bleeding caused by platelet dysfunction may be an important complication in patients with various acquired disorders, such as uremia. Commonly available confirmatory tests occasionally provide useful information regarding platelet dysfunction. Various morphologic abnormalities of the platelets may be seen on the blood smear. Strikingly large platelets are characteristic of certain inherited disorders, such as Bernard–Soulier syndrome. A markedly elevated platelet count is present in the myeloproliferative disorder essential thrombocytosis.

Definitive methods for the study of platelet dysfunction are time consuming and technically difficult. The absence of platelet aggregation by ADP, collagen, and epinephrine is characteristic of Glanzmann thrombasthenia. Deficient secondary wave aggregation is associated with various disorders of the release reaction, such as inherited deficiency of storage nucleotides, uremia, and aspirin ingestion. Abnormal responses to ristocetin indicate vWD or Bernard–Soulier syndrome. Disorders of platelet function are discussed in [Chapter 58](#).

### Disorders of the Intrinsic Pathway of Coagulation

Disorders of the intrinsic pathway of coagulation are characterized by a prolonged aPTT and a normal PT ( [Table 51.3](#)). Inherited forms include deficiencies of factors VIII or IX (hemophilia A and B), prekallikrein, high-molecular-weight kininogen, factor XI, or factor XII ( [Fig. 51.8](#)). Factor XII (Hageman factor) deficiency and deficiencies of prekallikrein or high-molecular-weight kininogen can be excluded readily because they are not associated with excessive clinical bleeding. Distinguishing between deficiencies of factors VIII, IX, and XI is done by performing specific assays for these factors. Screens (mixing studies) should also be performed to exclude antibodies to the intrinsic factor under study. If a factor VIII inhibitor is identified, the titer should be quantitated (see [Chapter 60](#)). An algorithm approach for evaluating bleeding patients with an isolated, prolonged PTT is shown in [Figure 51.9](#).



**Figure 51.8.** Laboratory diagnosis of inherited coagulation disorders. Results of primary

screening tests of coagulation [activated partial thromboplastin time (aPTT), prothrombin time (PT)] are summarized in the center block. Additional tests (*blocks*) and a suggested sequence for their performance are presented as a flow diagram. A more complete list of the differential diagnosis of bleeding disorders is presented in [Table 51.3](#). A, abnormal; HMWK, high-molecular-weight kininogen; N, normal; PTT, partial thromboplastin time.



**Figure 51.9.** Evaluation of a patient with bleeding and an isolated, prolonged partial thromboplastin time (PTT). Asterisk indicates that patients with clinical bleeding but normal studies should be evaluated further for lupus anticoagulants associated with either platelet dysfunction or thrombocytopenia. aPTT, activated partial thromboplastin time; PT, prothrombin time; vWD, von Willebrand disease; vWF, von Willebrand factor. (From Kjeldsberg C, ed. *Practical diagnosis of hematologic disorders*, 3rd ed. Chicago: ASCP Press, 2000:780, with permission.)

Acquired coagulation disorders associated with a prolonged aPTT and a normal PT include the lupus inhibitor and antibodies to factor VIII. Prolongation of the aPTT is commonly the result of heparin administration or poorly collected blood samples.

### Disorders of the Common Pathway of Coagulation

Prolongation of the aPTT and PT in a patient with an inherited bleeding disorder indicates a deficiency of one of the factors in the common pathway—factor X, factor V, prothrombin, or fibrinogen, or a dysfibrinogen ([Table 51.3](#) and [Fig. 51.8](#)). Such isolated deficiencies are exceedingly rare. On the other hand, deficiency of one or more of these factors is associated with additional abnormalities in the intrinsic and extrinsic pathways in many of the common acquired coagulation disorders, such as vitamin K deficiency, liver disease, and DIC. A prolonged PT usually suggests an acquired disorder (excluding the rare cases of inherited factor VII deficiency) and usually is associated with a complex abnormality involving multiple pathways, such as DIC.

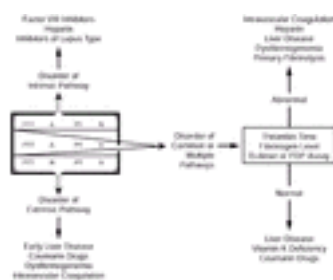
When confronted with this combination of findings, the first step should be to exclude or to identify an abnormality of fibrinogen. This may be accomplished by determination of the plasma fibrinogen level and tests for increased amounts of D-dimer or FDP. The most helpful ancillary procedures are the platelet count and examination of the blood smear for schistocytes. The laboratory findings characteristic of DIC are summarized in [Chapter 60](#).

Inherited disorders associated with a low fibrinogen level include afibrinogenemia, hypofibrinogenemia, and dysfibrinogenemia (see [Chapter 59](#)). In certain dysfibrinogenemias, large amounts of unclotted fibrinogen remain in the serum and are detected by tests for FDP.

Inherited deficiencies of factor V, factor X, and prothrombin can be diagnosed by specific factor assays.

### Disorders of the Extrinsic Pathway of Coagulation

A prolonged PT and a normal aPTT ([Table 51.3](#)) suggest an isolated deficiency of factor VII, which is rare and may be the result of an inherited or an acquired abnormality ([Fig. 51.8](#) and [Fig. 51.10](#)). Less commonly, inhibitors of factor VII have been reported ([132](#), [133](#)). Additionally, certain cases of DIC or dysfibrinogenemia may present with isolated prolonged PT values ([134](#)). Because factor VII is essential only in the tissue factor-activated extrinsic pathway of coagulation, the Stypven time is normal in patients with this disorder.



**Figure 51.10.** Laboratory diagnosis of acquired coagulation disorders. Results of primary screening tests of coagulation [partial thromboplastin time (PTT), prothrombin time (PT)] are summarized in the heavy black block. Additional tests (*blocks*) and a suggested sequence for their performance are presented as a flow diagram. Because of the complexity of acquired coagulation disorders and great variations in the results of laboratory tests that may be encountered in the various disorders and in individual patients, this diagram should be regarded as a general guide only. A more complete list of the differential diagnosis of bleeding disorders is presented in [Table 51.3](#). A, abnormal; FDP, fibrin degradation products; N, normal.

### Disorders in Which Results of Primary Screening Tests Are Normal

Screening tests usually yield normal results in patients with bleeding disorders related to vascular abnormalities ([Table 51.3](#) and [Table 51.4](#)). The diagnosis is usually made from the associated clinical findings that are often characteristic, such as the skin lesions of hereditary hemorrhagic telangiectasia, allergic purpura, scurvy, and senile purpura. A positive reaction to a specific skin test may confirm the diagnosis of autoerythrocyte sensitization and related disorders. The results of screening tests also are normal in factor XIII (fibrin-stabilizing factor) deficiency, a disorder in which the diagnosis is made by the demonstration of characteristic clot solubility in urea or monochloroacetic acid.

**TABLE 51.4.** Bleeding Disorders in Which the Results of Primary Screening Tests May



## Be Normal

---

von Willebrand disease

Mild inherited coagulation disorders, particularly factor XI deficiency

Heterozygous carriers of inherited coagulation disorders

Factor XIII (fibrin-stabilizing factor) deficiency

Some forms of dysfibrinogenemia

Disordered platelet function, particularly deficient release reaction; Scott syndrome

Hereditary hemorrhagic telangiectasia

Allergic and other vascular purpuras

$\alpha_2$ -plasmin inhibitor deficiency

Elevated levels of plasminogen activator

---

Although abnormal in the typical case, the results of screening tests may be normal or equivocal in patients with mild coagulation disorders (including heterozygous carriers), certain disorders of platelet function, mild forms of vWD, and dysfibrinogenemia or abnormal fibrinolysis ( [102](#), [135](#) ). More definitive tests are required to establish the diagnosis in these patients ( [Table 51.4](#) ). An increasing number of reports have indicated that many bleeding patients with normal screening studies have disorders of platelet procoagulant activity, such as Scott syndrome ( [136](#) ).

There are patients with a significant bleeding history in whom the results of detailed studies of hemostasis and blood coagulation are normal. Some have disorders of hemostasis that cannot be detected by methods currently available. The clinical management of these cases requires great care, and the fact that a clear-cut history of bleeding is always more significant than negative laboratory data cannot be overemphasized. Trauma may be denied in physically abused patients and may be self-inflicted in psychotic or neurotic patients.

## PREOPERATIVE HEMOSTASIS EVALUATION

The value of obtaining routine screening tests before surgical procedures has been debated for years ( [137](#) ). The screening tests for hemostasis are not totally satisfactory in detecting all mild hemostatic defects. Nevertheless, routine preoperative laboratory screening is of great value in certain high-risk patients who have disorders that predispose them to unexpected postsurgical bleeding, even from limited biopsy procedures. Important in this category are patients with liver disease, biliary obstruction, renal disease (particularly if complicated by azotemia), myelofibrosis, polycythemia vera, and other myeloproliferative disorders, particularly those associated with thrombocytosis and those with paraproteinemias. Included in this list should be all patients scheduled to undergo procedures involving the use of extracorporeal circulatory devices.

One approach to the question of preoperative hemostasis screening tests is to balance the financial costs of laboratory testing with the extent of surgery to be performed and with the amount of bleeding that can be safely tolerated. This approach makes the patient's hemostasis history particularly important. Patients scheduled for minor surgical procedures (dental, skin biopsy) do not need routine hemostasis screening tests if they have a negative history. In contrast, patients undergoing neurosurgery or other procedures that may induce a hemostatic defect (use of a bypass pump) or patients with a positive bleeding history need a hemostasis evaluation by the laboratory. [Table 51.5](#)

summarizes the recommendations of Rapaport in evaluating preoperative patients ( 137 ).

**TABLE 51.5. Guidelines for Preoperative Hemostasis Evaluation**

| Level | Bleeding History | Surgical Procedure                     | Recommended Hemostasis Evaluation   |
|-------|------------------|--|---|
| I     | Negative         | Minor                                  | None  |
| II    | Negative         | Major                                  | Platelet count, aPTT  |
| III   | Equivocal        | Major, involving hemostatic impairment | PT, aPTT, platelet count, factor XIII assay, euglobulin clot lysis time   |
| IV    | Positive         | Major or minor                         | Level III tests; if negative, then factors VIII, IX, and XI assays, thrombin time, a <sub>2</sub> -antiplasmin assay; consider von Willebrand disease and platelet aggregation testing; consider specific tests for abnormal fibrinolysis |

aPTT, activated partial thromboplastin time; PT, prothrombin time.

NOTE: Information in this table is a revision based on the suggested preoperative guidelines for hemostasis testing by Rapaport ( 137 ). The bleeding time is omitted as a hemostasis test due to more recent appreciation of its weakness as a useful test.

From Rodgers GM. Preoperative hemostasis screening. In: Kjeldsberg C, ed. Practical diagnosis of hematologic disorders, 3rd ed. Chicago: ASCP Press, 2000:815, with permission.

## EVALUATION OF THE NEONATE

Laboratory investigation of hemostasis and blood coagulation in the neonate and infant differs from that just outlined in several respects ( 138 , 139 ). First, the quantity of blood that can be obtained is limited, and often, the venipuncture is difficult. Various microtechniques and modifications of standard coagulation techniques that involve the use of capillary blood have been developed to circumvent this problem ( 140 ). In most cases, however, they are not entirely satisfactory ( 141 ). Second, in terms of adult norms, the results of some tests are abnormal, even in healthy full-term infants ( Table 51.6 ). Such physiologic abnormalities presumably are the result of deficiencies of the vitamin K-dependent factors and of additional abnormalities in the contact phase of coagulation and in the thrombin-fibrinogen reaction ( 4 , 142 ). The results of screening tests in healthy newborns are similar to those of adults within 2 to 6 months of age.

**TABLE 51.6. Age-Related Coagulation Reference Values in Newborns, Children, and Adults**

| Coagulation Test   | Age       |           |           |           |           |           |
|--------------------|-----------|-----------|-----------|-----------|-----------|-----------|
|                    | 5 Days    | 90 Days   | 1-5 Yr    | 6-10 Yr   | 11-16 Yr  | Adult     |
| Fibrinogen (g/L)   | 1.62-4.62 | 1.50-3.79 | 1.70-4.05 | 1.57-4.00 | 1.54-4.48 | 1.50-3.50 |
| Prothrombin (U/ml) | 0.33-0.93 | 0.45-1.05 | 0.71-1.16 | 0.67-1.07 | 0.61-1.04 | 0.79-1.31 |
| Factor V (U/ml)    | 0.45-1.45 | 0.48-1.32 | 0.79-1.27 | 0.63-1.16 | 0.55-0.99 | 0.62-1.39 |

|  |           |           |           |                        |                        |                        |
|--|-----------|-----------|-----------|------------------------|------------------------|------------------------|
| Factor VII (U/ml)                      | 0.35–1.43 | 0.39–1.43 | 0.55–1.16 | 0.52–1.20              | 0.58–1.15              | 0.50–1.29              |
| Factor VIII (U/ml)                     | 0.50–1.54 | 0.50–1.25 | 0.59–1.42 | 0.58–1.32              | 0.53–1.31              | 0.50–1.50              |
| Factor IX (U/ml)                       | 0.15–0.91 | 0.21–1.13 | 0.47–1.04 | 0.63–0.89              | 0.59–1.22              | 0.65–1.50              |
| Factor X (U/ml)                        | 0.19–0.79 | 0.35–1.07 | 0.58–1.16 | 0.55–1.01              | 0.50–1.17              | 0.77–1.31              |
| Factor XI (U/ml)                       | 0.23–0.87 | 0.41–0.97 | 0.56–1.50 | 0.52–1.20              | 0.50–0.97              | 0.65–1.50              |
| Factor XII (U/ml)                      | 0.11–0.83 | 0.25–1.09 | 0.64–1.29 | 0.6–1.4                | 0.34–1.37              | 0.50–1.50              |
| High-molecular-weight kininogen (U/ml) | 0.16–1.32 | 0.30–1.46 | 0.64–1.32 | 0.6–1.3                | 0.63–1.19              | 0.60–1.46              |
| Prekallikrein (U/ml)                   | 0.20–0.76 | 0.41–1.05 | 0.65–1.30 | 0.66–1.31              | 0.53–1.45              | 0.60–1.46              |
| von Willebrand factor antigen (U/ml)   | 0.50–2.54 | 0.50–2.06 | 0.6–1.2   | <sup>a</sup> 0.44–1.44 | <sup>a</sup> 0.46–1.53 | <sup>a</sup> 0.43–1.50 |
| Ristocetin cofactor (U/ml)             | —         | —         | —         | —                      | —                      | 0.52–1.60              |
| Antithrombin (U/ml)                    | 0.41–0.93 | 0.73–1.21 | 0.82–1.39 | 0.90–1.31              | 0.77–1.32              | 0.85–1.22              |
| Protein C (U/ml)                       | 0.20–0.64 | 0.28–0.80 | 0.40–0.92 | 0.45–0.93              | 0.55–1.11              | 0.78–2.32              |
| Protein S (U/ml)                       | 0.22–0.78 | 0.54–1.18 | 0.54–1.18 | 0.41–1.14              | 0.52–0.92              | 0.58–1.46              |
| Plasminogen (U/ml)                     | —         | —         | 0.78–1.18 | 0.75–1.08              | 0.68–1.03              | 0.74–1.24              |
| Tissue plasminogen activator (ng/ml)   | —         | —         | 1.0–4.5   | <sup>a</sup> 1.0–5.0   | <sup>a</sup> 1.0–4.0   | <sup>a</sup> 3.0–12.0  |
| Plasminogen activator inhibitor (U/ml) | —         | —         | 1.0–10.0  | 2.0–12.0               | 2.0–10.0               | 2.0–15.0               |
| a <sub>2</sub> -antiplasmin (U/ml)     | —         | —         | 0.93–1.17 | 0.89–1.10              | 0.78–1.18              | 4.4–8.5                |

mg/dl <sup>c</sup>

<sup>a</sup> Results are of antigenic assays (all other results are of functional assays).

<sup>b</sup> The adult fibrinolysis tests (i.e., tissue plasminogen activator and plasminogen activator inhibitor) are based on reference range values drawn between 7 to 9 a.m.

<sup>c</sup> Adult a<sub>2</sub>-antiplasmin values are listed in terms of mg/dl.

NOTE: Prothrombin time and partial thromboplastin time values are not shown because these values depend on reagent selection. Adult values represent those of the University of Utah Medical Center Hemostasis and Thrombosis Laboratory. Pediatric values are for healthy full-term infants taken from Andrew M, Vegh P, Johnston M, et al. Maturation of the hemostatic system during childhood. *Blood* 1992;80:1998; and Andrew M, Paes B, Johnston M. Development of the hemostatic system in the neonate and young infant. *Am J Pediatr Hematol Oncol* 1990;12:95.

From Kjeldsberg C, ed. *Practical diagnosis of hematologic disorders*, 3rd ed. Chicago: ASCP Press, 2000:910–911, with permission.

The PT may be prolonged but often is normal if vitamin K is administered to the infant or mother ( <sup>142</sup> ). Abnormalities of the thrombin time and the aPTT ( <sup>60</sup> ) are present in many normal neonates. These findings usually disappear within 2 to 6 months ( <sup>4</sup>, <sup>139</sup>, <sup>143</sup> ). These abnormalities and moderate deficiencies of the vitamin K-dependent factors (prothrombin; factors VII, IX, and X; and proteins C and S) are more pronounced in the premature than in the full-term infant, and in extent, they are inversely proportional to gestational age and birthweight. Tests for FDP and the euglobulin lysis time may be unreliable if carried out on cord blood ( <sup>144</sup> ). Plasma levels of fibrinogen and factor VIII increase slightly with increasing gestational age in thriving premature infants ( [Table 51.6](#) ) ( <sup>145</sup> ). Levels of factors VIII and V as well as antithrombin may be low in extremely

premature infants ( [146](#) ). Factor VIII levels and the ratio of vWF<sub>Ag</sub> to VIIIc are higher in term infants than in adults or older children.

Levels of factor V are normal in both neonates and thriving premature infants ( [142](#) , [145](#) , [147](#) ). Levels of antithrombin and other physiologic inhibitors of coagulation and of factor XIII are below adult norms in term neonates ( [148](#) ). Significant abnormalities of platelet aggregation and of the results of other platelet function tests may be seen in normal neonates ( [149](#) ). The newborn also is abnormally susceptible to drugs that impair platelet function, including those transferred placentally from the mother. The platelet count in term infants, as well as in thriving premature infants, is within the range found in adults and older children. [Table 51.6](#) summarizes coagulation reference ranges in newborns, children, and adults.

## REFERENCES

1. Wahlberg T, Blomback M, Hall P, Axelsson G. Application of indicators, predictors and diagnostic indices in coagulation disorders. *Methods Inf Med* 1980;19:194–200.
2. Wishart C. Oral surgery in the hemorrhagic states. *J Oral Surg* 1964;22:178–183.
3. Lorand L, Losowsky MS, Miloszewski KJM. Human factor XIII: fibrin–stabilizing factor. *Prog Hemost Thromb* 1980;5:245–290.
4. Oski FA, Naiman JL. Hematologic problems in the newborn. Philadelphia: WB Saunders, 1966.
5. Glader BE, Buchanan GR. The bleeding neonate. *Pediatrics* 1976;58:548–555.
6. Biggs R, MacFarlane RG. Haemophilia and related conditions: a survey of 187 cases. *Br J Haematol* 1958;4:1–27.
7. Biggs R. Human blood coagulation, haemostasis and thrombosis. Oxford: Blackwell Science, 1976.
8. Lind SE. Prolonged bleeding time. *Am J Med* 1984;77:305–312.
9. Day HJ, Rao AK. Evaluation of platelet function. *Semin Hematol* 1986;23:89–101.
10. Livio M, Gotti E, Marchesi D. Uraemic bleeding: role of anaemia and beneficial effect of red cell transfusions. *Lancet* 1982;2:1013–1015.
11. Weiss HJ, Rogers J. Fibrinogen and platelets in the primary arrest of bleeding. Study in two patients with congenital afibrinogenemia. *N Engl J Med* 1971;285:369–374.
12. Breederveld K, van Royen EA, ten Cate JW. Severe factor V deficiency with prolonged bleeding time. *Thromb Diath Haemorrh* 1974;32:538–548.
13. Evensen SA, Myhre L, Stormorken H. Haemostatic studies in osteogenesis imperfecta. *Scand J Haematol* 1984;33:177–179.
14. Rodgers RPC, Levin J. A critical reappraisal of the bleeding time. *Semin Thromb Hemost* 1990;16:1–144.
15. O’Laughlin JC, Hoftiezer JW, Mahoney JP, Ivey KJ. Does aspirin prolong bleeding from gastric biopsies in man? *Gastrointest Endosc* 1981;27:1–5.
16. Lind SE. The bleeding time does not predict surgical bleeding. *Blood* 1991;77:2547–2552.
17. Lehman CM, Blaylock RC, Alexander DP, Rodgers GM. Discontinuation of the bleeding time test

without detectable adverse clinical impact. *Clin Chem* 2001;47:1204–1211.

18. Peterson P, Hayes TE, Arkin CF, et al. The preoperative bleeding time test lacks clinical benefit. *Arch Surg* 1998;133:134–139.
19. Manthorpe R, Kofod B, Wiik A, et al. Pseudothrombocytopenia. *In vitro* studies on the underlying mechanism. *Scand J Haematol* 1981;26:385–392.
20. Onder O, Weinstein A, Hoyer LW. Pseudothrombocytopenia caused by platelet agglutinins that are reactive in blood anticoagulated with chelating agents. *Blood* 1980;56:177–182.
21. Lindsay RM, Koens F, Linton AL. An evaluation of the Coulter Thrombo-counter in counting platelets before and after contact with foreign surfaces and its use in tests of platelet retention. *J Lab Clin Med* 1975;86:863–872.
22. Kjeldsberg CR, Hershgold EJ. Spurious thrombocytopenia. *JAMA* 1974;227:628–630.
23. Nicholls PD. Erroneous platelet counts on the Coulter Model S Plus counter after correction for hyperlipaemia. *Med Lab Sci* 1983;40:69–71.
24. Payne BA, Pierre RV. Pseudothrombocytopenia: a laboratory artifact with potentially serious consequences. *Mayo Clin Proc* 1984;59:123–125.
25. Savage RA. Pseudoleukocytosis due to EDTA-induced platelet clumping. *Am J Clin Pathol* 1984;81:317–322.
26. Akwari AM, Ross DW, Stass SA. Spuriously elevated platelet counts due to microspherocytosis. *Am J Clin Pathol* 1982;77:220–221.
27. Armitage JO, Goeken JA, Feagler JR. Spurious elevation of platelet count in acute leukemia. *JAMA* 1978;239:433–434.
28. Morton BD, Orringer EP, LaHart L, Stass SA. Pappenheimer bodies. An additional cause for a spurious platelet count. *Am J Clin Pathol* 1980;74:310–311.
29. Trowbridge EA, Martin JF. The platelet volume distribution: a signature of the prethrombotic state in coronary artery disease? *Thromb Haemost* 1987;58:714–717.
30. Bessman JD, Gardner FH. Platelet size in thrombocytopenia due to sepsis. *Surg Gynecol Obstet* 1983;156:177–180.
31. Karpatkin S, Freedman ML. Hypersplenic thrombocytopenia differentiated from increased peripheral destruction by platelet volume. *Ann Intern Med* 1978;89:200–203.
32. Milton JG, Yung W, Frojmovic MM. Dependence of platelet volume measurements on heterogeneity of platelet morphology. *Biophys J* 1981;35:257–261.
33. Roper-Drewinko PR, Drewinko B, Corrigan G, et al. Standardization of platelet function tests. *Am J Hematol* 1981;11:183–203.
34. Feinman RD, Lubowsky J, Charo I, Zabinski MP. The lumi-aggregometer: a new instrument for simultaneous measurement of secretion and aggregation by platelets. *J Lab Clin Med* 1977;90:125–129.
35. Walsh PN, Mills DCB, White JG. Metabolism and function of human platelets washed by albumin density gradient separation. *Br J Haematol* 1977;36:281–296.
36. Challen A, Branch WJ, Cummings JH. Quantitation of platelet mass during aggregation in the electronic (Wellcome) whole-blood aggregometer. *J Pharmacol Methods* 1982;8:115–122.
37. Ingerman-Wojenski CM, Silver MJ. A quick method for screening platelet dysfunctions using the whole-blood lumi-aggregometer. *Thromb Haemost* 1984;51:154–156.
38. Miller JL. Platelet function testing: an improved approach utilizing lumi-aggregation and an interactive

- computer system. *Am J Clin Pathol* 1984;81:471-476.
39. Fratantoni JC, Poindexter BJ. Measuring platelet aggregation with microplate reader: a new technical approach to platelet aggregation studies. *Am J Clin Pathol* 1990;94:613-617.
  40. Hardisty RM, Hutton RA, Montgomery D, et al. Secondary platelet aggregation: a quantitative study. *Br J Haematol* 1970;19:307-319.
  41. Weiss HJ, Chervenick PA, Zalusky R, Factor A. A familial defect in platelet function associated with impaired release of adenosine diphosphate. *N Engl J Med* 1969;281:1264-1270.
  42. Niewiarowski S, Lowery CT, Hawiger J, et al. Immunoassay of human platelet factor 4 (PF4, antiheparin factor) by radial immunodiffusion. *J Lab Clin Med* 1976;87:720-733.
  43. Fareed J, Bick RL, Squillaci G, et al. Molecular markers of hemostatic disorders: implications in the diagnosis and therapeutic management of thrombotic and bleeding disorders. *Clin Chem* 1983;29:1641-1658.
  44. Hardisty RM, Dormandy KM, Hutton RA. Thrombasthenia: studies on three cases. *Br J Haematol* 1964;10:371-387.
  45. Harrison P. Progress in the assessment of platelet function. *Br J Haematol* 2000;111:733-744.
  46. Kundu SK, Heilmann EJ, Sio R, et al. Description of an *in vitro* platelet function analyzer-PFA-100. *Semin Thromb Hemost* 1995;21:106-112.
  47. Ortel TL, James AH, Thames EH, et al. Assessment of primary hemostasis by PFA-100 analysis in a tertiary care center. *Thromb Haemost* 2000;84:93-97.
  48. Jacobsson B, Nilsson IM. Catheter material and blood coagulation studies *in vitro*. *Scand J Haematol* 1969;6:386-394.
  49. Koepke JA, Rodgers JL, Ollivier MJ. Pre-instrumental variables in coagulation testing. *Am J Clin Pathol* 1975;64:591-596.
  50. Bell WN, Alton HG. A brain extract as a substitute for platelet suspensions in the thromboplastin generation test. *Nature* 1954;174:880-881.
  51. Goulian M, Beck WS. The partial thromboplastin time test. *Am J Clin Pathol* 1965;44:97-103.
  52. Nye SW, Graham JB, Brinkhous KM. The partial thromboplastin time as a screening test for the detection of latent bleeders. *Am J Med Sci* 1962;243:279-287.
  53. Martin BA, Branch DW, Rodgers GM. The preparation of a sensitive partial thromboplastin reagent from bovine brain. *Blood Coagul Fibrinolysis* 1992;3:287-294.
  54. Edson JR, Krivit W, White JG. Kaolin partial thromboplastin time: high levels of procoagulants producing short clotting times or masking deficiencies of other procoagulants or low concentrations of anticoagulants. *J Lab Clin Med* 1967;70:463-470.
  55. Proctor RR, Rapaport SI. The partial thromboplastin time with kaolin. *Am J Clin Pathol* 1961;36:212-219.
  56. Robbins JA, Rose SD. Partial thromboplastin time as a screening test. *Ann Intern Med* 1979;90:796-797.
  57. Margolis J. Initiation of blood coagulation by glass and related surfaces. *J Physiol (Lond)* 1957;137:95-109.
  58. Hattersley PG, Hayse D. The effect of increased contact activation time on the activated partial thromboplastin time. *Am J Clin Pathol* 1976;66:479-482.
  59. Andrew M, Karpatkin M. A simple screening test for evaluating prolonged partial thromboplastin times

in newborn infants. *J Pediatr* 1982;101:610–612.

60. Gallistl S, Muntean W, Leschnik B, Meyers W. Longer aPTT values in healthy children than in adults: no single cause. *Thromb Res* 1997;88:355–359.
61. Reddy NM, Hall SW, MacKintosh FR. Partial thromboplastin time. Prediction of adverse events and poor prognosis by low abnormal values. *Arch Intern Med* 1999;159:2706–2710.
62. Quick AJ. Determination of prothrombin. *Am J Med Sci* 1935;190:501–511; *Proc Soc Exp Biol Med* 1939;42:788–789; *Am J Clin Pathol* 1945;15:560–566.
63. Boekhout–Mussert MJ, vander Kolk–Schaap PJ, Hermans J, Loeliger EA. Prospective double–blind clinical trial of bovine, human, and rabbit thromboplastins in monitoring long–term oral anticoagulation. *Am J Clin Pathol* 1981;75:297–303.
64. Tripodi A, Chantarangkul V, Braga M, et al. Results of a multicentre study assessing the status of a recombinant thromboplastin. *Thromb Haemost* 1994;72:261–267.
65. Owren PA, Aas K. The control of dicumarol therapy and the quantitative determination of prothrombin and proconvertin. *Scand J Clin Lab Invest* 1951;3:201–208.
66. Biggs R, Douglas AS. The thromboplastin generation test. *J Clin Pathol* 1953;6:23–29.
67. Ellis BC, Stransky A. A quick and accurate method for the determination of fibrinogen in plasma. *J Lab Clin Med* 1961;58:477–488.
68. Ratnoff OD, Menzie C. A new method for the determination of fibrinogen in small samples of plasma. *J Lab Clin Med* 1951;37:316–320.
69. Feinberg JG. A new quantitative method for antigen–antibody titration in gels. *Nature* 1956;177:530–531.
70. Koepke JA. Standardization of fibrinogen assays. *Scand J Haematol Suppl* 1980;37:130–138.
71. Alving BM, Bell WR. Methods for correcting inhibitory effects of fibrinogen degradation products in fibrinogen determinations. *Thromb Res* 1976;9:1–8.
72. Saleem A, Krieg AF, Fretz K. Improved micromethod for plasma fibrinogen unaffected by heparin therapy. *Am J Clin Pathol* 1975;63:426–433.
73. Rodgers, GM, Garr SB. Comparison of functional and antigenic fibrinogen values from a normal population. *Thromb Res* 1992;68:207–210.
74. Jim RTS. A study of the plasma thrombin time. *J Lab Clin Med* 1957;50:45–60.
75. Marder VJ, Matchett MO, Sherry S. Detection of serum fibrinogen and fibrin degradation products. *Am J Med* 1971;51:71–82.
76. Leavelle DE, Mertens BF, Bowie EJW, Owen CA. Staphylococcal clumping on microtiter–plate; a rapid, simple method for measuring fibrinogen split products. *Am J Clin Pathol* 1971;55:452–457.
77. Marder VJ, Cruz GO, Schumer BR. Evaluation of a new anti–fibrinogen–coated latex particle agglutination test in the measurement of serum fibrin degradation products. *Thromb Haemost* 1977;37:183–191.
78. Thomas DP, Niewiarowski S, Myers AR, et al. A comparative study of four methods for detecting fibrinogen degradation products in patients with various diseases. *N Engl J Med* 1970;283:663–668.
79. Merskey C, Kleiner GJ, Johnson AJ. Quantitative estimation of split products of fibrinogen in human serum, relation to diagnosis and treatment. *Blood* 1966;28:1–18.
80. Rutstein JE, Holahan JR, Lyons RM, Pope RM. Rheumatoid factor interference with the latex



- agglutination test for fibrin degradation products. *J Lab Clin Med* 1978;92:529–535.
81. Edgington TS. Fibrinogen and fibrin degradation products: their differentiation. *Thromb Haemost* 1975;34:671–676.
  82. Greenberg CS, Devine DV, McCrae KM. Measurement of plasma fibrin D-dimer levels with the use of a monoclonal antibody coupled to latex beads. *Am J Clin Pathol* 1987;87:94–100.
  83. Breen FA, Tullis JL. Ethanol gelation: a rapid screening test for intravascular coagulation. *Ann Intern Med* 1968;69:1197–1206.
  84. von Kaulla E, von Kaulla KN. Detection of hypercoagulability states by a modified ethanol gelation test and its correlation with other coagulation procedures. *Am J Clin Pathol* 1974;61:810–822.
  85. Gurewich V, Hutchinson E. Detection of intravascular coagulation by a serial-dilution protamine sulfate test. *Ann Intern Med* 1971;75:895–902.
  86. Francis JL. The detection and measurement of factor XIII activity: a review. *Med Lab Sci* 1980;37:137–147.
  87. Lowe ML, Cannon DC. Improved method for euglobulin clot lysis time. *Clin Biochem* 1975;8:206–212.
  88. Boberg M, Killander A. Evaluation of euglobulin clot lysis time as a screening method for determination of blood plasma fibrinolytic activity after venous occlusion. *Acta Med Scand* 1983;213:309–311.
  89. Wu KK, Jacobsen CD, Hoak JC. Highly sensitive method for the assay of plasminogen. *J Lab Clin Med* 1973;81:484–488.
  90. Moroz LA, Gilmore NJ. A rapid and sensitive  $^{125}\text{I}$ -fibrin solid-phase fibrinolytic assay for plasmin. *Blood* 1975;46:543–553.
  91. Chandler WL, Schurer G, Stratton JR. Optimum conditions for the stabilization and measurement of tissue plasminogen activator in human plasma. *J Lab Clin Med* 1989;113:362–371.
  92. Angleton P, Chandler WL, Schmer G. Diurnal variation of tissue-type plasminogen activator and its rapid inhibitor (PAI-1). *Circulation* 1989;79:101–106.
  93. Chandler WL, Jascur ML, Henderson PJ. Measurement of different forms of tissue plasminogen activator in plasma. *Clin Chem* 2000;46:38–46.
  94. Astrup T, Mullertz S. The fibrin plate method for estimating fibrinolytic activity. *Arch Biochem Biophys* 1952;40:346–351.
  95. Rogers JS, Eyster ME. Relationship of factor VIII-like antigen (VIII AGN) and clot promoting activity (VIII AHF) as measured by one- and two-stage assays in patients with liver disease. *Br J Haematol* 1976;34:655–661.
  96. Ware AG, Seegers WH. Two-stage procedure for the quantitative determination of prothrombin concentration. *Am J Clin Pathol* 1949;19:471–482.
  97. Johnson JF, Seegers WH. Estimation of Ac-globulin activity by the two-stage method. In: Tocantins LM, ed. *The coagulation of blood, methods of study*. New York: Grune & Stratton, 1955:127–140.
  98. Essien EM, Ingram GIC. Diagnosis of haemophilia: use of an artificial factor VIII-deficient human plasma system. *J Clin Pathol* 1967;20:620–623.
  99. Stapp WF. The assay of factor IX. *Scand J Clin Lab Invest* 1965;17[Suppl 84]:109–118.
  100. Denson KW. The specific assay of Prower-Stuart factor and factor VII. *Acta Haematol (Basel)* 1961;25:105–120.
  101. Horowitz HI, Wilcox WP, Fujimoto MM. Assay of plasma thromboplastin antecedent (PTA) with

artificially depleted normal plasma. *Blood* 1963;22:35–43.

102. Rodgers GM. Bleeding disorders. In: Kjeldsberg C, Elenitoba–Johnson K, Foucar K, et al., eds. *Practical diagnosis of hematologic disorders*, 3rd ed. Chicago: ASCP Press, 2000:719–816.

103. Schleider MA, Nachman RL, Jaffe EA, Coleman M. A clinical study of the lupus anticoagulant. *Blood* 1976;48:499–509.

104. Rodgers GM, Chandler WL. Laboratory and clinical aspects of inherited thrombotic disorders. *Am J Hematol* 1992;41:113–122.

105. Holmes EW, Fareed J, Bermes EW. Automation of plasma antithrombin III assays. *Clin Chem* 1981;27:816–818.

106. Buller HR, ten Cate JW. Acquired antithrombin III deficiency: laboratory diagnosis, incidence, clinical implications, and treatment with antithrombin III concentrate. *Am J Med* 1989;87[Suppl 3B]:44S–48S.

107. Marler RA, Adcock DM. Clinical evaluation of protein C: a comparative review of antigenic and functional assays. *Hum Pathol* 1989;20:1040–1047.

108. Comp PC. Measurement of the natural anticoagulant protein S: how and when. *Am J Clin Pathol* 1990;94:242–243.

109. Edson JR, Vogt JM, Huesman DA. Laboratory diagnosis of inherited protein S deficiency. *Am J Clin Pathol* 1990;94:176–186.

110. Klee GG, Didisheim P, Johnson RJ, Giere GM. An evaluation of four automated coagulation instruments. *Am J Clin Pathol* 1978;70:646–654.

111. Sibley C, Singer JW. Comparison of the fibrometer system and the Bio/Data coagulation analyzer. *Am J Clin Pathol* 1972;57:369–372.

112. Fewell RG, Cundy A, Jenkins GC. The one stage prothrombin test: a comparative study of a mechanized prothrombinmeter and manual testing. *Med Lab Technol* 1972;29:147–154.

113. Siefring GE, Riabov DK, Wehrly JA. Development and analytical performance of a functional assay for fibrinogen on the Du Pont ACA analyzer. *Clin Chem* 1983;29:614–617.

114. Perry JF, Siefring GE, Reider MC, et al. Development and analytical performance of automated tests for antithrombin III and plasminogen on the Du Pont ACA analyzer. *Clin Chem* 1983;29:609–613.

115. Flanders MM, Crist R, Safapour S, Rodgers GM. Evaluation and performance characteristics of the STA-R coagulation analyzer. *Clin Chem* 2002;48:1622–1624.

116. de Nicola P. *Thromboelastography*. Springfield: Charles C Thomas, 1957.

117. Zuckerman L, Cohen E, Vagher JP, et al. Comparison of thromboelastography with common coagulation tests. *Thromb Haemost* 1981;46:752–756.

118. Olson JD, Arkin CF, Brandt JT, et al. Laboratory monitoring of unfractionated heparin therapy. *Arch Pathol Lab Med* 1998;122:782–798.

119. Tripodi A, Chantarangkul V, Mannucci PM. Near-patient testing devices to monitor oral anticoagulant therapy. *Br J Haematol* 2001;113:847–852.

120. Fareed J, Messmore HL, Bermes EW. New perspectives in coagulation testing. *Clin Chem* 1980;26:1380–1391.

121. Mattler LE, Bang NU. Serine protease specificity for peptide chromogenic substrates. *Thromb Haemost* 1977;38:776–792.

122. Friberger P. Chromogenic peptide substrates. Their use for the assay of factors in the fibrinolytic

and the plasma kallikrein-kinin systems. *Scand J Clin Lab Invest* 1982;42[Suppl 162]:3-98.

123. Huseby RM, Smith RE. Synthetic oligopeptide substrates: their diagnostic application in blood coagulation, fibrinolysis, and other pathologic states. *Semin Thromb Hemost* 1980;6:173-314.

124. Bergstrom K, Egberg N. Determination of vitamin K sensitive coagulation factors in plasma. *Thromb Res* 1978;12:531-547.

125. Kahle LH, Schipper HG, Jenkins CSP, ten Cate JW. Antithrombin III. I. Evaluation of an automated antithrombin III method. *Thromb Res* 1978;12:1003-1014.

126. Nieuwenhuizen W, Wijngaards G, Groeneveld E. Fluorogenic substrates for sensitive and differential estimation of urokinase and tissue plasminogen activator. *Haemostasis* 1978;7:146-149.

127. Klufft C. Determination of prekallikrein in human plasma: optimal conditions for activating prekallikrein. *J Lab Clin Med* 1978;91:83-95.

128. Friberger P, Knos M, Gustavsson S, et al. Methods for determination of plasmin, antiplasmin and plasminogen by means of substrate S-2251. *Haemostasis* 1978;7:138-145.

129. Fisher NC, Hinds-Aldrich N, Haddow JE, Hudson GA. A cellulose sandwich fluoroimmunoassay for factor VIII-related antigen. *Thromb Res* 1983;31:145-154.

130. Mitchell GA, Abdullahad CM, Ruiz JA, et al. Fluorogenic substrate assays for factors VIII and IX: introduction of a new solid phase fluorescent detection method. *Thromb Res* 1981;21:573-584.

131. Abildgaard CF, Suzuki Z, Harrison J, et al. Serial studies in von Willebrand disease: variability versus "variants." *Blood* 1980;56:712-716.

132. Campbell E, Sanal S, Mattson J, et al. Factor VII inhibitor. *Am J Med* 1980;68:962-964.

133. Ndimbie OK, Raman BKS, Saeed SM. Lupus anticoagulant associated with specific inhibition of factor VII in a patient with AIDS. *Am J Clin Pathol* 1989;91:491-493.

134. Colman RW, Robboy SJ, Minna JD. Disseminated intravascular coagulation: a reappraisal. *Annu Rev Med* 1979;30:359-374.

135. Bachman F. Diagnostic approach to mild bleeding disorders. *Semin Hematol* 1980;17:292-305.

136. Solum NO. Procoagulant expression in platelets and defects leading to clinical disorders. *Arterioscler Thromb Vasc Biol* 1999;19:2841-2846.

137. Rapaport SI. Preoperative hemostatic evaluation: which tests, if any? *Blood* 1983;61:229-231.

138. Buchanan GR. Coagulation disorders in the neonate. *Pediatr Clin North Am* 1986;33:203-220.

139. Buchanan GR. Neonatal coagulation: normal physiology and pathophysiology. *Clin Haematol* 1978;7:85-109.

140. Margolis J. Some experiences with a simplified micromethod for coagulation studies. *Br J Haematol* 1961;7:21-35.

141. Barnard DR. Inherited bleeding disorders in the newborn infant. *Clin Peri-natol* 1984;11:309-337.

142. Aballi AM, de Lamerens S. Coagulation changes in the neonatal period and in early infancy. *Pediatr Clin North Am* 1962;9:785-817.

143. Hathaway WE, Bonnar J. In: Oliver TK, ed. Perinatal coagulation. New York: Grune & Stratton, 1978.

144. Stiehm ER, Clatanoff DV. Split products of fibrin in the serum of newborns. *Pediatrics* 1969;43:770-774.

145. Sell EJ, Corrigan JJ. Platelet counts, fibrinogen concentrations, and factor V and factor VIII levels in healthy infants according to gestational age. *J Pediatr* 1973;82:1028-1032.
146. Barnard DR, Simmons MA, Hathaway WE. Coagulation studies in extremely premature infants. *Pediatr Res* 1979;13:1330-1335.
147. Holmberg L, Henriksson P, Ekelund H, Astedt B. Coagulation in the human fetus. Comparison with term newborn infants. *J Pediatr* 1974;85:860-864.
148. Mahasandana C, Hathaway WE. Circulating anticoagulants in the newborn: relation to hypercoagulability and the idiopathic respiratory distress syndrome. *Pediatr Res* 1973;7:670-673.
149. Mull MM, Hathaway WE. Altered platelet function in newborns. *Pediatr Res* 1970;4:229-237.

2004 Lippincott Williams & Wilkins  
John P. Greer, John Foerster, John N. Lukens  
George M. Rodgers, Frixos Paraskevas, Bertil Glader  
Wintrobe's Clinical Hematology

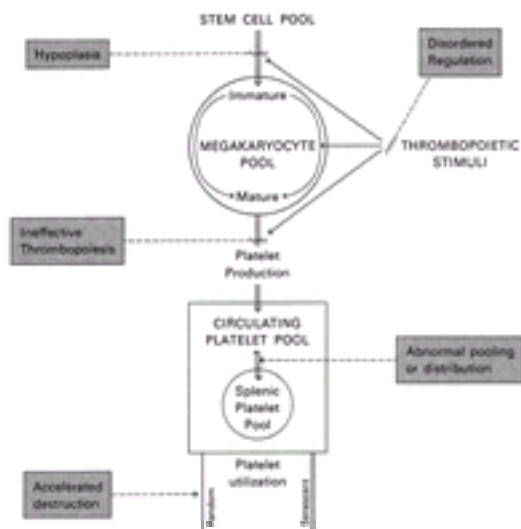
## Thrombocytopenia: Pathophysiology and Classification

[PATHOPHYSIOLOGY](#)  
[ARTIFACTUAL THROMBOCYTOPENIA](#)  
[ACCELERATED PLATELET DESTRUCTION](#)  
[DEFICIENT PLATELET PRODUCTION](#)  
[ABNORMAL POOLING](#)  
[CLASSIFICATION](#)  
[REFERENCES](#)

Purpura in association with pestilential fevers was described by Hippocrates and later writers, but it was not until the sixteenth century (Lusitanus) and the early part of the seventeenth century (La Riviere) that purpura in the absence of fever was recognized (<sup>1</sup>). In 1735, Werlhof distinguished *morbus maculosus hemorrhagicus* as a separate entity, and in 1808, Willan classified purpura under the headings *simplex*, *haemorrhagica*, *urticans*, and *contagiosa*, thus separating the types later described by Schönlein (1829) and Hensch (1868) that now bear their names. The marked diminution in “hematoblasts” (platelets) in purpura hemorrhagica was recognized by Krauss (1883) and Denys (1887). Hayem (1895) noted the nonretractility of the blood clot, and Duke (1912) demonstrated the prolonged bleeding time. Abnormal capillary fragility was observed by writers in different countries (*le signe du lacet*, Grocco–Frugoni sign, and the Rumpel–Leede phenomenon).

### PATHOPHYSIOLOGY

*Thrombocytopenia* may be defined as a subnormal number of platelets in the circulating blood. It is the most common cause of abnormal bleeding. The pathophysiology of thrombocytopenia is similar to that of anemia, but the latter is better understood. Thus, despite the number and diversity of disorders that may be associated etiologically, thrombocytopenia results from only four processes: artifactual thrombocytopenia, deficient platelet production, accelerated platelet destruction, and abnormal distribution or pooling of the platelets within the body ([Fig. 52.1](#)). The changes in the basic parameters of thrombopoiesis that are characteristic of each of these processes are summarized in [Table 52.1](#).



**Figure 52.1.** The pathophysiology of thrombocytopenia. A simplified diagram of the biodynamics of the megakaryocyte–platelet system (*solid lines*) and the mechanisms (*dashed lines*) by which pathologic processes (*shaded blocks*) produce thrombocytopenia.

**TABLE 52.1. ThrombokinetiC Patterns in Various Forms of Thrombocytopenia**

| Measurement  | Decreased Production                         |   |                                      |                  |
|--|--|---|--------------------------------------|------------------|
|  | Hypoproliferation or Hypoplasia <sup>a</sup> | Ineffective Thrombopoiesis <sup>b</sup> | Accelerated Destruction <sup>c</sup> | Abnormal Pooling |
| Total megakaryocyte mass <sup>d</sup>                  | Decreased                                    | Increased                               | M increased                          | V increased      |
| Megakaryocyte number                                   | Decreased                                    | M increased                             | Increased                            | V increased      |
| Megakaryocyte volume                                   | Increased                                    | Normal or V decreased                   | Increased                            | V increased      |
| Platelet turnover rate or production rate <sup>e</sup> | Decreased                                    | Decreased                               | Increased                            | V increased      |
| Total platelet mass                                    | Decreased                                    | Decreased                               | Decreased                            | ? Normal         |
| Splenic platelet pool                                  | Decreased                                    | Decreased                               | Decreased <sup>f</sup>               | Increased        |
| Platelet survival                                      | Normal                                       | V shortened                             | Shortened                            | V shortened      |

M, markedly; V, variably.

<sup>a</sup> Includes myelophthiC processes.

<sup>b</sup> Mainly in megaloblastic hematopoiesis; component of accelerated destruction present in some cases.

<sup>c</sup> Minor component of ineffective thrombopoiesis present in some cases.

<sup>d</sup> Equated to total thrombopoiesis.

<sup>e</sup> Equated to effective thrombopoiesis.

<sup>f</sup> Not representative of sequestered antibody–sensitized platelets.

Based on references [10](#), [12](#), [17](#), and [18](#).

## ARTIFACTUAL THROMBOCYTOPENIA

*Artifactual thrombocytopenia*, or falsely low platelet counts, occurs *ex vivo* when platelets are not counted accurately. This mechanism should be considered in patients who have thrombocytopenia but no petechiae or ecchymoses. Although inaccurate counting may occur in the presence of giant platelets ( [2](#) ) or with platelet satellitism ( [3](#), [4](#) ), the most common cause of artifactual thrombocytopenia is platelet clumping (pseudothrombocytopenia) ( [5](#) ). Platelet clumping in pseudothrombocytopenia appears to be caused by anticoagulant-dependent platelet agglutinins that are immunoglobulins (Igs) of IgG, IgA, or IgM subtypes. Although clumping is most commonly seen when blood is collected into ethylenediaminetetraacetic acid anticoagulant, other anticoagulants may cause clumping, even hirudin or Phe-Pro-Arg chloromethyl ketone ( [6](#) ). Platelet clumping is also time dependent and varies with the type of instrumentation used for automatic counting ( [6](#) ). There is evidence that the autoantibodies bind to glycoprotein IIb/IIIa ( [7](#) ), and in one study, there was over 80% concordance between the presence of anticardiolipin antibody and platelet agglutinins in individual patient plasmas ( [8](#) ). These autoantibodies have no known associations with disease or drugs and have been noted in some patients for over 10 years ( [9](#) ).

## ACCELERATED PLATELET DESTRUCTION

Accelerated platelet destruction is the most common cause of thrombocytopenia. It leads to stimulation of thrombopoiesis and, consequently, to an increase in the number, size, and rate of maturation of the precursor megakaryocytes ( [Fig. 52.1](#) ) ( [10](#) ). When the rate of platelet destruction exceeds this compensatory increase in platelet production, thrombocytopenia develops. “Compensated” platelet destruction without thrombocytopenia also may occur in patients with prosthetic heart valves and in patients with idiopathic thrombocytopenic purpura after splenectomy ( [11](#), [12](#), [13](#), [14](#), [15](#), [16](#) and [17](#) ).

Platelet destruction may result from both intracorporeal defects and extracorporeal abnormalities. Intracorporeal defects are rare but have been demonstrated in certain forms of hereditary thrombocytopenia, such as Wiskott-Aldrich syndrome (see [Chapter 55](#) ) ( [18](#) ). In such disorders, the survival of affected platelets is shortened in the circulation of both the patient and normal recipients. Platelets injured by either intracorporeal or extracorporeal processes usually are removed from the circulation by the spleen, liver, and reticuloendothelial system. Platelet destruction most often is the result of extracorporeal factors; various immunologic phenomena are the most common. Immunologic platelet destruction is discussed in [Chapter 53](#).

Platelet consumption in intravascular thrombi or on damaged endothelial surfaces is another cause of thrombocytopenia. This occurs in disseminated intravascular coagulation (see [Chapter 60](#) ) and in thrombotic thrombocytopenic purpura (see [Chapter 54](#) ) and other microangiopathic processes. Thrombocytopenia caused by such nonimmunologic platelet destruction is discussed in [Chapter 55](#).

## DEFICIENT PLATELET PRODUCTION

Deficient platelet production may result from any of a number of processes. Those that depopulate the stem cell or megakaryocyte compartments are the most common, such



as marrow injury by myelosuppressive drugs or irradiation and aplastic anemia. Deficient platelet production also may be the consequence of disordered proliferation within a precursor compartment of normal or even increased size. For example, in disorders characterized by megaloblastic hematopoiesis, hypertrophy of the precursor compartment occurs in response to thrombopoietic stimuli, but thrombopoiesis is ineffective, and platelet production is insufficient. Rarely, abnormalities of the processes that normally regulate thrombocytopoiesis appear to underlie deficient platelet production, such as deficiency of thrombopoietin and cyclic thrombocytopenia.

## ABNORMAL POOLING

Abnormal pooling or abnormal *in vivo* distribution of an essentially normal total platelet mass may produce thrombocytopenia. This type of thrombocytopenia is seen in the various disorders associated with splenomegaly (see [Chapter 55](#)), in which platelet production is normal or even increased, but most of the platelets are sequestered in the vastly enlarged extravascular splenic pool. Thrombocytopenia may also be caused by dilution of platelets when patients are massively transfused during blood loss. A discussion of various forms of thrombo-cytopenia attributable to deficient or ineffective thrombopoiesis or abnormal platelet pooling is included in [Chapter 55](#).

## CLASSIFICATION

A classification of thrombocytopenia based on pathophysiologic criteria is presented in [Table 52.2](#). Such a classification must be regarded as tentative because current methods for studying thrombopoiesis are crude, and in many disorders, multiple pathogenetic factors may simultaneously or sequentially play a role in the production of thrombocytopenia. The discussion and various tables included in [Chapter 53](#), [Chapter 54](#), and [Chapter 55](#) are based on the most suitable nosologic features of both the etiologic and the pathophysiologic classifications because neither alone is entirely satisfactory.

**TABLE 52.2. Pathophysiologic Classification of Thrombocytopenia**

---

|  |
|--|
| Artifactual thrombocytopenia   |
| Platelet clumping caused by anticoagulant-dependent immunoglobulin (pseudothrombocytopenia)                        |
| Platelet satellitism   |
| Giant platelets  |
| Decreased platelet production (see <a href="#">Chapter 55</a> )  |
| Hypoplasia of megakaryocytes   |
| Ineffective thrombopoiesis   |
| Disorders of thrombopoietic control  |
| Hereditary thrombocytopenias   |
| Increased platelet destruction   |
| Caused by immunologic processes (see <a href="#">Chapter 54</a> )  |
| Autoimmune   |
| Idiopathic   |
| Secondary: infections, pregnancy, collagen vascular disorders, lymphoproliferative disorders, drugs, miscellaneous |
| Alloimmune   |
| Neonatal thrombocytopenia  |
| Posttransfusion purpura  |

Caused by nonimmunologic processes

Thrombotic microangiopathies

Disseminated intravascular coagulation (see [Chapter 60](#))

Thrombotic thrombocytopenic purpura (see [Chapter 54](#))

Hemolytic-uremic syndrome (see [Chapter 38](#))

Platelet damage by abnormal vascular surfaces (see [Chapter 55](#))

Miscellaneous (see [Chapter 55](#))

Infection

Massive blood transfusions

Abnormal platelet distribution or pooling (see [Chapter 55](#))

Disorders of the spleen (neoplastic, congestive, infiltrative, infectious, of unknown cause)

Hypothermia

Dilution of platelets with massive transfusions

---

Methods for the measurement of serum thrombopoietin concentrations or reticulated platelets have been recently established. These new techniques may both elucidate the pathophysiology of thrombocytopenia in various disease states and determine the mechanism of thrombocytopenia in individual patients. Serum thrombopoietin concentrations are elevated in patients with deficient platelet production and normal in patients with accelerated destruction, suggesting that thrombopoietin production correlates with megakaryocyte mass ([19](#), [20](#)). Reticulated platelets can be identified with fluorescent dyes that bind to nucleic acids, especially RNA. Measurement of the percentage of reticulated platelets identifies platelets that have recently been released from the bone marrow. There is an increased percentage of reticulated platelets in patients with thrombocytopenia caused by increased destruction and a normal to reduced percentage of reticulated platelets in patients with deficient production ([21](#), [22](#)). The sensitivity and specificity of this method of distinguishing between these categories are reported to be more than 95% ([23](#), [24](#)).

## REFERENCES

1. Jones HW, Tocantins LM. The history of purpura hemorrhagica. *Ann Med Hist* 1933;5:349-359.
2. Kjeldsberg CR, Hershgold EJ. Spurious thrombocytopenia. *JAMA* 1974;227:628-630.
3. Greipp PR, Gralnick HR. Platelet to leukocyte adherence phenomena associated with thrombocytopenia. *Blood* 1976;47:513-521.
4. Bizzaro N. Platelet satellitosis to polymorphonuclears: cytochemical, immunological, and ultrastructural characterization of eight cases. *Am J Hematol* 1991;36:235-242.
5. Gowland E, Kay HE, Spillman JC, Williamson JR. Agglutination of platelets by a serum factor in the presence of EDTA. *J Clin Pathol* 1969;22:460-464.
6. Schrezenmeier H, Müller H, Gunsilius E, et al. Anticoagulant-induced pseudothrombocytopenia and pseudoleukocytosis. *Thromb Haemost* 1995;73:506-513.
7. Pegels JG, Bruynes EC, Engelfriet CP, von dem Borne AE. Pseudothrombocytopenia: an immunologic study on platelet antibodies dependent on ethylene diamine tetra-acetate. *Blood* 1982;59:157-161.
8. Bizzaro N, Brandalise M. EDTA-dependent pseudothrombocytopenia: association with antiplatelet and

antiphospholipid antibodies. *Am J Clin Pathol* 1995;103:103–107.

9. Bizzaro N. EDTA-dependent pseudothrombocytopenia: a clinical and epidemiologic study of 112 cases, with 10-year follow-up. *Am J Hematol* 1995;50:103–109.

10. Harker LA. Megakaryocyte quantitation. *J Clin Invest* 1968;47:452–457.

11. Hess AF. The blood and the blood vessels in hemophilia and other hemorrhagic diseases. *Arch Intern Med* 1916;17:203–220.

12. Harker LA. Thrombokinetiks in idiopathic thrombocytopenic purpura. *Br J Haematol* 1970;19:95–104.

13. Branehög I, Kutti J, Weinfeld A. Platelet survival and platelet production in idiopathic thrombocytopenic purpura (ITP). *Br J Haematol* 1974;27:127–143.

14. Branehög I. Platelet kinetics in idiopathic thrombocytopenic purpura (ITP) before and at different times after splenectomy. *Br J Haematol* 1975;29:413–426.

15. Branehög I, Weinfeld A. Platelet survival and platelet production in idiopathic thrombocytopenic purpura before and during treatment with corticosteroids. *Scand J Haematol* 1974;12:69–79.

16. Hope AF, Heyns ADP, Lötter MG, et al. Kinetics and sites of sequestration of indium 111-labeled human platelets during cardiopulmonary bypass. *J Thorac Cardiovasc Surg* 1981;81:880–886.

17. Tomer A, Hanson SR, Harker LA. Autologous platelet kinetics in patients with severe thrombocytopenia: discrimination between disorders of production and destruction. *J Lab Clin Med* 1991;118:546–554.

18. Harker LA, Finch CA. Thrombokinetiks in man. *J Clin Invest* 1969;48:963–974.

19. Emmons RV, Reid DM, Cohen RL, et al. Human thrombopoietin levels are high when thrombocytopenia is due to megakaryocyte deficiency and low when due to increased platelet destruction. *Blood* 1996;87:4068–4071.

20. Kunishima S, Tahara T, Kato T, et al. Serum thrombopoietin and plasma glycofibrinogen concentrations as useful diagnostic markers in thrombocytopenic disorders. *Eur J Haematol* 1996;57:68–71.

21. Rinder HM, Munz UJ, Ault KA, et al. Reticulated platelets in the evaluation of thrombocytopenic disorders. *Arch Pathol Lab Med* 1993;117:606–610.

22. Watanabe K, Takeuchi K, Kawai Y, et al. Automated measurement of reticulated platelets in estimating thrombopoiesis. *Eur J Haematol* 1995;54:163–171.

23. Kienast J, Schmitz G. Flow cytometric analysis of thiazole orange uptake by platelets: a diagnostic aid in the evaluation of thrombocytopenic disorders. *Blood* 1990;75:116–121.

24. Richards EM, Baglin TP. Quantitation of reticulated platelets: methodology and clinical application. *Br J Haematol* 1995;91:445–451.

2004 Lippincott Williams & Wilkins  
John P. Greer, John Foerster, John N. Lukens  
George M. Rodgers, Frixos Paraskevas, Bertil Glader  
Wintrobe's Clinical Hematology

## Thrombocytopenia Caused by Immunologic Platelet Destruction

### IDIOPATHIC AUTOIMMUNE THROMBOCYTOPENIC PURPURA

#### Incidence

#### Pathophysiology

#### Clinical Picture

#### Bleeding Manifestations

#### Laboratory Findings

#### Differential Diagnosis

#### Treatment of Idiopathic Thrombocytopenic Purpura

### SECONDARY AUTOIMMUNE THROMBOCYTOPENIC PURPURA

#### Autoimmune Thrombocytopenic Purpura Secondary to Drugs

#### Autoimmune Thrombocytopenia in Systemic Lupus Erythematosus

#### Idiopathic Thrombocytopenic Purpura in Other Disorders

### ALLOIMMUNE THROMBOCYTOPENIA

#### Neonatal Alloimmune Thrombocytopenia

#### Posttransfusion Purpura

### REFERENCES

Autoimmune thrombocytopenic purpura is believed to occur when platelets undergo premature destruction as a result of autoantibody or immune complex deposition on their membranes. The site of destruction is usually the reticuloendothelial system of the spleen and, less commonly, the liver. In many instances, the underlying disorder responsible for the formation of platelet antibodies or immune complexes is known. This is commonly called *secondary autoimmune thrombocytopenia*. In other instances, there are no known etiologic factors, and the disorder is called *idiopathic thrombocytopenic purpura* (ITP) (Table 53.1).

**TABLE 53.1. Autoimmune Thrombocytopenic Purpura**

|                               |
|-------------------------------|
| Idiopathic (primary)          |
| Secondary                     |
| Infections                    |
| Collagen vascular diseases    |
| Lymphoproliferative disorders |
| Solid tumors                  |
| Drugs                         |
| Miscellaneous                 |

In this chapter, both idiopathic and secondary types of immune thrombocytopenia are discussed. Human immunodeficiency virus–related autoimmune thrombocytopenia, which is also in major part due to the deposition of autoantibody or immune complexes, or both,

on the platelet surface, is discussed in [Chapter 69](#).

The diagnosis of autoimmune thrombocytopenic purpura is primarily a diagnosis by exclusion because currently available clinical assays for platelet-associated antibodies or serum antiplatelet antibodies/immune complexes are neither specific nor sensitive enough for routine clinical use. These disorders are characterized by peripheral thrombocytopenia (confirmed by examination of the peripheral smear), with a normal number of megakaryocytes present on bone marrow examination, and absence of significant splenomegaly. Those patients who have no identifiable underlying cause, which might include infections, collagen vascular diseases, lymphoproliferative disorders (chronic lymphocytic leukemia or lymphoma), or drugs, are diagnosed as idiopathic (i.e., ITP). In some instances, the ITP may be the presenting manifestation of an underlying disease, and additional manifestations appear weeks to months later. Idiopathic and secondary thrombocytopenic purpuras are discussed separately in this chapter.

## IDIOPATHIC AUTOIMMUNE THROMBOCYTOPENIC PURPURA

The term *idiopathic thrombocytopenic purpura* usually refers to thrombocytopenia in which apparent exogenous etiologic factors are lacking and in which diseases known to be associated with secondary thrombocytopenia have been excluded. This syndrome has been reviewed in detail ([1](#), [2](#), [3](#), [4](#), [5](#), [6](#) and [7](#)).

Acute ITP and chronic ITP differ in incidence, prognosis, and therapy ([Table 53.2](#)). These differences may illustrate merely the wide spectrum of disorders that by definition are included in the syndrome, but many clinicians have long believed that acute ITP and chronic ITP are fundamentally different disorders.

**TABLE 53.2. Features of Acute and Chronic Idiopathic Thrombocytopenic Purpura (ITP)**

| Feature                        | Acute ITP               | Chronic ITP            |
|--------------------------------|-------------------------|------------------------|
| Peak age of incidence          | Children, 2–6 yr        | Adults, 20–40 yr       |
| Sex predilection               | None                    | 3:1 female to male     |
| Antecedent infection           | Common 1–3 wk before    | Unusual                |
| Onset of bleeding              | Abrupt                  | Insidious              |
| Hemorrhagic bullae in mouth    | Present in severe cases | Usually absent         |
| Platelet count                 | <20,000/ $\mu$ l        | 30,000–80,000/ $\mu$ l |
| Eosinophilia and lymphocytosis | Common                  | Rare                   |
| Duration                       | 2–6 wk; rarely longer   | Months or years        |
| Spontaneous remissions         | Occur in 80% of cases   | Uncommon               |

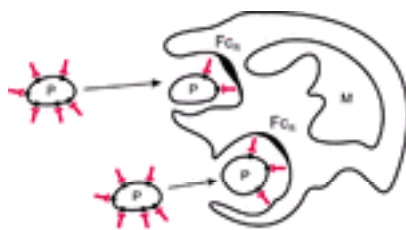
### Incidence

*Acute ITP*, defined as thrombocytopenia occurring for less than 6 months and usually resolving spontaneously, most often affects children and young adults. The incidence peaks in the winter and spring, following the incidence of viral infections ([8](#), [9](#)). Acute ITP is most common between 2 and 6 years of age. Approximately 7 to 28% of children with acute ITP develop the chronic variety ([9](#), [10](#) and [11](#)). Chronic ITP, lasting more than 6 months and requiring therapy to improve the thrombocytopenia, occurs most commonly in

adults. In the oldest reported series in the literature, in which both acute and chronic ITP cases were reviewed, 67% of 271 patients and 45% of 737 patients were younger than 21 years of age and 15 years of age, respectively ( [12](#), [13](#) and [14](#)). In chronic ITP in adults, the median age is usually 40 to 45 years ( [15](#), [16](#)), although in one large series of patients, 74% of 934 cases were younger than age 40 (range, 16 to 87 years of age) ( [17](#)). The ratio of females to males is nearly 1:1 in acute ITP ( [9](#), [10](#) and [11](#), [18](#)) and 2 to 3:1 in chronic ITP ( [16](#), [17](#)).


## Pathophysiology

Evidence is now convincing that the syndrome of ITP is caused by platelet-specific autoantibodies that bind to autologous platelets, which are then rapidly cleared from the circulation by the mononuclear phagocyte system via macrophage Fc receptors ( [19](#)) ( [Fig. 53.1](#)). The ITP antibody does not fix complement *in vitro* when tested by the usual techniques, but activation of components of complement on the platelet surface may be demonstrated ( [20](#), [21](#), [22](#), [23](#), [24](#), [25](#), [26](#) and [27](#)). Immune complexes have been detected in patients with chronic ITP, but their role in immune platelet destruction remains controversial ( [28](#), [29](#), [30](#), [31](#) and [32](#)). The concomitant role of the antibody binding to the same antigens on megakaryocytes and the resultant effect of this binding on platelet production are still unknown.



**Figure 53.1.** Antiplatelet-antibody-induced destruction of platelets (P) in chronic idiopathic thrombocytopenic purpura. Immunoglobulin G antibody binds to platelet-associated antigen resulting in phagocytosis by macrophages (M). Antiplatelet antibody-coated platelets bind to macrophages through macrophage Fc receptors (Fc<sub>R</sub>). \*, platelet membrane antigen; P, platelet autoantibody. (Modified from McMillan R. Chronic idiopathic thrombocytopenic purpura. *Blood* 1982;60:1050-1053.)

**Figure 53.1.** Antiplatelet-antibody-induced destruction of platelets (P) in chronic idiopathic thrombocytopenic purpura. Immunoglobulin G antibody binds to platelet-associated antigen resulting in phagocytosis by macrophages (M). Antiplatelet antibody-coated platelets bind to macrophages through macrophage Fc receptors (Fc<sub>R</sub>).

\*, platelet membrane antigen; , platelet autoantibody. (Modified from McMillan R. Chronic idiopathic thrombocytopenic purpura. *Blood* 1982;60:1050-1053.)

**PLATELET ANTIBODIES** In 1951, Harrington and colleagues first reported that the infusion of plasma from patients with ITP predictably induced thrombocytopenia in normal recipients ( [33](#)). Shulman and colleagues then demonstrated that the responsible factor was an immunoglobulin (Ig) of the IgG class that was species-specific and could be removed from serum by absorption with normal human platelets and subsequently eluted therefrom ( [34](#)). In addition, the platelet-depressing factor produced effects *in vivo* that were quantitatively and qualitatively similar to those produced by known platelet antibodies. In 1982, van Leeuwen first identified platelet membrane glycoprotein IIb/IIIa (CD41) as a dominant antigen by demonstrating that the autoantibodies eluted from ITP patients' platelets bound to normal platelets but not platelets from patients with Glanzmann's thrombasthenia ( [35](#)). Increased quantities of IgG have been demonstrated on

the platelet surface, and the rate of platelet destruction in ITP is proportional to levels of such platelet-associated Ig ( 36, 37 ). Autoantibodies are readily found in plasma or platelet eluate in patients with active disease but are infrequently found in patients in remission ( 38, 39 ). Disappearance of the antibodies correlates with the appearance of normal platelet counts ( 38 ). The antiplatelet antibodies and platelet antigens involved in ITP have been extensively studied ( Table 53.3 ) and several types of sensitive assays now permit the identification of the antigen for both plasma and platelet-associated autoantibody ( 39, 40 and 41 ). Platelet-associated autoantibodies have been detected in 75% of patients ( 41, 42 ). Serum antiplatelet IgG autoantibodies are detected in approximately 50 to 85% of patients. IgA serum antiplatelet antibodies appear to be as frequent as IgG, and in approximately 50% of cases, both Ig subtypes occur in the same patient. IgM antibodies are also detected in a small number of patients—but never as the sole autoantibody present ( 43 ). In one study, the presence of IgM antibodies had the strongest correlation with the platelet count ( 44 ). There is also evidence of light chain restriction of these autoantibodies that suggests clonal B-cell expansion in patients with chronic ITP ( 45, 46, 47 and 48 ).

**TABLE 53.3. Characteristics of Platelet Autoantibodies in Idiopathic Thrombocytopenic Purpura**

|                                 |   | Comments   |
|---------------------------------|---|--|
| Ig subtype                      | IgG, IgA, IgM   | IgG and IgA have equal frequency<br>IgM <sup>a</sup>   |
| Antigen specificity             | gpIIb/IIIa, Ib/IX<br>gpIa/IIa, IV<br>Granule membrane protein-140<br>Glycosphingolipid<br>Cardiolipin | Most common antigens<br>Never only antigen if positive<br>One patient reported<br>Rare; ?pathogenetic importance<br>Common; ?pathogenetic importance |
| Presence of antibody            |   |  |
| Plasma                          | 85% of patients   |  |
| Platelet eluate                 | 75% of patients   |  |
| Complement fixation by antibody | Rare  | Unresolved importance  |
| Circulating immune complexes    | Rare  | Unresolved importance  |

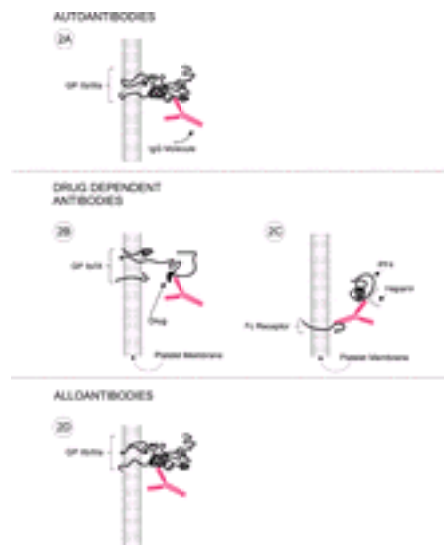
gp, glycoprotein; Ig, immunoglobulin.

<sup>a</sup> IgM is never present as the only antiplatelet Ig in an individual patient.

Antiplatelet autoantibodies bind to many of the major platelet membrane glycoproteins through the Fab portion of the molecule ( 49, 50 ) ( Fig. 53.2 ). Platelet gpIIb/IIIa was the first platelet antigen detected, but microtiter assays using platelet monoclonal antibodies to gpIb and gpIIb/IIIa demonstrated that platelet autoantibodies bound to both major platelet membrane glycoproteins ( 51, 52 and 53 ). gpIIb/IIIa and gpIb/IX are found to be the major platelet antigens with almost equal frequency; however, some autoantibodies also react with gpIV and Ia/IIa, although the plasma from these patients usually also contains autoantibodies reacting with one of the other two major platelet membrane antigens ( 54 ).



Only one patient has been reported who had serum autoantibodies that reacted with granule membrane protein-140 (P-selectin; CD42) in addition to gpIIb/IIIa ( [55](#) ). Serum antibodies to  $\alpha_v\beta_3$  have been detected as well, but their clinical significance is unknown ( [56](#) ).



**Figure 53.2.** The serologic investigation of patients with antibody-mediated platelet destruction. **A:** Platelet autoantibodies bind to variable external and internal platelet epitopes. **B:** Quinine/quinidine-dependent antibodies. The antibody target is a complex of drug and glycoprotein (GP) (usually GPIb/IX or GPIIb/IIIa). **C:** Heparin-dependent antibodies. The antigen-antibody complex [target: platelet factor 4 (PF4)/heparin] activates platelets by the binding of immunoglobulin G (IgG) to Fc $\gamma$ RII. **D:** Platelet alloantibodies bind to platelet tertiary conformational epitopes on the platelet membrane. (Modified from Kelton JG. The serologic investigation of patients with autoimmune thrombocytopenia. *Thromb Haemost* 1995;74:228-233.)

The incidence of serum autoantibodies to platelet gpIIb/IIIa is the same in the acute and chronic forms of childhood ITP (68% vs. 62%, respectively) ( [57](#) ). The presence of anti-gpIIb/IIIa, therefore, does not predict which children will develop the chronic form of the disease, and, in fact, these data provide the first evidence that the mechanism may be the same in both acute and chronic forms of ITP. The platelet membrane glycoproteins have a variety of antigenic epitopes that are recognized by the autoantibodies. There is considerable evidence that serum autoantibodies can react with IIb or IIIa or the intact IIb/IIIa complex ( [53](#), [58](#), [59](#), [60](#), [61](#), [62](#), [63](#), [64](#), [65](#), [66](#), [67](#) and [68](#) ). Platelet autoantibody binding to gpIb ( [27](#) ) and gp1ba ( [54](#) ) has been reported, but data indicate that the majority of Ib/IX autoantibodies are directed to the complex ( [69](#) ). Plasma autoantibodies and autoantibodies eluted from platelets in the same patient may have slight differences in antigen specificities within a membrane gp complex ( [62](#) ). The importance of the specific antigen epitopes on the course of the disease is controversial ( [23](#), [62](#), [69](#) ). Antibodies in ITP sera have also been demonstrated to bind to glycosphingolipids ( [70](#), [71](#) ) and cardiolipin ( [72](#), [73](#), [74](#) and [75](#) ). Although antiphospholipids were identified by lupus anticoagulant activity or anticardiolipin specificity in 46 and 38% of ITP patients at diagnosis, there was little clinical evidence that they played a role in the pathogenesis of the disease or affected outcome ( [76](#), [77](#) ). These autoantibodies bind to platelets and cause thrombocytopenia primarily by shortening platelet survival. However, rare autoantibodies have also been reported that bind to these glycoproteins and activate platelets ( [78](#), [79](#), [80](#), [81](#) and [82](#) ). Additionally, one patient with an anti-gpIIIa antibody is reported to have developed an antibody-related defect in aggregation and adhesion ( [83](#) ).

The role of cell-mediated immunity in ITP remains uncertain, although data from patients with ITP suggest that T lymphocytes demonstrate phenotypic and functional abnormalities. Platelet reactive T-cell clones can be identified from the peripheral blood of adults and peripheral blood and spleens of children with chronic ITP, suggesting that autoreactive peripheral T lymphocytes may mediate or participate in the pathophysiology of this immune disorder ( [66](#), [84](#), [85](#) ). T lymphocytes from patients with ITP also demonstrate a defect in T-cell function that is not due to a serum suppressor factor, abnormal production of interleukin-2, or changes in the interleukin-2 receptor ( [86](#) ). These patients have increased numbers of CD8<sup>+</sup> cells, decreased numbers of CD4<sup>+</sup> cells ( [87](#), [88](#), [89](#) and [90](#) ), and impaired autologous mixed lymphocyte reaction-induced suppressor function ( [91](#) ).

**PLATELET SURVIVAL** Platelet survival, measured using <sup>51</sup>chromium- or <sup>111</sup>indium-labeled platelets, is shortened in ITP, and the measured survival time can range from 2 to 3 days to a matter of minutes ( [92](#), [93](#), [94](#), [95](#), [96](#), [97](#), [98](#), [99](#), [100](#), [101](#), [102](#) and [103](#) ). Using <sup>111</sup>indium-labeled autologous platelets, some investigators have found an inverse correlation between venous platelet count and platelet survival ( [99](#), [101](#) ), and others have not ( [100](#) ). These differences between studies may be because of the types of patients included, as patients with mild to moderate thrombocytopenia have a longer measured survival than patients with severe thrombocytopenia. Splenic sequestration accounts for the shortened survival in most patients ( [104](#), [105](#) ), but the liver, and even the reticuloendothelial cells of the bone marrow, can play a major role in the sequestration of antibody-coated platelets, especially in patients with very low platelet counts or continued thrombocytopenia after splenectomy ( [96](#), [97](#), [101](#) ). Patients with severe thrombocytopenia have been found to have elevated macrophage colony-stimulating factor ( [106](#) ) and increased *in vitro* monocyte-platelet rosette formation ( [107](#) ). There also appears to be an inverse correlation between platelet count/platelet survival and impaired reticuloendothelial system function as assessed by clearance of IgG-sensitized, chromium-labeled autologous erythrocytes ( [108](#) ). Investigators are now studying the role of Fc $\gamma$ RII and Fc $\gamma$ RIII polymorphisms in ITP but early data are conflicting ( [109](#), [110](#) ). The spleen has also been implicated as a site of antibody formation ( [111](#), [112](#) ). In a pathologic study of 83 spleens that had been removed after patients did not respond to steroid therapy, investigators found splenic weights of less than 300 g, prominent secondary lymphoid follicles (28%), foamy macrophages (67%), and megakaryocytic extramedullary hematopoiesis (60%) ( [113](#) ). These pathologic changes reflect the two major pathogenic roles of the spleen: antiplatelet antibody production and macrophage-mediated platelet destruction. Whether megakaryopoiesis is reduced in some or many of these patients is still controversial. Survival studies have demonstrated decreased, normal, and increased platelet turnover ( [99](#), [102](#), [103](#) ). Antiplatelet antibodies can also bind to precursor bone marrow megakaryocytes ( [114](#), [115](#) and [116](#) ), and it is thus postulated that the reduced megakaryopoiesis may be secondary to the effects of the antiplatelet antibodies on platelet production. Megakaryocyte size was small in patients with anti-gpIb/IX autoantibodies and increased in size and cytoplasmic area in patients with anti-gpIIb/IIIa autoantibodies, suggesting to investigators that the anti-gpIIb/IIIa autoantibody impairs platelet production ( [117](#) ). Megakaryocyte colony formation (colony-forming unit megakaryocyte) is increased ( [118](#), [119](#) ) in acute ITP. In chronic ITP, decreased colony-forming unit megakaryocyte has been reported ( [120](#) ).

## Clinical Picture

**ACUTE IDIOPATHIC THROMBOCYTOPENIC PURPURA** In patients with acute ITP, the onset of the disorder usually is sudden ( [Table 53.2](#) ). A history of infection preceding the

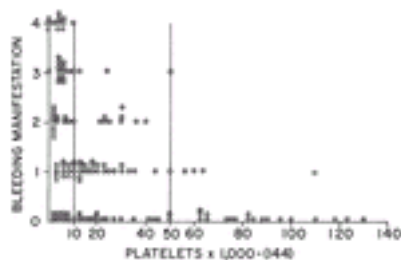
onset of bleeding has been documented repeatedly ( [121](#), [122](#)). In one series, such infections were noted within 3 weeks of the onset of ITP in 84% of cases ( [8](#), [9](#)). Common childhood exanthema (rubeola and rubella) and viral respiratory disease used to be the most common infections; now, varicella zoster virus and Epstein–Barr virus are the most frequently identifiable viruses, although nonspecific viral infections still predominate ( [123](#)). Acute ITP may also occur after vaccination ( [122](#), [124](#), [125](#)). Even though thrombocytopenia is likely to be severe, the bleeding manifestations of acute ITP in children usually are mild ( [126](#)), and intracranial hemorrhage occurs in less than 1% of patients. The rare adult with the acute form of the disorder, however, may suffer hemorrhage and a more fulminant course. Acute ITP in children usually is self-limited; spontaneous remissions occur in as many as 90% of patients ( [8](#), [9](#)). The duration of the disease ranges from a few days to a few months, with an average of 4 to 6 weeks ( [127](#)). The favorable prognosis of ITP in children reflects the preponderance of the acute form of the disease in this age group. Children with thrombocytopenia of greater than 6 months' duration are classified as chronic ITP, although spontaneous remissions may still occur in an occasional child after 6 months ( [128](#), [129](#)). Fever of mild degree has been reported, and the spleen tip may be palpable in up to 10% of patients, but this is believed to be the same incidence as is seen in normal children ( [130](#)). The spleen is usually of normal weight in those patients who proceed to splenectomy ( [121](#)).

**CHRONIC IDIOPATHIC THROMBOCYTOPENIC PURPURA** The onset of the chronic form of the disorder usually is insidious. A long history of hemorrhagic symptoms of mild to moderate severity is often described by the patient, but antecedent infections or fever and splenic enlargement are uncommon. Patients with chronic ITP usually have a fluctuating clinical course. Episodes of bleeding may last a few days or a few weeks and may be intermittent or even cyclic. Spontaneous remissions are uncommon and are likely to be incomplete. Relapses in some cases appear to be associated with vaccination ( [131](#)). Occasionally, the clinical course is surprisingly benign.

## Bleeding Manifestations

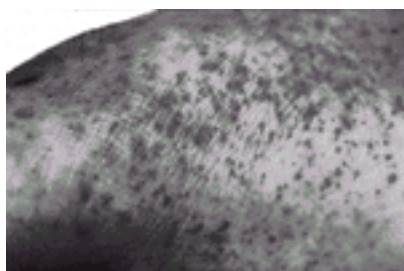
The hemorrhagic manifestations of ITP are of the purpuric type. Patients with only ecchymoses and petechiae have “dry” purpura; those with mucous membrane bleeding in addition to skin manifestations have “wet” purpura ( [132](#)). Platelet counts are usually lower and the complication rates higher in those with wet purpura. In a series of 712 patients reported by the Israeli ITP study group, 82% of all patients had bleeding limited to the skin, although 43% of adult women reported menomet–rorrhagia ( [122](#)).

In general, the severity and frequency of hemorrhagic manifestations correlate with the platelet count ( [Fig. 53.3](#)) ( [133](#)). Bleeding after trauma in the absence of spontaneous hemorrhage is usual in mildly affected patients with platelet counts higher than 50,000 per  $\mu\text{l}$ . Thrombocytopenia associated with counts between 10,000 and 50,000 per  $\mu\text{l}$  results in spontaneous hemorrhagic manifestations of varying severity, such as ecchymoses and petechiae. Patients with platelet counts below 10,000 per  $\mu\text{l}$  usually are at risk for serious morbidity and mortality from bleeding, although the mortality rate is actually quite low ( [134](#)). Patients who have an increased risk of bleeding include those with a history of bleeding, those with additional bleeding diatheses, and patients of advanced age (>60 years of age) ( [15](#), [134](#)). Older patients have also been reported to have an increased incidence of major, life-threatening bleeding ( [135](#), [136](#)).



**Figure 53.3.** Bleeding manifestations in relation to platelet count in patients with idiopathic thrombocytopenic purpura. Bleeding manifestations (or duration) are graded from 0 to 4, as follows: 0, no bleeding; 1, minimal, resulting from trauma; 2, spontaneous, but self-limited; 3, spontaneous, requiring special attention (e.g., nasal packs); and 4, massive uncontrolled or poorly controlled. (From Lacey JV, Penner JA. Management of idiopathic thrombocytopenic purpura in the adult. *Semin Thromb Hemost* 1977;3:160–174.)

**SKIN AND MUCOUS MEMBRANES** Spontaneous bleeding into the skin in the form of petechiae is characteristic. These lesions are minute, red to purple hemorrhages that range in size from that of a pinpoint to that of a pinhead ( [Fig. 53.4](#)). They are flat, do not blanch with pressure, and appear and regress, often in crops, over a period of days. They are most conspicuous in areas of vascular stasis, such as the areas below tourniquet sites, the dependent portions of the body (especially around the ankles), and areas subjected to constriction from belts or stockings, as well as on skin surfaces over bony prominences. The presence of petechiae on the face and neck is unusual, except as the result of coughing, and the patient may confuse these characteristic lesions with freckles or a rash.



**Figure 53.4.** Petechiae. Pinpoint, nonblanching erythematous capillary bleeding sites are most common in dependent body areas or pressure points. See [Color Plate](#).

Ecchymoses may develop on any skin surface. In ITP, they are seldom associated with subcutaneous hematomas and infrequently spread or dissect into deeper or adjacent structures. Large, purple, superficial ecchymoses may be seen, particularly on the back and thighs. Circular ecchymoses often surround even atraumatic venipuncture sites, but external bleeding from such sites is uncommon. Hemorrhagic vesicles or bullae may be seen inside the mouth and on other mucous surfaces. The bullae probably are the result of severe acute thrombocytopenia rather than a specific feature of any particular pathogenetic form. Gingival bleeding and epistaxis are common. The latter usually responds for a time to conservative measures, such as nasal packing or tamponade, often to recur intermittently. Epistaxis may originate from lesions resembling petechiae in the nasal mucosa. Such lesions also may be found in the mucous membranes of the throat and mouth, sometimes in the absence of cutaneous hemorrhage. In many patients, discrete bleeding points cannot be identified. The genitourinary tract is a frequent site of bleeding. Menorrhagia may be the only symptom of ITP and may appear for the first time at puberty. Hematuria also is a common symptom, the blood coming from the kidneys, the bladder, or the urethra, although bleeding into the kidney parenchyma is rare.

Gastrointestinal bleeding is usually manifested by melena or, less often, by hematemesis. **CENTRAL NERVOUS SYSTEM** Intracranial hemorrhage is the most serious complication of ITP. Fortunately, it is rare, affecting 1% or less of patients with severe thrombocytopenia ( [9](#), [10](#)). The hemorrhages usually are subarachnoid, often are multiple,

and vary in size from petechiae to large extravasations of blood. Numerous small hemorrhages often are seen in the retina; subconjunctival hemorrhage may also occur.

**BLEEDING AFTER TRAUMA** Excessive bleeding often follows tooth extractions, tonsillectomy, or other operations or injuries and may first suggest the diagnosis of ITP. In contrast to the hereditary coagulation disorders, such traumatic bleeding is seldom voluminous or rapid. Slow persistent oozing may occur after trivial cuts, razor nicks, and scratches. Delayed bleeding and spontaneous hemarthrosis, which are characteristic of the hereditary coagulation disorders, are extremely rare in association with ITP.

## Laboratory Findings

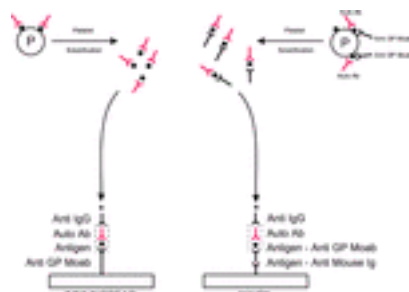
**BLOOD** Abnormalities in platelet size and morphologic appearance are common. The platelets often are abnormally large (3 to 4  $\mu\text{m}$  in diameter) and reveal more than normal variation in size and shape. Abnormally small platelets and platelet fragments ("microparticles") also are evident and may represent the equivalent of microspherocytes and schistocytes ( [137](#), [138](#), [139](#) and [140](#)). Although megakaryocyte fragments may be apparent in routine blood smears, quantitative studies reveal subnormal numbers of these fragments ( [141](#)). Estimates of mean platelet volume (MPV) and the extent of platelet size heterogeneity (platelet distribution width) by means of automated particle counters may provide useful information in the evaluation of patients with ITP ( [142](#)). The presence of numerous megathrombocytes results in high MPV values ( [143](#)). Platelet distribution width also is increased, presumably reflecting an abnormal degree of platelet anisocytosis ( [144](#)). The exact mechanism underlying such megathrombocytosis is still uncertain, but it may be the result of accelerated platelet production in response to platelet destruction. In patients with ITP, as in healthy subjects, MPV is inversely correlated in a nonlinear manner with the platelet count and remains within the normal range even in severe thrombocytopenia. These results contrast with significantly low values for MPV that have been reported in association with big spleen syndromes ( [144](#)) and some myeloproliferative disorders, after chemotherapy with cytotoxic drugs, and in patients with septic thrombocytopenia ( [145](#)). Anemia, if present, is proportional to the extent of blood loss and is usually normocytic. If bleeding has been severe and long standing, iron deficiency anemia may occur. Occasionally, recent severe hemorrhage may produce reticulocytosis and moderate macrocytosis. Antiplatelet antibodies in patients with ITP do not usually cross-react with erythrocytes, although erythrocyte fragmentation, presumably the result of weak complement activation, may occur ( [139](#)). Patients may also have a positive Coombs test and autoimmune hemolytic anemia; the combination is known as *Evans syndrome* ( [146](#), [147](#)). The total leukocyte count and the differential count usually are normal, except for those changes resulting from acute bleeding, such as slight to moderate neutrophilia with some increase in immature forms. Eosinophilia has been noted, particularly in children, but this finding is by no means consistent. Lymphocytosis with abnormal cells resembling those characteristic of infectious mononucleosis also has been reported ( [148](#), [149](#)). Tests of hemostasis and blood coagulation reveal only changes attributable to thrombocytopenia, such as a prolonged bleeding time and absent or deficient clot retraction. The results of tests of blood coagulation, including prothrombin time, partial thromboplastin time, and fibrinogen, are normal in patients with uncomplicated thrombocytopenia. Slight increases in the levels of fibrinogen degradation products have been demonstrated in the plasma of some patients with ITP ( [150](#)). Plasma levels of glyocalicin, a portion of platelet membrane gpIb, may be high in patients with ITP and other forms of platelet destruction, but concentrations of thrombopoietin are not significantly increased in contrast to patients with thrombocytopenia as a result of aplastic anemia.

**BONE MARROW** Alterations in the bone marrow are usually limited to the megakaryocytes, although normoblastic hyperplasia may develop as the result of blood loss. The leukocytes are essentially normal with the exception of occasional eosinophilia (



19, 151). Megakaryocytes usually are increased in size (152) and are plentiful (153, 154), the numbers correlating roughly with the MPV. Morphologic abnormalities of these giant cells are present in most patients with ITP. “Smooth” forms with single nuclei, scanty cytoplasm, and relatively few granules are common. Presumably, they represent the results of markedly accelerated platelet production and the presence of many young forms (155, 156). Examination of the bone marrow is occasionally helpful, particularly in ruling out other conditions with which ITP may be confused. The changes just summarized are similar to those found in most forms of thrombocytopenia caused by accelerated platelet destruction and are not characteristic or diagnostic of ITP. Differences between megakaryocytes found in the acute and chronic forms of ITP are not clear-cut (9), and marrow examination is not particularly helpful in determining prognosis.

**ANTIPLATELET ANTIBODIES** A number of different types of antiplatelet antibody tests have been developed and reported through the years (36, 157, 158, 159, 160, 161, 162, 163 and 164). Most of these tests were quite cumbersome and therefore never became available for routine testing. In addition, the tests measured different types of Ig, including serum antiplatelet antibodies, platelet-associated surface Ig, or total platelet Ig. When the assays were tested in specialized laboratories, they were reported to be quite sensitive for detection of platelet Ig, and the antibody titers correlated with the clinical course in the patients with ITP. However, these assays for antiplatelet antibody are not specific for thrombocytopenia caused by idiopathic immune thrombocytopenia, and in fact, Ig concentrations are increased in patients with nonimmune thrombocytopenia (165, 166, 167 and 168) and even in some normal individuals. Normal platelets contain Ig in their a-granules, in addition to other serum proteins like albumin (169). The quantity of the Ig is directly proportional to the amount of Ig in the serum; therefore, patients with polyclonal or monoclonal gammopathies have increased platelet Ig (170). The platelet Ig is released, along with other a-granule proteins, such as platelet factor 4 and β-thromboglobulin, during platelet activation and secretion. It is presumed that some of these released proteins bind to the platelet surface. These observations make it difficult to use either the platelet-associated IgG assays or the total platelet Ig assays for the diagnosis of ITP (171). The newest generation of antiplatelet antibody assays appears more promising (40, 41). In these tests, monoclonal antibodies for the specific platelet membrane glycoproteins that are implicated in ITP are used in antigen capture-type assays (also called *glycoprotein immobilization assays*; Fig. 53.5) (42). These tests are very specific for the presence of membrane-associated antibodies directed at specific platelet glycoproteins, but they are still not sensitive enough to detect the presence of antiplatelet antibody in more than 85% of patients (41, 43, 172). As long as these tests are not available for routine diagnostic use, the diagnosis of ITP in an individual patient will continue to be a diagnosis by exclusion.



**Figure 53.5.** Immune complex capture assays. The immunobead assay and the monoclonal antibody-specific immobilization of platelet antigen assay (MAIPA) are diagrammed. \*, antibody was labeled with either radioactivity or enzyme; antigen, protein containing the antigen; anti GP Moab, murine monoclonal antibody against the platelet glycoprotein containing the antigen; anti IgG, antibody against human immunoglobulin G; anti mouse Ig, antimouse immunoglobulin; auto Ab, autoantibody; P, platelet. (Modified from McMillan R.

Clinical role of antiplatelet antibody assays. *Semin Thromb Hemost* 1995;21:37–45.)

## Differential Diagnosis

The initial step in the evaluation of a thrombocytopenic patient is the inspection of the peripheral blood smear to confirm the decreased platelet count ( [173](#) ). Thrombocytopenia may be produced artifactually by clumping of the platelets in the blood sample caused by ethylenediaminetetraacetic acid–platelet agglutinins ( [174](#), [175](#) ), or the platelets may be unavailable for counting because they are bound in rosette formation to the surface of white blood cells in the venous blood sample (“platelet satellitism”) ( [176](#), [177](#) ).

The diagnosis of ITP is usually a diagnosis by exclusion based on a demonstration of peripheral thrombocytopenia, with a history, physical examination, and complete blood count that do not suggest another cause for the thrombocytopenia. Slight splenomegaly may be found in patients with ITP ( [121](#) ), but moderate or massive splenomegaly suggests that the thrombocytopenia is a result of hypersplenism related to the presence of a separate underlying disease associated with splenic enlargement. Alcoholic liver disease with portal hypertension, splenomegaly, and thrombocytopenia is an example of hypersplenism.

The initial manifestations of acute leukemia, myelodysplastic syndrome ( [178](#), [179](#) ), myelophthistic processes, and aplastic anemia may mimic ITP. These other types of underlying hematologic disorders are suggested by anemia out of proportion to blood loss and by changes in the leukocytes not attributable to either hemorrhage or complicating infection. ITP causes no characteristic bone marrow changes; therefore, bone marrow examination should not be routine. However, bone marrow aspiration may be helpful in the differential diagnosis of ITP versus myelodysplastic syndrome in patients older than 65 years of age or in patients who have atypical findings that may suggest some of these other etiologies.

The presence of schistocytes in the blood smear suggests that the thrombocytopenia may be associated with a microangiopathic process (see [Chapter 54](#)). In thrombotic thrombocytopenic purpura or hemolytic uremic syndrome, thrombocytopenia is associated with laboratory manifestations of hemolysis, including an elevated lactate dehydrogenase and indirect bilirubin. Patients may also have transient, multifocal neurologic signs or symptoms, or both, in thrombotic thrombocytopenic purpura or renal insufficiency in hemolytic uremic syndrome. Microspherocytes and coagulation abnormalities can also be found in thrombocytopenia resulting from disseminated intravascular coagulation.

After a diagnosis of immune thrombocytopenia, the next essential step is to distinguish between idiopathic immune thrombocytopenic purpura and secondary forms of immune thrombocytopenic purpura, such as human immunodeficiency virus, hepatitis C, or *Helicobacter pylori* infections; collagen vascular diseases like systemic lupus erythematosus (SLE); lymphoproliferative disorders like chronic lymphocytic leukemia; and drug ingestions. The importance of careful inquiry regarding drug ingestion or exposure to toxic substances cannot be overemphasized, because thrombocytopenia attributable to drugs or toxins often is indistinguishable from ITP. The development of thrombocytopenia in an adult, in particular, should arouse suspicion of a chemical etiologic agent, because many of the drugs associated with thrombocytopenia are used more often by adults than by children. If the patient is a hospitalized patient, it is also essential to eliminate the possibility that the thrombocytopenia is secondary to heparin administration. Immune thrombocytopenia may be produced by heparin administered in any dose and by any route of administration. It has even been reported in patients with indwelling heparin–bonded



catheters ( 180 ). Finally, the antiphospholipid antibody syndrome is a recently recognized disorder that may produce isolated thrombocytopenia in the absence of a clearly definable associated disorder. In the usual case, this disorder may be associated with thromboembolic manifestations, anticardiolipin antibodies, coagulation inhibitors of the lupus type, and false-positive results of serologic tests for syphilis ( 72 ).

### Treatment of Idiopathic Thrombocytopenic Purpura

Relatively few level 1 trials on the treatment of patients with ITP have been reported (i.e., randomized trials with low false-positive and false-negative errors). The American Society of Hematology has recently published a practice guideline on ITP, which was, therefore, primarily based on the opinions of a panel of experts ( 181, 182 ). The reader is referred to this practice guideline for specific questions regarding the treatment of patients with ITP.

**CHILDREN** Childhood ITP is usually benign and self-limited. Treatment is therefore reserved for patients with severe thrombocytopenia (<20,000 per  $\mu\text{l}$ ) and bleeding or patients who remain thrombocytopenic for more than 6 months—that is, those with chronic ITP ( Table 53.4 ) ( 183 ). The greatest fear in the acute form is intracranial hemorrhage, which occurs in approximately 1% of patients with platelet counts less than 20,000 per  $\mu\text{l}$ . Thus, several multicenter randomized trials have been performed in these high-risk patients with acute ITP to define whether treatment is associated with a more prompt increase in platelet counts. These clinical trials demonstrated that treatment with both oral prednisone and intravenous Ig was associated with a more rapid rise in platelet count to greater than 20,000 per  $\mu\text{l}$  than either no therapy or treatment with anti-D. Only intravenous Ig shortened the time necessary to reach a platelet count of greater than 50,000 per  $\mu\text{l}$  ( 125, 184 ). More recently, children with platelets fewer than 10,000 per  $\mu\text{l}$  or 10,000 to 29,000 per  $\mu\text{l}$  and mucosal bleeding were studied in a prospective randomized clinical trial, and intravenous Ig raised platelet counts faster than three corticosteroid regimens ( 185 ).

**TABLE 53.4. Recommendations for Treatment of Idiopathic Thrombocytopenic Purpura Patients with Platelet Counts Less Than 20,000  $\mu\text{l}$**

|  | Children   | Adults  |
|--|--|---|
| Asymptomatic   | None   | Prednisone (1–2 mg/kg/d)                      |
| Minor purpura  | IVIg (1 g/kg $\times$ 1 d)   | Prednisone (1–2 mg/kg/d)                      |
| Mucosal membrane bleeding that may require clinical intervention | High-dose oral glucocorticoid<br>IVIg (1 g/kg $\times$ 1 d)                  | Prednisone (1–2 mg/kg/d)                      |
| Severe, life-threatening bleeding                                | Hospitalization<br>IVIg (2 g/kg over 2–5 d)<br>High-dose oral glucocorticoid | Hospitalization                               |
|  | Hospitalization<br>IVIg (1 g/kg $\times$ 1 d)                                | Hospitalization<br>IVIg (1–2 g/kg over 1–5 d) |
|  | High-dose parenteral glucocorticoid<br>IVIg (2 g/kg over 2–5 d)              | Prednisone (1–2 mg/kg/d)                      |

## High-dose oral glucocorticoid

IVIg, intravenous immunoglobulin.

NOTE: In each category, the treatment options are listed in order of descending preference.

From George JN, Woolf SH, Raskob GE, et al. Idiopathic thrombocytopenic purpura: a practice guideline developed by explicit methods for the American Society of Hematology. *Blood* 1996;88:3–40, with permission.

---

**ADULTS** Patients with chronic ITP may have mild thrombocytopenia that can be followed without treatment. The incidence of bleeding is correlated with the platelet count; therefore, patients with platelet counts greater than 60,000 per  $\mu\text{l}$  rarely have spontaneous bleeding and may only require treatment if extensive operative procedures are planned. Patients with platelet counts less than 20,000 per  $\mu\text{l}$  or significant mucosal membrane bleeding with platelet counts less than 50,000 per  $\mu\text{l}$  are usually treated ([Table 53.4](#)). No prospective, inception cohort studies on prognosis after treatment are reported. However, investigators recently reported that most adult patients have a good response to treatment (without necessarily returning to normal platelet counts) and have no excess mortality when compared to the general population ([186](#)). A small group of patients who had severe thrombocytopenia after 2 years of primary and secondary therapies had a mortality risk of 4.2 (95% confidence interval, 1.7 to 10.0) due to both bleeding and infectious complications related to therapy. ITP is uncommon in elderly patients; only 30% of patients in reported series are older than 45 years of age ([151](#), [187](#)). However, these patients may be more refractory to therapy ([135](#)) and appear to have a higher incidence of hemorrhagic complications than younger patients ([15](#)). Guthrie and colleagues reported a 52% incidence of life-threatening or fatal bleeding in their series of 40 patients older than age 45 ([135](#)). This risk of fatal bleeding in patients with platelet counts that are chronically less than 30,000 per  $\mu\text{l}$  is estimated at 0.4% per year for patients younger than 40 years of age and 13.0% per year for patients older than 60 years of age ([188](#)). Patients with life-threatening bleeding may require parenteral glucocorticoids, intravenous Igs followed by platelet transfusions ([189](#)), plasmapheresis ([190](#)), or even emergency splenectomy as first-line treatment. Platelets should be administered as frequently as necessary to control the bleeding, even if there are only minimal changes in the platelet count. However, it has been demonstrated that some patients do have a demonstrable increase in platelet numbers, with 42% of platelet transfusions resulting in a platelet increase of at least 20,000 per  $\mu\text{l}$  ([191](#)).

**Steroids** Steroids are the conventional first-line therapy for adult ITP. Dameshek first reported his experience with prednisone therapy in 1958 ([192](#)) when 30 consecutive patients with acute (N = 11) or chronic (N = 19) ITP were treated with 20 to 150 mg/day of prednisone. Twenty-two of the patients demonstrated an increase in platelet count to normal after an average interval of 22 days and then were maintained on 2.5 to 15.0 mg/day of prednisone. In eight patients, prednisone was discontinued without relapse. Numerous retrospective studies of steroid treatment in both children and adults with ITP have been reported ([15](#), [16](#) and [17](#), [121](#), [122](#), [127](#), [151](#), [187](#), [193](#), [194](#), [195](#), [196](#), [197](#), [198](#) and [199](#)). The criteria for inclusion of patients in the individual studies and the criteria for response to treatment vary significantly among the reports; therefore, it is difficult to accurately combine the data. However, some useful observations can be made. Spontaneous remissions are very uncommon in adults, with an estimated occurrence of less than 5% ([16](#), [17](#), [193](#), [194](#) and [195](#)). Most spontaneous remissions occur early; however, remissions have been described after 6 months in a small number of patients ([16](#)). Complete and partial (>50,000 per  $\mu\text{l}$ ) responses in patients treated with prednisone (usually, 1 mg/kg/day as starting doses) average 65 to 85%, but sustained responses after

discontinuation of the drug occur in only 25% or less of patients ( 1, 200 ). Platelet counts increase within 1 week in responding patients and have usually reached peak values by 2 to 4 weeks. Patients who have not had any response by then are unlikely to respond to prednisone and therefore should be considered for splenectomy or other forms of treatment. No pretreatment patient characteristics have predicted a patient's response to steroids. Only two prospective randomized steroid treatment trials in patients with ITP have been reported ( 201, 202 ). Bellucci and colleagues randomized patients between low (0.25 mg/kg/day) or high (1.0 mg/kg/day) prednisone for 3 weeks, with taper and discontinuation by the end of the fourth week ( 202 ). If bleeding continued, patients could be increased from low dose to high dose, or a second 4-week course could be given. *Complete response*, defined as a platelet count greater than 100,000 per  $\mu\text{l}$  for at least 6 months, was seen in 74% of children and 41% of adults. Complete or partial responses occurred in 83% of children and 59% of adults. No significant differences were seen between low- and high-dose regimens in either age group. Mazzucconi and colleagues randomized patients between 0.5 mg/kg/day and 1.5 mg/kg/day ( 201 ). The response rates in adults were not significantly different between patients treated with low- versus high-dose steroids—30% and 34% complete response, respectively. In children, however, the rates were 64% for low-dose versus 81% for high-dose prednisone. Therefore, there is evidence to support the use of lower doses of steroids in adults than have conventionally been used at the beginning of treatment. There was one prospective randomized, controlled trial comparing prednisone (1 mg/kg/day) to intravenous Ig (400 mg/kg/day for 4 days), or to both in a small number of patients ( 203 ). A platelet count greater than 50,000 per  $\mu\text{l}$  was achieved in 82%, 54%, and 92% of patients. The median times to peak platelet counts were 8.5, 7.0, and 7.0 days. These authors concluded that there was no advantage for intravenous Ig over conventional corticosteroid treatment. In another recent randomized control trial, platelet counts above 50,000 per  $\mu\text{l}$  were achieved faster in patients receiving intravenous Ig than intravenous methylprednisolone, but long-term outcomes were the same ( 204 ).

### ***Mechanism of Action***

***EFFECT ON ENDOTHELIAL CELLS*** Experimental evidence suggests thinning of the endothelium with development of endothelial fenestrations in both animal models and humans with ITP, suggesting that platelets play a role in normal endothelial homeostasis ( 205, 206 ). Clinically, steroids are known to ameliorate the purpuric bleeding in ITP patients before the platelet count actually increases. Experimentally, investigators have demonstrated that 3 days after steroid therapy in rabbits and 4 days after steroid therapy in patients, the endothelial thinning reverts toward normal, providing a scientific explanation for this clinical observation ( 206, 207 ). This endothelial effect may in part be explained by the observation that when endothelial cells are cultured with steroids, cell morphology is altered, with greater confluence and increased protein synthesis and content ( 208 ).

***EFFECT ON THROMBOCYTOPENIA*** The mechanism of action of steroids in treating the thrombocytopenia is probably complex. Steroids are currently believed to ameliorate the thrombocytopenia by one or more mechanisms. Steroids may (a) decrease consumption of antibody-coated platelets by the spleen ( 209, 210 and 211 ) or bone marrow, (b) reduce antibody production by the spleen ( 111, 212 ), (c) decrease antibody production by the bone marrow ( 213 ), or (d) increase marrow platelet production by undetermined mechanisms ( 214 ). There is little doubt that corticosteroids in high doses ameliorate splenic sequestration of antibody-coated platelets. Corticosteroids decrease antibody-coated red blood cell sequestration in guinea pig spleens by decreasing Fc? receptor proteins on macrophages ( 215 ), and corrected *in vivo* and *in vitro* data support a similar action of steroids in humans ( 104, 105, 210, 216, 217 ). Corticosteroids also decrease monocyte Fc receptors in autoimmune hemolytic anemia ( 218 ). This down-regulation of monocyte/macrophage Fc receptors may account for the early effects of steroid

treatment on platelet counts. Chronic corticosteroid treatment is associated with a decrease in antibody production, but this usually occurs after several weeks of high-dose steroids. Steroid treatment also results in increased platelet production in some ITP patients ( [214](#) ), an effect that may be secondary to reduction of the antiplatelet Ig effect on thrombopoiesis, reduction in intramedullary destruction of antibody-coated platelets before their release into the circulation, or decreased antibody synthesis by bone marrow lymphocytes.

**Splenectomy** Patients with severe thrombocytopenia (<10,000 per  $\mu\text{l}$ ) who do not respond to steroids (administered for up to 6 weeks) or who relapse during steroid tapering, and patients with platelet counts of less than 30,000 per  $\mu\text{l}$  for periods up to 3 months should be considered for splenectomy. This recommendation is based on only level 5 evidence (i.e., case reports) ( [181](#) ). Most patients demonstrate a response to steroids within 2 to 4 weeks, but a late response is possible. Therefore, the best time for splenectomy in a patient who does not respond to steroid therapy must be determined individually. Sustained complete responses to splenectomy (variously defined as platelet counts 100,000 or 150,000 per  $\mu\text{l}$ ) have been reported in approximately 50 to 80% of patients, depending on the series of patients ( [1](#), [15](#), [16](#) and [17](#), [121](#), [122](#), [127](#), [151](#), [187](#), [193](#), [194](#), [195](#) and [196](#), [198](#), [200](#), [219](#), [220](#), [221](#), [222](#), [223](#), [224](#), [225](#), [226](#), [227](#), [228](#) and [229](#) ). After the operation, the platelet count may increase rapidly, often within 24 to 48 hours, and may reach levels as high as 1 million per  $\mu\text{l}$  or even higher in approximately 10 days ( [121](#) ). Operative mortality is less than 1%, and perioperative bleeding is rare ( [16](#), [17](#), [122](#), [193](#), [194](#) ). Platelet transfusions are usually only given if the patient has bleeding after the spleen has been removed. Postsplenectomy infections are also rare, especially if patients have received pneumococcal immunizations before splenectomy. Laparoscopic splenectomies in ITP patients are as successful as conventional splenectomies, although patients occasionally may require conversion to an open procedure ( [230](#), [231](#) ). Therapeutic responses are reported also when splenic ultrasound ( [232](#) ), splenic radiation ( [233](#), [234](#) ), or partial splenic embolization ( [235](#) ) was used instead of splenectomy. Patients who do not respond to splenectomy or who relapse after an initial response to splenectomy should be studied for the presence of accessory spleens ( [226](#), [236](#), [237](#), [238](#), [239](#) and [240](#) ). The incidence of accessory spleens found at the time of the original splenectomy ranges from 15 to 20% ( [221](#), [226](#) ). The incidence of accessory spleens in patients who relapse after splenectomy may be as high as 50% ( [151](#), [227](#), [228](#) ), and surprisingly, the majority of these patients demonstrate postsplenectomy changes (i.e., Howell-Jolly bodies) on their peripheral blood smears. Relapse secondary to accessory spleen may occur weeks to years after the initial splenectomy. Scanning methods have varying sensitivities; conventional  $^{99\text{m}}$ Tc scans,  $^{99\text{m}}$ Tc scans using heat-denatured red blood cells, or CT scans can be used. Accessory spleens as small as 0.5 cm have been found when  $^{111}\text{In}$  scans were performed preoperatively and isotope detector probes were used intraoperatively to detect all accessory splenic tissue ( [221](#) ). A review of 56 published cases demonstrated a 73% excellent therapeutic response and a 27% moderate response to accessory splenectomy ( [221](#) ).

**Mechanism of Action** The effectiveness of splenectomy in the therapy for ITP is attributed to removal of the organ primarily responsible for the destruction of antibody-sensitized platelets. The increase in platelet count correlates with an increase in platelet survival, whereas platelet production remains unchanged ( [214](#) ). The removal of the spleen may also result in a reduction of antibody production, but this effect is probably of minimal significance in view of the immediate favorable responses to splenectomy. No factors have consistently predicted a response to splenectomy; age, concentration of platelet-associated IgG, the time between diagnosis and splenectomy, the patient's response to steroids, intravenous immune globulin or intravenous anti-D, and the peak postoperative platelet count have all been studied ( [220](#), [241](#), [242](#), [243](#), [244](#) and [245](#) ).

The site of platelet sequestration, based on preoperative <sup>51</sup>chromium- and <sup>111</sup>indium-labeled platelet survival studies, may be predictive of response ( [224](#), [246](#) ), but these techniques are seldom used.

**Treatment of Refractory Idiopathic Thrombocytopenic Purpura** No randomized controlled trials have been reported of treatment options for patients who do not respond to treatment with both steroids and splenectomy ( [247](#) ). Patients who are asymptomatic and have platelet counts between 30,000 and 50,000 per  $\mu\text{l}$  may be managed with careful observation ( [1](#), [181](#) ). Symptomatic patients with platelet counts less than 30,000 per  $\mu\text{l}$  who had an initial response to steroids can be retreated with prednisone and then tapered to find the minimum dose that can maintain the patients hemorrhage-free even if the platelet count is not above 30,000 per  $\mu\text{l}$ . If they can be maintained on 10 mg every other day, additional treatment may not be indicated. Some patients observed for years with platelet counts of 10,000 per  $\mu\text{l}$  have had no significant bleeding other than some ecchymoses or petechiae, even without steroid therapy ( [219](#) ). Additional therapies that have been beneficial in some patients with refractory ITP include intravenous Ig, pulse dexamethasone or methylprednisolone, anti-D, immunosuppression with azathioprine or cyclophosphamide, vinca alkaloids, danazol, and  $\alpha$ -interferon. Because no level 1 evidence existed for these alternate therapies, there was little panel consensus regarding preferred therapy from the American Society of Hematology ITP Practice Guideline ( [181](#) ).

**Immunosuppressive Drugs** Immunosuppressive therapy for ITP has yet to be evaluated thoroughly; the overall effectiveness of these potent drugs has been variable, and the remissions achieved have been short lived. Poor results have been reported in children ( [248](#) ). Favorable results are nevertheless noteworthy, because they were obtained in patients who had not responded to splenectomy or to corticosteroids. Immunosuppressive therapy should probably be reserved for such refractory cases ( [249](#) ). Preliminary reports of successful treatment in refractory patients have been published, using high-dose methylprednisolone ( [250](#), [251](#) ) and cyclophosphamide-based combination chemotherapy ( [252](#) ). Pulse high-dose dexamethasone was effective in a small series of patients ( [253](#) ), but this has not been confirmed by other investigators ( [254](#), [255](#) and [256](#) ). Cyclophosphamide alone, either daily oral or pulse intravenous therapy, induced remissions in 16 to 55% of patients ( [17](#), [249](#), [257](#), [258](#) and [259](#) ). However, this drug must be administered for several weeks before the platelet count rises and often must be continued for an indefinite period to maintain the remission, and side effects such as leukopenia, alopecia, and cystitis often are significant. Azathioprine, cyclosporine A, actinomycin, and other immunosuppressive agents, either alone or in combination with corticosteroids, are of variable success ( [260](#), [261](#), [262](#), [263](#), [264](#) and [265](#) ). Vincristine and vinblastine, administered intravenously at weekly intervals, may be as effective as cyclophosphamide but act more rapidly ( [266](#), [267](#) and [268](#) ), often increasing the platelet count within 7 days ( [266](#), [269](#) ). In addition to their suppressive effects on cellular and humoral immune responses ( [270](#) ), these agents increase platelet production in both animals and normal human subjects ( [271](#), [272](#) ). In ITP, their mechanism of action has been postulated to be inhibition of microtubule-dependent events required for macrocyte-monocyte phagocytic function ( [273](#), [274](#) ). Anti-CD20 monoclonal antibody, probably through its effect on B lymphocytes, can produce objective responses in up to 50% of patients ( [275](#), [276](#) and [277](#) ). Most of the patients in these pilot studies had no response to prior treatments, including splenectomy. The side effects were mild and usually seen most commonly after the first of four weekly infusions. Many of these responses were maintained without additional therapy, and some patients who relapsed responded to an additional infusion.

**High-Dose Immunoglobulin** The intravenous administration of polyvalent Ig, first used in 1981 ( [278](#) ), may induce remissions in patients with life-threatening bleeding or in patients with refractory ITP. Ig therapy has proved most effective in infants and small children ( [279](#), [280](#) ), an age group in which the response is difficult to evaluate because of the



frequency of spontaneous remissions. In adults, this extremely expensive regimen has produced relatively less impressive long-term results ( 281 , 282 , 283 and 284 ), although an occasional patient enters complete remission after the initial treatment and a series of booster doses ( 285 , 286 , 287 and 288 ). In a review of 28 published reports of intravenous Ig in 282 adults, 64% of patients had a peak platelet count of greater than 100,000 per  $\mu$ l, and 83% had peak platelet counts greater than 50,000 per  $\mu$ l ( 289 ) after the initial infusion. Platelets may begin to rise after 2 days and usually reach peak levels by 1 week after treatment ( 290 ). Regimens of 400 mg/kg/day for 5 days versus 1000 mg/kg for 2 days ( 291 ) or 1000 mg/kg/day versus 500 mg/kg/day ( 285 ), each for 2 days, have been equally effective in randomized trials, and doses of 0.5 g/kg are as effective as 1.0 g/kg for maintenance therapy ( 292 ). These doses produce significant increases in serum and platelet levels of IgG ( 279 , 285 , 287 ). In a recent randomized controlled trial, 1000 mg/kg was superior to 500 mg/kg in raising platelet counts to greater than 80,000 per  $\mu$ l by day 4 ( 293 ). Most of these patients were being prepared for splenectomy or delivery. The mechanism of action of intravenous Ig is unclear ( 294 ). Some studies suggest blockade of the Fc receptors of the reticuloendothelial cells ( 285 , 287 , 295 , 296 and 297 ) and suppression of antibody production and binding ( 298 , 299 , 300 and 301 ), which may be a result of antiidiotype antibodies that bind antiplatelet antibodies and modulate the immune response ( 302 , 303 ). The ability of intravenous Ig to modulate antiinflammatory activity through the inhibitory Fc $\gamma$ RII receptor is also under active investigation ( 304 , 305 ). No evidence exists that reduction of antiplatelet antibodies accounts for the acute effects of therapy ( 306 ). Therapy with intravenous Ig remains expensive. The rapid nature of the response to treatment makes it an ideal agent for treatment of patients for life-threatening bleeding or before surgery; however, the role of intravenous Ig in long-term therapy remains uncertain. The major side effect of treatment is headache, although some patients develop fever, myalgias, and skin rashes ( 303 ). There are now also reports of acute renal failure occurring in up to 7% of patients, especially older patients and those with diabetes, or baseline increases in creatinine (or both) ( 307 , 308 ). The patients may be oliguric, and most demonstrate peak creatinine levels by day 5 after the Ig infusion. Hemodialysis may be required acutely; however, several patients required chronic dialysis.

**Anti-D** Intravenous Rho (D) immune globulin has been studied in children with acute ITP and refractory chronic ITP as an alternative to intravenous Ig ( 184 , 309 , 310 ). The mechanism of action is unknown; however, it is believed that the antibody coats the red blood cells of Rh-positive patients and either blocks the reticuloendothelial clearance of the patients' platelets or modulates the immune system, resulting in an increase in the platelet count ( 310 , 311 ). Children respond better than adults, and nonsplenectomized patients respond better than splenectomized patients ( 312 ). The platelet count does not begin to increase for 48 to 72 hours, so it is not effective for the treatment of life-threatening bleeding. The effect lasts for several weeks to a month, and patients respond well to retreatment. They may even respond to intramuscular injections given weekly as maintenance ( 313 ). Only occasionally, patients have a sustained remission ( 314 ). Most patients exhibit a modest decrease in hemoglobin, and most have signs of mild hemolysis ( 312 ), with decreased haptoglobin, increased lactate dehydrogenase, and increased indirect bilirubin. Red cell survival is only modestly reduced ( 315 ). No correlation has been found between the amount of hemolysis ( 311 ) and the platelet response, leading some investigators to question the proposed effect on reticuloendothelial blockade ( 316 ). Reinfusion of autologous red blood cells that have been opsonized with anti-D has produced both complete and partial remissions in a small number of patients, even after splenectomy ( 317 ).

**Other Proposed Therapy** A number of other therapies have been reported to be

successful in single case reports or in small series of patients ( 247 ). Danazol, an attenuated androgen, has been effective in increasing platelet counts in patients with ITP in doses ranging from 50 mg/day ( 318 ) to 800 mg/day ( 319 , 320 and 321 ). The mechanism of action is postulated to be a danazol-induced reduction of Fc receptors on phagocytic cells ( 322 ). Recombinant  $\alpha$ -interferon can increase platelet counts in up to 50% of patients when injected subcutaneously three times a week. Side effects are minimal, and some responses are durable after stopping treatment ( 323 , 324 , 325 , 326 , 327 and 328 ).

**Supportive Measures** Physical activity should be restricted to minimize the hazards of trauma, particularly head injury. Drugs that impair platelet functions should be avoided. Blood loss should be treated as otherwise indicated, and if platelets are needed, platelet concentrates should be administered ( 329 ). However, even large numbers of platelets produce only a slight and transitory increase in the platelet count—no doubt because of the rapidity with which they are destroyed *in vivo* ( 330 ). Platelet transfusions, nevertheless, may produce some increase in platelet numbers in many patients ( 191 ), often diminish bleeding for a time, and can be effective in the management of serious complications such as subarachnoid hemorrhage. They should be reserved for such life-threatening emergencies or for the immediate preoperative treatment of patients with serious hemorrhage before splenectomy. A single large dose of intravenous Ig followed by a platelet transfusion can be effective in arresting hemorrhage in some critically ill patients ( 189 ). In most patients with platelet counts greater than 50,000 per  $\mu$ l, preoperative platelet transfusions are not indicated. Platelet transfusions should be avoided in patients with chronic ITP because of the possible development of alloantibodies. Exchange plasmapheresis may be valuable in critically ill patients and may be particularly effective in children ( 331 , 332 and 333 ). Anovulatory hormones are useful when menorrhagia is a major complaint. Because of the risk of septicemia, polyvalent pneumococcal vaccine, *Haemophilus influenzae* B vaccine, and quadrivalent meningococcal polysaccharide vaccine should be administered at least 2 weeks before elective splenectomy in both adults and children ( 181 ).

**IDIOPATHIC THROMBOCYTOPENIC PURPURA IN PREGNANCY** Both immune and nonimmune thrombocytopenia may occur during pregnancy ( 334 , 335 ). Thrombocytopenia was present in 7% of women when they were admitted to the hospital for a full-term delivery in a prospective 7-year study of 15,741 mothers and 15,932 newborns ( 336 , 337 and 338 ). Most platelet counts were between 100,000 and 150,000 per  $\mu$ l; however, 1% of women had platelet counts less than 100,000 per  $\mu$ l. The thrombocytopenia was detected incidentally in the majority of women, and only 0.01% of their infants had fetal platelet counts less than 50,000 per  $\mu$ l. None of the infants had hemostatic impairment, and most mothers had normal or near-normal platelet counts by discharge. If the mothers had an obstetric or medical complication, the incidence of thrombocytopenia (<50,000 per  $\mu$ l) in the infants was 0.35%. It is unclear when the incidental thrombocytopenia (also called *gestational thrombocytopenia*) developed during the pregnancy, and the etiology of this mild abnormality is likewise unknown. Antiplatelet antibody testing was not sufficiently specific to differentiate patients with gestational thrombocytopenia from those with ITP ( 339 ). Maternal thrombocytopenia occurs in 7% of pregnancies, and 74% of these women appear to have incidental thrombocytopenia, and only 4% have immune thrombocytopenia ( 340 ). It is, therefore, recommended that healthy women, who, at delivery, have a platelet count of 70,000 to 80,000 to 150,000 per  $\mu$ l, require no specific treatment, and the mode of delivery should be determined only by obstetric indications. Platelet autoantibodies in pregnant patients with ITP cross the placenta and can produce thrombocytopenia and clinical bleeding in the infant. During pregnancy, both maternal and infant health must be considered. Management of women with ITP, diagnosed before or during the pregnancy, is therefore more difficult and still controversial ( 340 , 341 ). Women with severe thrombocytopenia should be treated with intravenous Ig or the lowest dose of corticosteroids needed to maintain a platelet count above 50,000 to 60,000 per  $\mu$ l, even though when mothers have been treated during pregnancy, changes in their platelet



counts do not correlate with the fetal platelet counts when these have been sampled before and after treatment ( [342](#) ). When betamethasone or placebo was given for 4 weeks before delivery in a randomized trial, no differences were seen in either the maternal or infant platelet counts or the incidence of bleeding at delivery ( [343](#) ). Splenectomy during pregnancy may have higher complication rates, but it is not contraindicated. Intravenous Igs can be used before delivery to increase the platelet count rapidly. The safety of other forms of therapy used in nonpregnant ITP patients is uncertain. At the time of delivery, the physician must decide whether to deliver the infant by cesarean section or by vaginal delivery. When 474 infants were analyzed from series reported over a 20-year period, 10% of infants had platelet counts between 50,000 and 100,000 per  $\mu\text{l}$ , and 15% had platelet counts less than 50,000 per  $\mu\text{l}$  ( [344](#) ). Intracranial hemorrhages occurred in 3%, but no significant association existed between intracranial hemorrhage and mode of delivery. More recent data demonstrate that the incidence of morbidity and mortality in infants with neonatal thrombocytopenia is lower than originally reported. In 1993, Burrows and Kelton published a systematic review of pregnancy in patients with ITP, selecting only those series with more than ten patients and those that included fetal platelet counts and infant outcome ( [345](#) ). Eleven series published between January 1980 and December 1990 fulfilled these criteria. They reported 288 live births and an incidence of fetal thrombocytopenia of 10% with platelet counts less than 50,000 per  $\mu\text{l}$  and 4% with platelet counts less than 20,000 per  $\mu\text{l}$ . There were no deaths and no cases of intracranial hemorrhage, and there was no difference in morbidity between cesarean sections and vaginal births. During the decade from 1990 to 2000, these cumulative totals from 13 prospective studies were 9% and 4% ( [340](#) ). Three percent of infants had minor bleeding complications, and 2% had major bleeding complications. Many studies have been done to determine what characteristics of the mother correlate with severe thrombocytopenia in the newborn ( [340](#) ) and to help with decisions regarding method of delivery. To date, only the birth of a previously affected infant correlates with the incidence of neonatal thrombocytopenia. Other variables that were analyzed, such as the mother's platelet count or prior splenectomy, were predictive in some studies but not in others. Fetal platelet counts might be able to predict newborn risks of bleeding, but scalp vein platelet counts can be artifactually low, and the incidence of complications to percutaneous umbilical blood sampling is higher than the incidence of postnatal major bleeding. In all of these reports, it was also noted that the infant platelet count could fall for several days after delivery. It is, therefore, currently recommended that the mode of delivery should be determined by obstetric indications.

## SECONDARY AUTOIMMUNE THROMBOCYTOPENIC PURPURA

Autoimmune thrombocytopenia is also associated with drugs and with several common diseases (i.e., SLE, infections, lymphoproliferative disorders, and Graves' disease). Secondary immune thrombocytopenias are discussed separately in this section because of their unique features and the issues of diagnosis and management. Immune thrombocytopenia associated with human immunodeficiency virus infection is discussed in [Chapter 69](#).

### Autoimmune Thrombocytopenic Purpura Secondary to Drugs

Numerous drugs have been associated with immune thrombocytopenia. In some cases, the evidence relating a given drug to the production of immune thrombocytopenia is circumstantial. However, a recent systematic review is available in which specific criteria were established to determine the likelihood of drug-induced immune thrombocytopenia due to specific drugs ( [Table 53.5](#) ) ( [346](#) , [347](#) ). The most common drugs with level 1 evidence are quinidine, quinine, rifampin, trimethoprim-sulfamethoxazole, danazol, methyldopa (Aldomet), acetaminophen, and digoxin. The most common drugs with level 2 evidence are gold, procainamide, carbamazepine, hydrochlorothiazide, ranitidine, and

chlorpropamide. Heparin, which causes immune thrombocytopenia in as many as 1% of patients, is discussed in [Chapter 61](#).

**TABLE 53.5. Drugs Associated with Immune Thrombocytopenia and Criteria for Their Classification**

|  | Level 1 <sup>a</sup>          | Level 2 <sup>b</sup> |
|--|-------------------------------|----------------------|
| Acetaminophen                            | Iopanoic acid                 | Acetazolamide        |
| Alprenolol                               | Isoniazid                     | Ampicillin           |
| Aminoglutethimide                        | Levamisole                    | Captopril            |
| Aminosalicylic acid                      | Lithium                       | Carbamazepine        |
| Amiodarone                               | Meclofenamate                 | Chlorpropamide       |
| Amphotericin B                           | Mesalamine                    | Fluconazole          |
| Amrinone                                 | Methicillin                   | Glibenclamide        |
| Atorvastatin                             | Methyldopa (Aldomet)          | Gold                 |
| Cephalothin                              | Minoxidil                     | Hydrochlorothiazide  |
| Chlorothiazide                           | Nalidixic acid                | Ibuprofen            |
| Chlorpromazine                           | Naphazoline                   | Oxyphenbutazone      |
| Cimetidine                               | Nitroglycerine                | Oxytetracycline      |
| Danazol                                  | Novobiocin                    | Phenytoin            |
| Deferoxamine                             | Oxprenolol                    | Procainamide         |
| Diatrizoate meglumine/diatrizoate sodium | Pentoxifylline                | Ranitidine           |
|  | Piperacillin                  | Sulindac             |
| Diazepam                                 | Quinidine                     | Ticlopidine          |
| Diazoxide                                | Quinine                       |                      |
| Diclofenac                               | Rifampin                      |                      |
| Diethylstilbestrol                       | Sulfasalazine                 |                      |
| Difluormethylornithine                   | Sulfasoxazole                 |                      |
| Digoxin                                  | Tamoxifen                     |                      |
| Ethambutol                               | Thiothixene                   |                      |
| Haloperidol                              | Tolmetin                      |                      |
| Indinavir                                | Trimethoprim-sulfamethoxazole |                      |
| Interferon- $\alpha$                     | Vancomycin                    |                      |

Criteria <sup>a, b</sup>

1. The candidate drug preceded thrombocytopenia, and recovery from thrombocytopenia was complete and sustained after the drug was discontinued.
2. The candidate drug was the only drug used before the onset of thrombocytopenia, or other drugs were continued or reintroduced after discontinuation of the candidate drug with a sustained normal platelet count.
3. Other etiologies for thrombocytopenia were excluded.
4. Reexposure to the candidate drug resulted in recurrent thrombocytopenia.

<sup>a</sup> Level 1 evidence met criteria 1–4.

<sup>b</sup> Level 2 evidence met criteria 1–3.

From George JN, Raskob GE, Shah SR, et al. Drug-induced thrombocytopenia: a systematic review of published case reports. *Ann Intern Med* 1998;129:886–890, with permission; and Rizvi MA, Kojouri K, George JN. Drug-induced thrombocytopenia: an updated systematic review. *Ann Intern Med* 2001;134:346, with permission.

---

**PATHOPHYSIOLOGY** Drug-induced platelet antibodies are the result of an idiosyncratic reaction that develops in only a small percentage of persons exposed to a drug. This ranges from an estimated 38 cases per 1 million for trimethoprim-sulfamethoxazole, to 6 cases per 100 for rifampin ( 348 ), to as many as 1 in 100 patients for gold salts or heparin ( 349 , 350 and 351 ). It is not clear whether there are predisposing risk factors for most of the drugs that cause immune thrombocytopenia. However, strong evidence suggests that the risk of developing antibodies to gold salts depends on host HLA type, and the majority of patients studied have had HLA-DR3 alloantigen. Drug-induced antibodies may be complement- or noncomplement-activating antibodies that react with platelets either in the absence (autoantibodies) or presence of drugs. The most completely studied antibodies are those that develop in response to quinidine/quinine and heparin. Most drug-induced antibodies bind specifically to platelet membrane glycoproteins in the IIb/IIIa or the Ib/IX complex through the Fab portion of the antibody molecule ( Fig. 53.2B ). Many recent studies demonstrate a strong preference for epitopes on Iba or IX ( 348 , 352 , 353 ). In contrast, antibodies to heparin bind to a heparin-platelet factor 4 complex, and the immune complex then binds to the platelet membrane via the Fc portion of the antibody molecule ( Fig. 53.2C ). More than ten patients have been studied who developed thrombocytopenia and hemolytic uremic syndrome in association with the administration of quinine, suggesting that this antibody may bind to both endothelial cells and platelets in this unique syndrome ( 354 , 355 , 356 and 357 ). Most of the drug-induced antibodies are developed in response to the parent drug, and drug-dependent antibodies can be demonstrated in a variety of *in vitro* tests. In some cases, however, these tests are negative when the parent compound is present but positive if known metabolites are used instead of the parent compound. Antibodies against drug metabolites have been reported with acetaminophen, paraaminosalicylic acid, naproxen, and trimethoprim-sulfamethoxazole ( 40 , 358 , 359 and 360 ).

**CLINICAL FEATURES** Drug-induced thrombocytopenia is associated with a heterogeneous clinical picture and varying degrees of bleeding. Thrombocytopenia and bleeding usually appear abruptly and may be severe. Mucosal membrane bleeding from all sites and oral hemorrhagic bullae may occur, and patients often develop fever, chills, nausea, vomiting, and fatigue as part of a prodrome to the bleeding. Severe thrombocytopenia usually develops within hours in sensitized patients ingesting quinidine or quinine; however, a minimum of 6 to 7 days are required to initiate a primary immune response in individuals taking the drug for the first time. Some patients do not develop thrombocytopenia for months or years—a characteristic that seems more dependent on the host than the type of drug. The amount of drug that is required to cause thrombocytopenia is quite variable; however, even the amount of quinine present in a gin and tonic (15 mg) is sufficient to produce severe thrombocytopenia and bleeding in a patient who has been previously sensitized to quinine (“cocktail purpura”) ( 361 ). After the drug is stopped, platelet counts return to normal within days and usually are normal by 1 week. Thrombocytopenia induced by gold salts resolves more slowly, usually over weeks or months, because gold remains in the tissues.

**DIAGNOSIS** It is often difficult to make a definite diagnosis of drug-associated immune thrombocytopenia because either the patient has taken the medication intermittently or a hospitalized patient is receiving more than one drug that may cause thrombocytopenia. Although it may be possible to demonstrate drug-dependent antibodies against the parent drug or its metabolites, this type of testing is beyond the scope of hospital laboratories. The readministration of the suspected drug in an attempt to confirm an etiologic relationship is not recommended as a routine diagnostic measure. Most of the level 1

drugs listed in [Table 53.5](#) were demonstrated to cause immune-mediated thrombocytopenia because of patient response to an inadvertent *in vivo* challenge. **TREATMENT** Ordinarily, no therapy is needed, because withdrawal of the offending drug is followed by recovery. Intravenous Ig and plasmapheresis may be helpful if life-threatening bleeding occurs. Many patients are treated with corticosteroids, and a normal platelet count is usually restored within 1 week. The major exception is gold-induced thrombocytopenia, which may persist for weeks or even months. British antilewisite (dimercaprol) may accelerate the excretion of gold and speed recovery ([362](#)).

### Autoimmune Thrombocytopenia in Systemic Lupus Erythematosus

Thrombocytopenia may complicate collagen-vascular diseases and other various disorders associated with disordered immunologic responses, for example, thymoma ([363](#)) and myasthenia gravis ([364](#), [365](#) and [366](#)). In most instances, the ITP in SLE appears to result from immunologic platelet injury and is identical to idiopathic ITP in most respects.

From 5 to 15% of patients with ITP fulfill the criteria for diagnosis of SLE at the time of presentation ([151](#), [187](#), [367](#), [368](#)). Other patients have a positive antinuclear antibody test when they are first diagnosed with ITP, and a small number of them may develop SLE within several years. Patients with high-titer antinuclear antibody (speckled pattern) and antibodies against native DNA and other nuclear antigens are the patients most likely to develop SLE ([367](#), [369](#), [370](#), [371](#) and [372](#)). SLE is a chronic and fatal disease, so it is important to identify such patients so therapy can be directed at all aspects of the autoimmune disease.

ITP in SLE patients may be the result of either specific platelet autoantibodies or immune complex deposition on platelets. Only a few studies have been reported in which the newest platelet antigen capture autoantibody tests have been used, and in these patients, platelet autoantibodies to platelet membrane glycoproteins have been detected ([373](#), [374](#), [375](#) and [376](#)). Thrombocytopenia correlates with SLE disease activity ([377](#)) but not the presence of antiphospholipid antibodies ([378](#), [379](#) and [380](#)). These antibodies, which may be present in SLE or in otherwise healthy patients, also bind to platelet membrane gpIIb/IIIa or Ib/IX ([375](#), [376](#)). It is unclear, however, whether these autoantibodies are specific to these glycoproteins or cross-reactive.

Patients with ITP and SLE should be treated the same as patients with idiopathic immune thrombocytopenia even though there are conflicting reports on the success rate of splenectomy in this population ([381](#), [382](#)).

### Idiopathic Thrombocytopenic Purpura in Other Disorders

Immune thrombocytopenia has been reported in association with a number of other medical conditions, including infections, neoplasms, and thyroid disease, and it is unknown whether this increased platelet destruction is the result of binding of autoantibodies or immune complexes or to antibody-mediated complement activation.

Immune thrombocytopenia has been documented in patients with infectious mononucleosis, cytomegalovirus, varicella or zoster ([383](#), [384](#), [385](#) and [386](#)), hepatitis B and C ([387](#), [388](#)), tuberculosis ([389](#)), and human immunodeficiency virus infections (discussed in [Chapter 69](#)). During the last several years, immune thrombocytopenia was also reported in patients with *Helicobacter pylori*, and platelet counts may or may not normalize with

treatment directed only at *Helicobacter* ( 390 , 391 , 392 , 393 , 394 and 395 ).

ITP is a well-known complication of chronic lymphocytic leukemia ( 396 ), although it is not as frequent as autoimmune hemolytic anemia in these patients. It has also been reported in patients with other lymphoproliferative disorders including Hodgkin disease ( 121 , 397 , 398 , 399 , 400 , 401 , 402 , 403 , 404 and 405 ). Thrombocytopenia in patients with a variety of solid tumors has also been thought to most likely be immune mediated ( 363 , 400 , 401 ).

Thrombocytopenia may accompany Graves disease and Hashimoto thyroiditis ( 406 , 407 , 408 and 409 ), but it is not certain if it is immunologically mediated. Platelet-associated IgG has been increased when studied ( 408 , 409 ), but there may also be enhanced reticuloendothelial phagocytosis.

## ALLOIMMUNE THROMBOCYTOPENIA

Platelets express membrane-associated epitopes due to polymorphisms in discrete regions of the platelet membrane surface glycoproteins ( 410 ). No natural antibodies to human platelet antigens are known. Acquired platelet alloantibodies are of clinical importance in three circumstances: (a) neonatal alloimmune thrombocytopenia, which is the result of the placental transfer of alloantibodies formed by the mother to incompatible fetal platelet antigens ( 411 ); (b) posttransfusion purpura (PTP), a rare disorder in which the transfusion of platelet-containing blood products provokes the formation of alloantibodies that act as autoantibodies ( 412 ); and (c) passive transfer of platelet alloantibodies after transfusion from a multiparous or multiply transfused donor ( 413 , 414 , 415 and 416 ).

### Neonatal Alloimmune Thrombocytopenia

**PATHOPHYSIOLOGY** Immunologic thrombocytopenia in the newborn may result from the placental transfer of platelet antibodies formed as the result of active immunization of the mother by fetal platelet antigens. Pathophysiologically, such neonatal alloimmune thrombocytopenia is similar to erythroblastosis fetalis. Thus, as a consequence of the inheritance by the fetus of platelet antigens lacking in the mother, alloantibodies are formed in the maternal circulation and cross the placenta, producing thrombocytopenia in the fetus. Antibodies can be detected as early as the nineteenth week, and thrombocytopenia has been found *in utero* by 20 weeks' gestation ( 417 ). Immunization to human platelet alloantigen (HPA)-1a (PL<sup>A</sup>, Zw<sup>A</sup>) ( 418 , 419 and 420 ) and HPA-5b (Br<sup>A</sup>, Zav, Hc) ( 421 , 422 ) is most common; however, other antigens have been detected and found responsible for occasional cases of neonatal alloimmune thrombocytopenia ( Fig. 53.2D ) ( 418 , 419 , 421 , 423 , 424 , 425 , 426 , 427 , 428 and 429 ). All of the platelet polymorphisms found to date are caused by a single base pair mutation leading to a single amino acid substitution in the polypeptide chain of the specific gp. Rarely, HLA antibodies are responsible ( 418 , 421 ). Alloimmunization to platelet antigens commonly develops during the first pregnancy and then recurs in more than 80% of patients during subsequent pregnancies. However, not all mothers who are missing the antigens presented by the fetus develop antibodies, and not all fetuses and neonates develop thrombocytopenia in spite of antibody development ( 420 ). HPA-1 mismatch is present in 1 in 50 births, yet neonatal alloimmune thrombocytopenia only occurs in 1 in 1000 to 2000 births ( 417 , 419 , 420 , 430 ). Maternal HLA class II determinants appear important. A high incidence of maternal allotypes HLA-DR3 and HLA-DRw52a has been demonstrated in mothers isoimmunized to fetal alloantigen HPA-1



([420](#), [431](#)), and a high incidence of HLA-DR6 has been reported in mothers sensitized to PLA-5b ([421](#)).

**CLINICAL FEATURES** Infants with neonatal alloimmune thrombocytopenia are born with signs of purpura and severe thrombocytopenia. Thrombocytopenia usually is present at birth, but the platelet count may fall further during the perinatal period. Intracranial hemorrhage occurs in 20 to 30%, with one-half of the episodes occurring *in utero* ([432](#)). An overall mortality rate of 6 to 14% has been reported ([419](#), [423](#)). Thrombocytopenia usually resolves after 10 to 14 days. Platelet antibody titers during the second half of the pregnancy appear to correlate with the risk of thrombocytopenia or bleeding, or both, in neonatal alloimmune thrombocytopenia ([433](#), [434](#)).

**LABORATORY DIAGNOSIS** When infants are born with platelet counts less than 20,000  $\mu$ l, neonatal alloimmune thrombocytopenia must be suspected, and platelet typing and platelet antibody assays should be performed on both parents. Neonatal alloimmune thrombocytopenia is diagnosed when platelet antigen incompatibility is found between the parents, maternal antipaternal platelet antibodies are present, and the antibody detected corresponds to the incompatibility of platelet antigens that have been noted.

**TREATMENT** Severely thrombocytopenic children should be treated aggressively with intravenous Ig and platelet transfusions of compatible, irradiated platelets. Maternal platelets can be obtained by pheresis, concentrated, irradiated, and transfused. Screening studies to detect neonatal thrombocytopenia during the first pregnancy have been limited to patients with known PL<sup>A1</sup> incompatibility and an HLA allotype associated with an increased incidence of antibody formation ([431](#)). However, after the birth of one child with neonatal alloimmune thrombocytopenia, subsequent pregnancies should be evaluated antenatally. It is recommended that fetal platelet typing ([418](#), [435](#), [436](#), [437](#) and [438](#)) and platelet counts should be obtained at, or approximately at, 20 weeks ([417](#), [439](#)). If platelet incompatibility is noted and the infant is thrombocytopenic, *in utero* platelet transfusions or maternal treatment with intravenous Ig should be instituted and maintained during the pregnancy ([417](#), [440](#), [441](#)). The use of cordocentesis may be associated with fetal exsanguination if the fetus is severely thrombocytopenic or a prior pregnancy was complicated by *in utero* intracranial hemorrhage. The use of steroids and exchange plasmapheresis is still controversial.

## Posttransfusion Purpura

Alloantibodies that develop as a result of transfusion of incompatible platelets are responsible for the destruction of the transfused platelets. Rarely, however, severe thrombocytopenia in the recipient—that is, destruction of host platelets—is produced by the transfusion of incompatible platelets, and this potentially fatal reaction is known as *posttransfusion purpura* (PTP) ([442](#), [443](#) and [444](#)). PTP is characterized by the abrupt onset of thrombocytopenia and mucosal bleeding that occurs approximately 1 week after the transfusion of packed red blood cells. PTP has also occasionally been described after the transfusion of other blood components including fresh plasma ([445](#)).

The syndrome occurs most commonly in multiparous women; however, previously transfused patients may also develop PTP. The antibody most commonly develops against PL<sup>A1</sup> (HPA-1a) in PL<sup>A2</sup> (HPA-1b) homozygous recipients, but the Bak (HPA-3a/HPA-3b), Pen (HPA-4a/HPA-4b), Br (HPA-5a/HPA-5b), and Nak<sup>a</sup> polymorphisms have been implicated as well ([412](#), [443](#), [444](#), [446](#), [447](#), [448](#) and [449](#)) ([Table 53.6](#)). The diagnosis of PTP is a clinical one, and physicians must therefore consider this diagnosis in any patient developing thrombocytopenia within 3 to 14 days after transfusion of any blood product.

**TABLE 53.6. Platelet Alloantigens Implicated in the Development of Posttransfusion Purpura**

| Serologic Designation     | Alternative Designation | Phenotype Frequency | Antigen Location    |
|---------------------------|-------------------------|---------------------|---------------------|
| PL <sup>A1</sup> (HPA-1a) | Zw <sup>a</sup>         | 0.96–0.99           | gpIIIa              |
| PL <sup>A2</sup> (HPA-1b) | Zw <sup>b</sup>         | 0.27                | gpIIIa              |
| Bak <sup>a</sup> (HPA-3a) | Lek <sup>a</sup>        | 0.78–0.89           | gpIIb               |
| Bak <sup>b</sup> (HPA-3b) | Lek <sup>b</sup>        | 0.50–0.70           | gpIIb               |
| Pen <sup>a</sup> (HPA-4a) | Yuk <sup>b</sup>        | 0.99                | gpIIIa <sup>a</sup> |
| Pen <sup>b</sup> (HPA-4b) | Yuk <sup>a</sup>        | 0.01                | gpIIIa <sup>a</sup> |
| Br <sup>b</sup> (HPA-5a)  | Zav <sup>b</sup>        | 0.99                | gpIa                |
| Br <sup>a</sup> (HPA-5b)  | Zav <sup>a</sup>        | 0.18–0.20           | gpIa                |

HPA, human platelet alloantigen; gp, glycoprotein.

<sup>a</sup> Antigen appears to be distinct from PL <sup>A1</sup> (HPA-1a).

Modified from McCrae KR, Herman JH. Posttransfusion purpura: two unusual cases and a literature review. *Am J Hematol* 1996;52:205–211.

The pathophysiology of this rare but severe thrombocytopenia is still uncertain, but several hypotheses have been proposed: (a) autologous platelets are destroyed because of binding of immune complexes to their surface; (b) recipient platelets acquire the phenotype of the donor's platelets because they bind soluble antigens from the transfused blood product, and the platelets are then destroyed by the alloantibodies; and (c) exposure to foreign platelets in the transfused products induces the formation of autoantibodies to the recipient's platelets ( [412](#), [450](#), [451](#) ).

PTP is self-limited, resolving within 1 to 3 weeks in most patients. Treatment with steroids, plasmapheresis, or intravenous Ig may shorten the period of thrombocytopenia. Plasmapheresis is effective in 80% ( [452](#), [453](#) and [454](#) ), but intravenous Ig, in doses of 2 g/kg over 2 days, may be preferable because plasmapheresis requires central venous access with large bore catheters and places the patient in danger of significant bleeding ( [455](#), [456](#) and [457](#) ). Platelet transfusions should be reserved for life-threatening hemorrhage, because patients often develop a febrile reaction and infrequently respond by increasing their platelet count.

## REFERENCES

- George JN, El-Harake MA, Raskob GE. Chronic idiopathic thrombocytopenic purpura. *N Engl J Med* 1994;331:1207–1211.
- Aster RH, George JN, McMillan R, et al. Workshop on autoimmune (idiopathic) thrombocytopenic purpura: pathogenesis and new approaches to therapy. *Am J Hematol* 1998;58:231–234.
- Chong BH, Keng TB. Advances in the diagnosis of idiopathic thrombocytopenic purpura. *Semin Hematol* 2000;37:249–260.
- McMillan R. Autoantibodies and autoantigens in chronic immune thrombocytopenic purpura. *Semin*



Hematol 2000;37:239–248.

5. Blanchette V, Carcao M. Approach to the investigation and management of immune thrombocytopenic purpura in children. *Semin Hematol* 2000;37:299–314.
6. George JN, Kojouri K, Perdue JJ, et al. Management of patients with chronic, refractory idiopathic thrombocytopenic purpura. *Semin Hematol* 2000;37:290–298.
7. Cines DB, Blanchette VS. Immune thrombocytopenic purpura. *N Engl J Med* 2002;346:995–1008.
8. Lusher JM, Zuelzer WW. Idiopathic thrombocytopenic purpura in childhood. *J Pediatr* 1966;68:971–979.
9. Lusher JM, Iyer R. Idiopathic thrombocytopenic purpura in children. *Semin Thromb Hemost* 1977;3:175–199.
10. Choi SI, McClure PD. Idiopathic thrombocytopenic purpura in childhood. *Can Med Assoc J* 1967;97:562–568.
11. Komrower GM, Watson GH. Prognosis in idiopathic thrombocytopenic purpura of childhood. *Arch Dis Child* 1954;29:502.
12. Brown DN, Elliott RHE. The results of splenectomy in thrombocytopenic purpura. *JAMA* 1936;107:1781–1788.
13. Eliason EL, Ferguson LK. Splenectomy in purpura hemorrhagica. *Ann Surg* 1932;96:801–829.
14. Wintrobe MM, Hanrahan EM, Thomas CB, et al. Purpura haemorrhagica with special reference to course and treatment. *JAMA* 1937;109:1170–1176.
15. Cortelazzo S, Finazzi G, Buelli M, et al. High risk of severe bleeding in aged patients with chronic idiopathic thrombocytopenic purpura. *Blood* 1991;77:31–33.
16. Stasi R, Stipa E, Masi M, et al. Long-term observation of 208 adults with chronic idiopathic thrombocytopenic purpura. *Am J Med* 1995;98:436–442.
17. Pizzuto J, Ambriz R. Therapeutic experience on 934 adults with idiopathic thrombocytopenic purpura: multicentric trial of the Cooperative Latin American Group on Hemostasis and Thrombosis. *Blood* 1984;64:1179–1183.
18. Hirsch EO, Dameshek W. “Idiopathic” thrombocytopenia. *Arch Intern Med* 1951;88:701–728.
19. Kiefel V, Santoso S, Mueller-Eckhardt C. Serological, biochemical, and molecular aspects of platelet autoantigens. *Semin Hematol* 1992;29:26–33.
20. Hauch TW, Rosse WF. Platelet-bound complement (C3) in immune thrombocytopenia. *Blood* 1977;50:1129–1136.
21. Horstman L, Jy W, Schultz DR, et al. Complement-mediated fragmentation and lysis of opsonized platelets: gender differences in sensitivity. *J Lab Clin Med* 1994;123:515–525.
22. Brand A, Witvliet M, Claas FHJ, Eernisse JG. Beneficial effect of intravenous gammaglobulin in a patient with complement-mediated autoimmune thrombocytopenia due to IgM-antiplatelet antibodies. *Br J Haematol* 1988;69:507–511.
23. Nomura S, Yanabu M, Soga T, et al. Analysis of idiopathic thrombocytopenic purpura patients with antiglycoprotein IIb/ IIIa or Ib autoantibodies. *Acta Haematol* 1991;86:25–30.
24. Panzer S, Szamait S, Bodeker RH, et al. Platelet-associated immunoglobulins IgG, IgM, IgA and complement C3 in immune and nonimmune thrombocytopenic disorders. *Am J Hematol* 1986;23:89–99.
25. Kayser W, Mueller-Eckhardt C, Budde U, Schmidt RE. Complement-fixing platelet autoantibodies in autoimmune thrombocytopenia. *Am J Hematol* 1981;11:213–219.

26. Tsubakio T, Tani P, Curd JG, McMillan R. Complement activation *in vitro* by antiplatelet antibodies in chronic immune thrombocytopenic purpura. *Br J Haematol* 1986;63:293–300.
27. Szatkowski NS, Kunicki TJ, Aster RH. Identification of glycoprotein Ib as a target for autoantibody in idiopathic (autoimmune) thrombocytopenic purpura. *Blood* 1986;67:310–315.
28. Kiefel V, Spaeth P, Mueller–Eckhardt C. Immune thrombocytopenic purpura: autoimmune or immune complex disease? *Br J Haematol* 1986;64:57–68.
29. Trent RJ, Clancy RL, Danis V, Basten A. Immune complexes in thrombocytopenic patients: cause or effect? *Br J Haematol* 1980;44:645–654.
30. Clancy R, Trent R, Danis V, Davidson R. Autosensitization and immune complexes in idiopathic thrombocytopenic purpura. *Clin Exp Immunol* 1980;39:170–175.
31. Lurhuma AZ, Riccomi H, Masson PL. The occurrence of circulating immune complexes and viral antigens in idiopathic thrombocytopenic purpura. *Clin Exp Immunol* 1977;28:49–55.
32. Kurata Y, Hayashi S, Aochi H, et al. Analysis of antigen involved in circulating immune complexes in patients with idiopathic thrombocytopenic purpura. *Clin Exp Immunol* 1987;67:293–299.
33. Harrington WJ, Minnich V, Hollingsworth JW, Moore CV. Demonstration of a thrombocytopenic factor in the blood of patients with thrombocytopenic purpura. *J Lab Clin Med* 1951;38:1–10.
34. Shulman NR, Marder VJ, Weinrach RS. Similarities between known antiplatelet antibodies and factor responsible for thrombocytopenia in idiopathic thrombocytopenic purpura. *Ann N Y Acad Sci* 1965;124:499.
35. van Leeuwen EF, van der Ven JT, Engelfriet CP, von dem Borne AE. Specificity of autoantibodies in autoimmune thrombocytopenia. *Blood* 1982;59:23–26.
36. Dixon R, Rosse W, Ebbert L. Quantitative determination of antibody in idiopathic thrombocytopenic purpura: correlation of serum and platelet bound antibody with clinical response. *N Engl J Med* 1975;292:230–236.
37. Kernoff LM. Influence of the amount of platelet–bound IgG on platelet survival and the site of sequestration in autoimmune thrombocytopenia. *Blood* 1980;55:730–733.
38. Berchtold P, Wenger M. Autoantibodies against platelet glycoproteins in autoimmune thrombocytopenic purpura: their clinical significance and response to treatment. *Blood* 1993;81:1246–1250.
39. Hou M, Stockelberg D, Kutti J, Wadenvik H. Antibodies against platelet GPIb/IX, GPIIb/IIIa, and other platelet antigens in chronic idiopathic thrombocytopenic purpura. *Eur J Hematol* 1995;55:307–314.
40. Kiefel V, Santoso S, Weisheit M, Mueller–Eckhardt C. Monoclonal antibody–specific immobilization of platelet antigens (MAIPA): a new tool for the identification of platelet–reactive antibodies. *Blood* 1987;70:1722–1726.
41. McMillan R, Tani P, Millard F, et al. Platelet–associated and plasma antiglycoprotein antibodies in chronic ITP. *Blood* 1987;70:1040–1045.
42. McMillan R. Clinical role of antiplatelet antibody assays. *Semin Thromb Hemost* 1995;21:37–45.
43. He BR, Reid DM, Jones CE, Shulman NR. Spectrum of Ig classes, specificities, and titers of serum antiglycoproteins in chronic idiopathic thrombocytopenic purpura. *Blood* 1994;83:1024–1032.
44. Panahi MR, LeBlanc S, Schober O, et al. Study of platelet–associated immunoglobulins of IgG, IgM, IgA and IgE classes and platelet kinetics in 33 patients with idiopathic thrombocytopenic purpura. *Ann Haematol* 1994;69:121–128.
45. Stockelberg D, Hou M, Jacobsson S, et al. Evidence for a light chain restriction of glycoprotein Ib/IX and IIb/IIIa reactive antibodies in chronic idiopathic thrombocytopenic purpura (ITP). *Br J Hematol*

1995;90:175–179.

46. Stockelberg D, Hou M, Jacobsson S, et al. Light chain-restricted autoantibodies in chronic idiopathic thrombocytopenic purpura, but no evidence for circulating clonal B-lymphocytes. *Ann Hematol* 1996;72:29–34.
47. Christie DJ, Sauro SC, Fairbanks KD, Kay NE. Detection of clonal platelet antibodies in immunologically mediated thrombocytopenias: association with circulating clonal/oligoclonal B cells. *Br J Hematol* 1993;85:277–284.
48. van der Harst D, de Jong D, Limpens J, et al. Clonal B-cell populations in patients with idiopathic thrombocytopenic purpura. *Blood* 1990;76:2321–2326.
49. Kelton JG. The serologic investigation of patients with autoimmune thrombocytopenia. *Thromb Haemost* 1995;74:228–233.
50. Hou M, Stockelberg D, Kutti J, Wadenvik H. Fab-mediated binding of glycoprotein Ib/IX and IIb/IIIa specific antibodies in chronic idiopathic thrombocytopenic purpura. *Br J Hematol* 1995;91:944–950.
51. Woods VL, Oh E, Mason D, McMillan R. Autoantibodies against the platelet glycoprotein IIb/IIIa complex in patients with chronic ITP. *Blood* 1984;63:368–375.
52. Woods VL, Kurata Y, Montgomery RR, et al. Autoantibodies against platelet glycoprotein Ib in patients with chronic immune thrombocytopenic purpura. *Blood* 1984;64:156–160.
53. Beardsley DS, Spiegel JE, Jacobs MM, et al. Platelet membrane glycoprotein IIIa contains target antigens that bind antiplatelet antibodies in immune thrombocytopenias. *J Clin Invest* 1984;74:1701–1707.
54. He R, Reid DM, Jones CE, Shulman NR. Extracellular epitopes of platelet glycoprotein Iba reactive with serum antibodies from patients with chronic idiopathic thrombocytopenic purpura. *Blood* 1995;86:3789–3796.
55. Bierling P, Bettaieb A, Fromont P, et al. Anti-GMP 140 (CD62) autoantibody in a patient with autoimmune thrombocytopenic purpura. *Br J Haematol* 1994;87:631–633.
56. Kosugi S, Tomiyama Y, Honda S, et al. Anti- $\alpha_v\beta_3$  antibodies in chronic immune thrombocytopenia. *Thromb Haemost* 2001;85:36–41.
57. Taub JW, Warrier I, Holtkamp C, et al. Characterization of autoantibodies against the platelet glycoprotein antigens IIb/ IIIa in childhood idiopathic thrombocytopenia purpura. *Am J Hematol* 1995;48:104–107.
58. Tsubakio T, Tani P, Woods VL, McMillan R. Autoantibodies against platelet GPIIb/IIIa in chronic ITP react with different epitopes. *Br J Haematol* 1987;67:345–348.
59. Tomiyama Y, Kurata Y, Mizutani H, et al. Platelet glycoprotein IIb as a target antigen in two patients with chronic idiopathic thrombocytopenic purpura. *Br J Haematol* 1987;66:535–538.
60. Tomiyama Y, Kurata Y, Shibata Y, et al. Immunochemical characterization of an autoantigen on platelet glycoprotein IIb in chronic ITP: comparison with the Bak<sup>a</sup> alloantigen. *Br J Haematol* 1989;71:77–83.
61. Fujisawa K, O'Toole TE, Tani P, et al. Autoantibodies to the presumptive cytoplasmic domain of platelet glycoprotein IIIa in patients with chronic immune thrombocytopenic purpura. *Blood* 1991;77:2207–2213.
62. Fujisawa K, Tani P, O'Toole TE, et al. Different specificities of platelet-associated and plasma autoantibodies to platelet GPIIb-IIIa in patients with chronic immune thrombocytopenic purpura. *Blood* 1992;79:1441–1446.
63. Fujisawa K, Tani P, McMillan R. Platelet-associated antibody to glycoprotein IIb/IIIa from chronic immune thrombocytopenic purpura patients often binds to divalent cation-dependent antigens. *Blood* 1993;81:1284–1289.

64. Bowditch RD, Tani P, McMillan R. Reactivity of autoantibodies from chronic ITP patients with recombinant glycoprotein IIIa peptides. *Br J Hematol* 1995;91:178–184.
65. Hou M, Stockelberg D, Kutti J, Wadenvik H. Glycoprotein IIb/IIIa autoantigenic repertoire in chronic idiopathic thrombocytopenic purpura. *Br J Hematol* 1995;91:971–975.
66. Kuwana M, Kaburaki J, Kitasato H, et al. Immunodominant epitopes on glycoprotein IIb–IIIa recognized by autoreactive T cells in patients with immune thrombocytopenic purpura. *Blood* 2001;98:130–139.
67. Kosugi S, Tomiyama Y, Honda S, et al. Platelet-associated anti-GPIIb–IIIa autoantibodies in chronic immune thrombocytopenic purpura recognizing epitopes close to the ligand-binding site of glycoprotein (GP) IIb. *Blood* 2001;98:1819–1827.
68. McMillan R, Lopez-Dee J, Loftus JC. Autoantibodies to  $\alpha_{IIb}\beta_3$  in patients with chronic immune thrombocytopenic purpura bind primarily to epitopes on  $\alpha_{IIb}$ . *Blood* 2001;97:2171–2172.
69. Kiefel V, Santoso S, Kaufmann E, Mueller-Eckhardt C. Autoantibodies against platelet glycoprotein Ib/IX: a frequent finding in autoimmune thrombocytopenic purpura. *Br J Haematol* 1991;79:256–262.
70. van Vliet HH, Kappers-Klune MC, van der Hel JW, Abels J. Antibodies against glycosphingolipids in sera of patients with idiopathic thrombocytopenic purpura. *Br J Haematol* 1987;67:103–108.
71. Koerner TAW, Weinfeld HM, Bullard LSB, Williams LCJ. Antibodies against platelet glycosphingolipids: detection in serum by quantitative HPTLC–autoradiography and association with autoimmune and alloimmune processes. *Blood* 1989;74:274–284.
72. Harris EN, Asherson RA, Gharavi AE, et al. Thrombocytopenia in SLE and related autoimmune disorders: association with anticardiolipin antibody. *Br J Haematol* 1985;59:227–230.
73. Nomura S, Yanabu M, Fukuroi T, et al. Anti-phospholipid antibodies bind to platelet microparticles in idiopathic (autoimmune) thrombocytopenic purpura. *Ann Haematol* 1992;65:46–49.
74. Nomura S, Yanabu M, Miyake T, et al. Relationship of microparticles with  $\beta_2$ -glycoprotein I and P-selectin positivity to anticardiolipin antibodies in immune thrombocytopenic purpura. *Ann Haematol* 1995;70:25–30.
75. Arfors L, Winiarski J, Lefvert AK. Prevalence of antibodies to cardiolipin in chronic ITP and reactivity with platelet membranes. *Eur J Haematol* 1996;56:230–234.
76. Stasi R, Stipa E, Masi M, et al. Prevalence and clinical significance of elevated antiphospholipid antibodies in patients with idiopathic thrombocytopenic purpura. *Blood* 1994;84:4203–4208.
77. Diz-Kucukkaya R, Hacıhanefioglu A, Yeneral M, et al. Antiphospholipid antibodies and antiphospholipid syndrome in patients presenting with immune thrombocytopenic purpura: a prospective cohort study. *Blood* 2001;98:1760–1764.
78. Sugiyama T, Okuma M, Ushikubi F, et al. A novel platelet-aggregating factor found in a patient with defective collagen-induced platelet aggregation and autoimmune thrombocytopenia. *Blood* 1987;69:1712–1720.
79. Yanabu M, Nomura S, Fukuroi T, et al. Synergistic action in platelet activation induced by an antiplatelet autoantibody in ITP. *Br J Haematol* 1991;78:87–93.
80. Yanabu M, Nomura S, Fukuroi T, et al. Platelet activation induced by an antiplatelet autoantibody against CD9 antigen and its inhibition by another autoantibody in immune thrombocytopenic purpura. *Br J Haematol* 1993;84:694–701.
81. Hashimoto Y, Tanabe J, Mohri H, Ohkubo T. Autoimmune antibody in a patient with idiopathic thrombocytopenic purpura reacted to the platelet low molecular weight glycoproteins and activated platelets. *Am J Clin Pathol* 1994;101:370–374.
82. Deckmyn H, DeReys S. Functional effects of human antiplatelet antibodies. *Semin Thromb Hemost*

1995;21:46–59.

83. Balduini CL, Bertolino G, Noris P, et al. Defect of platelet aggregation and adhesion induced by autoantibodies against platelet glycoprotein IIIa. *Thromb Haemost* 1992;68:208–213.
84. Ware RE, Howard TA. Phenotypic and clonal analysis of T lymphocytes in childhood immune thrombocytopenic purpura. *Blood* 1993;82:2137–2142.
85. Semple JW, Milev Y, Cosgrove D, et al. Differences in serum cytokine levels in acute and chronic autoimmune thrombocytopenic purpura: relationship to platelet phenotype and antiplatelet T-cell reactivity. *Blood* 1996;87:4245–4254.
86. Garcia-Suarez J, Prieto A, Manzano L, et al. T lymphocytes from autoimmune thrombocytopenic purpura show a defective activation and proliferation after cytoplasmic membrane and intracytoplasmic mitogenic signals. *Am J Hematol* 1993;44:1–8.
87. Trent R, Adams E, Erhardt C, Basten A. Alterations in T ? cells in patients with chronic idiopathic thrombocytopenic purpura. *J Immunol* 1981;127: 621–626.
88. Mylvaganam R, Garcia RO, Ahn YS, et al. Depressed functional and phenotypic properties of T but not B lymphocytes in idiopathic thrombocytopenic purpura. *Blood* 1988;71:1455–1460.
89. Garcia-Suarez J, Prieto A, Reyes E, et al. The clinical outcome of autoimmune thrombocytopenic purpura patients is related to their T cell immunodeficiency. *Br J Haematol* 1993;84:464–470.
90. Garcia-Suarez J, Prieto A, Reyes E, et al. Severe chronic autoimmune thrombocytopenic purpura is associated with an expansion of CD56+ CD3–natural killer subset. *Blood* 1993;82:1538–1545.
91. Furubayashi T, Mizutani H, Take H, et al. Impaired suppressor function of T cells induced by autologous mixed lymphocyte reaction in patients with idiopathic thrombocytopenic purpura. *Acta Haematol* 1992;87:32–36.
92. Aster RH, Keene WR. Sites of platelet destruction in idiopathic thrombocytopenic purpura. *Br J Haematol* 1969;15:61–73.
93. Harker LA. Thrombokinetics in idiopathic thrombocytopenic purpura. *Br J Haematol* 1970;19:95–104.
94. Branhog I, Kutti J, Ridell B, et al. The relation of thrombokinetics to bone marrow megakaryocytes in idiopathic thrombocytopenic purpura (ITP). *Blood* 1975;45:551–562.
95. Ries CA, Price DC. [ <sup>51</sup>Cr ] platelet kinetics in thrombocytopenia: correlation between splenic sequestration of platelets and response to splenectomy. *Ann Intern Med* 1974;80:702–707.
96. Heynes AduP, Lotter MG, Badenhorst PN, et al. Kinetics and sites of destruction of <sup>111</sup>indium–oxine–labeled platelets in idiopathic thrombocytopenic purpura: a quantitative study. *Am J Hematol* 1982;12:167–177.
97. Heynes AduP, Badenhorst PN, Lotter MG, et al. Platelet turnover and kinetics in immune thrombocytopenic purpura: results with autologous <sup>111</sup>In–labeled platelets and homologous <sup>51</sup>Cr–labeled platelets differ. *Blood* 1986;67:86–92.
98. Stoll D, Cines DB, Aster RH, Murphy S. Platelet kinetics in patients with idiopathic thrombocytopenic purpura and moderate thrombocytopenia. *Blood* 1985;65:584–588.
99. Ballem PJ, Segal GM, Stratton JR, et al. Mechanisms of thrombocytopenia in chronic autoimmune thrombocytopenic purpura: evidence of both impaired platelet production and increased platelet clearance. *J Clin Invest* 1987;80:33–40.
100. Tomer A, Hanson SR, Harker LA. Autologous platelet kinetics in patients with severe thrombocytopenia: discrimination between disorders of production and destruction. *J Lab Clin Med* 1991;118:546–554.
101. Stratton JR, Ballem PJ, Gernsheimer T, et al. Platelet destruction in autoimmune thrombocytopenic

- purpura: kinetics and clearance of indium-111-labeled autologous platelets. *J Nucl Med* 1989;30:629-637.
102. Siegel RS, Rae JL, Barth S, et al. Platelet survival and turnover: important factors in predicting response to splenectomy in immune thrombocytopenic purpura. *Am J Hematol* 1989;30:206-212.
103. Schmidt KG, Rasmussen JW. Kinetics and distribution *in vivo* of <sup>111</sup>In-labelled autologous platelets in idiopathic thrombocytopenic purpura. *Scand J Haematol* 1985;34:47-56.
104. Shulman NR, Weinrach RS, Libre EP, et al. The role of the reticuloendothelial system in the pathogenesis of idiopathic thrombocytopenic purpura. *Trans Assoc Am Physicians* 1965;78:374-390.
105. McMillan R, Longmire RL, Tavassoli M, et al. *In vitro* platelet phagocytosis by splenic leukocytes in idiopathic thrombocytopenic purpura. *N Engl J Med* 1974;290:249-251.
106. Ziegler ZR, Rosenfeld CS, Nemunaitis JJ, et al. Increased macrophage colony-stimulating factor levels in immune thrombocytopenic purpura. *Blood* 1993;81:1251-1254.
107. Saleh MN, Moore DL, Lee JY, LoBuglio AF. Monocyte-platelet interaction in immune and nonimmune thrombocytopenia. *Blood* 1989;74:1328-1331.
108. Kelton JG, Carter CJ, Rodger C, et al. The relationship among platelet-associated IgG, platelet lifespan, and reticuloendothelial function. *Blood* 1984;63:1434-1438.
109. Fujimoto TT, Inoue M, Shimomura T, et al. Involvement of Fc $\gamma$  receptor polymorphism in the therapeutic response of idiopathic thrombocytopenic purpura. *Br J Haematol* 2001;115:125-130.
110. Trikalinos TA, Karassa FB, Ioannidis JPA. Meta-analysis of the association between low-affinity Fc $\gamma$  receptor gene polymorphisms and hematologic and autoimmune diseases. *Blood* 2001;98:1634-1635.
111. McMillan R, Longmire RL, Yelenosky R, et al. Immunoglobulin synthesis *in vitro* by splenic tissue in idiopathic thrombocytopenic purpura. *N Engl J Med* 1972;286:681-684.
112. Karpatkin S, Strick N, Siskind GW. Detection of splenic anti-platelet antibody synthesis in idiopathic autoimmune thrombocytopenic purpura (ATP). *Br J Haematol* 1972;23:167-176.
113. Chang CS, Li CY, Cha SS. Chronic idiopathic thrombocytopenic purpura: splenic pathologic features and their clinical correlation. *Arch Pathol Lab Med* 1993;117:981-985.
114. McMillan R, Luiken GA, Levy R, et al. Antibody against megakaryocytes in idiopathic thrombocytopenic purpura. *JAMA* 1978;239:2460-2462.
115. Hoffman R, Zaknoen S, Yang HH, et al. An antibody cytotoxic to megakaryocyte progenitor cells in a patient with immune thrombocytopenia. *N Engl J Med* 1985;312:1170-1174.
116. Nagasawa T, Hasegawa Y, Komeno T, et al. Simultaneous measurements of megakaryocyte-associated IgG (MAIgG) and platelet-associated IgG (PAIgG) in chronic idiopathic thrombocytopenic purpura. *Eur J Haematol* 1995;54:314-320.
117. Hasegawa Y, Nagasawa T, Kamoshita M, et al. Effects of anti-platelet glycoprotein Ib and/or IIb/IIIa autoantibodies on the size of megakaryocytes in patients with immune thrombocytopenia. *Eur J Haematol* 1995;55:152-157.
118. de Alarcon PA, Mazur EM, Schneider JA. *In vitro* megakaryocytopoiesis in children with acute idiopathic thrombocytopenic purpura. *Am J Pediatr Hematol Oncol* 1987;9:212-218.
119. Podolak-Dawidziak M. Megakaryocyte progenitors in immune thrombocytopenic purpura/ITP. *Thromb Res* 1991;62:93-96.
120. Abgrall JF, Berthou C, Sensebe L, et al. Decreased *in vitro* megakaryocyte colony formation in chronic idiopathic thrombocytopenic purpura. *Br J Haematol* 1993;85:803-804.
121. Doan CA, Bouroncle BA, Wiseman BK. Idiopathic and secondary thrombocytopenic purpura: clinical

- study and evaluation of 381 cases over a period of 28 years. *Ann Intern Med* 1960;53:861–876.
122. Ben-Yehuda D, Gillis S, Eldor A, Israeli ITP Study Group. Clinical and therapeutic experience in 712 Israeli patients with idiopathic thrombocytopenic purpura. *Acta Haematol* 1994;91:1–6.
123. Buchanan GR. Overview of ITP treatment modalities in children. *Blut* 1989;59:96–104.
124. Meindersma TE, de Vries SI. Thrombocytopenic purpura after smallpox vaccination. *BMJ* 1962;1:226–228.
125. Blanchette VS, Luke B, Andrew M, et al. A prospective, randomized trial of high-dose intravenous immune globulin G therapy, oral prednisone therapy, and no therapy in childhood acute immune thrombocytopenic purpura. *J Pediatr* 1993;123:989–995.
126. Kurtzberg J, Stockman JA. Idiopathic thrombocytopenic purpura. *Adv Pediatr* 1994;41:111–134.
127. Meyers MC. Results of treatment in 71 patients with idiopathic thrombocytopenic purpura. *Am J Med Sci* 1961;242:295–302.
128. Reid MM. Chronic idiopathic thrombocytopenic purpura: incidence, treatment, and outcome. *Arch Dis Child* 1995;72:125–128.
129. Aronis S, Platokouki H, Mitsika A, et al. Seventeen years of experience with chronic idiopathic thrombocytopenic purpura in childhood. Is therapy always better? *Pediatr Hematol Oncol* 1994;11:487–498.
130. McWilliams NB, Mauer HM. Acute idiopathic thrombocytopenic purpura in children. *Am J Hematol* 1979;7:87–96.
131. Kelton JG. Vaccination-associated relapse of immune thrombocytopenia. *JAMA* 1981;245:369–371.
132. Crosby WH. Wet purpura, dry purpura. *JAMA* 1975;232:744–745.
133. Lacey JV, Penner JA. Management of idiopathic thrombocytopenic purpura in the adult. *Semin Thromb Hemost* 1977;3:160–174.
134. Schattner E, Bussel J. Mortality in immune thrombocytopenic purpura: report of seven cases and consideration of prognostic indicators. *Am J Hematol* 1994;46:120–126.
135. Guthrie TH, Brannan DP, Prisant LM. Idiopathic thrombocytopenic purpura in the older adult patient. *Am J Med Sci* 1988;296:17–21.
136. Linares M, Cervero A, Colomina P, et al. Chronic idiopathic thrombocytopenic purpura in the elderly. *Acta Haematol* 1995;93:80–82.
137. Jy W, Horstman LL, Arce M, Ahn YS. Clinical significance of platelet microparticles in autoimmune thrombocytopenias. *J Lab Clin Med* 1992;119:334–345.
138. Khan I, Zucker-Franklin D, Karpatkin S. Microthrombocytosis and platelet fragmentation associated with idiopathic/autoimmune thrombocytopenic purpura. *Br J Haematol* 1975;31:449–460.
139. Zucker-Franklin D, Karpatkin S. Red-cell and platelet fragmentation in idiopathic thrombocytopenic purpura. *N Engl J Med* 1977;297:517–523.
140. Zucker-Franklin D. Clinical significance of platelet microparticles. *J Lab Clin Med* 1992;119:321–322.
141. Ikkala E, Suhonen O. Circulating megakaryocytes in immune thrombocytopenias. *Ann Clin Res* 1972;4:1–6.
142. Nelson RB, Kehl D. Electronically determined platelet indices in thrombocytopenic patients. *Cancer* 1981;48:954–956.
143. Garg SK, Lackner H, Karpatkin S. The increased percentage of megathrombocytes in various clinical



disorders. *Ann Intern Med* 1972;77:361–369.

144. Karpatkin S, Freedman ML. Hypersplenic thrombocytopenia differentiated from increased platelet destruction by platelet volume. *Ann Intern Med* 1978;89:200–203.

145. Bessman JD, Gardner FH. Platelet size in thrombocytopenia due to sepsis. *Surg Gynecol Obstet* 1983;156:177–180.

146. Evans RS, Takahashi K, Duane RT, et al. Primary thrombocytopenic purpura and acquired hemolytic anemia. *Arch Intern Med* 1951;87:48–65.

147. Pegels JG, Helmerhorst FM, van Leeuwen EF, et al. The Evans syndrome: characterization of the responsible autoantibodies. *Br J Haematol* 1982;51:445–450.

148. Rosenberg A, Van Slyck EJ. A syndrome resembling infectious mononucleosis after splenectomy for idiopathic thrombocytopenic purpura. *Ann Intern Med* 1965;63:965–971.

149. Tager M, Klinghoffer KA. Acute thrombocytopenic purpura hemorrhagica with lymphocytosis; report of a case. *Ann Intern Med* 1943;18:96.

150. Nagasawa T, Kono I, Sakurai T, Kashiwagi H. Fibrinogen/fibrin degradation products in serum of patients with idiopathic thrombocytopenic purpura: elevated levels during severe thrombocytopenic phase of the disease. *Thromb Haemost* 1976;35:628–634.

151. DiFino SM, Lachant NA, Kirshner JJ, Gottlieb AJ. Adult idiopathic thrombocytopenic purpura: clinical findings and response to therapy. *Am J Med* 1980;69:430–442.

152. Harker LA. Megakaryocyte quantitation. *J Clin Invest* 1968;47:452–457.

153. Harker LA, Finch CA. Thrombokinetics in man. *J Clin Invest* 1969;48:963–974.

154. Louwes H, Lathori OAZ, Vellenga E, et al. Platelet kinetic studies in patients with idiopathic thrombocytopenic purpura. *Am J Med* 1999;106:430–434.

155. Pisciotta AV, Stefanini M, Dameshek W. Studies on platelets X. Morphologic characteristics of megakaryocytes by phase contrast microscopy in normals and in patients with idiopathic thrombocytopenic purpura. *Blood* 1953;8:703.

156. Queisser U, Queisser W, Spiertz B. Polyploidization of megakaryocytes in normal humans, in patients with idiopathic thrombocytopenia and with pernicious anemia. *Br J Haematol* 1971;20:489–501.

157. Luiken GA, McMillan R, Lightsey AL, et al. Platelet-associated IgG in immune thrombocytopenic purpura. *Blood* 1977;50:317–325.

158. LoBuglio AF, Court WS, Vinocur L, et al. Use of a 125I-labeled antihuman IgG monoclonal antibody to quantify platelet-bound IgG. *N Engl J Med* 1983;309:459–463.

159. Sugiura K, Steiner M, Baldini MG. Platelet antibody in idiopathic thrombocytopenic purpura. *J Lab Clin Med* 1980;96:640–653.

160. Karpatkin M, Siskind GW, Karpatkin S. The platelet factor 3 immunoinjury technique re-evaluated. Development of a rapid test for antiplatelet antibody. Detection in various clinical disorders, including immunologic drug-induced and neonatal thrombocytopenias. *J Lab Clin Med* 1977;89:400–408.

161. Cines DB, Schreiber AD. Immune thrombocytopenia. Use of a Coombs antiglobulin test to detect IgG and C3 on platelets. *N Engl J Med* 1979;300:106–111.

162. Hirschman RJ, Shulman NR. The use of platelet serotonin release as a sensitive method for detecting anti-platelet antibodies and plasma anti-platelet factor in patients with idiopathic thrombocytopenic purpura. *Br J Haematol* 1973;24:793–802.

163. Mueller-Eckhardt C, Kayser W, Mersch-Baumert K, et al. The clinical significance of

- platelet-associated IgG: a study on 298 patients with various disorders. *Br J Haematol* 1980;46:123-131.
164. Hegde UM, Ball S, Zuiable A, Roter BLT. Platelet associated immunoglobulins (PAIgG and PAIgM) in autoimmune thrombocytopenia. *Br J Haematol* 1985;59:221-226.
165. Kelton JG, Neame PB, Gauldie J, Hirsch J. Elevated platelet-associated IgG in the thrombocytopenia of septicemia. *N Engl J Med* 1979;300:760-764.
166. Kelton JG, Murphy WG, Lucarelli A, et al. A prospective comparison of four techniques for measuring platelet-associated IgG. *Br J Haematol* 1989;71:97-105.
167. Court WS, Bozeman JM, Soong SJ, et al. Platelet surface-bound IgG in patients with immune and nonimmune thrombocytopenia. *Blood* 1987;69:278-283.
168. von dem Borne AE, Vos JJ, van der Lelie J, et al. Clinical significance of positive platelet immunofluorescence test in thrombocytopenia. *Br J Haematol* 1986;64:767-776.
169. George JN, Saucerman S, Levine SP, et al. Immunoglobulin G is a platelet a granule-secreted protein. *J Clin Invest* 1985;76:2020-2025.
170. George JN, Saucerman S. Platelet IgG, IgA, IgM, and albumin: correlation of platelet and plasma concentrations in normal subjects and in patients with ITP or dysproteinemia. *Blood* 1988;72:362-365.
171. George JN. Platelet immunoglobulin G: its significance for the evaluation of thrombocytopenia and for understanding the origin of a-granule proteins. *Blood* 1990;76:859-870.
172. Brighton TA, Evans S, Castaldi PA, et al. Prospective evaluation of the clinical usefulness of an antigen-specific assay (MAIPA) in idiopathic thrombocytopenic purpura and other immune thrombocytopenias. *Blood* 1996;88:194-201.
173. Nilsson T, Norberg B. Thrombocytopenia and pseudothrombocytopenia: a clinical and laboratory problem. *Scand J Haematol* 1986;37:341-346.
174. Casonato A, Bertomoro A, Pontara E, et al. EDTA dependent pseudothrombocytopenia caused by antibodies against the cytoadhesive receptor of platelet gpIIb-IIIa. *J Clin Pathol* 1994;47:625-630.
175. Bizzaro N. EDTA-dependent pseudothrombocytopenia: a clinical and epidemiological study of 112 cases, with 10-year followup. *Am J Hematol* 1995;50:103-109.
176. Bizzaro N. Platelet satellitosis to polymorphonuclears: cytochemical, immunological, and ultrastructural characterization of eight cases. *Am J Hematol* 1991;36:235-242.
177. Bizzaro N, Goldschmeding R, von dem Borne AE. Platelet satellitism is Fc gamma RIII (CD16) receptor-mediated. *Am J Clin Pathol* 1995;103:740-744.
178. Menke DM, Colon-Otero G, Cockerill KJ, et al. Refractory thrombocytopenia: a myelodysplastic syndrome that may mimic immune thrombocytopenic purpura. *Am J Clin Pathol* 1992;98:502-510.
179. Najean Y, Lecompte T. Chronic pure thrombocytopenia in elderly patients. *Cancer* 1989;64:2506-2510.
180. Laster J, Silver D. Heparin-coated catheters and heparin-induced thrombocytopenia. *J Vasc Surg* 1988;7:667-672.
181. George JN, Woolf SH, Raskob GE, et al. Idiopathic thrombocytopenic purpura: a practice guideline developed by explicit methods for the American Society of Hematology. *Blood* 1996;88:3-40.
182. The American Society of Hematology ITP Practice Guideline Panel. Diagnosis and treatment of idiopathic thrombocytopenic purpura: recommendations of the American Society of Hematology. *Ann Intern Med* 1997;126:319-326.
183. Dickerhoff R, von Ruecker A. The clinical course of immune thrombocytopenic purpura in children who did not receive intravenous immunoglobulins or sustained prednisone therapy. *J Pediatr*

2000;137:629-632.

184. Blanchette V, Imbach P, Andrew M, et al. Randomized trial of intravenous immunoglobulin G, intravenous anti-D, and oral prednisone in childhood acute immune thrombocytopenic purpura. *Lancet* 1994;344:703-707.
185. Fujisawa K, Iyori H, Ohkawa H, et al. A prospective randomized trial of conventional, dose-accelerated corticosteroids and intravenous immunoglobulin in children with newly diagnosed idiopathic thrombocytopenic purpura. *Int J Hematol* 2000;72:376-383.
186. Portielje JEA, Westendorp RGJ, Kluin-Nelemans HC, et al. Morbidity and mortality in adults with idiopathic thrombocytopenic purpura. *Blood* 2001;97:2549-2554.
187. Jiji RM, Firozvi T, Spurling CL. Chronic idiopathic thrombocytopenic purpura: treatment with steroids and splenectomy. *Arch Intern Med* 1973;132:380-383.
188. Cohen YC, Djulbegovic B, Shamai-Lubovitz O, et al. The bleeding risk and natural history of idiopathic thrombocytopenic purpura in patients with persistent low platelet counts. *Arch Intern Med* 2000;160:1630-1638.
189. Baumann MA, Menitove JE, Aster RH, Anderson T. Urgent treatment of idiopathic thrombocytopenic purpura with single-dose gammaglobulin infusion followed by platelet transfusion. *Ann Intern Med* 1986;104:808-809.
190. Flick JT, Grush O, Morgan S, et al. Case report: the role of apheresis in the support of life-threatening ITP relapse. *Am J Med Sci* 1987;294:444-447.
191. Carr JM, Kruskall MS, Kaye JA, Robinson SH. Efficacy of platelet transfusions in immune thrombocytopenia. *Am J Med* 1986;80:1051-1054.
192. Dameshek W, Rubio F, Mahoney JP, et al. Treatment of idiopathic thrombocytopenic purpura (ITP) with prednisone. *JAMA* 1958;166:1805-1815.
193. Jacobs P, Wood L, Dent DM. Results of treatment in immune thrombocytopenia. *QJM* 1986;58:153-165.
194. den Ottolander JJ, Gratama JW, de Koning J, Brand A. Long-term follow-up study of 168 patients with immune thrombocytopenia: implications for therapy. *Scand J Haematol* 1984;32:101-110.
195. Ikkala E, Kivilaakso E, Kotilainen M, Hastbacka J. Treatment of idiopathic thrombocytopenic purpura in adults: long-term results in a series of 41 patients. *Ann Clin Res* 1978;10:83-86.
196. Thompson RL, Moore RA, Hess CE, et al. Idiopathic thrombocytopenic purpura: long-term results of treatment and the prognostic significance of response to corticosteroids. *Arch Intern Med* 1972;130:730-734.
197. Bunting WL, Kiely JM, Campbell DC. Idiopathic thrombocytopenic purpura: treatment in adults. *Arch Intern Med* 1961;108:733-738.
198. Carpenter AF, Wintrobe MW, Fuller EA, et al. Treatment of idiopathic thrombocytopenic purpura. *JAMA* 1959;171:1911-1916.
199. Shashaty GG, Rath CE. Idiopathic thrombocytopenic purpura in the elderly. *Am J Med Sci* 1978;276:263-267.
200. Berchtold P, McMillan R. Therapy of chronic idiopathic thrombocytopenic purpura in adults. *Blood* 1989;74:2309-2317.
201. Mazzucconi GB, Francesconi M, Fidani P, et al. Treatment of idiopathic thrombocytopenic purpura (ITP): results of a multicentric protocol. *Haematologica* 1985;70:329-336.
202. Bellucci S, Charpak Y, Chastang C, Tobelem G, and the Cooperative Group on immune thrombocytopenic purpura. Low doses v conventional doses of corticoids in immune thrombocytopenic

purpura (ITP): results of a randomized clinical trial in 160 children, 223 adults. *Blood* 1988;71:1165–1169.

203. Jacobs P, Wood L, Novitsky N. Intravenous gammaglobulin has no advantages over oral prednisone as primary therapy for adults with immune thrombocytopenia: a prospective randomized clinical trial. *Am J Med* 1994;97:55–59.

204. Godeau B, Chevret S, Varet B, et al. Intravenous immunoglobulin or high-dose methylprednisolone, with or without oral prednisone, for adults with untreated severe autoimmune thrombocytopenic purpura: a randomized, multicentre trial. *Lancet* 2002;359:23–29.

205. Kitchens CS, Weiss L. Ultrastructural changes of endothelium associated with thrombocytopenia. *Blood* 1975;46:567–578.

206. Kitchens CS, Pendergast JF. Human thrombocytopenia is associated with structural abnormalities of the endothelium that are ameliorated by glucocorticosteroid administration. *Blood* 1986;67:203–206.

207. Kitchens CS. Amelioration of endothelial abnormalities by prednisone in experimental thrombocytopenia in the rabbit. *J Clin Invest* 1977;60:1129–1134.

208. Maca RD, Fry GL, Hoak JC. The effects of glucocorticoids on cultured human endothelial cells. *Br J Haematol* 1978;38:501–509.

209. Handin RI, Stossel TP. Phagocytosis of antibody-coated platelets by human granulocytes. *N Engl J Med* 1974;290:989–993.

210. Handin RI, Stossel TP. Effect of corticosteroid therapy on the phagocytosis of antibody-coated platelets by human leukocytes. *Blood* 1978;51:771–779.

211. Verp M, Karpatkin S. Effect of plasma, steroids, or steroid products on the adhesion of human opsonized thrombocytes to human leukocytes. *J Lab Clin Med* 1975;85:478–486.

212. Fujisawa K, Tani P, Piro L, McMillan R. The effect of therapy on platelet-associated autoantibody in chronic immune thrombocytopenic purpura. *Blood* 1993;81:2872–2877.

213. McMillan R, Longmire R, Yelenosky R. The effect of corticosteroids on human IgG synthesis. *J Immunol* 1976;116:1592–1595.

214. Gernsheimer T, Stratton J, Ballem PJ, Slichter SJ. Mechanisms of response to treatment in autoimmune thrombocytopenic purpura. *N Engl J Med* 1989;230:974–980.

215. Atkinson JP, Frank MM. Complement-independent clearance of IgG-sensitized erythrocytes: inhibition by cortisone. *Blood* 1974;44:629–637.

216. Branehög I, Weinfeld A. Platelet survival and platelet production in idiopathic thrombocytopenic purpura (ITP) before and during treatment with corticosteroids. *Scand J Haematol* 1974;12:69–79.

217. Greendyke RM, Bradley EM, Swisher SN. Studies of the effects of administration of ACTH and adrenal corticosteroids on erythrophagocytosis. *J Clin Invest* 1965;44:746–753.

218. Fries LF, Brickman CM, Frank MM. Monocyte receptors for the Fc portion of IgG increase in number in autoimmune hemolytic anemia and other hemolytic states and are decreased by glucocorticoid therapy. *J Immunol* 1983;131:1240–1245.

219. Picozzi VJ, Roeske WR, Creger WP. Fate of therapy failures in adult idiopathic thrombocytopenic purpura. *Am J Med* 1980;69:690–694.

220. Kernoff LM, Malan E. Platelet antibody levels do not correlate with response to therapy in idiopathic thrombocytopenic purpura. *Br J Haematol* 1983;53:559–562.

221. Akwari OE, Itani KMF, Coleman RE, Rosse WF. Splenectomy for primary and recurrent immune thrombocytopenic purpura. *Ann Surg* 1987;206:529–541.

222. Schwartz SI, Hoepf LM, Sachs S. Splenectomy for thrombocytopenia. *Surgery* 1980;88:497–506.
223. Mintz SJ, Petersen SR, Cheson B, et al. Splenectomy for immune thrombocytopenic purpura. *Arch Surg* 1981;116:645–650.
224. Gugliotta L, Isacchi G, Guarini A, et al. Chronic idiopathic thrombocytopenic purpura (ITP): site of platelet sequestration and results of splenectomy. *Scand J Haematol* 1981;26:407–412.
225. Brennan MF, Rapoport JM, Moloney WC, Wilson RE. Correlation between response to corticosteroids and splenectomy for adult idiopathic thrombocytopenic purpura. *Am J Surg* 1975;129:490–492.
226. Chirletti P, Cardi M, Barillari P, et al. Surgical treatment of immune thrombocytopenic purpura. *World J Surg* 1992;16:1001–1005.
227. Fabris F, Zanatta N, Gasonata A, et al. Response to splenectomy in idiopathic thrombocytopenic purpura: prognostic value of the clinical and laboratory evaluation. *Acta Haematol* 1989;81:28–33.
228. Gibson J, May J, Rickard KA, et al. Management of splenectomy failures in chronic immune thrombocytopenic purpura: role of accessory splenectomy. *Aust N Z J Med* 1986;16:695–698.
229. Naouri A, Feghali B, Chabal J, et al. Results of splenectomy for idiopathic thrombocytopenic purpura. *Acta Haematol* 1993;89:200–203.
230. Szoid A, Schwartz J, Abu-Abeid S, et al. Laparoscopic splenectomies for idiopathic thrombocytopenic purpura: experience of 60 cases. *Am J Hematol* 2000;63:7–10.
231. Kathouda N, Grant SW, Mavor E, et al. Predictors of response after laparoscopic splenectomy for immune thrombocytopenic purpura. *Surg Endosc* 2001;15:484–488.
232. Cervi P, Murdock A, Rees D. Use of splenic ultrasound: a new wave for immune thrombocytopenic purpura. *J Clin Pathol* 1994;47:414–417.
233. Calverly DC, Jones GW, Kelton JG. Splenic radiation for corticosteroid-resistant immune thrombocytopenia. *Ann Intern Med* 1992;116:977–981.
234. Caulier MT, Darloy F, Rose C, et al. Splenic irradiation for chronic autoimmune thrombocytopenic purpura in patients with contra-indications to splenectomy. *Br J Haematol* 1995;91:208–211.
235. Miyazaki M, Itoh H, Kaiho T, et al. Partial splenic embolization for the treatment of chronic idiopathic thrombocytopenic purpura. *AJR Am J Roentgenol* 1994;163:123–126.
236. Wallace D, Fromm D, Thomas D. Accessory splenectomy for idiopathic thrombocytopenic purpura. *Surgery* 1982;91:134–136.
237. Ambriz P, Munoz R, Quintanar E, et al. Accessory spleen complicating response to splenectomy for idiopathic thrombocytopenic purpura. *Radiology* 1985;155:793–796.
238. Verheyden CN, Beart RW, Clifton MD, Phyliky RL. Accessory splenectomy in management of recurrent idiopathic thrombocytopenic purpura. *Mayo Clin Proc* 1978;53:442–446.
239. Massey MD, Stevens JS. Residual spleen found on denatured red blood cell scan following negative colloid scans. *J Nucl Med* 1991;32:2286–2287.
240. Facon T, Caulier MT, Fenaux P, et al. Accessory spleen in recurrent chronic immune thrombocytopenic purpura. *Am J Hematol* 1992;41:184–189.
241. Julia A, Araguas C, Rossello J, et al. Lack of useful clinical predictors of response to splenectomy in patients with chronic idiopathic thrombocytopenic purpura. *Br J Haematol* 1990;76:250–255.
242. Ruivard M, Caulier MT, Vantelon JM, et al. The response to high-dose intravenous immunoglobulin or steroids is not predictive of outcome after splenectomy in adults with autoimmune thrombocytopenic

purpura. *Br J Haematol* 1999;105:1130–1132.

243. Choi CW, Kim BS, Seo JH, et al. Response to high-dose intravenous immune globulin as a valuable factor predicting the effect of splenectomy in chronic idiopathic thrombocytopenic purpura patients. *Am J Hematol* 2001;66:197–2002.

244. Fabris F, Tassan T, Ramon R, et al. Age as the major predictive factor of long-term response to splenectomy in immune thrombocytopenic purpura. *Br J Haematol* 2001;112:637–640.

245. Bussel JB, Kaufman CP, Ware RE, et al. Do the acute platelet responses of patients with immune thrombocytopenic purpura (ITP) to IV anti-D and to IN gammaglobulin predict response to subsequent splenectomy? *Am J Hematol* 2001;67:27–33.

246. Najean Y, Dufour V, Rain JD, Toubert ME. The site of platelet destruction in thrombocytopenic purpura as a predictive index of the efficacy of splenectomy. *Br J Haematol* 1991;79:271–276.

247. McMillan R. Therapy for adults with refractory chronic immune thrombocytopenic purpura. *Ann Intern Med* 1997;126:307–314.

248. Joseph A, Evans DIK. Immunosuppressive treatment of idiopathic thrombocytopenic purpura in children. *Acta Paediatr Scand* 1982;71:467–469.

249. Finch SC, Castro O, Cooper M, et al. Immunosuppressive therapy of chronic thrombocytopenic purpura. *Am J Med* 1974;56:4–12.

250. von dem Borne AE, Vos JJ, Pegels JG, et al. High dose intravenous methylprednisolone or high dose intravenous gammaglobulin for autoimmune thrombocytopenia. *BMJ* 1988;296:249–250.

251. Godeau B, Zini JM, Schaeffer A, Bierling P. High-dose methylprednisolone is an alternative treatment for adults with autoimmune thrombocytopenic purpura refractory to intravenous immunoglobulins and oral corticosteroids. *Am J Hematol* 1995;48:282–284.

252. Figueroa M, Gehlsen J, Hammond D, et al. Combination chemotherapy in refractory immune thrombocytopenic purpura. *N Engl J Med* 1993;328:1226–1229.

253. Andersen JC. Response of resistant idiopathic thrombocytopenic purpura to pulsed high-dose dexamethasone therapy. *N Engl J Med* 1994;330:1560–1564.

254. Caulier MT, Rose C, Roussel MT, et al. Pulsed high-dose dexamethasone in refractory chronic idiopathic thrombocytopenic purpura: a report on 10 cases. *Br J Haematol* 1995;91:477–479.

255. Godeau B, Bierling P, Oksenhendler E, et al. High-dose dexamethasone therapy for resistant autoimmune thrombocytopenic purpura. *Am J Hematol* 1996;51:334.

256. Schiavotto C, Ruggeri M, Rodeghiero F. Failure of repeated courses of high dose intravenous immunoglobulin to induce stable remissions in patients with chronic idiopathic thrombocytopenic purpura. *Ann Hematol* 1995;70:89–90.

257. Laros RK, Penner JA. “Refractory” thrombocytopenic purpura treated successfully with cyclophosphamide. *JAMA* 1971;215:445–449.

258. Verlin M, Laros RK, Penner JA. Treatment of refractory thrombocytopenic purpura with cyclophosphamide. *Am J Hematol* 1976;1:97–104.

259. Reiner A, Gernsheimer T, Slichter SJ. Pulse cyclophosphamide therapy for refractory autoimmune thrombocytopenic purpura. *Blood* 1995;85:351–358.

260. Bouroncle BA, Doan CA. Refractory idiopathic thrombocytopenic purpura treated with azathioprine. *N Engl J Med* 1966;275:630–635.

261. Bouroncle BA, Doan CA. Treatment of refractory idiopathic thrombocytopenic purpura. *JAMA* 1969;207:2049–2052.

262. Hilgartner MW, Lanzkowsky P, Smith CH. The use of azathioprine in refractory thrombocytopenic purpura in children. *Acta Paediatr Scand* 1970;59:409-415.
263. Quiquandon I, Fenaux P, Gaulier MT, et al. Re-evaluation of the role of azathioprine in the treatment of adult chronic idiopathic thrombocytopenic purpura: a report on 53 cases. *Br J Haematol* 1990;74:223-228.
264. Kappers-Klune MC, Van't Veer MB. Cyclosporin A for the treatment of patients with chronic idiopathic thrombocytopenic purpura refractory to corticosteroids or splenectomy. *Br J Haematol* 2001;114:121-125.
265. Ahn YS, Harrington WJ, Steelman RC, Eytel CS. Vincristine therapy of idiopathic and secondary thrombocytopenias. *N Engl J Med* 1974;291:376-380.
266. Manoharan A. Slow infusion of vincristine in the treatment of idiopathic thrombocytopenic purpura. *Am J Hematol* 1986;21:135-138.
267. Manoharan A. Targeted-immunosuppression with vincristine infusion in the treatment of immune thrombocytopenia. *Aust N Z J Med* 1991;21:405-407.
268. Sultan Y, Delobel J, Jeanneau C, Caen JP. Effect of periwinkle alkaloids in idiopathic thrombocytopenic purpura. *Lancet* 1971;1:496-497.
269. Aisenberg AC, Wilkes B. Studies on the suppression of immune response by the periwinkle alkaloids vincristine and vinblastine. *J Clin Invest* 1964;43:2394-2403.
270. Robertson JH, McCarthy GM. Periwinkle alkaloids and the platelet-count. *Lancet* 1969;2:353-355.
271. Hwang YF, Hamilton HE, Sheets RF. Vinblastine-induced thrombocytosis. *Lancet* 1969;2:1075-1076.
272. Owellen RJ, Owens AH, Donigian DW. The binding of vincristine, vinblastine and colchicine to tubulin. *Biochem Biophys Res Commun* 1972;47:685-691.
273. Paulson JC, McClure WO. Inhibition of axoplasmic transport by colchicine, podophyllotoxin, and vinblastine: an effect on microtubules. *Ann N Y Acad Sci* 1975;253:517-527.
274. Stasi R, Pagano A, Stipa E, et al. Rituximab chimeric anti-CD20 monoclonal antibody treatment for adults with chronic idiopathic thrombocytopenic purpura. *Blood* 2001;98:952-957.
275. Saleh MN, Moore M, Feinberg B, et al. A pilot study of anti-CD20 moab rituximab in patients with refractory immune thrombocytopenia. *Blood* 2001;98:521A.
276. Cooper N, Feuerstein M, Bussel JB. The use of rituximab, a chimeric anti-CD20 monoclonal antibody, in adults with refractory immune thrombocytopenic purpura. *Blood* 2001;98:521.
277. Imbach P, Barandun S, d'Apuzzo V, et al. High-dose intravenous gammaglobulin for idiopathic purpura in childhood. *Lancet* 1981;1:1228-1231.
278. Warrier I, Lusher JM. Intravenous gamma globulin treatment for chronic idiopathic thrombocytopenic purpura in children. *Am J Med* 1984;76:193-198.
279. Warrier IA, Lusher JM. Intravenous gammaglobulin (Gamimune) for treatment of chronic idiopathic thrombocytopenic purpura (ITP): a two-year follow-up. *Am J Hematol* 1986;23:323-328.
280. Korninger C, Panzer S, Graninger W, et al. Treatment of severe chronic idiopathic thrombocytopenic purpura in adults with high-dose intravenous immunoglobulin. *Scand J Haematol* 1985;34:128-132.
281. Schiavotto C, Ruggeri M, Castaman G, Rodeghiero F. High-dose dexamethasone in adult refractory idiopathic thrombocytopenic purpura. *Br J Haematol* 1996;93:491-498.
282. Uchino H, Yasunaga K, Akatsuka JI. A cooperative clinical trial of high-dose immunoglobulin therapy



in 177 cases of idiopathic thrombocytopenic purpura. *Thromb Haemost* 1984;51:182–185.

283. Oral A, Nusbacher J, Hill JB, Lewis JH. Intravenous gamma globulin in the treatment of chronic idiopathic thrombocytopenic purpura in adults. *Am J Med* 1984;76:187–192.

284. Godeau B, Lesage S, Divine M, et al. Treatment of adult chronic autoimmune thrombocytopenic purpura with repeated high-dose intravenous immunoglobulin. *Blood* 1993;82:1415–1421.

285. Bierling P, Divine M, Farcet JP, et al. Persistent remission of adult chronic autoimmune thrombocytopenic purpura after treatment with high-dose intravenous immunoglobulin. *Am J Hematol* 1987;25:271–275.

286. Bussel JB, Kimberly RP, Inman RD, et al. Intravenous immunoglobulin treatment of chronic idiopathic thrombocytopenic purpura. *Blood* 1983;62:480–486.

287. Bussel JB, Pham LC, Aledort L, Nachman R. Maintenance treatment of adults with chronic refractory immune thrombocytopenic purpura using repeated intravenous infusions of gammaglobulins. *Blood* 1988;72:121–127.

288. Bussel JB, Pham LC. Intravenous treatment with gammaglobulin in adults with immune thrombocytopenic purpura: a review of the literature. *Vox Sang* 1987;52:206–211.

289. Carroll RR, Noyes WD, Kitchens CS. High-dose intravenous immunoglobulin therapy in patients with immune thrombocytopenic purpura. *JAMA* 1983;249:1748–1750.

290. Kurlander R, Coleman RE, Moore J, et al. Comparison of the efficacy of a two-day and a five-day schedule for infusing intravenous gamma globulin in the treatment of immune thrombocytopenic purpura in adults. *Am J Med* 1987;83[Suppl 4A]:17–24.

291. Bussel JB, Fitzgerald-Pedersen J, Feldman C. Alternation of two doses of intravenous gammaglobulin in the maintenance treatment of patients with immune thrombocytopenic purpura: more is not always better. *Am J Hematol* 1990;33:184–188.

292. Godeau B, Caulier MT, Decuyper L, et al. Intravenous immunoglobulin for adults with autoimmune thrombocytopenic purpura: results of a randomized trial comparing 0.5 and 1 g/kg b.w. *Br J Haematol* 1999;107:716–719.

293. Newland AC. Annotation: the use and mechanisms of action of intravenous immunoglobulin: an update. *Br J Haematol* 1989;72:301–305.

294. Fehr J, Hofmann V, Kappeler U. Transient reversal of thrombocytopenia in idiopathic thrombocytopenic purpura by high dose intravenous gamma globulin. *N Engl J Med* 1982;306:1254–1258.

295. Kimberly RP, Salmon JE, Bussel JB, et al. Modulation of mononuclear phagocyte function by intravenous  $\gamma$ -globulin. *J Immunol* 1984;132:745–750.

296. Saleh M, Court W, Huster W, et al. Effect of commercial immunoglobulin G preparation on human monocyte Fc $\gamma$ -receptor dependent binding of antibody coated platelets. *Br J Haematol* 1988;68:47–51.

297. Dammacco F, Iodice G, Campobasso N. Treatment of adult patients with idiopathic thrombocytopenic purpura with intravenous immunoglobulin: effects on circulating T cell subsets and PWM-induced antibody synthesis *in vitro*. *Br J Haematol* 1986;62:125–135.

298. Winiarski J, Kreuger A, Ejderhamn J, Holm G. High dose intravenous IgG reduces platelet associated immunoglobulins and complement in idiopathic thrombocytopenic purpura. *Scand J Haematol* 1983;31:342–348.

299. Delfraissy JF, Tchernia G, Laurian Y, et al. Suppressor cell function after intravenous gammaglobulin treatment in adult chronic idiopathic thrombocytopenic purpura. *Br J Haematol* 1985;60:315–322.

300. Tsubakio T, Kurata Y, Katagiri S, et al. Alteration of T cell subsets and immunoglobulin synthesis *in vitro* during high dose  $\gamma$ -globulin therapy in patients with idiopathic thrombocytopenic purpura. *Clin Exp Immunol* 1983;53:697–702.

301. Berchtold P, Dale GL, Tani P, McMillan R. Inhibition of autoantibody binding to platelet glycoprotein IIb/IIIa by anti-idiotypic antibodies to intravenous immunoglobulin. *Blood* 1989;74:2414–2417.
302. Smiley JD, Talbert MG. High-dose intravenous gamma globulin therapy: how does it work? *Am J Med Sci* 1995;309:295–303.
303. Samuelsson A, Towers TL, Ravetch JV. Anti-inflammatory activity of IVIG mediated through the inhibitory Fc receptor. *Science* 2001;291:484–486.
304. Williams Y, Lynch S, McCann S, et al. Correlation of platelet Fc  $\gamma$ RIIA polymorphism in refractory idiopathic (immune) thrombocytopenic purpura. *Br J Haematol* 1998;101:779–782.
305. Barbano G, Saleh MN, Mori PG, et al. Effect of intravenous gammaglobulin on circulating and platelet bound antibody in immune thrombocytopenia. *Blood* 1989;73:662–665.
306. Sati HIA, Ahya R, Watson HG. Incidence and associations of acute renal failure complicating high-dose intravenous immunoglobulin therapy. *Br J Haematol* 2001;113:556–557.
307. Gupta N, Ahmed I, Nissel-Horowitz S, et al. Intravenous immunoglobulin-associated acute renal failure. *Am J Hematol* 2001;66:151–152.
308. Salama A, Kiefel V, Amberg R, Mueller-Eckhardt C. Treatment of autoimmune thrombocytopenic purpura with rhesus antibodies [Anti-Rh<sub>0</sub>(D)]. *Blut* 1984;49:29–35.
309. Salama A, Mueller-Eckhardt C. Use of Rh antibodies in the treatment of autoimmune thrombocytopenia. *Transfus Med Rev* 1992;6:17–25.
310. Andrew M, Blanchette VS, Adams M, et al. A multicenter study of the treatment of childhood chronic idiopathic thrombocytopenic purpura with anti-D. *J Pediatr* 1992;120:522–527.
311. Scaradavou A, Woo B, Woloski BMR, et al. Intravenous anti-D treatment of immune thrombocytopenic purpura: experience in 272 patients. *Blood* 1997;89:2689–2700.
312. Becker T, Kuenzlen E, Salama A, et al. Treatment of childhood idiopathic thrombocytopenic purpura with Rhesus antibodies (anti-D). *Eur J Pediatr* 1986;145:166–169.
313. Gringeri A, Cattaneo M, Santagostino E, Mannucci PM. Intramuscular anti-D immunoglobulins for home treatment of chronic immune thrombocytopenic purpura. *Br J Haematol* 1992;80:337–340.
314. Cooper N, Woloski BMR, Fodero EM, et al. Does treatment with intermittent infusions of intravenous anti-D allow a proportion of adults with recently diagnosed immune thrombocytopenic purpura to avoid splenectomy? *Blood* 2002;99:1922–1927.
315. Salama A, Kiefel V, Mueller-Eckhardt C. Effect of IgG anti-Rh<sub>0</sub>(D) in adult patients with chronic autoimmune thrombocytopenia. *Am J Hematol* 1986;22:241–250.
316. Panzer S, Grumayer ER, Haas OA, et al. Efficacy of rhesus antibodies (anti-Rh<sub>0</sub>(D)) in autoimmune thrombocytopenia: correlation with response to high dose IgG and the degree of hemolysis. *Blut* 1986;52:117–121.
317. Ruiz-Arguelles GJ, Apreza-Molina MG, Perez-Romano B, Ruiz-Arguelles A. The infusion of anti-RhO-(D) opsonized erythrocytes may be useful in the treatment of patients, splenectomized or not, with chronic, refractory autoimmune thrombocytopenic purpura—a prospective study. *Am J Hematol* 1993;43:72–73.
318. Mylvaganam R, Ahn YS, Garcia RO, et al. Very low dose danazol in idiopathic thrombocytopenic purpura and its role as an immune modulator. *Am J Med Sci* 1989;298:215–220.
319. Ahn YS, Harrington WJ, Simon SR, et al. Danazol for the treatment of idiopathic thrombocytopenic purpura. *N Engl J Med* 1983;308:1396–1399.

320. Buelli M, Cortelazzo S, Viero P, et al. Danazol for the treatment of idiopathic thrombocytopenic purpura. *Acta Haematol* 1985;74:97-98.
321. Ahn YS, Mylvaganam R, Garcia RO, et al. Low-dose danazol therapy in idiopathic thrombocytopenic purpura. *Ann Intern Med* 1987;107:177-181.
322. Schreiber AD, Chien P, Tomaski A, Cines DB. Effect of danazol in immune thrombocytopenic purpura. *N Engl J Med* 1987;316:503-508.
323. Dubbeld P, Hillen HFP, Schouten HC. Interferon treatment of refractory idiopathic thrombocytopenic purpura (ITP). *Eur J Haematol* 1994;52:233-235.
324. Proctor SJ. Alpha interferon therapy in the treatment of idiopathic thrombocytopenic purpura. *Eur J Cancer* 1991;27[Suppl 4]:S63-S68.
325. Proctor SJ, Jackson G, Carey P, et al. Improvement of platelet counts in steroid-unresponsive idiopathic immune thrombocytopenic purpura after short-course therapy with recombinant a 2b interferon. *Blood* 1989;74:1894-1897.
326. Hurtado R, Pita L, Karpovitch XL, et al. Recombinant interferon a-2b in refractory idiopathic immune thrombocytopenia. *Blood* 1990;75:1744-1745.
327. Bellucci S, Bordessoule D, Coiffier B, Tabah I. Interferon alpha-2b therapy in adult chronic thrombocytopenic purpura (ITP). *Br J Haematol* 1989;73:578-579.
328. Fujimura K, Takafuta T, Kuriya SI, et al. Recombinant human interferon a-2b (rh IFNa-2b) therapy for steroid resistant idiopathic thrombocytopenic purpura (ITP). *Am J Hematol* 1996;51:37-44.
329. Kahn RA. Clinical evaluation of platelet transfusions in thrombocytopenic patients: methods and interpretation. *Vox Sang* 1981;40[Suppl]1:87-97.
330. Zucker MB, Lundberg A. Platelet transfusions. *Anesthesiology* 1966;27:385-398.
331. Branda RF, Tate DY, McCullough JJ, Jacob HS. Plasma exchange in the treatment of fulminant idiopathic (autoimmune) thrombocytopenic purpura. *Lancet* 1978;1:688-690.
332. Marder VJ, Nusbacher J, Anderson FW. One-year follow-up of plasma exchange therapy in 14 patients with idiopathic thrombocytopenic purpura. *Transfusion* 1981;21:291-298.
333. Novak R, Wilimas J. Plasmapheresis in catastrophic complications of idiopathic thrombocytopenic purpura. *J Pediatr* 1978;92:434-436.
334. Kaplan C, Forestier F, Dreyfus M, et al. Maternal thrombocytopenia during pregnancy: diagnosis and etiology. *Semin Thromb Hemost* 1995;21:85-94.
335. McCrae KR, Samuels P, Schreiber AD. Pregnancy-associated thrombocytopenia: pathogenesis and management. *Blood* 1992;80:2697-2714.
336. Burrows RF, Kelton JG. Incidentally detected thrombocytopenia in healthy mothers and their infants. *N Engl J Med* 1988;319:142-145.
337. Burrows RF, Kelton JG. Thrombocytopenia at delivery: a prospective survey of 6715 deliveries. *Am J Obstet Gynecol* 1990;162:731-734.
338. Burrows RF, Kelton JG. Fetal thrombocytopenia and its relation to maternal thrombocytopenia. *N Engl J Med* 1993;329:1463-1466.
339. Lescale KB, Eddleman KA, Cines DB, et al. Antiplatelet antibody testing in thrombocytopenic pregnant women. *Am J Obstet Gynecol* 1996;174:1014-1018.
340. Gill KK, Kelton JG. Management of idiopathic thrombocytopenic purpura in pregnancy. *Semin*

Hematol 2000;37:275–289.

341. Silver RM, Branch W, Scott JR. Maternal thrombocytopenia in pregnancy: time for a reassessment. *Am J Obstet Gynecol* 1995;173:479–482.
342. Kaplan C, Daffos F, Forestier F, et al. Fetal platelet counts in thrombocytopenic pregnancy. *Lancet* 1990;336:979–982.
343. Christiaens GC, Nieuwenhuis HK, von dem Borne AE, et al. Idiopathic thrombocytopenic purpura in pregnancy: a randomized trial on the effect of antenatal low dose corticosteroids on neonatal platelet count. *Br J Obstet Gynaecol* 1990;97:893–898.
344. Cook RL, Miller RC, Katz VL, Cefalo RC. Immune thrombocytopenic purpura in pregnancy: a reappraisal of management. *Obstet Gynecol* 1991;78:578–583.
345. Burrows RF, Kelton JG. Pregnancy in patients with idiopathic thrombocytopenic purpura: assessing the risks for the infant at delivery. *Obstet Gynecol Surv* 1993;48:781–788.
346. George JN, Raskob GE, Shah SR, et al. Drug-induced thrombocytopenia: a systematic review of published case reports. *Ann Intern Med* 1998;129:886–890.
347. Rizvi MA, Kojouri K, George JN. Drug-induced thrombocytopenia: an updated systematic review. *Ann Intern Med* 2001;134:346.
348. Pereira J, Hidalgo P, Ocqueteau M, et al. Glycoprotein Ib/IX complex is the target in rifampicin-induced immune thrombocytopenia. *Br J Haematol* 2000;110:907–910.
349. Aster RH. Heparin-induced thrombocytopenia and thrombosis. *N Engl J Med* 1995;332:1374–1376.
350. Kaufman DW, Kelly JP, Johannes CB, et al. Acute thrombocytopenic purpura in relation to use of drugs. *Blood* 1993;82:2714–2718.
351. Warkentin TE, Kelton JG. Temporal aspects of heparin-induced thrombocytopenia. *N Engl J Med* 2001;344:1286–1292.
352. Burgess JK, Lopez JA, Berndt MC, et al. Quinine-dependent antibodies bind a restricted set of epitopes on the glycoprotein Ib-IX complex: characterization of the epitopes. *Blood* 1998;92:2366–2373.
353. Gentilini G, Curtis BR, Aster RH. An antibody from a patient with ranitidine-induced thrombocytopenia recognizes a site on glycoprotein IX that is a favored target for drug-induced antibodies. *Blood* 1998;92:2359–2365.
354. Pfueller SL, Bilston RA, Jane S, Gibson J. Expression of the drug-dependent antigen for quinine-dependent antiplatelet antibodies on GP IIIa but not on GPIb, IIb or IX on human endothelial cells. *Thromb Hemost* 1990;63:279–281.
355. Maguire RB, Stroncek DF, Campbell AC. Recurrent pancytopenia, coagulopathy, and renal failure associated with multiple quinine-dependent antibodies. *Ann Intern Med* 1993;119:215–217.
356. Gottschall JL, Elliot W, Lianos E, et al. Quinine-induced immune thrombocytopenia associated with hemolytic uremic syndrome: a new clinical entity. *Blood* 1991;77:306–310.
357. Gottschall JL, Neahring B, McFarland JG, et al. Quinine-induced immune thrombocytopenia with hemolytic uremic syndrome: clinical and serological findings in nine patients and review of the literature. *Am J Hematol* 1994;47:283–289.
358. Eisner EV, Shahidi NT. Immune thrombocytopenia due to a drug metabolite. *N Engl J Med* 1972;287:376–381.
359. Eisner EV, Kasper K. Immune thrombocytopenia due to a metabolite of para-aminosalicylic acid. *Am J Med* 1972;53:790–796.
360. Bougie D, Aster R. Immune thrombocytopenia resulting from sensitivity to metabolites of naproxen

and acetaminophen. *Blood* 2001;97:3846–3850.

361. Belkin GA. Cocktail purpura: an unusual case of quinine sensitivity. *Ann Intern Med* 1967;66:583–586.

362. Pedersen-Bjergaard U, Anderson M, Hansen PB. Drug-specific characteristics of thrombocytopenia caused by non-cytotoxic drugs. *Eur J Clin Pharmacol* 1998;54:701–706.

363. Kobayashi H, Kitano K, Ishida F, et al. Aplastic anemia and idiopathic thrombocytopenic purpura with antibody to platelet glycoprotein IIb/IIIa following resection of malignant thymoma. *Acta Haematol* 1993;90:42–45.

364. Bowen LM, Williams DM. Association of myasthenia gravis and idiopathic thrombocytopenic purpura. *South Med J* 1981;74:513–514.

365. Anderson MJ, Woods VL, Tani P, et al. Autoantibodies to platelet glycoprotein IIb/IIIa and to the acetylcholine receptor in a patient with chronic idiopathic thrombocytopenic purpura and myasthenia gravis. *Ann Intern Med* 1984;100:829–831.

366. Jansen PHP, Renier WO, deVaas G, et al. Effect of thymectomy on myasthenia gravis and autoimmune thrombocytopenic purpura in a 13-year-old girl. *Eur J Pediatr* 1987;146:587–589.

367. Panzer S, Penner E, Graninger W, et al. Antinuclear antibodies in patients with chronic idiopathic autoimmune thrombocytopenia followed 2–30 years. *Am J Hematol* 1989;32:100–103.

368. Nossent JC, Swaak AJG. Prevalence and significance of haematological abnormalities in patients with systemic lupus erythematosus. *QJM* 1991;291:605–612.

369. Anderson MJ, Peebles CL, McMillan R, Curd JG. Fluorescent antinuclear antibodies and anti-SS-A/Ro in patients with immune thrombocytopenia subsequently developing systemic lupus erythematosus. *Ann Intern Med* 1985;103:548–550.

370. Kurata Y, Miyagawa S, Kosugi S, et al. High-titer antinuclear antibodies, anti-SSA/Ro antibodies and antinuclear RNP antibodies in patients with idiopathic thrombocytopenic purpura. *Thromb Haemost* 1994;71:184–187.

371. Perez HD, Katler E, Embury S. Idiopathic thrombocytopenic purpura with high-titer, speckled pattern antinuclear antibodies: possible marker for systemic lupus erythematosus. *Arthritis Rheum* 1985;28:596–597.

372. Miescher PA, Tucci A, Beris P, Favre H. Autoimmune hemolytic anemia and/or thrombocytopenia associated with lupus parameters. *Semin Hematol* 1992;29:13–17.

373. Kurata Y, Hayashi S, Kosugi S, et al. Elevated platelet-associated IgG in SLE patients due to anti-platelet antibody: differentiation between autoantibodies and immune complexes by ether elution. *Br J Haematol* 1993;85:723–728.

374. Berchtold P, Harris JP, Tani P, et al. Autoantibodies to platelet glycoproteins in patients with disease-related immune thrombocytopenia. *Br J Haematol* 1989;73:365–368.

375. Macchi L, Rispoli P, Cloufent-Sanchez G, et al. Anti-platelet antibodies in patients with systemic lupus erythematosus and the primary antiphospholipid antibody syndrome: their relationship with the observed thrombocytopenia. *Br J Haematol* 1997;98:336–341.

376. Godeau B, Piette JC, Fromont P, et al. Specific antiplatelet glycoprotein autoantibodies are associated with the thrombocytopenia of primary antiphospholipid syndrome. *Br J Haematol* 1997;98:873–879.

377. Pujol M, Ribera A, Vilardell M, et al. High prevalence of platelet autoantibodies in patients with systemic lupus erythematosus. *Br J Haematol* 1995;89:137–141.

378. Averbuch M, Koifman B, Levo Y. Lupus anticoagulant, thrombosis and thrombocytopenia in systemic lupus erythematosus. *Am J Med Sci* 1987;293:1–5.

379. Out HJ, deGroot PG, van Vliet M, et al. Antibodies to platelets in patients with anti-phospholipid

antibodies. *Blood* 1991;77:2655–2659.

380. Fabris F, Steffan A, Cordiano I, et al. Specific antiplatelet antibodies in patients with antiphospholipid antibodies and thrombocytopenia. *Eur J Haematol* 1994;53:232–236.

381. Coon WW. Splenectomy for cytopenias associated with systemic lupus erythematosus. *Am J Surg* 1988;155:391–394.

382. Hall S, McCormick JL, Griep PR, et al. Splenectomy does not cure the thrombocytopenia of systemic lupus erythematosus. *Ann Intern Med* 1985;102:325–328.

383. Kappers-Klunne MC, van Vliet HHDM. IgM and IgG platelet antibodies in a case of infectious mononucleosis and severe thrombocytopenia. *Scand J Haematol* 1984;32:145–148.

384. Kahane S, Dvilansky A, Estok L, et al. Detection of anti-platelet antibodies in patients with idiopathic thrombocytopenic purpura (ITP) and in patients with rubella and herpes group viral infections. *Clin Exp Immunol* 1981;44:49–56.

385. Ellman L, Carvalho A, Jacobson BM, Colman RW. Platelet autoantibody in a case of infectious mononucleosis presenting as thrombocytopenic purpura. *Am J Med* 1973;55:723–726.

386. Krishnamurthy M, Lee CK, Dosik H. Case report: infectious mononucleosis and severe thrombocytopenia. *Am J Med Sci* 1976;272:221–224.

387. Pivetti S, Novarino A, Merico F, et al. High prevalence of autoimmune phenomena in hepatitis C virus antibody positive patients with lymphoproliferative and connective tissue disorders. *Br J Haematol* 1996;95:204–211.

388. Pawlotsky JM, Bouvier M, Fromont P, et al. Hepatitis C virus infection and autoimmune thrombocytopenic purpura. *J Hepatol* 1995;23:635–639.

389. Al-Majed SA, Al-Momen AK, Al-Kassimi FA, et al. Tuberculosis presenting as immune thrombocytopenic purpura. *Acta Haematol* 1995;94:135–138.

390. Gasbarrini A, Franceschi F, Tartaglione R, et al. Regression of autoimmune thrombocytopenia after eradication of *Helicobacter pylori*. *Lancet* 1998;352:878.

391. Grimaz S, Damiani D, Brosolo P, et al. Resolution of thrombocytopenia after treatment for *Helicobacter pylori*: a case report. *Haematologica* 1999;84:283–284.

392. Tohda S, Ohkusa T. Resolution of refractory idiopathic thrombocytopenic purpura after eradication of *Helicobacter pylori*. *Am J Hematol* 2000;65:329–330.

393. Emilia G, Longo G, Luppi M, et al. *Helicobacter pylori* eradication can induce platelet recovery in idiopathic thrombocytopenic purpura. *Blood* 2001;97: 812–814.

394. Bussel JB. Novel approaches to management of immune thrombocytopenic purpura: results of recent trials. In: American Society of Hematology Education Book. 2001;282–293.

395. Jarque I, Andreu R, Llopis I, et al. Absence of platelet response after eradication of *Helicobacter pylori* infection in patients with chronic idiopathic purpura. *Br J Haematol* 2001;115:1002–1003.

396. Ebbe S, Wittels B, Dameshek W. Autoimmune thrombocytopenic purpura (“ITP” type) with chronic lymphocytic leukemia. *Blood* 1962;19:23–37.

397. Hassidim K, McMillan R, Conjalka MS, Morrison J. Immune thrombocytopenic purpura in Hodgkin disease. *Am J Hematol* 1979;6:149–153.

398. Waddell CC, Cimo PL. Idiopathic thrombocytopenic purpura occurring in Hodgkin disease after splenectomy: report of two cases and review of the literature. *Am J Hematol* 1979;7:381–387.

399. Lehman HA, Lehman LO, Rustagi PK, et al. Complement-mediated autoimmune thrombocytopenia: monoclonal IgM antiplatelet antibody associated with lymphoreticular malignant disease. *N Engl J Med*

1987;316:194–198.

400. Schwartz KA, Slichter SJ, Harker LA. Immune-mediated platelet destruction and thrombocytopenia in patients with solid tumors. *Br J Haematol* 1982;51:17–24.
401. Kim HD, Boggs DR. A syndrome resembling idiopathic thrombocytopenic purpura in 10 patients with diverse forms of cancer. *Am J Med* 1979;67:371–377.
402. Xiros N, Binder T, Anger B, et al. Idiopathic thrombocytopenic purpura and autoimmune hemolytic anemia in Hodgkin's disease. *Eur J Haematol* 1988;40:437–441.
403. Kaden BR, Rosse WF, Hauch TW. Immune thrombocytopenia in lymphoproliferative disorders. *Blood* 1979;53:545–551.
404. Krsnik I, Perez-Rus G, Calero MA, et al. Peripheral thrombocytopenia, accessory spleen and Hodgkin's disease: an unusual combination. *Acta Haematol* 1994;91:35–36.
405. Kuznetsov AI, Ivanov AL, Idelson LI, Mazurov AV. Mechanisms of thrombocytopenia in patients with lymphoproliferative disorders. *Eur J Haematol* 1992;49:113–118.
406. Valenta LJ, Treadwell T, Berry R, Elias AN. Idiopathic thrombocytopenic purpura and Graves disease. *Am J Hematol* 1982;12:69–72.
407. Adrouny A, Sandler RM, Carmel R. Variable presentation of thrombocytopenia in Grave's disease. *Arch Intern Med* 1982;142:1460–1464.
408. Hymes K, Blum M, Lackner H, Karpatkin S. Easy bruising, thrombocytopenia, and elevated platelet immunoglobulin G in Graves' disease and Hashimoto's thyroiditis. *Ann Intern Med* 1981;94:27–30.
409. Bizzaro N. Familial association of autoimmune thrombocytopenia and hyperthyroidism. *Am J Med* 1992;39:294–298.
410. Newman PJ. Nomenclature of human platelet alloantigens: a problem with the HPA system? *Blood* 1994;83:1447–1451.
411. Goldman M, Filion M, Proulx C, et al. Neonatal alloimmune thrombocytopenia. *Transfus Med Rev* 1994;8:123–131.
412. McCrae KR, Herman JH. Posttransfusion purpura: two unusual cases and a literature review. *Am J Hematol* 1996;52:205–211.
413. Warkentin TE, Smith JW, Hayward CP, et al. Thrombocytopenia caused by passive transfusion of anti-glycoprotein Ia/IIa alloantibody (anti-HPA-5b). *Blood* 1992;79:2480–2484.
414. Ballem PJ, Buskard NA, Decary F, Doubroff P. Post-transfusion purpura secondary to passive transfer of anti-P1A1 by blood transfusion. *Br J Haematol* 1987;66:113–114.
415. Nijjar TS, Bonacosa IA, Israels LG. Severe acute thrombocytopenia following infusion of plasma containing anti P1A1. *Am J Hematol* 1987;25:219–21.
416. Scott EP, Moilan-Bergeland J, Dalmasso AP. Posttransfusion thrombocytopenia associated with passive transfusion of a platelet-specific antibody. *Transfusion* 1988;28:73–76.
417. Kaplan C, Daffos F, Forestier F, et al. Management of alloimmune thrombocytopenia: antenatal diagnosis and in utero transfusion of maternal platelets. *Blood* 1988;72:340–343.
418. von dem Borne AE, van Leeuwen EF, von Riesz LE, et al. Neonatal alloimmune thrombocytopenia: detection and characterization of the responsible antibodies by the platelet immunofluorescence test. *Blood* 1981;57:649–656.
419. Mueller-Eckhardt C, Kiefel V, Grubert A, et al. 348 cases of suspected neonatal alloimmune thrombocytopenia. *Lancet* 1989;1:363–366.



420. Blanchette VS, Chen L, de Friedberg ZS, et al. Alloimmunization to the PLA-1 antigen: results of a prospective study. *Br J Haematol* 1990;74:209-215.
421. Panzer S, Auerbach L, Cechova E, et al. Maternal alloimmunization against fetal platelet antigens: a prospective study. *Br J Haematol* 1995;90:655-660.
422. Kaplan C, Morel-Kopp MC, Kroll H, et al. HPA-5b (Br(a)) neonatal alloimmune thrombocytopenia: clinical and immunological analysis of 39 cases. *Br J Haematol* 1991;78:425-429.
423. Noris P, Simsek S, de Bruijne-Admiraal LG, et al. Max<sup>a</sup>, a new low frequency platelet-specific antigen localized on glycoprotein IIb, is associated with neonatal alloimmune thrombocytopenia. *Blood* 1995;86:1019-1026.
424. Mueller-Eckhardt C, Becker T, Weisheit M, et al. Neonatal alloimmune thrombocytopenia due to fetomaternal Zwb incompatibility. *Vox Sang* 1986;50:94-96.
425. Mueller-Eckhardt C. Annotation: post-transfusion purpura. *Br J Haematol* 1986;64:419-424.
426. McFarland JG, Blanchette V, Collins J, et al. Neonatal alloimmune thrombocytopenia due to a new platelet-specific alloantibody. *Blood* 1993;81:3318-3323.
427. McFarland JG, Aster RH, Bussel JB, et al. Prenatal diagnosis of neonatal alloimmune thrombocytopenia using allele-specific oligonucleotide probes. *Blood* 1991;78:2276-2282.
428. Glade-Bender J, McFarland JG, Kaplan C, et al. Anti-HPA-3A induces severe neonatal alloimmune thrombocytopenia. *J Pediatr* 2001;138:862-867.
429. Berry JE, Murphy CM, Smith GA, et al. Detection of Gov system antibodies by MAIPA reveals an immunogenicity similar to the HPA-5 alloantigens. *Br J Haematol* 2000;110:735-742.
430. Sainio S, Jarvenpaa AL, Renlund M, et al. Thrombocytopenia in term infants: a population-based study. *Obstet Gynecol* 2000;95:441-446.
431. Valentin N, Vergracht A, Bignon JD, et al. HLA-DRw52a is involved in alloimmunization against PL-A1 antigen. *Hum Immunol* 1990;27:73-79.
432. Doughty HA, Murphy MF, Metcalfe P, Waters AH. Antenatal screening for fetal alloimmune thrombocytopenia: the results of a pilot study. *Br J Haematol* 1995;90:321-325.
433. Williamson LM, Hackett G, Rennie J, et al. The natural history of fetomaternal alloimmunization to the platelet-specific antigen HPA-1a (PI<sup>A1</sup>, ZW<sup>a</sup>) as determined by antenatal screening. *Blood* 1998;92:2280-2287.
434. Ohto H, Yamaguchi T, Takeuchi C, et al. Anti-HPA-5b induced neonatal alloimmune thrombocytopenia: antibody titre as a predictor. *Br J Haematol* 2000;110:223-227.
435. van Leeuwen EF, Leeksa OC, van Mourik JA, et al. Effect of binding of anti-Zw<sup>a</sup> antibodies on platelet function. *Vox Sang* 1984;47:280-289.
436. von dem Borne AE, Verheugt FW, Oosterhof F, et al. A simple immunofluorescence test for the detection of platelet antibodies. *Br J Haematol* 1978;39:195-207.
437. Clemenceau S, Perichon B, Elion J, et al. An improved DNA-based identification of fetuses at risk for HPA-1a (PLA-1) neonatal alloimmune thrombocytopenia. *Br J Haematol* 1986;86:198-200.
438. Furihata K, Nugent DJ, Bissonette A, et al. On the association of the platelet-specific alloantigen, Pena, with glycoprotein IIIa. Evidence for heterogeneity of glycoprotein IIIa. *J Clin Invest* 1987;80:1624-1630.
439. Daffos F, Forestier F, Kaplan C, Cox W. Prenatal diagnosis and management of bleeding disorders

- with fetal blood sampling. *Am J Obstet Gynecol* 1988;158:939–946.
440. Wenstrom KD, Weiner CP, Williamson RA. Antenatal treatment of fetal alloimmune thrombocytopenia. *Obstet Gynecol* 1992;80:433–435.
441. Lynch L, Bussel JB, McFarland JG, et al. Antenatal treatment of alloimmune thrombocytopenia. *Obstet Gynecol* 1992;80:67–71.
442. Shulman NR, Aster RH, Leitner A, Hiller MC. Immunoreactions involving platelets. V Post-transfusion purpura due to complement-fixing antibody against a genetically controlled platelet antigen. A proposed mechanism for thrombocytopenia and its relevance in “autoimmunity.” *J Clin Invest* 1961;40:1597–1620.
443. Vogelsang G, Kickler TS, Bell WR. Post-transfusion purpura: a report of five patients and a review of the pathogenesis and management. *Am J Hematol* 1986;21:259–267.
444. Chapman JF, Murphy MF, Berney SI, et al. Post-transfusion purpura associated with anti-Bak<sup>a</sup> and anti-PL<sup>A2</sup> platelet antibodies and delayed hemolytic transfusion reactions. *Vox Sang* 1987;52:313–317.
445. Cimo PL, Aster RH. Post-transfusion purpura: successful treatment by exchange transfusion. *N Engl J Med* 1972;287:290–292.
446. Keimowitz RM, Collins J, Davis K, Aster RH. Post-transfusion purpura associated with alloimmunization against the platelet-specific antigen, Bak<sup>a</sup>. *Am J Hematol* 1986;21:79–88.
447. Kickler TS, Herman JH, Furihata K, et al. Identification of Bak<sup>a</sup>, a new platelet-specific antigen associated with posttransfusion purpura. *Blood* 1988;71:894–898.
448. Christie DJ, Pulkrabek S, Putnam JL, et al. Post-transfusion purpura due to an alloantibody reactive with glycoprotein Ia/IIa (anti-HPA-5b). *Blood* 1991;77:2785–2789.
449. Bierling P, Godeau B, Fromont P, et al. Posttransfusion purpura-like syndrome associated with CD36 (Nak<sup>a</sup>) isoimmunization. *Transfusion* 1995;35:777–782.
450. Taaning E, Tonnesen F. Pan-reactive platelet antibodies in post-transfusion purpura. *Vox Sang* 1999;76:120–123.
451. Lucas GF, Pittman SJ, Davies S, et al. Post-transfusion purpura (PTP) associated with anti-HPA-1a, anti-HPA-2b and anti-HPA-3a antibodies. *Transfusion Med* 1997;7:295–299.
452. Gerstner JB, Smith MJ, Davis KD, et al. Post-transfusion purpura: therapeutic failure of PL<sup>A1</sup>-negative platelet transfusion. *Am J Hematol* 1979;6:71–75.
453. Laursen B, Morling N, Rosenkvist J, et al. Post-transfusion purpura treated with plasma exchange by Haemonetics Cell Separator. *Acta Med Scand* 1978;203:539–543.
454. Lau P, Sholtis CM, Aster RH. Post-transfusion purpura: an enigma of alloimmunization. *Am J Hematol* 1980;9:331–336.
455. Becker T, Panzer S, Maas D, et al. High-dose intravenous immunoglobulin for post-transfusion purpura. *Br J Haematol* 1985;61:149–155.
456. Berney SI, Metcalfe P, Wathen NC, Waters AH. Post-transfusion purpura responding to high dose intravenous IgG: further observations on pathogenesis. *Br J Haematol* 1985;61:627–632.
457. Glud TK, Rosthøj S, Jensen MK, et al. High-dose intravenous immunoglobulin for post-transfusion purpura. *Scand J Haematol* 1983;31:495–500.

## Thrombotic Thrombocytopenic Purpura and Other Forms of Nonimmunologic Platelet Destruction

### THROMBOTIC THROMBOCYTOPENIC PURPURA

Pathophysiology

Clinical Manifestations

Laboratory Findings

Differential Diagnosis

Treatment

### PLATELET DAMAGE BY ABNORMAL VASCULAR SURFACES

### MISCELLANEOUS FORMS OF NONIMMUNOLOGIC PLATELET DESTRUCTION

### REFERENCES

The various forms of thrombocytopenia discussed in this chapter result from platelet destruction by processes that are independent of immunologic phenomena ([Table 54.1](#)). They have little else in common. The major disease in this category is *thrombotic thrombocytopenic purpura* (TTP), which is one of the thrombotic microangiopathies (for recent review, see references [1](#), [2](#), [3](#) and [4](#)). Hemolytic-uremic syndrome (HUS), another thrombotic microangiopathic disorder, shares many features with TTP and may be closely related. However, it occurs more commonly in children and is discussed separately in [Chapter 38](#). There are adults who have an HUS-like disease with more renal failure and less neurologic disease than with typical TTP. These patients are usually considered as having TTP-HUS and are included in the literature cited in this chapter.

**TABLE 54.1. Causes of Nonimmunologic Platelet Destruction**

---

|  |
|--|
| Diffuse thrombotic microangiopathy                                       |
| Thrombotic thrombocytopenic purpura: primary and secondary               |
| Disseminated intravascular coagulation (see <a href="#">Chapter 60</a> ) |
| Localized thrombotic microangiopathy                                     |
| Hemolytic-uremic syndrome (see <a href="#">Chapter 38</a> )              |
| Abnormal and artificial vascular surfaces                                |
| Stenosed or artificial heart valves                                      |
| Catheters or artificial vascular grafts                                  |
| Coronary artery bypass   |
| Extracorporeal or implanted circulatory pumps                            |
| Miscellaneous  |
| Burns, cryopathy, hypothermia  |
| Platelet-agglutinating drugs   |
| Hyperbaric exposure  |

---

## THROMBOTIC THROMBOCYTOPENIC PURPURA

TTP is characterized by disseminated thrombotic occlusions of the microcirculation and a syndrome of hemolytic anemia, thrombocytopenia, neurologic symptoms, fever, and renal dysfunction. The disorder was first described by Moschcowitz in 1924 ([5](#)) and is one of the group of diseases called *thrombotic microangiopathies*, which includes TTP, HUS, and disseminated intravascular coagulation. TTP is more common in women than in men (ratio of 2:1) and has a peak incidence in people between the ages of 30 and 40 years. The disorder is uncommon but not rare, and its incidence may be increasing.

### Pathophysiology

The thrombotic lesions of TTP typically involve terminal arterioles and capillaries ([5](#), [6](#)). The thrombi are composed of platelets, von Willebrand factor (vWF), and only small amounts of fibrin ([7](#)) and vary morphologically from loose platelet aggregates to densely coherent platelet plugs ([8](#)). The lesions are associated with hyaline deposits in the subendothelial layers of capillaries and between the endothelium and muscular layers of arterioles ([9](#)). The subendothelial lesions are regarded as the most characteristic histopathologic feature of the disorder ([10](#), [11](#)) and probably result from platelet thrombi that are eventually incorporated into the vascular wall and covered by newly formed endothelial cells ([7](#)). Fibrinoid necrosis, vascular inflammation, and perivascular inflammation are lacking.

The lesions of TTP are seen most commonly in the brain, kidney, pancreas, heart, spleen, and adrenal glands ([7](#)), but they may be found throughout the body. In the brain, vessels in the cortical gray matter and brain stem are most often affected. The clinical manifestations of TTP result from consumptive thrombocytopenia and partial and complete occlusions in many organs, which in turn lead to varying degrees of organ dysfunction. Red cells are damaged as the result of interactions with the microthrombi and fibrin networks in the small vessels (“microangiopathic” hemolysis and thrombotic microangiopathy). Such interactions produce schistocytes that have limited deformability and, as a result, are destroyed rapidly in the spleen and microcirculation (see [Chapter 38](#)).

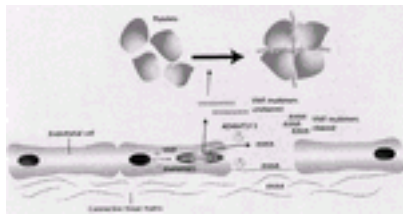
Although little doubt exists that the thrombotic lesions give rise to the characteristic manifestations of TTP, the exact cause of the thrombotic lesions remains unclear. The primary process may involve endothelial damage caused by any number of immune, infectious, or chemical causes; the platelet thrombus may be initiated primarily by plasma-aggregating or -agglutinating agents; or the process may be a combination of both mechanisms, the predominance of which depends on the precipitating etiology. Attempts to transfer TTP passively have been unsuccessful ([12](#)).

There are a number of reports of TTP-HUS occurring in siblings, suggesting a genetic susceptibility to the development of thrombotic microangiopathies ([13](#), [14](#), [15](#), [16](#), [17](#) and [18](#)). Preliminary data suggest that the absence of the supertypic HLA II antigen DR53 may govern this susceptibility ([19](#)).

**VASCULAR ABNORMALITIES** There is growing evidence that TTP plasma can injure endothelial cells and increase apoptosis ([20](#), [21](#), [22](#), [23](#), [24](#), [25](#), [26](#) and [27](#)). This occurs primarily in microvascular endothelial cells, mimicking the distribution of hyaline thrombi in TTP. The endothelial damage may be due to antibodies ([28](#), [29](#) and [30](#)), immune complexes

([31](#), [32](#)), infections ([33](#)), toxins ([34](#)), or other as yet unidentified factors. An antibody to CD36 (platelet membrane glycoprotein IV, which is also found on endothelial cells) is present in 65 to 80% of TTP serum tested, depending on the assay used ([29](#)). Damage to the endothelial cells then may promote platelet thrombi formation by release of ultra-large endothelial cell vWF (ULvWF), changes in the normal endothelial cell modulation of procoagulant and anticoagulant forces, or both ([32](#), [35](#), [36](#), [37](#), [38](#), [39](#), [40](#) and [41](#)).

**von Willebrand Factor vWF** is a multimeric protein that is synthesized and stored in endothelial cells. There is considerable evidence that perturbed endothelial cells release vWF and that release of ULvWF multimers plays an important role in the pathogenesis of platelet thrombi in TTP ([42](#)) ([Fig. 54.1](#)). In normal individuals, ULvWF molecules are released from endothelial cells, unfolded by exposure to high shear stresses present in the microvascular circulation, and proteolyzed by a metalloprotease between the amino acids tyrosine 842 and methionine 843. The vWF metalloprotease gene on chromosome 9 was recently cloned, and the protease was determined to be a member of the ADAMTS family of metalloproteases (ADAMTS13) ([43](#), [44](#), [45](#), [46](#) and [47](#)). In TTP, there is either a familial deficiency of the metalloprotease or an acquired deficiency due to either an antibody inhibitor or release of ULvWF from injured endothelial cells ([48](#), [49](#), [50](#) and [51](#)). These ULvWF multimers bind avidly to platelets, promoting platelet agglutination as is seen in the arterioles and capillaries of patients with TTP. Patients with TTP have increased platelet-associated vWF and circulating platelet aggregates when studied by flow cytometry, lending support to this hypothesis ([52](#)).



**Figure 54.1.** von Willebrand factor (VWF) is synthesized in endothelial cells as a monomer that is subsequently made into multimers that are secreted. Large multimers best support platelet adhesion to collagen, but the largest multimers have high affinity for platelets and may cause platelets to agglutinate. It is hypothesized that ADAMTS13, a metalloprotease, cleaves secreted VWF to limit the size of the multimers and prevent platelet agglutination in the circulation. See [Color Plate](#).

Moake was the first investigator to implicate abnormal vWF homeostasis in TTP. He reported that 50% of patients who had a single episode of TTP demonstrated the presence of unusually large multimers of vWF (ULvWF) in their earliest plasma samples ([53](#), [54](#)). These ULvWF multimers resembled those synthesized by endothelial cells when analyzed by sodium dodecyl sulfate-agarose gel electrophoresis and may represent vWF released from injured endothelial cells or stimulation of vWF release from endothelial cell Weibel-Palade bodies. In patients with intermittent or chronic relapsing TTP, plasma vWF multimer patterns showed the presence of ULvWF multimers between episodes and when patients were in remission, and the disappearance of both the ULvWF and largest plasma multimers of vWF during relapse ([54](#), [55](#) and [56](#)). The disappearance of these largest multimers during relapse may reflect binding to platelets, leading to agglutination. Infusion of fresh frozen plasma or supernatant from cryoprecipitated plasma was followed by a decrease or disappearance of the ULvWF within 30 to 90 minutes, suggesting the presence of a plasma protease for ULvWF ([57](#)). Several different types of metalloprotease assay are now available. Almost all healthy control subjects have normal protease concentrations, although levels are lower in neonates, elderly patients, and women in their third trimester of pregnancy ([58](#)). In the initial reports of protease activity in TTP patients, severe deficiencies were found in almost all patients with classic TTP ([50](#)).

, 51). An immunoglobulin (Ig) inhibitor could be demonstrated in the majority of these patients and in 76% of patients studied in the Canadian Apheresis Trial (58). In more recent large survey studies, many, but not all, TTP patients have decreased protease activity (<10%), and many of these latter patients do have measurable inhibitors (59, 60 and 61). In contrast, most patients with HUS have normal protease levels. Protease deficiencies are also reported in other patient groups: cirrhosis, renal insufficiency, inflammatory diseases, and disseminated intravascular coagulation (DIC). Recent studies on the ADAMTS13 protease gene should make it possible to develop immunoassays that may improve the ability to diagnose TTP and differentiate TTP and HUS. There is a congenital, severe deficiency of metalloprotease that is transmitted in an autosomal-recessive manner (Upshaw-Shulman syndrome) and becomes manifest during infancy or childhood (48, 62, 63 and 64). In these patients, the plasma ULvWF accumulates slowly, resulting in cyclical thrombocytopenia and microangiopathic hemolysis. These intervals occur most commonly at 3- to 4-week intervals, although less frequent episodes are reported in some patients. Many children with this congenital deficiency of metalloprotease can be maintained in long-term remission by prophylactic administration of plasma infusions approximately every 21 days (65, 66). Several groups of patients with secondary TTP have also been studied since the metalloprotease assays were developed. Patients with ticlopidine-associated TTP were found to have increased platelet-associated vWF, decreased concentrations of the largest plasma vWF multimers, severe deficiency of the metal-loprotease, and IgG inhibitors (67). Several patients with clopidogrel-associated TTP and one patient with human immunodeficiency virus-TTP demonstrated severe deficiency of metalloprotease and IgG inhibitors to the protease (68, 69). In contrast, patients with bone marrow transplant-associated TTP have normal concentrations of metalloprotease, which may explain why they respond poorly to plasma therapy (70).

**PLATELET-AGGREGATING AGENTS** Investigators have demonstrated that plasma from many affected patients contains substances that induce platelet agglutination or aggregation (71, 72). At least three types of factors have been described, each from a small subset of patients. The relationships among these aggregating agents and vWF and the incidence of each factor in TTP are unknown, so their importance still is controversial. Platelet-aggregating factor p37 (PAF p37) is a 37-kd polypeptide, compact, globular glycoprotein that has been identified and purified from plasma of a subset of patients with active TTP (71, 73, 74). It agglutinates autologous and homologous platelets and does not require fibrinogen, vWF, calcium, energy metabolism, adenosine diphosphate release, or cyclooxygenase activity. Calpain, a second PAF, has been identified in 86% of a small series of patients with acute, untreated TTP when a platelet aggregation assay was enriched with vWF to increase the sensitivity (75). This aggregating factor is the cysteine protease calpain, which is normally found in the cytosol of platelets and many other cell types (76). A third aggregating factor has been described from plasma and serum samples of patients with active TTP but not after remission (77, 78). This factor is also a cysteine protease, but the sensitivity of the enzyme to standard inhibitors demonstrates that it is a lysosomal cathepsin rather than a cytoplasmic calpain.

## Clinical Manifestations

TTP is characterized by the pentad of microangiopathic hemolytic anemia, thrombocytopenia, neurologic symptoms, renal dysfunction, and fever (Table 54.2). In the series of 258 patients reported by Ridolfi and Bell, 74% of patients had the triad consisting of anemia, thrombocytopenia, and neurologic disorders, and only 40% of the patients had the full pentad of features (79), incidences that have been confirmed in more recent series of patients (80). Many patients presented with nonspecific symptoms, such as malaise and weakness, in addition to one or more symptoms of the pentad. Neurologic

symptoms or hemorrhagic symptoms were the most common chief complaints. Neurologic symptoms may develop and progress rapidly, although they are classically multifocal and transient but recurrent in nature. Diffuse lesions are less often transient (81). Manifestations can include headache, cranial nerve palsies, dysphasia or aphasia, paresis, confusion, stupor, coma, and seizures. Purpura and retinal hemorrhages are the most common type of hemorrhage, but gastrointestinal and genitourinary hemorrhages are also seen. Fever is present at admission in approximately 50% of patients but develops during the course of the illness in many others, although the fever may now be more commonly a side effect of plasma exchange. Renal manifestations include proteinuria, hematuria, and mild renal insufficiency.

**TABLE 54.2. Incidence of Pentad Features in Patients with Thrombotic Thrombocytopenic Purpura**

| Symptom                                    | Amorosi and Ultmann (6) |                         | Ridolfi and Bell (79) |                         |
|--|-------------------------|-------------------------|-----------------------|-------------------------|
|  | Symptom (N)/Study (N)   | % Symptom (N)/Study (N) | Symptom (N)/Study (N) | % Symptom (N)/Study (N) |
| Microangiopathic hemolytic anemia          | 246/256                 | 96                      | 254/258               | 98                      |
| Thrombocytopenic purpura or other bleeding | 241/251                 | 96                      | 214/258               | 83                      |
| Neurologic symptoms                        | 250/271                 | 92                      | 218/258               | 84                      |
| Renal disease                              | 191/217                 | 88                      | 196/258               | 76                      |
| Fever                                      | 237/243                 | 98                      | 252/258               | 98                      |

Other manifestations may occur during the course of TTP. These include acute respiratory distress syndrome (82), cardiac conduction abnormalities and infarcts (83, 84), abdominal pain caused by pancreatitis (6, 85, 86) or bowel wall infarcts (87, 88), and erythromelalgia (89).

TTP usually occurs in previously healthy people, but in a significant number of cases, the syndrome is associated with other disorders (Table 54.3). A thrombotic microangiopathy that may resemble TTP or HUS has been described in association with infections, drugs, cancer, bone marrow transplantation, collagen-vascular diseases, and pregnancy. The thrombotic microangiopathy in these patients may not be identical in pathophysiology to primary TTP in that many of these disorders are associated with vasculitis and DIC or more closely resemble HUS. The prognosis in these patients may vary significantly depending on the associated condition.

**TABLE 54.3. Diseases Associated with Thrombotic Thrombocytopenic Purpura**

**Infections**

Human immunodeficiency virus (33, 80, 90, 91, 92, 93, 94, 95, 96, 97 and 98)

*Escherichia coli*, *Shigella* (99, 100, 54 and 102)

Pancreatitis (103, 104)

Drug treatment

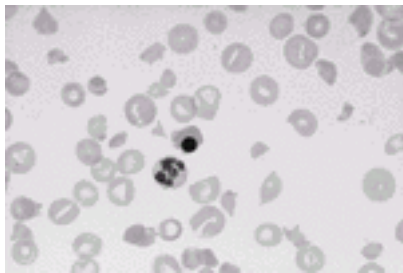


Cyclosporin A, tacrolimus (FK506) ( [105](#), [106](#), [107](#) and [108](#))  
Antineoplastic agents ( [106](#), [109](#), [110](#) and [111](#))  
Ticlopidine, clopidogrel ( [67](#), [68](#), [112](#))  
Quinine ( [113](#))  
Collagen-vascular diseases ( [114](#), [115](#), [116](#), [117](#), [118](#), [119](#), [120](#), [121](#), [122](#), [123](#), [124](#), [125](#),  
[126](#), [127](#), [128](#), [129](#), [130](#) and [131](#))  
Pregnancy and the puerperium ( [132](#), [133](#))  
Cancer ( [134](#), [135](#) and [136](#))  
Bone marrow transplantation ( [137](#))

---

## Laboratory Findings

Erythrocyte abnormalities in TTP are those of microangiopathic red cell destruction. The reticulocyte count is increased to a degree appropriate for the severity of the anemia. The blood smear reveals polychromasia, stippling, nucleated red cells, and schistocytes ( [Fig. 54.2](#)). Serum lactic dehydrogenase (LDH) and unconjugated bilirubin concentrations are increased, with LDH concentrations ranging from 400 to more than 1000. The LDH increase may be due to release from a variety of injured tissues in addition to the breakdown of red blood cells ( [138](#)). Hemolysis is of the intravascular type, meaning that haptoglobin levels are reduced and hemoglobinuria and hemosiderinuria usually are present. The majority of patients have hemoglobin concentrations less than 10 g/100 ml. Moderate neutrophilia with some increase in immature forms is common. Platelet counts can range from less than 10,000/ $\mu$ l to 100,000/ $\mu$ l, but most patients have platelet counts below 50,000/ $\mu$ l ( [139](#)). LDH levels and the platelet count are sensitive indices of the response of the disorder to therapy ( [140](#), [141](#)).

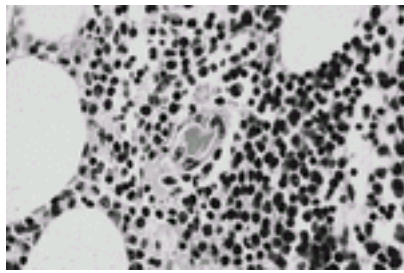


**Figure 54.2.** Peripheral blood smear from a patient with acute thrombotic thrombocytopenic purpura. Polychromasia, a nucleated red blood cell, and numerous schistocytes are present ( $\times 1000$ ; Wright-Giemsa stain). See [Color Plate](#).

Normoblastic hyperplasia and increased numbers of megakaryocytes usually are apparent in the bone marrow. Surveys of large numbers of patients with TTP reveal that significant intravascular coagulation is rarely associated with TTP ( [139](#), [142](#), [143](#)). The results of screening tests of coagulation usually are normal, although slight elevations in the levels of fibrin degradation products are common ( [41](#), [144](#)). Measurements of plasma vWF antigen and factor VIIIc by the usual methods yield normal or increased levels; special techniques, such as agarose gel electrophoresis, are required to demonstrate the presence of abnormal vWF multimers. Proteinuria and microscopic hematuria, mild azotemia, and abnormalities of liver function tests are common. Analysis of the cerebrospinal fluid usually reveals elevated protein levels and some xanthochromia; less commonly, it is

frankly bloody. Computed tomograms and magnetic resonance imaging of the brain may reveal reversible bilateral cerebral edema, ischemic strokes, and frank hematomas ( [145](#), [146](#) and [147](#) ).

The antemortem histopathologic demonstration of lesions of TTP often is difficult. Skin, gingivae, and bone marrow may be biopsied and examined for hyaline thrombi within arterioles ( [Fig. 54.3](#) ) ( [6](#), [10](#), [11](#), [79](#), [148](#), [149](#), [150](#), [151](#) and [152](#) ). Biopsies are diagnostic in only approximately 50% of cases, and similar abnormalities often are noted in association with DIC, various forms of vasculitis, HUS, and a variety of unrelated disorders.



**Figure 54.3.** Bone marrow biopsy in a patient with acute thrombotic thrombocytopenic purpura. There is a hyaline thrombus within one of the arterioles in the bone marrow ( $\times 1000$ ; hematoxylin and eosin stain). See [Color Plate](#).

## Differential Diagnosis

HUS and related microangiopathic processes (see [Chapter 38](#)) are closely related to TTP. HUS may be regarded as a localized form of the disorder in which microangiopathic blood destruction and vascular damage occur principally in the kidney. The incidence of HUS is high in children, and the disorder often follows a prodromal infection. Abdominal pain and gastrointestinal symptoms often usher in HUS; anuria, severe renal failure, and hypertension are common early in the course of the disorder. However, abdominal pain secondary to pancreatitis or bowel wall infarcts can also be seen in patients with TTP. Neurologic symptoms are less common in patients with HUS, and complement levels often are low. Spontaneous remission occurs in many cases and relapses are rare.

In pregnant women, eclampsia or hemolysis, elevated liver enzymes, and low platelet count (“HELLP”) syndrome may present with many similar manifestations, which may be confused with TTP. In contrast to TTP, eclampsia has a favorable prognosis and may be associated with low-grade intravascular coagulation. Other disorders that may mimic TTP include microangiopathic hemolysis associated with disseminated cancer or intravascular coagulation, active systemic lupus erythematosus with immune thrombocytopenic purpura and vasculitis, severe idiopathic thrombocytopenic purpura with autoimmune hemolytic anemia (especially if intracranial hemorrhage has occurred), and paroxysmal nocturnal hemoglobinuria.

## Treatment

Before the introduction of exchange plasmapheresis and plasma infusions in the 1970s for the treatment of TTP, the disease was fatal in more than 80% of patients within 3 months; fewer than 10% survived 1 year ( [6](#) ). Over 80% of patients who are treated aggressively with exchange plasmapheresis now survive the initial episode of TTP ( [1](#), [32](#), [80](#), [127](#), [143](#), [150](#) ).

, [151](#), [152](#), [153](#), [154](#), [155](#), [156](#), [157](#), [158](#), [159](#), [160](#), [161](#), [162](#), [163](#), [164](#), [165](#), [166](#), [167](#), [168](#) and [169](#) ). Investigators have not consistently found any presenting factors that can predict which patients will have a favorable outcome; in fact, patients with significant renal failure have the same response rate to aggressive plasma exchange ( [32](#), [169](#), [170](#) and [171](#) ). The exact mechanism of these remarkable therapeutic effects remains unknown. Possible explanations include the removal of abnormal vWF multimers, PAFs, or circulating immune complexes and the replacement of a processing factor that can modify ULvWF multimers (i.e., cleaving metalloprotease) or prostacyclin production. The therapeutic effects of plasmapheresis in the critically ill patient with TTP often are dramatic. Severe neurologic manifestations may disappear, and laboratory abnormalities may diminish in a few hours. Some patients may respond completely to infusions of large amounts of fresh plasma daily ( [143](#), [172](#), [173](#), [174](#) and [175](#) ), but in the controlled prospective therapeutic trial of plasma exchange or plasma infusion, plasma exchange was demonstrated to be significantly better ( [143](#) ). Use of cryoprecipitate-poor plasma for replacement as initial therapy during plasma exchange was not superior to fresh frozen plasma in a recent small randomized controlled trial ( [176](#) ).

Seriously ill patients should receive plasma infusions for several hours until plasmapheresis can be arranged. Thereafter, plasma exchange of at least a single plasma volume daily should be performed until several days after the platelet count is normal and there is minimal hemolysis. The procedure must sometimes be continued for 10 days or longer to obtain a complete remission in seriously ill patients. Therapy is then frequently tapered and discontinued if normal values are maintained. Up to one-third of patients may have early relapses (i.e., less than 1 month after complete remission) or late relapses up to 10 years after their first episode ( [177](#) ).

Evaluating other therapeutic measures in TTP is difficult because most patients are given multiple therapeutic agents simultaneously ( [Table 54.4](#) ). Patients are often treated with corticosteroids or antiplatelet drugs during plasmapheresis, but the benefit of these therapies is still uncertain ( [159](#), [178](#), [179](#), [180](#) and [181](#) ). Patients who are refractory to plasmapheresis may respond to cryosupernatant plasma therapy ( [57](#), [182](#), [183](#) and [184](#) ), vincristine ( [185](#), [186](#), [187](#), [188](#), [189](#), [190](#), [191](#) and [192](#) ), intravenous Ig ( [193](#), [194](#), [195](#), [196](#), [197](#), [198](#), [199](#), [200](#), [201](#) and [202](#) ), prostacyclin ( [203](#), [204](#), [205](#) and [206](#) ), or splenectomy ( [207](#), [208](#), [209](#), [210](#), [211](#), [212](#), [213](#), [214](#), [215](#), [216](#), [217](#) and [218](#) ), but these therapies have not been systematically studied in this setting. Therefore, individual hematologists have their own preferred salvage therapies. Some patients with chronic, relapsing TTP have responded to splenectomy.

**TABLE 54.4. Treatment of Thrombotic Thrombocytopenic Purpura**

---

|  |
|--|
| Plasmapheresis with exchange of at least one volume of plasma daily.         |
| Inclusion of antiplatelet agents and corticosteroids is of unproven benefit. |
| Salvage therapy.   |
| Infusions of fresh frozen plasma   |
| Plasmapheresis and exchange with cryosupernatant plasma                      |
| Vincristine  |
| Intravenous immunoglobulin   |
| Splenectomy  |
| Prostacyclin   |

---

Platelet transfusions should be avoided because patients have had marked deterioration in either renal or neurologic status during platelet transfusions ( [164](#), [219](#), [220](#) and [221](#) ). There is even concern that rapid recovery of the platelet pool during treatment may explain subsequent deterioration in some patients' clinical course ( [221](#) ).

## PLATELET DAMAGE BY ABNORMAL VASCULAR SURFACES

To an even greater extent than erythrocytes, platelets are subject to damage by interactions with "unphysiologic" surfaces within the vascular system. Pathologic alterations of vessels that may produce such platelet damage include stenotic and roughened heart valves ( [222](#) ), extensive atherosclerosis, metastatic cancer ( [223](#) ), and kidney diseases that are associated with severe vascular changes in renal vessels ( [224](#) ). An increasing number of surgical techniques involve the implantation of devices containing foreign material within the vascular system. Such circulatory prostheses include cardiac valves, vascular grafts of many types, indwelling catheters [including Swan-Ganz catheters ( [225](#) )], intraaortic balloon pumps ( [226](#) ), extracorporeal life support ( [227](#) ), and artificial hearts. An attempt has been made to render such materials nonthrombogenic, but most of these devices produce varying degrees of platelet destruction as well as hemolysis ( [228](#) ). Finally, even short-term contact between platelets and foreign surfaces, as in cardiopulmonary bypass, is associated with platelet damage ( [229](#) ).

Bleeding during cardiopulmonary bypass surgery appears to be multifactorial. In addition to dilution of clotting factors, inadequate neutralization of heparin, and mild thrombocytopenia, there is a defect in platelet function that results in a prolongation of the bleeding time. Hemodilution leads to a rapid reduction in platelet counts by as much as 50% shortly after cardiopulmonary bypass surgery begins. The bleeding time defect is maximal during cardiopulmonary bypass surgery and usually disappears within 24 hours of surgery. Similar changes in platelet counts, bleeding time, and postoperative bleeding occur regardless of whether bubble or membrane oxygenators are used ( [229](#) ). The nature of the platelet defect is controversial, and there is currently disagreement as to whether it is even intrinsic ( [230](#), [231](#), [232](#) and [233](#) ) or extrinsic ( [233](#) ) to the platelet. Investigators report partial platelet degranulation, circulating activated platelets by flow cytometry, and defects in platelet membrane glycoprotein Ib/IX and IIb/IIIa ( [234](#), [235](#) ). Platelet survival is shortened, and accumulation of radio-labeled platelets can be demonstrated both on the membrane in the cardiopulmonary pump and in the patient liver ( [236](#) ). Bleeding can be reduced by infusions of normal platelets, 1-deamino-8-D-arginine vasopressin, epsilon amino caproic acid, or aprotinin ( [237](#), [238](#), [239](#) and [240](#) ). Additional agents that provide temporary, reversible inhibition of platelet activation are being tested in simulated extracorporeal circulation ( [241](#) ).

## MISCELLANEOUS FORMS OF NONIMMUNOLOGIC PLATELET DESTRUCTION

Extensive burns are associated with mild to moderate thrombocytopenia that results from nonimmunologic platelet destruction ( [242](#) ). The mechanism by which this occurs is unclear. Thrombocytopenia may become severe and bleeding may develop when complicating sepsis or DIC develops. Fortunately, the latter syndrome is uncommon, even in cases involving severe burns in the absence of infection. Thrombocytopenia has been well described after hepatic cryotherapy ( [243](#) ) and in moderate hypothermia treatment for

hemispheric stroke ( [244](#) ). Certain drugs may produce thrombocytopenia by nonimmunologic phenomena. Ristocetin, an antituberculosis agent no longer used clinically, promotes the attachment of vWF to a platelet receptor and initiates direct platelet-to-platelet interaction by means of an agglutination phenomenon. Studies of ristocetin-induced platelet aggregation have provided much information concerning von Willebrand disease (see [Chapter 59](#) ). vWF concentrates of bovine or porcine origin predictably produce platelet aggregation and mild thrombocytopenia in the recipient, apparently as the result of attachment of the heterologous vWF to a platelet receptor. Similar agglutination phenomena also are produced by polycations, such as polybrene, protamine, and pentosan ( [245](#) ). Protamine may produce reversible sequestration of platelets in the liver ( [246](#) ) but seldom is the cause of significant thrombocytopenia. Aggregation of platelets independent of immune mechanisms plays a role in type 1 heparin-induced thrombocytopenia. Thrombocytopenia is a consistent feature of postdecompression sickness in divers and has been attributed to intravascular platelet aggregation ( [247](#) ).

## REFERENCES

1. Rock GA. Management of thrombotic thrombocytopenic purpura. *Br J Haematol* 2000;109:496–507.
2. Cines DB, Konkle BA, Furlan M. Thrombotic thrombocytopenic purpura: a paradigm shift? *Thromb Haemost* 2000;84:528–535.
3. Moake JL, Sadler JE, Mannucci P, et al. Report on the workshop: von Willebrand factor and thrombotic thrombocytopenic purpura. *Am J Hematol* 2001;68:122–126.
4. Moake JL. Thrombotic thrombocytopenic purpura: the systemic clumping “plague.” *Annu Rev Med* 2002;53:75–88.
5. Moschowitz E. An acute febrile pleiochromic anemia with hyaline thrombosis of the terminal arterioles and capillaries. *Arch Int Med* 1925;36:89–93.
6. Amorosi EL, Ultmann JE. Thrombotic thrombocytopenic purpura: report of 16 cases and review of the literature. *Medicine* 1966;45:139–159.
7. Asada Y, Sumiyoshi A, Hayashi T, et al. Immunohistochemistry of vascular lesion in thrombotic thrombocytopenic purpura, with special reference to factor VIII related antigen. *Thromb Res* 1985;38:469–479.
8. Neame PB, Lechago J, Ling ET, Koval A. Thrombotic thrombocytopenic purpura: report of a case with disseminated intravascular platelet aggregation. *Blood* 1973;42:805–814.
9. Gore I. Disseminated arteriolar and capillary platelet thrombosis. *Am J Pathol* 1950;26:155–175.
10. Goodman A, Ramos R, Petrelli M, et al. Gingival biopsy in thrombotic thrombocytopenic purpura. *Ann Int Med* 1978;89:501–504.
11. Nishioka GJ, Chilcoat CC, Aufdemorte TB, Clare N. The gingival biopsy in the diagnosis of thrombotic thrombocytopenic purpura. *Oral Surg Oral Med Oral Pathol* 1988;65:580–585.
12. Brittingham TE, Chaplin H. Attempted passive transfer of thrombotic thrombocytopenic purpura. *Blood* 1957;12:480–482.
13. Norkin SA, Freedman HH, Evans GW. Thrombotic thrombocytopenic purpura in siblings. *Am J Med* 1967;43:294–303.
14. Wallace DC, Lovric A, Clubb JS, Carseldine DB. Thrombotic thrombocytopenic purpura in four siblings. *Am J Med* 1975;58:724–734.

15. Fuchs WE, George JN, Dotin LN, Sears DA. Thrombotic thrombocytopenic purpura: occurrence two years apart during late pregnancy in two sisters. *JAMA* 1976;235:2126–2127.
16. Hellman RM, Jackson DV, Buss DH. Thrombotic thrombocytopenic purpura and hemolytic-uremic syndrome in HLA-identical siblings. *Ann Intern Med* 1980;93:283–284.
17. Crowley JP, Zaroulis CG, O'Shea PA, Clark DD. Thrombotic thrombocytopenic purpura in southeastern New England. *Arch Intern Med* 1983;143:1011–1013.
18. Wiznitzer A, Mazor M, Leiberman JR, et al. Familial occurrence of thrombotic thrombocytopenic purpura in two sisters during pregnancy. *Am J Obstet Gynecol* 1992;166:20–21.
19. Joseph G, Smith KJ, Hadley TJ, et al. HLA-DR53 protects against thrombotic thrombocytopenic purpura/adult hemolytic uremic syndrome. *Am J Hematol* 1994;47:189–193.
20. Takahashi H, Hanano M, Wada H, et al. Circulating thrombomodulin in thrombotic thrombocytopenic purpura. *Am J Hematol* 1991;38:174–177.
21. Wada H, Ohiwa M, Kaneko T, et al. Plasma thrombomodulin as a marker of vascular disorders in thrombotic thrombocytopenic purpura and disseminated intravascular coagulation. *Am J Hematol* 1992;39:20–24.
22. Wada H, Kaneko T, Ohiwa M, et al. Increased levels of vascular endothelial markers in thrombotic thrombocytopenic purpura. *Am J Hematol* 1993;44:101–105.
23. Kobayashi M, Wada H, Wakita Y, et al. Decreased plasma tissue factor pathway inhibitor levels in patients with thrombotic thrombocytopenic purpura. *Thromb Haemost* 1995;73:10–14.
24. Laurence J, Mitra D, Steiner M, et al. Plasma from patients with idiopathic and human immunodeficiency virus-associated thrombotic thrombocytopenic purpura induces apoptosis in microvascular endothelial cells. *Blood* 1996;87:3245–3254.
25. Chang CT, Magid MS, Weksler B, et al. Enhanced endothelial cell apoptosis in splenic tissues of patients with thrombotic thrombocytopenic purpura. *Blood* 1999;93:1264–1270.
26. Mauro M, Kim J, Costello C, et al. Role of transforming growth factor TGF- $\beta$ 1 in microvascular endothelial cell apoptosis associated with thrombotic thrombocytopenic purpura and hemolytic-uremic syndrome. *Am J Hematol* 2001;66:12–22.
27. Jimenez JJ, Jy W, Lucia LM, et al. Elevated endothelial microparticles in thrombotic thrombocytopenic purpura: findings from brain and renal microvascular cell culture and patients with active disease. *Br J Haematol* 2001;112:81–90.
28. Burns ER, Zucker-Franklin D. Pathologic effects of plasma from patients with thrombotic thrombocytopenic purpura on platelets and cultured vascular endothelial cells. *Blood* 1982;60:1030–1037.
29. Tandon NN, Rock G, Jamieson GA. Anti-CD36 antibodies in thrombotic thrombocytopenic purpura. *Br J Haematol* 1994;88:816–825.
30. Schultz DR, Arnold PI, Jy W, et al. Anti-CD36 autoantibodies in thrombotic thrombocytopenic purpura and other thrombotic disorders: identification of an 85 kD form of CD36 as a target antigen. *Br J Haematol* 1998;103:849–857.
31. Sacher RA, Phillips TM, Shashaty GG, et al. Demonstration of immune complexes in thrombotic thrombocytopenic purpura and effect of exchange transfusion. *Scand J Haematol* 1980;24:373–380.
32. Rock G, Shumak K, Kelton J, et al. Thrombotic thrombocytopenic purpura: outcome in 24 patients with renal impairment treated with plasma exchange. *Transfusion* 1992;32:710–714.
33. del Arco A, Martinez MA, Peña JM, et al. Thrombotic thrombocytopenic purpura associated with human immunodeficiency virus infection: demonstration of p24 antigen in endothelial cells. *Clin Infect Dis*

1993;17:360–363.

34. Noris M, Ruggenenti P, Todeschini M, et al. Increased nitric oxide formation in recurrent thrombotic microangiopathies: a possible mediator of microvascular injury. *Am J Kidney Dis* 1996;27:790–796.
35. Wu KK, Hall ER, Rossi EC, Papp AC. Serum prostacyclin binding defects in thrombotic thrombocytopenic purpura. *J Clin Invest* 1985;75:168–174.
36. Machin SJ, McVerry BA, Parry H, Marrow WJ. A plasma factor inhibiting prostacyclin-like activity in thrombotic thrombocytopenic purpura. *Acta Haematol* 1982;67:8–12.
37. Pini M, Manotti C, Megha A, et al. Normal prostacyclinlike activity and response to plasma exchange in thrombotic thrombocytopenic purpura. *Acta Haematol* 1982;67:198–205.
38. Chen YC, Hall ER, McLeod B, Wu KK. Accelerated prostacyclin degradation in thrombotic thrombocytopenic purpura. *Lancet* 1981;2:267–269.
39. Remuzzi G, Marchesi D, Misiani R, et al. Familial deficiency of a plasma factor stimulating vascular prostacyclin activity. *Thromb Res* 1979;16:517–525.
40. Glas-Greenwalt P, Hall JM, Panke TW, et al. Fibrinolysis in health and disease: abnormal levels of plasminogen activator, plasminogen activator inhibitor, and protein C in thrombotic thrombocytopenic purpura. *J Lab Clin Med* 1986;108:415–422.
41. Monteagudo J, Pereira A, Reverter JC, et al. Thrombin generation and fibrinolysis in the thrombotic thrombocytopenic purpura and the hemolytic uremic syndrome. *Thromb Haemost* 1991;66:515–519.
42. Moake J. Thrombotic thrombocytopenic purpura. *Thromb Haemost* 1995;74:240–245.
43. Zheng X, Chung D, Takayama TK, et al. Structure of von Willebrand factor–cleaving protease (ADAMTS13), a metalloprotease involved in thrombotic thrombocytopenic purpura. *J Biol Chem* 2001;276:41059–41063.
44. Gerritsen HE, Robles R, Lammle B, et al. Partial amino acid sequence of purified von Willebrand–cleaving protease. *Blood* 2001;98:1654–1661.
45. Fujikawa K, Suzuki H, McMullen B, et al. Purification of human von Willebrand factor–cleaving protease and its identification as a new member of the metalloproteinase family. *Blood* 2001;98:1662–1666.
46. Levy GG, Nichols WC, Lian EC, et al. Mutations in a member of the ADAMTS gene family cause thrombotic thrombocytopenic purpura. *Nature* 2001;413:488–494.
47. Brass L. vWF meets the ADAMTS family. *Nat Med* 2001;7:1177–1178.
48. Furlan M, Robles R, Solenthaler M, et al. Deficient activity of von Willebrand factor–cleaving protease in chronic relapsing thrombotic thrombocytopenic purpura. *Blood* 1997;89:3097–3103.
49. Furlan M, Robles R, Solenthaler M et al. Acquired deficiency of von Willebrand factor–cleaving protease in a patient with thrombotic thrombocytopenic purpura. *Blood* 1998;91:2839–2846.
50. Tsai HM, Lian EC. Antibodies to von Willebrand factor–cleaving protease in acute thrombotic thrombocytopenic purpura. *N Engl J Med* 1998;339:1585–1594.
51. Furlan M, Robles R, Galbusera M, et al. von Willebrand factor–cleaving protease in thrombotic thrombocytopenic purpura and the hemolytic–uremic syndrome. *N Engl J Med* 1998;339:1578–1584.
52. Chow TW, Turner NA, Chintagumpala M, et al. Increased von Willebrand factor binding to platelets in single episode and recurrent types of thrombotic thrombocytopenic purpura. *Am J Hematol* 1998;57:293–302.
53. Moake JL, Rudy CK, Troll JH, et al. Case report: von Willebrand factor abnormalities and endothelial cell perturbation in a patient with acute thrombotic thrombocytopenic purpura. *Am J Med Sci*



1986;291:47–50.

54. Moake JL, McPherson PD. Abnormalities of von Willebrand factor multimers in thrombotic thrombocytopenic purpura and the hemolytic–uremic syndrome. *Am J Med* 1989;87:3N–9N.
55. Moake JL, Rudy CK, Troll JH, et al. Unusually large plasma factor VIII: von Willebrand factor multimers in chronic relapsing thrombotic thrombocytopenic purpura. *N Engl J Med* 1982;307:1432–1435.
56. Chintagumpala MM, Hurwitz RL, Moake JL, et al. Chronic relapsing thrombotic thrombocytopenic purpura in infants with large von Willebrand factor multimers during remission. *J Pediatr* 1992;120:49–53.
57. Moake JL, Byrnes JJ, Troll JH, et al. Effects of fresh–frozen plasma and its cryosupernatant fraction on von Willebrand factor multimeric forms in chronic relapsing thrombotic thrombocytopenic purpura. *Blood* 1985;65:1232–1236.
58. Tsai HM, Li Anping, Rock G. Inhibitors of von Willebrand factor–cleaving protease in thrombotic thrombocytopenic purpura. *Clin Lab* 2001;47:387–392.
59. Mannucci PM, Canciani MT, Forza I, et al. Changes in health and disease of the metalloprotease that cleaves von Willebrand factor. *Blood* 2001;98:2730–2735.
60. Moore JC, Hayward CP, Warkentin TE, et al. Decreased von Willebrand factor protease activity associated with thrombocytopenic disorders. *Blood* 2001;98:1842–1846.
61. Veyradier A, Obert B, Houllier A, et al. Specific von Willebrand factor–cleaving protease in thrombotic microangiopathies: a study of 111 cases. *Blood* 2001;98:1765–1772.
62. Allford SL, Harrison P, Lawrie AS, et al. von Willebrand factor–cleaving protease activity in congenital thrombotic thrombocytopenic purpura. *Br J Haematol* 2000;111:1215–1222.
63. Furlan M, Robles R, Morselli B, et al. Recovery and half–life of von Willebrand factor–cleaving protease after plasma therapy in patients with thrombotic thrombocytopenic purpura. *Thromb Haemost* 1999;81:8–13.
64. Stark GL, Wallis JP, Allford SL, et al. Chronic relapsing thrombotic thrombocytopenic purpura due to a deficiency of von Willebrand factor–cleaving protease activity. *Br J Haematol* 2002;117:247–254.
65. Maes P, Brichard B, Vermeylen C, et al. Chronic relapsing thrombotic thrombocytopenic purpura: three case reports and update of the pathogenesis and therapeutic modalities. *Eur J Pediatr* 1998;157:468–472.
66. Barbot J, Costa E, Guerra M, et al. Ten years of prophylactic treatment with fresh–frozen plasma in a child with chronic relapsing thrombotic thrombocytopenic purpura as a result of a congenital deficiency of von Willebrand factor–cleaving protease. *Br J Haematol* 2001;113:649–651.
67. Tsai HM, Rice L, Sarode R, et al. Antibody inhibitors to von Willebrand factor metalloproteinase and increased binding of von willebrand factor to platelets in ticlopidine–associated thrombotic thrombocytopenic purpura. *Ann Intern Med* 2000;132:794–799.
68. Bennett CL, Connors JM, Carwile JM, et al. Thrombotic thrombocytopenic purpura associated with clopidogrel. *N Engl J Med* 2000;342:1773–1777.
69. Sahud MA, Claster S, Liu L, et al. von Willebrand factor–cleaving protease inhibitor in a patient with human immunodeficiency syndrome–associated thrombotic thrombocytopenic purpura. *Br J Haematol* 2002;116:909–911.
70. Van der Plas RM, Schiphorst ME, Hulzinga EG, et al. von Willebrand factor proteolysis is deficient in classic, but not in bone marrow transplantation–associated, thrombotic thrombocytopenic purpura. *Blood* 1999;93:3798–3802.
71. Lian EC, Harkness DR, Byrnes JJ, et al. Presence of a platelet aggregating factor in the plasma of patients with thrombotic thrombocytopenic purpura (TTP) and its inhibition by normal plasma. *Blood* 1979;53:333–338.
72. Hussey CV, Hause LL, Gottschall JL, Anderson T. A platelet aggregating factor in thrombotic thrombocytopenic purpura: initial activity, fluctuations, and removal by plasma exchange. *Thromb Res*

1986;44:355-364.

73. Siddiqui FA, Lian EC-Y. Novel platelet agglutinating protein from a thrombotic thrombocytopenic plasma. *J Clin Invest* 1985;76:1330-1337.
74. Siddiqui FA, Lian EC-Y. Characterization of platelet agglutinating protein p37 purified from the plasma of a patient with thrombotic thrombocytopenic purpura. *Biochem Mol Biol Int* 1993;30:385-395.
75. Kelton JG, Moore J, Santos A, Sheridan D. Detection of a platelet-agglutinating factor in thrombotic thrombocytopenic purpura. *Ann Int Med* 1984;101:589-593.
76. Murphy WG, Moore JC, Kelton JG. Calcium-dependent cysteine protease activity in the sera of patients with thrombotic thrombocytopenic purpura. *Blood* 1987;70:1683-1687.
77. Consonni R, Falanga A, Barbui T. Further characterization of platelet-aggregating cysteine proteinase activity in thrombotic thrombocytopenic purpura. *Br J Haematol* 1994;87:321-324.
78. Falanga A, Consonni R, Ruggenenti P, Barbui T. A cathepsin-like cysteine proteinase proaggregating activity in thrombotic thrombocytopenic purpura. *Br J Haematol* 1991;79:474-480.
79. Ridolfi RL, Bell WR. Thrombotic thrombocytopenic purpura: report of 25 cases and review of the literature. *Medicine* 1981;60:413-428.
80. Thompson CE, Damon LE, Ries CA, Linker CA. Thrombotic microangiopathies in the 1980s: clinical features, response to treatment, and the impact of the human immunodeficiency virus epidemic. *Blood* 1992;80:1890-1895.
81. Silverstein A. Thrombotic thrombocytopenic purpura: the initial neurologic manifestations. *Arch Neurol* 1968;18:358-362.
82. Chang JC, Aly EM. Acute respiratory distress syndrome as a major clinical manifestation of thrombotic thrombocytopenic purpura. *Am J Med Sci* 2001;321:124-128.
83. Ridolfi RL, Hutchins GM, Bell WR. The heart and cardiac conduction system in thrombotic thrombocytopenic purpura: a clinicopathologic study of 17 autopsied patients. *Ann Intern Med* 1979;91:357-363.
84. Case records of the Massachusetts General Hospital (Case 30-1991). *N Engl J Med* 1991;325:265-273.
85. Olsen H. Thrombotic thrombocytopenic purpura as a cause of pancreatitis: report of a case and review of the literature. *Dig Dis* 1973;18:238-246.
86. Vegara M, Modolell I, Puig-Divi V, et al. Acute pancreatitis as a triggering factor for thrombotic thrombocytopenic purpura. *Am J Gastroenterol* 1998;93:2215-2218.
87. Elias M, Flatau E, Bar-El Y. Thrombotic thrombocytopenic purpura presenting as an acute abdomen. *Br J Surg* 1985;72:286.
88. Winwood PJ, Iredale JP, Williamson PJ, et al. Thrombotic thrombocytopenic purpura mimicking acute small bowel Crohn's disease. *Gut* 1992;33:857-859.
89. Yosipovitch G, Krause I, Blickstein D. Erythromelalgia in a patient with thrombotic thrombocytopenic purpura. *J Am Acad Dermatol* 1992;26:825-827.
90. Leaf AN, Laubenstein LJ, Raphael B, et al. Thrombotic thrombocytopenic purpura. *Ann Intern Med* 1988;109:194-197.
91. Nair JMG, Bellevue R, Bertoni M, Dosik H. Thrombotic thrombocytopenic purpura in patients with the acquired immunodeficiency syndrome (AIDS)-related complex. *Ann Intern Med* 1988;109:209-212.
92. Botti AC, Hyde P, DiPillo F. Thrombotic thrombocytopenic purpura in a patient who subsequently

- developed the acquired immunodeficiency syndrome (AIDS). *Ann Intern Med* 1988;109:242–243.
93. Salem G, Terebello H, Raman S. Human immunodeficiency virus associated with thrombotic thrombocytopenic purpura: successful treatment with zidovudine. *South Med J* 1991;84:493–495.
94. Shivaram U, Cash M. Purpura fulminans, metastatic endophthalmitis, and thrombotic thrombocytopenic purpura in an HIV-infected patient. *N Y State J Med* 1992;92:313–314.
95. Rarick MU, Espina B, Mocharnuk R, et al. Thrombotic thrombocytopenic purpura in patients with human immunodeficiency virus infection: a report of three cases and review of the literature. *Am J Hematol* 1992;40:103–109.
96. Veenstra J, van der Lelie J, Mulder JW, Reiss P. Case report: low-grade thrombotic thrombocytopenic purpura associated with HIV-1 infection. *Br J Haematol* 1993;83:346–347.
97. Ucar A, Fernandez HF, Byrnes JJ, et al. Thrombotic microangiopathy and retroviral infections: a 13-year experience. *Am J Hematol* 1994;45:304–309.
98. Chu QD, Medeiros J, Fisher AE, et al. Thrombotic thrombocytopenic purpura and HIV infection. *South Med J* 1995;88:82–86.
99. Ashkenazi S. Role of bacterial cytotoxins in hemolytic uremic syndrome and thrombotic thrombocytopenic purpura. *Ann Rev Med* 1993;44:11–18.
100. Hoffman SL. Shiga-like toxins in hemolytic uremic syndrome and thrombotic thrombocytopenic purpura. *Am J Med Sci* 1993;306:398–406.
101. Morrison DM, Tyrrell DLJ, Jewell LD. Colonic biopsy in verotoxin-induced hemorrhagic colitis and thrombotic thrombocytopenic purpura (TTP). *Am J Clin Pathol* 1986;86:108–112.
102. Kovacs MJ, Roddy J, Grégoire S, et al. Thrombotic thrombocytopenic purpura following hemorrhagic colitis due to *Escherichia coli* O157:H7. *Am J Med* 1990;88:177–179.
103. Silva VA. Thrombotic thrombocytopenic purpura/hemolytic uremic syndrome secondary to pancreatitis. *Am J Hematol* 1995;50:53–56.
104. Jackson B, Files JC, Morrison FS, Scott-Conner CEH. Thrombotic thrombocytopenic purpura and pancreatitis. *Am J Gastroenterol* 1989;84:667–669.
105. Holman MJ, Gonwa TA, Cooper B, et al. FK506-associated thrombotic thrombocytopenic purpura. *Transplantation* 1993;55:205–206.
106. Charba D, Moake JL, Harris MA, Hester JP. Abnormalities of von Willebrand factor multimers in drug-associated thrombotic microangiopathies. *Am J Hematol* 1993;42:268–277.
107. Hochstetler LA, Flanigan MJ, Lager DJ. Transplant-associated thrombotic microangiopathy: the role of IgG administration as initial therapy. *Am J Kidney Dis* 1994;23:444–450.
108. Dzik WH, Georgi BA, Khettry U, Jenkins RL. Cyclosporine-associated thrombotic thrombocytopenic purpura following liver transplantation—successful treatment with plasma exchange. *Transplantation* 1987;44:570–572.
109. Doll DC, Weiss RB. Hemolytic anemia associated with antineoplastic agents. *Cancer Treat Rep* 1985;69:777–782.
110. Byrnes JJ, Baquerizo H, Gonzalez M, Hensley GT. Thrombotic thrombocytopenic purpura subsequent to acute myelogenous leukemia chemotherapy. *Am J Hematol* 1986;21:299–304.
111. Nagaya S, Wada H, Oka K, et al. Hemostatic abnormalities and increased vascular endothelial cell markers in patients with red cell fragmentation syndrome induced by mitomycin C. *Am J Hematol* 1995;50:237–243.
112. Bennett CL, Weinberg PD, Rozenberg-Ben-Dror K, et al. Thrombotic thrombocytopenic purpura

associated with ticlopidine. *Ann Intern Med* 1998;128:541–544.

113. Kojouri K, Vesely SK, George JN. Quinine-associated thrombotic thrombocytopenic purpura-hemolytic uremic syndrome: frequency, clinical features, and long-term outcomes. *Ann Intern Med* 2001;135:1047–1051.

114. Levine S, Shearn MA. Thrombotic thrombocytopenic purpura and systemic lupus erythematosus. *Arch Intern Med* 1964;113:826–836.

115. Dekker A, O'Brien ME, Cammarata RJ. The association of thrombotic thrombocytopenic purpura with systemic lupus erythematosus: a report of two cases with successful treatment of one. *Am J Med Sci* 1974;267:243–249.

116. Gatenby PA, Smith H, Kirwan P, Lauer CS. Systemic lupus erythematosus and thrombotic thrombocytopenic purpura. A case report and review of relationship. *J Rheumatol* 1981;8:504–508.

117. Cecere FA, Yoshinoya S, Popo RM. Fatal thrombotic thrombocytopenic purpura in a patient with systemic lupus erythematosus: relationship to circulating immune complexes. *Arthritis Rheum* 1981;24:550–553.

118. Dixit R, Krieg AM, Atkinson JP. Thrombotic thrombocytopenic purpura developing during pregnancy in a C2-deficient patient with a history of systemic lupus erythematosus. *Arthritis Rheum* 1985;28:341–344.

119. Devinsky O, Petito CK, Alonzo DR. Clinical and neuropathological findings in systemic lupus erythematosus: the role of vasculitis, heart emboli, and thrombotic thrombocytopenic purpura. *Ann Neurol* 1988;23:380–384.

120. Jonsson OG, Fink CW. Systemic lupus erythematosus presenting as thrombotic thrombocytopenic purpura. *J Rheumatol* 1990;17:973–974.

121. Hess DC, Sethi K, Awad E. Thrombotic thrombocytopenic purpura in systemic lupus erythematosus and antiphospholipid antibodies: effective treatment with plasma exchange and immunosuppression. *J Rheumatol* 1992;19:1474–1478.

122. Stricker RB, Davis JA, Gershow J, et al. Thrombotic thrombocytopenic purpura complicating systemic lupus erythematosus. Case report and literature review from the plasmapheresis era. *J Rheumatol* 1992;19:1469–1473.

123. Cockerell CJ, Lewis JE. Systemic lupus erythematosus-like illness associated with syndrome of abnormally large von Willebrand's factor multimers. *South Med J* 1993;86:951–953.

124. Jain R, Chartash E, Susin M, Furie R. Systemic lupus erythematosus complicated by thrombotic microangiopathy. *Semin Arthritis Rheum* 1994;24:173–182.

125. Bray VJ, West SG, Kristo DA. Simultaneous presentation of thrombotic thrombocytopenic purpura and systemic lupus erythematosus. *South Med J* 1994;87:827–830.

126. Neshor G, Hanna VE, Moore TL, et al. Thrombotic microangiopathic hemolytic anemia in systemic lupus erythematosus. *Semin Arthritis Rheum* 1994;24:165–172.

127. Lichtin AE, Schreiber AD, Hurwitz S, et al. Efficacy of intensive plasmapheresis in thrombotic thrombocytopenic purpura. *Arch Intern Med* 1987;147:2122–2126.

128. Cookson S, Krueger ML, Bennett RM. Fulminant thrombotic thrombocytopenic purpura in a patient with the limited form of scleroderma: successful outcome using plasma exchange. *J Rheumatol* 1991;18:900–901.

129. Salyer WR, Salyer DC, Heptinstall RH. Scleroderma and microangiopathic hemolytic anemia. *Ann Intern Med* 1973;78:895–897.

130. ter Borg EJ, Houtman PM, Kallenberg CGM, et al. Thrombocytopenia and hemolytic anemia in a patient with mixed connective tissue disease due to thrombotic thrombocytopenic purpura. *J Rheumatol* 1988;15:1174–1177.

131. Ellingson TL, Wilske K, Aboulafia DM. Case report: thrombotic thrombocytopenic purpura in a patient with polymyositis: therapeutic importance of early recognition and discussion of pathogenic mechanisms. *Am J Med Sci* 1992;303:407-410.
132. Ezra Y, Rose M, Eldor A. Therapy and prevention of thrombotic thrombocytopenic purpura during pregnancy: a clinical study of 16 pregnancies. *Am J Hematol* 1996;51:1-6.
133. Esplin MS, Branch DW. Diagnosis and management of thrombotic microangiopathies during pregnancy. *Clin Obstet Gynecol* 1999;42:360-367.
134. Murgo AJ. Thrombotic microangiopathy in the cancer patient including those induced by chemotherapeutic agents. *Semin Hematol* 1987;24:161-177.
135. Sill H, Höfler G, Kaufmann P. Angiotropic large cell lymphoma presenting as thrombotic microangiopathy (thrombotic thrombocytopenic purpura). *Cancer* 1995;75:1167-1170.
136. Bäck H, Nilsson G, Hansson GK, et al. M-component with reactivity against actin associated with thrombotic thrombocytopenic purpura. *Am J Med* 1991;91:429-433.
137. Fuge R, Bird JM, Fraser A, et al. The clinical features, risk factors and outcome of thrombotic thrombocytopenic purpura occurring after bone marrow transplantation. *Br J Haematol* 2001;113:58-64.
138. Cohen JA, Brecher ME, Bandarenko N. Cellular source of serum lactate dehydrogenase elevation in patients with thrombotic thrombocytopenic purpura. *J Clin Apheresis* 1998;13:16-19.
139. Cuttner J. Thrombotic thrombocytopenic purpura: a ten-year experience. *Blood* 1980;56:302-306.
140. Patton JF, Manning KR, Case D, Owen J. Serum lactate dehydrogenase and platelet count predict survival in thrombotic thrombocytopenic purpura. *Am J Hematol* 1994;47:94-99.
141. Crowley JP, Metzger JB, L'Europa RA. The blood counts and lactic dehydrogenase levels in thrombotic thrombocytopenic purpura. *Am J Clin Pathol* 1983;80:700-702.
142. Jaffe EA, Nachman RL, Merskey C. Thrombotic thrombocytopenic purpura-coagulation parameters in twelve patients. *Blood* 1973;42:499-507.
143. Rock GA, Shumak KH, Buskard NA, et al. Comparison of plasma exchange with plasma infusion in the treatment of thrombotic thrombocytopenic purpura. *N Engl J Med* 1991;325:393-397.
144. Neame PB, Hirsch J, Browman G, et al. Thrombotic thrombocytopenic purpura: a syndrome of intravascular platelet consumption. *Can Med Assoc J* 1976;114:1108-1112.
145. Mizock BA, Ramsey RG, Barreta T. Computed tomographic brain scan of thrombotic thrombocytopenic purpura. *Scand J Haematol* 1984;32:271-274.
146. Kay AC, Solberg LA, Nichols DA, Petitt RM. Prognostic significance of computed tomography of the brain in thrombotic thrombocytopenic purpura. *Mayo Clin Proc* 1991;66:602-607.
147. Bakshi R, Shaikh ZA, Bates VE, et al. Thrombotic thrombocytopenic purpura: brain CT and MRI findings in 12 patients. *Neurology* 1999;52:1285-1288.
148. Goldenfarb PB, Finch SC. Thrombotic thrombocytopenic purpura: a ten-year survey. *JAMA* 1973;226:644-647.
149. Umlas J, Kaiser J. Thrombohemolytic thrombocytopenic purpura (TTP). *Am J Med* 1970;49:723-728.
150. Evans TL, Winkelstein A, Zeigler ZR, et al. Thrombotic thrombocytopenic purpura: clinical course and response to therapy in eight patients. *Am J Hematol* 1984;17:1984.
151. Blitzer JB, Granfortuna JM, Gottlieb AJ, et al. Thrombotic thrombocytopenic purpura: treatment with plasmapheresis. *Am J Hematol* 1987;24:329-339.

152. Bukowski RM, Hewlett JS, Harris GC, et al. Exchange transfusions in the treatment of thrombotic thrombocytopenic purpura. *Semin Hematol* 1976;13:219–232.
153. Lichtin AE, Schreiber AD, Hurwitz S, et al. Efficacy of intensive plasmapheresis in thrombotic thrombocytopenic purpura. *Arch Intern Med* 1987;147:2122–2126.
154. Rubinstein MA, Kagan BM, MacGillviray MH, et al. Unusual remission in a case of thrombotic thrombocytopenic purpura syndrome following fresh blood exchange transfusions. *Ann Intern Med* 1959;51:1409–1419.
155. Bukowski RM, King JW, Hewlett JS. Plasmapheresis in the treatment of thrombotic thrombocytopenic purpura. *Blood* 1977;50:413–417.
156. Taft EG. Thrombotic thrombocytopenic purpura and dose of plasma exchange. *Blood* 1979;54:842–849.
157. Pisciotto AV, Garthwaite T, Darin J, Aster RH. Treatment of thrombotic thrombocytopenic purpura by exchange transfusion. *Am J Hematol* 1977;3:73–82.
158. Pisciotto P, Rosen D, Silver H, et al. Treatment of thrombotic thrombocytopenic purpura: evaluation of plasma exchange and review of the literature. *Vox Sang* 1983;45:185–196.
159. Myers TJ, Wakem CJ, Ball ED, Tremont SJ. Thrombotic thrombocytopenic purpura: combined treatment with plasmapheresis and antiplatelet agents. *Ann Intern Med* 1980;92:149–155.
160. Rose M, Eldor A. High incidence of relapses in thrombotic thrombocytopenic purpura. *Am J Med* 1987;83:437–444.
161. Roberts AW, Gillett EA, Fleming SJ. Hemolytic uremic syndrome/thrombotic thrombocytopenic purpura: outcome with plasma exchange. *J Clin Apheresis* 1991;6:150–154.
162. Shepard KV, Bukowski R. The treatment of thrombotic thrombocytopenic purpura with exchange transfusions, plasma infusions, and plasma exchange. *Semin Hematol* 1987;24:178–193.
163. Shepard KV, Fishleder A, Lucas FV, et al. Thrombotic thrombocytopenic purpura treated with plasma exchange or exchange transfusions. *West J Med* 1991;154:410–413.
164. Bell WR, Braine HG, Ness PM, Kickler TS. Improved survival in thrombotic thrombocytopenic purpura–hemolytic uremic syndrome. *N Engl J Med* 1991;325:398–403.
165. Onundarson PT, Rowe JM, Heal JM, Francis CW. Response to plasma exchange and splenectomy in thrombotic thrombocytopenic purpura. *Arch Intern Med* 1992;152:791–796.
166. Dawson RB, Brown JA, Mahalati K, et al. Durable remissions following prolonged plasma exchange in thrombotic thrombocytopenic purpura. *J Clin Apheresis* 1994;9:112–115.
167. Hayward CPM, Sutton DMC, Carter WH, et al. Treatment outcomes in patients with adult thrombotic thrombocytopenic purpura–hemolytic uremic syndrome. *Arch Intern Med* 1994;154:982–987.
168. George JN. How I treat patients with thrombotic thrombocytopenic purpura–hemolytic uremic syndrome. *Blood* 2000;96:1223–1229.
169. Conlon PJ, Howell DN, Macik G, et al. The renal manifestations and outcome of thrombotic thrombocytopenic purpura/ hemolytic uremic syndrome in adults. *Nephrol Dial Transplant* 1995;10:1189–1193.
170. Lara PN, Coe TL, Zhou H, et al. Improved survival with plasma exchange in patients with thrombotic thrombocytopenic purpura–hemolytic uremic syndrome. *Am J Med* 1999;107:573–579.
171. Dervenoulas J, Tsigiotis P, Bolas G, et al. Thrombotic thrombocytopenic purpura/hemolytic uremic syndrome (TTP/HUS): treatment outcome, relapses, prognostic factors. A single-center experience of 48

cases. *Ann Hematol* 2000;79:66–72.

172. Byrnes JJ, Khurana M. Treatment of thrombotic thrombocytopenic purpura with plasma. *N Engl J Med* 1977;297:1386–1389.

173. Ruggenti P, Galbusera M, Cornejo RP, et al. Thrombotic thrombocytopenic purpura: evidence that infusion rather than removal of plasma induces remission of the disease. *Am J Kidney Dis* 1993;21:314–318.

174. Lian EC, Byrnes JJ, Harkness DR. Two successful pregnancies in a woman with chronic thrombotic thrombocytopenic purpura treated by plasma infusion. *Am J Hematol* 1984;16:287–291.

175. Novitsky N, Jacobs P, Rosenstrauch W. The treatment of thrombotic thrombocytopenic purpura: plasma infusion or exchange. *Br J Hematol* 1994;87:317–320.

176. The North American TTP Group: Zeigler ZR, Shaddock RK, Gryn JF, et al. Cryoprecipitate poor plasma does not improve early response in primary adult thrombotic thrombocytopenic purpura (TTP). *J Clin Apheresis* 2001;16:19–22.

177. Shumak KH, Rock GA, Nair RC, and the Canadian Apheresis Group. Late relapses in patients successfully treated for thrombotic thrombocytopenic purpura. *Ann Intern Med* 1995;122:569–572.

178. Rosove MH, Ho WG, Goldfinger D. Ineffectiveness of aspirin and dipyridamole in the treatment of thrombotic thrombocytopenic purpura. *Ann Intern Med* 1982;96:27–33.

179. Eckel RH, Crowell EB, Waterhouse BE, Bozdech MJ. Platelet-inhibiting drugs in thrombotic thrombocytopenic purpura. *Arch Intern Med* 1977;137:735–737.

180. Faguet GB, King MB. Thrombotic thrombocytopenic purpura: treatment with antiplatelet agents. *Am J Med Sci* 1974;268:113–116.

181. Bobbio-Pallavicini E, Gugliotta L, Centurioni R, et al. Antiplatelet agents in thrombocytopenic purpura (TTP). Results of a randomized multicenter trial by the Italian Cooperative Group for TTP. *Haematologica* 1997;82:429–435.

182. Byrnes JJ, Moake JL, Klug P, Periman P. Effectiveness of the cryosupernatant fraction of plasma in the treatment of refractory thrombotic thrombocytopenic purpura. *Am J Hematol* 1990;34:169–174.

183. Obrador GT, Zeigler ZR, Shaddock RK, et al. Effectiveness of cryosupernatant therapy in refractory and chronic relapsing thrombotic thrombocytopenic purpura. *Am J Hematol* 1993;42:217–220.

184. Koyama T, Suehiro A, Kakishita A, et al. Efficacy of the high molecular weight fraction of plasma for the maintenance of pregnancy associated with thrombotic thrombocytopenic purpura. *Am J Hematol* 1990;35:179–183.

185. Gutterman LA, Stevenson TD. Treatment of thrombotic thrombocytopenic purpura with vincristine. *JAMA* 1982;247:1433–1436.

186. Sennett ML, Conrad ME. Treatment of thrombotic thrombocytopenic purpura: plasmapheresis, plasma transfusion, and vincristine. *Arch Intern Med* 1986;146:266–267.

187. Welborn JL, Emrick P, Acevedo M. Rapid improvement of thrombotic thrombocytopenic purpura with vincristine and plasmapheresis. *Am J Hematol* 1990;35:18–21.

188. O'Connor NTJ, Bruce-Jones P, Hill LF. Vincristine therapy for thrombotic thrombocytopenic purpura. *Am J Hematol* 1992;39:234–236.

189. Bobbio-Pallavicini E, Porta E, Centurioni C, et al. Vincristine sulfate for the treatment of thrombotic thrombocytopenic purpura refractory to plasma-exchange. *Eur J Haematol* 1994;52:222–226.

190. Van Gool S, Brock P, Van Laer P, et al. Successful treatment of recurrent thrombotic thrombocytopenic purpura with plasmapheresis and vincristine. *Eur J Pediatr* 1994;153:517–519.

191. Mazzei C, Pepkowitz S, Klapper D, et al. Treatment of thrombotic thrombocytopenic purpura: a role



for early vincristine administration. *J Clin Apheresis* 1998;13:20–22.

192. Ferrara F, Copia C, Annunziata M, et al. Vincristine as salvage treatment for refractory thrombotic thrombocytopenic purpura. *Ann Hematol* 1999;78:521–523.

193. Wong P, Itoh K, Yoshida C. Treatment of thrombotic thrombocytopenic purpura with intravenous gamma globulin. *N Engl J Med* 1986;314:385–386.

194. Viero P, Cortelazzo S, Buelli M, et al. Thrombotic thrombocytopenic purpura and high-dose immunoglobulin treatment. *Ann Intern Med* 1986;104:282.

195. Finn NG, Wang JC, Hong KJ. High-dose intravenous g-immunoglobulin infusion in the treatment of thrombotic thrombocytopenic purpura. *Arch Intern Med* 1987;147:2165–2167.

196. Gutterman LA. High-dose intravenous g-immunoglobulin infusion in the treatment of thrombotic thrombocytopenic purpura. *Arch Intern Med* 1989;149:475.

197. Heyman MR, Sweet T. Thrombotic thrombocytopenic purpura treated with high-dose intravenous gamma globulin. *South Med J* 1990;83:1471–1474.

198. Raniele DP, Opsahl JA, Kjellstrand CM. Should intravenous immunoglobulin G be first-line treatment for acute thrombotic thrombocytopenic purpura? Case report and review of the literature. *Am J Kidney Dis* 1991;18:264–268.

199. Finazzi G, Bellavita P, Falanga A, et al. Inefficiency of intravenous immunoglobulin in patients with low-risk thrombotic thrombocytopenic purpura/hemolytic-uremic syndrome. *Am J Hematol* 1992;41:165–169.

200. Porta C, Bobbio-Pallavicini E, Centuriono R, et al. Thrombotic thrombocytopenic purpura resistant to plasma-exchange: salvage treatment with high-dose IgG or vincristine. *Int J Artif Organs* 1993;16 S-5:201–204.

201. Kolodziej M. Case report: high-dose intravenous immunoglobulin as therapy for thrombotic thrombocytopenic purpura. *Am J Med Sci* 1993;305:101–102.

202. Porta C, Bobbio-Pallavicini E. High dose human immunoglobulins in thrombotic thrombocytopenic purpura. *Am J Hematol* 1994;45:99–100.

203. de Belder AJ, Weston MJ. Epoprostenol infusions in thrombotic microangiopathy of pregnancy. *Lancet* 1992;339:741–42.

204. Tardy B, Page Y, Comtet C, et al. Intravenous prostacyclin in thrombotic thrombocytopenic purpura: case report and review of the literature. *J Intern Med* 1991;230:279–282.

205. Johnson JE, Mills GM, Batson AG, et al. Ineffective epoprostenol therapy for thrombotic thrombocytopenic purpura. *JAMA* 1983;250:3089–3091.

206. Fitzgerald GA, Maas RL, Stein R, et al. Intravenous prostacyclin in thrombotic thrombocytopenic purpura. *Ann Intern Med* 1981;95:319–322.

207. Bernard RP, Bauman AW, Schwartz S. Splenectomy for thrombotic thrombocytopenic purpura. *Ann Surg* 1969;169:616–624.

208. Cuttner J. Splenectomy, steroids, dextran 70 in thrombotic thrombocytopenic purpura. *JAMA* 1974;227:397–402.

209. Reynolds PM, Jackson JM, Brine JAS, Vivian AB. Thrombotic thrombocytopenic purpura—remission following splenectomy: report of a case and review of the literature. *Am J Med* 1976;61:439–447.

210. Salky BA, Kreel I, Gelernt IM, et al. Splenectomy for thrombotic thrombocytopenic purpura. *Mt Sinai J Med* 1983;50:56–59.

211. Thompson HW, McCarthy LJ. Thrombotic thrombocytopenic purpura: potential benefit of

splenectomy after plasma exchange. *Arch Intern Med* 1983;143:2117–2119.

212. Liu ET, Linker CA, Shuman MA. Management of treatment failures in thrombotic thrombocytopenic purpura. *Am J Hematol* 1986;23:347–361.

213. Wells AD, Majumdar G, Slater MGP, Young AE. Role of splenectomy as a salvage procedure in thrombotic thrombocytopenic purpura. *Br J Surg* 1991;78:1389–1390.

214. Höffkes HG, Weber F, Uppenkamp M, et al. Recovery by splenectomy in patients with relapsed thrombotic thrombocytopenic purpura and treatment failure to plasma exchange. *Semin Thromb Hemost* 1995;21:161–165.

215. Winslow GA, Nelson EW. Thrombotic thrombocytopenic purpura: indications for and results of splenectomy. *Am J Surg* 1995;170:558–563.

216. Crowther MA, Heddle N, Hayward CP, et al. Splenectomy done during hematologic remission to prevent relapse in patients with thrombotic thrombocytopenic purpura. *Ann Intern Med* 1996;125:294–296.

217. Mant MJ, Turner AR, Ritchie DBC, et al. Splenectomy during partial remission in thrombotic thrombocytopenic purpura with prolonged plasma exchange dependency. *Am J Hematol* 1999;62:56–57.

218. Schwartz J, Eldor A, Szold A. Laparoscopic splenectomy in patients with refractory or relapsing thrombotic thrombocytopenic purpura. *Arch Surg* 2001;136:1236–1238.

219. Harkness DR, Byrnes JJ, Lian EC, et al. Hazard of platelet transfusion in thrombotic thrombocytopenic purpura. *JAMA* 1981;246:1931–1933.

220. Knupp CL. Thrombotic thrombocytopenic purpura in older patients. *JAGS* 1988;36:331–338.

221. Gordon LI, Kwaan HC, Rossi EC. Deleterious effects of platelet transfusions and recovery thrombocytosis in patients with thrombotic microangiopathy. *Semin Hematol* 1987;24:194–201.

222. Jacobson RJ, Rath CE, Perloff JK. Intravascular haemolysis and thrombocytopenia in left ventricular outflow obstruction. *Br Heart J* 1973;35:849–854.

223. Lin YC, Chang HK, Sun CF, Shih LY. Microangiopathic hemolytic anemia as an initial presentation of metastatic cancer of unknown primary origin. *South Med J* 1995;88:683–687.

224. Appel GB, Pirani CL, D'Agati V. Renal vascular complications of systemic lupus erythematosus. *J Am Soc Nephrol* 1994;4:1499–1515.

225. Kim YL, Richman KA, Marshall BE. Thrombocytopenia associated with Swan–Ganz catheterization in patients. *Anesthesiology* 1980;53:261–262.

226. Vonderheide RH, Thadhani R, Kuter DJ. Association of thrombocytopenia with the use of intra-aortic balloon pumps. *Am J Med* 1998;105:27–32.

227. Plötz FB, van Oeveren W, Bartlett RH, Wildevuur CRH. Blood activation during neonatal extracorporeal life support. *J Thorac Cardiovasc Surg* 1993;105:823–832.

228. Bick RL. Hemostasis defects associated with cardiac surgery, prosthetic devices, and other extracorporeal circuits. *Semin Thromb Hemost* 1985;11:249–279.

229. Woodman RC, Harker LA. Bleeding complications associated with cardiopulmonary bypass. *Blood* 1990;76:1680–1697.

230. Metzelaar MJ, Korteweg J, Sixma JJ, Nieuwenhuis HK. Comparison of platelet membrane markers for the detection of platelet activation in vitro and during platelet storage and cardiopulmonary bypass surgery. *J Lab Clin Med* 1993;121:579–587.

231. Rinder CS, Bonan JL, Rinder HM, et al. Cardiopulmonary bypass induces leukocyte–platelet adhesion. *Blood* 1992;79:1201–1205.

232. Harker LA, Malpass TW, Branson HE, et al. Mechanism of abnormal bleeding in patients undergoing cardiopulmonary bypass: acquired transient platelet dysfunction associated with selective  $\alpha$ -granule release. *Blood* 1980;56:824-834.
233. Kestin AS, Valeri CR, Khuri SF, et al. The platelet function defect of cardiopulmonary bypass. *Blood* 1993;82:107-117.
234. Wenger RK, Lukasiewicz H, Mikuta BS, et al. Loss of platelet fibrinogen receptors during clinical cardiopulmonary bypass. *J Thorac Cardiovasc Surg* 1989;97:235-239.
235. Rinder CS, Mathew JP, Rinder HM, et al. Modulation of platelet surface adhesion receptors during cardiopulmonary bypass. *Anesthesiology* 1991;75:563-570.
236. Hope AF, Heyns ADP, Lötter MG, et al. Kinetics and sites of sequestration of  $^{111}$ indium-labeled human platelets during cardiopulmonary bypass. *J Thorac Cardiovasc Surg* 1981;81:880-886.
237. Despotis GJ, Levine V, Saleem R, et al. Use of point-of-care test in identification of patients who can benefit from desmopressin during cardiac surgery: a randomized controlled trial. *Lancet* 1999;354:106-110.
238. Levi M, Cromheecke ME, de Jonge E, et al. Pharmacological strategies to decrease excessive blood loss in cardiac surgery: a meta-analysis of clinically relevant endpoints. *Lancet* 1999;354:1940-1947.
239. Munoz JJ, Birkmeyer NJ, Birkmeyer JD, et al. Is  $\epsilon$ -aminocaproic acid as effective as aprotinin in reducing bleeding with cardiac surgery? A meta-analysis. *Circulation* 1999;99:81-89.
240. Ray MJ, O'Brien MF. Comparison of epsilon aminocaproic acid and low-dose aprotinin in cardiopulmonary bypass: efficiency, safety, and cost. *Ann Thor Surg* 2001;71:838-843.
241. Bernabei A, Gikakis N, Kowalska MA, et al. Iloprost and echistatin protect platelets during simulated extracorporeal circulation. *Ann Thorac Surg* 1995;59:149-153.
242. Eurenium K, Mortensen RF, Meserol PM, Curreri PW. Platelet and megakaryocyte kinetics following thermal injury. *J Lab Clin Med* 1972;79:247-257.
243. Cozzi PJ, Stewart GJ, Morris DL. Thrombocytopenia after hepatic cryotherapy for colorectal metastases: correlates with hepatic injury. *World J Surg* 1994;18:774-777.
244. Schwab S, Georgiadis D, Berrouschot J, et al. Feasibility and safety of moderate hypothermia after massive hemispheric infarction. *Stroke* 2001;32:2033-2035.
245. Tardy-Poncet B, Tardy B, Grelac F, et al. Pentosan polysulfate-induced thrombocytopenia and thrombosis. *Am J Hematol* 1994;45:252-257.
246. Heyns AD, Lötter MG, Badenhorst PN, et al. Kinetics and in vivo redistribution of  $^{111}$ indium-labelled human platelets after intravenous protamine sulfate. *Thromb Haemost* 1980;44:65-68.
247. Slichter SJ, Stegall P, Smith K, et al. Dysbaric osteonecrosis: a consequence of intravascular bubble formation, endothelial damage, and platelet thrombosis. *J Lab Clin Med* 1981;98:568-590.

2004 Lippincott Williams & Wilkins  
John P. Greer, John Foerster, John N. Lukens  
George M. Rodgers, Frixos Paraskevas, Bertil Glader  
Wintrobe's Clinical Hematology

**CONGENITAL THROMBOCYTOPENIA**[Congenital Thrombocytopenia with Megakaryocytic Hypoplasia](#)[Autosomal-Dominant Macrothrombocytopenia](#)[X-Linked Congenital Macrothrombocytopenia](#)[X-Linked Macrothrombocytopenia with Dyserythropoiesis](#)**ACQUIRED THROMBOCYTOPENIA**[Deficient Platelet Production](#)[Thrombocytopenia Caused by Abnormal Platelet Pooling](#)[Thrombocytopenia Associated with Infections](#)[Thrombocytopenia after Massive Blood Transfusions](#)**REFERENCES**

This chapter provides a summary of various miscellaneous forms of congenital and acquired thrombocytopenia ( [Table 55.1](#)), including thrombocytopenia attributable to deficient platelet production, associated with abnormal platelet pooling in the spleen, and resulting from dilution with massive transfusions.

**TABLE 55.1. Miscellaneous Forms of Thrombocytopenia****Congenital thrombocytopenia**

- Congenital thrombocytopenia with megakaryocytic hypoplasia

- Autosomal-recessive disorder (congenital amegakaryocytic thrombocytopenia) due to c- *mp<sub>v</sub>* receptor mutations

- Autosomal-recessive disorders associated with absent radius: thrombocytopenia with absent radius syndrome

- Autosomal-dominant disorders associated with radial-ulnar synostosis and *HOXA11* gene mutations

- Autosomal-dominant giant platelet disorders ( *MYH9* gene defects)

- May-Hegglin anomaly

- Sebastian syndrome and variants

- Fechtner syndrome

- Epstein syndrome

- X-linked microthrombocytopenia (WAS gene mutations)

- Wiskott-Aldrich syndrome (WAS)

- X-linked thrombocytopenia (XLT)

- X-linked macrothrombocytopenia with dyserythropoiesis ( *GATA1* mutations)

**Acquired thrombocytopenias**

- Decreased platelet production

- Thrombocytopenia caused by abnormal platelet pooling

- Disorders of the spleen

- Hypothermia

- Thrombocytopenia associated with infections

Viruses  
Bacteria and protozoans  
Thrombocytopenia after massive blood transfusion

---

## CONGENITAL THROMBOCYTOPENIA

Enormous recent progress has been made in our understanding of the congenital thrombocytopenias. Hereditary forms of thrombocytopenia with diverse genetic, clinical, and laboratory features have now been documented in numerous kindreds. In this section, the genetic abnormalities identified as of early 2002 are reviewed.

Hereditary thrombocytopenias have been well documented and may be inherited as an autosomal-dominant trait, an autosomal-recessive trait, or an X-linked recessive trait. Bleeding can be mild, and in some instances, the affected family members are virtually asymptomatic, being identified only through incidental platelet counts or family studies after the identification of the proband. It is important to recognize these mild forms of familial thrombocytopenia because although they resemble autoimmune thrombocytopenic purpura, patients do not respond to steroid treatment or intravenous immunoglobulin, and these forms of therapy may be harmful.

### Congenital Thrombocytopenia with Megakaryocytic Hypoplasia

Congenital thrombocytopenia associated with megakaryocytic hypoplasia occurs in several different types of disorders. In some cases, thrombocytopenia with megakaryocytic hypoplasia on bone marrow examination appears during childhood and appears to be an early manifestation of bone marrow aplasia (1, 2, 3 and 4). In other cases, megakaryocytes are the only progenitor cell affected, and the thrombocytopenia occurs early in the neonatal period and is associated with skeletal and soft tissue abnormalities. The best studied group of patients are those with thrombocytopenia with absent radius.

Purpura and ecchymoses usually are apparent in affected infants at birth, and serious bleeding manifestations, particularly intracranial bleeding, are often noted. Examination of the bone marrow reveals marked diminution in the number of megakaryocytes; in many patients, they may be totally absent. A leukemoid reaction of the granulocytic type or eosinophilia with myeloid hyperplasia of the marrow has been documented in as many as 50% of patients (5). Shortened platelet survival and platelet dysfunction with decreased platelet-dense bodies have been demonstrated in some cases (6, 7). These findings, as well as the platelet count, may fluctuate from time to time.

**CONGENITAL AMEGAKARYOCYTIC THROMBOCYTOPENIA** Congenital amegakaryocytic thrombocytopenia is a rare autosomal-recessive disorder characterized by thrombocytopenia at birth and progressive bone marrow aplasia with pancytopenia (8, 9, 10, 11 and 12). These patients all have markedly elevated serum levels of thrombopoietin and mutations in the *c-mpl* gene. Multiple mutations have recently been reported, including deletions, nonsense mutations, and missense mutations. Many of the patients studied are compound heterozygotes with one mutation inherited from each parent. Stem cell transplant is the only curative treatment for these patients, and matched sibling transplants have been successful. Investigators postulate that thrombopoietin and *c-mpl* must play an important role in the growth and maintenance of multipotent stem cells because these patients all develop progressive bone marrow aplasia.

**THROMBOCYTOPENIA WITH ABSENT RADIUS** Thrombocytopenia with absent radius syndrome is a group of disorders with neonatal thrombocytopenia, marked hypoplasia of megakaryocytes, skeletal abnormalities, and other soft tissue congenital defects ( [5](#), [13](#), [14](#), [15](#), [16](#) and [17](#) ). Associated skeletal abnormalities are present in virtually every patient, most commonly bilateral agenesis of the radius ( [13](#) ). In some infants, the ulna and humerus are also absent, but fingers and thumbs are always present. Less commonly, patients manifest cardiac defects (atrial septal defects and tetralogy of Fallot), microcephaly, micrognathia, and various other minor anomalies ( [18](#), [19](#) ). These patients have elevated serum thrombopoietin and normal *c-mpl* and *HOX* genes. However, they have a profound defect in megakaryocyte differentiation and platelet production and no response of megakaryocytes to thrombopoietin ( [20](#), [21](#) and [22](#) ). There may be a slight increase in platelet count in response to recombinant human erythropoietin ( [23](#) ). Diagnosis is rarely difficult and may be made prenatally by radiography, ultrasonography, and fetal platelet counts ( [24](#), [25](#), [26](#), [27](#) and [28](#) ). Congenital rubella and some variants of Fanconi syndrome should be excluded. Platelet counts gradually increase during the first 2 years of life. With few exceptions, corticosteroid administration, intravenous immunoglobulin, and splenectomy have proved therapeutically useless.

**THROMBOCYTOPENIA WITH RADIO-ULNAR SYNOSTOSIS** Thrombocytopenia with radio-ulnar synostosis is a newly described congenital thrombocytopenic disorder that is characterized by amegakaryocytic hypoplasia and extremely limited pronation and supination of the forearm ( [29](#), [30](#) ). Two unrelated, nonconsanguineous families were studied and found to have mutations in the *HOXA11* gene.

### Autosomal-Dominant Macrothrombocytopenia

A number of families have been described who have autosomal-dominant inheritance of an isolated mild thrombocytopenia characterized by normal platelet survival and a normal number of bone marrow megakaryocytes; a constellation of findings that suggests ineffective thrombopoiesis ( [31](#), [32](#) and [33](#) ). Thrombocytopenia (platelet counts between 20,000 and 100,000/ $\mu$ l) or a history of increased bruisability is apparent early in life, and examination of the peripheral blood smear demonstrates platelet macrocytosis (mean platelet volume above 10  $\mu$ m<sup>3</sup>). Splenic size is always normal. Platelet aggregation abnormalities have been described in some families, but platelet membrane glycoproteins have been normal when studied ( [32](#) ).

**MUTATIONS IN *MYH9* GENE FOR NONMUSCLE MYOSIN HEAVY CHAIN** A group of autosomal-dominant macrothrombocytopenias due to mutations in the *MYH9* gene with variable penetrance and expression was recently defined ( [34](#), [35](#), [36](#), [37](#), [38](#), [39](#), [40](#), [41](#), [42](#) and [43](#) ). These include May-Hegglin anomaly, Sebastian syndrome and its variants, Epstein syndrome, and Fechtner syndrome. Although all of these disorders have congenital macrothrombocytopenia, there are differences in the presence of Döhle-like inclusions in granulocytes, hereditary deafness, and hereditary nephritis ( [Table 55.2](#) ). The genetic defects in these disorders all affect the *MYH9* gene located at chromosome 22q12.3-13.1, and more than ten mutations have already been defined. The function of the *MYH9* gene and how these mutations cause the thrombocytopenia are currently unknown.

**TABLE 55.2. Syndromes Caused by *MYH9* Gene Defects**

| Syndrome    | Macrothrombocytopenia | Döhle-Like Bodies | Nephritis | Deafness | Cataracts |
|-------------|-----------------------|-------------------|-----------|----------|-----------|
| May-Hegglin | Yes                   | Yes               | No        | No       | No        |
| Sebastian   | Yes                   | Yes               | No        | No       | No        |
| Fechtner    | Yes                   | Yes               | Yes       | Yes      | Yes       |

May–Hegglin anomaly and Sebastian syndrome both have macrocytopenia and granulocyte inclusions, but ultrastructural analysis of the Döhle-like inclusions demonstrates diagnostic differences between these two syndromes and that both types of inclusions can also be distinguished from the Döhle bodies seen in acute infection. Fechtner syndrome and Epstein syndrome both are Alport-like disorders but can be distinguished based on the presence or absence of granulocyte inclusions ( [44](#), [45](#), [46](#), [47](#), [48](#) and [49](#) ). These two disorders are due to allelic mutations at amino acid 702, which cause conformational changes to the myosin head. The R702H mutation in Epstein syndrome does not result in protein aggregation, and these patients lack granulocyte inclusions. There is a recent report of a family with congenital dysmegakaryopoietic thrombocytopenia (Paris–Trousseau) in which there are giant platelet  $\alpha$ -granules and a chromosome 11 deletion at 11q23 ( [50](#) ). This deletion was previously described in children with mental retardation and other structural anomalies; only 47% have been thrombocytopenic. Platelet-type von Willebrand disease is another autosomal-dominant type of hereditary thrombocytopenia characterized by abnormal binding of large von Willebrand factor multimers to platelets. This intrinsic platelet defect results in mild thrombocytopenia, increased ristocetin-induced platelet aggregation, and a selective loss of high-molecular-weight von Willebrand factor multimers from the plasma. This disorder most resembles type IIb von Willebrand disease (see [Chapter 59](#) ).

### X-Linked Congenital Macrothrombocytopenia

Wiskott–Aldrich syndrome and X-linked thrombocytopenia are allelic mutations of the WASp gene at Xp11.22–p11.23 ( [51](#), [52](#), [53](#), [54](#), [55](#), [56](#) and [57](#) ). All of the patients present with thrombocytopenia and small platelets with mean platelet volume approximately half normal. At one end of the clinical spectrum, patients exhibit platelet abnormalities only and, at the other end, manifest thrombocytopenia, eczema, and immune abnormalities with progressive T-cell lymphopenia and increased susceptibility to infection. Multiple mutations in the WASp gene have been identified in these patients, and the milder phenotypes are more commonly associated with mutations in exon 2 ( [52](#) ). However, even within families, the same genotype can be associated with varying phenotypes. Measurement of the WASp protein is now possible, making diagnosis less difficult ( [53](#) ).

The WASp protein is expressed in the cytoplasm of hematopoietic cells and plays a role in the regulation and organization of actin. However, cytoskeletal abnormalities are not apparent in these platelets, and it is now believed that the WASp protein delays apoptosis ( [54](#) ). Severe protein deficiencies are found in Wiskott–Aldrich patients, and abnormal regulation of the apoptotic response may explain the progressive lymphopenia and severe immune abnormalities in these children.

Megakaryocyte mass is normal or increased. Differentiation and platelet production are normal, and platelets produced *in vitro* are normal in size. These observations suggest that increased destruction in the spleen is responsible for both the thrombocytopenia and decreased platelet size. Splenectomy definitely improves platelet counts in these patients, which frequently returns to normal ( [52](#) ).

### X-Linked Macrothrombocytopenia with Dyserythropoiesis

*GATA1* transcriptional activator, which is necessary for megakaryocyte differentiation, is mutated in families with macrothrombocytopenia and dyserythropoiesis with or without



anemia ( [58](#), [59](#), [60](#) and [61](#)). Each of the missense mutations occurs in the N-terminal zinc finger, and different amino acid substitutions at the same site result in different severities of disease. Mutations that interfere most with the association of *GATA1* with FOG1 (friend of *GATA1*) result in the most severe macrothrombocytopenia and anemia. The human gene encoding *GATA1* is located at Xp11.23, but platelet size, the severity of bleeding, and the lack of immune abnormalities distinguish *GATA1* disorders from Wiskott–Aldrich syndrome.

## ACQUIRED THROMBOCYTOPENIA

### Deficient Platelet Production

Deficient platelet production may result from three mechanisms: hypoplasia or suppression of the precursor megakaryocytes; ineffective thrombopoiesis despite a normal precursor mass; or, rarely, deficiency or aberration of thrombopoietic control mechanisms.

**ACQUIRED PURE AMEGAKARYOCYTIC THROMBOCYTOPENIC PURPURA** Acquired pure amegakaryocytic thrombocytopenic purpura is a rare cause of thrombocytopenia associated with decreased or absent megakaryocytes in an otherwise normal bone marrow. A wide variety of exogenous factors and endogenous processes may lead to hypoplasia of the megakaryocytes and deficient platelet production, including viral infections, toxin exposure, drug ingestion, cytokine deficiencies, antibody-mediated suppression of megakaryocytopoiesis, and cellular suppression of megakaryocytopoiesis ( [62](#), [63](#), [64](#) and [65](#)). It may also be an early manifestation of an intrinsic stem cell abnormality, as some patients have subsequently developed aplastic anemia or leukemia. In uncomplicated marrow hypoplasia, platelet survival usually is normal. The differential diagnosis of patients with severe thrombocytopenia and isolated amegakaryocytosis includes a misdiagnosis of immune thrombocytopenic purpura; ethanol use or drug ingestion; immune suppression associated with diseases such as systemic lupus erythematosus; and prodromal manifestations of acquired aplastic anemia, myelodysplastic disorders, or acute leukemia ( [65](#), [66](#)). Thrombocytopenia and amegakaryocytosis caused by postchemotherapy or postradiation therapy myelosuppression should be apparent. Patients with acquired amegakaryocytic thrombocytopenia do not have a palpable spleen. The platelets are usually small or normal in size. An increased mean cell volume is a common red cell finding, and associated immune abnormalities, such as a positive Coombs test, may suggest a previously undiagnosed underlying autoimmune disorder, although positive antinuclear antibody tests are not uncommon ( [65](#), [67](#), [68](#)). Chromosome studies are usually normal, but a duplication of the long arm of chromosome 3 and a Philadelphia chromosome, without any features of chronic myelocytic leukemia, have been reported ( [68](#), [69](#) and [70](#)). In most patients, an etiology cannot be determined, and empirical therapy is necessary. Platelet transfusions should be used to treat bleeding and may be required prophylactically in some patients. Although there are occasional spontaneous remissions, most sustained remissions have occurred in patients receiving immunosuppressive therapy ( [71](#)). Patients may respond to treatment with corticosteroids, cyclophosphamide, vinca alkaloids, cyclosporin A, and antithymocyte globulin ( [71](#), [72](#), [73](#), [74](#) and [75](#)). Two patients treated with antithymocyte globulin and cyclosporin A demonstrated rapid improvement and a sustained remission after discontinuing therapy ( [76](#)).

**CHEMICAL AND PHYSICAL AGENTS THAT PRODUCE GENERALIZED BONE MARROW SUPPRESSION** Chemical and physical agents, such as ionizing radiation, alkylating agents, antimetabolites, and cytotoxic drugs, may produce thrombocytopenia as the result of a predictable suppression of the marrow. The mechanisms by which these agents act are well defined, and thrombocytopenia is a common complication when they are used in immunosuppression and cancer chemotherapy. In addition, many drugs, such as

chloramphenicol, produce marrow hypoplasia as a result of idiosyncratic reactions. The pathophysiology in these cases is poorly understood. Drugs producing thrombocytopenia by both mechanisms damage other bone marrow precursors as well as megakaryocytes, and the usual picture is one of diffuse bone marrow hypoplasia and pancytopenia. Rarely, only thrombocytopenia may be present. Platelets often are the last cell type to return to normal after recovery from bone marrow hypoplasia; in some patients, thrombocytopenia may persist indefinitely.

#### **DRUGS THAT SELECTIVELY SUPPRESS THE MEGAKARYOCYTE**

**Chlorothiazides** Chlorothiazides and various congeners may produce thrombocytopenia by one of at least two mechanisms: by the formation of platelet antibodies or by a poorly understood suppression of thrombopoiesis ( [77](#) ). The latter action is by far the most common. Evidence of marrow suppression is largely indirect ( [78](#) ). Serologic tests for platelet antibodies usually yield negative results. Diminution in the number of megakaryocytes has been observed in infants born of mothers who were taking these drugs, but few instances of megakaryocytic hypoplasia have been documented in adults. Mild asymptomatic thrombocytopenia may occur in as many as 25% of patients taking these agents, an observation that implies that thrombocytopenia may be a pharmacologic rather than an idiosyncratic effect. Recovery from thrombocytopenia associated with the use of thiazide drugs is slow, and thrombocytopenia usually can be reproduced only by readministration of the drug for a protracted period.

**Estrogens** Estrogenic hormones appear to affect platelet kinetics in animals both by facilitating reticuloendothelial phagocytosis and by impairing thrombopoiesis. Neither effect has been convincingly demonstrated in humans, but several instances of “amegakaryocytic” thrombocytopenia have been reported after the administration of diethylstilbestrol. In one patient, thrombocytopenia recurred when the hormone was readministered ( [79](#) ).

**Ethanol** Ethanol can suppress platelet production, a phenomenon that may be a common cause of mild thrombocytopenia in the alcoholic patient ( [80](#) ). In most reported cases, nutritional factors, folate deficiency, and splenomegaly were excluded, but patients did have evidence of impaired hepatic function ( [81](#), [82](#), [83](#) and [84](#) ). Platelet counts below 100,000/ $\mu$ l occur in as many as 26% of acutely ill alcoholics ( [80](#), [84](#) ), and platelet counts as low as 10,000/ $\mu$ l have been described ( [82](#) ). The experimental administration of ethanol produces thrombocytopenia with decreased platelet survival and platelet turnover ( [85](#), [86](#) ). Large doses are required, and the duration of ethanol administration before the onset of thrombocytopenia ranges from hours to weeks, observations suggestive of a component of individual idiosyncrasy. Bleeding is rare, and when ethanol is withdrawn, the platelet count begins to increase in 2 to 3 days and returns to normal or supranormal levels in 2 to 3 weeks ( [82](#), [84](#) ). Several patients developed venous thromboembolic disease when platelet counts reached values above 500,000/ $\mu$ l ( [87](#) ). Pathophysiologic studies in alcohol-induced thrombocytopenia reveal accelerated platelet destruction and a subnormal compensatory increase in thrombopoiesis ( [85](#), [88](#), [89](#) ). Platelet function abnormalities have also been described ( [80](#), [90](#), [91](#) ). The bone marrow usually reveals normal numbers of megakaryocytes, although in one patient, megakaryocytes could be recognized only by immunologic techniques ( [92](#) ). Pronormoblasts and promyelocytes may demonstrate vacuolization ( [81](#) ). Studies using mice and guinea pig megakaryocytes demonstrate that the effect of ethanol is primarily on the maturing megakaryocyte, a finding consistent with ineffective thrombopoiesis ( [93](#) ). Several cases of bone marrow hypoplasia secondary to consumption of excessive alcohol have also been described ( [94](#), [95](#) ). Colony-forming unit granulocyte-macrophage-derived colony formation in one of these patients was inhibited by much lower concentrations of ethanol than that of normal volunteers ( [94](#) ).

**INEFFECTIVE THROMBOPOIESIS** Ineffective thrombopoiesis may play a role in several different types of thrombocytopenia. Thrombocytopenia is a consistent feature of

megaloblastic hematopoiesis that results from deficiency of vitamin B<sub>12</sub> or folic acid. Although seldom severe and rarely of clinical significance, this form of thrombocytopenia results from a distinctive abnormality of platelet production called *ineffective thrombopoiesis*. This abnormality was first demonstrated in thrombokinetic studies and is characterized by diminished platelet production despite the presence of an increased megakaryocyte mass. Thus, it is analogous to ineffective erythropoiesis, which is also characteristic of the megaloblastic anemias. Platelet production, whether calculated per megakaryocyte or per nuclear unit, is diminished. Although the number of megakaryocytes increases in response to thrombopoietic stimuli, the normal concomitant increase in their volume does not occur. This phenomenon presumably results from impaired DNA synthesis and the consequent limitation in nuclear endoreduplication. In stained smears, the megakaryocytes often appear hyperlobulated, and circulating platelets are abnormally large (96). Moderate shortening of platelet survival and, rarely, hypoplasia of the megakaryocytes may be important contributory factors in the production of thrombocytopenia in some cases.

### Thrombocytopenia Caused by Abnormal Platelet Pooling

**DISORDERS OF THE SPLEEN** The splenic pool normally contains approximately one-third of the total platelet mass, and this pool may increase in size as a result of disorders that are associated with splenomegaly, such as cirrhosis with portal hypertension, sarcoidosis and other granulomatous infections, Gaucher and other lipid storage diseases, leukemias and lymphomas, and Felty's syndrome (97, 98 and 99). This shift of platelets into the spleen may result in thrombocytopenia in the circulating blood despite a normal or even increased total platelet mass. The clinical picture in hypersplenic thrombocytopenia is usually dominated by the underlying disease, and numerous other hematologic abnormalities, such as neutropenia, anemia, and coagulation defects, may also be present. The pathophysiology of thrombocytopenia in disorders associated with splenomegaly is not completely understood. Rat spleens demonstrate large numbers of platelets adherent to reticuloendothelial cells (100). It is also hypothesized that the increase in splenic pool may occur because of very slow passage of platelets through the tortuous splenic vasculature. The platelets in the splenic pool are in equilibrium with the circulating pool and can be mobilized with an infusion of epinephrine or during plateletpheresis (101, 102 and 103). This is in contrast to the irreversible thrombocytopenia caused by splenic removal of damaged or antibody-coated platelets in disorders such as autoimmune thrombocytopenic purpura. There is some evidence for accelerated platelet destruction in many instances of thrombocytopenia associated with disorders of the spleen (104, 105). Survival of isotopically labeled platelets is shortened in some patients with cirrhosis and portal hypertension, even though the major mechanism of thrombocytopenia in these patients appears to be splenic pooling. The usual laboratory findings are pancytopenia with mild thrombocytopenia and a normal or moderately increased number of megakaryocytes in the bone marrow. Platelet counts in cirrhotic patients have been as low as 20,000/ $\mu$ l, although thrombocytopenia of this severity is uncommon. Patients with hypersplenism have smaller platelets than those with autoimmune thrombocytopenia, so platelet sizing may provide a means of differentiating between thrombocytopenia primarily related to immunologic platelet destruction and that related to big-spleen syndromes. In general, the severity of the thrombocytopenia correlates poorly with the size of the spleen, but it is nonetheless difficult to entertain a diagnosis of thrombocytopenia caused by abnormal splenic platelet pooling in the absence of significant splenic enlargement (106). Therapy is seldom indicated for thrombocytopenia alone, but splenectomy, embolic occlusion of the splenic vasculature, and splenic damage secondary to infusion of radiolabeled particles can improve the thrombocytopenia and sometimes alleviate the pancytopenia completely (104, 107, 108, 109, 110, 111 and 112). Patients with thrombocytopenia secondary to cirrhosis with portal hypertension may benefit from portocaval shunts or transjugular intrahepatic portosystemic shunts (113, 114

).

**HYPOTHERMIA** Platelets become more sticky, swell, and undergo various morphologic changes when stored *in vitro* at temperatures below 37° C. This process usually is reversible, but clumping, release of adenosine diphosphate, and irreversible aggregation follow protracted chilling ( 115 ). Similar changes *in vivo* may lead to sequestration of platelets in the spleen and liver and may underlie the thrombocytopenia that is associated with hypothermic anesthesia ( 116 , 117 ). In humans, mild reversible thrombocytopenia is a predictable consequence of surgical hypothermia below 25° C and is usually of no clinical consequence ( 117 ). In some patients, thrombocytopenia persists after rewarming and may produce hemorrhage. In children subjected to deep hypothermia, brain damage was attributed to *in vivo* platelet clumping ( 118 ). Thrombocytopenia has also been noted after hypothermia caused by environmental exposure, and in three patients with episodic hypothermia, thrombocytopenia was associated with erythroid hypoplasia and sideroblastic anemia ( 119 , 120 ). Finally, thrombocytopenia occurs in almost all patients undergoing one- or two-cycle cryotherapy for hepatic metastases from colorectal adenocarcinoma ( 121 , 122 ). There is a significant correlation between serum alanine aminotransferase concentrations and the percentage reduction in platelet count. The maximal reduction occurs the first or second day after surgery in most patients. It is interesting that two patients who had previously been splenectomized did not develop thrombocytopenia, suggesting that splenic sequestration of damaged platelets may occur.

### Thrombocytopenia Associated with Infections

Purpura was recognized as a manifestation of pestilential fevers 2000 years ago. Several factors are now known to cause bleeding in association with infections, of which thrombocytopenia is the most common.

**VIRUSES** Viruses may produce thrombocytopenia by several different mechanisms: impaired platelet production as a result of invasion of megakaryocytes by the virus, impaired platelet production caused by toxic effects of viral proteins on progenitor cells, viral-induced hemophagocytosis, destruction of circulating platelets by the virus, and increased platelet destruction caused by binding of viral-induced autoantibodies or viral antigen-antibody complexes. The administration of live measles vaccine produced significant yet subclinical thrombocytopenia in most normal children ( 123 ). Degenerating, vacuolated megakaryocytes were evident 3 days after administration of the vaccine, at which time plasma levels of acid phosphatase were subnormal. The nadir of the platelet count occurred 7 days after vaccination. There are now several reports of thrombocytopenia occurring after immunization with measles-mumps-rubella vaccine, monovalent measles vaccine, and measles-mumps vaccine ( 124 , 125 ). Thrombocytopenia has been severe (below 20,000/ $\mu$ l), and some patients have had significant hemorrhagic complications. The majority of the patients have been younger than 2 years of age, but the age range was 1 to 40 years ( 125 ). There is no proof of a causal relationship between the thrombocytopenia and the vaccination, and there are no data regarding the pathophysiology. Thrombocytopenia after vaccination for hepatitis A and B and varicella has also been noted ( 126 , 127 , 128 and 129 ). Children with neonatal infections with mumps and rubella are often thrombocytopenic ( 130 , 131 and 132 ), and hepatomegaly and splenomegaly may also be present. The pathophysiology of the thrombocytopenia remains speculative. Cytomegalovirus infection is usually asymptomatic in immunocompetent adults. However, there are reports of severe thrombocytopenia and even thrombocytopenia with hemolysis ( 133 , 134 ). It is unclear whether the thrombocytopenia is caused by a direct cytopathologic effect of the virus on megakaryocytes, viral-induced hemophagocytosis, or immunologic destruction. Parvovirus B19 is the etiologic agent responsible for erythema infectiosum. It is also cytotoxic to erythroid progenitors and can cause aplastic crises in patients with hemolytic anemia and chronic bone marrow failure in

immunocompromised hosts. Thrombocytopenia may occur in some of these patients, and recent studies demonstrate cytotoxic effects of viral nonstructural-1 proteins on megakaryocytes ( 135, 136 and 137 ).

**BACTERIA AND PROTOZOANS** Thrombocytopenia commonly is associated with septicemia resulting from both gram-negative and gram-positive bacteria. This complication is particularly common in infants and children, and the presence of unexplained thrombocytopenia, particularly in this age group, should always alert the physician to the possibility of septicemia. The etiology of thrombocytopenia may be multifactorial. Thrombocytopenia may be caused by disseminated intravascular coagulation (DIC), and the diagnosis of DIC may be apparent when coagulation studies are performed. Thrombocytopenia has also been described in patients with gram-negative or gram-positive septicemia, and 46% of these patients had elevated platelet-associated immunoglobulin G without evidence of DIC. These studies were interpreted as demonstrating the presence of platelet destruction caused by splenic destruction of immune complex-coated platelets. These data must be reinterpreted with third-generation immune complex capture assays that can better define platelet autoantibodies and immune complexes. Platelet adherence to damaged vascular surfaces may also account for thrombocytopenia in certain bacterial infections, such as meningococcemia. Endotoxins, exotoxins, or platelet-activating factor may damage platelets, resulting in increased clearance. Patients with sepsis syndrome may develop hemophagocytic histiocytosis with phagocytosis of platelets, white cells, and platelets in bone marrow histiocytes ( 138 ). Thrombocytopenia may also be caused by direct platelet toxicity caused by the microorganism. Thrombocytopenia occurs in over 80% of patients with malaria, and human platelets have been demonstrated to contain plasmodia ( 139 ). Early experimental evidence demonstrated that patients with malaria had elevated platelet-associated immunoglobulin G, suggesting immune-mediated destruction. However, in 1993, it was demonstrated that there were significant ultrastructural changes in platelets of patients with malaria, and the extent of abnormal findings correlated with the level of parasitemia ( 140 ). Theoretically, any bacterial or protozoal infection can be associated with thrombocytopenia that is caused by one of the mechanisms hypothesized in this chapter. There are recent reports of thrombocytopenia in Lyme disease and *Mycoplasma pneumoniae*, a manifestation of these infections that appears to be uncommon ( 141, 142 ). Patients with thrombocytopenia associated with infection should be tested for the presence of DIC. At this time, no other clinically available tests can be used to define the precise etiology in patients without evidence of DIC. The most important therapy for infection-related thrombocytopenia is that directed at the underlying infection. Platelet transfusions, even when they do not result in an increased platelet count, can be used to control bleeding until the antimicrobial therapy takes effect.

### Thrombocytopenia after Massive Blood Transfusions

*Massive blood transfusion* is defined as complete replacement of a patient's blood volume within 24 hours, usually ten units of packed red blood cells in an average-sized adult. Current practices in the United States favor the use of crystalloid over colloids with packed cell transfusions for replacement of blood volume. Because packed red blood cells do not contain a significant number of functional platelets and do not replace labile clotting factors, there has been concern about the incidence of developing hemostatic abnormalities and clinical bleeding in patients given only packed red blood cells.

Some studies demonstrate a correlation between the number of units of packed red blood cells transfused and both reduction in platelet counts ("dilutional thrombocytopenia") and increases in prothrombin and partial thromboplastin times. However, significant changes (platelets, 50,000 to 100,000/ $\mu$ l) are not apparent until patients have received more than 15 units of blood ( 143, 144 ). *Severe thrombocytopenia*, defined as a platelet count below 50,000/ $\mu$ l, is most common in patients receiving more than 20 units of blood ( 143, 144 ).



Microvascular bleeding occurs in 20 to 60% of patients who are massively transfused, but neither the platelet count nor changes in coagulation studies can be used to predict which patients will bleed ( [145](#) ). Although bleeding appears to be more dependent on thrombocytopenia than on coagulation abnormalities, prophylactic administration of platelets was not any more effective than equivalent volumes of prophylactic fresh frozen plasma infusions in preventing this bleeding ( [146](#) ). Therefore, it is currently recommended that platelet and plasma replacement during massive transfusions be guided by serial monitoring of platelet counts, prothrombin time, and partial thromboplastin time, and that platelet counts be kept above 75,000/ $\mu$ l and prothrombin time and partial thromboplastin time below 1.5 times normal ( [144](#) ). The coagulopathy associated with massive blood transfusion is discussed further in [Chapter 60](#).

## REFERENCES

1. Griffiths AD. Constitutional aplastic anemia: a family with a new X linked variety of amegakaryocytic thrombocytopenia. *J Med Genet* 1983;20:361–364.
2. Guinan EC, Lee YS, Lopez KD, et al. Effects of interleukin-3 and granulocyte colony-stimulating factor on thrombopoiesis in congenital amegakaryocytic thrombocytopenia. *Blood* 1993;81:1691–1698.
3. Myllylä G, Pelkonen R, Ikkala E, Apajalahti J. Hereditary thrombocytopenia: report of three families. *Scand J Haematol* 1967;4:441–452.
4. Freedman MH, Estrov Z. Congenital amegakaryocytic thrombocytopenia: an intrinsic hematopoietic stem cell defect. *Am J Pediatr Hematol Oncol* 1990;12:225–230.
5. Hall JG, Levin J, Kuhn JP, et al. Thrombocytopenia with absent radius (TAR). *Medicine* 1969;48:411–439.
6. Day HJ, Holmsen H. Platelet adenine nucleotide “storage pool deficiency” in thrombocytopenic absent radii syndrome. *JAMA* 1972;221:1053–1054.
7. Sultan Y, Scrobohaci ML, Rendu F, Caen JP. Abnormal platelet function, population, and survival time in a boy with congenital absent radii and thrombocytopenia. *Lancet* 1972;2:653.
8. Ballmaier M, Germeshausen M, Schulze H, et al. c-mpl mutations are the cause of congenital amegakaryocytic thrombocytopenia. *Blood* 2001;97:139–146.
9. Germeshausen M, Ballmaier M, Welte K. Implications of mutations in hematopoietic growth factor receptor genes in congenital cytopenias. *Ann N Y Acad Sci* 2001;938:305–320.
10. Lackner A, Basu O, Bierings M, et al. Hematopoietic stem cell transplantation for amegakaryocytic thrombocytopenia. *Br J Haematol* 2000;109:773–775.
11. Van Den Oudenrijn S, Bruin M, Folman CC, et al. Mutations in the thrombopoietin receptor, Mpl, in children with congenital amegakaryocytic thrombocytopenia. *Br J Haematol* 2000;110:441–448.
12. Tonelli R, Scardovi AL, Pession A, et al. Compound heterozygosity for two different amino-acid substitution mutations in the thrombopoietin receptor (c-mpl gene) in congenital amegakaryocytic thrombocytopenia (CAMT). *Hum Genet* 2000;107:225–233.
13. Shaw S, Oliver RA. Congenital hypoplastic thrombocytopenia with skeletal deformities in siblings. *Blood* 1959;14:374–377.
14. Homans AC, Cohen JL, Mazur EM. Defective megakaryocytopoiesis in the syndrome of thrombocytopenia with absent radii. *Br J Haematol* 1988;70:205–210.
15. Gounder DS, Pullon HW, Ockelford PA, Nicol RO. Clinical manifestations of the thrombocytopenia and absent radii (TAR) syndrome. *Aust N Z J Med* 1989;19:479–482.

16. Hedberg VA, Lipton JM. Thrombocytopenia with absent radii: a review of 100 cases. *Am J Pediatr Hematol Oncol* 1988;10:51–64.
17. deAlarcon PA, Graeve JA, Levine RF, et al. Thrombocytopenia and absent radii syndrome: defective megakaryocytopoiesis–thrombopoiesis. *Am J Pediatr Hematol Oncol* 1991;13:77–83.
18. MacDonald MR, Schaefer GB, Olney AH, Patton DF. Hypoplasia of the cerebellar vermis and corpus callosum in thrombocytopenia with absent radius syndrome on MRI studies. *Am J Med Genet* 1994;50:46–50.
19. Fivush B, McGrath S, Zinkham W. Thrombocytopenia absent radius syndrome associated with renal insufficiency. *Clin Pediatr* 1990;29:182–184.
20. Letestu R, Vitrat N, Masse A, et al. Existence of a differentiation blockage at the stage of a megakaryocytic precursor in the thrombocytopenia and absent radii (TAR) syndrome. *Blood* 2000;95:1633–1641.
21. Strippoli P, Savoia A, Iolascon A, et al. Mutational screening of thrombopoietin receptor gene (*c-mpl*) in patients with congenital thrombocytopenia and absent radii (TAR). *Br J Haematol* 1998;103:311–314.
22. Ballmaier M, Schulze H, Straub G, et al. Thrombopoietin in patients with congenital thrombocytopenia and absent radii: elevated serum levels, normal receptor expression, but defective reactivity to thrombopoietin. *Blood* 1997;90:612–619.
23. Dempfle CE, Burck C, Grutzmacher T, et al. Increase in platelet count in response to rHuEpo in a patient with thrombocytopenia and absent radii syndrome. *Blood* 2001;97:2189–2190.
24. Luthy DA, Hall JG, Graham CB. Prenatal diagnosis of thrombocytopenia with absent radii. *Clin Genet* 1979;15:495–499.
25. LaBrune PH, Pons JC, Khalil M, et al. Antenatal thrombocytopenia in three patients with TAR (thrombocytopenia with absent radii) syndrome. *Prenat Diagn* 1993;13:463–466.
26. Weinblatt M, Petrikovsky B, Bialer M, et al. Prenatal evaluation and in utero platelet transfusion for thrombocytopenia absent radii syndrome. *Prenat Diagn* 1994;14:892–896.
27. Donnerfeld AE, Wiseman B, Lavi E, Weiner S. Prenatal diagnosis of thrombocytopenia absent radius syndrome by ultrasound and cordocentesis. *Prenat Diagn* 1990;10:29–35.
28. Boute O, Depret–Mosser S, Vinatier D, et al. Prenatal diagnosis of thrombocytopenia–absent radius syndrome. *Fetal Diagn Ther* 1996;11:224–230.
29. Thompson AA, Nguyen LT. Amegakaryocytic thrombocytopenia and radio–ulnar synostosis are associated with *HOXA 11* mutation. *Nat Genet* 2000;26:397–398.
30. Thompson AA, Woodruff K, Feig SA, et al. Congenital thrombocytopenia and radio–ulnar synostosis: a new familial syndrome. *Br J Haematol* 2001;113:866–870.
31. Najean Y, Lecompte T. Genetic thrombocytopenia with autosomal dominant transmission: a review of 54 cases. *Br J Haematol* 1990;74:203–208.
32. Greaves M, Pickering C, Martin J, et al. A new familial “giant platelet syndrome” with structural, metabolic and functional abnormalities of platelets due to a primary megakaryocytic defect. *Br J Haematol* 1987;65:429–435.
33. Downton SB, Beardsley D, Jamison D, et al. Studies of a familial platelet disorder. *Blood* 1985;65:557–563.
34. Seri M, Savino M, Bordo D, et al. Epstein syndrome: another renal disorder with mutations in the nonmuscle myosin heavy chain 9 gene. *Hum Genet* 2002;110:182–186.
35. D’Apolito M, Guarnieri V, Boncristiano M, et al. Cloning of the murine non–muscle myosin heavy chain



- IIA gene ortholog of human *MYH9* responsible for May–Hegglin, Sebastian, Fechtner, and Epstein syndromes. *Gene* 2002;286:215–222.
36. Pecci A, Noris P, Invernizzi R, et al. Immunocytochemistry for the heavy chain of the non-muscle myosin IIA as a diagnostic tool for *MYH9*-related disorders. *Br J Haematol* 2002;117:164–167.
37. White JG, Mattson JC, Nichols WL, et al. A variant of the Sebastian platelet syndrome with unique neutrophil inclusions. *Platelets* 2002;13:121–127.
38. Arrondel C, Vodovar N, Knebelmann B, et al. Expression of the nonmuscle myosin heavy chain IIA in the human kidney and screening for *MHY9* mutations in Epstein and Fechtner syndromes. *J Am Soc Nephrol* 2001;13:65–74.
39. Kunishima S, Kojima T, Matsushita T, et al. Mutations in the *NMMHC-A* gene cause autosomal dominant macrothrombocytopenia with leukocyte inclusions (May–Hegglin anomaly/Sebastian syndrome). *Blood* 2001;97:1147–1149.
40. The May–Hegglin/Fechtner Syndrome Consortium. Mutations in *MYH9* result in the May–Hegglin anomaly, and Fechtner and Sebastian syndromes. *Nat Genet* 2000;26:103–105.
41. Kelley M, Jawien W, Lin A, et al. Autosomal dominant macrothrombocytopenia with leukocyte inclusions (May–Hegglin anomaly) is linked to chromosome 22q12–13. *Hum Genet* 2000;106:557–564.
42. Toren A, Rozenfeld–Granot G, Rocca B, et al. Autosomal–dominant giant platelet syndromes: a hint of the same genetic defect as in Fechtner syndrome owing to a similar genetic linkage to chromosome 22q11–13. *Blood* 2000;96:3447–3451.
43. Kelley MJ, Jawien W, Ortel TL, et al. Mutation of *MYH9*, encoding non–muscle myosin heavy chain A, in May–Hegglin anomaly. *Nat Genet* 2000;26:106–108.
44. Peterson LC, Rao KV, Crosson JT, White JG. Fechtner syndrome—a variant of Alport's syndrome with leukocyte inclusions and macrothrombocytopenia. *Blood* 1985;65:397–406.
45. Bernheim J, Dechavanne M, Bryon PA, et al. Thrombocytopenia, macrothrombocytopenia, nephritis and deafness. *Am J Med* 1976;61:145–150.
46. Parsa KP, Lee DB, Zamboni L, Glasscock RJ. Hereditary nephritis, deafness and abnormal thrombopoiesis: study of a new kindred. *Am J Med* 1976;60:665–672.
47. Gutenberger J, Trygstad CW, Stiehm ER, et al. Familial thrombocytopenia, elevated serum IgA levels and renal disease. *Am J Med* 1970;49:729–741.
48. Epstein CJ, Sahud MA, Piel CF, et al. Hereditary macrothrombocytopenia, nephritis and deafness. *Am J Med* 1972;52:299–310.
49. Eckstein JD, Filip DJ, Watts JC. Hereditary thrombocytopenia, deafness, and renal disease. *Ann Intern Med* 1975;82:639–645.
50. Breton–Gorius J, Favier R, Guichard J, et al. A new congenital dysmegakaryopoietic thrombocytopenia (Paris–Trousseau) associated with giant platelet a–granules and chromosome 11 deletion at 11q23. *Blood* 1995;85: 1805–1814.
51. Notarangelo LD, Mazza C, Giliani S, et al. Missense mutations of the WASP gene cause intermittent X-linked thrombocytopenia. *Blood* 2002;99:2268–2269.
52. Ho LL, Ayling J, Prosser I, et al. Missense C168T in the Wiskott–Aldrich syndrome protein gene is a common mutation in X-linked thrombocytopenia. *Br J Haematol* 2001;112:76–80.
53. Qasim W, Gilmour KC, Heath S, et al. Protein assays for diagnosis of Wiskott–Aldrich syndrome and X-linked thrombocytopenia. *Br J Haematol* 2001;113:861–865.
54. Rengan R, Ochs HD, Sweet LI, et al. Actin cytoskeletal function is spared, but apoptosis is increased,

in WAS patient hematopoietic cells. *Blood* 2000;95:1283–1292.

55. Oda A, Ochs HD. Wiskott–Aldrich syndrome protein and platelets. *Immunol Rev* 2000;178:111–117.
56. Haddad E, Cramer E, Riviere C, et al. The thrombocytopenia of Wiskott Aldrich syndrome is not related to a defect in proplatelet formation. *Blood* 1999;94:509–518.
57. Zhu Q, Watanabe C, Liu T, et al. Wiskott–Aldrich syndrome/X-linked thrombocytopenia: WASP gene mutations, protein expression, and phenotype. *Blood* 1997;90:2680–2689.
58. Freson K, Matthijs G, Thys C, et al. Different substitutions at residue D218 of the X-linked transcription factor *GATA1* lead to altered clinical severity of macrothrombocytopenia and anemia and are associated with variable skewed X inactivation. *Hum Mol Genet* 2002;11:147–152.
59. Mehaffey MG, Newton AL, Gandhi MJ, et al. X-linked thrombocytopenia caused by a novel mutation of *GATA-1*. *Blood* 2001;98:2681–2688.
60. Freson K, Devriendt K, Matthijs G, et al. Platelet characteristics in patients with X-linked macrothrombocytopenia because of a novel *GATA1* mutation. *Blood* 2001;98:85–92.
61. Nichols KE, Crispino JD, Ponz M, et al. Familial dyserythropoietic anemia and thrombocytopenia due to an inherited mutation in *GATA1*. *Nat Genet* 2000;24:266–270.
62. Hoffman R, Bruno E, Elwell J, et al. Acquired amegakaryocytic thrombocytopenic purpura: a syndrome of diverse etiologies. *Blood* 1982;60:1173–1178.
63. Gewirtz AM, Sacchetti MK, Bien R, Barry WE. Cell-mediated suppression of megakaryocytopoiesis in acquired amegakaryocytic thrombocytopenic purpura. *Blood* 1986;68:619–626.
64. Nagasawa T, Sakurai T, Kashiwagi H, Abe T. Cell-mediated amegakaryocytic thrombocytopenia with systemic lupus erythematosus. *Blood* 1986;67:479–483.
65. Hoffman R. Acquired pure amegakaryocytic thrombocytopenic purpura. *Semin Hematol* 1991;28:303–312.
66. Griner PF, Hoyer LW. Amegakaryocytic thrombocytopenia in systemic lupus erythematosus. *Arch Intern Med* 1970;125:328–332.
67. Koduri PR. Amegakaryocytic thrombocytopenia with a positive direct Coombs test. *Am J Hematol* 1993;44:68–69.
68. Stoll DB, Blum S, Pasquale D, Murphy S. Thrombocytopenia with decreased megakaryocytes. *Ann Intern Med* 1981;94:170–175.
69. Hallett JM, Martell RW, Sher C, Jacobs P. Amegakaryocytic thrombocytopenia with duplication of part of the long arm of chromosome 3. *Br J Haematol* 1989;71:291–298.
70. Xue Y, Zhang R, Guo Y, et al. Acquired amegakaryocytic thrombocytopenic purpura with a Philadelphia chromosome. *Cancer Genet Cytogenet* 1993;69:51–56.
71. Manoharan A, Williams NT, Sparrow R. Acquired amegakaryocytic thrombocytopenia: report of a case and review of the literature. *QJM* 1989;70:243–252.
72. Hill W, Landgraf R. Successful treatment of amegakaryocytic thrombocytopenic purpura with cyclosporine. *N Engl J Med* 1985;312:1060–1061.
73. Telek B, Kiss A, Pecze K, et al. Cyclic idiopathic pure acquired amegakaryocytic thrombocytopenic purpura: a patient treated with cyclosporin A. *Br J Haematol* 1989;73:128–129.
74. Peng CT, Kao LY, Tsai CH. Successful treatment with cyclosporin A in a child with acquired pure amegakaryocytic thrombocytopenic purpura. *Acta Paediatr* 1994;83:1222–1224.
75. Trimble MS, Glynn MF, Brain MC. Amegakaryocytic thrombocytopenia of 4 years duration: successful

treatment with antithymocyte globulin. *Am J Hematol* 1991;37:126–127.

76. Leach JW, Hussein KK, George JN. Acquired pure megakaryocytic aplasia report of two cases with long-term responses to antithymocyte globulin and cyclosporine. *Am J Hematol* 1999;62:115–117.

77. Kutti J, Weinfeld A. The frequency of thrombocytopenia in patients with heart disease treated with oral diuretics. *Acta Med Scand* 1968;183:245–250.

78. Miescher PA. Drug-induced thrombocytopenia. *Semin Hematol* 1973;10:311–325.

79. Cooper BA, Bigelow FS. Thrombocytopenia associated with the administration of diethylstilbestrol in man. *Ann Intern Med* 1960;52:907–909.

80. Cowan DH. Effect of alcoholism on hemostasis. *Semin Hematol* 1980;17:137–147.

81. Sullivan LW, Herbert V. Suppression of hematopoiesis by ethanol. *J Clin Invest* 1964;43:2048–2062.

82. Post RM, Desforges JF. Thrombocytopenia and alcoholism. *Ann Intern Med* 1968;68:1230–1236.

83. Lindenbaum J, Hargrove RL. Thrombocytopenia in alcoholics. *Ann Intern Med* 1968;68:526–532.

84. Cowan DH, Hines JD. Thrombocytopenia of severe alcoholism. *Ann Intern Med* 1971;74:37–43.

85. Cowan DH. Thrombokinetic studies in alcohol-related thrombocytopenia. *J Lab Clin Med* 1973;81:64–76.

86. Ryback R, Desforges J. Alcoholic thrombocytopenia in three inpatient drinking alcoholics. *Arch Int Med* 1970;125:475–477.

87. Haselager EM, Vreeken J. Rebound thrombocytosis after alcohol abuse: a possible factor in the pathogenesis of thromboembolic disease. *Lancet* 1977;1:774–775.

88. Sahud MA. Platelet size and number in alcoholic thrombocytopenia. *N Engl J Med* 1972;286:355–356.

89. Sullivan LW, Adams WH, Liu YK. Induction of thrombocytopenia by thrombopheresis in man: patterns of recovery in normal subjects during ethanol ingestion and abstinence. *Blood* 1977;49:197–207.

90. Cowan DH, Graham RC. Studies on the platelet defect in alcoholism. *Thrombos Diathes Haemorrh* 1975;33:310–327.

91. Haut MJ, Cowan DH. The effect of ethanol on hemostatic properties of human blood platelets. *Am J Med* 1974;56:22–33.

92. Gewirtz AM, Hoffman R. Transitory hypomegakaryocytic thrombocytopenia: aetiological association with ethanol abuse and implications regarding regulation of human megakaryocytopoiesis. *Br J Haematol* 1986b;62:333–344.

93. Levine RF, Spivak JL, Meagher RC, Sieber F. Effect of ethanol on thrombopoiesis. *Br J Haematol* 1986;62:345–354.

94. Nakao S, Harada M, Kondo K, et al. Reversible bone marrow hypoplasia induced by alcohol. *Am J Hematol* 1991;37:120–123.

95. Ballard HS. Alcohol-associated pancytopenia with hypocellular bone marrow. *Am J Clin Pathol* 1980;73:830–834.

96. Queisser U, Queisser W, Spiertz B. Polyploidization of megakaryocytes in normal humans, in patients with idiopathic thrombocytopenia and with pernicious anemia. *Br J Haematol* 1971;20:489–501.

97. Aster RH. Pooling of platelets in the spleen: role in the pathogenesis of “hypersplenic” thrombocytopenia. *J Clin Invest* 1966;45:645–657.

98. Heyns AD, Lötter MG, Badenhorst PN, et al. Kinetics and fate of (111)indium-oxine labelled blood platelets in asplenic subjects. *Thromb Haemost* 1980;44:100-104.
99. Peters AM, Klonizakis I, Lavendar JP, Lewis SM. Use of <sup>111</sup>indium-labelled platelets to measure spleen function. *Br J Haematol* 1980;46:587-593.
100. Weiss L. A scanning electron microscopic study of the spleen. *Blood* 1974;43:665-691.
101. Wadenvik H, Kutti J. The effect of an adrenaline infusion on the splenic blood flow and intrasplenic platelet kinetics. *Br J Haematol* 1987;67:187-192.
102. Heyns A du P, Badenhorst PN, Lötter MG, et al. Kinetics and mobilization from the spleen of indium-111-labeled platelets during platelet apheresis. *Transfusion* 1985;25:215-218.
103. Lee EJ, Schiffer CA. Evidence for rapid mobilization of platelets from the spleen during intensive plateletpheresis. *Am J Hematol* 1985;19:161-165.
104. Noguchi H, Hirai K, Aoki Y, et al. Changes in platelet kinetics after a partial splenic arterial embolization in cirrhotic patients with hypersplenism. *Hepatology* 1995;22:1682-1688.
105. Cooney DP, Smith BA. The pathophysiology of hypersplenic thrombocytopenia. *Arch Intern Med* 1968;121:332-337.
106. Kutti J, Weinfeld A, Westin J. The relationship between splenic platelet pool and spleen size. *Scand J Haematol* 1972;9:351-354.
107. McAllister E, Goode S, Cordista AG, Rosemurgy A. Partial portal decompression alleviates thrombocytopenia of portal hypertension. *Am Surg* 1995;61:129-131.
108. Becker CD, Rösler H, Biasiutti FD, Baer HU. Congestive hypersplenism: treatment by means of radioembolization of the spleen with Y-90. *Radiology* 1995;195:183-186.
109. Sangro B, Bilbao I, Herrero I, et al. Partial splenic embolization for the treatment of hypersplenism in cirrhosis. *Hepatology* 1993;18:309-314.
110. Israel DM, Hassall E, Gordon JA, Phillips RR. Partial splenic embolization in children with hypersplenism. *J Pediatr* 1994;124:95-100.
111. Pinca A, DiPalma A, Soriani S, et al. Effectiveness of partial splenic embolization as treatment for hypersplenism in thalassaemia major: a 7-year followup. *Eur J Haematol* 1992;49:49-52.
112. Coon WW. Splenectomy for thrombocytopenia due to secondary hypersplenism. *Arch Surg* 1988;123:369-371.
113. Alvarez OA, Lopera GA, Patel V, et al. Improvement of thrombocytopenia due to hypersplenism after transjugular intrahepatic portosystemic shunt placement in cirrhotic patients. *Am J Gastroenterol* 1996;91:134-137.
114. Pursnani KG, Sillin LF, Kaplan DS. Effect of transjugular intrahepatic portosystemic shunt on secondary hypersplenism. *Am J Surg* 1997;173:169-173.
115. Bull BS, Zucker MB. Changes in platelet volume produced by temperature, metabolic inhibitors and aggregating agents. *Proc Soc Exp Biol Med* 1965;120:296-301.
116. Pina-Cabral JM, Amaral I, Pinto MM, Paz LH. Hepatic and splenic platelet sequestration during deep hypothermia in the dog. *Haemostasis* 1973/1974;2:235-244.
117. Villalobos TJ, Adelson E, Riley PA, Crosby WH. A cause of the thrombocytopenia and leukopenia that occurs in dogs during deep hypothermia. *J Clin Invest* 1958;37:1-7.
118. Björk VO, Hultquist G. Brain damage in children after deep hypothermia for open heart surgery.

Thorax 1960;15:284–291.

119. O'Brien H, Arness JA, Mollin DL. Recurrent thrombocytopenia, erythroid hypoplasia and sideroblastic anemia associated with hypothermia. *Br J Haematol* 1982;51:451–456.

120. Chan KM, Beard K. A patient with recurrent hypothermia associated with thrombocytopenia. *Postgrad Med J* 1993;69:227–229.

121. Goodie DB, Horton MD, Morris RW, et al. Anesthetic experience with cryotherapy for treatment of hepatic malignancy. *Anaesth Intensive Care* 1992;20:491–496.

122. Cozzi PJ, Stewart GJ, Morris DL. Thrombocytopenia after hepatic cryotherapy for colorectal metastases: correlates with hepatocellular injury. *World J Surg* 1994;18:774–777.

123. Oski FA, Naiman JL. Effect of live measles vaccine on the platelet count. *N Engl J Med* 1966;275:352–356.

124. Nieminen U, Peltola H, Syrjälä MT, et al. Acute thrombocytopenic purpura following measles–mumps and rubella vaccination: a report on 23 patients. *Acta Paediatr* 1993;82:267–270.

125. Beeler J, Varricchio F, Wise R. Thrombocytopenia after immunization with measles vaccines: review of the vaccine adverse events reporting system (1990–1994). *Pediatr Infect Dis J* 1996;15:88–90.

126. Poullin P, Gabriel B. Thrombocytopenic purpura after recombinant hepatitis B vaccine. *Lancet* 1994;344:1293.

127. Meyboom RH, Fucik H, Edwards IR. Thrombocytopenia reported in association with hepatitis B and A vaccines. *Lancet* 1995;345:1638.

128. Yeager AM, Zinkham WH. Varicella-associated thrombocytopenia: clues to the etiology of childhood idiopathic thrombocytopenic purpura. *Johns Hopkins Med J* 1980;146:270–274.

129. Myllylä G, Vaheri A, Vesikari T, Penttinen K. Interactions between human blood platelets, viruses and antibodies. IV. Post-rubella thrombocytopenic purpura and platelet aggregation by rubella antigen-antibody reaction. *Clin Exp Immunol* 1969;4:323–332.

130. Berge T, Brunnhage F, Nilsson LR. Congenital hypoplastic thrombocytopenia in rubella embryopathy. *Acta Paediatr* 1963; 52:349–352.

131. Cooper LZ, Green RH, Krugman S, et al. Neonatal thrombocytopenic purpura and other manifestations of rubella contracted in utero. *Am J Dis Child* 1965;110:416–427.

132. Lacour M, Maherzi M, Vienny H, Suter S. Thrombocytopenia in a case of neonatal mumps infection: evidence for further clinical presentations. *Eur J Pediatr* 1993;152:739–741.

133. Van Spronsen DJ, Breed WP. Cytomegalovirus-induced thrombocytopenia and haemolysis in an immunocompetent adult. *Br J Haematol* 1996;92:218–220.

134. Eisenberg MJ, Kaplan B. Cytomegalovirus-induced thrombocytopenia in an immunocompetent adult. *West J Med* 1993;158:525–526.

135. Nagai K, Morohoshi T, Kudoh T, et al. Transient erythroblastopenia of childhood with megakaryocytopenia associated with parvovirus B19 infection. *Br J Haematol* 1992;76:131–132.

136. Yoto Y, Kudoh T, Suzuki N, et al. Thrombocytopenia induced by human parvovirus B19 infections. *Eur J Haematol* 1993;50:255–257.

137. Murray JC, Morad AB, Pierce MA, Mihm S. Thrombocytopenia accompanying early postnatal infection by human parvovirus B19. *Am J Hematol* 1995;49:360.

138. Stephan F, Thiolere B, Verdy E, et al. Role of hemophagocytic histiocytosis in the etiology of thrombocytopenia in patients with sepsis syndrome or septic shock. *Clin Infect Dis* 1997;25:1159–1164.

139. Fajardo LF, Tallent C. Malarial parasites within human platelets. *JAMA* 1974;229:1205–1207.
140. El-Shoura S. Falciparum malaria in naturally infected humans. III. Platelet ultrastructural alterations during thrombocytopenia. *Virchows Arch B Cell Pathol Incl Mol Pathol* 1993;63:257–262.
141. Ballard HS, Bottino G, Bottino J. The association of thrombocytopenia and Lyme disease. *Postgrad Med J* 1994;70:285–287.
142. Pugliese A, Levchuck S, Cunha BA. *Mycoplasma pneumoniae* induced thrombocytopenia. *Heart Lung* 1993;22:373–375.
143. Leslie SD, Toy PT. Laboratory hemostatic abnormalities in massively transfused patients given red blood cells and crystalloid. *Am J Clin Pathol* 1991;96:770–773.
144. Harvey MP, Greenfield TP, Sugrue ME, Rosenfeld D. Massive blood transfusion in a tertiary referral hospital: clinical outcomes and haemostatic complications. *Med J Aust* 1995;163:356–359.
145. Harrigan C, Lucas CE, Ledgerwood AM, et al. Serial changes in primary hemostasis after massive transfusion. *Surgery* 1985;98:836–844.
146. Reed RL, Ciavarella D, Heimbach DM, et al. Prophylactic platelet administration during massive transfusion. *Ann Surg* 1986;203:40–48.

2004 Lippincott Williams & Wilkins  
John P. Greer, John Foerster, John N. Lukens  
George M. Rodgers, Frixos Paraskevas, Bertil Glader  
Wintrobe's Clinical Hematology

MECHANICAL PURPURASTRUCTURAL MALFORMATIONS OF VESSELSHereditary Hemorrhagic TelangiectasiaVascular MalformationsKasabach-Merritt SyndromeOther VasculopathiesBLEEDING DUE TO DISORDERS OF PERIVASCULAR TISSUEEhlers-Danlos DiseaseOsteogenesis ImperfectaPseudoxanthoma ElasticumMarfan SyndromeScurvySteroid-Induced PurpuraSenile PurpuraVASCULITISCutaneous Leukocytoclastic VasculitisAntineutrophil Cytoplasmic Antibody-Positive VasculitisCryoglobulinemiaHypergammaglobulinemic PurpuraUrticarial VasculitisAcute Infantile Hemorrhagic EdemaHenoch-Schönlein PurpuraSerum SicknessPURPURA ASSOCIATED WITH INFECTIONAcute Febrile Illness with PetechiaePapular-Purpuric Gloves and Socks SyndromeRickettsial DiseasesBrazilian Purpuric FeverRat Bite FeverStrongyloidesHemorrhagic Fever VirusesPURPURA ASSOCIATED WITH VASCULAR OBSTRUCTIONCryofibrinogenemiaCholesterol Embolization SyndromePURPURA ASSOCIATED WITH SKIN DISEASESPigmented Purpuric DermatitisPurpuric Contact DermatitisDrug ReactionsPSYCHOGENIC PURPURAAutoerythrocyte SensitizationAutosensitivity to DNAFactitious PurpuraReligious StigmataREFERENCES

*Purpura* is the term used to describe the skin lesions that develop when red blood cells extravasate from capillaries. *Purpura* refers to pinpoint lesions called *petechiae* or more widespread lesions known as *ecchymoses*. Purpura can be differentiated from other



erythematous lesions by the use of diascopy, which is the application of a glass slide to the border of the lesions. True purpura does not blanch with pressure ( [1](#) ).

This chapter discusses causes of bleeding that are not the result of thrombocytopenia, coagulation factor deficiency, or qualitative platelet defects.

## MECHANICAL PURPURA

External pressure such as blunt trauma results in ecchymoses when the force is sufficient to disrupt vascular integrity and allow extravasation of red blood cells. The size of the resulting lesion is dependent on the durability of the tissue traumatized, the vascularity of the region, the density of the surrounding tissue, and the time elapsed ( [2](#), [3](#) ). The extent of bruising can increase over time, and tracking through tissue planes can occur, resulting in bruises in areas remote from the area of trauma ( [4](#) ). The color of the lesion is in part dependent on the location of the red cells—lesions near the surface have a more reddish color, and deeper lesions appear bluish. This finding is due to optical scattering in the dermis, and the fact that blue wavelengths scatter and reflect more than red ( [5](#) ). Bruises change color with time, but recent evidence suggests more variability in this than previously recognized ( [4](#) ).

Mechanical purpura can be seen on occasion with minor trauma such as blood pressure cuff monitoring in anticoagulated patients ( [3](#) ) or even vigorous scratching. Young adults playing active sports such as basketball can develop calcaneal petechiae resulting from relatively minor, but repetitive, heel trauma ( [6](#) ). Periorbital, face, or neck purpura can occur after a sudden increase in intravascular pressure with a Valsalva maneuver ( [7](#) ) and has been described after bungee-jumping ( [8](#) ). This may also be the mechanism of purpura in other forms of exercise-induced, nontraumatic purpura recently described ( [9](#), [10](#) and [11](#) ).

Suction purpura occurs when negative pressure is applied to the skin in sufficient force to result in extravasation of erythrocytes. Young healthy people develop petechiae with 350 to 400 mm Hg negative pressure, but the required amount of pressure to induce purpura decreases with age to as low as 100 mm Hg ( [12](#) ). The application of rubber suction devices to the forehead can result in circumscribed purpura. This seems to occur mostly when new parents apply children's suction toys to their foreheads and has been termed *Cyclops purpura* ( [13](#) ). A similar, relatively common cause of suction purpura is seen in adolescents who place a drinking glass over their chin and suck out the air to form a vacuum, ultimately causing chin or perioral purpura ( [14](#) ). Adolescents are also prone to develop small purpuric lesions in the neck region from "hickeys" or "love bites," another form of suction purpura.

Larger ecchymotic areas also may demonstrate certain patterns that can be a clue to underlying pathology. The well-known Cullen sign refers to bluish discoloration around the umbilicus, and Grey Turner sign is flank ecchymosis. Both may indicate hemorrhagic pancreatitis or a rectus sheath hematoma ( [15](#) ). Scrotal ecchymosis may be a clue to intraperitoneal hemorrhage, and perianal ecchymosis has been described as a manifestation of aneurysmal rupture into the sigmoid mesocolon ( [16](#), [17](#) ). "Raccoon eyes" and mastoid ecchymosis (Battle sign) may indicate a basilar skull fracture after head trauma ( [18](#) ).

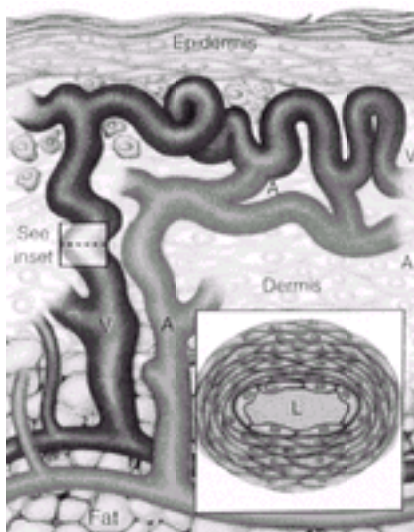
## STRUCTURAL MALFORMATIONS OF VESSELS

### Hereditary Hemorrhagic Telangiectasia

Hereditary hemorrhagic telangiectasia (HHT) was first described in 1864 by Sutton ([19](#)) and later recognized and reported by Rendu ([20](#)), Osler ([21](#)), and Weber ([22](#)), and it is thus also known as *Osler-Weber-Rendu syndrome*. It is an autosomal-dominant disorder characterized by multiple telangiectatic lesions involving the skin and mucous membranes associated with epistaxis and other bleeding complications. HHT has an estimated prevalence of 1 in 50,000 but may be as high as 1 in 16,500 ([23](#)), with complete penetrance by 40 years of age ([24](#)). Some geographic locations have even a higher prevalence ([25](#)).

Recent genetic studies have begun to identify the genetic defects responsible for the vascular malformations. In 1994, linkage analysis established the loci for HHT in some families to markers on chromosome 9q33-34 ([26](#), [27](#)). The gene was later identified as the endoglin gene ([28](#)). *Endoglin* is an integral membrane glycoprotein expressed on endothelial cells in arterioles, venules, and capillaries. This glycoprotein serves as a binding protein for transforming growth factor- $\beta$ . Some families show linkage to another locus on chromosome 12q ([29](#)). This gene has now been identified as ALK1, another receptor for transforming growth factor- $\beta$  ([30](#)). Transforming growth factor- $\beta$  regulates many transcriptional targets and plays a crucial role in vascular development and homeostasis. The molecular defects in HHT have been recently reviewed ([31](#), [32](#)).

The mechanisms by which these genetic defects result in telangiectatic lesions have not been identified. Ultrastructural analysis of cutaneous HHT lesions suggests that postcapillary venule dilation is the earliest identifiable morphologic abnormality ([25](#), [33](#)). As the venules enlarge, they become convoluted and interconnect with arterioles through capillary segments. The capillary segments eventually disappear, and direct arteriolar-venular communications are established ([Fig. 56.1](#)). An infiltrate of mononuclear cells appears in the perivascular region of the HHT lesions.



**Figure 56.1.** Arteriovenous malformations in hereditary hemorrhagic telangiectasia. In a

fully developed cutaneous telangiectasia, the venule ( *V* ) and its branches have become dilated and convoluted throughout the dermis. The connecting arterioles ( *A* ) have also become dilated and communicate directly with the venules without intervening capillaries. A perivascular infiltrate is present. The thickened wall of a dilated postcapillary venule is also shown. L, lumen of the vessel. See [Color Plate](#). (From Guttmacher AE, Marchuk DA, White RI. Hereditary hemorrhagic telangiectasia. *N Engl J Med* 1995;333:918–924, with permission.)

The bleeding manifestations are thought to occur because of an inherent mechanical fragility of these vessels. However, some investigators have reported various abnormalities of the hemostatic system as possible contributing factors in some patients. The significance of these reports is not clear, but common abnormalities in the hemostatic system do not seem to represent a major factor in the underlying bleeding tendency.

**CLINICAL MANIFESTATIONS** The cutaneous lesions usually appear in affected persons by 40 years of age, and they increase in number with age. The lesions measure 1 to 3 mm in diameter and are sharply demarcated in appearance ( [Fig. 56.2](#) ). They blanch with pressure, but the blanching may be incomplete as a result of “strangulation” of coiled loops of vessels ( [34](#), [35](#) ). The telangiectatic lesions are most commonly found on the face, lips, nares, tongue, nailbeds, and hands. Some patients have only a few lesions necessitating a thorough search in anyone suspected of having HHT. Bleeding from these cutaneous telangiectasias is uncommon and rarely of clinical importance.



**Figure 56.2.** Telangiectasias of the tongue and lower lip in a patient with hereditary hemorrhagic telangiectasia. See [Color Plate](#). (From Guttmacher AE, Marchuk DA, White RI. Hereditary hemorrhagic telangiectasia. *N Engl J Med* 1995;333:918–924, with permission.)

Epistaxis is the presenting complaint in up to 90% of patients with HHT. This symptom results from bleeding telangiectatic lesions over the inferior turbinates and nasal septum. Symptoms usually occur before 35 years of age and are highly variable. Approximately one-third of patients have mild symptoms requiring no treatment, and another third has moderate symptoms requiring only outpatient treatment. The remaining third has severe symptoms often requiring inpatient treatment, transfusions or chronic iron replacement therapy, and surgery ( [35](#) ). The nosebleeds may become more difficult to control as the patient ages. Pulmonary arteriovenous malformations (PAVMs) occur in 5 to 30% of patients with HHT, and 85 to 90% of people with PAVM are found to have HHT ( [25](#), [34](#), [35](#), [36](#) and [37](#) ). Recent genetic linkage studies have found that patients with 9q-linked mutations have significantly higher rates of PAVMs than HHT patients with other mutations ( [38](#), [39](#) and [40](#) ). The PAVMs are primarily located in the lower lung lobes and are multiple. These PAVMs may result in a significant right-to-left shunt, and patients may develop significant dyspnea, cyanosis, clubbing, fatigue, decreased exercise tolerance, migraine headaches, and polycythemia. Paradoxical emboli can occur and result in brain abscesses, transient ischemic attacks, and strokes. The prevalence of cortical infarcts has been reported to be as high as 14% in patients with a single PAVM and increases to

27% in patients with multiple PAVMs (41). These lesions may also bleed and result in hemoptysis or hemothorax. The detection of PAVMs may be difficult in patients with few or no symptoms. Physical examination may uncover an end-inspiratory bruit (34). A chest x-ray may detect a coin lesion but often misses smaller lesions. Gravitational shifts in blood flow to the lung bases result in increased right-to-left shunting in the sitting or standing position. Physiologic tests such as measuring O<sub>2</sub> saturation in the supine and standing position (on room air and 100% O<sub>2</sub>) can detect the positional change in shunting and can be used to screen patients for PAVMs. However, the best screening test for PAVM appears to be contrast echocardiography (42, 43). Patients with a positive screening test should undergo an unenhanced spiral computed tomography to confirm and further characterize the PAVM (44, 45). Pulmonary angiography is a less-sensitive study but is necessary in treatment planning. Approximately 20% of patients with HHT develop significant upper and lower gastrointestinal (GI) tract hemorrhage. Bleeding is rare before the fifth decade of life. Approximately 40% of the bleeding episodes occur from upper GI tract lesions, whereas only 10% occur in the colon, and a full one-half are indeterminate after evaluation (35). Unlike epistaxis, spontaneous regression of GI bleeding is rare, and steady progression or chronic intermittent bleeding is the norm. Symptomatic hepatic involvement by HHT is rare. Patients may have hepatomegaly, a hepatic bruit or thrill, or elevated liver function studies (36, 46). Significant left-to-right arteriovenous shunting results in high-output heart failure (46, 47), and the shunt can be detected by cardiac catheterization with oximetry. Anicteric cholestasis and atypical cirrhosis caused by HHT have been reported (46, 47). Hepatic arteriovenous malformations (AVMs) can be detected by dynamic computed tomography (46), color Doppler ultrasound (48), or celiac angiography. The neurologic manifestations of HHT result from PAVM in up to two-thirds of cases (25). The remainder of the neurologic symptoms are the result of cerebrovascular telangiectasias, AVMs, aneurysms, and cavernous hemangiomas (36). Ten to twenty percent of patients with HHT have cerebral AVM, but only 10% of people who have cerebral AVM are found to have HHT (49). The cerebral AVMs are often multiple (49, 50). The annual risk of bleeding from cerebral AVM is low, reported as 0.41 to 0.72%/year (compared to 2 to 4% risk for sporadic, non-HHT AVM) (49, 51). Magnetic resonance imaging is probably the best test for detecting these lesions, but the role of screening asymptomatic patients is controversial (51, 52).

**TREATMENT** Recurrent epistaxis can be a perplexing problem, and few trials exist that compare various treatment modalities. Prophylactic measures include humidification and saline nose drops. Nasal trauma from vigorous nose blowing, straining, and finger manipulation should be avoided. Antihistamines should also be avoided to prevent drying of the nasal mucosa. Mild bleeding can be treated with absorptive packing and direct pressure. Cautery is commonly used to stop persistent bleeding, but repeated cauterizations can result in necrosis and septal perforation and should be avoided (53). The neodymium:yttrium-aluminum-garnet (Nd:YAG) laser system has been shown to be effective treatment for epistaxis. One center emphasizes the technique of using 1064-nm wavelengths for greater depth of penetration, moisturizing the mucosa first to prevent coagulation necrosis of the superficial mucosa, and using low-power wattage with short application times (54). Argon plasma coagulation also appears promising, and application of topical estrogens may improve the benefit (55). Arterial embolization or ligation is effective in some patients. Septal dermoplasty is a technique of removing diseased nasal mucosa and the subepithelial telangiectasias and replacing abnormal tissue with an enduring barrier. In refractory cases, rhinotomy with forehead flap reconstruction may be required (53, 54, 56). The use of estrogen and ε-aminocaproic acid is discussed in the following section. PAVMs are treated with transcatheter embolotherapy (57, 58) to diminish the risk of paradoxical emboli and other complications. PAVMs with feeder artery diameters greater than 3 mm should be treated. This procedure is effective at decreasing

the right-to-left shunt and improving oxygen saturation, and it has a low complication rate. In cases in which embolotherapy is technically difficult, surgical resection should be used. After embolotherapy or surgery, small AVMs may enlarge and become clinically significant. For this reason, patients should undergo screening helical computed tomography scans every 5 years ( [25](#) ). Because brain abscesses and septic emboli occur in 1 to 20% of patients with HHT and PAVM, these patients should receive prophylactic antibiotic therapy before dental or surgical procedures ( [59](#) ). Bleeding GI vascular malformations can be treated with endoscopic thermal devices including bipolar electrocautery and laser techniques. The mucosa coagulates and sloughs, leaving a small ulcer in the place of the vascular lesion ( [60](#) ). The ulcer reepithelializes over the next few days. These treatments are rarely effective for the long-term, however, because new lesions continue to develop and small intestinal lesions are not accessible. Estrogen and progesterone have been effective in decreasing the bleeding episodes. Cerebral AVMs have been treated with surgery, stereotactic radiosurgery, and embolotherapy. A follow-up angiogram should be repeated at 1 year, followed by periodic magnetic resonance imaging. Hepatic malformations have been treated with transcatheter embolization using a polyvinyl alcohol sponge, but the complication rate is significant ( [61](#) ). The mortality rate of this procedure in HHT has been calculated to be as high as 25 to 40% ( [60](#), [62](#) ). Other treatments that have been successfully used include hepatic artery ligation for localized vascular malformations ( [63](#) ) and liver transplant in patients with extensive lesions ( [64](#) ).

**MEDICAL THERAPY** Observations in the 1950s that epistaxis decreased during pregnancy and increased after menopause led to the use of estrogens as therapy for HHT. Estrogens in large doses result in metaplasia of the nasal mucosa, resulting in thick layers of squamous epithelium, and electron microscopy studies indicated that estrogen reestablished endothelial cell continuity ( [65](#), [66](#) ). A small randomized trial of 3 months' duration showed no benefit in reducing the number of bleeding episodes with estradiol valerate ( [67](#) ). However, another author reported 100% success in an uncontrolled series of 67 consecutively treated patients who continued with high-dose estrogen therapy ( [65](#) ). Several case reports and one small randomized controlled trial evaluated the use of low-dose estrogen-progesterone combination therapy in patients with severe GI bleeding. The bleeding episodes and transfusion requirements significantly diminished in treated patients ( [68](#) ). Aminocaproic acid has been useful in some patients with HHT and recurrent bleeding ( [69](#) ), but other patients have not responded ( [70](#) ). Recent reports suggest that oral or intranasal tranexamic acid may be helpful as well ( [71](#) ). Virtually all patients with HHT have iron-deficiency anemia. The treatment of iron-deficiency anemia in this setting usually requires more than oral iron replacement. Patients with significant blood loss and anemia who do not respond or do not tolerate maximal doses of oral iron should be given intravenous iron therapy. Three products are available for parenteral iron therapy: iron dextran, iron gluconate, and iron sucrose. Patients who have toxicity with iron dextran should receive one of the other products. With the currently available options for iron replacement in anemic HHT patients, red cell transfusion should rarely be necessary. Genetic counseling should be part of the treatment, and referral to a designated HHT center should be considered in most cases. Six U.S. and Canadian HHT centers currently exist and are listed on the HHT Foundation International, Inc. Web site ( [www.hht.org](http://www.hht.org) ).

## Vascular Malformations

Vascular malformations result from localized errors of angiogenic development. The underlying molecular genetics of angiogenesis are complex and are the subject of recent reviews ( [72](#), [73](#) ) (see [Chapter 22](#) ). Mutations in the angiogenic pathways can result in a variety of malformations including capillary or venous angiomas, cerebral cavernous



malformations, and AVMs, either as isolated or multifocal lesions. Bleeding problems occur from rupture or leakage from these vascular anomalies, and the clinical sequelae depend on their location.

Skin lesions are the most common vascular malformation and include a variety of birthmarks. Central nervous system vascular lesions include AVMs, berry aneurysms, and cavernomas. Bleeding from these lesions in the lung may account for 30% of spontaneous intraparenchymal lobar bleeds ( [74](#) ). These lesions are usually detected by magnetic resonance imaging/magnetic resonance angiography, but some lesions are only detected by angiography ( [75](#) ). Hemoptysis can result from pulmonary vascular anomalies including AVM and a rare disease known as *pulmonary capillary hemangiomatosis*. Hematuria may rarely be due to genitourinary AVMs or hemangiomas.

GI bleeding may be due to vascular malformations such as the blue rubber nevus syndrome, gastric antral vascular ectasia, telangiectasias, and AVM. GI angiodysplastic lesions deserve special attention given their frequency. They appear to be due to degenerative dysplasia and are the most frequent cause of obscure GI bleeding. The cause is thought to be due to intermittent obstruction of the submucosal veins where they penetrate the muscular layers of the colon, ultimately leading to dilated, tortuous submucosal veins and venules ( [76](#) ). Small intestinal angiodysplastic lesions can be particularly hard to detect, but it is hoped that the new technique of wireless capsule endoscopy will facilitate this diagnosis ( [77](#) ). Endoscopic-based therapy or surgery may be required for treatment. This disorder is frequently associated with aortic stenosis, and there are reports of cessation of bleeding after aortic valve repair. Continuous estrogen-progestin treatment is not useful in the prevention of rebleeding from GI angiodysplasia ( [78](#) ).

### **Kasabach–Merritt Syndrome**

Patients with this syndrome have structural vascular abnormalities resulting in large cavernous hemangiomas. A bleeding diathesis may occur as a result of localized disseminated intra-vascular coagulation, and patients may present with ecchymoses. This syndrome is discussed in detail in [Chapter 60](#).

### **Other Vasculopathies**

**AMYLOIDOSIS** Patients with multiple myeloma or systemic amyloidosis may have light chain deposits in the cutaneous blood vessels. These vessels are particularly fragile, and purpura can occur as a result of minor trauma (“pinch purpura”). The eyelids and periorbital regions are particularly prone to developing purpura ( [Fig. 56.3](#) ), and a classic sign is postproctoscopic periorbital purpura occurring after proctoscopies (for diagnostic rectal biopsies done in the past) or after Valsalva maneuvers. Purpura also commonly develops in other flexural skin areas such as the nasolabial folds, neck, axillae, and umbilicus ( [79](#) ). Biopsies of the cutaneous vascular lesions demonstrate amyloid deposits in the dermis and subcutaneous tissues, and inflammatory cells are scarce. The diagnosis and treatment of these disorders are discussed in detail in [Chapter 99](#).



**Figure 56.3.** Periorbital purpura in a 58-year-old woman with immunoglobulin A  $\lambda$  plasma cell dyscrasia associated with secondary amyloidosis. See [Color Plate](#). This photograph was kindly provided by Drs. Theresa Scholz and Pamela Nemzer (Department of Dermatology, University of Utah Health Sciences Center).

**MOYAMOYA DISEASE** *Moyamoya disease* is a chronic cerebral vasculopathy initially described in Japan. The disease is characterized by occlusion of the terminal portion of the internal carotid arteries along with an abnormal vascular network in the regional area of occlusion. Cerebral infarcts are common in children, but adults have a higher propensity for intracranial hemorrhage. The risk of bleeding appears to be highest in adult Asians ([80](#)). The etiology is unknown, and diagnosis rests on characteristic angiographic findings.

**CALCIPHYLAXIS** *Calciphylaxis* is a small vessel vasculopathy noted in patients with renal failure. Histologically, the vessels demonstrate calcification of the tunica media with intimal proliferation. This vasculopathy results in tissue ischemia and necrosis; patients present with painful skin lesions that progress to ulcers. Risk factors for calciphylaxis include female sex, obesity, and diabetes. The mortality rate is high. Treatment includes tissue débridement, skin grafting, hyperbaric oxygen, and control of calcium and phosphorus levels ([81](#)).

## BLEEDING DUE TO DISORDERS OF PERIVASCULAR TISSUE

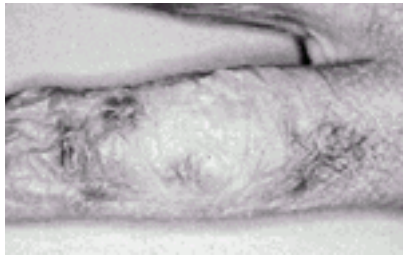
### Ehlers–Danlos Disease

The *Ehlers–Danlos syndromes* (EDSs) are a group of rare connective tissue disorders caused by abnormalities of collagen synthesis or processing. The prevalence is estimated to be between 1 in 10,000 to 20,000 births. A simplified classification system has identified six major types of EDSs and their genetic defects ([82](#), [83](#)). The clinical features include hyperextensible, fragile skin associated with joint hypermobility. The majority of patients with EDSs also report a history of excessive bruising and bleeding ([84](#), [85](#)). Other bleeding manifestations may include subcutaneous nodular hematomas, mucosal oozing after dental procedures, hemoptysis, and GI bleeding. In most patients, screening tests show no hemostatic abnormalities, and the bleeding is thought to result from abnormalities in the perivascular collagens leading to fragility of the subcutaneous vessels. However, several authors have noted abnormal bleeding times and platelet aggregation studies, as well as factor deficiencies in individual patients ([84](#), [86](#)).

Certain types of EDSs have an increased risk of major bleeding episodes. In particular, vascular EDS (type IV) has unique clinical features of interest to hematologists. This disorder is due to quantitative or qualitative defects in type 3 collagen, which is particularly abundant in the arterial wall ([82](#), [87](#)). Patients with this disorder are prone to develop arterial aneurysms and dissections as well as significant bleeding complications from spontaneous rupture of vessels ([87](#), [88](#) and [89](#)). Carotid–cavernous fistula is another well-documented complication, and clinical diagnosis is based on the findings of pulsatile exophthalmia, tinnitus, thrill, and headache. In addition to vascular abnormalities, patients with vascular EDS have characteristic facial features and thin, translucent skin with a



conspicuous venous network. Papyrus scarring ( [Fig. 56.4](#)) may be present, but patients usually have minimal joint hypermobility (often limited to the hands) or skin hyperextensibility. The diagnosis can be confirmed by biochemical or molecular assays of type 3 collagen.



**Figure 56.4.** “Papyrus” scarring and thin skin with petechiae in a patient with Ehlers–Danlos syndrome. (From Anstey A, Mayne K, Winter M, et al. Platelet and coagulation studies in Ehlers–Danlos syndrome. *Br J Dermatol* 1991;125:155–163, with permission.)

Patients with EDS, particularly vascular EDS, should generally avoid contact sports and isometric exercise and are advised to avoid medications with antiplatelet properties ([87](#)). Arterial rupture should be considered in the differential diagnosis when these patients present with new-onset symptoms such as abdominal pain. Diagnostic procedures that involve arterial puncture are relatively contraindicated because of a high incidence of complications ([87](#), [88](#)). Surgery should be avoided when possible, as there is an increased risk of fatal intraoperative vascular complications. If surgery is mandatory, extreme care should be used in the manipulation of vascular tissues. Postpartum hemorrhage is a major risk for pregnant patients with EDS, and the management of pregnancy has been recently reviewed in case reports ([90](#), [91](#) and [92](#)). Genetic counseling and referral to the Ehlers–Danlos National Foundation ([www.ednf.org](http://www.ednf.org)) should be considered. An educational CD–Rom for the patient and caregivers has been developed and can be useful in the general management of patients with this disorder.

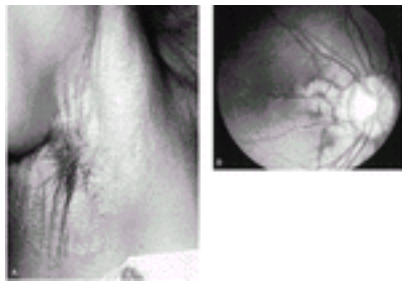
## Osteogenesis Imperfecta

*Osteogenesis imperfecta* (OI) is an autosomal–dominant disease characterized by brittle bones with pathologic fractures as a result of a deficiency in bone matrix. Approximately 95% of cases are caused by mutations in the genes COLA1 and COLA2, which code for the pro- $\alpha$ 1(1) and pro- $\alpha$ 2(2) peptides of type 1 collagen ([93](#)). There are two  $\alpha$ <sub>1</sub>-chains and one  $\alpha$ <sub>2</sub>-chain in each type 1 collagen, and more than 100 different mutations in the genes coding for these subunits have been characterized ([94](#)). Four clinical types of OI are currently recognized ([95](#)). Approximately 25% of patients have been noted to bruise easily; this tendency appears to vary with the clinical type ([96](#)). Skin contains predominantly type 1 collagen, and bruising is thought to be the result of defective supporting structures. The ecchymoses are generally mild and insignificant compared to the broader clinical picture. Excessive bleeding from wound sites after surgery has also been described ([97](#), [98](#)). Recombinant factor VIIa and desmopressin have been reported to be useful in postoperative bleeding in case reports ([99](#), [100](#)). The Osteogenesis Imperfecta Foundation can be accessed at the following Web address: [www.oif.org](http://www.oif.org).

## Pseudoxanthoma Elasticum

*Pseudoxanthoma elasticum* is an inherited connective tissue disorder that results in calcification of elastic fibers ( [101](#)). The basic genetic defect is now known to be a variety of mutations in the gene encoding the transmembrane transporter protein ABC-C6 ( [102](#), [103](#)). This protein is in the multiple drug resistance family of proteins and may function as an efflux pump, but it is not yet known what the substance transported is or how the mutation causes the disease. It is possible that this defect could result in accumulation of compounds that could lead to the calcification of the elastin fibers ( [103](#)).

Patients with pseudoxanthoma elasticum have skin that becomes grooved and thickened over time and has been described as resembling Moroccan leather ( [104](#)). Other cutaneous features include the development of yellow cutaneous plaques usually in the neck or axillary region or in other flexural sites. Ocular disease results from ruptures in elastin-containing membranes and presents as angioid streaks ( [Fig. 56.5A](#) and [Fig. 56.5B](#)). Cardiovascular disease results from calcification of the arterial internal elastic lamina. Criteria for the diagnosis of pseudoxanthoma elasticum have been published ( [101](#), [105](#)), and five clinical types are identified.



**Figure 56.5.** Cutaneous plaques with redundant skin folds (A) and angioid streaks (B) in a patient with pseudoxanthoma elasticum. (From Lebwohl M, Neldner K, Pope FM, et al. Classification of pseudoxanthoma elasticum: report of a consensus conference. *J Am Acad Dermatol* 1994;30:103–107, with permission.)

Bleeding can result when the calcified vessels rupture. The manifestations include bruising, epistaxis, and bleeding from the uterus, bladder, and joints ( [101](#)). GI bleeding occurs in 13% of patients, usually between 20 and 30 years of age, and is usually of gastric origin ( [106](#)). Treatment should include the avoidance of gastric irritants and careful control of hypertension and hypercholesterolemia. Regular ophthalmology evaluations are also recommended ( [107](#)). The National Association for Pseudoxanthoma Elasticum can be contacted at 1240 Ogden Street, Denver, Colorado, USA, 80128 [(303) 832–5055].

## Marfan Syndrome

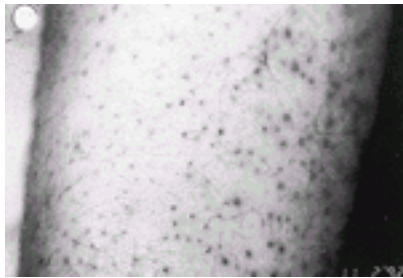
*Marfan syndrome* is a genetic disorder with characteristic ocular, skeletal, and cardiovascular abnormalities. The basic defect has recently been identified as mutations in the fibrillin gene on chromosome 15 ( [108](#)). Easy bruisability has been reported ( [109](#)) but does not seem to be a major feature of the Marfan syndrome ( [110](#)). However, the risk of postpartum hemorrhage is reported to be increased ( [111](#)). The National Marfan

Foundation web address is [www.marfan.org](http://www.marfan.org).

## Scurvy

Humans require vitamin C in the diet to promote the peptidyl hydroxylation of procollagen. In the absence of vitamin C, collagen strands are weakened as a result of abnormal triple helical structures. The abnormal collagen results in defective perivascular supportive tissues, which predispose to capillary fragility and delayed wound healing ( [112](#), [113](#), [114](#) and [115](#) ).

The clinical manifestations of scurvy depend on the severity of vitamin C deficiency. Patients classically develop perifollicular petechiae ( [Fig. 56.6](#) ) ( [112](#) ). The petechiae can coalesce and form purpura, particularly in a “saddle” distribution, and patients may develop gingival or intramuscular hemorrhage ( [113](#) ). Up to 75% of patients have a multifactorial normochromic, normocytic anemia ( [114](#) ). Other manifestations include peripheral edema and fatigue.



**Figure 56.6.** Perifollicular hemorrhages and corkscrew hairs in a patient with scurvy. (From Ghorbani AJ, Eichler C. Scurvy. *J Am Acad Dermatol* 1994;30:881–883, with permission.)

Patients at risk for scurvy include elderly edentulous patients who cook for themselves, alcoholics, mentally ill patients, and people on unusual diets. The treatment is replacement of ascorbic acid in doses of 200 mg/day ( [112](#) ).

## Steroid-Induced Purpura

Patients on chronic steroids develop thinning of the connective tissues, and minor trauma can result in extensive purpura, especially in older patients. Avoidance of trauma is the best prophylaxis for bleeding in these patients.

## Senile Purpura

*Senile purpura* is a common phenomenon first described in 1817 by Bateman. The lesions are typically located on the extensor surfaces of the forearms and dorsum of the hands and occur without recognized preceding trauma ( [Fig. 56.7](#) ) ( [116](#) ). The prevalence in hospitalized patients older than 65 years of age is approximately 5% but increases exponentially with age to include up to 30% of men 90 years of age or older ( [117](#) ). The skin in elderly people is thin as a result of loss of subcutaneous fat and changes in both the amount and quality of collagen ( [118](#) ). Skin lesions are thought to develop by incidental lateral displacement of slack skin with resulting capillary shearing. The lesions tend to last longer than other purpuric lesions and do not generally undergo the changes in hue that

other ecchymotic lesions do ( [116](#) ). Hemostasis tests are normal, and no treatment other than reassurance is indicated.



**Figure 56.7.** Senile purpura (also known as *Bateman purpura*) in a 70-year-old man. See [Color Plate](#). This photograph was kindly provided by Dr. Kappa Meadows (Department of Dermatology, University of Utah Health Sciences Center).

## VASCULITIS

The nomenclature of the vasculitides is quite confusing, but a recent international consensus conference has proposed a system based on vessel size. This classification system recommends abandoning the term *hypersensitivity vasculitis* in favor of *microscopic polyangiitis* for small vessel vasculitides with few or no immune complexes and *cutaneous leukocytoclastic vasculitis* for small vessel vasculitis with isolated skin involvement ( [119](#) ).

### Cutaneous Leukocytoclastic Vasculitis

Leukocytoclastic vasculitis is characterized by immune complex deposition in postcapillary venules resulting in an inflammatory infiltrate, red cell extravasation, fibrinoid necrosis of the vessel wall, and fragmentation of nuclei (leukocytoclasia). The lesions typically develop 7 to 10 days after exposure to the offending antigen.

Palpable purpura is the classic clinical finding associated with cutaneous small vessel vasculitis. The lesions are the result of extravasation of erythrocytes into the inflamed dermis; therefore, the lesions do not blanch with pressure. The lesions range in size from pinpoint to several centimeters in diameter and are most prominent on the lower legs. The diagnosis should be confirmed by skin biopsy. Evaluation for the etiologic agent can be challenging and requires a detailed history to identify causative agents ( [Table 56.1](#) ) ( [120](#) , [121](#) , [122](#) , and [123](#) ). Helpful laboratory studies include complete blood cell count, blood cultures, serum protein electrophoresis, cryoglobulins, rheumatoid factor, antinuclear antibody, antineutrophil cytoplasmic antibodies (ANCA), and complement. Systemic involvement should be determined by the history and physical as well as a urinalysis, chest x-ray, and electrocardiogram.

### TABLE 56.1. Etiologies of Leukocytoclastic Vasculitis

#### Underlying disorders

Malignancy (leukemia, lymphoma, myeloma, cryoglobulinemia)

Autoimmune disease (systemic lupus, ulcerative colitis, periarteritis nodosa, Sjögren syndrome, viral hepatitis, primary biliary cirrhosis, and so forth)

Infections (viral, bacterial, mycobacterial, fungal)

Drugs/chemicals

Penicillin, aspirin, phenothiazines, tetracycline, retinoids, colony-stimulating factors, contrast dye, insecticides, herbicides

Idiopathic

---

## Antineutrophil Cytoplasmic Antibody-Positive Vasculitis

A major advance in understanding and classifying vasculitides has been the recognition of ANCA in specific vasculitic syndromes. Patients with ANCA-associated small vessel vasculitis include three major categories, which are histologically identical. Speed in the diagnosis of ANCA-associated small vessel vasculitis is critical, as early treatment with immunosuppressive drugs can prevent life-threatening organ damage ([120](#)).

Wegener granulomatosis is distinguished by necrotizing granulomatous inflammation and pulmonary, upper respiratory, and renal involvement. Vascular inflammation in these areas can cause epistaxis, hemoptysis, and hematuria. Churg-Strauss disease is defined by the presence of necrotizing granulomas with asthma and eosinophilia. Vasculitis affects the nerves, GI tract, and skin primarily. Microscopic polyangiitis is recognized by the characteristic histology with the absence of asthma and granulomas. The vasculitis typically occurs in males older than 50 years of age. Prodromal symptoms include fever, myalgias, and arthralgias. Microhematuria, proteinuria, and oliguric renal failure may develop, and 30 to 40% of patients develop cutaneous lesions (splinter hemorrhages, palpable purpura). Pulmonary involvement occurs in one-third of patients.

## Cryoglobulinemia

Essential cryoglobulinemic vasculitis is a vasculitis with cryoglobulin immune deposits. Cryoglobulins are immunoglobulins (Igs) that form a precipitate in cooled serum. They were first described by Wintrobe and Buell in 1933 ([124](#)). The cryoglobulins can precipitate in dermal vessels and result in leukocytoclastic vasculitis ([125](#)) and palpable purpura. When the cryocrit is significantly elevated (e.g., in lymphoproliferative diseases), hyaline thrombi can form and result in vasculopathy without associated vasculitis ([125](#)). Clinically, patients develop crops of purpuric macules, papules, and patches most prominently over the lower extremities that are occasionally associated with burning or pruritus. Cutaneous infarcts and petechiae are also occasionally present. Only rarely are these symptoms precipitated by exposure to cold; more commonly, prolonged standing or exercise is the inciting event. Systemic manifestations of cryoglobulinemia include arthralgias, asthenia, neuropathy, and renal disease ([125](#)).

Cryoglobulinemia can be divided into three types depending on the clonality of the precipitated Ig ([126](#)). Type I cryoglobulinemia is present when the cryoglobulin is monoclonal, and it is often associated with lymphoproliferative disease. Type II cryoglobulins are both polyclonal and monoclonal, and type III is polyclonal only. Types II and III are usually associated with autoimmune or inflammatory disease.

Essential cryoglobulinemia is diagnosed when no underlying disease is identified. With the development of sensitive assays for the hepatitis C virus (HCV), it has become evident that 43 to 85% of cases previously diagnosed as essential mixed cryoglobulinemia are associated with chronic infection with HCV ([127](#), [128](#)). These patients have more

cutaneous involvement and higher cryocrits than patients with essential cryoglobulinemia who are HCV-negative. The HCV antigens are present in the serum as well as in the cryoprecipitate. Interferon is effective treatment for skin manifestations of HCV-related cryoglobulinemia ( [129](#) ), but the cryoglobulins invariably recur when HCV becomes detectable again after interferon therapy is discontinued. Combination therapy with interferon and ribavirin showed much better short- and long-term results, but treatment needs to be continued for 18 to 24 months ( [128](#) , [129](#) and [130](#) ). Other treatments that may be effective in acute settings include steroids, immunosuppression, and plasmapheresis. Chronic symptoms may be refractory to therapy. Cryoglobulinemia is further discussed in [Chapter 101](#).

## Hypergammaglobulinemic Purpura

*Hypergammaglobulinemic purpura* (HP) is a syndrome first described by Waldenström in 1943; this disorder is characterized by polyclonal hypergammaglobulinemia associated with recurrent attacks of palpable or nonpalpable purpura ( [131](#) ). The syndrome has a marked predilection for women. The onset is often in the third and fourth decades of life, but young children and octogenarians have also been reported to develop this syndrome ( [132](#) , [133](#) ). The attacks of purpura are often sudden in onset and sometimes occur after prolonged standing, exercise, dancing, wearing tight-fitting clothes (e.g., jeans), and alcohol ingestion ( [133](#) , [134](#) ). Some patients have premonitory symptoms such as stinging, itching, or mild pain before the development of purpura ( [134](#) ). The purpura typically involves the lower extremities and is palpable in approximately 75% of cases ( [135](#) ). Associated systemic symptoms include arthralgias (particularly adjacent to the purpura), low-grade fever, and lower extremity edema. The purpura usually resolves over 2 to 10 days. Recurrences are common but highly variable. Some patients have up to four attacks/week; others have only rare recurrences ( [135](#) ).

HP can be divided into primary and secondary forms. Primary HP occurs with no underlying disease process; secondary HP is identified when the typical symptoms of HP develop in patients with underlying diseases such as Sjögren syndrome, systemic lupus erythematosus, or other autoimmune, inflammatory, or neoplastic diseases ( [134](#) , [135](#) and [136](#) ). The purpuric lesions can occur years before ( [134](#) ) or after ( [135](#) ) the diagnosis of autoimmune disease.

The laboratory features of HP include hypergammaglobulinemia, elevated erythrocyte sedimentation rate, mild anemia, and mild leukopenia. Both primary and secondary HP have a high prevalence of positive rheumatoid factor (88 to 100%) ( [134](#) , [135](#) ). Anti-Ro antibodies are similarly elevated in both primary HP and HP associated with Sjögren syndrome ( [133](#) , [137](#) ) and in up to 100% of HP associated with systemic lupus ( [135](#) ). Histopathologically, the lesions show inflammation of the superficial dermal vessels with an early neutrophil infiltrate followed by a mononuclear cell infiltrate and varying degrees of leukocytoclasia. Skin biopsies are often positive under direct immunofluorescence for IgM and IgG. Circulating immune complexes have also been identified ( [132](#) , [133](#) , [135](#) ).

Treatment in the past has been described as unsatisfactory ( [134](#) ). However, a recent prospective, nonrandomized trial of 17 patients suggests that milder cases respond to indomethacin or hydroxychloroquine (200 mg twice daily) and more severe cases respond to prednisone at doses more than 20 mg/day ( [135](#) ). Plasmapheresis results in only temporary relief of symptoms ( [132](#) , [138](#) ).



A relative deficiency of IgG<sub>2</sub> has been reported in some patients despite the hypergammaglobulinemia. IgG subclass determination should be considered in HP patients with recurrent infections ( [139](#) ).

### Urticarial Vasculitis

Patients who present with purpura after resolution of urticaria may have urticarial vasculitis. Typically, the urticarial lesions burn, sting, or itch and last longer than 24 hours. Residual hyperpigmentation may be present after resolution of the skin lesions. The pathogenesis appears to be due to immune complexes that activate complement and lead to mast cell degranulation. Patients with normal complement levels usually have minimal, if any, systemic involvement, whereas patients with depressed complement levels may have more severe disease ( [140](#) ).

### Acute Infantile Hemorrhagic Edema

*Acute infantile hemorrhagic edema* is a leukocytoclastic vasculitis confined to the skin in infants 4 to 24 months of age. Patients present with the dramatic onset of ecchymotic purpura involving the limbs and face with inflammatory edema. Spontaneous and complete resolution occurs in 1 to 3 weeks. Pathology shows leukocytoclastic vasculitis. Perivascular IgA deposits are often identified, and some authors consider this disorder to be a variant of Henoch–Schönlein purpura (HSP) ( [141](#) , [142](#) and [143](#) ).

### Henoch–Schönlein Purpura

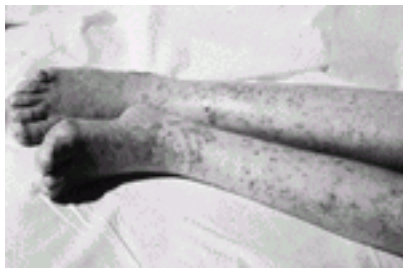
*HSP* is an acute vasculitic syndrome with features of colicky abdominal pain, nephritis, arthritis, and palpable purpura. The manifestations of the syndrome were initially described by Schönlein in 1837 and further developed by Henoch in 1874 ( [142](#) , [143](#) ). The disease occurs primarily in children, with a peak incidence occurring between 4 and 11 years of age. There appears to be a seasonal variation, with most reported cases occurring from fall to spring and a paucity of cases in the summer ( [142](#) , [144](#) ). Many of the cases occur after upper respiratory infections. Streptococcal infections are thought to be a common preceding event, but studies have not conclusively demonstrated this. Epidemiologic studies generally suggest that HSP occurs as sporadic cases, but clustering does occasionally occur. In 1987, a series of 20 cases occurred in Connecticut in a 5-month span and were found to be clustered in one ethnic group ( [145](#) ). This space-time clustering suggests a possible role for an infectious agent in precipitating the disease.

Biopsies of the superficial dermis and bowel in HSP show an acute vasculitis of precapillary arterioles and postcapillary venules. Immunofluorescent staining commonly shows IgA deposits in the walls of the arterioles of both the involved and noninvolved skin ( [146](#) ). Only the IgA1 subclass appears to be involved, and preliminary evidence suggests that aberrant glycosylation of IgA1 may be important in the pathogenesis. In patients with renal involvement, a proliferative and necrotizing vasculitis is described, and IgA deposits are found in the glomerular mesangium ( [147](#) ). Circulating immune complexes containing IgA are detected in approximately 70% of patients shortly after the onset of purpura, followed by the appearance of complement and IgA, IgM, and IgG immune complexes later in the disease course ( [148](#) ). IgG autoantibodies to a mesangial cell antigen have also been described and appear to correlate with the severity of hematuria ( [149](#) ).

The onset of symptoms is usually acute, with fever and palpable purpura involving the



extremities and buttocks ( [142](#), [143](#) ). The purpuric lesions appear in symmetric crops with a predilection for extensor surfaces of the extremities ( [Fig. 56.8](#) ). They are most abundant around the knees, ankles, and elbows ( [143](#) ). A transient oligoarticular arthritis involving the large joints occurs in approximately 40% of cases, and the pain is often out of proportion to the physical findings. Renal involvement is manifest as proteinuria or hematuria. The renal abnormalities are almost always transient in younger children, but up to 20 to 25% of older children and adults have progressive renal disease ( [142](#), [150](#) ). Poor prognostic factors for renal disease include nephrotic syndrome and greater than 50% glomerular crescent formation on renal biopsy ( [151](#) ).



**Figure 56.8.** Lower extremity palpable purpura in a patient with Henoch–Schönlein purpura. See [Color Plate](#). (From Van Hale HM, Gibson LE, Schroeter AL. Henoch–Schönlein vasculitis: direct immunofluorescence study of uninvolved skin. *J Am Acad Dermatol* 1986;15:665–670, with permission.)

Diffuse, crampy abdominal pain occurs in more than one-third of the cases and may occur before the characteristic purpura. The abdominal pain can be severe enough to mimic a surgical abdomen. Rare complications that require surgery do occur, however, and include intussusception, perforation, and bowel necrosis ( [152](#) ). Melena and testicular pain may also occur.

Criteria for the classification of HSP have been published ( [142](#) ). The presence of two of the following four criteria can usually accurately differentiate HSP from other forms of vasculitis: palpable purpura, age of onset 20 years or younger, acute abdominal pain, and biopsy showing granulocytes in the walls of arterioles or venules. The prognosis depends in part on the age at presentation. Children usually recover completely from HSP, but relapses may occur over a 3- to 6-week period before complete resolution of symptoms ( [142](#) ). Adults have more severe disease at presentation, with a worse renal prognosis. Mortality in one larger study with long follow-up was high (26%), but the leading cause of death was cancer ( [150](#) ).

Supportive care alone is used to treat mild cases. Steroids may be useful in GI vasculitis and in severe cases, but their effectiveness is controversial ( [153](#) ). In adults with HSP, steroids can relieve some of the signs and symptoms of the acute stage and may prevent progression of the renal disease in some cases ( [154](#) ).

## Serum Sickness

*Serum sickness* is a specific clinical syndrome with systemic features and immune complex-induced vasculitis. The clinical syndrome typically occurs 7 to 12 days after administration of heterologous serum. The features include fever, urticaria, palpable purpura or other rash, and lymphadenopathy ( [155](#) ). The purpura is caused by immune

complex deposition, and skin biopsies show a necrotizing angitis. Drugs such as cefaclor, penicillin, hydralazine, sulfonamides, and thiazide diuretics have been associated with serum sicknesslike reactions ( [156](#) ).

## PURPURA ASSOCIATED WITH INFECTION

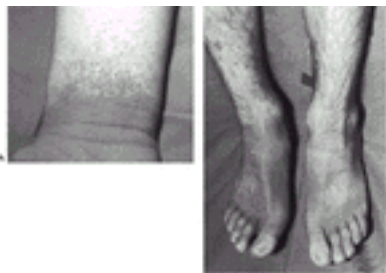
Infectious agents can cause petechiae, purpura, and diffuse bleeding manifestations through a variety of mechanisms including disseminated intravascular coagulation, vasculitis, septic emboli, vascular toxins, and direct vascular or endothelial invasion ( [157](#) ). Certain clinical syndromes in the latter two categories are considered here.

### Acute Febrile Illness with Petechiae

Acute febrile illnesses in children are often associated with petechiae and immediately raise the concern for possible meningococemia. Although a florid meningococcal infection may be instantly recognizable, children who present with small skin hemorrhages and fever, but who are not acutely ill, can be a diagnostic challenge. Petechiae that are present only above the nipple line in the distribution of the superior vena cava are often due to the coughing or vomiting that accompanies the acute infection. Bacterial agents such as streptococcal infections, pneumococcus, and *Haemophilus influenzae* may cause fever and petechiae. Viral illnesses due to enterovirus and adenovirus are well-known causes of fever and petechiae as well. To help clinicians distinguish between the agents responsible (and to avoid missing an early meningococcal infection), algorithms have recently been developed ( [158](#), [159](#), and [160](#) ). Certain febrile illnesses such as rickettsial infections and parvovirus B19 infections have well-described syndromes that are discussed below.

### Papular–Purpuric Gloves and Socks Syndrome

Patients with sharply demarcated purpura involving the hands and feet may have a newly described syndrome known as *papular–purpuric “gloves and socks” syndrome* as shown in [Figure 56.9](#). This syndrome was initially described in 1990 ( [161](#) ) and has been confirmed in several other reports ( [162](#), [163](#) and [164](#) ). Patients are usually adolescents or young adults that present in the spring or summer with pruritic edema and erythema of the hands and feet. Petechiae and confluent purpura follow, with a relatively sharp demarcation at the wrists and ankles. Oral mucosal involvement is common, and patients may have other systemic signs or symptoms including lymphadenopathy, fever, elevated liver function studies, and cytopenias. The syndrome is usually associated with parvovirus B19, but cytomegalovirus, hepatitis B, measles, rubella, and human herpesvirus 6 have also been implicated. Immunohistochemical and virology studies show invasion of the endothelial cells and epidermal cells by the parvovirus ( [165](#) ).



**Figure 56.9.** Skin lesions of hands and feet associated with papular–purpuric gloves (A)

and socks syndrome (B). See [Color Plate](#). (From Harms M, Feldmann R, Saurat J-H. Papular-purpuric “gloves and socks” syndrome. *J Am Acad Dermatol* 1990;23:850–854, with permission.)

## Rickettsial Diseases

Rickettsiae are small gram-negative obligate intracellular bacteria that reside free in the cytosol of infected endothelial cells. Infection results in damage to the endothelial cell with a characteristic multifocal lymphohistiocytic immune response causing increased vascular permeability, decreased perfusion, and activation of coagulation.

Rocky Mountain spotted fever is transmitted by the bite of ixodid ticks and, therefore, has a peak incidence in the United States in May, June, and July. The incubation period is 2 to 14 days (mean, 7 days), and symptoms usually include the sudden onset of fever, chills, headache, and myalgia. A pink macular rash develops on the wrists, hands, and ankles and spreads to cover most of the body. After 2 to 7 days, the lesions become petechial, and hemorrhagic areas may coalesce to form large areas of ecchymosis. The major complications are a result of vascular injury, and multiple organs may become involved. Diagnosis is based on serologic studies showing a rise in antibody titers or biopsy of the skin lesions with immunofluorescent identification of the organisms. Treatment is with a tetracycline or chloramphenicol.

Other rickettsial diseases such as Mediterranean spotted fever, Asian tick typhus, and Queensland tick typhus are generally milder and have an eschar (tache noire) at the site of the primary tick bite. The treatment is the same as for Rocky Mountain spotted fever ([166](#)).

## Brazilian Purpuric Fever

*Brazilian purpuric fever* is a disease of pediatric patients and usually begins with purulent conjunctivitis followed 7 to 16 days later by acute onset of fever, bacteremia, petechiae, purpura, and vascular collapse. The etiologic agent is *H. influenzae* biogroup aegyptius. The purpuric tendency appears to be due to direct invasion of endothelial cells with subsequent vascular damage ([167](#)).

## Rat Bite Fever

*Rat bite fever* is an acute illness caused by rodent bite or exposure, due to organisms that are part of the normal oral flora. Most cases are due to *Streptobacillus moniliformis*, but others are due to *Spirilla minus*. The onset of symptoms is usually within 1 week of the bite but can occur several weeks after the wound has healed. Initial symptoms include headache, fever, chills, malaise, and cough and are followed by morbilliform or petechial rash often involving the palms and soles. Migratory polyarthritides develops in 50% of patients with the *Streptobacillus* type. Treatment is with procaine penicillin, tetracycline, or streptomycin ([168](#)).

## Strongyloides

Disseminated strongyloidiasis occurs in immunocompromised hosts, especially in patients in the southeast United States taking corticosteroids. The infective larvae may molt at a rapid rate, and hyperinfection can occur. Periumbilical and diffuse purpura have been described, and biopsy of the skin lesions frequently reveals the larvae ([169](#)). Other

bleeding manifestations include alveolar hemorrhage.

### Hemorrhagic Fever Viruses

The *hemorrhagic fever viruses* are a diverse group of small RNA viruses with a lipid envelope. The clinical presentations vary, but symptoms usually begin with fever, headache, and myalgias progressing to generalized malaise. These symptoms last 3 to 4 days and are followed by petechiae, mucosal bleeding, and GI tract hemorrhage. The pathophysiology for most of the hemorrhagic fever viruses is not well defined. However, infection of the endothelium may be common to all (170). Some of the viruses have almost no cytopathologic effect, whereas others are highly destructive to the endothelial cells. Varying degrees of thrombocytopenia and disseminated intravascular coagulation are present and contribute to the bleeding diathesis (Table 56.2).

**TABLE 56.2. Hemorrhagic Fever Viruses**

| Viral HF                      | Cytopathic Effect | Endothelial Cell Infection | Cytokine Activation | Disseminated Intravascular Coagulation |
|-------------------------------|-------------------|----------------------------|---------------------|--|
| South American HF             | ±                 | ++                         | ++++                | No                                     |
| Lassa fever                   | ±                 | ++                         | +++                 | No                                     |
| Rift Valley fever             | ++++              | ?                          | ?                   | Yes                                    |
| Crimean Congo HF              | +                 | +                          | ?                   | Yes                                    |
| Hantavirus pulmonary syndrome | 0                 | ++++                       | ++++                | No                                     |
| Filovirus HF                  | +++               | +++                        | +++                 | Yes                                    |
| Yellow fever                  | ++                | ?                          | ?                   | No                                     |

HF, hemorrhagic fever; 0, no effect; ±, negligible effect; + through +++++, minimal to major effect.

The major etiologic agents and the distinctive clinical features are outlined in Table 56.3 (171). A high index of suspicion is required to diagnose hemorrhagic fever virus. Risk factors for naturally occurring cases include foreign travel, handling of animal carcasses, contact with sick animals or people, and arthropod bites within 21 days of the onset of symptoms. Lack of identifiable risk factors should raise the suspicion of a bioterrorist attack.

**TABLE 56.3. Clinical Syndromes of Some Viral Hemorrhagic Fevers**

| Virus   | Clinical Syndrome             | Person-to-Person Transmission | Mortality (%) |
|---------|-------------------------------|-------------------------------|---------------|
| Ebola   | Fever, prostration, rash, DIC | Yes                           | 50–90         |
| Marburg | Fever, myalgias, rash, DIC    | Yes                           | 23–70         |

|                   |  |     |       |
|-------------------|--|-----|-------|
| Lassa fever       | Fever, nausea, abdominal pain, pharyngitis, oral ulcers, cervical adenopathy, head and neck swelling | Yes | 15–20 |
| Rift Valley fever | Fever, headache, photophobia, jaundice   | No  | <1    |
| Yellow fever      | Fever, myalgia, facial flushing; late symptoms: fever, jaundice, renal failure, bleeding             | No  | 20    |

DIC, disseminated intravascular coagulation.

Adapted from Borio L, Inglesby T, Peters CJ, et al. Hemorrhagic fever viruses as biological weapons. *Medical and public health management*. JAMA 2002;287:2391–2405.

Rapid diagnosis is currently available only by sending clinical specimens to the Centers for Disease Control and Prevention or the U.S. Army Medical Research Institute of Infectious Disease in Frederick, Maryland. Suspected cases should be reported immediately to the health department. Protective measures from nosocomial spread should be followed. A consensus conference recommends the use of IV ribavirin in unknown cases, but this has not been approved by the U.S. Food and Drug Administration, and the clinician should check for the latest recommendations from the Centers for Disease Control and Prevention.

## PURPURA ASSOCIATED WITH VASCULAR OBSTRUCTION

Although oversimplified, it is often convenient to think of some disorders as causing purpura by intravascular obstruction with subsequent hemorrhage due to hemorrhagic necrosis, vasculitic injury, or consumptive coagulopathy. [Table 56.4](#) lists disorders that can be grouped together as causing decreased blood flow with some tendency to bleed. Note that cold agglutinins are not included given the fact that necrosis and bleeding are not expected complications. Most of these conditions are discussed in [Chapter 34](#).

**TABLE 56.4. Classification of Bleeding Disorders Associated with Vascular Obstruction**

| Vascular Obstruction Component | Disease Examples   |
|--------------------------------|--|
| Thrombus                       | Warfarin-induced skin necrosis, disseminated intravascular coagulation |
| Emboli                         |  |
| Thromboemboli                  | Atrial fibrillation  |
| Septic emboli                  | Endocarditis   |
| Marantic emboli                | Sterile endocarditis   |
| Cholesterol emboli             | Invasive vascular procedures, warfarin blue toe syndrome               |
| Immunoglobulins                | Waldenström macroglobulinemia, myeloma                                 |
| Plasma proteins                | Cryoglobulinemia   |
| Fibrin                         | Cryofibrinogenemia   |
| Red cells                      | Polycythemia   |
| Platelets                      | Thrombocytosis, heparin-induced skin necrosis                          |
| Fat                            | Fat emboli syndrome  |

## Cryofibrinogenemia

*Cryofibrinogens* are cold-precipitable plasma proteins that dissolve when plasma is rewarmed. These proteins are distinct from cryoglobulins, which precipitate on cooling of serum. Approximately 3% of hospitalized patients have detectable cryofibrinogens when appropriate assays are used ( [172](#) ). Cryofibrinogens can be associated with underlying malignancies or inflammatory processes or be present as an isolated finding (essential cryofibrinogenemia). A familial form has been described as well ( [173](#) ). When analyzed, the cryoprecipitate contains fibrinogen, fibrin, fibronectin, and other plasma proteins ( [174](#) ).

Although patients with cryofibrinogenemia are often asymptomatic, they may present with symptoms of cold intolerance, cutaneous purpura, gangrene, or Raynaud phenomenon ( [175](#) ). Most patients have an elevated total fibrinogen level ( [172](#) ). The pathogenesis of the cutaneous lesions is believed to be the result of fibrin thrombi obstructing the small dermal vessels ( [175](#) ). Biopsies of these lesions show eosinophilic thrombi with a sparse lymphocytic infiltrate ( [176](#) ). Leukocytoclasia has been described in a few patients ( [177](#) ).

To measure cryofibrinogens, blood should be anticoagulated with ethylenediaminetetraacetic acid, citrate, or oxalate. Heparin can result in false-positive results ( [178](#) ). The sample should be maintained at 37° C until centrifuged, and the separated plasma should be chilled to 4° C for 72 hours. The cryocrit is expressed as a percentage of the plasma sample volume ( [178](#) ).

Cryofibrinogenemia may be asymptomatic and require no treatment. Mild cases can be treated with avoidance of cold. Patients with more severe symptoms have been treated with heparin, warfarin, fibrinolytic agents, and plasmapheresis with variable results.

Immunosuppressive agents have been reported to be effective as well ( [176](#) ). A small clinical trial suggested that stanozolol, an androgenic steroid with fibrinolytic activity, produced excellent results ( [175](#) , [179](#) ).

## Cholesterol Embolization Syndrome

*Cholesterol embolization syndrome* is an increasingly recognized disorder caused by dislodging cholesterol crystals from atherosclerotic plaques. This occurs after vascular procedures or can be due to warfarin (blue toe syndrome) and results in renal insufficiency, peripheral emboli, and, possibly, GI or central nervous system involvement. Livedo reticularis is the most common skin finding and can best be appreciated with the patient in an upright position. Cyanosis, purpura, ulcers, and gangrene can all occur ( [180](#) ). The diagnosis can be made by biopsying the cutaneous lesions, including livedo reticularis ( [181](#) ). There is no specific treatment.

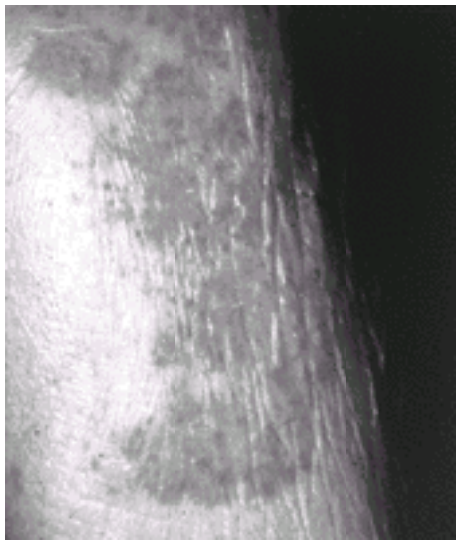
## PURPURA ASSOCIATED WITH SKIN DISEASES

### Pigmented Purpuric Dermatitis

Pigmented purpuric eruptions encompass a group of related skin diseases that have in common the clinical appearance of red-brown skin pigmentation (caused by hemosiderin deposits) associated with purpura or petechiae. These lesions tend to develop on the lower extremities of middle-aged people and are usually chronic. Histologically, there is a



mononuclear upper dermal infiltrate without evidence of leukocytoclasia. Extravasated red blood cells are present around the capillaries, and hemosiderin deposits are found in older lesions. Six skin diseases are commonly classified as pigmented purpura. In Schamberg progressive pigmentary dermatosis, the lesions appear as orange-brown patches of skin with “cayenne pepper spots” at the borders or within the lesion ( [Fig. 56.10](#)). Majocchi purpura annularis is distinguished by an annular 0.5- to 2.0-cm patch of reddish-brown macules. Eczematoid-like purpura has a seasonal pattern and appears as pinpoint lesions that spread rapidly over 2 to 4 weeks and develop a slight scale. The lesion in pigmented purpura lichenoid dermatitis (Gougerot-Blum purpura) is a reddish-brown macule with telangiectasias. These lesions tend to coalesce and form plaques. Itching purpura presents with an acute onset of pigmented macules associated with severe pruritus. Lastly, lichen aureus is described as “grouped copper-orange to purple lichenoid papules forming an irregular, usually singular, plaque” ( [182](#)). The etiology of pigmented purpura is unknown, but some degree of venous stasis is apparent in many patients and may be a factor in its development. The importance of these lesions is to differentiate them from other causes of chronic purpura with hemosiderin deposits such as purpura associated with abnormal proteins. The lesions may clear in up to two-thirds of patients with long-term follow-up ( [183](#)). Pigmented purpuric eruptions have been described in children ( [184](#)) ( [Fig. 56.11](#)). Treatment in the past has been with fluorinated steroids, but recently, psoralen plus ultraviolet light of A wave length has been found to be effective in some cases ( [185](#)).



**Figure 56.10.** Skin lesions associated with Schamberg progressive pigmentary dermatosis. Note the irregular patches of punctate hemorrhagic lesions with yellow-brown discoloration of hemosiderin deposits. See [Color Plate](#). (From Sherertz EF. Pigmented purpuric eruptions. *Semin Thromb Hemost* 1984;10:190-195, with permission.)





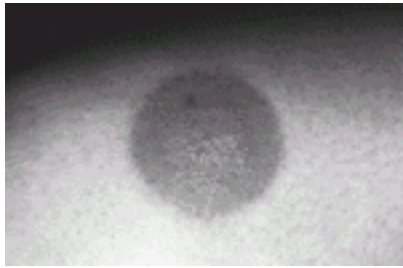
**Figure 56.11.** Pigmented purpura in a child. See [Color Plate](#). This photograph was kindly provided by Drs. Payem Tristani-Firouzi and Sheryll Vanderhooft (Department of Dermatology, University of Utah Health Sciences Center).

### Purpuric Contact Dermatitis

Purpura can be a presenting sign of allergic contact dermatitis. Reported antigens include textile dyes and resins, benzoyl peroxide, epoxy resin, and agave sap ([186](#)).

### Drug Reactions

Drug reactions can cause a nonthrombocytopenic purpura by a number of different mechanisms, including leukocytoclastic vasculitis, serum sickness, and, occasionally, a pigmented purpura. These topics are discussed in the section [Vasculitis](#). A fixed drug reaction can occur, with an isolated purpuric-appearing lesion occurring in a location without preceding trauma ([Fig. 56.12](#)).



**Figure 56.12.** A fixed drug eruption lesion. This 30-year-old woman developed this thigh lesion after taking ibuprofen. See [Color Plate](#). This photograph was kindly provided by Dr. Pamela Nemzer (Department of Dermatology, University of Utah Health Sciences Center).

## PSYCHOGENIC PURPURA

### Autoerythrocyte Sensitization

*Autoerythrocyte sensitization* is a rare disorder characterized by recurrent spontaneous ecchymotic lesions in patients with otherwise normal hemostasis. The syndrome was first described in 1955 by Gardner and Diamond after their discovery that intra-dermal injections of autologous red blood cells reproduced the skin lesion ([187](#)). Since the original description, more than 200 cases have been described, with the largest series collected by Ratnoff ([188](#)).

The cutaneous lesions are usually preceded by localized symptoms, including pain and a burning or stinging sensation in the involved area. The area then becomes erythematous, raised, and warm, and within hours, ecchymoses occur in the inflamed area. The ecchymoses can range in size from 1 to 2 cm to extensive involvement of the trunk or an extremity. The erythema and swelling usually subside within 48 hours of the development of ecchymoses. The lesions can recur weeks to years later. The ecchymotic lesions are usually only one symptom among many. Patients commonly have systemic symptoms including headaches, paresthesias, syncopal episodes, abdominal pain, nausea, vomiting,

chest pain, dyspnea, dysuria, and arthralgia.

Autoerythrocyte sensitization typically affects adolescent to middle-aged females who have significant underlying emotional problems. Patients are commonly found to suffer from depression, anxiety, and inability to handle hostile feelings, as well as hysterical and masochistic character traits. They have often sustained significant physical and emotional trauma in the past, and up to two-thirds of the patients describe significant emotional stress present at the time the initial purpuric lesions develop.

The skin lesions can classically be reproduced in most patients with the intradermal injection of 0.1 ml autologous whole blood, packed red blood cells, or red cell stroma ( [Fig. 56.13](#)). However, this test has limited sensitivity, and some authorities recommend using clinical criteria to diagnose this disorder ( [189](#)).



**Figure 56.13.** Skin lesion of psychogenic purpura (autoerythrocyte sensitization) induced by administration of intradermal autologous blood. A saline control elicited no response. See [Color Plate](#). [From Berman DA, Roenigk HH, Green D. Autoerythrocyte sensitization syndrome (psychogenic purpura). *J Am Acad Dermatol* 1992;27:829–832, with permission.]

No specific therapy is of proven value in psychogenic purpura. Psychotherapy appears to be beneficial in some younger patients but is less effective in the older population.

### Autosensitivity to DNA

A similar syndrome of recurrent ecchymoses after a prodrome of localized itching was described in 1961 by Levin and Pinkus ( [190](#)). This patient developed the typical skin lesions described above after the intradermal injection of frozen and thawed buffy coat leukocytes or purified calf thymus DNA. There are few data concerning the emotional background of these patients. Since the initial description, a few other cases have been reported, but some of these also had a positive reaction to intradermal injection of blood or washed red cells ( [191](#), [192](#), [193](#), [194](#), and [195](#)). Chloroquine can induce remissions, and cyproheptadine was useful in one patient ( [191](#), [192](#), [193](#), [194](#), and [195](#)).

### Factitious Purpura

Self-inflicted ecchymoses can be difficult to diagnose. This disorder should be considered when there is a clear secondary gain present, when the lesions only occur in accessible areas, or when ecchymotic lesions assume unusual shapes. Circular, well-circumscribed lesions around the upper limbs and breasts may be a result of sucking of the skin.

### Religious Stigmata

Purpuric religious stigmata are bruises that allegedly occur spontaneously and resemble the wounds of the crucified body of Christ. The phenomenon usually occurs in women, and many have belonged to a religious order. The etiology is thought to be either a conversion reaction or self-induced ([188](#)).

## REFERENCES

1. Fitzpatrick TB, Bernhard JD. The structure of skin lesions and fundamentals of diagnosis. In: Fitzpatrick TB, Eisen AZ, Wolff K, et al., eds. *Dermatology in general medicine*, 4th ed. New York: McGraw-Hill, 1993:27-55.
2. Simpson K, Knight B. Types of injury and wounds. In: *Forensic medicine*. London: Edward Arnold, 1985:48-70.
3. Pedley CF, Bloomfield RL, Colflesh MJ, et al. Blood pressure monitor-induced petechiae and ecchymosis. *Am J Hypertens* 1994;7:1031-1032.
4. Stephenson T, Bialas Y. Estimation of the age of bruising. *Arch Dis Child* 1996;74:53-55.
5. Bohnert M, Baumgartner R, Pollak S. Spectrophotometric evaluation of the color of intra- and subcutaneous bruises. *Int J Legal Med* 2000;113:343-348.
6. Casas JG, Woscoff A. Calcaneal petechiae. *Arch Dermatol* 1977;109:571.
7. Allan SJR, Humphrey F, Buxton PK. Annular purpura and step aerobics. *Clin Exp Dermatol* 1994;19:418.
8. Leung AKC, Grant RM, Truscott R. Exercise-induced purpura. *J Sports Med Phys Fitness* 1990;30:329-330.
9. Forbes CD. Vascular and non-thrombocytopenic purpuras. In: Bloom A, ed. *Haemostasis and thrombosis*, 3rd ed. New York: Churchill Livingstone, 1994:1079.
10. Amgwerd MG. Acute venous stasis in the area of the head after bungee-jumping. A report of two cases. *Unfallchirurg* 1995;98:447-448.
11. Pierson JC, Suh PS. Powerlifter's purpura: A Valsalva-associated phenomenon. *Cutis* 2002;70:93-94.
12. Gough KR. Capillary resistance to suction in hypertension. *BMJ* 1962;1:21-24.
13. Fisher AA. Suction purpura: Part 1. "Sucker Daddy" or "Cyclops purpura." *Cutis* 1992;49:393-394.
14. Metzker A, Merlob P. Suction purpura. *Arch Dermatol* 1992;128:822-824.
15. Guthrie CM, Stanfey HA. Rectus sheath haematoma presenting with Cullen's sign and Grey-Turner's sign. *Scott Med J* 1996;41:54-55.
16. Ratzan RM, Donaldson MC, Foster JH. The blue scrotum sign of Bryant: a diagnostic clue to ruptured abdominal aortic aneurysm. *J Emerg Med* 1987;5:323-329.
17. Amoury RA, Barth GW, Hall RT, et al. Scrotal ecchymosis: sign of intraperitoneal hemorrhage in the newborn. *South Med J* 1982;75:1471-1475, 1478.
18. Herbella FA, Mudo M, Delminti C, et al. 'Raccoon eyes' (periorbital hematoma) as a sign of skull base fracture. *Injury* 2001;32:745-747.
19. Sutton HG. Epistaxis as an indication of impaired nutrition and of degeneration of the vascular system. *Med Mirror* 1864;1:786.
20. Rendu M. Epistaxis repetees chez un sujet porteur de petis angiomes cutanes et muquenx. *Bull Soc*

Med Hop Paris 1896;13:731–733.

21. Osler W. On a family form of recurring epistaxis associated with multiple telangiectasias of the skin and mucous membranes. *Bull Johns Hopkins Hosp* 1901;12:333–337.
22. Weber FP. Multiple hereditary developmental angiomas (telangiectases) of the skin and mucous membranes associated with recurring haemorrhages. *Lancet* 1907;2:160–162.
23. Guttmacher AE, McKinnon WC, Upton MD. Hereditary hemorrhagic telangiectasia: a disorder in search of the genetics community. *Am J Med Genet* 1994;52:252–253.
24. Plauchu H, deChadarevian JP, Bidean A, Robert JM. Age-related clinical profile of hereditary hemorrhagic telangiectasia in an epidemiologically recruited population. *Am J Med Genet* 1989;32:291–297.
25. Guttmacher AE, Marchuk DA, White RI. Hereditary hemorrhagic telangiectasia. *N Engl J Med* 1995;333:918–924.
26. McDonald MT, Paperberg K, Ghosh S, et al. Genetic linkage of hereditary haemorrhagic telangiectasia maps to chromosome 9q33–34. *Nat Genet* 1994;6:197–204.
27. Shovlin CL, Hughes JMB, Tuddenham EGD, et al. A gene for hereditary haemorrhagic telangiectasia maps to chromosome 9q3. *Nat Genet* 1994;6:205–209.
28. McAllister KA, Grogg KM, Johnson DW, et al. Endoglin, a TGF- $\beta$  binding protein of endothelial cells, is the gene for hereditary haemorrhagic telangiectasia type 1. *Nat Genet* 1994;8:345–351.
29. Johnson DW, Berg JN, Gallione CJ, et al. A second locus for hereditary hemorrhagic telangiectasia maps to chromosome 12. *Genome Res* 1995;5:21–28.
30. Johnson DW, Berg JN, Baldwin MA, et al. Mutations in the activin receptor-like kinase gene in hereditary haemorrhagic telangiectasia type 2. *Nat Genet* 1996;13:189–195.
31. Shovlin CL, Letarte M. Hereditary hemorrhagic telangiectasia and pulmonary arteriovenous malformations: issues in clinical management and review of pathogenic mechanisms. *Thorax* 1999;54:714–729.
32. Shovlin CL. Molecular defects in rare bleeding disorders: hereditary haemorrhagic telangiectasia. *Thromb Haemost* 1997;78:145–150.
33. Braverman IM, Keh A, Jacobsen BS. Ultrastructure and three-dimensional organization of the telangiectasias of hereditary hemorrhagic telangiectasia. *J Invest Dermatol* 1990;95:422–427.
34. Porteous MEM, Burn J, Proctor SJ. Hereditary haemorrhagic telangiectasia: a clinical analysis. *J Med Genet* 1992;29:527–530.
35. Reilly PJ, Nostrant TT. Clinical manifestations of hereditary hemorrhagic telangiectasia. *Am J Gastroenterol* 1984;79:363–367.
36. Peery WH. Clinical spectrum of hereditary hemorrhagic telangiectasia (Osler-Weber-Rendu disease). *Am J Med* 1987;82:989–997.
37. Kjeldsen AD, Oxhøj H, Andersen PE, et al. Prevalence of pulmonary arteriovenous malformations (PAVMS) and occurrence of neurologic symptoms in patients with hereditary hemorrhagic telangiectasia (HHT). *J Int Med* 2000;248:255–262.
38. Haitjema T, Westermann CJJ, Overtoom TTC. Hereditary hemorrhagic telangiectasia (Osler-Weber-Rendu disease): new insights in pathogenesis, complications and treatment. *Arch Intern Med* 1996;156:714–719.
39. McAllister K, Lennon F, Bowles-Biesecker B, et al. Genetic heterogeneity in hereditary hemorrhagic telangiectasia: possible correlation with clinical phenotype. *J Med Genet* 1994;31:927–932.
40. Heutink P, Haitjema T, Breedveld GJ, et al. Linkage of hereditary haemorrhagic telangiectasia to

chromosome 9q34 and evidence for locus heterogeneity. *J Med Genet* 1994;31:933–936.

41. Moussouttas M, Fayad P, Rosenblatt M, et al. Pulmonary arteriovenous malformations. Cerebral ischemia and neurologic manifestations. *Neurology* 2000;55:959–964.
42. Nanthakumar K, Graham AT, Robinson TI, et al. Contrast echocardiography for detection of pulmonary arteriovenous malformations. *Am Heart J* 2001;141:243–246.
43. Kjeldsen AD, Oxhøj H, Andersen PE, et al. Pulmonary arteriovenous malformations. Screening procedures and pulmonary angiography in patients with hereditary hemorrhagic telangiectasia (HHT). *Chest* 1999;116:432–439.
44. White RI, Jr. Pulmonary arteriovenous malformations: how do we diagnose them and why is it important to do so? *Radiology* 1992;182:633–636.
45. Remy J, Remy-Jardin M, Giraud F, Watinne L. Angioarchitecture of pulmonary arteriovenous malformations: clinical utility of three dimensional helical CT. *Radiology* 1994;191:657–664.
46. Bernard G, Mion F, Henry L, et al. Hepatic involvement in hereditary hemorrhagic telangiectasia: clinical, radiological and hemodynamic studies of 11 cases. *Gastroenterology* 1993;105:482–487.
47. Bourgeois N, Delcour C, Deviere J, et al. Osler–Weber–Rendu disease associated with hepatic involvement and high output heart failure. *J Clin Gastroenterol* 1990;12:236–238.
48. Ralls PW, Johnson MB, Radin DR, et al. Hereditary hemorrhagic telangiectasia: findings in the liver with color Doppler sonography. *AJR Am J Roentgenol* 1992;159:59–61.
49. Willemse RB, Johannes JM, Westerman CJJ, et al. Bleeding risk of cerebrovascular malformations in hereditary hemorrhagic telangiectasia (HHT). *J Neurosurg* 2000;92:779–784.
50. Matsubara S, Manzia JL, Brugge KT, et al. Angiographic and clinical characteristics of patients with cerebral arteriovenous malformations associated with hereditary hemorrhagic telangiectasia. *AJNR Am J Neuroradiol* 2000;21:1016–1020.
51. Maher CO, Piepgras DG, Brown RD, et al. Cerebrovascular manifestations in 321 cases of hereditary hemorrhagic telangiectasia. *Stroke* 2001;32:877–882.
52. Manzia J, Henderson K, Faughham M, et al. Compelling reasons to screen brain in HHT. *Stroke* 2001;32:2957–2958.
53. Rebeiz EE, Bryan DJ, Ehrlichman RJ, Shapshay SM. Surgical management of life-threatening epistaxis due to Osler–Weber–Rendu disease. *Ann Plast Surg* 1995;35:208–213.
54. Shah RK, Dhingra JK, Shapshay SM. Hereditary hemorrhagic telangiectasia: a review of 76 cases. *Laryngoscope* 2002;112:767–773.
55. Bergler W, Sadick H, Gotte K, et al. Topical estrogens combined with argon plasma coagulation in the management of epistaxis in hereditary hemorrhagic telangiectasia. *Ann Otol Rhinol Laryngol* 2002;111[3 Pt 1]:222–228.
56. Zohar Y, Sadov R, Shvili Y, et al. Surgical management of epistaxis in hereditary hemorrhagic telangiectasia. *Arch Otolaryngol Head Neck Surg* 1987;113:754–757.
57. Dutton JAE, Jackson JE, Hughes JMB, et al. Pulmonary arteriovenous malformations: results of treatment with coil embolization in 53 patients. *AJR Am J Roentgenol* 1995;165:1119–1125.
58. Lee DW, White RI, Eggin TK, et al. Embolotherapy of large pulmonary arteriovenous malformations: long-term results. *Ann Thorax Surg* 1997;64:930–940.
59. Mohler ER, Monahan B, Canty MD, Flockhart DA. Cerebral abscess associated with dental procedure in hereditary hemorrhagic telangiectasia. *Lancet* 1991;338:508–509.

60. Buchi KN. Vascular malformations of the gastrointestinal tract. *Surg Clin North Am* 1992;72:559–570.
61. Whiting JH, Morton KA, Datz FL, et al. Embolization of hepatic arteriovenous malformations using radiolabeled and non-radiolabeled polyvinyl alcohol sponge in a patient with hereditary hemorrhagic telangiectasia: case report. *J Nucl Med* 1992;33:260–262.
62. Whiting JH, Korzenik JR, Miller FJ, et al. Fatal outcome after embolotherapy for hepatic arteriovenous malformations of the liver in two patients with hereditary hemorrhagic telangiectasia. *JVIR* 2000;11:855–858.
63. Zentler-Munro P, Howard ER, Karani J, Williams R. Variceal haemorrhage in hereditary hemorrhagic telangiectasia. *Gut* 1989;30:1293–1297.
64. Bauer T, Britton P, Lomas D, et al. Liver transplantation for hepatic arteriovenous malformation in hereditary hemorrhagic telangiectasia. *J Hepatol* 1995;22:586–590.
65. Harrison DFN. Use of estrogen in treatment of familial hemorrhagic telangiectasia. *Laryngoscope* 1982;92:314–320.
66. Menefee MG, Flessa HC, Glueck HI, Hogg SP. Hereditary hemorrhagic telangiectasia. *Arch Otolaryngol* 1975;101:246–251.
67. Vase P. Estrogen treatment of hereditary hemorrhagic telangiectasia. A double-blind controlled clinical trial. *Acta Med Scand* 1981;209:393–396.
68. van Cutsem E, Rutgeerts P, Vantrappen G. Treatment of bleeding gastrointestinal malformations with oestrogen-progesterone. *Lancet* 1990;335:953–955.
69. Saba HI, Morelli GA, Logrono LA. Treatment of bleeding in hereditary hemorrhagic telangiectasia with aminocaproic acid. *N Engl J Med* 1994;330:1789–1790.
70. Korzenik JR, Topazian MD, White R. Treatment of bleeding in hereditary hemorrhagic telangiectasia with aminocaproic acid [Letter]. *N Engl J Med* 1994;331:1236.
71. Klepfish A, Berrebi A, Schattner A. Intranasal tranexamic acid treatment for severe epistaxis in hereditary hemorrhagic telangiectasia. *Arch Intern Med* 2001;161:767.
72. Oettgen P. Transcriptional regulation of vascular development. *Circ Res* 2001;89:380–383.
73. Kurz H. Physiology of angiogenesis. *J Neurooncol* 2000;50:17–35.
74. Barnes B, Cawley CM, Barrow DL. Intracerebral hemorrhage secondary to vascular lesions. *Neurosurg Clin North Am* 2002;13:289–297.
75. Zhu XL, Chan MSY, Poon WS. Spontaneous intracranial hemorrhage: which patients need diagnostic cerebral angiography? A prospective study of 206 cases and review of the literature. *Stroke* 1997;28:1406–1409.
76. Sharma R, Gorbien MJ. Angiodysplasia and lower gastrointestinal tract bleeding in elderly patients. *Arch Intern Med* 1995;155:807–812.
77. Seapa E, Jacob H, Lewkowicz S, et al. Initial experience of wireless-capsule endoscopy for evaluating occult gastrointestinal bleeding and suspected small bowel pathology. *Am J Gastroenterol* 2002;97:2776–2779.
78. Junquera F, Feu F, Papo M. A multicenter, randomized clinical trial of hormonal therapy in the prevention of rebleeding from gastrointestinal angio-dysplasia. *Gastroenterology* 2001;121:1073–1079.
79. Williams JT, Arrington J, Gruber HM. Purpura as the presenting sign of an internal disease. Multiple myeloma. *Arch Dermatol* 1993;129:775–776.
80. Chiu D, Shedden P, Bratina P, et al. Clinical features of moyamoya disease in the United States.

Stroke 1998;29:1347–1351.

81. Wilmer WA, Magro CM. Calciphylaxis: emerging concepts in prevention, diagnosis and treatment. *Semin Dial* 2002;15:172–186.

82. Yeowell HN, Pinnell SR. The Ehlers–Danlos syndromes. *Semin Dermatol* 1993;12:229–240.

83. Byers PH. Ehlers–Danlos syndrome: recent advances and current understanding of the clinical and genetic heterogeneity. *J Invest Dermatol* 1994;103:47S–52S.

84. Anstey A, Mayne K, Winter M, et al. Platelet and coagulation studies in Ehlers–Danlos syndrome. *Br J Dermatol* 1991;125:155–163.

85. Ainsworth SR, Aulicino PL. A survey of patients with Ehlers–Danlos syndrome. *Clin Orthop* 1993;286:250–256.

86. Nuss R, Manco–Johnson M. Hemostasis in Ehlers–Danlos syndrome: patient report and literature review. *Clin Ped* 1995;34:552–555.

87. De Paepe A. Ehlers–Danlos syndrome type IV. Clinical and molecular aspects and guidelines for diagnosis and management. *Dermatology* 1995;189[Suppl 2]:21–25.

88. Mattar SG, Kumar SG, Lumsden AB. Vascular complication in Ehlers–Danlos syndrome. *Am Surg* 1994;60:827–831.

89. Byers PH. Ehlers–Danlos syndrome type IV: a genetic disorder in many guises. *J Invest Dermatol* 1995;105:311–312.

90. Rochelson B, Caruso R, Davenport D, Kaelber A. The use of prophylactic desmopressin (DDAVP) in labor to prevent hemorrhage in a patient with Ehlers–Danlos syndrome. *NY State J Med* 1991;91:268–269.

91. Weinbaum PJ, Cassidy SB, Campbell WA, et al. Pregnancy management and successful outcome of Ehlers–Danlos syndrome type IV. *Am J Perinatol* 1987;4:134–137.

92. Attala A, Page I. Ehlers–Danlos syndrome type III in pregnancy. *Obstet Gynecol* 1988;71:508–509.

93. Francis MJO. Conference on osteogenesis imperfecta. *Int J Exp Pathol* 1994;75:A47–A56.

94. Lehmann HN. Hydroxylation of collagen type I: evidence that both lysyl and prolyl residues are over-hydroxylated in osteogenesis imperfecta. *Eur J Clin Invest* 1995;25:306–310.

95. Smith R. Osteogenesis imperfecta: from phenotype to genotype and back again. *Int J Exp Pathol* 1994;75:233–241.

96. Falvo KA, Root L, Bullough PG. Osteogenesis imperfecta: clinical evaluation and management. *J Bone Joint Surg Am* 1974;56:783–793.

97. Edge G, Okafor B, Fennelly ME. An unusual manifestation of bleeding diathesis in a patient with osteogenesis imperfecta. *Eur J Anaesth* 1997;14:215–219.

98. Morton MG. Excessive bleeding after surgery in osteogenesis imperfecta. *Br J Oral Maxillofacial Surg* 1987;25:507–511.

99. Kastrup M, von Heymann C, Hotz H, et al. Recombinant Factor VIIa after aortic valve replacement in a patient with osteogenesis imperfecta. *Ann Thorac Surg* 2002;74:910–912.

100. Keegan M, Whatcott BD, Harrison BA. Osteogenesis imperfecta, perioperative bleeding and desmopressin. *Anesthesiology* 2002;97(4):1011–1013.

101. Lebwohl M, Nelder K, Pope M, et al. Classification of pseudoxanthoma elasticum: report of a consensus conference. *J Am Acad Dermatol* 1994;30:103–107.

102. Struk B, Cai L, Zack S, et al. Mutations of the gene encoding the transmembrane transporter protein,



ABC-C6, cause pseudoxanthoma elasticum. *J Mol Med* 2000;78:282-286.

103. Le Saux O, Beck K, Sachsinger C, et al. A spectrum of ABCC6 mutations is responsible for pseudoxanthoma elasticum. *Am J Hum Genet* 2001;69:749-764.

104. Luft FC. Pseudoxanthoma elasticum revisited. *J Mol Med* 2000;78:237-238.

105. Christiano AM, Lebowitz MG, Boyd CD, Uitto J. Workshop on pseudoxanthoma elasticum: molecular biology and pathology of the elastic fibers. Jefferson Medical College, Philadelphia, Pennsylvania, June 10, 1992. *J Invest Dermatol* 1992;99:660-663.

106. McCreedy CA, Zimmerman TJ, Webster SF, et al. Management of upper gastrointestinal hemorrhage in patients with pseudoxanthoma elasticum. *Surgery* 1989;105:170-174.

107. Pope MF. Pseudoxanthoma elasticum. In: Lapiere CM, Krieg T, eds. *Connective tissue diseases of the skin*. New York: Marcel Dekker Inc, 1993:245-262.

108. Tsiouras P, Del Mastro R, Sarfarazi M, et al. Genetic linkage of the Marfan syndrome, ectopic lentis, and congenital contractural arachnodactyly to the fibrillin genes on chromosomes 5 and 15. *N Engl J Med* 1992;326:905-909.

109. Estes JW, Carey RJ, Desai RG. Marfan's syndrome: hematological abnormalities in a family. *Arch Intern Med* 1965;116:889-893.

110. Pyeritz RE, McKusick VA. The Marfan syndrome: diagnosis and management. *N Engl J Med* 1979;300:772-777.

111. Irons DW, Pollard KP. Post-partum haemorrhage secondary to Marfan's disease of the uterine vasculature. *Br J Obstet Gynecol* 1993;100:279-281.

112. Ghorbani AJ, Eichler C. Scurvy. *J Am Acad Dermatol* 1994;30:881-883.

113. Case records of the Massachusetts General Hospital. Weekly clinicopathological exercises. Case 39-1995. A 72-year-old man with exertional dyspnea, fatigue, and extensive ecchymoses and purpuric lesions (clinical conference). *N Engl J Med* 1995;333:1695-1702.

114. Reuler JB, Broudy JC, Cooney TG. Adult scurvy. *JAMA* 1985;253:805-807.

115. Levine M. New concepts in the biology and biochemistry of ascorbic acid. *N Engl J Med* 1986;314:892-902.

116. Schuster S, Scarborough H. Senile purpura. *Q J Med* 1961;30:33-40.

117. Wong HY. Hypothesis: senile purpura is a prognostic feature in elderly patients. *Age Ageing* 1988;6:422-424.

118. Shiozawa S, Tanaka T, Miyahara T, et al. Age related change in the reducible cross-linking of human skin and aorta collagens. *Gerontology* 1979;25:247-254.

119. Jennette JC, Falk RJ, Andrassy K, et al. Nomenclature of systemic vasculitides. Proposal of an international consensus conference. *Arthritis Rheum* 1994;37:187-192.

120. Koutkia P, Mylonakis E, Rounds S, et al. Leukocytoclastic vasculitis: an update for the clinician. *Scand J Rheumatol* 2001;30:315-322.

121. Soter NA. Cutaneous necrotizing vasculitis. In: Fitzpatrick TB, Eisen AZ, Wolff K, et al., eds. *Dermatology in general medicine*, 4th ed. New York: McGraw-Hill, 1993:1501-1510.

122. Lightfoot RW, Davis JS, Williams WJ. Palpable purpura: identifying the cause. *Hosp Pract* 1992;27(12):39-47.

123. Stevens GL, Adelman HM, Wallach PM. Palpable purpura: an algorithmic approach. *Am Fam Physician*

1995;52:1355–1362.

124. Wintrobe MM, Buell MV. Hyperproteinemia associated with multiple myeloma: with report of a case in which an extraordinary hyperproteinemia was associated with thrombosis of the retinal veins and symptoms suggesting Raynaud's disease. *Bull Johns Hopkins Hosp* 1933;52:156–165.

125. Cohen SJ, Pittelkow MR, Su WPD. Cutaneous manifestations of cryoglobulinemia: clinical and histopathologic study of seventy-two patients. *J Am Acad Dermatol* 1991;25:21–27.

126. Brouet JC, Clauvel JP, Danon F, et al. Biologic and clinical significance of cryoglobulins. A report of 86 cases. *Am J Med* 1974;57:775–788.

127. Cocoub P, Fabiani FL, Musset L, et al. Mixed cryoglobulinemia and hepatitis C virus. *Am J Med* 1994;96:124–132.

128. Cacoub P, Costedoat-Chalumeau N, Lidove O, et al. Cryoglobulinemic vasculitis. *Curr Opin Rheumatol* 2002;14:29–35.

129. Misiani R, Bellavita P, Fenili D, et al. Interferon alfa-2a therapy in cryoglobulinemia associated with hepatitis C virus. *N Engl J Med* 1994;330:751–756.

130. Della Rossa A, Tavoni A, Baldini C, et al. Treatment of chronic hepatitis C infection with cryoglobulinemia. *Curr Opin Rheumatol* 2002;13:231–237.

131. Waldenström J. Clinical methods for determination of hyperproteinemia and their practical value for diagnosis. *Nord Med* 1943;20:2228–2295.

132. Olmstead AD, Zone JJ, LaSalle BA, Krueger GG. Immune-complexes in the pathogenesis of hypergammaglobulinemic purpura. *J Am Acad Dermatol* 1980;3:174–179.

133. Ferreiro JE, Pasarin G, Quesada R, Gould E. Benign hypergammaglobulinemic purpura of Waldenström associated with Sjögren's syndrome. Case report and review of immunologic aspects. *Am J Med* 1986;81:734–740.

134. Kyle RA, Gleich GJ, Bayrd ED, Vaughan JH. Benign hypergammaglobulinemic purpura of Waldenström. *Medicine* 1971;50:113–123.

135. Senecal JL, Chartier S, Rothfield N. Hypergammaglobulinemic purpura in systemic autoimmune rheumatic diseases: predictive value of anti-Ro (SSA) and anti-La (SSB) antibodies and treatment with indomethacin and hydroxychloroquine. *J Rheumatol* 1995;22:868–875.

136. Oosterkamp HM, van der Pijl H, Derksen J, et al. Arthritis and hypergammaglobulinemic purpura in hypersensitivity pneumonitis. *Am J Med* 1996;100:478–479.

137. Alexander EL, Arnett FC, Provost TT, Stevens MB. Sjögren's syndrome: association of anti-Ro (SS-A) antibodies with vasculitis, hematologic abnormalities and serologic hyperactivity. *Ann Intern Med* 1983;98:155–159.

138. Hewitt P, Davies S, Cohen H, Machin S. Therapy of Waldenström's benign hypergammaglobulinemia by regular plasmapheresis. *Acta Haematol* 1984;71:345–349.

139. Al-Mayout SM, Ghoniaim A, Bahabri S. Hypergammaglobulinemic purpura associated with IgG subclass imbalance and recurrent infection. *Clin Rheumatol* 2000;19:499–501.

140. Venzor J, Lee WL, Huston PP. Urticarial vasculitis. *Clin Rev Allergy Immunol* 2002;23:201–216.

141. Caksen H, Odabas D, Kosen M, et al. Report of eight infants with acute infantile hemorrhagic edema and review of the literature. *J Dermatol* 2002;29:290–295.

142. Mills JA, Michel BA, Bloch DA, et al. The American College of Rheumatology 1990 criteria for the classification of Henoch-Schonlein purpura. *Arthritis Rheum* 1990;33:1114–1121.

143. Patrignelli R, Sheikh SH, Shaw-Stiffel TA. Henoch-Schönlein purpura. A multisystem disease also

seen in adults. *Postgrad Med* 1995;97(5):123–134.

144. Saulsbury FT. Epidemiology of Henoch–Schönlein purpura. *Cleve Clin J Med* 2002;69[Suppl II]:87–89.

145. Nielsen HE. Clusters or clustering of Henoch–Schönlein purpura [Letter]. *Am J Dis Child* 1990;144:620.

146. Van Hale HM, Gibson LE, Schroeter AL. Henoch–Schönlein vasculitis: direct immunofluorescence study of uninvolved skin. *J Am Acad Dermatol* 1986;15:665–670.

147. Levy M, Broyer M, Arsan A, et al. Anaphylactoid purpura nephritis in childhood: natural history and immunopathology. *Adv Nephrol Necker Hosp* 1976;6:183–228.

148. Kaufmann RH, Herrmann WA, Meyer CJ, et al. Circulating IgA-immune complexes in Henoch–Schönlein purpura. A longitudinal study of their relationship to disease activity and vascular deposition of IgA. *Am J Med* 1980;69:859–866.

149. O'Donoghue DJ, Darvill A, Ballardie FW. Mesangial cell autoantigens in immunoglobulin A nephropathy and Henoch–Schönlein purpura. *J Clin Invest* 1991;88:1522–1530.

150. Pillebout E, Thervet E, Hill G, et al. Henoch–Schönlein purpura in adults: outcome and prognostic factors. *J Am Soc Nephrol* 2002;13:1271–1278.

151. Counahan R, Winterborn MH, White RHR, et al. Prognosis of Henoch–Schönlein nephritis in children. *BMJ* 1977;2:11–14.

152. Katz S, Borst M, Seekri I, Grosfeld JL. Surgical evaluation of Henoch–Schönlein purpura: experience with 110 children. *Arch Surg* 1991;126:849–854.

153. Cassidy JT. Systemic lupus erythematosus, juvenile dermatomyositis, scleroderma and vasculitis. In: Kelly WN, Harris ED, Ruddy S, Sledge CB, eds. *Textbook of rheumatology*, 4th ed. Philadelphia: WB Saunders, 1993:1224–1247.

154. Roth DA, Wilz DR, Theil GB. Schönlein–Henoch syndrome in adults. *Q J Med* 1985;55:145–152.

155. Gigli I, Rosen FS. Angioedema associated with complement abnormalities. In: Fitzpatrick TB, Eisen AZ, Wolff K, et al., eds. *Dermatology in general medicine*, 4th ed. New York: McGraw–Hill, 1993:1494–1500.

156. Reynolds RD. Cefaclor and serum sickness–like reactions. *JAMA* 1996;276:950.

157. Kingston ME, Mackey D. Skin clues in the diagnosis of life–threatening infections. *Rev Infect Dis* 1986;8:1–11.

158. Brogan PA, Raffles A. The management of fever and petechiae: making sense of rash decisions. *Arch Dis Child* 2000;83:506–507.

159. Nielsen HE, Andersen EA, Anderson J, et al. Diagnostic assessment of haemorrhagic rash and fever. *Arch Dis Child* 2001;85:160–165.

160. Nelson DG, Leake J, Bradley J, et al. Evaluation of febrile children with petechial rashes: is there a consensus among pediatricians? *Pediatr Infect Dis J* 1998;17:1135–1140.

161. Harms M, Feldmann R, Saurat JH. Papular–purpuric “gloves and socks” syndrome. *J Am Acad Dermatol* 1990;23:850–854.

162. Evans LM, Grossman ME, Gregory N. Koplik spots and a purpuric eruption associated with parvovirus B19 infection. *J Am Acad Dermatol* 1992;27:466–467.

163. Carrascosa JM, Bielsa I, Ribera M, Ferrandiz C. Papular–purpuric gloves and socks syndrome related to cytomegalovirus infection. *Dermatology* 1995; 191:269–270.

164. Guibal F, Buffet P, Mouly F, et al. Papular–purpuric gloves and socks syndrome with hepatitis B

infection. *Lancet* 1996;347:473.

165. Aractingi S, Bakhos D, Flageul B, et al. Immunohistochemical and virological study of skin in the papular-purpura gloves and socks syndrome. *Br J Dermatol* 1996;135:599-602.

166. Gentile GA, Lang JE. Tick-borne diseases. In: Auerbach PS, ed. *Wilderness medicine*, 4th ed. St. Louis: Mosby, 2001:769-806.

167. Brazilian purpuric fever—Mato Grosso, Brazil. *MMWR Morb Mortal Wkly Rep* 1990;39:903-905.

168. Ojukwu IC, Christy C. Rat-bite fever in children: case report and review. *Scand J Infect Dis* 2002;34:474-477.

169. Chaudhary K, Smith RJ, Himelright IM, et al. Case report: purpura in disseminated strongyloidiasis. *Am J Med Sci* 1994;308:186-191.

170. Peters CJ, Zaki SR. Role of endothelium in viral hemorrhagic fevers. *Crit Care Med* 2002;30[Suppl]:S268-S273.

171. Borio L, Inglesby T, Peters CJ. Hemorrhagic fever viruses as biologic weapons. Medical and public health management. *JAMA* 2002;287:2391-2405.

172. Smith SB, Arkin C. Cryofibrinogenemia: incidence, clinical correlations and a review of the literature. *Am J Clin Pathol* 1972;58:524-530.

173. van Geest AJ, von Dooren-Greebe RJ, Andriessen MP, et al. Familial primary cryofibrinogenemia. *J Eur Acad Dermatol Venereol* 1999;12:47-50.

174. Stathakis NE, Caramanolis D, Koukoulis G, Tsianos E. Characterization of cryofibrinogen isolated from patient's plasma. *Haemostasis* 1981;10:195-202.

175. Klein AD, Kerdel FA. Purpura and recurrent ulcers on the lower extremities. *Arch Dermatol* 1991;127:113.

176. Beightler E, Diven DG, Sanchez RL, Solomon AR. Thrombotic vasculopathy associated with cryofibrinogenemia. *J Am Acad Dermatol* 1991;24:342-345.

177. Jantunen E, Soppi E, Neittaanmaki H, Lahtinen R. Essential cryofibrinogenemia, leukocytoclastic vasculitis and chronic purpura. *J Intern Med* 1991;234:331-333.

178. Ireland TA, Werner DA, Rietschel RL, et al. Cutaneous lesions in cryofibrinogenemia. *J Pediatr* 1984;105:67-69.

179. Falanga V, Kirsner RS, Eaglstein WH, et al. Stanozolol in the treatment of leg ulcers due to cryofibrinogenemia. *Lancet* 1991;338:347-348.

180. Falanga V, Fine MJ, Kapora WN. The cutaneous manifestations of cholesterol crystal embolization. *Arch Dermatol* 1986;122:1194-1198.

181. Pennington M, Yeager J, Skelton H, et al. Cholesterol embolization syndrome: cutaneous histopathological feature and the variable onset of symptoms in patients with different risk factors. *Br J Dermatol* 2002;146:511-517.

182. Sherertz EF. Pigmented purpuric eruptions. *Semin Thromb Hemost* 1984;10:190-195.

183. Ratnam KV, Su WPD, Peters MS. Purpura simplex (inflammatory purpura without vasculitis): a clinicopathologic study of 174 cases. *J Am Acad Dermatol* 1991;25:642-647.

184. Tristani-Firouzi P, Meadows KP, Vanderhooft S. Pigmented purpuric eruptions of childhood: a series of cases and review of the literature. *Ped Dermatol* 2001;18:299-304.

185. Krizsa J, Hunyadi J, Dobozy A. PUVA treatment of pigmented purpuric lichenoid dermatitis

(Gougerot-Blum). *J Am Acad Dermatol* 1992;27:778-780.

186. Ricks MR, Vogel PS, Elston DM. Purpuric agave dermatitis. *J Am Acad Dermatol* 1999;40[2 Pt 2]:356-358.

187. Gardner FH, Diamond LK. Autoerythrocyte sensitization. A form of purpura producing painful bruises following autosensitization to red blood cells in certain women. *Blood* 1955;10:675-690.

188. Ratnoff OD. The psychogenic purpuras: a review of autoerythrocyte sensitization, autosensitivity to DNA, "hysterical" and factitial bleeding and the religious stigmata. *Semin Hematol* 1980;17:192-213.

189. Ratnoff OD. Psychogenic purpura (autoerythrocyte sensitization): an unsolved dilemma. *Am J Med* 1989;87[Suppl 3N]:16N-21N.

190. Levin MB, Pinkus H. Autosensitivity to deoxyribonucleic acid (DNA). Report of a case with inflammatory skin lesions controlled by chloroquine. *N Engl J Med* 1961;264:533-537.

191. Little AS, Bell HE. Painful subcutaneous hemorrhages of the extremities with unusual reaction to injected deoxyribonucleic acid. *Ann Intern Med* 1964;60:886-891.

192. Chandler D, Nalbandian RN. DNA autosensitivity. *Am J Med Sci* 1966;251:145-149.

193. Pinnas JL, Tan EM, Teplitz RL, Boyer JT. Autosensitization to DNA: evidence for an immunologic basis. *J Invest Dermatol* 1979;72:157-160.

194. Schwartz RS, Lewis FB, Dameshek W. Hemorrhagic cutaneous anaphylaxis due to autosensitization to deoxyribonucleic acid. *N Engl J Med* 1962;267:1105-1111.

195. Spiera H, Schwartz AL. Autoerythrocyte sensitization reproducible by both autologous red cells and heterologous DNA. *Mt Sinai J Med NY* 1970;37:108-111.

2004 Lippincott Williams & Wilkins  
John P. Greer, John Foerster, John N. Lukens  
George M. Rodgers, Frixos Paraskevas, Bertil Glader  
Wintrobe's Clinical Hematology

**ETIOLOGY**  
**HEREDITARY THROMBOCYTHEMIA**  
**ESSENTIAL THROMBOCYTHEMIA**

[Pathophysiology](#)  
[Clinical Picture](#)  
[Laboratory Findings](#)  
[Differential Diagnosis](#)  
[Treatment](#)

**REACTIVE THROMBOCYTOSIS**

[Pathophysiology](#)  
[Clinical Picture](#)  
[Laboratory Findings](#)  
[Treatment](#)

**REFERENCES**

*Thrombocytosis* is the presence of an abnormally high number of platelets in the circulating blood. It may result from the various physiologic stimuli and pathologic processes summarized in [Table 57.1](#). It is a common feature of the myeloproliferative syndromes, in which there is clonal hematopoiesis: essential thrombocythemia, polycythemia vera (see [Chapter 85](#)), chronic myelocytic leukemia (see [Chapter 84](#)), and myelofibrosis (see [Chapter 86](#)). Thrombocytosis may be a significant pathophysiologic feature in the production of hemorrhage or thrombosis in these disorders. An elevated platelet count also is commonly associated with various infections and inflammatory and neoplastic disorders. In these conditions, the increase in platelet numbers seldom produces symptoms but often is of considerable diagnostic significance.

**TABLE 57.1. Causes of Thrombocytosis**

|  |
|--|
| Physiologic  |
| Exercise, parturition, epinephrine   |
| Primary  |
| Myeloproliferative syndromes   |
| Essential thrombocythemia  |
| Polycythemia vera  |
| Chronic myelocytic leukemia  |
| Myelofibrosis  |
| Secondary  |
| Infectious diseases  |
| Inflammatory diseases  |
| Neoplasms  |
| Rapid blood regeneration after hemorrhage and in various hemolytic anemias |
| Rebound after recovery from thrombocytopenia                               |
| Asplenia (anatomic or functional)  |

## ETIOLOGY

Transitory thrombocytosis may result from the mobilization of extravascular platelet pools, as after epinephrine administration ( [1](#) ), childbirth, or vigorous exercise ( [2](#), [3](#) ). Chronic thrombocytosis can result from mobilization of the intrasplenic pool after splenectomy or in the presence of functional asplenia, as is seen in patients with sickle cell disease. There also are reports of benign familial thrombocytosis affecting multiple family members in several generations ( [4](#), [5](#) ). All other forms of thrombocytosis apparently are the result of accelerated platelet production, which may be autonomous, as in the clonal myeloproliferative disorders (MPDs), or the result of increased concentrations of one or more hematopoietic growth factors or inflammatory cytokines.

In primary thrombocytosis, platelet production is unresponsive to normal regulatory processes. Autonomous production of platelets has been likened to neoplastic proliferation of other hematopoietic cells. The factors leading to accelerated platelet production in reactive thrombocytosis are now being elucidated, and several pathophysiologic mechanisms may be responsible depending on the underlying disease. One mechanism, for which there are accumulating data, is the presence of increased concentrations of interleukin-6 (IL-6), one of the hematopoietic growth factors.

Most cases of thrombocytosis are reactive, and, when it is found to be a manifestation of a myeloproliferative disorder, only a small percentage of patients have essential thrombocytosis (ET). When 100 consecutive patients with platelet counts greater than 500,000/ $\mu$ l were reported in 1973 ( [6](#) ), 36% were found to have a malignancy (which was usually disseminated) and only 6% a myeloproliferative disorder (five patients had polycythemia vera, one patient had chronic myelocytic leukemia). Only 8% had an acute infection. In a more recent 1-year prospective study of sequential Saudi Arabian patients with platelet counts greater than 500,000/ $\mu$ l ( [7](#) ), 21% of 777 thrombocytosis cases were found to be caused by infection, 18% by tissue damage, 13% by chronic inflammation, and 19% by rebound after bleeding, iron deficiency, or cancer chemotherapy. Thrombocytosis occurring in patients with malignancy, splenectomy or myeloproliferative disorders accounted for less than 5% in each instance. In a study of sequential patients presenting with platelet counts above 1 million/ $\mu$ l, reactive thrombocytosis accounted for 82% of patients, myeloproliferative disorders accounted for 14%, and 4% were of uncertain etiology ( [8](#) ). Infection was the most common cause of reactive thrombocytosis (31%), with postsplenectomy (19%), malignancy (14%), and trauma (14%) being the next most common etiologies. Among the patients with myeloproliferative disorders, nearly half had chronic myelocytic leukemia (42%), 29% essential thrombocythemia, 13% polycythemia vera, 5% myelofibrosis, and 11% unclassified. In a brief report of 158 sequential patients described as "platelet millionaires," myeloproliferative disorders accounted for 18% ( [9](#) ).

## HEREDITARY THROMBOCYTHEMIA

There are at least 12 families reported with familial thrombocytosis affecting several generations. At presentation, they are difficult, if not impossible, to distinguish from other patients with thrombocytosis, and many of them have thrombohemorrhagic complications. All except one of these families demonstrate autosomal-dominant inheritance; in a Bedouin Arab family, there is presumed X-linked transmission ( [10](#) ).



Genetic studies performed in several families suggest that these cases are due to mutations involving the thrombopoietin gene on chromosome 3, which results in increased translation and production of thrombopoietin through loss of translational repression ( [11](#), [12](#), [13](#) and [14](#) ). These patients have both elevated platelet counts and elevated thrombopoietin levels. Other families have near normal thrombopoietin levels and normal thrombopoietin and *c-mpl* genes ( [15](#), [16](#) ).

## ESSENTIAL THROMBOCYTHEMIA

*Thrombocythemia* (primary, essential), first described by Epstein and Goedel in 1934, is characterized by abnormal proliferation of the megakaryocytes and belongs to the spectrum of myeloproliferative disorders discussed in [Chapter 84](#), [Chapter 85](#), and [Chapter 86](#) ( [17](#) ). The disease has been demonstrated to be a clonal disorder of a multipotent stem cell, a mechanism common to chronic myelocytic leukemia, polycythemia vera, and myelofibrosis ( [18](#) ). Its major clinical manifestations are bleeding and thromboembolic diathesis ( [19](#), [20](#), [21](#), [22](#), [23](#) and [24](#) ). The disorder is uncommon and is seen most commonly in people in middle and adult life, although series of younger patients ( [25](#), [26](#) ) and children have been reported ( [27](#), [28](#), [29](#) and [30](#) ). There are several reports of familial thrombocytosis. In some families, this occurs without other types of myeloproliferative disorders ( [5](#), [31](#), [32](#), [33](#), [34](#), [35](#), [36](#) and [37](#) ). In others, multiple generations are affected by various myeloproliferative disorders ( [29](#), [38](#) ).

### Pathophysiology

*Essential thrombocythemia* has been demonstrated by X-chromosome-linked polymorphisms to be a clonal disorder of a multipotent stem cell that gives rise to erythrocytic, granulocytic, or megakaryocytic series in the majority of patients studied. X-linked polymorphic markers and methods used include the protein glucose-6-phosphate dehydrogenase ( [39](#) ); DNA methylation of specific genes, such as the human androgen receptor (HUMARA) ( [40](#), [41](#), [42](#) and [43](#) ); and expression of RNA transcripts for polymorphic genes ( [44](#) ). In a 1994 study in which monoclonality was assessed by restriction fragment length polymorphisms of the X-chromosome phosphoglycerate kinase and hypoxanthine phosphoribosyltransferase, all 13 patients with thrombocythemia had monoclonal patterns of X-inactivation in the granulocyte fraction, with nonclonal patterns of X-inactivation in the T-lymphocyte fraction in 8 of the 13 patients and with monoclonal patterns in the remaining five ( [45](#) ). This suggests that, in some patients, the clonal proliferation involves a multipotent stem cell that gives rise to both lymphoid and myeloid lineages. These analyses of clonality are complicated by the observation that there is increased skewing of alleles in older normal women, and T cells are needed as a control. In addition, many studies are equivocal or demonstrate polyclonal hematopoiesis in patients who fulfill the diagnostic criteria for essential thrombocythemia as established by the Polycythemia Vera Study Group ( [41](#) ).

In early thrombokinetic studies, platelet production was demonstrated to be 2 to 15 times normal, and the decrease in megakaryocyte size normally resulting from an increase in circulating mass was not seen ( [46](#) ). There is spontaneous growth of megakaryocyte colonies from peripheral blood or bone marrow from patients with ET ( [47](#), [48](#), [49](#), [50](#), [51](#) and [52](#) ), even in serum-free culture systems ( [53](#), [54](#), [55](#) and [56](#) ). The colonies are increased in size, and endomitotic megakaryocyte development is abnormal with subnormal endoreduplication reported ( [57](#) ). The pathophysiology of autonomous growth of

megakaryocytes in essential thrombocythemia is still uncertain. The increased colony formation is not caused by increased megakaryocyte colony-stimulating activity in the plasma of patients with ET, and growth is not modified by addition of antibodies to IL-3, IL-6, or granulocyte-macrophage colony-stimulating factor (GM-CSF). Thrombopoietin levels in plasma and serum are normal or increased ( [58](#), [59](#), [60](#), [61](#), [62](#) and [63](#) ), and there is decreased expression of *c-mpl*, the thrombopoietin receptor on platelets and megakaryocytes ( [64](#), [65](#) and [66](#) ). No mutations in the *c-mpl* receptor DNA and no change in the activation state of the receptor have been found ( [56](#), [64](#), [65](#), [66](#) and [67](#) ).

Cytogenetic analysis demonstrates abnormalities in less than 25% of patients, and multiple abnormalities (i.e., no dominant patterns) have been found. Trisomy 8 was most common in one group of 12 patients ( [68](#) ). In a series of 33 patients in which criteria for diagnosis were rigidly performed, modal chromosome number was 46 in all except two elderly men who were missing Y chromosomes, and banding analysis of 50 metaphases in each patient failed to reveal any deletions or translocations ( [69](#) ). There is a preliminary report of p53 gene mutations in 3 of 51 patients with essential thrombocythemia in chronic or leukemic phase ( [70](#) ). None of this series of patients had ras oncogene mutations, unlike other BCR/ABL-negative chronic myeloproliferative disorders.

The mechanisms by which thrombocythemia produces either hemorrhage or thrombosis are not well defined. There are a number of reports of qualitative abnormalities of the platelets, but some of these findings are not found in enough patients to represent a major or universal mechanism, and many of them are also seen in platelets of patients with reactive thrombocytosis. There was a comprehensive review of reported abnormalities in 1984 ( [71](#) ). Abnormalities reported in the last decade include decreased aggregation with collagen, adenosine diphosphate, and epinephrine ( [72](#) ), hyperaggregation ( [72](#) ) or spontaneous aggregation, defects in the intracellular concentrations of adenine nucleotides ( [73](#) ) and serotonin, decreased intracellular platelet-derived growth factor ( [74](#) ) and  $\beta$ -thromboglobulin ( [75](#) ), increased thromboxane generation ( [76](#), [77](#) and [78](#) ), decreased prothrombinase expression ( [79](#) ), changes in the membrane glycoproteins ( [80](#) ), decreased platelet membrane sialylation ( [81](#) ), increased membrane thrombospondin and P-selectin ( [82](#), [83](#) ), and an abnormal proteolyzed form of thrombospondin ( [84](#) ) or an abnormal “flip-flop” mechanism of the membrane resulting in an increase in thrombin generation ( [85](#) ).

In addition to the platelet abnormalities described above, there are reports of decreased von Willebrand factor (vWF) activity and decreased high-molecular-weight vWF multimers in some patients with myeloproliferative disorders and, especially, essential thrombocythemia ( [86](#), [87](#), [88](#), [89](#), [90](#), [91](#) and [92](#) ). Factor VIII:C and vWF antigen concentrations are normal. The most significant changes have been seen in the patients with the highest platelet counts and correlate directly with both a prolonged bleeding time and hemorrhagic symptoms. Reduction of the platelet count is associated with normalization of the vWF parameters. Similar changes have also been reported in patients with reactive thrombocytosis postsplenectomy, suggesting that these changes are secondary to the increased number of platelets, not abnormalities in clonal populations of platelets ( [90](#) ). Normal amounts of vWF are released in ET patients in response to 1-deamino-8-D-arginine vasopressin, but the half-life of vWF activity is significantly reduced ( [93](#) ). These changes are also normalized after cytoreduction.

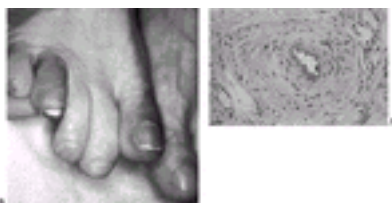
There are preliminary reports of reduced concentrations of antithrombin, protein C, and protein S in patients with ET, especially when comparing patients with a history of thrombosis with those who had not had thrombotic complications. These were not familial

deficiencies in patients in whom family studies were conducted, suggesting that the deficiencies were acquired, possibly secondary to low-grade activation of coagulation ( [94](#), [95](#) ).

## Clinical Picture

The earliest series of patients with essential thrombocythemia were published in the 1960s ( [96](#), [97](#) ). However, the diagnostic criteria were quite different from those being used in current studies; for example, in the Gunz report, patients had to have an extremely high platelet count and a history of hemorrhage to be included. Accurate information about the clinical picture is therefore best obtained from series of patients in which criteria for inclusion were better defined, although in these studies the platelet count required for inclusion varies from over 450,000/ $\mu$ l to over 700,000/ $\mu$ l ( [29](#), [98](#), [99](#) and [100](#) ). The average age of patients at diagnosis ranges from 50 to 60 years. In almost every series reported, female subjects outnumber male subjects. The majority of patients are symptomatic at the time of diagnosis. The most common presenting symptoms are caused by disturbances of the microcirculation, especially fingers and toes (erythromelalgia) ( [101](#), [102](#) ) and the central nervous system, in which headache, dizziness, and visual and acoustic symptoms are common ( [103](#), [104](#) ). A variable number of patients present with thrombotic (18 to 84%) or hemorrhagic problems (13 to 37%) ( [29](#), [98](#), [99](#) ). A smaller number of patients present with a combination of both.

Occlusion of the microcirculation, *erythromelalgia*, is characterized by warm, red, congested extremities and painful burning sensations, especially of the forefoot sole and one or more toes. It affects the lower extremities more than the upper extremities and may be asymmetric. The pain is initiated and aggravated by standing, exercise, or warmth and is relieved by elevation or cooling of the affected extremity ( [105](#) ). Erythromelalgia may lead to painful acrocyanosis and peripheral gangrene ( [106](#), [107](#), [108](#) and [109](#) ). Biopsies from these patients demonstrate arteriolar inflammation with vessel narrowing caused by proliferation of smooth muscle cells ( [Fig. 57.1](#) ) ( [108](#), [110](#), [111](#) ). Arterioles are often occluded by thrombi composed of platelet aggregates and platelet prostaglandins, and other secretion products are believed to be of primary importance in the development of these lesions ( [104](#) ). Patients have dramatic improvement in symptoms and platelet survival lasting several days and reversal of vascular changes after treatment with aspirin ( [108](#), [112](#), [113](#) and [114](#) ). Erythromelalgia has also been seen when thrombocytosis occurs in the other myeloproliferative disorders ( [115](#) ).



**Figure 57.1.** Patient with erythromelalgia secondary to essential thrombocythemia. **A:** There are painful, erythematous toes on both feet. **B:** Biopsy of affected region demonstrates smooth muscle cell hyperplasia of the arteriole ( $\times 430$ ; hematoxylin and eosin stain). See [Color Plate](#). (From Naldi L, Brevi A, d'Oro LC, et al. Painful distal erythema and thrombocytosis. *Arch Dermatol* 1993;129:105–106, 109, with permission.)

The clinical course is complicated in the majority of patients by hemorrhage and thrombosis ( [68](#), [116](#), [117](#) ). Thrombosis has been reported to be more common than hemorrhage, and arterial thrombi are more common than venous. The occurrence of thrombosis appears to be independent of either the platelet count or tests of hemostasis ( [118](#), [119](#) ). It is unclear whether arterial thrombi are more common in patients with cardiovascular risk factors, although the risk appears to be increased by smoking ( [120](#), [121](#) ). Some investigators believe that the frequency of hemorrhage increases with increasing platelet count, and many investigators have demonstrated that the incidence is greatest when the platelet count is greater than 1 million. However, others found no correlation between hemorrhage or thrombosis and platelet count ( [122](#) ).

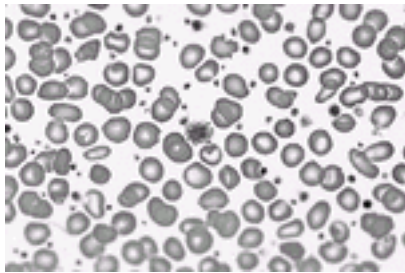
A recent cohort of patients who were younger than 60 years old, had a platelet count of less than 1.5 million/ $\mu$ l, and no prior history of hemorrhage or thrombosis had a very low incidence of thrombohemorrhagic complications ( [123](#) ). Therefore, some authors recommend only aspirin therapy, not chemotherapy, for younger patients ( [25](#), [122](#), [124](#) ) regardless of the platelet count. However, Mitus et al. reported a 39% incidence of hemorrhage or thrombosis in 44 patients younger than age 45 ( [125](#) ). Twenty-three of the complications were serious, and two patients died of thrombosis: An 18-year-old died a sudden cardiac death and was found to have a myocardial infarction at autopsy, and a 17-year-old died of cerebral sinus vein occlusion. In another recently reported series of young patients (younger than age 40), four of eight patients presented with life-threatening complications, including portal vein thrombosis and variceal hemorrhage, mesenteric vein thrombosis and small bowel infarction, femoral artery thrombosis requiring amputation, and, lastly, retinal artery occlusion and two episodes of deep vein thrombosis/pulmonary embolism ( [120](#) ). Finally, in a third series of patients between the ages of 22 and 35, 11 of 13 patients presented with thrombohemorrhagic symptoms, and two of these had acute myocardial infarctions and one a cerebrovascular accident ( [126](#) ). There is also evidence, in patients with essential thrombocythemia or other MPDs, that antiplatelet therapy increases the incidence of gastrointestinal bleeding ( [122](#), [127](#) ) and that such patients have a more pronounced prolongation of bleeding time than control group patients, 2 hours after a single intravenous infusion of aspirin ( [128](#) ).

Arterial thrombi occur in the cardiac, cerebral, or peripheral arteries ( [129](#), [130](#) ). Venous thrombosis has been reported in the deep venous system of the legs, the splanchnic-mesenteric system, and the cerebral venous sinuses. Gastrointestinal hemorrhage is most common, but skin and mucosal bleeding in other sites also occurs. Moderate splenomegaly has been reported in 20 to 50% of patients ( [29](#), [96](#), [98](#), [99](#) and [100](#), [131](#), [132](#) ); however, progressive enlargement is unusual. Hepatomegaly may be present, but lymphadenopathy is rare.

Investigators who calculated actuarial survival for 247 Spanish patients demonstrated that essential thrombocythemia is associated with a life expectancy close to normal ( [133](#) ). However, the relative risk of death was increased fourfold in a 1999 analysis of 187 consecutive Italian patients ( [134](#) ). A small number of patients undergo transformation to acute nonlymphocytic leukemia (French/American/British classification, M0-M7) or acute lymphocytic leukemia ( [135](#), [136](#), [137](#), [138](#), [139](#) and [140](#) ), but the majority of these patients have been treated with alkylating agents ( [29](#), [31](#), [98](#), [99](#), [141](#), [142](#), [143](#), [144](#) and [145](#) ).

## Laboratory Findings

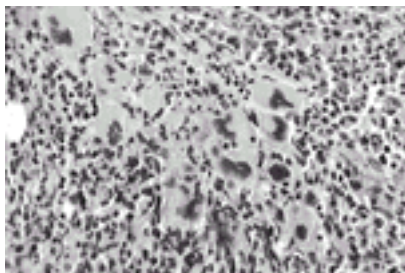
In most patients with thrombocythemia, the platelet count exceeds 1 million/ $\mu\text{l}$ , and counts as high as 14 million/ $\mu\text{l}$  have been recorded ([96](#)). Abnormalities of size, shape, and structure often are striking, and megakaryocyte fragments may be apparent in the blood ([Fig. 57.2](#)) ([29](#), [98](#)). Mild anemia may occur, but most patients have normal hemoglobin concentrations ([29](#), [98](#), [99](#)). Leukocytosis, usually less than 20,000/ $\mu\text{l}$ , is found in 35 to 72% of patients. White blood cell counts have been reported as high as 30,000/ $\mu\text{l}$ , although this is rare. The differential demonstrates neutrophilia, and a mild shift to the left may be seen. Slight eosinophilia and basophilia often are present ([29](#)). Leukocyte alkaline phosphatase may be increased in up to 40% of patients ([98](#)).



**Figure 57.2.** Peripheral blood smear from a patient with newly diagnosed essential thrombocytosis and a platelet count of 2 million/ $\mu\text{l}$ . A significant increase in platelets and one giant platelet can be seen in this field ( $\times 1000$ ; Wright–Giemsa stain). See [Color Plate](#).

The bleeding time is prolonged in very few patients, which is surprising considering the number of patients who have hemorrhagic symptoms at presentation or during their course. Other screening tests of hemostasis (prothrombin time, partial thromboplastin time) are usually normal. Serum uric acid and lactate dehydrogenase are elevated in up to 25% of patients. The presence of thrombocytosis produces pseudohyperkalemia as well as spurious increases in serum levels of acid phosphatase and inorganic phosphorus ([146](#), [147](#) and [148](#)).

The bone marrow reveals marked hyperplasia of the megakaryocytes, which often appear in clumps ([Fig. 57.3](#)). Bone marrow reticulin is increased in the majority of patients, but collagen is rarely seen. Hyperplasia of the granulocyte or erythrocyte precursors is a common finding. Cytogenetic studies are usually normal.



**Figure 57.3.** Bone marrow biopsy from the patient with newly diagnosed essential thrombocytosis and a platelet count of 2 million/ $\mu\text{l}$  presented in [Figure 57.2](#). Megakaryocytes are increased in number and present in clusters ( $\times 1000$ ; Wright–Giemsa stain). See [Color Plate](#).



## Differential Diagnosis

There have been many attempts to develop criteria for a positive diagnosis of essential thrombocythemia, but most often, it is still diagnosed by exclusion of other entities that may present with thrombocytosis ( 149 ). The most commonly used criteria are those established and then modified by the Polycythemia Vera Study Group ( 127 , 150 ) ( Table 57.2 ). These criteria were established to distinguish essential thrombocythemia from the other MPDs and from all of the many causes of reactive thrombocytosis. Some patients may be diagnosed with essential thrombocythemia at platelet counts less than 600,000/ $\mu$ l ( 151 , 152 ). In addition, some essential thrombocythemia patients may have the *BCR/ABL* gene rearrangement but no difference in prognosis or clinical course ( 153 , 154 and 155 ).

**TABLE 57.2. Polycythemia Vera Study Group Diagnostic Criteria for Essential Thrombocythemia**

---

|   |
|---|
| I. Platelet count >600,000/ $\mu$ l   |
| II. Hemoglobin =13 g/dl or normal red blood cell mass (males <36 ml/kg, females <32 ml/kg)  |
| III. Stainable iron in marrow or failure of iron trial (<1 g/dl rise in hemoglobin after 1 mo of iron therapy)  |
| IV. No Philadelphia chromosome (t9;22)  |
| V. Collagen fibrosis of marrow  |
| A. Absent or  |
| B. <1/3 biopsy area without both splenomegaly and leukoerythroblastic reaction  |
| VI. No known cause for reactive thrombocytosis  |
| From Murphy S, Iland H, Rosenthal D, Laszlo J. Essential thrombocythemia: an interim report from the Polycythemia Vera Study Group. <i>Semin Hematol</i> 1986;23:177–182. |

---

In a number of recent publications, investigators compare diagnostic tests in patients with thrombocytosis ( Table 57.3 ). Patients with thrombocytosis must first be diagnosed as having primary or reactive thrombocytosis, and then decisions about the type of MPD must be made. Spontaneous megakaryocyte and erythroid colony formation occurs in most of the bone marrows from patients with MPDs and, rarely, with the bone marrows of patients with reactive thrombocytosis, but this is neither discriminatory nor diagnostic ( 50 , 55 , 156 , 157 , 158 and 159 ). DNA analysis by X-linked DNA polymorphism in conjunction with methylation patterns can distinguish patients with clonal proliferation from those with reactive proliferation, but not all patients who are believed to have essential thrombocythemia demonstrate clonal hematopoiesis ( 160 ).

**TABLE 57.3. Clinical and Laboratory Features That Distinguish Essential Thrombocythemia from Reactive Thrombocytosis**

---

| Feature                  | Essential Thrombocythosis | Reactive Thrombocytosis |
|--------------------------|---------------------------|-------------------------|
| Thrombosis or hemorrhage | +                         | –                       |

---

|                                 |   |   |
|---------------------------------|---|---|
| Splenomegaly                    | + | - |
| Increased acute phase reactants | - | + |
| Interleukin-6                   |   |   |
| C-reactive protein              |   |   |
| Plasma fibrinogen               |   |   |
| BM reticulum fibrosis           | + | - |
| BM megakaryocyte clusters       | + | - |
| Clonal hematopoiesis            | + | - |
| Spontaneous colony formation    | + | - |
| Abnormal cytogenetics           | + | - |

BM, bone marrow.

Modified from Tefferi A, Hoagland HC. Issues in the diagnosis and management of essential thrombocythemia. *Mayo Clin Proc* 1994;69:651-655.

---

Majer et al. compared platelet size, aggregation and adhesion, dense granule and  $\alpha$ -granule components, plasma fibrinogen, and vWF and found considerable overlap between patients with MPDs and reactive thrombocytosis. The plasma fibrinogen was the best discriminator, with values greater than 500 mg/dl indicating reactive thrombocytosis ([161](#)). However, plasma fibrinogen failed to accurately predict thrombocytosis in four patients with iron deficiency in a retrospective survey of 31 patients with MPD and 26 patients with reactive thrombocytosis ([162](#)). Serum IL-6 concentrations were elevated in 86% of 143 patients with reactive thrombocytosis, but concentrations were elevated in none of the 13 patients with thrombocytosis and MPD ([163](#)). Tefferi et al. measured plasma IL-6 and C-reactive protein (CRP) levels in reactive versus clonal thrombocytosis and found that these tests were elevated in 60% of patients with reactive thrombocytosis ([164](#)). There was a correlation between IL-6 and CRP levels ( $R = 0.6$ ), so the CRP can be used as a surrogate measurement. Therefore, a normal IL-6 or CRP value is not discriminatory, but an elevated value suggests reactive thrombocytosis. Serum thrombopoietin levels are nondiscriminatory ([165](#), [166](#)).

Bone marrows from 47 patients with MPD and 16 patients with reactive thrombocytosis and platelet counts over 1 million/ $\mu$ l were analyzed by three independent pathologists who were blinded to diagnosis. They assessed bone marrow cellularity, iron and reticulin content, the number of megakaryocytes per square millimeter, and the presence of megakaryocyte clusters and concluded that the spectrum of bone marrow findings was indistinguishable among the MPDs and there was considerable overlap with reactive thrombocytosis ([167](#)). Megakaryocyte ploidy, by analysis of Feulgen-stained bone marrow aspirate smears and by two-color flow cytometry, was also assessed in patients with ET and reactive thrombocytosis and was not found to be discriminatory ([168](#), [169](#) and [170](#)). The presence of emperipolesis in paraffin sections of the bone marrow was also not discriminating ([171](#)).

A simple scoring system has been devised for distinguishing patients with MPD from patients with reactive thrombocytosis ([172](#)). Items to be scored include splenomegaly, endogenous erythroid production in culture, platelet nucleotide ratio, platelet distribution width, and the presence or absence of clinical ischemia. Although this scoring system did predict primary thrombocythemia, it has not been confirmed and is not easily translated into clinical practice.



## Treatment

Treatment of patients with ET remains controversial, although many physicians have long favored treatment of all symptomatic patients or patients who have platelet counts above 1 million/ $\mu\text{l}$  or 1.5 million/ $\mu\text{l}$ . Earliest treatment modalities included radioactive phosphorus ( $^{32}\text{P}$ ) ( [173](#), [174](#) ) or alkylating agents (i.e., melphalan and busulfan) ( [173](#) ), but both of these therapies appear to increase the transition rate to acute leukemia, myelodysplastic syndrome, and secondary malignancies. Current investigation continues to be directed toward finding the least leukemogenic therapy, especially for young patients who require long-term therapy.

**ANTIPLATELET AGENTS** Aspirin is effective at reducing symptoms and signs of microvascular occlusion in essential thrombocythemia and should be considered the treatment of choice for these lesions. A single dose of aspirin relieves symptoms of erythromelalgia for 2 to 3 days in the majority of patients ( [108](#), [115](#) ). Daily aspirin therapy also abolishes cerebral microvascular symptoms, although aspirin may prolong the bleeding time more in ET patients than in healthy controls ( [104](#), [175](#) ).

**HYDROXYUREA** There is now extensive experience using hydroxyurea, a ribonucleotide reductase inhibitor, for treatment of ET and the other MPDs ( [176](#) ). When this drug was introduced, it was not believed to be leukemogenic. Recent studies demonstrate that the incidence of acute leukemia is less than 5%, and cytogenetic changes in chromosome 17 can be detected ( [177](#), [178](#) ). The incidence increases in patients treated with hydroxyurea in combination with other alkylating agents ( [135](#), [177](#), [178](#) and [179](#) ). Hydroxyurea (at doses of 15 to 30 mg/kg/day) has a rapid onset of action, with control of thrombocytosis achieved in most patients between 2 and 6 weeks ( [127](#) ). Patients who are symptomatic and require emergent care should simultaneously begin daily plateletpheresis. In combination with hydroxyurea at a dose of 1.5 to 3.0 g/day, plateletpheresis can lower platelet counts to 500,000/ $\mu\text{l}$  or less in several daily treatments ( [180](#) ). Dose-related, rapidly reversible leukopenia is the major side effect of hydroxyurea, so close monitoring of the blood count is recommended. Patients also develop chronic macrocytosis, with mean corpuscular volume typically in the range of 100 to 120  $\mu\text{m}^3$ , and hydroxyurea-induced dermatologic manifestations ( [181](#), [182](#) ). Bone marrow myelofibrosis has been reduced during treatment with hydroxyurea in patients with essential thrombocythemia and other MPDs ( [183](#) ). Hydroxyurea was the drug used in the only published prospective trial in which patients with ET were either treated or observed to determine the benefit of therapy ( [184](#) ). Patients who were older than 60 years of age, or had a previous thrombosis, or both, and had a platelet count between 600,000 and 1,500,000/ $\mu\text{l}$  were randomized between observation and treatment, and the rates of thrombosis and hemorrhage were compared. There was a significant difference in thrombotic episodes between the groups; the treated group had one cerebral and one cardiac occlusive episode, and the untreated patients had 14 episodes: 1 cerebral occlusive episode, 5 transient ischemic attacks, 5 episodes of digital microvascular ischemia, 2 episodes of superficial phlebitis, and 1 episode of iliofemoral venous thrombosis. The authors recently extended their period of observation of these patients to a median of 6 years. It is important that none of the 20 patients who remained untreated developed a secondary malignancy compared to 3.9% in the hydroxyurea-alone group and 33.0% of the hydroxyurea-plus-busulfan group ( [178](#) ). Although this is a landmark prospective randomized study of treatment versus no treatment, these results must be examined carefully before all patients with thrombocythemia are committed to potentially harmful long-term treatment programs. At this time, it is appropriate to treat patients with platelet counts greater than 1.5 million/ $\mu\text{l}$ , symptomatic patients, and asymptomatic older patients who may also have vascular disease, which makes them more likely to have cardiovascular or cerebrovascular complications of thrombocytosis.

Asymptomatic younger patients with platelet counts less than 1.5 million/ $\mu$ l can probably be followed closely without treatment to reduce the risk of leukemia, which still may be a concern of long-term hydroxyurea treatment.

**ANAGRELIDE** Results of a multicenter trial demonstrate that daily oral anagrelide, a quinazolin derivative, promptly lowers platelet counts in over 80% of patients with essential thrombocythemia ( [185](#), [186](#), [187](#), [188](#) and [189](#) ). The drug probably lowers platelet counts in humans by inhibiting the maturation of megakaryocytes and decreasing megakaryocyte proliferation, not by changing platelet survival ( [190](#), [191](#) ). Anagrelide has little effect on the white blood cell count but does lower the red blood cell count slightly in approximately one-third of patients. Long-term treatment may be associated with significant anemia ( $>3$  g/dl) in up to 25% of patients ( [189](#) ). The most common and prominent nonhematologic side effects in the study were cardiovascular, with 25% of patients developing fluid retention or edema. Several patients developed congestive heart failure, and there were two episodes of sudden death. Patients may also develop headaches, nausea, or diarrhea, which decrease with continued treatment.

**$\alpha$ -INTERFERON** A number of reports document the effectiveness of  $\alpha$ -interferon administered subcutaneously in reducing platelet counts and reducing the number of symptoms in patients with thrombocythemia and thrombocytosis caused by other MPDs ( [192](#), [193](#), [194](#), [195](#), [196](#), [197](#), [198](#), [199](#), [200](#), [201](#), [202](#), [203](#), [204](#), [205](#), [206](#) and [207](#) ). Dosages used have ranged from 21 to 35 million units per week for the induction phase of treatment, which usually lasts 4 to 6 weeks. Complete and partial response rates are usually above 80% in most patient series reported. Maintenance doses are then based on the minimal dose required to sustain a complete (below 450,000/ $\mu$ l) or partial (below 600,000/ $\mu$ l) remission and usually are 3 million units three times per week to 3 million units daily. Side effects include initial flulike symptoms and then leukopenia, weight loss, alopecia, and development of thyroiditis ( [199](#) ) or thyroid antibodies ( [196](#) ) with long-term treatment. Platelet counts usually rise quickly after therapy is stopped ( [195](#), [196](#), [208](#) ), but there are several reports of patients who have maintained sustained responses lasting months after a long-term maintenance dose was stopped ( [199](#), [204](#), [205](#) ).  $\alpha$ -Interferon appears to reduce platelet counts primarily by its antiproliferative effect, as demonstrated in both *in vivo* and *in vitro* studies ( [209](#), [210](#) and [211](#) ). A slight reduction was noted in platelet mean lifespan, but no effect was noted on splenic platelet pools ( [212](#) ) or reticuloendothelial activity in the spleen. Serial bone marrow examinations have demonstrated decreased megakaryocyte density and size ( [196](#), [213](#) ) but little reduction in reticulin in most patients ( [198](#) ). Serial platelet function studies have demonstrated only partial correction despite reduction in platelet numbers ( [201](#) ).

**TREATMENT DURING PREGNANCY** Patients with ET who become pregnant have a normal delivery of a full-term, healthy infant in 50 to 57% of pregnancies ( [214](#), [215](#) and [216](#) ). The remainder of the pregnancies were complicated by increased first trimester spontaneous abortions, intrauterine death, or growth retardation ( [29](#), [215](#), [216](#), [217](#), [218](#), [219](#), [220](#), [221](#) and [222](#) ). Placentas from some of these pregnancies demonstrate infarction and villous fibrosis, suggesting that platelet aggregation results in placental thrombosis and fetal intrauterine growth retardation ( [213](#), [218](#), [223](#), [224](#) ). Platelet counts decrease during pregnancy in patients who were either untreated or treated with only aspirin ( [216](#), [217](#), [219](#), [223](#), [224](#) and [225](#) ). In each of the reported cases, the platelet count then rose to prepregnancy levels in the postpartum period. The nadir in platelet count occurred during the second trimester and was maintained until term ( [216](#), [225](#) ). During normal pregnancy, a reduction in platelet count of 15 to 20% is not uncommon because of the modest increase in blood volume ( [226](#), [227](#) ). However, the reduction of platelet counts in patients with ET is greater than expected and has been theorized to be caused by either increased concentrations of estrogen or adrenocortical hormones ( [217](#) ) or the elaboration of a placental or fetal factor that down-regulates platelet production ( [223](#) ). Patients with

essential thrombocythemia who become pregnant have been either observed ( [214](#), [223](#), [228](#) ) or treated with aspirin ( [213](#), [214](#), [215](#), [216](#), [217](#), [218](#) and [219](#), [222](#), [224](#), [225](#), [229](#) ), plateletpheresis ( [220](#), [221](#) ), hydroxyurea ( [230](#) ), or α-interferon ( [231](#), [232](#), [233](#), [234](#), [235](#) and [236](#) ). There is no evidence that any of these therapies made a significant difference in outcome, and the need for treatment and the best treatment remain controversial. However, if a patient needs to be treated, α-interferon appears to be well tolerated, and even if the therapy is started before conception, the pregnancies have resulted in normal, full-term infants.

## REACTIVE THROMBOCYTOSIS

As noted in [Table 57.1](#), there are a number of causes for secondary or reactive thrombocytosis ( [237](#), [238](#), [239](#), [240](#), [241](#), [242](#), [243](#), [244](#), [245](#) and [246](#) ), and the Polycythemia Vera Study Group criteria for the diagnosis of essential thrombocythemia require that each of them be ruled out before a diagnosis of essential thrombocythemia is made.

### Pathophysiology

Reactive thrombocytosis may result from persistent overproduction of one or more thrombopoietic factors that act on megakaryocytes or their precursors. IL-6, leukemia inhibitory factor, stem cell factor ( [247](#) ), and granulocyte colony-stimulating factor or GM-CSF ( [248](#) ) may all contribute to the platelet overproduction. The evidence for a primary role for IL-6 is currently the strongest, and there is evidence in mice that other cytokines, such as IL-1 and tumor necrosis factor, increase megakaryocytopoiesis through production of IL-6 ( [249](#) ). IL-6 is a growth factor produced mainly by monocytes, although lymphocytes, endothelial cells, and fibroblasts are also capable of production ( [250](#) ). Serum levels of IL-6 are increased in inflammatory disorders, malignancies, and after surgery and trauma, and it is believed to play a role in inflammation and the immune response. Increased serum IL-6 was found in only a few patients with thrombocytosis and iron deficiency ( [163](#) ), suggesting that thrombocytosis in these patients may have an entirely different pathophysiologic mechanism.

Recombinant IL-6 increases megakaryocyte counts ( [251](#) ) and megakaryocyte size ( [252](#) ) in culture, and infusions of IL-6 lead to increased platelet production and numbers in mice ( [253](#) ), primates ( [254](#), [255](#) ), and humans ( [256](#), [257](#) ). Treatment with anti-IL-6 in patients with IL-6 infusion-induced thrombocytosis progressively diminishes platelet counts with a return to baseline several days after the infusion is stopped ( [256](#) ).

Cultured mesothelial tumor cells from a patient with marked thrombocytosis produced large amounts of IL-6 and small amounts of GM-CSF and macrophage colony-stimulating factor ( [258](#) ), and serum IL-6 concentrations were reported to be increased in patients with metastatic cancer-related thrombocytosis ( [259](#) ). Serum and ascitic fluid concentrations of IL-6 were increased in patients with epithelial ovarian cancer ( [260](#) ). Serum IL-6 levels correlated with disease activity and thrombocytosis in patients with rheumatoid arthritis ( [261](#), [262](#) ). Finally, serum concentrations were increased in more than 80% of patients with reactive thrombocytosis ( [24](#), [163](#) ).

Temporally, serum IL-6 increases before thrombopoietin levels, and then platelet counts rise in postoperative patients, patients with acute infection, and patients with thrombocytosis and Kawasaki disease ( [263](#), [264](#) and [265](#) ). Administration of IL-6 to cancer patients results in a corresponding increase in thrombopoietin plasma levels ( [266](#) ). The

relationship between IL-6 and thrombopoietin still needs to be clarified.

## Clinical Picture

Patients with reactive thrombocytosis may have platelet counts as high as those of patients with MPDs, but hemorrhage and thrombosis are unusual. Schilling's series of "platelet millionaires" demonstrated that only 28 of 158 patients had a MPD ([9](#)). The remainder of patients had reactive thrombocytosis. There is even a single report of a patient with lung cancer who had a sustained platelet count of 6 million/ $\mu$ l, which decreased to normal after a single course of chemotherapy and irradiation of the lung neoplasm ([267](#)). Bleeding, thrombosis, and vasoocclusive phenomena occur in less than 5% of patients, although there are case reports of acute myocardial infarctions and cerebrovascular occlusions in patients after splenectomy or coronary artery bypass surgery and in those with iron deficiency-related thrombocytosis ([244](#), [245](#), [268](#)).

Thrombocytosis is a predictable finding after splenectomy, with platelet counts peaking 1 to 3 weeks after surgery at levels that may exceed 1 million/ $\mu$ l. The platelet count usually returns to normal, but weeks, months, or even years may be required. If a splenectomy is performed in patients with thrombocytosis associated with hemolytic anemia, the postsplenectomy thrombocytosis persists for as long as the anemia persists. These findings suggest some relationship between erythropoietic and thrombopoietic control mechanisms. This relationship may explain in part the thrombocytosis of iron deficiency associated with chronic blood loss as well.

## Laboratory Findings

There are no specific laboratory findings in patients with reactive thrombocytosis, and the diagnosis ultimately depends on diagnosis of the underlying problem. Serum IL-6 concentrations (measured by activity assays or enzyme-linked immunosorbent assay) are increased in the majority of patients believed to have reactive thrombocytosis and in none of the patients with clonal megakaryopoiesis, but these tests are not clinically available.

Hollen found increased serum IL-6 concentrations in 80 to 100% of his patients with inflammation, malignancy, or recent surgery ([163](#)). Only 50% of the anemic patients had increased concentrations of IL-6, and only one of five patients with iron deficiency were in this group.

Tefferi et al. compared serum IL-6 and CRP in patients with primary and secondary thrombocytosis, hoping to find a surrogate marker for IL-6 production ([164](#)). They found that 19% of patients with reactive thrombocytosis had an increased serum IL-6 but a normal CRP, and 19% had normal serum concentrations of both. Thus, an elevated CRP might be useful for diagnosis of reactive thrombocytosis, but a normal serum concentration is not discriminatory.

## Treatment

Reactive thrombocytosis resolves when the underlying disorder is treated successfully, and it is rare for any additional therapy to be required. However, symptomatic patients may benefit from simultaneous plateletpheresis and hydroxyurea therapy until symptoms resolve and the platelet count is controlled.

## REFERENCES

1. Bierman HR, Kelly KH, Cordes FL, et al. The release of leukocytes and platelets from the pulmonary circulation by epinephrine. *Blood* 1952;7:683-692.
2. Dawson AA, Ogston D. Exercise-induced thrombocytosis. *Acta Haematol* 1969;42:241-246.
3. Chamberlain KG, Tong M, Penington DG. Properties of the exchangeable splenic platelets released into the circulation during exercise-induced thrombocytosis. *Am J Hematol* 1990;34:161-168.
4. Williams EC, Shahidi NT. Benign familial thrombocytosis. *Am J Hematol* 1991;37:124-125.
5. Kikuchi M, Tayama T, Hayakawa H, et al. Familial thrombocytosis. *Br J Haematol* 1995;89:900-902.
6. Davis WM, Mendez Ross AO. Thrombocytosis and thrombocythemia: the laboratory and clinical significance of an elevated platelet count. *Am J Clin Pathol* 1973;59:243-247.
7. Santhosh-Kumar CR, Yohannan MD, Higggy KE, Al-Mashhadani SA. Thrombocytosis in adults: analysis of 777 patients. *J Intern Med* 1991;229:493-495.
8. Buss DH, Cashell AW, O'Connor ML, et al. Occurrence, etiology, and clinical significance of extreme thrombocytosis: a study of 280 cases. *Am J Med* 1994;96:247-253.
9. Schilling RF. Platelet millionaires. *Lancet* 1980;2:372.
10. Stuhmann M, Bashawri L, Ahmed MA, et al. Familial thrombocytosis as a recessive, possibly X-linked trait in an Arab family. *Br J Haematol* 2001;112:616-620.
11. Kondo T, Okabe M, Sanada M, et al. Familial essential thrombocytosis associated with one-base deletion in the 5'-untranslated region of the thrombopoietin gene. *Blood* 1998;92:1091-1096.
12. Wiestner A, Schlemper RJ, van der Mass APC, et al. An activating splice donor mutation in the thrombopoietin gene causes hereditary thrombocythemia. *Nat Genet* 1998;18:49-52.
13. Ghilardi N, Wiestner A, Kikuchi M, et al. *Br J Haematol* 1999;107:310-316.
14. Ghilardi N, Skoda RC. A single-base deletion in the thrombopoietin (TPO) gene causes familial essential thrombocythemia through a mechanism of more efficient translation of RPO mRNA. *Blood* 1999;94:1480-1482.
15. Kunishima S, Mizuno S, Naoe T, et al. Genes for thrombopoietin and c-mpl are not responsible for familial thrombocythaemia: a case study. *Br J Haematol* 1998;100:383-386.
16. Wiestner A, Padosch SA, Ghilardi N, et al. Hereditary thrombocythaemia is a genetically heterogeneous disorder: exclusion of TPO and MPL in two families with hereditary thrombocythaemia. *Br J Haematol* 2000;110:104-109.
17. Epstein E, Goedel A. Hamorrhagische thrombocythamie bei vascularer schrumpfmilz. *Virch Arch (Pathol Anat)* 1934;292:233.
18. Blanchard KL, Gilliland DG, Bunn HF. Clonality in myeloproliferative disorders. *Am J Med Sci* 1992;304:125-130.
19. Tefferi A, Silverstein MN, Hoagland HC. Primary thrombocythaemia. *Semin Oncol* 1995;22:334-340.
20. van Genderen PJ, Michiels JJ. Primary thrombocythemia: diagnosis, clinical manifestations and management. *Ann Hematol* 1993;67:57-62.
21. Frenkel EP. The clinical spectrum of thrombocytosis and thrombocythemia. *Am J Med Sci* 1991;301:69-80.

22. Mitus AJ, Schafer AI. Thrombocytosis and thrombocythemia. *Hematol Oncol Clin North Am* 1990;4:157-178.
23. Kutti J. The management of thrombocytosis. *Eur J Haematol* 1990;44:81-88.
24. Tefferi A, Hoagland HC. Issues in the diagnosis and management of essential thrombocythemia. *Mayo Clin Proc* 1994;69:651-655.
25. Hoagland HC, Silverstein MN. Primary thrombocythemia in the young patient. *Mayo Clin Proc* 1978;53:578-580.
26. Randi ML, Fabris F, Girolami A. Thrombocytosis in young people: evaluation of 57 cases diagnosed before the age of 40. *Blut* 1990;60:233-237.
27. Sceats DJ, Baitlon D. Primary thrombocythemia in a child. *Clin Pediatr* 1980;19:298-300.
28. Linch DC, Hutton R, Cowan D, et al. Primary thrombocythaemia in childhood. *Scand J Haematol* 1982;28:72-76.
29. Bellucci S, Janvier M, Tobelem G. Essential thrombocythemia: clinical evolutionary and biologic data. *Cancer* 1986;58:2440-2447.
30. Sutor AH. Thrombocytosis in childhood. *Semin Thromb Hemost* 1995;21:330-339.
31. Fickers M, Speck B. Thrombocythaemia: familial occurrence and transition into blastic crisis. *Acta Haematol* 1974;51:257-265.
32. Dodsworth H. Primary thrombocythaemia in monozygotic twins. *BMJ* 1980;280:1506.
33. Slee PH, van Everdingen JJE, Geraedts JPM, et al. Familial myeloproliferative disease. *Acta Med Scand* 1981;210:321-327.
34. Eyster ME, Saletan SL, Rabellino EM, et al. Familial essential thrombocythemia. *Am J Med* 1986;80:497-502.
35. Randi ML, Fabris F, Vio C, Girolami A. Familial thrombocythaemia and/or thrombocytosis—apparently a rare disorder. *Acta Haematol* 1987;78:63.
36. Janssen JWG, Anger BR, Drexler HG, et al. Essential thrombocythemia in two sisters originating from different stem cell levels. *Blood* 1990;75:1633-1636.
37. Schlemper RJ, van der Maas AP, Eikenboom JC. Familial essential thrombocythemia: clinical characteristics of 11 cases in one family. *Ann Hematol* 1994;68:153-158.
38. Pérez-Encinas M, Bello JL, Pérez-Crespo S, et al. Familial myeloproliferative syndrome. *Am J Hematol* 1994;46:225-229.
39. Fialkow PJ, Faguet GB, Jacobson RJ, et al. Evidence that essential thrombocythemia is a clonal disorder with origin in a multipotent stem cell. *Blood* 1981;58:916-918.
40. Mitterbauer G, Winkler K, Gisslinger H, et al. Clonality analysis using X-chromosome inactivation at the human androgen receptor gene (HUMARA). *Am J Clin Path* 1999;112:93-100.
41. Harrison CN, Gale RE, Machin SJ, et al. A large proportion of patients with a diagnosis of essential thrombocythemia do not have a clonal disorder and may be at lower risk of thrombotic complications. *Blood* 1999;93:417-424.
42. Shih LY, Lin TL, Dunn P, et al. Clonality analysis using X-chromosome inactivation patterns by HUMARA-PCR assay in female controls and patients with idiopathic thrombocytosis in Taiwan. *Exp Hematol* 2001;29:202-208.
43. Chiusolo P, La Barbera O, Laurenti L, et al. Clonal hemopoiesis and risk of thrombosis in young female

patients with essential thrombocythemia. *Exp Hematol* 2001;29:670–676.

44. El-Kassar N, Hetet G, Briere J, et al. Clonality analysis of hematopoiesis in essential thrombocythemia: advantages of studying T lymphocytes and platelets. *Blood* 1997;89:128–134.
45. Tsukamoto N, Morita K, Maehara T, et al. Clonality in chronic myeloproliferative disorders defined by X-chromosome linked probes: demonstration of heterogeneity in lineage involvement. *Br J Hematol* 1994;86:253–258.
46. Harker LA, Finch CA. Thrombokinetics in man. *J Clin Invest* 1969;48:963–974.
47. Komatsu N, Suda T, Sakata Y, et al. Megakaryocytopoiesis in vitro of patients with essential thrombocythaemia: effect of plasma and serum on megakaryocytic colony formation. *Br J Hematol* 1986;64:241–252.
48. Han ZC, Brière J, Abgrall JF, et al. Spontaneous formation of megakaryocyte progenitors (CFU-MK) in primary thrombocythaemia. *Acta Haematol* 1987;78:51–53.
49. Juvonen E, Patanen S, Ruutu T. Colony formation by megakaryocytic progenitors in essential thrombocythaemia. *Br J Haematol* 1987;66:161–164.
50. Juvonen E, Ikkala E, Oksanen K, Ruutu T. Megakaryocyte and erythroid colony formation in essential thrombocythaemia and reactive thrombocytosis: diagnostic value and correlation to complications. *Br J Haematol* 1993;83:192–197.
51. Grossi A, Vannucchi AM, Rafanelli D, et al. Megakaryocyte progenitors in the bone marrow and peripheral blood of patients with myeloproliferative diseases. *Am J Hematol* 1987;25:371–376.
52. Hamaguchi H, Takano N, Sakamaki H, et al. Heterogeneity of in vitro growth pattern of megakaryocyte progenitors (CFU-M) in myeloproliferative disorders. *Eur J Haematol* 1988;41:163–169.
53. Kobayashi S, Teramura M, Hoshino S, et al. Circulating megakaryocyte progenitors in myeloproliferative disorders are hypersensitive to interleukin-3. *Br J Haematol* 1993;83:539–544.
54. Li Y, Hetet G, Maurer AM, et al. Spontaneous megakaryocyte colony formation in myeloproliferative disorders is not neutralizable by antibodies against IL-3, IL-6, and GM-CSF. *Br J Haematol* 1994;87:471–476.
55. Mi JQ, Blanc-Jouvan F, Wang J, et al. Endogenous megakaryocytic colony formation and thrombopoietin sensitivity of megakaryocytic progenitor cells are useful to distinguish between essential thrombocythemia and reactive thrombocytosis. *J Hematol Stem Cell Res* 2001;10:405–409.
56. Taksin AL, Le Couedic JP, Dusanter-Fourt I, et al. Autonomous megakaryocyte growth in essential thrombocythemia and idiopathic myelofibrosis is not related to a c-mpl mutation or to an autocrine stimulation by mpl-l. *Blood* 1999;93:125–139.
57. Mazur EM, Cohen JL, Bogart L. Growth characteristics of circulating hematopoietic progenitor cells from patients with essential thrombocythemia. *Blood* 1988;71:1544–1550.
58. Espanol I, Hernandez A, Cotes M, et al. Patients with thrombocytosis have normal or slightly elevated thrombopoietin levels. *Haematologica* 1999;84:312–316.
59. Uppenkamp M, Makarova E, Petrasch S, et al. *Ann Hematol* 1998;77:217–223.
60. Griesshamer M, Hornkohl A, Nichol JL, et al. High levels of thrombopoietin in sera of patients with essential thrombocythemia: cause or consequence of abnormal platelet production. *Ann Hematol* 1998;77:211–215.
61. Tomita N, Motomura S, Sakai R, et al. Strong inverse correlation between serum TPO level and platelet count in essential thrombocythemia. *Am J Hematol* 2000;63:131–135.
62. Hou M, Carneskog J, Mellqvist UH, et al. Impact of endogenous thrombopoietin levels on the differential diagnosis of essential thrombocythaemia and reactive thrombocytosis. *Eur J Haematol*



1998;61:119–122.

63. Hsu HC, Tsai WH, Jiang ML, et al. Circulating levels of thrombopoietic and inflammatory cytokines in patients with clonal and reactive thrombocytosis. *J Lab Clin Med* 1999;134:392–397.
64. Li J, Xia Y, Kuter DJ. The platelet thrombopoietin receptor number and function are markedly decreased in patients with essential thrombocythaemia. *Br J Haematol* 2000;111:943–953.
65. Harrison CN, Gale RE, Pezella F, et al. Platelet c-mpl expression is dysregulated in patients with essential thrombocythaemia but this is not of diagnostic value. *Br J Haematol* 1999;107:139–147.
66. Horikawa Y, Matsumura I, Hashimoto K, et al. Markedly reduced expression of platelet c-mpl receptor in essential thrombocythemia. *Blood* 1997;90:4031–4038.
67. Kiladjian JJ, Elkassar N, Hetet G, et al. Study of the thrombopoietin receptor in essential thrombocythemia. *Leukemia* 1997;11:1821–1826.
68. Colombi M, Radaelli F, Zocchi L, Maiolo AT. Thrombotic and hemorrhagic complications in essential thrombocythemia. *Cancer* 1991;67:2926–2930.
69. Case DC. Absence of a specific chromosomal marker in essential thrombocythemia. *Cancer Genet Cytogenet* 1984;12:163–165.
70. Neri A, Fracchiolla NS, Radaelli F, et al. p53 Tumour suppressor gene and RAS oncogenes: molecular analysis in the chronic and leukaemic phases of essential thrombocythaemia. *Br J Haematol* 1996;93:670–673.
71. Schafer AI. Bleeding and thrombosis in the myeloproliferative disorders. *Blood* 1984;64:1–12.
72. Baker RI, Manoharan A. Platelet function in myeloproliferative disorders: characterization and sequential studies show multiple platelet abnormalities, and change with time. *Eur J Haematol* 1988;40:267–272.
73. Leoncini G, Maresca M, Buzzi E, et al. Platelets of patients affected with essential thrombocythemia are abnormal in plasma membrane and adenine nucleotide content. *Eur J Haematol* 1990;44:115–119.
74. Baglin TP, Price SM, Boughton BJ. A reversible defect of platelet PDGF content in myeloproliferative disorders. *Br J Haematol* 1988;69:483–486.
75. Ireland H, Lane DA, Wolff S, Foadi M. In vivo platelet release in myeloproliferative disorders. *Thromb Haemost* 1982;48:41–45.
76. Zahavi J, Zahavi M, Firsteter E, et al. An abnormal pattern of multiple platelet function abnormalities and increased thromboxane generation in patients with primary thrombocytosis and thrombotic complications. *Eur J Haematol* 1991;47:326–332.
77. Mayordomo O, Cárcamo C, Vecino AM, et al. Arachidonic acid metabolism in platelets of patients with essential thrombocythaemia. *Thromb Res* 1995;78:315–321.
78. Rocca B, Ciabattini G, Tartaglione R, et al. Increased thromboxane biosynthesis in essential thrombocythemia. *Thromb Haemost* 1995;74:1225–1230.
79. Crook M, Machin SJ, Crawford N. Basal and induced prothrombinase expression in platelets from patients with essential thrombocythaemia. *Br J Haematol* 1990;76:256–259.
80. Mazzucato M, DeMarco L, DeAngelis V, et al. Platelet membrane abnormalities in myeloproliferative disorders: decrease in glycoproteins Ib and IIb/IIIa complex is associated with deficient receptor function. *Br J Haematol* 1989;73:369–374.
81. Clezardin P, McGregor JL, Dechavanne M, Clemetson KJ. Platelet membrane glycoprotein abnormalities in patients with myeloproliferative disorders and secondary thrombocytosis. *Br J Haematol* 1985;60:331–344.

82. Lawler J, Cohen AM, Chao FC, Moriarty DJ. Thrombospondin in essential thrombocythemia. *Blood* 1986;67:555–558.
83. Griesshammer M, Beneke H, Nussbaumer B, et al. Increased platelet surface expression of P-selectin and thrombospondin as markers of platelet activation in essential thrombocythaemia. *Thromb Res* 1999;96:191–196.
84. Legrand C, Belluci S, Disdier M, et al. Platelet thrombospondin and glycoprotein IV abnormalities in patients with essential thrombocytosis: effect of  $\alpha$ -interferon therapy. *Am J Hematol* 1991;38:307–313.
85. Lee LH, Baglin T. Altered platelet phospholipid-dependent thrombin generation in thrombocytopenia and thrombosis. *Br J Haematol* 1995;89:131–136.
86. Budde U, Schaefer G, Mueller N. Acquired von Willebrand's disease in the myeloproliferative syndrome. *Blood* 1984;64:981–985.
87. Budde U, Dent JA, Berkowitz SD, et al. Subunit composition of plasma von Willebrand factor in patients with the myeloproliferative syndrome. *Blood* 1986;68:1213–1217.
88. Fabris F, Casonato A, Grazia del Ben M, et al. Abnormalities of von Willebrand factor in myeloproliferative disease: a relationship with bleeding diathesis. *Br J Haematol* 1986;63:75–83.
89. Tatewaki W, Takahashi H, Takakuwa E, et al. Plasma von Willebrand factor proteolysis in patients with chronic myeloproliferative disorders: no possibility of ex vivo degradation by calcium-dependent proteases. *Thromb Res* 1989;56:191–199.
90. Budde U, Scharf RE, Franke P, et al. Elevated platelet count as a cause of abnormal von Willebrand factor multimer distribution in plasma. *Blood* 1993;82:1749–1757.
91. van Genderen PJ, Michiels JJ, van der Poel-van de Luytgaarde SC, van Vliet HH. Acquired von Willebrand disease as a cause of recurrent mucocutaneous bleeding in primary thrombocythaemia: relationship with platelet count. *Ann Hematol* 1994;69:81–84.
92. Mazzucconi MG, Ferrari A, Solinas S, et al. Studies of von Willebrand factor in essential thrombocythemia patients treated with  $\alpha$ -2b recombinant interferon. *Haemostasis* 1991;21:135–140.
93. van Genderen PJ, Prins FJ, Lucas IS, et al. Decreased half-life time of plasma von Willebrand factor collagen binding activity in essential thrombo-cythaemia: normalization after cytoreduction of the increased platelet count. *Br J Hematol* 1997;99:832–836.
94. Wiczorek I, MacGregor IR, Ludlam CA. Low proteins C and S and activation of fibrinolysis in treated essential thrombocythemia. *Am J Hematol* 1995;49:277–281.
95. Bucalossi A, Marotta G, Bigazzi C, et al. Reduction of antithrombin III, protein C, and protein S levels and activated protein C resistance in polycythemia vera and essential thrombocythemia patients with thrombosis. *Am J Hematol* 1996;52:14–20.
96. Gunz FW. Hemorrhagic thrombocythemia: a critical review. *Blood* 1960;14:706–723.
97. Silverstein MN. Primary or hemorrhagic thrombocythemia. *Arch Intern Med* 1968;122:18–22.
98. Hehlmann R, Jahn M, Baumann B, Köpcke W. Essential thrombocythemia: clinical characteristics and course of 61 cases. *Cancer* 1988;61:2487–2496.
99. Fenaux P, Simon M, Caulier MT, et al. Clinical course of essential thrombocythemia in 147 cases. *Cancer* 1990;66:549–556.
100. Meisel S, Shpilberg O, Ramot B, Ben-Bassat I. Essential thrombocythemia: a relatively benign long term course. *Isr J Med Sci* 1993;29:190–194.
101. Kurzrock R, Cohen PR. Erythromelalgia: review of clinical characteristics and pathophysiology. *Am J*

Med 1991;91:416-422.

102. Michiels JJ, van Joost T. Erythromelalgia and thrombocythemia: a causal relation. *J Am Acad Dermatol* 1990;22:107-111.
103. Jabaily J, Iland HJ, Laszlo J, et al. Neurologic manifestations of essential thrombocythemia. *Ann Intern Med* 1983;99:513-518.
104. Michiels JJ, Koudstaal PJ, Mulder AH, Van Vliet HH. Transient neurologic and ocular manifestations in primary thrombocythemia. *Neurology* 1993;43:1107-1110.
105. Brown GE. Erythromelalgia and other disturbances of the extremities accompanied by vasodilation and burning. *Am J Med Sci* 1932;183:468-485.
106. Singh AK, Wetherly-Mein G. Microvascular occlusive lesions in primary thrombocythemia. *Br J Haematol* 1977;36:553-564.
107. Hussain S, Schwartz JM, Friedman SA, Chua SN. Arterial thrombosis in essential thrombocythemia. *Am Heart J* 1978;96:31-36.
108. Michiels JJ, Abels J, Steketee J, et al. Erythromelalgia caused by platelet-mediated arteriolar inflammation and thrombosis in thrombocythemia. *Ann Intern Med* 1985;102:466-471.
109. Michiels JJ, Van Genderen PJJ, Van Vliet HH. Erythromelalgia and arterial thrombophilia in thrombocythemia. *Ann N Y Acad Sci* 1994;714:318-321.
110. Redding KG. Thrombocythemia as a cause of erythromelalgia. *Arch Dermatol* 1977;113:468-471.
111. Michiels JJ, ten Kate FWJ, Vuzevski VD, Abels J. Histopathology of erythromelalgia in thrombocythaemias. *Histopathology* 1984;8:669-678.
112. Smith LA, Allen EV. Erythromelalgia (erythromelalgia) of the extremities: a syndrome characterized by redness, heat, and pain. *Am Heart J* 1938;16:175-188.
113. van Genderen PJ, Michiels JJ, van Strik R, et al. Platelet consumption in thrombocythemia complicated by erythromelalgia: reversal by aspirin. *Thromb Haemost* 1995;73:210-214.
114. van Genderen PJ, Prins FJ, Michiels JJ, et al. Thromboxane-dependent platelet activation in vivo precedes arterial thrombosis in thrombocythaemia: a rationale for the use of low dose aspirin as an antithrombotic agent. *Br J Haematol* 1999;104:438-441.
115. Michiels JJ, ten Kate FJW. Erythromelalgia in thrombocythemia of various myeloproliferative disorders. *Am J Hematol* 1992;39:131-136.
116. Lahuerta-Palacios JJ, Bornstein R, Fernández-Deborja FJ, et al. Controlled and uncontrolled thrombocytosis: its clinical role in essential thrombocytosis. *Cancer* 1988;61:1207-1212.
117. Wehmeier A, Daum I, Jamin H, Schneider W. Incidence and clinical risk factors for bleeding and thrombotic complications in myeloproliferative disorders: a retrospective analysis of 260 patients. *Ann Hematol* 1991;63:101-106.
118. Barbui T, Cortelazzo S, Viero P, et al. Thrombohaemorrhagic complications in 101 cases of myeloproliferative disorders: relationship to platelet number and function. *Eur J Cancer Clin Oncol* 1983;19:1593-1599.
119. Regev A, Stark P, Blickstein D, et al. Thrombotic complications in essential thrombocythemia with relatively low platelet counts. *Am J Hematol* 1997;56:168-172.
120. Watson KV, Key N. Vascular complications of essential thrombocythaemia: a link to cardiovascular risk factors. *Br J Haematol* 1993;83:198-203.
121. Jantunen R, Juvonen E, Ikkala E, et al. The predictive value of vascular risk factors and gender for

- the development of thrombotic complications in essential thrombocythemia. *Ann Hematol* 2001;80:74–78.
122. Kessler CM, Klein HG, Havlik RJ. Uncontrolled thrombocytosis in chronic myeloproliferative disorders. *Br J Haematol* 1982;50:157–167.
123. Ruggeri M, Finazzi G, Tosetto A, et al. No treatment for low-risk thrombocythaemia: results from a prospective study. *Br J Haematol* 1998;103:772–777.
124. McIntyre KJ, Hoagland HC, Silverstein MN, Petitt RM. Essential thrombocythemia in young adults. *Mayo Clin Proc* 1991;66:149–154.
125. Mitus AJ, Barbui T, Shulman LN, et al. Hemostatic complications in young patients with essential thrombocytosis. *Am J Med* 1990;88:371–375.
126. Millard FE, Hunter CS, Anderson M, et al. Clinical manifestations of essential thrombocythemia in young adults. *Am J Hematol* 1990;33:27–31.
127. Murphy S, Iland H, Rosenthal D, Laszlo J. Essential thrombocythemia: an interim report from the Polycythemia Vera Study Group. *Semin Hematol* 1986;23:177–182.
128. Barbui T, Buelli M, Cortelazzo S, et al. Aspirin and risk of bleeding in patients with thrombocythemia. *Am J Med* 1987;83:265–268.
129. Reisner SA, Rinkevich D, Markiewicz W, et al. Cardiac involvement in patients with myeloproliferative disorders. *Am J Med* 1992;93:498–504.
130. Arboix A, Besses C, Acín P, et al. Ischemic stroke as first manifestation of essential thrombocythemia. *Stroke* 1995;26:1463–1466.
131. Iland HJ, Laszlo J, Peterson P, et al. Essential thrombocythemia: clinical and laboratory characteristics at presentation. *Trans Assoc Am Phys* 1983;96:165–174.
132. Carneskog J, Wadenvik H, Fjälling M, Kutti J. Assessment of spleen size using gamma camera scintigraphy in newly diagnosed patients with essential thrombocythaemia and polycythaemia vera. *Eur J Haematol* 1996;56:158–162.
133. Rozman C, Giralt M, Feliu E, et al. Life expectancy of patients with chronic nonleukemic myeloproliferative disorders. *Cancer* 1991;67:2658–2663.
134. Bazzan M, Tamponi G, Schinco P, et al. Thrombosis-free survival and life expectancy in 187 consecutive patients with essential thrombocythemia. *Ann Hematol* 1999;78:539–543.
135. Shibata K, Shimamoto Y, Suga K, et al. Essential thrombocythemia terminating in acute leukemia with minimal myeloid differentiation—a brief review of recent literature. *Acta Haematol* 1994;91:84–88.
136. Frei-Lahr D, Barton JC, Hoffman R, et al. Blastic transformation of essential thrombocythemia: dual expression of myelomonoblastic/megakaryoblastic phenotypes. *Blood* 1984;63:866–872.
137. Murphy PT, Sivakumaran M, van Rhee F, et al. Acute lymphoblastic transformation of essential thrombocythaemia. *Br J Haematol* 1995;89:921–992.
138. Furgerson JL, Vukelja SJ, Baker J, O'Rourke TJ. Acute myeloid leukemia from essential thrombocythemia in two patients treated with hydroxyurea. *Am J Hematol* 1996;51:137–140.
139. Grande M. Central nervous system granulocytic sarcoma in a patient with essential thrombocythemia. *Am J Hematol* 1996;51:64–67.
140. Patino-Sarcinelli F, Knecht H, Pechet L, et al. Leukemia with megakaryocytic differentiation following essential thrombocythemia and myelofibrosis. Case report and review of the literature. *Acta Haematol* 1996;95:122–128.
141. Raman SBK, Mahmood A, Van Slyck EJ, Saeed SM. Essential thrombocytopenia with transition into

acute leukemia. *Ann N Y Acad Sci* 1981;370:145–153.

142. Toh BT, Gregory SA, Knospe WH. Acute leukemia following treatment of polycythemia vera and essential thrombocythemia with uracil mustard. *Am J Hematol* 1988;28:58–60.

143. Higuchi T, Okada S, Mori H, et al. Leukemic transformation of polycythemia vera and essential thrombocythemia possibly associated with an alkylating agent. *Cancer* 1995;75:471–477.

144. Sedlacek SM, Curtis JL, Weintraub J, Levin J. Essential thrombocythemia and leukemic transformation. *Medicine* 1986;65:353–364.

145. Cervantes F, Tassies D, Salgado C, et al. Acute transformation in nonleukemic chronic myeloproliferative disorders: actuarial probability and main characteristics in a series of 218 patients. *Acta Haematol* 1991;85:124–127.

146. Davey MG, Lander H. Potassium and acid phosphatase levels in serum and plasma of patients with high platelet counts. *Med J Aust* 1965;1:272–273.

147. Zucker MB, Woodard HQ. Elevation of serum acid glycerophosphatase activity in thrombocytosis. *J Lab Clin Med* 1962;59:760–770.

148. Lutomski DM, Bower RH. The effect of thrombocytosis on serum potassium and phosphorus concentrations. *Am J Med Sci* 1994;307:255–258.

149. Harrison CN, Linch DC, Machin SJ. Desirability and problems of early diagnosis of essential thrombocytosis. *Lancet* 1998;351:846–847.

150. Murphy S. Diagnostic criteria and prognosis in polycythemia vera and essential thrombocytosis. *Semin Hematol* 1999;36:9–13.

151. Lengfelder E, Hochhaus A, Kronawitter U, et al. Should a platelet limit of  $600 \times 10^9/l$  be used as a diagnostic criterion in essential thrombocythaemia? An analysis of the natural course including early stages. *Br J Haematol* 1998;100:15–23.

152. Sacchi S, Vinci G, Gugliotta L, et al. Diagnosis of essential thrombocythemia at platelet counts between 400 and  $600 \times 10^9/l$ . Gruppo Italiano Malattie Mieloproliferative Croniche (GIMMC). *Haematologica* 2000;85: 492–495.

153. Blickstein D, Aviram A, Luboshitz J, et al. BCR-ABL transcripts in bone marrow aspirates of Philadelphia-negative essential thrombocythemia patients: clinical presentation. *Blood* 1997;90:2768–2771.

154. Emilia G, Marasca R, Zucchini P, et al. BCR-ABL rearrangement is not detectable in essential thrombocythemia. *Blood* 2001;97:2187–2189.

155. Heller P, Kornblihtt LI, Cuello MT, et al. BCR-ABL transcripts may be detected in essential thrombocythemia but lack clinical significance. *Blood* 2001;98:1990.

156. Sawyer BM, Westwood NB, Pearson TC. Circulating megakaryocytic progenitor cells in patients with primary thrombocytosis: results using a serum-deprived culture assay and a positive detection technique. *Eur J Haematol* 1994;53:108–113.

157. Turhan AG, Cashman JD, Eaves CJ, et al. Variable expression of features of normal and neoplastic stem cells in patients with thrombocytosis. *Br J Haematol* 1992;82:50–57.

158. Florensa L, Besses C, Woessner S, et al. Endogenous megakaryocyte and erythroid colony formation from blood in essential thrombocythaemia. *Leukemia* 1995;9:271–273.

159. Rolovic Z, Basara N, Gotic M, et al. The determination of spontaneous megakaryocyte colony formation is an equivocal test for discrimination between essential thrombocythaemia and reactive thrombocytosis. *Br J Haematol* 1995;90:326–331.

160. Kriepe H, Felgner J, Jaquet K, et al. DNA analysis to aid in the diagnosis of chronic

myeloproliferative disorders. *Am J Clin Pathol* 1992;98:46–54.

161. Majer RV, Dawe A, Jones-Lecointe A, Green PJ. Which tests are most useful in distinguishing between reactive thrombocytosis and the thrombocytosis of myeloproliferative disease? *Clin Lab Haematol* 1991;13:9–15.

162. Randi ML, Fabris F, Rossi C, Girolami A. Which tests are most useful in distinguishing between reactive thrombocytosis and the thrombocytosis of myeloproliferative disease? *Clin Lab Haematol* 1992;14:267–268.

163. Hollen CW, Henthorn J, Koziol JA, Burstein SA. Elevated serum interleukin-6 levels in patients with reactive thrombocytosis. *Br J Haematol* 1991;79:286–290.

164. Tefferi A, Ho TC, Ahmann GJ, et al. Plasma interleukin-6 and C-reactive protein levels in reactive versus clonal thrombocytosis. *Am J Med* 1994;97:374–378.

165. Cerutti A, Custodi P, Duranti M, et al. Thrombopoietin levels in patients with primary and reactive thrombocytosis. *Br J Haematol* 1997;99:281–284.

166. Wang JC, Chen C, Novetsky AD, et al. Blood thrombopoietin levels in clonal thrombocytosis and reactive thrombocytosis. *Am J Med* 1998;104:451–455.

167. Buss DH, O'Connor ML, Woodruff RD, et al. Bone marrow and peripheral blood findings in patients with extreme thrombocytosis. *Arch Pathol Lab Med* 1991;115:475–480.

168. Woods MJ, Greaves M, Trowbridge EA. Megakaryocyte ploidy in thrombocytosis: improved microdensitometric measurements with a new image analysis system. *Eur J Haematol* 1990;44:220–226.

169. Kanz L, Hollen C, Friese P, Burstein SA. Analysis of megakaryocyte ploidy in patients with thrombocytosis. *Int J Cell Cloning* 1990;8:299–306.

170. Jacobsson S, Carneskog J, Ridell B, et al. Flow cytometric analysis of megakaryocyte ploidy in chronic myeloproliferative disorders and reactive thrombocytosis. *Eur J Haematol* 1996;56:287–292.

171. Cashell AW, Buss DH. The frequency and significance of megakaryocytic emperipoiesis in myeloproliferative and reactive states. *Ann Hematol* 1992;64:273–276.

172. Dudley JM, Messinezy M, Eridani S, et al. Primary thrombocythaemia: diagnostic criteria and a simple scoring system for positive diagnosis. *Br J Haematol* 1989;71:331–335.

173. Murphy S, Rosenthal DS, Weinfeld A, et al. Essential thrombocythaemia: response during first year of therapy with melphalan and radioactive phosphorus: a polycythemia vera study group report. *Cancer Treat Rep* 1982;66:1495–1500.

174. Brandt L, Anderson H. Survival and risk of leukaemia in polycythemia vera and essential thrombocythaemia treated with oral radiophosphorus: are safer drugs available? *Eur J Haematol* 1995;54:21–26.

175. Cortelazzo S, Marchetti M, Orlando E, et al. Aspirin increases the bleeding site effects in essential thrombocythemia independent of the cyclooxygenase pathway: role of the lipoxigenase pathway. *Am J Hematol* 1998;57:277–282.

176. Löfvenberg E, Wahlin A. Management of polycythemia vera, essential thrombocythaemia and myelofibrosis with hydroxyurea. *Eur J Haematol* 1988;41:375–381.

177. Sterkers Y, Preudhomme C, Lai JL, et al. Acute myeloid leukemia and myelodysplastic syndromes following essential thrombocythemia treated with hydroxyurea: high proportion of cases with 17p deletion. *Blood* 1998;91:616–622.

178. Finazzi G, Ruggeri M, Rodeghiero F, et al. Second malignancies in patients with essential thrombocythemia treated with busulfan and hydroxyurea: long-term follow-up of a randomized clinical trial. *Br J Haematol* 2000;110:577–583.

179. Nand S, Stock W, Godwin J, Fisher SG. Leukemogenic risk of hydroxyurea therapy in polycythemia

- vera, essential thrombocythemia, and myeloid metaplasia with myelofibrosis. *Am J Hematol* 1996;52:42–46.
180. Baron BW, Mick R, Baron JM. Combined plateletpheresis and cytotoxic chemotherapy for symptomatic thrombocytosis in myeloproliferative disorders. *Cancer* 1993;72:1209–1218.
181. Löfvenberg E, Nilsson T, Wahlin A, Jacobsson L. Hydroxyurea treatment of myeloproliferative disorders. *Acta Med Scand* 1987;222:169–174.
182. Radaelli F, Calori R, Faccini P, et al. Early cutaneous lesions secondary to hydroxyurea therapy. *Am J Hematol* 1998;58:82–83.
183. Löfvenberg E, Wahlin A, Roos G, Öst A. Reversal of myelofibrosis by hydroxyurea. *Eur J Haematol* 1990;44:33–38.
184. Cortelazzo S, Finazzi G, Ruggeri M, et al. Hydroxyurea for patients with essential thrombocythaemia and a high risk of thrombosis. *N Engl J Med* 1995;332:1132–1136.
185. Silverstein MN, Petitt RM, Solberg LA, et al. Anagrelide: a new drug for treating thrombocytosis. *N Engl J Med* 1988;318:1292–1294.
186. Anagrelide Study Group. Anagrelide, a therapy for thrombocythaemic states: experience in 577 patients. *Am J Med* 1992;92:69–76.
187. Petit RM, Silverstein MN, Petrone ME. Anagrelide for control of thrombocythemia in polycythemia and other myeloproliferative disorders. *Semin Hematol* 1997;34:51–54.
188. Petrides PE, Beykirch MK, Trapp OM. Anagrelide, a novel platelet lowering option in essential thrombocythaemia: treatment experience in 48 patients in Germany. *Eur J Haematol* 1998;61:71–76.
189. Storen E, Tefferi A. Long-term use of anagrelide in young patients with essential thrombocythemia. *Blood* 2001;97:863–866.
190. Solberg LA, Tefferi A, Oles KJ, et al. The effects of anagrelide on human megakaryocytopoiesis. *Br J Haematol* 1997;99:174–180.
191. Tomer A. Effects of anagrelide on in vivo megakaryocyte proliferation and maturation in essential thrombocythemia. *Blood* 2002;99:1602–1609.
192. Velu T, Delwiche F, Gangji D, et al. Therapeutic effect of human recombinant interferon- $\alpha$ -2c in essential thrombocythaemia. *Oncology* 1985;42[Suppl 1]:10–14.
193. Ludwig H, Linkesch W, Gisslinger H, et al. Interferon- $\alpha$  corrects thrombocytosis in patients with myeloproliferative disorders. *Cancer Immunol Immunother* 1987;25:266–273.
194. May D, Wandl UB, Niederle N. Treatment of essential thrombocythaemia with interferon alpha 2b. *Lancet* 1989;1:96.
195. Gisslinger H, Ludwig H, Linkesch W, et al. Long-term interferon therapy for thrombocytosis in myeloproliferative diseases. *Lancet* 1989;1:634–637.
196. Gisslinger H, Chott A, Scheithauer W, et al. Interferon in essential thrombocythaemia. *Br J Haematol* 1991;79[Suppl 1]:42–47.
197. Seewan HL, Zikulnig R, Gallhofer G, Schmid C. Treatment of thrombocytosis in chronic myeloproliferative disorders with interferon alfa-2b. *Eur J Cancer* 1991;27[Suppl 4]:S58–S63.
198. Yataganas X, Meletis J, Plata E, et al. Alpha interferon treatment of essential thrombocythaemia and other myeloproliferative disorders with excessive thrombocytosis. *Eur J Cancer* 1991;27:[Suppl 4]:S69–S71.
199. Sacchi S, Tabilio A, Leoni P, et al. Interferon alpha-2b in the long term treatment of essential thrombocythemia. *Ann Hematol* 1991;63:206–209.
200. Sacchi S, Tabilio A, Leoni P, et al. Sustained complete hematologic remission in essential



- thrombocythaemia after discontinuation of long-term  $\alpha$ -IFN treatment. *Ann Hematol* 1993;66:245–246.
201. Catani L, Gugliotta L, Cascione ML, et al. Platelet function and interferon alpha-2a treatment in essential thrombocythaemia. *Eur J Haematol* 1991;46:158–162.
202. Giralat M, Rubio D, Cortés MT, et al. Alpha interferon in the management of essential thrombocythaemia. *Eur J Cancer* 1991;27[Suppl 4]:S72–S74.
203. Middlehoff G, Boll I. A long term clinical trial of interferon alpha-therapy in essential thrombocythaemia. *Ann Hematol* 1992;64:207–209.
204. Kasparu H, Bernhart M, Krieger O, Lutz D. Remission may continue after termination of rIFN $\alpha$ -2b treatment for essential thrombocythemia. *Eur J Haematol* 1992;48:33–36.
205. Rametta V, Ferrara F, Marottoli V, et al. Recombinant interferon alpha-2b as treatment of essential thrombocythaemia. *Acta Haematol* 1994;91:126–129.
206. Törnebohm-Roche E, Merup M, Lockner D, Paul C.  $\alpha$ -2a Interferon therapy and antibody formation in patients with essential thrombocythemia and polycythemia vera with thrombocytosis. *Am J Hematol* 1994;48:163–167.
207. Gilbert HS. Long-term treatment of myeloproliferative disease with interferon- $\alpha$ -2b. *Cancer* 1998;83:1205–1213.
208. Bentley M, Taylor K, Grigg A, et al. Long-term interferon- $\alpha$  2A does not induce sustained hematologic remission in younger patients with essential thrombocythemia. *Leuk Lymphoma* 1999;36:123–128.
209. Ganser A, Carlo-Stella C, Greher J, et al. Effect of recombinant interferons alpha and gamma on human bone marrow-derived megakaryocytic progenitor cells. *Blood* 1987;70:1173–1179.
210. Gugliotta L, Bagnara G, Catani L, et al. *In vivo* and *in vitro* inhibitory effect of  $\alpha$ -interferon on megakaryocyte colony growth in essential thrombocythaemia. *Br J Haematol* 1989;71:177–181.
211. Wadenvik H, Kutti J, Ridell B, et al. The effect of  $\alpha$ -interferon on bone marrow megakaryocytes and platelet production rate in essential thrombocythemia. *Blood* 1991;77:2103–2108.
212. Wadenvik H, Örténwall P, Kutti J, Risberg B. Splenic platelet kinetics and platelet production after major reconstructive vascular surgery. *Acta Med Scand* 1988;223:147–152.
213. Chott A, Gisslinger H, Thiele J, et al. Interferon- $\alpha$ -induced morphologic changes of megakaryocytes: a histomorphometrical study on bone marrow biopsies in chronic myeloproliferative disorders with excessive thrombocytosis. *Br J Haematol* 1990;74:10–16.
214. Randi ML, Barbone E, Rossi C, Girolami A. Essential thrombocythemia and pregnancy: a report of six normal pregnancies in five untreated patients. *Obstet Gynecol* 1994;83:915–917.
215. Beressi AH, Tefferi A, Silverstein MN, et al. Outcome analysis of 34 pregnancies in women with essential thrombocythemia. *Arch Int Med* 1995;155:1217–1222.
216. Wright CA, Tefferi A. A single institution experience with 43 pregnancies in essential thrombocytosis. *Eur J Haematol* 2001;66:152–159.
217. Kaibara M, Kobayashi T, Matsumoto S. Idiopathic thrombocythemia and pregnancy: report of a case. *Obstet Gynecol* 1985;65:18S–19S.
218. Snethlage W, Ten Cate JW. Thrombocythaemia and recurrent late abortions: normal outcome of pregnancies after antiaggregatory treatment. *Br J Obstet Gynaecol* 1986;93:386–388.
219. Lishner M, Amato D, Farine D. Different outcomes of pregnancy in women with essential thrombocytosis. *Isr J Med Sci* 1993;29:100–102.
220. Mercer B, Drouin J, Jolly E, d'Anjou G. Primary thrombocythemia in pregnancy: a report of two

cases. *Am J Obstet Gynecol* 1988;159:127–128.

221. Falconer J, Pineo G, Blahey W, et al. Essential thrombocythemia associated with recurrent abortions and fetal growth retardation. *Am J Hematol* 1987;25:345–347.

222. Beard J, Hillmen P, Anderson CC, et al. Primary thrombocythaemia in pregnancy. *Br J Haematol* 1991;77:371–374.

223. Jones EC, Mosesson MW, Thomason JL, Jackson TC. Essential thrombocythemia in pregnancy. *Obstet Gynecol* 1988;71:501–503.

224. Sanada M. Three successful pregnancies in a woman with essential thrombocythemia. *Eur J Hematol* 1989;42:215–216.

225. Chow EY, Haley LP, Vickars LM. Essential thrombocythemia in pregnancy: platelet count and pregnancy outcome. *Am J Hematol* 1992;41:249–251.

226. Cairns JW, Mahon A, Waters DAW, Chanarin I. Platelet levels in pregnancy. *J Clin Pathol* 1977;30:392.

227. Sejeny SA, Eastham RD, Baker SR. Platelet counts during normal pregnancy. *J Clin Pathol* 1975;28:812–813.

228. Linares M, Pastor E, Jarque I, et al. Essential thrombocythemia and pregnancy. *Am J Hematol* 1988;28:66.

229. Pineo GF, Blahey WB. Essential thrombocythemia and complications of pregnancy. *Am J Hematol* 1991;36:221.

230. Cinkotai KI, Wood P, Donnai P, Kendra J. Pregnancy after treatment with hydroxyurea in a patient with primary thrombocythaemia and a history of recurrent abortion. *J Clin Pathol* 1994;47:769–770.

231. Vianelli N, Gugliotta L, Tura S, et al. Interferon- $\alpha$ 2a treatment in a pregnant woman with essential thrombocythemia. *Blood* 1994;83:874–875.

232. Williams JM, Schlesinger PE, Atherton GG. Successful treatment of essential thrombocythaemia and recurrent abortion with alpha interferon. *Br J Haematol* 1994;88:647–648.

233. Pardini S, Dore F, Murineddu M, et al.  $\alpha$ 2b-Interferon therapy and pregnancy—report of a case of essential thrombocythaemia. *Am J Hematol* 1993;43:78–79.

234. Thornley S, Manoharan A. Successful treatment of essential thrombocythemia with alpha interferon during pregnancy. *Eur J Haematol* 1994;52:63–64.

235. Petit JJ, Callis M, deSevilla AF. Normal pregnancy in a patient with essential thrombocythemia treated with interferon- $\alpha$ 2b. *Am J Hematol* 1992;40:80.

236. Delage R, Demers C, Cantin G, Roy J. Treatment of essential thrombocythemia during pregnancy with interferon- $\alpha$ . *Obstet Gynecol* 1996;87:814–817.

237. Davis RB, Theologides A, Kennedy BJ. Comparative studies of blood coagulation and platelet aggregation in patients with cancer and nonmalignant diseases. *Ann Int Med* 1969;71:67–80.

238. Tranum BL, Haut A. Thrombocytosis: platelet kinetics in neoplasia. *J Lab Clin Med* 1974;84:615–619.

239. Bunting RW, Doppelt SH, Lavine LS. Extreme thrombocytosis after orthopedic surgery. *J Bone Joint Surg Br* 1991;73:687–688.

240. Olesen LL, Thorshauge H. Thrombocytosis in patients with malignant pleural mesothelioma. *Cancer* 1988;62:1194–1196.

241. Baynes RD, Bothwell TH, Flax H, et al. Reactive thrombocytosis in pulmonary tuberculosis. *J Clin Pathol* 1987;40:676–679.

242. Schloesser LL, Kipp MA, Wenzel FJ. Thrombocytosis in iron-deficiency anemia. *J Lab Clin Med* 1965;66:107-114.
243. Dinçol K, Aksoy M. On the platelet levels in chronic iron deficiency anemia. *Acta Haematol* 1969;41:135-143.
244. Knizley H, Noyes WD. Iron deficiency anemia, papilledema, thrombocytosis, and transient hemiparesis. *Arch Intern Med* 1972;129:483-486.
245. Alexander MB. Iron deficiency anemia, thrombocytosis, and cerebrovascular accident. *South Med J* 1983;76:662-663.
246. Baldwin JG, Sellers GA. Profound thrombocytosis in a patient with iron-lack anemia. *South Med J* 1989;82:662-663.
247. Hunt P, Zsebo KM, Hokom MM, et al. Evidence that stem cell factor is involved in the rebound thrombocytosis that follows 5-fluorouracil treatment. *Blood* 1992;80:904-911.
248. Suzuki A, Takahashi T, Nakamura K, et al. Thrombocytosis in patients with tumors producing colony-stimulating factor. *Blood* 1992;80:2052-2059.
249. Dan K, Gomi S, Inokuchi K, et al. Effects of interleukin-1 and tumor necrosis factor on megakaryocytopoiesis: mechanism of reactive thrombocytosis. *Acta Haematol* 1995;93:67-72.
250. Heinrich PC, Castell JV, Andus T. Interleukin-6 and the acute phase response. *Biochem J* 1990;265:621-636.
251. Bruno E, Hoffman R. Effect of interleukin 6 on in vitro human megakaryocytopoiesis: its interaction with other cytokines. *Exp Hematol* 1989;17:1038-1043.
252. Ishibashi T, Kimura H, Uchida T, et al. Human interleukin 6 is a direct promoter of maturation of megakaryocytes *in vitro*. *Proc Natl Acad Sci U S A* 1989;86:5953-5957.
253. Hill RJ, Warren MK, Levin J. Stimulation of thrombopoiesis in mice by human recombinant interleukin 6. *J Clin Invest* 1990;85:1242-1247.
254. Asano S, Okano A, Ozawa K. In vivo effects of recombinant human interleukin-6 in primates: stimulated production of platelets. *Blood* 1990;75:1602-1605.
255. Mayer P, Geissler K, Valent P, et al. Recombinant human interleukin 6 is a potent inducer of the acute phase response and elevates the blood platelets in nonhuman primates. *Exp Hematol* 1991;19:688-696.
256. Blay JY, Favrot M, Rossi JF, Wijdenes J. Role of interleukin-6 in paraneoplastic thrombocytosis. *Blood* 1993;82:2261-2262.
257. Weber J, Yang JC, Topalian SL, et al. Phase I trial of subcutaneous interleukin-6 in patients with advanced malignancies. *J Clin Oncol* 1993;11:499-506.
258. Higashihara M, Sunaga S, Tange T, et al. Increased secretion of interleukin-6 in malignant mesothelioma cells from a patient with marked thrombocytosis. *Cancer* 1992;70:2105-2108.
259. Estrov Z, Talpaz M, Mavligit G, et al. Elevated plasma thrombopoietic activity in patients with metastatic cancer-related thrombocytosis. *Am J Med* 1995;98:551-558.
260. Gastl G, Plante M, Finstad CL, et al. High IL-6 levels in ascitic fluid correlate with reactive thrombocytosis in patients with epithelial ovarian cancer. *Br J Haematol* 1993;83:433-441.
261. deBenedetti F, Massa M, Robbioni P, et al. Correlation of serum interleukin-6 levels with joint involvement and thrombocytosis in systemic juvenile rheumatoid arthritis. *Arthritis Rheum* 1991;34:1158-1163.

262. Haznedaroglu IC, Ertenli I, Özcebe OI, et al. Megakaryocyte-related interleukins in reactive thrombocytosis versus autonomous thrombocythemia. *Acta Haematol* 1996;95:107-111.
263. Folman CC, Ooms M, Bart Kuenen B, et al. The role of thrombopoietin in post-operative thrombocytosis. *Br J Haematol* 2001;114:126-133.
264. Ishiguro A, Ishikita T, Shimbo T, et al. Elevation of serum thrombopoietin precedes thrombocytosis in Kawasaki disease. *Thromb Haemost* 1998;79:1096-1100.
265. Ishiguro A, Suzuki Y, Mito M, et al. Elevation of serum thrombopoietin precedes thrombocytosis in acute infections. *Br J Haematol* 2002;116:612-618.
266. Kaser A, Brandacher G, Steuer W, et al. Interleukin-6 stimulates thrombopoiesis through thrombopoietin: role in inflammatory thrombocytosis. *Blood* 2001;98:2720-2725.
267. Spigel SC, Mooney LR. Extreme thrombocytosis associated with malignancy. *Cancer* 1977;39:339-341.
268. Crowley JJ, Hannigan M, Daly K. Reactive thrombocytosis and stroke following cardiopulmonary bypass surgery: case report on three patients. *Eur Heart J* 1994;15:1144-1146.

2004 Lippincott Williams & Wilkins  
John P. Greer, John Foerster, John N. Lukens  
George M. Rodgers, Frixos Paraskevas, Bertil Glader  
Wintrobe's Clinical Hematology

**HEREDITARY DISORDERS OF PLATELET FUNCTION**[Defect in Platelet Adhesion: Bernard–Soulier Syndrome](#)[Defect in Platelet Aggregation: Glanzmann Thrombasthenia](#)[Defects in Secretion](#)[Abnormal Receptor–Mediated Signal Transduction and Secretion](#)[Defects of Platelet Coagulant Activity](#)**ACQUIRED DISORDERS OF PLATELET FUNCTION**[Drug–Induced Platelet Dysfunction](#)[Uremia](#)[Paraproteinemias](#)[Clonal Hematopoietic Disorders](#)**REFERENCES**

Disorders of platelet function are difficult to classify because of the rarity of many of the disorders and the numerous incompletely studied cases. However, the study of patients with congenital disorders of platelet function has made it possible to understand the critical structure–function relationships that determine the normal function of platelets. Information concerning disordered platelet function has accumulated at an unprecedented rate in the past decade and has been reviewed comprehensively ( [1](#), [2](#), [3](#), [4](#), [5](#), [6](#), [7](#), [8](#), [9](#), [10](#) and [11](#) ).

In the classification presented in [Table 58.1](#) and [Figure 58.1](#), hereditary disorders are divided into groups based primarily on the major platelet abnormality responsible for the coagulopathy. Platelet dysfunction also may complicate a wide variety of acquired disorders, but seldom is it the sole abnormality. The acquired disorders of platelet function discussed in this chapter emphasize disorders in which abnormal platelet function appears to be a major cause of bleeding.

**TABLE 58.1. Disorders of Platelet Function****Hereditary disorders of platelet function**

Adhesion defect

Bernard–Soulier syndrome

Aggregation defect

Glanzmann thrombasthenia

Secretion disorders

Granule deficiencies

a–Granule abnormalities

Gray platelet syndrome

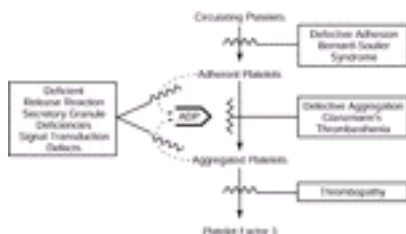
d–Granule (dense body) abnormalities

Storage pool disease: isolated dense body deficiency

Hermansky–Pudlak syndrome

- Chédiak–Higashi syndrome
- Wiskott–Aldrich syndrome
- Thrombocytopenia and absent radii
- a/d–Granule deficiency
- Defects of signal transduction and secretion
  - Impaired liberation of arachidonic acid
  - Cyclooxygenase deficiency
  - Thromboxane synthetase deficiency
  - Thromboxane A<sub>2</sub> receptor abnormalities
- Defects in calcium mobilization
- Defects of platelet coagulant activity
- Miscellaneous
  - Hereditary macrothrombopathy/sensorineural hearing loss
- Acquired disorders of platelet function
  - Drug–induced platelet dysfunction
    - Analgesics
    - Antibiotics
    - Cardiovascular drugs
    - Psychotropic drugs
  - Uremia
  - Disorders of the hematopoietic system
    - Paraproteinemias
    - Myelodysplastic syndrome/acute nonlymphocytic leukemia
    - Myeloproliferative disorders

---



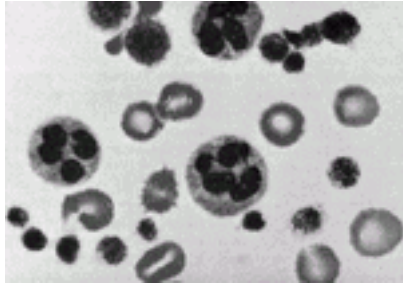
**Figure 58.1.** Pathophysiology of common disorders of platelet function. Illustrated are the sites at which various disorders impair the processes of platelet adhesion and aggregation ( *solid arrows*), and the release reaction ( *dashed arrows*). ADP, adenosine diphosphate.

## HEREDITARY DISORDERS OF PLATELET FUNCTION

### Defect in Platelet Adhesion: Bernard–Soulier Syndrome

Bernard–Soulier syndrome is a rare disorder that was first described in 1948 as “dystrophie thrombocytaire hemorrhagipare congenitale” ( [12](#) ). It is characterized by an increased bleeding time, mild thrombocytopenia, giant platelets, defective adhesion, and bleeding out of proportion to the reduction in platelet numbers ( [1](#), [3](#), [13](#) ). The morphologic abnormalities of the platelets are the most consistent and striking feature of the disorder ( [Fig. 58.2](#) ), with platelets as large as 10  $\mu\text{m}$  or more in diameter ( [14](#) ). In one study, platelet size was normal when intact platelets were studied in plasma, in contrast to

marked platelet “giantism” evident in stained smears, suggesting that giant platelets are formed as the result of an aberrant shape change after platelet activation ( [15](#) ).



**Figure 58.2.** Bernard–Soulier platelets. Giant platelets in the Bernard–Soulier syndrome ( $\times 1200$ , Wright stain). (From Bithell TC, Parekh SJ, Strong RR. Platelet function studies in the Bernard–Soulier syndrome. *Ann N Y Acad Sci* 1972; 201:145–160, with permission.)

There are no specific abnormalities in the ultrastructure of affected platelets, but a dilated canalicular system, prominent dense tubular system, and vacuolization have been described ( [16](#), [17](#) ). Freeze–fracture studies have demonstrated abnormal distribution and size of membrane–associated particles that were similar to those changes seen in thrombasthenia, the other major defect of platelet membrane glycoproteins ( [18](#) ). The megakaryocytes are normal or increased in number, but they reveal no characteristic morphologic abnormalities when viewed with light microscopy. Electron microscopic studies have revealed abnormalities of the dense tubular system ( [19](#) ) and vacuolization of the demarcation membrane system ( [20](#) ).

**GLYCOPROTEIN ABNORMALITIES** Biochemical studies of platelets from patients with the Bernard–Soulier syndrome reveal a quantitative or qualitative abnormality of the membrane GPIb/IX/V complex in platelets ( [21](#), [22](#), [23](#), [24](#), [25](#), [26](#), [27](#), [28](#) and [29](#) ) and megakaryocytes ( [20](#), [30](#) ). GPIb is a surface membrane heterodimer consisting of an alpha (Ib $\alpha$ ) and a beta chain (Ib $\beta$ ) that are covalently linked by a disulfide bond. Glycoprotein Ib forms a noncovalent complex with GPIX and GPV. These glycoproteins are all members of the leucine–rich glycoprotein family and are required in the interaction between von Willebrand factor (vWF) and the platelet membrane that is essential for normal platelet adhesion during the early phases of primary hemostasis ( [31](#) ). This view has been supported by the demonstration that affected platelets do not adhere to denuded vascular segments when perfused at a high shear rate ( [19](#), [32](#), [33](#) and [34](#) ) and do not bind normally to noncollagenous subendothelial microfibrils ( [35](#) ). Deletion of glycoprotein Ib/IX/V also explains the failure of affected platelets to aggregate in the presence of ristocetin (even after addition of normal plasma or vWF) or bovine vWF. A variety of mutations in the glycoprotein Iba, Ib $\beta$ , and IX genes have been now described in classic Bernard–Soulier patients ( [36](#) ). A genetic mutation and deficiencies of GPIba, GPIb $\beta$ , or GPIX, but not GPV, result in decreased expression of the Ib/IX/V complex on the surface of the platelets ( [37](#), [38](#) and [39](#) ). Variant forms of Bernard–Soulier syndrome have also been described in which patients have decreased, but measurable amounts of presumably nonfunctional glycoproteins on the platelet surface ( [40](#), [41](#), [42](#), [43](#), [44](#), [45](#) and [46](#) ).

**CLINICAL FEATURES** Onset of moderate to severe bleeding of the purpuric type, including bruising, epistaxis, gingival bleeding, and menorrhagia, usually begins at an early age. Petechiae are rare, and patients do not usually demonstrate spontaneous bleeding, but posttraumatic and postoperative bleeding may be severe; hemorrhagic deaths have



occurred. The disorder is usually inherited as an autosomal-recessive disorder, and consanguinity is common in reported kindreds. An occasional patient with dominant inheritance has been reported (47). Heterozygotes typically are asymptomatic but have “giant” platelets and reduced levels of GP Ib/IX/V (14). An acquired pseudo-Bernard-Soulier syndrome has been reported in association with autoantibody formation (48, 49). A platelet autoantibody isolated from a patient with the Bernard-Soulier syndrome who had received multiple transfusions was shown to impair aggregation of normal platelets induced by ristocetin and bovine vWF (50). An additional Bernard-Soulier patient developed a transient autoantibody to Ib/IX (51).

**LABORATORY FINDINGS** Laboratory findings usually are characteristic (Table 58.2). The magnitude of thrombocytopenia is variable, appearing to fluctuate from time to time in some patients. The bleeding time is prolonged, but clot retraction and platelet aggregation by adenosine diphosphate (ADP), epinephrine, and collagen are normal. Platelet aggregation by ristocetin is deficient (52, 53) and is not corrected by the addition of normal vWF. Platelet survival studies have demonstrated shortened survival in some patients (30). Determination of GPIb/IX/V levels in platelets by using platelet membrane analysis and/or immunologic techniques is a precise method for diagnosis of this disorder (27, 30, 36, 54, 55).

**TABLE 58.2. Laboratory Findings in Disorders of Platelet Function**

| Test   | Bernard-Soulier Syndrome          | Thrombasthenia           | Storage Pool Disease                                  | Abnormal Release Mechanism                            |
|--|-----------------------------------|--------------------------|---|---|
| Platelet count   | Mild to moderate thrombocytopenia | U normal                 | U normal  | U normal  |
| Platelet morphology  | Characteristic “giant” platelets  | Normal <sup>a</sup>      | Normal; microcytic or macrocytic in some cases        | U normal  |
| Bleeding time  | U prolonged                       | Markedly prolonged       | V abnormality   | U prolonged   |
| Clot retraction  | Normal                            | Deficient                | Normal  | Normal  |
| Specific tests for platelet factor-3 activity                          | U normal                          | Abnormal <sup>b, c</sup> | V abnormality <sup>b</sup>                            | V abnormality <sup>b</sup>                            |
| Platelet retention in glass-bead columns (glass “adhesion”)            | Reduced                           | Reduced <sup>c</sup>     | Reduced <sup>d</sup>                                  | Reduced   |
| Platelet aggregation by 5 μM ADP                                       | Normal <sup>e</sup>               | Deficient                | Normal  | Normal  |
| Platelet aggregation by “threshold” concentrations of ADP (0.2–1.5 μM) | Normal <sup>e</sup>               | Deficient                | Deficient second phase with subsequent disaggregation | Deficient second phase with subsequent disaggregation |

|   |  |  |  |  |
|---|--|--|--|--|
| Platelet aggregation by dilute collagen suspensions and 5 $\mu$ M epinephrine | Normal <sup>e</sup>  | Deficient  | Deficient <sup>f</sup>   | Deficient <sup>f</sup>   |
| Platelet aggregation by ristocetin (1.2–1.5 mg/ml)                            | Deficient <sup>e, g</sup>  | Normal   | Normal   | Normal   |
| Storage nucleotide pool   | Normal <sup>h</sup>  | Normal   | Diminished   | Normal   |
| Ancillary laboratory features   | Initial shape change lacking or aberrant; membrane GPIb/IX/V deficient | Platelet fibrinogen commonly decreased; platelet alloantigen PLA-1 absent; membrane GPIIb and IIIa deficient | Platelet dense bodies reduced in number; ratio platelet ATP:ADP increased; aggregation abnormalities may be “corrected” by addition of aspirin-treated platelets | <i>In vitro</i> effects of aspirin are additive; ratio platelet ATP:ADP normal |

ADP, adenosine diphosphate; ATP, adenosine triphosphate; GP, glycoprotein; U, usually; V, variable.

<sup>a</sup> Platelets appear discrete and rounded in stained smears.

<sup>b</sup> Results depend on exact technique used.

<sup>c</sup> Not corrected by added ADP.

<sup>d</sup> Corrected by added ADP.

<sup>e</sup> Aggregation may be abnormally rapid.

<sup>f</sup> Second wave of epinephrine-induced aggregation absent or reduced.

<sup>g</sup> Not corrected by added factor VIII.

<sup>h</sup> Corrected for increased platelet volume.

**TREATMENT** No effective treatment for the Bernard–Soulier syndrome has been described. The effects of platelet transfusions have not been studied systematically, but in one case, massive platelet transfusions shortened the bleeding time and appeared to be therapeutically effective. However, alloimmunization may occur when platelet transfusions are used in patients with any of these platelet disorders, and HLA-matched platelets may be required. Administration of deamino-D-arginine-vasopressin (DDAVP) may transiently improve the bleeding time (<sup>56</sup>, <sup>57</sup> and <sup>58</sup>) and hemostasis following procedures (<sup>59</sup>). Recombinant factor VIIa was used successfully to treat recurrent epistaxis in a child with Bernard–Soulier syndrome (<sup>60</sup>). Results from use of antifibrinolytic agents are more variable, and the administration of adrenal corticosteroids and splenectomy are usually ineffective.

### Defect in Platelet Aggregation: Glanzmann Thrombasthenia

*Glanzmann thrombasthenia* is an autosomal-recessive disorder of platelet aggregation characterized by a life-long bleeding tendency due to quantitative or qualitative

abnormalities of the platelet membrane complex glycoprotein IIb–IIIa (GPIIb–IIIa) ( [61](#), [62](#), [63](#), [64](#), [65](#), [66](#), [67](#) and [68](#)). In denuded vascular segments, thrombasthenic platelets adhere to the subendothelium and undergo shape change and degranulate normally, but platelet-to-platelet interaction is totally lacking due to the lack of GPIIb–IIIa, the site of platelet fibrinogen binding ( [69](#), [70](#)). Binding sites for thrombin are preserved in thrombasthenic platelets ( [71](#)). Furthermore, studies of platelet enzymes and of the biochemical pathways within affected platelets that lead to the synthesis of prostaglandins and thromboxanes and provide energy for various cellular functions appear normal ( [72](#)).

**GLYCOPROTEIN ABNORMALITIES** Deficiency or aberration of either membrane glycoprotein IIb or IIIa is the basic biochemical defect in thrombasthenia. GPIIb–IIIa is a calcium-dependent heterodimer complex that is a member of the integrin family of cellular receptors (α<sub>IIb</sub>β<sub>3</sub>) and can bind fibrinogen, fibronectin, vitronectin, and vWF. The genes for GPIIb and GPIIIa are distinct but are physically located within 250–260 kb of each other on the long arm of chromosome 17 (17;q21–22). The genetic abnormalities that have been identified involve one or the other glycoprotein; however, heterodimer assembly in the Golgi region, is required to form the normal membrane complex. If genetic defects prevent normal synthesis of one of the glycoproteins, the heterodimer is not normally formed in the Golgi region and neither molecule of the heterodimer is expressed on the cell surface ( [73](#), [74](#) and [75](#)). The unaffected glycoprotein is then retained in the endoplasmic reticulum and degraded. This results in the lack of a fibrinogen receptor and defective fibrinogen binding after platelet activation. Platelet aggregation, which requires this protein, is therefore deficient or completely absent ( [65](#), [76](#), [77](#)), and the binding of fibronectin to thrombin-stimulated thrombasthenic platelets is also reduced ( [78](#)). The glycoprotein abnormalities associated with thrombasthenia are uniform throughout the platelet population ( [79](#)) and are present in the precursor megakaryocyte ( [80](#)) and endothelial cells ( [81](#)). Thrombasthenic patients are classified as type 1, type 2, or variant depending on the severity of their GPIIb–IIIa deficiency, fibrinogen binding, and clot retraction ( [82](#), [83](#)) ( [Table 58.3](#)).

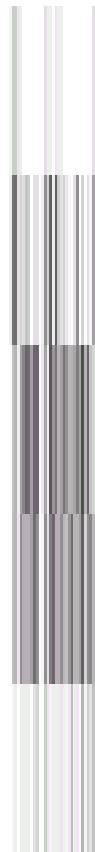
**TABLE 58.3. Classification of Glanzmann Thrombasthenia**

| Glycoprotein IIb–IIIa | Fibrinogen Binding           | Clot Retraction                |
|-----------------------|------------------------------|--------------------------------|
| Type 1 <5%            | Absent or severely deficient | Absent                         |
| Type 2 10–20%         | Present                      | Normal or moderately deficient |
| Variant >50%          | Variable                     | Variable                       |

More than 50 genetic abnormalities have been described in patients with Glanzmann thrombasthenia, including missense mutations, nonsense mutations, splice site mutations, deletions, and point mutations ( [84](#), [85](#)). Both GPIIb and IIIa mutations are found in each of the types of thrombasthenia, and the genetic defects are constant within a specific cluster of patients. The Iraqi Jews and the Arab patients in Israel have distinct and separate genetic defects even though they are phenotypically identical. Marked diminution of platelet alloantigens associated with GPIIb and GPIIIa occurs in patients with thrombasthenia. These include PLA-1 (Zwa) and its allele PLA-2, Bak (Lek), and Pen (Yuk) ( [86](#), [87](#), [88](#) and [89](#)). Autoantibodies that presumably are specific for the deleted glycoproteins were demonstrated in the blood of transfused patients with thrombasthenia ( [90](#), [91](#)), and these antibodies could reproduce the thrombasthenic defect in normal platelets. Acquired thrombasthenia has resulted from *de novo* development of similar antibodies ( [92](#)).

thrombasthenia is inherited as an autosomal-recessive trait, and is found in affected kindreds, resulting in geographic clusters of the disorder around the world. Most patients are diagnosed before 5 years of age. Clinical features include bleeding of the purpuric type, epistaxis, menorrhagia, and bruising (83, 93, 94). Bleeding at menarche is severe enough to require transfusion. Petechiae are uncommon, but generalized spontaneous bleeding is uncommon but may be disabling. Hemarthrosis and hematomas are rare (83, 95), but posttraumatic and may be serious. Pregnancy and delivery represent a severe complication that may not always be preventable with platelet transfusions. Thrombasthenia is defined as a severe bleeding disorder. However, the severity of the disorder is highly variable, and there is no correlation with the amount of von Willebrand factor in the plasma. Prognosis is excellent with supportive care, and most patients survive into old age. The severity of bleeding appears to decrease with age. Some patients are asymptomatic, and laboratory studies usually reveal no abnormalities. Patients with thrombasthenia have approximately one-half the normal amount of von Willebrand factor; techniques involving the use of hybridoma-produced monoclonal antibodies may provide an accurate means of detecting such abnormalities.

The laboratory findings associated with this disorder are listed in Table 58.2. A prolonged bleeding time, deficient clot retraction, and deficient platelet aggregation with ADP, collagen, epinephrine, and ristocetin are characteristic features. Ristocetin-induced aggregation and thrombosthenic platelets are present in normal numbers when viewed by light microscopy. In stained blood smears, platelets are small, discrete, round, and separate as a result of deficient aggregation. These findings may explain reports of morphologic abnormalities. Electron microscopy reveals a highly variable and probably nonspecific ultrastructural abnormality in thrombasthenic platelets (99). Studies using the freeze-etching technique have demonstrated persistent membrane abnormalities (18). Methods using monoclonal antibodies are highly sensitive and specific as a means of demonstrating the presence of von Willebrand factor on the platelet membrane (27).



**Figure 58.3.** Aggregometry tracings in patients with storage pool disease and thrombasthenia (A). Aggregating agents were added at zero time. Storage pool disease (SPD): note the disaggregation observed with low adenosine diphosphate (ADP) concentrations (B), the absence of a secondary wave of epinephrine-induced aggregation (C), and the absence of collagen-induced aggregation (D). The patient was a 31-year-old man with partial albinism. Ancillary findings included characteristic pigmented reticulum cells in the bone marrow and abnormally small platelets. Thrombasthenia (TA): note the absence of aggregation. The patient was a 25-year-old woman.

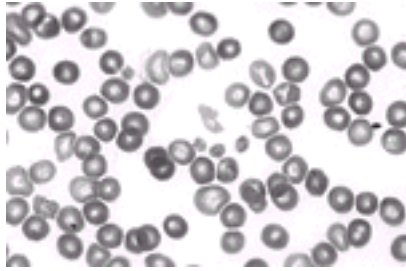
**TREATMENT** No specific treatment for thrombasthenia is known. It is important to anticipate the risks of bleeding before performing procedures and to administer prophylactic platelet transfusions even if the patient does not have a history of prior

bleeding, because bleeding in thrombasthenia is so unpredictable. Transfusions should be continued until wound healing is complete. However, a significant number of transfused patients will develop HLA and/or specific antibodies to IIb/IIIa, which will limit future treatment with platelets. Bleeding can also be treated with local measures (compression), local agents (topical thrombin, fibrin glue), and antifibrinolytic agents (ε-aminocaproic acid, tranexamic acid). Some patients demonstrate shortening of their bleeding time after treatment with DDAVP ( [57](#) ). Patients who have severe menorrhagia should be treated with hormone therapy. Birth control pills usually will control blood loss, and iron should be replaced as necessary to prevent iron deficiency anemia. There is accumulating evidence that recombinant VIIa infusions are both effective and usually quite safe in patients with inherited platelet qualitative disorders, including thrombasthenia ( [100](#), [101](#) and [102](#) ). Several patients with severe bleeding have been successfully treated with allogeneic bone marrow transplantation, and there is a recent report of successful megakaryocyte synthesis of the integrin  $\beta_3$  subunit after gene therapy ( [103](#) and [104](#) ).

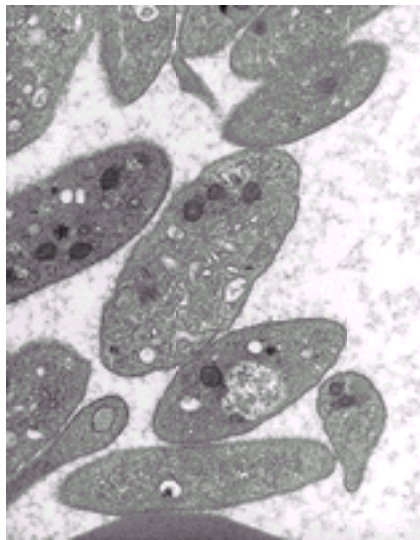
## Defects in Secretion

Abnormal platelet secretion may be caused by either defects or deficiencies in platelet granules (α, δ, or both) or defects in receptor-mediated signal transduction. Patients have been identified with each of these types of defects, and their platelets have been well studied to define the defect as accurately as possible. However, little is known about the pathogenetic mechanisms for these abnormalities of platelet morphogenesis or abnormal secretion.

**α-GRANULE DEFICIENCY: GRAY PLATELET SYNDROME** Gray platelet syndrome is a rare platelet disorder characterized by a selective deficiency in the number and contents of platelet α-granules ( [105](#), [106](#) ). Megakaryocytes demonstrate early formation of α-granules, but granules then decrease during maturation, resulting in mature megakaryocytes with only occasional small, abnormal granules ( [106](#), [107](#) and [108](#) ). GPIV ( [109](#) ), GPIIb-IIIa ( [110](#) ), and P-selectin ( [111](#), [112](#) ) are present in the membranes of these abnormal granules and demonstrate redistribution during activation. Endothelial cells in the dermal capillary network in gray platelet patients demonstrate normal Weibel-Palade bodies, vWF, and membrane P-selectin; therefore, the defect appears limited to megakaryocytes and platelets ( [113](#) ). A similar defect in neutrophils was recently reported in a single family ( [114](#) ). Deficiencies of α-granule proteins include platelet factor 4, β-thromboglobulin, fibrinogen, fibronectin, vWF, platelet-derived growth factor, and thrombospondin ( [115](#), [116](#), [117](#), [118](#), [119](#) and [120](#) ). These proteins appear to be synthesized but not stored normally in the α-granules. Immunoglobulins and albumin are variably present ( [121](#), [122](#) ). Lysosomes, mitochondria, and dense bodies are present in normal numbers in gray platelets, and dense bodies contain normal amounts of adenine nucleotides and serotonin ( [107](#), [119](#) ). The lack of α-granules gives rise to characteristic morphologic abnormalities of affected platelets. In Wright-stained blood smears, they are gray or blue, vacuolated, and washed-out or ghostlike in appearance ( [Fig. 58.4](#) ). In electron photomicrographs, an almost total lack of α-granules is evident in platelets and in megakaryocytes ( [Fig. 58.5](#) ) ( [107](#), [116](#) ). The α-granules that are present are both small and abnormal in appearance. Some patients may demonstrate increased emperipolesis ( [123](#) ). Gray platelets have a normal aggregation and release response to arachidonic acid and ionophore and generate thromboxane normally. Aggregation to ADP, epinephrine, collagen, and thrombin is more variable. Release from dense bodies usually is subnormal, particularly when induced by thrombin ( [119](#), [122](#) ). Abnormal calcium influx and mobilization from intracellular stores have also been reported ( [124](#), [125](#) ).



**Figure 58.4.** Gray platelet syndrome platelets. Giant platelets in the gray platelet syndrome. ( $\times 1200$ , Wright stain). See [Color Plate](#).



**Figure 58.5.** Gray platelet syndrome platelets. The large platelets are devoid of  $\alpha$ -granules but contain normal numbers of mitochondria and dense bodies. (Figure courtesy of Dr. Paula E. Stenberg.)

**Clinical Features** The disorder is inherited as an autosomal trait and is associated with mild to moderate thrombocytopenia (20,000 to 150,000/ $\mu$ l) and moderately enlarged platelets ([126](#)). Bleeding time usually is prolonged, and platelet aggregation induced by collagen or thrombin usually is deficient ([116](#), [119](#)). Platelet survival may be shortened, but splenomegaly is rare ([127](#)). The bleeding diathesis usually is mild, and treatment is seldom required. The bone marrow in many patients is inaspirable and demonstrates a normal number of megakaryocytes and increased reticulin, occasionally around clusters of megakaryocytes ([116](#), [126](#), [127](#), [128](#), [129](#), and [130](#)). Patients do not, however, demonstrate clinical signs of myelofibrosis.

**Treatment** Corticosteroids are ineffective, and DDAVP shortens the bleeding time in some ([120](#)), but not all, patients ([131](#)). Platelet transfusions have not been evaluated systematically.

**d-GRANULE DEFICIENCY: DENSE BODY DEFICIENCY** Some patients have a single deficiency of dense bodies; others have dense body deficiency in association with other defects such as oculocutaneous albinism (i.e., Hermansky Pudlak syndrome) or immune deficiencies (Wiskott–Aldrich syndrome).

**Storage Pool Disease** The abnormality of the release reaction associated with this disorder appears to be the result of a deficiency of dense bodies (d-granules), which store adenine nucleotides and serotonin in affected platelets and megakaryocytes ([132](#), [133](#) and [134](#)). The platelets are morphologically normal on Wright-stained smears, but they are deficient in dense bodies by electron microscopy. Electron microscopic analysis has revealed both subnormal numbers of dense bodies in the platelets of patients with this



disorder ( 17, 133 ) and empty dense bodies ( 135, 136 ). The morphologic changes that accompany activation of platelets, including the “centralization” of organelles and degranulation, are essentially normal in storage pool disease (SPD) ( 133 ).  $\alpha$ -Granules are normal, and lysosomal granule enzymes are secreted normally ( 137 ). The total amount of platelet ADP and adenosine triphosphate (ATP) in the platelet is reduced, and the ratio of ATP to ADP is increased due to the change in distribution between the metabolic and granule pools of nucleotides ( 132, 138, 139 ). The conversion of labeled ATP into inosine monophosphate and hypoxanthine proceeds normally, an observation that suggests the pathways that supply metabolic ATP to the release mechanism are intact ( 132, 140, 141 ). The platelets are deficient in serotonin, calcium, and pyrophosphate, which are also contained in the dense bodies ( 141, 142 and 143 ). Abnormalities of platelet adhesion have been reported in some patients ( 132, 144, 145 ), especially at hematocrit concentrations between 30 and 40% ( 146 ). These abnormalities can, however, be corrected by the addition of red blood cells, suggesting that ADP may be necessary for normal platelet spreading on the subendothelium ( 146 ). The release mechanism also is abnormal in some patients with SPD ( 137 ). Collagen-induced production of prostanoids  $E_2$  and  $F_{2a}$  and the potentiating effects of prostaglandin  $E_2$  on the release reaction are deficient ( 147 ), even though the platelets can convert arachidonic acid to the prostaglandin metabolites (malondialdehyde,  $PGG_2$ ,  $PGH_2$ , thromboxane  $A_2$ ) ( 148, 149 ).

**Clinical Features** Patients with SPD have a bleeding diathesis that can be mild to moderate. The most common symptoms are epistaxis, purpura, menorrhagia, and posttraumatic and postsurgical bleeding. The ADP content of the dense bodies has been correlated with the bleeding time ( 150 ). Inheritance is believed to be autosomal dominant ( 139 ).

**Laboratory Findings** Bleeding time is increased, with normal platelet counts and morphology. Aggregation studies are abnormal, demonstrating an impaired response to collagen and a deficient secondary wave with ADP, epinephrine, and low concentrations of thrombin ( Fig. 58.3, Table 58.2 ) ( 134, 139 ). Ristocetin aggregation is normal ( 134, 139 ). Subsets of patients have been identified who have a prolonged bleeding time, decreased dense bodies, and ADP release but normal platelet aggregation ( 151, 152 ). The diagnosis of dense-body SPD requires a combination of studies, including bleeding time, platelet aggregation with lumiaggregometry to assess storage pool adenine nucleotides, thrombin-induced radioactive serotonin uptake and release, and transmission electron microscopy. Methods have recently been developed to diagnose SPD using mepacrine and flow cytometry ( 153, 154 ).

**Treatment** Approximately 75% of patients with SPD demonstrate shortening of their prolonged bleeding times 1 hour after infusion of DDAVP ( 57, 155, 156 and 157 ). This improvement in hemostasis is associated with less bleeding after procedures ( 158 ), and in combination with an antifibrinolytic agent, such as tranexamic acid ( 159 ) or ethamsylate ( 160 ), the treatment may be even more effective. There is no correlation between pretreatment concentrations of plasma vWF antigen or activity and response to DDAVP. In addition, there is no correlation between efficacy and posttreatment changes in platelet aggregation ( 57 ). Preliminary data suggest that intranasal concentrated DDAVP may be similarly effective ( 161 ). Side effects of DDAVP are minimal, but very young children should have electrolytes and fluid intake followed for 24 hours. However, this response to DDAVP has not been confirmed in a double-blind, placebo-controlled trial in four patients ( 162 ). Hemostasis is also improved after infusion of cryoprecipitate ( 163 ). Platelet transfusions should be reserved for life-threatening bleeding because of the development of alloantibodies.

**Other Storage Pool Abnormalities** SPD, when associated with oculocutaneous albinism and ceroid pigment accumulation in reticuloendothelial cells, has been termed the



*Hermansky–Pudlak syndrome* ( [164](#), [165](#) and [166](#) ). This disorder is inherited as an autosomal-recessive trait. There is worldwide distribution, although the highest prevalence is in Puerto Rico. Three separate Hermansky–Pudlak-causing genes are known ( [167](#), [168](#) ). Patients have a life-long history of easy bruisability, minor bleeding episodes, and prolonged bleeding times. More severe bleeding has been demonstrated to be associated with simultaneous familial deficiencies of vWF ( [169](#), [170](#) ). Pulmonary fibrosis and inflammatory bowel disease, associated with infiltration of ceroid-pigmented reticuloendothelial cells in the lung and colon, have been reported in several cases of this syndrome ( [171](#) ). SPD also may be associated with the Chédiak–Higashi syndrome ( [172](#), [173](#), [174](#) and [175](#) ), Wiskott–Aldrich syndrome ( [176](#), [177](#), [178](#), [179](#), [180](#) and [181](#) ), and TAR syndrome (thrombocytopenia with absent radii) ( [182](#), [183](#) ).

**a-d-GRANULE DEFICIENCY** Patients have been described who demonstrate both a deficiency in dense bodies and a variable deficiency of a-granules ( [141](#), [148](#) ). These platelets form significantly smaller thrombi in flowing blood than even platelets with dense body deficiency ( [145](#) ). Platelet aggregation studies demonstrate defects in secondary aggregation and defects in primary aggregation that are even greater than in SPD ( [149](#) ). One patient with severe a-granule deficiency also demonstrated decreased P-selectin after activation ( [111](#) ). Bleeding in this disorder is clinically similar to bleeding in SPD and gray platelet syndrome.

### **Abnormal Receptor-Mediated Signal Transduction and Secretion**

Abnormalities of platelet secretion may be caused by abnormalities of membrane receptors for one specific agonist ( [184](#), [185](#), [186](#) and [187](#) ) or post receptor-mediated secretory events. A variety of platelet function defects exist that are characterized by an aspirinlike defect in aggregation and secretion. Platelet counts are normal, bleeding times are usually prolonged, and platelet aggregation studies demonstrate abnormalities with weak agonists (i.e., lack of secondary aggregation responses with ADP and epinephrine, and variably deficient aggregation and secretion with collagen) ( [2](#) ). The platelets usually aggregate and secrete normally with thrombin and ristocetin. These defects have been reported in case reports only or a limited series of patients. Patients demonstrate mild to moderate bruising, mucosal membrane bleeding, and bleeding after procedures.

**IMPAIRED LIBERATION OF ARACHIDONIC ACID** Four patients have been described in whom platelet aggregation and secretion responses are normal to exogenous arachidonic acid, with normal generation of thromboxane B<sub>2</sub>, but who demonstrate impaired hydrolysis of membrane arachidonic acid and decreased aggregation, secretion, and thromboxane B<sub>2</sub> with ADP, epinephrine, and collagen. Calcium-dependent myosin light chain phosphorylation was normal, demonstrating that the defect is not related to calcium-dependent phospholipase activity ( [188](#) ).

**CYCLOOXYGENASE DEFICIENCY** Several patients have demonstrated abnormal aggregation and secretion responses to exogenous arachidonic acid but normal aggregation and secretion with exogenous PGG<sub>2</sub> and PGH<sub>2</sub> ( [189](#), [190](#), [191](#), [192](#), [193](#) and [194](#) ). This suggests that the defect in the prostaglandin metabolic pathway is related to the cyclooxygenase enzyme. The defect was also present in the endothelial cell in one patient, resulting in deficient prostacyclin synthesis as well ( [192](#) ). Cyclooxygenase has been present in normal amounts but nonfunctional when measured ( [194](#) ).

**THROMBOXANE SYNTHETASE DEFICIENCY** At least three patients have demonstrated a defect in thromboxane synthetase activity with absent aggregation with arachidonic acid and prostaglandin endoperoxides and decreased production of thromboxane B<sub>2</sub> ( [195](#), [196](#) ). These patients and the patients with deficient cyclooxygenase activity produce increased products from the lipoxygenase pathway (hydroxy-icosatetraenoic acid) instead of

thromboxane B<sub>2</sub> and HHT.

**IMPAIRED RESPONSE TO THROMBOXANE A<sub>2</sub>** Thromboxane A<sub>2</sub> generated from hydrolysis of platelet membrane arachidonic acid is a powerful platelet-activating agent, and its activity, in combination with ADP released from dense bodies, is critical for platelet activation with weak agonists such as ADP, epinephrine, and low concentrations of collagen. Several patients have demonstrated normal thromboxane B<sub>2</sub> production with arachidonic acid but abnormal aggregation and secretion with ADP and epinephrine ( [197](#), [198](#), [199](#) and [200](#) ). There is also a defective platelet response to U46619, a thromboxane A<sub>2</sub> agonist, suggesting that the thromboxane receptor is abnormal in this group of patients. An Arg60 to Leu mutation in the thromboxane A<sub>2</sub> receptor has been documented in two unrelated families, with normal ligand-binding affinities, but decreased guanosine triphosphatase activity and second messenger formation as a result of this mutation ( [201](#), [202](#) ). Phospholipase A<sub>2</sub>-mediated reactions remain normal in these patients, suggesting a dissociation between phospholipase C-mediated and phospholipase A<sub>2</sub>-mediated reactions.

**IMPAIRED CALCIUM MOBILIZATION** Several patients have been reported to have abnormal platelet function, which is characterized by an abnormal response to A23187 (calcium ionophore) and appears to be limited to abnormalities in calcium mobilization ( [203](#), [204](#), [205](#), [206](#), [207](#), [208](#) and [209](#) ). Platelets from these patients may have a variety of defects, each of which could result in the inability to release calcium from intracellular storage organelles and/or influx of extracellular calcium across the plasma membrane. These include abnormalities in thrombin-induced calcium mobilization in patients with macrothrombocytopenia and abnormal membrane complexes ( [209](#) ), an abnormality in phospholipase C-mediated hydrolysis of phosphatidylinositol biphosphate and formation of inositol triphosphate and diacylglycerol ( [207](#), [208](#) ), or a defect in calcium-mediated phosphorylation of one of the proteins necessary for normal secretion ( [204](#) ).

## Defects of Platelet Coagulant Activity

Isolated abnormalities of platelet coagulant activity have been described in several patients ( [210](#), [211](#), [212](#) and [213](#) ), but the best studied and understood defect is that found in Scott syndrome ( [214](#) ). Mrs. Scott had a normal bleeding time and no increased bruising or bleeding from superficial cuts. She bled extensively after procedures and developed a spontaneous pelvic hematoma. The defect in these patients is manifested by reduced platelet coagulant activity; platelet adhesion, aggregation, secretion, and morphology are all normal. The binding of factors Va-Xa and factors VIIIa-IXa complexes is impaired, resulting in decreased thrombin generation and impaired platelet-dependent fibrin formation on subendothelium. These defects are linked to a defect in calcium-mediated vesiculation of the plasma membrane and decreased membrane exposure of phosphatidylserine, which may be due to a defect in the enzyme scramblase ( [214](#), [215](#), [216](#), [217](#), [218](#) and [219](#) ).

## ACQUIRED DISORDERS OF PLATELET FUNCTION

### Drug-Induced Platelet Dysfunction

A great many chemically and biologically active substances can be shown to inhibit platelet function. These range from various ionophores, structural analogues of ADP, and supraphysiologic concentrations of various drugs, to common dietary items such as garlic ( [220](#), [221](#), [222](#) and [223](#) ), red pepper ( [224](#) ), various Chinese herbs ( [225](#) ), black tree fungus ( [226](#) ), and fish oil ( [227](#) ). The present discussion is limited to drugs in common use that impair

platelet function in therapeutic concentrations ( [Table 58.4](#)). An extensive list of drugs that impair platelet function has recently been published ( [228](#)), and the drugs that are used to treat thromboembolic disorders are discussed further in [Chapter 61](#).

**TABLE 58.4. Drugs Affecting Platelet Function**

---

|   |
|---|
| Analgesics                                    |
| Aspirin                                       |
| Nonsteroidal antiinflammatory drugs           |
| Acetaminophen                                 |
| Antibiotics                                   |
| $\beta$ -Lactams: penicillins, cephalosporins |
| Cardiovascular drugs                          |
| Nitrates                                      |
| Nitroprusside                                 |
| Psychotropic drugs                            |

---

In otherwise healthy persons, the impairment of platelet function produced by drugs usually is of no clinical significance. On the contrary, in patients with coagulation disorders, in uremic or thrombocytopenic patients, and in patients receiving heparin or coumarin anticoagulants, impairment of platelet function by drugs may remove one of the remaining hemostatic defenses and result in serious bleeding ( [229](#)). Analgesics that are presumably safe for use by these patients include codeine and other opiates and synthetic narcotics such as meperidine, acetaminophen, and propoxyphene. However, even acetaminophen has some effect on *in vitro* and *ex vivo* platelet function ( [230](#)).

### ANALGESICS

**Aspirin** Acetylsalicylic acid is a potent inhibitor of the platelet release reaction as the consequence of acetylation by the drug of the active center of platelet cyclooxygenase (COX-1>COX-2), the enzyme responsible for the conversion of arachidonic acid into cyclic endoperoxides within the platelet ( [231](#)). This effect occurs within 15 to 30 minutes after ingestion with doses as low as 40 to 80 mg, is irreversible, and persists as long as the affected platelet cohort survives ( [232](#), [233](#) and [234](#)). Consequently, a single small dose of aspirin impairs the release reaction for up to 96 hours ( [234](#)). However, some patients may be nonresponders who do not demonstrate an effect on platelet function when ingesting 325 mg of aspirin ( [235](#)). Inhibition of cyclooxygenase blocks the synthesis of prosta-glandins E<sub>2</sub> and F<sub>2</sub> a and thromboxane A<sub>2</sub> by the platelet, as well as production of prostacyclin (PGI<sub>2</sub>) by the endothelium ( [236](#)). Prostacyclin production is less completely and less persistently inhibited than is the synthesis of thromboxane A<sub>2</sub> and prostaglandin E<sub>2</sub>, with the result that the effects of aspirin are, overall, antithrombotic in the doses usually administered ( [232](#)). When aspirin-treated platelets are perfused through denuded arterial segments, they adhere normally to the subendothelium but do not interact with one another ( [144](#)). Electron photomicrographs reveal that centralization of organelles, which normally occurs in collagen-activated platelets, does not occur in aspirin-treated platelets ( [133](#)). Aggregometry tracings obtained with aspirin-treated platelets reveal deficient collagen-induced aggregation and the absence of the secondary wave of aggregation induced by epinephrine and low concentrations of ADP ( [237](#)).

Aspirin-treated platelets fail to release normal amounts of ADP, ATP, and serotonin, but higher doses may be necessary to block  $\alpha$ -granule secretion ( 238 ). Aspirin prolongs the bleeding time significantly but seldom produces values that are above the normal range. This effect is more pronounced in men than women ( 239 , 340 ). In a small percentage of normal subjects, and in some patients with minor platelet dysfunction, the bleeding time is markedly prolonged after aspirin ingestion ( 241 ). Aspirin has a dose-related gastrointestinal toxic effect ( 242 ). Studies using  $^{51}\text{Cr}$ -labeled erythrocytes demonstrate that aspirin ingestion predictably causes the loss of small amounts of blood into the gastrointestinal tract, and this effect is enhanced by the ingestion of ethanol ( 232 , 243 , 244 ). Current evidence suggests that aspirin only affects surgical bleeding in patients undergoing surgery in areas where increased fibrinolytic activity may compound the effect of nonsteroidal antiinflammatory drugs (NSAIDs) (oral cavity or genitourinary tract) or in patients with other coexisting coagulation disorders ( 245 ).

**Nonsteroidal Antiinflammatory Drugs** Both the analgesic effects and the antiinflammatory actions of a wide variety of nonsteroidal drugs are the consequence of inhibition of prostaglandin synthesis, and they affect platelet function by blocking prostaglandin synthesis in a reversible reaction ( 246 ). Although it is apparent that most NSAID use is associated with increases in bleeding times, there is still controversy about whether there is increased bleeding following procedures ( 247 ). The effect of NSAIDs on platelet function usually resolves within 48 hours, but, the long-acting drug piroxicam blocks prostaglandin synthesis for longer than 72 hours ( 248 ). The COX-2 inhibitors were recently developed to provide antiinflammatory effects of cyclooxygenase blockade without affecting platelet function.

**ANTIBIOTICS**  $\beta$ -Lactam antibiotics produce dose-dependent platelet dysfunction *in vitro* and *ex vivo*, increase the bleeding time, and predispose patients to increased bleeding, especially if they have renal insufficiency or are undergoing surgical procedures ( 249 , 250 , 251 , 252 and 253 ). The effect on platelet function can be measured in aggregation studies in which platelets incubated with these antibiotics or exposed *in vivo* demonstrate a dose-dependent reduction in aggregation to ADP, epinephrine, and collagen ( 254 , 255 , 256 , 257 and 258 ). These drugs appear to bind to and modify the platelet membrane, resulting in decreased agonist binding and decreased calcium flux ( 259 , 260 and 261 ). The effect can be demonstrated after several days of treatment with these antibiotics and does not resolve until 7 to 10 days after discontinuation. This suggests that megakaryocyte membranes may be similarly affected. Penicillins and cephalosporins that have an  $\alpha$ -carboxy group adjacent to the  $\beta$ -lactam ring are most likely to produce platelet dysfunction and clinical bleeding. Moxalactam and cefotetan can produce clinical bleeding as a result of both platelet dysfunction and the N-methylthiotetrazole side chain effect on vitamin K-dependent clotting factor synthesis ( 262 , 263 and 264 ).

**CARDIOVASCULAR DRUGS** A number of cardiovascular drugs affect platelet function *in vitro* and after ingestion or infusion. There is no evidence that these effects result in increased bleeding; in fact, the antiplatelet effect may be beneficial in patients with coronary syndromes or undergoing cardiopulmonary bypass. Whole blood flow cytometry assessment of platelet activation antigens now permits more accurate assessment of these drugs. In one of the first of these types of evaluations, in normal volunteers, nitrate infusions inhibited aggregation (fibrinogen binding) and degranulation (P-selectin expression), the calcium channel antagonist amlodipine enhanced platelet degranulation, and the  $\beta$ -blocker atenolol enhanced aggregation ( 265 ).

**PSYCHOTROPIC DRUGS** Psychotropic drugs, such as phenothiazines and tricyclic antidepressants, have been demonstrated to have an inhibitory effect on platelet aggregation when drugs are incubated with platelets *in vitro* ( 266 , 267 ). These effects are believed to be due to a direct effect of the drugs on the phospholipid bilayer and by inhibition of arachidonic liberation from platelet membranes ( 268 , 269 ). However, the clinical relevance of this effect on platelet function is uncertain, as therapeutic doses of

these drugs, when administered to human subjects, demonstrate little effect on platelet aggregation and no prolongation of the bleeding time ( [270](#), [271](#) ).

## Uremia

Uremia was one of the first “acquired thrombopathies” to be described. Although the hemostatic defect in uremia is complex and may include thrombocytopenia and minor coagulation abnormalities, platelet dysfunction is probably the most consistent and clinically important feature as evidenced by the prolonged bleeding time. Although multiple abnormalities in platelet function have been described, including abnormalities of adhesion, aggregation, and secretion, there is still no unifying pathophysiologic mechanism to explain all of the recognized platelet defects. In addition, the degree of anemia is also an important determinant of bleeding and correlates directly with the prolongation of the bleeding time in uremia ( [272](#), [273](#) and [274](#) ).

These defects in platelet function have been ascribed to the accumulation of guanidinosuccinic acid, phenol and phenolic acids, uremic middle molecules, and, most recently, nitric oxide ( [275](#), [276](#), [277](#), [278](#), [279](#), [280](#), [281](#) and [282](#) ).

**ENDOTHELIAL CELL FUNCTION** Uremic patients have increased concentrations of L-arginine (precursor of nitric oxide) and cyclic guanosine monophosphate (the second messenger for nitric oxide), uremic platelets generate more nitric oxide, and uremic plasma promoted nitric oxide synthesis by cultured vascular endothelium, supporting a possible role for nitric oxide in uremic bleeding ( [283](#), [284](#) ). In support of this mechanism is the data that when normal volunteers inhale nitric oxide there is prolongation of their

bleeding time, and infusion of nitric oxide inhibitors shortens the bleeding time ( [280](#) ).

**PLATELET ADHESION** Some investigators have demonstrated that platelet adhesion is abnormal as demonstrated by the observation that uremic platelets do not adhere and spread on subendothelial surfaces in experiments performed with flowing blood ( [285](#), [286](#) ).

Others have found adhesion of uremic platelets to be equal to control platelets but demonstrated that more vWF was required to maintain this level of adhesion ( [287](#) ). The amount of vWF, vWF multimer patterns, and vWF antigen/activity ratios have been described as both normal and abnormal in reported studies ( [287](#), [288](#), [289](#) and [290](#) ). Platelet GPIIb/IX receptor number and function is described as both normal and reduced ( [291](#), [292](#) ).

**PLATELET AGGREGATION** Shear-induced platelet aggregation with high shear stresses is reduced with platelets from uremic patients, but it is unclear whether these changes are due to reductions in the availability of GPIIb/IIIa ( [293](#) ) or GPIb ( [294](#) ).

Activation-dependent receptor function of GPIIb/IIIa for binding the adhesive proteins fibrinogen and vWF was reported to be defective in uremia, even though the number of receptors was normal ( [291](#) ). This reduction in GPIIb/IIIa-fibrinogen binding has been observed by other investigators ( [295](#), [296](#) ), and the number of GPIIb receptors and extent of fibrinogen binding does not return to normal, even after 4 months of hemodialysis ( [297](#) ).

Platelet aggregation to exogenous agents is also reduced in many uremic patients ( [298](#) ). Threshold aggregating concentrations for collagen, ADP, and epinephrine have been found to be higher, and thromboxane B<sub>2</sub> generation and granule content of ADP lower for uremic than control platelets ( [299](#), [300](#) ); however, aggregation responses to ADP, collagen, and ristocetin were normal or increased with uremic platelets in another study ( [301](#) ). In some patients, aggregation with platelet-activating factor was the only aggregating defect noted ( [302](#) ).

**PLATELET SECRETION** Increased platelet concentrations of adenylate cyclase and cyclic adenosine monophosphate and a decreased rise in platelet cytosolic calcium concentration have been noted in some patients with uremia, demonstrating that there



are intrinsic platelet defects ( 303, 304 ). There is also an impairment of cytoskeletal organization in resting and thrombin-treated uremic platelets, suggesting a defect in the association of the contractile proteins with the cytosolic matrix of platelets upon activation ( 305 ).

**CLINICAL MANIFESTATIONS** Bleeding may be severe in the uremic patient. Widespread ecchymoses and intractable slow gastrointestinal bleeding are common, and large hematomas into serous cavities and into muscles may occur. The incidence of serious hemorrhage associated with uremia has diminished significantly in recent years as the result of more intensive dialysis and the avoidance of drugs, such as aspirin, that compound the defects in platelet function.

**THERAPY** Hemodialysis and peritoneal dialysis remain the mainstays in the treatment of uremic bleeding ( 281, 306 ); however, there appears to be a transient worsening of platelet function immediately after dialysis, which may be multifactorial ( 307 ). There is a decrease in shear-induced platelet aggregation due to loss of platelet membrane glycoproteins Ib and IIb/IIIa but no change in calcium flux or thromboxane B<sub>2</sub> generation. There is also an increase in P-selectin exposure early during hemodialysis demonstrating platelet activation ( 308 ). Finally, there is a decrease in platelet aggregation and platelet RNA content after hemodialysis, suggesting that the youngest and most active platelets may be more prone to activation and loss during dialysis ( 309 ). When platelet function was prospectively evaluated after renal transplantation, platelet aggregation, F-actin, and platelet cytoskeletal abnormalities were completely normal by 8 weeks after renal transplant (310). Either red blood cell transfusions or improvement of anemia by erythropoietin therapy (rHUEPO) is associated with decreased bleeding, shortening of the bleeding time, and increased platelet adhesiveness in hemodialyzed uremic patients ( 311 ). The effects of rHUEPO result from both an increase in red blood cell mass and a slight effect on platelet function that is independent of the increased hematocrit ( 312 ). However, there also was an increase in fistula thrombosis in a placebo-controlled trial of patients treated with rHUEPO, suggesting that some patients may become hypercoagulable ( 313 ). Preliminary studies demonstrated that the administration of cryoprecipitate (10 units at 24-hour intervals) or DDAVP (0.3 µg/kg) shortens the bleeding time and is temporarily effective in the control of bleeding in some uremic patients ( 314, 315 ). The mechanism by which cryoprecipitate and DDAVP improve hemostasis is unknown, although improvement in adhesion and changes in vWF activity have been postulated ( 316, 317 ). A prolonged reduction in the severity of uremic bleeding was reported after the administration of conjugated estrogens ( 318 ). However, a single perioperative dose does not improve hemostasis (as measured by bleeding time, platelet aggregation, changes in factor VIII or vWF) or intraoperative blood loss ( 319 ).

## Paraproteinemias

The bleeding diathesis that may complicate the various paraproteinemias that may occur in association with multiple myeloma, Waldenstrom macroglobulinemia, monoclonal gammopathies of undetermined significance, or even polyclonal hypergammaglobulinemia is very complex. A variety of mechanisms have been postulated, including (a) thrombocytopenia or impaired platelet function, (b) inhibitors to plasma coagulation factors, (c) circulating monoclonal proteins that bind to coagulation factors and promote enhanced clearance of the complex, and (d) hyperviscosity syndrome ( 320, 321 ).

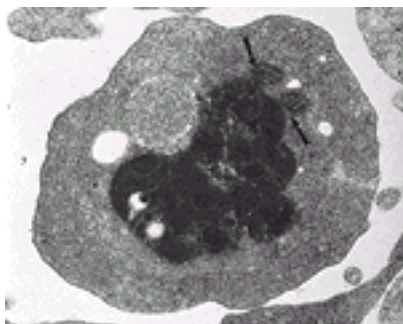
Bleeding occurs more commonly in patients with IgA myeloma and macroglobulinemia than with other types of myeloma and often is limited to purpura and mucosal membrane bleeding ( 322 ). Abnormalities in platelet function that correlate best with clinically significant bleeding are the bleeding time and platelet adhesion. There is poor correlation

between a prolonged bleeding time and results of other tests of platelet function ( [321](#) ), although abnormalities in every type of platelet function test have been documented when large numbers of patients have been studied ( [321](#) , [322](#) , [323](#) , [324](#) and [325](#) ).

Abnormal platelet function is believed to be the result of nonspecific binding of immunoglobulins to the platelet surface, and in fact a correlation between serum IgG, platelet membrane IgG, and platelet function with both monoclonal and polyclonal hypergammaglobulinemia has been demonstrated ( [326](#) ). Only a few patients have been reported in whom the monoclonal antibody appears to modify platelet function by a specific antigen–antibody reaction. Antibodies have been reported that bind to platelet membrane GPIIIa, collagen, and components of the factor VIII–vWF complex ( [327](#) , [328](#) , [329](#) , [330](#) , [331](#) , [332](#) and [333](#) ). Although antibodies against factor VIII–vWF are not strictly related to the platelet, adhesion of platelets to vascular subendothelium is compromised.

### Clonal Hematopoietic Disorders

**MYELODYSPLASTIC SYNDROME/ACUTE NONLYMPHOCYTIC LEUKEMIA** In addition to well-known abnormalities of hemostasis, such as thrombocytopenia or acute and chronic disseminated intravascular coagulation, a relatively specific abnormality of platelet function may contribute to the hemorrhagic diathesis associated with myelodysplastic syndrome (MDS) and acute nonlymphocytic leukemia. Electron photomicrographs of the bone marrow in patients with these disorders reveal micromegakaryocytes with hypolobulation and hypogranularity ( [334](#) , [335](#) , [336](#) , [337](#) and [338](#) ). These morphologically abnormal megakaryocytes suggest that thrombopoiesis is similarly affected. When studied ultrastructurally, affected platelets manifest a number of abnormalities, including a marked variation in size, a dilated canalicular system, and a diminished number of poorly structured marginal microtubules ( [339](#) , [340](#) ). The most striking abnormality, however, is granular dysplasia ( [341](#) , [342](#) , [343](#) and [344](#) ). Granules may be markedly reduced, or giant platelet granules may be formed by the fusion of several single granules, changes that may be evident even on ordinary blood smears ( [Fig. 58.6](#) ). Platelets with such giant granules and unilobar, atypical micromegakaryocytes have been regarded as markers of a stem cell disorder that often terminates in acute leukemia.



**Figure 58.6.** Platelet granular dysplasia in myelomonoblastic leukemia. Gigantic “fusion” granule with perhaps as many as 14 subcomponents. Note mitochondria ( *arrows* ) approximating or being included in the abnormal granule (  $\times 39,700$  ). (From Maldonado Jr. Platelet granulopathy: a new morphologic feature in preleukemia and myelomonocytic leukemia: light microscopy and ultrastructural morphology and cytochemistry. *Mayo Clin Proc* 1976;51:452–462, with permission.)

Platelet function is difficult to study because of the frequent presence of thrombocytopenia. Bleeding times are usually prolonged more than would be expected based on platelet count, and multiple platelet aggregation defects can be detected ( [340](#) , [345](#) , [346](#) ). An acquired Bernard–Soulier–like platelet defect was described in a patient with



juvenile MDS, demonstrating that even acquired defects in the platelet membrane can occur ( 347 ).

**MYELOPROLIFERATIVE DISORDERS** Abnormalities of aggregation and the release reaction, deficient lipid peroxidation and responses to thromboxane A<sub>2</sub>, subnormal serotonin uptake and storage, abnormal expression of Fc receptors, and a combined defect in membrane expression and activation of GPIIb-IIIa complexes have been demonstrated in the platelets of patients with myelofibrosis, polycythemia vera, chronic myelocytic leukemia, and thrombocythemia ( 347 , 348 , 349 , 350 , 351 , 352 , 353 , 354 , 355 , 356 and 357 ). Acquired SPD has also been well documented ( 358 ). Although bleeding is recognized as a complication of these disorders, the clinical importance of platelet dysfunction remains unclear. Common manifestations include ecchymoses, epistaxis, gastrointestinal bleeding, and a propensity to serious hemorrhage after trauma or minor surgical procedures. The pattern of laboratory abnormalities often is inconsistent, and the correlation between the extent of these abnormalities and the severity of bleeding is poor ( 348 , 349 , 358 ). Studies of megakaryocyte replication using ultrastructural and cell culture techniques suggest that, as in MDS and acute leukemia, platelet dysfunction in chronic myeloproliferative disorders is determined at the level of the progenitor cell ( 334 , 359 ). Patients with chronic myeloproliferative disorders may also have abnormal platelet function that resembles von Willebrand disease, due to the reduction of high-molecular-weight forms of plasma and platelet vWF ( 360 , 361 , 362 and 363 ). These abnormalities in vWF may be associated with increased bleeding times, especially in essential thrombocytosis ( 360 ). It is currently hypothesized that the loss of high-molecular-weight vWF is related to proteolysis, which may result from white blood cell or platelet protease activity. This hypothesis is strengthened by the observation that vWF multimers normalize after reduction in white blood cell and platelet counts ( 362 ).

## REFERENCES

1. George JN, Nurden AT, Phillips DR. Molecular defects in interactions of platelets with the vessel wall. *N Engl J Med* 1984;311:1084-1098.
2. Rao AK. Congenital disorders of platelet function. *Hematol Oncol Clin North Am* 1990;4:65-86.
3. Bennett JS, Kolodziej MA. Disorders of platelet function. *Dis Mon* 1992;38:577-631.
4. Bray PF. Inherited diseases of platelet glycoproteins: considerations for rapid molecular characterization. *Thromb Haemost* 1994;72:492-502.
5. Bick RL. Laboratory evaluation of platelet function. *Clin Lab Med* 1995;15:1-38.
6. Caen JP, Rosa JP. Platelet-vessel wall interaction: from the bedside to molecules. *Thromb Haemost* 1995;74:18-24.
7. Jantunen E. Inherited giant platelet disorders. *Eur J Haematol* 1994;53:191-196.
8. White JG. Structural defects in inherited and giant platelet disorders. *Adv Hum Genet* 1990;19:133-234.
9. Nurden AT. Inherited abnormalities of platelets. *Thromb Haemost* 1999;82:468-480.
10. Rao AK. Congenital disorders of platelet function: disorders of signal transduction and secretion. *Am J Med Sci* 1998;316:69-76.
11. Nurden AT, Nurden P. Inherited defects of platelet function. *Rev Clin Exp Hematol* 2001;4:314-344.
12. Bernard J, Soulier JP. Sur une nouvelle variété de dystrophie thrombocytaire hémorragipare parse congenitale. *Semin Hop Paris* 1948;24:3217-3223.

13. Bithell TC, Parekh SJ, Strong RR. Platelet function studies in the Bernard–Soulier syndrome. *Ann N Y Acad Sci* 1972;201:145–160.
14. George JN, Reimann TA, Moake JL, et al. Bernard–Soulier disease: a study of four patients and their parents. *Br J Haematol* 1981;48:459–467.
15. Frojmovic MM, Milton JG, Caen JP, Tobelem G. Platelets from “giant platelet syndrome (BSS)” are discocytes and normal sized. *J Lab Clin Med* 1978;91:109–116.
16. Maldonado JE, Gilchrist GS, Brigden LP, Bowie EJ. Ultrastructure of platelet in Bernard–Soulier syndrome. *Mayo Clin Proc* 1975;50:402–406.
17. White JG. Inherited abnormalities of the platelet membrane and secretory granules. *Hum Path* 1987;18:123–139.
18. Chevalier J, Nurden AT, Thiery JM, et al. Freeze–fracture studies on the plasma membranes of normal, thrombasthenic, and Bernard–Soulier platelets. *J Lab Clin Med* 1979;94:232–245.
19. Caen JP, Nurden AT, Jeanneau C, et al. Bernard–Soulier syndrome: a new platelet glycoprotein abnormality. Its relationship with platelet adhesion to subendothelium and with the factor VIII von Willebrand protein. *J Lab Clin Med* 1976;87:586–596.
20. Hourdille P, Pico M, Jandrot–Perrus M, et al. Studies on the megakaryocytes of a patient with the Bernard–Soulier syndrome. *Br J Haematol* 1990;76:521–530.
21. Hagen I, Nurden A, Bjerrum OJ, et al. Immunochemical evidence from protein abnormalities in platelets from patients with Glanzmann thrombasthenia and Bernard–Soulier syndrome. *J Clin Invest* 1980;65:722–731.
22. Nurden AT, Caen JP. Specific roles for platelet surface glycoproteins in platelet function. *Nature* 1975;255:720–722.
23. Degos L, Tobelem G, Lethielleux P, et al. Molecular defect in patients with Bernard–Soulier syndrome. *Blood* 1977;50:899–903.
24. Nurden AT, Dupuis D, Kunicki TJ, Caen JP. Analysis of the glycoprotein and protein composition of Bernard–Soulier platelets by single and two–dimensional sodium dodecyl sulfate–polyacrylamide gel electrophoresis. *J Clin Invest* 1981;67:1431–1440.
25. Kunicki TJ, Nurden AT, Pidard D, et al. Characterization of human platelet glycoprotein antigens giving rise to individual immunoprecipitates in crossed–immuno electrophoresis. *Blood* 1981;58:1190–1197.
26. Clemetson KJ, McGregor JL, James E, et al. Characterization of the platelet membrane glycoprotein abnormalities in Bernard–Soulier syndrome and comparison with normal by surface–labeling techniques and high–resolution two dimensional gel electrophoresis. *J Clin Invest* 1982;70:304–311.
27. Montgomery RR, Kunicki TJ, Taves C, et al. Diagnosis of Bernard–Soulier syndrome and Glanzmann’s thrombasthenia with a monoclonal assay on whole blood. *J Clin Invest* 1983;71:385–389.
28. Berndt MC, Gregory C, Chong BH, et al. Additional glycoprotein defects in Bernard–Soulier’s syndrome: confirmation of genetic basis by parental analysis. *Blood* 1983;62:800–807.
29. Drouin J, McGregor JL, Parmentier S, et al. Residual amounts of glycoprotein Ib concomitant with near–absence of glycoprotein IX in platelets of Bernard–Soulier patients. *Blood* 1988;72:1086–1088.
30. Tomer A, Scharf RE, McMillan R, et al. Bernard–Soulier syndrome: quantitative characterization of megakaryocytes and platelets by flow cytometric and platelet kinetic measurements. *Eur J Haematol* 1994;52:193–200.
31. Roth GR. Developing relationships: arterial platelet adhesion, glycoprotein Ib, and leucine–rich glycoproteins. *Blood* 1991;77:5–19.

32. Weiss HJ, Tschopp TB, Baumgartner HR, et al. Decreased adhesion of giant (Bernard-Soulier) platelets to subendothelium. *Am J Med* 1974;57:920-925.
33. Weiss HJ, Tschopp TB, Baumgartner HR, et al. Decreased adhesion of giant (Bernard-Soulier) platelets to subendothelium: further implications on the role of the von Willebrand factor in hemostasis. *Am J Med* 1974;57:920-925.
34. Weiss HJ, Turitto VT, Baumgartner HR. Effect of shear rate on platelet interaction with subendothelium in citrated and native blood. I. Shear rate-dependent decrease of adhesion in von Willebrand disease and the Bernard-Soulier syndrome. *J Lab Clin Med* 1978;92:750-764.
35. Fauvel-Lafeve F, Tabaka V, Caen JP, Legrand YJ. Defective adhesion of blood platelets to vascular microfibrils in the Bernard-Soulier syndrome. *Blood* 1993;82:1985-1988.
36. Lopez JA, Andrews RK, Afshar-Kharghan V, et al. Bernard-Soulier syndrome. *Blood* 1998;91:4397-4418.
37. Lopez JA, Leung B, Reynolds CC, et al. Efficient plasma membrane expression of a functional platelet glycoprotein Ib-IX complex requires the presence of its three subunits. *J Biol Chem* 1992;267:12851-12859.
38. Meyer S, Kresbach G, Haring P, et al. Expression and characterization of functionally active fragments of the platelet glycoprotein (GP) Ib-IX complex in mammalian cells. *J Biol Chem* 1993;268:20555-20562.
39. Kahn ML, Diacovo TG, Bainton DF, et al. Glycoprotein V-deficient platelets have undiminished thrombin responsiveness and do not exhibit a Bernard-Soulier phenotype. *Blood* 1999;94:4112-4121.
40. Arai M, Yamamoto N, Akamatsu N, et al. Substantial expression of glycoproteins IX and V on the platelet surface from a patient with Bernard-Soulier syndrome. *Br J Haematol* 1994;87:185-188.
41. Bunescu A, Lindahl T, Solum NO, et al. Partial expression of GPIb measured by flow cytometry in two patients with Bernard-Soulier syndrome. *Thromb Res* 1994;76:441-450.
42. Clemetson JM, Kyrie PA, Brenner B, Clemetson KJ. Variant Bernard-Soulier syndrome associated with a homozygous mutation in the leucine-rich domain of glycoprotein IX. *Blood* 1994;84:1124-1131.
43. Kunishima S, Miura H, Fukutani H, et al. Bernard-Soulier syndrome Kagoshima: Ser 444 to stop mutation of glycoprotein (GP) Iba resulting in circulating truncated GPIba and surface expression of GPIb $\beta$  and GPIX. *Blood* 1994;84:3356-3362.
44. Ware J, Russell SR, Marchese P, et al. Point mutation in a leucine-rich repeat of glycoprotein Iba resulting in the Bernard-Soulier syndrome. *J Clin Invest* 1993;92:1213-1220.
45. De Marco L, Mazzucato M, Fabris F, et al. Variant Bernard-Soulier syndrome type Bolzano. A congenital bleeding disorder due to a structural and functional abnormality of the platelet glycoprotein Ib-IX complex. *J Clin Invest* 1990;86:25-31.
46. Miller JL, Lyle VA, Cunningham D. Mutation of leucine-57 to phenylalanine in a platelet glycoprotein Iba leucine tandem repeat occurring in patients with an autosomal variant of Bernard-Soulier disease. *Blood* 1992;79:439-446.
47. Savoia A, Balduini CL, Savino M, et al. Autosomal dominant macrothrombocytopenia in Italy is most frequently a type of heterozygous Bernard-Soulier syndrome. *Blood* 2001;97:1330-1335.
48. Beales LL. An acquired-pseudo Bernard Soulier syndrome occurring with autoimmune chronic active hepatitis and anti-cardiolipin antibody. *Postgrad Med J* 1994;70:305-308.
49. Devine DV, Currie MS, Rosse WF, Greenberg CS. Pseudo-Bernard-Soulier syndrome: thrombocytopenia caused by autoantibody to platelet glycoprotein Ib. *Blood* 1987;70:428-431.
50. Tobelem G, Levy-Toledano S, Nurden AT, et al. Further studies on a specific platelet antibody found in Bernard-Soulier syndrome and its effects on normal platelet function. *Br J Haematol* 1979;41:427-436.

51. Korte W, Baumgartner C, Feldges A, et al. Coincidence of familial platelet glycoprotein Ib/IX deficiency (Bernard-Soulier syndrome), idiopathic autoantibody against platelet glycoprotein Ib/IX, familial appearance of antiphospholipid antibodies, and familial factor XII deficiency. *Ann Hematol* 1994;68:101-104.
52. Howard MA, Firkin BG. Ristocetin—a new tool in the investigation of platelet aggregation. *Thromb Haemost* 1971;26:362-369.
53. Howard MA, Hutton RA, Hardisty RM. Hereditary giant platelet syndrome; a disorder of a new aspect of platelet function. *BMJ* 1973;2:586-588.
54. DeMarco L, Fabris F, Casonato A, et al. Bernard-Soulier syndrome: diagnosis by an ELISA method using monoclonal antibodies in 2 new unrelated patients. *Acta Haematol* 1986;75:203-208.
55. Poulsen LO, Taaning E. Variation in surface glycoprotein Ib expression in Bernard-Soulier syndrome. *Haemostasis* 1990;20:155-161.
56. Cuthbert RJ, Watson HH, Handa SI, et al. DDAVP shortens the bleeding time in Bernard-Soulier syndrome. *Thromb Res* 1988;49:649-650.
57. DiMichele DM, Hathaway WE. Use of DDAVP in inherited and acquired platelet dysfunction. *Am J Hematol* 1990;33:39-45.
58. Waldenstrom E, Holmberg L, Axelsson U, et al. Bernard-Soulier syndrome in two Swedish families: effect of DDAVP on bleeding time. *Eur J Haematol* 1991;46:182-187.
59. Greinacher A, Potzsch B, Kiefel V, et al. Evidence that DDAVP transiently improves hemostasis in Bernard-Soulier syndrome independent of von Willebrand-factor. *Ann Hematol* 1993;67:149-150.
60. Peters M, Heijboer H. Treatment of a patient with Bernard-Soulier syndrome and recurrent nosebleeds with recombinant factor VIIa. *Thromb Haemost* 1998;80:352.
61. Caen JP, Castaldi PA, Leclerc JC, et al. Congenital bleeding disorders with long bleeding time and normal platelet count. *Am J Med* 1966;41:4-26.
62. Nurden AT, Caen JP. An abnormal platelet glycoprotein pattern in three cases of Glanzmann's thrombasthenia. *Br J Haematol* 1974;28:253-260.
63. Phillips DR, Agin PP. Platelet membrane defects in Glanzmann's thrombasthenia. *J Clin Invest* 1977;60:535-545.
64. McEver RP, Baenziger NL, Majerus PW. Isolation and quantitation of the platelet membrane glycoprotein deficient in thrombasthenia using a monoclonal hybridoma antibody. *J Clin Invest* 1980;66:1311-1318.
65. Lee H, Nurden AT, Thomaidis A, Caen JP. Relationship between fibrinogen binding and the platelet glycoprotein deficiencies in Glanzmann's thrombasthenia type I and type II. *Br J Haematol*. 1981;48:47-57.
66. Nurden AT, Rosa JP, Fournier D, et al. A variant of Glanzmann's thrombasthenia with abnormal glycoprotein IIb-IIIa complexes in the platelet membrane. *J Clin Invest* 1987;79:962-969.
67. Jung SM, Yoshida N, Aoki N, et al. Thrombasthenia with an abnormal platelet membrane glycoprotein IIb of different molecular weight. *Blood* 1988;71:915-922.
68. Meyer M, Herrmann FH. Diversity of glycoprotein deficiencies in Glanzmann's thrombasthenia. *Thromb Haemost* 1985;54:626-629.
69. Peterson DM, Stathopoulos NA, Gioglio TD, et al. Shear-induced platelet aggregation requires von-Willebrand factor and platelet membrane glycoproteins Ib and IIb-IIIa. *Blood* 1987;69:625-628.
70. Sakariassen KS, Nievelstein PF, Coller BS, Sixma JJ. The role of platelet membrane glycoproteins Ib and IIb-IIIa in platelet adherence to human artery endothelium. *Br J Haematol* 1986;63:681-691.

71. White GC, Workman EF, Lundblad RL. Thrombin binding to thrombasthenic platelets. *J Lab Clin Med* 1978;91:76-82.
72. Malmsten C, Kindahl H, Samuelsson B, et al. Thromboxane synthesis and the platelet release reaction in Bernard-Soulier syndrome, thrombasthenia Glanzmann and Hermansky-Pudlak syndrome. *Br J Haematol* 1977;35:511-520.
73. Duperray A, Troesch A, Berthier R, et al. Biosynthesis and assembly of platelet GPIIb-IIIa in human megakaryocytes: evidence that assembly between pro-GPIIb and GPIIIa is a prerequisite for expression of the complex on the cell surface. *Blood* 1989;74:1603-1611.
74. O'Toole TE, Loftus JC, Plow EF, et al. Efficient surface expression of platelet GPIIb-IIIa requires both subunits. *Blood* 1989;74:14-18.
75. Basani RB, Vilaire G, Shattil SJ, et al. Glanzmann thrombasthenia due to a two amino acid deletion in the fourth calcium-binding domain of a  $\text{IIb}_3$ : demonstration of the importance of calcium-binding domains in the conformation of a  $\text{IIb}_3$ . *Blood* 1996;88:167-173.
76. Collier BS. Interaction of normal, thrombasthenic, and Bernard-Soulier platelet with immobilized fibrinogen: defective platelet-fibrinogen interaction. *Blood* 1980;55:169-178.
77. Mustard JF, Kinlough-Rathbone, Packham MA, et al. Comparison of fibrinogen association with normal and thrombasthenic platelets on exposure to ADP and chymotrypsin. *Blood* 1979;54:987-993.
78. Ginsberg MH, Forsyth J, Lightsey A, et al. Reduced surface expression and binding of fibronectin by thrombin-stimulated thrombasthenic platelets. *J Clin Invest* 1983;71:619-624.
79. Johnston GI, Heptinstall S, Robins RA, Price MR. The expression of glycoproteins on single blood platelets from healthy individuals and from patients with congenital bleeding disorders. *Biochem Biophys Res Commun* 1984;123:1091-1098.
80. Hourdille P, Fialon P, Belloc F, et al. Megakaryocytes from the marrow of a patient with Glanzmann's thrombasthenia lacked GPIIb-IIIa complexes. *Thromb Haemost* 1986;56:66-70.
81. Giltay JC, Leeksa OC, Breederveld C, van Mourik JA. Normal synthesis and expression of endothelial IIb/IIIa in Glanzmann's thrombasthenia. *Blood* 1987;69:809-812.
82. Caen J. Glanzmann thrombasthenia. *Clin Haematol* 1972;1:383-392.
83. George JN, Caen JP, Nurden AT. Glanzmann's thrombasthenia: the spectrum of clinical disease. *Blood* 1990;75:1383-1395.
84. French DL, Seligsohn U. Platelet glycoprotein IIb/IIIa receptors and Glanzmann's thrombasthenia. *Arterioscler Thromb Vasc Biol* 2000;20:607-610.
85. French DL, Collier BS. Hematologically important mutations: Glanzmann thrombasthenia. *Blood Cells Mol Dis* 1997;23:39-51. Also see <http://med.mssm.edu/glanzmannodb>.
86. Kunicki TJ, Aster RH. Deletion of the platelet-specific alloantigen PL<sup>A1</sup> from platelets in Glanzmann's thrombasthenia. *J Clin Invest* 1977;61:1225-1231.
87. Kunicki TJ, Pidar D, Cazenave JP, et al. Inheritance of the human platelet alloantigen PL<sup>A1</sup>, in type 1 Glanzmann's thrombasthenia. *J Clin Invest* 1981;67:717-724.
88. Boizard B, Wautier JL. Lek<sup>a</sup>, a new platelet antigen absent in Glanzmann's thrombasthenia. *Vox Sang* 1984;46:47-54.
89. Kunicki TJ, Newman PJ. The molecular immunology of human platelet proteins. *Blood* 1992;80:1386-1404.
90. Levy-Toledano S, Tobelem G, Legrand C, et al. Acquired IgG antibody occurring in a thrombasthenic

patient: its effect on human platelet function. *Blood* 1978;51:1065–1071.

91. Jallu V, Diaz-Ricart M, Ordinas A, et al. Two human antibodies reacting with different epitopes on integrin B<sub>3</sub> of platelets and endothelial cells. *Eur J Biochem* 1994;222:743–51.
92. Niessner H, Clemetson KJ, Panzer S, et al. Acquired thrombasthenia due to GPIIb/IIIa-specific platelet autoantibodies. *Blood* 1986;68:571–576.
93. Awidi AS. Delivery of infants with Glanzmann thrombasthenia and subsequent blood transfusion requirements: a follow-up of 39 patients. *Am J Hematol* 1992;40:1–4.
94. Markovitch O, Ellis M, Holzinger M, et al. Severe juvenile vaginal bleeding due to Glanzmann's thrombasthenia: case report and review of the literature. *Am J Hematol* 1998;57:225–227.
95. Kloforn RW, Lightsey AL. Hemarthrosis associated with Glanzmann's thrombasthenia. *Arthritis Rheum* 1979;22:1390–1393.
96. Zonneveld GT, van Leeuwen EF, Sturk A, tenCate JW. Detection of carriers in Glanzmann's thrombasthenia. *Thromb Haemost* 1983;49:182–186.
97. Collier BS, Seligsohn U, Zivelin A, et al. Immunologic and biochemical characterization of homozygous and heterozygous Glanzmann thrombasthenia in the Iraqi-Jewish and Arab populations of Israel: comparison of techniques for carrier detection. *Br J Haematol* 1986;62:723–735.
98. Stormorken H, Gogstad GO, Solum NO, Pande H. Diagnosis of heterozygotes in Glanzmann's thrombasthenia. *Thromb Haemost* 1982;48:217–221.
99. Castaldi PA. A morphologic study of platelets in Glanzmann's thrombasthenia. *Aust J Exp Biol Med Sci* 1964;42:86–88.
100. Poon M-C, Demers C, Jobin F, et al. Recombinant factor VIIa is effective for bleeding and surgery in patients with Glanzmann thrombasthenia. *Blood* 1999;94:3951–3953.
101. D'Oiron R, Menart C, Trzeciak MC, et al. Use of recombinant factor VIIa in 3 patients with inherited type I Glanzmann's thrombasthenia undergoing invasive procedures. *Thromb Haemost* 2000;83:644–647.
102. Poon M-C, d'Oiron R, Hann I et al. Use of recombinant VIIa (Novoseven) in patients with Glanzmann thrombasthenia. *Sem Hematol* 2001;38:21–25.
103. Bellucci S, Damaj G, Boval B, et al. Bone marrow transplantation in severe Glanzmann's thrombasthenia with antiplatelet alloimmunization. *Bone Marrow Transplant* 2000;25:327–330.
104. Wilcox DA, Olsen JC, Ishizawa L, et al. Megakaryocyte-targeted synthesis of the integrin B<sub>3</sub>-subunit results in the phenotypic correction of Glanzmann thrombasthenia. *Blood* 2000;95:3645–3652.
105. Raccuglia G. Gray platelet syndrome: a variety of qualitative platelet disorder. *Am J Med* 1971;51:818–828.
106. White JG. Ultrastructural studies of the gray platelet syndrome. *Am J Pathol* 1979;95:445–462.
107. Breton-Gorius J, Vainchenker W, Nurden A, et al. Defective α-granule production in megakaryocytes from gray platelet syndrome. *Am J Pathol* 1981;102:10–19.
108. Cramer EM, Vainchenker W, Vinci G, et al. Gray platelet syndrome: immunoelectron microscopic localization of fibrinogen and von Willebrand factor in platelets and megakaryocytes. *Blood* 1985;66:1309–1316.
109. Berger G, Caen JP, Berndt MC, Cramer EM. Ultrastructural demonstration of CD36 in the α-granule membrane of human platelets and megakaryocytes. *Blood* 1993;82:3034–3044.
110. Cramer EM, Savidge GF, Vainchenker W, et al. Alpha-granule pool of glycoprotein IIb-IIIa in normal and pathologic platelets and megakaryocytes. *Blood* 1990;75:1220–1227.

111. Lages B, Shattil SJ, Bainton DF, Weiss HJ. Decreased content and surface expression of  $\alpha$ -granule membrane protein GMP-140 in one of two types of platelet ad storage pool deficiency. *J Clin Invest* 1991;87:919-929.
112. Rosa JP, George JN, Bainton DF, et al. Gray platelet syndrome: demonstration of alpha granule membranes that can fuse with the cell surface. *J Clin Invest* 1987;80:1138-1146.
113. Gebrane-Younes J, Cramer EM, Orceel L, Caen JP. Gray platelet syndrome: association between abnormal sorting in megakaryocyte  $\alpha$ -granules and normal sorting in Weibel-Palade bodies of endothelial cells. *J Clin Invest* 1993;92:3023-3028.
114. Drouin A, Favier R, Masse J-M, et al. Newly recognized cellular abnormalities in the gray platelet syndrome. *Blood* 2001;98:1382-1391.
115. Gerrard JM, Phillips DR, Rao GH, et al. Biochemical studies of two patients with the gray platelet syndrome. *J Clin Invest* 1980;66:102-109.
116. Levy-Toledano S, Breton-Gorius J, Rendu F, et al. Gray platelet syndrome:  $\alpha$ -granule deficiency. *J Lab Clin Med* 1981;98:831-848.
117. Nurden AT, Kunicki TJ, Dupuis D, et al. Specific protein and glycoprotein deficiencies in platelets isolated from two patients with the gray platelet syndrome. *Blood* 1982;59:709-718.
118. Vermynen C, Vermynen J, Hoet B, et al. Gray platelet syndrome: evidence for alpha-granule localization of the platelet plasminogen activator inhibitor-1 pool. *Pediatr Hematol Oncol* 1991;8:111-120.
119. Srivastava PC, Powling MJ, Nokes TJ, et al. Grey platelet syndrome: studies on platelet alpha-granules, lysosomes and defective response to thrombin. *Br J Haematol* 1987;65:441-446.
120. Pfueller SL, Howard MA, White JG, et al. Shortening of bleeding time by 1-deamino-8-arginine vasopressin (DDAVP) in the absence of platelet von Willebrand factor in gray platelet syndrome. *Thromb Haemost* 1987;58:1060-1063.
121. Pfueller SL, David R. Platelet-associated immunoglobulins G, A and M are secreted during platelet activation: normal levels but defective secretion in grey platelet syndrome. *Br J Haematol* 1988;68:235-241.
122. Rendu F, Marche P, Hovig T, et al. Abnormal phosphoinositide metabolism and protein phosphorylation in platelets from a patient with the grey platelet syndrome. *Br J Haematol* 1987;67:199-206.
123. Falik-Zaccai TC, Anikster Y, Rivera CE, et al. A new genetic isolate of gray platelet syndrome (GPS): clinical, cellular, and hematologic characteristics. *Mol Genet Metab* 2001;74:303-313.
124. Enouf J, Lebret M, Bredoux R, et al. Abnormal calcium transport into microsomes of grey platelet syndrome. *Br J Haematol* 1987;65:437-440.
125. Enouf J, Corvazier E, Papp B, et al. Abnormal cAMP-induced phosphorylation of *rap 1* protein in gray platelet syndrome platelets. *Br J Haematol* 1994;86:338-346.
126. Jantunen E, Hanninen A, Naukkarinen A, et al. Gray platelet syndrome with splenomegaly and signs of extramedullary hematopoiesis: a case report with review of the literature. *Am J Hematol* 1994;46:218-224.
127. Kohler M, Hellstern P, Morgenstern E, et al. Gray platelet syndrome: selective  $\alpha$ -granule deficiency and thrombocytopenia due to increased platelet turnover. *Blut* 1985;50:331-340.
128. Aronson I, DuToit JM, Jacobs P. Grey platelet syndrome. *Lancet* 1994;344:1233-1234.
129. Berrebi A, Klepfish A, Varon D, et al. Gray platelet syndrome in the elderly. *Am J Hematol* 1988;28:270-272.
130. Berndt MC, Castaldi PA, Gordon S, et al. Morphological and biochemical confirmation of gray platelet



syndrome in two siblings. *Aust N Z J Med* 1983;13:387–389.

131. Kohler M. Treatment of gray platelet syndrome. *Thromb Haemost* 1988;60:123.

132. Holmsen H, Weiss HJ. Further evidence for a deficient storage pool of adenine nucleotides in platelets from some patients with thrombocytopathia—“storage pool disease.” *Blood* 1972;39:197–209.

133. Weiss HJ, Ames RP. Ultrastructural findings in storage pool disease and aspirin-like defects of platelets. *Am J Pathol* 1973;71:447–466.

134. Weiss HJ, Tschopp TB, Rogers J, Brand H. Studies of platelet 5-hydroxytryptamine (serotonin) in storage pool disease and albinism. *J Clin Invest* 1974;54:421–433.

135. Weiss HJ, Lages B, Vicic W, et al. Heterogeneous abnormalities of platelet dense granule ultrastructure in 20 patients with congenital storage pool deficiency. *Br J Haematol* 1993;83:282–295.

136. McNichol A, Israels SJ, Robertson C, Gerrard JM. The empty sack syndrome: a platelet storage pool deficiency associated with empty dense granules. *Br J Haematol* 1994;86:574–582.

137. Holmsen H, Setkowsky CA, Lages B, et al. Content and thrombin-induced release of acid hydrolases in gel-filtered platelets from patients with storage pool disease. *Blood* 1975;46:131–142.

138. Pareti FI, Day HJ, Mills DC. Nucleotide and serotonin metabolism in platelets with defective secondary aggregation. *Blood* 1974;44:789–800.

139. Weiss HJ, Chervenick PA, Zalusky R, Factor A. A familial defect in platelet function associated with impaired release of adenosine diphosphate. *N Engl J Med* 1969;281:1264–1270.

140. Holmsen H, Weiss HJ. Hereditary defect in the platelet release reaction caused by a deficiency in the storage pool of platelet adenine nucleotides. *Br J Haematol* 1970;19:643–649.

141. Weiss HJ, Witte LD, Kaplan KL, et al. Heterogeneity in storage pool deficiency: studies on granule-bound substances in 18 patients including variants deficient in  $\alpha$ -granules, platelet factor 4,  $\beta$ -thromboglobulin, and platelet-derived growth factor. *Blood* 1979;54:1296–1319.

142. Lages B, Scrutton MC, Holmsen H, et al. Metal ion contents of gel-filtered platelets from patients with storage pool disease. *Blood* 1975;46:119–130.

143. Lages B, Holmsen H, Weiss HJ, Dangelmaier C. Thrombin and ionophore A23187-induced dense granule secretion in storage pool deficient platelets: evidence for impaired nucleotide storage as the primary dense granule defect. *Blood* 1983;61:154–162.

144. Weiss HJ, Tschopp TB, Baumgartner HR. Impaired interaction (adhesion-aggregation) of platelets with the subendothelium in storage-pool disease and after aspirin ingestion. *N Engl J Med* 1975;293:619–623.

145. Weiss HJ, Turitto VT, Baumgartner HR. Platelet adhesion and thrombus formation on subendothelium in platelets deficient in glycoproteins IIb-IIIa, Ib, and storage granules. *Blood* 1986;67:322–330.

146. Weiss HJ, Lages B, Hoffman T, Turitto VT. Correction of the platelet adhesion defect in d-storage pool deficiency at elevated hematocrit—possible role of adenosine diphosphate. *Blood* 1996;87:4214–4222.

147. Weiss HJ, Willis AL, Kuhn D, Brand H. Prostaglandin E2 potentiation of platelet aggregation induced by LASS endoperoxide: absent in storage pool disease, normal effect after aspirin ingestion. *Br J Haematol* 1976;32:257–272.

148. Weiss HJ, Lages B. Platelet malondialdehyde production and aggregation responses induced by arachidonate, prostaglandin-G2, collagen, and epinephrine in 12 patients with storage pool deficiency. *Blood* 1981;58:27–33.

149. Weiss HJ, Lages B. The response of platelets to epinephrine in storage pool deficiency—evidence pertaining to the role of adenosine diphosphate in mediating primary and secondary aggregation. *Blood*

1988;72:1717-1725.

150. Akkerman JW, Nieuwenhuis HK, Mommersteeg-Leautaud ME, et al. ATP-ADP compartmentation in storage pool deficient platelets: correlation between granule-bound ADP and the bleeding time. *Br J Haematol* 1983;55:135-143.

151. Nieuwenhuis HK, Akkerman JW, Sixma JJ. Patients with a prolonged bleeding time and normal aggregation tests may have storage pool deficiency: studies on one hundred six patients. *Blood* 1987;70:620-623.

152. Israels SJ, McNicol A, Robertson C, Gerrard JM. Platelet storage pool deficiency: Diagnosis in patients with prolonged bleeding times and normal platelet aggregation. *Br J Haematol* 1990;75: 118-121.

153. Wall JE, Buijs-Wilts M, Arnold JT, et al. A flow cytometric assay using mepacrine for study of uptake and release of platelet dense granule contents. *Br J Haematol* 1995;89:380-385.

154. Gordon N, Thom J, Cole C, Baker R. Rapid detection of hereditary and acquired storage pool deficiency by flow cytometry. *Br J Haematol* 1995;89:117-123.

155. Nieuwenhuis HK, Sixma JJ. 1-desmimo-8-D-argininine vasopressin (Desmopressin) shortens the bleeding time in storage pool deficiency. *Ann Intern Med* 1988;108:65-67.

156. Van Dorp DB, Wijermans PW, Meire F, Vrensen G. The Hermansky-Pudlak syndrome. Variable reaction to 1-desmimo-8-D-argininine vasopressin for correction of the bleeding time. *Ophthal Pediatr Genet* 1990;11:237-244.

157. Castaman G, Rodeghiero F. Consistency of responses to separate desmopressin infusions in patients with storage pool disease and isolated prolonged bleeding time. *Thromb Res* 1993;69:407-412.

158. Kentro TB, Lottenberg R, Kitchens CS. Clinical efficacy of desmopressin acetate for hemostatic control in patients with primary platelet disorders undergoing surgery. *Am J Hematol* 1987;24:215-219.

159. Schulman S, Johnsson H, Egberg N, Blomback M. DDAVP-induced correction of prolonged bleeding time in patients with congenital platelet function defects. *Thromb Res* 1987;45:165-174.

160. Kobrinsky NL, Israels ED, Bickis MG. Synergistic shortening of the bleeding time by desmopressin and ethamsylate in patients with various constitutional bleeding disorders. *Am J Pediatr Hematol Oncol* 1991;13:437-441.

161. Lethagen S, Ragnarson-Tennvall G. Self-treatment with desmopressin intranasal spray in patients with bleeding disorders: effect on bleeding symptoms and socioeconomic factors. *Ann Hematol* 1993;66:257-260.

162. Rao AK, Ghosh S, Sun L, et al. Mechanisms of platelet dysfunction and response to DDAVP in patients with congenital platelet function defects. *Thromb Haemost* 1995;74:1071-1078.

163. Gerritsen SW, Akkerman JW, Sixma JJ. Correction of the bleeding time in patients with storage pool deficiency by infusion of cryoprecipitate. *Br J Haematol* 1978;40:153-160.

164. Hermansky F, Pudlak P. Albinism associated with hemorrhagic diathesis and unusual pigmented reticular cells in the bone marrow: report of two cases with histochemical studies. *Blood* 1959;14:162-169.

165. White JG, Edson JR, Desnick SJ, Witkop CJ. Studies of platelets in a variant of the Hermansky-Pudlak syndrome. *Am J Pathol* 1971;63:326-329.

166. Hardisty RM, Mills DCB, Ketsa-Ard K. The platelet defect associated with albinism. *Br J Haematol* 1972;23:679-692.

167. Huizing M, Anikster Y, Fitzpatrick DL, et al. Hermansky-Pudlak syndrome type 3 in Ashkenazi Jews and other non-Puerto Rican patients with hypopigmentation and platelet storage-pool deficiency. *Am J Hum Genet* 2001;69:1022-1032.

168. Oh J, Ho L, Ala-Mello S, et al. Mutation analysis of patients with Hermansky-Pudlak syndrome: a

frameshift hot spot in the HPS gene and apparent locus heterogeneity. *Am J Hum Genet* 1998;62:593–598.

169. Witkop CJ, Bowie EJW, Krumwiede MD, et al. Synergistic effect of storage pool deficient platelets and low plasma von Willebrand factor on the severity of the hemorrhagic diathesis in Hermansky–Pudlak syndrome. *Am J Hematol* 1993;44:256–259.

170. McKeown LP, Hansmann KE, Wilson O et al. Platelet von Willebrand factor in Hermansky–Pudlak syndrome. *Am J Hematol* 1998;59:115–120.

171. Garay SM, Gardella JE, Fazzini EP, Goldring RM. Hermansky–Pudlak syndrome. Pulmonary manifestations of a ceroid storage disorder. *Am J Med* 1979;66:737–747.

172. Apitz–Castro R, Cruz MR, Ledezma E, et al. The storage pool deficiency in platelets from humans with the Chediak–Higashi syndrome: study of six patients. *Br J Haematol* 1985;59:471–483.

173. Rendu F, Breton–Gorius J, Leuret M, et al. Evidence that abnormal platelet functions in human Chédiak–Higashi syndrome are the result of a lack of dense bodies. *Am J Pathol* 1983;111:307–314.

174. Haddad E, Cramer E, Riviere C, et al. The thrombocytopenia of Wiskott Aldrich syndrome is not related to a defect in proplatelet formation. *Blood* 1999;94:509–518.

175. Mehaffey MG, Newton AL, Ghanadi MJ, et al. X–linked thrombocytopenia caused by a novel mutation of GATA–1. *Blood* 2001;98:2681–2688.

176. Schwartz M, Bekassy A, Donner M, et al. Mutation spectrum in patients with Wiskott–Aldrich syndrome and X–linked thrombocytopenia: identification of twelve different mutations in the WASP gene. *Thromb Haemost* 1996;75:546–550.

177. Rocca B, Bellacosa A, De Cristofaro R, et al. Wiskott–Aldrich syndrome: report of an autosomal dominant variant. *Blood* 1996;45:38–4543.

178. Higgins EA, Siminovitch KA, Zhuang D, et al. Aberrant C–linked oligosaccharide biosynthesis in lymphocytes and platelets from patients with the Wiskott–Aldrich syndrome. *J Biol Chem* 1991;266:6280–6290.

179. Stormorken H, Hellum B, Egeland T, et al. X–linked thrombocytopenia and thrombocytopathia: attenuated Wiskott–Aldrich syndrome: functional and morphological studies of platelets and lymphocytes. *Thromb Haemost* 1991;65:300–305.

180. Zhu QZ, Watanabe C, Liu T et al. Wiskott–Aldrich syndrome/X–linked thrombocytopenia: WASP gene mutations, protein expression, and phenotype. *Blood* 1997;90:2680–2689.

181. Grottum KA, Hovig T, Holmsen H, et al. Wiskott–Aldrich syndrome: qualitative platelet defects and short platelet survival. *Br J Haematol* 1969;17:373–388.

182. Hall JG, Levin J, Kuhn JP, et al. Thrombocytopenia with absent radii (TAR). *Medicine* 1969;48:411–439.

183. Hall JG. Thrombocytopenia with absent radius (TAR) syndrome. *J Med Genet* 1987;24:79–83.

184. Rao AK, Willis J, Kowalska MA, et al. Differential requirements for platelet aggregation and inhibition of adenylate cyclase by epinephrine. Studies of a familial platelet alpha 2–adrenergic receptor defect. *Blood* 1988;71:494–501.

185. Nieuwenhuis HK, Sakariassen KS, Houdijk WP, et al. Deficiency of membrane glycoprotein Ia associated with a decreased platelet adhesion to subendothelium: a defect in platelet spreading. *Blood* 1986;68:692–695.

186. Pelczar–Wissner CJ, McDonald EG, Sussman II. Absence of platelet–activating factor (PAF) mediated platelet aggregation: a new platelet defect. *Am J Hematol* 1984;16:419–422.

187. Nurden P, Savi P, Hellmann E, et al. An inherited bleeding disorder linked to a defective interaction

between ADP and its receptor on platelets. *J Clin Invest* 1995;95:1612–1622.

188. Rao AK, Koike K, Willis J, et al. Platelet secretion defect associated with impaired liberation of arachidonic acid and normal myosin light chain phosphorylation. *Blood* 1984;64:914–921.

189. Malmsten C, Hamberg M, Svensson J, Samuelsson B. Physiologic role of an endoperoxide in human platelets: hemostatic defect due to platelet cyclo-oxygenase deficiency. *Proc Natl Acad Sci U S A* 1975;72:1446–1450.

190. Lagarde M, Bryon PA, Vargaftig BB, Dechavanne M. Impairment of platelet thromboxane A<sub>2</sub> generation and of the platelet release reaction in two patients with congenital deficiency of platelet cyclo-oxygenase. *Br J Haematol* 1978;38:251–264.

191. Horellou MH, Lecompte T, Lecrubier C, et al. Familial and constitutional bleeding disorder due to platelet cyclo-oxygenase deficiency. *Am J Hematol* 1983;14:1–9.

192. Pareti FI, Mannucci PM, D'Angelo A, et al. Congenital deficiency of thromboxane and prostacyclin. *Lancet* 1980;1:898–901.

193. Rak K, Boda Z. Hemostatic balance in congenital deficiency of platelet cyclo-oxygenase. *Lancet* 1980;2:44.

194. Ehara H, Yoshimoto T, Yamamoto S, Hattori A. Enzymological and immunological studies on a clinical case of platelet cyclooxygenase abnormality. *Biochim Biophys Acta* 1988;960:35–42.

195. Defreyn G, Machin SJ, Carreras LO, et al. Familial bleeding tendency with partial platelet thromboxane synthetase deficiency: reorientation of cyclic endoperoxide metabolism. *Br J Haematol* 1981;49:29–41.

196. Mestel F, Oetliker O, Beck E, et al. Severe bleeding associated with defective thromboxane synthetase. *Lancet* 1980;1:157.

197. Wu KK, Minkoff IM, Rossi EC, Chen YC. Hereditary bleeding disorder due to a primary defect in platelet release reaction. *Br J Haematol* 1981;47:241–249.

198. Wu KK, LeBreton GC, Tai HH, Chen YC. Abnormal platelet response to thromboxane A<sub>2</sub>. *J Clin Invest* 1981;67:1801–1804.

199. Samama M, Lecrubier C, Conard J, et al. Constitutional thrombocytopathy with subnormal response to thromboxane A<sub>2</sub>. *Br J Haematol* 1981;48:293–303.

200. Lages B, Weiss HJ. Heterogeneous defects of platelet secretion and responses to weak agonists in patients with bleeding disorders. *Br J Haematol* 1988;68:53–62.

201. Fuse I, Mito M, Hattori A, et al. Defective signal transduction induced by thromboxane A<sub>2</sub> in a patient with a mild bleeding disorder: impaired phospholipase C activation despite normal phospholipase A<sub>2</sub> activation. *Blood* 1993;81:994–1000.

202. Hirata T, Kakizuka A, Ushibuki F, et al. Arg60 to Leu mutation of the human thromboxane A<sub>2</sub> receptor in a dominantly inherited bleeding disorder. *J Clin Invest* 1994;94:1662–1667.

203. Lages B, Malmsten C, Weiss HJ, Samuelsson B. Impaired platelet response to thromboxane-A<sub>2</sub> and defective calcium mobilization in a patient with a bleeding disorder. *Blood* 1981;57:545–552.

204. Hardisty RM, Machin SJ, Nokes TJ, et al. A new congenital defect of platelet secretion: impaired responsiveness of the platelets to cytoplasmic free calcium. *Br J Haematol* 1983;53:543–557.

205. Machin SJ, Keenan JP, McVerry BA. Defective platelet aggregation to the calcium ionophore A23187 in a patient with a lifelong bleeding disorder. *J Clin Pathol* 1983;36:1140–1144.

206. Koike K, Rao AK, Holmsen H, Mueller PS. Platelet secretion defect in patients with the attention

deficit disorder and easy bruising. *Blood* 1984;63:427-433.

207. Rao AK, Kowalska MA, Disa J. Impaired cytoplasmic ionized calcium mobilization in inherited platelet secretion defects. *Blood* 1989;74:664-672.

208. Rao AK, Disa J, Yang X. Concomitant defect in internal release and influx of calcium in patients with congenital platelet dysfunction and impaired agonist-induced calcium mobilization: thromboxane production is not required for internal release of calcium. *J Lab Clin Med* 1993;121:52-63.

209. Parker RI, Bray GL, McKeown LP, White JG. Failure to mobilize intracellular calcium in response to thrombin in a patient with familial thrombocytopathy characterized by macrothrombocytopenia and abnormal membrane complexes. *J Lab Clin Med* 1993;122:441-449.

210. Girolami A, Brunetti A, Fioretti D, Gravina E. Congenital thrombocytopathy (platelet factor 3 defect) with prolonged bleeding time but normal platelet adhesiveness and aggregation. *Acta Haematol* 1973;50:116-123.

211. Sultan Y, Brouet JC, Devergie A. Isolated platelet factor 3 deficiency. *N Engl J Med* 1976;294:1121.

212. Minkoff IM, Wu KK, Walasek J, Lightfoot B. Bleeding disorder due to an isolated platelet factor 3 deficiency. *Arch Intern Med* 1980;140:366-367.

213. Weiss HJ, Vicic WJ, Lages BA, Rogers J. Isolated deficiency of platelet procoagulant activity. *Am J Med* 1979b;67:206-213.

214. Weiss HJ. Scott's syndrome: a disorder of platelet coagulant activity. *Semin Hematol* 1994;31:312-319.

215. Weiss HJ, Lages B. Platelet prothrombinase activity and intracellular calcium responses in patients with storage pool deficiency, glycoprotein IIb-IIIa deficiency, or impaired platelet coagulant—a comparison with Scott's syndrome. *Blood* 1997;89:1599-1611.

216. Toti F, Fressinaud E, Meyer D et al. Scott's syndrome, characterized by impaired transmembrane migration of procoagulant phosphatidylserine and hemorrhagic complications, is an inherited disorder. *Blood* 1996;87:1409-1415.

217. Weiss HJ, Lages B. Family studies in Scott's syndrome. *Blood* 1997;90:475-476.

218. Zhou Q, Sims PJ, Wiedner T. Expression of proteins controlling transbilayer movement of plasma membrane phospholipids in the B lymphocytes from a patient with Scott's syndrome. *Blood* 1998;92:1707-1712.

219. Dachary-Prigent J, Pasquet J-M, Fressinaud E, et al. Aminophospholipid exposure, microvesiculation and abnormal protein tyrosine phosphorylation in the platelets of a patient with Scott's syndrome: a study using physiologic agonists and local anaesthetics. *Br J Haematol* 1997;99:959-967.

220. Apitz-Castro R, Cabrera S, Cruz MR, et al. Effects of garlic extract and of three pure components isolated from it on human platelet aggregation, arachidonate metabolism, release reaction and platelet ultrastructure. *Thromb Res* 1983;32:155-169.

221. Apitz-Castro R, Escalante J, Vargas R, Jain MK. Ajoene, the antiplatelet principle of garlic, synergistically potentiates the antiaggregatory action of prostacyclin, forskolin, indomethacin and dipyridamole on human platelets. *Thromb Res* 1986;42:303-311.

222. Apitz-Castro R, Ledezma E, Escalante J, Jain MK. The molecular basis of the antiplatelet action of ajoene: direct interaction with the fibrinogen receptor. *Biochem Biophys Res Comm* 1986;141:145-150.

223. Apitz-Castro R, Badimon JJ, Badimon L. Effect of ajoene, the major antiplatelet compound from garlic, on platelet thrombus formation. *Thromb Res* 1992;68:145-155.

224. Wang JP, Hsu MF, Teng CM. Antiplatelet effect of capsaicin. *Thromb Res* 1984;36:497-507.

225. Wang Z, Roberts JM, Grant PG, et al. The effect of a medicinal Chinese herb on platelet function.

Thromb Haemost 1982;48:301–306.

226. Hammerschmidt DE. Szechuan purpura. N Engl J Med 1980;302:1191–1193.

227. Goodnight SH, Harris WS, Connor WE. The effects of dietary omega 3 fatty acids on platelet composition and function in man: a prospective, controlled study. Blood 1981;58:880–885.

228. George JN, Shattil SJ. The clinical importance of acquired abnormalities of platelet function. N Engl J Med 1991;324:27–39.

229. Kaneshiro MM, Mielke CH, Kasper CK, Rapaport SI. Bleeding time after aspirin in disorders of intrinsic clotting. N Engl J Med 1969;281:1039–1042.

230. Lages B, Weiss HJ. Inhibition of human platelet function *in vitro* and *ex vivo* by acetaminophen. Thromb Res 1989;53:603–613.

231. Roth GJ, Majerus PW. The mechanism of the effect of aspirin on human platelets. I. Acetylation of a particulate fraction protein. J Clin Invest 1975;56:624–632.

232. Hirsch J, Dalen JE, Fuster V, et al. Aspirin and other platelet-active drugs. The relationship among dose, effectiveness, and side effects. Chest 1995;108(Suppl):247S–257S.

233. Dabaghi SF, Kamat SG, Payne J. Effects of low dose aspirin on *in vitro* platelet aggregation in the early minutes after ingestion in normal subjects. Am J Cardiol 1994;74:720–723.

234. Jimenez AH, Stubbs ME, Tofler GH, et al. Rapidity and duration of platelet suppression by enteric-coated aspirin in healthy young men. Am J Cardiol 1992;258–262.

235. Buchanan MR, Brister SJ. Individual variation in the effects of ASA on platelet function: implications for the use of ASA clinically. Can J Cardiol 1995;11:221–227.

236. Smith JB, Willis AL. Aspirin selectively inhibits prostaglandin production in human platelets. Nature 1971;231:235–237.

237. Cronberg S, Wallmark E, Soderberg I. Effect on platelet aggregation of oral administration of 10 non-steroidal analgesics to humans. Scand J Haematol 1984;33:155–159.

238. Rinder CS, Student LA, Bonan JL, et al. Aspirin does not inhibit adenosine diphosphate-induced platelet a-granule release. Blood 1993;82:505–512.

239. Young VP, Giles AR, Pater J, Corbett WE. Sex differences in bleeding time and blood loss in normal subjects following aspirin ingestion. Thromb Res 1980;20:705–709.

240. Harker LA, Slichter SJ. The bleeding time as a screening test for evaluation of platelet function. N Engl J Med 1972;287:155–159.

241. Czapek EE, Deykin D, Salzman E, et al. Intermediate syndrome of platelet dysfunction. Blood 1978;52:103–113.

242. Roderick PJ, Wilkes HC, Meade TW. The gastrointestinal toxicity of aspirin: an overview of randomized controlled trials. Br J Clin Pharmacol 1993;35:219.

243. DeSchepper PJ, Tjandramaga TB, DeRoo M, et al. Gastrointestinal blood loss after diflunisal and after aspirin: effect of ethanol. Clin Pharmacol Ther 1978;23:669–676.

244. Dybdahl JH, Daae LN, Larsen S, et al. Acetylsalicylic acid-induced gastrointestinal bleeding determined by a <sup>51</sup>Cr method on a day-to-day basis. Scand J Gastroenterol 1980;15:887–895.

245. Schafer AI. Effects of nonsteroidal anti-inflammatory therapy on platelets. Am J Med 1999;106:25S–36S.

246. Ali M, McDonald JW. Reversible and irreversible inhibition of platelet cyclooxygenase and serotonin

release by nonsteroidal antiinflammatory drugs. *Thromb Res* 1978;13:1057–1065.

247. Kenny GN. Potential renal, haematological and allergic adverse effects associated with nonsteroidal anti-inflammatory drugs. *Drugs* 1992;44(Suppl 5):31–37.

248. McQueen EG, Facoory B, Faed JM. Non-steroidal anti-inflammatory drugs and platelet function. *N Z Med J* 1986;99:358–360.

249. Jeter EK, Scott A, Kizer J, Lazarchick J. Impaired platelet function associated with parenteral nafcillin. *Ann Clin Lab Sci* 1990;20:79–84.

250. Fass RJ, Copelan EA, Brandt JT, et al. Platelet-mediated bleeding caused by broad-spectrum penicillins. *J Infect Dis* 1987;155:1242–1248.

251. Lee M, Strobnicki M, Sharifi R. Hemorrhagic complications of piperacillin therapy. *J Urol* 1986;136:454–455.

252. Sattler FR, Weitekamp MR, Ballard JO. Potential for bleeding with the new beta-lactam antibiotics. *Ann Intern Med* 1986;105:924–931.

253. Weitekamp MR, Aber RC. Prolonged bleeding times and bleeding diathesis associated with moxalactam administration. *JAMA* 1983;249:69–71.

254. Cazenave JP, Packham MA, Guccione MA, Mustard JF. Effects of penicillin G on platelet aggregation, release, and adherence to collagen. *Proc Soc Exp Biol Med* 1973;142:159–166.

255. Brown CH, Natelson EA, Bradshaw W, et al. The hemostatic defect produced by carbenicillin. *N Engl J Med* 1974;291:265–270.

256. Brown CH, Bradshaw MW, Natelson EA, et al. Defective platelet function following the administration of penicillin compounds. *Blood* 1976;47:949–956.

257. Copelan EA, Kusumi RK, Miller L, Fass RJ. A comparison of the effects of mezlocillin and carbenicillin on haemostasis in volunteers. *J Antimicrob Chemother* 1983;11(Suppl C):43–49.

258. Fletcher C, Pearson C, Choi SC, et al. *In vitro* comparison of antiplatelet effects of beta-lactam penicillins. *J Lab Clin Med* 1986;108:217–223.

259. Shattil SJ, Bennett JS, McDonough M, Turnbull J. Carbenicillin and penicillin G inhibit platelet function *in vitro* by impairing the interaction of agonists with the platelet surface. *J Clin Invest* 1980;65:329–337.

260. Burroughs SF, Johnson GJ.  $\beta$ -Lactam antibiotic-induced platelet dysfunction: evidence for irreversible inhibition of platelet activation *in vitro* and *in vivo* after prolonged exposure to penicillin. *Blood* 1990;75:1473–1480.

261. Burroughs SF, Johnson GJ. Beta-lactam antibiotics inhibit agonist-stimulated platelet calcium flux. *Thromb Haemost* 1993;69:503–508.

262. Sunakawa K, Akita H, Iwata S, et al. Effects of antibiotics on platelet aggregation. *Drugs* 1988;35(Suppl 2):205–207.

263. Ingalls CS, Freimer EH. Detection of antibiotic-induced platelet dysfunction in whole blood using flow cytometry. *J Antimicrob Chemother* 1991;29:313–321.

264. Thompson JW, Jacobs RF. Adverse effects of newer cephalosporins. An update. *Drug Saf* 1993;9:132–142.

265. Knight CJ, Panesar M, Wilson DJ, et al. Different effects of calcium antagonists, nitrates, and  $\beta$ -blockers on platelet function. *Circulation* 1997;95:125–132.

250. Rysanek K, Svehla C, Spankova H, Mlejnkova M. Comparison of the effect of various



- sympathocolytics on thrombocyte aggregation. *J Pharm Pharmacol* 1968;20:154–155.
266. Boullin DJ, Grahame-Smith DG, Grimes RP, Woods HF. Inhibition of 5-hydroxytryptamine-induced human blood platelet aggregation by chlorpromazine and its metabolites. *Br J Pharmacol* 1975;53:121–125.
267. Ishigooka J, Tanaka K, Suzuki Y, et al. Selective inhibitory effects of chlorpromazine and imipramine on platelet aggregation. *Int Pharmacopsychiat* 1980;15:270–280.
268. Jain MK, Eskow K, Kuchibhotla J, Colman RW. Correlation of inhibition of platelet aggregation by phenothiazines and local anesthetics with their effects on a phospholipid bilayer. *Thromb Res* 1978;13:1067–1075.
269. Warlow C, Ogston D, Douglas AS. Platelet function after the administration of chlorpromazine to human subjects. *Haemostasis* 1976;5:21–26.
270. Buchanan GR, Martin V, Levine PH, et al. The effects of “anti-platelet” drugs on bleeding time and platelet aggregation in normal human subjects. *Am J Clin Pathol* 1977;68:355–359.
271. Livio M, Marchesi D, Remuzzi G, et al. Uraemic bleeding: role of anaemia and beneficial effect of red cell transfusions. *Lancet* 1982;2:1013–1015.
272. Fernandez F, Goudable C, Sie P, et al. Low hematocrit and prolonged bleeding time in uraemic patients: effect of red cell transfusions. *Br J Haematol* 1985;59:139–148.
273. Hellem AJ, Borchgrevink CF, Ames SB. The role of red cells in haemostasis: the relation between haematocrit, bleeding time and platelet adhesiveness. *Br J Haematol* 1961;7:42–50.
274. Remuzzi G, Perico N, Zoja Z, et al. Role of endothelium-derived nitric oxide in the bleeding tendency of uremia. *J Clin Invest* 1990;86:1768–1771.
275. Davis JW, McField JR, Phillips PE, Graham BA. Guanidinosuccinic acid on human platelet effects of exogenous urea, creatinine, and aggregation *in vitro*. *Blood* 1972;39:388–397.
276. Rabiner SF, Molinas F. The role of phenol and phenolic acids on the thrombocytopeny and defective platelet aggregation of patients with renal failure. *Am J Med* 1970;49:346–351.
277. Horowitz HI, Stein IM, Cohen BD. Further studies on the platelet-inhibitory effect of guanidinosuccinic acid and its role in uremic bleeding. *Am J Med* 1970;49:336–345.
278. Eknayan G, Wacksman SJ, Glueck HI, Will JJ. Platelet function in renal failure. *N Engl J Med* 1969;280:677–681.
279. Noris M, Remuzzi G. Uremic bleeding: closing the circle after 30 years of controversies. *Blood* 1999;94:2569–2574.
280. Weigert AL, Schafer AI. Uremic bleeding: pathogenesis and therapy. *Am J Med Sci* 1998;316:94–104.
281. Ribeiro AC, Brunini TM, Ellory JC, et al. Abnormalities in L-arginine transport and nitric oxide biosynthesis in chronic renal and heart failure. *Cardiovasc Res* 2001;49:697–712.
282. Vallance P, Leone A, Calver A, et al. Accumulation of an endogenous inhibitor of nitric oxide synthesis in chronic renal failure. *Lancet* 1992;339:572–575.
283. Noris M, Benigni A, Boccardo P, et al. Enhanced nitric oxide synthesis in uremia; implications for platelet dysfunction and dialysis hypotension. *Kidney Int* 1993;44:445–450.
284. Castillo R, Lozano T, Escolar G, et al. Defective platelet adhesion on vessel subendothelium in uremic patients. *Blood* 1986;68:337–342.
285. Escolar G, Cases A, Bastida E, et al. Uremic platelets have a functional defect affecting the interaction of von Willebrand factor with glycoprotein IIb-IIIa. *Blood* 1990;76:1336–1340.
286. Zwaginga JJ, Ijseldijk JW, Beeser-Visser N, et al. High von Willebrand factor concentration

compensates a relative adhesion defect in uremic blood. *Blood* 1990;75:1498–1508.

287. Gralnick HR, McKeown LP, Williams SB, et al. Plasma and platelet von Willebrand factor defects in uremia. *Am J Med* 1988;85:806–810.

288. Castaman G, Lattuada A, Ruggeri M, et al. Platelet von Willebrand factor abnormalities in myeloproliferative syndromes. *Am J Hematol* 1995;49:289–293.

289. Harsfalvi J, Boda Z, Mikita J, et al. Effect of recombinant human erythropoietin on plasma von Willebrand factor in chronic hemodialysis patients. *Am J Hematol* 1994;47:144–145.

290. Benigni A, Boccardo P, Galbusera M, et al. Reversible activation defect of the platelet glycoprotein IIb–IIIa complex in patients with uremia. *Am J Kidney Dis* 1993;22:668–676.

291. Salvati F, Liani M. Role of platelet surface receptor abnormalities in the bleeding and thrombotic diathesis of uremic patients on hemodialysis and peritoneal dialysis. *Int J Artif Organs* 2001;24:131–135.

292. Sreedhara R, Itagaki I, Hakim RM. Uremic patients have decreased shear-induced platelet aggregation mediated by decreased availability of glycoprotein IIb–IIIa receptors. *Am J Kidney Dis* 1996;27:355–364.

293. Yoshida E, Fujimura Y, Ikeda Y, et al. Impaired high-shear-stress-induced platelet aggregation in patients with chronic renal failure undergoing haemodialysis. *Br J Haematol* 1995;89:861–867.

294. Gawaz MP, Dobos G, Spath M, et al. Impaired function of platelet membrane glycoprotein IIb–IIIa in end-stage renal disease. *J Am Soc Nephrol* 1994;5:36–46.

295. Walkowiak B, Pawlowska Z, Michalak E, Cierniewski CS. Expression of fibrinogen receptors on platelets of uremic patients is correlated with the content of GPIIb and plasma level of creatinine. *Thromb Haemost* 1994;71:164–168.

296. Krzeslowska J, Rysz J, Cierniewski CS, Luciak M. Expression of fibrinogen receptors and GPIIb molecules on uraemic platelets: effect of recombinant human erythropoietin therapy. *Nephrol Dialysis Transplant* 1995;10:653–656.

297. Steiner RW, Coggins C, Carvalho AC. Bleeding time in uremia: a useful test to assess clinical bleeding. *Am J Hematol* 1979;7:107–117.

298. DiMinno G, Martinez J, McKean ML, et al. Platelet dysfunction in uremia: multifaceted defect partially corrected by dialysis. *Am J Med* 1985;79:552–559.

299. Remuzzi G, Benigni A, Dodesini P, et al. Reduced platelet thromboxane formation in uremia: evidence for a functional cyclooxygenase defect. *J Clin Invest* 1983;71:762–768.

300. Godge MP, Faint RW, Rylance PB, Neild GH. Platelet function and the bleeding time in progressive renal failure. *Thromb Haemost* 1988;60:83–87.

301. Macconi D, Vigano G, Bisogno G, et al. Defective platelet aggregation in response to platelet-activating factor in uremia associated with low platelet thromboxane A<sub>2</sub> generation. *Am J Kidney Dis* 1992;19:318–325.

302. Ware JA, Clark BA, Smith M, Salzman EW. Abnormalities of cytoplasmic Ca<sup>2+</sup> in platelets from patients with uremia. *Blood* 1989;73:172–176.

303. Vlachoyannis J, Schoeppe W. Adenylate cyclase activity and cAMP content of human platelets in uraemia. *Eur J Clin Invest* 1982;12:379–381.

304. Escolar G, Diaz-Ricart M, Cases A, et al. Abnormal cytoskeletal assembly in platelets from uremic patients. *Am J Pathol* 1993;143:823–831.

305. Remuzzi G, Livio M, Marchiaro G, et al. Bleeding in renal failure: altered platelet function in chronic uraemia only partially corrected by haemodialysis. *Nephron* 1978;22:347–353.

306. Sreedhara R, Itagaki I, Lynn B, Hakim RM. Defective platelet aggregation in uremia is transiently

worsened by hemodialysis. *Am J Kidney Dis* 1995;25:555–563.

307. Reverter JC, Escolar G, Sanz C, et al. Platelet activation during hemodialysis measured through exposure of p-selectin: analysis by flow cytometric and ultrastructural techniques. *J Lab Clin Med* 1994;124:79–85.

308. Tassies D, Reverter JC, Cases A, et al. Reticulated platelets in uremic patients: effect of hemodialysis and continuous ambulatory peritoneal dialysis. *Am J Hematol* 1995;50:161–166.

309. Campistol JM, Cofan F, Ricart MD, et al. Correction of uremic platelet dysfunction after renal transplantation. *Transplant Proc* 1995;27:2244–2245.

311. Moia M, Vizzotto L, Cattaneo M, et al. Improvement in the haemostatic defect of uraemia after treatment with recombinant human erythropoietin. *Lancet* 1987;2:1227–1229.

312. Cases A, Escolar G, Reverter JC, et al. Recombinant human erythropoietin treatment improves platelet function in uremic patients. *Kidney Int* 1992;42:668–672.

313. Canadian Erythropoietin Study Group. Association between recombinant human erythropoietin and quality of life and exercise capacity of patients receiving haemodialysis. *BMJ* 1990;300:573–578.

314. Janson PA, Jubelirer SJ, Weinstein MJ, Deykin D. Treatment of the bleeding tendency in uremia with cryoprecipitate. *N Engl J Med* 1980;303:1318–1322.

315. Mannucci PM, Remuzzi G, Pusineri F, et al. Deamino-8-D-arginine vasopressin shortens the bleeding time in uremia. *N Engl J Med* 1983;308:8–12.

316. Escolar G, Cases A, Montegudo J, et al. Uremic plasma after infusion of desmopressin (DDAVP) improves the interaction of normal platelets with vessel subendothelium. *J Lab Clin Med* 1989;114:36–42.

317. Zeigler ZR, Megaludis A, Fraley DS. Desmopressin (d-DAVP) effects on platelet rheology and von Willebrand factor activities in uremia. *Am J Hematol* 1992;39:90–95.

318. Livio M, Mannucci PM, Vigano G, et al. Conjugated estrogens for the management of bleeding associated with renal failure. *N Engl J Med* 1986;315:731–735.

319. Jacobs P, Jacobson J, Kahn D. Perioperative administration of a single dose of conjugated oestrogen to uraemic patients is ineffective in improving haemostasis. *Am J Hematol* 1994;46:24–28.

320. Lackner H. Hemostatic abnormalities associated with dysproteinemias. *Semin Hematol* 1973;10:125–133.

321. Robert F, Mignucci M, McCurdy SA, et al. Hemostatic abnormalities associated with monoclonal gammopathies. *Am J Med Sci* 1993;306:359–366.

322. Perkins HA, MacKenzie MR, Fudenberg HH. Hemostatic defects in dysproteinemias. *Blood* 1970;35:695–707.

323. Saraya AK, Kasturi J, Kishan R. A study of haemostasis in macroglobulinemia. *Acta Haematol* 1972;47:33–42.

324. Wallace MR, Simon SR, Ershler WB, Burns SL. Hemorrhagic diathesis in multiple myeloma. *Acta Haematol* 1984;72:340–342.

325. Rozenberg MC, Dintenfuss L. Platelet aggregation in Waldenstrom's macroglobulinemia. *Thromb Haemost* 1965;14:202–208.

326. McGrath KM, Stuart JJ, Richards F. Correlation between serum IgG, platelet membrane IgG, and platelet function in hypergammaglobulinemic states. *Br J Haematol* 1979;42:585–591.

327. DiMinno G, Coraggio F, Carbone AM, et al. A myeloma paraprotein with specificity for platelet glycoprotein IIIa in a patient with a fatal bleeding disorder. *J Clin Invest* 1986;77:157–164.

328. Vigliano EM, Horowitz HI. Bleeding syndrome in a patient with IgA myeloma: interaction of protein and connective tissue. *Blood* 1967;29:823–836.
329. Mohri H, Nguchi T, Kodama F, et al. Acquired von Willebrand disease due to inhibitor of human myeloma protein specific for von Willebrand factor. *Am J Clin Pathol* 1987;87:663–668.
330. Bovill EG, Ershler WB, Golden EA, et al. A human myeloma-produced mono-clonal protein directed against the active subpopulation of von Willebrand factor. *Am J Clin Pathol* 1986;85:115–123.
331. Mazurier C, Parquet-Gernez A, Descamps J, et al. Acquired von Willebrand's syndrome in the course of Waldenstrom's disease. *Thromb Haemost* 1980;44:115–118.
332. Takahashi H, Nagayama R, Tanabe Y, et al. DDAVP in acquired von Willebrand syndrome associated with multiple myeloma. *Am J Hematol* 1986;22:421–429.
333. Spangenberg P, Kirchmaier CM, Schirmer A, et al. Functional studies on platelets of a patient with an acquired disorder of platelet function associated with autoantibodies against membrane glycoprotein IIb/IIIa complex. *Thromb Res* 1993;69:435–442.
334. Thiele J, Holgado S, Choritz H, Georgii A. Abnormalities of megakaryocytes in myelitis and chronic myeloproliferative diseases. *Virchows Arch* 1982;41:67–81.
335. Thiele J, Quitmann H, Wagner S, Fischer R. Dysmegakaryopoiesis in myelodysplastic syndromes (MDS): an immunomorphometric study of bone marrow trephine biopsy specimens. *J Clin Pathol* 1991;44:300–305.
336. Tricot G, DeWolf-Peeters C, Hendrickx B, Verwilghen RL. Bone marrow histology in myelodysplastic syndromes. *Br J Haematol* 1984;57:423–430.
337. Kuriyama K, Tomonaga M, Matsuo T, et al. Diagnostic significance of detecting pseudo-Pelger-Huet anomalies and micro-megakaryocytes in myelodysplastic syndrome. *Br J Haematol* 1986;63:665–669.
338. Wong KF, Chan JK. Are “dysplastic” and hypogranular megakaryocytes specific markers for myelodysplastic syndrome? *Br J Haematol* 1991;77:509–514.
339. Widell S, Hast R. Balloon-like platelets in myelodysplastic syndromes—a feature of dysmegakaryopoiesis? *Leuk Res* 1987;11:747–752.
340. Cowan DH, Graham RC, Baunach D. The platelet defect in leukemia: platelet ultrastructure, adenine nucleotide metabolism, and the release reaction. *J Clin Invest* 1975;56:188–200.
341. Gerrard JM, McNichol A. Platelet storage pool deficiency, leukemia, and myelodysplastic syndrome. *Leuk Lymphoma* 1992;8:277–281.
342. Maldonado JE, Pierre RV. The platelets in preleukemia and myelomonocytic leukemia: ultrastructural cytochemistry and cytogenetics. *Mayo Clin Proc* 1975b;50:573–587.
343. Pintado T, Maldonado JE. Ultrastructure of platelet aggregation in refractory anemia and myelomonocytic leukemia. II. Individual platelet abnormalities: thrombasthenia-like platelets, surface defects, and dissociation phenomena. *Mayo Clin Proc* 1976;51:443–451.
344. Maldonado JE. Platelet granulopathy: a new morphologic feature in preleukemia and myelomonocytic leukemia: light microscopy and ultrastructural morphology and cytochemistry. *Mayo Clin Proc* 1976;51:452–462.
345. Pamphilon DH, Aparicio SR, Roberts BE, et al. The myelodysplastic syndromes—a study of hemostatic function and platelet ultrastructure. *Scand J Haematol* 1984;33:486–491.
346. Stuart JJ, Lewis JC. Platelet aggregation and electron microscopic studies of platelets in preleukemia. *Arch Pathol Lab Med* 1982;106:458–461.
347. Berndt MC, Kabral A, Grimsley P, et al. An acquired Bernard–Soulier-like platelet defect associated

with juvenile myelodysplastic syndrome. *Br J Haematol* 1988;68:97–101.

348. Castaldi PA, Berndt MC, Booth W, et al. Evidence for a platelet membrane defect in the myeloproliferative syndromes. *Thromb Res* 1982;27:601–609.

349. Waddell CC, Brown JA, Repinecz YA. Abnormal platelet function in myeloproliferative disorders. *Arch Pathol Lab Med* 1981;105:432–435.

350. Jubelirer SJ, Russel F, Vaillancourt R, Deykin D. Platelet arachidonic acid metabolism and platelet function in ten patients with chronic myelogenous leukemia. *Blood* 1980;56:728–731.

351. Keenan JP, Wharton J, Shepherd AJ, Bellingham AJ. Defective platelet lipid peroxidation in myeloproliferative disorders: a possible defect of prostaglandin synthesis. *Br J Haematol* 1977;35:275–283.

352. Takayama H, Okuma M, Kanaji K, et al. Altered arachidonate metabolism by leukocytes and platelets in myeloproliferative disorders. *Prostaglandins Leukot Med* 1983;12:261–272.

353. Okuma M, Takayama H, Uchino H. Subnormal platelet response to thromboxane A<sub>2</sub> in a patient with chronic myeloid leukemia. *Br J Haematol* 1982;51:469–477.

354. Smith IL, Martin TJ. Platelet thromboxane synthesis and release reactions in myeloproliferative disorders. *Haemostasis* 1982;11:119–127.

355. Caranobe C, Sie P, Fernandez F, et al. Abnormal platelet serotonin uptake and binding sites in myeloproliferative disorders. *Thromb Haemost* 1984;51:349–353.

356. Moore A, Nachman RL. Platelet Fc receptor. Increased expression in myeloproliferative disease. *J Clin Invest* 1981;67:1064–1071.

357. Kaplan R, Gabbeta J, Sun L, et al. Combined defect in membrane expression and activation of platelet GPIIb–IIIa complex without primary sequence of abnormalities in myeloproliferative disease. *Br J Haematol* 2000;111:954–964.

358. Boneu B, Nouvel C, Sie P, et al. Platelets in myeloproliferative disorders. I. A comparative evaluation with certain platelet function tests. *Scand J Haematol* 1980;25:214–220.

359. Pedersen NT, Laursen B. Megakaryocytes in cubital venous blood in patients with chronic myeloproliferative disorders. *Scand J Haematol* 1983;30:50–58.

360. Castaman G, Rodeghiero F, Lattuada A, et al. Multimeric pattern of plasma and platelet von Willebrand factor is normal in uremic patients. *Am J Hematol* 1993a;44:266–269.

361. Lopez-Fernandez MF, Lopez-Berges C, Martin R, et al. Abnormal structure of von Willebrand factor in myeloproliferative syndrome is associated to either thrombotic or bleeding diathesis. *Thromb Haemost* 1987;58:753–757.

362. Budde U, Schaefer G, Mueller N, et al. Acquired von Willebrand's disease in the myeloproliferative syndrome. *Blood* 1984;64:981–985.

363. Budde U, Dent JA, Berkowitz SD, et al. Subunit composition of plasma von Willebrand factor in patients with the myeloproliferative syndrome. *Blood* 1986;68:1213–1217.

2004 Lippincott Williams & Wilkins  
John P. Greer, John Foerster, John N. Lukens  
George M. Rodgers, Frixos Paraskevas, Bertil Glader  
Wintrobe's Clinical Hematology

**NOMENCLATURE****PRINCIPLES OF PATHOPHYSIOLOGY****HEMOPHILIA A**

## Pathophysiology

## Incidence

## Genetics

## Variants

## Carrier Detection

## Hemophilia in the Female

## Clinical Manifestations

## Course and Prognosis

## Laboratory Diagnosis

## Differential Diagnosis

**VON WILLEBRAND DISEASE**

## Incidence

## Nomenclature

## Genetics

## Pathophysiology

## Response to Transfusion

## Clinical Manifestations

## Laboratory Diagnosis

## Quantitative Defects of von Willebrand Factor

## Qualitative Defects of von Willebrand Factor

## Platelet-Type (Pseudo) von Willebrand Disease

**HEMOPHILIA B**

## Variants

## Genetics

## Detection of Carriers

## Clinical Features

## Laboratory Diagnosis

**CLINICAL DISORDERS OF THE FIBRINOGEN MOLECULE**

## Pathogenesis of Quantitative Fibrinogen Disorders

## Afibrinogenemia

## Dysfibrinogenemia

**FACTOR XIII DEFICIENCY**

## Pathogenesis

## Molecular Genetics

## Clinical Aspects

## Differential Diagnosis

## Laboratory Diagnosis

**PROTHROMBIN DEFICIENCY****FACTOR V DEFICIENCY**

## Pathophysiology

## Clinical Features

## Laboratory Diagnosis

**FACTOR VII DEFICIENCY**

## Pathophysiology

## Clinical Features

## Laboratory Diagnosis

**FACTOR X DEFICIENCY**

- FACTOR XI DEFICIENCY
  - Clinical Features
  - Laboratory Diagnosis
- FACTOR XII DEFICIENCY
  - Pathophysiology
  - Clinical Features
  - Laboratory Diagnosis
- PREKALLIKREIN DEFICIENCY
  - Pathophysiology
  - Clinical Features
  - Laboratory Diagnosis
- HIGH-MOLECULAR-WEIGHT KININOGEN DEFICIENCY
  - Pathophysiology
  - Laboratory Diagnosis
- MISCELLANEOUS INHERITED COAGULATION DISORDERS
  - Combined Defects
    - Deficiency of Factors V and VIII
    - Combined Deficiency of Factors II, VII, IX, and X
- ABNORMALITIES OF PROTEASE INHIBITORS
  - $\alpha$ 2-Antiplasmin Deficiency
  - Plasminogen Activator Inhibitor-1 Deficiency
  - $\alpha$ 1-Antitrypsin Pittsburgh
- TREATMENT
  - Replacement Therapy
  - Hemostatic Levels
  - In Vivo Recovery and Survival of Infused Coagulation Factors
  - Materials
- MAJOR AND MINOR BLEEDING
  - Hemophilia A Minor Bleeding
  - Hemophilia A Major Bleeding
  - von Willebrand Disease
  - Hemophilia B
  - Gene Therapy for Hemophilia
  - Factor VII Deficiency
  - Factor XIII Deficiency
  - Miscellaneous Disorders
- SPECIAL ASPECTS OF TREATMENT
  - Hemarthrosis
  - Hemophilic Cysts
  - Intracranial Bleeding
  - Acquired Immunodeficiency Syndrome
  - Thrombocytopenia
  - Hepatitis
  - Antibodies to Coagulation Factors
  - Home Treatment Programs
  - Dental Care
- REFERENCES

Inherited disorders of coagulation usually are the result of a deficiency or abnormality of a single plasma protein. As a consequence, these disorders provide a unique opportunity to study the phenomena of blood coagulation. If von Willebrand disease (vWD) is included, the inherited coagulation abnormalities ( [Table 59.1](#) ) are common; for example, vWD may affect up to 1% of the population. The other inherited coagulation disorders affect at most 1 in 10,000 to 15,000 persons.

**TABLE 59.1. Inherited Disorders of Coagulation**

---

X-linked recessive traits



Hemophilia A

Hemophilia B (i.e., CRM<sup>+</sup> and CRM<sup>-</sup> variants; hemophilia B<sub>m</sub>, B Leyden, etc.)

Autosomal-recessive traits

Factor XI deficiency

Prothrombin deficiency

Factor V deficiency

Factor VII deficiency

Factor X deficiency (i.e., Prower variant, Stuart variant, Friuli variant, others)

Afibrinogenemia

Hypofibrinogenemia

Factor XII deficiency

Factor XIII deficiency

Autosomal-dominant traits

von Willebrand disease

Dysfibrinogenemias

Combined abnormalities

Associated with factor VIII deficiency (i.e., factor V deficiency, hemophilia B, factor XI deficiency, factor VII deficiency, von Willebrand disease, dysfibrinogenemias, platelet dysfunction)

Involving vitamin K-dependent factors (i.e., factors II, VII, IX, and X; factors IX and XII; others)

Miscellaneous

Prekallikrein deficiency

High-molecular-weight kininogen deficiency

Deficiency of physiologic inhibitors [i.e., a<sub>2</sub>-antiplasmin, abnormal a<sub>1</sub>-antitrypsin (antithrombin Pittsburgh)]

CRM, cross-reacting material.

---

With the exception of vWD, the inherited coagulation disorders associated with bleeding produce similar signs and symptoms, regardless of the particular factor that is lacking. Consequently, the clinical picture of hemophilia A is emphasized in the following discussion as the prototypical bleeding disorder. Clinical features of the other forms that differ significantly from this prototype are cited in the sections dealing with these other conditions. Treatment of the inherited coagulation disorders is discussed later in the chapter.

## NOMENCLATURE

Many names have been proposed for the inherited coagulation disorders, most of which incorporate the word *hemophilia*, such as *pseudohemophilia* or *parahemophilia*. The international roman numeral designations for these disorders are summarized in [Table 21.1](#). The term *hemophilia A* is synonymous with *factor VIII deficiency*, and *hemophilia B* is also known as *factor IX deficiency* or *Christmas disease*.

Like abnormal hemoglobins, qualitatively abnormal fibrinogens are designated by the name of the city in which they were first discovered, as in *fibrinogen Paris*. Specific terms are also used for variants of other disorders, if such terms have become widely used, such as *factor X Friuli*.

The activity of the various coagulation factors is expressed in terms of units, defined as the activity present in 1 ml of fresh plasma from normal donors. The concentration of all coagulation factors in normal-pooled plasma is thus 1 U/ml or 100 U/dl, or 100% activity; levels in blood bank plasma are approximately 80 U/dl because of the dilution with anticoagulant.

## PRINCIPLES OF PATHOPHYSIOLOGY

With the exception of fibrinogen and prothrombin, the coagulation factors are trace proteins. Traditional laboratory measurements of their activity are bioassays, which are inherently incapable of distinguishing between a quantitative abnormality (the absence of a specific factor) and a qualitative abnormality (a nonfunctional or hypofunctional factor that is present in normal amounts). For many years, the general assumption was that the inherited coagulation disorders were the result of a quantitative deficiency of trace plasma proteins. However, results of studies using various immunologic techniques demonstrate that the absence of coagulant activity in the plasma of patients with these disorders may result from either deficient biosynthesis of a requisite protein or defective biosynthesis, leading to the production of normal amounts of functionally inactive or functionally abnormal analogs ([1](#)).

The results of immunologic tests for the presence of coagulation factors usually can be expressed as positive or negative for cross-reacting material (CRM). A positive test for CRM implies that a substance that is antigenically similar to the normal coagulation factor is present in the plasma. A coagulation disorder characterized by the presence of such a substance often is described as a *CRM-positive or qualitative disorder or variant*. Designations based on immunologic cross-reactivity are meaningful only with respect to a specific antibody and a specific neutralization technique.

Some qualitatively abnormal coagulation factors produce abnormalities in coagulation that differ from those associated with a true quantitative deficiency of the factor. For want of a more specific term, such factors are called *abnormal* or *aberrant factors* to distinguish them from completely nonfunctional analogs. The most clearly defined disorders of this type are the dysfibrinogenemias, in which the abnormal fibrinogen is not totally nonfunctional but may inhibit the function of normal fibrinogen. Other disorders characterized by aberrant coagulation factors include the B<sub>m</sub> variant of hemophilia B and some of the variants of prothrombin deficiency. Aberrant procoagulant proteins also may be synthesized in acquired deficiencies of the vitamin K-dependent factors ([Chapter 60](#)).

A negative test for CRM indicates the absence of antigenically competent protein and suggests that the disorder is caused by deficient biosynthesis of the requisite factor. Such quantitative or CRM-negative disorders include afibrinogenemia and factor V deficiency. However, available techniques do not exclude aberrations of sufficient magnitude to alter the antigenic determinants of the molecule, the subunit of the active coagulation factor, or the production of an analog that is catabolized at an abnormally rapid rate ([1](#), [2](#)). Multiple variants of many of the inherited coagulation disorders have been defined, such as factor X deficiency, which may be CRM positive or CRM negative or associated with an aberrant form of factor X.

Two major genetic aberrations of the factor VIII-von Willebrand factor (vWF) complex are now well documented: hemophilia A and vWD, the two most common inherited bleeding disorders. These disorders are the result of qualitative or quantitative abnormalities of different subunits or regions of the factor VIII complex (factor VIII-vWF) and give rise to distinct clinical disorders. In this chapter, the international nomenclature for subunits of

the factor VIII molecule is used ( [Table 59.2](#)). The unqualified term *factor VIII* still is commonly used with reference to preparations containing varying amounts of factor VIII and vWF. These abbreviations are used in a functional sense; the exact biochemical or structural features of this complex molecule that determine its functions and attributes are discussed in [Chapter 21](#). *Factor VIII coagulant activity* (factor VIIIc) refers to the functional property of the factor VIII molecule that corrects the coagulation defect of patients with hemophilia A. The antigenic expression of factor VIIIc activity is called *factor VIII<sub>Ag</sub>*. The large plasma protein required for normal platelet adhesion that is deficient or aberrant in patients with vWD is called *vWF*. The antigenic expression of this protein is designated *vWF antigen* (vWFAg). The functional property of vWF that promotes platelet agglutination by the drug ristocetin is called *ristocetin-cofactor activity*.

**TABLE 59.2. Nomenclature for Factor VIII and von Willebrand Factor**

| Definition   | International Nomenclature             | Outmoded Synonyms   |
|--|--|---|
| Protein lacking or aberrant in hemophilia A  | Factor VIII                            | Factor VIIIc;<br>antihemophilic factor                            |
| Functional property of factor VIII that is deficient in hemophilia A and measured using coagulation assays | Factor VIIIc                           | Factor VIII coagulant activity                                    |
| Antigenic property of factor VIII that is measured by immunoassays in which homologous antibodies are used | Factor VIII <sub>Ag</sub>              | Factor VIIIc <sub>Ag</sub>  |
| Protein required for normal platelet adhesion that is aberrant or deficient in von Willebrand disease      | von Willebrand factor (vWF)            | Factor VIII-related antigen (VIII:Ag); Factor VIII <sub>vWF</sub> |
| Antigenic property of vWF that is measured by immunoassays in which heterologous antibodies are used       | von Willebrand factor antigen (vWFAg)  | Factor VIII:Ag  |
| Property of vWF required for platelet agglutination by ristocetin  | Ristocetin cofactor activity (vWF:RCo) | Factor VIII:RCo   |

NOTE: This table is based on recommendations of the International Committee on Thrombosis and Haemostasis.

From Marder VJ, Mannucci PM, Firkin BG, et al. Standard nomenclature for factor VIII and von Willebrand factor: a recommendation by the International Committee on Thrombosis and Haemostasis. *Thromb Haemost* 1985;54:871–872; and Mazurier C, Rodeghiero F. Recommended abbreviations for von Willebrand factor and its activities. *Thromb Haemost* 2001;86:712.

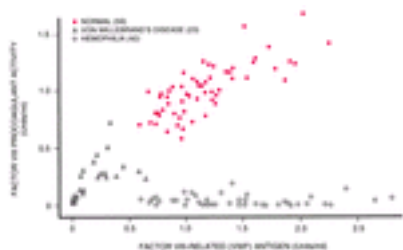
## HEMOPHILIA A

A severe and often fatal hemorrhagic diathesis that affected the male children of certain families was well recognized in antiquity. This is evident from the writings of Rabbi Simon ben Gamaliel (second century A.D.) in the Talmud, and those of Maimonides, the Hebrew physician and philosopher, and Albucasis, the Arab (twelfth century) ( [3](#) ). Complete monographs have reviewed the early literature ( [4](#) ).

## Pathophysiology

The hemostatic abnormality in hemophilia A (factor VIII deficiency, classic hemophilia) is a deficiency or abnormality of a plasma protein. This substance (the antihemophilic factor, antihemophilic globulin, factor VIII) was elusive and difficult to purify. Preparations of factor VIII are capable of correcting all coagulation abnormalities in the blood of hemophiliacs; they are equally effective *in vitro* and *in vivo*, and their administration can prevent and arrest hemorrhage in patients with hemophilia A.

Factor VIII normally circulates in the plasma bound to a much larger molecule, vWF, as part of the factor VIII complex. The functional attribute of this complex that is essential in coagulation is designated VIIIc. Factor VIIIc and its functional and immunologic properties are aberrant or deficient in patients with hemophilia A. vWF (formerly called VIII<sub>A</sub>g) acts as a carrier for factor VIII and is abnormal in vWD. The production of vWF is coded by an autosomal gene, and this protein apparently is qualitatively normal and is present in normal or increased amounts in patients with hemophilia A ( Fig. 59.1 ) ( 5 , 6 and 7 ). Few *in situ* studies of hemostatic plugs in patients with hemophilia A have been performed. Available evidence suggests that reinforcement of platelet plugs with fibrin is defective ( 8 ).



**Figure 59.1.** The relationship of factor VIII procoagulant activity and factor VIII-related antigen [von Willebrand factor (VWF)] in the plasma of normal subjects and patients with hemophilia or von Willebrand disease. (From Hoyer LW. The factor VIII complex: structure and function. *Blood* 1981;58:1–13, with permission.)

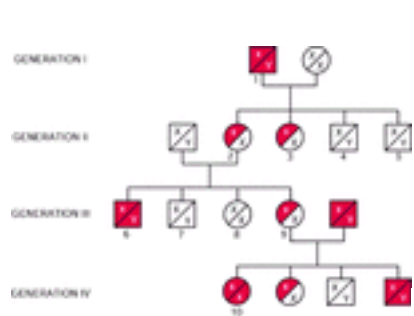
## Incidence

Hemophilia A has been recognized in all areas of the world where adequate information is available. Hemophilia A is the second most common of the inherited coagulation disorders. Estimates of its incidence range from 1 in 20,000 to as high as 1 in 10,000 persons ( 9 ). The disorder seems to be rare among Chinese, and the early literature indicated that hemophilia A was uncommon in Africans ( 10 ). However, a population-based study of the southeastern United States by the Centers for Disease Control and Prevention found that 11 cases per 100,000 persons had hemophilia A and that the prevalence was similar among different racial groups ( 11 ). This same survey estimated that in 1994, there were 13,320 cases of hemophilia A and 3640 cases of hemophilia B in the United States ( 11 ).

## Genetics

Hemophilia A is the classic example of an X-linked recessive trait ( 10 ). The genetics of this disorder has been studied intensively ( 12 , 13 ). In such a disorder, the defective gene

is located on the X chromosome (<sup>14</sup>); the factor VIII gene maps to Xq28. In males who lack a normal allele, the defect is manifested by clinical hemophilia (Fig. 59.2; generation I, number 1). The affected male does not transmit the disorder to his sons (generation II, numbers 4 and 5) because his Y chromosome is normal. However, all of his daughters are carriers of the trait because they inherit his X chromosome (generation II, numbers 2 and 3). Most of these women are unaffected clinically because of the presence of a normal allele from the mother. The female carrier transmits the disorder to half of her sons (generation III, numbers 6 and 7) and the carrier state to half of her daughters (generation III, numbers 8 and 9).



**Figure 59.2.** The inheritance of hemophilia A and hemophilia B. The pedigree is hypothetical. Squares indicate male; circles indicate female; fully shaded squares or circles indicate affected members; half-shaded circles indicate carriers. X, normal X chromosome; x, abnormal X chromosome.

The severity of bleeding—that is, the expressivity of the genetic defect—varies from kindred to kindred in hemophilia A. Within a given kindred, however, the clinical severity of the disorder is constant; that is, relatives of severe hemophiliacs are likely to be affected severely (<sup>15</sup>). Hemophilia A has been observed several times in twins (<sup>16</sup>). The coinheritance of the factor V Leiden mutation (discussed in Chapter 61) with hemophilia A in certain patients may explain the variability in clinical phenotype observed between patients sharing the same molecular defect in factor VIII (<sup>17</sup>). The coinheritance of the factor V Leiden mutation or other prothrombotic risk factors in children with severe hemophilia A delays the first symptomatic bleeding event (<sup>18</sup>).

It might be expected that, with random mating in a large population, a rare defect, such as hemophilia A, would die out after several generations, particularly because in the past the disorder was often fatal in childhood. That this has not occurred suggests that the mutation rate for the responsible gene may be unusually high (<sup>19</sup>). The large size of the factor VIII gene (186 kb) and the presence of hot spots (e.g., CpG dinucleotide mutations) predispose the factor VIII gene to mutation (<sup>20</sup>). In fact, no evidence or history of abnormal bleeding is found in other members of the families of at least one-third of all hemophiliacs (<sup>21</sup>). This percentage is consistent with the Haldane hypothesis, which predicted that maintenance of a consistent frequency of a genetic disorder in the population would require that approximately one-third of cases result from spontaneous mutation. In other instances, neonatal deaths or the passage of the trait through a succession of female carriers may explain the negative family history. For practical purposes, therefore, a negative family history is of little value in excluding the possibility of hemophilia A.

Examination of hemophilic genes by detailed molecular methods has failed to demonstrate a uniform abnormality (<sup>2, 22</sup>). In an early study of 200 hemophilia genes, seven different mutations were demonstrated by Western blotting techniques. Four of these mutations

were transpositions of single bases, of which three transformed a codon for arginine into a stop codon, which arrested factor VIII synthesis and resulted in truncated factor VIII and severe hemophilia. The fourth mutation resulted in substitution of a single amino acid and mild hemophilia. The other three mutations involved deletion of several thousand nucleotides and produced severe hemophilia (2). A 1995 hemophilia A database has been published (23), and a web site exists for continual update of the hemophilia A mutation database (24). The genetic defects of hemophilia A encompass deletions, insertions, and mutations throughout the factor VIII gene (25). Point mutations involving CpG dinucleotides are especially common. Approximately 5% of patients with hemophilia A have large (>50 nucleotides) deletions in the factor VIII gene (26).

Approximately 40% of severe hemophilia A results from a major inversion of a section of the tip of the long arm of the X chromosome, one breakpoint of which is situated within intron 22 of the factor VIII gene (27). This common inversion is associated with severe hemophilia A. It is presumed that in the absence of homologous X chromosome pairing during male meiosis, an intrachromosomal recombination event occurs on the single X chromosome, resulting in this inversion. Another common inversion accounts for 5% of severe factor VIII deficiency (28). Thus, two inversions of the factor VIII gene are seen in nearly one-half of all severely affected patients with hemophilia A. In contrast, point mutations are most likely found in patients with mild to moderate hemophilia A (25). The genetic basis for CRM(+) patients with hemophilia A has also been described (29). The first case of hemophilia A caused by unequal homologous Alu/Alu recombination has been reported (30). Because there are approximately 50 Alu repeats in the factor VIII gene, it is possible that many cases of hemophilia may result from this mechanism (30). Approximately 80 to 95% of hemophilia A patients have mutations detected (31). Approximately 2% of hemophilia A patients have no detectable mutations in the coding region of the factor VIII gene (32). These results indicate that a substantial number of families with severe hemophilia A can undergo accurate gene tracking and carrier analysis. An algorithmic approach to rapid laboratory genetic testing has been described (33).

## Variants

Hemophilia A with autosomal-dominant transmission has been reported (34). In two other families, marked deficiencies of factor VIII and hemorrhagic manifestations in the female carriers appeared to be the consequence of an unusual allele or an abnormality of genes that independently affect the biosynthesis of factor VIII (35). It is important to distinguish these variant hemophilia A patients with negative X-linked transmission from patients with variant vWD (type 2N, vWD Normandy), an autosomal vWD subtype caused by defective factor VIII binding to vWF and with a clinical picture similar to hemophilia A (36).

## Carrier Detection

Carrier detection is based on three approaches: first, patient and family history; second, coagulation-based assays; and third, DNA testing. Some family history predictors of the female carrier state exist: If a female being evaluated for the carrier state had a hemophilic father, then she is a carrier; if she has two sons with hemophilia, then she is a carrier; if she has one son with hemophilia and a family history of hemophilia, then she is a carrier; if she has one son with hemophilia and a negative family history, the odds are approximately 67% that she is a carrier.

**COAGULATION-BASED ASSAYS** These assays may be useful in confirming or excluding



the carrier state, although they have limitations. The regularity with which the abnormal factor VIII gene is suppressed by the normal allele in female carriers of hemophilia varies because of the phenomenon of random X-chromosome inactivation (the Lyon hypothesis). Thus, although the mean concentration of factor VIIIc in the plasma of heterozygous female carriers is approximately 50% of that in normal women (15, 37), observed values scatter widely around this mean and often overlap with those found in the normal population (15). This is a result, in part, of the large error of assay methods and the wide range of factor VIIIc levels in normal subjects (15). Although the demonstration of subnormal levels of factor VIIIc by means of the usual assay methods strongly suggests the presence of the carrier state, the converse statement cannot be made with equal certainty—that is, the presence of normal levels of factor VIIIc does not reliably exclude the carrier state (38). Furthermore, pregnancy and hormonal medications may increase the levels of factor VIIIc in female carriers (39). Some investigators report lower levels of vWFAg in maternal carriers than in paternal carriers (40) or concordant reductions in the two subunits (41). Normal women and carriers with blood types A, B, or AB have higher levels of VIIIc and vWFAg than those with blood type O (36). A link between genes coding for ABO blood group antigens and vWF production has been proposed (42). The use of immunoassays for vWF has improved carrier detection in hemophilia A (43). These methods allow measurement of levels of vWF, which are normal (44) or increased in carriers of the disorder, despite mild but variable deficiencies of factor VIIIc. Results obtained when a bioassay and an immunoassay are performed on the same sample and the ratio of VIIIc to vWF is computed differentiate between the carrier population and the normal population with minimal overlap (45). This ratio normally ranges from 0.74 to 2.20 and was found to be from 0.18 to 0.90 in obligatory carriers. The overall detection rate ranged from 72 to 94% in such obligatory carriers (43, 44, 46) and from 48 to 51% in women without hemophilic sons or fathers (43). In the latter group (possible carriers), 50% would be predicted to be carriers. Abnormally low ratios of VIIIc:vWF (false-positives) have been encountered in an occasional normal subject (44, 46), in whom they may be attributable to nonspecific variables such as stress (47). Pregnancy and the use of oral contraceptives, blood type (42), or contamination of plasma samples with thrombin (47) or other proteolytic enzymes may produce falsely high ratios (false-negatives) in documented obligatory carriers. Testing of several samples from the same woman improves the accuracy of carrier detection and may be essential in some cases (44). Linear discriminant analysis (44, 48) has been recommended for the expression and analysis of such laboratory data. The carrier detection rates using standardized assays with discriminant analysis exceed 90% (49, 50).

**DNA-BASED ASSAYS** Previously, techniques using polymorphic probes required identification of the specific gene defect in the affected male hemophiliac; potentially affected family members could then be screened for the known genetic defect. However, these linkage analysis methods were unsuccessful in a significant number of patients. The identification of the intron 22 (27) and other (28) inversions has increased the detection rate to more than 90%, especially in kindreds of severe hemophilia A patients. Based on the frequency of the intron 22 inversion, severe hemophilia A patients should be initially screened for this defect. Inversion-negative patients and those with mild or moderate hemophilia A should have systematic sequencing of the factor VIII promoter, exons, and splice junctions performed. Such an approach has been reported to identify mutations in 97% of hemophilia A patients (33). These methods have also been adapted to prenatal diagnosis (51). The preferred method is to obtain chorionic villi samples during the eleventh to twelfth gestational week and perform direct genotype testing (52). Alternatively, genetic linkage analysis of polymorphisms can be performed. The subject of genetic counseling in hemophilia has been reviewed (51, 53).



## Hemophilia in the Female

Hemophilia has been well documented in human females ( [54](#), [55](#) and [56](#)). The most common form is that seen in a minority of heterozygous carriers, discussed previously, in whom X-chromosome inactivation may occur at an unusually early stage of embryogenesis, resulting in unusually low levels of factor VIII.

A second cause of female hemophilia is a mating between an affected male and a carrier female ( [Fig. 59.2](#); generation IV, number 10) ( [56](#), [57](#)). One-half the female offspring of such a match would inherit two abnormal X chromosomes, one from the father and one from the mother. Such homozygous female hemophilia was once thought to be lethal and to inhibit the development of the embryo. That this is not true was first suggested by the successful experimental production of hemophilia in female dogs. Homozygous hemophilia is now well authenticated in several women ( [56](#), [57](#) and [58](#)) and resembles the disorder seen in affected males in all respects.

In a unique kindred, three generations of women were affected with severe hemophilia A transmitted as an autosomal-dominant trait ( [34](#)). These latter patients may be difficult to distinguish from patients with type 2N vWD, which is transmitted in an autosomal-recessive manner ( [36](#)). A chromosomal abnormality resulting in a hemizygous genotype in the female rarely may be responsible such as 45XX/45X mosaicism ( [55](#)), 46 XY karyotype ( [59](#)), inactive X isochromosome ( [60](#)), or deleted X chromosome (Turner syndrome) ( [61](#)). Unusual degrees of X-chromosome inactivation (hyperlyonization) may produce severe factor VIII deficiency in some carriers of hemophilia A.

## Clinical Manifestations

The most dramatic manifestation of hemophilia A is exsanguinating hemorrhage from a trivial traumatic injury. However, the most characteristic bleeding manifestations, such as hemarthrosis, often develop without significant trauma. Their frequency and severity generally are related to the blood level of factor VIII ( [9](#), [62](#)) ( [Table 59.3](#)). Three categories of severity have been defined by a consensus committee ( [Table 59.3](#)) ( [63](#)). Severe deficiency (factor VIII level <1 U/dl) is manifested clinically by repeated and severe hemarthroses that almost invariably result in crippling arthropathy in the absence of replacement therapy; such severe cases often are called *classic hemophilia*. Moderate deficiency (factor VIII level of 1 to 5 U/dl) is associated with less frequent and less severe hemarthroses and seldom results in serious orthopedic disability. In mild deficiency (factor VIII level of 6 to 40 U/dl), hemarthroses and other spontaneous bleeding manifestations may be absent altogether, although serious bleeding may follow surgical procedures or traumatic injury ( [64](#)). As indicated in [Table 59.3](#), most patients with hemophilia A have severe disease. However, one epidemiologic survey reported variable differences of severity between individual states within the United States; for example, 13% of hemophilia cases were of moderate severity in Massachusetts, whereas 35% of cases in Georgia were classified as moderate severity ( [11](#)).

**TABLE 59.3. Prevalence and Severity of Hemophilia A and Hemophilia B in the United States**

---

| Factor VIII or IX Level<br>(U/dl) | Clinical Picture <sup>a</sup>                       | Incidence (%) <sup>b</sup> |                 |
|-----------------------------------|---|----------------------------|-----------------|
|                                   |   | Hemophilia<br>A            | Hemophilia<br>B |
| <1                                | Severe, spontaneous bleeding                        | 70                         | 50              |
| 1–5                               | Moderate bleeding with minimal trauma<br>or surgery | 15                         | 30              |
| 6–40                              | Mild bleeding with major trauma or<br>surgery       | 15                         | 20              |

<sup>a</sup> The criteria for classifying hemophilia severity are taken from White GC, Rosendaal F, Aledort LM, et al. Definitions in hemophilia. *Thromb Haemost* 2001;85:560.

<sup>b</sup> Incidence figures are for the United States in 1989 and were provided by the National Hemophilia Foundation (Courtesy of Kathleen F. Cortes, PhD).

From Rodgers GM. Common clinical bleeding disorders. In: Boldt DH, ed. Update on hemostasis: contemporary management in internal medicine. New York: Churchill–Livingstone, 1990:75–120, with permission.

**HEMARTHROSIS** *Hemarthrosis* is the most common, the most painful, and the most physically, economically, and psychologically debilitating manifestation of the inherited coagulation disorders ( [Fig. 59.3](#)).



**Figure 59.3.** Hemophilic arthropathy. This figure illustrates the sequelae of recurrent joint bleeding. See [Color Plate](#).

**Pathophysiology** Bleeding presumably originates from the synovial vessels and develops spontaneously or as the result of imperceptible or trivial trauma. Hemorrhage occurs into the joint cavity or into the diaphysis or epiphysis of the bone. In the acute stage, the synovial space is distended with blood. Muscular spasm further increases the intrasynovial pressure. Hemorrhage into the periarticular structures is a common complicating feature that occurs most often around small joints. The joint may regain normal function after the first episodes of hemarthrosis. More often, however, the absorption of intraarticular blood is incomplete, the retained blood produces chronic inflammation of the synovial membrane, and the joint remains swollen, tender, and painful for months or years, often in the absence of bleeding. The accumulation of iron within synovial cells triggers cytokine–mediated inflammation. Release of inflammatory cell proteolytic enzymes initiates destruction of cartilage and bone ( [65](#) ). Acute hemarthroses

almost invariably recur from time to time. With each recurrence, the synovium becomes progressively more thickened and vascular; folds and villi, which predispose to synovial injury during even minimal activity, may form. Proliferating synovium often fills and distends the joint, which remains swollen and enlarged in the absence of bleeding or pain (chronic proliferative synovitis) ( 66 ). Together with the weakening of the periarticular supporting structures, this process predisposes the joint to recurrent episodes of bleeding. Repeated bouts of hemarthrosis, with the associated subchondral and synovial ischemia, result in progressive loss of hyaline cartilage, particularly at the margins of the joint. Large punched-out areas of destruction are sometimes produced by subchondral hemorrhages and, in the cancellous structure of the bone, cavitation may be caused by intraosseous hemorrhage. Through disuse, diffuse demineralization of the involved bones also may occur. Subperiosteal hemorrhages are not common. The terminal stage of hemarthrosis is called *chronic hemophilic arthropathy* ( 67 ). It is manifested by fibrous or bony ankylosis of larger joints; complete destruction may take place in the smaller articulations because of the weaker joint structure and the thinner cortices of the smaller bones. Other permanent sequelae of hemarthrosis include atrophy and proliferation of bone, roughening of the articular surfaces with lipping and osteophyte formation, bone necrosis and cyst formation, stunted growth as the result of interference with the nutrition of the bone, and accelerated development and overgrowth of the epiphyses caused by excessive blood flow ( Fig. 59.3 and Fig. 59.4 ). Chronic hemophilic arthropathy is less common now because of widespread use of prophylactic replacement therapy and improved availability of factor replacement therapy.



**Figure 59.4.** Elbow and knee joints in a patient with hemophilia A. Thickening of synovium with deposition of calcium is shown in (A) and (A1); increased intercondylar notch is shown in (B); increased density and decreased interarticular space are shown in (A), (B), and (C); and lipping along the borders of the joint surfaces is shown in (C).

A radiologic classification of hemophilic arthropathy has been proposed ( 68 ); this scoring system includes identifying radiologic changes of osteoporosis, epiphyseal enlargement, subchondral irregularity, joint space narrowing, subchondral cyst formation, joint erosion, and deformity ( 68 ). Magnetic resonance imaging is superior to standard radiography for assessment of early arthropathy ( 69 ). A scoring system for magnetic resonance joint evaluation has also been reported ( 69 ) ( Table 59.4 ).

**TABLE 59.4. Scoring System for Hemophilic Arthropathy Using Magnetic Resonance Imaging**

| Score | Abnormalities on Imaging |
|-------|--------------------------|
|-------|--------------------------|

- O None
  - I Minimal hemosiderin
  - II Large amount of hemosiderin and cartilaginous erosion
  - III Cartilage destruction, bone erosion, subchondral cysts
  - IV Osteoarthritis with or without ankylosis
- 

**Clinical Picture** Some hemophiliacs report a characteristic warm, tingling sensation before the onset of hemarthrosis; this is called the *aura*. The earliest definite symptom is pain, which in the acute form may be excruciating. Physical examination reveals muscle spasm and limited motion of the affected joint. The joint may be warm and grossly distended and discolored, but external evidence of bleeding may be minimal or absent in chronically damaged large joints because of thickening of the articular capsule. Generally, only one joint is involved at a time, although bleeding may develop simultaneously in two or more joints. The knee is most commonly affected and is the joint most often permanently crippled. Other joints that may be involved are the ankles, elbows, hips, wrists, shoulders, and small joints of the hands and feet, the vertebral articulations, and the temporomandibular joints.

**SUBCUTANEOUS AND INTRAMUSCULAR HEMATOMAS** Large ecchymoses and subcutaneous and intramuscular hematomas are common in hemophilia A and characteristically spread within fascial spaces and dissect deeper structures (see [Fig. 51.2](#)). Subcutaneous bleeding may extend over as much as one-half the body and does so in a characteristic manner. At the site of origin, the tissue is hard, indurated, raised, and purplish black. From this center, the hemorrhage extends in all directions, with each successive concentric extension less deeply colored. The point of origin of the hemorrhage may be absorbed entirely while the margin is still progressing. Intramuscular and subcutaneous hematomas may produce leukocytosis, fever, and severe pain in the absence of significant discoloration of the overlying skin. Hematomas may produce serious consequences from the compression of vital structures. Bleeding into the tongue, throat, or neck may develop spontaneously and is especially dangerous because it may compromise the airway with surprising rapidity ([70](#)). Gangrene may result from pressure on arteries, and ischemic contractures are common sequelae of hemorrhage into the calves or forearms, as in Volkmann contracture. Peripheral nerve lesions of varying severity are common complications of hemorrhage into joints or muscles, as in femoral nerve compression caused by hematomas of the iliacus. Hemophilic cysts are discussed in the section [Special Aspects of Treatment](#).

**PSOAS AND RETROPERITONEAL HEMATOMAS** Spontaneous hemorrhage into internal fascial spaces and muscles of the abdomen is common in hemophilia A ([71](#)). Bleeding into or around the iliopsoas muscle produces pain of progressively increasing severity and tenderness; when it occurs on the right side, it may closely simulate acute appendicitis. Femoral nerve involvement may be partial or complete, with the development of pain on the anterior surface of the thigh. The psoas sign is positive, and the hip is held in partial flexion. Paresthesias, partial or complete anesthesia, and, ultimately, weakness or paralysis of the thigh extensors with eventual muscular atrophy may ensue. Retroperitoneal hemorrhage and intraperitoneal hemorrhage also are common. Computed tomography may be helpful in the diagnosis of these hematomas ([71](#)).

**GASTROINTESTINAL AND GENITOURINARY BLEEDING** Hemorrhage from the mouth, gums, lips, frenulum, and tongue is common and often serious. The eruption and shedding of deciduous teeth usually occur without abnormal bleeding, but they may be accompanied by hemorrhage that lasts for days or weeks. Epistaxis occurs in many patients and may be of exsanguinating proportions. Hematemesis, melena, or both are not uncommon. The source of the blood is usually the upper gastrointestinal tract. In most patients in whom bleeding is persistent or recurrent, it originates from a structural lesion, most commonly a peptic ulcer or gastritis. Hemorrhage may be accompanied by abdominal pain, distention, increased peristalsis, fever, and leukocytosis. Intramural bleeding into the

intestinal wall may result in intussusception or obstruction. Hematuria, although more common than gastrointestinal bleeding, is less often the result of a demonstrable pathologic condition in the genitourinary tract. The bleeding may arise in the bladder or in one or both kidneys and may persist for days or weeks (<sup>72</sup>). When clots form, ureteral colic may develop.

**TRAUMATIC BLEEDING** Patients with coagulation disorders seldom bleed abnormally from small cuts such as razor nicks. After larger injuries, however, hemorrhage out of proportion to the extent of the injury is characteristic. This may persist as a slow continuous oozing for days, weeks, or months, or it may be massive and life-threatening. Delayed bleeding is common. Thus, although hemostasis after an injury or a minor surgical procedure may appear to be adequate, hemorrhage, often of sudden onset and serious proportions, may develop several hours or even days later. This phenomenon apparently occurs because the processes of primary hemostasis are only temporarily effective. Delayed bleeding may occur in patients with mild hemophilia and is a significant hazard after minor surgical procedures, particularly those performed on an outpatient basis, such as tooth extractions and tonsillectomy. Venipuncture, if skillfully performed, is without danger to the hemophiliac because of the elasticity of the venous walls. If venipuncture is traumatic, digital pressure on the puncture site or a pressure dressing may prevent further complications. Subcutaneous, intracutaneous, and small intramuscular injections seldom produce hematomas if firm finger pressure is maintained for at least 5 minutes. Large intramuscular injections should be avoided.

**OTHER CLINICAL ASPECTS** Infants usually are asymptomatic because they are insulated from trauma (<sup>73</sup>); hematomas are seen first when children become active, and hemarthroses seldom develop until they begin to walk. Occasionally, evidence of the disorder is not seen until patients reach teenage or young adult life. Spontaneous hemorrhage may be cyclic in nature. Petechiae, which are characteristic of disorders of platelets and blood vessels, are rare in patients with hemophilia but have been noted in severely affected patients during an exacerbation of bleeding. Hemorrhage from the umbilical cord or stump is unusual, but prolonged bleeding after circumcision is common and brought hemophilia to the attention of the ancient Hebrews. Pulmonary and pleural bleeding are uncommon, although mediastinal and pleural shadows have been noted radiographically and presumably originate from fresh or old hematomas. Intraocular hemorrhage is uncommon, but bleeding into the orbit and conjunctiva occurs often. Spontaneous rupture of the spleen has been reported. Wound healing is often slow in hemophiliacs, probably because of continued or intermittent hemorrhage or complicating infection. There is no evidence that factor VIII has any specific role in wound healing, as has been postulated for fibrinogen and factor XIII. Intracranial bleeding is discussed in the section [Special Aspects of Treatment](#). The Web site for the National Hemophilia Foundation is <http://www.hemophilia.org>.

## Course and Prognosis

In recent years, the prognosis in severe hemophilia has improved greatly. With proper treatment using sterile replacement products, a nearly normal lifespan can be expected, and the crippling sequelae of the disease can be minimized. The disorder does not appear to protect older hemophiliac patients from thromboembolic disorders (<sup>74</sup>) or atherosclerosis (<sup>75</sup>, <sup>76</sup>). Details of hemophilia complications are discussed in the section [Special Aspects of Treatment](#).

## Laboratory Diagnosis

Basic hematologic examinations reveal nothing characteristic in hemophilia A. The presence or absence of anemia or of signs of blood regeneration depends on the severity and frequency of bleeding. Neutrophilia may accompany severe hemorrhage. As in other instances of posthemorrhagic anemia, the bone marrow reflects the response to blood

loss.

**SCREENING TESTS OF HEMOSTASIS AND COAGULATION** The partial thromboplastin time (PTT) usually is prolonged in patients with hemophilia A ( [Table 59.5](#)). Abnormal results are usually obtained if the factor VIII level is less than 25% of normal; however, some PTT reagents are insensitive to mild factor VIII deficiency ( [77](#)). The abnormality of the PTT can be normalized by mixing the patient's plasma with normal plasma if no factor VIII antibodies are present.

**TABLE 59.5. Laboratory Findings in Common Inherited Coagulation Disorders**

| Disorder                               | Partial Thromboplastin Time | Prothrombin Time | Thrombin Time     | Ancillary Tests  |
|--|-----------------------------|------------------|-------------------|--|
| Hemophilia A                           | A                           | N                | N                 | vWF antigen and activities are normal or increased, ratio VIIIc:vWF is low.  |
| Hemophilia B <sup>a</sup>              | A                           | N <sup>a</sup>   | N                 | —  |
| von Willebrand disease <sup>a, b</sup> | vA                          | N                | N                 | vWF antigen and VIIIc are usually low, ratio VIIIc:vWF is variable; ristocetin-induced platelet aggregation and ristocetin cofactor activity are usually diminished. |
| Afibrinogenemia                        | A                           | A                | A                 | Platelet function may be abnormal.   |
| Dysfibrinogenemia <sup>a</sup>         | vA                          | vA               | A <sup>c, d</sup> | Hypofibrinogenemia, <sup>e</sup> reptilase time is prolonged, <sup>a</sup> fibrin(ogen) degradation products levels are increased. <sup>a</sup>                      |
| Hypoprothrombinemia <sup>a</sup>       | A                           | A                | N                 | Two-stage assay is abnormal. <sup>f</sup>  |
| Factor V deficiency                    | A                           | A                | N                 | —  |
| Factor VII deficiency <sup>a</sup>     | N                           | A                | N                 | Stypven (Russell viper venom) time is normal.  |
| Factor X deficiency <sup>a</sup>       | A                           | A                | N                 | Stypven time is abnormal.  |
| Factor XI deficiency                   | A                           | N                | N                 | —  |
| Factor XII deficiency                  | A                           | N                | N                 | —  |
| Factor XIII deficiency                 | N                           | N                | N                 | Clot solubility tests are abnormal.  |

A, abnormal; N, normal; v, variable; vWF, von Willebrand factor.

<sup>a</sup> Findings are significantly different in some variants.

<sup>b</sup> Coagulation abnormalities are caused by deficiency of factor VIIIc.

<sup>c</sup> Patient's plasma may inhibit normal coagulation.

<sup>d</sup> Abnormality may be corrected by increasing calcium concentration and may be magnified by diluting the thrombin solution.

<sup>e</sup> Abnormality varies depending on technique.



<sup>f</sup> Results of one-stage techniques may be uninterpretable.

---

The platelet count usually is normal or elevated. Thrombocytosis may reflect a response to acute or chronic hemorrhage, but in many hemophiliacs, it has been found in the absence of significant bleeding.

**FACTOR VIII ASSAYS** Assay of factor VIII is a simple technique. Two-stage methods ( [78](#) ), one-stage methods ( [79](#) ), and micromethods ( [80](#) ) are suitable for diagnosis. The one-stage techniques are used most widely because they are simple to perform. They require either a supply of plasma from a known severe hemophiliac, which is available commercially, or artificial substrate plasma ( [81](#) ). Two-stage assays detect approximately 20% more factor VIII than do one-stage methods ( [82](#) ), and they are less subject to variables ( [83](#) ) such as fluctuations attributable to contaminating traces of thrombin or other proteolytic enzymes. The World Health Organization makes international standards, but many laboratories purchase commercial secondary standards that are calibrated to the international standard. Under most circumstances, a pool of citrated plasma carefully collected from normal subjects and frozen in individual laboratories also serves as an acceptable standard. The factor VIII assay has a large potential for error, even in expert hands. Therefore, when borderline values are obtained, the assay should always be repeated. Extensive studies of the many variables of the factor VIII assay have been reported ( [84](#) , [85](#) ). Assays for both factor VIII and vWF may be carried out with reasonable accuracy on material obtained by fetoscopy—that is, mixtures of blood and amniotic fluid ( [86](#) ) or unmixed fetal blood ( [87](#) ). The availability of a new recombinant form of factor VIII (B domain-deleted factor VIII, Refacto) has raised concerns about accurate laboratory monitoring of patients receiving this product ( [88](#) ). Chromogenic substrate assays or typical one-stage PTT assays using physiologic phospholipids are needed to accurately quantitate factor VIII levels in patients receiving B domain-deleted factor VIII ( [89](#) ). Alternatively, a standard one-stage PTT assay using B domain-deleted factor VIII as the assay standard would be appropriate. The use of concentrate standards (rather than plasma standards) diluted in factor VIII-deficient plasma has been proposed as a solution to resolve discordant results using different assay methods ( [90](#) ).

**FACTOR VIIIAG (CAG) ASSAYS** Highly specific but complicated assays using immunoradiometric methods (immunoradiometric assay) and enzyme-linked immunoabsorbent assay (ELISA) techniques ( [91](#) ) are available to measure factor VIII Ag (VIII Ag). The latter methods use liquid- and solid-phase principles and both natural factor VIII antibodies and monoclonal antibodies. ELISA techniques were more precise than immunoradiometric assay methods in one comparative study ( [92](#) ). The results of both of these techniques demonstrate the absence of factor VIII Ag in most severely affected hemophiliacs and correlate well with factor VIIIc measurements in most cases. Results are more variable when mild hemophiliacs are tested. In most series, approximately 10% of patients have detectable levels of factor VIII Ag and a low VIIIc to VIII Ag ratio (the CRM-positive variant). Immunoassays for vWF are discussed in the section [Laboratory Diagnosis](#).

## Differential Diagnosis

The diagnosis of hemophilia A is seldom difficult, especially in the severely affected patient in whom repeated and often serious hemorrhagic manifestations, including such characteristic signs as hemarthrosis, are clearly apparent early in life. Hemarthrosis with significant orthopedic disability is rare in patients with coagulation disorders other than hemophilia A and hemophilia B.

In patients with the mild forms of the disorder, however, failure to recognize the existence



of the disease or to make the correct diagnosis is more likely. Such patients may have little spontaneous bleeding, and the family history tends to be vague or negative. Because the diagnosis of hemophilia often is equated erroneously with a prolonged PTT value, a normal value may be misleading. It must be emphasized that mildly affected hemophiliacs are prone to hazardous hemorrhage after trauma or during surgical procedures ( 93 ). A normal PTT value cannot be relied on to exclude the possibility of hemophilia. In the mildly affected patient, specific factor assays must be performed to confirm or exclude the diagnosis of hemophilia.

The results of screening tests ( [Table 59.5](#) ) usually are sufficient to exclude the possibility of acquired hemorrhagic disorders associated with serious bleeding. Such disorders are seldom associated with a prolonged PTT and a normal prothrombin time (PT), a combination that strongly suggests an inherited disorder or an inhibitor. Among the inherited disorders characterized by this combination of findings [hemophilia A, hemophilia B, and deficiencies of factors XI, XII, prekallikrein, and high-molecular-weight kininogen (HMWK)], deficiency of the latter three factors can be readily excluded because their deficiency is not associated with excessive clinical bleeding. Factor XI deficiency in males may mimic mild hemophilia, and hemophilia B is clinically identical to hemophilia A. Both factor XI deficiency and hemophilia B must be distinguished from hemophilia A in the laboratory. The best way to accomplish this in evaluating patients with an isolated prolonged PTT is by performing specific assays of these three factors in the order of their statistical frequency—that is, VIII, IX, and XI. A PTT-mixing study should also be performed to exclude an inhibitor. A definitive diagnosis is of great importance because specific products are used to treat each of these disorders.

Severe vWD in males may be indistinguishable from mild hemophilia A. Confirmatory tests for vWD are needed to make this distinction. Patients with the uncommon type 2N vWD may also be clinically indistinguishable from patients with hemophilia A ( 36 ). An X-linked family history of bleeding supports a diagnosis of hemophilia A in these patients, and an autosomal-recessive family history of bleeding supports a diagnosis of type 2N vWD.

Bleeding manifestations in hemophilia may simulate a variety of conditions. However, serious confusion results only when the correct diagnosis has not been considered and appropriate laboratory studies have not been ordered. Thus, a deep hematoma may be mistaken for a suppurative condition, and surgical drainage may be attempted. Bleeding into a small joint may produce a clinical and radiologic picture suggestive of sarcoma; when larger joints are involved, findings simulate tuberculosis, arthritis, or Perthe disease. Bleeding elsewhere may suggest local causes such as kidney tumor, pulmonary disease, or peptic ulcer.

Intraabdominal bleeding raises particularly serious diagnostic and therapeutic problems in the patient with hemophilia, even when the hemophilia has been accurately diagnosed. Thus, hemorrhage into the psoas, when on the right side, may simulate acute appendicitis so closely that, in the opinion of many experienced clinicians, there is no reliable clinical means to differentiate between the two. A retroperitoneal hematoma may be mistaken for an appendiceal abscess. Intraperitoneal hemorrhage and bleeding into and around other viscera may simulate perforating peptic ulcer, bowel obstruction, or virtually any acute intraabdominal condition. Computed tomography scanning and sonography may be particularly helpful in differentiating between intraabdominal conditions that require surgical intervention and retroperitoneal and psoas hemorrhages ( 94 ).

## VON WILLEBRAND DISEASE

The historical confusion that has surrounded the pathogenesis of vWD is apparent from the many names that have been applied to this disorder. These designations include

*angiohemophilia, vascular hemophilia, pseudohemophilia, constitutional thrombopathy, and idiopathic prolonged bleeding time.* von Willebrand first recognized the disorder in a 1926 study of the inhabitants of the Åland islands (95). von Willebrand thought that the hemostatic defect resulted from combined defects in platelet function and vascular endothelium. The discovery that plasma from normal volunteers or patients with hemophilia A corrected the hemostatic defect of vWD suggested that a plasma protein distinct from factor VIII caused vWD. In its most common form (type 1), the disorder is characterized by mild mucocutaneous hemorrhage, a prolonged bleeding time, deficiency of vWF, and less pronounced reduction in levels of factor VIIIc. The disorder is not homogeneous, however, in part due to the multiple physiologic functions played by vWF. The recognition of a number of variants (96, 97), together with the demonstration of multiple genetic patterns, suggests that vWD is very heterogeneous. However, all forms of vWD can be traced to insufficient amounts of vWF or defective function of this protein. Recently, both brief and more extensive reviews of this topic have been written (98, 99).

## Incidence

Epidemiologic studies indicate that vWD is the most common bleeding disorder, affecting approximately 1% of the population. The high incidence of the disease is not limited to certain ethnic groups (100, 101); however, only a fraction of people come to medical attention because of bleeding symptoms. This may be due to either the relatively mild nature of disease in many affected individuals or a lack of recognition of excessive bleeding in response to either physiologic challenge (e.g., heavy menstrual bleeding) or trauma.

## Nomenclature

The identification of numerous variants of vWD has led to attempts to simplify classification of this disorder (102). Table 59.6 summarizes the revised classification. Quantitative defects are divided into partial deficiency (type 1) and severe deficiency with complete absence of vWF (type 3). The qualitative defects (type 2) are divided into four categories according to the nature of the defect of vWF function. *Type 2A* refers to variants with impaired interaction between vWF and platelets due to a deficiency of intermediate- and high-molecular-weight multimers of vWF. *Type 2B* refers to variants in which vWF exhibits increased affinity for its receptor, platelet glycoprotein (gp) Ib. Paradoxically, bleeding in these patients develops due to clearance of larger vWF multimers and platelets from the circulation. *Type 2M* refers to variants with defective interaction between vWF and the platelet gpIb receptor that is not due to deficiency of high-molecular-weight multimers of vWF from plasma but to defects within the gpIb binding domain of vWF. Finally, variants of vWD in which decreased affinity of vWF for factor VIII results in depressed plasma factor VIII levels are classified as *type 2N* (102).

**TABLE 59.6. Revised Classification of von Willebrand Disease**

| Revised Type | Features  | Previous Type <sup>a</sup>        |
|--------------|---|-----------------------------------|
| 1            | Partial deficiency of vWF   | I-1, I-2, IA                      |
| 2A           | vWF variants with loss of high-molecular-weight multimers and decreased platelet-dependent function                 | IIA, IIC, IID, IIE, IIF, IIG, IIH |
| 2B           | vWF variants with loss of high-molecular-weight multimers caused by increased affinity for platelet glycoprotein Ib | IIB, I New York, Malmo            |

|    |   |                                 |
|----|---|---------------------------------|
| 2M | vWF variants with decreased platelet-dependent function not associated with the loss of high-molecular-weight multimers | B, Vicenza, IC, ID              |
| 2N | vWF variants with decreased affinity for factor VIII  | Defective VIII binding Normandy |
| 3  | Severe deficiency of vWF  | III                             |

vWF, von Willebrand factor.

<sup>a</sup> Original references for definitions of previous von Willebrand disease types are given in Sadler JE, Matsushita T, Dong Z, et al. Molecular mechanism and classification of von Willebrand disease. *Thromb Haemost* 1995;74:161–166.

Data from Sadler JE. A revised classification of von Willebrand disease. *Thromb Haemost* 1994;71:520–525.

## Genetics

A gene on chromosome 12 codes the synthesis of the vWF macromolecule. The genetic message is composed of 52 exons covering a span of 158 kb ( [103](#), [104](#) ). The vWF gene encodes for a protein with multiple copies of homologous motifs, including three A, three B, two C, and four D motifs. These motifs, in turn, encode for protein domains that subserve the various functions of vWF. The A1 domain contains binding sites for platelet gpIb and ristocetin ( [105](#) ), the A2 domain contains a protease-sensitive domain that may play a regulatory role in vWF function ( [106](#), [107](#) ), the A3 domain contains an important collagen-binding domain ( [107](#), [108](#) ), the C1 domain has an RGD sequence capable of interacting with platelet gpIIb/IIIa ( [109](#) ), and the D' and D3 domains contain a factor VIII binding sequence ( [107](#) ).

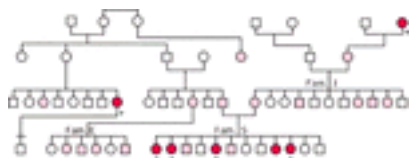
vWD appears to be inherited by multiple genetic mechanisms ( [Table 59.7](#) ). The most common form of the disorder (type 1 vWD) is inherited as an incompletely dominant autosomal trait with variable penetrance. The expressivity of the genetic abnormality is highly variable, even among members within a single kindred. For example, an affected parent would be predicted to transmit vWD to 50% of his or her children; however, because of variable penetrance and expression of vWD, only approximately 33% of children may be affected. [Figure 59.5](#) illustrates one of the original pedigrees described by von Willebrand.

**TABLE 59.7. Features of Common Variants of von Willebrand Disease**

| Features               | Type 1              | Type 2A            | Type 2B   | Type 3              | Platelet-Type                                       |
|------------------------|---------------------|--------------------|---|---------------------|---|
| Inheritance            | Autosomal dominant  | Autosomal dominant | Autosomal dominant                                  | Autosomal recessive | Autosomal dominant                                  |
| Bleeding time          | Normal or prolonged | Prolonged          | Prolonged   | Prolonged           | Prolonged   |
| Factor VIIIc in plasma | Normal or reduced   | Normal or reduced  | Normal or reduced                                   | Reduced             | Normal or reduced                                   |
| vWF antigen            | Normal or reduced   | Normal or reduced  | Normal or reduced; increased affinity for platelets | Reduced             | Normal or reduced; increased affinity for platelets |

|   |   |   |  |   |  |
|---|---|---|--|---|--|
| vWF multi-meric analysis                | Normal  | Absence of large and intermediate-sized multimers   | Absence of large multimers   | Variable abnormalities; preponderance of small multi-mers or absent multimers   | Reduction in large multimers caused by "consumption" by platelets  |
| Ristocetin cofactor activity            | Normal or reduced   | Reduced   | Normal or reduced  | Reduced   | Reduced or normal  |
| Ristocetin-induced platelet aggregation | Normal or diminished  | Diminished  | Increased aggregation at low ristocetin concentrations   | Markedly diminished   | Hyperaggregation with patient's platelets, normal plasma, and low concentration of ristocetin  |
| vWF in platelets                        | Normal or reduced   | Normal or absence of large and intermediate-sized multimers   | Normal   | Absent  | Normal   |
| Ancillary findings                      | DDAVP usually produces significant increase in plasma VIIIc and vWF | DDAVP produces rise in factor VIIIc, but functional vWF increase is variable and may be of short duration | Variable response to DDAVP, with intravascular platelet aggregation and thrombocytopenia in some cases; ristocetin cofactor levels and ristocetin-induced platelet aggregation enhanced in presence of patient's plasma; cryoprecipitate does not aggregate platelets <i>in vitro</i> unless ristocetin is added | Response to DDAVP lacking; endothelial vWF absent; carriers difficult to detect | Transfusion of vWF or DDAVP may produce intravascular platelet aggregation and thrombocytopenia; cryoprecipitate produces <i>in vitro</i> platelet aggregation |

DDAVP, 1-deamino-8-D-arginine vasopressin; vWF, von Willebrand factor.



**Figure 59.5.** Pedigree of patients described by von Willebrand. Three families are emphasized: S, E, and J. Clinical details of bleeding events in these families have been reported. Open circles indicate female nonbleeders, open squares indicate male nonbleeders. Shaded circles and squares indicate female and male bleeders, respectively. Solid symbols indicate family members who experienced severe bleeding, and crosses

indicate family members who experienced hemorrhagic deaths. (Modified from von Willebrand EA. Über hereditäre pseudohämophilie. Acta Med Scand 1931;76:521–550, with permission of the publisher.)

Twin studies demonstrated that approximately 60% of the variation in vWF level and approximately 50% of the variation in factor VIII level is attributable to genetic factors ( [110](#) ). The genetic mutations that underlie type 1 vWD remain largely undefined. Genetic loci outside of the vWF gene contribute to variation of vWF level. Individuals with blood group O have vWF levels that are on average 30% lower than that of people with blood groups A, B, or AB ( [111](#) ), and it is likely that carbohydrate groups attached to vWF play a subtle role in clearance of vWF from plasma ( [112](#) ). In addition, variation in expression of levels of other hemostatically active proteins, such as variation in the level of platelet adhesion receptors, may modulate the severity of symptoms conferred by vWF deficiency ( [113](#) ). vWF levels are under hormonal and other controls, which further complicates disease expression. Variation in levels of as much as 20% has been reported with menstrual cycle, with levels lowest in the early follicular phase (before day 7 of the cycle), and levels increase with age, rising approximately 15% for each decade increase in age ( [114](#) ).

Type 2 vWD is characterized by production of a qualitatively defective protein, and the genetics of these variant forms is more straightforward than that of type 1 vWD. In families affected by types 2B and 2M, as well as in the majority of families with type 2A vWD, inheritance is autosomal dominant. Rare cases of type 2A disease are transmitted in an autosomal-recessive fashion, as are most cases of type 2N disease. vWF gene sequencing studies combined with vWF mutation expression analysis have revealed that single missense point mutations underlie the majority of type 2 disorders ( [115](#), [116](#) ). Type 3 vWD is also inherited as a recessive trait and occurs when both copies of the vWF gene are defective. In type 3 disease, gene abnormalities include large or partial gene deletions, disruption of orderly messenger RNA transcription (frameshift mutation, splice site, or nonsense mutation), and missense mutation. For patients with recessively inherited vWD phenotypes (type 2N, type 3, or some rare type 2A), genetic analysis may reveal either homozygous or compound heterozygous gene abnormalities. Members of the International Society of Thrombosis and Haemostasis maintain a database of vWD mutations ( <http://www.shef.ac.uk/vwf/index.html> ).

## Pathophysiology

The basic defect in vWD is a deficiency or abnormality of vWF function. vWF is synthesized in endothelial cells and megakaryocytes ( [117](#) ). The primary transcription product is 2813 amino acids in length. It undergoes extensive further processing, including dimerization and polymerization, to form very-large-molecular-weight multimers ( [118](#) ). Multimerization and intracellular trafficking of vWF are directed by the vWF propeptide (vWFpp, formerly called *von Willebrand antigen I*), which is cleaved off the “mature subunit” after multimer assembly ( [119](#) ). Large vWF multimers are stored in endothelial cells in Weibel-Palade bodies ( [120](#) ) and in platelet α-granules ( [121](#) ). The majority of circulating vWF is present in plasma, with approximately 15% of circulating vWF present intracellularly within platelets. Ultra-large multimers released into the plasma are further degraded to smaller multimers, presumably through the activity of “vWF cleaving protease” ( [106](#) ). The cDNA sequence of this protein has recently been determined and shown to be a metalloproteinase of the ADAMTS family ( [122](#), [123](#) ). The physiologic importance of enzymatic degradation of vWF after release is demonstrated clinically by the association of an inherited form of thrombotic microangiopathy (Schulman-Upshaw syndrome) with congenital absence of the protease due to defects of the ADAMTS-13

gene ( [122](#) ) and the observation of plasma deficiency of the protease with presence of autoantibody in some patients with sporadic thrombotic thrombocytopenic purpura ( [124](#) , [125](#) ). Endothelial stores of vWF can be released therapeutically through administration of desmopressin ( [126](#) ).

vWF is required for normal platelet adhesion ( [Chapter 20](#) ) and also acts as a carrier of factor VIII in the plasma. When vWF is deficient or aberrant, both factor VIII deficiency and abnormalities in the early steps of primary hemostasis result. vWD is thus manifested as a hybrid hemostatic defect. Both abnormalities—factor VIII deficiency and abnormal primary hemostasis—give rise to characteristic and distinct laboratory abnormalities, and both defects contribute to the bleeding tendency.

**ABNORMALITIES OF PRIMARY HEMOSTASIS** Until the 1950s, the abnormality in primary hemostasis in vWD was thought to be the result of either a primary vascular defect or an intrinsic abnormality of the platelets. Neither of these hypotheses found significant support, and convincing evidence now exists that the platelets, although intrinsically normal, do not adhere to subendothelium normally because of deficient or defective vWF ( [127](#) ). This abnormality is well demonstrated by methods that measure platelet adhesion to subendothelial surfaces under flow conditions (the Baumgartner technique). Results of experimental studies suggest that platelet adhesion to collagen in a flowing stream of blood may be particularly deficient at high rates of shear when only a short time is available for formation of a platelet–collagen bond ( [128](#) ). Deficient platelet plug formation has been observed directly in experimental wounds ( [129](#) ).

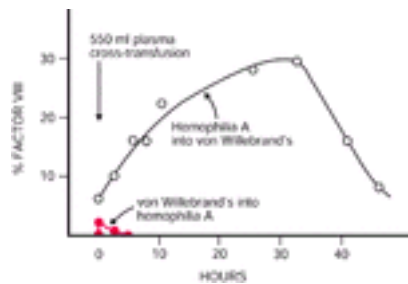
**ABNORMALITIES OF SECONDARY HEMOSTASIS** A second function of vWF is as a molecular chaperone for factor VIII, increasing the plasma half-life of factor VIII approximately fivefold ( [130](#) ). This effect may occur through the protection of factor VIII from activated protein C–mediated degradation ( [131](#) ). Furthermore, the binding of vWF to subendothelium at sites of vascular injury serves to co-localize factor VIII, where it can participate in its role in the regulation of hemostasis on the activated platelet membrane ( [105](#) ).

**ABNORMALITIES OF VON WILLEBRAND FACTOR** Quantitative or qualitative abnormalities of vWF underlie the abnormality in primary hemostasis described earlier. Materials rich in this factor correct deficient platelet adhesion as measured by the Baumgartner method ( [132](#) ). When administered intravenously to patients with vWD, vWF-containing concentrate shortens the bleeding time for a brief period. Immunoassays reveal subnormal levels of vWF activity in most patients with vWD. In most patients with the type 1 disorder, vWF is qualitatively normal, and vWF activity is decreased in proportion to vWF antigen assay. In keeping with the chaperone role of vWF, both vWF antigen and factor VIII activity are diminished in most patients with type 1 vWD; however, factor VIII levels are generally reduced to a lesser extent. In severe vWD (type 3), vWF and its propeptide (vWFpp) are completely absent ( [133](#) ). Factor VIII levels are in the mild to moderate hemophilia range in type 3 vWD. This situation contrasts with hemophilia A ( [134](#) ), in which a selective deficiency or aberration of factor VIIIc is associated with normal or supernormal levels of vWF. Some observations point to heterogeneity of type 1 vWD. Platelet levels of vWF are normal to low in the type 1 disorder, and the bleeding time may correlate more closely with the platelet content of vWF than with plasma ristocetin cofactor activity ( [135](#) ). Functional assay of vWF interaction with platelets is generally assessed with the antibiotic ristocetin, which induces platelet agglutination. The process that occurs in the presence of this drug is not dependent on platelet metabolic activity and may not fully mirror the physiologic activation of vWF that occurs at sites of vascular injury ( [136](#) ). The empiric observation that ristocetin does not agglutinate the platelets of many patients with vWD to a normal extent provides a unique tool for the study of the disorder ( [137](#) ). The ristocetin cofactor activity represents one functional property of vWF,



and abnormalities of ristocetin cofactor activity often are dissociated from other vWF properties in patients with qualitative abnormalities of vWF (type 2 vWD).

**ABNORMALITIES OF FACTOR VIII** Factor VIII is noncovalently bound to vWF in normal plasma and is diminished in amount in most patients with vWD. The factor VIII deficiency is attributable to failure of vWF to bind, protect, or stabilize factor VIII (138). The exact explanation for this phenomenon remains to be clarified. Plasma levels of vWF usually are proportional to levels of VIIIc or VIII<sub>Ag</sub> (cAg) in normal individuals, but in cases of quantitative vWF deficiency, the ratio of VIIIc to vWF may be moderately increased. Thus, factor VIIIc levels may be normal or near normal in type 1 vWD. This finding may also be observed after transfusion therapy in vWD ( Fig. 59.6).



**Figure 59.6.** The phenomenon of new factor VIII synthesis in patients with von Willebrand disease (vWD) who receive plasma transfusion. Open circles indicate changes in the plasma factor VIII levels of a patient with vWD after infusion of plasma from a patient with severe hemophilia A. A significant and sustained increase in the factor VIII levels of the recipient was observed even though no active factor VIII was present in the infused plasma. Solid circles indicate effects of infusing plasma from a patient with vWD into a patient with severe hemophilia A. The factor VIII level in the infused plasma was 15% of normal. Note the slight and transitory effects. [From Shulman NR, Cowan DH, Libre EP, et al. The physiologic basis for therapy of classic hemophilia (factor VIII deficiency) and related disorders. *Ann Intern Med* 1967;67:856–882, with permission.]

## Response to Transfusion

When blood products containing the vWF–factor VIII complex are infused into patients with hemophilia A, peak levels of factor VIIIc are present immediately after the infusion; this activity then declines rapidly, with an overall half-life of 8 to 10 hours ( Fig. 59.6). Twenty-four hours later, factor VIIIc activity is minimal. This response is highly predictable and is discussed in a later section concerning replacement therapy for hemophilia A. In most patients with vWD, the infusion of normal vWF–factor VIII complex produces an initial peak level of factor VIIIc that is predicted from the preinfusion level and the amount of factor infused. This is followed by a sustained but variable rise in factor VIIIc activity that reaches a plateau approximately 24 hours later and may persist for 48 to 72 hours. This phenomenon is highly variable and irregular; in some patients, a rapid initial fall of factor VIIIc is followed by a secondary rise in activity. This disproportionate response to transfused factor VIII has been called the *secondary transfusion response*, *de novo* or *new factor VIII synthesis*, or *in vivo complementation* and apparently is a unique feature of vWD.

Various hypotheses have been advanced to explain the disproportionate response to transfusion described above. The leading hypothesis is that the infused vWF results in stimulation of increased factor VIII release into the plasma with the attachment of the newly released factor VIII onto infused vWF (138).

Transfusions of blood products containing vWF shorten the bleeding time to a variable degree in patients with vWD. This corrective effect seldom persists for more than a few



hours, even after massive transfusions that raise vWF to high levels. The correction of the bleeding time apparently requires the large molecular forms of vWF that are present in cryoprecipitate and select intermediate-purity factor VIII concentrates ( [139](#) ) but completely absent from monoclonally purified or recombinant concentrates of factor VIII ( [140](#) ). Failure of the skin template bleeding time of patients with vWD to show sustained correction with appropriate replacement therapy has been noted and does not necessarily predict defective surgical hemostasis ( [141](#) ). This apparent paradox may be due to sensitivity of the bleeding time test to platelet  $\alpha$ -granule vWF, which is not replenished during vWF replacement therapies ( [142](#) ).

## Clinical Manifestations

The bleeding manifestations in vWD are heterogeneous but consistent with the dual roles of vWF in supporting both primary and secondary hemostasis ( [105](#) ). Thus, in the mild forms of vWD, the clinical picture is dominated by cutaneous and mucosal bleeding, which appears to be mainly the result of disordered primary hemostasis. In the most severe forms of the disorder, in which factor VIII levels are low, hemarthroses and dissecting intramuscular hematomas may develop. As in mild classic hemophilia, serious hemorrhage resulting from traumatic injuries or after surgical procedures is a significant hazard in severe vWD. Petechiae are rare, but hematoma formation and the extent of bruising are excessive compared with the inciting trauma.

The bleeding manifestations in the usual patient with type 1 vWD are mild, however, and many patients are virtually asymptomatic. The disorder may be symptomatic at any age but is not always recognized. Mucosal bleeding is particularly common. Childhood epistaxis, a life-long history of easy bruising, bleeding with dental extraction, heavy menstrual bleeding or anemia attributed to excessive menstrual blood losses, or postpartum hemorrhage are all included in the spectrum of vWD symptomatology. Systemic bleeding disorders are often not considered in women with menorrhagia ( [143](#) ), but clinical studies reveal that the prevalence of vWD is significant in individuals who present with this complaint ( [144](#) ). Angiodysplasia of various vascular beds, particularly those in the gut, has been demonstrated in some patients with vWD and may be an important contributory factor in chronic gastrointestinal bleeding ( [145](#) ). The disorder may decrease in severity with advancing age. In type 1 vWD, symptoms usually become milder during pregnancy or with estrogen therapy when the vWF and factor VIIIc level rises significantly ( [39](#) ). Bleeding manifestations tend to be more prominent in patients with more severe quantitative deficiency and in patients with qualitative (type 2) defects.

While eliciting the history of bleeding, one should bear in mind that women are often inaccurate assessors of whether their menstrual flow is normal or excessive. Supplemental questioning regarding the frequency of changes of menstrual protection and questions regarding a history of iron deficiency anemia may be informative. Retrospective studies of women with vWD show that abnormal bleeding can often be traced to menarche ( [146](#) ). Family history also may provide important clues to a diagnosis. The physician should specifically seek history of the response to hemostatic challenge such as dental extraction, tonsillectomy, surgical procedure, menstruation, and peripartum hemorrhage. Excessive bleeding in response to challenge with aspirin may also point toward a bleeding disorder, but this history is not specific for vWD.

## Laboratory Diagnosis

Criteria for the laboratory diagnosis of vWD are imperfect. The large number of assays available reflects the breadth of function of vWF, and no test by itself is sensitive or

specific enough to diagnose all patients ( [147](#) ). Furthermore, the results of various tests correlate imprecisely with the extent of hemorrhagic manifestations ( [105](#) ). Both vWF and factor VIII are “acute phase reactants,” increasing with stress, trauma, estrogen therapy, or pregnancy, such that levels may fluctuate from time to time ( [97](#) ). In one study, less than one-half of the patients had decreased levels of factor VIIIc, and in 20% of cases, both the bleeding time and the factor VIIIc levels were normal ( [148](#) ). Even with the more elaborate confirmatory tests now available, the diagnosis of this disorder may be difficult and may require repeated observations over a period of time. However, pregnancy and acute phase reaction are unlikely to obscure diagnosis in patients with more severe quantitative deficiency or qualitative defects.

Diagnosis of vWD is complicated, due to both the breadth of vWF functions and the spectrum of disorders constituting vWD. Consequently, a battery of studies should be considered to conclusively evaluate a patient for vWD ( [105](#) ). Screening tests, such as bleeding time and PTT, are supplemented with specific tests such as vWF antigen, vWF activity, and factor VIII level. Correlating the value of these various quantitative assays with each other or obtaining qualitative tests, such as vWF multimer analysis or low-dose ristocetin-induced platelet aggregation, may provide important clues toward a diagnosis of type 2 vWD ( [Table 59.7](#) ).

**BLEEDING TIME** The template bleeding time, the Ivy bleeding time, or technical modifications thereof may be useful in detecting the abnormality characteristic of vWD. However, the bleeding time may be normal in many patients with vWD ( [149](#) ). Consequently, the bleeding time adds to the diagnosis of vWD if it is prolonged but otherwise may have little clinical use in the diagnosis and management of patients with vWD. The bleeding time may not correct after replacement therapy with vWF, and monitoring is generally not recommended ( [141](#) ), as surgical bleeding is generally prevented through replacement of plasma vWF.

**PLATELET FUNCTION ANALYZER** Standardization issues, inconvenience, and residual scarring of patients are some of the issues that have fostered development of *in vitro* techniques to replace the bleeding time. The PFA-100 is a new platelet function analyzer that evaluates platelet adhesion and aggregation to collagen in a whole blood assay under high shear conditions ( [150](#) ). Citrate-anticoagulated whole blood is aspirated through an aperture in a collagen-coated membrane, and the device measures the time from first flow until flow ceases as the “closure time.” PFA-100 closure times are sensitive to multiple factors, including vWF function, platelet count, platelet function, and hematocrit. Studies in vWD patients have revealed that the assay is sensitive to most forms of vWD. However, the closure time may remain normal in acquired vWD despite a very reduced plasma vWF level, as the platelet vWF level may be normal, and in patients with type 2N vWD in which the major defect is low factor VIII levels. Correction of plasma vWF level in the absence of concomitant correction of the platelet vWF may be insufficient to correct the closure time, so that this test may not be very helpful for peri-operative monitoring of patients on replacement therapy ( [151](#) , [152](#) and [153](#) ).

**PARTIAL THROMBOPLASTIN TIME AND FACTOR VIIIc ASSAY** Among the simple screening tests ( [Table 59.5](#) ), the PTT may be abnormal, reflecting reduced levels of factor VIIIc. Plasma levels of factor VIIIc vary greatly in this disorder and range from as low as 3 U/dl in patients with type 3 vWD to normal in patients with mild type 1 vWD. Because factor VIIIc deficiency is often mild in patients with vWD, a diagnosis of vWD may be missed by the routine screening PTT, especially in patients with mild disease. Consequently, a specific assay is required to reliably detect factor VIIIc deficiency in this syndrome.

**VON WILLEBRAND FACTOR IMMUNOASSAY** The immunoassay of vWF is a quantitative measure of vWF protein and is one of the most sensitive methods available for the diagnosis of vWD ( [154](#) ). A variety of methods have been used, all of which depend on

antibodies specific to vWF. The electroimmunodiffusion method of Laurell was initially widely used because it was simple to perform, but ELISA or automated assays using related methodology have now largely replaced this technique. Average levels of vWF antigen (vWF:Ag) obtained by different laboratories vary, but a level of approximately 45 to 50 U/dl is the lower limit of normal reported by many laboratories. The ratio of factor VIIIc to vWF also varies by laboratory but normally ranges from approximately 0.7 to 2.2 ( [Fig. 59.1](#)). Plasma levels of vWF:Ag are regulated to some extent by carbohydrate residues attached to the protein; lower vWF antigenic levels have been noted in patients with blood type O compared to patients with other blood types ( [42](#)). Whether these patients actually have vWD type 1 is subject to debate, and some laboratories use blood group-specific reference ranges for diagnosis of vWD ( [105](#)). Patients with type 2 vWD may have normal vWF:Ag levels, emphasizing the need to use more than just a vWF antigen assay to evaluate a patient for vWD.

**VON WILLEBRAND FACTOR FUNCTIONAL ASSAYS** vWF has multiple functions, and assays have been devised to specifically evaluate many of these. The function most often clinically assessed is its ability to interact with platelets. An assay that evaluates the ability of vWF to interact with collagen has also been proposed as a functional assay, but the relevance of collagen binding activity analysis is questioned for routine screening. Collagen-binding activity assay has not gained widespread acceptance in the United States. Finally, vWF binding of factor VIII can be assessed in special circumstances when questioning whether mild factor VIII deficiency is due to failure of vWF chaperone function. vWF functional assay generally correlates well with vWF:Ag in patients with quantitative disorders of vWF. Observing a discrepancy between vWF function and vWF:Ag provides a useful clue for qualitative defects provided that the testing laboratory uses the same control plasma for performing both assays ( [155](#)).

#### **RISTOCETIN COFACTOR ACTIVITY AND RISTOCETIN-INDUCED PLATELET**

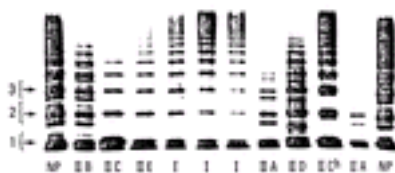
**AGGREGATION** The assay for ristocetin cofactor activity (vWF:RCo) is a quantitative technique for estimating the ability of vWF in the plasma to bind target platelets that are specially preserved or fixed for use in the assay ( [156](#)). Ristocetin induces an “activation” of vWF such that it then binds platelets via the platelet gpIb receptor, mimicking the *in vivo* sequence that drives an interaction between subendothelial tissue-bound vWF with platelets. Quantitation of vWF:RCo is held to be the single most sensitive and specific assay for vWD by multiple authorities ( [105](#), [157](#), [158](#) and [159](#)). vWF:RCo activity is adversely affected by loss of the larger-molecular-weight vWF multimers. The discrepancy between vWF:RCo and vWF:Ag that is observed in qualitative defects characterized by loss of both the intermediate- and higher-molecular-weight multimers (e.g., type 2A vWD) is thought to be on this basis. Ristocetin cofactor activity is also generally used to follow a vWD patient’s response to therapeutic interventions. However, the typical ristocetin cofactor activity is a time-consuming procedure, and assay standardization remains somewhat problematic. Simpler ELISA-based methods using monoclonal antibody to the gpIb binding domain of vWF have been explored for estimating vWF activity ( [160](#)). However, commercialized functional epitope assays have not performed sufficiently well to allow them to replace vWF:RCo assay ( [161](#), [162](#)). Ristocetin-induced platelet aggregation is a test distinct from ristocetin cofactor activity. Ristocetin-induced platelet aggregation is a qualitative test that involves evaluating the rate or extent of agglutination of patient-derived platelet-rich plasma in response to the addition of the antibiotic ristocetin. The concentration of vWF and platelets present in the test plasma, as well as the amount of ristocetin added, affect ristocetin-induced platelet aggregation. The assay is relatively insensitive to mild deficiency of vWF ( [148](#)) but is abnormal both in more severe deficiency and in patients with Bernard-Soulier syndrome (in which platelets are missing the gpIb receptor). Titrating down the amount of ristocetin added in the assay may be of specific interest in defining variants of vWD in which there are “gain of function” mutations (type 2B and platelet-type pseudo-vWD) that are characterized by increased sensitivity of patient vWF or platelets to the effect of ristocetin ( [163](#)). However, insensitivity of patient samples to low-dose ristocetin aggregation is seen in occasional

patients with type 2B vWD when there is marked reduction in the amount of high- and intermediate-molecular-weight multimers, and genetic analysis may be required to distinguish some cases of type 2B disease from type 2A vWD. In addition, low-dose ristocetin aggregation cannot differentiate type 2B vWD from the rarer platelet-type (pseudo) vWD, and mixing studies using patient plasma and donor platelets have been devised to help make that distinction at the phenotypic level ( 164 ).

**VON WILLEBRAND COLLAGEN-BINDING ACTIVITY** vWF contains collagen-binding sites in both the A1 and A3 domains of the vWF protein, and collagen-binding activity (vWF:CB) may be an important function to allow vWF to tether to platelets at sites of vascular injury. The assay is done in an ELISA format, in which type I or type III collagen is plated into microtiter wells, and the amount of vWF captured is assayed ( 165 , 166 ). vWF:CB correlates well with vWF:Ag in normal individuals and those with quantitative deficiency of vWF, and discrepant results are indicative of vWD subtypes that are characterized by deficiency of larger vWF multimers. A single case of vWD characterized by mutation of the vWF A3 domain with isolated loss of collagen-binding function despite the presence of a normal multimer distribution has recently been described ( 108 ).

**ASSAY OF VON WILLEBRAND FACTOR'S ABILITY TO BIND FACTOR VIII** Factor VIII binding by vWF (vWF:FVIII) can be measured in a few reference coagulation laboratories and is indicated for the evaluation of patients suspected of having factor VIII deficiency on the basis of defective vWF chaperone function (type 2N vWD) ( 167 ). In this ELISA format assay, ELISA plate wells are coated with antibody to vWF to capture vWF from patient plasma. After washing patient-derived factor VIII from the well, the ability of patient-derived vWF to capture recombinant factor VIII (r-FVIII) is assessed using a chromogenic assay for factor VIII, and the quantity of patient-derived vWF:Ag in the well is quantified by standard ELISA technique. The calculated ratio of r-FVIII to vWF:Ag is expected to be in the normal range when testing plasma from a patient with hemophilia A, whereas it is abnormally low in the rare cases of type 2N vWD ( 168 ).

**MULTIMERIC ANALYSIS OF VON WILLEBRAND FACTOR** Normal vWF in plasma consists of a complex series of multi-mers, ranging in size from approximately 800 kd to 20,000 kd. vWD initially diagnosed by abnormal assays for factor VIIIc, vWF antigen, or ristocetin cofactor activity should be further characterized by multimeric analysis. In this test, the structural integrity of the patient's vWF is assessed by size-based separation of vWF multimers via agarose gel electrophoresis, and vWF multimers are imaged by immunologic methods such as autoradiography or immunoperoxidase technique ( 169 ). This method confirms the presence of the entire spectrum of vWF multimers in normal individuals and those with type 1 vWD and allows identification of the loss of intermediate- or high-molecular-weight multimers of vWF as is characteristic of the type 2A and type 2B qualitative defects ( 169 ). However, distinction between type 2A and type 2B vWD is not always possible using multimer analysis alone, necessitating further testing. Results of multimeric analysis may be helpful in predicting response to 1-deamino-8-D-arginine vasopressin (DDAVP; desmopressin) therapy. Multimeric analysis is a very labor-intensive test and is usually performed only in coagulation reference laboratories. The multimeric composition of plasma from normal subjects and patients with vWD is shown in [Figure 59.7](#).



**Figure 59.7.** Multimeric composition of von Willebrand factor from normal plasma and that from types I, IIA, IIB, IIC, IID, and IIE von Willebrand disease (vWD), as well as from a type IIC heterozygote (IIC<sup>h</sup>). Using the revised classification scheme, these types would correspond to 1, 2A, 2B, 2A, 2A, and 2A, respectively. The three brackets include the smallest normal oligomers, with arrows pointing to the central predominant band in each.



In type 1 vWD, the relative concentration of large multi-mers varies. (From Zimmerman TS, Ruggeri ZM. von Willebrand disease. Hum Pathol 1987;18:140–152, with permission.)

**GENETIC STUDIES OF SPECIFIC CDNA REGIONS** Direct mutational analysis by vWF gene sequencing, allele-specific polymerase chain reaction, or restriction enzyme analysis is useful in confirming a diagnosis of type 2 variant vWD ( [170](#)). The functional domain structure of the vWF gene results in clustering of the various type 2 vWD defects in limited areas of the vWF sequence ( [171](#)). vWF exon 28 encodes for the A1 loop of vWF responsible for the interaction of vWF with platelet gpIb, and vWD variants characterized by defects of this interaction (types 2B and 2M) are encoded for by genetic mutations clustered in this exon ( [172](#)). Mutations of exon 28 also underlie the majority of type 2A defects, as it also encodes for the A2 domain. The A2 domain may direct intracellular vWF transport but also contains a protease-sensitive area. On rare occasions, type 2A vWD results from a defect of the multimerization process. The carboxy-terminal of the vWF peptide (encoded by exons 51 to 52) is involved in dimer formation, and the amino-terminal (encoded by exons 1 to 17) of the vWF peptide is involved in subsequent multimer assembly. Mutations responsible for defective interaction of vWF with factor VIII (type 2N vWD) are predominantly clustered in exons 18 to 20, which encode for the factor VIII binding domain of vWF; however, rare cases have been attributed to mutation in exon 24. An on-line database of defects found in vWD patients can be accessed at <http://www.shef.ac.uk/vwf/index.html/> ( [173](#)).

### Quantitative Defects of von Willebrand Factor

Decreased production of a functionally normal protein underlies type 1 vWD. Complete absence of vWF is responsible for the most extreme form of vWD, and this is classified as type 3 vWD ( [102](#)).

**TYPE 1 VON WILLEBRAND DISEASE** Patients with bleeding attributed to decreased production of qualitatively normal vWF are classified as having type 1 vWD. Most patients with vWD (70 to 80%) fall into this category ( [105](#)). The majority of type 1 vWD patients have a mildly symptomatic disorder, but bleeding may increase with physical trauma or surgery or during menstruation. vWF levels are usually in the 30 to 50 U/dl range, with concordant reduction of vWF:Ag and vWF:RCo (and vWF:CB if that is measured). Factor VIII levels are generally equal to, or higher than, vWF levels, and all vWF multimers should be present if that analysis is performed as part of the patient evaluation. Although type 1 vWD has been subcategorized by platelet vWF content and this may help predict DDAVP responsiveness ( [174](#)), most laboratories do not perform such specialized testing. The majority of type 1 vWD patients show a favorable response to DDAVP, which is the preferred form of therapy to raise vWF levels in type 1 vWD ( [99](#)).

**TYPE 3 VON WILLEBRAND DISEASE** Type 3 vWD is the most severe form of vWD, due to complete failure of vWF synthesis. This bleeding disorder is generally diagnosed during infancy. Hematoma formation is common, epistaxis may be life-threatening, and hemarthrosis may occur owing to the low factor VIII levels that are seen in this condition. Plasma from patients with type 3 vWD contains essentially no detectable vWF, and vWF is not present in either platelets or endothelial cells. The factor VIII level is generally in the 1 to 10 U/dl range, similar to that seen in moderate to mild hemophilia A. Multimeric analysis of the little vWF present yields variable results—in some cases revealing only small multimers ( [169](#)). Type 3 vWD is rare, with an estimated frequency of 1 in 1 million persons ( [175](#)). Genetic analysis reveals either homozygous or compound (double) heterozygous defects of the vWF gene with gene deletions, frameshift mutations, missense mutations, or nonsense mutations ( [176](#)). Careful laboratory evaluation of the parents of patients with type 3 disease may reveal mild quantitative deficiency of vWF, but parents are frequently asymptomatic, consistent with the impression that type 3



**Figure 59.8. A:** Structure and functional domains of von Willebrand factor (vWF). The open rectangles indicate domains of pre-pro-vWF. The first 22 amino acids of pre-pro-vWF are the signal sequence. The left arrow identifies the site of cleavage of the signal peptide, resulting in pre-vWF monomers. Pro-vWF monomers form dimers, and the vWF propeptide (vWAgII) is cleaved from mature vWF (right arrow indicates cleavage site). Dimer S-S and multimer S-S indicate locations of disulfide bonds that covalently link monomeric vWF into dimers and dimeric vWF into multimers, respectively. The red rectangle identifies exon 28, which encodes the A1 and A2 domains of mature vWF. Functional domains are identified above the open rectangles. The factor VIII binding site is located in the D' and D3 domains in the amino terminal, 272 amino acids of mature vWF. The A domains of vWF contain the binding site for the platelet glycoprotein (gp) Ib/IX complex, as well as binding sites for heparin, collagen, and sulfatides. The gpIIb/IIIa complex binding site of activated platelets is located at the carboxy-terminal portion of the C1 domain and contains the Arg-Gly-Asp sequence. The numbers below the open rectangles indicate amino acid numbers: signal peptide, 22 amino acids; propeptide (vWAgII), 741 amino acids; mature vWF, 2050 amino acids. **B:** Mutations associated with type 2A von Willebrand disease (vWD). The open rectangle represents vWF exon 28 encoding domains A1 and A2. The arrow indicates the site of proteolysis seen in type 2A vWD. Mutations are identified using the single letter code for amino acids. I and II identify group I and group II missense mutations that result in impaired synthesis of vWF or increased sensitivity to proteolysis in plasma, respectively. The disulfide bridge shown represents the boundary of the Cys 509-Cys 695 loop in the A1 domain. Type 2A vWD mutations associated with defective vWF multimerization are not shown in this figure; these latter mutations occur in the propeptide (vWAgII) D1 and D2 domains. **C:** Mutations associated with types 2B and 2M vWD. The large open rectangle represents exon 28, which encodes domains A1 and A2 of vWF. The mutations responsible for type 2B vWD are shown above the rectangle. Most type 2B mutations lie between residues 540 and 578 of mature vWF. The mutations responsible for type 2M vWD are shown below the rectangle. Asterisks identify mutations that reduce the platelet-dependent function of vWF and vWF multimeric size. ? indicates deletion of an amino acid sequence. [Modified from the Symposium Proceedings of the National Hemophilia Foundation's 1995 Annual Meeting. Diagnosis and management of severe von Willebrand disease (types 2 and 3). Kroner PA, Montgomery RR. The molecular basis of von Willebrand disease. 1996:15-25. Published with permission of Advanstar Communications.]

**TYPE 2A vWD** based on defective interaction of vWF and platelets due to deficiency of intermediate- and high-molecular-weight forms of vWF is classified as type 2A vWD ([102](#)). This form of the disorder is generally inherited as an autosomal-dominant trait ([180](#)) and accounts for the majority of patients with type 2 defects. Levels of factor VIIIc and vWF:Ag in the plasma may be normal or reduced. The vWF activity as assayed by either vWF:RCo or vWF:CB is significantly lower than vWF:Ag because of the absence of the larger multimers (which are more potent in their ability to interact with platelet gpIb and collagen). Analysis of vWF multimers reveals a relative reduction in intermediate- and high-molecular-weight species ([169](#)). In structural terms, the presence of abnormal amounts of 176,000-d and 140,000-d subunits has been identified ([181](#)), and additional studies suggested that *in vivo* proteolytic degradation of vWF occurs and may explain the multimeric abnormalities ([182](#)). Further protein studies and then genetic analysis of the basis of type 2A vWD revealed multiple mechanisms for the generation of this disorder ([181](#), [183](#), [184](#)). In some patients, there is failure to synthesize full-length multimers (group 1). However, other patients are able to synthesize large multimers that are, in turn, rapidly degraded in plasma through proteolysis (group 2). Other investigators identified the site of cleavage as occurring between tyrosine 842 and methionine 843 of the mature vWF protein sequence. More recently, a plasma metalloproteinase capable of performing this cleavage has been identified ([185](#)). Inheritance of type 2A vWD is generally autosomal dominant, with the majority of cases caused by mutations clustered in the region of exon



28, which encodes the vWF A2 homologous repeat ( [Fig. 59.8](#)) ( [102](#), [115](#) ). Rare recessive forms of type 2A vWD (formerly called *types IIC* and *IID*) due to defective multimerization attributed to defects in the vWF propeptide or carboxy-terminal region have also been described. Because of the abnormality of the vWF produced in these patients, neither stress nor pregnancy significantly increases the functional amount of protein. Similarly, the administration of DDAVP does not consistently normalize either the bleeding time or platelet adhesion in patients with the type 2A variant, but a very short-lived correction may be observed in some patients.

**TYPE 2B** This bleeding disorder is characterized by deficient vWF function attributable to mild reduction of vWF:Ag, a somewhat more marked deficiency of vWF:RCo activity, and multimeric analysis reveals a deficiency of the highest-molecular-weight vWF multimers. Measurements of factor VIIIc are variable. Many patients with the type 2B variant have mild persistent thrombocytopenia ( [186](#) ). Type 2B vWD is actually a paradoxical bleeding disorder, as increased interaction of patient vWF with platelets is demonstrated *in vitro* in the presence of low doses of ristocetin. Increased *in vivo* interaction of the larger multimers of type 2B vWF with platelets is thought to result in the formation of vWF/platelet complexes, which are subsequently cleared from circulation, leaving the patient with a hemostatic defect caused by the absence of larger multimers from plasma and mild thrombocytopenia. The platelet count may fall further during physiologic stresses or pregnancy, in association with surgical procedures, or after the administration of DDAVP ( [187](#) ). Further laboratory evaluation is required to support a diagnosis of type 2B vWD. This includes (a) multimeric analysis revealing the absence of higher-molecular-weight forms of plasma vWF and (b) platelet aggregation studies involving the use of titrated doses of ristocetin to reveal enhanced interaction of patient vWF and platelets with unusually small amounts of the drug. Finally, to differentiate the more common type of 2B vWD from the rare platelet type, pseudo-vWD, one should prove that the defect resides in vWF. This is done either through performing mixing studies of patient plasma with donor platelets ( [164](#) ) or by sequence analysis of the patient's vWF gene. Type 2B vWD is inherited as an autosomal-dominant trait. A small cluster of mutations within the portion of vWF exon 28, which encodes for the vWF A1 domain that interacts with platelet gpIb, accounts for the majority of cases of type 2B vWD ( [Fig. 59.8](#)) ( [102](#), [115](#) ).

**TYPE 2M** The *type 2M vWD variant* is defined by the diminished interaction of patient vWF with platelets, which is not due to deficiency of vWF multimers ( [115](#) ). Thus, these patients have a laboratory profile that in many ways is similar to that of patients with type 2A vWD, revealing variable deficiency of vWF:Ag but disproportionately decreased interaction of vWF with platelets in the presence of ristocetin as measured by vWF:RCo assay. Factor VIII level is proportionate to the vWF:Ag, and the platelet counts are normal. What differentiates type 2M vWD from the type 2A patients is that the vWF multimeric analysis is normal (and if measured, the vWF:CB is, therefore, similar to the vWF:Ag). Type 2M vWD is inherited as an autosomal-dominant trait, and, when investigated, mutations have been found in the region of exon 28 that encodes the A1 domain of vWF. Unlike the type 2B mutations, 2M mutations cause impairment of the binding of vWF to the gpIb receptor and have been shown to be localized to an alternative area in the A1 domain ( [Fig. 59.8](#)) ( [172](#) ).

**TYPE 2N** Mutations affecting the association of vWF with factor VIII can result in "autosomal hemophilia" in which factor VIII levels are significantly reduced relative to vWF ( [36](#) ). Affected patients have factor VIII levels in the 5 to 30 U/dl range, attributed to mutations at the factor VIII binding site near the amino terminus of the vWF subunit ( [188](#) ). Indeed, genetic studies have indicated that the majority of mutations underlying type 2N vWD involve vWF exons 18, 19, and 20, which encode for the bulk of the factor VIII binding domain of vWF. The other functions of the vWF in patients with type 2N vWD are qualitatively normal; thus, vWF laboratory parameters (vWF:Ag, ristocetin cofactor activity, and so forth) are usually normal (unless there is co-inheritance of type 1 vWD). This variant was originally named *vWD Normandy* and has been renamed *type 2N vWD* in the

revised classification ( [102](#) ). The factor VIII binding defect in these patients is inherited in an autosomal-recessive manner; thus, affected patients must inherit 2N alleles from each of their two parents or inherit type 1 vWD from one parent and a 2N allele from the other. Patients with factor VIII deficiency and a bleeding disorder that is not clearly transmitted as an X-linked disorder or who respond incompletely to hemophilia A therapy should be evaluated for type 2N vWD ( [189](#) ). Currently, only a few reference laboratories perform assays that assess the interaction of factor VIII with vWF ( [167](#), [168](#) ) or genetic studies of the vWF gene. A survey of almost 400 unrelated patients with either hemophilia A or type 1 vWD indicated a prevalence of type 2N vWD in these patient populations of 3.0% and 1.5%, respectively ( [190](#) ).

### Platelet-Type (Pseudo) von Willebrand Disease

Platelet-type (pseudo) vWD resembles type 2B vWD in most respects except the basis for platelet-type vWD is a structural defect in platelet gpIb ( [191](#) ) rather than a defect of vWF [thus, platelet-type (pseudo) vWD is a form of platelet dysfunction]. However, similar to type 2B vWD, a genetic defect results in increased affinity of gpIb for normal vWF. Phenotypically, platelet-type (pseudo) vWD is manifested by mild thrombocytopenia, a prolonged bleeding time, and variable deficiency of plasma vWF and factor VIIIc. The reductions in plasma vWF and factor VIIIc may be a result of the attachment of these proteins to platelets that are subsequently removed from the circulation. This “consumption” of vWF and platelets results mainly in a loss of high-molecular-weight multimers ( [191](#) ). *In vitro* platelet aggregation studies reveal platelet agglutination at unusually low concentrations of ristocetin. Spontaneous intravascular platelet clumping may also occur. Platelet-type pseudo-vWD is inherited as an autosomal-dominant trait in most families ( [191](#), [192](#) ).

The differentiation between the rare platelet-type pseudo-vWD from type 2B disease requires special studies. In type 2B vWD, the ristocetin-induced platelet hyperaggregability is the result of an abnormality of plasma vWF; ristocetin-induced platelet aggregation is abnormal only when plasma from the patient is used. In platelet-type vWD, ristocetin-induced aggregation is abnormal only when platelets from the patient are used. Thus, mixing studies using patient and normal plasma and platelets to study aggregation in the presence of low-dose ristocetin may be informative. Evaluation of whether *in vitro* platelet aggregation is induced by the addition of cryoprecipitate to patient platelet-rich plasma may also be useful in distinguishing between platelet-type pseudo-vWD and type 2B vWD ( [193](#) ). A monoclonal antibody assay using patient plasma and formalin-fixed donor platelets has been developed to distinguish between type 2B vWD and platelet-type vWD ( [164](#) ). Finally, genetic analysis of the vWF and gpIb gene can clarify the diagnosis.

## HEMOPHILIA B

That hemophilia represents at least two different disorders was recognized in 1947 ( [194](#) ). Hemophilia B (Christmas disease, factor IX deficiency, and plasma thromboplastin component or plasma thromboplastin component deficiency) was first distinguished from hemophilia A by Aggeler et al. in 1952 ( [195](#), [196](#) and [197](#) ). Hemophilia A is four to eight times more common than hemophilia B ( [21](#) ).

### Variants

When plasma from patients with hemophilia B is tested against autologous antibodies,

three distinct groups can be defined: a CRM-positive variant, the most common form; a CRM-negative variant; and a third form of the disorder in which antibody neutralization is variable in extent and is approximately proportional to coagulant factor IX activity (the CRM-R variant) ( [198](#) ).

In a disorder called *hemophilia B Leyden* ( [199](#) ), the clinical manifestations tend to diminish with advancing age in association with a rise in the factor IX level from as low as 1 U/dl in childhood to levels of 20 U/dl or more in adult life. The Leyden variant is characterized as CRM negative at birth but becomes CRM positive or CRM-R with advancing age ( [200](#) ). The basis for this variant is that mutations responsible for hemophilia B Leyden occur in the factor IX gene promoter region; this region contains an androgen response element that, with age, stimulates factor IX gene transcription and protein synthesis ( [200](#) , [201](#) ).

In another variant of hemophilia B, the PT is prolonged when performed with ox brain thromboplastin ( [202](#) ). This disorder has been called *hemophilia B<sub>m</sub>* and is characterized by the presence in the plasma of CRM that neutralizes both autologous and heterologous antibodies to factor IX ( [202](#) ). The degree of abnormality of the ox brain PT is proportional to the plasma level of CRM in both affected males and carrier females. This variant results from mutations in the carboxy terminus of the factor IX molecule, resulting in a factor IX molecule that interacts abnormally with ox brain thromboplastin.

A number of factor IX mutations have been recognized. Factor IX purified from the plasma of affected members of one kindred did not fragment normally when activated *in vitro* (hemophilia B Chapel Hill) ( [203](#) ). The molecular defect was found to be a substitution of histidine for arginine at position 145, a defect that inhibits cleavage by factor XIa ( [204](#) ). Studies of factor IX obtained from another family ( [205](#) ) revealed biochemical abnormalities identical to those characteristic of the descarboxy analog of this factor that is found in vitamin K deficiency or produced by coumarin drugs. Such molecules lack Ca<sup>2+</sup>-binding sites and do not undergo conformational changes induced by Ca<sup>2+</sup>. Another report concerns a unique variant with deficient Ca<sup>2+</sup> binding and an abnormally high-molecular-weight (factor IX Zutphen) ( [206](#) ).

## Genetics

Hemophilia B is inherited as an X-linked recessive trait, but the locus on the X chromosome of the gene controlling factor IX production is remote from that involved with factor VIII biosynthesis ( [13](#) ). Factor IX levels below 10% have been documented in a few women, including some with chromosomal abnormalities ( [207](#) , [208](#) and [209](#) ). Ten useful polymorphisms have been described that are associated with the factor IX gene ( [51](#) ). A 1998 hemophilia B database includes more than 1700 patient mutations with clinical data ( [210](#) ); an updated Internet listing of mutations is available at <http://www.kcl.ac.uk/ip/petergreen/haemBdatabase.html>. Unlike hemophilia A, the spontaneous mutation rate is low ( [19](#) ), and most patients with hemophilia B have positive family histories.

## Detection of Carriers

Detection of heterozygous carriers of hemophilia B involves the same principles and limitations described for hemophilia A. Carrier detection based on coagulation assay alone usually is more clear-cut than is the case with hemophilia A ( [211](#) ). Thus, in one series of

45 obligatory carriers, the mean factor IX level in the plasma was 33 U/dl; 40 from the group had levels below 50 U/dl, and 10 had levels below 25 U/dl. As a consequence of these low levels of factor IX, abnormal hemorrhage is not uncommon in carriers of hemophilia B.

Results of immunoassays of factor IX and the ratio of factor IX-related antigen to coagulant factor IX levels in the carrier population overlap with the normal population to a considerable degree, particularly in the CRM-positive variants ( [212](#) ). Such studies provide a lower overall detection rate among obligatory carriers of hemophilia B than is the case with hemophilia A ( [212](#), [213](#) ). Levels of factor IX-related antigen obtained by immunoassay are significantly increased by the use of oral contraceptives. The use of DNA probes ( [57](#), [214](#) ) and monoclonal immunoassays ( [215](#) ) provides a highly accurate method of determining carrier status. Prenatal diagnosis of hemophilia B has been successful in the CRM-negative variants ( [216](#) ).

### Clinical Features

Severely affected patients (those with factor IX levels <1 U/dl) are less common than in hemophilia A ( [Table 59.3](#) ), but the clinical manifestations of the two disorders are identical. Specific factor assays are necessary to distinguish between hemophilia A and hemophilia B. Mild factor IX deficiency should always be considered in the differential diagnosis of patients with coagulation-type bleeding and normal routine coagulation test results (PT, PTT) ( [217](#) ). Many PTT reagents do not detect mild factor IX deficiency (factor IX levels of 20 to 30%) ( [77](#) ).

### Laboratory Diagnosis

The laboratory diagnosis of hemophilia B involves the same approach and methods as those described for the recognition of hemophilia A ( [Table 59.5](#) ). The screening tests reveal similar abnormalities in the two disorders, except the PT is abnormal in the B<sub>m</sub> variant when either ox brain or Thrombotest is used as the thromboplastin.

Hemophilia A may be easily distinguished from hemophilia B by a specific factor assay. One-stage and two-stage assays for factor IX use the same principles as those discussed for factor VIIIc. Sensitive immunoassay methods for factor IX have been developed ( [218](#) ).

## CLINICAL DISORDERS OF THE FIBRINOGEN MOLECULE

The clinical disorders of fibrinogen can be divided into overlapping classes of abnormalities based on whether the defect is predominantly a quantitative or qualitative abnormality of the fibrinogen molecule. Quantitative abnormalities are disorders associated with the complete absence of fibrinogen (afibrinogenemia) or with low levels of fibrinogen (hypofibrinogenemia). Qualitative abnormalities are disorders resulting from synthesis of an abnormal fibrinogen molecule (dysfibrinogenemia) with altered properties. Dysfibrinogenemia may be asymptomatic and identified only through laboratory studies or may be associated with either hemorrhagic or thrombotic consequences.

Fibrinogen is a 340-kd plasma protein that circulates at a concentration of 1.5 to 3.5 mg/ml. It is a symmetric disulfide-linked dimer with a central E domain linked via “coiled-coil” peptide chains to outer D domains ( [219](#) ). Each half-molecule consists of a set of three different peptide chains termed *A<sub>α</sub>*, *B<sub>β</sub>*, and *γ*, which are linked at their amino

terminals by disulfide bonds to form the E domain. The D domains are formed by disulfide linkages near the carboxy terminals of the peptides. Fibrinogen is synthesized in hepatocytes ( [220](#), [221](#) ) by coordinated expression of three separate genes on chromosome 4 ( [222](#), [223](#) ). The circulation half-life of plasma fibrinogen is approximately 4 days. Fibrinogen participates in multiple physiologic processes, including fibrin clot formation mediated by the enzymatic activities of thrombin and factor XIIIa, and cohesion of activated platelets through interaction with the gpIIb/IIIa receptor. Fibrinogen also acts as a plasma carrier for factor XIII. Several excellent reviews provide detailed discussion of fibrinogen physiology ( [219](#), [224](#) ).

The congenital disorders of fibrinogen associated with afibrinogenemia and hypofibrinogenemia are reviewed in the next section, followed by a discussion of the dysfibrinogenemias. Afibrinogenemia is a very uncommon condition. The first case was described in 1920 ( [225](#) ), and approximately 300 cases have been reported since then ( [224](#) ). Congenital hypofibrinogenemia was first reported in 1935 ( [226](#) ), and at least 40 cases have been reported in the literature. However, it is likely that many of the cases of hypofibrinogenemia were actually cases of dysfibrinogenemia with a reduced level of circulating clottable fibrinogen.

### Pathogenesis of Quantitative Fibrinogen Disorders

In congenital afibrinogenemia and hypofibrinogenemia, defects in synthesis, secretion, or intracellular processing of the final gene product result in deficiency of plasma fibrinogen ( [227](#), [228](#) and [229](#) ). When newly synthesized fibrinogen is not secreted, the protein may accumulate in the rough endoplasmic reticulum of hepatocytes or other cells, resulting in amyloidlike accumulations ( [219](#), [230](#), [231](#) ). In both afibrinogenemia and hypofibrinogenemia, the fibrinolytic system and other coagulation pathways are completely normal. Similarly, there is no evidence of blood coagulation activation, which could cause consumption, or degradation of the fibrinogen molecule. The fibrinogen gene locus is located on chromosome 4; it contains three distinct genes that encode for the Aa, BB, and ? peptide chains that compose the fibrinogen molecule ( [232](#) ). The inheritance pattern of afibrinogenemia is autosomal recessive in nature ( [233](#) ), and many reported cases are the result of consanguineous relationships between asymptomatic parents with symptomatic homozygote offspring. The molecular basis for this genetic defect is currently an area of ongoing study. Deletion of an 11-kb region of the fibrinogen a gene appears to be a recurrent finding in unrelated families from both Europe and the United States, but nonsense, splice-site, and frameshift mutations involving all three of the components of the fibrinogen gene locus have been described ( [234](#) ). A database, which includes genetic defects that have been identified in patients with afibrinogenemia, is accessible at [http://www.geht.org/pages/database\\_ang.html](http://www.geht.org/pages/database_ang.html). As of late 2002, 282 molecular abnormalities were present in the database.

### Afibrinogenemia

It is somewhat of an anomaly that patients who are afibrinogenemic have little hemorrhage, despite the fact that their blood cannot clot normally. This may be, in part, due to the presence of functional vWF, which allows platelet adhesion and aggregation, with the formation of loose thrombi even in the absence of fibrinogen ( [235](#) ). A similar phenotype was recently described for afibrinogenemic mice created by gene-targeted knock-out ( [236](#) ). In patients with afibrinogenemia, life-threatening hemorrhages do occur, but in many situations, the bleeding is not as severe as is seen in hemophilia. The diagnosis is often made early in infancy when prolonged umbilical stump bleeding occurs ( [233](#) ). A major cause of death is intracranial hemorrhage during infancy or childhood ( [233](#) ),



<sup>237</sup>). The clinical manifestations include mucosal membrane bleeding such as epistaxis, menorrhagia, or gastrointestinal hemorrhage. An increased incidence of first-trimester abortion, placental abruption, and postpartum hemorrhage has also been observed in these patients (<sup>233</sup>, <sup>238</sup>). Fetuses of female afibrinogenemic patients rarely reach full term unless replacement therapy is given. Although 20% of afibrinogenemic patients are affected with hemarthrosis, the severity is generally less than that seen in patients with hemophilia. There is a paradoxical increase in thromboembolic disease in patients with afibrinogenemia who are given fibrinogen replacement therapy (<sup>239</sup>), and transgenic afibrinogenemic mice demonstrate abundant thrombus formation in a vascular injury model (<sup>235</sup>). The basis for this is not well understood but may be in part related to the fact that fibrinogen has nonsubstrate binding sites for thrombin that could potentially modulate thrombin availability to activate platelets (<sup>240</sup>). Patients with congenital hypofibrinogenemia do not typically have any spontaneous bleeding unless the fibrinogen level is less than 50 mg/dl. These patients may actually have hypodysfibrinogenemia, which is discussed in the section [Dysfibrinogenemia](#).

**LABORATORY DIAGNOSIS** Coagulation tests from afibrinogenemic and hypofibrinogenemic patients typically have a marked prolongation of all tests in which the endpoint is the appearance of fibrin clot, as severe fibrinogen deficiency renders plasma nonclottable. These tests include the PT, PTT, thrombin clotting time, and reptilase time. These test abnormalities are usually corrected when patient plasma is mixed with normal plasma. A diagnosis of afibrinogenemia depends on the specific finding of undetectable fibrinogen antigen in the plasma of these patients (<sup>241</sup>). Platelet fibrinogen is also absent. Mild thrombocytopenia has been reported in some afibrinogenemic patients, but typically the platelet count is usually not lower than 100,000/ $\mu$ l (<sup>242</sup>). The bleeding time is prolonged in approximately one-third of patients with afibrinogenemia, presumably caused by the failure of platelets to aggregate in the absence of plasma or platelet fibrinogen. These abnormalities are correctable by infusion of plasma (<sup>243</sup>). Furthermore, afibrinogenemic patients who undergo hypersensitivity reaction skin testing do not typically show an induration response to allergens (<sup>244</sup>). They show only erythema because the later phases of the hypersensitivity reaction depend on the deposition of subcutaneous fibrin.

**DIFFERENTIAL DIAGNOSIS AND THERAPY OF AFIBRINOGENEMIA** Congenital quantitative defects in fibrinogen must be carefully distinguished from acquired quantitative defects in the fibrinogen molecule, which are often seen in the setting of liver disease or disseminated intravascular coagulation. Acquired hypofibrinogenemia has been reported after therapy with L-asparaginase, which impairs hepatic synthesis of fibrinogen (<sup>245</sup>). Furthermore, patients with aplastic anemia treated with antithymocyte globulin and corticosteroids are prone to develop hypofibrinogenemia (<sup>246</sup>). In the absence of purified fibrinogen concentrates, cryoprecipitate administration is used for replacement therapy for patients with severe afibrinogenemia. Prophylactic therapy is recommended only for pregnant patients or patients with a history of central nervous system (CNS) hemorrhage (<sup>247</sup>). Replacement therapy is indicated for any episode of acute active bleeding, preoperatively, and in pregnant patients. Fibrinogen levels between 50 and 100 mg/dl are usually adequate for normal hemostasis (<sup>248</sup>). Levels greater than 100 mg/dl are recommended for maintenance during pregnancy based on empiric clinical observations (<sup>224</sup>). Each bag of cryoprecipitate contains approximately 250 mg of fibrinogen; five to ten bags of cryoprecipitate are usually sufficient in the average adult patient. Each bag of cryoprecipitate typically raises plasma fibrinogen levels by approximately 10 mg/dl. Because the fractional catabolic rate of fibrinogen is 25%/day, acute-care patients should receive one-third of their loading dose daily for as long as fibrinogen support is desired (<sup>219</sup>). Measurement of plasma fibrinogen levels after infusion is recommended to confirm that a patient has obtained the desired therapeutic effect. The complications of

replacement therapy in afibrinogenemia include allergic reactions, development of antifibrinogen antibodies, and anaphylaxis ( [249](#) ). Thromboembolic complications after cryoprecipitate infusions include deep venous thrombosis and pulmonary emboli; the risk of these complications may be increased when an inhibitor of fibrinolysis or oral contraceptive therapy is also administered ( [239](#) , [250](#) ). Low-molecular-weight heparin in combination with fibrinogen replacement has been used to avoid these thromboembolic complications ( [251](#) ).

## Dysfibrinogenemia

The first reported case of dysfibrinogenemia mediated by a qualitatively abnormal fibrinogen molecule occurred in 1965; since that time, more than 300 families have been reported with this disorder. The molecular genetic basis of fibrinogen dysfunction has been fairly well established in many families that have been studied. However, uncertainty persists concerning the linkage of genetic defects of fibrinogen and the disease phenotype expressed by patients, as environmental factors and other concomitant genetic abnormalities may be influencing disease manifestations. For more in-depth discussions of the fibrinogen biology, molecular genetics, and mechanisms of disease, the reader is referred to several recent reviews that contain compendia of the described defects underlying dysfibrinogenemia and discussion of the biochemical and clinical consequences of these defects ( [219](#) , [224](#) ). A database containing an updated list of the genetic defects is accessible at [http://www.geht.org/pages/database\\_ang.html](http://www.geht.org/pages/database_ang.html).

**MOLECULAR BASIS OF DYSFIBRINOGENEMIA** The reported abnormalities in the fibrinogen molecule include defects in each of the major steps of fibrin formation and stabilization. The conversion of fibrinogen to an insoluble fibrin clot requires that the molecule first be cleaved by thrombin between arginine 16 and glycine 17 of the A $\alpha$ -chain to release fibrinopeptide A and between arginine 14 and valine 15 of the B $\beta$ -chain to release fibrinopeptide B. This produces a fibrin monomer capable of undergoing the second step, fibrin polymerization. Once these molecules polymerize, they are stabilized by the action of factor XIIIa. Fibrinogen also supports the hemostatic process through interaction with platelets during platelet cohesion (aggregation). Finally, during the process of wound healing and tissue remodeling, the fibrin clot undergoes fibrinolysis by concerted activities of plasminogen and plasminogen activators. Fibrinogen dysfunction may affect any of these various steps of fibrin clot formation, platelet interaction, or lysis. It is, therefore, expected that the dysfibrinogenemias can be associated with abnormal clinical bleeding, thrombotic tendency, disorders of wound healing, or no clinically apparent disease. Domain location of a mutation does not necessarily predict the associated disease phenotype. Defects of fibrinopeptide release have been associated with both hemorrhagic and thrombotic complications. Similarly, disruption of D-D interactions has been associated with both bleeding and thrombosis. Patients who have heterozygous dysfibrinogenemia typically have approximately 50% of normal fibrinogen levels, which should be adequate for hemostasis. Clottable fibrinogen protein measurements may not be a reliable indicator of plasma fibrinogen concentration because functionally abnormal molecules are not always incorporated into the clot. An abnormal fibrinogen may actually inhibit the conversion of normal fibrinogen to fibrin, so the tendency for many of these patients to bleed is higher than one would suspect. Hypodysfibrinogenemia occurs when an abnormality of the fibrinogen molecule results in decreased secretion or increased clearance of the protein. Approximately 23 families have been reported with hypodysfibrinogenemia. Autosomal amyloidosis has been attributed to genetic disorders of fibrinogen, as well as to genetic disorders of several other proteins (including transthyretin, gelsolin, apolipoprotein A, and lysozyme) ( [252](#) , [253](#) ). Hereditary renal amyloid disease has been associated with genetic defects of the A $\alpha$ -chain ( [219](#) ), and renal amyloid has recurred in renal transplants ( [253](#) , [254](#) ). Hepatic amyloid disease has also been attributed to abnormalities of fibrinogen ( [255](#) ). Dysfibrinogenemia is typically inherited as



an autosomal-dominant trait with high levels of penetrance. Most of these patients are heterozygotes, but a few homozygotes and some rare compound heterozygotes have been reported in the literature. Approximately 40% of dysfibrinogenemic patients are asymptomatic, and 45 to 50% have a bleeding disorder ( [256](#) ). The remaining 10 to 15% have either a thrombotic disorder (venous or arterial) or both bleeding and thrombotic tendencies. The bleeding associated with dysfibrinogenemia is generally mild and includes soft tissue hemorrhage, easy bruising, and menorrhagia. Although intraoperative and postoperative bleeding have been reported, most bleeding is not life-threatening. There are only a few families in which a thrombotic tendency can unambiguously be associated with dysfibrinogenemia, and criteria for making this association have been proposed. These criteria include a demonstrated molecular defect, thrombosis at an early age or in multiple family members, presence of no other predisposing factor for thrombosis, strong association between the fibrinogen defect and thrombus complications within a family, and association of the same molecular defect with thrombosis in another unrelated kindred ( [257](#), [258](#) ). Studies indicate a distinct thrombotic tendency in individuals with dysfibrinogenemia related to defects in the  $\alpha$ -C domain of the A $\alpha$ -chain of fibrinogen, especially if new cysteine residues are encoded that can become disulfide linked to albumin. In contrast, dysfibrinogenemic patients with defective cross-linking experience primarily defective wound healing.

**LABORATORY DIAGNOSIS OF DYSFIBRINOGENEMIA** The thrombin clotting time remains a sensitive screening test for dysfibrinogenemias, and the PT appears to be more sensitive than the PTT to the effects of dysfibrinogenemia. In some cases, clot formation may be absent. The reptilase time is often more prolonged than the thrombin clotting time, especially in patients who have defective fibrinopeptide A release. Some dysfibrinogenemias exhibit a very short thrombin clotting time, and these patients may have thrombotic complications. The fibrinogen concentration can be either low or normal in these patients. Most patients with dysfibrinogenemia have a significant discrepancy between the level of clottable fibrinogen and that detected by immunologic methods. Criteria for diagnosing dysfibrinogens using ratios of immunologic and functional fibrinogen assays have been reported ( [259](#) ). The euglobulin clot lysis time is a crude measure of fibrinolytic potential and may be helpful in detecting abnormal fibrinogens that show increased susceptibility to fibrinolysis. For example, with fibrinogen St. Louis ( [260](#) ), the euglobulin clot lysis time is shortened, and fibrinogen degradation products are elevated in the plasma. The diagnosis of inherited dysfibrinogenemia must be distinguished from hypofibrinogenemia, which is either acquired or congenital in nature. Acquired dysfibrinogenemia occurs typically in the setting of severe liver disease, and the suspicion can be readily investigated by evaluation of liver function tests. Acquired dysfibrinogenemias are also associated with malignancies that produce an abnormal fibrinogen molecule [e.g., some hepatomas ( [Chapter 60](#) ) and renal cell carcinoma ( [261](#) )], as well as autoimmune disorders. Acquired inhibitors to fibrin formation that interfere with fibrinogen to fibrin conversion may also be confused with dysfibrinogenemia. These acquired inhibitors include heparinlike molecules, elevated levels of fibrin split products, and antibodies at concentrations as may occur in macroglobulinemia, multiple myeloma, or other disorders that interfere with fibrin polymerization ( [262](#), [263](#) ). Acquired antibodies against the fibrinogen molecule are quite rare but have been reported in association with a variety of diseases ( [264](#), [265](#) and [266](#) ).

**THERAPY** The majority of patients with dysfibrinogenemia do not require any specific therapy. Any bleeding complications that develop can be managed with transfusion of either plasma or cryoprecipitate. Antifibrinolytic drugs have been used in some patients but should be especially avoided in patients who have thrombotic tendencies. Patients with repeated venous thrombotic episodes may actually require long-term antithrombotic therapy. A patient with life-threatening thrombophilic manifestations was successfully managed with plasma exchange before surgery ( [267](#) ), but one wonders whether simple anticoagulation therapy would have been sufficient to provide a satisfactory outcome. In women with dysfibrinogenemia, recurrent miscarriages may be prevented using

prophylactic cryoprecipitate, and successful pregnancy outcomes in such cases have been reported ( [268](#), [269](#) ).

## FACTOR XIII DEFICIENCY

The initial hemostatic plug is not sufficient to prevent blood loss unless it is stabilized by the action of plasma factor XIII (fibrin-stabilizing factor). A complex set of reactions among thrombin, fibrin, and plasma factor XIII is necessary for clot stabilization ( [Chapter 21](#) ). When fibrin begins to polymerize after thrombin cleaves the fibrinopeptides, a complex forms between thrombin and fibrin, which promotes the conversion of factor XIII to factor XIIIa. Fibrin is the main catalytic substrate for factor XIIIa ( [270](#) ). Factor XIIIa transforms the unstable, noncovalently associated fibrin clot to a stable covalently cross-linked set of fibrin fibers that are mechanically stronger, more rigid, and more elastic. A cross-linked fibrin clot is more resistant to mechanical as well as enzymatic degradation by plasmin than non-cross-linked fibrin. Factor XIIIa is a transglutaminase that catalyzes the formation of intermolecular  $\gamma$ -glutamyl- $\epsilon$ -lysyl covalent (isopeptide) bonds between the  $\gamma$ -chains and  $\epsilon$ -chains of fibrin strands within the clot. Cross-linkage of  $\gamma$ -chain Gln 398 and Lys 406 residues appears to occur earlier, with  $\epsilon$ -chain linkages between Gln 328 and 366 with Lys 508, 556, and 562 occurring more slowly ( [271](#) ). In addition, several other plasma and extracellular matrix proteins are linked to the fibrin clot through the action of factor XIII. Incorporation of a  $\alpha_2$ -antiplasmin into fibrin clots further increases the resistance of the clot to plasmin degradation ( [272](#) ). Linkage of fibrin to fibronectin may improve adhesion to vessel walls ( [273](#) ) and may play a role in cell migration during wound healing ( [274](#) ). In fact, fibronectin is the second most abundant material in fibrin clot, accounting for 4% of the total protein ( [275](#) ).

The importance of factor XIII function in normal health is emphasized by the clinical scenarios characteristic of inherited and acquired deficiency of factor XIII. In the following sections, the pathogenesis, molecular genetics, and clinical laboratory, diagnostic, and therapeutic elements of the diagnosis and treatment of factor XIII deficiency are discussed.

### Pathogenesis

In 1944, Robbins postulated that a deficiency of fibrin-stabilizing factor, which later became known as *factor XIII*, would produce a serious bleeding disorder ( [276](#) ). However, it was not until the first case of factor XIII deficiency was described in 1960 that the severe nature of this bleeding disorder was recognized ( [277](#) ). During the last four decades, more than 200 cases of congenital factor XIII deficiency have been reported in the literature ( [274](#) ). It is estimated that approximately 1 in every 1 to 5 million persons has factor XIII deficiency ( [278](#) ). The disorder is inherited as an autosomal-recessive trait ( [279](#) ).

The factor XIII molecule is present in plasma and blood platelets and monocytes. Approximately 50% of the total blood factor XIII activity resides in the platelet. Tissue-based factor XIII resides in monocyte/macrophages. Structurally, platelet and monocyte factor XIII consists of only A-dimers, present within the cytoplasm of both platelets and megakaryocytes. The plasma factor XIII molecular complex is a heterotetramer, containing two of each of the A and B subunits. The A subunit mediates factor XIII function, containing an activation peptide, calcium-binding site, and enzymatic domain with an active site sulfhydryl residue that is characteristic of this class of enzymes ( [280](#) ). The three-dimensional structure for the A subunit has been determined by x-ray crystallography ( [281](#) ). The majority of the A subunit in circulation is derived from

cells of marrow origin ( [282](#) ). The B subunit of plasma factor XIII is synthesized in the liver and probably associates with the A subunit in the plasma phase after release from the hepatocyte. The B subunit appears to promote stabilization of the A subunit in plasma and may play an important role in regulating both the localization of the A subunit to the fibrin clot and thrombin-dependent activation of the protein ( [283](#) ). Three distinct forms of factor XIII deficiency have been described, based on whether the A and B subunits are absent or present ( [274](#), [284](#), [285](#) ). In type I deficiency, the concentration of both the A and B subunits is reduced. In type II deficiency, the A subunit is absent, and the B subunit is present. In type III deficiency, there is a selective deficiency of the B subunit.

## Molecular Genetics

The genetics of factor XIII deficiency is beginning to be carefully defined using recent advances in molecular biology. Since the protein was initially described in human serum in 1944, both the A and B subunits have been purified, and cDNA sequence and gene structure have been established ( [286](#), [287](#), [288](#) and [289](#) ). The A subunit is encoded on chromosome 6 ( [290](#) ), containing 15 exons, and spans a region of 160 kb. A common genetic polymorphism of the A subunit has been described that results in Val 34 replacement by Leu only three amino acid residues from the site of cleavage of the activation peptide. This polymorphism may influence factor XIII activation and has been investigated in reference to risk for myocardial infarction ( [291](#) ). The B subunit is encoded by chromosome 1 ( [292](#) ). Because the mode of inheritance of factor XIII deficiency is autosomal recessive in nature, only homozygotes or compound heterozygotes are clinically symptomatic. The homozygotes reported in the literature are often children of consanguineous marriages ( [293](#) ).

In the cases reported to date, factor XIII deficiency is more frequently attributed to mutation of the gene encoding for the A subunit, confirming the functional importance of this subunit. To date, at least 30 mutations have been described ( [274](#) ). The majority of defects observed are “point mutations” resulting in stop codons, missense errors, or frameshifts and small deletions. Inherited deficiency of the factor XIII–A–chain is not restricted to any specific ethnic group ( [294](#) ).

Factor XIII–B–chain deficiency is a very rare autosomal–recessive disorder, with only three reported cases in the literature ( [295](#) ). One unique patient displayed a complete absence of the B–chain and a shortened half–life of the A–chain. Interestingly, this B–chain–deficient patient had many of the same symptoms as an A–chain–deficient patient. The ability of the B–chain to promote A–chain binding to the fibrinogen molecule may account for this clinical finding ( [296](#) ).

## Clinical Aspects

Clinically affected factor XIII–deficient patients typically have plasma levels that are less than 1% of normal ( [297](#) ), with bleeding attributed to accelerated fibrin clot degradation. Abnormal bleeding manifests shortly after birth, when bleeding from the healthy umbilical cord remnant occurs ( [298](#) ). This has been a prominent feature in many of the reported cases ( [293](#) ) but is an uncommon presentation for other congenital bleeding disorders. Rebleeding at circumcision is also common. Other bleeding manifestations in these patients include soft–tissue hemorrhage, hemarthrosis, hematomas, and the development of large pseudocysts ( [298](#) ). Surgery in these patients is often complicated by abnormal wound healing and excessive postoperative bleeding, which can occur either immediately

or later ( 277, 299 ). Delayed bleeding may occur several days after surgery or tissue injury, and patients may experience cycles of repetitive bleeding that span weeks to months. The most life-threatening complication of factor XIII deficiency is spontaneous intracranial hemorrhage. Intracranial hemorrhage is more prevalent in factor XIII deficiency than in other inherited bleeding disorders ( 293 ). Approximately 25% of factor XIII-deficient patients experience intracranial hemorrhage ( 297 ), and this forms the basis for the recommendation for prophylactic therapy of factor XIII-deficient patients. The affected males in some families also have oligospermia, resulting in infertility. Furthermore, infertility in affected females results from spontaneous abortions. Females with this deficiency cannot carry a pregnancy to term unless plasma factor XIII levels are maintained at levels that prevent bleeding ( 300 ).

## Differential Diagnosis

Congenital or acquired factor XIII deficiency must be considered when a patient has a major bleeding disorder and all of the initial screening laboratory tests are normal, including PT, PTT, platelet count, and bleeding time. Bleeding can occur spontaneously or after major surgery. It remains imperative in the adult to exclude both inherited and acquired factor XIII deficiency because patients can develop antibodies to factor XIII that interfere with fibrin stabilization. Specific antibodies to factor XIII were reported in patients taking isoniazid ( 301 ), phenytoin ( 302 ), procainamide ( 303 ), and penicillin ( 304 ). Factor XIII antibodies also occur in association with autoimmune disease, in patients with monoclonal gammopathy, or as an idiopathic occurrence. Acquired factor XIII deficiency has been reported in Henoch-Schönlein purpura ( 305 ), liver disease, Crohn disease ( 306 ), and ulcerative colitis ( 307 ).

## Laboratory Diagnosis

The solubility of a fibrin clot in 5 mol/L urea or 1% monochloroacetic acid is the most useful screening test for factor XIII deficiency. The PT and PTT assays are normal ( Table 59.5 ). In these conditions, clots formed in the absence of factor XIII activity dissolve within minutes ( 308 ). In contrast, normal clots covalently modified by factor XIIIa remain insoluble for at least 24 hours. Most clinical laboratories currently use the 5 M urea solubility test (also called the *clot stability test*). Deficiency of a  $\alpha_2$ -antiplasmin may also cause a bleeding disorder with normal coagulation screening studies and increased urea clot solubility; a specific assay for a  $\alpha_2$ -antiplasmin should be considered to exclude this possibility ( 309 ). Quantitative measurements of factor XIIIa activity can also be done, and specialized laboratories can measure either ammonia production (an end product of the factor XIIIa reaction) ( 310 ) or the incorporation of fluorescent or radioactive amines (e.g., dansylcadaverine) into proteins such as casein ( 311 ). However, the most sensitive and specific measurement of factor XIIIa activity remains the functional assay measuring the stability of a covalently cross-linked fibrin clot ( 312 ). Finally, immunologic-based assays that detect factor XIII antigen are available such as ELISAs specific for either the A or B subunits of factor XIII ( 313 ). These immunologic assays correlate with factor XIII activity assays.

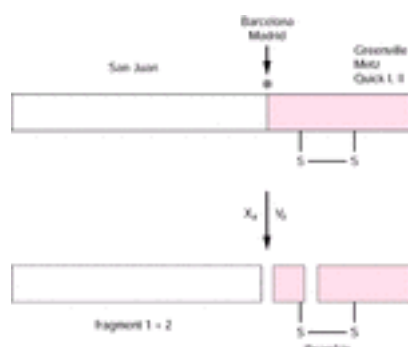
## PROTHROMBIN DEFICIENCY

Hereditary hypoprothrombinemia is exceedingly rare, with fewer than 100 cases reported ( 314, 315, 316, 317 and 318 ). There are no human cases of total prothrombin deficiency, and mice with prothrombin gene deletions experience embryonic lethality due to bleeding ( 319 ).

). It is also proposed that embryonic lethality of prothrombin deficiency also results from absence of developmental activity of thrombin on yolk sac vasculature. The human disorder is inherited as an autosomal-recessive trait and manifests clinically as a mild hemorrhagic diathesis. Spontaneous hemorrhage is uncommon, and posttraumatic bleeding is the most common complaint. Bleeding from the umbilical stump is common in affected infants. Hemarthrosis has been reported ( 318 ). The extent of prothrombin deficiency does not necessarily correlate with clinical bleeding.

As with deficiencies of the other vitamin K-dependent coagulation factors, both CRM-positive (dysprothrombinemia) and CRM-negative variants of hypoprothrombinemia have been described; both are autosomal-recessive traits. The CRM-negative form is characterized by a true deficiency of prothrombin and appears to be the more common variety ( 315 ). In true hypoprothrombinemia, immunoassays correlate closely with functional assays. A significant hemostatic defect is not induced unless prothrombin levels are less than 1 to 2% of normal; normal hemostasis requires prothrombin levels above 25% ( 315 ). Homozygotes usually have prothrombin activity levels less than 10% of normal, whereas heterozygotes have 40 to 60% of normal activity ( 314 ).

In the CRM-positive variants, the presence of antigenically competent prothrombin in amounts that far exceed functional prothrombin has been demonstrated by quantitative immunologic assays. These disorders have been called *constitutional dysprothrombinemias* ( 315 , 317 ), and the abnormal prothrombins have been designated by various proper names such as *prothrombin Cardeza* ( 317 ). Calcium binding by prothrombin San Juan I is deficient; most other abnormal prothrombins appear to be normal in this respect ( 315 ). The genetic basis for dysprothrombinemias is missense mutations that result in either a protein with abnormally slow prothrombin activation or a protein that is activated to a defective thrombin molecule (dysprothrombin) ( 320 ). For example, prothrombins Barcelona ( 321 ) and Madrid ( 322 ) demonstrate loss of the factor Xa cleavage site, whereas prothrombins Quick I and II are dysprothrombins that exhibit diminished activity toward fibrinogen ( 323 , 324 ). Figure 59.9 illustrates the relationship between the location of certain prothrombin mutations and the resulting functional abnormality.



**Figure 59.9.** Schematic representation of prothrombin activation by factors Xa and Va and sites of certain prothrombin mutations leading to inherited prothrombin deficiency. The fragment 1+2 domain contains  $\gamma$ -carboxyglutamic acid (Gla) residues responsible for prothrombin binding to calcium and phospholipid surfaces. Prothrombin San Juan possesses abnormal calcium-binding properties. Prothrombins Barcelona and Madrid have a mutation at the factor Xa cleavage site ( *asterisk*) (Arg<sup>271</sup>  $\rightarrow$  Cys). Mutations in the thrombin domain, such as occurs in prothrombins Metz, Greenville, and Quick I and II, result in abnormal thrombin activity toward substrates such as fibrinogen.



New prothrombin mutations continue to be identified ( 325, 326 ). Analysis of structures of these mutant prothrombin molecules has led to proposals for functional consequences of mutant prothrombins ( 326 ). As of 2002, 32 genetic defects in the prothrombin molecule had been identified ( 327 ).

The laboratory findings in this disorder are summarized in Table 59.5. Specific factor assays for prothrombin are used in diagnosis. Acquired deficiency of prothrombin caused by vitamin K deficiency or to an antiprothrombin antibody associated with antiphospholipid antibodies should be considered before making the diagnosis of inherited prothrombin deficiency. Treatment of prothrombin deficiency with plasma or prothrombin complex concentrates (PCCs) is discussed in Table 59.10.

**TABLE 59.10. Replacement Therapy in Other Inherited Coagulation Disorders**

| Disorder               | Therapeutic Material                      | Loading Dose         | Maintenance Dose                    |
|------------------------|---|----------------------|-------------------------------------|
| von Willebrand disease | Humate-P <sup>a</sup>                     | 40–60 U/kg           | 40–50 U/kg every 12 h for up to 7 d |
|                        | Cryoprecipitate <sup>b</sup>              | Not required         | 1 bag/10 kg daily                   |
| Fibrinogen deficiency  | Cryoprecipitate                           | 1–2 bags/10 kg       | 1 bag/10 kg every other d           |
|                        | Purified fibrinogen <sup>c</sup>          | 50–100 mg/kg         | 20 mg/kg every other d              |
| Prothrombin deficiency | Fresh frozen plasma <sup>d</sup>          | 15 ml/kg             | 5–10 ml/kg daily                    |
| Dysprothrombinemia     | Purified prothrombin complex <sup>e</sup> | 20 U/kg              | 10 U/kg daily                       |
| Factor V deficiency    | Fresh frozen plasma                       | 20 ml/kg             | 10 ml/kg every 12–24 h              |
| Factor VII deficiency  | Fresh frozen plasma <sup>d</sup>          | 20 ml/kg             | 5 ml/kg every 6–24 h                |
|                        | Purified prothrombin complex <sup>e</sup> | 30 U/kg              | 10–20 U/kg every 6–24 h             |
| Factor X deficiency    | Fresh frozen plasma <sup>d</sup>          | 15–20 ml/kg          | 5–10 ml/kg daily                    |
|                        | Purified prothrombin complex <sup>e</sup> | 15 U/kg              | 10 U/kg daily                       |
| Factor XI deficiency   | Fresh frozen plasma <sup>d</sup>          | 15–20 ml/kg          | 5 ml/kg every 12–24 h               |
| Factor XIII deficiency | Fresh frozen plasma <sup>f</sup>          | 5 ml/kg every 1–2 wk | Not usually required                |

NOTE: The replacement therapy regimens suggested in this table are for major bleeding or surgical prophylaxis. Patients with minor bleeding may require lower dosages of these replacement materials. Confirmation of hemostatic levels of the appropriate coagulation factor being replaced should be done, with dosage adjustments performed as needed.

<sup>a</sup> Labeled in ristocetin cofactor units. Alphanate can also be used to treat von Willebrand disease.

<sup>b</sup> Recommended only if purified factor replacement therapy is not available.

<sup>c</sup> Not routinely available in the United States.

<sup>d</sup> Plasma after removal of cryoprecipitate is satisfactory.

<sup>e</sup> Prothrombin complex concentrates are thrombogenic and should be used only for major bleeding or major surgery. Antifibrinolytic drugs (ε-aminocaproic acid, tranexamic acid) should not be used in conjunction with prothrombin complex concentrates.

<sup>f</sup> A factor XIII concentrate is currently under investigation in the United States.

---

## FACTOR V DEFICIENCY

Inherited deficiency of factor V (parahemophilia, labile factor, or proaccelerin deficiency) is an uncommon disease that was first described by Owren ( [328](#) ). It has been reported from various parts of the world and is transmitted as an autosomal-recessive trait that manifests clinically only in patients who inherit the defective gene from both parents. Other modes of inheritance have been implicated in certain kindreds ( [329](#) ). In heterozygotes, the levels of factor V in the plasma are approximately one-half of normal, and the carriers are easy to identify by routine laboratory studies. The incidence of factor V deficiency is estimated at 1 in 1 million. As of 1999, approximately 150 cases of inherited factor V deficiency had been reported ( [318](#) ).

### Pathophysiology

The basic pathophysiologic mechanism in most patients with factor V deficiency is failure of biosynthesis of the requisite protein. The absence of CRM in the plasma of most patients with this disorder has been demonstrated by antibody neutralization studies ( [330](#) ). Variants with an abnormal, nonfunctional factor V protein have been defined ( [331](#) ). The platelets of patients with factor V deficiency contain variable amounts of factor V-related antigen ( [332](#) ). Factor V Quebec is a disorder associated with moderately reduced plasma factor V levels and significantly depressed platelet factor V levels ( [333](#) ). This variant results from deficiency of a unique platelet protein, multimerin, which apparently serves as an important carrier protein for platelet factor V ( [334](#) ).

### Clinical Features

The clinical manifestations of the disorder usually are mild but vary greatly, even within the same family. Mildly affected patients experience spontaneous epistaxis, tendency to bruise easily, menorrhagia, and excessive bleeding after dental extractions or surgical procedures. In severely affected patients, hematomas, spontaneous gingival bleeding, and bleeding into the gastrointestinal tract or CNS may occur. The disorder seldom produces bleeding in affected neonates and has been associated with a high incidence of other congenital abnormalities ( [329](#) ).

A genetic model of factor V deficiency has been developed in mice. In addition to significant hemorrhage, homozygous factor V-deficient mice have increased fetal loss *in utero*, suggesting not only that factor V is critical for hemostasis, but also that this protein is important in development ( [335](#) ). In contrast, a patient with severe factor V deficiency (no detectable plasma and platelet factor V) has been reported with only mild bleeding symptoms ( [336](#) ). One possible explanation for these discordant observations is that minimal factor V gene expression, below limits of routine detection, may “rescue” affected patients ( [337](#) ). Even though very low levels of factor V are associated with delayed thrombin generation, the amount of thrombin generation can be significant ( [338](#) ).



Bleeding symptoms may correlate better with the platelet factor V content than the plasma factor V level ( [333](#) ).

The variable clinical manifestations of inherited factor V deficiency likely result from a variable spectrum of mutations in the factor V gene seen in these patients. As of 2001, 17 mutations had been reported associated with factor V deficiency ( [339](#) ); most are found in unique families, and most result in type I deficiency ( [339](#) ).

### Laboratory Diagnosis

The usual laboratory features of factor V deficiency are summarized in [Table 59.5](#). Specific assays for factor V are based on the PT and are easy to perform. Good results may be obtained by using aged oxalated or ethylenediaminetetraacetic acid plasma as a factor V–deficient substrate ( [340](#) ) or artificially depleted substrate plasmas.

Inherited factor V deficiency must be distinguished from combined deficiency of factors V and VIII ( [341](#) ). Consequently, specific assays for factors V and VIII should be performed to exclude the rare combined deficiency, which would require different replacement therapy. Acquired factor V deficiency due to liver disease, disseminated intravascular coagulation, or antibodies to factor V should also be excluded before making a diagnosis of inherited factor V deficiency. Treatment of factor V deficiency with plasma is discussed in [Table 59.10](#).

## FACTOR VII DEFICIENCY

Factor VII deficiency was first described in 1951 by Alexander et al. under the name *serum prothrombin conversion accelerator deficiency* ( [342](#) ). Approximately 200 cases of true factor VII deficiency have been reported, and the population prevalence is estimated to be 1 in 500,000 ( [318](#) ). Also known as *stable factor* or *proconvertin deficiency*, the condition is inherited as an autosomal–recessive trait that produces severe deficiency in the homozygote and mild deficiency, usually without clinical manifestations, in the heterozygote.

### Pathophysiology

Factor VII is secreted as a single–chain proenzyme glycoprotein of approximately 50 kd by hepatocytes. Factor VII has the shortest plasma half–life of all coagulation factors (approximately 5 hours), and its plasma concentration is very low, approximately 500 ng/ml ( [343](#), [344](#) ). The 406–amino acid zymogen undergoes extensive processing before secretion, with steps that include vitamin K–dependent  $\gamma$ –carboxylation of glutamic acid residues,  $\beta$ –hydroxylation of aspartic acid 63, O– and N–linked gly–cosylation steps, and cleavage of the signal and propolypeptides. Structurally, the protein contains the N–terminal gla domain, two epidermal growth factor–like domains, an activation peptide sequence, and the serine protease domain. Factor VII is activated via limited proteolysis by cleavage of the arginine 152–isoleucine 153 bond to form the active (two–chain) factor VIIa. This limited proteolysis activation step can be performed by factor Xa, factor IXa, or thrombin, or via autoactivation activity of factor VIIa ( [309](#) ). Factor VIIa is detectable in trace amounts in normal plasma ( [345](#) ), and sensitive assays indicate that approximately 1% of circulating factor VII is in the activated form ( [345](#) ). The circulating half–life of activated factor VIIa is quite long, at approximately 2.5 hours ( [346](#) ). Tissue factor increases the rate of activation of factor VII significantly ( [345](#), [347](#) ), and the current theory is that coagulation is initiated in the presence of tissue factor that is exposed at sites of

vascular injury or on blood monocytes ( 348 ).

The factor VII gene includes nine exons and spans 128 kb on chromosome 13 ( 349 ). It is located just upstream of the factor X gene. In a mouse knock-out model in which factor VII is completely lacking, fatal hemorrhage occurs perinatally ( 350 ). In humans, factor VII deficiency occurs as a recessive trait due to homozygous or compound heterozygous mutation. Thirty-five mutations had been reported by 1997 ( 351 ), and more than 115 mutations were listed in 2002 in a registry maintained by the Medical Research Council ( <http://europium.csc.mrc.ac.uk> ). Most reported genetic defects are single base substitutions, including missense, splice site, and nonsense mutations. Most mutations affect only a few patients, but one mutation (Ala<sup>242</sup>Val) was detected in 23 “apparently” unrelated Jews in Israel. More extended haplotype testing suggests a “founder effect” ( 352 ). Although Dubin–Johnson syndrome is associated with factor VII deficiency ( 344 ), the genetic defect underlying that syndrome is located on chromosome 10, and the association of Dubin–Johnson syndrome and factor VII deficiency may simply reflect a high consanguinity rate in one population ( 309 ).

### Clinical Features

Only severe factor VII deficiency is associated with hemorrhagic symptoms, and heterozygous carriers are asymptomatic. Factor VII levels do not completely correlate with the severity of symptoms, but patients with levels greater than 10 to 15 U/dl rarely manifest bleeding ( 353 , 354 ). Patients with levels between 5 and 10 U/dl tend to have milder symptoms such as epistaxis and gingival, genitourinary, and gastrointestinal bleeding. Patients with levels below 1 U/dl may have symptoms similar to patients with hemophilia A or hemophilia B, with spontaneous joint and deep-muscle bleeding. Bleeding into the CNS is particularly common and was observed in 16% of 138 patients in one series ( 355 ). CNS bleeds often present during the neonatal period ( 355 ), and the risk of recurrence is high enough that prophylaxis with factor replacement therapy should be considered in patients who present with this complication ( 356 ). The severity of bleeding after trauma or surgical procedures varies to a surprising degree in this disorder, with oral and urogenital cavity procedures being particularly troublesome, possibly reflecting the high local fibrinolytic activity in these regions of the body. Some report that patients with factor VII deficiency may also be more prone to various thromboembolic manifestations ( 357 ). The explanation for this phenomenon is unknown, but some authors report diet-responsive factor VII deficiency in the metabolic disorder homocystinuria ( 358 ) and hypothesize that many patients with inherited factor VII deficiency who experience thrombotic events may have homocystinuria (homocysteinemia) and that the metabolic disorder may explain both factor VII deficiency and thrombosis in these patients ( 358 ).

### Laboratory Diagnosis

In factor VII deficiency, normal results are obtained with coagulation tests that bypass the extrinsic pathway of coagulation and factor VII ( Table 59.5 )—that is, the PTT and Stypven time. Thus, a diagnosis of factor VII deficiency is suspected in a patient with a life-long history of bleeding when there is an isolated prolonged PT and normal PTT. The PT corrects on 1:1 mixing of patient plasma with normal plasma, but a diagnosis of factor VII deficiency requires a specific factor VII assay for confirmation. Levels of factor VII in heterozygous carriers overlap the normal range. Before making a diagnosis of factor VII deficiency, one should exclude causes for acquired abnormalities such as vitamin K deficiency, liver disease, or warfarin therapy. Also, rare conditions, such as combined deficiency of all vitamin K-dependent factors, and combined factor VII and factor X

deficiency should be considered.

Phenotypically, patients have been characterized by possessing plasma levels of factor VII antigen (or CRM). CRM<sup>-</sup> patients have low factor VII antigen due to lack of synthesis or increased factor clearance, whereas CRM<sup>+</sup> patients produce factor VII that is antigenically detected but structurally abnormal with deficient function. CRM-R individuals presumably represent a combination of these two entities. Further complexity of the factor VII-deficient phenotype is introduced because of insensitivity of some factor VII activity assays to low levels of factor VII or from variability in assays that is introduced by the use of varying animal sources of tissue thromboplastin.

Treatment of factor VII deficiency with plasma or PCCs is discussed in the section [Prothrombin Complex Concentrates, Factor IX, and Factor VII \(VIIa\)](#). Although the necessity for correcting factor VII deficiency has been questioned ([359](#)), patients who have factor VII deficiency and a history of excessive clinical bleeding should be given replacement therapy before surgery. It has been reported that patients with factor VII deficiency who have factor VII levels above 10% when assayed using human thromboplastin reagents have minimal bleeding symptoms.

## FACTOR X DEFICIENCY

Factor X deficiency was discovered independently by Telfer et al. ([360](#)) and Hougie et al. ([361](#)) and is known also by the surnames of the patients who were first found to manifest the defect [Stuart ([361](#)) and Prower ([360](#))]. Fewer than 100 cases have been reported ([318](#)). Factor X deficiency is inherited as an autosomal incompletely recessive trait, and the genetic features and clinical manifestations resemble those of factor VII deficiency. Patients with factor X levels of 10% or more have a mild bleeding disorder. However, patients with factor X levels less than 10% have severe bleeding, and in a comparative analysis of uncommon bleeding disorders, severe factor X-deficient patients appear to have the most serious bleeding disorder ([318](#)). This clinical observation is supported by studies in factor X knock-out mice in which factor X<sup>-/-</sup> mice exhibited partial embryonic lethality and fatal neonatal bleeding ([362](#)).

In several studies using the techniques of immunodiffusion and antibody neutralization, investigators established the existence of CRM-positive and CRM-negative variants of factor X deficiency ([363](#), [364](#)). Significant differences in the laboratory abnormalities encountered in various kindreds further suggest at least two different CRM-positive variants ([363](#)), namely, that present in the Prower kindred ([360](#)), in which the Stypven time is abnormal, and factor X Friuli ([365](#)), in which the Stypven time is normal. In the CRM-negative variant (the disorder in the Stuart kindred), the Stypven time is abnormal ([361](#)).

A variety of mutations have been found in inherited factor X-deficient patients ([320](#), [366](#), [367](#)), including deletions, nonsense mutations, and missense mutations. Deletion mutations usually result in loss of the factor X catalytic domain, whereas missense mutations may impair phospholipid binding, activation of factor X, or synthesis or secretion of the protein. As of 2002, 47 mutations had been reported in association with inherited factor X deficiency ([367](#)).

Factor X deficiency typically results in prolongation of the PT and PTT assays. A specific factor assay for factor X is used to diagnose factor X deficiency. Prolongation of the

Stypven time is characteristic in the Stuart and Prower variants ( [Table 59.5](#)). Factor X variants associated with isolated prolongation of the PT ( [368](#)) or the PTT ( [369](#)) have been reported. Consequently, patients who present with features of an inherited bleeding disorder, and in whom the typical disorders are excluded based on PT and PTT profiles ( [Table 59.5](#)), should be evaluated with a specific factor X assay to exclude variant factor X deficiency.

Acquired factor X deficiency [vitamin K deficiency, liver disease, warfarin therapy, amyloidosis ( [370](#))] should be excluded before a diagnosis of inherited deficiency is made. Treatment of factor X deficiency with plasma or PCCs is discussed later in the section [Prothrombin Complex Concentrates, Factor IX, and Factor VII \(VIIa\)](#) and in [Table 59.10](#).

## FACTOR XI DEFICIENCY

Factor XI deficiency (plasma thromboplastin antecedent or plasma thromboplastin antecedent deficiency) was first recognized by Rosenthal et al. in 1953 ( [371](#)) and was called *hemophilia C*. Factor XI deficiency is transmitted as an incompletely recessive autosomal trait manifested either as a major defect in homozygous patients with factor XI levels below 20 U/dl or as a minor defect in heterozygous patients with levels ranging from 30 to 65 U/dl ( [372](#)). The incidence of this disorder varies widely, with estimates of frequency in the general population being 1 in 1 million persons. A particularly high frequency of the disorder exists in people of Jewish extraction ( [372](#), [373](#)), with an estimated gene frequency of 5 to 11% in Ashkenazi Jews ( [374](#)). Up to 0.3% of this population is homozygous for factor XI deficiency ( [374](#)).

Factor XI deficiency has been reported to result from three major types of mutations: Type I mutations result in disruption of splicing; type II mutations result in a stop codon and nonfunctional molecule; and type III mutations result in amino acid substitutions and a dysfunctional molecule ( [375](#)). Patients with type II mutations have the greatest bleeding tendency ( [376](#)). Type II and III mutations are most common in Ashkenazi Jews. The type II mutation is also common in Iraqi Jews ( [377](#)), who may represent the ancient gene pool of Jews ( [378](#)). In general, all factor XI mutations result in decreased factor XI protein proportionate to factor XI clotting activity. Approximately 20 factor XI mutations have been reported ( [379](#)).

### Clinical Features

The clinical manifestations of factor XI deficiency are extremely variable and generally are milder than those of hemophilia A or B ( [379](#), [380](#)). As a rule, spontaneous bleeding is rare, and hemorrhage usually occurs only after trauma or a surgical procedure. The extent of factor XI deficiency does not correlate with bleeding ( [379](#), [380](#)). Hemarthrosis is uncommon, but delayed bleeding is a particularly treacherous feature in some patients ( [371](#), [381](#), [382](#)), especially for surgical procedures involving tissues rich in fibrinolytic activity. Mild factor XI deficiency may be associated with Noonan syndrome ( [383](#)) and Gaucher disease ( [384](#)). Hemorrhagic manifestations may be absent in certain patients ( [385](#), [386](#)), especially in those with type I mutations. Approximately one-half of heterozygous factor XI-deficient patients have a bleeding tendency ( [387](#)). Factor XI deficiency should be considered in female patients with menorrhagia ( [388](#)). In one study of women with menorrhagia, the prevalence of factor XI deficiency was 4% ( [389](#)).

## Laboratory Diagnosis

In the homozygous form of factor XI deficiency ( [390](#) ), the PTT is prolonged. In most patients, factor XI levels in the plasma are in the range of 3 to 15 U/dl. In people with the mild form of the disorder, the PTT often is normal because most PTT reagents are insensitive to mild factor XI deficiency ( [77](#) ). Abnormalities in the plasma of such mildly affected patients may be removed by freezing. Specific factor assays are used to diagnose factor XI deficiency. The bleeding time and thrombin time are normal. Factor XI deficiency has also been reported in combination with inherited factor IX deficiency (type VI familial multiple factor deficiency) ( [391](#) ).

Treatment of factor XI deficiency with plasma is discussed later in this chapter in [Table 59.10](#) and the section [Plasma](#).

## FACTOR XII DEFICIENCY

Factor XII deficiency was discovered by Ratnoff and Colopy during routine preoperative coagulation studies on John Hageman, an adult who had no evidence or history of abnormal bleeding ( [392](#), [393](#) and [394](#) ). The disorder, subsequently named *Hageman factor deficiency*, is inherited as an autosomal-recessive trait. Factor XII deficiency has been identified in 1.5 to 3.0% of a healthy blood donor population ( [395](#) ).

### Pathophysiology

The plasma of most patients with factor XII deficiency does not contain material that reacts with antibodies to this factor, as judged by antibody neutralization, hemagglutination inhibition, and immunodiffusion ( [396](#), [397](#) ). Radioimmunoassays with heterologous antibodies have demonstrated antigenic material identical to normal factor XII in only 2 of 42 ( [398](#) ) and 2 of 31 ( [397](#) ) separate kindreds. One large study of 31 factor XII-deficient kindreds identified most mutations in the serine protease domain ( [397](#) ).

### Clinical Features

Factor XII deficiency usually is not associated with hemorrhagic manifestations ( [392](#), [399](#) ). It is noteworthy that myocardial infarction and thrombophlebitis have been observed in patients with severe factor XII deficiency ( [400](#) ) and that Hageman died of thromboembolic complications ( [401](#) ). It was originally thought that factor XII deficiency might actually predispose to thrombosis, possibly as the result of deficient activation of fibrinolysis ( [402](#) ). However, more recent surveys indicate that factor XII deficiency is not associated with an excessive risk of thrombosis ( [74](#), [403](#), [404](#) ).

Results of *in vitro* experiments suggest that factor XII has a central role in the initiation of the intrinsic pathway of coagulation and apparently mediates a variety of other processes such as fibrinolysis, complement activation, inflammation, and chemotaxis ( [399](#), [405](#) ). The physiologic importance of these factor XII-mediated phenomena nevertheless remains obscure because patients with even severe deficiency of this proenzyme reveal no evidence of deficiency or aberrance of host defenses.

The discrepancy between *in vitro* evidence of grossly abnormal blood coagulation and the

absence of hemorrhagic manifestations in factor XII deficiency poses a fundamental question regarding the role of the intrinsic coagulation pathway in hemostasis and the significance of laboratory measurements of coagulation. Alternative mechanisms for initiation of coagulation are discussed in [Chapter 21](#). For practical purposes, factor XII deficiency remains a laboratory curiosity and is of little clinical significance.

### Laboratory Diagnosis

Factor XII-deficient patients typically present with a negative history of clinical bleeding and an isolated, prolonged PTT that corrects with mixing with normal plasma. The coagulant effects of contact activation are diminished or absent in plasma from subjects with factor XII deficiency ([406](#)). Normal levels of factor XII range from 50 to 150 U/dl. As with factor XI, accurate assays of factor XII depend on a source of deficient substrate plasma. Laboratory demonstration of the heterozygous state is difficult. The mean level of factor XII in the plasma of carriers is approximately 50% of normal, but observed values are distributed in a bimodal manner, an observation interpreted to suggest the presence of multiple abnormal alleles ([407](#)).

## PREKALLIKREIN DEFICIENCY

An additional abnormality of the intrinsic pathway of coagulation was defined and named *Fletcher factor deficiency* by Hathaway in 1965 ([408](#)). In 1972, Wuepper et al. established that Fletcher factor was identical to plasma prekallikrein, a protein that had been studied for many years in terms of its role in inflammation ([409](#)). The convergence of these two avenues of research demonstrated that prekallikrein, in addition to its role in inflammation and chemotaxis, is essential for the optimal activation and fragmentation of factor XII in the early steps of coagulation ([405](#)).

### Pathophysiology

Prekallikrein deficiency apparently is inherited as an autosomal-recessive trait ([408](#)), although genetic information is scanty. Heterozygotes with approximately 50% of normal plasma levels of prekallikrein can be identified. The disorder is associated with the absence of antigenically competent prekallikrein in most cases ([410](#), [411](#)). A CRM-positive variant has been demonstrated in several cases.

### Clinical Features

Prekallikrein deficiency, like factor XII deficiency, is not associated with abnormal bleeding. Studies of affected patients revealed variable deficiencies in stress-induced fibrinolysis, chemotaxis, immediate and delayed inflammatory responses, and responses to preformed permeability enhancing activity (PF-Dil) ([412](#)). These abnormalities are not associated with any apparent deleterious effects. Most patients with prekallikrein deficiency are of African ancestry ([413](#)). Prekallikrein deficiency is not associated with an excessive risk of thrombosis ([74](#)).

### Laboratory Diagnosis

Prekallikrein deficiency is associated with a moderate prolongation of the PTT. The PT and thrombin time are normal. The euglobulin lysis time is prolonged. The time required for release of vascular plasminogen activators *in vivo* after venous occlusion is prolonged



([414](#)). The disorder is characterized by abnormally slow contact activation. Thus, the PTT may be normalized by prolonged incubation (10 to 15 minutes) of plasma with particulate activators ([408](#), [415](#)). This phenomenon appears to result from autoactivation of factor XII ([416](#)). Specific assays for prekallikrein are based on traditional coagulation techniques and chromogenic substrate assays ([417](#)).

## HIGH-MOLECULAR-WEIGHT KININOGEN DEFICIENCY

A unique inherited coagulation abnormality associated with deficiencies of kinin formation and fibrinolysis was described in three unrelated kindreds in 1975. The disorder received the names of the affected families [ *Fitzgerald trait* ([418](#)), *Williams trait* ([419](#)), *Flaujeac trait*, and *Fujiwara trait* ([420](#))] and has subsequently been found to be the result of deficiency of HMWK. Patients with this disorder are asymptomatic. The data suggest that HMWK functions in its nonactivated form as a cofactor, binding prekallikrein and factor XI to anionic surfaces, accelerating their activation by surface-bound factor XIIa ([Chapter 21](#)).

### Pathophysiology

Deficiency of HMWK appears to be inherited as an autosomal-recessive trait ([421](#)). Mildly affected heterozygotes have been identified in some families. Detailed biochemical studies of five kindreds revealed considerable heterogeneity ([419](#), [421](#)). Thus, HMWK levels in the plasma ranged from nil ([419](#)) to 50 U/dl ([418](#)). With the exception of the Fitzgerald kindred, associated deficiencies in low-molecular-weight kininogen have been demonstrated in all families. Variable deficiency of prekallikrein also was present in the Williams, Fitzgerald, and Fujiwara kindreds; prekallikrein levels were normal in the Flaujeac kindred. Immunologic studies revealed the absence of kininogen antigen in the homozygotes and 50% of normal levels in the heterozygotes ([422](#)). The associated prekallikrein deficiency also apparently is of the CRM-negative type ([422](#)). The absence of the stabilizing effects of HMWK may lead to accelerated degradation and deficiency of prekallikrein in this disorder ([422](#)). HMWK deficiency is not associated with excessive clinical bleeding or thrombosis. There is limited information on the genetic basis for HMWK deficiency ([423](#), [424](#)).

### Laboratory Diagnosis

Deficiency of HMWK is manifested by an isolated, prolonged PTT. The PTT assay results are abnormal whether particulate or soluble contact activators are used, and values are not normalized by prolonged incubation of the plasma with particulate activators. The euglobulin lysis time is prolonged.

## MISCELLANEOUS INHERITED COAGULATION DISORDERS

### Combined Defects

Of unusual interest are reports concerning the presence of combined deficiencies of two or more coagulation factors. Deficiency of factors V and VIII and combined deficiency of various vitamin K-dependent factors appear to be the most common combined deficiency disorders. Several other combined coagulation defects have been described ([Table 59.1](#)).



## Deficiency of Factors V and VIII

This combined defect, reported in fewer than 100 kindreds, is inherited as an autosomal-recessive trait ( [425](#), [426](#) ) by means of two different genetic mechanisms: a doubly heterozygous pattern (type I) and a dual abnormality of a common gene (type II) ( [427](#), [428](#) ). Combined deficiency of factors V and VIII manifests clinically with mild mucosal and cutaneous bleeding. Severe posttraumatic and postsurgical bleeding is common (e.g., after tooth extractions) ( [426](#) ). Hemarthrosis is rare. Laboratory findings in homozygous patients include a prolonged PTT and PT and levels of factor VIIIc and Vc that average 15 U/dl ( [425](#) ). Levels of factor VIIIaAg (VIIIcAg) and VAg are low and are proportional to those obtained by coagulation measurements ( [429](#) ).

Linkage analysis of combined factor V and VIII deficiency to chromosome 18q excluded all known hemostasis proteins, suggesting that the basis for the disease is a defect affecting a process common to the biosynthesis of factors V and VIII. Indeed, subsequent studies by two groups identified the genetic basis for most patients with the disorder as mutations in the endoplasmic reticulum-Golgi intermediate compartment (ERGIC) protein 53. ERGIC-53 functions as a molecular chaperone for the transport of several secreted proteins, including factors V and VIII ( [430](#), [431](#) ). Other patients with this combined defect have mutations in another protein termed *CFD $\zeta$*  ( [432](#) ).

## Combined Deficiency of Factors II, VII, IX, and X

This coagulation disorder has been identified in only a small number of patients ( [433](#) ). In addition to affecting levels of the vitamin K-dependent factors, skeletal abnormalities may also be seen, due to effects on bone Gla proteins ( [434](#) ). Levels of the vitamin K-dependent proteins range from less than 12 to 50% of normal; thus, clinical bleeding manifestations may vary widely. Mutations in the  $\gamma$ -glutamyl carboxylase gene have been identified in a few patients with this disorder ( [435](#), [436](#) ), and another group has identified a second gene locus causing this defect ( [437](#) ). Some patients have clinical improvement and correction of the coagulopathy with vitamin K therapy ( [433](#), [436](#) ).

## ABNORMALITIES OF PROTEASE INHIBITORS

Rare abnormalities of three plasma antiproteases, which are associated with bleeding, are described in this section. Other, more numerous abnormalities of the components of the antiprotease system and the fibrinolytic enzyme system that may be associated with thrombosis are discussed in [Chapter 61](#).

### $\alpha_2$ -Antiplasmin Deficiency

Severe bleeding, including hemarthrosis, was associated with deficiency of  $\alpha_2$ -antiplasmin in several kindreds ( [438](#), [439](#) and [440](#) ). This disorder appears to be inherited as an autosomal-recessive trait, in which heterozygotes have detectable deficiencies of this antiprotease but only mild bleeding. CRM-positive and CRM-negative forms have been identified ( [441](#) ). A review published in 2001 identified 13 cases; five cases had genetic abnormalities defined ( [442](#) ). Three of these five cases had mutations in exon 10, which is the location of the active site, and the plasminogen binding site ( [442](#) ).

Bleeding presumably is the result of premature lysis of hemostatically important fibrin plugs caused by unregulated plasmin activity. The laboratory findings are variable. Hypofibrinogenemia and increased clot solubility in urea have been reported, but in many patients, only a shortened euglobulin clot lysis time can be demonstrated. Fibrinogen degradation product levels and platelet counts were normal in most cases ( 441 ). When assayed qualitatively by fluorometric or photochromogenic techniques, a  $\alpha_2$ -antiplasmin levels usually are below 10 U/dl. Treatment of bleeding episodes with tranexamic acid and other antifibrinolytic agents may be helpful in some cases.

### Plasminogen Activator Inhibitor–1 Deficiency

Deficiency of this inhibitor to tissue plasminogen activator is associated with a moderate bleeding disorder ( 443 ). Only approximately 10 to 20 families have been reported ( 444 ). One study investigated a large kindred with multiple family members homozygous for this disorder ( 445 ). Homozygous patients, but not heterozygous patients, exhibited clinical bleeding ( 445 ). The null gene mutation responsible for plasminogen activator inhibitor (PAI)–1 deficiency was identified in this kindred ( 445 ). The basis of the bleeding is similar to that described for a  $\alpha_2$ -antiplasmin deficiency: excessive plasmin activity, caused in this case by excessive activation of plasminogen. Laboratory screening studies are typically normal, but the euglobulin clot lysis time is shortened. It is recommended that measurement of PAI–1 antigen and activity in both serum and plasma be done to screen for PAI–1 deficiency ( 445 ).

#### $\alpha_1$ -Antitrypsin Pittsburgh

A life-long hemorrhagic diathesis in a 14-year-old boy was associated with a unique qualitatively abnormal form of a  $\alpha_1$ -antitrypsin (antithrombin III Pittsburgh) ( 446 , 447 ). This disorder is the result of the substitution of a single amino acid (arginine for methionine at position 358 in the  $\alpha_1$ -antitrypsin molecule) ( 447 ). This site corresponds to the P1 residue or “bait” amino acid of the molecule, and the substitution produced a mutation of a  $\alpha_1$ -antitrypsin, a weak antiprotease with little affinity for thrombin, into a potent antithrombin that impaired blood coagulation to a significant degree. The mutant molecule also is a potent inhibitor of factor XIa, factor XIIIf, and kallikrein, a property lacking in the normal molecule ( 448 ). The plasma concentration of the abnormal molecule increased after trauma, possibly as the result of an acute phase reaction. The patient ultimately died of bleeding. Other amino acid substitutions at position 358 have been produced artificially by genetic engineering ( 449 , 450 ).

## TREATMENT

Various styptics, drugs, diets, and hormones periodically have been advocated for the treatment of the inherited coagulation disorders. These include oral contraceptives ( 451 ) and corticosteroids ( 452 ). In general, none of these remedies is of proven value, although estrogens may be useful in treating female patients with vWD ( 453 ). Topical hemostatics may be temporarily effective in small injuries, and certain other measures may prove to have adjunctive value under specific circumstances such as DDAVP and inhibitors of fibrinolysis ( 454 ). The principal treatment for the inherited coagulation disorders, however, is replacement therapy—that is, the intravenous administration of the required factor in the form of blood products derived from normal people or animals ( 455 ) or recombinant

coagulation proteins ( 456 ).

## Replacement Therapy

The objective of replacement therapy is to obtain a concentration of the required factor at the bleeding site such that coagulation may become hemostatically effective. Its achievement involves a consideration of several biodynamic properties of the various coagulation factors ( Table 59.8 ), a general knowledge of the available therapeutic materials, and clinical assessment of the severity of the hemorrhagic manifestations. Replacement products can be given on the basis of body weight ( Table 59.9 and Table 59.10 ) or plasma volume. This latter method may be more precise in patients who do not have a normal plasma volume because of bleeding. In this method, blood volume is considered to be 7% of body weight; plasma volume is then calculated using the patient's hematocrit. Next, the therapeutic objective is assessed (e.g., the desired incremental increase in factor VIII level). For example, if a patient with severe hemophilia A (<1% factor VIII) has a plasma volume of 3000 ml and requires major surgery, the target factor VIII level should be 100% of normal. Infusion of 3000 U factor VIII would result in a calculated peak factor VIII level of 1 U/ml (100% of normal). Peak factor levels should be monitored to document attainment of the expected response; dosage adjustment can then be made, if needed.

**TABLE 59.8. Biodynamic Properties of Coagulation Factors of Concern in Replacement Therapy**

| Disorder                              | Hemostatic Level (U/dl) <sup>a</sup> | Initial <i>In Vivo</i> Recovery (% of Infused Material) | <i>In Vivo</i> Survival of Infused Coagulation Factors |                                     |
|---------------------------------------|--------------------------------------|---|--|-------------------------------------|
|                                       |                                      |   | First Phase Diffusion Half-Life (h)                    | Second Phase Biologic Half-Life (h) |
| Hemophilia A (factor VIII deficiency) | 25–30                                | 80  | 4–6  | 12                                  |
| Hemophilia B (factor IX deficiency)   | 15–30                                | 25–50   | 2–3  | 24                                  |
| Fibrinogen deficiency                 | 100 mg/dl                            | 50  | 12   | 77–106                              |
| Prothrombin deficiency                | ?20–40                               | 50–100  | 8  | 72–96                               |
| Factor V deficiency                   | 15–25                                | ?50–100   | <sup>b</sup>   | ?12–36                              |
| Factor VII deficiency                 | 10–20                                | ?100  | 0.5  | 5                                   |
| Factor X deficiency                   | 10–20                                | 50–100  | 2–9  | 24–48                               |
| Factor XI deficiency                  | 10–20                                | ~100  | <sup>b</sup>   | ?48–84                              |
| Factor XIII deficiency                | 3–5                                  | 50–100  | <sup>b</sup>   | ~9 d                                |

?, insufficient data or significant disagreement among published figures.

<sup>a</sup> Values represent the minimum desired level. Patients undergoing major surgery or experiencing major bleeding should receive dosages to achieve higher factor levels; for example, patients with hemophilia A should have replacement such that factor VIII levels approach 100% of normal. For patients with factor XIII deficiency and major trauma, plasma factor XIII levels of at least 25% should be achieved.

<sup>b</sup> In most patients, the survival curve is monophasic and lacks an initial component.

**TABLE 59.9. Replacement Therapy in Hemophilia A and Hemophilia B**

| Disorder                              | Therapeutic Material                | Minor Bleeding (i.e., Uncomplicated Hemarthroses; Hematomas in Noncritical Areas; Hematuria; Dressing Changes; <sup>a</sup> Arthrocentesis; <sup>a</sup> Removal of Sutures and Drains <sup>a</sup> ) |   | Major Bleeding (Hematomas in Critical Locations; Traumatic Injuries; Multiple Tooth Extractions; Major Surgical Procedures) |  |
|---------------------------------------|-------------------------------------|---|---|---|--|
|                                       |                                     | Loading Dose  | Maintenance Dose                          | Loading Dose  | Maintenance Dose   |
| Hemophilia A (factor VIII deficiency) | Cryoprecipitate <sup>b</sup>        | Not required  | 1.25–1.75 bags/10 kg every 12 h for 1–3 d | 3.5 bags/10 kg  | 1.75 bags/10 kg every 8 h for 1–2 d; every 12 h thereafter |
|                                       | Purified factor VIII <sup>c</sup>   | Not required  | 10–15 U/kg every 12 h for 2–4 d           | 30–40 U/kg  | 30–40 U/kg every 12 h                                      |
| Hemophilia B (factor IX deficiency)   | Prothrombin complex <sup>b, c</sup> | 20–30 U/kg  | 15 U/kg every 24 h for 2–4 d              | 40–60 U/kg  | 20–25 U/kg every 24 h                                      |
|                                       | Purified factor IX <sup>c, d</sup>  | 20–30 U/kg  | 15 U/kg every 24 h for 2–4 d              | 60–70 U/kg  | 20–40 U/kg every 24 h                                      |

NOTE: Because weight-based calculations may not correctly predict plasma volumes in bleeding patients, confirmation of the hemostatic level of the coagulation factor being replaced should always be performed for patients with major bleeding indications, with appropriate dosage adjustments performed based on these results.

<sup>a</sup> Single dose of 15 U/kg or equivalent amounts of concentrated material usually are sufficient.

<sup>b</sup> Recommended only if purified factor replacement therapy is not available. Antifibrinolytic therapy should not be used with prothrombin complex concentrates.

<sup>c</sup> Initial *in vivo* recovery of active factor varies somewhat depending on preparation.

<sup>d</sup> Recombinant factor IX may require higher doses.

## Hemostatic Levels

The *hemostatic level* may be defined as the lowest plasma concentration of a given

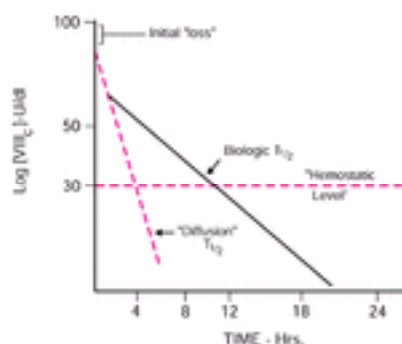
coagulation factor that is required for normal hemostasis ( [Table 59.8](#)). This value was determined by purely empiric means—that is, by measurement of the blood levels of the deficient factor at which bleeding appeared to stop in patients with one of the inherited coagulation disorders during the course of replacement therapy. Such estimates obviously may be inaccurate. In patients with hemophilia A, the hemostatic level of factor VIIIc is approximately 25 to 30 U/dl; in those with hemophilia B, values range from 15 to 30 U/dl. Plasma levels of factor XIII as low as 2 to 3 U/dl are adequate for normal hemostasis. However, for patients with major trauma or those undergoing surgery, higher plasma levels of these coagulation proteins should be achieved (i.e., 100% for factors VIII or IX; 25 to 50% for factor XIII).

### ***In Vivo* Recovery and Survival of Infused Coagulation Factors**

When a coagulation factor is infused intravenously into a recipient deficient in that factor, the levels present in the circulation after intravascular mixing usually are significantly lower than those that would be expected merely from dilution in the recipient's plasma. That this initial *in vivo* recovery of infused coagulation factors ( [Table 59.8](#)) is less than 100% presumably is the result of loss of these proteins out of the intravascular space. The adsorption of coagulation factors by platelets and various cell and vascular surfaces may also be involved. The initial recovery of infused coagulation factors is difficult to quantify and ranges from nearly 100% of factor XI to as low as 30% of factor IX.

After *in vivo* mixing is complete, the activity of most coagulation factors in the plasma declines in a biphasic manner—that is, an initial rapid loss of activity is followed by a more gradual decline ( [Fig. 59.8](#)) ( [457](#)). The first or rapid phase presumably is the result of diffusion into extravascular pools. This diffusion half-life ( [Table 59.8](#)) ranges from minutes for factor VII to several hours for factor VIII. In general, it is the rapidity of this first phase, together with the initial *in vivo* recovery of the particular factor, that determines the necessity for and the size of the preliminary or loading dose of therapeutic material.

The second or slow phase of the survival curve presumably is the result of degradation and reflects the true biologic half-life of the infused factor ( [Table 59.8](#); [Fig. 59.10](#)). This parameter, together with the hemostatic level for the factor of concern, is the main determinant of the frequency of administration and the size of the maintenance dose of therapeutic material. For example, approximately 80% of factor VIII infused is initially recovered in the circulation; its initial (diffusion) and subsequent (biologic) half-lives are approximately 6 and 12 hours, respectively ( [458](#)). Thus, in the treatment of patients with hemophilia A, doses are administered every 8 to 12 hours. In patients with hemophilia B, the initial recovery of factor IX is 50% or less; its initial and subsequent half-lives are approximately 3 and 24 hours, respectively ( [459](#)). Hence, a large loading dose is essential, but only small and infrequent daily maintenance doses are required.



**Figure 59.10.** Biodynamics of factor VIII. A hypothetical survival curve obtained in a

patient with severe hemophilia A after transfusion of sufficient factor VIII to increase the plasma factor VIIIc level to 100 U/dl is shown.  $T_{1/2}$ , half-life.

After a large loading dose or after several courses of therapeutic material have been administered, the survival curves of infused coagulation factors become nearly monophasic, presumably because extravascular spaces and the other mechanisms that remove infused coagulation factors from the circulation are saturated.

## Materials

Before 1960, plasma was the only agent generally available for the treatment of the inherited coagulation disorders. Several concentrated blood products are now available for this purpose, as well as recombinant coagulation proteins. The potency or extent of purification of various preparations of coagulation factors usually is expressed in terms of the ratio of coagulant activity:unit weight of protein in the concentrate to that in plasma. [Table 59.9](#), [Table 59.10](#), [Table 59.11](#) and [Table 59.12](#) summarize therapeutic choices available to treat certain inherited bleeding disorders.

**TABLE 59.11. Comparison of Factor VIII Products**

| Product  | Comments  | Cost/IU |
|--|---|---------|
| Human plasma-derived factor VIII products                                  |   |         |
| Koate-DVI (Bayer)  | —   | \$0.92  |
| Humate-P (Aventis)   | More vWF than monoclonal antibody-purified products           | \$1.00  |
| Alphanate (Alpha Therapeutics)   | Useful in von Willebrand disease                              | \$0.90  |
| Human plasma-derived factor VIII products with immunoaffinity purification |   |         |
| Monarc-M (American Red Cross)  | —   | \$0.93  |
| Hemofil M (Baxter)   | Reduced amounts of vWF  | \$0.98  |
| Monoclante-P (Aventis)   | Reduced amounts of vWF; highly purified source of factor VIII | \$0.95  |
| Recombinant factor VIII products   |   |         |
| Recombinate (Baxter)   | High-purity source of factor VIII <sup>a</sup>                | \$1.30  |
| Helixate FS (Aventis)  | High-purity source of factor VIII                             | \$1.38  |
| Refacto (Wyeth)  | High-purity source of factor VIII                             | \$1.36  |
| Kogenate FS (Bayer)  | High-purity source of factor VIII                             | \$1.41  |
| Porcine factor VIII product  |   |         |
| Hyate:C (Ipsen)  | For patients with human factor VIII inhibitors                | \$2.15  |

vWF, von Willebrand factor.

NOTE: Commercial products used to treat hemophilia A are summarized, including their hospital acquisition cost per international unit (IU) for the University of Utah Health Sciences Center Pharmacy in 2002. Humate-P and Alphanate are also useful in the treatment of von Willebrand disease.

<sup>a</sup> This product contains pasteurized human albumin added as a stabilizer.



**TABLE 59.12. Comparison of Factor IX Products and Recombinant Factor VIIa**

| Product   | Comments  | Cost          |
|---|---|---------------|
| Factor IX complex products  |   |               |
| Konyne-80 Factor IX Complex (Bayer Biol)  | Not indicated for factor VII deficiency. Indicated for factor IX deficiency and factor VIII inhibitor therapy. Thrombotic potential exists. | \$0.50/IU     |
| Proplex T Factor IX Complex (Baxter)  | Indicated for factor VII and factor IX deficiency and factor VIII inhibitor therapy. Thrombotic potential exists.                           | \$0.35/IU     |
| Profilnine SD (Alpha Therapeutics)  | Not indicated for factor VII deficiency. Indicated for factor IX and factor VIII inhibitor therapy. Thrombotic potential exists.            | \$0.75/IU     |
| Bebulin VH (Baxter)   | Thrombotic potential exists.  | \$0.58/IU     |
| Activated factor IX complex products  |   |               |
| Autoplex T (Nabi)   | Thrombotic potential exists.  | \$1.50/IU     |
| Feiba VH (Baxter)   | Thrombotic potential exists.  | \$1.53/IU     |
| Purified factor IX products   |   |               |
| Alpha Nine SD (Alpha Therapeutics)  | Indicated for factor IX deficiency. Low risk of thrombotic potential.   | \$1.10/IU     |
| Mononine (Aventis)  | Indicated for factor IX deficiency. Low risk of thrombotic potential.   | \$1.18/IU     |
| Recombinant factor IX   |   |               |
| BeneFIX (Genetics Institute/Wyeth)  | No exogenous proteins are added.  | \$0.78/IU     |
| Recombinant factor VIIa   |   |               |
| NovoSeven (Novo Nordisk)  | Indicated for inhibitor patients but also used in other hemostatic disorders.   | \$1680/1.2 mg |
| NOTE: Commercial products used to treat hemophilia B are summarized, including their hospital acquisition cost per international unit (IU) or per mg to the University of Utah Health Sciences Center Pharmacy in 2002. |   |               |

**PLASMA** Although most current replacement therapies of coagulation factor deficiencies involve sterile purified concentrates or recombinant proteins, plasma therapy is still important in treating some deficient states such as factor XI deficiency. Fresh frozen plasma is usually preferred for therapeutic purposes. Both the rate of administration and the total dose of plasma administered are limited by the possibility of acute or chronic circulatory overload. The volume expansion resulting from even moderate doses of plasma also limits the blood levels that can be attained. As a consequence, therapy with plasma alone can be expected to increase the levels of a deficient factor no more than 20 U/dl above baseline values. When plasma is the only therapeutic agent available, plasmapheresis may be of adjunctive value ( [460](#) ). A sterile solvent detergent-treated plasma preparation is available ( [461](#) ), but activity of certain coagulation proteases and inhibitors in this product is not equivalent to that of fresh frozen plasma ( [462](#) , [463](#) ).

**PURIFIED OR CONCENTRATED COAGULATION FACTORS**

**Cryoprecipitate** A major advance in the therapy of hemophilia A was the demonstration by Pool et al. that cold insoluble material obtained from plasma contains high concentrations of factor VIII and fibrinogen ( [464](#) ). This cryoprecipitate, which for many



years was discarded during clarification of plasma, is prepared by slowly thawing rapidly frozen plasma at 2° to 4° C, then harvesting the precipitate by centrifugation. Cryoprecipitate prepared from 200 ml of fresh plasma (one unit) contains 50 to 120 units of factor VIII, approximately 250 mg of fibrinogen, and therapeutically useful amounts of factor XIII and vWF that are rich in the high-molecular-weight multimers. Cryoprecipitation provides 7- to 20-fold purification of factor VIII with respect to plasma and can be carried out by means of a closed double-bag system, even in small blood banks without special equipment. With the widespread availability of sterile factor VIII concentrates to treat hemophilia A and vWD, cryoprecipitate is now used primarily to treat hypofibrinogenemia.

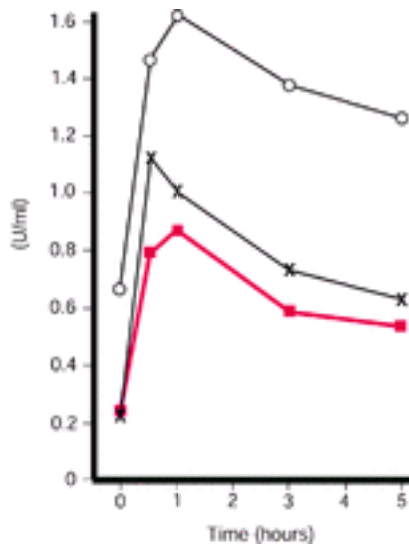
**PURIFIED FACTOR VIII** Among the many methods developed to purify factor VIII, several are suitable for the large-scale production of concentrates of the human protein for therapeutic use. They are sufficiently potent to attain *in vivo* factor VIIIc levels as high as 100 U/dl in hemophilic patients without significant expansion of the plasma volume. Most plasma-derived factor VIII concentrates contain vWF but lack the high-molecular-weight vWF multi-mers found in cryoprecipitate or plasma. Therapeutic doses are usually self-administered by patients. Before the mid-1980s, a considerable risk of viral transmission attended the use of most concentrated preparations because they were prepared from large plasma pools and specific virucidal treatment was not used. The risk of virus transmission has been greatly diminished by serologic testing of the plasma for viruses and by sterilization of the concentrate by solvent detergent treatment or heat sterilization ( 465 ). A high-potency preparation of factor VIII can be obtained by affinity chromatography using monoclonal antibodies ( 466 ). Recombinant factor VIII is also available for clinical use ( 467 ). Although these methods have reduced the risk of transmitting lipid-enveloped viruses [e.g., human immunodeficiency virus (HIV) and hepatitis B and C], transmission with non-lipid-enveloped viruses, such as hepatitis A and parvovirus B19, has been reported with sterilized plasma-derived products ( 468 ). Whether high-purity factor concentrates should be used exclusively is a controversial issue ( 469 ). Although *in vitro* studies suggest that the non-high-purity factor VIII products have immunosuppressive properties, the clinical importance of these studies is uncertain ( 470 ). The significant cost difference between products also enters into this controversy ( 469 ). A report that parvovirus B19 DNA ( 471 ) and the TT virus ( 472 ) are present in certain recombinant factor VIII products (a likely result of the addition of human albumin as a stabilizer) has also contributed to this discussion. Increasing use of recombinant factor products in prophylactic programs and manufacturing shortages of these products have led to limited availability and debate over whether recombinant products should continue to be the product of choice as recommended by hemophilia authorities ( 473 ). Although plasma-derived products are appropriate when recombinant products are not available, the safety data to date favor recommendation to exclusively use recombinant products ( 473 ). [Table 59.11](#) and [Table 59.12](#) summarize information on currently available products used to treat hemophilia A and hemophilia B. A second-generation product, B domain-deleted recombinant factor VIII (Refacto), is available; this product does not contain human albumin ( 474 ). Additionally, a full-length factor VIII product formulated with sucrose does not contain human albumin ( 475 ). One concern with the B domain-deleted product is that laboratory monitoring of patients receiving this product requires use of specific assays ( 88 , 89 ).

**PORCINE FACTOR VIII** Factor VIII purified from porcine plasma is available for treatment of hemophiliacs with high-titer factor VIII inhibitors ( 476 ). This product is antigenic, a drawback that usually limits its use to a single therapeutic course. Mild thrombocytopenia and other adverse reactions may develop in the recipient. Heterologous factor VIII apparently is less reactive with acquired antibodies to factor VIII than is the homologous protein, a property that is advantageous in the treatment of bleeding caused by such antibodies ( [Chapter 60](#) ) ( 476 ).

**PROTHROMBIN COMPLEX CONCENTRATES, FACTOR IX, AND FACTOR VII (VIA)** The

vitamin K-dependent factors (prothrombin; factors VII, IX, and X; and proteins C and S) are avidly absorbed by aluminum hydroxide or barium sulfate and can be readily concentrated by elution therefrom. This simple procedure is the starting point for several methods of preparing therapeutically useful concentrates of these proteins (477) (Table 59.12). Concentrates of vitamin K-dependent coagulation factors contain small but significant amounts of activated coagulation factors that may be thrombogenic when administered in large doses. The thrombogenicity of such concentrates varies from preparation to preparation and from lot to lot and has been variously attributed to thrombin, factor VIIa (478), factor Xa (479), factor IXa (480), and coagulant phospholipids (481). Attention has been directed to the serious and even fatal thromboembolic complications of these products, including disseminated intravascular coagulation (479, 482). Such complications are particularly common in infants and in patients with liver disease (483), as discussed in Chapter 60. The availability of monoclonally purified and recombinant factor IX products has led to decreased use of PCCs in the treatment of hemophilia B (484, 485 and 486). PCCs are now used primarily to treat patients with inhibitors to factor VIII, a condition in which the presence of thrombogenic materials is clinically useful (487). PCCs are also useful in treating deficiencies of prothrombin and factors VII and X. When treating hemophilia B with replacement factor IX products, it should be noted that factor IX distributes to both intravascular and extravascular compartments. Consequently, loading doses required to achieve 100% of the normal plasma factor IX level are usually 1.5 to 2.0 times greater than that calculated from the patient's plasma volume. Thus, when purified factor IX products are used, twice the calculated amount of factor IX should be given for the initial dose. On the other hand, PCCs are thrombogenic, and when these products are used to treat patients with hemophilia B, the dosage should be reduced below that given when the purified products are used. A factor VII concentrate was under investigation in the United States for treatment of patients with inherited factor VII deficiency (356). This material has been used prophylactically for patients with severe factor VII deficiency and for operative coverage in less severely affected patients (356). Recombinant factor VIIa is being used primarily for treatment of bleeding episodes in patients with hemophilia with inhibitors (488) but also in patients with bleeding due to refractory thrombocytopenia, platelet dysfunction, factor VII deficiency (discussed in section Factor VII Deficiency), or severe liver disease (discussed in Chapter 60).

**THERAPEUTIC ADJUNCTS** A congener of vasopressin, DDAVP, was originally developed for the treatment of diabetes insipidus. Its extrarenal actions stimulate vascular endothelial cells to release several proteins, including vWF in amounts sufficient to raise the plasma levels of this protein and associated factor VIII two to five times (Fig. 59.11) (489, 490). This effect is therapeutically useful in most patients with type 1 vWD (489, 491) and some with mild hemophilia A (492), and it is particularly useful because the biohazards of blood products are avoided (493). Excellent responses were obtained in the prevention of bleeding after minor surgical procedures, such as tooth extractions, and in some major surgical procedures (494, 495). It has been noted that young boys with mild to moderate hemophilia A have a lower response rate to DDAVP; the response rate of these patients improves later in life, and nonresponder children are candidates for retesting when they are older (496).



**Figure 59.11.** The response to desmopressin infusion (0.3 µg/kg body weight) in a hemophilic patient. Open circles indicate von Willebrand factor antigen, solid boxes indicate factor VIIIc activity, and crosses indicate factor VIIIc antigen. (From de la Fuente B, Kasper CK, Rickles FR, et al. Response of patients with mild and moderate hemophilia A and von Willebrand disease to treatment with desmopressin. *Ann Intern Med* 1985;103:6–14, with permission.)

The vWF released in response to DDAVP is rich in high-molecular-weight multimers ( 497 ) that increase adhesion and spreading of platelets at injury sites. This effect may explain the therapeutic efficacy of the drug in several disorders of platelet function, including uremia ( 498 ). DDAVP-responsive endothelium requires the presence of V<sub>2</sub> receptors ( 499 ). DDAVP has also been reported to be clinically useful in patients with hemophilia B ( 500 ). Although factor IX levels are minimally increased by DDAVP, the improved PTT values in hemophilia B patients given DDAVP associated with increases in factor VIII and vWF activity probably account for drug efficacy ( 500 ). Another group found DDAVP useful in hemophilia B patients when combined with antifibrinolytic therapy ( 501 ). DDAVP also induces the release of endothelial cell-derived plasminogen activators and has produced exaggerated fibrinolytic phenomena in several cases. For this reason, it is sometimes given with ε-aminocaproic acid (EACA) or other fibrinolytic enzyme inhibitors. DDAVP is a pressor agent and an antidiuretic. Neither effect has proved to be a major problem in its therapeutic use, but clinicians should use caution when treating patients with hypertension or congestive heart failure. Repeated doses of DDAVP may produce progressively diminishing amounts of vWF (tachyphylaxis), presumably because of exhaustion of stored vWF. DDAVP is available for parenteral use or by the nasal spray Stimate ( 502 ). DDAVP can be given parenterally (0.3 µg/kg, up to a maximal dose of 20 to 24 µg) ( 503 ). Physicians should be aware that two DDAVP nasal sprays are available and that only the higher DDAVP concentration nasal spray (Stimate, 1.5 mg/ml) is effective in treating vWD. DDAVP should be used cautiously in older patients with vascular disease because of the potential risk of drug-induced thrombosis ( 503 , 504 ). Increasing use of DDAVP has revealed certain limitations of this hemostatic drug. One report in adult patients indicated that approximately 20% of patients experienced toxicity with DDAVP, including nausea and headache, and symptomatic hyponatremia was seen in approximately 5% of patients ( 505 ). These side effects may be minimized with water restriction. Limitations of DDAVP in the pediatric population have been summarized ( 506 ). Inhibitors of fibrinolysis, such as EACA or tranexamic acid, may diminish bleeding in patients with inherited coagulation disorders, particularly those that arise in the mouth, tongue, tonsils, and pharynx and those associated with operative dental procedures ( 507 , 508 ). These drugs act to protect labile hemostatic plugs from fibrinolytic degradation. The use of

EACA alone has been effective in the treatment of patients with mild hemophilia A (plasma levels of factor VIII >5 U/dl) ( [509](#) ) and those with other mild inherited coagulation disorders such as vWD or factor XI deficiency. Some clinicians have used EACA as an adjunct to single-dose ( [510](#) ) or various other factor replacement regimens. EACA should be administered in oral doses (pills or syrup) of 6 g every 6 hours to adults and 100 mg/kg every 6 hours to children, for 3 to 4 days after tooth extraction. The drug can be given intravenously (1 g/hour) for patients who cannot swallow. Hematuria or abnormal renal function is a contraindication to the use of this drug because of the hazard of intrarenal or ureteral obstruction by blood clots ( [511](#) ). EACA also should not be given to patients with disseminated intravascular coagulation or active hepatitis or patients receiving PCCs, although an EACA mouthwash can be used with these latter drugs ( [508](#) , [512](#) ). These drugs may be teratogenic and should be used with caution in pregnant women.

## MAJOR AND MINOR BLEEDING

General treatment guidelines for patients, including newborns with hemophilia and other bleeding disorders, have been published ( [512](#) , [513](#) and [514](#) ).

For purposes of replacement therapy, the various bleeding manifestations commonly encountered in the inherited coagulation disorders may be divided into major and minor categories. Although this distinction is somewhat artificial, it has proved helpful clinically.

Manifestations falling into the minor category include bleeding associated with uncomplicated hemarthrosis, symptomatic hematomas in noncritical areas, and minor traumatic injuries, as well as such therapeutic procedures as minor dental procedures, arthrocentesis, and dressing changes. Small cuts and scratches, removal of stitches or drains, superficial ecchymoses, and small hematomas may require no replacement therapy.

Major bleeding is by definition life-threatening and includes hematomas in critical locations and bleeding resulting from traumatic injuries, particularly those in which external blood loss is significant. Major bleeding occurs in surgical procedures, including tonsillectomy and the extraction of molar teeth. In the treatment of major bleeding, the *in vivo* levels of the deficient factor should be maintained above the hemostatic level. In bleeding of a particularly critical nature, such as intracranial hemorrhage, or for the prevention of excessive bleeding during neurosurgery, factor levels should be maintained at 100% of normal.

### Hemophilia A Minor Bleeding

DDAVP is effective in the treatment of minor bleeding manifestations in hemophiliacs with baseline factor VIIIc levels greater than 5 U/dl, if patients have been previously demonstrated to respond ( [494](#) , [495](#) ). Side effects are more prominent if the total dose exceeds 24 µg. Both parenteral and intranasal administration produce significant increases in factor VIIIc and vWF ( [515](#) ). Repeated doses of DDAVP at approximately daily intervals may produce useful increments of factor VIII in many patients. At least 24 hours should elapse before repeat administration of the drug. Patients should be tested before surgery for their response to DDAVP by documenting factor VIII levels 30 to 60 minutes after treatment. This ensures that the drug will be effective in appropriate responders. Only small amounts of factor VIII are produced by DDAVP in severely affected hemophiliacs, and the use of this drug in patients with factor VIII levels below 5 U/dl is not recommended, even for minor bleeding manifestations. EACA (6 g orally every 6 hours) or tranexamic acid (25 mg/kg orally every 6 to 8 hours) has been administered

together with DDAVP in an attempt to minimize fibrinolysis ( 508 ). For maximal effectiveness, antifibrinolytic drugs should be given before oral surgical procedures.

Although effective in minor bleeding, plasma or cryoprecipitate is not currently used in the treatment of patients with hemophilia A. Factor VIII concentrates are widely available and are the most useful therapeutic materials. The regimens summarized in [Table 59.9](#) illustrate one approach to treating hemophilia A. For some minor bleeding manifestations, treatment for a minimum of 3 days is required, but in most cases, a single dose of 10 to 15 U/kg of factor VIII usually suffices ( 516 ). In the treatment of minor bleeding, loading doses are not required, and laboratory monitoring of *in vivo* factor VIII levels is unnecessary. The minor bleeding treatment regimens summarized in [Table 59.9](#) typically result in peak factor VIII levels of approximately 30%.

### Hemophilia A Major Bleeding

In the therapy for major bleeding in patients with hemophilia A, an initial loading dose of factor VIII should always be administered, and sufficient factor VIII must be given often enough to ensure that the blood level does not fall below 30 to 50 U/dl for any length of time. Maintenance doses usually are given every 8 to 12 hours. Regimens of continuous infusion of factor VIII are being used with increasing frequency ( 517 ). The administration of 2 U/kg/hour of factor VIII produces a mean factor VIIIc level in the plasma of approximately 50 U/dl and appears to be more cost effective than twice-daily intravenous bolus treatments ( 518 ). Continuous infusion also has the advantage of maintaining a consistent, therapeutic factor level ( 519 ). Cost-savings may approach 30 to 40% ( 520 ). Note that the treatment of postsurgical or major traumatic hemorrhage in patients with mild hemophilia A requires nearly as much therapeutic material as is needed for the severely affected patient. Most authors recommend treatment for 10 to 14 days after major surgical procedures, whereas others administer the full doses indicated in [Table 59.9](#) for 10 days and continue half doses for 4 days.

Determination in the laboratory of the *in vivo* levels of factor VIIIc is highly desirable in the treatment of patients with major hemorrhage. Incidents of unexpected subtherapeutic responses to infused factor VIII have been reported ( 521 ). The peak level of factor VIII 10 to 30 minutes after infusion of therapeutic material should be at least 75 U/dl if the level is not to fall below 25 U/dl on a 12-hour schedule. The use of the PTT to guide factor VIII replacement therapy is not recommended because the results of these tests may be normal at hazardously low levels of factor VIII ( 77 ).

### von Willebrand Disease

In a disease as heterogeneous as vWD, decisions about treatment begin with accurate diagnosis and complete evaluation. Fortunately, in the usual patient with vWD, bleeding manifestations are mild, and replacement therapy is seldom required. Unlike the situation in hemophilia in which there is a close correlation between factor levels and clinical outcome, treatment decisions are more complicated in vWD because it is unclear which measurement (of either vWF, factor VIII, or platelet function) best correlates with the severity of bleeding or clinical outcome ( 99 ). Many experts recommend following the vWF:RCo and factor VIII level ( 522 ). Bleeding times may not normalize, but a normal bleeding time is not required for a satisfactory response, and monitoring of the bleeding time is not recommended ( 523 ). Therapeutic goals include resolution of active bleeding and prevention of excessive bleeding in response to invasive procedures or trauma. The spectrum of therapeutic interventions includes desmopressin (DDAVP) for nonexogenous replacement therapy, blood product or concentrate infusion for transfusion replacement



therapy, and adjunctive therapy with medications that modulate bleeding symptoms by affecting either menstrual pattern or fibrinolysis. Dosing recommendations in vWD are empiric. In the case of a patient with major surgery or trauma, one recommendation is that clinicians attempt to bring the vWF (and factor VIII) level to near 100 U/dl and maintain it above 40 to 50 U/dl for the first 3 to 5 days, after which one recommended goal is to maintain the factor VIII level above 40 U/dl for a total of 7 to 10 days or until healing is completed ( [99](#), [105](#) ). In surgical settings, monitoring of factor levels seems prudent, but monitoring of bleeding time is discouraged, as surgeries have been done successfully in patients with type 3 vWD in the face of only partial bleeding time correction ( [524](#) ).

DDAVP is effective in the treatment of patients with mild forms of type 1 vWD. The dosage, route of administration, and contraindications described in the section [Therapeutic Adjuncts](#) also apply to the use of the drug in vWD. vWF and factor VIII levels generally increase by two- to fourfold over baseline. Concerns regarding tachyphylaxis, hyponatremia, and rare thrombotic complications are similar to those of treating patients with hemophilia A. Note that patients with non-type 1 vWD respond poorly or unpredictably to DDAVP. Type 3 patients have essentially no endogenous vWF synthesis and are DDAVP nonresponsive. In one large series of patients with type 2B vWD, the platelet count fell from an average of 86,000/ $\mu$ l to 60,000/ $\mu$ l after administration of this drug ( [186](#) ). Because thrombocytopenia may worsen after administration of DDAVP to patients with type 2B and the platelet-type form of the disorder, patients with these variants should not be treated routinely with DDAVP ( [99](#) ). However, some authors report good-responder-type 2B vWD patients who received DDAVP ( [525](#) ). Response in type 2A vWD is variable and may be of shorter duration than in type 1 patients due to increased vWF proteolysis. Similarly, factor VIII levels may rise in response to DDAVP in patients with type 2N vWD, but due to the deficient factor VIII stabilizing activity of vWF in this variant, levels of factor VIII then fall at an accelerated rate ( [526](#) ). Because of interindividual variability, a documented therapeutic response to DDAVP should be obtained before surgical prophylaxis with the drug to ensure adequate hemostasis postoperatively. It is recommended that this DDAVP trial be performed at the time of diagnosis of vWD.

Transfusion therapy with plasma-derived products is the therapy of choice in DDAVP-unresponsive patients who require factor support. To treat both the factor VIII deficiency and the defect in primary hemostasis seen in patients with severe vWD, it is generally necessary to give a product with factor VIIIc activity that also contains high-molecular-weight multimers of vWF. The concentration of vWF and factor VIII in fresh frozen plasma is insufficient for appropriate therapy. Cryoprecipitate contains approximately 80 to 100 U/bag, five to ten times the concentration of these factors compared to plasma. Cryoprecipitate has a small residual risk of viral transmission and is not currently suited to viral-inactivation therapy; pathogen-inactivated intermediate-purity factor VIII concentrates with demonstrated preservation of vWF multimers have been the preferred replacement product in the United States and Europe. At the time of this writing, only one commercial product was licensed in the United States for this indication (Humate-P, known as *Haemate-F* in Europe). However, several other commercial products have been used off-label for this indication ( [139](#) ). With its licensure in 1999, vials of Humate-P are now labeled by both its vWF:RCo and factor VIII activities. A Canadian multicenter study confirmed “excellent” or “good” outcome in 97% of patients treated, with a median recovery of 1.23 U/kg per IU/kg infused ( [527](#) ). Similarly, Alphanate was shown to ultimately control all bleeding episodes in one large multicenter trial ( [528](#) ). Alphanate is currently only labeled in factor VIII units, but vWF:RCo has been reported to be approximately 50% lower than the labeled Factor VIII content ( [139](#), [528](#) ). A chromatographically purified vWF concentrate with minimal factor VIII content is under

investigation ( [529](#) ). Very-high-purity plasma-derived factor VIII concentrates and recombinant factor VIII concentrates are essentially devoid of vWF and should not be used in vWD.

Some authors suggest using platelet transfusion in patients with severe vWD who exhibit bleeding despite plasma factor VIII concentrate therapy ( [530](#) ). Thrombocytopenia may be exacerbated by the administration of normal exogenous vWF in the platelet-type pseudo-vWD ( [531](#) ) but not in type 2B vWD. Patients with platelet-type vWD should receive platelet transfusions for significant bleeding or surgery.

With the recent labeling of vWF products such as Humate-P as to both factor VIII activity and vWF:RCo activities, reports of venous thrombosis have appeared in association with therapy ( [532](#) ). This complication may be due to the excessive rise in factor VIII achieved when ristocetin cofactor activity is normalized with these products. Optimal future therapy should provide correction of the vWF defect without increasing factor VIII levels excessively. A recombinant vWF product is under investigation ( [533](#) ).

Adjunctive therapy for vWD patients with menorrhagia usually takes the form of oral contraception or other hormonal intervention ( [99](#) ). Antifibrinolytic therapy and DDAVP have also found a role in control of menorrhagia ( [126](#) ). Failure of medical therapy may require surgical approaches such as endometrial resection ( [534](#) ) or even hysterectomy.

Pregnancy is a special situation for patients with vWD. vWF levels generally improve in patients with type 1 vWD as pregnancy proceeds, but improvement is less likely in type 2A vWD, and thrombocytopenia may actually worsen in patients with type 2B and platelet-type (pseudo) vWD variants. Older literature on this subject suggests a high rate of bleeding at delivery for these patients. More recent information indicates that the patient's factor VIII coagulant activity at delivery predicts the risk of bleeding, with a factor VIII level below 50% of normal at term being associated with excessive bleeding ( [535](#) ). If sufficient factor VIII levels are achieved, aggressive surgical hemostasis and efficient uterine contraction should prevent peripartum bleeding. If sufficient factor VIII levels are not achieved before delivery and the patient is known to respond to DDAVP, this drug can be given to the mother immediately postpartum. If the patient does not respond to DDAVP, then vWF/factor VIII concentrate should be administered peripartum. Finally, vWF levels fall quickly after parturition, and DDAVP or replacement therapy may be useful to prevent late bleeding in patients with vWD.

## Hemophilia B

Most of the comments concerning the replacement therapy of patients with hemophilia A apply to the treatment of those with hemophilia B ( [Table 59.9](#) ). Because of the low initial *in vivo* recovery and the rapid initial disappearance of factor IX from the circulation, loading doses are recommended, even for the treatment of minor bleeding. In patients with hemophilia B, purified factor IX concentrates are recommended for the treatment of major or minor hemorrhage because of the thrombotic potential of PCCs ( [479](#) , [482](#) ). At least two purified factor IX products are available that are not thrombogenic ( [Table 59.12](#) ) ( [485](#) , [536](#) ). Recombinant factor IX is now available for clinical use ( [537](#) , [538](#) ); one disadvantage of recombinant factor IX compared to plasma-derived factor IX is a lower *in vivo* recovery of recombinant factor IX (approximately 30% lower than predicted), perhaps related to different posttranslational modifications of the recombinant protein ( [538](#) ). It appears that higher doses of recombinant factor IX need to be routinely given to achieve therapeutic levels, and monitoring factor IX levels with this product should be routinely

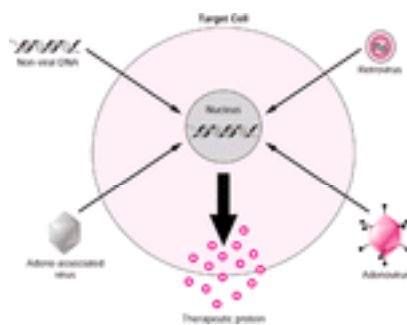


done ( 539 ), especially in young children ( 540 ).

An unusual complication of hemophilia B therapy is anaphylaxis. These patients typically have severe factor IX deficiency with inhibitors and complete gene deletions ( 541 ). These patients can be treated with immune tolerance induction with steroid and antihistamine pretreatment; nonresponders should be treated either with PCCs or recombinant factor VIIa ( Chapter 60 ) ( 542 ).

### Gene Therapy for Hemophilia

Gene therapy for the inherited bleeding disorders is under active investigation ( 543 , 544 ). Viral and nonviral constructs containing genes for factor VIII or factor IX have been used, as well as modified retrovirus, adenovirus, or adeno-associated virus vectors ( Figure 59.12 ). Sustained partial correction of factor IX deficiency was observed in mice ( 545 ) and in a dog model of hemophilia B using gene therapy ( 546 ). Even if gene therapy could only increase endogenous factor VIII or factor IX levels from less than 1% to 1 to 2 U/dl, this incremental change would dramatically alter the clinical course and treatment of patients with severe hemophilia.



**Figure 59.12.** Experimental approaches for gene therapy of hemophilia using viral and nonviral constructs.

A small number of trials have been reported or are in progress in hemophilia A and B patients. Experimental approaches for hemophilia B include *ex vivo* transduction of fibroblasts using a retrovirus ( 543 ) and gene transfer using an adeno-associated virus into muscle ( 547 ). Experimental approaches for hemophilia A include *ex vivo* transfection with a nonviral vector into fibroblasts subsequently implanted into omentum ( 548 ) and retrovirus infusion ( 543 ). In general, low levels of factor expression have been seen in these trials without significant toxicity. A major research focus will be to enhance factor expression to improve the clinical benefit without increasing toxicity.

### Factor VII Deficiency

There is no agreement on the likelihood of excessive bleeding in a patient with factor VII deficiency undergoing surgery, so multiple issues should be considered in the perioperative care of factor VII-deficient patients ( 309 , 549 ). Consider the patient's prior experiences and symptomatology: Patients with a history of hemarthrosis or CNS hemorrhage are at a higher risk for bleeding complications. Consider the area of the body involved: The oral and urogenital tracts are areas of high local fibrinolytic activity. Consider the patient's baseline factor VII level. The minimum factor VII level required for

surgical hemostasis is not known; patients with levels below 3 U/dl are at high risk for bleeding, whereas patients with levels of 15 to 25 U/dl are less likely to develop bleeding complications if associated with surgery. Finally, one should consider the logistics of therapy, as factor VII has a short half-life of approximately 5 to 6 hours ( 344 ). Volume overload is likely if plasma is used as a source for factor replacement, and the safety profile of the various factor VII-containing products varies.

Traditionally, plasma, PCCs, or plasma-derived factor VII concentrate have been used for factor VII replacement therapy ( 550 , 551 ). More recently, recombinant factor VIIa has joined the list of potential sources for factor replacement therapy ( 552 ). For patients treated with plasma, a loading dose of 15 to 20 ml/kg, followed by 4 to 6 ml/kg every 6 hours for 7 to 10 days, has been recommended. Care should be exercised to avoid volume overload; plasma exchange therapy has been used in some patients ( 553 ). PCCs have been used, but they carry some thrombotic risk, which may be associated with the generation of unnecessarily high levels of other activated vitamin K-dependent coagulation proteins. This is especially a problem with extended PCC use. A survey of several PCC products revealed that one PCC (Proplex T) was particularly rich in factor VII content ( 554 ). Proplex T (Baxter Healthcare) is viral-attenuated through dry-heat processing and labeled to indicate the factor VII content. Recovery studies indicate that an administered dose of 1 IU/kg raises the patient's plasma factor level by approximately 2 U/dl. If available, the use of further purified factor VII concentrate might decrease the thrombotic risk associated with the use of less-specific PCC. A heat-treated intermediate-purity factor VII concentrate (manufactured by Immuno A.G.) has been used for treatment of acute bleeds, as perioperative prophylaxis, and for prevention of recurrent CNS hemorrhage. Factor VII levels rose approximately 2.33 U/dl for each IU/kg infused, and the factor VII half-life was approximately 6 hours. Despite the short half-life of factor VII, infusions as infrequent as once/week were successful in preventing recurrent intracranial bleeding ( 356 ). For replacement therapy in a surgical setting, factor level monitoring is recommended to ensure that perioperative factor levels are above 25 U/dl.

Although initially developed and licensed for the treatment of hemophilia patients with inhibitors, recombinant human activated factor VII (rFVIIa) is clearly effective in the treatment of patients with factor VII deficiency ( 549 , 555 , 556 ). In a pilot study of patients with hemarthrosis or in need of surgery, all 17 patients were judged to have achieved an excellent response with dosing at approximately 25 µg/kg (calculated to normalize the PT 15 minutes after infusion) ( 556 ). Further reports of more than 40 patients with hereditary factor VII deficiency indicate successful treatment for bleeding episodes or surgery. In general, doses of between 15 to 30 µg/kg of rFVIIa were administered at intervals of 4 to 6 hours in these reports ( 549 , 552 , 557 , 558 ). The half-life of recombinant factor VIIa is between 2.5 and 3.0 hours, and the roles for continuous factor infusion and laboratory monitoring remain to be defined.

### **Factor XIII Deficiency**

Therapy for the congenital deficiency of factor XIII is based on the principle that only a small quantity of factor XIII must be present in human plasma to promote normal hemostasis. The long half-life of factor XIII [estimated between 9 and 19 days in the literature ( 559 )] makes prophylactic therapy both practical and highly advisable given the high frequency of intracranial hemorrhage ( 293 , 300 ). Factor concentrates have been successfully used to prevent factor XIII-associated bleeding, and these remain the treatment of choice. Pasteurized factor XIII concentrate that contained only the A subunit prepared from human placenta ( 560 ) has been replaced by a plasma-derived

preparation that contains both the A and B subunit ( [559](#), [561](#) ). Two preparations in use are Fibrogammin-P (manufactured by Aventis Behring), which is licensed in many countries (but not the United States or Canada), and a factor XIII preparation from Bio Products Laboratory that is only available in United Kingdom. Kinetic studies with Fibrogammin-P indicate a mean recovery of 65% and a plasma half-life of approximately 9 days ( [561](#) ). In the United States, Fibrogammin-P is obtained by compassionate release under a U.S. Food and Drug Administration investigational new drug license (the investigational new drug license was held by Dr. Diane Nugent at the time of this writing). Recommended dosing for factor XIII concentrate is 10 to 20 U/kg of body weight every 4 to 6 weeks for prophylaxis against unprovoked bleeding. Prophylactic therapy of affected patients undergoing surgery may actually require more intensive replacement therapy. If concentrates are unavailable, patients are typically given either fresh frozen plasma or cryoprecipitate ( [298](#), [299](#), [562](#) ). The typical plasma dose is 2 to 3 ml/kg of body weight, every 4 to 6 weeks. Cryoprecipitate at a dose of 1 bag/10 to 20 kg of body weight every 3 to 4 weeks is an alternative therapy that has the advantage of requiring transfusion of a smaller volume. It is recommended that factor XIII levels be kept between 25 and 50% of normal to achieve normal hemostasis after major trauma in these patients; doses of concentrate recommended are 35 U/kg preoperatively, followed by 10 U/kg/day for 5 more days. Affected patients with a history of spontaneous abortions can complete a normal pregnancy when they are managed with prophylactic fresh frozen plasma or factor XIII concentrates every 21 days ( [563](#), [564](#) ).

In the acquired deficiency states, more than 50% of the patients need aggressive therapy. The most useful therapy for patients who have acquired inhibitors to factor XIII remains exchange plasmapheresis with or without immunosuppression with cytotoxic drugs. In addition, infusions of platelets can be given with occasional success because platelets contain large amounts of factor XIII. Alternatively, replacement therapy with a factor XIII concentrate can be considered.

### Miscellaneous Disorders

Therapeutic regimens recommended for the treatment of patients with any of the less common inherited coagulation disorders are summarized in [Table 59.10](#). Patients with factor XI deficiency usually respond well to fresh or fresh frozen plasma. A solvent detergent plasma preparation has been developed ( [565](#) ) and may be the desired therapy not only for factor XI deficiency, but also for other factor deficiencies in which sterile concentrates are not available. However, some of these products have been shown to be thrombogenic in early clinical studies ( [566](#) ), and their clinical use may be limited by this toxicity.

The management of major bleeding caused by deficiencies of factor X and prothrombin has been facilitated by the availability of PCCs. However, the thrombogenicity of these products may be a serious problem ( [479](#), [482](#) ). Cryoprecipitate is also used in replacement therapy for afibrinogenemia, hypofibrinogenemia, and dysfibrinogenemia. When a sterile, nonthrombogenic fibrinogen concentrate becomes routinely available, it should replace cryoprecipitate for treating these latter disorders.

## SPECIAL ASPECTS OF TREATMENT

### Hemarthrosis

All patients with hemarthrosis should receive adequate replacement therapy because only in this manner can the permanent disability resulting from repeated bleeding into the

joints be minimized. Pain usually is relieved promptly and is a reliable index of the therapeutic response. Supportive therapy includes immobilization and the administration of analgesics.

Arthrocentesis usually is unnecessary, but it may be of significant benefit when the joint is severely distended or when resolution of the hemarthrosis is delayed despite adequate replacement therapy ( [567](#) ). Large volumes of blood seldom can be aspirated, but even a small volume may relieve symptoms. If performed, arthrocentesis should be done immediately after the administration of a covering dose of factor VIII.

Early but careful physiotherapy aimed at restoring the full range of motion of the affected joint should be instituted as soon as the acute stage of hemarthrosis has resolved. More energetic physiotherapeutic techniques should be carried out only in conjunction with an adequate course of replacement therapy. Various orthopedic devices (orthotics), such as braces and removable bivalve plaster casts, which provide additional support for chronically injured joints, have proved useful in reducing the frequency of recurrent hemarthrosis, particularly in the knee and ankle joints ( [568](#) ). For pain management of hemophilic arthropathy, nonsteroidal antiinflammatory agents may be helpful ( [569](#) ). In particular, salsalate (Disalcid) or choline magnesium trisalicylate (Trilisate) or the newer cyclooxygenase-2 inhibitors may be useful in patients with bleeding disorders because these drugs have antiinflammatory activity but do not impair platelet function. Daily or alternate-day prophylactic therapy with factor concentrates may prevent or significantly delay progression of hemophilic arthropathy (see the section [Home Treatment Programs](#) ).

Many reconstructive surgical procedures are available to improve the function of chronically damaged joints ( [570](#) , [571](#) and [572](#) ). Favorable results have been reported with total knee arthroplasty in several series ( [571](#) ). Long-term follow-up (>5 years) indicates adequately functioning prostheses and persistent pain relief in most patients. Synovectomy is effective in reducing the frequency of hemarthrosis that cannot be controlled by replacement therapy ( [573](#) ). Radioisotopic synovectomy is also effective therapy for hemophilic arthropathy ( [574](#) ). A review of the literature on radioisotopic synovectomy indicates that approximately 80% of patients benefit from the procedure ( [575](#) ).

## Hemophilic Cysts

This serious complication most commonly develops in patients with severe hemophilia A or B. Also known as *hemophilic pseudotumors*, such cysts are gradually expanding blood-filled loculations that apparently originate from hemorrhages into confined subperiosteal, tendinous, or fascial spaces ( [Fig. 59.13](#) ). The osmotic pressure created by breakdown products of blood in such confined spaces may produce further influx of fluid; this, together with recurrent bleeding, explains the progressive increase in the size of the cyst and its ability to erode contiguous structures. Such cysts most commonly develop in the thigh and may destroy bone as well as the soft tissues as they increase in size. These lesions are more readily prevented than treated. Although long-term replacement therapy combined with x-ray treatment has been successful in a few cases ( [576](#) ), hemophilic pseudocysts may require radical surgical procedures such as extensive resections or amputations. Even with optimal supportive therapy, these procedures often are unsuccessful and are often complicated by infection. A recent review has summarized surgical and nonsurgical approaches for pseudotumors ( [577](#) ). The modern use of home prophylaxis has made pseudo-tumors an unusual complication of hemophilia at this time.



**Figure 59.13.** Pseudotumor and destruction of the ilium in a patient with hemophilia B. (From Silber R, Christensen WR. Pseudotumor of hemophilia in a patient with PTC deficiency. *Blood* 1959;14:584–590, with permission.)

### Intracranial Bleeding

Despite the widespread use of prophylaxis programs, hemorrhage, including intracranial hemorrhage, remains a leading cause of death among hemophiliacs ( [578](#)). A hemophilia A mortality survey for the years 1995 to 1998 found that hemorrhage was the listed cause of death for 22% of hemophilia A patients who died during that time period ( [11](#)).

Approximately 50% of cases are associated with head injury ( [579](#)); the etiology is not apparent in 38% of cases (spontaneous cases) ( [580](#)). Bleeding may be subdural, epidural, or intracerebral. Subarachnoid bleeding occurs least commonly, but it carries the best prognosis. Hemorrhage also may develop in the spinal cord or spinal meninges. In cases associated with head trauma, the presence of a lucid interval and the absence of localizing neurologic signs at the time of presentation are commonly seen ( [580](#)).

Significant head injury must be treated early and intensively in patients with inherited coagulation disorders. Those with hemophilia A and B should immediately receive sufficient concentrate to raise the plasma level of deficient factor to 100 U/dl. Samples for essential coagulation studies should be drawn before administration of replacement therapy, but treatment should not be delayed while waiting for results of these studies. Radiologic procedures, such as computed tomography scanning, can be done while the therapeutic material is administered. If performed expertly, lumbar puncture usually can be carried out without serious risk, but many clinicians prefer to wait until replacement therapy has been given. In one series, replacement therapy given within 6 hours of head injury prevented any intracranial bleeding ( [581](#)). Computed tomography scanning has proved particularly valuable in locating and monitoring the progression or resolution of bleeding ( [582](#)).

In cases involving major cranial trauma, if neurologic signs or symptoms develop, or if intracranial bleeding is confirmed radiologically or otherwise, the administration of factor VIII or factor IX concentrates should continue on a schedule in doses sufficient to keep the nadir levels of the deficient factor above 30 U/dl. Treatment should be maintained for 10 to 14 days ( [580](#)). Before the widespread use of factor VIII concentrates, the mortality rate after intracranial bleeding averaged 70% ( [579](#)). In a more recent series, the overall mortality rate was 34%, even with optimal replacement therapy ( [581](#), [583](#)). Because of these risks, patients with hemophilia should always have ready access to factor concentrates, even those with mild disease.



## Acquired Immunodeficiency Syndrome

Acquired immunodeficiency syndrome (AIDS) was first recognized in 1978 and was found to be transmitted in blood products thereafter ( 584 ). A particularly high degree of viral contamination was found in concentrated preparations of factor VIII and IX. Such therapeutic materials are prepared by pooling the plasma of multiple donors so that the recipient receives hundreds to thousands of donor exposures with each therapeutic dose. Predictably, this practice produced rapid and widespread dissemination of HIV in the hemophilic population. Serologic evidence of AIDS is most common in severe hemophiliacs, as distinguished from mildly affected patients. In the 1980s, more than 90% of patients requiring extensive replacement therapy developed positive results of screening tests for HIV antibody and, ultimately, full-blown AIDS. The advent of sterile concentrates, together with rigid donor testing instituted in 1985, as well as the availability of recombinant products, has greatly diminished the risk of viral transmission. Many seropositive patients remain who do not yet have the diagnosis of AIDS but who constitute a pool of patients at high risk.

Cases of AIDS in association with hemophilia B are less common, probably because of the rarity of the disorder ( 585 ). Sterilization measures for hemophilia products have been summarized ( 465 ). A retrospective analysis of hemophilia mortality between 1900 and 1990 indicates that although survival in this population improved after widespread use of factor concentrates between 1971 and 1980 (median life expectancy of 68 years), median life expectancy in the next decade (1981 to 1990) declined to 49 years ( 586 ). This increase in relative mortality in hemophilia patients was attributed primarily to AIDS ( 587 ). It is likely that in the absence of viral infection, the life expectancy of patients with hemophilia would be similar to that of the general male population. The most recent mortality analysis for hemophilia A patients in the United States found a 41% decrease in HIV-related deaths; this improvement was attributed to increased use of antiviral therapy ( 588 ). Protease inhibitor therapy of HIV infection can be associated with an increased incidence of bleeding ( 589 , 590 ).

## Thrombocytopenia

Mild to moderate thrombocytopenia is not uncommon in hemophiliacs who receive large amounts of factor VIII concentrates ( 591 ). Most of these patients have positive tests for HIV, and their clinical findings are consistent with AIDS-related complex. The clinical features resemble the idiopathic thrombocytopenic purpura syndrome. Differences were noted between the serologic patterns in hemophiliacs, patients with idiopathic thrombocytopenic purpura, and drug addicts and homosexual men ( 590 , 592 ). Because of the desire to avoid steroid therapy or splenectomy in this immunocompromised population, immune thrombocytopenia persisting after optimal antiviral therapy has been treated with intravenous immunoglobulin G or anti-Rh(D) ( 593 ).

## Hepatitis

In the United States mortality survey of hemophilia A patients between 1995 and 1998, liver disease was listed as a cause of death in 15% of patients ( 588 ). As many as 75% of hemophiliacs have abnormalities of liver function that may persist for years, even though clinical evidence of hepatic dysfunction is minimal ( 594 ). Liver biopsies have confirmed the presence of chronic active hepatitis in most patients ( 595 ), and postnecrotic cirrhosis may occur in some cases. The disorder is usually the result of persistent infection with

the hepatitis C virus ( [596](#) ). There is evidence that other viruses may be responsible in some patients ( [597](#) ). A prospective study of United States hemophiliacs found that 88% were infected with hepatitis C and that 66% of the hepatitis C–infected hemophiliacs also had HIV infection ( [598](#) ). Coinfection was associated with a five- to sixfold increase in end-stage liver disease ( [598](#) ). Modern sterilization methods appear to render factor concentrates virus-free, especially the lipid-enveloped viruses. Patients who are seronegative for the hepatitis A and B viruses should receive immunizations for these viruses. However, standard solvent detergent-inactivated products may still transmit non-lipid-enveloped viruses such as parvovirus ( [471](#) ), hepatitis A ( [599](#) ), and other viruses ( [600](#) ). An unresolved issue is the transmission potential of the agent causing Creutzfeldt–Jakob disease. The concern about transmission of human viruses by products derived from human plasma has led many clinicians and patients to use recombinant factor products exclusively.

### **Antibodies to Coagulation Factors**

Many hemophiliacs develop antibodies (inhibitors) to factor VIII. This complication is less common in patients with hemophilia B and other inherited coagulation disorders. Such antibodies may seriously complicate the treatment of these patients ( [Chapter 60](#) ).

### **Home Treatment Programs**

In general, replacement therapy of hemarthrosis is more effective, and subsequent joint damage is minimized if treatment is begun immediately after the onset of symptoms. The availability of factor VIII concentrates that are stable in home refrigerators led to the development of various early home care programs ( [601](#) ). Parents and patients are trained to administer the material at the first sign of bleeding. Such programs have resulted in decreased bleeding episodes and improved preservation of joint function ( [602](#) , [603](#) ). Typical prophylactic regimens are 25 to 40 U/kg factor VIII three times/week for hemophilia A, and 25 to 40 U/kg factor IX twice/week for hemophilia B ( [603](#) ). Such therapy usually maintains the trough factor level at or above 1% of normal. A 30-year follow-up report confirms the efficacy of prophylaxis ( [604](#) ). An economic analysis of prophylaxis found that although higher costs were associated with prophylaxis programs, the approach was justified on medical grounds ( [605](#) ). It is recommended that patients begin prophylaxis soon after the first joint bleed ( [606](#) ).

### **Dental Care**

Special attention should be given to preventive dental care in patients with coagulation disorders, so as to minimize the complications, expense, and hazards of operative dental procedures. The extraction of even a single tooth may require replacement therapy. Multiple extractions may save time and expense but create a major bleeding hazard. Acrylic splints, orthodontic rubber bands, and other specialized dental techniques reduce the chance of serious postoperative bleeding. The suturing of bleeding tooth sockets after extractions, particularly of the third molar, should be avoided because it may lead to extension of bleeding into the neck. Mandibular block anesthesia produces similar complications in some patients but appears to be safe if performed expertly ( [509](#) , [510](#) ). Most authorities recommend that dental procedures in patients with inherited coagulation disorders be carried out under cover of replacement therapy and EACA. Probably the safest practice is to regard tooth extractions, particularly of molar or multiple contiguous teeth, as a major bleeding hazard, although only 2 to 3 days of maintenance therapy



usually are needed ( [509](#) , [510](#) ).

## REFERENCES

1. Ratnoff OD. The molecular basis of hereditary clotting disorders. In: Spaet TH, ed. Progress in hemostasis and thrombosis, vol 1. New York: Grune & Stratton, 1972:39–74.
2. Lawn RM, Vehar GA. The molecular genetics of hemophilia. *Sci Am* 1986;254:48–54.
3. Rosner F. Hemophilia in the Talmud and Rabbinic writings. *Ann Intern Med* 1969;70:833–837.
4. Ingram GIC. The history of haemophilia. *J Clin Pathol* 1976;29:469–479.
5. Hoyer LW, Breckenridge RT. Immunologic studies of antihemophilic factor (AHF, factor VIII). *Blood* 1968;32:962–971.
6. Hoyer LW. Immunologic studies of antihemophilic factor (AHF, factor VIII). *Blood* 1972;39:481–489.
7. Hoyer LW. Immunologic properties of antihemophilic factor. *Prog Hematol* 1973;8:191–221.
8. Sixma JJ, van den Berg A. The haemostatic plug in haemophilia A: a morphological study of haemostatic plug formation in bleeding time skin wounds of patients with severe haemophilia A. *Br J Haematol* 1984;58:741–753.
9. Hoyer LW. Hemophilia A. *N Engl J Med* 1994;330:38–47.
10. Pachman DJ. Hemophilia in Negroes. *J Pediatr* 1937;10:809–816.
11. Soucie JM, Evatt B, Jackson D, and the Hemophilia Surveillance System Project Investigators. Occurrence of hemophilia in the United States. *Am J Hematol* 1998;59:288–294.
12. Kerr CB, Preston AE, Barr A, Biggs R. Further studies on the inheritance of factor VIII. *Br J Haematol* 1966;12:212–233.
13. Davies SH, Gavin J, Goldsmith KLG, et al. The linkage relations of hemophilia A and hemophilia B (Christmas disease) to the Xg blood group system. *Am J Hum Genet* 1963;15:481–492.
14. Graham JB. Genetic control of factor VIII. *Lancet* 1980;1:340–342.
15. Pitney WR, Arnold BJ. Plasma antihaemophilic factor (AHF) concentrations in families of patients with haemorrhagic states. *Br J Haematol* 1959;5:184–193.
16. Quick AJ, Conway JP. Hemophilia in twins. *Am J Med* 1949;7:841–843.
17. Nichols WC, Amano K, Cacheris PM, et al. Moderation of hemophilia A phenotype by the factor V R506Q mutation. *Blood* 1996;88:1183–1187.
18. Ettingshausen CE, Halimeh S, Kurnik K, et al. Symptomatic onset of severe hemophilia A in childhood is dependent on the presence of prothrombotic risk factors. *Thromb Haemost* 2001;218–220.
19. Barrai I, Cann HM, Cavilli-Sforza LL, de Nicola P. The effect of parental age on rates of mutation for hemophilia and evidence for differing mutation rates for hemophilia A and B. *Am J Hum Genet* 1968;20:175–196.
20. Lawn RM. The molecular genetics of hemophilia: blood clotting factors VIII and IX. *Cell* 1985;42:405–406.
21. Biggs R, MacFarlane RG. Haemophilia and related conditions: a survey of 187 cases. *Br J Haematol* 1958;4:1–27.
22. Gitschier J, Wood WI, Goralka TM, et al. Characterization of the human factor VIII gene. *Nature*

1984;312:326–330; 1985;315:427–430.

23. Antonarakis SE, Kazazian HH, Tuddenham EGD. Molecular etiology of factor VIII. Deficiency in hemophilia A. *Hum Mutat* 1995;5:1–22.
24. Wacey AI, Kemball–Cook G, Kazazian HH, et al. The hemophilia A mutation search test and resource site: home page of the factor VIII mutation database. *Nucl Acids Res* 1996;24:100–102.
25. Antonarakis SE. Molecular genetics of coagulation factor VIII gene and hemophilia A. *Haemophilia* 1998;4[Suppl 2]:1–11.
26. Antonarakis SE, Kazazian HH, Gitschier J, et al. Molecular etiology of factor VIII deficiency in hemophilia A. In: Aledort LM, et al., eds. *Inhibitors to coagulation factors*. New York: Plenum Press, 1995:19–34.
27. Antonarakis SE, Rossiter JP, Young M, et al. Factor VIII gene inversions in severe hemophilia A: results of an international consortium study. *Blood* 1995;86:2206–2212.
28. Bagnall RD, Waseem N, Green PM, Gianelli F. Recurrent inversion breaking intron I of the factor VIII gene is a frequent cause of severe hemophilia A. *Blood* 2002;99:168–174.
29. Amano K, Sarkar R, Pemberton S, et al. The molecular basis for cross–reacting material–positive hemophilia A due to missense mutations within the A2–domain of factor VIII. *Blood* 1998;91:538–548.
30. Vidal F, Farssac E, Tussel J, et al. First molecular characterization of an unequal homologous Alu–mediated recombination event responsible for hemophilia. *Thromb Haemost* 2002;88:12–16.
31. Oldenburg J. Mutation profiling in haemophilia A. *Thromb Haemost* 2001;85:577–579.
32. Klopp N, Oldenburg J, Uen C, et al. 11 hemophilia A patients without mutations in the factor VIII encoding gene. *Thromb Haemost* 2002;88:357–360.
33. Vidal F, Farssac E, Altisent C, et al. Rapid hemophilia A molecular diagnosis by a simple DNA sequencing procedure: identification of 14 novel mutations. *Thromb Haemost* 2001;85:580–583.
34. Graham JB, Barrow ES, Roberts HR, et al. Dominant inheritance of hemophilia A in three generations of women. *Blood* 1975;46:175–188.
35. Eyster ME, Ladda RL, Bowman HS. Carriers with excessively low factor VIII procoagulant activity (VIII AHF): a study of two unrelated families with mild hemophilia A. *Blood* 1977;49:607–618.
36. Nishiro M, Girma JP, Rothschild C, et al. New variant of von Willebrand disease with defective binding to factor VIII. *Blood* 1989;74:1591–1599.
37. Mulder E, Mochtar IA, van Creveld S, Cardozo EBL. Factor VIII activity in carriers of haemophilia A. *Br J Haematol* 1965;11:206–209.
38. Rapaport SI, Patch MJ, Moore FJ. Antihemophilic globulin levels in carriers of hemophilia A. *J Clin Invest* 1960;39:1619–1625.
39. Bennett B, Ratnoff OD. Changes in antihemophilic factor (AHF, factor VIII) procoagulant activity and AHF–like antigen in normal pregnancy, and following exercise and pneumoencephalography. *J Lab Clin Med* 1972;80:256–263.
40. Jones PK, Ratnoff OD. Sources of variability in antihemophilic factor (factor VIII) procoagulant titers and precipitating antigen levels among obligate carriers of classic hemophilia. *Blood* 1981;57:928–932.
41. Graham JB, Rizza CR, Chediak J, et al. Carrier detection in hemophilia A: a cooperative international study. I. The carrier phenotype. *Blood* 1986;67:1554–1559.
42. Blann AD, Daly RJ, Amiral J. The influence of age, gender and ABO group on soluble endothelial cell markers and adhesion molecules. *Br J Haematol* 1996;92:498–500.

43. Ratnoff OD, Jones PK. The laboratory diagnosis of the carrier state for classic hemophilia. *Ann Intern Med* 1977;86:521–528.
44. Seligsohn U, Zivelin A, Perez C, Modan M. Detection of haemophilia A carriers by replicate factor VIII activity and factor VIII antigenicity determinations. *Br J Haematol* 1979;42:433–439.
45. Fishman DJ, Jones PK, Menitove JE, et al. Detection of the carrier state for classic hemophilia using an enzyme-linked immunosorbent assay (ELISA). *Blood* 1982;59:1163–1168.
46. Klein HG, Aledort LM, Bouma BN, et al. A cooperative study for the detection of the carrier state of classic hemophilia. *N Engl J Med* 1977;296:959–962.
47. Göbel U, von Kries R, Jurgens H, van Voss H. Problems in the detection of carriers of hemophilia A: the influence of stress and thrombin. *Blut* 1978;37:37–41.
48. Green PP, Mannucci PM, Briet E, et al. Carrier detection in hemophilia A: a cooperative international study. II. The efficacy of a universal discriminant. *Blood* 1986;67:1560–1567.
49. Lillicrap DP, White BN, Holden JJA, Giles AR. Carrier detection in the hemophilias. *Am J Hematol* 1987;26:285–296.
50. Ratnoff OD, Jones PK. Diagnosis of the carrier state in hemophilia. *Am J Hematol* 1988;28:132.
51. Peake I. Molecular genetics and counseling in haemophilia. *Thromb Haemost* 1995;74:40–44.
52. Ljung RCR. Prenatal diagnosis of haemophilia. *Haemophilia* 1999;5:84–87.
53. Miller R. Counseling about diagnosis and inheritance of genetic bleeding disorders: haemophilia A and B. *Haemophilia* 1999;5:77–83.
54. De La Chapelle A, Ikkala E, Nevanlinna HR. Haemophilia in a girl. *Lancet* 1961;2:578–580.
55. Gilchrist GS, Hammond D, Melnyk J. Hemophilia A in a phenotypically normal female with XX/XO mosaicism. *N Engl J Med* 1965;273:1402–1406.
56. Ulutin ON, Muftuoglu U, Palamar S. Haemophilia A in a girl with female sex-chromatin pattern. *Thromb Haemost* 1965;14:65–73.
57. Merskey C. The occurrence of haemophilia in the human female. *QJM* 1951;20:299–312.
58. Joist JH, Bouhasin JD, Roodman S. Classic hemophilia A in a female. *Acta Haematol (Basel)* 1977;58:94–102.
59. Nilsson IM, Bergman S, Reitalu J, Waldenström J. Haemophilia A in a “girl” with male sex-chromatin pattern. *Lancet* 1959;2:264–266.
60. Mori PG, Pasino M, Vadala CR, et al. Haemophilia A in a 46.X,i(Xq) female. *Br J Haematol* 1979;43:143–147.
61. Samama M, Perrotez C, Houissa R, et al. Hémophilie A féminine avec délétion d’une partie du bras long d’un chromosome X. *Pathol Biol (Paris)* 1977;25:10–17.
62. Mannucci PM, Tuddenham EGD. The hemophilias—from royal genes to gene therapy. *N Engl J Med* 2001;344:1733–1779.
63. White GC, Rosendaal F, Aledort LM, et al. Definitions in hemophilia. *Thromb Haemost* 2001;85:560.
64. Graham JB, McLendon WW, Brinkhous KM. Mild hemophilia: an allelic form of the disease. *Am J Med Sci* 1953;225:46–53.
65. Roosendaal G, Vianen ME, Wenting MJG, et al. Iron deposits and catabolic properties of synovial

- tissue from patients with haemophilia. *J Bone Joint Surg* 1998;80(B):450–545.
66. Gilbert MS. Musculoskeletal manifestations of hemophilia. *Mt Sinai J Med* 1977;44:339–358.
  67. Arnold WD, Hilgartner MW. Hemophilic arthropathy: current concepts of pathogenesis and management. *J Bone Joint Surg* 1977;59(A):287–305.
  68. Pettersson H, Ahlberg A, Nillson IM. A radiologic classification of hemophilic arthropathy. *Clin Orthop* 1980;149:153–159.
  69. Soler R, Lopez-Fernandez F, Rodriguez E, Marini M. Hemophilic arthropathy. A scoring system for magnetic resonance imaging. *Eur Radiol* 2002;12:836–843.
  70. Leatherdale RAL. Respiratory obstruction in haemophilic patients. *BMJ* 1960;1:1316–1320.
  71. Jones JJ, Kitchens CS. Spontaneous intra-abdominal hemorrhage in hemophilia. *Arch Intern Med* 1984;144:297–300.
  72. Prentice CRM, Lindsay RM, Barr RD, et al. Renal complications in haemophilia and Christmas disease. *QJM* 1971;40:47–61.
  73. Baehner RL, Strauss HS. Hemophilia in the first year of life. *N Engl J Med* 1966;275:524–528.
  74. Goodnough LT, Saito H, Ratnoff OD. Thrombosis or myocardial infarction in congenital clotting factor abnormalities and chronic thrombocytopenias: a report of 21 patients and a review of 50 previously reported cases. *Medicine* 1983;62:248–255.
  75. Dalldorf FG, Taylor RE, Blatt PM. Arteriosclerosis in severe hemophilia. *Arch Pathol Lab Med* 1981;105:652–654.
  76. Sramek A, Reiber JHC, Gerrits WBJ, Rosendaal FR. Decreased coagulability has no clinically relevant effect on atherogenesis. *Circulation* 2001;104:762–767.
  77. Martin BA, Branch DW, Rodgers GM. The preparation of a sensitive partial thromboplastin reagent from bovine brain. *Blood Coagul Fibrinolysis* 1992;3:287–294.
  78. Kekwick RA, Walton PL. An assay for antihaemophilic factor (factor VIII) with some considerations affecting the establishment of a standard reference preparation. *Br J Haematol* 1964;10:299–313.
  79. Margolis J. An improved procedure for accurate assays of factor VIII. *Pathology* 1979;11:149–159.
  80. Vermynen C, Verstraete M. A simple method for the assay of factor VIII, using 20 microliters of capillary blood. *Br J Haematol* 1968;14:241–245.
  81. Essien EM, Ingram GIC. Diagnosis of hemophilia: use of an artificial factor-VIII-deficient human plasma system. *J Clin Pathol* 1967;20:620–623.
  82. Kirkwood TBL, Barrowcliffe TW. Discrepancy between one-stage and two-stage assay of factor VIII:C. *Br J Haematol* 1978;40:333–338.
  83. Blombäck M, Kjellman H, Allain JP, et al. On the unreliability of one-stage factor VIII:c clotting assays after infusion of factor VIII concentrates. *Scand J Clin Lab Invest* 1987;47:561–566.
  84. Barrowcliffe TW, Kirkwood TBL. An international collaborative assay of factor VIII clotting activity. *Thromb Haemost* 1978;40:260–271.
  85. Kocoshis TA, Triplett DA. CAP survey results for factor VIII assays (1977–1978). *Am J Clin Pathol* 1979;72:346–351.
  86. Firshein SI, Hoyer LW, Lazarchick J, et al. Prenatal diagnosis of classic hemophilia. *N Engl J Med* 1979;300:937–941.
  87. Mibashan RS, Rodeck CH, Thumpston JK, et al. Plasma assay of fetal factors VIIIc and IX for prenatal

diagnosis of haemophilia. *Lancet* 1979;1:1309–1311.

88. Hanna W, Zimmerman CE. Lack of adequate bleed prevention and FVIII activity recovery with Refacto®: a series of case studies in hemophilia A patients. *Blood* 2001;98:531a.

89. Mikaelsson M, Oswaldsson U, Sandberg H. Influence of phospholipids on the assessment of factor VIII activity. *Haemophilia* 1998;4:646–650.

90. Barrowcliffe TW, Raut S, Sands D, Hubbard AR. Coagulation and chromogenic assays of factor VIII activity: general aspects, standardization, and recommendations. *Semin Thromb Hemost* 2002;28:247–256.

91. Hellstern P, Miyashita C, Köhler M, et al. Measurement of factor VIII procoagulant antigen in normal subjects and in hemophilia A patients by an immunoradiometric assay and by an enzyme-linked immunosorbent assay. *Haemostasis* 1987;17:173–181.

92. Parquet-Gernez A, Mazurier C, Goudemand M. Functional and immunological assays of FVIII in 133 haemophiliacs: characterization of a subgroup of patients with mild haemophilia A and discrepancy in 1- and 2-stage assays. *Thromb Haemost* 1988;59:202–206.

93. Pappas AM, Barr JS, Salzman EW, et al. The problem of unrecognized “mild hemophilia.” *JAMA* 1964;187:772–774.

94. McVerry BA, Voke J, Vicary FR, Dormandy KM. Ultrasonography in the management of haemophilia. *Lancet* 1977;1:872–874.

95. Nyman D, Eriksson AW, Blomback M, et al. Recent investigations of the first bleeder family in Aland (Finland) described by von Willebrand. *Thromb Haemost* 1981;45:73–76.

96. Bloom AL. The von Willebrand syndrome. *Semin Hematol* 1980;17:215–227.

97. Abildgaard CF, Suzuki Z, Harrison J, et al. Serial studies in von Willebrand disease; variability versus “variants.” *Blood* 1980;56:712–716.

98. Montgomery RR, Kroner PA. von Willebrand disease: a common pediatric disorder. *Pediatr Ann* 2001;30:534–540.

99. Mannucci PM. How I treat patients with von Willebrand disease. *Blood* 2001;97:1915–1919.

100. Rodeghiero F, Castaman G, Dini E. Epidemiological investigation of the prevalence of von Willebrand disease. *Blood* 1987;69:454–459.

101. Werner EJ, Broxson EH, Tucker EL, et al. Prevalence of von Willebrand disease in children: a multiethnic study. *J Pediatr* 1993;123:893–898.

102. Sadler JE. A revised classification of von Willebrand disease. *Thromb Haemost* 1994;71:520–525.

103. Ginsberg D, Handin RI, Bonthron DT, et al. Human von Willebrand factor (vWF): isolation of complementary DNA (cDNA) clones and chromosomal localization. *Science* 1985;228:1401–1406.

104. Sadler JE, Shelton-Inloes BB, Sorace JM, et al. Cloning and characterization of two cDNAs coding for human von Willebrand factor. *Proc Natl Acad Sci U S A* 1985;82:6394–6398.

105. Montgomery RR. Structure and function of von Willebrand factor. In: Colman RW, Hirsh J, Marder VJ, et al., eds. *Hemostasis and thrombosis: basic principles and clinical practice*, 4th ed. Philadelphia: Lippincott Williams & Wilkins, 2001:249–274.

106. Furlan M, Robles R, Lammle B. Partial purification and characterization of a protease from human plasma cleaving von Willebrand factor to fragments produced by in vivo proteolysis. *Blood* 1996;87:4223–4234.

107. Jenkins PV, Pasi KJ, Perkins SJ. Molecular modeling of the ligand and mutation sites of the type A domains of human von Willebrand factor and their relevance to von Willebrand disease. *Blood* 1998;91:2032.

108. Ribba AS, Loisel I, Lavergne JM, et al. Ser968Thr within the A3 domain of von Willebrand factor (VWF) in two related patients leads to a defective binding of VWF to collagen. *Thromb Haemost* 2001;86:848–854.
109. Fujimoto T, Ohara S, Hawiger J. Thrombin-induced exposure and prostacyclin inhibition of the receptor for factor VIII/von Willebrand factor on human platelets. *J Clin Invest* 1982;69:1212.
110. Orstavik KH, Magnus P, Reisner H, et al. Factor VIII and factor IX in a twin population. Evidence for a major effect of ABO locus on factor VIII level. *Am J Hum Genet* 1985;37:89–101.
111. Gill JC, Endres-Brooks J, Bauer PJ, et al. The effect of ABO blood group on the diagnosis of von Willebrand disease. *Blood* 1987;69:1691–1695.
112. Ginsberg D. Molecular genetics of von Willebrand disease. *Thromb Haemost* 1999;82:585–589.
113. Di Paola J, Federici AB, Mannucci PM, et al. Low platelet alpha2 beta1 levels in type I von Willebrand disease correlate with impaired platelet function in a high shear stress system. *Blood* 1999;93:3578–3582.
114. Kadir R, Economides DL, Sabin CA, et al. Variations in coagulation factors in women: effects of age, ethnicity, menstrual cycle and combined oral contraceptive. *Thromb Haemost* 1999;82:1456–1461.
115. Ginsberg D, Sadler JE. von Willebrand disease: a database of point mutations, insertions, and deletions. *Thromb Haemost* 1993;69:177–184.
116. Sadler JE, Matsushita T, Dong Z, et al. Molecular mechanism and classification of von Willebrand disease. *Thromb Haemost* 1995;74:161–166.
117. Hollestelle MJ, Thinnis T, Crain K, et al. Tissue distribution of factor VIII gene expression in vivo—a closer look. *Thromb Haemost* 2001;86:855–861.
118. Wagner DD. Cell biology of von Willebrand disease. *Annu Rev Cell Biol* 1990;6:217–246.
119. Verweij CL, Hart M, Pannekoek H. Expression of variant von Willebrand factor (vWF) cDNA in heterologous cells: requirement of the pro-polypeptide in vWF multimer formation. *EMBO J* 1987;6:2885–2890.
120. Wagner DD, Olmsted JB, Marder VJ. Immunolocalization of von Willebrand protein in Weibel-Palade bodies of human endothelial cells. *J Cell Biol* 1982;95:355–360.
121. Cramer EM, Meyer D, le Menn R, Breton-Gorius J. Eccentric localization of von Willebrand factor in an internal structure of platelet alpha-granule resembling that of Weibel-Palade bodies. *Blood* 1985;66:710–713.
122. Levy GG, Nichols WC, Lian EC, et al. Mutations in a member of the ADAMTS gene family cause thrombotic thrombocytopenic purpura. *Nature* 2001;413:488–494.
123. Zheng X, Chung D, Takayama TK, et al. Structure of von Willebrand factor-cleaving protease (ADAMTS13), a metalloprotease involved in thrombotic thrombocytopenic purpura. *J Biol Chem* 2002;276:41059–41063.
124. Tsai HM, Lian EC. Antibodies to von Willebrand factor cleaving protease in acute thrombotic thrombocytopenic purpura. *N Engl J Med* 1998;339:1585–1594.
125. Furlan M, Robles R, Solenthaler M, Lammle B. Acquired deficiency of von Willebrand factor-cleaving protease in a patient with thrombotic thrombocytopenic purpura. *Blood* 1998;91:2839–2846.
126. Mannucci PM. Hemostatic drugs. *N Engl J Med* 1998;339:245–253.
127. Hellem AJ. Platelet adhesiveness in von Willebrand disease: a study with a new modification of the glass bead filter method. *Scand J Haematol* 1970;7:374–382.
128. Baumgartner HR, Tschopp TB, Meyer D. Shear rate dependent inhibition of platelet adhesion and

aggregation on collagenous surfaces by antibodies to human factor VIII/von Willebrand factor. *Br J Haematol* 1980;44:127–139.

129. Hovig T, Stormorken H. Ultrastructural studies on the platelet plug formation in bleeding time wounds from normal individuals and patients with von Willebrand disease. *Acta Pathol Microbiol Scand* 1974;248[Suppl]:105–122.
130. Brinkhous KM, Sandberg H, Garris JB, et al. Purified human factor VIII procoagulant protein: comparative hemostatic response after infusion into hemophilic and von Willebrand disease dogs. *Proc Natl Acad Sci U S A* 1985;82:8752–8756.
131. Koedam JA, Meijers JC, Sixma JJ, Bouma BN. Inactivation of human factor VIII by activated protein C. Cofactor activity of protein S and protective effect of von Willebrand factor. *J Clin Invest* 1988;82:1236–1243.
132. Weiss HJ, Baumgartner HR, Tschopp TB, et al. Correction by factor VIII of the impaired platelet adhesion to subendothelium in von Willebrand disease. *Blood* 1978;51:267–279.
133. Montgomery RR, Zimmerman TS. Von Willebrand disease antigen II: a new plasma and platelet antigen deficient in severe von Willebrand disease. *J Clin Invest* 1978;61:1498–1507.
134. Zimmerman TS, Ratnoff OD, Powell AE. Immunologic differentiation of classic hemophilia (factor VIII deficiency) and von Willebrand disease. *J Clin Invest* 1971;50:244–254.
135. Gralnick HR, Rick ME, McKeown LP, et al. Platelet von Willebrand factor: an important determinant of the bleeding time in type I von Willebrand disease. *Blood* 1986;68:58–61.
136. Dong JF, Berndt MC, Schade A, et al. Ristocetin-dependent, but not botrocetin-dependent, binding of von Willebrand factor to platelet glycoprotein Ib-IX-V complex correlates with shear-dependent interactions. *Blood* 2001;97:162–168.
137. Weiss HJ. Abnormalities of factor VIII and platelet aggregation: use of ristocetin in diagnosing the von Willebrand syndrome. *Blood* 1975;45:403–412.
138. Weiss HJ, Sussman II, Hoyer LW. Stabilization of factor VIII in plasma by the von Willebrand factor: studies on posttransfusion and dissociated factor VIII and in patients with von Willebrand disease. *J Clin Invest* 1977;60:390–404.
139. Agrawal YP, Dzik W. The vWF content of factor VIII concentrates. *Transfusion* 2001;41:153–154.
140. Weinstein M, Deykin D. Comparison of factor VIII-related von Willebrand factor proteins prepared from human cryoprecipitate and factor VIII concentrate. *Blood* 1979;53:1095–1105.
141. Borchgrevink CF, Egeberg O, Godal HC, Hjort PF. The effect of plasma and Cohn's fraction I on the Duke and Ivy bleeding times in von Willebrand disease. *Acta Med Scand* 1963;173:235–242.
142. Castillo R, Escolar G, Monteagudo J, et al. Hemostasis in patients with severe von Willebrand disease improves after normal platelet transfusion and normalizes with further correction of the plasma defect. *Transfusion* 1987;37: 785–790.
143. Dilley A, Drews C, Lally C, et al. A survey of gynecologists concerning menorrhagia: perceptions of bleeding disorders as a possible cause. *J Womens Health Gender Based Med* 2002;11:39–44.
144. Kadir RA, Economides DL, Sabin CA, et al. Frequency of inherited bleeding disorders in women with menorrhagia. *Lancet* 1998;351:485–489.
145. Duray PH, Marcal JM, LiVolsi VA, et al. Gastrointestinal angiodysplasia: a possible component of von Willebrand disease. *Hum Pathol* 1984;15:539–544.
146. Ragni MV, Bontempo FA, Hassett AC. von Willebrand disease and bleeding in women. *Haemophilia* 1999;5:313–317.



147. Federici AB. Diagnosis of von Willebrand disease. *Haemophilia* 1998;4:654–660.
148. Lian EC, Deykin D. Diagnosis of von Willebrand disease: a comparative study of diagnostic tests of nine families with von Willebrand disease and its differential diagnosis from hemophilia and thrombocytopathy. *Am J Med* 1976;60:344–356.
149. Fressinaud E, Veyradier A, Truchard F, et al. Screening for von Willebrand disease with a new analyzer using high shear stress: a study of 60 cases. *Blood* 1998;91:1325–1331.
150. Kundu SK, Heilmann EJ, Sio R, et al. Description of an *in-vitro* platelet function analyzer–PFA–100. *Semin Thromb Hemost* 1995;21[Suppl 2]:106–112.
151. Favaloro EJ, Facey D, Henniker A, et al. Use of a novel platelet function analyzer (PFA–100) with high sensitivity to disturbances in von Willebrand factor to screen for von Willebrand disease and other disorders. *Am J Hematol* 1999;62:165–174.
152. Cattaneo M, Federici AB, Lecchi A, et al. Evaluation of the PFA–100 system in the diagnosis and therapeutic monitoring of patients with von Willebrand disease. *Thromb Haemost* 1999;82:35–39.
153. Fressinaud E, Veyradier A, Signaud M, et al. Therapeutic monitoring of von Willebrand disease: interest and limits of a platelet function analyzer at high shear rates. *Br J Haematol* 1999;106:777–783.
154. Sultan Y, Simeon J, Maisonneuve P, Caen JP. Immunologic studies in von Willebrand disease. *Thromb Haemost* 1976;35:110–119.
155. Federici AB, Canciani MT, Forza I, Cozzi G. Ristocetin cofactor and collagen binding activities normalized to antigen levels for a rapid diagnosis of type 2 von Willebrand disease: single center comparison of four different assays. *Thromb Haemost* 2000;84:1127–1128.
156. Brinkhous KM, Read MS. Preservation of platelet receptors for platelet aggregating factor/von Willebrand factor by air drying, freezing, or lyophilization: a new stable platelet preparation for von Willebrand factor assays. *Thromb Res* 1978;13:591–597.
157. Rodeghiero F, Castaman G, Tassetto A. von Willebrand factor antigen is less sensitive than ristocetin–cofactor for the diagnosis of type I von Willebrand disease: results based on an epidemiological investigation. *Thromb Haemost* 1990;64:349–352.
158. Werner EJ, Abshire TC, Giroux DS, et al. Relative value of diagnostic studies for von Willebrand disease. *J Pediatr* 1992;121:34–38.
159. Favaloro EJ, Smith J, Petinos P, et al. Laboratory testing for von Willebrand disease: an assessment of current diagnostic practice and efficacy by means of a multi–laboratory survey. RCPA Quality Assurance Program (QAP) in Haematology Haemostasis Scientific Advisory Panel. *Thromb Haemost* 1999;82:1276–1282.
160. Goodall AH, Jarvis J, Chand S, et al. An immunoradiometric assay for human factor VIII/von Willebrand factor (VIII:VWF) using a monoclonal antibody that defines a functional epitope. *Br J Haematol* 1985;59:565–577.
161. Preston FE. Assays for von Willebrand factor functional activity: a UK NEQAS survey. *Thromb Haemost* 1998;80:863.
162. Favaloro EJ. Detection of von Willebrand disorder and identification of quantitative von Willebrand factor defects: direct comparison of commercial ELISA–based von Willebrand factor activity options. *Am J Clin Pathol* 2000;114:608–618.
163. Firkin B, Firkin F, Stott L. von Willebrand disease type B: a newly defined bleeding diathesis. *Aust N Z J Med* 1973;3:225–229.
164. Scott JP, Montgomery RR. The rapid differentiation of type IIb von Willebrand disease from platelet–type (pseudo–) von Willebrand disease by the “neutral” monoclonal antibody binding assay. *Am J Clin Pathol* 1991;96:723–728.

165. Favaloro EJ. Collagen binding assay for von Willebrand factor (VWF:CBA): detection of von Willebrand disease and discrimination of von Willebrand disease subtypes, depends on collagen source. *Thromb Haemost* 2000;83:127–135.
166. Brown JE, Bosak JO. An ELISA for the binding of von Willebrand factor to collagen. *Thromb Res* 1986;43:303–311.
167. Casonato A, Pontara E, Zerbinati P, et al. The evaluation of factor VIII binding activity of von Willebrand factor by means of an ELISA method: significance and practical implications. *Am J Clin Pathol* 1997;109:347–352.
168. Kroner PA, Foster PA, Fahs SA, Montgomery RR. The defective interaction between von Willebrand factor and factor VIII in a patient with type 1 von Willebrand disease is caused by substitution of Arg19 and His54 in mature von Willebrand factor. *Blood* 1996;87:1013–1021.
169. Zimmerman TS, Ruggeri ZM. von Willebrand disease. *Hum Pathol* 1987;18:140–152.
170. Hambleton J. Diagnosis and incidence of inherited von Willebrand disease. *Curr Opin Hematol* 2001;8:306–311.
171. Sadler JE. Biochemistry and genetics of von Willebrand factor. *Annu Rev Biochem* 1998;67:395–424.
172. Hillery CA, Mancuso DJ, Sadler JE, et al. Type 2M von Willebrand disease: F606I and I662F mutations in the glycoprotein Ib binding domain selectively impair ristocetin- but not botrocetin-mediated binding of von Willebrand factor to platelets. *Blood* 1998;91:1572–1581.
173. Sadler JE, Ginsberg D. A database of polymorphisms in the von Willebrand factor gene and pseudogene. For the Consortium on von Willebrand Factor Mutations and Polymorphisms and the Subcommittee on von Willebrand Factor of the Scientific and Standardization Committee of the International Society on Thrombosis and Haemostasis. *Thromb Haemost* 1993;69:185.
174. Rodeghiero F, Castaman G, Di Bona E, et al. Hyper-responsiveness to DDAVP for patients with type I von Willebrand disease and normal intra-platelet von Willebrand factor. *Eur J Haematol* 1988;40:163–167.
175. Mannucci PM, Bloom AL, Larrieu MJ, et al. Atherosclerosis and von Willebrand factor. I. Prevalence of severe von Willebrand disease in Western Europe and Israel. *Br J Haematol* 1984;57:163–169.
176. Rick ME. Classification and pathophysiology of von Willebrand disease. *UpToDate* 2002;10.
177. Mancuso DJ, Tuley EA, Castillo R, et al. Characterization of partial gene deletions in type III von Willebrand disease with alloantibody inhibitors. *Thromb Haemost* 1994;72:180–185.
178. Montgomery RR, Gill JC, Scott JP. Hemophilia and von Willebrand disease. In: Nathan DG, Orkin SH, eds. *Nathan and Oski's hematology of infancy and childhood*, 5th ed. Philadelphia: WB Saunders, 1998:1631–1659.
179. Federici AB, Mannucci PM. Advances in the genetics and treatment of von Willebrand disease. *Curr Opin Pediatr* 2002;14:23–33.
180. Hill FGH, Enayat MS, George AJ. Investigation including VIIIIR: AG multimeric analysis of a large kindred with type IIa von Willebrand disease showing a dominant inheritance and similar gene expression in four generations. *Thromb Haemost* 1983;50:735–739.
181. Berkowitz SD, Dent J, Roberts J, et al. Epitope mapping of the von Willebrand factor subunit distinguishes fragments present in normal and type IIA von Willebrand disease from those generated by plasmin. *J Clin Invest* 1987;79:524–531.
182. Gralnick HR, Williams SB, McKeown LP, et al. In vitro correction of abnormal multimeric structure of von Willebrand factor in type IIa von Willebrand disease. *Proc Natl Acad Sci U S A* 1985;82:5968–5972.
183. Lyons SE, Bruck ME, Bowie EJW, Ginsburg D. Impaired intracellular transport produced by a subset

of type II A von Willebrand disease mutations. *J Biol Chem* 1992;67:4424–4430.

184. Ginsberg D, Konkle BA, Gill JC, et al. Molecular basis of human von Willebrand disease: analysis of platelet von Willebrand factor RNA. *Proc Natl Acad Sci U S A* 1989;86:3723–3727.

185. Tsai HM, Sussman II, Ginsberg D, et al. Proteolytic cleavage of recombinant type 2A von Willebrand factor mutants R834W and R834Q: inhibition by doxycycline and monoclonal antibody VP-1. *Blood* 1997;89:1954–1962.

186. Kyrle PA, Niessner H, Dent J, et al. IIB von Willebrand disease: pathogenetic and therapeutic studies. *Br J Haematol* 1988;69:55–59.

187. Holmberg L, Nilsson IM, Borge L, et al. Platelet aggregation induced by 1-desamino-8-D-arginine vasopressin (DDAVP) in type IIB von Willebrand disease. *N Engl J Med* 1983;309:816–821.

188. Foster PA, Fulcher CA, Marti T, et al. A major factor VIII binding domain resides within the amino-terminal 272 amino acid residues of von Willebrand factor. *J Biol Chem* 1987;262:8443–8446.

189. Mazurier C. von Willebrand disease masquerading as hemophilia A. *Thromb Haemost* 1992;67:391–396.

190. Schneppenheim R, Budde U, Krey S, et al. Results of a screening for von Willebrand disease type 2N in patients with suspected haemophilia A or von Willebrand disease type 1. *Thromb Haemost* 1996;76:598–602.

191. Miller JL, Castella A. Platelet-type von Willebrand disease: characterization of a new bleeding disorder. *Blood* 1982;60:790–794.

192. Bryckaert MC, Pietu G, Ruan C, et al. Abnormality of glycoprotein Ib in two cases of “pseudo”-von Willebrand disease. *J Lab Clin Med* 1985;106:393–400.

193. Ginsburg D. von Willebrand disease. In: Beutler E, Lichtman MA, Coller BS, et al., eds. *Williams' hematology*, 6th ed. New York: McGraw-Hill, 2001:1813–1828.

194. Pavlovsky A. Contribution to the pathogenesis of hemophilia. *Blood* 1947;2:185–191.

195. Aggeler PM, White SG, Glendening MB, et al. Plasma thromboplastin component (PTC) deficiency: a new disease resembling hemophilia. *Proc Soc Exp Biol Med* 1952;79:692–694.

196. White SG, Aggeler PM, Emery BE. Plasma thromboplastin component (PTC) potency of plasma fractions. *Proc Soc Exp Biol Med* 1953;83:69–71.

197. Aggeler PM, Spaet TH, Emery BE. Purification of plasma thromboplastin B (plasma thromboplastin component) and its identification as a  $\alpha_2$  globulin. *Science* 1954;119:806–807.

198. Neal WR, Tayloe DT, Cederbaum AI, Roberts HR. Detection of genetic variants of haemophilia B with an immunosorbent technique. *Br J Haematol* 1973;25:63–68.

199. Veltkamp JJ, Meilof J, Rimmelts HG, et al. Another genetic variant of hemophilia B, hemophilia B Leyden. *Scand J Haematol* 1970;7:82–90.

200. Briët E, Bertina RM, van Tilburg NH, Veltkamp JJ. Hemophilia B Leyden. A sex-linked hereditary disorder that improves after puberty. *N Engl J Med* 1982;306:788–790.

201. Crossley M, Ludwig M, Stowell KM, et al. Recovery from hemophilia B Leyden: an androgen-responsive element in the factor IX promoter. *Science* 1992;257:377–379.

202. Meyer D, Larrieu MJ. Factor VIII and IX variants. Relationship between hemophilia Bm and hemophilia B<sup>+</sup>. *Eur J Clin Invest* 1971;1:425–431.

203. Griffith MJ, Bretkreutz L, Trapp H, et al. Characterization of the clotting activities of structurally

different forms of activated factor IX. *J Clin Invest* 1985;75:4–10.

204. Noyes CM, Griffith MJ, Roberts HR, Lundblad RL. Identification of the molecular defect in factor IX Chapel Hill: substitution of histidine for arginine at position 145. *Proc Natl Acad Sci U S A* 1983;80:4200–4202.
205. Bertina RM, Veltkamp JJ. A genetic variant of factor IX with decreased capacity for Ca<sup>2+</sup> binding. *Br J Haematol* 1979;42:623–635.
206. Bertina RM, Van der Linden IK. Factor IX Zutphen. A genetic variant of blood coagulation factor IX with an abnormally high molecular weight. *J Lab Clin Med* 1982;100:695–704.
207. Bithell TC, Pizarro A, MacDiarmid WD. Variant of factor IX deficiency in a female with 45, X Turner's syndrome. *Blood* 1970;36:169–179.
208. Neuschatz J, Necheles TF. Hemophilia B in a phenotypically normal girl with XX (ring)/XO mosaicism. *Acta Haematol (Basel)* 1973;49:108–113.
209. Nisen P, Stamberg J, Ehrenpreis R, et al. The molecular basis of severe hemophilia B in a girl. *N Engl J Med* 1986;315:1139–1142.
210. Gianelli F, Green PM, Sommer SS, et al. Haemophilia B: database of point mutations and short additions and deletions—eighth edition. *Nucleic Acids Res* 1998;26:265–268.
211. Didisheim P, Vandervoort RLE. Detection of carriers for factor IX (PTC) deficiency. *Blood* 1962;20:150–155.
212. Orstavik KH, Veltkamp JJ, Bertina RM, Hermans J. Detection of carriers of haemophilia B. *Br J Haematol* 1979;42:293–301.
213. Pechet L, Tiarks CY, Stevens J, et al. Relationship of factor IX antigen and coagulant in hemophilia B patients and carriers. *Thromb Haemost* 1978;40:465–477.
214. Poon MC, Chui DHK, Patterson M, et al. Hemophilia B (Christmas disease) variants and carrier detection analyzed by DNA probes. *J Clin Invest* 1987;79:1204–1209.
215. Smith KJ, Thompson AR, McMullen BA, et al. Carrier testing in hemophilia B with an immunoassay that distinguishes a prevalent factor IX dimorphism. *Blood* 1987;70:1006–1013.
216. Holmberg L, Gustavii B, Cordesius E, et al. Prenatal diagnosis of hemophilia B by an immunoradiometric assay of factor IX. *Blood* 1980;56:397–401.
217. Aggeler PM, Hoag MS, Wallerstein RO, Whissell D. The mild hemophilias: occult deficiencies of AHF, PTC and PTA frequently responsible for unexpected surgical bleeding. *Am J Med* 1961;30:84–94.
218. Thompson AR. Factor IX antigen by radioimmunoassay: abnormal factor IX protein in patients on warfarin therapy and with hemophilia B. *J Clin Invest* 1977;59:900–910.
219. Mosesson MW. Hereditary Abnormalities of Fibrinogen. In: Beutler E, Lichtman MA, Coller BS, et al., eds. *Williams hematology*, 6th ed. New York: McGraw-Hill, 2001:1659–1671.
220. Franks JJ, Kirsch RE, Frith LO, et al. Effect of fibrinolytic products D and E on fibrinogen and albumin synthesis in the rat. *J Clin Invest* 1981;67:575–580.
221. Fuller GM, Nickerson JM, Adams MA. Translation and cotranslational events in fibrinogen synthesis. *Ann N Y Acad Sci* 1983;408:440–448.
222. Chung DW, Rixon MW, Que BG, Davie EW. Cloning of fibrinogen genes and their cDNA. *Ann N Y Acad Sci* 1983;408:449–506.
223. Crabtree GR, Kant JA, Fornace AJ, et al. Regulation and characterization of the mRNAs for the A $\alpha$ , B $\beta$  and ? chains of fibrinogen. *Ann N Y Acad Sci* 1983;408:457–468.

224. McDonagh J. Dysfibrinogenemia and other disorders of fibrinogen structure or function. In: Colman RW, Hirsh J, Marder VJ, et al., eds. Hemostasis and thrombosis: basic principles and clinical practice, 4th ed. Philadelphia: Lippincott Williams & Wilkins, 2001:863–892.
225. Rabe F, Salomon E. Uber faserstoffmangel in blut bei einen falle von haemophilie. (Lack of fibrin in blood of a hemophiliac boy). Dtsch Arch Klin Med 1920;132:240–244.
226. Risak E. Die fibrinopenie. Ztschr Klin Med 1935;128:605–629.
227. Uzan G, Courtois G, Besmond C, et al. Analysis of fibrinogen genes in patients with congenital afibrinogenemia. Biochem Biophys Res Commun 1984;120:376–383.
228. Gitlin D, Borges WH. Studies on the metabolism of fibrinogen in two patients with congenital afibrinogenemia. Blood 1953;8:679–686.
229. Hardisty RM, Pinniger JL. Congenital afibrinogenemia: further observations on the blood coagulation mechanism. Br J Haematol 1956;2:139–152.
230. Wehinger H, Klinge O, Alexandrakis E, et al. Hereditary hypofibrinogenemia with fibrinogen storage in the liver. Eur J Pediatr 1983;141:109–112.
231. Callea F, Tortora O, Kojima T, et al. Hypofibrinogenemia and fibrinogen storage disease. In: Mosesson MW, Amrani DL, Siebenlist KR, Diorio JP, eds. Fibrinogen 3: biochemistry, biologic functions, gene regulation and expression. New York: Elsevier, 1988:247–250.
232. Kant JA, Fornace AJ, Jr., Saxe D, et al. Evolution and organization of the fibrinogen locus on chromosome 4: gene duplication accompanied by transposition and inversion. Proc Natl Acad Sci U S A 1985;82:2344–2348.
233. Menache D. Congenital fibrinogen abnormalities. Ann N Y Acad Sci 1983;408:121–130.
234. Neerman-Arbez M. The molecular basis of inherited afibrinogenemia. Thromb Haemost 2001;86:154–163.
235. Ni H, Denis CV, Subbarao S, et al. Persistence of platelet thrombus formation in arterioles of mice lacking both von Willebrand factor and fibrinogen. J Clin Invest 2000;106:385–392.
236. Suh TT, Holmbäck K, Jensen NJ, et al. Resolution of spontaneous bleeding events but failure of pregnancy in fibrinogen-deficient mice. Genes Dev 1995;9:2020–2033.
237. Fried K, Kaufman S. Congenital afibrinogenemia in 10 offspring of uncle-niece marriages. Clin Genet 1980;17:223–227.
238. Goodwin TM. Congenital hypofibrinogenemia in pregnancy. Obstet Gynecol Surv 1989;44:157–161.
239. MacKinnon HH, Fekete JF. Congenital afibrinogenemia. Vascular changes and multiple thromboses induced by fibrinogen infusions and contraceptive medication. Can Med Assoc J 1971;104:597–599.
240. Meh DA, Siebenlist KR, Mosesson MW. Identification and characterization of the thrombin binding sites on fibrin. J Biol Chem 2002;271:23121–23125.
241. Alexander B, Goldstein R, Rich L, et al. Congenital afibrinogenemia: a study of some basic aspects of coagulation. Blood 1954;9:843–865.
242. Yamagata S, Mori K, Kayaba T, et al. A case of congenital afibrinogenemia and review of reported cases in Japan. Tohoku J Exp Med 1968;96:15–35.
243. Cattaneo M, Bettiga D, Lombardi E, et al. Sustained correction of the bleeding time in an afibrinogenemic patient after infusion of fresh frozen plasma. Br J Haematol 1992;82:388–390.
244. Colvin RB, Mosesson MW, Dvorak HF. Delayed-type hypersensitivity skin reactions in congenital

afibrinogenemia lack fibrin deposition and induration. *J Clin Invest* 1979;63:1302–1306.

245. Ramsay NKC, Coccia PF, Krivit W, et al. The effect of L-asparaginase on plasma coagulation factors in acute lymphoblastic leukemia. *Cancer* 1977;40:1398–1401.

246. Fischer M, Lechner K, Hinterberger W, et al. Deficiency of fibrinogen and factor VII following treatment of severe aplastic anaemia with anti-thymocyte globulin and high-dose methylprednisolone. *Scand J Haematol* 1985;34:312–316.

247. Gilibert J, Reganon E, Vila V, et al. Congenital hypofibrinogenemia and pregnancy, obstetric and hematological management. *Gynecol Obstet Invest* 1987;24:271–276.

248. Mason DY, Ingram GI. Management of the hereditary coagulation disorders. *Semin Hematol* 1971;8:158–188.

249. de Vries A, Rosenberg T, Kochwa S, Boss JH. Precipitating antifibrinogen antibody appearing after fibrinogen infusions in a patient with congenital afibrinogenemia. *Am J Med* 1961;30:486–494.

250. Cronin C, Fitzpatrick D, Temperley I. Multiple pulmonary emboli in a patient with afibrinogenemia. *Acta Haematol* 1988;79:53–54.

251. Calenda E, Borg JY, Peillon C, et al. Perioperative management of a patient with congenital hypofibrinogenemia [Letter]. *Anesthesiology* 1989;71:622–623.

252. Benson MD. Amyloidosis. In: Scriver C, Beaudet A, Sly W, Valle D, eds. *The metabolic basis of inherited disease*, 7th ed. New York: McGraw-Hill, 1995:410.

253. Benson MD, Liepnieks J, Uemichi T, et al. Hereditary renal amyloidosis associated with a mutant fibrinogen  $\alpha$ -chain. *Nat Genet* 1993;3:252–255.

254. Hamidi AL, Liepnieks JJ, Uemichi T, et al. Renal amyloidosis with a frame shift mutation in fibrinogen A $\alpha$ -chain gene producing a novel amyloid protein. *Blood* 1997;90:4799–4805.

255. Callea F, De Vos R, Pinackat J. Hereditary hypofibrinogenemia with hepatic storage of fibrinogen: a new endoplasmic reticulum storage disease. In: Lowe GDO, Douglas JT, Forbes CD, Henschen A, eds. *Fibrinogen 2. Biochemistry, biological functions, gene regulation, and expression*. Amsterdam: Elsevier, 1987:75.

256. Francis RB Jr. Clinical disorders of fibrinolysis: a critical review. *Blut* 1989;59:1–14.

257. Haverkate F, Samama M. Familial dysfibrinogenemia and thrombophilia. Report on a study of the SSC Subcommittee on Fibrinogen. *Thromb Haemost* 1995;73:151–161.

258. Mosesson MW. Dysfibrinogenemia and thrombosis. *Semin Thromb Hemost* 1999;3:311–319.

259. Rodgers GM, Garr SB. Comparison of functional and antigenic fibrinogen values from a normal population. *Thromb Res* 1992;68:207–210.

260. Sherman LA, Gaston LW, Kaplan ME, Spivack AR. Fibrinogen St. Louis: a new inherited fibrinogen variant, coincidentally associated with hemophilia A. *J Clin Invest* 1972;51:590–597.

261. Dawson NA, Barr CF, Alving BM. Acquired dysfibrinogenemia. Paraneoplastic syndrome in renal cell carcinoma. *Am J Med* 1985;78:682–686.

262. Lackner H. Hemostatic abnormalities associated with dysproteinemias. *Semin Hematol* 1973;10:125–133.

263. Galanakis DK, Ginzler EM, Fikrig SM. Monoclonal IgG anticoagulants delaying fibrin aggregation in two patients with systemic lupus erythematosus (SLE). *Blood* 1978;52:1037–1046.

264. Ghosh S, McEvoy P, McVerry BA. Idiopathic autoantibody that inhibits fibrin monomer polymerization. *Br J Haematol* 1983;53:65–72.

265. Hoots WK, Carrell NA, Wagner RH, et al. A naturally occurring antibody that inhibits fibrin polymerization. *N Engl J Med* 1981;304:857–861.
266. Marciniak E, Greenwood MF. Acquired coagulation inhibitor delaying fibrinopeptide release. *Blood* 1979;53:81–92.
267. Siebenlist KR, Mosesson MW, Meh DA, et al. Coexisting dysfibrinogenemia [fibrinogen Cedar Rapids ?–R275C] and factor V Leiden deficiency associated with thromboembolic disease. *Blood Coagul Fibrinolysis* 2000;11:293–304.
268. Gilabert J, Reganon E, Vila V, et al. Congenital hypofibrinogenemia and pregnancy, obstetric and hematological management. *Gynecol Obstet Invest* 1987;24:271–276.
269. Inamoto Y, Terao T. First report of case of congenital afibrinogenemia with successful delivery. *Am J Obstet Gynecol* 1985;153:803–804.
270. Muszbek L, Yee VC, Hevessy Z. Blood coagulation factor XIII: structure and function. *Thromb Res* 1999;94:271–305.
271. McKee PA, Mattock P, Hill RL. Subunit structure of human fibrinogen, soluble fibrin, and cross-linked insoluble fibrin. *Proc Natl Acad Sci U S A* 1970;66:738–744.
272. Sakata Y, Aoki N. Significance of cross-linking of alpha-2-plasmin inhibitor to fibrin in inhibition of fibrinolysis and in hemostasis. *J Clin Invest* 1982;69:536–542.
273. Mosher DF, Schad PE, Vann JM. Cross-linking of collagen and fibronectin by factor XIIIa: localization of participating glutamyl residues to a tryptic fragment of fibronectin. *J Biol Chem* 1980;255:1181–1188.
274. Loewy AG, McDonagh J, Mikkola H, et al. Structure and function of factor XIII. In: Colman RW, Hirsh J, Marder VJ, et al., eds. *Hemostasis and thrombosis: basic principles and clinical practice*, 4th ed. Philadelphia: Lippincott Williams & Wilkins, 2001:233–247.
275. Mosher DF. Cross-linking of plasma and cellular fibronectin by plasma transglutaminase. *Ann N Y Acad Sci* 1978;312:38–42.
276. Robbins KC. A study on the conversion of fibrinogen to fibrin. *Am J Physiol* 1944;142:581–588.
277. Duckert F, Jung E, Shmerling DH. A hitherto undescribed congenital haemorrhagic diathesis probably due to fibrin stabilizing factor deficiency. *Thromb Diath Haemorrh* 1960;5:179–186.
278. Lorand L, Losowsky MS, Miloszewski KJM. Human factor XIII: fibrin-stabilizing factor. *Prog Hemost Thromb* 1980;5:245–290.
279. Fear JD, Miloszewski KJA, Losowsky MS. Factor XIII levels in five families of patients with inherited factor XIII deficiency: support for an autosomal recessive inheritance. *Thromb Haemost* 1983;50:588–590.
280. Takagi T, Doolittle RF. Amino acid sequence studies on factor XIII and the peptide released during its activation by thrombin. *Biochemistry* 1974;13:750–756.
281. Yee VC, Pedersen L, Le Trong I, et al. Three-dimensional structure of a transglutaminase: human blood coagulation factor XIII. *Proc Natl Acad Sci U S A* 1994;91:7296–7300.
282. Poon MC, Russel JA, Low S, et al. Hematopoietic origin of factor XIII subunits in platelets, monocytes and plasma. Evidence from bone marrow transplantation studies. *J Clin Invest* 2002;84:787–792.
283. Bottenus RE, Ichinose A, Davie EW. Nucleotide sequence of the gene for the b subunit of human factor XIII. *Biochemistry* 1990;29:11195–11209.
284. Girolami A, Sartori MT, Simioni P. An updated classification of factor XIII defect [Letter; comment]. *Br J Haematol* 1991;77:565–566.
285. Ichinose A, Izumi T, Hashiguchi T. The normal and abnormal genes of the a and b subunits in



- coagulation factor XIII. *Semin Thromb Hemost* 1996;22:385–391.
286. Ichinose A, McMullen BA, Fujikawa K, Davie EW. Amino acid sequence of the b subunit of human factor XIII, a protein composed of ten repetitive segments. *Biochemistry* 1986;25:4633–4638.
287. Ichinose A, Hendrickson LE, Fujikawa K, Davie EW. Amino acid sequence of the a subunit of human factor XIII. *Biochemistry* 1986;25:6900–6906.
288. Bottenus RE, Ichinose A, Davie EW. Nucleotide sequence of the gene for the b subunit of human factor XIII. *Biochemistry* 1990;29:11195–11209.
289. Greenberg CS, Birckbichler PJ, Rice RH. Transglutaminases: multifunctional cross-linking enzymes that stabilize tissues. *FASEB J* 1991;5:3071–3077.
290. Board PG, Webb GC, McKee J, Ichinose A. Localization of the coagulation factor XIII A subunit gene (F13A) to chromosome bands 6p24 p25. *Cytogenet Cell Genet* 1988;48:25–27.
291. Kohler HP, Strickland MH, Ossei-Gerning N, et al. Association of a common polymorphism in the factor XIII gene with myocardial infarction. *Thromb Haemost* 1998;79:8–13.
292. Webb GC, Coggan M, Ichinose A, Board PG. Localization of the coagulation factor XIII B subunit gene (F13B) to chromosome bands 1q31–32.1 and restriction fragment length polymorphism at the locus. *Hum Genet* 1989;81:157–160.
293. Kitchens CS, Newcomb TF. Factor XIII. *Medicine (Baltimore)*. 1979;58:413–429.
294. Miloszewski KJM, Losowsky MS. Fibrin stabilization and factor XIII deficiency. In: Francis JL, ed. *Fibrinogen, fibrin stabilisation, and fibrinolysis: clinical, biochemical and laboratory aspects*. Chichester, UK: Ellis Horwood, 1988:175–202.
295. Greenberg DL, Davie EW. Blood coagulation factors: their complementary DNAs, genes, and expression. In: Colman RW, Hirsh J, Marder VJ, et al., eds. *Hemostasis and thrombosis: basic principles and clinical practice*, 4th ed. Philadelphia: Lippincott Williams & Wilkins, 2001:21–57.
296. Santiago MA, Santiago RJ, Achyuthan KE, et al. Factor XIII B-chains enhance the binding of A-chains to fibrin(ogen): role of the C-terminus of the A-chains. *Blood* 1994;84:391a.
297. Duckert F. Documentation of the plasma factor XIII deficiency in man. *Ann N Y Acad Sci* 1972;202:190–199.
298. Britten AFH. Congenital deficiency of factor XIII (fibrin-stabilizing factor): report of a case and review of the literature. *Am J Med* 1967;43:751–761.
299. Greenberg LH, Schiffman S, Wong YSS. Factor XIII deficiency. Treatment with monthly plasma infusions. *JAMA* 1969;209:264–265.
300. Ikkala E. Transfusion therapy in congenital deficiencies of plasma factor XIII. *Ann N Y Acad Sci* 1972;202:200–203.
301. Krumdieck R, Shaw DR, Huang ST, et al. Hemorrhagic disorder due to an isoniazid-associated acquired factor XIII inhibitor in a patient with Waldenström's macroglobulinemia. *Am J Med* 1991;90:639–645.
302. Godal HC, Ly B. An inhibitor of activated factor XIII, inhibiting fibrin cross-linking but not incorporation of amine into casein. *Scand J Haematol* 1977;19:443–448.
303. MacDonagh J. Structure and function of factor XIII. In: Colman RW, Hirsh J, Marder VJ, Salzman EW, eds. *Hemostasis and thrombosis: basic principles and clinical practice*, 3rd ed. Philadelphia: JB Lippincott, 1994:301.
304. Lorand L, Velasco PT, Rinne JR, et al. Autoimmune antibody (IgG Kansas) against the fibrin stabilizing factor (factor XIII) system. *Proc Natl Acad Sci U S A* 1988;85:232–236.
305. Wisen O, Gardlund B. Hemostasis in Crohn's disease: low factor XIII levels in active disease. *Scand J*

Gastroenterol 1988;23:961-966.

306. Oshitani N, Nakamura S, Matsumoto T, et al. Treatment of Crohn's disease fistulas with coagulation factor XIII [Letter]. *Lancet* 1996;347:119-120.

307. Van Bodegraven AA, Tuynman HARE, Schoorl M, et al. Fibrinolytic split products, fibrinolysis, and factor XIII activity in inflammatory bowel disease. *Scand J Gastroenterol* 1995;30:580-585.

308. Fickenscher K, Aab A, Stuber W. A photometric assay for blood coagulation factor XIII. *Thromb Haemost* 1991;65:535-540.

309. Seligsohn U, White JG. Inherited deficiencies of coagulation factors II, V, VII, XI, and XIII, and the combined deficiencies of factors V and VIII and of the vitamin K-dependent factors. In: Beutler E, Lichtman MA, Coller BS, et al., eds. *Williams hematology*, 6th ed. New York: McGraw-Hill, 2002:1617-1638.

310. Henriksson P, Stenberg P, Nilsson IM, et al. A specific, fluorescent activity staining procedure applied to plasma and red blood cells in congenital factor XIII deficiency. *Br J Haematol* 1980;44:141-147.

311. Lorand L, Urayama T, De Kiewiet JWC, Nossel HL. Diagnostic and genetic studies on fibrin-stabilizing factor with a new assay based on amine incorporation. *J Clin Invest* 1969;48:1054-1064.

312. Dempfle CE, Harenberg J, Hochreuter K, Heene DL. Microtiter assay for measurement of factor XIII activity in plasma. *J Lab Clin Med* 1992;119:522-528.

313. Fear JD, Miloszewski KJA, Losowsky MS. The half life of factor XIII in the management of inherited deficiency. *Thromb Haemost* 1983;49:102-105.

314. Girolami A, Scarano L, Saggiorato G, et al. Congenital deficiencies and abnormalities of prothrombin. *Blood Coagul Fibrinolysis* 1998;9:557-569.

315. Shapiro SS, McCord S. Prothrombin. *Prog Hemost Thromb* 1978;4:177-209.

316. Gill FM, Shapiro SS, Schwartz E. Severe congenital hypoprothrombinemia. *J Pediatr* 1978;93:264-266.

317. Shapiro SS, Martinez J, Holburn RR. Congenital dysprothrombinemia: an inherited structural disorder of human prothrombin. *J Clin Invest* 1969;48:2251-2259.

318. Peyvandi F, Mannuci PM. Rare coagulation disorders. *Thromb Haemost* 1999;82:1207-1214.

319. Xue J, Wu Q, Westfield LA, et al. Incomplete embryonic lethality and fatal neonatal hemorrhage caused by prothrombin deficiency in mice. *Proc Natl Acad Sci U S A* 1998;95:7603-7607.

320. Seligsohn U, White GC. Inherited deficiencies of coagulation factors II, V, VII, XI, and XIII and the combined deficiencies of factors V and VIII and of the vitamin K-dependent factors. In: Beutler E, Lichtman MA, Coller BS, et al., eds. *Williams hematology*, 6th ed. New York: McGraw-Hill, 2001:1617-1638.

321. Rabiet MJ, Furie BC, Furie B. Molecular defect of prothrombin Barcelona. Substitution of cysteine for arginine at residue 273. *J Biol Chem* 1986;261: 15045-15048.

322. Bezeaud A, Guillin MC, Olmeda F, et al. Prothrombin Madrid: a new familial abnormality of prothrombin. *Thromb Res* 1979;16:47-58.

323. Henriksen RA, Mann KG. Identification of the primary structural defect in the dysthrombin thrombin Quick I: substitution of cysteine for arginine 382. *Biochemistry* 1988;92:9160-9165.

324. Henriksen RA, Mann KG. Substitution of valine for glycerin-558 in the congenital dysthrombin, thrombin Quick II, alters primary substrate specificity. *Biochemistry* 1989;28:2078-2082.

325. Sun WY, Burkart MC, Holahan JR, Degen SJ. Prothrombin San Antonio: a single amino acid substitution at a factor X<sub>a</sub> activation site (Arg 320 to His) results in dysprothrombinemia. *Blood* 2000;95:711-714.

326. Akhavan S, Mannucci PM, Lak M, et al. Identification and three-dimensional structural analysis of nine novel mutations in patients with prothrombin deficiency. *Thromb Haemost* 2000;989-997.
327. Akhavan S, De Cristofaro R, Peyvandi F, et al. Molecular and functional characterization of a natural homozygous Arg67His mutation in the prothrombin gene of a patient with a severe procoagulant defect contrasting with a mild hemorrhagic phenotype. *Blood* 2002;100:1347-1353.
328. Owren PA. The coagulation of blood: investigations on a new clotting factor. *Acta Med Scand* 1947;[Suppl 194]:1-327.
329. Seeler RA. Parahemophilia: factor V deficiency. *Med Clin North Am* 1972;56:119-125.
330. Feinstein DI, Rapaport SI, McGehee WG, Patch MJ. Factor V anticoagulants: clinical, biochemical, and immunological observations. *J Clin Invest* 1970;49:1578-1588.
331. Chiu HC, Whitaker E, Colman RW. Heterogeneity of human factor V deficiency: evidence for the existence of antigen-positive variants. *J Clin Invest* 1983;72:493-503.
332. Breederveld K, Giddings JC, tenCate JW, Bloom AL. The localization of factor V within normal human platelets and the demonstration of platelet-factor V antigen in congenital factor V deficiency. *Br J Haematol* 1975;29:405-412.
333. Tracy PB, Giles AR, Mann KG, et al. Factor V (Quebec): a bleeding diathesis associated with a qualitative platelet factor V deficiency. *J Clin Invest* 1984;74:1221-1228.
334. Hayward CPM, Rivard GE, Kane WH, et al. An autosomal dominant, qualitative platelet disorder associated with multimerin deficiency, abnormalities in platelet factor V, thrombospondin, von Willebrand factor, and fibrinogen and an epinephrine aggregation defect. *Blood* 1996;87:4967-4978.
335. Cui J, O'Shea S, Purkayastha A, et al. Fatal haemorrhage and incomplete block to embryogenesis in mice lacking coagulation factor V. *Nature* 1996;384:66-68.
336. Guasch JF, Cannegieter S, Reitsma PH, et al. Severe coagulation factor V deficiency caused by a 4 bp deletion in the factor V gene. *Br J Haematol* 1998;101:32-39.
337. Yang TL, Cui J, Taylor JM, et al. Rescue of fatal neonatal hemorrhage in factor V deficient mice by low level transgene expression. *Thromb Haemost* 2000;83:70-77.
338. Mann KG. How much factor V is enough? *Thromb Haemost* 2000;83:3-4.
339. Van Wijk R, Nieuwenhuis K, van den Berg M, et al. Five novel mutations in the gene for human blood coagulation factor V associated with type I factor V deficiency. *Blood* 2001;98:358-367.
340. Bloom JW, Nesheim ME, Mann KG. A rapid technique for the preparation of factor V deficient plasma. *Thromb Res* 1979;15:595-599.
341. Fischer RR, Giddings JC, Rosenberg I. Hereditary combined deficiency of clotting factor V and factor VIII with involvement of von Willebrand factor. *Clin Lab Haematol* 1988;10:53-62.
342. Goodnight SH, Feinstein DI, Osterud B, Rapaport SI. Factor VII antibody-neutralizing material in hereditary and acquired factor VII deficiency. *Blood* 1971;38:1-8.
343. Fair DS. Quantitation of factor VII in the plasma of normal and warfarin-treated individuals by radioimmunoassay. *Blood* 1983;62:784-791.
344. Marder VJ, Shulman NR. Clinical aspects of congenital factor VII deficiency. *Am J Med* 1964;37:182-194.
345. Morrissey JH, Macik BG, Neuenschwander PF, Comp PC. Quantitation of activated factor VII levels in plasma using a tissue factor mutant selectively deficient in promoting factor VII activation. *Blood* 1993;81:734-744.

346. Seligsohn U, Kasper CK, Osterud B, Rapaport SI. Activated factor VII: presence in factor IX concentrates and persistence in the circulation after transfusion. *Blood* 1979;53:828–837.
347. Banner DW, D'Arcy A, Chene C, et al. The crystal structure of the complex of blood coagulation factor VIIa with soluble tissue factor. *Nature* 1996;380:41–46.
348. Edgington TS, Dickinson CD, Ruf W, et al. The structural basis of function of the TF–FVIIa complex in the cellular initiation of coagulation. *Thromb Haemost* 1997;78:401–405.
349. O'Hara PJ, Grant FJ, Haldeman BA, et al. Nucleotide sequence of the gene coding for human factor VII, a vitamin K–dependent protein participating in blood coagulation. *Proc Natl Acad Sci U S A* 1987;84:5158–5162.
350. Rosen ED, Chan JC, Idusogie E, et al. Mice lacking factor VII develop normally but suffer fatal perinatal bleeding. *Nature* 1997;390:290–294.
351. Cooper DN, Millar DS, Wacey A, et al. Inherited factor VII deficiency: molecular genetics and pathophysiology. *Thromb Haemost* 1997;78:157–160.
352. Tamary H, Fromovich Y, Shalmon L, et al. Ala244Val is a common, probably ancient mutation causing factor VII deficiency in Moroccan and Iranian Jews. *Thromb Haemost* 1996;76:283–291.
353. Roberts HR, White GC. Inherited disorders of prothrombin conversion. In: Colman RW, Hirsh J, Marder VJ, et al., eds. *Hemostasis and thrombosis: basic principles and clinical practice*, 4th ed. Philadelphia: Lippincott Williams & Wilkins, 2001:839–853.
354. Triplett DA, Brandt JT, Batard MGM, et al. Hereditary factor VII deficiency: heterogeneity defined by combined functional and immunochemical analysis. *Blood* 1985;66:1284–1287.
355. Ragni MV, Lewis JH, Spero JA, Hasiba U. Factor VII deficiency. *Am J Hematol* 1981;10:79–88.
356. Cohen LJ, McWilliams NB, Neuberg R, et al. Prophylaxis and therapy with factor VII concentrate (Human) Immuno, vapor heated in patients with congenital factor VII deficiency: a summary of case reports. *Am J Hematol* 1995;50:269–276.
357. Hall CA, Rapaport SI, Ames SB, DeGroot JA. A clinical and family study of hereditary proconvertin (factor VII) deficiency. *Am J Med* 1964;37:172–181.
358. Munnich A, Sandubray JM, Dautzenberg MD, et al. Diet–responsive proconvertin (Factor VII) deficiency in homocystinuria. *J Pediatr* 1983;102:730–734.
359. Yorke AJ, Mant MJ. Factor VII deficiency and surgery: is preoperative replacement therapy necessary? *JAMA* 1977;238:424–425.
360. Telfer TP, Denson KW, Wright DR. A “new” coagulation defect. *Br J Haematol* 1956;2:308–316.
361. Hougie C, Barrow EM, Graham JM. Stuart clotting defect. *J Clin Invest* 1957;36:485–496.
362. Dewerchin M, Liang Z, Moons L, et al. Blood coagulation factor X deficiency causes partial embryonic lethality and fatal neonatal bleeding in mice. *Thromb Haemost* 2000;83:185–190.
363. Denson KWE, Lurie A, de Cataldo F, Mannucci PM. The factor X defect: recognition of abnormal forms of factor X. *Br J Haematol* 1970;18:317–327.
364. Prydz H, Gladhaug A. Factor X: immunological studies. *Thromb Diath Haemorrh* 1971;25:157–165.
365. Girolami A, Molaro G, Lazzarin M, et al. A “new” congenital haemorrhagic condition due to the presence of an abnormal factor X (factor X Friuli): study of a large kindred. *Br J Haematol* 1970;19:179–192.
366. Cooper DN, Millar DS, Wacey A, et al. Inherited factor X deficiency: molecular genetics and pathophysiology. *Thromb Haemost* 1997;78:161–172.

367. Peyvandi F, Menegatti M, Santagustino E, et al. Gene mutations and three-dimensional structural analysis in 13 families with severe factor X deficiency. *Br J Haematol* 2002;117:685-692.
368. Bertina RM, Alderkamp GJH, DeNooy E. A variant of factor X that is defective only in extrinsic coagulation. *Thromb Haemost* 1981;46:88.
369. Parkin JD, Madaras F, Sweet B, Castaldi PA. A further inherited variant of coagulation factor X. *Aust N Z J Med* 1974;4:561-564.
370. Furie B, Greene E, Furie BC. Syndrome of acquired factor X deficiency and systemic amyloidosis. *N Engl J Med* 1977;297:81-85.
371. Rosenthal RL, Dreskin OH, Rosenthal N. New hemophilia-like disease caused by deficiency of a third plasma thromboplastin factor. *Proc Soc Exp Biol Med* 1953;82:171-174.
372. Rapaport SI, Proctor RR, Patch MJ, Yettra M. The mode of inheritance of PTA deficiency: evidence for the existence of major PTA deficiency and minor PTA deficiency. *Blood* 1961;18:149-165.
373. Seligsohn U, Modan M. Definition of the population at risk of bleeding due to factor XI deficiency in Ashkenazi Jews and the value of activated partial thromboplastin time in its detection. *Isr J Med Sci* 1981;17:413-415.
374. Seligsohn U. High gene frequency of factor XI (PTA) deficiency in Ashkenazi Jews. *Blood* 1978;51:1223-1228.
375. Asakai R, Chung DW, Ratnoff OD, Davie EW. Factor XI (plasma thromboplastin antecedent) deficiency in Ashkenazi Jews is a bleeding disorder that can result from three types of point mutations. *Proc Natl Acad Sci U S A* 1989;86:7667-7671.
376. Asakai R, Chung DW, Davie EW, Seligsohn U. Factor XI deficiency in Ashkenazi Jews in Israel. *N Engl J Med* 1991;325:153-158.
377. Shpilberg O, Peretz H, Zivelin A, et al. One of the two common mutations causing factor XI deficiency in Ashkenazi Jews (type II) is also prevalent in Iraqi Jews, who represent the ancient gene pool of Jews. *Blood* 1995;85:429-432.
378. Peretz H, Mulai A, Usher S, et al. The two common mutations causing factor XI deficiency in Jews stem from distinct founders: one of ancient Middle Eastern origin and another of more recent European origin. *Blood* 1997;90:2654-2659.
379. Bolton-Maggs PHB. Factor XI deficiency and its management. *Haemophilia* 2000;6[Suppl 1]:100-109.
380. Seligsohn U. Factor XI deficiency. *Thromb Haemost* 1993;70:68-71.
381. Rosenthal RL, Dreskin OH, Rosenthal N. Plasma thromboplastin antecedent (PTA) deficiency: clinical, coagulation, therapeutic and hereditary aspects of a new hemophilia-like disease. *Blood* 1955;10:120-131.
382. Phillips LL, Hyman GA, Rosenthal RL. Prolonged postoperative bleeding in a patient with factor XI (PTA) deficiency. *Ann Surg* 1965;162:37-42.
383. Kitchens CS, Alexander JA. Partial deficiency of coagulation factor XI as a newly recognized feature of Noonan syndrome. *J Pediatr* 1983;102:224-227.
384. Berrebi A, Malnick SDH, Vorst EJ, Stein D. High incidence of factor XI deficiency in Gaucher's disease. *Am J Hematol* 1992;40:153.
385. Edson JR, White JG, Krivit W. The enigma of severe factor XI deficiency without hemorrhagic symptoms. *Thromb Diath Haemorrh* 1967;18:342-348.
386. Todd M, Wright IS. Factor XI (PTA) deficiency with no hemorrhagic symptoms. *Thromb Diath Haemorrh* 1964;11:187-194.

387. Bolton-Maggs PHB, Patterson DA, Wensley RT, Tuddenham EGD. Definition of the bleeding tendency in factor XI-deficient kindreds: a clinical and laboratory study. *Thromb Haemost* 1995;73:194-202.
388. Kadir RA, Economides DL, Lee CA. Factor XI deficiency in women. *Am J Hematol* 1999;60:48-54.
389. Kadir RA, Economides DL, Sabin CA, et al. Frequency of inherited bleeding disorders in women with menorrhagia. *Lancet* 1998;351:485-489.
390. DeVries SI, Braat-van Straaten MAJ. Haemorrhagic diathesis as the result of severe deficiency of plasma thromboplastin antecedent (PTA, factor XI). *Thromb Haemost* 1964;11:167-186.
391. Soff GA, Levin J, Bell WR. Familial multiple coagulation factor deficiencies. II. Combined factor VIII, IX, and XI deficiency and combined factor IX and XI deficiency: two previously uncharacterized familial multiple factor deficiency syndromes. *Semin Thromb Hemost* 1981;7:149-169.
392. Ratnoff OD, Colopy JE. A familial hemorrhagic trait associated with a deficiency of a clot-promoting fraction of plasma. *J Clin Invest* 1955;34:602-613.
393. Ratnoff OD, Rosenblum JM. Role of Hageman factor in the initiation of clotting by glass. *Am J Med* 1958;25:160-168.
394. Ratnoff OD, Steinberg AG. Further studies on the inheritance of Hageman trait. *J Lab Clin Med* 1962;59:980-985.
395. Halbmayer WM, Haushofer A, Schon R, et al. The prevalence of moderate and severe FXII (Hageman factor) deficiency among the normal population: Evaluation of the incidence of FXII deficiency among 300 healthy blood donors. *Thromb Haemost* 1994;71:68-72.
396. Smink MM, Daniel TM, Ratnoff OD, Stavitsky AB. Immunologic demonstration of a deficiency of Hageman factor-like material in Hageman trait. *J Lab Clin Med* 1967;69:819-832.
397. Schloesser M, Zeerleder S, Lutze G, et al. Mutations in the human factor XII gene. *Blood* 1997;90:3967-3977.
398. Saito H, Scott JG, Movat HZ, Scialla SJ. Molecular heterogeneity of Hageman trait (factor XII deficiency). *J Lab Clin Med* 1979;94:256-265.
399. Wachtfogel YT, De La Cadena RA, Colman RW. Structural biology, cellular interactions and pathophysiology of the contact system. *Thromb Res* 1993;72:1-21.
400. Glueck HI, Roehill W. Myocardial infarction in a patient with a Hageman (factor XII) defect. *Ann Intern Med* 1966;64:390-396.
401. Ratnoff OD, Busse RJ, Sheon RP. The demise of John Hageman. *N Engl J Med* 1968;279:760-761.
402. Lodi S, Isa L, Pollini E, et al. Defective intrinsic fibrinolytic activity in a patient with severe factor XII-deficiency and myocardial infarction. *Scand J Haematol* 1984;33:80-82.
403. Koster T, Rosendaal FR, Briet E, Vandenbroucke JP. John Hageman's factor and deep-vein thrombosis: leiden thrombophilia study. *Br J Haematol* 1994;87:422-424.
404. Zeerleder S, Schloesser M, Rendondo M, et al. Reevaluation of the incidence of thromboembolic complications in congenital factor XII deficiency. *Thromb Haemost* 1999;82:1240-1246.
405. Colman RW, Schmaier AH. Contact system: a vascular biology modulator with anticoagulant, profibrinolytic, antiadhesive, and proinflammatory attributes. *Blood* 1997;90:3819-3843.
406. Nossel HL. The contact phase of blood coagulation. Oxford, UK: Blackwell Science, 1964.
407. Kasper CK, Buechy DY, Aggeler PM. Hageman factor (factor XII) in an affected kindred and in normal adults. *Br J Haematol* 1968;14:543-551.

408. Hathaway WE, Belhasen LP, Hathaway HS. Evidence for a new plasma thromboplastin factor. I. Case report, coagulation studies and physiochemical properties. *Blood* 1965;26:521–532.
409. Wuepper KD. Prekallikrein deficiency in man. *J Exp Med* 1973;138:1345–1355.
410. Saito H, Ratnoff OD, Donaldson VH. Defective activation of clotting, fibrinolytic and permeability-enhancing systems in human Fletcher trait plasma. *Circ Res* 1974;34:641–651.
411. Wuepper KD. Biochemistry and biology of components of the plasma kinin-forming system. In: Lewpow IH, Ward PA, eds. *Inflammation, mechanisms and control*. New York: Academic Press, 1972.
412. Weiss AS, Gallin JI, Kaplan AP. Fletcher factor deficiency: a diminished rate of Hageman factor activation caused by absence of prekallikrein with abnormalities of coagulation, fibrinolysis, chemotactic activity, and kinin generation. *J Clin Invest* 1974;53:622–633.
413. Sollo DG, Saleem A. Prekallikrein (Fletcher factor) deficiency. *Ann Clin Lab Sci* 1985;15:279–285.
414. Estelles A, Aznar J, Espana F. The absence of release of the plasminogen activator after venous occlusion in a Fletcher trait patient. *Thromb Haemost* 1983;49:66.
415. Abildgaard DF, Harrison J. Fletcher factor deficiency: family study and detection. *Blood* 1974;43:641–644.
416. Asmis LM, Sulzer I, Furlan M, Lammler B. Prekallikrein deficiency. The characteristic normalization of the severely prolonged aPTT following increased preincubation time is due to autoactivation of factor XII. *Thromb Res* 2002;105:463–470.
417. Soulier JP, Gozin D. Assay of Fletcher factor (plasma prekallikrein) using an artificial clotting reagent and a modified chromogenic assay. *Thromb Haemost* 1979;42:538–547.
418. Saito H, Ratnoff OD, Waldman R, Abraham JP. Fitzgerald trait. *J Clin Invest* 1975;55:1082–1089.
419. Colman RW, Bagdasarian A, Talamo RC, et al. Williams trait. *J Clin Invest* 1975;56:1650–1662.
420. Oh-Ishi S, Uemo A, Uchida Y, et al. Abnormalities in the contact activation through factor-XII in Fujiwara trait: a deficiency in both high and low-molecular-weight kininogens with low-level of prekallikrein. *Tohoku J Exp Med* 1981;133:67–80.
421. Wuepper KD, Miller DR, Lacombe MJ. Flaujeac trait: deficiency of human plasma kininogen. *J Clin Invest* 1975;56:1663–1672.
422. Donaldson VH, Kleniewski J, Saito H, Sayed JK. Prekallikrein deficiency in a kindred with kininogen deficiency and Fitzgerald trait clotting defect: evidence that high-molecular-weight kininogen and prekallikrein exist as a complex in normal human plasma. *J Clin Invest* 1977;60:571–583.
423. Hayashi H, Ishimaru F, Fugita T, et al. Molecular genetic survey of five Japanese families with high-molecular-weight kininogen deficiency. *Blood* 1990;75:1296–1304.
424. Cheung PP, Kunapuhi SP, Scott CF, et al. Genetic basis of total kininogen deficiency in Williams' trait. *J Biol Chem* 1993;268:23361–23365.
425. Soff GA, Levin J. Familial multiple coagulation factor deficiencies: review of the literature. *Semin Thromb Hemost* 1981;7:112–148.
426. Peyvandi F, Tuddenham EG, Akhtari AM, et al. Bleeding symptoms in 27 Iranian patients with the combined deficiency of factor V and factor VIII. *Br J Haematol* 1998;150:773–776.
427. Girolami A, Brunetti A, de Marco L. Congenital combined factor V and factor VIII deficiency in a male born from brother-sister incest. *Blut* 1974;28:33–42.
428. Seligsohn U, Zivelin A, Zwang E. Decreased factor VIII clotting antigen levels in the combined factor



V and VIII deficiency. *Thromb Res* 1983;33:95–98.

429. Seligsohn U, Zivelin A, Zwang E. Combined factor V and factor VIII deficiency among non-Ashkenazi Jews. *N Engl J Med* 1982;307:1191–1195.

430. Nichols WC, Seligsohn U, Zivelin A, et al. Mutations in the ER-Golgi intermediate compartment protein ERGIC-53 cause combined deficiency of coagulation factors V and VIII. *Cell* 1998;93:61–70.

431. Neerman-Arbez M, Johnson KM, Morris MA, et al. Molecular analysis of the ERGIC-53 gene in 35 families with combined factor V-factor VIII deficiency. *Blood* 1999;93:2253–2260.

432. Zhang B, Cunningham MA, Nichols WC, et al. CFD2 encodes a novel component of the ER-Golgi Intermediate Compartment and is the second gene responsible for combined deficiency of factor V and factor VIII. *Blood* 2002;100[Suppl]:4a.

433. Brenner B. Hereditary deficiency of vitamin K-dependent coagulation factors. *Thromb Haemost* 2000;84:935–936.

434. Goldsmith GH, Pence RE, Ratnoff OD, et al. Studies on a family with combined functional deficiencies of vitamin K-dependent coagulation factors. *J Clin Invest* 1982;69:1253–1260.

435. Brenner B, Sanchez-Vega B, Wu SM, et al. A missense mutation in  $\gamma$ -glutamyl carboxylase gene causes combined deficiency of all vitamin K-dependent blood coagulation factors. *Blood* 1998;92:4554–4559.

436. Spronk HMH, Farah RA, Buchanan GR, et al. Novel mutation in the  $\gamma$ -glutamyl carboxylase gene resulting in congenital combined deficiency of all vitamin K-dependent blood coagulation factors. *Blood* 2000;96:3650–3652.

437. Fregin A, Rost S, Wolz W, et al. Homozygosity mapping of a second gene locus for hereditary combined deficiency of vitamin K-dependent clotting factors to the centromeric region of chromosome 16. *Blood* 2002;100:3229–3232.

438. Aoki N, Saito H, Kamiya T, et al. Congenital deficiency of a  $\alpha_2$ -plasmin inhibitor associated with severe hemorrhagic tendency. *J Clin Invest* 1979;63:877–884.

439. Aoki N, Sakata Y, Matsuda M, Tateno K. Fibrinolytic states in a patient with congenital deficiency of a  $\alpha_2$ -plasmin inhibitor. *Blood* 1980;55:483–488.

440. Collen D. a  $\alpha_2$ -antiplasmin inhibitor deficiency. *Lancet* 1979;1:1039–1040.

441. Saito H. a  $\alpha_2$ -plasmin inhibitor and its deficiency states. *J Lab Clin Med* 1988;112:671–678.

442. Favier R, Aoki N, de Moerloose P. Congenital a  $\alpha_2$ -plasmin inhibitor deficiencies: a review. *Br J Haematol* 2001;114:4–10.

443. Lee MH, Vosburgh E, Anderson K, McDonagh J. Deficiency of plasma plasminogen activator inhibitor 1 results in hyperfibrinolytic bleeding. *Blood* 1993;81:2357–2362.

444. Minowa H, Takahashi Y, Tanaka T, et al. Four cases of bleeding diathesis in children due to congenital plasminogen activator inhibitor-1 deficiency. *Haemostasis* 1999;29:286–291.

445. Fay WP, Parker AC, Condrey LR, Shapiro AD. Human plasminogen activator inhibitor-1 (PAI-1) deficiency: characterization of a large kindred with a null mutation in the PAI-1 gene. *Blood* 1997;90:204–208.

446. Lewis JH, Iammarino RM, Spero JA, Hasiba U. Antithrombin Pittsburgh: an a  $\alpha_1$ -antitrypsin variant causing hemorrhagic disease. *Blood* 1978;51:129–137.

447. Owen MC, Brennan SO, Lewis JH, Carrell RW. Mutation of antitrypsin to antithrombin: a  $\alpha_1$ -antitrypsin Pittsburgh (358 Met Arg), a fatal bleeding disorder. *N Engl J Med* 1983;309:694–698.

448. Scott CF, Carrell RW, Glaser CB, et al. Alpha-1-antitrypsin Pittsburgh: a potent inhibitor of plasma factor XI<sub>a</sub>, kallikrein, and factor XII<sub>a</sub>. *J Clin Invest* 1986;77:631-634.
449. Courtney M, Jallat S, Tessier LH, et al. Synthesis in *E. coli* of a  $\alpha_1$  antitrypsin variants of therapeutic potential for emphysema and thrombosis. *Nature* 1985;313:149-151.
450. Rosenberg S, Barr PJ, Najarian RC, Hallewell RA. Synthesis in yeast of a functional oxidation-resistant mutant of human  $\alpha_1$  antitrypsin. *Nature* 1984;312:77-80.
451. Beck P, Bloom AL, Giddings JC, Sweetnam PM. A controlled trial of oral contraceptives in haemophilia. *Br J Haematol* 1970;19:667-673.
452. Bennet AE, Ingram GIC. A controlled trial of long-term steroid treatment in haemophilia. *Lancet* 1967;1:967-970.
453. Alperin JB. Estrogens and surgery in women with von Willebrand disease. *Am J Med* 1982;73:367-371.
454. Green D, Smith NJ. Hemophilia: current concepts in management. *Med Clin North Am* 1972;56:105-117.
455. Furie B, Limentani SA, Rosenfield CG. A practical guide to the evaluation and treatment of hemophilia. *Blood* 1994;84:3-9.
456. Lusher JM, Arkin S, Abildgaard CF, et al. Recombinant factor VIII for the treatment of previously untreated patients with hemophilia A. *N Engl J Med* 1993;328:453-459.
457. Bowie EJW, Thompson JH, Didisheim P, Owen CA. Disappearance rates of coagulation factors: transfusion studies in factor-deficient patients. *Transfusion* 1967;7:174-184.
458. Abildgaard CF, Cornet JA, Fort E, Schulman I. The in vivo longevity of antihemophilic factor (factor VIII). *Br J Haematol* 1964;10:225-237.
459. Smith KJ, Thompson AR. Labeled factor IX kinetics in patients with hemophilia-B. *Blood* 1981;58:625-629.
460. Perkins HA. Plasmapheresis of the patient as a method for achieving effective levels of plasma coagulation factors using fresh frozen plasma. *Transfusion* 1966;6:293-301.
461. Klein HG, Dodd RY, Dzik WH, et al. Current status of solvent/detergent-treated frozen plasma. *Transfusion* 1998;38:102-107.
462. Mast AE, Stadanick JE, Lockett JM, Dietzen DJ. Solvent/detergent-treated plasma has decreased antitrypsin activity and absent antiplasmin activity. *Blood* 1999;94:3922-3927.
463. Leebeek FWG, Schipperus MR, van Vliet HH. Coagulation factor levels in solvent/detergent-treated plasma. *Transfusion* 1999;39:1150-1151.
464. Pool JG, Shannon AE. Production of high-potency concentrates of antihemophilic globulin in a closed-bag system: assay in vitro and in vivo. *N Engl J Med* 1965;273:1443-1447.
465. Brettler DB, Levine PH. Factor concentrates for treatment of hemophilia: which one to choose? *Blood* 1989;73:2067-2073.
466. Miescher PA, Jaffe ER. Human factor VIII:C purified using monoclonal antibody to von Willebrand factor. *Semin Hematol* 1988;25[2 Suppl 1]:1-45.
467. Schwartz RS, Abildgaard CF, Aledort LM, et al. Human recombinant DNA-derived antihemophilic factor (factor VIII) in the treatment of hemophilia A. *N Engl J Med* 1990;323:1800-1805.
468. Flores G, Juarez JC, Mantoro JB, et al. Seroprevalence of parvovirus B19, cytomegalovirus, hepatitis

A virus and hepatitis E virus antibodies in haemophiliacs treated exclusively with clotting factor concentrates considered safe against human immunodeficiency and hepatitis C viruses. *Haemophilia* 1995;1:115–117.

469. Aledort LM. Can costs of hemophilia products be curtailed? Not as we do business today! *Thromb Haemost* 2002;88:451.
470. Gjerset GF, Pike MC, Mosley JW, et al. Effect of low- and intermediate-purity clotting factor therapy on progression of human immunodeficiency virus infection in congenital clotting disorders. *Blood* 1994;84:1666–1671.
471. Lefrere JJ, Mariotti M, Thauvin M. B19 parvovirus DNA in solvent/detergent-treated anti-haemophilia concentrates. *Lancet* 1994;343:211–212.
472. Azzi A, De Santis R, Morfini M, et al. TT virus contaminates first-generation recombinant factor VIII concentrates. *Blood* 2001;98:2571–2573.
473. Aledort LM. Hemophilia. *N Engl J Med* 2001;345:1066–1067.
474. Berntorp E. Second generation, B-domain deleted recombinant factor VIII. *Thromb Haemost* 1997;78:256–260.
475. Abshire TC, Brackmann HH, Scharrer I, et al. Sucrose formulated recombinant human antihemophilic factor VIII is safe and efficacious for treatment of hemophilia A in home therapy. *Thromb Haemost* 2000;83:811–816.
476. Lozier JN, Santagustino E, Kasper CK, et al. Use of porcine factor VIII for surgical procedures in hemophilia A patients with inhibitors. *Semin Hematol* 1993;30:10–21.
477. Zauber NP, Levin J. Factor IX levels in patients with hemophilia B (Christmas disease) following transfusion with concentrates of factor IX or fresh frozen plasma (FFP). *Medicine* 1977;56:213–224.
478. Seligsohn U, Kasper CK, Osterud B, Rapaport SI. Activated factor VII: presence in factor IX concentrates and persistence in the circulation after infusion. *Blood* 1979;53:828–837.
479. White GC, Roberts HR, Kingdon HS, Lundblad RL. Prothrombin complex concentrates: potentially thrombogenic materials and clues to the mechanism of thrombosis in vivo. *Blood* 1977;49:159–170.
480. Hultin MB. Activated clotting factors in factor IX concentrates. *Blood* 1979;54:1028–1038.
481. Giles AR, Nesheim ME, Hoogendoorn H, et al. The coagulant-active phospholipid content is a major determinant of in vivo thrombogenicity of prothrombin complex (factor IX) concentrates in rabbits. *Blood* 1982;59:401–407.
482. Campbell EW, Neff S, Bowdler AJ. Therapy with factor IX concentrate resulting in DIC and thromboembolic phenomena. *Transfusion* 1978;18:94–97.
483. Blatt PM, Lundblad RL, Kingdon HS, et al. Thrombogenic materials in prothrombin complex concentrates. *Ann Intern Med* 1974;81:766–770.
484. Shapiro AD, Ragni MV, Lusher JM, et al. Safety and efficacy of monoclonal antibody purified factor IX concentrate in previously untreated patients with hemophilia B. *Thromb Haemost* 1996;75:30–35.
485. Mannucci PM, Bauer KA, Gringeri A, et al. Thrombin generation is not increased in the blood of hemophilia B patients after the infusion of a purified factor IX concentrate. *Blood* 1990;76:2540–2545.
486. Brinkhous KM, Sigman JL, Read MS, et al. Recombinant human factor IX: replacement therapy, prophylaxis, and pharmacokinetics in canine hemophilia B. *Blood* 1996;88:2603–2610.
487. Lusher JM, Shapiro SS, Palascak JE, et al. Efficacy of prothrombin-complex concentrates in hemophiliacs with antibodies to factor VIII: a multicenter therapeutic trial. *N Engl J Med* 1980;303:421–425.
488. Glazer S, Hedner U, Falch JF. Clinical update on the use of recombinant factor VII. *Adv Exp Med Biol*

1995;386:163-174.

489. Editorial. DDAVP in haemophilia and von Willebrand disease. *Lancet* 1983;2:774-775.
490. Cash JD, Gader AMA, da Costa J. The release of plasminogen activator and factor VIIIc to lysine vasopressin, arginine vasopressin, 1-desamino-8-arginine vasopressin, angiotensin and oxytocin in man. *Br J Haematol* 1974;27:363-364.
491. Theiss W, Schmidt G. DDAVP in von Willebrand disease: repeated administration and the behaviour of the bleeding time. *Thromb Res* 1978;13:1119-1123.
492. Ingram GIC, Hilton PJ. DDAVP in haemophilia. *Lancet* 1977;2:721-722.
493. Mannucci PM. Desmopressin (DDAVP) in the treatment of bleeding disorders: the first 20 years. *Blood* 1997;90:2515-2521.
494. Warriar AI, Lusher JM. DDAVP: a useful alternative to blood components in moderate hemophilia A and von Willebrand disease. *J Pediatr* 1983;102:228-233.
495. de la Fuente B, Kasper CK, Rickles FR, Hoyer LW. Response of patients with mild and moderate hemophilia A and von Willebrand disease to treatment with desmopressin. *Ann Intern Med* 1985;103:6-14.
496. Revel-Vilk S, Blanchette VS, Sparling C, et al. DDAVP challenge tests in boys with mild/moderate haemophilia A. *Br J Haematol* 2002;117:947-951.
497. Ruggeri ZM, Mannucci PM, Lombardi R, et al. Multimeric composition of factor VIII/von Willebrand factor following administration of DDAVP: implications for pathophysiology and therapy of von Willebrand disease subtypes. *Blood* 1982;59:1272-1278.
498. Kobrinsky NL, Israels ED, Gerrard JM, et al. Shortening of bleeding time by 1-deamino-8-D-arginine vasopressin in various bleeding disorders. *Lancet* 1984;1:1145-1148.
499. Kaufmann JE, Oksche A, Wollheim CB, et al. Vasopressin-induced von Willebrand factor secretion from endothelial cells involves V<sub>2</sub> receptors and cAMP. *J Clin Invest* 2000;106:107-116.
500. Ehl S, Severin T, Sutor AH. DDAVP (desmopressin) treatment in children with hemophilia B. *Br J Haematol* 2000;111:1260-1262.
501. Kavakli K, Aydinok Y, Karapinar D, Balkan C. DDAVP treatment in children with haemophilia B. *Br J Haematol* 2001;114:733-734.
502. Rose EH, Aledort LM. Nasal spray desmopressin (DDAVP) for mild hemophilia A and von Willebrand disease. *Ann Intern Med* 1991;114:563-568.
503. Mannucci PM. Desmopressin: a nontransfusional form of treatment for congenital and acquired bleeding disorders. *Blood* 1988;72:1449-1455.
504. Bond L, Bevan D. Myocardial infarction in a patient with hemophilia treated with DDAVP. *N Engl J Med* 1988;318:121.
505. Dunn AL, Powers JR, Ribeiro MJ, et al. Adverse events during use of intranasal desmopressin acetate for hemophilia A and von Willebrand disease: a case report and review of 40 patients. *Haemophilia* 2000;6:11-14.
506. Sutor AH. DDAVP is not a panacea for children with bleeding disorders. *Br J Haematol* 2000;108:217-227.
507. Walsh PN, Rizza CR, Matthews JM, et al. Epsilon-aminocaproic acid therapy for dental extractions in haemophilia and Christmas disease: a double blind controlled trial. *Br J Haematol* 1971;20:463-475.
508. Mannucci PM. Hemostatic drugs. *N Engl J Med* 1998;339:245-253.

509. Kasper CK, Dietrich SL. Comprehensive management of haemophilia. *Clin Haematol* 1985;14:489–512.
510. Evans BE, Aledort LM. Hemophilia and dental treatment. *J Am Dental Assoc* 1978;96:827–834.
511. Stark S, White JG, Langer L, Krivit W. Epsilon aminocaproic acid therapy as a cause of intrarenal obstruction in haematuria of haemophiliacs. *Scand J Haematol* 1965;2:99–107.
512. Kasper CK. Hereditary plasma clotting factor disorders and their management. *Haemophilia* 2000;6[Suppl 1]:13–27.
513. Hemophilia of Georgia, USA. Protocols for the treatment of hemophilia and von Willebrand disease. *Haemophilia* 2000;6[Suppl 1]:84–93.
514. Kulkarni R, Lusher J. Perinatal management of newborns with haemophilia. *Br J Haematol* 2001;112:264–274.
515. Köhler M, Hellstern P, Miyashita C, et al. Comparative study of intranasal, subcutaneous and intravenous administration of desamino-D-arginine vasopressin (DDAVP). *Thromb Haemost* 1986;55:108–111.
516. Ashenhurst JB, Langehennig PL, Seeler RA. Early treatment of bleeding episodes with 10 U/kg of factor VIII. *Blood* 1977;50:181–182.
517. Bona RD, Weinstein RA, Weisman SJ, et al. The use of continuous infusion of factor concentrates in the treatment of hemophilia. *Am J Hematol* 1989;32:8–13.
518. Hathaway WE, Christian MJ, Clarke SL, Hasiba U. Comparison of continuous and intermittent factor VIII concentrate therapy in hemophilia A. *Am J Hematol* 1984;17:85–88.
519. Batarova A, Martinowitz U. Continuous infusion of coagulation factors. *Haemophilia* 2002;8:170–177.
520. Menart C, Petit PV, Attali O, et al. Efficacy and safety of continuous infusion of Mononine® during five surgical procedures in three hemophilic patients. *Am J Hematol* 1998;58:110–116.
521. Rodgers GM, Ford MH. Lack of response to commercial factor VIII concentrate in hemophilia A. *Am J Hematol* 1991;37:288.
522. Lusher JM. Clinical guideline for treating von Willebrand disease patients who are not candidates for DDAVP—a survey of European physicians. *Haemophilia* 1998;4 [Suppl 3]:11–14.
523. Rick ME. Treatment of von Willebrand disease. *UpToDate* 2002;10.
524. Mannucci PM, Tenconi PM, Castaman G, Rodeghiero F. Comparison of four virus-inactivated plasma concentrates for treatment of severe von Willebrand disease: a cross-over randomized trial. *Blood* 1992;79:3130–3137.
525. Fowler WE, Berkowitz LR, Roberts HR. DDAVP for type IIB von Willebrand disease. *Blood* 1989;74:1859–1860.
526. Mazurier C, Gaucher C, Jorieux S, et al. Biological effect of desmopressin in eight patients with type 2N (“Normandy”) von Willebrand disease. *Br J Haematol* 1994;88:849–854.
527. Lillicrap D, Poon MC, Walker I, et al. Efficacy and safety of the factor VIII/von Willebrand factor concentrate, Haemate-P/Humate-P: ristocetin cofactor unit dosing in patients with von Willebrand disease. *Thromb Haemost* 2002;87:224–230.
528. Mannucci PM, Chediak J, Hanna W, et al. Treatment of von Willebrand disease with a high-purity factor VIII/von Willebrand factor concentrate: a prospective, multicenter study. *Blood* 2002;99:450–456.
529. Goudemand J, Negrier C, Ounnoughene O, Sultan Y. Clinical management of patients with von Willebrand disease with a VHP VWF concentrate: the French experience. *Haemophilia* 1998;4:48–53.

530. Castillo R, Monteagudo J, Escolar G, et al. Hemostatic effect of normal platelet transfusion in severe von Willebrand disease patients. *Blood* 1991;77: 1901–1905.
531. Miller JL, Kupinski JM, Castella A, Ruggeri ZM. von Willebrand factor binds to platelets and induces aggregation in platelet-type but not type IIB von Willebrand disease. *J Clin Invest* 1983;72:1532–1542.
532. Makris M, Colvin B, Gupta V, et al. Venous thrombosis following the use of intermediate purity FVIII concentrate to treat patients with von Willebrand disease. *Thromb Haemost* 2002;88:387–388.
533. Schwarz HP, Turecek PL, Pichler L, et al. Recombinant von Willebrand factor. *Thromb Haemost* 1997;78:571–576.
534. O'Connor H, Magos A. Endometrial resection for the treatment of menorrhagia. *N Engl J Med* 1996;335:151–156.
535. Conti M, Mari D, Conti E, et al. Pregnancy in women with different types of von Willebrand disease. *Obstet Gynecol* 1986;68:282–285.
536. Kim HC, McMillan CW, White GC, et al. Purified factor IX using monoclonal immunoaffinity technique: clinical trials in hemophilia B and comparison to prothrombin complex concentrates. *Blood* 1992;79:568–575.
537. White GC, Beebe A, Nielsen B. Recombinant factor IX. *Thromb Haemost* 1997;78:261–265.
538. Roth DA, Kessler CM, Pasi J, et al. Human recombinant factor IX: safety and efficacy studies in hemophilia B patients previously treated with plasma-derived factor IX concentrates. *Blood* 2001;98:3600–3606.
539. Gioia KP, Bouhasin JD. Call for post-licensing human pharmacokinetic studies of administration of recombinant factor IX. *Haemophilia* 1998;4:67.
540. Poon MC, Lillicrap D, Hensman C, et al. Recombinant factor IX recovery and inhibitor safety: a Canadian post-licensure surveillance study. *Thromb Haemost* 2002;87:431–435.
541. Thorland EC, Drost JB, Lusher JM, et al. Anaphylactic response to factor IX replacement therapy in haemophilia B patients: complete gene deletions confer the highest risk. *Haemophilia* 1999;5:101–105.
542. Jadhav M, Warriar I. Anaphylaxis in patients with hemophilia. *Semin Thromb Hemost* 2000;26:205–208.
543. White GC. Gene therapy in hemophilia: clinical trials update. *Thromb Haemost* 2001;86:172–177.
544. Pasik J. Gene therapy for haemophilia. *Br J Haematol* 2001;115:744–757.
545. Dwarki VJ, Belloni P, Nijjar T, et al. Gene therapy for hemophilia A: production of therapeutic levels of human factor VIII *in vivo* in mice. *Proc Natl Acad Sci U S A* 1995;92:1023–1027.
546. Kay MA, Rothenberg S, Landen CN, et al. In vivo gene therapy of hemophilia B: sustained partial correction in factor IX-deficient dogs. *Science* 1993;262:117–119.
547. Manno CS, Chew AJ, Hutchinson S, et al. AAV-mediated factor IX gene transfer to skeletal muscle in patients with severe hemophilia B. *Blood* 2003;101:2963–2972.
548. Roth DA, Tawa NE, O'Brien JM, et al. Non-viral transfer of the gene encoding coagulation factor VIII in patients with hemophilia A. *N Engl J Med* 2001;344:1735–1742.
549. Ingerslev J, Knudsen L, Hvid I, et al. Use of recombinant factor VIIa in surgery in factor VII-deficient patients. *Haemophilia* 1997;3:215–218.
550. Roberts HR, Bingham MD. Other coagulation deficiencies. In: Loscalzo J, Schafer AI, eds. *Thrombosis and hemorrhage*, 2nd ed. Baltimore: Williams & Wilkins, 1998:773–802.
551. Ingerslev J, Kristensen HL. Clinical picture and treatment strategies in factor VII deficiency.

Haemophilia 1998;4:689-696.

552. Hedner U, Erhardtsen E. Potential role for rFVIIa in transfusion medicine. *Transfusion* 2002;42:114-124.

553. Briet E, Onvlee G. Hip surgery in a patient with severe factor VII deficiency. *Haemostasis* 1987;17:273-277.

554. Roberts HR, Eberst ME. Current management of hemophilia B. *Hematol Oncol Clin North Am* 1993;7:1269-1280.

555. Hedner U. Recombinant coagulation factor VIIa: from the concept to clinical application in hemophilia treatment in 2000. *Semin Thromb Hemostasis* 2000;26:363-366.

556. Mariani G, Testa MG, DiPaolantonio T, et al. Use of recombinant, activated factor VII in the treatment of congenital factor VII deficiencies. *Vox Sang* 1999;77:131-136.

557. Poon MC. Use of recombinant factor VIIa in hereditary bleeding disorders. *Curr Opin Hematol* 2001;8:312-318.

558. Scharrer I. Recombinant factor VIIa for patients with inhibitors to factor VIII or IX or factor VII deficiency. *Haemophilia* 1999;5:253-259.

559. Nugent D, Harwood E, Lusher J, et al. Pilot studies on the survival of infused factor XIII (Fibrogammin P, Aventis) and the incidence of anti-F-XIII antibodies in FXIII deficient patients. *Blood* 2000;96:639a.

560. Lorand L, Losowsky MS, Miloszewski KJM. Human factor XIII: fibrin-stabilizing factor. *Prog Hemost Thromb* 1980;5:245-290.

561. Gootenberg JE. Factor concentrates for the treatment of factor XIII deficiency. *Curr Opin Hematol* 1998;5:372-375.

562. Stenbjerg S. Prophylaxis in factor XIII deficiency [Letter]. *Lancet* 1980;2:257.

563. Rodeghiero F, Castaman GC, Di Bona E, et al. Successful pregnancy in a woman with congenital factor XIII deficiency treated with substitutive therapy. Report of a second case. *Blut* 1987;55:45-48.

564. Shapiro SS, McCord S. Prothrombin. *Prog Hemost Thromb* 1978;4:177-209.

565. Horowitz B, Bonomo R, Prince AM, et al. Solvent/detergent-treated plasma: a virus-inactivated substitute for fresh frozen plasma. *Blood* 1992;79:826-831.

566. Bolton-Maggs PHB, Colvin BT, Satchi G, et al. Thrombogenic potential of factor XI concentrate. *Lancet* 1994;334:748-749.

567. Ingram GIC, Mathews JA, Bennett AE. A controlled trial of joint aspiration in acute haemophilic haemarthrosis. *Br J Haematol* 1972;23:649-654.

568. Querol F, Aznar JA, Haya S, Cid A. Orthoses in haemophilia. *Haemophilia* 2002;8:407-412.

569. Inwood MJ, Killackey B, Startup SJ. The use and safety of ibuprofen in the hemophiliac. *Blood* 1983;61:709-711.

570. Arnold WD, Hilgartner MW. Hemophilic arthropathy: current concepts of pathogenesis and management. *J Bone Joint Surg Am* 1977;59:287-305.

571. Goldberg VM, Heiple KG, Ratnoff OD, et al. Total knee arthroplasty in classic hemophilia. *J Bone Joint Surg Am* 1981;63:695-701.

572. Rana NA, Shapiro GR, Green D. Long-term follow-up of prosthetic joint replacement in hemophilia. *Am J Hematol* 1986;23:329-337.



573. McCollough NC, Enis JE, Lovitt J, et al. Synovectomy or total replacement of the knee in hemophilia. *J Bone Joint Surg Am* 1979;61:69–75.
574. Molho P, Verrier P, Stieltjes N, et al. A retrospective study on chemical and radioactive synovectomy in severe haemophilia patients with recurrent haemarthrosis. *Haemophilia* 1999;5:115–123.
575. Dunn AL, Busch MT, Wyly JB, Abshire TC. Radionuclide synovectomy for hemophilic arthropathy: a comprehensive review of safety and efficacy and recommendation for a standardized treatment protocol. *Thromb Haemost* 2002;87:383–393.
576. Hilgartner MW, Arnold WD. Hemophilic pseudotumor treated with replacement therapy and radiation. *J Bone Joint Surg Am* 1975;57:1145–1146.
577. Rodriguez-Merchan EC. Haemophilic cysts (pseudotumors). *Haemophilia* 2002;8:393–401.
578. Blattner RJ. Recent developments in the management of hemophilia with particular reference to intracranial bleeding. *J Pediatr* 1967;70:449–452.
579. Silverstein A. Intracranial bleeding in hemophilia. *Arch Neurol* 1960;3:141–157.
580. Eyster ME, Gill FM, Blatt PM, et al. Central nervous system bleeding in hemophiliacs. *Blood* 1978;51:1179–1188.
581. Andes WA, Wulff K, Smith WB. Head trauma in hemophilia. *Arch Intern Med* 1984;144:1981–1983.
582. Kinney TR, Zimmerman RA, Butler RB, Gill FM. Computerized tomography in the management of intracranial-bleeding in hemophilia. *J Pediatr* 1977;91:31–35.
583. Seeler RA, Imana RB. Intracranial hemorrhage in patients with hemophilia. *J Neurosurg* 1973;39:181–185.
584. Curran JW, Lawrence DN, Jaffe H, et al. Acquired immunodeficiency syndrome (AIDS) associated with transfusions. *N Engl J Med* 1984;310:69–75.
585. Goldsmith JM, Variakojis D, Phair JP, Green D. The spectrum of human immunodeficiency virus infection in patients with factor IX deficiency (Christmas disease). *Am J Hematol* 1987;25:203–210.
586. Jones PK, Ratnoff OD. The changing prognosis of classic hemophilia (factor VIII “deficiency”). *Ann Intern Med* 1991;114:641–648.
587. Triemstra M, Rosendaal FR, Smit C, et al. Mortality in patients with hemophilia: changes in a Dutch population from 1986 to 1992 and 1973 to 1986. *Ann Intern Med* 1995;123:823–827.
588. Chorba TL, Holman RC, Clarke MJ, Evatt BL. Effects of HIV infection on age and cause of death for persons with hemophilia A in the United States. *Am J Hematol* 2001;16:229–240.
589. Wilde JT, Lee CA, Collins P, et al. Increased bleeding associated with protease inhibitor therapy in HIV-positive patients with bleeding disorders. *Br J Haematol* 1999;107:556–559.
590. Karpatkin S, Nardi M, Green D. Platelet and coagulation defects associated with HIV-1 infection. *Thromb Haemost* 2002;88:389–401.
591. Ratnoff OD, Menitove JE, Aster RH, Lederman MM. Coincident classic hemophilia and “idiopathic” thrombocytopenic purpura in patients under treatment with concentrates of antihemophilic factor (factor VIII). *N Engl J Med* 1983;308:439–442.
592. Karpatkin S, Nardi MA. Immunologic thrombocytopenic purpura in human immunodeficiency virus-seropositive patients with hemophilia. Comparison with patients with classic autoimmune thrombocytopenic purpura, homosexuals and thrombocytopenia, and narcotic addicts with thrombocytopenia. *J Lab Clin Med* 1988;111:441–448.
593. Martin MD, Rodgers GM. Hematologic and neoplastic aspects of human immunodeficiency virus

infection. In: Mazza JJ, ed. Manual of clinical hematology, 3rd ed. Philadelphia: Lippincott Williams & Wilkins, 2002:389–398.

594. Spero JA, Lewis JH, Van Thiel DH, et al. Asymptomatic structural liver disease in hemophilia. *N Engl J Med* 1978;298:1373–1378.

595. White GC, Zeitler KD, Lesesne HR, et al. Chronic hepatitis in patients with hemophilia A: histologic studies in patients with intermittently abnormal liver function tests. *Blood* 1982;60:1259–1262.

596. Fletcher ML, Trowell JM, Craske J, et al. Non-A non-B hepatitis after transfusion of factor VIII in infrequently treated patients. *BMJ* 1983;287:1754–1757.

597. Gerety RJ, Eyster ME, Tabor E, et al. Hepatitis-B virus, hepatitis-A virus and persistently elevated aminotransferases in hemophiliacs. *J Med Virol* 1980;6:111–118.

598. Goedert JJ, Eyster ME, Lederman MM, et al. End-stage liver disease in persons with hemophilia and transfusion-associated infections. *Blood* 2002;100:1584–1589.

599. Mannucci PM, Gdovin S, Gringeri A, et al. Transmission of hepatitis A to patients with hemophilia by factor VIII concentrates treated with organic solvent and detergent to inactivate virus. *Ann Intern Med* 1994;120:1–7.

600. Giangrande PLF. Hepatitis in haemophilia. *Br J Haematol* 1998;103:1–9.

601. Smith PS, Keyes NC, Forman EN. Socioeconomic evaluation of a state-funded comprehensive hemophilia care program. *N Engl J Med* 1982;306: 575–579.

602. Helske T, Ikkala E, Myllyla G, et al. Joint involvement in patients with severe haemophilia A in 1957–59 and 1978–79. *Br J Haematol* 1982;51:643–647.

603. Nilsson IM, Berntorp E, Lofqvist T, Pettersson H. Twenty-five years' experience of prophylactic treatment in severe haemophilia A and B. *J Intern Med* 1992;232:25–32.

604. Lofqvist T, Nilsson IM, Berntorp E, Pettersson H. Haemophilia prophylaxis in young patients—a long-term followup. *J Intern Med* 1997;241:395–400.

605. Bohn RL, Avorn J, Glynn RJ, et al. Prophylactic use of factor VIII: an economic evaluation. *Thromb Haemost* 1998;79:932–937.

606. Fischer K, van der Bom JG, Mauser-Bunschoten EP, et al. The effects of postponing prophylactic treatment on long-term outcome in patients with severe hemophilia. *Blood* 2002;99:2337–2341.

2004 Lippincott Williams & Wilkins  
John P. Greer, John Foerster, John N. Lukens  
George M. Rodgers, Frixos Paraskevas, Bertil Glader  
Wintrobe's Clinical Hematology

DEFICIENCIES OF VITAMIN K-DEPENDENT FACTORSVitamin K Deficiency Bleeding (Hemorrhagic Disease of the Newborn)Other Causes of Vitamin K DeficiencyLIVER DISEASEPathophysiologyClinical ManifestationsLaboratory DiagnosisTreatmentDISSEMINATED INTRAVASCULAR COAGULATIONEtiology and IncidencePathophysiologyClinical FeaturesLaboratory DiagnosisDifferential DiagnosisTreatmentSpecific Features of Various Forms of Disseminated Intravascular CoagulationPathologyNovel Therapies for Disseminated Intravascular CoagulationPRIMARY FIBRINOLYSIS (FIBRINOGENOLYSIS)EtiologyPathophysiologyClinical Features and Laboratory DiagnosisTreatmentPathologic Inhibitors of CoagulationAntibodies to Factor VIIIMonospecific Antibodies to Other Coagulation FactorsAntiphospholipid-Protein Antibodies: Lupus Anticoagulants and Anticardiolipin AntibodiesTransfusion-Associated Coagulation AbnormalitiesBleeding Associated with Extracorporeal CirculationDrug-Induced Coagulation AbnormalitiesAcquired Deficiencies of Single Coagulation FactorsOther Acquired Coagulation DisordersREFERENCES

Abnormalities in blood coagulation may complicate a large number of disorders ( [Table 60.1](#)). The acquired coagulation disorders are more complex than the inherited forms. In contrast to inherited disorders in which deficiency or abnormality of a single factor is characteristic, the acquired forms usually are associated with multiple coagulation abnormalities, and the disorder often is complicated by thrombocytopenia, deficient platelet function, abnormal inhibitors of coagulation, and vascular abnormalities. Because of the compound nature of the hemostatic defect, the severity of bleeding often correlates poorly with the results of laboratory tests in patients with acquired coagulation disorders, and replacement therapy may be ineffective. With some notable exceptions, however, bleeding usually is less severe than in the inherited forms, and the clinical picture often is complicated by signs and symptoms of the underlying disease.

## TABLE 60.1. Acquired Coagulation Disorders

---

### Deficiencies of vitamin K–dependent coagulation factors

Hemorrhagic disease of the newborn (vitamin K deficiency bleeding)

Biliary obstruction (gallstone, strictures, fistulas)

Malabsorption of vitamin K (sprue, idiopathic steatorrhea, celiac disease, ulcerative colitis, regional enteritis, gastrocolic fistulas, *Ascaris* infestation)

### Nutritional deficiency

### Drugs

1. Pharmacologic antagonists of vitamin K (coumarins, indandiones, others)
2. Those that alter gut flora (broad-spectrum antibiotics, sulfonamides)
3. Miscellaneous (cholestyramine)

### Liver disease (see [Table 60.3](#))

### Accelerated destruction of coagulation factors

Disseminated intravascular coagulation (see [Table 60.4](#))

Fibrinolysis (liver disease, thrombolytic agents, tumors, after surgery)

### Inhibitors of coagulation

Specific inhibitors (antibodies) (see [Table 60.7](#))

Antiphospholipid–protein antibodies

Miscellaneous (antithrombins, paraproteinemias)

### Miscellaneous

After massive transfusion

After extracorporeal circulation

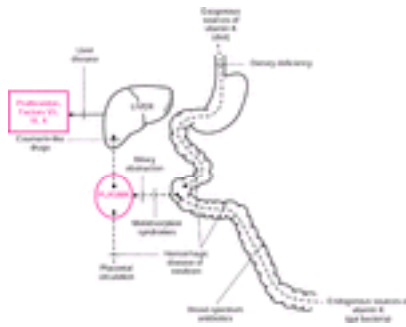
Drugs (antibiotics, antineoplastic agents, others)

Miscellaneous (polycythemia vera, congenital heart disease, amyloidosis, nephrotic syndrome, Sheehan syndrome, Gaucher disease, leukemia, others)

---

## DEFICIENCIES OF VITAMIN K–DEPENDENT FACTORS

Prothrombin; factors VII, IX, and X; and proteins C and S are synthesized by the liver by a process that depends on vitamin K (see [Chapter 21](#) and [Fig. 60.1](#)) (1). When stores of this vitamin are deficient or abnormal, hypofunctional analogs of these factors are synthesized, which inhibit normal coagulation. These descarboxy analogs of the vitamin K–dependent factors do not bind to cellular phospholipid surfaces and, therefore, do not participate in cell-associated coagulation reactions. This may occur in disorders in which intake or absorption of vitamin K is deficient and in disorders that impair the biosynthetic capacity of the liver ([Fig. 60.1](#)). A similar coagulation abnormality may be produced by anticoagulant drugs such as coumarin and indanediones, which antagonize the action of vitamin K (see [Chapter 61](#)).



**Figure 60.1.** Etiologies of vitamin K deficiency. Sources of vitamin K include the diet and gut bacterial synthesis. Processes leading to vitamin K deficiency are indicated with a solid line ending in a squiggle.

### Vitamin K Deficiency Bleeding (Hemorrhagic Disease of the Newborn)

*Hemorrhagic disease of the newborn* is the result of vitamin K deficiency in the neonate; this phrase was first used more than 100 years ago (2). The preferred term is *vitamin K deficiency bleeding (VKDB) in infancy* as proposed by a consensus committee (3). Formerly a major cause of bleeding, this disorder is now uncommon because of the routine administration of vitamin K at birth (4); however, it is still encountered in economically deprived populations.

**PATHOPHYSIOLOGY** The normal newborn has a moderate but significant deficiency of the vitamin K–dependent coagulation factors. The plasma levels of these factors normally fall even further during the first 2 to 5 days of life, rise again when the infant is 7 to 14 days old, and attain normal adult levels at approximately 3 months of age (5) (see also Table 51.6). This sequence of events normally does not produce bleeding. However, in VKDB, the initial fall is accentuated, and the secondary restoration is delayed and incomplete. As a consequence, coagulation abnormalities become severe, and bleeding results. The deficiency of the vitamin K–dependent coagulation factors that is present at birth, as well as the slow rate at which adult levels are attained, presumably is the result of intrinsic “liver immaturity”; neither of these physiologic phenomena is affected by vitamin K administration (5). On the other hand, the diminution in levels of these factors that occurs at age 2 to 5 days is prevented by vitamin K administration because it is the result of a transitory physiologic deficiency of this vitamin. Factors that further diminish the amount of vitamin K available at this juncture and those that further impair the synthetic capacity of the liver predispose neonates to hemorrhagic disease of the newborn. These factors are (a) prematurity, (b) inadequate dietary intake, (c) delayed gut colonization by bacteria, (d) various obstetric and perinatal complications, and, possibly, (e) maternal deficiency of vitamin K. Prematurity often has been associated with VKDB (6, 7). Levels of the vitamin K–dependent factors at birth are approximately proportional to gestational age and birth weight (8). In premature infants, the physiologic immaturity of the liver is marked, and the response to vitamin K that is present is subnormal. Most factors associated with deficient intake of vitamin K also delay the colonization of the gut by bacteria. These factors include delayed feeding, breast-feeding, vomiting, severe diarrhea, and antibiotics, including those present in maternal milk. Human milk and colostrum are poor sources of vitamin K (5), and reliance on breast milk as the sole source of nutrients in the neonatal period is an important factor in many cases of VKDB (4). Coumarin and indanedione drugs cross the placenta and may produce hemorrhagic disease in the newborn (9). Infants born of mothers who were taking diphenylhydantoin or other anticonvulsants, including barbiturates, or salicylates have developed a syndrome similar to VKDB (10). Treatment of the mother with vitamin K during the last trimester

may prevent this complication.

**CLINICAL FEATURES AND LABORATORY DIAGNOSIS** VKDB etiology is considered idiopathic (no cause other than breast-feeding) or secondary (malabsorption of vitamin K, liver disease, drugs) (3). VKDB can also be classified in terms of age of onset: early (onset <24 hours of age); classic (onset usually between 3 to 5 days); and late (onset on or after 8 days). Early VKDB is uncommon and usually results from placental transfer of maternal drugs that antagonize vitamin K in the newborn. Late VKDB occurs almost exclusively in breast-fed infants who may also have hepatobiliary disease (3). Bleeding in classic VKDB is severe (2). The most common manifestations are melena, large cephalohematomas, and bleeding from the umbilical stump and after circumcision. Generalized ecchymoses, often without petechiae, intracranial bleeding, and large intramuscular hemorrhages also may develop (2, 5). Laboratory diagnosis is relatively simple (Table 60.2), but physiologic differences in the results of various coagulation tests in normal neonates must be kept in mind (see Table 51.6) (11, 12). In infants with VKDB, the prothrombin time (PT) always is prolonged. The partial thromboplastin time (PTT) is also prolonged. The results of these tests may also be abnormal in unaffected neonates. Specific factor assays reveal deficiencies of prothrombin; factors VII, IX, and X; and proteins C and S. The presence of normal antigenic levels of the vitamin K-dependent factors may be demonstrated by immunoassays (13). Factors V and VIII, as well as fibrinogen, are present in normal amounts. The consensus committee recommends diagnosing VKDB with a prolonged PT value, a normal fibrinogen level, and a normal platelet count (3).

**TABLE 60.2. Laboratory Findings in Acquired Coagulation Disorders**

|  | Hemorrhagic Disease of the Newborn | Severe Liver Disease        | Disseminated Intravascular Coagulation | Primary Fibrinolysis | Antibodies to Factor VIII | Inhibitors of Lupus Type |
|--|------------------------------------|-----------------------------|--|----------------------|---------------------------|--------------------------|
| <b>Screening tests</b>                   |                                    |                             |  |                      |                           |                          |
| Platelet count <sup>a</sup>              | N                                  | vD                          | D                                      | uN                   | N                         | v <sup>a</sup>           |
| Prothrombin time <sup>b</sup>            | I                                  | I                           | I                                      | vI                   | N                         | v <sup>a</sup>           |
| Partial thromboplastin time <sup>b</sup> | I                                  | I                           | V                                      | vI                   | I                         | I                        |
| Thrombin time <sup>b</sup>               | vI                                 | uI                          | I                                      | I                    | N                         | N                        |
| Erythrocyte morphology <sup>a</sup>      | Macrocytes                         | Target cells and macrocytes | Schistocytes and microspherocytes      | uN                   | uN <sup>a</sup>           | uN <sup>a</sup>          |
| <b>Specific assays</b>                   |                                    |                             |  |                      |                           |                          |
| Fibrinogen                               | N                                  | vD                          | D                                      | vD                   | N                         | N                        |
| Prothrombin <sup>b</sup>                 | D                                  | D                           | V                                      | uN                   | N                         | vD <sup>c</sup>          |
| Factor V                                 | N                                  | uD                          | uD                                     | vD                   | N                         | N <sup>c</sup>           |
| Factor VII <sup>b</sup>                  | D                                  | D                           | V                                      | uN                   | N                         | N <sup>c</sup>           |
| Factor VIII <sup>c</sup>                 | N                                  | uI                          | uD <sup>c</sup>                        | vD                   | D                         | N <sup>c</sup>           |

|                                |    |    |                |                 |   |                |
|--------------------------------|----|----|----------------|-----------------|---|----------------|
| von Willebrand factor          | N  | uI | vI             | V               | N | N              |
| Factor IX <sup>b</sup>         | D  | D  | V <sup>c</sup> | uN              | N | N <sup>c</sup> |
| Factor X <sup>b</sup>          | D  | D  | vD             | uN              | N | N <sup>c</sup> |
| Factor XI <sup>b</sup>         | vD | vD | uN             | uN <sup>c</sup> | N | N <sup>c</sup> |
| Factor XIII <sup>d</sup>       | uN | vD | uD             | vD              | N | N              |
| Tests for fibrinolysis and FDP |    |    |                |                 |   |                |
| FDP                            | uN | uI | I              | I               | N | N <sup>e</sup> |
| Plasminogen <sup>b</sup>       | vD | vD | D              | D               | N | N              |
| a                              | uN | vD | V              | vD              | N | N              |
| <sup>2</sup> -Antiplasmin      |    |    |                |                 |   |                |
| Plasmin                        | N  | vI | uI             | uI              | N | N              |
| D-Dimer                        | uN | uN | I              | uN              | N | N <sup>e</sup> |
| Miscellaneous tests            |    |    |                |                 |   |                |
| Antithrombin                   | N  | vD | vD             | uN              | N | N              |
| Protein C                      | D  | D  | V              | uN              | N | uN             |
| Protein S                      | D  | D  | V              | uN              | N | V              |

D, decreased; FDP, fibrin(ogen) degradation products; I, increased; N, normal; u, usually; v, variably; V, variable.

<sup>a</sup> May reveal effects of acute bleeding or abnormality characteristic of underlying disease.

<sup>b</sup> Results may differ from adult norms in normal neonates.

<sup>c</sup> One-stage assays may yield aberrant results.

<sup>d</sup> Hypofibrinogenemia may alter results.

<sup>e</sup> The presence of immunoglobulin M rheumatoid factors in certain patients may lead to a false-positive result in latex-agglutination assays.

The clinician should not assume that bleeding in the neonate is invariably the result of vitamin K deficiency ( <sup>3</sup> ). In the differential diagnosis of VKDB, virtually all causes of bleeding, particularly thrombocytopenia (see [Chapter 52](#)) and disseminated intravascular coagulation (DIC), must be considered ( <sup>14</sup>, <sup>15</sup> ). The inherited coagulation disorders (see [Chapter 59](#)) also may produce serious hemorrhage in the neonatal period, but significant prolongation of the PT is not found in the most common forms, for example, hemophilia A and hemophilia B. Umbilical bleeding and hemorrhage after circumcision are relatively less common in the inherited coagulation disorders than in VKDB.

**TREATMENT** Vitamin K <sub>1</sub> (0.5 to 1.0 mg given intramuscularly) is dramatically effective in the treatment of VKDB ( <sup>16</sup> ). Shortening of the PT may be expected within 6 hours, and normal neonatal levels of the vitamin K-dependent factors usually are attained within 24 hours of administration. Parenteral administration of vitamin K is clearly more clinically beneficial than oral administration ( <sup>16</sup>, <sup>17</sup> ). In severe cases, two or three doses of vitamin K <sub>1</sub> at 4- to 8-hour intervals may be required. Larger (2 mg) or repeated (every 4 to 8 hours) doses of vitamin K <sub>1</sub> may be required to counteract the effects of coumarin drugs



in infants (5). The response in premature infants to vitamin K<sub>1</sub> usually is incomplete. The administration of large doses of vitamin K may produce hemolysis, hyperbilirubinemia, and even kernicterus in the neonate. These complications appear to be associated more commonly with the synthetic derivatives than with vitamin K<sub>1</sub>, but even the latter may be dangerous in large doses (5). In severe cases of VKDB, the transfusion of plasma may be helpful (5). Concentrates of vitamin K-dependent coagulation factors are effective but have led to thrombosis and intravascular coagulation in some infants, particularly in premature infants. This result has been attributed to immaturity of the hepatic clearance functions and physiologic deficiency of antithrombin. Fortunately, such replacement therapy is seldom required. Because VKDB is primarily a disease of breast-fed infants (18), VKDB can be prevented by the administration of vitamin K to the mother before delivery. Most authorities, however, recommend administering vitamin K<sub>1</sub> (1 mg parenterally; 2 mg orally) to the infant. This procedure is now routine in most nurseries. Many pediatricians also recommend the prophylactic administration of vitamin K<sub>1</sub> to infants 1 to 5 months of age, especially those who are breast-fed or who have a disorder that may impair vitamin K absorption (19). The usual dosage in such older infants is 50 to 100 µg daily or 1 mg monthly. Most pediatricians would attribute the decrease in incidence of VKDB in recent years to the prophylactic administration of vitamin K. Nevertheless, the value of this procedure has been questioned because of the rarity of biochemically evident vitamin K deficiency in apparently normal-term infants at birth (20). Additionally, some investigators question whether unknown hazards may exist for the widespread prophylactic use of vitamin K in newborn infants (21, 22). Nonetheless, there is widespread consensus on continuing vitamin K prophylaxis to newborns (3, 16). Administering vitamin K antenatally to premature neonates does not appear to be beneficial (23).

### Other Causes of Vitamin K Deficiency

Obstruction of the biliary tract, either intrahepatic or extrahepatic, produces vitamin K deficiency because of the absence of bile salts in the gut. Complete obstruction may lead to severe coagulation abnormalities and bleeding within 2 to 4 weeks. This was a major obstacle to surgical procedures on the biliary tract before the discovery of vitamin K.

Most malabsorption syndromes and various other chronic gastrointestinal disorders also may give rise to vitamin K deficiency. Such disorders include celiac disease, sprue, gastrocolic fistulas, ulcerative colitis, regional enteritis, extensive gut resections, protracted diarrhea of any cause, *Ascaris* infestations, and cystic fibrosis. The last named disorder often is complicated by liver disease (13). Severe abnormalities of coagulation and bleeding are less common in association with these disorders than with biliary obstruction, presumably because absorption of vitamin K is seldom completely deficient.

Because vitamin K normally is available from two independent sources (Fig. 60.1), neither nutritional deficiency nor gut sterilization alone produces deficiency of a degree that results in significant coagulation abnormalities. In normal adults, the daily oral intake of vitamin K must be reduced to 20 µg or less for several weeks to produce significant hypoprothrombinemia (1). However, vitamin K deficiency is more common than is usually realized in hospitalized patients with poor or negligible oral food intake, especially if they are also taking antibiotics (24, 25). Significant coagulation abnormalities may arise with surprising rapidity in such patients, and when unsuspected, they may be confused with DIC or may first be revealed by serious, unexpected postoperative hemorrhage (24). Antimicrobial agents presumably impair vitamin K production by inhibiting the synthesis of menadiones by gut bacteria (26), but they may also directly affect carboxylation reactions

([27](#), [28](#)). Vitamin K deficiency also may result from use of drugs other than antimicrobial agents, such as cholestyramine ([29](#)), which acts by binding bile salts, or mineral oil and other cathartics when used for protracted periods. Vitamin E may antagonize the metabolic action of vitamin K and potentiate the action of coumarins ([5](#)). When taken in large doses, this vitamin may prolong the PT ([30](#)). Antibiotic therapy, poor diet, or any of the aforementioned disorders may predispose patients to coumarin toxicity (see [Chapter 61](#)) ([31](#), [32](#)). Large doses of aspirin, as given to treat rheumatic disorders or in amounts associated with overdosage of the drug, may also induce vitamin K deficiency ([33](#)).

**TREATMENT** In adults, the parenteral administration of 10 to 20 mg of vitamin K<sub>1</sub> abolishes coagulation abnormalities within 12 to 24 hours if they are the consequence of a deficiency of this vitamin. Failure of vitamin K to normalize the PT is evidence for the presence of a complicating process, such as liver disease or DIC. Larger doses (50 mg) may be required to reverse the effects of coumarin toxicity. The synthetic vitamin K<sub>3</sub> (menadiones) may be absorbed in the absence of bile salts and in various malabsorption syndromes. However, these congeners of vitamin K have a more transient effect than the natural forms of this vitamin and offer minimal therapeutic advantage in the usual case. Replacement therapy with fresh frozen plasma is effective in the treatment of emergent vitamin K deficiency. Vitamin K may produce hemolytic anemia in patients with inherited deficiencies of various red cell enzymes (see [Chapter 33](#)). Because the intravenous route of administration is associated with a risk of anaphylaxis ([34](#)), subcutaneous injection is recommended in adults. Malnourished patients receiving broad-spectrum antibiotic therapy should receive vitamin K prophylactically, 5 mg twice weekly, orally or subcutaneously ([35](#)). Commercially available rodenticides that exhibit long-acting vitamin K antagonism have been associated with significant bleeding disorders when these compounds have been ingested by humans ([36](#)). These drugs are chemically distinct from warfarin, are 100 times more potent than warfarin, and can induce vitamin K deficiency lasting for months. In 1995 alone, more than 13,000 people were exposed to these agents and treated ([37](#)). Initial treatment of these patients may require up to 100 mg of vitamin K daily to normalize vitamin K metabolism ([37](#)).

## LIVER DISEASE

Virtually every hemostatic function may be impaired in patients with severe hepatic disease ([Table 60.3](#)) ([38](#), [39](#) and [40](#)) as the result of failure of both the biosynthetic and clearance functions of the liver. The pathophysiology of some of these abnormalities is tied to thrombocytopenia (see [Chapter 52](#)), platelet dysfunction (see [Chapter 58](#)), intravascular coagulation and fibrinolysis, and the effects of products of fibrinogen catabolism on hemostasis (see the following discussion).

**TABLE 60.3. Abnormalities of Hemostasis and Coagulation in Liver Disease**

### Deficient biosynthesis

Of fibrinogen; prothrombin; coagulation factors V ([46](#)), VII, IX, X, XI ([47](#)), XII, XIII ([48](#)); prekallikrein; high-molecular-weight kininogen

Of antiplasmins ([74](#)), antithrombin ([73](#)), proteins C and S

### Aberrant biosynthesis

Of abnormal fibrinogen ([50](#), [53](#)), factor V, factor VIII ([59](#), [63](#))

Of abnormal inhibitory analogs of prothrombin, factors VII, IX, and X ([56](#))

### Deficient clearance

Of hemostatic “products,” [e.g., fibrin monomers, fibrin(ogen) degradation products, platelet factor-3]

Of activated coagulation factors [IXa, Xa ( 195), XIa]

Of plasminogen activators ( 64)

Accelerated destruction of coagulation factors

Disseminated intravascular coagulation ( 82, 83, 84 and 85)

Localized intravascular coagulation (hepatic cell necrosis) ( 82)

Abnormal fibrinolysis ( 65)

Thrombocytopenia

Hypersplenism (portal hypertension)

Folic acid deficiency

Chronic ethanol intoxication

Disseminated intravascular coagulation

Platelet dysfunction

Acute and chronic ethanol intoxication

Effects of products of fibrinogen degradation ( 66, 67)

Uremia

Miscellaneous

Inhibition of coagulation byproducts of fibrinogen degradation ( 69, 70)

Loss or consumption of coagulation factors in ascitic fluid ( 87)

---

## Pathophysiology

**THROMBOCYTOPENIA** Patients with significant liver disease have portal hypertension, splenomegaly, and splenic sequestration of platelets, contributing to thrombocytopenia (see [Chapter 52](#)). The liver is also the major site of production of thrombopoietin, the principal humoral factor involved in megakaryocyte maturation and platelet formation (see [Chapter 19](#)). Recent studies have evaluated whether deficient levels of thrombopoietin occur in liver disease. Results indicate that thrombocytopenia in liver disease is not explained by deficient hepatic production of thrombopoietin ( 41, 42). However, there is a correlation between the extent of liver disease and platelet expression of the thrombopoietin receptor, c-Mpl ( 42), and this reduced expression may contribute to thrombocytopenia seen in liver disease.

**DEFICIENT OR ABERRANT SYNTHESIS OF COAGULATION FACTORS** In patients with liver disease, all coagulation factors except factor VIII may be deficient as a consequence of synthetic failure of the hepatic cells. Failure of biosynthesis of coagulation factors often correlates with the severity of hypoalbuminemia, but exceptions to this rule are common. Deficiencies of prothrombin; factors VII, IX, and X; and proteins C and S result mainly from synthetic incompetence. For example, factor VII expression in liver biopsies from patients with liver disease decreases as the severity of hepatic dysfunction increases ( 43). Impaired carboxylation of precursors may contribute to the defect ( 13). Superimposed vitamin K deficiency may result from a poor diet or malabsorption caused by insufficient production of bile salts or by exocrine pancreatic insufficiency ( 44). The failure of these coagulation abnormalities to respond to vitamin K administration provides good evidence of hepatic cell dysfunction, although large doses of vitamin K may prolong the PT in patients with liver disease. The explanation of this paradoxical effect is obscure ( 45). Factors V ( 46), XI ( 47), and XIII ( 48) are synthesized by the liver but are not vitamin K-dependent; all of these factors may be deficient in patients with severe liver disease. Plasma levels of factor XII, prekallikrein (Fletcher factor), and high-molecular-weight kininogen (Fitzgerald factor) also may be low in association with liver disease. Deficiencies

of these latter three factors do not contribute to a bleeding diathesis. Hypofibrinogenemia rarely may result from deficient hepatic biosynthesis ( 46 , 49 ) or may be the consequence of fibrinogenolysis or DIC, as discussed subsequently. In many patients with liver disease, prolongation of the thrombin time can be significant in the absence of hypofibrinogenemia or increased levels of fibrin(ogen) degradation products (FDPs) ( 50 ). This apparently is the result of a qualitatively abnormal fibrinogen that is synthesized by the diseased hepatic cell. Such acquired dysfibrinogenemia has been reported in most forms of liver disease, ranging from mild acute hepatitis to acute hepatic necrosis and cirrhosis ( 51 , 52 ). Fibrin monomer polymerization is delayed ( 53 ), and the abnormal fibrinogen molecule acts as an antithrombin ( 50 ). Additionally, this hepatic disease dysfibrinogen may have an abnormally high content of sialic acids ( 54 ) and may produce a structurally defective fibrin clot ( 55 ). Acquired dysfibrinogenemia, abnormal inhibitors of fibrinolysis, and the presence within the plasma of descarboxy analogs of prothrombin ( 56 ) have been reported in patients with hepatomas ( 57 ). Hepatoma-associated dysfibrinogens have also been noted to have an increased carbohydrate content ( 58 ). Plasma levels of factor VIIIc usually are elevated in both parenchymal and cholestatic liver disease ( 59 , 60 ); in some cases, levels may rise as high as 2000 to 3000 U/dl ( 61 ). Increases in both factor VIIIc and von Willebrand factor (vWF) have been demonstrated ( 62 ). Factor VIII in liver disease may be qualitatively abnormal ( 63 ).

**FIBRINOGENOLYSIS AND FIBRINOLYSIS** Endogenous plasminogen activators normally are removed from the circulation by the liver. In patients with severe liver disease, however, they may circulate for an abnormally long time and lead to the chronic or intermittent activation of the fibrinolytic enzyme system ( 64 ). This process usually is of no clinical importance, but in some patients, surgical procedures, trauma, certain drugs, or electroshock therapy may induce acute fibrinogenolysis ( 65 ) or serious oozing postoperatively as the result of the lysis of hemostatically important fibrin plugs. This process may be a contributory factor in the pathogenesis of hypofibrinogenemia in patients with liver disease. It also leads to the production of large amounts of FDP, which persist in the circulation for abnormally long periods because of deficient hepatic clearance, and may impair blood coagulation and platelet function ( 66 , 67 ). Such proteolytic activity also may produce a shift in the mean molecular weight of circulating fibrinogen from the normal species to a less-reactive species of lower molecular weight ( 68 ), thereby contributing to the “antithrombins of liver disease” ( 69 , 70 ). The incidence of hyperfibrinolysis was surveyed in patients with cirrhotic and noncirrhotic liver disorders ( 71 ). Hyperfibrinolysis, as measured by a shortened euglobulin clot lysis time, was present in approximately 30% of cirrhotic patients but not present in noncirrhotic patients ( 71 ). The role of thrombin-activatable fibrinolysis inhibitor deficiency in liver disease in contributing to hyperfibrinolysis has been studied; thrombin-activatable fibrinolysis inhibitor levels are reduced in liver disease, with lower levels seen in more severe liver disease ( 72 ). However, there was no association of low thrombin-activatable fibrinolysis inhibitor levels with hyperfibrinolysis, even in cirrhotic patients. These studies suggest that hyperfibrinolysis is not common in liver disease, even in cirrhosis ( 71 , 72 ). Plasma levels of antithrombin ( 73 ), antiplasmin ( 62 , 74 ), and plasminogen ( 62 , 75 ) are subnormal in patients with liver disease. The cirrhotic liver produces qualitatively abnormal forms of antithrombin ( 62 ) and plasminogen activator, as well as unstable antiplasmins ( 64 ). All of these abnormalities are of uncertain clinical importance.

**INTRAVASCULAR COAGULATION** Severe liver disease theoretically predisposes individuals to the development of DIC because DIC is associated with deficient hepatic clearance of activated coagulation factors and other coagulant substances. The *in vivo* turnover rates of prothrombin ( 76 ), fibrinogen ( 77 ), plasminogen ( 76 ), and antithrombin ( 73 ) often are accelerated in patients with cirrhosis and in those with extrahepatic

obstruction of the portal vein. Plasma levels of fibrinopeptide A are elevated in most patients with cirrhosis ( 78 ). All of these abnormalities may be normalized in some cases by the administration of heparin ( 79 ). The accelerated turnover of fibrinogen also may be normalized by the infusion of antithrombin concentrates ( 80 ). It has been hypothesized that accelerated catabolism of coagulation factors in these disorders is the result of DIC. The nature of the initiating process is unclear, but one suggestion is that DIC is activated by hypoperfusion of the congested portal bed ( 49 ). Indirect evidence suggests that in severe liver disease, activators of coagulation, possibly endotoxin, may originate in the gut. Evidence of DIC also is a common finding in patients with bleeding varices ( 81 ) and those with acute hepatic necrosis, a disorder in which fibrin deposits may be demonstrated histologically in liver sinusoids adjacent to necrotic hepatic cells ( 82 ). Low-grade DIC or localized intravascular coagulation indeed may occur in association with severe liver disease, but overt DIC is responsible only rarely for bleeding in the absence of other etiologic factors that trigger this process, for instance, sepsis, shock, and cancer ( 83 , 84 ). This conclusion is supported by findings in patients with stable cirrhosis that demonstrated no increased levels of markers of activation of coagulation, such as prothrombin fragment 1+2, thrombin-antithrombin complex, and so forth ( 85 ). Evidence for accelerated fibrinogen turnover in ascitic fluid suggests that the loss or consumption of coagulation factors in peritoneal fluid may be a contributory factor in the coagulopathy of chronic liver failure. Shunting of ascitic fluid into the venous circulation by means of LeVeen shunts consistently produces coagulation abnormalities consistent with DIC in cirrhotic patients ( 86 ). Although this phenomenon usually is attributed to intravascular coagulation, evidence shows that it may result in part from the presence of plasminogen activators and active plasmin ( 87 ) or collagen ( 88 ) in peritoneal fluid. A transitory coagulation disorder that resembles intravascular coagulation with active fibrinolysis has been documented during liver transplantation procedures. Coagulation abnormalities disappear promptly if the graft is successful ( 89 ). The complex coagulopathy seen with liver transplantation has been reviewed ( 90 ).

## Clinical Manifestations

In view of the numerous hemostatic abnormalities associated with severe liver disease, it is surprising that many patients do not bleed abnormally. Gastrointestinal hemorrhage is the most common bleeding manifestation, but it almost always originates from a local lesion, such as esophageal varices, peptic ulcer, or gastritis. The degree to which coagulation abnormalities contribute to such bleeding is uncertain. In one large series, gastrointestinal bleeding was not significantly more severe or protracted in patients with coagulation abnormalities than in those without them ( 91 ). In another study, serious hemorrhage occurred only in patients with prolonged PTs and significant factor IX deficiency ( 92 ). Moderate generalized bleeding manifestations, such as recurrent ecchymoses and epistaxis, are not uncommon, and severe generalized bleeding may complicate surgical procedures, including biopsies, tooth extractions, and other minor procedures.

## Laboratory Diagnosis

The laboratory findings in liver disease vary with the cause and severity of the underlying disorder and range from a slight prolongation of the PT in anicteric hepatitis to the findings summarized in [Table 60.2](#), which are seen in severe decompensated cirrhosis. In cirrhosis, coagulation abnormalities correlate with the presence of portal hypertension and may be minimal in inactive cirrhosis; thrombocytopenia alone is common in association with portal hypertension. Acute fibrinogenolysis is significantly more common in patients with cirrhosis ( 71 ) than in those with acute hepatocellular disease, such as hepatitis,



although elevations of FDP are consistently found in people with chronic aggressive hepatitis ( 51 ). Coagulation abnormalities are seldom marked in biliary cirrhosis, and some patients with this disorder have abnormally high levels of prothrombin and factors VII and X. Hemostatic abnormalities of any sort are rare in metastatic liver disease. In acute liver failure, the PT value has prognostic value and is indicative of the need for liver transplantation ( 93 ). The spectrum of coagulation abnormalities in liver disease has been reviewed ( 38 ).

Although screening tests of coagulation are almost invariably performed before liver biopsy, they apparently are of little value in predicting hemorrhage after this and other minor surgical procedures ( 94, 95 ). Similarly, the bleeding time test is of little clinical use in predicting bleeding ( 96 ). Many physicians use the international normalized ratio (INR) as a substitute coagulation test for the PT ( 97 ). When measured with a sensitive thromboplastin, the INR can quantitate vitamin K deficiency due to liver disease, but it should not be interpreted as in patients receiving warfarin ( 97 ).

## Treatment

Not all patients with the coagulopathy of liver disease require hemostatic correction before procedures such as liver biopsy. A retrospective study looked at the PT ratio (patient PT/mean of reference range PT) and degree of thrombocytopenia to determine the necessity of plasma and platelet transfusion ( 98 ). In patients with platelet counts of 50,000/ $\mu$ l or greater, there was no increased bleeding with liver biopsy compared with patients with normal platelet counts. With regard to elevated PT values, if the PT ratio was less than 1.5, no increased bleeding was observed ( 98 ). Therefore, patients with moderate thrombocytopenia and mild liver disease coagulopathy do not need routine hemostatic correction with blood products. One exception to this recommendation is patients with a diagnosis of malignancy, who may have a higher bleeding risk, possibly due to chronic DIC and elevated FDP levels ( 98 ).

Elevated FDP levels may be a significant hemostasis risk factor in liver disease. High levels of FDP may impair platelet function and fibrin monomer polymerization. The thrombin time can screen for the latter defect. A prolonged thrombin time in a patient with a normal functional fibrinogen level and high FDP levels, who is not receiving heparin, may constitute a significant bleeding risk, especially in the setting of moderate thrombocytopenia.

Vitamin K <sub>1</sub>, in doses of 10 to 20 mg, produces some improvement in the coagulation abnormalities in approximately 30% of patients with liver disease ( 92 ), but the PT often becomes prolonged again after an initially favorable response. Patients with severe liver disease have minimal or no response to vitamin K therapy.

Replacement therapy with fresh frozen plasma is indicated only in the presence of serious bleeding or before surgical procedures, and its effect is often disappointing in patients with liver disease ( 92 ). Reasons for this may include the short *in vivo* half-life of factor VII, hypovolemia, the loss of transfused factors into ascitic fluid, and the fact that the *in vivo* recovery of transfused factor IX is significantly lower than that of other factors, even in the absence of liver disease. Concentrates of vitamin K-dependent coagulation factors [prothrombin complex concentrate (PCC)] have been used in the replacement therapy of bleeding in patients with liver disease with variable success but, in several cases, have led to thromboembolic complications and DIC ( 99 ). Thrombosis presumably develops because such concentrates contain trace amounts of activated coagulation factors, particularly

factors IXa and Xa ( [99](#), [100](#) ), that normally are not cleared from the circulation by the diseased liver and because of antithrombin deficiency, which is commonly present. Because of this hazard, the use of these concentrates can be recommended in patients with liver disease only in the case of life-threatening hemorrhage. Fresh frozen plasma is preferable, but the effects of even maximum doses (20 to 30 ml/kg of body weight) often are transitory. The administration of antithrombin concentrates has been therapeutically successful in a few cases of acute hepatic necrosis, including cases associated with pregnancy and severe acquired deficiency of antithrombin ( [101](#) ). Cryoprecipitate is useful to maintain fibrinogen levels over 100 mg/dl.

Infusion of 1-desamino-8-D-arginine vasopressin (DDAVP) has diminished coagulation abnormalities in some cirrhotic patients. The mechanism of this effect is obscure ( [102](#) ). However, a controlled trial found that DDAVP is not helpful in management of variceal bleeding in cirrhotic patients ( [103](#) ).

Recombinant factor VIIa (rVIIa) is a promising therapy for liver disease patients with significant coagulopathy. It has been studied in diverse groups of liver disease patients, including those undergoing liver biopsy ( [104](#) ), experiencing variceal bleeding ( [105](#) ), and undergoing liver transplantation ( [106](#) ). A typical dose of 80 µg/kg of rVIIa normalized prolonged PT values for more than 12 hours ( [107](#) ). Additional trials are needed to determine if the laboratory correction with rVIIa is translated into clinical benefit. Disadvantages of rVIIa include its high cost and risk of DIC and thromboembolic complications.

The administration of antifibrinolytic agents may be indicated in patients with fibrinogenolysis, but the assessment of the clinical effectiveness of these enzyme inhibitors has proved difficult in chronic liver disease. In one series, ε-aminocaproic acid (EACA) produced favorable results in the treatment and prevention of acute postsurgical bleeding after placement of portacaval shunts ( [108](#) ). Another study found that liver disease patients with hyperfibrinolysis (assessed by the euglobulin clot lysis time) had clinical benefit with EACA when used to treat mucocutaneous bleeding ( [71](#) ). Thromboembolic complications have been reported after the administration of antifibrinolytic drugs in some patients ( [109](#) ).

Even though heparin administration may normalize fibrinogen catabolism, little evidence is cited that it decreases the duration or severity of bleeding in patients with low-grade DIC and severe liver disease ( [62](#) ). Heparin may be useful in conjunction with PCC therapy. In this setting, the addition of small amounts of normal plasma and heparin to vials of these thrombogenic concentrates inactivates activated proteases and minimizes the thrombotic risks of these concentrates ( [110](#) ).

For patients requiring liver biopsy who are deemed “high-risk” from the hemostasis perspective, the transjugular approach should be considered.

## **DISSEMINATED INTRAVASCULAR COAGULATION**

The syndrome of DIC (defibrination syndrome, consumption coagulopathy) has been one of the most intensively studied subjects in hematology. The development of new and highly sensitive diagnostic techniques has resulted in the recognition of DIC in a seemingly endless variety of clinical situations. This large body of information has been summarized in many detailed reviews and monographs ( [111](#), [112](#), [113](#), [114](#) and [115](#) ).



## Etiology and Incidence

DIC has been well documented in association with the disorders summarized in [Table 60.4](#). Several retrospective studies suggest that DIC remains a relatively uncommon entity, but in one large general hospital, its overall incidence was 1 in 1000 admissions ([116](#)). The incidence of the syndrome in association with many disorders is likely proportional to the energy with which the diagnosis is pursued ([116](#)). In one study, the most prevalent etiologic factor was infection ([116](#)), whereas in another institution, more than 50% of cases were obstetric patients ([117](#)). A recent Japanese study found that in a hospital population, 45% of DIC cases were associated with malignancy ([118](#)). In many of the disorders listed in [Table 60.4](#), DIC develops only in an occasional case. Thus, it is rare in heatstroke ([119](#)), autoimmune disorders ([120](#)), and hemolytic anemias ([121](#)). DIC is present in most cases of venomous snakebite, which is probably one of the most common causes of the disorder worldwide.

**TABLE 60.4. Etiologies of Disseminated Intravascular Coagulation**

---

### Obstetric complications

Abruptio placentae ([227](#), [228](#)), septic abortion and chorioamnionitis, amniotic fluid embolism, intrauterine fetal death, miscellaneous [degenerating hydatidiform moles and leiomyomas, postpartum hemolytic-uremic syndrome, abdominal pregnancy, tetracycline-induced hepatorenal failure, fetomaternal blood passage, saline- ([236](#)) and urea-induced ([237](#)) abortions]

### Infections

Viral (herpes, rubella, smallpox, acute hepatitis, Reye syndrome, cytomegalic inclusion disease, various epidemic hemorrhagic fevers, others)

Rickettsial (Rocky Mountain spotted fever, others)

Bacterial (meningococemia, septicemia, particularly that due to gram-negative organisms, many others)

Mycotic (histoplasmosis, aspergillosis)

Protozoal [malaria ([161](#)), kala-azar, trypanosomiasis]

### Neoplasms

Carcinomas ([122](#)) (prostate, pancreas, breast, lung, ovary, many others)

Miscellaneous (metastatic carcinoid, rhabdomyosarcoma, neuroblastoma, others)

### Disorders of the hematopoietic system

Acute leukemia [promyelocytic ([258](#)), other types]

Intravascular hemolysis [transfusion of incompatible blood ([271](#)), drug-induced ([672](#)), paroxysmal nocturnal hemoglobinuria ([673](#)), sickle cell anemia ([674](#)), fresh-water submersion ([675](#))]

Histiocytic medullary reticulosis

### Vascular disorders

Malformation [giant hemangiomas (Kasabach-Merritt syndrome [[265](#)]), aneurysms, coarctations of the aorta and other large vessels, Takayasu aortitis, large prosthetic arterial grafts ([676](#)), cyanotic congenital cardiac lesions]

Collagen-vascular disorders ([677](#))

Hypoxia and hypoperfusion [congestive failure with pulmonary emboli ([678](#)), myocardial infarction, cardiac arrest ([679](#)), various forms of shock, hypothermia]

Massive tissue injury

Large traumatic injuries and burns ( 270), extensive surgical intervention ( 680), extracorporeal circulation, fat embolism ( 681)

Miscellaneous

Acute iron toxicity, head trauma ( 682), snakebite ( 273), anaphylaxis, concentrates of vitamin K-dependent coagulation factors ( 99), heatstroke ( 119), allograft rejection, graft-versus-host disease, severe respiratory distress syndrome ( 165), diabetic acidosis ( 683), status epilepticus ( 684), acute pancreatitis ( 685), homozygous deficiency of protein C ( 686)

Pathophysiology

**MECHANISMS BY WHICH DISSEMINATED INTRAVASCULAR COAGULATION IS INITIATED** The pathophysiology of DIC is complex. The mechanisms that activate or “trigger” DIC act on processes that are involved in normal hemostasis—namely, the processes of platelet adhesion and aggregation and contact-activated (intrinsic) and tissue factor-activated (extrinsic) pathways of coagulation ( Fig. 60.2). These mechanisms have in common the capacity, in terms of either the magnitude or the duration of the activating stimulus, to exceed normal compensatory processes. Thrombin is persistently generated, and fibrin is formed in the circulating blood. Fibrinogen, various other coagulation factors, and platelets are consumed. The fibrinolytic mechanism is activated, and large amounts of FDP are produced, which further impair hemostatic function. Bleeding, shock, and vascular occlusion commonly supervene and produce profound alterations in the function of various organ systems. Normal compensatory processes may become impaired, creating a self-perpetuating “vicious cycle.” The ultimate outcome is determined by a dynamic interplay between the various pathologic processes and compensatory mechanisms; in other words, fibrin deposition versus fibrinolysis; depletion versus repletion of coagulation factors and platelets; and production versus clearance of fibrin, FDPs, and other products of coagulation ( Fig. 60.3). In most forms of DIC, the initiating factors are multiple and interrelated. For example, in meningococemia, endothelial cell injury may lead to expression of tissue factor and to collagen exposure; the latter then initiates platelet adhesion, aggregation, and thrombosis.



**Figure 60.2.** Initiating mechanisms of disseminated intravascular coagulation (DIC). The solid arrows indicate normal hemostatic pathways, and dotted arrows indicate pathways by which certain disorders associated with DIC initiate or promote the coagulopathy of DIC. Initiation of coagulation by expression of tissue factor activity is probably the most important mechanism triggering DIC.



**Figure 60.3.** Pathophysiology of disseminated intravascular coagulation (DIC). The critical event in DIC is the generation of thrombin in an unregulated fashion. The clinical consequences of thrombin production depend on the rate of thrombin formation as well as underlying host factors (marrow reserve of platelet production, liver function). Patients with adequate compensatory responses (ability to enhance platelet or coagulation factor production, fibrinolysis, intact clearance mechanisms) may have minimal symptoms, whereas other patients with defective compensatory responses may bleed, thrombose, or both. Major compensatory factors that influence clinical events are indicated in colored blocks. The zig-zag line indicates interruption of an adverse clinical event by a compensatory factor. FDP, fibrin(ogen) degradation products; PF, platelet factor.

**Tissue Factor** The exposure of procoagulant tissue extracts to blood is a major contributory factor in most forms of DIC and is of major pathogenetic importance in cases associated with abruptio placentae, intrauterine fetal death, acute promyelocytic leukemia, amniotic fluid embolism, massive trauma, and various neoplasms ([122](#)). The active component of such extracts is tissue factor (thromboplastin); that is, tissue factor interacts with factor VIIa to activate the extrinsic pathway of coagulation. In abruptio placentae ([123](#)), decidual fragments, serum-containing activated coagulation factors, and other substances from the placental site enter the intervillous “maternal lake” and, hence, the venous circulation. This process is initiated by rupture of the basal decidual plate. In amniotic fluid embolism, relatively weak thromboplastins that increase in potency with gestational age ([124](#)) and large amounts of particulate matter enter the circulation suddenly. Amniotic fluid contains high concentrations of plasminogen proactivators, but it lacks plasminogen activators. In intrauterine fetal death, thromboplastic substances from the dead fetus are slowly but continuously absorbed, producing a picture of chronic but progressive DIC. In neoplasms, tumor microemboli and tumor “vesicles” ([125](#)) are thought to enter the circulation and act as thromboplastins ([122](#), [126](#)). Tumor cell surface expression of tissue factor has been demonstrated ([127](#)). Some neoplasms secrete a factor X activator ([128](#)) or fatty acids that alone, or when combined with albumin ([129](#)), act as thromboplastins. DIC in association with acute leukemia presumably results from the formation or release of tissue factor by leukemic cells ([130](#)). Additional leukocyte enzymes such as elastase may contribute to DIC by proteolysis of coagulation zymogens and fibrinogen ([131](#)). Malignant promyelocytes, as seen in promyelocytic leukemia, express high levels of annexin II, a phospholipid-binding protein and receptor for plasminogen and tissue-plasminogen activator ([132](#)). This overexpression of annexin II results in enhanced plasmin production and increased fibrinolytic activity ([132](#)). The granules of various “blast” forms contain tissue factor, with the promyelocyte containing particularly high concentrations ([130](#)). In addition to myeloid leukemia being associated with DIC, T-cell lymphoid leukemias also have been linked with DIC. The induction of tissue factor by leukocytes as a result of the action of endotoxin is discussed later in this chapter. In DIC associated with massive trauma ([133](#)), major surgical procedures, or large burns, damaged tissue expressing tissue factor activity presumably is a major initiating factor. In such

cases, additional abnormalities and complications are important contributory factors ( [134](#) ): for example, “hypercoagulability,” azotemia, shock, intravascular hemolysis, massive transfusions of stored blood, septicemia, and hypoxia. Cerebral trauma of sufficient magnitude to produce significant brain destruction induces a brief episode of DIC, which, although transitory, may be significant in that it may perpetuate cerebral bleeding ( [135](#) ).

**Monocyte-Associated Procoagulants** It has been known for many years that monocytes and tissue macrophages may, when suitably activated, express substances capable of initiating blood coagulation ( [136](#) ). This phenomenon is thought to be of importance in inflammation and in tissue localization of infectious agents and tumors. More recently, it has become apparent that “recognition-coupled” responses of the monocyte-macrophage system ( [137](#) ) may be important in triggering DIC in association with meningococemia ( [138](#) ) and other forms of septicemia, certain forms of leukemia, major transfusion reactions, and anaphylaxis. The best defined model of this process is the induction of tissue factor by monocytes exposed to endotoxin ( [139](#) ) or immune complexes ( [140](#) ). This phenomenon is potentiated by corticosteroids and arachidonate and may explain the protective effects of leukopenia in animal models of endotoxin-induced DIC. Other substances that may induce monocyte procoagulant activity include anaphylatoxins ( [141](#) ), mitogens ( [142](#) ), aggregated Igs, and cytokines ( [142](#) ). Most of these substances induce the formation of monocyte coagulants only in the presence of T lymphocytes ( [143](#) ) and the complement system ( [141](#) , [144](#) ). A prothrombinase-like activity ( [145](#) ) and a specific activator of factor X ( [146](#) ) also are formed by appropriately conditioned monocytes.

**Vascular Endothelium** In addition to monocytes or macrophages, vascular endothelium can be induced to express tissue factor activity in the setting of experimental DIC ( [147](#) ). Endothelium can also be down-regulated in terms of anticoagulant properties (e.g., thrombomodulin activity, fibrinolysis) by stimuli relevant in the pathogenesis of DIC (see [Chapter 22](#) ). This altered endothelium is referred to as *activatea*; properties of activated endothelium include conversion of the normally anticoagulant phenotype to a procoagulant phenotype, expression of adhesion molecules, production of inflammatory mediators, and production of vasoactive agents ( [148](#) ). Many of these pathologic events are amplified by endothelial cell protease-activated receptors (see [Chapter 22](#) ). Vascular endothelium may also promote coagulation by formation of thrombogenic microparticles, which express anionic phospholipid ( [149](#) ). Microparticles in DIC may also originate from platelets or granulocytes ( [150](#) ). Thrombin generation caused by activation of factor XII in DIC appears to be less important than that initiated by tissue factor ( [151](#) ). Contact activation, instead, appears critical in mediating DIC-associated hypotension ( [152](#) ).

**Infections** DIC often accompanies septicemia as a result of bacteria that possess potent endotoxins. This correlation has led to the intensive study of the effects of endotoxin on the hemostatic mechanism. Purified endotoxin produces several effects that may lead to DIC—namely, activation of factor XII ( [153](#) ), platelet aggregation, inhibition of fibrinolysis, leukocyte aggregation, direct endothelial injury ( [154](#) ), cellular induction of tissue factor activity ( [155](#) ), and impairment of compensatory clearance functions. Many of these phenomena may be mediated by the interaction between endotoxin and monocytes, as discussed earlier. The coagulation abnormalities and the histopathologic appearance of lesions produced by endotoxin in the generalized Sanarelli-Shwartzman phenomenon in animals resemble those found in human DIC. Studies of the Shwartzman reaction in animals revealed the following to be of particular importance to DIC in humans: (a) Shwartzmanlike phenomena may be produced by agents other than endotoxin, such as factor Xa ( [156](#) ), substances that produce contact activation and platelet aggregation, and purified platelet factor-3 ( [157](#) ); (b) infusion of FDP, tissue factor (thromboplastin), red cell hemolysates, corticosteroids, and inhibitors of fibrinolysis produces changes that simulate the effects of reticuloendothelial blockade; (c) heparin ( [158](#) ), coumarin

anticoagulants, granulocytopenia, thrombocytopenia ( [159](#) ), activators of endogenous fibrinolysis, and inhibitors of factor XII activation inhibit the Shwartzman phenomenon; (d) continuous, slow infusion of endotoxin produces DIC in the absence of either a “priming” dose or reticuloendothelial blockade; and (e) the Shwartzman phenomenon can be produced in pregnant animals with only one dose of endotoxin. The pertinence of these data to human disease nevertheless remains uncertain. The Shwartzman phenomenon and the effects of endotoxin in general are highly species-specific, and DIC may complicate acute infections involving bacteria that lack potent endotoxins—for example, pneumococci, which produce DIC most often in asplenic individuals ( [160](#) ). In pneumococcal sepsis, intact pneumococci, their polysaccharide capsular antigens, or antigen-antibody complexes formed there may trigger coagulation by interacting with the complement system. In meningococcemia and other forms of endotoxemia ( [154](#) ), direct vascular injury results in the induction of tissue factor activity and even release of fragments of endothelial cells, platelets, and granulocytes ( [150](#) ) into the general circulation. A similar phenomenon may be involved in rickettsial and viral infections. These latter infectious agents have been shown to induce tissue factor activity in cultured endothelium (see [Chapter 22](#) ). Patients with malaria ( [161](#) ) may experience massive intravascular hemolysis. In most severe infections, the complicating influence of septic shock may be considerable.

**Shock, Hypoperfusion, and Hypoxemia** It has been suggested that DIC is involved in all forms of shock and that it is the central feature in irreversible or refractory forms. In septic shock, the interrelationships between septicemia, shock, and endotoxemia are exceedingly complex. In septicemia, both thrombocytopenia and septic shock may occur without DIC. Shock may favor the development of DIC by potentiating various activating stimuli that ordinarily would not exceed the capacity of compensatory processes and may perpetuate DIC after a transient activating stimulus has been dissipated. Hypoperfusion, even of normal vessels, acidosis, and hypoxemia produce hypercoagulability and favor intravascular platelet aggregation. Furthermore, splanchnic hypoperfusion impairs reticuloendothelial and hepatic clearance functions and is present in virtually all forms of shock. Shock also may impair hepatic synthesis of coagulation factors and thus contribute to the coagulation defect in DIC. Activated neutrophils may generate oxygen radicals and proteases to alter vascular permeability. Vascular injury may also occur with ischemia/reperfusion that elicits inflammatory responses. DIC in association with giant hemangiomas (Kasabach-Merritt syndrome) ( [162](#) ) or with aneurysms of the aorta or other large vessels ( [163](#) ) has been attributed to hypoperfusion and stasis in local vascular beds. In Kasabach-Merritt syndrome, large gaps in the endothelium that expose subendothelial collagen and other fibers, together with the induction of thromboplastic substances by poorly supported, recurrently injured vessels within the tumor, also may be important factors leading to the initiation of DIC. In adult respiratory distress syndrome and in pulmonary embolism, hypoxic injury to pulmonary capillary endothelial cells may trigger DIC, and obstruction of or damage to the pulmonary microvasculature by thrombin ( [164](#) ), platelet aggregates, or FDP may aggravate the pulmonary edema ( [165](#) ).

**Miscellaneous Activating Stimuli** Snake venoms contain enzymes that may trigger coagulation in unique ways. Such venoms may produce defibrination without affecting other coagulation factors, such as ancrod, an enzyme purified from the venom of the Malayan pit viper ( *Agkistrodon rhodostoma* ). Other venoms contain thrombinlike enzymes or substances that specifically activate factor X or prothrombin ( [166](#) ). Crude venoms also contain substances that act as thromboplastins and produce intravascular red cell hemolysis and massive vascular damage ( [167](#) ). An inventory of the biochemical properties of snake venoms and their constituent enzymes has been summarized elsewhere ( [168](#) , [169](#) , [170](#) and [171](#) ).

**Consumption of Coagulation Factors** DIC constitutes a model of accelerated turnover of various coagulation factors, the levels of which at any time are determined by the size of the plasma pool and the differences between the rates at which they are being destroyed and replenished. Results of quantitative studies have demonstrated accelerated turnover



rates for platelets, fibrinogen ( [172](#) ), and prothrombin. Numerous factors complicate a simple kinetic approach. For example, the depletion of plasma fibrinogen induces a compensatory release of large amounts of fibrinogen into the circulation, possibly from the hepatic-lymphatic system, and also increases the rate of fibrinogen synthesis. Other complexities include impaired hepatic synthesis of coagulation factors and the phenomenon of postdepletion “rebound” and “overshoot” ( [173](#) ). Generalizations based on the consumption of coagulation factors during *in vitro* coagulation are not always consistent with laboratory findings in patients with DIC. Plasma levels of factors that are normally consumed, such as fibrinogen, prothrombin, and factors V and XIII, often are reduced in severe DIC, but factors that normally are not consumed also may be deficient, such as factors VII, IX, and X. Prothrombin, which is consumed completely *in vitro*, often is at a normal level in patients with DIC. Significant hypoprothrombinemia must reflect either massive and protracted activation of coagulation or complicating factors, because in animals, severe depletion of platelets, fibrinogen, and factors V and VIII results from activation of only 10% of plasma prothrombin ( [174](#) ). Factor VIIIc levels are reduced to a greater extent than are vWF antigen levels ( [175](#) ). Proteins other than coagulation factors may be depleted as a result of DIC; those of potential importance include antithrombin ( [176](#) ), a  $\alpha_2$ -antiplasmin ( [177](#) ), and plasminogen ( [178](#) ). Plasminogen has great avidity for fibrin and may coprecipitate in fibrin thrombi. In experimental animals, depletion of tissue plasminogen activator, as well as plasminogen, can be produced by the protracted infusion of tissue factor. The numerous and diverse defense processes that are mediated by factor XIIa are activated in DIC, including the complement system and the kallikrein system. It has been suggested that the hypotensive effects of bradykinin may explain the conspicuous presence of hypotension in patients with DIC triggered by activation of factor XII ( [179](#) ), for example, that associated with endotoxemia.

**Consumption of Platelets** In DIC, the platelet count often is depressed out of proportion to the severity of coagulation abnormalities. This presumably reflects the limited production capacity of the megakaryocytes. Furthermore, thrombocytopenia may result from processes other than the consumption of platelets in thrombotic lesions. These processes include adhesion to denuded or damaged endothelial cell surfaces and intravascular aggregation with subsequent sequestration, which may be caused by endotoxin, antigen-antibody complexes, thrombin, particulate matter, and, possibly, fibrin-FDP complexes. All of these agents initiate the platelet release reaction, which may produce a population of partially activated platelets that are depleted of storage nucleotides (acquired storage pool disease). The resulting expressed platelet factor-3 activity alone may further accelerate the process of DIC ( [157](#) ). Partially activated platelets may contribute to impairment of clearance functions. Epinephrine and serotonin are released from the platelets and may reach extremely high concentrations in hypoperfused vascular beds. This process may produce sustained constriction of the afferent renal arteriole and may predispose to cortical necrosis. Serotonin also may produce pulmonary and cerebral hypoperfusion.

**Intravascular Fibrin Formation** The formation of fibrin, in the form of small strands and “microclots” ( [180](#) ), is the immediate result of DIC; the ultimate consequence of this process is determined by a balance between the rate of fibrin formation and the rate of its clearance from the circulation or lysis by the fibrinolytic enzyme system. Erythrocytes are injured mechanically during passage through fibrin networks in the microcirculation. Such microangiopathic hemolysis leads to the production of schistocytes and microspherocytes. Erythrocyte damage in metastatic carcinoma appears to be caused mainly by fibrin strands that form around tumor cell emboli as a result of low-grade DIC ( [181](#) ).

**Fibrinolysis** Fibrinolysis is present in virtually every patient with DIC, but it generally plays a homeostatic rather than a pathologic role. In the setting of DIC, this “secondary fibrinolysis” is an appropriate response to persistent thrombin generation. Fibrinolysis may be activated by several mechanisms. The major endogenous source of plasminogen activators is in the vascular endothelium of the microcirculation, and in DIC, such

activators, especially tissue-plasminogen activator, are apparently released as a result of thrombin formation and fibrin deposition on endothelial surfaces, endothelial injury, or hypoxia. Many of the thromboplastic substances that initiate DIC, such as tumor tissues and extracts of leukemic cells, also contain plasminogen activators. The release of plasminogen activators from platelets and leukocytes also may be significant. Finally, factor XIIa activates plasminogen by interacting with normal proactivators and the kinin system ( 182 ). Fibrinolysis must be distinguished clearly from the process of fibrinogenolysis, in which fibrinogen and other coagulation factors are proteolytically destroyed in the circulation. Fibrinogenolysis may be an inappropriate response in DIC associated with amniotic fluid embolism ( 183 ), heatstroke ( 119 ), and, rarely, carcinoma. It is uncommon in other forms of DIC; when present, it is usually transitory and overshadowed by marked fibrinolysis. Disorders in which fibrinogenolysis arises in the absence of DIC (primary fibrinolysis) are discussed elsewhere in this chapter.

**Fibrin(ogen) Degradation Products** The stepwise process by which fibrin is degraded proteolytically and the biologic effects of the various products of the process (FDPs) are discussed in Chapter 21 ( 184 ). These protein fragments act as antithrombins ( 69 , 70 ), inhibit fibrin polymerization, produce a structurally defective fibrin polymer ( 185 , 186 ), and may impair platelet ( 66 , 67 ) and reticuloendothelial clearance functions. The presence of large amounts of FDP in the circulation is a major factor in the production of hemorrhage in many patients with DIC. The infusion of large amounts of FDP (fragment D) into rabbits produces changes that resemble the posttraumatic respiratory distress syndrome in humans ( 187 ). This observation suggests that large amounts of FDP may directly damage the pulmonary vasculature, leading to respiratory distress syndrome, which has been reported in association with DIC and the use of thrombolytic agents ( 188 ). The smallest FDPs are peptides of 3000 to 4000 molecular weight that inhibit smooth muscle contractility, an effect that may explain the frequency of uterine inertia in abruptio placentae ( 189 ). In DIC, a large amount of fibrin remains in a soluble state as a consequence of the formation of complexes between fibrin monomers, various FDPs, and fibrinogen. This solubility has been regarded as a final defense against vascular occlusion. *In vitro*, the complexes dissociate in the presence of alcohol or protamine sulfate to form gels or precipitates of various types (paracoagulation).

**Impairment of Clearance Mechanisms** The numerous processes that normally remove procoagulant material from the circulation are of the utmost importance in DIC because of the presence of massive amounts of both activators and products of coagulation. Most of the products of intravascular coagulation [prothrombinase, platelet factor-3 activity, various types of FDPs and complexes thereof ( 190 , 191 ), and, possibly, free fibrin ( 192 )] as well as various initiators of the process (tissue fragments, endotoxin, antigen-antibody complexes, tissue factor, and red cell stroma) are removed from the circulation by the reticuloendothelial system ( 193 ) ( Fig. 60.3 ). The Kupffer cells of the liver ( 194 ) and splenic macrophages are of particular importance. In certain forms of DIC, large amounts of relatively inert particulate matter (e.g., amniotic fluid embolism) place an additional burden on the reticuloendothelial system. The hepatic cells are of primary importance in the clearance of activated coagulation factors [IXa, Xa ( 195 ), and XIa]. Investigators have suggested that various substances saturate and produce an “autoblockade” of reticuloendothelial and hepatic clearance functions in DIC in a manner comparable to that produced experimentally in the Shwartzman reaction ( 193 , 196 ). This blockade may be an important pathophysiologic factor, particularly in perpetuating DIC after a transient activating stimulus. Shock and endotoxemia, both of which produce significant hepatic hypoperfusion, may contribute indirectly to autoblockade of clearance functions.

**Chronic or “Compensated” Disseminated Intravascular Coagulation** Certain forms of DIC result from a weak or intermittent activating stimulus. In such patients, destruction and production of coagulation factors and platelets are balanced ( Fig. 60.3 ). The pathophysiology of such chronic, subacute, or “compensated” DIC is fundamentally the same as that in the acute case. Nevertheless, the distinction is valuable because the clinical picture and laboratory findings in the chronic form are quite variable and may be



diagnostically confusing. Chronic DIC has been described in most patients with intrauterine fetal death or giant hemangiomas (Kasabach–Merritt syndrome) and in many cases of adenocarcinoma ( 122 ). Other etiologic factors that may produce chronic DIC include various forms of vasculitis, acute leukemia, aneurysms, hemangiomatous transformation of the spleen, and renal allograft rejection. Chronic DIC has many clinical and laboratory features that resemble an intermediate stage between the “hypercoagulable state” (see Chapter 61) and acute DIC, an observation of more than theoretical interest. In cancer patients, a virtually continuous spectrum of clinical and laboratory features has been described; these range from recurrent venous thrombosis or arterial embolism ( 122 ) with high levels of platelets and coagulation factors to acute DIC with severe hemorrhage ( 122 ). The clinical and experimental evidence is incontrovertible that pregnancy, the best studied form of hypercoagulability, is associated with an increased propensity for the development of DIC ( 197 ). Indeed, even normal pregnancy has been suggested as a form of low-grade “physiologic” DIC ( 197 ), which, at term, becomes overt for a short time. Thus, transitory but significant elevations of FDP and corresponding diminution in fibrinogen levels are observed regularly during the first 4 hours after delivery ( 197 ). This may be triggered, in part, by the release of tissue factor into the circulation. Thus, the hypercoagulable state likely represents merely low-grade intravascular coagulation.

## Clinical Features

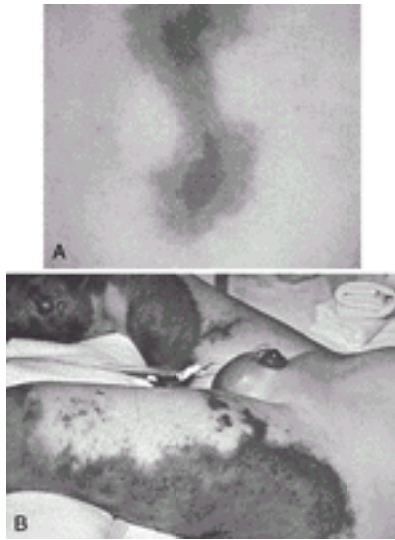
The major clinical features of DIC are bleeding, often of serious magnitude and abrupt onset; a variable element of shock that is often out of proportion to apparent blood loss; and symptoms of hypoperfusion of various vascular beds. Acute renal failure is common, and thromboembolic manifestations often are noted ( 198 ). Any of these features or signs and symptoms of the underlying disorder may predominate in a given case.

Evidence of major organ dysfunction is a common finding in patients with DIC, most often including signs, symptoms, and laboratory evidence of abnormal pulmonary, renal, hepatic, and central nervous system function. Although virtually all of these manifestations have been attributed to the underlying DIC, the clinical manifestations that have been described were the result of the underlying disorder. For example, one study observed that patients with DIC due to aortic aneurysm had laboratory features of DIC but minimal clinical manifestations. Patients with DIC due to obstetric disorders all had bleeding, but only 20% had organ dysfunction. In contrast, of patients with DIC due to sepsis, only 15% had bleeding, but 76% had organ failure ( 118 ). These results suggest that marked heterogeneity exists in clinical manifestations of DIC, and that the etiology of DIC is a major predictor of clinical events ( 118 ).

In this section, the clinical manifestations and diagnosis of DIC are discussed in general terms. Various specific clinical features and details regarding treatment of the most common forms follow in a separate section.

**ACUTE DISSEMINATED INTRAVASCULAR COAGULATION** Bleeding manifestations of virtually every kind have been described, and they may evolve rapidly in the patient with acute DIC. Generalized ecchymoses, petechiae, and bleeding from previously intact venipuncture sites or around indwelling intravenous needles or catheters are noted in many patients. Large, spreading, hemorrhagic skin lesions often are superimposed on familiar exanthems in patients with rickettsial and viral infections. “Geographic” acral cyanosis is a prominent feature in some patients. This grayish discoloration of the tips of the fingers, toes, and ears often develops in a symmetric distribution. Large, sharply demarcated ecchymotic areas may result from thrombotic occlusion of dermal vessels and may progress to skin infarction. Such infarcts are particularly common in patients

with purpura fulminans ( [Fig. 60.4](#)) and are seen also in coumarin-induced skin necrosis and inherited homozygous deficiency of protein C (see [Chapter 61](#)). In patients with meningococemia, cutaneous hemorrhage may be striking. Bleeding from apparently normal gingivae, epistaxis, gastrointestinal bleeding, pulmonary hemorrhage, and hematuria are common. In patients who develop DIC after surgical procedures, alarming hemorrhage may develop around drains and tracheostomies, and accumulations of blood may be concealed in serous cavities.



**Figure 60.4.** Purpura fulminans in infection-associated disseminated intravascular coagulation. Early lesions (A) are circumscribed; progressive lesions (B) may become necrotic. See [Color Plate](#). (From Dudgeon DL, Kellogg DR, Gilchrist GS, et al. Purpura fulminans. *Arch Surg* 1971;103:351–358; copyright 1971, American Medical Association, with permission.)

**CHRONIC DISSEMINATED INTRAVASCULAR COAGULATION** Superficial but extensive ecchymoses of the extremities, often without petechiae, may develop intermittently or may persist. Recurrent episodes of epistaxis or more serious internal mucosal bleeding may punctuate the course. Thrombophlebitis may develop in unusual sites, such as the axillary vein, and may occur repeatedly after cessation of anticoagulant therapy. Clearly, Trousseau sign (recurrent migratory thrombophlebitis in association with cancer) in most instances is a manifestation of chronic DIC. More serious hemorrhagic manifestations may develop as the underlying disease progresses or may arise with dramatic suddenness after surgical procedures such as a prostatectomy. Acute DIC may be heralded by further thrombophlebitis or pulmonary emboli. In some patients, evidence of vascular obstruction (e.g., impairment of renal function, confusion, transitory neurologic syndromes, or repeated episodes of cerebral thrombosis) may develop with minimal bleeding.

### Laboratory Diagnosis

The laboratory findings in DIC are summarized in [Table 60.2](#). Contrary to what is commonly assumed, they may be quite variable. The plasma fibrinogen level, PTT, PT, platelet count, and estimates of FDP or D-dimer are the cornerstones on which the diagnosis of DIC is based. These simple tests should always be performed first. Additional information may confirm, but seldom refutes, the diagnosis of DIC if typical abnormalities are demonstrated by these tests. Laboratory data may change with remarkable rapidity in DIC, based on disease progression or therapy.

Laboratory data must be interpreted with caution. Levels of platelets and various coagulation factors, fibrinogen, and factor VIII, in particular, may be elevated in many of the conditions associated with DIC, including pregnancy. Thus, a fibrinogen level of 200

mg/dl, although within the normal range determined in healthy subjects, may represent a significant decrease in a patient whose baseline level was 800 mg/dl.

The best test for diagnosing DIC is the D-dimer assay. The semiquantitative method is sensitive ( [199](#) ), and D-dimer values greater than 2000 ng/ml have been reported to be consistent with DIC ( [200](#) ). More sensitive, quantitative D-dimer assays are available, but DIC diagnostic ranges are not yet defined for this latter method.

A new test, measurement of the biphasic waveform in the PTT assay, has been reported to precede development of DIC and to predict DIC better than the D-dimer assay ( [201](#) ). The biphasic waveform results from the formation of a precipitate on plasma recalcification; the precipitate contains very-low-density lipoprotein complexed with C-reactive protein. If confirmed, this assay may be a useful addition to laboratory tests for DIC.

**BASIC BLOOD EXAMINATIONS** In patients with DIC, routine hematologic tests may reveal evidence of acute bleeding, accelerated red cell destruction, or signs of the underlying disease. Examination of the blood smear reveals schistocytes in approximately 50% of cases ( [117](#) , [202](#) ), but the degree of schistocytosis bears no necessary correlation with other facets of the disorder. More subtle evidence of intravascular hemolysis often is found, such as increased serum levels of lactic acid dehydrogenase and diminished haptoglobin levels. Rarely, massive intravascular hemolysis with hemoglobinemia and hemoglobinuria is noted ( [180](#) ). Thrombocytopenia is an early and consistent sign of acute DIC, and the consideration of this diagnosis in the presence of a persistently normal platelet count is difficult. Platelet counts in the range of 50,000 to 100,000/ $\mu$ l are the usual finding, but thrombocytopenia may be severe.

**COAGULATION DEFECT** The PTT, PT, and thrombin time are prolonged in most patients with acute DIC. Early in the course of the disorder and in chronic DIC, the PTT may be normal or even shorter than normal, which may be the result of the procoagulant effects of activated coagulation factors or elevated factor VIII levels. Occasionally, one can follow the process of DIC from its inception, and specific assays for various coagulation factors obtained at the time of diagnosis reveal a variable and rapidly changing picture. The plasma levels of fibrinogen and of factors V and XIII usually are significantly depressed; fibrinogen and factor V are the most consistently affected ( [203](#) ). The level of factor X may be lower than that of other "stable" factors (factors VII, IX, and XI), which usually are present in normal amounts ( [203](#) ). In many patients, particularly those with abruptio placentae, normal prothrombin levels are maintained ( [123](#) , [203](#) ), but marked hypoprothrombinemia often is present in those with septic DIC ( [204](#) ). The levels of factors VIII, IX, and XI as determined by one-stage assays may fluctuate widely as the result of the presence of activated factors ( [205](#) ), such as thrombin, and factor Xa ( [198](#) ). This problem is minimized in two-stage assays ( [203](#) ). Levels of factor VIIIc often are normal or increased, particularly when assayed by two-stage techniques ( [206](#) ). In many patients, the levels of coagulation factors tend to "overshoot" after repletion. As a consequence of the inhibitory effects of FDPs, the thrombin time may be prolonged out of proportion to the reduction in the fibrinogen level.

**TESTS FOR FIBRINOLYSIS: FIBRIN MONOMERS, FIBRIN(OGEN) DEGRADATION PRODUCTS, AND D-DIMER** In most patients with DIC, FDP levels as determined by quantitative methods, such as red cell hemagglutination inhibition or latex agglutination, are 25- $\mu$ g fibrinogen "equivalents"/ml or higher ( [203](#) ). All methods are most sensitive to large or "early" FDPs. These fragments, particularly fragment X, retain thrombin-binding sites or may form a complex with fibrinogen and consequently be removed during the preparation of serum for FDP tests. This phenomenon or the presence of only small FDPs may explain the normal levels of FDPs in some patients with otherwise typical DIC.

Fibrinopeptide A and certain fibrinogen fragments that are formed by the lysis of cross-linked fibrin, such as the DD-dimer and the DD-dimer-E complex, can be demonstrated by using special techniques. These latter FDPs provide direct evidence of the action of thrombin on fibrinogen and provide a means of differentiating fibrin degradation products from fibrinogen degradation products ( [207](#), [208](#) ). The simplicity, specificity, and sensitivity of the D-dimer test have led many laboratories to replace less sensitive or less convenient tests for DIC with the D-dimer test. Because false-positive results may be seen with FDP latex agglutination tests in patients with dysfibrinogenemia, the D-dimer test may be more specific in diagnosing DIC, especially in distinguishing the coagulopathy of liver disease from DIC ( [84](#), [199](#), [209](#) ). False-positive D-dimer latex agglutination tests may occur in patients with elevated levels of Ig (immunoglobulin) M (rheumatoid factor). “Paracoagulation” techniques are simple to perform, but they are less specific than tests for FDPs. The results of the ethanol gelation test, in particular, often are negative in DIC. To the contrary, results of protamine gelation tests usually are positive ( [210](#) ), but abnormal results are obtained in numerous other disorders, including many that commonly are associated with DIC.

**OTHER LABORATORY FINDINGS** Plasma levels of fibrinopeptide A ( [211](#) ) and the rate of incorporation of <sup>14</sup>C-labeled glycine ethyl ester into soluble “circulating fibrin” ( [212](#) ) are exceptionally sensitive indicators of DIC and may be abnormal even in patients with normal levels of FDP. Levels of antithrombin ( [213](#) ), a  $\alpha_2$ -antiplasmin, and proteins C and S may be diminished in some cases. Other parameters of activation of coagulation and fibrinolysis have been studied in DIC, especially in sepsis. Thrombin-antithrombin III (TAT) complexes and plasmin- $\alpha_2$ -antiplasmin (PAP) complexes are often elevated in sepsis-associated DIC. Assays such as TAT and PAP complexes may have prognostic significance in DIC, as may other coagulation parameters, including plasminogen activator inhibitor type-1, vWF antigen, and a  $\alpha_2$ -antiplasmin ( [214](#) ). In a primate model of gram-negative sepsis, a number of molecular markers of coagulation were investigated for their use in monitoring DIC ( [215](#) ). Markers such as soluble thrombomodulin and soluble fibrin monomer are useful in assessing the status of microvascular injury. The role of these assays in diagnosing or managing DIC patients at this time is uncertain. The International Society on Thrombosis and Haemostasis (ISTH) has proposed clinical and laboratory criteria using routine and esoteric assays to better define the spectrum of DIC cases ( [216](#) ).

## Differential Diagnosis

The causes of severe hemorrhage of abrupt onset in a patient who was previously free of bleeding are relatively few, and only a small number of acquired disorders give rise to significant coagulation abnormalities in which the cause is not obvious. Thus, the syndrome of DIC is seldom difficult to recognize. Problems arise when the diagnosis simply is not considered or in chronic forms, when the underlying coagulation disorder may be masked by features of the basic disease or by thromboembolic complications ( [217](#) ).

Two disorders, however, produce laboratory abnormalities that resemble DIC: severe liver disease, which is common, and primary fibrinogenolysis or “pathologic” fibrinolysis, which is rare ( [Table 60.2](#) ).

In patients with primary fibrinogenolysis, the following conditions may be evident: hypofibrinogenemia; increased levels of FDP; abnormalities of the PTT, PT, and thrombin time; and deficiencies of factors V and VIIIc. The euglobulin lysis time is significantly and persistently shortened, often in association with plasminemia. However, the platelet count usually is normal, the D-dimer level should be normal or only minimally elevated, and

protamine sulfate tests should be negative. Hypoprothrombinemia and deficiencies of stable coagulation factors VII, IX, X, and XI are rare. Thus, routine coagulation tests should be able to distinguish DIC from primary fibrinogenolysis.

In patients with liver disease, coagulation abnormalities and thrombocytopenia may originate from many pathologic processes ( [Table 60.3](#)). Chronic or intermittent fibrinogenolysis with high levels of FDP is common, particularly in patients with cirrhosis. In such patients, the exclusion of the diagnosis of DIC may be difficult. Factor VIIIc levels usually are elevated when liver disease is severe, and the levels of factors VII and IX typically are low. A helpful test in discriminating between the coagulopathy of liver disease and DIC is the D-dimer test, the results of which should be abnormal in DIC but normal in liver disease [unless additional disorders coexist ( [84](#), [209](#))].

DIC, particularly that associated with carcinoma, may be confused with various microangiopathic hemolytic anemias, such as thrombotic thrombocytopenic purpura and hemolytic-uremic syndrome; in these disorders, the clinical picture may resemble that of DIC in many respects. High levels of FDP may be encountered in patients with microangiopathic hemolytic anemias, but significant coagulation abnormalities are not commonly present. Many other disorders may produce slight to moderate elevations of FDP—for example, pulmonary embolism and chronic renal disease with uremia.

Moderate thrombocytopenia is a common consequence of the use of extracorporeal circulatory devices, and coagulation abnormalities often are noted immediately after their use because of the presence of residual heparin. Heparin levels also may rise several hours later (the rebound phenomenon) ( [218](#)). In such patients, the presence of thrombocytopenia together with the effects of heparin may be confused with DIC; similar difficulties may arise after hemodialysis. Even the small amounts of heparin required to irrigate indwelling catheters, or to contaminate Hickman catheters, are a common cause of “pseudo-DIC.”

## Treatment

DIC always is the end result of a serious underlying disorder. Although the patient may benefit greatly from measures directed at the DIC or from the replacement of depleted coagulation factors and platelets, cure of the syndrome depends on prompt and energetic treatment of the primary disorder. This—not the therapeutic measures described in this section—remains the cornerstone of therapy.

**ANTICOAGULANTS** Heparin is a specific activator of the physiologic antithrombin system and thereby inhibits a number of proteolytic enzymes, including factors IXa and Xa and thrombin (see [Chapter 61](#)). Antithrombin can neutralize free thrombin rapidly and can retard or prevent its further formation. The therapeutic efficacy of heparin is unquestionable in some animal models of DIC, but assessment of its effectiveness in humans has proved more difficult. In view of the complexity of DIC, inhibition of coagulation alters only one facet, albeit a fundamental one, of the pathophysiologic cycle. In patients with chronic DIC, the results of heparin therapy usually are favorable and may be dramatic. In most patients, heparin would not be expected to alter ultimate mortality because of the nature of the underlying diseases; however, this drug typically does reduce the severity of bleeding and thromboembolic manifestations and produces parallel improvement in the abnormalities of laboratory test values. Elevated levels of D-dimer and FDPs drop rapidly, and accelerated fibrinolysis, if present, disappears after the administration of heparin, often before the coagulation defect has been alleviated. The response of the platelet count to heparin therapy for DIC is slow and often erratic. In patients with acute DIC, particularly that associated with sepsis, the results of heparin therapy have been less encouraging ( [219](#), [220](#)). Heparin has been given concomitantly with



numerous other therapeutic measures in most patients, and in those with acute forms of DIC in which the activating stimulus is transitory (e.g., abruptio placentae), spontaneous cure is the rule. The apparent paradox of administering anticoagulants to a patient with a serious bleeding disorder has been emphasized repeatedly. Most clinicians are reluctant to use heparin in patients with acute DIC. Laboratory control of heparin therapy for DIC is difficult. Because baseline PTT values are usually prolonged in acute DIC, heparin levels may be required to monitor therapy (see [Chapter 61](#)).

**REPLACEMENT THERAPY WITH PLATELETS AND COAGULATION FACTORS** Many patients with DIC ultimately receive large amounts of blood products, even though evidence is only anecdotal that they are necessary or therapeutically effective ([221](#)). The major aim of replacement therapy with blood products in DIC is to replenish fibrinogen. This goal is best accomplished by the administration of cryoprecipitate, each unit of which contains approximately 250 mg of fibrinogen ([222](#)). The amount of cryoprecipitate given should be sufficient to elevate the plasma fibrinogen level to at least 100 to 150 mg/dl. As a general guide, 3 g of fibrinogen can be expected to raise the plasma level of an adult patient approximately 100 mg/dl. Fibrinogen administration probably should be restricted to the occasional patient with hypofibrinogenemia and significant bleeding, in whom DIC is self-limited or has been controlled by heparin therapy (e.g., in intrauterine fetal death before surgical intervention). Sterile fibrinogen concentrates are not yet available for routine therapeutic use in the United States. In theory, the infusion of fibrinogen in the presence of active DIC “adds fuel to the fire.” Thromboembolic complications have developed in some patients after the administration of lyophilized concentrates of this protein ([223](#)). In a larger number of patients, fibrinogen produced no apparent adverse effects. Patients with DIC, bleeding, and platelet counts less than 50,000/ $\mu$ l should be considered for platelet transfusion. Due to the acquired storage pool defect seen with DIC, as well as FDP inhibition of platelet function, DIC patients may require a higher platelet count for adequate hemostasis than patients with thrombocytopenia in the absence of platelet dysfunction. Infusions of semipurified antithrombin have produced encouraging results in some patients ([224](#)). The availability of purified, sterile antithrombin concentrates has led to its investigation in treating DIC. As seen in most studies ([225](#)), although antithrombin concentrates can normalize plasma levels of this protein in patients with DIC and improve hemostasis parameters, consistent clinical benefit in terms of survival is not evident. A large clinical trial recently demonstrated that high-dose antithrombin therapy in patients with sepsis had no effect on mortality ([226](#)). Novel therapies for DIC are discussed in the section [Novel Therapies for Disseminated Intravascular Coagulation](#).

**OTHER THERAPEUTIC MEASURES** Treatment of shock should be immediate and vigorous in all patients with DIC. Packed erythrocytes should be given promptly if indicated. The indiscriminate use of EACA and other antifibrinolytic drugs should be discouraged. EACA has been administered together with or after heparin in a few patients in whom DIC was associated with significant fibrinogenolysis. No serious adverse effects were observed, but the therapeutic value of EACA was difficult to assess. Because of the potential risks, fibrinolytic enzyme inhibitors should be administered only to carefully selected patients—that is, those in whom DIC has resulted from a transitory stimulus or has been arrested by heparin administration and in whom fibrinogenolysis or inappropriate fibrinolysis, hypofibrinogenemia, and adequate renal function have been clearly documented. The therapeutic use of EACA in fibrinogenolysis and appropriate dosage schedules are discussed elsewhere in this chapter.

## Specific Features of Various Forms of Disseminated Intravascular Coagulation

### OBSTETRIC DISORDERS

***Abruptio Placentae*** DIC complicates abruptio placentae in approximately 25% of cases ([227](#), [228](#)) in which fetal compromise occurs. Shock develops rapidly, but vaginal bleeding may be minimal or absent for a time and bears little relationship to the extent of

abruption. Brisk external hemorrhage may originate from episiotomies and lacerations, and large amounts of blood may be concealed behind the placenta and within the wall of the uterus. Severe placental abruption associated with fetal death is often linked with DIC ( [229](#)). Hemorrhage is the major factor leading to shock and renal complications in abruptio placentae, and the most essential therapeutic measures are the vigorous treatment of blood loss and the prompt evacuation of the uterus. Extensive replacement therapy seldom is required. Often, fibrinogen replacement is given if immediate surgical treatment is necessary. Fibrinogen replacement may be most useful in patients with fetal death requiring cesarean delivery. If the coagulation defect and thrombocytopenia are severe or persist for an unusually long time, the administration of platelets, fibrinogen in the form of cryoprecipitate, and fresh frozen plasma ( [230](#)) may reduce hemorrhage. Most obstetricians do not administer heparin because it may increase bleeding and because rapid spontaneous remission of DIC is usual when the uterus is evacuated.

***Intrauterine Fetal Death*** In the event of intrauterine fetal death, definite laboratory abnormalities are not seen until the dead fetus has been retained for 3 to 5 weeks; plasma levels of FDPs then begin to rise, and the platelet count and fibrinogen level gradually decline. Bleeding may be inconspicuous, but a progressive loss of renal function is not uncommon. In most women in whom delivery of the dead fetus is induced promptly according to usual obstetric practice, bleeding is not serious, even in the presence of low-grade DIC. Operative intervention is dangerous when hypofibrinogenemia is severe, and such patients should receive heparin until safe fibrinogen levels are restored ( [231](#)). If immediate surgery is imperative, heparin administration should be followed by platelet replacement and enough fibrinogen, in the form of cryoprecipitate, to produce plasma fibrinogen levels of 150 mg/dl or greater ( [232](#)). This situation is one of the few indications for the use of fibrinogen in the presence of DIC. Intrauterine fetal death rarely may be associated with the acute form of DIC.

***Amniotic Fluid Embolism*** In women who survive amniotic fluid embolism (mortality rate of up to 80%), DIC with severe hemorrhage may develop within 1 to 2 hours ( [233](#)). More recent surveys indicate a mortality rate of 20 to 30% ( [234](#)); 66% of patients with amniotic fluid embolism cases had DIC ( [234](#)). Often, the syndrome is complicated by significant fibrinolysis and even fibrinogenolysis ( [183](#)). Hypoxia and other sequelae of pulmonary vascular obstruction dominate the clinical picture and usually determine the outcome. The release of serotonin and other vasoactive substances from platelets may contribute to the profound pulmonary vasoconstriction. Heparin often is given, and the administration of EACA has been recommended when evidence of a disproportionate or inappropriate fibrinolytic response appears. Nevertheless, the efficacy of these drugs and risks associated with their use remain uncertain ( [235](#)), as does the value of intensive replacement therapy aimed at correcting the coagulation defect and thrombocytopenia.

***Miscellaneous Obstetric Disorders*** Intravascular coagulation has been well documented after abortions induced by intraamniotic injection of hypertonic saline solutions ( [236](#)) and hypertonic urea ( [237](#)), but it apparently does not complicate abortions performed by suction curettage or those induced by prostaglandin F<sub>2a</sub> ( [232](#)).

## **DISSEMINATED INTRAVASCULAR COAGULATION IN NEONATES AND INFANTS**

Several disorders unique to the neonate and infant may be associated with DIC ( [Table 60.2](#)) ( [238](#)). The transplacental passage of thromboplastins or other procoagulant substances has been the apparent cause of DIC in neonates born of mothers affected with DIC owing to abruptio placentae, eclampsia, or septicemia. Asphyxia may be a common precipitating factor for DIC in these disorders ( [239](#)). The development of DIC in a twin fetus has been attributed to “fetofetal” passage of thromboplastins ( [240](#)). Bacterial infection and generalized viral infections (e.g., herpes simplex, cytomegalic inclusion disease, and rubella), acidosis, and hypoxia are more common causes of DIC in infants than in adults ( [241](#)). DIC secondary to giant hemangiomas and purpura fulminans has been reported in neonates. Management of septic DIC in the neonate should emphasize



treatment of underlying infection. A controlled study that compared treatment with heparin, extensive replacement therapy with blood products, and supportive care only revealed no significant differences in outcome for the three groups ( [242](#) ). A more recent study confirms that clinical trials in neonatal sepsis have not identified a beneficial therapy ( [243](#) ). DIC associated with sepsis produces bleeding with approximately the same frequency and in the same clinical patterns as in other forms of DIC ( [244](#) ). The diagnosis seldom is difficult, but DIC must be distinguished from septic shock, endotoxin shock, or simple thrombocytopenia, all of which may develop independently of DIC in severe infections ( [245](#) ). Therapy should be directed at the underlying infection and complicating shock, if present. In many patients, no additional measures are required. No evidence has been cited that heparin has diminished mortality ( [204](#) ). In one series, the alleviation of septic shock appeared to be more important in the ultimate prognosis than did correction of the coagulation abnormalities ( [204](#) ). Recombinant activated protein C has been demonstrated to reduce mortality in adult patients with sepsis ( [246](#) ). Whether this therapy is effective in neonatal or pediatric sepsis is unknown.

**PURPURA FULMINANS** The hemorrhagic manifestations of purpura fulminans develop several days after an acute infection; these are most commonly scarlet fever or various viral respiratory diseases ( [244](#) ). Purpura fulminans is most common in children but is also well documented in adults. The most common manifestations are symmetric ecchymoses of the lower extremities and buttocks, sharply circumscribed infarcts of the skin and genitalia, and gangrene of the extremities that often involves the digits symmetrically ( [247](#) ). These ecchymotic lesions often become necrotic, ultimately forming blood-filled bullae ( [Fig. 60.4](#) ). Petechiae are rare. Fever and prostration are seen, but visceral lesions, including renal involvement, are relatively uncommon. The mortality rate associated with purpura fulminans ranges from 18% ( [244](#) ) to 40 to 70% ( [248](#) ). Heparin in therapeutic doses has often proved therapeutically effective, and it has been suggested that poor results obtained previously with this anticoagulant reflect late treatment of moribund patients. In patients with purpura fulminans, relapses are particularly common after cessation of heparin therapy ( [244](#) ), and the administration of this anticoagulant, possibly in reduced doses, should always be continued for 2 to 3 weeks. Evidence that purpura fulminans may be a manifestation of homozygous protein C deficiency ( [249](#) ) is discussed in [Chapter 61](#). The efficacy of protein C and activated protein C therapies in patients with sepsis and purpura fulminans is discussed below (see section [Novel Therapies for Disseminated Intravascular Coagulation](#)).

## NEOPLASTIC DISORDERS

**Carcinoma** In patients with DIC associated with carcinoma, the clinical picture is quite variable and often consists of a combination of bleeding and thromboembolic phenomena, including arterial embolism ( [122](#), [126](#), [127](#) ). The association of chronic DIC, thromboembolism, and cancer is often called *Trousseau syndrome* ( [122](#) ). Laboratory findings are variable. Evidence of chronic DIC, hypercoagulability, or acute DIC may be found ( [122](#), [126](#), [127](#) ). In a study of more than 1000 patients with solid tumors, 7% were diagnosed with DIC using standard coagulation tests (platelet count, fibrinogen, D-dimer, FDPs) ( [250](#) ). Risk factors associated with the occurrence of DIC included older age, male gender, advanced disease, breast cancer, and necrosis of the tumor specimen ( [250](#) ). One reason for the variability in cancer patients having venous thromboembolism relates to the histology of the malignancy. Analysis of a very large database of Medicare patients with cancer identified tissue-specific differences in thrombotic risks among cancers ( [251](#) ). Those cancers with a high risk of thrombosis included uterine, brain, leukemia, ovary, and pancreas (= twofold risk), whereas prostate, liver, head or neck, bladder, and breast cancer had less than a onefold risk (compared to noncancer patients) ( [251](#) ). DIC in association with carcinoma disappears with effective treatment of the underlying tumor. Heparin or low-molecular-weight heparin in therapeutic doses has proved effective in controlling the hemorrhagic and thromboembolic symptoms ( [122](#), [126](#), [252](#), [253](#) ). There is a

suggestion in the literature that the use of low-molecular-weight heparin therapy is associated with improved mortality in cancer patients ( 254 ). Prospective trials to formally address this hypothesis are under way. A significant minority of patients with cancer and thrombosis do not have success with oral anticoagulation ( 122 ) and benefit from long-term heparin or low-molecular-weight heparin. In the case of DIC associated with prostate cancer, adjunctive therapy with ketoconazole ( 255 ) or antiandrogens ( 256 ) may be useful.

**Acute Promyelocytic Leukemia** DIC has been reported in association with all forms of acute leukemia ( 257 ), but it is most common in the “hypergranular” promyelocytic variety ( 258 ), in which it may complicate from 60 to 100% of cases. The cause of the coagulopathy is multifactorial—tissue factor is present in the granules of the abnormal promyelocytes ( 130 ) as well as increased fibrinolysis and leukocyte proteases, including elastase ( 259 ). Enhanced fibrinolysis also results from increased promyelocyte expression of annexin II, a receptor for plasminogen and tissue-plasminogen activator ( 132 ). Additionally, the malignant promyelocytes contain plasminogen activators ( 260 ). The clinical picture usually is one of chronic progressive DIC with a significant fibrinolytic component that may antedate the other manifestations of the disease. Acute fulminant DIC may develop spontaneously or may be triggered by the administration of chemotherapeutic agents, which cause the release of thromboplastic contents of the promyelocytes. In some patients with acute leukemia, accelerated fibrinolysis is a conspicuous finding ( 259 ). In one series of patients, depletion of a  $\alpha_2$ -antiplasmin developed during induction of chemotherapy, a finding that was more predictive of bleeding complications than traditional indices of DIC, such as levels of fibrinogen, antithrombin, and plasminogen ( 261 ). This study suggests that “unregulated” fibrinolysis, by destroying functional hemostatic plugs and depleting fibrinogen, may be more important than DIC in some cases. In the past, heparin has produced clear-cut remissions in patients with chronic forms of DIC associated with acute leukemia. One approach ( 259 ) recommends fibrinogen replacement therapy for fibrinogen levels less than 100 mg/dl and platelet transfusion for platelet counts less than 20,000/ $\mu$ l. Fresh frozen plasma is given to patients with prolonged PT and PTT values who are bleeding. If the fibrinogen level is difficult to maintain over 100 mg/dl, or if FDP levels are rising, heparin is infused at 500 U/hour ( 259 ). When a  $\alpha_2$ -antiplasmin levels are below 30% of normal, EACA or another antifibrinolytic agent should be added to this regimen ( 261 ), and a  $\alpha_2$ -antiplasmin levels should be monitored during induction of chemotherapy. A newer approach that has virtually replaced the need for heparin and antifibrinolytic agents in the treatment of acute promyelocytic leukemia is the administration of all- *trans*-retinoic acid. This differentiation therapy appears to be successful ( 262 ). However, these patients still may require replacement therapy for hypofibrinogenemia and thrombocytopenia ( 262 ). Current protocols for acute promyelocytic leukemia combine all- *trans*-retinoic acid and combination chemotherapy to ameliorate the coagulopathy ( 263 ). Relapsed or refractory acute promyelocytic leukemic patients may benefit from arsenic trioxide therapy, another differentiation agent ( 264 ).

**KASABACH-MERRITT SYNDROME (GIANT HEMANGIOMAS)** The severity and incidence of DIC tends to parallel the size of the vascular tumors in the Kasabach-Merritt syndrome ( Fig. 60.5 ) ( 265 ). Platelet consumption, activation of coagulation, and microangiopathic red cell destruction take place mainly within the hemangioma (“sequestered” or localized intravascular coagulation), but laboratory evidence of DIC in the general circulation usually is clear-cut ( 162, 265 ). Recurrent bleeding from the surface of the tumor is the major hemorrhagic manifestation; in the presence of DIC, this bleeding may be intractable. Periodic swelling of the lesions often is observed. This phenomenon may be a consequence of intermittent obstruction of blood outflow from the hemangioma and may provoke serious hemorrhage. Irradiation and corticosteroids have produced

favorable results in a few cases, but surgical removal of the tumors has ultimately been required in most patients ( 265 ). Interferon- $\alpha$  has been successful in large numbers of patients; this cytokine probably acts as an antiproliferative/antiangiogenic agent ( 265 ). Antifibrinolytic therapy has been reported to be useful in controlling the coagulopathy ( 266 , 267 ). Other useful therapies include cryoprecipitate and platelets for replacement therapy to correct a severe coagulopathy. The use of heparin therapy is uncertain ( 265 ).



**Figure 60.5.** Kasabach-Merritt syndrome in a 17-year-old girl. This giant hemangioma enlarged progressively during childhood. Chronic disseminated intravascular coagulation was present, which responded to heparin therapy. (Courtesy of William Futrell.)

For patients with aneurysms associated with DIC, low-molecular-weight heparin has been reported to be useful in resolving the coagulopathy ( 268 ).

**SHOCK AND MASSIVE TRAUMA** Heparin therapy may be hazardous for patients with massive injuries. Even in the face of DIC, intensive supportive care and replacement therapy with plasma and platelets are the mainstays of treatment ( 269 ). In the occasional patient who develops overt DIC in association with severe burns, heparin has proved effective in the management of DIC ( 270 ).

**HEMOLYTIC TRANSFUSION REACTIONS** DIC is present in many patients with hemolytic transfusion reactions. Severe, acute hemolytic transfusion events are triggered by antigen-antibody reactions that initiate complement activation and activation of coagulation ( 271 ). These reactions are usually a result of ABO incompatibility. These patients may experience not only DIC, but also shock and renal failure. Primary therapy is directed to control of hypotension and restoration of renal blood flow. Fluid, diuretics, and dopamine may be useful therapies. Heparin therapy for DIC in hemolytic transfusion reactions is controversial ( 272 ).

**SNAKEBITE** DIC associated with snakebite differs from the usual form of the syndrome in several respects. Hemorrhage may be relatively inconspicuous ( 273 ), even in the presence of incoagulable blood ( 274 ). When present, it is mainly the result of a vascular toxin. Platelets often are spared, although the venom of the timber rattlesnake ( *Crotalus horridus horridus*) contains a unique serine protease that acts as a potent platelet activator ( 275 ). In some cases, a disorder manifested mainly by brisk fibrinolysis in the absence of evidence of DIC has been described ( 276 ). The specific coagulopathy seen in individual patients in large part depends on venom constituents present in the particular snake species. Detailed lists of venom constituents affecting hemostasis have been published ( 166 , 168 , 170 , 171 , 274 ). The treatment of snakebite involves the administration of specific antivenom and intensive supportive care. Heparin therapy has proved marginally

effective at best ( [273](#), [277](#) ). In general, it is not indicated when specific antivenom is available. Cryoprecipitate should be given to maintain the fibrinogen level over 100 mg/dl.

## Pathology

The fatality rate associated with DIC is up to 60% ( [175](#) ). In many cases, death is attributed to bleeding or thrombosis. Mortality increases with age, the number of clinical manifestations, and the severity of laboratory abnormalities.

The deposition of fibrin in small vessels represents the ultimate result of DIC. In many patients, fibrin can be formed and lysed without significant vascular occlusion. Indeed, after autopsy, fibrin thrombi in some subjects were absent or were demonstrated only with special stains or by electron microscopy. This may result from postmortem lysis or from deposition of thin films of fibrin on the vast endothelial surface and on the erythrocytes. The localization of fibrin thrombi varies somewhat with the cause of DIC. The usual distribution of lesions in the gut, pancreas, adrenal glands, brain, liver, skin, and kidneys is well documented. Bone marrow necrosis is a rare finding. The kidney is the single most common site of fibrin thrombi. Renal lesions range from patchy tubular necrosis to massive bilateral cortical necrosis and have been attributed to a sieving effect of the renal microvasculature. Nonthrombotic endocarditis and pulmonary hyaline membranes have been found in many patients ( [122](#), [278](#) ), especially those with cancer.

## Novel Therapies for Disseminated Intravascular Coagulation

The recognition of pathogenic mechanisms critical in initiation or progression of DIC has led to investigation of new therapeutic agents in animal models of DIC and clinical trials in humans. For example, protease inhibitors such as aprotinin ( [279](#) ) or gabexate ( [280](#) ) have been studied. Because aprotinin use can be associated with thrombosis ( [281](#) ), concomitant therapeutic heparin may need to be used. However, survival advantages have not been shown with these agents. Similarly, high-dose antithrombin replacement therapy has no effect on mortality in patients with severe sepsis ( [226](#) ).

The key role of tissue factor in triggering DIC ( [282](#) ) has led to studies in which neutralizing antibodies to this procoagulant were found to prevent lethal septic shock in animal models ( [283](#), [284](#) and [285](#) ). Inhibition of tissue factor activity by drugs such as dithiocarbamates has been investigated *in vivo* ( [286](#) ), and tissue factor pathway inhibitor is being studied in animal models and human DIC ( [287](#) ). A phase II study of recombinant tissue factor pathway inhibitor in septic patients demonstrated a trend toward mortality reduction and reduction in markers of activation of coagulation in treated patients ( [288](#) ). However, a phase III trial did not meet the primary endpoint in mortality reduction ( [289](#) ).

The role of protein C in ameliorating the mortality of sepsis has also been demonstrated; neutralization of protein C activity exacerbated the lethal response ( [290](#) ), and infusion of protein C ( [291](#) ) or activated protein C ( [290](#) ) prevented the lethal response in humans with meningococemia or in a primate model, respectively. The promising results with these novel agents have been confirmed in human studies demonstrating that recombinant activated protein C significantly reduced mortality in patients with sepsis ( [246](#) ). It has been speculated that activated protein C may be more effective than protein C in treating sepsis patients because the vascular endothelium in these patients may be dysfunctional and unable to efficiently activate the zymogen for patients given protein C ( [292](#) ).

However, there are no clinical data supporting this hypothesis.

In summary, although numerous agents have been tested in animal models of DIC, only activated protein C has been rigorously shown to alter clinical outcomes ([246](#)). There are suggestive, but unproven, data with protein C and tissue factor pathway inhibitor ([Table 60.5](#)).

**TABLE 60.5. Novel Therapies for Disseminated Intravascular Coagulation**

| Classification of Therapy    | Mechanism                                       | References  |
|------------------------------|---|---|
| TF inhibitors                |   |   |
| Monoclonal antibodies        | Inhibits TF activity                            | <a href="#">283</a> , <a href="#">284</a> and <a href="#">285</a> |
| TFPI                         | Inhibits TF activity; binds to endotoxin        | <a href="#">287</a> , <a href="#">288</a>                         |
| Protein C pathway components |   |   |
| Protein C                    | Promotes generation of APC                      | <a href="#">290</a> , <a href="#">291</a>                         |
| APC                          | Promotes anticoagulation; inhibits inflammation | <a href="#">246</a> , <a href="#">292</a>                         |

TF, tissue factor.

NOTE: Human trials in sepsis/disseminated intravascular coagulation have been reported for tissue factor pathway inhibitor (TFPI), protein C, and activated protein C (APC). As of 2002, only APC has been demonstrated to improve survival ([246](#)).

## PRIMARY FIBRINOLYSIS (FIBRINOGENOLYSIS)

Fibrinolysis is an appropriate response to thrombosis and necessary in the reestablishment of blood flow. This localized response, termed *physiologic fibrinolysis*, is discussed in [Chapter 21](#). The term *pathologic fibrinolysis* has been used indiscriminately to refer to any situation in which *in vitro* evidence of fibrinolysis was associated with bleeding. In retrospect, it seems probable that fibrinolysis in many cases was secondary to DIC and that in others it represented an essentially physiologic response to anoxia, shock, or stress. In fibrinogenolysis, on the other hand, the proteolytic destruction of fibrinogen and other proteins occurs in the general circulation, and severe bleeding may develop. The pathophysiology of fibrinogenolysis may represent a disproportionate or “inappropriate” response to underlying DIC or may result from a defective fibrinolytic mechanism that may be inherited or acquired.

### Etiology

Fibrinogenolysis may complicate various disorders, among which severe liver disease ([64](#)) is the most common. Fibrinogenolysis is a predominant laboratory feature in several patients with disseminated neoplasms ([293](#), [294](#) and [295](#)), especially urogenital neoplasms ([296](#)). The mechanism for enhanced fibrinolysis in these patients is probably increased secretion of plasminogen activators such as urokinase ([294](#)). Fibrinogenolysis and marked fibrinolysis rarely complicate the immediate puerperium ([232](#)), and they have been reported in association with acute promyelocytic leukemia ([259](#), [261](#)). Enhanced fibrinolysis



has also been associated with cardiac bypass surgery ( [297](#) ) and aortic clamping during vascular surgery ( [298](#) ); the protease inhibitor aprotinin is effective in reducing blood loss in these patients ( [299](#) , [300](#) ). Inherited deficiency of plasminogen activator inhibitor type-1 ( [301](#) ) or a  $\alpha_2$ -plasmin inhibitor ( [302](#) ) also results in hyperfibrinolysis and a bleeding tendency.

## Pathophysiology

Fibrinogenolysis is a consequence of the generation of plasmin within the general circulation (plasminemia). Potent plasma inhibitors (antiplasmins) normally neutralize free plasmin rapidly (see [Chapter 21](#)); the result is that the proteolytic effects of this enzyme normally are restricted to fibrin. Fibrinogenolysis occurs only when the capacity of the antiplasmins is exceeded.

The proteolytic action of plasmin is nonspecific. In addition to fibrin and fibrinogen, this enzyme may degrade factor VIIIc, factor XIII, other coagulation factors, and a wide variety of other plasma proteins, such as complement and various hormones. Free plasmin also may activate bradykinin, a phenomenon that may underlie the marked hypotension present in some patients with fibrinogenolysis. Thus, *pathologic proteolysis* is an appropriate synonym for *fibrinogenolysis*.

Fibrinogenolysis is activated by mechanisms that are remarkably similar to those that initiate DIC. Therefore, tumor tissue contains plasminogen activators in addition to tissue factor ( [294](#) ). The secretion of these activators into the circulation may rapidly activate most of the circulating plasminogen.

Hypoxia and hypoperfusion may lead to plasminogen activation and, occasionally, to fibrinogenolysis. However, in many of these patients, bleeding is minimal; when present, it cannot be clearly related to the presence of fibrinogenolysis. In these patients, fibrinogenolysis probably is a nonspecific, essentially physiologic response. Fibrinogenolysis may also result from therapy with thrombolytic agents, as discussed in [Chapter 61](#).

## Clinical Features and Laboratory Diagnosis

The clinical picture in most reported cases of fibrinogenolysis is similar to that of DIC. The usual laboratory findings are summarized in [Table 60.2](#) and are discussed in an earlier section of this chapter. Hypofibrinogenemia may be seen. The PTT, PT, and thrombin time may be prolonged because of the anticoagulant effects of FDPs. Moderate concentrations of EACA ( $4 \times 10^{-4}$  mol/L) inhibit plasminogen activators but not free plasmin. Thus, the euglobulin lysis time, which invariably is shortened in patients with fibrinogenolysis, is unaffected by the addition of EACA if free plasmin is present. Fibrinolysis in heated fibrin plates also measures free plasmin because plasminogen activators are thermolabile. Among the coagulation factors, factors V and VIIIc are the most sensitive to the proteolytic action of plasmin; factor XIII also is deficient in some patients. The plasma levels of other factors (e.g., factors VII and IX), including some that are degraded by plasmin *in vitro*, usually are normal in patients with fibrinogenolysis. Depletion of plasminogen and a  $\alpha_2$ -antiplasmin and the presence of a  $\alpha_2$ -antiplasmin-plasmin complexes in the plasma also may be demonstrated in many patients with fibrinogenolysis and in those with DIC and active fibrinolysis ( [303](#) ).

The standard FDP test does not discriminate between fibrinogen degradation products and fibrin degradation products. Measurements of fibrinopeptide A and the D-dimer, which is a specific indication of degraded cross-linked fibrin, yield normal results in

fibrinogenolysis. Thus, patients with hypofibrinogenemia, prolonged PT and PTT values, elevated FDP levels, and a normal D-dimer may have primary fibrinogenolysis. In the absence of intravascular coagulation, paracoagulable complexes containing fibrin monomers do not form in plasma; thus, plasma protamine gelation tests are negative in fibrinogenolysis. Assays for plasminogen and for the various inhibitors of the fibrinolytic enzyme system may reveal a pattern of depletion. In addition to normal results for D-dimer, patients with fibrinogenolysis have normal platelet counts or mild thrombocytopenia with bleeding out of proportion to the reduction in platelet count ( [294](#) ).

## Treatment

Antifibrinolytic agents would seem therapeutically desirable in the treatment of fibrinogenolysis; however, these drugs are hazardous in the presence of DIC ( [109](#) ). EACA and related agents are specific and potent inhibitors of fibrinolysis and fibrinogenolysis ( [304](#) ). In low concentrations ( $10^{-4}$  mol/L), EACA inhibits plasminogen activation competitively; in high concentrations (0.06 M), it inhibits plasmin directly in a noncompetitive manner. The clinical effectiveness of this drug is dramatic in carefully selected patients ( [305](#) ). EACA should be administered intravenously (0.1 g/kg every 6 hours, up to 24 g/day) if bleeding is severe. The drug is absorbed rapidly after oral administration, and intravenous doses of 1 g/hour, after a 5-g loading dose, are also effective. The total dosage should not exceed 24 g in a 24-hour period. Tranexamic acid is a newer antifibrinolytic agent that, like EACA, possesses the ability to bind to the lysine binding sites of plasminogen, thereby preventing plasmin that is generated from binding to fibrin. The oral dosage of tranexamic acid is 25 mg/kg, three or four times daily. The intravenous dosage is 10 mg/kg given three or four times daily.

Because antifibrinolytic agents are potentially dangerous drugs in the presence of DIC ( [109](#) ), the diagnosis of DIC should be excluded in these patients using a specific test, such as D-dimer, before administering these agents. Patients with DIC and a substantial secondary fibrinolytic component should be considered for heparin therapy before administration of antifibrinolytics ( [296](#) ).

Patients with hormone-refractory prostate cancer and fibrinogenolysis have been reported to benefit from docetaxel, with resolution of bleeding symptoms and laboratory evidence of hyperfibrinolysis ( [306](#) ).

## Pathologic Inhibitors of Coagulation

Circulating anticoagulants are pathologic endogenous inhibitors that can act at any stage in the process of coagulation. Most are antibodies that act as specific inhibitors, inactivating a single coagulation protein. The clinical and laboratory manifestations resemble the corresponding inherited coagulation disorders in many respects. Antibody disorders with wider effects on the coagulation system are sometimes seen, especially in the antiphospholipid-protein antibody (APA) disorders that have been traditionally called the *lupus inhibitor syndrome*. Other inhibitors of coagulation often have heparinlike activities and are much less common.

## Antibodies to Factor VIII

Factor VIII is the most common target of monospecific acquired anticoagulant antibodies ( [307](#) ). Conditions that are associated with monospecific factor VIII antibodies are outlined



in [Table 60.6](#).

**TABLE 60.6. Conditions Associated with Monospecific Factor VIII Antibodies**

---

|  |
|--|
| Alloantibodies in hemophilia A   |
| Autoantibodies in nonhemophilic patients                               |
| Autoimmune disease   |
| Systemic lupus erythematosus   |
| Rheumatoid arthritis   |
| Dermatologic conditions  |
| Psoriasis  |
| Pemphigus vulgaris   |
| Pregnancy (peripartum)   |
| Malignancy   |
| Lymphoproliferative disorders  |
| Plasma cell dyscrasias   |
| Nonhematologic   |
| Medications: penicillin, sulfa antibiotics, chloramphenicol, phenytoin |
| Idiopathic   |

---

#### **ALLOANTIBODIES IN HEMOPHILIA A**

**Frequency of Inhibitors** In older retrospective studies, alloantibodies to factor VIIIc were noted in 5 to 20% of patients with hemophilia A, averaging approximately 5 to 10% in all patients with hemophilia and approximately 10 to 15% in those more severely affected ([308](#), [309](#) and [310](#)). Prospective studies suggest a higher incidence of inhibitors than that historically appreciated ([311](#), [312](#) and [313](#)) (up to 45%), even in patients treated with traditional factor VIII concentrates. However, many patients have only transient inhibitors, and perhaps only 5 to 10% of hemophiliacs have persistent inhibitors ([314](#)). As a consequence, initial concerns ([315](#), [316](#)) based on historical prevalence controls suggesting that newer factor VIII concentrates, such as those purified by monoclonal antibody affinity chromatography or produced by recombinant technology, might be inducing an increased percentage of inhibitors that appear to be allayed. In fact, continued longitudinal surveillance of patients receiving such products indicates a similar or perhaps lower incidence of clinically significant persistent inhibitor induction ([317](#), [318](#)). Those at high risk of development of inhibitors include patients with CRM-negative severe hemophilia A whose factor VIII mutation prevents factor VIII synthesis or patients with CRM-positive mild or moderate hemophilia A whose factor VIII mutation in the A2 domain or near the junction of the C1-C2 domains results in an abnormal factor VIII molecule ([314](#)). This latter mutation results in a factor VIII molecule identified by the patient's immune system as abnormal. Other factors affecting the risk of inhibitor development include the patient's HLA class II haplotype and the type of factor VIII therapy used ([314](#)). Additional reports have confirmed these conclusions in patients with mild to moderate hemophilia ([319](#), [320](#)). A recent provocative study reported that patient age at initiation of therapy was an independent risk factor for inhibitor development ([321](#)). Patients beginning therapy before 6 months of age had three times the rate of inhibitors than patients beginning therapy after 1 year of age ([321](#)). If these data are confirmed, exposure of hemophilia A patients to factor VIII should be delayed, and patients should be treated with other products during the first year of life.

**Induced Antibody Titer** It is recognized, particularly in patients with mild hemophilia, that

50 to 75% of inhibitors are subclinical, occur relatively early (median of 10 days) after product exposure, are of low titer, are transient, and often resolve even with continuing product exposure ( [313](#), [317](#)). Hemophiliacs with inhibitors can be categorized as either strong or weak responders to administered factor VIII. Once an antibody has developed in a hemophiliac, further administered factor VIII may act as an inducing antigen. Additionally, it has been appreciated that certain factor VIII products, depending on the manufacturing process, may be immunogenic in hemophilia A patients ( [314](#)).

**AUTOANTIBODIES TO FACTOR VIII IN THE NONHEMOPHILIC PATIENT** It is estimated that acquired factor VIII autoantibodies are seen in 0.2 to 1.0 person/million population annually ( [322](#)). Monospecific antibodies to factor VIII can arise spontaneously in association with various autoimmune and chronic inflammatory diseases, such as systemic lupus erythematosus (SLE), rheumatoid arthritis, and ulcerative colitis ( [323](#), [324](#) and [325](#)). Antibodies to factor VIII can develop in the puerperium ( [326](#)), usually appearing at term or within several months after parturition in association with a first pregnancy. The antibody may disappear spontaneously in postpartum patients after 12 to 18 months. Reappearance during subsequent pregnancy seems to be very unusual, and in those patients who have persistent antibodies, remission can occur during a subsequent pregnancy ( [327](#)). Acquired hemophilia may also be seen in association with hematologic malignancies and solid tumors ( [328](#), [329](#) and [330](#)); certain medications such as penicillin ( [331](#)), sulfa antibiotics, chlorpromazine ( [332](#)), and phenytoin ( [333](#)); and dermatologic conditions such as psoriasis and pemphigus vulgaris ( [324](#)). Most often, acquired factor VIII antibodies are idiopathic, particularly in older persons without apparent underlying disease ( [334](#)). In children, penicillin therapy appears to be a significant risk factor for development of antibodies to factor VIII ( [331](#)).

***Pathophysiology of Development of Antibodies to Factor VIII*** The immunologic mechanism that underlies inhibitor induction in a select minority of patients with hemophilia A and the corresponding presumed lack of immunologic tolerance is unclear. Although inhibitor induction is more common in more severely affected patients, inhibitors are also seen in mild hemophilic patients ( [319](#), [335](#), [336](#)). In patients with severe hemophilia, major deletions, the intron 22 inversion, nonsense mutations, and early initiation of replacement therapy are risk factors for antibody development ( [314](#), [318](#), [321](#), [331](#)). Underlying genetic susceptibility factors have been suggested by studies of brother pairs with a significant predisposition to the development of inhibitors ( [337](#)). Specific associations between factor VIII genotype and HLA class II phenotype have been made ( [338](#)), but the associations are weak. Genetic influences on inhibitor development are postulated to be additive and polygenic ( [338](#)). Mutations resulting in a major loss of factor VIII gene coding information and a lack of circulating factor VIII antigen are associated with a high incidence of inhibitor formation ( [339](#)). For example, a high frequency (70%) of inhibitor development is seen in patients with either large, multidomain deletions or nonsense mutations in the factor VIII A3 domain ( [340](#)). Fewer patients with other gene defects (missense point mutation) form inhibitors. However, the presence of inhibitors is not consistent, even in a given family with similar factor VIII mutations, suggesting that other factors contribute to induction of factor VIII antibodies ( [314](#)). Another hypothesis as to how inhibitors to factor VIII might occur is that these antibodies arise from the expansion of preexisting natural factor VIII clones that possess neutralizing properties ( [341](#)); such antibodies have been identified from the IgG fraction of plasma from normal people ( [341](#)). Clonal expansion of anti-factor VIII antibodies may be modulated by the presence of antiidiotypic antibodies ( [342](#)). The immunizing events leading to the spontaneous development of antibodies in nonhemophilic individuals remain obscure. Incompatibility between maternal and fetal allotypes of factor VIII could explain the development of antibodies in the puerperium, but little evidence supports this hypothesis. No evidence exists that exogenous factor VIII acts as an antigen in nonhemophilic

patients. Clonal expansion of preexisting factor VIII antibodies has been postulated to also explain autoantibodies in nonhemophilic patients ( 341 ).

**Characteristics of Factor VIII Inhibitory Antibodies** The majority of antibodies to factor VIII are IgG immunoglobulins ( 343 ) that appear to be specific for the coagulant subunit of the factor VIII complex (VIIIc) ( 344 , 345 ). Common epitopes for allo- and autoantibodies include those in the A2 domain, the C2 domain, or both ( 346 ). Typically, hemophilic alloantibodies recognize both domains ( 347 ), whereas autoantibodies recognize the C2 domain more frequently than the A2 domain ( 346 ). Circulating factor VIII immune complexes have been identified in plasma from patients with acquired hemophilia A with autoantibodies ( 348 ). IgA or IgM inhibitors are rare, as are antibodies that inhibit both VIIIc and vWF ( 349 ). The factor VIII inhibitory antibody subunits in hemophilia A show limited heterogeneity ( 350 ) but are not truly monoclonal. In nonhemophiliacs, antibodies to factor VIII more often reveal normal heterogeneity of their subunits. Antibodies to factor VIII are disproportionately often of the IgG<sub>4</sub> subclass and do not fix complement. Precipitation and immunodiffusion techniques usually yield negative results because the factor VIII-antibody complex is soluble under most conditions ( 351 ). Antibodies inactivate factor VIII in a time- and temperature-dependent process ( 352 ), the kinetics and stoichiometry of which are variable. Two types of antibody inhibition are described ( 353 ): Type I inhibitors completely inhibit factor VIII activity following second-order kinetics (linear time course of inactivation); these antibodies are seen in hemophilia patients ( 354 ). Type II inhibitors have complex kinetics and do not completely inhibit factor VIII activity; these are autoantibodies seen in nonhemophilic patients ( 355 ). The type II inhibition phenomenon may produce aberrations in the assay system and may explain certain puzzling laboratory features in atypical cases, such as detectable factor VIII clotting activity in a patient with a high-titer inhibitor ( 356 ). A report on alloantibody inhibition of factor VIII activity indicated that certain alloantibodies possess catalytic activity that can proteolyze factor VIII ( 357 ).

**Laboratory Evaluation** Simple mixing techniques based on the PTT usually suggest the presence of an inhibitor. Factor VIII levels usually are undetectable in severely affected patients but may be detectable in patients with autoantibodies. Specific tests for antibodies involve the demonstration of progressive and time-dependent inactivation of factor VIII *in vitro* by the plasma or serum of the patient. Methods for detecting low-titer inhibitors and for quantifying the levels of antibody have been devised ( 358 ), and standardized inhibitor units [the Bethesda unit in the United States ( 359 ) and the Oxford unit in Britain ( 360 )] have been defined. In the Bethesda assay, *in vitro* tests are performed at 37° C using 2-hour incubation mixtures of various dilutions of patient plasma with normal plasma. The inhibitor titer is the reciprocal of the dilution of inhibitor plasma that neutralizes 50% of normal factor VIII activity. Because the Bethesda assay may underestimate the inhibitor titer in acquired hemophilia, it is recommended that the titer should be calculated from the lowest dilution that results in 50% residual factor VIII activity after the incubation period ( 361 ). The New Oxford method measures residual activity at 37° C after a 4-hour incubation. A Bethesda unit is generally equivalent to 1.21 Oxford units. The standard Bethesda assay does not control pH, permitting variable low-level inactivation of factor VIII by nonimmunologic mechanisms. The Nijmegen modification controls pH, thus improving classification of positive and negative samples ( 359 ). The Nijmegen modification of the Bethesda assay has been endorsed by the ISTH ( 362 ). Additional improvements in this assay have been described ( 363 ). Although an inhibitor unit does not imply that any specific number of factor VIII units infused into the patient will neutralize any specific number of inhibitor units, the titer provides a general estimate of the initial likelihood of response to infusion of factor VIII products.

**Clinical Manifestations** Acquired factor VIII inhibitors may explain some reports of hemophilia in women and may also underlie apparent occult hemophilia presenting later in

life. The bleeding manifestations resulting from antibodies to factor VIII are often similar to those seen in hemophilia A ( [324](#), [334](#), [364](#) ). Prolonged or unexpectedly severe hemorrhage may occur after comparatively trivial trauma, postoperatively, or postpartum. Soft tissue or muscle hematomas, hematuria, and spontaneous and intractable epistaxis seem relatively common. For unknown reasons, hemarthrosis is relatively less common than in congenital hemophilia A, but it may be severe ( [364](#) ). [Figure 60.6](#) illustrates soft tissue hematomas occurring in a nonhemophilic patient with an acquired inhibitor to factor VIII. When antibodies arise in patients with mild hemophilia A, bleeding typical of severe deficiency may develop; more significant, the bleeding may be refractory to replacement therapy. This condition may have serious consequences, and fatal events are seen in 10 to 20% of clinically symptomatic patients ( [324](#), [365](#) ). Antibodies to factor VIII arising during pregnancy may cross the placenta.



**Figure 60.6.** Soft-tissue hemorrhage in a 76-year-old man with a high-titer factor VIII inhibitor. This patient has a history of ischemic cardiomyopathy and diabetes and developed spontaneous extremity bruising as shown. The antihuman factor VIII antibody titer was 10 Bethesda units. See [Color Plate](#). (Courtesy of Alan Grosset.)

**Treatment** The treatment of bleeding in patients with antibodies to factor VIII presents several challenges ( [366](#), [367](#) ). No adequate randomized trials have been conducted to evaluate different forms of therapy or to investigate the timing and sequence of their application; therefore, practical treatment decisions are somewhat arbitrarily based on estimates of benefits and risks deduced from retrospective literature review and consideration of each patient's circumstances and comorbidities. A consensus group from the United Kingdom has published guidelines on treatment of inhibitors in patients with hemophilia ( [368](#) ). An algorithm that has some general applicability is shown in [Figure 60.7](#). As a first step, basic clinical information should be obtained, including whether the inhibitor arose in the setting of hemophilia or is acquired; the severity of bleeding; anticipated surgical procedures; inhibitor titer and persistence; prior inhibitor response and relation in time to previous factor infusions; possible triggering events such as recent medication exposure or pregnancy; and the presence of other diseases. For example, the mere presence of an inhibitor may in itself not warrant immediate therapy because we now know that many inhibitors are present in low titer and are often transient. Spontaneous remissions may occur in a significant number of patients, particularly if the inhibitor develops after penicillin therapy ( [335](#) ) or during the puerperium ( [326](#) ). At the other end of a spectrum, an unfortunate clinical scenario might involve significant spontaneous clinical hemorrhage, a persistent high-titer inhibitor, and incidental comorbidities such as cardiac, hepatic, or renal insufficiency.





IX products, may bypass the inhibitor, probably by providing activated factors (discussed in [Chapter 59](#)). The use of these concentrates is successful in approximately 50% of bleeding events ([373](#)), but prolonged and repeated infusions of PCC can be associated with a risk of thrombotic complications ([374](#)), DIC, and possible viral transmission. PCC products that are intentionally activated (APCCs, e.g., FEIBA and Autoplex; sometimes called *antiinhibitor coagulant complexes*) may be effective if PCC is ineffective, but theoretically, they carry an increased risk of inducing thrombosis ([375](#)). Recommended doses of APCC (Autoplex-T) are 80 to 100 U/kg at 4- to 8-hour intervals ([376](#)). PCC and APCC products have trace amounts of factor VIII antigen and rarely cause an increased inhibitor response, although this has been reported ([377](#)). rVIIa is a new treatment option for inhibitor patients ([378](#), [379](#)). This drug was originally thought to exert activity by binding to tissue factor at sites of vascular injury to initiate coagulation. More recent data indicate that at the pharmacologic concentrations of factor VIIa achieved during rVIIa therapy, there may be platelet-dependent, tissue factor-independent mechanisms to mediate hemostasis ([380](#)). The standard dose of rVIIa is 90 µg/kg every 2 hours for serious bleeding ([381](#)) or 90 µg/kg every 3 hours for mild to moderate bleeding in home treatment ([382](#)). Continuous infusion of rVIIa is also effective, targeting factor VII levels to 30 to 40 U/ml ([383](#)). rVIIa is also a useful therapy in children with inhibitors and serious bleeding ([384](#)). rVIIa, like PCC and APCC therapy, is associated with potential thrombotic complications, although the thrombosis rate appears to be low ([381](#), [382](#)). However, additional long-term monitoring of rVIIa adverse events is important ([385](#)). There are no studies directly comparing the efficacy of rVIIa versus PCC or APCC in inhibitor patients with serious bleeding. These products have similar efficacies ([386](#), [387](#)), and consensus recommendations generally include multiple treatment options ([368](#), [388](#)). For refractory patients, sequential therapy with PCC and rVIIa has been reported ([389](#)). Another useful product in inhibitor patients is porcine factor VIII (Hyate:C). Obtaining an antiporcine antibody titer is useful, but as a rule of thumb, the initial antiporcine titer is often 25% of the antihuman titer. However, the antiporcine titer may rapidly rise after administration of porcine factor VIII, and its use is associated with occasional thrombocytopenia. A 1994 survey reported that 80% of porcine factor VIII infusions in hemophilic patients with inhibitors resulted in a good or excellent clinical effect, with less than 10% of infusions resulting in a nonresponse ([390](#)). Some investigators consider porcine factor VIII to be the therapy of choice for patients with factor VIII antibodies in which the antibody has minimal cross-reactivity to porcine factor VIII ([391](#)), and consensus groups consider porcine factor VIII an appropriate treatment option ([368](#), [388](#)). A literature review ([392](#)) of the efficacy of intravenous Ig in the treatment of acquired factor VIII antibodies found a cumulative response rate of only 12%, suggesting that other modalities should be attempted first for these patients. In some patients with low- to intermediate-titer inhibitors (<5 Bethesda units), initial plasmapheresis with adsorption to a protein A column ([393](#)) or, sometimes, with adjunctive administration of intravenous Ig (1 g/kg for 2 days) ([342](#)) is used, but this approach is usually unsatisfactory because it is time consuming and ineffective in rapidly reducing levels of IgG. Standard immunosuppression should be reserved for patients with autoantibodies because this therapy is rarely beneficial in the alloimmune setting. Corticosteroids (e.g., prednisone in doses of 1.0 to 1.5 mg/kg/day) produced some improvement in approximately 50% of patients when administered on a long-term basis ([324](#)), with the best results obtained with nonhemophilic patients. Similar therapeutic responses have been reported when immunosuppressive drugs, such as cyclophosphamide (2 to 3 mg/kg/day), were administered alone or with prednisone ([369](#)). Remission of bleeding and reduction of antibody titer have been well documented, but total suppression of the antibody is rare. A randomized trial of steroid and cytotoxic therapy has reported that one-third of patients responded to steroids alone and that 50% of steroid nonresponders could be successfully treated with a cytotoxic drug

(cyclophosphamide) with or without steroids ( 394 ). More recent reports confirm the efficacy of this regimen ( 395 ). Rituximab, a monoclonal antibody to the CD20 antigen on B cells, has been reported to be effective in initial case series of patients with acquired factor VIII antibodies ( 395a ). In many patients with hemophilia A who have developed antibodies to factor VIII, infused factor VIII provokes a rapid increase in the antibody titer. However, in many of these patients, the administration of large doses of factor VIII for periods of months to years may produce immune tolerance to factor VIII. An international registry of patients treated with this approach reported that approximately 70% of patients achieved long-lasting tolerance ( 396 ). A 1997 update of this registry indicated that 52% of patients were successfully treated with immune tolerance ( 397 ). Several immune tolerance regimens have been summarized ( 398 , 399 ). The registry data suggest that success of inducing tolerance is greatest in patients given more than 100 U/kg/day factor VIII who had an initial inhibitor titer of less than 10 Bethesda U ( 396 , 397 ). Data from the North American Immune Tolerance Registry have been reported; the overall success rate was 70% ( 400 ). Achievement of tolerance to factor VIII in hemophilia A patients with inhibitors is associated with the development of antiinhibitors (idiotypes) ( 401 ). The cost-effectiveness of immune tolerance therapy has been demonstrated ( 402 ), but questions related to ideal patient selection and the optimal regimen remain ( 403 ).

### Monospecific Antibodies to Other Coagulation Factors

Table 60.7 summarizes certain conditions associated with antibodies to other coagulation factors.

**TABLE 60.7. Acquired Disorders Associated with Deficiency of a Single Coagulation Factor**

| Deficient Factor      | Specific Inhibitors <sup>a</sup>  | Other Disorders   |
|-----------------------|---|---|
| Fibrinogen            | Hereditary afibrinogenemia ( 437 ); lupus erythematosus; liver disease  | —   |
| Prothrombin           | Previously normal persons ( 438 )   | Lupus inhibitors ( 440 )  |
| Factor V              | Previously normal persons ( 413 ); often associated with streptomycin ( 414 , 415 ); rarely in inherited factor V deficiency; postoperative patients who received bovine thrombin ( 416 , 417 , 418 , 419 , 420 and 421 ) | Chronic myelocytic leukemia ( 688 )   |
| Factor VII            | Bronchogenic carcinoma ( 447 ), acquired immunodeficiency syndrome ( 448 )  | Aplastic anemia ( 659 ), liposarcoma ( 660 )                                  |
| Factor VIII (VIIIc)   | Hemophilia A ( 310 ); puerperium ( 326 ); inflammatory disorders; drug reactions; in absence of underlying disease ( 324 )  | —   |
| von Willebrand factor | Previously normal persons; lymphoproliferative disorders ( 427 , 428 , 429 and 430 ); rarely in von Willebrand disease; thrombocytosis  | Wilms tumor ( 687 )   |
| Factor IX             | Hemophilia B ( 404 , 405 ); rarely in previously normal persons ( 406 )   | Nephrotic syndrome ( 653 ); Sheehan syndrome ( 657 ); Gaucher disease ( 658 ) |



|             |  |  |
|-------------|--|--|
| Factor X    | —  | Amyloidosis ( <a href="#">643</a> , <a href="#">644</a> , <a href="#">645</a> , <a href="#">646</a> , <a href="#">647</a> , <a href="#">648</a> , <a href="#">649</a> and <a href="#">650</a> ); upper respiratory infection ( <a href="#">446</a> ) |
| Factor XI   | Lupus erythematosus ( <a href="#">443</a> ); rarely in inherited factor XI deficiency ( <a href="#">444</a> ); previously normal persons ( <a href="#">442</a> , <a href="#">445</a> ) | —  |
| Factor XII  | Lupus erythematosus, rarely  | Nephrotic syndrome; chronic myelocytic leukemia  |
| Factor XIII | Previously normal persons, often associated with isoniazid ( <a href="#">433</a> ); rarely in inherited factor XIII deficiency ( <a href="#">431</a> )                                 | Acute and chronic leukemia ( <a href="#">661</a> ), Crohn disease ( <a href="#">662</a> )  |

<sup>a</sup> Evidence suggests these inhibitors are antibodies. In patients with inherited deficiencies of the various factors, their development usually is related to transfusion of blood or blood products.

---

**FACTOR IX** Inhibitors of factor IX have been demonstrated in approximately 5% of patients with hemophilia B ( [404](#), [405](#) ) and rarely in previously normal persons (acquired hemophilia) ( [406](#) ). Hemophilia B patients who acquire antibodies to factor IX often have gross gene deletions ( [407](#) ). In contrast to antibodies to factor VIII, factor IX antibodies act instantaneously. One series of eight hemophilia B inhibitor patients found that antibodies typically were IgG<sub>1</sub> and IgG<sub>4</sub>, and that the antibodies targeted the Gla domain and protease domain epitopes of factor IX ( [408](#) ). Extracorporeal immunoabsorption of the blood of one patient with a factor IX inhibitor with protein A–Sepharose resulted in marked diminution in antibody concentration ( [409](#) ). More recently, rVIIa ( [410](#) ) or immune tolerance therapy ( [400](#) ) has been used, although immune tolerance for hemophilia B inhibitor patients may be less effective than for hemophilia A inhibitor patients ( [411](#) ). PCCs are also a treatment option ( [412](#) ). Patients with antibodies to factor IX may experience anaphylaxis when treated with factor IX–containing products ( [411](#) ); rVIIa may be the appropriate therapy for this patient group. A British consensus group has published guidelines on treating factor IX inhibitor patients ( [368](#) ).

**FACTOR V** Inhibitors of factor V ( [413](#) ) have developed spontaneously in previously normal older persons after administration of streptomycin ( [414](#), [415](#) ), gentamycin, or penicillin and after surgical procedures. More rarely, factor V inhibitors have been associated with tuberculosis, femoral fracture, and bullous pemphigoid and, occasionally, in inherited factor V deficiency after transfusion. These antibodies are usually of IgG isotype. Alloantibodies to factor V may occur in factor V–deficient patients who receive blood products ( [416](#) ). Over the past 20 years, an iatrogenic coagulopathy has been identified: the occurrence of antibodies to thrombin and factor V in patients treated with bovine thrombin during surgery ( [416](#), [417](#) ). The antithrombin antibody neutralizes bovine thrombin and therefore can prolong the thrombin time when bovine thrombin is used for this test ( [418](#), [419](#) and [420](#) ). However, no clinically significant hemostatic defect appears to result from this single laboratory abnormality. Some patients acquire additional antibodies to human factor V, which may result in significant factor V deficiency and bleeding ( [418](#), [419](#) ). In a large surgical series of patients exposed to bovine thrombin, more than 95% of patients developed antibodies to bovine thrombin or factor V, and 50% of these patients had antibodies cross-reacting to human coagulation proteins ( [421](#) ). These latter patients have a bleeding risk ( [421](#) ). In contrast to most other specific inhibitors, antibodies to

factor V seldom produce serious hemorrhage ( 416 , 422 ). Patients with alloantibodies to factor V typically have significant bleeding ( 421 ). In several patients with severe hemorrhage, platelet transfusions were therapeutically more effective than plasma ( 423 , 424 ). Plasmapheresis ( 425 ) and immunosuppression have been reported to be effective in resolving antibodies to factor V. In some cases, these antibodies resolve spontaneously ( 421 ). A small number of patients have been described with thrombosis symptoms associated with factor V antibodies. These patients may ( 416 ) or may not ( 426 ) have coexisting antiphospholipid antibodies.

**VON WILLEBRAND FACTOR** Acquired von Willebrand disease (vWD) has been reported in association with a variety of disorders, primarily including patients with lymphoproliferative disorders, myeloproliferative disorders, solid tumors, and autoimmune disease. An international registry identified lymphoproliferative and myeloproliferative disease as accounting for more than 60% of acquired vWD ( 427 ). A literature review concluded that most cases of acquired vWD result from an antibody that recognizes high-molecular-weight multimers of vWF and mediates subsequent antigen-antibody clearance ( 428 ). Another mechanism for the development of this disorder includes adsorption of vWF by tumor cells ( 429 ). Ristocetin cofactor activity is usually decreased, whereas factor VIII activity may be normal ( 427 ). In most patients, the hemostatic abnormalities disappear when the underlying disorder is treated. For patients with acquired vWD resulting from a lymphoproliferative disorder or monoclonal gammopathy, intravenous Ig may be effective ( 430 ). The consensus group recommends a trial of DDAVP as initial therapy ( 427 ); DDAVP failures are then treated with vWF concentrates (e.g., Humate-P) ( 427 ). Intravenous Ig is reserved for those patients having no success with DDAVP and vWF concentrates ( 427 ).

**FACTOR XIII** Inhibitors of factor XIII have been described after transfusions in patients with inherited deficiency of this proenzyme and in previously normal persons ( 431 , 432 ). Many of the latter group had received isoniazid ( 433 ), and it was suggested that this drug may alter factor XIII in such a manner that it becomes antigenic ( 434 ). These inhibitors may recognize the zymogen, impair the activation of factor XIII by thrombin, or may be directed against the cross-linking sites of fibrin ( 432 ). In one case, cyclophosphamide was therapeutically effective ( 435 ). A factor XIII concentrate, Fibro-gammin, if available, may also be useful ( 436 ).

**FIBRINOGEN AND PROTHROMBIN** A precipitating antibody to fibrinogen has been demonstrated after transfusions in patients with hereditary afibrinogenemia ( 437 ). Dysfibrinogenemia may occur in patients with liver disease or hepatoma (discussed in the section [Deficient or Aberrant Synthesis of Coagulation Factors](#)). Antibodies to prothrombin have also been reported ( 438 ). An unusual case of an autoantibody to prothrombin was described; the antibody induced protease activity from the zymogen, leading to neutralization by antithrombin ( 439 ). Hypoprothrombinemia usually occurs in the setting of the lupus anticoagulant when patients have antibodies to prothrombin that clear prothrombin activity from blood ( 440 , 441 ).

**FACTOR XI** Specific inhibitors of factor XI have been described ( 442 ), most often in association with autoimmune disease ( 443 , 444 and 445 ).

**FACTOR X** Antibodies to factor X are highly associated with upper respiratory tract infections ( 446 ), either viral or mycoplasma; however, in these cases, inhibitors to factor X have been directly proved infrequently ( 446 ). Bleeding has been controlled using PCCs ( 446 ).

**FACTOR VII** Antibodies to factor VII are rare, having been reported in lung cancer ( 447 ) and human immunodeficiency virus infection ( 448 ) and with no apparent disorder ( 449 ). Immunosuppression has been used successfully in anecdotal case reports of

autoantibodies to factor VII ( 450 ).

**TISSUE FACTOR** Antibodies to tissue factor are very uncommon, with one group reporting two patients who developed anti-tissue factor antibodies after liver surgery ( 451 ). Similar to patients who acquire antithrombin and anti-factor V antibodies after use of fibrin glue ( 416 , 417 and 418 ), the patients who developed anti-tissue factor antibodies were both treated with a topical hemostatic agent prepared from bovine tissue that contained tissue factor. The antibodies to bovine tissue factor did not cause clinical bleeding but did prolong PT values ( 451 ).

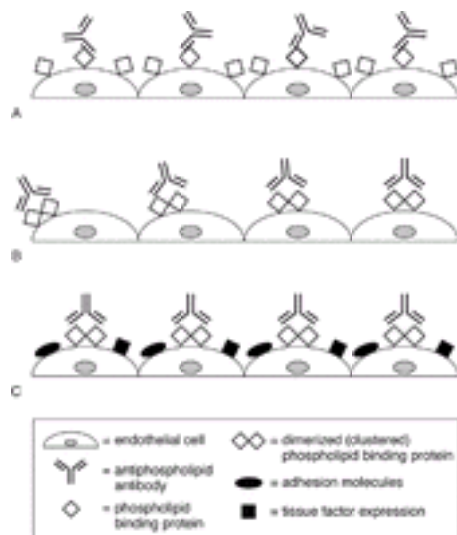
## Antiphospholipid-Protein Antibodies: Lupus Anticoagulants and Anticardiolipin Antibodies

**HISTORICAL CONSIDERATIONS AND NOMENCLATURE** The two most important clinical types of antiphospholipid-protein antibodies are traditionally called *lupus anticoagulant* (LA) and *anticardiolipin* (aCL) *antibodies*. These antibodies are associated in some patients, but not in others, with clinical illness ( 452 , 453 , 454 and 455 ) of varying severity. Individual patients may manifest arterial or venous thromboembolic disease, thrombocytopenia, recurrent pregnancy loss, and neurologic and skin abnormalities. The clinical importance, particularly of the LA or higher-titer aCL antibodies, has been increasingly recognized; these antibodies or their functional consequences are found in approximately 10% of patients with venous thromboembolic events ( 456 , 457 ). Bleeding is quite uncommon, and when present, it is usually the result of severe thrombocytopenia, platelet dysfunction, hypoprothrombinemia, or the effects of an underlying disease. On the other hand, thrombosis and its many manifestations are common. Synonyms for LA and aCL antibodies include *antiphospholipic* (aPL) *antibodies*, *APAs*, and *autoantibodies to phospholipid-binding plasma proteins* ( 458 ). The associated clinical manifestations including thrombosis are variously called the *LA syndrome*, *antiphospholipid syndrome* (APS), or *antiphospholipid-protein syndrome*. Although each of these terms reflects improved pathophysiologic understanding of this family of antibodies, these insights are relatively recent, and the synonyms are linguistically cumbersome. APS without a known well-defined autoimmune disease is termed *primary APS* (PAPS). A few patients with APA develop an acute, severe, multiple-organ APS illness. These patients are designated as having *catastrophic APS* (CAPS). The existence of these antibodies was first detected indirectly almost 50 years ago when it became apparent that approximately 15% of patients with active SLE have a false-positive Venereal Disease Research Laboratory (VDRL) test ( 459 ). The VDRL test assesses antibody reactivity to “reagin” (antigen), an acidic-phospholipid complex that is chemically extracted from bovine heart tissue. Reagin consists of a mixture of lecithin, cholesterol, and cardiolipin. A nonspecific antibody reaction to reagin is also seen less often in other autoimmune disorders and in some apparently healthy patients. Other laboratory assays discussed in this section identified a family of antibodies that were initially thought to have direct specificity to various phospholipids, although it is now known that the antibodies recognize phospholipid-protein complexes. The proteins often serve a critical cofactor role ( 460 ), and the antibodies collectively are thus most accurately called *antiphospholipid-protein antibodies* ( 461 ). Coagulation assays are sensitive to some of these antibodies. Plasma samples from some patients with SLE, often those with the abnormal VDRL tests, show an *in vitro* inhibitor effect in several coagulation assays. This association gave rise to the term *lupus anticoagulant* ( 462 ). Most often, a prolonged PTT result that is not corrected on mixing with normal plasma is observed; other phospholipid-dependent assays, including the modified Stypven time [dilute Russell viper venom time (DRVVT)], are also affected ( 422 ). Despite persistent clinical use, it is now known that most patients with an LA phenomenon do not have SLE ( 422 ). Moreover, clinical thrombosis is much more often seen than is bleeding with these APS antibodies. Patients with SLE occasionally have inhibitors to other hemostatic factors ( 463 ), but these inhibitors are not considered LAs.

In addition to the biologically false-positive VDRL results and the paradoxical *in vitro* lupus-anticoagulant effect, laboratory studies found a third phenomenon, initially detected by radioimmunoassay: antibodies to cardiolipin (464). In aCL-antibody assay systems, serum Igs bind to various anionic phospholipid-protein complexes, most commonly to cardiolipin in a coated microwell enzyme-linked immunosorbent assay (ELISA). The sensitivity and specificity of this assay are substantially higher than those of the VDRL. Most often these protein-dependent interactions have been investigated with anionic phospholipids, but antibodies with reactivity to the neutral phospholipids such as phosphatidylethanolamine have been described (465). More recently, a phospholipid-binding protein,  $\beta_2$ -glycoprotein I ( $\beta_2$ gpI), has been identified (466), and antibodies to this antigen can also be demonstrated in patients with APS (467).

**EPITOPE SPECIFICITY** In these disorders, the antibodies were initially thought to react with anionic phospholipids directly, but the presence of specific plasma proteins associated with phospholipids is now known to be of great importance (468). In the case of LAs, the seemingly paradoxical discordance between laboratory screening test results and clinical symptoms is most commonly the consequence of antibodies that bind to a complex of phospholipid-bound prothrombin (440, 469, 470). This antibody binding impairs the function of the standard prothrombin-binding synthetic anionic phospholipids (471) that are used routinely in the laboratory to replace platelets in phospholipid-dependent coagulation assays, such as the PTT. Less commonly, a lupus-anticoagulant effect is seen with the aCL antibodies that are discussed in the following paragraph. Other more natural phospholipids, or platelets themselves, are less affected by this phenomenon and are used in some assays as correction factors. In the case of aCL antibodies, especially in autoimmune and drug-induced aCL,  $\beta_2$ gpI (472) serves as a mandatory protein cofactor (466).  $\beta_2$ gpI is a 57-kd plasma apolipoprotein with an uncertain physiologic role, but it is often considered a noncomplement member of the complement-control family of proteins, with structural similarity to complement factor H but with distinct functions (473).  $\beta_2$ gpI has a number of anticoagulant activities (474, 475 and 476), but inherited deficiency of  $\beta_2$ gpI has no thrombophilic association (477). The plasma concentration of  $\beta_2$ gpI in patients with clinical thrombophilia and aPLs is normal (478) or high (479). The antibodies in these settings are often of IgG isotype, are relatively persistent and high in titer, are associated with an LA phenomenon in approximately 60% of patients, and are clearly associated with the clinical syndromes discussed subsequently (460). IgM and IgA antibodies occur less often. The general thinking now is that aCL antibodies are not directed primarily against cardiolipin itself, but against epitopes formed after  $\beta_2$ gpI binds to anionic phospholipid membranes or anionic synthetic surfaces. Recent data suggest that the epitopes for some APAs are adducts of oxidized phospholipid and  $\beta_2$ gpI (480). Although cardiolipin has no known procoagulant function, the aCL antibodies also bind to other procoagulant anionic phospholipids, including phosphatidylserine. The subgroup of aCL antibodies that enhances binding of  $\beta_2$ gpI to anionic phospholipids in such a way that coagulation assay abnormalities result has been termed *aCL type A*. Currently, there is no known difference in the clinical behavior of antiprothrombin-dependent LA antibodies and anti- $\beta_2$ gpI-dependent aCL antibodies with LA activity; consequently, clinical laboratories do not routinely distinguish between them.  $\beta_2$ gpI may also mediate aCL binding to endothelial cell membranes (481). Other proteins have been occasionally implicated as possible obligatory cofactors, including annexin V (482), factor Xa, protein C, protein S (483), phospholipase A<sub>2</sub>, and placental anticoagulant protein (484). Anti- $\beta_2$ gpI antibodies have been reported to induce acquired resistance to activated protein C (485). It was previously thought that APA recognized neoepitopes of the above phospholipid-binding proteins expressed on cell-surface binding. More recent information suggests that the true antibody target is an appropriate density ("clustering") of proteins bound to

phospholipid surfaces, which is necessary for antibody recognition ([486](#)). For example, based on *in vitro* data, it has been proposed that  $\beta_2$ gpI acts as an antigen *in vivo* only when the antigen ( $\beta_2$ gpI) clusters on membrane surfaces such as endothelium. When clustering occurs, this increased antigenic density allows antibody recognition to occur, leading to antibody binding and endothelial cell activation and potentially triggering cellular events resulting in thrombosis ([487](#)). [Figure 60.8](#) illustrates how this phenomenon might occur.



**Figure 60.8.** A proposed mechanism by which antiphospholipid antibodies induce endothelial cell activation and thrombosis. **A:** Endothelial cells express a phospholipid-binding protein (e.g.,  $\beta_2$ gpI). In the absence of high antigenic density (“clustering”), antibody binding is inefficient. **B:** Endothelial cells with dimerized (“clustered”) antigen, which allows for efficient antibody binding, resulting in endothelial cell activation and promotion of thrombosis (**C**).

In some other settings, particularly those related to infection, the aCL antibodies are often of IgM isotype, are often of low titer and relatively transitory, and have no identified cofactor protein ([460](#)). Although  $\beta_2$ gpI is an absolute protein cofactor requirement for aCL activity in autoimmune settings, it may, in contrast, be inhibitory in the infection-related circumstance ([460](#)). The clinical association with thrombophilia is less strong ([488](#)), particularly thrombosis occurring after drug administration ([489](#)), although exceptions to this generalization have been noted ([490](#)). The detection of subgroups of aPLs has been reviewed ([455](#)).

**MECHANISM OF THROMBOSIS** Three hypotheses have been presented to explain how aPL induces thrombosis ([455](#)). These include (a) endothelial cell activation, (b) oxidant-mediated vascular injury, and (c) interference with the function of phospholipid-binding proteins in regulating coagulation. In the first hypothesis, aPL antibodies directly bind to endothelium to up-regulate expression of adhesion molecules and cytokine secretion ([455](#)). In the second hypothesis, autoantibodies to oxidized low-density lipoprotein occur with aCL antibodies, and aCL antibodies recognize oxidized phospholipids and phospholipid-binding proteins ([491](#)). In the third hypothesis, aPL antibodies may interfere with the anticoagulant functions of protein C or annexin V or enhance procoagulant activity ([455](#)). Immunologic studies lend strong support for a direct pathophysiologic role of these antibodies in the clinically observed thrombotic syndromes ([492](#)). In animal models using standardized vessel injury to induce thrombosis, either passively conferred APA ([493](#)) or active induction of antibody with either APA or  $\beta_2$ gpI (



494, 495) resulted in thrombosis; this suggested that APAs are not merely epiphenomena of thrombi arising for other reasons but, in some cases, play a direct role in initiation, propagation, or maintenance of thrombosis. Immunization of mice or rabbits with  $\beta_2$ gpI produces two populations of antibodies: one with specificity for  $\beta_2$ gpI alone without binding to phospholipids and the other with specificities for both cardiolipin and  $\beta_2$ gpI (496). This dual specificity of antibodies is also seen with those aPLs that are present in patients with autoimmune diseases. It is possible that in some circumstances, APAs are epiphenomena that develop on antigen exposure or that the antibodies do not initiate thrombosis but might somehow augment or maintain a thrombotic process that is under way. For example, conformational changes of platelet phospholipids may influence  $\beta_2$ gpI binding and activity. Anionic phospholipids are asymmetrically located in the inner leaflet of the resting platelet membrane. Loss of this asymmetry occurs on platelet activation, and the newly exposed anionic phospholipids may then bind  $\beta_2$ gpI and, through the  $\beta_2$ gpI, indirectly but prerequisitely bind the IgG aPLs (497). Similar pathologic procoagulant surfaces may arise in apoptotic lymphocytes and senescent red blood cells (498). It appears that when  $\beta_2$ gpI is bound to anionic phospholipids or other suitable surfaces, a cryptic epitope is then expressed, and antibodies then bind to the  $\beta_2$ gpI–phospholipid complex (499). Epitope mapping studies using synthetic peptides to probe for the target sequence have been done (500); these studies may clarify the pathologic events mediated by these antibodies. The concept of hexagonal phase configuration has been popularized. This configuration is thought to arise *in vivo* in response to membrane damage (501, 502). Normally, polar heads of the phospholipids exist on the external surface, whereas in the hexagonal phase, lipid cylinders exist with internal aqueous channels formed by polar head groups (503). LA and aCL may represent antibodies generated in response to these neoantigens. APAs have been generated in mice immunized with hexagonal phase phospholipid (504); these antibodies reacted with cardiolipin and possessed functional LA activity. The precise cause of thrombosis in APS is unknown. Presumably, APAs act by interfering with coagulation (505, 506), possibly involving dysfunction or apoptosis (507) of endothelial cells, platelets, and coagulation proteins, and affect pregnancy outcome by interfering with embryo implantation and fetal development (455). Several reasons for pursuing further investigation in this area are given: the possible laboratory identification of specific pathophysiologic events that can serve as useful markers to help predict if and when individual patients with APAs will develop APS; a possible direct therapeutic importance by interrupting the relevant thrombotic mechanism; and a means to monitor therapy. None of these objectives is currently met because a poor correlation exists between thrombosis *in vivo* and the diverse laboratory inhibitory effects. Specific mechanisms of thrombosis that have been implicated include inhibition of activated protein C (508), acquired free protein S deficiency, platelet activation, and abnormalities in the antigenic levels or activity of endothelium-derived hemostatic factors, including inhibition of prostacyclin secretion, fibrinolysis, or disruption of annexin V (509). The thrombogenicity of APAs may also result from their interference with endothelial cell phospholipids required for antithrombin and proteins C and S anticoagulant activity and prostacyclin synthesis and increased endothelial cell expression of the following procoagulants: tissue factor, vWF, platelet-activating factor, and plasminogen activator inhibitor type-1 (455, 510).

**EPIDEMIOLOGY AND CLINICAL ASSOCIATIONS** Young, apparently healthy control subjects are reported to have a prevalence of 1 to 5% of aPL antibodies (511). In patients with systemic lupus, aPL occurs in 12 to 34%. After prolonged follow-up, APS may develop in more than 50% of patients with systemic lupus (455). LA and aCL antibodies have been reported in a variety of clinical disorders, including SLE and other autoimmune and connective tissue diseases and in disorders that are unrelated to SLE (Table 60.8). As with all associative relations, the degree to which a pathophysiologic condition

contributes to clinically significant symptoms by APA in these disease settings is uncertain. The presence of phospholipid-binding antibodies could in some cases be an epiphenomenon, a sign of other underlying vascular alterations that are potentially thrombogenic per se. In other cases, APAs may be of profound direct etiologic relevance. In general terms, although there are individual patient exceptions, clinical symptoms are seen less often with aCL than with LA, particularly when APAs are associated with infection or medication, are of low titer, and are of IgM isotype.

**TABLE 60.8. Clinical Diagnoses Associated with Antiphospholipid-Protein Antibodies**

---

|   |
|---|
| Primary antiphospholipid-protein syndrome   |
| Autoimmune disorder with no apparent cause  |
| Secondary autoimmune disorders  |
| Systemic lupus erythematosus; other autoimmune and connective tissue diseases; drug-induced: procainamide, hydralazine, quinidine, phenothiazines, penicillin |
| Malignancies  |
| Leukemia, lymphoproliferative and plasmacytic disorders, solid tumors, essential thrombocytosis   |
| Infections  |
| Viral, bacterial, protozoal, fungal   |
| Neurologic disorders  |
| Liver disease   |
| Valvular heart disease  |
| Peripheral arterial disease   |
| Chronic renal failure   |
| Sickle cell disease   |
| Ethylenediaminetetraacetic acid-dependent pseud thrombocytopenia  |
| No apparent disease   |

---

Interpretation of estimates of APA frequency must consider the sensitivity of the diverse assay systems that have been used by investigators. Different LA assay systems have been tested with plasma samples from a rigorously defined group of patients with the antiphospholipid-protein syndrome, confirming the importance of variables such as the concentration and composition of phospholipids used in the assay ( 512 ), phospholipid reagent conformation ( 503 ), and so forth. Laboratory aspects of antiphospholipid-antibody testing are discussed in the text that follows. In a large series of internal medicine patients, 7% were APA positive, and 2% fulfilled the criteria of antiphospholipid-antibody syndrome ( 513 ). The most commonly associated diseases were cancer and chronic or acute alcoholic intoxication. In another study, elevations of APA were found in approximately 20% of an unselected autopsy population, 10% of age- and sex-matched controls, and 2% of healthy normal subjects ( 514 ). Inhibitors of the lupus type originally were recognized in association with SLE ( 422 ). The prevalence of the LA in patients with SLE strongly depends on the type of LA assay system used; three standard PTT reagents detected LA in only 10% of SLE patients ( 515 ). A modified PTT with a reduced concentration of phospholipid detected LA activity in approximately 50% of SLE patients ( 515, 516 ). The kaolin clotting time, a test similar to the PTT, detected LA in 70% of patients with SLE ( 517 ). LA activity was associated with higher mortality in SLE patients ( 518 ). APAs have been seen in other connective tissue disorders, including rheumatoid arthritis and Behçet syndrome. APAs are present in many patients with malignancy ( 519 ). APAs have been associated with monoclonal gammopathy of undetermined significance and Waldenström macroglobulin-emia. APAs have been identified in liver disease, the prevalence increasing significantly as the liver disease progresses; APA positivity was as



high as 80% in patients with alcoholic hepatitis or cirrhosis ( 520 ). The antibodies have been found in many infections, including hepatitis C ( 521 ), infection with human immunodeficiency virus ( 522 , 523 ), human T-cell lymphotropic virus-1-associated tropical spastic paraparesis, Q fever, and malaria ( 524 ). Children with viral infections often acquire a transient LA effect ( 515 ). Perhaps as a result of the structural changes in the red cell membrane with increased hexagonal-phase content, APAs are common in sickle cell disease ( 525 ). Patients with transient ischemic attacks and cardiac valve lesions had a high incidence of APAs ( 514 ). APAs have been seen in a variety of unrelated neurologic disorders ( 526 ). Patients with essential thrombocytosis have an increased prevalence of APA and increased risk of thrombosis ( 527 ). Several medications are associated with APA, most often, phenothiazines such as chlorpromazine ( 489 ), procainamide ( 528 ), quinine and quinidine ( 529 ), hydralazine, and penicillin ( 530 ). APAs were common in patients with ethylenediaminetetraacetic acid-dependent pseud thrombocytopenia ( 531 ). aCL antibodies can occur in both active and quiescent Crohn disease, usually without concomitant LA expression ( 532 ), but their role in the thrombotic complications that can occur in the active phase of this disease is uncertain. APA positivity is a common finding in patients with idiopathic thrombocytopenic purpura ( 533 ), with either LA or elevated aCL antibodies in almost one-half of patients. Moreover, APA levels were not influenced by immunosuppressive therapy with steroids and are not related to the activity of idiopathic thrombocytopenic purpura. aCL antibodies and, less often, LA are seen in apparently healthy people ( 534 ), especially in the elderly ( 535 ). In studies of normal blood donors, 5 to 10% have aCL antibodies, often present transiently and in relatively low titer without a concomitant LA effect; these donors do not have an increased risk of developing thrombosis ( 536 ). An inherited predisposition to the development of lupus inhibitors was suggested by their presence in two pairs of siblings ( 537 ) and in familial studies ( 538 , 539 ). Further investigations have suggested associations with certain HLA types ( 540 , 541 ).

**CLINICAL MANIFESTATIONS** Although LAs are immunologically distinct from aCL antibodies, clinical manifestations associated with each antibody appear to be similar. Clinical experience suggests that venous thrombosis is more likely associated with the LA, and arterial thrombosis is more likely associated with high-titer aCL antibodies. The antiphospholipid-antibody syndrome is characterized by the clinical events of fetal loss or thromboembolic disease (arterial or venous), or both ( Table 60.9 ) ( 542 ). These clinical features are most highly associated with aPL antibodies in prospective studies ( 542 ). Older definitions included immune thrombocytopenia as a clinical event ( 543 ), but the newer classification omits thrombocytopenia ( 542 ). A wide variety of clinical features may be seen with APA ( 544 , 545 , 546 and 547 ). However, many patients with APA are asymptomatic. A proportion of asymptomatic patients develop SLE ( 548 ) or other disorders ( 549 ). The diverse clinical manifestations of APA are listed in Table 60.10.

**TABLE 60.9. Criteria for Diagnosis of the Antiphospholipid-Antibody Syndrome (APS)**

| Clinical Event      | Laboratory Abnormality  |
|---------------------|---|
| Venous thrombosis   | Positive lupus anticoagulant test (according to guideline in Table 60.12)                   |
| <i>or</i>           | <i>or</i>   |
| Arterial thrombosis | Positive anticardiolipin antibody test (moderate-titer or high-titer IgG or IgM antibodies) |
| <i>or</i>           |   |

Small-vessel thrombosis

Laboratory abnormality should persist for two or more occasions at least 6 wk apart

or

Complications of pregnancy

One or more unexplained deaths of normal fetuses at or after 10 wk of gestation

One or more premature births of normal neonates at or before 34 wk of gestation

Three or more unexplained consecutive spontaneous abortions before 10 wk of gestation

Ig, immunoglobulin.

NOTE: A diagnosis of definite APS requires the presence of at least one clinical event and at least one laboratory abnormality.

Criteria from Levine JS, Branch DW, Rauch J. The antiphospholipid syndrome. *N Engl J Med* 2002;346:752–763; and Wilson WA, Gharavi AE, Koike T, et al. International consensus statement on preliminary classification criteria for definite antiphospholipid syndrome: report of an international workshop. *Arthritis Rheum* 1999;42:1309–1311.

---

**TABLE 60.10. Clinical Manifestations of Antiphospholipid Antibodies**

---

Asymptomatic

Arterial and venous thromboembolism

  Avascular osteonecrosis

Hematologic

  Cytopenias: thrombocytopenia, autoimmune hemolytic anemia, leukopenia

  Coagulopathy: platelet dysfunction, prothrombin deficiency

Neurologic

  Acute ischemia (cerebrovascular accident, transient ischemic attack, encephalopathy); severe migraine; multiple infarct dementia; seizures; peripheral neuropathy; myasthenia gravis

Dermatologic

  Livedo reticularis; acrocyanosis (distal cutaneous ischemia, ulceration, gangrene); widespread cutaneous necrosis; pyoderma gangrenosum-like skin lesions; anetoderma in human immunodeficiency virus-1 disease

Cardiopulmonary

  Marantic endocarditis; myocardial ischemia and infarction; intracardiac thrombotic mass; peripheral arterial disease; thromboembolic and nonthrombotic pulmonary hypertension

Obstetric

  Recurrent spontaneous abortion; intrauterine growth restriction; preeclampsia; chorea gravidarum; low Apgar scores; prematurity

Catastrophic antiphospholipid syndrome

---

**Arterial and Venous Thromboembolic Disease** The most common clinical presentation of patients with LA or aCL antibodies, or both, is arterial or venous thromboembolism ( [550](#), [551](#) and [552](#) ), affecting up to 70% of patients in some series but averaging approximately 30 to 40% of patients in most studies ( [516](#), [552](#), [553](#) ). The most common site of thrombosis is

extremity deep vein thrombosis, but occasionally, unusual sites are involved, such as the axillary, retinal, and hepatic veins and cerebral venous sinus thrombosis ( 551 , 554 ). Cerebral thrombosis, often heralded by repeated transient ischemic attacks, is a common arterial lesion ( 555 ). Mesenteric artery occlusion, adrenal infarction, gastrointestinal ischemia or ulceration, and subclavian thrombosis with “pulseless” disease also have been described. Multiple cerebral infarcts with dementia in addition to coronary occlusions have occurred in unusually young age groups ( 556 ). A paradoxical syndrome of cerebral infarction with concurrent severe thrombocytopenia and bleeding has been reported in several cases ( 555 ). Antibodies to  $\beta_2$ gpI are highly associated with venous thrombosis ( 557 ), and in another study, assays for the LA correlated best with thrombosis, compared with assays for other APAs ( 558 ). This association between LA and thrombosis risk has been confirmed in a recent literature review ( 558a ). Another unusual ischemic syndrome associated with APA is avascular osteonecrosis ( 559 ).

**Thrombocytopenia** Moderate immune thrombocytopenia is noted in approximately 50% of patients with lupus inhibitors, but in many cases, it apparently is the result of the underlying disorder ( 560 ). Immune thrombocytopenia is no longer considered a clinical event for diagnosis of APS ( 542 ). Patients with thrombocytopenia of obscure etiology, including those with idiopathic thrombocytopenic purpura–like syndromes, probably should be screened for the LA and aCL antibodies. When bleeding occurs in patients with aPLs ( 561 ), this is generally attributed to coexistent thrombocytopenia, platelet dysfunction ( 562 ), prothrombin deficiency ( 563 ), or other underlying coagulopathies. Other cytopenias may be associated with APA, including autoimmune hemolytic anemia and leukopenia.

**Neurologic Syndromes** Various neurologic disorders have been linked with APA, including dementia, migraines, chorea, seizures, transverse myelopathy, Guillain–Barré syndrome, mononeuritis multiplex, transient global amnesia, and myasthenia gravis. Many of these disorders are not associated with ischemia or thrombosis, and the pathologic relationship of these disorders with APA is uncertain. However, in certain cases, immunosuppressive therapy for presumed PAPS may be therapeutically useful ( 564 ). In some studies ( 565 ), but not others ( 566 ), aCL antibodies appear to be an independent risk factor for stroke. Some investigators have noted a relationship between APA, migraine headaches, and subsequent ischemic infarction ( 567 ), whereas other investigators have not confirmed this association ( 568 ).

**Dermatologic Disorders** A variety of ischemic–dermatologic syndromes have been associated with aCL antibodies, including livedo reticularis, acrocyanosis (distal cutaneous ischemia, ulceration, gangrene), widespread cutaneous necrosis, and pyoderma gangrenosum–like skin lesions ( 569 ). Men with PAPS, in particular, may experience dermatologic problems.

**Cardiac Disorders** A high incidence of APA is seen in patients with peripheral arterial disease who experience an associated increased risk of early graft thrombosis ( 570 , 571 ). This may justify routine testing for APA before reconstructive vascular surgery, with consideration of perioperative antiplatelet agents or anticoagulation. Some reports have noted the presence of APA in survivors of myocardial infarction ( 572 ). Other reports have not confirmed this association ( 573 ).

**Pulmonary Disorders** Ischemic and thrombotic pulmonary disease is linked to APA, including pulmonary embolism, pulmonary hypertension, intraalveolar pulmonary hemorrhage, and adult respiratory distress syndrome ( 574 , 575 ). The latter syndrome has been reported in patients with CAPS ( 575 ).

**Obstetric Aspects** APAs are associated with obstetric complications ( 455 , 576 , 577 , 578 and 579 ), including intrauterine growth restriction, preeclampsia, chorea gravidarum, and, primarily, recurrent spontaneous fetal loss (RSFL) ( 455 ). Pregnancy losses in women with aPLs are often caused by fetal death despite normal fetal karyotypes. Spontaneous fetal

loss is perhaps most common in the first trimester, but paradoxically, early first-trimester pregnancy losses are relatively less common than in other patients with recurrent fetal loss ( 580 ). The international consensus statement listed obstetric criteria for diagnosis of APA: (a) one or more unexplained deaths of a morphologically normal fetus at or beyond the tenth week of gestation; (b) one or more premature births of a morphologically normal neonate at or before the thirty-fourth week of gestation because of preeclampsia, eclampsia, or placental insufficiency; or (c) three or more unexplained consecutive spontaneous abortions before the tenth week of pregnancy ( 542 ). There is a significantly increased incidence of elevated APA in women with a history of two or more miscarriages in the first trimester of pregnancy ( 581 ). Women with a history of RSFL should be tested for both LA and aCL antibodies ( 582 ). Repeat testing after an interval of at least 8 weeks is important because only 66% of LA-positive, 37% of IgG aCL-positive, and 36% of IgM aCL-positive women had a positive test result on repeat evaluation. Laboratory screening for LA is confounded in pregnancy because altered coagulation factor concentrations in normal pregnancy may change the observed normal range of coagulation tests, including the PTT. In two studies, the DRVVT was the most frequently positive test for the LA in this population. Rigorous adherence to diagnostic criteria is particularly appropriate in pregnancy because treatment may require potentially hazardous antithrombotic therapy. Elevated maternal serum levels of  $\alpha$ -fetoprotein ( 583 ) or human chorionic gonadotrophin ( 584 ) are common in women with aPLs and are significantly associated with fetal loss. Maternal APA testing may be appropriate if prenatal screening reveals an elevated human chorionic gonadotrophin level and ultrasonography demonstrates an otherwise normal singleton gestation. It is generally considered not appropriate to screen for APA in asymptomatic pregnancies without a history of RSFL ( 585 ). APAs were identified at the first prenatal visit in almost 25% of healthy pregnant women ( 586 ). LA appears to be much rarer than aCL antibodies in pregnancy ( 587 ). It appears that women with isolated IgM aCL or with low levels of IgG aCL are a distinct group that is not at risk for APA-related complications beyond the risk conferred by their medical histories ( 588 ). Although the mechanism by which APA causes recurrent pregnancy loss has not been fully explained, these antibodies may induce intervillous thrombosis and intravillous infarctions, resulting in poor placental perfusion, and have been shown to affect cytotrophoblast tissue *in vitro*. Placental elution studies from patients with a history of RSFL found IgG APA bound directly to placental tissues in patients with positive sera ( 589 ). The thrombotic phenomenon may be mediated by aPL antibodies interfering with trophoblastic annexin V ( 590 ).

**Catastrophic Antiphospholipid–Antibody Syndrome** Some patients with APA develop an acute, severe, multiorgan illness ( 455 , 575 , 591 ) characterized by diffuse small vessel ischemia and occlusion with extensive tissue damage, including myocardial infarction, limb ischemia, DIC, and a high mortality rate of 50% ( 592 ). The patients present with a dramatic illness, often without an obvious precipitating event, that prompts consideration of a wide differential diagnosis including severe lupus vasculitis, thrombotic thrombocytopenic purpura, or severe DIC. The syndrome is defined by clinical involvement of at least three different organ systems with histologic evidence of thrombosis ( 592 ). Typically, small vessel thrombotic lesions occur, with common sites of involvement including the kidney, lung, central nervous system, heart, and skin ( 592 ). In a larger series of CAPS patients, nearly one-half of the cases had systemic lupus, and 40% had PAPS ( 593 ). Precipitating factors for development of CAPS included infections, trauma/procedures, cancer, and subtherapeutic anticoagulation ( 593 ). LA activity and, particularly, high aCL antibody titers are usually present. Central nervous system symptoms and hypertension are common, and leukocytosis and a significantly elevated sedimentation rate are often also present. The clinical manifestations of this syndrome can include all the symptoms and signs indicated in [Table 60.10](#).

**LABORATORY DIAGNOSIS OF ANTIPHOSPHOLIPID–PROTEIN ANTIBODIES** LA and

high-titer aCL antibodies have similar clinical implications, although studies suggest a higher thrombotic risk in patients with the LA (558, 558a). In patients with SLE, the LA is the best predictor for both venous and arterial thrombosis. The laboratory should perform both fibrin-based coagulation assays to detect LA and solid-phase ELISA assays for aCL antibodies in patients suspected of having APA. Both antibodies are found in approximately 60% of circumstances, but there is discordance between the two test systems in detecting the remaining cases. A considerable array of phospholipid-responsive laboratory tests, such as the PTT, dilute PTT, kaolin clotting time, and DRVVT, may serve to screen for the LA (460, 594). LA may be defined as an immunoglobulin (IgG, IgM, IgA, or a mixture) that interferes with one or more of these *in vitro*, phospholipid-dependent coagulation tests. A more recent definition of the LA would be antibodies to  $\beta_2$ gpI or to prothrombin that prolong phospholipid-dependent coagulation assays. Coagulation tests that are phospholipid-independent are not affected by LA. Unless concurrent additional factor deficiencies are present, the standard PT is usually normal because of the large amount of phospholipids in this reagent. No individual test seems to have a universal detection rate; this observation may reflect LA subtypes with distinct activities or the requirement of various cofactors. Comparative studies suggest that activated PTT reagents with reduced levels or different types of phospholipids are more sensitive than routine PTT assays (460, 595). There are claims that assays based on venom activators of factor X and prothrombin may have particular advantages, such as reduced sensitivity to coagulation factor deficiency, that would be more suitable for analysis of plasmas from patients receiving oral anticoagulants (596). Platelet-poor plasma should be used in these screening assays, particularly if frozen plasma samples are to be tested (597). Table 60.11 indicates some of the clinical and laboratory differences between specific anticoagulant antibodies to particular factors, such as factor VIII and LA. Other nonspecific anticoagulants are uncommon but include the heparinlike anticoagulants discussed in the section [Other Acquired Coagulation Disorders](#). Confirmatory tests for LA based on activated PTT or DRVVT include abnormal mixing studies with normal plasma and correction with mixing using phospholipids, such as lysed washed platelets (platelet neutralization procedure), or with added hexagonal-phase phospholipids (598). A high concentration of liposomes prepared from rabbit brain extracts may achieve the most efficient correction of the defect (599), but this method is not widely used. The College of American Pathologists has published detailed recommendations for lupus anticoagulant testing (599a).

**TABLE 60.11. Comparison of Factor VIII Antibodies and Antiphospholipid-Protein Antibodies**

| Clinical Event or Laboratory Test                               | Factor VIII Antibodies | Antiphospholipid-Protein Antibodies   |
|---|------------------------|---|
| Bleeding  | Often severe           | Uncommon  |
| Thrombosis  | Rare                   | Common  |
| Obstetric complications (abortion and intrauterine fetal death) | Rare                   | Common  |
| Prothrombin time  | Normal                 | May be prolonged  |
| Thrombin time   | Normal                 | Occasionally prolonged  |
| Thrombocytopenia  | Rare                   | Common  |
| Inhibitory effect in plasma mixtures                            | Usually time dependent | Often is instantaneous; occasionally, mixing studies show time-dependent inhibition |
| Prothrombin level   | Normal                 | Occasionally deficient  |



|  |   |   |
|--|---|---|
| Factor VIII level  | Deficient; one-stage assay curve is aberrant with low-affinity antibodies | Normal when assayed in a dilute system; all one-stage assay curves are aberrant |
| Anticardiolipin antibodies                                   | Rare  | Anticardiolipin antibodies of either IgG or IgM classes are common              |
| Phospholipid or platelet correction of abnormal assay result | No  | Usually   |

Ig, immunoglobulin.

Several clinical points are worth stating. The search for LA or aCL antibodies should not be abandoned even if normal plasma in a mixing study corrects the test patient plasma, particularly in a human immunodeficiency virus-positive population (600). It is sometimes important for the clinician to discern the possible effect that heparin in the test patient plasma can have on the confirmatory laboratory assay; satisfactory correction procedures should be resistant to heparin. The ideal test to identify the LA is controversial; some investigators have reported the kaolin clotting time to be the most sensitive test (595, 601, 602). On the other hand, some DRVVT assays are more able to identify LA associated with thrombosis (603). A subgroup of patients with unexplained thrombosis with antibodies to phosphatidylethanolamine as the only abnormal APA test has been identified (604). Optimal detection of the LA requires more than one of the phospholipid-dependent assays described earlier (605). This latter suggestion is supported by reports that different phospholipid-dependent coagulation tests detect different populations of LA antibodies (606). Table 60.12 summarizes the recommendations of an ISTH consensus group on laboratory diagnosis of LA (605). Despite the ISTH recommendations of LA testing, the optimal strategy for evaluating LA is unknown (607). One report used decision analysis to determine optimal LA testing strategies (608). The preferred strategies identified by this group are shown in Table 60.13; these preferences are based on sensitivities and specificities for each strategy, as well as costs and patient outcomes and preferences (608).

**TABLE 60.12. Laboratory Diagnosis of Lupus Anticoagulant: ISTH Criteria**

|   |
|---|
| Prolongation of at least one phospholipid-dependent coagulation test with the use of platelet-poor plasma (e.g., the activated partial thromboplastin time, dilute prothrombin time, dilute Russell viper venom time, kaolin clotting time) |
| Failure to correct the prolonged coagulation time by mixing patient and normal plasma   |
| Confirmation of lupus anticoagulant by demonstrating correction of the prolonged coagulation time by addition of excess phospholipids or freeze-thawed platelets  |
| Exclusion of alternative coagulopathies using specific assays (e.g., factor VIII antibodies)  |

Diagnostic criteria from Levine JS, Branch DW, Rauch J. The antiphospholipid syndrome. *N Engl J Med* 2002;346:752-763; and Brandt JT, Triplett DA, Alving B, et al. Criteria for the diagnosis of lupus anticoagulants: an update. On behalf of the Subcommittee on Lupus Anticoagulant/Antiphospholipid Antibody of the Scientific and Standardisation Committee of the ISTH. *Thromb Haemost* 1995;74: 1185-1190.

**TABLE 60.13. Lupus Anticoagulant Testing Strategies Based on Decision Analysis**

| Patient Group   | Least Costly Strategy  | Greatest Patient Utility Strategy   |
|---|--|-------------------------------------|
| Healthy people with a prolonged activated partial thromboplastin time | No testing; assume all are negative  | No testing; assume all are negative |
| Systemic lupus erythematosus patients                                 | No testing; assume negative <i>or</i> TTI alone                                    | TTI?DRVVT?confirmatory DRVVT        |
| Patients with prior thrombosis or fetal loss                          | No testing; assume negative <i>or</i> TTI alone <i>or</i> confirmatory DRVVT alone | No testing; assume all are negative |

DRVVT, dilute Russell viper venom time; TTI, tissue thromboplastin inhibition test.  
 Strategies from Segal JB, Lehmann HP, Petri M, et al. Testing strategies for diagnosing lupus anticoagulant: decision analysis. *Am J Hematol* 2002;70:195–205.

aPLs may also be detected by ELISA or by radioimmunoassay (609). Commercial ELISA systems are reasonably well standardized. The aCL–antibody assay used to improve sensitivity and specificity has undergone several modifications (610). Using anti- $\beta$   $_{2}$ gpI–dependent assay systems is useful to discriminate between transiently positive aCL antibodies that are associated with infection, which characteristically do not have a  $\beta$   $_{2}$ gpI cofactor requirement, and those aCL antibodies associated with an increased risk of thrombosis (611). Definitional standardization of the criteria for clinical and laboratory APA have been published (455, 542, 605). For the diagnosis of APS, in addition to a clinical history (e.g., at least one venous or arterial thrombosis, pregnancy morbidity/mortality), positive laboratory tests for LA or aCL antibodies (in medium or high titer) should be found on two occasions at least 6 weeks apart (Table 60.9). It is recommended that aCL antibodies be measured by a standardized ELISA for  $\beta$   $_{2}$ gpI–dependent antibodies (542). Measurement of  $\beta$   $_{2}$ gpI antibodies is not recommended for diagnosing APS at this time (542). Although consensus criteria require persistence of the laboratory abnormality for at least 6 weeks, in clinical practice, a functional definition taking into account the number of clinical manifestations and the titer of aCL antibodies on even a single occasion may help categorize patients as having definite, probable, or doubtful APS (609) and may direct immediate treatment options. Even if the patient is asymptomatic, lupus inhibitors should always be identified correctly when discovered, even though costly and time-consuming laboratory study is required. If the cause for a prolonged PTT is not identified, the necessity for definitive laboratory evaluation almost invariably arises again, often in the context of an emergency. This may result in the unnecessary use of blood products and a delay of required surgical procedures.

**TREATMENT OF ANTIPHOSPHOLIPID–PROTEIN ANTIBODY SYNDROME** The optimal treatment of patients with APA syndrome has not been defined (610). Depending on the clinical symptoms, patients with APA may need no treatment or may need anticoagulant or immunosuppressive therapy. Although spontaneous remissions are uncommon and aCL antibodies and LA can be associated with life-threatening thromboembolic events, only 10 to 15% of asymptomatic patients with APA develop these complications. Based on the uncertainty of predicting when thrombotic events might occur, as well as the risks of anticoagulation, most investigators do not treat asymptomatic patients prophylactically, with the possible exception of short-term intervention when additional thrombophilic hazards such as immobilization or surgery are anticipated. Patients with significant thrombotic events (e.g., deep vein thrombosis, arterial ischemia, or fetal loss) are appropriate candidates for antithrombotic therapy. Although retrospective in design and somewhat arbitrary in its partition of INR values, a particularly useful study (612) of secondary prevention of thrombosis in patients with antiphospholipid–antibody syndrome



resulting from a variety of disorders suggested that high-intensity warfarin therapy, achieving an INR value at least equal to 3, with or without a low dose (75 mg) of aspirin daily, was considerably more effective than warfarin treatment at a lower intensity with or without low-dose aspirin, or treatment with aspirin alone, in preventing recurrent thrombotic events. Although bleeding complications were increased significantly by higher-intensity therapy, long-term persistent higher-intensity anticoagulation therapy was recommended for most patients ( 612 ). Long-term treatment with oral anticoagulation therapy is advised because of the high rate of recurrence even if the venous or arterial occlusion occurred many years previously ( 613 , 614 ). Patients receiving oral anticoagulants had no recurrence over 8 years, whereas patients in whom anticoagulant drugs had been discontinued had a 50% probability of a recurrent venous thromboembolic episode after 2 years and an almost 80% probability of recurrence after 8 years ( 615 ). This strategy is supported by a study that found that APS patients with thrombosis benefited from prolonged oral anticoagulation because persistent elevation of aCL levels predicted an increased risk of thrombosis recurrence and death ( 616 ). The bleeding risks of high-intensity oral anticoagulation in these patients appear to be similar to patients treated with standard low-intensity oral anticoagulation ( 617 ). Many investigators follow this approach, unless all laboratory evidence of LA and aCL in patients in whom high titers were initially detected or in whom a thrombotic risk was attributed to APA has been continually absent for at least 6 months; no other thrombophilic risk is present; and close surveillance is feasible. The optimal intensity of oral anticoagulation for APS patients is the subject of an ongoing study ( 618 ). Patients with the uncommon LA-hypoprothrombinemia syndrome who either have bleeding or need surgery may benefit from steroid therapy or intravenous IgG ( 619 ). Patients with the LA and acute thrombosis pose difficulty in terms of monitoring heparin anticoagulation. The usually prolonged PTT value seen with the LA renders this test unreliable. These patients can be monitored using heparin assays, which are now available by automated methodology (see [Chapter 61](#)). Alternatively, patients can be treated using a low-molecular-weight heparin, such as enoxaparin or tinzaparin, without the necessity for laboratory monitoring (see [Chapter 61](#)). In those patients with an LA and hypoprothrombinemia, or an LA that affects the PT, the use of the INR to monitor anticoagulation has been questioned. These patients may require monitoring with a test that is insensitive to the LA, such as a prothrombin-proconvertin assay or a chromogenic factor X assay ( 620 ). Corticosteroid use often diminishes or abolishes the coagulation abnormalities and immune thrombocytopenia of APA syndrome within a short time. However, for most patients, the role of steroids, other immunosuppressive agents, or aspirin is uncertain. Although immunosuppression with cyclophosphamide in pulse form is effective in reducing elevated antibody levels, there is often a rapid rebound to pretreatment levels shortly after discontinuation of the therapy. Consequently, additional therapies with aspirin or steroids or more aggressive immunosuppression are not used unless recurrent thrombotic or ischemic events are seen despite high-intensity warfarin therapy. High-dose corticosteroid therapy has equivocal efficacy and considerable toxicity and is reserved for treatment of underlying comorbid conditions such as active lupus and not for the laboratory phenomena of the antiphospholipid-antibody syndrome itself. In patients with CAPS who experience multisystem involvement, intensive treatment with corticosteroids, immunosuppression, intravenous IgG, or plasmapheresis may be useful ( 455 , 592 ). In one literature analysis of CAPS therapy, the highest response to therapy occurred in patients treated with anticoagulation and steroids (64%) ( 593 ). Immune thrombocytopenia and autoimmune hemolytic anemia in patients with APA are treated similarly as patients without APA.

**Obstetric Treatment** Because the risk of pregnancy loss in women with APS and prior pregnancy loss may exceed 60%, a history of recurrent fetal loss is an indication for treatment during pregnancy. Antiplatelet agents such as aspirin 80 mg/day ( 621 ), low-dose immunosuppressive agents such as prednisone 15 to 30 mg/day, or anticoagulants (heparin or low-molecular-weight heparin) have all been used in an attempt

to improve pregnancy outcome ( 455 ). Several randomized studies have provided information about useful treatment strategies in pregnancy-associated APS (reviewed in reference 455 ). Intravenous IgG is of no benefit in these patients, and heparin is more effective than aspirin. Heparin or low-molecular-weight heparin is the treatment of choice; pregnant patients without a history of thrombosis benefit from heparin in doses of 10,000 to 20,000 U daily in divided doses, whereas pregnant patients with a history of thrombosis should receive therapeutic anticoagulation, preferably with low-molecular-weight heparin ( 455 ).

### **Transfusion-Associated Coagulation Abnormalities**

The administration of blood products in a volume greater than 1.5 times the patient's estimated blood volume or replacement of total blood volume in less than 24 hours constitutes massive blood transfusion ( 622 ). Dilutional coagulopathy occurs when replacement therapy consists of crystalloid and packed red cells. Some authors recommend using whole blood to minimize this coagulopathy ( 623 ), whereas others recommend fresh frozen plasma ( 624 ). Platelet transfusion may be less important because platelets can be mobilized from reserve sites. One retrospective study observed that significant thrombocytopenia did not develop unless patients were given 20 or more units of red blood cell products, and that transfusion of more than 12 units of red blood cell products consistently prolonged the PT and PTT ( 625 ).

Some believe that clinical bleeding in patients receiving massive transfusion results less from the dilutional coagulopathy and more often is a result of DIC, which may be seen in 30% of such patients ( 626 ). Hypoperfusion, not transfusion, is thought to be of primary importance for these cases, and the occurrence of DIC relates more to the duration of hypovolemia than to the absolute volume lost or replaced ( 627 ). Obviously, coexisting diseases such as liver dysfunction, renal disease, and others may contribute to hemostatic impairment in patients receiving massive transfusion. The use of point of care monitoring may reduce use of blood products in the operating room setting ( 628 ).

Previous guidelines recommended routinely using platelets and plasma based on the quantity of blood transfused. More recent guidelines suggest using the basic hemostasis screening tests to monitor the necessity of using platelets or plasma replacement ( 629 ). An increase in the PT and PTT to more than 1.8 times the upper limit of normal may justify the use of fresh frozen plasma (4 units for an adult). If bleeding is present and the platelet count is less than 50,000/ $\mu$ l, 6 to 8 units of platelets should be given for an adult patient ( 629 ). DIC panels should be done to identify whether this entity is present and to determine whether fibrinogen replacement with cryoprecipitate is necessary.

### **Bleeding Associated with Extracorporeal Circulation**

Defective hemostasis with cardiopulmonary bypass is associated with multiple contributory causes, including hemodilution of coagulation factors, inadequate neutralization of heparin, acquired platelet dysfunction, and thrombocytopenia. These latter two defects are further discussed in [Chapter 58](#). In general, extracorporeal circulation-induced hemostatic defects may be ascribed to activation of platelets and coagulation proteins by artificial surfaces.

Platelet dysfunction (acquired storage pool defect) is considered the major hemostatic insult induced by bypass ( 630 ). Although DDAVP has been shown to reduce bleeding and transfusion requirements in these patients ( 631 ), subsequent trials suggested that the

typical “low-risk” patient does not benefit from DDAVP ( 632 ), and routine DDAVP therapy may be hazardous in older patients with significant vascular disease ( 633 ). The protease inhibitor aprotinin appears to be useful in reducing blood loss and transfusion requirements in bypass surgery ( 634 ); this drug is thought to inhibit plasma proteolytic activity induced by cardiopulmonary bypass, reducing the extent of platelet activation. Aprotinin is now available for parenteral use for this indication, especially in high-risk patients. A major toxicity of this drug is hypersensitivity, especially for patients who have previously received the drug. Aprotinin appears to be superior to EACA ( 635 ). The use of routine prophylactic platelet transfusions has no apparent benefit ( 636 ).

### Drug-Induced Coagulation Abnormalities

Broad-spectrum antibiotics, such as the  $\beta$ -lactam antibiotics, may induce a coagulopathy by inhibition of vitamin K synthesis by gut bacteria and direct inhibition of essential carboxylation reactions ( 28 ). A number of antibiotics may also inhibit platelet function (see Chapter 58).

L-asparaginase produces hypofibrinogenemia and deficiency of other coagulation factors ( 637, 638 ). Mithramycin may induce a coagulopathy as a result of deficient coagulation protein levels and platelet dysfunction ( 639 ). A number of cancer chemotherapeutic agents impair fibrin cross-linking *in vitro* ( 640 ). Hematin produces a complex coagulopathy ( 641 ). Valproic acid therapy has been associated with acquired vWD ( 642 ). Anticoagulant therapy is discussed in Chapter 61.

### Acquired Deficiencies of Single Coagulation Factors

A rare and largely unexplained phenomenon is the development of deficiency of a single coagulation factor during the course of an acquired disorder ( Table 60.7 ). Isolated deficiency of factor X is well documented in patients with primary amyloidosis and amyloidosis associated with multiple myeloma ( 643, 644 ). Factor X levels in these patients do not rise even after massive replacement therapy, and the findings from studies using  $^{131}\text{I}$ -labeled factor X suggest that this proenzyme is bound to subendothelial amyloid fibrils in blood vessels ( 645 ). A combined deficiency of factors IX and X in amyloidosis also has been reported ( 646 ). In many patients, the hemostatic defect is complicated by other abnormalities, such as vascular infiltration, liver disease, high levels of antithrombins, and azotemia with platelet dysfunction ( 647 ). Splenectomy abolished the factor X deficiency and produced complete remission of bleeding in several cases ( 648 ), presumably because of extensive amyloid infiltration in the splenic vasculature. Chemotherapy with melphalan and prednisone may resolve factor X deficiency in amyloidosis ( 649 ). High-dose chemotherapy with stem cell transplantation is also effective therapy ( 650 ). Factor X deficiency has also been associated with upper respiratory tract infections ( 446 ).

Hypoprothrombinemia has been reported as an isolated finding ( 651 ), most commonly in association with LAs, as discussed previously. Deficiencies of prothrombin, factors IX and XII, plasminogen, and antithrombin have been reported in some patients with the nephrotic syndrome ( 652, 653, 654, 655 and 656 ), presumably as the result of massive protein loss in the urine. In one patient with Sheehan syndrome, a selective deficiency of factor IX responded to treatment with corticosteroids and thyroid replacement ( 657 ). Isolated deficiency of factor IX in several patients with Gaucher disease also has been

documented ( [658](#) ). Acquired factor VII deficiency has been reported with aplastic anemia ( [659](#) ) and liposarcoma ( [660](#) ).

Factor XIII deficiency has been associated with chronic myelocytic leukemia and with various forms of acute leukemia ( [661](#) ). Particularly low levels of this factor, which bear no clear relationship to the presence or absence of DIC, have been demonstrated in patients with acute promyelocytic leukemia. Factor XIII deficiency has also been associated with inflammatory bowel disease ( [662](#) ), and isoniazid-induced antibodies to factor XIII have been reported ( [433](#) , [434](#) , [663](#) ). Factor XII deficiency has been described in association with chronic myelocytic leukemia ( [664](#) ). Factor XI deficiency has been linked to Gaucher disease ( [665](#) ) and Ehlers–Danlos syndrome ( [666](#) ). Factor V deficiency has been reported in chronic myeloid leukemia and in celiac disease. Acquired vWD was discussed earlier in the section [von Willebrand Factor](#).

### Other Acquired Coagulation Disorders

Heparinlike anticoagulants have been reported in patients with hematologic malignancies [e.g., plasma cell dyscrasias ( [667](#) ) or leukemias ( [668](#) , [669](#) ) or solid tumors ( [670](#) )]. A prolonged thrombin time and normal reptilase clotting time are typically seen in these patients. Significant clinical bleeding may occur with heparinlike anticoagulants; a titrated protamine sulfate infusion may be helpful in these patients.

Malignancy may also be associated with other inhibitors of coagulation, including FDPs and paraproteins, dysfibrinogenemias, and specific antibodies to coagulation factors (discussed earlier). A monoclonal antithrombin antibody associated with bleeding has been reported in a patient with myeloma ( [671](#) ).

### REFERENCES

1. Olson RE. The function and metabolism of vitamin K. *Annu Rev Nutr* 1984;4:281–337.
2. Townsend CW. The haemorrhagic disease of the newborn. *Arch Paediatr* 1894;11:559–565.
3. Sutor AH, von Kries R, Cornelissen EA, et al. Vitamin K deficiency bleeding (VKDB) in infancy. ISTH Pediatric/Perinatal Subcommittee. International Society on Thrombosis and Haemostasis. *Thromb Haemost* 1999;81:456–461.
4. Suntherland JM, Glueck HI, Gleser G. Hemorrhagic disease of the newborn. *Am J Dis Child* 1967;113:524–533.
5. Oski FA, Naiman JL. *Hematology in the newborn*, 2nd ed. Philadelphia: WB Saunders, 1972.
6. Aballi AJ, DeLamerens S. Coagulation changes in the neonatal period and early infancy. *Pediatr Clin North Am* 1962;9:785–817.
7. Aballi AJ, et al. Coagulation studies in the newborn period. Alterations of thromboplastin generation and effects of vitamin K in full-term and premature infants. *Am J Dis Child* 1957;94:589–603; 1959;97:549–554.
8. Cade JF, Hirsh J, Martin M. Placental barrier to coagulation factors: its relevance to the coagulation defect at birth and to haemorrhage in the newborn. *BMJ* 1969;2:281–283.
9. Fillmore SJ, McDevitt E. Effects of coumarin compounds on the fetus. *Ann Intern Med* 1970;73:731–735.
10. Mountain KR, Hirsh J, Gallus AS. Neonatal coagulation defect due to anticonvulsant drug treatment in

pregnancy. *Lancet* 1970;1:265–268.

11. Andrew M, Vegh P, Johnston M, et al. Maturation of the hemostatic system during childhood. *Blood* 1992;80:1998–2005.
12. Andrew M, Paes B, Johnston M. Development of the hemostatic system in the neonate and young infant. *Am J Pediatr Hematol Oncol* 1990;12:95–104.
13. Corrigan JJ, Jr., Taussig LM, Beckerman R, Wagener JS. Factor II (prothrombin) coagulant activity in immunoreactive protein: detection of vitamin K deficiency and liver disease in patients with cystic fibrosis. *J Pediatr* 1981;99:254–257.
14. Hathaway WE. The bleeding newborn. *Semin Hematol* 1975;12:175–188.
15. Mangurten HH, Honig GR. Hemorrhagic disease due to vitamin K deficiency in a premature infant: a syndrome which may resemble disseminated intravascular coagulation (DIC). *Clin Pediatr (Phila)* 1973;12:372–375.
16. Zipursky A. Prevention of vitamin K deficiency bleeding in newborns. *Br J Haematol* 1999;104:430–437.
17. Shearer MJ. Vitamin K. *Lancet* 1995;345:229–234.
18. Greer FR. Are breast-fed infants vitamin K deficient? *Adv Exp Med Biol* 2001;501:391–395.
19. Lukens JN. Vitamin K and the older infant. *Am J Dis Child* 1972;124:639–640.
20. Malia RG, Preston FE, Mitchell VE. Evidence against vitamin K deficiency in normal neonates. *Thromb Haemost* 1980;44:159–160.
21. Slattery JM. Why we need a clinical trial for vitamin K. *BMJ* 1994;308:908–910.
22. Golding J, Greenwood R, Birmingham K, Mott M. Childhood cancer, intramuscular vitamin K, and pethidine given during labour. *BMJ* 1992;305:341–346.
23. Thorp JA, Gaston L, Caspers DR, Pal ML. Current concepts and controversies in the use of vitamin K. *Drugs* 1995;49:376–387.
24. Ansell JE, Kumar R, Deykin D. The spectrum of vitamin K deficiency. *JAMA* 1977;238:40–42.
25. Pineo GF, Gallus AS, Hirsh J. Unexpected vitamin K deficiency in hospitalized patients. *Can Med Assoc J* 1973;109:880–883.
26. Klippel AP, Pitsinger B. Hypoprothrombinemia secondary to antibiotic therapy and manifested by massive gastrointestinal hemorrhage. Report of three cases. *Arch Surg* 1968;96:266–268.
27. Allison PM, Mummah-Schendel LL, Kindberg CG, et al. Effects of a vitamin K-deficient diet and antibiotics in normal human volunteers. *J Lab Clin Med* 1987;110:180–188.
28. Brown RB, Klar J, Lemeshow S, et al. Enhanced bleeding with cefoxitin or moxalactam. Statistical analysis within a defined population of 1493 patients. *Arch Intern Med* 1986;146:2159–2164.
29. Gross L, Brotman M. Hypoprothrombinemia and hemorrhage associated with cholestyramine therapy. *Ann Intern Med* 1970;72:95–96.
30. Corrigan JJ, Jr., Marcus FI. Coagulopathy associated with vitamin E ingestion. *JAMA* 1974;230:1300–1301.
31. Weser JK, Sellers EM. Drug interactions with coumarin anticoagulants. *N Engl J Med* 1971;285:487–498.
32. MacLeod SM, Sellers EM. Pharmacodynamic and pharmacokinetic drug interactions with coumarin

anticoagulants. *Drugs* 1976;11:461–470.

33. Goldsweig HG, Kapusta M, Schwartz J. Bleeding, salicylates, and prolonged prothrombin time: three case reports and a review of the literature. *J Rheumatol* 1976;3:37–42.
34. de la Rubia J, Grau E, Montserrat I, et al. Anaphylactic shock and vitamin K1. *Ann Intern Med* 1989;110:943.
35. Alperin JB. Coagulopathy caused by vitamin K deficiency in critically ill, hospitalized patients. *JAMA* 1987;258:1916–1619.
36. Routh CR, Triplett DA, Murphy MJ, et al. Superwarfarin ingestion and detection. *Am J Hematol* 1991;36:50–54.
37. Chua JD, Friedenbergr WR. Superwarfarin poisoning. *Arch Intern Med* 1998;158:1929–1932.
38. Amitrano L, Guardascione MA, Brancaccio V, Balzano A. Coagulation disorders in liver disease. *Semin Liver Dis* 2002;22:83–96.
39. Roberts HR, Cederbaum AI. The liver and blood coagulation: physiology and pathology. *Gastroenterology* 1972;63:297–320.
40. Mammen EF. Coagulation defects in liver disease. *Med Clin North Am* 1994;78:545–554.
41. Schoffski P, Tacke F, Trautwein C, et al. Thrombopoietin serum levels are elevated in patients with hepatitis B/C infection compared to other causes of chronic liver disease. *Liver* 2002;22:114–120.
42. Ishikawa T, Ichida T, Sugahara S, et al. Thrombopoietin receptor (c-Mpl) is constitutively expressed on platelets of patients with liver cirrhosis, and correlates with its disease progression. *Hepatol Res* 2002;23:115–121.
43. Rodriguez-Inigo E, Bartolome J, Quiroga JA, et al. Expression of factor VII in the liver of patients with liver disease: correlations with the disease severity and impairment in the hemostasis. *Blood Coagul Fibrinolysis* 2001;12:193–199.
44. Yanofsky RA, Jackson VG, Lilly JR, et al. The multiple coagulopathies of biliary atresia. *Am J Hematol* 1984;16:171–180.
45. Douvres PA. Effect of high parenteral doses of vitamin K analogs and serum albumin on the prothrombin level and liver function in alcoholic cirrhosis. *Am J Dig Dis* 1965;10:635–642.
46. Losowsky MS, Simmons AV, Miloszewski K. Coagulation abnormalities in liver disease. *Postgrad Med* 1973;53:147–152.
47. Rapaport SI. Plasma thromboplastin antecedent levels in patients receiving coumarin anticoagulants and in patients with Laennec's cirrhosis. *Proc Soc Exp Biol Med* 1961;108:115–116.
48. Walls WD, Losowsky MS. Plasma fibrin stabilizing factor (FSF) activity in normal subjects and patients with chronic liver disease. *Thromb Haemost* 1972;21:134–143.
49. Ratnoff OD. Hemostatic defects in liver and biliary tract diseases. In: Ratnoff OD, Forbes CD, eds. *Disorders of hemostasis*. New York: Grune & Stratton, 1984:1.
50. Palascak JE, Martinez J. Dysfibrinogenemia associated with liver disease. *J Clin Invest* 1977;60:89–95.
51. Ruggiero G, De Biasi R, Attanasio S, et al. Hemostatic abnormalities in chronic aggressive hepatitis and liver cirrhosis. *Acta Hepatogastroenterol (Stuttg)* 1975;22:221–228.
52. Weinstein MJ, Deykin D. Quantitative abnormality of an Aa chain molecular weight form in the fibrinogen of cirrhotic patients. *Br J Haematol* 1978;40: 617–630.
53. Lane DA, Scully MF, Thomas DP, et al. Acquired dysfibrinogenaemia in acute and chronic liver

disease. *Br J Haematol* 1977;35:301–308.

54. Martinez J, Palascak JE, Kwasniak D. Abnormal sialic acid content of the dysfibrinogenemia associated with liver disease. *J Clin Invest* 1978;61:535–538.
55. Soria J, Soria C, Ryckewaert JJ, et al. Study of acquired dysfibrinogenaemia in liver disease. *Thromb Res* 1980;19:29–41.
56. Blanchard RA, Furie BC, Jorgensen M, et al. Acquired vitamin K-dependent carboxylation deficiency in liver disease. *N Engl J Med* 1981;305:242–248.
57. Liebman HA, Furie BC, Tong MJ, et al. Des-gamma-carboxy (abnormal) prothrombin as a serum marker of primary hepatocellular carcinoma. *N Engl J Med* 1984;310:1427–1431.
58. Galnack HR, Givelber H, Abrams E. Dysfibrinogenemia associated with hepatoma. Increased carbohydrate content of the fibrinogen molecule. *N Engl J Med* 1978;299:221–226.
59. Green AJ, Ratnoff OD. Elevated antihemophilic factor (AHF, factor VIII) procoagulant activity and AHF-like antigen in alcoholic cirrhosis of the liver. *J Lab Clin Med* 1974;83:189–197.
60. Meili EO, Straub PW. Elevation of factor VIII in acute fatal liver necrosis. *Thromb Diath Haemorrh* 1970;24:161–174.
61. Rogers JS, Eyster E. Relationship of factor VIII-like antigen (VIII AGN) and clot promoting activity (VIII AHF) as measured by one- and two-stage assays in patients with liver disease. *Br J Haematol* 1976;34:655–661.
62. Kelly DA, Tuddenham EG. Haemostatic problems in liver disease. *Gut* 1986;27:339–349.
63. Maisonneuve P, Sultan Y. Modification of factor VIII complex properties in patients with liver disease. *J Clin Pathol* 1977;30:221–227.
64. Booth NA, Anderson JA, Bennett B. Plasminogen activators in alcoholic cirrhosis: demonstration of increased tissue type and urokinase type activator. *J Clin Pathol* 1984;37:772–777.
65. Fletcher AP, Biederman O, Moore D. Abnormal plasminogen-plasmin system activity (fibrinolysis) in patients with hepatic cirrhosis. *J Clin Invest* 1964;43:681–695.
66. Ballard HS, Marcus AJ. Platelet aggregation in portal cirrhosis. *Arch Intern Med* 1976;136:316–319.
67. Thomas DP, Ream VJ, Stuart RK. Platelet aggregation in patients with Laennec's cirrhosis of the liver. *N Engl J Med* 1967;276:1344–1348.
68. Lipinski B, Lipinska I, Nowak A, Gurewich V. Abnormal fibrinogen heterogeneity and fibrinolytic activity in advanced liver disease. *J Lab Clin Med* 1977;90:187–194.
69. Fletcher AP, Alkjaersig N, Sherry S. Pathogenesis of the coagulation defect developing during pathological plasma proteolytic ("fibrinolytic") states. I. The significance of fibrinogen proteolysis and circulating fibrinogen breakdown products. *J Clin Invest* 1962;41:896–916.
70. Fletcher AP, Alkjaersig N, Fisher S, Sherry S. The proteolysis of fibrinogen by plasmin: the identification of thrombin-clottable fibrinogen derivatives which polymerize abnormally. *J Lab Clin Med* 1962;68:780–802.
71. Hu KQ, Yu AS, Tiyyagura L, et al. Hyperfibrinolytic activity in hospitalized cirrhotic patients in a referral liver unit. *Am J Gastroenterol* 2001;96:1581–1586.
72. Lisman T, Leebeek FW, Mosnier LO, et al. Thrombin-activatable fibrinolysis inhibitor deficiency in cirrhosis is not associated with increased plasma fibrinolysis. *Gastroenterology* 2001;121:131–139.
73. Knot E, Ten Cate JW, Drijfhout HR, et al. Antithrombin III metabolism in patients with liver disease. *J Clin Pathol* 1984;37:523–530.



74. Tytgat G, Collen D, De Vreker R, Verstraete M. Investigations on the fibrinolytic system in liver cirrhosis. *Acta Haematol* 1968;40:265-274.
75. Gallus AS, Lucas CR, Hirsh J. Coagulation studies in patients with acute infectious hepatitis. *Br J Haematol* 1972;22:761-771.
76. Collen D, Rouvier J, Chamone DA, Verstraete M. Turnover of radiolabeled plasminogen and prothrombin in cirrhosis of the liver. *Eur J Clin Invest* 1978;8:185-188.
77. Tytgat GN, Collen D, Verstraete M. Metabolism of fibrinogen in cirrhosis of the liver. *J Clin Invest* 1971;50:169-701.
78. Coccheri S, Mannucci PM, Palareti G, et al. Significance of plasma fibrino-peptide A and high molecular weight fibrinogen in patients with liver cirrhosis. *Br J Haematol* 1982;52:503-509.
79. Cordova C, Musca A, Violi F, et al. Improvement of some blood coagulation factors in cirrhotic patients treated with low doses of heparin. *Scand J Haematol* 1982;29:235-240.
80. Schipper HG, ten Cate JW. Antithrombin III transfusion in patients with hepatic cirrhosis. *Br J Haematol* 1982;52:25-33.
81. Hiller E, Hegemann F, Possinger K. Hypercoagulability in acute esophageal variceal bleeding. *Thromb Res* 1981;22:243-251.
82. Hillenbrand P, Parbhoo SP, Jedrychowski A, Sherlock S. Significance of intravascular coagulation and fibrinolysis in acute hepatic failure. *Gut* 1974;15: 83-88.
83. Bloom AL. Intravascular coagulation and the liver. *Br J Haematol* 1975;30:1-7.
84. vanDeWater L, Carr JM, Aronson D, McDonagh J. Analysis of elevated fibrin(ogen) degradation product levels in patients with liver disease. *Blood* 1986;67:1468-1473.
85. Ben-Ari Z, Osman E, Hutton RA, Burroughs AK. Disseminated intravascular coagulation in liver cirrhosis: fact or fiction? *Am J Gastroenterol* 1999;94: 2977-2982.
86. Stein SF, Fulenwider JT, Ansley JD, et al. Accelerated fibrinogen and platelet destruction after peritoneovenous shunting. *Arch Intern Med* 1981;141:1149-1151.
87. Henderson JM, Stein SF, Kutner M, et al. Analysis of twenty-three plasma proteins in ascites. The depletion of fibrinogen and plasminogen. *Ann Surg* 1980;192:738-742.
88. Salem HH, Dudley FJ, Merrett A, et al. Coagulopathy of peritoneovenous shunts: studies on the pathogenic role of ascitic fluid collagen and value of antiplatelet therapy. *Gut* 1983;24:412-417.
89. Bohmig HJ. The coagulation disorder of orthotopic hepatic transplantation. *Semin Thromb Hemost* 1977;4:57-82.
90. Ozier Y, Steib A, Ickx B, et al. Haemostatic disorders during liver transplantation. *Eur J Anaesthesiol* 2001;18:208-218.
91. Chalmers TC, Bigelow FS, Desforges JF. The effects of massive gastrointestinal hemorrhage on hemostasis. II. Coagulation factors. *J Lab Clin Med* 1954;43:511-517.
92. Spector I, Corn M. Laboratory tests of hemostasis. The relation to hemorrhage in liver disease. *Arch Intern Med* 1967;119:577-582.
93. O'Grady JG, Alexander GJ, Hayllar KM, Williams R. Early indicators of prognosis in fulminant hepatic failure. *Gastroenterology* 1989;97:439-445.
94. Ewe K. Bleeding after liver biopsy does not correlate with indices of peripheral coagulation. *Dig Dis Sci* 1981;26:388-393.

95. McGill DB. Predicting hemorrhage after liver biopsy. *Dig Dis Sci* 1981; 26:385–387.
96. Lehman CM, Blaylock RC, Alexander DP, Rodgers GM. Discontinuation of the bleeding time test without detectable adverse clinical impact. *Clin Chem* 2001;47:1204–1211.
97. Deitcher SR. Interpretation of the international normalised ratio in patients with liver disease. *Lancet* 2002;359:47–48.
98. McVay PA, Toy PT. Lack of increased bleeding after liver biopsy in patients with mild hemostatic abnormalities. *Am J Clin Pathol* 1990;94:747–753.
99. Blatt PM, Lundblad RL, Kingdon HS, et al. Thrombogenic materials in prothrombin complex concentrates. *Ann Intern Med* 1974;81:766–770.
100. White GC II, Roberts HR, Kingdon HS, Lundblad RL. Prothrombin complex concentrates: potentially thrombogenic materials and clues to the mechanism of thrombosis in vivo. *Blood* 1977;49:159–170.
101. Liebman HA, McGehee WG, Patch MJ, Feinstein DI. Severe depression of antithrombin III associated with disseminated intravascular coagulation in women with fatty liver of pregnancy. *Ann Intern Med* 1983;98:330–333.
102. Mannucci PM, Vicente V, Vianello L, et al. Controlled trial of desmopressin in liver cirrhosis and other conditions associated with a prolonged bleeding time. *Blood* 1986;67:1148–1153.
103. de Franchis R, Arcidiacono PG, Carpinelli L, et al. Randomized controlled trial of desmopressin plus terlipressin vs. terlipressin alone for the treatment of acute variceal hemorrhage in cirrhotic patients: a multicenter, double-blind study. *New Italian Endoscopic Club. Hepatology* 1993;18:1102–1107.
104. Jeffers L, Chalasani N, Balart L, et al. Safety and efficacy of recombinant factor VIIa in patients with liver disease undergoing laparoscopic liver biopsy. *Gastroenterology* 2002;123:118–126.
105. Ejlersen E, Melsen T, Ingerslev J, et al. Recombinant activated factor VII (rFVIIa) acutely normalizes prothrombin time in patients with cirrhosis during bleeding from oesophageal varices. *Scand J Gastroenterol* 2001;36:1081–1085.
106. Hendriks HG, Meijer K, de Wolf JT, et al. Reduced transfusion requirements by recombinant factor VIIa in orthotopic liver transplantation: a pilot study. *Transplantation* 2001;71:402–405.
107. Bernstein D. Effectiveness of the recombinant factor VIIa in patients with the coagulopathy of advanced child's B and C cirrhosis. *Semin Thromb Hemost* 2000;26:437–438.
108. Grossi CE, Rousselot LM, Panke WF. Control of fibrinolysis during portacaval shunts. *JAMA* 1964;187:1005–1008.
109. Naeye RL. Thrombotic state after a hemorrhagic diathesis, a possible complication of therapy with epsilon-aminocaproic acid. *Blood* 1962;19:694–701.
110. Kasper CK, Dietrich SL. Comprehensive management of haemophilia. *Clin Haematol* 1985;14:489–512.
111. Colman RW, Robboy SJ, Minna JD. Disseminated intravascular coagulation: a reappraisal. *Annu Rev Med* 1979;30:359–374.
112. Muller-Berghaus G. Pathophysiologic and biochemical events in disseminated intravascular coagulation: dysregulation of procoagulant and anticoagulant pathways. *Semin Thromb Hemost* 1989;15:58–87.
113. Baglin T. Disseminated intravascular coagulation: diagnosis and treatment. *BMJ* 1996;312:683–687.
114. Carey MJ, Rodgers GM. Disseminated intravascular coagulation: clinical and laboratory aspects. *Am J Hematol* 1998;59:65–73.

115. Levi M, ten Cate H. Disseminated intravascular coagulation. *N Engl J Med* 1999;341:586–592.
116. Siegal T, Seligsohn U, Aghai E, Modan M. Clinical and laboratory aspects of disseminated intravascular coagulation (DIC): a study of 118 cases. *Thromb Haemost* 1978;39:122–134.
117. Jacobson RJ, Jackson DP. Erythrocyte fragmentation in defibrination syndromes. *Ann Intern Med* 1974;81:207–209.
118. Okajima K, Sakamoto Y, Uchiba M. Heterogeneity in the incidence and clinical manifestations of disseminated intravascular coagulation: a study of 204 cases. *Am J Hematol* 2000;65:215–222.
119. Shibolet S, Coll R, Gilat T, Sohar E. Heatstroke: its clinical picture and mechanism in 36 cases. *QJM* 1967;36:525–548.
120. Corrigan JJ, Jr. Studies on the coagulation and fibrinolytic systems in “autoimmune” disease. *Am J Dis Child* 1970;120:324–328.
121. Amris CJ, Hansen NE. Coagulation and fibrinolytic studies in paroxysmal nocturnal haemoglobinuria. *Acta Med Scand* 1968;184:551–559.
122. Sack GH, Jr., Levin J, Bell WR. Trousseau’s syndrome and other manifestations of chronic disseminated coagulopathy in patients with neoplasms: clinical, pathophysiologic, and therapeutic features. *Medicine (Baltimore)* 1977;56:1–37.
123. Sutton DM, Hauser R, Kulapongs P, Bachmann F. Intravascular coagulation in abruptio placentae. *Am J Obstet Gynecol* 1971;109:604–614.
124. Yaffe H, Hay-Am E, Sadovsky E. Thromboplastic activity of amniotic fluid in term and postmature gestations. *Obstet Gynecol* 1981;57:490–492.
125. Dvorak HF, Van DeWater L, Bitzer AM, et al. Procoagulant activity associated with plasma membrane vesicles shed by cultured tumor cells. *Cancer Res* 1983;43:4434–4442.
126. Rickles FR, Edwards RL. Activation of blood coagulation in cancer: Trousseau’s syndrome revisited. *Blood* 1983;62:14–31.
127. Callander N, Rapaport SI. Trousseau’s syndrome. *West J Med* 1993;158:364–371.
128. Gordon SG, Cross BA. A factor X-activating cysteine protease from malignant tissue. *J Clin Invest* 1981;67:1665–1671.
129. Fullerton WW, Boggust WA, O’Meara RA. Antithromboplastic and thromboplastic activities of fatty acids. *J Clin Pathol* 1967;20:624–628.
130. Gralnick HR, Abrell E. Studies of the procoagulant and fibrinolytic activity of promyelocytes in acute promyelocytic leukaemia. *Br J Haematol* 1973;24:89–99.
131. Plow EF. Leukocyte elastase release during blood coagulation. A potential mechanism for activation of the alternative fibrinolytic pathway. *J Clin Invest* 1982;69:564–572.
132. Menell JS, Cesarman GM, Jacovina AT, et al. Annexin II and bleeding in acute promyelocytic leukemia. *N Engl J Med* 1999;340:994–1004.
133. McKay DG. Trauma and disseminated intravascular coagulation. *J Trauma* 1969;9:646–660.
134. Attar S, Boyd D, Layne E, et al. Alterations in coagulation and fibrinolytic mechanisms in acute trauma. *J Trauma* 1969;9:939–965.
135. Goodnight SH, Kenoyer G, Rapaport SI, et al. Defibrination after brain-tissue destruction: a serious complication of head injury. *N Engl J Med* 1974;290: 1043–1047.
136. van Ginkel CJ, van Aken WG, Oh JI, Vreeken J. Stimulation of monocyte procoagulant activity by

adherence to different surfaces. *Br J Haematol* 1977;37:35-45.

137. Edgington TS. Recognition coupled responses of the monocyte: activation of coagulation pathways. *Nouv Rev Fr Hematol* 1983;25:1-6.
138. Osterud B, Flaegstad T. Increased tissue thromboplastin activity in monocytes of patients with meningococcal infection: related to an unfavourable prognosis. *Thromb Haemost* 1983;49:5-7.
139. Edwards RL, Rickles FR. Macrophage procoagulants. *Prog Hemost Thromb* 1984;7:183-209.
140. Lyberg T, Prydz H. Thromboplastin (factor III) activity in human monocytes induced by immune complexes. *Eur J Clin Invest* 1982;12:229-234.
141. Muhlfelder TW, Niemetz J, Kreutzer D, et al. C5 chemotactic fragment induces leukocyte production of tissue factor activity: a link between complement and coagulation. *J Clin Invest* 1979;63:147-150.
142. Zuckerman SH, Suprenant YM. Induction of endothelial cell/macrophage procoagulant activity: synergistic stimulation by gamma interferon and granulocyte-macrophage colony stimulating factor. *Thromb Haemost* 1989;61:178-182.
143. Schwartz BS, Edgington TS. Lymphocyte collaboration is required for induction of murine monocyte procoagulant activity by immune complexes. *J Immunol* 1981;127:438-443.
144. Osterud B, Eskeland T. The mandatory role of complement in the endotoxin-induced synthesis of tissue thromboplastin in blood monocytes. *FEBS Lett* 1982;149:75-79.
145. Rothberger H, McGee MP. Generation of coagulation factor V activity by cultured rabbit alveolar macrophages. *J Exp Med* 1984;160:1880-1890.
146. Shands JW, Jr. The endotoxin-induced procoagulant of mouse exudate macrophages: a factor-X activator. *Blood* 1983;62:333-340.
147. Drake TA, Cheng J, Chang A, Taylor FB, Jr. Expression of tissue factor, thrombomodulin, and E-selectin in baboons with lethal *Escherichia coli* sepsis. *Am J Pathol* 1993;142:1458-1470.
148. Hack CE, Zeerleder S. The endothelium in sepsis: source of and a target for inflammation. *Crit Care Med* 2001;29:S21-27.
149. Combes V, Simon AC, Grau GE, et al. In vitro generation of endothelial microparticles and possible prothrombotic activity in patients with lupus anticoagulant. *J Clin Invest* 1999;104:93-102.
150. Nieuwland R, Berckmans RJ, McGregor S, et al. Cellular origin and procoagulant properties of microparticles in meningococcal sepsis. *Blood* 2000;95:930-935.
151. Pixley RA, De La Cadena R, Page JD, et al. The contact system contributes to hypotension but not disseminated intravascular coagulation in lethal bacteremia. In vivo use of a monoclonal anti-factor XII antibody to block contact activation in baboons. *J Clin Invest* 1993;91:61-68.
152. Schapira M, Ramus MA, Waeber B, et al. Protection by recombinant a1-antitrypsin Ala357 Arg358 against arterial hypotension induced by factor XII fragment. *J Clin Invest* 1987;80:582-585.
153. Mason JW, Colman RW. The role of Hageman factor in disseminated intravascular coagulation induced by septicemia, neoplasia, or liver disease. *Thromb Diath Haemorrh* 1971;26:325-331.
154. McGrath JM, Stewart GJ. The effects of endotoxin on vascular endothelium. *J Exp Med* 1969;129:833-848.
155. Colucci M, Balconi G, Lorenzet R, et al. Cultured human endothelial cells generate tissue factor in response to endotoxin. *J Clin Invest* 1983;71:1893-1896.
156. Rodriguez-Erdmann F, Naimi S. Studies on the pathogenesis of the generalized Shwartzman reaction. IV. Production of a Shwartzman-like phenomenon with autoprothrombin-C. *Thromb Diath Haemorrh*

1967;17:156–164.

157. Rodriguez-Erdmann F. Intravascular activation of the clotting system with phospholipids. Production of the generalized Shwartzman reaction with platelet factor 3. *Blood* 1965;26:541–553.

158. Gurewich V, Lipinski B, Wetmore R. A study of the large heparin requirements in the generalized Shwartzman reaction. *Blood* 1976;47:297–304.

159. Kramer W, Muller-Berghaus G. Effect of platelet antiserum on the activation of intravascular coagulation by endotoxin. *Thromb Res* 1977;10:47–70.

160. Hawley HB, Yamada T, Mosher DF, et al. Disseminated intravascular coagulopathy during experimental pneumococcal sepsis: studies in normal and asplenic rhesus monkeys. *J Med Primatol* 1977;6:203–218.

161. Dennis LH, Eichelberger JW, Inman MM, Conrad ME. Depletion of coagulation factors in drug-resistant *Plasmodium falciparum* malaria. *Blood* 1967;29:713–721.

162. Hillman RS, Phillips LL. Clotting–fibrinolysis in a cavernous hemangioma. *Am J Dis Child* 1967;113:649–653.

163. Bieger R, Vreeken J, Stibbe J, Loeliger EA. Arterial aneurysm as a cause of consumption coagulopathy. *N Engl J Med* 1971;285:152–154.

164. Kaplan JE, Malik AB. Thrombin-induced intravascular coagulation: role in vascular injury. *Semin Thromb Hemost* 1987;13:398–415.

165. Bone RC, Francis PB, Pierce AK. Intravascular coagulation associated with the adult respiratory distress syndrome. *Am J Med* 1976;61:585–589.

166. Kornalik F, Blomback B. Prothrombin activation induced by Ecarin—a prothrombin converting enzyme from *Echis carinatus* venom. *Thromb Res* 1975;6:57–63.

167. Gold BS, Dart RC, Barish RA. Bites of venomous snakes. *N Engl J Med* 2002;347:347–356.

168. Pirkle H. Thrombin-like enzymes from snake venoms: an updated inventory. Scientific and Standardization Committee's Registry of Exogenous Hemostatic Factors. *Thromb Haemost* 1998;79:675–683.

169. Markland FS, Jr. Snake venom fibrinogenolytic and fibrinolytic enzymes: an updated inventory. Registry of Exogenous Hemostatic Factors of the Scientific and Standardization Committee of the International Society on Thrombosis and Haemostasis. *Thromb Haemost* 1998;79:668–674.

170. Matsui T, Fujimura Y, Titani K. Snake venom proteases affecting hemostasis and thrombosis. *Biochim Biophys Acta* 2000;1477:146–156.

171. Manjunatha Kini R, Morita T, Rosing J. Classification and nomenclature of prothrombin activators isolated from snake venoms. *Thromb Haemost* 2001;86:710–711.

172. Harker LA, Slichter SJ. Platelet and fibrinogen consumption in man. *N Engl J Med* 1972;287:999–1005.

173. Cooper HA, Bowie EJ, Didisheim P, Owen CA, Jr. Paradoxical changes in platelets and fibrinogen in chronically induced intravascular coagulation. *Mayo Clin Proc* 1971;46:521–523.

174. Rapaport SI, Hjort PF, Patch MJ, Jeremic M. Consumption of serum factors and prothrombin during intravascular clotting in rabbits. *Scand J Haematol* 1966;3:59–75.

175. Spero JA, Lewis JH, Hasiba U. Disseminated intravascular coagulation. Findings in 346 patients. *Thromb Haemost* 1980;43:28–33.

176. Braunstein KM, Eurenus K. Minimal heparin cofactor activity in disseminated intravascular

coagulation and cirrhosis. *Am J Clin Pathol* 1976;66:488–494.

177. Aoki N, Moroi M, Matsuda M, Tachiya K. The behavior of  $\alpha_2$ -plasmin inhibitor in fibrinolytic states. *J Clin Invest* 1977;60:361–369.

178. Velasco F, Torres A, Andres P, Duran MI. Functional activities and concentrations of plasmin inhibitors in normal subjects and D.I.C. patients. *Thromb Haemost* 1982;47:275–277.

179. Mason JW, Kleeberg U, Dolan P, Colman RW. Plasma kallikrein and Hageman factor in gram-negative bacteremia. *Ann Intern Med* 1970;73:545–551.

180. Rubenberg ML, Regoeczi E, Bull BS, et al. Microangiopathic haemolytic anaemia: the experimental production of haemolysis and red-cell fragmentation by defibrination in vivo. *Br J Haematol* 1968;14:627–642.

181. Lohrmann HP, Adam W, Heymer B, Kubanek B. Microangiopathic hemolytic anemia in metastatic carcinoma. Report of eight cases. *Ann Intern Med* 1973;79:368–375.

182. Ogston D, Ogston CM, Ratnoff OD, Forbes CD. Studies on a complex mechanism for the activation of plasminogen by kaolin and by chloroform: the participation of Hageman factor and additional cofactors. *J Clin Invest* 1969;48:1786–1801.

183. Beller FK, Douglas GW, Debrovner CH, Robinson R. The fibrinolytic system in amniotic fluid embolism. *Am J Obstet Gynecol* 1963;87:48–55.

184. Kwaan HC, Barlow GH. Nature and biological activities of degradation products of fibrinogen and fibrin. *Annu Rev Med* 1973;24:335–344.

185. Alkjaersig N, Fletcher AP, Sherry S. Pathogenesis of the coagulation defect developing during pathological plasma proteolytic (“fibrinolytic”) states: II. The significance, mechanism and consequences of defective fibrin polymerization. *J Clin Invest* 1962;41:917–934.

186. Bang NU, Fletcher AP, Alkjaersig N, Sherry S. Pathogenesis of the coagulation defect developing during pathological plasma proteolytic (“fibrinolytic”) states. III. Demonstration of abnormal clot structure by electron microscopy. *J Clin Invest* 1962;41:935–948.

187. Rinaldo JE, Rogers RM. Adult respiratory-distress syndrome: changing concepts of lung injury and repair. *N Engl J Med* 1982;306:900–909.

188. Martin TR, Sandblom RL, Johnson RJ. Adult respiratory distress syndrome following thrombolytic therapy for pulmonary embolism. *Chest* 1983;83: 151–153.

189. Kumar-Basu H. Fibrinolysis and abruptio placentae. *J Obstet Gynaecol Br Commonw* 1969;76:481–496.

190. Gans H, Lowman JT. The uptake of fibrin and fibrin-degradation products by the isolated perfused rat liver. *Blood* 1967;29:526–539.

191. Sherman LA, Lee J, Jacobson A. Quantitation of the reticuloendothelial system clearance of soluble fibrin. *Br J Haematol* 1977;37:231–238.

192. Emeis JJ, Lindeman J. Rat liver macrophages will not phagocytose fibrin during disseminated intravascular coagulation. *Haemostasis* 1976;5:193–210.

193. Lee L. Reticuloendothelial clearance of circulating fibrin in the pathogenesis of the generalized Schwartzman reaction. *J Exp Med* 1962;115:1065–1082.

194. Oka K, Shimamura K, Nakazawa M, et al. The role of Kupffer’s cells in disseminated intravascular coagulation. A morphologic study in thrombin-infused rabbits. *Arch Pathol Lab Med* 1983;107:570–576.

195. Deykin D, Cochios F, DeCamp G, Lopez A. Hepatic removal of activated factor X by the perfused rabbit liver. *Am J Physiol* 1968;214:414–419.

196. Ahlgren T, Berghem L, Lagergren H, et al. Phagocytic and catabolic function of the reticuloendothelial system in dogs subjected to defibrinogenation. *Thromb Res* 1976;8:819–828.
197. Kleiner GJ, Merskey C, Johnson AJ, Markus WB. Defibrination in normal and abnormal parturition. *Br J Haematol* 1970;19:159–178.
198. Deykin D. The clinical challenge of disseminated intravascular coagulation. *N Engl J Med* 1970;283:636–644.
199. Greenberg CS, Devine DV, McCrae KM. Measurement of plasma fibrin D–dimer levels with the use of a monoclonal antibody coupled to latex beads. *Am J Clin Pathol* 1987;87:94–100.
200. Calverly DC, Liebman HA. Disseminated intravascular coagulation. In: Hoffman R, Benz EJ, Shattil SJ, eds. *Hematology: basic principles and practice*, 3rd ed. New York: Churchill Livingstone, 2000:1983–1995.
201. Toh CH, Samis J, Downey C, et al. Biphasic transmittance waveform in the APTT coagulation assay is due to the formation of a Ca(++)–dependent complex of C–reactive protein with very–low–density lipoprotein and is a novel marker of impending disseminated intravascular coagulation. *Blood* 2002;100:2522–2529.
202. Visudhiphan S, Piankijagum A, Sathayapraseart P, Mitrchai N. Erythrocyte fragmentation in disseminated intravascular coagulation and other diseases. *N Engl J Med* 1983;309:113.
203. Merskey C, Johnson AJ, Kleiner GJ, Wohl H. The defibrination syndrome: clinical features and laboratory diagnosis. *Br J Haematol* 1967;13:528–549.
204. Corrigan JJ, Jr., Jordan CM. Heparin therapy in septicemia with disseminated intravascular coagulation. *N Engl J Med* 1970;283:778–782.
205. Niemetz J, Nossel HL. Activated coagulation factors: in–vivo and in–vitro studies. *Br J Haematol* 1969;16:337–351.
206. Giles AR, Nesheim ME, Mann KG. Studies of factors V and VIII:C in an animal model of disseminated intravascular coagulation. *J Clin Invest* 1984;74:2219–2225.
207. Marder VJ, Budzynski AZ. Degradation products of fibrinogen and crosslinked fibrin–projected clinical applications. *Thromb Diath Haemorrh* 1974;32:49–56.
208. Whitaker AN, Rowe EA, Masci PP, Gaffney PJ. Identification of D dimer–E complex in disseminated intravascular coagulation. *Thromb Res* 1980;18:453–459.
209. Carr JM, McKinney M, McDonagh J. Diagnosis of disseminated intravascular coagulation. Role of D–dimer. *Am J Clin Pathol* 1989;91:280–287.
210. Niewiarowski S, Gurewich V. Laboratory identification of intravascular coagulation. The serial dilution protamine sulfate test for the detection of fibrin monomer and fibrin degradation products. *J Lab Clin Med* 1971;77:665–676.
211. Nossel HL. Radioimmunoassay of fibrinopeptides in relation to intravascular coagulation and thrombosis. *N Engl J Med* 1976;295:428–432.
212. Kisker CT, Rush R. Detection of intravascular coagulation. *J Clin Invest* 1971;50:2235–2241.
213. Tanaka H, Kobayashi N, Maekawa T. Studies on production of antithrombin III with special reference to endotoxin–induced DIC in dogs. *Thromb Haemost* 1986;56:137–143.
214. Thijs LG, de Boer JP, de Groot MC, Hack CE. Coagulation disorders in septic shock. *Intensive Care Med* 1993;19[Suppl 1]:S8–15.
215. Wada H, Yamamuro M, Inoue A, et al. Comparison of the responses of global tests of coagulation with molecular markers of neutrophil, endothelial, and hemostatic system perturbation in the baboon model of *E. coli* sepsis—toward a distinction between uncompensated overt DIC and compensated non–overt DIC.



Thromb Haemost 2001;86:1489–1494.

216. Taylor FB, Jr., Toh CH, Hoots WK, et al. Towards definition, clinical and laboratory criteria, and a scoring system for disseminated intravascular coagulation. *Thromb Haemost* 2001;86:1327–1330.

217. Kim HS, Suzuki M, Lie JT, Titus JL. Clinically unsuspected disseminated intravascular coagulation (DIC): an autopsy survey. *Am J Clin Pathol* 1976;66:31–39.

218. Porter JM, Silver D. Alterations in fibrinolysis and coagulation associated with cardiopulmonary bypass. *J Thorac Cardiovasc Surg* 1968;56:869–878.

219. Feinstein DI. Diagnosis and management of disseminated intravascular coagulation: the role of heparin therapy. *Blood* 1982;60:284–287.

220. Gurewich V, Lipinski B. Case report: low-dose intravenous heparin in the treatment of disseminated intravascular coagulation. *Am J Med Sci* 1977;274:83–86.

221. Bick RL, Schmalhorst WR, Fekete L. Disseminated intravascular coagulation and blood component therapy. *Transfusion* 1976;16:361–365.

222. Ness PM, Perkins HA. Cryoprecipitate as a reliable source of fibrinogen replacement. *JAMA* 1979;241:1690–1691.

223. Pitney WR. Disseminated intravascular coagulation. *Semin Hematol* 1971; 8:65–83.

224. Schipper HG, Jenkins CS, Kahle LH, ten Cate JW. Antithrombin-III transfusion in disseminated intravascular coagulation. *Lancet* 1978;1:854–856.

225. Lechner K, Kyrle PA. Antithrombin III concentrates—are they clinically useful? *Thromb Haemost* 1995;73:340–348.

226. Warren BL, Eid A, Singer P, et al. Caring for the critically ill patient. High-dose antithrombin III in severe sepsis: a randomized controlled trial. *JAMA* 2001;286:1869–1878.

227. Pritchard JA. Treatment of the defibrination syndromes of pregnancy. *Mod Treat* 1968;5:401–422.

228. Pritchard JA, Brekken AL. Clinical and laboratory studies on severe abruptio placentae. *Am J Obstet Gynecol* 1967;97:681–700.

229. Sher G, Statland BE. Abruptio placentae with coagulopathy: a rational basis for management. *Clin Obstet Gynecol* 1985;28:15–23.

230. Barbara C, Hirsh J. Severe post-partum bleeding in abruptio placentae: failure to respond to fibrinogen infusion. *Med J Aust* 1968;2:1182–1184.

231. Strauss JH, Ballard JO, Chamlian D. Consumption coagulopathy associated with intrauterine fetal death: the role of heparin therapy. *Int J Gynaecol Obstet* 1978;16:225–227.

232. Beller FK, Uszynski M. Disseminated intravascular coagulation in pregnancy. *Clin Obstet Gynecol* 1974;17:250–278.

233. Bonnar J. Blood coagulation and fibrinolysis in obstetrics. *Clin Haematol* 1973;2:213–233.

234. Gilbert WM, Danielsen B. Amniotic fluid embolism: decreased mortality in a population-based study. *Obstet Gynecol* 1999;93:973–977.

235. Owen CA, Jr., Bowie EJ. Chronic intravascular coagulation syndromes. A summary. *Mayo Clin Proc* 1974;49:673–679.

236. Laros RK, Jr., Penner JA. Pathophysiology of disseminated intravascular coagulation in saline-induced abortion. *Obstet Gynecol* 1976;48:353–356.

237. Burkman RT, Bell WR, Atienza MF, King TM. Coagulopathy with midtrimester induced abortion:

- association with hyperosmolar urea administration. *Am J Obstet Gynecol* 1977;127:533–536.
238. Whaun JM, Oski FA, Urmson J. Experience with disseminated intravascular coagulation in a children's hospital. *Can Med Assoc J* 1972;107:963–967.
239. Suzuki S, Morishita S. Hypercoagulability and DIC in high-risk infants. *Semin Thromb Hemost* 1998;24:463–466.
240. Moore CM, McAdams AJ, Sutherland J. Intrauterine disseminated intravascular coagulation: a syndrome of multiple pregnancy with a dead twin fetus. *J Pediatr* 1969;74:523–528.
241. Hathaway WE, Mull MM, Pechet GS. Disseminated intravascular coagulation in the newborn. *Pediatrics* 1969;43:233–240.
242. Gross SJ, Filston HC, Anderson JC. Controlled study of treatment for disseminated intravascular coagulation in the neonate. *J Pediatr* 1982;100:445–448.
243. Kreuz W, Veldmann A, Fischer D, et al. Neonatal sepsis: a challenge in hemostaseology. *Semin Thromb Hemost* 1999;25:531–535.
244. Spicer TE, Rau JM. Purpura fulminans. *Am J Med* 1976;61:566–571.
245. Neame PB, Kelton JG, Walker IR, et al. Thrombocytopenia in septicemia: the role of disseminated intravascular coagulation. *Blood* 1980;56:88–92.
246. Bernard GR, Vincent JL, Laterre PF, et al. Efficacy and safety of recombinant human activated protein C for severe sepsis. *N Engl J Med* 2001;344:699–709.
247. Dudgeon DL, Kellogg DR, Gilchrist GS, Woolley MM. Purpura fulminans. *Arch Surg* 1971;103:351–358.
248. Gamper G, Oschatz E, Herkner H, et al. Sepsis-associated purpura fulminans in adults. *Wien Klin Wochenschr* 2001;113:107–112.
249. Smith OP, White B. Infectious purpura fulminans: diagnosis and treatment. *Br J Haematol* 1999;104:202–207.
250. Sallah S, Wan JY, Nguyen NP, et al. Disseminated intravascular coagulation in solid tumors: clinical and pathologic study. *Thromb Haemost* 2001;86:828–833.
251. Thodiyil PA, Kakkar AK. Variation in relative risk of venous thromboembolism in different cancers. *Thromb Haemost* 2002;87:1076–1077.
252. Walsh-McMonagle D, Green D. Low-molecular-weight heparin in the management of Trousseau's syndrome. *Cancer* 1997;80:649–655.
253. Eikelboom JW, Baker RI. Low-molecular-weight heparin for the treatment of venous thrombosis in patients with adenocarcinoma. *Am J Hematol* 1998;59:260–261.
254. Valentine KA, Hull RD, Pineo GF. Low-molecular-weight heparin therapy and mortality. *Semin Thromb Hemost* 1997;23:173–178.
255. Litt MR, Bell WR, Lepor HA. Disseminated intravascular coagulation in prostatic carcinoma reversed by ketoconazole. *JAMA* 1987;258:1361–1362.
256. Martinez JF, Taberero Redondo MD, Alberca Silva I, Lopez-Borrascas A. Disseminated intravascular coagulation in prostatic carcinoma reversed by antiandrogenic therapy. *JAMA* 1988;260:2507.
257. Baker WE, Bang NU, Nachman RL, et al. Hypofibrinogenemic hemorrhage in acute myelogenous leukemia treated with heparin, with autopsy findings of widespread intravascular clotting. *Ann Intern Med* 1964;61:116–123.
258. Sultan C, Heilmann-Gouault M, Tulliez M. Relationship between blast-cell morphology and

- occurrence of a syndrome of disseminated intravascular coagulation. *Br J Haematol* 1973;24:255–259.
259. Tallman MS, Kwaan HC. Reassessing the hemostatic disorder associated with acute promyelocytic leukemia. *Blood* 1992;79:543–553.
260. Kaplan R, De La Cadena RA. Mechanism of the coagulopathy associated with acute promyelocytic leukemia—clinical conference. *Am J Hematol* 1998;59:234–237.
261. Schwartz BS, Williams EC, Conlan MG, Mosher DF. Epsilon-aminocaproic acid in the treatment of patients with acute promyelocytic leukemia and acquired a-2-plasmin inhibitor deficiency. *Ann Intern Med* 1986;105:873–877.
262. Warrell RP, Jr., Frankel SR, Miller WH, Jr., et al. Differentiation therapy of acute promyelocytic leukemia with tretinoin (all-trans-retinoic acid). *N Engl J Med* 1991;324:1385–1393.
263. Tallman MS, Nabhan C, Feusner JH, Rowe JM. Acute promyelocytic leukemia: evolving therapeutic strategies. *Blood* 2002;99:759–767.
264. Soignet SL, Maslak P, Wang ZG, et al. Complete remission after treatment of acute promyelocytic leukemia with arsenic trioxide. *N Engl J Med* 1998;339:1341–1348.
265. Hall GW. Kasabach–Merritt syndrome: pathogenesis and management. *Br J Haematol* 2001;112:851–862.
266. Warrell RP, Jr., Kempin SJ. Treatment of severe coagulopathy in the Kasabach–Merritt syndrome with aminocaproic acid and cryoprecipitate. *N Engl J Med* 1985;313:309–312.
267. Ortel TL, Onorato JJ, Bedrosian CL, Kaufman RE. Antifibrinolytic therapy in the management of the Kasabach Merritt syndrome. *Am J Hematol* 1988;29:44–48.
268. Cummins D, Segal H, Hunt BJ, et al. Chronic disseminated intravascular coagulation after surgery for abdominal aortic aneurysm: clinical and haemostatic response to dalteparin. *Br J Haematol* 2001;113:658–660.
269. Hehne HJ, Nyman D, Burri H, Wolff G. Management of bleeding disorders in traumatic–haemorrhagic shock states with deep frozen fresh plasma. *Eur J Intensive Care Med* 1976;2:157–161.
270. McManus WF, Eurenium K, Pruitt BA, Jr. Disseminated intravascular coagulation in burned patients. *J Trauma* 1973;13:416–422.
271. Goldfinger D. Acute hemolytic transfusion reactions—a fresh look at pathogenesis and considerations regarding therapy. *Transfusion* 1977;17:85–98.
272. Rock RC, Bove JR, Nemerson Y. Heparin treatment of intravascular coagulation accompanying hemolytic transfusion reactions. *Transfusion* 1969;9:57–61.
273. Hasiba U, Rosenbach LM, Rockwell D, Lewis JH. DIC-like syndrome after envenomation by the snake, *Crotalus horridus horridus*. *N Engl J Med* 1975;292:505–507.
274. Markland FS, Pirkle H. Thrombin-like enzyme from the venom of *Crotalus adamanteus* (eastern diamondback rattlesnake). *Thromb Res* 1977;10:487–494.
275. Schmaier AH, Claypool W, Colman RW. Crotalocytin: recognition and purification of a timber rattlesnake platelet aggregating protein. *Blood* 1980;56: 1013–1019.
276. Budzynski AZ, Pandya BV, Rubin RN, et al. Fibrinogenolytic afibrinogen–emia after envenomation by western diamondback rattlesnake ( *Crotalus atrox*). *Blood* 1984;63:1–14.
277. Warrell DA, Pope HM, Prentice CR. Disseminated intravascular coagulation caused by the carpet viper ( *Echis carinatus*): trial of heparin. *Br J Haematol* 1976;33:335–342.
278. Kim HS, Suzuki M, Lie JT, Titus JL. Nonbacterial thrombotic endocarditis (NBTE) and disseminated

intravascular coagulation (DIC): autopsy study of 36 patients. *Arch Pathol Lab Med* 1977;101:65–68.

279. Svartholm E, Haglund U, Ljungberg J, Hedner U. Influence of aprotinin, a protease inhibitor, on porcine *E. coli* shock. Studies on coagulation, fibrinolytic and hemodynamic response. *Acta Chir Scand* 1989;155:7–13.

280. Umeki S, Adachi M, Watanabe M, et al. Gabexate as a therapy for disseminated intravascular coagulation. *Arch Intern Med* 1988;148:1409–1412.

281. Sundt TM III, Kouchoukos NT, Saffitz JE, et al. Renal dysfunction and intravascular coagulation with aprotinin and hypothermic circulatory arrest. *Ann Thorac Surg* 1993;55:1418–1424.

282. Key NS, Bach RR. Tissue factor as a therapeutic target. *Thromb Haemost* 2001;85:375–376.

283. Levi M, ten Cate H, Bauer KA, et al. Inhibition of endotoxin-induced activation of coagulation and fibrinolysis by pentoxifylline or by a monoclonal anti-tissue factor antibody in chimpanzees. *J Clin Invest* 1994;93:114–120.

284. Taylor FB, Jr., Chang A, Ruf W, et al. Lethal *E. coli* septic shock is prevented by blocking tissue factor with monoclonal antibody. *Circ Shock* 1991;33:127–134.

285. Dackiw AP, McGilvray ID, Woodside M, et al. Prevention of endotoxin-induced mortality by antitissue factor immunization. *Arch Surg* 1996;131: 1273–1278; discussion 1278–1279.

286. Drollinger AG, Netser JC, Rodgers GM. Dithiocarbamates ameliorate the effects of endotoxin in a rabbit model of disseminated intravascular coagulation. *Semin Thromb Hemost* 1999;25:429–433.

287. Bajaj MS, Bajaj SP. Tissue factor pathway inhibitor: potential therapeutic applications. *Thromb Haemost* 1997;78:471–477.

288. Abraham E, Reinhart K, Svoboda P, et al. Assessment of the safety of recombinant tissue factor pathway inhibitor in patients with severe sepsis: a multicenter, randomized, placebo-controlled, single-blind, dose escalation study. *Crit Care Med* 2001;29:2081–2089.

289. Kaufman M. Drugwatch—blood disorders. *Formulary* 2002;37:486.

290. Taylor FB, Jr., Chang A, Esmon CT, et al. Protein C prevents the coagulopathic and lethal effects of *Escherichia coli* infusion in the baboon. *J Clin Invest* 1987;79:918–925.

291. White B, Livingstone W, Murphy C, et al. An open-label study of the role of adjuvant hemostatic support with protein C replacement therapy in purpura fulminans-associated meningococemia. *Blood* 2000;96:3719–3724.

292. Yan SB, Dhainaut JF. Activated protein C versus protein C in severe sepsis. *Crit Care Med* 2001;29:S69–74.

293. Zacharski LR, Memoli VA, Ornstein DL, et al. Tumor cell procoagulant and urokinase expression in carcinoma of the ovary. *J Natl Cancer Inst* 1993;85:1225–1230.

294. Bennett B, Croll AM, Robbie LA, Herriot R. Tumour cell u-PA as a cause of fibrinolytic bleeding in metastatic disease. *Br J Haematol* 1997;99:570–574.

295. Bell WR. The fibrinolytic system in neoplasia. *Semin Thromb Hemost* 1996;22:459–478.

296. Taylor RN, Lacey CG, Shuman MA. Adenocarcinoma of Skene's duct associated with a systemic coagulopathy. *Gynecol Oncol* 1985;22:250–256.

297. Kevy SV, Glickman RM, Bernhard WF, et al. The pathogenesis and control of the hemorrhagic defect in open heart surgery. *Surg Gynecol Obstet* 1966;123:313–318.

298. Illig KA, Green RM, Ouriel K, et al. Primary fibrinolysis during supraceliac aortic clamping. *J Vasc Surg* 1997;25:244–251; discussion 252–244.

299. Bidstrup BP, Royston D, Sapsford RN, Taylor KM. Reduction in blood loss and blood use after cardiopulmonary bypass with high dose aprotinin (Trasylol). *J Thorac Cardiovasc Surg* 1989;97:364–372.
300. Segal H, Hunt BJ. Aprotinin: pharmacological reduction of perioperative bleeding. *Lancet* 2000;355:1289–1290.
301. Lee MH, Vosburgh E, Anderson K, McDonagh J. Deficiency of plasma plasminogen activator inhibitor 1 results in hyperfibrinolytic bleeding. *Blood* 1993;81:2357–2362.
302. Aoki N, Saito H, Kamiya T, et al. Congenital deficiency of a 2-plasmin inhibitor associated with severe hemorrhagic tendency. *J Clin Invest* 1979;63:877–884.
303. Booth NA, Bennett B. Plasmin–a 2–antiplasmin complexes in bleeding disorders characterized by primary or secondary fibrinolysis. *Br J Haematol* 1984;56:545–556.
304. Marder VJ, Francis CW. Hyperfibrinolysis and therapy with antifibrinolytic agents. In: Beutler E, Lichtman MA, Coller BS, Kipps TJ, eds. *Williams hematology*, 5th ed. New York: McGraw–Hill, 1995:1517–1524.
305. Nilsson IM, Andersson L, Bjorkman SE. Epsilon–aminocaproic acid (E–ACA) as a therapeutic agent based on 5 years' clinical experience. *Acta Med Scand Suppl* 1966;448:1–46.
306. Sallah S, Gagnon GA. Reversion of primary hyperfibrinogenolysis in patients with hormone–refractory prostate cancer using docetaxel. *Cancer Invest* 2000;18:191–196.
307. Green D. Factor VIII and other coagulation factor inhibitors. In: Loscalzo J, Schafer AI, eds. *Thrombosis and hemorrhage*, 2nd ed. Philadelphia: Williams & Wilkins, 1998:803–815.
308. Margolius A, Jackson DP, Ratnoff OD. Circulating anticoagulants. A study of 40 cases and a review of the literature. *Medicine* 1961;40:145–202.
309. Kasper CK. Incidence and course of inhibitors among patients with classic hemophilia. *Thromb Diath Haemorrh* 1973;30:263–271.
310. Gill FM. The natural history of factor VIII inhibitors in patients with hemophilia A. In: Hoyer LW, ed. *Factor VIII inhibitors*. New York: Alan R. Liss, 1984:19–29.
311. McMillan CW, Shapiro SS, Whitehurst D, et al. The natural history of factor VIII:C inhibitors in patients with hemophilia A: a national cooperative study. II. Observations on the initial development of factor VIII:C inhibitors. *Blood* 1988;71:344–348.
312. Rasi V, Ikkala E. Haemophiliacs with factor VIII inhibitors in Finland: prevalence, incidence and outcome. *Br J Haematol* 1990;76:369–371.
313. Ehrenforth S, Kreuz W, Scharrer I, et al. Incidence of development of factor VIII and factor IX inhibitors in haemophiliacs. *Lancet* 1992;339:594–598.
314. Hay CR. Why do inhibitors arise in patients with haemophilia A? *Br J Haematol* 1999;105:584–590.
315. Schwartz RS, Abildgaard CF, Aledort LM, et al. Human recombinant DNA–derived antihemophilic factor (factor VIII) in the treatment of hemophilia A. Recombinant Factor VIII Study Group. *N Engl J Med* 1990;323:1800–1805.
316. Lusher JM. Current perspectives on the significance and interpretation of factor VIII and factor IX inhibitors. *Blood Coagul Fibrinolysis* 1991;2[Suppl 1]:3–5.
317. Lusher JM, Salzman PM. Viral safety and inhibitor development associated with factor VIII:C ultra–purified from plasma in hemophiliacs previously unexposed to factor VIII:C concentrates. The Monoclate Study Group. *Semin Hematol* 1990;27:1–7.
318. Lusher JM, Arkin S, Abildgaard CF, Schwartz RS. Recombinant factor VIII for the treatment of previously untreated patients with hemophilia A. Safety, efficacy, and development of inhibitors. *Kogenate*

Previously Untreated Patient Study Group. *N Engl J Med* 1993;328:453–459.

319. Hay CR, Ludlam CA, Colvin BT, et al. Factor VIII inhibitors in mild and moderate-severity haemophilia A. UK Haemophilia Centre Directors Organisation. *Thromb Haemost* 1998;79:762–766.
320. Goodeve AC, Williams I, Bray GL, Peake IR. Relationship between factor VIII mutation type and inhibitor development in a cohort of previously untreated patients treated with recombinant factor VIII (Recombinate). Recombinate PUP Study Group. *Thromb Haemost* 2000;83:844–848.
321. Lorenzo JI, Lopez A, Altisent C, Aznar JA. Incidence of factor VIII inhibitors in severe haemophilia: the importance of patient age. *Br J Haematol* 2001;113:600–603.
322. Morrison AE, Ludlam CA. Acquired haemophilia and its management. *Br J Haematol* 1995;89:231–236.
323. Shapiro SS, Hultin M. Acquired inhibitors to the blood coagulation factors. *Semin Thromb Hemost* 1975;1:336–385.
324. Green D, Lechner K. A survey of 215 non-hemophilic patients with inhibitors to factor VIII. *Thromb Haemost* 1981;45:200–203.
325. Soriano RM, Matthews JM, Guerado-Parra E. Acquired haemophilia and rheumatoid arthritis. *Br J Rheumatol* 1987;26:381–383.
326. Solymoss S. Postpartum acquired factor VIII inhibitors: results of a survey. *Am J Hematol* 1998;59:1–4.
327. Hauser I, Schneider B, Lechner K. Post-partum factor VIII inhibitors. A review of the literature with special reference to the value of steroid and immunosuppressive treatment. *Thromb Haemost* 1995;73:1–5.
328. Hultin MB. Acquired inhibitors in malignant and nonmalignant disease states. *Am J Med* 1991;91:9S–13S.
329. Hauser I, Lechner K. Solid tumors and factor VIII antibodies. *Thromb Haemost* 1999;82:1005–1007.
330. Sallah S, Nguyen NP, Abdallah JM, Hanrahan LR. Acquired hemophilia in patients with hematologic malignancies. *Arch Pathol Lab Med* 2000;124:730–734.
331. Moraca RJ, Ragni MV. Acquired anti-FVIII inhibitors in children. *Haemophilia* 2002;8:28–32.
332. Glazier RL, Crowell EB, Jr. Factor VIII inhibition associated with chlorpromazine-induced hepatic injury. *Thromb Haemost* 1977;37:523–526.
333. Poon MC, Saito H, Ratnoff OD, et al. Techniques for demonstration of the specificity of circulating anticoagulants against antihemophilic factor (factor VIII), with studies of two cases possibly related to diphenylhydantoin therapy. *Blood* 1977;49:477–482.
334. Bossi P, Cabane J, Ninet J, et al. Acquired hemophilia due to factor VIII inhibitors in 34 patients. *Am J Med* 1998;105:400–408.
335. Green D. Spontaneous inhibitors of factor VIII. *Br J Haematol* 1968;15:57–75.
336. Beck P, Giddings JC, Bloom AL. Inhibitor of factor VIII in mild haemophilia. *Br J Haematol* 1969;17:283–288.
337. Frommel D, Allain JP. Genetic predisposition to develop factor VIII antibody in classic hemophilia. *Clin Immunol Immunopathol* 1977;8:34–38.
338. Hay CR, Ollier W, Pepper L, et al. HLA class II profile: a weak determinant of factor VIII inhibitor development in severe haemophilia A. UKHCDO Inhibitor Working Party. *Thromb Haemost* 1997;77:234–237.
339. Tuddenham EG, McVey JH. The genetic basis of inhibitor development in haemophilia A. *Haemophilia* 1998;4:543–545.

340. Hoyer LW. Why do so many haemophilia A patients develop an inhibitor? *Br J Haematol* 1995;90:498–501.
341. Moreau A, Lacroix–Desmazes S, Stieltjes N, et al. Antibodies to the FVIII light chain that neutralize FVIII procoagulant activity are present in plasma of nonresponder patients with severe hemophilia A and in normal polyclonal human IgG. *Blood* 2000;95:3435–3441.
342. Sultan Y, Kazatchkine MD, Maisonneuve P, Nydegger UE. Anti–idiotypic suppression of autoantibodies to factor VIII (antihaemophilic factor) by high–dose intravenous gammaglobulin. *Lancet* 1984;2:765–768.
343. Feinstein DI, Rapaport SI, Chong MN. Immunologic characterization of 12 factor VIII inhibitors. *Blood* 1969;34:85–90.
344. Allain JP, Gaillandre A, Frommel D. Acquired haemophilia: functional study of antibodies to factor VIII. *Thromb Haemost* 1981;45:285–289.
345. Allain JP, Croissant MP, Lerolle D, et al. In vivo interactions of autoantibodies to factor VIII with the factor VIII complex. *Thromb Haemost* 1982;48:142–145.
346. Prescott R, Nakai H, Saenko EL, et al. The inhibitor antibody response is more complex in hemophilia A patients than in most nonhemophiliacs with factor VIII autoantibodies. Recombinate and Kogenate Study Groups. *Blood* 1997;89:3663–3671.
347. Scandella D, DeGraaf Mahoney S, Mattingly M, et al. Epitope mapping of human factor VIII inhibitor antibodies by deletion analysis of factor VIII fragments expressed in *Escherichia coli*. *Proc Natl Acad Sci U S A* 1988;85: 6152–6156.
348. Nogami K, Shima M, Giddings JC, et al. Circulating factor VIII immune complexes in patients with type 2 acquired hemophilia A and protection from activated protein C–mediated proteolysis. *Blood* 2001;97:669–677.
349. Gralnick HR, Flaum MA, Kessler CM, et al. IgA inhibitor to factor VIII/von Willebrand factor. *Br J Haematol* 1985;59:149–158.
350. Allain JP, Gaillandre A, Lee H. Immunochemical characterization of antibodies to factor VIII in hemophilic and nonhemophilic patients. *J Lab Clin Med* 1981;97:791–800.
351. Lazarchick J, Hoyer LW. The properties of immune complexes formed by human antibodies to factor VIII. *J Clin Invest* 1977;60:1070–1079.
352. Pool JG, Miller RG. Assay of the immune inhibitor in classic haemophilia: application of virus–antibody reaction kinetics. *Br J Haematol* 1972;22:517–528.
353. Gawryl MS, Hoyer LW. Inactivation of factor VIII coagulant activity by two different types of human antibodies. *Blood* 1982;60:1103–1109.
354. Biggs R, Austen DE, Denson KW, et al. The mode of action of antibodies which destroy factor VIII. I. Antibodies which have second–order concentration graphs. *Br J Haematol* 1972;23:125–135.
355. Biggs R, Austen DE, Denson KW, et al. The mode of action of antibodies which destroy factor VIII. II. Antibodies which give complex concentration graphs. *Br J Haematol* 1972;23:137–155.
356. Ewing NP, Kasper CK. In vitro detection of mild inhibitors to factor VIII in hemophilia. *Am J Clin Pathol* 1982;77:749–752.
357. Lacroix–Desmazes S, Moreau A, Sooryanarayana, et al. Catalytic activity of antibodies against factor VIII in patients with hemophilia A. *Nat Med* 1999;5:1044–1047.
358. Kasper CK, Aledort LM, Counts RB. A more uniform measurement of factor VIII inhibitors. *Thromb Diath Haemorrh* 1975;34:869–872.



359. Verbruggen B, Novakova I, Wessels H, et al. The Nijmegen modification of the Bethesda assay for factor VIII:C inhibitors: improved specificity and reliability. *Thromb Haemost* 1995;73:247–251.
360. Rizza CR, Biggs R. The treatment of patients who have factor-VIII antibodies. *Br J Haematol* 1973;24:65–82.
361. Kasper CK. Laboratory tests for factor VIII inhibitors, their variation, significance and interpretation. *Blood Coagul Fibrinolysis* 1991;2:7–10.
362. Giles AR, Verbruggen B, Rivard GE, et al. A detailed comparison of the performance of the standard versus the Nijmegen modification of the Bethesda assay in detecting factor VIII:C inhibitors in the haemophilia A population of Canada. Association of Hemophilia Centre Directors of Canada. Factor VIII/IX Subcommittee of Scientific and Standardization Committee of International Society on Thrombosis and Haemostasis. *Thromb Haemost* 1998;79:872–875.
363. Verbruggen B, Giles A, Samis J, et al. The type of factor VIII deficient plasma used influences the performance of the Nijmegen modification of the Bethesda assay for factor VIII inhibitors. *Thromb Haemost* 2001;86:1435–1439.
364. Shulman NR, Hirschman RJ. Acquired hemophilia. *Trans Assoc Am Physicians* 1969;82:388–397.
365. Lottenberg R, Kentro TB, Kitchens CS. Acquired hemophilia. A natural history study of 16 patients with factor VIII inhibitors receiving little or no therapy. *Arch Intern Med* 1987;147:1077–1081.
366. Aledort L. Inhibitors in hemophilia patients: current status and management. *Am J Hematol* 1994;47:208–217.
367. Aledort LM, White GC. Challenges in the treatment of haemophilia with inhibitors. *Haemophilia* 1999;5[Suppl 3]:1–51.
368. Hay CR, Baglin TP, Collins PW, et al. The diagnosis and management of factor VIII and IX inhibitors: a guideline from the UK Haemophilia Centre Doctors' Organization (UKHCDO). *Br J Haematol* 2000;111:78–90.
369. Herbst KD, Rapaport SI, Kenoyer DG, et al. Syndrome of an acquired inhibitor of factor VIII responsive to cyclophosphamide and prednisone. *Ann Intern Med* 1981;95:575–578.
370. Brox AG, Laryea H, Pelletier M. Successful treatment of acquired factor VIII inhibitors with cyclosporin. *Am J Hematol* 1998;57:87–88.
371. Mudad R, Kane WH. DDAVP in acquired hemophilia A: case report and review of the literature. *Am J Hematol* 1993;43:295–299.
372. Grunewald M, Beneke H, Guthner C, et al. Acquired haemophilia: experiences with a standardized approach. *Haemophilia* 2001;7:164–169.
373. Lusher JM, Shapiro SS, Palascak JE, et al. Efficacy of prothrombin-complex concentrates in hemophiliacs with antibodies to factor VIII: a multicenter therapeutic trial. *N Engl J Med* 1980;303:421–425.
374. Lusher JM. Thrombogenicity associated with factor IX complex concentrates. *Semin Hematol* 1991;28:3–5.
375. Chavin SI, Siegel DM, Rocco TA, Jr., Olson JP. Acute myocardial infarction during treatment with an activated prothrombin complex concentrate in a patient with factor VIII deficiency and a factor VIII inhibitor. *Am J Med* 1988;85:245–249.
376. Penner JA. Management of haemophilia in patients with high-titre inhibitors: focus on the evolution of activated prothrombin complex concentrate AUTOPLEX T. *Haemophilia* 1999;5[Suppl 3]:1–9.
377. Kasper CK. Effect of prothrombin complex concentrates on factor VIII inhibitor levels. *Blood* 1979;54:1358–1368.
378. Hay CR, Negrier C, Ludlam CA. The treatment of bleeding in acquired haemophilia with recombinant

factor VIIa: a multicentre study. *Thromb Haemost* 1997;78:1463–1467.

379. Kessler CM. New products for managing inhibitors to coagulation factors: a focus on recombinant factor VIIa concentrate. *Curr Opin Hematol* 2000;7:408–413.
380. Monroe DM, Hoffman M, Oliver JA, Roberts HR. A possible mechanism of action of activated factor VII independent of tissue factor. *Blood Coagul Fibrinolysis* 1998;9[Suppl 1]:S15–20.
381. Shapiro AD, Gilchrist GS, Hoots WK, et al. Prospective, randomised trial of two doses of rFVIIa (NovoSeven) in haemophilia patients with inhibitors undergoing surgery. *Thromb Haemost* 1998;80:773–778.
382. Key NS, Aledort LM, Beardsley D, et al. Home treatment of mild to moderate bleeding episodes using recombinant factor VIIa (Novoseven) in haemophiliacs with inhibitors. *Thromb Haemost* 1998;80:912–918.
383. Ewenstein BM. Continuous infusion of recombinant factor VIIa: continue or not? *Thromb Haemost* 2001;86:942–944.
384. O'Connell N, McMahon C, Smith J, et al. Recombinant factor VIIa in the management of surgery and acute bleeding episodes in children with haemophilia and high responding inhibitors. *Br J Haematol* 2002;116:632–635.
385. Aledort LM. Adverse reactions related to rVIIa? *Am J Hematol* 2001;67:213.
386. Teitel JM. Recombinant factor VIIa versus aPCCs in haemophiliacs with inhibitors: treatment and cost considerations. *Haemophilia* 1999;5[Suppl 3]:43–49.
387. Aledort LM. rFVIIa—its thrombogenicity. *Thromb Haemost* 2000;84:522–523.
388. Kulkarni R, Aledort LM, Berntorp E, et al. Therapeutic choices for patients with hemophilia and high-titer inhibitors. *Am J Hematol* 2001;67:240–246.
389. Key NS, Christie B, Henderson N, Nelsestuen GL. Possible synergy between recombinant factor VIIa and prothrombin complex concentrate in hemophilia therapy. *Thromb Haemost* 2002;88:60–65.
390. Hay CR, Lozier JN, Lee CA, et al. Porcine factor VIII therapy in patients with congenital hemophilia and inhibitors: efficacy, patient selection, and side effects. *Semin Hematol* 1994;31:20–25.
391. Morrison AE, Ludlam CA, Kessler C. Use of porcine factor VIII in the treatment of patients with acquired hemophilia. *Blood* 1993;81:1513–1520.
392. Crenier L, Ducobu J, des Grottes JM, et al. Low response to high-dose intravenous immunoglobulin in the treatment of acquired factor VIII inhibitor. *Br J Haematol* 1996;95:750–753.
393. Erskine JG, Burnett AK, Walker ID, Davidson JF. Plasma exchange in non-haemophiliac patients with inhibitors to factor VIII. *Br Med J (Clin Res Ed)* 1981;283:760.
394. Green D, Rademaker AW, Briet E. A prospective, randomized trial of prednisone and cyclophosphamide in the treatment of patients with factor VIII autoantibodies. *Thromb Haemost* 1993;70:753–757.
395. Shaffer LG, Phillips MD. Successful treatment of acquired hemophilia with oral immunosuppressive therapy. *Ann Intern Med* 1997;127:206–209.
- 395a. Wiestner A, Cho HJ, Asch AS, et al. Rituximab in the treatment of acquired factor VIII inhibitors. *Blood* 2002;100:3426–3428.
396. Mariani G, Ghirardini A, Bellocco R. Immune tolerance in hemophilia—principal results from the International Registry. Report of the factor VIII and IX Subcommittee. *Thromb Haemost* 1994;72:155–158.
397. Mariani G, Kroner B. International immune tolerance registry, 1997 update. *Vox Sang* 1999;77[Suppl 1]:25–27.
398. Nilsson IM, Berntorp E, Zettervall O. Induction of immune tolerance in patients with hemophilia and

antibodies to factor VIII by combined treatment with intravenous IgG, cyclophosphamide, and factor VIII. *N Engl J Med* 1988;318:947–950.

399. Mauser–Bunschoten EP, Nieuwenhuis HK, Roosendaal G, van den Berg HM. Low–dose immune tolerance induction in hemophilia A patients with inhibitors. *Blood* 1995;86:983–988.
400. DiMichele DM, Kroner BL. The North American Immune Tolerance Registry: practices, outcomes, outcome predictors. *Thromb Haemost* 2002;87:52–57.
401. Gilles JG, Desqueper B, Lenk H, et al. Neutralizing antiidiotypic antibodies to factor VIII inhibitors after desensitization in patients with hemophilia A. *J Clin Invest* 1996;97:1382–1388.
402. Colowick AB, Bohn RL, Avorn J, Ewenstein BM. Immune tolerance induction in hemophilia patients with inhibitors: costly can be cheaper. *Blood* 2000;96:1698–1702.
403. Aledort LM. Immune tolerance in hemophiliacs: can we afford it? Is it worth it? Baxter Previously Untreated Patient Study Group. *Transfusion* 1999;39:1034–1035.
404. Giannelli F, Choo KH, Rees DJ, et al. Gene deletions in patients with haemophilia B and anti–factor IX antibodies. *Nature* 1983;303:181–182.
405. Ljung RC. Gene mutations and inhibitor formation in patients with hemophilia B. *Acta Haematol* 1995;94[Suppl 1]:49–52.
406. Largo R, Sigg P, von Felten A, Straub PW. Acquired factor–IX inhibitor in a nonhaemophilic patient with autoimmune disease. *Br J Haematol* 1974;26:129–140.
407. Ljung R, Petrini P, Tengborn L, Sjorin E. Haemophilia B mutations in Sweden: a population–based study of mutational heterogeneity. *Br J Haematol* 2001;113:81–86.
408. Christophe OD, Lenting PJ, Cherel G, et al. Functional mapping of anti–factor IX inhibitors developed in patients with severe hemophilia B. *Blood* 2001;98:1416–1423.
409. Knobl P, Derfler K. Extracorporeal immunoadsorption for the treatment of haemophilic patients with inhibitors to factor VIII or IX. *Vox Sang* 1999;77[Suppl 1]:57–64.
410. Ekert H, Brewin T, Boey W, et al. Cost–utility analysis of recombinant factor VIIa (NovoSeven) in six children with long–standing inhibitors to factor VIII or IX. *Haemophilia* 2001;7:279–285.
411. Lusher JM. Inhibitor antibodies to factor VIII and factor IX: management. *Semin Thromb Hemost* 2000;26:179–188.
412. Barthels M. Clinical efficacy of prothrombin complex concentrates and recombinant factor VIIa in the treatment of bleeding episodes in patients with factor VII and IX inhibitors. *Thromb Res* 1999;95:S31–38.
413. Feinstein DI. Acquired inhibitors of factor V. *Thromb Haemost* 1978;39:663–674.
414. Coots MC, Muhleman AF, Glueck HI. Hemorrhagic death associated with a high titer factor V inhibitor. *Am J Hematol* 1978;4:193–206.
415. Stenbjerg S, Husted S, Mygind K. A circulating factor V inhibitor: possible side effect of treatment with streptomycin. *Scand J Haematol* 1975;14:280–285.
416. Ortel TL. Clinical and laboratory manifestations of anti–factor V antibodies. *J Lab Clin Med* 1999;133:326–334.
417. Streiff MB, Ness PM. Acquired FV inhibitors: a needless iatrogenic complication of bovine thrombin exposure. *Transfusion* 2002;42:18–26.
418. Stricker RB, Lane PK, Leffert JD, et al. Development of antithrombin antibodies following surgery in patients with prosthetic cardiac valves. *Blood* 1988;72:1375–1380.
419. Zehnder JL, Leung LL. Development of antibodies to thrombin and factor V with recurrent bleeding

in a patient exposed to topical bovine thrombin. *Blood* 1990;76:2011–2016.

420. Rapaport SI, Zivelin A, Minow RA, et al. Clinical significance of antibodies to bovine and human thrombin and factor V after surgical use of bovine thrombin. *Am J Clin Pathol* 1992;97:84–91.
421. Ortel TL, Mercer MC, Thames EH, et al. Immunologic impact and clinical outcomes after surgical exposure to bovine thrombin. *Ann Surg* 2001;233:88–96.
422. Feinstein DI, Rapaport SI. Acquired inhibitors of blood coagulation. *Prog Hemost Thromb* 1972;1:75–95.
423. Chediak J, Ashenhurst JB, Garlick I, Desser RK. Successful management of bleeding in a patient with factor V inhibitor by platelet transfusions. *Blood* 1980;56:835–841.
424. Nesheim ME, Nichols WL, Cole TL, et al. Isolation and study of an acquired inhibitor of human coagulation factor V. *J Clin Invest* 1986;77:405–415.
425. Grace CS, Wolf P. Proceedings: a high titre circulating inhibitor of human factor V: clinical, biochemical and immunological features and its treatment by plasmapheresis. *Thromb Diath Haemorrh* 1975;34:322.
426. Kalafatis M, Simioni P, Tormene D, et al. Isolation and characterization of an antifactor V antibody causing activated protein C resistance from a patient with severe thrombotic manifestations. *Blood* 2002;99:3985–3992.
427. Federici AB, Rand JH, Bucciarelli P, et al. Acquired von Willebrand syndrome: data from an international registry. *Thromb Haemost* 2000;84:345–349.
428. Rinder MR, Richard RE, Rinder HM. Acquired von Willebrand's disease: a concise review. *Am J Hematol* 1997;54:139–145.
429. Veyradier A, Jenkins CS, Fressinaud E, Meyer D. Acquired von Willebrand syndrome: from pathophysiology to management. *Thromb Haemost* 2000;84:175–182.
430. Tefferi A, Nichols WL. Acquired von Willebrand disease: concise review of occurrence, diagnosis, pathogenesis, and treatment. *Am J Med* 1997;103:536–540.
431. Lorand L, Jacobsen A, Bruner-Lorand J. A pathological inhibitor of fibrin cross-linking. *J Clin Invest* 1968;47:268–273.
432. Boggio LN, Green D. Acquired hemophilia. *Rev Clin Exp Hematol* 2001;5:389–404.
433. Lewis JH, Szeto ILF, Ellis LD, Bayer WL. An acquired inhibitor to coagulation factor XIII. *Johns Hopkins Med J* 1967;120:401–407.
434. Lorand L, Maldonado N, Fradera J, et al. Haemorrhagic syndrome of autoimmune origin with a specific inhibitor against fibrin stabilizing factor (factor XIII). *Br J Haematol* 1972;23:17–27.
435. Nakamura S, Kato A, Sakata Y, Aoki N. Bleeding tendency caused by IgG inhibitor to factor XIII, treated successfully by cyclophosphamide. *Br J Haematol* 1988;68:313–319.
436. Green D. Spontaneous inhibitors to coagulation factors. *Clin Lab Haematol* 2000;22[Suppl 1]:21–25.
437. DeVries A, Rosenberg T, Kochwa S, Boss JH. Precipitating antifibrinogen antibody appearing after fibrinogen infusions in a patient with congenital afibrinogenemia. *Am J Med* 1961;30:486–494.
438. Scully MF, Ellis V, Kakkar VV, et al. An acquired coagulation inhibitor to factor II. *Br J Haematol* 1982;50:655–664.
439. Madoiwa S, Nakamura Y, Mimuro J, et al. Autoantibody against prothrombin aberrantly alters the proenzyme to facilitate formation of a complex with its physiological inhibitor antithrombin III without thrombin conversion. *Blood* 2001;97:3783–3789.

440. Bajaj SP, Rapaport SI, Fierer DS, et al. A mechanism for the hypoprothrombinemia of the acquired hypoprothrombinemia-lupus anticoagulant syndrome. *Blood* 1983;61:684-692.
441. Galli M, Barbui T. Antiprothrombin antibodies: detection and clinical significance in the antiphospholipid syndrome. *Blood* 1999;93:2149-2157.
442. Reece EA, Clyne LP, Romero R, Hobbins JC. Spontaneous factor XI inhibitors. Seven additional cases and a review of the literature. *Arch Intern Med* 1984;144:525-529.
443. Leone G, Accorra F, Boni P. Circulating anticoagulant against factor XI and thrombocytopenia with platelet aggregation inhibition in systemic lupus erythematosus. *Acta Haematol* 1977;58:240-245.
444. Stern DM, Nossel HL, Owen J. Acquired antibody to factor XI in a patient with congenital factor XI deficiency. *J Clin Invest* 1982;69:1270-1276.
445. Goodrick MJ, Prentice AG, Copplestone JA, et al. Acquired factor XI inhibitor in chronic lymphocytic leukaemia. *J Clin Pathol* 1992;45:352-353.
446. Mulhare PE, Tracy PB, Golden EA, et al. A case of acquired factor X deficiency with in vivo and in vitro evidence of inhibitor activity directed against factor X. *Am J Clin Pathol* 1991;96:196-200.
447. Campbell E, Sanal S, Mattson J, et al. Factor VII inhibitor. *Am J Med* 1980;68:962-964.
448. Ndimbie OK, Raman BK, Saeed SM. Lupus anticoagulant associated with specific inhibition of factor VII in a patient with AIDS. *Am J Clin Pathol* 1989;91:491-493.
449. Delmer A, Horellou MH, Andreu G, et al. Life-threatening intracranial bleeding associated with the presence of an antifactor VII autoantibody. *Blood* 1989;74:229-232.
450. Okajima K, Ishii M. Life-threatening bleeding in a case of autoantibody-induced factor VII deficiency. *Int J Hematol* 1999;69:129-132.
451. Tsuda H, Higashi S, Iwanaga S, et al. Development of antitissue factor antibodies in patients after liver surgery. *Blood* 1993;82:96-102.
452. Hughes GR. Hughes' syndrome: the antiphospholipid syndrome. A historical view. *Lupus* 1998;7[Suppl 2]:S1-4.
453. Greaves M. Antiphospholipid antibodies and thrombosis. *Lancet* 1999;353: 1348-1353.
454. Thiagarajan P, Shapiro SS. Lupus anticoagulants and antiphospholipid antibodies. *Hematol Oncol Clin North Am* 1998;12:1167-1192.
455. Levine JS, Branch DW, Rauch J. The antiphospholipid syndrome. *N Engl J Med* 2002;346:752-763.
456. Doig RG, O'Malley CJ, Dauer R, McGrath KM. An evaluation of 200 consecutive patients with spontaneous or recurrent thrombosis for primary hypercoagulable states. *Am J Clin Pathol* 1994;102:797-801.
457. Ginsberg JS, Wells PS, Brill-Edwards P, et al. Antiphospholipid antibodies and venous thromboembolism. *Blood* 1995;86:3685-3691.
458. Roubey RA. Autoantibodies to phospholipid-binding plasma proteins: a new view of lupus anticoagulants and other "antiphospholipid" autoantibodies. *Blood* 1994;84:2854-2867.
459. Moore JE, Lutz WB. The natural history of systemic erythematosus: an approach to its study through chronic biologic false-positive reactors. *J Chronic Dis* 1955;1:297-316.
460. Triplett DA. Antiphospholipid-protein antibodies: laboratory detection and clinical relevance. *Thromb Res* 1995;78:1-31.
461. Vermeylen J, Arnout J. Is the antiphospholipid syndrome caused by antibodies directed against

physiologically relevant phospholipid-protein complexes? *J Lab Clin Med* 1992;120:10-12.

462. Mueller JF, Ratnoff O, Heinle RW. Observations on the characteristics of an unusual circulating anticoagulant. *J Lab Clin Med* 1951;38:254-261.

463. Simone JV, Cornet JA, Abildgaard CF. Acquired von Willebrand's syndrome in systemic lupus erythematosus. *Blood* 1968;31:806-812.

464. Harris EN, Gharavi AE, Boey ML, et al. Anticardiolipin antibodies: detection by radioimmunoassay and association with thrombosis in systemic lupus erythematosus. *Lancet* 1983;2:1211-1214.

465. Smirnov MD, Triplett DT, Comp PC, et al. On the role of phosphatidylethanolamine in the inhibition of activated protein C activity by antiphospholipid antibodies. *J Clin Invest* 1995;95:309-316.

466. McNeil HP, Simpson RJ, Chesterman CN, Krilis SA. Anti-phospholipid antibodies are directed against a complex antigen that includes a lipid-binding inhibitor of coagulation: beta 2-glycoprotein I (apolipoprotein H). *Proc Natl Acad Sci U S A* 1990;87:4120-4124.

467. Gomez-Pacheco L, Villa AR, Drenkard C, et al. Serum anti-beta2-glycoprotein-I and anticardiolipin antibodies during thrombosis in systemic lupus erythematosus patients. *Am J Med* 1999;106:417-423.

468. Roubey RA. Antigenic specificities of "antiphospholipid" autoantibodies. *Springer Semin Immunopathol* 1994;16:211-222.

469. Loeliger A. Prothrombin as co-factor of the circulating anticoagulant in systemic lupus erythematosus. *Thromb Diath Haemorrh* 1959;3:237-256.

470. Bevers EM, Galli M, Barbui T, et al. Lupus anticoagulant IgG's (LA) are not directed to phospholipids only, but to a complex of lipid-bound human prothrombin. *Thromb Haemost* 1991;66:629-632.

471. Simmelink MJ, Horbach DA, Derksen RH, et al. Complexes of anti-prothrombin antibodies and prothrombin cause lupus anticoagulant activity by competing with the binding of clotting factors for catalytic phospholipid surfaces. *Br J Haematol* 2001;113:621-629.

472. Kandiah DA, Krilis SA. Beta 2-glycoprotein I. *Lupus* 1994;3:207-212.

473. Puurunen M, Jokiranta S, Vaarala O, Meri S. Lack of functional similarity between complement factor H and anticardiolipin cofactor, beta 2-glycoprotein I (apolipoprotein H). *Scand J Immunol* 1995;42:547-550.

474. Wurm H. Beta 2-glycoprotein-I (apolipoprotein H) interactions with phospholipid vesicles. *Int J Biochem* 1984;16:511-515.

475. Nimpf J, Wurm H, Kostner GM. Beta 2-glycoprotein-I (apo-H) inhibits the release reaction of human platelets during ADP-induced aggregation. *Atherosclerosis* 1987;63:109-114.

476. Nimpf J, Bevers EM, Bomans PH, et al. Prothrombinase activity of human platelets is inhibited by beta 2-glycoprotein-I. *Biochim Biophys Acta* 1986;884:142-149.

477. Haupt H, Schwick HG, Storiko K. [On a hereditary beta-2-glycoprotein I deficiency]. *Humangenetik* 1968;5:291-293.

478. De Benedetti E, Reber G, Miescher PA, de Moerloose P. No increase of beta 2-glycoprotein I levels in patients with antiphospholipid antibodies. *Thromb Haemost* 1992;68:624.

479. Galli M, Cortelazzo S, Daldossi M, Barbui T. Increased levels of beta 2-glycoprotein I (aca-cofactor) in patients with lupus anticoagulant. *Thromb Haemost* 1992;67:386.

480. Horkko S, Miller E, Branch DW, et al. The epitopes for some antiphospholipid antibodies are adducts of oxidized phospholipid and beta 2-glycoprotein I (and other proteins). *Proc Natl Acad Sci U S A* 1997;94:10356-10361.

481. Le Tonqueze M, Salozhin K, Dueymes M, et al. Role of beta 2-glycoprotein I in the antiphospholipid

antibody binding to endothelial cells. *Lupus* 1995;4:179-186.

482. Nakamura N, Kuragaki C, Shidara Y, et al. Antibody to annexin V has anti-phospholipid and lupus anticoagulant properties. *Am J Hematol* 1995;49:347-348.

483. Roubey RA. The antiphospholipid antibody syndrome: new pieces to the puzzle. *Bull Rheum Dis* 1994;43:6-8.

484. Sammaritano LR, Gharavi AE, Soberano C, et al. Phospholipid binding of antiphospholipid antibodies and placental anticoagulant protein. *J Clin Immunol* 1992;12:27-35.

485. Galli M, Ruggeri L, Barbui T. Differential effects of anti-beta 2-glycoprotein I and antiprothrombin antibodies on the anticoagulant activity of activated protein C. *Blood* 1998;91:1999-2004.

486. Sheng Y, Kandiah DA, Krilis SA. Anti-beta 2-glycoprotein I autoantibodies from patients with the "antiphospholipid" syndrome bind to beta 2-glycoprotein I with low affinity: dimerization of beta 2-glycoprotein I induces a significant increase in anti-beta 2-glycoprotein I antibody affinity. *J Immunol* 1998;161:2038-2043.

487. Triplett DA, Asherson RA. Pathophysiology of the catastrophic antiphospholipid syndrome (CAPS). *Am J Hematol* 2000;65:154-159.

488. Pierangeli SS, Goldsmith GH, Krnic S, Harris EN. Differences in functional activity of anticardiolipin antibodies from patients with syphilis and those with antiphospholipid syndrome. *Infect Immun* 1994;62:4081-4084.

489. Canoso RT, Sise HS. Chlorpromazine-induced lupus anticoagulant and associated immunologic abnormalities. *Am J Hematol* 1982;13:121-129.

490. Triplett DA, Brandt JT, Musgrave KA, Orr CA. The relationship between lupus anticoagulants and antibodies to phospholipid. *JAMA* 1988;259:550-554.

491. Horkko S, Miller E, Dudl E, et al. Antiphospholipid antibodies are directed against epitopes of oxidized phospholipids. Recognition of cardiolipin by monoclonal antibodies to epitopes of oxidized low density lipoprotein. *J Clin Invest* 1996;98:815-825.

492. Pierangeli SS, Barker JH, Stikovac D, et al. Effect of human IgG antiphospholipid antibodies on an in vivo thrombosis model in mice. *Thromb Haemost* 1994;71:670-674.

493. Pierangeli SS, Liu XW, Barker JH, et al. Induction of thrombosis in a mouse model by IgG, IgM and IgA immunoglobulins from patients with the antiphospholipid syndrome. *Thromb Haemost* 1995;74:1361-1367.

494. Kouts S, Wang MX, Adelstein S, Krilis SA. Immunization of a rabbit with beta 2-glycoprotein I induces charge-dependent crossreactive antibodies that bind anionic phospholipids and have similar reactivity as autoimmune anti-phospholipid antibodies. *J Immunol* 1995;155:958-966.

495. Yodfat O, Blank M, Krause I, Shoenfeld Y. The pathogenic role of anti-phosphatidylserine antibodies: active immunization with the antibodies leads to the induction of antiphospholipid syndrome. *Clin Immunol Immunopathol* 1996;78:14-20.

496. Gharavi AE, Sammaritano LR, Bovastro JL, Jr., Wilson WA. Specificities and characteristics of beta 2 glycoprotein I-induced antiphospholipid antibodies. *J Lab Clin Med* 1995;125:775-778.

497. Vazquez-Mellado J, Llorente L, Richaud-Patin Y, Alarcon-Segovia D. Exposure of anionic phospholipids upon platelet activation permits binding of beta 2 glycoprotein I and through it that of IgG antiphospholipid antibodies. Studies in platelets from patients with antiphospholipid syndrome and normal subjects. *J Autoimmun* 1994;7:335-348.

498. Obringer AR, Rote NS, Walter A. Antiphospholipid antibody binding to bilayer-coated glass microspheres. *J Immunol Methods* 1995;185:81-93.

499. Pengo V, Biasiolo A, Fior MG. Autoimmune antiphospholipid antibodies are directed against a cryptic epitope expressed when beta 2-glycoprotein I is bound to a suitable surface. *Thromb Haemost*



1995;73:29–34.

500. Kandiah DA, Hunt JE, Krilis SA. Epitope mapping studies of antiphospholipid antibodies and beta 2-GPI using synthetic peptides. *Lupus* 1995;4[Suppl 1]:S7–11.

501. Rote NS, Ng AK, Dostal-Johnson DA, et al. Immunologic detection of phosphatidylserine externalization during thrombin-induced platelet activation. *Clin Immunol Immunopathol* 1993;66:193–200.

502. Casciola-Rosen L, Rosen A, Petri M, Schlissel M. Surface blebs on apoptotic cells are sites of enhanced procoagulant activity: implications for coagulation events and antigenic spread in systemic lupus erythematosus. *Proc Natl Acad Sci U S A* 1996;93:1624–1629.

503. Rauch J, Tannenbaum M, Tannenbaum H, et al. Human hybridoma lupus anticoagulants distinguish between lamellar and hexagonal phase lipid systems. *J Biol Chem* 1986;261:9672–9677.

504. Rauch J, Janoff AS. Phospholipid in the hexagonal II phase is immunogenic: evidence for immunorecognition of nonbilayer lipid phases in vivo. *Proc Natl Acad Sci U S A* 1990;87:4112–4114.

505. Zini JM. Physiopathology of thrombosis induced by antiphospholipid antibodies. *Clin Rev Allergy Immunol* 1995;13:5–9.

506. Violi F, Ferro D, Quintarelli C. Antiphospholipid antibodies, hypercoagulability and thrombosis. *Haematologica* 1995;80:131–135.

507. Bordron A, Dueymes M, Levy Y, et al. The binding of some human antiendothelial cell antibodies induces endothelial cell apoptosis. *J Clin Invest* 1998;101:2029–2035.

508. Male C, Mitchell L, Julian J, et al. Acquired activated protein C resistance is associated with lupus anticoagulants and thrombotic events in pediatric patients with systemic lupus erythematosus. *Blood* 2001;97:844–849.

509. Rand JH, Wu XX, Andree HA, et al. Antiphospholipid antibodies accelerate plasma coagulation by inhibiting annexin-V binding to phospholipids: a “lupus procoagulant” phenomenon. *Blood* 1998;92:1652–1660.

510. Esmon NL, Smirnov MD, Esmon CT. Thrombogenic mechanisms of antiphospholipid antibodies. *Thromb Haemost* 1997;78:79–82.

511. Petri M. Epidemiology of the antiphospholipid antibody syndrome. *J Autoimmun* 2000;15:145–151.

512. Kelsey PR, Stevenson KJ, Poller L. The diagnosis of lupus anticoagulants by the activated partial thromboplastin time—the central role of phosphatidyl serine. *Thromb Haemost* 1984;52:172–175.

513. Schved JF, Dupuy-Fons C, Biron C, et al. A prospective epidemiological study on the occurrence of antiphospholipid antibody: the Montpellier Antiphospholipid (MAP) Study. *Haemostasis* 1994;24:175–182.

514. Ford SE, Kennedy L, Ford PM. Clinicopathologic correlations of antiphospholipid antibodies. An autopsy study. *Arch Pathol Lab Med* 1994;118:491–495.

515. Feinstein DI, Francis RB. The lupus anticoagulant and anticardiolipin antibodies. In: Wallace DJ, Hahn BH, eds. *Dubois' lupus erythematosus*, 4 ed. Philadelphia: Lea & Febiger, 1993:246–253.

516. Boey ML, Colaco CB, Gharavi AE, et al. Thrombosis in systemic lupus erythematosus: striking association with the presence of circulating lupus anticoagulant. *Br Med J (Clin Res Ed)* 1983;287:1021–1023.

517. Exner T, Rickard KA, Kronenberg H. A sensitive test demonstrating lupus anticoagulant and its behavioural patterns. *Br J Haematol* 1978;40:143–151.

518. Jouhikainen T, Stephansson E, Leirisalo-Repo M. Lupus anticoagulant as a prognostic marker in systemic lupus erythematosus. *Br J Rheumatol* 1993;32:568–573.

519. Stasi R, Stipa E, Masi M, et al. Antiphospholipid antibodies: prevalence, clinical significance and

correlation to cytokine levels in acute myeloid leukemia and non-Hodgkin's lymphoma. *Thromb Haemost* 1993;70:568-572.

520. Chedid A, Chadalawada KR, Morgan TR, et al. Phospholipid antibodies in alcoholic liver disease. *Hepatology* 1994;20:1465-1471.

521. Prieto J, Yuste JR, Beloqui O, et al. Anticardiolipin antibodies in chronic hepatitis C: implication of hepatitis C virus as the cause of the antiphospholipid syndrome. *Hepatology* 1996;23:199-204.

522. Bloom EJ, Abrams DI, Rodgers G. Lupus anticoagulant in the acquired immunodeficiency syndrome. *JAMA* 1986;256:491-493.

523. Gotoh M, Matsuda J. Human immunodeficiency virus rather than hepatitis C virus infection is relevant to the development of an anti-cardiolipin antibody. *Am J Hematol* 1995;50:220-222.

524. Facer CA, Agiostratidou G. High levels of anti-phospholipid antibodies in uncomplicated and severe *Plasmodium falciparum* and in *P. vivax* malaria. *Clin Exp Immunol* 1994;95:304-309.

525. Kucuk O, Gilman-Sachs A, Beaman K, et al. Antiphospholipid antibodies in sickle cell disease. *Am J Hematol* 1993;42:380-383.

526. Levine SR, Welch KM. The spectrum of neurologic disease associated with antiphospholipid antibodies. Lupus anticoagulants and anticardiolipin antibodies. *Arch Neurol* 1987;44:876-883.

527. Harrison CN, Donohoe S, Carr P, et al. Patients with essential thrombocythaemia have an increased prevalence of antiphospholipid antibodies which may be associated with thrombosis. *Thromb Haemost* 2002;87:802-807.

528. Bell WR, Boss GR, Wolfson JS. Circulating anticoagulant in the procainamide-induced lupus syndrome. *Arch Intern Med* 1977;137:1471-1473.

529. Bird MR, O'Neill AI, Buchanan RR, et al. Lupus anticoagulant in the elderly may be associated with both quinine and quinidine usage. *Pathology* 1995;27:136-139.

530. Orris DJ, Lewis JH, Spero JA, Hasiba U. Blocking coagulation inhibitors in children taking penicillin. *J Pediatr* 1980;97:426-429.

531. Bizzaro N, Brandalise M. EDTA-dependent pseudothrombocytopenia. Association with antiplatelet and antiphospholipid antibodies. *Am J Clin Pathol* 1995;103:103-107.

532. Chamouard P, Grunebaum L, Wiesel ML, et al. Prevalence and significance of anticardiolipin antibodies in Crohn's disease. *Dig Dis Sci* 1994;39:1501-1504.

533. Stasi R, Stipa E, Masi M, et al. Prevalence and clinical significance of elevated antiphospholipid antibodies in patients with idiopathic thrombocytopenic purpura. *Blood* 1994;84:4203-4208.

534. Shi W, Krilis SA, Chong BH, et al. Prevalence of lupus anticoagulant and anticardiolipin antibodies in a healthy population. *Aust N Z J Med* 1990;20:231-236.

535. Manoussakis MN, Tzioufas AG, Silis MP, et al. High prevalence of anti-cardiolipin and other autoantibodies in a healthy elderly population. *Clin Exp Immunol* 1987;69:557-565.

536. Vila P, Hernandez MC, Lopez-Fernandez MF, Batlle J. Prevalence, follow-up and clinical significance of the anticardiolipin antibodies in normal subjects. *Thromb Haemost* 1994;72:209-213.

537. Exner T, Barber S, Kronenberg H, Rickard KA. Familial association of the lupus anticoagulant. *Br J Haematol* 1980;45:89-96.

538. Goldberg SN, Conti-Kelly AM, Greco TP. A family study of anticardiolipin antibodies and associated clinical conditions. *Am J Med* 1995;99:473-479.

539. Molta C, Meyer O, Dosquet C, et al. Childhood-onset systemic lupus erythematosus: antiphospholipid

antibodies in 37 patients and their first-degree relatives. *Pediatrics* 1993;92:849–853.

540. Camps MT, Cuadrado MJ, Ocon P, et al. Association between HLA class II antigens and primary antiphospholipid syndrome from the south of Spain. *Lupus* 1995;4:51–55.

541. Colucci AT, Di Lorenzo G, Ingrassia A, et al. Blood antiphospholipid antibody levels are influenced by age, sex and HLA-B8, DR3 phenotype. *Exp Clin Immunogenet* 1992;9:72–79.

542. Wilson WA, Gharavi AE, Koike T, et al. International consensus statement on preliminary classification criteria for definite antiphospholipid syndrome: report of an international workshop. *Arthritis Rheum* 1999;42:1309–1311.

543. Oeffinger KC, Roaten SP, Jr. Antiphospholipid syndrome. *J Fam Pract* 1994;38:611–619.

544. Morgan M, Downs K, Chesterman CN, Biggs JC. Clinical analysis of 125 patients with the lupus anticoagulant. *Aust N Z J Med* 1993;23:151–156.

545. Cervera R, Asherson RA, Lie JT. Clinicopathologic correlations of the antiphospholipid syndrome. *Semin Arthritis Rheum* 1995;24:262–272.

546. Triplett DA. Protean clinical presentation of antiphospholipid–protein antibodies (APA). *Thromb Haemost* 1995;74:329–337.

547. Kampe CE. Clinical syndromes associated with lupus anticoagulants. *Semin Thromb Hemost* 1994;20:16–26.

548. Derksen RH, Gmelig–Meijling FH, de Groot PG. Primary antiphospholipid syndrome evolving into systemic lupus erythematosus. *Lupus* 1996;5:77–80.

549. Silver RM, Draper ML, Scott JR, et al. Clinical consequences of antiphospholipid antibodies: an historic cohort study. *Obstet Gynecol* 1994;83:372–377.

550. Bowie EWJ, Thompson JH, Jr., Pascuzzi CA, Owen CA, Jr. Thrombosis in systemic lupus erythematosus despite circulating anticoagulants. *J Lab Clin Med* 1963;62:416–430.

551. Elias M, Eldor A. Thromboembolism in patients with the “lupus”–type circulating anticoagulant. *Arch Intern Med* 1984;144:510–515.

552. Gastineau DA, Kazmier FJ, Nichols WL, Bowie EJ. Lupus anticoagulant: an analysis of the clinical and laboratory features of 219 cases. *Am J Hematol* 1985;19:265–275.

553. Mueh JR, Herbst KD, Rapaport SI. Thrombosis in patients with the lupus anticoagulant. *Ann Intern Med* 1980;92:156–159.

554. Boggild MD, Sedhev RV, Fraser D, Heron JR. Cerebral venous sinus thrombosis and antiphospholipid antibodies. *Postgrad Med J* 1995;71:487–489.

555. Coull BM, Levine SR, Brey RL. The role of antiphospholipid antibodies in stroke. *Neurol Clin* 1992;10:125–143.

556. Levine SR, Brey RL, Sawaya KL, et al. Recurrent stroke and thrombo–occlusive events in the antiphospholipid syndrome. *Ann Neurol* 1995;38:119–124.

557. Sanmarco M, Soler C, Christides C, et al. Prevalence and clinical significance of IgG isotype anti–beta 2–glycoprotein I antibodies in antiphospholipid syndrome: a comparative study with anticardiolipin antibodies. *J Lab Clin Med* 1997;129:499–506.

558. Horbach DA, van Oort E, Donders RC, et al. Lupus anticoagulant is the strongest risk factor for both venous and arterial thrombosis in patients with systemic lupus erythematosus. Comparison between different assays for the detection of antiphospholipid antibodies. *Thromb Haemost* 1996;76:916–924.

558a. Galli M, Luciani D, Bertolini G, Barbui T. Lupus anticoagulants are stronger risk factors for thrombosis than anticardiolipin antibodies in the antiphospholipid syndrome: a systematic review of the

literature. *Blood* 2003;101:1827–1832.

559. Asherson RA, Liote F, Page B, et al. Avascular necrosis of bone and antiphospholipid antibodies in systemic lupus erythematosus. *J Rheumatol* 1993;20:284–288.

560. Galli M, Finazzi G, Barbui T. Thrombocytopenia in the antiphospholipid syndrome. *Br J Haematol* 1996;93:1–5.

561. Ordi J, Vilardel M, Oristrell J, et al. Bleeding in patients with lupus anticoagulant. *Lancet* 1984;2:868–869.

562. Dorsch CA, Meyerhoff J. Mechanisms of abnormal platelet aggregation in systemic lupus erythematosus. *Arthritis Rheum* 1982;25:966–973.

563. Natelson EA, Cyprus GS, Hettig RA. Absent factor II in systemic lupus erythematosus. Immunologic studies and response to corticosteroid therapy. *Arthritis Rheum* 1976;19:79–82.

564. Van Horn G, Arnett FC, Dimachkie MM. Reversible dementia and chorea in a young woman with the lupus anticoagulant. *Neurology* 1996;46:1599–1603.

565. Anticardiolipin antibodies are an independent risk factor for first ischemic stroke. The Antiphospholipid Antibodies in Stroke Study (APASS) Group. *Neurology* 1993;43:2069–2073.

566. Altes A, Abellan MT, Mateo J, et al. Hemostatic disturbances in acute ischemic stroke: a study of 86 patients. *Acta Haematol* 1995;94:10–15.

567. Silvestrini M, Cupini LM, Matteis M, et al. Migraine in patients with stroke and antiphospholipid antibodies. *Headache* 1993;33:421–426.

568. Tsakiris DA, Kappos L, Reber G, et al. Lack of association between antiphospholipid antibodies and migraine. *Thromb Haemost* 1993;69:415–417.

569. Alegre VA, Gastineau DA, Winkelmann RK. Skin lesions associated with circulating lupus anticoagulant. *Br J Dermatol* 1989;120:419–429.

570. Taylor LM, Jr., Chitwood RW, Dalman RL, et al. Antiphospholipid antibodies in vascular surgery patients. A cross-sectional study. *Ann Surg* 1994;220:544–550.

571. Fligelstone LJ, Cachia PG, Ralis H, et al. Lupus anticoagulant in patients with peripheral vascular disease: a prospective study. *Eur J Vasc Endovasc Surg* 1995;9:277–283.

572. Hamsten A, Norberg R, Bjorkholm M, et al. Antibodies to cardiolipin in young survivors of myocardial infarction: an association with recurrent cardiovascular events. *Lancet* 1986;1:113–116.

573. Cortellaro M, Boschetti C, Cardillo M, Barbui T. Antiphospholipid antibodies in patients with previous myocardial infarction. *Lancet* 1992;339:929–930.

574. Asherson RA, Mackworth-Young CG, Boey ML, et al. Pulmonary hypertension in systemic lupus erythematosus. *Br Med J (Clin Res Ed)* 1983;287:1024–1025.

575. Asherson RA. The catastrophic antiphospholipid syndrome. *J Rheumatol* 1992;19:508–512.

576. Branch DW, Scott JR, Kochenour NK, Hershegold E. Obstetric complications associated with the lupus anticoagulant. *N Engl J Med* 1985;313:1322–1326.

577. Harris EN, Chan JK, Asherson RA, et al. Thrombosis, recurrent fetal loss, and thrombocytopenia. Predictive value of the anticardiolipin antibody test. *Arch Intern Med* 1986;146:2153–2156.

578. Feinstein DI. Lupus anticoagulant, anticardiolipin antibodies, fetal loss, and systemic lupus erythematosus. *Blood* 1992;80:859–862.

579. Shapiro GA. Antiphospholipid syndrome in obstetrics and gynecology. *Semin Thromb Hemost*

1994;20:64–70.

580. Oshiro BT, Silver RM, Scott JR, et al. Antiphospholipid antibodies and fetal death. *Obstet Gynecol* 1996;87:489–493.
581. MacLean MA, Cumming GP, McCall F, et al. The prevalence of lupus anticoagulant and anticardiolipin antibodies in women with a history of first trimester miscarriages. *Br J Obstet Gynaecol* 1994;101:103–106.
582. Rai RS, Regan L, Clifford K, et al. Antiphospholipid antibodies and beta 2-glycoprotein-I in 500 women with recurrent miscarriage: results of a comprehensive screening approach. *Hum Reprod* 1995;10:2001–2005.
583. Silver RM, Draper ML, Byrne JL, et al. Unexplained elevations of maternal serum alpha-fetoprotein in women with antiphospholipid antibodies: a harbinger of fetal death. *Obstet Gynecol* 1994;83:150–155.
584. Clark F, Dickinson JE, Walters BN, et al. Elevated mid-trimester hCG and maternal lupus anticoagulant. *Prenat Diagn* 1995;15:1035–1039.
585. Harris EN, Spinnato JA. Should anticardiolipin tests be performed in otherwise healthy pregnant women? *Am J Obstet Gynecol* 1991;165:1272–1277.
586. Lynch A, Marlar R, Murphy J, et al. Antiphospholipid antibodies in predicting adverse pregnancy outcome. A prospective study. *Ann Intern Med* 1994;120:470–475.
587. Rix P, Stentoft J, Aunsholt NA, et al. Lupus anticoagulant and anticardiolipin antibodies in an obstetric population. *Acta Obstet Gynecol Scand* 1992;71:605–609.
588. Silver RM, Porter TF, van Leeuwen I, et al. Anticardiolipin antibodies: clinical consequences of “low titers.” *Obstet Gynecol* 1996;87:494–500.
589. Katano K, Aoki K, Ogasawara M, et al. Specific antiphospholipid antibodies (aPL) eluted from placentae of pregnant women with aPL-positive sera. *Lupus* 1995;4:304–308.
590. Rand JH, Wu XX, Andree HA, et al. Pregnancy loss in the antiphospholipid-antibody syndrome—a possible thrombogenic mechanism. *N Engl J Med* 1997;337:154–160.
591. Voisin L, Derumeaux G, Borg JY, et al. Catastrophic antiphospholipid syndrome with fatal acute course in rheumatoid arthritis. *J Rheumatol* 1995;22:1586–1588.
592. Asherson RA, Cervera R, Piette JC, et al. Catastrophic antiphospholipid syndrome. Clinical and laboratory features of 50 patients. *Medicine (Baltimore)* 1998;77:195–207.
593. Asherson RA, Cervera R, Piette JC, et al. Catastrophic antiphospholipid syndrome: clues to the pathogenesis from a series of 80 patients. *Medicine (Baltimore)* 2001;80:355–377.
594. Exner T. Diagnostic methodologies for circulating anticoagulants. *Thromb Haemost* 1995;74:338–344.
595. Martin BA, Branch DW, Rodgers GM. Sensitivity of the activated partial thromboplastin time, the dilute Russell’s viper venom time, and the kaolin clotting time for the detection of the lupus anticoagulant: a direct comparison using plasma dilutions. *Blood Coagul Fibrinolysis* 1996;7:31–38.
596. Rooney AM, McNally T, Mackie IJ, Machin SJ. The Taipan snake venom time: a new test for lupus anticoagulant. *J Clin Pathol* 1994;47:497–501.
597. Brien WF, Schaus MR, Cooper KE, et al. Lupus anticoagulant testing: effect of the platelet count on the activated partial thromboplastin time. *Br J Biomed Sci* 1993;50:114–116.
598. Rauch J, Tannenbaum M, Janoff AS. Distinguishing plasma lupus anticoagulants from anti-factor antibodies using hexagonal (II) phase phospholipids. *Thromb Haemost* 1989;62:892–896.
599. Stevenson KJ, Seddon JM. The role of lipids in the detection of lupus anticoagulant by the dilute Russell viper venom test: are platelets or reagents containing hexagonal HII phases necessary? *Br J*

Haematol 1994;86:583–589.

599a. Triplett DA. Antiphospholipid antibodies. Arch Pathol Lab Med 2002; 126:1424–1429.

600. Clyne LP, Yen Y, Kriz NS, Breitenstein MG. The lupus anticoagulant. High incidence of “negative” mixing studies in a human immunodeficiency virus-positive population. Arch Pathol Lab Med 1993;117:595–601.

601. Lo SC, Oldmeadow MJ, Howard MA, Firkin BG. Comparison of laboratory tests used for identification of the lupus anticoagulant. Am J Hematol 1989;30:213–220.

602. Lesperance B, David M, Rauch J, et al. Relative sensitivity of different tests in the detection of low titer lupus anticoagulants. Thromb Haemost 1988;60:217–219.

603. Galli M, Dlott J, Norbis F, et al. Lupus anticoagulants and thrombosis: clinical association of different coagulation and immunologic tests. Thromb Haemost 2000;84:1012–1016.

604. Sanmarco M, Alessi MC, Harle JR, et al. Antibodies to phosphatidylethanolamine as the only antiphospholipid antibodies found in patients with unexplained thromboses. Thromb Haemost 2001;85:800–805.

605. Brandt JT, Triplett DA, Alving B, Scharrer I. Criteria for the diagnosis of lupus anticoagulants: an update. On behalf of the Subcommittee on Lupus Anticoagulant/Antiphospholipid Antibody of the Scientific and Standardisation Committee of the ISTH. Thromb Haemost 1995;74:1185–1190.

606. Kandiah DA, Krillis SA. Heterogeneity of lupus anticoagulant (LA) antibodies: LA activity in dilute Russell’s Viper Venom Time and dilute Kaolin Clotting Time detect different populations of antibodies in patients with the “antiphospholipid” syndrome. Thromb Haemost 1998;80:250–257.

607. Jennings I, Kitchen S, Woods TA, et al. Potentially clinically important inaccuracies in testing for the lupus anticoagulant: an analysis of results from three surveys of the UK National External Quality Assessment Scheme (NEQAS) for Blood Coagulation. Thromb Haemost 1997;77:934–937.

608. Segal JB, Lehmann HP, Petri M, et al. Testing strategies for diagnosing lupus anticoagulant: decision analysis. Am J Hematol 2002;70:195–205.

609. Piette JC, Wechsler B, Bletry O, Godeau P. [What criteria for the diagnosis of antiphospholipid syndrome?]. Rev Med Interne 1993;14:799–803.

610. Lockshin MD. Which patients with antiphospholipid antibody should be treated and how? Rheum Dis Clin North Am 1993;19:235–247.

611. McNally T, Purdy G, Mackie IJ, et al. The use of an anti-beta 2-glycoprotein-I assay for discrimination between anticardiolipin antibodies associated with infection and increased risk of thrombosis. Br J Haematol 1995;91:471–473.

612. Khamashta MA, Cuadrado MJ, Mujic F, et al. The management of thrombosis in the antiphospholipid-antibody syndrome. N Engl J Med 1995;332:993–997.

613. Ordi-Ros J, Perez-Peman P, Monasterio J. Clinical and therapeutic aspects associated to phospholipid binding antibodies (lupus anticoagulant and anticardiolipin antibodies). Haemostasis 1994;24:165–174.

614. Khamashta MA, Hughes GR. Antiphospholipid antibodies and antiphospholipid syndrome. Curr Opin Rheumatol 1995;7:389–394.

615. Derksen RH, de Groot PG, Kater L, Nieuwenhuis HK. Patients with antiphospholipid antibodies and venous thrombosis should receive long term anticoagulant treatment. Ann Rheum Dis 1993;52:689–692.

616. Schulman S, Svenungsson E, Granqvist S. Anticardiolipin antibodies predict early recurrence of thromboembolism and death among patients with venous thromboembolism following anticoagulant therapy. Duration of Anticoagulation Study Group. Am J Med 1998;104:332–338.

617. Ruiz-Irastorza G, Khamashta MA, Hunt BJ, et al. Bleeding and recurrent thrombosis in definite

antiphospholipid syndrome: analysis of a series of 66 patients treated with oral anticoagulation to a target international normalized ratio of 3.5. *Arch Intern Med* 2002;162:1164–1169.

618. Finazzi G. Ongoing randomized trials for the treatment of thrombosis in the antiphospholipid antibody syndrome. *Haemostaseologie* 2001;21:71–81.

619. Pernod G, Arvieux J, Carpentier PH, et al. Successful treatment of lupus anticoagulant–hypoprothrombinemia syndrome using intravenous immuno–globulins. *Thromb Haemost* 1997;78:969–970.

620. Moll S, Ortel TL. Monitoring warfarin therapy in patients with lupus anticoagulants. *Ann Intern Med* 1997;127:177–185.

621. Balasch J, Carmona F, Lopez–Soto A, et al. Low–dose aspirin for prevention of pregnancy losses in women with primary antiphospholipid syndrome. *Hum Reprod* 1993;8:2234–2239.

622. Donaldson MD, Seaman MJ, Park GR. Massive blood transfusion. *Br J Anaesth* 1992;69:621–630.

623. Grosso SM, Keenan JO. Whole blood transfusion for exsanguinating coagulopathy in a US field surgical hospital in postwar Kosovo. *J Trauma* 2000;49:145–148.

624. Hiippala S. Replacement of massive blood loss. *Vox Sang* 1998;74[Suppl 2]:399–407.

625. Leslie SD, Toy PT. Laboratory hemostatic abnormalities in massively transfused patients given red blood cells and crystalloid. *Am J Clin Pathol* 1991;96:770–773.

626. Mannucci PM, Federici AB, Sirchia G. Hemostasis testing during massive blood replacement. A study of 172 cases. *Vox Sang* 1982;42:113–123.

627. Reiss RF. Hemostatic defects in massive transfusion: rapid diagnosis and management. *Am J Crit Care* 2000;9:158–165.

628. von Kier S, Smith A. Hemostatic product transfusions and adverse outcomes: focus on point–of–care testing to reduce transfusion need. *J Cardiothorac Vasc Anesth* 2000;14:15–21; discussion 37–18.

629. Ciavarella D, Reed RL, Counts RB, et al. Clotting factor levels and the risk of diffuse microvascular bleeding in the massively transfused patient. *Br J Haematol* 1987;67:365–368.

630. Woodman RC, Harker LA. Bleeding complications associated with cardiopulmonary bypass. *Blood* 1990;76:1680–1697.

631. Salzman EW, Weinstein MJ, Weintraub RM, et al. Treatment with desmopressin acetate to reduce blood loss after cardiac surgery. A double–blind randomized trial. *N Engl J Med* 1986;314:1402–1406.

632. Hackmann T, Gascoyne RD, Naiman SC, et al. A trial of desmopressin (1–desamino–8–D–arginine vasopressin) to reduce blood loss in uncomplicated cardiac surgery. *N Engl J Med* 1989;321:1437–1443.

633. Bond L, Bevan D. Myocardial infarction in a patient with hemophilia treated with DDAVP. *N Engl J Med* 1988;318:121.

634. Royston D. The serine antiprotease aprotinin (Trasylol): a novel approach to reducing postoperative bleeding. *Blood Coagul Fibrinolysis* 1990;1:55–69.

635. Pinosky ML, Kennedy DJ, Fishman RL, et al. Tranexamic acid reduces bleeding after cardiopulmonary bypass when compared to epsilon aminocaproic acid and placebo. *J Card Surg* 1997;12:330–338.

636. Simon TL, Akl BF, Murphy W. Controlled trial of routine administration of platelet concentrates in cardiopulmonary bypass surgery. *Ann Thorac Surg* 1984;37:359–364.

637. Bettigole RE, Himelstein ES, Oettgen HF, Clifford GO. Hypofibrinogenemia due to L–asparaginase: studies of fibrinogen survival using autologous 131–I–fibrinogen. *Blood* 1970;35:195–200.

638. Ramsay NK, Coccia PF, Krivit W, et al. The effect of L–asparaginase on plasma coagulation factors



in acute lymphoblastic leukemia. *Cancer* 1977;40:1398–1401.

639. Monto RW, Talley RW, Caldwell MJ, et al. Observations on the mechanism of hemorrhagic toxicity in mithramycin (NSC 24559) therapy. *Cancer Res* 1969;29:697–704.

640. Komp DM, Lyles RL, Jr., Boyd TH III, et al. The effect of cancer chemotherapeutic agents on fibrin formation and stabilization in vitro. *Pediatr Res* 1974;8:75–81.

641. Glueck R, Green D, Cohen I, Ts'ao CH. Hematin: unique effects of hemostasis. *Blood* 1983;61:243–249.

642. Kreuz W, Linde R, Funk M, et al. Valproate therapy induces von Willebrand disease type I. *Epilepsia* 1992;33:178–184.

643. Bernhardt B, Valletta M, Brook J, Lejniaks I. Amyloidosis with factor X deficiency. *Am J Med Sci* 1972;264:411–414.

644. Glenner GG. Factor X deficiency and systemic amyloidosis. *N Engl J Med* 1977;297:108–109.

645. Furie B, Voo L, McAdam KP, Furie BC. Mechanism of factor X deficiency in systemic amyloidosis. *N Engl J Med* 1981;304:827–830.

646. McPherson RA, Onstad JW, Ugoretz RJ, Wolf PL. Coagulopathy in amyloidosis: combined deficiency of factors IX and X. *Am J Hematol* 1977;3:225–235.

647. Yood RA, Skinner M, Rubinow A, et al. Bleeding manifestations in 100 patients with amyloidosis. *JAMA* 1983;249:1322–1324.

648. Rosenstein ED, Itzkowitz SH, Penziner AS, et al. Resolution of factor X deficiency in primary amyloidosis following splenectomy. *Arch Intern Med* 1983;143:597–599.

649. Camoriano JK, Greipp PR, Bayer GK, Bowie EJ. Resolution of acquired factor X deficiency and amyloidosis with melphalan and prednisone therapy. *N Engl J Med* 1987;316:1133–1135.

650. Choufani EB, Sancharawala V, Ernst T, et al. Acquired factor X deficiency in patients with amyloid light-chain amyloidosis: incidence, bleeding manifestations, and response to high-dose chemotherapy. *Blood* 2001;97:1885–1887.

651. Karpatkin S, Ingram GIC, Graham JB. Severe isolated prothrombin deficiency: an acquired state with complete recovery. *Thromb Diath Haemorrh* 1962;8:221–234.

652. Vaziri ND, Toohey J, Paule P, et al. Urinary excretion and deficiency of prothrombin in nephrotic syndrome. *Am J Med* 1984;77:433–436.

653. Natelson EA, Lynch EC, Hettig RA, Alfrey CP, Jr. Acquired factor IX deficiency in the nephrotic syndrome. *Ann Intern Med* 1970;73:373–378.

654. Thompson AR. Factor XII and other hemostatic protein abnormalities in nephrotic syndrome patients. *Thromb Haemost* 1982;48:27–32.

655. Kauffmann RH, Veltkamp JJ, Van Tilburg NH, Van Es LA. Acquired antithrombin III deficiency and thrombosis in the nephrotic syndrome. *Am J Med* 1978;65:607–613.

656. Panicucci F, Sagripanti A, Vispi M, et al. Comprehensive study of haemostasis in nephrotic syndrome. *Nephron* 1983;33:9–13.

657. Brown CH III, Kvols LK, Hsu TH, Levin J. Factor IX deficiency and bleeding in a patient with Sheehan's syndrome. *Blood* 1972;39:650–657.

658. Boklan BF, Sawitsky A. Factor IX deficiency in Gaucher disease. An in vitro phenomenon. *Arch Intern Med* 1976;136:489–492.

659. Weisdorf D, Hasegawa D, Fair DS. Acquired factor VII deficiency associated with aplastic anaemia:

correction with bone marrow transplantation. *Br J Haematol* 1989;71:409–413.

660. de Raucourt E, Dumont MD, Tourani JM, et al. Acquired factor VII deficiency associated with pleural liposarcoma. *Blood Coagul Fibrinolysis* 1994;5:833–836.

661. Rasche H, Dietrich M, Gaus W, Schleyer M. Factor XIII–activity and fibrin subunit structure in acute leukemia. *Biomedicine* 1974;21:61–66.

662. Oshitani N, Kitano A, Hara J, et al. Deficiency of blood coagulation factor XIII in Crohn's disease. *Am J Gastroenterol* 1995;90:1116–1118.

663. Tosetto A, Castaman G, Rodeghiero F. Acquired plasma factor XIII deficiencies. *Haematologica* 1993;78:5–10.

664. McGrath K, Koutts J. A case of Hageman factor deficiency with myeloid leukaemia. *Aust N Z J Med* 1975;5:155–157.

665. Berrebi A, Malnick SD, Vorst EJ, Stein D. High incidence of factor XI deficiency in Gaucher's disease. *Am J Hematol* 1992;40:153.

666. Anstey A, Mayne K, Winter M, et al. Platelet and coagulation studies in Ehlers–Danlos syndrome. *Br J Dermatol* 1991;125:155–163.

667. Khoory MS, Nesheim ME, Bowie EJ, Mann KG. Circulating heparan sulfate proteoglycan anticoagulant from a patient with a plasma cell disorder. *J Clin Invest* 1980;65:666–674.

668. Bussel JB, Steinherz PG, Miller DR, Hilgartner MW. A heparin–like anticoagulant in an 8–month–old boy with acute monoblastic leukemia. *Am J Hematol* 1984;16:83–90.

669. Llamas P, Outeirino J, Espinoza J, et al. Report of three cases of circulating heparin–like anticoagulants. *Am J Hematol* 2001;67:256–258.

670. Rodgers GM, Corash L. Acquired heparinlike anticoagulant in a patient with metastatic breast carcinoma. *West J Med* 1985;143:672–675.

671. Colwell NS, Tollefsen DM, Blinder MA. Identification of a monoclonal thrombin inhibitor associated with multiple myeloma and a severe bleeding disorder. *Br J Haematol* 1997;97:219–226.

672. Weiss HJ, Berger RE, Tice AD, Phillips LL. Fatal disseminated intravascular coagulation and hemolytic anemia following stibophen therapy: a study of basic mechanisms. *Am J Med Sci* 1972;264:375–384.

673. Steinberg D, Carvalho AC, Chesney CM, Colman RW. Platelet hypersensitivity and intravascular coagulation in paroxysmal nocturnal hemoglobinuria. *Am J Med* 1975;59:845–850.

674. Gilman WL, Macdougall LG, Judisch JM. Sick cell disease and disseminated intravascular coagulation. Report of a childhood case. *Clin Pediatr (Phila)* 1973;12:600–602.

675. Ports TA, Deuel TF. Intravascular coagulation in fresh–water submersion: report of three cases. *Ann Intern Med* 1977;87:60–61.

676. Myers TJ, Hild DH. Consumption coagulopathy and microangiopathic hemolytic anemia with an axillo–femoral graft. *Circulation* 1977;56:891–893.

677. Whitaker AN, Emmerson BT. Acute disseminated intravascular coagulation in systemic lupus erythematosus. *Aust N Z J Med* 1972;2:182–187.

678. Stahl RL, Javid JP, Lackner H. Unrecognized pulmonary embolism presenting as disseminated intravascular coagulation. *Am J Med* 1984;76:772–778.

679. Mehta B, Briggs DK, Sommers SC, Karpatkin M. Disseminated intravascular coagulation following cardiac arrest: a study of 15 patients. *Am J Med Sci* 1972;264:353–363.

680. Cafferata HT, Aggeler PM, Robinson AJ, Blaisdell FW. Intravascular coagulation in the surgical patient: its significance and diagnosis. *Am J Surg* 1969;118:281-291.
681. Bradford DS, Foster RR, Nossel HL. Coagulation alterations, hypoxemia, and fat embolism in fracture patients. *J Trauma* 1970;10:307-321.
682. Drayer BP, Poser CM. Disseminated intravascular coagulation and head trauma. Two case studies. *JAMA* 1975;231:174-175.
683. Kwaan HC, Colwell JA, Suwanwela N. Disseminated intravascular coagulation in diabetes mellitus, with reference to the role of increased platelet aggregation. *Diabetes* 1972;21:108-113.
684. Fischer SP, Lee J, Zatuchni J, Greenberg J. Disseminated intravascular coagulation in status epilepticus. *Thromb Haemost* 1977;38:909-913.
685. Ranson JH, Lackner H, Berman IR, Schinella R. The relationship of coagulation factors to clinical complications of acute pancreatitis. *Surgery* 1977;81:502-511.
686. Marlar RA, Montgomery RR, Broekmans AW. Report on the diagnosis and treatment of homozygous protein C deficiency. Report of the Working Party on Homozygous Protein C Deficiency of the ICTH-Subcommittee on Protein C and Protein S. *Thromb Haemost* 1989;61:529-531.
687. Scott JP, Montgomery RR, Tubergen DG, Hays T. Acquired von Willebrand's disease in association with Wilm's tumor: regression following treatment. *Blood* 1981;58:665-669.
688. Hasegawa DK, Bennett AJ, Coccia PF, et al. Factor V deficiency in Philadelphia-positive chronic myelogenous leukemia. *Blood* 1980;56:585-595.

2004 Lippincott Williams & Wilkins  
John P. Greer, John Foerster, John N. Lukens  
George M. Rodgers, Frixos Paraskevas, Bertil Glader  
Wintrobe's Clinical Hematology

PHYSIOLOGY AND PATHOPHYSIOLOGY OF THROMBOSISVIRCHOW TRIADAbnormalities of Blood FlowVascular InjuryAbnormalities of the Blood: HypercoagulabilityACTIVATION OF COAGULATIONINHERITED THROMBOTIC DISORDERSAntithrombin DeficiencyHeparin Cofactor II DeficiencyProtein C DeficiencyProtein S DeficiencyActivated Protein C Resistance (Factor V Leiden)Prothrombin MutationsHyperhomocysteinemiaIncreased Factor VIII ActivityImpaired Endogenous FibrinolysisDysfibrinogenemiaThrombomodulin DeficiencyLipoprotein (a)Combined DefectsInherited Risk Factors in Childhood Venous ThrombosisPerspective on Laboratory Testing for Inherited Thrombotic DisordersLaboratory Testing for the Prethrombotic StateANTITHROMBOTIC THERAPYAntiplatelet DrugsAnticoagulant DrugsThrombolytic DrugsMANAGEMENT OF VENOUS THROMBOEMBOLIC DISEASECalf Deep Venous ThrombosisProximal Deep Venous ThrombosisPulmonary EmbolismInitial Anticoagulation TherapyChronic Phase AnticoagulationCatheter-Directed Thrombolysis of Deep Venous ThrombosisThrombolysis for Pulmonary EmbolismVENOUS THROMBOEMBOLIC DISEASE PREVENTIONHEPARIN-INDUCED THROMBOCYTOPENIAREFERENCES

This humour...immediately congeals not only outside the body but actually contained in its own surroundings: and this congealing of itself, we see terminate in the *thrombus* for by this term the Greeks name the congealed blood.

Galen, C Black bile. Corpus medicorum Graecorum Quae Exstant V: 106, Leipzig, Cnoblock, 1823

The term *thrombosis* refers to the formation, from constituents of the blood, of a mass *within* the venous or arterial vasculature of a living animal. Hemostatic thromboses, namely self-limited and localized thromboses that prevent excessive blood loss, represent

the body's natural and desired response to acute vascular injury. Pathologic thromboses such as deep venous thrombosis (DVT), pulmonary embolism (PE), coronary arterial thrombosis leading to myocardial infarction (MI), and cerebrovascular thrombotic occlusion represent the body's undesired response to acute and chronic perturbations of the vasculature, blood, or both. The terms *coagulated blood* and *clot* are not synonymous with thrombosis and refer to the formation of a solid mass of blood components *outside* of the vascular tree. Examples of clots include soft tissue, body cavity (e.g., peritoneal), and visceral hematomas. Coagulated blood best describes clots formed *ex vivo*.

Thrombosis of the veins and arteries, together with complicating embolic phenomena, is perhaps the most important cause of sickness and death in the developed countries of the world at the present time. Deaths from MI and thrombotic stroke consistently represent the major causes of death in the United States, numbering more than 800,000 people annually (more than one-third of all deaths) in a recent report (<sup>1</sup>). Venous thromboembolic disease is the third most common cardiovascular disease, after atherosclerotic heart disease and stroke. It has been estimated that between 500,000 and 2 million venous thromboembolic events (VTE) including calf vein thrombosis, proximal DVT (e.g., lower extremity and pelvic veins), and PE occur annually in the United States alone (<sup>2</sup>). The incidence of pathologic thrombosis, prevalence of disorders that predispose to thrombosis, and morbidity and mortality associated with thrombotic events all reflect the magnitude of the importance of the study of thrombotic mechanisms and development of effective antithrombotic therapies.

In this chapter, the pathophysiology of arterial and venous thrombosis and mechanisms of action of antithrombotic pharmacologic agents including antiplatelet drugs, anticoagulants, and fibrinolytic agents are summarized and discussed. Inherited conditions that predispose an individual to thrombosis, also termed *hypercoagulable states*, and the management of venous thromboembolic disease are covered. The management of arterial thrombotic events is beyond the scope of this chapter, and the reader is referred to several excellent recent review articles (<sup>3</sup>, <sup>4</sup>, <sup>5</sup> and <sup>6</sup>).

## PHYSIOLOGY AND PATHOPHYSIOLOGY OF THROMBOSIS

The human hemostatic system consists of multiple independent, yet integrally related, cellular and protein components that function to maintain blood fluidity under normal conditions and promote localized, temporary thrombus (hemostatic thrombus) formation at sites of vascular injury. A normal hemostatic system is the human physiologic defense against exsanguination. An abnormal hemostatic system can result in pathologic bleeding, vascular thrombosis, or both.

The hemostatic system is comprised of six major components: platelets, vascular endothelium, procoagulant plasma protein "factors," natural anticoagulant proteins, fibrinolytic proteins, and antifibrinolytic proteins. Each of these six hemostatic components must be present in fully functional form, in adequate quantity, and at the proper location to prevent excessive blood loss after vascular trauma and, at the same time, to prevent pathologic thrombosis. The hemostatic system is highly regulated and maintains a delicate balance between a prohemorrhagic state and a prothrombotic state. Any significant acquired or congenital imbalance in the hemostatic "scales" can lead to a pathologic outcome.

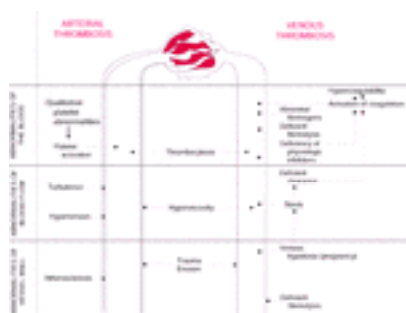
Normal hemostasis in response to vascular injury can be divided into two major processes of equal importance known as *primary* and *secondary hemostasis*. *Primary hemostasis* comprises the reactions needed to form a platelet plug at a site of vascular damage, whereas *secondary hemostasis* comprises a series of reactions (coagulation cascade) needed to generate cross-linked fibrin required to stabilize the platelet plug and form a

durable thrombus. Natural anticoagulants [antithrombin (AT) and activated protein C] function to confine thrombus formation to the sites of vascular injury and limit thrombus size to prevent vessel occlusion and flow interruption in the affected vessel. The activity of AT is greatly enhanced by endothelial cell heparan sulfate and pharmacologic heparins. The function of activated protein C (APC) is enhanced by its cofactor, protein S. Physiologic fibrinolysis is initiated by endothelial cell-derived tissue-type plasminogen activator (t-PA), which converts plasminogen to plasmin. Plasmin can degrade cross-linked fibrin, limit thrombus size, and help dissolve a thrombus once the vascular injury has been repaired. The fibrinolytic system is regulated and localized by antiplasmin and plasminogen activator inhibitor (PAI)-1. Details of the hemostatic mechanisms and endothelial cell regulation of hemostasis are given in [Chapter 21](#) and [Chapter 22](#).

Specific alterations in the quantitative and qualitative status of any hemostatic cellular or protein element can lead to pathologic thrombosis. A marked increase in the platelet count (thrombocytosis) and accentuated platelet aggregation [“sticky platelet syndrome” (SPS)] are associated with thromboembolic events. Elevated levels of procoagulant factors such as factor VIII, fibrinogen, factor IX, factor XI, and factor VII, as well as factor V resistance to inactivation by activated protein C, are recognized risk factors for vascular disease and thrombosis. Deficiency of a natural anticoagulant protein such as protein C, protein S, and AT is associated with venous thromboembolic disease. Deficiency of a fibrinolytic cascade component, such as t-PA or plasminogen, and excess plasma levels of the fibrinolytic inhibitor PAI-1 have been linked to hypercoagulability and thrombosis. Deficient endothelial cell production of thrombomodulin or release of t-PA may be associated with a thrombotic tendency. It is the net balance between the participating and, at times, opposing groups of proteins and not the level of any individual factor that is most critical to hemostatic regulation.

## VIRCHOW TRIAD

In the mid-nineteenth century (1854), German pathologist Rudolph Virchow postulated that vascular obstruction was precipitated by, and thrombosis resulted from, three interrelated factors: (a) “decreased blood flow” (stasis of blood flow), (b) “inflammation of or near the blood vessels” (vascular endothelial injury), and (c) “intrinsic alterations in the nature of the blood itself” (hypercoagulability) ([7](#)). Many students of coagulation medicine, though, do not realize that Virchow actually recognized his “triad” as being the result of vascular occlusion—not necessarily as the original precipitant of vascular thrombosis. Nonetheless, the vascular, rheologic, and hematologic aspects of thrombosis known as Virchow triad remain relevant and instructive today ([Fig. 61.1](#)).



**Figure 61.1.** Pathophysiology of thrombosis. Factors implicated in the pathogenesis of arterial thrombosis (*left*) and venous thrombosis (*right*) are depicted. Examples of disorders leading to platelet activation and arterial thrombosis include the myeloproliferative disorders, heparin-associated thrombocytopenia/thrombosis syndrome, thrombotic thrombocytopenic purpura, and certain platelet polymorphisms. Examples of

disorders leading to venous thrombosis in the category of deficiency of physiologic inhibitors include the inherited disorders, factor V Leiden, proteins C and S deficiencies, and AT deficiency. Many patients with thrombosis may have more than one of the risk factors listed. Estrogen therapy is a risk factor for venous thrombosis; its use is associated with activation of coagulation.

## Abnormalities of Blood Flow

Arterial thrombosis initially occurs under conditions of rapid blood flow (high shear stress), a condition in which von Willebrand factor (vWF) is critical for platelet adhesion ( [8](#) ). Arterial thrombi usually are composed of tightly coherent masses of platelets, which contain small amounts of fibrin and a few erythrocytes and leukocytes. These thrombi are the classic “white thrombi,” which resemble, in many respects, normal hemostatic plugs. As arterial thrombi enlarge, progressive or intermittent deposition of new layers of platelets and fibrin produces the characteristic lines of Zahn; partial or complete obstruction of blood flow may produce a “tail” of “red thrombus.” The most serious consequences of arterial thrombosis are vascular occlusion with resultant ischemia and infarction of tissue and distal thrombus embolization.

Hypertension, turbulent blood flow at arterial branch points and at sites of focal atherosclerosis, and hyperviscosity may be contributory factors in certain forms of arterial thrombosis. Causes of plasma hyperviscosity that can precipitate thrombosis and exacerbate ischemia include acute myeloid leukemia, myeloproliferative syndromes such as polycythemia rubra vera, cryoglobulinemia and the plasma cell dyscrasias, including multiple myeloma and Waldenström macroglobulinemia. Immunoglobulin (Ig) paraproteins produced by plasma cell dyscrasias can increase viscosity, promote red blood cell agglutination, and, in select cases, induce a natural anticoagulant deficiency ( [9](#) ).

Venous thrombosis typically develops under conditions of slow blood flow (low shear stress) and is augmented by further retardation and stagnation of flow caused by the developing thrombus itself. Right-sided heart failure, preexistent venous thrombosis, extrinsic vascular compression by tumor, and chronic venous insufficiency all promote venous stasis, blood pooling, and a concentration of procoagulant factors ( [10](#) ). The anatomic structure of venous valves results in retrograde eddy currents, which produce pockets of stasis even in normal veins ( [11](#) ). The venous arcades in the soleus muscles of the calves may represent another site of physiologic venous stasis. These structures may enlarge and lose vascular tone with aging ( [12](#), [13](#) ). These facts may partially explain why DVT most commonly occurs in the valve cusps and veins of the pelvis and lower extremities.

Venous thrombi are composed of large amounts of fibrin containing numerous erythrocytes. In these loose, friable masses (the red thrombus), the platelets and leukocytes are enmeshed in random fashion. Venous thrombi resemble blood clots formed *in vitro*, and they usually produce significant obstruction to blood flow from the outset, but their most serious consequence is embolization. Blood flow obstruction secondary to venous thrombosis itself promotes the further formation of thrombus. Results of studies of clots formed in a thromboviscometer at varying rates of shear suggest that the differences in the structure of venous and arterial thrombi may be mainly the result of the velocity of blood flow. The many and complicated rheologic factors that may be involved in thrombosis have been reviewed ( [14](#) ).

## Vascular Injury



Permanent and transient vascular injuries play major roles in the development of arterial thrombosis. Intraluminal vascular endothelial cell injury, atherosclerotic plaque rupture, hyperhomocysteinemia, arterial outflow obstruction, aneurysm formation, and vessel dissection are among the recognized risk factors for arterial thrombosis (15, 16). Arterial thrombosis usually begins with platelet adhesion to an abnormal vascular endothelial surface or exposed subendothelial constituent such as collagen. The adherent platelets become activated, leading to the release of  $\alpha$ - and dense granule contents (15). Platelet-dense granules (dense bodies) release adenosine diphosphate (ADP), adenosine triphosphate, calcium, and serotonin into the surrounding milieu, resulting in the recruitment and activation of additional platelets (15, 17). This release reaction and platelet synthesis of thromboxane A<sub>2</sub> (TxA<sub>2</sub>) and other agonists induce the aggregation of more platelets and enlargement of the temporary platelet plug. In addition to the recruitment of additional platelets, the original nidus of adherent platelets provides a phospholipid surface rich in phosphatidylserine to support and concentrate the generation of thrombin and fibrin necessary to reinforce and stabilize the platelet plug.

New insights into arterial thrombus formation have been gleaned from experiments using confocal and wide-field microscopy to image real-time thrombus formation in live-mouse cremaster muscle arterioles (18). Thrombosis is precipitated by laser-induced endothelial injury. These experiments demonstrated that the initiation of blood coagulation *in vivo* involves the initial accumulation of tissue factor (TF) on the upstream and thrombus-vessel wall interface of the developing thrombus. The TF is biologically active and is associated with intrathrombus fibrin generation. TF density is highest at the thrombus-vessel wall interface and is eventually observed throughout the thrombus. Leukocyte rolling is noted approximately 2 minutes after endothelial cell injury and correlates with P-selectin expression on the outer aspect of the thrombus. Minimal TF and fibrin are detected in platelet thrombi formed in mice lacking P-selectin or the P-selectin ligand, PSGL-1.

In venous thrombosis, the luminal surface of the vessel wall is usually histologically normal, and factors extrinsic to the vessel appear to have a major pathophysiologic role. Exceptions to this generalization are direct venous trauma, extrinsic venous compression, and vascular endothelial cell injury due to the toxic effect of cancer chemotherapy and excess levels of homocysteine (16). A limited quantity of activated platelets likely serve as a phospholipid surface to support local thrombin and fibrin formation. A generalized reduction in venous tone may be an important pathophysiologic factor in venous thrombosis in pregnant women and in women taking oral contraceptives (19).

### **Abnormalities of the Blood: Hypercoagulability**

The term *hypercoagulable state* and its synonym *thrombophilia* refer to any inherited or acquired abnormality of the hemostatic system, which places an individual at increased risk for venous or arterial thrombosis (or both). Blood from patients with active thrombosis or with a hypercoagulable state may clot at an abnormally rapid rate *in vitro* (20). The concept of hypercoagulability has gained widespread acceptance, and it is generally appreciated that these hemostatic changes are important in the pathogenesis of thrombosis, and that testing for these disorders may be helpful in patient management (3, 21, 22 and 23).

**PLATELET ABNORMALITIES** Although platelets may be incorporated into virtually any thrombus, they appear to be pathogenetically most important in arterial thrombosis. The relative lack of use of antiplatelet agents for the primary and secondary prevention of

VTE indirectly supports this notion. Increased platelet turnover (shortened platelet survival, compensated platelet destruction) occurs in vascular disease and thrombosis, including arterial and venous thrombosis, coronary artery disease, vasculitis, hyperhomocysteinemia, and valvular heart disease ( [24](#) , [25](#) , [26](#) , [27](#) , [28](#) , [29](#) and [30](#) ). Increased platelet turnover can also be seen in patients with risk factors for vascular disease, including those who use tobacco and those with hyperlipidemia ( [31](#) , [32](#) ). The increased platelet turnover and activation can reflect thromboembolic disease and also probably contribute to an exacerbation of thrombotic events. As a consequence of platelet–vessel wall interactions in patients with vascular disease, platelet adhesion, activation, and aggregation occur, resulting in acquired storage pool disease and the presence in the blood of platelet granule–derived proteins such as platelet factor–4 and  $\beta$ –thromboglobulin ( [33](#) , [34](#) ). Although elevated blood levels of these proteins indicate increased platelet turnover, improper blood collection technique may artifactually result in abnormal levels, and the clinical use of such testing is uncertain. Vascular endothelium possesses multiple antiplatelet properties that may be important in preventing platelet adhesion, promoting vasodilation, and inhibiting platelet aggregation ( [35](#) , [36](#) , [37](#) and [38](#) ). However, interruption of endothelial cell prostacyclin synthesis by aspirin does not result in a net thrombotic tendency. The potential role of hyperactive platelets in patients with thrombosis, as well as the use of platelet function testing in this setting, is somewhat controversial. SPS is an autosomal–dominant disorder characterized by *in vitro* platelet hyperaggregability in response to ADP and epinephrine ( [39](#) ). Up to 21% of people with unexplained arterial occlusive events and many with recurrent arterial thrombotic events have SPS. Clinical events associated with SPS appear to follow bouts of emotional stress. Aspirin therapy at a dose as low as 81 mg daily normalizes the *in vitro* aggregation defect in the majority of patients. Because of the importance of vWF in mediating platelet adhesion to subendothelium, the role of vWF in human vascular disease has been a topic of investigation. Pigs affected with von Willebrand disease (vWD) are resistant to atherosclerosis; however, a human autopsy study found that severe vWD did not protect against atherosclerosis ( [40](#) , [41](#) ). On the other hand, there was no pathologic evidence for arterial thrombosis in the autopsy study ( [41](#) ). An association between elevated plasma vWF levels and recurrent MI has been demonstrated, and vWF antigen is an independent predictor of coronary artery disease ( [42](#) ). Platelet polymorphisms have been evaluated as risk factors for arterial thrombosis. These include polymorphisms for glycoprotein (gp) IIIa (PI<sup>A2</sup>), gpIa (807 T allele), and gpIb ( [43](#) ). The PI<sup>A2</sup> polymorphism is linked with coronary artery disease; PI<sup>A2</sup>–positive platelets exhibit a lower threshold for activation and also have variable aspirin sensitivity ( [43](#) ).

**COAGULATION ABNORMALITIES** Coagulation disorders that can contribute to hypercoagulability can be divided in three risk factor categories: situational, inherited, and acquired ( [21](#) , [44](#) , [45](#) and [46](#) ). Situational risk factors represent well–defined, transient clinical circumstances that are associated with increased thrombosis risk both while they are present and for a short period after they have resolved. Examples include surgery, prolonged immobilization, oral contraceptive pill (OCP) use, hormone replacement therapy (HRT), pregnancy, cancer chemotherapy, and heparin–induced thrombocytopenia (HIT). Inherited risk factors represent genetic mutations and polymorphisms that result in deficiency of a natural anticoagulant (e.g., protein C, protein S, or AT), procoagulant factor accumulation (e.g., prothrombin G20210A or the thermolabile variant of the enzyme methylenetetrahydrofolate reductase), or coagulation factor resistance to inactivation by a natural anticoagulant (i.e., factor V G1691A, also known as *factor V Leiden*). These conditions are characterized by a disruption in the normally highly regulated coagulation mechanism resulting in greater thrombin generation and an increased risk of clinical thrombosis. Acquired risk factors result either from medical conditions or from nonfamilial hematologic abnormalities that interfere with normal hemostasis or blood rheology. Examples include cancer, inflammatory bowel disease, nephrotic syndrome, vasculitis, antiphospholipid antibodies, myeloproliferative syndromes, paroxysmal nocturnal

hemoglobinuria, and hyperviscosity syndromes. These acquired risk factors are distinct from situational risk factors by the fact that they represent alterations in hemostatic homeostasis as a result of disease or, for the most part, nonreversible processes. In contrast, situational risk factors result from either a therapeutic intervention or an adverse reaction from such an intervention. Hyperhomocysteinemia and increased factor VIII functional activity are examples of thrombosis risk factors that can be acquired in nature or have a genetic predisposition ( [30](#), [47](#)). Age defies categorization but remains the single most predictable risk factor for thrombosis. The estimated baseline annual age-associated risk of VTE is 1 in 10,000 people younger than 40 years of age, increasing to 1 in 100 people older than 75 years of age ( [48](#), [49](#) and [50](#)). Recent reports have focused on elevated levels of various coagulation factors, particularly fibrinogen and factors V, VII, VIII, X, and XI, that have been documented in patients with thrombosis and prethrombotic disorders, including pregnancy and estrogen-containing contraceptive use ( [51](#)). Fibrinogen and factors V and VIII are acute-phase reactants, and their plasma levels may rise in patients with virtually any disorder associated with tissue damage or inflammation, including most thrombotic processes. Whether increased because of a genetic factor or an acute-phase reaction, excess procoagulant factor concentrations may tilt the hemostatic scales in favor of hypercoagulability and may be associated with an increased risk of thrombosis. Epidemiologic studies have identified elevated plasma levels of fibrinogen and factor VII activity as independent risk factors for cardiovascular disease ( [52](#), [53](#) and [54](#)).

**FIBRINOLYTIC ABNORMALITIES** Abnormal fibrinolysis has also been linked to vascular disease. Low fibrinolytic activity (measured by dilute clot lysis) was a significant determinant of coronary artery disease in the Northwick Park Heart Study, and elevated PAI-1 activity was associated with major ischemic events in another study ( [55](#), [56](#)). In the European Concerted Action on Thrombosis and Disabilities study, an increased incidence of vascular events was associated with higher baseline PAI-1 antigen concentrations (  $p = .02$ ) and PAI-1 activity (  $p = .001$ ) ( [57](#)). Defects in endogenous fibrinolytic capacity have also been found in young patients with severe limb ischemia or unexplained arterial thromboembolism. Deficient t-PA release was found in 45% of such patients, and elevated levels of PAI-1 were found in 59% ( [58](#)). Excess PAI-1 resulting in impaired endogenous fibrinolysis has also been associated with venous thrombosis in select cases ( [59](#)). One must appreciate that elevated levels of coagulation zymogens not only occur in a number of medical disorders as a result of an acute-phase response; certain coagulation proteins may also have predictive importance when elevated in cardiovascular disease. Fibrinogen, factor VII, PAI-1, and vWF appear to be particularly useful in this regard.

## ACTIVATION OF COAGULATION

Mechanisms leading to activation of coagulation in patients with thrombosis have been proposed. TF is thought to be the primary initiator of *in vivo* coagulation ( [60](#)). In the absence of TF expression, endothelial cells actively maintain thromboresistance. TF may be expressed in trace amounts during various physiologic processes, such as during normal parturition and after even minimal trauma, including minor head injuries.

Immunologic injury of endothelium may lead to the exposure of TF ( [61](#)). Antibodies formed to exogenous heparin may bind to heparan sulfate on the endothelium, resulting in cell injury, the expression of TF, and the initiation of coagulation ( [62](#), [63](#)). In a similar manner, endothelial cells may be induced to express TF by interleukin-1, homocysteine, tumor necrosis factor, and endotoxin ( [64](#), [65](#), [66](#) and [67](#)). TF antigen expression by endothelium has been demonstrated in pathologic primate and human tissues ( [68](#), [69](#) and [70](#)). Activation of coagulation may also occur on monocytes, and platelets can be activated to mediate factor Xa-catalyzed prothrombin conversion to thrombin ( [71](#), [72](#)). Deficient hepatic clearance of activated coagulation factors may represent an important

thrombogenic factor in premature infants and in patients with liver disease, especially after administration of prothrombin complex concentrates that contain trace amounts of activated vitamin K-dependent coagulation factors.

Various other mechanisms may be responsible for low-grade *in vivo* coagulation under certain conditions. Adenocarcinoma tumor cells can directly promote thrombin generation by producing TF, expressing the coagulation factor X activator known as *cancer procoagulant*, or displaying surface sialic acid residues that can support nonenzymatic factor X activation ( 73, 74 ). Tumor cells can also indirectly promote thrombin generation by eliciting TF expression by monocytes and endothelial cells. Selected tumors may mediate an accentuation of platelet activation and accumulation, whereas other tumor cells may express surface phospholipid species such as phosphatidylserine, which can support prothrombin and factor X activation ( 75 ).

Kinetic studies have been performed in an attempt to demonstrate accelerated catabolism of coagulation factors in hypercoagulable states. The turnover of fibrinogen is accelerated in patients with major venous thrombosis and in diabetics with hyperglycemia, but not in patients with small thrombotic lesions ( 76, 77 ). The turnover of radioiodinated prothrombin is normal, even in the setting of major thrombosis ( 78 ).

A laboratory picture similar to that described in the hypercoagulable state may also be seen in patients with nonovert (compensated or chronic) disseminated intravascular coagulation (DIC) ( 79 ). In such patients, the prothrombin time (PT) and the activated partial thromboplastin time (aPTT) may be shortened because of the presence of traces of thrombin or other activated coagulation factors. These activated factors affect one-stage, but not two-stage, clot endpoint coagulation assays. High levels of factor V and factor VIII activity may reflect the presence of thrombin-activated forms of these factors in the circulation. Pregnancy, which can be regarded as a hypercoagulable state, has also been described as a physiologic form of nonovert DIC by some clinicians ( 80 ). Pregnancy increases the risk of venous thromboembolism approximately fivefold among the general population, and female patients who have experienced prior venous thrombosis have a threefold risk of venous thrombosis during pregnancy ( 81 ). The use of estrogen-containing oral contraceptives and estrogen HRT is clearly associated with an increased risk of venous thromboembolism ( 82 ). A prospective study of these patients indicates that estrogens induce activation of coagulation as well as reduction in levels of natural anticoagulants such as AT and protein S ( 83 ). However, many patients who experience venous thromboembolism while taking oral contraceptives have a common inherited thrombotic disorder, APC resistance (APC-R), or prothrombin G20210A ( 84 ). Another report indicated that oral contraceptives induced “acquired activated protein C resistance” in females ( 85 ). The relative risk of venous thromboembolism in postmenopausal women using estrogen replacement is 2.14, and the risk is highest during the first year of use ( 86 ). [Table 61.1](#) summarizes acquired etiologies predisposing one to thrombosis.

**TABLE 61.1. Acquired Disorders Predisposing to Thrombosis**

---

|  |
|--|
| Vascular disorders   |
| Atherosclerosis  |
| Diabetes   |
| Vasculitis   |
| Prosthetic materials (grafts, valves, indwelling vascular catheters) |

## Abnormal rheology

Stasis (immobilization, surgery, congestive heart failure)

Hyperviscosity (polycythemia vera, Waldenström macroglobulinemia, acute leukemia, sickle cell disease)

## Other disorders associated with hypercoagulability

Cancer (Trousseau syndrome)

Cancer chemotherapeutic agents, thalidomide

Oral contraceptives, estrogen therapy, selective estrogen receptor modulators

Pregnancy

Infusion of prothrombin complex concentrates

Nephrotic syndrome

Myeloproliferative disorders

Paroxysmal nocturnal hemoglobinuria

Inflammatory bowel disease

Thrombotic thrombocytopenic purpura

Disseminated intravascular coagulation

Antiphospholipid antibody syndrome

Heparin-induced thrombocytopenia/thrombosis

Human immunodeficiency virus infection

---

## INHERITED THROMBOTIC DISORDERS

Several recent monographs and reviews have covered the topic of inherited thrombotic disorders in detail ([3](#), [21](#), [22](#), [46](#), [51](#), [87](#), [88](#)). [Table 61.2](#) summarizes the prevalence of selected inherited and acquired hypercoagulable states in different populations, whereas [Table 61.3](#) summarizes the clinical presentations of venous thrombosis that may be suggestive of particular hypercoagulable states. Many patients who experience thrombosis are found to have a combination of defects, for example, APC-R plus use of oral contraceptive agents ([84](#)), or a combination of inherited defects ([88](#)). Although people with inherited hypercoagulable states are at a greater risk for developing a thrombotic event than those without such disorders, not all people with a well-defined hypercoagulable state develop an overt thrombosis, and not all people with thrombosis have an identifiable hypercoagulable state. Testing for an inherited hypercoagulable state is likely to uncover an abnormality in more than 60% of patients presenting with idiopathic (i.e., spontaneous or unprovoked) venous thrombosis ([22](#), [88](#)). Although the remaining 30 to 40% have unremarkable test results, this does not imply a true absence of a hypercoagulable state. Some of these individuals may have an acquired condition such as cancer or antiphospholipid antibodies, whereas others may have a disorder or genetic defect that has not yet been discovered or characterized.

**TABLE 61.2. Prevalence of Selected Inherited and Acquired Hypercoagulable States in Different Patient Populations**

| Hypercoagulable State | General Population (%) | Patients with First Venous Thromboembolism (%) | Thrombophilic Families (%) |
|-----------------------|------------------------|--|----------------------------|
| Factor V Leiden       | 3–7 <a href="#">a</a>  | 20   | 50                         |
| Prothrombin G20210A   | 1–3                    | 6  | 18                         |

|                                     |         |       |      |
|-------------------------------------|---------|-------|------|
| Protein C deficiency                | 0.2–0.4 | 3     | 6–8  |
| Protein S deficiency                | N/A     | 1–2   | 3–13 |
| Antithrombin deficiency             | 0.02    | 1     | 4–8  |
| Mild hyperhomocysteinemia           | 5–10    | 10–25 | N/A  |
| Elevated factor VIII                | 11      | 25    | N/A  |
| Lupus anticoagulant                 | 0–3     | 5–15  | N/A  |
| Elevated anticardiolipin antibodies | 2–7     | 14    | N/A  |

N/A, not available or unknown.

<sup>a</sup> Prevalence as high as 15% in northern Europe.

**TABLE 61.3. Clinical Presentations of Venous Thromboembolism That May Suggest Certain Hypercoagulable States**

| Venous Thromboembolism Presentation  | Hypercoagulable State   |
|--|---|
| Cerebral vein thrombosis in women using oral contraceptives  | PT G20210A mutation   |
| Cerebral vein thrombosis in general  | Paroxysmal nocturnal hemoglobinuria, essential thrombocythemia, antiphospholipid antibodies, antithrombin deficiency, PT G20210A mutation |
| Intraabdominal vein thrombosis (inferior vena cava, renal vein, portal vein, mesenteric and hepatic veins) | Antiphospholipid antibodies, paroxysmal nocturnal hemoglobinuria, myeloproliferative syndromes, cancer, antithrombin deficiency           |
| Warfarin skin necrosis   | Protein C, protein S deficiencies   |
| Unexplained recurrent fetal loss   | Antiphospholipid antibodies; factor V Leiden  |
| Recurrent superficial thrombophlebitis   | Factor V Leiden, polycythemia vera, protein C, protein S, or antithrombin deficiency  |
| Migratory superficial thrombophlebitis (Trousseau syndrome)  | Adenocarcinoma (particularly of the gastrointestinal tract)   |
| Neonatal purpura fulminans   | Homozygous protein C or protein S deficiency  |

### Antithrombin Deficiency

AT, formally known as *AT-III*, deficiency was first described by Egeberg in 1965 ([89](#)). AT, a serine protease inhibitor, regulates coagulation by inactivating thrombin and other procoagulant enzymes, including factors Xa, IXa, XIa, and XIIa. Like most inherited thrombotic disorders, AT deficiency is inherited as an autosomal-dominant disorder ([90](#), [91](#)). A blood bank survey reported that 1 in 600 people have AT deficiency ([92](#)). The interactions of unfractionated and low-molecular-weight heparin (LMWH) with AT are discussed in the section [Heparin](#).

**PATHOPHYSIOLOGY AND GENETICS** Patients with AT deficiency may have either type I (quantitative deficiency) or type II (qualitative abnormality) disease. Type I AT-deficient patients usually have concordant reductions in AT measured by both immunologic and



functional assays. Type II patients have reduced functional AT activity associated with normal amounts of AT protein. Plasma concentrations of the thrombin activation peptide, prothrombin fragment 1+2, are elevated in patients with AT deficiency, indicating persistent activation of coagulation as a result of deficient neutralization of factor Xa in these patients ( [93](#) ). The genetic basis for type I AT deficiency is either deletion of a gene segment or the occurrence of point mutations or deletions, resulting in a nonsense mutation and an incomplete protein. The genetic basis for type II AT deficiency is the occurrence of point mutations that do not impair synthesis of the protein, but that result in a dysfunctional protease inhibitor. A summary of AT mutations (greater than 100) has been reported ( [94](#) ). In general, mutant AT molecules exhibit deficient heparin binding, deficient protease inhibition, or both.

**CLINICAL ASPECTS** AT deficiency is manifested primarily by recurrent venous thromboembolism ( [90](#), [91](#) ). Almost every vein site has been reported to be involved with thrombosis in AT-deficient patients, including unusual sites such as mesenteric vessels ( [95](#) ). Thrombosis may occur in the absence of precipitating factors or may result from events such as pregnancy, estrogen use, trauma, or surgery. AT deficiency can result in heparin resistance manifesting as a normal to minimally increased aPTT in patients receiving large doses of heparin ( [96](#) ). However, most patients with AT deficiency do not exhibit heparin resistance, and most cases of heparin resistance are not due to AT deficiency. In family studies, venous thrombosis occurred in 85% of AT-deficient relatives before 55 years of age ( [96](#) ). The estimated increased lifetime relative risk of venous thrombosis has been reported to be up to 40-fold ( [97](#), [98](#) ). An annual absolute risk of venous thrombosis of 27.5% has been reported in women carriers of AT deficiency who also use OCPs ( [99](#) ). Early studies reported pregnancy-related venous thrombosis rates as high as 70% for AT-deficient women ( [100](#), [101](#) ). Most AT-deficient patients are heterozygotes and possess approximately 50% of normal activity levels. Although homozygotes have been reported in consanguineous kindreds, in general, homozygous type I AT deficiency is believed to be fatal *in utero* ( [102](#) ).

**LABORATORY DIAGNOSIS** Results of the PT and aPTT are normal in AT-deficient patients. A variety of commercial assays are available to measure AT levels, including functional and immunologic assays. Functional assays are preferable because they detect both type I and type II patients. One report found that approximately 40% of patients with AT deficiency had type II disease ( [103](#) ). Functional assays for AT measure heparin cofactor activity using a chromogenic substrate method to quantitate thrombin or factor Xa neutralization ( [104](#) ). A potential disadvantage of functional AT assays is that plasma AT levels may be overestimated because of the presence of heparin cofactor II (HCII) in the sample. The use of bovine thrombin and a low heparin concentration (3 U/ml) in the assay system can minimize this problem ( [105](#) ). Immunologic assays for AT use Laurell rocket immunoelectrophoresis, microlatex-particle immunoassay, radial immuno-diffusion, or enzyme-linked immunosorbent assay (ELISA) methods ( [106](#) ). Ideally, patients should be evaluated for AT deficiency at a time when they are not receiving therapeutic heparin or oral anticoagulants, because heparin depresses AT levels, whereas long-term warfarin therapy increases plasma AT levels in some patients ( [91](#), [107](#) ).

**TREATMENT** Some AT patients may experience heparin resistance, requiring the administration of AT by using virally inactivated, plasma-derived AT concentrates or fresh frozen plasma. A transgenic AT concentrate has been developed and is currently in clinical trial. Supplemental AT may make it easier to achieve therapeutic anticoagulation with heparin in these patients. Patients with recurrent thrombosis should receive long-term warfarin therapy at a dosage to maintain an international normalized ratio (INR) value of 2.0 to 3.0 (discussed in the section [Warfarin](#)). Patients with a single thrombotic event should receive at least 3 to 6 months of warfarin therapy and, because of an increased recurrence rate, should be considered for long-term therapy beyond 6 months. Patients with massive venous thrombosis or PE may be candidates for thrombolytic therapy. AT-deficient patients who become pregnant or who will undergo general surgery



should be considered for anticoagulant prophylaxis, including AT concentrate administration ( [108](#) ). Most asymptomatic patients should not be treated. The avoidance of estrogens should be considered in AT-deficient patients.

**ACQUIRED ANTITHROMBIN DEFICIENCY** AT deficiency is also associated with numerous disorders, including DIC, liver disease, nephrotic syndrome, preeclampsia, and is seen in patients taking oral contraceptive agents and during pregnancy ( [109](#) , [110](#) , [111](#) and [112](#) ). Although logic would suggest that correction of AT deficiency might be clinically useful in disorders such as DIC or liver disease, there are no conclusive data supporting AT replacement therapy outside the setting of prophylaxis of high-risk patients, such as pregnant, AT-deficient patients ( [113](#) ).

### Heparin Cofactor II Deficiency

HCII is another heparin-dependent thrombin inhibitor, differing from AT in that a glycosaminoglycan other than heparin, dermatan sulfate, catalyzes this inhibitor of coagulation ( [114](#) ). HCII deficiency is inherited as an autosomal-dominant trait. Although there have been anecdotal studies of thrombosis associated with HCII-deficient kindreds, a larger study has concluded that HCII deficiency by itself may not be an inherited risk factor for thrombosis ( [115](#) , [116](#) and [117](#) ). Commercial assays to measure HCII levels are available, but the clinical use of such assays in routine evaluation of patients for inherited thrombosis is uncertain.

### Protein C Deficiency

Protein C is a vitamin K-dependent plasma protein that, when activated by the thrombin-thrombomodulin complex to activated protein C, inactivates factors Va and VIIIa to inhibit coagulation ( [118](#) ). APC also possesses profibrinolytic activity that results from neutralization of PAI-3 activity ( [119](#) ). Inherited deficiency of protein C and its association with thrombosis were first described by Griffin and co-workers in 1981 ( [120](#) ). Protein C deficiency was believed to be inherited in an autosomal-dominant pattern with incomplete penetrance. Recent studies have suggested that protein C deficiency may be an autosomal-recessive disorder and that coinheritance of another defect (particularly factor V Leiden) results in a high degree of penetrance that appears as dominant inheritance in double-heterozygous carriers ( [121](#) , [122](#) ).

**PATHOPHYSIOLOGY AND GENETICS** As with AT deficiency, patients with protein C deficiency may have type I (quantitative deficiency) or type II (qualitative abnormality) disease. Most patients are heterozygotes with approximately 50% of normal protein C levels. A hypercoagulable state can be demonstrated in nonanticoagulated protein C-deficient patients using activation peptide (fragment 1+2) assays ( [123](#) ). In type I protein C deficiency, more than half of the gene mutations identified are missense mutations. Point mutations affecting protein function appear to be common in patients with type II protein C deficiency. A 1995 review of protein C mutations identified 16 distinct mutations in type II protein C deficiency ( [124](#) , [125](#) ). More than 160 different gene abnormalities have been associated with both types of protein C deficiency ( [94](#) , [126](#) ). An updated summary of protein C mutations is available at [www.ISTH.org](http://www.ISTH.org). Despite the clear association of protein C deficiency with thrombosis in large epidemiologic studies, there are also definitive data indicating that many protein C-deficient patients are asymptomatic ( [127](#) ). For example, one report found that heterozygous protein C deficiency occurred in approximately 1:250 subjects, whereas a large Scottish study estimated the prevalence to be approximately 1:500 ( [121](#) , [128](#) ). No patient in either study had a history of symptomatic venous thrombosis. These findings indicate that additional

risk factors—acquired, genetic, or both—are necessary to provoke thrombosis in heterozygous protein C-deficient patients. Indeed, in one study, up to 20% of symptomatic protein C-deficient patients also had APC-R, supporting the concept that many patients with recurrent thrombosis have more than one risk factor ( [122](#) ).

**CLINICAL ASPECTS** Three clinical syndromes are associated with protein C deficiency: venous thromboembolism in heterozygous adults, neonatal purpura fulminans in homozygous newborns, and warfarin-induced skin necrosis in certain heterozygous adults. The predominant clinical symptom of protein C-deficient patients is recurrent venous thromboembolism, although arterial thrombotic events, including stroke, have been reported ( [129](#) , [130](#) ). As mentioned above, many patients are found to have risk factors other than inherited protein C deficiency on investigation, such as APC-R, use of oral contraceptive agents, and pregnancy. Protein C deficiency has been linked to fetal loss ( [131](#) ). Neonatal purpura fulminans is seen in homozygous newborns of heterozygous parents. These children develop DIC at birth, associated with extensive venous or arterial thrombosis (or both) and very low levels of protein C (<5% of normal) ( [132](#) ).

Warfarin-induced skin necrosis is an unusual syndrome seen in certain patients with heterozygote protein C deficiency ( [133](#) ). Most patients who develop this syndrome have received large doses of warfarin in the absence of concomitant overlapping therapeutic parenteral anticoagulation. The basis for this syndrome is that warfarin therapy, especially in large loading doses, reduces protein C levels more rapidly than the vitamin K-dependent procoagulant factors, leading to exacerbation of the basal hypercoagulable state and thrombosis. In family studies, venous thrombosis occurred in 50% of protein C-deficient relatives of affected probands before 40 years of age ( [134](#) ). The estimated increased lifetime relative risk of venous thrombosis has been reported to be up to 31-fold ( [97](#) , [98](#) ). As stated above, other studies did not detect an increased thrombosis risk in carriers of protein C deficiency. Differences in risk between family- and population-based studies can be in part explained by greater difficulty in obtaining reliable population-based estimates due to the overall low prevalence of this and other natural anticoagulant deficiencies. In studies of unselected patients with venous thrombosis, the odds ratio of having protein C deficiency is increased six- to ninefold compared to controls ( [46](#) , [134](#) , [135](#) and [136](#) ). An annual absolute risk of venous thrombosis of 4.3% has been reported in women carriers of a natural anticoagulant deficiency such as protein C deficiency who also use OCPs ( [99](#) , [137](#) ). Protein C activity less than 0.68 U/ml, measured at the time of thrombosis in individuals without a known hypercoagulable state, has been associated with increased rates of recurrent venous thrombosis ( [138](#) ).

**LABORATORY DIAGNOSIS** Patients with heterozygous protein C deficiency have normal PT and aPTT values, whereas patients with homozygous protein C deficiency have abnormal coagulation tests consistent with DIC. Because both type I and type II disorders may occur, functional assays are suggested to optimize identification of affected patients. The most commonly used commercial assay uses a snake venom activator (Protac) in a chromogenic substrate or clot-based assay ( [139](#) ). The limitations of Protac-based assays have been reviewed ( [139](#) ). Some investigators prefer the clot endpoint-based assay, because it measures complete function of the protein C molecule, including those patients with abnormal protein C molecules that possess normal activity by a chromogenic substrate assay. However, therapeutic heparin levels affect the clot-based assay. A College of American Pathologists' consensus conference on thrombophilia recommends use of the chromogenic substrate assay ( [140](#) ). A recent report indicated that measurement of the protein C to protein S antigen ratio was useful in identifying carriers of protein C deficiency ( [141](#) ). Protein C levels can also be measured by immunologic methods, including Laurell rocket immunoelectrophoresis and ELISA ( [139](#) ). However, immunologic assays may not detect type II patients and may overestimate protein C levels in warfarin-treated patients. Immunologic assays may be more useful in evaluating patients with homozygous deficiency and DIC. Age-related changes occur with protein C levels ( [142](#) ). Consequently, it is important to consider this when testing younger

patients (<30 years); otherwise, normal subjects may be misclassified as protein C-deficient. A common problem faced by laboratories is measuring protein C levels in patients taking oral anticoagulants. Many clinicians forget that protein C is a vitamin K-dependent molecule, and that otherwise hemostatically normal people taking warfarin may have low protein C levels. Griffin and co-workers suggested that protein C data be normalized against the level of another vitamin K-dependent protein to distinguish inherited protein C-deficient patients from normal subjects taking warfarin (120). One author reported that using a ratio between protein C and prothrombin optimally categorized patients (143). However, for this method to be useful, patients must be stably anticoagulated for at least 2 weeks, and the laboratory must obtain plasma samples and reference ranges from patients taking warfarin for reasons other than recurrent thrombosis. The consensus conference did not recommend assaying protein C levels in patients on oral anticoagulants (140).

**TREATMENT** Many patients with protein C deficiency are asymptomatic, especially those identified in screening studies. Asymptomatic patients should not be treated but should be considered for prophylaxis when they experience high-risk procedures, such as surgery. Symptomatic protein C-deficient patients should be anticoagulated with heparin and then considered for long-term secondary prophylaxis with warfarin at an INR of 2.0 to 3.0. Those patients with a single thrombotic event should receive at least 3 to 6 months of warfarin. The American College of Chest Physicians' Consensus Conference on Antithrombotic Therapy does not recommend indefinite anticoagulation for protein C-deficient patients with a single uncomplicated thrombotic event (144). Patients with more than one thrombotic event, or patients with a single life-threatening thromboembolic event, should be considered for long-term anticoagulation. Patients with massive thrombosis or PE may be candidates for thrombolytic therapy. Infants with neonatal purpura fulminans should be treated with protein C replacement therapy. Protocols using a purified protein C concentrate or prothrombin complex concentrates have been described (145, 146). Use of the purified concentrate normalizes activation of coagulation in these homozygous patients (147). The role of replacement therapy using the recently approved recombinant APC concentrate in patients with protein C deficiency remains to be determined.

**ACQUIRED PROTEIN C DEFICIENCY** Because protein C is a vitamin K-dependent protein, any disorder associated with vitamin K deficiency may result in protein C deficiency, including warfarin use, liver disease, and malnutrition (148). Protein C levels are also reduced in DIC, presumably reflecting thrombin activation of the zymogen and consumption of APC (149). Protein C levels may also be reduced in renal disease, especially the nephrotic syndrome (150).

## Protein S Deficiency

Protein S is a vitamin K-dependent plasma protein that facilitates the anticoagulant activity of activated protein C. Protein S deficiency in association with inherited thrombotic disease was first described by two groups in 1984 (151, 152). As with AT and protein C deficiencies, protein S deficiency is inherited as an autosomal-dominant trait. A recent large epidemiologic study found that protein S deficiency may not be a true risk factor for thrombosis, and others have reported that many patients with a previous diagnosis of protein S deficiency actually have APC-R (127, 153, 154). This diagnostic error results from interference in the functional protein S assay of patients with the inherited disorder, APC-R, and misclassification of patients. These patients have a "pseudo" protein S deficiency, often display a type II deficiency pattern, and have protein S activity levels that correlate with the APC ratio. Based on these reports and the high incidence of APC-R in the general population, the true importance of protein S deficiency in inherited thrombosis is uncertain (153, 154 and 155).

**PATHOPHYSIOLOGY AND GENETICS** As described for AT and protein C deficiencies, patients with protein S deficiency may have quantitative or qualitative disorders. Under normal circumstances, protein S exists in plasma in two forms: bound to C4b-binding protein (60% of total protein S) and free (40% of total). Because only free protein S has cofactor activity, a revised classification system has been proposed for protein S deficiency ( [156](#) ). Type I protein S deficiency is a quantitative disorder in which protein S functional activity, total antigen, and free antigen levels are equally reduced to approximately 50% of normal. Type IIa protein S deficiency is a deficiency of free protein S with preserved normal levels of total protein S. In type IIb protein S deficiency, the levels of both total and free protein S antigen are normal. Apparent type IIb protein S deficiency has been described in patients with APC-R ( [155](#) ). An acquired type IIa protein S deficiency may result from excess levels of C4b-binding protein or the presence of free protein S inhibitory and clearing autoantibodies. More than 100 different mutations have been identified in the gene that codes for protein S ( [94](#) ). A full listing of protein S gene mutations and polymorphisms can be found at [www.ISTH.org](http://www.ISTH.org). As with protein C deficiency, many patients with protein S deficiency and thrombosis have additional risk factors. In one study, among patients with protein S deficiency, approximately 40% also had APC-R; of family members with thrombosis, 72% had both defects, whereas less than 20% of patients with single defects experienced thrombosis ( [157](#) ).

**CLINICAL ASPECTS** Like AT and protein C-deficient patients, most patients with protein S deficiency and thrombosis have experienced venous thromboembolism ( [151](#), [152](#) ). However, unlike most other inherited thrombotic disorders, up to 25% of patients with protein S deficiency may experience arterial thrombosis including stroke ( [158](#) ). As mentioned previously, many patients with protein S deficiency and thrombosis have other risk factors, including APC-R, estrogen use, or pregnancy ( [157](#) ). Neonatal purpura fulminans, fetal loss, and warfarin-induced skin necrosis have also been associated with protein S deficiency ( [131](#), [159](#) ). In family studies, venous thrombosis occurred in 100% of protein S-deficient relatives of affected probands by 70 years of age ( [160](#) ). The estimated lifetime increased relative risk of thrombosis has been reported to be as high as 36-fold for protein S deficiency ( [97](#), [98](#) ). As mentioned above, other studies including the Leiden Thrombophilia study cast doubt on the association between thrombosis and protein S deficiency alone.

**Laboratory Diagnosis** Patients with heterozygous protein S deficiency have normal PT and aPTT values. The laboratory diagnosis of protein S deficiency is complicated by four factors: the levels of C4b-binding protein, the coexistence of APC-R in certain patients, elevated factor VIII activity levels, and warfarin therapy. C4b-binding protein is an acute-phase reactant protein S-binding protein, often elevated in thromboembolism, resulting in reduced free protein S levels from the patient's true baseline. Consequently, measurement of protein S levels in patients with acute thrombosis may yield misleading results. Similarly, false-positive results may be seen when functional protein S assays are performed on patients who have APC-R or factor VIII activity levels greater than or equal to 250% ( [155](#) ). Patients should not be assumed to have protein S deficiency (diagnosed by functional assay) until APC-R has been excluded. Lastly, because protein S is a vitamin K-dependent protein, warfarin therapy and vitamin K deficiency pose the same difficulty as described for patients evaluated for protein C deficiency. Protein S levels may also be decreased in the setting of pregnancy, but not necessarily associated with thrombotic events. Both functional and immunologic assays are commercially available to quantitate plasma protein S levels. Functional assays may be PT- or aPTT-based, measuring inhibition of factor Va by APC ( [161](#) ). These assays have the advantage of measuring free protein S activity. Immunologic assays to measure either total (free plus C4b-binding protein-bound) or free protein S levels are available ( [162](#), [163](#) ). Immunologic assays may be useful in evaluating patients who have coexisting APC-R. Total protein S levels are measured by Laurell rocket immunoelectrophoresis or ELISA. In the interpretation of immunologic assays, one should consider the report that the mean plasma level of protein



S antigen in males is higher than it is in females ( 163 ).

**TREATMENT** Asymptomatic patients should not be treated but should be considered for prophylaxis when they experience high-risk procedures, such as surgery. Symptomatic protein S-deficient patients should be anticoagulated as described for protein C-deficient patients. Those patients with recurrent thrombosis, or patients with a single life-threatening thromboembolic event, should be considered for long-term anticoagulation. Protein S concentrates are under development.

### Activated Protein C Resistance (Factor V Leiden)

Before 1993, most patients with idiopathic venous thrombosis evaluated for inherited thrombosis were not given a diagnosis, because AT, protein C, and protein S deficiencies together were found in less than 20% of patients. In 1993, Dahlback and colleagues from Sweden postulated that certain patients with recurrent thrombosis might have additional abnormalities of the protein C pathway, resulting in a hypercoagulable state ( 164 ). They found that addition of APC to plasma obtained from patients with recurrent thrombosis did not prolong the aPTT to the same degree as that seen when APC was added to normal plasma ( 164 ). These patients did not have any previously recognized inherited thrombotic disorder. The term *APC resistance* was used for these patients. Other investigators then used the aPTT-based APC screening test to examine other populations for this phenotype. APC-R was found in 20 to 60% of patients with recurrent thrombosis ( 165 , 166 and 167 ). Like other inherited thrombotic disorders, APC-R was inherited in an autosomal-dominant manner.

**PATHOPHYSIOLOGY AND GENETICS** Dominant inheritance renders the factor Va heavy chain partially (but not completely) resistant to inactivation by APC. APC inactivates factor Va in an orderly and sequential series of cleavages, first at Arg506, and then at Arg306 and Arg679 ( 168 , 170 ). Although the affected factor V cleavage site in APC-R is not directly responsible for complete inactivation of factor Va, APC cleavage at this site is necessary for subsequent proteolytic events. This “partial resistance” is explained by the fact that cleavage of factor Va by APC at Arg306 continues to occur, albeit at a slower rate ( 171 ). In fact, factor V Arg506Gln (factor V Leiden) is inactivated ten times slower than normal factor Va. This provides a pathophysiologic explanation for why factor V Leiden, although common, is a relatively weak risk factor for VTE. Because factor Va functions as a cofactor in the conversion of prothrombin to thrombin, the mutation results in greater amounts of factor Va available for coagulation reactions, “shifting” the hemostatic balance toward greater thrombin generation ( 21 , 94 ). APC-R due to factor V Leiden is the most common inherited predisposition to hypercoagulability in Caucasian populations of northern European background ( 21 ). Factor V Leiden follows a geographic and an ethnic distribution: The mutation occurs most frequently in northern and western Europe (the highest prevalences of 10 to 15% have been reported in Cyprus, Sweden, and Turkey) but is rare in the Asian and African continents as well as in ethnic groups from Asian descent, such as Inuit Eskimos, Amerindians, Australian Aborigines, and Polynesians ( 172 ). In the United States, factor V Leiden is most commonly seen in Caucasians (6.0%), with lower prevalences in Hispanics (2.2%), African and Native Americans (1.2%), and Asian Americans (0.45%) ( 173 ). Factor V Leiden accounts for 92% of cases of APC-R, with the remaining 8% of cases due to pregnancy, oral contraceptive use, cancer, selected antiphospholipid antibodies, plasma glucosylceramide deficiency, and other factor V point mutations ( 21 , 174 , 175 and 176 ). Therefore, the terms *factor V Leiden* and *APC-R* should not be considered synonymous; in fact, APC-R is an independent risk factor for VTE even in the absence of factor V Leiden ( 177 ). It is estimated that the mutation arose in a single Caucasian ancestor some 21,000 to 34,000 years ago—well after the evolutionary separation of non-Africans from Africans (approximately 100,000 years ago) and of Caucasoid (white Caucasians) from Mongoloid (Asians) subpopulations (approximately

60,000 years ago) ( [178](#) ).

**CLINICAL ASPECTS** Heterozygous carriers of factor V Leiden have a two- to tenfold increased lifetime relative risk of developing VTE ( [97](#) , [137](#) , [179](#) , [180](#) , [181](#) , [182](#) , [183](#) and [184](#) ). This risk is further increased in combination with pregnancy (9-fold), OCP use (36-fold), and HRT (13- to 16-fold) ( [185](#) , [186](#) , [187](#) and [188](#) ). Venous thromboembolism is the most common clinical symptom of APC-R in patients who experience thrombosis. In general, there is a notable lack of association of APC-R with arterial thrombosis ( [182](#) ). Another clinical association with APC-R is recurrent miscarriage, with one study reporting that 20% of patients with second trimester pregnancy loss have APC-R ( [131](#) , [189](#) ). Factor V Leiden does not appear to be a cause of recurrent pregnancy loss occurring late in the first trimester ( [189](#) , [190](#) ). Neonatal purpura fulminans has been reported in a patient with factor V Leiden who did not have proteins C or S deficiency ( [191](#) ). APC-R is also a common inherited risk factor for cerebral venous thrombosis ( [192](#) ). The factor V Leiden mutation has also been identified in children who experience thrombosis ( [193](#) ). However, this mutation does not appear to play a major role in the hypercoagulability of cancer ( [194](#) ). An intriguing report has demonstrated that the factor V Leiden mutation is a risk factor for MI in young women; the combination of factor V Leiden with smoking increased the risk of MI more than 30-fold ( [195](#) ). Factor V Leiden has also been associated with MI in individuals with coronary artery thrombosis in the absence of evidence of underlying fixed atherosclerotic lesions ( [196](#) ). There are conflicting data on the role of factor V Leiden heterozygosity as an independent risk factor for VTE recurrence ( [197](#) , [198](#) ). Two studies (“positive studies”) have found an increased risk of VTE recurrence compared to control subjects, with relative risk of 4.1 and 2.4, respectively. Six other studies (“negative studies”) have found no such association ( [199](#) , [200](#) , [201](#) , [202](#) , [203](#) and [204](#) ). The positive studies by Ridker et al. and Simioni et al. were prospective but included a small number of patients with factor V Leiden heterozygosity (14 and 41, respectively) ( [197](#) , [198](#) ). The Physicians’ Health Study (by Ridker et al.) included only men ( [197](#) ). Among the negative studies, four were prospective, and two were retrospective ( [199](#) , [200](#) , [201](#) , [202](#) , [203](#) and [204](#) ). Three of the prospective studies and the large retrospective cohort study by De Stefano et al. each included 80 to 112 patients with factor V Leiden heterozygosity ( [199](#) , [200](#) , [202](#) , [204](#) ). The two positive studies and three of the negative studies had a patient follow-up period of 4 or more years ( [197](#) , [198](#) , [200](#) , [202](#) , [204](#) ). The study by Simioni et al. and two of the negative studies did include some patients in whom the diagnosis of VTE recurrence was made on clinical grounds alone, without objective imaging assessment ( [198](#) , [200](#) , [204](#) ). When only objectively confirmed cases of VTE recurrence were analyzed, the negative study by Lindmarker et al. showed a nonstatistically significant trend toward more VTE recurrence in individuals heterozygous for factor V Leiden compared to noncarriers (16.1% vs. 12.4%). One positive study and three of the negative studies also included patients with upper-extremity and distal lower-extremity (calf) DVT, whereas the positive study by Simioni et al. had the greatest proportion of patients with proximal lower-extremity DVT (>90%). A recent reevaluation of the study by Simioni et al. did confirm the original study findings of increased relative risk of recurrent VTE in heterozygous carriers of factor V Leiden ( [205](#) ). Additional data from recently completed large-scale prospective trials will hopefully clarify the question of whether factor V Leiden heterozygosity is a risk factor for VTE recurrence. One study, the PREVENT trial, demonstrated equivalent rates of recurrent VTE in patients with and without factor V Leiden ( [499](#) ). Homozygous carriers of the factor V Leiden mutation are estimated to have an 80-fold increased lifetime relative risk of VTE ( [181](#) ). A more recent estimate, derived from a pooled analysis of a larger population, has confirmed an increased risk of VTE but of lower magnitude (tenfold) ( [184](#) ). The discrepancy is likely due to the very low prevalence of factor V Leiden homozygosity found in the healthy controls from the general population ( [181](#) , [184](#) ). Most homozygous

carriers present with VTE before 40 years of age, but some can live thrombosis-free until the sixth or seventh decade of life or even remain asymptomatic for life ( [206](#), [207](#) ). The majority of VTE is situational, and women appear more likely to develop VTE than men, suggesting an important role of OCP use and pregnancy in triggering thrombosis ( [206](#), [207](#) and [208](#) ). Based on data from the first prospective Duration of Anticoagulation trial, the risk of VTE recurrence is significantly increased in homozygous factor V Leiden carriers (36.4% at 48 months) when compared to heterozygous carriers (16.1%) and controls (12.4%) ( [200](#) ).

**LABORATORY DIAGNOSIS** APC-R has only been recognized as a disease entity since 1993, but the intense interest in this common inherited thrombotic disorder has focused substantial attention on laboratory methods for its diagnosis. Laboratory aspects of its discovery have been reviewed by Dahlback ( [209](#) ). The disorder can be evaluated by coagulation assays that have as their basis inhibition of factor Va by APC and prolongation of the clotting time. Typically, APC is added to patient plasma, and a clotting assay is performed (usually the PTT), with results expressed as a ratio:

$$\frac{\text{Patient aPTT} + \text{APC}}{\text{Patient aPTT} - \text{APC}}$$

Reference ranges are established for normal patients with and without addition of APC. Affected patients with mutant factor V have clotting times prolonged to a lesser extent (lower ratio) than normals. Alternatively, a DNA test can be done to specifically look for the Arg506Gln mutation; this highly conserved point mutation is present in most patients with APC-R. With properly collected plasma samples, the APC-R clotting test can correctly classify nearly 100% of patients, when normalized to a control plasma pool ( [210](#) ). However, most laboratories do not use a normalized assay, relying instead on commercial APC-R assay kits, some of which cannot reliably distinguish between normals and patients with factor V Leiden. Predilution of the patient sample with factor V-deficient plasma has improved the performance characteristics of most currently available commercial assays ( [211](#) ). These disadvantages of routine clotting assays have led to the development of alternative methods to diagnose APC-R. Samples from patients with baseline abnormal coagulation studies (e.g., anticoagulant therapy, lupus anticoagulants, liver disease) yield uninterpretable results. A TF-dependent factor V assay has been described that is useful in patients taking oral anticoagulants or with the lupus anticoagulant ( [212](#) ). The polymerase chain reaction test for factor V Leiden uses the restriction enzyme *MnI* to digest a 267-base pair amplified fragment of patient DNA ( [169](#) ). Consensus recommendations on methodologies to assay for factor V Leiden have been presented ( [213](#) ).

**TREATMENT** Therapy of venous thromboembolism in patients with APC-R is similar to that described for patients without an identified hypercoagulable state. Long-term secondary prophylaxis is not necessary for heterozygotes unless they experience more than one thrombotic event or experience life-threatening thromboembolism. Asymptomatic patients with APC-R should not be treated, but female patients with this disorder should be informed about the additional thrombotic risk associated with oral contraceptive use, pregnancy, and HRT ( [85](#), [214](#) ). Prophylaxis for high-risk situations, such as surgery, should be given. Unresolved questions in this area include whether female patients should be screened for APC-R before initiating estrogen therapy and whether asymptomatic pregnant females with APC-R should receive anticoagulant prophylaxis.

### Prothrombin Mutations

The prothrombin G20210A mutation is the second most common inherited predisposition to hypercoagulability ( [21](#) ). Heterozygous prothrombin G20210A has been found in 18% of probands of thrombophilic families, 6% of unselected patients with deep vein thrombosis,



and 2% of normal Caucasian individuals ( [21](#), [215](#) ).

More recently, a novel single-point mutation of the prothrombin gene at position 20209 has been reported in four unrelated patients, two of whom had a history of VTE and one of whom had a history of stroke ( [216](#) ). Although the clinical significance of the PT C20209T mutation is unknown, it may be underrecognized because it is not detected by the polymerase chain reaction/digestion assay commonly used for prothrombin gene mutation testing ( [215](#), [216](#) ). Interestingly, all four reported individuals with PT C20209T were African-Americans. Two additional African-American patients with this mutation have been identified by the same group of investigators.

**PATHOPHYSIOLOGY AND GENETICS** Prothrombin G20210A is a single-point mutation (G-to-A substitution at nucleotide 20210) in the 3' untranslated region of the prothrombin gene ( [21](#), [215](#) ). This autosomal-dominant mutation appears to result in elevated concentrations of plasma prothrombin ( [215](#) ). In fact, the VTE risk increases as the plasma prothrombin level increases, with levels greater than 115 IU/dl leading to a 2.1-fold increased relative risk of VTE ( [215](#) ). The G20210A mutation leads to a "gain of function" of the prothrombin gene, perhaps by resulting in an altered polyadenylation pattern in mutant prothrombin mRNA ( [217](#) ). An *in vitro* study of thrombin generation found that increasing prothrombin levels to 150% of normal resulted in enhanced thrombin activity ( [218](#) ). The mutation appears to follow a geographic and ethnic distribution, with the highest prevalence occurring, unlike factor V Leiden, in Caucasians from southern Europe (3%) ( [218](#) ). This prevalence is nearly twice that observed in northern Europe (1.7%) ( [219](#) ). Similar to factor V Leiden, the prothrombin G20210A mutation is also found in the Middle East and Indian regions, but it is virtually absent in individuals of Asian and African backgrounds ( [219](#) ). These distributions provide support to the estimate that both mutations (factor V Leiden and prothrombin G20210A) originated relatively recently in the European founding population, after the evolutionary divergences of subpopulations. A recent evaluation of patients in Northeast Ohio who underwent hypercoagulability evaluations revealed an equivalent prevalence of prothrombin gene mutations in whites and blacks ( [216](#) ).

**CLINICAL ASPECTS** Heterozygous PT G20210A is associated with a two- to sixfold increased lifetime relative risk of VTE ( [46](#), [207](#), [215](#), [220](#) ). The risk appears to be further increased in combination with pregnancy (15-fold) and OCP use (16-fold) ( [185](#), [221](#) ). The relative risk of cerebral vein thrombosis is increased 10-fold in women with this mutation who are not on OCPs, as opposed to 150-fold in pill users ( [222](#) ). Homozygosity for PT G20210A has an estimated population prevalence of 0.014%, and homozygous carriers appear to have greater predisposition to develop early (before 40 years of age) idiopathic recurrent VTE than heterozygotes ( [215](#), [223](#), [224](#) ). The role of PT G20210A as a risk factor for VTE recurrence is less controversial than it is for factor V Leiden, but data are also somewhat conflicting. Simioni et al., reevaluating a prospective study from 1997, retrospectively determined patients' PT G20210A mutation status and found that the hazard ratio of VTE recurrence was 2.4 ( [205](#) ). However, three prospective studies, which each included 28 to 52 patients, found no increased risk of recurrent VTE in heterozygous PT G20210A carriers ( [200](#), [225](#), [226](#) ). A fourfold increased risk of MI has been demonstrated, particularly in young women carriers of this mutation. A large case-control study of more than 14,000 men, though, revealed no increased risk of stroke or MI associated with this abnormal prothrombin gene. The reasons for this apparent male/female disparity are unknown ( [195](#), [227](#) ).

**LABORATORY DIAGNOSIS** The prothrombin G20210A mutation can only be reliably and routinely identified using molecular biologic techniques. Measurements of functional prothrombin activity do not sufficiently differentiate between carriers and noncarriers of

this gene mutation ( [21](#) ). Testing can accurately be performed despite concomitant treatment with any form of anticoagulation. Detection of the G20209T mutation was performed using rapid polymerase chain reaction with fluorescent hybridization probes, analysis for abnormal melting curves, and direct gene sequencing ( [216](#) ).

**TREATMENT** Treatment paradigms for patients with prothrombin G20210A heterozygosity parallel those for heterozygous factor V Leiden.

## Hyperhomocysteinemia

Homocysteine is a sulfhydryl amino acid formed during the conversion of methionine to cysteine. Hyperhomocysteinemia has been identified as an independent risk factor for stroke, MI, peripheral arterial disease, and venous thrombotic disease ( [228](#), [229](#) and [230](#) ). Even mild to moderate hyperhomocysteinemia is a significant risk factor for vascular disease. Hyperhomocysteinemia results when homocysteine metabolism is deranged. Homocysteine is normally metabolized by either cystathionine  $\beta$ -synthase (CBS)-mediated transsulfuration to cystathionine or methylene tetrahydrofolate reductase (MTHFR)-dependent remethylation to methionine ( [231](#), [232](#) ). Mutations and deficiencies of the enzymes and essential vitamin cofactors (B<sub>6</sub>, B<sub>12</sub>, and folate) involved in these metabolic pathways can result in an accumulation of homocysteine.

**PATHOPHYSIOLOGY AND GENETICS** The amino acid homocysteine is normally metabolized via the transsulfuration pathway by the enzyme CBS, which requires vitamin B<sub>6</sub> as cofactor, and via the remethylation pathway by the enzymes MTHFR, which is folate dependent, and methionine synthase, which requires vitamin B<sub>12</sub> as cofactor ( [231](#), [232](#) ). Inherited severe hyperhomocysteinemia (plasma level >100  $\mu$ mol/L), as seen in classic homocystinuria, may result from homozygous MTHFR and CBS deficiencies and, more rarely, from inherited errors of cobalamin metabolism ( [231](#), [232](#) ). Inherited mild to moderate hyperhomocysteinemia (plasma level >15 to 100  $\mu$ mol/L) may result from heterozygous MTHFR and CBS deficiencies but most commonly results from the thermolabile variant of MTHFR (tMTHFR) that is encoded by the C677T gene polymorphism ( [231](#), [232](#) ). This single-point mutation (C677T) is in the coding region for the MTHFR binding site (exon 4) leading to substitution of a valine for an alanine, resulting in the thermolabile enzyme. Acquired hyperhomocysteinemia may be caused by folate deficiency, vitamins B<sub>6</sub> and B<sub>12</sub> deficiencies, renal insufficiency, hypothyroidism, type II diabetes mellitus, pernicious anemia, inflammatory bowel disease, advanced age, climacteric state, carcinoma (particularly involving breast, ovaries, or pancreas), and acute lymphoblastic leukemia, as well as methotrexate, theophylline, and phenytoin therapy ( [231](#), [232](#) ). The precise mechanisms underlying the thrombogenicity of homocysteine remain unclear. Several diverse mechanisms have been proposed including endothelial cell desquamation, low-density lipoprotein (LDL) oxidation, promotion of monocyte adhesion to endothelium, and factor V activation and promotion of thrombin generation ( [16](#) ). Homocysteine also enhances platelet aggregation and adhesiveness as well as turnover, presumably as a result of endothelial cell injury ( [233](#) ). A recent study found that moderate hyperhomocysteinemia does not impair the activation of protein C by thrombin and does not impair the inactivation of factor Va by APC ( [234](#) ). A novel mechanism of hyperhomocysteinemia resulting from DNA hypo-methylation has been proposed ( [234a](#) ). Severe homocysteinemia usually results from homozygous CBS deficiency. The incidence of this disorder is approximately 1:335,000 live births. Classic symptoms for homozygous patients include premature vascular disease and thrombosis, mental retardation, ectopic lens, and skeletal abnormalities ( [235](#) ). Recently, heterozygous homocysteinemia has been recognized as a disease entity; this disorder may affect 0.3 to 1.0% of the general population ( [235](#) ).

**CLINICAL ASPECTS** Heterozygous carriers of the t1MTHFR mutation have normal plasma homocysteine levels unless folate levels are reduced ( [236](#) ). More important, the majority of case-control studies have not demonstrated an increased VTE risk in homozygous carriers of the t1MTHFR, and the majority of individuals with hyperhomocysteinemia do not have the t1MTHFR polymorphism. Thus, characterization of the t1MTHFR polymorphism is not useful to determine an individual's VTE risk. VTE risk is most closely related to elevated fasting plasma homocysteine levels, regardless of etiology. Hyperhomocysteinemia (plasma level >18.5 μmol/L) has been associated with a two- to fourfold increased VTE risk ( [237](#) , [238](#) ). Interestingly, in the Physicians' Health Study, hyperhomocysteinemia (plasma level above the ninety-fifth percentile; 17.2 μmol/L) did increase the risk of idiopathic VTE (relative risk, 3.4) but not the risk of all (situational and idiopathic) VTE ( [183](#) ). The cumulative probability of VTE recurrence 2 years after discontinuation of anticoagulation has been shown to be higher in patients with persistent hyperhomocysteinemia (plasma levels above the ninety-fifth percentile) than in controls (19.2% vs. 6.3%; relative risk, 2.7;  $p = .009$ ) ( [239](#) ). The majority of reports linking hyperhomocysteinemia to thrombosis have focused on venous thromboembolic disease. The link between hyperhomocysteinemia and peripheral arterial thrombosis has been less well studied. Kottke-Marchant et al. compared 23 patients with documented arterial peripheral thrombosis to age- and sex-matched controls ( [240](#) ). Elevated homocysteine levels (>13 μm) conferred an odds ratio of 7.8 for thrombosis. Elevated homocysteine levels were found in 73% of cases versus 28% of controls. Only smoking and homocysteine level were independent risk factors for arterial thrombosis. Currie et al. evaluated homocysteine and cardiovascular risk factors in 66 adult patients with vascular disease. Hyperhomocysteinemia was identified in 29% of patients and was an independent risk factor for the failure of vascular procedures (  $p = .006$ ) ( [241](#) ).

**LABORATORY DIAGNOSIS** The initial step in the evaluation of the patient with suspected hyperhomocysteinemia involves measurement of fasting total plasma homocysteine (the sum of nonprotein bound and protein bound) ( [231](#) ). Many laboratories report homocysteine values in reference to published "normal" ranges such as 5 to 15 μmol/L, but, ideally, a local, laboratory specific normal range should always be established. A normal value in the nonfasting setting does not normally require repeating. Under ideal laboratory circumstances, patients with a normal fasting value should undergo repeat testing after an oral methionine challenge. Testing 2 to 8 hours after an oral methionine load (100 mg/kg) increases the sensitivity of detecting occult vitamin B<sub>6</sub> deficiency and obligate heterozygotes for CBS deficiency ( [242](#) ). A separate normal range for post-methionine loading homocysteine levels should be used. Vitamin B<sub>12</sub> and folate deficiency do not affect post-methionine loading homocysteine values. In patients found to have elevated levels of homocysteine, testing for vitamin B<sub>12</sub> deficiency is advocated to avert missing subclinical deficiency before beginning oral folic acid therapy.

Metho-dologies to measure homocysteine levels have been reviewed ( [16](#) , [243](#) ).

**TREATMENT** Thrombotic events in homocysteinemic patients should be treated as described for other inherited disorders. An additional treatment strategy is to lower plasma homocysteine levels, hopefully alleviating the risk factor for thrombosis. Folic acid supplementation is the mainstay of effective hyperhomocysteinemia therapy ( [231](#) , [244](#) ). A recent metaanalysis of 1114 patients enrolled in 12 randomized studies of vitamin supplementation to lower homocysteine levels demonstrated a 25% reduction in homocysteine levels with similar effects across a dosage range from 0.5 to 5.0 mg daily ( [245](#) ). The usual recommended dose is 0.4 to 1.0 mg daily. Whether patients unresponsive to one dose benefit from an escalation in dose is unclear. Because patients with subclinical vitamin B<sub>12</sub> deficiency may be prone to developing peripheral neuropathy if they receive folic acid supplementation alone, additional treatment with 0.5 mg/day of oral vitamin B<sub>12</sub> has been advocated ( [244](#) ). In the same metaanalysis, an additional 7% reduction of homocysteine levels was noted with vitamin B<sub>12</sub> supplementation ( [245](#) ).

Vitamin B<sub>12</sub> administration results in normalization of homocysteine levels in B<sub>12</sub>-deficient individuals. Oral supplementation of vitamin B<sub>12</sub> may be insufficient in patients with pernicious anemia or other malabsorption syndromes. In these patients, a monthly intramuscular injection of 200 to 1000 µg of vitamin B<sub>12</sub> is considered adequate replacement. Vitamin B<sub>6</sub> supplementation did not appear to have any effect on homocysteine levels. However, in patients with vitamin B<sub>6</sub> deficiency, replacement doses of 10 to 50 mg daily are typically recommended. Betaine, a nutritional supplement derived from beets, functions as an alternative methyl donor in the remethylation of homocysteine to methionine. Betaine has been used in individuals with homocystinuria and may facilitate homocysteine reduction in individuals not responsive to folate and vitamin B<sub>6</sub> ( [246](#) ).

### Increased Factor VIII Activity

It is now appreciated that elevated levels of procoagulant coagulation factors, in addition to deficiencies of natural anticoagulant proteins, are risk factors for VTE. Factor VIII levels greater than 1.5 IU/ml (150%) are associated with a threefold and a sixfold greater relative risk of VTE when compared to levels below 1.5 IU/ml (150%) and below 1.0 IU/ml (100%), respectively ( [247](#) ). VTE risk is increased 11-fold with levels greater than 200%, but it does not appear to be accentuated by concomitant OCP use ( [248](#) , [249](#) ). Elevated activity levels of factor VIII associated with VTE risk seem to be persistent and not solely attributable to acute-phase response ( [250](#) ). Transiently elevated factor VIII levels associated with acute-phase protein release, though, may in part explain the hypercoagulability associated with inflammatory disorders such as inflammatory bowel disease and cancer. Individuals with plasma factor VIII activity greater than 234% (above the ninetieth percentile cut-off point for the study population) have a 6.7-fold increased relative risk of recurrent VTE compared to those with activity levels of less than 120% ( [47](#) ).

Because factor VIII is indeed an acute-phase reactant and its levels can be affected by many factors, including blood type and vWF concentration, determination of the true meaning of an elevated factor VIII level in an individual patient with VTE is challenging. In the study by Koster et al., in which blood samples for factor VIII activity were obtained a minimum of 6 months after the VTE, it was impossible to completely distinguish between inherited elevation and postthrombotic, transient elevation of factor VIII ( [207](#) , [247](#) ). Nonetheless, the fact that an increased factor VIII level is prevalent in persons with VTE may, in fact, imply that elevated factor VIII is not only frequent, but also an important risk factor for VTE ( [207](#) ). The College of American Pathologists' consensus conference recommendations are to not routinely measure factor VIII levels in patients with venous or arterial thrombosis ( [251](#) ).

### Impaired Endogenous Fibrinolysis

The endogenous fibrinolytic system is comprised of plasminogen, plasminogen activators (PAs), and antifibrinolytic regulatory proteins. Intravascular plasminogen is converted to the active fibrinolytic enzyme plasmin primarily by t-PA derived from vascular endothelial cells and by urokinase-type plasminogen activator (u-PA) from leukocytes. The principal physiologic inhibitor of t-PA is PAI-1, whereas plasmin itself is inactivated by circulating and thrombus-bound a<sub>2</sub>-antiplasmin. Decreased endogenous fibrinolytic activity as a result of qualitative and quantitative abnormalities of plasminogen, an inadequate release of t-PA in response to vascular injury, and excessive production of PAI-1, such as is found in inflammatory and malignant diseases, can result in impaired endogenous

fibrinolysis and accumulation of pathologic thrombus ( [252](#) ).

Abnormal fibrinolysis was previously thought to account for a large proportion of patients with inherited thrombosis. However, the discovery of APC-R as a common inherited disorder and a literature review that concluded that a causal relationship between abnormal fibrinolysis and inherited thrombosis had not been clearly demonstrated have diminished enthusiasm for routinely evaluating patients with recurrent thrombosis for abnormal fibrinolysis ( [253](#) ).

**PLASMINOGEN DEFICIENCY** Quantitative and qualitative abnormalities of plasminogen have been reported in patients with recurrent venous thrombosis ( [254](#), [255](#) ). Quantitative deficiency is inherited as an autosomal-dominant disorder, whereas qualitative plasminogen defects (dysplasminogenemia) are usually inherited as autosomal-recessive disorders. Dysplasminogenemia is more common in Japanese subjects, and a single mutation accounts for more than 90% of cases in this population ( [256](#) ). One report has suggested that quantitative plasminogen deficiency may not be a risk factor for thrombosis ( [257](#) ). Optimal assays for plasminogen deficiency use a functional chromogenic substrate assay to detect type I and type II patients; in this assay, streptokinase (SK) is added to the plasma sample, and the SK-plasminogen complex formed hydrolyzes a synthetic substrate ( [258](#) ).

**TISSUE PLASMINOGEN ACTIVATOR DEFICIENCY** Defective synthesis or release of t-PA from the vessel wall represents a potential mechanism for thrombosis. Plasma t-PA activity is unstable, and for accurate assays, citrated plasma samples must be immediately acidified and red blood cells removed ( [259](#), [260](#) ). Addition of a platelet activation inhibitor to the blood collection tube may help reduce the release of platelet-derived PAI-1, which can interfere with t-PA activity quantification. A plasminogen-chromogenic substrate assay is used to measure t-PA activity; t-PA antigen can be measured by ELISA using citrated plasma.

**INCREASED PLASMINOGEN ACTIVATOR INHIBITOR-1 LEVELS** Increased levels of PAI-1 have been associated with venous or arterial thrombosis. Plasma PAI-1 activity is measured in citrated plasma using a back-titration method with single-chain t-PA ( [261](#) ). Because blood fibrinolytic activity exhibits a diurnal rhythm (decreased fibrinolysis in the morning as a result of peak PAI-1 levels; increased fibrinolysis in the evening as a result of low PAI-1 levels), plasma samples should be obtained at standardized times, such as between 8:00 and 9:00 a.m. ( [262](#) ). Additionally, because fibrinolytic component levels can be affected by acute-phase changes, patients should not be evaluated for abnormal fibrinolysis until 2 to 3 months after an acute thrombotic event. In the European Concerted Action on Thrombosis and Disabilities study, an increased incidence of vascular events was associated with higher baseline PAI-1 antigen concentrations (  $p = .02$  ) and PAI-1 activity (  $p = .001$  ) ( [57](#) ). Elevated levels of PAI-1 may effectively reduce t-PA activity levels, thereby blocking the activation of plasminogen to plasmin and inducing impaired fibrinolysis that may ultimately lead to thrombosis. Theoretically, markedly elevated levels of PAI-1 might also impair attempts at pharmacologic thrombolysis in the setting of acute arterial and venous thrombosis ( [263](#) ). Defects in endogenous fibrinolytic capacity have also been found in young patients with unexplained arterial thromboembolism. Deficient t-PA release was found in 45% of such patients, and elevated levels of PAI-1 were found in 59% ( [264](#) ). Similar defects have been detected in individuals with recurrent venous thrombosis. It has been noted that patients who have undergone major surgical procedures might experience a transient "fibrinolytic shutdown" due to elevated PAI-1 levels as part of an acute-phase response ( [265](#) ). Avoidance of obesity and associated insulin resistance, correction of hypertriglyceridemia, cessation of smoking, and exercise may improve the innate fibrinolytic status ( [57](#), [266](#), [267](#) ). Treatment of hypertension with angiotensin-converting enzyme inhibitors or angiotensin II receptor



antagonists has been associated with significantly reduced PAI-1 production ( [268](#) , [269](#) ). The lipid-lowering agent gemfibrozil has also been shown to decrease the PAI-1 synthesis rate ( [270](#) ). Modest alcohol consumption and hormone replacement treatment in postmenopausal women also seem to be beneficial ( [271](#) , [272](#) ).

## Dysfibrinogenemia

The clinical and biochemical aspects of dysfibrinogens are reviewed in [Chapter 59](#). In general, dysfibrinogens associated with thrombosis have as their molecular defect generation of an abnormal fibrin resistant to fibrinolysis. An updated summary of dysfibrinogen molecular abnormalities is presented at [www.ISTH.org](http://www.ISTH.org). Dysfibrinogenemia as a cause of inherited thrombosis is uncommon.

Certain patients with dysfibrinogenemia may have a prolonged PT; more typically, these patients are detected by prolonged thrombin and reptilase times, suggesting a defect in the conversion of fibrinogen to fibrin ( [273](#) ). Confirmation of a dysfibrinogen can be done by simultaneous measurement of functional and immunologic fibrinogen levels. Typically, immunologic levels are found to be higher than levels measured by functional assay. Published guidelines in the healthy population indicate that for fresh plasma samples, the ratio of immunologic to functional fibrinogen ranges from 1.12 to 1.65; ratios greater than 1.65 are suggestive of dysfibrinogenemia ( [274](#) ).

Another potentially useful test to evaluate patients for dysfibrinogenemia is the fibrinogen lysis time. This test requires partial purification of the patient's fibrinogen, followed by clotting and lysis in a standardized assay ( [275](#) ). Dysfibrinogens may also result in a false-positive test for fibrin(ogen) degradation products (FDPs) as assayed by latex agglutination, because residual fibrinogen remains in serum after clotting and is detected by the antibody-coated latex beads. An algorithm for the laboratory diagnosis of dysfibrinogenemia has been reported ( [276](#) ).

## Thrombomodulin Deficiency

Thrombomodulin complexed with thrombin is required to activate protein C. In theory, thrombomodulin deficiency should result in hypercoagulability. A number of mutations in the thrombomodulin gene have been identified in patients with venous thrombosis and their families ( [277](#) ). Routine laboratory testing for this disorder is not yet available, but an Italian study of thrombosis patients indicated that thrombomodulin deficiency is not a common cause of thrombosis ( [278](#) ). However, thrombomodulin gene mutations have been linked to myocardial infarction ( [279](#) ). In the prospective Atherosclerosis Risk in Communities study, soluble thrombomodulin levels had a graded, inverse association with, and were a good predictor of, coronary artery disease ( [280](#) ). The levels correlated in their extreme quartiles with the coagulation activation marker prothrombin fragment 1+2 ( [280](#) ).

## Lipoprotein (a)

Lipoprotein (a) [Lp(a)] is a lipoprotein moiety similar to LDL cholesterol in core lipid composition and in the fact that it has apolipoprotein (apo) B-100 as a surface apolipoprotein. In addition, Lp(a) has a unique glycoprotein, apo(a), which is bound to apoB-100. Apo(a) is structurally similar to plasminogen but lacks fibrinolytic activity ( [281](#) ). Lp(a) has both atherogenic and thrombogenic properties. Its thrombogenic effect is derived from stimulation of PAI-1 synthesis, promotion of intercellular adhesion molecule-1 expression by vascular endothelium, inhibition of both plasminogen and t-PA

binding to fibrin, inhibition of plasminogen activation by t-PA, and competition with plasminogen for binding sites on endothelial cells and fibrin ( [282](#) ). The cumulative effect is impaired activation of plasminogen to plasmin at the vessel wall, inhibition of fibrinolysis, and increased risk for thrombosis.

The exact mechanisms that control Lp(a) levels are unknown, but genetic factors that regulate hepatic synthesis of apo(a) are likely important. One's plasma Lp(a) level is stabilized during infancy and maintained throughout life ( [283](#) ). Plasma concentrations greater than 20 mg/dl seem to increase the risk of coronary artery disease, peripheral arterial occlusive disease (PAOD), and stroke ( [282](#) ). Lippi et al. evaluated Lp(a) in 68 patients subjected to vascular and endovascular surgery ( [284](#) ). Significant restenosis or reocclusion occurred in 23 (34%) patients. Lp(a) concentrations were significantly higher in those with restenosis and reocclusion compared with those in the no restenosis group. Occlusive complications were unlikely to occur in patients with Lp(a) concentrations below 5 mg/dl ( [284](#) ). Different isoforms of the apo(a) component of Lp(a) have different atherogenic potential and possibly different thrombogenic potential.

There are, as yet, no definitive studies demonstrating that reduction of elevated Lp(a) levels reduce the risk of atherosclerotic vascular occlusion or arterial thrombosis. Because a significant component of Lp(a) excess cardiovascular risk appears to be related to concomitant LDL cholesterol excess, measurement of Lp(a) as a general screening test is not currently recommended ( [285](#) ). Measurement of Lp(a) should be considered mainly in individuals with atherosclerosis in the absence of classic risk factors, rapidly progressive atherosclerotic lesions despite aggressive risk factor modification, and individuals with acute arterial thrombosis ( [283](#), [285](#), [286](#) ). Because it is an acute-phase reactant, an elevated Lp(a) level must be carefully interpreted if drawn shortly after surgery, acute thrombosis, or acute coronary syndromes ( [287](#) ).

Patients with elevated Lp(a) benefit most from aggressive LDL cholesterol lowering. Current National Cholesterol Education Program guidelines recommend achievement of a target LDL level less than 100 mg/dl in individuals with peripheral arterial disease ( [288](#) ). Although hepatic 3-methylglutaryl coenzyme A reductase inhibitors ("statins") may be the ideal agents for LDL lowering and atherosclerotic plaque stabilization, this class of drug does not appreciably lower Lp(a) levels themselves ( [289](#) ). Nicotinic acid (niacin), usually in high doses, is the first-line pharmacologic therapy to lower Lp(a) levels. Reductions up to 38% have been reported ( [290](#) ). Because nicotinic acid therapy may be poorly tolerated, a gradual escalation in dose and pretreatment with aspirin are recommended. In women, estrogen replacement therapy can lower Lp(a) levels by as much as 50% ( [286](#) ). The goal of therapy for Caucasian populations is to reduce Lp(a) levels to less than 30 mg/dl ( [285](#) ).

## Combined Defects

Compound heterozygosity for two different natural anticoagulant deficiencies is extremely rare due to the low prevalence of each individual defect. The phenotypic presentation of such compound heterozygotes does not appear to be as severe as it is for the homozygous forms of each deficiency, with the rarely reported patient presenting with VTE of early onset (in the teenage years) ( [97](#), [207](#) ). Because factor V Leiden is the most common inherited thrombophilia, double heterozygosity for factor V Leiden and a natural anticoagulant deficiency have been described in some families ( [122](#), [291](#) ). In families harboring factor V Leiden and protein C deficiency, 73% of compound heterozygotes reported a history of VTE, compared with 31% and 13% of relatives with protein C



deficiency only and factor V Leiden only, respectively ( [122](#) ). In families with factor V Leiden and AT deficiency, 92% of double-heterozygous carriers had a history of VTE, as opposed to 57% and 20% of individuals with AT deficiency only and factor V Leiden only, respectively ( [291](#) ).

Although it is clear that VTE is more frequent in double-heterozygous carriers from thrombophilic families as described above, evaluation of a true interaction and estimation of VTE risk cannot be determined due to lack of power ( [184](#), [207](#) ). However, combined heterozygosity for both factor V Leiden and prothrombin G20210A mutations, which is estimated to occur in 1 in 1000 persons, does appear to be associated with an increased relative risk of both first and recurrent VTE ( [184](#), [204](#), [292](#) ). In a pooled analysis of eight case-control studies including more than 2000 patients with VTE, a 2.2% prevalence for the combined mutations was found in patients ( [184](#) ). Twelve percent of patients with factor V Leiden were also heterozygous for PT G20210A, and 23% of patients with PT G20210A were also heterozygous for factor V Leiden ( [184](#) ). Double heterozygosity was associated with a 20-fold increased relative risk of VTE ( [184](#) ). The risk of recurrent VTE for heterozygous carriers of both factor V Leiden and PT G20210A also appears to be increased (2.6-fold) ( [204](#) ).

The prevalence of factor V Leiden carriership in combination with acquired hypercoagulable states has also been studied. Factor V Leiden appears to increase the risk of VTE in patients with antiphospholipid antibodies but is not a prerequisite for the development of VTE in those patients ( [207](#), [293](#) ). The interaction between factor V Leiden and hyperhomocysteinemia has been a matter of interest since the observation, not corroborated by further studies, that factor V Leiden appeared to be a prerequisite for VTE in individuals from families with classic homocystinuria ( [294](#) ). Nonetheless, two studies on the interaction between mild to moderate hyperhomocysteinemia and factor V Leiden have yielded somewhat different findings. Den Heijer et al. found that the risk of VTE associated with the combination of conditions (twofold) did not exceed the risk associated with each condition alone (9.5-fold for factor V Leiden, 2.2-fold for hyperhomocysteinemia) ( [237](#) ). However, in the large Physicians' Health Study, the concomitant presence of both conditions did appear to be synergistic ( [183](#) ). The relative risks of 21.8 and 9.7 for idiopathic VTE and all VTE (situational and idiopathic), respectively, far exceeded the risk of VTE associated with each condition alone ( [183](#) ). Thus, it is uncertain whether the interaction between factor V Leiden and hyperhomocysteinemia is, in fact, synergistic. Because both studies used the ninety-fifth percentile cut-off point for plasma homocysteine levels, the discrepancies in the reported relative risks (2.0 and 21.8 in the Dutch and the American study, respectively) could have resulted from the small number of patients with both conditions ( [183](#), [207](#), [237](#) ). In the Physicians' Health Study, only four patients and two controls had the combined defects ( [183](#) ).

### **Inherited Risk Factors in Childhood Venous Thrombosis**

Many of the common inherited thrombotic disorders described in adult patients have been linked to pediatric thrombosis. A prospective European study identified a single genetic risk factor in 54% of pediatric thrombosis patients ( [295](#) ). Common defects identified were factor V Leiden (32%), protein C deficiency (9%), protein S deficiency (6%), prothrombin gene mutation (4%), and AT deficiency (3%) ( [295](#) ). In most patients, thrombosis is precipitated by superimposed nongenetic risk factors that included central venous catheters, cancer, sepsis, immobility, surgery, trauma, or use of oral contraceptives ( [296](#) ). For neonatal patients with thrombosis, the most significant factor associated with

thrombosis is the presence of a central venous catheter ( 297 ). In children with recurrent thrombosis, the factor V Leiden mutation is present in most patients ( 298 ). Homozygous deficiencies of protein C or protein S are causal in neonatal purpura fulminans ( 132 , 159 ). When pediatric patients are evaluated for protein C, protein S, or AT deficiency, pediatric reference ranges are mandatory because age-related changes occur in the levels of these proteins.

A consensus panel of the International Society on Thrombosis and Haemostasis has recommended that pediatric patients with thrombosis be routinely tested for inherited and acquired disorders in a comprehensive fashion ( 299 ). However, many of the suggested tests are not recommended by the College of American Pathologists' consensus panel, and there are no data to indicate that patients with a genetic predisposition to thrombosis—children or adults—should be treated differently ( 299a ) (discussed in the following section).

### Perspective on Laboratory Testing for Inherited Thrombotic Disorders

Mounting interest in hypercoagulability, increased availability of hypercoagulable state test “panels,” and enhanced ability to identify an abnormality in tested patients have prompted widespread testing of thrombosis patients. Testing for acquired and inherited hypercoagulable states uncovers an abnormality in more than 50% of patients presenting with an initial VTE but may have minimal actual impact on management in most of these patients ( 21 , 97 , 300 , 301 ). Such laboratory screening should be reserved for patients for whom the results of individual tests significantly impact the choice of anticoagulant agent, intensity of anticoagulant therapy, therapeutic monitoring, family screening, family planning, prognosis determination, and most of all, duration of antithrombotic therapy. Testing “just to know” is neither cost effective nor clinically appropriate. Table 61.4 lists situations in which hypercoagulable state testing should be considered, but not necessarily performed, unless an *a priori* use of the test results has been determined. Table 61.5 lists potential elements of an initial battery of tests to detect a defined hypercoagulable state.

**TABLE 61.4. Clinical Circumstances in Which Selected Hypercoagulable State Testing May Be Considered**

---

|  |
|--|
| Idiopathic VTE   |
| VTE in unusual sites   |
| Recurrent VTE (especially if idiopathic)                                   |
| VTE at young age (<45 yr)  |
| VTE in the setting of a strong family history of VTE                       |
| Unexplained recurrent pregnancy loss                                       |
| Family members of VTE patients with known inherited hypercoagulable states |
| VTE, venous thromboembolism.   |

---

**TABLE 61.5. Screening Laboratory Evaluation for Patients Suspected of Having a Hypercoagulable State**

---

|   |
|---|
| Activated protein C resistance (diluting patient plasma with factor V-deficient plasma) |
| Prothrombin G20210A mutation testing by polymerase chain reaction                       |

Activity assays for antithrombin, protein C, and protein S <sup>a</sup>

Activated partial thromboplastin time, mixing studies, and dilute Russell viper venom time <sup>a</sup>

Fasting total plasma homocysteine level

Anticardiolipin antibody testing by enzyme-linked immunosorbent assays

Factor VIII activity <sup>a</sup>

<sup>a</sup> Assays should not be done at the time of acute thrombosis or while the patient is anticoagulated.

---

Patients should be considered for evaluation of these disorders if they are young (<45 years of age) with recurrent thrombosis, or if they have had a single thrombotic event and have a positive family history ( <sup>22</sup>, <sup>88</sup> ). This recommendation is based on the fact that, with the exception of hyperhomocysteinemia and qualitative abnormalities of plasminogen, inherited thrombotic disorders, especially the five most common (APC-R, prothrombin G20210A, protein C deficiency, protein S deficiency, and AT deficiency), are autosomal-dominant disorders, and most patients with these disorders have supportive family histories ( <sup>22</sup> ). Patients without a family history of thrombosis should be evaluated for common acquired etiologies for thrombosis, including malignancy, myeloproliferative disorders, and antiphospholipid antibodies ( <sup>22</sup>, <sup>88</sup> ). Because thrombosis may induce an acute-phase response that may affect functional coagulation assays, testing is ideally done when the patient has fully recovered from the acute event and is not receiving anticoagulants ( <sup>22</sup> ). Functional assays are preferred over immunologic assays, so that both type I and type II disorders can be detected. An important exception to this recommendation is APC-R, which can be screened for using a DNA test that is not affected by acute-phase responses or anticoagulant therapy ( <sup>22</sup> ). Diagnosis of protein C or S deficiency in patients already anticoagulated with warfarin can be facilitated by parental testing, testing symptomatic family members not receiving anticoagulation, referral to a reference laboratory that has standardized assays for these natural anticoagulants in anticoagulated patients, or temporary cessation of warfarin therapy (minimum of 3 to 4 weeks) ( <sup>22</sup>, <sup>88</sup> ). Patients with arterial thrombosis should be considered for testing for hyperhomocysteinemia, Lp(a), and, possibly, protein S deficiency ( <sup>3</sup> ).

In addition to a positive family history of thrombosis, other clinical features may suggest inherited thrombosis, including recurrent spontaneous thromboses, thrombosis in unusual sites (mesenteric vein), thrombosis at an early age, heparin resistance (suggestive of AT deficiency), warfarin-induced skin necrosis and neonatal purpura fulminans (suggestive of protein C or protein S deficiency), and thrombosis occurring with estrogen therapy or pregnancy (suggestive of APC-R or prothrombin G20210A) ( <sup>22</sup> ). The presence of these clinical events may justify laboratory evaluation of these patients. Even in situations in which the relative risk of thrombosis and recurrent thrombosis is increased, the absolute risk for a particular patient may not warrant the risks of chronic anticoagulation. Thus, one should always assess the pretest use of hypercoagulable state testing before embarking on an expensive investigation.

A more fundamental question is whether routine laboratory testing for inherited thrombotic disorders will change treatment (intensity or duration of anticoagulation). This is a controversial subject because the available data do not support the contention that patients with an inherited thrombotic disorder should be managed differently than patients without such a disorder ( <sup>301</sup> ). At a minimum, physicians electing to test patients should

inform them of the pros and cons of testing ( [302](#) ).

There are two thrombotic risk factors that may influence treatment strategy: the presence of antiphospholipid antibodies (discussed in [Chapter 60](#)) and hyperhomocysteinemia. Patients with antiphospholipid antibodies may require a higher intensity of oral anticoagulation, and many patients with homocysteinemia respond to vitamin therapy to resolve this thrombosis risk factor. [Table 61.6](#) summarizes the clinical laboratory testing recommendations made by the College of American Pathologists' Consensus Conference on Thrombophilia ( [302](#) ).

**TABLE 61.6. Summary of the College of American Pathologists' Recommendations on Laboratory Testing for Inherited Thrombosis**

| Thrombotic Disorder       | Who Should Be Tested?   | Test Method(s)  | Comments  |
|---------------------------|---|---|---|
| FVL                       | First VTE at age <50 yr<br>Recurrent VTE<br>First unprovoked VTE<br>First VTE, unusual site<br>First VTE, positive family history<br>First VTE related to pregnancy or hormonal therapy<br>Unexplained second or third trimester pregnancy loss | APC-R assay using factor-V deficient plasma <i>or</i> DNA-based assay | Patients with relatives who are known to have FVL should be tested directly with DNA-based assays. Patients with positive APC-R assays should have confirmatory DNA tests.  |
| Prothrombin gene mutation | As above  | DNA-based assay   | Prothrombin activity assays should not be used.   |
| Homocysteinemia           | Arterial vascular disease;<br>controversial for VTE   | High-performance liquid chromatography or immunoassays                | Genotyping for methylenetetrahydrofolate reductase mutations is not recommended. Fasting may not be necessary. Proper sample processing is necessary. Testing in VTE patients may be appropriate to identify and treat affected patients with vitamins. |

|                                   |  |  |   |
|-----------------------------------|--|--|---|
| PC deficiency                     | Infants with neonatal purpura fulminans VTE patient from a family with known PC deficiency<br>Asymptomatic female from a known PC-deficient family before hormonal therapy | Chromogenic substrate assays preferred<br>Functional assays are useful<br>Immunologic assays are discouraged | Avoid testing during acute thrombosis or anticoagulant therapy. Exclude causes of acquired PC deficiency. Consider age-dependent reference ranges.  |
| PS deficiency                     | Patient with VTE from a family with known PS deficiency  | Functional assay or immunoassay for free PS<br>Total PS antigen assays not recommended                       | Abnormal functional assay results should be confirmed with an immunoassay for free PS.<br>Exclude acquired causes of PS deficiency. Avoid testing during acute thrombosis, anticoagulant therapy, and pregnancy. Consider age- and gender-dependent reference ranges. |
| AT deficiency                     | Patient with VTE from a family with known AT deficiency<br>Asymptomatic female from a known AT-deficient family before hormonal therapy                                    | Chromogenic substrate assays preferred<br>AT antigen assays not recommended                                  | Exclude acquired causes of AT deficiency. Avoid testing during acute thrombosis or anticoagulant therapy.   |
| Elevated factor VIII levels       | Controversial  | Factor VIII activity assay   | Test 6 months after thrombosis. Avoid anticoagulant therapy.  |
| Dysfibrinogenemia                 | Not recommended  |  |   |
| Heparin cofactor II               | Not recommended  |  |   |
| Factor XIII polymorphisms         | Not recommended  |  |   |
| Plasminogen activator inhibitor-1 | Not recommended  |  |   |
| Plasminogen deficiency            | Test in non-DVT patients with ligneous conjunctivitis  |  |   |

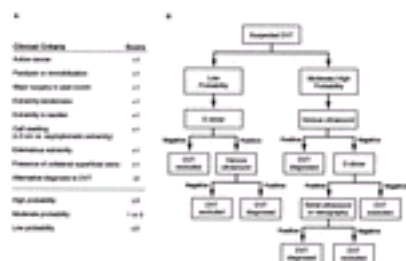
APC, activated protein C; AT, antithrombin; FVL, factor V Leiden; PC, protein C; PS, protein S; VTE, venous thromboembolism.

From the College of American Pathologists' Consensus Conference on Thrombophilia. Arch Pathol Lab Med 2001;126:1277-1433, with permission.

## Laboratory Testing for the Prethrombotic State

Levels of fibrin degradation products, including cross-linked fibrin degradation products (D-dimer), are usually increased in the presence of acute venous thromboembolism. Absence of an elevated level of D-dimer in patients undergoing an evaluation for acute DVT or PE has an excellent negative predictive value for thrombosis (303). Recently, D-dimer measured 3 months after oral anticoagulation for DVT treatment was discontinued has been shown to have a negative predictive value of 95.6% for VTE recurrence. It has also been recently shown that baseline elevations of D-dimer are strongly and positively related to the occurrence of future venous thrombosis (303a). Plasma levels of fibrinopeptide A can be increased in venous thrombosis patients, but this assay has the disadvantage of requiring rigorous attention to specimen collection to avoid an activated plasma sample (304). The activation peptide generated when prothrombin is cleaved to form thrombin, prothrombin fragment 1+2, is a sensitive measure of thrombin formation (305). Other markers of activation of coagulation include thrombin-AT complex and plasmin-antiplasmin complex.

One active area of investigation is combining a sensitive D-dimer assay with clinical criteria to exclude venous thromboembolism (306) or risk of recurrent venous thromboembolism (307). Figure 61.2 depicts one strategy algorithm to incorporate D-dimer testing in thrombosis evaluation.



**Figure 61.2.** Algorithm for excluding deep vein thrombosis (DVT) using clinical criteria, D-dimer testing, and venous ultrasound. Clinical criteria are based on those of Wells PS, Anderson DR, Bormanis J, et al. Value of assessment of pretest probability of deep-vein thrombosis in clinical management. *Lancet* 1997;350:1795–1798. D-dimer methods are similar to those described by Hirsh J, Lee AY. How we diagnose and treat deep vein thrombosis. *Blood* 2002;99:3102–3110. **A:** Based on clinical criteria fulfilled by the patient, the cumulative score is tallied. High probability is a score greater than or equal to 3, moderate probability is 1 or 2, low probability is less than or equal to 0. **B:** The probability score is used with D-dimer assay and ultrasound to determine which patients may be excluded from DVT testing.

## ANTITHROMBOTIC THERAPY

Arterial and venous thrombotic events combined, including acute coronary syndromes, stroke, peripheral arterial thrombosis, DVT, and PE, are likely responsible for more morbidity and mortality than any other condition in the developed world.

Coronary artery occlusive disease was responsible for more than 500,000 deaths in the United States alone in 1999 (one of every five total deaths), and it is estimated that 1.1 million Americans had a new or recurrent MI in 2002 ( 308 ). Acute limb ischemia secondary to peripheral arterial thrombosis and thromboembolism involving native and prosthetic vessels is a relatively uncommon, but ominous form, of vascular accident. National databases suggest a rate of 16 events annually per 100,000 population ( 309 ). Outcomes are inferior if treatment is delayed, and the incidence appears to steadily increase with patient age ( 310 ). In a similar fashion to coronary artery thrombosis, acute peripheral arterial thrombosis typically develops at sites of preexistent atherosclerotic PAOD. PAOD has been diagnosed in as many as 17% of men and 20% of women older than 55 years of age and is highly predictive for the coexistence of coronary and cerebral vascular disease. It has been estimated that PAOD progresses to critical limb ischemia in 15 to 20% of patients ( 311 , 312 ).

Acute VTE, including DVT and PE, is a common, potentially life-threatening, often preventable vascular condition associated with trauma, major surgery, advanced congestive heart failure, pregnancy, HRT, malignancy, and inherited hypercoagulability ( 313 ). Proximal lower-extremity DVT can result in venous limb gangrene (phlegmasia cerulea dolens), chronic stasis changes related to the postthrombotic syndrome, and symptomatic PE. PE in its most severe presentation can result in pulmonary hypertension, right-sided heart failure, cardiopulmonary collapse, and death.

A common feature of the management of *a//* thromboembolic vascular diseases is the use of antithrombotic agents. Antithrombotic agents, including antiplatelet drugs, anticoagulants, and thrombolytic agents, are used to prevent thrombotic events, prevent or mitigate the complications of thrombotic events, and restore vascular patency to prevent loss of tissue, organ, and limb function, as well as life. Based on the pathologic basis of thrombosis involving different vascular beds, drugs that inhibit platelet activation and aggregation play a primary role in arterial disease management, whereas drugs that inhibit thrombin and fibrin generation play a primary role in venous disease management. The following sections describe the pharmacodynamics, pharmacokinetics, and clinical uses of select antithrombotic agents.

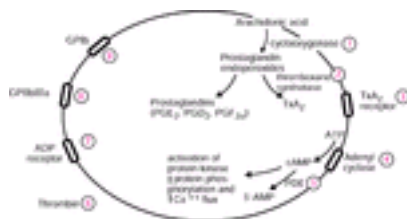
## Antiplatelet Drugs

Given the important role of platelets in mediating arterial thrombosis and the significant morbidity and mortality of arterial thrombotic disorders, the safety and efficacy of antiplatelet drugs have been evaluated in numerous primary and secondary prevention trials. A 1988 metaanalysis indicated that antiplatelet treatment reduced overall mortality from vascular disease by 15% and that nonfatal vascular events were reduced by 30% ( 314 ). A 1995 update on this subject supports the original observation of the efficacy of antiplatelet therapy ( 315 ). The American College of Chest Physicians' consensus conference has summarized the status of clinical trials with aspirin and other antiplatelet drugs ( 316 ).

Numerous potential targets exist for antiplatelet therapy ( Fig. 61.3 ). Platelet cyclooxygenase (COX) is the target of acetylation and irreversible inactivation by aspirin ( 317 ). ADP-induced platelet aggregation can be selectively inhibited by the thienopyridines ticlopidine and clopidogrel ( 318 , 319 ). Inhibitors to thromboxane synthetase and the TxA<sub>2</sub> receptor (ridogrel) have been studied ( 320 ). Infusion of prostaglandin E<sub>1</sub> or stable analogs of prostacyclin (Iloprost) increase platelet cyclic AMP concentrations, inhibiting platelet



activation ( 316 ). Dipyridamole alters platelet function, in part, by inhibition of cyclic nucleotide phosphodiesterase to increase platelet cyclic AMP levels ( 316 ). Other potential targets for antiplatelet therapy include the platelet membrane receptor, gpIb, mediator of platelet adhesion, and inhibitors to thrombin, the most potent stimulus to platelet activation ( 317 ). Interference with fibrinogen-mediated platelet aggregation by anti-gpIIb-IIIa antibodies and peptides is well established ( 321 ).



**Figure 61.3.** Targets for antiplatelet agents. This diagram summarizes certain aspects of platelet function relevant to antiplatelet therapy. Platelet metabolic pathways, membrane receptors, and enzymes are depicted with specific therapeutic targets enumerated. Four target categories for antiplatelet drugs are the arachidonic acid pathway that regulates production of prostaglandins (PGs) and thromboxanes, the cyclic-adenosine monophosphate (AMP) mechanism that modulates important metabolic events, platelet membrane glycoproteins (GPs) that act as receptors for platelet agonists, and thrombin, a key stimulus to platelet activation. Specific targets for antiplatelet therapies include the following: ( 1 ) Cyclooxygenase is the target of acetylation and irreversible inactivation by aspirin, as well as reversible inactivation by the nonsteroidal antiinflammatory agents; ( 2 ) inhibitors to thromboxane synthetase such as dazoxiben and imidazole analogs prevent generation of thromboxane A<sub>2</sub> (TxA<sub>2</sub>); ( 3 ) an example of a TxA<sub>2</sub> receptor antagonist is BM 13177; ( 4 ) infusion of PGE<sub>1</sub> or stable analogs of prostacyclin (Iloprost) increases platelet concentrations of cyclic AMP (cAMP) via stimulation of adenylate cyclase; ( 5 ) dipyridamole increases platelet cAMP concentrations by inhibition of cyclic nucleotide phosphodiesterase (PDE); ( 6 ) because thrombin is the most potent stimulus to platelet activation, inhibitors of thrombin (heparin, argatroban, lepirudin, and bivalirudin) may be important agents in preventing platelet-dependent thrombosis; ( 7 ) ticlopidine and clopidogrel inhibit platelet activation by inhibition of adenosine diphosphate (ADP)-induced aggregation; ( 8 ) monoclonal antibodies or peptides directed against the GPIIb-IIIa complex inhibit fibrinogen binding to platelets and subsequent platelet aggregation; and ( 9 ) inhibitors of the von Willebrand factor receptor (GPIb) are being developed to prevent platelet adhesion. ATP, adenosine triphosphate. (Reproduced and modified from Greenberg PL, Negrin R, Rodgers GM. Hematologic disorders. In: Melmon KL, Morrelli HF, Hoffman BB, et al., eds. Clinical pharmacology: basic principles in therapeutics, 3rd ed. McGraw-Hill, 1992:524-599.)

**ASPIRIN** Aspirin (acetylsalicylic acid) is the prototypical antiplatelet drug, exerting its antithrombotic action by irreversibly inactivating (by acetylation) the COX activity of platelet prostaglandin H synthase-1 (COX-1) and prostaglandin H synthase-2 (COX-2) ( 322 ). This COX inhibition leads to the prevention of TxA<sub>2</sub> synthesis and impairment of platelet secretion and aggregation ( 323 ). A variety of nonsteroidal antiinflammatory drugs can inhibit TxA<sub>2</sub>-dependent platelet function via competitive, reversible inhibition of COX-1. A lesser degree of COX-1 inhibition may explain why long-term use of nonaspirin nonsteroidal antiinflammatory drugs is not protective against first MIs in postmenopausal women ( 324 ). Aspirin is the least expensive, most widely studied, and most widely used antiplatelet drug. Aspirin (when not enteric coated) is rapidly absorbed from the upper gastrointestinal tract; plasma salicylate concentrations peak within 1 hour of ingestion. The effects of aspirin on platelet function occur within 1 hour and last for the duration of

the affected platelets' lifespan (approximately 1 week). The toxicity of aspirin is dose related, explaining why clinical studies have focused on finding the lowest effective antithrombotic dose of the drug. Toxicities include gastrointestinal discomfort and blood loss and the risk of systemic bleeding. Clinical trials suggest that aspirin doses as low as 75 mg/day or 30 mg/day are antithrombotic ( 325 , 326 , 327 and 328 ). In addition to reducing aspirin toxicity, lower aspirin doses also inhibit vascular endothelial cell prostacyclin production to a lesser extent, because inhibition of endothelial cell COX is of shorter duration and requires higher aspirin doses than does platelet COX ( 329 ). The inhibitory effects of chronic low-dose aspirin administration are cumulative ( 330 ). However, even when taken chronically in large doses, aspirin is not believed to be thrombogenic ( 331 ). The 2001 consensus conference statement on antiplatelet therapy indicates that aspirin has been convincingly demonstrated to be effective in treatment of the following thrombotic disorders: stable and unstable angina, acute MI, transient ischemic attack and incomplete stroke, stroke after carotid artery surgery, atrial fibrillation, and prosthetic heart valves (in combination with warfarin) ( 315 , 316 ). The minimum effective aspirin dose for these indications is 75 to 325 mg/day. Aspirin has also been shown to reduce mortality post-coronary artery bypass surgery and to be effective for primary prevention of cardiovascular events ( 332 , 333 and 334 ). A summary of 142 trials indicated that for patients with acute MI or stroke, aspirin prevents 35 to 40 events/1000 patients treated (secondary prevention). In contrast, when used in primary prevention, aspirin prevents four events per 1000 subjects treated ( 316 ). It is recommended that all patients with acute MI and unstable angina receive 75.0 to 162.5 mg of non-enteric coated aspirin to chew and swallow as soon as possible ( 316 ). Aspirin in this dosage should be continued indefinitely. Aspirin should be considered for primary prevention in men and women older than 50 years of age who have at least one major risk factor for coronary artery disease ( 316 ). Aspirin may modify the natural history of intermittent claudication from lower extremity arteriosclerosis. Because these patients are at high risk for future cardiovascular and cerebrovascular atherothrombotic events, life-long aspirin therapy is recommended ( 315 , 316 ). Similar therapy is advisable after peripheral arterial bypass surgery and carotid endarterectomy ( 315 , 316 ). The Pulmonary Embolism Prevention trial was a large-scale, double-blind, multicenter study of 13,356 patients undergoing surgery for hip fracture and an additional 4088 patients undergoing elective knee or hip arthroplasty ( 335 ). Patients were assigned to a regimen of 160 mg of aspirin or placebo once daily for 5 weeks, with the first dose given before surgery. Other forms of prophylaxis were allowed, and 40% of patients received unfractionated heparin (UFH) or LMWH in addition to the aspirin. The study demonstrated that aspirin reduces the incidence of fatal PE (58% risk reduction) and symptomatic nonfatal DVT or PE (36% risk reduction) in patients with hip fracture ( 335 ). Although beneficial when compared to placebo, aspirin cannot be recommended as first-line VTE prophylaxis in hip fracture patients because the benefit of aspirin is less than with anticoagulants ( 336 ).

**THIENOPYRIDINES** Ticlopidine and clopidogrel are structurally related compounds that selectively inhibit ADP-induced platelet aggregation and likely ADP-mediated amplification of the platelet response to other agonists ( 337 ). A lack of *in vitro* platelet aggregation inhibition suggests that *in vivo* hepatic transformation to an active metabolite is necessary for an antiplatelet effect ( 316 ). Both agents were initially used as aspirin substitutes in aspirin-intolerant patients. Although more effective than aspirin in reducing stroke rates in people with transient ischemic attacks; more effective than placebo in reducing the combined risk of stroke, MI, and vascular death in patients with thromboembolic stroke; more effective than conventional antianginal therapy in reducing vascular death in patients with unstable angina; and more effective than control therapy in reducing vascular complications in patients with peripheral vascular disease, enthusiasm for ticlopidine has been dampened by associated hematologic complications ( 316 , 338 ). Ticlopidine has been associated with neutropenia, thrombocytopenia, aplastic anemia, and

thrombotic thrombocytopenic purpura ( 339 , 340 and 341 ). Clopidogrel is rapidly absorbed and extensively metabolized. The plasma half-life of the main systemic metabolite, SR 26334, is roughly 8 hours ( 342 ). Clopidogrel inhibits ADP-induced platelet aggregation in a dose-dependent fashion with inhibition detectable 2 hours after an oral dose of 400 mg ( 342 ). On repeated daily dosing of 50 to 100 mg, 25 to 30% inhibition of ADP-induced platelet aggregation is noted on the second day of therapy with 50 to 60% steady-state inhibition noted after 4 to 7 days ( 316 ). Platelet function returns to normal approximately 7 days after the last dose of clopidogrel. The phase III Clopidogrel Versus Aspirin in Patients at Risk of Ischemic Events trial compared clopidogrel to aspirin in patients who had experienced a recent stroke or a recent MI and in those presenting with symptomatic peripheral arterial disease ( 343 ). A modest difference in efficacy was observed. The annual ischemic event rate for aspirin was 5.83% compared to 5.32% for clopidogrel, with a relative risk reduction of 8.7% (95% confidence interval, 0.3 to 16.5%;  $p = .043$ ) ( 341 ). The majority of the difference in efficacy occurred in the patients who entered because of symptomatic peripheral arterial disease, with a 23.8% relative risk reduction (95% confidence interval, 8.9 to 36.2%;  $p = .0028$ ) ( 343 ). The Clopidogrel in Unstable Angina to Prevent Recurrent Events trial has demonstrated an advantage of clopidogrel plus aspirin over aspirin alone in patients with acute coronary syndromes ( 344 ). Clopidogrel, like ticlopidine, can rarely precipitate thrombotic thrombocytopenic purpura ( 345 ).

**INTEGRIN  $\alpha_{IIb}\beta_3$  (GLYCOPROTEIN IIb/IIIa) RECEPTOR ANTAGONISTS** Because of the multitude of pathways that lead to platelet aggregation, it is not surprising that the clinical efficacy of the antiplatelet agents described above is only partial. Even combination therapy with clopidogrel and aspirin, resulting in partial inhibition of TxA<sub>2</sub>- and ADP-mediated platelet aggregation, leaves platelets susceptible to agonists like thrombin and collagen ( 316 ). Because expression of functionally active gpIIb/IIIa on platelet surfaces is the final common pathway of platelet aggregation regardless of initial stimulus, it is logical to target this glycoprotein receptor with antiplatelet agents. gpIIb/IIIa is a member of the integrin family of receptors. These receptors recognize the amino acid sequence arginine-glycine-aspartate [Arg-Gly-Asp (RGD)], which represents the cell attachment regulation sequence present in certain adhesive proteins like fibrinogen ( 346 , 347 ). Inhibitors of fibrinogen binding to gpIIb/IIIa, called the *disintegrins*, include a chimeric monoclonal antibody against the receptor, naturally occurring RGD sequence-containing peptides from snake (pit viper) venoms, synthetic RGD peptides, synthetic Lys-Gly-Asp (KGD) peptides, peptidomimetics, and nonpeptide RGD mimetics ( 321 , 348 ). Reviews of this subject are available for further details ( 349 , 350 and 351 ). Three parenteral gpIIb/IIIa inhibitors have been extensively studied, primarily in the settings of percutaneous coronary intervention (PCI), unstable angina, and non-Q-wave MI. These are abciximab, eptifibatide, and tirofiban ( 316 ). Abciximab (c7E3 Fab) is a chimeric Fab fragment of human and murine protein that binds to gpIIb/IIIa. Abciximab is unique among the gpIIb/IIIa antagonists because it also blocks the  $\alpha_{v}\beta_3$  receptor ( 352 ). Eptifibatide is a synthetic cyclic heptapeptide with a KGD sequence that is more specific for gpIIb/IIIa than the RGD sequence ( 316 , 348 ). Tirofiban is a synthetic peptidomimetic based on the RGD sequence ( 353 ). Oral gpIIb/IIIa inhibitors have been generally unsuccessful. The reader is referred to an excellent review that covers the use of the oral agents ( 354 ).

## Anticoagulant Drugs

Anticoagulant drugs are ubiquitous in medical and surgical practice. Anticoagulants are used to prevent and treat thrombosis. Short-term anticoagulation is usually provided in the form of an intravenous infusion or subcutaneous injection. More chronic anticoagulation is facilitated by the use of oral agents. Each agent has its strengths and weaknesses. A current trend toward the development of narrow-spectrum (single protein

target) anticoagulants (e.g., fondaparinux and ximelagatran) to supplant more broad-spectrum anticoagulants (e.g., heparin and warfarin) is likely to continue.

**HEPARIN** Heparin is a naturally occurring, highly sulfated glycosaminoglycan normally present in human tissues ( [Fig. 61.4](#)). McLean first isolated heparin from ox liver and identified its anticoagulant properties ( [355](#)). Commercial UFH is obtained from either bovine lung or porcine intestinal mucosa and consists of a heterogeneous mixture of polysaccharides (glycosaminoglycans) with molecular weights ranging from 4000 to 30,000 daltons (d), with a mean molecular weight of approximately 15,000 d (approximately 45 saccharide units). UFH molecules possessing anticoagulant activity constitute approximately one-third by weight of commercial heparin products ( [356](#)). Sodium and calcium salts of heparin are available, and most commercial heparin preparations have specific activities of approximately 150 U/mg. Heparin structure consists of alternating residues of uronic acid and glucosamine that are variably sulfated ( [357](#)). Sulfation of residues in heparin is a major determinant of the anticoagulant activity of a given heparin preparation; the heparin molecules with anticoagulant activity exhibit high-affinity binding to AT. Vascular endothelium synthesizes and expresses a related glycosaminoglycan, termed *heparan sulfate*.



**Figure 61.4.** Structure of the common active saccharide moieties found in commercial unfractionated heparin. These polymeric structures are termed *glycosaminoglycans*. From left to right, the saccharide structures are 2-deoxy-2-sulfamino- $\alpha$ -D-glucose-6-sulfate;  $\alpha$ -L-iduronic acid-2-sulfate; 2-acetamido-2-deoxy- $\alpha$ -D-glucose;  $\beta$ -D-glucuronic acid; and  $\alpha$ -L-iduronic acid. (Reproduced from Greenberg PL, Negrin R, Rodgers GM. Hematologic disorders. In: Melmon KL, Morrelli HF, Hoffman BB, et al., eds. Clinical pharmacology: basic principles in therapeutics, 3rd ed. McGraw-Hill, 1992:524-599, with permission.)

UFH molecules contain a randomly distributed unique pentasaccharide sequence that binds to AT. Once bound to UFH, the natural anticoagulant effect of AT is potentiated resulting in the accelerated binding and inactivation of serine proteases, in general, and factor Xa and thrombin, in particular ( [358](#), [359](#)). The inhibition of these factors has an impact on the common pathway of coagulation resulting in decreased formation of thrombin and fibrin. Heparin's interaction with AT is thought to occur as follows and is depicted in [Figure 61.5](#). A ternary complex with heparin, thrombin, and AT first occurs; this association permits inactivation of thrombin by the active site inhibitor domain of AT. Lastly, heparin dissociates from the AT-thrombin complex to subsequently catalyze additional AT-mediated reactions ( [360](#)). A synthetic pentasaccharide (fondaparinux) described later contains only the AT binding sequence and promotes factor Xa inhibition substantially but has minimal effect on thrombin inhibition ( [361](#)). In this case, only the conformational change induced by the pentasaccharide is necessary for factor Xa inhibition to occur. Oligosaccharides of greater length (at least 18 residues) are necessary for enhancement of thrombin inhibition by AT. It is likely that in this latter case, a ternary complex between ATIII, thrombin, and heparin forms to mediate protease inhibition ( [362](#)). These observations form the basis for the development and clinical use of LMWHs in the prophylaxis and treatment of thrombosis; these drugs, like the synthetic pentasaccharide, primarily inhibit factor Xa and have a lesser effect on inhibition of thrombin. *In vitro* experiments suggest that UFH exerts its major anticoagulant effect by promoting AT suppression of thrombin-dependent amplification reactions ( [363](#)).



**Figure 61.5.** Inhibition of thrombin activity by the heparin (H)–antithrombin (AT) mechanism. Reaction 1 indicates that in the absence of heparin catalysis, AT can irreversibly inactivate thrombin (T), albeit in an inefficient manner. In the presence of H, a conformation change occurs in the AT molecule, and heparin also acts as a template to bind both AT and T, promoting rapid inactivation of coagulation (reaction 2). In reaction 3, heparin is released from the AT–T complex and is available to catalyze subsequent reactions. Inhibition of factor Xa by AT–H does not require binding of heparin to the factor Xa molecule.

In addition to its anticoagulant activity, heparin possesses other unrelated biologic effects (364). Heparin hydrolyzes triglycerides from chylomicrons and very–low–density lipoproteins by release of endothelial cell lipoprotein lipase into the blood (365). Heparin can also activate platelets, suppress cell–mediated immunity, and affect metabolism of aldosterone and thyroxine. Heparin is active when given parenterally, either intravenously or subcutaneously. Because of its highly charged nature and inability to cross biologic membranes alone, oral use of heparin has historically been viewed as impossible. Recently, delivery systems have been developed that make oral heparin a reality. These delivery systems use synthetic amino acids such as sodium N–(8[2–hydroxybenzoyl]amino) caprylate or sodium N–(8[2–hydroxybenzoyl]amino) caprylate derivatives to facilitate oral heparin gut absorption (366). When sufficient amounts of heparin are orally administered, a prophylactic intensity of anticoagulation can be achieved. The half–life of heparin varies with the dosage given, with the half–life increasing with increasing dosage (367). A 100–U/kg intravenous dose is cleared with a half–life of approximately 1 hour. The clearance of heparin is also affected by the extent of thromboembolism, with extensive thrombosis decreasing heparin half–life (368). Heparin is cleared by the reticuloendothelial system and metabolized by the liver, and metabolic products are excreted in the urine. The anticoagulant effect of heparin is also altered by its nonspecific binding to plasma proteins and cells (369). Given these numerous variables affecting the plasma half–life of heparin, therapeutic use of this drug requires close laboratory monitoring to ensure attainment of a therapeutic effect and regulation of heparin levels within a range that minimizes the bleeding risk. These pharmacokinetic disadvantages of standard heparin are not shared by the LMWHs and are major reasons for the ever–increasing clinical use of the newer drugs. An additional challenge to the use of heparin to prevent and treat thrombosis is heparin resistance. “True” heparin resistance manifests as inadequate anticoagulant and antithrombotic responses from what would otherwise be perceived as an adequate, and probably weight–based, dose of heparin. Some have deemed a requirement of greater than 35,000 units of heparin per 24–hour period, regardless of patient weight, to reflect this form of heparin resistance (370). With true heparin resistance, both a measurement of anticoagulant activity like the aPTT and a measurement of antithrombotic activity like the anti–factor Xa activity assay demonstrate inadequate degrees of heparin activity. True heparin resistance most likely results from the nonspecific binding of heparin to mononuclear white cells, vascular endothelial cells, and acute–phase proteins such as histidine–rich glycoprotein, vitronectin, and platelet factor–4, resulting in an inadequate quantity of free or AT–bound heparin (369). Another potential cause of heparin resistance is compensated DIC–associated AT deficiency as can be seen in cancer patients. Patients can also manifest an “apparent” heparin resistance characterized by dissociation between the aPTT and heparin assays (370). In these patients, the aPTT may be normal or near normal, whereas the anti–factor Xa activity assay reveals a therapeutic heparin activity level between 0.3 and 0.7 IU/ml. Simply escalating the dose of heparin to achieve the desired aPTT without checking a heparin assay may result in a pronounced bleeding risk.



Dissociation between the aPTT and heparin concentration likely reflects elevated levels of factor VIII that can shorten the *in vitro* aPTT without affecting the antithrombotic actions of the drug. [Table 61.7](#) illustrates an example of a weight-based nomogram for using UFH. This assumes that the hospital laboratory has calibrated the aPTT values such that an aPTT range from 1.5 to 2.5 times the mean laboratory control aPTT is equivalent to plasma heparin levels of 0.3 to 0.7 U/ml, as measured by anti-factor Xa activity ([369](#)).

**TABLE 61.7. Weight-Based Nomogram of Unfractionated Heparin (UFH) in Treatment of Venous Thromboembolism**

|   |            |
|---|------------|
| Initial UFH bolus   | 80 U/kg    |
| Initial UFH infusion rate   | 18 U/kg/hr |
| Check aPTT after 6 hr of IV infusion; modify infusion rate as follows:  |            |
| If aPTT <1.2 × control, repeat bolus (80 U/kg) and increase infusion rate by  | 4 U/kg/hr  |
| If aPTT is 1.2–1.5 × control, repeat bolus (40 U/kg) and increase infusion rate by  | 2 U/kg/hr  |
| If aPTT is 1.5–2.3 × control, no change   | —          |
| If aPTT is 2.3–3.0 × control, decrease infusion rate by   | 2 U/kg/hr  |
| If aPTT >3 × control, hold infusion for 1 hr, then decrease infusion by   | 3 U/kg/hr  |
| aPTT, activated partial thromboplastin time.  |            |
| Data based on Raschke RA, Reilly BM, Guidry JR, et al. The weight-based heparin dosing nomogram compared with a “standard care” nomogram. <i>Ann Intern Med</i> 1993;119:874–881. |            |

**LOW-MOLECULAR-WEIGHT HEPARINS** LMWH is derived from the enzymatic or chemical cleavage of UFH to produce a mixture of low-molecular-weight glycosaminoglycan molecules with a mean molecular weight of approximately 5000 d (approximately 15 saccharide units) ([369](#)). For example, enoxaparin sodium is produced by benzoylation followed by alkaline hydrolysis, dalteparin sodium is produced by controlled nitrous acid depolymerization, and tinzaparin sodium is produced by enzymatic digestion with heparinase. LMWH binds AT via the same pentasaccharide sequence as UFH ([359](#)). However, due to the predominance of molecules less than 18 saccharide units in length, LMWH has limited AT activity compared to its anti-factor Xa activity. Whereas UFH has an anti-factor Xa to AT activity ratio of 1:1, LMWHs have reported ratios of 1.9:1 to 4.1:1 ([369](#)). Because of limited thrombin inhibition, LMWH therapy is unable to be monitored using the aPTT. Other differences between LMWH preparations include the degree of TF pathway inhibitor release, degree of sulfation, and degree of stimulated vWF release ([371](#), [372](#) and [373](#)). These differences form the basis for many medical organizations stating that LMWHs are unique drugs and not therapeutically interchangeable ([144](#), [374](#), [375](#)). At low doses, subcutaneous LMWH has 90% bioavailability compared to 30% for UFH. LMWHs have limited nonspecific binding to plasma proteins and platelets, endothelial cells, and macrophages compared to UFH, as well as a predictable clearance and a longer half-life that facilitates once or twice daily administration ([369](#), [376](#)). Unlike UFH, the half-life of LMWH is not dose dependent ([369](#)). These characteristics make LMWH preferred in settings that may normally result in heparin resistance. These advantages of LMWH allow these drugs to be given subcutaneously, once or twice daily in dosages based solely on body weight, and without the need for laboratory monitoring ([369](#)). Similar to UFH, absolute contraindications for LMWH include active bleeding, HIT, or a history of HIT, and known sensitivity to LMWH, UFH, or pork products. LMWH is cleared by renal mechanisms; therefore, multiday therapeutic use of LMWH in patients with significant renal insufficiency (creatinine clearance <30 ml/minute) should be avoided ([376](#)).

Reversible elevations of the liver transaminases alanine aminotransferase and aspartate aminotransferase may occur during the administration of LMWH. LMWH does not have the same capacity (approximately 60%) to be reversed after the administration of protamine sulfate (377). Table 61.8 summarizes the LMWH products available in the United States and their properties and U. S. Food and Drug Administration (FDA)-approved indications.

**TABLE 61.8. Comparison of Low-Molecular-Weight Heparin Products and Pentasaccharides Available or Under Study in the United States**

| Generic Name, Brand Name, and Manufacturer       | Molecular Weight | Factor Xa to Factor IIa Inhibition Ratio | Purification Method                       | Therapeutic Uses  | FDA-Approved Dose or Status for FDA Approval  |
|--|------------------|--|---|---|---|
| Low-molecular-weight heparins                    |                  |  |   |   |   |
| Dalteparin, Fragmin (Kabi 2165), Pfizer          | 5000 (2000–9000) | 2:1.0                                    | Nitrous acid depolymerization             | Prophylaxis of ischemic complications of non-Q-wave myocardial infarction or complications of unstable angina<br><br>VTE prophylaxis before abdominal surgery<br><br>VTE prophylaxis before hip replacement surgery<br><br>Treatment of VTE in oncology patients<br><br>Prevention of VTE in high-risk medical patients | 120 units/kg SQ every 12 hr for 5 to 8 days, given concurrently with aspirin 75–165 mg/day PO; do not exceed 10,000 units/dose<br><br>2500–5000 units SQ QD, starting 1–2 hr before surgery<br><br>Preoperative start, evening before surgery: 5000 units SQ QD<br><br>Phase III<br><br>Phase I PREVENT trial |
| Enoxaparin, Lovenox, Clexane (PK 10169), Aventis | 4500 (3000–8000) | 2.7–3.8:1.0                              | Benzylation and alkaline depolymerization | VTE prophylaxis before knee replacement surgery   | 30 mg SQ every 12 hr, starting 12–24 hr after surgery   |



|   |                     |                            |  |  |
|---|---------------------|----------------------------|--|--|
|   |                     |                            | Prophylaxis of ischemic complications of non-Q-wave myocardial infarction or unstable angina             | 1 mg/kg SQ every 12 hr, given concurrently with aspirin 100–325 mg/day PO  |
|   |                     |                            | VTE prophylaxis before abdominal surgery   | 40 mg SQ QD, starting 2 hr before surgery  |
|   |                     |                            | VTE prophylaxis in medical patients during acute illness   | 40 mg SQ QD  |
|   |                     |                            | VTE prophylaxis before hip replacement surgery   | 30 mg SQ every 12 hr, starting 12–24 hr after surgery; alternative regimen is 40 mg SQ QD, starting 9–15 hr before surgery |
|   |                     |                            | Inpatient treatment of DVT with/without PE (inpatient therapy) or outpatient treatment of DVT without PE | 1 mg/kg SQ every 12 hr, or 1.5 mg/kg SQ QD (at the same time each day); start warfarin when appropriate                    |
|   |                     |                            | Treatment of VTE in patients 0–11 yr   | Phase III  |
|   |                     |                            | Treatment of acute myocardial infarction in combination with TNKase                                      | Phase II ENTIRE trial; phase III ASSENT 3 trial  |
| Tinzaparin, Innohep (Novo 4500 HLN 1), Pharmion | 1.8:1.0 (3000–6000) | Enzymatic depolymerization | Inpatient treatment of DVT with/without PE   | 175 anti-Xa units/kg SQ QD; start warfarin when appropriate  |

|   |         |                                   |           |  |  |
|---|---------|-----------------------------------|-----------|--|--|
|   |         |                                   |           | Prevention of VTE in oncology patients   | Preclinical                                      |
| Pentasaccharides  |         |                                   |           |  |  |
| Fondaparinux, Arixtra (SR-90107a/ORG-31540), Sanofi/Organon | 1728    | Selective inhibition of factor Xa | Synthetic | Prophylaxis in patients undergoing hip fracture, hip replacement, and knee replacement surgery | 2.5 mg SQ QD, starting 6–8 hr after surgery      |
|   |         |                                   |           | Treatment of VTE   | MATISSE PE and DVT trials; 5–10 mg SQ QD         |
|   |         |                                   |           | Prevention of VTE in high-risk surgery and medical patients                                    | Phase III study                                  |
|   |         |                                   |           | Treatment of unstable angina and myocardial infarction   | Phase IIb  |
| Idraparinux, Sanofi-Synthelabo/Organon (SanOrg-34006)       | Unknown | Selective inhibition of factor Xa | Synthetic | Treatment of cardiovascular disease  | Phase III, once-weekly injection                 |
|   |         |                                   |           | Prevention and treatment of VTE  | Phase IIb (treatment dose is 2.5 mg once weekly) |

DVT, deep venous thrombosis; FDA, United States Food and Drug Administration; PE, pulmonary embolism; VTE, venous thromboembolism.

**HEPARINOIDS** Heparinoids are low-molecular-weight glycosaminoglycans not derived from heparin. Heparinoids include dermatan sulfate and danaparoid sodium. Dermatan sulfate and low-molecular-weight dermatan sulfate act as anticoagulants by activating HCII ( 378 , 379 ). Danaparoid sodium is a glycosaminoglycan mixture derived from porcine intestinal mucosa composed of heparan sulfate (84%), dermatan sulfate (12%), and chondroitin sulfate (4%) ( 380 ). Danaparoid has an anti-factor Xa activity to AT activity ratio of greater than 22:1 (compared to a 1:1 ratio for heparin), which explains why it is minimally neutralized by protamine sulfate ( 380 ). The largest collection of clinical experience with danaparoid is provided by Magnani who published an overview of 230 patients treated for HIT ( 381 ). Danaparoid was associated with a favorable outcome in 92.5% of patients. Of the 15 patients considered to have had unsuccessful outcomes, two patients had bleeding events (one fatal), four developed recurrent thrombocytopenia, five had persistent thrombocytopenia, and four had thromboembolic events. Overall, five patients demonstrated danaparoid cross-reactivity with HIT-IgG (one developed a new thrombosis). Mortality reported as possibly or probably attributed to danaparoid treatment

occurred in 3% of patients and included episodes of bleeding, thrombosis, and septic shock. In a recent series, Tardy-Poncet et al. treated 42 patients with either therapeutic intensity (26 patients) or prophylactic intensity (16 patients) danaparoid (382). No new thrombotic events were reported, two patients developed major bleeding, and two patients died as a result of HIT with associated paradoxical thrombosis (HITT). Danaparoid may cross-react with 10 to 50% of HIT sera, but *in vivo* cross-reactivity, although reported, has not been commonly observed (383, 384). Danaparoid has a relatively long half-life of approximately 24 hours that may make its use less desirable in patients at high risk for developing bleeding or those likely to need surgery. Significant experience exists with the administration of danaparoid by both intravenous and subcutaneous routes. Danaparoid anticoagulation is monitored using an anti-factor Xa activity chromogenic assay calibrated with danaparoid standards. The drug is approved for deep vein thromboprophylaxis after orthopedic surgery at a dose of 750 anti-Xa units twice daily by subcutaneous injection. A common dose for the treatment of active thrombosis in patients with normal renal function is 1500 units as an intravenous bolus followed by 1500 units subcutaneously twice daily. The target therapeutic anti-factor Xa activity is 0.5 to 0.8 U/ml. Danaparoid's potential for cross-reactivity and the longer half-life make it less desirable than a direct thrombin inhibitor (DTI) for the treatment of patients with HIT (369). The manufacturer of the drug has discontinued availability of danaparoid in the United States.

**PENTASACCHARIDES** Fondaparinux is a newly available synthetic pentasaccharide (molecular weight, 1728 d) that causes selective indirect inhibition of factor Xa (385). Fondaparinux is administered subcutaneously and does not require therapeutic monitoring. Fondaparinux elimination is prolonged in patients with renal impairment. The reduction in clearance increases as the creatinine clearance decreases. Elimination is also prolonged in patients older than 75 years of age and in those weighing less than 50 kg. Phase III trials comparing fondaparinux with LMWH for the initial management of patients with acute DVT and PE have been completed; the preliminary data indicate that fondaparinux is equivalent to enoxaparin in treatment of venous thromboembolism and equivalent to UFH in treatment of PE (386). Fondaparinux is currently FDA-approved for primary thromboprophylaxis in patients with hip fracture undergoing surgery and in those undergoing elective knee and hip joint replacement (387). Fondaparinux may result in less HIT than UFH and LMWH. A long-acting pentasaccharide under development, idraparinux, has a half-life of 130 hours, which may facilitate once-weekly dosing for primary and secondary prevention of thromboembolic events (388).

**DIRECT THROMBIN INHIBITORS** Elimination of all heparin exposure is the most essential element in the treatment of HIT. This includes discontinuing heparin intravenous catheter flushes, prophylactic subcutaneous heparin or LMWH, and heparin-coated indwelling catheters. Despite heparin discontinuation and platelet count recovery, patients with isolated, serologically confirmed HIT have up to a 50% risk of developing a confirmed thrombotic event during the 30-day period after heparin cessation (389). The persistent prothrombotic tendency associated with HIT and the patient's original indication for heparin therapy warrant use of an alternative anticoagulant agent after heparin cessation (Table 61.9).

**TABLE 61.9. Comparison of Direct Thrombin Inhibitors**

| Drug Profile   | Lepirudin (Refludan)      | Argatroban (Argatroban)   | Bivalirudin (Angiomax)          |
|----------------|---------------------------|---------------------------|---------------------------------|
| Derivative     | Recombinant hirudin       | L-arginine derivative     | Synthetic hirudin-based peptide |
| Action         | Direct thrombin inhibitor | Direct thrombin inhibitor | Direct thrombin inhibitor       |
| Clearance      | Renal                     | Hepatic                   | Renal                           |
| Administration | IV (or SC)                | IV                        | IV or SC                        |

|   |             |        |             |
|---|-------------|--------|-------------|
| Half-life                                     | 1.5 hr      | 40 min | 25 min      |
| Monitoring                                    | aPTT or ECT | aPTT   | aPTT or ACT |
| Heparin cross-reactivity                      | None        | None   | None        |
| Effect on international normalized ratio      | Yes         | Yes    | Yes         |
| Approved for heparin-induced thrombocytopenia | Yes         | Yes    | No          |
| Immunogenic                                   | Yes         | No     | Unknown     |

ACT, activated clotting time; aPTT, activated partial thromboplastin time; ECT, ecarin clotting time.

---

**Lepirudin** Lepirudin is a recombinant hirudin analog that received FDA approval in 1998 for anticoagulant treatment in patients with HIT in the setting of thromboembolic disease to prevent further thrombosis ( 390 ). Lepirudin differs from native hirudin, found in the saliva of the medicinal leech, in that it lacks sulfation on the tyrosine at position 63 and has a leucine at position 1 rather than isoleucine ( 391 ). Lepirudin is a potent direct AT that lacks any structural homology with heparin, does not cross-react with heparin, has a short half-life, is able to inactivate clot-bound thrombin, and can be monitored using the ubiquitous aPTT assay or the less readily available ecarin clotting time ( 392 ). A prospective, multicenter, historically controlled study described lepirudin use in 82 patients with laboratory-confirmed HIT ( 393 ). Fifty-one HIT patients with thrombosis received 0.4 mg/kg as a bolus followed by a continuous infusion of 0.15 mg/kg/hour; 5 HIT patients with thrombosis receiving thrombolysis received a 0.2-mg/kg bolus followed by a 0.1-mg/kg/hour infusion; 18 patients without thrombosis received a prophylactic infusion of 0.1 mg/kg/hour; and 8 patients undergoing cardiopulmonary bypass received a 0.25-mg/kg bolus and 5-mg boluses as needed. Platelet counts increased rapidly in 88.7% of lepirudin-treated patients with acute HIT. The incidence of the combined endpoint of death, amputation, and new thromboembolic events was reduced by greater than 50% (  $p = .014$  ) in the group that received lepirudin compared with 120 historical controls. Bleeding events and transfusion requirements were no greater in the lepirudin-treated patients ( 393 ). Current lepirudin dosing recommendations for acute HIT management are 0.4 mg/kg as a bolus followed by 0.15 mg/kg/hour (up to 110 kg). The target aPTT is 1.5 to 2.5 times the median value for the normal range. Monitoring during bypass requires performance of the less readily available ecarin clotting time with a target plasma lepirudin concentration of 2.0  $\mu\text{g/ml}$  ( 394 ). The activated clotting time (ACT) and point-of-care aPTT assays do not appear to be suitable for lepirudin therapeutic monitoring ( 395 ). Outpatient subcutaneous lepirudin has been used to treat patients with HIT and thrombosis and patients refractory to other anticoagulant therapy ( 396 ). The major challenges of lepirudin treatment are the lack of an antidote, the extreme care needed when treating patients with even mild renal insufficiency, and immunogenicity. In the event of lepirudin overdose or lepirudin-induced bleeding, infusions of prothrombin complex concentrates or recombinant factor VIIa may help promote hemostasis ( 390 ). High flux capillary hemodialysis membranes may facilitate the hemofiltration of lepirudin in some cases ( 397 ). Partial exchange transfusions, plasmapheresis, and immobilized thrombin affinity columns have also been tried to neutralize the effects of lepirudin ( 390 ). Marked bolus and infusion rate reductions are necessary in patients with a creatinine clearance of less than 60 ml/minute (serum creatinine >1.6 mg/dl). Lepirudin is to be avoided completely or administered with extreme care in the settings of hemodialysis and acute renal failure and in patients undergoing continuous venovenous hemodialysis even in the setting of a normal serum creatinine. Careful monitoring of both the aPTT and serum creatinine are indicated during lepirudin therapy. Approximately 40% of HIT patients treated with lepirudin develop antihirudin antibodies of the IgG class ( 398 ). The antibodies

seem to be capable of decreasing renal elimination of the drug rather than exerting any *in vivo* neutralizing effect. This paradoxical enhancement of the anticoagulant effect of lepirudin often warrants a significant infusion rate reduction.

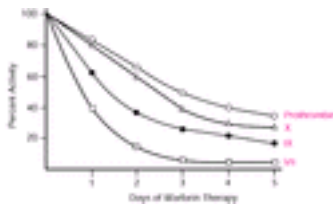
**Argatroban** Argatroban is a synthetic, small-molecule, L-arginine derivative that received FDA approval in June 2000 for prophylaxis and treatment of thrombosis in patients with HIT. Argatroban is a rapid and reversible DTI, in contrast to lepirudin, which is an irreversible thrombin inhibitor. Argatroban is capable of inhibiting both free and fibrin-associated thrombin. Argatroban exerts its antithrombotic effects by inhibiting thrombin-mediated reactions including fibrin formation; activation of coagulation factors V, VIII, and XIII; activation of the natural anticoagulant protein C; and platelet activation ( [399](#) ). Like lepirudin, argatroban does not cross-react with heparin. Argatroban is metabolized by the liver with biliary excretion and has a half-life of only 40 minutes. Renal excretion has also been documented; however, renal impairment has been shown to have little adverse effect on drug clearance and half-life. Unlike lepirudin, argatroban does not require dose adjustment in the setting of renal insufficiency. Dose reduction is required in patients with significant hepatic disease ( [399](#) ). Lewis et al. published findings from a large, prospective, historically controlled trial in 2001 ( [400](#) ). This study treated 160 patients with HIT alone and 144 patients with HIT and thrombosis with argatroban dosed to maintain an aPTT 1.5 to 3.0 times baseline value. In patients with HIT alone, the combined incidence of death, amputation, and new thromboembolic events was significantly lower in argatroban recipients compared with controls (26% vs. 39%;  $p = .014$ ). In patients with HIT and thrombosis at baseline, the incidence of this combined endpoint was not significantly lower in argatroban recipients compared with controls (44% vs. 57%;  $p = .131$ ). Argatroban recipients also showed significant improvements in platelet count relative to the historical controls. No difference in bleeding events between the argatroban and control groups was noted ( [400](#) ). Argatroban is dosed based on patient weight. The recommended starting intravenous infusion rate is 2  $\mu\text{g}/\text{kg}/\text{minute}$  with a target aPTT of 1.5 to 3.0 times the baseline value. Therapy may also be monitored by whole blood ACT and the ecarin clotting time. Like lepirudin, argatroban prolongs the PT as well as the aPTT. This PT prolongation makes determination of an accurate INR during conversion to oral warfarin therapy a challenge. Holding the infusion of either DTI for several hours before INR determination is prudent. A recent publication showed that argatroban provides adequate anticoagulation with minimal bleeding risk while enabling procedural success in HIT patients undergoing PCI ( [401](#) ). Patients were given argatroban 350  $\mu\text{g}/\text{kg}$  bolus followed by 25  $\mu\text{g}/\text{kg}/\text{minute}$  titrated to achieve an ACT of 300 to 450 seconds. This dosing regimen may provide satisfactory anticoagulation during cardiopulmonary bypass and allow intraoperative dose adjustments based on the readily available ACT.

**Bivalirudin** Bivalirudin is a semisynthetic, bivalent DTI consisting of a dodecapeptide analog of the carboxy-terminal of hirudin ( [402](#) ). Bivalirudin has four glycine residues that connect the thrombin exosite 1 and thrombin active-site moieties. Bivalirudin produces only transient inhibition of the thrombin active site. The short half-life of bivalirudin may enhance its safety profile. Bivalirudin is primarily used during PCI in which it has been shown to be at least as effective as heparin with an improved safety profile ( [403](#) , [404](#) and [405](#) ). Bivalirudin may have a larger role to play in the management of patients with HIT, especially in those requiring cardiac surgery.

**Ximelagatran** Ximelagatran is a new oral prodrug of the DTI melagatran. Ximelagatran is administered in a fixed-dose fashion, does not require therapeutic monitoring, and has no apparent major food or drug interactions ( [406](#) ). Ximelagatran is rapidly absorbed (peak levels in 15 to 30 minutes) and rapidly converted to melagatran (peak levels in 1 to 2 hours). Melagatran is eliminated by the kidney. Ximelagatran-derived melagatran binds to the thrombin active site resulting in inhibition of thrombin-mediated activation of coagulation factors (V, VIII, XIII, and fibrinogen) and platelets ( [407](#) ). It is active against free and clot-bound thrombin in an AT-independent manner. Ximelagatran may also enhance endogenous fibrinolysis. Melagatran appears to be nonteratogenic in animals. Phase III trials are currently evaluating oral ximelagatran for the treatment of acute VTE,

chronic management of atrial fibrillation, and prevention of VTE in the orthopedic setting. Ximelagatran holds promise as a potential substitute for parenteral agents as well as oral warfarin. Its role in HIT remains to be determined. A standard dose in VTE treatment trials was 24 mg twice daily ( 408 ).

**WARFARIN** In the 1920s, cattle developed a bleeding disorder when they were fed spoiled sweet clover. Campbell and Link later identified the active agent as bishydroxycoumarin (dicoumarol) ( 409 ). Drugs that inhibit the biosynthesis of the vitamin K-dependent coagulation proteins are derived either from 4-hydroxycoumarin or 1,3-indanedione. Although the indanediones are used in Europe, a coumarin derivative, warfarin, is the major oral anticoagulant used in the United States. Warfarin inhibits  $\gamma$ -carboxylation of select glutamic acid residues in the N-terminus of prothrombin and factors VII, IX, and X, as well as the vitamin K-dependent natural anticoagulants, protein C and protein S ( 410 ). Warfarin inhibits the two enzymes critical for the generation of reduced vitamin K, namely vitamin K epoxide reductase and vitamin K reductase ( 411 , 412 ). Reduced vitamin K is necessary for catalyzing  $\gamma$ -carboxylation of glutamic acid residues. Inhibition of  $\gamma$ -carboxylation by warfarin leads to synthesis of incomplete, hypofunctional coagulation proteins that are unable to bind to cellular surfaces to mediate coagulation reactions. The effect of warfarin on vitamin K-dependent procoagulant protein production is depicted in Figure 61.6. Details of vitamin K metabolism are presented in Chapter 21.



**Figure 61.6.** Effects of standard warfarin therapy on the plasma vitamin K-dependent procoagulant coagulation proteins. Administration of 5 to 10 mg daily of warfarin results in inhibition of synthesis of functional vitamin K-dependent proteins. The coagulant activity of these proteins in plasma declines as a function of their half-life. Half-lives of factors VII, IX, and X and prothrombin are 6, 24, and 40 and 60 hours, respectively. Although 1 to 2 days of warfarin prolongs the PT assay (because of the rapid decrease in factor VII concentration), therapeutic anticoagulation requires at least 4 to 5 days. (Data from O'Reilly RA. The pharmacodynamics of the oral anticoagulant drugs. *Prog Hemost Thromb* 1974;2:175–213; reproduced from Greenberg PL, Negrin R, Rodgers GM. Hematologic disorders. In: Melmon KL, Morrelli HF, Hoffman BB, et al., eds. *Clinical pharmacology: basic principles in therapeutics*, 3rd ed. McGraw-Hill, 1992:524–599, with permission.)

Commercially available warfarin is a racemic mixture of levorotatory and dextrorotatory forms of the drug. The half-life of warfarin in blood is approximately 36 hours ( 413 ). Laboratory monitoring of warfarin therapy is best done using functional coagulation tests, such as the PT. Plasma warfarin levels are most useful in evaluating the unusual patient who does not respond to standard warfarin dosages or in whom malabsorption, noncompliance, or inherited drug resistance is an issue ( 412 , 414 ). Because factor X and prothrombin have half-lives greater than 2 days, reduction of all vitamin K-dependent coagulation proteins into the therapeutic range (approximately 20% of normal) requires 4 to 5 days of therapy ( 415 ). This is the basis for the “heparin overlap” period of 4 to 5 days during which patients receive therapeutic heparin while waiting to achieve the therapeutic effects of warfarin ( 416 ). An animal study indicated that depression of both factor X and prothrombin levels by warfarin was important in prevention of hypercoagulability ( 415 ). Warfarin dosage is influenced by numerous variables, including the patient’s dietary stores of vitamin K, liver function, coexisting medical disorders, concurrent medications, and presence or absence of a common cytochrome P-450 2C9 gene mutation ( 417 , 418 and 419 ). Patients with liver disease, malnutrition, or other factors associated with sensitivity to warfarin should receive lower warfarin dosages. The most



common adverse interaction of warfarin use occurs in a patient with marginal dietary vitamin K intake (postoperative state) who is given a broad-spectrum antibiotic, reducing enteric bacterial synthesis of vitamin K, resulting in increased sensitivity to warfarin (412). Starting warfarin therapy early after heparin therapy (day 1 or 2) has many advantages, including earlier hospital discharge on adequate oral anticoagulation and potential reduction in the incidence of HIT (420). The metabolism of warfarin may be affected by other drugs metabolized by the cytochrome P-450 enzyme complex; drugs that displace albumin-bound warfarin into the circulation; drugs that impair gastrointestinal absorption; and many antibiotics that alter the natural flora of the colon (an endogenous source of vitamin K) (412) ( Table 61.10).

**TABLE 61.10. Drugs and Medical Conditions Affecting Warfarin Potency**

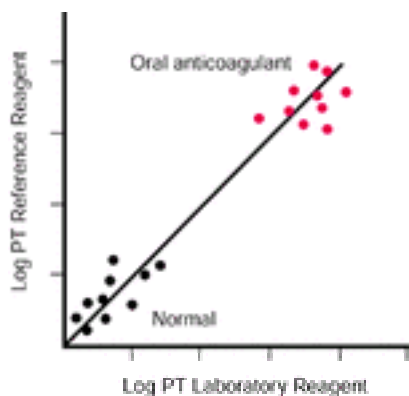
| Potentiators                           | Antagonists                      |
|--|----------------------------------|
| Drugs                                  | Drugs                            |
| Acetaminophen                          | Adrenal corticosteroids          |
| Anabolic steroids                      | Barbiturates                     |
| Broad-spectrum antibiotics             | Carbamazepine                    |
| Chloral hydrate                        | Chlordiazepoxide                 |
| Cimetidine                             | Cholestyramine                   |
| Clofibrate                             | Efavirenz                        |
| Disulfiram                             | Griseofulvin                     |
| Fluconazole                            | Nafcillin                        |
| Indomethacin                           | Rifampin                         |
| Influenza vaccine                      | Sucralfate                       |
| Lovastatin                             | Trazodone                        |
| Metronidazole                          | Medical conditions               |
| Omeprazole                             | Excess dietary vitamin K         |
| Phenylbutazone                         | Inherited resistance to warfarin |
| Phenytoin                              | Hypothyroidism                   |
| Propranolol                            | Nephrotic syndrome               |
| Protease inhibitors (except ritonavir) |                                  |
| Quinine/quinidine                      |                                  |
| Salicylates                            |                                  |
| Tamoxifen                              |                                  |
| Thyroid drugs                          |                                  |
| Trimethoprim/sulfamethoxazole          |                                  |
| Medical conditions                     |                                  |
| Older age                              |                                  |
| Liver disease                          |                                  |
| Biliary disease                        |                                  |
| Malabsorption                          |                                  |
| Congestive heart failure               |                                  |
| Fever                                  |                                  |
| Hyperthyroidism                        |                                  |
| Malnutrition                           |                                  |
| Vitamin K deficiency                   |                                  |
| Cancer                                 |                                  |

Data from the 2003 Physicians' Desk Reference. Montvale, NJ: Thomson Healthcare; and Hirsh J, Dalen JE, Anderson DR, et al. Oral anticoagulants: mechanism of action, clinical effectiveness, and optimal therapeutic range. Chest 2001;119(Suppl):108S-121S.

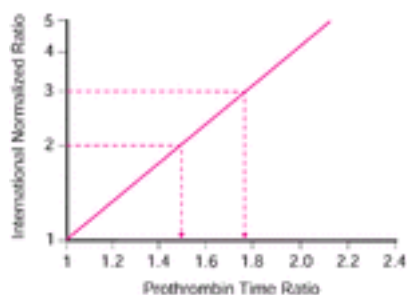


Certain patients may require very large doses of warfarin (>50 mg/day) to achieve therapeutic anticoagulation; the term *warfarin resistance* has been applied (414). Patients who are difficult to anticoagulate with warfarin, either because they exhibit warfarin resistance or because they are very sensitive to the drug and cannot be safely regulated, may be candidates for adjusted-dose subcutaneous heparin or LMWH.

**Laboratory Monitoring of Warfarin Therapy** The PT assay is useful to monitor warfarin therapy because this assay measures three vitamin K-dependent coagulation proteins—factors VII, X, and prothrombin. The PT is particularly sensitive to factor VII deficiency; with a half-life of 4 to 6 hours, the factor VII level may drop rapidly after only 1 day of warfarin therapy and prolong the PT value. However, because the other vitamin K-dependent proteins have longer half-lives, therapeutic anticoagulation takes 4 to 5 days. There is no advantage to giving larger loading doses of warfarin; this regimen only results in a more rapid drop in factor VII levels, delay in attainment of a stable PT, a precipitous fall in protein C levels, and predisposition to warfarin-induced skin necrosis (413, 421, 422). To understand current recommendations for monitoring warfarin therapy, it is important to appreciate the concept of the INR, a method that standardizes PT assays (412, 423). An international reference thromboplastin preparation has been adopted by the World Health Organization (WHO). Each new commercial thromboplastin is calibrated against the primary WHO reference preparation. These results are used to calculate the relative sensitivity of the unknown preparation compared with the WHO standard [international sensitivity index (ISI)]. The method to determine the ISI for a particular thromboplastin is depicted in Figure 61.7. By adjusting for the ISI of a particular thromboplastin, an INR, defined as the PT ratio that would have been obtained if the WHO standard thromboplastin had been used, can be determined. The INR is calculated using the following formula:  $INR = [PT \text{ ratio}]^{ISI}$  ( Fig. 61.8).



**Figure 61.7.** Method for determination of an international sensitivity index (ISI) value for a laboratory's thromboplastin preparation. Log prothrombin time (PT) values are determined using a reference thromboplastin reagent and the commercial laboratory thromboplastin reagent on patients receiving stable (2 weeks) oral anticoagulant therapy and a group of normal, untreated volunteers. The best fit line is determined, and the slope of this line multiplied by the ISI of the reference thromboplastin reagent is the ISI value for the commercial thromboplastin reagent. (From Rodgers GM. Laboratory monitoring of anticoagulant and fibrinolytic therapy. In: Kjeldsberg C, McKenna R, Perkins S, et al., eds. Practical diagnosis of hematologic disorders, 2nd ed. Chicago: ASCP Press, 1995:745–755, with permission.)



**Figure 61.8.** Relationship between a patient’s prothrombin time (PT) ratio on warfarin therapy and the corresponding international normalized ratio (INR) value. The slope of the line represents the international sensitivity index (ISI) value of the particular thromboplastin preparation used in the laboratory’s PT assay. In this example, for low-intensity-warfarin therapy (INR, 2.0 to 3.0), a PT ratio between 1.50 and 1.75 would be required. Thromboplastins with higher ISI values would have slopes greater than that shown and would be less sensitive reagents for the PT assay, whereas thromboplastins with lower ISI values would have slopes less than that shown (more sensitive reagents). (From Greenberg PL, Negrin R, Rodgers GM. Hematologic disorders. In: Melmon KL, Morrelli HF, Hoffman BB, et al., eds. Clinical pharmacology: basic principles in therapeutics, 3rd ed. McGraw-Hill, 1992:524–599, with permission.)

The American College of Chest Physicians’ consensus panel recommends low-intensity warfarin therapy (INR, 2.0 to 3.0) for all indications except prosthetic mechanical heart valves and prophylaxis of recurrent MI, for which higher-intensity warfarin therapy (INR, 2.5 to 3.5) is suggested ( [412](#) ). A summary of recommendations is shown in [Table 61.11](#).

**TABLE 61.11. Recommended Therapeutic Range for Warfarin Therapy**

| Indication                                    | International Normalized Ratio |
|---|--------------------------------|
| Low-intensity                                 | 2.0–3.0                        |
| Prophylaxis of venous thrombosis              |                                |
| High-risk surgery                             |                                |
| Treatment of venous thromboembolism           |                                |
| Prevention of systemic embolism               |                                |
| Tissue heart valves                           |                                |
| Acute myocardial infarction                   |                                |
| Atrial fibrillation                           |                                |
| Valvular heart disease                        |                                |
| High-intensity                                | 2.5–3.5                        |
| Prosthetic mechanical heart valves            |                                |
| Prevention of recurrent myocardial infarction |                                |

From Hirsh J, Dalen JE, Anderson DR, et al. Oral anticoagulants: mechanism of action, clinical effectiveness, and optimal therapeutic range. Chest 2001;119[Suppl]:8S–21S, with permission.

Increasing use of the INR format has led to appreciation of its limitations ( [426](#) , [427](#) ). These include less accuracy and precision when insensitive (high ISI value) thromboplastins are used, incorrect assignment of an ISI value by the manufacturer, use of a different reagent-instrument combination than that used by the manufacturer, and use of an incorrect control PT value ( [428](#) ).

**Adverse Effects of Warfarin Therapy**

**Bleeding** A direct relationship exists between the risk of bleeding and the intensity of anticoagulation, with patients receiving higher-intensity (INR >3.0) therapy having a

fivefold greater risk of bleeding ( 429 ). Other major factors contributing to bleeding include coexisting conditions, such as structural gastrointestinal lesions, hypertension, renal disease, and cerebrovascular disease ( 430 , 431 ). Investigation of patients who experience visceral bleeding while on warfarin therapy often results in identification of structural disease ( 432 ). Highest bleeding rates occur in patients with cerebrovascular disease ( 430 ). For patients given low-intensity warfarin therapy for prophylaxis of venous thromboembolism, the risk of major bleeding is less than 1%. Antiplatelet medications or other drugs that potentiate warfarin activity are important contributors to bleeding ( Table 61.10 ). Treatment strategy of bleeding in patients receiving warfarin depends on several factors: the duration of expected warfarin therapy, the severity of bleeding, and the extent of INR elevation. Patients with minor bleeding (bruising, microscopic hematuria) and an INR of less than 6.0 can have warfarin withheld until the INR approaches the therapeutic range. Warfarin can then be resumed at a lower maintenance dosage. If patients have visceral bleeding that is not life-threatening and are concluding their warfarin treatment course, their coagulopathy can be reversed with vitamin K, 10 mg, SC or PO. Patients with significant emergent bleeding and who require continued warfarin therapy should be reversed with fresh frozen plasma (four to five units) or prothrombin complex concentrates. If the INR is between 6 to 10 and no clinical bleeding exists, small doses of vitamin K can be given (1 to 2 mg PO or SC), with slow correction toward the therapeutic range within 24 hours. For an INR greater than 10 in patients without bleeding, higher doses of vitamin K can be given (2 to 4 mg, PO or SC) and repeated at 12- to 24-hour intervals, depending on posttreatment INR values. Patients requiring warfarin who are excessively corrected with vitamin K should receive therapeutic heparin or LMWH until oral anticoagulation is reestablished. Failure of vitamin K to correct the coagulopathy suggests that another process is present such as liver disease or DIC. The management of warfarin overdose and reversal has been reviewed ( 433 ). Patients who ingest rodenticides that contain long-acting vitamin K antagonists (“superwarfarins”) may require massive daily doses (=100 mg) of vitamin K to correct the coagulopathy, for periods of weeks to months (see Chapter 60 ). For patients on long-term warfarin therapy who require procedures or elective surgery, bridging therapy with LMWH is acceptable when warfarin is discontinued 4 to 5 days before surgery. Postoperatively, heparin or LMWH is given and continued until a 4- to 5-day overlap period of warfarin has been achieved ( 434 ). Nonhemorrhagic adverse effects of warfarin therapy include alopecia, gastrointestinal discomfort, rash, and liver dysfunction ( 430 ). A warfarin embryopathy can occur when pregnant mothers receive warfarin during the first trimester. A bone matrix protein, osteocalcin, is vitamin K-dependent, and in the presence of vitamin K deficiency induced by warfarin, osteocalcin is synthesized in a nonfunctional manner, resulting in fetal bone malformations ( 435 ). Additional fetal abnormalities have been noted when warfarin is used during pregnancy. Because of these fetal risks, most practitioners avoid warfarin during pregnancy ( 436 ).

**Warfarin-Induced Skin Necrosis** Skin necrosis is an unusual but devastating complication of warfarin therapy, occurring within the first week of initiating therapy. Affected patients have usually received large, loading doses of warfarin, perhaps in the absence of therapeutic heparin anticoagulation. Many patients with this syndrome have been found to have heterozygous protein C deficiency ( 133 ). The basis for this complication is thought to be a warfarin-induced rapid reduction in protein C levels in patients with a preexisting inherited protein C deficiency that results in a hypercoagulable state and thrombosis. Not all heterozygous protein C-deficient patients receiving warfarin experience this complication, and not all patients with this complication have protein C deficiency. Clinically, the skin lesions begin on certain subcutaneous areas of the body (breasts, abdomen, thighs) as erythematous patches ( 437 ). Lesions progress to blebs followed by demarcated skin necrosis ( Fig. 61.9 ). Skin biopsy reveals generalized thrombosis of skin vessels. This complication may require amputation, plastic reconstructive surgery, or both. The use of standard maintenance doses of warfarin (5.0 to 7.5 mg/day) beginning after patients are therapeutically anticoagulated with heparin may avoid this complication.

Patients who experience warfarin-induced skin necrosis should be heparinized, warfarin should be discontinued, and vitamin K should be administered promptly ([133](#)). Patients experiencing this complication should be screened for protein C deficiency. A few cases of warfarin-induced skin necrosis have been reported in protein S-deficient patients ([438](#)). A literature review of warfarin-induced skin necrosis found that warfarin therapy could be reinstated in affected patients; smaller initial doses of warfarin were recommended ([439](#)).



**Figure 61.9.** Warfarin-induced skin necrosis. The patient was a 75-year-old female given warfarin in the absence of heparin therapy. An initial area of tenderness over the right calf became erythematous and indurated and then evolved into overt skin necrosis as shown. (From Schleicher SM, Fricker MP. Coumarin necrosis. *Arch Dermatol* 1980;116:444–445, with permission.)

The “purple toe syndrome” is an uncommon disorder that has been described in patients with underlying atherosclerotic vascular disease who are receiving warfarin therapy ([440](#), [441](#) and [442](#)). These patients present with atheroembolic symptoms including ischemic toes (purple toes), livedo reticularis, gangrene, abdominal pain, or symptoms of renal infarction. Involved visceral organs include the kidneys, pancreas, spleen, and liver. This complication may be difficult to distinguish from warfarin-induced skin necrosis, except that on biopsy, cholesterol emboli are present in the purple toe syndrome, and widespread vascular thromboses are seen in skin necrosis. Treatment involves prompt recognition of the syndrome and discontinuing warfarin therapy ([443](#)).

### Thrombolytic Drugs

The major reaction of the fibrinolytic (plasminogen) system involves the conversion by PAs of the inactive proenzyme, plasminogen, into the active enzyme, plasmin. Plasmin can degrade fibrinogen, fibrin monomers, and cross-linked fibrin (as found in thrombi) into FDPs. These plasmin-mediated reactions generate many species of FDP including unique species of FDP such as fragment X from fibrinogenolysis and cross-linked FDP such as (DD)E- and D-dimer from cross-linked fibrin ([444](#), [445](#)). Knowledge of these reactions is necessary to appreciate the mechanisms of action and limitations of commercial PAs.

A common feature of the management of *a//* thromboembolic diseases is the desire to restore vascular patency in a timely fashion to prevent loss of tissue, organ, and limb function, as well as life. Acute arterial thrombosis warrants an attempt at immediate thrombolysis, whereas venous thrombosis only warrants such intervention in extreme

cases. Recognition of the importance of the endogenous fibrinolytic system in limiting the size of hemostatic thrombi, clearing hemostatic thrombi after vascular repair, and preventing pathologic thrombosis has resulted in the development of pharmacologic fibrinolytic (thrombolytic) agents to facilitate rapid restoration of vascular patency. Most thrombolytic agents are recombinant forms of physiologic PAs. The commercially available PAs differ with regards to plasma half-life, fibrin selectivity, primary clinical usage, primary infusion strategy, and immunogenicity. Currently available PAs and their key characteristics are summarized in [Table 61.12](#).

**TABLE 61.12. Properties of Currently Available Thrombolytic Agents**

| Thrombolytic Agent  | Molecular Weight (Daltons) | Plasma Half-Life (Min)          | Key Properties  |
|---|----------------------------|---------------------------------|---|
| Streptokinase (Streptase)   | 47,000                     | 20 (drug); 90 (lytic effect)    | Complexes with plasminogen to gain activity   |
| Anisoylated plasminogen streptokinase activator complex (Eminase) | 131,000                    | 40–90                           | Streptokinase and plasminogen complex   |
| Urokinase (Abbokinase)  | 34,000/54,000              | 15                              | Direct plasminogen activator derived from fetal kidney cells  |
| Recombinant urokinase   | 54,000                     | 7                               | Recombinant high-molecular-weight urokinase   |
| Recombinant prourokinase (ProLyse)                                | 49,000                     | 7                               | Active after conversion to urokinase  |
| Alteplase (Activase)  | 65,000                     | 4–8                             | A recombinant t-PA  |
| Retepase (recombinant plasminogen activator) (Retavase)           | 39,000                     | 15                              | Truncated t-PA with an extended half-life   |
| TNK-recombinant t-PA (TNKase)                                     | 65,000                     | 20 (initial); 90–130 (terminal) | A modified t-PA with an extended half-life, enhanced plasminogen activator inhibitor-1 resistance, and greater fibrin specificity |

t-PA, tissue-type plasminogen activator.

Most thrombolytic agents are fashioned after endogenous t-PA or urokinase. Traditional thrombolytic drugs include bacteria-derived SK, anisoylated plasminogen SK activator complex, urokinase (two-chain u-PA), and recombinant t-PA (rt-PA). Newer molecules have been and are being developed in an attempt to improve on the traditional agents. Major goals of new thrombolytic agent development include increasing fibrin specificity to theoretically reduce bleeding complications, prolonging initial plasma half-life to facilitate single- or double-bolus administration, reducing sensitivity to inactivation by PAI-1, and improving production efficiency. New thrombolytic agents include mutants of PAs, chimeric PAs, conjugates of PAs with monoclonal antibodies, and novel PAs from animal or bacterial origin.

**STREPTOKINASE** SK is obtained from cultures of  $\beta$ -hemolytic streptococci. By itself, SK has no PA activity, but after combining with plasminogen, a complex is formed that is capable of activating other plasminogen molecules to plasmin ( [446](#) ). Purified SK has a



molecular weight of 47,000 d. SK was the first clinically used thrombolytic agent. It is not fibrin-selective in that its therapeutic use results in systemic fibrin(ogen)olysis and what is termed the *lytic state* from proteolysis of fibrinogen, factors V and VIII, and other plasma proteins ( 446 ). Platelet function may also be perturbed because plasmin can proteolyze key platelet membrane receptors ( 447 ). Generation of FDPs also contributes to the significant hemostatic defect of thrombolytic therapy. Although the lytic state predisposes patients to bleeding, the benefit of decreased blood viscosity that results from the lytic state may be clinically important. The half-life of SK is approximately 20 minutes. Because SK is a bacterial protein, it is antigenic, and allergic reactions occur in approximately 6% of patients. Anaphylaxis during SK use occurs in approximately 0.1% of patients ( 448 ). Patients previously exposed to SK or with previous streptococcal infections may acquire antistreptococcal antibody levels sufficient to neutralize the activity of SK. Therefore, all patients receiving SK should be monitored to ensure attainment of the lytic state. This can be done with the thrombin time assay. SK has been primarily used to treat venous thromboembolism and MI, as well as to treat central venous access device-associated thrombosis.

**UROKINASE-TYPE PLASMINOGEN ACTIVATOR** In the past, u-PA was obtained from human fetal kidney cell cultures. It is currently produced using nonhuman mammalian tissue cultures. Its molecular weight is 34,000. u-PA is not fibrin-selective, and this drug also produces a lytic state. The half-life of u-PA is approximately 15 minutes. u-PA is used to treat venous thromboembolism, MI, and thrombolysis of clotted catheters.

**TISSUE-TYPE PLASMINOGEN ACTIVATOR** Currently, t-PA is produced by recombinant technology as a two-chain species, with a molecular weight of approximately 65,000 ( 449 , 450 ). *In vitro*, t-PA is fibrin-specific, because of its high affinity for fibrin with which it forms a ternary complex with plasminogen. However, with t-PA dosage regimens currently being used, the lytic state is produced ( 451 ). Consequently, bleeding complications with t-PA are similar to those of SK or u-PA ( 452 ). The half-life of t-PA is much shorter than that of SK or u-PA, approximately 5 minutes. t-PA is used to treat venous thromboembolism and acute MI ( 452 , 453 and 454 ) and recently has been approved for use in acute thrombotic stroke ( 455 , 456 ). Laboratory monitoring of t-PA therapy is usually not recommended.

**TISSUE-TYPE PLASMINOGEN ACTIVATOR VARIANTS** Recombinant PA (r-PA; reteplase) is a nonglycosylated deletion mutant of wild-type human t-PA comprised of only the kringle 2 and the protease domains of the parent molecule. Lack of the finger domain imparts lower fibrin binding affinity ( 457 ). Lack of glycosylation, a finger domain, and an epidermal growth factor domain imparts an extended half-life (15 minutes vs. 5 minutes). The longer half-life allows for double-bolus administration. TNK-tPA differs from t-PA by three sets of mutations. The Asn<sup>117</sup>?Gln and Thr<sup>103</sup>?Asn mutations promote a lower plasma clearance rate and greater fibrin specificity. The Lys<sup>296</sup>-His<sup>297</sup>-Arg<sup>298</sup>-Arg<sup>299</sup>?Ala-Ala-Ala-Ala mutation imparts an 80-fold increased resistance to PAI-1 ( 458 ). The longer half-lives of r-PA and TNK-rt-PA compared with t-PA facilitate bolus administration primarily for acute coronary thrombosis.

**Newer Non-Tissue-Type Plasminogen Activator Thrombolytics** Recombinant glycosylated prourokinase has a greater stability than recombinant nonglycosylated prourokinase and is rapid acting and safe in the clinical doses used ( 459 ). Staphylokinase is produced by *Staphylococcus aureus*. It appears to have substantial thrombolytic activity, but it may also be immunogenic ( 460 ). Vampire bat (*Desmodus rotundus*) salivary PA possesses 85% primary structure homology to human t-PA but lacks a kringle 2 domain. Alfimeprase is a novel thrombolytic based on the snake venom-derived protein, fibrolase. Alfimeprase is not a PA, is neutralized by a  $\alpha_2$ -macroglobulin, and is currently in phase I/II development ( 461 ).

**THROMBOLYTIC THERAPY-ASSOCIATED BLEEDING** Bleeding is the most common complication associated with thrombolytic therapy, regardless of the agent. The bleeding

stems from plasmin's inability to differentiate between hemostatic and pathologic thrombi. This complication can range from minor bleeding at an intravenous infusion site to life-threatening hemorrhage (462). Intracranial hemorrhage is a relatively uncommon but serious complication of thrombolysis in patients being treated for acute MI. The factors that increase the risk for bleeding during thrombolytic therapy are not fully understood. However, Gurwitz and associates used the National Registry for Myocardial Infarction to determine risk factors for this adverse event in individuals treated with t-PA (463). Their analysis of 673 patients with intracranial hemorrhage indicated that older age, female sex, black ethnicity, systolic blood pressure greater than or equal to 140 mm Hg, diastolic blood pressure greater than or equal to 100 mm Hg, history of stroke, t-PA dose greater than 1.5 mg/kg, and lower body weight were all significantly associated with an increased risk for intracranial hemorrhage. It is also possible that the properties of the agent used for thrombolysis may contribute to the risk for bleeding complications.

**THROMBOLYTIC FIBRIN SPECIFICITY AND HEMORRHAGIC RISK** Thrombolytic agents can be characterized along a variety of dimensions, but one that is often mentioned is fibrin specificity (464). The ability of a thrombolytic agent (PA) to distinguish between plasminogen in the general circulation and plasminogen bound to fibrin surfaces dictates its fibrin specificity. Activation of fibrin-bound plasminogen results in the generation of fibrin-bound plasmin that is protected from inactivation by a  $\alpha_2$ -antiplasmin. Bound plasmin generates soluble fibrin degradation products; circulating plasmin degrades fibrinogen into FDPs. Fibrin specificity differs from fibrin affinity, which is a measure of how avidly a given agent binds to fibrin, but not its specificity for this molecule (464). At present, there is little evidence to support the view that differences in fibrin affinity among PAs are significantly correlated with either the efficacy or safety of these preparations (465, 466). High fibrin specificity is thought to be associated with lower risk for hemorrhagic complications in patients undergoing thrombolytic therapy because of the belief that plasmin generated on the fibrin surface of a thrombus restricts its activity only to that surface. This view is not universally supported by available data from large-scale clinical trials. The relationship between high fibrin specificity and reduced bleeding risk is supported by the results of a recent study (467). The results of the Assessment of the Safety and Efficacy of a New Thrombolytic (ASSENT)-2 trial, which included 16,949 patients with acute MI, showed that the use of the highly fibrin-specific thrombolytic agent TNK-tPA, compared with rt-PA, was associated with a significantly lower risk for major noncerebral bleeding (467). This lower rate of bleeding complications was correlated with a significant reduction in the need for blood transfusions. The ASSENT-2 investigators also reported that TNK-tPA was associated with a significantly lower risk for noncerebral bleeding than the less-specific agent alteplase (468). Intracranial bleeding rates were comparable with the two agents. Results from other large-scale studies support the opposing view that high fibrin specificity may actually be associated with increased risk for intracranial bleeding in patients undergoing thrombolytic therapy for acute MI. For example, the Global Utilization of Streptokinase and Tissue Plasminogen Activator for Occluded Coronary Arteries (GUSTO) trial showed that the risk of intracranial bleeding was slightly higher in 41,021 patients with MIs who received treatment with rt-PA as compared with SK (469). These findings are consistent with those from another very large-scale comparison of SK with rt-PA in 20,768 patients with MI [Gruppo Italiano per lo Studio della Streptochinasi nell'Infarto Miocardico 2 (GISSI-2)], which showed a significantly higher risk of stroke in patients who received the latter, more fibrin-specific agent (470). Similarly, the Third International Study of Infarct Survival (ISIS-3) showed that treatment of patients with anisoylated plasminogen SK activator complex was associated with increased risk for intracranial bleeding compared with SK in a large cohort of 41,299 patients who received thrombolytic therapy for suspected MI (471). There are a number of potential explanations for the association between high fibrin specificity and increased intracranial bleeding observed in the patients treated in the GUSTO, GISSI-2, and ISIS-3 trials. These include the inability of fibrin-specific agents to distinguish between pathologic thrombi and hemostatic thrombi and the possibility that



treatment with fibrin-specific agents resulted in greater degradation of hemostatic fibrinogen and other circulating coagulation factors than SK. Finally, it may be that fibrin-specific therapy resulted in increased production and accumulation of fragment X, and that this enhanced the bleeding risk. PAs once believed to be safer because of their fibrin specificity may actually result in greater bleeding risk by virtue of their generation of the fibrin degradation product (DD)E and fragment X. (DD)E is a cross-linked fibrin degradation product that can bind both plasminogen and t-PA and protect bound plasmin from a  $\alpha_2$ -antiplasmin (472). Fragment X is a high-molecular-weight “clottable” FDP, which, when incorporated into a forming thrombus, makes a thrombus more readily lysed (473). The sequence of molecular events that can lead to a loss of rt-PA fibrin specificity includes the following: (a) rt-PA and plasminogen bind to a fibrin surface on a pathologic thrombus, resulting in the generation of fibrin-bound plasmin; (b) fibrin-bound plasmin degrades the thrombus, resulting in the formation of fibrin degradation products, such as (DD)E; (c) other rt-PA (via their kringle 2 domains) and plasminogen molecules bind to circulating (DD)E and generate non-fibrin-bound plasmin in the circulation far from the target thrombus; and (d) the circulating plasmin activity degrades circulating fibrinogen and leads to the production and accumulation of fragment X. Hypofibrinogenemia ensues, and hemostatic thrombi that have incorporated fragment X become prone to rapid lysis by circulating and bound plasmin (474). Because vampire bat salivary PA lacks a kringle 2 domain, it does not promote the generation of fragment X. This potential for enhanced safety combined with *in vitro* evidence of enhanced rapidity of clot lysis compared to other thrombolytics makes vampire bat salivary PA an excellent candidate for commercial development (475). Fragment X persists in the circulation for as long as 24 hours after an infusion of rt-PA in patients with acute coronary thrombosis. Similar patients given SK have lower circulating levels of fragment X and higher concentrations of smaller degradation products, such as fragment D and fragment E, in their circulation. Bolus administrations of rt-PA may result in less fragment X production than infusions given over several hours. When added to the plasma of healthy dogs, fragment X results in significant lengthening of the thrombin time, and this effect is thought to be due to competition between fragment X and fibrinogen for the fibrinogen binding sites on thrombin (476). Unlike in acute MI in which intravenous bolus PA dosing is necessary to rapidly achieve high concentrations of plasmin activity at the site of thrombosis and facilitate rapid lysis of a relatively small thrombus, lysis of larger-diameter and longer peripheral thromboses is best achieved with catheter-directed infusions of PA over several hours to days. Drugs designed for bolus or brief infusion administration to treat acute coronary thrombosis may be associated with an excessive bleeding risk when given by extended continuous infusion. Such infusions may foster the loss of “fibrin specificity” described above, accumulation of fragment X, and increased rates of bleeding.

## MANAGEMENT OF VENOUS THROMBOEMBOLIC DISEASE

It has been estimated that between 500,000 and 2 million VTE cases including calf vein thrombosis, proximal DVT, and PE occur annually in the United States alone. It is estimated that up to 50% of DVT and PE is asymptomatic or undetected (477). The extremely high incidence of DVT and PE likely reflects inadequate attention to VTE prophylaxis in high-risk surgical and medically ill patients.

The major clinical consequences of extremity DVT include the postthrombotic syndrome (chronic swelling, stasis dermatitis, stasis ulceration, and venous claudication—all secondary to venous insufficiency) and PE. The major clinical consequences of PE include chronic dyspnea, pulmonary hypertension, pulmonary infarction, and death. DVT restricted to the calf veins uncommonly results in clinically important PE and is rarely associated with a fatal outcome. In contrast, inadequately treated DVT involving the popliteal or more proximal leg veins is associated with a 20 to 50% risk of clinically relevant recurrence and is strongly associated with both symptomatic and fatal PE (478, 479). In untreated

patients, death from PE occurs most frequently within 24 to 48 hours of initial presentation. All-cause mortality rates in treated patients with PE is as high as 11% at 2 weeks and 17% at 3 months ( [477](#) ). Even small PE in patients with emphysema, cardiac disease, or lung involvement with malignancy may result in death. Any VTE in a patient with a contraindication to anticoagulation presents a therapeutic challenge and greater likelihood of adverse outcome. In part, for these reasons, calf DVT, proximal DVT, and PE are considered distinct manifestations of thromboembolic disease.

### **Calf Deep Venous Thrombosis**

It is perceived by many that calf DVT is uncommon and of limited clinical significance. This misunderstanding and underappreciation of the morbidity and mortality associated with calf DVT have resulted in a lack of clear consensus on the optimal management strategy for this thrombotic disease. Contemporary clinical studies have revealed that isolated calf DVT may account for as few as 6.2% of all symptomatic acute DVT and as many as 43.0% of all acute VTE ( [479](#), [480](#) ). Studies have also demonstrated that, although calf DVT and proximal DVT may be considered separate diseases at their outset, 15 to 25% of calf DVT propagates and converts into proximal DVT ( [481](#), [482](#) and [483](#) ). Both symptomatic and asymptomatic calf DVT appear to propagate with an equal frequency ( [482](#) ). Such “proximal conversion” renders what was initially a calf DVT just as dangerous as any proximal DVT. Proximal conversion has been shown to occur within the initial 2 weeks after diagnosis in the majority of cases and warrants treatment accordingly ( [484](#), [485](#), [486](#) and [487](#) ). Despite past reports of inadequate ultrasound sensitivity and specificity for calf DVT, newer imaging hardware and software have made calf DVT diagnosis very feasible by experienced vascular technologists.

Whereas the primary goals of proximal DVT treatment include the prevention of DVT recurrence and PE, the most essential goal of calf DVT treatment should be to prevent early proximal conversion. Current treatment approaches for isolated calf DVT range from identical intensity and duration of anticoagulant therapy as is used for proximal DVT to a complete lack of any pharmacologic therapy at all. Acceptable management, which falls between these extremes, includes serial duplex ultrasound surveillance with therapy begun only in the event of proximal conversion and abbreviated courses of standard anticoagulation. Surveillance consists of noninvasive imaging twice weekly for typically no more than 3 weeks (includes the usual period for proximal conversion). Limitations of serial surveillance include cost, compliance, and convenience. Serial surveillance seems especially prudent in situations such as patients with recent gastrointestinal bleeding for whom the risk of anticoagulation would likely exceed the benefit.

Whereas 6 months of anticoagulation have been shown to be superior to 6 weeks' duration of therapy in patients with proximal DVT, the shorter course of therapy has *not* been shown to be inferior in patients with initial distal thrombosis ( [480](#) ). Situational calf DVT (DVT with a clear precipitant such as an inflammatory bowel disease flare and prolonged bed rest) can be safely treated for only 6 weeks assuming the precipitating illness or event has resolved. Inferior vena cava (IVC) filter placement is not recommended for calf DVT in most circumstances.

### **Proximal Deep Venous Thrombosis**

Before selecting an approach to proximal (popliteal vein up to the distal inferior vena cava) DVT management, one must clearly appreciate the goals of therapy. The goals of DVT management include the following: (a) prevention of embolization, (b) prevention of thrombus extension, (c) prevention of early and late recurrence, (d) restoration of venous patency, and (e) prevention of the postthrombotic syndrome. Accomplishment of all five

goals should prevent thromboembolic death.

Different treatment strategies accomplish different goals. Supportive care alone (i.e., doing nothing) accomplishes none of these goals. Clinical studies done before the routine use of anticoagulant therapy demonstrated that 20% of patients with untreated DVT died of PE ( 488 ). Published by Barritt and Jordan in 1960, the landmark study of patients with clinically diagnosed symptomatic PE using heparin followed by oral anticoagulation demonstrated a dramatic mortality reduction in deaths from PE, as well as a reduction in nonfatal recurrence of PE ( 489 ). Placement of an IVC filter effectively prevents all PE in the short run, but probably at the expense of a greater long-term DVT recurrence rate ( 490 ). Intravenous, aPTT-adjusted UFH and weight-based LMWH do effectively prevent embolization, extension, and recurrence. LMWHs appear to be slightly, but significantly better, than standard heparin at restoring venous patency and may reduce the incidence of early postthrombotic syndrome. Catheter-directed thrombolytic therapy is the most effective means of completely restoring patency but is associated with excessive bleeding and significant cost. Thrombolysis is best reserved for iliofemoral DVT in the young and those with extensive thrombosis resulting in venous limb gangrene (phlegmasia cerulea dolens).

Several prospective, randomized, controlled trials have demonstrated the efficacy and safety equivalency of UFH and LMWH for the treatment of DVT ( 491 , 492 , 493 , 494 and 495 ). The major advantage of subcutaneous LMWH is the ability to be self-administered at home without the need for therapeutic monitoring. This translates into a significant reduction in mean hospital length of stay (6.5 days vs. 1.1 days) ( 491 ). Patients may be started on LMWH in the hospital and then discharged in an “accelerated” fashion to continue their conversion to oral warfarin or may be treated exclusively in the outpatient setting. LMWHs are associated with less osteopenia, less HIT, and less nonspecific protein binding than UFH ( 369 ). Metaanalyses have demonstrated a survival advantage in those patients with acute DVT who have been treated initially with LMWH versus those treated initially with heparin ( 497 ). It seems as if this overall survival advantage is derived primarily from a survival advantage imparted to cancer patients with DVT.

The optimal duration of anticoagulation has been widely studied and debated. For idiopathic DVT, 3 months of therapy are better than 4 weeks, and 6 months are better than 6 weeks ( 480 ). In short, the risk of VTE recurrence is very low as long as therapeutic anticoagulation is continued. It is the 3 to 4% annual risk of major hemorrhage secondary to warfarin that prevents physicians from prescribing long-term anticoagulation with abandon ( 498 ). Long-term anticoagulation with an attenuated intensity of warfarin therapy may provide ample protection with greatly reduced risk of major bleeding. This latter concept has been reinforced by recently published data indicating that an INR intensity of 1.5 to 2.0 for extended prophylaxis appears to be effective and safe in treating VTE recurrence ( 499 ). Three to six months of anticoagulation are generally prescribed for individuals with an initial DVT. Recurrent DVT after the completion of a course of anticoagulation usually warrants long-term therapy. Patients with persistent risk factors for thrombosis, such as antiphospholipid antibody syndrome, hyperhomocysteinemia, incurable malignancy, or a deficiency of a natural anticoagulant (protein C, protein S, and AT), usually benefit from long-term therapy. Representative recommended durations of anticoagulation are listed in [Table 61.13](#).

**TABLE 61.13. Duration of Anticoagulation in Venous Thromboembolic Disease**

| Disease | Duration |
|---------|----------|
|---------|----------|

|  |                          |
|--|--------------------------|
| Situational DVT                            | 6 wk to 3 mo             |
| Idiopathic DVT                             | 6 mo (minimum)           |
| Recurrent idiopathic DVT                   | 12 mo (minimum)          |
| DVT with ongoing risk factors <sup>a</sup> | Long-term/indefinite     |
| Pulmonary embolism                         | 6 mo                     |
| Massive pulmonary embolism                 | Long-term/indefinite     |
| Calf vein DVT                              | See DVT categories above |
| DVT, deep venous thrombosis.               |                          |

<sup>a</sup> For example, malignancy, antiphospholipid antibody syndrome, or natural anticoagulant deficiency.

## Pulmonary Embolism

In general, acute PE should be treated in the same fashion as acute DVT. It is actually advisable to start anticoagulation at the time of suspected PE even before diagnostic testing has been performed. LMWHs have been shown to be safe and effective in patients with acute PE treated in hospital ( [496](#), [500](#) ). Outpatient treatment of PE seems reasonable but has not been extensively studied. Placement of an IVC filter at the time of PE diagnosis is usually reserved for those with an absolute contraindication to anticoagulation. Many physicians, however, place filters in patients with underlying cardiac or pulmonary disease who are perceived as being at risk for death should they develop a second PE.

## Initial Anticoagulation Therapy

The mainstay of pharmacologic therapy for VTE is anticoagulation. Treatment with heparin or LMWH should be begun as soon as possible, unless an absolute contraindication exists. A delay in achieving a therapeutic intensity of initial parenteral therapy may have a negative impact on a patient's long-term VTE recurrence rate ( [501](#), [502](#) ). Weight-based initial dosing of heparin (80-U/kg bolus followed by 18 U/kg/hour) with subsequent dose adjustments based on a standardized nomogram ( [Table 61.7](#) ) facilitates achieving a therapeutic aPTT ( [503](#) ). Several nomograms have been published and their use depends on individual preference. Use of any published nomogram helps facilitate the rapid achievement of therapeutic anticoagulation. Adjusted-dose subcutaneous UFH and intermittent intravenous UFH boluses have also been used effectively in the treatment of VTE ( [478](#) ). The therapeutic intensity of UFH is monitored using the aPTT. An aPTT 1.5 to 2.5 times the control aPTT is often considered therapeutic. An aPTT therapeutic range that correlates with an anti-FXa activity level of 0.3 to 0.7 IU/ml is preferred ( [144](#) ). The aPTT should be checked every 4 to 6 hours until the aPTT surpasses the minimum of the target range. Fixed-dose boluses and initial infusions are preferred by some and are not necessarily inferior to weight-based dosing ( [144](#) ).

Absolute contraindications to the administration of UFH include active bleeding, HIT or a history of HIT, and known sensitivity to UFH or pork products ( [144](#) ). Relative contraindications to anticoagulation are listed in [Table 61.14](#). Patients with acute DVT and active bleeding require placement of an IVC filter. It is important to note that active bleeding may be a treatable and transient contraindication to anticoagulation. An IVC filter should not be viewed as an equivalent substitute to anticoagulation in the setting of acute VTE and is certainly not an "insurance policy" against subsequent PE. In patients with

filters placed because of bleeding, appropriate anticoagulation should begin as soon as the bleeding source has been properly and completely treated. Because of the significant risk of rebleeding, such a patient should have his or her anticoagulation begun in the hospital. Placement and subsequent removal of a temporary (or retrievable) IVC filter once the contraindication to anticoagulation has passed seems ideal. Placement of an IVC filter because of a “free-floating” DVT may not be necessary in all patients ( 504 ).

**TABLE 61.14. Relative Contraindications to Anticoagulation Therapy**

---

|   |
|---|
| Bacterial endocarditis  |
| Recent organ biopsy or noncompressible arterial intervention site |
| Recent gastrointestinal or genitourinary bleeding (<10 d)         |
| Thrombocytopenia or marked anemia                                 |
| History of a bleeding disorder                                    |
| History of intracranial, spinal, or ocular bleeding               |
| Recent (<2 wk) history of major surgery, stroke, or trauma        |
| Hepatic insufficiency   |

---

Patients who are excessively anticoagulated with heparin without serious bleeding can be treated simply by stopping the drug; the short half-life (1 to 2 hours) of heparin ensures rapid return of the aPTT to the therapeutic range. Caution must be used to avoid loss of therapeutic anticoagulation in patients treated for thrombosis. Patients who are excessively anticoagulated and actively bleeding should be considered for reversal of anticoagulation with protamine sulfate. Protamine is given by slow IV infusion, with 1 mg of protamine neutralizing approximately 100 U of heparin ( 369 ). Because heparin has a short half-life, it is important to give an appropriate protamine dose for the heparin level remaining at that time, so that excess protamine is not administered ( 369 ). Protamine infusion may be associated with anaphylaxis, and excess protamine may lead to a paradoxical bleeding disorder ( 369 ).

Nonhemorrhagic heparin-associated toxicities include allergy, osteoporosis, and decreased plasma AT levels ( 107, 505 ). Patients who are hypersensitive to one heparin preparation (e.g., porcine heparin) can receive another (e.g., bovine heparin), or a LMWH. Osteoporosis results from heparin-induced bone resorption and occurs when patients receive therapeutic dosages of heparin for periods greater than 3 to 4 months ( 505 ).

Weight-based subcutaneous LMWH is an established standard of care in many communities and hospitals. UFH and LMWH have been demonstrated to be equally safe and efficacious in patients with acute VTE. The choice of which agent to use should be determined for each patient, taking into consideration the individual patient profile including medical history, thrombotic risk factors, bleeding risk, and ambulatory status. Enoxaparin sodium is dosed at 1.0 mg/kg body weight every 12 hours or 1.5 mg/kg once daily. Tinzaparin is dosed at 175 IU/kg once daily ( 497, 506 ). Dalteparin is dosed at 200 IU/kg (up to 18,000 IU) once daily. At this time, only enoxaparin and tinzaparin are FDA-approved for VTE treatment in the United States.

Patients at increased risk for bleeding should probably be treated initially in an inpatient setting. Such patients include those with active bleeding (including occult stool blood), a history of recent surgery, past gastrointestinal tract or neuraxial bleeding, recent trauma



or stroke, concomitant regular nonsteroidal antiinflammatory drug use, thrombocytopenia, and renal insufficiency. Severe renal dysfunction (creatinine clearance <30 cc/minute) results in a 25% or greater reduction in LMWH clearance and thus results in drug accumulation ( [369](#), [376](#) ). LMWH therapy may not be suitable for the morbidly obese ( [507](#) ). Most reported clinical trials have enrolled patients weighing less than or equal to 100 kg. Based on a recent pharmacokinetic analysis in obese patients up to 165 kg, tinzaparin can be dosed based on actual weight without dose adjustment ( [507](#) ). Monitored heparin therapy is always a choice for the obese patient with acute DVT.

Therapeutic monitoring of LMWH therapy using the anti-factor Xa activity assay is not necessary in most patients. An exact therapeutic range has not been carefully determined, but a consensus panel has recommended a target peak LMWH range of 0.5 to 1.1 U/ml (for twice-daily dosing of a LMWH) ( [508](#) ). Adjusting the dose of LMWH based on such testing may not be superior to simple weight-based dosing. In occasional patients with thrombosis, the aPTT assay may not be reliable in monitoring heparin therapy—for example, patients with the lupus anticoagulant and a prolonged baseline aPTT. For these patients, one option would be to use heparin levels that can now be obtained by an automated assay using an anti-factor Xa method. In this instance, the targeted therapeutic range would be 0.35 to 0.7 U/ml. Alternatively, these patients could be given a LMWH, with the dosage determined solely by body weight and no necessity for laboratory monitoring. Patients with marked elevation in factor VIII levels may also be more reliably anticoagulated using LMWH ( [370](#) ).

A recently presented abstract demonstrated that fondaparinux is equivalent to enoxaparin for the initial management of DVT and is equivalent to intravenous UFH for the initial management of PE ( [386](#) ). Trials evaluating ximelagatran, the oral DTI, in VTE management have recently been completed.

### Chronic Phase Anticoagulation

Warfarin therapy can be started as soon as an aPTT greater than 1.5 times control has been achieved with heparin or after an initial weight-based therapeutic dose of LMWH has been given. Bolus dosing of warfarin does not help achieve a stable, target INR faster and may actually delay achievement of a stable INR and prolong hospitalization ( [413](#) ). Initial dosing of warfarin with 2.5 to 7.5 mg/day (based on patient weight and nutritional status) seems prudent. Heparin and LMWH therapy must overlap oral warfarin therapy for a minimum of 4 days or, ideally, until a stable, target range (2.0 to 3.0) INR has been achieved ( [415](#), [416](#) ). Patients with massive DVT or PE may benefit from 7 to 10 days of initial heparin or LMWH therapy. Because of its teratogenic effects, warfarin therapy is contraindicated in pregnancy, so long-term heparin or LMWH is prudent for pregnant patients. LMWH may be preferred in pregnancy, because osteopenia occurs less with LMWH than UFH ( [505](#) ).

Warfarin therapy *alone* is contraindicated in the setting of acute thrombosis because of the inherent delay in achieving therapeutic anticoagulation and the theoretical transient exacerbation of hypercoagulability caused by a rapid reduction in protein C levels ( [416](#) ). This warfarin-induced paradoxical hypercoagulability may explain warfarin-induced skin necrosis and warfarin-induced limb gangrene in patients with HIT. The INR, not the PT or PT ratio, should be used to monitor warfarin therapy. Monitoring at least every 4 weeks is recommended; patients beginning on warfarin therapy need more frequent monitoring. More frequent monitoring does help maintain the INR within the target range for a greater amount of time ( [509](#) ).

The optimal duration of anticoagulation should be determined for each individual patient. Guidelines for the duration of therapy are suggested in [Table 61.13](#). Patients with DVT secondary to a time-limited risk factor such as recent surgery, immobilization, trauma, or pregnancy may be anticoagulated for a short duration of 6 weeks to 3 months, as long as the risk factor has resolved. Patients with a first idiopathic VTE should be anticoagulated for a minimum of 6 months. Patients with recurrent idiopathic VTE (two or more events) or ongoing risk factors, such as malignancy or antiphospholipid antibody syndrome, may require long-term (possibly indefinite) therapy. The predicted long-term bleeding risk must be offset by the long-term benefit before a protracted course of anticoagulation should be prescribed.

All patients anticoagulated with warfarin should be educated regarding maintaining a stable diet. Patients should be encouraged to consume a constant intake of dietary vitamin K and avoid large variations or fluctuations in their diet. Because of the number of pharmacologic interactions that exist between warfarin and other drugs ([Table 61.10](#)), patients should be instructed to inform their physician of the addition or withdrawal of any medication during warfarin therapy. In addition, patients should be encouraged to avoid over-the-counter multivitamin supplements or herbal preparations that contain vitamin K or vitamin K analogs and those known to have an impact on warfarin anticoagulation (e.g., ginkgo biloba). The risk of bleeding during therapy should be explained to all patients. It is strongly recommended that patients avoid high-risk activities including contact sports. Patients should be instructed to seek medical attention for severe bleeding or bleeding that is not controlled after 10 to 15 minutes of continuous compression. The appropriate use of protective gear, such as bicycle helmets, should be emphasized. Patients should be instructed to carry a wallet card that identifies their use of an anticoagulant. In addition, they should be encouraged to wear a medical identification bracelet or necklace. Patient instruction is best provided by anticoagulation clinics that specifically focus on anticoagulation monitoring and education. Point-of-care instruments that can reliably monitor a patient's INR values in the hospital or home setting are being increasingly used ([510](#)).

### **Catheter-Directed Thrombolysis of Deep Venous Thrombosis**

Catheter-directed thrombolytic therapy is usually reserved for patients with extensive DVT involving the IVC or iliac veins and for patients who have signs and symptoms of actual or impending phlegmasia cerulea dolens ([511](#), [512](#), [513](#), [514](#), [515](#) and [516](#)).

Catheter-directed thrombolysis is normally not used for PE because of a lack of demonstrated superiority to peripheral intravenous thrombolytic administration. An initial venogram is performed via a distal vessel, usually a popliteal or foot vein, to fully delineate the extent of the DVT. Access for the vascular access sheath is best accomplished via the popliteal vein, typically using ultrasound guidance to assure nontraumatic, single-puncture catheter placement. A multiside hole catheter is advanced and imbedded within the thrombus. Thrombolytic agent is infused through this catheter. Low-dose heparin (500 units/hour) should be infused through the sheath to prevent sheath thrombosis. Periodic surveillance with venography should be performed to assess resolution of the DVT. As lysis is achieved, the multiside hole catheter may require repositioning to maintain infusion within the thrombus ([511](#)).

Lytic therapy for DVT carries the same contraindications as for lysis of PE. Active bleeding is an absolute contraindication to the procedure; relative contraindications include those for any anticoagulant. In addition, a history of contrast allergy or renal insufficiency is a relative contraindication to the procedure. Complications are similar to the complications for PE lysis. The main complication associated with the use of lytic agents is bleeding. Access site bleeding is the most common complication. Bleeding in the



popliteal space may be particularly significant because the popliteal vein is poorly compressible. Additional complications such as intracranial bleeding are also seen with lytic infusion for DVT lysis. PE, potentially fatal, has been reported in patients undergoing DVT lytic therapy.

Only SK has an approved indication for use in lytic treatment of DVT. Urokinase, rt-PA, r-PA, and TNK-t-PA are not approved for DVT lysis. After the completion of thrombolytic therapy, patients should be anticoagulated with an appropriate parenteral agent (UFH, LMWH, or DTI) and converted to warfarin in the usual fashion. Patients who have a contraindication to lysis may be able to derive some benefit from suction (mechanical) thrombectomy performed at the time of venography/intervention. However, suction thrombectomy should not be attempted in patients with a contraindication to anticoagulation because any benefit from suction thrombectomy would likely be lost without maintenance of therapeutic anticoagulation.

Benefits of DVT thrombolysis include the ability to subsequently diagnose and treat any underlying venous stenosis, venous compression (as in May-Thurner syndrome), or venous webs that may be discovered after thrombolysis ( [512](#), [513](#) ). The use of angioplasty, stent placement, or both may improve outcomes in these patients ( [514](#) ). Use of thrombolysis results in improved venous patency and symptom resolution and a decrease in postthrombotic symptoms and may improve health-related quality of life ( [516](#) ).

### Thrombolysis for Pulmonary Embolism

Most patients with symptomatic PE should be treated with anticoagulation following the same guidelines for treatment that are applied to DVT. Some patients with PE may derive benefit from thrombolytic therapy to actively degrade the thrombus obstructing the pulmonary vasculature. Clear indications for PE thrombolysis are debated ( [517](#), [518](#) ). Thrombolysis has been demonstrated to improve survival in patients with massive PE plus shock and is probably indicated in these patients. When compared to anticoagulation alone, thrombolytic therapy results in more rapid thrombus lysis, an early improvement in pulmonary blood flow, and improvement of right ventricular function ( [519](#) ). However, these improvements in cardiopulmonary function alone have not resulted in decreased mortality in stable patients without significant hemodynamic compromise. It remains unclear whether patients with PE and evidence of right ventricular dysfunction or elevated cardiac troponin levels (or both) benefit from thrombolysis.

Currently approved drug regimens for PE lysis include the following: SK, 250,000 IU IV bolus over 30 minutes followed by 100,000 IU IV infusion/hour for 24 hours; rt-PA, 100 mg IV infusion over 2 hours; and urokinase, 4400 IU/kg bolus over 10 minutes followed by IV infusion of 4400 IU/kg/hour for 12 hours. Reteplase is not FDA approved for PE management, but when administered as two 10-U boluses separated by 30 minutes, it has been shown to improve pulmonary vascular resistance and blood flow more rapidly than standard-dose rt-PA ( [520](#) ). Lytic therapy is contraindicated in patients with an increased risk of bleeding. Active bleeding is an absolute contraindication to therapy. In addition, recent organ biopsy or arterial puncture in a noncompressible site and recent cardiopulmonary resuscitation, uncontrolled hypertension, and pregnancy or recent delivery are relative contraindications. For all patients, the potential benefits of lysis must be weighed heavily against the potential risks of bleeding ( [521](#) ).

Major hemorrhage rates have varied between 4 to 22% when used in studies at the currently recommended doses. Extrapolation from acute MI thrombolysis trials supports intracranial hemorrhage rates between 1 to 3%, approximately one-half of which are fatal. There is no benefit to lytic infusion via a centrally placed catheter when compared to

peripheral infusion in patients with PE. Many believe heparin should not be administered concomitantly with the lytic agent. An aPTT should be determined at the completion of the lysis; if the aPTT is less than or equal to 2.5 times the control, then heparin infusion should be started/resumed. If the aPTT is greater than 2.5 times the control, the aPTT should be repeated every 4 hours; once it decreases into an acceptable range, the heparin infusion may be initiated. If a complication of therapy occurs, the lytic agent and any other anticoagulants should be held. Fresh frozen plasma and cryoprecipitate may be used to replete fibrinogen and clotting factors. Consideration should be given to the use of antifibrinolytic agents to reverse excessive fibrinolysis ( [517](#), [518](#) ).

## VENOUS THROMBOEMBOLIC DISEASE PREVENTION

If physicians focused more on VTE prophylaxis, much less time would be needed to emphasize methods for VTE diagnosis and treatment. Fatal PE is considered to be the most common preventable cause of hospital death ( [522](#) ). Because the clinical diagnosis of venous thromboembolism is unreliable and serial surveillance of all high-risk patients is expensive, widespread use of anticoagulants (or other prophylactic measures) has been recommended ( [336](#) ).

It has been shown in a study of general surgery residents that the key to proper prophylaxis is the recognition of risk factors for thrombosis ( [523](#) ). Established clinical risk factors include advanced age; prolonged immobility, stroke, or paralysis; prior VTE; active malignancy and its treatment; major surgery, especially that involving the abdomen, pelvis, and lower extremities; trauma, especially involving fracture of the pelvis, hip, or leg; obesity; varicose veins; depressed left ventricular ejection fraction; central venous access devices; inflammatory bowel disease; nephrotic syndrome; pregnancy; estrogen use; and inherited and acquired hypercoagulable states ( [336](#) ). Most patients possess multiple risk factors at any given point in time. In patients undergoing general surgery, the number of risk factors, risk of DVT, risk of clinical PE, risk of fatal PE, and the required intensity of prophylactic therapy necessary to mitigate the risk all seem to increase in parallel.

*Low-risk general surgery* is defined as minor surgery in patients younger than 40 years of age with no additional risk factors ( [336](#) ). *Moderate risk* includes minor surgery in patients with additional risk factors, nonmajor surgery in patients 40 to 60 years of age without additional risk factors, and major surgery in patients younger than 40 years of age without additional risk factors ( [336](#) ). *High risk* includes nonmajor surgery in patients older than 60 years of age or with additional risk factors and major surgery in patients older than 40 years of age or with additional risk factors ( [336](#) ). *Highest risk* includes major surgery in patients older than 40 years of age who have or have had cancer, prior VTE, or a molecular hypercoagulable state; hip or knee arthroplasty; hip fracture surgery; major trauma; or acute spinal cord injury ( [336](#) ). Appropriate doses of pharmacologic agents used for thromboprophylaxis are listed in Geerts et al. ( [336](#) ).

Not all patients at risk develop a thrombosis, and not all thromboses result in symptoms, morbidity, or death. The benefit of pharmacologic thromboprophylaxis must always be weighed against the bleeding risk. Patients at high risk for bleeding should still receive prophylaxis in the form of an intermittent pneumatic compression device, thromboembolism deterrence stockings, or both. [Table 61.14](#) lists relative contraindications to anticoagulant therapy.

Although the venous thrombosis risk associated with surgical intervention has been appreciated and addressed for some time, appreciation of the risk in the medically ill has lagged behind. A recent study has significantly increased physician awareness of this

problem. The MEDENOX (Prophylaxis of Venous Thromboembolism in *Medical Patients with Enoxan*) those immobilized with severe cardiopulmonary disease) have a 14.9% risk of developing DVT within 14 days of admission in the absence of active prophylaxis (524). The DVT rate is reduced to 5.5% by the addition of a once-daily dose of LMWH (enoxaparin, 40 mg SC) without a significant increase in bleeding risk. Other studies have demonstrated equivalency between LMWH and heparin 5000 U administered every 8 hours in medical patients with acute cardiac or pulmonary disease (336).

Extension of thromboprophylaxis beyond hospitalization has resulted in a reduction primarily in calf vein thrombosis. Whether such therapy has a significant impact on patient morbidity and mortality to a degree that justifies the cost is being questioned. Aspirin is not recommended for venous thromboprophylaxis in any group of at-risk patients because more efficacious methods exist.

Table 61.15 summarizes acceptable approaches to VTE prevention.

**TABLE 61.15. Evidence-Based Venous Thromboembolism Prophylaxis Strategies**

| Setting             | Risk Level   | Early Ambulation | Low-Dose Subcutaneous Unfractionated Heparin | Low-Molecular-Weight Heparin | PENTA Adjusted-Dose Unfractionated Heparin |
|---------------------|--|------------------|--|------------------------------|--|
| General surgery     | Low risk   | X                |  |                              |  |
|                     | Moderate risk  |                  | X  | X                            |  |
|                     | High risk  |                  | X  | X                            |  |
|                     | Highest risk   |                  |  |                              |  |
| Urologic surgery    | Low risk (e.g., transurethral resection of the prostate) | X                |  |                              |  |
|                     | Major, open procedures                                   |                  | X  | X                            |  |
|                     | Highest risk   |                  |  |                              |  |
| Neurologic surgery  |  |                  | X  | X                            |  |
| Gynecologic surgery | Brief procedure for benign disease                       | X                |  |                              |  |
|                     | Major procedure for benign disease                       |                  | X  | X                            |  |
|                     | Extensive procedure for malignancy                       |                  | X  | X                            |  |

|                    |                           |   |   |   |   |
|--------------------|---------------------------|---|---|---|---|
| Orthopedic surgery | Elective hip replacement  |   | X | X | X |
|                    | Elective knee replacement |   | X | X |   |
|                    | Hip fracture surgery      |   | X | X |   |
| Trauma             |                           |   | X |   |   |
| Spinal cord injury | Acute                     |   | X |   |   |
|                    | Rehab phase               |   | X |   |   |
| Medically ill      |                           | X | X |   |   |

COMBO, mechanical prophylaxis combined with low-dose subcutaneous unfractionated heparin or low-dose low-dose fondaparinux.

<sup>a</sup> Data on fondaparinux in nonorthopedic settings are lacking.

## HEPARIN-INDUCED THROMBOCYTOPENIA

HIT, also known as the *white clot syndrome*, is a relatively common, often underrecognized, potentially devastating immune-mediated complication of pharmacologic heparin administration ( [525](#), [526](#) and [527](#) ). HIT constitutes the major life and limb-threatening complication of HIT ( [525](#) ). The facts that thrombocytopenia is most commonly associated with a bleeding tendency and that heparin is most commonly used to prevent and treat pathologic thrombosis lend to the mystery and underappreciation of HIT(T). The prompt consideration of HIT(T) in patients who develop thrombocytopenia during heparin therapy, with or without new or propagating venous and arterial thromboses, is the cornerstone to appropriate HIT(T) diagnosis. Immediate discontinuation of all forms and routes of heparin exposure constitutes the essential component of HIT(T) treatment. The pathologic basis of HIT(T) is production of antibodies to the heparin-platelet factor-4 complex; subsequently, immune complexes consisting of IgG-heparin-platelet factor-4 bind to platelet Fc receptors, resulting in intense platelet activation, formation of platelet microparticles, thrombocytopenia, and a profound hypercoagulable state ( [528](#) ).

HIT usually develops between 5 and 14 days after the commencement of heparin therapy and produces a variable but often profound degree of thrombocytopenia ( [529](#), [530](#) ). A platelet count fall that begins before day 5 of heparin is not likely to represent HIT except in patients with a recent (within 3 months) heparin exposure ( [525](#) ). These patients may experience an abrupt onset of thrombocytopenia on reexposure to heparin as a result of acute platelet activation due to preformed, circulating HIT-associated antibodies.

Although the exact incidence of HIT has not been well established, HIT has been noted to develop in up to 3 to 5% of patients exposed to unfractionated porcine intestine-derived heparin ( [389](#) ). Thirty-six to fifty percent of patients with HIT have been noted to develop life- or limb-threatening thromboses ( [389](#) ). The thrombotic tendency associated with HIT can last for at least 30 days, and HIT can develop well after the discontinuation of heparin and platelet count recovery. The fact that the thrombocytopenia seen in HIT usually resolves within 3 to 7 days of heparin withdrawal is a useful aid to making the diagnosis of HIT.

Patients exposed to bovine lung-derived UFH have been reported to have a greater likelihood of developing HIT than those exposed to porcine intestine-derived UFH ( 531 ). HIT(T) appears to occur infrequently, though, as a result of primary LMWH therapy in heparin-naïve individuals ( 525 ). Warkentin et al. evaluated the incidence of HIT(T) in 665 patients randomized to receive subcutaneous UFH or LMWH for venous thromboprophylaxis after elective hip surgery. HIT was diagnosed in 2.7% (9/332) of patients given UFH versus 0% (0/333) of those given LMWH. HITT developed in 88.9% (8/9) of the patients who developed HIT compared with a thrombosis rate of 17.8% (117/656) in patients without HIT. This study substantiated previous reports of discordance between HIT-IgG formation and the development of clinical HIT. HIT-IgG was detected in 7.8% and 2.2% of patients treated with UFH and LMWH, respectively. These rates of “seroconversion” are considerably higher than the documented HIT rates of 2.7% and 0%, respectively. Such seroconversion has been documented in up to 17% of heparin-treated patients and 8% of LMWH-treated patients ( 532 ). The difference in seroconversion rate may stem from the fact that LMWHs appear to less readily complex with platelet factor-4 than UFH and, thus, generate less of an immune response.

Thrombosis is the major complication of HIT. Venous thrombosis is more common than arterial thrombosis in HIT patients, especially in those who receive heparin for postoperative DVT prevention ( 530 , 533 ). Extremity deep vein thrombosis is the most frequently encountered venous thrombotic complication in HIT patients, followed in frequency by PE and cerebral sinus thrombosis ( 526 ). Most HIT-associated arterial thromboses involve the extremities, but stroke, MI, and renal artery thrombosis related to heparin infusions have been described ( 534 ). HITT after coronary artery bypass grafting may present as bypass-graft occlusion, left atrial thrombus formation, valvular thrombosis, or PE ( 534 ). Acute graft occlusion secondary to HIT has been described in vascular surgery patients even after platelet count normalization. It is reasonable to assume that patients with preexisting vascular lesions, intravascular catheters, sepsis, and postoperative venous stasis are particularly susceptible to the thrombotic complications of HIT. Thus, cardiac and orthopedic patients have the highest incidence of HIT.

Other clinical presentations of HIT include heparin-induced skin lesions, heparin “resistance,” and adrenal vein thrombosis leading to hemorrhagic infarction ( 535 , 536 ). Heparin-induced skin lesions have been observed in approximately 10 to 20% of patients who generate HIT-IgG in response to subcutaneous UFH injections. The skin lesions develop at heparin injection sites and can range from painful, red plaques to overt skin necrosis reminiscent of warfarin-induced skin necrosis. Thrombocytopenia may not develop in the majority of patients with heparin-induced skin lesions, but those who develop skin lesions and thrombocytopenia appear to be at extremely high risk for arterial thrombosis. The thrombocytopenia that develops in HIT is not normally associated with hemorrhagic events, and platelet transfusion may exacerbate the HIT-induced prothrombotic tendency ( 527 ).

HIT and HITT are primarily clinical diagnoses. HIT(T) should be strongly suspected in any patient who develops thrombocytopenia while receiving heparin in any dose or route of administration. Whereas HIT(T) is usually associated with a platelet count below the lower limits of normal (150,000/ $\mu$ l in most laboratories), the degree of thrombocytopenia is quite variable and may be profound ( 525 ). The diagnosis should be strongly considered in any patient in whom the platelet count falls below 50% of the baseline value (even if still within the normal range) after the fifth day of heparin treatment. A 30% fall in baseline platelet count combined with any form of thrombosis in a patient receiving heparin should be considered HITT until proven otherwise. Thrombotic events occurring or progressing

during therapeutic intensity heparin therapy, even if the platelet count is normal, may constitute a HIT variant ( [537](#), [538](#) and [539](#) ). The identification of any platelet-rich “white clot” during surgical thrombectomy or extracorporeal blood circulation should alert health care personnel to the possible existence of HIT.

The currently available *in vitro* diagnostic assays for HIT are either functional assays or immunoassays ( [540](#) ). Functional assays detect normal platelet aggregation or platelet activation after exposure to suspected HIT serum and heparin. Functional assays include the platelet aggregation test, the heparin-induced platelet aggregation test, heparin-induced platelet release of adenosine triphosphate detected by lumi-aggregometry, the <sup>14</sup>C-serotonin release assay ( <sup>14</sup>C-SRA), heparin-induced platelet microparticle formation detected by flow cytometry, and enzyme immunoassay detection of platelet serotonin release. Immunoassays detect the presence of heparin-platelet factor-4 antibodies using ELISA methodology ( [541](#) ).

Traditionally, the <sup>14</sup>C-SRA has been considered the “gold standard” for HIT diagnostic confirmation. However, most studies evaluating the diagnostic use of the available functional assays and immunoassays, including studies of <sup>14</sup>C-SRA, used a clinical diagnosis of HIT as the true “gold standard.” Additionally, the SRA is tedious to perform, has lengthy turn-around times, and is offered by few laboratories. Therefore, HIT diagnostic assays should be reserved for HIT confirmation and possibly for anticoagulant cross-reactivity testing. In some instances, a HIT test may be used to confirm the absence of circulating functional HIT-IgG before repeat heparin exposure in patients with a questionable past diagnosis of HIT, or if alternate antithrombotic agent use is deemed undesirable. It is our belief that a stereotypical clinical presentation suggestive of HIT should be treated as HIT even in the presence of normal heparin-induced platelet aggregation, <sup>14</sup>C-SRA, or ELISA testing. Because of the inherent delay in receiving the results of HIT diagnostic assays and limited availability of such testing at many facilities, HIT management with a DTI (see section [Direct Thrombin Inhibitors](#) above) should begin at the earliest clinical recognition of the syndrome.

Warfarin anticoagulation may be desired for long-term therapy but should never be used as the sole alternative anticoagulant in patients with HIT(T). Warfarin has the disadvantage of requiring at least 5 days to achieve full therapeutic effect and has been associated with venous limb gangrene when used alone. Warfarin treatment is the major factor contributing to limb amputation caused by progression of otherwise unremarkable deep vein thromboses to phlegmasia cerulea dolens in patients with HIT ( [542](#), [543](#) ). The combination of HIT-associated hypercoagulability and warfarin-induced protein C deficiency most likely produces a profound procoagulant state that causes venous limb gangrene. The existence of this syndrome justifies the absolute need for systemic anticoagulation with lepirudin, argatroban, or danaparoid during the initiation of warfarin anticoagulation in patients with HIT(T).

Considering the complexity of HIT diagnosis and treatment, HIT prevention must be emphasized. Patients receiving heparin should have platelet count monitoring at baseline and at least every third day between day 5 and day 14 of heparin exposure. Early oral warfarin anticoagulation initiation in patients receiving heparin therapy for an acute thrombosis or atrial fibrillation should allow the duration of heparin exposure to be kept to a minimum and, hopefully, under 5 days. Appropriate medical record documentation and patient education should help avert heparin reexposure in patients with a history of HIT(T). Reexposure to heparin in patients with past HIT(T) should be delayed at least 3 months, kept to a minimum duration to provide succinct anamnesis, and avoided whenever possible. LMWH may be preferable to UFH for both the treatment and prevention of thromboembolic disease because of the greatly reduced likelihood of instigating HIT(T) (



## REFERENCES

1. Jemal A, Thomas A, Murray T, Thun M. Cancer statistics, 2002. *CA Cancer J Clin* 2002;52:23–47.
2. Goldhaber S, Visani L, De Rosa M. Acute pulmonary embolism: clinical outcomes in the International Cooperative Pulmonary Embolism Registry (ICOPER). *Lancet* 2002;52:23–47.
3. Deitcher SR, Carman TL, Sheikh MA, Gomes M. Hypercoagulable syndromes: evaluation and management strategies for acute limb ischemia. *Semin Vasc Surg* 2001;14:74–85.
4. Patel VB, Topol EJ. The pathogenesis and spectrum of acute coronary syndromes: from plaque formation to thrombosis. *Cleve Clin J Med* 1999;66:561–571.
5. Broderick JP, Hacke W. Treatment of acute ischemic stroke: Part I: recanalization strategies. *Circulation* 2002;106:1563–1569.
6. Broderick JP, Hacke W. Treatment of acute ischemic stroke: Part II: neuroprotection and medical management. *Circulation* 2002;106:1736–1740.
7. Virchow R. *Gesammelte Abhandlungen zur Wissenschaftlichen Medicin*. [Thrombosis and Emboli; translated by AC Matzdorff and WR Bell. 1998.]. Canton, MA: Science History Publications/USA, 1856:220–380 (original text).
8. Badimon L, Badimon JJ, Galvez A, et al. Influence of arterial wall damage and wall shear rate on platelet deposition: ex-vivo study in a swine model. *Arteriosclerosis* 1986;6:312–320.
9. Deitcher SR, Erban JK, Limentani SA. Acquired free protein S deficiency associated with multiple myeloma. *Am J Hematol* 1996;51:319–323.
10. Thomas DP. Overview of venous thrombogenesis. *Semin Thromb Hemost* 1988;14:1–8.
11. Strandness DE, Ward K, Krugmire R. The present status of acute deep-venous thrombosis. *Surg Gynecol Obstet* 1977;145:433–445.
12. Nicolaides AN, Kakkar VV, Renney JTG. The soleal sinuses: origin of deep-vein thrombosis. *Br J Surg* 1970;57:860.
13. Nicolaides AN, Kakkar VV, Renney JTG. Soleal sinuses and stasis. *Br J Surg* 1971;58:307.
14. Goldsmith HL. The flow of model particles and blood cells and its relation to thrombogenesis. *Prog Hemost Thromb* 1972;1:97–139.
15. Ross R. The pathogenesis of atherosclerosis: a perspective for the 1990s. *Nature* 1993;362:801–809.
16. Rees MM, Rodgers GM. Homocysteinemia: association of a metabolic disorder with vascular disease and thrombosis. *Thromb Res* 1993;71:337–359.
17. Begent N, Born GVR. Growth rate in vivo of platelet thrombi, produced by iontophoresis of ADP, as a function of mean blood flow velocity. *Nature* 1970;227:926–930.
18. Falati S, Gross P, Merrill-Skoloff G, et al. Real-time in vivo imaging of platelets, tissue factor and fibrin during arterial thrombus formation in the mouse. *Nat Med* 2002;8:1175–1181.
19. Goodrich SM, Wood JE. Peripheral venous distensibility and velocity of venous blood flow during pregnancy or during oral contraceptive therapy. *Am J Obstet Gynecol* 1964;90:740–744.
20. Hirsh J. Hypercoagulability. *Semin Hematol* 1977;14:409–425.
21. Deitcher SR, Caiola E, Jaffer A. Demystifying two common genetic predispositions to venous



thrombosis. *Cleve Clin J Med* 2000;67:825–836.

22. Deitcher SR, Gomes MPV. Hypercoagulable state testing and malignancy screening following venous thromboembolic events. *Vasc Med* 2003;8:33–46.
23. Martinelli I. Risk factors in venous thromboembolism. *Thromb Haemost* 2001;86:395–403.
24. Harker LA, Slichter SJ. Arterial and venous thromboembolism: kinetic characterization and evaluation of therapy. *Thromb Diath Haemorrh* 1974;31: 188–203.
25. Salky N, Dugdale M. Platelet abnormalities in ischemic heart disease. *Am J Cardiol* 1973;32:612–617.
26. Abrahamsen AF, Eika C, Godal HC, Lorentsen E. Effect of acetylsalicylic acid and dipyridamole on platelet survival and aggregation in patients with atherosclerosis obliterans. *Scand J Haematol* 1974;13:241–245.
27. Rickles FR, O'Leary DS. Role of coagulation system in pathophysiology of sickle cell disease. *Arch Intern Med* 1974;133:635–641.
28. Steele P, Weily HS, Davies H, Genton E. Platelet survival in patients with rheumatic heart disease. *N Engl J Med* 1974;290:537–539.
29. Steele P, Weily H, Davies H, et al. Platelet survival time following aortic valve replacement. *Circulation* 1975;51:358–362.
30. Welch GN, Loscalzo J. Homocysteine and atherothrombosis. *N Engl J Med* 1998;338:1042–1050.
31. Miller GJ, Bauer KA, Cooper JA, Rosenberg RD. Activation of the coagulant pathway in cigarette smokers. *Thromb Haemost* 1998;79:549–553.
32. Harker LA, Hazzard W. Platelet kinetic studies in patients with hyperlipoproteinemia: effects of clofibrate therapy. *Circulation* 1979;60:492–496.
33. Nichols AB, Owen J, Kaplan KL, et al. Fibrinopeptide A, platelet factor 4, and  $\beta$ -thromboglobulin levels in coronary heart disease. *Blood* 1982;60:650–654.
34. Sobel M, Salzman EW, Davies GC, et al. Circulating platelet products in unstable angina pectoris. *Circulation* 1981;63:300–306.
35. Moncada S. Prostacyclin and arterial wall biology. *Arteriosclerosis* 1982;2:193–207.
36. Radomski MW, Palmer RMJ, Moncada S. Endogenous nitric oxide inhibits human platelet adhesion to vascular endothelium. *Lancet* 1987;2:1057–1058.
37. Pearson JD, Gordon JL. Nucleotide metabolism by endothelium. *Annu Rev Physiol* 1985;47:617–627.
38. Marcus AJ, Broekman MJ, Drosopoulos JHF, et al. The endothelial cell ecto-ADPase responsible for inhibition of platelet function is CD39. *J Clin Invest* 1997;99:1351–1360.
39. Mammen EF. Sticky platelet syndrome. *Semin Thromb Hemost* 1999;25:361–365.
40. Reddick RL, Griggs TR, Lamb MA, Brinkhous KM. Platelet adhesion to damaged coronary arteries: comparison in normal and von Willebrand disease swine. *Proc Natl Acad Sci U S A* 1982;79:5076–5079.
41. Federici AB, Mannucci PM, Fogato E, et al. Autopsy findings in three patients with von Willebrand disease type II B and type III: presence of atherosclerotic lesions without occlusive arterial thrombi. *Thromb Haemost* 1993;70:758–761.
42. Thompson SG, Kienast J, Pyke SDM, et al. Hemostatic factors and the risk of myocardial infarction or sudden death in patients with angina pectoris. *N Engl J Med* 1995;332:635–641.

43. Williams MS, Bray PF. Genetics of arterial prothrombotic risk states. *Exp Biol Med* 2001;226:409–419.
44. Schafer AI. The hypercoagulable states. *Ann Intern Med* 1985;102:814–828.
45. Weinmann EE, Salzman EW. Deep-vein thrombosis. *N Engl J Med* 1994;331:1630–1641.
46. Rosendaal FR. Risk factors for venous thrombotic disease. *Thromb Haemost* 1999;82:610–619.
47. Kyrle PA, Minar E, Hirschl M, et al. High plasma levels of factor VIII and the risk of recurrent venous thromboembolism. *N Engl J Med* 2000;343:457–462.
48. Anderson FA, Wheeler HB, Goldberg RJ, et al. A population-based perspective of the hospital incidence and case-fatality rates of deep vein thrombosis and pulmonary embolism. The Worcester DVT Study. *Arch Intern Med* 1991;151:933–938.
49. Nordström M, Lindblad B, Bergqvist D, Kjellström T. A prospective study of the incidence of deep-vein thrombosis within a defined urban population. *J Intern Med* 1992;232:155–160.
50. Oger E, Baron N, Bressollette L, et al. Incidence of venous thromboembolism: a community-based study in Western France. *Thromb Haemost* 2000;83:657–660.
51. Crowther MA, Kelton JG. Congenital thrombophilic states associated with venous thrombosis: a qualitative overview and proposed classification system. *Ann Intern Med* 2003;138:128–134.
52. Kannel WB, Wolf PA, Castelli WP, D'Agostino RB. Fibrinogen and risk of cardiovascular disease: The Framingham Study. *JAMA* 1987;258:1183–1186.
53. Ernst E, Resch KL. Fibrinogen as a cardiovascular risk factor: a meta-analysis and review of the literature. *Ann Intern Med* 1993;118:956–963.
54. Meade TW, Mellows S, Brozovic M, et al. Haemostatic function and ischaemic heart disease: principal results of the Northwick Park Heart Study. *Lancet* 1986;2:533–537.
55. Meade TW, Rudduck V, Stirling Y, et al. Fibrinolytic activity, clotting factors, and long-term incidence of ischaemic heart disease in the Northwick Park Heart Study. *Lancet* 1993;342:1076–1079.
56. Cortellaro M, Cofrancesco E, Boschetti C, et al. Increased fibrin turnover and high PAI-1 activity as predictors of ischaemic events in atherosclerotic patients: a case-control study. *Arterioscler Thromb* 1993;13:1412–1417.
57. Juhan-Vague I, Pyke SD, Alessi MC, et al. Fibrinolytic factors and the risk of myocardial infarction or sudden death in patients with angina pectoris. ECAT Study Group. *Circulation* 1996;94:2057–2063.
58. Valentine RJ, Kaplan HS, Green R, et al. Lipoprotein (a), homocysteine, and hypercoagulable states in young men with premature peripheral atherosclerosis: a prospective, controlled analysis. *J Vasc Surg* 1996;23:53–63.
59. Juhan-Vague I, Valadier J, Alessi MC, et al. Deficient t-PA release and elevated PA inhibitor levels in patients with spontaneous or recurrent deep venous thrombosis. *Thromb Haemost* 1987;57:67–72.
60. Nemerson Y. Tissue factor and hemostasis. *Blood* 1988;71:1–8.
61. Vermynen J, Blockmans D, Spitz B, Deckmyn H. Thrombosis and immune disorders. *Clin Haematol* 1986;15:393–412.
62. Visentin GP, Ford SE, Scott JP, Aster RH. Antibodies from patients with heparin-induced thrombocytopenia/thrombosis are specific for platelet factor 4 complexed with heparin or bound to endothelial cells. *J Clin Invest* 1994;93:81–88.
63. Deitcher SR, Carman TL. Heparin-induced thrombocytopenia: natural history, diagnosis, and management. *Vasc Med* 2001;6:113–119.

64. Bevilacqua MP, Pober JS, Majeau GR, et al. Interleukin I (IL-1) induces biosynthesis and cell surface expression of procoagulant activity in human vascular endothelial cells. *J Exp Med* 1984;160:618-623.
65. Fryer RH, Wilson BD, Gubler DB, et al. Homocysteine, a risk factor for premature vascular disease and thrombosis, induces tissue factor activity in endothelial cells. *Arterioscler Thromb* 1993;13:1327-1333.
66. Nawroth PP, Stern DM. Modulation of endothelial cell hemostatic properties by tumor necrosis factor. *J Exp Med* 1986;163:740-745.
67. Colucci M, Balconi G, Lorenzet R, et al. Cultured human endothelial cells generate tissue factor in response to endotoxin. *J Clin Invest* 1983;71:1893-1896.
68. Courtney MA, Haidaris PJ, Marder VJ, Sporn LA. Tissue factor mRNA expression in the endothelium of an intact umbilical vein. *Blood* 1996;87:174-179.
69. Drake TA, Cheng J, Chang A, Taylor FB. Expression of tissue factor, thrombomodulin, and E-selectin in baboons with lethal *Escherichia coli* sepsis. *Am J Pathol* 1993;142:1458-1470.
70. Speiser W, Kapiotis S, Kopp CW, et al. Effect of intradermal tumor necrosis factor- $\alpha$ -induced inflammation on coagulation factors in dermal vessel endothelium: an in vitro study of human skin biopsies. *Thromb Haemost* 2001;85:362-367.
71. Edwards RL, Rickles FR, Bobrove AM. Mononuclear cell tissue factor: cell of origin and requirement for activation. *Blood* 1979;54:359-370.
72. Miletich JP, Jackson CM, Majerus PW. Properties of the factor Xa binding site on human platelets. *J Biol Chem* 1978;253:6908-6916.
73. Callender N, Rapaport SI. Trousseau's syndrome. *West J Med* 1993;158:364-371.
74. Gordon SG, Cross BA. A factor X-activating cysteine protease from malignant tissue. *J Clin Invest* 1981;67:1665-1671.
75. Deitcher SR. Cancer-related deep venous thrombosis: clinical importance, treatment challenges, and management strategies. *Semin Thromb Hemost* 2003;29:247-258.
76. Fletcher AP, Alkjaersig NK, O'Brien JR, Tulevski V. Fibrinogen catabolism in the surgically treated patient and in those with postoperative venous thrombosis. *J Lab Clin Med* 1977;89:1349-1364.
77. Jones RL, Peterson CM. Reduced fibrinogen survival in diabetes mellitus. *J Clin Invest* 1979;63:485-493.
78. Kitchens CS. Concept of hypercoagulability: a review of its development, clinical application, and recent progress. *Semin Thromb Hemost* 1985;11: 293-315.
79. Taylor FB, Kinasewitz GT. The diagnosis and management of disseminated intravascular coagulation. *Curr Heme Reports* 2002;1:34-40.
80. Weiner CP, Kwaan H, Hauck WW, et al. Fibrin generation in normal pregnancy. *Obstet Gynecol* 1984;64:46-48.
81. Pabinger I, Grafenhofer H, Kyrle A, et al. Temporary increase in the risk for recurrence during pregnancy in women with a history of venous thromboembolism. *Blood* 2002;100:1060-1062.
82. Grodstein F, Stampfer MJ, Goldhaber SZ, et al. Prospective study of exogenous hormones and risk of pulmonary embolism in women. *Lancet* 1996;348:983-987.
83. Quehenberger P, Loner U, Kapiotis S, et al. Increased levels of activated factor VII and decreased plasma protein S activity and circulating thrombomodulin during use of oral contraceptives. *Thromb Haemost* 1996;76:729-734.
84. Vandenbroucke JP, Koster T, Briet E, et al. Increased risk of venous thrombosis in oral-contraceptive

users who are carriers of Factor V Leiden mutation. *Lancet* 1994;344:1453–1457.

85. Rosing J, Tans G, Nicolaes AF, et al. Oral contraceptives and venous thrombosis: different sensitivities to activated protein C in women using second- and third-generation oral contraceptives. *Br J Haematol* 1997;97:233–238.
86. Miller J, Chan BKS, Nelson HD. Postmenopausal estrogen replacement and risk for venous thromboembolism: a systematic review and meta-analysis for the U.S. Preventive Services Task Force. *Ann Intern Med* 2002;136:680–690.
87. Bertina RM. Genetic approach to thrombophilia. *Thromb Haemost* 2001;86:92–103.
88. Robetorye RS, Rodgers GM. Update on selected venous thrombotic disorders. *Am J Hematol* 2001;68:256–268.
89. Egeberg O. Inherited antithrombin deficiency causing thrombophilia. *Thromb Diath Haemorrh* 1965;13:516–530.
90. Cosgriff TM, Bishop DT, Hershgold EJ, et al. Familial antithrombin III deficiency: its natural history, genetics, diagnosis and treatment. *Medicine* 1983; 62:209–220.
91. Marciniak E, Farley CH, DeSimone PA. Familial thrombosis due to antithrombin III deficiency. *Blood* 1974;43:219–231.
92. Tait RC, Walker ID, Perry DJ, et al. Prevalence of antithrombin deficiency in the healthy population. *Br J Haematol* 1994;87:106–112.
93. Bauer KA, Rosenberg RD. The pathophysiology of the prethrombotic state in humans: insights gained from studies using markers of hemostatic system activation. *Blood* 1987;70:343–350.
94. Seligsohn U, Lubetsky A. Genetic susceptibility to venous thrombosis. *N Engl J Med* 2001;344:1222–1231.
95. Gruenberg JC, Smallridge RC, Rosenberg RD. Inherited antithrombin-III deficiency causing mesenteric venous infarction: a new clinical entity. *Ann Surg* 1975;181:791–794.
96. Hirsh J. Congenital antithrombin III deficiency. Incidence and clinical features. *Am J Med* 1989;87[Suppl 3B]:34S–38S.
97. Martinelli I, Mannucci PM, De Stefano V, et al. Different risks of thrombosis in four coagulation defects associated with inherited thrombophilia: a study of 150 families. *Blood* 1998;92:2353–2358.
98. Van den Belt AGM, Prins MH, Huisman MV, Hirsh J. Familial thrombophilia: a review analysis. *Clin Appl Thromb Hemost* 1996;2:227–236.
99. Pabinger I, Schneider B, and the GTH Study Group on Natural Inhibitors. Thrombotic risk of women with hereditary antithrombin III-, protein C- and protein S-deficiency taking oral contraceptive medication. *Thromb Haemost* 1994;71:548–552.
100. Togli MR, Weg JG. Venous thromboembolism during pregnancy. *N Engl J Med* 1996;335:108–114.
101. Friederich PW, Sanson BJ, Simioni P, et al. Frequency of pregnancy-related venous thromboembolism in anticoagulant factor-deficient women: implications for prophylaxis. *Ann Intern Med* 1996;125:955–960.
102. Boyer C, Wolf M, Vedrenne J, et al. Homozygous variant of antithrombin III: AT III Fontainebleau. *Thromb Haemost* 1986;56:18–22.
103. Harper PL, Luddington RJ, Daly M, et al. The incidence of dysfunctional antithrombin variants: four cases in 210 patients with thromboembolic disease. *Br J Haematol* 1991;77:360–364.
104. Holmes EW, Fareed J, Bermes EW. Automation of plasma antithrombin III assays. *Clin Chem*

1981;27:816–818.

105. Tollefsen DM. Laboratory diagnosis of antithrombin and heparin cofactor II deficiency. *Semin Thromb Haemost* 1990;16:162–168.

106. Buller HR, ten Cate JW. Acquired antithrombin III deficiency: laboratory diagnosis, incidence, clinical implications, and treatment with antithrombin III concentrate. *Am J Med* 1989;87[Suppl 3B]:44S–48S.

107. Marciniak E, Gockerman JP. Heparin-induced decrease in circulating antithrombin III. *Lancet* 1997;2:581–584.

108. Brandt P. Observations during the treatment of antithrombin-III deficient women with heparin and antithrombin concentrate during pregnancy, parturition, and abortion. *Thromb Res* 1981;22:15–24.

109. Damus PS, Wallace GA. Immunologic measurement of antithrombin III-heparin cofactor and alpha 2-macroglobulin in disseminated intravascular coagulation and hepatic failure coagulopathy. *Thromb Res* 1975;6:22–38.

110. Kauffmann RH, Veltkamp JJ, van Tilburg NH, van Es LA. Acquired antithrombin III deficiency and thrombosis in the nephrotic syndrome. *Am J Med* 1978;65:607–613.

111. Friedman KD, Borok Z, Owen J. Heparin cofactor activity and antithrombin III antigen levels in preeclampsia. *Thromb Res* 1986;43:409–416.

112. Ball AP, McKee PA. Fibrin formation and dissolution in women receiving oral contraceptive drugs. *J Lab Clin Med* 1977;89:751–762.

113. Lechner K, Kyrle PA. Antithrombin III concentrates—are they clinically useful? *Thromb Haemost* 1995;73:340–348.

114. Tollefsen DM, Pestka CA, Monafu WJ. Activation of heparin cofactor II by dermatan sulfate. *J Biol Chem* 1983;258:6713–6716.

115. Tran TH, Marbet GA, Duckert F. Association of hereditary heparin cofactor II deficiency with thrombosis. *Lancet* 1985;2:413–414.

116. Sie P, Dupouy D, Pichon J, Boneu B. Constitutional heparin co-factor II deficiency associated with recurrent thrombosis. *Lancet* 1985;2:414–416.

117. Bertina RM, van der Linden IK, Engesser L, et al. Hereditary heparin cofactor II deficiency and the risk of development of thrombosis. *Thromb Haemost* 1987;57:196–200.

118. Esmon CT. The roles of protein C and thrombomodulin in the regulation of blood coagulation. *J Biol Chem* 1989;264:4743–4746.

119. Esmon CT. The regulation of natural anticoagulant pathways. *Science* 1987;235:1348–1352.

120. Griffin JH, Evatt B, Zimmerman TS, et al. Deficiency of protein C in congenital thrombotic disease. *J Clin Invest* 1981;68:1370–1373.

121. Miletich J, Dherman L, Broze G. Absence of thrombosis in subjects with heterozygous protein C deficiency. *N Engl J Med* 1987;317:991–996.

122. Koeleman BPC, Reitsma PH, Allart CF, Bertina RM. Activated protein C resistance as an additional risk factor for thrombosis in protein C-deficient families. *Blood* 1994;84:1031–1035.

123. Bauer KA, Broekmans AW, Bertina RM, et al. Hemostatic enzyme generation in the blood of patients with hereditary protein C deficiency. *Blood* 1988;71:1418–1426.

124. Aiach M, Gandrille S, Eimmerich J. A review of mutations causing deficiencies of antithrombin, protein C and protein S. *Thromb Haemost* 1995;74:81–89.

125. Reitsma PH, Bernardi F, Doig RG, et al. Protein C deficiency: a database of mutations, 1995 update.

Thromb Haemost 1995;73:876–889.

126. Reitsma PH. Protein C deficiency: from gene defects to disease. *Thromb Haemost* 1997;78:344–350.

127. Koster T, Rosendaal FR, Briet E, et al. Protein C deficiency in a controlled series of unselected outpatients: an infrequent but clear risk factor for venous thrombosis (Leiden Thrombophilia Study). *Blood* 1995;85:2756–2761.

128. Tait RC, Walker ID, Reitsma PH, et al. Prevalence of protein C deficiency in the healthy population. *Thromb Haemost* 1995;73:87–93.

129. Bovill EG, Bauer KA, Dickerman JD, et al. The clinical spectrum of heterozygous protein C deficiency in a large New England kindred. *Blood* 1989;73:712–717.

130. Camerlingo M, Finazzi G, Casto L, et al. Inherited protein C deficiency and non hemorrhagic arterial stroke in young adults. *Neurology* 1991;41:1371–1373.

131. Preston FE, Rosendaal FR, Walker ID, et al. Increased fetal loss in women with heritable thrombophilia. *Lancet* 1996;348:913–916.

132. Marlar RA, Montgomery RR, Broekmans AW. Report on the diagnosis and treatment of homozygous protein C deficiency. *Thromb Haemost* 1989;61:529–531.

133. McGehee WG, Klotz TA, Epstein DJ, Rapaport SI. Coumarin necrosis associated with hereditary protein C deficiency. *Ann Intern Med* 1984;100:59–60.

134. Alaart CF, Poort SR, Rosendaal FR, et al. Increased risk of venous thrombosis in carriers of hereditary protein C deficiency defect. *Lancet* 1993;341:134–138.

135. Van der Meer FJM, Koster T, Vandenbroucke JP, et al. The Leiden Thrombophilia Study (LETS). *Thromb Haemost* 1997;78:631–635.

136. Koster T, Rosendaal FR, Briet E, et al. Protein C deficiency in a controlled series of unselected outpatients: an infrequent but clear risk factor for venous thrombosis (Leiden Thrombophilia Study). *Blood* 1995;85:2756–2761.

137. Simioni P, Sanson BJ, Prandoni P, et al. Incidence of venous thromboembolism in families with inherited thrombophilia. *Thromb Haemost* 1999;81:198–202.

138. Deitcher SR, Schulman S, Lindmarker P. Significance of early natural anticoagulant activity testing for the risk of venous thromboembolism recurrence. *Thromb Haemost* 2001;86[Suppl]:abstr P2950.

139. Marlar RA, Adcock DM. Clinical evaluation of protein C: a comparative review of antigenic and functional assays. *Hum Pathol* 1989;20:1040–1047.

140. Kottke-Marchant K, Comp P. Laboratory issues in diagnosing abnormalities of protein C, thrombomodulin, and endothelial cell protein C receptor. *Arch Pathol Lab Med* 2002;126:1337–1348.

141. Libourel EJ, Meinardi JR, deKam PJ, et al. Protein C/S ratio, an accurate and simple test to identify carriers of a protein C gene mutation. *Br J Haematol* 2002;118:615–618.

142. Tait RC, Walker ID, Islam SIA, et al. Age related changes in protein C activity in healthy adult males. *Thromb Haemost* 1991;65:326–327.

143. Pabinger I, Kyrle PA, Speiser W, et al. Diagnosis of protein C deficiency in patients on oral anticoagulant treatment: comparison of three different protein C assays. *Thromb Haemost* 1990;63:407–412.

144. Hyers TM, Agnelli G, Hull RD, et al. Antithrombotic therapy for venous thromboembolic disease. *Chest* 2001;119[Suppl]:176S–193S.

145. Dreyfus M, Magny JF, Bridey F, et al. Treatment of homozygous protein C deficiency and neonatal purpura fulminans with a purified protein C concentrate. *N Engl J Med* 1991;325:1565–1568.

146. Marlar RA, Sills RH, Groney PK, et al. Protein C survival during replacement therapy in homozygous protein C deficiency. *Am J Hematol* 1992;41:24-31.
147. Conard J, Bauer KA, Gruber A, et al. Normalization of markers of coagulation activation with a purified protein C concentrate in adults with homozygous protein C deficiency. *Blood* 1993;82:1159-1164.
148. D'Angelo SV, Comp PC, Esmon CT, D'Angelo A. Relationship between protein C antigen and anticoagulant activity during oral anticoagulation and in selected disease states. *J Clin Invest* 1986;77:416-425.
149. Griffin JH, Mosher DF, Zimmerman TS, Kleiss AJ. Protein C, an antithrombotic protein, is reduced in hospitalized patients with intravascular coagulation. *Blood* 1982;60:261-264.
150. Sorensen PJ, Knudsen F, Nielsen AH, Dyerberg J. Protein C activity in renal disease. *Thromb Res* 1985;38:243-249.
151. Comp PC, Esmon CT. Recurrent venous thromboembolism in patients with a partial deficiency of protein S. *N Engl J Med* 1984;311:1525-1528.
152. Schwartz HP, Fischer M, Hopmeier P, et al. Plasma protein S deficiency in familial thrombotic disease. *Blood* 1984;64:1297-1300.
153. Faioni EM, Franchi F, Asti D, et al. Resistance to activated protein C in nine thrombophilic families: interference in a protein S functional assay. *Thromb Haemost* 1993;70:1067-1071.
154. Cooper PC, Hampton KK, Makris M, et al. Further evidence that activated protein C resistance can be misdiagnosed as inherited functional protein S deficiency. *Br J Haematol* 1994;88:201-203.
155. Deitcher SR, Volner JS, Kottke-Marchant K. Activated protein C resistance (APC-R) and elevated factor VIII (FVIII) activity associated interference in functional protein S assays. *Blood* 1998;92[Suppl 1]:131b.
156. Comp PC. Measurement of the natural anticoagulant protein S: how and when. *Am J Clin Pathol* 1990;94:242-243.
157. Zoller B, Berntsdotter A, de Frutos GP, Dahlback B. Resistance to activated protein C as an additional genetic risk factor in hereditary deficiency of protein S. *Blood* 1995;85:3518-3523.
158. Sie P, Boneu B, Bierme R, et al. Arterial thrombosis and protein S deficiency. *Thromb Haemost* 1989;62:1040.
159. Mahasandana C, Suvatte V, Chuansumrit A, et al. Homozygous protein S deficiency in an infant with purpura fulminans. *J Pediatr* 1990;117:750-753.
160. Simmonds RE, Ireland H, Lane DA, et al. Clarification of the risk for venous thrombosis associated with hereditary protein S deficiency by investigation of a large kindred with a characterized gene defect. *Ann Intern Med* 1998;128:8-14.
161. Boyer-Neumann C, Bertina RM, Tripodi A, et al. Comparison of functional assays for protein S: European collaborative study of patients with congenital and acquired deficiency. *Thromb Haemost* 1993;70:946-950.
162. Hubbard AR, Wong MY. A collaborative study in the measurement of protein S antigen in plasma. *Thromb Haemost* 1992;68:115-118.
163. Edson JR, Vogt JM, Huesman DA. Laboratory diagnosis of inherited protein S deficiency. *Am J Clin Pathol* 1990;94:176-186.
164. Dahlback B, Carlsson M, Svensson PJ. Familial thrombophilia due to a previously unrecognized mechanism characterized by poor anticoagulant response to activated protein C: prediction of a cofactor to activated protein C. *Proc Natl Acad Sci U S A* 1993;90:1004-1008.



165. Koster T, Rosendaal FR, de Ronde, et al. Venous thrombosis due to poor anticoagulant response to activated protein C: Leiden Thrombophilia Study. *Lancet* 1993;342:1503–1506.
166. Svensson PJ, Dahlback B. Resistance to activated protein C as a basis for venous thrombosis. *N Engl J Med* 1994;330:517–522.
167. Griffin JH, Evatt B, Wideman C, Fernandez JA. Anticoagulant protein C pathway defective in majority of thrombophilic patients. *Blood* 1993;82:1989–1993.
168. Lane DA, Mannucci PM, Bauer KA, et al. Inherited thrombophilia: part 1. *Thromb Haemost* 1996;76:651–662.
169. Bertina RM, Koeleman BPC, Koster T, et al. Mutation in blood coagulation factor V associated with resistance to activated protein C. *Nature* 1994;369:64–67.
170. Kalafatis M, Haley PE, Lu D, et al. Proteolytic events that regulate factor V activity in whole plasma from normal and activated protein C (APC)–resistant individuals during clotting: an insight into the APC resistance assay. *Blood* 1996;87:4695–4707.
171. Heeb MJ, Kojima Y, Greengard JS, Griffin JH. Activated protein C resistance: molecular mechanisms based on studies using purified Gln506–factor V. *Blood* 1995;85:3405–3411.
172. De Stefano V, Chiusolo P, Paciaroni K, Leone G. Epidemiology of factor V Leiden. *Semin Thromb Hemost* 1998;24:367–379.
173. Ridker PM, Miletich JP, Hennekens CH, Buring JE. Ethnic distribution of factor V Leiden in 4047 men and women: implications for venous thromboembolism screening. *J Am Med Assoc* 1997;277:1305–1307.
174. Deguchi H, Fernández JA, Pabinger I, et al. Plasma glucosylceramide deficiency as potential risk factor for venous thrombosis and modulator of anticoagulant protein C pathway. *Blood* 2001;97:1907–1914.
175. Galli M, Ruggeri L, Barbui T. Differential effects of anti-β<sub>2</sub>-glycoprotein I and antiprothrombin antibodies on the anticoagulant activity of activated protein C. *Blood* 1998;91:1999–2004.
176. Smirnov MD, Triplett DT, Comp PC, et al. On the role of phosphatidylethanolamine in the inhibition of activated protein C activity by antiphospholipid antibodies. *J Clin Invest* 1995;95:309–316.
177. Rodeghiero F, Tosetto A. Activated protein C resistance and factor V Leiden mutation are independent risk factors for venous thromboembolism. *Ann Intern Med* 1999;130:643–650.
178. Zivelin A, Griffin JH, Xu X, et al. A single genetic origin for a common Caucasian risk factor for venous thrombosis. *Blood* 1997;89:397–402.
179. Middeldorp S, Henkens CMA, Koopman MMW, et al. The incidence of venous thromboembolism in family members of patients with factor V Leiden mutation and venous thrombosis. *Ann Intern Med* 1998;128:15–20.
180. Koster T, Rosendaal FR, de Ronde H, et al. Venous thrombosis due to poor anticoagulant response to activated protein C: Leiden Thrombophilia Study. *Lancet* 1993;342:1503–1506.
181. Rosendaal FR, Koster T, Vandenbroucke JP, Reitsma PH. High risk of thrombosis in patients homozygous for factor V Leiden (activated protein C resistance). *Blood* 1995;85:1504–1508.
182. Ridker PM, Hennekens CH, Lindpaintner K, et al. Mutation in the gene coding for coagulation factors V and the risk of myocardial infarction, stroke, and venous thrombosis in apparently healthy men. *N Engl J Med* 1995;332:912–917.
183. Ridker PM, Hennekens CH, Selhub J, et al. Interrelation of hyperhomocyst(e)inemia factor V Leiden, and risk of future venous thromboembolism. *Circulation* 1997;95:1777–1782.
184. Emmerich J, Rosendaal FR, Cattaneo M, et al. Combined effect of factor V Leiden and prothrombin

- 20210A on the risk of venous thromboembolism: pooled analysis of 8 case-control studies including 2310 cases and 3204 controls. *Thromb Haemost* 2001;86:809-816.
185. Gerhardt A, Scharf RE, Beckmann MW, et al. Prothrombin and factor V mutations in women with a history of thrombosis during pregnancy and the puerperium. *N Engl J Med* 2000;342:374-380.
186. Rosendaal FR, Vessey M, Rumley A, et al. Hormonal replacement therapy, prothrombotic mutations and the risk of venous thrombosis. *Br J Haematol* 2002;116:851-854.
187. Herrington DM, Vittinghoff E, Howard TD, et al. Factor V Leiden, hormone replacement therapy, and the risk of venous thromboembolic events in women with coronary disease. *Arterioscler Thromb Vasc Biol* 2002;22:1012-1017.
188. Lowe G, Woodward M, Vessey M, et al. Thrombotic variables and risk of idiopathic venous thromboembolism in women aged 45-64 years. *Thromb Haemost* 2000;83:530-535.
189. Kutteh WH, Park VM, Deitcher SR. Hypercoagulable state mutation analysis in white patients with early first-trimester recurrent pregnancy loss. *Fertil Steril* 1999;71:1048-1053.
190. Rai R, Regan L, Hadley E, et al. Second trimester pregnancy loss is associated with activated protein C resistance. *Br J Haematol* 1996;92:489-490.
191. Pipe SW, Schmaier AH, Nichols WC, et al. Neonatal purpura fulminans in association with factor V R506Q mutation. *J Pediatr* 1996;128:706-709.
192. Martinelli I, Landi G, Merati G, et al. Factor V gene mutation is a risk factor for cerebral venous thrombosis. *Thromb Haemost* 1996;75:393-394.
193. Gurgey A, Mesci L, Renda Y, et al. Factor V Q506 mutation in children with thrombosis. *Am J Hematol* 1996;53:37-39.
194. Otterson GA, Monahan BP, Harold N, et al. Clinical significance of the FV: Q<sup>506</sup> mutation in unselected oncology patients. *Am J Med* 1996;101:406-412.
195. Rosendaal FR, Siscovick DS, Schwartz SM, et al. Factor V Leiden (resistance to activated protein C) increases the risk of myocardial infarction in young women. *Blood* 1997;89:2817-2821.
196. Mansourati J, Da Costa A, Munier S, et al. Prevalence of factor V Leiden in patients with myocardial infarction and normal coronary angiography. *Thromb Haemost* 2000;79:822-825.
197. Ridker PM, Miletich JP, Stampfer MJ, et al. Factor V Leiden and risks of recurrent idiopathic venous thromboembolism. *Circulation* 1995;92:2800-2802.
198. Simioni P, Prandoni P, Lensing AWA, et al. The risk of recurrent venous thromboembolism in patients with an Arg<sup>506</sup>? Gln mutation in the gene for factor V (factor V Leiden). *N Engl J Med* 1997;336:399-403.
199. Eichinger S, Pabinger I, Stümpflen A, et al. The risk of recurrent venous thromboembolism in patients with and without factor V Leiden. *Thromb Haemost* 1997;77:624-628.
200. Lindmarker P, Schulman S, Sten-Linder M, et al., and the DURAC Trial Study Group. The risk of recurrent venous thromboembolism in carriers and non-carriers of the G1691A allele in the coagulation factor V gene and the G20210A allele in the prothrombin gene. *Thromb Haemost* 1999;81:684-689.
201. Kearon C, Gent M, Hirsh J, et al. A comparison of three months of anticoagulation with extended anticoagulation for a first episode of idiopathic venous thromboembolism. *N Engl J Med* 1999;340:901-907.
202. Eichinger S, Weltermann A, Mannhalter C, et al. The risk of recurrent venous thromboembolism in heterozygous carriers of factor V Leiden and a first spontaneous venous thromboembolism. *Arch Intern Med* 2002;162:2357-2360.
203. Rintelen C, Pabinger I, Knöbl P, et al. Probability of recurrence of thrombosis in patients with and without factor V Leiden. *Thromb Haemost* 1996;75:229-232.

204. De Stefano V, Martinelli I, Mannucci PM, et al. The risk of recurrent deep venous thrombosis among heterozygous carriers of both factor V Leiden and the G20210A prothrombin mutation. *N Engl J Med* 1999;341:801–806.
205. Simioni P, Prandoni P, Lensing AWA, et al. Risk of subsequent venous thromboembolic complications in carriers of the prothrombin or the factor V Leiden gene mutation with a first episode of deep-vein thrombosis. *Blood* 2000;96:3329–3333.
206. Emmerich J, Alhenc-Gelas M, Aillaud MF, et al. Clinical features in 36 patients homozygous for the ARG 506 ? GLN factor V mutation. *Thromb Haemost* 1997;77:620–623.
207. Rosendaal FR. Risk factors for venous thrombosis: prevalence, risk, and interaction. *Semin Hematol* 1997;34:171–187.
208. Rintelen C, Mannhalter C, Ireland H, et al. Oral contraceptives enhance the risk of clinical manifestation of venous thrombosis at a young age in females homozygous for Factor V Leiden. *Br J Haematol* 1996;93:487–490.
209. Dahlback B. The discovery of activated protein C resistance. *J Thromb Haemost* 2003;1:3–9.
210. de Ronde H, Bertina RM. Laboratory diagnosis of APC resistance: a critical evaluation of the test and the development of diagnostic criteria. *Thromb Haemost* 1994;72:880–886.
211. Jorquera JI, Montoro JM, Fernandez MA, et al. Modified test for activated protein C resistance. *Lancet* 1994;344:1162–1163.
212. Le DT, Griffin JH, Greengard JS, et al. Use of a generally applicable tissue factor-dependent factor V assay to detect activated protein C resistant factor Va in patients receiving warfarin and in patients with a lupus anticoagulant. *Blood* 1995;85:1704–1711.
213. Press RD, Bauer KA, Kujovich JL, Heit JA. Clinical utility of factor V Leiden (R506Q) testing for the diagnosis and management of thromboembolic disorders. *Arch Pathol Lab Med* 2002;126:1304–1318.
214. Bokarewa MI, Bremme K, Blomback M. Arg 506 Gln mutation in factor V and risk of thrombosis during pregnancy. *Br J Haematol* 1996;92:473–478.
215. Poort SR, Rosendaal FR, Reitsma PH, Bertina RM. A common genetic variation in the 3' untranslated region of the prothrombin gene is associated with elevated plasma prothrombin levels and an increase in venous thrombosis. *Blood* 1996;88:3698–3703.
216. Warshawsky I, Hren C, Sercia L, et al. Detection of a novel point mutation of the prothrombin gene at position 20209. *Diagn Mol Pathol* 2002;11:152–156.
217. Pollak ES, Lam HS, Russell JE. The G20210 A mutation does not affect the stability of prothrombin mRNA in vivo. *Blood* 2002;100:359–362.
218. Butenas S, van't Veer C, Mann KG. "Normal" thrombin generation. *Blood* 1999;94:2169–2178.
219. Rosendaal FR, Doggen CJM, Zivelin A, et al. Geographic distribution of the 20210A G to A prothrombin variant. *Thromb Haemost* 1998;79:706–708.
220. Margaglione M, Brancaccio V, Giuliani N, et al. Increased risk for venous thrombosis in carriers of the prothrombin G?A<sup>20210</sup> gene variant. *Ann Intern Med* 1998;129:89–93.
221. Martinelli I, Taioli E, Bucciarelli P, et al. Interaction between G20210A mutation of the prothrombin gene and oral contraceptive use in deep vein thrombosis. *Arterioscler Thromb Vasc Biol* 1999;19:700–703.
222. Martinelli I, Sacchi E, Landi G, et al. High risk of cerebral vein thrombosis in carriers of a prothrombin-gene mutation and in users of oral contraceptives. *N Engl J Med* 1998;338:1793–1797.
223. Zawadzki C, Gaveriaux V, Trillot N, et al. Homozygous G20210A transition in the prothrombin gene associated with severe thrombotic disease: two cases in a French family. *Thromb Haemost*

1998;80:1027–1028.

224. Kyrle PA, Mannhalter C, Beguin S, et al. Clinical studies and thrombin generation in patients homozygous and heterozygous for the G20210A mutation in the prothrombin gene. *Arterioscler Thromb Vasc Biol* 1998;18:1287–1291.

225. De Stefano V, Martinelli I, Mannucci PM, et al. The risk of recurrent venous thromboembolism among heterozygous carriers of the G20210A prothrombin gene mutation. *Br J Haematol* 2001;113:630–635.

226. Eichinger S, Minar E, Hirschl M, et al. The risk of early recurrent venous thromboembolism after oral anticoagulant therapy in patients with the G20210A transition in the prothrombin gene. *Thromb Haemost* 1999;81:14–17.

227. Ridker PM, Hennekens CH, Miletich JP, et al. G20210A mutation in prothrombin gene and risk of myocardial infarction, stroke, and venous thrombosis in a large cohort of US men. *Circulation* 1999;99:999–1004.

228. Clarke R, Daly L, Robinson K, et al. Hyperhomocysteinemia: an independent risk factor for vascular disease. *N Engl J Med* 1991;324:1149–1155.

229. Stampfer MJ, Malinow MR, Willett WC, et al. A prospective study of plasma homocyst(e)ine and risk of myocardial infarction in U.S. physicians. *JAMA* 1992;268:877–881.

230. Molgaard J, Malinow MR, Lassvik C, et al. Hyperhomocyst(e)inemia: an independent risk factor for intermittent claudication. *J Intern Med* 1992;231:273–279.

231. Welch GN, Loscalzo J. Homocysteine and atherothrombosis. *N Engl J Med* 1998;338:1042–1050.

232. Guba SC, Fonseca V, Fink LM. Hyperhomocystinemia and thrombosis. *Semin Thromb Hemost* 1999;25:291–309.

233. Harker LA, Slichter SJ, Scott CR, Ross R. Homocystinemia: vascular injury and arterial thrombosis. *N Engl J Med* 1974;291:537–543.

234. Lentz SR, Piegors DJ, Fernandez JA, et al. Effect of hyperhomocystinemia on protein C activation and activity. *Blood* 2002;100:2108–2112.

234a. Ingrosso D, Cimmino A, Perna AF, et al. Folate treatment and unbalanced methylation and changes of allelic expression induced by hyperhomocysteinemia in patients with uraemia. *Lancet* 2003;361:1693–1699.

235. Mudd SH, Levy HL, Skovby F. Disorders of transsulfuration. In: Scriver CR, Beaudet AL, Sly WS, Valle D, ed. *The metabolic basis of inherited disease*, 6th ed. New York: McGraw–Hill, 1989:693–734.

236. Hanson NQ, Aras O, Yang F, Tsai MY. C677T and A1298C polymorphisms of the methylenetetrahydrofolate reductase gene: incidence and effect of combined genotypes on plasma fasting and post-methionine load homocysteine in vascular disease. *Clin Chem* 2001;47:661–666.

237. Den Heijer M, Koster T, Blom HJ, et al. Hyperhomocystinemia as a risk factor for deep-vein thrombosis. *N Engl J Med* 1996;334:759–762.

238. Simioni P, Prandoni P, Burlina A, et al. Hyperhomocystinemia and deep-vein thrombosis: a case-control study. *Thromb Haemost* 1996;76:883–886.

239. Eichinger S, Stümpflen A, Hirschl M, et al. Hyperhomocystinemia is a risk factor of recurrent venous thromboembolism. *Thromb Haemost* 1998;80:566–569.

240. Kottke-Marchant K, Green R, Jacobsen DW, et al. High plasma homocysteine: a risk factor for arterial and venous thrombosis in patients with normal coagulation profiles. *Clin Appl Thromb Hemost* 1997;34:239–244.

241. Currie JC, Wilson YG, Scott J, et al. Homocysteine: an independent risk factor for the failure of

vascular intervention. *Br J Surg* 1996;83:1238–1241.

242. Van Cott EM, Laposata M. Laboratory evaluation of hypercoagulable states. *Hematol Oncol Clin North Am* 1998;12:1141–1166.

243. Ueland PM, Refsum H, Stabler SP, et al. Total homocysteine in plasma or serum: methods and clinical applications. *Clin Chem* 1993;39:1764–1779.

244. Deitcher SR, Carman TL, Sheikh MA, Gomes MPV. Hypercoagulable syndromes: evaluation and management strategies for acute limb ischemia. *Semin Vasc Surg* 2001;14:74–85.

245. Homocysteine Lowering Trialists' Collaboration. Lowering blood homocysteine with folic acid based supplements: meta-analysis of randomized trials. *BMJ* 1998;316:894–898.

246. Wilcken DE, Wilcken B, Dudman NP, et al. Homocysteine—the effects of betaine in the treatment of patients not responsive to pyridoxine. *N Engl J Med* 1983;309:448–453.

247. Koster T, Blann AD, Briët E, et al. Role of clotting factor VIII in effect of von Willebrand factor on occurrence of deep-vein thrombosis. *Lancet* 1995;345: 152–155.

248. Kraaijenhagen RA, Pieternella S, Anker PS, et al. High plasma concentration of factor VIIIc is a major risk factor for venous thromboembolism. *Thromb Haemost* 2000;83:5–9.

249. Bloemenkamp KWM, Helmerhorst FM, Rosendaal FR, Vandenbroucke JP. Venous thrombosis, oral contraceptives and high factor VIII levels. *Thromb Haemost* 1999;82:1024–1027.

250. O'Donnel J, Mumford AD, Manning RA, Laffan M. Elevation of factor VIII:C in venous thromboembolism is persistent and independent of the acute phase response. *Thromb Haemost* 2000;83:10–13.

251. Chandler WL, Rodgers GM, Sprouse JT, Thompson AR. Elevated hemostatic factor levels as potential risk factors for thrombosis. *Arch Pathol Lab Med* 2002;126:1405–1414.

252. Hong JJ, Kwaan HC. Hereditary defects in fibrinolysis associated with thrombosis. *Semin Thromb Hemost* 1999;25:321–331.

253. Prins MH, Hirsh J. A critical review of the evidence supporting a relationship between impaired fibrinolytic activity and venous thromboembolism. *Arch Intern Med* 1991;151:1721–1731.

254. Aoki N, Moroi M, Sakata Y, et al. Abnormal plasminogen: a hereditary molecular abnormality found in a patient with recurrent thrombosis. *J Clin Invest* 1978;61:1186–1195.

255. Dolan G, Greaves M, Cooper P, Preston FE. Thrombovascular disease and familial plasminogen: a report of three kindreds. *Br J Haematol* 1988;70:417–421.

256. Tsutsumi S, Saito T, Sakata T, et al. Genetic diagnosis of dysplasminogenemia: detection of an Ala<sup>601</sup>-Thr mutation in 118 out of 125 families and identification of a new Asp<sup>676</sup>-Asn mutation. *Thromb Haemost* 1996;76:135–138.

257. Shigekiyo T, Uno Y, Tomonari A, et al. Type I congenital plasminogen deficiency is not a risk factor for thrombosis. *Thromb Haemost* 1992;67:189–192.

258. Friberger P, Knos M, Gustavsson S, et al. Methods for determination of plasmin, antiplasmin and plasminogen by means of substrate S-2251. *Haemostasis* 1978;7:138–145.

259. Chandler WL, Trimble SL, Loo SC, et al. Effect of PAI-1 levels on the molar concentrations of active tissue plasminogen activator (t-PA) and t-PA/PAI-1 complex in plasma. *Blood* 1990;76:930–937.

260. Chandler WL, Schmer G, Stratton JR. Optimum conditions for the stabilization and measurement of tissue plasminogen activator activity in human plasma. *J Lab Clin Med* 1989;113:362–371.

261. Chandler WL, Loo SC, Nguyen SV, et al. Standardization of methods for measuring plasminogen

activator inhibitor in human plasma. *Clin Chem* 1989;35:787–793.

262. Angleton P, Chandler WL, Schmer G. Diurnal variation of tissue-type plasminogen activator and its rapid inhibitor (PAI-1). *Circulation* 1989;79:101–106.

263. Stringer HA, van Swieten P, Heijnen HF, et al. Plasminogen activator inhibitor-1 release from activated platelets plays a key role in thrombolysis resistance. Studies with thrombi generated in the Chandler loop. *Arterioscler Thromb* 1994;14:1452–1458.

264. Valentine RJ, Kaplan HS, Green R, et al. Lipoprotein (a), homocysteine, and hypercoagulable states in young men with premature peripheral atherosclerosis: a prospective, controlled analysis. *J Vasc Surg* 1996;23:53–63.

265. D'Angelo A, Kluft C, Verheijen JH, et al. Fibrinolytic shut down after surgery: impairment of the balance between tissue-type plasminogen activator and its specific inhibitor. *Eur J Clin Invest* 1985;15:308–312.

266. Hamsten A, Wiman B, de Faire U, et al. Increased plasma levels of a rapid inhibitor of plasminogen activator in young survivors of myocardial infarction. *N Engl J Med* 1985;313:1557–1563.

267. Meade TW, Chakrabarti R, Haines AP, et al. Characteristics affecting fibrinolytic activity and plasma fibrinogen concentrations. *BMJ* 1979;1:153–156.

268. Vaughan DE, Rouleau JL, Ridker PM, et al. Effects of ramipril on plasma fibrinolytic balance in patients with acute anterior myocardial infarction. HEART Study Investigators. *Circulation* 1997;96:442–447.

269. Pahor M, Franse LV, Deitcher SR, et al. Fosinopril versus amlodipine comparative treatments study: a randomized trial to assess effects on plasminogen activator inhibitor-1. *Circulation* 2002;105:457–461.

270. Fujii S, Sobel BE. Direct effects of gemfibrozil on the fibrinolytic system: diminution of synthesis of plasminogen activator inhibitor type I. *Circulation* 1992;85:1888–1893.

271. Gebara OC, Mittleman MA, Sutherland P, et al. Association between increased estrogen status and increased fibrinolytic potential in the Framingham Offspring Study. *Circulation* 1995;91:1952–1958.

272. Ridker PM, Vaughan DE, Stampfer MJ, et al. Association of moderate alcohol consumption and plasma concentration of endogenous tissue-type plasminogen activator. *JAMA* 1994;272:929–933.

273. Bithell TC. Hereditary dysfibrinogenemia. *Clin Chem* 1985;31:509–516.

274. Rodgers GM, Garr SB. Comparison of functional and antigenic fibrinogen values from a normal population. *Thromb Res* 1992;68:207–210.

275. Carrell N, Gabriel DA, Blatt PM, et al. Hereditary dysfibrinogenemia in a patient with thrombotic disease. *Blood* 1983;62:439–447.

276. Cunningham MT, Brandt JT, Laposata M, Olson JD. Laboratory diagnosis of dysfibrinogenemia. *Arch Pathol Lab Med* 2002;126:499–505.

277. Kunz G, Öhlin AK, Adami A, et al. Naturally occurring mutations in the thrombomodulin gene leading to impaired expression and function. *Blood* 2002;99:3646–3653.

278. Faioni EM, Franchi F, Castaman G, et al. Mutations in the thrombomodulin gene are rare in patients with severe thrombophilia. *Br J Haematol* 2002;118:595–599.

279. Ireland H, Kunz G, Kyriakoulis K, et al. Thrombomodulin gene mutations associated with myocardial infarction. *Circulation* 1997;96:15–18.

280. Salomaa V, Matei C, Aleksic N, et al. Soluble thrombomodulin as a predictor of incident coronary heart disease and symptomless carotid artery atherosclerosis in the Atherosclerosis Risk in Communities (ARIC) Study: a case-cohort study. *Lancet* 1999;353:1729–1734.

281. Scanu AM. Structural and functional polymorphism of lipoprotein (a): Biological and clinical

implications. *Clin Chem* 1995;41:170–172.

282. Kullo IJ, Gau GT, Tajik AJ. Novel risk factors for atherosclerosis. *Mayo Clin Proc* 2000;75:369–380.

283. Miles LA, Plow EF. Lp(a): an interloper into the fibrinolytic system? *Thromb Haemost* 1990;63:331–335.

284. Lippi G, Veraldi GF, Dorucci V, et al. Usefulness of lipids, lipoprotein(a) and fibrinogen measurements in identifying subjects at risk of occlusive complications following vascular and endovascular surgery. *Scand J Clin Lab Invest* 1998;58:497–504.

285. Stein JH, Rosenson RS. Lipoprotein Lp(a) excess and coronary heart disease. *Arch Intern Med* 1997;157:1170–1176.

286. Scanu AM. Lipoprotein (a). A genetic risk factor for premature coronary heart disease. *JAMA* 1992;267:3326–3329.

287. Maeda S, Abe A, Seishima M, et al. Transient changes of serum lipoprotein(a) as an acute phase protein. *Atherosclerosis* 1989;78:145–150.

288. Summary of the Second Report of the National Cholesterol Education Program (NCEP) Expert Panel in Detection, Evaluation and Treatment of High Blood Cholesterol in Adults. *JAMA* 1993;269:3015–3023.

289. Maher VM, Brown BG, Marcovina SM, et al. Effects of lowering elevated LDL cholesterol on the cardiovascular risk of lipoprotein(a). *JAMA* 1995;274: 1771–1774.

290. Carlson LA, Hamsten A, Asplund A. Pronounced lowering of serum levels of lipoprotein Lp(a) in hyperlipidemic subjects treated with nicotinic acid. *J Intern Med* 1989;226:271–276.

291. Van Boven HH, Reitsma PH, Rosendaal FR, et al. Factor V Leiden (FV R506Q) in families with inherited antithrombin deficiency. *Thromb Haemost* 1996;75:417–421.

292. Margaglione M, D'Andrea G, Colaizzo D, et al. Coexistence of factor V Leiden and factor II A20210 mutations and recurrent venous thromboembolism. *Thromb Haemost* 1999;82:1583–1587.

293. Dizon-Townson D, Hutchison C, Silver R, et al. The factor V Leiden mutation which predisposes to thrombosis is not common in patients with antiphospholipid syndrome. *Thromb Haemost* 1995;74:1029–1031.

294. Mandel H, Brenner B, Berant M, et al. Coexistence of hereditary homocystinuria and factor V Leiden. Effect on thrombosis. *N Engl J Med* 1996;334:763–768.

295. Junker R, Koch HG, Auberger K, et al. Prothrombin G20210A gene mutation and further prothrombotic risk factors in childhood thrombophilia. *Arterioscler Thromb Vasc Biol* 1999;19:1568–1572.

296. Sifontes MT, Nuss R, Hunger SP, et al. Activated protein C resistance and the factor V Leiden mutation in children with thrombosis. *Am J Hematol* 1998;57:29–32.

297. Chalmers EA. Neonatal thrombosis. *J Clin Pathol* 2000;53:419–423.

298. Nowak-Gottl U, Junker R, Kreuz W, et al. Risk of recurrent venous thrombosis in children with combined prothrombotic risk factors. *Blood* 2001;97:858–862.

299. Manco-Johnson MJ, Grabowski EF, Hellgreen M, et al. Laboratory testing for thrombophilia in pediatric patients. *Thromb Haemost* 2002;88:155–156.

299a. Tormene D, Simioni P, Prandoni P, et al. The incidence of venous thromboembolism in thrombophilic children: a prospective cohort study. *Blood* 2002;100:2403–2405.

300. Schafer AI. Hypercoagulable states: molecular genetics to clinical practice. *Lancet* 1994;344:1739–1742.

301. Bauer KA. The thrombophilias: well-defined risk factors with uncertain therapeutic implications. *Ann*



Intern Med 2001;135:367–373.

302. College of American Pathologists' Consensus Panel on Thrombophilia. Arch Pathol Lab Med 2001;126:1277–1433.

303. Turkstra F, van Beek EJR, ten Cate JW, Buller HR. Reliable rapid blood test for the exclusion of venous thromboembolism in symptomatic outpatients. Thromb Haemost 1996;76:9–11.

303a. Cushman M, Folsom AR, Wang L, et al. Fibrin fragment D-dimer and the risk of future venous thrombosis. Blood 2003;101:1243–1248.

304. Yudelman IM, Nossel HL, Kaplan KL, Hirsh J. Plasma fibrinopeptide A levels in symptomatic venous thromboembolism. Blood 1978;51:1189–1195.

305. Teitel JM, Bauer KA, Lau HK, Rosenberg RD. Studies of prothrombin activation pathway utilizing radioimmunoassays for the F<sub>2</sub>/F<sub>1+2</sub> fragment and thrombin-antithrombin complex. Blood 1982;59:1086–1097.

306. Kearon C, Ginsberg JS, Douketis J, et al. Management of suspected deep vein thrombosis in outpatients by using clinical assessment and D-dimer testing. Ann Intern Med 2001;135:108–111.

307. Palareti G, Legnani C, Cosmi B, et al. Risk of venous thromboembolism recurrence: high negative predictive value of D-dimer performed after oral anticoagulation is stopped. Thromb Haemost 2002;87:7–12.

308. American Heart Association. 2002 Heart and Stroke Statistical Update. Dallas, TX: American Heart Association, 2001.

309. Davies B, Braithwaite BD, Birch PA, et al. Acute leg ischaemia in Gloucestershire. Br J Surg 1997;84:504–508.

310. Ljungman C, Holmberg L, Bergqvist D, et al. Amputation risk and survival after embolectomy for acute arterial ischaemia. Time trends in a defined Swedish population. Eur J Vasc Endovasc Surg 1996;11:176–182.

311. Ouriel K. Peripheral arterial disease. Lancet 2001;358:1257–1264.

312. Weitz JI, Byrne J, Clagett P, et al. Diagnosis and treatment of chronic arterial insufficiency of the lower extremities: a critical review. Circulation 1996;94:3026–3049.

313. Deitcher SR, Carman TL. Deep venous thrombosis and pulmonary embolism. Curr Treat Options Cardiovasc Med 2002;4:223–238.

314. Antiplatelet Trialists' Collaboration. Secondary prevention of vascular disease by prolonged antiplatelet treatment. Br Med J 1988;296:320–331.

315. Antiplatelet Trialists' Collaboration Collaborative overview of randomized trials of antiplatelet therapy. I. Prevention of death, myocardial infarction, and stroke by prolonged antiplatelet categories of patients. BMJ 1994;308:81–106.

316. Patrono C, Collier B, Dalen JE, et al. Platelet-active drugs: the relationship among dose, effectiveness, and side effects. Chest 2001;119[Suppl]:39S–63S.

317. Schafer AI. Antiplatelet therapy. Am J Med 1996;101:199–209.

318. Feliste R, Delebassee D, Simon MF, et al. Broad spectrum anti-platelet activity of ticlopidine and PCR 4099 involves the suppression of released ADP. Thromb Res 1987;48:403–415.

319. Di Minno G, Cerbone AM, Mattioli PL, et al. Functionally thrombasthenic state in normal platelets following the administration of ticlopidine. J Clin Invest 1985;75:328–338.

320. Fiddler GI, Lumley P. Preliminary clinical studies with thromboxane synthase inhibitors and thromboxane receptor blockers: a review. Circulation 1990;81[Suppl I]:169–178.

321. Lefkowitz J, Plow EF, Topol EJ. Platelet glycoprotein IIb/IIIa receptors in cardiovascular medicine. *N Engl J Med* 1995;32:1553–1559.
322. Roth GJ, Majerus PW. The mechanism of the effect of aspirin on human platelets. I. Acetylation of a particulate fraction protein. *J Clin Invest* 1975;56:624–632.
323. Catella-Lawson F, Reilly MP, Kapoor SC. Cyclooxygenase inhibitors and antiplatelet effects of aspirin. *N Engl J Med* 2001;345:1809–1817.
324. Garcia Rodriguez LA, Varas C, Patrono C. Differential effects of aspirin and non-aspirin nonsteroidal anti-inflammatory drugs in the primary prevention of myocardial infarction in postmenopausal women. *Epidemiology* 2000;11:382–387.
325. Juul-Moller S, Edvardsson N, Jahnmatz B, et al. Double-blind trial of aspirin in primary prevention of myocardial infarction in patients with stable chronic angina pectoris. *Lancet* 1992;340:1421–1425.
326. Lindblad B, Persson NH, Takolander R, et al. Does low dose acetylsalicylic acid prevent stroke after carotid surgery? A double-blind, placebo-controlled randomized trial. *Stroke* 1993;24:1125–1128.
327. The Dutch TIA Trial Study Group. A comparison of two doses of aspirin (30 mg vs 283 mg a day) in patients after a transient ischemic attack or minor ischemic stroke. *N Engl J Med* 1991;325:1261–1266.
328. Antithrombotic Trialists' Collaborative. Collaborative meta-analysis of randomized trials of antiplatelet therapy for prevention of death, myocardial infarction, and stroke in high risk patients. *BMJ* 2002;324:71–86.
329. Masotti G, Galanti G, Poggesi L, et al. Differential inhibition of prostacyclin production and platelet aggregation by aspirin. *Lancet* 1979;2:1213–1216.
330. Patrignani P, Filabozzi P, Patrono C. Selective cumulative inhibition of platelet thromboxane production by low-dose aspirin in healthy subjects. *J Clin Invest* 1982;69:1366–1372.
331. Hirsh J. The optimal antithrombotic dose of aspirin. *Arch Intern Med* 1985;145:1582–1583.
332. Mangano DT. Aspirin and mortality from coronary bypass surgery. *N Engl J Med* 2002;347:1309–1317.
333. Lauer MS. Aspirin for primary prevention of coronary events. *N Engl J Med* 2002;346:1468–1474.
334. Hayden M, Pignone M, Phillips C, et al. Aspirin for the primary prevention of cardiovascular events: a summary of the evidence for the U.S. Preventive Services Task Force. *Ann Intern Med* 2002;136:161–172.
335. Pulmonary Embolism Prevention (PEP) Trial Collaborative Group. Prevention of pulmonary embolism and deep vein thrombosis with low dose aspirin: Pulmonary Embolism Prevention (PEP) trial. *Lancet* 2000;355:1295–1302.
336. Geerts WH, Heit JA, Clagett GP, et al. Prevention of venous thromboembolism. *Chest* 2001;119[Suppl]:132S–175S.
337. Quinn MJ, Fitzgerald DJ. Ticlopidine and clopidogrel. *Circulation* 1999;100:1667–1672.
338. Sharis PJ, Cannon CP, Loscalzo J. The antiplatelet effects of ticlopidine and clopidogrel. *Ann Intern Med* 1998;129:394–405.
339. Gent M, Blakely JA, Easton JD, et al. The Canadian American Ticlopidine Study (CATS) in thromboembolic stroke. *Lancet* 1989;1:1215–1220.
340. Chen DK, Kim JS, Sutton DM. Thrombotic thrombocytopenic purpura associated with ticlopidine: a report of 3 cases and review of the literature. *Arch Intern Med* 1999;159:311–314.
341. FitzGerald GA. Ticlopidine in unstable angina: a more expensive aspirin? *Circulation* 1990;82:296–298.
342. Herbert JM, Frehel D, Vallee E, et al. Clopidogrel, a novel antiplatelet and antithrombotic agent.

Cardiovasc Drug Rev 1993;11:180–198.

343. CAPRIE Steering Committee. A randomized, blinded, trial of clopidogrel versus aspirin in patients at risk of ischaemic events (CAPRIE). *Lancet* 1996;348:1329–1339.
344. Mehta SR, Yusuf S, Peters RJ, et al. Effects of pretreatment with clopidogrel and aspirin followed by long-term therapy in patients undergoing percutaneous coronary intervention: the PCI-CURE study. *Lancet* 2001;358:527–533.
345. Bennett CL, Connors JM, Carwile JM, et al. Thrombotic thrombocytopenic purpura associated with clopidogrel. *N Engl J Med* 2000;342:1773–1777.
346. Charo IF, Nannizzi L, Phillips DR, et al. Inhibition of fibrinogen binding to GPIIb–IIIa by a GPIIIa peptide. *J Biol Chem* 1991;266:1415–1421.
347. Hynes RO. Integrins: versatility, modulation, and signaling in cell adhesion. *Cell* 1992;69:11–25.
348. Dennis MS, Henzel WJ, Pitti RM, et al. Platelet glycoprotein IIb–IIIa protein antagonists from snake venoms: evidence for a family of platelet aggregation inhibitors. *Proc Natl Acad Sci U S A* 1989;87:2471–2475.
349. Topol EJ, Byzova TV, Plow EF. Platelet GPIIb/IIIa blockers. *Lancet* 1999;353:227–231.
350. Scarborough RM, Kleiman NS, Phillips DR. Platelet glycoprotein IIb/IIIa antagonists: what are the relevant issues concerning their pharmacology and clinical use? *Circulation* 1999;100:437–444.
351. Nurden AT, Poujol C, Durrieu–Jais C, et al. Platelet glycoprotein IIb/IIIa inhibitors: basic and clinical aspects. *Arterioscler Thromb Vasc Biol* 1999;19:2835–2840.
352. Coller BS. Binding of abciximab to alpha V beta 3 and activated alpha M beta 2 receptors: with a review of platelet–leukocyte interactions. *Thromb Haemost* 1999;82:326–336.
353. Barrett JS, Murphy G, Peerlinck K, et al. Pharmacokinetics and pharmacodynamics of MK–383, a selective non–peptide platelet glycoprotein–IIb/IIIa receptor antagonist, in healthy men. *Clin Pharmacol Ther* 1994;56:377–388.
354. Vorchheimer DA, Fuster V. Oral platelet glycoprotein IIb/IIIa receptor antagonists: the present challenge is safety. *Circulation* 1998;97:5–9.
355. McLean J. The thromboplastic action of cephalin. *Am J Physiol* 1916;41:250–257.
356. Lam LH, Silbert JE, Rosenberg RD. The separation of active and inactive forms of heparin. *Biochem Biophys Res Commun* 1976;69:570–577.
357. Rosenberg RD, Edelberg JM, Zhang L. The heparin/antithrombin system: a natural anticoagulant mechanism. In: Colman RW, Hirsh J, Marder VJ, et al., eds. *Hemostasis and thrombosis: basic principles and clinical practice*, 4th ed. Philadelphia: JB Lippincott, 2001:711–732.
358. Bjork I, Jackson CM, Jornvall H, et al. The active site of antithrombin: release of the same proteolytically cleaved form of the inhibitor from complexes with factor IXa, factor Xa, and thrombin. *J Biol Chem* 1982;257:2406–2411.
359. Choay J, Petitou M, Lormeau JC, et al. Structure–activity relationship in heparin: a synthetic pentasaccharide with high affinity for antithrombin III and eliciting high anti–factor Xa activity. *Biochem Biophys Res Commun* 1983;116:492–499.
360. Olson ST, Bjork I. Predominant contribution of surface approximation to the mechanism of heparin acceleration of the antithrombin–thrombin reaction: elucidation from salt concentration effects. *J Biol Chem* 1991;266:6353–6364.
361. Olson ST, Bjork I, Sheffer R, et al. Role of the antithrombin–binding pentasaccharide in heparin acceleration of antithrombin–proteinase reactions: resolution of the antithrombin conformational change

- contribution to heparin rate enhancement. *J Biol Chem* 1992;267:12528–12538.
362. Danielsson A, Raub E, Lindahl U, Bjork I. Role of ternary complexes, in which heparin binds both antithrombin and proteinase, in the acceleration of the reactions between antithrombin and thrombin or factor Xa. *J Biol Chem* 1986;261:15467–15473.
363. Ofosu FA, Hirsh J, Esmon CT, et al. Unfractionated heparin inhibits thrombin-catalyzed amplification reactions of coagulation more efficiently than those catalyzed by factor Xa. *Biochem J* 1989;257:143–150.
364. Jaques LB. Heparin. A unique misunderstood drug. *Trends Pharmacol Sci* 1982;3:289–291.
365. Bengtsson-Olivecrona G, Olivecrona T. Binding of active and inactive forms of lipoprotein lipase to heparin: effects of pH. *Biochem J* 1985;226:409–413.
366. Rivera TM, Leone-Bay A, Paton DR, et al. Oral delivery of heparin in combination with sodium N-[8-(2-hydroxybenzoyl)amino] caprylate: pharmacologic considerations. *Pharm Res* 1997;14:1830–1834.
367. Nyman D, Thurnherr N, Duckert F. Heparin dosage in extracorporeal circulation and its neutralization. *Thromb Diath Haemorrh* 1974;33:102–104.
368. Hirsh J, van Aken WG, Gallus AS, et al. Heparin kinetics in venous thrombosis and pulmonary embolism. *Circulation* 1976;53:691–695.
369. Hirsh J, Warkentin TE, Shaughnessy SG, et al. Heparin and low-molecular-weight heparin: mechanisms of action, pharmacokinetics, dosing, monitoring, efficacy, and safety. *Chest* 2001;119[Suppl]:64S–94S.
370. Levine MN, Hirsh J, Gent M, et al. A randomized trial comparing activated thromboplastin time with heparin assay in patients with acute venous thromboembolism requiring large daily doses of heparin. *Arch Intern Med* 1994;154:49–56.
371. Nader HB, Walenga JM, Berkowitz SD, et al. Preclinical differentiation of low molecular weight heparins. *Semin Thromb Hemost* 1999;25:63–72.
372. Casu B, Torri G. Structural characterization of low molecular weight heparins. *Semin Thromb Hemost* 1999;25:17–25.
373. Montalescot G, Collet JP, Lison L, et al. Effects of various anticoagulant treatments on von Willebrand factor release in unstable angina. *J Am Coll Cardiol* 2000;36:110–114.
374. Ryan TJ, Antman EM, Brooks NH, et al. 1999 update: ACC/AHA guidelines for the management of patients with acute myocardial infarction. A report of the American College of Cardiology/American Heart Association Task Force on Practice Guidelines. *J Am Coll Cardiol* 1999;34:890–911.
375. Antman EM, Fox KM. Guidelines for the diagnosis and management of unstable angina and non-Q-wave myocardial infarction: proposed revisions. *International Cardiology Forum. Am Heart J* 2000;139:461–475.
376. Palm M, Mattsson CH. Pharmacokinetics of heparin and low molecular weight heparin fragment (Fragmin) in rabbits with impaired renal or metabolic clearance. *Thromb Haemost* 1987;58:932–935.
377. Woltz M, Weltermann A, Nieszpaur-Los M, et al. Studies on the neutralizing effects of protamine on unfractionated and low molecular weight heparin (Fragmin) at the site of activation of the coagulation system in man. *Thromb Haemost* 1995;73:439–443.
378. Tollefsen DM. Insights into the mechanism of action of heparin cofactor II. *Thromb Haemost* 1995;74:1209–1214.
379. Miglioli M, Pironi L, Ruggeri E, et al. Bioavailability of desmin, a low molecular weight dermatan sulphate, after subcutaneous administration to healthy volunteers. *Int J Clin Lab Res* 1997;27:195–198.
380. Chong BH. Danaparoid for the treatment of heparin-induced thrombocytopenia. In: Warkentin TE,

- Greinacher A, eds. Heparin-induced thrombocytopenia. New York: Marcel Dekker, 2000:291-311.
381. Magnani HN. Heparin-induced thrombocytopenia (HIT): an overview of 230 patients treated with Orgaran (Org 10172). *Thromb Haemost* 1993;70:554-561.
382. Tardy-Poncet B, Tardy B, Reynaud J, et al. Efficacy and safety of danaparoid sodium (ORG 10172) in critically ill patients with heparin-associated thrombocytopenia. *Chest* 1999;115:1616-1620.
383. Greinacher A, Amiral J, Dummel V, et al. Laboratory diagnosis of heparin-associated thrombocytopenia and comparison of platelet aggregation test, heparin-induced platelet activation test, and platelet factor 4/heparin enzyme-linked immunosorbent assay. *Transfusion* 1994;34:381-385.
384. Tardy B, Tardy-Poncet B, Viallon A, et al. Fatal danaparoid-sodium induced thrombocytopenia and arterial thromboses. *Thromb Haemost* 1998;80:530.
385. Herbert JM, Herault JP, Bernat A, et al. Biochemical and pharmacologic properties of SANORG 340006, a potent and long-acting synthetic pentasaccharide. *Blood* 1998;91:4197-4205.
386. The Matisse Investigators. Fondaparinux (Arixtra) in comparison to (low molecular weight) heparin for the initial treatment of symptomatic deep vein thrombosis or pulmonary embolism-The Matisse Clinical Outcomes Studies. *Blood* 2002;100:83a.
387. Turpie AGG, Bauer KA, Eriksson BI, Lassen MR. Fondaparinux vs enoxaparin for the prevention of venous thromboembolism in major orthopedic surgery: a meta-analysis of 4 randomized double-blind studies. *Arch Intern Med* 2002;162:1833-1840.
388. Persist Investigators. A novel long-acting synthetic factor Xa inhibitor (idraparinux sodium) to replace warfarin for secondary prevention in deep vein thrombosis. A phase II evaluation. *Blood* 2002;100:82a (abstract).
389. Warkentin TE, Kelton JG. A 14-year study of heparin-induced thrombocytopenia. *Am J Med* 1996;101:502-507.
390. Markwardt F. The development of hirudin as an antithrombotic drug. *Thromb Res* 1994;74:1-23.
391. Schiele F, Vuilleminot A, Kramarz P, et al. Use of recombinant hirudin as antithrombotic treatment in patients with heparin-induced thrombocytopenia. *Am J Hematol* 1995;50:20-25.
392. Warkentin TE, Chong BH, Greinacher A. Heparin-induced thrombocytopenia: towards consensus. *Thromb Haemost* 1998;79:1-7.
393. Greinacher A, Völpel H, Janssens U, et al. Recombinant hirudin (lepirudin) provides safe and effective anticoagulation in patients with heparin-induced thrombocytopenia: a prospective study. *Circulation* 1999;99:73-80.
394. Pötzsch B, Madlener K, Seelig C, et al. Monitoring of r-hirudin anticoagulation during cardiopulmonary bypass: assessment of the whole blood ecarin clotting time. *Thromb Haemost* 1997;77:920-925.
395. Topoulos AP, Bartholomew JR, Mee R, et al. Recludan™ (lepirudin) in pediatrics: safe use for heparin-induced thrombocytopenia (HIT) and extracorporeal membrane oxygenation (ECMO). *Thromb Haemost* 1999;394[Suppl]: 1250.
396. Begelman SM, Deitcher SR. Outpatient management of venous thromboembolic disease with subcutaneous lepirudin: a case report. *J Thromb Thrombolysis* 2002;13:183-185.
397. Frank RD, Farber H, Stefanidis I, et al. Hirudin elimination by hemofiltration: a comparative in vitro study of different membranes. *Kidney Int* 1999;58[Suppl]72:S41-45.
398. Eichler P, Olbrich K, Pötzsch B, Greinacher A. Anti-hirudin antibodies in patients treated with recombinant hirudin for more than five days, a prospective study. *Thromb Haemost* 1997;78[Suppl]:PS 2014.
399. Hursting MJ, Alford KL, Becker JC, et al. Novastan® (brand of argatroban): a small-molecule, direct

thrombin inhibitor. *Semin Thromb Hemost* 1997;23:503–516.

400. Lewis BE, Wallis DE, Berkowitz SD, et al. Argatroban anticoagulant therapy in patients with heparin-induced thrombocytopenia. *Circulation* 2001;103:1838–1843.
401. Lewis BE, Matthai WH, Jr., Cohen M, et al. Argatroban anticoagulation during percutaneous coronary intervention in patients with heparin-induced thrombocytopenia. *Catheterization Cardiovasc Interv* 2002;57:177–184.
402. Maraganore JM, Bourdon P, Jablonski J, et al. Design and characterization of hirulogs: a novel class of bivalent peptide inhibitors of thrombin. *Biochemistry* 1990;29:7095–7101.
403. Bittl JA, Strony J, Brinker JA, et al. Treatment with bivalirudin (Hirulog) as compared with heparin during coronary angioplasty for unstable or postinfarction angina: Hirulog Angioplasty Study Investigators. *N Engl J Med* 1995;333:764–769.
404. Bittl JA, Feit F. A randomized comparison of bivalirudin and heparin in patients undergoing coronary angioplasty for postinfarction angina: Hirulog Angioplasty Study Investigators. *Am J Cardiol* 1998;82:43–49.
405. Kong D, Topol E, Bittl J, et al. Clinical outcomes of bivalirudin for ischemic heart disease. *Circulation* 1999;100:2049–2053.
406. Kaplan KL, Francis CW. Direct thrombin inhibitors. *Semin Hematol* 2002;39:187–196.
407. Hopfner R. Ximelagatran. *Curr Opin Invest Drugs* 2002;3:246–251.
408. Eriksson H, Wahlander K, Lundstrom T, et al. Extended secondary prevention with the oral direct thrombin inhibitor ximelagatran for 18 months after 6 months of anticoagulation in patients with venous thromboembolism: a randomized placebo-controlled trial. *Blood* 2002;100:81a.
409. Campbell HA, Link KP. Studies on the hemorrhagic sweet clover disease: IV. The isolation and crystallization of the hemorrhagic agent. *J Biol Chem* 1941;138:21–33.
410. Furie B, Furie BC. Molecular basis of vitamin K-dependent  $\gamma$ -carboxylation. *Blood* 1990;75:1753–1762.
411. Fasco MJ, Principe LM, Walsh WA, Friedman PA. Warfarin inhibition of vitamin K 2, 3-epoxide reductase in rat liver microsomes. *Biochemistry* 1983; 22:5655–5660.
412. Hirsh J, Dalen JE, Anderson DR, et al. Oral anticoagulants: mechanism of action, clinical effectiveness, and optimal therapeutic range. *Chest* 2001;119[Suppl]:8S–21S.
413. O'Reilly RA. The pharmacodynamics of the oral anticoagulant drugs. *Prog Hemost Thromb* 1974;2:175–213.
414. O'Reilly RA, Aggeler PM, Hoag MS, et al. Hereditary transmission of exceptional resistance to coumarin anticoagulant drugs. The first reported kindred. *N Engl J Med* 1964;271:809–815.
415. Zivelin A, Rao LVM, Rapaport SI. Mechanism of the anticoagulant effect of warfarin as evaluated in rabbits by selective depression of individual procoagulant vitamin K-dependent clotting factors. *J Clin Invest* 1993;92:2131–2140.
416. Choueiri T, Deitcher SR. Why shouldn't we solely use warfarin to treat acute venous thrombosis? *Cleve Clinic J Med* 2002;69:546–548.
417. Wells PS, Holbrook AM, Crowther NR, Hirsh J. Interactions of warfarin with drugs and food. *Ann Intern Med* 1994;121:676–683.
418. Deitcher SR. Interpretation of the international normalized ratio (INR) in patients with liver disease. *Lancet* 2002;359:47–48.
419. Aithal GP, Day CP, Kesteven PJ, et al. Association of polymorphisms in the cytochrome P450

- CYP2C9 with warfarin dose requirement and risk of bleeding complications. *Lancet* 1999;353:717–719.
420. Deitcher SR. Heparin induced thrombocytopenia: pathogenesis, management, and prevention. *Formulary* 2001;36:26–41.
421. Hirsh J. Oral anticoagulant drugs. *N Engl J Med* 1991;324:1865–1875.
422. Harrison L, Johnston M, Massicotte MP, et al. Comparison of 5-mg and 10-mg loading doses in initiation of warfarin therapy. *Ann Intern Med* 1997;126:133–136.
423. Hirsh J, Poller L. The international normalized ratio: a guide to understanding and correcting its problems. *Arch Intern Med* 1994;154:282–288.
424. Reference deleted.
425. Reference deleted.
426. Moriarty HT, Lam-Po-Tang PR, Anastas N. Comparison of thromboplastins using the ISI and INR system. *Pathology* 1990;22:71–76.
427. Ng VL, Levin J, Corash L, Gottfried EL. Failure of the international normalized ratio to generate consistent results within a local medical community. *Am J Clin Pathol* 1993;99:689–694.
428. Garr SB, Rodgers GM. Laboratory monitoring of warfarin therapy in Utah. *Am J Hematol* 1994;45:85–87.
429. Hull R, Hirsh J, Jay R, et al. Different intensities of oral anticoagulant therapy in the treatment of proximal-vein thrombosis. *N Engl J Med* 1982;307:1676–1681.
430. Levine MN, Raskob G, Landefeld S, Kearon C. Hemorrhagic complications of anticoagulant treatment. *Chest* 2001;119[Suppl]:108S–121S.
431. Beyth RJ, Quinn LM, Landefeld CS. Prospective evaluation of an index for predicting the risk of major bleeding in outpatients treated with warfarin. *Am J Med* 1998;105:91–99.
432. Landefeld CS, Rosenblatt MW, Goldman L. Bleeding in outpatients treated with warfarin: relation to the prothrombin time and important remediable lesions. *Am J Med* 1989;87:153–159.
433. Ansell J, Hirsh J, Dalen J, et al. Managing oral anticoagulant therapy. *Chest* 2001;119[Suppl]:22S–38S.
434. Johnson J, Turpie AGG. Temporary discontinuation of oral anticoagulants: role of low molecular weight heparin. *Thromb Haemost* 1999;82[Suppl]:62–63.
435. Hall JAG, Pauli RM, Wilson KM. Maternal and fetal sequelae of anticoagulation during pregnancy. *Am J Med* 1980;68:122–140.
436. Ginsberg JS, Hirsh J, Turner DC, et al. Risks to the fetus of anticoagulant therapy during pregnancy. *Thromb Haemost* 1989;61:197–203.
437. Faraci PA, Deterling RA, Stein AM, et al. Warfarin induced necrosis of the skin. *Surg Gynecol Obstet* 1978;146:695–700.
438. Grimaudo V, Gueissaz F, Hauert J, et al. Necrosis of skin induced by coumarin in a patient deficient in protein S. *BMJ* 1989;298:233–234.
439. Jillella AP, Lutcher CL. Reinstating warfarin in patients who develop warfarin skin necrosis. *Am J Hematol* 1996;52:117–119.
440. Feder W, Auerbach R. “Purple toes”: an uncommon sequela of oral coumarin drug therapy. *Ann Intern Med* 1961;55:911–917.
441. Moldvee-Geronimus M, Merriam JC. Cholesterol embolization: from pathological curiosity to clinical



entity. *Circulation* 1967;35:946–953.

442. Sallah S, Thomas DP, Roberts HR. Warfarin and heparin-induced skin necrosis and the purple toe syndrome: infrequent complications of anticoagulant treatment. *Thromb Haemost* 1997;78:785–790.

443. Bruns FJ, Segel DP, Adler S. Control of cholesterol embolization by discontinuation of anticoagulant therapy. *Am J Med Sci* 1978;275:105–108.

444. Collen D, Lijnen HR. Molecular basis of fibrinolysis, as relevant for thrombolytic therapy. *Thromb Haemost* 1995;74:167–171.

445. Eisenberg PR, Sobel BE, Jaffe AS. Characterization in vivo of the fibrin specificity of activators of the fibrinolytic system. *Circulation* 1988;78:592–597.

446. Marder VJ, Bell WR. Fibrinolytic therapy. In: Colman RW, Hirsh J, Marder VJ, Salzman EW, ed. *Hemostasis and thrombosis: basic principles and clinical practice*, 2nd ed. Philadelphia: JB Lippincott, 1987:1393–1437.

447. Stricker RB, Wong D, Shiu DT, et al. Activation of plasminogen by tissue plasminogen activator on normal and thrombasthenic platelets: effects on surface proteins and platelet aggregation. *Blood* 1986;68:275–280.

448. Sharma GVRK, Cella G, Parisi AF, Sasahara AA. Thrombolytic therapy. *N Engl J Med* 1982;306:1268–1276.

449. Bell W. Therapeutic agents—pharmacokinetics and pharmacodynamics. *Rev Cardiovasc Med* 2002;3[Suppl 2]:S34–S44.

450. Pennica D, Holmes WE, Kohr WJ, et al. Cloning and expression of human tissue-type plasminogen activator cDNA in *E. coli*. *Nature* 1983;301:214–221.

451. Collen D, Bounameaux H, De Cock F, et al. Analysis of coagulation and fibrinolysis during intravenous infusion of recombinant human tissue-type plasminogen activator in patients with acute myocardial infarction. *Circulation* 1986;73:511–517.

452. Goldhaber SZ, Vaughn DE, Markis JE, et al. Acute pulmonary embolism treated with tissue plasminogen activator. *Lancet* 1986;2:886–889.

453. Rapaport E. Thrombolytic agents in acute myocardial infarction. *N Engl J Med* 1989;320:861–864.

454. Neuhaus KL, Feuerer W, Jeep-Tebbe S, et al. Improved thrombolysis with a modified dose regimen of recombinant tissue-type plasminogen activator. *J Am Coll Cardiol* 1989;14:1566–1569.

455. The National Institute of Neurological Disorders and Stroke rt-PA Stroke Study Group. TPA for acute ischemic stroke. *N Engl J Med* 1995;333:1581–1587.

456. Adams HP, Brott TG, Furlan AJ, et al. Guidelines for thrombolytic therapy for acute stroke: a supplement to the guidelines for the management of patients with acute ischemic stroke. *Circulation* 1996;94:1167–1174.

457. Kohnert U, Rudolph R, Verheijen JH, et al. Biochemical properties of the kringle 2 and protease domains are maintained in the refolded t-PA deletion variant BM 06.022. *Protein Eng* 1992;5:93–100.

458. Keyt BA, Paoni NF, Refino CJ, et al. A faster-acting and more potent form of tissue plasminogen activator. *Proc Natl Acad Sci U S A* 1994;91:3670–3674.

459. Gurewich V, Pannell R, Louie S, et al. Effective and fibrin-specific clot lysis by a zymogen precursor form of urokinase (pro-urokinase). A study in vitro and in two animal species. *J Clin Invest* 1984;73:1731–1739.

460. Verstraete M. Third-generation thrombolytic drugs. *Am J Med* 2000;109:52–58.

461. Jones G, Ronk M, Mori F, Zhang Z. Disulfide structure of alfineprase: a recombinant analog of

fibrolase. *Protein Sci* 2001;10:1264–1267.

462. Berkowitz SD, Granger CB, Pieper KS, et al. Incidence and predictors of bleeding after contemporary thrombolytic therapy for myocardial infarction. *Circulation* 1997;95:2508–2516.

463. Gurwitz JH, Gore JM, Goldberg RJ, et al. Risk for intracranial hemorrhage after plasminogen activator treatment for acute myocardial infarction. Participants in the National Registry of Myocardial Infarction 2. *Ann Intern Med* 1998;129:597–604.

464. Ouriel K. Safety and efficacy of the various thrombolytic agents. *Rev Cardiovasc Med* 2002;3[Suppl 2]:S17–S24.

465. Lijnen HR, Collen D. Remaining perspectives of mutant and chimeric plasminogen activators. *Ann N Y Acad Sci* 1992;667:357–364.

466. Erickson LA, Marotti KR. Design of novel thrombolytic agents via domain modifications. *Toxicol Pathol* 1990;18:597–602.

467. Assessment of the Safety and Efficacy of a New Thrombolytic Investigators. Single-bolus tenecteplase compared with front-loaded alteplase in acute myocardial infarction: the ASSENT-2 double-blind randomized trial. *Lancet* 1999;354:716–722.

468. Van de Werf F, Barron HV, Armstrong PW, et al. Incidence and predictors of bleeding events after fibrinolytic therapy with fibrin-specific agents: a comparison of TNK-tPA and rt-PA. *Eur Heart J* 2001;22:2253–2261.

469. Gore JM, Granger CB, Simons ML, et al. Stroke after thrombolysis: mortality and functional outcomes in the GUSTO-I trial. *Circulation* 1995;92:2811–2818.

470. Maggioni AP, Franzosi MG, Santoro E, et al. The risk of stroke in patients with acute myocardial infarction after thrombolytic and antithrombotic treatment. Gruppo Italiano per lo Studio della Sopravvivenza nell'Infarto Miocardico II (GISSI-2), and the International Study Group. *N Engl J Med* 1992;327:1–6.

471. Third International Study of Infarct Survival Collaborative Group. ISIS-3: a randomised comparison of streptokinase vs tissue plasminogen activator vs anistreplase and of aspirin plus heparin vs aspirin alone among 41,299 cases of suspected acute myocardial infarction. *Lancet* 1992;339:753–770.

472. Lee AY, Fredenburgh JC, Stewart RJ, et al. Like fibrin, (DD)E, the major degradation product of crosslinked fibrin, protects plasmin from inhibition by alpha-2-antiplasmin. *Thromb Haemost* 2001;85:502–508.

473. Weitz JI. Limited fibrin specificity of tissue-type plasminogen activator and its potential link to bleeding. *J Vasc Interv Radiol* 1995;6[Suppl 2]:19S–23S.

474. Nieuwenhuizen W, Gravesen M. Anticoagulant and calcium-binding properties of high molecular weight derivatives of human fibrinogen, produced by plasmin (fragments X). *Biochem Biophys Acta* 1981;668:81–88.

475. Sakharov DV, Barrett-Bergshoeff M, Hekkenberg RT, Rijken DC. Fibrin-specificity of a plasminogen activator affects the efficiency of fibrinolysis and responsiveness to ultrasound: comparison of nine plasminogen activators in vitro. *Thromb Haemost* 1999;81:605–612.

476. Mischke R, Wolling H. Influence of fibrinogen degradation products on thrombin time, activated partial thromboplastin time and prothrombin time of canine plasma. *Haemostasis* 2000;30:123–130.

477. Goldhaber S, Visani L, De Rosa M. Acute pulmonary embolism: clinical outcomes in the International Cooperative Pulmonary Embolism Registry (ICOPER). *Lancet* 1999;353:1386.

478. Hull RD, Raskob GE, Hirsh J, et al. Continuous intravenous heparin compared with intermittent subcutaneous heparin in the initial treatment of proximal-vein thrombosis. *N Engl J Med* 1986;315:1109–1114.

479. Prandoni P, Lensing AWA, Cogo A, et al. The long-term clinical course of acute deep venous

thrombosis. *Ann Intern Med* 1996;125:1–7.

480. Schulman S, Rhedin AS, Lindmaker P, et al. A comparison of six weeks with six months of oral anticoagulant therapy after a first episode of venous thromboembolism. *N Engl J Med* 1995;332:1661–1665.

481. Philbrick JT, Becker DM. Calf deep venous thrombosis. A wolf in sheep's clothing? *Arch Intern Med* 1988;148:2131–2138.

482. Lohr JM, Lutter KS, Cranley RD, et al. Lower extremity calf thrombosis: to treat or not to treat? *J Vasc Surg* 1991;14:618–623.

483. Kelly J, et al. The natural history of untreated subclinical below knee deep vein thrombosis (DVT) following acute ischemic stroke. *Blood* 2002;100[Suppl 1]: abstract 106.

484. Caps MT, Meissner MH, Tullis MJ, et al. Venous thrombus stability during acute phase of therapy. *Vasc Med* 1999;4:9–14.

485. Solis MM, Ranval TJ, Nix ML, et al. Is anticoagulation indicated for asymptomatic postoperative calf vein thrombosis? *J Vasc Surg* 1992;16:414–419.

486. Krupski WC, Bass A, Dilley RB, et al. Propagation of deep venous thrombosis identified by duplex ultrasonography. *J Vasc Surg* 1990;12:467–475.

487. Deitcher SR, Clark T, Garman TL. Clinical course of patients with calf vein thrombosis followed by serial duplex ultrasound. *The American Venous Forum* 2003;(abstract):8.

488. Zilliacus H. On the specific treatment of thrombosis and pulmonary embolism with anticoagulants, with particular reference to the post-thrombotic sequelae. *Acta Med Scand* 1946;171[Suppl]:1–221.

489. Barritt DW, Jordan SC. Anticoagulant drugs in the treatment of pulmonary embolism. A controlled trial. *Lancet* 1960;1:1309–1312.

490. Decousus H, Leizorovicz A, Parent F, et al. A clinical trial of vena caval filters in the prevention of pulmonary embolism in patients with proximal deep-vein thrombosis. *N Engl J Med* 1998;338:409–415.

491. Levine M, Gent M, Hirsch J, et al. A comparison of low-molecular-weight heparin administered primarily at home with unfractionated heparin administered in the hospital for proximal deep-vein thrombosis. *N Engl J Med* 1996;334:677–681.

492. Koopman MM, Prandoni P, Piovella F, et al. Treatment of venous thrombosis with intravenous unfractionated heparin administered in the hospital as compared with subcutaneous low-molecular-weight heparin administered at home. *N Engl J Med* 1996;334:682–687.

493. Hull RD, Raskob GL, Pineo GF, et al. Subcutaneous low-molecular-weight heparin compared with continuous intravenous heparin in the treatment of proximal vein thrombosis. *N Engl J Med* 1992;326:975–982.

494. Lindmarker P, Holmstrom M, Granqvist S, et al. Comparison of once-daily subcutaneous Fragmin with continuous intravenous unfractionated heparin in the treatment of deep vein thrombosis. *Thromb Haemost* 1994;72:186–190.

495. The Columbus Investigators. Low-molecular-weight heparin in the treatment of patients with venous thromboembolism. *N Engl J Med* 1997;337: 657–662.

496. Merli G, Spiro TE, Olsson CG, et al. Subcutaneous enoxaparin once or twice daily compared with intravenous unfractionated heparin for treatment of venous thromboembolic disease. *Ann Intern Med* 2001;134:191–202.

497. Gould MK, Dembitzer AD, Doyle RL, et al. Low-molecular-weight heparins compared with unfractionated heparin for treatment of acute deep vein thrombosis. A meta-analysis of randomized, controlled trials. *Ann Intern Med* 1999;130:800–809.

498. Kearon C, Gent M, Hirsh J, et al. Extended anticoagulation prevented recurrence after a first episode

of idiopathic venous thromboembolism. *N Engl J Med* 1999;340:901–907.

499. Ridker PM, Goldhaber SZ, Danielson E, et al. Long-term, low-intensity warfarin therapy for the prevention of recurrent venous thromboembolism. *N Engl J Med* 2003;348:1425–1434.

500. Simonneau G, Sors H, Charbonnier B, et al. A comparison of low-molecular-weight heparin with unfractionated heparin for acute pulmonary embolism. *N Engl J Med* 1997;337:663–669.

501. Anand SS, Bates S, Ginsberg JS, et al. Recurrent venous thrombosis and heparin therapy; an evaluation of the importance of early activated partial thromboplastin times. *Arch Intern Med* 1999;159:2029–2032.

502. Hull RD, Raskob GE, Brant RF, et al. Relation between the time to achieve the lower limit of the APTT therapeutic range and recurrent venous thromboembolism during heparin treatment for deep vein thrombosis. *Arch Intern Med* 1997;157:2562–2568.

503. Raschke RA, Reilly BM, Guidry JR, et al. The weight-based heparin dosing nomogram compared with a standard care nomogram: a randomized, controlled trial. *Ann Intern Med* 1993;119:874–881.

504. Pacouret G, Alison D, Pottier JM, et al. Free-floating thrombus and embolic risk in patients with angiographically confirmed proximal deep venous thrombosis: a prospective study. *Arch Intern Med* 1997;157:305–308.

505. Ginsberg JS, Kowalchuk G, Hirsh J, et al. Heparin effect on bone density. *Thromb Haemost* 1990;64:286–289.

506. Dolovich LR, Ginsberg JS, Douketis JD, et al. A meta-analysis comparing low-molecular-weight heparins with unfractionated heparin in the treatment of venous thromboembolism. *Arch Intern Med* 2000;160:181–188.

507. Hainer JW, Barrett JS, Assaid CA, et al. Dosing in heavy-weight/obese patients with the LMWH, tinzaparin: a pharmacodynamic study. *Thromb Haemost* 2002;87:817–823.

508. Laposata M, Green D, van Cott EM, et al. College of American Pathologists' Conference XXXI on laboratory monitoring of anticoagulant therapy: the clinical use and laboratory monitoring of low-molecular-weight heparin, danaparoid, hirudin and related compounds, and argatroban. *Arch Pathol Lab Med* 1998;122:799–807.

509. Fihn SD, McDonnell M, Martin D, et al. Risk factors for complications of chronic anticoagulation. *Ann Intern Med* 1993;118:511–520.

510. Ansell J, Hirsh J, Dalen J, et al. Managing oral anticoagulant therapy. *Chest* 2001;119[Suppl]:22S–38S.

511. Mewissen MW, Seabrook GR, Meissner MH, et al. Catheter-directed thrombolysis for lower extremity deep venous thrombosis: report of a national multicenter registry. *Radiology* 1999;211:39–49.

512. Patel NH, Stookey KR, Ketcham DB, et al. Endovascular management of acute extensive iliofemoral deep venous thrombosis caused by May-Thurner syndrome. *J Vasc Interv Radiol* 2000;11:1297–1302.

513. O'Sullivan GJ, Semba CP, Sittner CA, et al. Endovascular management of iliac vein compression (May-Thurner) syndrome. *J Vasc Interv Radiol* 2000;11:823–836.

514. AbuRahma A, Perkins SE, Wulu JT, et al. Iliofemoral deep vein thrombosis: conventional therapy versus lysis and percutaneous transluminal angioplasty and stenting. *Ann Surg* 2001;233:752–760.

515. Schweizer J, Kirch W, Koch R, et al. Short- and long-term results after thrombolytic treatment of deep venous thrombosis. *J Am Coll Cardiol* 2000;36:1336–1343.

516. Comerota AJ, Thom RC, Mathias SD, et al. Catheter-directed thrombolysis for iliofemoral deep venous thrombosis improves health-related quality of life. *J Vasc Surg* 2000;32:130–137.

517. Goldhaber SZ. Thrombolysis in pulmonary embolism: a debatable indication. *Thromb Haemost*

2001;86:444-451.

518. Arcasoy SM, Kreit JW. Thrombolytic therapy of pulmonary embolism: a comprehensive review of current evidence. *Chest* 1999;115:1695-1707.
519. Konstantinides S, Tiede N, Geibel A, et al. Comparison of alteplase versus heparin for resolution of major pulmonary embolism. *Am J Cardiol* 1998;82:966-970.
520. Tebbe U, Graf A, Kamke W, et al. Hemodynamic effects of double bolus reteplase versus alteplase infusion in massive pulmonary embolism. *Am Heart J* 1999;138:39-44.
521. Kanter DS, Mikkola KM, Patel SR, et al. Thrombolytic therapy for pulmonary embolism: frequency of intracranial hemorrhage and associated risk factors. *Chest* 1997;111:1241-1245.
522. Morrell MT, Dunnill MS. The post-mortem incidence of pulmonary embolism in a hospital population. *Br J Surg* 1965;55:347-352.
523. Kimmerly WS, Sellers KD, Deitcher SR. Graduate surgical trainee attitudes towards post-operative thromboprophylaxis. *South Med J* 1999;92:790-794.
524. Samama MM, Cohen AT, Darmon JY, et al. A comparison of enoxaparin with placebo for the prevention of venous thromboembolism in acutely ill medical patients. *N Engl J Med* 1999;341:793-800.
525. Warkentin TE, Levine MN, Hirsh J, et al. Heparin-induced thrombocytopenia in patients treated with low-molecular-weight heparin or unfractionated heparin. *N Engl J Med* 1995;332:1330-1335.
526. Chong BH, Berndt MC. Heparin-induced thrombocytopenia. *Blut* 1989;58:53-57.
527. Chong BH. Heparin-induced thrombocytopenia. *Br J Haematol* 1995;89:431-439.
528. Warkentin TE, Hayward CPM, Boshkov LD, et al. Sera from patients with heparin-induced thrombocytopenia generate platelet-derived microparticles with procoagulant activity; an explanation for the thrombotic complications of heparin-induced thrombocytopenia. *Blood* 1994;84:3691-3699.
529. King DJ, Kelton JG. Heparin-associated thrombocytopenia. *Ann Intern Med* 1984;100:535-540.
530. Warkentin TE, Kelton JG. Heparin-induced thrombocytopenia. *Prog Hemost Thromb* 1991;10:1-34.
531. Bell WR, Royall RM. Heparin-associated thrombocytopenia: a comparison of three heparin preparations. *N Engl J Med* 1980;303:902-907.
532. Amiral J, Peynard-Debaille E, Wolf M, et al. Generation of antibodies to heparin-PF4 complexes without thrombocytopenia in patients treated with unfractionated or low-molecular-weight heparin. *Am J Hematol* 1996;52:90-95.
533. Hunter JB, Lonsdale RJ, Wenham PW, et al. Heparin-induced thrombosis: an important complication of heparin prophylaxis for thromboembolic disease in surgery. *BMJ* 1993;307:53-55.
534. Singer RL, Mannion JD, Bauer TL, et al. Complications from heparin-induced thrombocytopenia in patients undergoing cardiopulmonary bypass. *Chest* 1993;104:1436-1440.
535. Warkentin TE. Heparin-induced skin lesions. *Br J Haematol* 1996;92:494-497.
536. Ansell J, Deykin D. Heparin-induced thrombocytopenia and recurrent thromboembolism. *Am J Hematol* 1980;8:325-332.
537. Klement D, Rammos S, Van Kries R, et al. Heparin as a cause of thrombus progression. Heparin-associated thrombocytopenia is an important differential diagnosis in pediatric patients even with normal platelet counts. *Eur J Pediatr* 1996;155:11-14.
538. Hach-Wunderle V, Kainer K, Salzmann G, et al. Heparin-related thrombosis despite normal platelet counts in vascular surgery. *Am J Surg* 1997;173:117-119.

539. Calaitges JG, Liem TK, Spadone D, et al. The role of heparin-associated antiplatelet antibodies in the outcome of arterial reconstruction. *J Vasc Surg* 1999;29:779-785.

540. Chong BH, Eisbacher M. Pathophysiology and laboratory testing of heparin-induced thrombocytopenia. *Semin Hematol* 1998;35(4 Suppl 5):3-8; discussion 35-36.

541. Warkentin TE. Platelet count monitoring and laboratory testing for heparin-induced thrombocytopenia. Recommendations of the College of American Pathologists. *Arch Pathol Lab Med* 2002;126:1415-1423.

542. Warkentin TE, Russett JI, Johnston M, et al. Warfarin treatment of deep vein thrombosis complicating heparin-induced thrombocytopenia (HIT) is a risk factor for initiation of venous limb gangrene: report of nine patients implicating the interacting procoagulant effects of two anticoagulant agents. *Thromb Haemost* 1995;73:1110.

543. Warkentin TE. Heparin-induced thrombocytopenia: IgG-mediated platelet activation, platelet microparticle generation, and altered procoagulant/anticoagulant balance in the pathogenesis of thrombosis and venous limb gangrene complicating heparin-induced thrombocytopenia. *Transfus Med Rev* 1996;10:249-258.

544. Warkentin TE. Heparin-induced thrombocytopenia: pathogenesis and management. *Br J Haematol* 2003;121:535-555.

2004 Lippincott Williams & Wilkins  
John P. Greer, John Foerster, John N. Lukens  
George M. Rodgers, Frixos Paraskevas, Bertil Glader  
Wintrobe's Clinical Hematology

## Diagnostic Approach to Malignant and Nonmalignant Disorders of the Phagocytic and Immune Systems

[EXAMINATION OF THE BLOOD](#)  
[EXAMINATION OF THE BONE MARROW](#)  
[EXAMINATION OF LYMPH NODES AND TISSUES](#)  
[EXAMINATION OF THE SPLEEN](#)  
[FEVER OF UNKNOWN ORIGIN](#)  
[RECURRENT INFECTIONS](#)  
[SUMMARY](#)  
[REFERENCES](#)

This chapter introduces an approach to disorders that produce abnormalities of circulating blood cells, constitutional symptoms, or enlargement of lymph nodes or the spleen. The emphasis is on distinguishing benign from malignant disease. The disorders may take the form of (a) reactions to disease, particularly infections, resulting in changes in blood leukocytes, lymphadenopathy, and/or organomegaly; (b) neoplastic diseases (leukemias, lymphomas, and plasmacytic neoplasms and related diseases); and (c) inherited or acquired diseases that result in immunodeficiency.

Patients with disorders of the phagocytic or immune system usually come to medical attention with symptoms and signs suggestive of infection. Many patients with hematopoietic lymphoid neoplasms may also present with fever or other nonlocalizing constitutional signs and symptoms such as fatigue, generalized lymphadenopathy, abnormal bleeding, weight loss, bone pain, arthralgias, and pruritus. Suspicion of an underlying immune disorder, benign or malignant, may be raised during the course of a routine examination or during the evaluation of unrelated disorders by the detection of skin lesions, lymphadenopathy, splenomegaly, or hilar or mediastinal masses. In other instances, routine blood examination may disclose abnormalities in the numbers or morphology of circulating red cells, white cells, or platelets.

A detailed history should be obtained, and a thorough physical examination should be performed. Age of the patient, immunocompetence (focusing on types and number of infections), family history, travel history, animal exposure, and drug ingestion are particularly important areas to address. Complete blood cell count (CBC) and blood examination (including study of red cells, white cells, platelets, and the blood smear) may be diagnostic or help determine the next step in diagnosis. Chest x-ray and computed tomography (CT) may assist in identifying possible biopsy sites. Electrophoresis to characterize serum or urine immunoglobulins (Igs), immunophenotyping of peripheral blood, marrow examination, lymph node aspiration or biopsy, liver biopsy, and splenectomy may be necessary. In addition, evaluation of delayed type hypersensitivity and tests of neutrophil and/or lymphocyte function may be required. Clearly, not all or even most of these tests and surgical procedures are indicated for each patient who has the symptoms or signs described. Rather, a logical sequence is undertaken for each patient, tailored to the particular findings. A diagrammatic summary of a sequential approach is shown in [Figure 62.1](#).





The major differential diagnosis of patients with thrombocytopenia includes (a) thrombocytopenia secondary to autoantibody-mediated platelet destruction [idiopathic thrombocytopenic purpura (ITP), systemic lupus erythematosus (SLE), drug-related thrombocytopenia, and perhaps human immunodeficiency virus (HIV)]; (b) primary marrow disease, particularly MDS or acute leukemia; and (c) peripheral consumption secondary to intravascular activation of clotting (e.g., disseminated intravascular coagulation, thrombotic thrombocytopenic purpura, or hemolytic uremic syndrome). Although thrombocytopenia can be secondary to a nutritional deficiency (e.g., folate, vitamin B<sub>12</sub>), usually the macrocytic anemia is the dominant clinical feature.

In ITP and drug-related thrombocytopenias, the peripheral smear red cell and white cell morphology should be normal and rare megathrombocytes are present. Thrombocytopenic patients with SLE may also be neutropenic and lymphopenic. Lymphopenia is often present in thrombocytopenia with HIV infection. MDS and leukemia rarely present with isolated thrombocytopenia. Most myelodysplastic patients are anemic and have white blood cell (WBC) abnormalities (e.g., blasts or hyposegmented or hypogranulated polymorphonuclear neutrophils) that indicate primary marrow disease. Schistocytes and polychromatophilic red cells in patients with disseminated intravascular coagulation, thrombotic thrombocytopenic purpura, and hemolytic uremic syndrome are helpful in pointing away from marrow disease or an autoimmune thrombocytopenia.

Bone marrow examination with cytogenetic studies is essential only in the cases of thrombocytopenia in patients with suspected MDS or acute leukemia or in those whom the diagnosis of autoimmune or consumptive thrombocytopenia is in doubt. In most children or young adults with otherwise normal counts and a normal blood smear, a bone marrow is probably not needed. So-called amegakaryocytic thrombocytopenias secondary to genetic or autoimmune disease are exceedingly rare.

Thrombocytosis with platelet counts of greater than 600,000 cells/ $\mu$ l are commonly seen on a transient basis during a variety of infections, after splenectomy, after acute blood loss, or during recovery from marrow injury or nutritional deficiency. The concern in persistent thrombocytosis is the presence of an underlying myeloproliferative disorder or occult malignancy. The presence of myeloproliferative disease is almost always suggested by the peripheral blood counts and smear [e.g., polycythemia in polycythemia vera, leukoerythroblastic changes in agnogenic myeloid metaplasia, and leukocytosis with immature myeloid precursors in chronic myeloid leukemia (CML)]. The one myeloproliferative disease in which thrombocytosis is often an isolated finding is essential thrombocythemia, a diagnosis that is best supported by the demonstration of megakaryocytic dysplasia on bone marrow examination.

Changes in blood leukocytes may provide the diagnosis (as in the leukemias) or may strongly suggest the correct diagnosis. Certain rare diseases associated with frequent infection can be recognized by morphologic changes in leukocytes (e.g., Chédiak-Higashi syndrome).

Leukocyte changes in the blood of patients with acute leukemia provide the diagnosis in more than one-half of this group and strongly suggest it in virtually all such patients (6). In approximately 60% of these individuals, the smear confirms the diagnosis by virtue of the presence of a large proportion of immature cells, whether or not the leukocyte count is increased. Blasts are easily demonstrable in blood smears of more than 90% of patients, and, even in patients whose blood smears have few blasts, anemia, thrombocytopenia, neutropenia, or combinations of these changes are suggestive of acute leukemia. For almost all such patients, bone-marrow aspiration proves diagnostic. Patients with two indolent leukemias, hairy cell leukemia, and leukemia of large granular lymphocytes (LGLs),

often present with bacterial infections secondary to neutropenia. Circulating hairy cells may be few in number, but a bone marrow test is diagnostic. Identification of an increase in LGLs on blood smear should lead to confirmatory phenotypic studies and molecular genetic studies for clonality in LGL leukemia.

More than 10,000 small lymphocytes per  $\mu\text{l}$  of blood is usually indicative of chronic lymphocytic leukemia, especially if the patient is middle-aged or elderly. Characteristic signs and symptoms of chronic lymphocytic leukemia may be absent at a time when a diagnosis can be made by flow cytometric demonstration of light chain restriction, with small B lymphocytes coexpressing CD5 and CD23. Proceeding with other examinations in such patients, such as lymph node biopsy or bone marrow examination, is unnecessary.

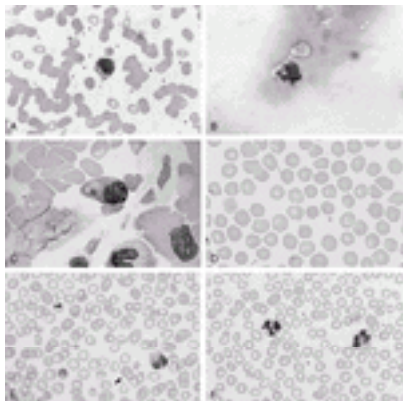
The presence of CML is strongly considered in a patient with neutrophilic leukocytosis, particularly when the WBC count is greater than  $50.0 \times 10^9/\text{L}$  and is accompanied by an increase in circulating immature myeloids and basophilia. Additional findings suggesting the diagnosis of CML include (a) symptoms limited to fatigue, bone pain, left upper quadrant mass, or fullness; (b) sternal tenderness and splenomegaly revealed by physical examination; and (c) thrombocytosis. A “leukemoid reaction” must also be considered. Marrow examination confirms the diagnosis of CML by detecting the Philadelphia chromosome [t(9;22)] by cytogenetics or the chimeric bcr-abl gene by molecular analysis.

Patients with multiple myeloma usually have a few plasma cells in the blood, although occasionally large numbers are noted (plasma cell leukemia). Such patients almost invariably have other symptoms and signs of myeloma. A few plasma cells may also be observed in blood smears of patients with infectious mononucleosis or other viral infections. Plasma cells also are seen in the blood of persons recovering from bacterial infections or having allergic reactions, especially serum sickness. The next step when the diagnosis of myeloma is considered is to perform studies of serum and urine Igs. The technique of immunoelectrophoresis has largely been replaced by electrophoresis with immunofixation. This sensitive and specific technique identifies a monoclonal serum Ig and/or light chain in urine in more than 90% of patients with myeloma. The diagnosis is confirmed on bone marrow examination.

Blood leukocyte changes that are secondary to a variety of diseases usually consist of neutrophilia, eosinophilia, monocytosis, or abnormal-appearing lymphocytes. Changes in the distribution or appearance of circulating WBCs may provide important clues to the presence and type of an underlying infection. Eosinophilia is common in atopic individuals but can be seen in many parasitic infections. Atypical lymphocytosis is a helpful diagnostic clue in infections caused by Epstein-Barr virus, cytomegalovirus, and in primary HIV infections. In many parasitic diseases, such as malaria, acute Chagas disease, and filariasis, the infectious agent is easily demonstrated in peripheral blood. However, these three parasitic diseases are rarely autochthonous in North America, and the diagnosis is suggested by the nationality of the patient as well as the recent travel history of the patient ( [7](#), [8](#), [9](#) and [10](#) ).

Although in most infections the causative agents are not demonstrable in peripheral blood, there are certain notable exceptions. In HIV infection or in other severely immunocompromised patients, mycobacteria ( [Fig. 62.2A](#) ), fungi, such as histoplasmosis ( [Fig. 62.2B](#) ), or *Candida* may occasionally be identified on the peripheral blood smear. Residents of the Midwest (particularly Arkansas and Missouri) and Southeast may acquire ehrlichiosis through tick vectors. The typical inclusions of *Ehrlichia* in mononuclear cells ( *Ehrlichia chaffeensis* ) ( [Fig. 62.2C](#) ) or in neutrophils ( *Ehrlichia phagocytophila* ) are present in up to one-third of these patients, who often present with unexplained fever with accompanying leukopenia and elevated transaminases. The diagnosis of ehrlichiosis may be confirmed either serologically or by polymerase chain reaction methods ( [11](#) ).

Babesiosis, first recognized in the 1890s as the cause of Texas cattle fever, has now been identified in febrile patients in the Northeast (Nantucket, Martha's Vineyard, Connecticut), Wisconsin, and on the West Coast. Infections can be life threatening in splenectomized patients. The diagnosis is suggested by the finding of single ring forms 1.0 to 3.5 micra in diameter in red blood cells ( [Fig. 62.2D](#)) (characteristic tetrads are usually seen only in infected animals) ( [12](#)). Although fungi, such as histoplasmosis, are rarely visible in the blood of nonimmunocompromised patients, in patients with indwelling venous catheters, *Malassezia furfur* ( [Fig. 62.2E](#)), *Candida*, and *Torulopsis* ( *C. glabrata*) may be identified in peripheral blood ( [13](#), [14](#)). In bacterial sepsis, visible circulating bacteria are rare, but the presence of cytoplasmic neutrophilic vacuoles in a fresh finger stick blood smear is a specific clue to the diagnosis of septicemia ( [Fig. 62.2F](#)). Toxic granulation (also seen in patients with sepsis) is often quite prominent in uninfected patients receiving granulocyte or granulocyte/macrophage-colony stimulating factor. Neutropenia may provide an explanation for the presence of infection and requires consideration of its various causes. Lymphopenia is produced by a wide variety of causes, but usually it is a transient phenomenon. Persistent lymphopenia suggests a defect in cellular immunity, such as that present in patients with Hodgkin disease or acquired immunodeficiency syndrome (AIDS).



**Figure 62.2.** Wright-stained peripheral blood smears demonstrating (A) *Mycobacteria tuberculosis* as negative staining rods in monocyte from patient with human immunodeficiency virus infection, (B) *Histoplasma capsulatum* with three intracellular yeast forms in monocyte at feather edge of smear in patient with acquired immunodeficiency syndrome, (C) *Ehrlichia chaffeensis* as single basophilic cytoplasmic inclusion (photomicrogram courtesy of Dr. Charles Coleman, University of Missouri), (D) Babesia as single intracellular ring forms in two erythrocytes (photomicrograph courtesy of Dr. Ahn Dao, Vanderbilt University), (E) *Malassezia furfur* as extracellular budding yeasts (one of which is overlying an erythrocyte) in an infant on total parenteral alimentation, (F) intracellular bacteria in neutrophil with adjacent vacuolated neutrophil in patient with septicemia. See [Color Plate](#).

## EXAMINATION OF THE BONE MARROW

If a diagnosis is not established by examining the blood, bone marrow examination may be helpful ( [Table 62.1](#)). Needle biopsy is usually performed in addition to aspiration, particularly if lymphoma, carcinoma, granulomatous conditions, or myelofibrosis are under consideration. To adequately triage marrow, the stained aspirate smear is reviewed along with clinical information and previous studies shortly after the procedure. This allows decisions about cytogenetics, molecular genetics, and flow cytometry to be made when viable cells are still available and also limits inappropriate studies ( [Table 62.2](#)). In the case of inaspirable marrows, sufficient cells for flow cytometry may be obtained by maintaining

negative pressure on withdrawal of the biopsy or aspirate needle and then rinsing the needle in nutrient media or buffered saline.

**TABLE 62.1. Indications for Bone Marrow Examination**

---

|  |
|--|
| Unexplained cytopenia  |
| Evaluation of leukemia   |
| Confirmation of myeloproliferative disorder  |
| Unexplained lymphadenopathy  |
| Splenomegaly without a diagnosis   |
| Diagnosis or staging of lymphoid neoplasms   |
| Constitutional symptoms (fever, weight loss) without a diagnosis   |
| Bone pain with abnormal laboratory work (e.g., complete blood cell count, ? protein, ? lactate dehydrogenase, and ? uric acid) |
| ?, increased.  |

---

**TABLE 62.2. Suspected Diagnosis on Marrow Smear**

---

| Suspected Diagnosis   | Flow<br>Cytometry | Cyto-Chemistry | Cytogenetics | Molecular<br>Genetics | Electron<br>Microscopy |
|---|-------------------|----------------|--------------|-----------------------|------------------------|
| Acute leukemia  | +                 | +              | +            | <i>a</i>              | <i>b</i>               |
| Suspected<br>myelodysplasia   | <i>c</i>          | <i>d</i>       | +            | -                     | -                      |
| Myeloproliferative<br>(particularly chronic<br>granulocytic leukemia) | <i>e</i>          | <i>e</i>       | +            | BCR                   | -                      |
| Lymphocytosis (small<br>nondysplastic)                                |                   |                |              |                       |                        |
| Child   | No                | No             | No           | No                    | -                      |
| Adult   | +                 | No             | <i>a</i>     | <i>a</i>              | -                      |
| Suspected<br>non-Hodgkin<br>lymphoma (large cells<br>± dysplasia)     | +                 | No             | +            | <i>a</i>              | <i>b</i>               |

---

<sup>a</sup> If marrow transplantation is a therapeutic consideration, such baseline studies may be useful in assessing success of purging in autologous transplants and monitoring patients posttransplant.

<sup>b</sup> Marrow can be held pending completion of other studies.

<sup>c</sup> Potentially helpful but not well established in literature.

<sup>d</sup> Periodic acid-Schiff staining of erythroids is helpful diagnostically in myelodysplasia. Sudan black stains may reveal Auer rods, overlooked on Wright stain.

<sup>e</sup> Helpful only in blast crisis.

---



In cases of acute leukemia, cytochemistry allows classification of most cases of acute nonlymphocytic leukemia in which Auer rods are not easily identified. For acute leukemias in which the cells are Sudan black or peroxidase negative (FAB, M0 and M7; ALL), flow cytometry or other immunophenotypic studies are essential for classification ( [15](#) ). These account for approximately one-third of cases of acute leukemia at our institution ( [16](#) ). Flow cytometry may also be helpful in peroxidase/Sudan black-positive cases of acute nonlymphocytic leukemia in which immunophenotypic features suggest clinically important subtypes (e.g., DR negativity in acute promyelocytic leukemia). The flow cytometric profile of the blasts in which there is asynchronous antigen expression may allow diagnosis of relapse before morphologic relapse ( [17](#), [18](#) ). Cytogenetics are playing an expanded role in classification of acute leukemia and identifying prognostically important subsets of disease such as M3 with t(15;17), M4 with abnormal eosinophils (inversion 16), or M2 with 8;21 translocation ( [15](#), [19](#), [20](#), [21](#) and [22](#) ). In suspected MDS, cytogenetic studies are particularly helpful when morphologic abnormalities in hematopoietic cells are relatively subtle. Flow cytometry is of no help in the evaluation of myeloproliferative disease except when the presence of increased blasts on marrow smear point to an evolving acute leukemia.

Lymphocytosis on a marrow smear is common in very young children. Phenotypically, the lymphocytes are usually B cells in all stages of differentiation (so-called "hematogones"). In such cases, the numbers and morphology of the myeloid, megakaryocytic, and erythroid cell lines are usually normal, which is helpful in differentiating these cells from the blasts of the L1 subtype of acute lymphoblastic leukemia ( [23](#), [24](#) ). Lymphocytosis on marrow smear in an older adult should always have phenotypic studies by flow cytometry. Otherwise, important information about clonality and phenotype may not be retrievable from the paraffin-embedded tissues. In patients with dysplastic cells (large or small) on aspirate smear, material should be put up for electron microscopy in all cases. Flow cytometry and cytogenetics should be performed in those in whom morphology suggests the dysplastic cells are of hematologic or lymphoid origin.

Bone marrow examination should also be considered in patients who complain of bone pain whether or not bone lesions have been demonstrated radiographically and particularly if there is an abnormal CBC or abnormal chemistries, such as an elevated lactate dehydrogenase, total protein, or uric acid. Some processes, including myeloma, lymphoma, carcinoma, neuroblastoma, and granulomatous infections, may be quite focal and missed on marrow examination. Occasionally, radionuclide scans with gallium-67 or indium <sup>111</sup>, CT, magnetic resonance imaging, and/or positron emission tomography scans may be helpful in localizing various types of tumors and identifying specific marrow sites for biopsy ( [25](#), [26](#), [27](#) and [28](#) ). Again, serum and urine electrophoresis, with immunofixation (which allows detection of monoclonal Igs hiding in the Beta region) should be performed on adults with bone pain. Screening tests for neuroblastoma, including urine catecholamines, should be performed in children with bone pain and a nondiagnostic marrow examination.

## EXAMINATION OF LYMPH NODES AND TISSUES

This section is concerned with the evaluation of the patient with palpable or visible enlargement of cervical, supraclavicular, axillary, inguinal, mediastinal, or hilar lymph nodes or tonsils. If the blood and marrow (when indicated, as discussed in the previous sections) fail to provide a diagnosis, the clinician should consider a fine-needle aspiration or biopsy of enlarged lymphoid tissue. The presence of a variety of signs and symptoms may modify and shorten the diagnostic evaluation. For example, if the clinical picture is fairly typical

of a lymphoma, lymph node biopsy should be performed immediately.

How large must lymphoid tissue be before it is considered abnormal? Exact limits cannot be set. The answer varies with the age and occupation of the patient and the location of the lymph nodes. Careful physical examination by an experienced physician reveals palpable small lymph nodes and visible tonsillar tissue in most patients.

The most common cause of lymphoid enlargement is lymphocyte proliferation in response to antigenic stimulation. The frequency of trichophyton infection of toes and trauma to feet and legs is reflected in the frequency of palpable inguinal nodes (usually smaller than 1 cm in diameter). If the patient's occupation or hobby leads to frequent trauma of hands and arms, small palpable epitrochlear and axillary nodes are expected. Thus, the assessment of the lymphoid system in a laborer differs somewhat from that of an educator (unless the latter's hobby is gardening or hunting).

Children and adolescents commonly have more palpable nodes than do adults ([29](#)). This difference is presumed to reflect their more frequent exposure to new antigens and a larger total lymphoid mass in relation to body weight as compared to adults. Thus, significant generalized adenopathy has a more liberal definition in the young than in adults. Prominently visible tonsils, protruding into the oropharynx, are expected in preschool children but are uncommon in adults.

Retroperitoneal lymphadenopathy must be extreme before an abdominal mass becomes palpable. CT scan and lymphangiography (LG), provide complementary information concerning the status of retroperitoneal lymph nodes, although LG is no longer commonly used ([30](#)). Abdominal CT scan provides images of nodal areas that usually are not visualized with LG, such as pararectal, omental, and superior retroperitoneal images, and the hilus of the spleen and liver. LG may disclose qualitative abnormalities in small nodes, such as a "foamy" appearance in lymphoma or filling defects that may not be discerned by CT. Other imaging techniques, such as gallium scan, positron emission tomography scan, and radiolabeled monoclonal antibody scans, may further delineate worrisome lymph nodes.

Experience with many patients is the best guide in the selection and timing of lymph node biopsies. If doubt exists as to whether enlargement is significant, the choice between immediate biopsy or periodic observation to discover whether the nodes will enlarge or shrink should be made on the basis of ancillary findings. If other signs and/or symptoms are suggestive of lymphoma, biopsy of small, questionably enlarged nodes may yield a diagnosis. Biopsy should be performed after no more than 1 or 2 months of observation if the physician is still suspicious that the nodes are abnormal. Again, however, the physician's suspicion must be tempered by experience. Persistently enlarged lymph nodes considered abnormal in an adult may be well within the limits of normal in a child or adolescent patient.

Slap et al. ([31](#)) developed a simple means by which to determine whether biopsy of an enlarged lymph node will disclose a condition requiring treatment (primarily tumor and granulomatous conditions). A multifactorial, retrospective analysis involving 22 clinical findings was made of 123 patients, ages 9 to 25 years, in whom results of lymph node biopsies were known. Only three simple variables proved to have significant discriminatory function; nodes larger than 2 cm in diameter on physical examination and abnormal findings on chest radiographs favored the diagnosis of a disorder necessitating treatment, whereas a history of recent symptoms related to otolaryngologic disease in the presence of enlarged cervical nodes was strong evidence against the presence of a disease requiring therapy. With the use of these variables, 84 of 88 patients were categorized correctly in the retrospective review, as were 32 of 33 in a subsequent prospective study.



The causes of enlargement of lymph nodes are extremely varied. [Table 62.3](#) outlines the major categories of disease leading to lymphadenopathy. This table is in no sense exhaustive. The approach to lymphadenopathy is similar to that of FUO, with the most common broad diagnoses being infection, cancer, and immune disorders. The first step is determining whether adenopathy is localized or generalized, and this differentiation points to a local disease versus systemic illness.

**TABLE 62.3. Conditions Leading to Lymph Node Enlargement**

---

Lymphadenopathy primarily related to immune response

- Infections
  - Pyogenic infections
    - Local enlargement of nodes draining areas of local infection (e.g., furuncles caused by staphylococci and oral infection)
    - Generalized enlargement from fairly indolent infections (e.g., *Salmonella* septicemia and bacterial endocarditis)
  - Viral infections
    - Local enlargement of nodes draining portals of entry of infection (e.g., cat-scratch fever and lymphogranuloma venereum)
    - Generalized lymphadenopathy with systemic infections (e.g., infectious mononucleosis, measles, infectious hepatitis, and acquired immunodeficiency syndrome)
  - Miscellaneous types of organisms
    - Local enlargement of nodes draining the portal of entry of such infections as cryptococcosis, primary chancre of syphilis, and tularemia
    - Generalized adenopathy (e.g., secondary syphilis and toxoplasmosis)
- Lymphadenopathy primarily from infection of the node by organisms
  - Pyogenic infection; the classic example is the bubo of *Pasteurella pestis*; more commonly, abscess formation by staphylococcal invasion.
  - Granuloma formation. The entrance of tubercle bacilli or fungi, such as *Histoplasma capsulatum*, into nodes often results in granuloma formation as well as hypertrophy; identifiable organisms are present within the granuloma in many instances.
- Neoplastic evolution or invasion of nodes
  - Primary neoplastic diseases of nodes
    - Non-Hodgkin lymphoma
    - Hodgkin disease
  - Secondary neoplastic processes occurring in nodes
    - Lymphoid leukemias: acute lymphocytic leukemia and chronic lymphocytic leukemia
    - Myeloid leukemias: acute myeloid leukemia and chronic myeloid leukemia
    - Idiopathic myelofibrosis with extramedullary hematopoiesis, producing lymph node enlargement
  - Metastases from carcinoma, producing lymph node enlargement
- Diseases of unknown cause leading to lymph node enlargement
  - Autoimmune diseases (e.g., systemic lupus erythematosus, rheumatoid arthritis, Sjögren syndrome, and Hashimoto thyroiditis)
  - Reaction to drugs, such as the hydantoins
  - Miscellaneous diseases
    - Granuloma formation as seen with sarcoid or in patients exposed to beryllium
    - Reactive hyperplasia, as seen in hyperthyroidism
    - Kikuchi disease (histiocytic necrotizing lymphadenitis)
    - Kawasaki disease

Certain physical characteristics of nodes aid in the diagnosis of the cause of lymphadenopathy. Infected nodes usually are tender, and the overlying skin often is inflamed. Such nodes may be matted together. In certain types of infection, such as tuberculosis (TB), aspergillosis, or actinomycosis, sinus tract formation is common. Infected nodes may be fluctuant. Nodes undergoing an immune response to infection also may be tender, but other signs of inflammation usually are absent. Tenderness may be related to other conditions, but this is uncommon. Carcinomatous nodes usually are hard and may be bound to one another and to surrounding tissue. Lymphomatous nodes are more often firm, rubbery, discrete, and freely movable; occasionally, Ki-1+ anaplastic large cell lymphoma has a significant inflammatory component.

The location of the nodes may be helpful in diagnosis, and, again, the age and immunocompetence of the patient are critical factors in determining the approach. Axillary and inguinal adenopathy are often enlarged due to trauma or infection distally. Cervical lymphadenopathy is also often due to localized infections but also can represent metastatic disease from the head and neck. Posterior occipital lymphadenopathy is classically seen in rubella (also toxoplasmosis) usually in conjunction with a maculopapular rash. Supraclavicular lymphadenopathy more often represents distant metastases than cervical adenopathy or contiguous spread from the mediastinum. Isolated mediastinal adenopathy in a young person is often Hodgkin disease. Large, bilateral hilar nodes without other detectable adenopathy are unusual in lymphomas and are more suggestive of sarcoidosis.

Infections may be either localized or generalized as the cause of lymphadenopathy. The most common forms of localized infections with cervical lymphadenopathy are pharyngitis and tonsillitis due to viral, mycoplasmal, and pyogenic infections (streptococcus, *Staphylococcus aureus*, and *S. epidermidis*) ( [32](#) ). Although the above usually cause bilateral adenopathy, unilateral adenopathy occurs with tonsillar abscesses, salivary adenitis, and dental abscesses ( [32](#) ). Systemic infections that may present with localized adenopathy include cat scratch disease, Lyme disease, tularemia, toxoplasmosis, and bubonic plague, but these patients usually have constitutional symptoms and may give a history of animal or tick exposure, or have a characteristic rash (e.g., Lyme disease). TB involving the cervical lymph nodes (scrofula) is one of the more common presentations of extrapulmonary TB ( [33](#) ). Adenopathy in HIV patients tends to be generalized and painless and can be due to HIV alone or other infections (e.g., atypical mycobacteria, toxoplasmosis, syphilis, or lymphoma).

Immunologic disorders may present with adenopathy as a prominent clinical feature. Kikuchi disease (histiocytic necrotizing lymphadenitis) is a self-limiting illness characterized by cervical adenopathy and systemic symptoms; excisional biopsy is often performed to rule out neoplasia ( [34](#), [35](#) ). Kawasaki disease is a multisystem vasculitis of infants and children usually with mucocutaneous lesions and cervical adenopathy; therapy with intravenous gamma-globulin and aspirin can prevent or ameliorate coronary artery abnormalities ( [36](#), [37](#) ). Patients with SLE and rheumatoid arthritis may develop adenopathy but usually have characteristic clinical features and serology. Early lymph node biopsy should be considered in patients at increased risk for developing lymphoma such as those with an underlying autoimmune disorder (e.g., Sjögren syndrome and rheumatoid arthritis treated with methotrexate) or immunodeficiency (e.g., HIV infection and posttransplant). Drugs, such as phenytoin, can be associated with diffuse adenopathy

that may regress with discontinuation of the drug.

In the event of a strong presumption of metastatic carcinoma or direct infection of the node, or in lymphadenopathy in areas difficult to biopsy (retroperitoneum), needle biopsy or aspiration may be considered. The procedure for lymph node puncture is simple and can produce diagnostic information in the time it takes to stain and examine the smears. However, the frequency of indeterminate or incorrect diagnosis is higher with needle biopsy than with excisional biopsy (38) as the histologic diagnosis often depends on changes in the overall architecture of the lymph node in addition to the cytology of individual cells. Excisional biopsy also yields more tissue for diagnostic studies, facilitating preparation of multiple histologic sections for routine and special stains as well as providing more adequate material for cultures and immunophenotypic and genetic studies. The smears from lymph node puncture or the touch preps from lymph node biopsy should be examined to guide the use of these ancillary studies.

For excisional biopsy, the largest palpable node available is given preference. More than one node should be removed, if possible, avoiding irradiated areas. When other considerations are equal, biopsy of cervical or supraclavicular nodes is preferable to biopsy of axillary nodes, and biopsy of nodes from any of these regions is preferable to that of inguinal nodes. As previously mentioned, inguinal nodes frequently are enlarged from chronic foot infection, in which case the architecture often is distorted. Axillary nodes, unless enlarged, may be difficult to find during surgical procedures because of the complex and changed anatomy during exposure of this area.

In the “good old days” when most diagnoses of disease involving marrow or lymph nodes were made (or not made) based solely on the morphology of smears and tissue sections, coordination of the efforts of the clinician, surgeon, and pathologist was less important and much less complex. Today, with a bewildering array of morphologic, cytochemical, immunologic, molecular genetic, and cytogenetic techniques available (and essential for many diagnoses), the clinician, surgeon, and pathologist must work closely together to optimize the diagnostic information of any biopsy and at the same time limit and control expense. The major pitfall in these efforts is improper specimen handling, precluding the use of important techniques available only in fresh tissue (i.e., cultures for pathogenesis, cytogenetics, and flow cytometry for surface markers).

The process of evaluation begins before the procedure. The studies that are done are guided by clinical information and review of previous biopsy material. At the time of biopsy or needle aspiration, the studies available within minutes of the procedure (i.e., the Wright-stained marrow aspirate smear of bone marrow or the hematoxylin and eosin stained smear of a lymph biopsy touch prep) are used to decide which diagnostic techniques will be applied to any given case. If the suspicion of infection is high, material for cultures is best obtained in the sterile environment of the operating room before sending it to pathology.

[Table 62.4](#) includes guidelines for the diagnostic evaluation of tissue biopsies based on clinical information and the aspirate smear/touch prep appearance. The most important clinical information is the likelihood that a process is (a) a non-Hodgkin lymphoma (NHL), (b) Hodgkin lymphoma, (c) a carcinoma, or (d) a reactive process. The clinical information, including the age of the patient along with the touch prep or smear appearance, often helps in determining whether flow cytometry or cytogenetics is needed (as in many cases of NHL or leukemia).

---

**TABLE 62.4. Guidelines for Evaluation of Lymph Node Biopsies/Fine Needle Aspiration**

---

### Touch Prep Cytology

| Factors or Tests to Consider    | Small Lymphocytes    | Mixed Small Lymphocytes and Large Lymphocytes (No Dysplastic Large Cells) |                      | Mixed Small and Large Lymphocytes and Occasional Large Dysplastic Cells |                      | Frequent Large Lymphocytes or Blasts |                |
|---------------------------------|----------------------|---|----------------------|---|----------------------|--------------------------------------|----------------|
|                                 | Child or young adult | Adult   | Child or young adult | Adult   | Child or young adult | Adult                                | Child or adult |
| Freeze                          | +                    | +   | +                    | +   | +                    | +                                    | +              |
| Flow cytometry                  | No                   | Yes   | <sup>a</sup>         | <sup>a</sup>  | <sup>b</sup>         | <sup>b</sup>                         | Yes            |
| Cytogenetics/molecular genetics | No                   | <sup>c</sup>  | <sup>d</sup>         | <sup>d</sup>  | <sup>d</sup>         | <sup>d</sup>                         | Yes            |

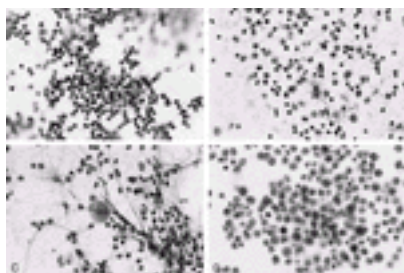
<sup>a</sup> If clinical features are highly suggestive of non-Hodgkin lymphoma or tissue is from a site difficult to sample (e.g., mediastinum or retroperitoneum) a limited panel for B-cell monotypism and T-cell distribution may be helpful.

<sup>b</sup> If clinical features and gross appearance are typical for nodular sclerosing disease, do not do flow cytometry or perform cytogenetics.

<sup>c</sup> If patient is a transplant candidate, such studies may facilitate monitoring.

<sup>d</sup> Usually not helpful except if screening flow cytometric studies demonstrate an abnormal B- or T-cell population and patient is a transplant candidate.

NHL would be very uncommon in a child or young adult with a predominance of small lymphocytes on touch preps ( Fig. 62.3A), but would more likely occur in an elderly patient. In a child or teenager, the major differential diagnosis would be a reactive node or lymphocyte-predominant Hodgkin disease. In neither would either immunologic typing studies or cytogenetics be of much help. On the other hand, in an older patient in whom a small B-cell NHL is more likely, immunophenotyping is of great help in proving monotypism and also identifying subsets of NHL of therapeutic and prognostic significance (e.g., hairy cell leukemia and mantle cell lymphoma). The role of cytogenetic studies is assuming increasing importance in the diagnosis of small B-cell lymphomas, particularly follicular [t(14;18)] and mantle cell [t(11;14)] lymphoma, and is prognostically important in subsets of extranodal marginal zone lymphoma [e.g., t(11;18)] ( 39, 40 and 41 ).

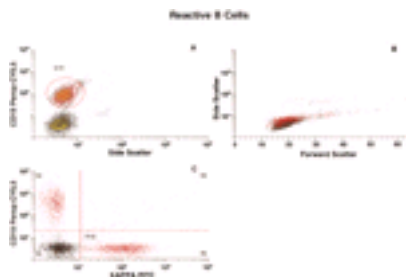


**Figure 62.3.** High power of hematoxylin eosin-stained touch preps of lymph node biopsies demonstrating (A) predominance of small lymphocytes in an adult with a small B-cell lymphoma; (B) mixed pattern of small and large lymphocyte macrophages, plasma cells,

and neutrophils in a child with reactive adenitis; (C) mixed population of small and large lymphocytes with occasional large dysplastic cells in a patient with Hodgkin disease; and (D) predominance of large lymphocytes (many with polylobate nuclei) in a patient with large B-cell lymphoma of the mediastinum. See [Color Plate](#).

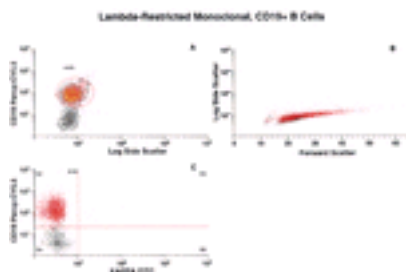
In most older adolescents and young adults with touch prep showing a polymorphous mix of small and large lymphocytes and inflammatory cells ( [Fig. 62.3B](#)), we do not perform flow cytometry. Most patients with touch preps with such mixed pattern will have a reactive process or Hodgkin disease ( [Fig. 62.3C](#)); however, a few B-cell NHL and peripheral T-cell lymphomas may show such patterns. If the clinical likelihood of NHL is high or in those patients with occasional large dysplastic cells who do not have clinical features of Hodgkin disease, a limited and inexpensive panel for B-cell monotypism and T-cell distribution (looking for aberrant T-cell phenotypes) can be performed. If these studies demonstrate an abnormality either in the small- or large-cell population, then more expanded panels can be run. If the case is not typed and on permanent tissue sections appears to be NHL, information about clonality (T and B) can be retrieved from frozen tissue or the paraffin-embedded tissue as needed ( [42](#), [43](#)).

In patients with numerous large cells or blasts on touch preps ( [Fig. 62.3D](#)) typing studies (and in many, cytogenetics) are essential in identifying prognostically significant patient subgroups. For example, in patients with blast cells on touch prep, the differential diagnosis would be lymphoblastic lymphoma (both B and T), blastic transformation of mantle cell lymphoma, and extramedullary acute leukemia. Flow cytometry is quite useful in the differential diagnosis and can provide an answer in hours (well in advance of other cytogenetic or immunohistologic techniques) ( [Fig. 62.4](#) and [Fig. 62.5](#)). Tissue should also be placed in glutaraldehyde for electron microscopy in these cases, because poorly differentiated tumors, such as neuroblastoma or rhabdomyosarcoma, may mimic hematopoietic neoplasms on touch prep.



**Figure 62.4.** Flow cytometry of reactive B cells. **A:** Histogram (picture) of anti-CD19 antibody expression versus log side scatter (signal of cellular complexity), which is used to define and identify the B-cell lymphocytes. The CD19<sup>+</sup> population is then focused on by using an isolation mechanism or *gate* (*R1*) to further describe this population. **B:** Histogram shows lymphocytes based on forward scatter signal (size) versus log side scatter signal (cell complexity or granularity). The red population represents the CD19<sup>+</sup> B cells and their location in relation to the CD19<sup>-</sup> population (*black dots*). **C:** A two-parameter histogram of anti-Kappa fluorescein isothiocyanate (FITC) versus anti-Lambda phycoerythrin. Red dots are the CD19<sup>+</sup> B cells from histogram **A**; the black dots represent the CD19<sup>-</sup> population. The pattern shown includes statistics of each population. The *R2 area* represents the anti-Lambda, CD19<sup>+</sup> population and equals approximately 16.5% of the total cells present. The *R3 area* represents the anti-Kappa positive, anti-Lambda positive CD19<sup>+</sup> population. This population is usually negative. The

*R5 area* represents the anti-Kappa, CD19<sup>+</sup> population and equals approximately 27.7% of the total cells present. *R4* represents the anti-Kappa<sup>-</sup> and anti-Lambda<sup>-</sup> population. Percp, peridinin chlorophyll protein. See [Color Plate](#). (Diagrams courtesy of Bruce Grieg, MT, Vanderbilt University.)



**Figure 62.5.** Flow cytometry of monotypic B cells. This set of pictures demonstrates CD19<sup>+</sup> B cells that have a dominant expression of one particular light chain and is an example of monoclonal light-chain restriction. **A:** Histogram (picture) of anti-CD19 antibody expression versus log side scatter (signal of cellular complexity), which is used to define and identify the B-cell lymphocytes. The CD19<sup>+</sup> population is then focused on by using an isolation mechanism or *gate* (*R1*) to further describe this population. Subsequent R1+ events are shown as red dots. Black dots represent CD19<sup>-</sup> non-B cells. **B:** Histogram shows lymphocytes based on forward scatter signal (size) versus log side scatter signal (cell complexity or granularity). The red population represents the CD19<sup>+</sup> B cells and their location in relation to the CD19<sup>-</sup> population (*black dots*). **C:** A two-parameter histogram of anti-Kappa fluorescein isothiocyanate (FITC) versus anti-Lambda phycoerythrin. Red dots are the CD19<sup>+</sup> B cells from histogram **A**; the black dots represent the CD19<sup>-</sup> population. The pattern shown includes statistics of each population. The *R2 area* represents the anti-Lambda, CD19<sup>+</sup> population and equals approximately 80% of the total cells present. The *R5 area* represents the anti-Kappa, CD19<sup>+</sup> population and in this case is <1% of the total cells present. Percp, peridinin chlorophyll protein. See [Color Plate](#). (Diagrams courtesy of Bruce Grieg, MT, Vanderbilt University.)

A histologic appearance of reactive hyperplasia or of nonspecific granulomatous changes does not rule out the possibility of Hodgkin disease or NHL at another site. For example, not all enlarged nodes from patients known to have Hodgkin disease show evidence of the disease ([44](#)); it is not surprising that the first biopsy may give negative findings in a patient in whom a second biopsy is diagnostic ([45](#), [46](#)). Similarly, analysis of surface antigens on cells from an initial biopsy may indicate that the B-cell population is polyclonal when later specimens showed a monoclonal proliferation ([47](#)). Molecular studies may identify monoclonal lymphoid populations earlier than flow cytometry or routine immunoperoxidase stains in selected cases. In equivocal or difficult cases, particularly those in which there are discrepancies between the histologic diagnosis, clinical picture, and the results of ancillary studies, consideration should be given to obtaining consultation in hematopathology ([48](#)). If more than one node is removed initially, the likelihood of positive findings is enhanced. In nondiagnostic biopsies, the decision to obtain more tissue for further study must be individualized. If no other nodes are enlarged and the patient has few or no symptoms, observation may be advisable. Prompt diagnosis and proper therapy are important in bacterial and fungal infections, Hodgkin disease, and aggressive NHL, but are less important for the eventual outcome of the other conditions



listed in [Table 62.3](#).

## EXAMINATION OF THE SPLEEN

Many of the conditions that lead to lymphadenopathy also produce a palpably enlarged spleen. Consequently, the preceding discussion regarding evaluation of the patient with lymphadenopathy is equally applicable to the patient with splenomegaly. When splenomegaly is associated with systemic infection (acute splenic tumor), the spleen usually is barely palpable, soft to firm, but not hard, and splenomegaly disappears shortly after recovery from the infection. A palpable spleen usually indicates disease, but a soft spleen tip can be palpated by an experienced physician in approximately 1 to 2% of apparently healthy persons ([49](#)).

Splenic puncture may be helpful in the evaluation of patients with certain conditions (e.g., leishmaniasis and kala-azar), but is rarely used in North America ([50](#), [51](#)). Diagnostic splenectomy is required in some patients, especially those in whom the only palpably enlarged tissue is the spleen. Before this procedure is considered, however, numerous other studies should be made and may include liver/spleen scan and imaging studies to outline splenic vein patency, as well as hepatic blood flow, and any associated adenopathy. In many cases, results of these studies indicate the diagnosis. For instance, splenic hypertrophy owing to increased red cell destruction, such as occurs in hereditary spherocytosis and thalassemia, should be detected by means of appropriate blood and other examinations. Biopsy of enlarged nodes should always be carried out before splenectomy is undertaken. Examination of the marrow should also be considered. Liver function tests and needle biopsy of the liver also are warranted to exclude, among other considerations, the possibility that the splenomegaly results from hepatic disease, producing increased portal pressure.

Indications for splenectomy are discussed in [Chapter 70](#) and elsewhere in relation to the various diseases associated with splenomegaly. If no explanation is found for splenomegaly, splenectomy should be considered to make or to exclude a diagnosis of lymphoma.

## FEVER OF UNKNOWN ORIGIN

The classic definition of FUO proposed by Petersdorf and Beeson is a temperature elevation of 38.3° C (101° F) or higher persisting over 3 weeks in duration and without a diagnosis after 1 week of intensive in-hospital investigation ([52](#), [53](#)). There have been many attempts to modify the definition according to the host involved or length of fever, and the changing medical environment has required a shift to an initial outpatient evaluation; however, altering the definition dilutes its significance and changes a valid approach to FUO ([52](#), [53](#), [54](#) and [55](#)). Still, because of changing medical practices and different types of patients with prolonged fever, FUO is currently subdivided according to four categories: (a) classic FUO, (b) nosocomial FUO, (c) immune-deficient FUO, and (d) HIV-associated FUO ([53](#)). Host factors (e.g., age of the patient and immunocompetence) and environment (e.g., socioeconomic status and geographic location) are factors in the evaluation of FUO.

The “big three” categories of FUO remain infections, autoimmune diseases, and malignancies ([Table 62.5](#)), although the incidence of cancer has declined probably due to improved diagnostic techniques ([56](#)). Miscellaneous diseases and undiagnosed conditions round out the main five categories of FUO. In a series of 167 patients from the Netherlands with classic FUO, 70% of the patients were accurately diagnosed, with 37%



due to infections, 34% due to noninfectious inflammatory conditions, and 18% due to neoplasms ( 57 ). In developing countries, infections, particularly TB, often represent more than one-half the cases of FOU, whereas developed countries have a higher incidence of autoimmune diseases and neoplasms ( 58 , 59 ). Undiagnosed conditions and infections are more common in younger patients, whereas autoimmune diseases, including temporal arteritis and polymyalgia rheumatica, are more common in the elderly ( 59 ).

**TABLE 62.5. Diseases Causing Fever of Unknown Origin**

| Malignancy  | Autoimmune disease   |
|---|--|
| Common  | Common   |
| Hodgkin disease: classic Pel–Ebstein, lymphocyte depleted subtype   | Still disease  |
| Non–Hodgkin lymphoma: usually advanced stage  | Temporal arteritis (polymyalgia rheumatica)                  |
| Renal cell carcinoma: elevated sed rate, often encapsulated   | Uncommon   |
| Metastatic carcinoma: liver, central nervous system   | Periarteritis nodosa   |
| Uncommon/rare   | Rheumatoid arteritis   |
| Hepatomas   | Wegener granulomatosis                                       |
| Pancreatic carcinoma  | Rare   |
| Acute leukemia/myelodysplasia   | Systemic lupus erythematosus                                 |
| Atrial myxoma   | Vasculitis (Takayasu arteritis, hypersensitivity vasculitis) |
| Neuroblastoma   | Felty syndrome   |
| Central nervous system tumor  | Acute rheumatic fever  |
| Infection   | Pseudogout   |
| Common  | Sjögren syndrome   |
| Tuberculosis: extrapulmonary—renal, meningitis, miliary   | Behçet disease   |
| Abscesses   | Familial Mediterranean fever                                 |
| Intraabdominal  | Polymyositis   |
| Subdiaphragmatic (periappendiceal, pericolic, hepatic)  | Tumor necrosis factor receptor–associated periodic syndrome  |
| Pelvic  | Miscellaneous  |
| Uncommon  | Common   |
| Abscesses: splenic, perinephric, dental, brain  | Drug fever   |
| Subacute bacterial endocarditis (if culture negative, suspect right–sided endocarditis, intravenous drug abuse) | Cirrhosis  |
| Cytomegalovirus   | Alcoholic hepatitis  |
| Toxoplasmosis   | Uncommon: granulomatous hepatitis                            |
| <i>Salmonella</i> enteric fevers  | Rare   |
|   | Gastrointestinal: regional enteritis, Whipple disease        |

Rare

Localized, culture-negative infections: sinusitis, osteomyelitis, chronic meningitis, cholecystitis, urinary tract infection, mastoiditis

Viruses: Epstein-Barr, hepatitis (all types), human immunodeficiency virus, parvovirus, other

Cat scratch disease

Brucellosis

Listeriosis

Spirochetal infections

Relapsing fever

Lyme disease

Leptospirosis

Rat bite fever

Rickettsial infections: Rocky Mountain spotted fever, endemic typhus, Q fever, ehrlichiosis, trench fever, bacillary angiomatosis

Parasitic disease: malaria, babesiosis, toxoplasmosis, trypanosomiasis, leishmaniasis, trichinosis, amebic liver abscess

Fungal infections: blastomycosis, histoplasmosis, coccidioidomycosis, cryptococcosis, candidiasis

*Yersinia* infections

Chlamydial infections: psittacosis, lymphogranuloma venereum

Foreign object-related infections: vascular grafts, indwelling catheters, prosthetic devices

Vascular infections: aortic aneurysm, jugular phlebitis

Adapted from Cunha BA. Fever of unknown origin (FUO). In: Gorbach SL, Bartlett JB, Blacklow RN, eds. Infectious diseases, 2nd ed. Philadelphia: WB Saunders, 1996.

---

Endocrine: hyperthyroidism, hyperparathyroidism, pheochromocytoma, Addison disease, subacute thyroiditis, hypothalamic dysfunction

Granulomatous disease: sarcoidosis

Vascular related: pulmonary emboli, subacute dissecting aneurysm, giant hepatic hemangioma, occult hematomas

Immune-related: hyper immunoglobulin D syndrome, pseudolymphoma

Factitious fever

Habitual hyperthermia

Cyclic neutropenia

Other: Fabry disease, Kikuchi disease, Weber-Christian disease, mesenteric fibromatosis, malakoplakia, Castleman disease, hemophagocytic syndromes  
Undiagnosed conditions

Nosocomial FUO is a particular problem for the patient in an intensive care unit and is related to the type of instrumentation, including indwelling vascular lines, Foley catheters, and endotracheal tubes (60), along with a specific spectrum of microorganisms and their antimicrobial sensitivity. More than 60% of FUO in the immunodeficient host is due to infections; the type and severity of infection correlates with the depth and length of

neutropenia ( 61 ).

The initial exposure to HIV may cause FUO, and the HIV may go undetected due to lack of seroconversion ( 62 ). In general, FUO in HIV patients is usually diagnosed and is due to an opportunistic infection ( 62 ). Atypical and typical mycobacteria are the most common infections in HIV patients; other infections causing FUO in AIDS include cytomegalovirus, *Pneumocystis carinii*, toxoplasmosis, histoplasmosis, leishmaniasis, and cryptococcosis ( 59 ). Lymphoma and drug reactions may also be a cause of FUO in HIV patients. The use of highly active antiretroviral therapy (HARRT) in AIDS has accompanied a decline in FUO ( 63 ).

The pattern of fever has been extensively evaluated, but rarely is so specific to be diagnostic of a disease. Possible exceptions include a Pel–Ebstein pattern of recurrent high fever and intermittent afebrile, asymptomatic periods in Hodgkin disease; the tertian and quartan patterns of malaria, the pulse–temperature dissociation of typhoid fever, the reversal of the normal diurnal pattern observed in disseminated TB, and a cyclical pattern (every 3 weeks) with cyclical neutropenia ( 59 , 64 ).

In the evaluation of a patient with FUO, history and physical examinations often need to be repeated frequently ( 65 , 66 and 67 ). Host factors (e.g., HIV, sickle cell disease, prior malignancy, organ transplant, cardiac valve disease, diabetes, and prior surgery) and external factors (e.g., occupation; travel; and exposures to infections, animals, and drugs) may point to the types of studies warranted to diagnose the etiology of FUO. The physical examination should pay particular attention to the skin (e.g., rashes, subcutaneous nodules, aphthous ulcers, and nailbeds), eyes (e.g., uveitis and Roth’s spots and infections on funduscopic examination), sinuses, lymph nodes, heart (e.g., rubs and murmurs), lungs, organomegaly, and perirectal area. Bone, joint, and musculoskeletal examinations are important when symptoms of pain, limping, or weakness are associated with FUO.

The laboratory evaluation of FUO includes baseline screening (e.g., CBC, sedimentation rate, sequential multiple analysis, and chest x–ray) and examination of the blood smear for pathogenesis suggested by the history. Table 62.6 outlines possible etiologies as suggested by the findings on CBC and sedimentation rate. Improved blood culture techniques, serology for autoimmune disorders, and imaging studies (e.g., CT, magnetic resonance imaging, and radioisotope scans) have altered the distribution but not type of illnesses causing FUO ( 65 ). Autoimmune diseases that have remained a cause of FUO are those that are not readily diagnosed by serologic testing, such as temporal arteritis and Still disease ( 65 ). There are few “new” causes of FUO, but some include Kikuchi disease and hyperimmunoglob–ulinemia IgD syndrome ( 65 ).

**TABLE 62.6. Complete Blood Cell Count Clues to Fever of Unknown Origin**

| Monocytosis          | Eosinophilia         | Erythrocyte sedimentation rate (>100 mm/h) |
|----------------------|----------------------|--|
| Tuberculosis         | Trichinosis          | Adult Still disease                        |
| Polyarteritis nodosa | Lymphomas            | Temporal arteritis                         |
| Temporal arteritis   | Drug fever           | Hypernephroma                              |
| Cytomegalovirus      | Addison disease      | Subacute bacterial endocarditis            |
| Sarcoidosis          | Polyarteritis nodosa | Drug fever                                 |

|                                  |                              |                                  |
|----------------------------------|------------------------------|----------------------------------|
| Brucellosis                      | Hypersensitivity vasculitis  | Carcinomas                       |
| Subacute bacterial endocarditis  | Hypernephroma                | Lymphomas                        |
| Systemic lupus erythematosus     | Myeloproliferative diseases  | Myeloproliferative diseases      |
| Lymphomas                        | Thrombocytopenia             | Abscesses                        |
| Carcinomas                       | Leukemias                    | Subacute osteomyelitis           |
| Regional enteritis               | Lymphomas                    | Polymyositis                     |
| Myeloproliferative diseases      | Myeloproliferative diseases  | Hyper immunoglobulin D syndrome  |
| Atypical lymphocytosis           | Relapsing fever              | Basophilia                       |
| Epstein–Barr virus mononucleosis | Epstein–Barr virus           | Carcinomas                       |
| Cytomegalovirus                  | Drug fever                   | Lymphomas                        |
| Brucellosis                      | Systemic lupus erythematosus | Pre-leukemias                    |
| Toxoplasmosis                    | Human immunodeficiency virus | Myeloproliferative diseases      |
| Drug fever                       | Leukopenia                   | Lymphocytosis                    |
| Thrombocytosis                   | Miliary tuberculosis         | Tuberculosis                     |
| Myeloproliferative diseases      | Brucellosis                  | Epstein–Barr virus mononucleosis |
| Tuberculosis                     | Systemic lupus erythematosus | Cytomegalovirus                  |
| Carcinomas                       | Lymphomas                    | Toxoplasmosis                    |
| Lymphomas                        | Pre-leukemias                | Non-Hodgkin lymphoma             |
| Sarcoidosis                      | Typhoid fever                | Lymphocytopenia                  |
| Vasculitis                       | Kikuchi disease              | Human immunodeficiency virus     |
| Temporal arteritis               |                              | Hodgkin disease                  |
| Subacute osteomyelitis           |                              | Whipple disease                  |
| Hypernephroma                    |                              | Tuberculosis                     |
|                                  |                              | Systemic lupus erythematosus     |
|                                  |                              | Sarcoidosis                      |

Adapted from Cunha BA. Fever of unknown origin (FUO). In: Bartlett JB, Blacklow NR, eds. Infectious diseases, 2nd ed. Philadelphia: WB Saunders, 1996.

Rare, hereditary disorders characterized by recurrent episodes of fever and autoimmune features include familial Mediterranean fever, tumor necrosis factor–receptor–associated periodic syndrome, and the hyperimmunoglobulinemia D syndrome (68). Familial Mediterranean fever is an autosomal–recessive disorder and is caused by mutations in the pyrin–marenostin gene, which provides inhibitory signals to inflammatory cells (69). Tumor necrosis factor–receptor–associated periodic syndrome is an autosomal dominant condition caused by missense mutations in the gene encoding type I tumor necrosis factor–receptor, which results in an exaggerated response to tumor necrosis factor (70). Hyperimmunoglobulin D syndrome is due to mutations in the gene mevalonate kinase, but the mechanism producing fever and autoimmune features is unknown (71).

After the initial evaluation, specific organ systems and diagnoses can usually be

addressed. Bone marrow examination with cultures may be useful as well as liver biopsy if liver function tests are abnormal. Laparotomy is rarely performed unless there is adenopathy that is not easily approached by less invasive procedures, including fine-needle aspiration, mediastinoscopy, laparoscopy, and thoracoscopy. The goal is to identify treatable diseases as expediently as possible.

Empirical antibiotic trials are rarely warranted except in the immunocompromised patient with neutropenia and fever ( 72 ). Occasionally, antibiotics are given in culture-negative endocarditis; and antituberculosis therapy is used in the elderly with suspected miliary TB ( 65 , 73 ). High-dose steroids with or without alkylating agents should probably only be given in biopsy-proven cases of vasculitis ( 65 ). Naprosyn has been advocated as a means to distinguish fever of malignancy from infection but should not prevent the search for infection ( 65 ). Treatment for malignancy should never be instituted without a tissue diagnosis.

## RECURRENT INFECTIONS

The most common clinical presentation of immunodeficiency (either congenital or acquired) is infection ( Table 62.7 ). More than one infection requiring hospitalization, infection with unusual pathogens, or an inappropriately delayed response to optimal therapy should all be tip-offs to possible underlying immunodeficiency. Occasionally, patients may present with sequelae of immunodeficiency (e.g., delayed growth or failure to thrive in children or unexplained chronic obstructive pulmonary disease). In some patients, particularly those with HIV infection, lymphoma or a nonhematologic malignancy may be the presenting manifestation. In congenital immunodeficiency diseases, such as IgA deficiency, or deficiency of classic pathway complement components, features of autoimmunity may dominate the clinical picture ( 74 , 75 ).

**TABLE 62.7. Clinical Approach to Immunodeficiency**

---

Red flags for immunodeficiency

- More than one hospitalization for infection
- Infection with organisms not usually pathogenic
- Growth failure in children
- Delayed or absent response of infection on appropriate therapy

Initial evaluation

- History
  - Onset of infection
  - Family history
  - Type of infection
- Physical examination

Initial investigation for:

- Bacterial infection (implies B-cell, phagocyte, or complement deficiency)
  - CBC and differential for neutrophil count and morphology, quantitative immunoglobulins, CH50
  - Infection with intracellular organisms (implies deficient T cell/cellular immunity)
  - Human immunodeficiency virus serology, CBC and differential for lymphocyte count, T-subset analysis, skin testing in adults
  - CBC, complete blood cell count.
-

The first test in any patient of any age with suspected immunodeficiency is HIV serology. In the HIV-negative patient, the type of infection or problem should dictate the tests ordered. In a patient with recurrent bacterial infection, the three major screening tests are a CBC and differential WBC, quantitative Igs, and a CH50 ( [76](#) ). Interpretation of quantitative Igs depends on an awareness of the variation in the normal ranges with age. IgG, IgA, and IgM are markedly decreased in children with physiologic hypogammaglobulinemia of infancy, common variable immunodeficiency, and X-linked agammaglobulinemia ( [Chapter 68](#) ). In the first two conditions, patients have circulating B cells by flow cytometry whereas in X-linked agammaglobulinemia, they do not ( [77](#), [78](#) and [79](#) ). Thymoma is another circumstance with decreased Igs and decreased or absent B cells ( [80](#) ). In hyper IgM syndrome, the presence of markedly elevated IgM with depressed IgG and IgA is virtually diagnostic ( [81](#), [82](#) ). Patients with Wiskott-Aldrich syndrome who respond poorly to encapsulated bacteria often have an isolated decrease in IgM or may also have increases in IgE and IgA ( [83](#) ). Marked elevations of IgE are seen in patients with chemotactic defects and recurrent staphylococcal skin disease ( [84](#) ).

In adults with low IgG, three major considerations include common variable immunodeficiency, chronic lymphocytic leukemia, and multiple myeloma. Patients with chronic lymphocytic leukemia have lymphocytosis and immunophenotypic studies demonstrating a monotypic CD5<sup>+</sup>, CD23<sup>+</sup> B-cell population ( [85](#) ). In myeloma patients with a decreased IgA, IgM, or IgG, electrophoresis of serum identifies a paraprotein in more than 80% of patients, although immunofixation may be required to uncover IgA monoclonals hiding in the Beta region. Some myeloma patients have a negative serum electrophoresis with immunofixation. Most of these patients have a monoclonal light chain on urine electrophoresis ( [86](#) ).

Congenital complement deficiencies are rare. All patients with deficiency of C1, C2, C3, C4, C5, C6, C7, and C8 have a zero CH50 (also seen with improperly handled specimens and occasionally in patients with severe immune complex disease) ( [87](#) ). Patients with deficiency in the early classic pathway complement pathway deficiencies often have autoimmune disease (e.g., systemic lupus erythematosus and rheumatoid arthritis), which in part may be related to the physiologic role of the classic pathway in clearing immune complexes from the circulation ( [87](#) ). Patients with congenital C3 deficiency or acquired C3 deficiency (e.g., liver disease and autoantibodies that stabilize the C3 converting factor C3NEF) have severe bacterial infections as do patients with factor I deficiency ( [88](#) ). Deficiency of late components C5, 6, 7, 8, and 9 and properdin often present with fulminant infections with neisseria.

The CBC and differential will not only pick up patients with bacterial infections secondary to neutropenia, but review of white cell morphology identifies patients with Chédiak-Higashi syndrome ( [89](#) ). Small platelets may suggest a diagnosis of Wiskott-Aldrich syndrome. Persistent neutrophilic leukocytosis is frequently present in patients with leukocyte adhesion deficiency, which can be confirmed by flow cytometric analysis of neutrophils for the CD11b/CD18 (Mac1) ( [90](#), [91](#) ).

If quantitative Igs, CH50, the absolute neutrophil count, and neutrophil morphology are normal in a patient with recurrent bacterial infections, WBC functional studies for chronic granulomatous disease or other enzyme deficiencies are indicated ( [Chapter 64](#) ). The nitroblue tetrazolium test is abnormal in many, but not all, of these defects ( [92](#) ). Flow cytometry for the CD11/CD18 complex is diagnostic of rare patients with leukocyte



adhesion deficiency ( [90](#), [91](#) ). In occasional patients with recurrent bacterial infection, measurement of IgG subclasses or responses to individual antigens (e.g., tetanus and diphtheria) may be helpful ( [92](#) ).

In HIV-negative children with infections suggesting defective cell-mediated immunity (viral, fungal, or mycobacterial), the evaluation begins with the absolute lymphocyte count ( [Chapter 68](#) ). Because 75% of circulating lymphocytes are T cells, moderate lymphopenia implies T-cell lymphopenia. In most forms of severe combined immunodeficiency, such as adenosine deaminase deficiency, both T and B cells are decreased ( [93](#) ). In X-linked severe combined immunodeficiency, T cells are absent whereas B-cell numbers are normal or may be elevated, masking T-cell lymphopenia ( [93](#) ). In DiGeorge syndrome (suggested by hypocalcemia and congenital heart disease), T-cell numbers are decreased whereas B cells are normal or elevated (sometimes masking T-cell lymphopenia) ( [94](#) ). In the bare lymphocyte syndrome in which either class I or class II HLA antigens are observed, the CD8 T-cell subset is decreased in defects involving class I HLA, and CD4 T cells are decreased in defects involving class II ( [95](#) ). Skin testing is of little value in children younger than 1 year because they are unlikely to have previously been exposed to antigen used in testing. In older children and adults, the presence of reactive skin tests to recall antigens virtually excludes a significant defect in cell-mediated immune response.

In HIV-negative adults, acquired defects in cell-mediated immunity with unusual susceptibility to viral, fungal, or mycobacterial infection are most commonly secondary to immunosuppressive therapy or malnutrition. Patients with sarcoidosis and neoplasms, such as Hodgkin disease, may be anergic on skin testing but usually do not develop infection before immunosuppressive therapy ( [96](#), [97](#) ). A rare group of HIV-negative patients with a profound decrease in CD4 T-cell numbers and low CD4/CD8 ratios present with opportunistic infections similar to those seen in AIDS. A second group of HIV-negative patients have CD4 T-cell lymphopenia and normal CD4/CD8 ratios, but do not usually have infection ( [98](#), [99](#) ).

Clinicians should be aware that absolute CD4 T-cell counts used in following HIV-positive patients are affected by several preanalytic factors. New therapies with interleukin-2 or proteasome inhibitors have more dramatic effects on CD4 T-cell counts than were seen with reverse transcriptase inhibitors such as zidovudine ( [100](#), [101](#) ). There is a diurnal and seasonal variation of CD4 T-cell numbers, so ideally the blood should be drawn for analysis at the same time of day ( [102](#) ). In addition, intercurrent viral infections, such as influenza, are associated with lymphopenia, so that testing is best avoided during acute infection and the month after infection ( [103](#) ). A portion of blacks are deficient in an epitope recognized by one of the commercially available CD4 antibodies and may have falsely low CD4 T-cell counts ( [104](#) ). The total lymphocyte count is usually performed by the hematology laboratory on ethylenediaminetetraacetic acid blood and should be performed within 6 hours of drawing the sample. The absolute CD4<sup>+</sup> cell count is the product of the percent CD4 lymphocytes and the total lymphocyte count. Substantial variation in the absolute lymphocyte count is possible if the WBC differential is done manually and less than 400 cells are counted. Management in AIDS patients is directed toward not only improving the CD4 count but also in decreasing the HIV viral load ( [105](#) ).

## SUMMARY

This chapter is a brief overview and introduction to the subsequent chapters in Part VI on nonmalignant disorders of the phagocytic and immune system. A primary objective is



to separate benign from malignant disorders. Identifying a specific defect in the immune system begins with a history and physical examination followed by tests to identify the defect. A single gene mutation may account for a congenital immune deficiency, and prenatal diagnosis may be possible by sex determination *in utero* if X-linked or by fetal blood sampling if the defective gene is known or if characteristic abnormalities in the peripheral blood can be identified. Some of the congenital immune deficiencies, such as severe combined immunodeficiency and its variants, represent medical emergencies. Acquired immune abnormalities, particularly functional asplenia, severe hypogammaglobulinemia, and iatrogenic neutropenia or T-cell deficiency, can also be life threatening. Knowledge of the site of the defect in a host's immune system—whether in the neutrophils, humoral, cell-mediated, or complement arms or combination of defects—is critical in predicting types of infections that can occur and instituting appropriate therapy.

## REFERENCES

1. Ford RJ, Cramer M, Davis FM. Identification of human lymphoma cells by antisera to malignancy-associated nucleolar antigens. *Blood* 1984;63:559-565.
2. Knowles DM II, Tolidian B, Marboe CC, et al. Distribution of antigens defined by OKB monoclonal antibodies on benign and malignant lymphoid cells and on nonlymphoid tissues. *Blood* 1984;63:886-896.
3. Knowles DM, Athan E, Ubricco A, et al. Extranodal noncutaneous lymphoid hyperplasias represent a continuous spectrum of B-cell neoplasia: demonstration by molecular genetic analysis. *Blood* 1989;73:1635-1645.
4. Knowles DM. Immunophenotypic and immunogenotypic approaches useful in distinguishing benign and malignant lymphoid proliferations. *Semin Oncol* 1993;20:583-610.
5. Spencer J, Diss TC, Isaacson PG. Primary B cell gastric lymphoma. A genotypic analysis. *Am J Pathol* 1989;135:557-564.
6. Boggs DR, Wintrobe MM, Cartwright GE. The acute leukemias. *Medicine* 1962;41:163-225.
7. Dabrow MD. Malaria in New Jersey. *N Engl J Med* 1994;331:22-23.
8. Ochs DE, Hnilica S, Moser DR, et al. Postmortem diagnosis of autochthonous acute chagasic myocarditis by polymerase chain reaction amplification of a species-specific DNA sequence of *trypanosoma cruzi*. *Am J Trop Med Hyg* 1996;54:526-529.
9. Ottensen EA. Filariasis now. *Am J Trop Med Hyg* 1989;41[Suppl]:9-17.
10. Caldwell CW, Everett D, McDonald G, et al. Lymphocytosis of CD4 T cells in human ehrlichiosis. *Am J Clin Pathol* 1995;103:761-766.
11. Dao AH. Human babesiosis. *Compr Ther* 1996;22:713-718.
12. Dankner WM, Spector A, Fierer J, Davis CE. *Malassezia* fungemia in neonates and adults: complication of hyperalimentation. *Rev Infect Dis* 1987;9:743-753.
13. Portnoy J, Wolf PL, Webb M, Remington JS. *Candida* blastospores and pseudohyphae in blood smears. *N Engl J Med* 1971;285:1010-1011.
14. Zieve PD, Haghsheenas M, Blanks M. Vacuolization of the neutrophil. *Arch Intern Med* 1966;118:356-357.
15. Venditti A, Del Poeta G, Buccisano F, et al. Minimally differentiated acute myeloid leukemia (AML-M0): comparison of 25 cases with other French-American-British subtypes. *Blood* 1997;89:621-629.
16. Larson RS, McCurley TL. CD4 predicts nonlymphocytic lineage in acute leukemia. Insights from analysis of 125 cases using two-color flow cytometry. *Am J Clin Pathol* 1995;104:204-211.

17. Hurwitz CA, Loken MR, Graham ML, et al. Asynchronous antigen expression in B lineage acute lymphoblastic leukemia. *Blood* 1988;72:299–307.
18. Campana D, Pui CH. Detection of minimal residual disease in acute leukemia: methodologic advances and clinical significance. *Blood* 1995;85:1416–1434.
19. Davey DD, Patil SR, Echternacht H, et al. 8;21 Translocation in acute nonlymphocytic leukemia. Occurrence in M1 and M2 FAB subtypes. *Am J Clin Pathol* 1989;92:172–176.
20. Pui CH, Crist WM, Look AT. Biology and clinical significance of cytogenetic abnormalities in childhood acute lymphoblastic leukemia. *Blood* 1990;76:1449–1463.
21. Yunis JJ, Brunning RD, Howe RB, Lobell M. High-resolution chromosomes as an independent prognostic indicator in adult acute nonlymphocytic leukemia. *N Engl J Med* 1984;311:812–818.
22. Grignani F, Fagioli M, Alcalay M, et al. Acute promyelocytic leukemia: from genetics to treatment. *Blood* 1994;83:10–25.
23. Clark P, Normansell DE. Phenotype analysis of lymphocyte subsets in normal human bone marrow. *Am J Clin Pathol* 1990;94:632–636.
24. Caldwell CW, Poje E, Helikson MA. B-cell precursors in normal pediatric bone marrow. *Am J Clin Pathol* 1991;95:816–823.
25. McCaffrey JA, Rudders RA, Kahn PC, et al. Clinical usefulness of gallium scanning in the malignant lymphomas. *Am J Med* 1976;60:523–530.
26. Gilbert EH, Earle JD, Glatstein E, et al. Indium-III bone marrow scintigraphy as an aid in selecting marrow biopsy sites for evaluation of marrow elements in patients with lymphoma. *Cancer* 1976;38:1560–1567.
27. Lapela M, Leskinen S, Minn HRI, et al. Increased glucose metabolism in untreated non-Hodgkin's lymphoma: a study with positron emission tomography and fluorine 18 fluorodeoxyglucose. *Blood* 1995;86:3522–3527.
28. Greenfield S, Jordan MC. The clinical investigation of lymphadenopathy in primary care practice. *JAMA* 1978;240:1388–1393.
29. Knight PJ, Mulne AF, Vassy LE. When is lymph node biopsy indicated in children with enlarged peripheral nodes? *Pediatrics* 1981;69:391–396.
30. Wittenberg J. Computed tomography of the body. *N Engl J Med* 1983;309:1160–1165.
31. Slap GB, Brooks JS, Schwartz JS. When to perform biopsies of enlarged peripheral lymph nodes in young patients. *JAMA* 1984;252:1321–1326.
32. Case records of the Massachusetts General Hospital. A 24-year-old woman with cervical lymphadenopathy fever and leukopenia. *N Engl J Med* 1997;336:492–499.
33. Shriner KA, Mathisen GE, Goetz MB. Comparison of mycobacterial lymphadenitis among persons infected with human immunodeficiency virus and seronegative controls. *Clin Infect Dis* 1992;15:601–605.
34. Kikuchi M, Yoshizumi T, Nakamura H. Necrotizing lymphadenitis: possible acute toxoplasmic infection. *Virchows Arch A Pathol Anat Histol* 1977;376:247–253.
35. Nieman RB. Diagnosis of Kikuchi's disease [Letter]. *Lancet* 1990;335:295.
36. Kawasaki T, Kosaki F, Okaway S, et al. A new infantile acute febrile mucocutaneous lymph node syndrome (MLNS) prevailing in Japan. *Pediatrics* 1974;54:271–276.
37. Rowley AH, Shulman ST. Kawasaki syndrome. *Pediatr Clin North Am* 1999;46:313–329.

38. Kline TS, Kannan V, Kline IK. Lymphadenopathy and aspiration biopsy cytology. Review of 376 superficial nodes. *Cancer* 1984;54:1076–1081.
39. Johnson PWM, Price CGA, Smith T, et al. Detection of cells bearing the t(14;18) translocation following myeloablative treatment and autologous bone marrow transplantation for follicular lymphoma. *J Clin Oncol* 1994;12:798–805.
40. Williams ME, Zukerberg LR, Harris NL, et al. Mantle cell/centrocytic lymphoma: molecular and phenotypic analysis including analysis of the bcl-1 major translocation cluster by PCR. *Curr Top Microbiol Immunol* 1995;194:341–346.
41. Liu H, Ye H, Ruskone-Fourmesttraux A, et al. T(11;18) is a marker for all stage gastric MALT lymphomas that will not respond to H. pylori eradication. *Gastroenterology* 2002;122:1286–1294.
42. Sukpanichnant S, Vnencak-Jones C, McCurley TL. Determination of B-cell clonality in paraffin-embedded endoscopic biopsy specimens of abnormal lymphocytic infiltrates and gastrointestinal lymphoma by polymerase chain reaction. *Am J Clin Pathol* 1994;102:299–305.
43. Aisenberg AC. Utility of gene rearrangements in lymphoid malignancies. *Ann Rev Med* 1993;44:75–84.
44. Glatstein E, Guernsey JM, Rosenberg SA, Kaplan HS. The value of laparotomy and splenectomy in the staging of Hodgkin's disease. *Cancer* 1969;24:709–718.
45. Hyland CH, Murad TM, Dismukes WE. Evolution of reactive lymphadenopathy into lymphoma over a nine-year period. A clinicopathologic study. *Am J Clin Pathol* 1977;68:606–610.
46. Kissane JM, Gephardt GN. Lymphadenopathy in childhood. Long term follow up in patients with nondiagnostic lymph node biopsies. *Hum Pathol* 1974;5:431–439.
47. Evans HL. Extranodal small lymphocytic proliferation: a clinicopathologic and immunocytochemical study. *Cancer* 1982;49:84–96.
48. Dorfman R, Warnke R. Lymphadenopathy simulating the malignant lymphomas. *Hum Pathol* 1974;5:519–550.
49. McIntyre OR, Ebaugh FG. Palpable spleens in college freshmen. *Ann Intern Med* 1967;66:301.
50. Moeschlen S. Spleen puncture. London: Heinemann, 1951.
51. Shields JW, Hargraves MM. An evaluation of splenic puncture. *Mayo Clin Proc* 1956;31:440.
52. Petersdorf RG, Beeson PB. Fever of unexplained origin: report on 100 cases. *Medicine* 1961;40:1–30.
53. Durack DT. Fever of unknown origin. In: Mackowiak PA, ed. *Fever. Basic mechanisms and management*, 2nd ed. Philadelphia: Lippincott-Raven, 1997:237–249.
54. Knockaert DC, Vanneste LJ, Laurent J, et al. Recurrent or episodic fever of unknown origin: review of 45 cases and survey of the literature. *Medicine* 1993;72:184–196.
55. Kazanjian PH. Fever of unknown origin: review of 86 patients treated in community hospitals. *Clin Infect Dis* 1992;15:968–973.
56. Knockaert DC, Vanneste LJ, Vanneste SB, Bobbaers HJ. Fever of unknown origin in the 1980s: an update of the diagnostic spectrum. *Arch Intern Med* 1992;152:51–55.
57. deKleijn EM, Vandenbroucke JP, van der Meer JW. Fever of unknown origin (FUO). I. A prospective multicenter study of 167 patients with FUO, using fixed epidemiologic entry criteria. *Medicine* 1997;76:392–400.
58. Kejarawal D, Sarkar N, Chakraborti SK, et al. Pyrexia of unknown origin: a prospective study of 100 cases. *J Postgrad Med* 2002;48:155–156.

59. Mackowiak PA, Durack DT. Fever of unknown origin. In: Principles and practice of infectious diseases, 5th ed. Mandell GL, Bennett JE, Dolin R, eds. Philadelphia: Churchill Livingstone, 2000:622–633.
60. Manthous CA. Toward a more thoughtful approach to fever in critically ill patients. *Chest* 2000;117:627–628.
61. Hughes WT, Armstrong D, Bodey GP, et al. Guidelines for the use of antimicrobial agents in neutropenic patients with unexplained fever. *J Infect Dis* 1990;161:381–396.
62. Bissuel F, Leport C, Petrone C, et al. Fever of unknown origin in HIV infected patients: a critical analysis of a retrospective series of 57 cases. *J Intern Med* 1994;236:529–535.
63. Lozano F, Torre-Cisneros J, Santos J, et al. Impact of highly active antiretroviral therapy on fever of unknown origin in HIV-infected patients. *European J Clin Microbiol Infect Dis* 2002;21:137–139.
64. Welte K, Boxer LA. Severe chronic neutropenia: pathophysiology and therapy. *Semin Hematol* 1997;34:267–278.
65. Cunha BA. Fever of unknown origin. *Infect Dis Clin North Am* 1996;10:111–127.
66. Jacoby GA, Swartz MN. Fever of undetermined origin. *N Engl J Med* 1973;289:1407–1410.
67. Miller ML, Szer I, Yogev R, Bernstein B. Fever of unknown origin. *Pediatr Clin North Am* 1995;42:999–1015.
68. Arkwright PD, Abinun M, Cant AJ. Autoimmunity in human primary immunodeficiency disease. *Blood* 2002;99:2694–2702.
69. Centola M, Wood G, Frucht DM, et al. The gene for familial Mediterranean fever, MEFV, is expressed in early leukocyte development and is regulated in response to inflammatory mediators. *Blood* 2000;95:3223–3231.
70. Galon J, Aksentijevich I, McDermott MF, et al. TNFRSF1A mutations and autoinflammatory syndromes. *Curr Opin Immunol* 2000;12:479–486.
71. Drenth JP, Cisset L, Grateau G, et al. Mutations in the gene encoding mevalonate kinase cause hyper-IgD and periodic fever syndrome. International Hyper IgD Study Group. *Nat Genet* 1999;22:178–181.
72. Donowitz GR. Fever in the compromised host. *Infect Dis Clin North Am* 1996;10:129–139.
73. Bissuel F, Leport C, Perrone C, et al. Fever of unknown origin in HIV-infected patients: a critical analysis of a retrospective series of 57 cases. *J Intern Med* 1994;236:529–535.
74. Rosen FS, Cooper MD, Wedgwood RJP. The primary immunodeficiencies. *N Engl J Med* 1995;333:431–440.
75. Buckley RH. Primary immunodeficiency diseases due to defects in lymphocytes. *N Engl J Med* 2000;343:1313–1324.
76. Shearer WT, Paul ME, Smith CW, Huston DP. Laboratory assessment of immune deficiency disorders. *Immunol Allergy Clin North Am* 1994;14:265–299.
77. Manis J, Schwartz RS. Agammaglobulinemia and insights into B cell differentiation. *N Engl J Med* 1996;335:1523–1525.
78. Sneller MC, Strober W, Eisenstein, et al. New insights into common variable immunodeficiency. *Ann Intern Med* 1993;118:720–730.
79. Siegel RL, Issekutz T, Schwaber J, et al. Deficiency of T helper cells in transient hypogammaglobulinemia of infancy. *N Engl J Med* 1981;305:1307–1313.
80. Peal ER, Vogler LB, Okos AJ, et al. B lymphocyte precursors in human bone marrow: an analysis of

- normal individuals and patients with antibody-deficiency states. *J Immunol* 1978;120:1169-1175.
81. Notarangelo LD, Duse M, Ugazio A. Immunodeficiency with hyper-IgM (HIM). *Immunodef Rev* 1992;3:101-122.
  82. Allen RC, Armitage RJ, Conley ME, et al. CD40 ligand gene defects responsible for x-linked hyper-IgM syndrome. *Science* 1993;259:990-993.
  83. Remond-O'Donnell E, Rosen FS, Kenney DM. Defects in Wiskott-Aldrich syndrome blood cells. *Blood* 1996;87:2621-2631.
  84. Matter L, Wilhelm JA, Roth F, Scopfer K. Abnormal humoral immune response to staphylococcus aureus in patients with staphylococcus aureus hyper IgE syndrome. *Clin Exp Immunol* 1986;66:450-456.
  85. di Ematologia D, Regionale O. Infections in chronic lymphocytic leukemia: risk factors, and impact on survival, and treatment. *Leuk Lymph* 1994;13:203-214.
  86. Jacobson DR, Zolla-Pazner S. Immunosuppression and infection in multiple myeloma. In: Wiernik PH, Canellos GP, Kyle RA, Schiffer CA, eds. *Neoplastic diseases of the blood*. New York: Churchill Livingstone, 1991:415-426.
  87. Morgan BP, Walport MJ. Complement deficiency and disease. *Immunol Today* 1991;12:301-304.
  88. Figueroa JE, Densen P. Infectious diseases associated with complement deficiencies. *Clin Microbiol Rev* 1991;4:359-395.
  89. Wolff SM, Dale DC, Clark RA, et al. The Chediak-Higashi syndrome: studies of host defenses. *Ann Intern Med* 1972;76:293-306.
  90. Etzioni A, Doerschuk CM, Harlan JM. Of man and mouse: leukocyte and endothelial adhesion molecule deficiencies. *Blood* 1999;94:3281-3288.
  91. Hibbs ML, Wardlaw AJ, Stacker SA, et al. Transfection of cells from patients with leukocyte adhesion deficiency with an integrin B subunit (CD18) restores lymphocyte function-associated antigen-1 expression and function. *J Clin Invest* 1990;85:674-681.
  92. Heiner DC. Significance of immunoglobulin G subclasses. *Am J Med* 1984;76:1-6.
  93. Voss SD, Hong R, Sondel PM. Severe combined immunodeficiency, interleukin 2 (IL-2), and the IL-2 receptor: experiments of nature continue to point the way. *Blood* 1994;83:626-635.
  94. Driscoli DA, Salvin J, Sellinger B, et al. Prevalence of 22q11 microdeletions in DiGeorge and velocardiofacial syndromes: implications for genetic counseling and prenatal diagnosis. *J Med Genet* 1993;30:813-817.
  95. Lisowska-Groszpiette B, Charron DJ, de Preval C, et al. A defect in the regulation of major histocompatibility complex class II gene expression in human HLA-DR negative lymphocytes from patients with combined immunodeficiency syndrome. *J Clin Invest* 1985;76:381-385.
  96. Thomas PD, Hunninghake GW. Current concepts of the pathogenesis of sarcoidosis. *Am Rev Respir Dis* 1987;135:747-760.
  97. Twomey JJ, Laughter AH, Rice L, Ford R. Spectrum of immunodeficiencies with Hodgkin's disease. *J Clin Invest* 1980;66:629-637.
  98. Smith DK, Neal JJ, Holmberg SD. Unexplained opportunistic infections and CD4+ T-lymphocytopenia without HIV infection. *N Engl J Med* 1993;328:378-379.
  99. Laurence J. T-cell subsets in health, infectious disease, and idiopathic CD4+ T lymphocytopenia. *Ann Intern Med* 1993;119:55-62.
  100. Kovacs JA, Baseler M, Dewar RJ, et al. Increases in CD4 T lymphocytes with intermittent courses of

interleukin-2 in patients with human immunodeficiency virus infection. *N Engl J Med* 1995;332:567-575.

101. Choi S, Lagakos SW, Schooley, Volberding PA. CD4+ lymphocytes are an incomplete surrogate marker for clinical progression in persons with symptomatic HIV infection taking zidovudine. *Ann Intern Med* 1993;118:674-680.

102. Levi F, Canon C, Toulou Y, et al. Seasonal modulation of the circadian time structure of circulating T and natural killer lymphocyte subsets from healthy subsets. *J Clin Invest* 1988;81:407-413.

103. Lewis DE, Gilbert BE, Knight V. Influenza virus infection induces functional alterations in peripheral blood lymphocytes. *J Immunol* 1986;137:3777-3781.

104. Casey TT, Posey DH, McCurley TL. OKT4 epitope deficiency in significant proportions of the black population. A cause for underestimation of helper/suppressor lymphocyte ratios. *Arch Pathol Lab Med* 1986;110:702-704.

105. Mellors JW, Munoz A, Giorgi JV, et al. Plasma viral load and CD4+ lymphocytes as prognostic markers of HIV-1 infection. *Ann Intern Med* 1997;126:946-954.

2004 Lippincott Williams & Wilkins  
John P. Greer, John Foerster, John N. Lukens  
George M. Rodgers, Frixos Paraskevas, Bertil Glader  
Wintrobe's Clinical Hematology

[DEFINITION AND CLASSIFICATION](#)[CLINICAL PRESENTATION](#)[DIFFERENTIAL DIAGNOSIS](#)[Pseudoneutropenia](#)[Acquired Neutropenias](#)[Congenital or Chronic Neutropenias](#)[EVALUATION OF THE PATIENT WITH NEUTROPENIA](#)[GENERAL PRINCIPLES OF MANAGEMENT OF NEUTROPENIA](#)[WEB SITES](#)[REFERENCES](#)

## DEFINITION AND CLASSIFICATION

*Neutropenia* is defined as a significant reduction in the absolute number of circulating neutrophils in the blood. *Agranulocytosis* implies a severe form of neutropenia or total absence of circulating neutrophils. Neutropenia is described by the absolute neutrophil count (ANC), which is calculated by multiplying the total white blood cell count by the percentage of neutrophils plus bands noted on the differential cell count. Normal values are traditionally defined for a given population as the mean  $\pm$  two standard deviations from the mean. Because the human neutrophil count varies by age, sex, race, and other factors (<sup>1</sup>), the lower limits of normal ANC differ somewhat in varied populations. [Table 63.1](#) demonstrates the age-specific white blood cell counts and ANCs from birth to adulthood (see [Appendix A](#)). Normal values also exist for term (<sup>2</sup>) and preterm (<sup>3</sup>) infants. In general, 1500 cells/mm<sup>3</sup> is considered the lower limit of normal ANC for most children and adults and is used to define neutropenia in most populations. Blacks demonstrate slightly lower neutrophil counts than whites, with a lower limit of normal neutrophil counts of 1000 cells/mm<sup>3</sup> (<sup>4</sup>, <sup>5</sup>).

**TABLE 63.1. Normal Neutrophil Counts**

|        | Total Leukocytes |          | Neutrophils |             |
|--------|------------------|----------|-------------|-------------|
|        | Mean             | Range    | Mean        | Range %     |
| Birth  | 22.0             | 9.0–30.0 | 13.2        | 3.6–24.0 60 |
| 1–4 wk | 12.0             | 5.0–21.0 | 4.8         | 2.0–8.4 40  |
| 6 mo   | 11.9             | 6.0–17.0 | 3.8         | 1.0–8.5 32  |
| 1 yr   | 11.4             | 6.0–17.0 | 3.5         | 1.5–8.5 31  |
| 2 yr   | 10.6             | 6.0–17.0 | 3.5         | 1.5–8.5 33  |
| 4 yr   | 9.1              | 5.5–15.5 | 3.8         | 1.5–8.5 42  |
| 6 yr   | 8.5              | 5.0–14.5 | 4.3         | 1.5–8.0 51  |
| 8 yr   | 8.3              | 4.5–13.5 | 4.4         | 1.5–8.0 53  |
| 10 yr  | 8.1              | 4.5–13.5 | 4.4         | 1.8–8.0 54  |

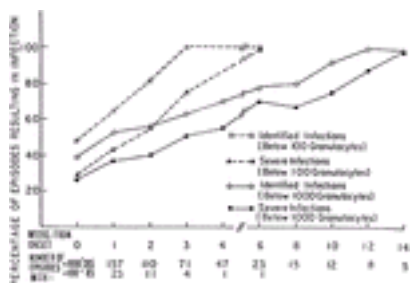


|       |     |          |     |         |    |
|-------|-----|----------|-----|---------|----|
| 16 yr | 7.8 | 4.5–13.0 | 4.4 | 1.8–8.0 | 57 |
| 21 yr | 7.4 | 4.5–11.0 | 4.4 | 1.8–7.7 | 59 |

NOTE: Expressed as cells  $\times 10^3/\text{mm}^3$ ; ranges expressed as 95% confidence limits. Neutrophils include band forms.

Data from Rudolph AM, ed. Rudolph's pediatrics, 19th ed. East Norwalk, CT: Appleton-Lange, 1991:1142; and Miller DR, Baehner RL, eds. Blood diseases of infancy and childhood, 7th ed. St. Louis: Mosby, 1995:39.

Often, neutropenia is classified as mild, moderate, or severe based on the level of ANC. Mild neutropenia corresponds to an ANC between 1000 and 1500 cells/mm<sup>3</sup>, moderate with 500 to 1000 cells/mm<sup>3</sup>, and severe with less than 500 cells/mm<sup>3</sup>. This classification is useful in predicting the risk of severe bacterial infection. In a classic study involving infection risk in patients with neutropenia complicating acute leukemia, Bodey et al. demonstrated that the risk of infection is directly correlated with the degree and duration of neutropenia (6). Figure 63.1, reproduced from Bodey's original report, shows that with ANCs below 100 cells/mm<sup>3</sup>, the infection rate was essentially 100% by 4 weeks of neutropenia, whereas with ANCs up to 1000 cells/mm<sup>3</sup>, three times longer exposure was necessary for comparable infection rates. In fact, with brief episodes of neutropenia (few days to weeks), the risk of serious infection is generally limited to patients with severe neutropenia (7). However, as detailed in the discussions that follow, the best classification of neutropenia is based on the infection history itself. Some patients with quantitatively severe neutropenia have few infections, whereas other patients with less severe neutropenia experience severe and recurrent infections.



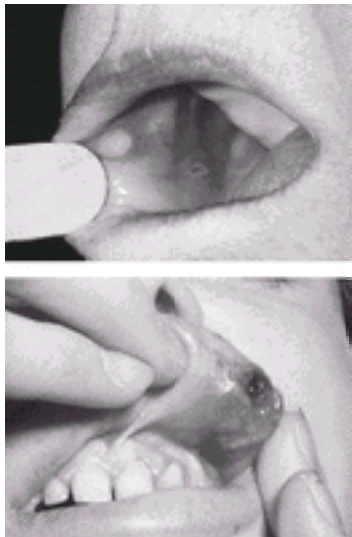
**Figure 63.1.** The effect of duration of neutropenia on the frequency of infection. The duration of neutropenia is plotted against the percentage of episodes resulting in infection. Along the x-axis are recorded the number of episodes of neutropenia (absolute neutrophil count below 1000 cells/mm<sup>3</sup>) or severe neutropenia (absolute neutrophil count below 100 cells/mm<sup>3</sup>) for each time interval. The risk of developing infection is directly related to the severity and duration of neutropenia. (From Bodey GP, Buckley M, Sathe YS, Freireich EJ. Quantitative relationships between circulating leukocytes and infection in patients with leukemia. *Ann Intern Med* 1966;64:328, with permission.)

## CLINICAL PRESENTATION

In 1922, Werner Schultz (8) drew attention to a syndrome of unknown cause observed in middle-aged women and characterized by severe sore throat, prostration, extreme reduction or even complete disappearance of the granulocytes from the blood, and, in

rapid succession, sepsis and death. He called this clinical entity *agranulocytosis*. Detailed reports of similar conditions were previously reported by Brown and Ophuls ( [9](#) ) in 1902 and by Türk ( [10](#) ) in 1907. In recognition of Schultz early work, older references to the fulminate form of severe neutropenia use the eponym *Schultz disease* ( [11](#) ). These early reports document the progressive, fatal nature of severe neutropenia in the preantibiotic era.

Recurrent infections are the hallmark of significant neutropenia, and neutropenia in the absence of infections is not necessarily a disease state. Common sites of infection include the oral cavity and mucous membranes ( [Fig. 63.2](#) ), with mouth ulcers, pharyngeal inflammation, and periodontitis common. The skin is a second sentinel site of infection with rashes, ulcerations, abscesses, and poor wound healing. Perirectal and genital areas are also susceptible to repeated infections. The classic signs of local infection—especially swelling (tumor) and heat (calor)—are less evident in neutropenic patients than in nonneutropenic patients ( [12](#) ). With persistent, severe neutropenia, systemic infections of the lungs, gastrointestinal tract, and bloodstream appear and may prove fatal. Isolated neutropenia does not increase susceptibility to viral or parasitic infections.



**Figure 63.2.** Mucous membrane lesions in neutropenia. Shown are oral ulcerations commonly noted in neutropenic patients. (From Sandoz atlas of clinical hematology. New York: Gower Medical Publishing, 1988, with permission.)

Endogenous bacterial flora are the most common pathogens: *Staphylococcus aureus* from the skin and gram-negative organisms from the gastrointestinal and genitourinary systems. Other rare bacterial pathogens, nosocomial organisms, and fungi are possible pathogens in cases of prolonged severe neutropenia, especially in patients with multiple antibiotic exposure, indwelling catheters, or prolonged hospitalization. As discussed in the section [General Principles of Management of Neutropenia](#), initial and subsequent antibiotic choice must take these epidemiologic features into consideration.

## DIFFERENTIAL DIAGNOSIS

The differential diagnosis of neutropenia includes congenital and acquired, benign and severe disorders and is outlined in [Table 63.2](#). Neutropenia is also a common manifestation of more global marrow defects, such as the aplastic anemias, and acquired

intrinsic marrow defects, such as leukemia and myelodysplasia. These global hematopoietic defects are discussed in [Chapter 44](#). This chapter concentrates on disorders in which neutropenia is an isolated or predominant feature.

**TABLE 63.2. Differential Diagnosis**

---

|  |
|--|
| Pseudoneutropenia                                      |
| Acquired neutropenia                                   |
| Infections   |
| Bacterial  |
| Viral  |
| Protozoal  |
| Rickettsial  |
| Fungal   |
| Drugs and chemicals                                    |
| Nutritional  |
| Cachexia and debilitated states                        |
| Vitamin B <sub>12</sub> and folate deficiencies        |
| Copper deficiency                                      |
| Immune neutropenia                                     |
| Isoimmune neonatal neutropenia                         |
| Chronic autoimmune neutropenia                         |
| T-? lymphocytosis                                      |
| Miscellaneous immunologic neutropenias                 |
| Felty syndrome   |
| Neutropenia associated with complement activation      |
| Dialysis, bypass                                       |
| Extracorporeal membrane oxygenation                    |
| Anaphylactoid shock                                    |
| Splenic sequestration                                  |
| Congenital or chronic neutropenias                     |
| Severe congenital neutropenia (Kostmann syndrome)      |
| Cyclic neutropenia                                     |
| Chronic benign neutropenia                             |
| Familial   |
| Nonfamilial (chronic granulocytopenia of childhood)    |
| Idiopathic chronic severe neutropenia                  |
| Neutropenias associated with congenital immune defects |
| Neutropenia with immunoglobulin abnormality            |
| Neutropenia with defective cell-mediated immunity      |
| Reticular dysgenesis                                   |
| Neutropenias associated with phenotypic abnormalities  |
| Shwachman syndrome                                     |
| Cartilage-hair hypoplasia                              |
| Dyskeratosis congenita                                 |
| Barth syndrome   |
| Chédiak-Higashi syndrome                               |
| Myelokathexis  |

Lazy leukocyte syndrome  
Metabolic disease

---

## Pseudoneutropenia

An obvious initial step in the differential diagnosis of neutropenia is to ensure that the number of circulating neutrophils is actually low. In today's computerized society, many laboratories report white blood cell differential counts generated by automated counters. In all cases in which neutropenia is reported by automated examination, a manual differential white blood cell count is necessary to confirm automated data. Factitious neutropenia can occur if blood cell counts are performed at long periods after blood has been drawn. The presence of paraproteinemia or the use of certain anticoagulants can likewise result in neutrophil clumping and spuriously low neutrophil counts ( 13 ). A final cause of pseudoneutropenia is the asymmetric distribution of circulating neutrophils to the marginated pool ( 14 ).

## Acquired Neutropenias

**INFECTIONS** Arguably, the most common cause of acquired neutropenia is infection. A wide variety of infections are associated with neutropenia ( Table 63.3 ). In many instances, especially with viral infections, the neutropenia develops during the initial 1 to 2 days of illness in association with the peak viremic phase and persists for 3 to 7 days. The severity of neutropenia with common viral infections varies from mild to severe, but because it is usually short-lived, it rarely results in bacterial superinfection. Therefore, although very common, virus-mediated neutropenia is rarely clinically significant. The common mechanisms of virus-induced neutropenia include redistribution of neutrophils from the circulating to the marginating pool, aggregation and sequestration of neutrophils after activation by complement, and destruction of neutrophils by circulating antibodies ( 42 , 43 and 44 ).

### TABLE 63.3. Infections Associated with Neutropenia (Reference)

---

#### Viruses and viral illnesses

- Colorado tick fever ( 15 )
- Cytomegalovirus ( 16 )
- Dengue fever ( 17 )
- Epstein-Barr virus ( 18 )
- Hepatitis virus ( 19 )
- Herpes simplex virus ( 20 )
- Human immunodeficiency virus type I ( 21 )
- Influenza A and B ( 22 )
- Measles ( 23 )
- Mumps ( 24 )
- Parvovirus ( 25 )
- Poliomyelitis ( 26 )
- Psittacosis ( 22 )
- Respiratory syncytial virus ( 22 )
- Roseola ( 26 )
- Rubella ( 27 )
- Sandfly fever ( 28 )

|                                |                      |
|--------------------------------|----------------------|
| Smallpox (                     | <a href="#">26</a> ) |
| Varicella (                    | <a href="#">29</a> ) |
| Yellow fever (                 | <a href="#">30</a> ) |
| Bacterial infections           |                      |
| Brucellosis (                  | <a href="#">31</a> ) |
| Gram-negative septicemia (     | <a href="#">32</a> ) |
| Paratyphoid fever (            | <a href="#">33</a> ) |
| Tuberculosis (                 | <a href="#">34</a> ) |
| Tularemia (                    | <a href="#">35</a> ) |
| Typhoid fever (                | <a href="#">36</a> ) |
| Fungal infections              |                      |
| Histoplasmosis (               | <a href="#">24</a> ) |
| Protozoal infections           |                      |
| Leishmaniasis (                | <a href="#">37</a> ) |
| Malaria (                      | <a href="#">38</a> ) |
| Rickettsial infections         |                      |
| Rickettsial pox (              | <a href="#">39</a> ) |
| Rocky Mountain spotted fever ( | <a href="#">40</a> ) |
| Typhus fever (                 | <a href="#">41</a> ) |

---

A few viruses produce more severe, protracted, and dangerous episodes of neutropenia. Hepatitis B virus, Epstein-Barr virus, and human immunodeficiency virus (HIV) are prime examples. The mechanisms of protracted neutropenia involve direct viral infection and damage of hematopoietic precursor cells, thus impairing production or replacement of granulocytes. Alternatively, autoantibody production of antineutrophil antibodies may result in protracted, infection-mediated neutropenia. HIV infection leads to significant cytopenias, including neutropenia, caused by both of these mechanisms ([45](#)). Severe cytopenias are often a hallmark of worsening HIV infection and present difficult management problems. The hematologic aspects of HIV-1 infection are discussed in detail in [Chapter 69](#). Severe and clinically significant neutropenias are also associated with a number of bacterial, fungal, rickettsial, and protozoal infections ([Table 63.3](#)). Mechanisms of neutropenia in these infections include those discussed for viral infections. Additional mechanisms include direct bone marrow suppression of myelopoiesis by toxins derived from the infectious organisms, depletion of neutrophil marrow stores by release into the circulation, migration of neutrophils to sites of infection, and hastened neutrophil destruction by the infection via complement activation and by infection-mediated decreased myeloid growth factor production ([17](#), [46](#), [47](#)). Bacterial septicemia, particularly with gram-negative organisms, is one of the most serious causes of acquired neutropenia. Bacteremia and endotoxemia lead to increased neutrophil destruction and impaired production by the multitude of processes described in this section ([48](#), [49](#)). Patients with impaired bone marrow reserves, including neonates, the undernourished, alcoholics, and patients recovering from systemic chemotherapy or radiation, are especially prone to neutropenia when severe infection occurs ([50](#)). In these instances, the coexistence of septicemia and neutropenia carries a grave prognosis ([51](#)). The management of neutropenia complicating infection requires good supportive care, as discussed in the section [General Principles of Management of Neutropenia](#). Attention should focus on proper therapy of the underlying infection if an antimicrobial agent is available. In many cases, the neutropenia is short-lived and does not require other specific therapy. In rare cases of progressive, overwhelming bacterial septicemia, especially in neonates, specific supportive therapy with granulocyte colony-stimulating factor (G-CSF) or white blood cell transfusions is indicated ([52](#), [53](#)). If the neutropenia is secondary to

immune-complex-mediated destruction, blockade of autoantibodies with intravenous immunoglobulin (Ig) therapy has proved efficacious ( 54).

**DRUG-INDUCED AGRANULOCYTOSIS AND NEUTROPENIA** The second most common etiology of neutropenia is medication exposure ( Table 63.4). Drugs and chemicals were first associated with agranulocytosis and neutropenia in 1931, when Kracke first noted a history of use of the analgesic aminopyrine (Pyramidon) in patients with agranulocytosis ( 180). Confirmation of the association of aminopyrine use and neutropenia led to the elimination of this agent from clinical use ( 181, 182 and 183). However, the introduction of new drugs into clinical use was followed by the recognition of new cases of drug-induced neutropenia, and today, drug use is undoubtedly a common cause of isolated neutropenia.

**TABLE 63.4. Drugs Associated with Neutropenia (Reference)**

---

Heavy metals

Gold ( 57)

Arsenic compounds ( 58, 59)

Mercury ( 60)

Analgesics and antiinflammatory agents ( 61, 62)

Aminopyrine ( 63)

Dipyron ( 64)

Phenylbutazone ( 65)

Indomethacin ( 66)

Ibuprofen ( 67)

Acetylsalicylic acid, diflunisal, sulindac ( 68)

Tolmetin ( 69)

Benoxaprofen ( 70)

Barbiturates ( 71)

Mesalazine ( 72)

Quinine ( 73)

Antipsychotics, antidepressants, neuropharmacologic agents

Phenothiazines (chlorpromazine, methylpromazine, mepazine, promazine, thioridazine, prochlorperazine, trifluoperazine, trimeprazine) ( 74, 75)

Clozapine ( 76)

Risperidone ( 77)

Imipramine, desipramine ( 78)

Diazepam, chlordiazepoxide ( 79)

Amoxapine ( 80)

Meprobamate ( 68)

Thiothixene ( 81)

Haloperidol ( 82)

Riluzole ( 83)

Olanzapine ( 84)

Anticonvulsants

Valproic acid ( 85)

Phenytoin ( 86)

Trimethadione ( 87)

Mesantoin ( 88)

Ethosuximide ( 89)

Carbamazepine ( 90)

Lamotrigine ( 91)

Antithyroid drugs ( 92)

Thiouracil ( [93](#), [94](#))  
Propylthiouracil ( [95](#))  
Methimazole ( [96](#))  
Carbimazole ( [97](#))  
Potassium perchlorate ( [98](#))  
Thiocyanate ( [98](#))

#### Cardiovascular drugs

Procainamide ( [99](#))  
Captopril ( [100](#))  
Aprindine ( [55](#))  
Propranolol ( [101](#))  
Hydralazine ( [102](#))  
Methyldopa ( [103](#))  
Quinidine ( [104](#))  
Diazoxide ( [105](#))  
Nifedipine ( [106](#))  
Propafenone ( [107](#))  
Ticlopidine ( [108](#))  
Vesnarinone ( [109](#))  
Enalapril ( [110](#))  
Amiodarone ( [111](#))

#### Antihistamines

Cimetidine ( [112](#))  
Ranitidine ( [113](#))  
Tripeleminamine (pyribenzamine) ( [114](#))  
Methaphenilene ( [115](#))  
Thenalidine ( [116](#))  
Brompheniramine ( [117](#))  
Mianserin ( [118](#))

#### Antimicrobials ( [119](#))

Penicillins ( [120](#), [121](#) and [122](#))  
Cephalosporins ( [123](#))  
Vancomycin ( [124](#))  
Chloramphenicol ( [125](#))  
Gentamicin ( [126](#))  
Clindamycin ( [127](#))  
Doxycycline ( [128](#))  
Flucytosine ( [129](#))  
Nitrofurantoin ( [130](#))  
Novobiocin ( [131](#))  
Minocycline ( [132](#))  
Griseofulvin ( [56](#))  
Lincomycin ( [133](#))  
Metronidazole ( [134](#))  
Rifampin ( [135](#))  
Isoniazid ( [136](#))  
Streptomycin ( [137](#))  
Thiacetazone ( [138](#))  
Mebendazole ( [139](#))



Pyrimethamine ( [140](#))  
 Levamisole ( [141](#))  
 Ristocetin ( [142](#))  
 Sulfonamides ( [143](#))  
 Antimalarials (chloroquine, hydroxychloroquine, quinacrine) ( [144](#))  
   Ethambutol ( [145](#))  
   Dapsone ( [146](#))  
   Ciprofloxacin ( [147](#))  
   Trimethoprim ( [148](#))  
   Imipenem/cilastatin ( [149](#))  
 Antivirals [zidovudine ( [150](#)), fludarabine ( [151](#)), acyclovir ( [152](#)), ganciclovir ( [153](#))]  
   Terbinafine ( [154](#))  
 Miscellaneous  
   Allopurinol ( [155](#))  
   Colchicine ( [156](#))  
   Aminoglutethimide ( [157](#))  
   Famotidine ( [158](#))  
   Bezafibrate ( [159](#))  
   Flutamide ( [160](#))  
   Tamoxifen ( [161](#))  
   Penicillamine ( [162](#))  
   Retinoic acid ( [163](#))  
   Metoclopramide ( [164](#))  
   Phenindione ( [165](#))  
   Dinitrophenol ( [166](#))  
   Ethacrynic acid ( [167](#))  
   Dichlorodiphenyltrichloroethane ( [168](#))  
   Cinchophen ( [169](#))  
   Antimony ( [170](#))  
   Pyrithyldione ( [171](#))  
   Rauwolfia ( [172](#))  
   Ethanol ( [173](#))  
   Oral hypoglycemic agents (chlorpropamide, tolbutamide) ( [174](#))  
   Thiazide diuretics ( [103](#))  
   Spironolactone ( [175](#))  
   Methazolamide ( [176](#))  
   Acetazolamide ( [177](#))  
   Intravenous immunoglobulin ( [178](#))  
   Omeprazole ( [179](#))  
   Levodopa ( [56](#))

Modified from Young NS. Agranulocytosis. JAMA 1994;271:935; and Vincent PC. Drug-induced aplastic anemia and agranulocytosis. Drugs 1986;31:52.

---

Many drugs, chemicals, and toxins produce hematopoietic toxicity, including neutropenia. With some, blood dyscrasias occur in all patients given the drug for sufficient time or in sufficient dose (e.g., the cancer chemotherapy agents). Because these agents rarely produce isolated neutropenia, but instead pancytopenia, they are discussed in [Chapter 73](#). This section and [Table 63.4](#) emphasize agents reported to cause isolated neutropenia and agranulocytosis unpredictably or in a minority of exposed patients. The pattern of

association of drugs with the development of agranulocytosis or neutropenia is familiar and well described in this passage by John W. Athens from the ninth edition of this textbook:

A new agent is described and in a few years it is widely used. At first, it is hailed as being nontoxic; ultimately a report appears describing the development of agranulocytosis in association with its use. This description is followed by another case, and another, and the circumstantial evidence becomes impressive. The drug loses popularity and is used with greater discrimination. The number of cases of agranulocytosis related to use of this agent decreases sharply, only to be replaced by other cases as new drugs are added to the therapeutic regimen.

The drugs listed in [Table 63.4](#) are associated with the development of neutropenia or agranulocytosis. The list is probably incomplete, and in many cases, assignment of cause and effect to the temporal association of medication use and development of neutropenia is uncertain. The true incidence of drug-induced neutropenia is indeterminate because of variations in definition of agranulocytosis and neutropenia and inherent under-reporting. The best estimates of annual incidence come from the 10-year nationwide study in Sweden that predicted an annual incidence of drug-induced neutropenia of 1.0 case per million population per year ([184](#)), from a 5-year Dutch study that demonstrated an annual incidence between 1.6 and 2.5 cases per million ([185](#)), and from the International Aplastic Anemia and Agranulocytosis study, which found an overall incidence of all causes of agranulocytosis of 3.4 cases per million per year ([186](#)). Because a majority of cases of agranulocytosis are drug related, comparison of these estimates reveals close correlation. These estimates reflect the more severe forms of drug-induced neutropenia and thus underestimate the incidence of milder forms. The incidence is higher in women and the elderly, perhaps reflecting more frequent medication use or other genetic or physiologic traits in these populations. Several pathogenetic mechanisms for drug-induced neutropenia are postulated or supported by experimental evidence. These mechanisms include immune-mediated destruction of granulocytes or granulocytic precursors, dose-dependent inhibition of granulopoiesis, and direct toxic effect on myeloid precursors or the marrow microenvironment. With a given drug exposure, these mechanisms are not mutually exclusive. However, for categorization and descriptive purposes, representative agents in each category are discussed. Immune-mediated drug-induced neutropenia may occur by two mechanisms. In one mechanism, characteristic of neutropenia and agranulocytosis secondary to aminopyrine, penicillin, propylthiouracil, antithyroid drugs, and gold, the agent acts as a hapten to induce antibody formation, complement fixation, and neutrophil destruction. Physical presence of the drug is required to induce neutropenia, and antineutrophil antibodies are often identified by *in vitro* studies only when the drug is also present ([187](#), [188](#)). In a second immunologic mechanism, manifested by quinidine-induced neutropenia, circulating immune complexes are formed in response to the inducing drug. These immune complexes bind to neutrophils and result in granulocyte destruction. Once formed, the immune complexes do not require continued drug presence for destruction, and *in vitro* antineutrophil antibodies are often present even in the absence of the inducing drug ([104](#)). Another mechanism of drug-induced neutropenia is a dose-dependent inhibition of granulopoiesis. This mechanism is documented for  $\beta$ -lactam antibiotics ([189](#)), carbamazepine ([190](#)), and valproic acid ([85](#)). In one representative study, valproic acid was added at varying concentrations to normal donor marrow cells and colony-forming units granulocyte-macrophage (CFU-GM), quantified, and compared to controls in soft agar and plasma clot assays. At valproic acid concentrations of 60  $\mu\text{g}/\text{ml}$  (mimicking low serum therapeutic levels), CFU-GM production was decreased  $26 \pm 4\%$ . At concentrations of 120 and 240  $\mu\text{g}/\text{ml}$ , CFU-GM production was inhibited by  $67 \pm 15\%$  and  $84 \pm 27\%$ , respectively ([85](#)). Both valproic acid and carbamazepine induce inhibition of CFU-GM in nearly all marrow samples at high

concentration. However, the effects are more variable at lower drug concentrations, perhaps explaining patient-to-patient variability noted in clinical studies. The third general mechanism of drug-induced agranulocytosis and neutropenia is direct damage to the bone marrow micro-environment or myeloid precursor cells by the drug or a drug metabolite. In a few cases, genetic or acquired factors predispose to toxicity with drug exposure. With sulfasalazine, individuals who inherit the slow-acetylator phenotype are at increased risk for agranulocytosis (191). Jewish people exhibit greater susceptibility to levamisole-mediated neutropenia (192). Captopril-induced agranulocytosis is more common in patients with renal insufficiency (193). These genetic predispositions probably relate to inherent differences in drug or drug metabolite clearance or metabolism. The granulocytopenia associated with phenothiazine use is based on a cumulative dose-dependent inhibition of granulopoiesis after 3 to 4 weeks of therapy (194). With chlorpromazine, the effect is based on inhibition of nucleic acid synthesis in myeloid precursor cells (195). The time of onset of drug-induced neutropenia is variable and depends in part on the mechanism of neutropenia. With immune-mediated neutropenia, the onset is rapid (hours to 1 to 2 days), especially in patients with previous drug exposure and prior antibody production (196). In contrast, agents that produce direct marrow suppression or toxicity often have delayed onset (weeks) of neutropenia (194, 195). The duration of neutropenia is also variable for the same reasons, with a range of 3 to 56 days (mean, 12 days) in one study (197). Bone marrow findings in drug-induced neutropenia are nonspecific and depend on the underlying pathophysiology. The bone marrow may manifest myeloid hypocellularity with neutrophil maturation arrest or hypercellularity with increased myeloid precursors (198). Diagnosis of drug-induced agranulocytosis or neutropenia is based on recognition of neutropenia during or immediately after drug exposure. Table 63.5 shows relative risk calculations for the most frequently invoked drugs and chemicals. Specific therapy for the drug-induced neutropenias begins with discontinuation of the suspect drug or agent. Supportive care follows the general principles of support outlined elsewhere in this chapter. In severe cases failing to respond to removal of the offending drug, treatment with recombinant human G-CSF is indicated and often effective (199).

**TABLE 63.5. Risks of Agranulocytosis Associated with Select Drugs**

| Drug                          | Multivariant Relative Risk Estimate | Excess Risk <sup>a</sup> |
|-------------------------------|-------------------------------------|--------------------------|
| Antithyroid drugs             | 97.0                                | 5.30                     |
| Macrolides                    | 54.0                                | 6.70                     |
| Procainamide                  | 50.0                                | 3.10                     |
| Aprindine                     | 49.0                                | 2.70                     |
| Dipyron                       | 16.0                                | 0.60                     |
| Trimethoprim-sulfamethoxazole | 16.0                                | 1.70                     |
| Thenalidine                   | 16.0                                | 2.40                     |
| Carbamazepine                 | 11.0                                | 0.60                     |
| Digitalis                     | 2.5-9.9                             | 0.10-0.30                |
| Indomethacin                  | 6.6                                 | 0.40                     |
| Sulfonylureas                 | 4.5                                 | 0.20                     |
| Corticosteroids               | 4.1                                 | —                        |
| Butazones                     | 3.9                                 | 0.20                     |
| Dipyridamole                  | 3.8                                 | 0.20                     |
| β-Lactams                     | 2.8                                 | 0.20                     |
| Propranolol                   | 2.5                                 | 0.10                     |
| Salicylates                   | 2.0                                 | 0.06                     |

<sup>a</sup> Excess risk is expressed as number of cases per 1 million users in 1 week.

Data from the International Agranulocytosis and Aplastic Anemia Study. Risks of agranulocytosis and aplastic anemia. A first report of their relation to drug use with special reference to analgesics. International Agranulocytosis and Aplastic Anemia Study. JAMA 1986;256:1749.

---

**NUTRITIONAL CAUSES OF NEUTROPENIA** Severe, generalized nutritional deficiencies occurring in the setting of starvation, anorexia nervosa, marasmus, or cachexia may produce pancytopenia or selective hematologic defects including neutropenia ( 200 , 201 , 202 and 203 ). The pathogenesis is usually impaired blood cell production caused by lack of protein building blocks. Megaloblastic pancytopenia results from deficiencies of vitamin B<sub>12</sub> or folic acid. Lack of these essential cofactors interferes with nucleic acid synthesis of myeloid precursors in the bone marrow and results in ineffective granulopoiesis ( 204 ). One morphologic hallmark of megaloblastic granulopoiesis is hypersegmented polymorphonuclear leukocytes with a lobe count of more than five per cell common. The administration of folic acid antagonists (trimethoprim–sulfamethoxazole, methotrexate) may mimic nutritional deficiencies. Copper deficiency is also reported to cause neutropenia ( 205 ), although the mechanism remains incompletely defined ( 206 ).

**IMMUNE CAUSES OF NEUTROPENIA** Neutropenia may result from the presence of specific antineutrophil antibodies that mediate destruction either by splenic sequestration of opsonized cells or by complement–mediated neutrophil lysis. Immune–mediated neutropenia is analogous to similar disorders of the platelet (immune thrombocytopenic purpura; see Chapter 53) and the red blood cells (immune hemolytic anemia; see Chapter 35 and Chapter 36). Selective immune–mediated neutropenia results from the presence and expression of unique neutrophil–specific antigens not shared with other hematopoietic cells. The most common and best characterized neutrophil–specific antigens are shown in Table 63.6 ( 207 , 208 and 209 ). Neutrophils also express HLA antigens and several erythrocyte antigens, including the Kx antigen of the McLeod system ( 210 ). The leukocyte integrins CD11/CD18 are identified as autoantibody targets in some cases of neutropenia ( 211 ). Each of these antigenic determinants is associated with cases of immune neutropenia; in fact, most neutrophil–specific antigens have been identified through the investigation of immune neutropenia. The structure of several of the specific neutrophil antigens is known. For example, NA1 and NA2 are both isoforms of a neutrophil Fc receptor ( 212 ). Other antigens are identified only by molecular weight or remain unidentified ( 213 ).

**TABLE 63.6. Human Neutrophil–Specific Antigens**

| Antigen Phenotype | Frequency (%) |
|-------------------|---------------|
| NA1               | 54            |
| NA2               | 93            |
| NB1               | 92            |
| NC1               | 96            |
| ND1               | 99            |
| NE1               | 23            |
| 9A                | ?             |

Immune neutropenia may occur as an isolated condition involving mature neutrophils only, as a myeloid–specific neutropenia manifested by absence of some or all myeloid forms, or in association with other cytopenias. Autoimmune neutropenia is also classified as

primary, if neutropenia is the sole abnormality, or secondary, if the neutropenia is a manifestation of a broader autoimmune condition. The clinical presentation depends on the lineage distribution of the antigen targeted by the autoantibody ( 214, 215 ). Recent studies suggest that in primary autoimmune neutropenia, the neutrophil autoantibody is specific for a single NA isoform, whereas in secondary autoimmune neutropenia, the antibodies react with all NA isotypes (panantibodies) ( 216 ). Another key determinant of the clinical course is whether the antineutrophil antibody is of restricted or nonrestricted clonality ( 210 ). Autoantibodies produced during the course of immune reaction to another foreign antigen by chance cross-reactivity are polyclonal in nature and thus are composed of mixtures of  $\alpha$ - and  $\beta$ -light chain Igs. This is the usual pattern in self-limited neutropenias after or associated with infections or medication exposure. In contrast, antibodies associated with the loss of suppression of a clone of cells reacting with autoantigens are produced from a single clone (monoclonal) and express a single light-chain type. Monoclonal autoantibodies imply a more fundamental defect of the immune system and predict a longer and more severe degree of neutropenia. An example of neutropenia caused by neutrophil antibodies of restricted clonality is that associated with Graves disease ( 217 ), an autoimmune disease in its own right. Lalezari reported the first demonstration of circulating antibodies reactive against neutrophil-specific antigens in neutropenic patients in 1975 ( 218 ). Since that initial report, the methodology available to detect antineutrophil antibodies has markedly improved, allowing much of the progress in understanding the pathophysiology and antigenic targets of immune neutropenia. Table 63.7, adapted from reference 210, lists several methods used to detect antineutrophil antibodies. In general, antibodies can be detected directly on the neutrophil surface, or the effect of antibody binding to the neutrophil can be determined by indirect methods. Each method has its own strengths and weaknesses ( 201, 219 ), a discussion too complex for this text. Further, technology continues to change and improve, and the superiority of one method today may not persist in the future. It is important to recognize the complexity and pitfalls of neutrophil antibody testing and invoke the help of expert laboratories when studying or evaluating specific patients.

**TABLE 63.7. Methods to Detect Antineutrophil Antibodies**

| Category                           | Method                          |
|------------------------------------|---------------------------------|
| Detection of neutrophil surface Ig | Radiolabeled                    |
|                                    | Anti-IgA                        |
|                                    | Protein A                       |
|                                    | Anti-IgM                        |
|                                    | Intact staphylococci            |
|                                    | Immunofluorescence              |
|                                    | Flow cytometry                  |
| Detection of antibody effects      | Enzyme-linked immunoassays      |
|                                    | Agglutination                   |
|                                    | Opsonization                    |
|                                    | Complement activation           |
|                                    | Antibodies to C3                |
|                                    | Cytotoxicity                    |
|                                    | Antibody-dependent cytotoxicity |

Ig, immunoglobulin.

Modified from Shastrik KA, Logue GL. Autoimmune neutropenia. *Blood* 1993;81:1984.

Immune-mediated neutropenia is clinically similar to other forms of acquired neutropenia.

The ANC is usually below 500 cells/mm<sup>3</sup>. Bone marrow examination reveals variable results dependent on the lineage specificity of the antibody. In general, however, the bone marrow is hypercellular or normocellular and lacking in mature neutrophils ( 220 ). Only the finding of antineutrophil antibodies distinguishes cases of immune-mediated disease. Antineutrophil antibodies are involved in the pathophysiology of neutropenias occurring in several settings, including infection, drug exposure, and immune deficiencies. Each of these clinical presentations is discussed elsewhere. In addition, three distinct disorders in which the neutropenia is specifically caused by characteristic immune mechanisms are discussed here: isoimmune neonatal neutropenia, chronic autoimmune neutropenia, and T-? lymphocytosis.

***Isoimmune Neonatal Neutropenia*** Isoimmune neonatal neutropenia is the neutrophil equivalent of Rh hemolytic disease of the newborn. During gestation, the mother is sensitized to antigens on fetal neutrophils that are not shared by the mother, resulting in production of IgG antineutrophil antibody able to cross the placenta and sensitize fetal neutrophils. The incidence is estimated at 3% of live births ( 221 ). The antigenic targets are those described earlier. The maternal neutrophils do not express the reactive antigen, but the father's neutrophils do. Thus, identification and characterization of the antibody are often aided by study of the father's neutrophils. Clinical manifestations include fever soon after birth, pneumonia, skin infections, urinary infections, and septicemia. Pathogens are those of the neonatal period and include gram-negative organisms, *S. aureus*, and group B *Streptococcus*. Neutropenia is especially dangerous in this age group because of the intrinsic risk of neonatal and perinatal infection. Deaths from overwhelming septicemia are reported ( 222 ). The duration of the neutropenia is related to the lifespan of the transplacentally conveyed Ig. The average duration of neutropenia is 7 weeks, but a range of 2 to 17 weeks is reported ( 223 ). The treatment of isoimmune neonatal neutropenia is primarily supportive, with antibiotic therapy chosen based on the clinical presentation and suspected pathogens. In life-threatening infections, other therapies including plasma exchange to remove the offending antibodies ( 224 ), transfusion of maternal neutrophils [which by definition lack the immunogenic antigen ( 225 )], intravenous Ig ( 226 ), or G-CSF ( 227 ) have been used individually or in combination.

***Chronic Autoimmune Neutropenia*** In a subset of cases of chronic neutropenia, antineutrophil antibodies are identified that are presumed to have pathophysiologic significance. Age of onset varies from the neonatal period ( 228 ) to older than 70 years ( 229 ). These cases of antibody-mediated neutropenia are analogous to autoimmune hemolytic anemia or chronic immune thrombocytopenic purpura. Like these two more common immunologic diseases, the autoimmune process may be short-lived with benign clinical sequelae or may be associated with a more generalized autoimmune disorder having a prolonged course. Several disease states are associated with autoimmune neutropenia, including Wegener's granulomatosis, rheumatoid arthritis, systemic lupus erythematosus, and chronic hepatitis ( 230 ). These generalized autoimmune diseases are distinct from isolated autoimmune neutropenia. Autoimmune neutropenia of infancy and childhood is becoming more common. The estimated incidence in one study was 1 in 100,000 population per year in the age range of 6 months to 10 years. In contrast to isoimmune neonatal neutropenia, the infection risk appears to be less. Most patients manifest only mild infections, including otitis media, gastroenteritis, or cellulitis.

Importantly, many of these children regain normal neutrophil numbers with time ( 231 ). Chronic autoimmune neutropenia is often recognized in adults of all ages. As many as 36% of adults with chronic idiopathic neutropenia have antineutrophil antibodies in the serum ( 232 ). Unless, as discussed previously, the neutropenia is a manifestation of a global autoimmune disorder, the problem is usually not life-threatening. Skin and lower respiratory infections predominate ( 233 ). Management decisions in autoimmune neutropenia are based on the presence or absence of associated autoimmune processes. Supportive care is indicated. If the immune neutropenia is isolated, specific therapy is usually not indicated because of the typically benign natural history. However, if the



autoimmune neutropenia is one manifestation of a more generalized autoimmune disorder, specific therapy for the autoimmune illness is indicated. Corticosteroids are used to treat many immune-mediated cytopenias, including neutropenia ( 234 ). The primary mechanism of action of corticosteroids is decreased antibody production and reticuloendothelial blockade. Corticosteroids are not as effective in all types of immune neutropenia and should be prescribed with caution and understanding of the pathophysiology of the underlying defect.

**T-? Lymphocytosis** *T-? lymphocytosis* describes a group of patients with a syndrome of autoimmune neutropenia (and at times, thrombocytopenia and anemia as well) in association with infiltration of the bone marrow with large granular lymphocytes ( 235 ). *In vitro* evaluation of the lymphocytes and autoantibody reveals a clonal disorder of cytotoxic/suppressor T lymphocytes. This clonality identifies this syndrome as leukemia of large granular lymphocytes ( 236 ). The T-? lymphocytosis is also associated with other autoimmune diseases, including rheumatoid arthritis ( 237 ). The antineutrophil antibody associated with large granular lymphocytes or T-? lymphocytosis is usually high titer and complement activating, so the neutropenia is usually severe and long lived. Treatment in this disorder is directed not only at management and prevention of bacterial infections but also toward eradication or correction of the clonal disorder. Splenectomy has been used with some success in reducing infection risk and correcting the neutropenia but does not affect the lymphocytic infiltration ( 238 ). Corticosteroids have not produced good responses in this disorder and actually increase infection risk ( 239 ). G-CSF ( 240 ), cytotoxic chemotherapy, plasmapheresis ( 241 ), and cyclosporine ( 242 ) are all reported to have therapeutic benefit.

**Miscellaneous Immunologic Neutropenias** Autoimmune neutropenias also are reported after bone marrow transplantation and in association with reactions to transfused blood products. After bone marrow transplantation, autoantibodies directed against neutrophils develop in a minority of cases. The process of marrow transplantation, graft-versus-host prophylaxis, or treatment of manifestations of the underlying disease process all are potential immunomodulatory events equally able to result in autoantibody production ( 243 ). Nearly all cellular blood products are contaminated with neutrophils. With repeated transfusion, the recipient may become sensitized to antigens on the neutrophil surface (typically HLA antigens). Subsequent transfusion with blood products containing neutrophils of identical antigenic type may result in immunologic reaction, neutrophil damage, and occasionally complement fixation. If the antineutrophil antibody is directed against HLA antigens shared by the host, the circulating antibody may result in sufficient damage to host neutrophils to cause neutropenia ( 244 , 245 ).

**FELTY SYNDROME** *Felty syndrome* is the eponym used to describe the triad of rheumatoid arthritis, splenomegaly, and neutropenia ( 246 ). Patients with Felty syndrome are at increased risk of infection, with the risk related in large measure to the severity of neutropenia ( 247 ). The pathophysiology of neutropenia in Felty syndrome is multifactorial. Destruction of neutrophils by antineutrophil autoantibodies ( 248 ) or immune complexes ( 249 ) plays a key role. Defective cell-mediated immunity with resultant T-lymphocyte-mediated immune destruction is also theorized ( 250 ). A further mechanism of accelerated neutrophil destruction is the splenomegaly itself ( 251 ). Finally, a neutrophil production defect manifested by defective granulopoiesis is reported ( 252 ). As expected, therapeutic interventions for this multifactorial disease process are many. Splenectomy is the oldest therapy, with the first reported use in 1932 ( 253 ). Initial response to splenectomy may approach 90%, but neutropenia recurs at a later date in 10 to 20% ( 254 , 255 ). In one series, the postoperative mortality rate was 4% ( 255 ). This fact must be kept in mind when considering splenectomy, especially in light of newer therapeutic options.

Treatment of the underlying rheumatoid arthritis with gold therapy ( 256 ), D-penicillamine ( 257 ), cyclosporine ( 258 ), or other cytotoxic drugs ( 259 ) may be beneficial. Plasmapheresis



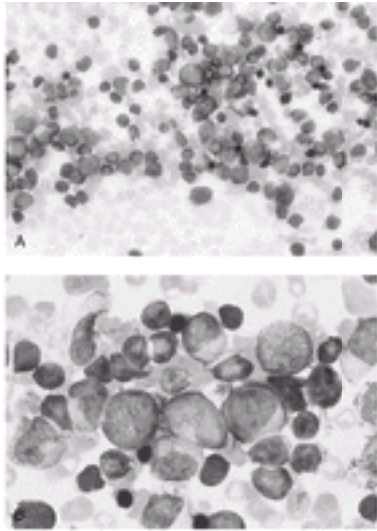
has also been used with some success ( [260](#) ). Cortico-steroids ( [261](#) ) and intravenous Ig ( [262](#) ) have proved less useful. The hematopoietic growth factors granu-locyte-macrophage colony-stimulating factor (GM-CSF) and G-CSF are often reported as successful in ameliorating the neutropenia and infection risk ( [263](#) , [264](#) and [265](#) ). The preferred growth factor and duration of therapy remain incompletely defined ( [266](#) ). One important risk to consider with growth factor therapy of Felty syndrome is the effect of such therapy on the underlying autoimmune disease, rheumatoid arthritis. In several cases, arthritis symptoms are exacerbated during growth factor treatment ( [263](#) , [267](#) ).

**NEUTROPENIA ASSOCIATED WITH COMPLEMENT ACTIVATION** The exposure of blood to artificial membranes used in medical procedures including dialysis ( [268](#) ), cardiopulmonary bypass ( [269](#) ), apheresis ( [270](#) ), and extracorporeal membrane oxygenation ( [271](#) ) may result in complement activation *in vivo* ( [272](#) ). The complement is typically C3a or C5a produced by the classic complement activation pathway ( [273](#) , [274](#) ). Complement activation induces neutrophil aggregation and adherence to endothelial surfaces (often in the lung) with resultant neutropenia and cardiopulmonary symptoms ( [275](#) ). The onset of symptoms is soon after blood exposure to the membrane. The effect is transient but may result in severe symptoms. In hemodialysis, the incidence of this effect may be as high as 20% ( [276](#) ). The neutropenia of anaphylaxis manifests a similar pathophysiology.

**SPLENIC SEQUESTRATION** Enlargement of the spleen, irrespective of etiology, may result in neutropenia ( [277](#) ). The reduction in neutrophil number results from splenic trapping and destruction and often is mirrored by similar degrees of anemia and thrombocytopenia. The severity of neutropenia relates to the size of the spleen and the bone marrow's response to the call for increased production. Rarely is the neutropenia alone severe enough to cause severe infection. Therapy should be directed at correcting the underlying cause of the splenomegaly.

## Congenital or Chronic Neutropenias

**SEVERE CONGENITAL NEUTROPENIA (KOSTMANN SYNDROME)** In 1956, Kostmann reported severe congenital neutropenia (SCN) in nine families in a remote, isolated region of northern Sweden ( [278](#) ). He named the disorder *infantile genetic agranulocytosis*. The syndrome is also known as *SCN* or *Kostmann syndrome*. In the highly inbred population initially described by Kostmann, consanguinity was common and the inheritance pattern probably autosomal-recessive ( [279](#) ). Similar cases of this disorder are reported from other geographic regions, where they are apparently sporadic in nature or follow autosomal-dominant modes of inheritance. The clinical presentation is remarkably consistent ( [278](#) , [279](#) ). The predominant manifestation is recurrent bacterial infections with the onset in early infancy in association with persistent severe agranulocytosis. Common initial bacterial infections include skin and soft tissue abscesses, boils and sores, omphalitis, otitis media, pneumonia, gingivitis, and urinary infections. The oral cavity and perirectal area are especially common sites of infection. The infections begin very early (often in the first days or weeks of life). Nearly all cases are apparent by 3 months of age. Fatal infections include septicemia, peritonitis, and enteritis. In initial reports, death from overwhelming infection occurred in infancy or early childhood. The most common bacterial pathogens are *S. aureus*, *Escherichia coli*, and *Pseudomonas aeruginosa*. Granulocytopenia is universally severe, with the ANC typically less than  $0.2 \times 10^9/L$ . In many cases, no mature granulocytes are seen. Compensatory monocytosis is a common associated finding with or without variable degrees of eosinophilia. Bone marrow findings are typified by a myeloid maturation arrest at the promyelocyte-myelocyte stage ( [Fig. 63.3](#) ). There is a marked absence of mature granulocyte forms. Early reports noted prominent vacuoles in the myeloid progenitors that were present, although the etiology and significance of the vacuoles remain unclear ( [280](#) ).



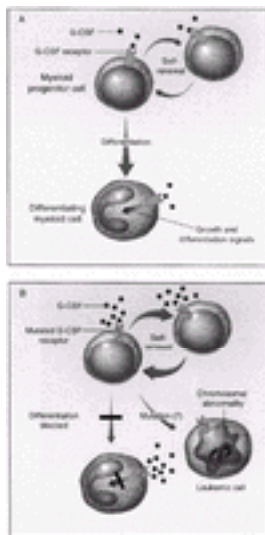
**Figure 63.3.** Bone marrow findings in severe congenital neutropenia (Kostmann neutropenia). Shown are a low-power view ( $\times 40$ ) (A) and a high-power view ( $\times 100$ ) (B) of a bone marrow aspiration from a child with severe congenital neutropenia. Note a cellular specimen with an apparent maturation arrest of myeloid differentiation at the promyelocyte stage. See [Color Plate](#). (Photomicrographs courtesy of David Kelly, M.D.)

The underlying basis and pathophysiology remain incompletely defined despite aggressive global studies. As discussed in [Chapter 6](#) and [Chapter 10](#), myeloid maturation and differentiation depend on several cytokines with G-CSF, the most prominent and myeloid specific. G-CSF interacts with myeloid progenitor cells via specific high-affinity G-CSF receptors. The events after G-CSF binding to the G-CSF receptor that lead to myeloid maturation and differentiation remain incompletely defined. However, it is precisely these postbinding signal transduction pathways that appear to be dysfunctional in the SCNs. This assumption is based on the following findings:

- Normal numbers of myeloid colony-forming cells are found in the blood and bone marrow of affected patients, which fail to mature *in vitro* ([281](#), [282](#)).
- The addition of extrinsic G-CSF to marrow cultures from patients with SCN results in normalized differentiation of myeloid colonies, although the concentrations of G-CSF required are higher than those required for normal marrow cells ([283](#)).
- The production of G-CSF by mononuclear cells from patients with SCN is normal compared with that of controls ([284](#)).
- Biologically normal to increased levels of G-CSF are found in the circulation of patients with SCN ([285](#)).
- G-CSF receptor number and function are normal to increased in patients with SCN before and after exposure to G-CSF ([286](#), [287](#)).
- G-CSF (but not GM-CSF) ([288](#), [289](#)) at pharmacologic doses administered to children with SCN may result in correction of neutropenia and improvement in clinical condition.

The data outlined above suggest that hematopoiesis in SCN is abnormal due to defective cytokine responses in primitive myeloid progenitor cells. These yet undefined defects are partially corrected *in vitro* with increased cytokine (predominately G-CSF) concentration ([290](#), [291](#)). Knowledge of the molecular basis of SCN continues to expand. Two major groups of genetic mutations are described. The most frequently identified mutations in patients with sporadic and autosomal-dominant ([292](#)) but not autosomal-recessive ([293](#)) forms of SNC involve mutations of the gene encoding neutrophil elastase (ELA2 gene) on chromosome 19. It is hypothesized that the neutrophil elastase mutations result in

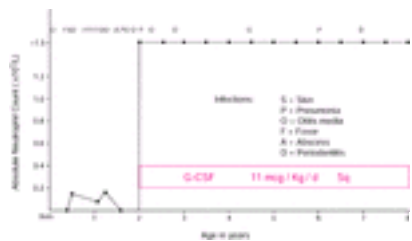
accelerated apoptosis of myeloid progenitor cells and explain the defects of hematopoiesis outlined above. A second group of patients with SCN demonstrates mutations in the cytoplasmic component of the G-CSF receptor gene ([294](#)). These mutations appear to result in inability or altered ability to transmit a growth and differentiation signal from the G-CSF receptor to the myeloid cell. Importantly, the subset of patients with SCN and these G-CSF receptor mutations is at increased risk of developing acute myeloid leukemia ([295](#)). [Figure 63.4](#) demonstrates one potential mechanism of leukemic transformation in such patients. Data suggest that the G-CSF receptor mutations are acquired ([296](#)) and that, over time, new mutations of the G-CSF receptor occur concurrent with the development of acute myeloid leukemia ([297](#)). Evidence shows that the receptor mutations result in impaired receptor internalization and sustained receptor activation with resultant prolongation of cell survival and resistance to apoptosis ([298](#)). Together, these mutations may play a role in leukemic transformation. The risk of myelodysplasia or leukemic transformation in SCN patients receiving G-CSF therapy is approximately 9%. The risk is associated with the presence of G-CSF receptor mutations or monosomy 7 but is not correlated with age of patient, gender, G-CSF dose, or G-CSF therapy duration ([299](#)). Thus, G-CSF therapy should not be withheld from patients with severe neutropenia because the potential clinical benefit of the therapy clearly outweighs the risk in most patients.



**Figure 63.4.** Possible mechanism for leukemic transformation. During normal, steady-state hematopoiesis (A), only a small proportion of myeloid progenitors renew themselves. The majority differentiate into mature granulocytes. Granulocyte colony-stimulating factor (G-CSF) plays a major part in the process through an interaction with the G-CSF receptor that transmits the growth and differentiation signals. In cells with mutated G-CSF receptors (B), more G-CSF is needed to activate the receptor. Abnormal proliferative signaling causes an accumulation of immature cells that do not differentiate. One such cell, constantly stimulated by G-CSF, may undergo a random mutation and acquire neoplastic properties. See [Color Plate](#). (From Naparstek E. G-CSF, congenital neutropenia and acute myeloid leukemia. *N Engl J Med* 1995;333:517, with permission.)

Before the availability of genetically produced growth factors, multiple therapies were used to treat SCN. Treatment with corticosteroids ([300](#)), testosterone ([301](#)), splenectomy ([302](#)), vitamin B<sub>6</sub>, and lithium ([282](#), [288](#)) was ineffective. Allogeneic bone marrow transplantation is curative, but toxicity and donor availability problems limit its usefulness ([303](#)). Since the 1980s, recombinant human G-CSF has become the treatment of choice for patients with SCN ([298](#)). Data from the Severe Chronic Neutropenia International Registry (SCNIR) at the University of Washington provide the most complete information

on the effects of G-CSF therapy in patients with SCN. More than 90% of patients respond to G-CSF therapy with an increase in total neutrophil count and ANC as well as a decrease in infection incidence ( 304 ). Most patients respond to doses of G-CSF between 3 and 10  $\mu\text{g}/\text{kg}/\text{day}$ . Some patients, however, require higher G-CSF doses, and *nonresponders* are defined as those who do not respond to doses of 120  $\mu\text{g}/\text{kg}/\text{day}$ . For some nonresponding patients, the concurrent administration of prednisone with G-CSF may result in clinical and laboratory improvement ( 305 ). Figure 63.5 is a graphic demonstration of the effect of daily G-CSF therapy on the infection history of a patient with Kostmann neutropenia. GM-CSF, a related but distinct cyto-kine, is not as effective as G-CSF in SCN ( 289 ). For patients with severe neutropenia responding to G-CSF, the therapy must continue indefinitely. In some cases, the frequency of growth factor administration can be decreased to every other day or three times per week. However, in most patients, the drug must be administered daily to achieve therapeutic benefit.

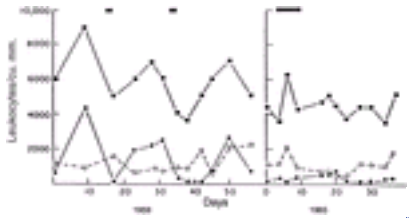


**Figure 63.5.** Effect of granulocyte colony-stimulating factor (G-CSF) therapy on infection history in a patient with severe congenital neutropenia. Shown are infections documented in a child with severe congenital neutropenia before and during therapy with G-CSF. Note the marked decrease in infection episodes with G-CSF therapy.

The chronic nature of G-CSF therapy for SCN brings into question the long-term safety of G-CSF. Review of data from the SCNIR defines possible long-term toxicities in patients with SCN treated with G-CSF ( 306 ). The relationship of G-CSF therapy to the reported toxicity is uncertain. Before cytokine therapy for SCN, mortality was high and life expectancy short. Thus, it is unclear whether some noted effects of G-CSF therapy in SCN represent medication side effects or an altered natural history of SCN. As discussed above, the most serious long-term concern with SCN and G-CSF therapy is myelodysplasia or acute leukemia. This complication occurs in approximately 9% of patients with SCN reported to the registry but not in patients with cyclic or autoimmune neutropenia. Acquired mutations of the G-CSF receptor or monosomy 7 are markers for leukemic transformation. The second most common complication of G-CSF therapy is osteoporosis, which may develop in as many as 50% of patients. The etiology of osteoporosis in SCN is unknown. Other less common associations include vasculitis, splenomegaly, hepatomegaly, and glomerulonephritis. Some authors recommend yearly evaluation of patients receiving G-CSF therapy for SCN to include renal and hepatic function tests, bone marrow for morphology and cytogenetics, and bone density study.

**CYCLIC NEUTROPENIA** *Cyclic neutropenia* is a rare defect of granulopoiesis characterized by regular periodic oscillations in the circulating neutrophil count from normal to neutropenic levels ( 307 , 308 and 309 ). The original case, reported by Leale in 1910, was an infant with repeated episodes of fever, stomatitis, skin infections, and neutropenia ( 308 , 310 ). Subsequently, more than 100 patients with a similar disorder were reported. In affected individuals, neutrophil counts drop to very low levels (ANC usually less than 200) followed by a recovery phase marked by return of nearly normal neutrophil numbers to the circulation ( Fig. 63.6 ). During periods of neutropenia, patients experience repeated episodes of malaise, fever, skin, and oral mucosal infections and adenopathy. In the intervening periods of normal neutrophil numbers, patients typically are asymptomatic. This characteristic clinical syndrome usually presents in infancy or childhood either as a sporadic case or in a familial form. Most reported familial cases are inherited in an autosomal-dominant fashion ( 311 ). Acquired adult forms of the disease also are reported

and are often associated with large granular lymphocytosis (312). The pathophysiology of these acquired adult cases appears distinct, and therapeutic approaches differ from apparent congenital cases. The discussion that follows deals primarily with the congenital forms of this disorder. The reader is referred to Chapter 92 and Chapter 93 for further information on large granular lymphocytosis.

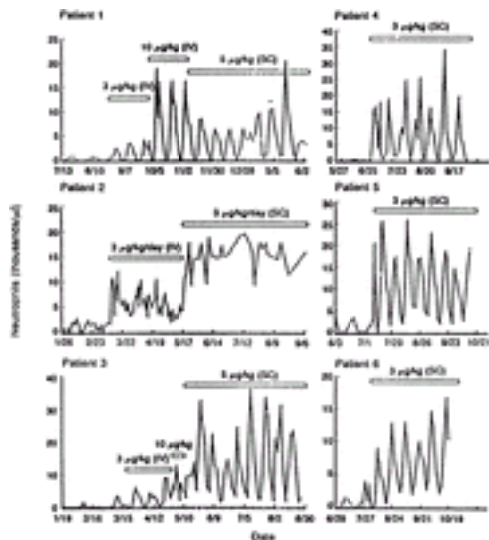


**Figure 63.6.** Cycling of blood elements in cyclic neutropenia. Shown are total leukocyte (squares), neutrophil (solid circles), and monocyte (open circles) counts in the patient over the period of observation, denoted in days. The black bars document episodes of mouth ulceration. (From Morley AA, Carew JP, Baikie AG. Familial cyclical neutropenia. *Br J Haematol* 1967;13:719, with permission.)

The average periodicity of neutrophil cycling in three-fourths of patients is  $21 \pm 3$  days. In the remaining one-fourth, the period varies from as short as 12 days to as long as 36 days (313). Typically, the period of neutropenia lasts from 3 to 10 days. During the neutropenic period, the severity of infection tends to mirror the severity and duration of neutropenia. Most patients manifest mild infections of the skin and oral mucosa. When periods of neutropenia are long, more serious infections may occur, including sinusitis, mastoiditis, pneumonia, cellulitis, intraabdominal infections, and septicemia (314). These systemic infections are uncommon because the periods of neutropenia are usually brief. However, fatal infections occur in 10% of reported patients. A common pathogenic organism in fatal cases is *Clostridium perfringens* presenting as peritonitis and sepsis (315). Between episodes of neutropenia, most patients recover to nearly normal neutrophil counts and are generally well, without evidence of infection or systemic symptoms. Occasionally, sites of chronic infection and inflammation develop that may persist through several cycles. In general, cyclic neutropenia is a benign disorder and associated with prolonged survival. In several patients followed for a prolonged period of time, the cyclic nature of the disease became less prominent, and the condition came to resemble a chronic neutropenia (316). Detailed studies of other hematopoietic cells in cyclic neutropenia reveal cycling of platelets, reticulocytes, monocytes, and eosinophils as well (317). Based on this global cycling of hematopoietic elements, the term *cyclic hematopoiesis* is preferred by some authors. During the period of neutropenia, many patients manifest compensatory lymphocytosis, monocytosis, or eosinophilia (318). In contrast to the neutrophils, which cycle between normal and low numbers, the other blood cells oscillate between normal and elevated levels (319). The oscillatory cycle of the different blood elements may not coincide exactly, but the periodicity is usually similar. Sequential bone marrow studies in cyclic neutropenia demonstrate absence of granulocytes and granulocyte precursors or a maturation arrest before the onset of peripheral neutropenia. As hematopoiesis cycles, the myeloid precursor numbers return to normal before restoration of normal neutrophil counts (320). The cycling of blood neutrophils, platelets, reticulocytes, and monocytes in this disorder is attributed to fluctuating rates of marrow cell production. The basic mechanism responsible for the cycling remains largely unknown. Findings suggest that the disorder results from periodic failure of blood cell production, probably at a multipotent stem cell level. One proposed mechanism for the cycling is impaired response of marrow progenitor cells to growth factor stimulation. *In vitro*, marrow precursor cells from patients with cyclic neutropenia demonstrate impaired CFU-GM growth in response to stimulation with either G-CSF or GM-CSF (321, 322). This defect is not caused by lack of specific growth factor receptors



because G-CSF receptor number and affinity are normal ( 286 ). Available evidence suggests that the defect in cyclic hematopoiesis involves impaired survival of marrow progenitor cells ( 323 ). Further clues to the pathophysiology of cyclic neutropenia are obtained from study of a unique animal model of the disease. An autosomal-recessive form of cyclic neutropenia is described in gray collie dogs ( 324 ). The syndrome varies somewhat in mode of inheritance, duration of cycling, and associated pigmentary defects but otherwise is remarkably similar to the human disease. In dogs, oscillations of production of all hematopoietic cells are noted ( 325 ). The disease can be transmitted from affected to normal animals by bone marrow transplantation, and conversely, bone marrow transplantation of normal animal marrow into affected animals results in clinical cure ( 326 ). In humans, cyclic neutropenia was transferred by allogeneic bone marrow transplantation from one sibling to another concurrent with transplantation therapy for acute lymphocytic leukemia ( 327 ). Thus, available evidence supports the hypothesis of an intrinsic hematopoietic stem cell regulatory defect. The genetic basis of autosomal-dominant cyclic neutropenia was recently defined with the identification of point mutations in the neutrophil elastase gene on chromosome 19p13.3 ( 328 ). The mechanism by which neutrophil elastase mutations result in cyclic hematopoiesis remains uncertain but is hypothesized to involve accelerated apoptosis of myeloid precursors ( 323 ). In a single Chinese family with cyclic neutropenia and oligospermia, mutation of the Y chromosome was defined ( 329 ). Diagnosis of cyclic neutropenia is based on the findings of characteristic recurrent infections with cycling of blood elements, especially neutrophil numbers. Because the cycling periodicity may vary from patient to patient, twice weekly blood samples should be obtained for 4 weeks when seeking to document cyclic neutropenia. Therapy should include close attention to management of identified infections. Many short-lived fevers, aphthous ulcers, and upper respiratory infections require no therapy. However, a high index of suspicion must be maintained to identify and treat more serious bacterial infections. The specific therapy of adult onset cyclic neutropenia occurring in association with clonal large granular lymphocytosis is distinct. Treatment with daily or alternate-daily corticosteroids or cyclosporine has resulted in durable remissions of the hematologic manifestations of the adult forms of the disease ( 330 , 331 ). In the congenital or pediatric onset forms of the disorder, therapeutic trials with corticosteroids, androgens, lithium, and splenectomy are generally ineffective ( 307 , 314 ). Therefore, current specific therapy relies on the human growth factors G-CSF and GM-CSF. Daily intravenous or subcutaneous G-CSF therapy results in an increase in the mean neutrophil count, reduction in the duration of severe neutropenia, and amelioration of the number and severity of infectious episodes ( Fig. 63.7 ) ( 332 ). Interestingly, G-CSF therapy does not prevent the cycling of blood elements and indeed accentuates the cycles. In contrast, GM-CSF therapy results in a less impressive increase in neutrophil number but does dampen or eliminate the hematopoietic cycling ( 333 ). Although these findings raise the possibility of combined cyto-kine therapy for patients with cyclic neutropenia, G-CSF therapy is considered the treatment of choice. Long-term (years) follow-up of patients with cyclic neutropenia treated with G-CSF therapy shows that the drug is generally well tolerated. One unique finding is of gradually increasing splenic enlargement, although no symptoms are reported attributable to the splenic size ( 316 ).



**Figure 63.7.** Effects of granulocyte colony–stimulating factor therapy on cyclic neutropenia. Shown are neutrophil counts performed every 1 to 2 days on patients with cyclic neutropenia. The dosage of granulocyte colony–stimulating factor is indicated above each rectangle. (From Hammond WP 4th, Price TH, Souza LM, Dale DC. Treatment of cyclic neutropenia with granulocyte colony stimulating factor. *N Engl J Med* 1989;320:1306, with permission.)

**CHRONIC BENIGN NEUTROPENIA** *Chronic benign neutropenia* is a heterogeneous group of disorders sharing the common features of chronic neutropenia with little if any increased risk of infection in an otherwise healthy patient. Both familial and nonfamilial forms of this disorder are described.

**Familial Chronic Benign Neutropenia** Familial chronic benign neutropenia is an autosomal–dominant disorder found in families of Jewish Yemenite ( [334](#) ), African ( [335](#) ), and Western European ( [336](#) ) origins. Affected family members demonstrate moderate to severe neutropenia without associated leukopenia, relative monocytosis, and lymphocytosis with variable eosinophilia ( [337](#) ). Most patients are asymptomatic, and families are identified by chance. Infections, if present, typically are mild skin infections or oral cavity infections including gingivitis, periodontitis, and mouth sores ( [338](#) , [339](#) ). Bone marrow studies reveal normal cellularity with reduced mature granulocytes. Neutrophil kinetic studies reveal a reduced bone marrow myeloid reserve pool, reduced mitotic pool size, and reduced concentration of colony–forming unit–culture. Based on these studies, the presumed defect is faulty release of mature neutrophils from the bone marrow ( [340](#) , [341](#) ). Because the disease is benign in most affected families, therapy with cortico–steroids or growth factors is not indicated.

**Nonfamilial Chronic Benign Neutropenia** Other cases of chronic benign neutropenia are described in which no familial pattern is identified. Chronic neutropenia with a benign phenotype is described in all ages. The common feature of these heterogeneous disorders is the absence of severe or recurrent infections despite chronic neutropenia. In one form, chronic benign granulocytopenia of infancy and childhood, neutropenia with or without minor infections may be noted soon after birth ( [342](#) ). Unlike in SCN, life–threatening infections do not occur. The neutropenia is typically quantitatively severe, and a compensatory monocytosis and eosinophilia are noted. Bone marrow studies demonstrate hypercellularity and myeloid hyperplasia with maturation through the band stage. When stressed with severe infection or challenged with epinephrine or cortisol administration, the circulating neutrophil count increases. This response to stress explains why severe infections do not occur ( [343](#) ). In some cases of chronic benign neutropenia, careful evaluation reveals the presence of autoantibodies, thus suggesting an immune etiology ( [344](#) , [345](#) ). In other cases, abnormal phagocytosis of mature neutrophils by marrow



macrophages is documented ( [346](#) ). It is likely that multiple pathophysiologies result in the same clinical features. In the childhood form, spontaneous resolution of the neutropenia is noted by age 4 years in a majority of cases ( [343](#) ). G-CSF therapy has proved effective in elevating the neutrophil count in most patients ( [347](#), [348](#) ). However, because by definition, patients with this disorder manifest a benign course, specific therapy with steroids, androgens, splenectomy, or growth factors is not indicated.

**IDIOPATHIC CHRONIC SEVERE NEUTROPENIA** In some patients, chronic, symptomatic, severe neutropenia presents in later childhood or during adulthood. If the search for other underlying etiologies is not fruitful, the diagnosis of idiopathic chronic severe neutropenia is used ( [349](#), [350](#) ). This diagnosis probably represents a heterogeneous group of disorders. The distinction between chronic severe neutropenia and chronic benign neutropenia should be based on the natural history in a given patient. Thus, at presentation of a new patient, close attention to infection history and careful physical examination with emphasis on signs of chronic infection are crucial. The severity of neutropenia typically varies, and the infection risk depends in part on the degree of neutropenia ( [351](#) ). In the severe forms, the ANC is typically less than 500 cells/mm<sup>3</sup>. Bone marrow evaluation may reveal myeloid hypoplasia, maturation arrest, or normal morphology. Forms with myeloid hypoplasia have been called *chronic hypoplastic neutropenia* ( [352](#) ). Before diagnosing an idiopathic form of chronic severe neutropenia, careful evaluation for other forms should be concluded with emphasis on search for autoantibodies. Some forms of chronic severe neutropenia may represent a continuum of forms of benign neutropenia, but studies of this group of patients are not sufficient to define specific pathophysiologies. It is also possible that no true idiopathic forms exist and only reflect insufficient evaluation or insensitive laboratory methods. Clinically severe forms of chronic neutropenia deserve specific growth factor therapy.

**NEUTROPENIAS ASSOCIATED WITH CONGENITAL IMMUNE DEFECTS** As previously discussed, acquired immune deficiency secondary to HIV infection is often complicated by neutropenia of multifactorial origin. Likewise, patients with congenital primary immunologic defects of Ig production or cell-mediated immunity are at increased risk of symptomatic neutropenia. The coexistence of defects in immune function and neutropenia presents great danger to the patient.

***Neutropenia with Immunoglobulin Abnormality*** As many as one-third of patients with X-linked agammaglobulinemia manifest symptomatic neutropenia at some time during their disease course ( [353](#) ). Many patients with hyper-IgM syndrome also manifest cyclic or persistent neutropenia ( [354](#) ). Neutropenia is reported to complicate dysgammaglobulinemia type I ( [355](#) ). Isolated IgA deficiency is reported to cause neutropenia via production of autoantibodies ( [356](#) ). Familial forms of hypo-gammaglobulinemia with neutropenia are described, including a father and daughter pair, suggesting autosomal-dominant inheritance ( [357](#), [358](#) ). Clinically, all patients with combined defects of neutrophil number and Ig synthesis are at high risk of infection. Therapy should include a trial of intravenous Ig, which may correct both defects ( [359](#) ). Specific growth factor therapy can also be used in patients who do not respond to Ig replacement.

***Neutropenia with Defective Cell-Mediated Immunity*** A familial syndrome of severe neutropenia with associated defective cell-mediated immunity was reported in 1976, affecting three girls and a boy ( [360](#) ). The patients manifested eczema, poly-arthralgias, pneumonias, recurrent otitis media, and neutropenia with eosinophilia. Serum IgA levels were elevated, but antibody production in response to tetanus and poliomyelitis vaccines was impaired. The cell-mediated immune defect resulted in disseminated varicella infection in two of the four affected children.

**RETICULAR DYSGENESIS** This rare disorder results from an unidentified intrinsic failure of hematopoietic stem cells committed to myeloid and lymphoid development (both marrow and thymic derived). Red blood cell and platelet production are normal, but severe neutropenia, lymphopenia, agammaglobulinemia, and absent cell-mediated immunity result

in extreme vulnerability to fatal bacterial or viral infection ( 361 , 362 , 363 and 364 ). Postmortem evaluation of affected patients reveals complete absence of lymphoid tissue, plasma cells, or splenic follicles. Bone marrow transplantation has proved curative in this disorder ( 365 , 366 ). Reticular dysgenesis is one of the few causes of neutropenia that does not respond to G-CSF therapy ( 367 ).

### **NEUTROPENIAS ASSOCIATED WITH PHENOTYPIC ABNORMALITIES**

**Shwachman Syndrome** *Shwachman syndrome*, initially described in 1964, is a rare autosomal-recessive disorder characterized by metaphyseal chondrodysplasia, pancreatic exocrine insufficiency, dwarfism, and neutropenia ( 368 ). Other associated findings include anemia, thrombocytopenia, developmental and mental retardation, diarrhea, weight loss, failure to thrive, eczema, recurrent otitis media and pneumonia, and neutrophil motility defects ( 369 , 370 ). Patients with Shwachman syndrome are also at increased risk of bone marrow failure or leukemic transformation ( 371 ). The basic underlying genetic basis of the disorder remains undetermined. Bone marrow evaluation typically shows hypoplasia. Myelodysplasia or clonal cytogenetic abnormalities (usually monosomy 7) are found in up to one-third of patients. In one patient, increased spontaneous chromosomal breakage was noted in stimulated peripheral blood lymphocytes, suggesting a primary defect in DNA repair or protection similar to Fanconi anemia ( 372 ). In 2001, marrow failure in the Shwachman syndrome was linked to increased progenitor apoptosis mediated via the Fas pathway ( 373 ). The associated neutropenia appears to be secondary to marrow myeloid hypoplasia ( 374 ). The degree of neutropenia is usually moderate to severe with an average ANC between 200 and 800 cells/mm<sup>3</sup> ( 375 ). Most patients present in early infancy with failure to thrive, diarrhea, feeding problems, and recurrent bacterial infections. Growth failure and dwarfism usually are apparent by the second year of life. Chondrodysplasia, especially of the hip, appears with further growth. Death from infection is reported from septicemia, pneumonia, and osteomyelitis. The reported mortality rate in Shwachman syndrome is 15 to 25%, primarily from infection, bleeding, marrow failure, or malignancy ( 376 ). Treatment of the pancreatic insufficiency with dietary manipulation and pancreatic enzyme supplementation can improve the malabsorption but has no effect on the dwarfism or neutropenia. G-CSF therapy increases the neutrophil count and ameliorates the infectious predisposition of this disorder ( 377 ).

**Cartilage-Hair Hypoplasia** *Cartilage-hair hypoplasia* is an autosomal-recessive disorder noted primarily in the Amish ( 378 ) and Finnish populations ( 379 ). Characteristic findings include short-limb dwarfism, fine hair, moderate to severe neutropenia (ANC, 100 to 2000 cells/mm<sup>3</sup>), and defects of cell-mediated immunity ( 380 ). Other associated findings include anemia with macrocytosis and gastroesophageal defects (Hirschsprung disease, anal stenosis, esophageal atresia). The combination of neutropenia and cellular immunologic defects predisposes patients to infections, especially varicella-zoster virus infections. Linkage analysis studies have localized the gene responsible for cartilage-hair hypoplasia to the short arm of chromosome 9 ( 381 ). The underlying etiology of this constellation of findings remains unknown. Allogeneic bone marrow transplantation is reported to correct hematologic and immunologic defects ( 382 ). G-CSF would be expected to increase the neutrophil count, although no reports of its use in this disorder exist.

**Dyskeratosis Congenita** *Dyskeratosis congenita* is a rare multiorgan syndrome characterized by reticulated hyperpigmentation of the skin, nail dystrophy, and leukoplakia of the mucous membranes ( 383 , 384 ). Originally described in 1906, this syndrome is also known as *Zinsser-Cole-Engman syndrome*. Other manifestations of the syndrome include mental retardation, growth failure, endocrine dysfunction, and minor defects of the eyes, ears, and bone ( 385 , 386 , 387 and 388 ). Hematologic manifestations include neutropenia, refractory anemia, thrombocytopenia, marrow failure syndromes, and cell-mediated immune dysfunction ( 389 ). The majority of reported cases are male patients, and the

defective gene designated the *DKC1 gene* has been linked to Xq28 ( 390 ).

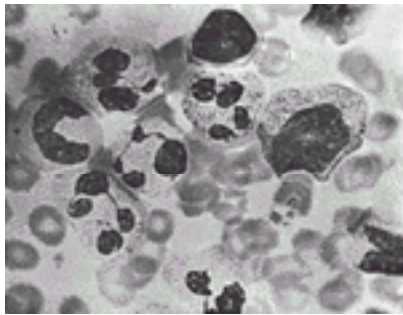
Autosomal-dominant and -recessive pedigrees are also reported ( 391 ). The affected *DKC1*, dyskerin, is involved in RNA function and telomere maintenance. The exact pathophysiology of dyskeratosis congenita remains unknown, but the hematologic manifestations share remarkable similarity to Fanconi anemia ( 392 ). Like Fanconi anemia, dyskeratosis congenita is associated with defects of DNA repair or maintenance ( 393 , 394 ). Also, as in Fanconi anemia, allogeneic bone marrow transplantation has been used successfully in dyskeratosis congenita to correct hematologic abnormalities ( 395 ). Patients with Fanconi anemia and dyskeratosis congenita require reduction in the intensity of the conditioning regimen for marrow transplantation ( 389 ). G-CSF or GM-CSF therapy can improve the neutropenia associated with dyskeratosis congenita ( 389 , 396 ).

**Barth Syndrome** *Barth syndrome* is an X-linked recessive cardioskeletal myopathy with associated neutropenia ( 397 ). Affected male patients manifest skeletal myopathy, cardiomyopathy, short stature, and recurrent bacterial infection secondary to neutropenia ( 398 ). In most cases, dilated cardiomyopathy is the initial presenting symptom in infancy. The cardiomyopathy may be severe and fatal. The associated neutropenia is usually moderate to severe, with ANC from 0 to 500 cells/mm<sup>3</sup> ( 399 ). The neutropenia may be intermittent and tends to improve with advancing age. Infections tend to involve the skin and mucous membranes. Bone marrow evaluation usually reveals myeloid hypoplasia ( 398 ). In the original report by Barth, vacuolation of neutrophil precursors was noted ( 397 ), but this finding has not been noted in subsequent reports. The basic etiology of this syndrome is unknown. The gene for Barth syndrome is identified as the *TAZ gene* (previously *G4,5 gene*) located in the region of Xq28 ( 400 ). Metabolic abnormalities including low carnitine levels ( 399 ) and 3-methylglutaconic aciduria ( 401 ) are associated with Barth syndrome, but it remains uncertain whether these findings are primary or secondary defects ( 398 ). Genetic analysis of the *TAZ gene* sequence demonstrates homology to a family of acyltransferases, suggesting that defects of lipid synthesis or metabolism may be involved in disease pathogenesis ( 402 ). Primary clinical treatment of most patients with this rare disorder has focused on the cardiomyopathy. There are no reports of G-CSF or GM-CSF use in Barth syndrome, but these agents should prove effective if required for serious infections.

**Chédiak-Higashi Syndrome** *Chédiak-Higashi syndrome* (CHS) is a rare autosomal-recessive disorder characterized by recurrent infections, partial oculocutaneous albinism, and pathognomonic large lysosomal granules in nucleated blood cells, neurons, renal tubular epithelial cells, and tissue macrophages. Associated findings include photophobia, nystagmus, gingivitis, periodontitis, abnormal bleeding, mental retardation, neuropathy, immune dysfunction, and neutropenia ( 403 ). Neutropenia is present in at least 75% of reported patients with the degree of neutropenia moderate to severe ( 404 ). Infections include recurrent fevers, pyoderma, otitis media, gingivitis, and septicemia. The infection risk in CHS is magnified by coexistent defects of cellular and humoral immunity and neutrophil functional defects ( 405 ). The neutropenia of CHS appears to be secondary to increased destruction of granulocytes ( 406 ) and perhaps impaired bone marrow neutrophil release ( 407 ). The etiology of CHS is thought to be secondary to abnormal granule membrane fusion and function. In 2000, mutations in the lysosomal trafficking regulator (*LYST*) gene on chromosome 1 were found in CHS patients from multiple families ( 408 ). Available data suggest that the pathophysiology of CHS involves defective trafficking of proteins to organelles. Many patients later develop an accelerated phase characterized by lymphomalike mononuclear cell infiltration of lymph nodes, spleen, liver, and bone marrow. This accelerated phase may be related to an abnormal immune response to Epstein-Barr virus infection ( 409 ). Treatment is primarily supportive. Bone marrow transplantation has resulted in apparent cure ( 410 ).

**MYELOKATHEXIS** *Myelokathexis* is a rare form of chronic neutropenia characterized by

bizarre granulocyte nuclear morphology ( [411](#), [412](#), [413](#), [414](#) and [415](#)). The mature neutrophils reveal cytoplasmic vacuolization, pyknotic nuclei, nuclear hypersegmentation, and thin nuclear strands connecting nuclear lobes ( [Fig. 63.8](#)). Moderate neutropenia and recurrent bacterial infections are noted. Bone marrow studies demonstrate myeloid hyperplasia with degenerating granulocytes. Leukokinetic and morphologic studies suggest an intrinsic granulocyte abnormality resulting in increased intramedullary and systemic destruction of mature neutrophils as the basis of the disorder. Neutrophil lifespan is shortened in the circulation of affected patients as well as in the circulation of normal volunteers injected with myelokathexis neutrophils. Normal neutrophils injected into patients have a normal lifespan ( [412](#)). Most reported cases are congenital with onset of symptoms in infancy. In a 1997 review, 80% of reported cases were female ( [415](#)). An acquired form of myelokathexis as a paraneoplastic syndrome is the subject of one case report ( [416](#)). The basic biochemical defect resulting in granulocyte destruction is uncertain. In one family, hypogammaglobulinemia was also present ( [358](#)). Both GM-CSF and G-CSF are reported to correct the neutropenia and ameliorate infections in myelokathexis ( [417](#), [418](#), [419](#) and [420](#) ).



**Figure 63.8.** Marrow specimen from a patient with myelokathexis. Note the pyknotic nuclei, cytoplasmic vacuoles, and hypersegmented neutrophils with long, thin, intrasegmental chromatin strands. (From Krill CE, Smith HD, Mauer AM. Chronic idiopathic granulocytopenia. *N Engl J Med* 1964;270:973, with permission.)

**LAZY LEUKOCYTE SYNDROME** *Lazy leukocyte syndrome* was the term chosen by Miller et al. in 1971 to describe an apparently unique syndrome characterized by neutropenia, normal bone marrow granulocyte number, and defective neutrophil motility *in vitro* and *in vivo* ( [421](#)). In the initial report, two unrelated children manifested severe neutropenia (ANC below 200 cells/mm<sup>3</sup>), normal bone marrow myeloid morphology, defective neutrophil chemotaxis and chemokinesis, and recurrent, primarily minor infections. Subsequently, a few similar cases have been reported ( [422](#), [423](#), [424](#) and [425](#)). Most described cases present in infancy, although the diagnosis has also been made in adults ( [423](#), [424](#)). In one infant, the neutropenia and neutrophil motility defect resolved before 2 years of age, suggesting a transient disorder ( [425](#)). In general, described patients have manifested quantitatively severe neutropenia but have experienced few life-threatening infections. The etiology of this syndrome remains unidentified. Defects of the neutrophil cytoskeleton have been hypothesized based on the findings of defective motility and the apparent inability of mature neutrophils to exit the bone marrow. However, no direct proof of cytoskeletal defect exists, and other patients with known neutrophil cytoskeletal defects (neutrophil actin dysfunction) do not manifest neutropenia ( [426](#), [427](#) and [428](#)). Clinical management is primarily supportive. Most reported patients have responded well to appropriate antibiotic therapy. There are no reports of growth factor therapy in lazy leukocyte syndrome.

**METABOLIC DISEASES** Several congenital metabolic disorders, including glycogen storage disease type Ib ( [429](#)), propionic acidemia ( [430](#)), methylmalonic acidemia ( [431](#)), and isovaleric acidemia ( [432](#)), are complicated by chronic or intermittent neutropenia of

variable severity. In glycogen storage disease type Ib, the neutropenia is a consequence of disturbed myeloid maturation (433) and is severe enough to result in recurrent infections beginning in the first year of life. G-CSF and GM-CSF are effective in correcting the neutropenia associated with glycogen storage disease type Ib and are worthy of trial in other metabolic disorders with symptomatic neutropenia (434, 435 and 436).

## EVALUATION OF THE PATIENT WITH NEUTROPENIA

The clinical evaluation of neutropenia uses the diagnostic tools of history, physical examination, and selective laboratory studies to determine its chronicity and severity. An algorithmic approach to evaluation of a patient with severe chronic neutropenia is shown in Figure 63.9.



**Figure 63.9.** Diagnostic approach to neutropenia. ANC, absolute neutrophil count; CBC, complete blood cell count. (From Zeidler C, Boxer L, Dale DC, et al. Review: management of Kostmann syndrome in the G-CSF era. *Br J Haematol* 2000;109:490, with permission.)

The history should focus on a detailed evaluation of infection history; including type, severity, and frequency; duration of the recurrent infections or neutropenia; and age of onset of symptoms as clues to whether the disorder is congenital or acquired. Medication use and exposure must be carefully evaluated because drug exposure is a very common cause of transient, acquired neutropenia, and medication exposure is very common in our society. History of recent infections may provide clues to severity of the neutropenia, and infections may also be a cause as well as a result of neutropenia. Family history should focus on recurrent infections or unexplained sudden deaths. In neonatal neutropenia, maternal history is likewise important. Crucial but often overlooked historical information may require the assistance of other health care providers to obtain previous blood cell count values. Complete blood cell counts are often performed in physicians' offices while evaluating a myriad of complaints and often provide rapid confirmation that an episode of neutropenia is acquired or of recent onset.

The physical examination likewise focuses on delineation of evidence of current or recent infection. The skin and oral mucosa are especially common sites of chronic or recurrent infection and inflammation in patients with neutropenia. In children, growth and development should be documented. Recurrent, severe bacterial infection of long duration



invariably results in growth failure. A thorough examination is indicated to evaluate for phenotypic abnormalities, especially bony defects. Specific areas of examination also include close attention for evidence of pallor or petechial bleeding suggesting deficiency of red blood cells or platelets and a search for adenopathy or splenomegaly. The perineum and perirectal area should not be neglected because the rectum is a common location of mucosal irritation and inflammation.

Laboratory evaluation, at a minimum, should include a complete blood cell count with manual white blood cell differentiation. The manual differential cell count offers important advantages over automated machine differential counts and is an early step in laboratory evaluation of presumed neutropenia. The complete blood cell count often offers important clues to guide further evaluation; for example, if concurrent abnormalities of red blood cells or platelet numbers are noted, bone marrow aspiration or biopsy is the next diagnostic test. If isolated neutropenia is noted, further laboratory evaluation should be based on the chronicity and severity of symptoms. For example, if mild or moderate neutropenia is noted in a healthy-appearing patient with recent or current viral infection or concurrent with suspicious exposure to medication (e.g., sulfonamides), clinical observation without further diagnostic study may be indicated. In contrast, if the history is chronic and severe, more detailed testing is in order. [Table 63.8](#) lists some of the available laboratory investigations and major indications for each. Older tests of neutrophil mobilization, including the hydrocortisone stimulation test (which tests marrow myeloid reserve) ([437](#)), the epinephrine challenge test (which evaluates for the size of the marginating neutrophil pool) ([438](#)), and the Rebutk skin window (which evaluates neutrophil migration into tissues) ([439](#)), are rarely used in diagnosis of neutropenic syndromes.

**TABLE 63.8. Laboratory Tests Useful in Evaluation of Neutropenia**

| Test                                    | Indications and Use  |
|---|--|
| Twice-weekly complete blood cell counts | Screen for cyclic neutropenia.   |
| Bone marrow aspiration/biopsy           | Monitor for resolution of neutropenia.<br>Search for intrinsic marrow defects.<br>Myelokathexis.<br>Severe congenital neutropenia: maturation arrest at promyelocyte stage.<br>Benign congenital neutropenia: maturation arrest at metamyelocyte stage.<br>Morphologic identification of fungal infection.<br>Evidence of megaloblastosis (vitamin B <sub>12</sub> -folate). |
| Antineutrophil antibody screens         | Autoimmune or isoimmune neutropenias.<br>Evaluation of parents helpful in neonates.  |
| Immune evaluation                       | Screen for defects of cellular or humoral immunity.<br>Human immunodeficiency virus testing.   |
| Metabolic studies                       | Copper, vitamin B <sub>12</sub> , or folate levels.<br>Diagnosis of inborn metabolic errors.   |
| Radiographs of long bones               | Evaluation for phenotypic forms of neutropenia.  |
| Cytogenetic studies                     | Barth syndrome.  |
| Chromosomal fragility/breakage studies  | Fanconi anemia.<br><br>Dyskeratosis congenita.   |

|                                    |  |
|------------------------------------|--|
| Pancreatic exocrine function study | Shwachman syndrome.  |
| Bone marrow culture                | Evaluation of colony-forming unit granulocyte-macrophage production. |

---

## GENERAL PRINCIPLES OF MANAGEMENT OF NEUTROPENIA

Management of neutropenia is based on the etiology of the neutropenia, if known, and assessment of the chronicity and severity of the disorder. Treatment of neutropenia after cancer chemotherapy or in the setting of bone marrow failure or bone marrow transplantation is a special topic discussed in detail elsewhere in this book. General and specific therapeutic options exist in isolated neutropenia and are discussed separately.

The general approach to treatment of neutropenic patients involves preventive measures to limit the number and severity of infections as well as direct efforts to rapidly identify and treat infections that do arise. Preventive measures begin with close attention to areas of high infection risk. Because the mouth and oral mucosa are common sites of infection, good oral hygiene is imperative, including cleaning and attention to and correction of dental problems. The perirectal area is protected by avoidance of trauma, such as rectal temperature measurement. If constipation is a concern, stool softeners are prescribed to minimize trauma and straining. Patients should be encouraged to report perirectal pain or irritation. The skin is the other common site of bacterial entry in neutropenic patients and should be kept clean. Skin abrasions or cuts need prompt cleaning and antibacterial topical therapy. Prophylactic antibiotics are used in some instances and may limit infectious risks in patients with severe chronic neutropenias. The most commonly used agent is trimethoprim-sulfamethoxazole.

Despite all of these efforts, infection is inevitable in patients with chronic, severe forms of neutropenia. Thus, the clinician must have a high index of suspicion for bacterial and fungal infections and initiate rapid diagnostic evaluation. Because the classic signs of infection, especially swelling (tumor) and heat (calor) may be absent or minimal ([440](#)), the examination may not reveal the usual clues of infection. Fever becomes a key systemic sign of infection, and the presence of fever in a severely neutropenic patient must provoke the presumption of infection. Febrile neutropenic patients should have samples of appropriate body fluids obtained for culture, and broad-spectrum antimicrobial agents should be initiated promptly. Because the common bacterial pathogens are *Staphylococcus* species and gram-negative enteric organisms, initial antibiotic therapy usually involves a combination of antibiotics with activity against the most common pathogens. As discussed elsewhere in this book, specific antibiotic choice depends in part on local patterns of drug sensitivity. In high-risk patients, therapy is usually initiated in the hospital setting. Lack of response to antibiotic therapy should initiate further diagnostic study or empiric antifungal therapy. In patients with benign clinical forms of neutropenia, clinical judgment is indicated, and outpatient management often appropriate. As previously discussed under individual disease entities, in some cases of mild acquired forms of neutropenia, no therapy at all is indicated.

Several specific therapies for neutropenia exist, dependent in large measure on the specific etiology of neutropenia. In neutropenia associated with drug exposure, an obvious specific measure is the discontinuation of the presumed causative agent. If the neutropenia is associated with gold or arsenic exposure, specific heavy metal therapy with British antilewisite (or dimercaprol) or penicillamine may help in correction of the neutropenia ([441](#)). Specific therapies for immune-mediated neutropenias, including corticosteroids, intravenous Igs, and plasmapheresis, are discussed under specific disease



entities. Further options for therapy include granulocyte transfusion or stimulation of neutrophil production with granulocyte growth factors.

Therapeutic transfusions of granulocyte concentrates (obtained initially by filtration leukapheresis and now by large-volume centrifugation leukapheresis) have been used for over two decades to treat neutropenic patients with documented, severe bacterial and fungal infections (see [Chapter 24](#)). The popularity of this therapy has waxed and waned through the years, and the clinical efficacy in individual patients or small studies remains controversial ([442](#)). Granulocyte transfusions are expensive, the short survival time of granulocytes necessitates frequent reinfusions, large numbers of granulocytes (10<sup>10</sup>) are necessary for clinical efficacy, and the transfusions are not without hazard. Risks include febrile reactions, transmission of viral infections (cytomegalovirus, hepatitis, HIV, and toxoplasma), pulmonary toxicity, and, potentially, transfusional graft-versus-host disease ([443](#)). Despite these risks, in selected neutropenic patients with severe bacterial or fungal infections that progress despite appropriate antimicrobial therapy, granulocyte transfusions may be life-saving ([442](#)). This therapeutic option appears especially useful in neonates with documented gram-negative septicemia and severe neutropenia ([444](#)). Once a decision to use granulocyte transfusions is made, large volumes of cells should be administered daily until the infection or neutropenia resolves. The use of growth factors to stimulate granulocyte number before leukapheresis may result in availability of high yields of granulocytes and stimulate a further revival of the popularity of this therapy ([445](#)).

The advent of recombinant human granulocyte factors and GM-CSFs has revolutionized the approach to the neutropenia patient. The pharmacology, pharmacokinetics, and historical development of these myeloid growth factors are the subject of several recent reviews ([304](#), [446](#), [447](#) and [448](#)). Both GM-CSF and G-CSF are hematopoietic growth factors that act primarily to stimulate proliferation and differentiation of committed progenitor cells into mature granulocytes. GM-CSF also stimulates monocyte and, variably, eosinophil maturation, whereas G-CSF stimulates primarily neutrophils. In treatment of the chronic severe neutropenias, these growth factors allow correction of neutropenia and thus prevention or amelioration of infection in many cases. The use of growth factors to hasten resolution of established infections is not as well defined as their preventive role. As detailed previously for individual disease states, G-CSF (and, less often, GM-CSF) is effective in increasing circulating neutrophil numbers and decreasing infection incidence in most forms of chronic neutropenia. Individual patient response varies, and the dosage range required in individual diseases and patients varies. However, most patients respond to G-CSF doses of 5 to 10 µg/kg/day. Equally important, the incidence of signs and symptoms of infections in these patients fell dramatically during G-CSF therapy ([Table 63.9](#)). The goal of G-CSF therapy is to prevent infections by maintaining a nearly normal blood neutrophil count. This goal is met in a majority of patients with severe neutropenia. Long-term treatment results remain incompletely defined. For patients with SCN, cyclic neutropenia, or chronic severe neutropenias, the duration of growth factor therapy is probably life-long. Because initial therapy with growth factors for these disorders did not begin until 1987, long-term follow-up remains limited. As outlined above in the discussion of G-CSF therapy for SCN, the most important long-term concerns include myelodysplasia or leukemic transformation, osteoporosis, and organomegaly. The growth and development of many patients with SCN are abnormal, but it remains uncertain whether growth failure is a stigmata of the underlying cellular defects in SCN or in some way associated with therapy for the disorder ([306](#)). Patients tolerate daily injections quite well.

**TABLE 63.9. Incidence of Signs and Symptoms during Therapy with Recombinant Human**

## Granulocyte Colony-Stimulating Factor (rHuG-CSF)

| Symptom         | Untreated (%) | rHuG-CSF (mo 0-5) (%) | rHuG-CSF (mo 5-17) (%) |
|-----------------|---------------|-----------------------|------------------------|
| Fever           | 77            | 27                    | 28                     |
| Stomatitis      | 60            | 20                    | 11                     |
| Sore throat     | 18            | 10                    | 10                     |
| Lymphadenopathy | 11            | 4                     | 4                      |
| Abdominal pain  | 15            | 9                     | 10                     |
| Cellulitis      | 8             | 2                     | 1                      |
| Pustules        | 6             | 1                     | 2                      |
| Diarrhea        | 18            | 15                    | 6                      |
| Rash            | 4             | 10                    | 6                      |
| Headache        | 24            | 17                    | 24                     |
| Bone pain       | 6             | 17                    | 5                      |
| Pain            | 10            | 25                    | 11                     |

From Dale DC. Hematopoietic growth factors for the treatment of severe chronic neutropenia. *Stem Cells* 1995;13:94, with permission.

Cost of the recombinant growth factors GM-CSF and G-CSF remains high. In 2002, the wholesale cost for a 300- $\mu$ g/ml vial of G-CSF was approximately \$200. Because G-CSF vials are single use only, the \$200 represents the daily cost of therapy for patients up to approximately 60 kg (5  $\mu$ g/kg/day). Thus, daily cost for 1 year of treatment for a patient with SCN is approximately \$73,000. Obviously, costs depend on local pricing, daily dose, patient size, and other factors. Regardless, growth factor treatment of neutropenia is costly. In this era of cost control and justification, the decision to prescribe growth factor therapy must be based on an understanding of the natural history of the disorder and a careful evaluation of risk of infection.

## WEB SITES

Severe Chronic Neutropenia International Registry: <http://depts.washington.edu/registry/>

Neutropenia Support Association, Inc.: <http://www.neutropenia.ca/>

National Organization for Rare Disorders, Inc.: <http://www.rarediseases.org>

Mayo Clinic: <http://www.mayoclinic.com>

National Heart, Lung and Blood Institute: <http://www.nhlbi.nih.gov>

## REFERENCES

1. Wheetman RM, Boxer LA. Childhood neutropenias. *Pediatr Clin North Am* 1980;27:361.
2. Manroe BL, Weinberg AG, Rosenfeld CR, Browne R. The neonatal blood count in health and disease. I. Reference values for neutrophilic cells. *J Pediatr* 1979;95:89.
3. Mouzinho A, Rosenfeld CR, Sanchez PJ, Risser R. Revised reference ranges for circulating neutrophils in very-low-birth-weight neonates. *Pediatrics* 1994;94:76.

4. Broun GO Jr, Herbig FK, Hamilton JR. Leukopenia in negroes. *N Engl J Med* 1966;275:1410.
5. Reed WW, Diehl LF. Leukopenia, neutropenia and reduced hemoglobin levels in healthy American Blacks. *Arch Intern Med* 1991;151:501.
6. Bodey GP, Buckley M, Sathe YS, Freireich EJ. Quantitative relationships between circulating leukocytes and infection in patients with leukemia. *Ann Intern Med* 1966;64:328.
7. Alario AJ, O'Shea JS. Risk of infectious complications in well appearing children with transient neutropenia. *Am J Dis Child* 1989;143:973.
8. Schultz W. Uber eigenartige Halserkrankungen. *Dtsch Med Wochenschr* 1922;48:1495.
9. Brown PK, Ophuls W. A fatal case of acute primary infectious pharyngitis with extreme leukopenia. *Am Med* 1902;3:649.
10. Türk W. Septische Erkrankungen bei Verkümmerng des Granulocytensystems. *Wien Klin Wochenschr* 1907;20:157.
11. Hartl W. Drug allergic agranulocytosis (Schultz's disease). *Semin Hematol* 1965;2:313.
12. Sickles EA, Greene WH, Wiernik PH. Clinical presentation of infection in granulocytopenic patients. *Arch Intern Med* 1975;135:715.
13. Galifi M, Schinella M, Nicoli M, Lippi G. Instrumental reports and effect of anticoagulants in a case of neutrophil agglutination in vitro. *Haematologica* 1993;78:364.
14. Joyce RA, Boggs DR, Hasiba U, Srodes CH. Marginal neutrophil pool size in normal subjects and neutropenic patients as measured by epinephrine infusion. *J Lab Clin Med* 1976;88:614.
15. Johnson ES, Napoli VM, White WC. Colorado tick fever as a hematologic problem. *Am J Clin Pathol* 1960;34:118.
16. Ivarsson SA, Ljung R. Neutropenia and congenital cytomegalovirus infection (letter). *Pediatr Infect Dis J* 1988;7:436.
17. Bokisch VA, Top FH Jr, Russell PK, et al. The potential pathogenic role of complement in dengue hemorrhagic shock syndrome. *N Engl J Med* 1973;289:996.
18. Hammond WP, Harlan JM. Severe neutropenia in infectious mononucleosis. *West J Med* 1979;131:92.
19. Nagaraju M, Weitzman S, Baumann G. Viral hepatitis and agranulocytosis. *Am J Dig Dis* 1973;18:247.
20. Cines DB, Lyss AP, Bina M, et al. Fc and C3 receptors induced by herpes simplex virus on cultured human endothelial cells. *J Clin Invest* 1982;69:123.
21. Murphy MF, Metcalfe P, Waters AH, et al. Incidence and mechanism of neutropenia and thrombocytopenia in patients with human immunodeficiency virus infection. *Br J Haematol* 1987;66:337.
22. Murdoch JM, Smith CC. Hematological aspects of systemic disease: infection. *Clin Haematol* 1972; 1:619.
23. Benjamin B, Ward SM. Leukocytic responses to measles. *Am J Dis Child* 1932;44:921.
24. Boxer LA, Blackwood RA. Leukocyte disorders: quantitative and qualitative disorders of the neutrophil, part 1. *Pediatr Rev* 1996;17:19.
25. McClain K, Estrov Z, Chen H, Mahoney DH. Chronic neutropenia of childhood: frequent association with parvovirus infection and correlations with bone marrow culture studies. *Br J Haematol* 1993;85:57.

26. Horsfall FL, Tamm L. Viral and rickettsial infections of man, 4th ed. Philadelphia: JB Lippincott, 1965.
27. Hillenbrand FKM. The blood picture in rubella. *Lancet* 1956;2:66.
28. Sabin AB, et al. Phlebotomus (pappataci or sandfly) fever. *JAMA* 1944;125:603.
29. Holbrook AA. The blood picture in chicken pox. *Arch Intern Med* 1941;68:294.
30. Berry GP, Kitchen SF. Yellow fever accidentally contracted in the laboratory. *Am J Trop Med* 1931;11:365.
31. Castaneda MR, Guerrero G. Studies on the leucocytic picture in brucellosis. *J Infect Dis* 1946;78:43.
32. Bethell FH. The response to infection in bone marrow dyscrasias. *J Lab Clin Med* 1935;20:362.
33. Lien-Keng K, et al. Diagnostic value of bone marrow and blood picture in salmonellosis. *Ann Paediatrici* 1960;194:141.
34. Ball K, Joules H, Pagel W. Acute tuberculous septicaemia with leucopenia. *BMJ* 1951;2:869.
35. Pullen RL, Stuart BM. Tularemia. *JAMA* 1945;129:495.
36. Dietrich HF. Typhoid fever in children. A study of 60 cases. *J Pediatr* 1937;10:191.
37. Cartwright GE, Chung HL, Chang A. Studies on the pancytopenia of kala-azar. *Blood* 1948;3:249.
38. Dale DC, Wolff SM. Studies of the neutropenia of acute malaria. *Blood* 1973;41:197.
39. Rose HM. The clinical manifestations and laboratory diagnosis of rickettsialpox. *Ann Intern Med* 1949;31:871.
40. Harrel GT. Rocky Mountain spotted fever. *Medicine* 1949;28:333.
41. Woodward TE, Bland EF. Clinical observations in typhus fever. *JAMA* 1944;126:287.
42. Downie AW. Pathway of virus infection. In: Smith E, ed. *Mechanisms of virus infection*. New York: Academic Press, 1963.
43. MacGregor RR, Friedman HM, Macarak EJ, Kefalides NA. Virus infection of endothelial cells increases granulocyte adherence. *J Clin Invest* 1980;65:1469.
44. Schooley RT, Densen P, Harmon D, et al. Antineutrophil antibodies in infectious mononucleosis. *Am J Med* 1984;76:85.
45. Zon LI, Groopman JE. Hematologic manifestations of the human immune deficiency virus. *Semin Hematol* 1988;25:208.
46. Stockman JA. Disorders of leukocytes. In: Oski FA, Naiman JL, eds. *Hematologic problems of the newborn*. Philadelphia: WB Saunders, 1982:223.
47. Andersen RD, Entringer MA, Robinson WA. Virus-induced leukopenia: Colorado tick fever as a human model. *J Infect Dis* 1985;151:449.
48. Brigham KL, Begley CJ, Bernard GR, et al. Septicemia and lung injury. *Clin Lab Med* 1983;3:719.
49. Nathan CF. Neutrophil activation on biological surfaces. *J Clin Invest* 1987;80:1550.
50. McFarland W, Libre EP. Abnormal leukocyte response in alcoholism. *Ann Intern Med* 1963;59:865.
51. Christensen RD, Rothstein G. Exhaustion of mature marrow neutrophils in neonates with sepsis. *J*

Pediatr 1980;96:316.

52. Cairo M. Review of G-CSF and GM-CSF. Effects on neonatal neutrophil kinetics. *Am J Pediatr Hematol Oncol* 1989;11:238.
53. Cairo M. Granulocyte transfusions in neonates with presumed sepsis. *Pediatrics* 1987;80:738.
54. Cairo MS, Worcester CC, Rucker RW, et al. Randomized trial of granulocyte transfusions versus intravenous immune globulin therapy for neonatal neutropenia and sepsis. *J Pediatr* 1992;120:281.
55. Young NS. Agranulocytosis. *JAMA* 1994;271:935.
56. Vincent PC. Drug-induced aplastic anemia and agranulocytosis. *Drugs* 1986;31:52.
57. Lockie LM, et al. Treatment of two reactions due to gold. *JAMA* 1947;133:754.
58. Kasich M. Agranulocytosis following Mapharsen therapy. *Arch Dermatol* 1944;50:302.
59. Loveman AB. Toxic granulocytopenia, purpura hemorrhagica and aplastic anemia following the arsphenamines. *Ann Intern Med* 1932;5:1238.
60. Koszewski BJ, Hubbard TF. Immunologic agranulocytosis due to mercurial diuretics. *Am J Med* 1956;20:958.
61. International Agranulocytosis and Aplastic Anemia Study. Risks of agranulocytosis and aplastic anemia. A first report of their relation to drug use with special reference to analgesics. International Agranulocytosis and Aplastic Anemia Study. *JAMA* 1986;256:1749.
62. Strom BL, Carson JL, Schinnar R, et al. Nonsteroidal anti-inflammatory drugs and neutropenia. *Arch Intern Med* 1993;153:2119.
63. Discombe G. Agranulocytosis caused by amidopyrine. *BMJ* 1952;1:1270.
64. Huguley CM Jr. Agranulocytosis induced by dipyrone, a hazardous antipyretic and analgesic. *JAMA* 1964;189:934.
65. Steinberg CL, et al. Agranulocytosis following phenylbutazone (Butazolidin) therapy. *JAMA* 1953;152:33.
66. Panel on Hematology, Council on Drugs. Adverse reactions, registry on, tabulation of reports. Chicago: AMA, July 1964, May 1965, June 1967.
67. Gryfe CI. Agranulocytosis and aplastic anemia possibly due to ibuprofen. *Can Med Assoc J* 1976;114:877.
68. Best WR. Drug associated blood dyscrasias. *JAMA* 1963;185:286.
69. Sakai J, Joseph MW. Tolmetin and agranulocytosis. *N Engl J Med* 1978;298:1203.
70. Simon LS. Actions and toxicity of non-steroidal anti-inflammatory drugs (review). *Curr Opin Rheumatol* 1995;7:159.
71. Hadler AJ. Granulocytopenia following barbiturate therapy. *N Engl J Med* 1940;222:755.
72. Wyatt S, Joyner MV, Daneshmend TK. Filgrastim for mesalazine-associated neutropenia. *Lancet* 1993;341:1476.
73. Blayney DW. Quinine-associated immune thrombopenia, neutropenia, and renal failure in a patient with Klinefelter's syndrome. *Blood* 1992;80:2686.
74. Korst DR. Agranulocytosis caused by phenothiazine derivatives. *JAMA* 1959;170:2076.

75. Pisciotta AV. Agranulocytosis induced by certain phenothiazine derivatives. *JAMA* 1969;208:1862.
76. Hummer M, Kurz M, Barnas C, et al. Clozapine induced transient white blood count disorders. *J Clin Psychiatry* 1994;55:429.
77. Meylan C, Bondolfi G, Aubert AC, Baumann P. Reversible neutropenia during a cold: possible involvement of risperidone? A case report. *Eur Neuro-psychopharmacol* 1995;5:1.
78. Goodman HL. Agranulocytosis associated with tofranil. *Ann Intern Med* 1961;55:321.
79. Hollis DA. Diazepam: its scope in anaesthetic practice. *Proc R Soc Med* 1969;62:806.
80. Sedlacek SM, Rudolph PM, Kaehny WD. Amoxapine associated agranulocytosis with thrombocytopenia occurring early during recovery. *Am J Med* 1986;80:533.
81. Cutler NR, Heiser JF. Leukopenia following treatment with thiothixene and haloperidol. *JAMA* 1979;242:2872.
82. Jurivich DA, Hanlon J, Andolsek K. Neuroleptic induced neutropenia in the elderly. *J Am Geriatr Soc* 1987;35:248.
83. North WA, Khan AM, Yamase HT, Sporn JR. Reversible granulocytopenia in association with riluzole therapy. *Ann Pharmacother* 2000;34:322.
84. Teter CJ, Early JJ, Frachtling RJ. Olanzapine-induced neutropenia in patients with history of clozapine treatment: two case reports from a state psychiatric institution. *J Clin Psychiatry* 2000;61:872.
85. Watts RG, Emanuel PD, Zuckerman KS, Howard TH. Valproic acid induced cytopenias: evidence for a dose related suppression of hematopoiesis. *J Pediatr* 1990;117:495.
86. Sparberg M. Diagnostically confusing complications of diphenylhydantoin therapy. *Ann Intern Med* 1963;59:914.
87. Davis JP, Lennox WG. The effect of trimethyloxazolidine dione (Tridione) on the blood. *J Pediatr* 1947;31:24.
88. Abbott JA, Schwals RS. The serious side effects of the newer antiepileptic drugs. Their control and prevention. *N Engl J Med* 1950;242:943.
89. Massey GV, Dunn NL, Hekel JL, et al. Aplastic anemia following therapy for absence seizures with ethosuximide (review). *Pediatr Neurol* 1994;11:59.
90. O'Conner CR, Schraeder PL, Kurland AH, O'Conner WH. Evaluation of the mechanisms of antiepileptic drug related chronic leukopenia. *Epilepsia* 1994;35:149.
91. Solvason HB. Agranulocytosis associated with lamotrigine. *Am J Psychiatry* 2000;157:1704.
92. Cooper DS, Goldminz D, Levin AA, et al. Agranulocytosis associated with antithyroid drugs. *Ann Intern Med* 1983;98:26.
93. Morton H. Agranulocytosis caused by thiouracil: a review of fifty nine cases in the literature and a report of two additional cases. *Am J Med* 1947;2:53.
94. Lesses MF, Gargill SL. Thiouracil as a cause of neutropenia and agranulocytosis. *N Engl J Med* 1945;233:803.
95. Bartels EC. Agranulocytosis during propylthiouracil therapy. *Am J Med* 1948;5:48.
96. H'Doubler FT Jr, H'Doubler PB. Toxic reactions from methimazole. *Missouri Med* 1954;51:888.

97. Tait GB. Fatal agranulocytosis during carbimazole therapy. *Lancet* 1957;1:303.
98. International agranulocytosis and aplastic anemia study: risk of agranulocytosis and aplastic anemia in relation to use of antithyroid drugs. *BMJ* 1988;297:262.
99. Wang RIH, Schuller G. Agranulocytosis following procainamide administration. *Am Heart J* 1969;78:282.
100. Cooper RA. Captopril associated neutropenia. Who is at risk? *Arch Intern Med* 1983;143:659.
101. Nawabi IU, Ritz ND. Agranulocytosis due to propranolol. *JAMA* 1973;223:1376.
102. Australian Drug Evaluation Committee. Report of suspected adverse drug reaction, no. 5. Canberra, Australia: Australian Government Publishing Service, 1981.
103. Lundh B, Hasselgren KH. Hematological side effects from antihypertensive agents. *Acta Med Scand Suppl* 1979;628:73.
104. Eisner EV, Carr RM, Mackinney AA. Quinidine-induced agranulocytosis. *JAMA* 1977;238:884.
105. Combs JT, Grunt JA, Brandt IK. Hematologic reactions to diazoxide. *Pediatrics* 1967;40:90.
106. Heimpel H. Drug induced agranulocytosis. *Med Toxicol* 1988;3:449.
107. Miwa LJ, Jolson HM. Propafenone associated agranulocytosis. *Pacing Clin Electrophysiol* 1992;15:387.
108. Ono K, Kurohara K, Yoshihara M, et al. Agranulocytosis caused by ticlopidine and its mechanism. *Am J Hematol* 1991;37:239.
109. Bertolet BD, White BG, Pepine CJ. Neutropenia during treatment with vesnarinone (OPC08212). *Am J Cardiol* 1994;74:968.
110. Donadio C, Lucchesi A. Neutropenia after treatment of posttransplantation erythrocytosis with enalapril. *Transplantation* 2001;72:553.
111. Gronebert DA, Barkhuizen A. Neutropenia during treatment with amiodarone. *Am J Med* 2001;110:671.
112. Strom BL, Carson JL, Schinnar R, Shaw M. Is cimetidine associated with neutropenia? *Am J Med* 1995;99:282.
113. Patton WN, Holyoake TL, Yates JM, et al. Accelerated recovery from drug induced agranulocytosis following G-CSF therapy. *Br J Haematol* 1992;80:564.
114. Cahan AM, Neilman E, Jacobson BM. Agranulocytosis following pyribenzamine. *N Engl J Med* 1949;241:865.
115. Drake TG. Agranulocytosis during therapy with the antihistaminic agent methaphenilene (Diatrin). *JAMA* 1950;142:477.
116. Adams DA, Perry S. Agranulocytosis associated with thenalidine (Sandostene) tartrate therapy. *JAMA* 1958;167:1207.
117. Hardin AS, Padilla F. Agranulocytosis during therapy with a brompheniramine medication. *J Ark Med Soc* 1978;75:206.
118. Curson DA, Hale AS. Mianserin and agranulocytosis. *BMJ* 1979;1:378.
119. Julia A, Olona M, Bueno J, et al. Drug induced agranulocytosis: prognostic factors in a series of 168 episodes. *Br J Haematol* 1991;79:366.



120. Walz B, Zupnick J, Uden D, Keating A. Penicillin-induced agranulocytosis. *West J Med* 1988;149:460.
121. McElfresh AE, Huang NN. Bone-marrow depression resulting from the administration of methicillin. *N Engl J Med* 1962;266:246.
122. Kahn JB. Oxacillin-induced agranulocytosis. *JAMA* 1978;240:2632.
123. Levin AS, Weiner RS, Fudenberg HH, et al. Granulocytopenia caused by anticephalothin antibodies. *Clin Res* 1971;19:424.
124. Borland CD, Farrar WE. Reversible neutropenia from vancomycin. *JAMA* 1979;242:2392.
125. Wintrobe MM. The therapeutic millennium and its price: a view from the haematopoietic system. The Lilly Lecture, 1968. *J R Coll Physicians Lond* 1969;3:99.
126. Chang JC, Reyes B. Agranulocytosis associated with gentamicin. *JAMA* 1975;232:1154.
127. Fleming GF, Crowe GR. Granulocytopenia due to clindamycin. *Med J Aust* 1976;1:70.
128. Hadnagy C, Macavei I, Bornuz F, et al. [Bone marrow damaging effect of various drugs.] *Zeitschrift fur Arztliche Fortbildung* 1985;79:385.
129. Wise GJ, Goldberg P, Kozinn PJ, Nawabi IU. Agranulocytosis associated with flucytosine for urinary candidiasis. *Urology* 1976;8:490.
130. Levy SB, Meyers B, Mellin H. Reversible granulocytopenia in a patient with polycythemia vera taking nitrofurantoin. *J Mt Sinai Hosp* 1969;36:26.
131. Simon HJ, Rogers DE. Agranulocytosis associated with novobiocin administration. *Ann Intern Med* 1957;46:778.
132. Kaufmann D, Pichler W, Beer JH. Severe episode of high fever with rash, lymphadenopathy, neutropenia, and eosinophilia after minocycline therapy for acne. *Arch Intern Med* 1994;154:1983.
133. Brown EB, Cunningham CE. Granulocytopenia during administration of lincomycin. *JAMA* 1965;194:668.
134. Taylor JAT. Metronidazole and transient leukopenia. *JAMA* 1965;194:1331.
135. Dawson AA. Drug-induced haematological disease. *BMJ* 1979;1:1195.
136. Ahuja BK, Sabharwal BD. Agranulocytosis due to INH toxicity. A case report. *J Postgrad Med* 1970;16:45.
137. Geller BS. [Acute drug agranulocytosis caused by streptomycin therapy.] *Vrachebnoe Delo* 1968;11:122.
138. Bansal OP, Wahal PK, Atal PR. Agranulocytosis during unithiben therapy. (A case report). *Indian Pract* 1965;18:841.
139. Shcherbakov AM, Kozlova TL, Bebris NK. [Agranulocytosis—a complication of chemotherapy of echinococcosis with mebendazole.] *Meditssinskaia Parazitologiya I Parazitarnye Bolezni* 1992;5-6:9.
140. McAuley J, Boyer KM, Patel D, et al. Early and longitudinal evaluations of treated infants and children and untreated historical patients with congenital toxoplasmosis: the Chicago Collaborative Treatment Trial. *Clin Infect Dis* 1994;18:38.
141. Teerenhovi L, Heinonen E, Grohn P, et al. High frequency of agranulocytosis in breast cancer patients treated with levamisole. *Lancet* 1978;2:151.
142. Gangarosa EJ, Landerman NS, Rosch PJ, Herndon EG Jr. Hematologic complications arising during

ristocetin therapy. Relation between dose and toxicity. *N Engl J Med* 1958;259:156.

143. Arneborn P, Palmblad J. Drug induced neutropenia in the Stockholm region 1973–75: frequency and causes. *Acta Med Scand* 1978;204:283.

144. Propp RP, Stillman JS. Agranulocytosis and hydroxychloroquine. *N Engl J Med* 1967;277:492.

145. Wong CF, Yew WW. Ethambutol induced neutropenia and eosinophilia. *Chest* 1994;106:1638.

146. Woodbury GR Jr, Fried W, Ertle JO, Malkinson FD. Dapsone associated agranulocytosis and severe anemia in a patient with leukocytoclastic vasculitis. *J Am Acad Dermatol* 1993;28:781.

147. Imrie K, Gold W, Salit I, Keating A. Ciprofloxacin induced neutropenia and erythema multiforme. *Am J Hematol* 1993;43:159.

148. Hawkins T, Carter JM, Romeril KR, et al. Severe trimethoprim induced neutropenia and thrombocytopenia. *N Z Med J* 1993;106:251.

149. Farinas MC, de Vega T, Carmendia J, Gonzalez–Macias J. Severe neutropenia in a patient treated with imipenim/cilastatin. *Eur J Clin Microbiol Infect Dis* 1993;12:303.

150. Koch MA, Volderbing PA, Lagakos SW, et al. Toxic effects of zidovudine in asymptomatic human immunodeficiency virus infected individuals with CD4+ cell counts of  $0.50 \times 10^9/L$  or less. Detailed and updated results from protocol 019 of the AIDS Clinical Trials Group. *Arch Intern Med* 1992;152:2286.

151. Woodcock BE. Cytopenia and fludarabine. *Lancet* 1993;342:1049.

152. Feder HM Jr, Goyal RK, Krause PJ. Acyclovir induced neutropenia in an infant with herpes simplex encephalitis: case report. *Clin Infect Dis* 1995;20:1557.

153. Goodrich JM, Mori M, Gleaves CA, et al. Early treatment with ganciclovir to prevent cytomegalovirus disease after allogeneic bone marrow transplantation. *N Engl J Med* 1991;325:1601.

154. Kovacs MJ, Alshammari S, Guenther L, Bourcier M. Neutropenia and pancytopenia associated with oral terbinafine. *J Am Acad Dermatol* 1994;31:806.

155. Wilkinson DG. Allopurinol and agranulocytosis. *Lancet* 1977;2:1282.

156. Durkales J, Koscinski R. [Agranulocytosis with erythroderma following treatment of gout with colcemid.] *Polski Tygodnik Lekarski* 1971;26:1048.

157. Harris AL, Hughes G, Barrett AJ, et al. Agranulocytosis associated with aminoglutethimide: pharmacological and marrow studies. *Br J Cancer* 1986;54:119.

158. Oymak O, Akpolat T, Arik N, et al. Reversible neutropenia and thrombocytopenia during famotidine treatment. *Ann Pharmacother* 1994;28:406.

159. Ariad S, Hechtlinger V. Bezafibrate–induced neutropenia. *Eur J Haematol* 1993;50:179.

160. McDonnell ND, Livingston RB. Severe reversible neutropenia following treatment of prostate cancer with flutamide. *J Urol* 1994;151:1353.

161. Mike V, Currie VE, Gee TS. Fatal neutropenia associated with long–term tamoxifen therapy. *Lancet* 1994;344:541.

162. Corcos JM, Soler–Bechara J, Mayer K, et al. Neutrophilic agranulocytosis during administration of penicillamine. *JAMA* 1964;189:265.

163. Friedman SJ. Leukopenia and neutropenia associated with isotretinoin. *Arch Dermatol* 1987;123:293.

164. Harvey RL, Luzar MJ. Metoclopramide induced agranulocytosis. *Ann Intern Med* 1988;108:214.

165. Pastor BH, Tetreault AF. Agranulocytosis and scarlatiniform eruption due to phenindione. *JAMA* 1956;161:873.
166. Halverson PB, Kozin F, Bernhard GC, Goldman AL. Toxicity of penicillamine: a serious limitation to therapy in rheumatoid arthritis. *JAMA* 1978;240:1870.
167. Walker JG. Fatal agranulocytosis complicating treatment with ethacrynic acid. *Ann Intern Med* 1966;64:1303.
168. Stone TT, Gladstone L. DDT (dichlorodiphenyltrichloroethane). *JAMA* 1951;145:1342.
169. Sternlieb P, Eisman SH. Toxic hepatitis and agranulocytosis due to cinchophen. *Ann Intern Med* 1957;47:826.
170. Zia LS, Forkner CE. Syndrome of acute agranulocytosis and its occurrence as complication of kala-azar. *Am J Med Sci* 1934;188:624.
171. Tyson TL. Agranulocytosis following pyrithyldione (Presidon) therapy. *JAMA* 1949;141:128.
172. Wilson JHP, Cazemier T, Nieweg HO. Agranulocytosis associated with ajmalin therapy. *Acta Med Scand* 1971;190:35.
173. Herbert V, Tisman G. Hematologic effect of alcohol. *Ann N Y Acad Sci* 1975;252:307.
174. Erdmann H, Heimpel H. [Immune leukocytopenia.] *Medizinische Klinik* 1970;65:763.
175. Ferguson I, Fogg C, Baughan P. Spironolactone induced agranulocytosis. *Med J Aust* 1993;159:837.
176. Burke WJ, Ranno AE. Neutropenia with clozapine and methazolamide. *J Clin Psychopharmacol* 1994;14:357.
177. Fraunfelder FT, Meyer SM, Bagby GC Jr, Dreis MW. Hematologic reactions to carbonic anhydrase inhibitors. *Am J Ophthalmol* 1985;100:79.
178. Ben-Chetrit E, Putterman C. Transient neutropenia induced by intravenous immune globulin. *N Engl J Med* 1992;326:270.
179. Holt TL, Coombes ID, Pillans PI, Scott IA. Neutropenia associated with omeprazole. *Med J Aust* 1999;170:141.
180. Kracke RR. Recurrent agranulocytosis. *Am J Clin Pathol* 1931;1:385.
181. Plum P. Clinical and experimental investigations in agranulocytosis. London: HK Lewis & Co. Ltd., 1937.
182. Madison FW, Squier TL. Etiology of primary granulocytopenia (agranulocytic angina). *JAMA* 1934;102:755.
183. Watkins CH. The possible role of barbiturates and amidopyrine in the causation of leucopenic states. *Mayo Clin Proc* 1933;8:713.
184. Bottiger LE, Furhoff AK, Holmberg L. Drug-induced blood dyscrasias. A ten year material from the Swedish Adverse Drug Reaction Committee. *Acta Med Scand* 1979;205:457.
185. van der Klauw MM, Goudsmit R, Halie MR, et al. A population-based case-cohort study of drug-associated agranulocytosis. *Arch Intern Med* 1999;159:369.
186. Kaufman DW, Kelly JP, Levy M, Shapiro S. The drug etiology of agranulocytosis and aplastic anemia. In: Kelsey JL, Marmot MG, Stolley PD, Vesspe MP, eds. *Monographs in epidemiology and biostatistics*, volume 18. New York: Oxford University Press, 1991.

187. Salama A, Schutz B, Kiefel V, et al. Immune mediated agranulocytosis related to drugs and their metabolites: mode of sensitization and heterogeneity of antibodies. *Br J Haematol* 1989;72:127.
188. Murphy MF, Chapman JF, Metcalf P, Waters AH. Antibiotic induced neutropenia. *Lancet* 1985;2:1306.
189. Neftel KA, Hauser SP, Muller MR. Inhibition of granulopoiesis in vivo and in vitro by betalactam antibiotics. *J Infect Dis* 1985;152:90.
190. Irvine AE, French A, Daly A, et al. Drug induced neutropenia due to direct effects on CFU-C. Ten years of culture experience. *Eur J Haematol* 1994;52:21.
191. Schroder H, Evans DAP. Acetylator phenotype and adverse effects of sulfasalazine in healthy subjects. *Gut* 1972;13:278.
192. Hodinka L, Geher P, Meretey K, et al. Levamisole induced neutropenia and agranulocytosis: association with HLA B27 leukocyte agglutinating and lymphocytotoxic antibodies. *Int Arch Allergy Appl Immunol* 1981;65:460.
193. Singhvi SM, Duchin KL, Willard DA, et al. Renal handling of captopril: effect of probenecid. *Clin Pharmacol Ther* 1982;32:182.
194. Pisciotta AV. Immune and toxic mechanisms in drug induced agranulocytosis. *Semin Hematol* 1973;10:279.
195. Pisciotta AV, Kaldahl J. Studies on agranulocytosis. IV. Effects of chlorpromazine on nucleic acid synthesis of bone marrow cells in vitro. *Blood* 1962;20:364.
196. Carpenter J. Neutropenia induced by semisynthetic penicillin. *South Med J* 1980;73:745.
197. Heit W, Heimpel H, Fischer A, Frickhofen N. Drug induced agranulocytosis: evidence for the commitment of bone marrow haematopoiesis. *Scand J Haematol* 1985;35:459.
198. Price TH, Dale DC. The selective neutropenias. *Clin Haematol* 1978;7:501.
199. Muroi K, Ito M, Sasaki R, et al. Treatment of drug induced agranulocytosis with granulocyte colony stimulating factor. *Lancet* 1989;2:55.
200. Drenick EJ, Alvarez LC. Neutropenia in prolonged fasting. *Am J Clin Nutr* 1971;24:859.
201. Rosen EU, Geefhuysen J, Anderson J, et al. Leukocyte function in children with kwashiorkor. *Arch Dis Child* 1975;50:220.
202. Pearson HA. Marrow hypoplasia in anorexia nervosa. *J Pediatr* 1967;71:211.
203. Shapiro YL. Changes in differential leukocyte counts and prolonged total alimentary starvation. *Fed Proc* 1964;23[suppl]:447.
204. Finch SC. Granulocytopenia. In: Williams JW, Beutler E, Erslev AJ, Reynolds RW, eds. *Hematology*. New York: McGraw-Hill, 1972.
205. Dunlap WM, James GW, Hume DM. Anemia and neutropenia caused by copper deficiency. *Ann Intern Med* 1974;80:470.
206. Percival SS. Neutropenia caused by copper deficiency: possible mechanisms of action. *Nutr Rev* 1995;53:59.
207. Minchinton RM, Waters AH. The occurrence and significance of neutrophil antibodies. *Br J Haematol* 1984;56:521.
208. Verheugt FW, von dem Borne AE, van Noord-Bokhorst JC, et al. Serological, immunochemical and

immunocytological properties of granulocyte antibodies. *Vox Sang* 1978;35:294.

209. Verheugt FW, von dem Borne AE, van Noord-Bokhorst JC, et al. ND1, a new neutrophil granulocyte antigen. *Vox Sang* 1978;35:13.

210. Shastri KA, Logue GL. Autoimmune neutropenia. *Blood* 1993;81:1984.

211. Hartman KR, Wright DG. Identification of autoantibodies specific for the neutrophil adhesion glycoproteins CD11b/CD 18 in patients with autoimmune neutropenia. *Blood* 1991;78:1096.

212. Ory PA, Clark MR, Kwoh EE, et al. Sequences of complementary DNAs that encode the NA1 and NA2 forms of FC receptor III on human neutrophils. *J Clin Invest* 1989;84:1688.

213. Rothko K, Kickler TS, Clay ME, et al. Immunoblotting characterization of neutrophil antigenic targets in autoimmune neutropenia. *Blood* 1989;74:1689.

214. Harmon DC, Weitzman SA, Stossel TP. The severity of immune neutropenia correlates with the maturational specificity of antineutrophil antibodies. *Br J Haematol* 1984;58:209.

215. Hartman KR, LaRussa VF, Rothwell SW, et al. Antibodies to myeloid precursor cells in autoimmune neutropenia. *Blood* 1994;84:625.

216. Bruin MCA, von dem Borne AEG, Tamminga RYJ, et al. Neutrophil antibody specificity in different types of childhood autoimmune neutropenia. *Blood* 1999;94:1797.

217. Knight J, Laing P, Knight A, et al. Thyroid stimulating autoantibodies usually contain only lambda light chains: evidence for the "forbidden clone" theory. *J Clin Endocrinol Metab* 1986;62:342.

218. Lalezari P, Jiang AF, Yegen L, et al. Chronic autoimmune neutropenia due to anti-NA2 antibody. *N Engl J Med* 1975;293:744.

219. McCullough J, Clay M, Press C, Kline W. Methods for detection of granulocyte antibodies. In: McCullough J, ed. *Granulocyte serology: a clinical and laboratory guide*. Chicago: American Society of Clinical Pathologists, 1988.

220. Boxer LA. Immune neutropenias. Clinical and biological implications. *Am J Pediatr Hematol Oncol* 1981;3:89.

221. Verheugt FW, van Noord-Bokhorst JC, von dem Borne AE, Engelfriet CP. A family with allo-immune neonatal neutropenia. Group specific pathogenecity of maternal antibodies. *Vox Sang* 1979;36:1.

222. Lalezari P, Radel E. Neutrophil specific antigens: immunology and clinical significance. *Semin Hematol* 1974;11:281.

223. Lalezari P, Nussbaum M, Gelman S, Spaet T. Neonatal neutropenia due to maternal isoimmunization. *Blood* 1960;15:236.

224. Rios E, Heresi G, Arevalo M. Familial alloimmune neutropenia of NA2 specificity. *Am J Pediatr Hematol Oncol* 1991;13:296.

225. Cartron J, Tchernia G, Celton JL, et al. Alloimmune neonatal neutropenia. *Am J Pediatr Hematol Oncol* 1991;13:21.

226. Bux J, Jung KD, Kauth T, Mueller-Eckhardt C. Serological and clinical aspects of granulocyte antibodies leading to alloimmune neonatal neutropenia. *Transfus Med* 1992;2:143.

227. Gilmore MM, Stroncek DF, Korones DN. Treatment of alloimmune neonatal neutropenia with granulocyte colony stimulating factor. *J Pediatr* 1994;125:948.

228. Calhoun DA, Rimsza LM, Burchfield DJ, et al. Congenital autoimmune neutropenia in two premature neonates. *Pediatrics* 2001;108:181.

229. Boxer LA, Greenberg MS, Boxer GJ, Stossel TP. Autoimmune neutropenia. *N Engl J Med*

1975;293:748.

230. Boxer LA, Yokoyama M, Wiebe RA. Autoimmune neutropenia associated with chronic active hepatitis. *Am J Med* 1972;52:279.

231. Lyall EG, Lucas GF, Eden OB. Autoimmune neutropenia of infancy. *J Clin Pathol* 1992;45:431.

232. Logue GL, Shastri KA, Laughlin M, et al. Idiopathic neutropenia: antineutrophil antibodies and clinical correlations. *Am J Med* 1991;90:211.

233. Dale DC, Guerry D, Wewerka JR, et al. Chronic neutropenia. *Medicine* 1979;58:128.

234. Cines DB, Passero F, Guerry D IV, et al. Granulocyte associated IgG in neutropenic disorders. *Blood* 1982;59:124.

235. Rosenstein ED, Kramer N. Felty's and pseudo-Felty's syndrome. *Semin Arthritis Rheum* 1991;21:129.

236. Loughran TP Jr, Kadin ME, Starkebaum G, et al. Leukemia of large granular lymphocytes: association with clonal chromosomal abnormalities and autoimmune neutropenia, thrombocytopenia and hemolytic anemia. *Ann Intern Med* 1985;102:169.

237. Saway PA, Prasthofer EF, Barton JC. Prevalence of granular lymphocyte proliferation in patients with rheumatoid arthritis and neutropenia. *Am J Med* 1989;86:303.

238. Loughran TP Jr, Starkebaum G, Clark E, et al. Evaluation of splenectomy in large granular lymphocyte leukemia. *Br J Hematol* 1987;67:135.

239. Loughran TP Jr, Starkebaum G. Large granular lymphocyte leukemia: report of 38 cases and review of the literature. *Medicine* 1987;66:397.

240. Lang DF, Rosenfeld CS, Diamond HS, et al. Successful treatment of T-gamma lymphoproliferative disease with human recombinant granulocyte colony stimulating factor. *Am J Hematol* 1992;40:66.

241. Caligaris-Cappio F, Camussi G, Gavsto F. Idiopathic neutropenia with normocellular bone marrow: an immune complex disease. *Br J Haematol* 1979;43:595.

242. Garipidou V, Tsatalas C, Sinacos Z. Severe neutropenia in a patient with large granular lymphocytosis: prolonged successful control with cyclosporin A. *Haematologica* 1991;76:424.

243. Minchinton RM, Waters AH. Autoimmune thrombocytopenia and neutropenia after bone marrow transplantation. *Blood* 1985;66:752.

244. Sirchia G, Rebulli P, Mascaretti L, et al. The clinical importance of leukocyte depletion in regular erythrocyte transfusions. *Vox Sang* 1986;51:2.

245. Meryman HT. Transfusion induced alloimmunization and immunosuppression and the effects of leukocyte depletion. *Trans Med Rev* 1989;3:180.

246. Felty AR. Chronic arthritis in the adult, associated with splenomegaly and neutropenia. *Johns Hopkins Med J* 1924;35:16.

247. Louie JS, Pearson CM. Felty's syndrome. *Semin Hematol* 1971;8:216.

248. Campion G, Maddison PJ, Goulding N, et al. The Felty syndrome: a case matched study of clinical manifestations and outcome, serologic features, and immunogenetic associations. *Medicine* 1990;69:69.

249. Breedveld FC, Lafeber GJM, De Vries E, et al. Immune complexes and the pathogenesis of neutropenia in Felty's syndrome. *Ann Rheum Dis* 1986;45:696.

250. Bagby GC Jr, Lawrence JH, Neerhout RC. T-lymphocyte-mediated granulocyte-poietic failure. *J Clin Invest* 1983;307:1073.

251. Vincent PC, Levi JA, MacQueen A. The mechanism of neutropenia in Felty's syndrome. *Br J*

Haematol 1974;27:463.

252. About NI. Heterogeneity of bone marrow directed immune mechanisms in the pathogenesis of Felty's syndrome. *Arthritis Rheum* 1983;26:947.

253. Hanrahan EM, Miller SR. Effect of splenectomy in Felty's syndrome. *JAMA* 1932;99:1247.

254. Laszlo J, Jones R, Silberman HR, Banks PM. Splenectomy for Felty's syndrome. Clinicopathological study of 27 patients. *Arch Intern Med* 1978;138:597.

255. Sheth SB, Crowley JP. Splenectomy for Felty's syndrome. *R I Med J* 1985;68:275.

256. Dillon AM, Luthra HS, Conn DL, Ferguson RH. Parenteral gold therapy in Felty's syndrome. *Medicine (Baltimore)* 1986;65:107.

257. Lakhanpal S, Luthra HS. D-penicillamine in Felty's syndrome. *J Rheumatol* 1985;12:703.

258. Canvin JM, Dalal BI, Baragar F, Johnston JB. Cyclosporine for the treatment of granulocytopenia in Felty's syndrome. *Am J Hematol* 1991;36:219.

259. Fiechter JJ, Miller DR, Starkegbaum G. Reversal of neutropenia with methotrexate treatment in patients with Felty's syndrome. Correlation of response with neutrophil reactive IgG. *Arthritis Rheum* 1989;32:194.

260. Clotet B, Argelagues E, Junca J, et al. Plasmapheresis in Felty's syndrome. *Scand J Rheum* 1985;14:438.

261. Barnes CG, Turnbull AL, Vernon-Roberts B. Felty's syndrome: a clinical and pathological survey of 21 patients and their response to treatment. *Ann Rheum Dis* 1971;30:359.

262. Breedveld FC, Brand A, van Aken WG. High dose intravenous gammaglobulin for Felty's syndrome. *J Rheumatol* 1985;12:700.

263. Hazenberg BPC, Van Leeuwen MA, Van Rijswijk MH, et al. Correction of granulocytopenia in Felty's syndrome by granulocyte-macrophage colony stimulating factor. Simultaneous induction of interleukin-6 release and flare up of arthritis. *Blood* 1989;148:2769.

264. Joseph G, Neustadt DH, Hamm J, et al. GM-CSF in the treatment of Felty syndrome. *Am J Hematol* 1991;35:55.

265. Choi MFV, Mant MJ, Turner AR, et al. Successful reversal of neutropenia in Felty's syndrome with recombinant granulocyte colony stimulating factor. *Br J Haematol* 1994;86:663.

266. Graham KE, Coodley GO. A prolonged use of granulocyte colony stimulating factor in Felty's syndrome. *J Rheumatol* 1995;22:174.

267. Hayat SQ, Heath-Holmes M, Wolf RE. Flare of arthritis with successful treatment of Felty's syndrome with granulocyte colony stimulating factor (G-CSF). *Clin Rheumatol* 1995;14:211.

268. Craddock PR, Fehr J, Dalmaso AP, et al. Hemodialysis leukopenia: pulmonary vascular leukostasis resulting from complement activation by dialyzer cellophane membranes. *J Clin Invest* 1977;59:879.

269. Chenoweth ED, Cooper SW, Hugli TE, et al. Complement activation during cardiopulmonary bypass: evidence for generation of C3a and C5a anaphylatoxins. *N Engl J Med* 1981;304:497.

270. Boogaerts MA, Roelant C, Goossens W, Verwilghen RL. Complement activation and adult respiratory distress syndrome during intermittent flow apheresis procedures. *Transfusion* 1986;26:82.

271. Hocker JR, Simpson PM, Rabalais GP, et al. Extracorporeal membrane oxygenation and early onset group B streptococcal sepsis. *Pediatrics* 1992;89:1.

272. Kaplow LS, Goffinet JA. Profound neutropenia during the early phase of hemodialysis. *JAMA*



1968;203:1135.

273. Craddock PR, Hammerschmidt D, White JG, et al. Complement (C5a)-induced granulocyte aggregation in vitro: a possible mechanism of complement-mediated leukostasis and leukopenia. *J Clin Invest* 1977;60:260.
274. Lundahl J, Hed J, Jacobson SH. Dialysis granulocytopenia is preceded by an increased surface expression of the adhesion promoting glycoprotein Mac-1. *Nephron* 1992;61:163.
275. Sacks T, Moldow CF, Craddock PR, et al. Oxygen radicals mediate endothelial cell damage by complement stimulated granulocytes: an in vitro model of immune vascular damage. *J Clin Invest* 1978;61:1161.
276. Craddock PR, Fehr J, Brigham KL, et al. Complement and leukocyte mediated pulmonary dysfunction in hemodialysis. *N Engl J Med* 1977;296:769.
277. Amorosi EL. Hypersplenism. *Semin Hematol* 1965;2:249.
278. Kostmann R. Infantile genetic agranulocytosis. *Acta Paediatr Scand* 1956;45[Suppl 105]:1.
279. Kostmann R. Infantile genetic agranulocytosis: a review with presentation of ten new cases. *Acta Paediatr Scand* 1975;64:362.
280. Zucker-Franklin D, L'Esperance P, Good RA. Congenital neutropenia. An intrinsic cell defect demonstrated by electron microscopy of soft agar colonies. *Blood* 1977;49:425.
281. Parmley RT, Ogawa M, Darby CP Jr, Spicer SS. Congenital neutropenia: neutrophil proliferation with abnormal maturation. *Blood* 1975;56:723.
282. Wriedt K, Kauder E, Mauer AM. Defective myelopoiesis in congenital neutropenia. *N Engl J Med* 1970;283:1072.
283. Hestdal K, Welte K, Lie SO, et al. Severe congenital neutropenia: abnormal growth and differentiation of myeloid progenitors to granulocyte colony stimulating factor (G-CSF) but normal response to G-CSF plus stem cell factor. *Blood* 1993;82:2991.
284. Pietsch T, Buhner C, Mempel MK, et al. Blood mononuclear cells from patients with severe congenital neutropenia are capable of producing granulocyte colony stimulating factor. *Blood* 1991;77:1234.
285. Mempel K, Pietsch T, Menzel T, et al. Increased serum levels of granulocyte colony stimulating factor (G-CSF) in patients with severe congenital neutropenia. *Blood* 1991;77:1919.
286. Kyas U, Pietsch T, Welte K. Expression of receptors for G-CSF on neutrophils from patients with severe congenital neutropenia and cyclic neutropenia. *Blood* 1992;79:1144.
287. Guba SC, Sartor CA, Hutchinson R, et al. Granulocyte colony stimulating factor (G-CSF) production and G-CSF receptor structure in patients with congenital neutropenia. *Blood* 1994;83:1486.
288. Bonilla MA, Gillio AP, Ruggeiro M, et al. Effects of recombinant human G-CSF on neutropenia in patients with congenital agranulocytosis. *N Engl J Med* 1989;320:1574.
289. Welte K, Zeidler C, Reiter A, et al. Differential effects of GM-CSF and G-CSF in children with severe congenital neutropenia. *Blood* 1990;75:1056.
290. Nakamura K, Kobayashi M, Konishi, et al. Abnormalities of primitive myeloid progenitor cells expressing granulocyte colony stimulating factor receptor in patients with severe congenital neutropenia. *Blood* 2000;96:4366.
291. Konishi N, Kobayashi M, Miyagawa SI, et al. Defective proliferation of primitive myeloid progenitor cells in patients with severe congenital neutropenia. *Blood* 1999;94:4077.
292. Dale DC, Person RE, Bolyard AA, et al. Mutations in the gene encoding neutrophil elastase in

congenital and cyclic neutropenia. *Blood* 2000;96:2317.

293. Ancliff PJ, Gale RE, Liesner R, et al. Mutations in the ELA2 gene encoding neutrophil elastase are present in most patients with sporadic congenital neutropenia but only in some patients with the familial form of the disease. *Blood* 2001;98:2645.

294. Dong F, Hoefsloot LH, Schelen AM, et al. Identification of a nonsense mutation in the granulocyte colony stimulating factor receptor in severe congenital neutropenia. *Proc Natl Acad Sci U S A* 1994;91:4480.

295. Dong F, Brynes RK, Tidow N, et al. Mutations in the gene for the granulocyte colony stimulating factor receptor in patients with acute myeloid leukemia preceded by severe congenital neutropenia. *N Engl J Med* 1995;333:487.

296. Ward AC, van Aesch YM, Schelen AM, Touw IP. Defective internalization and sustained activation of truncated granulocyte colony stimulating factor receptor found in severe congenital neutropenia/acute myeloid leukemia. *Blood* 1999;93:447.

297. Tschan CA, Pilz C, Zeidler C, et al. Time course of increasing numbers of mutations in the granulocyte colony stimulating factor receptor gene in a patient with congenital neutropenia who developed leukemia. *Blood* 2001;97:1882.

298. Hunter MG, Avalos BR. Granulocyte colony stimulating factor receptor mutations in severe congenital neutropenia transforming to acute myelogenous leukemia confer resistance to apoptosis and enhance cell survival. *Blood* 2000;95:2132.

299. Freedman MH, Bonilla MA, Fier C, et al. Myelodysplasia syndrome and acute myeloid leukemia in patients with congenital neutropenia receiving G-CSF therapy. *Blood* 2000;96:429.

300. Gilman PA, Jackson DP, Guild HG. Congenital agranulocytosis: prolonged survival and terminal acute leukemia. *Blood* 1970;36:576.

301. Lange JE, Cutting HO. Infantile genetic agranulocytosis. *Pediatrics* 1965;35:596.

302. Beard MEJ, Newmark P, Smith ME, et al. Infantile genetic agranulocytosis associated with changes in serum vitamin B<sub>12</sub> binding proteins. *Acta Paediatr Scand* 1972;61:526.

303. Zeidler C, Welte K, Barak Y, et al. Stem cell transplantation in patients with severe congenital neutropenia without evidence of leukemic transformation. *Blood* 2000;95:1195.

304. Zeidler C, Boxer L, Dale DC, et al. Review: management of Kostmann syndrome in the G-CSF era. *Br J Haematol* 2000;109:490.

305. Dror Y, Ward AC, Touw IP, Freedman MH. Combined corticosteroid/granulocyte colony stimulating factor (G-CSF) therapy in the treatment of severe congenital neutropenia unresponsive to G-CSF: activated glucocorticoid receptors synergize with G-CSF signals. *Exp Hematol* 2000;28:1381.

306. Dale DC, Cottle TE, Fier CJ, et al. Severe chronic neutropenia: treatment and follow up of patients in the Severe Chronic Neutropenia International Registry. *Am J Hematol* 2003;72:82.

307. Dale DC, Hammond WP. Cyclic neutropenia: a clinical review. *Blood Rev* 1988;2:178.

308. Leale M. Recurrent furunculosis in an infant showing an unusual blood picture. *JAMA* 1910;54:1845.

309. Haurie C, Dale DC, Mackey MC. Cyclical neutropenia and other periodic hematologic disorders: a review of mechanisms and mathematical models. *Blood* 1998;92:2629.

310. Rutledge BH, Hansen-Pruss OC, Thayer WS. Recurrent agranulocytosis. *Johns Hopkins Hosp Bull* 1930;46:369.

311. Morley AA, Carew JP, Baikie AG. Familial cyclic neutropenia. *Br J Haematol* 1967;13:719.

312. Loughran TP, Clark EA, Price TH, Hammond WP. Adult onset cyclic neutropenia is associated with

increased large granular lymphocytes. *Blood* 1986;68:1082.

313. Lange RD. Cyclic hematopoiesis: human cyclic neutropenia. *Exp Hematol* 1983;11:435.

314. Wright DG, Dale DC, Fauci AS, Wolff SM. Human cyclic neutropenia: clinical review and long term follow-up of patients. *Medicine* 1981;60:1.

315. Geelhoed GW, Kane MA, Dale DC, Wells SA. Colonic perforation in cyclic neutropenia: report of a survivor with peritonitis and clostridial septicemia. *J Pediatr Surg* 1973;8:379.

316. Dale DC, Bolyard AA, Hammond WP. Cyclic neutropenia: natural history and effects of long term treatment with recombinant human granulocyte colony stimulating factor. *Cancer Invest* 1993;11:219.

317. Guerry D, Dale DC, Omine M, et al. Periodic hematopoiesis in human cyclic neutropenia. *J Clin Invest* 1973;52:3220.

318. Page AR, Good RA. Studies on cyclic neutropenia. *Am J Dis Child* 1957;94:623.

319. Engelhard D, Landreth KS, Kapoor N, et al. Cycling of peripheral blood and marrow lymphocytes in cyclic neutropenia. *Proc Natl Acad Sci U S A* 1983;80:5743.

320. Quesenberry PJ. Cyclic hematopoiesis disorders of primitive hematopoietic stem cells. *Exp Hematol* 1983;8:687.

321. Wright DG, LaRussa VF, Salvade AJ, Knight RD. Abnormal responses of myeloid progenitor cells to granulocyte macrophage colony stimulating factor in human cyclic neutropenia. *J Clin Invest* 1989;84:1414.

322. Hammond WP, Chatta GS, Andrews RG, Dale DC. Abnormal responsiveness of granulocyte committed progenitor cells in cyclic neutropenia. *Blood* 1992;79:2536.

323. Aprikyan AAG, Liles WC, Rodger E, et al. Impaired survival of bone marrow hematopoietic progenitor cells in cyclic neutropenia. *Blood* 2001;97:147.

324. Lund JE, Paolgett GA, Ott RA. Cyclic neutropenia in grey collie dogs. *Blood* 1967;29:452.

325. Dale DC, Ward SB, Kimball HR, Wolff SM. Studies of neutrophil production and turnover in gray collie dogs with cyclic neutropenia. *J Clin Invest* 1972;51:2190.

326. Dale DC, Graw RG Jr. Transplantation of allogeneic bone marrow in canine cyclic neutropenia. *Science* 1974;183:83.

327. Krance RA, Spruce WE, Forman SJ, et al. Human cyclic neutropenia transferred by allogeneic bone marrow grafting. *Blood* 1982;60:1263.

328. Horwitz M, Benson KF, Person RE, et al. Mutations in ELA2, encoding neutrophil elastase, define a 21-day biological clock in cyclic hematopoiesis. *Nat Genet* 1999;23:433.

329. Pen HW, Chou CF, Liang DC. Hereditary cyclic neutropenia in the male members of a Chinese family with inverted Y chromosome. *Br J Haematol* 2000;110:438.

330. Wright DG, Fauci AS, Dale DC, Wolff SM. Correction of human cyclic neutropenia with prednisolone. *N Engl J Med* 1978;298:295.

331. Selleri C, Catalano L, Alfinito F, et al. Cyclosporin A in adult onset cyclic neutropenia. *Br J Haematol* 1988;68:137.

332. Hammond WP, Price TH, Souza LM, Dale DC. Treatment of cyclic neutropenia with granulocyte colony stimulating factor. *N Engl J Med* 1989;320:1306.

333. Wright DG, Kenney RF, Oette DH, et al. Contrasting effects of recombinant human granulocyte-macrophage colony stimulating factor (CSF) and granulocyte CSF treatment on the cycling of blood elements in childhood onset cyclic neutropenia. *Blood* 1994;84:1257.

334. Djaldeetti M et al. Familial leukopenia–neutropenia in Yemenite Jews. *Bull Res Counc Isr* 1961;9E:24.
335. Shaper AG, Lewis P. Genetic neutropenia in people of African origin. *Lancet* 1971;2:1021.
336. Jacobs P. Familial benign chronic neutropenia. *S Afr Med J* 1975;49:692.
337. Cutting HO, Lang JE. Familial benign chronic neutropenia. *Ann Intern Med* 1964;61:876.
338. Stabholz A, Soskolne V, Machtei E, et al. Effect of benign familial neutropenia on the periodontium of Yemenite Jews. *J Periodontol* 1990;61:51.
339. Shoenfeld Y, Alkan ML, Asaly A, et al. Benign familial leukopenia and neutropenia in different ethnic groups. *Eur J Haematol* 1988;41:273.
340. Mintz U, Sachs L. Normal granulocyte colony forming cells in the bone marrow of Yemenite Jews with genetic neutropenia. *Blood* 1973;41:745.
341. Joyce RA, Boggs DR, Chervenick PA. Neutrophil kinetics in hereditary and congenital neutropenias. *N Engl J Med* 1976;295:1385.
342. Zuelzer WW, Bajoghli M. Chronic granulocytopenia in childhood. *Blood* 1964;23:359.
343. Jonsson OG, Buchanan GR. Chronic neutropenia during childhood: a 13 year experience in a single institution. *Am J Dis Child* 1991;145:232.
344. Komiyama A, Ishiguro A, Kubo T, et al. Increases in neutrophil counts by purified human urinary colony–stimulating factor in chronic neutropenia of childhood. *Blood* 1988;71:41.
345. Sabbe LJ, Claas FH, Langerak J, et al. Group specific auto–immune antibodies directed to granulocytes as a cause of chronic benign neutropenia in infants. *Acta Haematol* 1982;68:20.
346. Parmley RT, Crist WM, Ragab AH, et al. Phagocytosis of neutrophils by marrow macrophages in childhood chronic benign neutropenia. *J Pediatr* 1981;98:207.
347. Jakubowski AA, Souza L, Kelly F, et al. Effects of human granulocyte colony stimulating factor in a patient with idiopathic neutropenia. *N Engl J Med* 1989;320:38.
348. Sonoda Y, Yashige H, Fujii H, et al. Treatment of idiopathic neutropenia in the elderly with recombinant human granulocyte colony stimulating factor. *Acta Haematol* 1991;85:146.
349. Kyle RA. Natural history of chronic idiopathic neutropenia. *N Engl J Med* 1980;302:908.
350. Kyle RA, Linman JW. Chronic idiopathic neutropenia. *N Engl J Med* 1968;279:1015.
351. Lipton A. Chronic idiopathic neutropenia. *Arch Intern Med* 1969;123:694.
352. Spaet TH, Dameshek W. Chronic hypoplastic neutropenia. *Am J Med* 1952;13:35.
353. Buckley RH, Rowlands DT Jr. Agammaglobulinemia, neutropenia, fever and abdominal pain. *J Allergy Clin Immunol* 1973;51:308.
354. Rosen FS, Craig J, Vawter G, Janeway CA. The dysgammaglobulinemias and sex linked thymic hypoplasia. *Birth Defects* 1968;4:67.
355. Kozlowski C, Evans DI. Neutropenia associated with X–linked agammaglobulinaemia. *J Clin Pathol* 1991;44:388.
356. Ng RP, Prankerd TA. IgA deficiency and neutropenia. *BMJ* 1976;1:563.
357. Lonsdale D, Deodhar SD, Mercer RD. Familial granulocytopenia and associated immunoglobulin

abnormality. *J Pediatr* 1967;71:790.

358. Mentzer WC Jr, Johnston RB Jr, Baehner RL, Nathan DG. An unusual form of chronic neutropenia in a father and daughter with hypogammaglobulinaemia. *Br J Haematol* 1977;36:313.

359. Rieger CHL, Moohr JW, Rothberg RM. Correction of neutropenia associated with dysgammaglobulinemia. *Pediatrics* 1974;54:508.

360. Bjorksten B, Lundmark KM. Recurrent bacterial infections in four siblings with neutropenia, eosinophilia, hyperimmunoglobulinemia A, and defective neutrophil chemotaxis. *J Infect Dis* 1976;133:63.

361. de Vaal OM, Seynhaeve V. Reticular dysgenesis. *Lancet* 1959;2:1123.

362. Gitlin D, Vawter G, Craig JM. Thymic aplasia and congenital aleukocytosis. *Pediatrics* 1964;33:184.

363. Ownby DR, Pizzo S, Blackmon L, et al. Severe combined immunodeficiency with leukopenia (reticular dysgenesis) in siblings: immunologic and histopathologic findings. *J Pediatr* 1976;89:382.

364. Roper M, Parmley RT, Crist WM, et al. Severe congenital leukopenia (reticular dysgenesis): immunologic and morphologic characterization of leukocytes. *Am J Dis Child* 1985;139:832.

365. Levinsky RJ, Tidedman K. Successful bone marrow transplantation for reticular dysgenesis. *Lancet* 1983;1:671.

366. Fischer A, Griscelli C, Friedrich W, et al. Bone marrow transplantation for immunodeficiencies and osteopetrosis: European survey 1968. *Lancet* 1986;2: 1080.

367. Bujan W, Ferster A, Azzi N, et al. Use of recombinant human granulocyte colony stimulating factor in reticular dysgenesis. *Br J Haematol* 1992;81:128.

368. Shwachman H, Diamond LK, Oski FA, Khaw KT. The syndrome of pancreatic insufficiency and bone marrow dysfunction. *J Pediatr* 1964;65:645.

369. Burke V, Colebatch JH, Anderson CM, Simmons MJ. Association of pancreatic insufficiency and chronic neutropenia in childhood. *Arch Dis Child* 1967;42:147.

370. Aggett PJ, Harries JT, Harvey BA, Soothill JF. An inherited defect of neutrophil mobility in Shwachman syndrome. *J Pediatr* 1979;94:391.

371. Ginzberg H, Shin J, Ellis L, et al. Shwachman syndrome: phenotypic manifestations of sibling sets and isolated cases in a large patient cohort are similar. *J Pediatr* 1999;135:81.

372. Tada H, Ri T, Yoshida H, et al. A case of Shwachman syndrome with increased spontaneous chromosome breakage. *Hum Genet* 1987;77:289.

373. Dror Y, Freedman MH. Shwachman–Diamond syndrome marrow cells show abnormally increased apoptosis mediated through the Fas pathway. *Blood* 2001;97:3011.

374. Saunders EF, Gall G, Freedman MH, et al. Granulopoiesis in Shwachman's syndrome (pancreatic insufficiency and bone marrow dysfunction). *Pediatrics* 1979;64:515.

375. Bodian M, Sheldon W, Lightwood RL. Congenital hypoplasia of the exocrine pancreas. *Acta Paediatr* 1964;53:282.

376. Woods WG, Roloff JS, Lukens JN, Krivit W. The occurrence of leukemia in patients with the Shwachman syndrome. *J Pediatr* 1981;99:425.

377. Ventura A, Dragovich D, Luxardo P, Zanazzo G. Human granulocyte colony stimulating factor (rHuG-CSF) for treatment of neutropenia in Shwachman syndrome. *Haematologica* 1995;80:227.

378. McKusick VA, Eldridge R, Hostetler JA, et al. Dwarfism in the Amish. II. Cartilage–hair hypoplasia.

Bull Johns Hopkins Hosp 1965;116:285.

379. Makitie O, Kaitila I. Cartilage-hair hypoplasia—clinical manifestations in 108 Finnish patients. *Eur J Pediatr* 1993;152:211.

380. Lux SE, Johnston RB Jr, August CS, et al. Chronic neutropenia and abnormal cellular immunity in cartilage-hair hypoplasia. *N Engl J Med* 1970;282: 231.

381. Sulisalo T, Sistonen P, Hastbacka J, et al. Cartilage-hair hypoplasia gene assigned to chromosome 9 by linkage analysis. *Nat Genet* 1993;3:338.

382. O'Reilly RJ, Brochstein J, Dinsmore R, Kirkpatrick D. Marrow transplantation for congenital disorders. *Semin Hematol* 1984;21:188.

383. Trowbridge AA, Sirinavin C, Linman JW. Dyskeratosis congenita: hematologic evaluation of a sibship and review of the literature. *Am J Hematol* 1977;3:143.

384. Sirinavin C, Trowbridge AA. Dyskeratosis congenita: clinical features and genetic aspects. Report of a family and review of the literature. *J Med Genet* 1975;12:339.

385. Connor JM, Teague RH. Dyskeratosis congenita: report of a large kindred. *Br J Dermatol* 1981;105:321.

386. Davidson HR, Connor JM. Dyskeratosis congenita. *J Med Genet* 1988;25:843.

387. Jacobs P, Saxe N, Gorden W, Nelson M. Dyskeratosis congenita: hematologic, cytogenetic and dermatologic studies. *Scand J Haematol* 1984;32:461.

388. Ogden GR, Connor E, Chisolm DM. Dyskeratosis congenita: report of a case and review of the literature. *Oral Surg Oral Med Oral Pathol* 1988;65:586.

389. Putterman C, Safadi R, Zlotogora J, et al. Treatment of the hematological manifestations of dyskeratosis congenita. *Ann Hematol* 1993;66:209.

390. Mitchell JR, Wood E, Collins K. A telomerase component is defective in the human disease dyskeratosis congenita. *Nature* 1999;402:551.

391. Drachtman RA, Alter BP. Dyskeratosis congenita: clinical and genetic heterogeneity. Report of a new case and review of the literature. *Am J Pediatr Hematol Oncol* 1992;14:297.

392. Steier W, Van Voolen GA, Selmanowitz VJ. Dyskeratosis congenita: relationship to Fanconi's anemia. *Blood* 1972;39:510.

393. Aguilar-Martinez A, Lautre-Ecenarro MJ, Urbina-Gonzalez F, et al. Cytogenetic abnormalities in dyskeratosis congenita: report of five cases. *Clin Exp Dermatol* 1988;13:100.

394. Dokal I, Luzzatto L. Dyskeratosis congenita is a chromosomal instability disorder. *Leuk Lymphoma* 1994;15:1.

395. Mahmoud HK, Shaefer VW, Schmidt CG, et al. Marrow transplantation for pancytopenia in dyskeratosis congenita. *Blut* 1985;51:57.

396. Russo CL, Glader BE, Israel RJ, Galasso F. Treatment of neutropenia associated with dyskeratosis congenita with GM-CSF. *Lancet* 1990;336:751.

397. Barth PG, Scholte HR, Berden JA, et al. An x-linked mitochondrial disease affecting cardiac muscle, skeletal muscle, and neutrophil leukocytes. *J Neurol Sci* 1983;62:327.

398. Christodoulou J, McInnes RR, Jay V, et al. Barth syndrome: clinical observations and genetic linkage studies. *Am J Med Genet* 1994;50:255.

399. Ino T, Sherwood WG, Cutz E, et al. Dilated cardiomyopathy with neutropenia, short stature, and

abnormal carnitine metabolism. *J Pediatr* 1988;113:511.

400. Barth PG, Wanders RJA, Vreken P, et al. X-linked cardioskeletal myopathy and neutropenia (Barth Syndrome)—MIM 302060. *J Inher Metab Dis* 1999;22:555.
401. Kelley RI, Cheatham JP, Clark BJ, et al. X-linked dilated cardiomyopathy with neutropenia, growth retardation, and 3-methylglutaconic aciduria. *J Pediatr* 1991;119:738.
402. Neuwald AF. Barth syndrome may be due to an acyltransferase deficiency. *Curr Biol* 1997;7:R465.
403. Watts RG, Howard TH. Functional disorders of granulocytes and monocytes. In: Bick RL, ed. *Hematology: clinical and laboratory practice*, 2nd ed. St. Louis: Mosby, 1993:1106.
404. Blume RS, Wolff SM. The Chediak-Higashi syndrome: studies in four patients and a review of the literature. *Medicine* 1972;51:247.
405. Root RK, Rosenthal AS, Balestra DJ. Abnormal bactericidal, metabolic, and lysosomal functions of Chediak-Higashi syndrome leukocytes. *J Clin Invest* 1972;51:649.
406. Oberling F, Lang JM, Juif JG, Luckel JC. Autophagia in myeloid precursors: an explanation for neutropenia in Chediak-Higashi syndrome? *Scand J Haematol* 1976;17:105.
407. Blume RS, Bennett JM, Yankee RA, Wolff SM. Defective granulocyte regulation in the Chediak-Higashi syndrome. *N Engl J Med* 1968;279:1009.
408. Certain S, Barrat F, Pastural E, et al. Protein truncation test of LYST reveals heterogenous mutations in patients with Chediak-Higashi syndrome. *Blood* 2000;95:979.
409. Merino F, Amesty C, Henle W, et al. Chediak-Higashi syndrome: immunological responses to Epstein-Barr virus studies in gene heterozygotes. *J Clin Immunol* 1986;6:242.
410. Haddad E, Le Deist F, Blanche S, et al. Treatment of Chediak-Higashi syndrome by allogeneic bone marrow transplantation: report of 10 cases. *Blood* 1995;85:3328.
411. Krill CE, Smith HD, Mauer AM. Chronic idiopathic granulocytopenia. *N Engl J Med* 1964;270:973.
412. Zuelzer WW et al. "Myelokathexis"—a new form of chronic granulocytopenia. *N Engl J Med* 1964;270:699.
413. Bohinjec J. Myelokathexis: chronic neutropenia with hyperplastic bone marrow and hypersegmented neutrophils in two siblings. *Blut* 1981;42:191.
414. Bassan R, Viero P, Minetti B, et al. Myelokathexis: a rare form of chronic benign granulocytopenia. *Br J Haematol* 1984;58:115.
415. Hord JD, Whitlock JA, Gay JC, Lukens JN. Clinical features of myelokathexis and treatment with hematopoietic cytokines: a case report of two patients and review of the literature. *J Pediatr Hematol Oncol* 1997;19:443.
416. Maran R, Mittleman M, Cohen AM, Djaldetti M. Myelokathexis and monocytosis in a patient with gastric cancer. *Acta Haematol* 1992;87:210.
417. Weston B, Axtell RA, Todd RF, et al. Clinical and biologic effects of granulocyte colony stimulating factor in the treatment of myelokathexis. *J Pediatr* 1991;118:229.
418. Hess U, Ganser A, Schnurch HG, et al. Myelokathexis treated with recombinant human granulocyte macrophage colony stimulating factor (rhGM-CSF). *Br J Haematol* 1992;80:254.
419. Wetzler M, Talpaz M, Kellagher MJ, et al. Myelokathexis: normalization of neutrophil counts and morphology by GM-CSF. *JAMA* 1992;267:2179.
420. Bohinjec J, Andoljsek D. Neutrophil releasing activity of recombinant human granulocyte macrophage



colony stimulating factor in myelokathexis. *Br J Haematol* 1992;82:169.

421. Miller ME, Oski FA, Harris MB. Lazy leucocyte syndrome: a new disorder of neutrophil function. *Lancet* 1971;1:665.
422. Constantopoulos A, Karpathios T, Nicolaidou P, et al. Lazy leukocyte syndrome: a case report. *J Pediatr* 1975;87:945.
423. Pinkerton PH, Robinson JB, Senn JS. Lazy leucocyte syndrome—disorder of the granulocyte membrane? *J Clin Pathol* 1978;31:300.
424. Patrone F, Dallegri F, Rebora A, Sacchetti C. Lazy leukocyte syndrome. *Blut* 1979;39:265.
425. Yoda S, Morosawa H, Komiyama A, Akabane T. Transient “lazy leukocyte” syndrome during infancy. *Am J Dis Child* 1980;134:467.
426. Boxer LA, Hedley-Whyte ET, Stossel TP. Neutrophil actin dysfunction and abnormal neutrophil behavior. *N Engl J Med* 1974;291:1093.
427. Coates TD, Torkildson JC, Torres M, et al. An inherited defect of neutrophil motility and microfilamentous cytoskeleton associated with abnormalities of 47 kd and 89 kd proteins. *Blood* 1991;78:1338.
428. Ribeiro RC, Howard TH, Brandalise S, et al. Giant actin inclusions in hematopoietic cells associated with transfusion dependent anemia and grey skin discoloration. *Blood* 1994;83:3717.
429. Beaudet AL, Anderson DC, Michels VV, et al. Neutropenia and impaired neutrophil migration in type IB glycogen storage disease. *J Pediatr* 1980;97:906.
430. Childs B, Nyhan WL. Further observations of a patient with hyperglycinemia. *Pediatrics* 1964;33:403.
431. Matsui SM, Mahoney MJ, Rosenberg LE. The natural history of the inherited methylmalonic acidemias. *N Engl J Med* 1983;308:857.
432. Sidbury JB, Smith EK, Harlan W. An inborn error of short chain fatty acid metabolism. *J Pediatr* 1967;70:8.
433. Schaub J, Heyne K. Glycogen storage disease type Ib. *Eur J Pediatr* 1983;140:283.
434. Hurst D, Kilpatrick L, Becker J, et al. Recombinant human GM-CSF treatment of neutropenia in glycogen storage disease 1b. *Am J Pediatr Hematol Oncol* 1993;15:71.
435. Wendel U, Schrotten H, Burdach S, Wahn V. Glycogen storage disease type Ib: infectious complications and measures for prevention. *Eur J Pediatr* 1993;152[Suppl 1]:S49.
436. Calderwood S, Kilpatrick L, Douglas SD, et al. Recombinant human granulocyte colony stimulating factor therapy for patients with neutropenia and or neutrophil dysfunction secondary to glycogen storage disease type 1b. *Blood* 2001;97:376.
437. Senn H, Holland JF, Banerjee T. Kinetic and comparative studies on localized leukocyte mobilization in normal man. *J Lab Clin Med* 1969;74:742.
438. Athens JW, Haab OP, Raab SO, et al. Leukokinetic studies IV. The total blood, circulating and marginal granulocyte pools, and the granulocyte turnover rate in normal subjects. *J Clin Invest* 1961;40:989.
439. Rebuck JW, Crowley JH. A method of studying leukocyte functions *in vivo*. *Ann N Y Acad Sci* 1955;59:757.
440. Sickles EA, Greene WH, Wiernik PH. Clinical presentation of infection in granulocytopenic patients. *Arch Intern Med* 1975;135:715.
441. Eyring EJ, Engleman EP. Interaction of gold and penicillamine. *Arthritis Rheum* 1963;6:216.

442. Yeghen T, Devereux S. Granulocyte transfusion: a review. *Vox Sang* 2001;81:87.
443. Hubel K, Dale DC, Liles WC. Granulocyte transfusion therapy: update on potential clinical applications. *Curr Opin Hematol* 2001;8:161.
444. Christensen R, Rothstein G, Anstall H, Bybee B. Granulocyte transfusions in neonates with bacterial infection, neutropenia, and depletion of mature neutrophils. *Pediatrics* 1982;70:1.
445. Bensinger WI, Price TH, Dale DC, et al. The effects of daily recombinant human granulocyte colony stimulating factor administration on normal granulocyte donors undergoing leukapheresis. *Blood* 1993;81:1883.
446. Frampton JE, Lee CR, Faulds D. Filgrastim: a review of its pharmacological properties and therapeutic efficacy in neutropenia. *Drugs* 1994;48:731.
447. Frampton JE, Yarker YE, Goa KL. Lenograstim: a review of its pharmacological properties and therapeutic efficacy in neutropenia and related clinical settings. *Drugs* 1995;49:767.
448. Gabrilove J. The development of granulocyte colony stimulating factor in its various clinical applications. *Blood* 1992;80:1382.

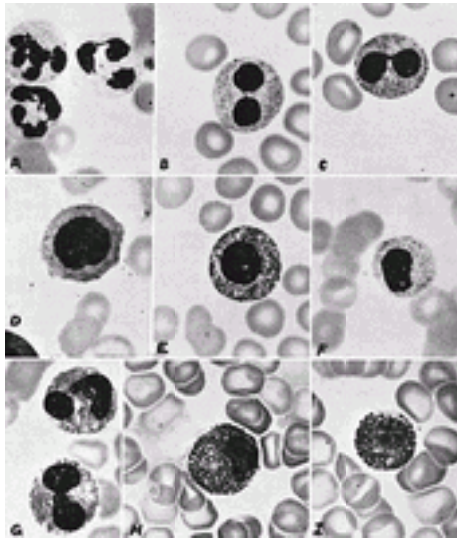
2004 Lippincott Williams & Wilkins  
John P. Greer, John Foerster, John N. Lukens  
George M. Rodgers, Frixos Paraskevas, Bertil Glader  
Wintrobe's Clinical Hematology

DISORDERS OF PHAGOCYTIC LEUKOCYTES CHARACTERIZED BY MORPHOLOGIC CHANGESPelger–Huët AnomalyPseudo- or Acquired Pelger–Huët AnomalyAlder–Reilly AnomalyMay–Hegglin AnomalyChédiak–Steinbrink–Higashi Anomaly (Congenital Gigantism of Peroxidase Granules)Familial Vacuolization of Leukocytes (Jordan Anomaly)Other Inclusions in LeukocytesAbnormal Specific (Secondary) Granule FormationHereditary Giant NeutrophiliaHereditary Hypersegmentation of Neutrophil NucleiHypersegmentation of Eosinophils and Negative Staining for Peroxidase and PhospholipidsFUNCTIONAL DISORDERS OF LEUKOCYTES NOT CHARACTERIZED BY MORPHOLOGIC CHANGESChronic Granulomatous Disease of ChildhoodLipochrome HistiocytosisGlucose-6-Phosphate Dehydrogenase DeficiencyGlutathione Peroxidase DeficiencyGlutathione Synthetase or Reductase DeficiencyCatalase DeficiencyJob SyndromeMyeloperoxidase DeficiencyOther Enzymatic DefectsLeukocyte Adhesion DefectsFc $\gamma$ RIII DeficiencyActin DysfunctionLocalized Juvenile PeriodontitisDesensitizationViral InfectionHyperalimentation HypophosphatemiaHyperglycemiaMiscellaneousNeutrophil Dysregulation in the Systemic Inflammatory Response SyndromeFREQUENCY OF IDENTIFIABLE QUALITATIVE NEUTROPHIL DISORDERSWEB SITESREFERENCES**DISORDERS OF PHAGOCYTIC LEUKOCYTES CHARACTERIZED BY MORPHOLOGIC CHANGES**

For the most part, the disorders considered here are rare, usually familial, and often reflect a general metabolic defect, the major manifestation of which may be more serious in tissues other than in leukocytes. Nevertheless, the leukocytic morphologic abnormalities may come to the attention of the hematologist, and familiarity with them and the associated diseases may facilitate diagnosis.

**Pelger–Huët Anomaly**

Pelger–Huët anomaly is a benign anomaly of leukocytes and is inherited as a nonsex–linked, dominant trait. It is characterized by distinctive shapes of the nuclei of leukocytes, a reduced number of nuclear segments (best seen in the neutrophils), and coarseness of the chromatin of the nuclei of neutrophils, lymphocytes, and monocytes. The nuclei appear rodlike, dumbbell–shaped, peanut–shaped, and spectaclelike (“pince–nez”) with smooth, round, or oval individual lobes ( [Fig. 64.1B](#) and [Fig. 64.1C](#)), contrasted with the irregular lobes seen in normal neutrophils ( [Fig. 64.1A](#)) ( [1](#)). The incidence of this disorder in different studies has ranged from as high as 1 in 1000 persons ( [2](#), [3](#)) to 1 in 4000 ( [4](#), [5](#)), 6000 ( [6](#)), or even 10,000 ( [7](#)). Originally observed mainly in Holland, Germany, and Switzerland, the anomaly has now been described in other parts of the world, including individuals of Asian ( [8](#)) and African descent and whites. The practical importance of identifying the Pelger–Huët anomaly lies in distinguishing this defect from the shift to the left that occurs in association with infection.



**Figure 64.1.** The morphologic changes of Pelger–Huët cells as compared with normal leukocytes. **A**, Normal neutrophils; **B** and **C**, neutrophils with bilobed or “pince–nez” nuclei; **D**, normal myelocyte, to contrast with **E** and **F**, mature Pelger–Huët neutrophils with round or indented nuclei; **G**, normal eosinophils; **H** and **I**, mature eosinophils with round nuclei. (From Skendzel LP, Hoffman GC. The Pelger anomaly of leukocytes: forty–one cases in seven families. *Am J Clin Pathol* 1962;37:294, with permission.)

The discovery of this anomaly in rabbits led to breeding experiments and the production of homozygotes ( [2](#), [5](#)). These studies demonstrated that, in the heterozygote, bilobed, rod–shaped, and spectacle forms predominate, whereas in the homozygote, round nuclei with no evidence of segmentation are predominant. In rabbits, the homozygous form was often lethal, with most animals dying *in utero*; some survivors suffered skeletal malformations.

Two human homozygotes have been reported ( [2](#), [9](#)). In them, the cytoplasm of the neutrophils appeared mature, but the nuclei were round or oval in all the neutrophils, in contrast to the fewer than 40% single–lobed neutrophils present in heterozygotes ( [Table 64.1](#)) ( [2](#), [6](#), [9](#)). In the homozygotes, the eosinophils, basophils, and megakaryocytes also were characterized by dense nuclear chromatin and rounded nuclear lobes; these individuals had fewer nuclear lobes than normal subjects ( [2](#)). Examination of the bone

marrow revealed normal morphologic features in myeloid precursors through the myelocyte stage, and electron microscopy revealed persistence of nucleoli in the otherwise mature neutrophils that contained single oval nuclei (9). This finding was interpreted as indicating some retardation of nuclear maturation because no cytochemical defects were noted in the cytoplasm.

**TABLE 64.1. Distribution of Nuclear Lobes in Neutrophils of Normal Persons and in Those with Pelger–Huët Anomaly**

|  | Cases Examined | Number of Lobes <sup>a</sup> |      |      |      |      |
|--|----------------|------------------------------|------|------|------|------|
|  |                | 1                            | 2    | 3    | 4    | 5    |
| Normals <sup>b</sup>                   | 50             | 2.8                          | 22.0 | 54.3 | 18.1 | 2.8  |
|  |                | ±2.8                         | ±6.3 | ±5.3 | ±6.9 | ±2.1 |
| Pelger–Huët heterozygotes <sup>b</sup> | 34             | 31.3                         | 63.8 | 4.9  | 0.3  | 0    |
|  |                | ±9.2                         | ±9.5 | ±3.7 | —    | —    |
| Pelger–Huët homozygotes <sup>2,9</sup> | 2              | 100.0                        | —    | —    | —    | —    |

<sup>a</sup> Mean and variance.

<sup>b</sup> Modified from Davidson WM, et al. The Pelger–Huët anomaly: investigation of family “A.” *Ann Hum Genet* 1954;19:1.

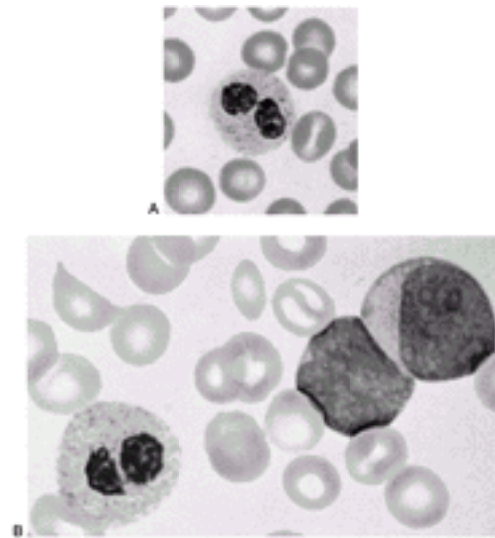
Pelger–Huët cells appear to be normal functionally (9, 10 and 11), are able to phagocytize and kill microorganisms (5), and survive normally in the circulation in both humans (12) and dogs (13, 14).

The Pelger–Huët heterozygote is recognized by finding (a) 69 to 93% of the neutrophils to be of the bilobed, pince-nez type; (b) few cells with three lobes (usually less than 10%); and (c) rare or no cells with four lobes (Table 64.1) (4, 5 and 6). In normal blood smears, no more than 27% of the cells are bilobed, and significant numbers of cells have three or more lobes (Table 64.1) (5). The presence of similar abnormalities in the blood smear in other family members also is helpful in establishing the diagnosis. In heterozygotes, mature neutrophils with round or oval nuclei of the type that is characteristic of the homozygous state may increase after stress such as the injection of colchicine (15) or pyripher (3). A shift toward increased numbers of neutrophil lobes was described in a patient with the anomaly who developed pernicious anemia (16).

### Pseudo- or Acquired Pelger–Huët Anomaly

Cells with morphologic changes, such as those just described, have been observed occasionally in association with myxedema, acute enteritis, agranulocytosis, multiple myeloma, malaria, leukemoid reactions secondary to metastases to the bone marrow (17), drug sensitivity (18), or chronic lymphocytic leukemia (3). More commonly, pseudo-Pelger–Huët cells (Fig. 64.2) (19) are seen in patients with myeloid leukemia of either the acute or chronic type or in those with myeloid metaplasia (20, 21). In these subjects, the pseudo-Pelger–Huët cells tend to appear late in the disease, often after

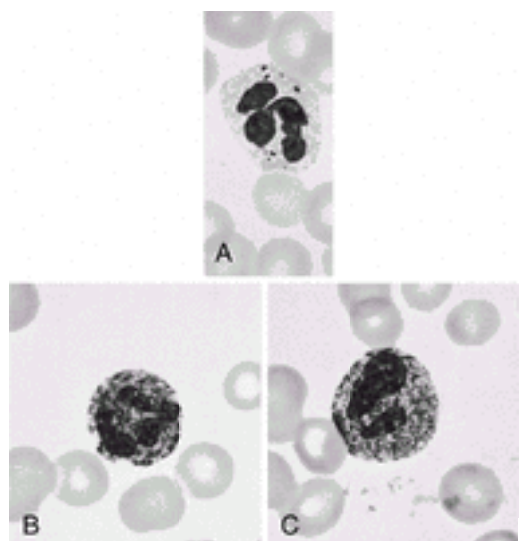
considerable chemotherapy has been administered. In addition, most of the nuclei are of the single oval type characteristic of the homozygous state ([20](#)).



**Figure 64.2.** A: Pseudo-Pelger-Huët cells. B: From a patient with acute myeloblastic leukemia. See [Color Plate](#).

### Alder-Reilly Anomaly

Alder-Reilly anomaly, inherited as a recessive trait ([22](#)), apparently does not interfere with leukocyte function ([23](#)). It is characterized by the presence of larger-than-normal azurophil and basophil granules (Alder-Reilly bodies), which may be easily confused with granulations due to toxic states ([Fig. 64.3](#)). These granules stain dark lilac with Wright-Giemsa stains and are seen in patients with various types of bone and cartilage abnormalities ([24](#), [25](#), [26](#) and [27](#)). They are most common, however, in association with Hurler syndrome, Hunter syndrome, and Maroteaux-Lamy polydystrophic dwarfism ([28](#)).



**Figure 64.3.** Neutrophils with Alder–Reilly bodies (A) compared with neutrophils exhibiting toxic granulation (B,C). See [Color Plate](#).

Similar inclusions may be seen in blood lymphocytes (Gasser cells) and monocytes ( [26](#) , [29](#) ). The lymphocyte inclusions stain dark red or purple with May–Grünwald–Giemsa stain and metachromatically with toluidine blue; normal azurophilic granules do not stain at all ( [26](#) ). Such lymphocyte granules are found in all types of mucopolysaccharidoses except Morquio syndrome, but they are most common in the Hurler, Hunter, Sanfilippo, and Maroteaux–Lamy syndromes ( [26](#) , [28](#) ). They tend to occur in clusters rather than diffusely throughout the cytoplasm, are surrounded by vacuoles, and are shaped like a dot or comma. In one series of 19 patients, 8 to 50% of the lymphocytes contained the inclusions, and their presence was thought to be of diagnostic significance ( [26](#) ).

These inclusions are seen inconsistently in the blood but are more common in the bone marrow. For example, in a series of 18 patients with Hurler form of mucopolysaccharidosis, Alder–Reilly bodies were present in the blood of less than 10% of them. Careful examination of the bone marrow, however, revealed mucopolysaccharide granules in large mononuclear cells (Buhot cells) in 17 of 18 patients ( [30](#) , [31](#) and [32](#) ).

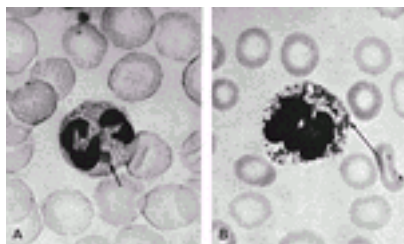
The type of inclusion seen is not diagnostic of a particular type of mucopolysaccharidosis, and the frequency of the inclusions is not correlated with clinical severity ( [33](#) ). The basic defect in this group of diseases lies in the incomplete degradation of the protein–carbohydrate complexes known as *mucopolysaccharides*, and the different forms of mucopolysaccharidosis involve different enzymatic deficiencies ( [28](#) ). The accumulation of partially degraded mucopolysaccharide within lysosomes has been demonstrated by electron microscopy ( [28](#) ); the degradation of the protein core of the mucopolysaccharide appears to proceed normally, but catabolism of the carbohydrate side chains is impaired.

### May–Hegglin Anomaly

The May–Hegglin anomaly is a rare, dominantly inherited disorder characterized by large (2 to 5  $\mu\text{m}$ ), well-defined, basophilic and pyroninophilic inclusions in granulocytes (neutrophils, eosinophils, basophils, monocytes) and accompanied by variable thrombocytopenia and giant platelets containing few granules ( [34](#) ). For the most part, affected family members have not been ill, but occasionally abnormal bleeding has occurred ( [35](#) , [36](#) , [37](#) and [38](#) ). Clot retraction time is prolonged, and the reaction to the tourniquet test may be positive. Platelet survival was short [half-life = 3 days as compared with the normal, which is  $6.9 \pm 1.5$  (1 standard deviation) days] ( [39](#) ). Platelet aggregation and retraction were normal, but spreading and serotonin uptake was increased ( [40](#) ). Enzyme and substrate content per platelet was increased, but this value was decreased as related to platelet volume ( [40](#) ). The granulocyte inclusions ( [Fig. 64.4](#) ) are similar to Döhle bodies in appearance, but they often are larger, more round and discrete, and may be present in a large percentage of the cells. ( [37](#) , [38](#) , [41](#) ). It is claimed that these inclusions differ from the Döhle bodies of infection in morphologic appearance in that they are present in granulocytes other than neutrophils ( [41](#) ). Like Döhle bodies ( [41](#) , [37](#) ), the inclusions were felt to consist mainly of RNA ( [38](#) , [42](#) ), apparently derived from the rough endoplasmic reticulum. More recently, mutations of the NMMHC–A gene have been found in this syndrome ( [43](#) , [44](#) and [45](#) ). NMMHC–A is a nonmuscle myosin heavy chain that is part of a family of genes coding for proteins that form part of the actin–myosin force generating complexes ( [46](#) ). In the bone marrow, clumping of the



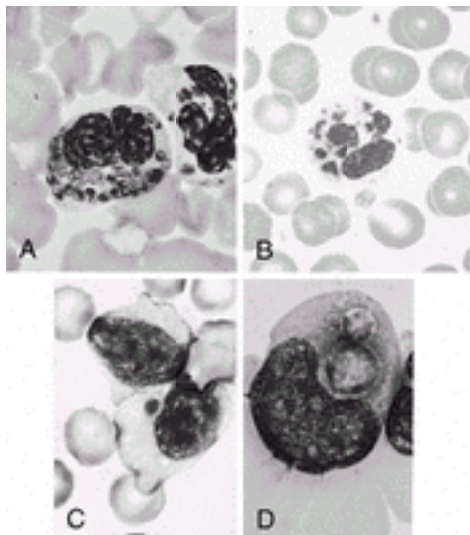
megakaryocyte cytoplasm has also been reported ( [36](#) ).



**Figure 64.4.** **A:** Neutrophil containing a typical May–Hegglin inclusion ( *arrow*). **B:** Neutrophil showing a Döhle body of infection ( *arrow*). Also note the toxic granulation in this cell. (From Cawley JC, Hayhoe FGJ. The inclusions of the May–Hegglin anomaly and Döhle bodies of infection: an ultrastructural comparison. *Br J Haematol* 1972;22:491, with permission.)

### Chédiak–Steinbrinck–Higashi Anomaly (Congenital Gigantism of Peroxidase Granules)

Chédiak–Steinbrinck–Higashi anomaly, an autosomal–recessive disorder, has been reported in humans ( [47](#), [48](#), [49](#) and [50](#) ), mice ( [51](#) ), mink ( [52](#) ), cattle ( [52](#) ), cats ( [53](#) ), rats ( [54](#) ), and a killer whale ( [55](#) ). It is characterized by partial ocular and cutaneous albinism, increased susceptibility to pyogenic infections, the presence of large lysosomelike organelles in most granule–containing cells, and a bleeding tendency ( [56](#) ). The abnormal granules are most readily seen in blood and marrow leukocytes, especially granulocytes, ( [Fig. 64.5](#) ) and in melanocytes.



**Figure 64.5.** Inclusion bodies in Chédiak–Steinbrinck–Higashi anomaly. **A** and **B**, neutrophils; **C**, a lymphocyte; **D**, a monocytoid cell. See [Color Plate](#).

In the first families that were reported with this anomaly, the mothers noted that some of their children exhibited pale hair ( [Fig. 64.6](#) ) and photophobia ( [47](#), [48](#) ). Because these children often had infections and adenopathy and died at an early age, the children born

subsequently who were similarly affected were brought to medical attention in the hope of avoiding a fatal outcome ( 48 ). It was then that the large, peroxidase-positive granules were noted in their blood and marrow granulocytes ( 47 , 48 and 49 ). Nevertheless, most patients die in infancy or early childhood; only a few survive into early adult life ( 57 , 58 and 59 ).



**Figure 64.6.** The characteristic silver-gray hair of a child ( *left* ) with Chédiak–Steinbrinck–Higashi anomaly contrasted with that of her mother. (Courtesy of Dr. Dorothy Windhorst, National Institutes of Health.) See [Color Plate](#).

During the 30 years after the first description of Chédiak–Higashi syndrome (CHS) ( 60 ), 59 cases were reported ( 57 ). The similar disorder in animals is of use in investigations of the pathogenic defect and is of significant economic impact in mink, in that affected animals, inbred for their unusual color, seldom survive more than a year and exhibit increased susceptibility to a slow viral infection that produces hepatitis and a myelomalike illness (Aleutian mink disease) ( 52 ).

**ETIOLOGY AND PATHOGENESIS** The manifestations of this disorder appear to result from abnormal granule fusion with larger, fewer-than-normal, and perhaps defective granules being formed in most granule-containing cells throughout the body ( 61 ). Findings of a study of the formation of hepatic lysosomes in mice with the syndrome suggested that the abnormal granules arise from dilated portions of the Golgi-endoplasmic reticulum-lysosome apparatus, but whether this distortion reflects delayed granule detachment from the Golgi-endoplasmic reticulum-lysosome apparatus, abnormal granule membrane lipid, or some other defect remains unclear ( 62 ). The resulting abnormalities can be found in the hematopoietic tissues, hair, ocular pigment, skin, adrenal glands, pituitary gland, gastrointestinal organs, peripheral nerves, and elsewhere ( 61 ). In neutrophils, the anomalously large, peroxidase-positive granules seen by light microscopy ( 47 , 48 ) have been shown by electron microscopy to be abnormal primary (azurophilic) granules, the contents of which remain pleomorphic, the normal granule crystalloid structure not being formed ( 61 , 63 ). Characterization of the abnormal granules by means of immunofluorescence microscopy demonstrated that they were formed by the progressive aggregation and fusion of azurophilic granules ( 64 , 65 ). In a subsequent electron microscopic study, investigators demonstrated the presence of two types of giant, peroxidase-positive granules in CHS neutrophils: large, round, or oval granules with homogeneous internal structure similar to normal azurophilic granules; and irregular granules much larger than those of the first type. Because basophils and eosinophils from CHS patients do not contain type 2 granules, and because type 2 granules are less common in promyelocytes, myelocytes, and young neutrophils in the bone marrow than in blood neutrophils, the authors suggested that normal primary (azurophilic) granules are formed, but progressive granule fusion occurs during maturation, especially in the blood. In this process, granules and bits of cytoplasm are trapped within the fused granules ( 66 ).

An abnormal calcium uptake pump in CHS lysosomes may be the underlying defect (67). Also noted is an increased tendency to autophagic vacuole formation in Chédiak-Higashi neutrophils, perhaps because of increased permeability and leakage of injurious materials from the massive granules (68). The abnormal granules in monocytes result from granule fusion (64) and may be phagolysosomes. In lymphocytes and plasma cells, they may be primary granules. A secretory defect appears to prevent granule release in CHS T cells (69). Abnormal granules have been observed less often in erythroid cells, whereas in megakaryocytes and platelets, the granules appear normal by light microscopy (61). By electron microscopy, however, a decrease in dense bodies was seen (61), and decreased serotonin, adenosine triphosphate, and adenosine diphosphate levels were noted (56). Similar large granules containing a glycolipid have been observed in the Schwann cells of peripheral nerves, in neurons in the central nervous system (68, 70), in renal tubular cells (70), and in the vascular endothelium and fibroblasts (57, 71). In addition, giant pigment granules have been demonstrated in melanosomes (70) and in hair strands (57, 70). In the several different tissues affected, the consistent feature is that the histochemical reactions of the large abnormal granules are those usually seen in normal granules of that cell line (70); no qualitative alteration in granule enzyme content is noted, but some decrease in granule enzymes and an increase in cytoplasmic enzyme content have been described (72). The effects of the abnormality in different tissues depend on granule function in that tissue. Thus, the large but fewer melanin granules produce pigment dilution, which explains the peculiar hair color, partial albinism, photophobia, and nystagmus (70). On the other hand, the abnormal large granules in neutrophils lead to increased susceptibility to infection. Infection occurs despite an above-normal rate of phagocytosis and a normal postphagocytic metabolic burst ( $H_2O_2$  production) (73). Apparently, the intracellular destruction of some bacteria by Chédiak-Higashi leukocytes is delayed because the postphagocytic delivery of lysosomal enzymes into phagosomes is inefficient and incomplete (74). A similar defect in granule extrusion has been noted in the renal tubule (75). Chédiak-Higashi neutrophils from humans lack cathepsin G and elastase (76) and have reduced C3b<sub>i</sub> receptor expression (77). Because measurements of elastase and cathepsin G were normal in the bone marrow of beige mice, the primary lesion is thought not to be a gene defect but rather is likely a disorder of protein processing, protein synthesis, or granule assembly (76). In addition, a defect in cellular response to chemotactic stimuli both in *in vitro* and in *in vivo* skin windows has been demonstrated in humans, mice, and mink (78, 79), and a neutrophil membrane abnormality consisting of spontaneous cap formation has been described (80). This defect appears to result from an absence of microtubule assembly (similar to that produced in normal cells by colchicine) and can be restored toward normal by agents such as cyclic guanosine monophosphate, cholinergic agonists (81), and ascorbic acid (82).

**INHERITANCE** In 1972, in families with 127 children, 59 were reported to be affected (57). Judging by this statistic and on the basis of animal studies (52), this disorder is almost certainly inherited as an autosomal-recessive trait. Male and female subjects are affected at a ratio of 0.87:1.00. A high proportion of marriages producing affected children have been consanguineous. Some heterozygotes may be identifiable by the presence of granulation in some of their lymphocytes (83, 84).

**CLINICAL FEATURES AND COURSE** The partial albinism (more properly, pigment dilutional defect) (70), silvery hair (Fig. 64.6), and photophobia are usually noted early in infancy. The poor resistance to respiratory and cutaneous infection, especially by *Staphylococci* and other gram-positive organisms, soon becomes evident. Four patients studied for more than 1 year experienced 29 episodes of fever and pyogenic infection (59). Increased bleeding with abnormal platelet function has also been recognized (85). Many of the afflicted children die of infection during infancy or early childhood. In others, the

disease remains quiescent. Eventually, in more than 85% of patients, it changes to an *acceleratec* phase that is characterized by lymphadenopathy, hepatosplenomegaly, neuropathy, anemia, neutropenia, and, less often, thrombocytopenia ( [86](#) ). During this phase, infiltration of the tissues by mononuclear cells is widespread, a change that has been termed *lymphoma* by some, but is more likely a reactive lymphohistiocytic response ( [57](#) , [87](#) ). During the accelerated phase, neurologic manifestations (peripheral neuropathy) may become prominent, and hemorrhage may occur.

**LABORATORY FINDINGS** The characteristic microscopic findings are the large, often multiple, peroxidase-positive lysosomal granules in the granulocytes of the blood and bone marrow, and the large melanosomes in the hair. Less common are granules in the lymphocytes. Abnormal platelet aggregation can be demonstrated regularly ( [56](#) ). During the early phases of the disease, blood counts yield normal values, but as the disease progresses, anemia, neutropenia, and thrombocytopenia often develop. Immunoglobulin and complement levels are normal, as are cellular immune reactions. In the accelerated phase, erythrocyte and granulocyte survival may be shortened ( [57](#) ).

**GENE DEFECT** The origin of CHS in mice has been found to be a mutation in the *Lyst* gene, which codes for a lysosomal trafficking regulatory protein ( [88](#) , [89](#) ). The human homolog CHS1 has since been cloned, and mutations of this gene have been found in patients with CHS ( [89](#) , [90](#) , [91](#) , [92](#) and [93](#) ).

**MANAGEMENT** Although unproven, some believe that the prophylactic administration of antibiotics may be beneficial ( [59](#) ). The administration of ascorbic acid corrected the defective leukocyte function *in vitro* and *in vivo* in several patients ( [82](#) , [94](#) ), and the administration of cholinergic agonists was effective in mice ( [80](#) , [81](#) ). The increased susceptibility to infection has been corrected in mice by the transplantation of normal bone marrow, and the hematopoietic defects can be transmitted to normal mice by transplanting marrow from an animal with CHS ( [95](#) ). In the accelerated phase, splenectomy has been only temporarily helpful ( [57](#) ); a few patients have been treated with a combination of vincristine and prednisone. Bone marrow transplantation appears to be a logical treatment, if possible ( [96](#) , [97](#) and [98](#) ).

### Familial Vacuolization of Leukocytes (Jordan Anomaly)

Jordan anomaly is characterized by the presence of vacuoles in the cytoplasm of granulocytes, monocytes, and occasionally lymphocytes and plasma cells. In members of one family, all of the blood neutrophils and more than 70% of the monocytes contained 3 to 10 vacuoles ranging in size from 2 to 5  $\mu\text{m}$ ; fewer and smaller vacuoles were seen in eosinophils, basophils, and lymphocytes ( [99](#) ). By means of histochemical and fluorescence microscopic analysis, the vacuoles were shown to contain lipids. These lipids were seen in promyelocytes, myelocytes, metamyelocytes, and occasionally in plasma cells in the bone marrow, but they were not present in myeloblasts, erythroblasts, or megakaryocytes ( [99](#) ). This type of vacuolization must be distinguished from that characterized by fat-staining vacuoles occurring in people with serious infections, toxic hepatitis, or diabetic ketoacidosis ( [100](#) ).

The disorder appears to be familial. Two members were affected in each of two unrelated families ( [99](#) , [100](#) ). None of the four patients had acute disease, but in members of one family, progressive muscular dystrophy was present ( [99](#) ), whereas in members of the other, ichthyosis was associated ( [100](#) ).

### Other Inclusions in Leukocytes

In an infant with congenital bile duct atresia, amorphous, round-to-oval bodies stained green or gray-green with Romanovsky stains in 3 to 13% of the blood neutrophils and in 1 to 5% of the monocytes ( [101](#) ). Similar inclusions were present in all stages of myeloid cells in the bone marrow but not in lymphocytes or plasma cells. Electron microscopic analysis showed that the inclusions were not enclosed in a phagocytic vesicle.

In the blood monocytes of patients with the Hermansky-Pudlak syndrome ( [102](#) ), a rare familial disorder characterized by albinism, mild bleeding related to platelet dysfunction, accumulation of ceroidlike pigment in marrow macrophages, and deficiency of the tetraspan protein CD63 in platelets ( [103](#) ), lipopigment bodies as well as another type of inclusion were demonstrated.

### **Abnormal Specific (Secondary) Granule Formation**

A syndrome of recurrent staphylococcal skin and sinus infections associated with abnormal chemotaxis, impaired staphylococcal killing, and morphologic abnormalities in the neutrophils was described in a 14-year-old boy ( [104](#) ). No other family members were affected. The patient's polymorphonuclear neutrophils exhibited bilobed nuclei with unevenly distributed chromatin, drumsticklike nuclear projections, and nearly absent cytoplasmic granules that stained with peroxidase but not with alkaline phosphatase. Electron microscopy revealed primary granules, but specific granules were small and reduced in number. These neutrophils were capable of phagocytosis, generated H<sub>2</sub>O<sub>2</sub>, reduced nitroblue tetrazolium (NBT) dye, and killed *Candida*, but staphylococcal killing was impaired.

Since the original report, at least five cases of specific granule deficiency (SGD) have been identified with both sexes affected, leading to the assumption that the disorder is an autosomal-recessive disease ( [105](#), [106](#) ). SGD neutrophils exhibit decreased chemotaxis and bacterial killing *in vitro* and decreased migration into skin windows *in vivo*, and they fail to up-regulate CD11/CD18, laminin, or f-met-leu-phe (FMLP) receptors after activation ( [105](#) ), although oxygen radical generation is apparently normal. Myeloperoxidase (MPO)-positive primary granules are present, but the specific secondary granules appeared to be absent in Wright-stained blood smears and were decreased in number and small when viewed with electron microscopy ( [104](#) ). These structures do not stain with alkaline phosphatase. The specific granule constituents lactoferrin and B<sub>12</sub> binding protein are reduced or absent.

Lactoferrin deficiency in patients with SGD is tissue specific (i.e., confined to myeloid cells, whereas lactoferrin is secreted normally in nasal secretions) and is secondary to a deficiency of RNA transcripts ( [107](#) ). Because morphologic changes have been described in the primary granule ( [108](#) ) and other granule proteins, such as primary granule defensin ( [76](#) ) and "tertiary" granule gelatinase, are also deficient in SGD neutrophils, one suggestion is that the basic defect in SGD is one of regulation of production of these proteins ( [107](#) ). Thus, this disorder may be one of incomplete granule synthesis rather than a true SGD ( [108](#) ).

### **Hereditary Giant Neutrophilia**

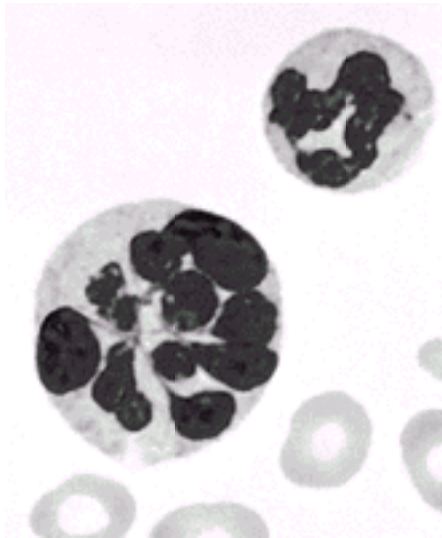
Neutrophils with a diameter of approximately 17 μm (as compared with a normal diameter of about 13 μm) are rare in blood smears from normal people (1 in 20,000 neutrophils or less). They may be seen with greater frequency in patients who are ill, but even then the



number rarely exceeds 0.2% unless a disease involving leukocyte production is present or a reaction to a cytotoxic drug occurs ( [109](#) ). A family with giant neutrophils in healthy members of three generations has been reported ( [109](#) ). Over several years, the proband had an average of 1.6% giant neutrophils in the blood. The large neutrophils appeared to be nearly double the normal cell volume and contained from 6 to 10 nuclear lobes. Therefore, it was suggested that the cells may have been tetraploid. This anomaly appeared to be transmitted as an autosomal-dominant trait.

### Hereditary Hypersegmentation of Neutrophil Nuclei

Several families have been described whose members had a hereditary (autosomal-dominant) increase in the number of neutrophil nuclear segments ( [Fig. 64.7](#) ) ( [110](#) ). The proportion of neutrophils containing five lobes or more exceeded 10% in most heterozygotes and was greater than 14% in several suspected homozygotes, as compared with no more than 10% in normal controls ( [110](#) ). The bone marrow findings suggested a tendency toward nuclear indentation in early myeloid forms (eosinophils and basophils as well as neutrophils) ( [110](#) ). The normal size of these neutrophils was thought to provide evidence against tetraploidy, but in one study of five female family members, the mean number of nuclear drumsticks appeared to be increased above normal ( [111](#) ). The chief significance of this anomaly is in its differentiation from other causes of hypersegmentation such as folate or vitamin B<sub>12</sub> deficiency.



**Figure 64.7.** Hypersegmented neutrophil. See [Color Plate](#).

### Hypersegmentation of Eosinophils and Negative Staining for Peroxidase and Phospholipids

Hypersegmentation of eosinophils can be inherited as an autosomal-recessive trait, and the abnormality is characterized by a lack of sudanophilia and peroxidase activity in all of the eosinophils, whereas these histochemical reactions remain positive in the neutrophils and monocytes ( [112](#), [113](#) ). In addition, the number of eosinophilic granules per cell appears to be reduced, and some hypersegmentation of the eosinophil nucleus may occur. No disease accompanies the disorder. This has been most commonly reported in people of Jewish (predominantly Yemenite) extraction, although members of other races have not

been studied adequately.

## FUNCTIONAL DISORDERS OF LEUKOCYTES NOT CHARACTERIZED BY MORPHOLOGIC CHANGES

The topic of neutrophil dysfunction is under active study. Several reviews summarize this topic ( [114](#), [115](#), [116](#) and [117](#)); the reader is also referred to the current literature.

### Chronic Granulomatous Disease of Childhood

Chronic granulomatous disease (CGD) is a rare clinical syndrome that results from inherited defects of leukocyte function ( [118](#), [119](#), [120](#), [121](#), [122](#), [123](#) and [124](#) ). Recent reviews have been published ( [114](#), [115](#), [123](#), [124](#), [125](#), [126](#), [127](#), [128](#) and [129](#) ).

CGD neutrophils are characterized by a defective respiratory burst during phagocytosis and an inability to generate superoxide. The impaired superoxide production usually occurs transiently in each phagosome with phagocytosis and leads to recurrent bacterial and fungal infections, most commonly at epithelial surfaces. CGD is characterized by recurrent infections with catalase-positive bacteria. CGD neutrophils can use  $H_2O_2$  produced by ingested bacteria to generate HOCl via MPO and aid in killing the bacteria. Catalase-positive bacteria generate  $H_2O_2$  levels in the phagocytic vacuole that are too low for generation of sufficient HOCl to contribute to significant bacterial killing via this mechanism ( [125](#) ). This syndrome can be the result of different genetic defects in the superoxide generating system. Variable inheritance patterns have been observed with approximately two-thirds of the pedigrees being X-linked and one-third autosomal recessive. Multiple molecular defects have been identified that result in the CGD phenotype ( [114](#), [115](#), [125](#), [126](#), [127](#), [128](#), [129](#) and [130](#) ). Potential treatments include prophylactic antibiotics and interferon- $\gamma$ . Knowledge in this field is changing rapidly.

CGD neutrophils, eosinophils, monocytes, and macrophages fail to generate superoxide, hydrogen peroxide, and other oxygen radicals after particle phagocytosis (or other stimulation), and thus have decreased microbicidal activity. CGD is associated with no leukocyte morphologic abnormalities and was first noted in male children with a history, beginning in early childhood, of recurrent suppurative infections caused by organisms of low-grade pathogenicity, including fungi, or by staphylococci. The eczematoid, granulomatous, and sometimes purulent skin infections recur repeatedly and clear slowly. Associated adenopathy develops and may persist. Pulmonary and other infections (e.g., osteomyelitis) also are common, and progressive granulomatous disease of the lungs, liver, and other sites develops. Hepatosplenomegaly is common, and biopsy reveals necrotizing granulomas, often with associated purulent inflammation. The disorder often progresses to death in early childhood ( [131](#), [132](#) ), but some patients survive longer ( [118](#), [133](#) ). Although rare, CGD has assumed great importance as a prototype of defects in leukocyte bactericidal capacity.

**HISTORY AND MODE OF INHERITANCE** CGD was first described from 1954 to 1957 ( [131](#), [132](#) ) as affecting only males. By 1970, more than 90 cases were reported ( [121](#), [133](#) ). X-linked inheritance was established, and female heterozygotes were identifiable by the presence of defective leukocyte bactericidal capacity intermediate in degree between that of affected patients and that of normal individuals ( [134](#) ). Measurements of postphagocytic release of  $^{14}CO_2$  from glucose-1- $^{14}C$  or reduction of NBT dye were used to detect the defect. By means of the NBT dye test, female carriers were found to have a mixed population of neutrophils, approximately one-half being NBT negative and one-half being



NBT positive ( [Table 64.2](#)). The defect is transmitted on an X chromosome, and the degree of deficit in female subjects varies according to random X chromosome inactivation. Consequently, one may expect to find an occasional female carrier with clinical disease as severe as that in male patients ( [134](#), [135](#)).

**TABLE 64.2. Proportion of Postphagocytic Neutrophils That Are Nitroblue Tetrazolium–Positive in Family Members and Patients with Chronic Granulomatous Disease as Compared with Normal Subjects**

|  | Number | % Nitroblue Tetrazolium–Positive Cells |
|--|--------|--|
| Patients (hemizygotes)                   | 7      | 9.9 ± 4.2                              |
| Mothers and grandmothers (heterozygotes) | 9      | 49.8 ± 5.4                             |
| Carrier sisters                          | 7      | 51.3 ± 6.6                             |
| Fathers, brothers, and normal sisters    | 18     | 74.4 ± 5.4                             |
| Normal subjects                          | 12     | 89.5 ± 5.4                             |

<sup>a</sup> Mean ± 2 SD.

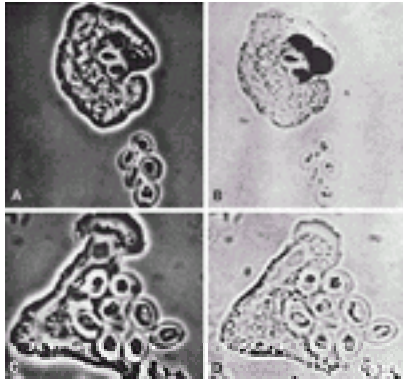
From Windhorst DB, et al. The pattern of genetic transmission of the leukocyte defect in fatal granulomatous disease of childhood. *J Clin Invest* 1968;47:1026, with permission.

Because of the clinical and pathologic picture of chronic recurrent infection caused by low-grade pathogens and the resultant granuloma formation, it was suggested that a defect in inflammatory response results in lesions comparable to those that normal people develop after infection with tubercle bacilli or brucella ( [120](#)). No abnormality in antibody response to diphtheria, tetanus, or poliovirus was demonstrated in these patients, and their delayed hypersensitivity response also was normal ( [120](#)). In addition, leukocyte migration and surface phagocytosis were normal ( [120](#)). Nevertheless, when leukocytes of CGD patients were incubated with bacteria, such as staphylococci, serratia, or other organisms causing infection in these patients, decreased bacterial killing and prolonged bacterial survival in the phagocytic vacuoles were observed ( [136](#), [137](#)). Decreased killing of fungi and incomplete inactivation of vaccinia and herpes virus also was reported ( [120](#), [138](#)), but streptococci were killed normally by CGD leukocytes ( [137](#), [139](#)). Although the mechanisms of bacterial killing by normal leukocytes are still incompletely understood, it is clear that phagocytosis is followed by fusion of lysosomes with the phagocytic vacuole, discharge of lysosomal enzymes into the phagosome, and a burst of postphagocytic metabolic activity. These events are usually accompanied by bacterial death and digestion (see [Chapter 10](#)). Early studies of CGD reported that a deficiency of nicotinamide adenine dinucleotide phosphate (NADPH) oxidase or an abnormality in its activation is the underlying cause of this syndrome ( [140](#)). The finding that iodination of bacteria in the phagosome appears to be one mode of bacterial killing, and that this process is defective in CGD leukocytes and can be partially repaired by the insertion of an oxidase into the phagosome, either carried on oxidase-coated polystyrene particles ( [141](#), [142](#)) or as part of the ingested bacteria ( [143](#)), provided strong evidence incriminating defective generation of H<sub>2</sub>O<sub>2</sub>, superoxide ( [144](#)), or related ions ( [145](#)) as the pathogenic defect in this disorder ( [141](#), [146](#)). Although most studies have focused on neutrophils, it was recognized in the earliest reports that lipid-laden macrophages were present in the granulomatous lesions ( [147](#)), and a defect in the mononuclear phagocytes ( [148](#)) and in eosinophils ( [149](#)) also has since been demonstrated. The platelets appear normal ( [150](#)). In the late 1960s and 1970s, an autosomal-recessive form of CGD was described ( [121](#), [122](#)). It is clinically identical to

the X-linked forms, with the exception that the parents of affected children usually have normal neutrophil function, and the clinical course may be milder (119).

**MOLECULAR PATHOLOGY** In 1978, a unique cytochrome *b*, termed *b*<sub>558</sub> (named for its absorption spectrum) or *b*<sub>245</sub> (named for its midpoint potential) present only in phagocytic cells, was described and suggested to be a primary component of the oxidase that normally generates superoxide but, when defective, results in CGD (151). This cytochrome was absent from X-linked CGD phagocytes (thus termed *X*<sup>-</sup>) but was present in phagocytes from patients with autosomal-recessive inheritance patterns (*A*<sup>+</sup>) (151). In 1985, a family with CGD and an autosomal-recessive inheritance pattern but with absence of cytochrome *b* was reported, thus identifying a third type of CGD (*A*<sup>-</sup>) (152). In these studies, a somatic cell hybridization technique was used to demonstrate that fusing monocytes from any two of these three types of CGD (*X*<sup>-</sup>, *A*<sup>+</sup>, or *A*<sup>-</sup>) restored their ability to oxidize NBT, thus defining three distinct molecular defects (152). Also in 1985, several groups demonstrated that both membrane and cytosolic components are necessary for superoxide generation, and deficiencies in either can result in CGD (119). In 1987, cytochrome *b* was purified and shown to be a heterodimer composed of two polypeptides, a heavily glycosylated, 91,000-dalton heavy chain (approximately 50,000 of the molecular weight is peptide) and a 22,000-dalton light chain (153). Antibodies to these two polypeptides showed them both to be absent from the phagocytes of two types of CGD (*X*<sup>-</sup> and *A*<sup>-</sup>). The defective gene in X-linked, cytochrome-negative CGD has been cloned and shown to encode for the polypeptide portion of the 91,000-dalton subunit of cytochrome *b* (153, 154). Presumably, the gene for the 22,000-dalton subunit is on an autosome, and the absence of either gene (and/or gene product) results in cytochrome *b*-negative CGD (154). A large number of different genetic defects have now been described (114, 115, 127, 128 and 129, 155, 156, 157, 158, 159, 160, 161, 162, 163, 164, 165, 166, 167 and 168). Because postphagocytic activation of the respiratory burst with generation of superoxide and peroxide, as well as bacterial killing, involves complex reactions and multiple enzymes [e.g., phospholipases, protein kinases, NADPH oxidase, glucose-6-phosphate dehydrogenase (G6PD), glutathione peroxidase] (119), one might expect that defects other than those described in NADPH oxidase would result in a disorder phenotypically like that described in the section [Variants](#).

**CLINICAL AND LABORATORY FEATURES** The clinical picture of CGD includes the development of recurrent infections, especially of the skin and lungs, with septic lymphadenitis, development of hepatosplenomegaly and granulomas, and ultimately death from infection (118, 120, 131). The blood neutrophil count is not reduced, and it increases appropriately with infection or after endotoxin injection; monocytosis is sometimes observed (120). Because chronic infection is common, the immunoglobulin levels often are elevated, and plasma cells may be present in increased numbers in the bone marrow. Immunoglobulin deficiencies have not been encountered, and antibody titers (both IgM and IgG) increase normally after antigenic stimulation. Reticuloendothelial clearance of colloidal gold also is normal. Peroxidase staining of blood cells demonstrates more intense dye uptake in CGD neutrophils than in normal cells (149). The simplest method for detecting the defect is the postphagocytic, intraphagosomal reduction of almost colorless NBT dye to blue-black formazan (Fig. 64.8) (149, 169). When tests are properly standardized with respect to time of incubation of leukocytes with the dye-tagged zymosan particles, affected patients and most carriers are readily recognized (Table 64.2). When the reaction to this test is negative in suspected carriers, the reaction to the quantitative dye reduction test usually is positive (149).



**Figure 64.8.** Phase ( **A** and **C** ) and bright field ( **B** and **D** ) photomicrographs of normal neutrophil ( **A** and **B** ) and a neutrophil from a patient with chronic granulomatous disease ( **C** and **D** ). In **A** and **B**, note nitroblue tetrazolium reduction ( *black area* ) that has occurred in the normal neutrophil 20 minutes after ingestion of zymosan granules and nitroblue tetrazolium dye. In **C** and **D**, zymosan ingestion is normal, but there is no dye reduction. (From Nathan DJ, et al. Failure of nitro blue tetrazolium reduction in the phagocytic vacuoles of leukocytes in chronic granulomatous disease. *J Clin Invest* 1969;48:1895, with permission.)

**COURSE AND PROGNOSIS** There is considerable heterogeneity in the severity of the clinical course of patients with CGD. Without treatment, this disease usually runs a progressive downhill course because of repeated infections and granuloma formation. The average life expectancy was reported to be 5 to 7 years in 1968 ( [120](#) ).

**TREATMENT** Treatment of infections with appropriate antibiotics and surgical procedures remains the cornerstone of management ( [122](#), [170](#), [171](#) ). Prophylactic use of antibiotics is generally recommended ( [123](#), [124](#), [125](#) and [126](#), [171](#) ). Trimethoprim–sulfamethoxazole alone or in combination with dicloxacillin can prolong the infection–free interval in many CGD patients ( [170](#) ). In some patients with CGD, the administration of interferon- $\gamma$  has induced partial correction of cytochrome *b* content and restored phagocyte bactericidal capacity toward normal, and reports have suggested that interferon- $\gamma$  increases the ability of CGD neutrophils to kill aspergillus and decreases the number of serious infections in patients with CGD ( [171](#), [172](#), [173](#) and [174](#) ). The exact mechanism by which interferon- $\gamma$  exerts its beneficial effect in CGD is unclear and may include other effects in addition to augmentation of the respiratory burst. Bone marrow transplantation has been tried, but its effectiveness is unclear ( [170](#) ).

**VARIANTS** Because the clinical picture of CGD results from delayed killing of catalase–positive bacteria, enzymatic defects in the bactericidal system other than decreased NADPH oxidase may produce an almost identical picture. Results of several studies demonstrate clearly that such biochemical variants exist. For example, in a brother and sister with the clinical picture of CGD, after phagocytosis of latex particles by their neutrophils, all oxidative metabolic reactions were absent. If the latex particles were opsonized with immunoglobulin, however, postphagocytic oxidative changes were stimulated dramatically ( [175](#) ). Another patient was reported in whom no oxidative changes (measured by chemiluminescence) occurred after phagocytosis of a variety of opsonized particles (latex, bacteria, or zymosan), but normal chemiluminescent responses occurred when the neutrophils were stimulated with soluble agents (concanavalin A and phorbol myristate acetate) ( [176](#) ). These patients appear to have a defect in signal transduction and activation of the oxidase system rather than in the oxidase enzyme(s). Another patient with clinically mild, X–linked CGD exhibited normal membrane depolarization (and therefore presumably normal activation), but NADPH oxidase apparently had a low affinity for NADPH and thus produced low but measurable amounts of superoxide ( [177](#) ).

## Lipochrome Histiocytosis

A clinical variant lipochrome histiocytosis was described in three sisters with rheumatoid arthritis, hyperglobulinemia, splenomegaly, pulmonary infiltrates, and increased susceptibility to infection ( [178](#) ). No granulomas were found in tissue biopsies, but lipochrome pigmentation in large macrophages was present throughout the tissues. Studies of blood leukocyte function in two of the sisters revealed impaired postphagocytic respiration, NBT reduction, and hexose monophosphate shunt activity identical to that seen in patients with CGD ( [179](#) ).

## Glucose-6-Phosphate Dehydrogenase Deficiency

NADPH is the major substrate for the respiratory burst oxidase. A bactericidal defect similar to CGD has been described in a patient with a complete deficiency of G6PD, an enzyme important in the generation of NADPH ( [180](#) ). Apparently, almost complete absence of G6PD activity is necessary to interfere with bacterial killing because no difference from normal could be detected in cells with 25% activity or greater ( [181](#) ).

## Glutathione Peroxidase Deficiency

Two unrelated 9- and 13-year-old girls presented a clinical picture similar to that of CGD and with decreased bactericidal capacity ( [182](#) ). The findings in these girls differed from those in males with CGD only in that no heterozygotes were detected in their families and their clinical course was somewhat more mild. These patients were reported before the nature of the NADPH oxidase was known, and it was suggested that the CGD phenotype was due to glutathione peroxidase deficiency, resulting in inhibition of the oxidase by accumulated peroxides. A recent study, however, suggested that glutathione peroxidase activity was normal in these patients and that both had mutations in the NADPH oxidase ( [183](#) ). Thus, there is no firm evidence that glutathione peroxidase deficiency is a cause of the CGD phenotype.

## Glutathione Synthetase or Reductase Deficiency

Reduced glutathione (GSH) plays an important role in protecting neutrophils (including the NADPH oxidase system) from reactive metabolites, including  $H_2O_2$ . Because GSH levels are generated by both direct synthesis via glutathione synthetase and the reduction of oxidized glutathione by glutathione reductase, deficiencies of these enzymes might be expected to result in defective neutrophil function. The neutrophils of a normally growing infant with a relatively benign history of recurrent otitis and repeated episodes of neutropenia were found to have 5% of normal glutathione synthetase activity and 10 to 20% of normal glutathione content. The cells ingested particles and metabolized  $I-^{14}C$  glucose normally, but after phagocytosis, excess peroxide accumulated and impaired iodination and killing of bacteria were demonstrable. Electron microscopic examination showed damage to the microtubules and membranes of the neutrophils ( [184](#), [185](#) ). Neutrophil dysfunction resulting from a deficiency of glutathione reductase has also been reported ( [186](#) ). Patients with glutathione reductase deficiency or glutathione synthetase deficiency generally pursue a fairly benign clinical course. Vitamin E may be useful in patients with severe glutathione synthetase deficiency ( [187](#) ).

## Catalase Deficiency

The neutrophil is protected from products of the NADPH oxidase not only by glutathione but also by superoxide dismutase, which generates H<sub>2</sub>O<sub>2</sub> from superoxide, and by catalase, which converts H<sub>2</sub>O<sub>2</sub> to H<sub>2</sub>O and O<sub>2</sub>. A deficiency in neutrophil catalase has been reported in which the surface of the neutrophil was more susceptible to damage by H<sub>2</sub>O<sub>2</sub> than normal ( [188](#) ). These patients do not appear to have severe complications with infections ( [188](#) ).

### Job Syndrome

Job syndrome was reported as occurring in two unrelated girls with red hair and fair skin who suffered from repeated staphylococcal cold abscesses, sinusitis, eczema, and pulmonary disease, a syndrome not unlike the affliction of Job ( [189](#) ). The leukocytes of these patients were capable of normal phagocytosis, bacterial killing, NBT reduction, and iodine fixation ( [189](#) , [190](#) ), unlike those of patients with CGD. Subsequently, hyperimmunoglobulinemia E and defective chemotaxis were demonstrated, but the exact nature of the abnormality remains obscure ( [191](#) , [192](#) ). It is now clear that this disorder is not limited to red-haired women, in that it is seen in both sexes and in patients of varied racial background and hair color ( [191](#) ). The common features are increased susceptibility to infection (usually evident in the first 6 weeks of life), chronic dermatitis, and hyperimmunoglobulinemia E.

Job syndrome is rare in that only 9 of 100 patients suspected to have it and referred to a major research center for further evaluation merited the diagnosis ( [191](#) ). Fungal, viral, and bacterial infections are common. Blood eosinophilia and elevated IgE levels are the most common laboratory findings; and the IgE, if directed against *Staphylococcus aureus*, is a relatively specific diagnostic parameter ( [191](#) ). Prophylactic treatment with dicloxacillin or trimethoprim-sulfamethoxazole may be helpful in managing afflicted patients. The role of interferon- $\gamma$  is unclear ( [193](#) , [194](#) and [195](#) ). A primary defect of chemotaxis seems unlikely, and it is postulated that histamine released by the interaction of IgE with mast cells may interfere with neutrophil function ( [192](#) ) or that excess antistaphylococcal IgE production and a deficiency in synthesis of other protective antibodies are involved ( [191](#) ).

### Myeloperoxidase Deficiency

An inherited deficiency of MPO was described in 1969 ( [196](#) ). The 49-year-old male proband, one of his two sisters, and all four sons exhibited decreased MPO activity; no increased frequency of infections accompanied this defect. In two other families, apparently similarly affected, infection was also not a problem ( [196](#) ).

Until the late 1970s, this disorder was described in only rare cases (some familial, others apparently sporadic and acquired) ( [197](#) , [198](#) and [199](#) ). This frequency seemed consistent with the apparently pivotal role of MPO in the oxygen-dependent killing of microorganisms ( [196](#) , [198](#) ). With the development of flow cytometry and automated differential cell-counting techniques, however, MPO deficiency was often detected (approximately 1 in 2000 subjects) during routine hematologic evaluation of patients admitted to the hospital ( [197](#) , [199](#) , [200](#) ). From these studies, MPO deficiency clearly is the most common disorder of neutrophil function ( [199](#) ), and in those families studied, it appears to be an autosomally transmitted disorder ( [199](#) , [200](#) ) (although the genetic defect is still not

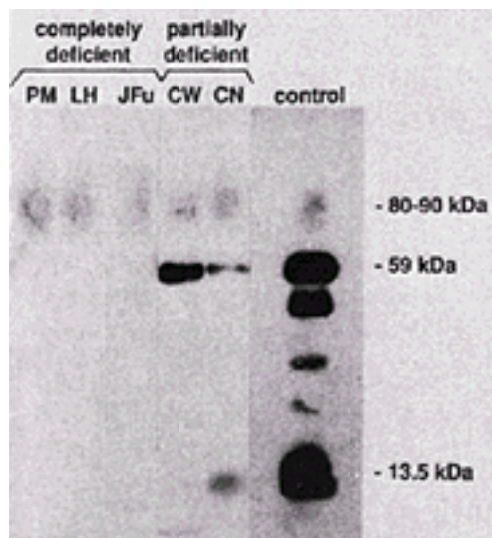


completely understood) ( [198](#), [201](#) ).

Most studies of MPO-deficient neutrophils reveal that bacteria and fungi are phagocytized normally, and ingestion is followed by a vigorous respiratory burst. Bactericidal killing, however, is somewhat delayed, reaching normal levels only after 1 to 3 hours ( [198](#) ). Findings of these studies and the rarity of clinical infections in MPO-deficient individuals support the concept of MPO-independent microbicidal mechanisms ( [196](#), [198](#) ). In contrast, although ingested normally, several *Candida* species and *Aspergillus* are killed poorly, if at all, and several MPO-deficient patients, including one of the first reported cases, suffered from disseminated fungal infection ( [196](#), [198](#) ).

The respiratory burst in MPO-deficient cells is actually prolonged and supernormal, and evidence exists that MPO normally acts to modulate and terminate the inflammatory response; for example, MPO oxidizes the methionine group in FMLP, thus modulating chemotaxis, and it also modulates NADPH oxidase activity ( [198](#) ).

Results of studies of the structure of MPO have shown it to be a tetramer (150,000 d) composed of two heavy and two light chains (a  $2\beta_2$ ) of 55,000 to 60,000 and 10,000 to 15,000 daltons, respectively ( [201](#), [202](#) ). Polymorphonuclear neutrophils from normal and MPO-deficient subjects contained an 89,000-dalton protein immunochemically related to MPO and thought to be a precursor protein ( [198](#), [201](#) ). Normal neutrophils, however, contain several smaller peptides (59,000 and 13,500 daltons) that react with antibody to MPO and are thought to be the subunits of MPO. In one study, completely MPO-deficient neutrophils lacked all of these subunits but contained the precursor protein, whereas partially MPO-deficient neutrophils contained decreased amounts of the precursor protein and the subunits derived from it ( [Fig. 64.9](#) ). Because Southern blot analysis for MPO-related sequences showed the genomic DNA of MPO-deficient cells to be identical to that of normal neutrophils, and because mRNA from control and completely MPO-deficient subjects' myeloid precursors were of the same size and were present in the same amount, the genetic defect in these MPO-deficient patients likely results in the formation of a modified pro-MPO that undergoes defective posttranslational processing ( [201](#) ). In other studies, investigators did not detect the 89,000-d precursor protein and suggested that MPO deficiency results from a variety of defects, as in the case of thalassemia ( [202](#) ). Specific mutations in the MPO gene in MPO deficiency have been described ( [203](#) ).



**Figure 64.9.** Immunoblot analysis of myeloperoxidase (MPO)-related peptides in neutrophils from control and MPO-deficient subjects. Neutrophils ( $5 \times 10^6$ ) were solubilized, and the proteins were separated by sodium dodecyl sulfate-polyacrylamide gel electrophoresis, blotted to nitrocellulose, and probed with monospecific polyclonal antibody to MPO. Neutrophils from completely deficient subjects (PM, LH, and JFu) lacked the normal MPO peptides but contained a diffuse band at 80 to 90 kd. Neutrophils from partially deficient subjects (CW and CN) contained small amounts (25 to 50%) of the normal subunits as well as the 80- to 90-kd band. For comparison, control neutrophils containing normal MPO activity and spectra have the major subunits of 59.0 and 13.5 kd. The bands at 39 and 24 kd are related to the 59.0- and 13.5-kd subunits, respectively. (From Nauseef WM. Aberrant restriction endonuclease digests of DNA from subjects with hereditary myeloperoxidase deficiency. *Blood* 1989;73:290, with permission.)

MPO deficiency also occurs as an acquired defect in a variety of situations (e.g., pregnancy, lead intoxication, Hodgkin disease, and activated coagulation) ([198](#)), but it is encountered most commonly in association with acute myeloblastic leukemia (up to 48% of patients), myeloproliferative states (20 to 60% in chronic myelogenous leukemia, 32% in myelofibrosis), and myelodysplastic syndromes (25%) ([198](#)). In many of these conditions, only some of the circulating myeloid cells are deficient, presumably those produced by the abnormal clone ([198](#)).

### Other Enzymatic Defects

Two siblings with negative peroxidase, oxidase, and lipid reactions in the neutrophils and monocytes also have been reported ([204](#)).

### Leukocyte Adhesion Defects

As described in [Chapter 10](#), cell-cell adhesion plays an important role in neutrophil function. Two types of leukocyte adhesion deficiency (LAD) have been described.

**LEUKOCYTE ADHESION DEFICIENCY-1 (CD11/CD18 DEFICIENCY)** CD11/CD18 deficiency is a rare, inherited disorder of leukocyte function first reported in 1974. It usually is detected in infancy or early childhood as a result of frequent bacterial (and sometimes viral) infections or delayed umbilical cord separation, and high neutrophil counts ([205](#)). The infections are recurrent, often life-threatening or fatal, and usually



involve the skin and subcutaneous tissues, middle ear, and oropharynx. Neutrophils are present in the blood in increased numbers (even between infections) and appear normal but fail to migrate into Rebutck skin windows or sites of infection in normal numbers. When studied *in vitro*, they exhibit defects in motility, phagocytosis, granule secretion, and particle-stimulated respiratory burst activity. Humoral (immunoglobulins and complement) and cellular immunity (skin tests and lymphocyte stimulation tests) otherwise appeared normal, and no specific enzyme deficiencies were detectable. The pathogenesis of this disorder was first suggested in 1980 when a patient's neutrophils were found to lack a high-molecular-weight glycoprotein ( [206](#) ). Subsequent work revealed the absence of CD11/CD18. As described in [Chapter 2](#) and [Chapter 10](#), the CD11/CD18 family consists of three heterodimeric proteins each composed of a noncovalently associated  $\alpha$  ( $\alpha_L$ ,  $\alpha_M$ , or  $\alpha_X$ ) and  $\beta$  ( $\beta_2$ ) chain ( [Table 64.3](#) ). Translocation of  $\alpha$  and  $\beta$  chains to the cell surface requires assembly of the  $\alpha\beta$  heterodimer. Mutations in the  $\beta_2$  chain prevent normal assembly of the  $\alpha\beta$  heterodimer and subsequent translocation to the surface. CD11/CD18-deficient neutrophils roll normally on endothelial cells but do not adhere or migrate with chemotactic stimulation ( [207](#) ) ( [Table 64.3](#) ). Studies involving eight patients revealed two distinct phenotypes: patients with severe deficiency (less than 0.3%) and patients with moderate deficiency (2.5 to 31.0%) of CD11a/CD18 glycoproteins on the neutrophil surface. The severity of clinical manifestations correlated directly with the degree of glycoprotein deficiency ( [208](#) ). Results of other studies further expand the heterogeneity of defects causing this disorder in which mutations in CD18 have been identified ( [205](#), [209](#), [210](#), [211](#), [212](#), [213](#), [214](#), [215](#), [216](#), [217](#), [218](#), [219](#), [220](#), [221](#) and [222](#) ). The disease has also been reported in cattle ( [223](#), [224](#), [225](#) and [226](#) ).

**TABLE 64.3. Leukocyte  $\beta_2$  Integrins**

| Neutrophil Integrin                      | Expression   | Ligand   |
|--|--|--|
| $\alpha_L\beta_2$ LFA-1,<br>CD11a/CD18   | All leukocytes                                       | ICAM-1 (CD54)<br><br>ICAM-2 (CD102)<br>ICAM-3 (CD50) |
| $\alpha_M\beta_2$ HMac-1,<br>CD11b/CD18  | Monocytes, neutrophils, some<br>natural killer cells | ICAM-1, iC3b, fibrinogen,<br>factor X                |
| $\alpha_X\beta_2$ p150,95,<br>CD11c/CD18 | Monocytes, neutrophils                               | iC3b, fibrinogen                                     |

No specific therapy for this disorder is known. Some patients have demonstrated improvement after bone marrow transplantation ( [205](#), [227](#) ).

**LEUKOCYTE ADHESION DEFICIENCY-2** A second form of LAD has also been described in which the patients have severe mental retardation, short stature, a distinctive facial appearance, the Bombay (hh) blood phenotype, and recurrent bacterial infections, including pneumonia, otitis media, peridontitis, and localized cellulitis without the accumulation of pus, in association with an elevated white count ( [207](#), [228](#), [229](#), [230](#) and [231](#) ). Phagocytosis was normal, but motility and homotypic aggregation were defective. Surface CD18 expression was normal. As described in [Chapter 2](#) and [Chapter 10](#), cell surface selectins, including CD62E (E-selectin), CD62P (P-selectin), and CD62L (L-selectin), and their ligands [carbohydrates whose structures appear to be related to sialyl-Le<sup>x</sup> (CD15s)], play an important role in neutrophil adhesion. The critical structure of CD15s [NeuAc  $\alpha$  2 $\beta$  3 Gal  $\beta$  1 $\beta$  4, (Fuc  $\alpha$  1 $\beta$  3) GlcNAc] and the Bombay phenotype is a deficiency of Fuc  $\alpha$  1 $\beta$  2 Gal linkages, which serves as the core of the A, B, and O blood groups ( [232](#) ). LAD-2 neutrophils were found to lack CD15s expression and did not bind

IL-1 $\beta$ -stimulated endothelial cells (which express E-selectin). Because these patients had deficiencies of several fucosylated carbohydrates, the syntheses of which depend on different fucosyltransferase genes, a general defect in fucose metabolism has been postulated ( [228](#) ). LAD-2 neutrophils do not roll well on endothelial cells and do not adhere under shear stress ( [207](#) ). However, under static conditions LAD-2 neutrophils can adhere and migrate ( [207](#) ). Few patients have been described, and these cases may represent different biochemical defects ( [233](#) , [234](#) , [235](#) , [236](#) , [237](#) , [238](#) and [239](#) ). Oral fucose supplementation may be useful in some patients ( [233](#) , [234](#) , [235](#) , [236](#) , [237](#) , [238](#) and [239](#) ). Bone marrow transplantation might be considered in some cases.

## Fc $\gamma$ RIII Deficiency

Several patients who lack the IgG receptor Fc $\gamma$ RIIIB (CD16) ( [240](#) , [241](#) , [242](#) , [243](#) , [244](#) , [245](#) , [246](#) , [247](#) and [248](#) ) have recently been reported. Two homologues of Fc $\gamma$ RIII (Fc $\gamma$ RIIIA and Fc $\gamma$ RIIIB) have been identified. Fc $\gamma$ RIIIB is glycosyl-phosphatidyl inositol-linked and expressed on neutrophils. Because Fc $\gamma$ RIII bears the NA1 and NA2 polymorphic neutrophil-specific antigens, these cells are NA1 and NA2 negative. The clinical expression of this deficiency ranges from a normal state to one characterized by multiple infections ( [240](#) , [241](#) , [242](#) , [243](#) , [244](#) , [245](#) , [246](#) , [247](#) and [248](#) ).

## Actin Dysfunction

A genetic disorder of neutrophil actin function (NAD), characterized by recurrent bacterial infections and defects in chemotaxis, adhesion, and phagocytosis, due to actin dysfunction also has been described ( [249](#) , [250](#) , [251](#) and [252](#) ). These cells appeared to have actin that did not polymerize well and had lower levels of F-actin in both the resting state and after stimulation. Subsequent studies after the death of the index case found that one, but not both, parent was heterozygous for LAD-1. Most patients with LAD-1 do not have abnormal actin polymerization. Patients with this syndrome and overexpression of 47- and 89-kd proteins (NAD 47/89) were also described ( [252](#) ). A more recent patient was described with overexpression of leufactin, an F-actin binding protein that regulates microfilaments, and neutrophil actin dysfunction with serious infections ( [252](#) , [253](#) and [254](#) ). Leufactin was shown to be the 47-kd protein overexpressed in NAD 47/89. Overexpression of leufactin, also known as *lymphocyte specific protein 1*, can create the morphologic and motility abnormalities seen in leufactin-overexpressing neutrophils ( [254](#) ).

## Localized Juvenile Peridontitis

Localized juvenile peridontitis is an adolescent disease characterized by alveolar bone loss, most prominently of the incisors and first molars ( [255](#) , [256](#) ). Interestingly, these patients do not have demonstrable problems with extraoral infections. Abnormal neutrophil chemotaxis to FMLP and C5a in these patients has been reported ( [255](#) , [256](#) ), and a similar chemotactic defect was also observed in siblings of patients before developing clinical disease. Neutrophils from patients with localized juvenile peridontitis have been reported to express CR2 (the C3d receptor) on the cell surface, in contrast to control cells, which do not ( [257](#) ). CR2 is present on normal immature neutrophils but is lost during maturation before release from the marrow. The mechanism of this abnormality has not been defined.

## Desensitization

After previous exposure to a stimulus, neutrophils react less to subsequent stimulation by the same stimulus ( [258](#), [259](#) and [260](#) ). This phenomenon has been termed *desensitization*. In some cases, the desensitization appears specific to the original stimulus, but in other cases desensitization to different stimuli is also observed (cross-desensitization) ( [257](#), [258](#), [259](#) and [260](#) ).

Such desensitization has been observed in patients undergoing hemodialysis, in which exposure of blood to a cuprophane dialyzer membrane results in the generation of C5a which causes a transient neutropenia due to pulmonary leukostasis, as described in [Chapter 10](#) ( [261](#), [262](#) ). Although C5a generation persists throughout dialysis, the neutropenia is transient ( [263](#) ). In contrast to neutrophils obtained at the start of dialysis, neutrophils obtained after 2 hours of dialysis (after the leukostasis has resolved) do not aggregate in response to plasma leaving the dialyzer membrane, demonstrating desensitization *in vivo* ( [263](#) ). A patient with cytomegalovirus infection, whose serum induced granulocyte aggregation (presumably due to C5a), did not experience neutropenia during dialysis, and his neutrophils did not aggregate in response to serum leaving the dialyzer, in contrast to control cells, also demonstrating *in vivo* desensitization ( [263](#) ). Similar desensitization was demonstrated in rabbits using the chemotactic peptide FMLP, wherein continuous intravenous infusion of FMLP reproduced a transient neutropenia due to pulmonary sequestration ( [264](#) ). It is likely that neutrophil desensitization may also occur in other pathologic states, including infection, trauma, and multiorgan failure syndrome, and may contribute to neutrophil dysfunction, although the clinical significance of this phenomenon is unclear.

### **Viral Infection**

Neutrophil dysfunction has been reported to occur in response to influenza A exposure. Both influenza A virus and its purified hemagglutinin activate neutrophils and neutrophil responses to other stimuli are depressed after preexposure to influenza A and parainfluenza ( [245](#), [246](#), [247](#) and [248](#), [265](#), [266](#), [267](#), [268](#), [269](#) and [270](#) ). Neutrophils from patients with human immunodeficiency virus (HIV) infection also may exhibit abnormal function. In one study, neutrophils from patients with early HIV infection had enhanced superoxide production in response to bacterial products ( [271](#) ). Another study found evidence for neutrophil activation in patients with HIV infection as manifested by increased CD11b expression, decreased CD62L expression, increased H<sub>2</sub>O<sub>2</sub> production, and increased actin polymerization ( [272](#) ). Interestingly, H<sub>2</sub>O<sub>2</sub> production in response to FMLP after tumor necrosis factor and interleukin-8 priming was decreased, and CD62L down-regulation in response to FMLP was less complete; these abnormalities correlated with the clinical stage of disease. Whether these abnormalities are a direct effect of the HIV virus, a manifestation of desensitization as described in the previous section, or due to another mechanism is unclear. These observations suggest that neutrophil dysfunction may occur in response to other viral infections as well, although the clinical significance of such a phenomenon is unclear.

### **Hyperalimentation Hypophosphatemia**

In the past, the use of hyperalimentation without adequate phosphate occasionally resulted in hypophosphatemia that was associated with neutrophil dysfunction, including impaired chemotaxis ( [273](#) ). The exact mechanism of this defect is unclear, and this syndrome is now rarely encountered, although evidence suggests that the impairment of phagocytosis seen in phosphate depletion may result from an increase in intracellular

calcium ( [274](#) ).

## Hyperglycemia

Abnormalities have been observed in several neutrophil functions in patients with poorly controlled diabetes, including phagocytosis, chemotaxis, adhesion, and the oxidative burst ( [275](#) , [276](#) , [277](#) , [278](#) , [279](#) , [280](#) and [281](#) ). Improvement in glucose control is associated with an improvement in neutrophil function ( [281](#) , [282](#) ). Improvement in neutrophil function can occur after incubation with insulin for as little as 15 minutes ( [281](#) ). In patients with non-insulin-dependent diabetes, neutrophil dysfunction is associated with an increased intracellular calcium that returns to normal in association with normalization of phagocytic function when glucose control is improved ( [276](#) ).

## Miscellaneous

Other apparently unique neutrophil disorders have been reported. One patient with leukocytosis, severe bacterial infections, and impaired wound healing had neutrophils that appeared to have a defect in signal transduction ( [283](#) ). These cells had a severe defect in chemotaxis, activation of the respiratory burst, and azurophil granule release in response to a variety of chemotaxins. In contrast, FMLP induced a normal increase in intracellular free calcium and specific granule release. Actin polymerization was defective in response to FMLP but normal in response to some other stimuli. Phagocytosis of opsonized bacteria was normal. Presumably, these cells have a defect in the intracellular signal transduction pathway.

## Neutrophil Dysregulation in the Systemic Inflammatory Response Syndrome

Although this chapter has primarily addressed disorders resulting in decreased neutrophil function, neutrophil activity may also be increased. For example, one study reported increased neutrophil functional activity in patients with severe acute pancreatitis ( [284](#) ). The clinical significance of this phenomenon is unclear.

## FREQUENCY OF IDENTIFIABLE QUALITATIVE NEUTROPHIL DISORDERS

Most patients suspected of having a defect in neutrophil function do not have a well-defined abnormality. In one study of 100 patients referred for evaluation of a suspected neutrophil abnormality, only four were identified as a described syndrome ( [285](#) ). Some degree of impaired chemotaxis or superoxide production was found in 53 of 100 patients, but no abnormality was found in 41 of 100.

## WEB SITES

[www.magicbydesign.com/cgd/guide/index.html](http://www.magicbydesign.com/cgd/guide/index.html)

[www.niaid.nih.gov/publications/dateline/0196/page3.htm](http://www.niaid.nih.gov/publications/dateline/0196/page3.htm)

[www.jmfworld.com/html/](http://www.jmfworld.com/html/)

[www.icondata.com/health/pedbase/files/CHEDIAK-.HTM](http://www.icondata.com/health/pedbase/files/CHEDIAK-.HTM)

## REFERENCES

1. Klein A, et al. Pelger–Huët anomaly of the leukocytes. *N Engl J Med* 1955;253:1057.
2. Begemann NH, Campagne AVL. Homozygous form of Pelger–Huët's nuclear anomaly in man. *Acta Haematol (Basel)* 1952;7:295.
3. Heinivaara O, Kaipainen WJ. Pelger–Huët anomaly in lymphocytic leukaemia. *Acta Haematol (Basel)* 1961;25:375.
4. Ebbing VHC. Beitrage zur genetik der Pelger–anomalie. *Schweiz Med Wochenschr* 1959;89:1082.
5. Skendzel LP, Hoffman GC. The Pelger anomaly of leukocytes: forty–one cases in seven families. *Am J Clin Pathol* 1962;37:294.
6. Davidson WM, et al. The Pelger–Huët anomaly: investigation of family “A.” *Ann Hum Genet* 1954;19:1.
7. Ludden TE, Harvey M. Pelger–Huët anomaly of leukocytes. *Am J Clin Pathol* 1962;37:302.
8. Yamasowa Y, et al. The Pelger–Huët familial anomaly of leukocytes. *Blood* 1953;8:370.
9. Stobbe VH, Jorke D. Befunde an homozygoten Pelger–Merkmalstragern. *Schweiz Med Wochenschr* 1965;95:1524.
10. Johnson CA, et al. Functional and metabolic studies of polymorphonuclear leukocytes in the congenital Pelger–Huët anomaly. *Blood* 1980;55:466.
11. Matsumoto T, et al. Cytogenetic and functional studies of leukocytes with Pelger–Huët anomaly. *Acta Haematol (Basel)* 1984;72:264.
12. Rosse WF, Gurney CW. The Pelger–Huët anomaly in three families and its use in determining the disappearance of transfused neutrophils from the peripheral blood. *Blood* 1959;14:170.
13. Latimer KS, et al. Leukocyte function in Pelger–Huët anomaly of dogs. *J Leukocyte Biol* 1989;45:301.
14. Carper HA, Hoffman PL. The intravascular survival of transfused canine Pelger–Huët neutrophils and eosinophils. *Blood* 1966;27:739.
15. Harm VH. Beeinflussung des weißen Blutbildes von Pelger–und nicht–Pelgerkaninchen durch Colchicin. *Acta Haematol (Basel)* 1953;10:95.
16. Ardeman S, et al. The Pelger–Huët anomaly and megaloblastic anemia. *Blood* 1963;22:472.
17. Shanbrom E, Tanaka KR. Acquired Pelger–Huët granulocytes in severe myxedema. *Acta Haematol (Basel)* 1962;27:289.
18. Kaplan JM, Barrett O. Reversible pseudo–Pelger anomaly related to sulfisoxazole therapy. *N Engl J Med* 1967;277:421.
19. Kaur J, et al. Familial acute myeloid leukaemia with acquired Pelger–Huet anomaly and aneuploidy of C group. *BMJ* 1972;4:327.
20. Dorr AD, Moloney WC. Acquired pseudo–Pelger anomaly of granulocytic leukocytes. *N Engl J Med* 1959;261:742.
21. Shanbrom E, et al. “Acquired” Pelger–Huët cells in blood dyscrasias. *Am J Med Sci* 1960;240:732.
22. Alder A. Über konstitutionell bedingte Granulations–veränderungen der Leukozyten. *Dtsch Arch Klin Med* 1939;183:372; *Schweiz Med Wochenschr* 1950;80:1095.

23. Jordans GHW. Hereditary granulation anomaly of the leucocytes (Alder). *Acta Med Scand* 1947;129:348.
24. Fricker–Alder H. Die aldersche Granulationsanomalie. *Schweiz Med Wochenschr* 1958;88:989.
25. Mauri C, Soldati M. Les caracteristiques cytochimiques des granulations cellulaires de Alder. *J Suisse Med* 1958;88:992.
26. Mittwoch U. Abnormal lymphocytes in gargoylism. *Br J Haematol* 1959;5:365; *Nature* 1961;191:1315; *Acta Haematol (Basel)* 1963;29:202.
27. Strouth JC, et al. Leukocyte abnormalities in familial amaurotic idiocy. *N Engl J Med* 1966;274:36.
28. Groover RV, et al. The genetic mucopolysaccharidoses. *Semin Hematol* 1972;9:371.
29. Griac VZ, Kalafatiac Z. Drei Falle von inkompletter Alder–anomalie. *Schweiz Med Wochenschr* 1958;88:994.
30. Griffiths SB, Findlay M. Gargoylism: clinical, radiological and haematological features in two siblings. *Arch Dis Child* 1958;33:229.
31. Pearson HA, Lorincz AE. A characteristic bone marrow finding in the Hurler’s syndrome. *Pediatrics* 1964;34:281.
32. Peterson L, et al. Mucopolysaccharidosis type VII. A morphologic, cytochemical, and ultrastructural study of the blood and bone marrow. *Am J Clin Pathol* 1982;78:544.
33. Matsaniotis N, et al. Urinary excretion of acid mucopolysaccharide in sibs with Morquio’s syndrome and Reilly’s granules in leucocytes. *Arch Dis Child* 1967;42:652.
34. Buchanan JG, et al. The May–Hegglin anomaly. *Br J Haematol* 1964;10:508.
35. Hamilton RW, et al. Platelet function, ultrastructure and survival in the May–Hegglin anomaly. *Am J Clin Pathol* 1980;74:663.
36. Hegglin VR, et al. Anomalie Hegglin–May (polyphyle Reifungsstörung). *Schweiz Med Wochenschr* 1964;94:1357.
37. Lusher JM, et al. The May–Hegglin anomaly: platelet function, ultrastructure and chromosome studies. *Blood* 1968;32:950.
38. Wassmuth DR, et al. May–Hegglin anomaly. *JAMA* 1963;183:737.
39. Davis JW, Wilson SJ. Platelet survival in the May–Hegglin anomaly. *Br J Haematol* 1966;12:61.
40. Lechner K, et al. May–Hegglin’sche anomalie. *Acta Haematol (Basel)* 1969;42:303.
41. Cawley JC, Hayhoe FGJ. The inclusions of the May–Hegglin anomaly and Döhle bodies of infection: an ultrastructural comparison. *Br J Haematol* 1972;22:491.
42. Jordan SW, Larsen WE. Ultrastructural studies of the May–Hegglin anomaly. *Blood* 1965;25:921.
43. Kunishima S, Kojima T, et al. Mutations in the NMMHC–A gene cause autosomal dominant macrothrombocytopenia with leukocyte inclusions (May–Hegglin anomaly/Sebastian syndrome). *Blood* 2001;97:1147.
44. Seri, M, Cusano R, et al. Mutations in MYH9 result in the May–Hegglin anomaly, and Fechtner and Sebastian syndromes. The May–Hegglin/Fechtner Syndrome Consortium. *Nat Genet* 2000;26:103–105.
45. Kelley, MJ, Jawien W, et al. Mutation of MYH9, encoding non–muscle myosin heavy chain A, in

May-Hegglin anomaly. *Nat Genet* 2000;26:106–108.

46. Weiss AS, Schiaffino, et al. Comparative sequence analysis of the complete human sarcomeric myosin heavy chain family: implications for functional diversity. *J Mol Biol* 1999;290:61–75

47. Chediak MM. Nouvelle anomalie leucocytaire de caractere constitutionnel et familial. *Rev Haematol* 1952;7:362.

48. Higashi O. Congenital abnormality of peroxidase granules—a case of “congenital gigantism of peroxidase granules,” preliminary report. *Tohoku J Exp Med* 1953;58:246; 1954;59:315.

49. Sato A. Chediak and Higashi’s disease. Probable identity of “a new leucocytal anomaly (Chediak)” and “congenital gigantism of peroxidase granules (Higashi).” *Tohoku J Exp Med* 1955;61:201.

50. Steinbrinck W. Uber eine neue granulationsanomalie der leukocyten. *Dtsch Arch Klin Med* 1948;193:577.

51. Lutzner MA, et al. Giant granules in leukocytes of the beige mouse. *J Hered* 1967;58:299.

52. Padgett GA, et al. The familial occurrence of the Chediak–Higashi syndrome in mink and cattle. *Genetics* 1964;49:505.

53. Kramer JW, et al. An inherited condition of enlarged leukocyte and melanin granules in cats: probable homology with Chediak–Higashi syndrome. *Fed Proc* 1975;34:861.

54. Nishimura M, et al. Beige rat: a new animal model of Chediak–Higashi syndrome. *Blood* 1989;74:270.

55. Taylor RF, Farrell RK. Light and electron microscopy of peripheral blood neutrophils in a killer whale affected with Chediak–Higashi syndrome. *Fed Proc* 1973;32:822.

56. Bell TG, et al. Decreased nucleotide and serotonin storage associated with defective function in Chediak–Higashi syndrome cattle and human platelets. *Blood* 1976;48:175.

57. Blume RS, Wolff SM. The Chediak–Higashi syndrome: studies in four patients and a review of the literature. *Medicine* 1972;51:247.

58. Kritzler RA, et al. Chediak–Higashi syndrome. *Am J Med* 1964;36:583.

59. Wolff SM, et al. The Chediak–Higashi syndrome: studies of host defenses. *Ann Intern Med* 1972;76:293.

60. Cesar AB. Neutropenia cronica maligna familiar con granulaciones atipicas de los leucocitos. *Boll Soc Cub Ped* 1943;15:900.

61. Davis WC, Douglas SD. Defective granule formation and function in the Chediak–Higashi syndrome in man and animals. *Semin Hematol* 1972;9:431.

62. Essner E, Oliver C. Lysosome formation in hepatocytes of mice with Chediak–Higashi syndrome. *Lab Invest* 1974;30:596.

63. Efrati P, Danon D. Electron–microscopical study of bone marrow cells in a case of Chediak–Higashi–Steinbrinck syndrome. *Br J Haematol* 1968;15:173.

64. Rausch PG, et al. Immunocytochemical identification of azurophilic and specific granule markers in the giant granules of Chediak–Higashi neutrophils. *N Engl J Med* 1978;298:693.

65. Kjeldsen L, Calafat J, et al. Giant granules of neutrophils in Chediak–Higashi syndrome are derived from azurophil granules but not from specific and gelatinase granules. *J Leukoc Biol* 1998;64:72–77.

66. White JG, Krumwiede M. Normal–sized primary lysosomes are present in Chediak–Higashi syndrome neutrophils. *Pediatr Res* 1987;22:208.

67. Styrt BS, Pollack CR, Klempner MS. An abnormal calcium uptake pump in Chediak–Higashi neutrophil



lysosomes. *J Leukocyte Biol* 1988;44:130.

68. White JG. The Chediak-Higashi syndrome: cytoplasmic sequestration in circulating leukocytes. *Blood* 1967;29:435; *Am J Pathol* 1972;69:225.

69. Baetz K, Isaaz S, Griffiths GM. Loss of cytotoxic T lymphocyte function in Chediak-Higashi syndrome arises from a secretory defect that prevents lytic granule exocytosis. *J Immunol* 1995;154:6122-6131.

70. Windhorst DB, et al. Chediak-Higashi syndrome: hereditary gigantism of cytoplasmic organelles. *Science* 1966;151:81; *J Invest Dermatol* 1968;50:9.

71. Burkhardt JK, Wiebel FA, Hester S, Argon Y. The giant organelles in beige and Chediak-Higashi fibroblasts are derived from late endosomes and mature lysosomes. *J Exp Med* 1993;178:1845-1856.

72. Kimball HR, et al. Lysosomal enzymes in normal and Chediak-Higashi blood leukocytes. *J Lab Clin Med* 1975;86:616.

73. Root RK, et al. Abnormal bactericidal, metabolic and lysosomal functions of Chediak-Higashi syndrome leukocytes. *J Clin Invest* 1972;51:649.

74. Stossel TP, et al. Phagocytosis in chronic granulomatous disease and the Chediak-Higashi syndrome. *N Engl J Med* 1972;286:120.

75. Brondt EJ, et al. Defective lysosomal enzyme secretion in kidneys of Chediak-Higashi (beige) mice. *J Cell Biol* 1975;67:774.

76. Ganz T, et al. Microbicidal/cytotoxic proteins of neutrophils are deficient in two disorders: Chediak-Higashi syndrome and "specific" granule deficiency. *J Clin Invest* 1988;82:552.

77. Cairo MS, et al. Fluorescent cytometric analysis of polymorphonuclear leukocytes in Chediak-Higashi syndrome: diminished C3bi receptor expression (OKM1) with normal granular cell density. *Pediatr Res* 1988;24:673.

78. Clark RA, Kimball HR. Defective granulocyte chemotaxis in the Chediak-Higashi syndrome. *J Clin Invest* 1971;50:2645.

79. Clark RA, et al. Granulocyte chemotaxis in the Chediak-Higashi syndrome of mink. *Blood* 1972;39:644.

80. Oliver JM, Zurier RB. Correction of characteristic abnormalities of microtubule function and granule morphology in Chediak-Higashi syndrome with cholinergic agonists. *J Clin Invest* 1976;57:1239.

81. Oliver JM. Impaired microtubule function correctable by cyclic GMP and cholinergic agonists in the Chediak-Higashi syndrome. *Am J Pathol* 1976;85:395.

82. Boxer LA, et al. Correction of leukocyte function in Chediak-Higashi syndrome by ascorbate. *N Engl J Med* 1976;295:1041.

83. Douglas SD, et al. Fine structural studies of leukocytes from patients and heterozygotes with the Chediak-Higashi syndrome. *Blood* 1969;33:527.

84. Moran TJ, Estevez JM. Chediak-Higashi disease. *Arch Pathol Lab Med* 1969;88:329.

85. Costa JL, et al. A platelet abnormality in the Chediak-Higashi syndrome of man. *Blood* 1976;48:517.

86. Blume RS, et al. Defective granulocyte regulation in the Chediak-Higashi syndrome. *N Engl J Med* 1968;279:1009.

87. Kruger GRF, et al. Lymphoreticular tissue lesions in Steinbrinck-Chediak-Higashi syndrome. *Virchows Arch [A]* 1971;353:273.

88. Perou C M, Moore KJ, et al. Identification of the murine beige gene by YAC complementation and positional cloning. *Nat Genet* 1996;13:303-308.

89. Barbosa MD, Nguyen QA, et al. Identification of the homologous beige and Chediak–Higashi syndrome genes. *Nature* 1996;382:262–265.
90. Nagle, DL, Karim MA, et al. Identification and mutation analysis of the complete gene for Chediak–Higashi syndrome. *Nat Genet* 1996;14:307–311.
91. Perou, CM, Leslie JD, et al. The Beige/Chediak–Higashi syndrome gene encodes a widely expressed cytosolic protein. *J Biol Chem* 1997;272:29790–29794.
92. Karim, MA, Nagle DL, et al. Mutations in the Chediak–Higashi syndrome gene (CHS1) indicate requirement for the complete 3801 amino acid CHS protein. *Hum Mol Genet* 1997;6:1087–1089.
93. Barbosa, MD, Barrat FJ, et al. Identification of mutations in two major mRNA isoforms of the Chediak–Higashi syndrome gene in human and mouse. *Hum Mol Genet* 1997;6:1091–1098.
94. Baehner RL, Boxer LA. Disorders of polymorphonuclear leukocyte function related to alterations in the integrated reactions of cytoplasmic constituents with the plasma membrane. *Semin Hematol* 1979;16:148.
95. Kazmierowski JA, et al. Chediak–Higashi syndrome: reversal of increased susceptibility to infection by bone marrow transplantation. *Blood* 1976;47:555.
96. Fischer A, et al. Bone–marrow transplantation for immunodeficiencies and osteopetrosis: European survey, 1968–1985. *Lancet* 1986;2:1080.
97. Haddad E, LeDeist F, Blanche S, et al. Treatment of Chediak–Higashi syndrome by allogenic bone marrow transplantation: report of 10 cases. 1995;85:3328–3333.
98. Mottonen M, Lanning M, Saarinen UM. Allogeneic bone marrow transplantation in Chediak–Higashi syndrome. *Ped Hematol Oncol* 1995;12:55–59.
99. Rozenszajn L, et al. Jordan anomaly in white blood cells. *Blood* 1966;28:258.
100. Jordans GH. The familial occurrence of fat containing vacuoles in the leukocytes. *Acta Med Scand* 1953;145:419.
101. Smith H. Unidentified inclusions in haemopoietic cells, congenital atresia of the bile ducts and livedo reticularis in an infant? A new syndrome. *Br J Haematol* 1967;13:695.
102. White JG, et al. The Hermansky–Pudlak syndrome: inclusions in circulating leucocytes. *Br J Haematol* 1973;24:761.
103. Nishibori M, Cham B, McNicol A, et al. The protein CD63 is in platelet dense granules, is deficient in a patient with Hermansky–Pudlak syndrome, and appears identical to granulophysin. *J Clin Invest* 1993;91:1775–1782.
104. Strauss RG, et al. An anomaly of neutrophil morphology with impaired function. *N Engl J Med* 1974;290:478.
105. Boxer LA, Smolen JE. Neutrophil granule constituents and their release in health and disease. *Hematol Oncol Clin North Am* 1988;2:101.
106. Gallin JI. Neutrophil–specific granule deficiency. *Ann Rev Med* 1985;36:263.
107. Lomax KJ, et al. Selective defect in myeloid cell lactoferrin gene expression in neutrophil–specific granule deficiency. *J Clin Invest* 1989;83:514.
108. Parmley RT, Gilbert CS, Boxer LA. Abnormal peroxidase–positive granules in “specific granule” deficiency. *Blood* 1989;73:838.
109. Davidson WM, et al. Giant neutrophil leucocytes: an inherited anomaly. *Br J Haematol* 1960;6:339.

110. Undritz VE. Eine neue Sippe mit erblich-konstitutionellen Hochsegmentierung der Neutrophilenkerne. *Schweiz Med Wochenschr* 1958;88:1000; 1964;94:1365.
111. Lüers VT. Das numerische Verhalten der geschlechts-spezifischen Kernanhangs bei der erblich-konstitutionellen Hochsegmentierung der Neutrophilenkerne Undritz. *Schweiz Med Wochenschr* 1960;90:246.
112. Joshua H, et al. The incidence of peroxidase and phospholipid deficiency in eosinophilic granulocytes among various Jewish groups in Israel. *Am J Hum Genet* 1970;22:574.
113. Presentey B. A new anomaly of eosinophilic granulocytes. *Am J Clin Pathol* 1968;49:887; 1969;51:451, 458.
114. Malech HL, Nauseef WM. Primary inherited defects in neutrophil function: etiology and treatment. *Semin Hematol* 1997;34:279-290.
115. Matzner Y. Acquired neutrophil dysfunction and diseases with an inflammatory component. *Semin Hematol* 1997;34:291-302.
116. Holland SM, Gallin JI. Evaluation of the patient with recurrent bacterial infections. *Annu Rev Med* 1998;49:185-199.
117. Boxer, LA, Blackwood RA. Leukocyte disorders: quantitative and qualitative disorders of the neutrophil, part 1. *Pediatr Rev* 1996;17:19-28.
118. Carson ML, et al. Thirteen boys with progressive septic granulomatosis. *Pediatrics* 1965;35:405.
119. Curnutte JT, Babior BM. Chronic granulomatous disease. *Adv Hum Genet* 1987;16:229.
120. Good RA, et al. Fatal (chronic) granulomatous disease of childhood. *Semin Hematol* 1968;5:215.
121. Johnston RB, Baehner RL. Chronic granulomatous disease: correlation between pathogenesis and clinical findings. *Pediatrics* 1971;48:730.
122. Klebanoff SJ, Clark RA. Chronic granulomatous disease. In: *The neutrophil: function and clinical disorders*. New York: North-Holland Publishing Co., 1978.
123. Quie P. Chronic granulomatous disease of childhood: a saga of discovery and understanding. *Pediatr Infect Dis J* 1993;12:395-398.
124. Thrasher AJ, Keep NH, Wientjes F, et al. Chronic granulomatous disease. *Biochim Biophys Acta* 1994;1227:1-24.
125. Curnutte JT. Chronic granulomatous disease: the solving of a clinical riddle at the molecular level. *Clin Immunol Immunopath* 1993;67:S2-S15.
126. Maly FE, Schurer-Maly CC. How and why cells make superoxide: the "phagocytic" NADPH oxidase. *NIPS* 1995;10:233-238.
127. Roos D. X-CGDbase: a database of X-CGD-causing mutations. *Immunol Today* 1996;17:517-521.
128. Roos D, de Boer M, et al. Mutations in the X-linked and autosomal recessive forms of chronic granulomatous disease. *Blood* 1996;87:1663-1681.
129. Heyworth PG, Curnutte JT, et al. Hematologically important mutations: X-linked chronic granulomatous disease—an update. *Blood Cells Mol Dis* 1997;23:443-450.
130. Thelen M, Dewald B, Baggiolini M. Neutrophil signal transduction and activation of the respiratory burst. *Physiol Rev* 1993;73:797-821.
131. Berendes H, et al. A fatal granulomatosis of childhood: the clinical, pathological and laboratory

- features of a new syndrome. *Minn Med* 1957;40:2055; *Am J Dis Child* 1959;97:387.
132. Janeway CA, Craig J, Davidson M, et al. Hypergammaglobulinemia associated with severe recurrent and chronic non-specific infection. *Am J Dis Child* 1954;88:388-392.
133. Mandell GL, Hook EW. Leukocyte function in chronic granulomatous disease of childhood. *Am J Med* 1969;47:473.
134. Windhorst DB, et al. The pattern of genetic transmission of the leukocyte defect in fatal granulomatous disease of childhood. *J Clin Invest* 1968;47:1026.
135. Dupree E, et al. Undetected carrier state in chronic granulomatous disease. *J Pediatr* 1972;81:770.
136. Kauder E, et al. Leukocyte degranulation and vacuole formation in patients with chronic granulomatous disease of childhood. *J Clin Invest* 1968;47:1753.
137. Quie PG, et al. In vitro bactericidal capacity of human polymorphonuclear leukocytes: diminished activity in chronic granulomatous disease of childhood. *J Clin Invest* 1967;46:668.
138. Macfarlane PS, et al. Fatal granulomatous disease of childhood and benign lymphocytic infiltration of the skin (congenital dysphagocytosis). *Lancet* 1967;1:408.
139. Kaplan EL, et al. Studies of polymorphonuclear leukocytes from patients with chronic granulomatous disease of childhood: bactericidal capacity for streptococci. *Pediatrics* 1968;41:591.
140. Hohn DC, Lehrer RI. NADPH oxidase deficiency in X-linked chronic granulomatous disease. *J Clin Invest* 1975;55:707.
141. Baehner RL, et al. Correction of metabolic deficiencies in the leukocytes of patients with chronic granulomatous disease. *J Clin Invest* 1970;49:865.
142. Johnston RB, Baehner RL. Improvement of leukocyte bactericidal activity in chronic granulomatous disease. *Blood* 1970;35:350.
143. Klebanoff SJ, White LR. Iodination defect in the leukocytes of a patient with chronic granulomatous disease of childhood. *N Engl J Med* 1969;280:460.
144. Curnutte JT, et al. Defective superoxide production by granulocytes from patients with chronic granulomatous disease. *N Engl J Med* 1974;290:593.
145. Fridovich I. Superoxide radical and the bactericidal action of phagocytes. *N Engl J Med* 1974;290:624.
146. Baehner RL, Karnovsky ML. Deficiency of reduced nicotinamide-adenine dinucleotide oxidase in chronic granulomatous disease. *Science* 1968;162:1277.
147. Landing BH, Shirkey HS. A syndrome of recurrent infection and infiltration of viscera by pigmented lipid histiocytes. *Pediatrics* 1957;20:431.
148. Davis WC, et al. A defect in circulating mononuclear phagocytes in chronic granulomatous disease of childhood. *J Immunol* 1968;101:1093.
149. Nathan DG, et al. Failure of nitro blue tetrazolium reduction in the phagocytic vacuoles of leukocytes in chronic granulomatous disease. *J Clin Invest* 1969;48:1895.
150. DeJesus M, et al. Phagocytosis-stimulated nitroblue tetrazolium reduction by platelets. *J Lab Clin Med* 1972;80:117.
151. Segal AW, et al. Absence of cytochrome b-245 in chronic granulomatous disease. *Nature* 1978;276:515.
152. Weening RS, et al. Cytochrome b deficiency in an autosomal form of chronic granulomatous disease (a third form of chronic granulomatous disease recognized by monocyte hybridization). *J Clin Invest*

1985;75:915.

153. Parkos CA, et al. Purified cytochrome b from human granulocyte plasma membrane is comprised of two polypeptides with relative molecular weights of 91,000 and 22,000. *J Clin Invest* 1987;80:732.

154. Parkos CA, et al. Absence of both the 91kd and 22kd subunits of human neutrophil cytochrome b in two genetic forms of chronic granulomatous disease. *Blood* 1989;73:1416.

155. Curnutte JT, et al. Chronic granulomatous disease due to a defect in the cytosolic factor required for nicotinamide adenine dinucleotide phosphate oxidase activation. *J Clin Invest* 1988;81:606.

156. Dinauer MG, et al. A missense mutation in the neutrophil cytochrome b heavy chain in cytochrome-positive X-linked chronic granulomatous disease. *J Clin Invest* 1989;84:2012.

157. Bu-Ghanim HN, Segal AW, Keep NH, Casimir CM. Molecular analysis in three cases of X91<sup>-</sup> variant chronic granulomatous disease. *Blood* 1995;86: 3575-3582.

158. de Boer M, Hilarius-Stokman PM, Hossle JP, et al. Autosomal recessive chronic granulomatous disease with absence of the 67-kd cytosolic NADPH oxidase component: identification of mutation and detection of carriers. *Blood* 1994;83:531-536.

159. Cross AR, Rae J, Curnutte JT. Cytochrome b-245 of the neutrophil superoxide-generating system contains two nonidentical hemes. Potentiometric studies of a mutant form of gp91phox. *J Biol Chem* 1995;270:17075-17077.

160. Cross AR, Heyworth PG, Rae J, et al. A variant X-linked chronic granulomatous disease patient (X91<sup>+</sup>) with partially functional cytochrome b. *J Biol Chem* 1995;270:8194-8200.

161. deMendez I, Leto TL. Functional reconstitution of the phagocyte NADPH oxidase by transfection of its multiple components in a heterologous system. *Blood* 1995;85:1104-1110.

162. Tanugi-Cholley LC, Issartel JP, Lunardi J, et al. A mutation located at the 5' splice junction sequence of intron 3 in the p67phox gene causes the lack of p67phox mRNA in a patient with chronic granulomatous disease. *Blood* 1995;85:242-249.

163. Woodman RC, Newburger PE, Anklesaria P, et al. A new X-linked variant of chronic granulomatous disease characterized by the existence of a normal clone of respiratory burst-competent phagocytic cells. *Blood* 1995;85:231-241.

164. Li F, Linton GF, Sekhsaria S, et al. CD34<sup>+</sup> peripheral blood progenitors as a target for genetic correction of the two flavocytochrome b558 defective forms of chronic granulomatous disease. *Blood* 1994;84:53-58.

165. Ariga T, Sakiyama Y, Matsumoto S. Two novel point mutations in the cytochrome b558 heavy chain gene, detected in two Japanese patients with X-linked chronic granulomatous disease. *Human Genetics* 1994;94:441.

166. Roos D. The genetic basis of chronic granulomatous disease. *Immunol Rev* 1994;138:121-157.

167. Seger RA, Ezekowitz RA. Treatment of chronic granulomatous disease. *Immunodeficiency* 1994;5:113-130.

168. Roos D, DeBoer M, DeKlein A, et al. Chronic granulomatous disease: mutations in cytochrome b558. *Immunodeficiency* 1993;4:289-301.

169. Baehner RL, Nathan DG. Leukocyte oxidase: defective activity in chronic granulomatous disease. *Science* 1967;155:835.

170. Gallin JI, et al. Recent advances in chronic granulomatous disease. *Ann Intern Med* 1983;99:657.

171. Gallin JI. Chronic granulomatous disease. In: Gallin JI, moderator. Interferon-gamma in the management of infections diseases. *Ann Intern Med*. 1995;123:216-224.

172. Rex JH, Bennett JE, Gallin JI, et al. *In vivo* interferon gamma therapy augments the *in vitro* ability of chronic granulomatous disease neutrophils to damage aspergillus hyphae. *J Infect Dis* 1991;163:849–852.
173. Woodman RC, Erickson RW, Rae J, et al. Prolonged recombinant interferon-gamma therapy in chronic granulomatous disease: evidence against enhanced neutrophil oxidase activity. *Blood* 1992;79:1558–1562.
174. The International Chronic Granulomatous Disease Cooperative Study Group. A controlled trial of interferon-gamma to prevent infection in chronic granulomatous disease. *N Engl J Med* 1991;324:509–516.
175. Weening RS, et al. Defective initiation of the metabolic stimulation in phagocytizing granulocytes. A new congenital defect. *J Lab Clin Med* 1976;88:757.
176. Harvath L, Andersen BR. Defective initiation of oxidative metabolism in polymorphonuclear leukocytes. *N Engl J Med* 1979;300:1130.
177. Lew PD, et al. A variant of chronic granulomatous disease: deficient oxidative metabolism due to a low affinity NADPH oxidase. *N Engl J Med* 1981;305:1329.
178. Ford DK, et al. Familial lipochrome pigmentation of histiocytes with hyperglobulinemia, pulmonary infiltration, splenomegaly, arthritis and susceptibility to infection. *Am J Med* 1962;33:478.
179. Rodey GE, et al. Defective bactericidal activity of peripheral blood leukocytes in lipochrome histiocytosis. *Am J Med* 1970;49:322.
180. Cooper MR, et al. Complete deficiency of leukocyte glucose-6-phosphate dehydrogenase with defective bacteriocidal activity. *J Clin Invest* 1970;49:21a; *Lancet* 1970;2:110; *J Clin Invest* 1972;51:769.
181. Rodey GE, et al. Leukocyte G-6-PD levels and bactericidal activity. *Lancet* 1970;1:335.
182. Holmes B, et al. Chronic granulomatous disease in females. *N Engl J Med* 1970;283:217.
183. Newburger PE, et al. Chronic granulomatous disease and glutathione peroxidase deficiency, revisited. *Blood* 1994;84:3861–3869.
184. Spielberg SP, et al. Oxidative damage to neutrophils in glutathione synthetase deficiency. *Br J Haematol* 1979;42:215.
185. Boxer LA, Oliver JM, Spielberg SP, et al. Protection of granulocytes by vitamin E in glutathione synthetase deficiency. *N Engl J Med* 1979;301:901–905.
186. Roos D, Weening RS, Voetman AA, et al. Protection of phagocytic leukocytes by endogenous glutathione: Studies in a family with glutathione reductase deficiency. *Blood* 1979;53:851–866.
187. Boxer LA, Oliver JM, et al. Protection of granulocytes by vitamin E in glutathione synthetase deficiency. *N Engl J Med* 1979;301:901–905.
188. Roos D, Weening RS, Wyss SR, et al. Protection of human neutrophils by endogenous catalase. Studies with cells from catalase-deficient individuals. *J Clin Invest* 1980;65:1515–1522.
189. Davis SD, et al. Job's syndrome: recurrent "cold" staphylococcal abscesses. *Lancet* 1966;1:1013.
190. White LR, et al. Leukocytes in Job's syndrome. *Lancet* 1969;1:630.
191. Leung OYM, Geha RS. Clinical and immunologic aspects of the hyperimmunoglobulin E syndrome. *Hematol/Oncol Clin North Am* 1988;2:81.
192. Schopfer K, et al. Staphylococcal IgE antibodies, hyperimmunoglobulinemia E and *Staphylococcus aureus* infections. *N Engl J Med* 1979;300:835.
193. King CL, Gallin JI, Malech HL, et al. Regulation of immunoglobulin production in hyperimmunoglobulin

E recurrent-infection syndrome by interferon gamma. Proc Natl Acad Sci U S A 1989;86:10085-10089.

194. Jeppson JD, Jaffe HS, Hill HR. Use of recombinant human interferon gamma to enhance neutrophil chemotactic responses in Job syndrome of hyperimmunoglobulin E and recurrent infections. J Pediatr 1991;3:383-387.
195. Nutman TM. Protozoal infections and hyper-IgE states. In: Gallin JI, moderator. Interferon-gamma in the management of infectious diseases. Ann Intern Med 1995;123:216-224.
196. Lehrer RI, Cline MJ. Leukocyte myeloperoxidase deficiency and disseminated candidiasis: the role of myeloperoxidase in resistance to *Candida* infection. J Clin Invest 1969;48:1478; Nature 1969;223:78.
197. Kitahara M, Simonian Y, Eyre HJ. Neutrophil myeloperoxidase: a simple, reproducible technique to determine activity. J Lab Clin Med 1979;93:232.
198. Nauseef WM. Myeloperoxidase deficiency. Hematol Oncol Clin North Am 1988;2:135.
199. Parry MF, et al. Myeloperoxidase deficiency. Ann Intern Med 1981;95:293.
200. Kitahara M, et al. Familial leukocyte myeloperoxidase deficiency. Blood 1981;57:888.
201. Nauseef WM. Aberrant restriction endonuclease digests of DNA from subjects with hereditary myeloperoxidase deficiency. Blood 1989;73:290.
202. Tobler A, et al. Evidence for a pretranslational defect in hereditary and acquired myeloperoxidase deficiency. Blood 1989;73:1980.
203. Romano M, Dri P, et al. Biochemical and molecular characterization of hereditary myeloperoxidase deficiency. Blood 1997;90:4126-4134.
204. Grignaschi VJ, et al. A new cytochemical picture: spontaneous negativity of the peroxidase, oxidase and lipid reactions in neutrophil progeny and in the monocytes of 2 siblings. Rev Assoc Med Argent 1963;77:218.
205. Todd RF III, Freyer DR. The CD11/CD18 leukocyte glycoprotein deficiency. Hematol Oncol Clin North Am 1988;2:13.
206. Crowley CA, et al. An inherited abnormality of neutrophil adhesion. N Engl J Med 1980;302:1163.
207. von Andrian UH, Berger EM, Ramezani L, et al. *In vivo* behavior of neutrophils from two patients with distinct inherited leukocyte adhesion deficiency syndromes. J Clin Invest 1993;91:2893-2897.
208. Anderson DC, et al. The severe and moderate phenotypes of heritable Mac-1, LFA-1 deficiency: their quantitative definition and relation to leukocyte dysfunction and clinical features. J Infect Dis 1985;152:668.
209. Anderson DC, Smith CW, Springer TA. Leukocyte adhesion deficiency and other disorders of leukocyte motility. In: Scriver CR, Beaudet AL, Sly WS, eds. The metabolic basis of inherited disease, 6th ed. New York: McGraw-Hill, 1989:2751-2777.
210. Matsuura S, Kishi F, Tsukahara M, et al. Leukocyte adhesion deficiency: identification of novel mutations in two Japanese patients with a severe form. Biochem Biophys Res Commun 1992;184:1460-1467.
211. Sligh JE Jr, Hurwitz MY, Zhu CM, et al. The initiation codon mutation in CD18 in association with the moderate phenotype of leukocyte adhesion deficiency. J Biol Chem 1992;267:714-718.
212. Corbi AL, Vara A, Ursa A, et al. Molecular basis for a severe case of leukocyte adhesion deficiency. Eur J Immunol 1992;22:1877-1881.
213. Harlan JM. Leukocyte adhesion deficiency syndrome: insights into the molecular basis of leukocyte emigration. Clin Immunol Immunopath 1993;67:S16-S24.



214. Lopez-Rodriguez C, Nueda A, Gros-pierre B, et al. Characterization of two new CD18 alleles causing severe leukocyte adhesion deficiency. *Eur J Immunol* 1993;23:2792-2798.
215. Back AL, Kerkering M, Baker D, et al. A point mutation associated with leukocyte adhesion deficiency type 1 of moderate severity. *Biochem Biophys Res Commun* 1993;193:912-918.
216. Wright AH, Douglass WA, Taylor GM, et al. Molecular characterization of leukocyte adhesion deficiency in six patients. *Eur J Immunol* 1995;25:717-722.
217. Kobayashi K, Fujita K, Okino F, et al. An abnormality of neutrophil adhesion: autosomal recessive inheritance associated with missing neutrophil glycoproteins. *Pediatrics* 1984;73:606-610.
218. Dimanche MT, LeDeist F, Fischer A, et al. LFA-1 b chain synthesis and degradation in patients with leukocyte adhesive protein deficiency. *Eur J Immunol* 1987;17:417-419.
219. Dana N, Clayton LK, Tennen DG, et al. Leukocytes from four patients with complete or partial Leu-CAM deficiency contain the common b-subunit precursor and b-subunit messenger RNA. *J Clin Invest* 1987;79:1010-1015.
220. Kishimoto TK, Hollander N, Roberts TM, et al. Heterogeneous mutations in the beta subunit common to the LFA-1, Mac-1, and p150,95 glycoproteins cause leukocyte adhesion deficiency. *Cell* 1987;50:193-202.
221. Wardlaw AJ, Hibbs ML, et al. Distinct mutations in two patients with leukocyte adhesion deficiency and their functional correlates. *J Exp Med* 1990;172:335-345.
222. Arnaout MA, Dana N, et al. Point mutations impairing cell surface expression of the common beta subunit (CD18) in a patient with leukocyte adhesion molecule (Leu-CAM) deficiency. *J Clin Invest* 1990;85:977-981.
223. Ryncarz RE, Dietz AB, Kehrli ME Jr. Recognition of leukochimerism during genotyping for bovine leukocyte adhesion deficiency (BLAD) by polymerase-chain-reaction-amplified DNA extracted from blood. *J Veter Diag Invest* 1995;7:569-572.
224. Muller KE, Bernadina WE, Kalsbeek HC, et al. Bovine leukocyte adhesion deficiency-clinical course and laboratory findings in eight affected animals. *Vet Quart* 1994;16:65-71.
225. Nagahata H, Kehrli ME Jr, Murata H, et al. Neutrophil function and pathologic findings in Holstein calves with leukocyte adhesion deficiency. *Am J Vet Res* 1994;55:40-48.
226. Nagahata H, Nochi H, Tamoto K, et al. Characterization of functions of neutrophils from bone marrow of cattle with leukocyte adhesion deficiency. *Am J Vet Res* 1995;56:167-171.
227. Thomas C, LeDeist F, Cavazzana-Calvo M, et al. Results of allogeneic bone marrow transplantation in patients with leukocyte adhesion deficiency. *Blood* 1995;86:1629-1635.
228. Etzioni A, Frydman M, Pollack S, et al. Brief report: recurrent severe infections caused by a novel leukocyte adhesion deficiency. *N Engl J Med* 1992; 327:1789-1792.
229. Frydman M, Etzioni A, Eidlitz-Markus, et al. Rambam Hasharon syndrome of mental retardation, short-limbed dwarfism, defective neutrophil chemotaxis and Bombay phenotype. *Am J Med Genet* 1992;44:297-302.
230. Price TH, Ochs HD, Gershoni-Baruch R, et al. *In vivo* neutrophil and lymphocyte functions studies in a patient with leukocyte adhesion deficiency type II. *Blood* 1994;84:1635-1639.
231. Etzioni A, Phillips LM, Paulson JC, et al. Leukocyte adhesion deficiency (LAD) II. Ciba Foundation Symposium 1995;189:51-58.
232. Le Pendu J, Cartron JP, Lemieux RU, et al. The presence of a least two different H-blood-group-related b-D-Gal a-2-L-fucosyltransferases in human serum and the genetics of blood group H substances. *Am J Hum Genet* 1985;37:749-760.

233. Etzioni A, Tonetti M. Fucose supplementation in leukocyte adhesion deficiency type II. *Blood* 2000;95:3641–3642.
234. Vestweber D, Marquardt T. Fucose supplementation in leukocyte adhesion deficiency type II. *Blood* 2000;95:3642–3643.
235. Marquardt T, Luhn K, et al. Correction of leukocyte adhesion deficiency type II with oral fucose. *Blood* 1999;94:3976–3985.
236. Marquardt T, Brune T, et al. Leukocyte adhesion deficiency II syndrome, a generalized defect in fucose metabolism. *J Pediatr* 1999;134:681–688.
237. Sturla L, Etzioni A, et al. Defective intracellular activity of GDP-D-mannose-4,6-dehydratase in leukocyte adhesion deficiency type II syndrome. *FEBS Lett* 1998;429:274–278.
238. Karsan A, Cornejo CJ, et al. Leukocyte adhesion deficiency type II is a generalized defect of *de novo* GDP-fucose biosynthesis. Endothelial cell fucosylation is not required for neutrophil rolling on human nonlymphoid endothelium. *J Clin Invest* 1998;101:2438–2445.
239. Lubke T, Marquardt T, et al. A new type of carbohydrate-deficient glycoprotein syndrome due to a decreased import of GDP-fucose into the golgi. *J Biol Chem* 1999;274:25986–25989.
240. Huizinga TW, Kuijpers RW, Kleijer M, et al. Maternal genomic neutrophil FcRIII deficiency leading to neonatal isoimmune neutropenia. *Blood* 1990;76:1927–1932.
241. de Haas M, Kleijer M, van Zwieten R, et al. Neutrophil Fc $\gamma$ RIII deficiency, nature, and clinical consequences: a study of 21 individuals from 14 families. *Blood* 1995;86:2403–2413.
242. Clark MR, Liu L, Clarkson SB, et al. An abnormality of the gene that encodes neutrophil Fc receptor III in a patient with systemic lupus erythematosus. *J Clin Invest* 1990;86:341–346.
243. Stroncek DF, Skubitz KM, Plachta LB, et al. Alloimmune neonatal neutropenia due to an antibody to the neutrophil Fc-gamma receptor III with maternal deficiency of CD16 antigen. *Blood* 1991;77:1572–1580.
244. Fromont P, Bettaieb A, Skouri H, et al. Frequency of the polymorphonuclear FcGamma receptor III deficiency in the French population and its involvement in the development of neonatal alloimmune neutropenia. *Blood* 1992;79:2131–2134.
245. Abramson JS, Mills EL. Depression of neutrophil function induced by viruses and its role in secondary microbial infections. *Clin Infect Dis* 1988;10:326–341.
246. Cassidy LF, Lyles DS, Abramson JS. Depression of polymorphonuclear leukocyte-functions by purified influenza virus hemagglutinin and sialic acid-binding lectins. *J Immunol* 1989;142:4401–4406.
247. Ruutu P, Vaheri A, Kosunen TU. Depression of human neutrophil motility by influenza virus *in vitro*. *Scand J Immunol* 1977;6:897–906.
248. Abramson JS, Mills EL, Giebink GS, et al. Depression of monocyte and polymorphonuclear leukocyte oxidative metabolism and bactericidal capacity by influenza A virus. *Infect Immun* 1982;35:350–355.
249. Southwick FS, Howard TH, Holbrook T, et al. The relationship between CR3 deficiency and neutrophil actin assembly. *Blood* 1989;73:1973–1979.
250. Boxer LA, Hedley-Whyte ET, Stossel TP. Neutrophil actin dysfunction and abnormal neutrophil behavior. *N Engl J Med* 1974;291:1093–1099.
251. Southwick FS, Dabiri GA, Stossel TP. Neutrophil actin dysfunction is a genetic disorder associated with partial impairment of neutrophil actin assembly in three family members. *J Clin Invest* 1988;82:1525–1531.
252. Coates TD, Torkildson JC, Torres M, et al. An inherited defect of neutrophil motility and microfilamentous cytoskeleton associated with abnormalities in 47 kd and 89 kd proteins. *Blood*

1991;78:1338-1346.

253. Li Y, Guerrero A, et al. The actin-binding protein, lymphocyte-specific protein 1, is expressed in human leukocytes and human myeloid and lymphoid cell lines. *J Immunol* 1995;155:3563-3569.
254. Howard TH, Hartwig J, et al. Lymphocyte-specific protein 1 expression in eukaryotic cells reproduces the morphologic and motile abnormality of NAD 47/89 neutrophils. *Blood* 1998;91:4786-4795.
255. Van Dyke TE, Levine MJ, Tabak LA, et al. Reduced chemotactic peptide binding in juvenile periodontitis: a model for neutrophil function. *Biochem Biophys Res Comm* 1981;100:1278-1284.
256. Van Dyke TE, Levine MJ, Genco RJ. Neutrophil function and oral disease. *J Oral Pathol* 1985;14:95-120.
257. Genco RJ, van Dyke TE, Levine MJ, et al. Molecular factors influencing neutrophil defects in periodontal disease. *J Dent Res* 1986;64:1377-1391.
258. Ward PA, Becker EL. The deactivation of rabbit neutrophils by chemotactic factor and the nature of the activatable esterase. *J Exp Med* 1968;127:693-709.
259. O'Flaherty JT, Kreutzer DL, Showell HJ, et al. Selective neutrophil desensitization to chemotactic factors. *J Cell Biol* 1979;80:564-572.
260. Webster RO, Hong SR, Johnston RB, et al. Biological effects of the human complement fragments C5a and C5a<sub>desarg</sub> on neutrophil function. *Immuno-pharmacology* 1980;2:201-219.
261. Craddock PR, Fehr J, Dalmaso AP, et al. Hemodialysis leukopenia: pulmonary vascular leukostasis resulting from complement activation by dialyzer cellophane membranes. *J Clin Invest* 1977;59:879-888.
262. Craddock PR, Hammerschmidt DE, White JG, et al. Complement (C5a)-induced granulocyte aggregation *in vitro*. A possible mechanism of complement-mediated leukostasis and leukopenia. *J Clin Invest* 1977;60:260-264.
263. Skubitz KM, Craddock PR. Reversal of hemodialysis granulocytopenia and pulmonary leukostasis. *J Clin Invest* 1981;67:1383-1391.
264. Skubitz KM, Craddock PR, Hammerschmidt DE, et al. Corticosteroids block binding of chemotactic peptide to its receptor on granulocytes and cause disaggregation of granulocyte aggregate *in vitro*. *J Clin Invest* 1981;68:13-20.
265. Larson HE, Parry RP, Tyrrell DAJ. Impaired polymorphonuclear leucocyte chemotaxis after influenza virus infection. *Br J Dis Chest* 1980;74:56-62.
266. Abramson JS, Hudnor HR. Role of sialophorin (CD43) receptor in mediating influenza A virus-induced polymorphonuclear leukocyte dysfunction. *Blood* 1995;85:1615-1619.
267. Larson HE, Blades R. Impairment of human polymorphonuclear leucocyte function by influenza virus. *Lancet* 1976;1:283.
268. Abramson JS, Lyles DS, Heller KA, et al. Influenza A virus-induced polymorphonuclear leukocyte dysfunction. *Infect Immun* 1982;37:794-799.
269. Hartshorn KL, Reid KB, et al. Neutrophil deactivation by influenza A viruses: mechanisms of protection after viral opsonization with collectins and hemagglutination-inhibiting antibodies. *Blood* 1996;87:3450-3461.
270. Colamussi ML, White MR, et al. Influenza A virus accelerates neutrophil apoptosis and markedly potentiates apoptotic effects of bacteria. *Blood* 1999;93:2395-2403.
271. Bandres JC, Trial J, Musher DM, et al. Increased phagocytosis and generation of reactive oxygen products by neutrophils and monocytes of men with stage I human immunodeficiency virus infection. *J Infect Dis* 1993;168:75-83.

272. Elbim C, Prevot MH, Bouscarat F, et al. Polymorphonuclear neutrophils from human immunodeficiency virus-infected patients show enhanced activation, diminished fMLP-induced L-Selectin shedding, and an impaired oxidative burst after cytokine priming. *Blood* 1994;84:2759-2766.
273. Craddock PR, Yawata Y, Van Santen L, et al. Acquired phagocyte dysfunction: a complication of parenteral hyperalimentation. *N Engl J Med* 1974;290:1403-1407.
274. Kiersztejn M, Chervu I, Smogorzewski M, et al. On the mechanism of impaired phagocytosis in phosphate depletion. *J Am Soc Nephrol* 1992;2:1484-1489.
275. Bagdade JD, Root RK, Bulger RJ. Impaired leukocyte function in patients with poorly controlled diabetes. *Diabetes* 1974;23:9-15.
276. Alexiewicz JM, Kumar D, Smogorzewski M, et al. Polymorphonuclear leukocytes in non-insulin-dependent diabetes mellitus: abnormalities in metabolism and function. *Ann Intern Med* 1995;123:919-924.
277. Bagdade JD, Stewart M, Walters E. Impaired granulocytes adherence: a reversible defect in host defense in patients with poorly controlled diabetes. *Diabetes* 1978;27:677-681.
278. Andersen B, Goldsmith GH, Spagnuolo PJ. Neutrophil adhesive dysfunction in diabetes mellitus: the role of cellular and plasma factors. *J Lab Clin Med* 1988;111:275-285.
279. Brayton RG, Stokes PE, Schwartz MS, et al. Effect of alcohol and various diseases on leukocyte mobilization, phagocytosis and intracellular bacterial killing. *N Engl J Med* 1970;282:123-128.
280. Marhoffer W, Stein M, Maeser E, et al. Impairment of polymorphonuclear leukocyte function and metabolic control of diabetes. *Diabetes Care* 1992;15:256-260.
281. Repine JE, Clawson CC, Goetz FC. Bactericidal function of neutrophils from patients with acute bacterial infections and from diabetics. *J Infect Dis* 1980;142:869-875.
282. Kunin CM. Detection, prevention, and management of urinary tract infections, 4th ed. Philadelphia: Lea & Febiger, 1987.
283. Roos D, Kuijpers TW, Mascart-Lemone F, et al. A novel syndrome of severe neutrophil dysfunction: unresponsiveness confined to chemotaxin-induced functions. *Blood* 1993;81:2735-2743.
284. Simms HH, D'Amico R. Polymorphonuclear leukocyte dysregulation during the systemic inflammatory response syndrome. *Blood* 1994;83:1398-1407.
285. Ottonello L, Dapino P, Pastorino G, et al. Neutrophil dysfunction and increased susceptibility to infection. *Euro J Clin Invest* 1995;25:687-692.

2004 Lippincott Williams & Wilkins  
John P. Greer, John Foerster, John N. Lukens  
George M. Rodgers, Frixos Paraskevas, Bertil Glader  
Wintrobe's Clinical Hematology

## Abnormalities of the Monocyte–Macrophage System: Lysosomal Storage Diseases

### [PATHOPHYSIOLOGY OF LYSOSOMAL STORAGE DISEASES](#)

#### [GAUCHER DISEASE](#)

##### [Definition and History](#)

##### [Etiology and Pathogenesis](#)

##### [Pathology](#)

##### [Clinical Manifestations](#)

##### [Diagnosis](#)

##### [Treatment](#)

#### [NIEMANN–PICK DISEASE](#)

##### [Definition](#)

##### [Etiology and Pathogenesis](#)

##### [Pathology](#)

##### [Clinical Manifestations](#)

##### [Diagnosis](#)

##### [Treatment](#)

#### [FABRY DISEASE](#)

##### [Definition and History](#)

##### [Etiology and Pathogenesis](#)

##### [Pathology](#)

##### [Clinical Manifestations](#)

##### [Hematologic Features](#)

##### [Diagnosis](#)

##### [Treatment](#)

#### [WEB SITES](#)

#### [REFERENCES](#)

Abnormalities of the monocyte–macrophage system include certain of the inherited lysosomal storage diseases that result from specific defects in lysosomal function. Most of these disorders are caused by the deficiency of a particular hydrolytic enzyme, but others are due to impaired receptors or deficiencies of crucial cofactors or protective proteins. Prevalent among these disorders are the *sphingolipidoses*, which are a unique family of diverse diseases related by their molecular pathology. Here, the clinical, biochemical, and genetic features of three of these disorders are presented: Fabry disease due to defects in the  $\alpha$ -galactosidase A gene on Xq21, Niemann–Pick disease (NPD) due to defects in the acid sphingomyelinase gene on 11p, and Gaucher disease due to defects in the acid  $\beta$ -glucosidase gene at 1q. In each of these inherited disorders, a nucleotide–base substitution in a specific DNA segment that encodes a lysosomal enzyme results in a defective gene product (i.e., a noncatalytic enzyme), which is unable to perform its normal function as a hydrolase. The deficiency of these lysosomal hydrolases results in abnormal metabolism of the enzyme’s specific sphingolipid substrate and accumulation of the sphingolipid within the cells of the monocyte–macrophage system. For example, in Gaucher disease and NPD, anemia, thrombocytopenia, leukopenia, or hepatosplenomegaly can be the presenting symptoms. Thus, these disorders are frequently diagnosed by the hematologist and must be included in the differential diagnosis for patients with monocyte–macrophage involvement.

## PATHOPHYSIOLOGY OF LYSOSOMAL STORAGE DISEASES

The underlying defect in the inherited lipidoses is the accumulation of metabolites, including the glycolipids and sphingomyelin. The glycosphingolipids, which have a major structural function in many cells, are formed by the addition of various carbohydrates to a backbone of ceramide, an acylated sphingosine ( Fig. 65.1). The fatty acid portion of ceramide consists primarily of stearic acid (C<sub>18</sub>) in the brain, whereas in nonneural tissues, it is somewhat longer (C<sub>20</sub> to C<sub>24</sub>). Each sphingolipid is characterized by the nature of the compound that is esterified to the first carbon of the ceramide molecule. For example, the addition of hexoses and *N*-acetylneuraminic acid to ceramide forms the gangliosides, which are found in brain, and the neutral glycolipids, which are found more ubiquitously in cell membranes. The blood group antigens are also glycosphingolipids. In the lysosomal storage diseases, certain lipid compounds are present in different cell types, so their abnormal accumulation due to a specific lysosomal enzyme defect leads to a specific phenotype ( Fig. 65.2).

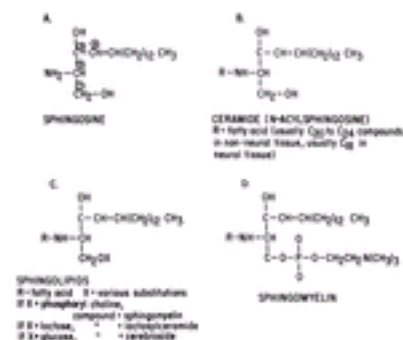


Figure 65.1. Formulae of some of the sphingolipids.



Figure 65.2. Schematic structure of globoside (A) and ganglioside (B) to show site of action of the several catabolic enzymes, which result in one of the storage diseases when defective.

## GAUCHER DISEASE

### Definition and History

*Gaucher disease* is a lipid storage disease characterized by the deposition of glucosylceramide in cells of the macrophage–monocyte system ( 1 ). It was first described by Gaucher in 1882, and the storage of glucocerebroside was first recognized by Epstein

in 1924 (1). Brady et al. subsequently delineated the metabolic defect, the deficiency of the lysosomal hydrolase acid  $\beta$ -gluco-sidase (2). There are three clinical subtypes that are delineated by the absence or presence and progression of neurologic involvement: type 1 or the adult, nonneuronopathic form; type 2, the infantile or acute neuronopathic form; and type 3, the juvenile or Norrbotten form. All three subtypes are inherited as autosomal-recessive traits. Type 1 disease is the most common lysosomal storage disease and the most prevalent genetic disorder among Ashkenazi Jewish individuals, with an incidence of approximately 1 in 1000 and a carrier frequency of approximately 1 in 16 to 1 in 18 (3).

### Etiology and Pathogenesis

All three subtypes of Gaucher disease result from the deficient activity of the lysosomal hydrolase acid  $\beta$ -glucosidase. The molecular basis of Gaucher disease has been identified for 90 to 95% of Ashkenazi Jewish patients (Table 65.1). Genotype/phenotype correlations have been noted for the different subtypes and may provide the molecular basis for the remarkable clinical variation in type 1 Gaucher disease. Presumably, the amount of residual enzymatic activity determines disease subtype and severity. For example, type 1 patients homozygous for the milder N370S mutation tend to have a later onset and milder course than patients with one N370S allele and another mutant allele. However, the wide variability in clinical presentation among Gaucher disease patients cannot be fully explained by the underlying acid  $\beta$ -glucosidase mutations. The lesions causing the severe type 2 (infantile) disease express little, if any, enzymatic activity *in vitro*.

**TABLE 65.1. Molecular Genetics of Gaucher, Niemann–Pick, and Fabry Diseases**

| Disease                          | Chromosome Assignment | Molecular Characteristics   | Comments   |
|----------------------------------|-----------------------|---|--|
| Gaucher                          | 1q21                  | cDNA, functional and pseudogenomic sequences, >200 mutant alleles known | 4 mutations (N370S, L444P, 84insG, IVS2 <sup>+</sup> 1) account for 90–95% of mutant alleles in Ashkenazi Jewish patients. |
| Niemann–Pick<br>Types A<br>and B | 11p15.1 to<br>p15.4   | cDNA, entire genomic sequence, >30 mutant alleles known                 | 4 mutations account for >95% of mutant alleles in Ashkenazi Jewish patients with type A disease.                           |
| Type C                           | 18q11–q12<br>region   | cDNA, entire genomic sequence, >100 mutant alleles known                | Over 100 mutations in NPC1 gene.   |
| Fabry                            | Xq22.1                | cDNA, entire genomic sequences, >200 mutant alleles known               | Over 200 private mutations detected occurring in single or a few families.   |

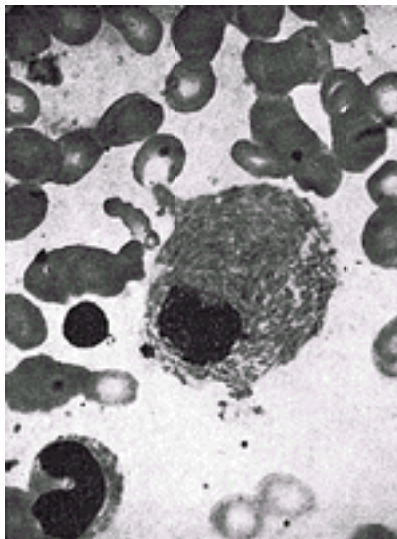
cDNA, complementary DNA.

### Pathology

The pathologic hallmark in Gaucher disease is the presence of the Gaucher cell in the



macrophage–monocyte system, particularly in the bone marrow ( [Fig. 65.3](#)). These cells, which are 20 to 100  $\mu\text{m}$  in diameter, have a characteristic wrinkled–paper appearance resulting from intracytoplasmic substrate deposition. Gaucher cells stain strongly positive with periodic acid–Schiff, and their presence in bone marrow, other tissues, or both suggests the diagnosis. The accumulated glycolipid, glucosyl–ceramide, is derived primarily from the phagocytosis and degradation of senescent leukocytes and, to a lesser extent, erythrocyte membranes. Glycolipid storage results in organomegaly and pulmonary infiltration. Neuronal cell loss in patients with types 2 and 3 disease presumably results from the accumulation of the cytotoxic glycolipid, glucosylsphingosine, in the brain due to the severe deficiency of acid  $\beta$ –glucosidase activity. Glucosylceramide accumulation in the bone marrow, liver, spleen, lungs, and kidney leads to pancytopenia, massive hepatosplenomegaly, diffuse infiltrative pulmonary disease, and nephropathy or glomerulonephritis. The progressive infiltration of Gaucher cells in the bone marrow causes thinning of the cortex, pathologic fractures, bone pain, bony infarcts, and osteopenia. Central nervous system involvement occurs only in patients with types 2 and 3 disease.



**Figure 65.3.** Typical Gaucher cell together with a lymphocyte and a juvenile neutrophil from the sternal bone marrow in a patient with Gaucher disease.

### Clinical Manifestations

There is a broad spectrum of clinical expression among patients with type 1 disease, in part due to a combination of different mutant alleles. Onset of clinical manifestations occurs from early childhood to late adulthood, with the more severely affected patients presenting by adolescence. At presentation, patients may have easy bruisability due to thrombocytopenia, chronic fatigue secondary to anemia, hepatomegaly with or without elevated liver function tests, splenomegaly, and bone pain or pathologic fractures. Occasionally, patients present with pulmonary involvement. Patients who are diagnosed in the first 5 years of life are frequently non–Jewish and typically have a more malignant disease course. Patients with a milder form of the disease are identified later in life during evaluations for hematologic or skeletal problems or are found to have splenomegaly on routine examinations. In symptomatic patients, splenomegaly is progressive and can become massive. Clinically apparent bony involvement, which occurs in over 20% of patients, can present as bone pain or pathologic fractures. Most patients have radiologic evidence of skeletal involvement, including an Erlenmeyer flask deformity of the distal femur, which is an early skeletal change. In patients with symptomatic bone disease, lytic

lesions can develop in the long bones, ribs, and pelvis, and osteosclerosis may be evident at an early age. Bone crises with severe pain and swelling can occur. Bleeding secondary to thrombocytopenia may manifest as epistaxis and bruising and is frequently overlooked until other symptoms become apparent. Children with massive splenomegaly are short of stature due to the energy expenditure required by the enlarged organ.

Type 2 disease, which is rare and panethnic in distribution, is characterized by a rapid neurodegenerative course with extensive visceral involvement and death within the first 2 years of life. The disease presents in infancy with increased tone, strabismus, and organomegaly. Failure to thrive and stridor due to laryngospasm are typical. The progressive psychomotor degeneration leads to death by 2 to 3 years, usually due to respiratory compromise.

Type 3 disease presents in infancy or childhood. Neurologic involvement is present in addition to organomegaly and bony manifestations. There is a high frequency of type 3 disease in Sweden (1 in 50,000), which has been traced to a common founder couple in the seventeenth century. Type 3 disease has been further classified as types 3a and 3b based on the extent of neurologic involvement and whether there is progressive myotonia and dementia (type 3a) or isolated supranuclear gaze palsy (type 3b).

## Diagnosis

Gaucher disease should be considered in the differential diagnosis of patients who present with unexplained organomegaly, easy bruisability, or bone pain. Bone marrow examination usually reveals the presence of Gaucher cells; however, all suspect diagnoses should be confirmed by demonstrating deficient acid  $\beta$ -glucosidase activity in isolated leukocytes or cultured fibroblasts. For possible genotype/phenotype correlations, the specific acid  $\beta$ -glucosidase mutation(s) may be determined, particularly in Ashkenazi Jewish patients. Carrier identification can be achieved by enzymatic assay confirmed with DNA testing in most Jewish families. Testing should be offered to all family members, keeping in mind that heterogeneity even among members of the same kindred can be so great that asymptomatic affected individuals may be diagnosed during such testing. Prenatal diagnosis is available by determining enzymatic activity or specific mutations in chorionic villi or cultured amniotic fluid cells.

## Treatment

In the past, management of patients with type 1 disease was primarily symptomatic and included blood transfusions for anemia, partial or total splenectomy for severe mechanical cardiopulmonary compromise or hypersplenism, analgesics for bone pain, and orthopedic procedures for joint replacement. A small number of patients also have undergone bone marrow transplantation, which is curative if successful ([4](#)). However, a matched donor is required, and significant morbidity and mortality are associated with the procedure. No effective treatment is known for the neurologic involvement in types 2 and 3 disease. However, during the past 10 years, the safety and efficacy of enzyme replacement using recombinant acid  $\beta$ -glucosidase have been clearly demonstrated in type 1 disease ([2](#)). Most of the extraskeletal symptoms are reversed by an initial debulking dose of enzyme (60 IU/kg) administered by intravenous infusion every other week. The effectiveness of enzyme replacement in reversing and preventing bone manifestations is still under study; however, the data indicate that enzyme replacement decreases the frequency of bone pain crises and stabilizes or improves the bone disease. In addition, early treatment is efficacious in normalizing linear growth and bone morphology in affected children. Efforts are also under way to develop gene therapy for type 1 disease.

# NIEMANN-PICK DISEASE

## Definition

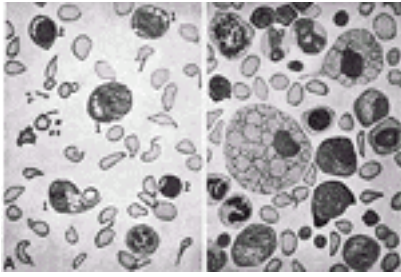
*NPD types A and B* are lipid storage disorders that result from the deficiency of the lysosomal enzyme, acid sphingomyelinase, and the subsequent accumulation of its substrate, sphingomyelin (<sup>3</sup>). The original description of NPD referred to what is now known as type A NPD, which is a fatal disorder of infancy characterized by failure to thrive, hepatosplenomegaly, and a rapidly progressive neurodegenerative course that leads to death by age 2 to 3 years. Type B is a nonneuronopathic form observed in children and adults. In addition, several other subtypes of NPD have been described, the major subtype being type C, which results from defective cholesterol transport. Previously, a type D disease was identified in patients from Nova Scotia. Studies have now shown that these type D patients have mutations in the major gene causing type C disease. All of the subtypes are inherited as autosomal-recessive traits and display variable clinical features.

## Etiology and Pathogenesis

NPD types A and B result from deficient acid sphingomyelinase activity. In type C NPD, the genetic defect involves the defective transport of cholesterol from the lysosome to the cytosol. Two different genes causing the altered cholesterol transport in type C disease were recently identified, permitting more precise diagnosis, carrier detection, and prenatal diagnosis in affected families.

## Pathology

The pathologic hallmark in types A and B NPD is the histochemically characteristic lipid-laden foam cell, often referred to as the *Niemann-Pick cell* ( [Fig. 65.4](#)). These cells, which can be readily distinguished from Gaucher cells by their histologic and histochemical characteristics, are not pathognomic for NPD because histologically similar cells are found in patients with Wolman disease, cholesterol ester storage disease and lipoprotein lipase deficiency, and in some patients with GM<sub>1</sub> gangliosidosis, type 2. Sphingomyelin is the major lipid that accumulates in the cells and tissues of patients with types A and B NPD. In most normal tissues, sphingomyelin constitutes from 5 to 20% of the total cellular phospholipid content; however, in patients with types A and B NPD, the sphingomyelin levels may be elevated up to 50-fold, constituting approximately 70% of the total phospholipid fraction. Lysosomal sphingomyelin accumulation in brain, liver, kidney, and lungs has been documented with organs from types A and B NPD patients containing approximately the same amount of sphingomyelin, with the notable exception that type B NPD patients have little or no lipid storage in their central nervous systems. In general, patients with type A disease have less than 5% of normal acid sphingomyelinase activity when determined in cultured fibroblasts, lymphocytes, or both, whereas cells from type B patients typically have 10 to 20% of normal activity that presumably prevents the development of the neurologic symptoms.



**Figure 65.4.** Drawings of representative cells in smears made from (A) peripheral blood and (B) sternal bone marrow in a patient with Niemann–Pick disease showing numerous vacuoles in the cytoplasm of monocytes ( 1) and lymphocytes ( 2) in the blood and foam cells in the marrow. (From Kato K. Sternal marrow puncture in infants and children. *Am J Dis Child* 1937;54:269, with permission.)

### Clinical Manifestations

The clinical presentation and course of type A NPD is relatively uniform and is characterized by a normal appearance at birth, although the newborn period is sometimes complicated by prolonged jaundice. Hepatosplenomegaly, moderate lymphadenopathy, and psychomotor retardation are evident by 6 months of life followed by rapid neurodegeneration. The loss of motor function and the deterioration of intellectual capabilities are progressive. In later stages, spasticity and rigidity are evident with affected infants experiencing complete loss of contact with their environment.

In contrast to the stereotyped type A phenotype, the clinical presentation and course of patients with type B disease are more variable. Most patients are diagnosed in infancy or childhood when enlargement of the liver, spleen, or both is detected during a routine physical examination. At diagnosis, type B patients also have evidence of mild pulmonary involvement, usually detected as a diffuse reticular or finely nodular infiltration on chest roentgenogram. In most patients, hepatosplenomegaly is particularly prominent in childhood, but with increasing linear growth, the abdominal protuberance decreases and becomes less conspicuous. In mildly affected patients, the splenomegaly may not be noted until adulthood, and there may be minimal disease manifestations. In most type B patients, decreased pulmonary diffusion due to alveolar infiltration becomes evident in childhood and progresses with age. Severely affected individuals may experience significant pulmonary compromise by age 15 to 20. Such patients have low  $pO_2$  values and dyspnea on exertion. Life-threatening bronchopneumonias may occur, and cor pulmonale has been described. Severely affected patients also may have liver involvement leading to life-threatening cirrhosis, portal hypertension, and ascites. Clinically significant pancytopenia due to secondary hypersplenism may necessitate partial or total splenectomy. Typically, type B patients do not have neurologic involvement and are intellectually intact.

Patients with NPD type C disease often have prolonged neonatal jaundice, appear normal for 1 to 2 years, and then experience a slowly progressive and variable neurodegenerative course. Their hepatosplenomegaly is less severe than in patients with type A or B disease, and they may survive into adulthood.

### Diagnosis

Type A disease is diagnosed in the patient's first year of life by failure to thrive, organomegaly, and severe psychomotor retardation. In type B disease, splenomegaly is usually noted early in childhood; however, in very mild cases, the enlargement may be subtle, and detection may be delayed until adolescence or adulthood. The presence of the

characteristic Niemann–Pick cells in the bone marrow supports the diagnosis. However, patients with type C disease also have infiltration of these cells in the bone marrow. Thus, all suspected cases should be evaluated enzymatically to confirm the clinical diagnosis by measuring the acid sphingomyelinase activity in peripheral leukocytes, cultured fibroblasts, or lymphoblasts. Patients with types A and B disease have markedly decreased levels of enzymatic activity (1 to 10% of normal), whereas patients with type C disease may have slightly decreased sphingomyelinase activity (50 to 75% of normal), and patients with Gaucher disease and other storage disorders characterized by hepatosplenomegaly, neurologic involvement, or both have normal or near-normal levels. The enzymatic identification of types A and B carriers is problematic. However, in families in which the specific molecular lesion has been identified, family members can be accurately tested for heterozygote status by DNA analysis ( [Table 65.1](#) ). Type C disease can be biochemically documented by demonstrating the cholesterol transport defect in cultured fibroblasts. Heterozygote identification for type C disease can be accomplished by DNA analysis in families whose mutations have been identified. Prenatal diagnosis of types A and B disease may be reliably made by measuring acid sphingomyelinase activity in cultured amniocytes or chorionic villi. In type C disease, the cholesterol defect can be demonstrated by filipin staining, but DNA diagnosis is most accurate. Thus, in types A, B, and C, prenatal diagnosis can be made by DNA analysis of fetal cells in families in which the specific molecular lesions are known.

## Treatment

At present, no specific treatment is available for any of the NPD subtypes. Orthotopic liver transplantation in an infant with type A disease and amniotic cell transplantation in several patients with type B disease have been attempted without success. Bone marrow transplantation in a type B patient was successful in reducing the spleen and liver volumes, the sphingomyelin content of the liver, and the number of Niemann–Pick cells in the marrow and radiologically detected infiltration of the lungs. However, the patient experienced severe graft-versus-host disease, which complicated her quality of life. Future prospects for treatment of type B disease include enzyme replacement and gene therapy. Treatment of types A and C disease is presently precluded by their severe neurologic involvement.

## FABRY DISEASE

### Definition and History

*Fabry disease* is an X-linked inborn error of glycosphingolipid metabolism that was first described in 1898 by two dermatologists, Anderson and Fabry, who independently reported patients with angiokeratoma corporis diffusum. The lipid storage nature of the disorder was subsequently established by Scriba, and although the familial occurrence of the disease was recognized earlier, it was not until 1965 that Opitz et al. ( [5](#) ) documented X-linked recessive inheritance by pedigree analysis. In 1967, Brady et al. ( [6](#) ) demonstrated that the enzymatic defect was in ceramide trihexosidase, or  $\alpha$ -galactosidase A activity. The disease is characterized by the presence of angiokeratomas (telangiectatic skin lesions), hypohidrosis, corneal and lenticular opacities, acroparesthesias, and vascular disease of the kidney, heart, or brain. It has an estimated prevalence of approximately 1 in 40,000 males and is panethnic.

### Etiology and Pathogenesis

Fabry disease is an X-linked recessive trait that is manifested in affected hemizygous males. Atypical male variants with residual  $\alpha$ -galactosidase A activity may be asymptomatic or have late-onset, mild disease manifestations primarily limited to the



heart. Heterozygous females are usually asymptomatic or exhibit mild manifestations. The disease results from the deficient activity of the lysosomal hydrolase,  $\alpha$ -galactosidase A. Affected males who have blood group B or AB have a more severe disease course because the blood group B substance also accumulates as it is normally degraded by  $\alpha$ -galactosidase A. The molecular basis of Fabry disease has been identified for a number of patients ( [Table 65.1](#)).

## Pathology

Fabry disease is characterized by the marked deposition of globotriaosylceramide and related glycosphingolipids with terminal  $\alpha$ -galactosyl moieties primarily in the plasma and in the lysosomes of endothelial, perithelial, and smooth muscle cells of blood vessels ( [4](#)). These glycosphingolipid deposits also are prominent in epithelial cells of the cornea, in glomeruli and tubules of the kidney, in muscle fibers of the heart, and in ganglion cells of the dorsal roots and autonomic nervous system. The skin lesions are telangiectases. Capillaries, venules, and arterioles show pathologic lipid storage, and there is marked dilatation of the capillaries of the dermal papillae just below the epidermis. The larger lesions are usually located in the upper dermis, where they may produce elevation, flattening, or hypertrophy of the epithelium with keratosis—hence the term *angiokeratoma*. Ultrastructurally, the glycosphingolipid inclusions in lysosomes have a concentrically arranged lamellar or myelinlike structure.

## Clinical Manifestations

The angiokeratomas usually occur in childhood and may lead to early diagnosis. They increase in size and number with age and range from barely visible to several millimeters in diameter. The lesions are punctate, dark red to blue-black, and flat or slightly raised ( [Fig. 65.5](#)). They do not blanch with pressure, and the larger ones may show slight hyperkeratosis. Characteristically, the lesions are most dense between the umbilicus and knees, in the “bathing trunk area,” but may occur anywhere, including the oral mucosa. The hips, thighs, buttocks, umbilicus, lower abdomen, scrotum, and glans penis are common sites, and there is a tendency toward bilateral symmetry. Variants without skin lesions have been described. Sweating is usually decreased or absent. Corneal opacities and characteristic lenticular lesions, observed in slit-lamp examination, are present in affected males as well as in approximately 70% of asymptomatic heterozygotes. Conjunctival and retinal vascular tortuosity are common and result from the systemic vascular involvement.



**Figure 65.5.** Typical skin lesions on the buttocks of a patient with Fabry disease.

Pain is the most debilitating symptom in childhood and adolescence. Fabry crises, lasting from minutes to several days, consist of agonizing, burning pain in the hands and feet and proximal extremities and are usually associated with exercise, fatigue, or fever. These

painful acroparesthesias usually become less frequent in the third and fourth decades of life, although in some men, they may become more frequent and severe. Attacks of abdominal or flank pain may simulate appendicitis or renal colic.

With increasing age, the major morbid symptoms result from the progressive involvement of the vascular system. Early in the course of the disease, casts, red cells, and lipid inclusions with characteristic birefringent “Maltese crosses” appear in the urinary sediment. Proteinuria, isosthenuria, gradual deterioration of renal function, and development of azotemia occur in the second to fourth decades of life. Cardiovascular findings may include hypertension, left ventricular hypertrophy, anginal chest pain, myocardial ischemia or infarction, and congestive heart failure. Mitral insufficiency is the most common valvular lesion. Abnormal electrocardiographic and echocardiographic findings are common. Cerebrovascular manifestations result primarily from multifocal small vessel involvement. Other features may include chronic bronchitis and dyspnea, lymphedema of the legs without hypoproteinemia, episodic diarrhea, osteoporosis, retarded growth, and delayed puberty. Death most often results from uremia or vascular disease of the heart or brain. Before hemodialysis or renal transplantation, the mean age of death for affected men was 41 years (7).

Atypical male variants with residual  $\alpha$ -galactosidase A activity who are asymptomatic or mildly affected have been described whose manifestations include late-onset, isolated cardiac disease and proteinuria but normal renal function for age. These cardiac variant patients do not have the early classic manifestations such as angiokeratoma, acroparesthesias, hypohidrosis, corneal opacities, and so forth. They have cardiomegaly, usually involving the left ventricular wall and interventricular septum, and electrocardiographic abnormalities consistent with cardiomyopathy. Others have had hypertrophic cardiomyopathy, myocardial infarction, or both. They develop proteinuria with age but usually have normal renal function and a normal lifespan.

### **Hematologic Features**

Anemia that is probably due to decreased erythrocyte survival has been noted. A decreased serum iron concentration, normal erythrocyte fragility, and an elevated reticulocyte count also have been reported. Increased platelet aggregation and a high concentration of  $\beta$ -thromboglobulin have been described. Lipid-laden foamy-appearing macrophages are present in the bone marrow.

### **Diagnosis**

The diagnosis in classically affected males is most readily made from the history of painful acroparesthesias, hypohidrosis, the presence and distribution of the skin lesions, and the observation of the characteristic corneal opacities and lenticular lesions (8). The disorder is often misdiagnosed as rheumatic fever, erythromyalgia, or neurosis. The skin lesions must be differentiated from the benign angiokeratomas of the scrotum (Fordyce disease) and from angiokeratoma circumscriptum. Angio-keratomas identical to those of Fabry disease have been reported in fucosidosis, aspartylglycosaminuria, late-onset GM<sub>1</sub> gangliosidosis, galactosialidosis,  $\alpha$ -N-acetylgalactosaminidase deficiency, and sialidosis. The diagnosis of the mild cardiac variants should be considered in individuals who present with left ventricular hypertrophy, cardiomyopathy, or both. The diagnosis of classic and variant patients is confirmed biochemically by markedly decreased  $\alpha$ -galactosidase A activity in plasma, isolated leukocytes, or cultured fibroblasts or lymphoblasts.

Heterozygous females may have corneal opacities, isolated skin lesions, and intermediate activities of  $\alpha$ -galactosidase A in plasma or cell sources. Rare female heterozygotes may have manifestations as severe as those in affected males. However, at-risk females in



families affected by Fabry disease who are asymptomatic should be optimally diagnosed by the direct analysis of their family's specific mutation. Prenatal detection of affected males can be accomplished by demonstrating deficient  $\alpha$ -galactosidase A activity or by detecting the family's specific gene mutation in chorionic villi obtained in the first trimester of pregnancy or in cultured amniocytes obtained by amniocentesis in the second trimester.

## Treatment

Until recently, treatment for Fabry disease has been nonspecific and limited to supportive care. These measures included the use of phenytoin, carbamazepine, or both, which has been shown to decrease the frequency and severity of the chronic acroparesthesias and the periodic crises of excruciating pain. Renal transplantation and long-term hemodialysis also have become life-saving procedures for patients with renal failure. More recently, clinical trials with recombinant  $\alpha$ -galactosidase (Fabrazyme, Genzyme Corporation, Cambridge, MA; Replagal, TKT Corporation, Cambridge, MA) have demonstrated the safety and effectiveness of enzyme replacement therapy for Fabry disease. A phase I/II dose-escalation trial demonstrated that the enzyme was well tolerated, and its use resulted in histologic, biochemical, and ultrastructural reductions in the levels of accumulated tissue globotriaosylceramide (5). The results of a recent phase III, multicenter, double-blind, randomized, placebo-controlled study of 58 patients with Fabry disease, half of whom received recombinant  $\alpha$ -galactosidase and the other half placebo, showed that the treatment group had very significant clearance of globotriaosylceramide from the vascular endothelial cells of the kidney, heart, and skin (9). The placebo group had no change. After 20 weeks, patients in the placebo group were switched to recombinant  $\alpha$ -galactosidase, and all had clearance to normal or near-normal levels of the vascular endothelial globotriaosylceramide in the kidney and skin and significant reductions in the heart. These studies demonstrated the safety and effectiveness of enzyme replacement therapy for this disease. Expert recommendations for the treatment of patients with Fabry disease were published recently (8).

## WEB SITES

<http://www.gaucherdisease.com>

<http://www.childrensgaucher.org>

<http://www.gaucher.org.uk>

<http://www.ncbi.nlm.nih.gov/disease/Gaucher.html>

<http://www.nnpdf.org>

[http://www.ninds.nih.gov/health\\_and\\_medical/disorders/niemann.doc.htm](http://www.ninds.nih.gov/health_and_medical/disorders/niemann.doc.htm)

[http://www.ninds.nih.gov/health\\_and\\_medical/disorders/fabrys.doc.htm](http://www.ninds.nih.gov/health_and_medical/disorders/fabrys.doc.htm)

## REFERENCES

1. Epstein E. Beitrag zur chemie der Gaucherschen krankheit. *Biochem Z* 1924;145:398-402.
2. Brady RO, Kanfer JN, Shapiro D. Metabolism of glucocerebrosides. II: Evidence of an enzymatic

deficiency in Gaucher's disease. *Biochem Biophys Res Commun* 1965;18:221–225.

3. Eng CM, Schechter C, Robinowitz J, et al. Prenatal genetic carrier testing using triple disease screening. *JAMA* 1997;278:1268–1272.
4. Hobbs JR, Jones KH, Shaw PJ, et al. Beneficial effect on pre-transplant splenectomy on displacement bone marrow transplantation for Gaucher's syndrome. *Lancet* 1987;8542:1111–1115.
5. Opitz JM, Stiles FC, Wise D, et al. The genetics of angiokeratoma corporis diffusum (Fabry's disease), and its linkage with Xg(a) locus. *Am J Hum Genet* 1964;17:325–331.
6. Brady RO, Gal AE, Bradley RM, et al. Enzymatic defect in Fabry's disease. Ceramidetrihexosidase deficiency. *N Engl J Med* 1967;276:1163–1167.
7. Colombi A, Kostyal A, Bracher R, et al. Angiokeratoma corporis diffusum—Fabry disease. *Helv Med Acta* 1967;34:67–83.
8. Desnick RJ, Brady RO, Barranger J, et al. Fabry disease, and under-recognized multisystemic disorder: expert recommendations for diagnosis, management, and enzyme replacement therapy. *Ann Intern Med* 2003;138:338–346.
9. Eng CM, Guffon N, Wilcox WR, et al. Safety and efficacy of recombinant human  $\alpha$ -galactosidase A replacement therapy in Fabry's disease. *N Engl J Med* 2001;345:9–16.

2004 Lippincott Williams & Wilkins  
John P. Greer, John Foerster, John N. Lukens  
George M. Rodgers, Frixos Paraskevas, Bertil Glader  
Wintrobe's Clinical Hematology

[HISTORY](#)  
[EPIDEMIOLOGY](#)  
[PATHOLOGY AND PATHOPHYSIOLOGY](#)  
[CLINICAL FEATURES](#)  
[PROGNOSIS](#)  
[DIAGNOSIS](#)  
[MANAGEMENT AND TREATMENT](#)  
[REFERENCES](#)

Langerhans cell histiocytosis (LCH) is a disorder characterized by proliferations of cells in the mononuclear phagocyte system. Since the first case was described more than a century ago ([1](#)), LCH has often been a source of confusion. This is perhaps best demonstrated by the several labels given to the disorder during the past 100 years. Since 1985, *Langerhans cell histiocytosis* has been the preferred term ([2](#), [3](#)), replacing *histiocytosis X*, which was coined in 1953 ([4](#)). The *X* demonstrated the lack of knowledge about the etiology and pathophysiology of LCH, and about how the different clinical syndromes were related. The term *histiocytosis X* did serve to bind the syndromes, which included Hand–Schüller–Christian syndrome, Letterer–Siwe disease, eosinophilic granuloma, Hashimoto–Pritzker syndrome ([5](#)), self-healing histiocytosis ([6](#)), and pure cutaneous histiocytosis ([7](#)), into one clinical entity. The term *Langerhans cell histiocytosis* was proposed to reflect the central role of the Langerhans cell in these diseases. LCH also distinguishes these disorders from other histiocytic syndromes, which include primary and secondary lymphohistiocytoses, and neoplastic disorders such as acute monocytic leukemia, malignant histiocytosis, and true histiocytic lymphoma ([8](#)). This chapter focuses on LCH.

## HISTORY

The clinical triad of defects in membranous bone, exophthalmos, and polyuria in children, which became known as *Hand–Schüller–Christian disease* ([8](#)), was described in 1921 in a review by Hand ([9](#)). Hand described the first six cases, including those of Christian, Schüller, and his own first case reported in 1893 ([1](#)). All six patients had hepatosplenomegaly, lymphadenopathy, and bone lesions. However, not all had exophthalmos and polyuria. Attempts to link the disorder to xanthoma tuberosum, lipid storage disease, and the xanthomatoses proved unsuccessful, and to this day, no evidence exists that a specific biochemical defect is responsible for the condition. However, the foamy or xanthoma cell came to be regarded as a pathognomonic feature of the syndrome ([10](#)).

A different syndrome, consisting of fever, bilateral otitis media, hepatosplenomegaly, and adenopathy in a young infant who died was described by Letterer in 1924 ([11](#)). In 1933, Siwe described a 16-month-old girl who died after a 3-month illness characterized by fever, hepatosplenomegaly, lymphadenopathy, neutrophilia, and a destructive lesion in her fibula ([12](#)). At autopsy, massive infiltrates of large cells resembling histiocytes were found. Siwe reviewed five other cases from the literature (including that of Letterer) and

concluded that they constituted a single clinical entity ( [12](#) ).

In 1940, two groups of investigators described a syndrome in which a characteristic feature was infiltration of bone by eosinophilic granulomas ( [13](#), [14](#) ). In 1942, Green and Farber described a series of patients with eosinophilic granulomas of bone, which usually healed promptly after irradiation or curettage ( [15](#) ). They noted that these cases shared pathologic features similar to those of the Letterer–Siwe and Hand–Schüller–Christian syndromes. In 1953, because of the similarity of the histiocytes observed in these three disorders, Lichtenstein combined them into a single entity called *histiocytosis X* to indicate their unknown cause ( [4](#) ). The recognition that these three disorders were related was an important contribution. Understanding of these disorders improved, however, and the term *Langerhans cell histiocytosis* was proposed in 1985 ( [3](#) ). LCH also differentiates this group of diseases from reactive and malignant histiocytic processes of the mononuclear phagocyte system.

## EPIDEMIOLOGY

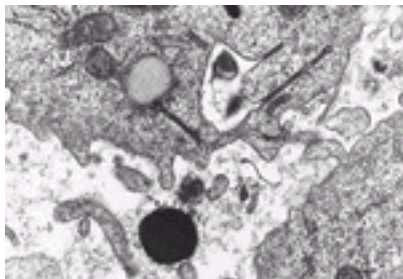
Even with advances in the understanding of the central role played by the Langerhans cell in LCH, little is known about the etiology of LCH. The annual incidence has been estimated to be 4 per million ( [16](#) ), and there seems to be a slight predominance of cases in males ( [17](#), [18](#), [19](#) and [20](#) ). Most cases of LCH with multisystem disease occur before 2 years of age ( [21](#), [22](#) ), whereas half of all cases in which LCH is limited to a single bony lesion occur after age 5 years ( [23](#) ). In an exploratory case–control study comparing 177 children with LCH to children with cancer and community controls ( [20](#) ), LCH was associated with a family history of benign tumors and less strongly with feeding problems during infancy. Other factors associated with LCH in this study were maternal urinary tract infections during pregnancy and blood transfusions during infancy. Factors not associated with LCH were the typical childhood viral infections and medication use. In a case–control study of 459 children with LCH, which compared risk factors in children with LCH to those in both community and cancer controls ( [24](#) ), LCH was associated with neonatal infections, solvent exposure, and thyroid disease in the proband or the family. Childhood immunizations appeared to be protective. Links with both solid tumors and leukemia have also been documented ( [25](#) ). Although some cancers after LCH may be secondary to therapy, this does not explain all cases because in some, cancer preceded the diagnosis of LCH. Patients with LCH may have a predisposition to cancer and vice versa. Patients with multisystem LCH are more likely to have chromosomal instability ( [26](#) ); this suggests a genetic predisposition to LCH, but further studies are needed to identify such a predisposition.

## PATHOLOGY AND PATHOPHYSIOLOGY

The basic histologic lesion in LCH is granulomatous, with lesions containing histiocytes, mature eosinophils, and lymphocytes ( [27](#) ); other cells present may include giant cells, neutrophils, and plasma cells. Initially, lesions are proliferative and dominated by histiocytes, some of which are Langerhans cells. Although mitotic figures may occasionally be identified, the histiocytes are not neoplastic by histologic criteria. As lesions progress, necrosis may develop, and the number of eosinophils and phagocytic cells containing cellular debris increases. Ultimately, xanthomatous changes and fibrosis may occur, and late in the course of disease, Langerhans cells may no longer be demonstrable. Multinucleated giant cells occasionally are prominent, especially in bone and lymph nodes. The histologic findings do not correlate with the extent or

aggressiveness of disease ( [22](#), [28](#) ).

The Langerhans cell is the sine qua non of the diagnostic lesion. These pathologic Langerhans cells or LCH cells are similar to the normal Langerhans cells found in skin. Although its demonstration is essential for diagnosis ( [22](#) ), the Langerhans cell may constitute no more than a small proportion of histiocytes within lesions ( [29](#) ). Viewed by light microscopy, these cells appear as large mononuclear cells with few cytoplasmic vacuoles and little or no phagocytic material ( [30](#) ). The nuclei are irregularly shaped and contain a fine chromatin pattern. Electron microscopic or immunohistochemical studies may be required to identify Langerhans cells with confidence. The former demonstrate structures known as *Birbeck granules* (Langerhans bodies, X granules) ( [29](#), [30](#) and [31](#) ), rod-shaped organelles with a central striation and occasional terminal vesicular dilation, giving them a tennis racket appearance ( [Fig. 66.1](#) ). They are thought to be produced by invagination of the cell membrane, and their function is not known. The percentage of histiocytes with Birbeck granules is not prognostic ( [32](#) ). The other feature that conclusively establishes the diagnosis of LCH is the demonstration of the CD1a antigen on the surface of LCH cells by immunohistochemical staining ( [26](#) ). Other distinctive features of Langerhans cells that can be demonstrated with immunohistochemical techniques include the demonstration of S-100 protein ( [29](#), [33](#) ), Ia-like antigen ( [34](#) ), and membrane-bound adenosine triphosphatase activity ( [35](#) ). Paraffin-embedded tissue can be used to demonstrate S-100 protein ( [33](#) ) and a distinctive distribution of peanut agglutination ( [36](#), [37](#) ). The cell surface also expresses CD101; this may be of use in frozen sections ( [38](#) ).



**Figure 66.1.** Electron micrograph of Langerhans cells from a bone lesion demonstrating characteristic Birbeck granules with a trilaminar structure. (Magnification  $\times 45,000$ ; courtesy of Roma Chandra.)

Langerhans cells are classified as dendritic cells because of their capacity to form long cytoplasmic extensions through which they establish intimate contact with other cells. The presence of fascin, a highly selective marker of dendritic cells, on the surface of Langerhans cells confirms their derivation from dendritic cells ( [39](#) ). Langerhans cells are found primarily in normal epidermis, but also are evident in lymph nodes and spleen. A hematopoietic progenitor of Langerhans cells has been identified in normal bone marrow ( [40](#) ). In the skin, Langerhans cells form a trap for external contact antigens and are involved in delayed hypersensitivity. Despite low phagocytic activity, they fix antigens for presentation to other cells, especially T lymphocytes ( [41](#), [42](#) ). In tissue culture, Langerhans cells purified from bony LCH lesions secrete interleukin-1 (IL-1) and prostaglandin E<sub>2</sub>, both of which induce bone resorption *in vitro* ( [43](#) ). These lesions also secrete angiotensin-converting enzyme, transforming growth factor- $\beta$ 1 and IL-2 ( [44](#) ).

These mediators are probably responsible for the osteolytic lesions that are a prominent clinical feature of LCH.

The focal accumulation of Langerhans cells, macrophages, lymphocytes, and eosinophils suggests that LCH is immunologically mediated. This reasoning is supported by both histologic abnormalities of the thymus and disturbances of immunoregulation in patients with active disease ( 45 ). Thymic abnormalities were noted by Letterer in his initial description of the disorder, later known as Letterer–Siwe disease ( 11 ). Abnormalities noted on pretherapy biopsy samples and postmortem material include dysmorphic changes, dysplasia, and nonspecific involution ( 46, 47, 48 and 49 ). In patients with LCH, the number of normal thymocytes (expressing CD6) and late differentiating suppressor lymphocytes (expressing CD8) is decreased ( 50 ). These abnormalities are noted even when the disease is limited in its distribution ( 50 ). Qualitatively similar alterations have been described in association with combined immunodeficiency ( 51 ), graft–versus–host disease ( 52 ), and acquired immunodeficiency syndrome ( 53 ).

Recognition of the possible pathogenic significance of thymic abnormalities prompted several studies of T lymphocytes in blood. The demonstration of decreased numbers of H<sub>2</sub> receptors on blood lymphocytes suggested loss of T-suppressor cells ( 49 ). This loss was confirmed by quantitation of T-cell subsets in patients with active disease. Both the relative and absolute numbers of suppressor T lymphocytes (CD8<sup>+</sup> cells) are decreased, resulting in an increase in the T4 to T8 ratio ( 54 ). Suppressor cell activity as measured by the concanavalin A and indomethacin stimulation assays also is poor ( 54 ). That T-suppressor cell deficiency may be causally related to a functionally abnormal thymus is suggested by the normalization of T4 to T8 ratios with thymic extract ( 49 ) and a synthetic peptide with thymic hormone activity ( 55 ). Moreover, the apparent ability of crude thymic extract to reverse disease activity in some patients suggests that the T-cell abnormalities may be of primary pathogenic significance ( 49 ). However, deficiency of blood T-suppressor lymphocytes is not specific to LCH ( 56 ).

Although less consistent, other abnormalities in immune regulation also have been described, including hypergammaglobulinemia ( 57 ), deficiency in antibody-dependent monocyte-mediated cytotoxicity ( 58 ), and abnormal *in vitro* response to mitogens and antigens ( 47 ). However, most investigators note normal mitogen-induced responses and normal delayed hypersensitivity ( 59, 60 ). A deficiency in helper T cells rather than suppressor T cells was noted in one patient with LCH ( 61 ). Also, several cytokines are increased in LCH ( 62 ). Cytokines serve as mediators of inflammation, regulators of lymphocyte growth and differentiation, and activators of specialized effector cells. Cytokines that have been demonstrated to be increased in the serum of LCH patients include granulocyte-macrophage colony-stimulating factor (GM-CSF), IL-3, IL-8, and tumor necrosis factor- $\alpha$ . These cytokines are related to local activation of T lymphocytes and other inflammatory leukocytes. In addition, GM-CSF receptors are expressed by Langerhans cells ( 63 ). GM-CSF induces Langerhans cell proliferation and activation *in vitro*, and serum levels of GM-CSF have been correlated with the extent of disease ( 63 ). Thus, GM-CSF stimulation may be a critical element in the pathogenesis of LCH.

The link between proliferation of Langerhans cells and immune dysfunction has not entirely been worked out. One suggestion is that the disorder results from a physiologically appropriate response of the Langerhans cell to an external antigen or neoantigen, possibly infectious in origin ( 33 ). However, the lack of seasonal variation or



geographic clustering argues against an infectious basis (64). In addition, no direct evidence for a viral etiology (viral particles or nuclear material) in LCH lesions has been demonstrated (65, 66). Alternatively, LCH may result from an appropriate response of the Langerhans cell to abnormal signals from other cells in the immune system, perhaps from T lymphocytes. In either event, deficiency of T-suppressor cells may disrupt the mechanism for termination of immune responses. Failure of this homeostatic mechanism could result in unrestrained macrophage proliferation. Patients with interferon- $\gamma$  deficiency present with findings that mimic LCH (67). The Langerhans cells in LCH differ significantly from the Langerhans cell that normally occurs in the skin (68). Abnormal cellular adhesion molecules in LCH cells, suggested by the presence of CD2, CD11a, CD11b, and CD11d, may contribute to the migration of Langerhans cells into LCH lesions, as well as their abnormal persistence and proliferation (69). Compared to normal Langerhans cells, LCH cells are defective in their alloantigen-presenting activity (70).

Whether LCH is primarily a reactive or neoplastic process has long been debated. The predominant theory has been that LCH is a reactive process to an unknown stimulus (71). However, in 1994 two groups showed that the lesional cells are clonal (72, 73); clonality occurred in patients with all forms of LCH, including acute disseminated LCH and unifocal LCH, and in those with intermediate forms of the disease. T cells within LCH lesions were polyclonal (62). However, at least some cases of pulmonary LCH are not clonal (74). Although the clonality of LCH cells has fueled the argument that LCH may be a neoplastic disorder, the debate continues.

## CLINICAL FEATURES

LCH can present along a continuum of illness, ranging from indolent to explosive disease. In some disorders, pathologic lesions are solitary, whereas in others they are widely disseminated. Moreover, the distribution of lesions in a given patient may vary considerably over time. Although LCH can occur at any age, it occurs with greatest frequency in infants and children. The median age at diagnosis for all disease variants is 2 to 3 years (75, 76). The acute disseminated form of the disease characteristically occurs in children younger than 3 years of age (77). The more indolent forms of LCH occur primarily in older children and young adults (13, 17). The most commonly involved organ in adults is bone, often accompanied by an adjacent soft-tissue mass. Other organs that are involved less often in adults include lungs and pituitary gland (78). In adults, multisystem disease, including liver, lymph node, and bone marrow involvement, is extremely rare. Males are affected more often than females (17, 19, 79, 80 and 81); in one large series of patients with localized bone disease, the male to female ratio was 1.8:1.0 (82), and in another, with all types of LCH, males outnumbered females by 3:1 (81).

The traditional classification of clinical variants was based on patterns of organ involvement (4, 8, 77). Eosinophilic granuloma was used to describe a syndrome characterized by single or multiple bone lesions in the absence of visceral involvement (13). When granulomas involved liver, spleen, lymph nodes, skin, central nervous system (CNS), or bone marrow as well as bones, the disorder was called *Letterer-Siwe disease* (11, 12). The triad of multiple bone lesions, exophthalmos (resulting from retro-orbital granulomas), and diabetes insipidus (DI) (the result of hypothalamic or pituitary involvement) constituted Hand-Schüller-Christian disease (Fig. 66.2 and Fig. 66.3) (9). The separation of eosinophilic granuloma involving bone from syndromes characterized by visceral dissemination proved to be useful prognostically. However, the distinction between Letterer-Siwe disease and Hand-Schüller-Christian disease was often subtle



Current classification is based on the number of organ systems involved and the number of sites involved within an organ system. The main types are unifocal eosinophilic granuloma (i.e., single-system, single-site), multifocal eosinophilic granuloma (i.e., single-system, multiple sites), and acute disseminated histiocytosis (i.e., multiple systems). The presence and degree of organ dysfunction are important in the classification of the disease (83).

Magnetic resonance image of the orbits in a 4-year-old boy with Langerhans cell histiocytosis and marked proptosis. There are lesions bilaterally. **B:** Computed tomography scan of same patient showing lesions of skull and orbit.

**Figure 66.3.** Sagittal magnetic resonance imaging scan showing thickened pituitary stalk in the same patient shown in [Figure 66.2](#). He had a long-standing history of diabetes insipidus.

Bone is the most commonly involved organ, with the skull being the most commonly involved site in both children and adults (84). Unifocal eosinophilic granuloma of bone is the most common form of the disease (10, 85). Multifocal bone involvement may or may not be associated with visceral disease. The bones most commonly affected are shown in [Table 66.1](#). Characteristically, patients note mild discomfort at the site of bone involvement. However, skull lesions are often painless and are found only because of a

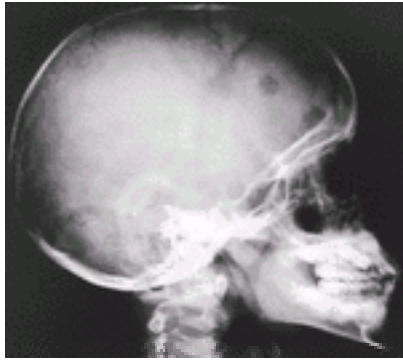
soft-tissue mass over the bony defect. Mandibular lesions are responsible for premature loss of teeth and faulty dentition. Involvement of the Petrus ridge of the temporal bone and mastoid is common, predisposing to chronic otitis media. Vertebral lesions pose special problems because of the risk of injury to the spinal cord. Vertebral collapse gives rise to vertebral plana ( 86 ). Extension of granulomas into the spinal space may compress the cord, causing permanent neurologic damage ( 87 ). Recurrent bony lesions in children are often associated with DI ( 84 ).

**TABLE 66.1. Sites of Lesions in Unifocal Bone Disease**

| Site     | Age <15 yr (No. of Patients) | Age >15 yr (No. of Patients) | Total |
|----------|------------------------------|------------------------------|-------|
| Head     | 7                            | 3                            | 10    |
| Scapula  | 1                            | 1                            | 2     |
| Clavicle | 1                            | 1                            | 2     |
| Humerus  | 2                            | 1                            | 3     |
| Radius   | 1                            | —                            | 1     |
| Spine    | 2                            | —                            | 2     |
| Ribs     | 1                            | 9                            | 10    |
| Ilium    | 5                            | —                            | 5     |
| Pubis    | 2                            | —                            | 2     |
| Femur    | 9                            | 2                            | 11    |
| Tibia    | 2                            | —                            | 2     |

From Lieberman PH, et al. A reappraisal of eosinophilic granuloma of bone, Hand-Schüller-Christian syndrome and Letterer-Siwe syndrome. *Medicine* 1969;48: 375, with permission.

Radiographically, skeletal lesions are characterized by sharply demarcated rarefactions of the medullary portions of bone, producing a “punched out” appearance ( Fig. 66.4 ) ( 10, 84, 85 ). Reactive sclerosis in surrounding uninvolved bone is unusual at diagnosis, but when present, signifies that healing has begun. Both tables of the skull characteristically are involved, the outer more so than the inner. Erosion of mandibular bone around unerupted teeth give them the appearance of floating in space. Skeletal lesions are well delineated with conventional radiography, computed tomography, and magnetic resonance imaging ( 88 ). Radionuclide studies, on the other hand, often are falsely negative ( 89, 90 and 91 ). As healing occurs, the sharp endosteal margins become less distinct, and sclerosis is often seen.



**Figure 66.4.** Skull radiograph showing active osteolytic lesions in a patient with disseminated Langerhans cell histiocytosis. Note absence of reactive sclerosis.

Head and neck involvement is common in young children, especially in those with multifocal lesions of the skull. Gingival swelling and inflammation, usually associated with cervical adenopathy, often are the first manifestations of disease. Premature eruption or loss of teeth and breakdown of the lower alveolar ridge result from involvement of the mandible ( [92](#), [93](#) and [94](#) ). Mandibular lesions may be palpable and painful, giving rise to facial swelling ( [95](#) ). The maxilla and upper gingival ridge are involved less often. Cervical adenopathy generally accompanies all forms of oral involvement.

Skin involvement is a common feature of acute disseminated histiocytosis ( [96](#) ). The lesions are vesiculopustular and may have a hemorrhagic crust. They are similar in appearance to those of seborrheic dermatitis. LCH is often suspected after a seborrheic rash fails to respond to treatment. The rash has a predilection for the scalp, postauricular areas, and diaper area ( [Fig. 66.5](#) ). The back, axillae, and intertriginous areas also may be involved ( [97](#), [98](#) ). With advanced stages of the disease, the entire integument may be affected. Breakdown of severely affected areas is common, and concurrent thrombocytopenia imparts a hemorrhagic component to the rash.



**Figure 66.5.** Erythematous maculopapular rash in a boy with disseminated Langerhans cell histiocytosis. See [Color Plate](#). (From Esterly NB, Maurer HS, Gonzalez-Crussi F. Histiocytosis X: a seven year experience at a children's hospital. *J Am Acad Dermatol* 1985;13:481-496, with permission.)

A rash indistinguishable from that seen in acute disseminated histiocytosis may occur as a congenital, self-limited phenomenon not associated with skeletal or visceral disease. This form of histiocytosis has been called *congenital self-healing histiocytosis* or *Hashimoto-Pritzker syndrome* ( [5](#), [99](#)). The lesions are present at birth or appear within the first 2 or 3 weeks of life. They are most numerous over the scalp and face, but also may extend over the trunk and proximal extremities. Mucous membranes are spared. Langerhans cells present in biopsy material have the same immunophenotypic characteristics as those in the other variants of histiocytosis, although they contain fewer Birbeck granules ( [99](#)). The lesions undergo spontaneous regression, with complete healing by the time the patient is 3 to 4 months of age. The prognosis is uniformly excellent without therapy.

CNS involvement is increasingly appreciated as a problem in LCH ( [100](#), [101](#)). CNS involvement occurs by contiguous spread of skull lesions into brain substance or by granulomatous infiltration of deep structures. The disease demonstrates a predilection for the hypothalamic nuclei ( [102](#)) and cerebellum ( [103](#), [104](#)), although focal lesions may occur in the temporal lobe, occipital lobe, and spinal cord. Rarely, CNS lesions are found in patients who have no other evidence of histiocytosis. Focal cranial nerve involvement occurs rarely ( [105](#)). Neurologic signs and symptoms include ataxia, nystagmus, dysmetria, seizures, dysphagia, and spastic paraparesis ( [106](#), [107](#)). DI resulting from infiltration of the hypothalamus or pituitary stalk is common. Whereas mass lesions are satisfactorily visualized by computed tomography or magnetic resonance imaging, infiltrative lesions within the hypothalamus and elsewhere often are of similar density to adjacent brain tissue and produce little or no mass effect. Some of these lesions may be seen with magnetic resonance imaging ( [99](#)). CNS involvement may leave survivors with permanent sequelae ( [100](#), [101](#), [108](#)).

Of the endocrinopathies associated with LCH, DI is the most common ( [109](#)), LCH is a common cause of DI in both adults and children ( [110](#)). DI is caused by infiltration of the hypothalamus, pituitary stalk, or posterior pituitary by Langerhans cells. The prevalence of DI in large series of patients ranges from 10 to 50% ( [10](#), [17](#), [77](#), [107](#), [109](#), [111](#), [112](#)). The cumulative risk of DI in 119 children with histiocytosis studied prospectively was 11% at 5 years by life-table analysis ( [111](#)), substantially lower than the 42% at 4 years reported in an earlier study ( [113](#)). DI is more common in patients with multisystem disease and in those with proptosis ( [113](#)). DI is not a complication of unifocal bone disease. Characteristically, its onset is after the diagnosis of LCH is made; symptoms occur within 2 years of diagnosis in most children and rarely, if ever, after 4 to 5 years ( [113](#)). Although most affected patients have complete absence of antidiuretic hormone, partial deficiency may occur. Progression from partial to complete DI may occur, and once complete DI has developed, it cannot be reversed ( [114](#)).

Growth retardation resulting from growth hormone (GH) deficiency is another complication of LCH ( [109](#), [111](#), [115](#)). Although GH deficiency is usually due to involvement of the hypothalamus or anterior pituitary by Langerhans cells ( [116](#)), radiation therapy given for skull lesions may also contribute ( [117](#)). Prospective studies of prepubertal children indicate that GH deficiency is less common than previously thought ( [115](#), [117](#)). In 82 children with LCH and GH deficiency, GH replacement was safe and effective ( [118](#)).

Thyroid involvement by histiocytosis gives rise to goiter and may lead to hypothyroidism (

97, 115). Obstruction of the upper airway by diffuse enlargement of the thyroid gland has been described ( 119). Most children with thyroid involvement have DI and other evidence of disseminated disease ( 109).

Enlargement of the liver, often associated with abnormal liver function, is observed in many children with the disseminated form of LCH ( 27, 120, 121 and 122). In some patients, liver involvement leads to portal cirrhosis or intrahepatic cholestasis ( 122). For reasons that are not clear, death from progressive liver failure is observed less often now than previously, although liver transplant is sometimes required ( 122). Tissue from liver biopsies obtained from children with hepatomegaly infrequently shows the infiltrates of Langerhans cells, eosinophils, and lymphocytes that are hallmarks of the disease in other organs. Instead, subtle changes in the portal triads are observed, including triaditis, bile duct proliferation, and fibrosis ( 122, 123). Patients with triaditis alone at diagnosis are less likely to have abnormal liver function or progressive liver disease than those with fibrohistiocytic or cirrhotic changes. Persistent abnormality of liver function is a well-recognized adverse prognostic indicator ( 17, 19, 75, 76, 124).

Involvement of lymph nodes and spleen is often a feature of disseminated disease. Lymph nodes may be involved because of contiguous bone or skin disease or as a result of widespread histiocytic dissemination. Node enlargement occurs because of sheets of Langerhans cells that often have a syncytial arrangement ( 27). Splenomegaly is caused by portal hypertension or involvement of the spleen by large numbers of histiocytes. Curiously, Birbeck granules are rarely seen in otherwise characteristic Langerhans cells in the spleen and liver ( 27).

Although not common, the lungs may be involved with disseminated histiocytosis ( 4, 125). As with other forms of disseminated disease, lung involvement occurs primarily in infants and young children. In contrast, primary pulmonary histiocytosis is principally a disease of young and middle-aged adults ( 126, 127, 128 and 129), although it does occur in children ( 114, 130); smoking is often associated with pulmonary LCH ( 131). Affected patients are without apparent multisystem disease at diagnosis; with further evaluation, however, some patients have asymptomatic bone lesions ( 130, 132, 133), and as many as 10% subsequently develop DI ( 132). Signs and symptoms of pulmonary involvement may be subtle or may include growth failure or weight loss, dyspnea, tachypnea, and hemoptysis. Recurrent pneumothoraces occur in as many as 20 to 25% of cases ( 133). Lung involvement is characterized radiographically by diffuse micronodular densities with cyst formation, sometimes giving rise to a picture of “honeycomb lung.” Lesions are usually prominent in the perihilar regions and the upper lung fields. Costophrenic angles are usually spared, and enlargement of hilar nodes is unusual. Permanent pulmonary sequelae often occur ( 134), and reactivation in the lungs may be associated with smoking ( 135).

Bone marrow involvement by Langerhans cells has been described most often in infants with disseminated disease ( 10, 17, 19, 96, 136, 137). It is characterized by anemia, neutropenia, and thrombocytopenia, occurring singly or together. Erythrophagocytosis may rarely be a factor in the pathogenesis of anemia ( 138). Because bone marrow and splenic involvement often occur together, splenic sequestration of blood cells may further exaggerate the cytopenia of bone marrow involvement.

## PROGNOSIS

For most patients with LCH, the prognosis is excellent. Although LCH may wax and wane over many years, most patients improve over time. However, patients with multisystem disease may experience organ failure, which can be fatal.

Most patients with unifocal bone disease experience complete resolution of lesions with or without treatment. Progression of bone erosion and recurrences at new sites are the exception rather than the rule ( [17](#), [72](#), [139](#) ). In the event of recurrence, the sites almost always are limited to the skeleton. In contrast, disease that is multifocal at the time of diagnosis usually is chronic and is characterized by one or more recurrences after disease control. In one large series, of patients who experienced disease exacerbations, final recurrences occurred within 1 year in 19%, between 1 and 4 years in 66%, and after more than 4 years in 15% ( [75](#) ). In another series, 72% of patients who initially responded to treatment experienced recurrent LCH 2 months to more than 5 years after cessation of therapy, and most recurrences were in previously uninvolved sites ( [17](#) ). Young children, especially those younger than 2 years of age at diagnosis, are at particular risk for multiple relapses ( [17](#), [19](#), [123](#) ). However, in most patients the disease appears to eventually burn out ( [140](#) ). On the other hand, approximately one-third of adults with pulmonary LCH die from the disease ( [129](#) ). After disease resolution, LCH survivors may be left with permanent complications, including DI, pulmonary difficulties, neurologic complications, neuropsychological impairment, dental problems, chronic otitis, or hearing impairment.

Several staging or scoring systems have been proposed as having prognostic and therapeutic relevance. Most cite age (age younger than 2 years being a liability), extent of disease, and the function of involved organs as the important prognostic variables. Perhaps the most widely accepted system is that proposed by Lahey, who assigned a point for each functional or anatomic abnormality involving the skin, liver, spleen, lymph nodes, lung, pituitary, skeleton, or bone marrow (i.e., anemia, leukopenia, or thrombocytopenia) ( [19](#) ). A nearly linear relationship between score and survival was observed. Subsequent staging systems introduced additional variables ( [21](#), [22](#), [77](#), [141](#) ). Although more elaborate, they did not have greater clinical utility. All staging attempts are confounded by what appears to be a change in the natural history of extraskeletal histiocytosis. Not only is acute disseminated histiocytosis less common now than formerly, but also it is lethal less often. In contrast to earlier analyses ( [19](#), [77](#), [142](#) ), recent experience fails to confirm a relationship between the extent of disease at diagnosis and survival ( [17](#), [75](#), [143](#) ). Age also may be of less prognostic significance ( [17](#), [75](#) ). The most important adverse prognostic factor clearly is functional compromise of the organs affected by histiocytosis ( [17](#), [75](#), [124](#) ). Jaundice related to liver involvement and cytopenias resulting from bone marrow invasion by histiocytes are associated with high mortality rates ( [17](#), [124](#) ). Disease limited to the skeleton is associated with a uniformly favorable prognosis ( [17](#), [77](#), [82](#), [144](#) ), and the number of bony lesions does not affect survival ( [7](#), [17](#) ). Skin involvement in the absence of deep visceral lesions also confers a good prognosis.

## DIAGNOSIS

The clinical and radiographic features of LCH are distinctive enough to suggest the diagnosis in most patients. However, the diagnosis must be made pathologically, and for a definitive diagnosis, the presence of Birbeck granules or the presence of CD1a on the surface of LCH cells must be demonstrated.



Assessment of the extent of disease is critical. To help standardize the workup and management of LCH patients, the Histiocyte Society has published guidelines on how to evaluate and follow patients ( [145](#) ). Bony lesions may be diagnosed by either bone scan or skeletal survey. Each modality has been shown to discover lesions missed by the other. However, radionuclide bone scan may miss osteolytic lesions that do not have any osteoblastic characteristics. This is particularly true for skull lesions ( [146](#) ). Other studies required include a chest radiograph, blood counts, assessment of liver function, and determination of renal concentrating ability. A bone marrow examination is required if cytopenias exist, and pulmonary function studies are helpful in documenting pulmonary involvement. Although not required to evaluate disease, some authors have recommended studies of T- and B-cell numbers, T-cell subsets, and lymphocyte function. New imaging modalities, including positron emission tomography and octreotide scans, may be useful in LCH, but they require additional study ( [147](#) , [148](#) ).

## MANAGEMENT AND TREATMENT

The first principle to remember when developing a treatment plan for a patient with LCH is that this is not a malignant disorder. Management is dictated by the likely natural history of the disease based on the location and extent of lesions and by the presence of specific organ involvement and/or dysfunction. Given that LCH tends to improve with time, most patients do not require treatment aimed at ablating the disease. Treatment decisions should be based on the number of systems involved and on whether a particular lesion is likely to result in disability. Children with single-system disease, particularly if they have a solitary lesion of bone (e.g., eosinophilic granuloma of bone), may require no therapy other than curettage ( [139](#) ). However, some patients have aggressive disease, warranting treatment similar to that required for neoplastic diseases ( [125](#) ). Also, a single patient may require different approaches at different points in time. Rarely are aggressive approaches, such as bone marrow or liver transplantation, justified.

Because unifocal bone disease is associated with a uniformly excellent prognosis, therapy with potential late effects should be avoided. The surgical procedure required for diagnostic purposes often is definitively therapeutic as well. Bone lesions are treated effectively with curettage ( [139](#) ). Lesions other than those for which curettage is performed for diagnostic purposes often heal spontaneously ( [139](#) , [149](#) ). Lesions that progress or recur; those that threaten an important function, such as sight or hearing; and those that pose a risk of pathologic fracture or future disability may be treated effectively with low-dose radiotherapy. Doses of 600 to 1000 cGy in three to five fractions effect local control in most patients ( [77](#) , [143](#) , [150](#) , [151](#) ). Lesions in weight-bearing sites, such as the neck of the femur, may require curettage and autologous bone grafting. Some advocate steroid injection into the lesion ( [152](#) ); however, the benefit of this treatment has never been proved in a randomized fashion. Skin lesions respond at least temporarily to radiation with ultraviolet light ( [153](#) ), and oral lesions may need surgery only ( [154](#) ).

Systemic therapy is required for soft-tissue disease and for multifocal skeletal disease that is progressive or recurrent. A notable exception is isolated histiocytosis of the skin in infants, a condition that regresses spontaneously ( [5](#) , [99](#) , [155](#) , [156](#) ). Approximately 50% of patients requiring systemic therapy respond to corticosteroids alone ( [157](#) ). Because of the toxicity of corticosteroids when used for more than brief periods, however, other chemotherapeutic agents are now the mainstay of management. Vinblastine, vincristine, 6-mercaptopurine, methotrexate, alkylating agents, anthracyclines, and etoposide, singly or in combinations, are effective in controlling LCH ( [157](#) , [158](#) ). Although multiagent



regimens appear to have no advantage over monochemotherapy for many patients ( [159](#), [160](#) ), people with liver, lung, or bone marrow dysfunction probably are best treated with combination chemotherapy ( [76](#) ). In a clinical trial in which patients were stratified by risk, treatment included induction chemotherapy with vinblastine, etoposide, and prednisone followed by maintenance chemotherapy with etoposide, vinblastine, prednisone, 6–mercaptopurine, and methotrexate ( [124](#) ), two–thirds of those with organ dysfunction achieved a complete remission, as did approximately 90% of those with either multisite bony disease or soft–tissue disease without organ dysfunction. The Histiocyte Society has conducted multinational randomized clinical trials in LCH ( [83](#) ). In the first international trial (LCH I) ( [83](#) ), 143 patients were randomized to receive 24 weeks of vinblastine (6 mg/m<sup>2</sup> intravenously weekly) or etoposide (150 mg/m<sup>2</sup>/day intravenously for 3 days, every 3 weeks); all patients received a single dose of steroids. Both of those monotherapies were equivalent. Due to the risk of secondary leukemias with etoposide, subsequent studies have been built from the vinblastine arm. One robust finding in this study was that the response at 6 weeks was strongly prognostic, regardless of initial treatment. However, LCH I did not produce superior results compared to the earlier DAL studies ( [161](#) ). Survival was similar, but the DAL studies ( [124](#), [161](#) ) had superior reactivation rate and reactivation rate interval and less permanent disabilities. In most patients, disease manifestations are reversed with therapy that is far less intensive than that used for neoplastic disease. Courses of chemotherapy are generally limited to 3 to 8 months. As noted previously, multiple courses of treatment may be required for recurrences noted once therapy is discontinued. DI is not ameliorated by chemotherapy. Although some authors describe reversal of DI with radiotherapy directed to the hypothalamus–pituitary region soon after the onset of symptoms ( [150](#), [159](#), [162](#) ), the consensus is that radiotherapy, like chemotherapy, is without benefit in this situation ( [111](#), [136](#), [143](#), [163](#) ).

The demonstration of deficient suppressor T cells in patients with LCH prompted attempts to reverse the course of the disorder with immunotherapy ( [49](#) ). Most early clinical trials involved the use of suppressin, a hormone derived from calf thymus that induces differentiation and maturation of suppressor T cells ( [164](#) ). Other immunomodulating agents that have been used successfully in case reports or small case series include interferon alpha ( [165](#) ). Cyclosporine had shown some initial promise ( [166](#) ) but, when systematically studied in patients with reactivated LCH, did not have sufficient activity to be further developed ( [167](#) ). Conversely, the early promise of 2–CDA ( [168](#) ) has now been confirmed in several small series ( [169](#), [170](#), [171](#) and [172](#) ), and 2–CDA is being further evaluated by the Histiocyte Society ( [172](#) ).

Novel agents are needed, including those that might help differentiate the Langerhans cells ( [173](#) ). An improved understanding of the biology of LCH might also lead to targeted therapies.

A few patients with recurrent, progressive LCH refractory to conventional therapy have benefited from allogeneic bone marrow transplantation ( [174](#), [175](#), [176](#), [177](#) and [178](#) ). In addition, a small number of patients have required liver transplantation ( [179](#), [180](#) ).

## REFERENCES

1. Hand A. General tuberculosis. *Trans Pathol Soc Phila* 1893;16:282.
2. Chu A, et al. Report and recommendations of the workshop on the childhood histiocytosis. *Med Pediatr*

Oncol 1986;14:116.

3. Writing Group of the Histiocyte Society: Histiocytosis syndromes in children. *Lancet* 1987;1:208.
4. Lichtenstein L. Histiocytosis X: integration of eosinophilic granuloma of bone, Letterer–Siwe disease and Schüller–Christian disease as related manifestations of a single nosologic entity. *Arch Pathol Lab Med* 1953;56:84.
5. Hashimoto K, Pritzker MS. Electron microscopic study of reticulohistiocytoma. An usual case of congenital, self–healing reticulohistiocytosis. *Arch Dermatol* 1973;107:263.
6. Hashimoto K, et al. Self–healing reticulohistiocytosis. *Cancer* 1982;49:331.
7. Wolfson SL, et al. Pure cutaneous histiocytosis X. *Cancer* 1981;48:2236.
8. Komp DM. Historical perspectives of Langerhans cell histiocytosis. *Hematol Oncol Clin North Am* 1987;1:9.
9. Hand A. Defects of membranous bones, exophthalmos and polyuria in childhood. *Am J Med Sci* 1921;162:509.
10. Lieberman PH, et al. A reappraisal of eosinophilic granuloma of bone, Hand–Schüller–Christian syndrome and Letterer–Siwe syndrome. *Medicine* 1969;48:375.
11. Letterer E. Aleukamische Retikuloose (ein Beitrag zu den proliferativen Erkrankungen des Retikuloendothelialapparates). *Frankfurt Z Pathol* 1924;30:377.
12. Siwe SA. Die Reticuloendotheliose: ein neues Krankheitsbild unter den Hepatosplenomegalien. *Z Kinderheilkd* 1933;55:212.
13. Lichtenstein L, Jaffe HL. Eosinophilic granuloma of bone. *Am J Pathol* 1940;16:595.
14. Otani S, Ehrlich JC. Solitary granuloma. *Am J Pathol* 1940;16:479.
15. Green WT, Farber S. ‘Eosinophilic or solitary granuloma’ of bone. *J Bone Joint Surg* 1942;24:499.
16. Kaatsch P, Maaf HG, Michalis J, eds. ‘Jahresbericht 1993 des Deutschen Kinderkrebregisters.’ (Vol 6) Mainz: IMSD Johannes Gutenberg, Universität Institut für Medizinische Statistik und Dokumentation, 1994:14–15.
17. Matus–Ridley M, Raney B, Jr., Thawerani H, Meadows AT. Histiocytosis X in children: patterns of disease and results of treatment. *Med Pediatr Oncol* 1983;11:99–105.
18. Lahey ME, et al. Prognosis in reticuloendotheliosis in children. *J Pediatr* 1962;60:664.
19. Lahey ME. Histiocytosis X: an analysis of prognostic factors. *J Pediatr* 1975;87:184.
20. Hamre M, Hedberg J, Buckley J, et al. Langerhans cell histiocytosis: an exploratory epidemiologic study of 177 cases. *Med Pediatr Oncol* 1997;28:92–97.
21. Komp DM, Herson J, Starling KA, et al. A staging system for histiocytosis X. *Cancer* 1981;47:798–800.
22. Nezelof C, Rileux–Herbert F, Cronier–Sachot J. Disseminated histiocytosis X. *Cancer* 1979;44:1824–1838.
23. Salter JM, Swasm OJ. Eosinophilic granuloma of bone. *Med Pediatr Oncol* 1980;8:151–164.
24. Bhatia S, Nesbit ME, Egeler RM, et al. Epidemiologic study of Langerhans cell histiocytosis in children. *J Pediatr* 1977;130:774–784.
25. Egeler RM, Neglia JP, Puccetti DM, et al. Association of Langerhans cell histiocytosis with malignant

neoplasms. *Cancer* 1993;71:865–873.

26. Scappaticci S, Danesino C, Rossi E, et al. Cytogenetic abnormalities in PHA-stimulated lymphocytes from patients with Langerhans cell histiocytosis. *IEOP-Istiocitosi Group. Br J Haematol* 2000;111:258–262.

27. Favara BE, Jaffe R. The histopathology of Langerhans cell histiocytosis. *Br J Cancer* 1994;70[Suppl 23]:S17–23.

28. Risdall RJ, Dehner LP, Duray, et al. Histiocytosis X (Langerhans' cell histiocytosis). Prognostic role of histopathology. *Arch Pathol Lab Med* 1983;107:59–63.

29. Mierau GW, et al. Electron microscopy in histiocytosis X. *Ultrastruct Pathol* 1982;3:137.

30. Favara BE, et al. Histiocytosis X. *Hum Pathol* 1983;14:663.

31. Birbeck MD, et al. An electron microscopic study of basal melanocytes and high level clear cells (Langerhans cells) in vitiligo. *J Invest Dermatol* 1961;37:51.

32. Hamoudi AB, et al. Significance of X granules in histiocytosis X. *Pediatr Pathol* 1985;3:93.

33. Favara BE, et al. Histiocytosis X. In: Finegold M, ed. *Pathology of neoplasia in children and adolescents*. Philadelphia: WB Saunders, 1986.

34. Rowden G. Expression of Ia antigens on Langerhans cells in mice, guinea pigs, and man. *J Invest Dermatol* 1980;75:22.

35. Beckstead JH, et al. Histiocytosis X cells and Langerhans cells. Enzyme histochemical and immunologic similarities. *Hum Pathol* 1984;15:826.

36. Jaffe R. Pathology of histiocytosis X. *Perspect Pediatr Pathol* 1987;9:4.

37. Ree HJ, Kadin ME. Peanut agglutinin. A useful marker for histiocytosis X and interdigitating reticulum cells. *Cancer* 1986;57:282.

38. Bouloc A, Boulland ML, Geissmann F, et al. CD101 expression by Langerhans cell histiocytosis cells. *Histopathology* 2000;36:229–232.

39. Pinkus GS, Lones MA, Matsumura F, et al. Langerhans cell histiocytosis immunohistochemical expression of fascin, a dendritic cell marker. *Am J Clin Pathol* 2002;118:335–343.

40. Ried CDL, et al. Identification of hematopoietic progenitors of macrophages and dendritic Langerhans cells (DL-CFU) in human bone marrow and peripheral blood. *Blood* 1990;76:1139.

41. Choi KL, Saunderson DN. The role of Langerhans cells and keratinocytes in epidermal immunity. *J Leukocyte Biol* 1986;39:343.

42. Ishii E, Watanabe S. Biochemistry and biology of the Langerhans cell. *Hematol Oncol Clin North Am* 1987;1:99.

43. Arenzana-Seisdedos F, et al. Histiocytosis X. Purified (T6+) cells from bone granuloma produce interleukin 1 and prostaglandin E2 in culture. *J Clin Invest* 1986;77:326.

44. Brown RE. Angiotensin-converting enzyme, transforming growth factor beta (1), and interleukin 11 in the osteolytic lesions of Langerhans cell histiocytosis. *Arch Pathol Lab Med* 2000;124:1287–1290.

45. Leikin SL. Immunobiology of histiocytosis-X. *Hematol Oncol Clin North Am* 1987;1:49.

46. Hamoudi AB, et al. Thymic changes in histiocytosis. *Am J Clin Pathol* 1982;77:169.

47. Nesbit ME, et al. The immune system and the histiocytosis syndromes. *Am J Pediatr Hematol Oncol* 1981;3:141.

48. Newton WA, et al. Role of the thymus in histiocytosis X. *Hematol Oncol Clin North Am* 1987;1:63.
49. Osband ME, et al. Histiocytosis X. Demonstration of abnormal immunity, T-cell histamine-H2-receptor deficiency, and successful treatment with thymic extract. *N Engl J Med* 1981;304:146.
50. Bove KE, et al. Thymus in untreated systemic histiocytosis-X. *Pediatr Pathol* 1985;4:99.
51. Borzy MS, et al. Thymic morphology in immunodeficiency disease: results of thymic biopsies. *Clin Immunol Immunopathol* 1979;12:31.
52. Kruger GRF, et al. Graft-vs-host disease. *Am J Pathol* 1971;63:179.
53. Joshi VV, et al. Thymus biopsy in children with acquired immunodeficiency syndrome. *Arch Pathol Lab Med* 1986;110:837.
54. Shannon BT, Newton WA. Suppressor cell dysfunction in children with histiocytosis-X. *J Clin Immunol* 1986;6:1.
55. Davies EG, et al. Thymic hormone therapy for histiocytosis X? *N Engl J Med* 1983;309:493.
56. Hoffman SL, et al. Reinduction of suppressor T lymphocytes in the tropical splenomegaly syndrome. *N Engl J Med* 1984;310:337.
57. Lahey ME, et al. Hypergammaglobulinemia in histiocytosis X. *J Pediatr* 1985;107:252.
58. Kragballe K, et al. Histiocytosis X: an immune deficiency disease? Studies on antibody-dependent monocyte-mediated cytotoxicity. *Br J Dermatol* 1981;105:13.
59. Leikin SL. Immunologic parameters in histiocytosis-X. *Cancer* 1973;32:796.
60. Thommesen P, et al. Immunologic response assessed by lymphocyte transformation tests. *Acta Radiol Oncol* 1978;17:524.
61. Scully RS, ed. Weekly clinicopathological exercises: Case 40-1985. *N Engl J Med* 1984;313:874.
62. Kannourakis G, Abbas A. The role of cytokines in the pathogenesis of Langerhans cell histiocytosis. *Br J Cancer* 1994;70[Suppl 23]:S37-S40.
63. Emile JF, Fraitag S, Andry P, et al. Expression of GM-CSF receptor by Langerhans' cell histiocytosis cells. *Virchows Arch* 1995;427:125-129.
64. Glass AG, Miller RW. US mortality from Letterer-Siwe disease, 1960-1964. *Pediatrics* 1968;42:364.
65. Mierau GW, Wills EJ, Steele PO. Ultrastructural studies in Langerhans cell histiocytosis: a search for evidence of viral etiology. *Pediatr Pathol* 1994;14:895-904.
66. McClain K, Jin H, Gresik V, Favara B. Langerhans cell histiocytosis: lack of a viral etiology. *Am J Hematol* 1994;47:16-20.
67. Edgar JD, Smyth AE, Pritchard J, et al. Interferon gamma receptor deficiency mimicking Langerhans' cell histiocytosis. *J Pediatr* 2001;139:600-603.
68. Chu T, Jaffe R. The normal Langerhans cell and the LCH cell. *Br J Cancer* 1994;70[Suppl 23]:S4-S10.
69. de Graff JH, Tamminga RYJ, Kamps WA, Timens W. Expression of cellular adhesion molecules in Langerhans cell histiocytosis and normal Langerhans cells. *Am J Pathol* 1995;147:1161-1171.
70. Yu RC, Alaibac M, Chu AC. Functional defect in cells involved in Langerhans cell histiocytosis. *Arch Dermatol Res* 1995;287:627-631.

71. Komp DL. Langerhans cell histiocytosis. *N Engl J Med* 1987;316:747-748.
72. Yu RC, Chu C, Buluwela L, Chu AC. Clonal proliferation of Langerhans cells in Langerhans cell histiocytosis. *Lancet* 1994;343:767-768.
73. Willman CL, Busque L, Griffith BB, et al. Langerhans'-cell histiocytosis (Histiocytosis X): a clonal proliferative disease. *N Engl J Med* 1994;331:154-160.
74. Yousem SA, Colby TV, Chen YY, et al. Pulmonary Langerhans' cell histiocytosis: molecular analysis of clonality. *Am J Surg Pathol* 2001;25:630-636.
75. Berry DH, et al. Natural history of histiocytosis X. *Med Pediatr Oncol* 1986;14:1.
76. Raney RB, D'Angio GJ. Langerhans' cell histiocytosis (histiocytosis X): experience at the Children's Hospital of Philadelphia, 1970-84. *Med Pediatr Oncol* 1989;17:20.
77. Greenberger J, et al. Results of treatment of 127 patients with systemic histiocytosis: Letterer-Siwe syndrome, Schüller-Christian syndrome and multifocal eosinophilic granuloma. *Medicine* 1981;60:311.
78. Baumgartner I, von Hochstetter A, Baumert B, et al. Langerhans' cell histiocytosis in adults. *Med Pediatr Oncol* 1997;28:9-14.
79. Grundy P, Ellis R. Histiocytosis X: a review of the etiology, pathology, staging and therapy. *Med Pediatr Oncol* 1986;14:45.
80. Lahey ME. Prognosis in reticuloendotheliosis in children. *J Pediatr* 1962;60:664.
81. Islinger RB, Kuklo TR, Owens BD, et al. Langerhans' cell histiocytosis in patients older than 21 years. *Clin Orthop* 2000;379:231-235.
82. Slater JM, Swarm OJ. Eosinophilic granuloma of bone. *Med Pediatr Oncol* 1980;8:151.
83. Gardner H, Grois N, Arico M, et al. A randomized trial of treatment for multisystem Langerhans' cell histiocytosis. *J Pediatr* 2001;138:728-734.
84. Kilpatrick SE, Wenger DE, Gilchrist GS, et al. Langerhans' cell histiocytosis (histiocytosis X) of bone. *Cancer* 1995;76:2471-2484.
85. Titgemeyer C, Grois N, Minkov M, et al. Pattern and course of single-system disease in Langerhans cell histiocytosis data from the DAL-HX 83- and 90- study. *Med Pediatr Oncol* 2001;34:108-114.
86. Ochsner SF. Eosinophilic granuloma of bone. *AJR* 1966;97:719.
87. Esterly NB, Maurer HS, Gonzalez-Crussi F. Histiocytosis X: a seven year experience at a children's hospital. *J Am Acad Dermatol* 1985;13:481-496.
88. Moore JB, et al. The MRI in multifocal eosinophilic granuloma. Staging disease and monitoring response to therapy. *Am J Pediatr Hematol Oncol* 1989;11:174.
89. Crone-Munzebrock W, Brassow F. A comparison of radiographic and bone scan findings in histiocytosis X. *Skeletal Radiol* 1983;9:170.
90. Parker BR, et al. Relative efficacy of radiographic and radionuclide bone surveys in the detection of skeletal lesions of histiocytosis X. *Radiology* 1980;134:377.
91. Siddiqui AR, et al. Nuclear medicine studies in evaluation of skeletal lesions in children with histiocytosis X. *Radiology* 1981;140:787.
92. Hartman KS. Histiocytosis X: a review of 114 cases with oral involvement. *Oral Surg Oral Med Oral Pathol* 1980;49:38.

93. McDonald JS, et al. Histiocytosis-X. A clinical presentation. *J Oral Pathol* 1980;9:342.
94. Rapidis AD, et al. Histiocytosis X: an analysis of 50 cases. *Int J Oral Surg* 1978;7:76.
95. Smith RJH, Evans JNG. Head and neck manifestations of histiocytosis X. *Laryngoscope* 1984;94:395.
96. Hurwitz S. *Clinical pediatric dermatology*, 2nd ed. Philadelphia: WB Saunders, 1981:643.
97. Avery ME, et al. The course and prognosis of reticuloendotheliosis (eosinophilic granuloma, Schüller-Christian disease and Letterer-Siwe disease). *Am J Med* 1957;22:636.
98. Winkelmann RK. The skin in histiocytosis X. *Mayo Clin Proc* 1969;44:535.
99. Kanataakis J, et al. Congenital self-healing histiocytosis (Hashimoto-Pritzker syndrome). *Cancer* 1988;61:508.
100. Barthez MA, Araujo E, Donadieu J. Langerhans cell histiocytosis and the central nervous system in childhood: evolution and prognostic factors. Results of a collaborative study. *J Child Neurol* 2000;15:150-156.
101. Bouloc A, Boulland ML, Geissman F, et al. CD101 expression by Langerhans cell histiocytosis cells. *Histopathology* 2000;36:229-232.
102. Rothman JG, et al. Hypothalamic endocrinopathy in Hand-Schüller-Christian disease. *Ann Intern Med* 1978;88:512.
103. Grois N, Barkovich J, Rosenau W, Ablin AR. Central nervous system disease associated with Langerhans' cell histiocytosis. *Am J Pediatr Hematol Oncol* 1993;15:245-254.
104. Shuper A, Start B, Yaniv Y, et al. Cerebellar involvement in Langerhans' cell histiocytosis: a progressive neuropsychiatric disease. *J Child Neurol* 2000;15:824-826.
105. Pierrot-Deseillegnny C, Goasguen J. Isolated abducens nucleus damage due to histiocytosis X: electro-oculographic analysis and physiological deductions. *Brain* 1984;107:1019.
106. Fabiani A, et al. Histiocytosis X: a reappraisal of nosological concepts with some remarks about brain pathology. *Zentralbl Neurochir* 1981;42:221.
107. Grois N, Flucher-Wolfram B, Heitger A, et al. Diabetes insipidus in Langerhans cell histiocytosis: results from the DAL-HX 83 study. *Med Pediatr Oncol* 1995;24:248-256.
108. Whitsett SF, Kneppers K, Coppes MJ, Egeler RM. Neuropsychologic deficits in children with Langerhans cell histiocytosis. *Med Pediatr Oncol* 1999;33:486-492.
109. Nanduri VR, Bareille P, Pritchard J, Stanhope R. Growth and endocrine disorders in multisystem Langerhans' cell histiocytosis. *Clin Endocrinol* 2000;53:509-515.
110. Maghnie M, Cusi G, Genovese E, et al. Central diabetes insipidus in children and young adults. *N Engl J Med* 2000;343:998-1007.
111. Braunstein GD, Kohler PO. Endocrine manifestations of histiocytosis. *Am J Pediatr Hematol Oncol* 1981;3:67.
112. Sims DG. Histiocytosis X: followup of 43 cases. *Arch Dis Child* 1977;52:433.
113. Dunger DB, et al. The frequency and natural history of diabetes insipidus in children with Langerhans-cell histiocytosis. *N Engl J Med* 1989;321:1157.
114. Helbock J, et al. Patterns of anti-diuretic function in diabetes insipidus caused by histiocytosis X. *J Lab Clin Med* 1971;78:194.

115. Latorre H, et al. Short stature and growth hormone deficiency in histiocytosis X. *J Pediatr* 1974;85:813.
116. Baunstein GD, et al. Response of growth retarded patients with Hand-Schüller-Christian disease to growth hormone therapy. *N Engl J Med* 1975;292:332.
117. Dean HJ, et al. Growth hormone deficiency in patients with histiocytosis X. *J Pediatr* 1986;615.
118. Howell SJ, Wilton P, Shalet SM. Growth hormone replacement in patients with Langerhans cell histiocytosis. *Arch Dis Child* 1998;78:469-473.
119. Lahey ME, et al. Involvement of the thyroid in histiocytosis X. *Am J Pediatr Hematol Oncol* 1986;8:257.
120. Leblanc A, et al. Obstructive jaundice in children with histiocytosis X. *Gastroenterology* 1981;80:134.
121. Thompson HH, et al. Sclerosing cholangitis and histiocytosis X. *Gut* 1984;25:526.
122. Braier J, Ciocca M, Latella A, et al. Cholestasis, sclerosing cholangitis and liver transplantation in Langerhans cell histiocytosis. *Med Pediatr Oncol* 2002;38:178-182.
123. Heyn RM, et al. Pretreatment liver biopsy in 20 children with histiocytosis X: a clinicopathologic correlation. *Med Pediatr Oncol* 1990;18:110.
124. Gadner H, Heitger A, Grois N, et al. Treatment strategy for disseminated Langerhans cell histiocytosis. *Med Pediatr Oncol* 1994;23:72-80.
125. Carlson RA, et al. Pulmonary involvement by histiocytosis X in the pediatric age group. *Mayo Clin Proc* 1976;51:541.
126. Basset F, et al. Pulmonary histiocytosis X. *Am Rev Respir Dis* 1978;118:811.
127. Friedman PJ, et al. Eosinophilic granuloma of lung: clinical aspects of primary pulmonary histiocytosis in the adult. *Medicine* 1981;60:385.
128. Marcy TW, Reynolds HY. Pulmonary histiocytosis X. *Lung* 1985;163:129.
129. Vassallo R, Ryu JH, Schroeder DR, et al. Clinical outcomes of pulmonary Langerhans' cell histiocytosis in adults. *N Engl J Med* 2002;346:484-490.
130. Nondahl SR, et al. A case report and literature review of 'primary' pulmonary histiocytosis X of childhood. *Med Pediatr Oncol* 1986;14:57.
131. Watanabe R, Tatsumi K, Hashimoto S, et al. The respiratory failure research group of Japan. Clinico-epidemiological features of pulmonary histiocytosis X. *Intern Med* 2001;40:988-1003.
132. Lewis JG. Eosinophilic granuloma and its variants with special reference to lung involvement. *Q J Med* 1964;33:337.
133. Roland AS, et al. Recurrent spontaneous pneumothorax: a clue to the diagnosis of histiocytosis X. *N Engl J Med* 1942;270:73.
134. Bernstrand C, Cederlund K, Sandstedt B, et al. Pulmonary abnormalities at long-term follow-up of patients with Langerhans cell histiocytosis. *Med Pediatr Oncol* 2001;36:459-468.
135. Bernstrand C, Cederlund K, Asahrom L, Henter JI. Smoking preceded pulmonary involvement in adults with Langerhans' cell histiocytosis diagnosed in childhood. *Acta Paediatr* 2000;89:1389-1392.
136. Berry DH, Gresik MV, Humphrey GB, et al. Natural history of histiocytosis X: a Pediatric Oncology Group study. *Med Pediatr Oncol* 1986;14:1-5.



137. Lucaya J. Histiocytosis X. *Am J Dis Child* 1971;121:289.
138. Favara BE, Jaffe R, Egeler RM. Macrophage activation and hemophagocytic syndrome in Langerhans cell histiocytosis: report of 30 cases. *Pediatr Dev Pathol* 2002;5:130-140.
139. Berry DH, et al. Histiocytosis X in bone only. *Med Pediatr Oncol* 1990;18:292.
140. Broadbent V, et al. Spontaneous remission of multi-system histiocytosis-X. *Lancet* 1984;1:253.
141. Lavin PT, Osband ME. Evaluating the role of therapy in histiocytosis-X: clinical studies, staging, and scoring. *Hematol Oncol Clin North Am* 1987;1:35.
142. Lahey ME. Prognostic factors in histiocytosis X. *Am J Pediatr Hematol Oncol* 1981;3:57.
143. Selch MT, Parker RG. Radiation therapy in the management of Langerhans cell histiocytosis. *Med Pediatr Oncol* 1990;18:97.
144. Bunch W. Orthopedic and rehabilitation aspects of eosinophilic granuloma. *Am J Pediatr Hematol Oncol* 1981;3:151.
145. Broadbent V, Gardner H, Komp DM, Ladisch S. Histiocytosis syndromes in children: II. Approach to the clinical and laboratory evaluation of children with Langerhans cell histiocytosis. *Med Pediatr Oncol* 1989;17:492-495.
146. Van Nieuwenhuysse JP, Clapuyt P, Malghem J, et al. Radiographic skeletal survey and radionuclide bone scan in Langerhans cell histiocytosis of bone. *Pediatr Radiol* 1996;26:734-738.
147. Calming U, Bernstrand C, Mosskin M, et al. Brain 18-FDG PET scan in central nervous system Langerhans cell histiocytosis. *J Pediatr* 2002;141:435-440.
148. Lastoria S, Montella L, Catalano L, et al. Functional imaging of Langerhans cell histiocytosis by (111) In-DTPA-D-Phe(1)-octreotide scintigraphy. *Cancer* 2002;94:633-640.
149. Womer RB, et al. Healing rates of treated and untreated bone lesions in histiocytosis X. *Pediatrics* 1985;76:286.
150. Cassady JR. Current role of radiation therapy in the management of histiocytosis X. *Hematol Oncol Clin North Am* 1987;1:123.
151. Smith DG, et al. Histiocytosis X: role of radiation therapy with special reference to dose levels employed. *Radiology* 1973;106:419.
152. Cohen M, et al. Direct injection of methylprednisolone in the treatment of solitary eosinophilic granuloma of bone. *Radiology* 1980;136:289.
153. Iwatsuki K, et al. The effect of phototherapies on cutaneous lesions of histiocytosis X in the elderly. *Cancer* 1986;57:1931.
154. Bartnick A, Friedrich RE, Roeser K, Schmelzle R. Oral Langerhans cell histiocytosis. *J Craniomaxillofacial Surg* 2002;30:91-96.
155. Stein SL, Paller AL, Haut PR, Mancini AJ. Langerhans cell histiocytosis presenting in the neonatal period: a retrospective case series. *Arch Pediatr Adolesc Med* 2001;155:778-783.
156. Larralde M, Rositto A, Giardelli M, et al. Congenital self-healing histiocytosis (Hashimoto-Pritzker). *Int J Dermatol* 1999;38:693-696.
157. Lahey ME. Histiocytosis X: comparison of three treatment regimens. *J Pediatr* 1975;87:179.
158. Starling KA. Chemotherapy of histiocytosis X. *Hematol Oncol Clin North Am* 1987;1:119.

159. Pritchard J. Histiocytosis X. Natural history and management in childhood. *Clin Exp Dermatol* 1979;4:421.
160. Wester SM, et al. Langerhans cell granulomatosis (histiocytosis X) of bone in adults. *Am J Surg Pathol* 1982;6:113.
161. Mindov M, Grois N, Heitger A, et al. Treatment of multisystem Langerhans cell histiocytosis. Results of the DAL-HX 83 and DAL-HX 90 studies. DAL-HX Study Group. *Klinische Padiatrie* 2000;212:139-144.
162. Greenberger J, et al. Radiation therapy in patients with histiocytosis; management of diabetes insipidus and bone lesions. *Int J Radiat Oncol Biol Phys* 1979;5:1749.
163. Gramatovici R, D'Angio GH. Radiation therapy in soft-tissue lesions in histiocytosis X (Langerhans' cell histiocytosis). *Med Pediatr Oncol* 1988;16:259.
164. Osband ME. Immunotherapy of histiocytosis X. *Hematol Oncol Clin North Am* 1987;1:131.
165. Chang SE, Koh GJ, Choi KH, et al. Widespread skin-limited adult Langerhans cell histiocytosis: long-term follow-up with good response to interferon alpha. *Clin Exp Dermatol* 2002;24:135-137.
166. Arico M, Colella R, Conter V, et al. Cyclosporine therapy for refractory Langerhans cell histiocytosis. *Med Pediatr Oncol* 1995;25:12-16.
167. Minkov M, Grois N, Broadbent V, et al. Cyclosporin A therapy for multisystem Langerhans cell histiocytosis. *Med Pediatr Oncol* 1999;33:482-485.
168. Saven A, Foon KA, Piro L. 2-Chlorodeoxyadenosine-induced complete remissions in Langerhans-cell histiocytosis. *Ann Intern Med* 1994;121:430-432.
169. Rodriguez-Galindo C, Kelly P, Jeng M, et al. Treatment of children with Langerhans cell histiocytosis with 2-chlorodeoxyadenosine. *Am J Hematol* 2002;69:179-184.
170. Grau J, Ribera JM, Tormo M, et al. Results of treatment with 2-chlorodeoxyadenosine in refractory or relapsed Langerhans cell histiocytosis. Study of 9 patients. *Med Clin (Barc)* 2001;116:339-342.
171. Watts J, Files B. Langerhans cell histiocytosis: central nervous system involvement treated successfully with 2-chlorodeoxyadenosine. *Pediatr Hematol Oncol* 2001;18:119-204.
172. Weitzman S, Wayne AS, Arceci R, et al. Nucleoside analogues in the therapy of Langerhans cell histiocytosis: a survey of members of the histiocyte society and review of the literature. *Med Pediatr Oncol* 1999;33:476-481.
173. Geissmann F, Lepelletier Y, Fraitag S, et al. Differentiation of Langerhans cells in Langerhans cell histiocytosis. *Blood* 2001;97:1241-1248.
174. Stool M, Freund M, Schmid H, et al. Allogeneic bone marrow transplantation for Langerhans cell histiocytosis. *Cancer* 1990;66:284-288.
175. Greinix HT, Storb R, Sanders JE, Petersen FB. Marrow transplantation for treatment of multisystem progressive Langerhans cell histiocytosis. *Bone Marrow Transplant* 1992;10:39-44.
176. Suminoe A, Matsuzaki A, Hattori H, et al. Unrelated cord blood transplantation for an infant with chemotherapy-resistant progressive Langerhans cell histiocytosis. *J Pediatr Hematol Oncol* 2001;23:633-639.
177. Nagarajan R, Neglia J, Ramsay N, Baker KS. Successful treatment of refractory Langerhans cell histiocytosis with unrelated cord blood transplantation. *J Pediatr Hematol Oncol* 2001;23:629-632.
178. Kimugawa N, Imashuki S, Hirota Y, et al. Hematopoietic stem cell transplantation (HSCT) for Langerhans cell histiocytosis (LCH) in Japan. *Bone Marrow Transplant* 1999;24:935-938.
179. Zandi P, Panis Y, Debray D, et al. Pediatric liver transplantation for Langerhans' cell histiocytosis.

Hepatology 1995;21:129-133.

180. Concepcion W, Esquivel CO, Terry A, et al. Liver transplantation in Langerhans' cell histiocytosis (histiocytosis X). Semin Oncol 1991;18:24-28.

2004 Lippincott Williams & Wilkins  
John P. Greer, John Foerster, John N. Lukens  
George M. Rodgers, Frixos Paraskevas, Bertil Glader  
Wintrobe's Clinical Hematology

## Infectious Mononucleosis and Other Epstein–Barr Virus–Related Disorders

### HISTORICAL BACKGROUND

### PATHOPHYSIOLOGY OF EPSTEIN–BARR VIRUS INFECTION

#### Epstein–Barr Virus Infection

#### Immune Response to Epstein–Barr Virus Infection

### INFECTIOUS MONONUCLEOSIS

#### Epidemiology

#### Clinical Features

#### Laboratory Findings

#### Histologic Findings

#### Diagnosis

#### Differential Diagnosis

#### Complications

#### Treatment

#### Prognosis

### OTHER EPSTEIN–BARR VIRUS–RELATED DISEASES

#### Chronic Active Epstein–Barr Virus Infection

#### Fulminant Infectious Mononucleosis or Epstein–Barr Virus–Associated Hemophagocytic Lymphohistiocytosis

#### Epstein–Barr Virus–Associated Disorders in Immunodeficiency

#### Epstein–Barr Virus–Associated Malignancies

### REFERENCES

Epstein–Barr virus (EBV) infects the majority of human individuals but usually results in subclinical infections. EBV has been etiologically linked to a wide spectrum of human disease, but it has been shown to be the etiologic agent in relatively few. Although infectious mononucleosis (IM) is a diagnosis made from a constellation of clinical and laboratory features, EBV has been identified as the etiologic agent. Classically, EBV has been associated with Burkitt lymphoma (BL), nasopharyngeal carcinoma (NPC), and the inherited immunodeficiency, X–linked lymphoproliferative disease (XLP). EBV has also been associated with many human malignancies, such as non–Hodgkin lymphoma (NHL) [B–cell, T–cell, and natural killer (NK)–cell phenotype], Hodgkin disease (HD), leiomyosarcoma, gastric carcinoma, hepatocellular carcinoma, and breast cancer, as well as oral hairy leukoplakia and lymphoproliferative disorders (LPDs) seen in patients with primary or secondary immunodeficiencies. In addition, EBV has been associated with several nonmalignant, but often fatal, human diseases such as virus–associated hemophagocytic syndrome (VAHS) and chronic active EBV infection (CAEBV). The role of EBV in the pathogenesis of these disorders remains to be fully understood. This chapter reviews the biology of EBV and IM in detail. Additionally, other diseases that have been associated with EBV infection are discussed, focusing on data pertaining to the role EBV may play in the pathogenesis.

## HISTORICAL BACKGROUND

In the first decade of the twentieth century, several cases of glandular enlargement, sore throat, and increased numbers of mononuclear cells on the blood smear were described by Turk ( <sup>1</sup> ), Cabot, Marchant, and others ( <sup>2</sup> ). These cases were sometimes reported as

acute leukemia that apparently resulted in spontaneous remission and cure. In the 1920s, Sprunt et al. ( [3](#) ) classified these cases and six of their own as *infectious mononucleosis*, emphasizing the peculiar blastlike cells present in the blood. In 1923, Downey et al. published a detailed morphologic description of these cells ( [4](#) ).

The search for the infectious agent responsible for IM included bacteria, spirochetes, protozoa, and several viruses ( [2](#) ). The relationship between EBV and IM began in 1958 when Denis Burkitt described an unusual, rapidly growing lymphosarcoma in children of Uganda and central Africa ( [5](#) ). In March 1961, Dr. Burkitt gave a lecture to medical students at Middlesex Hospital Medical School in London. The title of the lecture was *The Commonest Children's Cancer in Tropical Africa*, and it was about the epidemiology of this lymphoma that now bears his name ( [6](#) ). A young doctor named Epstein was in attendance at the lecture and became interested in the possibility of a viral etiology for this tumor. Dr. Epstein made arrangements for Dr. Burkitt to have biopsy specimens sent to his laboratory. For 3 years, Dr. Epstein and his colleagues were unsuccessful in finding viruses in the tumor tissue. However, in 1964, Dr. Epstein reported, along with Achong and Barr, the presence of viral particles in lymphoblasts cultured from tumor biopsies ( [7](#) ).

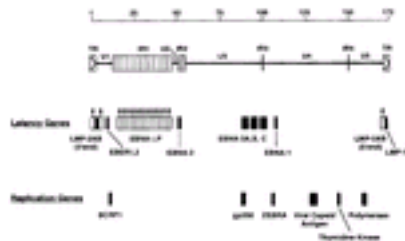
The discovery of EBV as the cause of IM was the result of a chance observation made in 1967 ( [8](#) ). The Henles noted that blood taken from a laboratory technician who had contracted IM led to the spontaneous establishment of a lymphoid cell line containing characteristic EBV particles, whereas previous attempts to establish cell lines from this individual's blood had been unsuccessful. They also discovered that sera obtained before the onset of IM had shown anti-EBV titers of less than 1:10 and a negative heterophil response. After the onset of clinical IM, however, anti-EBV and heterophil titers rose. On the basis of these provocative clues, the Henles and associates studied the sera of a number of students from Yale University, where a prospective study of IM had been in progress for many years. In all instances of clinical IM, the anti-EBV and heterophil titers rose together from a negative baseline. Of even greater interest was the observation that the anti-EBV titer remained persistently elevated, in contrast to the transient nature of the heterophil response. Other reports have provided further evidence that EBV is the etiologic agent in the majority of cases of IM ( [9](#) , [10](#) , [11](#) , [12](#) and [13](#) ).

## **PATHOPHYSIOLOGY OF EPSTEIN-BARR VIRUS INFECTION**

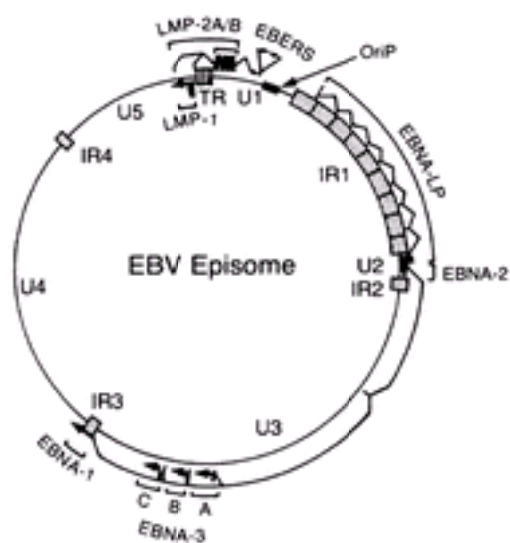
EBV is one of eight known human herpesviruses and is subgrouped into the gamma-herpesvirus subfamily. Immature virus particles that measure 75 to 80 nm can be found in both the nucleus and the cytoplasm of infected cells. Mature, fully infectious particles, with a diameter of 150 to 200 nm, are found only in the cytoplasm ( [9](#) , [14](#) ). The infectious virus particle has three components: a nucleoid, a capsid, and an envelope. The doughnut-shaped central core, or nucleoid, contains the viral DNA in linear form. Surrounding the nucleoid is the capsid, which is icosahedral and is made up of hollow, tubular protein subunits called *capsomers*. Finally, the nucleocapsid (the capsid and the contained viral DNA) is enclosed in a protective envelope that is derived either from the nuclear membrane or the outer membrane of the host cell. The envelope contains a number of viral antigens (proteins) that are manufactured and inserted into the host cell membrane before the assembly of virus particles.

The EBV genome ( [Fig. 67.1](#) ) is a double-stranded DNA molecule of approximately 173,000 base pairs (bp) organized into a series of unique coding regions (U1 to U5), divided by interval repeat regions (IR1 to IR4) and terminal repeat (TR) domains ( [15](#) ). The genome encodes approximately 100 proteins ( [16](#) ). When EBV infects a cell, its linear genome circularizes to form an episome, an extrachromosomal element in the nucleus of

the cell ( [13](#), [17](#), [18](#) ). Several of the EBV genes expressed during viral latency and replication are emphasized in [Figure 67.1](#) and [Figure 67.2](#) and are discussed in the section [Epstein–Barr Virus Infection](#).



**Figure 67.1.** Epstein–Barr virus (EBV) genome and its organization. Schematic representation of linear EBV DNA showing the general organization in a series of unique ( *U1* to *U5* ), internal repeat ( *IR1* to *IR4* ), and terminal repeat ( *TF* ) domains. The location of several EBV genes expressed during viral latency and replication is shown. EBER, EBV–encoded RNA; EBNA, EBV–determined nuclear antigen; gp, glycoprotein; LMP, latent membrane protein; ZEBRA, Z EBV replication activator. [From Tosato G, Tata K, Angiolillo AL, et al. Epstein–Barr virus as an agent of hematological disease. *Baillere Clin Hematol* 1995;8(1):165–199, with permission.]



**Figure 67.2.** Circularized Epstein–Barr virus (EBV) genome; EBV DNA. Schematic representation of circular EBV DNA episomes, showing the general organization of unique ( *U* ) and major tandem internal repeat ( *IR* ) DNA domains and the location of latency genes within the circular DNA structure. EBER, EBV–encoded RNA; EBNA, EBV–determined nuclear antigen; LMP, latent membrane protein. [From Tosato G, Tata K, Angiolillo AL, et al. Epstein–Barr virus as an agent of hematological disease. *Baillere Clin Hematol* 1995;8(1):165–199, with permission.]

Although many variants have been reported, two major types exist: EBV–1 (A type) and EBV–2 (B type) ( [9](#), [13](#), [16](#) ). They are differentiated mainly by their differences in gene structure encoding the EBV–determined nuclear antigens (EBNA) 2, 3A, and 3C ( [19](#) ). Both types of EBV are found in most populations. Although EBV type B is frequently detected in the oropharyngeal secretions of individuals living in developed countries, recovery of EBV type B from peripheral blood lymphocytes is unusual ( [20](#) ). The

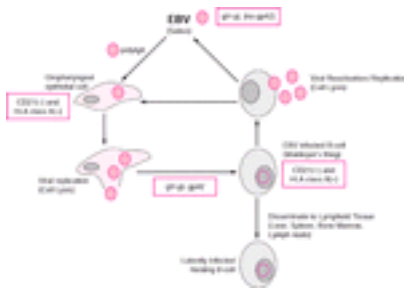
relationship between these different strains and specific diseases remains to be determined. Recently, variants with differences in EBNA-1 have been reported to be associated with specific EBV-associated diseases, such as BL, but the incidence of these variants has been shown to be similar in the general population of a particular geographic region (21). Furthermore, mutations (so-called 30-bp or 69-bp deletions) of latent membrane protein (LMP-1), one of the viral proteins associated with cell immortalization, have been reported to be highly associated with the development of HD, certain forms of T- and B-cell lymphoma, and NPC (22, 23, 24, 25 and 26). But again, it has been demonstrated that these mutations are only reflective of regional EBV variations (26, 27). Therefore, caution must be exercised when attributing specific virus strains to particular diseases in the absence of geographically matched control isolates. Further studies are needed to clarify disease specificities of virus subtypes.

## Epstein-Barr Virus Infection

The only host that the virus infects naturally is the human, although lymphocytes from other species, namely New World primates (i.e., cottontop marmosets, owl monkeys, and tamarins), are infectable (28, 29). EBV has been found in a variety of tissue types associated with disease (i.e., T lymphocytes, NK cells, HD, leiomyosarcoma, gastric carcinoma, hepatocellular carcinoma, and breast cancer) (30, 31, 32, 33, 34, 35 and 36). However, B lymphocytes and epithelium of the oronasopharynx are the only natural cell targets of the virus. Cellular infection for herpesviruses requires two distinct events: cellular attachment and entry. Infection of B lymphocytes begins with attachment of the virus envelope glycoprotein (gp) 350/220 to the complement receptor C3d, also known as CR2 or CD21 (16, 37, 38 and 39). For entry into B lymphocytes, a complex of three viral proteins (gH-gL-gp42) is required, and HLA class II molecules serve as a co-receptor for gp42 (40). Attachment of EBV to epithelium is not via CD21, and viral entry is by infectious virions binding to polymeric immunoglobulin (Ig) A (41). EBV entry into epithelial cells does not require gp42/HLA class II but is mediated by a two-part complex of gH-gL. It has also been shown that virus that replicates in epithelial cells produces an abundance of gH-gL-gp42, favoring B-lymphocyte tropism, whereas virus produced by B lymphocytes lacks gp42, favoring epithelial tropism (40).

The life cycle of EBV in humans is illustrated in [Figure 67.3](#). It is believed that virus contained in infectious saliva is produced by B lymphocytes of the oropharynx (42, 43, 44 and 45); therefore, virus in saliva would contain two-part complexes (gH-gL) and favor infection of the epithelium. Infection of epithelium leads to the lytic replication of the virus with the release of large quantities of viral particles (37), containing three-part complexes (gH-gL-gp42) that favor infection of HLA class II and CD21-expressing cells (i.e., B lymphocytes located in the oropharyngeal lymphoid tissues of the Waldeyer ring). These B cells may remain latently infected in the oropharynx, but if viral reactivation and replication occur, cellular lysis and death result, and virus can be shed into the saliva. Salivary virus may then be transmitted to another host or may infect host epithelium, resulting in virus that may infect other B lymphocytes. Alternatively, infected B lymphocytes may disseminate throughout the body as resting memory B cells in secondary lymphatic organs (i.e., lymph nodes, spleen, and bone marrow) (46) and become the reservoir for latent EBV infection (47). The number of latently infected B cells is approximately  $10^{-5}$  to  $10^{-6}$  of all B cells and remains stable for the majority of the life of the infected individual (47, 48).





**Figure 67.3.** Life cycle of Epstein-Barr virus (EBV). gp, glycoprotein; Ig, immunoglobulin.

Latent infection is characterized by the expression of nine virally encoded proteins. [Figure 67.1](#) and [Figure 67.2](#) illustrate the transcriptions of the nine latent proteins of EBV (EBNA-1, EBNA-2, EBNA-3A, EBNA-3B, EBNA-3C, leader protein, LMP-1, LMP-2A, and LMP-2B) ([9](#), [13](#), [16](#)). Nomenclature for the EBNAs varies such that EBNA-3A, -3B, and -3C are also known as *EBNA-3*, -4, and -5, respectively ([16](#)). The EBV-encoded RNAs (EBERs) EBER-1 and EBER-2 are seen in all latently infected cells, but they do not code for any proteins, and their function has not been determined. Additionally, the Bam HI-A rightward transcript (BART) is generally found in infected cells, but its function also remains to be fully delineated ([49](#)).

The state of latent infection is maintained by EBNA-1, which binds to a nucleotide sequence called *ori-F*, part of the DNA origin of EBV replication, thereby allowing the viral genome to be maintained in the nucleus of the latently infected B cell ([50](#), [51](#)). By this mechanism, the EBV DNA is assured of being maintained in B cells that undergo replication. EBNA-2, EBNA-3A, EBNA-3C, and LMP-1 appear to be required for B-cell immortalization. EBNA-2 transactivates the expression of two EBV LMPs—LMP-1 and LMP-2 ([52](#), [53](#), [54](#), [57](#)). EBNA leader protein augments the ability of EBNA-2 to up-regulate LMP-1 ([9](#), [13](#)). LMP-1 and LMP-2 are associated with a cellular tyrosine kinase ([56](#), [57](#)). The function of LMP-1 is similar to that of other members of the tumor necrosis factor (TNF) receptor family and is similar—but not identical—to that of CD40. LMP-1 interacts with TNF receptor-associated factors and the TNF receptor-associated death domain in infected cells and activates nuclear factor- $\kappa$ B and c-Jun N-terminal kinase pathways, resulting in B-cell activation and proliferation ([57](#), [58](#), [59](#) and [60](#)). Additionally, LMP-1 expression also induces bcl-2 expression and can prevent apoptosis in B cells ([61](#)). LMP-2 prevents viral reactivation by blocking tyrosine phosphorylation and promotes B-cell survival ([56](#), [62](#)). The EBNA-3 proteins regulate expression of cellular genes, including specific cellular receptors such as CD28, CD19, CD21, CD23, and CD30; T-cell co-stimulatory molecules CD80/CD86; adhesion molecules such as intercellular adhesion molecule-1, leukocyte factor antigen-1, and leukocyte factor antigen-3; and a member of the src oncogene family, c-fgr ([9](#), [13](#), [63](#), [64](#)).

Expression of EBV genes varies among the spectrum of EBV-associated diseases and often differs from *in vitro* immortalized B cells or normal human resting B cells infected by EBV ([55](#)). Briefly, EBV-positive BL cells commonly express only EBNA-1, EBER-1, and EBER-2 (type I latency), and type I latency is also observed in a portion of EBV-positive gastric carcinoma. EBV-positive NPC, T-cell NHL, and HD cells express EBNA-1, LMP-1, LMP-2, EBER-1, and EBER-2 (type II latency). However, EBV-infected cells of lymphoproliferative disease observed in immunodeficient patients resemble *in vitro* immortalized B cells; lymphoblastoid cell lines generally express all nine of the EBV-related latent proteins (type III latency). Recently, it has been shown that the peripheral resting CD23-positive B cells are the site of EBV latency in seropositive healthy individuals. These EBV-infected resting B cells express only LMP-2, EBER-1, and

EBER-2 together with BART (type IV latency) ( [65](#) ).

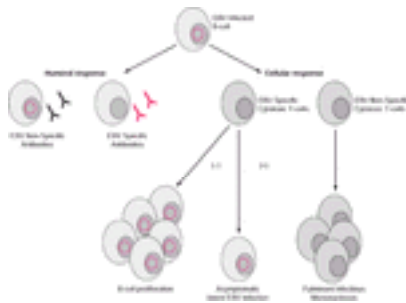
Virus reactivation and replication are characterized by the expression of the EBV BZLF-1 gene product or ZEBRA (Z EBV replication activator) protein, an immediate early gene product that triggers viral replication in these cells ( [16](#), [66](#) ). This protein also transactivates other immediate early genes, which then up-regulate the expression of early gene products essential for viral replication, including viral DNA polymerase and viral thymidine kinase. Late gene products follow, including viral capsid antigen (VCA), the major envelope glycoprotein (gp350), and the viral protein BCRF-1, 70% of whose structure is identical to that of interleukin (IL)-10 ( [13](#), [16](#), [67](#) ). Viral replication always results in lysis and death of the host cell.

### Immune Response to Epstein-Barr Virus Infection

Understanding the immune response to EBV infection is essential to comprehend the pathogenesis of EBV-related disease. EBV is a very potent immune stimulus. The immune system controls lymphoproliferation in the normal host and maintains a host/virus symbiosis. [Figure 67.4](#) illustrates the delicate balance between the host T-cell immune response and control of B-cell proliferation of latently infected B cells. In a healthy individual, although only  $10^{-5}$  to  $10^{-6}$  B cells are latently infected with EBV, approximately 1 to 5% of all circulating CD8<sup>+</sup> T cells are capable of reacting against EBV ( [48](#), [68](#), [69](#) and [70](#) ). Initially, there is B-cell proliferation, producing both EBV-specific and -nonspecific antibodies. The number of these virus-containing B cells rises during the acute phase of the infection but never exceeds 0.03 to 0.1% of the circulating mononuclear cells ( [71](#), [72](#) and [73](#) ). A cellular immune response follows, which is comprised primarily of cytotoxic T lymphocytes (CTLs), that are again EBV-specific and -nonspecific. [Figure 67.5](#) illustrates the pathologic consequences of an abnormal CTL response to EBV infection. A deficient CTL response, either quantitative or qualitative, results in an EBV-driven B-cell proliferative process. The lack of an appropriate CTL response can also result in an aggressive, predominantly T-cell and histiocytic reaction that is not EBV specific. This reaction is characterized by extensive infiltration of lymphoid and parenchymal organs with hemophagocytosis, and tissue destruction is often observed. If unchecked, this reaction can be rapidly fatal ( [74](#), [75](#) ).

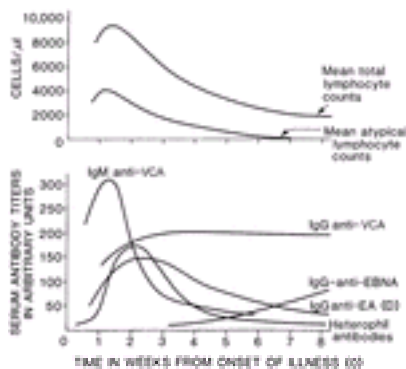


**Figure 67.4.** Balance of immune control in Epstein-Barr virus (EBV) infections. CTL, cytotoxic T lymphocyte.



**Figure 67.5.** Immune response to Epstein-Barr virus (EBV) infection.

The humoral response to EBV is well characterized ( [Fig. 67.6](#) ) ( [72](#), [76](#), [77](#), [78](#) and [79](#) ). VCA antibodies are the earliest to appear—first IgM and, later, IgG. IgM antibodies probably arise during the incubation period, peak with symptoms, and then decline rapidly ( [80](#), [81](#) ). IgA anti-VCA antibodies are seen in some patients and, like IgM anti-VCA antibodies, are gone within several weeks ( [82](#), [83](#) ). IgG anti-VCA antibodies reach a peak 2 to 3 weeks after their IgM predecessors and persist for life ( [80](#), [82](#) ). The majority of patients also have a transient response to the EBV early antigen (EA), peaking usually within a month of infection ( [80](#) ). Antibodies to EBNA may appear several weeks after the onset of the illness in some patients but, in general, take several months to appear, and titers rise slowly over 1 to 2 years and persist for life. The majority of normal individuals have detectable IgG to EBNA by 6 months after EBV infections, although it may take years to develop detectable anti-EBNA titers. In young children, the anti-VCA and -EA responses may be much less intense, and anti-EBNA may take much longer to be seen ( [84](#) ).



**Figure 67.6.** Laboratory tests I. Time course relationship between heterophil antibodies, various anti-Epstein-Barr virus antibodies, and the mean total and atypical lymphocyte counts. EA, early antigen; EBNA, Epstein-Barr nuclear antigen; D, diffuse component; Ig, immunoglobulin; VCA, viral capsid antigen.

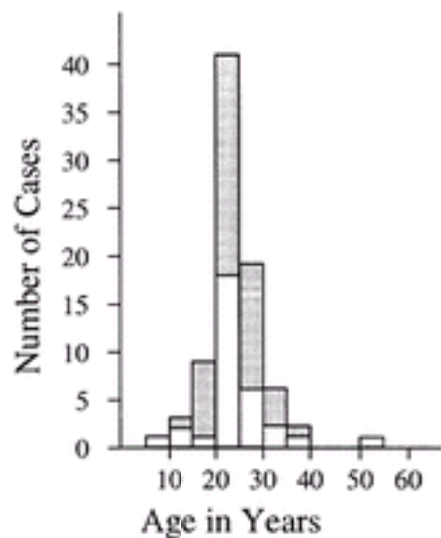
An EBV-nonspecific humoral response also occurs with EBV infection. Paul et al. ( [85](#) ) first described this phenomenon in 1932 when they reported that the sera of patients with IM contained heterophil antibodies against sheep erythrocytes in concentrations far above normal. The use of heterophil antibodies in the diagnosis of IM is discussed in detail in the section [Infectious Mononucleosis: Diagnosis](#). Many of these EBV-nonspecific antibodies function as autoantibodies and include cold reactive anti-i antibodies, Donath-Landsteiner cold hemolysins, and antibodies against smooth muscle, thyroid, and stomach ( [86](#), [87](#), [88](#) and [89](#) ). In addition, antinuclear antibodies have been found in the sera of some patients ( [90](#), [91](#) ), as well as rheumatoid factors ( [92](#) ), including anti-Gm antibodies

([93](#)), anticardiolipin antibodies ([94](#)), and antiactin and anticytoskeletal antibodies ([94](#)). The serum of some persons with IM may contain cryoglobulins ([95](#), [96](#)). Some of these autoantibodies have been reported to be monoclonal ([86](#), [89](#)).

Although neutralizing antibodies produced after primary infection may play a role in thwarting the spread to additional B cells, EBV-specific antibodies are most useful for diagnosis, whereas the cellular response is the most important for control of EBV infections. NK cells and CD4<sup>+</sup> T cells have been shown to play a role, but CD8<sup>+</sup> memory cytotoxic T cells (EBV-CTL) are the primary defense in controlling EBV infections ([9](#), [10](#), [97](#), [98](#), [99](#), [100](#), [101](#) and [102](#)). Although the absolute number of NK cells may be increased, a decrease in NK function is usually observed, returning to normal gradually over several weeks ([98](#)). Initially, cytotoxic T cells are polyclonal and are neither EBV specific nor HLA restricted, evidenced by their ability to kill readily EBV-negative and major histocompatibility complex (MHC)-incompatible targets ([99](#)). They resemble activated killer cells induced *in vitro* by the exposure of T cells to nonspecific mitogens or IL-2 ([13](#), [99](#)). These CD8<sup>+</sup> lymphocytes account for the majority of cells causing the lymphocytosis and the large, pleomorphic, atypical lymphocytes, or “Downey cells,” characteristic of IM ([9](#), [13](#), [73](#), [97](#), [99](#), [103](#)). It is the amount of these T cells in the peripheral blood that correlates with symptoms seen in IM, not the number of EBV-infected B cells or the viral load ([104](#)). These cells disappear during convalescence ([99](#)) to be replaced by EBV-CTLs, which maintain a latent viral infection and control EBV-driven B-cell proliferation ([99](#), [100](#), [101](#) and [102](#)).

This symbiosis of EBV and the infected host is maintained by interactions between viral gene expression in latently infected B cells and host EBV-CTL surveillance. The reservoir of viral latency is found among the resting memory B cells ([47](#)). These resting memory B cells do not express high levels of adhesion molecules or T-cell co-stimulatory molecules, making them poor antigen-presenting cells. Also, these EBV latently infected resting B cells express only LMP-2, EBER-1, and EBER-2, together with BART (type IV latency) ([46](#), [65](#)). When these cells divide, EBNA-1 is expressed to assure passage of viral DNA to progeny cells ([105](#)). All attempts to demonstrate or produce EBNA-1-specific cytotoxic T cells have failed ([106](#)). It has been shown that the gly-ala internal repeats in EBNA-1 block their own degradation by proteasomes and, hence, peptide presentation through MHC class I molecules ([107](#)). Thus, resting EBV-infected B cells expressing EBNA-1 are not recognized by the immune system. However, activated EBV-infected B cells express MHC class I antigens; various adhesion molecules including CD44; leukocyte family antigens (CD18, CD58); intercellular adhesion molecules; and B-cell activation markers or co-stimulatory molecules such as CD23, CD30, CD39, CD40, CD70, CD80, and CD86 ([63](#), [64](#)), making these proliferating EBV-infected B cells good antigen-presenting cells. Proliferating, latently infected B cells express all latent proteins, including EBNA-2, EBNA-3A, EBNA-3C, LMP-1, and LMP-2 (type III latency). These proliferating EBV-infected B cells are highly susceptible to cellular lysis by EBV-CTLs and are eliminated during convalescence, whereas memory EBV-CTLs provide lifetime immunosurveillance against EBV-driven B-cell proliferation. The immunodominant epitope of the EBV-CTL response is highly restricted by the HLA type of the individual, making it difficult to develop vaccine strategies to prevent EBV infections ([99](#), [106](#), [108](#)) ([Fig. 67.7](#)).





**Figure 67.8.** Age incidence. Age and sex of 82 patients with infectious mononucleosis at Johns Hopkins Hospital. Shaded columns, males; open columns, females.

Despite common opinion, the contagiousness of IM is quite low. It is rare for members of a patient's family, roommates of the same sex, and other close associates to develop symptoms of IM ([120](#), [121](#)). "Kissing disease," the colloquial term for IM, underscores the association of intimate kissing with IM ([72](#), [110](#), [122](#), [123](#)). Although oral shedding occurs throughout the life of a carrier ([69](#)), data suggest that acute infections are more likely to occur from a recently infected individual. Oral shedding in an immunocompetent individual peaks shortly after infection but is often readily detectable for 18 months or longer ([122](#), [124](#), [125](#)). Other modes of acquiring EBV infection include transplantation of organs or hematopoietic cells in which transmission to the transplant recipient is common ([126](#), [127](#), [128](#) and [129](#)). Although it is not thought to occur, there are anecdotal reports of transmission from blood transfusions ([130](#), [131](#)), *in utero*, or perinatally ([132](#), [133](#)). Although there are anecdotal reports of virus detected in cervical epithelium and semen, sexual transmission has never been demonstrated ([134](#)).

### Clinical Features

Many individuals have held that the manifestations of IM are protean ([135](#)) and that many disorders may be simulated by this condition. IM is classically characterized by the clinical triad of fever, pharyngitis, and generalized adenopathy, with demonstration of an *atypical lymphocytosis*, defined as an absolute lymphocytosis with more than 50% lymphocytes and 10% or more atypical forms in the differential count, and the presence of heterophil antibodies ([110](#)). Usually, IM occurs only once in the lifetime of a host, although recurrences have been reported, and exacerbations of unresolved infection or transition to a chronic course may also occur. (See section [Chronic Active Epstein-Barr Virus Infections](#).)

The signs and symptoms of IM are summarized in [Table 67.1](#). The clinical course based on physical signs and symptoms is illustrated in [Figure 67.9](#) and [Figure 67.10](#). In most young adults, the symptoms are fairly abrupt in onset, although close questioning frequently elicits vague complaints of lassitude and ill-being for several days before the onset of more pronounced symptoms. Most of the early symptoms are nonspecific. Myalgias do occur, but they are usually mild and are often confined to the neck and upper back. Excessive fatigue and general malaise may be accompanied by fever, sweating, and chills.

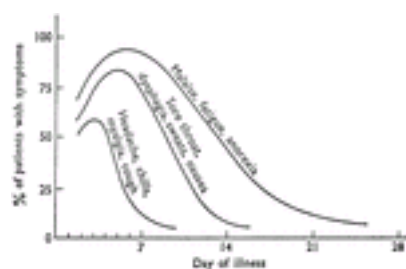


Severe rigors rarely occur, and the patterns of fever are generally moderate and nonspecific. The fever is of no characteristic type. It may be transient and slight in degree, but in as many as one-third of patients, it reaches a peak of 40° C (135). A secondary rise in temperature may occur after an initial drop to normal and may accompany the onset of glandular swelling or sore throat.

**TABLE 67.1. Symptoms and Signs of Infectious Mononucleosis**

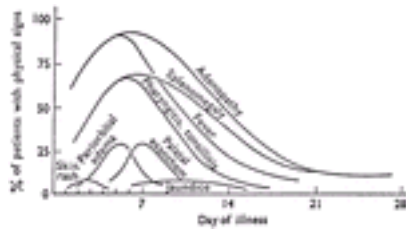
| Symptoms                | %      | Signs                       | %     |
|-------------------------|--------|-----------------------------|-------|
| Malaise and fatigue     | 90–100 | Adenopathy                  | 100   |
| Sweats                  | 80–95  | Fever                       | 80–95 |
| Sore throat, dysphagia  | 80–85  | Pharyngitis                 | 65–85 |
| Anorexia                | 50–80  | Splenomegaly                | 50–60 |
| Nausea                  | 50–70  | Bradycardia                 | 35–50 |
| Headache                | 40–70  | Periorbital edema           | 25–40 |
| Chills                  | 40–60  | Palatal exanthem            | 25–35 |
| Cough (mild)            | 30–50  | Liver or splenic tenderness | 15–30 |
| Myalgia                 | 12–30  |                             |       |
| Ocular muscle pain      | 10–20  | Hepatomegaly                | 15–25 |
| Chest pain              | 5–20   | Rhinitis                    | 10–25 |
| Arthralgia              | 5–10   | Jaundice                    | 5–10  |
| Diarrhea or soft stools | 5–10   | Skin rash                   | 3–6   |
| Photophobia             | 5–10   | Conjunctivitis              | 5     |
| Abdominal pain          | 5      | Pneumonitis                 | 3     |
| Epistaxis               | 3      |                             |       |

From Finch SC. Clinical symptoms and signs of infectious mononucleosis. In: Carter RL, Penman HG, eds. Infectious mononucleosis. Oxford: Blackwell Scientific, 1969, with permission.



**Figure 67.9.** Major symptoms. Usual frequency and duration of major symptoms in young adults with infectious mononucleosis. (From Finch SC. Clinical symptoms and signs of infectious mononucleosis. In: Carter RL, Penman HG, eds. Infectious mononucleosis. Oxford: Blackwell Scientific, 1969, with permission.)





**Figure 67.10.** Physical signs. Usual frequency and duration of major physical signs in young adults with infectious mononucleosis. (From Finch SC. Clinical symptoms and signs of infectious mononucleosis. In: Carter RL, Penman HG, eds. Infectious mononucleosis. Oxford: Blackwell Scientific, 1969, with permission.)

Anorexia is a common early symptom. Its intensity and duration are often linked to the severity of sore throat and dysphagia. The anorexia often persists for several weeks. Nausea is equally common and may be one of the earliest symptoms of IM, but vomiting is rare. Sore throat and dysphagia are among the most important manifestations of IM and may be the only symptoms in some patients. These symptoms usually develop gradually and subside in 1 to 2 weeks. For most patients, the symptoms of pharyngitis are mild, but occasionally, even taking sips of water may be painful.

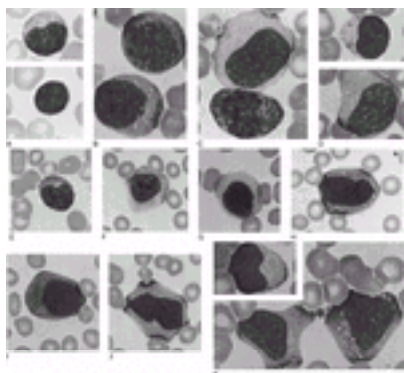
Lymph node enlargement is invariably present at some time ([136](#), [137](#) and [138](#)). Adenopathy usually appears during the first week of illness and slowly resolves thereafter. Anterior and posterior cervical node enlargement is almost always present, and palpable axillary and inguinal nodes are common. Radiographically detectable hilar adenopathy is rare (<1%) ([139](#)). Although splenomegaly is expected, the spleen is palpable in only one-half to three-fourths of all patients. Massive splenomegaly can be observed but is rare ([135](#), [138](#)). Hepatomegaly is detected in 15 to 25% of patients and is usually accompanied by percussion tenderness over the liver and discomfort on palpation. The course of hepatomegaly closely follows that of adenopathy and splenomegaly ([140](#)). Pharyngeal inflammation usually appears in the first week and then subsides rapidly. In approximately 25% of patients, pharyngitis first occurs after the initial week of illness, and there are no pathognomonic features. It varies in intensity, but rarely, massive tonsillar and pharyngeal edema may cause virtually complete pharyngeal obstruction ([138](#)). Severe cough is relatively rare, although mild cough is common.

Headaches occur early, as well as photophobia, and ocular muscle pain can occur. Ocular manifestations occur in approximately one-third of patients and include eyelid edema, conjunctivitis, dry eyes, keratitis, uveitis, choroiditis, retinitis, papillitis, and ophthalmoplegia ([141](#)). Rashes are also common with primary EBV infection and may be the only symptom in young children ([142](#), [143](#)). Several observers have noted that patients experiencing IM are peculiarly prone to rashes when treated with ampicillin, which appear to be the result of vasculitis caused by circulating ampicillin-antibody complexes ([144](#), [145](#), [146](#) and [147](#)).

### Laboratory Findings

Hematologic abnormalities in IM are observed in virtually all patients. The hematologic changes persist for a minimum of 2 weeks and usually for 1 to 2 months. One of the classic features of IM is the atypical lymphocytosis. The pleomorphism of the mononuclear cells found in the blood is usually striking. In addition to normal lymphocytes and monocytes, large mononuclear cells, or atypical lymphocytes, are observed in the blood ([Fig. 67.11](#)). Although nonspecific ([148](#)) because they may be found in the blood of

patients with a variety of conditions, including other viral infections ([149](#)), they are a prominent feature of IM. The abnormal cells vary greatly in size and shape. They possess a nucleus that may be oval, kidney-shaped, or slightly lobulated and cytoplasm that most often is nongranular and vacuolated or foamy. The nuclear chromatin forms a coarse network of strands and masses and is not clearly differentiated from the parachromatin. The identity of these cells has been shown to be CD8<sup>+</sup> T lymphocytes, as discussed previously (see [Immune Response to Epstein-Barr Virus Infection](#)) ([9](#), [13](#), [73](#), [97](#), [103](#)). The rapid proliferation of these activated T cells is, in turn, responsible for the large numbers of atypical cells seen in the peripheral blood, as well as the generalized lymphadenopathy and hepatosplenomegaly, the tonsillar and adenoidal changes, and the cellular infiltration seen in many parenchymal organs, and is discussed in detail in the section [Infectious Mononucleosis: Histologic Findings](#).



**Figure 67.11.** Lymphocytes and cells of infectious mononucleosis. **A:** Large and small lymphocytes from the blood of normal subjects. **B:** Lymphocytes resembling plasma cells (“plasmacytoid” cells) in the blood of a patient with viral pneumonia. **C:** Somewhat atypical lymphocyte and plasmacytoid lymphocytes in blood. **D:** Lymphocytes from the blood of a patient with viral infection; azurophilic granules are clearly seen in one of the cells. **E–J:** Infectious mononucleosis; lymphocytes showing increasing levels of atypia. **E:** Downey type I. **F, G:** Downey type II. **H–J:** Downey type III. **K:** Lymphocytes from blood of patient with infectious mononucleosis. See [Color Plate](#).

Most patients with IM have slightly or moderately increased total white blood cell counts in the range of  $10.0$  to  $20.0 \times 10^9$  cells/L, with approximately 15% of patients reaching levels in excess of  $20.0 \times 10^9$ /L ([76](#), [123](#)). The absolute lymphocyte count most often exceeds  $5.0 \times 10^9$  cells/L; because the number of atypical lymphocytes usually is greater than 20% ([123](#)), minimum atypical lymphocyte counts of  $1.0 \times 10^9$ /L can be expected. Lymphocytosis begins toward the end of the first week of illness and reaches a peak corresponding to symptoms, as does the total leukocyte count ([Fig. 67.12](#)). Leukopenia has also been observed and can be manifested as lymphopenia or granulocytopenia ([150](#)). Most patients with IM have normal hemoglobin levels, and severe thrombocytopenia is rare, although mild depressions of platelet counts ( $=100 \times 10^9$ /L) may be found in perhaps one-half of patients ([150](#), [151](#)). Neutropenia and thrombocytopenia may be very ominous signs, as they are frequently seen in the hemophagocytic reactions [VAHS or EBV-hemophagocytic lymphohistiocytosis (HLH)].



**Figure 67.12.** Laboratory tests II. Major laboratory findings in adults with infectious mononucleosis. (From Finch SC. Clinical symptoms and signs of infectious mononucleosis. In: Carter RL, Penman HG, eds. Infectious mononucleosis. Oxford: Blackwell Scientific, 1969, with permission.)

Nonhematologic abnormalities are also commonly observed in patients with IM. Many patients show mild to moderate abnormal liver function tests ([150](#)). The reported incidence varies from approximately 40 to 100%, depending on the severity of the disease, the time of testing, and the diligence with which the changes were sought. Reported enzyme changes include elevations of lactate dehydrogenase, alkaline phosphatase, glutamic pyruvate transaminase, phosphohexose isomerase, and aldolase, in roughly that order of frequency. Perhaps one-third of patients have mild to moderate elevations of serum bilirubin values; levels above 8 mg/dl (135  $\mu$ mol/L) are exceedingly rare but have been reported ([150](#), [152](#)). Occasionally, proteinuria or hematuria is present, but renal function is usually unimpaired. When the patient is jaundiced, bile and increased concentrations of urobilinogen may be found. Lumbar puncture has been performed to evaluate patients with severe headaches. In these cases, the cerebrospinal fluid pressure may be elevated, and pleocytosis and increased levels of protein are often noted. The sugar content is normal. In a few patients, heterophil antibodies have even been demonstrated in the cerebrospinal fluid ([153](#)).

### Histologic Findings

The main pathologic feature of IM is a notable proliferative response within the reticuloendothelial system, especially by the lymph nodes and the spleen. It can be difficult to distinguish between malignant lymphoma and nonmalignant disease associated with EBV infection, especially in the immunodeficient patient population ([75](#)). In summary, the histologic diagnosis of IM is one of suspicion rather than certainty ([154](#)).

The lymph node architecture is generally intact ([155](#), [156](#)) but may be distorted ([154](#), [155](#), [156](#) and [157](#)). Other morphologic features mimicking lymphoma include extensive immunoblastic proliferation in sheets and nodules and significant cellular atypia ([155](#)). Clonality studies are often necessary to differentiate IM from malignant disease. The germinal centers are usually identifiable, but follicular prominence is diminished, probably because of the irregular and vaguely defined borders that result from the lymphocytic and reticuloendothelial hyperplasia of paracortical structures and, to a lesser extent, the medullary cords. This intense proliferative activity within the paracortical areas is in keeping with the characterization of atypical lymphocytes as T cells ([157](#)). In addition, focal proliferations of macrophages are noted, as is, most characteristically, the presence of “typical” IM cells throughout the pulp, on the edges of germinal centers, and in the sinuses ([156](#)). Reed–Sternberg (RS)–like cells ([154](#), [155](#), [157](#)) are often observed in association with areas of necrosis ([75](#)). Because the presence of EBV has been demonstrated in approximately 50% of Hodgkin lymphoma specimens ([158](#), [159](#) and [160](#)), the identification of the virus or EBV–determined antigens is not particularly helpful in the

differential diagnosis of these two disorders.

The spleen is striking for infiltration of its fibromuscular structures by mononuclear cells ( [161](#) ). Both the capsule and trabeculae are often thin and invaded by proliferating lymphocytes. This may explain the incidence of splenic rupture in this disease. *In vitro* hybridization studies can be used to track the distribution pattern of cells carrying the viral genome ( [43](#), [154](#), [162](#) ). Most labeled cells are found in the hyperplastic T-cell zones, the paracortical or interfollicular areas ( [43](#), [154](#), [162](#) ); smaller numbers are found within the epithelioid venules, the lymph node sinuses, and, occasionally, the germinal centers and the mantle zone ( [162](#) ). In the spleen, labeled cells are found mainly within pulp cords ( [162](#) ). Most of the labeled cells are small lymphocytes, but occasional labeled blasts, dendritic cells, and macrophages can be identified ( [162](#) ).

The bone marrow may be cellular with generalized hyperplasia of erythroid, myeloid, and megakaryocytic elements ( [163](#) ). With special techniques, sarcoidlike granulomas may also be demonstrated ( [163](#), [164](#) and [165](#) ). In most instances, however, routine marrow aspiration reveals no abnormalities of note.

## Diagnosis

The diagnosis of IM rests primarily on documentation of a primary EBV infection. Because EBV cannot be cultured, the humoral response to EBV infection, which has been discussed in the section [Immune Response to Epstein-Barr Virus Infection](#), is the usual method to discern infection. In summary, a recent, primary EBV infection is characterized serologically by (a) a positive heterophil antibody titer; (b) high titers of anti-VCA antibodies, both IgM and IgG; (c) high titers of anti-EA antibodies; and (d) the absence of anti-EBNA-1 antibodies. Convalescent sera demonstrate the disappearance of IgM anti-VCA antibodies and the appearance of anti-EBNA-1 antibodies ( [79](#), [80](#) ). Rapid test systems using recombinant EBV antigens and enzyme-linked immunosorbent or other assay technologies have been developed for use in clinical laboratories ( [166](#), [167](#) ), but false-positive tests, especially for anti-EBV IgM antibodies, are common ( [168](#) ).

Because so many antibodies have been linked to the development of IM, elevation of Ig levels in association with this disease is not surprising ( [169](#), [170](#) ). Although this change is especially true for IgM globulins, lesser elevations have also been seen in IgG and IgA globulins. The pattern of changes is similar to that seen in the normal immune response: IgM is elevated first and IgG later ( [171](#) ). A general increase in titers of IgG antibodies and production of IgM antibodies against other infectious agents is common during the primary EBV infection ( [172](#) ) and must be taken into account when performing a diagnostic workup. Antibodies with recognized antigenic specificities, such as the heterophil antibody, make up only a small proportion of the total  $\gamma$ -globulins of the serum ( [169](#), [173](#) ), and the antigenic specificity of most of the increased  $\gamma$ -globulins remains unknown.

A serologic diagnostic test for IM has been available since Paul and associates ( [85](#) ) discovered that the sera of patients with IM contain agglutinins against sheep red cells. They called the antibody *heterophi* because it reacted with a heterologous antigen that obviously had not elicited its production. Most authorities considered a positive response to the heterophil antibody test to be a *sine qua non* in the diagnosis of IM in adults. Investigators soon learned that the antibody reacted not only with sheep red cells but also with beef and horse erythrocytes ( [171](#), [174](#), [175](#) ). The heterophil antibody is an IgM globulin ( [176](#), [177](#) and [178](#) ), which, in some studies ( [179](#) ), was shown to have  $\gamma$  light chains

only. The Paul Bunnell (PB) antigen with which the heterophil antibody interacts is thermostable ( [174](#), [176](#) ), in contrast to the Forssman antigen. Its immunologically reactive sites appear to be carbohydrate in nature ( [180](#) ). The carbohydrate nature of the antigen probably explains the observation that the antibody response is almost exclusively IgM. PB antigens are found also on cells other than heterologous erythrocytes ( [176](#) ). Of particular interest is the demonstration of PB-like antigens on murine T lymphocytes, Thy-1-positive murine lymphoma cells, and murine neutrophilic granulocytes ( [176](#) ). In addition, PB antigens have been demonstrated in various tissues of IM patients during the early stages of the disease ( [176](#), [181](#) ), in cultures of some lymphoid cell lines ( [182](#) ), in fresh BL tissues ( [183](#) ), and in the spleens of some patients experiencing lymphoma or leukemia ( [176](#) ). The formation of PB antibodies by cultures of lymphocytes from IM patients also has been demonstrated ( [184](#) ).

Heterophil antibodies in titers of up to 1:28 are present in most normal persons and, occasionally, in titers of 1:56 ( [185](#) ). A study of more than 3000 IM patients showed the following age distribution of PB antibodies: 5 to 9 years of age, 4%; 10 to 14 years of age, 8%; 15 to 24 years of age, 80%; 25 to 29 years of age, 3%; and older than 30 years of age, 5% ( [186](#) ). For these reasons, the test for heterophil antibodies has been called “presumptive” ( [187](#) ), but in the presence of clinical and hematologic findings suggestive of IM and a titer of 1:256 or higher, the diagnosis of IM is likely. In patients with IM, positive heterophil reactions almost always appear during the first 2 weeks of the illness ( [Fig. 67.6](#) ). Highest titers usually are found during the second and third weeks. As a rule, positive reactions last 4 to 8 weeks, but they have been observed to persist for as short as 7 to 9 days or as long as 18 weeks ( [185](#) ). The titer bears no relation to the severity of the disease or to the leukocyte changes. Although elevated heterophil antibody titers are quite common in EBV infection, occasionally patients with other disorders produce elevated levels ( [188](#) ). Therefore, confirmatory EBV-specific antibody titers are warranted if the diagnosis is suspect (e.g., a previously documented case of IM, a young child or older adult, or unusually severe or persistent symptoms).

Molecular diagnostic techniques are useful for the demonstration of EBV in tissues and body fluids. *In situ* hybridization techniques ( [154](#), [162](#), [189](#) ), Southern blot analyses ( [190](#), [191](#) ), and the polymerase chain reaction ( [192](#), [193](#) ) are most commonly used. The use of quantitative EBV polymerase chain reaction has been evaluated for diagnostic and prognostic value in EBV-related diseases ( [193](#), [194](#) and [195](#) ). It appears that the amount of EBV DNA detectable in the blood of a patient with EBV-related disease may be useful in monitoring response to therapy in some diseases, but its value for diagnosis or prognosis still remains to be determined.

## Differential Diagnosis

The diagnosis of IM usually is not difficult. In most instances, a young adult complains of malaise, fatigue, anorexia, and a sore throat and is found to have fever, adenopathy, pharyngitis, and splenomegaly. Examination of the blood, a positive heterophil antibody test, or appropriate changes in EBV titers, or all three, confirm the diagnosis. Complications are rare, and signs of significant respiratory, cardiovascular, intestinal, urinary, or joint disease make considerations of other diagnoses mandatory.

The fever and general malaise can be seen in many infectious diseases including salmonella infections, listeriosis, brucellosis, subacute bacterial endocarditis, the lymphadenopathic form of toxoplasmosis, and malaria. Generalized lymph node enlargement, including the postauricular and occipital nodes, is also characteristic of



rubella ( [75](#) ). The pharyngitis of IM must be differentiated from acute streptococcal pharyngitis, diphtheria, and acute viral pharyngitis of other types. Beta-hemolytic streptococci are isolated relatively often from patients with classic IM ( [136](#) ). Thus, a positive throat culture for streptococci does not make a search for an EBV infection unnecessary. In addition, a palatine exanthem may be present in patients with rubella, and atypical lymphocytes have been described in this condition. Drug fever and serum sickness-like reactions may also suggest IM, because they often are characterized by fever, jaundice, lymph node enlargement, and atypical lymphocytes ( [75](#) ).

Lymphocytosis, absolute or relative, may be encountered in association with diseases other than IM. These disorders include tuberculosis, tularemia, pertussis, dengue, mumps, chickenpox, German measles, typhoid fever, infectious hepatitis, serum sickness, and various other allergic states. In association with some of these conditions, abnormal lymphocytes resembling those of IM have been observed, as mentioned previously. Leukocytosis due to small lymphocytes of normal appearance and not associated with splenomegaly, lymphadenopathy, or a positive heterophil agglutination reaction, is suggestive of acute infectious lymphocytosis.

The hematologist may be called on to differentiate IM from other more serious hematologic diseases, such as acute leukemia, especially when the patient is heterophil negative. Under most circumstances, this is easily accomplished on the basis of clinical and laboratory data. Although many leukocytes of patients with IM appear abnormal, few contain nucleoli, and thrombocytopenia and anemia are rare in these patients. The appearance of the peripheral blood is constantly fluctuating in IM, whereas this fluctuation does not happen in leukemia. Bone marrow examination is rarely necessary to differentiate IM from acute leukemia. Patients who have had IM do not have a higher incidence of leukemia, but a few cases of concurrent IM and leukemia have been reported ( [196](#), [197](#), [198](#), and [199](#) ). The differentiation of the adenopathy seen in IM from that occurring regularly in HD and in NHL can be difficult. (See section [Histologic Findings](#).)

A number of heterophil-negative, self-limiting diseases are associated with a peripheral blood picture that satisfies all of the morphologic criteria established for the diagnosis of IM; failure to recognize these illnesses can result in unnecessary lymph node or liver biopsies, bone marrow aspiration, or other irrelevant diagnostic tests. The most common causes of heterophil-negative mononucleosis-like illnesses include cytomegalovirus (CMV), rubella, hepatitis and adenoviruses, *Toxoplasma gondii*, trichinosis, human immunodeficiency virus (HIV), and human herpesvirus-6, as well as a number of bacterial infections ( [200](#), [201](#), [202](#), [203](#), [204](#), and [205](#) ). However, CMV is the most common ( [200](#), [204](#), [206](#), [207](#) ).

When CMV-mononucleosis occurs, the illness is associated with fever (94%), sore throat (31%), splenomegaly (22%), prominent lymphadenopathy (17%), and myalgias (13%) ( [200](#) ). Blood smears are indistinguishable from those seen in EBV-induced IM; most patients have abnormal liver functions, and a surprising two-thirds have hemoglobin values of less than 120 g/L ( [200](#) ). Approximately one-half of anemic individuals have evidence of hemolysis ( [200](#) ). Lymphocytosis with atypical cells is the most characteristic laboratory feature of the syndrome, and the peripheral smear may be indistinguishable from that of IM. The white cell count usually does not exceed 15.0, but, occasionally, leukemoid reactions with counts of 35.0 to 75.0  $\times 10^9/L$  are observed ( [208](#) ). The bone marrow is stated to appear normal. Normochromic normocytic anemia with varying degrees of reticulocytosis is a routine finding and, in some instances at least, appears to be associated with a positive reaction to the antiglobulin test or with cold agglutinins ( [208](#), [209](#) ). Other immunologic aberrations include rheumatoid factors, antinuclear antibodies, and

cryoglobulins ( [208](#), [210](#) ). Mildly to moderately abnormal tests of liver function are common ( [204](#) ). In most patients with CMV, the infection is mild and resolves within a few weeks; on occasion, the manifestations last for several months or longer. The diagnosis is confirmed by demonstrating the presence of IgM antibodies to CMV in virtually all cases ( [136](#), [200](#) ). Most CMV-positive, heterophil-negative patients have no anti-EBV antibodies or have uncomplicated serologic data indicating long-past EBV infections ( [200](#), [205](#) ). A few patients present with evidence of simultaneous CMV and EBV infection ( [200](#) ).

## Complications

Unusual clinical patterns and serious complications are probably seen in no more than 1% of all patients ( [138](#) ). Misconceptions about a higher incidence stem from the fact that most of the medical literature concerning IM deals with complications and from impressions of subspecialists who usually do not see patients with uncomplicated disease. The most frequent reported complications are listed in [Table 67.2](#) and [Table 67.3](#).

**TABLE 67.2. Hematologic Complications of Infectious Mononucleosis** [a](#)

---

Immune hemolytic anemia  
 Immune thrombocytopenia  
 Granulocytopenia  
 Marrow aplasia  
 Virus-associated hemophagocytic syndrome  
 Acquired immune deficiencies

<sup>a</sup> See text for references.

---

**TABLE 67.3. Nonhematologic Complications of Infectious Mononucleosis**

---

Splenic rupture ( [242](#), [243](#), [244](#) and [245](#) )  
 Neurologic complications  
   Guillain-Barré syndrome ( [246](#), [247](#), [248](#) and [249](#) )  
   Encephalitis ( [250](#), [251](#), [252](#), [253](#) and [254](#) )  
   Reye syndrome ( [255](#) )  
   Meningitis ( [247](#), [256](#), [257](#) )  
   Meningoencephalitis ( [247](#), [258](#), [259](#) )  
   Cranial nerve palsies ( [250](#), [259](#), [260](#) and [261](#) )  
   Optic neuritis ( [141](#), [262](#) )  
   Peripheral neuropathy ( [263](#), [264](#), [265](#), [266](#) and [267](#) )  
   Cerebellar ataxia ( [268](#), [269](#) and [270](#) )  
   Transverse myelitis ( [271](#), [272](#) )  
 Cardiac complications  
   Electrocardiography changes ( [142](#), [273](#) )  
   Pericarditis ( [274](#), [275](#) and [276](#) )  
   Myocarditis ( [87](#) )  
 Respiratory complications  
   Acute airway obstruction ( [277](#), [278](#) )



Pleural effusion ( [279](#), [280](#) and [281](#))  
Parenchymal changes ( [279](#), [280](#), [282](#))  
Liver failure ( [242](#), [283](#), [284](#) and [285](#))  
Pancreatitis ( [286](#), [287](#))  
Renal failure ( [288](#))

---

Hematologic complications are the most common. The incidence of hemolytic anemia may be as high as 3% ( [211](#), [212](#) and [213](#)). Hemolysis usually is mild; in approximately 70% of the patients with hemolytic anemia, the reaction to the antiglobulin test (or Coombs test) is positive, and in approximately the same number, the titers of cold agglutinins are increased ( [213](#)), usually with anti-i specificity ( [217](#), [218](#)). Occasionally, hemolysis has been attributed to anti-i antibodies ( [214](#)), and occasional cases of hemolysis caused by Donath–Landsteiner cold hemolysins have been reported ( [215](#), [216](#)). Although the cold agglutinins are specific for the red cell antigen i, a similar incidence of anti-i antibodies (70%) is found also in patients without hemolysis ( [217](#), [218](#)), and the role of these antibodies in red cell destruction is therefore unclear. In summary, anti-i antibodies are extremely common, but hemolytic anemia is rare ( [217](#), [219](#), [220](#) and [221](#)). Sometimes, however, no antibody of any kind is detectable. IM has been associated with accelerated hemolysis in patients with underlying hereditary spherocytosis ( [222](#), [223](#)), elliptocytosis ( [224](#)), or thalassemia ( [225](#)), and in one patient, the onset of paroxysmal nocturnal hemoglobinuria coincided with the development of IM ( [226](#)).

Hematologic cytopenias are common. Although mild depression of the platelet count (100 to 140  $10^9$ /L) may be found in perhaps one-half of patients with IM ( [151](#)), thrombocytopenic purpura is a rare complication that is seen primarily in younger children ( [227](#), [228](#) and [229](#)). Thrombocytopenia occurring in acute IM has been attributed to increased destruction by an enlarged spleen or the production of platelet autoantibodies ( [230](#), [231](#)). Occasionally, immune thrombocytopenia precedes the development of severe aplastic anemia ( [228](#)). Mild granulocytopenia is a common finding in patients with IM ( [234](#), [243](#)), but severe granulocytopenia is rare ( [232](#), [233](#), [234](#), [235](#), [236](#), [237](#) and [238](#)). When marrow examination has been performed, myeloid hyperplasia has been noted with increased numbers of promyelocytes—but with depletion of more mature neutrophilic cells ( [232](#), [238](#)). This picture is compatible with a proliferative response to an earlier marrow injury or peripheral destruction or increased use of granulocytes. Serious suppression of the entire marrow is rare ( [213](#), [239](#), [240](#) and [241](#)). Fatal aplastic anemia has been noted after what appeared to be typical IM ( [191](#), [213](#)) but is more commonly associated with hemophagocytic reactions (VAHS or EBV–HLH).

One of the most common reported complication is splenic rupture, which has led to death in several cases ( [242](#), [243](#) and [244](#)) but has been reported to occur with an incidence of 0.1 to 0.2% in North America. Of the 107 cases reported in the world literature up to 1978, only 18 were considered “spontaneous” by one reviewer ( [244](#)). The diagnosis of a ruptured spleen should be entertained whenever a patient with IM has severe or even moderate pain below the left costal margin, especially if the pain is accompanied by radiation to the left shoulder and supraclavicular area, or has evidence of impending peripheral vascular collapse. Other signs include those characteristic of peritoneal irritation, abdominal tenderness, and shifting dullness if massive intraabdominal bleeding has occurred. Frank rupture may be preceded by one or more episodes of subcapsular

hemorrhage or minor capsular tears, which may be difficult to differentiate from rupture. Because potentially fatal bleeding may occur at any time, it is recommended that surgical intervention be pursued whenever the typical pain pattern is accompanied by signs of hemodynamic instability ( 243 , 245 ). Delayed surgical intervention often is attributable to the misconception that abdominal pain is a common feature of the uncomplicated disease. Preservation of splenic function by surgical repair of the capsular tear (splenorrhaphy) or partial splenectomy has been recommended by some but is not generally recommended, as the altered splenic architecture in IM makes it unlikely that such interventions will be successful ( 243 , 245 ).

Complications of almost all organ systems have been described in association with IM ( 289 ) and are listed in [Table 67.3](#). Neurologic manifestations are not infrequent in IM and may occur in 1 to 2% of patients ( 244 , 247 , 249 ). When serious neurologic complications occur, the mortality rate may be as high as 8 to 11% ( 256 ), and, in addition, the incidence of serious residual damage may be as high as 12% ( 256 ). Cardiac complications are rare, although electrocardiographic abnormalities may occur in approximately 10% of patients ( 142 , 273 ). A case of fatal myocarditis has been reported in association with IM ( 87 ). The most serious respiratory complication is acute airway obstruction, which usually is the result of extreme hyperplasia of the tonsils and other pharyngeal lymphatic tissue ( 277 , 278 ). Pleural effusion and pulmonary parenchymal changes are exceedingly rare ( 279 , 280 , 281 and 282 ), but occasional cases are characterized by extensive interstitial infiltrates (lymphoid interstitial pneumonitis), and severe respiratory insufficiency has been reported ( 280 ). Evidence for some degree of hepatic involvement is found in most patients but is usually mild; the necrosis and inflammatory exudate seen in association with infectious hepatitis are encountered only rarely ( 242 , 283 , 284 and 285 ). Liver failure is rare ( 242 , 283 ) but appears to be a prominent feature in fatal cases of IM [fulminant infectious mononucleosis (FIM) or EBV–HLH] ( 283 ), including those associated with subtle forms of immune deficiency ( 283 ). Acute pancreatitis has been associated with IM ( 286 , 267 ). An association between IM and irreversible renal failure was postulated in one patient ( 288 ).

## Treatment

Most patients experiencing uncomplicated acute IM require only symptomatic therapy. Bed rest is recommended for patients with fever, malaise, and myalgias. Strenuous exercises, especially contact sports, should be avoided for at least 1 month or until resolution of splenomegaly. Nonsteroidal antiinflammatory drugs, such as acetaminophen or ibuprofen, should be used to control pain, although in patients with severe hepatitis, these agents should be used judiciously. It has been suggested that aspirin may prolong convalescence ( 290 ). Aspirin also interferes with platelet function, potentially increasing the risk of bleeding in thrombocytopenic patients, and Reye syndrome has been reported in association with IM, albeit rarely ( 255 ). Antibiotics are of no value in uncomplicated IM, but many patients show culture or serologic evidence of a recent streptococcal infection ( 136 ), and these should be treated with appropriate antibiotics. Ampicillin and amoxicillin should be avoided because they often cause a severe rash ( 136 , 143 , 145 , 146 ).

Corticosteroids have been used in cases of life-threatening complications such as airway obstruction, carditis, lymphoid interstitial pneumonitis, pleural effusions, or cerebral edema. Their efficacy is largely anecdotal and is presumably due to their antiinflammatory and lympholytic properties. The cumulative results of several small, controlled clinical trials suggest that corticosteroids hasten the resolution of fever and tonsillopharyngeal symptoms but do not provide significant benefits in the therapy of lymphadenopathy or

hepatosplenomegaly ( [13](#), [291](#), [292](#) and [293](#) ). Caution should be exercised when using corticosteroids ( [294](#) ). There are reports of encephalitis or myocarditis in association with steroid use in IM ( [293](#), [295](#) ), and secondary bacterial and fungal infections can occur. However, in the face of severe complications, the use of steroids may well be indicated and necessary ( [290](#), [294](#), [296](#), [297](#) ).

Several antiviral agents such as acyclovir, ganciclovir, zidovudine, foscarnet, and the interferons (IFNs) have been shown to inhibit the replication of EBV *in vitro* ( [298](#) ). Only the linear form of the genome, not the latent circular form, is susceptible to inhibition. The efficacy of acyclovir in the therapy of uncomplicated IM has been assessed in several controlled trials ( [299](#), [300](#), [301](#), [302](#) and [303](#) ). In general, acyclovir inhibited viral shedding during the time of therapy, but viral shedding resumed when therapy was discontinued ( [13](#) ). The trials documented few clinical benefits as measured by duration of illness and sore throat, weight loss, or absence from school or work, even when acyclovir was given in combination with steroids ( [293](#), [303](#) ). IFN- $\alpha$  has been used in a few patients experiencing persistent EBV infection with severe complications of interstitial pneumonitis, encephalitis, or genital ulcers, apparently with some success ( [304](#) ). Patients with IM-associated immune thrombocytopenia have responded to therapy with large doses of intravenously administered  $\gamma$ -globulin ( [231](#) ). A viral protein vaccine has been developed, that protects marmosets from developing lymphoproliferative disease ( [305](#), [306](#) ) but not from infection. Several groups are working on the development of EBV vaccines ( [307](#), [308](#), [309](#) and [310](#) ), but with the tight MHC restriction of the CTL response, large-scale population studies are problematic. Therefore, the use of the vaccine in the prevention of IM is controversial, but it may be beneficial in endemic areas of BL or NPC ( [308](#), [309](#) ).

## Prognosis

IM is rarely fatal, and the prognosis for a complete recovery within 2 months occurs in the majority of patients. Because recurrences of IM are extremely rare, one must question either the initial or the present diagnosis. IM is fatal in approximately 1 in 3000 cases, or approximately 50 cases annually in the United States ( [78](#), [311](#) ). Penman ( [242](#) ), in reviewing the world literature on IM, catalogued 87 fatalities attributed to the disease or its complications. Only 20 of these reports, however, contained adequate evidence for an unequivocal diagnosis. Of these 20 cases, 9 fatalities were related to neurologic complications, 4 were related to respiratory failure from peripheral neuropathy of the Guillain-Barré type, and 5 were related to central respiratory paralysis; 3 were related to splenic rupture; and 3 were related to secondary infection. Other fatal complications included hepatic failure (two cases) and myocarditis (one case). In two cases, the cause of death was unrelated to IM. The majority of deaths associated with IM occur in patients who develop VAHS or EBV-HLH ( [78](#), [311](#) ).

## OTHER EPSTEIN-BARR VIRUS-RELATED DISEASES

Recently, methods for detecting infectious agents in human disease have become highly developed. Consequently, many ubiquitous infectious agents have been etiologically linked to certain human diseases (e.g., EBV infection has been associated with a wide spectrum of human diseases). Classically, EBV is associated with the development of human malignancies such as BL and NPC. EBV infection has also been associated with other human malignancies, such as NHL (B-cell, T-cell, and NK-cell phenotype), HD, gastric carcinoma, leiomyosarcoma, hepatocellular carcinoma, breast cancer, and LPDs, which may occur in patients with primary or secondary immunodeficiencies. In addition, EBV infection has been associated with several nonmalignant, but often fatal, human diseases,

such as VAHS or EBV-HLH, and CAEBV, in which development of malignant lymphoma can occur. Although association has been demonstrated, it remains controversial whether EBV is causative in these disorders. The following discussion focuses on diagnosis of and evidence for the role of EBV in the pathogenesis of these diseases.

### Chronic Active Epstein-Barr Virus Infection

EBV rarely causes recurrent or persistent symptomatic infections in apparently immunocompetent hosts. CAEBV is characterized by persistent or recurrent IM-like symptoms, such as recurrent fever, lymphadenopathy, and hepatosplenomegaly, and unusual anti-EBV antibody patterns (317). Diagnostic criteria for CAEBV have been proposed by Strauss (318) and Okano (317) and consist of (a) evidence of severe, progressive EBV illness beginning as a primary EBV infection and lasting more than 6 months with anti-EBV titers of IgG anti-VCA =1:5120, anti-EA =1:640, or anti-EBNA <1:2, or all three; (b) histologic evidence of major organ involvement; and (c) increased amounts of EBV in peripheral blood or affected tissues, or both. CAEBV occurs most commonly in patients who develop IM as older children or young adults (317, 319). This entity may be more prevalent in Asia, as most of the published literature is from Japan. Recently, Kimura et al. reported 30 patients with CAEBV; the mean age was 14 years with a range from 5 to 31 years of age (319). Manifestations of CAEBV in this cohort were fever (100%), liver dysfunction (90%), splenomegaly (90%), lymphadenopathy (50%), thrombocytopenia (50%), anemia (50%), hypersensitivity to mosquito bites (43%), calcification in the basal ganglia (18%), and oral ulcer (18%). Only two-thirds of these patients had elevated anti-EBV titers fitting the diagnostic criteria mentioned above, but all had high levels of EBV DNA in the peripheral blood detected by the quantitative polymerase chain reaction.

In the peripheral blood of patients with CAEBV, high levels of EBV DNA have been found in CD4<sup>+</sup> T cells and NK cells, but not in B cells (320). The significance of this finding in the pathogenesis of CAEBV and the mechanism of infection of these cells, because they lack the CD21 receptors, remain to be elucidated. However, the predominant cell type infected by EBV may have prognostic value. One study showed that patients with a predominance of infected T cells have higher titers of anti-EBV antibodies and shorter survival than patients with a predominance of NK-cell infection (319). Although EBV is believed to be the etiologic agent in CAEBV, the precise underlying pathogenic mechanisms remain uncertain. However, it is believed that cellular immunologic abnormalities are responsible for the development of CAEBV because many patients showed defective NK-cell activity and extremely high levels of circulating cytokines such as IL-10 (321).

CAEBV can be lethal, with a 30 to 50% mortality within 5 years of diagnosis (30, 319). Life-threatening complications include the hemophagocytic syndrome (21%), coronary artery aneurysm (21%), hepatic failure (18%), malignant lymphoma (16%), and interstitial pneumonia (12%) (319). The majority of deaths are due to hemophagocytic syndromes or hematologic malignancies, which may be of T-cell, B-cell, or NK-cell phenotype (30, 319).

Jones et al. first reported three patients with T-cell lymphoma infected with EBV, who had grossly elevated antibody titers against EBV-replicative antigens such as VCA and EA (322). During the 1980s, approximately 30 similar patients were reported, mainly from industrialized countries. More recently, a distinct clinicopathologic syndrome was proposed, called "fulminant EBV-positive T-cell LPD following acute/chronic EBV infection" (323). This entity may overlap with severe or fulminant IM (FIM or EBV-HLH) and CAEBV. Further studies are needed to differentiate between these enigmatic

disorders and determine the role of EBV infection in their pathogenesis.

A standard treatment approach to CAEBV has not been established. Most reports are anecdotal but include antiviral agents (acyclovir, ganciclovir, and vidarabine) ( [317](#), [319](#), [324](#), [325](#) ) and immunomodulating agents (IFN- $\alpha$  or IL-2) ( [319](#), [326](#), [327](#) ). Immunochemotherapy (e.g., etoposide, corticosteroids, and cyclosporin A), which has been effective in treating the EBV-hemophagocytic syndrome, has been used to control symptoms and treat hemophagocytic complications ( [319](#) ). Hematologic malignancies have been treated with standard NHL therapy ( [319](#) ), but curative therapy for the severely affected patient appears to require the replacement of the patient's immune system with a normally functioning immune system to control the EBV infection—for instance, by an allogeneic stem cell or marrow transplant ( [319](#), [328](#) ) or by allogeneic adoptive T-cell therapy ( [329](#) ).

CAEBV infections should be differentiated from the so-called chronic mononucleosis, or chronic fatigue syndrome. Due to the similar symptoms and reports of elevated anti-VCA and EA titers, EBV has been suggested to be the etiologic agent in the chronic fatigue syndrome ( [330](#) ). In controlled studies, no specific EBV serologies have been found that differentiate chronic fatigue syndrome patients from controls ( [331](#) ). In a randomized, placebo-controlled trial of acyclovir, clinical improvement was seen as frequently with the placebo ( [332](#) ). Chronic fatigue syndrome has been associated with other infections (viral and bacterial) and, therefore, should not be considered a disease caused by EBV ( [333](#), [334](#) ).

### **Fulminant Infectious Mononucleosis or Epstein-Barr Virus-Associated Hemophagocytic Lymphohistiocytosis**

The self-limited course of IM contrasts with the atypical responses that can occur in FIM, also called *VAHS* or *EBV-associated HLH* ( [74](#) ). Death occurs in approximately 1 in 3000 IM cases, or approximately 50 cases annually in the United States ( [78](#), [311](#) ). The median age at presentation of FIM/EBV-HLH is similar to that of uncomplicated IM (i.e., 13 years of age). Whereas FIM/EBV-HLH is the most common manifestation in males affected with XLP, it often occurs outside the context of XLP ( [74](#), [75](#), [311](#), [335](#), [336](#) ). In the latter cases, the male to female ratio is approximately 1:1 ( [311](#) ). VAHS has been associated with CMV, herpes simplex virus, and adenovirus, but EBV is the most common ( [74](#), [337](#), [338](#) ). Clinically, FIM/EBV-HLH is indistinguishable from other types of VAHS, familial HLH, and the accelerated phase of Chédiak-Higashi disease ( [74](#), [75](#), [338](#) ). Because FIM/EBV-HLH is rare, a search for a heritable immune deficiency in family members is mandatory.

Patients who progress to FIM/EBV-HLH initially present with the usual signs and symptoms of IM, but these symptoms are often more severe ( [311](#) ). The usual EBV antibody responses vary considerably and may be lacking or unusually high; therefore, it may be difficult to differentiate FIM/EBV-HLH from other hemophagocytic syndromes, CAEBV, acute leukemia, other malignancies, or even overwhelming sepsis ( [75](#), [311](#), [335](#) ). The course and progression of the disease are variable, ranging from multiorgan failure developing over hours to persistent or recurring symptoms of IM lasting for months. An atypical lymphocytosis usually is present at early stages of the disease, but patients subsequently develop severe, persistent pancytopenia, hepatic dysfunction resulting in fulminant hepatitis, meningoencephalitis, and varying degrees of myocarditis ( [75](#), [311](#), [335](#), [339](#) ). The development of hepatic dysfunction, often with coagulation abnormalities secondary to liver failure or disseminated intravascular coagulation, and pancytopenia is an ominous sign, as are other signs of hemophagocytic syndromes, such as



hypofibrinogenemia and elevated triglyceride levels ( 74 , 75 , 311 , 335 , 336 , 338 ).

As discussed previously, EBV is a potent stimulus to the immune system, resulting in a massive EBV-specific and -nonspecific response of both the humoral and cellular immune systems ( Fig. 67.5 ). In FIM/EBV-HLH, the EBV-nonspecific response, primarily the cellular immune response, is uncontrolled. FIM/EBV-HLH is characterized by extensive infiltration of parenchymal organs by lymphoid cells, primarily CD8<sup>+</sup> cells in varying degrees of transformation and histiocytes with surprisingly few B cells ( 74 , 337 , 340 ). The cells infected by EBV in FIM/EBV-HLH are usually T cells ( 74 , 320 , 323 ) and are generally CD8<sup>+</sup>, as opposed to the CD4<sup>+</sup> or NK cells observed in CAEBV ( 320 ).

If this aggressive immune reaction proceeds unabated, all organs ultimately sustain extensive damage ( 74 , 75 , 311 , 335 , 341 ). Early in the course of the disease, the bone marrow may be hypercellular with few infiltrating histiocytes; erythrophagocytosis is seen best in smears of marrow aspirates. The marrow later becomes hypocellular with varying numbers of infiltrating histiocytes ( 337 ). Lymph nodes initially show an intense lymphoblastic proliferative response, again primarily T cells, but later, lymphoid depletion supervenes ( 337 ). Liver biopsies reveal active portal infiltration with lymphocytes and histiocytes, with occasional erythrophagocytosis in liver sinusoids ( 337 ). In the spleen, extensive necrosis of white pulp develops. Perivascular mononuclear cell infiltrates of the brain, mononuclear cell myocarditis, and interstitial nephritis also are observed ( 75 , 335 , 336 , 339 , 342 , 342a , 343 ). The thymus shows thymocyte depletion and necrosis of thymic epithelia, reminiscent of that observed in experimental and human graft-versus-host disease (GVHD) ( 344 , 345 ) and acquired immunodeficiency syndrome (AIDS) ( 345 ). Increased serum levels of IL-2, IFN- $\gamma$ , IL-6, TNF- $\alpha$ , and soluble IL-2 receptors have been demonstrated ( 74 , 346 ). The T cells that are activated in response to EBV are believed to stimulate and activate macrophages, the major source of IL-6 and TNF- $\alpha$ . This reaction culminates in the phagocytosis, tissue destruction, and cellular depletion seen in FIM/EBV-HLH ( 74 , 75 ), and death usually follows shortly thereafter due to multisystem organ failure.

Once FIM/EBV-HLH develops, therapy is difficult and usually unsuccessful, with a median survival time of approximately 4 weeks ( 311 , 335 ). Antiviral drugs, Igs, IL-2, IFN- $\alpha$ , IFN- $\gamma$ , plasmapheresis, corticosteroids, and most cytotoxic drugs have been ineffective ( 74 , 78 ). There is one report of 20 patients with IM and hemophagocytosis, but lacking severe symptoms of FIM/EBV-HLH, successfully treated with chloroquine ( 347 ). The most consistent success in the treatment of FIM/EBV-HLH is with the early use of etoposide, which reduces the activity of stimulated macrophages *in vitro* ( 348 , 349 and 350 ).

Combinations of etoposide and intravenous Igs have been recommended by others ( 74 , 350 , 351 and 352 ). The best results appear to be obtained with a combination of etoposide and concomitant immunosuppression with corticosteroids and cyclosporin A or tacrolimus (FK506) ( 74 , 78 , 350 ). Therapy may have to be continued for 6 to 12 months. These patients are profoundly immunocompromised from their disease and the therapy. Therefore, a successful outcome is dependent on control of FIM/EBV-HLH symptoms as well as the prevention and successful treatment of life-threatening infectious complications. Even with remission of symptoms, recurrences are common and carry a poor prognosis. For the patient with severe or recurrent disease, curative therapy may involve replacement of the patient's immune system with a normal immune system by allogeneic stem cell or marrow transplantation ( 350 , 353 ).

## Epstein–Barr Virus–Associated Disorders in Immunodeficiency

In the mid–1970s, Purtilo et al. described XLP, in which affected males were thought to have a specific immunodeficiency to EBV, resulting in severe or fatal IM, malignant lymphoma, hypogammaglobulinemia or agammaglobulinemia, or aplastic anemia ( [354](#) ). Later, it was noted that patients with ataxia telangiectasia, a primary immunodeficiency, had high antibody titer responses against EBV–replicating antigens, and EBV genome–positive malignant lymphomas were observed ( [355](#), [356](#) ). Similar antibody patterns and EBV–associated B–cell LPDs (EBV–LPD) were also reported in patients with Wiskott–Aldrich syndrome ( [357](#) ). With more efficacious immunosuppression, EBV–LPD was also observed more frequently in recipients of organ and marrow transplants, whereas stopping or decreasing the dose of immunosuppressants sometimes resulted in the regression of EBV–LPD, suggesting that a deficiency of immunosurveillance was responsible for the development of EBV–LPD in such patients ( [358](#) ). In the late 1980s, an increased incidence of EBV–LPD, including BL, was reported in association with a growing number of patients with AIDS ( [359](#) ). In recent years, advances in the treatment of autoimmune disorders, the expanding number of organ transplants, and the spread of HIV have dramatically increased the number of patients at risk of EBV–associated diseases. However, not all LPDs seen in immunodeficient patients are associated with EBV. This raises the question of the specific role of EBV in the pathogenesis of LPD in immunodeficiencies.

**PRIMARY IMMUNODEFICIENCIES** As mentioned previously, the main immune defense against EBV–driven B–cell proliferation is EBV–CTLs. Patients with primary immunodeficiencies often lack T–cell functions, which may manifest as insufficient EBV–CTL activity. There are numerous reports of the occurrence of EBV–LPD in patients with a primary immunodeficiency disease (e.g., ataxia telangiectasia, Wiskott–Aldrich syndrome, Chédiak–Higashi syndrome, severe combined immunodeficiency, and common variable immunodeficiency) ( [360](#) ). Generally, type III EBV latency is predominantly seen in these lymphomas ( [30](#), [360](#) ), suggesting a lack of appropriate EBV–CTL immunosurveillance (see section [Immune Response to Epstein–Barr Virus Infection](#)). Additionally, relapses are common and may not represent failure to eradicate the original clone, but a new clonal proliferation ( [361](#) ). These data underscore the role of immunosurveillance in the pathogenesis of these malignancies. The treatment is often difficult because of the underlying serious immunodeficiency and genetic susceptibility to chemotherapeutic agents. Antiviral therapy has had little effect in the treatment of EBV–LPD in primary immunodeficiency ( [362](#) ). Patients with antibody deficiencies, but at least partial T–cell immunity, have been treated successfully with IFN–α ( [362](#) ). Although complete remissions can be achieved with chemotherapy, immunodeficient patients with NHL have a far inferior outcome compared to those expected for immunocompetent children with NHL receiving similar therapy ( [363](#), [364](#) ). These poor results are due to increased toxicity of chemotherapy, especially in ataxia telangiectasia patients, but also increased fatal infections and NHL relapses. Because recurrences can be of different clonal origin, successful treatment depends on controlling B–cell proliferation by developing appropriate EBV–CTL immunity. In the majority of cases, the only way to achieve this is allogeneic bone marrow transplantation (BMT) ( [353](#), [361](#), [362](#) ).

**X–Linked Lymphoproliferative Disease** In 1974, there were two reports of maternally related boys dying of IM ( [354](#), [365](#), [366](#) ). In 1975, Purtilo described a kindred, in which 6 of 18 boys died of a lymphoproliferative disease associated with EBV infection ( [365](#) ). XLP has also been called *Duncan disease*, after the original kindred, or *Purtilo disease*. XLP is a rare disorder, affecting an estimated 1 out of every 1 million male individuals ( [336](#) ).



Initially, three phenotypes were described in XLP patients, and these continue to characterize the majority of patients: FIM, malignant lymphoma (LPD), and dysgammaglobulinemia (336). Less commonly reported manifestations include disorders such as vasculitis, pulmonary lymphomatoid granulomatosis, and hematologic cytopenias, including aplastic anemia and pure red cell aplasia (336, 341, 367, 368). The “disease state” is capricious, as it may feature a single phenotype or two or more phenotypes, which may develop sequentially in susceptible individuals (336, 369). Reflecting on the ubiquitous nature of EBV infection, FIM is the most common XLP phenotype, affecting approximately 50% of patients in the XLP registry (336, 368, 369). FIM is decidedly the most lethal of the XLP phenotypes, as most of the boys die within 1 month and only 7% of FIM patients have survived (367). The median age of onset for XLP-associated FIM is 5 years of age, but the condition has occurred up to 40 years of age. The pathology and clinical findings of FIM associated with XLP are identical to those seen in patients without XLP, as discussed previously. Interestingly, 39% of XLP patients with evidence of current or prior EBV infection never develop FIM (369). This observation puts into question the role of EBV and the immunologic defect caused by the genetic abnormality in XLP. Dysgammaglobulinemia is the second most common XLP phenotype, affecting approximately one-fourth of boys (336, 368, 369). Most boys developing this phenotype demonstrate global decreases of serum Ig levels. However, some featured increased levels of IgM or IgA, or both, as well as variable deficiencies in IgG1 and IgG3 subclasses (370). Although hypogammaglobulinemia often occurs after EBV infection, some XLP patients develop hypogammaglobulinemia without prior evidence of EBV infection (369). Mice with the XLP gene “knock-out” can manifest progressive hypogammaglobulinemia (J. Sumegi, personal communication, June 2002). The pathogenesis of dysgammaglobulinemia in XLP has not been delineated. An LPD develops in approximately one-fourth of XLP patients (336, 368, 369). Most lymphomas are of B-cell phenotype and are characterized by a small noncleaved (Burkitt) or diffuse large cell histology (75, 371). Karyotypic analysis has not been extensively performed; however, the t(8;14) associated with BL is rare (372, 373). Approximately 10% of LPDs are not of B-cell phenotype, including a small number of patients with HD or T-cell LPDs, including lymphoblastic lymphoma, lymphomatoid granulomatosis, or angiocentric immunoproliferative lesions (75, 367). As in other immunodeficiencies, the role of EBV in the LPD of XLP is unclear, because approximately one-half of the boys with LPD have had no evidence of prior EBV infection, and EBV is detectable in only 25% of tumor specimens (367, 369). Distinct from the marrow depletion seen with FIM, a limited number (4%) of boys have developed isolated hematologic cytopenias (336, 368, 369). Most manifest with suppression of two or more hematologic cell lines, including aplastic anemia, but pure red cell aplasia has also been observed. Again, the role of EBV in this manifestation of XLP is unclear, as 40% of cases observed in XLP have occurred without evidence of prior EBV infection (369). Initially, it was thought that males affected with XLP only manifested symptoms after primary EBV infection. Although IM is, by definition, caused by EBV, other XLP phenotypes developed in EBV-seronegative patients (369, 374). Data from the XLP registry demonstrated that at least 12.5% of affected boys manifest symptoms of XLP before exposure to EBV (336, 368, 369). There is no difference in the age of onset of clinical symptoms between males that have or have not been previously exposed to EBV (369). Therefore, prevention of EBV infection in boys with XLP does not avert clinical manifestations. In addition, whereas approximately 40% of the boys develop FIM after primary infection with EBV, others develop LPD, dysgammaglobulinemia, and hematologic cytopenias, and a few have no symptoms (369). These data suggest that other genetic or environmental factors, or both, influence host susceptibility to EBV and are important in determining the clinical phenotype of XLP. Before the isolation of *SH2D1A*, the gene known to be absent or mutated in XLP, it was often difficult to make a diagnosis of XLP based solely on clinical or laboratory features. Laboratory investigations of lymphocyte

numbers, immunophenotype, and function were generally unhelpful because results were either normal ( 367, 375, 376 ) or hard to interpret due to immune depletion resulting from primary EBV infection or lymphoma treatment. Evaluation of humoral responses gave inconsistent results, with some patients displaying normal values ( 375 ) and others demonstrating increases in IgA or IgM (or both), as well as variable deficiencies in the levels of total IgG or the IgG1 and IgG3 subclasses ( 370 ). The only consistent findings were lack of anti-EBNA responses in EBV-infected males and inability of IgM to switch to IgG after secondary challenge with FX174 bacteriophage ( 377 ), although these findings can be seen also in other inherited T-cell deficiencies. Investigations of EBV-specific immunity have been more controversial. Based on these issues, establishing an XLP diagnosis used to rely on the identification of two or more maternally related males demonstrating a characteristic phenotype usually after EBV infection ( 378 ). Now, the diagnosis can more easily be made based on the identification of an abnormal *SH2D1A* gene sequence ( 369 ) or protein expression ( 379 ). Although only 50% of their lymphocytes express *SH2D1A* on average, due to random X-chromosome inactivation ( 380 ), female carriers display no overt clinical manifestations of XLP. Molecular analysis should be pursued in females at risk of being a carrier to provide accurate genetic counseling. Recent genetic studies have also demonstrated that *SH2D1A* mutations can arise in affected boys whose mothers do not have a mutated gene ( 381 ). One might predict that mutations that delete the XLP gene or truncate the protein would be more likely to be associated with a severe phenotype, whereas missense mutations would occur preferentially in mildly affected patients. Attempts to correlate mutations of the *SH2D1A* gene and the clinical manifestations of XLP found that it was not uncommon to observe different phenotypes with identical mutations, even within the same family ( 369 ). No significant differences were observed in the phenotypes or severity of disease based on the type (missense, nonsense, truncating) or localization of *SH2D1A* mutations. The age of onset of clinical manifestations of XLP varied considerably, from younger than 1 to 40 years of age, as did survival, but there was no correlation with the type of mutation. Therefore, genetic analysis does not predict the phenotype or severity of disease. The *SH2D1A* gene codes for a protein of 128 amino acid residues that consists of an SH2 domain and a 25-amino acid C-terminal tail ( 382, 383 ). *SH2D1A* is expressed throughout thymocyte development, as well as in CD4<sup>+</sup> and CD8<sup>+</sup> peripheral T cells ( 384 ). In contrast to T lymphocytes, *SH2D1A* has a more limited expression in B cells ( 384 ). The *SH2D1A* protein appears to function in the regulation of immune responses. The *SH2D1A* protein interacts with several proteins, including SLAM ( signaling lymphocyte activating protein; CD150), also called *SLAM-associated protein* ( 383 ). SH2D1A/SLAM-associated protein also has been demonstrated to interact with members of the CD2 superfamily of molecules, including CD2, CD48, CD583, CD84, Ly-9, and 2B4, and with a new family of RasGAP adapter proteins such as p62Dok [Dok ( downstream of kinases)-1], p56Dok (Dok-2), and Dok-3 ( 385, 386, 387, 388 and 389 ). The immunologic effects of *SH2D1A* interactions with these proteins are under investigation. Mice genetically deficient in *Sh2d1a* (the murine homolog) expression have been generated ( 390 ). Consistent with human XLP, mutant animals are viable and fertile, transmit the gene defect in an X-linked mendelian fashion, and display no significant defects in the number and phenotype of developing thymocytes or circulating T, B, or NK cells. After infection, however, *Sh2d1a*-deficient mice recapitulate important aspects of the human disease. For example, these mice exhibit abnormal lymphocyte responses to lymphocytic choriomeningitis virus, a virus that, like EBV, elicits large CD8<sup>+</sup> cytotoxic T-cell responses ( 390 ). In comparison to T-cell hyperactivation, B-cell responses appear to be blunted, with the numbers of total and lymphocytic choriomeningitis virus-specific antibody-secreting cells decreasing dramatically over time ( 391 ). Previous investigations of XLP patients have demonstrated elevated levels of IFN- $\gamma$  and IL-2 during IM ( 367 ), suggesting that a bias toward production of T-helper cell-type (Th1) cytokines may contribute to the overwhelming

macrophage activation after primary EBV infection. In agreement with this human clinical observation, *Sh2d1a*-deficient mice produce more IFN- $\gamma$  after *in vitro* as well as *in vivo* stimulation ( 390 ). The increased T-cell activation, biased Th1 cytokine secretion, and defects in antibody production that occur in *Sh2d1a*-deficient mice suggest that they will provide a valuable tool with which to better understand FIM/EBV-HLH and how *Sh2d1a* may regulate *in vivo* immune responses to viral and other infectious agents. XLP is highly lethal; 75% of patients have died by 10 years of age, although the oldest known survivor is 49 years of age ( 336 , 367 ). Antiviral therapies, including acyclovir, ganciclovir, intravenous Ig, and IFN- $\alpha$  have been used to treat primary EBV infection; none has been particularly effective ( 367 ). The only therapy that has been consistently beneficial for males with FIM is etoposide and immunosuppression, as discussed previously ( 336 , 367 ). Recently, a patient with FIM was successfully treated with corticosteroids and monoclonal anti-CD20 antibody (K. Nichols, personal communication, June 2002). Even with remissions, relapses are invariable. Therefore, an allogeneic BMT is recommended once the patient's condition is stabilized and a suitable donor has been identified ( 353 , 361 , 391 ). Patients with hypogammaglobulinemia require regular Ig supplementation to prevent bacterial and viral infections. However, Ig infusions do not offer the guarantee of protection from primary EBV infection in an EBV-seronegative patient ( 336 , 367 , 369 ). For patients with lymphoma or hematologic cytopenias, standard therapeutic protocols suffice. Although treatment can induce disease remissions, relapses and other XLP phenotypes invariably occur, and allogeneic BMT is recommended ( 353 ). With definitive diagnosis by genetic mutational analysis, BMT now can be performed before the appearance of clinical manifestations of the disease ( 391 ).

**SECONDARY IMMUNODEFICIENCIES** It is well recognized that patients infected with HIV and experiencing AIDS, as well as transplant recipients, are at increased risk of developing LPDs that are often associated with EBV. Rarely, elderly patients, malnourished patients, and those with cancer develop EBV-associated atypical lymphoproliferation ( 75 , 392 ). EBV-induced LPDs have been reported in patients without severe immunodeficiency (i.e., individuals who received methotrexate as treatment for rheumatoid arthritis) ( 393 ). Therefore, a high index of suspicion is warranted in any patient who may be immunosuppressed.

**Human Immunodeficiency Virus/Acquired Immunodeficiency Syndrome** Patients with AIDS or the AIDS-related complex often show signs of EBV reactivation, including a transient elevation of antibodies to EBV antigens ( 394 ), an expanded pool of EBV-infected B cells in the peripheral circulation ( 395 ), and an increased production of the ZEBRA protein, that triggers viral replication and transactivates other genes that up-regulate the expression of early gene products essential for viral replication ( 13 , 66 , 396 ). In addition, there is an increase in EBV shedding in the saliva, especially in the presence of oral hairy leukoplakia, characterized by white, raised lesions with a hairy corrugated surface, 0.5 to 3.0 cm in diameter, occurring predominantly on the lateral margins of the tongue ( 396 ). EBV DNA has been found in the oral leukoplakia of HIV-infected patients ( 396 ). These wartlike lesions carry EBV-replicating cells in the upper five to six cell layers ( 397 ) and respond very well to oral therapy with acyclovir ( 398 ). EBV-positive monoclonal expansions of lymphocytes have been found in the lymph nodes of approximately one-third of HIV-positive individuals experiencing persistent generalized lymphadenopathy ( 192 , 399 ). Often, EBV-positive cells are increased five- to tenfold in lymphoid tissues of HIV-infected patients compared to non-HIV patients ( 75 ). Children with AIDS often develop lymphoid interstitial pneumonitis due to EBV-induced polyclonal B-cell proliferation ( 400 ). Adults with AIDS have a 100-fold increased risk of developing malignant lymphomas ( 401 ). It has been demonstrated that AIDS patients who develop EBV-associated lymphoma have a loss of EBV-CTL function ( 402 ). NHL is a common late manifestation of infection with HIV; the probability of developing such a

complication has been estimated to range between 20 and 30% (403). Only 30 to 40% of these NHL tumors contain EBV genomes (9, 404). It has been demonstrated that central nervous system lymphomas are almost always EBV positive (405), as are the rare lymphomas that involve preferentially the pleural, pericardial, and peritoneal cavities (406). As with NHL associated with other immunodeficiencies, most AIDS-associated NHL is of B-cell phenotype and tends to involve extranodal sites, especially the central nervous system (17 to 42%), the gastrointestinal tract (4 to 28%), the bone marrow (21 to 33%), and the liver (9 to 16%) (9). Histologically, many of these tumors are high grade and aggressive and most commonly are classified as small noncleaved (BL) or large cell diffuse (9, 399, 407, 408). It appears that diffuse large cell NHL is more likely to develop in severely immunosuppressed patients, whereas BL is increased in less immunosuppressed patients with AIDS (408). Studies have demonstrated conflicting results on the effect of highly active antiretroviral therapy on the incidence of AIDS-associated NHL (409, 410, 411, 412, 413 and 414). Studies have shown that the incidence of central nervous system NHL and large cell lymphomas has decreased, but not that of BL (411, 414). As for NHL associated with primary immunodeficiency, the prognosis for HIV-associated NHL is much worse than the prognosis for NHL occurring in immunocompetent individuals. Studies have demonstrated that survival may be improved with less-intensive chemotherapy (415). One study demonstrated that patients with EBV-positive tumors had a worse prognosis (416).

**Posttransplant Lymphoproliferative Disease** Figure 67.3 illustrates the importance of a qualitatively and quantitatively appropriate T-cell response in maintaining homeostasis and preventing EBV-driven B-cell proliferation. Therefore, after very immunosuppressive therapy and the transfer of EBV-infected B cells via blood, marrow, or organ grafts, complications due to EBV are frequently seen in transplant patients. Perhaps it is surprising that more patients do not experience EBV-related disease post-BMT. Posttransplant lymphoproliferative disease (PTLD) represents a spectrum of clinical and morphologic heterogeneous lymphoid proliferations (392, 417, 418, 419, 420 and 421). EBV lymphoproliferative disease posttransplant may manifest as isolated hepatitis, lymphoid interstitial pneumonitis, or meningoencephalitis or as an IM-like syndrome with peripheral adenopathy, fever, or hepatitis, or all three. Frequently, the definition of PTLD is limited to lymphomatous lesions (localized or diffuse) that are often extranodal (often in the allograft). Although less frequent, the most fulminant presentation of EBV-LPD in the posttransplant patient is as disseminated, systemic disease that clinically resembles septic shock and histologically resembles FIM. Histologically, EBV disease is quite heterogeneous as well. There have been several histologic classifications for PTLD over the years (417, 418, 420), but the World Health Organization has now proposed a classification, which includes (a) polymorphic hyperplasia, seen in IM presentations, (b) polymorphic PTLD, and (c) monomorphic PTLD. The last resembles intermediate- to high-grade NHL (422). Lesions associated with the IM presentation usually have a polymorphic histology with a mixture of B cells and infiltrating T cells. This pattern is also seen in EBV hepatitis, meningoencephalitis, and lymphoid interstitial pneumonitis lesions, in which the predominant cellular component consists of CD8<sup>+</sup> T cells (75, 419). PTLD is typically composed of plasmacytoid B cells, with few T cells, and, often, regional areas of necrosis. Distinguishing between a polyclonal and a monoclonal PTLD often requires lymphoid receptor gene analysis, because up to 50% of PTLDs do not express surface Ig (75, 419). The majority of PTLDs are CD20<sup>+</sup> and EBV early RNA (EBER)-positive by *in situ* hybridization, whereas immunohistochemistry staining for the LMP-1 protein is negative in 25% of cases (75, 423). Although PTLD may appear histologically identical to NHL or even HD, clinically and genetically, it appears differently. Cytogenetic abnormalities are rare in PTLD, even with Burkittlike histology, and abnormalities in genes observed in NHL (i.e., c-myc; N-, H-, and K-ras; p53; and bcl-2, bcl-6, etc.) are rare in PTLD (419, 420, 424, 425). Clonality and morphology have been poor predictors of outcome in PTLD, especially



after BMT ( [127](#), [392](#), [426](#) ). More than 90% of early (<6 months posttransplant) PTLDs are EBV positive, when EBV-CTL immunity is lowest ( [392](#), [419](#), [426](#), [427](#), [428](#) and [429](#) ), whereas late (>2 years posttransplant) PTLDs are frequently EBV negative, can be of T-cell origin, and have a much poorer prognosis ( [430](#), [431](#), [432](#) and [433](#) ). The etiology of EBV-negative PTLD is not known, and no other virus has been identified as an etiologic agent. These late PTLDs may be a different disease and appear more akin to LPDs observed in other immunodeficient states (e.g., AIDS and primary immunodeficiencies), in which B-cell origin and EBV association are not universal. Currently, it is estimated that approximately 1000 new cases of PTLD a year are diagnosed in the United States ( [434](#) ). The risk factors for PTLD are well described and include the type of organ transplanted, frequency of rejection episodes requiring intensified immunosuppression (especially the use of T-cell antibody therapy or T-cell depletion with BMT), EBV seronegativity at time of transplant, the age of recipients (especially <5 years of age) in the case of organ transplants, and older age of donor in BMT ( [392](#), [417](#), [419](#), [426](#), [427](#), [435](#), [436](#) ). The incidence ranges from 1 to 5% in low-risk procedures (e.g., renal, heart, liver, and non-T-cell-depleted bone marrow transplants) to 10 to 30% in the high-risk procedures (e.g., lung, small bowel, and T-cell-depleted bone marrow transplants) ( [437](#) ). Because of the increased incidence in children receiving organ transplantation ( [435](#), [436](#) ), PTLD may soon become the one of the most common types of lymphoma in children in the United States. Successful treatment of EBV-LPD necessitates controlling the B-cell proliferation and facilitating the development of an appropriate memory cytotoxic T-cell (EBV-CTL) response to maintain an asymptomatic state of viral latency ( [Fig. 67.3](#) ). Additional factors that contribute to the difficulty of treating these patients include increased toxicity from therapy or secondary infections and the increased risk of organ rejection or GVHD due to the enhancement of alloreactive T-cell immunity. Surgery, radiotherapy, or both, are effective in curing localized disease, but this benefits only a small percentage of patients ( [392](#), [434](#) ). The use of antiviral agents such as acyclovir or ganciclovir and/or intravenous Ig may reduce viral replication and thereby limit the number of infected B cells and may be useful in prophylaxis or preemptive therapy ( [392](#), [437](#), [438](#) and [439](#) ). The efficacy of antiviral drugs in treating PTLD is controversial because they are seldom used without other interventions (e.g., reduction of immunosuppression); in addition, if viral replication, which is lytic to the infected B cells, is suppressed, B-cell proliferation could theoretically be enhanced. The approach most widely used as initial therapy is reduction of immunosuppression ( [392](#), [437](#) ). Many times, this is sufficient for controlling the disease, especially in localized, polymorphic cases or cases that present like IM. As opposed to PTLD after solid organ transplantation, immune suppression is rarely successful in BMT patients with PTLD, because the major immunosuppression after BMT is from delayed EBV-CTL recovery, not suppression of EBV-CTL function. Patients who do not tolerate reduction of immunosuppression because of graft rejection or GVHD, or who do not respond to immunosuppression reduction, require more aggressive therapy and have a much poorer prognosis ( [392](#), [417](#), [426](#), [427](#), [434](#), [437](#) ). IFN- $\alpha$  has been used successfully to treat PTLD ( [392](#), [426](#), [440](#), [441](#) ) but is not generally used due to apparent increased organ rejection and infections, the latter presumably from marrow suppression. Anti-B-cell monoclonal antibodies have been used successfully, including anti-CD21 and anti-CD23 ( [442](#) ) and, more recently, anti-CD20 ( [443](#), [444](#) ). Chemotherapy has also been used successfully for PTLD ( [434](#), [445](#), [446](#) ). This approach is attractive because it kills proliferating B cells and is immunosuppressive enough to treat or prevent GVHD or organ rejection ( [447](#) ). However, at conventional doses used in the treatment of NHL, posttransplant patients appear to have more end-organ toxicity and susceptibility to infection, especially after BMT ( [392](#), [434](#), [437](#), [445](#) ). Additionally, conventional dose chemotherapy may also inhibit the development of EBV-CTLs. Low-dose chemotherapy approaches have been shown to be at least as effective in controlling PTLD ( [434](#) ). Because the problem in most cases of PTLD is an inadequate number of EBV-CTLs,

replacement of EBV-CTLs would be of great benefit. Infusion of donor leukocytes has been demonstrated to be successful in the treatment of PTLD post-BMT ( 448 ). However, severe GVHD has also been associated with infusion of donor leukocytes, death due to a “shock-like syndrome” has been reported, and the PTLD is not always controlled ( 448 , 449 ). To avoid the GVHD and other associated toxicities, *ex vivo*-generated EBV-specific CTLs have been shown to be effective in treating and preventing PTLD post-BMT ( 450 ); however, this approach is not feasible for most centers due to the cost and regulatory oversight necessary to generate and administer the *in vitro*-generated EBV-CTLs. The use of adoptive T-cell therapy in an organ transplant recipient is complex. First, cadaver organs are most widely used; therefore, donor leukocytes are often not available. Second, as opposed to BMT, after organ transplant, the PTLD cells are usually of recipient origin, so the immunologic recognition, specificity, and efficacy of donor leukocytes are uncertain. Third, the use of closely matched relatives' leukocytes runs the risk of both rejection and GVHD. Finally, the *ex vivo* generation of EBV-specific CTLs takes several weeks ( 450 , 451 ) and requires a high level of technology and cost.

### Epstein-Barr Virus-Associated Malignancies

**BURKITT LYMPHOMA** The neoplastic cells in BL have a mature B-cell phenotype as demonstrated by the expression of B-cell-associated antigens (CD19, 20, and 21) and the presence of Ig on the cell surface ( 9 ). Approximately 95% of endemic African BLs contain EBV, as compared with 20% of sporadic BL occurring mainly in Europe and North America ( 10 , 30 ). BL tumor cells express type I latency EBV gene expression (i.e., EBNA-1 and the EBERs, but not EBNA-2, EBNA-3, or LMP proteins) ( 13 , 55 , 452 , 453 ). Also, many of the adhesion molecules and co-stimulatory molecules seen in latency type III infected cells are not expressed on BL tumor cells, making them less susceptible to immunosurveillance ( 30 ). EBV-positive lymphomas contain a single clone of episomal EBV genome, suggesting that virus infection preceded malignant transformation ( 454 ). Both endemic and sporadic forms of BL are characterized by specific chromosomal translocations that involve chromosomes 8 and 14 [t(8;14)] in 70% of cases, or 8 and 22 [t(8;22)] and 8 and 2 [t(8;2)] in the remainder ( 455 , 456 ). As a result, the *c-myc* protooncogene becomes juxtaposed to one of the heavy or light chain Ig gene loci found on chromosome 14 (heavy chain), chromosome 22 (?-light chain), or chromosome 2 (?-light chain) ( 457 , 458 ). As a consequence, the normal control of the *c-myc* oncogene expression is disrupted, and the oncogene is deregulated ( 458 ). Chronic B-cell stimulation by EBV, HIV, or malaria ( 340 , 458 ) appears to play an additional, as yet undefined, role in the pathogenesis of BL. It has been postulated that EBV infection works as an initial trigger for B-cell proliferation and accounts for the increased incidence of BL in endemic areas. But EBV may not be required once the malignant transformation has been established ( 30 ). Interestingly, by analyzing EBV genome-positive and genome-negative clones originating from the same BL cell line, one study has shown that EBV infection was essential for malignant transformation ( 459 ). Others have suggested that EBERs were essential for transformation in BL cells ( 460 ). These findings suggest that EBV infection may be important not only in the development of BL but also for the maintenance of the malignant phenotype. Despite numerous attempts, the induction of the BL phenotype by infecting resting B cells with EBV *in vitro* has not been achieved. Therefore, the role of EBV in the pathogenesis of BL remains to be fully delineated.

**NASOPHARYNGEAL CARCINOMA** NPC is another important EBV-associated malignant disorder. This tumor is mainly observed in Southeast Asia, Southern China, and a few other limited regions of the world ( 10 , 30 , 461 ). In these areas, NPC is the most frequent malignant disorder. The evidence linking EBV to NPC is even more compelling than with BL ( 10 , 461 ). The etiologic link between NPC and EBV was first suggested by serologic

evidence ( [462](#), [463](#) ), especially IgA antibodies directed against EBV–EA diffuse or viral capsid antigens that are present in high titers in NPC patients as compared with matched controls, IM patients, and BL patients ( [10](#) ). Prospective screening for these IgA antibodies also appears to be useful in detecting preclinical NPC and in anticipating recurrences after therapy ( [464](#) ). The association between EBV and NPC was confirmed by demonstrating the presence of EBV DNA in NPC cells ( [314](#), [315](#) and [316](#) ). The finding of monoclonal EBV found in precancerous lesions of NPC is noteworthy, as it suggests EBV infection takes place early in the pathogenesis and is essential in the development of NPC ( [190](#), [465](#) ). As stated before, NPC tumor cells demonstrate type II viral latency gene expression (i.e., EBNA–1 but not EBNA–2 or EBNA–3 proteins); 60% also express LMP–1; LMP–2A can be detected in most, and LMP–2B is expressed in a smaller number of cases ( [55](#), [466](#), [467](#) ). EBERs have been demonstrated consistently in tissues derived from patients with undifferentiated NPC ( [468](#) ). A genetic predisposition appears to be an additional major factor in the development of this epithelial malignancy. First-generation of southern Chinese immigrants to the United States have an incidence of NPC that is approximately one-half that of native Chinese, suggesting that both genetic and environmental factors contribute to the development of NPC ( [469](#) ). Other studies have identified loss of heterozygosity—that is, the deletion of genetic material from one of the chromosomes in tumor DNA; deletions at 3p25 and 3p14 have been identified ( [470](#) ). Putative tumor-suppressor genes at these sites remain to be confirmed ( [461](#) ). Other factors also may play a role in oncogenesis, including exposure to toxins contained in traditional Chinese medicines, such as *Euphorbia* plant extracts, which induce EBV replication, and the ingestion of nitrosamines or other oncogenic substances in salted fish ( [10](#) ).

**HODGKIN DISEASE** A pathologic link between EBV and HD has been suspected for some time on the basis of serologic studies that demonstrated unusually high titers of antibodies to VCA and EAs, as well as the observation that individuals with high antibody titers to EBV have an increased risk of developing the disease ( [471](#), [472](#) and [473](#) ). More recently, the presence of EBV has been demonstrated conclusively within the RS cells and their mononuclear variants in 40 to 50% of Hodgkin lymphoma specimens ( [158](#), [159](#) and [160](#) ). The virus appears to be monoclonal in any given individual, suggesting that infection occurred before the clonal expansion of RS cells ( [474](#) ). Nodular sclerosing and mixed cellularity types of HD are positive for EBV in more than 80 to 90% of cases, whereas lymphocyte-predominant and lymphocyte-depleted types are usually negative ( [158](#), [159](#) and [160](#) ). The pattern of latent gene expression is similar to that seen in most cases of NPC (i.e., type II latency) ( [55](#), [159](#), [160](#), [475](#) ). LMP expression in RS cells occurs at very high levels ( [476](#), [477](#) ). Furthermore, TNF receptor-associated factor–1, IL–10, and IL–6 have been reported to be overexpressed in EBV-positive RS cells ( [478](#), [479](#) and [480](#) ). These observations suggest a possible role for LMP–1 in the pathogenesis of HD. Because LMPs can elicit a cellular immune response, it has been suggested that factors within the microenvironment of the RS cells may induce a local suppression of EBV-specific immunity ( [481](#) ). Although the presence of viral genome does not prove the causative role of EBV in HD, these findings support that EBV infection is responsible or works as a cofactor in the development of EBV genome-positive HD.

**T-CELL LYMPHOMA** EBV genome-positive T-cell lymphoma was first described unexpectedly in three patients who had extraordinarily high IgG antibody titers to EBV–VCA and –EA ( [322](#) ). After this report, EBV genome-positive peripheral T-cell lymphoma had been increasingly reported mainly in Chinese populations ( [482](#) ). Type II latency is predominantly shown in these malignancies ( [55](#) ). The mechanism of EBV infection into human T cells still remains to be elucidated. CD21 expression has been reported on some T-cell lines ( [483](#) ); however, *in vitro* experiments have failed to demonstrate continuous presence of EBV in such T-cell lines. Variable clinical



manifestations are observed in patients with T-cell lymphoma. This may be in part due to cytokine production and cytotoxic functions that can be observed in these tumor cells. Interestingly, this type of lymphoma is often associated with severe CAEBV ( [317](#), [319](#) ), as discussed previously. These malignancies are highly resistant, and the outcome is very poor.

**NATURAL KILLER CELL LYMPHOMA/LEUKEMIA** Patients with EBV genome-positive, CD3-negative NK-cell proliferations were initially reported by Japanese investigators ( [484](#) ). Type II latency is predominant in these malignancies as well ( [30](#) ). NK-cell lymphoma/leukemia has often been associated with mosquito bite sensitivity ( [485](#) ) and CAEBV (see discussion in section [Chronic Active Epstein-Barr Virus Infection](#)). Midline granuloma, which is predominantly of T-/NK-cell origin, was first reported in Asia ( [486](#) ), but now, cases in North America and Europe have been shown to be EBV genome-positive, with monoclonal viral episomes detected in virtually all tumor cells. In general, these malignancies have the same poor prognosis as EBV-positive T-cell malignancies.

**GASTRIC CARCINOMA** Gastric carcinoma is a leading cause of death due to cancer in Japan. Shibata and Weiss initially reported the presence of EBV genome by *in situ* hybridization ( [32](#) ). The incidence of the EBV genome in gastric carcinoma in Japan is approximately 7% ( [43](#) ). These cancerous lesions also contain a monoclonal EBV genome but express only EBNA-1, EBERs, and BART (type I latency), similar to EBV genome-positive BL ( [487](#) ). Therefore, EBV infection must occur before malignant cell proliferation. Due to the high percentage of EBV genome-negative cases, causality in regard to EBV and gastric carcinoma remains unclear, but the hypothetical mechanisms to genome-negative BL may apply.

**MISCELLANEOUS EPSTEIN-BARR VIRUS-ASSOCIATED HUMAN CANCERS** EBV genome-positive pyothorax-associated lymphoma has occurred uniquely in the pleural cavity of patients with long-standing pyothorax who have no obvious immunodeficiency, although lymphoma cells actually show type III latency, suggesting local immune suppression ( [489](#) ). There are anecdotal reports of several other human malignancies, in which the EBV genome has been detected. They include lymphoepithelial carcinomas of the salivary glands, tonsillar carcinoma, parotid gland carcinoma, and thymoma ( [488](#) ). EBV DNA has been found in leiomyosarcomas of children with AIDS ( [35](#) ) and organ transplant recipients ( [36](#) ). The precise etiologic role of EBV is not understood in these cases.

## REFERENCES

1. Turk W. Septische Erkrankungen bei Verkuering des Granulozytensystems. *Wien Klin Wochenschr* 1907;20:157.
2. Wintrobe MM. *Clinical hematology*, 6th ed. Philadelphia: Lea & Febiger, 1967.
3. Sprunt TP, et al. Mononuclear leukocytosis in reaction to acute infection ("infectious mononucleosis"). *Bull Johns Hopkins Hosp* 1920;31:410.
4. Downey H, et al. Acute lymphadenosis compared with acute lymphatic leukemia. *Arch Intern Med* 1923;32:82.
5. Burkitt D. A sarcoma involving the jaws in African children. *Br J Surg* 1958;46:218-223.
6. Burkitt D. Discovering Burkitt's lymphoma: a special address to the Second International Symposium on the Epstein-Barr virus and associated diseases. In: Levine PH, Ablashi DV, et al., eds. *Epstein-Barr virus and human disease*. Clifton: Humana Press, 1987:1
7. Epstein MA, et al. Virus particles in cultured lymphoblasts from Burkitt's lymphoma. *Lancet* 1964;1:702.
8. Henle G, et al. Relation of Burkitt's tumor associated herpes-type virus to IM. *Proc Natl Acad Sci U S*

A 1968;39:94.

9. Tosato G, Tata K, Angiolillo AL, Sgadari C. Epstein-Barr virus as an agent of hematological disease. *Baillieres Clin Hematol* 1995;8(1):165-199.
10. De-Th G. Epidemiology of Epstein-Barr virus and associated diseases in man. In: Roizman B, ed. *The herpes virus*, vol 1. New York: Plenum Press, 1982:25.
11. Evans AS, et al. Seroepidemiologic studies of IM and EBV. *N Engl J Med* 1968;279:1121.
12. Sawyer RN, et al. Prospective studies of a group of Yale University freshman. I. Occurrence of infectious mononucleosis. *J Infect Dis* 1971;123:263.
13. Straus SE, Cohen JI, Tosato G, Meier J. Epstein-Barr virus infections: biology, pathogenesis, and management. *Ann Intern Med* 1993;118(1):45-58.
14. Epstein MA, Achong BG. Morphology of the virus and of virus-induced cytopathologic changes. In: Epstein MA, Achong BG, eds. *The Epstein-Barr virus*. New York: Springer-Verlag, 1979:23-37.
15. Baer R, Bankier AT, Biggin MD, et al. DNA sequence and expression of the B95-8 Epstein-Barr virus genome. *Nature* 1984;310:207-211.
16. Kieff E. Epstein-Barr virus and its replication. In: Fields BN, Knipe DM, Howley PM, eds. *Fields virology*, 3rd ed., vol. 2. Philadelphia: Lippincott-Raven, 1996:2343-2396.
17. Thorley-Lawson D, Mann K. Early events in EB viral infection provide a model for B cell activation. *J Exp Med* 1985;162:45-59.
18. Knutson J, Sugden B. Immortalization of B lymphocytes by Epstein-Barr virus: what does the virus contribute to the cell? In Klein G, ed. *Advances in viral oncology*. New York: Raven Press, 1989:151.
19. Rowe M, Young L, Cadwallader K, et al. Distinction between Epstein-Barr virus type A (EBNA 2A) and type B (EBNA 2B) isolates extends to the EBNA 3 family of nuclear proteins. *J Virol* 1989;63:1031-1039.
20. Sixbey JW, Shirley P, Chesney PJ, et al. Detection of a second widespread strain of Epstein-Barr virus. *Lancet* 1989;2:761-765.
21. Habeshaw G, Yao QY, Bell AI, et al. Epstein-Barr virus nuclear antigen 1 sequences in endemic and sporadic Burkitt's lymphoma reflect virus strains prevalent in different geographic areas. *J Virol* 1999;73:965-975.
22. Hu L-F, Chen F, Zheng X, et al. Isolation and sequencing of the Epstein-Barr virus BNF-1 gene (LMP1) from Chinese nasopharyngeal carcinoma. *J Gen Virol* 1991;72:2399-2409.
23. Chen ML, Tsai CN, Liang CL, et al. Cloning and characterization of the latent membrane protein (LMP) of specific Epstein-Barr virus variant derived from the nasopharyngeal carcinoma in Taiwanese population. *Oncogene* 1992;7:2131-2140.
24. Knecht H, Bachmann E, Brousset P, et al. Deletions within the LMP1 oncogene of Epstein-Barr virus are clustered in Hodgkin's disease and identical to those observed in nasopharyngeal carcinoma. *Blood* 1993;82:2937-2942.
25. Knecht H, Martius F, Bachmann E, et al. A deletion mutant of the LMP1 oncogene of Epstein-Barr virus is associated with evolution of angioimmunoblastic lymphadenopathy into B immunoblastic lymphoma. *Leukemia* 1995;9:458-465.
26. Chang YS, SU IJ, Chung PJ, et al. Detection of an Epstein-Barr virus variant in T-cell lymphoma tissues identical to the distinct strain observed in nasopharyngeal carcinoma in Taiwanese population. *Int J Cancer* 1995;62:673-677.
27. Jenkins PJ, Farrell PJ. Are particular Epstein-Barr virus strains linked to disease? *Semin Cancer Biol* 1996;7:209-215.

28. Shope T, Dechairo D, Miller G. Malignant lymphoma in cottontop marmosets after inoculation with Epstein-Barr virus. *Proc Natl Acad Sci U S A* 1973;70:2487.
29. Cleary ML, Epstein MA, Finerty S, et al. Individual tumors of multifocal EBV virus-induced malignant lymphomas in tamarins arise from different B-cell clones. *Science* 1985;228:772.
30. Okano M, Gross TG. From Burkitt's lymphoma to chronic active Epstein-Barr virus (EBV) infection: an expanding spectrum of EBV associated diseases. *Pediatr Hematol Oncol* 2001;18:427-442.
31. Weiss LM, Strickler JG, Warnke RA, et al. Epstein-Barr virus DNA in tissues of Hodgkin's disease. *Am J Pathol* 1987;129:86-91.
32. Shibata D, Weiss LM. Epstein-Barr virus-associated gastric adenocarcinoma. *Am J Pathol* 1992;140:769-774.
33. Sugawara Y, Mizuzaki Y, Uchida T, et al. Detection of Epstein-Barr virus (EBV) in hepatocellular carcinoma tissue: a novel EBV latency characterized by the absence of EBV-encoded small RNA expression. *Virology* 1999;256:196-202.
34. Bennet M, Guinebretiere JM, Kremmer E, et al. Detection of Epstein-Barr virus in invasive breast cancers. *J Natl Cancer Inst* 1999;91:1376-1381.
35. McClain KL, Leach CT, Jenson HB, et al. Association of Epstein-Barr virus with leiomyosarcomas in young people with AIDS. *N Engl J Med* 1995;332:12-18.
36. Lee ES, Locker J, Nalesnik M, et al. The association of Epstein-Barr virus with smooth-muscle tumors occurring after organ transplantation. *N Engl J Med* 1995;332:19-25.
37. Sixbey JW, Nedrud JG, Raab-Traub N, et al. Epstein-Barr virus in replication in oropharyngeal epithelial cells. *N Engl J Med* 1984;310:1225-1230.
38. Fingerhuth JD, Weiss JJ, Tedder TF, et al. Epstein-Barr virus receptor of human B lymphocytes is the C3d receptor CR2. *Proc Natl Acad Sci U S A* 1984;81:4510-4514.
39. Tanner J, Weis J, Fearon D, et al. Epstein-Barr virus gp350/220 binding to the B lymphocyte C3d receptor mediates adsorption, capping and endocytosis. *Cell* 1987;203-213.
40. Borza CM, Hutt-Fletcher LM. Alternate replication in B cells and epithelial cells switches tropism of Epstein-Barr virus. *Nat Med* 2002;8:594-599.
41. Sixby JW, Tao QY. Immunoglobulin A-induced shift of Epstein-Barr virus. *Science* 1992;255:1578-1580.
42. Anagnostopoulos I, Hummel M, Kreschel C, Stein H. Morphology, immunophenotype, and distribution of latently and/or productively Epstein-Barr virus-infected cells in acute mononucleosis: implications for the interindividual infection route of Epstein-Barr virus. *Blood* 1995;85:744-750.
43. Li QX, Young LS, Niedobitek G, et al. Epstein-Barr virus infection and replication in a human epithelial cell system. *Nature* 1992;356:347-350.
44. Niedobitek G, Hamilton-Dutoit S, Herbst H, et al. Identification of Epstein-Barr virus-infected cells in tonsils of acute infectious mononucleosis by in situ hybridization. *Hum Pathol* 1989;20:796-799.
45. Niedobitek G, Agathangelou A, Herbst H, et al. Epstein-Barr virus (EBV) infection in infectious mononucleosis: viral latency, replication and phenotype of EBV-infected cells. *J Pathol* 1997;278:151-159.
46. Masucci MG, Ernberg I. Epstein-Barr virus: adaptation to a life within the immune system. *Trends Microbiol* 1994;2(4):125-130.
47. Babcock GJ, Decker LL, Volk M, Thorley-Lawson DA. EBV persistence in memory B cells in vivo. *Immunity* 1998;9:395-404.

48. Yang J, Tao Q, Flinn IW, et al. Characterization of Epstein-Barr virus-infected B cells in patients with posttransplantation lymphoproliferative disease: disappearance after rituximab therapy does not predict clinical response. *Blood* 2000;96:4055-4063.
49. Brooks LA, Lean AC, Young LS, et al. Transcription from the Epstein-Barr virus BamHI A fragment are detectable in all three forms of virus latency. *J Virol* 1993;67:3182-3190.
50. Rawlins D, Milman G, Hayward S, Hayward G. Sequence specific DNA binding of the Epstein-Barr virus nuclear antigen (EBNA-1) to clustered sites in the plasmid maintenance region. *Cell* 1985;42:859.
51. Yates JL, Warren N, Sugden B. Stable replication of plasmids derived from Epstein-Barr virus in various mammalian cells. *Nature* 1985;313:812-815.
52. Johannsen E, Koh E, Mosialos G, et al. Epstein-Barr virus nuclear protein 2 transactivation of the latent membrane protein 1 promoter is mediated by J kappa and PU1. *J Virol* 1995;69:253-262.
53. Cohen JI, Wang F, Mannick J, Kieff E. Epstein-Barr virus nuclear protein 2 is a key determinant of lymphocyte transformation. *Proc Natl Acad Sci U S A* 1989;86:9558-9562.
54. Wang F, Gregory C, Sample C, et al. Epstein-Barr virus latent membrane protein (LMP1) and nuclear proteins 2 and 3C are effectors of the phenotypic changes in B lymphocytes; EBNA-2 and LMP1 cooperatively induce CD23. *J Virol* 1990;64:2309-2318.
55. Cohen JI. Epstein-Barr virus infection. *N Engl J Med* 2000;343:481-492.
56. Miller CL, Burkhardt AL, Lee JH, et al. Integral membrane protein 2 of Epstein-Barr virus regulates reactivation from latency through dominant negative effects on protein-tyrosine kinases. *Immunity* 1995;2:155-166.
57. Rowe M. The EBV latent membrane protein-1 (LMP1): a tale of two functions. *EBV Rep* 1995;2:99-104.
58. Izumi KM, Kieff ED. The Epstein-Barr virus oncogene product latent membrane protein 1 engages the tumor necrosis factor-associated death domain protein to mediate B lymphocyte growth transformation and activate NF- $\kappa$ B. *Proc Natl Acad Sci U S A* 1996;94:12592-12597.
59. Eliopoulos AG, Young LS. Activation of the cJun N-terminal kinase (JNK) pathway by the Epstein-Barr virus-encoded latent membrane protein 1 (LMP1). *Oncogene* 1998;16:1731-1742.
60. Liebowitz D. Epstein-Barr virus and a cellular signaling pathway in lymphomas from immunosuppressed patients. *N Engl J Med* 1998;338:1413-1421.
61. Henderson S, Rowe M, Gregory C, et al. Induction of bcl-2 expression by Epstein-Barr virus latent membrane protein 1 protects infected B cells from programmed cell death. *Cell* 1991;65:1107-1115.
62. Caldwell RG, Wilson JB, Anderson SJ, et al. Epstein-Barr virus LMP2A drives B cell development and survival in the absence of normal B cell receptor signals. *Immunity* 1998;9:405-411.
63. Gregory CD, Murray RJ, Edwards CF, Rickinson AB. Downregulation of cell adhesion molecules LFA-3 and ICAM-1 in Epstein-Barr virus-positive Burkitt's lymphoma underlies tumor cell escape from virus-specific T cell surveillance. *J Exp Med* 1988;167:1811-1824.
64. Young LS, Rowe M. Epstein-Barr virus, lymphomas and Hodgkin's disease. *Semin Cancer Biol* 1992;3:273-284.
65. Chen H, Smith P, Ambinder PF, et al. Expression of Epstein-Barr virus BamHI-A rightward transcripts in latency infected B cells from peripheral blood. *Blood* 1999;93:3026-3032.
66. Miller G. The switch between latency and replication of Epstein-Barr virus. *J Infect Dis* 1990;161:833-844.
67. Hsu DH, de Waal Malefyt R, Fiorentino DF, et al. Expression of interleukin-10 activity by Epstein-Barr

virus protein BCRF1. *Science* 1990;250:830–832.

68. Yang J, Lemas VM, Flinn IW, et al. Application of the ELISPOT assay to the characterization of CD8<sup>+</sup> responses to Epstein–Barr virus antigens. *Blood* 2000;95:241–248.
69. Kuzushima K, Hoshino Y, Fujii K, et al. Rapid determination of Epstein–Barr virus–specific CD8<sup>+</sup> T–cell frequencies by flow cytometry. *Blood* 1999;94:3094–3100.
70. Tan LC, Gudgeon N, Annels NE, et al. A re–evaluation of the frequency of CD8<sup>+</sup> T cells specific for EBV in healthy carriers. *J Immunol* 1999;162:1827–1835.
71. Thorley–Lawson DA. Basic virological aspects of Epstein–Barr virus infection. *Semin Hematol* 1988;25:247.
72. Epstein MA, Achong BG. Pathogenesis of infectious mononucleosis. *Lancet* 1977;2:1270.
73. Tosato G, Magrath I, Koski I, et al. Activation of suppressor T cells during Epstein–Barr virus–induced infectious mononucleosis. *N Engl J Med* 1979;301:1133.
74. Okano M, Gross TG. Epstein–Barr virus–associated hemophagocytic syndrome and fatal infectious mononucleosis. *Am J Hematol* 1996;53:111–115.
75. Greiner TC, Gross TG. Atypical immune lymphoproliferations. In: Hoffman R, et al., eds. *Hematology: basic principles and practice*, 3rd ed. Philadelphia: Churchill–Livingstone, 2000:1416.
76. Pearson G. Infectious mononucleosis: the humoral response. In: Schlossberg D, ed. *Infectious mononucleosis*. New York: Springer–Verlag, 1989:89–99.
77. Norwitz CA, Henle W, Henle G, et al. Long–term serological follow–up of patients for Epstein–Barr virus after recovery from infectious mononucleosis. *J Infect Dis* 1985;151:1150–1153.
78. Okano M, Thiele GM, Davis JR, et al. Epstein–Barr virus and human diseases: recent advances in diagnosis. *Clin Microbiol Rev* 1988;1:300–312.
79. Lennette ET, Rymo L, Yadav M, et al. Disease–related differences in antibody patterns against EBV–encoded nuclear antigens EBNA 1, EBNA 2 and EBNA 6. *Eur J Cancer* 1993;29A(11):1584–1589.
80. Henle W, et al. The Epstein–Barr virus–specific diagnostic tests in infectious mononucleosis. *Hum Pathol* 1974;5:551.
81. Evans AS, Niederman JC, Cenabre LC, et al. A prospective evaluation of heterophile and Epstein–Barr virus–specific IgM antibody tests in clinical and subclinical infectious mononucleosis: specificity and sensitivity of the tests and persistence of antibody. *J Infect Dis* 1975;132:546–554.
82. Nikoskelainen J, et al. Epstein–Barr virus–specific serum immunoglobulin A as an acute phase antibody in infectious mononucleosis. *J Clin Microbiol* 1979;10:75.
83. Hewetson JF, et al. Neutralizing antibodies to Epstein–Barr virus in healthy populations and patients with infectious mononucleosis. *J Infect Dis* 1973;128:283.
84. Durbin WA, Sullivan JL. Epstein–Barr virus infection. *Pediatr Rev* 1994;15:63–68.
85. Paul JR, et al. The presence of heterophile antibodies in infectious mononucleosis. *Am J Med Sci* 1932;183:90.
86. Ritter K, et al. IgM autoantibodies against two cellular antigens always appear in acute Epstein–Barr virus infection. *Scand J Infect Dis* 1990;22:135.
87. Frishman W, et al. Infectious mononucleosis and fatal myocarditis. *Chest* 1977;72:535.
88. Garzelli C, et al. Mechanisms other than polyclonal B cell activation possibly involved in Epstein–Barr

virus-induced autoimmunity. *Clin Exp Immunol* 1989;76:412.

89. Garzelli C, et al. EBV-transformed lymphocytes produce monoclonal autoantibodies that react with antigens in multiple organs. *J Virol* 1984;52:722.
90. Kaplan ME, Pan EM. Antinuclear antibodies in infectious mononucleosis. *Lancet* 1968;1:561.
91. Elling P, Faber V. Antinuclear antibodies in infectious mononucleosis. *Lancet* 1968;1:918.
92. Capra JD, et al. Cold-reactive rheumatoid factors in infectious mononucleosis and other diseases. *Arthritis Rheum* 1969;12:67.
93. Grubb R. The Gm system. Anti-Gm's: characteristics in rheumatoid arthritis: experimental induction without resort to allotype; frequent occurrence in mononucleosis. *Scand J Rheumatol* 1988;75[Suppl]:227.
94. Misra R, et al. Anti-cardiolipin antibodies in infectious mononucleosis react with the membrane of activated lymphocytes. *Clin Exp Immunol* 1989;75:35.
95. Kaplan ME. Cryoglobulinemia in infectious mononucleosis: quantitation and characterization of the cryoproteins. *J Lab Clin Med* 1968;71:745.
96. Kaplan ME. Transient cryoglobulinemia in infectious mononucleosis. *J Lab Clin Med* 1966;68:885.
97. Tomkinson BE, et al. Activated lymphocytes during acute Epstein-Barr virus infection. *J Immunol* 1987;139:3802.
98. Williams ML, Loughran TP, Jr., Kidd PG, Starkebaum GA. Polyclonal proliferation of activated suppressor/cytotoxic T cells with transient depression of natural killer cell function in acute infectious mononucleosis. *Clin Exp Immunol* 1989;77:71-76.
99. Rickinson AB, Moss DJ. Human cytotoxic T lymphocyte responses to Epstein-Barr virus infection. *Annu Rev Immunol* 1997;15:405-431.
100. Callan MFC, Tan L, Annels N, et al. Direct visualization of antigen-specific CD8+ T cells during the primary immune response to Epstein-Barr virus in vivo. *J Exp Med* 1998;187:1395-1402.
101. Tan L, Gudgeon N, Annels N, et al. A re-evaluation of the frequency of CD8+ T cells specific for EBV in healthy carriers. *J Immunol* 1999;162:1827-1835.
102. Appay V, Dunbar PR, Callan M, et al. Memory CD8+ T cells vary in differentiation phenotype in different persistent virus infections. *Nat Med* 2002;8:379-385.
103. McKenna RW, et al. Ultrastructural, cytochemical, and membrane surface marker characteristics of the atypical lymphocytes in infectious mononucleosis. *Blood* 1977;50:505.
104. Silins SL, Sherritt MA, Silleri JM, et al. Asymptomatic primary Epstein-Barr virus infection occurs in the absence of blood T-cell repertoire perturbations despite high levels of systemic viral load. *Blood* 2001;98:3739-3744.
105. Sugden B, Phelps M, Domoradzki J. Epstein-Barr virus DNA is amplified in transformed lymphocytes. *J Virol* 1979;31:590-595.
106. Klein G. Epstein-Barr virus strategy in normal and neoplastic B cells. *Cell* 1994;77:791-793.
107. Levitskaya J, Shapiro A, Leonchiks A, et al. Inhibition of ubiquitin/proteasome-dependent protein degradation by the Gly-Ala repeat of the Epstein-Barr virus nuclear antigen 1. *Proc Natl Acad Sci U S A* 1997;94:12616-12621.
108. Callan MFC, Steven N, Krausa P, et al. Large clonal expansions of CD8+ T cells in acute infectious mononucleosis. *Nat Med* 1996;2:906-911.
109. Karzow DT. Infectious mononucleosis. *Adv Pediatr* 1976;22:231.

110. Rapp C, Hewetson J. Infectious mononucleosis and the Epstein-Barr virus. *Am J Dis Child* 1978;132:78-86.
111. Shurin SB. Infectious mononucleosis. *Pediatr Clin North Am* 1979;26:315.
112. Lehane DE. A seroepidemiologic study of infectious mononucleosis. *JAMA* 1970;212:2240.
113. Reference deleted.
114. Reference deleted.
115. Carter JW, et al. Infectious mononucleosis in the older patient. *Mayo Clin Proc* 1978;53:146.
116. Golden RL. Geriatric infectious mononucleosis. *J Am Geriatr Soc* 1969;17:426.
117. Horwitz CA, et al. Infectious mononucleosis in patients aged 40 to 72 years. *Medicine* 1983;62:256.
118. Schmader KE, et al. Epstein-Barr virus and the elderly host. *Rev Infect Dis* 1989;11:64.
119. Shapiro CM, et al. Infectious mononucleosis in the aged. *Ann Intern Med* 1959;51:1092.
120. Bender CE. Clinical epidemiology of mononucleosis at a State University. *Northwest Med* 1959;58:697.
121. Nye FJ, Lambert HP. Epstein-Barr virus antibody in cases and contacts of infectious mononucleosis; a family study. *J Hyg (Lond)* 1973;71:151.
122. Miller G, et al. Prolonged oropharyngeal excretion of Epstein-Barr virus after infectious mononucleosis. *N Engl J Med* 1973;288:229.
123. Straus S, Fleisher LG. Infectious mononucleosis epidemiology and pathogenesis. In: Schlossberg D, ed. *Infectious mononucleosis*. New York: Springer-Verlag, 1989:8-28.
124. Mygand N. The Epstein-Barr virus carrier state in infectious mononucleosis. *N Engl J Med* 1973;289:867.
125. Niederman JC, et al. Infectious mononucleosis. Epstein-Barr virus shedding in saliva and oropharynx. *N Engl J Med* 1976;294:1355.
126. Gratama JW, Oosterveer MA, Lepoutre J, et al. Persistence and transfer of Epstein-Barr virus after allogeneic bone marrow transplantation. *Transplant Proc* 1989;21:3097-3098.
127. Shapiro RS, McClain K, Frizzera G, et al. Epstein-Barr virus associated B cell lymphoproliferative disorders following bone marrow transplantation. *Blood* 1988;71:1234-1243.
128. Gross TG, Hinrichs SH, Davis JR, et al. Effect of counterflow elutriation (CE) on Epstein-Barr virus (EBV) infected cells in donor bone marrow. *Exp Hematol* 1988;26:395-399.
129. Cen H, Breinig MC, Atchinson RW, et al. Epstein-Barr virus transmission via donor organs in solid organ transplantation polymerase chain reaction and restriction fragment length polymorphism analysis of IR2, IR3 and IR4. *J Virol* 1991;65:976-980.
130. Alfieri C, Tanner J, Carpentier L, et al. Epstein-Barr virus transmission from a blood donor to an organ transplant recipient with recovery of the same virus strain from the recipient's blood and oropharynx. *Blood* 1996;87:812-817.
131. Gerber P, Walsh JH, Rosenblum EN, Purcell RH. Association of EB-virus infection with the post-perfusion syndrome. *Lancet* 1969;1:593-595.
132. Goldberg GN, Fulginiti VA, Ray G, et al. In utero Epstein-Barr virus (infectious mononucleosis)



infection. *JAMA* 1981;246:1579–1581.

133. Joncas JH, Wills A, McLaughlin B. Congenital infection with cytomegalovirus and Epstein–Barr virus. *Can Med J* 1977;117:1417–1418.

134. Sixbey JW, Lemon SM, Pagano JS. A second site for Epstein–Barr virus shedding: the uterine cervix. *Lancet* 1986;2:1122–1124.

135. Bernstein A. Infectious mononucleosis. *Medicine* 1940;19:85.

136. Cheeseman SH. Infectious mononucleosis. *Semin Hematol* 1988;25:261.

137. Contratto AW. Infectious mononucleosis. *Arch Intern Med* 1944;73:449.

138. Finch SC. Clinical symptoms and signs of infectious mononucleosis. In: Carter RL, Penman HG, eds. *Infectious mononucleosis*. Oxford: Blackwell Science, 1969.

139. Rosenthal T, Hertz M. Mediastinal lymphadenopathy in infectious mononucleosis. *JAMA* 1975;233:1300.

140. Kilpatrick ZM. Structural and functional abnormalities of liver in infectious mononucleosis. *Arch Intern Med* 1966;117:47.

141. Matoba AY. Ocular disease associated with Epstein–Barr virus infection. *Surv Ophthalmol* 1990;35:145–150.

142. Dunnet WN. Infectious mononucleosis. *BMJ* 1963;1:1187.

143. Brown GL, Kanwar GS. Drug rashes in glandular fever. *Lancet* 1967;2:1418.

144. Pullen H, et al. Hypersensitivity reactions to antibacterial drugs in infectious mononucleosis. *Lancet* 1967;2:1176.

145. Weary PE, et al. Eruptions from ampicillin in patients with infectious mononucleosis. *Arch Dermatol* 1970;101:86.

146. Lund BMA, Bergan T. Temporary skin reactions to penicillins during the acute stage of infectious mononucleosis. *Scand J Infect Dis* 1975;7:21.

147. McKenzie H, et al. IgM and IgG antibody levels to ampicillin in patients with infectious mononucleosis. *Clin Exp Immunol* 1976;26:214.

148. Downey H, et al. The pathology of the lymph nodes in infectious mononucleosis. *Folia Haematol* 1936;54:417.

149. Wood TA, Frenkel EP. The atypical lymphocyte. *Am J Med* 1967;43:923.

150. Finch SC. Laboratory findings in infectious mononucleosis. In: Carter RL, Penman HG, eds. *Infectious mononucleosis*. Oxford: Blackwell Science, 1969:47–62.

151. Carter RL. Platelet levels in infectious mononucleosis. *Blood* 1965;25:817.

152. Fuhrman SA, et al. Marked hyperbilirubinemia in infectious mononucleosis. *Arch Intern Med* 1987;147:850.

153. Freedman MJ, et al. Infectious mononucleosis with diffuse involvement of nervous system. *Arch Neurol* 1953;69:49.

154. Strickler JG, Fedeli F, Horwitz CA, et al. Infectious mononucleosis in lymphoid tissue. Histopathology, in situ hybridization, and differential diagnosis. *Arch Pathol Lab Med* 1993;117:269–278.

155. Childs CC, Parham DM, Berard CW. Infectious mononucleosis. The spectrum of morphologic changes

- simulating lymphoma in lymph nodes and tonsils. *Am J Surg Pathol* 1987;11:122–132.
156. Gall EA, Stout HA. The pathology of lymph nodes of infectious mononucleosis. *Am J Pathol* 1940;16:433.
157. Gowing NFC. Infectious mononucleosis: histopathologic aspects. *Pathol Annu* 1975;10:1.
158. Anagnostopoulos I, Herbst H, Niedobitek G, Stein H. Demonstration of monoclonal EBV genomes in Hodgkin's disease and Ki-1 positive anaplastic large cell lymphoma by combined Southern blot and in situ hybridization. *Blood* 1989;74:810–816.
159. Pallesen G, Hamilton-Dutoit SJ, et al. Expression of Epstein-Barr virus latent gene products in tumor cells of Hodgkin's disease. *Lancet* 1991;337:320–322.
160. Herbst H, Dallenbach F, Hummel M, et al. Epstein-Barr virus latent membrane protein expression in Hodgkin and Reed-Sternberg cells. *Proc Natl Acad Sci U S A* 1991;88:4766–4770.
161. Custer RP, et al. The pathology of infectious mononucleosis. *Blood* 1948;3:830.
162. Prang E, Trautmann JC, Kreipe H, et al. Detection of Epstein-Barr virus in lymphoid tissues of patients with infectious mononucleosis by in situ hybridization. *J Pathol* 1992;166:113–119.
163. Boyd JF, Reid D. Bone marrow in nine cases of clinical glandular fever and a review of the literature. *J Clin Pathol* 1968;21:683.
164. Martin MFR. Atypical infectious mononucleosis with bone marrow granulomas and pancytopenia. *BMJ* 1977;2:200.
165. Schleicher EM. Reticulum hyperplasia and proliferation of lymphoid cells in the bone marrow in infectious mononucleosis. *Acta Haematol (Basel)* 1949;2:242.
166. Gorgievski-Hrisoho M, et al. Serodiagnosis of infectious mononucleosis by using recombinant Epstein-Barr virus antigens and enzyme-linked immunosorbent assay technology. *J Clin Microbiol* 1990;28:2305.
167. Matheson BA, et al. Assessment of rapid ELISA test for detection of Epstein-Barr virus infection. *J Clin Pathol* 1990;43:691.
168. Levine D, Tilton RC, Parry MF, et al. False positive EBNA IgM and IgG antibody tests for infectious mononucleosis in children. *Pediatrics* 1994;94:892–894.
169. Wollheim FA, et al. Polyclonal immunoglobulin class M (IgM) increase in infectious mononucleosis. *N Engl J Med* 1966;274:64.
170. Allansmith M, Bergstresser P. Sequence of immunoglobulin changes resulting from an attack of infectious mononucleosis. *Am J Med* 1968;44:124.
171. Lee CL, et al. Horse agglutinins in infectious mononucleosis. I. *Am J Clin Pathol* 1968;49:3; II. The spot test. *Am J Clin Pathol* 1968;49:12; III. Criterion for differential diagnosis. *J Clin Pathol* 1968;21:631.
172. Haukenes G, Viggen B, Boye B, et al. Viral antibodies in infectious mononucleosis. *FEMS Immunol Med Microbiol* 1994;8:219–224.
173. Leikola J. Quantitative aspects of mononucleosis antibodies. *Int Arch Allergy* 1968;33:105.
174. Bailey GH, et al. Hemolytic antibodies for sheep and ox erythrocytes in infectious mononucleosis. *J Clin Invest* 1935;14:228.
175. Beer P. The heterophil antibodies in infectious mononucleosis and after the injection of serum. *J Clin Invest* 1936;15:541.
176. Kanok MF. Heterophil antigens and antibodies in medicine. *Curr Top Microbiol Immunol* 1977;77:43.

177. Wilkinson PC, Carmichael DS. Immunochemical characterization and serologic behavior of antibodies against red cells in infectious mononucleosis. *J Lab Clin Med* 1964;64:529.
178. Yoshida K, et al. Specific heterophil antibody from infectious mononucleosis serum. *Proc Soc Exp Biol Med* 1967;124:515.
179. Yoshida K, Nahmias A. Further characterization of specific heterophil antibody from infectious mononucleosis serum. *Proc Soc Exp Biol Med* 1967;126:872.
180. Springer GF, Rapaport MJ. Specific release of heterogenic "mononucleosis receptor" by influenza viruses, receptor destroying enzyme and plant proteases. *Proc Soc Exp Biol Med* 1957;96:103.
181. Andres GA, et al. Immune deposit nephritis in infectious mononucleosis. *Int Arch Allergy* 1976;52:136.
182. Malave I, et al. Reactions of infectious mononucleosis sera with lymphoid cell cultures. *Fed Proc* 1972;31:762; *Int Arch Allergy* 1973;44:601.
183. Lowenthal RM, et al. Human antigen for Paul-Bunnell antibody. *Nature* 1973;244:109.
184. Mori T, et al. Formation of Paul-Bunnell antibodies by cultures of lymphocytes from infectious mononucleosis. *Cell Immunol* 1977;34:289.
185. Davidsohn I, et al. The differential test for infectious mononucleosis. *Am J Clin Pathol* 1951;21:1101; *J Lab Clin Med* 1955; 45:561; *Med Clin North Am* 1962;46:225; *J Immunol* 1963;91:783.
186. McCort JJ. Infectious mononucleosis. *AJR Am J Roentgen* 1949;62:645.
187. Davidsohn I, et al. Serologic diagnosis of infectious mononucleosis. A comparative study of five tests. *Am J Clin Pathol* 1964;41:115.
188. Schultz LE. Heterophile antibody titer in diseases other than infectious mononucleosis. *Arch Intern Med* 1948;81:328-333.
189. Chang KL, Chen YY, Shibata D, et al. Description of an in situ hybridization methodology for detection of Epstein-Barr virus RNA in paraffin embedded tissues. *Diagn Mol Pathol* 1992;1:246.
190. Raab-Traub N, Flynn K. The structure of the termini of the Epstein-Barr virus as a marker of clonal cellular proliferation. *Cell* 1986;47:883-889.
191. Baranski B, Armstrong G, Truman JT, et al. Epstein-Barr virus in the bone marrow of patients with aplastic anemia. *Ann Intern Med* 1988;109:695-704.
192. Shibata D, Weiss L, Nathwaini B, et al. Epstein-Barr virus in benign lymph node biopsies from individuals infected with the human immunodeficiency virus is associated with concurrent or subsequent development of non-Hodgkin's lymphoma. *Blood* 1991;177:1527-1533.
193. Rooney CM, Loftin SK, Holladay HS, et al. Early identification of Epstein-Barr virus-associated post transplantation lymphoproliferative disease. *Br J Hematol* 1995;89:98-103.
194. Wagner HJ, Bein G, Bitsch A, Kirchner H. Detection and quantification of latently infected B lymphocytes in Epstein-Barr virus-seropositive, healthy individuals by polymerase chain reaction. *J Clin Microbiol* 1992;30:2826-2829.
195. Rowe DT, Qu L, Reyes J, et al. Use of quantitative competitive PCR to measure Epstein-Barr virus genome load in the peripheral blood of pediatric transplant patients with lymphoproliferative disorders. *J Clin Microbiol* 1997;35:1612-1615.
196. Deardorff WL, et al. Infectious mononucleosis in acute leukemia with rising Epstein-Barr virus antibody titers. *Ann Intern Med* 1970;72:235.
197. Freedman MH, et al. Concurrent infectious mononucleosis and acute leukemia. *JAMA* 1970;214:1677.

198. Stevens DA, et al. Concurrent infectious mononucleosis and acute leukemia. *Am J Med* 1971;50:208.
199. Fraumeni JK. Infectious mononucleosis and acute leukemia. *JAMA* 1971;215:1159.
200. Horwitz CA, et al. Clinical and laboratory evaluation of cytomegalovirus-induced mononucleosis in previously healthy individuals. *Medicine* 1986;65:124.
201. Beverley JKA, Beattie CP. Glandular toxoplasmosis. A survey of 30 cases. *Lancet* 1958;2:379.
202. Cooper DA, et al. Acute AIDS virus infection. *Lancet* 1985;1:537.
203. Gaines H, et al. Clinical picture of primary HIV infection presenting as a glandular- fever-like illness. *BMJ* 1988;297:1363.
204. Horwitz CA, et al. Heterophile-negative infectious mononucleosis and mononucleosis-like illnesses. *Am J Med* 1977;63:947.
205. Steeper TA, et al. The spectrum of clinical and laboratory findings resulting from human herpesvirus-6 (HHV-6) in patients with mononucleosis-like illnesses not resulting from Epstein-Barr virus or cytomegalovirus. *Am J Clin Pathol* 1990;93:776.
206. Cohen JI, Corey GR. Cytomegalovirus infection in the normal host. *Medicine* 1985;64:100.
207. Klemola E, et al. Infectious mononucleosis-like disease with negative heterophil agglutination test; clinical features in relation to EB virus and cytomegalovirus antibodies. *J Infect Dis* 1970;121:608.
208. Kantor GL, Goldberg LS. Cytomegalovirus-induced postperfusion syndrome. *Semin Hematol* 1971;8:261.
209. Berlin BS, et al. Anti-i antibody and hemolytic anemia associated with cytomegalovirus mononucleosis. *Am J Clin Pathol* 1977;67:459.
210. Klemola E, et al. Cytomegalovirus mononucleosis in previously healthy individuals. *Ann Intern Med* 1969;71:11.
211. Deaton JG, et al. Acute hemolytic anemia complicating infectious mononucleosis: the mechanisms of hemolysis. *Tex Rep Biol Med* 1967;25:309.
212. Worledge SM, Dacie JV. Hemolytic and other anemias in infectious mononucleosis. In: Carter RL, Penman HG, eds. *Infectious mononucleosis*. Oxford: Blackwell Science, 1969.
213. Mahoney D, Fernbach D. The hematologic response. In: Schlossberg D, ed. *Infectious mononucleosis*. New York: Springer-Verlag, 1989:80-88.
214. Woodruff RK, McPherson AJ. Severe hemolytic anemia complicating infectious mononucleosis. *Aust N Z J Med* 1976;6:569.
215. Wishart MM, Davey MG. Infectious mononucleosis complicated by acute haemolytic anemia with a positive D-L reaction. *J Clin Pathol* 1973;26:332.
216. Uzokwe CO, Gwynn AM, Gorst DW, Adamson AR. Infectious mononucleosis complicated by haemolytic anaemia due to the Donath Landsteiner antibody and by severe neutropenia. *Clin Lab Haematol* 1993;15:137-140.
217. Hossaini AA. Anti-i in infectious mononucleosis. *Am J Clin Pathol* 1970;53:198.
218. Rosenfield RE, et al. Anti-i, a frequent cold agglutinin in infectious mononucleosis. *Vox Sang* 1965;10:631.
219. Capra JD, et al. An incomplete cold-reactive G antibody with i specificity in infectious

mononucleosis. *Vox Sang* 1969;16:10.

220. Calvo R, et al. Acute hemolytic anemia due to anti-i. *J Clin Invest* 1965;44:1033.

221. Jenkins WJ, et al. Infectious mononucleosis: an unsuspected source of anti-i. *Br J Haematol* 1965;11:480.

222. DeNardo GL, Ray JP. Hereditary spherocytosis and infectious mononucleosis with acquired hemolytic anemia. *Am J Clin Pathol* 1963;39:284.

223. Godal HC, Skaga E. Aggravation of congenital spherocytosis during infectious mononucleosis. *Scand J Haematol* 1969;6:33.

224. Ho-Yen DO. Autoimmune hemolytic anemia complicating infectious mononucleosis in a patient with hereditary elliptocytosis. *Acta Haematol (Basel)* 1978;59:45.

225. Thurm RH, Bassen F. Infectious mononucleosis and acute hemolytic anemia. *Blood* 1955;10:841.

226. Vogel SJ, Reinhard EH. Paroxysmal nocturnal hemoglobinuria associated with infectious mononucleosis. *Blood* 1979;54:351.

227. Clarke BF, et al. Severe thrombocytopenia in infectious mononucleosis. *Am J Med Sci* 1964;248:703.

228. Weinblatt ME. Immune thrombocytopenic purpura evolving into aplastic anemia in association with Epstein-Barr virus infection. *Am J Pediatr Hematol Oncol* 1991;13(4):465-469.

229. Sumaya C, Ench Y. Epstein-Barr virus infectious mononucleosis in children. I. Clinical and general laboratory findings. *Pediatrics* 1985;75:1003-1010.

230. Wong S, Bennett B. Natural history of severe thrombocytopenia in infectious mononucleosis. *Postgrad Med J* 1982;58:249-251.

231. Cyran EM, Rowe JM, Bloom RE. Intravenous gammaglobulin treatment for immune thrombocytopenia associated with infectious mononucleosis. *Am J Hematol* 1991;38:124-129.

232. Hammond WP, et al. Severe neutropenia in infectious mononucleosis. *West J Med* 1979;131:92.

233. Levy M, Kelly JP, Kaufman DW, Shapiro S. Risk of agranulocytosis and aplastic anemia in relation to history of infectious mononucleosis: a report from the international agranulocytosis and aplastic anemia study. *Ann Hematol* 1993;67:187-190.

234. Dorman JM, et al. Complications of infectious mononucleosis. *Am J Dis Child* 1974;128:239.

235. Fisher BD. Neutropenia in infectious mononucleosis. *N Engl J Med* 1973;288:633.

236. Schooley R, Densen P, Harmon D, et al. Antineutrophil antibodies in infectious mononucleosis. *Am J Med* 1984;76:85-90.

237. Neel EU. Infectious mononucleosis: death due to agranulocytosis and pneumonia. *JAMA* 1976;236:1493.

238. Stevens DL, et al. Infectious mononucleosis with severe neutropenia and opsonic antineutrophil activity. *South Med J* 1979;72:519.

239. Lazarus KH, Baehner RL. Aplastic anemia complicating infectious mononucleosis: a case report and review of the literature. *Pediatrics* 1981;67:907.

240. Sawka CA, et al. Aplastic anemia complicating infectious mononucleosis. *Can Med Assoc J* 1987;136:730.

241. Shadduck RK, et al. Aplastic anemia following infectious mononucleosis. Possible immune etiology.

Exp Hematol 1979;7:264.

242. Penman HG. Fatal infectious mononucleosis: a critical review. *J Clin Pathol* 1970;23:765–771.

243. Farley DR, Zietlow SP, Bannon MP, Farnell MB. Spontaneous rupture of the spleen due to infectious mononucleosis. *Mayo Clin Proc* 1992;67:846–853.

244. Rutkow IM. Rupture of the spleen in infectious mononucleosis. *Arch Surg* 1978;113:718.

245. Aldrete JS. Spontaneous rupture of the spleen in patients with infectious mononucleosis. *Mayo Clin Proc* 1992;67:910–912.

246. Grose C, et al. Primary Epstein–Barr virus infections in acute neurologic diseases. *N Engl J Med* 1975;292:392.

247. Connelly KP, DeWitt D. Neurologic complications of infectious mononucleosis. *Pediatr Neurol* 1994;10(3):181–184.

248. Ricker W, Blumberg A, Peters C, Widerman A. The association of the Guillain–Barre syndrome with infectious mononucleosis. *Blood* 1947;2:217–226.

249. Feasby TE. Inflammatory–demyelinating polyneuropathies. *Neurol Clin* 1992;10:651–670.

250. Kennard C, Swash M. Acute viral encephalitis. Its diagnosis and outcome. *Brain* 1981;104:129–148.

251. Lange BJ, et al. Encephalitis in infectious mononucleosis. Diagnostic considerations. *Pediatrics* 1976;58:877.

252. Demey HE, et al. Coma as a presenting sign of Epstein–Barr encephalitis. *Arch Intern Med* 1988;148:1459.

253. Sworn MJ, Ulrich H. Acute encephalitis in infectious mononucleosis. *J Pathol* 1970;100:201.

254. Copperman SM. “Alice in Wonderland” syndrome as a presenting symptom of infectious mononucleosis in children. *Clin Pediatr* 1977;16:143–146.

255. Fleisher G, Schwartz J, Lennette E. Brief clinical and laboratory observations. Primary Epstein–Barr virus infection in association with Reye syndrome. *J Pediatr* 1980;97:935–937.

256. Heinze EG, Quinn L. Aseptic meningitis in siblings with infectious mononucleosis. *Henry Ford Hosp Med Bull* 1966;14:229.

257. Graman PS. Mollaret’s meningitis associated with acute EBV mononucleosis. *Arch Neurol* 1987;44:1204.

258. Friedland R, Yahr M. Meningoencephalopathy secondary to infectious mononucleosis. *Arch Neurol* 1977;34:186–188.

259. Sibert JR. Hypoglossal nerve palsy complicating a case in infectious mononucleosis. *Postgrad Med J* 1972;48:691–692.

260. Williams LL, Lowery HW, Glaser P. Sudden hearing loss following infectious mononucleosis: possible effect of altered immunoregulation. *Pediatrics* 1985;75:1020–1027.

261. Grose LC, Feorino PM, Dye LA, Rand J. Bell’s palsy and infectious mononucleosis. *Lancet* 1973;2:231–232.

262. Tanner OR. Ocular manifestations of infectious mononucleosis. *Arch Ophthalmol* 1954;51:229–241.

263. Watson P, Ashby P. Brachial plexus neuropathy associated with infectious mononucleosis. *Can Med Assoc J* 1976;114:758–767.

264. Dussalix E, LeTouze P, Tardieu M. Neuropathy of the brachial plexus complicating infectious mononucleosis in an 18 month old child. *Arch Fr Pediatr* 1986;43:129-130.
265. Yahr M, Frontera A. Acute autonomic neuropathy. *Arch Neurol* 1975;32:132-133.
266. Estanol-Vidal B, Perez-Ortega R, Vargas-Lugo B, et al. Acute autonomic neuropathy. *Arch Invest Med* 1979;10:53-64.
267. Vassallo M, et al. Gastrointestinal motor dysfunction in acquired selective cholinergic dysautonomia associated with infectious mononucleosis. *Gastroenterology* 1991;100:252.
268. Cleary TG, et al. Acute cerebellar ataxia associated with Epstein-Barr virus infection. *JAMA* 1980;243:148.
269. Erzurum S, Kalasusky SM, Watanakunakorn C. Acute cerebellar ataxia and hearing loss as initial symptoms of infectious mononucleosis. *Arch Neurol* 1983;40:760-762.
270. Wadhwa HK, Ghose RR. Acute cerebellar ataxia and infectious mononucleosis. *Postgrad Med J* 1983;59:457-458.
271. Cotton PB, Webb-Peploe MM. Acute transverse myelitis as a complication of glandular fever. *BMJ* 1966;1:654-655.
272. Junker AK, Roland EH, Hahn G. Transverse myelitis with Epstein-Barr virus infection with delayed antibody response. *Neurology* 1991;41:1523-1524.
273. Hoagland RJ. Mononucleosis and heart disease. *Am J Med Sci* 1964;248:1.
274. Roseman DM, et al. Acute pericarditis as the first manifestation of infectious mononucleosis. *Ann Intern Med* 1957;47:351.
275. Shugoll GI. Pericarditis associated with infectious mononucleosis. *Arch Intern Med* 1957;100:630.
276. Smith CH. Complications of infectious mononucleosis. *Ann Intern Med* 1956;44:861.
277. Maddern BR, Werkhaven J, Wessell H, Yunis E. Infectious mononucleosis with airway obstruction and multiple cranial nerve paresis. *Otolaryngol Head Neck Surg* 1991;104:529-532.
278. Snyderman NL. Otolaryngologic presentation of infectious mononucleosis. *Pediatr Clin North Am* 1981;29:1011.
279. Fermaglich DR. Pulmonary involvement in infectious mononucleosis. *J Pediatr* 1975;86:93.
280. Haller A, von Segesser L, Baumann PC, Krause M. Severe respiratory insufficiency complicating Epstein-Barr virus infection: case report and review. *Clin Infect Dis* 1995;21:206-209.
281. Eaton OM, et al. Infectious mononucleosis with pleural effusion. *Arch Intern Med* 1965;115:87.
282. Offit PA, Fleisher GR, Koven NL, Plotkin SA. Severe Epstein-Barr virus pulmonary involvement. *J Adolesc Health Care* 1981;2:121-125.
283. Markin RS, et al. Hepatitis in fatal infectious mononucleosis. *Gastroenterology* 1987;93:1210.
284. Pelletier LL, et al. Disseminated intravascular coagulation and hepatic necrosis. *JAMA* 1976;235:1144.
285. Tazawa Y, Nishinomiya F, Noguchi H, et al. A case of fatal infectious mononucleosis presenting with fulminant hepatic failure associated with an extensive CD8-positive lymphocyte infiltration in the liver. *Hum Pathol* 1993;24:1135-1139.



286. Everett ED, et al. Pancreatitis in infectious mononucleosis. *South Med J* 1969;62:359.
287. Wislocki LG. Acute pancreatitis in infectious mononucleosis. *N Engl J Med* 1966;275:322.
288. Lowery TA, et al. Renal failure in infectious mononucleosis. *South Med J* 1976;69:1212.
289. Evans AS. Complications of infectious mononucleosis. *Hosp Med* 1967;3:24.
290. Schumacher HR, et al. Treatment of infectious mononucleosis. *Ann Intern Med* 1963;58:217.
291. Prout C, Dalrymple W. A double-blind study of eighty-two cases of infectious mononucleosis treated with corticosteroids. *J Am Coll Health Assoc* 1966;15:62-66.
292. Klein EM, Cochran JF, Buck RL. The effects of short-term corticosteroid therapy on the symptoms of infectious mononucleosis pharyngotonsillitis: a double-blind study. *J Am Coll Health Assoc* 1969;17:446-450.
293. Andersson J, Ernberg I. Management of Epstein-Barr virus infections. *Am J Med* 1988;85:107-115.
294. McGowan JE, Jr., Chesney PJ, Crossley KB, LaForce FM. Guidelines for the use of systemic glucocorticosteroids in the management of selected infections. Working Group on Steroid Use, Antimicrobial Agents Committee, Infectious Diseases Society of America. *J Infect Dis* 1992;165:1-13.
295. Waldo RT. Neurologic complications on infectious mononucleosis after steroid therapy. *South Med J* 1981;74:1159-1160.
296. Bender CE. The value of corticosteroids in the treatment of infectious mononucleosis. *JAMA* 1967;199:529.
297. Brandfonbrener A, et al. Corticosteroid therapy in Epstein-Barr virus infection. *Arch Intern Med* 1986;146:337.
298. Straus SE. Epstein-Barr virus and human herpesvirus type 6. In: Galasso GJ, Whitely RJ, Merigan TC, eds. *Antiviral agents and viral diseases of man*, 3rd ed. New York: Raven Press, 1990:647-668.
299. Pagano JS, Sixbey JW, Lin JC. Acyclovir and Epstein-Barr virus infection. *J Antimicrob Chemother* 1983;12[Suppl B]:113-121.
300. Andersson J, Britton S, Ernberg I, et al. Effect of acyclovir on infectious mononucleosis: a double-blind, placebo-controlled study. *J Infect Dis* 1986;153:283-290.
301. Andersson J, Skildenberg B, Henle W, et al. Acyclovir treatment in infectious mononucleosis: a clinical and virological study. *Infection* 1987;15:14-20.
302. Van der Horst C, Joncas J, Ahronhein G, et al. Lack of effect of peroral acyclovir for the treatment of infectious mononucleosis. *J Infect Dis* 1991;164:788-792.
303. Tynell E, Aurelius E, Brandell A, et al. Acyclovir and prednisolone treatment of acute infectious mononucleosis: a multicenter, double-blind, placebo-controlled study. *J Infect Dis* 1996;174:324-331.
304. Andersson J. EBV, everybody's virus: the management of Epstein-Barr virus infections. *Herpes* 1996;3(2):55-62.
305. Morgan AJ. Control of viral disease: the development of Epstein-Barr virus vaccine. *Springer Semin Immunopathol* 1991;13:249-262.
306. Cox C, Naylor BA, Mackett M, et al. Immunization of common marmosets with Epstein-Barr virus (EBV) envelope glycoprotein gp340: effect on viral shedding following EBV challenge. *J Med Virol* 1998;55:255-261.
307. Khanna R, Sherritt M, Burrows SR. EBV structural antigens, gp350 and gp85, as targets for ex vivo virus-specific CTL during acute infectious mononucleosis: potential use of gp350/gp85 CTL epitopes for

vaccine design. *J Immunol* 1999;162(5):3063–3069.

308. Khanna R, Moss DJ, Burrows SR. Vaccine strategies against Epstein–Barr virus–associated diseases: lessons from studies on cytotoxic T–cell–mediated immune regulation. *Immunol Rev* 1999;170:49–64.

309. Jung S, Chung YK, Chang SH, et al. DNA–mediated immunization of glycoprotein 350 of Epstein–Barr virus induces the effective humoral and cellular immune responses against the antigen. *Mol Cells* 2001;12:41–49.

310. Herr W, Ranieri E, Olson W, et al. Mature dendritic cells pulsed with freeze–thaw cell lysates define an effective in vitro vaccine designed to elicit EBV–specific CD4(+) and CD8(+) T lymphocyte responses. *Blood* 2000;96:1857–1864.

311. Weisenburger DD, Purtilo DT. In: Epstein MA, Achong BG, eds. *The Epstein–Barr virus: recent advances*. London: Heinemann, 1986:127–161.

312. Reference deleted.

313. Reference deleted.

314. Nonoyama M, Huang CH, Pagano JS, et al. DNA of Epstein–Barr virus detected in tissue of Burkitt's lymphoma and nasopharyngeal carcinoma. *Proc Natl Acad Sci U S A* 1973;70:3265–3268.

315. Wolf H, zur Hausen H, Becker V. EB viral genomes in epithelial nasopharyngeal carcinoma cells. *Nat (Lond) Biol* 1973;244:245–257.

316. Klein G, Giovanella BC, Lindahl T, et al. Direct evidence for the presence of Epstein–Barr virus DNA and nuclear antigen in malignant epithelial cells from patients with poorly differentiated carcinoma of the nasopharynx. *Proc Natl Acad Sci U S A* 1974;71:4737–4741.

317. Okano M, Matsumoto S, Osato T, et al. Severe chronic active Epstein–Barr virus infection syndrome. *Clin Microbiol Rev* 1991;4:129–135.

318. Straus SE. Acute progressive Epstein–Barr virus infection. *Annu Rev Med* 1992;43:437–449.

319. Kimura H, Kanegane H, Tsuge I, et al. Clinical and virologic characteristics of chronic active Epstein–Barr virus infection. *Blood* 2001;98:280–286.

320. Kasahara Y, Yachie A, Takei K, et al. Differential cellular targets of Epstein–Barr virus (EBV) infection between acute EBV–associated hemophagocytic lymphohistiocytosis and chronic active EBV infection. *Blood* 2001;98:1882–1888.

321. Kanegane H, Wakiguchi H, Kanegane C, et al. Viral interleukin–10 in chronic active Epstein–Barr virus infection. *J Infect Dis* 1997;176:254–257.

322. Jones J, Shurin S, Abramowsky C, et al. T–cell lymphomas containing Epstein–Barr viral DNA in patients with chronic Epstein–Barr virus infections. *N Engl J Med* 1988;318:733–741.

323. Quintanilla–Martinez L, Kumar S, Fend F, et al. Fulminant EBV<sup>+</sup> T–cell lymphoproliferative disorder following acute/chronic EBV infection: a distinct clinicopathologic syndrome. *Blood* 2000;96:443–451.

324. Ishida Y, Yokota Y, Tauchi H, et al. Ganciclovir for chronic active Epstein–Barr virus infection. *Lancet* 1993;341:560–561.

325. Kimura H, Morita M, Tsuge I, et al. Vidarabine therapy for severe chronic active Epstein–Barr virus infection. *J Pediatr Hematol Oncol* 2001;23:294–299.

326. Kawa–Ha K, Franco E, Doi S, et al. Successful treatment of chronic active Epstein–Barr virus infection with recombinant interleukin–2. *Lancet* 1987;1:154.

327. Sakai Y, Ohga S, Tonegawa Y, et al. Interferon–alpha therapy for chronic active Epstein–Barr virus infection: potential effect on the development of T–cell lymphoproliferative disease. *J Pediatr Hematol*

Oncol 1998;20:342–346.

328. Okamura T, Hatsukawa Y, Arai H, et al. Blood stem cell transplantation for chronic active Epstein–Barr virus with lymphoproliferation. *Lancet* 2000;358:223–224.
329. Kuzushima K, Yamamoto M, Kimura H, et al. Establishment of an anti–Epstein–Barr virus (EBV) cellular immunity by adoptive transfer of virus–specific cytotoxic T lymphocytes from HLA–matched sibling to a patient with severe chronic active EBV infection. *Clin Exp Immunol* 1996;103:192–198.
330. Jones JF, Ray CG, Minnich LL, et al. Evidence of active Epstein–Barr virus infection in patients with persistent unexplained illness: elevated anti–early antigen antibodies. *Ann Intern Med* 1985;102:1–7.
331. Holmes GP, Deplane JE, Stewart JA, et al. A cluster of patients with chronic mononucleosis–like syndrome; is Epstein–Barr virus the cause? *JAMA* 1987;257:2297–2302.
332. Straus SE, Dale JK, Tobi M, et al. Acyclovir treatment of the chronic fatigue syndrome: lack of efficacy in a placebo–controlled trial. *N Engl J Med* 1988;319:1692–1698.
333. Andersson JP. Clinical aspects of Epstein–Barr virus infection. *Scand J Infect* 1991;78[Suppl]:94–104.
334. Straus SE. Studies of herpesvirus infection in chronic fatigue syndrome. *Ciba Found Symp* 1993;173:132–145.
335. Harrington DS, Weisenburger DD, Purtilo DT. Epstein–Barr virus–associated lymphoproliferative lesions. *Clin Lab Med* 1988;8:97.
336. Seemayer TA, Gross TG, Egeler RM, et al. X–linked lymphoproliferative disease: twenty–five years after the discovery. *Pediatr Res* 1995;38:471–478.
337. Sullivan JL, et al. Epstein–Barr virus–associated hemophagocytic syndrome: virological and immunopathological studies. *Blood* 1985;65:1097.
338. Henter JI, Elinder G, Ost A. Diagnostic guidelines for hemophagocytic lymphohistiocytosis. *Semin Oncol* 1991;18:29.
339. Seemayer TA, Gross TG, Hinrichs SH, Egeler RM. Massive diffuse histiocytic myocardial infiltration in Epstein–Barr virus–associated hemophagocytic syndrome and fulminant infectious mononucleosis. *Cell Vision* 1994;1:260.
340. Sullivan JL. Epstein–Barr virus and lymphoproliferative disorders. *Semin Hematol* 1988;25:269–279.
341. Dutz JP, Benoit L, Wang X, et al. Lymphocytic vasculitis in X–linked lymphoproliferative disease. *Blood* 2001;97:95–100.
342. Mroczek EC, Weisenburger DD, Grierson HL, et al. Fatal infectious mononucleosis and virus–associated hemophagocytic syndrome. *Arch Pathol Lab Med* 1987;111:530–535.
- 342a. Mroczek EC, Seemayer TA, Grierson HL, et al. Thymic lesions in fatal infectious mononucleosis. *Clin Immunol Immunopathol* 1987;43:243–255.
343. Seemayer TA, Lapp WS, Bolande RP. Thymic involution in murine graft–versus–host reaction: epithelial injury mimicking human dysplasia. *Am J Pathol* 1977;88:119–134.
344. Seemayer TA, Bolande RP. Thymic involution mimicking thymic dysplasia, a consequence of transfusion–induced graft–versus–host disease in a premature infant. *Arch Pathol Lab Med* 1980;104:141–144.
345. Seemayer TA, Laroche AC, Russo P, et al. Precocious thymic involution manifest by epithelial injury in the acquired immune deficiency syndrome. *Hum Pathol* 1984;15:469–474.
346. Akashi K, Hayashi S, Gondo H, et al. Involvement of interferon–gamma and macrophage colony–stimulating factor in pathogenesis of haemophagocytic lymphohistiocytosis in adults. *Br J Haematol*

1994;87:243.

347. Gong XS. Effective control of infection-associated hemophagocytic syndrome with chloroquine. *J Pediatr Hematol Oncol* 2002;24:330-333.

348. Ambruso DR, Hays T, Zwartjes WJ, et al. Successful treatment of lymphohistiocytic reticulosis with phagocytosis with epipodophyllotoxin VP16-213. *Cancer* 1980;45:2516.

349. Pracher E, Grumayer-Panzer ER, Zonbek A, et al. Bone marrow transplantation during fulminant EBV-infection in Duncan's syndrome. *Lancet* 1993;342:1362.

350. Imashuku S, Kuriyama K, Teramura T, et al. Requirement for etoposide in the treatment of Epstein-Barr virus associated hemophagocytic lymphohistiocytosis. *J Clin Oncol* 19;19:2665-2673.

351. Chen RL, Lin KH, Lin DT, et al. Immunomodulation treatment for childhood virus-associated hemophagocytic lymphohistiocytosis. *Br J Haematol* 1995;89:282.

352. Henter JI, Arico M, Egeler RM, et al. HLH-94: a treatment for hemophagocytic lymphohistiocytosis. HLH Study Group of the Histiocyte Society. *Med Pediatr Oncol* 1997;28:342.

353. Gross TG, Filipovich AH, Conley ME, et al. Cure of X-linked lymphoproliferative disease (XLP) with allogeneic bone marrow transplantation (BMT): report from the XLP Registry. *Bone Marrow Transplant* 1996;17:741-744.

354. Purtilo DT, Cassel CK, Yang JPS, et al. X-linked recessive progressive combined variable immunodeficiency (Duncan's disease). *Lancet* 1975;1:935-941.

355. Saemundsen AK, Berkel AI, Henle W, et al. Epstein-Barr virus carrying lymphoma in a patient with ataxia telangiectasia. *Br Med J* 1981;282:425-427.

356. Joncas J, LaPointe N, Gervais F, Leyritz M. Unusual prevalence of Epstein-Barr virus early antigen (EBV-EA) antibody in ataxia-telangiectasia. *J Immunol* 1977;119:1857-1859.

357. Okano M, Mizuno F, Osato T, et al. Wiskott-Aldrich syndrome and Epstein-Barr virus-induced lymphoproliferation. *Lancet* 1984;2:933-934.

358. Starzl TE, Nalesnik MA, Porter KA, et al. Reversibility of lymphomas and lymphoproliferative lesions developing under cyclosporine A-prednisolone immunosuppression. *Lancet* 1984;1:583-587.

359. Beral V, Peterman T, Berkelman R, Jaffe H. AIDS-associated non-Hodgkin lymphoma. *Lancet* 1991;337:805-809.

360. Okano M, Gross TG. A review of Epstein-Barr virus infection in patients with immunodeficiency disorders. *Am J Med Sci* 2000;319:392-396.

361. Hoffman T, Heilman C, Madsen HO, et al. Matched unrelated allogeneic bone marrow transplantation for recurrent malignant lymphoma in a patient with X-linked lymphoproliferative disease (XLP). *Bone Marrow Transplant* 1998;22:603-604.

362. Filipovich AH, Jyonouchi H, Gross TG, Shapiro RS. Hematologic and oncologic complications of primary and secondary immunodeficiencies, including EBV related disorders. In: Stiehm ER, ed. *Immunologic disorders of infants and children*, 4th ed. Philadelphia: Saunders;1996:855-888.

363. Sandoval C, Swift M. Treatment of lymphoid malignancies in patients with ataxia-telangiectasia. *Med Pediatr Oncol* 1998;31:491-497.

364. Seideman K, Tiemann M, Henze G, et al. Therapy for non-Hodgkin lymphoma in children with primary immunodeficiency; analysis of 19 patients from the BFM trials. *Med Pediatr Oncol* 1999;33:536-544.

365. Bar RS, DeLor CJ, Clausen KP, et al. Fatal infectious mononucleosis in a family. *N Engl J Med* 1974;290:363-367.

366. Purtilo DT, Cassels C, Yang JPS. Fatal infectious mononucleosis in familial lymphohistiocytosis. *N*

Engl J Med 1974;291:736.

367. Seemayer TA, Greiner TG, Gross TG, et al. X-linked lymphoproliferative disease. In: Goedert JJ, ed. Infectious causes of cancer, targets for intervention. Totowa: Humana Press, 2000:51-61.
368. Sumegi J, Gross TG, Seemayer TA. The molecular genetics of X-linked lymphoproliferative (Duncan's) disease. *Cancer J Sci Am* 1999;5:57-62.
369. Sumegi J, Huang D, Lanyi A, et al. Correlation of mutations of the SH2D1A gene and Epstein-Barr virus infection with clinical phenotype and outcome in X-linked lymphoproliferative disease. *Blood* 2000;96:3118-3125.
370. Grierson HL, Skare J, Hawk J, et al. Immunoglobulin class and subclass deficiencies prior to Epstein-Barr virus infection in males with X-linked lymphoproliferative disease. *Am J Med Genet* 1991;40:294-297.
371. Harrington DS, Weisenburger DD, Purtilo DT. Malignant lymphoma in the X-linked lymphoproliferative syndrome. *Cancer* 1987;59:1419-1429.
372. Egeler RM, de Kraker J, Slater R, Purtilo DT. Documentation of Burkitt lymphoma with t(8;14)(q24;q32) in X-linked lymphoproliferative disease. *Cancer* 1992;70:683-687.
373. Williams LL, Rooney CM, Conley ME, et al. Correction of Duncan's syndrome by allogeneic bone marrow transplantation. *Lancet* 1993;2:587-588.
374. Brandau O, Schuster V, Weiss M, et al. Epstein-Barr virus-negative boys with non-Hodgkin lymphoma are mutated in the SH2D1A gene, as are patients with X-linked lymphoproliferative disease (XLP). *Hum Mol Genet* 1999;8:2407-2413.
375. Lindsten T, Seeley JK, Ballow M, et al. Immune deficiency in the X-linked lymphoproliferative syndrome. II. Immunoregulatory T cell defects. *J Immunol* 1982;129:2536-2540.
376. Schuster V, Kreth HW. X-linked lymphoproliferative disease is caused by deficiency of a novel SH2 domain-containing signal transduction adaptor protein. *Immunol Rev* 2000;178:21-28.
377. Purtilo DT, Grierson HL, Ochs H. detection of X-linked lymphoproliferative disease (XLP) using molecular and immunovirological markers. *Am J Med* 1989;87:421-424.
378. Seemayer TA, Grierson H, Pirruccello SJ, et al. X-linked lymphoproliferative disease. *Am J Dis Child* 1993;147:1242-1245.
379. Gilmour KC, Cranston T, Jones A, et al. Diagnosis of X-linked lymphoproliferative disease by analysis of SLAM-associated protein expression. *Eur J Immunol* 2000;30:1691-1697.
380. Conley ME, Sullivan JL, Neidich JA, Puck JM. X chromosome inactivation patterns in obligate carriers of X-linked lymphoproliferative syndrome. *Clin Immunol Immunopathol* 1990;55:486-491.
381. Arico M, Imashuku S, Clementi R, et al. Hemophagocytic lymphohistiocytosis due to germline mutations in SH2D1A, the X-linked lymphoproliferative disease gene. *Blood* 2001;97:1131-1133.
382. Coffey AJ, Brooksbank RA, Brandau O, et al. The aberrant host response to EBV infection in X-linked lymphoproliferative disease results from mutations in a novel SH2-domain encoding gene, SH2D1A. *Nat Genet* 1998;20:129-135.
383. Sayos J, Wu C, Morra M, et al. The X-linked lymphoproliferative-disease gene product SAP regulates signals induced through the co-receptor SLAM. *Nature* 1998;395:462-469.
384. Nichols KE, Harkin DP, Levitz S, et al. Inactivating mutations in an SH2 domain-encoding gene in X-linked lymphoproliferative syndrome. *Proc Natl Acad Sci U S A* 1998;95:13765-13770.
385. Latour S, Gish G, Helgason CD, et al. Regulation of SLAM-mediated signal transduction by SAP, the X-linked lymphoproliferative gene product. *Nat Immunol* 2001;2:681-690.

386. Lewis J, Eiben LJ, Nelson DL, et al. Distinct interactions of the X-linked lymphoproliferative syndrome gene product SAP with cytoplasmic domains of members of the CD2 receptor family. *Clin Immunol* 2001;100:15-23.
387. Parolini S, Bottino C, Falco M, et al. X-linked lymphoproliferative disease. 2B4 molecules displaying inhibitory rather than activating function are responsible for the inability of natural killer cells to kill Epstein-Barr virus-infected cells. *J Exp Med* 2000;192:337-344
388. Sylla BS, Murphy K, Cahir-McFarland E, et al. The X-linked lymphoproliferative syndrome gene product SH2D1A associates with p62dok (Dok1) and activates NF-kappa B. *Proc Natl Acad Sci U S A* 2000;97:7470-7475.
- 388a. Nichols KE, Gross TG, Koretzky GA. X-linked lymphoproliferative disease. In: *Immunology and allergy clinics of North America-immunodeficiency disorders*. Philadelphia: WB Saunders Co, (*In press*)
389. Wu C, Nguyen KB, Pien GC, et al. SAP controls T cell responses to virus and terminal differentiation of TH2 cells. *Nat Immunol* 2001;2:410-414.
390. Czar MJ, Kersh EN, Mijares LA, et al. Altered lymphocyte responses and cytokine production in mice deficient in the X-linked lymphoproliferative disease gene SH2D1A/DSHP/SAP. *Proc Natl Acad Sci U S A* 2001;98:7449-7454.
391. Ziegner UH, Ochs HD, Schanen C, et al. Unrelated umbilical cord stem cell transplantation for X-linked immunodeficiencies. *J Pediatr* 2001;138:570-573.
392. Cohen JI. Epstein-Barr virus lymphoproliferative disease associated with acquired immunodeficiency. *Medicine* 1991;70:137-160.
393. Salloum E, Cooper DL, Howe G, et al. Spontaneous regression of lymphoproliferative disorders in patients treated with methotrexate for rheumatoid arthritis and other rheumatic diseases. *J Clin Oncol* 1996;6:1943-1949.
394. Birx D, Redfield R, Tosato G. Defective regulation of Epstein-Barr virus infection in patients with acquired immunodeficiency syndrome (AIDS) or AIDS-related disorders. *N Engl J Med* 1986;14:874-879.
395. Joab I, Triki H, de Saint Martin J, et al. Detection of anti-Epstein-Barr virus *trans*-activator (ZEBRA) antibodies in sera from patients with human immunodeficiency virus. *J Infect Dis* 1991;163:53-56.
396. Patton DF, Shirley P, Raab-Traub N, et al. Defective viral DNA in Epstein-Barr virus-associated oral hairy leukoplakia. *J Virol* 1990;64:397-400.
397. Greenspan JS, Greenspan D, Lennette ET, et al. Replication of Epstein-Barr virus within the epithelial cells of oral "hairy" leukoplakia, an AIDS-associated lesion. *N Engl J Med* 1986;313:1564-1570.
398. Schofer H, Ochsendorf FR, Helm EB, Millbrandt R. Treatment of oral "hairy" leukoplakia in AIDS patients with vitamin A acid (topically) or acyclovir (systemically). *Dermatologica* 1987;174:150-151.
399. Pelicci P, Knowles D, Arlin S. Multiple monoclonal B-cell expansions and c-myc oncogene rearrangements in AIDS-related lymphoproliferative disorders: implications for lymphomagenesis. *J Exp Med* 1986;164:2049-2060.
400. Katz BZ, Berkman AB, Shapiro ED. Serologic evidence of active Epstein-Barr virus infection in Epstein-Barr virus-associated lymphoproliferative disorders of children with acquired immunodeficiency syndrome. *J Pediatr* 1992;120:228.
401. Goedert JJ, Cote TR, Virgo P, et al. Spectrum of AIDS-associated malignant disorders. *Lancet* 1998;351:1833-1839.
402. van Baarle D, Hovenkamp E, Callan MFC, et al. Dysfunctional Epstein-Barr virus (EBV)-specific CD8+ T lymphocytes and increased EBV load in HIV-1 infected individuals progressing to AIDS-related non-Hodgkin lymphoma. *Blood* 2001;98:146-155.

403. Levine AM. Acquired immunodeficiency syndrome-related lymphoma. *Blood* 1992;80:8-20.
404. Ballerini P, Gaidano G, Gong J. Multiple genetic lesions in AIDS related non-Hodgkin lymphoma. *Blood* 1993;81:166-176.
405. MacMahon E, Glass J, Hayward S, et al. Epstein-Barr virus in AIDS-related primary central nervous system lymphoma. *Lancet* 1991;2:969-973.
406. Knowles D, Inghirami G, Ubriaco A, Dalla-Favera R. Molecular genetic analysis of three AIDS associated neoplasms of uncertain lineage demonstrates their B-cell derivation and the possible pathogenetic role of the Epstein-Barr virus. *Blood* 1989;73:792-799.
407. Shiramizu B, McGrath MS. Molecular pathogenesis of AIDS-associated non-Hodgkin's lymphoma. *Hematol Oncol Clin North Am* 1991;5:323-330.
408. Beral V, Peterman T, Berkelman R, et al. AIDS-associated non-Hodgkin lymphoma. *Lancet* 1991;337:805-809.
409. Imperial Cancer Research Fund Cancer Epidemiology Unit. Highly active antiretroviral therapy and the incidence of human immunodeficiency virus-infected adults. *J Natl Cancer Inst* 2000;92:1823-1830.
410. Rabkin CS, Testa M, Von Roenn JH. Kaposi's sarcoma and non-Hodgkin's lymphoma incidence trends in AIDS Clinical Trial Group study participants. *J Acquir Immune Defic Syndr Hum Retrovirol* 1999;21[Suppl 1]:S31-S33.
411. Buchbinder SP, Holmberg S, Scheer S, et al. Combination antiretroviral therapy and incidence of AIDS-related malignancies. *J Acquir Immune Defic Syndr Hum Retrovirol* 1999;21[Suppl 1]:S23-S26.
412. Jacobsen LP, Yamashita TE, Margolick JB, et al. Impact of potent antiretroviral therapy on the incidence of Kaposi's sarcoma and non-Hodgkin's lymphoma among HIV-1 infected individuals. *J Acquir Immune Defic Syndr Hum Retrovirol* 1999;21[Suppl 1]:S34-S41.
413. Matthews GV, Bower M, Mandalia S, et al. Changes in acquired immunodeficiency syndrome-related lymphoma since the introduction of highly active retroviral therapy. *Blood* 2000;96:2730-2734.
414. Jones JL, Hanson DL, Dworkin MS, et al. and the Adult/Adolescent Spectrum of HIV Disease Project Group. Effect of antiretroviral therapy on recent trends in selected cancers among HIV-infected persons. *J Acquir Immune Defic Syndr Hum Retrovirol* 1999;21[Suppl 1]:S11-S17.
415. Kaplan LD, Straus DJ, Testa MA, et al. Low-dose compared to standard-dose m-BACOD chemotherapy for non-Hodgkin's lymphoma associated with human immunodeficiency virus infection. *N Engl J Med* 1997;336:1641-1648.
416. Kaplan LD, Shiramizu B, Herndier B, et al. Influence of molecular characteristics on clinical outcome in human immunodeficiency virus-associated non-Hodgkin's lymphoma: identification of a subgroup with favorable clinical outcome. *Blood* 1995;85:1727-1735.
417. Nalesnik MA, Makowka L, Starzl TE. The diagnosis and treatment of posttransplant lymphoproliferative disorders. *Curr Probl Surg* 1998;25:367-472.
418. Frizzera G, Hanto DW, Gajl-Peczalska KJ, et al. Polymorphic diffuse B-cell hyperplasias and lymphomas in renal transplant recipients. *Cancer Res* 1981;41:4262-4279.
419. Swerdlow SH. Post-transplant lymphoproliferative disorders: a morphologic, phenotypic and genotypic spectrum of disease. *Histopathology* 1992;20:373-385.
420. Knowles DM, Cesarman E, Chadburn A, et al. Correlative morphologic and molecular genetic analysis demonstrates three distinct categories of posttransplantation lymphoproliferative disorders. *Blood* 1995;85:552-565.
421. Malatack JJ, Gartner JC, Urbach AH, et al. Orthotopic liver transplantation, Epstein-Barr virus,



cyclosporine, and lymphoproliferative disease: a growing concern. *J Pediatr* 1991;118:667-675.

422. Harris NL, Jaffe ES, Diebold J, et al. World Health Organization classification of neoplastic diseases of the hematopoietic and lymphoid tissues: report of the clinical advisory committee meeting—Airlie House, Virginia, November 1997. *J Clin Oncol* 1999;17:3835-3849.

423. Dhir RK, Nalesnik MA, Demetris AJ, Randhawa PS. Latent membrane protein expression in posttransplant lymphoproliferative disease. *Appl Immunohistochem* 1995;3:123.

424. Young L, Alfieri C, Hennessey K, et al. Expression of Epstein-Barr virus transformation-associated antigens in tissues of patients with EBV lymphoproliferative disease. *N Engl J Med* 1989;321:1080-1085.

425. Greiner TC, Abou-Ellella AA, Smir BN, et al. EBNA-1 substrain and p53 mutation analysis in Epstein-Barr virus positive posttransplant lymphoproliferative disorders. *Leuk Lymphoma* 2000;38:563-576.

426. Gross TG, Steinbuch M, DeFor T, et al. B cell lymphoproliferative disorder following hematopoietic stem cell transplantation: risk factors, treatment and outcome. *Bone Marrow Transplant* 1999;23:251-258.

427. Curtis RE, Travis LB, Rowings PA, et al. Risk of lymphoproliferative disorders after bone marrow transplantation: a multi-institutional study. *Blood* 1999;94:2208-2216.

428. Lucas KG, Small TN, Heller G, et al. The development of cellular immunity to Epstein-Barr virus after allogeneic bone marrow transplantation. *Blood* 1996;87:2594-2603.

429. Haque T, Thomas JA, Parratt R, et al. A prospective study in heart and lung transplant recipients correlating persistent Epstein-Barr virus infection with clinical events. *Transplantation* 1997;64:1028-1034.

430. Dotti G, Fiocchi, Motts T, et al. Epstein-Barr virus-negative lymphoproliferative disorders in long-term survivors after heart, kidney and liver transplant. *Transplantation* 2000;69:827-833.

431. Leblond V, Davi F, Charlotte F, et al. Posttransplant lymphoproliferative disorders not associated with Epstein-Barr virus: a distinct entity? *J Clin Oncol* 1998;16:2052-2059.

432. Hanson MN, Morrison VA, Peterson BA, et al. Posttransplant T-cell lymphoproliferative disorders—an aggressive, late complication of solid-organ transplantation. *Blood* 1996;88:3626-3633.

433. Swerdlow A, Higgins CD, Hunt BJ, et al. Risk of lymphoid neoplasia after cardiothoracic transplantation. *Transplantation* 2000;69:897-904.

434. Gross TG. Low-dose chemotherapy for treatment of children with PT-LPD. In: Oertel SH, Riess HB, eds. *Recent results cancer Res, immunosurveillance, immunodeficiencies and lymphoproliferations*. Berlin-Heidelberg: Springer-Verlag, 2002.

435. Ho M, Jaffe R, Miller G, et al. The frequency of Epstein-Barr virus infection and associated lymphoproliferative syndrome after transplantation and its manifestations in children. *Transplantation* 1988;45:719-727.

436. Newell KA, Alonso EM, Whittington PF, et al. Posttransplant lymphoproliferative disease in pediatric liver transplantation. *Transplantation* 1996;61:370-375.

437. Paya CV, Fung JJ, Nalesnik MA, et al. Epstein-Barr virus-induced posttransplant lymphoproliferative disorders. *Transplantation* 1999;68:1517-1525.

438. Green M, Micheals MG, Webber SA, et al. The management of Epstein-Barr virus associated post-transplant lymphoproliferative disorders in pediatric solid organ transplant recipients. *Pediatr Transplant* 1999;3:271-281.

439. McDiarmid SV, Jordan S, Lee GS, et al. Prevention and preemptive therapy of posttransplant lymphoproliferative disease in pediatric liver recipients. *Transplantation* 1998;66:1604-1611.

440. Liebowitz D, Anastasi J, Hagos F, et al. Post-transplant lymphoproliferative disorders (PTLD): clinicopathologic characterization and response to immunomodulatory therapy with interferon-alpha. *Ann*

Oncol 1996;7[Suppl 3]:28(abst).

441. Davis CL, Wood BL, Sabath DE, et al. Interferon-alpha treated post-transplant lymphoproliferative disorder in recipients of solid organ transplants. *Transplantation* 1998;66:1770-1179.
442. Benkerrou M, Jais JP, Leblond V, et al. Anti-B-cell monoclonal antibody treatment of severe post-transplant B-lymphocyte disorder: prognostic factors and long-term outcome. *Blood* 1998;92:3137-3147.
443. Milpied N, Vasseur B, Parquet N, et al. Humanized anti-CD20 monoclonal antibody (rituximab) in post transplant B-lymphoproliferative disorder: a retrospective analysis on 32 patients. *Ann Oncol* 2000;11:113-116.
444. Kuehnle I, Huls MH, Liu Z, et al. CD20 monoclonal antibody (rituximab) for therapy of Epstein-Barr virus lymphoma after hemopoietic stem-cell transplantation. *Blood* 2000;95:1502-1505.
445. Swinnen LJ, Mullen GM, Carr TJ, et al. Aggressive treatment for postcardiac lymphoproliferation. *Blood* 1995;86:3333-3340.
446. Hayashi RJ, Kraus MD, Patel AL, et al. Posttransplant lymphoproliferative disease in children: correlation of histology to clinical behavior. *J Pediatr Hematol Oncol* 200;23:14-18.
447. Balfour IC, Wall D, Luisiri A, Gross TG. Cyclophosphamide/prednisone for combination immunosuppression and therapy of post-transplant lymphoproliferative disease. *J Heart Lung Transplant* 1999;18:492-495.
448. Papadopoulos EB, Ladanyi M, Emanuel D, et al. Infusions of donor leukocytes to treat Epstein-Barr virus-associated lymphoproliferative disorders after allogeneic bone marrow transplantation. *N Engl J Med* 1994;330:1185-1191.
449. Lucas KG, Burton RL, Zimmerman SE, et al. Semiquantitative Epstein-Barr virus (EBV) polymerase chain reaction for determination of patients at risk for EBV-induced lymphoproliferative disease after stem cell transplantation. *Blood* 1998;91:3654-3661.
450. Rooney CM, Smith CA, Ng CC, et al. Infusion of cytotoxic T cells for prevention and treatment of Epstein-Barr virus-induced lymphoma in allogeneic transplant recipients. *Blood* 1998;92:1549-1555.
451. Khanna R, Bell S, Sherritt M, et al. Activation and adoptive transfer of Epstein-Barr virus-specific cytotoxic T cells in solid organ transplant patients with posttransplant lymphoproliferative disease. *Proc Natl Acad Sci U S A* 2000;96:10391-10396.
452. Gregory C, Rowe M, Rickinson A. Different Epstein-Barr virus (EBV)-B cell interactions in phenotypically distinct clones of a Burkitt lymphoma cell line. *J Gen Virol* 1990;71:1481-1495.
453. Sample J, Brooks L, Sample C, et al. Restricted Epstein-Barr virus protein expression in Burkitt lymphoma is due to a different Epstein-Barr nuclear antigen-1 transcription initiation site. *Proc Natl Acad Sci U S A* 1991;88:6343-6347.
454. Neri A, Barriga F, Inghirami G, et al. Epstein-Barr virus infection precedes clonal expansion in Burkitt's and acquired immunodeficiency associated lymphoma. *Blood* 1991;77:1092-1095.
455. Manolov G, Manolova Y, Klein G, et al. Alternative involvement of two cytogenetically distinguishable break-points on chromosome 8 in Burkitt's lymphoma associated translocations. *Cancer Genet Cytogenet* 1986;20:95-99.
456. Bernheim A, Berger R, Lenoir G. Cytogenic studies on African Burkitt's lymphoma cell lines; t(8;14), t(2;8) and t(8;22) translocations. *Cancer Genet Cytogenet* 1981;3:307-315.
457. Croce C. Molecular biology of lymphomas. *Semin Oncol* 1993;20[Suppl 5]:31-46.
458. Klein G. Viral latency and transformation: the strategy of Epstein-Barr virus. *Cell* 1989;58:5-8.
459. Shimizu N, Tanabe-Tochikura A, Kuroiwa Y, et al. Isolation of Epstein-Barr virus (EBV)-negative cell clones from EBV-positive Burkitt's lymphoma (BL) line Akata: malignant phenotypes of BL cells are

dependent on EBV. *J Virol* 1994;68:6069–6073.

460. Kumano J, Maruo S, Kurozumi K, et al. EBERs have oncogenic functions in BL cells. *J Virol* 1999;73:9827–9831.

461. Liebowitz D. Nasopharyngeal carcinoma: the Epstein–Barr virus association. *Semin Oncol* 1994;21(3):376–381.

462. Zeng Y, Zhang LG, Wu YC, et al. Prospective studies on nasopharyngeal carcinoma in Epstein–Barr virus IgA/VCA antibody–positive persons in Wuzhou City, China. *Int J Cancer* 1986;36:545–548.

463. Henle G, Henle W. Epstein–Barr virus–specific IgA serum antibodies as an outstanding feature of nasopharyngeal carcinoma. *Int J Cancer* 1976;17:1–7.

464. de–Vathaire F, Sancho–Garnier H, de–The H, et al. Prognostic value of EBV markers in the clinical management of nasopharyngeal carcinoma (NPC): a multicenter follow–up study. *Int J Cancer* 1988;42:176–181.

465. Pathmanathan K, Prasad U, Sadler R, et al. Clonal proliferations of cells infected with Epstein–Barr virus in preinvasive lesions related to nasopharyngeal carcinoma. *N Engl J Med* 1995;333:693–698.

466. Fahraeus R, Fu HL, Ernberg I, et al. Expression of Epstein–Barr virus–encoded proteins in nasopharyngeal carcinoma. *Int J Cancer* 1988;42:329–338.

467. Young LS, Dawson CW, Clark D, et al. Epstein–Barr virus gene expression in nasopharyngeal carcinoma. *J Gen Virol* 1988;69:1051–1065.

468. Chao TY, Chow KC, Change JY, et al. Expression of Epstein–Barr virus–encoded RNAs as a marker for metastatic undifferentiated nasopharyngeal carcinoma. *Cancer* 1996;78(1):24–29.

469. Muir CS. Nasopharyngeal carcinoma in non–Chinese populations with special reference to South–East Asia and Africa. *Int J Cancer* 1971;8:351.

469a. Ho JHC. Epidemiology of nasopharyngeal carcinoma. *JR Coll Surg Edinb* 1975;20:223.

470. Huang DP, Lo KW, Choi PH, et al. Loss of heterozygosity on the short arm of chromosome 3 in nasopharyngeal carcinoma. *Cancer Genet Cytogenet* 1991;54:91–99.

471. Munoz N, Davidson RJL, Withoff B, et al. Infectious mononucleosis and Hodgkin’s disease. *Int J Cancer* 1978;22:10–13.

472. Rosdahl N, Larsen SO, Clemmensen J. Hodgkin’s disease in patients with previous infectious mononucleosis: 30 years experience. *BMJ* 1974;2:253–256.

473. Mueller N, Evans A, Harris N. Hodgkin’s disease and Epstein–Barr virus. Altered antibody pattern before diagnosis. *N Engl J Med* 1989;320:689–695.

474. Gledhill S, Gallagher A, Jones D. Viral involvement in Hodgkin’s disease: detection of clonal type A EBV genomes in tumor samples. *Br J Cancer* 1991;64:227–232.

475. Deacon E, Pallesen G, Niedobitek G, et al. Epstein–Barr virus and Hodgkin’s disease: transcriptional analysis of virus latency in the malignant cells. *J Exp Med* 1993;177:339–349.

476. Hammerschmidt W, Sugden B, Baichwal VR. The transforming domain of the Epstein–Barr virus is toxic to cells when expressed at high levels. *J Virol* 1989;63:2469–2473.

477. Knecht H, Bachmann E, Joske JL. Molecular analysis of the LMP (latent membrane protein) in Hodgkin’s disease. *Leukemia* 1993;7:580–584.

478. Durkop H, Foss HD, Denel G, et al. Tumor necrosis factor receptor–associated factor 1 is overexpressed in Reed–Sternberg cells of Hodgkin’s disease and Epstein–Barr virus–transformed lymphoid cells. *Blood* 1999;93:617–623.

479. Herbst H, Foss HD, Sanol J, et al. Frequent expression of interleukin-10 by Epstein-Barr virus-harboring tumor cells of Hodgkin's disease. *Blood* 1996;87:2918-2929.
480. Herbst H, Sanol J, Foss HD, et al. Modulation of interleukin-6 expression in Hodgkin and Reed-Sternberg cells by Epstein-Barr virus. *J Pathol* 1997;182:299-306.
481. Frisan T, Sjoberg J, Dolcetti R, et al. Local suppression of Epstein-Barr virus (EBV)-specific cytotoxicity in biopsies of EBV-positive Hodgkin's disease. *Blood* 1995;86:1493-1501.
482. Su IJ, Hsieh HC, Lin KH, et al. Aggressive peripheral T cell lymphomas containing Epstein-Barr viral DNA: a clinicopathological and molecular genetic study. *Blood* 1991;77:799-808.
483. Fingeroth J, Clabby M, Strominger J. Characterization of a T-lymphocyte Epstein-Barr virus/C3 receptor (CD21). *J Virol* 1988;62:1442-1447.
484. Kawa-Ha K, Ishihara S, Ninomiya T, et al. CD3-negative lymphoproliferative disease of granular lymphocytes containing Epstein-Barr viral DNA. *J Clin Invest* 1989;84:51-54.
485. Ishihara S, Oshima K, Tokura Y, et al. Hypersensitivity to mosquito bites conceals clonal lymphoproliferation of Epstein-Barr viral DNA-positive natural killer cells. *Jpn J Cancer Res.* 1997;88:82-87.
486. Harabuchi Y, Yamanaka Y, Kataura A, et al. Epstein-Barr virus in nasal T-cell lymphoma in patients with lethal midline granuloma. *Lancet* 1990;335:128-130.
487. Osato T, Imai S. Epstein-Barr virus and gastric carcinoma. *Semin Cancer Biol* 1996;7:175-182.
488. Okano M, et al. EBV and human diseases: recent advances in diagnosis. *Clin Microbiol Rev* 1988;1:300.
489. Ohsawa M, Tomita Y, Kanno H, et al. Role of Epstein-Barr virus in pleural lymphomagenesis. *Mod Pathol* 1995;8:848-853.

2004 Lippincott Williams & Wilkins  
John P. Greer, John Foerster, John N. Lukens  
George M. Rodgers, Frixos Paraskevas, Bertil Glader  
Wintrobe's Clinical Hematology

DISORDERS OF INNATE IMMUNITYComplementToll ReceptorsDefects in the Interleukin-12/Interferon- $\gamma$  Pathway, Interferon- $\gamma$ , Tumor Necrosis Factor, and Interleukin-12 DefectsIMMUNOGLOBULIN AND ANTIBODY DEFICIENCY SYNDROMESCongenital X-Linked HypogammaglobulinemiaOther Characteristics of Congenital Antibody Deficiency SyndromesOther Characteristics of Acquired Antibody Deficiency Syndromes: Common Variable ImmunodeficiencyTreatmentComplications of HypogammaglobulinemiaSelective Immunoglobulin A DeficiencyOther Antibody Deficiency SyndromesDEFECTS AFFECTING T LYMPHOCYTESCombined Immunodeficiency SyndromesOther Syndromes with Severe Impairments of Cell-Mediated ImmunityThymic Hypoplasia: DiGeorge SyndromeDEFECTS OF ANTIGEN PROCESSING/PRESENTATION: BARE LYMPHOCYTE SYNDROMEOTHER BIOCHEMICAL DEFECTS, SOMETIMES ASSOCIATED WITH IMMUNODEFICIENCYAtaxia-TelangiectasiaBloom SyndromeWiskott-Aldrich SyndromeAutoimmune Lymphoproliferative SyndromesSCREENING FOR IMMUNODEFICIENCYREFERENCES

The primary immunodeficiency diseases described in this chapter are mostly single gene defects and are rare, presumably because defenses against infection are an important requirement for survival. Immune responses, however, are complex and subject to multiple regulatory interactions. Polymorphisms for the many genes that contribute to immunity are likely to affect the speed or effectiveness of an immune response to an infecting agent, so there is plenty of scope for inheritable differences between individuals. The importance of complex inheritance traits is already clear in the case of autoimmune diseases, and they may eventually be recognized as causing definable immunodeficiencies. Secondary immunodeficiency is much more common than primary immunodeficiency and, worldwide, results principally from malnutrition or human immunodeficiency virus infection. This chapter concentrates on primary immunodeficiencies because of the insights that they give into the functioning of immune responses and because of their hematologic consequences. Disorders are principally grouped according to their clinical associations rather than their etiology.

The most familiar consequence of defective immunity is a delay in, or failure of, clearance of an infecting agent. Examples include the bacterial respiratory tract infections that complicate antibody deficiency syndromes and the mycobacterial infections seen when the interferon- $\gamma$  (IFN- $\gamma$ ) pathway is defective. In a few instances [i.e., chronic cryptosporidiosis, *Pneumocystis carinii* (PC)], the identity of the infecting organism gives useful clues to the nature of the underlying immunodeficiency, but, in general, the correlations are not good enough to be clinically useful. Other consequences of immunodeficiency have been increasingly recognized over the past decade:

lymphadenopathy, autoimmunity, and even periodic fever syndromes. Further developments in these areas may allow associations to be made with certain chronic infections and certain chronic diseases, raising the possibility that immunity to a restricted range of organisms may fail selectively.

Mechanisms of innate and specific immunity are reviewed in [Chapter 16](#), [Chapter 17](#) and [Chapter 18](#), and knowledge of these makes the etiology of most immunodeficiency disorders easier to understand. Some of the principal associations are summarized in [Table 68.1](#). Even when an immune response pathway has been well defined in mice, it is often not directly testable in humans. Confident diagnosis, in consequence, often requires a molecular approach.

**TABLE 68.1. Principal Disorders Associated with Defective Innate Immunity**

| Complement Components  | Associated Diseases  |
|--|--|
| C1q, C1r, C1s, C4, C2<br>C3, factor D  | SLE-like syndromes, rarely infections<br>SLE-like syndromes, pyogenic infections             |
| Properdin<br>C5, C6, C7, C8, C9  | <i>Neisseria</i> infections<br>Recurrent <i>Neisseria</i> infections, immune-complex disease |
| Toll and Toll-like receptor defects<br>Mannan-binding protein  | —<br>Various bacterial, meningococcal infections   |
| NOD2<br>Tumor necrosis factor, interleukin-12,<br>interferon-?   | Inflammatory bowel disease<br>Mycobacteria, including atypical species                       |
| Natural killer cells, perforin, SHP2   | Herpesviruses, especially Epstein-Barr virus   |
| Chédiak-Higashi syndrome, cathepsin C<br>deficiency, other lysosomal defects<br>SLE, systemic lupus erythematosus. | Periodontitis  |

## DISORDERS OF INNATE IMMUNITY

### Complement

Immunoglobulin (Ig) G or IgM antibodies that are bound to cell surfaces activate the complement cascade of proteins. C3a and C5a fragments that are cleaved during activation attract neutrophils, whereas the C3b that remains on a bacterial surface can be bound by receptors on phagocytic cells. Deficiencies of individual proteins are symptomatic only when homozygous, which is rare. Lack of component C1, C2, or C4 is associated with immune complex disorders, particularly systemic lupus erythematosus, chronic glomerulonephritis, dermatomyositis, and cutaneous vasculitis ([Table 68.1](#)). Complete deficiency of C3 results in severe and recurrent bacterial infections because neither the classic nor the alternative pathways can opsonize bacteria for phagocytosis. Treatment is mostly with antibiotics. The heterozygous relatives of C3-deficient patients have had problems with nephritis. There is also an association with partial lipodystrophy, in which antibody to C3 (nephritic factor) is thought to stabilize and prolong the function

of C3 convertase ( <sup>1</sup> ). Serum levels of C3 are occasionally low enough in conditions with a circulating C3 activator (nephritic factor) to increase susceptibility to infection.

*Properdin* is a plasma protein that binds to microbial surfaces and stabilizes the subsequent binding of C3b,Bb convertase. The gene is at Xp11, and a small number of families, totaling approximately 100 individuals with various mutations in the gene, are described. These families share an increased susceptibility to severe meningococcal infection ( <sup>2</sup> ).

Deficiencies of C5, C6, C7, C8, and C9 are associated with neisserial infections that disseminate, increasing the risk for arthritis in patients with gonorrhea and recurrences of meningitis. Survivors of meningococcal meningitis should probably have their complement tested with a functional (hemolytic) assay to screen for a defect for which they should receive antibiotic prophylaxis.

## Toll Receptors

A series of at least nine Toll-like receptors binds bacterial products that include endotoxin (bound through CD14 to Toll 4), flagellin (Toll 5), CpG dinucleotides (Toll 9), and certain carbohydrate conformations, including mannan. In the case of the mannan-binding lectin (MBL), binding can be followed by the activation of complement through the deposition of the membrane attack complex, or it can opsonize to enhance phagocytosis. Toll proteins have polymorphisms with variable function, and approximately 7% of the population has MBL alleles associated with reduced function. Some variants in MBL are associated with susceptibility to meningococcal meningitis ( <sup>3</sup> ). Susceptibility to other infections seems to fall with age in infants with low MBL levels ( <sup>4, 5</sup> ). Polymorphisms in other Toll and Toll-like proteins may contribute to susceptibility to inflammatory bowel disease. For example, NOD2 protein with leucine-rich repeats was recently shown to be associated with susceptibility to inflammatory bowel disease ( <sup>6</sup> ).

## Defects in the Interleukin-12 Interferon- $\gamma$ Pathway: Interferon- $\gamma$ , Tumor Necrosis Factor, and Interleukin-12 Defects

IFN- $\gamma$  is made principally by T and natural killer (NK) cells, and production is increased by signaling through the interleukin (IL)-12 receptor and IFN- $\alpha$ -signal transducer and activator of transcription-dependent pathways. A small number of subjects with mutations in both IFN- $\gamma$  genes has had severe infections from atypical mycobacteria, such as *Mycobacterium avium* ( <sup>7</sup> ). Analysis of other patients with atypical mycobacterial infections has disclosed a range of mutations affecting IL-12 ( <sup>8</sup> ) and the IFN- $\gamma$  receptors and signaling pathway that seems likely to account for the severe or prolonged mycobacterial infections. The failure of normal cytokine signaling interferes with the generation of memory CD4 T cells. Some of these patients have recovered from the mycobacterial infection after antibiotic treatment; others have required prolonged or continuous treatment to survive. One girl with complete IFN- $\gamma$  receptor-1 improved after BMT from an HLA-identical sister.

Cytotoxicity, by T or NK cells, is mediated through perforin, granzyme, and tumor necrosis factor-like cell surface ligands such as Fas. Defects of perforin and granzyme are both associated with enhanced susceptibility to infection. One population of NK cells arises in the marrow and another (NK T cells) in the thymus, and both appear to recognize nonpolymorphic major histocompatibility complex (MHC) determinants. NK cells lyse target cells by perforin-dependent mechanisms. Defects are most commonly associated with severe herpesvirus infections. Principal among these is Epstein-Barr virus, causing hemophagocytic lymphohistiocytosis in Chédiak-Higashi and Griscelli syndromes. A



familial variety of hemophagocytic lymphohistiocytosis is now reported, resulting either from autoantibodies to NK cells or from lack of NK cell surface receptors for IgG. Symptoms result from infection, most notably, herpesvirus infections. Perforin deficiency appears to account for approximately 20% of familial hemophagocytic lymphohistiocytosis cases (9), and others result from defects in the SH2DIA gene that cause the X-linked lymphoproliferative syndrome. The lymphohemophagocytic component is associated with uncontrolled T-cell activation and cytokine secretion.

Other cytotoxic defects follow defects of lysosomal trafficking, as in Chédiak–Higashi syndrome. This results from mutations in the gene for a large cytoplasmic protein (CHS1) that affects the sorting of proteins. Defective CHS1 gene function in humans is followed by the accumulation of secreted proteins in large nonfunctional granules and a clinical phenotype of partial oculocutaneous albinism. In the related Griscelli syndrome, a partial oculocutaneous albinism is accompanied by neurologic defects ranging from developmental delay to fatal neurodegeneration. The immunodeficiency also is variable, and some patients have developed a hemophagocytic syndrome with T-cell and macrophage activation. The phenotype is linked to 15q21, but mutations in two genes in this location appear to result in an almost identical phenotype (10). Chédiak–Higashi syndrome patients and cathepsin C-deficient humans (who have Papillon–Lefevre or Haim–Munk syndrome) have severe periodontitis.

## IMMUNOGLOBULIN AND ANTIBODY DEFICIENCY SYNDROMES

Antibody-deficient patients with low levels of all Ig isotypes (IgG, IgA, IgM, and IgE) are described as having *hypogammaglobulinemia*, and they usually present as a consequence of recurrent infections, particularly of the respiratory tract. A small number of subjects make Igs that lack the quality required to bind to pathogens and to opsonize. These patients are more appropriately described as antibody-deficient because they are not truly hypogammaglobulinemic. A small number of single gene defects cause primary congenital hypogammaglobulinemia or agammaglobulinemia, of which the best known is the X-linked variety described by Bruton (11) that serves as the prototype for the following description. Antibody deficiency can also be acquired, occurring usually as a consequence of another immunodeficiency or an autoimmune syndrome (Table 68.2).

**TABLE 68.2. Differential Diagnosis of Immunoglobulin Deficiency**

| Mechanism                     | Example  | Comment  |
|-------------------------------|--|--|
| Secondary immunodeficiencies  |  |  |
| Protein loss from gut         | Protein-losing enteropathy   | Serum albumin is low.  |
| Protein loss from kidney      | Nephrotic syndrome   | Loss may be selective.   |
| Drug-induced                  | Phenytoin and other anticonvulsants, antimalarials, glucocorticoids, penicillamine | Phenytoin lowers IgA more than other isotypes. Levels recover when drug is discontinued. |
| Hypercatabolism               | Dystrophia myotonica   | IgG depression greatest.   |
| Primary immunodeficiencies    |  |  |
| Antibody deficiency syndromes | X-linked agammaglobulinemia, X-linked hyper-IgM, common variable immunodeficiency  | Isotypes differently affected.   |
| Ataxia telangiectasia         | IgG2, IgA  | —  |

|  |   |  |
|--|---|--|
| Severe combined immunodeficiency syndromes<br>After certain infections | Multiple types<br><br>Congenital rubella<br>Epstein–Barr virus<br><br>Human immunodeficiency virus                                | Some make abnormal Igs.<br><br>—<br>Some X–linked lymphoproliferative syndrome patients.<br>Hypergammaglobulinemia more common.                                |
| Malignancy   | Thymoma, chronic lymphocytic leukemia, non–Hodgkin lymphoma, myelodysplastic syndrome with monosomy 7                             | Up to 10% of thymoma patients have hypogammaglobulinemia, some with impaired T–cell function. Chemotherapy contributes to Ig deficiency on other malignancies. |
| Other primary metabolic disorders                                      | Transcobalamin II deficiency and hypogammaglobulinemia<br>Immunodeficiency, centromere instability, and facial anomalies syndrome | Rare; neutrophils more affected.<br>—  |

Ig, immunoglobulin.

---

### Congenital X–Linked Hypogammaglobulinemia

The underlying defect in congenital X–linked hypogammaglobulinemia interferes with B–cell development before birth. Newborns, however, are protected from most infections by transplacentally acquired IgG for the first 3 months of life. The respiratory tract is the principal site of infections, with pneumococci and *Haemophilus influenzae* causing recurrent otitis media and sinusitis. The skin is the second most common site for infections, presenting mostly as furunculosis, pyoderma, and sometimes cellulitis. When the lower respiratory tract is infected and pneumonia develops, these children typically are ill, with high fever and rapidly progressing symptoms. Spread of the infecting organism is common, so that the boy originally described by Bruton had several episodes of septicemia and meningitis before a lack of Igs was recognized (11). Affected boys do not have visible tonsils or (by x–ray) adenoids, but there are no other useful physical signs. The response of infections to antibiotics parallels that seen in hosts with normal immunity, and recurrent antibiotic courses may keep an antibody–deficient subject sufficiently free from infections for the diagnosis to be delayed for years. Over the past decade, some opportunistic infections characteristic of antibody deficiency have been recognized. For example, *Mycoplasma* species, including *hominis*, can cause lung, abdominal, or bone infections that are remarkably hard to eradicate. Ureaplasma urealyticum infections are another possible cause for arthritis, urethritis, and pneumonia. *Helicobacter* species causing cellulitis, septicemia, or both have been a problem in some men.

Infections of the peripheral or central nervous system can be devastating. With the shift from live attenuated to killed poliovirus for immunization, cases of vaccine polio in hypogammaglobulinemic subjects should cease. Echovirus meningoencephalitis, in contrast, is likely to persist. This is a rare complication with a course ranging from rapid respiratory paralysis to a slow progression starting with optic atrophy. The complication is less common than previously, perhaps because the amount of IgG used to treat

hypogammaglobulinemia syndromes has generally risen in the past decade.

### Other Characteristics of Congenital Antibody Deficiency Syndromes

**B-CELL TYROSINE KINASE DEFICIENCY** The structural gene for B-cell tyrosine kinase (Btk) is on the X chromosome at Xq21.3, and mutations that interfere with enzyme function cause a spectrum of defects ranging from absence of B lymphocytes from blood and tissues to a selective failure to make antibody to carbohydrate antigens (in mice). Btk is a member of the Tec family of cytoplasmic tyrosine kinases and is required for B-cell transition from a cell making only  $\mu$  heavy chains to one that expresses a heavy-light chain dimer on the cell surface. The clinical phenotype in affected boys includes a lack of tonsils and low to undetectable numbers of B lymphocytes in the blood. Diagnostic criteria include male gender with less than 2% CD19<sup>+</sup> B cells and either a mutation in Btk, absent Btk messenger RNA on Northern blot analysis of neutrophils or monocytes, absent Btk protein in monocytes or platelets, or maternal cousins, uncles, or nephews with less than 2% CD19<sup>+</sup> B cells. Often, the diagnosis is assumed if there is evidence for X-linked transmission and B cells are lacking in blood. Identification of the underlying Btk mutation becomes important in the context of chorionic villous biopsy analysis if antenatal diagnosis is desired. There is a small number of other gene defects that result in a clinical phenotype similar to XLA, but which also affect girls. They include defects in signaling pathways and, in two families, structural defects in the  $\mu$  heavy chain gene ([12](#)).

**TNFSF5 DEFICIENCY: HYPER-IMMUNOGLOBULIN M SYNDROME** *Tnfsf5* deficiency describes a failure of CD40 ligand production that results from mutations in the gene at Xq26 on the X chromosome. Affected boys are unique among subjects with selective antibody deficiencies in that they often present with PC or *Cryptosporidium parvum* (CP) infections ([13](#)). They commonly have episodes of lymphadenopathy, and, when this occurs in the retropharyngeal tissues, the respiratory tract can be obstructed. Blood counts show episodes of severe cytopenias, possibly as a consequence of autoantibody production. B lymphocytes are present, and T-cell numbers are generally normal. Tests for CD154 expression on activated T cells are of limited value for diagnosis because some affected individuals are able to express protein with impaired function on the cell surface. They usually have very low levels of IgG, IgA, and IgE with normal or raised levels of IgM and are described as having hyper-IgM syndrome (HIGM1). The receptor, CD40, is encoded at Xq26.3, and homozygosity for a null mutation should be a rare cause of an almost identical syndrome. Heterozygosity is more common and can result in a partial phenotype because CD40 functions as a trimer. Mutations that interfere with CD40 function are symptomatic when even one chain of the trimer is defective. Another X-chromosome-encoded gene, a nuclear factor- $\kappa$ B modifier, is downstream in the CD154 signaling pathway and, when mutated, causes a syndrome similar to HIGM1. Recessively inherited forms of HIGM1, named HIGM2 and HIGM3, result from mutations in an activation-induced cytidine deaminase gene or in CD40 itself.

**CD40-CD154 SIGNALING DEFECTS** CD40-CD154 signaling is important for the function of antigen-presenting cells as well as B cells, and NK cells may signal through CD154 too. When this pathway fails, impairment of certain aspects of cell-mediated immunity is added to the antibody deficiency. When Ig is replaced, the cell-mediated immunity defects persist, although they are not as severe as those that occur in the congenital combined immunodeficiency syndromes. *Candida* and papillomavirus infections are not usually a problem, although herpesvirus infections can be prolonged or severe. The failure to clear PC or CP infections can result in chronic inflammation of the lung or gut and biliary tree. T-cell cytokines could account for much of the pathology. PC infections respond well to standard antibiotics, but CP is less responsive. The chronic inflammation seems a likely contributor to the high incidence of bile duct cancers seen in these patients. The role of bone marrow transplantation for HIGM1 is still being evaluated. The prognosis for the subset of HIGM1 patients that develops bile duct disease is so poor that the risks of transplantation are well justified. Ig gene defects do not cause antibody deficiency unless they affect B-cell function, as do mutations of  $\mu$  heavy chain or the surrogate light chain

expressed on developing B cells. Mutations affecting individual heavy chains can impair or block synthesis of the corresponding isotype, but antibody function in other isotypes remains normal.

### **Other Characteristics of Acquired Antibody Deficiency Syndromes: Common Variable Immunodeficiency**

Common variable immunodeficiency (CVID) is a diverse group of antibody deficiency syndromes with varying severity and variable Ig levels. When first described, the syndrome was subdivided on the basis of the individual isotypes that were deficient, but the better understanding of the isotype switch process has made these classifications mechanistically untenable. The principal advance in past years has been the association of CVID with the extended HLA A1B8DR3 haplotype that is also overrepresented in subjects with selective IgA deficiency (<sup>14</sup>). Whether the link is with a single gene in this region is not known, but the association clearly raises the possibility that the hypogammaglobulinemia results from disordered immunoregulation. In a subset of individuals, CVID arises several years after either selective IgA deficiency or systemic lupus erythematosus has been diagnosed. Many patients have impaired T-cell function in that delayed hypersensitivity skin responses may be negative or CD4/CD8 numbers in blood are abnormal. B-cell numbers in blood are generally normal, whereas germinal center formation in lymph nodes is abnormal, and few, if any, plasma cells are present in the marrow or the lamina propria.

Suggested diagnostic criteria include a decrease at least two standard deviations below the mean for age in two of three major isotypes (IgM, IgG, and IgA) in an individual aged greater than 2 years who lacks isohemagglutinins, has a poor response to vaccines, or both. Additionally, other defined causes of hypogammaglobulinemia must be excluded. The average age at diagnosis is 28 years, the prevalence is approximately 1 in 50,000, and both sexes are affected. The range of infections resembles XLA unless T-cell function is significantly impaired, in which case viral or fungal infections occur too. CVID significantly reduces life expectancy, with almost 20% of subjects developing some sort of lymphoma and another 10% developing respiratory failure from recurrent infections. Gastrointestinal symptoms are common, and hypertrophy of Peyer patches causes the appearance of nodular lymphoid hyperplasia on gut contrast x-rays. Some 20% of subjects have additional autoimmune-like disorders, including immune cytopenias, hepatitis, neuropathy, and endocrinopathies. Skin involvement ranges from alopecia and vitiligo to a granuloma annulare.

### **Treatment**

**IMMUNOGLOBULIN REPLACEMENT** IgG has a half-life in the circulation of approximately 21 days, so intravenous infusions of approximately 600 mg of IgG per kg body weight given every 3 to 4 weeks maintain an IgG level of approximately 500 mg/dl (approximately 50% of levels in healthy adults, see reference <sup>15</sup>). This is usually sufficient to prevent upper respiratory tract infections as well as pneumonias, septicemia, and meningitis. The impact of lower levels of IgG replacement on recurrent bacterial infections of the upper respiratory tract is more variable, depending, perhaps, in part on the severity of damage to ciliated mucosal clearance that preceded diagnosis. Some patients seem to avoid sinusitis or productive cough when treated with 300 mg every 4 weeks. Persistence of sinusitis symptoms is a major clinical problem, and, when this occurs, it is worth trying more closely spaced infusions. The IgG is prepared from donor plasma and therefore contains antibody of the specificities common in the donor population. The IgG for intravenous infusions is stabilized with a sugar, and the rate of infusion is limited by reactions that generally comprise headache, chills, backache, and, if severe, hypotension. Activation of inflammatory pathways by complexes present either in the infusion or

formed by antibody binding within the recipient seems a likely mechanism for these events. The rate and severity of reactions to intravenous formulations of IgG are greatly reduced by slowing the rate of infusion and by premedicating the recipient with paracetamol and an antihistamine. Subjects whose reactions persist may need 100 mg of cortisol at the beginning of the infusion, or they may be helped by switching to a different brand of IgG. IgG preparations are now generally free of hepatitis C virus, but previously infected individuals need to be followed for alanine transaminases. IgG concentrates for intramuscular injection are still available but are less used than previously because of the large volumes that need to be injected. Slow subcutaneous infusions of the intramuscular formulations have not achieved much popularity with patients in the United States, but adequate levels can be achieved if IgG preparations are given at 10 to 30 ml/hour through 25-gauge needles by subcutaneous infusions over the lower abdomen.

**OTHER ASPECTS OF MANAGEMENT** Respiratory tract damage from chronic sinusitis or chronic bronchitis is important in the context of survival. At least, simple spirometry should be performed every 6 months, and any loss of function should be investigated by chest computed tomography scan. Bronchoalveolar lavage may be needed to identify unusual organisms, and courses of antibiotics may have to be prolonged to reduce lung damage. Stool exams for parasites of fastidious organisms are of relatively little value, and it is the increasing range of stool enzyme-linked immunosorbent assay tests for pathogens that has a higher diagnostic yield. Liver and bile duct enzyme tests can give an early indication of inflammation at these sites.

### **Complications of Hypogammaglobulinemia**

The problems listed below are more the complications of the dysregulation responsible for antibody deficiency or the results of structural damage caused by recurrent infections than truly complications of the immunodeficiency itself. They are described separately here because they occur in only a subset of patients and because they may require different approaches to treatment.

**CHRONIC GASTRITIS, ACHLORHYDRIA, AND PERNICIOUS ANEMIA** Diarrhea, abdominal pain, and malabsorption are significant problems in approximately 10% of hypogammaglobulinemic patients. *Helicobacter pylori* was isolated from approximately 40% of antibody-deficient patients with gastrointestinal symptoms in one series (16). Overall, there are insufficient data to exclude immunoregulatory disorders as contributors to gastrointestinal symptoms. The complications of malabsorption are severe enough to justify endoscopy and biopsy, when appropriate. There are few, if any, treatments for the range of possible opportunists that includes corona and enteroviruses, microsporidia, and *Helicobacter* species. As the survival of antibody-deficient patients was prolonged by IgG replacement, it became clear that some developed B<sub>12</sub> deficiency secondary to chronic gastritis. The incidence of gastric carcinoma was also increased in antibody-deficient subjects compared with healthy controls. The mechanism for the difference is not clear. The loss of intrinsic factor production is not generally accompanied by the production of autoantibodies to parietal cells, but the gastric mucosa does show an increased infiltrate of lymphocytes. Conceivably, these occur in response to an unidentified infection that might, for example, resemble the *H. pylori* infections associated with gastric ulcer.

**DERMATOMYOSITIS AND CELLULITIS SYNDROMES** A minority of subjects develop cutaneous ulcers, particularly on the legs, that associate with the recovery of opportunistic organisms, such as *Helicobacter cinaedi*, from the blood. These organisms are not well characterized and are able to develop resistance to multiple antibiotics. They are difficult to diagnose because they are not always detected by routine blood culture technologies that rely on CO<sub>2</sub> production from cultures. Treatment requires antimicrobial combinations that are selected on the basis of antibiotic sensitivities of the organism (17).

**ECHOVIRUS MENINGOENCEPHALITIS SYNDROMES** Encephalitis associated with echoviruses in the cerebrospinal fluid was recognized in the 1970s as a cause of death in



approximately 10% of hypogammaglobulinemic boys. The incidence of this complication appears to have fallen greatly since the introduction of intravenous IgG replacement, perhaps because the recipient's plasma levels of IgG are so much higher. Some encephalitis cases have resolved after the dose of IgG was increased, whereas other cases have required treatment with ribavirin ( [18](#) ). IFN- $\alpha$  is another potential line for treatment.

### Selective Immunoglobulin A Deficiency

With an incidence of approximately 1 in 1000, selective IgA deficiency is the most common primary immunodeficiency. The underlying mechanisms are poorly understood. Inheritance is polygenic, and there is a strong association with the HLA A1B8DR3 haplotype and with disorders such as celiac disease and type 1 diabetes. The symptoms of selective IgA deficiency stem more from the immunoregulatory disorder than from infections occurring secondary to a failure of host defense ( [19](#) ).

IgA has two isoforms and is made predominantly at mucosal surfaces. Subjects older than 4 years of age with serum levels consistently less than 7 mg/dl and whose levels of IgG and IgM are normal are described as *selectively IgA deficient*, with the term *partial IgA deficiency* sometimes used for adults with serum levels in the 7 to 20 mg/dl range. The condition is difficult to diagnose in childhood because adult blood levels of IgA (50 to 200 mg/dl) are not usually attained until 12 years of age or older. The frequency of cell-surface IgA-positive blood lymphocytes is normal in subjects with selective IgA deficiency. Up to 20% of IgA-deficient subjects have reduced levels of another Ig isotype—mostly IgG2.

IgA deficiency occurs occasionally in infants with congenital rubella and may develop during treatment with penicillamine or phenytoin—both drugs associated with the development of lymphadenopathy. IgA levels rise again when the drug is discontinued.

**CLINICAL FEATURES** Perhaps 50% of selectively IgA-deficient subjects have no symptoms that are clearly referable to their deficiency. When symptoms do occur, they range from allergy and arthritis to diarrhea, upper respiratory tract infections, and sinusitis. There are still no clear indications of the morbidity that might result directly from the IgA deficiency and that which might result from the underlying immunopathologic process. Sensitization to IgA itself is a problem for a minority of IgA-deficient subjects. One consequence is a reaction to nonpolymorphic determinants on a-chains that can cause severe anaphylaxis during blood transfusion. Overall, these are rare events, occurring in less than 1 in 20,000 transfusions.

### Other Antibody Deficiency Syndromes

**TRANSIENT HYPOGAMMAGLOBULINEMIA** Maternal IgG is transported across the placenta at a rate that increases in the last month of pregnancy, so that newborns have IgG concentrations equal to their mothers'. The levels fall as the infant grows, and the IgG is catabolized to reach its nadir at 200 to 400 mg/dl around 4 months of age. Term infants whose levels dip below 200 mg/dl and subsequently return to control values are described as having *transient hypogammaglobulinemia*, so this is a diagnosis that can only be made in retrospect ( [20](#) ). The time to recovery can extend to 3 years but is generally less. The condition is usually recognized because frequent infections lead to Ig level measurement. One approach to management has been to immunize affected infants with killed vaccines and to start those who make no antibody response on replacement IgG. Infants who do respond to immunization with antibody production are usually safe with symptomatic management. Premature infants receive less maternal IgG, so they have low trough IgG levels. Although IgG replacement seems rational, it has been difficult to show

the benefit clearly.

**IMMUNOGLOBULIN G SUBCLASS DEFICIENCIES** The roughly 1000 mg/dl of IgG in plasma is distributed between four subclasses, with approximately 60% as IgG1 and 30% as IgG2. IgG2 contains much, but not all, antibody to bacterial polysaccharides and does not normally reach adult levels before 2 years of age. Differences in the rate and ultimate levels of subclass appearance reflect immunoregulatory differences. The genes for these subclasses lie with the rest of the Ig genes on chromosome 14. Mutations affecting the surface expression and production of IgG2 are reported, although they are very rare (<sup>21</sup>). The link that is more commonly made between low levels of an IgG subclass and recurrent respiratory tract infections is not a consequence of heavy chain gene mutations but, in at least some cases, may result from a CVID-like process. IgA levels may be low in adults with chronically low IgG2 levels. Subclass deficiencies generally are not treated by IgG replacement.

**Immunodeficiency, Centromere Instability, and Facial Anomalies Syndrome** Children affected with immunodeficiency, centromere instability, and facial anomalies syndrome have facial dysmorphisms such as hypertelorism, a flat nasal bridge, and low-set ears. The immunodeficiency includes low IgA and, sometimes, low IgG or IgM with or without impaired lymphocyte proliferation. The centromeric instability describes breaks, deletions, isochromosomes, and triradial figures that typically affect chromosomes 1, 9, and 16 in karyotype spreads (<sup>22</sup>). Most cases are identified in developmentally delayed children. Recurrent or prolonged respiratory infections, diarrhea, and skin infections are reported. Many, but perhaps not all, cases are associated with deletions of one of three proteins responsible for maintaining DNA methylation. Although gene undermethylation is thought to be the unifying mechanism in the phenotype, the basis for the immunodeficiency and facial anomalies has yet to be established (<sup>23</sup>).

## DEFECTS AFFECTING T LYMPHOCYTES

### Combined Immunodeficiency Syndromes

*Combinea* described the concurrence of impaired antibody production with failure of cell-mediated immunity as assessed by a lack of blood lymphocytes or proliferative response to mitogens. The term remains useful as a descriptor of a clinical syndrome characterized by diarrhea, malabsorption, and susceptibility to a range of infections that accompany hypogammaglobulinemia and a failure to make cell-mediated immune responses. These defects can result from a wide range of mutations in genes for enzymes, receptors, cytokines, or signaling molecules, in which case symptoms usually develop in infancy as a consequence of opportunistic infections. Typically, the infections are caused by PC, *Candida albicans*, or gram-positive cocci that cause bacterial skin infections. Affected infants are described as having a severe combined immunodeficiency (SCID) syndrome when their immunodeficiency is congenital. Comparably severe defects of antibody- and cell-mediated immunity are occasionally acquired in adults—these subjects are at the most severe extreme of the “common variable immunodeficiency” designator.

Infants presenting with SCID almost universally have diarrhea and may be diagnosed with multiple feeding intolerances. Changes in their formula feeding may bring short-lived remission of the diarrhea, but weight loss usually continues. Diagnosis is typically based on abnormal T-cell numbers in blood coupled with failure to make antibody in response to immunization. The great majority of syndromes (with the exceptions noted below) have both T lymphopenia and hypogammaglobulinemia. These defects are generally severe enough to be incompatible with successful host defense against infection, and their fatal outcome justifies the generic SCID descriptor. Diagnostic criteria for the congenital SCID syndromes include age of less than 2 years, less than 20% CD3<sup>+</sup> T cells (unless engrafted by maternal T cells), an absolute lymphocyte count of less than 3000/mm<sup>3</sup>, and at least



one of the following:

1. Mutation in the cytokine common  $\gamma$ -chain ( $\gamma_c$ )
2. Mutation in JAK3
3. Mutation in RAG1 or RAG2
4. Mutation in IL-7R $\alpha$
5. Adenosine deaminase (ADA) activity of less than 2% of control or mutations in both alleles of ADA

The clinical features of X-linked SCID adequately describe those shared by this group of conditions. The differences in management are described in relation to the underlying gene defect.

**X-LINKED SEVERE COMBINED IMMUNODEFICIENCY** X-linked SCID is the most common form of SCID, accounting for over 40% of cases. The condition results from mutations in the gene of the  $\gamma$ -chain that is shared by receptors for IL-2, IL-4, IL-7, IL-9, IL-15, and IL-21 ([24](#)). Affected infants have low counts of T and NK lymphocytes in their blood at (and before) birth. The percentage of B cells in their blood is very high, although the actual numbers are generally normal. The ability to make antibodies is nevertheless severely impaired, and the infants generally present with diarrhea, failure to thrive, and candidiasis. There are no useful physical signs other than a lack of palpable lymph nodes and reduced thymus size. Other presenting symptoms include pneumonia due to infection by PC, influenza, or adenoviruses. Congenital infections caused by herpesviruses can be fatal in these infants. Diaper rashes are severe, and perianal skin often breaks down as diarrhea continues. Progressive infections by bacille Calmette-Guérin or vaccinia were problematic when these were widely used as immunogens. Untreated, most infants with SCID-X1 die of infection within 1 year. A small number die of graft-versus-host disease after transfusion of unirradiated blood. Treatment by transplantation of HLA-matched sibling bone marrow effectively reconstitutes affected children (see [Treatment of Severe Combined Immunodeficiency Syndromes](#)). Infants without matched donors were offered reconstitution of autologous CD34 marrow cells in the first reports of a clearly successful gene therapy protocol for a combined immunodeficiency ([25](#)). Multiple cycles of transfection with retroviral vector encoding the common cytokine-receptor  $\gamma$ -chain gene were used to maximize the transfection rate. Six to twelve weeks after the transfected CD34<sup>+</sup> cells were reinfused, transfected T cells appeared in the blood and have persisted for over 3 years. Although B-cell transfection rate was low, at least some Ig production followed. Recent reports of a T-cell lymphoproliferative disease in two infants treated with the retroviral vector for  $\gamma_c$  have raised concerns that a vector that integrates randomly may pose unacceptable risks when marrow stem cells are transduced.

**INTERLEUKIN-7R DEFICIENCY** Among the cytokines whose binding requires  $\gamma_c$ , IL-7 appears to play a unique role in the production of T cells. Mutations in the gene for the  $\alpha$ -chain of the IL-7 receptor impair T-cell production but not the production of B or NK cells ([26](#)). The 16 subjects reported by Buckley ([27](#)) were ascertained in autosomal-recessive-inherited SCID who had intact  $\gamma_c$  genes. Their phenotype was a T-cell deficient SCID with B cells and NK cells present in blood.

**T-CELL RECEPTOR DEFICIENCIES** Rearrangement of the V, D, J, and constant regions of T- and B-cell receptors requires a family of recombinase and DNA ligating/repair enzymes. A failure in one of these processes results in lymphopenia, but production of NK cells in the thymus generally continues. Most of these conditions are rare, although isolated instances of gene enrichment are recorded. One phenotypic variant of RAG1/RAG2 deficiency is Omenn syndrome. Affected infants typically develop a desquamative erythema after birth that is associated with the presence of oligoclonal, activated T cells. Some infants have high IgG levels. A few have been successfully treated with immunosuppressives, such as cyclosporine, followed by bone marrow transplantation. "Artemis" acts with a DNA-PK complex to open the hairpin ends that form after double-strand cuts in DNA. Artemis is encoded on 10p, and mutations occur in SCID

patients whose fibroblasts are abnormally sensitive to radiation. There are substantial differences in severity of the immunodeficiency. A null mutation is associated with a severe phenotype that can present with noma. This accounts for a T/B-deficient SCID syndrome in the Na-dene (Navajo) population—a striking example of a founder effect ( [28](#) ). Many different mutations in artemis occur, as in affected families from Turkey, and alternative clinical phenotypes appear to include T-cell immunodeficiency with lymphomas ( [29](#) ). NK cell numbers are normal.

### **SIGNALING PATHWAY DEFECTS**

***JAK3 Deficiency*** JAK3 is the downstream signal transducer from the common cytokine receptor, and over 30 different mutations that impair signaling function are reported. They result in a phenotype generally resembling that of  $\gamma$ c deficiency, although up to one-third of patients is reported to make at least some T cells. In common with other defects in T-cell function, clones of abnormal T cells are sometimes produced, but they lack normal lifespan and function ( [30](#) ). T-cell development in the thymus requires cytokine signaling through phosphorylation of JAK3 and Stat1. Deficiency of either of these molecules impairs T-cell production to the levels seen in SCID-X1. T-cell lymphopenia, hypogammaglobulinemia, and opportunistic infections in a 4-month-old boy ( [31](#) ) were associated with a mutation in p56lck, and, more recently, CD4 lymphopenia in an adult was associated with low p56lck activity without a structural mutation. CD45 is a membrane glycoprotein present on most leukocytes. It has an intracellular domain that regulates Src kinases. Deletions affecting both CD45 alleles were responsible for a SCID phenotype in a very small number of T cell-deficient infants ( [32](#) ).

***Adenosine Deaminase Deficiency*** ADA catalyses the conversion of adenosine triphosphate (ATP) and guanosine triphosphate (GTP) and their deoxy-counterparts to adenosine diphosphate and guanosine diphosphate. When enzyme activity is impaired or absent, intracellular levels of deoxy-ATP (dATP) rise to interfere with ribonucleotide reductase, such that DNA synthesis and repair are slowed. T-cell apoptosis is increased, so affected infants typically have very low numbers of T (and B) lymphocytes in blood. Clinical presentation with opportunistic infections is usual in the first year of life. In addition to the T-cell deficiency, skeletal abnormalities with osseochondrous dysplasia are common. The diagnosis is made by detecting high dATP levels in red cells and low enzyme activity. The gene is at 20q13.11, and sequence studies have identified many different mutations. Some 10% of cases present in childhood or young adult life. This phenotypic heterogeneity likely reflects the substantial range of mutations that is reported. ADA deficiency accounts for 20% or more of autosomal-recessive SCID cases. Aside from bone marrow transplantation, ADA-deficient infants can be treated with polyethylene glycol-conjugated ADA, which is injected subcutaneously once per week ( [33](#) ). Treatment efficacy is gauged by measuring red cell dATP levels. Enzyme treatment has the advantage of speed of response coupled with safety. The treatment is very expensive, costing approximately \$100,000 per year in 2002. Bone marrow transplant has been successful in some, but not all, infants, with transplant rejection accounting for some of the failures. The first attempts at gene therapy used retroviral vectors to transfect the ADA gene into blood T cells, but this approach did not result in sustained T-cell reconstitution. The continued treatment of recipients with polyethylene glycol-ADA likely reduced the selective pressures on T cells that would have favored the survival of transfected cells. Nevertheless, follow-up of these early cases shows persistence of at least some transfected cells. More recently, the ADA gene has been transfected into the patient's own CD34<sup>+</sup> stem cells, which were then reinfused. A first report that used a retroviral vector suggests that this approach may be successful ( [34](#) ), but recent experience with  $\gamma$ c deficiency has raised concerns about the safety of randomly integrating vectors.

***Zap-70 Deficiency*** Zap-70 is a tyrosine kinase downstream of CD3 in the T-cell signaling pathway. The structural gene is at 2q12, and multiple mutations have been reported. Absence of functional enzyme results in a characteristic SCID phenotype with low numbers of CD4 cells in blood but few or no CD8 cells ( [35](#) ). Igs are low, and antibody

responses are not made. The CD4 T cells that are present in blood do not respond to antigen or plant mitogens, but they do proliferate and make cytokines after stimulation by combinations of phorbol and ionomycin. Bone marrow transplantation has reconstituted immunity of some affected infants.

**TREATMENT OF SEVERE COMBINED IMMUNODEFICIENCY SYNDROMES** SCID was uniformly lethal in the first years of life until Good and colleagues successfully reconstituted an affected infant with a transplant of sibling bone marrow. Experience in subsequent years has shown that infants with T- and B-cell-deficient SCID are reliably reconstituted for antibody- and cell-mediated immunity after intravenous infusion of  $10^7$  HLA-matched-sibling nucleated bone marrow cells per kilo. Matching, in this context, requires identity at all HLA A, B, and D loci as occurs, on average, for one in four siblings. Many SCID infants have significant diarrhea and weight loss by the time they reach a transplant center, and management generally starts with prophylaxis for (or treatment of) PC pneumonia, IgG replacement, and intravenous hyperalimentation. Identification of an HLA-matched sibling and parental consent are followed by the infusion of freshly drawn marrow cells. Clinical improvement after HLA-matched sibling bone marrow transplantation is often apparent as soon as a week to 10 days, presumably because the mature T cells present in the donor marrow are able to function in their new environment. Rashes, often with the histology of mild graft-versus-host disease, are common in the first week but generally resolve spontaneously. Blood lymphocyte responses to phytohemagglutinin are usually detected as the lymphocyte count rises in the 3 months after transplantation, and antibodies are made after 6 to 12 months ([36](#)). Transplant treatment has the best outcome when used early, even in neonates. Freedom from infections and perhaps relative resistance to graft-versus-host disease contribute to the better outcome in comparison with delayed transplant treatment ([37](#)). The majority of SCID infants who lack matched siblings are generally treated by infusions of parental (haploidentical) bone marrow from which T cells have been depleted by immunologic or physical means. Graft-versus-host disease is a significant risk and is avoided only when less than 500,000 donor T cells are present in the infusion. It takes 3 or more months for counts of CD3 T cells to climb after grafts of T-depleted haploidentical marrow, and numbers in the normal range may not be achieved for 1 year or more ([38](#)). Cell-mediated immunity is normally sufficiently reconstituted to avoid opportunistic infections, but persistence of antibody deficiency means that these patients need long-term IgG replacement. Several experimental treatments have been tested in recent years. Flake et al. infused some  $130 \times 10^6$  CD34-enriched paternal marrow cells into a fetus between 16.0 and 18.5 weeks' gestation with  $\gamma$ -chain-deficient SCID and obtained engraftment with donor cells without much graft-versus-host disease ([39](#)). Intrauterine infusion of human fetal liver was followed by the appearance of donor-derived CD4 cells in one infant with X-linked SCID ([40](#)). Most SCID cases are diagnosed after birth, and some, in the long term, may be open to correction by transfection of intact genes into the recipient's own bone marrow stem cells. Development in the area of vectors with predictable insertion points facilitates these advances.

### **Other Syndromes with Severe Impairments of Cell-Mediated Immunity**

**CARTILAGE-HAIR HYPOPLASIA** Cartilage-hair hypoplasia is a monogenic disorder resulting from mutations in the RMPG gene located at 9p21. The condition was first identified in Old Order Amish kindred and was subsequently found to have some geographic enrichment in western Finland. The principal clinical features include short-limb dwarfism, hypoplastic hair, and immunity defects that can result in fatal varicella infections. There is significant heterogeneity in the phenotype as regards effects on cartilage, gut innervation, and immunodeficiency that likely results from different underlying mutations. At its most severe, the immunodeficiency presents as a congenital SCID. Less severely affected subjects have problems only with herpesvirus infections or antibody production.

**PURINE NUCLEOSIDE PHOSPHORYLASE DEFICIENCY** Purine nucleoside phosphorylase is an enzyme that converts deoxyinosine to hypoxanthine. Mutations interfering with function cause deoxy-GTP accumulation and the inhibition of ribonucleotide reductase and DNA synthesis. T-cell function is impaired, increasing susceptibility to lethal DNA virus infections, particularly varicella. The increased deoxy-GTP levels are thought to inhibit ribonucleotide reductase, and, in a mouse model, they interfered with DNA repair (41). The earliest feature can be developmental delay and spasticity, often arising after the age of 4 years. Severe varicella is the most common presenting infection (42). The T-cell number in blood is very low; NK and B cells are generally normal, as are serum Igs. Approximately one-third of patients have developed autoimmune hemolytic anemia. Treatment with acyclovir or equivalent antiherpes agents may need to be continued for several weeks in the event of a varicella infection. Overall, the treatment of purine nucleoside phosphorylase-deficient children has been difficult. Allogeneic transplants have sometimes been rejected and did not reverse the neurologic disease even when successful (43). Approximately 10% of the small number of reported patients have died with malignant immunoblastic non-Hodgkin lymphoma. The mouse model suggests that enzyme replacement with polyethylene glycol-purine nucleoside phosphorylase may be useful.

**WINGED HELIX NUDE** The “nude” mouse is largely hairless and has a vestigial thymus that fails to support the development of T cells. The condition results from mutations in the winged helix nude gene. Two sisters with congenital alopecia, nail dystrophy, and T-cell immunodeficiency (44) were homozygous for a nonsense mutation in the winged helix nude gene, providing a human counterpart for the mouse condition. Bone marrow transplantation from an HLA-identical brother resulted in engraftment of T cells in the second winged helix nude  $-/-$  sister and the development of naïve and memory populations of CD8 cells. Antibody was made to hepatitis B immunization, but the numbers of donor CD4 cells declined during 6 years of follow-up, perhaps because no functional thymic tissue was available to support the development of new populations of naïve CD4 cells (45).

### Thymic Hypoplasia: DiGeorge Syndrome

DiGeorge syndrome comprises congenital cardiac defects, abnormal facies, thymic hypoplasia, cleft palate, and hypocalcemia, each in variable degree (46). Diagnostic criteria are given as a conotruncal cardiac defect (truncus arteriosus, tetralogy of Fallot, interrupted aortic arch, or aberrant right subclavian), hypocalcemia of greater than 3 weeks' duration that requires therapy, and deletion of chromosome 22q11.2 or possibly microdeletions at 10p12-13 (47). Other phenotypes arising from 22q11 microdeletions include the velocardiofacial syndrome and isolated conotruncal cardiac disease. The defective chromosome is usually inherited from the mother. The heterogeneity of the clinical phenotype may at least in part reflect differences in the expression of the VEGF isoform Vegf<sup>164</sup>. The hypocalcemia results from parathyroid hypoplasia, and the common major vessel abnormalities are truncus arteriosus, anomalous pulmonary venous drainage, or right-sided aortic arch. Clinically important issues include delayed speech acquisition and behavioral problems (48). Infants who have impaired rather than absent parathyroid or thymus function are often described as having partial DiGeorge syndrome. Clinical presentation usually results from cardiac failure or, after 24 or more hours, from hypocalcemia. Suggestive dysmorphisms include low-set, small ears and a short philtrum, small jaw, or both. Less than 500 per mm<sup>3</sup> CD3<sup>+</sup> T cells in the blood is a criterion for diagnosis of complete DiGeorge syndrome.

The diagnosis is sometimes made during the course of cardiac surgery when no thymus is found in the mediastinum. Postoperative hypocalcemia can be severe and persistent, requiring both calcium and vitamin D supplements. Despite receiving fresh blood

transfusions during cardiopulmonary bypass, patients do not usually develop graft-versus-host disease. The degree of thymic hypoplasia in infants diagnosed during surgery is variable, and, even if the number of CD3<sup>+</sup>CD4<sup>+</sup> T cells in the blood is low in the postnatal period or after surgery, it may rise later. The susceptibility to infection is variable, and few infants with DiGeorge syndrome die with septicemia, although they may have chronic candidiasis.

A subset of patients with DiGeorge syndrome has severe problems with production of autoantibodies to red cells, white cells, and platelets ([49](#)). These patients may respond to intravenous IgG or to corticosteroids. Treatment of other features of DiGeorge syndrome may require surgery for the cardiac defects and vitamin D and calcium to correct hypocalcemia. Blood for these patients should be irradiated. Grafting thymic hypoplasia patients with thymic fragments or epithelial cells is followed by the production of new populations of naïve T cells and an improvement in the lymphocyte response to mitogens ([50](#)). This may be a valuable treatment option for infants who do not acquire normal T cell populations spontaneously. Infusion of HLA-matched sibling blood or marrow has been tried in a few patients who did not improve spontaneously, but this carries a risk for graft-versus-host disease. With increasing use of intrauterine ultrasound, congenital heart disease is more frequently defined before birth. Infants with abnormalities of the great vessels should probably be monitored postnatally for T-cell deficiency.

## **DEFECTS OF ANTIGEN PROCESSING/PRESENTATION: BARE LYMPHOCYTE SYNDROME**

Assembly of the class I MHC with peptides cleaved from antigens occurs in the endoplasmic reticulum. Peptides that are generated in the cytosol are transported into the inner lumen of the endoplasmic reticulum by the proteins TAP1 and TAP2. Mutations in either of these, and of Tapasin to which they bind, have been identified. TAP mutations are associated with recurrent infections, particularly sinusitis and bronchitis. The diagnosis is usually suspected when serologic typing for HLA class I antigens fails to give interpretable results, although molecular typing indicates intact MHC DNA. Blood lymphocyte counts, including CD8 cells, have been normal in several subjects, whereas others have had low CD8 and NK cell numbers. Some of this heterogeneity is likely to reflect differences in the underlying mutation and in the gene affected. Survival into the third decade is described ([51](#)).

Defects that interfere with the assembly or cell-surface expression of the class II MHC-peptide complex are more severe than those affecting class I MHC, and clinical presentation usually occurs in infancy with diarrhea, failure to thrive, and a SCID-like syndrome. Affected children generally have normal or low numbers of CD4 cells in the blood, and these cells respond normally to mitogens. CD8 counts are normal. Reduced expression of class II MHC antigens on B cells and blood monocytes is the basis for the diagnosis. The combination of a positive lymphocyte response to mitogens and the presence of at least some CD4 T cells could delay the recognition of the syndrome.

## **OTHER BIOCHEMICAL DEFECTS SOMETIMES ASSOCIATED WITH IMMUNODEFICIENCY**

Several primary errors of metabolism adversely affect immunity. Transcobalamin II deficiency causes a megaloblastic anemia with impaired bacterial killing by neutrophils and reduced serum Igs of all classes. Biotin-dependent decarboxylase deficiencies may be associated with convulsions, alopecia, candidiasis, low serum IgA, and a reduced number of T cells. Lymphopenia and impaired cell-mediated immunity are reported in hereditary orotic aciduria. A severe variant of the X-linked dyskeratosis associated with mutation in



the *DKC1* gene can be associated with a SCID variant with T cells but no B or NK cells in blood. A systematic listing of genetic disorders with immunodeficiency is given in the review by Ming and others ( [52](#) ).

### **Ataxia Telangiectasia**

Ataxia telangiectasia is primarily a neurologic disorder, presenting with ataxia and progressing to choreoathetosis. Death in the second decade is common. The incidence is approximately 1 in 100,000 births, and the disorder is associated with mutations in a gene that maps to 11q23. Some 80% of affected individuals have low levels of IgG2, and 60% have low IgA. Most affected individuals have raised serum  $\alpha$ -fetoprotein levels. Clinical presentation is usually between the ages of 2 and 5 because of cerebellar ataxia that is followed by unsteady walking ( [53](#) ). Telangiectases typically develop first on the conjunctivae and later are seen on the nose, ears, and shoulders. When infections are a problem, they involve the respiratory tract. The progressive neurodegeneration can compromise coughing, so it is hard to determine whether respiratory infections occur more as a result of the immunodeficiency or the motor defects. Malignancies are an important complication in the longer term, and the DNA repair defect that underlies ataxia telangiectasia likely has a major role in their etiology. Acute leukemias are common and are often T-cell in origin with translocations affecting rearranged T-cell receptor genes. Lymphomas are generally B-cell in origin and are associated with deletions in the 11q22–23 region. There is also an increase in frequency of epithelial tumors in both homozygotes and ataxia telangiectasia heterozygotes.

### **Bloom Syndrome**

Bloom syndrome, in which mutations in a DNA helicase (*RecQ* proteinlike-3) result in excess sister chromatid exchanges, is associated principally with lymphoma and cancer ( [54](#) ). Multiple primary tumors occurring at an early age are common. Reduced growth in childhood results in a proportional dwarfism that, with cutaneous telangiectases, is a useful physical sign. Inheritance is autosomal and recessive, and the disease occurs with increased frequency in Ashkenazi Jewish populations. There is an increased frequency of life-threatening infections. Serum IgA and IgM are sometimes low, and lymphocytes respond abnormally in laboratory tests. No specific treatment is known to delay the onset of malignancies.

### **Wiskott–Aldrich Syndrome**

Wiskott–Aldrich syndrome is an X-linked disorder that usually presents in infancy on account of bloody diarrhea or stroke, recurrent upper respiratory tract infections, or eczema. Findings useful for diagnosis include thrombocytopenia and abnormally small platelets that fail to aggregate effectively. Serum Igs and T-cell numbers and functions are usually normal initially, and IgA levels are often high. Isohemagglutinins either fail to appear or have a very low titer. The disorder is caused by mutations in the Wiskott–Aldrich syndrome protein gene on the short arm of the X chromosome and occurs in approximately four live male births per million ( [55](#) ). Different mutations account for the spectrum of clinical disorders that, at their mildest, result only in thrombocytopenia. The Wiskott–Aldrich syndrome protein most likely functions as a signal transduction adaptor in a pathway that controls the Rho GTPases that affect cell membrane structure. The defect has adverse consequences for the function of antigen-presenting cells as well as for B, NK, and T lymphocytes. The most severe consequences for host defense arise from failure to clear bacterial infections and to protect from Epstein–Barr virus-associated lymphomas.

Clinical management has ranged from the provision of antibiotics to protect from infections by encapsulated microorganisms to splenectomy to increase the platelet count. Neither protects from lymphomas, so, in recent years, there has been increased interest in bone marrow transplantation as a means to restoring a fully functional immune system. Grafts from matched siblings have been substantially more successful than those from haploidentical or unrelated donors. Transfection of the individual's own marrow stem cells is currently being evaluated. Affected children should be evaluated for some form of intervention because survival without treatment is poor.

### Autoimmune Lymphoproliferative Syndromes

Lymphocyte homeostasis requires the elimination of self-reactive cells and responder populations as pathogens are cleared. Both processes are accomplished through apoptosis, and they require members of the tumor necrosis family: Fas, Fas ligand, and the downstream caspases. Mutations in the structural genes of any one of these cause an autoimmune lymphoproliferative syndrome featuring lymphadenopathy, thrombocytopenia, autoimmune hemolytic anemias, and, occasionally, Guillain-Barré syndrome or panniculitis. There is a significantly increased risk for lymphoma. One affected boy experienced multiple bacterial infections before dying of pneumococcal meningitis at age 6 (56).

## SCREENING FOR IMMUNODEFICIENCY

Although tests for immune responses have become relatively standardized, there is no clear indication as to who should be tested. Clues that can be useful are summarized in [Table 68.3](#).

**TABLE 68.3. Diagnostic Evaluation for Possible Immunodeficiency**

| Symptoms from                 | Type  | Mechanism                                 | Test  |
|-------------------------------|---|---|---|
| Infections                    | Atypical mycobacteria, some <i>Mycobacterium tuberculosis</i>                     | Interleukin-12 interferon-? pathway       | Measure production                                    |
|                               | Bacterial: <i>Staphylococcus</i> abscesses, <i>B. cepacia</i>                     | Complement, chronic granulomatous disease | Hemolytic assay, respiratory burst tests              |
|                               | <i>Helicobacter cinaed</i> , rappini cellulitis, arthritis                        | CVID/antibody deficiency                  | Serum immunoglobulins                                 |
|                               | Viral: progressive varicella, fatal Epstein-Barr virus, severe warts              | T cell, natural killer defects            | Count, activation                                     |
|                               | Fungal, apicomplexan: <i>Pneumocystis carinii</i> , <i>Cryptosporidium parvum</i> | CD40 signaling defects, SCID              | T-cell activation, counts                             |
| Weight loss/failure to thrive | —   | SCID in infants, CVID in adults           | T-cell counts, repertoire (57), serum immunoglobulins |
| Skin changes                  | Granuloma annulare  | CVID                                      | Immunoglobulins                                       |

CVID, common variable immunodeficiency; SCID, severe combined immunodeficiency.



## REFERENCES

1. Walport MJ. Complement. *N Engl J Med* 2001;344:1058–1066.
2. van den Bogaard R, Fijen CA, Schipper MG, et al. Molecular characterisation of 10 Dutch properdin type I deficient families: mutation analysis and X-inactivation studies. *Eur J Hum Genet* 2000;8:513–518.
3. Hibberd ML, Sumiya M, Summerfield JA, et al. Association of variants of the gene for mannose-binding lectin with susceptibility to meningococcal disease. Meningococcal Research Group. *Lancet* 1999;353:1049–1053.
4. Aittoniemi J, Baer M, Soppi E, et al. Mannan binding lectin deficiency and concomitant immunodefects. *Arch Dis Child* 1998;78:245–248.
5. Stevens DL. Toll receptors, CD14, MD-2 and NOD2: their role in health and acute and chronic infectious diseases. *Curr Opin Infect Dis* 2002;15:219–220.
6. Hugot JP, Chamaillard M, Zouali H, et al. Association of NOD2 leucine-rich repeat variants with susceptibility to Crohn's disease. *Nature* 2001;411:599–603.
7. Casanova JL, Abel L. Genetic dissection of immunity to mycobacteria: the human model. *Annu Rev Immunol* 2002;20:581–620.
8. Elloumi-Zghal H, Barbouche MR, Chemli J, et al. Clinical and genetic heterogeneity of inherited autosomal recessive susceptibility to disseminated *Mycobacterium bovis* bacille Calmette-Guerin infection. *J Infect Dis* 2002;185:1468–1475.
9. Stepp SE, Dufourcq-Lagelouse R, Le Deist F, et al. Perforin gene defects in familial hemophagocytic lymphohistiocytosis. *Science* 1999;286:1957–1959.
10. Pastural E, Ersoy F, Yalman N, et al. Two genes are responsible for Griscelli syndrome at the same 15q21 locus. *Genomics* 2000;63:299–306.
11. Bruton OC. Agammaglobulinemia. *Pediatrics* 1952;9:722–728.
12. Ballou M. Primary immunodeficiency disorders: antibody deficiency. *J Allergy Clin Immunol* 2002;109:581–591.
13. Notarangelo LD, Hayward AR. X-linked immunodeficiency with hyper-IgM (XHIM). *Clin Exp Immunol* 2000;120:399–405.
14. Vorechovsky I, Webster AD, Hammarstrom L. Mapping genes underlying complex disorders: progress on IgA deficiency and common variable immunodeficiency. *Adv Exp Med Biol* 2001;495:183–190.
15. Quartier P, Debre M, de Blic J, et al. Early and prolonged immunoglobulin replacement therapy in childhood agammaglobulinemia: a retrospective survey of 31 patients. *J Pediatr* 1999;134:589–595.
16. Zullo A, Romiti A, Rinaldi V, et al. Gastric pathology in patients with common variable immunodeficiency. *Gut* 1999;45:77–81.
17. O'Rourke JL, Grehan M, Lee A. Non-pylori helicobacter species in humans. *Gut* 2001;49:601–606.
18. Misbah SA, Spickett GP, Ryba PC, et al. Chronic enteroviral meningoencephalitis in agammaglobulinemia: case report and literature review. *J Clin Immunol* 1992;12:266–270.
19. Cunningham-Rundles C. Physiology of IgA and IgA deficiency. *J Clin Immunol* 2001;21:303–309.
20. Kilic SS, Tezcan I, Sanal O, et al. Transient hypogammaglobulinemia of infancy: clinical and immunologic features of 40 new cases. *Pediatr Int* 2000;42:647–650.

21. Buckley RH. Immunoglobulin G subclass deficiency: fact or fancy? *Curr Allergy Asthma Rep* 2002;2:356–360.
22. Hendrich B, Bickmore W. Human diseases with underlying defects in chromatin structure and modification. *Hum Mol Genet* 2001;10:2233–2242.
23. De Ravel TJ, Deckers E, Alliet PL, et al. The ICF syndrome: new case and update. *Genet Couns* 2001;12:379–385.
24. Buckley RH. Advances in the understanding and treatment of human severe combined immunodeficiency. *Immunol Res* 2001;22:237–251.
25. Fischer A, Hacein-Bey S, Cavazzana-Calvo M. Gene therapy of severe combined immunodeficiencies. *Nat Rev Immunol* 2002;2:615–621.
26. Roifman CM, Zhang J, Chitayat D, Sharfe N. A partial deficiency of interleukin-7R alpha is sufficient to abrogate T-cell development and cause severe combined immunodeficiency. *Blood* 2000;96:2803–2807.
27. Buckley RH. Primary cellular immunodeficiencies. *J Allergy Clin Immunol* 2002;109:747–757.
28. Li L, Moshous D, Zhou Y, et al. A founder mutation in Artemis, an SNM1-like protein, causes SCID in Athabaskan-speaking Native Americans. *J Immunol* 2002;168:6323–6329.
29. Moshous D, Li L, de Chasseval R, et al. A new gene involved in DNA doublestrand break repair and V(D)J recombination is located on human chromosome 10p. *Hum Mol Genet* 2000;9:583–588.
30. Brugnoni D, Notarangelo LD, Sottini A, et al. Development of autologous, oligoclonal, poorly functioning T lymphocytes in a patient with autosomal recessive severe combined immunodeficiency caused by defects of the Jak3 tyrosine kinase. *Blood* 1998;91:949–955.
31. Goldman FD, Ballas ZK, Schutte BC, et al. Defective expression of p56lck in an infant with severe combined immunodeficiency. *J Clin Invest* 1998;102:421–429.
32. Tchilian EZ, Wallace DL, Wells RS, et al. A deletion in the gene encoding the CD45 antigen in a patient with SCID. *J Immunol* 2001;166:1308–1313.
33. Hershfield MS. PEG-ADA: an alternative to haploidentical bone marrow transplantation and an adjunct to gene therapy for adenosine deaminase deficiency. *Hum Mutat* 1995;5:107–112.
34. Aiuti A, Slavin S, Aker M, et al. Correction of ADA-SCID by stem cell gene therapy combined with nonmyeloablative conditioning. *Science* 2002;296:2410–2413.
35. Elder ME. Severe combined immunodeficiency due to a defect in the tyrosine kinase ZAP-70. *Pediatr Res* 1996;39:743–748.
36. Stephan JL, Vlekova V, Le Deist F, et al. Severe combined immunodeficiency: a retrospective single-center study of clinical presentation and outcome in 117 cases. *J Pediatr* 1993;123:564–572.
37. Myers LA, Patel DD, Puck JM, Buckley RH. Hematopoietic stem cell transplantation for severe combined immunodeficiency in the neonatal period leads to superior thymic output and improved survival. *Blood* 2002;99:872–878.
38. Buckley RH, Schiff SE, Schiff RI, et al. Hematopoietic stem cell transplantation for the treatment of severe combined immunodeficiency. *N Engl J Med* 1999;340:508–516.
39. Flake AW, Roncarolo MG, Puck JM, et al. Treatment of X-linked severe combined immunodeficiency by in utero transplantation of paternal bone marrow. *N Engl J Med* 1996;335:1806–1810.
40. Westgren M, Ringden O, Bartmann P, et al. Prenatal T-cell reconstitution after in utero transplantation with fetal liver cells in a patient with X-linked severe combined immunodeficiency. *Am J Obstet Gynecol* 2002;187:475–482.

41. Arpaia E, Benveniste P, Di Cristofano A, et al. Mitochondrial basis for immune deficiency: evidence from purine nucleoside phosphorylase-deficient mice. *J Exp Med* 2000;191:2197-2207.
42. Banzho A, Schauer U, Riedel F, et al. Fatal varicella in a 5-year-old boy. *Eur J Pediatr* 1997;156:333-334.
43. Baguette C, Vermeylen C, Brichard B, et al. Persistent developmental delay despite successful bone marrow transplantation for purine nucleoside phosphorylase deficiency. *J Pediatr Hematol Oncol* 2002;24:69-71.
44. Pignata C, Fiore M, Guzzetta V, et al. Congenital alopecia and nail dystrophy associated with severe functional T-cell immunodeficiency in two sibs. *Am J Med Genet* 1996;65:167-170.
45. Pignata C, Gaetaniello L, Masci AM, et al. Human equivalent of the mouse Nude/SCID phenotype: long-term evaluation of immunologic reconstitution after bone marrow transplantation. *Blood* 2001;97:880-885.
46. Sullivan KE. DiGeorge syndrome/chromosome 22q11.2 deletion syndrome. *Curr Allergy Asthma Rep* 2001;1:438-444.
47. Van Esch H, Groenen P, Fryns JP, et al. The phenotypic spectrum of the 10p deletion syndrome versus the classical DiGeorge syndrome. *Genet Couns* 1999;10:59-65.
48. Heineman-de Boer JA, Van Haelst MJ, Cordia-de Haan M, Beemer FA. Behavior problems and personality aspects of 40 children with velo-cardio-facial syndrome. *Genet Couns* 1999;10:89-93.
49. Gennery AR, Barge D, O'Sullivan JJ, et al. Antibody deficiency and autoimmunity in 22q11.2 deletion syndrome. *Arch Dis Child* 2002;86:422-425.
50. Markert ML, Boeck A, Hale LP, et al. Thymus transplantation in complete DiGeorge syndrome. *N Engl J Med* 1999;341:1180-1189.
51. Yabe T, Kawamura S, Sato M, et al. A subject with a novel type I bare lymphocyte syndrome has tapasin deficiency due to deletion of 4 exons by Alu-mediated recombination. *Blood* 2002;100:1496-1498.
52. Ming JE, Stiehm ER, Graham JM Jr. Syndromes associated with immunodeficiency *Adv Pediatr* 1999;46:271-351.
53. Becker-Catania SG, Gatti RA. Ataxia-telangiectasia. *Adv Exp Med Biol* 2001;495:191-198.
54. Prigent C, Satoh MS, Daly G, et al. Aberrant DNA repair and DNA replication due to an inherited enzymatic defect in human DNA ligase I. *Mol Cell Biol* 1994;14:310-317.
55. Thrasher AJ. WASp in immune-system organization and function. *Nat Rev Immunol* 2002;2:635-646.
56. Nanan R, Strobel P, Haas JP, et al. Autoimmune lymphoproliferative syndrome associated with severe humoral immunodeficiency and monoclonal gammopathy. *Ann Hematol* 2002;81:332-335.
57. Hodges E, Krishna MT, Pickard C, Smith JL. Diagnostic role of tests for T cell receptor (TCR) genes. *J Clin Pathol* 2003;56:1-11.

2004 Lippincott Williams & Wilkins  
John P. Greer, John Foerster, John N. Lukens  
George M. Rodgers, Frixos Paraskevas, Bertil Glader  
Wintrobe's Clinical Hematology

**BACKGROUND**[Human Immunodeficiency Virus 1 Testing](#)[Mechanism of Action of Antiretroviral Drugs](#)**HEMATOLOGIC COMPLICATIONS OF HUMAN IMMUNODEFICIENCY VIRUS INFECTION**[Anemia](#)[Thrombocytopenia](#)[Neutropenia](#)[Lymphopenia](#)[Thrombotic Thrombocytopenic Purpura](#)[Hematologic Effects of Drug Therapy](#)[Pathophysiology of Bone Marrow Suppression in Human Immunodeficiency Virus Infection](#)[Peripheral Blood and Bone Marrow Examination in Human Immunodeficiency Virus 1 Infection](#)[Coagulation Abnormalities](#)**ACQUIRED IMMUNODEFICIENCY SYNDROME-RELATED MALIGNANCIES**[Non-Hodgkin Lymphoma](#)[Hodgkin Lymphoma](#)[Kaposi Sarcoma](#)**FUTURE DIRECTIONS****REFERENCES**

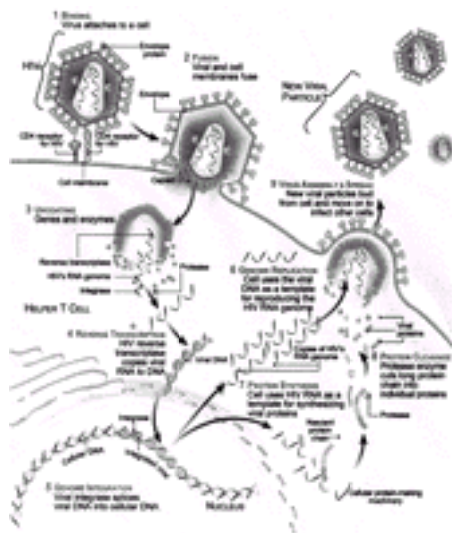
Despite significant strides in the prevention and treatment of human immunodeficiency virus (HIV) infection, acquired immunodeficiency syndrome (AIDS) remains a monumental problem, particularly in the developing world. According to the World Health Organization, 36 million people are currently living with AIDS globally, and 25 million of these live in sub-Saharan Africa. Within the United States and Western Europe, where highly active antiretroviral therapy (HAART) is available, the clinical picture and prognosis of HIV infection have changed. Still, in the United States, there have been more than 600,000 cases of AIDS diagnosed since 1981 and more than 400,000 deaths. Recently, because of HAART, many of the hematologic complications of HIV infections are less prominent. Cytopenias, once common, are now seen less frequently except in patients with advanced disease and in patients undergoing chemotherapy. Coagulation abnormalities are occasionally a clinical problem. Non-Hodgkin lymphoma (NHL) still poses challenges in management and leads to death in most of those affected. This chapter discusses diagnosis and management of the hematologic complications of HIV. A discussion of management of antiviral therapy and opportunistic infections (OIs) can be found elsewhere ([1](#), [2](#) and [3](#)).

**BACKGROUND**

HIV, a retrovirus first identified in 1983, is transmitted by sexual contact, transfusion or parenteral inoculation of infected blood, intravenous drug use, and vertical transmission from an infected mother to infant. Without treatment, HIV-1 infection generally progresses slowly, frequently becoming symptomatic years after initial infection. Currently, the Centers for Disease Control and Prevention (CDC) defines individuals as having AIDS using laboratory criteria: evidence of HIV-1 and CD4 counts less than 200 cells/ $\mu$ l. An earlier clinical classification system included individuals with a history of certain OIs and Kaposi sarcoma (KS) in the definition. Similar to other retroviruses, the

HIV-1 genome contains *gag*, *pol*, and *env* genes that encode for viral core proteins, enzymes controlling replication (reverse transcriptase, integrase and aa viral protease), and envelope glycoproteins. Viral *rev* and *tat* genes encode proteins that regulate transcription and processing of viral messenger RNA. HIV-1 also contains a number of other genes that mediate interaction with the host cell and infectivity (*nef*, *vif*, *vpr*, *vpu*).

The mechanism of infection is still not completely understood but is influenced by host factors, the presence of specific receptors on individual cell lines, and the strain of virus. To gain entry into the cell, HIV gp120 binds to the cell membrane via the CD4 receptor as well as via a second chemokine receptor (CXCR4 in the case of T-cell lymphotropic viruses and CCR5 in the case of macrophage tropic viruses) ( [Fig. 69.1](#)). The cognate ligands of these receptors are capable of inhibiting viral entry by these receptors ( [4](#)). Modulation of expression of chemokine receptors is affected by cytokines. Chemokine receptor expression can influence the susceptibility of the cell to viral infection and may account for the vulnerability of hematopoietic cells of different lineages to HIV infection. Persons with inherited mutations in the gene coding for the CCR5 receptor appear to be relatively resistant to infection or, if infected, are among those who do not develop progressive disease ( [5](#)). Expression of CD4 and a chemokine receptor may not be sufficient for HIV entry, however. Intracellular signaling events after the interaction between chemokine receptors and chemokines and the HIV envelope also may be important for viral entry.

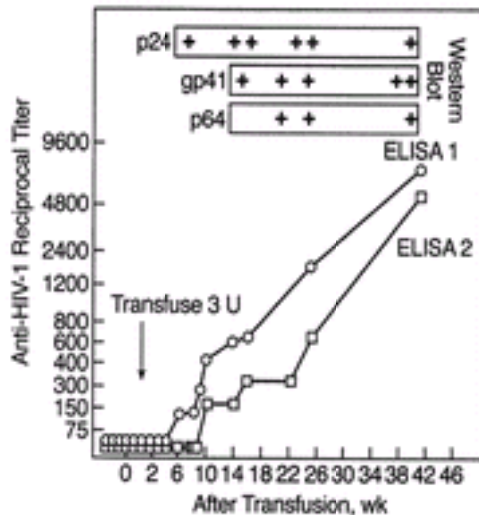


**Figure 69.1.** Human immunodeficiency virus (HIV) life cycle, deciphered with the help of genomic analyses, is unusually complex in its details, but all viruses undergo the same basic steps to infect cells and reproduce. See [Color Plate](#).

After entry into the cell, HIV is uncoated in the cytosol, and viral RNA is transcribed into double-stranded DNA by reverse transcriptase and transported to the nucleus, where it circularizes and is inserted randomly into the host chromosomes. Expression of new virus involves transcription of the provirus into genomic RNA and then translation into viral proteins. *Gag* and *Pol* precursor proteins are then cleaved, and the virus assembles at the inner surface of the plasma membrane, leading to budding from the cell and release as an infectious particle ( [Fig. 69.1](#)).

Initial infection is frequently associated with an illness that resembles acute aseptic viral meningitis, but more than 50% of individuals are asymptomatic. Immune response to the

virus follows rapidly, resulting in increased populations of cytotoxic T cells; a humoral response with appearance of immunoglobulin (Ig) M, then IgG follows within 4 to 12 weeks ( Fig. 69.2). Despite a vigorous immune response that may result in clearing of the virus from the circulation, viral replication continues in the lymph nodes and spleen, which act as a reservoir for infection even when effective antiviral therapy is given ( 6). Efforts to eliminate this virus from these sanctuaries have been unsuccessful.



**Figure 69.2.** The human immunodeficiency virus (HIV) test results of a cardiac surgery patient who received 1 unit of HIV-1-infected blood and subsequently tested positive for HIV. In this case, the enzyme-linked immunosorbent assay (ELISA) first tested positive 6 weeks after transfusion at a time when only anti-p24 was demonstrated on immunoblot. This period during which the ELISA tests negative in an infected person is referred to as the “window period.” Current ELISAs have narrowed the window period to less than 4 weeks, and polymerase chain reaction-based testing has narrowed it to 2 weeks.

### Human Immunodeficiency Virus 1 Testing

Currently, most HIV testing procedures rely on detecting HIV-1 antibodies, although more recent procedures that have been implemented for testing blood for transfusion rely on detection of HIV-1 antigens or nucleic acids. Antibodies to HIV-1 proteins that develop during the course of infection include antibodies to viral core antigen (p24) and antibodies to viral envelope proteins (gp120, gp41). Antibodies to HIV-1 polymerase (p55) develop later, if at all. The most widely used test, the enzyme-linked immunosorbent assay (ELISA), is used in conjunction with a confirmatory test, the Western blot (WB), for HIV-1 antibody ( Fig. 69.3). When a person becomes infected with HIV-1, viral genetic material is incorporated into the host T cell’s genome before viral replication. The early stages of infection are generally associated with a short period during which free virus is usually present in plasma. This is followed by seroconversion, or the development of antibody, after which virus may be absent from plasma. Development of antibody usually occurs 4 to 5 weeks after infection ( 7). A person is classified as HIV-1-seropositive when a blood sample results in a positive result in two successive ELISAs and in one confirmatory WB (or an equally sensitive and specific confirmatory test). The CDC standards require that two of the three bands of p24, gp41, and gp120/160 be present on WB for a sample to be designated as positive for antibody to HIV-1 ( Fig. 69.3). Only a fraction of persons testing positive for ELISA also test positive by WB. Assays for viral antigen and viral nucleic acids usually become positive at 16 and 11 days, respectively, after infection. A

rocedures used for testing blood for transfusion can be



**Figure 69.3.** In Western blot testing, recombinant viral antigens are separated by electrophoresis into core proteins (p55, p24, p17), envelope proteins (gp120, gp160, gp41), and polymerase proteins (p66, p51, p31). The separated viral proteins contained in the gel are blotted onto nitrocellulose paper and incubated with tagged antihuman antibody.

### Mechanism of Action of Antiretroviral Drugs

Infection with HIV results in the progressive destruction of CD4 T lymphocytes with the consequent development of immunodeficiency. The CD4 cells are destroyed through apoptosis or programmed cell death and through direct cytolysis by the virus. Apoptosis of lymphocytes results from many factors, including cytokine dysregulation, continued immune stimulation, and exposure to viral proteins (8, 9). In the HIV-infected person, the half-life of peripheral blood T cells is markedly shortened, from approximately 82 days to 23 days. Although increase in CD8 production by the marrow compensates for their increased destruction, CD4 production is not increased; therefore, without therapy, the CD4 counts gradually decrease. Antiretroviral therapy increases the production of CD4 cells without improving the survival of these cells. The life cycle of the virus is depicted in [Figure 69.1](#), which also shows the points targeted by drug therapy. The nucleoside reverse transcriptase inhibitors [zidovudine (ZDV), didanosine, zalcitabine, stavudine, and lamivudine] inhibit the reverse transcription of the viral RNA genome into a DNA form. This is a critical step in the life cycle of the retrovirus. Another group of drugs, the nonnucleoside transcriptase inhibitors (nevirapine, delavirdine), also inhibits the virus at this point. The protease inhibitors, yet another class of drug, suppress viral production by acting on the viral protease. Inhibition of this enzyme leads to aborted formation of the virus; defective particles that lack intact core protein are released instead of infectious virus. The hematologic effects of these drugs are discussed below and delineated in [Table 69.1](#). These medications are generally given in combinations to avoid the emergence of resistance.

**TABLE 69.1. Hematologic Toxicities of Antiretroviral Drugs**

| Medication | Type of Activity              | Hematologic Toxicity                 |
|------------|-------------------------------|--------------------------------------|
| Zidovudine | Nucleoside analogs, antiviral | Anemia, neutropenia (dose-dependent) |
| Stavudine  | Nucleoside analogs, antiviral | Anemia, neutropenia (dose-dependent) |



|                               |   |  |
|-------------------------------|---|--|
| Ganciclovir                   | Cytomegalovirus infection                 | Leukopenia, thrombocytopenia   |
| Trimethoprim/sulfamethoxazole | Antibiotic, <i>Pneumocystis</i> pneumonia | Dose-related neutropenia, anemia; methemoglobinemia especially in persons with G6PD deficiency |
| Primaquine                    | Antibiotic, <i>Pneumocystis</i> pneumonia | Rare agranulocytosis, thrombocytopenia; methemoglobinemia especially in G6PD deficiency        |
| Pentamidine                   | <i>Pneumocystis</i> pneumonia             | Infrequent anemia, leukopenia, thrombocytopenia  |
| Sulfadiazine                  | Toxoplasmosis                             | Leukopenia in 40%; thrombocytopenia in 12%   |
| Clindamycin/pyrimethamine     | Toxoplasmosis                             | Cytopenias in 31%  |
| Amphotericin B                | Antifungal, cryptococcal meningitis       | Anemia   |

G6PD, glucose-6-phosphate dehydrogenase.

---

HAART has resulted in a reduction of AIDS-defining illnesses in patients with advanced immunodeficiency on this treatment and in a reduction in death rates. A patient on HAART should have repeated measurement of the viral load to assess potency of the drug regimen. Variability in adsorption, bioavailability, and viral resistance may make response rates different even in individuals who appear similar with respect to their degree of immunosuppression. Viral load may also increase with time, signaling the development of drug resistance and the need to change therapy. It may transiently rise in response to an acute infection or after vaccination. Residual HIV replication occurs in sanctuary sites and in peripheral mononuclear cells despite suppression of plasma viral load below the level of detection. After starting HAART, viral load suppression is seen soon, whereas gradual increases in T cells occur in the ensuing months to years. The CD4 cells that remain are generally of the memory type (CD45RO<sup>+</sup> or CD45RA<sup>-</sup>), with naive T cell numbers increasing slowly with time. Naive cells bearing the T-cell receptor excision circle do eventually appear with time. Thymic reconstitution that occurs in patients on HAART is an important step in immune reconstitution. Prophylaxis against OIs is associated with an improvement in survival independent of that produced by HAART.

Long-term survivors of HIV may have the widespread problems of hyperlipidemia, insulin resistance, and abnormal fat redistribution, which may or may not be related to the use of protease inhibitors or other antivirals. It is unclear at this point whether this lipodystrophy translates into increased frequency of cardiovascular disease. The role of lipid-lowering agents in this population is still conjectural. Multiple ongoing clinical studies are attempting to resolve these issues and examine the mechanism of hyperlipidemia and insulin resistance.

## HEMATOLOGIC COMPLICATIONS OF HUMAN IMMUNODEFICIENCY VIRUS INFECTION

### Anemia

Anemia, a significant clinical problem early in the AIDS epidemic when high doses of ZDV were widely used, is now much less prevalent. The Viral Activated Transfusion Study ([10](#),

11) found that the frequency of transfusion for anemia decreased after institution of HAART when compared to historical controls ( 12). A number of studies, including the MultiCenter AIDS Cohort study, demonstrated that anemia was an independent predictor of survival ( 13). Cytomegalovirus (CMV), B19 parvovirus, or *Mycobacterium avium-intracellulare* suppress erythropoiesis and are potentially treatable causes of anemia in this population.

Although bone marrow failure is the likely cause of anemia, hemolytic anemia and anemia related to gastrointestinal bleeding also should be considered. Hemolysis is a rare cause of anemia in AIDS patients; antierythrocyte antibodies are frequent, but they are often clinically irrelevant and are also seen in many asymptomatic homosexual men ( 14). Although circulating erythropoietin (EPO) is often low, the degree of anemia nevertheless is often disproportionately severe for the EPO levels ( 12). Nutritional factors, such as B<sub>12</sub> deficiency ( 14a) resulting from malabsorption or malnutrition, as well as deranged iron metabolism ( 15) have been reported as a frequent cause of anemia in patients with HIV infection. Blood loss from repeated phlebotomies and gastrointestinal bleeding also contributes. As previously mentioned, ZDV is commonly associated with marrow toxicity, particularly with long-term administration. Use of lower ZDV doses in combination with other nonmyelosuppressive antiviral drugs (e.g., the protease inhibitors or other nucleoside analogs) has significantly decreased the frequency of anemia, although patients with advanced disease taking doses of ZDV of less than 500 mg/day still demonstrate significantly decreased hemoglobin levels when compared to similarly immunosuppressed HIV-infected patients not taking the drug ( 16).

Parvovirus B19 infection can cause pure red cell aplasia and anemia in immunosuppressed HIV-1-infected patients ( 17). Although the seroprevalence of IgG antibodies against B19 parvovirus is 40 to 60% in the adult population ( 18), virus can generally be detected only in patients with active early or persistent disease. B19 infection is associated with anemia, absence of reticulocytes, and pure red cell aplasia of the marrow with normal leukocyte and platelet counts. Large vacuolated proerythrocytes or giant pronormoblasts and markedly reduced numbers of all red cell precursors are evident in the bone marrow. Typical manifestations of fifth disease are absent in AIDS patients but may be observed after treatment with immune globulin as a result of iatrogenic immune complex formation. B19 accounted for anemia in 17 to 31% of transfusion-dependent anemic HIV-1-infected patients ( 19, 20 and 21). Neither the presence of IgM to B19 nor the marrow morphology correlate with chronic B19 infection ( 22). Although a negative polymerase chain reaction examination of serum excludes the diagnosis, DNA dot blot hybridization is more specific for chronic infection ( 19). Positive serology is only indicative of past contact, and persistently infected patients usually lack serum antibodies to the virus.

**TREATMENT** Some patients with HIV infection have significant anemia requiring frequent transfusion. Clinical and experimental evidence suggests that transfusion may be associated with substantial morbidity in HIV-infected patients. In one study, transfused patients with advanced disease had an increased incidence of human CMV infection and death ( 23). Although these studies were retrospective, some *in vitro* evidence suggests that transfusion may be associated with viral activation. Busch et al. ( 24) demonstrated that allogeneic lymphocytes present in transfused blood components activate viral production by HIV-infected lymphocytes *in vitro*. Furthermore, a study using quantitative polymerase chain reaction (PCR) to measure circulating HIV demonstrated increases in viral load in transfused HIV-infected patients 5 days after transfusion ( 25). However, most blood in the United States is now leuko-depleted and should not pose this risk. Because of the potential for diminishing the hazards of transfusions in patients with HIV, EPO is a potentially attractive alternative. Previous studies of recombinant EPO showed

that it increased the hemoglobin in patients with anemia, which complicates the administration of chemotherapy and anemia associated with renal failure. In HIV infection, EPO is effective in increasing the hemoglobin in patients receiving ZDV therapy ( 26 ). In HIV infection, as well in other anemic conditions, EPO has its greatest effect in patients with low endogenous EPO levels. In one multicenter study ( 26a ), patients received EPO therapy at doses of 100 to 200 IU/kg (intravenously or subcutaneously three times weekly for a total of 12 weeks or until a hematocrit of 38% or higher was achieved). Patients with EPO levels below 500 IU/L demonstrated significant increases in hemoglobin levels, decreases in transfusion requirements, and improvement in quality of life; EPO was ineffective in patients with high EPO levels. No significant toxicities have been reported. In the case of parvovirus infection, commercial immune globulin infusion is almost always associated with marked improvement in hemoglobin levels with resolution of anemia after a course of 400 mg/kg/day for 5 to 10 days ( 22 ). HIV-infected patients frequently develop repeated episodes of B19 infection requiring repeated treatments with intravenous Ig.

### Thrombocytopenia

Thrombocytopenia is also a common finding in patients with HIV infection and may be related to a number of factors. In patients with early disease, decreased platelet counts are more likely to be related to decreased survival than to marrow failure, whereas the reverse is true of patients with advanced disease ( 27 ). OI, splenomegaly, fever, and other undefined factors lead to decreased platelet survival. Although platelet-associated antibodies increase in prevalence with disease progression, their role in causing decreased platelet survival is dubious. The presence of platelet-associated antibodies has not been found to correlate with the presence or degree of thrombocytopenia ( 28 , 29 ). One confounding factor in interpreting data on platelet-associated antibodies is that conditions associated with platelet injury promote nonspecific antibody binding to the platelet membrane [sepsis, infection, and thrombotic thrombocytopenic purpura (TTP)]. Nonetheless, specific antibodies have been identified by some investigators. In hemophiliacs, a 7S platelet-reactive IgG capable of binding to homologous and autologous platelets was detected in serum, and an inverse relationship between the concentration of platelet-associated antibody and the platelet count was demonstrated ( 30 ). In a group of HIV-1-infected intravenous (IV) drug users presenting with idiopathic thrombocytopenic purpura, immune complexes on the platelet surface have been identified ( 27 ).

Defective megakaryocytopoiesis may also contribute to thrombocytopenia, particularly in patients with advanced disease. Megakaryocytes can be infected with certain strains of HIV, some of which can be cytopathic for the megakaryocytes ( 31 ). In addition, megakaryocytes arising from HIV-1-infected CD34<sup>+</sup> progenitor cells are defective in their ability to produce platelets ( 32 ).

**TREATMENT** Patients with idiopathic thrombocytopenic purpura and HIV infection respond to steroids with success equal to that of uninfected patients (60 to 80%). However, concern regarding the immunosuppressive effects of steroids is greater than for uninfected patients. If patients are not currently on antiretroviral therapy, its institution per se may result in improvement in the platelet count. Although most of the original work showed that ZDV increased the platelet production while not affecting the platelet survival, other antiviral regimens appear to affect the platelets in a similar fashion. Splenectomy remains an option, and concerns regarding its deleterious effect on the course of HIV infection appear to be unfounded ( 33 ). IV immune globulin also is effective, but its high cost, limited availability, and short duration of action make this a less attractive treatment. Similar to uninfected individuals, HIV-positive patients also appear to respond to anti-Rh immune globulin; this blood product has the advantage of

subcutaneous administration, wide availability, and cheaper cost but, again, is limited by its short duration of action. Vincristine is effective when given monthly, although its administration is complicated by neuropathy. Recombinant thrombopoietin or the long-acting truncated form (referred to as the *pegylated recombinant human megakaryocyte growth and development factor*) has been evaluated in phase I/II clinical trials in uninfected patients. Administration of this agent increases circulating platelet count by severalfold in patients receiving chemotherapy ( [34](#), [35](#)). Response is accompanied by significant increases in marrow megakaryocytes and marked mobilization of progenitor cells in the peripheral blood ( [35](#), [36](#)). In HIV-infected chimpanzees ( [37](#)), the pegylated form of thrombopoietin normalized platelet counts without increases in viral load. Development of antibodies to thrombopoietin with subsequent thrombocytopenia in normal controls has limited further study of thrombopoietin. Furthermore, patients with HIV infection and thrombocytopenia tend to have elevated thrombopoietin levels ( [38](#)). Interleukin (IL)-11, a cytokine that promotes megakaryocyte maturation, is licensed for treatment of chemotherapy-related thrombocytopenia. In phase III studies in breast cancer patients receiving cytoxan and doxorubicin, patients receiving granulocyte colony-stimulating factor (G-CSF) and IL-11 (50 µg/kg/day) demonstrated a decreased requirement for platelet transfusions as well as a decreased time before platelet recovery ( [39](#)). Undesired fluid retention reversed on discontinuation of the drug. No studies using IL-11 in HIV-infected patients have been reported, and IL-11 is generally ineffective in patients with primary bone marrow disorders.

## Neutropenia

Mild neutropenia is relatively common in patients with HIV infection. Although generally not of clinical significance, the limited bone marrow reserve that it reflects may become clinically apparent when administration of cytotoxic chemotherapy or other marrow suppressive drugs becomes necessary. Antineutrophil antibodies can frequently be seen ( [40](#)), but their presence does not correlate with the degree of neutropenia. Progenitor cell numbers are generally normal except in patients with advanced disease when they are modestly decreased ( [41](#)). Parenteral treatment with ganciclovir (GCV) or cytotoxic chemotherapy results in leukopenia in the majority of patients ( [42](#), [43](#)), frequently necessitating dose reduction and cytokine treatment ( [44](#)).

**TREATMENT** Neutropenic (absolute neutrophil count, <1000 cells/µl) HIV-positive patients may experience increased frequency of significant bacterial infections. In a case controlled study, Tumbarello et al. ( [45](#)) compared the neutrophil counts of groups of HIV-infected patients with and without bacteremia. Bacteremic patients were more likely to have an absolute neutrophil count of less than 1000 (38%) when compared with patients who are asymptomatic (19%). Another study ( [46](#)), using a matched cohort analysis to evaluate the frequency of bacteremia in neutropenic and nonneutropenic patients, found that the frequency of bacteremia was increased in neutropenic patients (12.60 events per 100 patient months compared with 0.87 events per 100 patient months in the nonneutropenia control patients). In another study of 1645 patients with an absolute neutrophil count of less than 500 cells per µl, the risk of gram-negative infection increased eightfold ( [47](#)). A number of studies have looked at the effect of recombinant growth factors on the incidence of infection and number of hospitalizations. (Doses and therapeutic effects of growth factors are listed in [Table 69.2](#).) G-CSF enhances the proliferation and differentiation of neutrophils and improves neutrophil function, whereas granulocyte-macrophage colony-stimulating factor (GM-CSF) stimulates the proliferation and differentiation of a variety of myeloid progenitor cells and inhibits migration of neutrophils, enhancing the function of mature neutrophils and macrophages ( [48](#)). G-CSF is the most widely used hematopoietic growth factor in HIV-infected patients, has fewer side effects, and increases the neutrophil count more rapidly. Although GM-CSF has been

associated with an increase in HIV-1 replication *in vitro* ( 49), no consistent observation of acceleration of disease progression or increase in p24 antigen levels in patients receiving the drug has been demonstrated.

**TABLE 69.2. Treatment of Human Immunodeficiency Virus (HIV) Patients with Hematopoietic Growth Factors**

| Drug   | Dosage   | Therapeutic Effect  | Adverse Effects  |
|--|--|---|--|
| Granulocyte-macrophage colony-stimulating factor | 0.25-8.00 µg/kg/d                                    | Improvement of leukocyte count and function   | Back pain, myalgia, chills, nausea, headache, fever, rash, ?increase HIV replication |
| G-CSF  | 150 µg/m <sup>2</sup> /d                             | Improvement of proliferation and differentiation of committed progenitor cells                      | Bone pain  |
| Erythropoietin                                   | 150 IU/kg 3 times/wk                                 | Improvement in hemoglobin in patients with low erythropoietin levels                                | None   |
| Stem cell factor                                 | <i>In vitro</i> studies, 10 ng/ml                    | Improvement of white cell count when used with G-CSF  | None   |
| IL-3   | <i>In vitro</i> studies, 10 ng/ml                    | Increase in erythropoiesis in presence of zidovudine and colony-forming unit granulocyte-macrophage | Fevers, headache, bone pain  |
| Interferon-α                                     | 3 × 10 <sup>6</sup> U subcutaneously every other day | Variable response in prolonging platelet survival   | Fever, myalgias, fatigue   |
| IL-2   | 1.5 million U/m <sup>2</sup> , 2-3 times/wk          | Increase in lymphopoiesis and decreased lymphocyte apoptosis; increase in CD4 count                 | ? partial prothrombin time, proteinuria, fever, rash, capillary leak                 |

G-CSF, granulocyte colony-stimulating factor; IL, interleukin; ?, increased.

Although beneficial effects, including decreased frequencies of OIs and increased tolerance for chemotherapy, have been reported with administration of G-CSF or GM-CSF, other studies have failed to reproduce these results, and no improvement in survival has ever been documented. G-CSF in combination with EPO leads to improvement in both leukocyte counts and hemoglobin levels. In one randomized, controlled trial of HIV-infected patients with life-threatening CMV retinitis, a group of investigators ( 50) used GM-CSF to ameliorate the myelotoxicity of GCV. In this study, there was a trend toward a decrease in the number of neutropenic episodes. GM-CSF administration resulted in a decrease in the number of times GCV therapy had to be interrupted as well as a longer mean time before progression of disease. Similar studies have been performed in patients receiving chemotherapy ( 44). In one study of patients receiving cyclophosphamide, hydroxydaunomycin, Oncovin (vincristine), and prednisone (CHOP) for NHL, the group receiving GM-CSF showed a reduction in the severity and



duration of neutropenia, along with a reduction in the number of febrile neutropenic episodes and the duration of hospitalization. Other studies have failed to show decreased frequencies of OIs despite improvements in leukocyte counts ( 51, 52 ). One study demonstrated an improved tolerance for chemotherapy in a group of patients receiving ProMACE–CytaBOM and G–CSF ( 37 ), but cytokine treatment did not result in a decreased incidence of fever, need for hospitalization, or an improved remission or survival rate. In another study using G–CSF in patients with advanced HIV disease with neutropenia (absolute neutrophil count, <1000), treatment decreased the frequency of bacterial infections by 31% and severe bacterial infections by 54%, requiring 26 fewer hospital days ( 53 ). A number of defects in neutrophil function have been demonstrated in HIV–infected patients. These include reduced L–selectin shedding and decreased H<sub>2</sub>O<sub>2</sub> production ( 54 ) as well as defects in leukocyte migration, chemotaxis, and chemiluminescence during phagocytosis. These defects were more prominent in patients with advanced disease ( 55 ). G–CSF and GM–CSF both improve leukocyte function *in vitro*. A number of studies have looked at potential benefits of these cytokines in animal models of immunosuppression. In a murine model of *Pneumocystis carinii* pneumonia, CD4<sup>+</sup>–depleted immunosuppressed mice that received G–CSF after experiential pulmonary infection with *F. carinii* demonstrated improved survival when compared with control mice receiving placebo. Similar benefits were demonstrated using mouse models of disseminated *M. avium* infection, systemic candidiasis, and streptococcal pneumonia ( 56 ). No clinical study using either G–CSF or GM–CSF to enhance leukocyte function has been performed.

## Lymphopenia

Increases in both CD4 and CD8 cell death and impairment in function are the *sine qua non* of HIV infection. IL–2 partially corrects the impaired lymphocyte proliferation and cytotoxicity seen in HIV infection *in vitro*. It also can partially block the enhanced tendency of lymphocytes obtained from HIV–infected patients to undergo programmed cell death (apoptosis) ( 57 ). In phase I trials of IL–2 in HIV–infected patients, it increased CD4 cell number and improved lymphocyte function ( 57 ). The development of a long–acting polyethylene glycol modified IL–2, which increases the half–life by 10– to 15–fold, allows for intermittent administration of the drug. Administration of doses of 1 to 5 million U/m<sup>2</sup>, two to three times weekly, resulted in modest but sustained increases in CD4 counts and improvement in natural killer activity in a patient with CD4 counts greater than 400 cells per  $\mu$ l ( 58 ) in 3 to 6 months. Fever, rash, and capillary leak are the most common toxicities ( 59 ). More recently, administration of very high doses of IL–2 (7.5 million IU twice daily to patients with early HIV infection) resulted in substantial increases in CD4 counts, compared with those seen in the group administered lower doses (1.5 million IU twice daily) ( 60 ). Of greater importance is the suggestion that intermittent administration of IL–2 in combination with HAART may lead to reduction in CD4<sup>+</sup> T–lymphocyte cells that contain replication–competent HIV ( 6 ).

## Thrombotic Thrombocytopenic Purpura

HIV infection is associated with an increased incidence of TTP and hemolytic–uremic syndrome, characterized by microangiopathic hemolytic anemia and thrombocytopenia with or without end–organ failure. Although no controlled studies comparing HIV–related TTP with classic TTP have been conducted, HIV–related TTP is generally thought to be associated with a milder course and a better response to therapy than classical TTP ( 61 ).

The pathogenesis of TTP and its relationship to HIV is still unclear, although a number of

investigators have proposed different scenarios. HIV can infect endothelial cells, and viral p24 antigen has been detected by immunochemical stain in splenic endothelial cells, in spinal cord specimens, and in bone marrow microvascular endothelial cells ( 62 ). Whether infection results in vascular dysfunction has not been clearly demonstrated. Other factors, including cytokine dysregulation, can affect endothelial function. Tumor necrosis factor (TNF)- $\alpha$  and IL-1 $\beta$ , two cytokines that are increased in HIV infection, could potentially lead to increases in endothelial expression of certain adhesion molecules, such as vascular cell adhesion molecule-1, intercellular adhesion molecule, and E-selectin, promoting localization of inflammatory cells to the endothelium with transmigration of lymphocytes through the endothelial wall. CMV, a virus that appeared to be associated with TTP in one large AIDS Clinical Trials Group drug study, increases procoagulant activity in cultures of endothelial cells, potentially by binding and activating coagulation factor X/Xa ( 62, 63 ). Endothelial cells from small, but not large, blood vessels undergo apoptosis when exposed to plasma from patients with TTP ( 62, 64 ).

**TREATMENT** Although the treatment of choice for TTP is plasmapheresis or plasma exchange, successes with antiplatelet agents, vincristine, splenectomy, and plasma infusion have been reported ( 33, 65 ). Well-controlled clinical trials using a single treatment are lacking. In one study of HIV-TTP, most patients undergoing plasma exchange in addition to other therapies achieved a complete response ( 62, 63 and 64, 66 ). It is recommended that plasma exchange replace 35 to 40 ml per kg per exchange ( 62, 67 ). The frequency of exchanges should be governed by the clinical situation; lactate dehydrogenase (LDH) values may be used to monitor the course of the disease. The physician should attempt to keep the platelet count above 50,000 cells per  $\mu$ l and the LDH below 700 IU per dl. Platelets should not be transfused because doing so may lead to thrombotic events. Although antiviral agents have been reported as efficacious in this disease, no controlled trial has been performed. Early diagnosis and treatment appear important in producing good outcomes. TTP should always be suspected in an individual with thrombocytopenia, anemia, and a rising LDH.

### Hematologic Effects of Drug Therapy

Drug-related hematologic toxicity is probably the most important clinical issue in the management of patients with AIDS ( Table 69.1 ). Long-term administration of ZDV may be associated with marrow toxicity, particularly when given in higher doses as monotherapy, as was common practice in the early 1980s. Anemia is the most frequent manifestation of ZDV toxicity. More recently, when lower doses of ZDV were used in combination with other nonmyelosuppressive antiviral drugs, anemia became less of a clinical problem. The AIDS Clinical Trials Group showed that, although a ZDV dose of 500 mg/day did not affect hemoglobin levels in asymptomatic patients, that dose still could cause anemia in patients with advanced disease ( 16 ). Although the mechanism responsible for ZDV-associated anemia, inhibition of thymidine kinase, and DNA chain termination should theoretically also affect cells of other lineages, neutropenia is less frequent and thrombocytopenia very uncommon. The factors leading to preferential suppression of erythropoiesis are not clear. In addition, other nucleoside analogs like didanosine (ddI) or dideoxycytosine (zalcitabine; ddC), lamivudine (3TC), and stavudine (D4T) do not appear to have significant bone marrow toxicity ( 68 ). Protease inhibitors, such as indinavir, ritonavir, crivivan, and nelfinavir, alone or in combination with ZDV or other nucleoside analogs, also have little or no effect on hematopoiesis ( 69 ).

Trimethoprim/sulfamethoxazole (TMP-SMX), an antibiotic commonly used for the prevention of *Pneumocystis* pneumonia, is associated with a high rate of side effects, including fever, rash, and pancytopenia, in AIDS patients ( 70 ). Although there is no evidence that TMP-SMX induces folate deficiency in normal persons, the drug can cause



megaloblastic anemia, leukopenia, and thrombocytopenia in patients with poor nutritional status and in combination with other predisposing factors (70). Bone marrow suppression, seemingly unrelated to folate deficiency, is a frequent side effect of TMP–SMX. In a comparative trial of patients treated with TMP–SMX or parenteral pentamidine, anemia was seen in 39% and 24%, respectively; mild neutropenia in 72% and 47%; and modest thrombocytopenia in 3% and 18% (71). TMP–SMX dose reduction to 20 mg/kg prevented development of neutropenia and thrombocytopenia. Dapsone (also used as prophylaxis of *P. carinii* pneumonia) is associated with fewer hematologic abnormalities than TMP–SMX (but is contraindicated in the presence of glucose–6–phosphate dehydrogenase deficiency).

Treatment of CMV infection with parenteral GCV may result in significant myelosuppression, producing leukopenia and thrombocytopenia after the second week of therapy (42, 43). Concurrent administration of hematopoietic growth factors may be necessary to prevent or improve severe neutropenia. Oral GCV (Valganciclovir) produces similar hematopoietic suppression to the intravenous form of the drug (72). Acyclovir, frequently used for treatment of recurrent herpetic lesions, has no bone marrow toxicity.

The antifungal amphotericin B is also frequently associated with myelosuppression. Hypochromic, normocytic anemia is the most common hematologic toxicity. In addition to direct effects on the bone marrow, amphotericin renal toxicity may result in diminished EPO production (73). Liposomal amphotericin products also produce anemia but to a lesser extent than the nonliposomal form of the drug.

### **Pathophysiology of Bone Marrow Suppression in Human Immunodeficiency Virus Infection**

Diverse factors responsible for impaired hematopoiesis in HIV infection include suppression of the bone marrow by the virus or by viral proteins, immune dysregulation, actual infection of the bone marrow progenitor cells by HIV, and alteration of stromal cell elements. A number of studies demonstrate that CD34 cells have both HIV receptors necessary for infection (i.e., CD4 and CXCR4 or CCR5) (74). CD4 expression, as well as CXCR4 and CCR5 coreceptor expression, increases with maturation of the CD34 cell, and the expression of each correlates with potential infectability (75). In addition, CXCR5 may be up-regulated by a number of different cytokines. Although it is clear that the CD34 cell can be infected by HIV under a number of conditions, it appears that bone marrow progenitor cells do not represent a significant reservoir of infection (76, 77). In one study, HIV was detected in CD34 cells in only 14% of HIV-infected patients recruited in the United States and in 36% of HIV-infected persons in Zaire (78). When found, CD34 infection was present in those patients with far-advanced disease. Many investigators could not detect HIV infection in any stem cells (79, 80). In one study, purified CD34<sup>+</sup> cells were infected *in vitro* and cultured on allogeneic stroma for extended periods of time (81). A highly sensitive PCR failed to detect HIV-1 in the most primitive long-term colony-initiating cells (i.e., the secondary colonies generated from clonogenic cells harvested from stroma). Thus, it appears that although some committed progenitor cells can be infected with HIV-1 under some circumstances, the most immature stem cells appear not to be susceptible to HIV-1 infection.

The effects of HIV-1 on colony formation have been studied, either using bone marrow cells derived from HIV-1-infected patients (79, 82, 83, 84 and 85) or after *in vitro* infection of hematopoietic cells from bone marrow of normal donors (86, 87 and 88). Results have been surprisingly divergent. Although the growth potential of committed bone marrow progenitor cells in methylcellulose cultures after challenge with HIV-1 appears to be

diminished, normal growth frequently has also been reported ( [79](#) ). Similar disparity exists in the results of studies performed with patient bone marrow. Such differences may be related to techniques in assaying colony growth (total bone marrow vs. purified CD34<sup>+</sup> cells), culture conditions (use of specific cytokines or growth factors), or patient selection. In some reports, inhibition of colony formation by virus was only observed in cultures of total bone marrow cells and not with isolated CD34<sup>+</sup> cells ( [89](#) ). Of interest is one report of abnormal progenitor cell function in HIV-negative infants born to infected mothers ( [90](#) ), implying that direct infection was not necessary for marrow suppression.

Marrow stromal function has been examined in patients with HIV infection. Stromal cells from some HIV-1-infected patients may be infected by the virus, demonstrating the importance of stromal infection in causing dysregulation of hematopoiesis. In one study ( [91](#) ), decreased colony formation has been observed when stroma infected *in vitro* was used to support growth of normal uninfected bone marrow progenitor cells. However, in another study, stroma obtained from HIV-infected patients supported growth of normal CD34<sup>+</sup> cells equally as well as stroma obtained from normal uninfected controls ( [41](#) ).

Although the stem cell compartment appears to be relatively well preserved early in the disease, in patients with low CD4 counts and history of OIs, there is a modest reduction of long-term colony-initiating cell numbers ( [92](#) ). However, the long-term colony-initiating cell numbers were far better preserved in this population than in patients with aplastic anemia with similar blood counts, implying that OIs, pharmacotherapy with antiparasitic, antimicrobial, antiviral, or cytotoxic agents, vitamin deficiencies, or poorly understood virally mediated immunomodulatory changes were the major contributors to bone marrow failure in patients with advanced HIV disease.

Inconsistencies in the results of experiments attempting to demonstrate the role of direct infection of HIV-1 on hematopoiesis have stimulated further search for pathophysiologic mechanisms of bone marrow suppression. Several cytokines that are released during the course of HIV-1 infection are potent inhibitors of hematopoiesis. Not only native virus and productive infection ( [89](#), [93](#) ) but also viral products, such as gp120, gp160, and viral *tat* proteins, induce the secretion of an array of cytokines, including TNF- $\alpha$ , lymphotoxin- $\beta$  (TNF- $\beta$ ), and IL-6 ( [89](#), [94](#) ). Perhaps the most prominent cytokine implicated in an array of pathophysiologic reactions in AIDS is TNF- $\alpha$  (or cachexin) ( [95](#), [96](#) ). In addition to its effect on body metabolism and immune system, TNF- $\alpha$  has inhibitory effects on hematopoiesis ( [89](#), [97](#), [98](#) ). High levels of interferon (IFN)- $\gamma$  were not only associated with a poor prognosis in HIV-1 infection but correlated with the degree of anemia ( [99](#) ). Although disordered cytokine production by both lymphoid tissue and bone marrow clearly occurs in HIV-1 infection, it is difficult to determine its ultimate role in suppression of hematopoiesis. Many inhibitory cytokines are produced in greatest quantities early in the course of HIV-1 infection when marrow suppression is least, and their levels decline as the disease progresses (when marrow suppression becomes most marked). In addition, increased levels of stimulatory cytokines have been observed in HIV-1 infection, and many cytokines never reach significant levels in the circulation. Local production of growth factors in bone marrow may be more important than systemically secreted factors. In support of this hypothesis, one study of genetically engineered stromal cells, designed to produce low levels of IFN- $\gamma$  constitutively, showed significant suppression of normal hematopoietic colony growth on IFN- $\gamma$  stroma, which could only be replicated by addition of large amounts of exogenous IFN- $\gamma$  to marrow grown on normal stroma.

Apoptosis of hematopoietic progenitor cells through the Fas-L/Fas-R pathway is a mechanism by which activated T cells can kill virus-infected cells ( [100](#) ). It is likely that

Fas-L and other cytokine products of activated T cells contribute to the hematopoietic inhibition seen in HIV-1 infection. Increased levels of Fas-L have been reported in patients with AIDS, and triggering of Fas-R on hematopoietic cells results in apoptosis ( [101](#) ).

## Peripheral Blood and Bone Marrow Examination in Human Immunodeficiency Virus 1 Infection

Morphologic abnormalities can be found in the majority of bone marrow samples from HIV-1-infected patients, but most are nonspecific except in OI, in which the bone marrow examination provides valuable diagnostic information. Therefore, the bone marrow examination rarely yields substantial clinical information except in the diagnosis of concurrent *M. avium-intracellulare*, tuberculosis, or fungal infection or as part of staging for malignancy ( [101a](#) ).

The histopathologic findings in the bone marrow of HIV-1-infected patients are varied. In one large study of 216 bone marrow examinations performed in 178 HIV-1-infected patients for evaluation of cytopenia, 69% of patients exhibited hypercellular marrow, 69% showed myelodysplastic changes, and 20% showed significant fibrosis ( [101a](#) ); only 5% of the biopsies were hypocellular. Granulomas were found in 13% and lymphoid aggregates in 36% (but in other studies, in up to 50%) of specimens. Higher numbers of plasma cells and elevated numbers of eosinophils were also present, especially in conjunction with increased reticulin. Hyperplasia involving the granulocytic and erythrocytic lineages has been most commonly reported; the myeloid to erythroid ratio has varied from 2:1 to 5:1 ( [102](#) ).

Morphologic changes tend to be more pronounced in more immunosuppressed patients and increase in frequency as disease progresses. All lineages can be involved ( [103](#) , [104](#) ). Megaloblastic changes and ringed sideroblasts are frequent. Using the morphologic criteria established for primary myelodysplastic syndromes, dysplasia involving at least one lineage was diagnosed in 69% of patients. Dysplastic changes increase with disease progression. However, in one study, there were significant differences in the numbers of erythroid precursors and in the morphology of megakaryocytes, which clearly differentiated patients with AIDS from those with myelodysplastic syndrome ( [105](#) ). The cumulative effects of drug toxicities, direct HIV-1 infection of marrow cells, and dysregulated cytokine production may be responsible for the morphologic changes that occur late in AIDS. However, there is no correlation between the dysplastic changes in an individual lineage and specific cytopenias.

## Coagulation Abnormalities

An increase in the incidence of thrombosis has been reported in uncontrolled, retrospective studies of HIV-infected patients. In one retrospective study, the prevalence of deep venous thrombosis among 4752 HIV-infected patients was 0.95%, or ten times that of the general hospital population ( [106](#) , [107](#) ). No analysis of the etiology of thrombosis was done in this study, making it difficult to interpret. Patients with HIV are, of course, subject to risk factors that affect other medically ill patients [e.g., inactivity, cancer, lymphedema, hypoalbuminemia, and medications that are associated with thrombosis (megace)] ( [108](#) ).

An increase in autoantibodies to phospholipids and to coagulation proteins has been reported in HIV-infected individuals. One study demonstrated lupus anticoagulant in 1% of patients with HIV infection ( [109](#) ). Antiphosphatidylcholine antibodies were present in 50%

of patients; anticardiolipin autoantibodies were present in 64% of patients. Patients with far-advanced disease frequently lost their antibody because of their significant immunocompromised state. Unlike patients without HIV infection, these patients do not appear to exhibit an increase in the frequency of thrombosis ( [110](#) ).

Levels of functional protein S are decreased in a fair proportion of HIV-infected patients (27 to 73%) with as many as 12% developing thrombotic complications as a result ( [111](#) , [112](#) and [113a](#) ). Increased levels of complement binding protein 4, which binds protein S, can sometimes account for decreased functional protein S. Of interest is the statistically significant association of diminished protein S with thrombosis. No clear guidelines are available for treatment of these patients; however, most recommend anticoagulating patients with protein C deficiency for an undefined period of time. Decreases in heparin cofactor II ( [114](#) ) have also been described, but no examination has been done to correlate these laboratory abnormalities with a thrombotic tendency.

## ACQUIRED IMMUNODEFICIENCY SYNDROME-RELATED MALIGNANCIES

KS, NHL, and Hodgkin lymphoma occur with increased frequency in patients infected with HIV ( [115](#) ). The development of these malignancies is related to a number of factors, including immunosuppression and concurrent infections with other viruses such as human herpesvirus 8 (HHV8) and Epstein-Barr virus (EBV), which foster malignant transformation. Although these malignancies also occur in the HIV-uninfected population, their presentation, as well as their appropriate treatment, is quite different in the HIV-infected patient. Designing a treatment plan for each patient with HIV infection must take into account the change in the aggressivity of the tumor, the effect of chemotherapy on the viral replication, drug interactions (should antiviral therapy be continued), and the limited hematopoietic reserve of these patients, which frequently necessitates modification of chemotherapeutic regimens. Despite our extensive experience in treating these disorders, the optimum therapy for many is still unclear, partially relating to the significant successes in the development of HAART therapy, which has prolonged the lives of patients with AIDS.

### Non-Hodgkin Lymphoma

**EPIDEMIOLOGY AND PATHOGENESIS** NHL is the AIDS-defining condition in approximately 3% of HIV-infected persons. Although the frequency of NHL increases with the degree of immunosuppression [particularly for central nervous system (CNS) lymphoma], there is no correlation with the mode of HIV transmission. The relative risk of development of immunoblastic lymphoma is approximately 627-fold greater than what is expected in the general population, whereas the increase in diffuse large cell lymphoma is 145-fold greater ( [116](#) , [117](#) ). HAART has been associated with a significant decline in the incidence of OI and KS, as well as NHL. Although the incidence of small noncleaved (Burkitt) lymphomas (BL) has decreased, the number of patients with diffuse large cell lymphoma has increased. The average CD4 count at time of diagnosis of lymphoma has also declined over time so that the patient with NHL today is more likely to be significantly immunosuppressed. It is unclear if these changes are related to the changing management of patients with HIV infection. Genetic factors also play a role in the development of NHL; patients who are heterozygotes for the ( [118](#) , [119](#) ) CCR5 delta 32 are less likely to develop lymphoma, whereas those with stromal cell-derived factor 1 mutations are more likely to develop lymphoma. The three main pathologic types of HIV-NHL are the BLs and Burkitt-like lymphomas, B-cell immunoblastic lymphomas, and primary effusion lymphomas (PEL); each differs in clinical presentation, underlying pathogenesis, and response to therapy. The majority of HIV-related lymphomas are of B-cell origin. T-cell lymphomas are rare, as are PEL (which are of B-cell origin). BL and

Burkitt-like lymphomas usually present with widespread disease and have a risk of CNS involvement ( [120](#), [121](#) and [122](#) ). Other less common lymphomas include polymorphic lymphoproliferative disorders resembling posttransplant-associated lymphoproliferative disease and lymphomatoid granulomatosis. It is estimated that between 35 and 65% of all HIV-related NHLs are Epstein-Barr-positive ( [123](#) ). CNS lymphoma, which comprises approximately 18% of all HIV-related lymphomas, is virtually always associated with Epstein-Barr infection. In addition, BL is associated with EBV infection, and EBV is generally considered a predisposing factor for the development of lymphoma ( [123](#), [124](#), [125](#), [126](#), [127](#) and [128](#) ). Diffuse large cell lymphoma is also frequently associated with EBV in the preponderance of cases. PEL, on the other hand, is associated with HHV8 infection. The role played by these viruses in the pathogenesis of the disease is speculative. EBV encodes for a number of cytokines promoting cell growth, whereas HHV8 encodes for genes that inhibit detection of virally infected and transformed cells. AIDS-BL is associated with activation of the *c MYC* proto-oncogene, and many cases are associated with inactivation of p53 as well as point mutations in BCL-6.

**CLINICAL MANIFESTATIONS** Patients with HIV-NHL frequently present with advanced stage II or IV disease. The majority presents with a rapidly growing mass or the development of systemic B symptoms (i.e., fever, night sweats, unexplained weight loss). The clinical presentation is dependent on the site of involvement, and extranodal involvement, including the bone marrow (25 to 40%), gastrointestinal tract (26%), and CNS (17 to 32%), is common ( [129](#) ). Involvement of the small bowel and rectum is also prevalent, particularly in those with large cell histology. Several prognostic factors affect survival, including CD4 count, Karnofsky performance, age, LDH level, and response to therapy ( [130](#) ). Special attention should be paid to the patient with advanced HIV who presents with confusion, memory loss, and lethargy, as these may be the presenting symptoms of CNS lymphoma. Clinical evaluation of these patients may reveal multiple, heterogenous, or ring-enhancing lesions on computed tomography scan or magnetic resonance imaging, making it difficult at times to differentiate some lesions from those related to toxoplasmosis. Biopsy or cytologic evaluation of the CNS fluids is critical for diagnosis. There are also clinical features that help to distinguish the two conditions; larger lesions (>2 cm) and those that are periventricular or cross the brain midline favor a diagnosis of lymphoma. Diagnosis is based on biopsy or detection of EBV DNA or RNA transcripts in the cerebrospinal fluid. Should biopsy be impossible, a short trial of treatment for toxoplasmosis for several weeks with regular computed tomography scanning to assess size change would be a reasonable course of action. PEL, which generally occurs in patients with low CD4 count and advanced HIV disease, presents with pericardial and pleural effusions or ascites ( [131](#) ). Diagnosis is made by pericardiocentesis, thoracentesis, or paracentesis with cytologic examination of the fluid and immunohistochemical evaluation. PEL cells have a pleomorphic morphology and are negative for CD3 and CD19. Examination for Ig gene rearrangement should show clonal rearrangement. Patients with CD4 counts less than 100 mm<sup>3</sup>, stage III or IV disease, age older than 35 years, history of drug abuse, and elevated LDH have a worse prognosis.

**STAGING** Staging evaluation for patients with AIDS-related lymphoma is similar to that for patients without HIV, except for the need to exclude CNS involvement and the necessity to exclude OI in the patient with B symptoms before starting therapy. All patients with AIDS-related lymphoma should undergo a head computed tomography scan or magnetic resonance imaging as well as a lumbar puncture.

#### **THERAPY**

**Primary Central Nervous System Lymphoma** The response to therapy in patients with primary CNS lymphoma has been very disappointing. Palliation with steroid and whole brain radiation (3000 to 5400 Gy) has response rates of 75%, and treatment with high-dose methotrexate has reportedly given similar results. Combination of radiation and chemotherapy is associated with unacceptable toxicity. The median survival is 2 to 4 months regardless of CD4 count ( [132](#), [133](#) ).

**Primary Effusion Lymphoma** Again, therapy is generally palliative in this condition.



Therapy with CHOP extends life from 5 months to 10 to 14 months ( [134](#) ), but the decision to undergo therapy should be based on the functional status of the patient, the degree of immunosuppression, and the likelihood that the quality of life would be improved.

**Disseminated Lymphoma** Early in the AIDS epidemic, before institution of HAART, patients frequently tolerated standard-dose chemotherapy poorly, and only a minority of patients had a complete response. In addition, responses were of short duration. (The results of chemotherapy trials are listed in [Table 69.3](#).) As a result, patients were treated with low-dose regimens with the expectation that patients would experience fewer OIs and less severe neutropenia. In one randomized, controlled trial comparing low-dose methotrexate, bleomycin, doxorubicin, cyclophosphamide, vincristine, and dexamethasone (m-BACOD) ( [135](#) ) to the full-dose regimen, the survivals of each arm were comparable, although there was a substantial decrease in the incidence of febrile neutropenia in the low-dose group as well as a better quality of life. One difficulty in interpretation of these results is that patients were not stratified according to CD4 count or AIDS-defining illness to determine if the minority of patients with more intact immune systems would benefit from more intensive regimens.

**TABLE 69.3. Results of Prospective Chemotherapy Trials in Acquired Immunodeficiency Syndrome-Related Lymphoma**

| Investigator                              | Regimen ( <a href="#">Chapter 90</a> )                                       | Complete Response (%) | Median Survival (mo) |
|---|--|-----------------------|----------------------|
| <a href="#">Little et al. (142)</a>       | Infusional EPOCH   | 79                    | Not yet reached      |
| <a href="#">Weiss et al. (178)</a>        | CHOP low dose; CHOP full dose  | 30; 38                | 4.0; 20.8            |
| <a href="#">Kaplan et al. (135)</a>       | mBACOD + granulocyte-macrophage colony-stimulating factor; mBACOD (low dose) | 52; 41                | 7.0; 8.0             |
| <a href="#">Sparano et al. (179)</a>      | Infusional CDE; infusional CDE + rituximab                                   | 42; 86                | 8.2; 9.0+            |
| <a href="#">Gisselbrecht et al. (137)</a> | LNH84  | 63                    | 9.3                  |
| <a href="#">Sawka et al. (180)</a>        | MACOP-B  | 33                    | 8.0                  |
| <a href="#">Levine et al. (132)</a>       | mBACOD (low dose)  | 46                    | 5.6                  |

Treatment of HIV-related lymphoma has changed radically since the institution of HAART, and remission has been reported after institution of HAART alone ( [136](#) ). The French-Italian Cooperative Group subsequently examined the role of low- versus high-dose therapy in patients with moderate and severe immunosuppression ( [137](#) ). Patients with CD4 counts over 200 received a dose-intensified regimen of ACVB versus standard CHOP. Both groups of HIV-infected patients in this trial had comparable responses, but toxicity was less in the CHOP arm. Patients with one adverse prognostic factor were randomly assigned to dose-reduced CHOP. High-risk patients were treated with dose-reduced CHOP or vincristine plus prednisone. In the intermediate-risk group, standard-dose CHOP was superior to dose-reduced CHOP, but overall survival remained similar in the two groups. Tirelli et al. studied the impact of continuing HAART during CHOP chemotherapy in a case-controlled study. Responses were equivalent in the two groups, but toxicity was greatest in the group receiving HAART ( [88](#) , [138](#) ) because of the

overlapping toxicity of the antiviral medications with the chemotherapy; in this and other studies ( [139](#), [140](#) ), mucositis was a particular problem. However, despite this, patients receiving HAART had a survival advantage, and there was a trend toward an increase in OIs in the group not receiving HAART. A number of chemotherapy regimens using infusions of chemotherapeutic agents appear initially to allow for maximum cytotoxic benefit without increasing systemic toxicity. Cyclophosphamide, doxorubicin, and etoposide ( [140](#) ) given as an infusion produced remission rates of 58% with a median response duration of 18 months in patients with resistant disease. Subsequently, a National Institutes of Health trial of dose-adjusted EPOCH produced responses in 74% of patients; at 53 months of median follow-up, the disease-free and overall survival rates are 92% and 60%, respectively. Retroviral treatment was suspended during treatment. Although the CD4 cell counts declined and viral loads rose during chemotherapy, they returned to pretreatment levels after reinstatement of antiretroviral therapy at the termination of chemotherapy ( [141](#) ). Controlled, randomized trials still have not been done to compare these infusional regimens to standard chemotherapy. Anti-CD20 monoclonal antibody (Rituxan) has been used alone in patients with relapsed lymphoma and appears to be well tolerated and has some activity. Preliminary studies show that it can be added to EPOCH without evidence of added toxicity ( [142](#) ). Although in non-HIV-related lymphomas, CNS involvement generally occurs only in patients with BL and large B-cell lymphomas who have extranodal disease, involvement of the CNS frequently occurs in patients with HIV (15 to 20%) ( [143](#) ). Hence, CNS prophylaxis (methotrexate or cytarabine) is standard practice in patients with HIV-NHL. Administration of hematopoietic growth factors may be of use after chemotherapy. A small study using GM-CSF was performed in patients receiving CHOP for AIDS-related NHL. In that study, patients were randomized to receive either CHOP chemotherapy or CHOP chemotherapy plus GM-CSF beginning 3 days postadministration for 10 days ( [144](#) ). A reduced incidence of fever, neutropenia, and days of hospitalization was observed in the GM-CSF cohort, but the study size was too small to assess impact on survival or relapse.

## Hodgkin Lymphoma

**EPIDEMIOLOGY AND PATHOGENESIS** The association between Hodgkin lymphoma and HIV has been supported by multiple studies. An Australian study showed a relative risk of Hodgkin lymphoma among HIV-infected persons of 8.5, whereas data from the United States and Puerto Rico revealed a relative risk of 7.6, and a more recent Italian study demonstrated a relative risk of 8.9 ( [145](#), [146](#) ). Hodgkin lymphoma appears to occur with decreased frequency in HIV-infected IV drug users ( [147](#) ). Hodgkin lymphoma in HIV-infected persons exhibits pathologic features different from those of Hodgkin lymphoma in the general population in that there is a preponderance of patients with unfavorable histologic subtypes—mixed cellularity is the most frequent histology, accounting for 41 to 100% of cases, whereas nodular sclerosis is the least frequent, accounting for 0 to 40% of cases. Some studies have described cases exhibiting a fibrohistiocytoid stromal cell proliferation, usually in bundles, surrounding nodular areas—a composition mimicking nodular sclerosis but distinguished from it by the absence of polarizable sclerosing reaction (and thus classified as having a mixed cellularity subtype). Another characteristic distinguishing the HIV-associated Hodgkin lymphoma from that not associated with HIV is the predominance of Reed-Sternberg cell-rich cases. The admixture of areas appearing as Hodgkin lymphoma alongside areas of NHL exhibiting large cell populations is not uncommon and can provide diagnostic as well as treatment dilemmas. Difficulties may also occur in distinguishing Hodgkin lymphoma from the CD30<sup>+</sup> anaplastic large cell lymphomas as both consistently include CD30<sup>+</sup> cells and expression of B cell-associated lymphoid antigens. However, Hodgkin lymphoma can be distinguished on the basis of a combination of activation markers and leukocyte common antigen LCA-CD45. Cellular markers, including CD30<sup>+</sup>, CD45<sup>-</sup>, and CD15<sup>+</sup>, are commonly



expressed on Reed–Sternberg cells, whereas anaplastic large cell lymphomas usually express CD30<sup>+</sup>, CD45<sup>+</sup>, and CD15<sup>-</sup>. AIDS–Hodgkin lymphoma, like AIDS–NHL, is characterized by a high frequency of EBV infection when compared to Hodgkin lymphoma in the HIV–negative population. The pathologic role of EBV in Hodgkin lymphoma is evidenced by the Reed–Sternberg cell expression of EBV–transforming protein.

**CLINICAL FINDINGS AND CLINICAL COURSE** Unlike Hodgkin lymphoma not associated with HIV infection, persons with HIV–Hodgkin lymphoma frequently present with B symptoms and widespread disease at time of diagnosis. One study showed that 70 to 90% of patients present with B symptoms, and 74 to 96% of patients have advanced disease (stage III or IV) at the time of diagnosis with frequent involvement of extranodal sites (60%), including bone marrow, liver, and spleen involvement. Another characteristic of HIV–Hodgkin lymphoma is the high incidence of noncontiguous spread of disease; patients develop liver involvement without splenic disease and lung involvement without mediastinal adenopathy. Mediastinal involvement is present in far fewer patients than is seen in patients not infected with HIV ( [145](#) ). Bone marrow involvement occurs in 40 to 50% of patients and may be the first indication of the disease. Unlike patients with NHL, Hodgkin lymphoma develops in patients who have higher CD4 counts, ranging from 275 to 306 cells per  $\mu\text{l}$  ( [148](#), [149](#) ). Response to therapy is also decreased when compared to patients without HIV infection ( [150](#) ); the higher proportion of unfavorable histologies is not entirely responsible for these differences. Although HIV–infected patients tolerate chemotherapy far better than before the institution of HAART, patients still develop frequent OIs and bacterial infections, the bulk of which are due to gram–positive cocci and gram–negative bacilli. Significant predictors of prolonged survival include achievement of complete response, absence of prior AIDS diagnosis, and CD4 count greater than 250 cells per  $\mu\text{l}$  ( [151](#), [152](#) ). Patients with a CD4 count greater than 250 cells per  $\mu\text{l}$  have a survival of 38 months, whereas those with lower CD4 counts have a median survival of only 11 months; similar findings were found in those studies ( [149](#), [153](#) ).

**THERAPY** The major difficulty associated with treatment of HIV patients with Hodgkin lymphoma is the frequency of OIs during chemotherapy. CD4 counts tend to fall during chemotherapy, and leukopenias make standard doses of chemotherapy difficult to administer. The response to standard chemotherapy, including MOPP (mechlorethamine, vincristine, procarbazine, and prednisone) and ABVD (doxorubicin, bleomycin, vinblastine, and dacarbazine), is lower than that of patients without HIV infection. One problem is that tolerance for chemotherapy is poor, resulting in a reduction of the doses or delay of chemotherapy. The median overall survival of patients is approximately 1.5 years ( [152](#), [154](#), [155](#) ). Because 85 to 95% of Hodgkin lymphoma patients have widespread disease, there are no data on the impact of radiation therapy in treatment of AIDS–related Hodgkin lymphoma.

#### **TRANSPLANTATION FOR HODGKIN DISEASE AND NON–HODGKIN LYMPHOMA**

Myeloablative transplants have been performed in patients with both NHL and Hodgkin lymphoma. Initial reports of patients receiving transplants without concomitant use of HAART have been punctuated with multiple OIs. At the City of Hope, 12 patients with NHL received stem cell transplants ( [156](#) ). Although 9 of 12 patients relapsed, three remained in remission. Patients received cytoxan (100 mg/kg), bischloroethylnitrosourea (450 mg/m<sup>2</sup>), and etoposide (60 mg/kg) as conditioning. OIs were seen in three patients; transient increases in viral load were seen in seven (related to HAART noncompliance). There were three deaths in this group (two with relapsed lymphoma); all others are currently alive at 18.5 months. Auto–logous transplantation has also been attempted. One study included eight patients with relapsed or resistant lymphoma, four with Hodgkin lymphoma, and four with NHL. Seven of eight continued HAART during transplant, and seven engrafted successfully. Although six of seven patients engrafted, only four patients went into complete remission ( [157](#) ). Nonmyeloablative transplantation has been used in patients with refractory disease and has produced short–term remissions (12 months) and was associated with little toxicity and few OIs ( [158](#) ).

## Kaposi Sarcoma

KS, a disorder characterized by endothelial proliferation and spindle cell formation, was first described by Moritz Kaposi, a dermatologist. In 1872, he depicted both indolent and aggressive cases in elderly Eastern European men, wherein lesions usually involved the lower extremities and only rarely involved visceral organs. An aggressive form was then described in Africa, affecting infants and children with frequent fatalities. Later, KS was described in renal transplant recipients receiving immunosuppression; here, the disease was mild and found primarily in patients from Italy and Saudi Arabia or of Jewish descent. Lesions frequently regressed with withdrawal of immunosuppression. In the early 1980s, the disease was seen in a much more aggressive form in HIV-infected men with homosexuality as their risk factor; the disorder rarely affected HIV-infected women, drug abusers, or recipients of transfusion. Here, lesions were generalized and frequently affected viscera–lung, and gastrointestinal involvement led to death in some patients. Despite differences in clinical presentation, the histologic picture was similar to classic KS.

**EPIDEMIOLOGY** The occurrence of KS among HIV-infected homosexual males is 200,000-fold increased over that of the general population. Even HIV-infected persons in risk groups considered low risk for KS (i.e., hemophiliacs, transfusion recipients, and IV drug users) have an incidence of KS 1000- to 10,000-fold that of the noninfected population ([159](#)). Risk factors associated with KS include increased numbers of sexual partners, CD4 counts of less than 200 cells per  $\mu\text{l}$ , and intensity of HIV antiviral therapy. Individuals receiving HAART are less likely to develop KS than those receiving monotherapy. In the United States, up to 40% of homosexuals with AIDS in the early 1980s presented with KS at the time of the initial AIDS diagnosis. Subsequent to the introduction of HAART, the incidence of KS has declined dramatically. HHV8 infection appears to be present in all patients with KS and can be visualized within the KS lesions themselves. Of particular interest is the observation that KS regresses during pregnancy when it occurs in women; this phenomenon was explained by the fact that human chorionic gonadotropin appears to down-regulate activator protein 1, interfering with genes supporting cell growth. The decreasing number of individuals with KS taking HAART supports a significant role of the immune system in modulating the disease. Although HHV8 has been identified in KS lesions, it is unclear exactly what role viral infection has in producing KS lesions ([159](#), [160](#), [161](#), [162](#) and [163](#)).

**PATHOGENESIS** The KS lesion is composed of a proliferation of spindle-shaped cells with surrounding inflammatory cells of different origin and an increased angiogenesis with erythrocyte extravasation. There is some disagreement as to whether the disorder is a true malignancy. Early KS cells did not appear to have the characteristics of a malignancy. KS lesions occur in different noncontiguous locations, and one frequently sees KS lesions in many different stages of development. In most cases, these lesions demonstrate polyclonality. However, in patients with more advanced KS, the disease behaves in a more malignant fashion; in these lesions, there is evidence of clonality, and aneuploidy may be present. Furthermore, a number of oncogenes and oncosuppressor genes are expressed in lesions, including *bcl-2*, *c-myc*, and *TP53*. Studies performed in long-term KS cell cultures have implicated a number of cytokines important in KS cell growth. Some of these cytokines include autocrine growth factors, including IL-1 $\beta$ , IL-6, and IL-8. Oncostatin M, basic fibroblast growth factor, and vascular endothelial growth factor also appear to be important in supporting growth. Transforming growth factor- $\beta$ , on the other hand, appears to suppress tumor growth. The KS lesion initiates as a granulation-like tissue, rich in inflammatory cells. Peripheral blood lymphocytes infiltrating the lesions produce inflammatory cytokines, including IFN- $\gamma$ , TNF- $\alpha$ , IL-1 $\beta$ , IL-2, IL-6, and many others. These inflammatory cytokines may induce recruitment of additional cells into the tissues via adhesion and chemotactic molecules as well as the production of angiogenic factors that promote angiogenesis, edema, and activation of endothelial cells ([164](#)). Of

interest is the observation by some investigators that administration of IFN- $\gamma$  and TNF- $\alpha$  to patients with HIV has led to the development of KS or to its progression. In addition, the onset of KS frequently occurs during OIs, which promote the secretion of inflammatory cytokines. HHV8 is ubiquitously associated with KS lesions and has been implicated as the factor that triggers this inflammatory process ( [165](#), [166](#) and [167](#) ). Data supporting the role of HHV8 in KS include serologic and PCR evidence of HHV8 infection in individual KS lesions; epidemiologic evidence shows that KS occurs more frequently in countries where HHV8 infection is most prevalent and in homosexuals with the highest antibody titers to HHV8. Despite this, other cofactors must be necessary to incite KS, as not everyone in high prevalence areas develops KS, and KS generally spares women with similar HHV8 antibody titers.

**CLINICAL PRESENTATION** KS most frequently presents as mucocutaneous disease characterized by purple raised lesions. Lesions on the limb may result in edema, ulceration, and bacterial infection. KS does not behave like many other tumors, as it may not spread to contiguous areas or metastasize by the lymphatics. Many different lesions at various stages of development can be found in many different areas of the body, seeming to indicate that each KS lesion develops *de novo* in response to a viral or related stimulus. Elimination of KS lesions by local treatment thus does not affect the eventual development of KS lesions in other parts of the body. KS often involves the head and neck, including the tip of the nose and the retroauricular and periorbital areas. Lesions of the hard and soft palate, as well as the gums, may destroy dentition and ultimately interfere with eating. Lymphatic involvement may result in edema of the limbs, periorbital area, and genitalia; cellulitis is a frequent complication of lymphatic involvement. Gastrointestinal involvement may result in gastrointestinal blood loss and obstruction. Involvement of the tracheobronchial tree, pulmonary parenchyma, and pleura may lead to death by respiratory failure.

**TREATMENT** All patients with KS should have a biopsy confirming the diagnosis, no matter how typical or atypical the lesion may look. Subsequent studies should include a chest x-ray and stool guaiac. Because HAART initiation may be associated with complete regression of the lesions, all patients with KS should be put on HAART and followed for a period of several months before other therapies are considered ( [168](#), [169](#) ). Patients with limited disease can have treatment addressing the local control and cosmetic treatment of individual lesions. The use of local interventions has increased because of the realization that no curative systemic therapy exists if the patient does not respond to HAART. Local control may be achieved by intralesional injection of dilute vinblastine, cryotherapy, radiation therapy, or laser therapy. Retinoids (alretinoin gel) have been modestly successful in producing remissions ( [170](#) ). Photodynamic therapy ( [170](#), [171](#) ) using intravenously administered photofrin before light exposure may be useful in small lesions. For patients with systemic disease that is too widespread to be amenable to local measures or who have pulmonary involvement, systemic therapy should be undertaken. One of the difficulties in performing therapeutic trials in patients with KS is assessing response to therapy. Frequently, people have a large number of lesions, and biopsy with histologic examination is necessary to document tumor cell death, as the lesions fade over the course of many months after effective treatment. IFN- $\alpha$  is an effective treatment for KS; it is associated with a 50% response rate in patients with a CD4 count greater than 200 cells per  $\mu\text{l}$  ( [172](#) ). However, many patients experience toxicity related to drug administration, including flulike symptoms, fever, and anemia. Thalidomide has been used in treatment of KS with the rationale that it decreases TNF- $\alpha$ , which may play a role in inducing KS, but results have been generally disappointing ( [173](#) ). A number of other agents possess activity against KS, including bleomycin, the vinca alkaloids, anthracyclines, paclitaxel, and etoposide. Patients respond well to liposomal anthracyclines that are generally comparable and less toxic than therapy with several agents (e.g., actinomycin D, bleomycin, and vincristine) ( [168](#), [174](#), [175](#) ). Paclitaxel in doses of 100 mg/m<sup>2</sup> every 2 weeks is effective in more than half of patients relapsing and unresponsive to other drugs. Current studies are investigating the efficacy of liposomal doxorubicin and paclitaxel ( [28](#) ). A phase II study comparing DaunoXome to triple drug

therapy (actinomycin D, bleomycin, and vincristine) demonstrated comparable responses with considerably less toxicity with DaunoXome. Doxil has been shown to be effective in patients who have received prior systemic chemotherapy and to result in comparable response rates to actinomycin D, bleomycin, and vincristine. Patients not responding to these may be treated with paclitaxel, which is highly effective against KS but is not without significant toxicity. One group demonstrated that paclitaxel given in a dose of 100 mg/m<sup>2</sup> every 2 weeks was well tolerated and resulted in partial or complete responses ( [28](#) ). Current multicenter studies comparing paclitaxel to liposomal anthracyclines are now under way. Large trials using antiangiogenic agents, such as AGM 1470, thalidomide, and glufanide disodium, are in progress after initial studies showed encouraging responses. Retinoic acids appear to block angiogenesis as well as proliferation of KS cells *in vitro*. A multicenter trial to examine the efficacy of intravenous administration of liposomal tretinoin (all- *trans*-retinoic acid) demonstrated responses in persons receiving the drug three times weekly ( [175a](#) ). Retinoids have also demonstrated efficacy administered topically and a topical compound, alitretinoin gel, was licensed by the U.S. Food and Drug Administration in 1999. IL-4 has been investigated and failed to yield promising results. *In vitro* cell culture studies and a murine model for KS have shown that human chorionic gonadotropin-associated factor has antiproliferative and cytotoxic effects on KS cells without toxic effects on normal endothelial cells and lymphocytes. Preliminary results in patients showed a 30 to 40% response rate without significant toxicity ( [176](#) ). Some patients with very advanced disease were among the responders. Because of the association of KS with HHV8, the efficacy of a number of antiviral agents has been tested. An antiherpes drug, cidofovir, failed to produce a response when injected into KS lesions. Among patients with previous CMV disease, use of GCV and foscarnet was associated with a nonsignificant decrease in the incidence of KS. However, in the MultiCenter AIDS Cohort Study, acyclovir use was not protective against subsequent KS development ( [177](#) ). Patients who are more likely to respond are those with more intact immune systems.

## FUTURE DIRECTIONS

Patients with HIV infections are living longer and experiencing better quality of life than ever before. Treatment of HIV-related lymphomas still represents a major challenge to the field. In the future, different strategies directed toward underlying inciting viral infections may perhaps be more successful than standard chemotherapy.

Efforts also need to be made to achieve immune reconstitution in infected persons. New and better antiviral medications not associated with viral resistance would help in this effort. In addition, studies directed toward altering bone marrow cells genetically so as to make them resistant to infection may be successful in promoting CD4 production and eliminating their early destruction. Additionally, work on development of better monoclonal antibodies active against HIV may help eradicate infected cells.

## REFERENCES

1. Cohen OJ, Fauci AS. Transmission of drug-resistant strains of HIV-1: unfortunate, but inevitable. *Lancet* 1999;354:697-698.
2. Cohen OJ, Fauci AS. Benchmarks for antiretroviral therapy. *J Clin Invest* 2000;105:709-710.
3. Cohen OJ, Fauci AS. Current strategies in the treatment of HIV infection. *Adv Intern Med* 2001;46:207-246.
4. Fischl MA, Parker CB, Pettinelli C, et al. A randomized controlled trial of a reduced daily dose of zidovudine in patients with the acquired immunodeficiency syndrome. The AIDS Clinical Trials Group. *N Engl*

J Med 1990;323:1009–1014.

5. Coyle TE. Hematologic complications of human immunodeficiency virus infection and the acquired immunodeficiency syndrome. *Med Clin North Am* 1997;81:449–470.
6. Chun TW, Engel D, Mizell SB, et al. Effect of interleukin-2 on the pool of latently infected, resting CD4+ T cells in HIV-1-infected patients receiving highly active anti-retroviral therapy. *Nat Med* 1999;5:651–655.
7. Sloand EM, Groopman JE. Transfusion in HIV disease. *Curr Opin Hematol* 1997;4:449–454.
8. Sloand EM, Young NS, Kumar P, et al. Role of Fas ligand and receptor in the mechanism of T-cell depletion in acquired immunodeficiency syndrome: effect on CD4+ lymphocyte depletion and human immunodeficiency virus replication. *Blood* 1997;89:1357–1363.
9. Badley AD, Pilon AA, Landay A, Lynch DH. Mechanisms of HIV-associated lymphocyte apoptosis. *Blood* 2000;96:2951–2964.
10. Busch MP, Collier A, Gernsheimer T, et al. The Viral Activation Transfusion Study (VATS): rationale, objectives, and design overview. *Transfusion* 1996;36:854–859.
11. Collier AC, Kalish LA, Busch MP, et al. Leukocyte-reduced red blood cell transfusions in patients with anemia and human immunodeficiency virus infection: the Viral Activation Transfusion Study: a randomized controlled trial. *JAMA* 2001;285:1592–1601.
12. Spivak JL, Barnes DC, Fuchs E, Quinn TC. Serum immunoreactive erythropoietin in HIV-infected patients. *JAMA* 1989;261:3104–3107.
13. Sullivan PS, Hanson DL, Chu SY, et al. Epidemiology of anemia in human immunodeficiency virus (HIV)-infected persons: results from the multistate adult and adolescent spectrum of HIV disease surveillance project. *Blood* 1998;91:301–308.
14. McGinniss MH, Macher AM, Rook AH, Alter HJ. Red cell autoantibodies in patients with acquired immune deficiency syndrome. *Transfusion* 1986;26:405–409.
- 14a. Markle HV. Cobalamin. *Crit Rev Clin Lab Sci* 1996;33:247–356.
15. Boelaert JR, Weinberg GA, Weinberg ED. Altered iron metabolism in HIV infection: mechanisms, possible consequences, and proposals for management. *Infect Agents Dis* 1996;5:36–46.
16. Koch MA, Volberding PA, Lagakos SW, et al. Toxic effects of zidovudine in asymptomatic human immunodeficiency virus-infected individuals with CD4+ cell counts of  $0.50 \times 10^9/L$  or less. Detailed and updated results from protocol 019 of the AIDS Clinical Trials Group. *Arch Intern Med* 1992;152: 2286–2292.
17. Brown KE, Young NS. Parvovirus B19 infection and hematopoiesis. *Blood Rev* 1995;9:176–182.
18. Kerr JR. Parvovirus B19 infection. *Eur J Clin Microbiol Infect Dis* 1996;15:10–29.
19. Abkowitz JL, Brown KE, Wood RW, et al. Clinical relevance of parvovirus B19 as a cause of anemia in patients with human immunodeficiency virus infection. *J Infect Dis* 1997;176:269–273.
20. Naides SJ, Howard EJ, Swack NS, et al. Parvovirus B19 infection in human immunodeficiency virus type 1-infected persons failing or intolerant to zidovudine therapy. *J Infect Dis* 1993;168:101–105.
21. Frickhofen N, Abkowitz JL, Safford M, et al. Persistent B19 parvovirus infection in patients infected with human immunodeficiency virus type 1 (HIV-1): a treatable cause of anemia in AIDS. *Ann Intern Med* 1990;113:926–933.
22. Fuller A, Moaven L, Spelman D, et al. Parvovirus B19 in HIV infection: a treatable cause of anemia. *Pathology* 1996;28:277–280.
23. Sloand EM, Kumar PN, Kim S, et al. Human immunodeficiency virus type 1 protease inhibitor modulates activation of peripheral blood CD4(+) T cells and decreases their susceptibility to apoptosis in

vitro and in vivo. *Blood* 1999;94:1021–1027.

24. Busch MP, Lee TH, Heitman J. Allogeneic leukocytes but not therapeutic blood elements induce reactivation and dissemination of latent human immunodeficiency virus type 1 infection: implications for transfusion support of infected patients. *Blood* 1992;80:2128–2135.

25. Mudido PM, Georges D, Dorazio D, et al. Human immunodeficiency virus type 1 activation after blood transfusion. *Transfusion* 1996;36:860–865.

26. Henry DH. Recombinant human erythropoietin treatment of anemic cancer patients. *Cancer Pract* 1996;4:180–184.

26a. Henry DH, Beall GN, Benson CA, et al. Recombinant human erythropoietin in the treatment of anemia associated with human immunodeficiency virus (HIV) infection and zidovudine therapy. Overview of four clinical trials. *Ann Intern Med* 1992;117:739–748.

27. Savona S, Nardi MA, Lennette ET, Karpatkin S. Thrombocytopenic purpura in narcotics addicts. *Ann Intern Med* 1985;102:737–741.

28. Gill PS, Tulpule A, Espina BM, et al. Paclitaxel is safe and effective in the treatment of advanced AIDS-related Kaposi's sarcoma. *J Clin Oncol* 1999;17:1876–1883.

29. Klaassen RJ, Mulder JW, Vlekke AB, et al. Autoantibodies against peripheral blood cells appear early in HIV infection and their prevalence increases with disease progression. *Clin Exp Immunol* 1990;81:11–17.

30. Karpatkin S, Nardi MA, Hymes KB. Immunologic thrombocytopenic purpura after heterosexual transmission of human immunodeficiency virus (HIV). *Ann Intern Med* 1988;109:190–193.

31. Kunzi MS, Groopman JE. Identification of a novel human immunodeficiency virus strain cytopathic to megakaryocytic cells. *Blood* 1993;81:3336–3342.

32. Zauli G, Re MC, Davis B, et al. Impaired in vitro growth of purified (CD34+) hematopoietic progenitors in human immunodeficiency virus-1 seropositive thrombocytopenic individuals. *Blood* 1992;79:2680–2687.

33. Barbui T, Cortelazzo S, Minetti B, et al. Does splenectomy enhance risk of AIDS in HIV-positive patients with chronic thrombocytopenia? *Lancet* 1987;2:342–343.

34. Fanucchi M, Glaspy J, Crawford J, et al. Effects of polyethylene glycol-conjugated recombinant human megakaryocyte growth and development factor on platelet counts after chemotherapy for lung cancer. *N Engl J Med* 1997;336:404–409.

35. Basser RL, Rasko JE, Clarke K, et al. Thrombopoietic effects of pegylated recombinant human megakaryocyte growth and development factor (PEG-rHuMGDF) in patients with advanced cancer. *Lancet* 1996;348:1279–1281.

36. Vadhan-Raj S. Recombinant human thrombopoietin: clinical experience and in vivo biology. *Semin Hematol* 1998;35:261–268.

37. Harker LA, Marzec UM, Novembre F, et al. Treatment of thrombocytopenia in chimpanzees infected with human immunodeficiency virus by pegylated recombinant human megakaryocyte growth and development factor. *Blood* 1998;91:4427–4433.

38. Emmons RV, Reid DM, Cohen RL, et al. Human thrombopoietin levels are high when thrombocytopenia is due to megakaryocyte deficiency and low when due to increased platelet destruction. *Blood* 1996;87:4068–4071.

39. Isaacs C, Robert NJ, Bailey FA, et al. Randomized placebo-controlled study of recombinant human interleukin-11 to prevent chemotherapy-induced thrombocytopenia in patients with breast cancer receiving dose-intensive cyclophosphamide and doxorubicin. *J Clin Oncol* 1997;15:3368–3377.

40. Klaassen RJ, Mulder JW, Vlekke AB, et al. Autoantibodies against peripheral blood cells appear early in HIV infection and their prevalence increases with disease progression. *Clin Exp Immunol* 1990;81:11–17.

41. Sloand EM, Young NS, Sato T, et al. Inhibition of interleukin-1beta-converting enzyme in human



hematopoietic progenitor cells results in blockade of cytokine-mediated apoptosis and expansion of their proliferative potential. *Exp Hematol* 1998;26:1093-1099.

42. Kotler DP, Culpepper-Morgan JA, Tierney AR, Klein EB. Treatment of disseminated cytomegalovirus infection with 9-(1,3 dihydroxy-2-propoxymethyl)guanine: evidence of prolonged survival in patients with the acquired immunodeficiency syndrome. *AIDS Res* 1986;2:299-308.

43. Laskin OL, Cederberg DM, Mills J, et al. Ganciclovir for the treatment and suppression of serious infections caused by cytomegalovirus. *Am J Med* 1987;83:201-207.

44. Kaplan LD, Kahn JO, Crowe S, et al. Clinical and virologic effects of recombinant human granulocyte-macrophage colony-stimulating factor in patients receiving chemotherapy for human immunodeficiency virus-associated non-Hodgkin's lymphoma: results of a randomized trial. *J Clin Oncol* 1991;9:929-940.

45. Tumbarello M, Tacconelli E, Caponera S, et al. The impact of bacteraemia on HIV infection. Nine years experience in a large Italian university hospital. *J Infect* 1995;31:123-131.

46. Keiser P, Higgs E, Smith J. Neutropenia is associated with bacteremia in patients infected with the human immunodeficiency virus. *Am J Med Sci* 1996;312:118-122.

47. Mathews WC, Caperna J, Toerner JG, et al. Neutropenia is a risk factor for gram-negative bacillus bacteremia in human immunodeficiency virus-infected patients: results of a nested case-control study. *Am J Epidemiol* 1998;148:1175-1183.

48. Pui CH, Boyett JM, Hughes WT, et al. Human granulocyte colony-stimulating factor after induction chemotherapy in children with acute lymphoblastic leukemia. *N Engl J Med* 1997;336:1781-1787.

49. Hammer SM, Gillis JM, Pinkston P, Rose RM. Effect of zidovudine and granulocyte-macrophage colony-stimulating factor on human immunodeficiency virus replication in alveolar macrophages. *Blood* 1990;75:1215-1219.

50. Hardy D, Spector S, Polsky B, et al. Combination of ganciclovir and granulocyte-macrophage colony-stimulating factor in the treatment of cytomegalovirus retinitis in AIDS patients. The ACTG 073 Team. *Eur J Clin Microbiol Infect Dis* 1994;13[Suppl 2]:S34-S40.

51. Barbaro G, Di Lorenzo G, Grisorio B, et al. Effect of recombinant human granulocyte-macrophage colony-stimulating factor on HIV-related leukopenia: a randomized, controlled clinical study. *AIDS* 1997;11:1453-1461.

52. Rossi G, Donisi A, Casari S, et al. Effects of recombinant granulocyte colony-stimulating factor (G-CSF) in patients treated with ProMACE-CytaBOM for HIV-related non-Hodgkin's lymphoma (NHL). *Haematologica* 1998;83:317-322.

53. Kuritzkes DR, Parenti D, Ward DJ, et al. Filgrastim prevents severe neutropenia and reduces infective morbidity in patients with advanced HIV infection: results of a randomized, multicenter, controlled trial. G-CSF 930101 Study Group. *AIDS* 1998;12:65-74.

54. Elbim C, Prevot MH, Bouscarat F, et al. Impairment of polymorphonuclear neutrophil function in HIV-infected patients. *J Cardiovasc Pharmacol* 1995;25[Suppl 2]:S66-S70.

55. Flo RW, Naess A, Nilsen A, et al. A longitudinal study of phagocyte function in HIV-infected patients. *AIDS* 1994;8:771-777.

56. Coffey MJ, Phare SM, George S, et al. Granulocyte colony-stimulating factor administration to HIV-infected subjects augments reduced leukotriene synthesis and anticryptococcal activity in neutrophils. *J Clin Invest* 1998;102:663-670.

57. Kovacs JA, Vogel S, Albert JM, et al. Controlled trial of interleukin-2 infusions in patients infected with the human immunodeficiency virus. *N Engl J Med* 1996;335:1350-1356.

58. Levy Y, Capitant C, Houhou S, et al. Comparison of subcutaneous and intravenous interleukin-2 in asymptomatic HIV-1 infection: a randomised controlled trial. ANRS 048 Study Group. *Lancet*



1999;353:1923–1929.

59. Wood R, Montoya JG, Kundu SK, et al. Safety and efficacy of polyethylene glycol–modified interleukin–2 and zidovudine in human immunodeficiency virus type 1 infection: a phase I/II study. *J Infect Dis* 1993;167:519–525.
60. Davey RT Jr, Chaitt DG, Albert JM, et al. A randomized trial of high– versus low–dose subcutaneous interleukin–2 outpatient therapy for early human immunodeficiency virus type 1 infection. *J Infect Dis* 1999;179:849–858.
61. Bell WR, Chulay JD, Feinberg JE. Manifestations resembling thrombotic microangiopathy in patients with advanced human immunodeficiency virus (HIV) disease in a cytomegalovirus prophylaxis trial (ACTG 204). *Medicine (Baltimore)* 1997;76:369–380.
62. del Arco A, Martinez MA, Pena JM, et al. Thrombotic thrombocytopenic purpura associated with human immunodeficiency virus infection: demonstration of p24 antigen in endothelial cells. *Clin Infect Dis* 1993;17:360–363.
63. Bell WR, Chulay JD, Feinberg JE. Manifestations resembling thrombotic microangiopathy in patients with advanced human immunodeficiency virus (HIV) disease in a cytomegalovirus prophylaxis trial (ACTG 204). *Medicine (Baltimore)* 1997;76:369–380.
64. Mitra D, Jaffe EA, Weksler B, et al. Thrombotic thrombocytopenic purpura and sporadic hemolytic–uremic syndrome plasmas induce apoptosis in restricted lineages of human microvascular endothelial cells. *Blood* 1997;89:1224–1234.
65. Nair JM, Bellevue R, Bertoni M, Dosik H. Thrombotic thrombocytopenic purpura in patients with the acquired immunodeficiency syndrome (AIDS)–related complex. A report of two cases. *Ann Intern Med* 1988;109: 209–212.
66. Moses AV, Williams S, Heneveld ML, et al. Human immunodeficiency virus infection of bone marrow endothelium reduces induction of stromal hematopoietic growth factors. *Blood* 1996;87:919–925.
67. Thompson CE, Damon LE, Ries CA, Linker CA. Thrombotic microangiopathies in the 1980s: clinical features, response to treatment, and the impact of the human immunodeficiency virus epidemic. *Blood* 1992;80: 1890–1895.
68. Sandstrom EG, Kaplan JC. Antiviral therapy in AIDS. Clinical pharmacological properties and therapeutic experience to date. *Drugs* 1987;34:372–390.
69. Deeks SG, Volberding PA. HIV–1 protease inhibitors. *AIDS Clin Rev* 1997:145–185.
70. Jaffe HS, Abrams DI, Ammann AJ, et al. Complications of co–trimoxazole in treatment of AIDS–associated *Pneumocystis carinii* pneumonia in homosexual men. *Lancet* 1983;2:1109–1111.
71. Fulton B, Wagstaff AJ, McTavish D. Trimetrexate. A review of its pharmacodynamic and pharmacokinetic properties and therapeutic potential in the treatment of *Pneumocystis carinii* pneumonia. *Drugs* 1995;49:563–576.
72. Spector SA, McKinley GF, Lalezari JP, et al. Oral ganciclovir for the prevention of cytomegalovirus disease in persons with AIDS. Roche Cooperative Oral Ganciclovir Study Group. *N Engl J Med* 1996;334:1491–1497.
73. Wolff M, Jelkmann W. Effects of chemotherapeutic and immunosuppressive drugs on the production of erythropoietin in human hepatoma cultures. *Ann Hematol* 1993;66:27–31.
74. Ruiz ME, Cicala C, Arthos J, et al. Peripheral blood–derived CD34+ progenitor cells: CXC chemokine receptor 4 and CC chemokine receptor 5 expression and infection by HIV. *J Immunol* 1998;161:4169–4176.
75. Chelucci C, Casella I, Federico M, et al. Lineage–specific expression of human immunodeficiency virus (HIV) receptor/coreceptors in differentiating hematopoietic precursors: correlation with susceptibility to T– and M–tropic HIV and chemokine–mediated HIV resistance. *Blood* 1999;94:1590–1600.
76. Kitano K, Abboud CN, Ryan DH, et al. Macrophage–active colony–stimulating factors enhance human

immunodeficiency virus type 1 infection in bone marrow stem cells. *Blood* 1991;77:1699–1705.

77. Steinberg HN, Crumpacker CS, Chatis PA. In vitro suppression of normal human bone marrow progenitor cells by human immunodeficiency virus. *J Virol* 1991;65:1765–1769.

78. Stanley SK, Kessler SW, Justement JS, et al. CD34+ bone marrow cells are infected with HIV in a subset of seropositive individuals. *J Immunol* 1992;149:689–697.

79. Molina JM, Scadden DT, Sakaguchi M, et al. Lack of evidence for infection of or effect on growth of hematopoietic progenitor cells after in vivo or in vitro exposure to human immunodeficiency virus. *Blood* 1990;76:2476–2482.

80. Neal TF, Holland HK, Baum CM, et al. CD34+ progenitor cells from asymptomatic patients are not a major reservoir for human immunodeficiency virus-1. *Blood* 1995;86:1749–1756.

81. Weichold FF, Zella D, Barabitskaja O, et al. Neither human immunodeficiency virus-1 (HIV-1) nor HIV-2 infects most primitive human hematopoietic stem cells as assessed in long-term bone marrow cultures. *Blood* 1998;91:907–915.

82. Molina JM, Schindler R, Ferriani R, et al. Production of cytokines by peripheral blood monocytes/macrophages infected with human immunodeficiency virus type 1 (HIV-1). *J Infect Dis* 1990;161:888–893.

83. Canque B, Marandin A, Rosenzweig M, et al. Susceptibility of human bone marrow stromal cells to human immunodeficiency virus (HIV). *Virology* 1995;208:779–783.

84. Louache F, Henri A, Bettaieb A, et al. Role of human immunodeficiency virus replication in defective in vitro growth of hematopoietic progenitors. *Blood* 1992;80:2991–2999.

85. Marandin A, Canque B, Coulombel L, et al. In vitro infection of bone marrow-adherent cells by human immunodeficiency virus type 1 (HIV-1) does not alter their ability to support hematopoiesis. *Virology* 1995;213:245–248.

86. Molina JM, Scadden DT, Sakaguchi M, et al. Lack of evidence for infection of or effect on growth of hematopoietic progenitor cells after in vivo or in vitro exposure to human immunodeficiency virus. *Blood* 1990;76:2476–2482.

87. Zauli G, Re MC, Davis B, et al. Impaired in vitro growth of purified (CD34+) hematopoietic progenitors in human immunodeficiency virus-1 seropositive thrombocytopenic individuals. *Blood* 1992;79:2680–2687.

88. Donahue RE, Johnson MM, Zon LI, et al. Suppression of in vitro haematopoiesis following human immunodeficiency virus infection. *Nature* 1987;326:200–203.

89. Maciejewski JP, Weichold FF, Young NS. HIV-1 suppression of hematopoiesis in vitro mediated by envelope glycoprotein and TNF- $\alpha$ . *J Immunol* 1994;153:4303–4310.

90. Nielsen SD, Jeppesen DL, Kolte L, et al. Impaired progenitor cell function in HIV-negative infants of HIV-positive mothers results in decreased thymic output and low CD4 counts. *Blood* 2001;98:398–404.

91. Rieckmann P, Poli G, Fox CH, et al. Recombinant gp120 specifically enhances tumor necrosis factor- $\alpha$  production and Ig secretion in B lymphocytes from HIV-infected individuals but not from seronegative donors. *J Immunol* 1991;147:2922–2927.

92. Sloand EM, Young NS, Sato T, et al. Secondary colony formation after long-term bone marrow culture using peripheral blood and bone marrow of HIV-infected patients. *AIDS* 1997;11:1547–1553.

93. Voth R, Rossol S, Klein K, et al. Differential gene expression of IFN- $\alpha$  and tumor necrosis factor- $\alpha$  in peripheral blood mononuclear cells from patients with AIDS related complex and AIDS. *J Immunol* 1990;144:970–975.

94. Clouse KA, Cosentino LM, Weih KA, et al. The HIV-1 gp120 envelope protein has the intrinsic capacity to stimulate monokine secretion. *J Immunol* 1991;147:2892–2901.

95. Lau AS, Williams BR. The role of interferon and tumor necrosis factor in the pathogenesis of AIDS. *J*

Exp Pathol 1990;5:111–122.

96. Odeh M. The role of tumour necrosis factor–alpha in the pathogenesis of complicated falciparum malaria. *Cytokine* 2001;14:11–18.
97. Selleri C, Sato T, Anderson S, et al. Interferon–gamma and tumor necrosis factor–alpha suppress both early and late stages of hematopoiesis and induce programmed cell death. *J Cell Physiol* 1995;165:538–546.
98. Rusten LS, Jacobsen FW, Lesslauer W, et al. Bifunctional effects of tumor necrosis factor alpha (TNF alpha) on the growth of mature and primitive human hematopoietic progenitor cells: involvement of p55 and p75 TNF receptors. *Blood* 1994;83:3152–3159.
99. Fuchs D, Reibnegger G, Werner ER, et al. Low haemoglobin in haemophilia children is associated with chronic immune activation. *Acta Haematol* 1991;85:62–65.
100. Kagi D, Vignaux F, Ledermann B, et al. Fas and perforin pathways as major mechanisms of T cell-mediated cytotoxicity. *Science* 1994;265:528–530.
101. Maciejewski JP, Selleri C, Sato T, et al. Increased expression of Fas antigen on bone marrow CD34+ cells of patients with aplastic anaemia. *Br J Haematol* 1995;91:245–252.
- 101a. Karcher DS, Frost AR. The bone marrow in human immunodeficiency virus (HIV)–related disease. Morphology and clinical correlation. *Am J Clin Pathol* 1991;95:63–71.
102. Zon LI, Arkin C, Groopman JE. Haematologic manifestations of the human immune deficiency virus (HIV). *Br J Haematol* 1987;66:251–256.
103. Harris CE, Biggs JC, Concannon AJ, Dodds AJ. Peripheral blood and bone marrow findings in patients with acquired immune deficiency syndrome. *Pathology* 1990;22:206–211.
104. Hromas RA, Murray JL. Bone marrow in the acquired immunodeficiency syndrome. *Ann Intern Med* 1984;101:877.
105. Thiele J, Titius BR, Quitmann H, et al. Megakaryocytopoiesis in bone marrow biopsies of patients with acquired immunodeficiency syndrome (AIDS). An immunohistochemical and morphometric evaluation with special emphasis on myelodysplastic features and precursor cells. *Pathol Res Pract* 1992;188:722–728.
106. Saber AA, Aboolian A, LaRaja RD, et al. HIV/AIDS and the risk of deep vein thrombosis: a study of 45 patients with lower extremity involvement. *Am Surg* 2001;67:645–647.
107. Feffer SE, Fox RL, Orsen MM, et al. Thrombotic tendencies and correlation with clinical status in patients infected with HIV. *South Med J* 1995;88:1126–1130.
108. Force L, Barrufet P, Herreras Z, Bolibar I. Deep venous thrombosis and megestrol in patients with HIV infection. *AIDS* 1999;13:1425–1426.
109. Abuaf N, Laperche S, Rajoely B, et al. Autoantibodies to phospholipids and to the coagulation proteins in AIDS. *Thromb Haemost* 1997;77:856–861.
110. Falco M, Sorrenti A, Priori R, et al. Anti–cardiolipin antibodies in HIV infection are true antiphospholipids not associated with antiphospholipid syndrome. *Ann Ital Med Int* 1993;8:171–174.
111. Bissuel F, Berruyer M, Causse X, et al. Acquired protein S deficiency: correlation with advanced disease in HIV–1–infected patients. *J Acquir Immune Defic Syndr* 1992;5:484–489.
112. Sorice M, Griggi T, Arcieri P, et al. Protein S and HIV infection. The role of anticardiolipin and anti–protein S antibodies. *Thromb Res* 1994;73:165–175.
113. Stahl CP, Wideman CS, Spira TJ, et al. Protein S deficiency in men with long–term human immunodeficiency virus infection. *Blood* 1993;81:1801–1807.
- 113a. Sugeran RW, Church JA, Goldsmith JC, Ens GE. Acquired protein S deficiency in children infected

with human immune deficiency virus (HIV). *Semin Hematol* 1998;25:208–218.

114. Toulon P, Lamine M, Ledjev I, et al. Heparin cofactor II deficiency in patients infected with the human immunodeficiency virus. *Thromb Haemost* 1993;70:730–735.

115. Scadden DT. AIDS-related malignancies. *Curr Opin Oncol* 1998;10:403–404.

116. Hagemester FB, Khetan R, Allen P, et al. Stage, serum LDH, and performance status predict disease progression and survival in HIV-associated lymphomas. *Ann Oncol* 1994;5[Suppl 2]:41–46.

117. Monfardini S, Tirelli U, Vaccher E, et al. Malignant lymphomas in patients with or at risk for AIDS: a report of 50 cases observed in Italy. *Cancer Detect Prev* 1988;12 237–241.

118. Sei S, O'Neill DP, Stewart SK, et al. Increased level of stromal cell-derived factor-1 mRNA in peripheral blood mononuclear cells from children with AIDS-related lymphoma. *Cancer Res* 2001;61:5028–5037.

119. Rabkin CS, Yang Q, Goedert JJ, et al. Chemokine and chemokine receptor gene variants and risk of non-Hodgkin's lymphoma in human immunodeficiency virus-1-infected individuals. *Blood* 1999;93:1838–1842.

120. Kaplan LD. AIDS-associated non-Hodgkin's lymphoma. *Curr Opin Oncol* 1989;1:62–67.

121. Northfelt DW, Kaplan LD. Clinical aspects of AIDS-related non-Hodgkin's lymphoma. *Curr Opin Oncol* 1991;3:872–880.

122. Philip T, Meckenstock R, Deconnick E, et al. Treatment of poor prognosis Burkitt's lymphoma in adults with the Societe Francaise d'Oncologie Pediatrique LMB Protocol—a study of the Federation Nationale des Centres de Lutte Contre le Cancer (FNLC). *Eur J Cancer* 1992;28A:1954–1959.

123. Ambinder RF. Epstein-Barr virus associated lymphoproliferations in the AIDS setting. *Eur J Cancer* 2001;37:1209–1216.

124. Carbone A, Gloghini A, Gaidano G, et al. AIDS-related Burkitt's lymphoma. Morphologic and immunophenotypic study of biopsy specimens. *Am J Clin Pathol* 1995;103:561–567.

125. Carbone A, Dolcetti R, Gloghini A, et al. Immunophenotypic and molecular analyses of acquired immune deficiency syndrome-related and Epstein-Barr virus-associated lymphomas: a comparative study. *Hum Pathol* 1996;27:133–146.

126. Gabarre J, Raphael M, Lepage E, et al. Human immunodeficiency virus-related lymphoma: relation between clinical features and histologic subtypes. *Am J Med* 2001;111:704–711.

127. Spina M, Tirelli U, Zagonel V, et al. Burkitt's lymphoma in adults with and without human immunodeficiency virus infection: a single-institution clinicopathologic study of 75 patients. *Cancer* 1998;82:766–774.

128. Vaccher E, Tirelli U. Burkitt's like lymphoma in patients with and without HIV infection. A report of 33 patients from north-east Italy. *Acta Oncol* 1994;33:507–511.

129. Tirelli U, Errante D, Carbone A, et al. Malignant lymphomas in patients with HIV infection. *Leuk Lymphoma* 1996;22:245–257.

130. Vaccher E, Tirelli U, Spina M, et al. Age and serum lactate dehydrogenase level are independent prognostic factors in human immunodeficiency virus-related non-Hodgkin's lymphomas: a single-institute study of 96 patients. *J Clin Oncol* 1996;14:2217–2223.

131. Morassut S, Vaccher E, Balestreri L, et al. HIV-associated human herpesvirus 8-positive primary lymphomatous effusions: radiologic findings in six patients. *Radiology* 1997;205:459–463.

132. Levine AM, Wernz JC, Kaplan L, et al. Low-dose chemotherapy with central nervous system prophylaxis and zidovudine maintenance in AIDS-related lymphoma. A prospective multi-institutional trial. *JAMA* 1991;266:84–88.

133. Sadler M, Brink NS, Gazzard BG. Management of intracerebral lesions in patients with HIV: a retrospective study with discussion of diagnostic problems. *QJM* 1998;91:205-217.
134. Okada T, Katano H, Tsutsumi H, et al. Body-cavity-based lymphoma in an elderly AIDS-unrelated male. *Int J Hematol* 1998;67:417-422.
135. Kaplan LD, Straus DJ, Testa MA, et al. Low-dose compared with standard-dose m-BACOD chemotherapy for non-Hodgkin's lymphoma associated with human immunodeficiency virus infection. National Institute of Allergy and Infectious Diseases AIDS Clinical Trials Group. *N Engl J Med* 1997;336:1641-1648.
136. Ratner L, Lee J, Tang S, et al. Chemotherapy for human immunodeficiency virus-associated non-Hodgkin's lymphoma in combination with highly active antiretroviral therapy. *J Clin Oncol* 2001;19:2171-2178.
137. Gisselbrecht C, Oksenhendler E, Tirelli U, et al. Human immunodeficiency virus-related lymphoma treatment with intensive combination chemotherapy. French-Italian Cooperative Group. *Am J Med* 1993;95:188-196.
138. Tirelli U, Spina M, Vaccher E, et al. Clinical evaluation of 451 patients with HIV related non-Hodgkin's lymphoma: experience on the Italian cooperative group on AIDS and tumors (GICAT). *Leuk Lymphoma* 1995;20:91-96.
139. Sparano JA, Anand K, Desai J, et al. Effect of highly active antiretroviral therapy on the incidence of HIV-associated malignancies at an urban medical center. *J Acquir Immune Defic Syndr* 1999;21[Suppl 1]:S18-S22.
140. Sparano JA, Wiernik PH, Strack M, et al. Infusional cyclophosphamide, doxorubicin and etoposide in HIV-related non-Hodgkin's lymphoma: a follow-up report of a highly active regimen. *Leuk Lymphoma* 1994;14:263-271.
141. Little RF, Pittaluga S, Grant N, et al. Highly effective treatment of acquired immunodeficiency syndrome-related lymphoma with dose-adjusted EPOCH: impact of antiretroviral therapy suspension and tumor biology. *Blood* 2003.
142. Little RF, Gutierrez M, Jaffe ES, et al. HIV-associated non-Hodgkin lymphoma: incidence, presentation, and prognosis. *JAMA* 2001;285:1880-1885.
143. Levine AM, Li P, Cheung T, et al. Chemotherapy consisting of doxorubicin, bleomycin, vinblastine, and dacarbazine with granulocyte-colony-stimulating factor in HIV-infected patients with newly diagnosed Hodgkin's disease: a prospective, multi-institutional AIDS clinical trials group study (ACTG 149). *J Acquir Immune Defic Syndr* 2000;24:444-450.
144. Kaplan LD, Kahn JO, Crowe S, et al. Clinical and virologic effects of recombinant human granulocyte-macrophage colony-stimulating factor in patients receiving chemotherapy for human immunodeficiency virus-associated non-Hodgkin's lymphoma: results of a randomized trial. *J Clin Oncol* 1991;9:929-940.
145. Errante D, Zagonel V, Vaccher E, et al. Hodgkin's disease in patients with HIV infection and in the general population: comparison of clinicopathological features and survival. *Ann Oncol* 1994;5[Suppl 2]:37-40.
146. Monfardini S, Tirelli U, Vaccher E, et al. Hodgkin's disease in 63 intravenous drug users infected with human immunodeficiency virus. Gruppo Italiano Cooperativo AIDS & Tumori (GICAT). *Ann Oncol* 1991;2[Suppl 2]:201-205.
147. Hessol NA, Katz MH, Liu JY, et al. Increased incidence of Hodgkin disease in homosexual men with HIV infection. *Ann Intern Med* 1992;117:309-311.
148. Aviles A, Rubio E. Danazol in idiopathic sideroblastic anemia. *Acta Haematol* 1988;79:229.
149. Rubio R, Pulido F, Pintado V, et al. [Non-Hodgkin's lymphomas associated with the acquired

- immunodeficiency syndrome. A multicenter clinical study of 77 cases]. *Med Clin (Barc)* 1995;104:481–486.
150. Wiktor-Jedrzejczak W, Bartocci A, Ferrante AW Jr, et al. Total absence of colony-stimulating factor 1 in the macrophage-deficient osteopetrotic (op/op) mouse. *Proc Natl Acad Sci U S A* 1990;87:4428–4832.
151. Tirelli U, Vaccher E, Rezza G, et al. Hodgkin's disease in association with acquired immunodeficiency syndrome (AIDS). A report on 36 patients. Gruppo Italiano Cooperativo AIDS and Tumori. *Acta Oncol* 1989;28:637–639.
152. Tirelli U, Errante D, Vaccher E, et al. Hodgkin's disease in 92 patients with HIV infection: the Italian experience. GICAT (Italian Cooperative Group on AIDS & Tumors). *Ann Oncol* 1992;3[Suppl 4]:69–72.
153. Andrieu JM, Roithmann S, Tourani JM, et al. Hodgkin's disease during HIV1 infection: the French registry experience. French Registry of HIV-associated Tumors. *Ann Oncol* 1993;4:635–641.
154. Spina M, Gabarre J, Fasan M, et al. Stanford V regimen and concomitant highly active antiretroviral therapy is feasible and active in patients with Hodgkin's disease and HIV infection. *AIDS* 2000;14:1457–1458.
155. Vaccher E, Spina M, Tirelli U. Clinical aspects and management of Hodgkin's disease and other tumours in HIV-infected individuals. *Eur J Cancer* 2001;37:1306–1315.
156. Molina A, Popplewell L, Kashyap A, Nademanee A. Hematopoietic stem cell transplantation in the new millennium: report from City of Hope National Medical Center. *Clin Transpl* 2000;317–342.
157. Gabarre J, Azar N, Autran B, et al. High-dose therapy and autologous haematopoietic stem-cell transplantation for HIV-1-associated lymphoma. *Lancet* 2000;355:1071–1072.
158. Kang EM, de Witte M, Malech H, et al. Nonmyeloablative conditioning followed by transplantation of genetically modified HLA-matched peripheral blood progenitor cells for hematologic malignancies in patients with acquired immunodeficiency syndrome. *Blood* 2002;99:698–701.
159. Olsen SJ, Chang Y, Moore PS, et al. Increasing Kaposi's sarcoma-associated herpesvirus seroprevalence with age in a highly Kaposi's sarcoma endemic region, Zambia in 1985. *AIDS* 1998;12:1921–1925.
160. Ascherl G, Hohenadl C, Schatz O, et al. Infection with human immunodeficiency virus-1 increases expression of vascular endothelial cell growth factor in T cells: implications for acquired immunodeficiency syndrome-associated vasculopathy. *Blood* 1999;93:4232–4241.
161. Gill J, Powles T, Bower M. The molecular genetics of human herpesvirus 8. *Hosp Med* 2000;61:306–309.
162. Gill PS, Tsai YC, Rao AP, et al. Evidence for multiclonality in multicentric Kaposi's sarcoma. *Proc Natl Acad Sci U S A* 1998;95:8257–8261.
163. Wilkinson J, Cope A, Gill J, et al. Identification of Kaposi's sarcoma-associated herpesvirus (KSHV)-specific cytotoxic T-lymphocyte epitopes and evaluation of reconstitution of KSHV-specific responses in human immunodeficiency virus type 1-infected patients receiving highly active antiretroviral therapy. *J Virol* 2002;76:2634–2640.
164. Ensoli B, Markham P, Kao V, et al. Block of AIDS-Kaposi's sarcoma (KS) cell growth, angiogenesis, and lesion formation in nude mice by antisense oligonucleotide targeting basic fibroblast growth factor. A novel strategy for the therapy of KS. *J Clin Invest* 1994;94:1736–1746.
165. Fiorelli V, Gendelman R, Samaniego F, et al. Cytokines from activated T cells induce normal endothelial cells to acquire the phenotypic and functional features of AIDS-Kaposi's sarcoma spindle cells. *J Clin Invest* 1995;95:1723–1734.
166. Fiorelli V, Gendelman R, Sirianni MC, et al. gamma-Interferon produced by CD8+ T cells infiltrating Kaposi's sarcoma induces spindle cells with angiogenic phenotype and synergy with human immunodeficiency virus-1 Tat protein: an immune response to human herpesvirus-8 infection? *Blood* 1998;91:956–967.
167. Fiorelli V, Barillari G, Toschi E, et al. IFN-gamma induces endothelial cells to proliferate and to

invade the extracellular matrix in response to the HIV-1 Tat protein: implications for AIDS-Kaposi's sarcoma pathogenesis. *J Immunol* 1999;162:1165-1170.

168. Bower M, Fox P, Fife K, et al. Highly active anti-retroviral therapy (HAART) prolongs time to treatment failure in Kaposi's sarcoma. *AIDS* 1999;13:2105-2111.

169. Tirelli U, Bernardi D. Impact of HAART on the clinical management of AIDS-related cancers. *Eur J Cancer* 2001;37:1320-1324.

170. Masood R, Nagpal S, Zheng T, et al. Kaposi sarcoma is a therapeutic target for vitamin D(3) receptor agonist. *Blood* 2000;96:3188-3194.

171. Allison RR, Mang TS, Wilson BD. Photodynamic therapy for the treatment of nonmelanomatous cutaneous malignancies. *Semin Cutan Med Surg* 1998;17:153-163.

172. Krown SE. Management of Kaposi sarcoma: the role of interferon and thalidomide. *Curr Opin Oncol* 2001;13:374-381.

173. Little RF, Wyvill KM, Pluda JM, et al. Activity of thalidomide in AIDS-related Kaposi's sarcoma. *J Clin Oncol* 2000;18:2593-2602.

174. Bennett CL, Golub RM, Stinson TJ, et al. Cost-effectiveness analysis comparing liposomal anthracyclines in the treatment of AIDS-related Kaposi's sarcoma. *J Acquir Immune Defic Syndr Hum Retrovirol* 1998;18:460-465.

175. Gill PS, Mitsuyasu RT, Montgomery T, et al. AIDS Clinical Trials Group Study 094: a phase I/II trial of ABV chemotherapy with zidovudine and recombinant human GM-CSF in AIDS-related Kaposi's sarcoma. *Cancer J Sci Am* 1997;3:278-283.

175a. Bernstein ZP, Chanan-Khan A, Miller KC, et al. A multicenter phase II study of the intravenous administration of liposomal tretinoin in patients with acquired immunodeficiency syndrome-associated Kaposi's sarcoma. *Cancer* 2002;95:2555-2561.

176. Gill PS, Lunardi-Ishkandar Y, Louie S, et al. The effects of preparations of human chorionic gonadotropin on AIDS-related Kaposi's sarcoma. *N Engl J Med* 1996;335:1261-1269.

177. Selik RM, Chu SY, Ward JW. Trends in infectious diseases and cancers among persons dying of HIV infection in the United States from 1987 to 1992. *Ann Intern Med* 1995;123:933-936.

178. Weiss R, Huhn D, Mitrou P, et al. HIV-related non-Hodgkin's lymphoma: CHOP induction therapy and interferon-alpha-2b/zidovudine maintenance therapy. *Leuk Lymphoma* 1998;29:103-118.

179. Sparano JA, Wiernik PH, Strack M, et al. Infusional cyclophosphamide, doxorubicin, and etoposide in human immunodeficiency virus- and human T-cell leukemia virus type I-related non-Hodgkin's lymphoma: a highly active regimen. *Blood* 1993;81:2810-2815.

180. Sawka CA, Shepherd FA, Brandwein J, et al. Treatment of AIDS-related non-Hodgkin's lymphoma with a twelve week chemotherapy program. *Leuk Lymphoma* 1992;8:213-220.

2004 Lippincott Williams & Wilkins  
John P. Greer, John Foerster, John N. Lukens  
George M. Rodgers, Frixos Paraskevas, Bertil Glader  
Wintrobe's Clinical Hematology



**DEVELOPMENT AND ANATOMY****Gross Anatomy****Microscopic Anatomy****SPLENIC FUNCTION****Filter Function****Immune Function****Cellular Reservoir Function****Hematopoietic Function****Iron Metabolism****SPLENIC DISORDERS AND INDICATIONS FOR SPLENECTOMY****Indications for Splenectomy****SPLENECTOMY: SURGICAL TECHNIQUE****Open Splenectomy****Laparoscopic Splenectomy****COMPLICATIONS OF SPLENECTOMY****Postsplenectomy Infection****WEB SITES****REFERENCES**

The spleen is a small, purplish, spongelike organ found in the left upper abdominal quadrant (<sup>1</sup>). Although there is no mention of the spleen in the Bible, it receives considerable attention in the Talmud and post-Talmudic literature. Classically identified as the seat of laughter, there has been much debate over whether the spleen is truly necessary (<sup>2</sup>). It is said that Galen called it an “organ full of mystery” as early as the second century A.D. (<sup>3</sup>, <sup>4</sup>). Although we have come to understand much about the structure and function of the spleen since those times, much of what intrigued Galen still remains a mystery today. For example, the basic question of which organ system the spleen belongs to remains a point of contention among authorities. Different investigators classify it as being a component of the circulatory system (<sup>5</sup>), the hematopoietic system (<sup>6</sup>), the mononuclear phagocyte system (<sup>7</sup>), or the lymphatic system (<sup>8</sup>). However, it is probably more accurate to describe the spleen as a clearinghouse for circulating cellular elements—a place where multiple organ systems converge in both structure and function. Through a careful study of splenic anatomy and physiology, as well as the consequences of splenectomy, much has been learned to help clarify these issues (<sup>2</sup>).

**DEVELOPMENT AND ANATOMY**

The spleen is derived from embryonic mesoderm (<sup>6</sup>, <sup>7</sup>, <sup>9</sup>). The developing organ first becomes apparent during the fifth week of gestation as mesodermal cells coalesce between the leaflets of the dorsal mesogastrium, posterior to the developing stomach (<sup>7</sup>, <sup>9</sup>, <sup>10</sup>). As development continues, independent lobules enveloped by mesogastrium become evident. In time, they fuse to form a multilobulated mass that eventually differentiates into a well-formed organ by late fetal life (<sup>9</sup>, <sup>10</sup>). Occasionally, a stray lobule may fail to fuse with the others, develop independently, and give rise to an accessory spleen, a functioning mass of splenic tissue set apart from the body of the

organ proper ( 7, 9). The mesogastrium enveloping the lobules eventually gives rise to the organ's capsule and trabecular skeleton, and the posterior and anterior attachments give rise to the primary supporting structures: the splenorenal and gastrosplenic ligaments, respectively ( 9, 11).

## Gross Anatomy

Grossly, the spleen may appear in a variety of shapes. It may be wedge-shaped (44%), tetrahedral (42%), or triangular (14%) depending on its relationships with neighboring organs during development ( 11). Adjacent organs that affect the shape of the spleen include the stomach, left kidney, pancreas, and colon ( 1, 12). Corresponding depressions on the surface of the developing spleen give rise to the observed gastric, renal, pancreatic, and colic impressions ( 1).

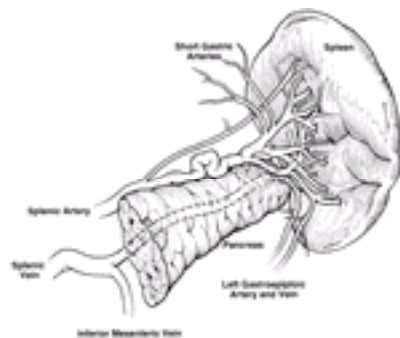
The size of the spleen varies with age as well as immunologic and nutritional status ( 1). However, the average adult spleen measures 13 to 15 cm in length, 8 to 10 cm in width, and 4 cm in thickness, with a weight of 150 g and a corresponding blood volume of approximately 300 ml ( 1, 8, 13, 14).

The nonperfused organ appears purplish in color with a solid, spongelike texture throughout. It is covered by a fibrous connective tissue capsule that is 1.5 mm thick and composed of collagen and elastin fibers ( 1). This capsule surrounds all but the hilum of the spleen ( 14). Continuous with the capsule, involutions penetrate the body of the organ to form trabeculae, the fibrous supporting skeleton of the spleen ( 1, 8, 14). Finally, a serosal membrane, derived from peritoneum, covers the organ externally and adheres to the capsule. This mesothelial membrane covers the entire organ except at its hilum and the reflections of its primary supporting ligaments ( 1).

Beneath the capsule, the spleen may be divided into segments or lobes; two are found in most people ( 15). Although the exact nature of these segments remains to be defined, it is generally agreed that avascular planes separate them from each other and that they are defined by discrete nonanastomosing circulatory pathways ( 1, 11, 15, 16). The overwhelming majority of people have two lobes: a superior lobe and an inferior lobe ( 15). However, other lobes have been identified and include an intermediate or accessory lobe as well as numerous subsegmental lobes ( 15, 16).

**LOCATION AND RELATIONSHIPS** The spleen is located in the left upper quadrant of the abdominal cavity, posteriorly, at the level of the ninth to eleventh thoracic vertebrae ( 1, 12). The superior, or diaphragmatic, surface of the organ is convex in shape, smooth, and related to the left hemidiaphragm, whereas the inferior, or visceral, surface is somewhat triangular and rests on the splenic flexure of the colon ( 1, 11, 12). The medial portion of the spleen is concave and divided by a longitudinal ridge into a gastric surface anteriorly and a renal surface posteriorly ( 1, 11). The gastric surface contains the hilum of the organ and relates to the fundus of the stomach and the tail of the pancreas ( 1). The tail of the pancreas touches the spleen in 30% of cases and is within 1 cm of it in 73% of the population ( 17), contributing to the risk of pancreatic injury in patients undergoing splenectomy. The renal surface borders the superolateral surface of the left kidney and left adrenal gland ( 11). [Figure 70.1](#) shows the gross appearance of the spleen as well as the relationship to the adjacent pancreatic tail and branch vessels of the splenic artery. The spleen's anterior, lateral, and posterior surfaces follow the contour of the left lower

rib cage (ninth, tenth, and eleventh ribs) to which they are related, with the diaphragm and pleura intervening ( [1](#), [12](#) ).



**Figure 70.1.** Illustration of the spleen and relationship to the adjacent pancreatic tail and branch vessels of the splenic artery and vein. (Redrawn and modified from Cameron JL, ed. Atlas of surgery. Philadelphia: BC Decker, 1990.)

The spleen is supported by a number of suspensory ligaments: the splenorenal posteriorly, the gastrosplenic anteromedially, the splenophrenic superiorly, and the splenocolic inferiorly ( [1](#) ). Associated ligaments that help to support the spleen include the pancreaticosplenic, phrenicocolic, and pancreaticocolic ligaments as well as the presplenic fold ( [11](#) ). The splenorenal and gastrosplenic ligament ( [11](#) ). The splenorenal ligament supports the organ posteriorly and serves as a conduit for the organ's neurovascular bundle, whereas the gastrosplenic ligament stabilizes the spleen anteromedially to the greater curvature of the stomach and contains the short gastric and gastroepiploic vessels ( [1](#), [11](#) ). The other ligaments of the spleen play a secondary role in the support of the organ and are generally avascular ( [1](#), [11](#) ). However, in certain pathologic states, such as portal hypertension, significant collateral circulation through these planes may occur ( [7](#), [11](#) ). Certain surgical procedures (such as the distal splenorenal shunt) use these collateral pathways to decompress gastroesophageal varices in patients who have bleeding complications of portal hypertension and are not responsive to medical measures.

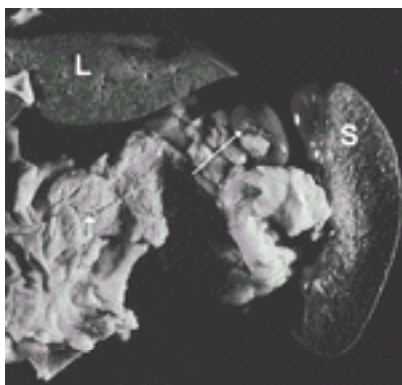
**VASCULAR SUPPLY** The spleen is a highly perfused organ. Although it represents only approximately 0.2% of the total body weight, it receives more than 5% of the total cardiac output ( [18](#) ). The main blood supply to the spleen is the splenic artery, which delivers 250 to 300 ml of arterial blood per minute ( [10](#), [18](#) ). It arises as a branch of the aorta's celiac trunk in the midline and follows a tortuous course to the left, enveloped within the splenorenal ligament, to supply the organ ( [1](#), [12](#) ). The splenic artery is a highly unpredictable vessel that displays variations in course and dimension ( [11](#) ). In 95% of the population, it travels along the upper border of the pancreas ( [15](#) ), but it may also travel in front of, within, or behind the pancreatic tissue ( [11](#) ). Along its tortuous course, the splenic artery gives rise to the left gastroepiploic artery and the short gastric arteries, both of which run within the gastrosplenic ligament ( [7](#) ). At its terminal end, the splenic artery branches into a number of smaller arteries, or segmental branches, before penetrating the hilum of the organ. These smaller arteries are also highly variable but are most often four in number and include the superior polar, superior middle, inferior middle, and inferior polar splenic arteries ( [1](#), [11](#), [12](#) ). The segmental branches penetrate the organ by traveling within the trabeculae (sheaths of fibrous connective tissue derived from the involution of the spleen's fibrous capsule) and ramify within the body of the organ ( [8](#) ). Additional sources of arterial blood to the spleen include direct tributaries and collateral circulation provided by branches of the pancreatic and short gastric arteries ( [1](#), [11](#) ). Venous drainage is facilitated primarily by the splenic vein ( [1](#), [11](#) ). It is formed by the coalescence of the segmental splenic veins, as they leave the hilum of the organ, and the

left gastroepiploic vein ( [7](#) ). Occasionally, short gastric veins may also participate ( [11](#) ). Once formed, the splenic vein courses toward the midline along the superior border of the pancreas, where it joins the superior mesenteric vein to form the portal vein ( [11](#) ). Along the way, the splenic vein receives venous tributaries from the pancreas and, in 60% of cases, also receives the inferior mesenteric vein ( [12](#) ).

**LYMPHATICS** The spleen, which is considered by many to be a lymphatic organ ( [8](#), [9](#), [19](#) ), has no afferent lymphatics ( [20](#) ), yet a significant amount of lymph fluid is expressed by the organ and drains via efferent vessels that form around the arterioles. The lymphatics travel with the neurovascular bundle through the trabeculae, exiting at the hilum ( [20](#) ). In turn, the lymphatic fluid is directed toward the nodes of the splenic hilum, the splenic artery, and the pancreas (the pancreaticosplenic nodes) and eventually drains to the nodes of the celiac axis ( [11](#) ).

**INNERVATION** The innervation of the spleen remains controversial. Some authors argue that sensory, myelinated fibers play a role in splenic physiology ( [11](#) ). However, it is generally held that nonmyelinated autonomic fibers exist exclusively ( [1](#) ). The autonomic fibers that are observed in the spleen originate within the sympathetic chain at the level of T-6 to T-8 and pass with the greater thoracic splanchnic nerve to the celiac ganglion ( [11](#) ). From there, they pass to the organ via the arterial tree, with resulting vasomotor function ( [1](#) ). It is believed that, similarly to other mammals, the autonomic nervous system regulates changes in spleen volume, resulting in the expulsion of stored red blood cells during times of physiologic need ( [14](#), [21](#) ). Of interest are studies that relate the sympathetic innervation of the spleen to the immune system ( [22](#), [23](#) ). These studies suggest that the sympathetic nerves that travel along the arterial tree also provide branches to the lymphocytic tissue of the white pulp. In this respect, these investigators argue, the central nervous system is hard-wired to the immune system and may mediate the observed immunosuppressive effects of stress ( [22](#), [23](#) ). It has been suggested that parasympathetic distribution to the organ exists, derived from the right posterior vagus nerve. The functional significance of this innervation is uncertain ( [11](#) ).

**ACCESSORY SPLEENS** An accessory spleen is a functioning lobule of splenic tissue set apart from the body of the spleen proper. It is an anatomic variant present in 10 to 30% of the general population ( [7](#), [9](#) ) and appears to be found with greater frequency in patients with hematologic disorders ( [10](#) ). [Figure 70.2](#) shows a typical example of an accessory spleen.



**Figure 70.2.** Autopsy photograph demonstrating accessory spleen ( *large arrow* ) and its relationship to the splenic hilum, pancreas ( *small arrow* ), and adjacent liver. L, liver; S, spleen. (Photograph provided by Hedi Wingard, M.D., Department of Pathology, Vanderbilt University Medical Center.)

These supernumerary organs arise during embryologic development when an encapsulated lobule of precursor cells fails to fuse with others forming the spleen proper ( [9](#) ); they are

solitary in approximately 88% but can be multiple in 10% of cases (10, 24). In the majority of cases, accessory spleens receive their blood supply from a tributary of the splenic artery and are found most often near the hilum of the organ or within one of the primary supporting ligaments (10). However, they may be found within secondary supporting ligaments or within the greater omentum or even in as remote a location as the pelvis of the female or the scrotum of the male (10). They may be mistaken for malignancy on imaging studies, such as computed tomography (CT) or endoscopic ultrasound (24), and can rarely develop abscesses just as a normal spleen (25). Because accessory spleens perform the same functions as the spleen proper, they are subject to the same pathologic conditions that affect the parent organ. Therefore, they may enlarge after splenectomy, causing a relapse of the disease process for which the spleen was removed (20). The presence of an unrecognized accessory spleen can account for failure of certain surgical procedures such as splenectomy for immune thrombocytopenic purpura (ITP). In patients who continue to have thrombocytopenia after splenectomy, search for a missed accessory spleen should be considered. Diagnosis may be made using abdominal sonography, CT, magnetic resonance imaging, nuclear scintigraphy, or Doppler sonography (26).

**SPLENOSIS** In addition to accessory spleens, extrasplenic tissue may occur via traumatic autotransplantation in the form of splenosis (27). This is the migration and subsequent proliferation of dislodged splenic tissue, and it is reported to occur in up to 75% of patients who undergo splenectomy for traumatic injury (27). Rarely, splenosis may be found in the gynecologic patient (28) or in the thorax after rupture of the spleen and left hemidiaphragm (29). In the era of laparoscopic splenectomy, there have been reports of splenosis at the retrieval port site (30). Histologic examination of splenetic tissue reveals the same elements of the parent organ: white pulp, red pulp, and marginal zones (31). It follows, therefore, that splenetic tissue should preserve at least some splenic function. Indeed, it has been observed that postsplenectomy patients with splenetic tissue do retain the ability to clear erythrocytes of undesirable inclusion bodies (32). However, it has not been demonstrated that this provides sufficient protection from postsplenectomy infectious complications (33).

**WANDERING SPLEEN** *Wandering spleen* refers to migration of the spleen from its normal location in the left upper quadrant (34). With an incidence of less than 0.5% in splenectomy series, the major complication of an ectopic spleen is torsion, either acutely or chronically. Signs and symptoms include vague or chronic abdominal discomfort and a tender abdominal mass, and CT assessment of viability leads to the decision of splenectomy versus splenopexy (34).

## Microscopic Anatomy

Splenic tissue is supported by a scaffold of trabeculae, a dense, fibrous connective tissue skeleton that gives rise to an intrasplenic meshwork of collagen fibers (1). Vascular elements enter the spleen at the hilum, branch through the trabeculae, and penetrate the body of the organ to supply the microcirculation (6). As the arterial elements enter the parenchyma, they become surrounded by an aggregate of lymphoid tissue, which follows vessels in a sheathlike distribution (1). Aggregates of lymphoid tissue are collectively called the *white pulp*. White pulp may be arranged in this coaxial fashion, or it may appear as isolated follicles within the parenchyma of the organ (19). The balance of splenic tissue beneath the capsule is known as the *red pulp*. It is composed of vascular, circulatory, and mononuclear phagocytic elements (1, 35). Additionally, an intermediate region can be observed at the junction between the white and red pulp; it is known as the *marginal zone* (1). Nerves and lymphatics follow the distribution of the larger vessels throughout the

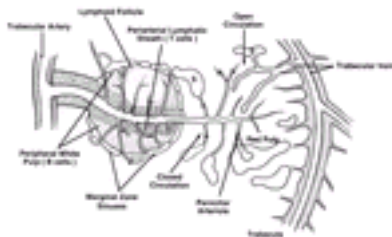


body of the organ ( 3 ).

**WHITE PULP** The white pulp represents roughly one-fourth of the splenic volume and is composed primarily of lymphoid elements ( 3 ). White pulp may be observed in one of two arrangements: a periarteriolar lymphatic sheath (PALS) or a lymphoid follicle ( 1 , 35 ). The *PALS* is a collection of (mostly) T lymphocytes that surrounds intraparenchymal arterioles and follows these vessels in a coaxial fashion for several millimeters throughout their terminal distribution ( 1 ). The *lymphoid follicles*, or *malpighian corpuscles*, are spherical collections of B lymphocytes measuring 0.25 to 1.00 mm in diameter ( 1 ). These follicles are usually distributed along the length of the PALS in an eccentric fashion or may be found toward the terminal ends and branching points of the arterioles ( 1 ).

**RED PULP** The red pulp represents approximately three-fourths of the splenic volume ( 1 ) and is composed primarily of vascular elements surrounded by a fibrocellular reticulum that contains mononuclear phagocytic cell lines and circulating elements of blood in transit ( 1 , 35 ). The chief vascular component of the red pulp is the *splenic sinus*, a preliminary venous element whose structure is unique to this organ ( 3 , 6 ). The sinus is composed of an incomplete lining of elongated endothelial cells surrounded by a highly fenestrated basement membrane ( 1 ). The structure is supported externally by reticulin fibers wrapped in a transverse fashion ( 1 , 6 , 19 ). The unique architecture of the splenic sinus has been compared to the structure of a wooden barrel, with the elongated endothelial cells resembling the planks or staves and the external reticulin fibers representing the hoops ( 19 ). The splenic sinuses permeate the surrounding fibrocellular reticulum that supports them. Two-dimensional histologic observation reveals an intervening reticulum arranged in cords called *splenic cords* or *cords of Billroth* ( 1 ). These cords actually are a three-dimensional meshwork of densely packed elements (fibroblasts, collagen fibers, and cells of the mononuclear phagocytic lines) ( 19 ). Terminal arterioles and capillaries deliver circulating blood to this meshwork that percolates through the cord toward the sinuses. Thus, circulating elements of blood in transit are also packed within the cords: erythrocytes, platelets, macrophages, lymphocytes, plasma cells, and granulocytes ( 1 , 19 , 35 ).

**MARGINAL ZONE** The *marginal zone* is a transitional region between the white and red pulp and contains both lymphocytic and mononuclear phagocytic elements ( 1 , 35 ). Within this transitional zone, three distinct regions can be identified. Moving from white to red pulp are the marginal sinus, the marginal zone proper, and the perimarginal cavernous sinus plexus ( 36 ). The *marginal sinus* is a vascular sinus that surrounds the white pulp and is a region where numerous arterioles terminate into an anastomosing complex of vascular spaces. External to the marginal sinus is the marginal zone. This transitional region contains elements of both white and red pulp and is where much of the circulating blood is presented to lymphocytic and mononuclear phagocytic cells ( 1 , 36 ). [Figure 70.3](#) illustrates a schematic view of the microcirculation within the spleen.



**Figure 70.3.** Schematic illustration of the microcirculation of the spleen. S, splenic sinus. (Redrawn and modified from Greep RO, ed. *The spleen*. New York: McGraw-Hill, 1966.)

**MICROVASCULATURE** As the splenic artery approaches the body of the organ, it divides

into a series of branches, the *proper splenic arteries*. On average, four proper splenic arteries then enter the organ at the hilum (1, 12) and branch into *trabecular arteries*, so named because they run within the framework of the fibrous connective tissue skeleton, the *trabeculae*. Trabecular arteries leave the fibrous trabeculae and penetrate the parenchyma by branching into central arteries that immediately become surrounded by a cuff of white pulp, the PALS (1, 35). Some investigators argue that as long as central arteries are surrounded by white pulp, they do not give rise to tributaries (37). However, most researchers support the notion that as the central arteries pass through the white pulp, they give off lateral branches at right angles, most of which terminate in and supply the marginal sinuses, and others that terminate within the marginal zone or red pulp (1, 38, 39). The right angle by which these lateral tributaries branch off from the central artery is thought to mediate a plasma-skimming effect (10). In other words, as the flow is directed through the tributaries, it is hemoconcentrated, presenting the vessels and structures downstream with a greater number of cellular elements (4). This skimming effect may also have implications for the hypothesized role of the spleen in the regulation of plasma volume (40). Central arteries continue from the white pulp sheath through the marginal zone and eventually terminate in the red pulp, giving off additional lateral branches along the way known as *penicillar arterioles* (1). The penicillar arterioles, which are named for their resemblance to penicillium molds, terminate in one of three fashions: They may circle back and supply the marginal sinus; they may terminate in the red pulp, supplying the splenic cords; and a minority may terminate directly into the venous sinuses for direct venous return (37, 38). Eventually, the central artery itself terminates within the red pulp (1, 19, 35). Circulating elements of splenic blood flow begin their return by first entering the splenic sinuses, the preliminary venous vessels (1). Flow may enter the sinuses directly from arterial connections in a closed circulatory fashion. Alternatively, plasma and blood cells may reach the sinuses only after percolating through the reticulum of the parenchyma in an open circulatory fashion (3). Eventually, the venous sinuses coalesce and drain into trabecular veins that give rise to the segmental veins and, finally, the splenic vein (1). The exact details of splenic microcirculation remain under investigation. The currently accepted models that describe the flow of blood through the vessels of the spleen discuss this in terms of the pathway taken, or route, and the kinetics or speed of flow (1, 38). In terms of the pathway taken, blood flow through the spleen may follow a closed or open circulatory pathway (1, 38). A closed circulation implies that blood passes directly from artery to capillary to vein. In terms of the spleen, blood traveling along a closed circulatory path follows the terminal arterioles to capillaries and, eventually, into the venous sinuses. Indeed, such direct connections have been observed (1, 37, 38, 41) and do support some degree of direct transit within the organ. The term *open circulation* implies that cells and plasma spend at least some of their circulating time outside the endothelium-lined vascular channels. As it pertains to the spleen, circulating blood may follow one of two open pathways: It may leave the endothelium-lined marginal sinus, traverse the white pulp, and drain into the open-ended sinuses of the perimarginal cavernous sinus plexus (38); or it may leave penicillar arterioles that terminate in stroma of the red pulp, traverse the splenic cords, and reenter the venous sinuses through their fenestrations (37). Indeed, the unique vascular channels and microarchitecture of the spleen can support these open circulatory pathways, which also have been observed (37, 38, 41). Another model for discussing splenic microcirculation describes it in terms of kinetics or speed of flow (1, 38). Accordingly, intrasplenic circulation may be fast, intermediate, or slow, traversing the organ in seconds, minutes, or hours (1). Fast flow occurs along paths of low resistance, traverses the organ in seconds, and accounts for approximately 90% of splenic flow (36). Pathways that support fast flow include the open circulation of the marginal zone and, to a lesser extent, the closed circulation of direct arterial, capillary, and sinus connections (38). Elements



that flow at an intermediate speed cross the circulation within minutes rather than seconds and represent approximately 9% of flow across the organ. These elements are thought to follow the open circulation through the cords where red cell processing—pitting and culling—occurs ( [38](#), [41](#)). Finally, slow-flowing elements may take more than a day to traverse the organ and represent 1% of splenic flow. This is thought to represent a pool of maturing reticulocytes, which travel to the spleen from the bone marrow and undergo maturation before being released into the circulation ( [38](#)). The role of the spleen in this function is well documented and supported by the fact that asplenic patients have a high concentration of immature reticulocytes in their peripheral circulation ( [42](#)).

## SPLENIC FUNCTION

The functions of the spleen are probably best understood in terms of its unique structure. Composed of several different tissue types, it lies at the crossroads between the arterial supply and venous return. In this respect, the spleen functions as a clearinghouse where elements of the circulatory, reticuloendothelial, and immune systems interact. Thus, it is ideally suited to play a critical role in the surveillance of circulating blood.

The spleen functions as a filter of the circulating blood, a coordinator of the immune response, and a reservoir for circulating cells and platelets. Additionally, the spleen may have a number of other responsibilities, including hematopoiesis, hemoglobin degradation and iron recovery, and plasma volume regulation ( [1](#), [3](#), [7](#), [8](#), [10](#)).

### Filter Function

According to most authorities, one of the primary functions of the spleen is to filter blood ( [1](#), [6](#), [7](#), and [8](#), [10](#)). Elements removed from circulation by the spleen include aging or abnormal red cells, intraerythrocyte inclusions, and foreign particulate matter ( [1](#), [7](#), [10](#)).

**CULLING** The removal of aging or abnormal red blood cells by the spleen occurs within the cords of Billroth and is known as *culling* ( [37](#)). The mechanism by which this occurs is still under investigation. However, it is generally agreed that cells bound for destruction become trapped, or perhaps held, within the reticulum meshwork of the splenic cords, and, as their splenic transit time increases, they succumb to phagocytosis by resident macrophages ( [1](#), [5](#)). Exactly how cells become delayed within the meshwork of the cords is not entirely clear, but several theories exist. Some argue that the hemoconcentration observed in the cords creates a limited pool of metabolites that is responsible ( [10](#)). A low supply of metabolites, it is reasoned, results in decreased adenosine triphosphate production, failure of the Na<sup>+</sup>/K<sup>+</sup> pump, and eventual swelling and entrapment of the cell within the meshwork ( [1](#)). Older cells may be especially susceptible to this sequence of events because their complement of metabolic enzymes is lower than that of younger cells. However, investigators who have shown that an ample reserve of O<sub>2</sub> and glucose exists within the cords ( [38](#)) have challenged this idea. Another theory to explain how red cells become trapped within the cords contends that as erythrocytes age, they lose significant amounts of cytoplasmic membrane. Senescent cells therefore lack the deformability necessary to negotiate the meshwork and ultimately become trapped in this fashion ( [5](#), [43](#)). Finally, it has been proposed that as erythrocytes age, they expose surface antigens that are recognized by self-directed antibodies ( [1](#)). Once opsonized with antibody, senescent cells are easily trapped by cordal macrophages. Regardless of the mechanism by which aging and abnormal red cells become trapped within the cords, it is clear that as splenic transit time increases, the cells succumb to destruction by resident phagocytic cells. Similar events occur for erythrocytes that are morphologically

abnormal secondary to congenital disorders such as sickle cell anemia and hereditary spherocytosis. These cells also are removed in the cords of the spleen by being trapped and phagocytized by resident macrophages (7). Splenic transit appears to be the common denominator and, thus, is currently viewed as an index of the organ's ability to clear red cells (44).

**PITTING** In addition to culling, the spleen also functions to remove intraerythrocyte inclusions from circulating red cells. The ability of the spleen to clear these inclusions while maintaining the integrity of the red cell itself is known as *pitting* and is an exclusive function of splenic tissue (4). Undesirable intracellular elements removed by the spleen include circulating particulate matter, Heinz bodies (denatured hemoglobin), Howell–Jolly bodies (nuclear remnants), and Pappenheimer bodies (iron granules) (3, 7). Pitting occurs as cells within the cords attempt to reenter the circulation through the splenic sinuses. To do this, they must pass through slitlike fenestrations of the sinus endothelium. As this occurs, the deformable portion of the cell bends to negotiate the opening, whereas the inclusion, which is nondeformable, is unable to pass through the narrow passage; thus, it is left behind to be phagocytized by resident macrophages (4). The passage of red cells through the slits may also be mediated by active changes within the sinus endothelial cells (1). These cells have been shown to have cytoskeletons that include the contractile protein components actin and vimentin (1). [Figure 70.4](#) is a schematic representation of the process of pitting.



**Figure 70.4.** Schematic representation of process of pitting by the spleen. This process is believed to be responsible for removal of undesirable elements from circulation, including particulate matter, Heinz bodies (denatured hemoglobin), Howell–Jolly bodies (nuclear remnants), and Pappenheimer bodies (iron granules). **A:** Red blood cell (RBC) flows from open circulation and approaches fenestration of sinus. **B:** RBC begins to enter sinus through fenestration; note inclusion body within RBC. **C:** RBC transverses sinus; membrane-bound inclusion body lags behind. Sinus macrophage begins to approach inclusion body. **D:** RBC within sinus returns to venous circulation. Inclusion body succumbs to sinus macrophage. [Modified from Weintraub LR. Splenectomy: who, when, and why? (see comments.) *Hosp Pract (Off Ed)* 1994;29.]

Evidence that supports the role of the spleen in culling and pitting is found in the fact that, after splenectomy, asplenic and hyposplenic patients lose their ability to clear damaged red cells and intraerythrocyte inclusion bodies from the circulation. These patients display peripheral blood smears with an abnormal variety of erythrocytes, many with intracellular inclusions (45). In fact, evaluation of morphologic abnormalities in peripheral smears is a standard method of assessing splenic function (42, 46).

**CLEARANCE OF PARTICULATE MATTER** Another important filtering function of the spleen is its ability to remove particulate matter from the circulation (1, 7). As blood travels through the meshwork of the cords, foreign particles are exposed to splenic macrophages that clear them by phagocytosis (35). Experiments with injected carbon particles have confirmed this process and have identified the cells chiefly responsible for this function: the macrophages surrounding the splenic sinuses.

## Immune Function

Because the spleen is composed of lymphocytic tissue, circulatory elements, and mononuclear phagocytic cell lines, it is ideally suited to play a coordinating role in the immune response. The organ's function in this respect includes its role in the nonspecific as well as the specific arm of the immune response. The nonspecific immune functions of the spleen include the clearance of pathogens, the clearance of opsonized erythrocytes and platelets, the production of complement, and the surveillance of malignant cells.

The spleen plays a significant role in the removal of bloodborne pathogens from the circulation. Once coated with complement, bacteria and viruses become circulating immune complexes. Although the liver clears some of these complexes, many others are delivered to and eliminated by the spleen (47). The contribution of the spleen to this process is supported by the fact that asplenic patients display a higher level of circulating immune complexes than do spleen-competent subjects (48).

The ability of the spleen to clear encapsulated bacteria is especially significant. Because these organisms have the ability to evade antibody and complement binding, their clearance depends on prolonged contact between pathogen and macrophage. This is most likely to occur in the cords of the spleen, where mononuclear phagocytic cells predominate and transition time is slow (47). Prolonged contact between pathogens and macrophages in the spleen may also help to protect patients with antibody or complement deficiencies (47). It is well recognized that asplenic or hyposplenic patients are prone to a syndrome of fulminant septicemia, most often involving encapsulated bacteria: overwhelming postsplenectomy sepsis (47).

The spleen also plays a major role in the removal of opsonized erythrocytes and platelets from the circulation. In certain pathologic states, such as autoimmune hemolytic anemia or ITP, circulating elements become opsonized with immunoglobulin (Ig) G antibody. The resulting cell-antibody complexes enter the spleen and encounter Fc receptor-laden macrophages in the marginal zone, where they are destroyed (49).

The role of the spleen in the production of complement remains controversial. According to one respected authority (7), mononuclear phagocytic cells of the spleen produce both properdin and tuftsin. *Properdin* is an opsonin that plays a critical role in the alternative pathway and has been detected in the monocytes of the spleen (50). Tuftsin stimulates interleukin-1 production and binds to granulocytes to initiate phagocytosis. Although these elements are also produced at other locations, the spleen's contribution is significant, and they are found in lower concentrations in the circulation of asplenic or hypo-splenic patients (7, 51). Patients who have lost their spleens also display a decreased concentration of C3 and factor B (52).

Another theory proposes that the spleen is not a major synthetic site of complement (53). It suggests that the decrease in alternative pathway components observed in splenectomized patients can be ascribed to a protein inflammatory response (53). These studies remain to be confirmed in the literature.

The role of the spleen in the surveillance and destruction of malignant cells is currently under investigation. According to some investigators, the ability of the spleen to destroy malignant cells is greatly underestimated (7). The spleen's high rate of perfusion and intricate meshwork of fibrocellular elements make it a likely candidate for metastatic foci.

Over 50% of spleens removed from patients with solid primary tumors do indeed display micrometastases (7). The ability of the spleen to trap metastatic foci suggests that there may be destruction of malignant cells within the organ (7). Other studies support the antineoplastic role of the spleen and attribute this ability to the organ's reservoir of activated natural killer cells (54, 55).

**SPECIFIC IMMUNE RESPONSE** The spleen is also uniquely suited to play a coordinating role in the specific arm of the immune response. Because white pulp and vascular elements lie adjacent to each other, this may serve as an interface between the lymphocytic populations of T and B cells and the elements of circulating blood. As circulating blood enters the spleen, 90% of it passes through the marginal sinuses and surrounding zones (36). Here, foreign antigens are exposed to the lymphocytic tissue of the PALS and the follicles, stimulating them to respond. The cascade of events that follows involves both the humoral and cellular arms of the immune response. Ultimately, it results in the production of IgM, plasma cells, and memory cells tailored to the particular invader (47). It should be noted that although these functions also occur within lymph nodes, asplenic patients demonstrate a specific response to bloodborne antigens. For example, the production of IgM in asplenic patients is both delayed and diminished (56). On the other hand, specific immune factors that rise in the circulation after a splenectomy include IgE and self-directed autoantibodies (48).

### Cellular Reservoir Function

The ability of the spleen to function as a reservoir for circulating elements has been the subject of much study. Platelet sequestration by the spleen is well documented (3, 7, 10), but its role as a reservoir for red cells remains controversial (1, 57). Some recent evidence supports the role of the spleen as a reservoir for white blood cells (58, 59 and 60).

The spleen is considered a reservoir for platelets because it can sequester large quantities of thrombocytes and, in turn, release them on demand. In nonpathologic states, the spleen sequesters approximately 30% of the body's platelets and can release them into the circulation in response to certain stimuli. For example, in response to an epinephrine challenge, the spleen may release significant numbers of sequestered thrombocytes into the circulation. The exact mechanism of this response is not fully understood, but it may occur secondary to the effect of epinephrine on splenic circulation (61).

The role of the spleen as a platelet reservoir is most dramatically demonstrated by the fact that pathologically enlarged spleens sequester greater quantities of platelets. In splenomegaly secondary to portal hypertension, for example, the organ can sequester up to 90% of the body's reserves and result in severe thrombocytopenia (4). On the other hand, in the postoperative period after splenectomy, there is a significant rise in circulating platelet counts. Sometimes this effect is transient, possibly because the liver compensates by increasing its ability to sequester thrombocytes (62).

It has been demonstrated in other mammals that the spleen may sequester up to 50% of the total red cell volume during times of inactivity, reducing blood viscosity and heart workload. Although the human spleen sequesters comparatively fewer red blood cells, evidence suggests that it may perform a similar role (14). Nuclear medicine studies have been used to demonstrate a reproducible increase in the hematocrit after exercise, with the spleen as the source of the increased erythrocytes (57). A similar rise in hematocrit

may be observed after serial apneas performed to simulate diving ( [14](#) ).

The mechanism of spleen volume change likely involves both direct innervation by autonomic fibers as well as the hormonal effects of catecholamines.  $\alpha$ -Adrenergic blockade abolished the responses of the spleen to norepinephrine and direct neural stimulation ( [14](#) ).

Because of its role in the immune response, the spleen might be expected to serve as a way station for circulating leukocytes, but only recently has this been demonstrated. One study has shown that as blood enters the spleen, lymphocytes selectively migrate to their respective zones: T cells to the lymphatic tissue of the PALS and B cells to the follicles and red pulp ( [58](#) ). Another study demonstrates that the spleen is a reservoir for granulocytes, readily mobilized under stress ( [59](#) ). Finally, it was shown recently that splenic tissue may function as a reservoir for memory B cells ( [60](#) ).

### **Hematopoietic Function**

The spleen produces red blood cells during fetal development and during certain pathologic states ( [5](#) ). During the fifth month of fetal development, it is a major source of red blood cell production, after which it loses this ability ( [6](#) ). Pathologic states associated with splenic hematopoiesis include myeloid metaplasia ( [5](#) ). However, the production of cells by the spleen under these abnormal conditions results not from the reactivation of fetal stem cells but from displaced bone marrow cells that take up residence in the confines of the organ ( [63](#) ).

### **Iron Metabolism**

As red blood cells are destroyed within the splenic cords, their contents are degraded. The iron released in this fashion is recycled and sent to the bone marrow for use in the manufacture of new erythrocytes. Although other cells in the body can metabolize iron in a similar fashion, asplenic patients display lower serum iron levels for a considerable amount of time after loss of the spleen ( [3](#) ).

It is interesting to note that subpopulations of splenic macrophages have different abilities to recycle iron. For example, the macrophages that occupy regions bordering the splenic sinuses are quite adept at this function. In conditions that lead to red cell destruction in the cords, such as spherocytosis, iron salvage is well managed. On the other hand, in conditions that lead to the destruction of red cells by wandering macrophages, such as autoimmune hemolytic anemia, iron salvage is poor ( [20](#) ).

## **SPLENIC DISORDERS AND INDICATIONS FOR SPLENECTOMY**

The causes of splenomegaly and indications for splenectomy can often be confusing. There are many potential causes of splenomegaly that must be considered in any patient undergoing evaluation with an unknown diagnosis. It can not be overstated that patients without a known cause of splenomegaly should rarely undergo splenectomy and then only after a thorough workup has been completed to assess the likely etiology of this finding.

Splenomegaly is often the result of some other condition, not the result of a primary pathologic state. The spleen rarely harbors a primary malignancy like lymphoma that is not apparent at other sites after a careful survey by history and physical examination and

with limited imaging studies. The temptation to perform a splenectomy for diagnostic purposes early in the workup of the stable patient should be strongly resisted. It is unlikely to yield a diagnosis, and, in some situations, may entail significant risk to the patient with no benefit (as in splenomegaly resulting from portal hypertension).

It is important to remember that splenic size is not always a reliable guide to splenic function because palpable spleens are not always pathologic and abnormal spleens are not always palpable ( 64 ). In a survey of healthy first-year college students, 3% were found to have splenomegaly, and 5% of all hospitalized patients have been noted to have splenomegaly ( 65 ). Patients with cirrhosis and portal hypertension almost always have splenomegaly, but even with significant thrombocytopenia, which is often present, no specific therapy is indicated because this condition rarely results in specific complications. The important clinical issue involves determining when abnormal splenic function is occurring, ascertaining the responsible etiology, if possible, and only then assessing therapeutic options.

Chauffard introduced the concept of hypersplenism in 1907 ( 3 ), although the exact clinical definition remains confusing in practice even today. The criteria for this diagnosis generally include four features: cytopenia with anemia, thrombocytopenia, leukopenia, or some combination; compensatory bone marrow hyperplasia; splenomegaly; and improvement or resolution in these findings after splenectomy ( 3 , 7 ). Hypersplenism has been further classified into *primary hypersplenism* when no etiologic factor for splenomegaly has been found and *secondary hypersplenism* when splenomegaly is the result of another recognized condition (such as portal hypertension or an infiltrative process). With continued progress in diagnosis of the causes of splenomegaly, there has been a continued drop in the frequency of cases of primary hypersplenism. Given the nonspecific nature of this diagnosis and uncertainties regarding its therapeutic implications, it is used less often today.

Primary hypersplenism is a diagnosis of exclusion and should be made only after a very thorough search has been made for a specific etiology. If no cause is found, corticosteroids or immune globulin may be effective in improving the cytopenia. Should these measures fail, splenectomy usually results in marked improvement in the hematologic derangement. Of note, lymphoma presenting with primary involvement of the spleen and no evidence of involvement at other sites occurs in less than 1% of patients with lymphoma. In this setting, there may be nonspecific splenic enlargement on CT scanning with no other intraabdominal findings.

Perhaps a more useful guide in the assessment of splenomegaly is to consider the mechanisms responsible for the splenic enlargement. Eichner et al. divided the causes of splenomegaly into six major categories, listed in [Table 70.1](#) ( 65 ). The likely mechanisms for resulting cytopenias in specific disease states are shown in [Table 70.2](#) ( 7 ). It is interesting that the degree of splenomegaly on physical examination, radiographic assessment, or at the time of splenectomy does not appear to correlate with the magnitude of cytopenia. This variability of cytopenia may be the result of differing degrees of red and white pulp infiltration depending on the specific disease state ( 43 ). Eichner et al. developed an algorithm to assist in diagnostic pathways in patients with splenomegaly ( 64 ), but given the complex and diverse disease conditions that may lead to splenomegaly, the algorithm is cumbersome for use in day-to-day practice.

#### **TABLE 70.1. Classification of Splenomegaly by Mechanism**

---



| Mechanism                                   | Causative Diseases  |
|---|---|
| Immune response work hypertrophy            | Subacute bacterial endocarditis<br>Infectious mononucleosis<br>Felty syndrome           |
| Red blood cell destruction work hypertrophy | Spherocytosis<br>Thalassemia major<br>Pyruvate kinase deficiency                        |
| Congestive (venous outflow obstruction)     | Cirrhosis and portal hypertension<br>Splenic vein thrombosis                            |
| Myeloproliferative                          | Chronic myelocytic leukemia<br>Myeloid metaplasia                                       |
| Infiltrative                                | Sarcoidosis<br>Amyloidosis<br>Gaucher disease   |
| Neoplastic                                  | Lymphoma<br>Chronic lymphocytic leukemia<br>Hairy cell leukemia<br>Metastatic carcinoma |
| Miscellaneous                               | Trauma<br>Splenic cysts<br>Hemangioma   |

Modified from Eichner ER ( [64](#), [65](#)) and Sheldon, et al. ( [7](#)).

**TABLE 70.2. Etiology of Splenomegaly and Cytopenia in Selected Disease States**

| Disease Condition            | Probable Mechanism                                   |
|------------------------------|--|
| Portal hypertension          | Increased pooling of blood cells                     |
| Hairy cell leukemia          | Retention of hairy cells in splenic pulp             |
| Felty syndrome               | Immune system work hypertrophy                       |
| Thalassemia major            | Reticuloendothelial system work hypertrophy          |
| Gaucher disease              | Increased pooling and flow-induced dilutional anemia |
| Agnogenic myeloid metaplasia | Extramedullary hematopoiesis                         |

Modified from Eichner ER ( [64](#), [65](#)) and Sheldon, et al. ( [7](#)).

Although most attention regarding splenic dysfunction relates to splenomegaly and related cytopenias, occasionally patients develop hyposplenic conditions, usually from splenic infarction (such as sickle cell disease). In this group, consideration should be given to vaccination against encapsulated organisms, and potential infectious complications should be considered if unexplained fever or signs of sepsis develop, similar to postsplenectomy patients.

### Indications for Splenectomy

A recent review of indications for splenectomy demonstrates the evolution of surgical management for splenic disorders. Over a 10-year period, the most common indications



for splenectomy (trauma, incidental, hematologic malignancy, iatrogenic, and cytopenia) saw a drop of between 30 and 50%. In addition, the absolute number of splenectomies decreased over the period of review ( 66 ). Nevertheless, splenectomy is an accepted and often definitive treatment modality for a number of diseases, as discussed below.

**IMMUNE THROMBOCYTOPENIC PURPURA** *ITP* is a condition in which circulating antiplatelet antibodies bind to platelets and are cleared by phagocytic cells from circulation (see [Chapter 53](#)). The humoral cause of the disease was established in 1951 when a hematologist in training infused himself with the plasma from a patient with ITP and developed thrombocytopenia and platelet destruction ( 67 ). In addition, T cells appear to play a major role in the pathophysiology of the disease ( 68 ). Platelets are cleared mainly by the spleen and liver ( 67 , 68 ). The spleen may have a dual role in this disease by both producing IgG and providing the location for platelets' removal from the circulatory system. The cause of this condition is unknown, although it likely involves cellular immune dysregulation ( 67 ). It most commonly presents in women in their 20s and 30s, and they often present with bleeding after minor trauma, with nosebleeds or petechiae. There are often no physical findings, and importantly, the spleen is almost always normal in size. The primary laboratory abnormality is thrombocytopenia with platelet counts typically less than 50,000 and sometimes as low as 10,000. There is evidence of immature platelets on peripheral smear, and bone marrow smears show increased numbers of megakaryocytes. Initial treatment of ITP is usually medical, with the goal of achieving and maintaining a hemostatic platelet count, usually defined as at least 10,000 to 50,000 per ml ( 69 ). Patients with mild to moderate thrombocytopenia do not require treatment. For those with more severe thrombocytopenia, initial treatment is with a short course of prednisone. However, in most cases, thrombocytopenia will recur after discontinuation of steroids. There is no consensus on the duration of long-term steroid therapy ( 69 ). Medical alternatives to steroids include anti-D (for Rh-positive patients), intravenous gammaglobulin (IVIg), and chemotherapy ( 70 ). A cost analysis of anti-D versus IVIg demonstrated similar efficacies but lower cost associated with the use of anti-D ( 71 ). For thrombocytopenic crises, a rapid increase in platelet count may be achieved with IVIg (1 g/kg) followed by platelet transfusion and steroid administration. Splenectomy is successful in the majority of patients who do not respond to medical measures or who initially respond but subsequently relapse ( 72 ). Initial response to splenectomy ranges from 40 to 86% ( 73 ). Over the long term, however, response rates appear to decline. Splenectomy can usually be performed electively unless patients have active, ongoing bleeding. Despite the thrombocytopenia, the circulating platelets function normally, and preoperative platelet transfusions are usually unnecessary and may be ineffective in raising the platelet count because of the rapid sequestration by the spleen. At the time of splenectomy, the surgeon should search for accessory spleens because they may later account for failure of splenectomy. Accessory spleens have been reported in 10 to 30% of patients with ITP ( 7 , 9 , 72 ). <sup>99</sup>Tc-methoxy sulfur colloid scanning or <sup>111</sup>In-labeled scanning may demonstrate accessory splenic tissue, although these studies are not recommended in the usual preoperative setting with newly diagnosed ITP. ITP can occur in childhood and often follows a viral illness. Most cases are acute and resolve spontaneously within 6 months to 1 year ( 69 ). However, a small number is at risk for major bleeding, and approximately 5% of children develop chronic severe thrombocytopenia that requires treatment, including splenectomy in some cases ( 74 ). Although ITP is thought to have a benign course, patient deaths do occur ( 75 ). These are usually related to bleeding (such as cerebral hemorrhage), which may be made worse by concomitant medical conditions, such as uremia or hemophilia, and may also result from infectious complications related to splenectomy or immunosuppressive medications. ITP occurs in the setting of human immunodeficiency virus infection in approximately 10% of patients. These patients can be treated in a similar fashion to non-human

immunodeficiency virus patients with ITP, namely, with steroids, IVIg, and anti-D, and with splenectomy for medical treatment failures. In this setting, the severity of the underlying disease should be a factor in the decision regarding operative intervention. There are reports of increases in CD4 counts after splenectomy ( 76 ), suggesting that the spleen may sequester CD4 cells in some of these cases.

**THROMBOTIC THROMBOCYTOPENIC PURPURA** Thrombotic thrombocytopenic purpura (TTP) generally occurs between the ages of 20 and 60 years and is more common in women than in men (see Chapter 54). The exact etiology is often unknown, although a minority of cases are observed after therapy with ticlopidine or clopidogrel. The disorder occasionally occurs during pregnancy or in the postpartum period, and a familial form of the disease exists. TTP is characterized by thrombocytopenia, microangiopathic hemolytic anemia, neurologic abnormalities, renal failure, and fever ( 77 ). TTP is likely to be the result of the abnormal presence of a platelet-aggregating agent in the circulation. Studies suggest that this agent is von Willebrand factor, which is found in excess in patients with TTP. Platelet aggregation leads to microvascular thrombi, typically in the brain, heart, spleen, kidneys, pancreas, and adrenals. With appropriate treatment, nearly 90% of adults will respond. This consists of daily plasma exchange with plasmapheresis and transfusion of fresh frozen plasma. Steroids are also administered to decrease autoantibody formation against the factor that cleaves von Willebrand factor ( 78 ). For treatment failures, other options include vincristine, azathioprine, and splenectomy ( 77 , 78 ). Surgical treatment is considered in patients who have frequent relapses of TTP and may prolong the disease-free interval ( 79 ). The rationale for splenectomy and the pathophysiology of its role in this disease are not well understood. Splenectomy generally plays a minor role in TTP, particularly in comparison to ITP, in which the spleen appears to be the major site of platelet destruction ( 80 ). Increasing experience with laparoscopic splenectomy may encourage surgeons to use this procedure more often in the treatment of chronic, relapsing TTP ( 81 ).

**HODGKIN DISEASE** *Hodgkin disease*, described by Thomas Hodgkin in 1832, is a malignant lymphoma characterized by typical multinucleated giant cells (Reed-Sternberg, Chapter 95). Most patients initially present with asymptomatic peripheral lymphadenopathy, most often in the cervical region (60 to 80%) ( 7 , 82 ). Other nodal regions, including the mediastinal, axillary, inguinal, and retroperitoneal regions, are less often involved at initial presentation. The presence of B symptoms, including fever, weight loss greater than 10%, and night sweats, is noted. Extralymphatic and splenic involvement is also used to stage patients, as outlined in Table 70.3 ( 83 ). Histologic subtypes fall into four categories: lymphocyte predominant, nodular sclerosing, mixed cellularity, and lymphocyte depleted ( 82 ).

**TABLE 70.3. Ann Arbor Staging Classification for Hodgkin Lymphoma**

| Stage | Criteria   |
|-------|--|
| I     | Involvement of a single lymph node region  |
| II    | Involvement of two or more lymph node regions on the same side of the diaphragm                            |
| III   | Involvement of lymph node sites on both sides of the diaphragm   |
| IV    | Diffuse involvement of one or more extralymphatic organs with or without associated lymph node involvement |
| E     | Involvement of adjacent extralymphatic site  |
| S     | Involvement of the spleen  |
| A     | Asymptomatic   |
| B     | Fever, night sweats, or weight loss  |

From Carbone PP, Kaplan HS, Musshoff K, et al. Report of the Committee on Hodgkin's Disease Staging Classification. *Cancer Res* 1971;31:1860-1861, with permission.

Historically, staging laparotomy has been used in patients with Hodgkin disease suspected to harbor disease below the diaphragm. In this procedure, lymph nodes are sampled from the paraaortic, paracaval, and iliac regions, and liver biopsies are performed along with splenectomy. More recent practice involves a shift away from the routine use of staging laparotomy ( [84](#), [85](#) ). This has occurred for several reasons, including the enhanced accuracy of CT and other imaging studies for staging purposes, heightened concerns regarding postsplenectomy infectious complications, and the increased effectiveness of medical treatments. This practice has resulted in a general trend away from splenectomy in patients with Hodgkin disease. A 1999 survey of 47 centers showed that 68% no longer perform splenectomy for the staging of Hodgkin disease ( [86](#) ). Laparoscopy, with its reduced morbidity and mortality compared to open procedures, may result in a small resurgence of operative staging for the disease, but the overall trend is for nonoperative evaluation ( [87](#) ).

**LEUKEMIA** In chronic lymphocytic leukemia and less often in chronic myelocytic leukemia, massive splenomegaly can result in significant symptoms from the mass effect of the enlarged spleen, necessitating splenectomy ( [Chapter 84](#) and [Chapter 92](#) ). Likewise, patients may develop significant cytopenia refractory to medical measures, and this may necessitate splenectomy. The decision to undertake splenectomy must be made with caution because these patients often are immunosuppressed and malnourished and have a higher operative mortality risk as well as a higher rate of perioperative complications. Hairy cell leukemia can lead to infiltrative splenomegaly and pancytopenia, which may limit cytotoxic chemotherapy ( [3](#), [5](#) ) (see [Chapter 93](#) ). In this setting, splenomegaly may allow for return of platelets and leukocytes to acceptable levels for the administration of chemotherapy. As discussed for chronic lymphocytic leukemia and chronic myelocytic leukemia, however, the surgeon and oncologist must weigh the increased perioperative risks against the possible benefits of splenectomy before making such a recommendation to any given patient.

**HEREDITARY ANEMIAS** Hereditary spherocytosis is inherited as an autosomal-dominant disease in which the red cell membrane includes a defective protein, spectrin ( [3](#), [4](#) ) (see [Chapter 32](#) ). The spleen destroys the resulting defective, spherical red cells. These patients have an anemia and significant reticulocytosis. Peripheral smears demonstrate spherocytes, and these patients have a negative Coombs test. Elective splenectomy will correct the anemia. Ideally, splenectomy is performed after the age of 5 or 6 years to minimize the potential risks of postsplenectomy infections. Because of the rapid red cell turnover, these patients often develop calcium bilirubinate gallstones, and consideration should be given to concomitant cholecystectomy at the time of splenectomy if they are present ( [74](#), [88](#) ). Sickle cell anemia is an autosomal-recessive condition that also results in defective red blood cells ( [3](#) ) (see [Chapter 40](#) ). Because of the frequency of sludging and thrombosis in small vessels, these patients more often develop infarcts in the spleen, which over time results in autosplenectomy. In rare patients, however, splenomegaly may develop, and, in these patients, splenectomy may be indicated if a significant cytopenia develops. Unlike hereditary spherocytosis, splenectomy has little effect on anemia related to the sickle cell condition. Thalassemia major is an autosomal-dominant condition in which abnormal hemoglobin forms protein precipitates in the red cell, recognized as Heinz bodies on a peripheral smear ( [3](#) ). These patients can develop significant splenomegaly with resulting cytopenia. In this condition, splenectomy can lessen the need for transfusion.

**MALIGNANT TUMORS OF THE SPLEEN** Lymphoma is a common tumor leading to splenomegaly or a splenic mass (see [Chapter 90](#) ). Splenic marginal zone lymphoma often presents with massive splenomegaly and, clinically, is improved with early splenectomy. Other primary tumors of the spleen are exceedingly rare. Hemangiosarcoma and hemangiopericytoma of the spleen have been reported, as has plasmacytoma. All of these tumors may present with splenomegaly only.

**BENIGN TUMORS OF THE SPLEEN** The most common benign tumors of the spleen are

lymphangiomas and hemangiomas ( [Fig. 70.5](#)) ( [7](#), [10](#)). These tumors are most often incidental findings when imaging studies or laparotomy are performed, or they may be found at autopsy. Occasionally, the patient may develop significant splenomegaly and cytopenia, leading to the need for splenectomy. Usually, however, the diagnosis can be made on the basis of imaging studies alone and splenectomy avoided. In cases of doubt, follow-up imaging studies showing the absence of change over time may allow avoidance of splenectomy.

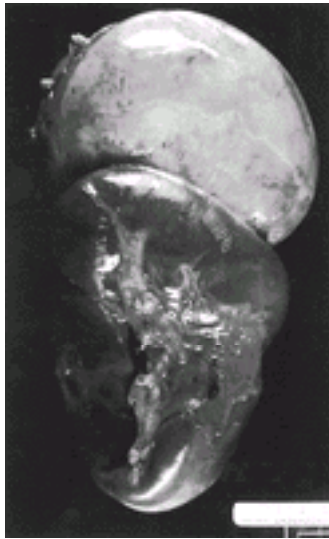


**Figure 70.5.** Computed tomographic scan (A) and gross photograph (B) of spleen in 35-year-old woman with marked splenomegaly from splenic hemangioma. The arrow demonstrates central hemangioma with surrounding uninvolved splenic parenchyma. This benign tumor had caused significant thrombocytopenia resulting in spontaneous bleeding before splenectomy. See [Color Plate](#).

**MYELOFIBROSIS** *Myelofibrosis with myeloid metaplasia* describes a group of disorders characterized by prominent bone marrow fibrosis and disruption of normal hematopoiesis with enlargement of the liver and spleen due to extramedullary hematopoiesis ( [89](#)) (see [Chapter 86](#)). Massive splenomegaly may lead to pancytopenia, portal hypertension, early satiety, and pain. Medical therapy, including blood transfusion, androgens, corticosteroids, erythropoietin, and interferon- $\alpha$ , has been generally disappointing. Reduction of splenic tissue may be accomplished by the use of cytotoxic agents, irradiation, or splenectomy ( [86](#), [89](#)).

**SPLENIC CYSTS AND ABSCESSSES** Cystic lesions of the spleen are rare but are increasingly being recognized with the increased use of CT and other imaging techniques ( [7](#), [10](#)). These are most often asymptomatic and are usually classified as either true cysts or pseudocysts. Parasitic cysts are exceedingly rare in the United States but may occur in patients from other parts of the world. Splenic abscesses may occur when a simple cyst is secondarily infected or as a primary abscess, usually from a hematogenous source. True cysts of the spleen have an epithelial lining and are thought to be congenital in origin. Cystic lymphangiomas are occasionally found and fall into this category. They can derive from inclusions of splenic surface mesothelium lining into the splenic parenchyma during development or from an accelerated secretion of lining cells from an unknown cause. Cyst fluid can be thin and serous in nature or turbid and viscid ( [90](#)). The majority of patients with splenic cysts are asymptomatic and do not require specific treatment ( [7](#), [10](#)). Nonoperative treatment is recommended for small cysts up to 5 cm in diameter ( [90](#)). In patients with large cysts, excision of the cyst wall and free wall lining with splenic preservation, whenever possible, should be undertaken. There have been reports of laparoscopic partial splenectomy and partial cystectomy, and these will likely become the procedures of choice as more surgeons gain familiarity with these advanced laparoscopic

techniques ( 90 ). Splenic pseudocysts lack an epithelial lining and are believed to result from trauma in the majority of cases ( Fig. 70.6 ). They are derived from large, subcapsular or intrasplenic hematomas that have failed to organize in the usual manner and are much more common than true cysts of the spleen ( 90 ). Often when these are discovered, the affected patient has no recollection of the traumatic injury or recalls what was considered to be trivial trauma. Symptomatic large cysts may be successfully treated with percutaneous aspiration with or without placement of a drainage catheter for a short duration. These cysts may recur after aspiration, however, necessitating cyst excision or splenectomy.



**Figure 70.6.** Large symptomatic splenic pseudocyst developing after blunt trauma to the spleen. See [Color Plate](#).

Pancreatic pseudocysts have been reported to burrow into the substance of the spleen, and this should be kept in mind in the patient with a history of pancreatic trauma or pancreatitis ( 91 ). Assessment of cyst fluid amylase levels may provide a clue to the pancreatic origin in such a case. Management of cysts in these cases is usually directed toward treatment of underlying pancreatitis. Parasitic cysts in the spleen are usually the result of *Echinococcus granulosus* and are most often found in association with hepatic cysts. These parasites are found in endemic regions of Europe and the Middle East with sheep as an intermediate host, thus accounting for the finding in farmers from these regions ( 7 , 10 ). CT scanning usually demonstrates daughter cysts in infected patients, and the diagnosis can be confirmed with serologic testing. Mebendazole is effective antiparasitic therapy, although splenectomy is required in a proportion of infected patients. Rupture or spillage of the cyst contents into the peritoneal cavity can lead to disseminated scoliceal infection as well as an anaphylactic reaction. For this reason, percutaneous aspiration of the cyst contents should not be undertaken in such patients, and splenectomy must be performed very carefully to avoid cyst spillage. Splenic abscesses usually develop from hematogenous seeding from endocarditis, from a distant site of infection, or in the setting of intravenous drug abuse ( 7 ). Often, these are present in immunocompromised patients and may also occur after a localized infarction, as in patients with sickle cell disease. There are rarely specific symptoms present suggesting the spleen as the specific site of infection, although left-upper-quadrant tenderness may be present in patients with significant abscess cavities. Abdominal CT scanning is the most helpful imaging technique, demonstrating low-density lesions in the spleen, which may contain gas and present peripheral enhancement ( 92 ). CT can also be used to direct placement of percutaneous drainage catheters, which can provide successful treatment in the majority of cases. Multilocular abscesses with thick septations or necrotic debris generally require surgery, although percutaneous catheter drainage may lead to



improvement of the patient's general condition without adverse effect on subsequent operation ( [92](#) ). Antimicrobial therapy is based on aspirate culture data, with *Staphylococcus* and *Streptococcus* species being common pathogens.

**FELTY SYNDROME** *Felty syndrome* is a rare complication of rheumatoid arthritis, leading to splenomegaly, neutropenia, and other systemic manifestations such as leg ulcers, rheumatoid nodules, vasculitis, lymphadenopathy, and hepatomegaly ( [93](#) ).

Antibody-coated neutrophils are cleared from the circulation in the spleen, and neutropenia can develop. Infection, a major source of morbidity, is due to the neutropenia as well as defects in neutrophil function ( [93](#) ). Treatment for rapid resolution of neutropenia begins with granulocyte colony-stimulating factor or granulocyte-macro-phage colony-stimulating factor. Low-dose methotrexate may be used for those who do not respond to growth factors, and splenectomy may be considered if no response is seen after 1 to 2 months ( [93](#) ).

**SPONTANEOUS SPLENIC RUPTURE** Patients with splenomegaly are at increased risk of splenic rupture when subjected to minor degrees of trauma. This probably occurs because of the increased capsular tension from the underlying parenchymal tissue. Patients with splenomegaly should be cautioned to avoid physical contact when possible. Occasionally, patients with rapid enlargement of the spleen experience spontaneous rupture. This is most often reported in the setting of acute mononucleosis ( [94](#) ) but can occasionally occur with leukemia and lymphoma. These patients usually develop acute left-upper-quadrant pain that may be associated with referred pain in the left shoulder. Initially, this may be contained beneath the splenic capsule as a subcapsular hematoma, but if intraperitoneal rupture occurs, patients may present with acute severe pain and hypovolemic shock. Ultrasonography or CT scanning is a confirmatory study, demonstrating intraperitoneal fluid (blood) and subcapsular hematoma. Urgent or emergent splenectomy is definitive treatment for these patients. Delayed splenic rupture has been reported in patients experiencing blunt abdominal trauma, a setting in which patients develop splenic hemorrhage more than 7 days after their original injury ( [95](#) ). This problem most likely represents an injury in evolution, when the initial imaging study (most commonly CT or ultrasound) at the time of the trauma fails to demonstrate a significant injury. These patients usually have an initial splenic contusion that continues to slowly enlarge and, at some later date, results in disruption of the splenic capsule. This is an uncommon occurrence but should be considered in any patient who develops significant left-upper-quadrant pain, distention, and signs of bleeding or shock after an episode of trauma ( [95](#) ).

## SPLENECTOMY: SURGICAL TECHNIQUE

### Open Splenectomy

Historically, splenectomy has been performed via a midline or left subcostal incision depending on the surgeon's preference and the presence or absence of significant splenomegaly. In patients with massive splenomegaly (more than 2000 g), a midline incision may be preferred to allow adequate mobilization and delivery of the spleen into the operative field.

Once the abdomen is entered, a careful search is made for accessory spleens, which may be present in 10 to 30% of patients ( [7](#), [9](#), [72](#) ). These may be found anywhere in the abdomen but are most often found in the splenic hilum or in the mesentery of the intestine. If present, they most often have the appearance of a 1- to 3-cm rounded nodule of tissue with texture and appearance similar to normal splenic tissue. If found, they are removed by ligating the vessels and lymphatics supplying this tissue.

In patients with significant splenomegaly, initial ligation of the splenic artery causes the

spleen to decrease in size, lessen its distention, and decrease the risk of capsular avulsions and decrease splenic bleeding should a capsular tear occur. This is performed by dividing the avascular gastrohepatic ligament above the pancreas and isolating the artery near its point of origin from the hepatic artery. Care must be taken to avoid injury to the adjacent pancreas. This step is optional and can be omitted if the artery is not readily accessible because aggressive attempts at splenic artery ligation can result in pancreatic injury.

There are ligamentous attachments to the spleen that must then be divided before the inflow vessels in the hilum can be ligated. The phrenosplenic attachment is avascular and can be divided with sharp dissection. This is performed as the surgeon lifts the spleen away from the diaphragm and allows mobilization of the spleen into the open incision, greatly facilitating the remainder of the dissection. After this is performed, the gastro-splenic ligament (and short gastric vessels) and the splenocolic ligament are divided. Finally, the inflow vessels to the splenic hilum are individually ligated, taking care during this portion of the procedure to avoid injury to the tail of the pancreas, which may lie in close proximity to the hilum of the spleen. Closed suction drainage of the splenic bed is not routinely used, but a drain can be placed if there is suspicion of a possible pancreatic injury. If this occurs, evacuation of pancreatic fluid minimizes the risk of abscess formation and allows for a controlled pancreatic fistula that will usually seal with observation alone. Conversely, if a symptomatic fluid collection develops in the bed of an undrained spleen in the postoperative period, then a percutaneous drain can be placed under CT or ultrasound guidance.

Partial splenectomy is unlikely to be a realistic option for patients with marked splenomegaly but may be an option for patients with splenic pseudocysts in whom unroofing of the cyst is the primary objective. This may also be an option in patients with splenic trauma in whom splenorrhaphy may allow splenic preservation. Uranus et al. report successful partial splenectomy using a surgical stapler ([96](#)), and this may occasionally be helpful. Partial splenectomy has also been reported in patients undergoing splenectomy for Gaucher disease ([97](#)).

### Laparoscopic Splenectomy

Since the description of the first laparoscopic splenectomy in 1991 ([98](#)), the procedure has become increasingly common. Similarly to other laparoscopic procedures, minimally invasive splenectomy offers shorter hospital stays, decreased analgesic use, earlier return to work, and significantly less morbidity ([98](#)). One study has demonstrated an improved quality of life after laparoscopic splenectomy as compared to the open technique ([99](#)). Initial reports restricted the laparoscopic approach to patients with normally sized or small spleens ([74](#), [100](#), [101](#) and [102](#)). More recent reports have shown that this approach can be used successfully in the setting of massive splenomegaly ([103](#)). Further, the indications for laparoscopic splenectomy have been expanded and now include ITP, hereditary spherocytosis, hemolytic anemia, TTP, leukemias, splenic myelofibrosis, sickle cell disease, lymphomas, myelodysplastic syndrome, multiple myeloma, and accessory splenectomy ([81](#), [104](#), [105](#), [106](#), [107](#) and [108](#)).

After induction of general anesthesia, a nasogastric tube and Foley catheter are placed to decompress the stomach and bladder, respectively. The patient is placed in the right lateral decubitus position, and three or four working ports are placed for the introduction of the laparoscopic instruments. An angled laparoscope is used, and a careful examination of the abdomen is carried out to identify other disease or the presence of accessory spleens.



The dissection then proceeds in five stages: division of the short gastric vessels, division of the splenocolic ligament, ligation of the inferior polar vessels, hilar control, and division of the phrenic attachments of the spleen ( 109 ). Much of the dissection may be carried out with harmonic shears, and the hilar structures are ligated and divided with an endoscopic stapling device, clips, or suture ligatures ( 110 ). The spleen is then placed in an extraction bag, morcellated *in situ*, and the fragments removed. Some surgeons prefer to add a “hand port,” which allows the use of one hand without disturbing the pneumoperitoneum required for laparoscopic surgery. In this case, the spleen may be removed through this larger incision without morcellation.

## COMPLICATIONS OF SPLENECTOMY

The most common complications of splenectomy include bleeding, injury to the adjacent pancreas with resulting pancreatitis, and pancreatic pseudocyst or fistula formation. These patients can also develop atelectasis, pancreatic abscess, or injury to the adjacent stomach or splenic flexure of the colon if care is not taken in dividing the ligamentous attachments to these structures.

Postoperative thrombocytosis can occur, and aspirin (one children’s aspirin per day) should be considered if the platelet count is above 1,500,000 to minimize the risks of thrombosis or embolism. The thrombocytosis is usually transient with return of platelet counts to normal ranges by 2 years after splenectomy ( 111 ).

Infectious complications are increased after splenectomy, and this can occur both in the early postoperative period and after a significant time has passed. The rate of early postoperative infections is particularly high when multiple other procedures are performed (e.g., after complex injuries in the setting of multiple trauma) ( 112 ). The complication of overwhelming postsplenectomy infection (OPSI) has received significant attention.

### Postsplenectomy Infection

One of the most important developments affecting the splenectomy procedure has been the recognition of the increased risk of sepsis after splenectomy. In 1919, Morris and Bullock concluded that removal of the spleen may lead to an increased susceptibility to infection ( 113 ). The first reported case of significant postsplenectomy infection occurred in 1929 ( 114 , 115 ), but it was not until 1953, when King and Schumacker observed five cases of sepsis in infants undergoing splenectomy for congenital spherocytosis ( 115 ), that this risk gained significant acceptance. In 1969, Diamond described a case of postsplenectomy fulminant bacteremia leading to rapid death and coined the term *OPSI* ( 116 ). In 1973, Singer further described this condition as a septicemia, meningitis, or pneumonia that was usually fulminant but not always fatal, occurring days to years after splenectomy ( 114 ). In 1983, Van Wyck described a syndrome with an extraordinarily fulminant course, often with absence of a defined septic focus: bacteremia, coma, shock, consumptive coagulopathy, and adrenal hemorrhage (Waterhouse–Friderichsen syndrome) ( 117 ). Other complications include purpura fulminans, extremity gangrene, and convulsions. Although cryptic infection is common in adults, focal infections, such as meningitis, are more common in children younger than 5 years of age ( 113 ).

**PATHOPHYSIOLOGY** In the early postoperative period, infection is usually caused by staphylococci and enteric gram-negative bacilli ( 113 ). Outside of this interval, the most

common organisms responsible for OPSI are encapsulated bacteria (6, 8, 118), with pneumococcus being most common (incidence, 48%) (114). Other responsible organisms include *Neisseria meningitidis*, *Escherichia coli*, *Haemophilus influenzae*, *Staphylococcus*, and *Streptococcus* and occur at rates that range from 7 to 12% (114). Rarer organisms include *Capnocytophaga* (a fastidious gram-negative organism contracted after dog bites or scratches), *Bartonella*, and intraerythrocytic parasites (*Babesia* and *Plasmodium*) (8, 119). The special susceptibility of the asplenic patient to *Pneumococcus*, *Meningococcus*, and *H. influenzae* is likely related to splenic clearance of encapsulated organisms (8). Three factors normally provided by the spleen that help to protect the body against encapsulated organisms are lost in the asplenic patient. They include the reticuloendothelial system/mononuclear phagocytic system meshwork of the splenic cords, complete and effective IgM-producing capability, and complete and effective opsonin-producing capability (6, 118). Studies confirm that bacteria-specific IgM production in asplenic patients is both delayed and diminished (6, 56). Also, it has been demonstrated that asplenic patients have lower circulating levels of certain complement factors, including properdin, tuftsin, C3, and factor B (7, 51, 52). There is also evidence that splenectomy results in defects of cellular immunity. After splenectomy for trauma, a cohort of patients was found to have a significant reduction in the percentage of CD4<sup>+</sup> T cells, specifically in the CD45RA<sup>+</sup> subset. This was accompanied by an impairment in primary immune responsiveness in a number of cellular and humoral assays (120).

**INCIDENCE** OPSI is most common in the very young, in patients with underlying malignancies or other medical conditions, and within the first 2 years after splenectomy, although it has been reported 20 to 40 years after surgery (6, 8, 10, 113, 114, 118, 121, 122, 123 and 124). The incidence of OPSI is greatest in the very young and diminishes with age: 15.7% in infants, 10.4% in children younger than 5 years, 4.4% in children younger than 16 years, and 0.9% in adults (8, 124). Although the incidence in adults is similar to that of the general population, mortality from sepsis is 58-fold increased in the asplenic population (113). Underlying pathology, like youth, also imparts an increased risk of OPSI (6, 8, 121, 122). The incidence of OPSI after splenectomy for trauma is approximately 0.5% (10). The incidence increases to approximately 1.5% if splenectomy is performed for diagnosis of lymphoma (125). Those who have undergone splenectomy for a serious primary disease (hepatic disease, Wiskott-Aldrich syndrome, storage diseases, and thalassemia major) are at even higher risk of OPSI (121, 122, 126). The highest risks of postsplenectomy sepsis appear to be associated with underlying immune disorders and Hodgkin disease, especially for those who receive chemotherapy (6, 113, 114, 123).

**CLINICAL COURSE** OPSI generally pursues a rapid course with evolution to sepsis and disseminated intravascular coagulation. Any asplenic patient with fever should be evaluated for possible OPSI. Key to successful treatment is prompt administration of broad-spectrum intravenous antibiotics. A complete septic workup, including routine laboratory tests, appropriate imaging, and microbiology cultures, should be performed but should never delay the initiation of antibiotics. In fully developed OPSI, mortality rates of 50 to 70% have been reported; 80% of deaths occur within 48 hours (113).

**PREVENTION OF OVERWHELMING POSTSPLENECTOMY INFECTION** The guidelines for the prevention of OPSI center around vaccination, antibiotic prophylaxis, patient education, and strategies aimed at preserving splenic function. Recommendations for postsplenectomy patients include immunization against encapsulated bacteria (10, 127, 128) with additional antibiotic prophylaxis for all asplenic and hyposplenic children (oral penicillin, amoxicillin, amoxicillin-clavulanic acid, trimethoprim-sulfamethoxazole, or cefuroxime axetil daily) for at least 2 years. Some advocate continued prophylaxis for 5 years or even until the age of 21 (129). Cefotaxime and ceftriaxone have been recommended for use in empiric treatment of symptomatic patients who have been taking

prophylactic antibiotics ( [129](#) ). There is some debate over which immunizations should be administered. Antipneumococcal vaccination is widely accepted, but there is disagreement over *H. influenzae* and *N. meningitidis*. Most patients receive immunization against *H. influenzae*, but *N. meningitidis* is not routinely recommended unless travel is anticipated to an area with increased risk of group A infection ( [113](#) ). Ideally, patients should receive the vaccinations 14 days before elective splenectomy ( [8](#), [118](#), [130](#) ). Patients who undergo emergent splenectomy should receive their vaccinations as soon as possible after surgery ( [126](#) ). With regard to revaccination (boosters), antipneumococcal vaccine should be administered every 5 to 10 years. Repeat antimeningococcal immunization is performed after 2 years. The requirement for reimmunization against *H. influenzae* is unclear ( [113](#) ). Regardless of the time frame, however, many patients do not receive any revaccination because of a general lack of understanding about their condition and the unclear role for revaccination ( [112](#) ). The ability of immunizations to reduce the incidence of OPSI has been well established ( [6](#), [8](#), [119](#) ). Nevertheless, the use of vaccinations and antibiotic prophylaxis is still the focus of much investigation. Some investigators question the existing regimens and have called for long-term randomized, controlled trials ( [127](#) ). Other investigators debate the efficacy and duration of immunization, citing numerous cases of OPSI in “immunized” patients ( [112](#) ). Finally, others argue that the risks associated with vaccination may outweigh the risks of OPSI ( [131](#) ). One of the most important, and most overlooked, aspects of prevention is patient education. Up to 50% of asplenic patients are unaware of their increased risk of serious infection, and 30 to 40% do not recall being vaccinated ( [113](#), [129](#) ). Few are provided with antibiotics to take empirically at the onset of fever, and one-half would not spontaneously tell an uninformed emergency department doctor about their splenectomies ( [113](#) ). Asplenic patients should be extensively counseled about their health risks, the need for reimmunization, and the importance of informing future caregivers of their condition.

**AUTOTRANSPLANTATION OF SPLENIC TISSUE** Extrasplenic tissue may emerge secondary to traumatic autotransplantation, known as *splenosis* ( [27](#) ). Splenic fragments may be intentionally implanted in the omentum at the time of splenectomy ( [132](#) ). Histologically, this tissue appears as normal spleen with white pulp, red pulp, and marginal zones ( [31](#) ). Extrasplenic tissue can preserve some of the functions of the parent organ (such as opsonin production) ( [32](#) ), but its ability to clear encapsulated organisms depends on blood supply and tissue mass and has not been fully established ( [31](#), [65](#), [133](#) ). In a study of pneumococcal vaccination after splenectomy, the development of humoral immunity based on antibody production was noted in those patients who underwent autotransplantation at the time of their surgery but not in patients who received only splenectomy ( [134](#), [135](#) ). This suggests that in cases in which immunization has not preceded splenectomy, autotransplantation with follow-up immunization may provide some measure of protection against pneumococcus.

## WEB SITES

Society of American Gastrointestinal Endoscopic Surgeons, <http://www.sages.org/>

Society of Laparoendoscopic Surgeons, <http://www.sls.org/>

Laparoscopy.com, <http://www.laparoscopy.com/>

## REFERENCES

1. Bannister LH. Haemolymphoid system. In: Williams PL, Bannister LH, eds. Gray's anatomy, 38th ed. New

York: Churchill Livingstone, 1995:1399–1442.

2. McClusky DA 3rd, Skandalakis LJ, Colborn GL, et al. Tribute to a triad: history of splenic anatomy, physiology, and surgery—part 2. *World J Surg* 1999;23:514–526.
3. Athens JW. The reticuloendothelial (mononuclear phagocyte) system and the spleen. In: Lee GR, Bithell TC, Foerster J, et al., eds. *Wintrobe's clinical hematology*, 9th ed. Philadelphia: Lea & Febiger, 1993:1704–1722.
4. Schwartz SI. Physiology of the spleen and the role of splenectomy in hematological disorders. In: Condon RE, DeCrosse J, eds. *Surgical critical care II*. Philadelphia: Lea & Febiger, 1985:118–125.
5. Robbins SL, Cotran RS, Kumar V, eds. *Robbins pathologic basis of disease*, 5th ed. Philadelphia: WB Saunders, 1994:629–672.
6. Neiman RS, Orazi A. Spleen. In: Damjanov I, Linder J, eds. *Anderson's pathology*, 10th ed. St. Louis: Mosby, 1996:1201–1217.
7. Sheldon GF, Croom RD, Meyer AA. The spleen. In: Sabiston DC, ed. *Textbook of surgery*, 14th ed. Philadelphia: WB Saunders, 1991:1108–1133.
8. Faller D. Disease of the lymph node and spleen. In: Wyngaarden JB, Smith LH, Bennett JC, eds. *Cecil textbook of medicine*, 19th ed. Philadelphia: WB Saunders, 1992:968–974.
9. Moore KL, Persaud TVN, eds. *The developing human*, 5th ed. Philadelphia: WB Saunders, 1993:245–248.
10. Schwartz SI. Spleen. In: Schwartz SI, Shires GT, Spencer FC, eds. *Principles of surgery*, 6th ed. New York: McGraw-Hill, 1994:1433–1447.
11. Skandalakis PN, Colborn GL, Skandalakis LJ, et al. The surgical anatomy of the spleen. *Surg Clin North Am* 1993;73:747–768.
12. Woodburne RT, Burkel WE, eds. *Essentials of human anatomy*, 8th ed. New York: Oxford University Press, 1988:446–448.
13. Otto AC, Ninham E, Pretorius PH, et al. Difference between splenic volume measured at necropsy and that measured *in vivo* by radionuclide tomography. *Clin Nucl Med* 1994;19:979–980.
14. Stewart IB, McKenzie DC. The human spleen during physiological stress. *Sports Med* 2002;32:361–369.
15. Liu DL, Xia S, Xu W, et al. Anatomy of vasculature of 850 spleen specimens and its application in partial splenectomy [see comments]. *Surgery* 1996;119:27–33.
16. Gomez Pellico L, Labrador Vallverdu J, Fernandez Camacho FJ. Venous segmentation of the spleen. *Surg Radiol Anat* 1994;16:157–164.
17. Poulin EC, Thibault C. The anatomical basis for laparoscopic splenectomy. *Can J Surg* 1993;36:484–488.
18. Oguro A, Taniguchi H, Koyama H, et al. Quantification of human splenic blood flow (quantitative measurement of splenic blood flow with H<sub>2</sub>(15)O and a dynamic state method: 1). *Ann Nucl Med* 1993;7:245–250.
19. Junqueira LC, Carneiro J, Kelley RO, eds. *Basic histology*, 8th ed. Norwalk, CT: Appleton & Lange, 1995:260–266.
20. Tavassoli M. Structure and function of the spleen. In: Williams WJ, Marshall AL, Ernest B, et al., eds. *Hematology*, 8th ed. New York: McGraw-Hill, 1990:54–62.
21. Espersen K, Frandsen H, Lorentzen T, et al. The human spleen as an erythrocyte reservoir in diving-related interventions. *J Appl Physiol* 2002;92:2071–2079.
22. Wan W, Vriend CY, Wetmore L, et al. The effects of stress on splenic immune function are mediated

by the splenic nerve. *Brain Res Bull* 1993;30:101–105.

23. Livnat S, Felten SY, Carlson SL, et al. Involvement of peripheral and central catecholamine systems in neural-immune interactions. *J Neuroimmunol* 1985;10:5–30.

24. Barawi M, Bekal P, Gress F. Accessory spleen: a potential cause of misdiagnosis at EUS. *Gastrointest Endosc* 2000;52:769–772.

25. Habib FA, Kolachalam RB, Swason K. Abscess of an accessory spleen. *Am Surg* 2000;66:215–218.

26. Herneth AM, Pokieser P, Philipp MO, et al. Role of Doppler sonography in the evaluation of accessory spleens after splenectomy. *J Ultrasound Med* 2001;20:1347–1351.

27. Normand JP, Rioux M, Dumont M, et al. Ultrasonographic features of abdominal ectopic splenic tissue. *Can Assoc Radiol J* 1993;44:179–184.

28. Pizarro AR, Gallaspy JW, Nawas S, et al. Splenosis and the gynecologic patient: a case report and review of literature. *J La State Med Soc* 2000;152:345–348.

29. Naylor MF, Karstaedt N, Finck SJ, et al. Noninvasive methods of diagnosing thoracic splenosis. *Ann Thorac Surg* 1999;68:243–244.

30. Kumar RJ, Borzi PA. Splenosis in a port site after laparoscopic splenectomy [see comments]. *Surg Endosc* 2001;15:413–414.

31. Carr NJ, Turk EP. The histological features of splenosis. *Histopathology* 1992;21:549–553.

32. Muller U, Rothlin M. Splenic neoformation following trauma-induced splenectomy: diagnosis and function. *Swiss Surg* 1995;(5):230–235.

33. Sherman R. Perspectives in management of trauma to the spleen: 1979 presidential address, American Association for the Surgery of Trauma. *J Trauma* 1980;20:1–13.

34. Gayer G, Zissin R, Apter S, et al. CT findings in congenital anomalies of the spleen. *Br J Radiol* 2001;74:767–772.

35. Ross MH, Reith EJ, Romrell LJ, eds. *Histology: a text and atlas*, 2nd ed. Philadelphia: Williams & Wilkins, 1989:324–328.

36. Schmidt EE, MacDonald IC, Groom AC. Comparative aspects of splenic microcirculatory pathways in mammals: the region bordering the white pulp. *Scanning Microsc* 1993;7:613–628.

37. Kashimura M, Fujita T. A scanning electron microscopy study of human spleen: relationship between the microcirculation and functions. *Scanning Microsc* 1987;1:841–851.

38. Groom AC, Schmidt EE, MacDonald IC. Microcirculatory pathways and blood flow in spleen: new insights from washout kinetics, corrosion casts, and quantitative intravital videomicroscopy. *Scanning Microsc* 1991;5:159–173; discussion 173–174.

39. van Krieken JH, te Velde J. Normal histology of the human spleen. *Am J Surg Pathol* 1988;12:777–785.

40. Jonsson V, Bock JE, Nielsen JB. Significance of plasma skimming and plasma volume expansion. *J Appl Physiol* 1992;72:2047–2051.

41. Kashimura M, Shibata A. [Structure and functions of the human spleen: relationship between microcirculation and splenic functions.] *Rinsho Ketsueki* 1989;30:1234–1238.

42. Corazza GR, Ginaldi L, Zoli G, et al. Howell-Jolly body counting as a measure of splenic function. A reassessment. *Clin Lab Haematol* 1990;12:269–275.

43. Weintraub LR. Splenectomy: who, when, and why? [see comments.] *Hosp Pract (Off Ed)*

1994;29:27-34.

44. Ferrant A, Leners N, Michaux JL, et al. The spleen and haemolysis: evaluation of the intrasplenic transit time. *Br J Haematol* 1987;65:31-34.
45. Stavem P, Brinch L, Hovig T. Miltens plukkfunksjon synliggjort hos en pasient. *Tidsskr Nor Laegeforen* 1994;114:2714-2715.
46. Zago MA. The evaluation of spleen function in man. *Braz J Med Biol Res* 1989;22:159-169.
47. Bohnsack JF, Brown EJ. The role of the spleen in resistance to infection. *Annu Rev Med* 1986;37:49-59.
48. Carbonell-Tatay F, Balsalobre B. [Humoral immunity following splenectomy in adults.] *Rev Clin Esp* 1992;190:447-449.
49. Kelton JG. Platelet and red cell clearance is determined by the interaction of the IgG and complement on the cells and the activity of the reticuloendothelial system. *Transfus Med Rev* 1987;1:75-84.
50. Maves KK, Weiler JM. Detection of properdin mRNA in human peripheral blood monocytes and spleen. *J Lab Clin Med* 1992;120:762-766.
51. Spirer Z, Zakuth V, Tzevoval E, et al. Tuftsin stimulates IL-1 production by human mononuclear cells, human spleen cells and mouse spleen cells *in vitro*. *J Clin Lab Immunol* 1989;28:27-31.
52. Ge Y, Gao H, Kong XT. Immunoglobulins and complement in splenectomised and autotransplanted subjects. *Ann Med* 1989;21:265-267.
53. Truedsson L, Sturfelt G, Offenbartl K, et al. The spleen is not a major synthetic site of alternative pathway components. *Comp Inflam* 1990;7:52-56.
54. Katano M, Yamamoto H, Kubota E, et al. The possible use of spleen cells for the adoptive immunotherapy of cancer patients. *Surg Today* 1993;23:13-20.
55. Akiyoshi T, Koba F, Arinaga S, et al. Cell-mediated cytotoxic activity of spleen cells from patients with gastric carcinoma. *Jpn J Surg* 1988;18:164-171.
56. Downey EC, Shackford SR, Fridlund PH, et al. Long-term depressed immune function in patients splenectomized for trauma. *J Trauma* 1987;27:661-663.
57. Laub M, Hvid-Jacobsen K, Hovind P, et al. Spleen emptying and venous hematocrit in humans during exercise. *J Appl Physiol* 1993;74:1024-1026.
58. Pabst R, Westermann J. The role of the spleen in lymphocyte migration. *Scanning Microsc* 1991;5:1075-1079; discussion 1079-1080.
59. Toft P, Tonnesen E, Helbo-Hansen HS, et al. Redistribution of granulocytes in patients after major surgical stress. *APMIS* 1994;102:43-48.
60. Dunn-Walters DK, Isaacson PG, Spencer J. Analysis of mutations in immunoglobulin heavy chain variable region genes of microdissected marginal zone (MGZ) B cells suggests that the MGZ of human spleen is a reservoir of memory B cells. *J Exp Med* 1995;182:559-566.
61. Wadenvik H, Kutti J. The effect of an adrenaline infusion on the splenic blood flow and intrasplenic platelet kinetics. *Br J Haematol* 1987;67:187-192.
62. Hill-Zobel RL, McCandless B, Kang SA, et al. Organ distribution and fate of human platelets: studies of asplenic and splenomegalic patients. *Am J Hematol* 1986;23:231-238.
63. Wilkins BS, Green A, Wild AE, et al. Extramedullary haemopoiesis in fetal and adult human spleen: a quantitative immunohistological study. *Histopathology* 1994;24:241-247.
64. Eichner ER, Whitfield CL. Splenomegaly. An algorithmic approach to diagnosis. *J Am Med Assoc*

1981;246:2858–2861.

65. Eichner ER. Splenic function: normal, too much and too little. *Am J Med* 1979;66:311–320.
66. Rose AT, Newman MI, Debelak J, et al. The incidence of splenectomy is decreasing: lessons learned from trauma experience. *2000;66:481–486.*
67. Beardsley DS. Pathophysiology of immune thrombocytopenic purpura. *Blood Rev* 2002;16:13–14.
68. Semple JW. Immune pathophysiology of autoimmune thrombocytopenic purpura. *Blood Rev* 2002;16:9–12.
69. George JN. Initial management of adults with idiopathic (immune) thrombocytopenic purpura. *Blood Rev* 2002;16:37–38.
70. Rosse WF. Clinical management of adult ITP prior to splenectomy: a perspective. *Blood Rev* 2002;16:47–49.
71. Adams JR, Nathan DP, Bennett CL. Pharmacoeconomics of therapy for ITP: steroids, i.v.Ig, anti-D, and splenectomy. *Blood Rev* 2002;16:65–67.
72. Chirletti P, Cardi M, Barillari P, et al. Surgical treatment of immune thrombocytopenic purpura. *World J Surg* 1992;16:1001–1004; discussion 1004–1005.
73. Bell WR Jr. Role of splenectomy in immune (idiopathic) thrombocytopenic purpura. *Blood Rev* 2002;16:39–41.
74. Holcomb GW 3rd. Indications for laparoscopy in children. *Int Surg* 1994;79:322–327.
75. Schattner E, Bussel J. Mortality in immune thrombocytopenic purpura: report of seven cases and consideration of prognostic indicators [see comments]. *Am J Hematol* 1994;46:120–126.
76. Tunkel AR, Kelsall B, Rein MF, et al. Case report: increase in CD4 lymphocyte counts after splenectomy in HIV-infected patients. *Am J Med Sci* 1993;306:105–110.
77. Moake JL. Thrombotic microangiopathies. *N Engl J Med* 2002;347:589–600.
78. Moake JL. Thrombotic thrombocytopenic purpura: the systemic clumping “plague.” *Annu Rev Med* 2002;53:75–88.
79. Veltman GA, Brand A, Leeksa OC, et al. The role of splenectomy in the treatment of relapsing thrombotic thrombocytopenic purpura. *Ann Hematol* 1995;70:231–236.
80. Hoffkes HG, Weber F, Uppenkamp M, et al. Recovery by splenectomy in patients with relapsed thrombotic thrombocytopenic purpura and treatment failure to plasma exchange. *Semin Thromb Hemost* 1995;21:161–165.
81. Schwartz J, Eldor A, Szold A. Laparoscopic splenectomy in patients with refractory or relapsing thrombotic thrombocytopenic purpura. *Arch Surg* 2001;136:1236–1238; discussion 1239.
82. Flexner J, Stein R, Greer J. Outline of treatment of lymphoma based on hematologic and clinical stage with expected end results. *Surg Oncol Clin N Am* 1993;2:283.
83. Carbone PP, Kaplan HS, Musshoff K, et al. Report of the Committee on Hodgkin’s Disease Staging Classification. *Cancer Res* 1971;31:1860–1861.
84. Mauch PM. Controversies in the management of early stage Hodgkin’s disease [see comments]. *Blood* 1994;83:318–329.
85. Straus DJ. Treatment of early stage Hodgkin’s disease. *Blood Rev* 1993;7:34–42.
86. Baccarani U, Terrosu G, Donini A, et al. Splenectomy in hematology. Current practice and new



perspectives. *Haematologica* 1999;84:431–436.

87. Walsh RM, Heniford BT. Role of laparoscopy for Hodgkin's and non-Hodgkin's lymphoma. *Semin Surg Oncol* 1999;16:284–292.
88. Blucher D, Lobe TE. Minimal access surgery in children: the state of the art. *Int Surg* 1994;79:317–321.
89. Mesa RA, Tefferi A. Palliative splenectomy in myelofibrosis with myeloid metaplasia. *Leuk Lymphoma* 2001;42:901–911.
90. Morgenstern L. Nonparasitic splenic cysts: pathogenesis, classification, and treatment. *J Am Coll Surg* 2002;194:306–314.
91. Wang SJ, Chen JJ, Changchien CS, et al. Sequential invasions of pancreatic pseudocysts in pancreatic tail, hepatic left lobe, caudate lobe, and spleen. *Pancreas* 1993;8:133–136.
92. Thanos L, Dailiana T, Papaioannou G, et al. Percutaneous CT-guided drainage of splenic abscess. *AJR Am J Roentgenol* 2002;179:629–632.
93. Rashba EJ, Rowe JM, Packman CH. Treatment of the neutropenia of Felty syndrome. *Blood Rev* 1996;10:177–184.
94. MacGowan JR, Mahendra P, Ager S, et al. Thrombocytopenia and spontaneous rupture of the spleen associated with infectious mononucleosis. *Clin Lab Haematol* 1995;17:93–94.
95. Kluger Y, Paul DB, Raves JJ, et al. Delayed rupture of the spleen—myths, facts, and their importance: case reports and literature review. *J Trauma* 1994;36:568–571.
96. Uranus S, Kronberger L, Kraft-Kine J. Partial splenic resection using the TA-stapler. *Am J Surg* 1994;168:49–53.
97. Zer M, Freud E. Subtotal splenectomy in Gaucher's disease: towards a definition of critical splenic mass [see comments]. *Br J Surg* 1992;79:742–744.
98. Katkhouda N, Mavor E. Laparoscopic splenectomy. *Surg Clin North Am* 2000;80:1285–1297.
99. Velanovich V, Shurafa MS. Clinical and quality of life outcomes of laparoscopic and open splenectomy for haematological diseases. *Eur J Surg* 2001;167:23–28.
100. Liew SC, Storey DW. Laparoscopic splenectomy. *Aust N Z J Surg* 1995;65: 743–745.
101. Lefor AT, Melvin WS, Bailey RW, et al. Laparoscopic splenectomy in the management of immune thrombocytopenia purpura. *Surgery* 1993;114:613–618.
102. Arregui ME, Barteau J, Davis CJ. Laparoscopic splenectomy: techniques and indications. *Int Surg* 1994;79:335–341.
103. Kercher KW, Matthews BD, Walsh RM, et al. Laparoscopic splenectomy for massive splenomegaly. *Am J Surg* 2002;183:192–196.
104. Glasgow RE, Mulvihill SJ. Laparoscopic splenectomy. *World J Surg* 1999;23:384–388.
105. Marcaccio MJ. Laparoscopic splenectomy in chronic idiopathic thrombocytopenic purpura. *Semin Hematol* 2000;37:267–274.
106. Berman RS, Yahanda AM, Mansfield PF, et al. Laparoscopic splenectomy in patients with hematologic malignancies. *Am J Surg* 1999;178:530–536.
107. Tanoue K, Hashizume M, Morita M, et al. Results of laparoscopic splenectomy for immune thrombocytopenic purpura. *Am J Surg* 1999;177:222–226.
108. Targarona EM, Espert JJ, Piulachs J, et al. Laparoscopic removal of accessory spleens after

- splenectomy for relapsing autoimmune thrombocytopenic purpura. *Eur J Surg* 1999;165:1199–1200.
109. Katkhouda N, Hurwitz MB. Laparoscopic splenectomy for hematologic disease. *Adv Surg* 1999;33:141–161.
110. Park A, Marcaccio M, Sternbach M, et al. Laparoscopic vs open splenectomy. *Arch Surg* 1999;134:1263–1269.
111. Jockovich M, Mendenhall NP, Sombeck MD, et al. Long-term complications of laparotomy in Hodgkin's disease. *Ann Surg* 1994;219:615–621; discussion 621–624.
112. Rutherford EJ, Livengood J, Higginbotham M, et al. Efficacy and safety of pneumococcal revaccination after splenectomy for trauma. *J Trauma* 1995;39:448–452.
113. Sumaraju V, Smith LG, Smith SM. Infectious complications in asplenic hosts. *Infect Dis Clin North Am* 2001;15:551–565.
114. Singer D. Postsplenectomy sepsis. In: Bolande R, ed. *Perspective in pediatric pathology*. Chicago: Year Book, 1973:285–305.
115. King H, Schumacker H. Splenic studies: susceptibility to infection after splenectomy performed in infancy. *Ann Surg* 1952;136:239–241.
116. Diamond LK. Splenectomy in childhood and the hazard of overwhelming infection. *Pediatrics* 1969;43:886–889.
117. Van Wyck DB. Overwhelming postsplenectomy infection (OPSI): the clinical syndrome. *Abdom Imaging* 1983;16:107–114.
118. Shaw JH, Print CG. Postsplenectomy sepsis. *Br J Surg* 1989;76:1074–1081.
119. Haynes BF. Enlargement of the lymph nodes and spleen. In: Isselbacher KJ, Wilson JD, Martin JB, et al., eds. *Harrison's principles of internal medicine*, 13th ed. New York: McGraw-Hill, 1994:1225–1229.
120. Wolf HM, Eibl MM, Georgi E, et al. Long-term decrease of CD4+CD45RA+ T cells and impaired primary immune response after post-traumatic splenectomy. *Br J Haematol* 1999;107:55–68.
121. Eraklis AJ, Kevy SV, Diamond LK, et al. Hazard of overwhelming infection after splenectomy in childhood. *N Engl J Med* 1967;276:1225–1229.
122. Lowdon A. Risk of serious infection following splenectomy. *BMJ* 1966;1:446.
123. Krivit W. Overwhelming postsplenectomy infection. *Am J Hematol* 1977;2:193–201.
124. Holdsworth RJ, Irving AD, Cuschieri A. Postsplenectomy sepsis and its mortality rate: actual versus perceived risks. *Br J Surg* 1991;78:1031–1038.
125. Desser RK, Ultmann JE. Risk of severe infection in patients with Hodgkin's disease or lymphoma after diagnostic laparotomy and splenectomy. *Ann Intern Med* 1972;77:143–146.
126. Platt R. Infection after splenectomy. *JAMA* 1982;248:2316.
127. Reid MM. Splenectomy, sepsis, immunisation, and guidelines [see comments]. *Lancet* 1994;344:970–971.
128. Francke EL, Neu HC. Postsplenectomy infection. *Surg Clin North Am* 1981;61:135–155.
129. Brigden ML. Detection, education and management of the asplenic or hyposplenic patient [see comments]. *Am Fam Physician* 2001;63:499–506.
130. Wegelius R. Postsplenectomy infections. *Lancet* 1982;1:1420–1421.

131. O'Sullivan ST, Reardon CM, O'Donnell JA, et al. "How safe is splenectomy?" *Ir J Med Sci* 1994;163:374-378.
132. Schwartz S. Progress symposium: diseases affecting the spleen. *World J Surg* 1985; 9:337.
133. Leonard AS, Giebink GS, Baesl TJ, et al. The overwhelming postsplenectomy sepsis problem. *World J Surg* 1980;4:423-432.
134. Leemans R, Harms G, Rijkers GT, et al. Spleen autotransplantation provides restoration of functional splenic lymphoid compartments and improves the humoral immune response to pneumococcal polysaccharide vaccine [see comments]. *Clin Exp Immunol* 1999;117:596-604.
135. Leemans R, Manson W, Snijder JA, et al. Immune response capacity after human splenic autotransplantation: restoration of response to individual pneumococcal vaccine subtypes. *Ann Surg* 1999;229:279-285.

2004 Lippincott Williams & Wilkins  
John P. Greer, John Foerster, John N. Lukens  
George M. Rodgers, Frixos Paraskevas, Bertil Glader  
Wintrobe's Clinical Hematology

## Hematopoietic–Lymphoid Neoplasms: Principles of Diagnosis

[PRINCIPLES OF DIAGNOSIS OF HEMATOPOIETIC–LYMPHOID SYSTEM NEOPLASMS](#)  
[CLASSIFICATION OF HEMATOPOIETIC AND LYMPHOID NEOPLASMS](#)  
[REFERENCES](#)

Leukemias and lymphomas are relatively common, affect all ages, and demonstrate extraordinary biologic, morphologic, and clinical heterogeneity ([1](#)). This complexity is due, in part, to the dramatic explosion in the last 25 years of our understanding of the hematopoietic–lymphoid system (HLS). Advances in monoclonal antibody technology, cytogenetics, and molecular genetics have revealed that the HLS is a heterogeneous population of cells organized into anatomically and functionally distinct compartments. These same techniques also have been applied to neoplasms and have provided insight into the diagnosis, classification, and pathogenesis of leukemias and lymphomas. As a result, many new types of leukemias and lymphomas have been described, each apparently representing the neoplastic counterpart of a specific functional compartment of the HLS. For example, the recent World Health Organization classification suggests as many as 30 distinct disease entities within lymphoid neoplasms, excluding Hodgkin lymphoma ([2](#)). It is not surprising, therefore, that the diagnosis and classification of these malignancies are challenging for pathologists, oncologists, and laboratory personnel.

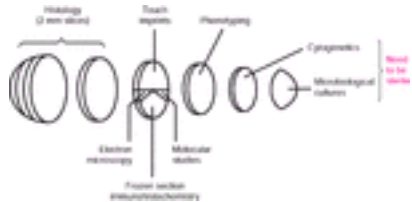
This chapter describes the general principles of diagnosis and classification of HLS neoplasms (specific topics of classification and differential diagnosis of acute leukemias, non–Hodgkin lymphomas, and Hodgkin disease are included in [Chapter 77](#), [Chapter 88](#), and [Chapter 95](#), respectively).

### PRINCIPLES OF DIAGNOSIS OF HEMATOPOIETIC–LYMPHOID SYSTEM NEOPLASMS

The diagnosis of leukemias and lymphomas requires clear communication and close cooperation between the oncologist, the surgeon, and the pathologist. A thorough clinical evaluation by the oncologist should help direct the surgeon or operator (in the case of fine–needle aspiration or marrow biopsy) to the most appropriate tissue for biopsy in the patient suspected of having a hematologic or lymphoid malignancy. Likewise, the pathologist needs to instruct the surgeon or operator in the proper handling and triaging of the tissue sample.

Tissue removed from patients suspected of having hematopoietic or lymphoid neoplasms should be handled to ensure the highest yield of diagnostic information. Most mistakes made in lymph node and bone marrow examination are due to improper processing of tissue specimens ([3](#)). Ideally, fresh, intact tissue should be quickly delivered to the surgical pathology laboratory. In all cases, tissue should be processed according to a pathologist–supervised protocol that incorporates a multiparameter approach to diagnosis [an example of a protocol, modified from Collins ([4](#)), for the evaluation of lymph nodes is illustrated in [Figure 71.1](#)]. Some leukemias and lymphomas require a combination of

routine morphologic examination and more sophisticated morphologic, phenotypic, or genotypic studies for precise diagnosis and classification. Collection and preservation of tissue for these studies require minimal initial time and expense, and, often, the necessity of a second biopsy to establish a diagnosis can be avoided.



**Figure 71.1.** Schematic of protocol for processing lymph node biopsies from patients suspected of having lymphoid malignancies.

The diagnosis of hematopoietic and lymphoid neoplasms is based first and foremost on careful morphologic examination ([1](#)). General diagnostic criteria include pattern of growth of the infiltrate, degree of cytologic atypia, degree and type of differentiation of the predominant neoplastic cell population, and the presence of characteristic nonneoplastic, reactive cellular components. The recognition of these features is facilitated by the use of tissue fixatives, such as B-5, which preserve fine cytologic detail, and carefully prepared, well-stained sections or smears. Fine-needle aspiration biopsy and cytology are now widely used for evaluation of patients with known or suspected lymphomas ([5](#), [6](#) and [7](#)). They are particularly useful in patients who are unable to undergo surgical excision and in patients with documented lymphomas suspected of having recurrent disease, especially in deep-seated nodes ([3](#)). Limitations include sampling errors and distinguishing reactive from malignant proliferations ([8](#)). Also, subclassification and grading of lymphomas can be problematic on fine-needle aspiration biopsy material. Molecular genetic analysis and immunophenotyping used in conjunction with fine-needle aspiration biopsy improve sensitivity and specificity ([9](#), [10](#)). Electron microscopy is now used infrequently in diagnostic hematopathology, mainly due to improvements in immunohistochemistry, which can be performed more rapidly and at lower cost.

Correlation of morphologic and special studies is essential, as independent interpretations of various components of marrow or node examinations may lead to misinterpretations of the entire case ([1](#)). Although routine morphologic examination is the cornerstone for evaluation of marrows and lymph nodes, supplemental studies ([Table 71.1](#)) often are required for proper diagnosis or management of leukemias and lymphomas. Detailed descriptions of these modalities are presented in [Chapter 76](#) and [Chapter 77](#) for acute leukemias and [Chapter 88](#) and [Chapter 89](#) for non-Hodgkin lymphomas. However, a few general comments about limitations of their applications are in order.

**TABLE 71.1. Various Modalities Used in the Diagnosis and Classification of Hematopoietic and Lymphoid Neoplasms**

---

|  |
|--|
| Morphology, including histopathology, fine needle aspiration cytology, and electron microscopy |
| Immunohistochemistry   |
| Cytochemistry  |
| Cytogenetics   |

The recent development of commercially available monoclonal antibodies that react with antigens in routinely processed paraffin-embedded tissue sections ( [Table 71.2](#)) ( [11](#), [12](#), [13](#) and [14](#)) has made immunohistochemical evaluation of lymphomas and leukemias available to virtually all pathologists and has greatly improved diagnostic accuracy. As a cautionary note, none of these antibodies is 100% sensitive or specific for cell lineage. Other factors, such as type and length of time of tissue fixation and method of processing, may significantly affect the reactivity of these antibodies. If a laboratory chooses to perform immunohistochemistry, testing should be done with meticulous quality control, using panels of antibodies, and performed often enough for technicians and pathologists to acquire adequate experience in the performance and interpretation of the assays.

**TABLE 71.2. Commonly Used Markers for the Characterization of Hematopoietic and Lymphoid Neoplasms in Paraffin-Embedded Tissue Sections**

| Category      | CD Antigen or Antibody | Reactivity in Normal Cells                                | Reactivity in Neoplasms  |
|---------------|------------------------|---|--|
| Pan-leukocyte | CD45                   | B cells, most T cells, macrophages, and granulocytes      | Most NHL and leukemias   |
| T cell        | CD1a                   | Cortical thymocytes and Langerhans cells                  | Precursor T-cell lymphoblastic leukemia/lymphoma, Langerhans cell histiocytosis  |
|               | CD2                    | T and NK cells  | Many T-cell lymphomas and leukemias  |
|               | CD3                    | T cells   | Most T-cell neoplasms  |
|               | CD5                    | T cells and subset of small B cells                       | Many T-cell lymphomas and leukemias and subset of diffuse small B-cell neoplasms, such as small lymphocytic lymphoma/chronic lymphocytic leukemia and mantle cell lymphoma |
|               | CD7                    | Most T cells and NK cells                                 | Many T-cell lymphomas and leukemias  |
|               | CD43                   | T cells, some macrophages, granulocytes, and plasma cells | Most T-cell lymphomas, some B-cell lymphomas, acute myeloid leukemias, and plasma cell neoplasms   |
|               | CD45RO                 | Most T cells, some macrophages, some myeloid cells        | Most T-cell lymphomas, some B-cell lymphomas   |
|               | CD57                   | Some NK cells, subset of T cells                          | Some NK- and T-cell lymphomas/leukemias and some lymphoblastic lymphomas   |

|                 |  |  |   |
|-----------------|--|--|---|
|                 | BF1 (β-chain of T-cell receptor)           | T cells  | Many T-cell lymphomas   |
| B cell          | CD10                                       | Precursor B cells and follicular center B cells                  | Many precursor B-lymphoblastic leukemias/lymphomas, some precursor T-lymphoblastic leukemias/lymphomas, many follicular lymphomas, Burkitt lymphoma |
|                 | CD20                                       | B cells  | Most B-NHL, L & H R-S cell in LPHD; R-S cells in some cases of classic Hodgkin disease  |
|                 | CD21                                       | Mantle and marginal zone B cells, FDC                            | Some mantle and marginal lymphomas, FDC tumors  |
|                 | CD23                                       | Mantle zone B cells, some FDC                                    | Chronic lymphocytic leukemia/small lymphocytic lymphoma   |
|                 | CD45RA                                     | B cells and subset of T cells                                    | B-cell NHL, L & H cells in LPHD, some T-cell lymphoid and myeloid leukemias   |
|                 | CD79a                                      | B cells  | Most B-cell NHL and many B-cell leukemias   |
|                 | Antiimmuno-globulin                        | B cells, plasma cells  | B-cell NHL and plasma cell neoplasms  |
| Hodgkin related | CD15                                       | Granulocytes and some macrophages                                | R-S cells in most cases of NS, MC, and LDHD; some T- and B-large cell lymphomas; some carcinomas  |
|                 | CD30                                       | Activated B and T cells, plasma cells                            | R-S cells in most cases of NS, MC, and LDHD; most cases of ALCL; other T- and B-cell NHL  |
| Miscellaneous   | CD34                                       | Progenitor cells   | Some acute myeloid leukemias and some precursor lymphoblastic leukemias/lymphomas   |
|                 | CD56                                       | NK cells, few T cells  | Many NK-cell neoplasms  |
|                 | CD68                                       | Macrophages and granulocytes                                     | True malignant histiocytosis; many myeloid leukemias  |
|                 | S100                                       | Langerhans cells, interdigitating dendritic cells, sometimes FDC | Langerhans cell histiocytosis, sinus histiocytosis with massive lymphadenopathy, rare T-cell lymphomas, myeloid leukemias                           |
|                 | Terminal deoxy-ribonucleotidyl transferase | Precursor marrow cells, cortical thymocytes                      | Most precursor B- or T-lymphoblastic leukemias/lymphomas, some acute myeloid leukemias  |
|                 | Ki-67                                      | Proliferating cells (not in G <sub>0</sub> -phase of cell cycle) | Proliferating cells   |
|                 | Myeloperoxidase                            | Myeloid cells  | Myeloid leukemias   |



|                             |   |   |
|-----------------------------|---|---|
| bcl-2                       | Nonfollicular center B cells, T cells             | Most follicular lymphomas, many other diffuse NHL and leukemias   |
| Epithelial membrane antigen | Various epithelia, plasma cells                   | L&H R-S cells in LPHD, plasma cell neoplasms, ALCL, some other B- and T-large cell NHL and many epithelial tumors |
| Cyclin D1                   | Minimal to no expression in normal lymphoid cells | Mantle cell lymphoma, hairy cell leukemia, and some cases of myeloma  |

ALCL, anaplastic large cell lymphoma; FDC, follicular dendritic cell; LDHD, lymphocyte-depletion Hodgkin disease; L & H, lymphocyte and histiocytic; LPHD, lymphocyte-predominance Hodgkin disease; MC, mixed cellularity; NHL, non-Hodgkin lymphoma; NK, natural killer; NS, nodular sclerosis; RS, Reed-Sternberg.

---

Flow cytometry is an important means of evaluating HLS neoplasms, especially for characterization of acute leukemias and the assessment of lineage and clonality of lymphoid proliferations ( [15](#), [16](#), [17](#), [18](#) and [19](#) ). Testing can usually be performed in several hours, is relatively inexpensive, and is widely available by transporting samples via overnight mail to reference laboratories. Performance and interpretation of flow cytometry testing require considerable expertise and experience. Correlation with histopathologic findings is essential, and diagnosing a process as leukemia or lymphoma based solely on flow cytometry should be avoided.

The cytogenetic and molecular characterization of leukemias and lymphomas using Southern analysis, polymerase chain reaction, *in situ* hybridization, karyotyping, and gene expression profiling has provided insight into the pathogenesis of these neoplasms, aided in diagnosis, classification, and prognosis, and improved recognition of minimal disease ( [20](#), [21](#), [22](#), [23](#), [24](#), [25](#), [26](#), [27](#), [28](#), [29](#), [30](#), [31](#), [32](#), [33](#), [34](#), [35](#) and [36](#) ). These techniques rely on the fact that virtually all HLS neoplasms are clonal and demonstrate alterations of DNA. However, equating clonality with neoplasia requires caution. Nonneoplastic-appearing lymphoproliferative processes with “benign” clinical courses have been shown to contain clonal populations of lymphoid cells or alterations in DNA ( [30](#), [37](#), [38](#), [39](#), [40](#) and [41](#) ). Like phenotypic assays, molecular studies require that interpretation be correlated with histopathologic examination.

Complicated or uncommon cases of leukemia and lymphoma should be sent to a consultant who is experienced in hematopathology ( [1](#) ). Many pathologists find the field of hematopathology difficult ( [5](#) ) because of the complexity of the HLS, the lack of reliable diagnostic criteria for some neoplasms, the similarity of some reactive processes to neoplasms, and the lack of experience with uncommon disorders ( [1](#) ). Controversy over terminology and classification of leukemias and lymphomas also causes confusion for many pathologists.

## CLASSIFICATION OF HEMATOPOIETIC AND LYMPHOID NEOPLASMS

The approach to classification of leukemias and lymphomas should be comparable to that used for other neoplasms ( [1](#) ). An ideal classification should be scientifically accurate,

reproducible by the average pathologist, and predict clinical behavior ( 42 ). It should incorporate the presumed site of origin of the tumor, the presumed cell of origin, the phenotype of the neoplastic cell, and the cell cycle or differentiation stage of the neoplastic population ( 1 ).

In no other area of oncology has the classification of tumors been more controversial than in the field of hematopoietic and lymphoid neoplasms, especially non-Hodgkin lymphomas. The existence of numerous classification systems, each with very different conceptual frameworks and terminology, coupled with rapid advances in immunologic and molecular genetic techniques used to identify new entities, has led to confusion and difficulty in communication ( 43 ).

In the past, classifications of non-Hodgkin lymphomas included the Working Formulation ( 44 ) and the Lukes-Collins system ( 1 ) in the United States, and, in Europe, the Kiel classification ( 45 ). Acute leukemias were generally classified by modifications of the French-American-British system ( 46 and 47 ).

Recently, the World Health Organization classification ( 2 ) of hematopoietic and lymphoid neoplasms ( Table 71.3 ) was developed as a joint effort of American and European professional societies and was based, in part, on the earlier revised European-American lymphoma (or so-called "REAL") classification ( 48 ). This classification has gained wide acceptance and is a listing of distinct clinicopathologic, immunophenotypic, and genetic entities among hematopoietic and lymphoid neoplasms. Refinements and modifications of the World Health Organization classification are likely to occur in the future as our knowledge of the HLS continues to expand and new biologic observations are translated into new clinical entities.

**TABLE 71.3. World Health Organization Classification of Hematopoietic and Lymphoid Neoplasms**

---

|   |
|---|
| Chronic myeloproliferative diseases                         |
| Chronic myelogenous leukemia                                |
| Chronic neutrophilic leukemia                               |
| Chronic eosinophilic leukemia/hypereosinophilic syndrome    |
| Polycythemia vera   |
| Chronic idiopathic myelofibrosis                            |
| Essential thrombocythemia                                   |
| Chronic myeloproliferative disease, unclassifiable          |
| Myelodysplastic/myeloproliferative diseases                 |
| Chronic myelomonocytic leukemia                             |
| Atypical chronic myeloid leukemia                           |
| Juvenile myelomonocytic leukemia                            |
| Myelodysplastic/myeloproliferative diseases, unclassifiable |
| Myelodysplastic syndromes                                   |
| Refractory anemia   |
| Refractory anemia with ringed sideroblasts                  |
| Refractory cytopenia with multilineage dysplasia            |
| Refractory anemia with excess blasts                        |
| Myelodysplastic syndrome, unclassifiable                    |

Myelodysplastic syndrome associated with isolated del(5q) chromosome abnormality  
AML

AML with recurrent cytogenetic abnormalities

AML with t(8;21) (q22;q22) (AML1/ETO)

AML with inv(16)(p13q22) or t(16,16) (p13;q22) (CBFB/MYH11)

Acute promyelocytic leukemia [AML with t(15;17)(q22;q12), (PML/RAR- $\alpha$ ) and variants]

AML with 11q23 (MLL) abnormalities

AML with multilineage dysplasia

AML and myelodysplastic syndrome, therapy-related

Alkylating agent-related

Topoisomerase II inhibitor-related

AML not otherwise categorized

AML minimally differentiated

AML without maturation

AML with maturation

Acute myelomonocytic leukemia

Acute monoblastic and monocytic leukemia

Acute erythroid leukemia

Acute megakaryocytic leukemia

Acute basophilic leukemia

Acute panmyelosis with myelofibrosis

Myeloid sarcoma

Acute leukemias of ambiguous lineage

Precursor B-cell neoplasms

Precursor B-lymphoblastic leukemia/lymphoma

Precursor T-lymphoblastic leukemia/lymphoma

Mature (peripheral) B-cell neoplasms

Chronic lymphocytic leukemia/small lymphocytic lymphoma

B-cell prolymphocytic leukemia

Lymphoplasmacytic lymphoma/Waldenström macroglobulinemia

Splenic marginal zone lymphoma

Hairy cell leukemia

Plasma cell neoplasms

Plasma cell myeloma

Plasmacytoma

Monoclonal immunoglobulin deposition diseases

Heavy chain diseases

Extranodal marginal zone B-cell lymphoma (MALT lymphoma)

Nodal marginal zone B-cell lymphoma

Follicular lymphoma

Mantle cell lymphoma

Diffuse large B-cell lymphoma

Mediastinal (thymic) large B-cell lymphoma

Intravascular large B-cell lymphoma

Primary effusion lymphoma

Burkitt lymphoma/leukemia

Lymphomatoid granulomatosis

Mature (peripheral) T-cell neoplasms

- T-cell prolymphocytic leukemia
- T-cell large granular lymphocytic leukemia
- Aggressive NK-cell leukemia
- Adult T-cell lymphoma/leukemia
- Extranodal NK/T-cell lymphoma, nasal type
- Enteropathy-type T-cell lymphoma
- Hepatosplenic T-cell lymphoma
- Subcutaneous panniculitis-like T-cell lymphoma
- Blastic NK-cell lymphoma
- Mycosis fungoides/Sézary syndrome
- Primary cutaneous CD30-positive T-cell lymphoproliferative disorders
  - Primary cutaneous anaplastic large cell lymphoma (C-ALCL)
  - Lymphomatoid papulosis
  - Borderline lesions
- Angioimmunoblastic T-cell lymphoma
- Peripheral T-cell lymphoma, unspecified
- Anaplastic large cell lymphoma
- Hodgkin lymphoma
  - Nodular lymphocyte-predominant Hodgkin lymphoma
  - Classical Hodgkin lymphoma
    - Nodular sclerosis Hodgkin lymphoma
    - Mixed cellularity Hodgkin lymphoma
    - Lymphocyte-rich classical Hodgkin lymphoma
    - Lymphocyte-depleted Hodgkin lymphoma
- Immunodeficiency-associated lymphoproliferative disorders
  - Lymphoproliferative diseases associated with primary immune disorders
  - Human immunodeficiency virus-related lymphomas
  - Posttransplant lymphoproliferative disorders
  - Methotrexate-associated lymphoproliferative disorders
- Histiocytic and dendritic cell neoplasms
  - Histiocytic sarcoma
  - Langerhans cell histiocytosis
  - Langerhans cell sarcoma
  - Interdigitating dendritic cell sarcoma/tumor
  - Follicular dendritic cell sarcoma/tumor
  - Dendritic cell sarcoma, not otherwise specified
- Mastocytosis
  - Cutaneous mastocytosis
  - Systemic mastocytosis
  - Mast-cell sarcoma
  - Extracutaneous mastocytoma

AML, acute myeloid leukemia; NK, natural killer.

Adapted from Jaffe ES, Harris NL, Stein H, Vardiman J, eds. Pathology and genetics of tumours of haematopoietic and lymphoid tissues. Lyon, France: IARC Press; 2001.

---

## REFERENCES

1. Lukes RJ, Collins RD. Tumors of the hematopoietic system. Atlas of tumor pathology, 2nd series, fascicle 28. Washington, DC: Armed Forces Institute of Pathology, 1992:1–38.
2. Jaffe ES, Harris NL, Stein H, Vardiman J, eds. Pathology and genetics of tumours of haematopoietic and lymphoid tissues. Lyon, France: IARC Press; 2001.
3. Cousar JB, Casey TT, Macon WR, et al. Lymph nodes. In: Sternberg SS, et al., eds. Diagnostic surgical pathology, 3rd ed. Philadelphia: Lippincott Williams & Wilkins, 1999:709–777.
4. Collins RD. Lymph node examination. What is an adequate workup? Arch Pathol Lab Med 1985;109:796–799.
5. Cousar JB. Surgical pathology examination of lymph nodes. Practice survey by American Society of Clinical Pathologists. Am J Clin Pathol 1995;104:126–132.
6. Kline TS, Kannan V, Kline IK. Lymphadenopathy and aspiration biopsy cytology: review of 376 superficial nodes. Cancer 1984;54:1076–1081.
7. Weiss LM, Pitts WC. The role of fine needle aspiration biopsy in diagnosis and management of hematopoietic neoplasms. In: Knowles DM, ed. Neoplastic hematopathology, 2nd ed. Baltimore: Lippincott Williams & Wilkins, 2001:483–505.
8. Hajdu SI, Melamed ZMR. Limitations of aspiration cytology in the diagnosis of primary neoplasms. Acta Cytol 1984;28:337–345.
9. Hu E, Homing S, Flynn S, et al. Diagnosis of B-cell lymphoma by analysis of immunoglobulin gene rearrangements in biopsy specimens obtained by fine needle aspiration. J Clin Pathol 1986;4:278–283.
10. Oertel J, Oertel B, Kastner M, et al. The value of immunocytochemical staining of lymph node aspirates in diagnostic cytology. Br J Haematol 1988;70:307–316.
11. Knowles DM. Immunophenotypic markers useful in the diagnosis and classification of hematopoietic neoplasms. In: Knowles DM, ed. Neoplastic hematopathology, 2nd ed. Baltimore: Lippincott Williams & Wilkins, 2001:93–226.
12. Perkins SL, Kjeldsberg CR. Immunophenotyping of lymphomas and leukemias in paraffin-embedded tissues. Am J Clin Pathol 1993;99:362–373.
13. Stetler-Stevenson M, Medeiros LJ, Jaffe ES. Immunophenotyping methods and findings in the diagnosis of lymphoproliferative diseases. In: Jaffe ES, ed. Surgical pathology of the lymph nodes and related organs, 2nd ed. Philadelphia: WB Saunders, 1995:22–57.
14. Warnke RA, Weiss LM, Chan JKC, et al. Tumors of the lymph nodes and spleen. Atlas of tumor pathology, 3rd series, fascicle. Washington, DC: Armed Forces Institute of Pathology, 1995:15–62.
15. Borowitz MJ, Bray R, Gascoyne R, et al. U.S.–Canadian consensus recommendations on the immunophenotypic analysis of hematologic neoplasia by flow cytometry: data analysis and interpretation. Cytometry 1997;30:236–244.
16. Davis BH, Foucar K, Szczarkawski W, et al. U.S.–Canadian consensus recommendations on the immunophenotypic analysis of hematologic neoplasia by flow cytometry: medical indications. Cytometry 1997;30:249–263.
17. Neame PB, Soamboonsrup P, Browman GP, et al. Classifying acute leukemia by immunophenotyping: a combined FAB-immunologic classification of AML. Blood 1986;68:1355–1362.
18. Terstappen LWMM, Safford M, Konemann S, et al. Flow cytometric characterization of acute myeloid leukemia. Leukemia 1991;5:757–767.

19. Traweek ST. Immunophenotypic analysis of acute leukemia. *Am J Clin Pathol* 1993;99:505–512.
20. Clare N, Hansen K. Cytogenetics in the diagnosis of hematologic malignancies. *Hematol Oncol Clin North Am* 1994;8:785–807.
21. Davis RE, Warnke RA, Dorfman RF, Cleary ML. Utility of molecular genetic analysis for the diagnosis of neoplasia in morphologically and immunophenotypically equivocal hematolymphoid lesions. *Cancer* 1991;67:2890–2899.
22. Drexler HG, Borkhart A, Janssen JW. Detection of chromosomal locations in leukemia–lymphoma cells by polymerase chain reaction. *Leuk Lymphoma* 1995;19:359–380.
23. Gray JN, Pallavicini MG. Molecular cytogenetics: solid tumors and leukemia. *Blood Cells* 1993;19:677–683.
24. Grody WW, Gatti RA, Naeim F. Diagnostic molecular pathology. *Mod Pathol* 1989;2:553–568.
25. Kay NE. Clinical utility of molecular probes in lymphoproliferative disorders. *Blood Rev* 1996;10:81–88.
26. LeBeau MM. Chromosomal abnormalities in non–Hodgkin’s lymphomas. *Semin Oncol* 1990;17:20–29.
27. Frizzera G, Wu CD, Inghirami G. The usefulness of immunophenotypic and genotypic studies in the diagnosis and classification of hematopoietic lymphoid neoplasms. *Am J Clin Pathol* 1999;111[Suppl 1]:513–539.
28. Mrozek K, Heinonen K, de la Chapelle A, Bloomfield CD. Clinical significance of cytogenetics in acute myeloid leukemia. *Semin Oncol* 1997;24:17–31.
29. Rowley JD. Recurring chromosome abnormalities in leukemia and lymphoma. *Semin Hematol* 1990;27:122–136.
30. Sklar J, Longtine J. The clinical significance of antigen receptor gene rearrangements in lymphoid neoplasia. *Cancer Suppl* 1992;70:1710–1718.
31. Veronese ML, Schichman SA, Croce CM. Molecular diagnosis of lymphoma. *Curr Opin Oncol* 1996;8:346–352.
32. Walker H, Smith FJ, Betts DR. Cytogenetics in acute myeloid leukemia. *Blood Rev* 1994;8:30–36.
33. Ratech H. The uses of molecular biology in hematopathology. Oncogenes as diagnostic markers in non–Hodgkin’s malignant lymphoma. *Am J Clin Pathol* 1993;99:381–384.
34. Staudt LM. Gene expression profiling of lymphoid malignancies. *Ann Rev Med* 2002;53:303–318.
35. Shipp MA, Ross KN, Tamayo P, et al. Diffuse large B–cell lymphoma outcome prediction by gene–expression profiling and supervised machine learning. *Nat Med* 2002;8:68–74.
36. Andreas R, Wright G, Chan WC, et al. The use of molecular profiling to predict survival after chemotherapy for diffuse large B–cell lymphoma. *N Engl J Med* 2002;346:1937–1947.
37. Aster JC, Kobayashi Y, Shiota M, et al. Detection of the t(14;18) at similar frequency in hyperplastic lymphoid tissues from American and Japanese students. *Am J Pathol* 1992;141:291–299.
38. Bignon YJ, Souteyrand P. Cutaneous lymphoma. *Curr Probl Dermatol* 1990;19:114–123.
39. Farhi DC, McGuire PW, Luckey CN. Monoclonality in reactive lymphadenopathy: gene rearrangement and multiparameter analysis. *Hematol Pathol* 1993;7:143–152.
40. Limpens J, deJong D, Krieken van JHJM, et al. Bcl–2/J<sub>H</sub> rearrangements in benign lymphoid tissues with follicular hyperplasia. *Oncogene* 1991;6:2271–2276.

41. Segal GH, Scott M, Jorgensen T, Braylan RC. Standard polymerase chain reaction analysis does not detect t(14;18) in reactive lymphoid hyperplasia. *Arch Pathol Lab Med* 1994;48:791–794.
42. Rosenberg SA. Classification of lymphoid neoplasms [editorial]. *Blood* 1994;84:1359–1360.
43. Magrath IT. Concepts and controversies in lymphoid neoplasia. In: Magrath IT, ed. *The non-Hodgkin's lymphomas*, 2nd ed. London: Arnold, 1997:3–46.
44. Non-Hodgkin's lymphoma pathologic classification project. National Cancer Institute sponsored study of classifications of non-Hodgkin's lymphomas: summary and description of a working formulation for clinical usage. *Cancer* 1982;49:2112–2135.
45. Lennert K, Feller A. *Histopathology of non-Hodgkin's lymphomas*, 2nd ed. New York: Springer-Verlag, 1992:13–52.
46. Bennett JM, Catovsky D, Daniel M-T, et al. Proposals for the classification of acute leukemias: French-American-British (FAB) co-operative group. *Br J Haematol* 1976;33:451–458.
47. Bennett JM, Catovsky D, Daniel M-T, et al. Proposed revised criteria for the classification of acute leukemia. *Ann Intern Med* 1985;103:620–625.
48. Harris NL, Jaffe ES, Stein H, et al. A revised European-American classification of lymphoid neoplasms: a proposal from the International Lymphoma Study Group. *Blood* 1994;84:1361–1392.

2004 Lippincott Williams & Wilkins  
John P. Greer, John Foerster, John N. Lukens  
George M. Rodgers, Frixos Paraskevas, Bertil Glader  
Wintrobe's Clinical Hematology



## Complications of Hematopoietic Neoplasms

### DEFECTS IN HOST DEFENSE

[Neutrophil Defects](#)

[Deficient Immunoglobulin Production](#)

[Defects in Cellular Immunity](#)

### HEMORRHAGE

[Thrombocytopenia](#)

[Platelet Dysfunction](#)

[Other Causes of Hemorrhage](#)

### ANEMIA

### ORGAN INFILTRATION AND DYSFUNCTION

[Intravascular Complications: Leukostasis and Intravascular Tumors](#)

[Neurologic Complications](#)

[Ocular Complications](#)

[Head and Neck Involvement](#)

[Thoracic Complications](#)

[Cardiac Complications](#)

[Breast Involvement](#)

[Abdominal Complications](#)

[Skin Involvement](#)

[Musculoskeletal Complications](#)

[Metabolic Complications](#)

### REFERENCES

Patients with hematologic neoplasms are at risk of complications from the neoplasms as well as from the treatment. Hematologic neoplasms commonly cause morbidity and mortality through three general mechanisms: (a) a deficit in cell number or function; (b) invasion of vital organs with impairment of organ function; and (c) systemic disturbance, as manifested by weight loss, fever, sweats, or pruritus, or metabolic alteration, such as tumor lysis. The frequency of these complications and their management vary according to the disease. For example, disseminated intravascular coagulation (DIC) commonly occurs in acute myeloid leukemia (AML), particularly acute promyelocytic leukemia (APL), whereas tumor lysis occurs in acute lymphoblastic leukemia (ALL), particularly with bulky disease as observed in T-ALL or Burkitt leukemia. Cytopenias are common to hematologic neoplasia and are addressed with the description of specific diseases in specific chapters (anemia, ; thrombocytopenia, Part V: ; neutropenia, [Chapter 63](#) and [Chapter 64](#)). Deficient immunoglobulin (Ig) production is common in chronic lymphocytic leukemia (CLL) and multiple myeloma (MM) and contributes to the frequency and types of infection. Fever and infection, often the result of neutropenia, are among the most serious complications; their diagnosis and management are addressed in [Chapter 75](#). Hemorrhage, often a result of thrombocytopenia, is another major problem associated with hematologic neoplasms. This chapter addresses defects in host defenses, hemorrhage, anemia, complications caused by invasion of vital organs, and metabolic disturbances associated with hematologic neoplasia.

### DEFECTS IN HOST DEFENSE

The natural course of hematologic neoplasia often includes a phase of impaired host defense. Multiple factors may contribute to decreased resistance, including those related to the host and those related to the disease. It is helpful to divide opportunistic infections into those caused by impairment of phagocytosis (mainly neutropenia), defective production of circulating antibody (humoral immunity), and impaired cellular immunity, or by a combination of these defects. [Table 72.1](#) outlines defects in host defense mechanisms associated with specific neoplasms. As discussed in [Chapter 75](#), other host factors, such as disruption of the skin by catheters or ulcerations and anatomic obstruction of respiratory or gastrointestinal tracts, predispose patients to infections. Concomitant illnesses, such as diabetes, nephrotic syndrome, cardiac disease, and liver disease, may also contribute to infections, as well as influence management decisions ([1](#)). Moreover, chemotherapy, malnutrition, and, rarely, transfusions may play roles in the development of infections.

**TABLE 72.1. Host Defects Predisposing to Complications in Hematologic Malignancies**

| Disease                      | Host Defect  | Complications   |
|------------------------------|--|---|
| Acute myeloid leukemia       | Neutropenia  | Bacterial infections, including perirectal abscess, typhlitis, sinusitis; superinfections when hospitalized; increasing problem of methicillin-resistant <i>Staphylococcus aureus</i> and coagulase-negative staphylococci; <i>Clostridium difficile</i> colitis; aspergillosis with prolonged neutropenia; viral infections (herpes simplex) |
|                              | Thrombocytopenia, disseminated intravascular coagulation | Hemorrhage  |
| Acute lymphoblastic leukemia | Hyperleukocytosis  | Leukostasis, tumor lysis  |
|                              | Neutropenia  | Bacterial infections (see <a href="#">Acute myeloid leukemia</a> )  |
|                              | Cellular immunity while on maintenance therapy           | <i>Pneumocystis carinii</i> , disseminated varicella  |
| Chronic myeloid leukemia     | Thrombocytopenia   | Hemorrhage  |
|                              | Hyperleukocytosis  | Tumor lysis, leukostasis  |
|                              | Mild defects in neutrophil function                      | No increased risk of infections except in blast crisis  |
| CLL                          | Thrombocytosis, platelet dysfunction                     | Increased risk of thrombosis and hemorrhage, similar to other myeloproliferative disorders  |
|                              | Decreased immunoglobulins                                | Infections with encapsulated organisms (pneumococcus, <i>Haemophilus influenzae</i> , meningococcus)  |
|                              | Cellular immunity  | Mycobacteria, fungal, viral (herpetic), <i>Salmonella</i>   |
|                              | Immune dysfunction                                       | AIHA, ITP, red cell aplasia   |

|   |  |  |
|---|--|--|
| Hodgkin disease   | Cellular immunity  | Viral (herpes zoster, other), <i>P. carinii</i> , fungal, mycobacteria, listeriosis, <i>Salmonella</i> |
|   | Cytokine production  | B symptoms, pruritus, eosinophilia   |
|   | Splenectomized   | Encapsulated organisms (above), increased risk of leukemia   |
| Immune dysfunction  |  | ITP, AIHA  |
|   | Mediastinal disease  | SVC syndrome   |
| Non-Hodgkin lymphoma  |  |  |
| Small B-cell lymphoma   | Decreased Igs  | Similar infections to CLL  |
| PTCL, particularly angioimmunoblastic and subcutaneous panniculitis-like PTCL | Immune dysfunction   | AIHA   |
|   | Cytokine production  | B symptoms, hemophagocytic syndrome, eosinophilia  |
| Large B-cell lymphoma   | Mediastinal disease  | SVC syndrome, pericardial disease  |
| T-lymphoblastic lymphoma  | Mediastinal disease  | SVC syndrome, tumor lysis, CNS disease   |
| Mantle-cell lymphoma  | Colonic polyposis  | Gastrointestinal bleed   |
| Burkitt lymphoma  | Gastrointestinal primary   | Obstruction, perforation, tumor lysis, CNS disease with advanced stage disease                         |
| Multiple myeloma  | Paraprotein  | Hyperviscosity, hemorrhage   |
|   | Decreased Igs  | Similar infections to CLL  |
|   | Osteoclast overactivity  | Hypercalcemia  |
| Waldenström macroglobulinemia   | IgM paraprotein  | Hyperviscosity, hemorrhage   |
| Hairy cell leukemia   | Neutropenia  | Bacterial infections, fungal   |
|   | Cellular immunity  | <i>P. carinii</i> , atypical mycobacteria  |
|   | Immune dysfunction   | Periarteritis nodosa, lymphocytic vasculitis   |
| T-cell large granular lymphocyte leukemia                                     | Monocytopenia  | —  |
|   | Neutropenia  | Bacterial infections   |
|   | Immune dysregulation, positive rheumatoid factor, antinuclear antibody | ITP, AIHA, red cell aplasia  |
| Adult T-cell leukemia/lymphoma  | Cellular immunity  | Opportunistic infections ( <i>Strongyloides stercoralis</i> , <i>P. carinii</i> )                      |
|   | Parathyroid hormone-related protein                                    | Hypercalcemia  |

AIHA, autoimmune hemolytic anemia; CLL, chronic lymphocytic leukemia; CNS, central nervous system; Ig, immunoglobulin; ITP, immune thrombocytopenic purpura; PTCL, peripheral T-cell lymphoma; SVC, superior vena cava.

---

## Neutrophil Defects

*Neutropenia*, defined as a decrease of the peripheral blood neutrophil count below 1000/mm<sup>3</sup>, predisposes to bacterial and fungal infections. The severity (<100/mm<sup>3</sup>) and length of neutropenia (>2 weeks) contribute to the risk of serious, overwhelming infections (2). Neutropenia is a common complication of acute leukemia (AL), is often prolonged during induction therapy, and predisposes the patient to specific sites and types of infections (Table 72.2). In patients with chronic myeloid leukemia (CML), neutropenia occurs only with blast crisis, in the face of developing myelofibrosis, or with therapy. In CLL, neutropenia is unusual in untreated patients (3, 4). Neutropenia is observed in myelofibrosis and may be mild in MM but is uncommon during untreated phases of other hematologic diseases. When neutropenia occurs in patients with Hodgkin disease (HD) or non-Hodgkin lymphoma (NHL), marrow invasion with tumor or fibrosis of marrow is usually present in conjunction with other cytopenias. In patients with hairy cell leukemia (HCL), opportunistic infections may occur as a result of neutropenia secondary to tumor cell invasion, splenomegaly, or both but may also result from defects in cell-mediated immunity, monocytopenia, and, more recently, decreased T cells after nucleoside analog therapy (5). Neutropenia may be the primary clinical problem in patients with T-cell large granular lymphocytic leukemia.

**TABLE 72.2. Opportunistic Infections Associated with Defects in Immunity in Hematologic Neoplasia**

| Defect            | Infections  |
|-------------------|---|
| Neutropenia       | Gram-negative bacteremia ( <i>Escherichia coli</i> , <i>Pseudomonas</i> , <i>Klebsiella</i> , <i>Proteus</i> )<br>Gram-positive bacteremia (methicillin-resistant <i>Staphylococcus aureus</i> , coagulase-negative staphylococci, <i>Streptococcus viridans</i> )<br>Fungemia ( <i>Candida</i> species, aspergillosis) |
| Humoral immunity  | Encapsulated organisms<br><br><i>Streptococcus pneumoniae</i><br><i>Haemophilus influenzae</i><br><i>Neisseria meningitidis</i>   |
| Cellular immunity | Bacteria  |

*Listeria monocytogenes*  
Mycobacteria  
*Legionella* species  
*Nocardia* species  
*Salmonella* species  
Viruses  
Herpes simplex  
Varicella zoster  
Parainfluenza, respiratory syncytial virus, cytomegalovirus  
Fungi  
*Cryptococcus neoformans*  
*Coccidioides immitis*  
*Histoplasma capsulatum*  
Parasites  
*Pneumocystis carinii*  
*Toxoplasma gondii*  
*Strongyloides stercoralis*

---

In any of the diseases under consideration, neutropenia is usually caused by decreased production. When neutropenia is severe, localizing signs and symptoms are often absent because of a lack of inflammatory response from absent granulocytes ([1](#), [6](#)). Fever remains the most common sign of infection associated with neutropenia and requires prompt attention ([Chapter 75](#)).

Functional defects in morphologically normal neutrophils have been described in hematologic malignancies, particularly myeloproliferative disorders and myelodysplasia (MDS); however, the effect of such defects on enhancing the susceptibility to infection is uncertain ([Chapter 63](#)). Neutrophils from untreated patients with CML may be mildly defective with respect to phagocytosis, oxygen consumption, and bactericidal capacity and tend to have decreased concentrations of lactoferrin, elastase, collagenase, and peroxidase ([7](#)).

Alternatively, neutrophil superoxide ( $O_2^-$ )-producing capacity has been increased in myeloproliferative disorders, including CML ([8](#)). Decreased lobation and abnormal granulation in MDS may contribute to increased infections ([Chapter 83](#)).

Immature leukemic cells, as found in ALs, are of no benefit to the host against infection ([6](#)). Lysosomal enzymes of possible importance in bacterial killing, such as lysozyme, lactoferrin, and peroxidase, have been found in reduced concentrations in neutrophils of some patients with AML ([9](#), [10](#) and [11](#)). In ALs, bactericidal capacity and lysozyme content have been reported to be reduced, but phagocytosis was normal ([11](#), [12](#)). Neutrophil function generally is normal in CLL, HD, and NHL, although serum factors inhibiting chemotaxis have been described in some patients. Impaired adhesiveness of granulocytes has been reported in MM. A variety of functional neutrophil defects may also occur secondary to both chemotherapy ([13](#), [14](#)) and radiation therapy ([15](#)).

## Deficient Immunoglobulin Production

Impaired humoral immunity is the second major cause of frequent and severe infection in patients with hematologic neoplasia. There is decreased Th2 CD4 T-lymphocyte-B-lymphocyte interaction, resulting in decreased antibody production, complement-mediated damage, and phagocytosis ( [1](#) ). Decreased Ig synthesis is a major cause of infection in patients with CLL ( [16](#) ) and MM ( [17](#) ) and in a smaller percentage of those with B-cell types of NHL ( [18](#) , [19](#) and [20](#) ). Hypogammaglobulinemia is unusual in those with other lymphomas or HD except in severely ill patients. Patients who have had splenectomy for hypersplenism or for staging in HD have impaired antibody response, have reduced levels of tuftsin, and are at risk for infections similar to those of patients with hypogammaglobulinemia, particularly encapsulated organisms ( *Streptococcus pneumoniae*, *Haemophilus influenzae*, and *Neisseria meningitidis* ) ( [21](#) ). Igs tend to be toward the lower limit of normal in ALL but are normal or increased in AML and CML unless extensive therapy has been used ( [22](#) ). Polyclonal hypergammaglobulinemia has been described in HD and in T-cell neoplasms, including peripheral T-cell lymphomas and T-CLL ( [23](#) ).

Defective production of circulating Ig is often reflected in hypogammaglobulinemia and by reduction in naturally occurring Igs such as isoantibodies to red cell antigens. Hypogammaglobulinemia may be observed in the absence of extensive CLL or MM, and such patients may die of infection at a time when their disease is in an early stage. All classes of Igs may be depressed, or one class may be selectively depressed. Replacement of gammaglobulin is warranted in selected patients with hypogammaglobulinemia and recurrent severe infections ( [24](#) ).

### Defects in Cellular Immunity

Depressed cell-mediated immunity is characterized by impairment of Th1 CD4<sup>+</sup> T lymphocytes or macrophage function or both, resulting in an increased risk of infections with intracellular bacteria, fungi, parasites, and viruses ( [Table 72.2](#) ) ( [1](#) ). The patient with HD who is anergic, as judged by loss of sensitivity to skin tests, has lymphocytes that fail to transform when exposed to phytohemagglutinin or pokeweed mitogen ( [25](#) ). Patients with HD often do not respond to new antigens and lose prior sensitivity as well ( [26](#) , [27](#) ). Patients with CLL usually show reduced or absent lymphocyte transformation with phytohemagglutinin ( [28](#) ) but do not lose skin hypersensitivity to antigens such as old tuberculin. Patients with HD do not mount either a primary or a secondary immune response, whereas those with CLL maintain secondary responses but cannot mount a primary response. Cell-mediated immune responses may be abnormal in MM, but these responses have not been as well characterized as in CLL or HD. Depressed cellular immunity is uncommon in AL ( [29](#) ) except during maintenance therapy in ALL ( [30](#) ) or when patients are extremely ill ( [31](#) ).

The frequency and severity of impaired cellular immunity are variable and dependent on multiple factors. There may be differences in the stages of disease studied, the therapy used, and the sensitivity of the tests used to measure cellular immunity. In HD, a direct correlation exists between impaired cell-mediated immunity and the severity and stage of disease ( [Chapter 95](#) ). Although therapy with a wide variety of antitumor drugs produces energy as a transient manifestation in either HD or CLL, treatment, if successful, may lead to eventual improvement of cell-mediated immunity ( [26](#) , [32](#) ). In HD, after apparent eradication of disease by radiotherapy or chemotherapy, cell-mediated immunity as judged by either skin tests or phytohemagglutinin transformation may return to normal, although many months are required in most cases ( [26](#) , [33](#) ). Herpes zoster often remains a

clinical problem in patients cured of HD. As noted previously, patients with HCL are compromised by combined defects in host defense, and their clinical courses have been often characterized by multiple infections, including gram-negative organisms as a result of neutropenia and opportunistic infections because of decreased cell-mediated immunity ( [34](#), [35](#) and [36](#) ). Immunosuppression after bone marrow transplantation is a common problem and is dependent on the type of transplant (autologous vs. allogeneic) and the severity of graft-versus-host disease.

## HEMORRHAGE

Serious, life-threatening hemorrhage is a common problem in the ALs and may occur in association with any of the diseases under consideration. Petechiae, purpura, and ecchymoses are the most common manifestations of hemorrhage and occur at diagnosis in 40 to 70% of patients with AL ( [37](#), [38](#) ). The most prevalent sites of hemorrhage are the skin, eyes, and mucosal membranes of the nose, gingiva, and gastrointestinal tract ( [37](#), [39](#), [40](#) ). Retinal bleeding occurs in approximately 15% of patients with AL at diagnosis and in up to 50% of patients as the disease progresses ( [37](#), [38](#), [41](#) ). Life-threatening hemorrhage is usually into the gastrointestinal tract or the central nervous system (CNS) but has also occurred in the lungs, uterus, and ovaries ( [38](#) ). Although infection has surpassed hemorrhage as the leading cause of death in AL, hemorrhage remains a prominent problem, contributing to death in approximately 40% of patients ( [27](#), [37](#), [38](#), [40](#) ).

Hemorrhage is less of a problem in both CML and CLL, although thromboses or thromboembolism frequently occurs in the chronic leukemias ( [37](#), [39](#) ). Hemorrhage by oozing from either the gastrointestinal tract or genitourinary tract may become a clinical problem in the chronic leukemias but is rarely life-threatening except during therapy or in advanced stages of the diseases, in blast crisis of CML, or marrow infiltration in CLL. Hemorrhage in hematologic neoplasia is most often caused by thrombocytopenia but may also occur as a result of platelet dysfunction, DIC, liver disease, fibrinolysis, and vascular defects. [Table 72.3](#) outlines hemostatic defects in hematologic neoplasms ( [37](#) ).

**TABLE 72.3. Defective Hemostasis in Hematologic Neoplasms**

---

|  |
|--|
| Thrombocytopenia                       |
| Platelet dysfunction                   |
| Disseminated intravascular coagulation |
| Leukemia cell procoagulant activity    |
| Bacteremia                             |
| Massive transfusions                   |
| Shock                                  |
| Coagulation protein defects            |
| Liver infiltration                     |
| Cholestasis                            |
| Drug-induced                           |
| Circulating inhibitors                 |
| Primary fibrinolysis                   |
| Leukemia cell proteolytic activity     |
| Drug-induced                           |
| Vascular defects                       |
| Infiltration                           |



Leukostasis  
Extramedullary hematopoiesis  
Paraproteins  
Hyperviscosity

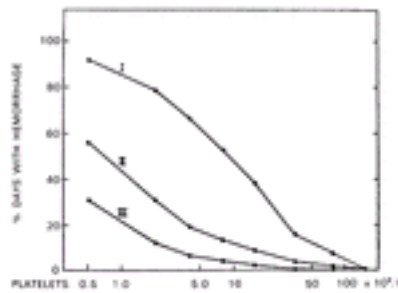
Adapted from Bick RL, Strauss JF, Frenkel EP. Thrombosis and hemorrhage in oncology patients. *Hematol Oncol Clin North Am* 1996;10:885.

---

## Thrombocytopenia

Reduced numbers of platelets in hematologic neoplasia are usually the result of chemotherapy or marrow infiltration; however, other less common causes include DIC, particularly in APL, infection-induced immune or nonimmune thrombocytopenia, idiopathic or immune thrombocytopenia, and hypersplenism secondary to splenomegaly ( 37 ).

The relationship of hemorrhage to the degree of thrombocytopenia has been defined in AL ( Fig. 72.1 ) ( 42 ). Although the risk of severe hemorrhage has been decreased by the use of platelet transfusions, an optimal platelet count threshold for prophylactic platelet transfusion in patients with AL remains controversial. Platelet counts below 20,000/ $\mu$ l have been used as the threshold for transfusion, but life-threatening hemorrhage is unusual unless the count is less than 5,000/ $\mu$ l ( 37 , 42 ). Moreover, randomized studies comparing a threshold of 10,000/ $\mu$ l or less with one of 20,000/ $\mu$ l or less showed no major differences in morbidity in adults with AL ( 43 , 44 and 45 ). Thus, it is reasonable to use a platelet count threshold of less than 10,000/ $\mu$ l for prophylactic platelet transfusion in patients without risk factors for hemorrhage who have ready access to medical care. If serious hemorrhage occurs with platelet counts above 20,000/ $\mu$ l, a cause of hemorrhage other than thrombocytopenia should be sought ( Table 72.3 ). Some authorities have advocated screening the urine and stool for bleeding and, if bleeding is not detected, transfusing patients only when platelets are below 5,000/ $\mu$ l ( 37 ). Patients with AL undergoing treatment require multiple platelet transfusions and have a risk of alloimmunization, which, in turn, can lead to platelet refractoriness. Platelets can be obtained from single donors or pooled from multiple random donors. The product can be modified by leukodepletion or by irradiation. The TRAP (Trial to Reduce Alloimmunization Study Group) compared the rate of alloimmunization in patients receiving unmodified pooled platelet from random donors, filtered (leukodepleted) pooled platelet from random donors, ultraviolet B-irradiated pooled platelet from random donors, and filtered platelets obtained by apheresis from a single random donor. They concluded that reduction of leucocytes by filtration was as effective as irradiated platelets in preventing alloantibody-mediated platelet refractoriness in patients undergoing chemotherapy for acute myeloid leukemia. Single donor platelets obtained by apheresis did not provide additional benefit ( 46 ). Platelet transfusion tends to fail in only two circumstances: in the febrile infected patient and in the patient who develops alloantibodies ( 46 ).



**Figure 72.1.** Relation between hemorrhage and platelet count. The percentage of days when hemorrhage occurred in the 92 patients combined is shown for each of the levels of platelet count. Curve I shows data for all hemorrhagic manifestations. In curve II, skin hemorrhage and epistaxis have been excluded. Curve III refers only to grossly visible hemorrhage. (From Gaydos LA. The quantitative relation between platelet count and hemorrhage in patients with acute leukemia. *N Engl J Med* 1962;266:905, with permission.)

DIC commonly complicates AL because of the release of procoagulant materials or enzymes from blasts; leukemic cells may also have fibrinolytic activity ([37](#), [39](#), [40](#), [47](#)). The most common AL associated with DIC is APL [French/American/British classification (FAB) M3], followed by acute myelomonocytic leukemia (FAB M4), acute myeloblastic leukemia (FAB M1 and M2), ALL, and then the chronic leukemias, with CML more commonly associated with DIC than CLL ([37](#)). DIC may be worsened by the initiation of antileukemic therapy; however, the availability of *trans*-retinoic acid in APL has lessened the length and severity of DIC in this subtype of AL ([Chapter 82](#)). A reasonable approach to the treatment of other patients with AL who have severe DIC as part of their clinical picture is to institute induction chemotherapy as quickly as possible to reduce the leukemic cell population as the presumed cause of DIC. Antibiotics should be used if infection is suspected, and replacement therapy should be given if severe thrombocytopenia, coagulopathy, or hypofibrinogenemia is present. If biochemical or clinical evidence suggests DIC is continuing or worsening, there may be a role for the use of heparin ([48](#)).

Immune thrombocytopenic purpura (ITP) ([Chapter 53](#)) is being recognized in an increasing number of patients with hematologic malignancies ([49](#)). Autoimmune destruction of platelets is assumed to be the causative mechanism, and platelet-bound IgG has been demonstrated in some patients ([50](#)). This syndrome complicates the course of 2 to 5% of patients with CLL ([49](#), [50](#) and [51](#)) and has also occurred in HD, MM, NHL, and ALL ([49](#), [51](#), [52](#), [53](#) and [54](#)). Simultaneous ITP and autoimmune hemolytic anemia (Evans syndrome) have been observed in a few patients ([51](#)). The time of onset of ITP bears little relation to the duration, severity, or state of activity of the neoplasm and, except for the hazard posed by ITP itself, has no adverse prognostic implications. The ITP syndrome has also occurred in patients previously splenectomized for HD ([52](#)). In hematologic neoplasia, therapy with prednisone, intravenous gammaglobulin, splenectomy, and other modalities is similar to that used in other forms of ITP ([Chapter 53](#)). Platelet sequestration resulting from hypersplenism and splenomegaly is another mechanism of thrombocytopenia common to CLL ([Chapter 92](#)) and some NHL ([Chapter 90](#)); its management with splenectomy is discussed in [Chapter 70](#).

### Platelet Dysfunction

Platelet dysfunction is often present in the myeloproliferative disorders regardless of the platelet count and may contribute to hemorrhage ([54](#)). Bleeding caused by platelet dysfunction occurs more commonly in polycythemia vera (PV) (approximately 70%)

followed by idiopathic myelofibrosis (50%) and then CML (30%) ( 55, 56 ). The most common defects are impaired aggregation to adenosine diphosphate and epinephrine, defective release of platelet factor 3, and deficiency of  $\alpha$ -granules ( 57 ). Although similar defects have been reported in some patients with AL ( 40, 58 ), bleeding as a result of platelet dysfunction is believed to be less of a problem in ALs than in the myeloproliferative disorders. Platelet transfusions should be administered with bleeding secondary to platelet dysfunction when the platelet count is normal or decreased. Platelet cytopheresis can decrease bleeding when platelet dysfunction is associated with thrombocytosis ( $>700,000/\mu\text{l}$ ) ( 37 ).

### Other Causes of Hemorrhage

Coagulation protein abnormalities caused by liver disease or circulating inhibitors, fibrinolysis, and vascular defects may contribute to hemorrhage in hematologic neoplasms ( 37 ). Liver infiltration is more common in ALs followed by CLL and then CML and results in decreased synthesis of vitamin K-dependent clotting factors (factors II, VII, IX, and X) ( 39, 40 ). Decreased fibronectin in AL is more commonly caused by DIC ( 59 ). Cholestasis in AL may contribute to decreased synthesis of clotting factors and, occasionally, to DIC ( 39, 40 ). Viral hepatitis and hepatotoxicity from therapy are other complications that can cause liver failure and decreased synthesis of clotting factors.

Acquired inhibitors to clotting factors have been associated with a variety of hematologic neoplasms, particularly lymphoid in origin, and may become difficult clinical management problems ( Chapter 60 ). Patients develop a sudden bleeding tendency, and coagulation tests usually show a prolonged partial thromboplastin time. Specific clotting factors have to be tested, with factor VIII and von Willebrand factor the most commonly recognized deficiencies ( 37, 60, 61, 62 and 63 ). Inhibitors of thrombin or factor X deficiency may develop in patients with MM and amyloidosis because of the binding of calcium-dependent clotting factors by amyloid ( 64 ). Therapy for the underlying malignancy may correct the bleeding tendency and eradicate the inhibitor. Other measures may also be required, including replacement therapy, immunosuppression, and plasmapheresis. The use of deamino-8-d-arginine vasopressin may decrease bleeding tendency in patients with acquired von Willebrand syndrome ( 37 ).

Changes in the fibrinolytic system have been reported more commonly in ALs than in chronic leukemias. The findings are inconsistent, with both increased and decreased activity being reported ( 37 ). The role of fibrinolysis in clinical hemorrhage in hematologic neoplasms and its management are controversial. In primary fibrinolysis, hemorrhage is caused by plasmin-induced degradation of many clotting factors, including fibrinogen, factor V, and factor VIII:C ( 37 ). The use of antifibrinolytics,  $\epsilon$ -aminocaproic acid, or tranexamic acid has been advocated for bleeding believed to be caused by excessive fibrinolysis, but their use is contraindicated in patients with DIC, a more prevalent problem in hematologic cancers ( 37 ).

Vascular defects more commonly develop in ALs than in chronic leukemias, and paraproteins in Waldenström macroglobulinemia and myeloma may contribute to hemorrhage, as well as thrombosis. Increased vascular permeability can occur in AL as a result of (a) infiltration of the vessel wall by blasts, (b) leukostasis with hyperviscosity of the vasa vasorum, and (c) extramedullary hematopoiesis within the vasculature ( 37 ). The incidence of hemorrhage related to paraproteins is partially dependent on the type of disease. Approximately 15% of patients with IgG myeloma, approximately 40% with IgA myeloma, and over 60% with Waldenström macroglobulinemia (IgM) experience hemorrhage

during the course of their illness ( 37, 65 ). Whereas paraproteins are often associated with hyperviscosity, other factors that can contribute to hemorrhage include organ failure (uremia, liver failure), platelet dysfunction, low-grade DIC, fibrinolysis, or vascular infiltration with amyloid.

## ANEMIA

Anemia is often a part of the clinical course of hematologic neoplasms and contributes to symptoms of fatigue and dyspnea. The mechanisms causing anemia vary according to the type of neoplasm ( Table 72.4 ). In the ALs and myeloma, it is such a common part of the clinical picture that making a diagnosis in the absence of anemia is unusual. Other mechanisms of anemia besides marrow replacement must be considered in hematologic neoplasms because the therapy may be dependent not only on the underlying neoplasm, but also on the mechanisms involved.

**TABLE 72.4. Anemia Associated with Hematologic Neoplasms**

| Mechanism of Anemia                    | Associated Neoplasms   |
|--|--|
| Marrow replacement                     | More prevalent in acute leukemias than in chronic leukemias<br>Advanced stage lymphomas<br>Myeloma (amyloidosis) |
| Blood loss                             |  |
| Caused by thrombocytopenia (DIC)       | Acute leukemias  |
| Caused by gastric ulcers               | Myeloproliferative disease, lymphomas  |
| Caused by gastrointestinal perforation | High-grade lymphomas (Burkitt)   |
| Anemia of malignancy (chronic disease) | Hodgkin disease  |
| Pure red cell aplasia                  | CLL, T-cell large granular lymphocyte leukemia   |
| Hemolytic anemia                       |  |
| Warm antibody-mediated                 | CLL, lymphomas   |
| Cold agglutinin disease                | Waldenström macroglobulinemia, lymphomas   |
| Microangiopathic hemolytic anemia      | Acute leukemias with DIC   |
| Hypersplenism                          | CLL, lymphomas, myelofibrosis  |
| Macrocytic anemia                      | Myelodysplasia, acute myelocytic leukemia  |
| Hemophagocytic syndrome                | Lymphomas (peripheral T-cell lymphoma), leukemias  |

CLL, chronic lymphocytic leukemia; DIC, disseminated intravascular coagulation.

The primary cause of anemia is marrow replacement by neoplastic cells, although other causes may contribute. Hypochromic, microcytic anemia suggests iron deficiency from chronic blood loss usually from gastrointestinal bleeding, but iron deficiency may also occur in the anemia of chronic disease. Serum iron levels are often low in many patients with CLL, HD ( 37, 66, 67 ), or MM, transferrin levels tend to be decreased, and serum ferritin levels are often increased. Pathophysiologic mechanisms in the anemias of

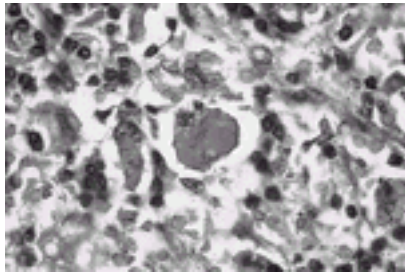
malignancy and chronic disease include a shortened red blood cell survival, a hypoproliferative response to erythropoietin, and an impaired release of iron ( [37](#), [68](#)). Cytokines, including tumor necrosis factor and some interleukins, probably contribute to the anemia of malignancy ( [37](#), [68](#)). Erythropoietin in doses larger than those needed in the treatment of anemia of renal failure may improve anemia associated with hematologic neoplasms, particularly MM and CLL ( [37](#), [68](#)). Pure red cell aplasia is an unusual complication in hematologic neoplasms; it is most commonly associated with CLL, less commonly with other B-cell lymphoproliferative neoplasms, and rarely with other hematologic malignancies ( [37](#), [69](#), [70](#)). It may respond to the use of intravenous gammaglobulin or to therapy for the underlying neoplasm.

Hemolytic anemias may be the presenting feature or may precede or follow the diagnosis of hematologic cancer; they do not correlate with prognosis. Warm antibody-mediated hemolytic anemia ( [Chapter 35](#)) complicates the course of 10 to 20% of patients with CLL and may occur in patients with other hematologic cancers ( [37](#), [71](#), [72](#), [73](#) and [74](#)). The onset is often sudden, and hemolysis can be so severe that death from cardiac failure may occur ( [37](#), [75](#), [76](#)). Therapy is directed at decreasing the production of antibody and splenic destruction of red blood cells. Adrenocortical steroids, transfusions, therapy for the underlying neoplasm, and splenectomy are used in autoimmune hemolytic anemia of warm antibody type. In cold agglutinin disease, the anemia is usually mild; steroids and splenectomy have little benefit. Avoiding cold exposure, plasmapheresis, and treatment of the underlying lymphoproliferative disorder may be effective in improving the anemia associated with cold agglutinin disease ( [Chapter 35](#)). Microangiopathic hemolytic anemia is seen most often as part of the DIC syndrome but has been reported in patients with hematologic neoplasms without evidence of DIC. Hypersplenism, the trapping or destruction of erythrocytes in an enlarged spleen, may contribute to anemia in hematologic cancers, particularly some low-grade lymphomas and CLL. Although there is little correlation between the size of the spleen and evidence for splenic pooling of erythrocytes, splenectomy has been used extensively in some centers for treatment of nonautoimmune hemolytic anemias in lymphoid malignancies ( [37](#), [77](#), [78](#)).

Macrocytic anemia with marrow cells resembling megaloblasts can be found in patients with erythroleukemia (Di Guglielmo syndrome), MDS, and some AML, in which the predominant cell is a myeloblast rather than the proerythroblast of erythroleukemia. The most common cause of macrocytic anemia is cytotoxic chemotherapy and the resultant inhibition of DNA synthesis. Agents whose primary effect is inhibition of DNA synthesis, such as the folic acid antagonists, cytosine arabinoside, 6-mercaptopurine, hydroxyurea, and procarbazine, are most commonly associated with macrocytic anemia. The abnormal nucleated red cells that may appear in AML in the absence of such drugs or occur as part of the terminal phase of myeloproliferative disorders have certain morphologic features that often allow their differentiation from megaloblasts resulting from vitamin deficiency. The nuclear chromatin is not as fine as in true megaloblasts, and a greater proportion of the erythroid precursors are more immature in most patients with erythroleukemia than in those with vitamin B<sub>12</sub> or folate deficiency. Furthermore, bi- and trinucleated erythroblasts are more numerous in erythroleukemia than in patients with vitamin B<sub>12</sub> and folate deficiency. Macroovalocytes and the changes in neutrophils characteristic of these vitamin deficiencies, such as hypersegmentation, giant metamyelocytes, and macropolycytes, are usually absent.

Hemophagocytic syndrome is rare and can be associated with viral infections and lymphoid neoplasia, particularly peripheral T-cell lymphoma [angiocentric T-/natural killer (NK) lymphoma and subcutaneous panniculitic peripheral T-cell lymphoma] ( [Fig. 72.2](#)) ( [37](#), [79](#), [80](#) and [81](#)). The mechanism of macrophage activation is unknown, but its presence is

often associated with a poor prognosis.

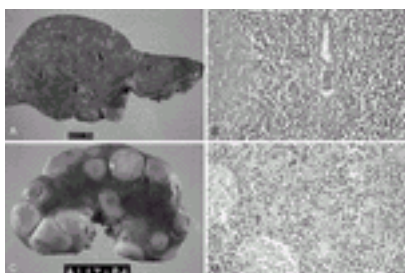


**Figure 72.2.** In the center of the field, two macrophages are stuffed with red blood cells (hemophagocytosis) in this high magnification view of spleen involved by a hepatosplenic T-cell lymphoma (hematoxylin and eosin stain). See [Color Plate](#). (Courtesy of Dr. William R. Macon, Department of Pathology, Mayo Medical Center, Rochester, MN.)

Therapy for anemia in hematologic malignancy is directed at the underlying mechanism and disease. Transfusions should be used when required for control of symptoms and signs caused by the anemia. Studies may be indicated to rule out deficiency of iron, vitamin B<sub>12</sub>, or folic acid as a cause of the anemia, but therapy with these agents as a routine procedure is of no benefit. Splenic irradiation may lead to reduction of anemia in patients with massive splenomegaly, but splenectomy is usually more effective. As noted previously, erythropoietin may improve the anemia caused by malignancy. In many cases, therapy for the underlying hematologic malignancy improves the anemia.

## ORGAN INFILTRATION AND DYSFUNCTION

Infiltration of organs by tumor is one of the most important causes of morbidity in patients with hematologic neoplasms. However, asymptomatic tumor infiltration diagnosed at autopsy is much more common than symptomatic organ dysfunction during life ([Fig. 72.3](#)). Organ infiltration from leukemia, lymphoma, myeloma, and related conditions is, in general, less likely to be symptomatic than organ infiltration from carcinoma. Organs may also have impaired function from paraneoplastic phenomena.



**Figure 72.3.** Systemic involvement of lymphoma at autopsy. **A:** Pale nodules of follicular small cleaved cell are present on the cut surface of the liver. **B:** Microscopically, the liver shows a pronounced periportal lymphocytic infiltrate that surrounds a residual bile duct (hematoxylin and eosin stain) (*upper center*). **C:** Numerous lymphomatous nodules are also present on the external surface of the kidney. **D:** Extensive interstitial lymphocytic infiltrates obliterate the renal tubules, whereas two residual glomeruli can be seen on the left (hematoxylin and eosin stain). See [Color Plate](#). (Courtesy of Dr. William R. Macon, Department of Pathology, Mayo Medical Center, Rochester, MN.)



Therapy for organ infiltration and dysfunction includes systemic chemotherapy; local therapies, including surgery, radiation, and topical therapy for skin lesions; or both. In diseases such as the ALs, HD, and the aggressive lymphomas in which the therapeutic goal is cure, therapy of symptomatic organ infiltration consists of systemic chemotherapy with or without local therapy. Therapies for specific neoplasms are discussed in [Chapter 76](#), [Chapter 77](#), [Chapter 78](#), [Chapter 79](#), [Chapter 80](#), [Chapter 81](#), [Chapter 82](#), [Chapter 83](#), [Chapter 84](#), [Chapter 85](#), [Chapter 86](#), [Chapter 87](#), [Chapter 88](#), [Chapter 89](#), [Chapter 90](#), [Chapter 91](#), [Chapter 92](#), [Chapter 93](#), [Chapter 94](#), [Chapter 95](#), [Chapter 96](#), [Chapter 97](#), [Chapter 98](#), [Chapter 99](#), [Chapter 100](#) and [Chapter 101](#). In diseases such as CLL or some low-grade B-cell lymphomas in which the therapeutic goal is often palliation, local therapy alone may be used. All of the hematologic neoplasms are sensitive to radiation; radiotherapy alone may be an excellent choice for cure of localized disease, particularly HD, or for palliation.

### **Intravascular Complications: Leukostasis and Intravascular Tumors**

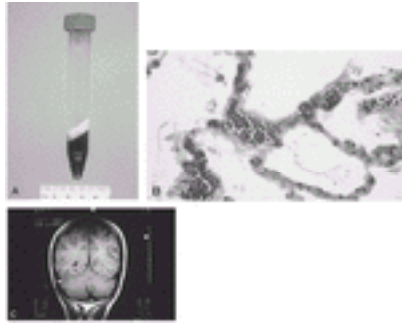
Two distinct entities can occur as a result of intravascular tumor cells. The first, termed *leukostasis*, is caused by “sludging” of leukemic cells in capillaries and is seen with extremely high white blood cell counts (hyperleukocytosis). This entity occurs in the leukemias. The second form occurs when tumor cells lodge and grow within vessels, which can lead to the formation of macroscopic tumors with secondary hemorrhage and thrombosis. Intravascular tumor may complicate AML and occurs in a rare form of NHL.

Increased serum viscosity without hypercellularity occurs in patients with increased quantities of monoclonal or polyclonal Igs. It complicates Waldenström macroglobulinemia, MM, and disease processes that are associated with polyclonal hyperglobulinemia such as human immunodeficiency virus (HIV) infection. The syndrome is usually manifested as bleeding or mental status abnormalities and is managed with plasmapheresis. Hyperviscosity is discussed in [Chapter 98](#), [Chapter 99](#) and [Chapter 100](#).

Leukostasis is a common postmortem finding in patients with AML or CML. McKee and Collins divided the pathologic findings into leukocyte thrombi and leukocyte aggregates based on the presence of fibrin in the former ([82](#)). The lesions were present in 40% of patients with AML and in 36% of patients with CML. The lesions were far more common in patients with CML in blast phase (15 of 30) than in patients in chronic phase (2 of 17). The lesions of leukostasis were rare in patients with lymphocytic leukemias, being present in 3 of 33 CLL patients and 0 of 39 ALL patients. The most common sites of involvement in this autopsy series were lung and brain. A direct correlation between the leukocyte count and risk of leukostasis was found in the myeloid leukemias.

Leukostatic sludging is believed to be related to increases in blood viscosity (cellular hyperviscosity). The viscosity of whole blood increases markedly with extreme elevations of the leukocyte count. A leukocrit of 20 to 25% is required to increase whole blood viscosity ([Fig. 72.4A](#)). This requires approximately 400,000 to 600,000 myeloblasts/ $\mu$ l or 500,000 to 1,000,000 lymphoblasts or lymphocytes/ $\mu$ l because of the increased size of myeloblasts. In addition, the blasts in AML are less deformable than other cells and may therefore have an increased tendency to sludge in capillary beds ([83](#), [84](#)).





**Figure 72.4.** Hyperleukocytosis and leukostasis. **A:** An elevated leukocrit is present in this tube of centrifuged peripheral blood from a patient with T-cell acute lymphoblastic leukemia who had a peripheral blood blast count of 250,000/ $\mu$ l. **B:** Pulmonary alveolar capillaries are expanded by leukocyte aggregates indicative of leukostasis in a patient with acute myeloid leukemia (hematoxylin and eosin stain). **C:** Ring-enhancing lesions on magnetic resonance imaging were attributed to hemorrhage in a patient with chronic granulocytic leukemia, hyperleukocytosis, and blurred vision (T1-weighted image). See [Color Plate](#).

Clinically, leukostasis is difficult to prove, and no agreed-on diagnostic criteria exist ([Table 72.5](#)). The symptoms are nonspecific and include dyspnea and hypoxemia from lung involvement ([Fig. 72.4B](#)) ([85](#), [86](#)). Hypoxemia, however, may be artifactual as a result of oxygen consumption by leukocytes *in vitro* ([87](#)). CNS involvement may be manifested by headache, confusion, tinnitus, papilledema, ataxia, stupor, and obtundation and can progress to CNS hemorrhage and death ([Fig. 72.4C](#)). The syndrome should be suspected in patients with any of these symptoms and a blast count of greater than 50,000/ $\mu$ l.

#### TABLE 72.5. Management of Leukostasis

---

Leukostasis should be suspected in leukemia in descending order of diagnosis: most prevalent in acute myelocytic leukemia, then in chronic myelocytic leukemia, then in acute lymphocytic leukemia, and least prevalent in chronic lymphocytic leukemia. Blasts are usually over 50,000/ $\mu$ l.

Symptoms of lung or brain involvement are medical emergencies.

Allopurinol and hydration should be initiated.

Red cell transfusions should be minimized early to avoid increasing viscosity.

The white count should be decreased rapidly.

If asymptomatic, hydroxyurea can be used.

If symptomatic or if blasts are markedly elevated, consider leukapheresis; platelet transfusions will be needed.

Initiate chemotherapy as soon as possible.

---

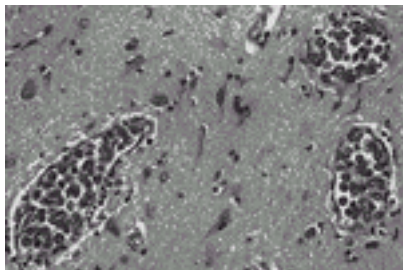
The syndrome is best prevented by institution of emergency therapy for hyperleukocytosis. In asymptomatic patients, hydroxyurea is generally used. This antimetabolite rapidly lowers the leukocyte count and whole blood viscosity ([88](#), [89](#) and [90](#)). For symptomatic patients, leukapheresis has been used. It has the advantages of having immediate onset of action and of not inducing the acute tumor lysis syndrome (ATLS) for which patients with hyperleukocytosis are at risk ([91](#), [92](#) and [93](#)). Nevertheless, some centers manage such patients conservatively with good results ([94](#)). Definitive

antileukemic therapy should be initiated as soon as possible. Transfusions of red blood cells should be avoided, as they may increase whole blood viscosity and worsen the syndrome ( [95](#) ). However, if the patient is thrombocytopenic, platelet transfusions are warranted, as platelets are removed during leukapheresis.

It is unclear how to manage patients with CLL and hyperleukocytosis. Symptomatic leukostasis is rare, and some patients may have hyperleukocytosis without other indications for therapy. Baer and co-workers reported three cases of cellular hyperviscosity among 16 patients with CLL and a sustained leukocyte count of more than 500,000/ $\mu\text{l}$  ( [96](#) ). Thus, it may be reasonable to institute cytoreductive therapy for patients with CLL and a leukocyte count of more than 500,000/ $\mu\text{l}$ .

Intravascular formation of tumors is currently rare; they occurred more frequently before the introduction of effective therapies for leukemia. The most common presentation is massive intracranial hemorrhage from intracranial tumors. A sharp rise in the leukocyte count appears to be associated with the presence of this syndrome. The formation of such tumors seems to be more common in monoblastic leukemia, in which they may occur without hyperleukocytosis ( [97](#) ).

Symptoms from intravascular tumor may also occur in NHL. *Angiotropic large cell lymphoma* is a large B-cell lymphoma that has also been called *malignant angioendotheliomatosis*, *intravascular lymphomatosis*, and other names. It consists of malignant large B lymphocytes within vessels ( [Fig. 72.5](#) ). The clinical manifestations are protean and result from vascular occlusion or thrombosis. Neurologic or pulmonary symptoms and skin lesions are the most common presenting features. This entity may present as fever of unknown origin. Most cases are diagnosed postmortem, but there are reports of response to systemic chemotherapy ( [98](#), [99](#), [100](#), [101](#) and [102](#) ).



**Figure 72.5.** Dilated vessels in the brain are filled by intravascular lymphoma in a patient with angiotropic large B-cell lymphoma (hematoxylin and eosin stain). (Courtesy of Dr. William R. Macon, Department of Pathology, Mayo Medical Center, Rochester, MN.)

## Neurologic Complications

Neurologic complications are common in hematologic malignancies. Here, involvement of the meninges, brain, and spinal cord are discussed as are rare paraneoplastic phenomena.

**MENINGEAL INVOLVEMENT** The meninges are a common site of involvement in hematologic neoplasms, including ALL, AML, and NHL ( [103](#), [104](#), [105](#) and [106](#) ). The clinical syndrome produced is generally related to increased intracranial pressure: headache, lethargy, nausea, and vomiting. As this meningeal syndrome progresses, papilledema and signs and symptoms of meningeal irritation, such as stiff neck and Kernig and Brudzinski signs, develop. Seizures and altered mental status are late sequelae. This constellation of

symptoms in conjunction with involvement of the meninges has been called the *meningeal syndrome* and is in contrast to many patients with AL who have meningeal involvement without symptoms at diagnosis. Cranial nerve palsies are present in approximately 20% of patients with clinical meningeal syndrome ( [107](#) ). Involvement of the trigeminal nerve can lead to the “numb chin syndrome.” Unusual syndromes have been reported that are likely related to involvement of the hypothalamus. These include hyperphagia and obesity as well as abnormalities of insulin and growth hormone secretion ( [108](#) , [109](#) ). The CNS is a “sanctuary” into which most drugs penetrate poorly, and isolated meningeal relapses may occur even after aggressive systemic therapy ( [110](#) ). In ALL and, to a lesser degree, in AML and NHL, prophylactic therapy is used to prevent isolated meningeal recurrence. Specific strategies include the use of intrathecal chemotherapy, cranial or craniospinal radiation, and high-dose chemotherapy designed to penetrate into the cerebrospinal fluid (CSF). Meningeal involvement is common in ALL and may be present at diagnosis or at any time in the course of the disease. In the late 1960s, Evans and co-workers described a 3.8% per month incidence during the first year that decreased to 2% over the second and third years ( [110a](#) ). Pavlovsky and colleagues reported that the risk of meningeal involvement was similar in age-matched patients with AML and ALL ( [111](#) ). Meningeal involvement was found in 7 of 39 newly diagnosed patients with AML who had a lumbar puncture (LP) as part of routine evaluation; of note, all seven had acute myelomonocytic leukemia ( [112](#) ). Acute myelomonocytic leukemia, particularly when eosinophilia and an inversion of chromosome 16 are present, appears to have a high incidence of meningeal involvement ( [113](#) , [114](#) ). The use of high-dose cytarabine (ara-C) consolidation appears to decrease this occurrence ( [115](#) ). Infiltration of the meninges occurs in certain types of NHL ( [105](#) , [116](#) , [117](#) ). CNS involvement is associated with high-grade lymphomas and extranodal disease ( [118](#) ). It is particularly common in T-cell lymphoblastic lymphoma ( [119](#) , [120](#) ); small, noncleaved “Burkitt-like” NHL; and Burkitt lymphoma. CNS prophylaxis is generally a component of therapy for these diseases ( [Chapter 89](#) ). In a case series at the National Cancer Institute, meningeal involvement has been reported in 24% of patients with small, noncleaved “Burkitt-like” lymphoma ( [121](#) ). Meningeal disease may occur in association with Burkitt lymphoma even when the disease is limited to the jaw ( [122](#) ). The incidence of meningeal involvement in mantle-cell lymphoma is variable ( [123](#) , [124](#) and [125](#) ). Although meningeal involvement is less common with other types of NHL, sinus and testicular NHLs have a higher predilection for meningeal spread at either diagnosis or relapse ( [115](#) , [116](#) ). Lymphomatous involvement of the meninges is common in patients with HIV infection ( [126](#) , [127](#) and [128](#) ) or in posttransplant lymphoproliferative disorders ( [129](#) ). This is likely also true of HIV-infected patients with HD ( [130](#) ). Other hematologic neoplasms occasionally involve the meninges. CML in chronic or, more commonly, blast phase can involve the meninges ( [131](#) , [132](#) ). Meningeal involvement appears to be more common in the lymphoid form of blast phase ( [133](#) , [134](#) ). It is rare that MM and plasma cell leukemia ( [135](#) , [136](#) ), CLL ( [137](#) ), and HD ( [130](#) ) have meningeal involvement. The diagnosis of meningeal involvement with a hematologic neoplasm is made by LP and examination of the spinal fluid. LP should be performed early in patients at risk or who have symptoms of the meningeal syndrome. In thrombocytopenic patients, there is a small risk of hematoma complicating LP, and platelet transfusion immediately before the procedure is recommended. It is reasonable to instill methotrexate (MTX) or ara-C at the time of LP in patients suspected of having the meningeal syndrome to avoid the need for repeat LP if cytology returns positive. The demonstration of tumor cells in spinal fluid by cytology proves meningeal involvement. The sensitivity is enhanced by the use of centrifugation of the CSF ( [138](#) ). More recently, immunophenotyping techniques have been investigated ( [139](#) , [140](#) ). In particular, staining for terminal deoxynucleotidyl transferase is helpful in distinguishing reactive from leukemic lymphocytes in ALL ( [140](#) , [141](#) ). Metaphase cytogenetics have also been performed on CSF samples. The classic criteria for diagnosis

of meningeal leukemia are a CSF cell count of greater than 5 cells/mm<sup>3</sup> and presence of a recognizable blast form on a cytopsin preparation. A more refined definition of CNS leukemia classifies CSF into three categories (142). *CNS1* indicates a clear CSF. *CNS3* represents unequivocal CSF leukemia. *CNS2* is defined by presence of a blast cell with a total cell count of less than 5 cells/mm<sup>3</sup>. The presence of blasts even with a cell count of fewer than five white blood cells (*CNS2*) indicates a risk for future meningeal involvement; conversely, some patients with fewer than ten blast cells on a routine LP and a history of leukemic meningitis do not go on to develop clinically apparent leukemic meningitis (143, 144). In ambiguous cases, an LP should be repeated in 1 to 2 weeks. The diagnosis of meningeal involvement is usually straightforward, but several difficult situations may occur. One such situation arises when meningeal malignancy and infection occur simultaneously. Also, the diagnosis of meningeal leukemia in patients with a past history of meningeal involvement is difficult (145). Therapy for patients with meningeal involvement of a hematologic malignancy depends on the clinical situation. The goal may be either temporary control or complete eradication of meningeal involvement. High-dose systemic chemotherapy (usually with ara-C or MTX) and craniospinal radiation are useful in eradicating meningeal disease. They are discussed in Chapter 78 as they relate to ALL. The same principles may be applied to other diseases. Here, we discuss intrathecal therapy designed to control local symptoms. The mainstay of therapy for the meningeal syndrome involves instillation of chemotherapeutic agents directly into the CSF (146, 147). The most widely used agent is MTX, although other antimetabolites, such as ara-C and 6-mercaptopurine, steroids, and the alkylating agents diaziquone (148) and thiotepa (149), have all been studied. Intrathecal dexamethasone can rapidly improve symptoms, presumably via an antiinflammatory effect. It may be a good choice for patients with refractory disease for whom short-term palliation is the goal of therapy. Intrathecal MTX should be injected slowly after an atraumatic LP. Immediately after the injection, the patient should be placed supine with the foot of the bed elevated to improve drug distribution (150). The drug should be sterile and in a saline or balanced salt solution. Preservative-free drug is generally used, but the advantage of this approach, if any, is unclear. Clinicians should be extremely vigilant when administering intrathecal agents so as to avoid overdose. More recently, a sustained release preparation of ara-C (DepoCyt) has been approved for treatment of neoplastic meningitis. It is given at a dose of 50 mg, intrathecal or intraventricular, every 2 weeks. Pharmacokinetic studies have shown therapeutic concentrations of ara-C in excess of 14 days. An open-label study in 110 patients with neoplastic meningitis who were treated for 1 month showed a response rate comparable to twice weekly intrathecal MTX. The adverse effects were low grade and transient and included headache and arachnoiditis (151). Agents administered intrathecally are distributed to the CNS. The volume of CNS varies with age rather than body size, so age- rather than body surface area-based dosing is appropriate for intrathecal drugs (Table 72.6) (152). There is no advantage to increasing the dose of MTX beyond 12 mg.

**TABLE 72.6. Pharmacokinetically Derived Dosing Schedules for Intrathecal Methotrexate**

| Age (yr) | Dose (mg) |
|----------|-----------|
| <1       | 6         |
| 1        | 8         |
| 2        | 10        |
| ≥3       | 12        |

Neither the optimal schedule nor the route (lumbar or intraventricular) of MTX is known, nor is the role of combination therapy such as “triple therapy,” consisting of a steroid,

MTX, and ara-C ( [153](#) ). MTX given every 2 or 3 days induces a CSF remission in most patients; however, relapse is often a problem ( [154](#) ). Although there is no clear proof of its superiority, most patients with meningeal involvement with a hematologic neoplasm receive intraventricular therapy via an Ommaya reservoir ( [155](#) ). This is better tolerated by patients and allows a more reliable and consistent CSF level of MTX. Care should be taken to avoid complications of the Ommaya reservoir ( [156](#) ). The procedure should be done under sterile conditions to avoid infections. Perioperative antibiotic use is important to prevent infections. Positioning of the reservoir is important to prevent intraparenchymal delivery of chemotherapy, which can lead to leukoencephalopathy. Most centers use single-agent MTX given twice weekly until all leukemic cells have cleared. The CSF protein concentration generally remains elevated. It is reasonable to give continued intrathecal therapy, craniospinal radiation, or high-dose systemic consolidation to those patients whose systemic disease is controlled. Toxicity is common after administration of intrathecal chemotherapy, although it is difficult to determine whether drug or disease cause a particular complication. Toxicities have been reported with MTX, ara-C, and intrathecal drugs combined with radiation. A transient, mild arachnoiditis is common ( [157](#) ). It may be associated with headache, nausea, and vomiting; reversible paresis and paraplegia have been reported. Severe and sometimes irreversible toxicities, including dementia, seizures, coma, and death, have been reported but are less common. A mild syndrome of fever and somnolence may occur 5 to 7 weeks after intrathecal therapy ( [157](#) ). Myelosuppression may occur after intrathecal chemotherapy, particularly in patients with renal failure. The risk of leukoencephalopathy is higher in older patients who have received brain irradiation.

**BRAIN INVOLVEMENT** The most common cause of brain masses in hematologic malignancy is NHL; intracerebral tumors related to hyperleukocytosis in AL were discussed previously. The lesions may occur in association with systemic lymphoma or may be primary CNS lymphomas. Primary CNS lymphoma is common in patients who are immunodeficient; this can be either iatrogenic (e.g., after organ transplantation) or related to HIV infection. The frequency of primary CNS lymphoma appears to be increasing rapidly in both immunocompromised and immunocompetent patients ( [158](#) ). Although rare, parenchymal brain masses have been reported in HD and MM.

**Spinal Cord Compression** Impingement of the spinal cord with associated neurologic signs or symptoms is a true medical emergency ( [Table 72.7](#) ). It can occur when a hematologic neoplasm involves the cord, meninges, dura, or a vertebra with compression of the cord. This complication occurs often in patients with MM and is not uncommon in patients with NHL and HD. Lymphoma is a common cause of spinal cord compression in children ( [159](#) ). Leukemia is a rare cause; a 1981 review of spinal cord involvement in leukemia found only 70 well-documented cases ( [160](#) ), although others have since been reported. Cord compression has resulted from extramedullary hematopoiesis. Cord compression may occur at any time in the course of a hematologic malignancy.

#### **TABLE 72.7. Management of Spinal Cord Compression**

---

The diagnosis should be suspected in patients who have multiple myeloma or non-Hodgkin lymphoma.

Pain and weakness are the most common symptoms; urinary incontinence and constipation occur later and confer a poor prognosis.

Leg weakness, hyperreflexia, and a Babinski reflex are common signs.

Total spine magnetic resonance imaging is the preferred imaging technique.

Steroids should be administered early, preferably as soon as the diagnosis is known.

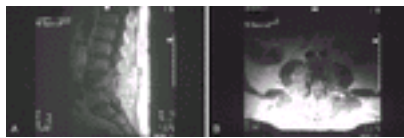
Definitive therapy may involve surgery, radiation, and/or chemotherapy.

---

Pain is the most common symptom of cord compression in both adults and children. Pain



that is not relieved when the patient is supine is particularly worrisome, as is pain with a radicular component. Weakness is the next most common symptom. It may be most often manifested as proximal muscle weakness preventing patients from ascending stairs or rising off the commode. Autonomic symptoms, such as urinary frequency, urgency, retention, or constipation, generally occur late in the course and are associated with a poor prognosis. Physical examination may reveal leg weakness; hyperreflexive deep tendon reflexes and a Babinski reflex may be present. Careful sensory examination may show a discrete sensory level. Patients with severe back pain or other symptoms suggestive of spinal cord compression should have an imaging procedure performed and appropriate referrals made rapidly. If the index of suspicion is high, then empiric corticosteroids may be administered before an imaging procedure, particularly if a patient is being transferred to a different facility; however, in cases without a known diagnosis, steroids may prevent or obscure the ability to make a tissue diagnosis because of necrosis. Magnetic resonance imaging has largely replaced myelography and computed tomography (CT) scanning as the imaging procedure of choice ( Fig. 72.6) ( 161, 162). Ideally, magnetic resonance imaging should image the entire spine, as multiple areas of compression are possible ( 163). Of note, plain radiographs are quite insensitive for detecting cord compression caused by lymphoma ( 159).



**Figure 72.6.** Spinal cord involvement shown by magnetic resonance imaging. **A:** Epidural mass on sagittal view is posterior to L4 and L5 vertebral bodies with invasion of the spinal canal (T1-weighted image). **B:** On axial view, the mass involves the L4 vertebral body, surrounds the thecal sac, and elevates the inferior vena cava and aorta (T1-weighted image). The diagnosis by biopsy was Hodgkin disease. (Courtesy of Dr. Kathleen Helton, Department of Radiology, Vanderbilt University School of Medicine, Nashville, TN.)

Therapy for cord compression consists of supportive measures, including corticosteroids (generally dexamethasone), and definitive therapy to shrink or remove the compressing tumor. The optimal dose and value of dexamethasone are controversial. High-dose therapy has been associated with increased life-threatening gastrointestinal complications ( 164, 165). A dexamethasone schedule of 10- to 100-mg initial bolus followed by at least 16 mg daily has been recommended ( 166). In patients with aggressive lymphomas, ATLS may occur after dexamethasone therapy ( *vide infra*). After diagnosis and administration of dexamethasone, radiation and surgery are the mainstays of therapy. Surgery is the modality of choice for patients without a previous diagnosis of malignancy, as it allows tissue sampling while relieving cord compression; it can also be used for areas that have been previously irradiated. Hematologic neoplasms are largely radiosensitive, and radiation should be part of initial therapy for most patients with cord compression. As cord compression is a sign of progressive disease or relapse, chemotherapy is often used after radiation. In patients with highly chemotherapy-sensitive tumors who present with cord involvement, chemotherapy may be used alone ( 167). Patients with myeloma or lymphoma have a good prognosis even if they present with cord compression. Many will be alive with no functional impairment 5 years after diagnosis if treated appropriately.

**OTHER NEUROLOGIC SYNDROMES** Peripheral neuropathies may occur in a variety of hematologic neoplasms. They are most common in monoclonal gammopathies ( 168, 169 and 170). It appears that, in many of these disorders, an IgM monoclonal protein binds to myelin-associated glycoprotein causing a demyelinating neuropathy ( 168, 171). A similar neuropathy may be seen in patients whose paraprotein forms a cryoglobulin. These neuropathies may respond to plasmapheresis. Peripheral neuropathy has long been recognized as a complication of osteosclerotic myeloma ( 172, 173). This neuropathy seems to respond well to chemotherapy for myeloma ( 173). Peripheral neuropathy can occur in

NHL and HD ( [174](#), [175](#)). Vital et al. have described eight distinct types of lymphoma-associated neuropathy ( [176](#)). Peripheral neuropathies have also been reported in leukemia ( [175](#)). The most common cause of peripheral neuropathy in patients with hematologic neoplasms is chemotherapy-induced toxicity ( [177](#)). Other rare, neurologic complications can occur. Granulomatous angiitis of the CNS has been reported in patients with HD ( [178](#)); the otherwise fatal disorder has responded to chemotherapy. Progressive multifocal leukoencephalopathy, which is common in HIV infection and other immunosuppressive conditions, has occurred in patients with hematologic neoplasms ( [179](#) ).

## Ocular Complications

The orbit and globe are uncommon but important sites of involvement by hematologic neoplasms. As in the case of the meninges, the eye is a sanctuary into which chemotherapy penetrates poorly ( [180](#)) and can be the sole site of relapse in ALL ( [181](#)) or AML ( [182](#)). Autopsy studies suggest that subclinical involvement of the eye with AL is common and correlates with the peripheral blood count ( [183](#)). Eye involvement has been reported in a variety of other hematologic neoplasms, including HD, MM, and CML ( [184](#), [185](#) and [186](#) ).

However, NHL is the hematologic malignancy that most commonly involves the eye. Although various aggressive NHL types have been described ( [187](#)), the most common ocular lymphocytic infiltrates are low grade ( [188](#), [189](#)). There has been some controversy about the classification of these lymphoid infiltrates. Medeiros et al. have performed a careful analysis of 61 patients with lymphocytic infiltrates of the orbit or conjunctiva. Using histology alone, they were able to identify 20 patients with definite low-grade malignant lymphoma, 14 patients with a definite benign, inflammatory infiltrate, and 27 patients with an indeterminate infiltrate. Twenty of these infiltrates had monotypic Ig expression and were classified as low-grade lymphoma. A correlation existed between evidence of clonality and the likelihood of dissemination and death ( [190](#)). More recently, it has become apparent that many of these low-grade lesions should be classified as marginal zone lymphomas of the mucosa-associated lymphoid tissue (MALT) type ( [191](#), [192](#)) using the International Lymphoma Study Group classification system ( [193](#)), which has been adopted by the World Health Organization classification. Ocular lymphoma may complicate HIV infection ( [194](#), [195](#)) or organ transplantation. Therapy of ocular lesions involves radiation with or without chemotherapy. Patients with high-grade lymphomas should usually receive chemotherapy and often have a poor prognosis ( [196](#) ).

## Head and Neck Involvement

The other organs of the head and neck are rarely involved by hematologic neoplasms, with several exceptions. The gums are typically involved by FAB M4 and M5 AML ( [Chapter 79](#)). There is a distinct clinicopathologic entity of nasal lymphoma ( [197](#), [198](#)). This is a NK- or T-cell lymphoma that frequently expresses the NK cell-associated antigen CD56, often has angiocentric histology, and is associated with Epstein-Barr virus infection ( [199](#), [200](#)). Many cases of “midline granuloma” likely were, in fact, cases of this entity ( [201](#)). The ideal treatment strategy is unknown but usually involves chemotherapy and radiation ( [202](#)). B-cell lymphomas may also involve the mouth, nose, or paranasal sinuses ( [203](#)). Waldeyer ring is a common site of involvement by both T/NK-cell and B-cell lymphomas, including mantle-cell lymphoma, and by lymphomas involving the



stomach ( [204](#) , [205](#) ).

Other rare complications include reports of rhinophyma, hearing and vestibular dysfunction, sinus involvement, and upper airway obstruction ( [206](#) ) as complications of hematologic neoplasms. Patients with Sjögren syndrome may develop lymphomas of the MALT type in their salivary glands ( [207](#) , [208](#) ). Lymphoma may also complicate autoimmune (Hashimoto) thyroiditis ( [209](#) , [210](#) ).

## Thoracic Complications

**LUNG INVOLVEMENT** Involvement of the lung is relatively common in patients with HD and NHL ( [211](#) ). Filly et al. described radiographic evidence of parenchymal disease in 11.6% of HD patients and in 3.7% of NHL patients at the time of diagnosis ( [212](#) ). Diehl et al. have demonstrated that the spread of HD in the thorax occurs in a stepwise manner from the mediastinal nodes to the hilar nodes and then to the lung parenchyma either by direct extension or hematogenously with the development of nodules ( [213](#) ). Secondary involvement with NHL is less predictable. Primary pulmonary HD is rare and generally has a nodular appearance on chest radiograph ( [214](#) ). Although more common than primary pulmonary HD, primary pulmonary NHL is also a rare disorder. Furthermore, various disorders that had been previously classified as “pseudolymphomas” are now considered malignant lymphomas; MALT lymphoma and lymphomatoid granulomatosis (principally a B-cell process) are examples ( [215](#) , [216](#) and [217](#) ). Cordier et al. described 70 cases of primary pulmonary lymphoma that they classified according to the updated Kiel classification. They reported 61 cases of low-grade and 9 cases of high-grade NHL; the rare high-grade lesions had markedly worse prognoses ( [218](#) ). Lung involvement is common in patients with HIV-associated lymphomas ( [219](#) ). Radiographically, NHL and HD can be nodular, bronchovascular-lymphangitic, or pneumonic-alveolar in appearance. Nodularity is the most common presentation ( [211](#) ). Many patients with NHL or HD of the lung are asymptomatic, and their disease is discovered only on a routine radiograph or CT scan. However, cough, chest pain, fever, hemoptysis, and dyspnea may all be presenting features ( [214](#) , [218](#) , [219](#) ). Patients with leukemia are at risk for a variety of pulmonary complications ( [220](#) ). Pulmonary symptoms in AL with hyperleukocytosis were discussed previously. A diffuse, interstitial process has also been described in the absence of leukocytosis ( [221](#) ). Alveolar proteinosis may occur in myeloid malignancies ( [222](#) ). Pulmonary hemorrhage may be a cause of diffuse infiltrates ( [223](#) ). Lung involvement in other hematologic neoplasms is rare. Other pulmonary diseases may occur in patients with hematologic neoplasia. Pulmonary embolus occurs even in thrombocytopenic patients. Alveolar deposition of paraproteins has been reported to cause respiratory failure ( [224](#) ). The most common pulmonary complication in patients with hematologic neoplasms is infection with bacterial or opportunistic pathogens. Patchy or focal infiltrates are likely to be bacterial, whereas diffuse infiltrates are likely to be caused by opportunistic infections. Management of pulmonary abnormalities depends on the entire clinical picture, including whether the underlying neoplasm is controlled. Patients with signs and symptoms that suggest bacterial infection can be treated presumptively. Those in whom the diagnosis is uncertain and for whom management depends on precise data should undergo bronchoscopy, open lung biopsy, or both.

**SUPERIOR VENA CAVA SYNDROME** The superior vena cava syndrome (SVCS) occurs when this central vessel is compressed, invaded, or thrombosed, leading to occlusion of venous flow. The resultant clinical syndrome consists of facial edema, plethora, cyanosis, and venous distention. Tachypnea and headache may occur. In the first part of the twentieth century, aortic aneurysms and tuberculous mediastinitis were the most common etiologies. However, although benign entities continue to occasionally cause SVCS, in the

second half of the twentieth century, malignancies became the most common cause ( [225](#), [226](#) ). As a cause of SVCS, NHL trails only lung cancer in incidence ( [Fig. 72.7](#) ). Of a total of 915 cases of NHL seen at the M.D. Anderson Cancer Center, 3.9% were associated with SVCS at presentation ( [227](#) ). Classified according to the Working Formulation ( [228](#) ), 23 patients had diffuse large-cell lymphoma (7% of all diffuse large-cell lymphoma patients), and 12 patients had lymphoblastic lymphoma (21% of lymphoblastic lymphoma patients). One patient with follicular large-cell lymphoma had SVCS. No patients had SVCS among the 474 other patients with follicular or small lymphocytic lymphoma, indicating that this is a rare occurrence in patients with low-grade NHL. The presence of SVCS in patients with low-grade NHL should prompt a search for other causes such as lung cancer or infection.



**Figure 72.7.** A patient with anterior mediastinal mass due to large B-cell lymphoma developed superior vena cava syndrome. Hematologic neoplasms associated with superior vena cava syndrome include lymphoblastic lymphoma, Hodgkin disease, and large B-cell lymphoma.

It is likely that many patients with SVCS who had diffuse large-cell lymphoma according to the Working Formulation would be reclassified as having primary mediastinal (thymic) B-cell lymphoma in the World Health Organization classification. This entity is often associated with SVCS ( [229](#), [230](#) ); therapy is controversial but generally consists of combination chemotherapy with or without radiation. Although results have been variable, adults with primary mediastinal B-cell lymphoma can have a good prognosis, with approximately 50% of patients achieving long-term disease-free survival ( [231](#), [232](#) ). In the pediatric population, SVCS is unusual. When SVCS caused by an underlying malignancy occurs in children, lymphoma is the most common cause, followed by ALL and HD ( [233](#) ). Although almost all children with mediastinal NHL have lymphoblastic lymphoma, a minority has primary mediastinal B-cell lymphoma. Prognosis for these children is good. SVCS from other hematologic neoplasms is rare but has included extramedullary myeloid tumor/granulocytic sarcoma (AML), malignant histiocytosis, angioimmunoblastic lymphadenopathy with dysproteinemia, and plasmacytoma. An increasingly common cause of SVCS in patients with hematologic neoplasms is thrombosis related to indwelling catheters. Therapy consists of anticoagulants and thrombolytics ( [234](#) ). Thrombosis can also complicate malignant obstruction of the superior vena cava ( [235](#) ). Although discussions of SVCS are often included under the title “oncologic emergencies,” recent reviews have emphasized the fact that life-threatening complications of SVCS are exceedingly rare ( [Table 72.8](#) ) ( [236](#) ). Thus, the focus of management has shifted from empiric radiation therapy to careful diagnostic evaluation. Physical examination should focus on potential sites of extrathoracic disease that may be suitable for biopsy. CT scanning has largely replaced venography as the imaging modality of choice. Although there is a concern about invasive procedures, particularly mediastinoscopy, in patients with SVCS, these procedures are, in fact, quite safe even in areas of high venous pressure ( [237](#) ).

**TABLE 72.8. Management of Superior Vena Cava Syndrome (SVCS)**

Accurate diagnosis and specific therapy are necessary for the optimal care of the patient who presents with SVCS. The following is a diagnostic approach to a patient who presents with SVCS.

**Assessment of respiratory status.** Radiation therapy should not be given empirically except for the <5% of patients who are in extremis at presentation. Steroids should be avoided until diagnosis is made.

**History and physical examination.** The examination should be focused on identifying extrathoracic sites for diagnostic biopsies, including the peripheral lymph nodes and testes.

**Laboratory studies.** A complete blood cell count and routine chemistries, including liver tests, should be obtained. A serum  $\beta$  human chorionic gonadotropin and  $\alpha$ -fetoprotein should be obtained in young men. The peripheral blood should be examined for lymphoblasts.

**Appropriate imaging studies.** All patients should have a chest radiograph, and most should have a chest computed tomography scan. Imaging studies of the abdomen should be obtained as dictated by the above studies.

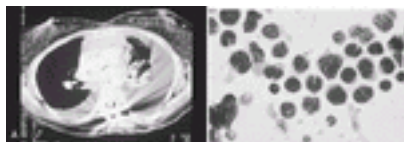
**Extrathoracic biopsies.** Biopsies of extrathoracic sites found by the above studies should be taken (e.g., excisional lymph node biopsy of a palpable node). Bone marrow aspiration and biopsy should be performed on patients with cytopenias.

**Mediastinoscopy and/or thoracoscopy.** A thoracic surgeon should evaluate patients who do not have a definitive diagnosis.

---

Thus, management of SVCS should focus on prompt diagnosis and specific therapy. Many patients with a hematologic neoplasm as the etiology of their SVCS have a chance to be cured with combination chemotherapy.

**PLEURAL EFFUSION** Pleural and peritoneal effusions are common complications in patients with advanced HD or NHL ([238](#)), particularly in children ([Fig. 72.8](#)). Effusions and pleural involvement from tumor have been reported in patients with AL ([239](#)), CLL, CML, HCL, Waldenström macroglobulinemia, and MM ([240](#)). Recently, a primary body cavity-based NHL has been described in patients with HIV infection. It presents as a serous effusion, has immunoblastic or anaplastic large cell cytology and a B-cell immunophenotype, and is associated with infection with human herpesvirus type 8 (Kaposi sarcoma-associated human herpesvirus 8) ([241](#), [242](#)). Another primary pleural lymphoma occurs in patients with long-standing tuberculous pyothorax. These so-called pyothorax-associated lymphomas are associated with Epstein-Barr virus infection and appear to arise in the setting of a polyclonal B-cell reaction ([243](#)).



**Figure 72.8.** A large left pleural effusion and smaller right pleural effusion can be seen in this computed tomography scan from a patient who also has a large anterior mediastinal mass (A). Pleural fluid cytology (Papanicolaou stain) shows numerous convoluted lymphoblasts characteristic of T-cell lymphoblastic lymphoma, a diagnosis confirmed by flow cytometric phenotypic analysis of the effusion (B). See [Color Plate](#). (Courtesy of Dr. Michael T. Lomis, Department of Pathology, Vanderbilt University School of Medicine, Nashville, TN.)

In a series of patients with pleural effusion complicating lymphoma, 17 of 19 had evidence of pleural involvement, suggesting that direct involvement rather than obstruction of pleural lymphatics or the thoracic duct is the major mechanism of pleural effusion. Pleural fluid cytology, however, was diagnostic in only two patients, and many required

thoracoscopic biopsy to obtain diagnostic material ( [244](#) ). The yield of pleural fluid cytology may be improved with immunophenotyping and molecular techniques. Care should be taken in making a cytologic diagnosis of HD as Reed–Sternberg–like cells have been described in the pleural fluid of a patient with pulmonary embolus and infarction ( [245](#) ). Management of malignant pleural effusions can be vexing. They generally recede if systemic disease is controlled. However, they can be a source of great discomfort to patients with refractory disease in whom the goal of therapy is to maximize comfort. Therapy for pleural effusions caused by hematologic neoplasms is similar to that for other malignant pleural effusions and ranges from repeated thoracentesis for palliation to aggressive measures like pleurodesis done bedside or under thoracoscopic guidance ( [246](#) , [247](#) ).

## Cardiac Complications

The most common cardiac complications in patients with hematologic neoplasms are related to therapy. These include pericarditis and premature coronary artery disease ( [248](#) , [249](#) ) from mediastinal radiation (usually for HD), arrhythmias related to ATLS ( *vide infra* ), and chemotherapy–induced cardiomyopathy. Infiltration of the heart and pericardium by hematologic neoplasms is not an uncommon finding at autopsy ( [250](#) , [251](#) ). However, it rarely causes symptoms.

Infiltration of the myocardium by amyloid fibrils with resultant diastolic dysfunction is common in patients with AL amyloidosis and is discussed in [Chapter 99](#). Symptomatic infiltration of the myocardium or pericardium is occasionally seen in NHL ( [252](#) ). Cardiac lymphoma has been reported as a primary tumor and as a metastatic site in patients who are immunosuppressed secondary to HIV or organ transplantation ( [253](#) , [254](#) and [255](#) ). Similar infiltrations of the heart may also occur, but quite rarely, in HD, leukemia, and plasmacytoma.

Infiltration of the pericardium is often asymptomatic, but cardiac tamponade, arrhythmias, or, rarely, myocardial rupture can be the clinical presentation. This can occur either at diagnosis or later in the course of the disease. A few patients have been reported in whom hematologic neoplasia led to a symptomatic stenosis of a coronary artery ( [256](#) , [257](#) ).

Infiltration of the heart is generally diagnosed by echocardiography; magnetic resonance imaging and thallium scintigraphy may also be of value ( [258](#) ). A diagnosis of hematologic neoplasia can be made by pericardial fluid cytology or by endomyocardial biopsy ( [259](#) ), although the diagnosis may be elusive.

Nonbacterial thrombotic (marantic) endocarditis has occasionally been reported to complicate hematologic neoplasms ( [260](#) ). Eosinophilic (Löffler) endocarditis has been described in a number of patients with high peripheral blood eosinophil counts preceding the overt development of ALL ( [261](#) ). The eosinophilic endocarditis resolved with therapy for ALL and appears to be prevented by the administration of hydroxyurea to patients with the hypereosinophilic syndrome. Löffler endocarditis has also been reported in patients with NHL and eosinophilia. High–output heart failure has been described in association with plasmacytic neoplasms ( [262](#) ).

## Breast Involvement

Involvement of the breast occurs in NHL and may be the only site of detectable disease.

The most common histology is diffuse large B-cell lymphoma, although other types, including MALT lymphomas, occur ( [263](#), [264](#), and [265](#) ). Presentation is similar to carcinoma of the breast, and the lesions may appear similar on mammography. An accurate diagnosis is best accomplished by core needle biopsy. Treatment should be similar to that used for stage IE NHL of other sites.

Breast involvement has been reported to occur in AL, HD, and MM. However, breast masses in patients with a history of hematologic neoplasia should be considered a primary breast cancer until proven otherwise, particularly in women who received irradiation for HD ( [263](#), [264](#), and [265](#) ).

## Abdominal Complications

**GASTROINTESTINAL COMPLICATIONS** Symptomatic involvement of the esophagus is rare in hematologic neoplasms. It has been most commonly reported in NHL ( [266](#), [267](#), and [268](#) ) and has also been reported in HD ( [269](#), [270](#) ) and leukemia. Bronchoesophageal fistulae may occur ( [270](#) ). The stomach is the most common site of extranodal NHL, which is discussed in [Chapter 90](#) and [Chapter 91](#). Gastric involvement may occur in HD ( [271](#) ), granulocytic sarcoma ( [272](#) ), MM ( [273](#) ), and amyloidosis ( [274](#) ). The intestines are often involved by NHL ( [Fig. 72.9](#) ). Burkitt lymphoma often presents with abdominal pain, obstruction, and a mass involving the ileocecal region of the gastrointestinal tract. Two distinct entities in the World Health Organization classification scheme typically involve the small bowel. Intestinal T-cell lymphoma is a complication of gluten-sensitive enteropathy (nontropical sprue) and has been called *enteropathy-associated T-cell lymphoma*. Intestinal T-cell lymphoma can occur without a history of nontropical sprue. Immunoproliferative small intestinal disease or Mediterranean lymphoma is a B-cell process that is rare in the West. Mantle-cell lymphoma may present with lymphomatous polyposis of the colon, which can be mistaken for familial polyposis. These and other gastrointestinal NHLs are discussed in [Chapter 90](#) and [Chapter 91](#).



**Figure 72.9.** A large mass near the ileocecal valve produced symptoms of intestinal obstruction in a patient with small, noncleaved cell (Burkitt) lymphoma. See [Color Plate](#). (Courtesy of Dr. William R. Macon, Department of Pathology, Mayo Medical Center, Rochester, MN.)

The intestines may be involved with leukemia, HD, or myeloma. Ischemic bowel resulting from angiocentric T/NK-cell lymphoma has been described ( [275](#) ).

**NEUTROPENIC ENTEROCOLITIS (TYPHLITIS)** One of the most serious complications of intensive chemotherapy for hematologic malignancies is neutropenic enterocolitis (typhlitis) ( [Table 72.9](#) ). Clinically, the syndrome has been defined as fever, abdominal pain, and abdominal tenderness occurring in a neutropenic patient ( [276](#) ). Other authors include radiographic evidence of right-sided colonic inflammation in the clinical definition ( [277](#) ). The syndrome has become increasingly common, probably because of intensification of therapy ( [277](#) ). In an autopsy series of 37 children with neutropenic enterocolitis, 7 had cecal involvement alone, 13 had cecal and other intestinal involvement, and 10 had cecal



involvement with scattered ulcerations throughout the gastrointestinal tract. The bowel wall consisted of a denuded mucosa with hemorrhagic necrosis ( 278 ).

### TABLE 72.9. Management of Typhlitis

Typhlitis tends to occur in an acute leukemia patient with prolonged neutropenia.

Fever and abdominal pain are common symptoms. The abdomen is tender, and bowel sounds are decreased or absent.

Imaging studies (flat plate and upright of abdomen, computed tomography scan) often indicate right-sided colonic inflammation; the bowel wall may be distended, edematous, and have air within the wall. Free air indicates perforation.

Therapy should be individualized.

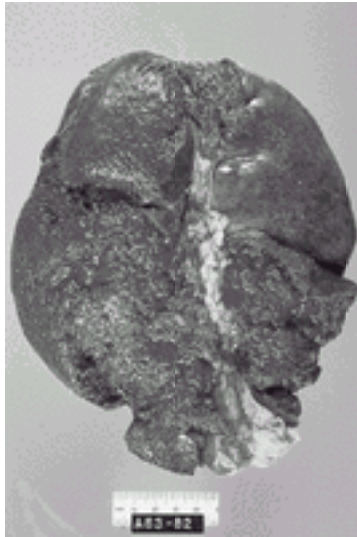
Administer broad-spectrum antibiotics and include anaerobic coverage; consider growth factors.

Nasogastric suction can be used to decompress the gastrointestinal tract.

Surgical consultation should be obtained early. An operation should be performed if perforation has occurred or if there is a question of necrotic bowel.

Neutropenic enterocolitis may be related to neutropenia of any cause but has most commonly been associated with AL. No association has been made with particular chemotherapeutic agents, although several recent reports have mentioned patients treated with taxanes ( 279 ), and ara-C may cause gastrointestinal toxicity ( 280 , 281 ). Although infection is believed to be the cause, this has not been proven pathologically ( 282 ). Neutropenic enterocolitis is a life-threatening complication; some have recommended immediate surgery for all patients ( 283 ), whereas others have reported good results with supportive therapy ( 277 ). Supportive treatment may be the best approach, with surgery reserved for patients who have evidence of bowel perforation or clinical deterioration.

**SPLenic INVOLVEMENT: SPLenOMEGALY AND SPLenic RUPTURE** The spleen is a common site of involvement with hematologic neoplasms. Splenomegaly with resultant abdominal fullness and pain as well as cytopenias may occur with direct involvement, or secondarily. The complications of splenomegaly can be improved with splenectomy or splenic irradiation ( 284 , 285 ). A life-threatening complication of splenic involvement is *spontaneous rupture*, which is defined as rupture of the spleen without trauma; it has also been called *pathologic splenic rupture* ( Fig. 72.10 ). In 1981, Bauer et al. described 5 cases of splenic rupture at the University of Nebraska and reviewed 48 cases from the English language literature. Of these 53 cases, 11 had AML, 9 had ALL, 6 had CML, 6 had HD, 3 had CLL, and 1 patient was reported with MM, macroglobulinemia, and HCL. The survival rate was 38%, and no patient survived without surgery ( 286 ). Guth et al. used conservative management prospectively in an intensive care unit for 11 patients who had grade one to four spontaneous splenic rupture (i.e., those without a completely shattered spleen) ( 287 ) and who did not require numerous immediate transfusions. All 11 survived without operation, suggesting that nonoperative management may be appropriate for selected patients with contained splenic rupture ( 288 ). Spontaneous splenic rupture can occur at any time during the disease course, including at presentation.



**Figure 72.10.** Spontaneous rupture of this friable spleen caused exsanguination of a patient with acute lymphocytic leukemia. See [Color Plate](#). (Courtesy of Dr. William R. Macon, Department of Pathology, Mayo Medical Center, Rochester, MN.)

**HEPATIC COMPLICATIONS** The liver is commonly involved by hematologic neoplasms, but patients rarely die from liver disease. NHL and HD may involve the liver. The prognosis depends on histology and overall staging and is not adversely affected based only on liver involvement. Liver disease is rare in MM but has been reported ([289](#)). Thrombosis of the portal vein leading to portal hypertension and bleeding esophageal varices is a potential complication of myeloproliferative and lymphoproliferative disorders ([290](#)). Hepatic vein thrombosis and the Budd–Chiari syndrome may also complicate myeloproliferative disorders ([291](#)) or lymphoid malignancies ([292](#)). If feasible, patients with Budd–Chiari syndrome caused by a myeloproliferative disorder can be considered for orthotopic liver transplantation. Molecular or cell culture techniques to study erythroid colony formation *in vitro* suggest that a high percentage of patients with “idiopathic” hepatic or portal vein thrombosis have an occult myeloproliferative disorder ([291](#)).

**RENAL COMPLICATIONS** Renal complications are common in MM and in other diseases associated with paraproteins. These are discussed in [Chapter 96](#), [Chapter 97](#), [Chapter 98](#), [Chapter 99](#), [Chapter 100](#) and [Chapter 101](#). The kidneys may be infiltrated by leukemias or lymphomas. However, fewer than 10% of patients with kidney infiltration at autopsy had renal impairment in life. Renal failure may accompany ureteral obstruction from NHL or HD. Enlarged kidneys may occur in patients with leukemia even after successful therapy and do not correlate with disease activity. Renal failure associated with the tumor lysis syndrome, urate nephropathy, and hypercalcemia is discussed later in the chapter. Nephrotic syndrome and glomerulonephritis may occur in conjunction with a variety of hematologic neoplasms. The association of nephrosis and HD is a well-established paraneoplastic syndrome ([293](#)). Most patients have minimal–change (nil) disease on renal biopsy. The renal lesion often precedes the diagnosis of HD and is steroid resistant. Successful therapy for HD generally leads to resolution of nephrosis. Patients with CLL or small lymphocytic lymphoma may present with membranoproliferative nephrotic syndrome and glomerulonephritis, generally in association with a paraprotein or cryoglobulin ([294](#)). The association of nephrotic syndrome and glomerulonephritis with other hematologic malignancies is less clear.

**UROLOGIC AND GYNECOLOGIC COMPLICATIONS** Infiltration of the prostate with resultant urinary retention may occur in lymphoma or leukemia. Priapism can complicate the leukemias (especially CML) or myeloma. Lymphoma has been reported to involve almost any part of the female genital tract, including the ovaries, uterus, and vulva. Leukemias, myeloma, or HD may also involve the female genital tract. The testes are commonly involved with hematologic neoplasms. Like the CNS, the testes are sanctuaries



into which chemotherapy penetrates poorly; they can be the sole site of relapse in ALL ( [295](#) ) or AML ( [296](#) ). Initial testicular involvement in ALL may portend a poor prognosis ( [297](#) ). The testicles can also be involved by NHL, which is the leading cause of testicular enlargement in elderly men. In the Danish Lymphoma Study Group database, 39 of 2687 cases of NHL had testicular involvement. Twenty-four of these 39 had disease limited to the testicle. Most patients had diffuse large B-cell lymphoma. Combination chemotherapy appeared to be beneficial as adjunctive therapy in localized disease. The value of this approach is supported by data from the University of British Columbia in Vancouver ( [298](#) ). Patients with testicular lymphoma should have a CT scan of the abdomen to rule out retroperitoneal lymph node involvement. Patients with disseminated disease at presentation and testicular involvement appear to have a poor prognosis because they are at risk for both CNS and late, contralateral testicular relapses ( [299](#) ). Patients with testicular lymphoma should receive CNS prophylaxis with intrathecal chemotherapy and radiation to the contralateral scrotal contents.

## Skin Involvement

The skin can be involved by NHL as a primary site or secondary to previously documented nodal/extranodal or marrow involvement. Cutaneous T-cell lymphoma ( [Chapter 94](#) ) and cutaneous-only anaplastic large cell lymphoma (typically anaplastic large cell kinase expression-negative) tend to be indolent. More recently, primary cutaneous B-cell lymphoma (no extracutaneous involvement) has been described. The prognoses of these depend on the histology. Many of the therapeutic modalities primarily used for patients with cutaneous T-cell lymphoma, such as topical chemotherapy or electron beam radiation, may be of use in palliating patients with skin involvement from other hematologic neoplasms.

Infiltration of the skin may occur in the ALs and the lymphomas, and it is rare in myeloma and HCL. Most skin lesions in patients with these neoplasms are infectious or reactive in nature. Extramedullary hematopoiesis has been reported to cause skin lesions ( [300](#) ). Skin involvement in systemic HD is rare; it complicated the course of only 0.5% of 1844 patients seen between 1944 and 1977 at the M.D. Anderson Cancer Center ( [301](#) ). Primary cutaneous involvement is extremely rare when methods are used that can exclude CD30-positive T-cell cutaneous lymphomas.

Cutaneous eruptions are fairly common in patients with leukemia. These can be divided into hemorrhagic lesions, infectious lesions, reactive or paraneoplastic lesions (e.g., Sweet syndrome), drug reactions, complications of bone marrow transplant, and leukemia cutis. Desch and Smoller reviewed 123 skin biopsies performed on patients with leukemia ( [302](#) ). Leukemia cutis was present in 37 of the biopsies (30%), and 23 of these patients had AML or MDS. Of note, however, was the fact that most patients who had skin biopsies with AML had a cutaneous process other than leukemia cutis, mainly infection or drug reaction. When graft-versus-host disease was excluded, leukemia cutis accounted for 50% of diagnoses in patients with CLL or ALL and for 88% of diagnoses in patients with CML ( [302](#) ). Thus, most cases of leukemia cutis occur in patients with AML, who are also at high risk for other cutaneous complications.

In Boggs et al.'s large series of patients with AL, leukemia cutis occurred in 11.0% of the patients with AML and in 1.3% of the ALL patients. Acute monocytic leukemia (FAB M5) is disproportionately represented ( [38](#) ). Clinically, leukemia cutis can present in a number of forms. Papules, nodules, plaques, and macules are the most common, although ulcerations, ecchymoses, bullous lesions, erythroderma, and vasculitic lesions may occur. Like other forms of extramedullary disease, leukemia cutis usually portends a poor

prognosis in patients with AML.

Paraneoplastic skin disorders commonly occur in patients with hematologic neoplasms. The most common of these is Sweet syndrome or febrile neutrophilic dermatosis. Of patients with malignancy-associated Sweet syndrome, 85% have a hematologic malignancy, most commonly AML ( 303 ). Paraneoplastic pemphigus, which can be fatal, and pyoderma gangrenosum may also occur.

Another serious cutaneous complication of CLL and NHL is the increased risk of skin cancer in these patients. The risk applies to both basal cell carcinoma and squamous cell carcinoma ( 304 ). The latter may be aggressive and difficult to control and may lead to morbidity and death.

### **Musculoskeletal Complications**

Osteolytic skeletal lesions are common in myeloma and are discussed in [Chapter 98](#).

Bone lesions are also common complications of adult T-cell leukemia lymphoma (ATLL) ( 305 ). Radiographic evidence of bone involvement is not uncommon in NHL and HD.

Primary NHL of bone is most often a diffuse large B-cell type ( 306 ). Second to skin, bone lesions are a metastatic site for T-anaplastic large cell lymphoma ( 307 ). Therapy for NHL or HD involving bone is generally a combination of chemotherapy with or without radiation. Bone destruction with pain can occur in CML in blastic phase, CLL, HCL, and Waldenström macroglobulinemia.

Bone pain is an extremely common presenting symptom of AL, particularly in ALL in children ( 308 ). This is presumably caused by massive proliferation of blasts in the medullary canal and under the periosteum. At presentation, a variety of radiographic abnormalities may be seen, including osteopenia, lytic lesions, sclerotic lesions, and radiolucent metaphyseal bands in long bones.

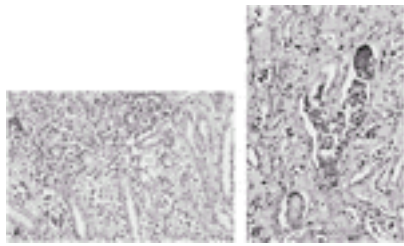
Osteoporosis can occur in ATLL or myeloma and can result from therapy for hematologic neoplasia as a result of ovulatory failure. Bisphosphonate therapy may be beneficial ( 309 ).

Muscle complications of hematologic neoplasms are rare. Primary lymphoma of muscle has been reported ( 310 ). Polymyositis has occurred in association with MM, NHL, HD, and CLL.

### **Metabolic Complications**

Patients with hematologic neoplasms often have metabolic derangements. Many are caused by the complex interactions of disease, toxic therapies, and other complications such as infection or hemorrhage. Many of these derangements are common in other critically ill patients and are not covered here. However, several metabolic problems are either unique to patients with hematologic neoplasms (such as ATLS) or are the result of direct effects of the neoplasm.

**ACUTE TUMOR LYSIS SYNDROME** ATLS occurs when neoplastic cells are killed and the intracellular contents are released into the circulation ( [Fig. 72.11](#) ). Clinically, it is marked by hyperphosphatemia, hyperkalemia, hyperuricemia, hypocalcemia, and acute, often oliguric renal failure. Patients are generally critically ill ( 311 ). ATLS most often occurs in patients with rapidly proliferating neoplasms, such as ALs, and high-grade NHL in response to aggressive therapy.



**Figure 72.11.** Karyorrhectic lymphoblast nuclei are present throughout the kidney in a patient with acute tumor lysis syndrome in whom cytotoxicity was initiated by administration of corticosteroids (A). Renal tubules contain calcium phosphate precipitates that contributed to acute tumor lysis–associated renal failure (hematoxylin and eosin stain) (B). See [Color Plate](#). (Courtesy of Dr. William R. Macon, Department of Pathology, Mayo Medical Center, Rochester, MN.)

Hande and Garrow have drawn a distinction between laboratory tumor lysis syndrome and clinical tumor lysis syndrome ([312](#)). They found that an asymptomatic change in two of four laboratory parameters (serum phosphate, urate, potassium, and blood urea nitrogen) occurred in 42% of patients receiving chemotherapy for intermediate- or high-grade NHL, but they also found only a 6% incidence of clinical ATLS, marked by renal failure or severe hyperkalemia. Thus, laboratory evidence of tumor lysis is far more common than the symptomatic clinical syndrome. ATLS has been reported in a variety of hematologic and solid tumor types. However, it is most common in bulky, rapidly proliferating tumors. Patients with small, noncleaved B-cell lymphoma (Burkitt and Burkitt-like types) and T-cell lymphoblastic lymphoma appear to be at highest risk. Patients with high lactate dehydrogenase and renal insufficiency are at high risk for developing clinical tumor lysis and should be monitored carefully. Although ATLS usually occurs with aggressive combination chemotherapy, the syndrome has been reported to occur spontaneously ([313](#)), in response to fever, and in patients treated solely with corticosteroids, intrathecal chemotherapy, or radiation. Several recent reports have described ATLS in patients with CLL who were treated with the newer purine analogs cladribine or fludarabine ([314](#), [315](#)). It has been described with a variety of other single agents. Monoclonal antibody therapy, like rituximab, has rarely caused tumor lysis ([316](#)). The etiology of the renal failure in ATLS is multifactorial. Urate nephropathy is a major cause. The ionization constant of uric acid is 5.6, so, at normal blood pH, the majority of uric acid is in its more soluble ionized form. However, the hyperosmolality and acidity of the kidney's collection ducts and distal tubules can lead to precipitation of uric acid crystals. This, in turn, can lead to mechanical obstruction of urine flow and a "postrenal" acute renal failure. Uric acid can also precipitate as renal calculi and cause frank hydronephrosis. Tumor breakdown leads to purine catabolism, which culminates in production of hypoxanthine and xanthine. Xanthine oxidase converts xanthine to uric acid, which, as mentioned above, precipitates in the renal milieu. Allopurinol is a competitive inhibitor of the enzyme xanthine oxidase and prevents the formation of uric acid. It is administered in a dose of 300 to 800 mg daily. Important drug interactions include the prolongation of the half-lives of 6-mercaptopurine and azathioprine. It can also cause life-threatening allergic reactions, including Stevens-Johnson syndrome. Allopurinol is available as an intravenous formulation, which is safe and efficacious in patients unable to take oral medications ([317](#)). It is usually given at a dose of 200 to 400 mg/m<sup>2</sup>/day in either a single infusion or divided over 6 to 8 hours. Even at appropriate doses of allopurinol, increased uric acid production can be seen after chemotherapy. Humans lack the enzyme uricase that converts uric acid to allantoin, which is water soluble. *Rasburicase* is a novel recombinant form of uric acid oxidase. In recent pediatric trials, rasburicase was shown to decrease uric acid production compared to allopurinol, despite intensive chemotherapy ([318](#)). Similar experience has been seen in the adult population ([319](#)). Hypersensitivity reactions were rare and did not recur on retreatment. The dosing schedule used in these studies

was 0.2 mg/kg as a 30-minute intravenous infusion for the first 5 to 7 days after starting chemotherapy. Patients at high risk for ATLS should receive prophylactic therapy in an effort to prevent the syndrome ( [Table 72.10](#)). This generally consists of intravenous hydration to promote a brisk urine output, alkalinization of the urine, and allopurinol to prevent renal and metabolic complications. Intravenous allopurinol and rasburicase are important developments in the management of tumor lysis.

### **TABLE 72.10. Management of the Acute Tumor Lysis Syndrome**

A clinician should consider the likelihood of tumor lysis when instituting therapy in any patient with a hematologic neoplasm. Those at low risk need no preventive therapy. The following measures should be undertaken for patients at risk.

All patients at intermediate or high risk (acute leukemia, intermediate- or high-grade lymphoma, chronic lymphocytic leukemia, being treated with fludarabine or cladribine) should receive allopurinol, 600 mg by mouth on the day before therapy and 300 mg daily during the first cycle of therapy.

Patients at high risk (acute leukemia or high-grade lymphoma with bulky disease or renal impairment) should be admitted to the hospital. Volume depletion should be corrected, and patients should receive 0.9% saline hydration at 250 cc/h overnight. Urine output should be monitored carefully. Alkalinization of urine may be indicated.

Patients at high risk should have electrocardiographic monitoring during institution of therapy. Serum calcium, phosphorous, magnesium, potassium, and uric acid should be monitored every 2–6 h for 2–3 d.

Plans for emergent hemodialysis should be in place before institution of chemotherapy.

Chemotherapy should be given even if dialysis is necessary. Less intensive therapy may be needed for debulking purposes before initiation of definitive chemotherapy.

Supportive care continues to remain a critical part of the management. Therapy for hyperkalemia and dialysis are often required. Hemodialysis is preferred over peritoneal dialysis because of its superior clearance of phosphate and urate ( [311](#)). Continuous arteriovenous dialysis and venovenous hemofiltration have been reported to be beneficial. For patients at very high risk for ATLS such as those with bulky high-grade NHL, nephrology consultation and plans for therapeutic or prophylactic dialytic treatments should be made before institution of chemotherapy.

**ALTERATIONS OF POTASSIUM METABOLISM** Low serum potassium levels are a common complication of AML. Ten percent of severely hypokalemic patients have AML, a 22-fold increase over the expected value ( [320](#)). Hypokalemia in AML is a result of decreased whole-body potassium. Although lysozymuria and alterations of the renin-angiotensin-aldosterone axis have been implicated, the exact pathophysiology is not defined in all cases. Antibiotic and antineoplastic therapy may contribute to low serum potassium. Pseudohyperkalemia caused by *in vitro* hemolysis is often encountered in patients with hematopoietic neoplasms and markedly elevated leukocyte or platelet counts ( [321](#)).

**ALTERATIONS OF SODIUM METABOLISM** Hyponatremia may be encountered in patients with hematologic neoplasms and is likely caused by inappropriate vasopressin release. Antineoplastic agents, including cyclophosphamide, vincristine, and biologic agents, can also cause hyponatremia ( [322](#)). Pseudohyponatremia is a sequela of paraproteinemia and is commonly seen in MM ( [323](#)). Hypernatremia is rare except in patients with CNS disease and central diabetes insipidus.

**ALTERATIONS OF URIC ACID METABOLISM** Uric acid is produced during purine metabolism. Its production is increased in hematologic malignancies with rapid tumor cell turnover. Thus, hyperuricemia or, more commonly, increased urate excretion is often seen at diagnosis in patients with AL, CML, PV, and idiopathic myelofibrosis. Less commonly, hyperuricemia may be seen in patients with newly diagnosed HD, NHL, and MM. Rapid cell

killing by cytotoxic chemotherapy causes increased urate production and hyperuricemia, which are manifestations of ATLS (discussed previously). Hyperuricemia has two main sequelae: urate crystal-induced arthritis and urate nephropathy. Urate crystal-induced arthritis (gout) is a relatively rare complication of hematologic neoplasia. The exception to this rule can be found in men with PV, in whom gout is common ( [324](#) ). Gout in women with PV is less common but more severe. Urate nephropathy, gout, or both can be the presenting complaint in patients with hematologic neoplasia. It has even been reported to precede the overt manifestations of AL. Nevertheless, the majority of cases occur in patients with clinically evident disease as a manifestation of ATLS. The Polycythemia Vera Study Group has recommended that allopurinol be administered to all patients with PV and hyperuricemia ( [325](#) ). Allopurinol is also reasonable therapy for patients with other myeloproliferative disorders who develop gout. Hypouricemia is rare. It has been reported in patients with HD as a result of a renal tubular defect ( [326](#) ).

**ALTERATIONS OF CALCIUM METABOLISM** Hypercalcemia is one of the most common complications of malignancy. It occurs in 5 to 10% of patients with solid tumors and generally portends a poor prognosis. It is less common in patients with hematologic neoplasms with two prominent exceptions. Hypercalcemia occurs in approximately one-third of patients with MM and in two-thirds of patients with human T-cell leukemia virus type 1-associated ATLL ( [Chapter 98](#) and [Chapter 90](#), respectively). Hypercalcemia occurs less often in other types of NHL and HD. It is a rare occurrence in leukemias but has been reported in all subtypes. The symptoms of hypercalcemia—*anorexia, nausea, pain, fatigue, constipation, weakness, polyuria, and altered mental status*—are nonspecific and common in patients with hematologic malignancy. Therefore, hypercalcemia should be suspected in patients with a variety of complaints. Lowering of the serum calcium in hypercalcemic patients is readily achievable and provides effective palliation ( [327](#) ). Calcium metabolism is complex and involves the interplay of parathyroid hormone, vitamin D metabolism, bone resorption, gastrointestinal absorption, and renal excretion. All of these mechanisms may be perturbed in malignancy-associated hypercalcemia. However, hypercalcemia from hematologic neoplasms generally results from one or more of three underlying mechanisms. First, the hypercalcemia of MM results from cytokine-mediated bone destruction. *Osteoclast-activating factor* (OAF) is a descriptive term used to denote the substance(s) elaborated by normal or neoplastic hematopoietic cells that results in activation of osteoclasts with resultant bone destruction and impaired bone formation ( [328](#) ). Interleukin-1 $\beta$ , lymphotoxin, and tumor necrosis factor- $\alpha$  appear to be the major molecules with OAF activity. Interleukin-1 $\beta$  appears to be the most important in MM and may be important in disease progression ( [329](#) ). A second mechanism is conversion of 1-OH vitamin D to 1,25-OH vitamin D (calcitriol). In normal calcium homeostasis, this conversion occurs in the kidney, and the calcitriol so produced causes increased gastrointestinal calcium absorption and increased resorption of calcium from bone. In both NHL and HD, an ectopic production of calcitriol can occur in the tumor. The increased levels of calcitriol lead to increased calcium absorption and hypercalcemia ( [330](#) ). The third mechanism of hypercalcemia in hematologic neoplasms is elaboration of parathyroid hormone-related peptide. This is the major mechanism of hypercalcemia in solid tumors. Like parathyroid hormone, parathyroid hormone-related peptide causes hypercalcemia by increasing release of calcium from bone. This mechanism of hypercalcemia appears to be important in human T-cell leukemia virus type 1-associated ATLL ( [331](#) ) and is the likely mechanism of action in occasional cases of CML in blast phase, AL, NHL, HD, and MM. There is no specific therapy. Patients with hematologic neoplasms may have hypercalcemia for reasons unrelated to their tumor. Primary hyperparathyroidism is the most common cause of hypercalcemia in outpatients and should be suspected in patients whose neoplasm is in good control. Immobilization is a cause of hypercalcemia and may cause worsening hypercalcemia in patients with MM or other hematologic neoplasms. Therapy of hypercalcemia consists of hydration and loop diuretics to increase calciuresis, corticosteroids for patients with hypercalcemia believed to be caused by OAF or calcitriol production, and therapies to prevent release of calcium



from bone such as bisphosphonates ( [Table 72.11](#) ) ( [332](#) ). Therapy for the underlying hematologic neoplasm should be undertaken.

### **TABLE 72.11. Management of Hypercalcemia**

---

Patients with symptomatic hypercalcemia and an underlying hematologic neoplasm can be effectively palliated. The approach consists of history and physical examination to look for other causes of altered mentation and a laboratory evaluation to assess renal function. Specific therapy to lower the serum calcium consists of the following.

Immediate vigorous hydration with 0.9% saline. The rate should be individualized based on assessment of the patient's volume status and cardiac function. Most patients require 3–5 L of saline to normalize his or her intravascular volume.

Intravenous furosemide should be used if signs or symptoms of volume overload develop. Diuretics should not be given to volume-depleted patients. Thiazide diuretics should be avoided.

Pamidronate, 90 mg intravenously over 4 h, should be given.

For patients with multiple myeloma or lymphoma, corticosteroids should be given. Prednisone, 60–100 mg daily, or an equivalent dose of dexamethasone or another steroid is effective.

In severe symptomatic hypercalcemia, calcitonin, 4 units/kg subcutaneously every 12 h for 4 doses, may be added to pamidronate and corticosteroids.

---

Hypercalcemia induces an osmotic diuresis, and patients are often markedly volume depleted. Volume depletion can lead to a decreased glomerular filtration rate, decreased calcium excretion, and worsening hypercalcemia. Thus, the mainstay of antihypercalcemic therapy is aggressive rehydration with isotonic saline. Other electrolytes, including sodium, potassium, and magnesium, should be monitored and repleted as necessary. Loop diuretics, such as furosemide, may increase calciuresis slightly. However, they should be withheld until the patient's intravascular volume status has been normalized, as they may worsen prerenal azotemia. Thiazide diuretics should be avoided. Corticosteroids impair release of OAF and ectopic production of calcitriol. They are useful as adjuncts to other therapies in patients with MM, HD, or NHL. They are ineffective in hypercalcemia because of other mechanisms. Bisphosphonates are now widely used as the main therapy for hypercalcemia. In the United States, pamidronate is most widely used. Pamidronate was originally given as 60 or 90 mg intravenously over 24 hours. However, a 4-hour infusion is safe and effective ( [333](#) ). Zoledronic acid is a new intravenous bisphosphonate that can be given safely and effectively over a 15-minute period and is not associated with more side effects than pamidronate ( [334](#) ). Rapid infusions of doses greater than 8 mg have been associated with an increased risk of renal dysfunction ( [335](#) ). Patients with creatinine of greater than 3 mg/dl should not be treated with this agent, as these patients have typically been excluded from clinical trials using zoledronic acid. There is less experience with bisphosphonates in children. Calcitonin results in a rapid lowering of serum calcium, but tachyphylaxis is common. Its use in combination with a bisphosphonate is reasonable for patients with severely symptomatic hypercalcemia. Gallium nitrate and mithramycin are also effective agents. However, the nephrotoxicity of the former and the marrow suppression of the latter limit their use. Hypocalcemia is a component of ATLS (discussed previously). Administration of calcitriol may be useful if hypocalcemia is prolonged. Hypocalcemia has also been reported in osteosclerotic myeloma and AL. In summary, as more antineoplastic agents are added to the arsenal, the diversity of complications arising from these agents will continue to increase. Physicians caring for patients should be astute in recognizing complications arising from the hematologic neoplasms and those that develop due to treatment. Some of these complications, including acute tumor lysis and leukostasis, can be life-threatening. Timely management of symptomatic cytopenias, using appropriate blood products, antibiotics, and growth

factors in the case of febrile neutropenia, is important.

## REFERENCES

1. Emmanouilides C, Glaspy J. Opportunistic infections in oncologic patients. *Hematol Oncol Clin North Am* 2002;10:841–860.
2. Wade JC, Sofferan SA, Wintrobe MM, Cartwright GE. Management of infections in patients with acute leukemia. *Hematol Oncol Clin North Am* 2002;7:293–315.
3. Boggs DR, Sofferan SA, Wintrobe MM, Cartwright GE. Factors influencing the duration of survival of patients with chronic lymphocytic leukemia. *Am J Med* 1966;40:243–254.
4. Shaw RK, et al. A study of prednisone therapy in chronic lymphocytic leukemia. *Blood* 1961;17:182.
5. Seymour JF, Kurzrock R, Freireich EJ, Estey EH. 2-chlorodeoxyadenosine induces durable remissions and prolonged suppression of CD4+ lymphocyte counts in patients with hairy cell leukemia. *Blood* 1994;83:2906–2911.
6. Jaffe RH. The morphology of the inflammatory defense reactions in leukemia. *Arch Pathol* 1932;14:177.
7. Olofsson T, Odeberg H, Olsson I. Granulocyte function in chronic granulocytic leukemia. II. Bactericidal capacity, phagocytic rate, oxygen consumption, and granule protein composition in isolated granulocytes. *Blood* 1976;48:581–593.
8. Iki S, Yuo A, Yagisawa M, et al. Increased neutrophil respiratory burst in myeloproliferative disorders: selective enhancement of superoxide release triggered by receptor-mediated agonists and low responsiveness to *in vitro* cytokine stimulation. *Exp Hematol* 1997;25:26–33.
9. Catovsky D, Galton DA, Robinson J. Myeloperoxidase-deficient neutrophils in acute myeloid leukaemia. *Scand J Haematol* 1972;9:142–148.
10. Davis AT, Brunning RD, Quie PG. Polymorphonuclear leukocyte myeloperoxidase deficiency in a patient with myelomonocytic leukemia. *N Engl J Med* 1971;285:789–790.
11. Karle H, Hansen NE, Killmann SA. Intracellular lysozyme in mature neutrophils and blast cells in acute leukemia. *Blood* 1974;44:247–255.
12. Humbert JR, Hutter JJ Jr, Thoren CH, DeArme PA. Decreased neutrophil bactericidal activity in acute leukemia of childhood. *Cancer* 1976;37:2194–2200.
13. Davies JE, Whittaker JA, Khurshid M. The effect of cytotoxic drugs on neutrophil phagocytosis *in vitro* and in patients with acute myelogenous leukaemia. *Br J Haematol* 1976;32:21–27.
14. Pickering LK, Ericsson CD, Kohl S. Effect of chemotherapeutic agents on metabolic and bactericidal activity of polymorphonuclear leukocytes. *Cancer* 1978;42:1741–1746.
15. Baehner RL, Neiburger RG, Johnson DE, Murrmann SM. Transient bactericidal defect of peripheral blood phagocytes from children with acute lymphoblastic leukemia receiving craniospinal irradiation. *N Engl J Med* 1973;289:1209–1213.
16. Fiddes P, Penny R, Wells JV, Rozenberg MC. Clinical correlations with immunoglobulin levels in chronic lymphatic leukaemia. *Aust N Z J Med.* 1972;2:346–350.
17. Linton AL, et al. Immune responses in myeloma. *BMJ* 1963;2:86.
18. Lichtenstein A, Taylor CR. Serum immunoglobulin levels in patients with non-Hodgkin lymphoma. *Am J Clin Pathol* 1980;74:12–17.
19. Advani SH, Dinshaw KA, Nair CN, et al. Immune dysfunction in non-Hodgkin lymphoma. *Cancer* 1980;45:2843–2848.



20. Jones SE, Griffith K, Dombrowski P, Gaines JA. Immunodeficiency in patients with non-Hodgkin lymphomas. *Blood* 1977;49:335-344.
21. Schwartz PE, Sterioff S, Mucha P, et al. Postsplenectomy sepsis and mortality in adults. *JAMA* 1982;248:2279-2283.
22. Dupuy JM, Kourilsky FM, Fradelizzi D, et al. Depression of immunologic reactivity of patients with acute leukemia. *Cancer* 1971;27:323-331.
23. Greer JP, Cousar JB, Miller RF, et al. T4+ (helper phenotype) chronic lymphocytic leukemia: case report with liver failure and literature review. *Med Pediatr Oncol* 1988;16:356-362.
24. Itala M, Helenius H, Nikoskelainen J, Remes K. Infections and serum IgG levels in patients with chronic lymphocytic leukemia. *Eur J Haematol* 1992;48:266-270.
25. Cohnen G, Douglas SD, Konig E, Brittinger G. *In vitro* lymphocyte response to phytohemagglutinin and pokeweed mitogen in Hodgkin disease. An electron microscopic and functional study. *Cancer* 1973;31:1346-1353.
26. McGee ZA, Schaffner W, Koenig MG. Superinfection in lymphoreticular diseases. *Annu Rev Med* 1971;22:25-38.
27. Hersh EV, Gutterman JU, Mavligit GM. Effect of haematological malignancies and their treatment on host defence factors. *Clin Haematol* 1976;5:425-448.
28. Winter GCB, et al. Leucocyte cultures with phytohaemagglutinin in chronic lymphocytic leukemia. *Lancet* 1964;2:563.
29. Jones LH, Hardisty RM, Wells DG, Kay HE. Lymphocyte transformation in patients with acute lymphoblastic leukaemia. *BMJ* 1971;4:329-330.
30. Campbell AC, Hersey P, MacLennan IC, et al. Immunosuppressive consequences of radiotherapy and chemotherapy in patients with acute lymphoblastic leukaemia. *BMJ* 1973;2:385-388.
31. Greene WH, Schimpff SC, Wiernik PH. Cell-mediated immunity in acute nonlymphocytic leukemia: relationship to host factors, therapy, and prognosis. *Blood* 1974;43:1-14.
32. Al Sarraf M, Wong P, Sardesai S, Vaitkevicius VK. Clinical immunologic responsiveness in malignant disease. I. Delayed hypersensitivity reaction and the effect of cytotoxic drugs. *Cancer* 1970;26:262-268.
33. King GW, Yanes B, Hurtubise PE, et al. Immune function of successfully treated lymphoma patients. *J Clin Invest* 1976;57:1451-1460.
34. Bouza E, Burgaleta C, Golde DW. Infections in hairy-cell leukemia. *Blood* 1978;51:851-859.
35. Stewart DJ, Bodey GP. Infections in hairy cell leukemia (leukemic reticuloendotheliosis). *Cancer* 1981;47:801-805.
36. Golomb HM, Hadad LJ. Infectious complications in 127 patients with hairy cell leukemia. *Am J Hematol* 1984;16:393-401.
37. Bick RL, Strauss JF, Frenkel EP. Thrombosis and hemorrhage in oncology patients. *Hematol Oncol Clin North Am* 1996;10:875-907.
38. Boggs DR, Wintrobe MM, Cartwright GE. Acute leukemias: analysis of 322 cases and review of the literature. *Medicine* 1962;41:163.
39. Colman RW, Rubin RN. Disseminated intravascular coagulation due to malignancy. *Semin Oncol* 1990;17:172-186.
40. Lisiewicz J. Mechanisms of hemorrhage in leukemias. *Semin Thromb Hemost* 1978;4:241-267.

41. Holt JM, Gordon-Smith EC. Retinal abnormalities in diseases of the blood. *Br J Ophthalmol* 1969;53:145-160.
42. Gaydos LA. The quantitative relation between platelet count and hemorrhage in patients with acute leukemia. *N Engl J Med* 1962;266:905.
43. Heckman KD, Weiner GJ, Davis CS, et al. Randomized study of prophylactic platelet transfusion threshold during induction therapy for adult acute leukemia: 10,000/microL versus 20,000/microL. *J Clin Oncol* 1997;15:1143-1149.
44. Rebulli P, Finazzi G, Marangoni F, et al. The threshold for prophylactic platelet transfusions in adults with acute myeloid leukemia. Gruppo Italiano Malattie Ematologiche Maligne dell'Adulto. *N Engl J Med* 1997;337:1870-1875.
45. Benjamin RJ, Anderson KC. What is the proper threshold for platelet transfusion in patients with chemotherapy-induced thrombocytopenia? *Crit Rev Oncol Hematol* 2002;42:163-171.
46. Leukocyte reduction and ultraviolet B irradiation of platelets to prevent alloimmunization and refractoriness to platelet transfusions. The Trial to Reduce Alloimmunization to Platelets Study Group. *N Engl J Med* 1997;337:1861-1869.
47. Girolami A, Clifton EE. Fibrinolytic and proteolytic activity in acute and chronic leukemia. *Am J Med Sci* 1966;251:638-645.
48. Gralnick HR, Bagley J, Abrell E. Heparin treatment for the hemorrhagic diathesis of acute promyelocytic leukemia. *Am J Med* 1972;52:167-174.
49. Kim HD, Boggs DR. A syndrome resembling idiopathic thrombocytopenic purpura in 10 patients with diverse forms of cancer. *Am J Med* 1979;67:371-377.
50. Kaden BR, Rosse WF, Hauch TW. Immune thrombocytopenia in lymphoproliferative diseases. *Blood* 1979;53:545-551.
51. Carey RW, McGinnis A, Jacobson BM, Carvalho A. Idiopathic thrombocytopenic purpura complicating chronic lymphocytic leukemia. *Arch Intern Med* 1976;136:62-66.
52. Kedar A, Khan AB, Mattern JQ, et al. Autoimmune disorders complicating adolescent Hodgkin disease. *Cancer* 1979;44:112-116.
53. Rao S, Pang EJ. Idiopathic thrombocytopenic purpura in acute lymphoblastic leukemia. *J Pediatr* 1979;94:408-409.
54. Cohen JR. Idiopathic thrombocytopenic purpura in Hodgkin disease: a rare occurrence of no prognostic significance. *Cancer* 1978;41:743-746.
55. Adams T, Schutz L, Goldberg L. Platelet function abnormalities in the myeloproliferative disorders. *Scand J Haematol* 1974;13:215-224.
56. Wehmeier A, Scharf RE, Fricke S, Schneider W. Bleeding and thrombosis in chronic myeloproliferative disorders: relation of platelet disorders to clinical aspects of the disease. *Haemostasis* 1989;19:251-259.
57. Cardamone JM, Edson JR, McArthur JR, Jacob HS. Abnormalities of platelet function in the myeloproliferative disorders. *JAMA* 1972;221:270-273.
58. Cowan DH, Haut MJ. Platelet function in acute leukemia. *J Lab Clin Med* 1972;79:893-905.
59. Bick RL, Kunkel LA. Disseminated intravascular coagulation syndromes. *Int J Hematol* 1992;55:1-26.
60. Fabris F, Casonato A, Grazia del Ben M, et al. Abnormalities of von Willebrand factor in myeloproliferative disease: a relationship with bleeding diathesis. *Br J Haematol* 1986;63:75-83.
61. Goudemand J, Samor B, Caron C, et al. Acquired type II von Willebrand disease: demonstration of a

- complexed inhibitor of the von Willebrand factor–platelet interaction and response to treatment. *Br J Haematol* 1988;68:227–233.
62. Sohngen D, Specker C, Bach D, et al. Acquired factor VIII inhibitors in nonhemophilic patients. *Ann Hematol* 1997;74:89–93.
63. Bendandi M, Zaccaria A, Zinzani PL, et al. Factor VIII inhibitor prior to and during secondary acute nonlymphocytic leukemia in a patient with cured Hodgkin disease. *Leuk Lymphoma* 1995;16:511–513.
64. Yood RA, Skinner M, Rubinow A, et al. Bleeding manifestations in 100 patients with amyloidosis. *JAMA* 1983;249:1322–1324.
65. Bick RL. Alterations of hemostasis associated with malignancy: etiology, pathophysiology, diagnosis and management. *Semin Thromb Hemost* 1978;5:1–26.
66. Al Ismail S, Cavill I, Evans IH, et al. Erythropoiesis and iron metabolism in Hodgkin disease. *Br J Cancer* 1979;40:365–370.
67. Beamish MR, Jones PA, Trevett D, et al. Iron metabolism in Hodgkin disease. *Br J Cancer* 1972;26:444–452.
68. Frenkel EP, Bick RL, Rutherford CJ. Anemia of malignancy. *Hematol Oncol Clin North Am* 1996;10:861–873.
69. Carlross HW, Saab GA, Tavassoli M. Pure red cell aplasia and lymphoma. *JAMA* 1979;242:67–68.
70. Kitahara M. Pure RBC aplasia associated with chronic granulocytic leukemia. *JAMA* 1978;240:376.
71. Cazenave JP, Gagnon JA, Girouard E, Bastarache A. Autoimmune hemolytic anemia terminating seven years later in Hodgkin disease. *Can Med Assoc J* 1973;109:748–749.
72. Chu JY, McElfresh AE, Waeltermann RM. Autoimmune hemolytic anemia as a presenting manifestation of Hodgkin disease. *J Pediatr* 1976;89:429–430.
73. Eisner E, Ley AB, Mayer K. Coombs'–positive hemolytic anemia in Hodgkin disease. *Ann Intern Med* 1967;66:258–273.
74. Kyle A. Acquired hemolytic anemia in chronic lymphocytic leukemia and lymphomas. *Arch Intern Med* 1959;104:61.
75. Brown RJK, Meynell MJ. Haemolytic anemia associated with Hodgkin disease. *Lancet* 1949;2:835.
76. Sthoeger ZM, Sthoeger D, Shtalrid M, et al. Mechanism of autoimmune hemolytic anemia in chronic lymphocytic leukemia. *Am J Hematol* 1993;43: 259–264.
77. Adler S, Stutzman L, Sokal J, Mittelman A. Splenectomy for hematologic depression in lymphocytic lymphoma and leukemia. *Cancer* 1975;35:521–528.
78. Toghil PJ, Green S. Factors influencing splenic pooling of erythrocytes in the myelo- and lympho-proliferative syndromes. *Acta Haematol* 1973;49:215–222.
79. Tiab M, Mechinaud F, Hamidou M, et al. [Hemophagocytic syndromes. A series of 23 cases]. *Ann Med Interne (Paris)* 1996;147:138–144.
80. Su IJ, Wang CH, Cheng AL, Chen RL. Hemophagocytic syndrome in Epstein–Barr virus–associated T–lymphoproliferative disorders: disease spectrum, pathogenesis, and management. *Leuk Lymphoma* 1995;19:401–406.
81. Ohshima K, Kikuchi M, Mizuno S, et al. Hepatosinusoidal leukaemia/lymphoma consisting of Epstein–Barr virus–containing natural killer cell leukaemia/lymphoma and T–cell lymphoma; mimicking malignant histiocytosis. *Hematol Oncol* 1995;13:83–97.
82. McKee LC Jr, Collins RD. Intravascular leukocyte thrombi and aggregates as a cause of morbidity and

mortality in leukemia. *Medicine (Baltimore)* 1974;53:463–478.

83. Lichtman MA, Rowe JM. Hyperleukocytic leukemias: rheological, clinical, and therapeutic considerations. *Blood* 1982;60:279–283.
84. Lichtman MA. Rheology of leukocytes, leukocyte suspensions, and blood in leukemia. Possible relationship to clinical manifestations. *J Clin Invest* 1973;52:350–358.
85. Vernant JP, Brun B, Mannoni P, Dreyfus B. Respiratory distress of hyperleukocytic granulocytic leukemias. *Cancer* 1979;44:264–268.
86. Myers TJ, Cole SR, Klatsky AU, Hild DH. Respiratory failure due to pulmonary leukostasis following chemotherapy of acute nonlymphocytic leukemia. *Cancer* 1983;51:1808–1813.
87. Fox MJ, Brody JS, Weintraub LR. Leukocyte larceny: a cause of spurious hypoxemia. *Am J Med* 1979;67:742–746.
88. Schwartz JH, Cannellos GP. Hydroxyurea in the management of the hematologic complications of chronic granulocytic leukemia. *Blood* 1975;46:11–16.
89. Berg J, Vincent PC, Gunz FW. Extreme leucocytosis and prognosis of newly diagnosed patients with acute non-lymphocytic leukaemia. *Med J Aust* 1979;1:480–482.
90. Sharma K, Rao S, Bhat SV. Effect of hydroxyurea on blood viscosity in chronic myelogenous leukemia with hyperleukocytosis. *Physiol Chem Phys Med NMR* 1991;23:261–268.
91. Lane TA. Continuous-flow leukapheresis for rapid cytoreduction in leukemia. *Transfusion* 1980;20:455–457.
92. Eisenstaedt RS, Berkman EM. Rapid cytoreduction in acute leukemia. Management of cerebral leukostasis by cell pheresis. *Transfusion* 1978;18:113–115.
93. Ablin AR. Supportive care for children with cancer. Guidelines of the Childrens Cancer Study Group. Managing the problem of hyperleukocytosis in acute leukemia. *Am J Pediatr Hematol Oncol* 1984;6:287–290.
94. Basade M, Dhar AK, Kulkarni SS, et al. Rapid cytoreduction in childhood leukemic hyperleukocytosis by conservative therapy. *Med Pediatr Oncol* 1995;25:204–207.
95. Harris AL. Leukostasis associated with blood transfusion in acute myeloid leukaemia. *BMJ* 1978;1:1169–1171.
96. Baer MR, Stein RS, Dessypris EN. Chronic lymphocytic leukemia with hyperleukocytosis. The hyperviscosity syndrome. *Cancer* 1985;56:2865–2869.
97. Tobelem G, Jacquillat C, Chastang C, et al. Acute monoblastic leukemia: a clinical and biologic study of 74 cases. *Blood* 1980;55:71–76.
98. Snyder LS, Harmon KR, Estensen RD. Intravascular lymphomatosis (malignant angioendotheliomatosis) presenting as pulmonary hypertension. *Chest* 1989;96:1199–1200.
99. Calamia KT, Miller A, Shuster EA, et al. Intravascular lymphomatosis. A report of ten patients with central nervous system involvement and a review of the disease process. *Adv Exp Med Biol* 1999;455:249–265.
100. Demirer T, Dail DH, Abouafia DM. Four varied cases of intravascular lymphomatosis and a literature review. *Cancer* 1994;73:1738–1745.
101. DiGiuseppe JA, Nelson WG, Seifter EJ, et al. Intravascular lymphomatosis: a clinicopathologic study of 10 cases and assessment of response to chemotherapy. *J Clin Oncol* 1994;12:2573–2579.
102. Stroup RM, Sheibani K, Moncada A, et al. Angiotropic (intravascular) large cell lymphoma. A clinicopathologic study of seven cases with unique clinical presentations. *Cancer* 1990;66:1781–1788.

103. Barcos M, Lane W, Gomez GA, et al. An autopsy study of 1206 acute and chronic leukemias (1958 to 1982). *Cancer* 1987;60:827–837.
104. Dekker AW, Elderson A, Punt K, Sixma JJ. Meningeal involvement in patients with acute nonlymphocytic leukemia. Incidence, management, and predictive factors. *Cancer* 1985;56:2078–2082.
105. Ersboll J, Schultz HB, Thomsen BL, et al. Meningeal involvement in non-Hodgkin lymphoma: symptoms, incidence, risk factors and treatment. *Scand J Haematol* 1985;35:487–496.
106. Rivera GK, Pinkel D, Simone JV, et al. Treatment of acute lymphoblastic leukemia. 30 years' experience at St. Jude Children's Research Hospital. *N Engl J Med* 1993;329:1289–1295.
107. Aysun S, Topcu M, Gunay M, Topaloglu H. Neurologic features as initial presentations of childhood malignancies. *Pediatr Neurol* 1994;10:40–43.
108. al Rashid RA. Hypothalamic syndrome in acute childhood leukemia. *Clin Pediatr (Phila)* 1971;10:53–54.
109. Greydanus DE, Burgert EO Jr, Gilchrist GS. Hypothalamic syndrome in children with acute lymphocytic leukemia. *Mayo Clin Proc* 1978;53:217–220.
110. Bleyer WA, Poplack DG. Prophylaxis and treatment of leukemia in the central nervous system and other sanctuaries. *Semin Oncol* 1985;12:131–148.
- 110a. Evans AE, Gilbert ES, Zandastra R. The increasing incidence of central nervous system leukemia in children (Children's Study Group A). *Cancer* 1970;26:404–409.
111. Pavlovsky S, Eppinger-Helft M, Sackmann MF. Factors that influence the appearance of central nervous system leukemia. *Blood* 1973;42:935–938.
112. Meyer RJ, Ferreira PP, Cuttner J, et al. Central nervous system involvement at presentation in acute granulocytic leukemia. A prospective cytocentrifuge study. *Am J Med* 1980;68:691–694.
113. Cuttner J, Conjalka MS, Reilly M, et al. Association of monocytic leukemia in patients with extreme leukocytosis. *Am J Med* 1980;69:555–558.
114. Holmes R, Keating MJ, Cork A, et al. A unique pattern of central nervous system leukemia in acute myelomonocytic leukemia associated with inv(16)(p13q22). *Blood* 1985;65:1071–1078.
115. MacKintosh FR, Colby TV, Podolsky WJ, et al. Central nervous system involvement in non-Hodgkin lymphoma: an analysis of 105 cases. *Cancer* 1982;49:586–595.
116. Bunn PA Jr, Schein PS, Banks PM, DeVita VT Jr. Central nervous system complications in patients with diffuse histiocytic and undifferentiated lymphoma: leukemia revisited. *Blood* 1976;47:3–10.
117. Bashir RM, Bierman PJ, Vose JM, et al. Central nervous system involvement in patients with diffuse aggressive non-Hodgkin lymphoma. *Am J Clin Oncol* 1991;14:478–482.
118. Litam JP, Cabanillas F, Smith TL, et al. Central nervous system relapse in malignant lymphomas: risk factors and implications for prophylaxis. *Blood* 1979;54:1249–1257.
119. Bernasconi C, Brusamolino E, Lazzarino M, et al. Lymphoblastic lymphoma in adult patients: clinicopathological features and response to intensive multiagent chemotherapy analogous to that used in acute lymphoblastic leukemia. *Ann Oncol* 1990;1:141–146.
120. Sweetenham JW, Mead GM, Whitehouse JM. Adult lymphoblastic lymphoma: high incidence of central nervous system relapse in patients treated with the Stanford University protocol. *Ann Oncol* 1992;3:839–841.
121. Haddy TB, Adde MA, Magrath IT. CNS involvement in small noncleaved-cell lymphoma: is CNS disease per se a poor prognostic sign? *J Clin Oncol* 1991;9:1973–1982.

122. Ziegler JL, Magrath IT, Bluming AZ. Management of Burkitt's lymphoma involving the central nervous system. *Afr J Med Med Sci* 1976;5:121-124.
123. Montserrat E, Bosch F, Lopez-Guillermo A, et al. CNS involvement in mantle-cell lymphoma. *J Clin Oncol* 1996;14:941-944.
124. Argatoff LH, Connors JM, Klasa RJ, et al. Mantle cell lymphoma: a clinicopathologic study of 80 cases. *Blood* 1997;89:2067-2078.
125. Velders GA, Kluin-Nelemans JC, De Boer CJ, et al. Mantle-cell lymphoma: a population-based clinical study. *J Clin Oncol* 1996;14:1269-1274.
126. Enting RH, Esselink RA, Portegies P. Lymphomatous meningitis in AIDS-related systemic non-Hodgkin lymphoma: a report of eight cases. *J Neurol Neurosurg Psychiatry* 1994;57:150-153.
127. Bomfim da Paz R, Kolmel HW. Meningitis with Burkitt like B-cell lymphoma in HIV infection. *J Neurooncol* 1992;13:73-79.
128. Lowenthal DA, Straus DJ, Campbell SW, et al. AIDS-related lymphoid neoplasia. The Memorial Hospital experience. *Cancer* 1988;61:2325-2337.
129. Penn I, Porat G. Central nervous system lymphomas in organ allograft recipients. *Transplantation* 1995;59:240-244.
130. Monfardini S, Tirelli U, Vaccher E, et al. Hodgkin disease in 63 intravenous drug users infected with human immunodeficiency virus. Gruppo Italiano Cooperativo AIDS & Tumori (GICAT). *Ann Oncol* 1991;2[Suppl 2]:201-205.
131. Schwartz JH, Canellos GP, Young RC, DeVita VT Jr. Meningeal leukemia in the blastic phase of chronic granulocytic leukemia. *Am J Med* 1975;59:819-828.
132. Kane SB, Advani SH, Gopal R, et al. Chronic myeloid leukemia blast crisis presenting with meningeal leukemia. *J Assoc Physicians India* 1985;33:240-241.
133. Cazzola M, Nalli G, Brusamolino E, et al. Meningeal leukemia following lymphoid blast crisis in chronic myeloid leukemia: therapeutic implications. *Tumori* 1982;68:257-263.
134. Saikia TK, Dhabhar B, Iyer RS, et al. High incidence of meningeal leukemia in lymphoid blast crisis of chronic myelogenous leukemia. *Am J Hematol* 1993;43:10-13.
135. Cavanna L, Invernizzi R, Berté R, et al. Meningeal involvement in multiple myeloma: report of a case with cytologic and immunocytochemical diagnosis. *Acta Cytol* 1996;40:571-575.
136. Woodruff RK, Malpas JS, Paxton AM, Lister TA. Plasma cell leukemia (PCL): a report on 15 patients. *Blood* 1978;52:839-845.
137. Cash J, Fehir KM, Pollack MS. Meningeal involvement in early stage chronic lymphocytic leukemia. *Cancer* 1987;59:798-800.
138. Ricevuti G, Savoldi F, Piccolo G, et al. Meningeal leukemia diagnosed by cytocentrifuge study of cerebrospinal fluid. A study of 631 cerebrospinal fluid samples from 87 patients. *Arch Neurol* 1986;43:466-470.
139. Homans AC, Barker BE, Forman EN, et al. Immunophenotypic characteristics of cerebrospinal fluid cells in children with acute lymphoblastic leukemia at diagnosis. *Blood* 1990;76:1807-1811.
140. Bradstock KF, Papageorgiou ES, Janossy G. Diagnosis of meningeal involvement in patients with acute lymphoblastic leukemia: immunofluorescence for terminal transferase. *Cancer* 1981;47:2478-2481.
141. Hooijkaas H, Hahlen K, Adriaansen HJ, et al. Terminal deoxynucleotidyl transferase (TdT)-positive cells in cerebrospinal fluid and development of overt CNS leukemia: a 5-year follow-up study in 113 children

with a TdT-positive leukemia or non-Hodgkin lymphoma. *Blood* 1989;74:416-422.

142. Smith M, Arthur D, Camitta B, et al. Uniform approach to risk classification and treatment assignment for children with acute lymphoblastic leukemia. *J Clin Oncol* 1996;14:18-24.
143. Odom LF, Wilson H, Cullen J, et al. Significance of blasts in low-cell-count cerebrospinal fluid specimens from children with acute lymphoblastic leukemia. *Cancer* 1990;66:1748-1754.
144. Tubergen DG, Cullen JW, Boyett JM, et al. Blasts in CSF with a normal cell count do not justify alteration of therapy for acute lymphoblastic leukemia in remission: a Childrens Cancer Group study. *J Clin Oncol* 1994;12:273-278.
145. Komp DM. Diagnosis of CNS leukemia. *Am J Pediatr Hematol Oncol* 1979;1: 31-35.
146. Pinkel D, Woo S. Prevention and treatment of meningeal leukemia in children. *Blood* 1994;84:355-366.
147. Balis FM, Poplack DG. Central nervous system pharmacology of antileukemic drugs. *Am J Pediatr Hematol Oncol* 1989;11:74-86.
148. Berg SL, Balis FM, Zimm S, et al. Phase I/II trial and pharmacokinetics of intrathecal diaziquone in refractory meningeal malignancies. *J Clin Oncol* 1992;10:143-148.
149. Gutin PH, Weiss HD, Wiernik PH, Walker MD. Intrathecal N, N', N'-triethylenethiophosphoramidate [thio-TEPA (NSC 6396)] in the treatment of malignant meningeal disease: phase I-II study. *Cancer* 1976;38:1471-1475.
150. Blaney SM, Poplack DG, Godwin K, et al. Effect of body position on ventricular CSF methotrexate concentration following intralumbar administration. *J Clin Oncol* 1995;13:177-179.
151. Jaeckle KA, Batchelor T, O'Day SJ, et al. An open label trial of sustained-release cytarabine (DepoCyt) for the intrathecal treatment of solid tumor neoplastic meningitis. *J Neurooncol* 2002;57:231-239.
152. Bleyer WA, Coccia PF, Sather HN, et al. Reduction in central nervous system leukemia with a pharmacokinetically derived intrathecal methotrexate dosage regimen. *J Clin Oncol* 1983;1:317-325.
153. Sullivan MP, Moon TE, Trueworthy R, et al. Combination intrathecal therapy for meningeal leukemia: two versus three drugs. *Blood* 1977;50:471-479.
154. Sullivan MP, Vietti TJ, Fernbach DJ, et al. Clinical investigations in the treatment of meningeal leukemia: radiation therapy regimens vs. conventional intrathecal methotrexate. *Blood* 1969;34:301-319.
155. Ommaya AK. Implantable devices for chronic access and drug delivery to the central nervous system. *Cancer Drug Deliv* 1984;1:169-179.
156. Bleyer WA, Pizzo PA, Spence AM, et al. The Ommaya reservoir: newly recognized complications and recommendations for insertion and use. *Cancer* 1978;41:2431-2437.
157. Duttera MJ, Bleyer WA, Pomeroy TC, et al. Irradiation, methotrexate toxicity, and the treatment of meningeal leukaemia. *Lancet* 1973;2:703-707.
158. Eby NL, Grufferman S, Flannelly CM, et al. Increasing incidence of primary brain lymphoma in the US. *Cancer* 1988;62:2461-2465.
159. Lewis DW, Packer RJ, Raney B, et al. Incidence, presentation, and outcome of spinal cord disease in children with systemic cancer. *Pediatrics* 1986;78:438-443.
160. Petursson SR, Boggs DR. Spinal cord involvement in leukemia: a review of the literature and a case of Ph1+ acute myeloid leukemia presenting with a conus medullaris syndrome. *Cancer* 1981;47:346-350.
161. Jordan JE, Donaldson SS, Enzmann DR. Cost effectiveness and outcome assessment of magnetic resonance imaging in diagnosing cord compression. *Cancer* 1995;75:2579-2586.
162. Carmody RF, Yang PJ, Seeley GW, et al. Spinal cord compression due to metastatic disease:



diagnosis with MR imaging versus myelography. *Radiology* 1989;173:225-229.

163. Bonner JA, Lichter AS. A caution about the use of MRI to diagnose spinal cord compression. *N Engl J Med* 1990;322:556-557.

164. Fadul CE, Lemann W, Thaler HT, Posner JB. Perforation of the gastrointestinal tract in patients receiving steroids for neurologic disease. *Neurology* 1988;38:348-352.

165. Heimdal K, Hirschberg H, Slettebo H, et al. High incidence of serious side effects of high-dose dexamethasone treatment in patients with epidural spinal cord compression. *J Neurooncol* 1992;12:141-144.

166. Byrne TN. Spinal cord compression from epidural metastases. *N Engl J Med* 1992;327:614-619.

167. Oviatt DL, Kirshner HS, Stein RS. Successful chemotherapeutic treatment of epidural compression in non-Hodgkin lymphoma. *Cancer* 1982;49:2446-2448.

168. Kyle RA. Monoclonal proteins in neuropathy. *Neurol Clin* 1992;10:713-734.

169. Osby E, Noring L, Hast R, et al. Benign monoclonal gammopathy and peripheral neuropathy. *Br J Haematol* 1982;51:531-539.

170. Gosselin S, Kyle RA, Dyck PJ. Neuropathy associated with monoclonal gammopathies of undetermined significance. *Ann Neurol* 1991;30:54-61.

171. Vrethem M, Cruz M, Wen-Xin H, et al. Clinical, neurophysiological and immunological evidence of polyneuropathy in patients with monoclonal gammopathies. *J Neurol Sci* 1993;114:193-199.

172. Rodriguez AR, Lutcher CL, Coleman FW. Osteosclerotic myeloma. *JAMA* 1976;236:1872-1874.

173. Kelly JJ Jr, Kyle RA, Miles JM, Dyck PJ. Osteosclerotic myeloma and peripheral neuropathy. *Neurology* 1983;33:202-210.

174. Vallat JM, De Mascarel HA, Bordessoule D, et al. Non-Hodgkin malignant lymphomas and peripheral neuropathies—13 cases. *Brain* 1995;118(Pt 5):1233-1245.

175. Sumi SM, Farrell DF, Knauss TA. Lymphoma and leukemia manifested by steroid-responsive polyneuropathy. *Arch Neurol* 1983;40:577-582.

176. Vital C, Vital A, Julien J, et al. Peripheral neuropathies and lymphoma without monoclonal gammopathy: a new classification. *J Neurol* 1990;237:177-185.

177. Mollman JE. Neuromuscular toxicity of therapy. *Curr Opin Oncol* 1992;4:540-546.

178. Greco FA, Kolins J, Rajjoub RK, Brereton HD. Hodgkin disease and granulomatous angiitis of the central nervous system. *Cancer* 1976;38:2027-2032.

179. Anders KH, Becker PS, Holden JK, et al. Multifocal necrotizing leukoencephalopathy with pontine predilection in immunosuppressed patients: a clinicopathologic review of 16 cases. *Hum Pathol* 1993;24:897-904.

180. Ninane J, Taylor D, Day S. The eye as a sanctuary in acute lymphoblastic leukaemia. *Lancet* 1980;1:452-453.

181. Bunin N, Rivera G, Goode F, Hustu HO. Ocular relapse in the anterior chamber in childhood acute lymphoblastic leukemia. *J Clin Oncol* 1987;5:299-303.

182. Hertler AA, Rosenwasser GO, Gluck WL. Isolated anterior chamber relapse in acute monoblastic leukemia. *Am J Hematol* 1986;23:401-403.

183. Leonardy NJ, Rupani M, Dent G, Klintworth GK. Analysis of 135 autopsy eyes for ocular involvement in leukemia. *Am J Ophthalmol* 1990;109:436-444.

184. Hendrick AM, Rogers JS, Guliner RJ. Ocular complications following blast transformation in chronic

myelogenous leukemia. *Am J Hematol* 1979;7:389–394.

185. Patel S, Rootman J. Nodular sclerosing Hodgkin disease of the orbit. *Ophthalmology* 1983;90:1433–1436.

186. Giarelli L, Melato M, Campos E, Falconieri G. Eye involvement in multiple myeloma. *Haematologica* 1981;66:57–67.

187. Whitcup SM, de Smet MD, Rubin BI, et al. Intraocular lymphoma. Clinical and histopathologic diagnosis. *Ophthalmology* 1993;100:1399–1406.

188. Laucirica R, Font RL. Cytologic evaluation of lymphoproliferative lesions of the orbit/ocular adnexa: an analysis of 46 cases. *Diagn Cytopathol* 1996;15:241–245.

189. Knowles DM, Jakobiec FA, McNally L, Burke JS. Lymphoid hyperplasia and malignant lymphoma occurring in the ocular adnexa (orbit, conjunctiva, and eyelids): a prospective multiparametric analysis of 108 cases during 1977 to 1987. *Hum Pathol* 1990;21:959–973.

190. Medeiros LJ, Harmon DC, Linggood RM, Harris NL. Immunohistologic features predict clinical behavior of orbital and conjunctival lymphoid infiltrates. *Blood* 1989;74:2121–2129.

191. White WL, Ferry JA, Harris NL, Grove AS Jr. Ocular adnexal lymphoma. A clinicopathologic study with identification of lymphomas of mucosa-associated lymphoid tissue type. *Ophthalmology* 1995;102:1994–2006.

192. Coupland SE, Hummel M, Stein H. Ocular adnexal lymphomas: five case presentations and a review of the literature. *Surv Ophthalmol* 2002;47:470–490.

193. Harris NL, Jaffe ES, Stein H, et al. A revised European–American classification of lymphoid neoplasms: a proposal from the International Lymphoma Study Group. *Blood* 1994;84:1361–1392.

194. Stanton CA, Sloan B III, Slusher MM, Greven CM. Acquired immunodeficiency syndrome–related primary intraocular lymphoma. *Arch Ophthalmol* 1992;110:1614–1617.

195. Rivero ME, Kuppermann BD, Wiley CA, et al. Acquired immunodeficiency syndrome–related intraocular B–cell lymphoma. *Arch Ophthalmol* 1999;117:616–622.

196. Platanius LC, Putterman AM, Vijayakumar S, et al. Treatment and prognosis of orbital non–Hodgkin lymphomas. *Am J Clin Oncol* 1992;15:79–83.

197. Jaffe ES, Chan JK, Su IJ, et al. Report of the Workshop on Nasal and Related Extranodal Angiocentric T/Natural Killer Cell Lymphomas. Definitions, differential diagnosis, and epidemiology. *Am J Surg Pathol* 1996;20:103–111.

198. Weiss LM, Arber DA, Strickler JG. Nasal T–cell lymphoma. *Ann Oncol* 1994;5[Suppl 1]:39–42.

199. Kanavaros P, Lescs MC, Briere J, et al. Nasal T–cell lymphoma: a clinicopathologic entity associated with peculiar phenotype and with Epstein–Barr virus. *Blood* 1993;81:2688–2695.

200. Jaffe ES. Nasal and nasal–type T/NK cell lymphoma: a unique form of lymphoma associated with the Epstein–Barr virus. *Histopathology* 1995;27:581–583.

201. Hartig G, Montone K, Wasik M, et al. Nasal T–cell lymphoma and the lethal midline granuloma syndrome. *Otolaryngol Head Neck Surg* 1996;114:653–656.

202. Liang R, Todd D, Chan TK, et al. Treatment outcome and prognostic factors for primary nasal lymphoma. *J Clin Oncol* 1995;13:666–670.

203. Tran LM, Mark R, Fu YS, et al. Primary non–Hodgkin lymphomas of the paranasal sinuses and nasal cavity. A report of 18 cases with stage IE disease. *Am J Clin Oncol* 1992;15:222–225.

204. Saul SH, Kapadia SB. Primary lymphoma of Waldeyer ring. Clinicopathologic study of 68 cases.

Cancer 1985;56:157–166.

205. Epstein JB, Epstein JD, Le ND, Gorsky M. Characteristics of oral and paraoral malignant lymphoma: a population-based review of 361 cases. *Oral Surg Oral Med Oral Pathol Oral Radiol Endod* 2001;92:519–525.

206. Fidas P, Wright C, Harris NL, et al. Primary tracheal non-Hodgkin lymphoma. A case report and review of the literature. *Cancer* 1996;77:2332–2338.

207. Pariente D, Anaya JM, Combe B, et al. Non-Hodgkin lymphoma associated with primary Sjogren's syndrome. *Eur J Med* 1992;1:337–342.

208. Zufferey P, Meyer OC, Grossin M, Kahn MF. Primary Sjogren's syndrome (SS) and malignant lymphoma. A retrospective cohort study of 55 patients with SS. *Scand J Rheumatol* 1995;24:342–345.

209. Scholefield JH, Quayle AR, Harris SC, Talbot CH. Primary lymphoma of the thyroid, the association with Hashimoto thyroiditis. *Eur J Surg Oncol* 1992;18:89–92.

210. Hyjek E, Isaacson PG. Primary B cell lymphoma of the thyroid and its relationship to Hashimoto thyroiditis. *Hum Pathol* 1988;19:1315–1326.

211. Berkman N, Breuer R, Kramer MR, Polliack A. Pulmonary involvement in lymphoma. *Leuk Lymphoma* 1996;20:229–237.

212. Filly R, Bland N, Castellino RA. Radiographic distribution of intrathoracic disease in previously untreated patients with Hodgkin disease and non-Hodgkin lymphoma. *Radiology* 1976;120:277–281.

213. Diehl LF, Hopper KD, Giguere J, et al. The pattern of intrathoracic Hodgkin disease assessed by computed tomography. *J Clin Oncol* 1991;9:438–443.

214. Yousem SA, Weiss LM, Colby TV. Primary pulmonary Hodgkin disease. A clinicopathologic study of 15 cases. *Cancer* 1986;57:1217–1224.

215. Tamura A, Komatsu H, Yanai N, et al. Primary pulmonary lymphoma: relationship between clinical features and pathologic findings in 24 cases. The Japan National Chest Hospital Study Group for Lung Cancer. *Jpn J Clin Oncol* 1995;25:140–152.

216. Fiche M, Caprons F, Berger F, et al. Primary pulmonary non-Hodgkin lymphomas. *Histopathology* 1995;26:529–537.

217. Nicholson AG, Wotherspoon AC, Diss TC, et al. Lymphomatoid granulomatosis: evidence that some cases represent Epstein-Barr virus-associated B-cell lymphoma. *Histopathology* 1996;29:317–324.

218. Cordier JF, Chailleux E, Lauque D, et al. Primary pulmonary lymphomas. A clinical study of 70 cases in nonimmunocompromised patients. *Chest* 1993;103:201–208.

219. Eisner MD, Kaplan LD, Herndier B, Stulbarg MS. The pulmonary manifestations of AIDS-related non-Hodgkin lymphoma. *Chest* 1996;110:729–736.

220. Hildebrand FL Jr, Rosenow EC III, Habermann TM, Tazelaar HD. Pulmonary complications of leukemia. *Chest* 1990;98:1233–1239.

221. Wells RJ, Weetman RM, Ballantine TV, et al. Pulmonary leukemia in children presenting as diffuse interstitial pneumonia. *J Pediatr* 1980;96:262–264.

222. Lakshminarayan S, Schwarz MI, Stanford RE. Unsuspected pulmonary alveolar proteinosis complicating acute myelogenous leukemia. *Chest* 1976;69:433–435.

223. Tenholder MF, Hooper RG. Pulmonary infiltrates in leukemia. *Chest* 1980;78:468–473.

224. Meijer WG, Van Marwijk KM, Ladde BE. A patient with multiple myeloma and respiratory insufficiency due to accumulation of paraprotein in the alveolar space. *Br J Haematol* 1994;87:663–665.

225. Parish JM, Marschke RF Jr, Dines DE, Lee RE. Etiologic considerations in superior vena cava syndrome. *Mayo Clin Proc* 1981;56:407-413.
226. Yellin A, Rosen A, Reichert N, Lieberman Y. Superior vena cava syndrome. The myth—the facts. *Am Rev Respir Dis* 1990;141:1114-1118.
227. Perez-Soler R, McLaughlin P, Velasquez WS, et al. Clinical features and results of management of superior vena cava syndrome secondary to lymphoma. *J Clin Oncol* 1984;2:260-266.
228. National Cancer Institute sponsored study of classifications of non-Hodgkin lymphomas: summary and description of a working formulation for clinical usage. The Non-Hodgkin Lymphoma Pathologic Classification Project. *Cancer* 1982;49:2112-2135.
229. Lazzarino M, Orlandi E, Paulli M, et al. Primary mediastinal B-cell lymphoma with sclerosis: an aggressive tumor with distinctive clinical and pathologic features. *J Clin Oncol* 1993;11:2306-2313.
230. al Sharabati M, Chittal S, Duga-Neulat I, et al. Primary anterior mediastinal B-cell lymphoma. A clinicopathologic and immunohistochemical study of 16 cases. *Cancer* 1991;67:2579-2587.
231. Kirn D, Mauch P, Shaffer K, et al. Large-cell and immunoblastic lymphoma of the mediastinum: prognostic features and treatment outcome in 57 patients. *J Clin Oncol* 1993;11:1336-1343.
232. van Besien K, Kelta M, Bahaguna P. Primary mediastinal B-cell lymphoma: a review of pathology and management. *J Clin Oncol* 2001;19:1855-1864.
233. Ingram L, Rivera GK, Shapiro DN. Superior vena cava syndrome associated with childhood malignancy: analysis of 24 cases. *Med Pediatr Oncol* 1990;18:476-481.
234. Gray BH, Olin JW, Graor RA, et al. Safety and efficacy of thrombolytic therapy for superior vena cava syndrome. *Chest* 1991;99:54-59.
235. Adelstein DJ, Hines JD, Carter SG, Sacco D. Thromboembolic events in patients with malignant superior vena cava syndrome and the role of anticoagulation. *Cancer* 1988;62:2258-2262.
236. Ahmann FR. A reassessment of the clinical implications of the superior vena caval syndrome. *J Clin Oncol* 1984;2:961-969.
237. Jahangiri M, Goldstraw P. The role of mediastinoscopy in superior vena caval obstruction. *Ann Thorac Surg* 1995;59:453-455.
238. Johnston WW. The malignant pleural effusion. A review of cytopathologic diagnoses of 584 specimens from 472 consecutive patients. *Cancer* 1985;56:905-909.
239. Acute lymphoblastic leukemia with pulmonary complications. *Am J Med* 1973;55:71-79.
240. Rodriguez JN, Pereira A, Martinez JC, et al. Pleural effusion in multiple myeloma. *Chest* 1994;105:622-624.
241. Said JW, Tasaka T, Takeuchi S, et al. Primary effusion lymphoma in women: report of two cases of Kaposi sarcoma herpes virus-associated effusion-based lymphoma in human immunodeficiency virus-negative women. *Blood* 1996;88:3124-3128.
242. Cesarman E, Nador RG, Aozasa K, et al. Kaposi sarcoma-associated herpesvirus in non-AIDS related lymphomas occurring in body cavities. *Am J Pathol* 1996;149:53-57.
243. Iuchi K, Aozasa K, Yamamoto S, et al. Non-Hodgkin lymphoma of the pleural cavity developing from long-standing pyothorax. Summary of clinical and pathological findings in thirty-seven cases. *Jpn J Clin Oncol* 1989;19:249-257.
244. Celikoglu F, Teirstein AS, Krellenstein DJ, Strauchen JA. Pleural effusion in non-Hodgkin lymphoma. *Chest* 1992;101:1357-1360.

245. Irwin RS, Saunders RL Jr, Isaac PC, et al. Sternberg–Reed–like cells in a pleural effusion secondary to pulmonary emboli with infarction: a cytological observation. *Arch Pathol Lab Med* 1978;102:76–78.
246. Ruckdeschel JC. Management of malignant pleural effusions. *Semin Oncol* 1995;22:58–63.
247. Reeder LB. Malignant pleural effusions. *Curr Treat Options Oncol* 2001;2:93–96.
248. Piovaccari G, Ferretti RM, Prati F, et al. Cardiac disease after chest irradiation for Hodgkin disease: incidence in 108 patients with long follow-up. *Int J Cardiol* 1995;49:39–43.
249. Corn BW, Trock BJ, Goodman RL. Irradiation–related ischemic heart disease. *J Clin Oncol* 1990;8:741–750.
250. Lam KY, Dickens P, Chan AC. Tumors of the heart. A 20–year experience with a review of 12,485 consecutive autopsies. *Arch Pathol Lab Med* 1993;117:1027–1031.
251. Abraham KP, Reddy V, Gattuso P. Neoplasms metastatic to the heart: review of 3314 consecutive autopsies. *Am J Cardiovasc Pathol* 1990;3:195–198.
252. Gill PS, Chandraratna PA, Meyer PR, Levine AM. Malignant lymphoma: cardiac involvement at initial presentation. *J Clin Oncol* 1987;5:216–224.
253. Rodenburg CJ, Kluin P, Maes A, Paul LC. Malignant lymphoma confined to the heart, 13 years after a cadaver kidney transplant. *N Engl J Med* 1985;313:122.
254. Goldfarb A, King CL, Rosenzweig BP, et al. Cardiac lymphoma in the acquired immunodeficiency syndrome. *Am Heart J* 1989;118:1340–1344.
255. Sanna P, Bertoni F, Zucca E, et al. Cardiac involvement in HIV–related non–Hodgkin lymphoma: a case report and short review of the literature. *Ann Hematol* 1998;77:75–78.
256. Perkkio M, Tikanoja T, Marin S. Leukemic coronary artery occlusion in a child with acute lymphoblastic leukemia. *Pediatr Cardiol* 1997;18:64–65.
257. Zeymer U, Hirschmann WD, Neuhaus KL. Left main coronary stenosis by a mediastinal lymphoma. *Clin Investig* 1992;70:1024–1026.
258. Tesoro–Tess JD, Biasi S, Balzarini L, et al. Heart involvement in lymphomas. The value of magnetic resonance imaging and two–dimensional echocardiography at disease presentation. *Cancer* 1993;72:2484–2490.
259. Flipse TR, Tazelaar HD, Holmes DR Jr. Diagnosis of malignant cardiac disease by endomyocardial biopsy. *Mayo Clin Proc* 1990;65:1415–1422.
260. Bedikian A, Valdivieso M, Luna M, Bodey GP. Nonbacterial thrombotic endocarditis in cancer patients: comparison of characteristics of patients with and without concomitant disseminated intravascular coagulation. *Med Pediatr Oncol* 1978;4:149–157.
261. Troxell ML, Mills GM, Allen RC. The hypereosinophilic syndrome in acute lymphocytic leukemia. *Cancer* 1984;54:1058–1061.
262. McBride W, Jackman JD Jr, Gammon RS, Willerson JT. High–output cardiac failure in patients with multiple myeloma. *N Engl J Med* 1988;319:1651–1653.
263. Abbondanzo SL, Seidman JD, Lefkowitz M, et al. Primary diffuse large B–cell lymphoma of the breast. A clinicopathologic study of 31 cases. *Pathol Res Pract* 1996;192:37–43.
264. Paulus DD. Lymphoma of the breast. *Radiol Clin North Am* 1990;28:833–840.
265. Wong WW, Schild SE, Halyard MY, Schomberg PJ. Primary non–Hodgkin lymphoma of the breast: The Mayo Clinic Experience. *J Surg Oncol* 2002;80:19–25.

266. Gupta NM, Goenka MK, Jindal A, et al. Primary lymphoma of the esophagus. *J Clin Gastroenterol* 1996;23:203–206.
267. Pearson JM, Borg-Grech A. Primary Ki-1 (CD 30)-positive, large cell, anaplastic lymphoma of the esophagus. *Cancer* 1991;68:418–421.
268. Bolondi L, De Giorgio R, Santi V, et al. Primary non-Hodgkin T-cell lymphoma of the esophagus. A case with peculiar endoscopic ultrasonographic pattern. *Dig Dis Sci* 1990;35:1426–1430.
269. Stein HA, Murray D, Warner HA. Primary Hodgkin disease of the esophagus. *Dig Dis Sci* 1981;26:457–461.
270. Lambert A. Malignant tracheoesophageal fistula secondary to Hodgkin disease. Successful surgical treatment with free fascia-muscle graft and left colon bypass. *J Thorac Cardiovasc Surg* 1975;69:820–826.
271. Soderstrom KO, Joensuu H. Primary Hodgkin disease of the stomach. *Am J Clin Pathol* 1988;89:806–809.
272. Brugo EA, Marshall RB, Riberi AM, Pautasso OE. Preleukemic granulocytic sarcomas of the gastrointestinal tract. Report of two cases. *Am J Clin Pathol* 1977;68:616–621.
273. Feingold ML, Goldstein MJ, Lieberman PH. Multiple myeloma involving the stomach. Report of a case with gastroscopic observations. *Gastrointest Endosc* 1969;16:107–110.
274. Macmanus Q, Okies JE. Amyloidosis of the stomach: report of an unusual case and review of the literature. *Am Surg* 1976;42:607–610.
275. Hsiao CH, Lee WI, Chang SL, Su IJ. Angiocentric T-cell lymphoma of the intestine: a distinct etiology of ischemic bowel disease. *Gastroenterology* 1996;110:985–990.
276. Shamberger RC, Weinstein HJ, Delorey MJ, Levey RH. The medical and surgical management of typhlitis in children with acute nonlymphocytic (myelogenous) leukemia. *Cancer* 1986;57:603–609.
277. Sloas MM, Flynn PM, Kaste SC, Patrick CC. Typhlitis in children with cancer: a 30-year experience. *Clin Infect Dis* 1993;17:484–490.
278. Katz JA, Wagner ML, Gresik MV, et al. Typhlitis. An 18-year experience and postmortem review. *Cancer* 1990;65:1041–1047.
279. Pestalozzi BC, Sotos GA, Choyke PL, et al. Typhlitis resulting from treatment with taxol and doxorubicin in patients with metastatic breast cancer. *Cancer* 1993;71:1797–1800.
280. Slavin RE, Dias MA, Saral R. Cytosine arabinoside induced gastrointestinal toxic alterations in sequential chemotherapeutic protocols: a clinical-pathologic study of 33 patients. *Cancer* 1978;42:1747–1759.
281. Johnson H, Smith TJ, Desforges J. Cytosine-arabioside-induced colitis and peritonitis: nonoperative management. *J Clin Oncol* 1985;3:607–612.
282. Katz JA, Wagner ML, Gresik MV, et al. Typhlitis. An 18-year experience and postmortem review. *Cancer* 1990;65:1041–1047.
283. Koea JB, Shaw JH. Surgical management of neutropenic enterocolitis. *Br J Surg* 1989;76:821–824.
284. Delpero JR, Houvenaeghel G, Gastaut JA, et al. Splenectomy for hypersplenism in chronic lymphocytic leukaemia and malignant non-Hodgkin lymphoma. *Br J Surg* 1990;77:443–449.
285. Paulino AC, Reddy SP. Splenic irradiation in the palliation of patients with lymphoproliferative and myeloproliferative disorders. *Am J Hosp Palliat Care* 1996;13:32–35.
286. Bauer TW, Haskins GE, Armitage JO. Splenic rupture in patients with hematologic malignancies.

Cancer 1981;48:2729–2733.

287. Moore EE, Cogbill TH, Jurkovich GJ, et al. Organ injury scaling: spleen and liver (1994 revision). J Trauma 1995;38:323–324.

288. Guth AA, Pachter HL, Jacobowitz GR. Rupture of the pathologic spleen: is there a role for nonoperative therapy? J Trauma 1996;41:214–218.

289. Curtis JM, Pellegrini V, Tappin JA. Case report: multiple myeloma—a rare presentation. Clin Radiol 1995;50:63–64.

290. Dubois A, Dauzat M, Pignodel C, et al. Portal hypertension in lymphoproliferative and myeloproliferative disorders: hemodynamic and histological correlations. Hepatology 1993;17:246–250.

291. Valla D, Casadevall N, Lacombe C, et al. Primary myeloproliferative disorder and hepatic vein thrombosis. A prospective study of erythroid colony formation *in vitro* in 20 patients with Budd–Chiari syndrome. Ann Intern Med 1985;103:329–334.

292. Bayraktar Y, Balkanci F, Kansu E, et al. Budd–Chiari syndrome: analysis of 30 cases. Angiology 1993;44:541–551.

293. Alpers CE, Cotran RS. Neoplasia and glomerular injury. Kidney Int 1986;30:465–473.

294. Moulin B, Ronco PM, Mougenot B, et al. Glomerulonephritis in chronic lymphocytic leukemia and related B–cell lymphomas. Kidney Int 1992;42:127–135.

295. Bowman WP, Aur RJ, Hustu HO, Rivera G. Isolated testicular relapse in acute lymphocytic leukemia of childhood: categories and influence on survival. J Clin Oncol 1984;2:924–929.

296. Shaffer DW, Burris HA, O'Rourke TJ. Testicular relapse in adult acute myelogenous leukemia. Cancer 1992;70:1541–1544.

297. Gajjar A, Ribeiro RC, Mahmoud HH, et al. Overt testicular disease at diagnosis is associated with high risk features and a poor prognosis in patients with childhood acute lymphoblastic leukemia. Cancer 1996;78:2437–2442.

298. Connors JM, Klimo P, Voss N, et al. Testicular lymphoma: improved outcome with early brief chemotherapy. J Clin Oncol 1988;6:776–781.

299. Touroutoglou N, Dimopoulos MA, Younes A, et al. Testicular lymphoma: late relapses and poor outcome despite doxorubicin–based therapy. J Clin Oncol 1995;13:1361–1367.

300. Mizoguchi M, Kawa Y, Minami T, et al. Cutaneous extramedullary hematopoiesis in myelofibrosis. J Am Acad Dermatol 1990;22:351–355.

301. Smith JL Jr, Butler JJ. Skin involvement in Hodgkin disease. Cancer 1980;45:354–361.

302. Desch JK, Smoller BR. The spectrum of cutaneous disease in leukemias. J Cutan Pathol 1993;20:407–410.

303. Cohen PR, Talpaz M, Kurzrock R. Malignancy–associated Sweet syndrome: review of the world literature. J Clin Oncol 1988;6:1887–1897.

304. Adami J, Frisch M, Yuen J, et al. Evidence of an association between non–Hodgkin lymphoma and skin cancer. BMJ 1995;310:1491–1495.

305. Tannir N, Riggs S, Velasquez W, et al. Hypercalcemia, unusual bone lesions, and human T–cell leukemia–lymphoma virus in adult T–cell lymphoma. Cancer 1985;55:615–619.

306. Reimer RR, Chabner BA, Young RC, et al. Lymphoma presenting in bone: results of histopathology, staging, and therapy. Ann Intern Med 1977;87:50–55.

307. Stein H, Foss HD, Durkop H, et al. CD30(+) anaplastic large cell lymphoma: a review of its



- histopathologic, genetic, and clinical features. *Blood* 2000;96:3681–3695.
308. Rogalsky RJ, Black GB, Reed MH. Orthopaedic manifestations of leukemia in children. *J Bone Joint Surg Am* 1986;68:494–501.
309. Berenson JR, Lichtenstein A, Porter L, et al. Efficacy of pamidronate in reducing skeletal events in patients with advanced multiple myeloma. Myeloma Aredia Study Group. *N Engl J Med* 1996;334:488–493.
310. Beggs I. Primary muscle lymphoma. *Clin Radiol* 1997;52:203–212.
311. Arrambide K, Toto RD. Tumor lysis syndrome. *Semin Nephrol* 1993;13:273–280.
312. Hande KR, Garrow GC. Acute tumor lysis syndrome in patients with high-grade non-Hodgkin lymphoma. *Am J Med* 1993;94:133–139.
313. Jasek AM, Day HJ. Acute spontaneous tumor lysis syndrome. *Am J Hematol* 1994;47:129–131.
314. Trendle MC, Tefferi A. Tumor lysis syndrome after treatment of chronic lymphocytic leukemia with cladribine. *N Engl J Med* 1994;330:1090.
315. Mulligan SP, Dean MG. Fludarabine causing tumour lysis syndrome in chronic lymphocytic leukaemia. *Aust N Z J Med* 1994;24:406–407.
316. Kanelli S, Ansell SM, Habermann TM, et al. Rituximab toxicity in patients with peripheral blood malignant B-cell lymphocytosis. *Leuk Lymphoma* 2001;42:1329–1337.
317. Smalley RV, Guaspari A, Haase-Statz S, et al. Allopurinol: intravenous use for prevention and treatment of hyperuricemia. *J Clin Oncol* 2000;18:1758–1763.
318. Goldman SC, Holcenberg JS, Finklestein JZ, et al. A randomized comparison between rasburicase and allopurinol in children with lymphoma or leukemia at high risk for tumor lysis. *Blood* 2001;97:2998–3003.
319. Jeha S, McDonald L, Irwin D, et al. Recombinant urate oxidase (Elitek) is safe and effective in prevention and treatment of malignancy-associated hyperuricemia in adult patients. *Blood* 2002;100(abst).
320. Lawson DH, Henry DA, Lowe JM, et al. Severe hypokalemia in hospitalized patients. *Arch Intern Med* 1979;139:978–980.
321. Bellevue R, Dosik H, Spergel G, Gussoff BD. Pseudohyperkalemia and extreme leukocytosis. *J Lab Clin Med* 1975;85:660–664.
322. Berghmans T. Hyponatremia related to medical anticancer treatment. *Support Care Cancer* 1996;4:341–350.
323. Vaswani SK, Sprague R. Pseudohyponatremia in multiple myeloma. *South Med J* 1993;86:251–252.
324. Yu T, Weinreb N, Wittman R, Wasserman LR. Secondary gout associated with chronic myeloproliferative disorders. *Semin Arthritis Rheum* 1976;5:247–256.
325. Berk PD, Goldberg JD, Donovan PB, et al. Therapeutic recommendations in polycythemia vera based on Polycythemia Vera Study Group protocols. *Semin Hematol* 1986;23:132–143.
326. Tykarski A. Mechanism of hypouricemia in Hodgkin disease. Isolated defect in postsecretory reabsorption of uric acid. *Nephron* 1988;50:217–219.
327. Ralston SH, Gallacher SJ, Patel U, et al. Cancer-associated hypercalcemia: morbidity and mortality. Clinical experience in 126 treated patients. *Ann Intern Med* 1990;112:499–504.
328. Durie BG, Salmon SE, Mundy GR. Relation of osteoclast activating factor production to extent of bone disease in multiple myeloma. *Br J Haematol* 1981;47:21–30.
329. Cozzolino F, Torcia M, Aldinucci D, et al. Production of interleukin-1 by bone marrow myeloma cells.

Blood 1989;74:380-387.

330. Seymour JF, Gagel RF. Calcitriol: the major humoral mediator of hypercalcemia in Hodgkin disease and non-Hodgkin lymphomas. *Blood* 1993;82:1383-1394.

331. Motokura T, Fukumoto S, Matsumoto T, et al. Parathyroid hormone-related protein in adult T-cell leukemia-lymphoma. *Ann Intern Med* 1989;111:484-488.

332. Bilezikian JP. Management of acute hypercalcemia. *N Engl J Med* 1992;326:1196-1203.

333. Gucaip R, Theriault R, Gill I, et al. Treatment of cancer-associated hypercalcemia. Double-blind comparison of rapid and slow intravenous infusion regimens of pamidronate disodium and saline alone. *Arch Intern Med* 1994;154:1935-1944.

334. Lipton A, Small E, Saad F, et al. The new bisphosphonate, Zometa (zoledronic acid), decreases skeletal complications in both osteolytic and osteoblastic lesions: a comparison to pamidronate. *Cancer Invest* 2002;20 [Suppl 2]:45-54.

335. Berenson JR. Zoledronic acid in cancer patients with bone metastases: results of Phase I and II trials. *Semin Oncol* 2001;28:25-34.

2004 Lippincott Williams & Wilkins  
John P. Greer, John Foerster, John N. Lukens  
George M. Rodgers, Frixos Paraskevas, Bertil Glader  
Wintrobe's Clinical Hematology

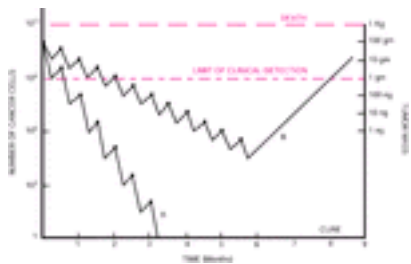
**PRINCIPLES OF CHEMOTHERAPY**[Cancer Biology](#)[Mechanisms of Antineoplastic Drug Action](#)[Resistance to Anticancer Drugs](#)[Drug Toxicity](#)[General Pharmacologic Principles](#)[Approach to the Patient with Cancer](#)**DRUGS USED TO TREAT CANCER**[Alkylating Agents](#)[Antimetabolites](#)[Topoisomerase Inhibitors](#)[Bleomycin](#)[Platinum Analogs](#)[Antimicrotubule Agents](#)[Asparaginase](#)[Biologic Therapies](#)[Signal Transduction Inhibitors](#)[Pharmacology of High-Dose Chemotherapy](#)**ACKNOWLEDGMENT****REFERENCES****PRINCIPLES OF CHEMOTHERAPY**

The modern era of chemotherapy began shortly after World War II when investigators at Yale successfully used nitrogen mustard to treat lymphomas (<sup>1</sup>), and Sidney Farber in Boston used folic acid antagonists to treat children with acute lymphocytic leukemia (<sup>2</sup>). Over the past six decades, the number of drugs available to treat various malignancies has grown at a steady rate. Knowledge of how these drugs work, their kinetics, and toxicity has increased dramatically. A common pathway for tumor cell kill by anticancer drugs (apoptosis) has been recognized. To optimally use antineoplastic agents, clinicians must understand the principles of cancer chemotherapy as well as the specific drugs used to treat cancer. The first section of this chapter reviews the current understanding of (a) cancer biology, (b) mechanisms of antineoplastic drug action, (c) mechanisms of drug resistance, (d) drug toxicities, (e) pharmacologic principles (common and unique), and (f) potentials and limitations of therapy for individual patients. Specific drugs used to treat hematologic malignancies are summarized in the last section of this chapter.

**Cancer Biology**

When children with acute leukemia were first treated with folic acid antagonists in the 1940s, there was initial enthusiasm as all malignant cells were cleared from the bloodstream (<sup>2</sup>). However, the rapid return of leukemia with cells resistant to further therapy led to disappointment. We now understand this common situation: the difficulty presented by the large numbers of tumor cells at diagnosis and the development of tumor cells resistant to antineoplastic agents (discussed later in the chapter). A tumor that is 1

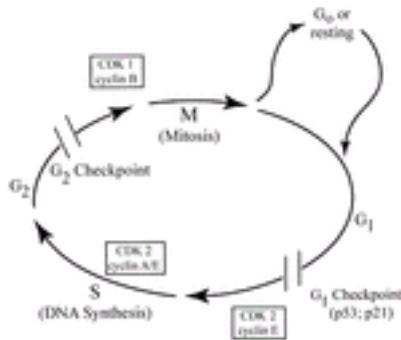
cm in diameter (rarely are tumors detected this early) contains  $10^9$  cells. A lethal tumor burden is only 3 logs higher ( $10^{12}$  cells). Chemotherapy can be modeled as killing a specific fraction of tumor cells present (3, 4). The fractional cell kill (e.g., 90%, 99%, 99.99% cell kill) depends on the sensitivity of cells to the antineoplastic drug and the dose of drug administered. The cell kill is proportional regardless of tumor burden. Although not completely accurate, this model helps us to understand two important principles regarding chemotherapy. First, because of the large number of cells present at diagnosis (e.g.,  $10^{11}$ ), multiple courses of treatment may be required for therapy even if a drug or a combination of drugs produces a 99.9% cell kill (i.e., kills 999 of every 1000 cells present). One treatment with a 99.9% cell kill reduces a tumor population from  $10^{11}$  to  $10^8$  cells. At least four treatments are therefore necessary to eliminate the final cancer cell, assuming that there is no tumor cell growth during the treatment period. In fact, because of toxicity to normal tissues and time needed for normal tissue recovery, cancer chemotherapy must be spaced out in treatment cycles. During the period between cycles, tumor regrowth occurs. Thus, most curative treatment regimens require multiple courses of chemotherapy, with the number depending on the tumor mass at the time of diagnosis and the sensitivity of the tumor to the drugs. A second principle from this model is that recurrent disease after “complete remission” (disappearance of all detectable disease) can be explained by our inability to detect fewer than  $10^3$  to  $10^4$  tumor cells in the body even by the most sensitive means. Chemotherapy that kills several logs of tumor cells (e.g., from  $10^{11}$  to  $10^4$ ) eliminates all evidence of cancer and prolongs survival, but the malignancy will recur at a later time. Examples of possible clinical treatment courses are illustrated in [Figure 73.1](#).



**Figure 73.1.** Schematic representation of clinical course of two patients with Hodgkin disease. Both patient A (A) and patient B (B) are diagnosed with a clinically detected tumor mass ( $10^{11}$  cells). Both patients are treated with ABVD (doxorubicin, bleomycin, vincristine, and dacarbazine) every 2 weeks. One course of therapy for patient A results in a 2-log tumor cell kill. Patient B’s therapy results in only a 1-log tumor cell kill. Some tumor growth occurs while waiting for normal tissue recovery before initiation of the next treatment. Three months into therapy, neither patient A nor patient B has clinically detectable disease. Treatment is stopped after 6 months of therapy. Patient A is cured, whereas disease recurs in patient B 3 months after stopping therapy.

The growth fraction of a cancer represents the percentage of cells actively progressing through the cell cycle. A cell cycle is marked by two observable events. During *S-phase* (synthesis), DNA replication occurs, and during *M-phase* (mitosis) cellular division into two daughter cells is seen (4).  $G_1$  (gap) is the time between the end of mitosis and the start of the next S-phase.  $G_2$  is the time between the completion of S-phase and the start of M-phase. Cells that have ceased to proliferate for prolonged periods have entered a  $G_0$ -phase (or resting phase) of the cell cycle ( [Fig. 73.2](#)). Some drugs cause cytotoxicity when exposed to cancer cells in any phase of the cell cycle. Some agents are

phase-specific; that is, they are cytotoxic to cells only in a particular phase of the cell cycle. Cytarabine, for example, is an S-phase-specific agent, whereas vincristine is M-phase specific. For cells to be killed by cytarabine, the drug must be present when the cell is synthesizing DNA.



**Figure 73.2.** The cell cycle. The cell cycle is marked by two observable events. During *S-phase* (synthesis), DNA replication occurs, and during the *M-phase* (mitosis), cells divide. *G<sub>1</sub>* and *G<sub>2</sub>* are times between completion of *M-phase* and the start of *S-phase* and between the completion of *S-phase* and beginning of *M-phase*, respectively. During *G<sub>1</sub>* and *G<sub>2</sub>*, the cell prepares for the *S-* and *M-phases* of the cell cycle. Cells may temporarily cease to divide and enter a resting or *G<sub>0</sub>*-phase of the cell cycle. The *G<sub>1</sub>-S* checkpoint is a critical phase in the cell cycle when directions for entering *S-phase* or committing to apoptosis (programmed cell death) are given. CDK, cyclin-dependent kinase.

Many cancers do not grow in an exponential manner but exhibit Gompertzian kinetics (3, 4). Gompertzian growth is sigmoid. In the Gompertzian model, the growth fraction of the tumor reduces as the tumor enlarges. In large cancers, not all cells are susceptible to chemotherapy as many drugs are effective only against dividing cells, and a proportion of cells in a large tumor mass are often in a resting or dormant phase, presumably due to lack of adequate nutrients or oxygen. The best opportunity for cell kill by chemotherapy is in the early portion of the growth curve when all cells are dividing.

### Mechanisms of Antineoplastic Drug Action

Antineoplastic agents interfere with some essential step required for cell growth or division. The initial target of antineoplastic drugs varies widely, from direct attack on the DNA molecule to inhibition of the formation of the mitotic spindle needed for cell division. However, all antineoplastic agents cause a disruption in a normal cellular process so significant that it requires the cell to either quickly repair the damage or initiate the process of apoptosis (programmed cell death). Essentially, all antineoplastic agents result in cell death through initiation of apoptosis (5). *Apoptosis* is the normal physiologic process of cellular suicide, which occurs in all living organisms to eliminate unwanted, functionally abnormal, or harmful cells. In apoptosis, in contrast to cellular necrosis, the cell shrinks and condenses, fragmenting into multiple membrane-bound bodies (apoptotic bodies), which are engulfed by surrounding cells without inflammation or damage to the surrounding tissues. Biochemically, apoptosis is characterized by fragmentation of nuclear DNA, demonstrated by a typical ladder pattern on agarose gel electrophoresis.

To understand how cytotoxic agents initiate apoptosis, an understanding of the events occurring in the normal cell cycle is important. As previously mentioned, DNA synthesis is

not continuous from one mitosis to the next but takes place in only a specific period of the cell cycle, the S-phase. Similarly, mitosis, or the M-phase, takes up only a small part of the cell cycle ( 4 ). In most, if not all, cells, the cell cycle is temporarily halted during the G<sub>1</sub>-S-phase checkpoint and at the G<sub>2</sub>-M-phase checkpoint. At these times, cells determine whether to continue into the S-phase, initiate the process of apoptosis, or undergo DNA repair ( 6 ). Passage into a new phase of the cell cycle requires activation of a series of enzymes called *cyclin-dependent kinases*, which activate another group of enzymes (the cyclins) ( 7 ). If cells are damaged by chemotherapeutic agents and are unable to repair the damage, apoptosis is initiated at the G<sub>1</sub>-S or G<sub>2</sub>-M checkpoint, provided that the mechanisms for apoptosis are in place. The critical factors needed for apoptosis remain an intense area of study, but some important components have been recognized. Two important factors are p53 and p21. *p53* is a nuclear phosphoprotein capable of binding to specific DNA sequences and activating selected target genes. Cells with a mutated *p53* gene have a relative resistance to cancer chemotherapeutic agents and are unable to properly initiate apoptosis ( 8 ). *p21* is a protein induced by p53 that binds to and inactivates the cyclins required for progression of cells into the S-phase. Other factors are known to affect the apoptotic pathway. A protein originally found in B-cell lymphomas, *bcl-2*, blocks apoptosis. Its exact site of action is under investigation, but this protein acts late in the apoptosis pathway. Caspases are the key machinery causing the breakdown of DNA and proteins. *Caspases* are specialized proteases existing as proenzymes, which can be rapidly activated by a number of factors. The Fas ligand and tumor necrosis factor stimulate the protease cascade. The apoptosis pathway is under intense investigation, and our understanding of essential control points in this pathway will increase ( 9 ). It is clear that antineoplastic agents provide the initial trigger for beginning the pathway to programmed cell death ( Fig. 73.3 ). However, the presence, or absence, of apoptotic proteins is as important as the initial interaction between a cytotoxic drug and its effector in determining whether tumor cell kill occurs.

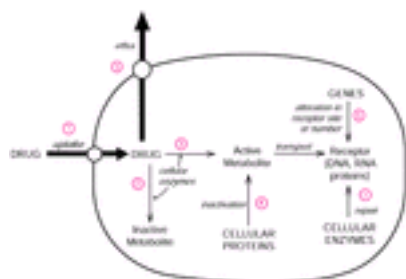


**Figure 73.3.** Potential pathways involved in cytotoxicity induced by chemotherapy. Chemotherapeutic drugs or growth factor deprivation damages cells. Cells are arrested at the G<sub>1</sub>-S checkpoint. If the damage is sublethal, it may be repaired, and the cell proceeds into the S-phase. If significant DNA damage is present, the process of programmed cell death is initiated. Critical factors, such as p53 and p21 gene products, are required for the cell to undergo apoptosis. G<sub>1</sub>, gap; S, S-phase or synthesis.

## Resistance to Anticancer Drugs

The presence of cancer cells resistant to chemotherapeutic agents is a common clinical occurrence. This vexing problem in cancer therapy is related, in part, to the many ways in which cells can become resistant to an antineoplastic agent. Steps in antineoplastic drug disposition within the cell are schematically represented in Figure 73.4. For an anticancer drug to be active it must (a) be taken up into a cancer cell and (b) be converted into an active agent. It must then make its way within the cell to its target without being (c) metabolically inactivated, (d) chemically inactivated, or (e) excreted from the cell. Once it interacts with its cellular target, the cell must not be able to (f) alter the target or (g) repair the damage to the target. Finally, (h) mechanisms for apoptosis must be in place as discussed in the preceding section. Examples of drug resistance at all of these steps have

been described ( [Table 73.1](#)). A tumor cell can become resistant to a particular drug in many ways. For example, resistance to methotrexate (MTX) has been described in some cell lines with altered folate transport limiting MTX uptake into cells. In other cell lines, MTX resistance results from the overexpression of the target enzyme, dihydrofolate reductase (DHFR).



**Figure 73.4.** Potential pathways for antineoplastic drug disposition within tumor cells. For a drug to be effective, the drug or its active metabolite must reach its target site within the cell. Possible steps required for a drug to reach its receptor include ( 1) uptake into a cell through a particular transport protein, ( 2) enzymatic conversion of the drug to an inactive metabolite, ( 3) enzymatic conversion of the drug to its active metabolite, ( 4) binding of an active metabolite by a cellular protein or thiol, thereby inactivating drug, ( 5) excretion of the drug from the cell via an efflux transport pump, ( 6) alteration in the genetic makeup of the cell, changing the drug receptor site or number, and ( 7) changes in the ability of a cell to repair damage of a drug at its receptor.

**TABLE 73.1. Mechanisms of Cancer Cell Resistance to Chemotherapeutic Agents**

| Resistance Mechanism           | Example  | Affected Drugs  | Reference          |
|--------------------------------|--|---|--------------------|
| Decreased drug uptake          | Altered folate receptor                          | Methotrexate  | <a href="#">10</a> |
| Decreased metabolic activation | Decreased concentrations of deoxycytidine kinase | Cytosine arabinoside                                    | <a href="#">11</a> |
| Increased catabolism           | Thiopurine methyltransferase excess              | 6-Mercaptopurine  | <a href="#">12</a> |
| Increased drug detoxification  | Increased glutathione production                 | Alkylating agents, platinum analogs                     | <a href="#">13</a> |
| Increased drug efflux          | Multidrug resistance                             | Vincas, epipodophyllotoxins, anthracyclines, paclitaxel | <a href="#">14</a> |
| Increased DNA repair           | O <sup>6</sup> alkylguanine alkyltransferase     | Nitrosoureas, procarbazine, dacarbazine                 | <a href="#">15</a> |
| Alteration of drug target      | Topoisomerase II mutations                       | Anthracyclines, epipodophyllotoxin                      | <a href="#">16</a> |

Cancer cells may become simultaneously resistant to several types of chemotherapeutic drugs. Cells expressing the multidrug resistance (MDR) gene produce a glycoprotein of 170-kD weight known as *p-glycoprotein* or *p170* ( [14](#)). Originally described in 1976, this



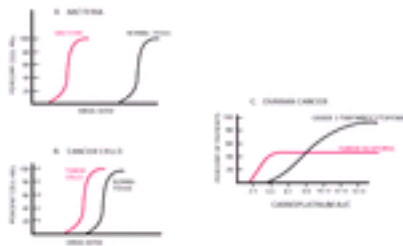
protein is a drug transporter that sits in the cell wall of resistant tumor cells. P-glycoprotein transports a number of antineoplastic agents, most of which are hydrophobic, including vinca alkaloids, epipodophyllotoxins, anthracyclines, actinomycin, and taxanes. Cells in which the MDR gene is activated develop simultaneous resistance to all of these antineoplastic agents. The presence of p-glycoprotein on tumor cells has been correlated with poor prognosis in hematologic tumors, sarcomas, small cell lung cancer, and carcinomas of the breast and ovary ( [17](#), [18](#) ). Because of the potential role of MDR in tumor resistance, efforts have been directed at blocking this transporter. A number of agents, including analogs of verapamil and cyclosporine, are inhibitors of MDR. Clinical trials of combinations of these inhibitors with anticancer drugs have been undertaken. MDR inhibitors may alter either the hepatic or renal excretion of several anticancer drugs, thereby increasing drug toxicity ( [19](#) ). Clinical effectiveness of these MDR inhibitors has not been clearly demonstrated.

Other cell lines have been characterized that do not overexpress p-glycoprotein but display a similar cross-resistance pattern. Some of these lines have a different type of transport protein called *MRP* or *MDR-associated protein* ( [20](#) ). MRP, like p-glycoprotein, is a member of the adenosine triphosphate (ATP)-binding cassette gene superfamily. However, MRP is structurally dissimilar to p-glycoprotein and has different inhibitors. The clinical significance of MRP is under study, but, like p-glycoprotein, its presence may be a poor prognostic factor.

In summary, tumor cells can develop resistance to antineoplastic drugs by numerous mechanisms. Resistance occurs as a result of random mutational changes in a population of cancer cells. Mutations to a drug-resistant cell line are estimated to occur at population size of  $10^4$  to  $10^6$  tumor cells, a size smaller than clinically detectable ( [21](#) ). Therefore, drug-resistant cancer cell populations are present in the majority of tumors at diagnosis. The early presence of resistant tumor cells leads to the rationale for (a) early treatment of cancers to avoid multiple resistant populations and (b) use of multiple agents with differing mechanisms of action.

## Drug Toxicity

As opposed to many other classes of drugs, the therapeutic window for chemotherapeutic agents is narrow ( [Fig. 73.5](#) ). The dose of drug needed to achieve adequate tumor cell kill often causes toxicity to normal tissues. For many antineoplastic agents, a sigmoidal curve defining the relationship between myelosuppressive toxicity and the dose of drug administered [or the area under the plasma drug concentration (AUC) vs. time curve] has been demonstrated. At low drug concentrations, no cytotoxicity is observed. With increasing concentration, cell kill is proportional to dose. At higher concentrations, the effect plateaus. Relationships correlating the dose of drug and antitumor response have also been demonstrated ( [Fig. 73.5C](#) ) ( [22](#) ). A positive relationship between the drug dose administered and tumor response rate has been demonstrated for many tumors, including the lymphomas. Higher response rates and an increased chance for cure are achieved with higher doses of selected agents ( [23](#), [24](#) ). For this reason, clinicians generally try to push doses of agents to toxicity to maximize the chance for cure. The optimal dose or AUC for an individual patient with a particular cancer is unknown.



**Figure 73.5.** Schematic representation curves relating drug concentrations to response. Antibacterial agents (A) have a wide therapeutic window with a significant difference in the dose that produces bacterial cell kill and the dose that causes toxicity to normal tissues. For antineoplastic drugs (B), the therapeutic window is narrow (e.g., doses adequate to produce tumor cell kill usually produce toxicity to normal tissues). For a few cancers, such as ovarian (C), the shape of the dose response curve has been defined (22). For most tumors, however, a specific dose response (or AUC response curve) has not been defined.

Chemotherapeutic agents cause a wide variety of toxicities (Table 73.2). Myelosuppression and nausea are seen, to some degree, with many anticancer drugs. Nausea and vomiting, although generally self-limited and not life-threatening, are very distressing to patients. The emetogenic potential of antineoplastic agents varies from drug to drug and is dose-dependent (25) (Table 73.3). The emetogenic potential of combination chemotherapy regimens can be estimated. Serotonin receptors, located within the vagal and splanchnic nerves of the gastrointestinal system and in the brain, are critical in the initiation of nausea by chemotherapeutic agents (26). The development of specific type 3 serotonin (5-hydroxytryptamine or 5HT<sub>3</sub>)-receptor blockers, such as ondansetron, dolasetron, and granisetron, has resulted in major improvement in control of chemotherapy-induced emesis (27). Combination therapy with a 5-HT<sub>3</sub>-receptor blocker and a steroid, such as dexamethasone (Decadron), has become standard preventive therapy for highly emetogenic combination chemotherapy regimens.

**TABLE 73.2. Antineoplastic Drug Toxicity**

| Nausea/Vomiting           | Bone Marrow                   | Mucositis                 | Alopecia                      | Neurologic                |
|---------------------------|-------------------------------|---------------------------|-------------------------------|---------------------------|
| Actinomycin               | Actinomycin <sup>a</sup>      | Actinomycin               | Actinomycin                   | Ara-C <sup>a</sup>        |
| Ara-C                     | Ara-C <sup>a</sup>            | Ara-C                     | Amsacrine                     | Asparaginase              |
| Arsenic trioxide          | Asparaginase                  | Bleomycin                 | Ara-C                         | Carboplatin               |
| Asparaginase              | Busulfan <sup>a</sup>         | Busulfan                  | Bleomycin                     | Cisplatin <sup>a</sup>    |
| Carboplatin               | Carboplatin <sup>a</sup>      | Capecitabine              | Busulfan                      | Cladribine                |
| Cisplatin <sup>a</sup>    | Chlorambucil <sup>a</sup>     | Cyclophosphamide          | Cyclophosphamide <sup>a</sup> | Docetaxel                 |
| Cyclophosphamide          | Cisplatin                     | Daunorubicin <sup>a</sup> | Cytarabine                    | Fludarabine               |
| Daunorubicin <sup>a</sup> | Cladribine <sup>a</sup>       | Docetaxel                 | Daunorubicin <sup>a</sup>     | Fluorouracil <sup>a</sup> |
| Denileukin difitox        | Cyclophosphamide <sup>a</sup> | Doxorubicin <sup>a</sup>  | Docetaxel                     | HMM                       |

|                           |   |                           |                          |                             |
|---------------------------|---|---------------------------|--------------------------|-----------------------------|
| Doxorubi-cin <sup>a</sup> | Daunorubicin <sup>a</sup>               | Epirubicin                | Doxorubicin <sup>a</sup> | Ifosfamide <sup>a</sup>     |
| DTIC <sup>a</sup>         | Docetaxel <sup>a</sup>                  | Etoposide                 | DTIC                     | Interferon                  |
| Epirubicin                | Doxorubicin <sup>a</sup>                | Fludarabine <sup>a</sup>  | Etoposide <sup>a</sup>   | L-Asparaginase <sup>a</sup> |
| Etoposide                 | DTIC <sup>a</sup>                       | Fluorouracil              | Fluorouracil             | Methotrexate                |
| Fludarabine               | Etoposide <sup>a</sup>                  | Hydroxyurea               | Hydroxyurea              | Nitrosourea                 |
| Fluorouracil              | Fludarabine <sup>a</sup>                | Idarubicin                | Idarubicin               | Paclitaxel <sup>a</sup>     |
| Gemcitabine               | Fluorouracil                            | Ifosfamide                | Ifosfamide <sup>a</sup>  | Pentostatin                 |
| HMM <sup>a</sup>          | Gemcitabine                             | Methotrexate <sup>a</sup> | Irinotecan               | Procarbazine                |
| Hydroxyurea               | Hydroxyurea <sup>a</sup>                | Mercaptopurine            | Methotrexate             | Tretinoin                   |
| Idarubicin                | Idarubicin <sup>a</sup>                 | Mitomycin                 | Mitoxantrone             | Vinblastine <sup>a</sup>    |
| Ifosfamide <sup>a</sup>   | Ifosfamide <sup>a</sup>                 | Mitoxantrone              | Mustard                  | Vincristine <sup>a</sup>    |
| Imatinib mesylate         | Interferon                              | Nitrosoureas              | Nitrosoureas             | Vinorelbine <sup>a</sup>    |
| Irinotecan                | Irinotecan                              | Paclitaxel                | Paclitaxel <sup>a</sup>  |                             |
| Methotrexate              | L-Phenylalanine<br>mustard <sup>a</sup> | Procarbazine              | Procarbazine             |                             |
| Mitomycin                 | Mercaptopurine <sup>a</sup>             | Thioguanine               | Vinblastine              |                             |
| Mitoxantrone              | Mitomycin <sup>a</sup>                  | Thiotepa (high<br>dose)   | Vincristine              |                             |
| Mustard <sup>a</sup>      | Mitoxantrone <sup>a</sup>               | Vinblastine               |                          |                             |
| Nitrosoureas              | Mustard <sup>a</sup>                    | Vincristine               |                          |                             |
| Pentostatin               | Nitrosoureas <sup>a</sup>               |                           |                          |                             |
| Procarbazine              | Paclitaxel <sup>a</sup>                 |                           |                          |                             |
| Thioguanine               | Pentostatin                             |                           |                          |                             |
| Thiotepa                  | Procarbazine                            |                           |                          |                             |
| Topotecan                 | Teniposide <sup>a</sup>                 |                           |                          |                             |
|                           | Thioguanine                             |                           |                          |                             |
|                           | Thiotepa                                |                           |                          |                             |

Ara-C, cytosine arabinoside; DTIC, dacarbazine; HMM, hexamethylmelamine.

<sup>a</sup> Major toxicity.

**TABLE 73.3. Emetic Potential of Selected Antineoplastic Agents**

| Grade | Emesis Frequency (%) | Drug   |
|-------|----------------------|--|
| 5     | >90                  | Carmustine >250 mg/m <sup>2</sup><br>Cisplatin<br>Cyclophosphamide >1500 mg/m <sup>2</sup><br>Dacarbazine<br>Methchlorethamine |

|   |       |  |
|---|-------|--|
| 4 | 60–90 | Carboplatin<br>Carmustine =250 mg/m <sup>2</sup><br>Cyclophosphamide 750–1500 mg/m <sup>2</sup><br>Cytarabine >1 g/m <sup>2</sup><br>Doxorubicin >60 mg/m <sup>2</sup><br>Methotrexate >1000 mg/m <sup>2</sup><br>Procarbazine (oral)              |
| 3 | 30–60 | Cyclophosphamide =750 mg/m <sup>2</sup><br>Cyclophosphamide (oral)<br>Doxorubicin 20–60 mg/m <sup>2</sup><br>Epirubicin =90 mg/m <sup>2</sup><br>Idarubicin<br>Ifosfamide<br>Irinotecan<br>Methotrexate 250–1000 mg/m <sup>2</sup><br>Mitoxantrone |
| 2 | 10–30 | Docetaxel<br>Etoposide<br>5-Fluorouracil<br>Methotrexate 50–250 mg/m <sup>2</sup><br>Paclitaxel<br>Topotecan   |
| 1 | <10   | Bleomycin<br>Busulfan<br>Chlorambucil (oral)<br>2-Chlorodeoxyadenosine<br>Fludarabine<br>Hydroxyurea<br>L-Phenylalanine mustard (oral)<br>Thioguanine (oral)<br>Vinblastine<br>Vincristine<br>Vinorelbine  |

NOTE: When considering combination chemotherapy regimens, identify the most emetogenic agent. Each grade 3 or 4 agent increases the emetogenic potential of the most emetic agent by one grade. All grade 2 drugs combined increase the emetogenic potential of the combination one level. Grade 1 agents do not add to the emetogenic potential.

Adapted from Hesketh PJ, Kris MG, Grunberg SM, et al. Proposal for classifying the emetogenicity of cancer chemotherapy. *J Clin Oncol* 1997;15:103–109.

---

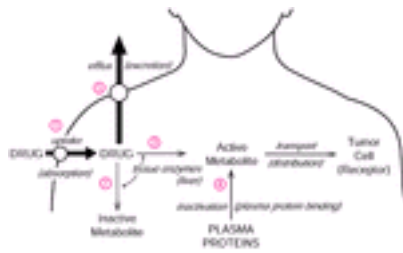
Myelosuppression is the most common dose-limiting antineoplastic agent toxicity. The suppression of hematopoietic cell lines is determined by the kinetics of the specific cell line in the peripheral compartment. Anemia occurs as a late effect because of the long

half-life of red blood cells (120 days). Thrombocytopenia occurs in an intermediate time frame (platelet half-life, 5 to 7 days), whereas granulocyte suppression occurs earliest. Granulocytopenia is a more frequent occurrence than thrombocytopenia or anemia. The white blood cell count usually drops 5 to 14 days after drug administration with recovery by 7 to 21 days. Several exceptions are recognized such as a predominant thrombocytopenia seen with carboplatin and delayed myelosuppression with busulfan and the nitrosoureas (occurring 4 to 5 weeks posttherapy). The degree and duration of bone marrow suppression are directly related to the dose of drug administered. High-dose chemotherapy regimens used with marrow transplantation generally result in 15 to 25 days with a neutrophil count less than 500 per mm<sup>3</sup> and thrombocytopenia lasting for a more extended period if growth factors are not used. An increased risk of infectious complications occurs that is directly related to the degree and duration of granulocytopenia ( [28](#), [29](#) ). The development of recombinant hematopoietic colony-stimulating factors (CSFs), such as erythropoietin, thrombopoietin, granulocyte-macrophage CSF, and granulocyte-CSF, has shortened the duration of bone marrow suppression but not eliminated it ( [30](#) ). CSFs are now commonly used with regimens expected to produce an incidence of febrile neutropenia greater than 40%. Guidelines for the use of these important, yet expensive, factors are available and should be used ( [31](#) ).

The range of toxicities associated with antineoplastic agents is too great to review in detail in this chapter. Readers are referred to reviews on oral ( [32](#) ), renal ( [33](#) ), neurologic ( [34](#) ), hepatic ( [35](#) ), pulmonary ( [36](#) ), cardiac ( [37](#) ), and cutaneous ( [38](#) ) toxicities of antineoplastic agents. Physicians must also remember that most antineoplastic agents have teratogenic and mutagenic potential. Alkylating agents are the most damaging to testicular and ovarian function. Damage is dependent on drug dose, age of patient (older patients are more likely to have toxicity), and sex (males greater than females) ( [39](#) ). Second malignancies (primarily acute leukemia) have been associated with alkylating agents, epipodophyllotoxins, nitrosoureas, and anthracyclines ( [40](#) ). Concomitant radiation therapy increases the risk of second malignancies (generally sarcomas) 5 to 9 years after therapy.

## General Pharmacologic Principles

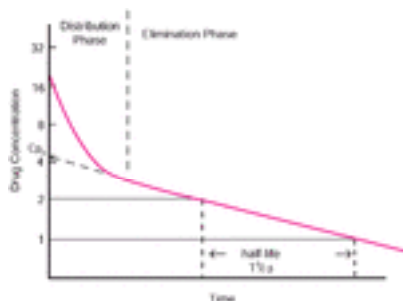
Antitumor activity of an antineoplastic agent is better correlated with the concentration of drug that reaches the site of drug action than with the dose of drug administered. As noted in the section [Resistance to Anticancer Drugs](#), several factors may affect what happens to a drug within the cell. Similarly, drug disposition within the body from the time it is administered until it reaches its target site is also critical to achieving an antitumor response ( [Fig. 73.6](#) ). Knowledge of the absorption, distribution, biotransformation, and excretion of a drug (its pharmacokinetic properties) helps physicians make adjustments in the dose, route, or schedule of drug administration to achieve the optimal drug effect. Pharmacokinetics represents an attempt to quantitatively predict how a patient will handle a given dose of drug ( [41](#) ). The four most important pharmacokinetic parameters are (a) bioavailability, (b) volume of distribution, (c) clearance, and (d) drug half-life.



**Figure 73.6.** Schematic representation of drug disposition within the body. For a drug to function, it must be taken into the body ( 1) and avoid being cleared from the body by metabolism ( 2) or excretion ( 3). It must reach its site of action in active form ( 6) without being inactivated by protein binding ( 4).

Bioavailability, the percentage of a dose of drug that reaches the plasma compartment, defines drug absorption. Drugs given intravenously, by definition, have 100% bioavailability. Factors that decrease the bioavailability of orally administered drugs include poor solubility in aqueous solutions and metabolism of the drug in the intestine or liver before entry into the systemic circulation (first pass effect). Bioavailability of poorly soluble etoposide decreases at high oral drug doses ( 42). Bioavailability of orally administered 6-mercaptopurine (6-MP) and 5-fluorouracil is low because of extensive, first-pass, hepatic drug metabolism ( 43, 44). With poor or widely variable bioavailability of a particular agent, an intravenous route of administration is preferred. The most important factor regarding bioavailability is the variation from patient to patient of the amount of oral drug absorbed (coefficient of variation). If bioavailability of an oral anticancer drug were 50% in all patients, simply doubling the drug dose would produce an equivalent response to intravenously administered drug. However, the variation from patient to patient in the AUC achieved is usually greater with oral than intravenously administered drug ( 45). Therefore, variation in toxicity is also greater.

After a drug reaches the bloodstream, it is distributed into tissues. Figure 73.7 shows a plasma concentration versus time curve for a drug with a typical two-phase (distribution and elimination) decline in plasma concentration. Distribution may be affected by drug binding to plasma proteins (usually albumin or a  $\gamma$ -acid glycoprotein). Only free drug is biologically active. Decreasing the percentage of bound drug by a decrease in the amount of albumin or displacing drug from its binding site may increase toxicity (seen with etoposide) ( 46). Distribution of drug into a “third-space,” such as ascites or a pleural effusion, may slow clearance and increase toxicity, as noted with MTX ( 47).



**Figure 73.7.** Plasma concentrations of a typical drug at various times after intravenous administration. After an early distribution phase, drug concentrations decrease in a log-linear manner.  $C_{p0}$  is the hypothetical drug plasma concentration at time zero if equilibrium were achieved instantaneously. The drug’s half-life is the time required for its concentration to decrease by half.

Clearance is expressed as the volume of biologic fluid (usually plasma) from which a drug can be removed per unit of time. Clearance of most drugs is constant over a range of plasma concentrations, which means that the mechanism for elimination is not saturated. However, some drugs, such as paclitaxel, demonstrate saturable elimination at high plasma concentrations (<sup>48</sup>). This means a greater proportional drug effect is noted when high doses are increased. Clearance measurements allow physicians to maintain a particular plasma concentration, as the dosage rate = clearance × desired plasma concentration. Removal of drugs from the circulation occurs primarily by metabolism, renal elimination, or hepatic excretion. If urinary excretion is an important route of elimination, renal failure results in slower removal of the drug from the body. Administration of the usual dosage of a renally excreted drug to a patient with renal insufficiency leads to greater drug accumulation and an increased likelihood of toxicity. In such cases, drug dosage should be modified so that a similar drug concentration–time profile is achieved in the plasma of the patient with renal insufficiency. Using available data on drug clearance, the appropriate dose in renal insufficiency may be calculated as follows:

$$\text{Dose in renal insufficiency} = \text{normal dose} \times \text{clearance in renal insufficiency} \div \text{normal clearance}$$

In contrast to a predictable decline in renal drug clearance when glomerular filtration is reduced, it is not possible to make a general prediction of the effect of liver disease on hepatic biotransformation of drugs. Even in advanced hepatocellular disease, the magnitude of impairment in drug clearance usually is only two- to fivefold. The extent of such changes cannot be predicted by common tests of liver function. Consequently, even when it is suspected that drug elimination is altered in liver disease, there is no quantitative base on which to adjust the dosage regimen other than assessment of clinical response. Antineoplastic drugs for which dose modifications are indicated for renal or hepatic insufficiency are listed in [Table 73.4](#).

**TABLE 73.4. Drugs Requiring Dose Alterations for Organ Toxicity**

| Nephrotoxicity                        | Hepatic Toxicity          |
|---------------------------------------|---------------------------|
| Bleomycin                             | Daunorubicin <sup>a</sup> |
| Carboplatin <sup>a</sup>              | Doxorubicin <sup>a</sup>  |
| Cisplatin <sup>a</sup>                | Epirubicin <sup>a</sup>   |
| Cladribine                            | Idarubicin                |
| Cyclophosphamide (if CrCl <20 ml/min) | Irinotecan                |
| Deoxycoformycin                       | Paclitaxel <sup>a</sup>   |
| Etoposide                             | Taxotere <sup>a</sup>     |
| Fludarabine                           | Vinblastine <sup>a</sup>  |
| Hydroxyurea                           | Vincristine <sup>a</sup>  |
| Ifosfamide                            | Vinorelbine <sup>a</sup>  |
| Methotrexate <sup>a</sup>             |                           |
| Mithramycin                           |                           |
| Mitomycin <sup>a</sup>                |                           |



Nitrosoureas <sup>a</sup>  
Pentostatin  
Streptozocin  
Topotecan

<sup>a</sup> Major dose adjustment.

---

The hepatic metabolism of drugs may be altered by genetic deficiency of a metabolizing enzyme or by inhibition of metabolism by another drug. Examples include the inherited deficiencies of dihydropyrimidine dehydrogenase, the enzyme that degrades 5-fluorouracil ( <sup>49</sup> ), and thiopurine methyltransferase, the enzyme degrading azathioprine and 6-MP ( <sup>50</sup> ). Individuals lacking these enzymes experience excessive drug toxicity. Certain antineoplastic drugs are metabolized by the hepatic P-450 microsomal enzyme system (vincas, epipodophyllotoxins, cyclophosphamide, and the taxanes). The activity of the microsomal enzyme systems may be increased with concomitant use of phenobarbital or other drugs. Use of anticonvulsants has been shown to increase the catabolism of teniposide, a drug eliminated from the body through hepatic microsomal metabolism ( <sup>51</sup> ). Clearance of drugs metabolized by the hepatic P-450 enzyme system, such as paclitaxel or docetaxel (Taxotere), can be decreased with concomitant use of P-450 inhibitors such as some antiretroviral agents.

It is important to recognize the unpredictable variation in the way chemotherapeutic drugs are handled by the body. Mean values for bioavailability, clearance, and volume of distribution of anticancer agents have standard deviations of 20%, 50%, and 30%, respectively. This means that target drug concentrations may vary widely from patient to patient, even those whose renal and hepatic function appears similar. This is particularly important for drugs with a low therapeutic index and necessitates that all patients receiving chemotherapy be carefully monitored.

### Approach to the Patient with Cancer

Before initiating cancer chemotherapy, a physician should (a) verify the accuracy of the diagnosis, (b) understand the natural history of the illness, and (c) identify, with the patient, the goals of therapy. Verification of the diagnosis, in nearly every case, requires histologic documentation of cancer. Once the diagnosis is established, the physician and patient must decide whether cure is possible or palliation is the optimal goal. If cure is the goal, the patient and physician may be willing to tolerate more severe toxicity. The patient must be a partner in such decisions. In many cases, several options may be reasonable, and an informed patient can direct the physician as to whether intensive, potentially toxic therapy should be tried for a relatively small chance of cure ( <sup>52</sup> , <sup>53</sup> ). Fortunately, curative therapy, even for disseminated disease, is available for many hematologic malignancies, including Hodgkin disease, non-Hodgkin lymphomas, and acute and chronic leukemias. In some illnesses, such as chronic lymphocytic leukemia and low-grade lymphomas, curative therapy is not available, and the disease is often indolent. A discussion of these illnesses and their natural histories can reassure patients and help them understand why chemotherapy is not being immediately initiated. If high-dose, aggressive curative chemotherapy is planned, patients and their families need to be aware of anticipated and potential toxicities.

The use of chemotherapy for treatment of an individual requires a detailed knowledge of the patient, including his or her medical and psychological status, specific knowledge of

the drugs to be used, and the availability of appropriate laboratory and hospital support services. Combination chemotherapy (use of several drugs simultaneously) is usually used and multiple cycles of drugs administered to achieve adequate tumor cell kill without life-threatening toxicity or the development of tumor cell resistance. Certain patient selection factors are important in planning treatment. Age alone is seldom a reason to exclude patients from chemotherapy ( 54, 55). However, age-related changes in organ function, including reduced marrow reserve and decreased renal function, are commonly seen and may increase the risk of toxicity. The performance status of a patient (either on the Karnofsky or American Joint Committee on Cancer scale) usually correlates with response to chemotherapy ( Table 73.5). The nutritional state of a patient is important. Malnourished patients with hypoalbuminemia may have increased toxicity when highly protein-bound drugs are used ( 46). Appropriate dosing guidelines for obese patients are not available ( 56). Doses based on actual body weight appear appropriate when the goal for therapy is cure ( 57), whereas doses based on ideal body weight, with potential escalations later, are reasonable when palliation is the intent. Altered organ function may eliminate the opportunity to use certain drugs (e.g., doxorubicin in patients with heart failure and bleomycin in patients with severe pulmonary toxicity). Drug doses are routinely modified for decreases in blood counts ( Table 73.6) and also for changes in renal and hepatic function (see section [General Pharmacologic Principles](#)). The patient must be carefully observed for toxicity and response to chemotherapy. It is common to reevaluate patients after two to three cycles of chemotherapy to determine treatment effectiveness. If a response is seen, therapy is usually continued for a set number of courses or two cycles past a complete response. If tumor progression is noted, therapy should be discontinued. For patients with stable disease, an assessment of drug toxicity is important. If therapy is tolerable, a decision to continue treatment is reasonable with the understanding that disease progression will eventually occur.

**TABLE 73.5. Karnofsky and American Joint Committee on Cancer (AJCC) Performance Status Scales**

| Karnofsky Scale (%) | Corresponding Description   | AJCC Scale | Corresponding Description                                       |
|---------------------|---|------------|---|
| 100                 | Normal; no complaints; no evidence of disease                             | 0          | Normal activity   |
| 90                  | Able to carry on normal activity; minor signs or symptoms of disease      | —          | —   |
| 80                  | Normal activity with effort; some signs or symptoms of disease            | 1          | Symptomatic and ambulatory; cares for self                      |
| 70                  | Cares for self; unable to carry on normal activity or to do active work   | —          | —   |
| 60                  | Requires occasional assistance but is able to care for most of own needs  | 2          | Ambulatory more than 50% of time; occasionally needs assistance |
| 50                  | Requires considerable assistance and frequent medical care                | 3          | Ambulatory 50% or less of time; nursing care needed             |
| 40                  | Disabled; requires special care and assistance                            | —          | —   |
| 30                  | Severely disabled; hospitalization indicated, although death not imminent | —          | —   |

|    |   |   |                                     |
|----|---|---|-------------------------------------|
| 20 | Very sick; hospitalization necessary; active supportive treatment necessary | 4 | Bedridden; may need hospitalization |
| 10 | Moribund, fatal processes progressing rapidly                               | — | —                                   |
| 0  | Dead  | — | —                                   |

**TABLE 73.6. Generalized Dose Adjustment Guidelines for Hematologic Toxicity <sup>a</sup>**

|                   | 100% Dose | 75% Dose       | 50% Dose      | Omit    |
|-------------------|-----------|----------------|---------------|---------|
| Granulocyte       | >2000     | 1500–1999      | 1000–1499     | <1000   |
| White blood cells | >3500     | 3000–3500      | 2500–2999     | <2500   |
| Platelet          | >100,000  | 75,000–100,000 | 50,000–74,999 | <50,000 |

<sup>a</sup> In selected circumstances, such as in the treatment of leukemia, these guidelines do not apply. Specific guidelines accompanying individual protocols should be sought.

## DRUGS USED TO TREAT CANCER

A comprehensive review of the pharmacology of all drugs used in the therapy of malignancies is beyond the scope of this chapter. The focus is a brief review of those agents most commonly used in the therapy of hematologic malignancies. Important information necessary for the optimal use of these drugs includes (a) mechanism of action; (b) pharmacology, including bioavailability, routes of elimination, and important drug interactions; and (c) toxicities. [Table 73.7](#) summarizes important information for most antineoplastic agents. A more detailed summary of the most commonly used antineoplastic agents for the therapy of hematologic malignancy follows.

**TABLE 73.7. Chemotherapeutic Agents**

| Drug Name (Synonym)                          | Drug Class                    | Action  | Clearance Route <sup>a</sup> | Major Toxicity   |
|--|-------------------------------|---|------------------------------|--|
| Altretamine (Hexalen);<br>Hexamethylmelamine | Nonclassical alkylating agent | Unknown, may alkylate DNA.  | Hepatic metabolism           | Hypersensitivity reaction, deficient synthesis of key proteins (clotting factors, insulin), CNS depression, pancreatitis |
| Arsenic trioxide (ATO)                       | Arsenical                     | Degrades PML–RAR fusion protein, allowing cellular differentiation. | Hepatic metabolism           | Hypokalemia, QT prolongation, retinoic acid syndrome   |

|   |                                    |   |                            |   |
|---|------------------------------------|---|----------------------------|---|
| Asparaginase (Elspar)                             | Enzyme                             | Breaks down the amino acid asparagine. Sensitive lymphocytes lack ability to synthesize asparagine. | Hepatic metabolism         | N & V, neurotoxicity, myelosuppression, diarrhea  |
| Bexarotene (Targretin)                            | Retinoid                           | Binds to RXR nuclear receptor, inducing apoptosis.  | Hepatic metabolism         | Hyperlipidemia, hypercholesterolemia, headache  |
| Bleomycin (Blenoxane)                             | Antibiotic                         | Single-strand DNA breaks.   | Renal                      | Hypersensitivity reaction, pulmonary fibrosis, skin and mucocutaneous reactions, fevers |
| Busulfan (Myleran)                                | Alkylating agent                   | Forms DNA cross-links.  | Metabolism                 | Myelosuppression, hepatotoxicity (venoocclusive disease), pulmonary fibrosis            |
| Carboplatin (CBDCA, Paraplatin)                   | Platinum complex                   | Produces DNA cross-links like alkylating agents but with platinum bridging.                         | Renal                      | Thrombocytopenia, leukopenia, nephrotoxicity, ototoxicity, neuropathy, N & V            |
| Carmustine (BCNU)                                 | Nitrosourea                        | Alkylates DNA at O <sup>6</sup> position of guanine.  | Hepatic metabolism         | Delayed (4–6 wk) myelosuppression, pulmonary toxicity, hepatotoxicity                   |
| Chlorambucil (Leukeran)                           | Alkylating agent                   | Cross-links DNA.  | Metabolism                 | Myelosuppression, pulmonary toxicity, hepatotoxicity                                    |
| Cisplatin (CDDP, Platinol)                        | Platinum complex                   | Produces DNA cross-links with platinum similar to alkylating agents.                                | Protein binding, renal     | Nephrotoxicity, N & V, ototoxicity, alopecia, neuropathy                                |
| Cladribine (Leustatin, 2-Chlorodeoxyadenosine)    | Antimetabolite (purine analog)     | Incorporation into DNA; NAD consumption.  | Renal                      | Myelosuppression, fever, renal toxicity (high dose)                                     |
| Cyclophosphamide (Cytoxan, Neosar)                | Alkylating agent                   | Cross-links DNA strands.  | Hepatic metabolism (renal) | Myelosuppression, N & V, cystitis, cardiac (high dose)                                  |
| Cytarabine (Cytosar, ara-C, cytosine arabinoside) | Antimetabolite (pyrimidine analog) | Incorporates into DNA; inhibits DNA poly-merase.  | Hepatic metabolism         | Myelosuppression, N & V, mucositis, ocular, hepatic                                     |
| Dacarbazine (DTIC)                                | Nonclassical alkylating agent      | DNA methylation.  | Renal (hepatic metabolism) | Vesicant, myelosuppression, N & V, hepatic  |
| Dactinomycin (Cosmegen, Actinomycin-D)            | Antibiotic                         | DNA intercalation.  | Biliary                    | Myelosuppression, N & V, vesicant, mucositis  |

|   |                                    |   |                                       |   |
|---|------------------------------------|---|---------------------------------------|---|
| Daunorubicin (Cerubidine)                                   | Antibiotic (anthracycline)         | Topoisomerase inhibition, DNA intercalation, free radical formation.          | Biliary excretion, hepatic metabolism | Myelosuppression, N & V, cardiomyopathy, vesicant, red urine, mucositis   |
| Denileukin difitox (Ontak)                                  | IL-2-linked toxin                  | Binds to the IL-2 receptor; the diphtheria toxin is internalized.             | Unknown                               | Hypersensitivity reaction, N & V, myalgias, headache, vascular leak syndrome  |
| Docetaxel (Taxotere)  | Plant alkaloid                     | Mitotic spindle inhibitor.  | Hepatic metabolism, biliary excretion | Myelosuppression, hypersensitivity (steroids needed), fluid retention, neuropathy   |
| Doxorubicin (Adriamycin, Rubex)                             | Antibiotic (anthracycline)         | Topoisomerase inhibition, DNA intercalation, free radical formation.          | Biliary excretion, hepatic metabolism | Myelosuppression, N & V, cardiomyopathy, vesicant, red urine, mucositis   |
| Etoposide (VePesid, VP-16); etoposide phosphate (Etopophos) | Plant alkaloid                     | Inhibits topoisomerase II.  | Renal, hepatic metabolism             | Myelosuppression, mucositis, hypersensitivity reaction  |
| Fludarabine (Fludarabine phosphate, Fludara)                | Antimetabolite (purine analog)     | Inhibits DNA polymerase; incorporation into DNA and RNA; NAD depletion.       | Renal                                 | Myelosuppression, mucositis, hypersensitivity reaction, neurologic  |
| Fluorouracil (5FU, Adrucil)                                 | Antimetabolite (pyrimidine analog) | Inhibits thymidylate synthetase; incorporated into DNA and RNA.               | Hepatic metabolism                    | Myelosuppression (more with bolus), diarrhea and mucositis (more with continuous infusion), stomatitis, cardiac ischemia, CNS (cerebellar ataxia) |
| Gemcitabine (Gemzar)  | Antimetabolite                     | Inhibits ribonucleotide reductase; incorporated into DNA as false nucleotide. | Metabolism                            | Myelosuppression, nausea, diarrhea, hepatic fever   |
| Hydroxyurea (Hydrea)  | Antimetabolite                     | Inhibits ribonucleotide reductase.  | Hepatic metabolism, renal             | Myelosuppression, mucositis   |
| Idarubicin (Idamycin)                                       | Antibiotic, anthracycline          | Similar to doxorubicin.   | Hepatic                               | Similar to doxorubicin  |
| Ifosfamide (Ifex, IFOS)                                     | Alkylating agent                   | Cross-links DNA strands through alkyl groups.                                 | Hepatic metabolism, renal excretion   | Myelosuppression, N & V, neurologic, alopecia, cystitis (must be given with Mesna)  |
| Imatinib mesylate (Gleevec, STI-575)                        | Signal transduction inhibitor      | Inhibits the tyrosine kinase of the bcr-abl and c-kit oncogenes.              | Hepatic metabolism                    | Nausea, diarrhea, fluid retention, abnormal liver function tests  |

|  |                                    |   |  |  |
|--|------------------------------------|---|--|--|
| Interferon- $\alpha$ (INF- $\alpha$ );<br>Intron A, ( $\alpha$ 2b); Alferon,<br>( $\alpha$ n); Roferon, ( $\alpha$ 2a);<br>Welferon, ( $\alpha$ n) | Biologic                           | Degradation of messenger RNAs; modulation of oncogene expression; increase in natural killer cells and other immunoregulatory elements. | Renal metabolism                         | Fever, chills, myalgias, headache, fatigue, anorexia, myelosuppression, hepatic, CNS                   |
| Irinotecan (Camptosar, CPT-11)   | Camptothecin analog                | Inhibits topoisomerase I.   | Metabolism, biliary excretion            | Myelosuppression, diarrhea, pneumonitis, stomatitis  |
| Levamisole (Ergamisol)   | Biologic                           | Unknown.  | Hepatic metabolism                       | Nausea, hepatic, fever, chills   |
| Lomustine (CeeNU, CCNU)  | Nitrosourea                        | Same as carmustine.   | Same as carmustine                       | Same as carmustine   |
| Mechlorethamine (Nitrogen mustard, Mustargen)  | Alkylating agent                   | Cross-links DNA via alkylation.   | Tissue binding                           | Vesicant, ototoxicity, myelosuppression, N & V   |
| Melphalan (Alkeran, L-PAM, Phenylalanine mustard)  | Alkylating agent                   | Cross-links DNA strands via alkylation.   | Spontaneous degradation, protein binding | Myelosuppression, pulmonary fibrosis (rare), N & V (high dose)   |
| Mercaptopurine (6MP, Purinethol)   | Antimetabolite (purine analog)     | Incorporation into DNA.   | Hepatic metabolism                       | Myelosuppression, hepatotoxicity   |
| Methotrexate (MTX, Amethopterin, Folex, Mexate)  | Antimetabolite (folic acid analog) | Inhibits dihydrofolate reductase with decreased thymidylate and protein synthesis.  | Renal excretion                          | Myelosuppression, mucositis, hepatotoxicity (chronic low dose), renal (high dose), pulmonary           |
| Mitomycin (Mutamycin, Mitomycin-C)   | Antibiotic                         | Cross-links DNA strands.  | Hepatic metabolism                       | Myelosuppression, N & V, vesicant, pulmonary, hepatic, renal   |
| Mitoxantrone (Novantrone, DHAD)  | Anthraquinone                      | Similar to doxorubicin.   | Hepatic metabolism                       | Similar to doxorubicin; blue-green urine   |
| Paclitaxel (Taxol)   | Plant alkaloid                     | Mitotic spindle inhibitor stabilizes microtubulin.  | Hepatic metabolism, biliary excretion    | Myelosuppression, hypersensitivity syndrome (use with steroids, antihistamines), mucositis, neuropathy |
| Pentostatin (Nipent, 2-Deoxycoformycin)  | Antimetabolite (purine analog)     | Adenosine deaminase inhibitor.  | Renal                                    | Myelosuppression, fever, rash, hepatotoxicity, pulmonary, CNS  |
| Procarbazine (Matulane, Natulan)   | Nonclassical alkylating agent      | Alkylates DNA, DNA strand breaks.   | Hepatic metabolism                       | Myelosuppression, N & V, CNS (confusion, depression), monoamine oxidase inhibition, hepatic, pulmonary |

|   |                                |  |                                       |  |
|---|--------------------------------|--|---------------------------------------|--|
| Streptozocin (Zanosar, Streptozotocin)                          | Nitrosourea                    | Methylation of O <sup>6</sup> -guanine of DNA.           | Renal                                 | Myelosuppression, N & V, renal, diabetes, vesicant             |
| Teniposide (VM-26, Vumon)                                       | Plant alkaloid                 | Binds to topoisomerase II, causing DNA strand breaks.    | Hepatic metabolism                    | Myelosuppression, hypersensitivity reactions                   |
| Thioguanine (6-Thioguanine, 6TG, Lanvis)                        | Antimetabolite (purine analog) | Incorporates into DNA as fraudulent nucleotide.          | Hepatic metabolism                    | Myelosuppression, hepatic venoocclusive disease                |
| Thiotepa (Thioplex)   | Alkylating agent               | Trifunctional alkylating agent; cross-links DNA.         | Metabolism                            | Myelosuppression, stomatitis                                   |
| Tretinoin (Retinoid Acid, <i>Trans</i> Retinoid Acid, Vesanoid) | Retinoid                       | Induces differentiation.                                 | Hepatic metabolism, biliary excretion | Mucocutaneous, headache, fever, neurologic, hepatic, pulmonary |
| Vinblastine (Velban)  | Plant alkaloid                 | Binds to tubulin, prevents formation of mitotic spindle. | Hepatic                               | Myelosuppression, vesicant, neurotoxin                         |
| Vincristine (Oncovin, Vincasar)                                 | Plant alkaloid                 | Binds to tubulin, prevents formation of mitotic spindle. | Hepatic                               | Neurotoxin, vesicant, CNS                                      |
| Vinorelbine (Navelbine)   | Plant alkaloid                 | Binds to tubulin, prevents formation of mitotic spindle. | Hepatic                               | Myelosuppression, vesicant, neuropathy                         |

CNS, central nervous system; IL, interleukin; N & V, nausea and vomiting; NAD, nicotinamide adenine dinucleotide.

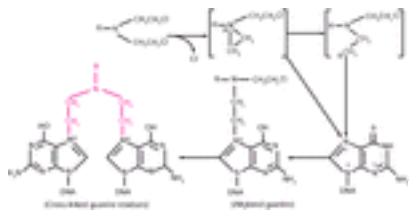
<sup>a</sup> Minor routes of elimination are indicated by parentheses.

## Alkylating Agents

**MECHANISM OF ACTION** Alkylating agents (busulfan, chlorambucil, cyclophosphamide, ifosfamide, melphalan, mechlorethamine, nitrosoureas, procarbazine) covalently bind alkyl groups (one or more saturated carbon atoms) to cellular molecules, including DNA, RNA, and proteins. Alkylating agents form reactive carbonyl groups in plasma and within tissues. Attack at electron-rich sites on adenine or guanine in the DNA molecule is the primary mechanism for cytotoxicity (58). Many alkylating agents (chlorambucil, cyclophosphamide, ifosfamide, mustard, melphalan) contain two reactive nitrochloroethyl groups, which allow them to react with both strands of DNA, forming cross-linkage (Fig. 73.8). Other agents (procarbazine, dacarbazine) produce only single-strand alkylation. The site of alkylation varies with the type of drug. Most alkylators preferentially attack the N<sub>7</sub> position of guanine. Nitrosoureas, procarbazine, and dacarbazine attack the O<sup>6</sup> position. Repair of alkylation sites on DNA by O<sup>6</sup> methyltransferase produces resistance to the nitrosoureas but not to nitrogen mustard or cyclophosphamide (59). Formation of DNA adducts,



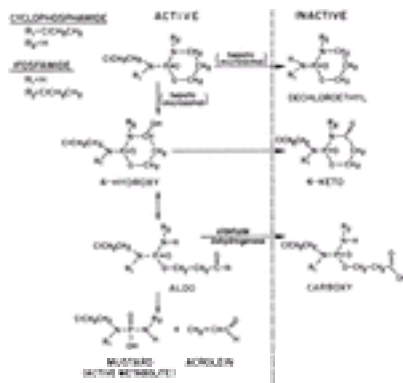
particularly DNA cross-links, leads to direct interference with cellular replication (60). Alkylating agents are cell cycle nonspecific. The most widely used alkylating agents are the nitrogen mustards, of which five are commonly used: mechlorethamine, cyclophosphamide, ifosfamide, melphalan, and chlorambucil. Thiotepa is an aziridine closely related to the mustards. Busulfan is an alkyl sulfonate that has a poorly understood selective toxicity for myeloid precursors. Procarbazine, hexamethylmelamine, and dacarbazine are metabolized to reactive intermediates that decompose to produce methyl diazonium, which covalently binds DNA. The basis of cytotoxicity of these nonfunctional alkylating agents is probably the formation of DNA strand breaks (60).



**Figure 73.8.** Mechanism of attachment of alkylating agents to DNA. Alkylating agents (in this case, those with two nitrochloroethyl groups) form reactive intermediates that bind to the N7 position of guanine. Bifunctional alkylating agents can bind to two guanine molecules, resulting in cross-linkage of DNA strands.

Cellular thiols can provide nucleophilic targets, which bind alkylating agents before they reach their DNA target. Increasing the concentration of these thiols impairs antineoplastic drug activity, toxicity, or both. Buthionine sulfonamide decreases glutathione synthesis (a naturally occurring thiol) and increases drug cytotoxicity (61). The radioprotective agent amifostine (WR2721) provides an exogenous nucleophilic thiol that can decrease alkylating agent toxicity (62). An important mechanism of cellular resistance to alkylating agents is through enhanced DNA repair mechanisms.

**CLINICAL PHARMACOLOGY** Binding of alkylating agents or their reactive intermediates to sulfhydryl groups on glutathione or proteins is the primary route of drug clearance. Dosage alterations for hepatic or renal function impairment are therefore usually not needed. Mechlorethamine rapidly degrades in solution and must be reconstituted just before administration. Cyclophosphamide and ifosfamide require activation via the cytochrome P-450 system to produce 4-hydroxy derivatives, which are taken up in tumor tissue (63) and decompose to form the active metabolite, phosphoramidate mustard (Fig. 73.9). Drugs that alter the microsomal enzyme system, such as phenobarbital, can alter the plasma kinetics of cyclophosphamide and its metabolites. However, these kinetics changes do not appear to have any effects on the toxicity of this drug. Ifosfamide, a structural analog of cyclophosphamide, is activated less readily than cyclophosphamide, so higher drug doses are required (64). Although only a small amount of a dichloroethyl metabolite is formed with cyclophosphamide, this metabolite is generated to a significant extent with ifosfamide and may account for the central nervous system (CNS) toxicity seen with this drug. The release of acrolein and dichloroethyl metabolites into the bladder results in cystitis. Mercaptoethane sulfonate (Mesna) is administered to all patients receiving ifosfamide and to patients receiving high-dose cyclophosphamide to prevent cystitis by binding these reactive urinary metabolites (65). In plasma, Mesna circulates in an inactive dimesna form so that antineoplastic activity is not affected. Oral bioavailability of cyclophosphamide is excellent, whereas the bioavailability of melphalan (30%) and chlorambucil (50%) is less and more variable. The AUC of melphalan is reduced by concomitant use of cimetidine (66).



**Figure 73.9.** Metabolism of cyclophosphamide and ifosfamide. These drugs can be metabolized to active agents (vertical metabolism) or to inactive metabolites (horizontal metabolism).

**TOXICITY** Although alkylating agents share a common mechanism of action, toxicity of alkylating agents varies significantly due to differences in pharmacokinetic features, lipid solubility, membrane transport properties, and presence of specific DNA repair mechanisms. Marrow suppression occurs in all cell types with the alkylating agents. However, the pattern of suppression varies from drug to drug. A relative platelet- and stem cell-sparing effect occurs with cyclophosphamide. In contrast, busulfan is especially damaging to stem cells. The hematopoietic depression produced by the nitrosoureas is delayed (3 to 6 weeks). Nausea and vomiting are frequent with high doses of alkylators but decrease with low-dose oral regimens. Alopecia is seen primarily with cyclophosphamide. Pulmonary fibrosis can be seen with all alkylating agents but particularly with busulfan and the nitrosoureas (67). Bladder toxicity is seen with ifosfamide and cyclophosphamide. Hepatic toxicity is noted with high-dose thiotepa, cyclophosphamide, busulfan, or carmustine (BCNU) therapy used in stem cell transplant regimens (68). Ifosfamide, busulfan, and the nitrosoureas cause CNS toxicity, more frequently at high doses (69). Renal toxicity is seen with the nitrosoureas and ifosfamide (70). High-dose cyclophosphamide produces water retention. All of the alkylating agents result in gonadal atrophy, and permanent loss of reproductive function can occur (71). All are teratogenic and carcinogenic (39). An increased risk of second cancers (usually acute myelogenous leukemia) has been reported with melphalan, procarbazine, and cyclophosphamide.

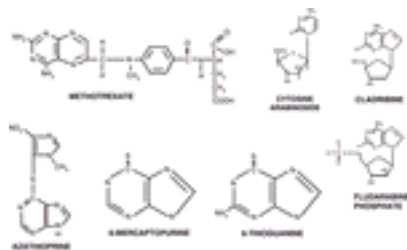
## Antimetabolites

Antimetabolites disrupt the synthesis of essential compounds required for DNA synthesis. Antimetabolites are cell cycle-specific agents that must be present during the S-phase of the cell cycle to produce toxicity, which explains the schedule-dependent nature of these agents. Most antimetabolites are prodrugs that require metabolism to express their cytotoxic effects.

### METHOTREXATE

**Mechanism of Action** MTX, an analog of folic acid (Fig. 73.10), is a tight-binding inhibitor of DHFR, the enzyme required for converting folate to its active (tetrahydrofolate) form (72). In the presence of MTX, tetrahydrofolates, needed as cofactors for purine and thymidine formation, are depleted leading to inhibition of DNA synthesis and cell death. Cytotoxicity is related to the time MTX or MTX polyglutamate concentrations are present within the cell at concentrations great enough to inhibit DHFR (73). 5-Formyl tetrahydrofolate (calcium leucovorin or citrovorum factor) administered 24 hours after the administration of MTX can rescue normal cells from the effects of MTX by providing a reduced form of folic acid to the cells. Resistance to MTX has been related to the

presence of increased levels of the target enzyme, DHFR, in cells as the result of increased expression or amplification of the DHFR gene.



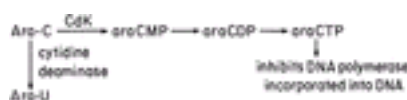
**Figure 73.10.** Structure of selected antimetabolites used for treatment of hematologic malignancies.

**Clinical Pharmacology** MTX can be given orally, intravenously, or by intrathecal injection. With standard oral doses (7.5 to 20 mg/m<sup>2</sup>), absorption is variable, with bioavailability decreasing at higher doses (74). MTX is primarily eliminated by glomerular filtration and renal tubular secretion. In patients with renal dysfunction, MTX clearance is delayed, resulting in prolonged exposure and increased toxicity (75). Patients with renal insufficiency should not be given MTX or must have plasma drug concentrations closely monitored with leucovorin rescue used if clearance is delayed (76). Retention of drug in ascites or pleural effusions can prolong MTX half-life and increase toxicity (47).

**Toxicity** The primary toxicities associated with MTX are myelosuppression and mucositis (76). High-dose MTX can result in renal failure as a consequence of drug precipitation in renal tubules in the presence of acidic urine. The routine use of adequate prehydration, alkalinization of the urine, and measurement of MTX concentrations after high-dose therapy are required (77). Chronic MTX administration can be associated with liver disease, manifested by portal fibrosis and occasional cases of cirrhosis (78). MTX is also associated with the development of pulmonary toxicity (79). CNS toxicity has been reported with MTX, particularly with high doses of MTX and concomitant cranial irradiation. Intrathecal MTX administration may cause arachnoiditis (80).

### CYTOSINE ARABINOSIDE

**Mechanism of Action** Cytosine arabinoside (ara-C, cytarabine and liposomal ara-C, DepoCyt) is an analog of deoxycytidine with substitution of an arabinose sugar for the normally occurring deoxyribose sugar ( Fig. 73.10). Ara-C must undergo metabolic activation to cytosine arabinoside triphosphate by a series of enzyme-mediated phosphorylation steps ( Fig. 73.11). Cytosine arabinoside triphosphate competitively inhibits DNA polymerase alpha. Cytosine arabinoside triphosphate is also incorporated into DNA, a feature that correlates closely with cytotoxicity. Incorporated ara-C inhibits both DNA template function and chain elongation (81). Ara-C-mediated DNA damage then induces apoptosis. Several mechanisms of resistance to ara-C have been described, including (a) deletion of deoxycytidine kinase, the initial enzyme involved in ara-C activation; (b) increased levels of cytidine deaminase in tumor cells, resulting in rapid conversion of ara-C to inactive uracil arabinoside (ara-U); and (c) decreased presence of nucleoside transport sites on tumor cells.



**Figure 73.11.** Metabolism of cytosine arabinoside (Ara-C) by tumor cells. Ara-C is phosphorylated to its active metabolite, cytosine arabinoside triphosphate (araCTP), by a series of enzymatic steps, beginning with deoxy-cytidine kinase (CdK). Metabolism via the enzyme cytidine deaminase converts Ara-C to the inactive metabolite uracil arabinoside (Ara-U). araCDP, cytosine arabinoside diphosphate; araCMP, cytosine arabinoside monophosphate.

**Clinical Pharmacology** Ara-C is rapidly converted to the inactive metabolite, ara-U, by the degradative enzyme, cytidine deaminase, present in great quantity in the liver. The large capacity of the liver for metabolizing ara-C results in (a) a short plasma half-life of ara-C (2 to 3 hours), (b) adequate capacity for clearance of ara-C even in the presence of hepatic damage, and (c) urinary excretion of high concentrations of ara-U ( 82 ). Because of the short drug half-life and the S-phase specificity of ara-C, prolonged infusion or multiple-day administration schedules are required for cytotoxicity. Cytarabine encapsulated into multivesicular lipid-based capsules (DepoCyt) has been developed as a means of sustaining cytotoxic ara-C concentrations at the tumor site. It acts as a depot form of ara-C. DepoCyt has been found useful in the therapy of neoplastic meningitis ( 83 ).

**Toxicity** Single high-dose boluses of ara-C are well tolerated but clinically ineffective because of the rapid inactivation of the agent. Continuous infusion or repeated administration of ara-C for 24 to 48 hours results in significant myelosuppression ( 84 ). Nausea, vomiting, and diarrhea often occur after ara-C administration, especially with high-dose regimens. These symptoms typically subside quickly after the treatment. High-dose ara-C regimens (doses of 3 g/m<sup>2</sup> every 6 to 12 hours for 12 doses) have been associated with the development of cholestatic jaundice and elevations of hepatic transaminases. In addition, cerebral and cerebellar dysfunction have been reported in approximately 20% of patients receiving high-dose ara-C ( 85 ). This toxicity is more common in patients older than 50 years of age and usually is reversible. A steroid-responsive conjunctivitis noted after high-dose ara-C has led to the routine prophylactic use of saline or steroid eye drops in patients receiving the high-dose regimens. Intrathecal injection of ara-C or DepoCyt is associated with chemical arachnoiditis (headache, fever, nausea, vomiting).

## HYDROXYUREA

**Mechanism of Action** The principal use of hydroxyurea is as a myelosuppressive agent for myeloproliferative syndromes, such as chronic myelogenous leukemia (CML) or polycythemia vera, or for treatment of sickle cell anemia. Hydroxyurea inhibits ribonucleotide reductase, the enzyme responsible for the conversion of ribonucleotide diphosphates to their deoxyribonucleotide forms used for DNA synthesis and repair ( 86 ). Hydroxyurea kills cells selectively in the S-phase of the cell cycle. Hydroxyurea blocks human immunodeficiency virus DNA synthesis also. Doses of 0.5 to 2.0 g/day result in a rapid (2 to 5 day) decrease in peripheral white blood cell counts. Doses are then titrated to clinical response. The rapid onset of effect on circulating leukemia cell populations and the brief duration of action have led to the routine use of this agent in patients with significantly elevated leukemic blast counts or in those with elevated platelet counts ( 87 ).

**Clinical Pharmacology** Hydroxyurea is well absorbed orally (90 to 100% bioavailability) with minimal patient-to-patient variability ( 88 ). It is excreted mostly in the urine with a plasma half-life of 4 hours ( 89 ). Although precise guidelines are not available, patients with renal failure should have drug doses reduced.

**Toxicity** The main toxicity of hydroxyurea is myelosuppression, which is rapidly reversible once the drug is discontinued ( 87 ). Reversal of myelosuppression is rapid after discontinuation of the drug. Nausea, vomiting, anorexia, and diarrhea can be seen but are typically mild. Skin changes (hyperpigmentation, rash, and banding of nail beds) have been noted with long-term therapy ( 90 ). Uncommon toxicities include pulmonary fibrosis, hepatotoxicity, and fever. Hydroxyurea-induced leg ulceration has been reported ( 91 ).

## 6-MERCAPTOPYRIMIDINE, 6-THIOGUANINE, AND AZATHIOPRINE

**Mechanism of Action** 6-MP is used in maintenance therapy for children with acute lymphoblastic leukemia. 6-Thioguanine is a second-line agent for therapy of acute myelogenous leukemia. Azathioprine, a prodrug of 6-MP, is used as an immunosuppressant. The mechanisms of action of these three agents are similar ( 92 ). All are purine analogs. 6-MP is an analog of hypoxanthine ( Fig. 73.10 ). It is converted

intracellularly to 6-MP ribose triphosphate, which is incorporated into DNA ( Fig. 73.12). 6-MP kills cells primarily by incorporation into DNA, compromising subsequent replication. 6-Thioguanine is activated in a manner similar to that outlined for 6-MP. Azathioprine is rapidly cleaved by nonenzymatic mechanisms to 6-MP and methyl-4-nitro-5-imidazole derivatives. 6-MP is incorporated into DNA. The imidazole derivatives react with glutathione and cysteine residues. The alkylation of lymphocyte thiol groups may be important in azathioprine immunosuppression ( 93). Azathioprine also interferes with cytokine synthesis ( 93).



**Figure 73.12.** Mechanism of activation and catabolism of azathioprine and 6-mercaptopurine (6-MP). Active metabolites are indicated by surrounding boxes. Inactive (or less active) metabolites are indicated by italic print. HGPRT, hypoxanthine-guanine phosphoribosyltransferase; TPMT, thiopurine methyltransferase; xo, xanthine oxidase.

**Clinical Pharmacology** Azathioprine is rapidly cleaved to 6-MP after absorption. Clearance of 6-MP occurs primarily through two routes of catabolism. 6-MP is oxidized to the inactive metabolite, 6-thiouric acid, by xanthine oxidase ( Fig. 73.12). 6-MP also undergoes S-methylation by the enzyme thiopurine methyl transferase (TPMT) to yield less active 6-methyl mercaptopurine. Oral absorption of 6-MP is incomplete and highly variable. The low bioavailability (5 to 37%) is a result of a large first pass effect as drug is absorbed into the portal circulation and metabolized by xanthine oxidase in the liver. The use of concomitant allopurinol (an inhibitor of xanthine oxidase) increases 6-MP bioavailability fivefold, increasing toxicity ( 94). This important drug interaction must be remembered for 6-MP and azathioprine. Patient-to-patient variation in TPMT activity can result in significant changes in 6-MP metabolism and drug toxicity. One in 300 subjects has absent TPMT activity. Patients with low TPMT activity are susceptible to severe 6-MP- and azathioprine-induced myelosuppression ( 95). Patients with high TPMT concentrations may be at greater risk for relapse due to rapid drug inactivation. Genetic testing for the TPMT gene is available ( 95).

**Toxicity** The dose-limiting toxicity of 6-MP, 6-thioguanine, and azathioprine is myelosuppression, occurring 1 to 4 weeks after onset of therapy and reversible when the drugs are discontinued ( 92, 96). Immunity to infectious agents or vaccines is subnormal. Gastrointestinal mucositis and stomatitis are modest but appear to be more common in adults than in children. Hepatotoxicity is seen in a small number of patients receiving 6-MP ( 97). It is usually mild and reversible with a clinical picture of cholestatic jaundice, although elevations of transaminase may be seen. Frank hepatic necrosis and venoocclusive disease can occur. 6-MP and azathioprine are potentially teratogenic. Acute leukemia with karyotypic changes of 7q/-7 has been seen after 6-MP use, with a greater risk associated with longer duration of therapy ( 98).

## FLUDARABINE

**Mechanism of Action** Fludarabine ( Fig. 73.10) is a fluoridated analog of 9-β-D-arabinofuranosyladenine (ara-A). When administered, fludarabine is dephosphorylated in plasma, enters cells, and then is again phosphorylated to 2-fluoro-ara-ATP (F-ara-ATP) ( Fig. 73.13) ( 99). F-ara-ATP inhibits DNA polymerase, ribonucleotide reductase, DNA primase, and DNA ligase I, resulting in DNA deletions and mutations ( 100). Fludarabine is also incorporated into DNA where it is an effective DNA chain terminator. Although the effects of F-ara-A on DNA synthesis account for its activity in dividing cells, fludarabine is also cytotoxic to cancers with very low growth fractions such as indolent lymphoma. Although the specific mechanism by which



fludarabine induces cell death among quiescent cells is under investigation, proposed mechanisms of action include fludarabine's ability to inhibit RNA polymerase and to deplete nicotinamide adenine dinucleotide with resultant decrease in cellular energy stores and interference with normal DNA repair processes ( [101](#) ).



**Figure 73.13.** Activation pathway and mechanism of action of fludarabine. F-ara-A, fluoroarabinofuranosyladenine; F-ara-AMP, 2-fluoro-ara-adenosine monophosphate; F-ara-ATP, 2-fluoro-ara-adenosine triphosphate; NAD, nicotinamide adenine dinucleotide.

**Clinical Pharmacology** Fludarabine undergoes rapid (2 to 4 minutes) conversion to 2-F-ara-A. 2-F-ara-A is excreted primarily in the urine with few metabolites noted. In patients with renal function impairment, total body clearance of 2-F-ara-A decreases significantly ( [100](#) ). Dose reduction is recommended for patients with renal dysfunction. Oral bioavailability is roughly 75%, and oral formulations for commercial use are being developed.

**Toxicity** The dose-limiting toxicity of 2-F-ara-adenosine monophosphate is myelosuppression occurring a median of 12 to 16 days after the beginning of therapy. Other toxicities include mild nausea and vomiting (36% of patients), fever (60%), infection (33%), peripheral sensorimotor neuropathy (rare), autoimmune hemolytic anemia (rare), and hepatocellular toxicity with elevations in serum transaminase (rare) ( [92](#), [100](#) ). An irreversible neurotoxicity syndrome has occurred in patients receiving high doses (greater than 40 mg/m<sup>2</sup>/day for 5 days). Mild, reversible neurotoxicity has been seen at lower doses with increased frequency and severity in older patients ( [102](#) ). Pulmonary toxicity, characterized by fever, cough, hypoxia, and diffuse interstitial pneumonitis, has also been reported. Fludarabine is immunosuppressive and associated with an increased risk of opportunistic infections ( [103](#), [104](#) ). CD4 and CD8 T-lymphocyte subpopulations drop to 150 to 200 per mm<sup>3</sup> after therapy.

## PENTOSTATIN

**Mechanism of Action** Pentostatin (deoxycoformycin, DCF) is a potent inhibitor of adenosine deaminase. It is active in the treatment of chronic lymphoid malignancies, particularly hairy cell leukemia ( [105](#) ). Inhibition of adenosine deaminase results in inability of the cell to catabolize adenosine and deoxyadenosine. Intracellular concentrations of deoxyadenosine triphosphate increase and exert a negative feedback on ribonucleotide reductase, resulting in an imbalance in deoxynucleotide pools. This imbalance inhibits DNA synthesis and impairs replication with arrest of cells in the G<sub>1</sub>- and S-phases of the cell cycle. These mechanisms are relevant to proliferating cells. The mechanism of action of pentostatin on nonproliferating cells is unclear.

**Clinical Pharmacology** Plasma pentostatin concentrations greatly exceed those needed to inhibit adenosine deaminase. Pentostatin's terminal half-life is 3 to 15 hours in humans. Only 40 to 80% of the drug is excreted unchanged in urine within 24 hours ( [106](#) ). Plasma clearance correlates with creatinine clearance. Dosage reduction should be considered for patients with impairment in renal function. Pentostatin is not bioavailable by the oral route as a result of its acid lability.

**Toxicity** At doses used in hairy cell leukemia (4 mg/m<sup>2</sup> biweekly), therapy is usually well tolerated ( [107](#) ). Toxicities include worsening of neutropenia, mild to moderate lethargy, anorexia, rash, and reactivation of herpes zoster late in therapy. Nausea, although often mild, can occasionally be severe. Delayed emesis is seen.

## CLADRIBINE

**Mechanism of Action** Cladribine (2-chlorodeoxyadenosine, 2-CdA) is an adenosine analog found to be more cytotoxic against lymphocytes than fludarabine ( [Fig. 73.10](#) ). The

5'-triphosphate metabolite [2-chloro-2'-deoxyadenosine 5' triphosphate (2-CdATP)] accumulates in cells rich in deoxycytidine kinase, primarily lymphoid cells. 2-CdATP is incorporated into DNA, producing DNA strand breaks and inhibition of DNA synthesis in dividing cells ( [108](#) ). Several mechanisms for drug toxicity to resting cells have been suggested. It is postulated that lymphocytes at rest are continually breaking and rejoining DNA, a process that is balanced by nicotinamide adenine dinucleotide consumption for repair of cellular breaks. By interfering with DNA repair, cladribine stimulates increased nicotinamide adenine dinucleotide use, triggering apoptosis ( [109](#) ).

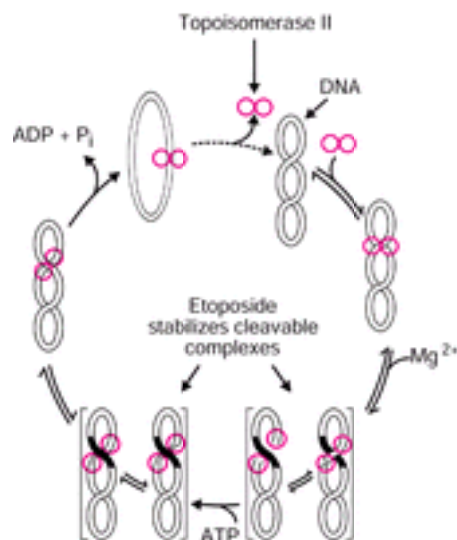
**Clinical Pharmacology** Bioavailability of subcutaneously administered cladribine is excellent. Oral bioavailability averages 50% ( [110](#) ). Cladribine is primarily cleared by the kidneys (50% of total dose) via a cation organic carrier system. Although dose-adjustment guidelines for patients with renal insufficiency are not available, caution should be used in giving cladribine to patients with renal insufficiency. Significant patient-to-patient variability ( $\pm 28\%$ ) exists in the AUC achieved after administration of drug by any method ( [111](#) ).

**Toxicity** The dose-limiting toxicity of cladribine is myelosuppression. Grade 3 or 4 neutropenia occurs in one-half of treated patients at standard doses. Fever (above  $100^{\circ}$  F) has been seen in two-thirds of patients, often beginning 5 to 7 days into therapy or during the period of neutropenia ( [112](#) ). Cladribine suppresses CD4<sup>+</sup> lymphocytes. The CD4:CD8 ratio may remain depressed for up to 16 months after therapy, with associated opportunistic infections including *Candida* or *Aspergillus* ( [104](#) ). After high-dose cladribine therapy (5 to 10 times the recommended therapeutic dose), renal failure and progressive irreversible motor weakness with paraparesis have been reported. Betticher et al. ( [113](#) ) have shown that reducing the dose of cladribine from 0.7 to 0.5 mg/kg/cycle decreased the rate of grade 3 myelosuppression (33 to 8%) and the infection rate (30 to 7%). No change in lymphoma response rate was noted with this dose reduction.

## Topoisomerase Inhibitors

**MECHANISM OF ACTION** DNA topoisomerases are nuclear enzymes that use ATP to modulate DNA topology by passing an intact helix through a transient break in the DNA backbone through a number of discrete steps. These enzymes make the transient strand breaks in DNA to allow the cell to manipulate its topology ( [114](#) ). DNA topoisomerase I makes single-strand breaks in the DNA, whereas the type II enzyme makes double-strand breaks and passes double-stranded DNA through the nick to allow relaxation of overcoiled DNA. Topoisomerase II functions in DNA replication, chromosome condensation, and chromosome segregation. Topoisomerase inhibitors (doxorubicin, daunorubicin, epirubicin, idarubicin, etoposide, and teniposide) act by poisoning these enzymes to prevent the enzyme from religating cleaved DNA ( [Fig. 73.14](#) ) ( [115](#) ). This converts topoisomerase into a toxin, which introduces high levels of transient protein-associated breaks in the genome of treated cells. Failure to repair the DNA break by the cell results in apoptosis.





**Figure 73.14.** The catalytic cycle of topoisomerase II. Dimeric topo-isomerase II binds to DNA. In the presence of magnesium and adenosine triphosphate (ATP), an intact DNA helix can pass through a temporary break in DNA with subsequent relegation. Topoisomerase II inhibitors block this cycle at the stage of DNA cleavage. ADP, adenosine diphosphate. (From Osheroff N, Zechiedrich EL, Gale KC. Catalytic function of DNA topoisomerase II. *Bioassays* 1991;12:269–275.)

Currently available topoisomerase I inhibitors are irinotecan (CPT-11) and topotecan. As these agents are not frequently used in treatment of hematologic neoplasms, they are not further discussed in this section. U.S. Food and Drug Administration (FDA)-approved topoisomerase II inhibitors are etoposide, teniposide, doxorubicin, idarubicin, epirubicin, and mitoxantrone.

### ANTHRACYCLINES

**Clinical Pharmacology** Anthracyclines include doxorubicin, daunorubicin, epirubicin, and idarubicin. Anthracycline elimination occurs through hepatic metabolism and biliary excretion. Urinary excretion accounts for approximately 10% of anthracycline clearance ( [116](#), [117](#) ). Dose reduction for patients with jaundice is required, although specific dose-reduction guidelines are not available. Studies with doxorubicin in patients with hepatic dysfunction showed no increase in cardiac toxicity, although an increase in mucositis and myelosuppression occurs. Liposomal encapsulated anthracyclines [doxorubicin hydrochloride liposome injection (Doxil) and liposome-encapsulated doxorubicin (Myocet)] act as a depot form of free drug ( [118](#), [119](#) ).

**Toxicity** The acute dose-limiting toxicity of the anthracyclines is myelosuppression, with a nadir in leukocytes expected around day 10 to 14 and recovery usually completed by day 21 to 28. Other acute systemic toxicities include nausea, vomiting, alopecia, and mucositis. Anthracyclines cause severe local tissue reactions if extravasation occurs during infusion. The most serious toxicity associated with anthracyclines is cardiotoxicity. Anthracyclines cause a dose-dependent congestive cardiomyopathy that often leads to congestive heart failure. Late-onset cardio-myopathy can appear months to years after treatment is completed ( [120](#) ). The mechanism underlying the cardiotoxic effects of anthracyclines is generally accepted to be via formation of free radicals generated by iron-doxorubicin complexes that damage cardiac cellular membranes ( [121](#) ). The cardiac damage caused by anthracyclines is cumulative. With total doses of doxorubicin less than 500 mg/m<sup>2</sup>, heart failure is seen in less than 7% of cases. The risk of toxicity is related to the peak plasma concentration, so continuous infusions reduce the risk of heart failure compared to administration by large bolus injections. At equally myelosuppressive doses, epirubicin is less cardiotoxic than doxorubicin ( [117](#) ). Liposomal formulations of doxorubicin and daunorubicin have been investigated in the hopes of increasing tumor selectivity, allowing an increase in the tolerated dose. Liposomal formulations of doxorubicin have

reduced cardiotoxicity. Liposomal formulations of doxorubicin and daunorubicin are, however, associated with a unique toxicity: palmar–plantar erythrodysesthesia syndrome ( [118](#), [119](#) ).

**MITOXANTRONE** Efforts to synthesize compounds with better antineoplastic activity and less toxicity than doxorubicin led to the discovery of mitoxantrone.

**Toxicity** The primary dose–limiting toxicity of mitoxantrone is myelosuppression. Other potential toxicities include nausea, vomiting, alopecia, and cardiotoxicity. At doses that produce equivalent drops in white blood cell and platelet counts (75 mg/m<sup>2</sup> of doxorubicin vs. 15 mg/m<sup>2</sup> of mitoxantrone), nausea, vomiting, and alopecia are less frequent with mitoxantrone than with doxorubicin ( [122](#), [123](#) ). With commonly used dosages, approximately twice as much mitoxantrone can be given before heart failure develops when compared with doxorubicin. Acute leukemia is a potential serious side effect of therapy using mitoxantrone.

**Clinical Pharmacology** Mitoxantrone is highly protein bound (78%) ( [122](#) ). Hepatic metabolism is the primary mechanism for mitoxantrone clearance, with only 6 to 11% being cleared by the kidney.

### EPIPODOPHYLLOTOXINS

**Toxicity** Common toxicities of epipodophyllotoxins etoposide and teniposide include bone marrow suppression, dose–dependent nausea or vomiting, and alopecia ( [124](#) ).

Myelosuppression is the dose–limiting toxicity at usual therapeutic doses. At very high doses, such as those used with bone marrow transplantation regimens, mucositis becomes the dose–limiting toxicity. Liver toxicity, fever, and chills are also seen with high–dose therapy. Hypersensitivity reactions, including vasomotor changes related to the pulmonary and gastrointestinal systems, can also be observed. These allergic reactions, although infrequent, can be life–threatening and are likely due to hypersensitivity to the polysorbate 80 (Tween 80) needed to solubilize the intravenous etoposide preparation. These reactions can usually be ameliorated with histamine blockade, by using a slower infusion, or both. Etoposide phosphate, a water–soluble prodrug that is rapidly changed to etoposide by endogenous phosphatases, may reduce the risk of a hypersensitivity reaction because no solubilizer is required ( [125](#) ). The most serious adverse event associated with etoposide and teniposide is the development of acute nonlymphocytic leukemia ( [126](#) ). Therapy–related acute myelogenous leukemia also occurs with other topoisomerase II inhibitors, but at a lower frequency. Leukemia develops relatively early after etoposide therapy (2 to 3 years) and can be distinguished from other therapy–related malignancies by a unique molecular marker: a balanced translocation involving the mixed–lineage leukemia gene on chromosome 11 band q23.

**Clinical Pharmacology** Etoposide is poorly soluble in water. It is dissolved in a solubilizer composed of polysorbate 80, polyethylene glycol, and alcohol and diluted to a concentration less than 0.4 mg/ml to avoid precipitation. These additives are believed to induce the hypersensitivity reactions occasionally seen with etoposide infusion. Approximately one–third of administered intravenous etoposide is excreted in the urine, and hepatic glucuronidation may account for another 25% of etoposide’s metabolism ( [127](#) ). Etoposide clearance is modestly decreased in patients with renal dysfunction but not in those with hepatic obstruction. Biliary drug excretion is minimal, and little or no dose adjustment is required in the presence of obstructive jaundice. Etoposide is highly bound to plasma proteins, with only 6 to 8% unbound. Because free drug is biologically active, conditions that decrease protein binding or decrease albumin increase the pharmacologic effect of a given drug dose. Teniposide has less water solubility and decreased renal clearance (10%) and is more tightly bound to plasma proteins than etoposide, with less than 1% of the total teniposide concentration unbound. Teniposide has a longer drug half–life and increased biliary clearance compared to etoposide. Anticonvulsants, such as phenobarbital and phenytoin, increase teniposide clearance, presumably by increasing hepatic metabolism ( [128](#) ). This increased clearance has been found to result in a lower efficacy of chemotherapy in children with acute lymphocytic leukemia receiving teniposide chemotherapy. Etoposide is available as an oral capsule. Bioavailability of oral etoposide

ranges from 40 to 80% and varies with the drug dose ( [124](#)). Oral etoposide absorption is linear up to doses of 250 mg but decreases with doses of greater than 300 mg. Oral etoposide administration results in significantly greater variability in drug exposure than does intravenous administration ( [129](#)).

## Bleomycin

**MECHANISM OF ACTION** Bleomycin is a mixture of low-molecular-weight glycopeptides, of which bleomycin A<sub>2</sub> is the major species. Bleomycin can be administered subcutaneously, intramuscularly, and intravenously and has been instilled into pleural and pericardial spaces to act as a sclerosing agent in patients with malignant effusions. Bleomycin produces single- and double-strand DNA breaks, which result in chromosomal deletions and fragmentation ( [130](#)). The DNA strand breaks are generated by the production of free radicals by an Fe (II)-bleomycin complex, which functions as a ferrous oxidase to catalyze the formation of a hydroperoxide ( [131](#)).

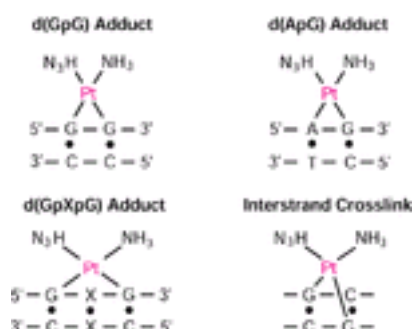
**CLINICAL PHARMACOLOGY** Absorption after intramuscular or subcutaneous injection of bleomycin is nearly complete. Renal clearance accounts for 65% of total drug clearance. Patients with renal failure have a prolonged drug half-life ( [132](#)) and an increased risk of developing pulmonary toxicity ( [133](#)). A 75% dose reduction has been recommended for patients with a creatinine clearance less than 25 ml/min. Approximately 45% of an intracavitary dose of bleomycin is absorbed into the systemic circulation, and 30% is excreted in urine ( [134](#)).

**TOXICITY** Unlike many antineoplastic agents, bleomycin is not myelosuppressive. Fever occurs within 48 hours of drug administration in approximately 25% of patients. Rare acute allergic reactions have been noted with this drug, which have led to the use of a 1-unit test dose of bleomycin in patients receiving the drug for the first time ( [135](#)). The most prominent toxic effect of bleomycin is a chronic interstitial pneumonitis, which may continue on to fibrosis, hypoxia, and death ( [136](#), [137](#)). Pulmonary toxicity, manifested by cough, dyspnea, and pulmonary infiltrates, occurs more often at higher cumulative drug doses but can occur after any dose. Approximately 10% of patients who receive a total drug dose of more than 450 mg develop pulmonary toxicity. Risk factors for pulmonary toxicity include individual doses over 25 U/m<sup>2</sup>, advancing age, underlying lung disease, and previous radiation therapy to the chest. Patients who receive high oxygen concentrations during anesthesia have an increased risk of lung toxicity ( [138](#)). No specific therapy is effective other than stopping the drug. Bleomycin can also result in cutaneous toxicities of hyperpigmentation, erythema, desquamation, nail changes, and alopecia ( [139](#)). Raynaud phenomenon has been reported. Skin and lung, tissues with the greatest susceptibility to bleomycin damage, have low concentrations of bleomycin hydrolase, an enzyme that cleaves bleomycin to inactive metabolites.

## Platinum Analogs

**MECHANISM OF ACTION** The platinum analogs cisplatin, carboplatin, and oxaliplatin are heavy metal complexes that induce tumor cell kill by cross-linking DNA strands in a manner analogous to the alkylating agents. Reactive aquated intermediates are formed within cells, which directly and covalently bind to DNA, leading to DNA cross-links ( [138](#)) ( [Fig. 73.15](#)). Cisplatin is more reactive in water than carboplatin or oxaliplatin. Chloride-containing solutions are required to stabilize cisplatin. The difference in aqueous stability, differences in the reactive groups, and spatial differences between platinum compounds appear to account for the variations in pharmacokinetics and toxicity among platinum agents. Cisplatin, carboplatin, and oxaliplatin form the same total amount of similar DNA lesions, although the time frame for forming DNA adducts varies, with oxaliplatin and carboplatin taking more time than cisplatin ( [141](#)). These compounds are

very effective in treating a variety of solid tumors and are also used as second-line agents in the treatment of lymphomas ( 142).



**Figure 73.15.** Sites of covalent binding of cisplatin to DNA. After forming an aquated reactive intermediate, cisplatin binds to guanine (and, occasionally, adenine) bases within the DNA molecule. Some adducts result in interstrand DNA cross-links.

**CLINICAL PHARMACOLOGY** The reactive intermediates of the platinum analogs rapidly bind to proteins and other nucleophilic compounds. Only the free (unbound) species are cytotoxic ( 143). Over 90% of cisplatin is protein bound and inactivated within 2 to 4 hours. ( 144). Thus, protein binding represents the major route of carboplatin elimination. In contrast, only 20 to 40% of carboplatin is protein bound at 2 hours after administration. Renal excretion is the primary route of carboplatin elimination (70 to 90% of total clearance). Carboplatin clearance is highly correlated with creatinine clearance ( 145). Carboplatin doses should be calculated based on an individual patient's creatinine clearance ( 146). Oxaliplatin is also extensively cleared by the kidney (50%) but to a lesser degree than carboplatin. Oxaliplatin dose reductions are needed for individuals with renal insufficiency ( 147).

**TOXICITY** The toxicity profiles of cisplatin, oxaliplatin, and carboplatin differ.

Myelosuppression is rare with cisplatin, although moderate anemia is common ( 140). Nausea and vomiting are common cisplatin toxicities, but the incidence can be reduced with pretreatment therapy using dexamethasone and serotonin antagonists ( 27). Nephrotoxicity, manifested by azotemia and electrolyte disturbances (primarily hypomagnesemia and hypokalemia), is dose related ( 148). Although pre- and posttreatment hydration (with chloride-containing solutions) and diuresis reduce the incidence and severity of cisplatin nephrotoxicity, moderate and permanent reductions in the glomerular filtration rate may still occur ( 149). Neurotoxicity from cisplatin is cumulatively dose related and usually begins as a “stocking-glove”-type peripheral neuropathy. Hearing loss, cortical blindness, and seizures also have been reported. The toxicity profile of carboplatin is different from that of cisplatin, with dose-limiting myelosuppression being the major toxicity after carboplatin administration ( 150). Renal, neurologic, and ototoxicities noted with cisplatin are infrequent after carboplatin administration. Dose reductions of carboplatin must be made in patients with impaired renal function, with formulas available for calculating dose adjustments based on creatinine clearance and desired nadir platelet count ( 145). Nausea and vomiting usually are mild to moderately severe after carboplatin. Reversible, cumulative peripheral sensory neuropathy is the primary dose-limiting toxicity with oxaliplatin therapy. Hematologic and gastrointestinal toxicities occur but are mild to moderate. Ototoxicity and nephrotoxicity are uncommon ( 151).

## Antimicrotubule Agents

### VINCA ALKALOIDS

**Mechanism of Action** The vinca alkaloids vinblastine, vincristine, and vinorelbine bind to

tubulin and prevent the formation of microtubulin, a protein that is essential for maintenance of cellular shape and for formation of the mitotic spindle ( [152](#) ). Vinca alkaloids bind to a site on microtubulin distinct from the taxanes. Cells treated with vinca alkaloids are arrested in metaphase ( [153](#) ). Disruption in microtubular formation leads to initiation of apoptosis. Differences in activity and toxicity of the vinca alkaloids result from differences in their pharmacokinetics, their differential effects on various tubulin isoforms, and variations in tissue penetration and cellular retention. Resistance is a result of the presence of p-glycoprotein or reduced tubulin binding due to mutations in tubulin.

**Clinical Pharmacology** All vincas are rapidly taken up into cells. However, the various agents differ in cellular retention (vinblastine greater than vincristine). All vincas are extensively bound to tissues and to proteins ( [154](#) ). Their terminal half-lives are long (20 to 60 hours). CNS penetration is poor. All of the vinca alkaloids are metabolized by the liver (via hepatic cytochrome P-450 3A4) and excreted into the bile. Drugs blocking CYP 3A4 may inhibit vinca clearance, causing increased toxicity ( [155](#) ). Doses of the vinca alkaloids should be reduced in patients with hepatic dysfunction but not in patients with renal insufficiency. Specific dose-reduction guidelines for hepatic function impairment are not available.

**Toxicity** Vincristine causes little myelosuppression. Its dose-limiting and most frequent toxicity is neurotoxicity ( [153](#) , [156](#) ), manifested by a symmetric, distal, sensory-motor neuropathy. Loss of deep tendon reflexes in the lower extremities and paresthesias of the fingers and toes are common early findings. Continued use of the drug can result in further motor neuropathy, manifested by foot-drop or wrist-drop, which may be only partially reversible or irreversible when the drug is stopped. Neuropathies of the motor cranial nerves have also been reported, as have constipation, cramps, and paralytic ileus. Hair loss is common after vincristine administration. The dose-limiting toxicity of vinblastine is hematopoietic, with thrombocytopenia and leukopenia commonly occurring after administration of the drug ( [157](#) ). The onset of myelosuppression tends to occur earlier with this agent than with other antineoplastic agents, with the leukocyte nadir typically seen by day 4 to 7 and recovery by day 10 to 14. Severe neurotoxic symptoms are unusual with vinblastine, but use of the drug is associated with myalgias and an autonomic neuropathy manifested by orthostatic hypotension or paralytic ileus.

Vinorelbine shows toxicities similar to other vincas ( [158](#) ). Its dose-limiting toxicity is myelosuppression. Vinorelbine is less neurotoxic than vincristine. Injection site reactions of erythema, pain, and vein discoloration occur in one-third of patients with severe toxicity, which is seen in 2% of patients treated with vinorelbine. Respiratory reactions have been reported. All vincas are potent vesicants, with severe local tissue damage associated with extravasation of these drugs into soft tissues.

## TAXANES

**Mechanism of Action** Taxanes paclitaxel and docetaxel are antineoplastic agents that exert their cytotoxic effects by binding to a unique site on microtubulin (distinct from the vinca alkaloids) that causes increased assembly and stabilization of microtubulin ( [159](#) ). Docetaxel binds with slightly greater affinity than paclitaxel. The bundling of microtubules induced by the taxanes blocks cells in metaphase and induces apoptosis ( [160](#) ). The taxanes are potent radiation therapy sensitizers.

**Clinical Pharmacology** Paclitaxel is primarily cleared from the body by hepatic metabolism via cytochrome P-450 2C8 and 3A4 enzymes ( [161](#) , [162](#) ). This route of elimination can be saturated, so nonlinear kinetics are noted at high paclitaxel doses ( [163](#) ). Inhibition of the P-450 system can delay drug clearance and increase toxicity. Docetaxel also undergoes microsomal metabolism, although primarily via CYP 3A4 ( [164](#) ). Dose reductions of both paclitaxel and docetaxel are needed in patients with hyperbilirubinemia. Many drug interactions with the taxanes have been recognized ( [165](#) ), including those with anthracyclines, carboplatin, and anticonvulsants due to the effect of these drugs on cytochrome P-450 metabolism.

**Toxicity** Myelosuppression is the principal toxicity of both paclitaxel and docetaxel,



although they have differing nonhematologic side effects. Hypersensitivity reactions with paclitaxel (dyspnea, urticaria, hypotension) were found in 25% of patients initially treated ( [166](#) ). With prophylactic use of dexamethasone and antihistamines, these reactions are uncommon (1%). Paclitaxel induces a peripheral neuropathy. Transient myalgias are seen in over one-third of patients and occur 2 to 5 days after treatment at doses over 170 mg/m<sup>2</sup>. Nausea and vomiting are uncommon, but alopecia is seen. Docetaxel induces edema formation due to fluid retention and an erythematous maculopapular rash ( [167](#) ). Both the rash and fluid retention are prevented by premedication with dexamethasone. Peripheral neuropathy is also seen with docetaxel. Neuromuscular toxicity is less severe than with paclitaxel.

## Asparaginase

**MECHANISM OF ACTION** Certain cells, in particular those of lymphocytic origin, lack the capacity to synthesize the amino acid asparagine. L-Asparaginase is an enzyme derived from bacteria that reduces blood asparagine to undetectable levels, thereby depriving cells of this amino acid. The cytotoxic effects of L-asparaginase on lymphoblasts result from the inhibition of protein synthesis when cells are depleted of asparagine ( [168](#) ).

**CLINICAL PHARMACOLOGY** After intravenous enzyme administration, plasma asparagine levels fall rapidly and remain low for up to 10 days ( [169](#) ). Asparaginase is detectable in the blood for 1 to 3 weeks, but as antibodies are formed, clearance of the drug is greatly accelerated. Asparaginase is degraded by protein metabolism.

**TOXICITY** Toxic effects of asparaginase related to inhibition of protein synthesis include a decrease in circulating levels of albumin, clotting factors, insulin, and lipoproteins ( [170](#) ). Synthesis of anticoagulant proteins, such as antithrombin III, protein C, and protein S, is also reduced. Hypersensitivity reactions (urticaria, anaphylaxis, serum sickness, and so forth) are common, with frequencies ranging from 20 to 40%. Factors that increase the risk of developing a reaction include type of administration (intravenous vs. intramuscular), dose, and repeated treatments. Changes in the source of the enzyme from *Escherichia coli* to *Erwinia* may be required when hypersensitivity develops to the commonly used *E. coli* preparation ( [171](#) ). Conjugation of polyethylene glycol to asparaginase (pegasparase, Oncaspar) at sites other than the active site of the enzyme prevents uptake of the drug by the reticuloendothelial system, making it less immunogenic and prolonging its circulating half-life. The incidence of hypersensitivity reactions to pegasparase in patients who have had reactions to *E. coli* asparaginase is approximately 30%. The relative effectiveness and toxicity of asparaginase and pegasparase remain to be established ( [172](#) ). Toxic reactions to both asparaginase and pegasparase include cerebral dysfunction (25% of patients), vomiting, chills (often an immediate reaction), pancreatitis (15% of patients), and liver function abnormalities (frequent) ( [173](#) ).

## Biologic Therapies

### INTERFERONS

**Mechanism of Action** Interferons (IFNs) are a family of glycoproteins, of which some are inhibitors of viral replication and tumor growth. At present, several IFN- $\alpha$  preparations are available. IFN- $\alpha$ 2b (Intron A) and IFN- $\alpha$ 2a (Roferon) are recombinant products differing by 1 amino acid out of 166. IFN- $\alpha$ n (Welferon) and IFN- $\alpha$ n<sup>3</sup> (Alferon) are naturally occurring IFNs purified from cell cultures. IFNs have multiple effects on cytokine production and regulation of tumor oncogenes and antioncogenes. The specific mechanism of antitumor activity for the IFNs is unclear, but the IFNs produce direct antiproliferative effects on tumor cells, increase host-mediated immune defenses, and inhibit angiogenesis ( [174](#), [175](#) ).

**Clinical Pharmacology** The IFNs can be administered subcutaneously, intramuscularly, or intravenously. After exposure to IFN, expression of over 20 genes is altered ( [174](#), [176](#) ).

The optimal dose and administration route of IFN are not clear. IFN- $\alpha$  is filtered through the glomeruli and undergoes rapid proteolytic degradation during tubular reabsorption.

**Toxicity** IFN- $\alpha$  use is associated with many potential toxicities, including a flulike syndrome manifested by myalgias and fatigue in patients not premedicated with antipyretics ( [177](#), [178](#) ). The severity of myalgias decreases with continued drug use. Nausea and vomiting are noted less often. Somnolence and lethargy occur when higher doses of IFN are used. Other side effects include myelosuppression, diarrhea, mild alopecia, skin rashes, and elevated hepatic enzymes. Depression, anxiety, and suicidal ideation may occur with IFN therapy ( [179](#) ). These toxic effects are readily reversed when administration of the IFN is stopped. Some of the immediate systemic toxicity associated with the use of this agent can be prevented by administration of acetaminophen or megestrol ( [180](#) ).

## DENILEUKIN DIFITOX

**Mechanism of Action** Denileukin difitox (DAB <sub>389</sub>IL-2, Ontak) is a fusion protein containing peptide sequences for human interleukin (IL-2) and for diphtheria toxin ( [181](#) ). The IL-2 portion of this fusion protein binds to cells that express IL-2 receptors. Once bound to the IL-2 receptor, the diphtheria toxin protein is internalized, inhibits cellular protein synthesis, and results in cell death. Three types of IL-2 receptors exist: high affinity, intermediate affinity, and low affinity. The fusion protein is internalized only with intermediate- or high-affinity IL-2 receptors. Expression of high-affinity IL-2 receptors is normally restricted to activated T lymphocytes or leukemias and lymphomatous cells of T- or B-cell origin. Denileukin difitox has been approved for use in cutaneous T-cell lymphomas.

**Clinical Pharmacology** There is wide variation in serum concentrations of denileukin difitox after intravenous administration (coefficient of variation, >50%) ( [182](#) ). A terminal half-life of roughly 75 minutes is seen with initial therapy, but this decreases to 43 minutes with continued therapy as antibodies to denileukin difitox appear.

**Toxicity** Hypersensitivity reactions, such as dyspnea, back pain, rash, hypertension, and chest tightness, occur during or within 24 hours of drug infusion in 60% of patients ( [181](#), [182](#) ). These symptoms can be controlled with the use of steroids or antihistamines or by slowing the drug infusion. Constitutional and gastrointestinal symptoms (nausea/vomiting, asthenia, myalgias, headache, diarrhea) are seen in 92% of patients (grade 3 or 4 in one-third). A vascular leak syndrome occurs in 25% of treated patients. Myelosuppression is uncommon.

## RETINOIDS

### All- Trans-Retinoic Acid

**Mechanism of Action** A specific cytogenetic abnormality within the retinoic acid receptor (RAR) gene locus exists in patients with acute promyelocytic leukemia (APL) ( [183](#) ). In APL, the RAR gene is translocated next to a nuclear protein gene (PML). Fusion of RAR protein with the nuclear protein, PML, prevents normal differentiation of the myeloid cell ( [185](#) ). Retinoids are vitamin A derivatives essential for normal controlled cellular growth and development. All- trans-retinoic acid (ATRA, tretinoin) induces remission in patients with APL ( [184](#) ). Pharmacologic concentrations of ATRA (1  $\mu$ M) reverse inhibition of differentiation and induce remission of APL.

**Clinical Pharmacology** Peak plasma ATRA concentrations of 350 ng/ml are achieved 1 to 2 hours after dosing and drop rapidly ( $t_{1/2} = 50$  minutes). ATRA is metabolized by the hepatic P-450 microsomal enzyme system. Use of ATRA stimulates this degradative pathway. ATRA plasma concentrations, therefore, decrease with prolonged drug use ( [186](#) ). Variations in hepatic microsomal metabolism account for significant patient-to-patient and day-to-day variation in ATRA clearance ( [183](#) ).

**Toxicity** ATRA has been administered with low morbidity. Patients may develop transient bone pain, dry skin, nasal stuffiness, and elevated levels of hepatic transaminases ( [184](#), [187](#) ). Pseudotumor cerebri has been observed. Some patients with APL treated with ATRA develop a syndrome of fever, pulmonary infiltrates, and leukocytosis ( [188](#) ). These



symptoms usually respond readily to the administration of corticosteroids. ATRA, like other retinoids, has significant teratogenic properties, particularly during the first trimester of pregnancy ( [189](#) ).

### **Bexarotene**

**Mechanism of Action** Bexarotene (Targretin) is the only retinoid approved for therapy of cutaneous T-cell lymphoma. Retinoid modulation of tumor growth is mediated through binding to nuclear receptors, which subsequently function as transcription factors to regulate gene expression. Two receptor families, retinoic acid nuclear receptors and retinoid X nuclear receptors, have been identified ( [190](#) ). Bexarotene selectively binds and activates retinoid X nuclear receptors. Binding to the retinoid X nuclear receptor can induce apoptosis in selected cell types, through triggering of a variety of downstream events ( [191](#) ).

**Clinical Pharmacology** Bexarotene is available as a topical gel for application to skin lesions or as an oral capsule for systemic therapy. Peak plasma concentrations are seen 2 to 3 hours after oral administration. Drug half-life is 3.5 hours. Bexarotene, like other retinoids, undergoes metabolism by the hepatic cytochrome P-450 enzyme system (3A4). Drug interactions with other CYP3A4-metabolized drugs may occur. Gemfibrozil increases bexarotene concentrations and toxicity ( [192](#) ).

**Toxicity** The most common bexarotene-associated toxicities are hyperlipidemia (82%), hypercholesterolemia (30%), hypothyroidism (29%), headache (20%), asthenia (16%), pruritus (13%), and leukopenia (11%) ( [192](#) ). Side effects are more common at higher drug doses. Pancreatitis may result from hyperlipidemia. Use of lipid-lowering agents is often required. Thyroid function tests must be monitored ( [193](#) ).

## **CORTICOSTEROIDS**

**Mechanism of Action** Several cancers are dependent on specific hormones for growth and cellular maintenance. Altering the hormonal balance can cause tumor regression in such patients. A comprehensive review of all hormonal therapies is beyond the space limitation of this chapter. Corticosteroids (prednisone and dexamethasone) are often used in the treatment of hematologic malignancies and are briefly reviewed. Steroids are also useful in managing complications of cancer, including chemotherapy-induced emesis, hypercalcemia, and increased intracranial pressure. The mechanism of corticosteroid cytotoxicity to lymphocytes is mediated via binding to the glucocorticoid receptors, which induces apoptosis in these hormone-sensitive cells ( [194](#) , [195](#) ).

**Clinical Pharmacology** Prednisone is an inactive prodrug that requires hepatic activation to produce prednisolone, the active moiety. Oral bioavailability of corticosteroids is excellent (greater than 80%). Corticosteroid half-life ranges from 0.5 to 2.0 hours. Both prednisolone and dexamethasone are inactivated via hepatic metabolism ( [196](#) ).

**Toxicity** Common corticosteroid toxicities include increased appetite, centripetal obesity, immunosuppression, myopathy, osteoporosis, aseptic necrosis, peptic ulceration, pancreatitis, psychiatric disorders, cataracts, hypertension, precipitation of diabetes, growth failure, amenorrhea, impaired wound healing, and atrophy of subcutaneous tissue ( [196](#) ). Many of these toxicities are seen only with long-term therapy.

## **ARSENIC TRIOXIDE**

**Mechanism of Action** The mechanism by which arsenic trioxide (ATO, Trisenox) is effective in the treatment of promyelocytic leukemia is not fully understood ( [197](#) ). It is thought that ATO degrades the fusion protein, PML-RAR. Degradation of PML-RAR allows malignant promyelocytes to overcome a maturation block ( [179](#) ). ATO also induces apoptosis. ATO appears to promote opening of the permeability transition pore of the mitochondria causing caspase activation. Several other biochemical changes are noted with ATO therapy, which may induce apoptosis ( [198](#) ).

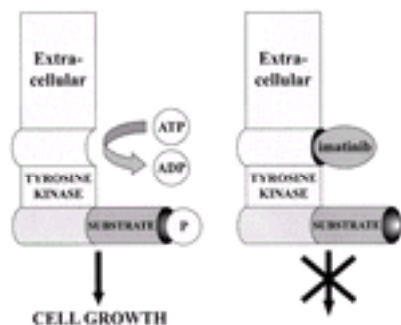
**Clinical Pharmacology** The pharmacology of ATO has been poorly studied. Plasma concentrations of 1.5 to 7.0  $\mu\text{M}$  are achieved after an intravenous dose of 0.08 to 0.15 mg/kg. Arsenic trioxide is presumably methylated in the liver and then excreted in the urine as metabolites. No dosage guidelines for patients with hepatic or renal insufficiency are currently available.

**Toxicity** Grade 3 or 4 toxicity occurs in the majority (68%) of patients treated with ATO ( [199](#)). The most common life-threatening toxicities include hypokalemia (13%), hyperglycemia (10%), neutropenia, and cardiac toxicity. The cardiac toxicity is primarily manifested by QT prolongation on the electrocardiogram, but torsades de pointes and sudden death have been reported ( [200](#)). The “retinoid acid syndrome,” similar to that noted after ATRA treatment, is frequently seen (25% of patients). Leukocytosis after ATO therapy is common (50%). Other toxicities include neuropathy, nausea (75%), fatigue, fever, headache, diarrhea, and skin rash.

## Signal Transduction Inhibitors

**IMATINIB MESYLATE** Imatinib mesylate (Gleevec, STI571), approved by the FDA in 2001 for the treatment of CML, is the first signal transduction inhibitor to be used in the therapy of cancer.

**Mechanism of Action** CML is characterized by a reciprocal exchange of genetic material between chromosomes 9 and 22 (t9;22). A new gene is formed, the BCR-ABL protooncogene, which encodes a signal transduction protein that is autonomous. Increased activity of the BCR-ABL protooncogene leads to cellular proliferation, decreased apoptosis, or both ( [201](#)). The intracellular component of the BCR-ABL signal transduction protein contains a tyrosine kinase, which activates subsequent signaling molecules by taking a phosphate from ATP and transferring it to a second signaling molecule. Imatinib mesylate binds to the ATP-binding site of the BCR-ABL oncoprotein and prevents transfer of phosphate from ATP to the second messenger ( [Fig. 73.16](#)). Imatinib inhibits the tyrosine kinase of the BCR-ABL, c-kit, and PDGF oncogenes ( [202](#)).



**Figure 73.16.** The BCR-ABL oncoprotein is schematically shown. This is a transmembrane protein with a tyrosine kinase on the intracellular part of the molecule. Imatinib mesylate (Gleevec) binds to the tyrosine kinase, preventing activation of second messenger proteins. ADP, adenosine diphosphate; ATP, adenosine triphosphate; P, phosphate.

**Clinical Pharmacology** Imatinib mesylate is given orally at doses of 400 to 800 mg/day. Bioavailability is 98% with a drug half-life of 18 hours. Imatinib is cleared by hepatic microsomal cytochrome P-450 metabolism (CYP3A4) to a metabolite that has similar potency ( [203](#)). Biliary excretion of parent drug and metabolite accounts for 70% of drug clearance. No dosage guidelines are available for patients with hepatic or renal insufficiency. Drugs that inhibit CYP3A4 (e.g., ketoconazole) may slow imatinib clearance.

**Toxicity** Mild nausea (70%), diarrhea (56%), and fluid retention are the most common toxicities associated with imatinib ( [203](#), [204](#)). Edema can usually be managed with diuretics or dose reductions. Hematologic toxicity is mild and associated with more advanced stage (e.g., CML blast crisis). Severe toxicity (grade 3 or 4) is rare (15% of patients). Abnormal liver function tests have been reported but require discontinuation of therapy in fewer than 0.5% of patients.

## Pharmacology of High-Dose Chemotherapy

As noted previously in this chapter, increased doses of an anticancer drug usually produce progressively greater tumor cell kill. However, the dose of drug that can be given is limited by its toxicity to normal tissues. For many antineoplastic agents, myelosuppression is the initial dose-limiting toxicity. With the use of bone marrow transplantation and good supportive care, dose-limiting myelosuppression can be abrogated. Drugs used for bone marrow transplant can have dose escalations until nonhematologic toxicities are noted. One basis for selecting drugs used for high-dose chemotherapy with marrow transplantation is the dose ratio of the drug to be considered ( [205](#), [206](#) ). The dose ratio is the maximum tolerated dose in the transplant setting divided by the standard dose. Most anticancer drugs with a high dose ratio are alkylating agents. These drugs have a steep dose-antitumor response relationship over a wide dose range and have predominant marrow toxicity. Other chemotherapeutic drugs used in high-dose regimens include etoposide, carboplatin, ara-C, and mitoxantrone. Many other agents have a dose ratio close to one. [Table 73.8](#) indicates the drugs used in stem cell rescue regimens, dose ratios, and extramedullary dose-limiting toxicities.

**TABLE 73.8. Dose Escalations and Major Nonhematopoietic Toxicities of Drugs Used in High-Dose Chemotherapy with Stem Cell Support**

| Drug             | Standard Dose<br>(mg/m <sup>2</sup> ) <sup>a</sup> | Transplant Dose<br>(mg/m <sup>2</sup> ) | Dose<br>Ratio | Extramedullary<br>Toxicity |
|------------------|--|---|---------------|----------------------------|
| Carmustine       | 175  | 1000                                    | 5.7           | Lung, liver                |
| Busulfan         | 70   | 640                                     | 9.0           | Mucositis, liver           |
| Carboplatin      | 400  | 2000                                    | 5.0           | Kidney, liver              |
| Cisplatin        | 100  | 200                                     | 2.0           | Kidney, nerve              |
| Cyclophosphamide | 1200   | 7000                                    | 5.8           | Cardiac                    |
| Etoposide        | 400  | 3200                                    | 8.0           | Mucositis                  |
| Ifosfamide       | 6000   | 16,000                                  | 2.7           | Renal, CNS                 |
| Melphalan        | 35   | 140                                     | 4.0           | Mucositis                  |
| Mitoxantrone     | 36   | 75                                      | 2.0           | Mucositis, cardiac         |
| Paclitaxel       | 250  | 725                                     | 3.0           | Mucositis, CNS,<br>renal   |
| Thiotepa         | 32   | 1000                                    | 31.0          | Mucositis, CNS,<br>liver   |

CNS, central nervous system.

<sup>a</sup> Approximate.

From Jones RB, Matthes S, Dalton C. Pharmacokinetics. In: Armitage JO, Antman KH, eds. High-dose cancer therapy: pharmacology, hematopoietins, stem cells. Baltimore: Williams & Wilkins, 1995:49-69, with permission.

Agents listed in [Table 73.8](#) have been combined in various myeloablative regimens. Drugs with nonoverlapping, nonhematopoietic toxicities should be selected to avoid serious new additive or synergetic toxicity. Depending on the regimen used, significant hepatic, gastrointestinal, renal, and pulmonary toxicities are encountered ( [206](#), [207](#) ). Correlations

between extramedullary toxicity and the plasma pharmacokinetics of busulfan ( 208 ), cyclophosphamide ( 209 ), and BCNU ( 210 ) have been found, suggesting that therapeutic drug monitoring could reduce the frequency of nonmarrow toxicity associated with bone marrow transplantation ( 211 ). Potential toxicities associated with high-dose chemotherapy are so significant that this therapy should only be used in a center with adequate facilities and physicians experienced in this type of therapy.

## ACKNOWLEDGMENT

The author would like to thank Mrs. Sharon Stokes for her help in the preparation of this manuscript.

## REFERENCES

1. Goodman LS, Wintrobe MM, Domeshek W, et al. Nitrogen mustard therapy; use of methyl-bis ( $\beta$ -chloroethyl) amine hydrochloride and tris  $\beta$ -chloroethyl) amine hydrochloride for Hodgkin's disease, lymphosarcoma, leukemia, and certain allied and miscellaneous disorders. *JAMA* 1946;132:126-132.
2. Farber S, Diamond LK, Mercer RD, et al. Temporary remissions in acute leukemia in children produced by the folic acid antagonist 4-aminopteroyl-glutamic acid (aminopterin). *N Engl J Med* 1948;238:787-793.
3. Chu E, DeVita VT. Principles of cancer management: chemotherapy. In: DeVita VT, Hellman S, Rosenberg SA, eds. *Cancer: principles and practice of oncology*, 6th ed. Philadelphia: JB Lippincott Co., 2001:289-333.
4. Tannock IF. Tumor growth and cell kinetics. In: Tannock IF, Hill RP, eds. *The basic science of oncology*. New York: Pergamon Press, 1987:140-159.
5. Hickman JA. Apoptosis induced by anticancer drugs. *Cancer Metastasis Rev* 1992;11:121-139.
6. Herr I, Debatim KM. Cellular stress response and apoptosis in cancer therapy. *Blood* 2001;98:2603-2614.
7. Roberts JM. Evolving ideas about cyclins. *Cell* 1999;98:129-132.
8. Shimamura A, Fisher DE. p53 in life and death. *Clin Cancer Res* 1996;2:435-440.
9. Ranger AM, Malynn BA, Korsmeyer JJ. Mouse models of cell death. *Nat Genet* 2001;28:113-118.
10. Kessel D, Hall TC, Roberts D, et al. Uptake as a determinant of methotrexate response in mouse leukemia. *Science* 1995;150:752-754.
11. Chu MY, Fisher GA. Comparative studies of leukemic cells sensitive and resistant to cytosine arabinoside. *Biochem Pharmacol* 1965;15:333-341.
12. Lennard L, Lilleyman JS, Van Loon JA, et al. Genetic variation in response to 6-mercaptopurine for childhood acute lymphoblastic leukemia. *Lancet* 1991;336:225-229.
13. Puchalski RB, Fahl WE. Expression of recombinant glutathione S-transferase pi, Ya, and Yb1 confers resistance to alkylating agents. *Proc Natl Acad Sci U S A* 1990;87:2443-2447.
14. Gottesman MM. How cancer cells evade chemotherapy: sixteenth Richard and Hinda Rosenthal Foundation award lecture. *Cancer Res* 1993;53:747-754.
15. Pegg AE. Mammalian O<sup>6</sup>-alkyl guanine-DNA alkyl transferase. Regulation and importance in response to alkylating carcinogenic and therapeutic agents. *Cancer Res* 1990;50:6119-6129.
16. Pommier Y, Kerrigan D, Schwartz RE, et al. Altered DNA topoisomerase II activity in Chinese hamster

cells resistant to topoisomerase II inhibitors. *Cancer Res* 1986;46:3075–3081.

17. Marie JP. Drug resistance in hematologic malignancies. *Curr Opin Oncol* 2001;13:463–469.
18. Holzmayer TA, Hilsenbeck S, Van Hoff DD, Roninson I. Clinical correlates of MDR1 (P-glycoprotein) gene expression in ovarian and small cell lung carcinomas. *J Natl Cancer Inst* 1992;84:1486–1491.
19. Matheny CJ, Lamb MW, Brouwer KR, et al. Pharmacokinetic and pharmacodynamic implications of p-glycoprotein modulation. *Pharmacotherapy* 2001;21:778–796.
20. Cole SP, Bhardwaj G, Gerlach JH, et al. Over expression of a transporter gene in a multidrug resistant human lung cancer cell line. *Science* 1992;258:1650–1654.
21. Goldie JH. Scientific basis for adjuvant and primary (neoadjuvant) chemotherapy. *Semin Oncol* 1987;14:1–7.
22. Jodrell DI, Egorin MJ, Caretta RM, et al. Relationship between carboplatin exposure and tumor response and toxicity in patients with ovarian cancer. *J Clin Oncol* 1992;10:520–528.
23. Frei E, Canellos GP. Dose: a critical factor in cancer chemotherapy. *Am J Med* 1980;69:585–594.
24. Wood W, Korzan AH, Cooper R, et al. Dose and dose intensity of adjuvant chemotherapy for stage II node positive breast cancer. *N Engl J Med* 1994;330:1253–1259.
25. Hesketh PJ, Kris MG, Grunberg SM, et al. Proposal for classifying the emetogenicity of cancer chemotherapy. *J Clin Oncol* 1997;15:103–109.
26. Tyers MB. 5-HT<sub>3</sub> receptors. *Ann N Y Acad Sci* 1990;600:194–202.
27. Gralla RJ. Antiemetic therapy. *Semin Oncol* 1998;28:577–583.
28. Bodey GP, Buckley M, Sathe YS, Freireich EJ. Quantitative relationships between circulating leukocytes and infection in patients with acute leukemia. *Ann Intern Med* 1966;64:328–340.
29. Pizzo PA. Management of fever in patients with cancer and treatment-induced neutropenia. *N Engl J Med* 1993;328:1323–1332.
30. Lieschke GJ, Burgess AW. Granulocyte colony factor and granulocyte macrophage colony stimulating factor. *N Engl J Med* 1992;327:99–106.
31. American Society of Clinical Oncology. Recommendation for the use of hematopoietic colony-stimulating factors: evidence based, clinical practice guidelines. *J Clin Oncol* 1994;12:2471–2508.
32. Knox JJ, Puodziunas AL, Feld R. Chemotherapy-induced oral mucositis; prevention and management. *Drugs Aging* 2000;17:257–267.
33. Kintzel PE, Dorr RT. Anticancer drug renal toxicity and elimination: dosing guidelines for altered renal function. *Cancer Treat Rev* 1995;21:33–64.
34. Tuxen MK, Hansen SW. Neurotoxicity secondary to antineoplastic drugs. *Cancer Treat Rev* 1994;20:191–214.
35. King PD, Perry MC. Hepatotoxicity of chemotherapy. *Oncologist* 2001;6:162–176.
36. Kreisman H, Wolkove N. Pulmonary toxicity of antineoplastic therapy. *Semin Oncol* 1992;19[suppl]:508–520.
37. Pai VB, Nahata MC. Cardiotoxicity of chemotherapeutic agents: incidence, treatment, and prevention. *Drug Saf* 2000;22:263–302.
38. Koppel RA, Boh EE. Cutaneous reactions to chemotherapeutic agents. *Am J Med Sci*

2001;321:327–335.

39. Howell SJ, Shalet SM. Testicular function following chemotherapy. *Hum Reprod Update* 2001;7:363–369.
40. Pui CH, Ribaerio RC, Hancock ML, et al. Acute myeloid leukemia in children treated with epipodophyllotoxins for acute lymphoblastic leukemia. *N Engl J Med* 1991;325:1682–1687.
41. Oates JA, Wilkinson GP. Principles of drug therapy. In: Fauci J, et al., eds. *Harrison's principles of internal medicine*. Philadelphia: McGraw-Hill, 1998:411–422.
42. Hande KR, Krozley MG, Greco FA, et al. Bioavailability of low dose oral etoposide. *J Clin Oncol* 1993;11:374–377.
43. Zimm S, Collins JM, Riccardi R, et al. Variable bioavailability of oral mercaptopurine. Is maintenance chemotherapy in acute lymphoblastic leukemia being optimally delivered? *N Engl J Med* 1983;308:1005–1009.
44. Fraile RJ, Baker LH, Buroker TR, et al. Pharmacokinetics of fluorouracil administered orally, by rapid intravenous, and by slow infusion. *Cancer Res* 1980;40:2223–2228.
45. Hande KR, Messenger M, Wagner J, et al. Inter and inpatient variability in etoposide kinetics with oral and intravenous drug administration. *Clin Cancer Res* 1999;5:2742–2747.
46. Stewart CF, Pieper JA, Arburk SG, Evans WE. Altered protein binding of etoposide in patients with cancer. *Clin Pharmacol Ther* 1989;45:49–55.
47. Chabner BA, Stoller RG, Hande KR, et al. Methotrexate disposition in humans: case studies in ovarian cancer following high dose infusion. *Drug Metab Rev* 1978;8:107–117.
48. Gianni L, Kearns CM, Giani A, et al. Nonlinear pharmacokinetics and metabolism of paclitaxel and its pharmacokinetic pharmacodynamic relationships in humans. *J Clin Oncol* 1995;13:180–190.
49. Diasio RB, Beavers TL, Carpenter JT. Familial deficiency of dihydropyrimidine dehydrogenase. *J Clin Invest* 1988;81:47–51.
50. Evans WE, Hon YY, Bomgaars L, et al. Predominance of thiopurine 5-methyltransferase deficiency and heterogeneity among patients intolerant to 6-mercaptopurine or azathioprine. *J Clin Oncol* 2001;19:2293–2301.
51. Baker DK, Reiling MV, Pui CH, et al. Increased teniposide clearance with concomitant anticonvulsant therapy. *J Clin Oncol* 1992;10:311–315.
52. Richards MA, Ramirez LF, Degner LF, et al. Offering choice of treatment to patients with cancers. *Eur J Cancer* 1995;31A:112–116.
53. Samet J, Hunt WB, Key C, et al. Choice of cancer therapy varies with age of the patient. *JAMA* 1986;255:3385–3390.
54. Einhorn LH. Approaches to drug therapy in older cancer patients. *Oncology* 1992;6[suppl]:69–73.
55. Balducci L, Corcoran MB. Antineoplastic chemotherapy of the older cancer patient. *Hematol Oncol Clin North Am* 2000;14:193–212.
56. Baker SD, Growchow LB, Donehower RB. Should anticancer drug doses be adjusted in the obese patient? *J Natl Cancer Inst* 1995;87:333–334.
57. Georgiadis MS, Steinberg SM, Hankins LA, et al. Obesity and therapy related toxicity in patients treated for small cell lung cancer. *J Natl Cancer Inst* 1995;87:362–366.
58. Tew KD, Colvin OM, Chabner BA. Alkylating agents. In: Chabner BA, Longo DL, eds. *Cancer chemotherapy and biotherapy*, 3rd ed. Philadelphia: Lippincott-Raven Publishers, 2001:373–414.
59. Brent TP, Houghton PJ, Houghton JA. O<sup>6</sup>-Alkyl guanine-DNA alkyltransferase activity correlates with

the therapeutic response of human rhabdomyosarcoma xenografts to 1-(2-chloroethyl)-3-(trans-4-methylcyclohexyl)-l-nitrosourea. *Proc Natl Acad Sci U S A* 1985;82:2985-2989.

60. Erickson LC, Bradley NO, Ducore JM, et al. DNA cross-linking and cytotoxicity in normal and transformed human cells treated with antitumor nitrosoureas. *Proc Natl Acad Sci U S A* 1980;77:467-471.
61. O'Dwyer PJ, Hamilton TC, Young RC, et al. Depletion of glutathione in normal and malignant human cells in vivo by buthionine sulfonamide. *J Natl Cancer Inst* 1992;84:264-267.
62. Hospers GA, Eisenhauer EA, deVries EG. The sulfhydryl containing compound WR-2721 and glutathione as radio and chemo protective agents: a review, indications for use and prospects. *Br J Cancer* 1999;80:629-638.
63. Moore MJ. Clinical pharmacokinetics of cyclophosphamide. *Clin Pharmacokinet* 1991;20:194-208.
64. Boddy AV, Yule SM. Metabolism and pharmacokinetics of oxazaphosphorines. *Clin Pharmacokinet* 2000;38:291-304.
65. Shaw IC, Graham MI. Mesna—a short overview. *Cancer Treat Rev* 1987;14:67-86.
66. Sviland L, Robinson A, Proctor SF, et al. Interaction of cimetidine with oral melphalan. A pharmacokinetic study. *Cancer Chemother Pharmacol* 1987;20:173-175.
67. Twohig KJ, Matthay RA. Pulmonary effects of cytotoxic agents other than bleomycin. *Clin Chest Med* 1990;11:31-54.
68. Rollins BJ. Hepatic veno-occlusive disease. *Am J Med* 1986;81:297-306.
69. Goren MP, Right RK, Pratt CB, et al. Dechloroethylation of ifosfamide and neurotoxicity. *Lancet* 1986;2:1219-1220.
70. Loebstein R, Atanackovic G, Bishai R, et al. Risk factors for long-term outcome of ifosfamide-induced nephrotoxicity in children. *J Clin Pharm* 1999;39:454-461.
71. Kenney LB, Lauter MR, Grant FD, et al. High risk of infertility and long-term gonadal damage in males treated with high-dose cyclophosphamide for sarcoma during childhood. *Cancer* 2001;91:613-666.
72. Jolivet J, Cowan KH, Curt GA, et al. The pharmacology and clinical use of methotrexate. *N Engl J Med* 1983;309:1094-1104.
73. Evans WE, Crom WR, Abromowitch M. Clinical pharmacodynamics of high-dose methotrexate in acute lymphocytic leukemia: identification of a relation between concentration and effect. *N Engl J Med* 1986;314:471-477.
74. Balis FM, Savitch JL, Bleyer WA. Pharmacokinetics of oral methotrexate in children. *Cancer Res* 1983;43:2342-2345.
75. Huffman DH, Wan SH, Azarnoff DL, Hoogstraten B. Pharmacokinetics of methotrexate. *Clin Pharmacol Ther* 1973;14:572-579.
76. Bleyer WA. The clinical pharmacology of methotrexate. *Cancer* 1978;41:36-51.
77. Stoller RG, Hande KR, Jacobs SA, et al. Use of plasma pharmacokinetics to predict and prevent methotrexate toxicity. *N Engl J Med* 1977;297:630-634.
78. Zachariae H, Kragballe K, Sogaard H. Methotrexate-induced cirrhosis. *Br J Dermatol* 1980;102:407-412.
79. Imokawa S, Colby TV, Leslie KO, et al. Methotrexate pneumonitis: a review of the literature and histopathologic findings in nine patients. *Eur Respir J* 2000;15:373-381.
80. Bleyer WA, Drake JC, Chabner BA. Neurotoxicity and elevated cerebral-fluid methotrexate



- concentrations in meningeal leukemia. *N Engl J Med* 1973;289:770-773.
81. Grant S. Ara-C: cellular and molecular pharmacology. *Adv Cancer Res* 1998;72:197-233.
  82. Ueda T, Matsuyama S, Yamauchi T, et al. Clinical pharmacology of intermediate and low-dose cytosine arabinoside (ara-C) therapy in patient with hematologic malignancies. *Adv Exp Med Biol* 1998;43:647-651.
  83. Murry DF, Blaney SM. Clinical pharmacology of encapsulated sustained-released cytarabine. *Ann Pharmacother* 2000;34:1173-1178.
  84. Stentoft J. The toxicity of cytarabine. *Drug Saf* 1990;5:7-27.
  85. Baker WJ, Royer GL, Weiss RB. Cytarabine and neurologic toxicity. *J Clin Oncol* 1991;9:679-693.
  86. Plagemann PGW, Erbe J. Intracellular conversion of deoxyribonucleotides by rat hepatoma cells and effect of hydroxyurea. *J Cell Physiol* 1994;83:321-336.
  87. Donehower RL. An overview of the clinical experience with hydroxyurea. *Semin Oncol* 1992;19[suppl 9]:11-19.
  88. Rodriguez GI, Kuhn JG, Weiss GR, et al. A bioavailability and pharmacokinetic study of oral and intravenous hydroxyurea. *Blood* 1998;91:1533-1541.
  89. Gwilt PR, Tracewell WG. Pharmacokinetics and pharmacodynamics of hydroxyurea. *Clin Pharmacokinetics* 1998;34:347-358.
  90. Kennedy BJ, Smith LR, Goltz RW. Skin changes secondary to hydroxyurea therapy. *Arch Dermatol* 1975;111:183-187.
  91. Best PJ, Daoud MS, Pittelkow MR, et al. Hydroxyurea-induced leg ulceration in 14 patients. *Ann Intern Med* 1998;128:29-32.
  92. Hande KR. Purine antimetabolites. In: Chabner BA, Longo DL, eds. *Cancer chemotherapy and biotherapy*, 3rd ed. Philadelphia: Lippincott-Raven Publishers, 2001:295-314.
  93. Elion GB. Significance of azathioprine metabolites. *Proc R Soc Med* 1972;65:257-260.
  94. Zimm S, Collins JM, O'Neill D, et al. Inhibition of first-pass metabolism in cancer chemotherapy: interaction of 6-mercaptopurine and allopurinol. *Clin Pharmacol Ther* 1983;34:810-817.
  95. Black AJ, McLeod HL, Capell HA, et al. Thiopurine methyltransferase gene type predicts therapy-limiting severe toxicity from azathioprine. *Ann Intern Med* 1998;129:716-718.
  96. Van Scoik KG, Johnson CA, Porter WR. The pharmacology and metabolism of the thiopurine drugs 6-mercaptopurine and azathioprine. *Drug Metab Rev* 1985;16:157-174.
  97. Einhorn M, Davidson I. Hepatotoxicity of 6-mercaptopurine. *JAMA* 1964;188:802-806.
  98. Kwong AL, Au WY, Liang RH. Acute myeloid leukemia after azathioprine treatment for autoimmune disease association with -7/7q-. *Cancer Genet Cytogenet* 1998;104:94-97.
  99. Chun HC, Leyland-Jones B, Cheson BD. Fludarabine phosphate: a synthetic purine antimetabolite with significant activity against lymphoid malignancies. *J Clin Oncol* 1991;9:175-188.
  100. Adkins JC, Peters DH, Markham A. Fludarabine: an update of its pharmacology and use in treatment of hematologic malignancies. *Drugs* 1997;53:1005-1037.
  101. Robertson LE, Chubb S, Meyn RE, et al. Induction of apoptotic cell death in chronic lymphocytic leukemia by 2-chloro-2-deoxyadenosine and 9- $\beta$ -D-arabinosyl-2-fluoroadenine. *Blood* 1993;81:143-150.
  102. Cheson BD, Vena DA, Foss FM, et al. Neurotoxicity of purine analogs: a review. *J Clin Oncol*

1994;12:2216–2228.

103. Anaissie EJ, Kontoyiannis DP, O'Brien S, et al. Infections in patients with chronic lymphocytic leukemia treated with fludarabine. *Ann Intern Med* 1998;129:559–566.

104. Cheson BD. Infectious and immunosuppressive complications of purine analog therapy. *J Clin Oncol* 1995;13:2431–2438.

105. Klohs WD, Kraker AJ. Pentostatin: future directions. *Pharmacol Rev* 1992;44:459–477.

106. Malspeis L, Weinrib AB, Staubus AE, et al. Clinical pharmacokinetics of 2'-deoxycoformycin. *Cancer Treat Symp* 1984;2:7–15.

107. Kane BJ, Kuhn JG, Roush MK. Pentostatin: an adenosine deaminase inhibitor for the treatment of hairy cell leukemia. *Ann Pharmacother* 1992;26:939–946.

108. Plunkett W, Saunders PP. Metabolism and action of purine nucleoside analogs. *Pharmacol Ther* 1991;49:239–268.

109. Carson DA, Wasson DB, Esparza LM, et al. Oral antilymphocyte activity and induction of apoptosis by 2-chloro-2'-arabino-2'-deoxyadenosine. *Proc Natl Acad Sci U S A* 1992;89:2970–2974.

110. Liliemark J. The clinical pharmacokinetics of cladribine. *Clin Pharmacokinet* 1997;32:120–131.

111. Bryson HM, Sorkin EM. Cladribine: a review of its pharmacodynamic and pharmacokinetic properties and therapeutic potential in hematological malignancies. *Drugs* 1993;46:872–894.

112. Piro LD. Chlorodeoxyadenosine treatment of lymphoid malignancies. *Blood* 1992;79:843–845.

113. Betticher DC, von Rohr A, Ratschiller D, et al. Fewer infections, but maintained antitumor activity with lower-dose vs standard dose cladribine in pretreated low-grade non-Hodgkin's lymphoma. *J Clin Oncol* 1998;16:850–858.

114. Froelich-Ammon SJ, Osheroff N. Topoisomerase poisons: harnessing the dark side of enzyme mechanism. *J Biol Chem* 1995;270:21429–21432.

115. Osheroff N. Effect of antineoplastic agents on the DNA cleavage/relegation reaction of eukaryotic topoisomerase II: inhibition of DNA relegation by etoposide. *Biochemistry* 1989;28:6157–6160.

116. Johnson SA, Richardson DS. Anthracyclines in haematology: pharmacokinetics and clinical studies. *Blood Rev* 1998;12:52–71.

117. Coukell AJ, Faulds D. Epirubicin. An updated review of its pharmacodynamic and pharmacokinetic properties and therapeutic efficacy in the management of breast cancer. *Drugs* 1997;53:453–482.

118. Gill PS, Espina BM, Muggia F, et al. Phase I/II clinical and pharmacokinetic evaluation of liposomal daunorubicin. *J Clin Oncol* 1995;13:996–1003.

119. Waterhouse DN, Tardi PG, Mayer LD, et al. A comparison of liposomal formulations of doxorubicin with drug administered in free form: changing toxicity profiles. *Drug Saf* 2001;24:903–920.

120. Kremer LC, van Dalen EC, Offringa M, et al. Anthracycline-induced clinical heart failure in a cohort of 607 children: long-term follow-up study. *J Clin Oncol* 2001;19:191–196.

121. Shadle SE, Bammell BP, Cusack BJ, et al. Daunorubicin cardiotoxicity: evidence for the importance of the quinone moiety in a free-radical-independent mechanism. *Biochem Pharmacol* 2000;60:1435–1444.

122. Faulds D, Balfour JA, Chrisp P, et al. Mitoxantrone: a review of its pharmacodynamic and pharmacokinetic properties, and therapeutic potential in the chemotherapy of cancer. *Drugs* 1991;41:400–449.

123. Posner LE, Dukart G, Goldberg J, et al. Mitoxantrone: an overview of safety and toxicity. *Invest New*

Drugs 1985;3:123–132.

124. Hande KR. Etoposide: four decades of development of a topoisomerase II inhibitor. *Eur J Cancer* 1998;34:1514–1521.

125. Thompson DS, Greco A, Miller AA, et al. A phase I study of etoposide phosphate administered as a daily 30-minute infusion for 5 days. *Clin Pharmacol Ther* 1995;57:499–507.

126. Pui CH, Relling MV. Topoisomerase II inhibitor-related acute myeloid leukemia. *Br J Haematol* 2000;109:13–23.

127. Hande KR, Wolff SN, Greco FA, et al. Etoposide kinetics in patients with obstructive jaundice. *J Clin Oncol* 1990;8:1101–1107.

128. Relling MV, Pui CH, Sandlund JT, et al. Adverse effect of anticonvulsants on efficacy of chemotherapy for acute lymphoblastic leukaemia. *Lancet* 2000;356:285–290.

129. Hande KR, Messenger M, Wagner J, et al. Inter and inpatient variability in etoposide kinetics with oral and intravenous drug administration. *Clin Cancer Res* 1999;5:2742–2747.

130. Lazo JS. Bleomycin. *Cancer Chemother Biol Response Modif* 1999;18:39–45.

131. Sansville EA, Stein RW, Reisach J, et al. Properties and products of the degradation of DNA by bleomycin and iron. *Biochemistry* 1978;17:2746–2754.

132. Croke ST, Comis RL, Einhorn LH, et al. Effects of variation in renal function on the clinical pharmacology of bleomycin administered as an IV bolus. *Cancer Treat Rep* 1977;61:6131–1636.

133. Dagleish AG, Woods RL, Levi JA. Bleomycin pulmonary toxicity: its relationship to renal dysfunction. *Med Pediatr Oncol* 1984;12:313–317.

134. Howell SB, Schiefer M, Andrews PA, et al. The pharmacology of intraperitoneally administered bleomycin. *J Clin Oncol* 1987;5:2009–2016.

135. Levy RL, Chiarillo S. Hyperpyrexia, allergic type response and death occurring after bleomycin administration. *Oncology* 1980;37:316–317.

136. Comis RL. Bleomycin pulmonary toxicity: current status and future directions. *Semin Oncol* 1992;19[Suppl 5]:64–70.

137. Sleijfer S. Bleomycin-induced pneumonitis. *Chest* 2001;120:617–624.

138. Waid-Jones MI, Coursin DB. Perioperative considerations for patients treated with bleomycin. *Chest* 1991;99:993–999.

139. Blum RH, Carter SK, Agre K. A clinical review of bleomycin—a new antineoplastic agent. *Cancer* 1973;31:903–914.

140. Reed E. Cisplatin. *Cancer Chemother Biol Response Modif* 1996;16:88–110.

141. Saris CP, van der Vaart PJ, Reitelback RC, et al. In vitro formation of DNA adducts by cisplatin, lobaplatin and oxaliplatin in calf thymus DNA in solution and cultured cells. *Carcinogenesis* 1996;17:2763–2769.

142. Go RS, Adjei AA. Review of the comparative pharmacology and clinical activity of cisplatin and carboplatin. *J Clin Oncol* 1999;17:409–422.

143. Chu G. Cellular responses to cisplatin. The roles of DNA-binding proteins and DNA repair. *J Biol Chem* 1994;269:787–790.

144. Himmelstein KJ, Patton FT, Belt RJ, et al. Clinical kinetics of intact cisplatin and some related species. *Clin Pharmacol Ther* 1984;29:658–664.

145. Calvert AH, Newell DR, Gimbrell LA, et al. Carboplatin dosage: prospective evaluation of a simple formula based on renal function. *J Clin Oncol* 1984;7:1748–1756.
146. Hande KR. Pharmacologic-based dosing of carboplatin: a better method. *J Clin Oncol* 1993;11:2295–2296.
147. O'Dwyer PJ, Stevenson JP, Johnson SW. Clinical pharmacokinetics and administration of established platinum drugs. *Drugs* 2000;59:19–27.
148. Blachley JD, Hill JB. Renal and electrolyte disturbances associated with cisplatin. *Ann Intern Med* 1981;95:628–632.
149. Pinzani V, Bressolle F, Haug IJ, et al. Cisplatin-induced renal toxicity and toxicity-modulating strategies: a review. *Cancer Chemother Pharmacol* 1994;35:1–9.
150. McKeage MJ. Comparative adverse effect profiles of platinum drugs. *Drug Saf* 1995;13:228–244.
151. Culy CR, Clemett D, Wiseman LR. Oxaliplatin: a review of its pharmacologic properties and clinical efficacy in colorectal cancer and its potential in other malignancies. *Drugs* 2000;60:895–924.
152. Correia JJ. Effect of antimetabolic agents on tubulin-nucleotide interactions. *Pharmacol Ther* 1991;52:127–147.
153. Gilding CE, Kallie SJ, Kamps WA, et al. Vincristine revisited. *Crit Rev Oncol Hematol* 1999;29:267–287.
154. Zhou XJ, Rahmani R. Preclinical and clinical pharmacology of vinca alkaloids. *Drugs* 1992;44[suppl 4]:1–16.
155. Chan JD. Pharmacokinetic drug interactions of vinca alkaloids: summary of case reports. *Pharmacotherapy* 1998;18:1304–1307.
156. Legha SS. Vincristine neurotoxicity: pathophysiology and management. *Med Toxicol* 1986;1:421–427.
157. Rowinsky EK, Donehower RC. The clinical pharmacology and use of antimicrotubule agents in cancer chemotherapeutics. *Pharmacol Ther* 1991;52:35–84.
158. Budman DR. Vinorelbine (Navelbine): a third generation vinca alkaloid. *Cancer Invest* 1997;15:475–490.
159. Schiff PH, Horwitz SB. Taxol stabilizes microtubules in mouse fibroblast cells. *Proc Natl Acad Sci U S A* 1980;77:1561–1563.
160. Wang TH, Wang HS, Soong YK. Paclitaxel-induced cell death: where the cell cycle and apoptosis come together. *Cancer* 2000;88:2619–2628.
161. Rowinsky EK, Donehower RC. Drug therapy: paclitaxel (Taxol). *N Engl J Med* 1996;332:1004–1014.
162. Cresteil T, Monsarrat B, Alvinerie P, et al. Taxol metabolism by human liver microsomes: identification of cytochrome P450 isoenzymes involved in its biotransformation. *Cancer Res* 1994;54:386–392.
163. Gianni L, Kearns CM, Giani A, et al. Nonlinear pharmacokinetics and metabolism of paclitaxel and its pharmacokinetic/pharmacodynamic relationships in humans. *J Clin Oncol* 1995;13:180–190.
164. Royer I, Monsarrat B, Sonnier M, et al. Metabolism of docetaxel by human cytochromes P450: interactions with paclitaxel and other antineoplastic drugs. *Cancer Res* 1996;56:58–65.
165. Baker AT, Dorr RT. Drug interactions with taxanes: clinical implications. *Cancer Treat Rev* 2001;27:221–233.
166. Rowinski EK, Eisenhauer EA, Chaudry V, et al. Clinical toxicities encountered with paclitaxel. *Semin*

Oncol 1993;20[suppl 3]:1-15.

167. Cortes JE, Pazdur R. Docetaxel. *J Clin Oncol* 1995;13:2643-2655.

168. Broome JD. Evidence that the L-asparaginase of guinea pig serum is responsible for its antilymphoma effects: Properties of the L-asparaginase of guinea pig serum in relation to those of the antilymphoma substance. *J Exp Med* 1963;118:99-120.

169. Ohnuma T, Holland JF, Freeman A, et al. Biochemical and pharmacological studies with asparaginase in man. *Cancer Res* 1970;30:2297-2305.

170. Oettgen HF, Stephenson PA, Schwartz MK, et al. Toxicity of *E. coli* L-asparaginase in man. *Cancer* 1970;25:253-278.

171. Muller HJ, Boos J. Use of L-asparaginase in childhood ALL. *Crit Rev Oncol Hematol* 1998;28:97-113.

172. Pegasparginase for acute lymphoblastic leukemia. *Med Lett Drugs Ther* 1995;37:23-24.

173. Leonard JV, Kay JDS. Acute encephalopathy and hyperamino-acidemia complicating treatment of acute lymphoblastic leukemia with asparaginase. *Lancet* 1986;1:162-163.

174. Kalvakolanu DV, Borden EC. An overview of the interferon system: signal transduction and mechanisms of action. *Cancer Invest* 1966;14:25-53.

175. Graner D, Einhorn S. Interferon and malignant disease—how does it work and why doesn't it always. *Acta Oncol* 1998;37:331-338.

176. Witt PL, Linder DJ, D'Cunha J, et al. Pharmacology of interferons: induced proteins, cell activation and antitumor activity. In: Chabner BA, Longo DL, eds. *Cancer chemotherapy and biotherapy*. Philadelphia: Lippincott-Raven Publishers, 1996:585-607.

177. Quesada JR, Talpaz M, Rios A, et al. Clinical toxicity of interferons in cancer patients: a review. *J Clin Oncol* 1986;7:234-243.

178. Roth MS, Foon KA. Alpha interferon in the treatment of hematologic malignancies. *Am J Med* 1986;81:871-882.

179. Trosk PC, Esper P, Riba M, et al. Psychiatric side effects of interferon therapy; prevalence, proposed mechanisms and future direction. *J Clin Oncol* 2000;18:2316-2326.

180. Borden EC, Parkinson D. Interferons: effectiveness, toxicities and cost. *Ann Intern Med* 1996;125:614-616.

181. Foss FM. Interleukin-2 fusion toxin: targeted therapy for cutaneous T-cell lymphoma. *Ann N Y Acad Sci* 2001;941:166-176.

182. Olsen E, Duvic M, Frankel A, et al. Pivotal Phase III trial of two dose levels of denileukin difitox for the treatment of cutaneous T-cell lymphoma. *J Clin Oncol* 2001;19:376-388.

183. Kakizuka A, Miller WH Jr, Umesono K, et al. Chromosomal translocation t(15;17) in human acute promyelocytic leukemia fuses RAR with a novel putative transcription factor, PML. *Cell* 1991;66:663-674.

184. Warrel RP Jr, Frankel SR, and Miller WH. Differentiation therapy of acute promyelocytic leukemia with tretinoin (all-trans-acid). *N Engl J Med* 1991;324:1385-1393.

185. Melnick A, Licht JD. Deconstructing a disease: RARα its fusion partners and their roles in promyelocytic leukemia. *Blood* 1999;93:3167-3215.

186. Rgazzi MD, Iacona I, Gervasutti C, et al. Clinical pharmacokinetics of tretinoin. *Clin Pharmacokinet* 1997;32:382-402.

187. Lee JS, Newman RA, Lippman SM, et al. Phase I evaluation of all-trans retinoic acid in adults with

solid tumors. *J Clin Oncol* 1993;11:959–966.

188. Frankel SR, Eardley A, Lauwers G, et al. The “retinoic acid syndrome” in acute promyelocytic leukemia. *Ann Intern Med* 1992;117:292–296.

189. Jick SS, Terris BZ, Jick H. First trimester topical retinoic and congenital disorders. *Lancet* 1993;341:1181–1182.

190. Mangelsdorf DF, Thummel C, Beato M. The nuclear receptor super family: the second decade. *Cell* 1995;83:835–839.

191. Boehm MF, Zhang L, Zhi L, et al. Design and synthesis of potent retinoid X receptor selective ligands that induce apoptosis in leukemic cells. *J Med Chem* 1995;38:3146–3155.

192. Duvic M, Hymes K, Heald P, et al. Bexarotene is effective and safe for treatment of refractory advanced-stage cutaneous T-cell lymphoma: multinational phase II–III trial results. *J Clin Oncol* 2001;19:2456–2471.

193. Wong SF. Oral bexarotene in the treatment of cutaneous T-cell lymphoma. *Ann Pharmacother* 2001;35:1056–1065.

194. Lippman ME, Yarbrow GK, Leventhal BG. Clinical implications of glucocorticoid receptors in human leukemia. *Cancer Res* 1978;38:4251–4256.

195. Smets LA, van der Berg JD. BCL-2-expression and glucocorticoid-induced apoptosis of leukemia and lymphoma cells. *Leuk Lymphoma* 1996;20:199–205.

196. Melby JC. Clinical pharmacology of systemic corticosteroids. *Annu Rev Pharmacol Toxicol* 1977;17:511–527.

197. Soignet SL, Maslak P, Wang ZG, et al. Complete remission after treatment of acute promyelocytic leukemia with arsenic trioxide. *N Engl J Med* 1998;339:1341–1348.

198. Miller WH. Molecular targets of arsenic trioxide in malignant cells. *Oncologist* 2002;7:14–19.

199. Soignet S, Frankel SR, Dower D, et al. United States multi-center study of arsenic trioxide in relapsed acute promyelocytic leukemia. *J Clin Oncol* 2001;19:3852–3860.

200. Unnikrishnan D, Dutcher JP, Varshneya N, et al. Torsades de pointes in 3 patients with leukemia treated with arsenic trioxide. *Blood* 2001;97:1514–1516.

201. Sawyers CL. Chronic myelogenous leukemia. *N Engl J Med* 1999;340:1330–1340.

202. Drucker BJ, Lydon NB. Lessons learned from the development of an abl tyrosine kinase inhibitor for chronic myelogenous leukemia. *J Clin Invest* 2000;105:3–7.

203. Savage DG, Antman KH. Imatinib mesylate—a new oral targeted therapy. *N Engl J Med* 2002;346:683–693.

204. Kantarjian H, Sawyers C, Hochhaus A, et al. Hematologic and cytogenetic responses to imatinib mesylate in chronic myelogenous leukemia. *N Engl J Med* 2002;346:645–652.

205. Frei E. Pharmacologic strategies for high-dose chemotherapy. In: Armitage JO, Antman KH, eds. *High-dose cancer therapy: pharmacology, hematopoietins, stem cells*. Baltimore: Williams & Wilkins, 1995:3–16.

206. Jones RB, Matthes S, Dalton C. Pharmacokinetics. In: Armitage JO, Antman KH, eds. *High-dose cancer therapy: pharmacology, hematopoietins, stem cells*. Baltimore: Williams & Wilkins, 1995:49–69.

207. Soutar RL, King DJ. Bone marrow transplantation. *BMJ* 1995;310:31–36.

208. Grochow LB, Jones RJ, Brundrett RB, et al. Pharmacokinetics of busulfan: correlation with veno-occlusive disease in patients undergoing bone marrow transplantation. *Cancer Chemother Pharmacol*

1989;25:55-61.

209. Ayash LJ, Wright JE, Tretyakov O, et al. Cyclophosphamide pharmacokinetics: correlation with cardiac toxicity and tumor response. *J Clin Oncol* 1992;10:995-1000.

210. Jones RB, Matthes S, Shpall EJ, et al. Acute lung injury following treatment with high-dose cyclophosphamide, cisplatin and carmustine: pharmacodynamic evaluation of carmustine. *J Natl Cancer Inst* 1993;85:640-647.

211. Jones RJ, Grochow LB. Pharmacology of bone marrow transplantation conditioning regimens. *Ann N Y Acad Sci* 1995;770:237-241.

2004 Lippincott Williams & Wilkins  
John P. Greer, John Foerster, John N. Lukens  
George M. Rodgers, Frixos Paraskevas, Bertil Glader  
Wintrobe's Clinical Hematology



[HISTORY](#)[INNATE IMMUNITY](#)[ADAPTIVE IMMUNITY](#)[Tumor Antigens](#)[T-Lymphocyte Activation and Response](#)[APPROACHES TO IMMUNOTHERAPY](#)[Antibody Approaches](#)[Cytokines](#)[Cellular Approaches](#)[Immunization Strategies](#)[OUTLOOK FOR THE FUTURE](#)[REFERENCES](#)

## HISTORY

There probably is no field in medicine that has provided as much hope, or as much disappointment, as the field of tumor immunology. A major relationship between the immune system and the oversight of neoplasms was postulated in the early part of the century by Paul Ehrlich ([1](#)). This theory of immunosurveillance envisioned that in long-lived animals, inheritable genetic changes in somatic cells must be common, and some proportion of these changes must represent steps toward malignant transformation. It was considered an evolutionary necessity, therefore, that some mechanisms exist for eliminating or inactivating such potentially dangerous mutant cells. This mechanism was thought to be immunologic. The theory of immunosurveillance was restated in the 1950s by Lewis Thomas ([2](#)), then popularized and championed by Sir Macfarlane Burnet ([3](#)). Supported by these powerful figures in medicine, the theory of immunosurveillance was so inherently appealing that it often was accepted uncritically, and evidence to the contrary often overlooked ([4](#)). For instance, although patients or animals who are immunosuppressed tend to have an increased incidence of tumors, these tumors are disproportionately of lymphoid origin or associated with an oncogenic virus. The development the common epithelial neoplasms (with the exception of certain skin cancers) in these patients occurs with much less impressive frequency ([5](#)).

The most obvious evolutionary necessity of the immune system was to survey a variety of infections, especially viral infections. In fact, the immunologic assault on viral infections is directed not so much against the virus as against virally infected cells. This is certainly true of the T-lymphocyte-mediated immunity against viruses. Early evidence seemed to indicate that immunity played a significant role in eradicating virally induced tumors ([6](#), [7](#)). On the other hand, it appeared to play a less significant, or less effective, role in prevention of tumors induced by physical or chemical carcinogens ([8](#), [9](#)).

Experimentation in the early part of the twentieth century demonstrated that spontaneously arising tumors in outbred animals could occasionally be transplanted from one animal to another of the same species and propagated in that fashion. Attempts to immunize against transplantable tumors soon followed. Animals injected with a small number of tumor cells often were able to eliminate those tumor cells—that is, there

appeared to be a threshold number of tumor cells required for tumor propagation. Animals that had eliminated a sublethal inoculum of tumor cells were often able to withstand inoculation with a large number of tumor cells that would have been lethal in a naive animal. Furthermore, preexposure to normal tissue of the donor often rendered the recipient resistant to challenge with a lethal number of tumor cells ( [10](#) ). These experiments brought into question the idea of tumor-specific antigens and ultimately led to the discovery of major histocompatibility complex (MHC) genes and their products ( [11](#), [12](#) ).

Modern tumor immunology finds its roots in the classical experiments of Prehn and Main ( [13](#) ). These investigators demonstrated, in genetically identical mice, that previous exposure to a chemically induced sarcoma rendered animals resistant to challenge with the same tumor, but that these animals would accept normal, nonneoplastic tissues transplanted from the tumor donor animal. Similarly, prior exposure to normal tissues from the donor animal did not render the recipient animal resistant to tumor challenge. These experiments revived the notion that tumor-specific (transplantation) antigens did exist. Subsequent experiments demonstrated that protection afforded by prior exposure to tumor was tumor specific ( [14](#) ). Thus, tumor transplantation behaved like an immune system, demonstrating memory and specificity.

Tumor immunity could be passively conveyed from one animal to another by transfer of lymphoid cells ( [15](#) ). The relevant cells for protection were shown to be T lymphocytes ( [16](#) ). Thus, it should have been clear to workers in the field that the relevant tumor antigens were those that could be recognized by T lymphocytes. However, as this work was beginning there was little understanding of how T lymphocytes recognized antigens or how those antigens were processed and presented to the T lymphocyte by antigen-presenting cells or the tumor target cells. Much time and effort was expended in search for membrane structures or tumor cell products that would distinguish the tumor from all others. Particularly after the description of monoclonal antibody technology ( [17](#) ), a fervent search was undertaken to define structures on tumor cells that would be tumor specific and potential targets for therapeutic intervention. Although many cell-surface structures were defined and the contribution to the understanding of biology cannot be overstated, this adventure produced only a single truly specific tumor antigen, the idiotype of clonally distributed immunoglobulin present on certain lymphomas.

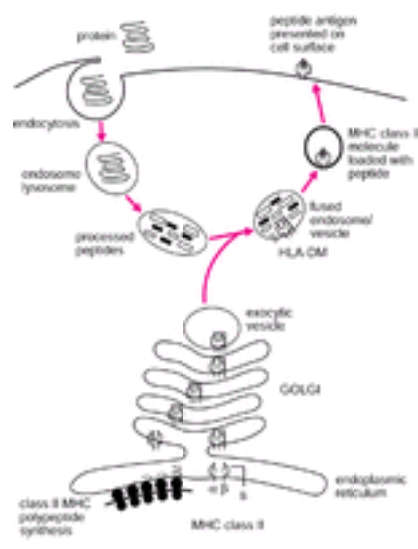
Only recently has convincing evidence for an effect of immunosurveillance been produced ( [18](#), [19](#) ). This new evidence relies, in great measure, on the availability of genetically manipulated animal systems. A variety of knock-out mice with defects in components of immune activation or effector function develop, at high frequency, spontaneous tumors or tumors after carcinogen exposure. Interferon- $\gamma$  receptor-deficient mice are more likely to develop methylcholanthrene-induced sarcoma and more susceptible to spontaneous development of sarcomas and lymphomas after loss of p53 alleles ( [20](#), [21](#) ). One in two aged perforin-deficient mice develop disseminated lymphomas ( [22](#) ). These tumors are rejected by histocompatible wild-type mice through a mechanism dependent on CD8<sup>+</sup> T lymphocytes. A high incidence of lymphoma is also seen in aged mice deficient in Fas/Fas ligand interactions ( [23](#) ). Aged mice doubly deficient in STAT1 and RAG2 develop adenocarcinomas (colon, breast, and lung) with high frequency. The frequency and distribution of tumors are increased in the doubly deficient mice over the frequencies and distributions seen in singly deficient mice ( [24](#) ). Many of these observations have been interpreted as evidence that the primary (both first and predominant) mechanism underlying tumor immunosurveillance is the system of innate immunity ( [25](#) ).

## INNATE IMMUNITY

The innate immune system is a widespread and evolutionarily ancient ( [26](#), [27](#) ) form of host defense against infection ( [28](#) ). The importance of the system is underscored by the fact that most defects in the system are lethal ( [28](#) ). Therefore, this system was not revealed in the same way that “experiments of nature” illuminated important aspects of the adaptive immune system. In recent years, there has been an explosion of information regarding innate immunity, including its role in host defense and its regulation of inflammation and adaptive immunity ( [29](#) ).

The innate immune system is made up of many cells. These include dendritic cells, macrophages, mast cells, neutrophils, eosinophils, natural killer (NK) cells, and a subset of T lymphocytes that bear certain NK structures, NKT cells ( [30](#), [31](#) ). Cells of the innate immune system bear receptors that detect “danger” ( [32](#), [33](#) ) in the form of pathogen-associated molecular patterns (PAMPs). Examples of PAMPs include bacterial lipopolysaccharide, lipoprotein, peptidoglycan, and lipoteichoic acids ( [34](#) ) and bacterial CpG DNA ( [35](#) ). The innate immune system is said to distinguish “infectious non-self” from “non-infectious self.” The pattern recognition receptors of the innate immune system are encoded in the germline. Unlike genes of the T-cell antigen receptor and the immunoglobulins, these genes do not undergo rearrangement. They are fixed and detect critical microbial components. Ten toll-like receptors, each with specificity for a different PAMP, have been describe in humans and mice ( [28](#), [34](#) ).

Cells of the innate immune system become activated during an inflammatory response. They rapidly differentiate into short-lived effector cells to rid the host of infection. They usually succeed without recourse to the system of adaptive immunity. However, when unable to effectively deal with the invaders, the innate immune system can instruct the adaptive immune system about the nature of the pathogen invader. This role is played primarily by dendritic cells (and other antigen-presenting cells, such as macrophages), which through antigen processing and up-regulation of co-stimulatory molecules (particularly CD80 and CD86), present antigen fragments in the context of MHC and, with appropriate second signals, to activate T lymphocytes ( [Fig. 74.1](#) ) (see section [T-Lymphocyte Activation and Response](#) ).



**Figure 74.1.** Presentation of extracellular antigens on class II major histocompatibility complex (MHC) products. Extracellular proteins are taken up by the antigen-presenting cell and processed to peptide fragments in endolysosomes. Class II MHC proteins are synthesized in the endoplasmic reticulum and associated with the chaperone Ii. Fusion of endosomes and exocytic vesicles provides an environment in which peptides are loaded, in the presence of HLA-DM, into the antigen-presentation cleft of the MHC class II molecule. The antigen-MHC complexes are then exposed on the cell surface.

It has been recognized for a long time that NK cells kill MHC class I-deficient tumor cells *in vivo* and *in vitro* (36). However, the identity and characterization of receptors mediating NK activation proved elusive for many years. Activation of NK cells now is understood to be dependent on the balance of activating and inhibitory signals emanating from activating and inhibitory receptors on the NK cell surface. These receptors fall into two major structural classes, those of the immunoglobulin superfamily (KIRs and LIRs) (37) and those of the C-type lectinlike family (NKG2D, CD94/NKG2A, and Ly49) (38). An activating receptor on NK cells, NKG2D, has now been shown to recognize a variety of stress-induced MHC class I-like molecules (39, 40, 41 and 42). Inhibitory receptors (e.g., CD94/NKG2A and KIR) recognize classic MHC molecules (43).

It is now possible to speculate that the innate immune system is involved in defense of the organism against tumor initiation (25, 44, 45). Cells have evolved complex mechanisms to assure successful repair of errors in the genome and survival, or alternatively, recognition of failed repair and programmed cell death. Cells that fail to repair damage yet escape apoptosis would present signs of cellular stress to the innate immune system in the form of heat shock proteins (46) and/or down-regulation of MHC class I molecules. NK cells and other innate effectors would be activated to kill the renegade cell. Some direct evidence for this model has been provided. Kusunoki et al. (47) demonstrated that after x-irradiation, MHC class I-deficient lymphocytes appear and then disappear. In animals depleted of NK cells, the disappearance of MHC class I-deficient lymphocytes was inhibited, suggesting that NK cells mediate elimination of this population of cells (47). These effects may be active in the clinic in the setting of acute myelogenous leukemia (AML) patients who receive HLA haplotype-mismatched transplants. Clinical trials, using KIR epitope-mismatched NK cells to facilitate engraftment of mismatched stem cells with reduced intensity conditioning and NK cell inhibitory receptor blockade have been proposed (45).

## ADAPTIVE IMMUNITY

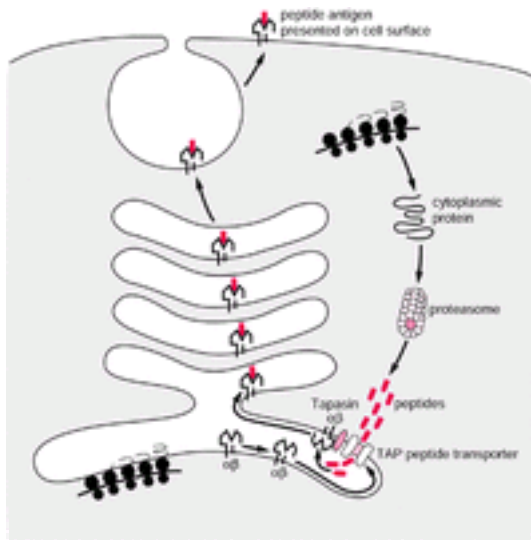
### Tumor Antigens

Tumor antigens are like all other antigens of adaptive immunity. That is, with few exceptions, they are peptides that are presented to T lymphocytes in the cleft of an MHC-encoded protein (48). These peptides are derived from two distinct pathways (49). Peptides representing proteins sampled from the extracellular world are presented in the context of class II MHC proteins. Peptides resulting from intracellular synthesis of proteins are presented in the peptide groove of the class I MHC proteins. The binding cleft of MHC molecules has a  $\beta$ -pleated sheet floor and  $\alpha$ -helical sides. An immunogenic peptide must be capable of forming noncovalent attachments to key residues along the cleft and interacting with the T-cell antigen receptor with other residues. The MHC contact residues of the peptide tend to be near the amino and carboxy terminal ends of the peptide. The cleft of the class I MHC molecule has closed ends and accommodates only a peptide of proper length, 9 to 11 amino acids. The cleft of the class II MHC

molecule, on the other hand, is open ended and can bind peptides of more diverse lengths, 10 to 30 amino acids, with most being 12 to 19 ( [50](#) ).

Peptides located in class II MHC molecules are derived from proteins that have been consumed by antigen-presenting cells ( [51](#) ) ( [Fig. 74.1](#) ). The proteins are taken up by phagocytosis, or receptor-mediated endocytosis in clathrin-coated pits, or engulfed by pinocytosis. Once internalized, the antigens are located in membrane-bound vesicles called *endosomes*. The endosomes then become continuous with lysosomes. The enzymology of the endo-lysosome has been described in some detail ( [52](#) ). There, in an acidic environment, proteases cleave the proteins to peptides. The endosome fuses with an exocytic vesicle budding from the Golgi apparatus that contains newly made class II MHC molecules associated with invariant chain, which has been shown to play a critical role in the assembly, intracellular transport, and function of MHC class II molecules ( [53](#), [54](#) ). In addition a chaperone, HLA-DM, plays a critical role in the loading of peptides onto MHC class II molecules. HLA-DM is a peptide exchange factor that binds with empty and peptide-loaded class II molecules in endosomal and lysosomal compartments ( [55](#), [56](#) ). In the fused vesicle, peptides are loaded into the class II MHC molecules. Fusion of the endosome with the plasma membrane ultimately displays the class II MHC molecule-peptide complexes on the cell surface.

Peptides are prepared for presentation on class I molecules in a different fashion ( [Fig. 74.2](#) ). These peptides are derived from intracellular protein synthesis ( [57](#) ). After protein synthesis, proteins introduced into the cytoplasm become the target of the proteasome, a cytoplasmic organelle whose major function is the degradation of proteins tagged for turnover by the addition of ubiquitin ( [58](#) ). These peptides are then transported into the exocytic pathway by the transporter associated with antigen-processing (TAP) proteins ( [59](#) ). Within the endoplasmic reticulum, assembly of class I MHC heavy chain molecules with  $\beta_2$ -microglobulin requires the presence of peptides. In fact, the tripartite assembly of MHC class I  $\alpha$ -chain, peptide, and  $\beta_2$ -microglobulin is required for dissociation of the MHC class I  $\alpha$ -chain from its chaperone. Tapasin is a transmembrane protein that tethers empty class I molecules in the endoplasmic reticulum to the transporter associated with antigen processing, TAP. Emerging evidence suggests that tapasin (and HLA-DM for MHC class II processing) retain unstable MHC molecules in peptide-loading compartments until they bind with high-affinity peptides. The assembled MHC class I-peptide complex transits the Golgi apparatus, proceeds in a vesicle to the cell surface, and is displayed on the cell surface after fusion of the vesicle membrane with the plasma membrane. Tapasin, therefore, promotes the surface expression of long-lived MHC-peptide complexes ( [55](#), [56](#) ). Defects in MHC class I and class II antigen-processing machinery have been found in association with malignant transformation ( [60](#) ). These may account, to some degree, for escape of tumor cells from T-cell recognition.



**Figure 74.2.** Presentation of intracellular antigens on class I major histocompatibility complex (MHC) products. Proteins synthesized within the cell are broken down to peptides in the proteasome. Resulting peptides are carried by the transporter associated with antigen processing (TAP) peptide transporter into the site of class I MHC product synthesis. There they are loaded, in the presence of tapasin, into the antigen presentation cleft of the MHC class I molecule. The antigen-MHC complexes are then exposed on the cell surface.

The nature of peptide antigens responsible for immune responses to tumors has been described in a classic set of experiments (48, 61, 62 and 63). In essence, two approaches were used. Neither made assumptions regarding the nature of the antigenic peptides. In the first approach, tumor-derived cloned cytolytic T lymphocytes (CTLs) were established. Next, a library of tumor complementary DNA or genomic DNA was constructed and used to transfect cells expressing appropriate MHC molecules but lacking the tumor-specific epitope. Transfected cells were tested for their ability to activate the tumor-specific CTLs. The transfected DNA was then recovered and sequenced, thus identifying the gene of origin (64). In the second approach, tumor-cell MHC molecules were isolated. Subsequently, peptides were eluted from the MHC molecules and fractionated chromatographically. These peptide fractions were then used to load antigen-presenting cells and presented to tumor-specific CTL. Peptide fractions that stimulated T-cell responses were then sequenced using conventional Edman degradation (65, 66) or tandem mass spectrometry (67, 68). These approaches have revealed some surprising characteristics of tumor-specific antigens. Most tumor-specific antigenic peptides, discovered thus far, have been derived from proteins not usually expressed in any normal adult tissues (69) (with the exception of testis), such as P1A (70, 71) and MAGE-1 (72, 73), or they represent differentiation antigens characteristic of the cellular lineage of the tumor, such as tyrosinase (74, 75 and 76), gp100 (68, 77, 78), and MART1/Aa (79, 80) in melanoma.

Early definition of tumor antigens focused on MHC class I-restricted peptides (81). This seemed to be the obvious approach because most tumors express MHC class I structures, but few express MHC class II molecules. Also, the point of immunotherapy was to eliminate tumors—a job for cytolytic cells (i.e., for CD8<sup>+</sup> cytotoxic lymphocytes that recognize antigen in the context of class I MHC molecules). Early clinical immunization trials (82, 83 and 84) demonstrated the feasibility and the potential efficacy of immunotherapy with peptides recognized by CD8<sup>+</sup> T cells. However, immune responses



were, in general, weak and short-lived. At the same time that the trials were being conducted, there was a growing realization of the importance of CD4<sup>+</sup> T cells in the immune response against tumors ( [85](#), [86](#) and [87](#)). Techniques, similar to those used to define antigens recognized by CTLs, have been used to define antigens for CD4<sup>+</sup> T cells. However, these techniques are slow and labor intensive. A genetic targeting expression system has been designed to expedite antigen screening ( [88](#)). It is likely that incorporation of both MHC class I- and II-restricted epitopes in tumor vaccines will be required to generate potent antitumor responses ( [89](#)).

While this direct approach to tumor antigen recognition has proceeded, other investigators have asked whether certain appealing target proteins could be immunogenic. In particular, molecules involved in the process of malignant transformation provide attractive targets for therapeutic intervention ( [90](#)). Because loss variants of tumor cells bearing these oncogenic proteins would presumably be nonmalignant ( [91](#)), an immunologic assault on these proteins might be particularly effective. Evidence has been provided that immune responses to both mutated and overexpressed oncogenic proteins can occur in patients with malignancy or can be elicited in animals. Target oncogenic proteins include mutated ras ( [92](#), [93](#), [94](#), [95](#) and [96](#)), Her-2/neu ( [97](#), [98](#)), bcr-abl ( [99](#), [100](#)), pml-RARa ( [101](#)), and mutated p53 ( [102](#)).

A new approach to definition of tumor-specific antigen targets for humoral immunity, termed *SEREX*, has been introduced ( [103](#), [104](#)). In the SEREX approach, a complementary DNA library is prepared from a patient's tumor specimen, packaged into phage vectors, and expressed in bacteria. Recombinant proteins from bacterial clones are transferred to nitrocellulose membranes and identified as relevant antigens by reactivity with immunoglobulin G (IgG) antibodies present in the patient's serum. Early studies defined three classes of antigens: (a) known tumor antigens, such as MAGE-1, MAGE-4a, and tyrosinase; (b) products of known genes, such as restin; and (c) unknown gene products ( [105](#), [106](#)). Because the cellular and humoral arms of immunity work in concert, it is likely that targets of antibody production will also prove to be targets of cellular immunity. The SEREX approach provides a direct approach to the definition of potentially relevant tumor antigens.

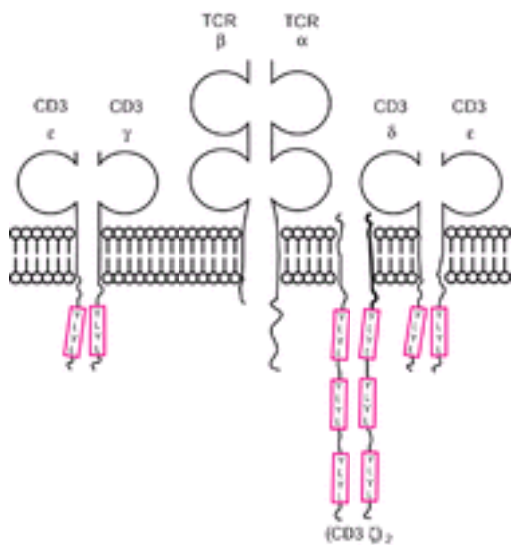
## T-Lymphocyte Activation and Response

The goal of antigen processing and presentation is the activation of appropriate T lymphocytes to proliferate, produce cytokines, and promote an immunologic reaction or become cytotoxic cells. The molecular basis of T-cell response has been elucidated since the 1980s. A number of groups contributed to the recognition of the T-lymphocyte antigen receptor, some using antibody detection ( [107](#), [108](#), [109](#) and [110](#)), others taking a genetic approach ( [111](#), [112](#) and [113](#)). This receptor is unique in that it does not recognize its ligand (antigen) in solution, but only in the context of an MHC molecule. Thus, T-cell responses are said to be restricted by products of the MHC ( [114](#)). The  $\alpha$  and  $\beta$  chains of the receptor, which have immunoglobulin-like domains, are sufficient for recognition of both the MHC molecule and the antigenic peptide. Although the interaction of T-cell antigen receptor and antigen-MHC provides specificity of response and initiates the crucial events of activation, the interactions are few and of low affinity ( [115](#)). The interaction between T-lymphocyte and antigen-presenting cell or target cell is initially stabilized by a number of nonspecific receptor-counterreceptor interactions ( [116](#)), leading to development of an immunologic synapse with its central supramolecular activation cluster ( [117](#)). Chief among these interactions is the coupling of CD2 on the T lymphocyte with lymphocyte function antigen-3 on the antigen-presenting cell. Also involved is the



interaction of the lymphocyte function antigen-1 molecule with intercellular adhesion molecule-1 and intercellular adhesion molecule-2. Once the cells have been apposed, the specific interaction of the T-cell antigen receptor and the antigen-MHC can occur. It now appears that the T cell proceeds toward activation only if certain threshold numbers of T-cell receptor (TCR)-MHC/antigen interactions occur ( [118](#) ).

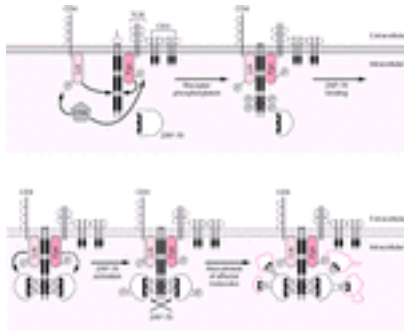
The T-cell antigen receptor is made up of a number of polypeptide chains ( [Fig. 74.3](#) ). The expression and aggregation of all of the subunit parts are required for membrane display of the receptor ( [119](#) ). The  $\alpha$  and  $\beta$  chains of the T-cell antigen receptor have very short intracytoplasmic portions that lack known signal transduction motifs. Therefore, the other components of the T-cell antigen receptor-CD3 complex are responsible for signal transduction. These chains include the immunoglobulin-like CD3- $\zeta$ , CD3-d, and CD3-e, which are arranged in heterodimers of  $\zeta$ -e and d-e, and the TCR- $\delta$  family of chains, which may be arrayed as  $\delta$ - $\delta$  homodimers or heterodimers of  $\delta$ - $\delta$ . Each of these chains contains one or more signal transduction motifs called *immunoglobulin receptor family tyrosine-based activation motifs* (ITAMs). These motifs have the structure (D/E)XXYXXLX<sub>7-8</sub>YXX(L/I) and were predicted to have important structural significance long before this fact could be demonstrated ( [120](#) ). In addition to the chains of the TCR-CD3 complex, the co-receptor CD4 and CD8 structures take part in the initial step of T-lymphocyte activation. These structures bind to nonpolymorphic portions of MHC class II and class I proteins, respectively.



**Figure 74.3.** Structure of the T-cell antigen receptor ( *TCR* ). Immunoglobulin-like antigen recognition units TCR- $\alpha$  and TCR- $\beta$  are associated with components of the CD3 complex, CD3- $\zeta$ , CD3-d, and CD3-e, arranged as heterodimers of CD3- $\zeta$ -CD3-e, and CD3-d-CD3-e, and with homodimeric TCR- $\delta$ . TCR- $\delta$  and the CD3 components contain multiple immunoglobulin receptor family tyrosine-based activation motifs characterized by YXXL-YXXL domains.

The earliest observable event of activation after ligation of the TCR is a wave of tyrosine phosphorylation ( [121](#) ) ( [Fig. 74.4](#) ). A number of nonreceptor protein tyrosine kinases (PTKs) are involved. Two members of the src kinase family are recruited immediately ( [122](#) ): pp56<sup>lck</sup>, which is physically associated with the CD4 or CD8 structures ( [123](#) ), and pp59<sup>fyn</sup>, which appears to associate directly with the TCR-CD3 complex ( [124](#), [125](#) ). Enzymatic

activity of these two PTKs is dynamically regulated by their phosphorylation state ( [126](#) ). Phosphorylation of the carboxy-terminal tyrosine of each PTK promotes a closed (inactive) conformation, the product of interaction between the phosphotyrosine and an SH2 domain. Phosphate transfer to the src family kinases is dependent on the cytoplasmic PTK, CSK ( [127](#) ). Dephosphorylation results from the action of the transmembrane protein tyrosine phosphatase, CD45 ( [128](#) ). Cell lines lacking CD45 exhibit markedly impaired T-lymphocyte activation, and animals lacking CD45 exhibit profound defects in thymocyte development and T-lymphocyte activation.



**Figure 74.4.** Activation of ZAP-70, a critical early event in T-lymphocyte activation. After antigen-major histocompatibility complex binding, the src-like protein tyrosine kinases (PTKs) pp56<sup>lck</sup> and pp59<sup>fyn</sup>, whose activation is regulated by CSK, phosphorylate tyrosine residues contained in the immunoglobulin receptor family tyrosine-based activation motifs (ITAMs) of T-cell receptor (TCR)- $\zeta$  and the CD3 components. Doubly phosphorylated ITAMs provide docking stations for the T-cell-specific PTK, ZAP-70. ZAP-70 activation depends on phosphorylation by the src-like PTKs and from cross-phosphorylation. Subsequently, scaffolding and effector molecules are recruited to the signalsome.

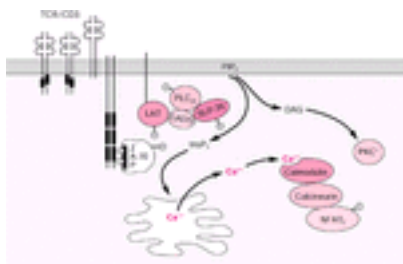
The Src family kinases are responsible for phosphorylation of the tyrosine residues within the ITAMs of the TCR- $\zeta$  chain and CD3 components. Tandemly phosphorylated tyrosines provide a docking site for the two SH2 domains of  $\zeta$ -associated protein, ZAP-70, a member of the syk family of PTKs ( [129](#), [130](#) and [131](#) ). Experiments in reconstituted systems suggest that the combination of an src-family PTK and the ZAP-70 (or syk) kinase is required for activation ( [129](#), [132](#) ). One variant of severe combined immunodeficiency syndrome has been associated with defects in ZAP-70 expression ( [133](#) ).

In addition to the src and syk families of PTKs, another family of PTKs, the Tec family, becomes activated after TCR engagement ( [134](#) ). These cytosolic PTKs contain pleckstrin homology domains that mediate interactions with membrane phospholipids, in addition to SH2, SH3, and kinase domains. Tec PTK knock-out mice exhibit abnormal T-lymphocyte activation ( [135](#) ).

Activation of ZAP-70 leads to recruitment of two scaffolding molecules to the receptor complex or signalsome ( [136](#), [137](#) and [138](#) ). These scaffolds provide sites on which many SH2-containing proteins can assemble. Among the signaling molecules known to associate with the signalsome are pp59<sup>fyn</sup> ( [124](#), [125](#) ), syk kinase, phospholipase C-1 (PLC-1) ( [139](#) ), PI3-kinase (PI3-K) ( [140](#) ), FAK-related PTK ( [141](#) ), Grb2 ( [142](#), [143](#) ), vav ( [144](#) ), and cbl ( [145](#) ). The first scaffold, LAT (linker of activated T cells) is a 36-kd integral membrane protein ( [146](#), [147](#) ). Its cytoplasmic tail contains several tyrosine residues arrayed appropriately to

bind the SH2 domains of other proteins. After stimulation, LAT becomes associated with Grb2, GADS, PLC- $\gamma$ , and PI3-K. LAT-deficient cell lines fail to transmit activation signals beyond ZAP-70 phosphorylation (148). Knock-out mice lacking LAT demonstrate abnormal T-lymphocyte development, reduced numbers of thymocytes, and absence of T cells in peripheral lymphoid organs (149). The second, SLP-76 participates in multiple, complex interactions with PLC $\gamma$  and LAT (150), and with vav (see below).

Several signaling pathways proceed from the activation of ZAP-70. The first described and best understood of these involves changes in inositol lipid metabolism (Fig. 74.5). PLC $\gamma$  becomes tyrosine phosphorylated and activated (151) as it associates with a 36-kd membrane protein, LAT (138, 139). Activation of PLC $\gamma$  leads to the hydrolysis of a minor membrane lipid, phosphatidylinositol bisphosphate (PIP<sub>2</sub>), to yield inositol trisphosphate (InsP<sub>3</sub>) and diacylglycerol (DAG) (152). Each of these products activates downstream events. InsP<sub>3</sub> leads to release of intracellular stores of calcium (153), whereas DAG activates the serine-threonine kinase protein kinase C (PKC). PKC- $\zeta$  plays a central role in T-cell activation (154). After engagement of the TCR, PKC- $\zeta$  translocates to the supramolecular activation complex (155). Peripheral T cells in PKC- $\zeta$ -deficient mice fail to activate nuclear factor- $\kappa$ B (NF $\kappa$ B) and AP-1, and fail to produce interleukin-2 (IL-2) (156).

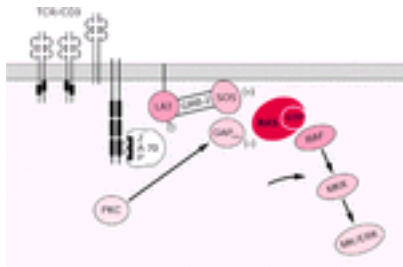


**Figure 74.5.** Calcium-dependent pathway of T-lymphocyte activation. Phospholipase C $\gamma$ -1 (PLC $\gamma$ -1) becomes associated with the T-cell receptor (TCR)-CD3-associated signalsome through complex interactions of LAT (linker of activated T cells), GADS, and SLP-76, and is activated by tyrosine phosphorylation. PLC $\gamma$ -1 catalyzes the hydrolysis of a phosphatidylinositol bisphosphate (PIP<sub>2</sub>) to the second messenger molecules, InsP<sub>3</sub> and diacylglycerol (DAG). DAG activates protein kinase C (PKC). Inositol trisphosphate (InsP<sub>3</sub>) releases intracellular stores of calcium. Increased intracellular calcium activates calmodulin and ultimately the cytoplasmic phosphatase calcineurin. Calcineurin action on the nuclear factor of activated T cells (NFAT $\zeta$ ) allows its translocation to the nucleus, where it serves a critical role in cytokine gene expression.

At the same time, phosphatidylinositol 3-kinase (PI3K) becomes tyrosine phosphorylated and activated (157). PI3K catalyzes the phosphorylation of phosphoinositides on the 3' position of the inositol ring, yielding PtdInsP, PtdInsP<sub>2</sub>, and PtdInsP<sub>3</sub>. These phosphorylated phosphoinositides are involved in regulation of several cytosolic serine/threonine kinases (158). Full activation of PI3K requires co-stimulation (described in section [Exploitation of Co-Stimulation](#)) (159).

Coupling of TCR occupancy and PTK activation to downstream events appears to be dependent on a number of adaptor proteins, the prototype of which is Grb2 (147). This

molecule is made up of two SH3 domains and one SH2 domain, the function of each being protein interaction. Grb2 couples the mammalian SOS (son of sevenless, mSOS) to the activation complex ( [142](#) ) ( [Fig. 74.6](#) ). Two pure adaptor molecules are particularly important in T-lymphocyte activation. GADS, a Grb2 family member, joins LAT to SLP-76 ( [137](#) ) ( [Fig. 74.5](#) ) and interacts with a Tec family kinase ( [160](#) ). The Src-like adaptor protein, SLAP, associates with CD3 $\zeta$ , ZAP-70, SLP-76, vav, and LAT. SLAP is involved in TCR endocytosis and is a negative regulator of TCR signaling ( [161](#), [162](#) ).



**Figure 74.6.** Ras-dependent pathway of T-lymphocyte activation. Through a series of scaffolding and adaptor molecules, the guanine nucleotide exchange factor, SOS, becomes associated with the signalsome. SOS positively regulates the g-protein, Ras. Simultaneously, activated protein kinase C (PKC) reduces the negative regulatory effects of guanosine triphosphatase activating protein of ras ( $GAP_{ras}$ ). Ras activation drives a cascade of mitogen-activated protein kinase activity, leading toward the nucleus. GTP, guanosine triphosphate; LAT, linker of activated T cells; MK, MAP kinase; MKK, MAP kinase kinase; TCR, T-cell receptor.

mSOS is a guanine nucleotide exchange factor that, when interacting with ras, promotes activation of ras in the guanosine triphosphate (GTP)-bound state ( [163](#) ) ( [Fig. 74.6](#) ). Ras activation also results from the negative regulatory influences on the guanosine triphosphatase activating protein of ras ( $GAP_{ras}$ ) ( [164](#) ).  $GAP_{ras}$  stimulates the enzymatic activity of ras to dephosphorylate GTP, leaving ras in the guanosine diphosphate-bound, or inactive, state. Although  $GAP_{ras}$  is a target of tyrosine phosphorylation in T cells, negative regulation of  $GAP_{ras}$  appears to result from a PKC-dependent interaction ( [165](#) ). Activation of ras sets off one or more cascades of mitogen-activated protein (MAP) kinase activity ( [166](#) ) ( [Fig. 74.6](#) ). The best characterized of these cascades involves the ras proximal protein kinase, raf, which acts as a MAP kinase kinase, activating the MAP kinase kinase MEK 1/2, which in turn activates the MAP kinase ERK 1/2. MAP kinases positively regulate the activities of several transcription factors, leading to increased production of the components of the AP-1 transcription complex ( [167](#) ).

Another phosphoprotein appears to play an important role in early T-lymphocyte signaling. The product of the protooncogene, vav, is a 95-kd protein that has been associated with ZAP-70 ( [168](#) ) and SLP-76. This remarkable protein contains two SH3 domains, an SH2 domain, a cysteine-rich domain that forms zinc fingers, a pleckstrin homology domain, and a guanine nucleotide exchange factor domain. Vav-deficient mature B and T lymphocytes from chimeric mice derived from blastocysts lacking the recombinase-activating gene and embryonic stem cells deficient in vav expression show profound defects in proliferation and cytokine production ( [169](#), [170](#) ). Vav increases IL-2 expression ( [168](#) ).

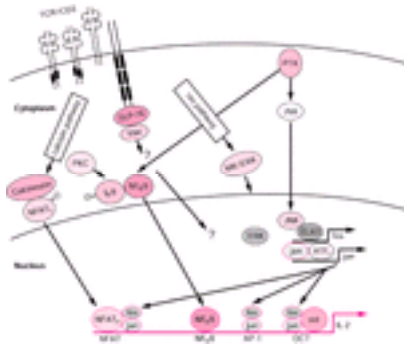
The previously described increases in intracellular calcium and production of DAG

contribute to the activation of PKC. PKC activation directly or indirectly activates phospholipase D, tapping a large reservoir of membrane lipid for further production of DAG from phosphatidic acid resulting from the action of phospholipase D on phosphatidylcholine ( [171](#), [172](#) ). PKC also plays an important part in the activation and translocation of the transcription factor NF- $\kappa$ B by the targeted phosphorylation of its cytoplasmic inhibitor, I- $\kappa$ B ( [173](#) ), and in the activation of MAP kinases ( [174](#) ).

Increased intracellular calcium concentration, through the multipurpose calcium receptor calmodulin, regulates the action of a cytoplasmic phosphatase, calcineurin ( [175](#) ). Calcineurin action on the cytoplasmic form of the nuclear factor of activated T cells (NFAT<sub>c</sub>) allows its translocation to the nucleus as NFAT<sub>n</sub>. The critical nature of calcineurin action is underlined by the observations that calcineurin is the target of the immunosuppressive actions of cyclosporine and FK506 bound to their cytoplasmic binding proteins ( [176](#) ). There is evidence that cytoplasmic-to-nuclear shuttling of NFAT<sub>c</sub> family members determines the duration of TCR occupancy necessary for IL-2 production ( [177](#) ).

The net result of this extremely complex activation system is the expression of new proteins, the acquisition of functional capacity, or the ability to proliferate. Recycling TCR- $\zeta$  chains and bound ZAP-70 appear to relocate and associate with elements of the cytoskeleton ( [178](#) ). These observations suggest that these components of the T-cell signaling mechanisms may play an important part in the reorganization of cellular structures required for change of function in cytotoxic cells and also correlate with the ability of cells to produce IL-2 and proliferate.

T-lymphocyte activation is best understood as a culmination of events leading to IL-2 production ( [179](#) ) ( [Fig. 74.7](#) ). The constraints on production of this cytokine are more rigorous than those relevant for production of other gene products (such as IL-2 receptor  $\alpha$ -chain and transcription factors). The promoter of the IL-2 gene is made up of a number of binding sites for transcription factors, including two NFAT sites, an NF- $\kappa$ B site, and an AP-1 site ( [180](#) ). Fos and jun components of AP-1 produced primarily as a result of the MAP kinase pathways bind to the AP-1 site. In addition, these components associate with NFAT<sub>n</sub>, which has translocated to the nucleus after dephosphorylation by calcineurin, to occupy the NFAT sites. The NF- $\kappa$ B site is occupied by the NF- $\kappa$ B liberated from its inhibitor by the action of PKC. The combination of production of IL-2 receptor  $\alpha$ -chain and IL-2 provides an adequate stimulus for the T lymphocyte to successfully proliferate, giving rise to the antigen-specific clonal expansion of lymphocytes characteristic of immunologic responses. However, there are extraordinary controls against inappropriate activation of T lymphocytes ( [181](#) ). In addition to a first signal delivered via the T-cell antigen receptor complex, full activation of T cells also requires a second signal ( [182](#) ). The best characterized origin of these second signals is the interaction of CD28 on the T-lymphocyte surface with its cognate ligand, CD80 (B7) on the antigen-presenting cell, the most potent of which is the dendritic cell. Failure to receive a second signal can lead the T lymphocyte to anergy or apoptosis.



**Figure 74.7.** Overview of T-lymphocyte activation leading to cytokine production and proliferation. The calcium-dependent and Ras-dependent activation pathways, in association with vav-dependent pathways and synergizing with signals emanating from CD28, converge in the nucleus, providing a number of transcription factors required for new gene expression. ERK, extracellular signal-regulated kinase; I- $\gamma$ B, inhibitor- $\gamma$ B; IL-2, interleukin-2; JNK, jun kinase; MK, MAP kinase; NFAT<sub>c</sub>, nuclear factor of activated T cell; NFAT<sub>n</sub>, nuclear factor of activated T-cell nucleus; NF- $\kappa$ B, nuclear factor- $\kappa$ B; PKC, protein kinase C; PTK, protein tyrosine kinase; TCR, T-cell receptor.

Defects in T-cell signaling associated with loss of TCR- $\gamma$  protein have been described in patients with neoplasms (183, 184). TCR- $\gamma$  is a substrate for caspase 3 and caspase 7 (185) as well as granzyme B (186). Loss of TCR- $\gamma$  in tumor-infiltrating lymphocytes (TILs) is predictive of poor outcome for the patient from whom the tumor was taken (183). Loss of TCR- $\gamma$ , signaling abnormalities, reduced proliferation, and apoptosis were associated with high levels of Fas ligand expression in the tumor (184).

## APPROACHES TO IMMUNOTHERAPY

### Antibody Approaches

**UNCONJUGATED ANTIBODIES** Unaltered antibodies have been used since the earliest trials of monoclonal antibody therapy in humans (187, 188 and 189). In early trials, success was limited by the absence of suitable tumor cell-surface targets, antigenicity of first generation (murine) monoclonal antibodies in humans, modulation of the target structure from the tumor cell surface, and poor recruitment of immune effector mechanisms (190, 191). However, enthusiasm for this approach was rekindled by the enormous success of genetically engineered, chimeric, or fully humanized versions of monoclonal antibodies, most notably rituximab for lymphoid malignancies and trastuzumab in solid tumors (191). Rituximab is a chimeric monoclonal antibody with humanized framework and Fc regions. It is directed against the CD20, pan B-cell antigen. CD20 is present on pre-B cells and mature B cells, but not on precursor cells or terminally differentiated plasma cells. The function of CD20 remains poorly understood (192), although it has been implicated in B-cell activation, regulation of B-cell growth, and regulation of transmembrane calcium flux. The antibody fixes human complement and elicits antibody-dependent cellular cytotoxicity. Rituximab was approved for use as monotherapy in patients with low-grade or follicular CD20<sup>+</sup> non-Hodgkin lymphoma (NHL). The pivotal study, involving 166 patients, was reported by McLaughlin et al. (193). All patients had relapsed or chemotherapy-resistant disease that, in the opinion of the treating physician, required antilymphoma therapy. The study excluded patients with chronic lymphocytic leukemia and patients with extremely bulky disease (larger than 10 cm diameter). Patients received four weekly infusions of rituximab at 375 mg/m<sup>2</sup>. In this patient population, rituximab



produced a tumor response in one-half of the patients. Median duration of response was 11.8 months, comparable to the patients' response duration on the last chemotherapy treatment. Human antichimeric antibody responses were uncommon. The most common adverse experience associated with rituximab was a constellation of acute infusion-related events, including chills, fever, headache, rhinitis, pruritus, vasodilation, asthenia, and angioedema. This syndrome can progress to hypotension, urticaria, bronchospasm, and, rarely, death. The risk is particularly great in patients with high circulating white cell counts ( [194](#) ). Other toxicities were, in general, mild and infrequent ( [195](#) ). Neutropenia and thrombocytopenia were unusual. Eighty-six percent of patients had no cytopenias. Circulating B cells were depleted and remained low until recovery at a median of 12 months. Immunoglobulin levels, however, remained normal. No increased incidence of infections was seen. Rituximab was evaluated again in the relapsed, refractory, low-grade or follicular NHL patient population, using eight weekly infusions rather than four ( [196](#) ). This extended regimen produced a response rate of 57% and a time to progression (TTP) in responding patients of more than 19.4 months. Adverse event reporting was commensurate with the longer treatment period. No unexpected toxicities were noted. The use of rituximab has quickly spread to other clinical situations. Davis et al. ( [197](#) ) reported results of the standard four-infusion regimen in patients with low-grade or follicular NHL who had bulky disease. The antibody produced a response rate of 43% and a TTP of 8.1 months in the patients with a significant poor prognostic factor. This is an important observation, as antibody penetration into bulky tumors had been a concern. Davis et al. ( [198](#) ) also reported on the use of rituximab as retreatment in patients who had progressed after an initial response to rituximab. Rituximab produced an overall response rate (ORR) of 40%. Estimated median TTP for responding patients was 17.8 months. The safety profile of the antibody in retreatment was not different than that associated with first treatment. Rituximab has been used in the first-line treatment of patients with low-grade lymphoma, both as monotherapy and in combination with chemotherapy. Hainsworth ( [199](#) ) reported the results of rituximab as monotherapy in 39 previously untreated patients. Patients received rituximab  $\times$  4 at the usual dose and schedule. Response was evaluated at week 6. At that time, 54% of patients were noted to be in response. Patients who had responded or who had stable disease were treated with an additional four weekly treatments of rituximab at 6-month intervals to a maximum of four treatment cycles. The ORR rose to 72% after the second course of treatment. Progression-free survival at 1 year was 77%. Toxicities were as expected. The addition of rituximab to cyclophosphamide, hydroxydaunomycin, Oncovin (vincristine), and prednisone (CHOP) chemotherapy produced impressive results. Patients were treated with six infusions of rituximab, one associated with each of six cycles of CHOP. In 40 patients with newly diagnosed (N = 31) or relapsed/refractory (N = 9) low-grade or follicular NHL, rituximab plus CHOP produced an ORR of 95%, complete response (CR) rate of 55%. With a median follow-up of 29 months, median duration of response and median TTP had not been reached. Eight of 18 patients tested for the bcl-2 (t(14;18)) translocation by polymerase chain reaction (PCR) testing were positive at initiation of therapy. Seven of these eight patients, after therapy, became negative for the translocation. The authors concluded that the addition of rituximab to CHOP produced benefits in efficacy parameters without significant additional toxicity. Elimination of PCR positivity for the t(14;18) translocation had not been previously reported with CHOP alone. Rituximab also has been used with success in patients with more aggressive lymphomas. Vose et al. ( [200](#) ) reported the results of rituximab plus CHOP chemotherapy (again using six infusions of rituximab in association with six cycles of CHOP) in 33 previously untreated patients with advanced aggressive (Working Formulation types D to H, excluding patients with mantle cell lymphoma, lymphoblastic lymphoma, and Burkitt lymphoma) B-cell NHL. The combination produced an ORR of 94% and a CR rate of 61%. With a median observation time of 26 months, 29 of 31 patients achieving a remission were in continuing remission at the time of the report. Thirteen patients were bcl-2 positive at study entry. Eleven of these 13 patients became bcl-2 negative after treatment, and 10 of the 11 remained bcl-2 negative. The authors concluded that the results were achieved without significant



added toxicities above those expected with CHOP. The Groupe d'Etude des Lymphomes de l'Adulte undertook a study to compare the utility of CHOP with that of rituximab plus CHOP in elderly patients with diffuse B-cell lymphoma ( [201](#) ). The elderly were chosen for study because though CHOP is the standard of care for initial therapy of younger patients with aggressive lymphoma, it induces complete remissions in only 40 to 50% of elderly patients, with a 3-year event-free survival of 30%. Attempts to increase CHOP efficacy in this population by adding other cytotoxic drugs had been unsuccessful. Patients between the ages of 60 and 80 years with untreated, diffuse large B-cell lymphoma were eligible for the study. Patients were randomly assigned to receive eight cycles of CHOP chemotherapy (197 patients) or to receive eight cycles of CHOP, each given after an infusion of rituximab (202 patients). Rituximab plus CHOP produced a superior rate of remission, 76% versus 63% (  $p = .005$  ). With a median follow-up of 2 years, event-free and overall survivals were significantly higher in the rituximab plus CHOP group (  $p < .001$  and  $p = .007$ , respectively). These results were achieved without a significant incremental increase in toxicity. The addition of rituximab to CHOP reduced the risk of treatment failure [risk ratio, 0.54; 95% confidence interval (CI): 0.44, 0.77] and the risk of death (risk ratio, 0.64; CI: 0.45, 0.89). The addition of immunotherapy to standard chemotherapy had accomplished what 25 years of chemotherapy manipulation had failed to do (i.e., improve on the results of CHOP chemotherapy) ( [202](#), [203](#) ). Rituximab has been used with limited success in patients with multiple myeloma ( [204](#), [205](#) and [206](#) ). This lack of success might be expected given the limited expression of CD20 on plasma cells, although the possibility of affecting proliferating precursor cells made trials worthwhile. The suggestion that a subset of patients with CD20 expression on bone marrow plasma cells may benefit from rituximab is provocative ( [206](#) ). The mechanism by which rituximab produces these impressive results is less clear. A number of possible mechanisms have been considered: initiation of complement-mediated cell lysis, induction of antibody-dependent cellular cytotoxicity, and signaling via CD20 leading to programmed cell death and/or sensitization to cytotoxic drugs. Indeed, there is no reason to believe that only a single mechanism is operative. There is, however, some evidence to suggest that induction of complement-mediated lysis may play a less important role. Pretreatment lymphoma cells from 29 patients were examined by flow cytometry for expression of complement inhibitors CD46, CD55, and CD59 ( [207](#) ). Expression of these cell-surface inhibitors of complement activation was not predictive of outcome to rituximab therapy. The authors point out that these data do not rule out a role for complement fixation in the genesis of the B-cell depletion or the side effects profile of the antibody. Considerable evidence suggests that induction of antibody-dependent cellular cytotoxicity plays an important role in rituximab's antilymphoma effects. A rituximab-like antibody for which an IgG4? framework was substituted for the IgG1 framework of rituximab was incapable of producing B-cell depletion in primates ( [208](#) ). Rituximab was relatively ineffective in eliminating Raji B-cell implants in FcR? <sup>-/-</sup>/nu/nu knock-out mice compared to nu/nu mice ( [209](#) ). These mice lack the activating receptor for Fc portions of antibodies, a critical component of the antibody-dependent cell-mediated cytotoxicity mechanism. In patients, response to rituximab has been shown to be associated with homozygosity for the high-affinity allotype of the Fc?RIIIa receptor ( [210](#) ). Evidence also exists that rituximab signaling or interference with normal signaling via CD20 may directly induce apoptosis or sensitize cells to the deleterious effects of chemotherapeutic agents ( [211](#) ). A direct, growth inhibitory effect of rituximab, with accompanying apoptosis, on cell lines cultured in the absence of complement was demonstrated ( [212](#) ). Anti-CD20-associated apoptosis has been associated with up-regulation of the pro-apoptotic protein, Bax ( [213](#) ), and down-regulation of antiapoptotic protein Bcl-2 through inactivation of signal transducer and activation of transcription (STAT) 3 ( [214](#) ). Down-regulation of STAT3 appears to be a result of down-regulation of an IL-10 autocrine pathway ( [215](#) ). These changes and/or others may be responsible for increased sensitivity to chemotherapeutic agents ( [216](#) ). In the wake of the stunning success of rituximab, a number of other

antilymphoma monoclonal antibodies have entered the clinic ( 217 ). Alemtuzumab is a humanized IgG1 monoclonal antibody directed against the CD52 cell-surface antigen. Precursors of the molecule were among the first monoclonal antibodies to be explored in humans. However, development in rheumatoid arthritis was abruptly abandoned when substantial acute toxicity and significant immunosuppression were encountered without substantial efficacy ( 191 ). CD52 is expressed on normal and malignant lymphocytes of B- and T-cell lineage, as well as NK cells, monocytes, and macrophages. Alemtuzumab is indicated for the treatment of B-cell chronic lymphocytic leukemia in patients who have been treated with alkylating agents and who have failed fludarabine therapy. The pivotal clinical trial was carried out in 93 patients with fludarabine-refractory chronic lymphocytic leukemia ( 218 ). Alemtuzumab produced a response rate of 33%. Virtually all of the responders were partial responders; the CR rate was 2%. Median duration of response was 7 months. Median TTP was 4.7 months for the group as a whole; 9.5 months for responders. The most common adverse events were infusion related—most were grade 1 or 2 in severity, including rigors in 90% of patients (grade 3 in 14%), fever in 85% of patients (grade 3 or 4 in 20%), nausea in 53% of patients, and vomiting in 38% of patients. Infusion-associated side effects declined with subsequent infusions. During the study, 28% of patients experienced dyspnea, 17% experienced hypotension, and 3% experienced hypoxia. Overall, 55% of patients developed an infection during the study. Approximately one-half of these infections were considered serious (grade 3 or 4). Septicemia occurred in 15% of patients, and two deaths resulted. Opportunistic infections occurred in 12% of patients. Ten percent of patients died during or within 30 days of treatment—one-third of these were attributed to progressive disease. Twenty-four percent of patients discontinued treatment because of a drug-related side effect. Most patients who discontinued had not responded to therapy. Serious infusion-related events associated with alemtuzumab appear to result from ligation of CD16 on NK cells resulting in what has been termed *cytokine storm*—release of IL-6, tumor necrosis factor- $\alpha$ , and interferon- $\gamma$  ( 219 ). Prolonged immunosuppression after use of alemtuzumab can result in opportunistic infections ( 220 ). Treatment schemas now use the routine use of prophylaxis with both antibiotics and antivirals. Two other monoclonal antibodies with potential utility in the treatment of lymphoma are in early clinical development ( 217 , 221 ). Epratuzumab is a humanized IgG1 monoclonal antibody directed against the CD22 antigen. CD22 is a pan B-cell antigen with distribution similar to that of CD20. Epratuzumab has a favorable safety profile in early trials. Approximately 50% of follicular lymphoma patients and 25% of diffuse large-cell lymphoma patients responded in a small phase II trial. Some of the responses have been long-lived. Apolizumab is a humanized IgG1 monoclonal antibody that binds to a variant of the HLA-DR  $\beta$ -chain. The antibody induces complement-mediated lysis, antibody-dependent cellular cytotoxicity, and tyrosine phosphorylation signaling events in cell lines *in vitro*. The antibody binds to approximately 70% of lymphoma specimens. Administration of the antibody to patients results in typical infusion-related side effects. Four of eight patients with follicular lymphoma responded to apolizumab.

**ANTIIDIOTYPE THERAPY** Much time and energy were expended searching for tumor antigens, particularly after the development of monoclonal antibody techniques ( 17 ). These brute-force immunization, hybridization, and screening procedures yielded little. They defined only a single truly tumor-specific antigen. That was the idiotype of clonally distributed antibody expressed on the surface of certain B-cell lymphomas. Because it represents a unique protein structure within the combining site of antibody, the idiotype can serve as an antigen for antibody production. This fact was demonstrated by Sirisinha and Eisen ( 222 ) in the early 1970s. Furthermore, they demonstrated that an immunologic response to idiotype could lead to tumor protection ( 223 ). Levy and Miller ( 224 ) have explored the utility of antiidiotype strategies in indolent B-cell lymphoma over many years. Initially, these investigators raised custom-made antiidiotype monoclonal antibodies ( 225 ) for passive administration. A first patient with far advanced, chemotherapy-refractory disease received antiidiotype monoclonal antibodies. Gradual

reductions in serum idiotype and tumor volume were noted. The patient then entered a long-term complete remission ( [226](#) ). In an initial series of patients treated with antiidiotype therapy, 11 patients were reported ( [227](#) ). In this group, a second near-complete remission, four partial remissions, and five insignificant responses were seen. There was little toxicity associated with administration of the antiidiotype antibodies. The most common side effects were chills and fever. Transient shortness of breath, headache, nausea, emesis, diarrhea, and myalgias were occasionally observed. Unusual toxicities included transient leukopenia or thrombocytopenia and transient elevations of hepatic enzymes. Several interesting problems of antiidiotype therapy were noted in this early series: the interfering effect of circulating idiotype, the development of human antimouse antibody, and the emergence of idiotype-negative tumor cell variants ( [228](#), [229](#), [230](#) and [231](#) ). An attempt to reduce the incidence of emergence of idiotype-negative lymphoma variants with a short course of chlorambucil was unsuccessful ( [232](#) ). The cumulative experience suggests that antiidiotype therapy can result in a 15% CR rate and a 50% partial response rate. The mechanism of tumor response in these trials remains unclear. However, response in these trials correlated with antiidiotype-induced signal transduction events in the lymphoma cells, suggesting that activation of apoptotic pathways may lead to lymphoma cell death after interaction of the antiidiotype antibody with the lymphoma surface-bound immunoglobulin receptor ( [233](#) ). This group has turned to active immunization strategies in indolent lymphoma (see [Immunization Strategies](#) section).

**RADIOIMMUNOTHERAPY** The use of immunoglobulin-radionuclide conjugates in cancer treatment represents appropriation of a classic guided-missile strategy. In theory, the antibody homes to its antigenic target and delivers a cytotoxic assault on the cell to which it attaches. Radionuclides offer certain advantages over other cytotoxic agents. They do not have to be internalized. Radioactive particles can deliver their effects over distances of 1 to 5 mm, thus limiting collateral damage to normal tissues while still potentially providing antitumor effects against antigen-negative variants in the vicinity in what has been termed a *cross-fire effect*. The principles of radiation physics underlying radioimmunotherapy have been reviewed by Press and Rasey ( [234](#) ). Radiolabeled antibodies deliver continuous, exponentially decreasing, low-dose-rate radiation. Traditional external beam radiotherapy delivers intermittent, fractionated radiation at higher dose rates. The most commonly used isotopes for radioimmunotherapy have been iodine 131 and yttrium 90. These radionuclides kill cells primarily through emission of  $\beta$  particles, resulting in DNA strand breaks. The  $\beta$  particles of yttrium 90 are more energetic than those of iodine 131. They affect cells in a radius of approximately 5 mm compared to approximately 1 mm for those of iodine 131. Iodine 131 also emits  $\gamma$  rays. This allows direct imaging of the distribution of the radioconjugate but raises issues regarding shielding and health care worker and family member safety. This field is poised on the threshold of widespread use, with one agent approved for use and others apparently close behind. Several recent reviews attest to the emergence of this field ( [217](#), [235](#), [236](#) and [237](#) ). A number of theoretical and experimentally generated concerns with radioimmunotherapy appear to have been overcome in the successful clinical studies described below. There had been concern that effective delivery of radioimmunoconjugates would be impeded by heterogeneous tumor vasculature, slow diffusion of these large molecules in interstitial spaces, heterogeneous biodistribution in tumor nodules, and high intratumoral pressures. The two products in the most advanced stages of development, yttrium Y 90 ibritumomab tiuxetan and iodine I 131 tositumomab, are both directed against the anti-CD20 antigen of B lymphocytes, the same structure targeted by rituximab. Both products are based on murine monoclonal antibodies. Both are administered after infusion of unconjugated anti-CD20 antibodies—rituximab in the case of yttrium 90 ibritumomab tiuxetan and tositumomab in the case of iodine I 131 tositumomab. Both use nuclear medicine imaging as a preparatory step to administration. Biodistribution of yttrium 90 ibritumomab tiuxetan is predicted by scans taken after administration of indium 111 ibritumomab tiuxetan. Simple dosimetry is accomplished for iodine I 131 tositumomab by capturing whole-body gamma counts after infusion of a 5 mCi “dosimetric dose” of the agent. Imaging is carried

out in yttrium 90 ibritumomab tiuxetan-treated patients to assure normal biodistribution. Whole-body dosimetry is carried out in iodine I 131 tositumomab-treated patients to allow calculation of a patient-specific activity (mCi) to deliver a desired total-body dose of radiation (cGy). Both have been studied most extensively in indolent lymphoma. Yttrium Y 90 ibritumomab tiuxetan was recently approved for the treatment of patients with relapsed or refractory low-grade, follicular, or transformed B-cell NHL, including patients with rituximab refractory follicular NHL. The approval for ibritumomab tiuxetan rested primarily on two clinical studies. The first was a randomized controlled comparison of the effectiveness of yttrium 90 ibritumomab tiuxetan to that of rituximab in patients with relapsed or refractory low-grade, follicular, or transformed B-cell NHL ( [238](#) ). The study involved 143 patients; 73 randomized to yttrium 90 ibritumomab tiuxetan (single administration), and 70 randomized to rituximab (weekly  $\times$  4). Patient characteristics were balanced between the arms. Median number of prior therapies was two. Approximately one-half of the patients failed to respond to or had a TTP of less than 6 months to their last chemotherapy regimen. Yttrium 90 ibritumomab tiuxetan produced a statistically superior response rate (using the response definitions of the International Workshop), 80% versus 56% ( $p = .002$ ). The number of durable responders at 6 months favored yttrium 90 ibritumomab tiuxetan-treated patients, but the significance of the observation was lost at 9 months and 12 months. Median TTP (estimated by Kaplan-Meier methods) was 11.2 months for patients treated with yttrium 90 ibritumomab tiuxetan and 10.1 months for patients treated with rituximab ( $p = .173$ ). Grade 3 and 4 nonhematologic adverse events were unusual in both groups. Yttrium 90 ibritumomab tiuxetan produced grade 3 or 4 neutropenia in 57% of patients, grade 3 or 4 thrombocytopenia in 60% of patients, and grade 3 or 4 anemia in 2% of patients. One patient in the yttrium 90 ibritumomab tiuxetan-treated group developed myelodysplasia. One patient in the rituximab-treated group developed pancreatic carcinoma. The second trial was a phase II experience in 57 patients who had failed to respond to rituximab or had a TTP of  $\leq$  6 months ( [239](#) ). These patients had a median of four prior therapies, and 74% had bulky tumors (greatest diameter  $\geq$  5 cm). In this patient population, yttrium 90 ibritumomab tiuxetan produced a response rate of 74% and CR rate of 15%. The median TTP was estimated at 6.8 months. Grade 4 neutropenia occurred in 35% of patients, grade 4 thrombocytopenia in 9% of patients, and grade 4 anemia in 4% of patients. An extensive experience with iodine I 131 tositumomab also has been reported. The pivotal study enrolled 60 patients with refractory low-grade or transformed low-grade NHL who had been treated with at least two different qualifying chemotherapy regimens ( [240](#) ). Patients must also have failed to achieve an objective response or relapsed within 6 months after completion of their last qualifying chemotherapy (LQC) regimen. The patients in this study had multiple poor prognostic characteristics, including median age of 60 years and a median of four prior chemotherapies, as well as clinical conditions such as presence of bulky disease, bone marrow involvement, elevated serum lactate dehydrogenase, advanced stage, and transformation from an initial low-grade histology to a higher-grade histology in 38% of the patients. The primary endpoint was a comparison of the number of patients having a longer duration of response after iodine I 131 tositumomab therapy to the number of patients having a longer duration of response after their LQC regimen. Secondary efficacy endpoints included ORR, CR rate, and TTP. A statistically significant improvement in the primary endpoint was achieved: there were significantly more patients with a longer duration of response ( $>30$  days) after iodine I 131 tositumomab therapy ( $N = 26$ ) than patients with a longer duration of response after their LQC ( $N = 5$ ;  $p < .001$ ). Improvements in secondary efficacy endpoints after iodine I 131 tositumomab compared to those after LQC were also achieved: overall response (47% vs. 12%;  $p < .001$ ), duration of response (11.7 vs. 4.1 months;  $p < .001$ ), and CR (22% vs. 2%;  $p = .002$ ). Fifteen of 60 (25%) patients were classified as long-term responders (patients with a MIRROR Panel-assessed TTP of a year or more). Nine (15%) of the 60 patients are still in CR, with TTP ranging from 41+ to 57+ months. A second trial examined the incremental benefit of the radioconjugate (iodine I 131 tositumomab) compared to the nonradioactive antibody (tositumomab) ( [241](#) ). This study was a randomized, two-arm, open-label, multicenter study that enrolled patients with chemotherapy-relapsed or refractory low-grade or



transformed low-grade NHL. Patients were randomized to receive either iodine I 131 tositumomab therapy or unlabeled tositumomab alone. The primary endpoint was a comparison of the rates of CR. Secondary endpoints included ORR, duration of responses, and TTP. A total of 78 patients (18% with transformation) participated in the study. Patients had been previously treated with one to three chemotherapy regimens. One or more therapies must have included an anthracycline, anthracenedione, or alkylating agent. A significant difference was observed for the primary efficacy endpoint. The CR rate was 33% (14 of 42 patients) for the patients treated with iodine I 131 tositumomab compared to 8% (3 of 36) for patients treated with unlabeled tositumomab ( $p = .012$ ). In addition, the ORR was greater after treatment with iodine I 131 tositumomab: 23 of 42 (55%) patients compared to 7 of 36 (19%) patients ( $p = .002$ ). Nineteen patients initially treated with the unlabeled antibody crossed over to receive iodine I 131 tositumomab after disease progression. A CR then was observed in 42% (8 of 19 patients) and an ORR in 68% (13 of 19 patients) in the crossover patient population. A total of 20 patients (33%) from the iodine I 131 tositumomab-treated populations, including patients in the crossover arm, were classified as having a long-term response, including ten patients continuing in CR, with TTP ranging from 23+ to 59+ months. The efficacy of iodine I 131 tositumomab was also evaluated in patients who had progressed after rituximab ( [242](#) ). The objectives of the study were to assess the response rate, duration of response, and safety of iodine I 131 tositumomab therapy in patients whose disease had not responded or had progressed soon after rituximab therapy. Forty-three patients were enrolled in the study, and 40 patients received the study drug. All patients were required to have prior treatment with at least four doses of rituximab without an objective response, or to have progressed during or after treatment. Twenty-four patients did not respond to their last treatment with rituximab, and, of the 16 patients who did respond to rituximab, four patients had a duration of response exceeding 6 months. A response occurred in 27 of 40 (68%) patients, with a median duration of response of 14.7 months (95% CI; 10.6 months no response). A CR occurred in 12 of 40 (30%) patients; the median duration of CR has not been reached (95% CI; 11 months no response). Outcomes after iodine I 131 tositumomab and after previous rituximab were compared. Of the 40 patients, 24 patients had a longer (at least 30 days) duration of response after iodine I 131 tositumomab than after rituximab, five patients had a longer duration of response after rituximab than after iodine I 131 tositumomab, nine patients had equivalent durations of response, and two patients were censored ( $p < .001$ ). A total of 14 patients (35%) had a TTP of 12 months or longer. Radioiodinated tositumomab also has been used at myeloablative doses, with stem-cell rescue in patients with relapsed B-cell lymphomas ( [243](#) , [244](#) and [245](#) ). Radioiodinated tositumomab was used initially as a single agent ( [244](#) ). Twenty-five patients were imaged after a tracer dose of radioiodinated tositumomab. Twenty-two of these 25 patients achieved favorable biodistributions (i.e., had tumor doses in excess of doses to normal organs). These 21 patients received therapeutic infusions of radioiodinated tositumomab (345 to 785 mCi) followed by reinfusion of autologous hematopoietic stem cells. All patients achieved bone marrow engraftment (19 with bone marrow stem cells, two with peripheral blood stem cells). However, two patients died before full neutrophil recovery; one of sepsis, one of progressive lymphoma. Nonhematologic toxicities included nausea in most patients, mild mucositis in five patients, and partial alopecia in four patients. One patient experienced reversible cardiomyopathy and interstitial pneumonitis. Eighteen patients responded to this therapy; 16 patients experienced a CR. With a median follow-up of 2 years, 2-year progression-free survival was estimated at 62%, with overall survival estimated at 93%. Press et al. ( [245](#) ) then combined radioiodinated tositumomab with chemotherapy and autologous stem cell transfusion in a series of patients with relapsed B-cell lymphomas. Fifty-two patients received the planned therapy. Patients were again given tracer doses of radioiodinated tositumomab and underwent sequential gamma camera imaging. Absorbed doses of radiation to tumor sites and normal organs were determined. Thereafter, patients received a therapeutic infusion of radioiodinated tositumomab calculated to deliver between 20 and 27 Gy to normal organs (e.g., liver, kidneys, and lungs). Patients then received etoposide, 60 mg/kg, and cyclophosphamide, 100 mg/kg,

followed by reinfusion of autologous hematopoietic stem cells. The maximal tolerated dose of radioiodinated tositumomab to be combined with chemotherapy was determined to be that dose that delivered 25 Gy to normal organs. Eight patients experienced 13 grade 3 or 4 toxic events. These included three patients with acute respiratory distress syndrome, three patients with severe mucositis or gastrointestinal toxicity, one patient with venoocclusive disease, and four patients with fatal infections. At 2 years, the Kaplan–Meier estimates of overall and progression–free survival for all treated patients were 83% and 68%, respectively. These findings were considered superior to results previously observed in patients who had undergone conventional external beam total–body radiation with etoposide/cyclophosphamide preparation for transplantation in the same institution.

**IMMUNOTOXINS AND FUSION TOXINS** This category of treatment reagents resembles those guided missiles of radioimmunotherapy. In this case, however, the warheads are chemical rather than nuclear, and the targeting is provided by antibodies or by lymphokines, growth factors, and so on that specifically bind receptors on the surfaces of target tumor cells. Attached to the targeting moiety is the cytolytic moiety. This is usually a toxin, derived from plants or bacteria, which works by inhibiting protein synthesis. They kill either resting or dividing cells and require fewer than ten molecules in the cytosol to be effective ( [246](#), [247](#) ). Toxins of this type tested in phase I trials include ricin A chain, blocked ricin, saporin, pokeweed antiviral protein, *Pseudomonas* exotoxin A, and diphtheria toxin. Recently, calicheamicin, a highly potent antitumor antibiotic that cleaves double–stranded DNA at specific sequences ( [248](#) ) has been successfully targeted to leukemia cells ( [249](#) ). A number of factors influence the efficacy of immunotoxins. These include the binding affinity of the ligand for its target and the target density on the tumor cell surface ( [250](#) ). The epitope to which binding occurs can affect the potency of the immunotoxin ( [251](#) ). Membrane–proximal epitopes appear to confer greater efficacy. Immunotoxin binding must lead to internalization of the target structure and the attached immunotoxin ( [252](#) ). Once internalized, the toxin moiety must translocate to the cytoplasm to be effective. This process is aided by certain translocation sequences in the toxin. This need for translocation signals provides the rationale for using blocked ricin toxin; targeting via the binding subunit is eliminated but translocation signals are preserved ( [253](#) ). The site of translocation may vary for different toxins. Increasing lysosomal pH protects cells from *Pseudomonas* exotoxin and diphtheria toxin but increases sensitivity to ricin ( [254](#), [255](#) and [256](#) ), suggesting that ricin may undergo translocation in the Golgi apparatus. Finally, these toxins affect protein synthesis by ADP–ribosylating elongation factor 2 ( [257](#) ) in the case of diphtheria toxin and *Pseudomonas* toxin, or by alteration of the 60s ribosomal subunit in the case of ricin ( [258](#) ). A number of phase I clinical trials using ricin–based, anti–pan B–cell antibody immunotoxins have been reported in B–cell lymphoma ( [259](#), [260](#), [261](#), [262](#), [263](#), [264](#), [265](#) and [266](#) ). These trials demonstrated that therapeutic doses of immunotoxins can be delivered with tolerable, reversible side effects. Toxicities include systemic symptoms of fever, nausea, vomiting, headache, and muscle aches; evidence of hepatocyte damage with transaminase elevations; and significant problems with capillary leak syndrome ( [267](#) ). Again recognized were the problems of human antimouse antibody formation and rapid clearance of immunotoxin in the presence of circulating antigenemia. Sporadic responses were seen in these trials, with response rates perhaps approaching 25% and CRs approaching 10%. There were hints that targeting via CD22 might be more useful than targeting via CD19 ( [268](#) ). Some experts have suggested that these agents will not become useful clinical tools until problems of their immunogenicity have been solved ( [190](#), [247](#) ). However, recent success has been reported for two agents of this class. A recombinant immunotoxin containing the anti–CD22 variable domain (Fv) fused to a truncated pseudomonas exotoxin has produced CRs in patients with hairy cell leukemia (HCL) ( [269](#) ). Sixteen patients whose disease was resistant to nucleoside analogs were treated by intravenous infusion every other day for three doses. Thirteen of 16 patients

responded—11 had CRs. The treatment was generally well tolerated. Common side effects included transient elevations of liver enzymes and hypoalbuminemia. Median follow-up was 16 months, during which 3 of the 11 complete responders relapsed. These three patients were retreated with the immunotoxin. Two of the three developed hemolytic uremic syndrome. Another immunotoxin has been approved for the treatment of elderly patients with CD33-positive acute myeloid leukemia in first relapse. This approval suggests that agents of this type may prove useful sooner than expected. Gemtuzumab ozogamicin is an immunotoxin composed of a recombinant human IgG4 $\mu$  monoclonal antibody conjugated with a cytotoxic antitumor antibiotic, calicheamicin ([270](#)). The antibody is directed against the CD33 antigen found on the surface of leukemic blasts and normal immature cells of myelomonocytic lineage, but not on hematopoietic stem cells. CD33 is a sialic acid-dependent adhesion molecule. In a phase I dose escalation trial, treatment with gemtuzumab ozogamicin resulted in elimination of leukemic cells from peripheral blood and bone marrow in 8 of 40 patients ([271](#)). These results were achieved with acceptable toxicity. The basis for approval of the drug was the experience in 142 patients participating in one of three similar trials designed to examine the efficacy and safety of gemtuzumab ozogamicin in patients in first relapse of AML ([272](#)). Two of the studies enrolled patients 18 years of age or older. The third enrolled only patients 60 years of age or older. Across the three studies, 80 patients were 60 years of age or older. The median duration of first remission for the group was 11.1 months. Most patients had received aggressive initial induction therapy. All 142 patients received a first dose of drug, 109 patients received two doses (the recommended treatment course), and five patients received three doses. Roughly 40% of patients were treated as outpatients. Median duration of hospitalization was 24 days. The ORR was 30%. This included patients achieving a CR [defined as (a) leukemic blasts absent from peripheral blood, (b) bone marrow blasts <5% of cellular elements, (c) recovery of neutrophils and platelets, and (d) rbc transfusion independence] and patients achieving a CRp (CR as defined except delayed platelet recovery). Median survival for the group as a whole was 5.9 months. Median relapse-free survival for responders was 6.8 months. Essentially, all patients had grade 3 or 4 neutropenia and thrombocytopenia. Fifteen percent of patients experienced grade 3 or 4 bleeding events. Infusion-associated events occurred in approximately 10% of patients. Sepsis occurred in 16% of patients; pneumonia in 7%. Grade 3 or 4 hypotension was seen in 9% of patients. Twenty-three percent of patients experienced grade 3 or 4 elevation of serum bilirubin levels, and 17% of patients had grade 3 or 4 elevations of hepatic transaminases. Two deaths were associated with liver abnormalities. Eleven patients died during the treatment period of causes other than disease progression. There was no treatment-associated cardiotoxicity, cerebellar dysfunction, or alopecia. Neoplasms bearing the high-affinity IL-2 receptor have been approached with a genetically engineered, bacterially expressed IL-2-diphtheria toxin fusion protein, denileukin diftitox ([273](#)). Denileukin diftitox was approved in 1998 for the treatment of patients with relapsed cutaneous T-cell lymphoma (CTCL). This was the first approval for drugs of the recombinant fusion toxin class. The development of this molecule is detailed in a recent review ([274](#)). The basis of approval was a pivotal trial conducted in 73 patients with disease that was refractory to other therapy (patients having received three or more previous treatments) ([275](#)). Patients were randomized to either a low dose (9  $\mu$ g/kg/day) or high dose (18  $\mu$ g/kg/day) of the fusion toxin. Patients were treated on 5 consecutive days in 21-day cycles for up to eight cycles. Seventy-one patients received a drug. The ORR was 30%, and CR rate was 10%. Rates and durations of response did not differ between the two treatment groups. Adverse events included flulike symptoms, acute infusion-related events, and vascular leak syndrome. Approximately three-fourths of the patients experienced transient elevations of hepatic transaminase levels and hypoalbuminemia; approximately 15% of patients experienced grade 3 or 4 elevations of liver enzymes or hypoalbuminemia. The success of this trial, to some extent, allays concern that a major problem with this family of fusion toxins would be previous immunization of most of the American population with diphtheria toxoid in childhood. Although approximately one-half of patients had antibodies against diphtheria toxin at



baseline and almost all patients had antibodies after treatment, these did not appear to affect treatment outcome ( [275](#), [276](#) ).

**BISPECIFIC ANTIBODIES** Bispecific antibodies are antibody constructions that recognize a tumor-associated antigen (TAA) with one arm and recognize and activate an immune effector cell structure with the other arm ( [277](#), [278](#) and [279](#) ). In theory, approximation of a tumor cell with an activated immune effector could result in tumor cell elimination. These bispecific antibodies can be obtained either by chemical heteroconjugation or by fusion of two hybridomas of desired specificity to yield a tetradoma. With either approach, chromatographic or other separation techniques are required to isolate the desired product. Strategies using antibodies to activate phagocytic cells, NK cells, and T lymphocytes have been examined. In preclinical models, antiidiotype × anti-CD3 bispecific antibodies have demonstrated the ability to inhibit tumor cell growth ( [280](#), [281](#) and [282](#) ). Recognizing the need for co-stimulation in T-cell response, other investigators have used a combination of bispecific antibodies, anti-CD3 × anti-TAA and anti-CD28 × anti-TAA, with interesting results ( [277](#) ). A phase I trial of anti-CD3 × anti-CD19 (a pan B-cell surface antigen) bispecific antibody treatment in patients with B-cell lymphoma has been reported ( [283](#), [284](#) ). Little treatment-related toxicity was observed, and some evidence of efficacy was seen. Bispecific antibodies have been used in the treatment of patients with refractory Hodgkin disease ( [285](#), [286](#) ). In an initial phase I/II trial ( [286](#) ), 15 patients were treated with an NK cell-activating bispecific monoclonal antibody directed against the Fc $\gamma$ -receptor III (CD16 antigen) and the Hodgkin-associated CD30 antigen. The antibody was administered every 3 to 4 days × 4. Dose-limiting toxicity was not encountered up to and including the highest dose administered, 64 mg/m<sup>2</sup>. Side effects were unusual, but included fever, pain in involved lymph nodes, and maculopapular rash. Nine of 15 patients developed a human antimouse antibody response that resulted in allergic reactions in four patients who were retreated. One complete and one partial remission were observed. Duration of CR was 16 months, and partial responses endured for a median of 3 months. These results prompted a second trial to investigate the effects of different administration schedules and the concomitant administration of cytokines on the effectiveness of the bispecific antibody ( [287](#) ). Sixteen patients were treated with 25 mg of the construct four times either as a continuous infusion for 4 days or a 1-hour infusion every other day. Patients who exhibited response were retreated at 4-week intervals, if possible. Patients with stable disease received retreatment after administration of IL-2 and granulocyte-macrophage colony-stimulating factor (GM-CSF). Four patients responded to the treatment (three partial remissions and one complete remission). Durations of response were from 5 to 9 months. Bispecific antibodies, as an approach to immunotherapy, appear to have garnered more enthusiasm and engendered more activity in the treatment of solid tumors. Relatively minor results have not given rise to large-scale trials.

## Cytokines

**INTERFERONS** The interferons constitute a family of cytokines that were initially recognized by their abilities to interfere with viral replication ( [166](#) ). Two major classes of interferons exist: type I, consisting primarily of interferon- $\alpha$  and interferon- $\beta$ ; and type II, consisting of interferon- $\gamma$ . Type I interferons are produced by many cell types. Type II interferon is produced by T lymphocytes. The biochemistry and structure of interferon receptors have recently been elucidated, as have the signal transduction pathways that emanate from those receptors. Signaling in this system involves the janus kinase (Jak) family and the STATs ( [288](#) ). Transmission of interferon-specific signals results in induction of a number of genes, including several transcription factors, MHC class I and class II (primarily in response to interferon- $\gamma$ ) molecules, and a number of proteins that are responsible for the antiviral activity of the interferons, including the (2'-5') oligoadenylate synthase-nuclease system ( [289](#) ). Promoters for these genes share an

interferon-stimulated response element that has a consensus structure of AGTTTCNNTTTCNC/T ( [290](#) ). The nature of the interferon antitumor action is as yet ill defined. Early observations involving virally induced tumors demonstrated that interferons could inhibit tumor growth ( [291](#) ). These observations were later extended to nonvirally induced tumors ( [292](#) ). The marriage of molecular biology and the entrepreneurial biotechnology industry produced recombinant interferons early on, and these molecules have been used extensively in clinical trials since the early 1980s. Interferon- $\alpha$  has found its way into the therapeutic armamentarium, but interferon- $\beta$  has not. The most successful applications of these substances have been in chronic myelogenous leukemia (CML) and HCL. In chronic-phase CML, interferon- $\alpha$  has demonstrated the ability to control blood counts and to induce complete hematologic response in perhaps 70% of patients and complete cytogenetic responses in 25% of patients ( [293](#), [294](#), [295](#), [296](#), [297](#), [298](#), [299](#) and [300](#) ). Typical administration schedules have been  $5 \times 10^6$  U/m<sup>2</sup>/day or three times weekly. These results have been achieved with significant side effects, including initial flulike symptoms that abate at approximately 2 weeks, then later fatigue, weight loss, neurotoxicity, depression, and insomnia. Rare cardiac and autoimmune side effects have occurred, including arrhythmias and congestive heart failure as well as hemolytic anemia, thrombocytopenia, rheumatologic disorders, hypothyroidism, and nephrotic syndrome. The role of interferon- $\alpha$  in the treatment of CML and its effect on remission duration and survival are controversial. One large multicenter trial failed to demonstrate a correlation between cytogenetic response to interferon- $\alpha$  and remission duration or survival ( [296](#) ), but in a head-to-head comparison of interferon- $\alpha$  with hydroxyurea, significantly improved survival was seen in the interferon- $\alpha$ -treated group ( [298](#), [301](#), [302](#) ). In this study, most of the benefit of interferon- $\alpha$  appeared to accrue to the patients who achieved a major cytologic response, all of whom were in the interferon- $\alpha$ -treated group. In the era of imatinib mesylate, the role for interferon- $\alpha$  remains to be defined ( [299](#), [300](#) ). In HCL, interferon- $\alpha$  became the first effective, nonsurgical treatment; splenectomy was the first treatment approach. A number of studies conducted with partially purified, then recombinant interferon- $\alpha$  demonstrated that approximately 75% of treated patients achieved a complete or partial response ( [303](#), [304](#), [305](#), [306](#) and [307](#) ). Median durations of response were 12 to 24 months, with virtually all patients eventually relapsing. However, most patients respond to a second treatment course of interferon- $\alpha$ . The mechanism of interferon- $\alpha$  action in this disease is unknown. Both antiproliferative ( [308](#) ) and immunomodulatory ( [309](#), [310](#) ) events have been demonstrated in treated patients. Although interferon- $\alpha$  is an active agent in HCL, the remarkable effectiveness of short courses of cladribine in inducing sustained complete clinical remissions in this disease make it the treatment of choice for most patients with the disease. Interferon- $\alpha$  also has been used in the treatment of NHL ( [190](#) ). As a single agent, interferon- $\alpha$  has modest activity in indolent lymphomas, but toxicities are significant (at the doses generally used) and remission durations are generally short. Therefore, a number of studies have investigated the ability of low-dose interferon- $\alpha$  to enhance the CR rate of standard chemotherapy or to sustain chemotherapy-induced remissions. In general, the effect of interferon- $\alpha$  in this setting has been modest, with little effect on response rates and perhaps a reduction in the rate of transformation to higher-grade lymphoma ( [311](#) ), moderate prolongation of remission durations, but, with one exception ( [312](#) ), no effect on overall survival. Interferon- $\alpha$  may also be a useful agent in the treatment of multiple myeloma ( [313](#), [314](#) ). When used in combination with chemotherapy, interferon- $\alpha$  may improve initial response rate and progression-free survival. A pilot trial conducted by the Eastern Cooperative Oncology Group suggested that interferon- $\alpha$  treatment in combination with chemotherapy led to increased response rates and prolonged disease-free interval, over that expected, by 12 months ( [315](#) ). In a large randomized trial of 256 patients ( [316](#) ), interferon- $\alpha$  maintenance treatment produced improved disease-free survival of 17.8 versus 8.2 months for the control group and overall survival

of 50.6 versus 34.4 months. Both differences were statistically significant. Inclusion of interferon- $\alpha$  during induction therapy appeared to confer further benefit. However, in a large cooperative group trial ( 317 ), no benefit was seen to interferon- $\alpha$  maintenance therapy. A metaanalysis of 24 randomized studies involving more than 4000 subjects indicated that interferon- $\alpha$  improves relapse-free survival to a moderate degree and overall survival to a marginal degree in multiple myeloma. Therefore, the role of interferon- $\alpha$  in the treatment of multiple myeloma remains controversial. Its cost and side effects must be considered when contemplating the use of interferon- $\alpha$ . Furthermore, its usefulness has been questioned in melphalan-prednisone-treated patients ( 318 ), in patients receiving high-dose steroids ( 319 ), and in the elderly ( 320 ).

**INTERLEUKIN-2** IL-2 was first recognized as a growth factor for T lymphocytes ( 321 , 322 ). Its discovery allowed the cloning and long-term propagation of antigen-specific T-cell clones ( 323 , 324 ). In addition, it was determined that IL-2 treatment led to gain of function, particularly increased cytotoxicity in T lymphocytes ( 325 ) and NK cells ( 326 ). The possibility of generating or potentiating specific immune responses for clinical applications made the production of IL-2 one of the earliest targets of the biotechnology industry. Recombinant IL-2 was available for clinical application by 1983 ( 327 ), only 5 years after the activity was first described. IL-2 binds specifically to receptors (IL-2R) on target cell surfaces ( 328 ). Most resting lymphocytes display only intermediate-affinity receptors made up of IL-2R $\beta$  and IL-2R $\gamma$  polypeptide chains. A number of stimulatory signals lead to production of IL-2R $\alpha$  chains and the display of high-affinity heterotrimeric receptors of IL-2R $\alpha$ , IL-2R $\beta$ , and IL-2R $\gamma$  chains. IL-2R $\alpha$  contributes a rapid association rate with IL-2, whereas the IL-2R $\beta$  and IL-2R $\gamma$  chains provide a slow dissociation rate. The resulting rapid on rate and slow off rate results in an equilibrium dissociation constant ( $K_d = 10^{-11}$  mol) ( 329 ). With approximately 750 receptors per cell surface, an endocytosis-related half-life of approximately 15 minutes, and an apparent requirement of 10,000 occupied receptors before commitment to cell cycle progression, it is likely that optimal treatment strategies will require prolonged, continuous administration of the cytokine ( 330 ). Early experience with IL-2 used increasing doses, seeking optimal effect. However, at high intravenous dose (greater than  $10^{-8}$  mol peak concentration, attempting to saturate intermediate affinity IL-2R on target cells), IL-2 produced significant, life-threatening toxicities ( 331 ). These side effects included fever and chills initially followed by a constellation of problems resulting from a capillary leak syndrome, including hypotension requiring pressor support in a majority of patients, significant weight gain, respiratory distress occasionally requiring intubation, oliguria, renal dysfunction, and death in approximately 1% of patients. Additional side effects included nausea, vomiting, diarrhea, cardiac arrhythmia, liver dysfunction, mental status changes, anemia, and thrombocytopenia. Because of these severe side effects, arbitrary *ad hoc* dose adjustments and well-controlled clinical trials have attempted to reduce dose while maintaining clinical efficacy. At doses approximately 300 to 500 times less than those initially used, marked increases in circulating levels of NK cells without induction of immune-mediated pathology have been demonstrated ( 332 ). Continuous intradermal and intermittent subcutaneous administration schedules have been evaluated ( 330 ). IL-2 has been used in the treatment of AML. A few studies have been conducted in patients with active disease ( 333 , 334 , 335 and 336 ). Of these patients, a small minority had complete remissions, which were generally of brief duration. However, in several instances the IL-2-induced/maintained remission duration exceeded that of previous remission durations. This experience prompted an examination of IL-2's ability to prolong remission after chemotherapy ( 337 ). Seventeen patients with AML were treated with IL-2 or IL-2 plus lymphokine-activated killer (LAK) cells after autologous bone marrow transplantation (BMT). Five of these patients relapsed between 2 and 10 months, one died in therapy, but 11 remained in complete remission 12 to 54 months after BMT. All of the surviving patients demonstrated remission inversion. Similar results were reported in seven patients

treated with polyethylene glycol-conjugated IL-2 administered as the sole postremission therapy after induction of a second complete remission ( 338 ). More recently, a pilot study of IL-2 in patients in first remission has been reported ( 339 ). The results suggest that more patients were alive at 3 years than would have been predicted by observations in historical controls. These results suggest that consolidative IL-2 administered early in remission induction can decrease relapse rate and suggest that prospective randomized comparisons are warranted. Despite difficulty meeting accrual goals in several studies ( 340 ), some experience has been gained using IL-2 in NHL, Hodgkin disease, and CTCL. In general, response durations in these diseases are brief and clinically insignificant ( 190 ). However, a few remissions of prolonged duration have been reported. European investigators examined continuous-infusion high-dose IL-2 alone in patients with heavily pretreated lymphomas of various subtypes ( 341 ). In 24 patients with low-grade lymphomas resistant to anthracycline-containing regimens, one CR was seen. In 23 patients with intermediate- or high-grade lymphomas refractory to primary therapy or salvage therapy, three complete remissions and two partial remissions were documented. No responses were seen in seven patients with Hodgkin disease. In seven patients with mycosis fungoides refractory to chemotherapy, one complete remission and four partial remissions were seen. These authors concluded that further testing with IL-2 in patients with aggressive lymphoma and CTCL was warranted. This experience with CTCL is particularly provocative because a direct effect of IL-2 on tumor cells, which often bear the IL-2R, is likely and may relate to the mechanism by which the IL-2 effect was manifest in this trial. Use of IL-2 has been investigated in myelodysplastic syndrome ( 342 ). Its utility, in this setting, remains to be defined.

## Cellular Approaches

**GRAFT-VERSUS-LEUKEMIA EFFECT** Despite the fact that early studies in murine leukemia suggested that allogeneic transplantation would confer a lower risk of relapse than syngeneic transplantation ( 343 ), and this information was used as part of the rationale for early clinical transplantation ( 344 ), the reality of a graft-versus-leukemia effect in human transplantation was slowly recognized ( 345 , 346 ). Significant indirect evidence for a graft-versus-leukemia effect can now be cited ( 347 ). Anecdotal reports have documented remission reinduction after a flare of graft-versus-host disease ( 348 ) or on rapid withdrawal of immunosuppression ( 349 ). Furthermore, a number of studies have confirmed that syngeneic BMT is associated with a higher risk of relapse than allogeneic BMT ( 350 , 351 ). Other studies, including large retrospective analyses by the International Bone Marrow Transplant Registry ( 352 ), have demonstrated a protective effect of graft-versus-host disease. Non-T-cell-depleted transplant recipients with acute, chronic, and acute plus chronic graft-versus-host disease had a lower likelihood of relapse than did patients receiving non-T-cell-depleted transplants who had no graft-versus-host disease. Patients who received non-T-cell-depleted transplants and experienced no graft-versus-host disease still had a lower likelihood of relapse than patients receiving syngeneic transplants. These data have been interpreted to support the notion that graft-versus-leukemia effects can be seen in the absence of graft-versus-host disease. Of note, it appears that the potency of the graft-versus-tumor effect differs among neoplasms ( 353 ). The graft-versus-tumor effect is obvious in AML and CML, has been suggested in lymphoma ( 354 ), but at least in one study was absent in acute lymphocytic leukemia ( 355 ), and has been less apparent in myeloma ( 356 ). The molecular and cellular mechanisms that underlie the graft-versus-leukemia effect are becoming better understood ( 347 , 353 , 357 , 358 ). Furthermore, the relationship between the graft-versus-leukemia effect and graft-versus-host disease is becoming better defined. Some antigens relevant to these

processes have been identified. Although MHC differences have long been associated with graft-versus-host disease, the role of minor histocompatibility antigen expression in graft-versus-host disease and graft-versus-leukemia effect is becoming apparent ( [353](#), [355](#), [356](#), [359](#), [360](#) ). In a murine model, administration of allogeneic T cells specific for a single minor histocompatibility antigen resulted in an antileukemic response without a graft-versus-host response ( [361](#) ). Other antigens may be important as well. Immune responses against the neoantigens expressed from the bcr/abl fusion in CML ( [362](#), [363](#) ) and the pml/rara fusion in acute promyelocytic leukemia ( [101](#) ) have been demonstrated. Their relevance is suggested by the disease-specific efficacy of donor leukocyte infusions, but their true relevance in the clinical setting remains to be defined. The immunologic effectors of graft-versus-host disease and graft-versus-leukemia effect also are being dissected. It is apparent that T lymphocytes must play a large role in these reactions, for their removal results in marked decrease in graft-versus-host disease and marked increases in relapse frequencies ( [364](#) ). NK cells may also be involved in the graft-versus-leukemia effect ( [365](#) ). Recent evidence suggests that CD4<sup>+</sup> T lymphocytes may be particularly important in the graft-versus-leukemia effect ( [366](#), [367](#) ). Allografts selectively depleted of CD8<sup>+</sup> T lymphocytes (CD4<sup>+</sup> T-lymphocyte preserved) demonstrated a low incidence of graft-versus-host disease yet a preserved graft-versus-leukemia effect similar to that seen with unfractionated transplants in patients with CML. These clinical findings are supported by similar findings in animal models ( [368](#) ) and by the demonstration of donor-derived, HLA-identical, cytotoxic CD4<sup>+</sup> T-cell clones of multiple specificities in a patient with severe graft-versus-host disease after transplantation for CML ( [369](#) ). T-helper subset 2 and T-cytotoxic subset 2 may be particularly important in the regulation of graft-versus-host disease and mediation of graft-versus-leukemia effects ( [370](#) ). Development of MHC-tetramer technology had provided a means to visualize antigen-specific T-cell responses ( [371](#) ). This technology can be used to correlate individual T-cell responses with clinical course. In an early application of the approach, Mutis et al. ( [372](#) ) demonstrated that the frequencies of T cells specific for the HY and HA-1 minor histocompatibility antigens correlated with severity of graft-versus-host disease. A number of strategies have been proposed to enhance the graft-versus-leukemia effect and reduce graft-versus-host disease ( [353](#), [373](#) ). These include a reduction in the total number of T lymphocytes used in transplantation, delayed transfusion of donor lymphocytes ( [374](#) ), CD8<sup>+</sup> T lymphocyte depletion, ablation of thymidine kinase gene-transfected donor T lymphocytes with ganciclovir administration in case of graft-versus-host disease ( [375](#), [376](#) ), administration of IL-2 ( [377](#) ), functional depletion of antihost lymphocytes without depletion of antimyeloid lymphocytes ( [378](#), [379](#) ), and *ex vivo* generation of leukemia-specific T lymphocytes ( [380](#) ). The approach that has garnered the most attention recently has been mini-allografting ( [357](#), [381](#), [382](#) ). High-dose chemotherapy with stem-cell rescue has proven to be an effective, potentially curative approach to the treatment of several malignancies. However, this technique is associated with significant morbidity and mortality. The success of donor leukocyte infusions (see section [Donor Leukocyte Infusions](#)) for the treatment of CML and other hematologic malignancies has suggested that much of the benefit of allogeneic transplantation is mediated by the graft-versus-malignancy effect. Several groups have evaluated the effects of safer, less toxic approaches to transplantation. Shimoni et al. ( [381](#) ) described their experience with allogeneic hematopoietic transplantation using nonmyeloablative regimens in 116 patients. These low-dose regimens were designed, not to eradicate host hematopoiesis, but to allow induction of the graft-versus-leukemia effect as the primary treatment mechanism. Forty-six patients with advanced age or significant organ dysfunction and diagnoses of CML, AML, or myelodysplasia, were treated with purine analog/cytarabine combinations to provide sufficient immunosuppression to allow engraftment of allogeneic progenitor cells. Thirty-six of 40 evaluable patients receiving



related-donor transplants engrafted with donor cells—23 patients—achieved complete donor chimerism, and 13 patients were mixed chimeras. Death attributed to treatment-related causes occurred in eight patients. Twenty-eight of 31 evaluable patients with AML or myelodysplastic syndrome achieved a CR. Three patients died in remission. Fifteen patients relapsed. Six of the 15 patients received donor leukocyte infusion, but none responded. Eleven patients had CML. Eight of nine patients who received related-donor grafts achieved complete hematologic and cytogenetic remission. Two-thirds of patients treated in chronic phase were alive at 2 years. Seventy patients were treated with purine analog/melphalan nonmyeloablative regimens in an attempt to improve outcomes for patients with active chemorefractory leukemia at the time of transplantation. Sixty-two of 64 evaluable patients had engraftment of donor hematopoietic cells. Treatment-related mortality was estimated at 45%. Median survival for the group was 4.5 months. Survival at 1 year was 37% and at 2 years was 31%.

**DONOR LEUKOCYTE INFUSIONS** A number of authorities consider the success of donor leukocyte infusions to be the most compelling proof of a graft-versus-leukemia effect ( [383](#) ). In 1990, Kolb et al. ( [384](#) ) reported three patients with relapsed CML after marrow transplantation who were treated with infusion of buffy coat leukocytes from the donor and interferon- $\alpha$ . Complete hematologic and cytogenetic responses were seen in these patients. Since then, the phenomenon has been replicated and extended by many investigators ( [383](#) , [385](#) , [386](#) ). A broad experience of 25 North American transplant centers has been reported ( [387](#) , [388](#) ), confirming the remarkable efficacy of this approach in patients with relapsed chronic phase CML and the less impressive response rates in advanced CML and acute leukemia. The collective experience suggests that in cytogenetic relapse or clinical chronic phase relapse of CML, complete cytogenetic remission can be attained in 80% of patients. However, patients with more advanced disease have a much lower, perhaps 25%, chance of remission. When the technique has been applied to patients with AML, relapsing after allogeneic BMT, response rates have been only 15 to 20% ( [386](#) ). Anecdotal reports of responses have been generated in multiple myeloma, chronic lymphocytic leukemia, Fanconi anemia, and polycythemia vera ( [386](#) ). When applied to patients with acute lymphocytic leukemia, Hodgkin disease, and NHL, few responses have been seen ( [386](#) ). Donor leukocyte infusions are not without complications. The two most worrisome are graft-versus-host disease and pancytopenia occurring weeks after infusion. Predictors of graft-versus-host disease after donor leukocytes were T-lymphocyte depletion in the original transplant marrow and concomitant interferon- $\alpha$  usage. The graft-versus-host disease induced by donor leukocyte infusions appears to respond more readily to immunosuppressive measures than does the graft-versus-host disease seen with transplantation. Predictors of myelosuppression include frank hematologic relapse and T-lymphocyte depletion ( [383](#) , [387](#) , [388](#) and [389](#) ). The optimal dose and timing of donor leukocyte infusions have yet to be determined ( [390](#) ). Administered dosage of leukocytes does not necessarily correlate with response ( [383](#) , [391](#) , [392](#) ), but there is some evidence that the incidence of graft-versus-host disease does correlate with dosage ( [392](#) ), making the notion of infusing fewer cells attractive. Regarding timing, the ability to detect relapse with molecular biologic techniques, such as PCR, allows definition of relapse long before it becomes hematologically apparent. Yet whether donor leukocyte infusions should be used before hematologic relapse remains a matter for clinical investigation because transient molecular relapses have been documented ( [390](#) ). Similarly, the requisite concomitant use of interferon- $\alpha$  has been questioned. In the European trials, use of interferon- $\alpha$  did not appear to improve the response rate to donor leukocyte infusions ( [383](#) ), and a number of studies have documented responses without the use of the cytokine ( [389](#) , [392](#) ).

**ADOPTIVE CELLULAR IMMUNOTHERAPY** The field of immunotherapy was rejuvenated in the early 1980s by reports of clinical trials with transfer of antitumor cells to tumor-bearing patients ( [393](#) , [394](#) ). Rosenberg et al. pioneered the use of LAK cells plus

IL-2 ( [395](#) , [396](#) ). LAK cells were derived from resting, autochthonous, peripheral blood mononuclear cells by culture *ex vivo* in high concentrations of IL-2. After culture, these cells were capable of lysing fresh tumor cells in an MHC-nonrestricted fashion ( [397](#) ). They were returned to tumor patients with concomitantly administered high-dose IL-2. Although the tumor target structure remains undefined, these determinants appear to be broadly distributed on fresh and culture tumor cells and not expressed on normal cells *in vivo*. LAK cells appear to be derived from the NK subset of human T lymphocytes, bearing the NK markers CD16 and CD56, and usually lacking the CD3 structure ( [398](#) , [399](#) ). Initial reports with LAK plus IL-2 in patients suggested a significant response rate in NHL, but most emphasis has been given to solid tumors, particularly renal cell carcinoma (RCC) and melanoma ( [400](#) , [401](#) ). Studies suggested that LAK cells do not consistently home to the site of tumor involvement, significantly limiting their therapeutic efficacy ( [402](#) ), and have demonstrated no advantage for the administration of LAK plus IL-2 over administration of IL-2 alone ( [400](#) ). A search for more potent killer cells resulted in the description of TILs ( [403](#) ). These cells could be isolated and grown from single-cell suspensions of tumor specimens in IL-2. They have the phenotype of classical cytotoxic T cells and kill tumor cells in an MHC-restricted manner. In animal studies, TILs are approximately 50 to 100 times more potent killers than are LAK cells. TILs also more efficiently home to and accumulate in tumor deposits ( [404](#) , [405](#) ). Pilot trials ( [394](#) , [406](#) ) have demonstrated a response rate of approximately 35% in patients with melanoma. The rather modest response rates, extremely labor-intensive nature of these treatments, and the serious toxicity of systemically administered IL-2 have markedly limited enthusiasm for these approaches to treatment, but they stand as important milestones on the road to effective immunologic treatments for neoplastic hematologic diseases and solid tumors. The remarkable success of adoptively transferred virally specific, *ex vivo*-expanded T lymphocytes for control of cytomegalovirus infection in patients after allogeneic BMT ( [407](#) , [408](#) and [409](#) ) suggests that, if appropriate tumor cell antigens can be found and exploited, this form of therapy may become a useful modality in the treatment of hematologic malignancies ( [410](#) , [411](#) ).

## Immunization Strategies

**ACTIVE IMMUNIZATION AGAINST IDIOTYPES** A natural outgrowth of the studies involving passive administration of antiidiotype antibodies has been an attempt to induce active immune responses against idiomorph ( [412](#) ). The feasibility of this approach was first demonstrated in animal models ( [413](#) ) and later in a pilot trial in patients with indolent B-cell lymphomas ( [414](#) ). A more complete evaluation was reported by Hsu et al. ( [415](#) ). Forty-one patients (32 in first remission and nine in subsequent remissions) with B-cell lymphoma received a series of injections of tumor-specific idiomorph protein coupled to keyhole limpet hemocyanin emulsified in immunologic adjuvant. Toxicities, immune response, and tumor status were evaluated. Twenty patients (49%) developed demonstrable immune responses against the idiomorph protein. Two patients with residual disease achieved CRs coincident with development of antiidiotype immunity. Median TTP and overall survival were significantly prolonged in patients who developed an immune response compared to those who did not. Similar results have been reported from the National Cancer Institute group ( [416](#) ). These investigators used idiomorph protein coupled to keyhole limpet hemocyanin injected with free GM-CSF, given monthly  $\times$  4. Clearance of PCR evidence of t(14;18) was accomplished in 8 of 11 evaluable patients. A number of other antiidiotype immunization strategies have been explored in animal models and patients. Protective antiidiotype antibody responses have been induced in mice using a fusion protein immunogen containing murine idiomorph determinants and constant region backbones appended to murine ( [417](#) ) and using intramuscular injection of a naked DNA construct coding for a similar idiomorph-GM-CSF fusion ( [418](#) ). In a pilot clinical trial



involving ten patients ( [217](#), [419](#), [420](#) ), autologous dendritic cells pulsed *ex vivo* with tumor-specific idiotype protein were infused intravenously. This procedure was followed by injection of idiotype antigen 2 weeks later. The cycle of pulsed dendritic cells and antigen was repeated two times at monthly intervals and again at approximately 6 months. Each of four patients reported in the study developed measurable tumor-specific cellular immune responses. Most impressively, two clinical CRs were seen. Durations of the responses were 44 and 54 months. Based on these impressive results, the study was extended to involve patients with follicular lymphoma in first remission ( [420](#) ). Id protein coupled to keyhole limpet hemocyanin was used to pulse the dendritic cells based on evidence of improved immunogenicity and tumor protection in a murine model ( [421](#) ). Revaccination with idiotype protein coupled to keyhole limpet hemocyanin at the time of lymphoma recurrence has resulted in tumor regression, in some cases ( [422](#) ). Dendritic cell-based idiotype vaccine strategies also have been explored in patients with multiple myeloma ( [204](#), [423](#), [424](#), [425](#) and [426](#) ).

**CYTOKINE-DRIVEN CELLULAR VACCINES** A number of studies demonstrated that creation of locally high concentrations of cytokines in proximity to tumor cells can lead to immunoinflammatory responses that are capable of tumor elimination, induction of specific resistance to tumor challenge, and, in certain cases, to eradication of established tumor ( [427](#) ). In early reports, Tepper et al. ( [428](#), [429](#) ) and Fearon et al. ( [430](#) ) demonstrated that transfection of tumor cell lines with genes for the IL-4 and IL-2, respectively, led to elimination of injected tumor cells by host animals. Subsequently, induction of specific tumor immunity, which resulted in the ability of challenged animals to reject wild-type tumor cells, was demonstrated. Thus, local destruction of cytokine gene-transfected tumor cells can lead to systemic immunity against nontransfected tumor cells. Golumbek et al. ( [431](#) ) then demonstrated that injection of cytokine gene-transfected cells led to elimination of established tumor at a distant site. This observation was a unique departure from previous tumor immunization studies and suggested that immunotherapy might be clinically relevant. An extensive evaluation of many cytokines in a single tumor model in mice was carried out ( [432](#) ). B16 melanoma cells were transfected with genes for several cytokines. Expression of none of the cytokines except IL-2 led to primary elimination of tumor cells. However, IL-2 failed to induce protective tumor-specific immunity in this model. Systemic toxicities of several cytokines were seen in animals bearing cytokine gene-transfected tumors. When cytokine gene-transfected B16 cells were irradiated before injection in mice, GM-CSF-producing cells stimulated potent, long-lasting tumor-specific immunity. IL-4 and IL-6 also demonstrated some ability to induce immunity. Although the ability of GM-CSF to induce tumor-specific immunity was somewhat unexpected, it has been speculated that locally high concentrations of GM-CSF led to the recruitment of professional antigen-presenting cells, such as macrophages and perhaps dendritic cells, which are particularly effective in presenting tumor antigens in the context of MHC products and display appropriate co-stimulatory molecules ( [427](#) ). An additional cytokine, not examined in the work described above, may hold promise as a inducer of antitumor immunity ( [433](#) ). IL-12-transduced adenocarcinoma cells ( [434](#) ) and myeloid leukemia cells ( [435](#) ) have produced impressive regressions of established tumors and protection against tumor challenge in animal model systems. Some studies in mice suggest that cytokine-driven immunotherapy approaches can be applied to lymphoma ( [436](#), [437](#) ). These and other studies have led to the initiation of a clinical immunotherapy trial using cytokine gene-transfected tumor cells in RCC ( [427](#), [438](#) ). Results of a phase I trial evaluating this strategy for safety and the induction of immune responses in patients with metastatic RCC have been reported ( [439](#) ). Patients were treated in a randomized, double-blind dose-escalation study with equivalent doses of autologous, irradiated RCC vaccine cells with or without *ex vivo* human GM-CSF gene transfer. The replication-defective retroviral vector MFG was used for GM-CSF gene transfer. No dose-limiting toxicities were encountered in 16 fully evaluable patients. GM-CSF gene-transduced vaccines were equivalent in toxicity to nontransduced

vaccines up to the feasible limits of autologous tumor vaccine yield. No evidence of autoimmune disease was observed. Biopsies of intradermal sites of injection with GM-CSF gene-transduced vaccines contained distinctive macrophage, dendritic cell, eosinophil, neutrophil, and T-cell infiltrates similar to those observed in preclinical models of efficacy. Histologic analysis of delayed-type hypersensitivity responses in patients vaccinated with GM-CSF-transduced vaccines demonstrated an intense eosinophil infiltrate that was not observed in patients who received nontransduced vaccines. An objective partial response was observed in a patient treated with GM-CSF gene-transduced vaccine who displayed the largest delayed-type hypersensitivity conversion. No replication-competent retrovirus was detected in vaccinated patients. This study demonstrated the feasibility, safety, and bioactivity of an autologous GM-CSF gene-transduced tumor vaccine for RCC patients but failed to live up to the high expectations that attended its initiation. A similar strategy was used in a phase I study in patients with multiple myeloma ( 440 ). Although 33 patients entered the trial, only 21 completed the planned immunization protocol. Metastatic lesions, biopsied after vaccination, demonstrated dense infiltration with T cells and plasma cells and extensive tumor destruction with fibrosis and edema. A single patient developed a partial remission. Three other patients were rendered free of disease with surgery or radiotherapy and remained without evidence of disease at 20 to 36 months. Although elegant in concept and execution, gene therapy approaches are not required for induction of cytokine-driven host antitumor responses. Depot forms of cytokine injected with irradiated tumor cells appear to be equally efficacious. Coinjection of microencapsulated GM-CSF with irradiated tumor cells led to induction of systemic immunity and elimination of preexisting tumor in a manner comparable to injection of GM-CSF gene-transfected tumor cells in the B16 model ( 441 ). Nongene-therapy approaches to tumor immunotherapy offer significant advantages by avoiding the uncertainties of tissue culture adaptation of tumor explants ( 438 , 439 and 440 ) and the custom-made, labor-intensive nature of each tumor transfectant. Recombinant products are available for several human cytokines. These products could be used off the shelf or after derivation to provide a more pharmaceutical approach to therapy.

**EXPLOITATION OF CO-STIMULATION** As noted in the discussion of T-lymphocyte activation, stimulation of the T-cell antigen receptor complex by antigen and MHC is required, but not sufficient, for commitment of the cell to IL-2 production and proliferation. This second signal requirement can be provided by the interaction of the CD28 cell-surface structure with its cognate ligands, CD80 (B7-1) and CD86 (B7-2), on the antigen-presenting cell ( 442 ). Few tumor cells express CD80 or CD86. Therefore, the tumor cell could be considered a poor antigen-presenting cell, a quality that might contribute to the poor immunogenicity of many tumors. A number of investigators have demonstrated in animal models that injection of tumor cells transfected with the gene for CD80 can elicit host responses, exhibiting enhanced immunogenicity capable of tumor elimination and induction of resistance to subsequent tumor challenge ( 443 , 444 and 445 ). This approach also has been shown to lead to elimination of preexisting tumors ( 446 , 447 and 448 ). However, the approach has not been universally successful and appears to be useful only in the enhancement of responses to tumors with poor but existent immunogenicity ( 449 ). The CD28 co-stimulatory system appears to be counterbalanced by a negative regulatory system mediated through the CTLA-4 cell-surface structure ( 450 , 451 ). T-cell activation promotes expression of CTLA-4, which binds CD80 and CD86 with affinities orders of magnitude greater than the affinity with which CD28 binds these ligands. Cells expressing CTLA-4 appear refractory to activation, perhaps through interference with co-stimulation when amounts of CD80 and CD86 are limiting ( 452 ). Therefore, it was argued that blockade of CTLA-4 stimulation might promote antitumor responses. This appears to be the case. *In vivo* administration of anti-CTLA-4 antibodies accelerated rejection of CD80<sup>+</sup> colon carcinoma, including preexisting tumors, in mice and resulted in systemic immunity protective against subsequent challenge ( 453 ). CTLA-4

blockade has been incorporated into phase I clinical trials in patients with prostate cancer and melanoma ( [454](#) ). Safety was a major concern in these studies as the CTLA-4 <sup>-/-</sup> mouse develops a lethal lymphoproliferative syndrome ( [455](#) ), and CTLA-4 blockade had been shown to exacerbate autoimmune disease in experimental models. For clinical studies, humanized anti-CTLA-4 was used. The prostate trial involved hormonal refractory patients who had progressed after at least one systemic therapy. The treatment was well tolerated, with no increase in activated T cells peripherally and no clinical signs of autoimmunity. Two of six patients who had not received chemotherapy showed clinical responses (>50% decreases in prostate-specific antigen) that lasted from 3 to 5 months. The melanoma trial involved patients who had refractory, progressive, unresectable metastatic disease. Adverse events in the trial were generally mild. Several patients showed mixed responses, and biopsies of tumor tissue post-therapy showed extensive tumor necrosis with inflammatory infiltrates in the tumor mass. These trials provide evidence that CTLA-4 blockade promotes antitumor effects as a single agent in two solid tumors. The most straightforward approach to the exploitation of co-stimulation is the use of dendritic cells in immunization schemes ( [456](#) , [457](#) , [458](#) , [459](#) and [460](#) ). Dendritic cells are a small population of cells that occupy the blood and tissues. Two types exist—one of myeloid origin, one of lymphoid origin ( [461](#) ). Stimulated immature dendritic cell precursors become mature dendritic cells that express many adhesive and co-stimulatory molecules, including CD40, CD50, CD54, CD80, CD86, and others. These cells are the most potent stimulators of T-lymphocyte activation, capable of transmitting all the requisite signals to cause resting or naïve T lymphocytes to undergo proliferation, produce cytokines, and acquire effector function. Dendritic cells can be generated *ex vivo*, either from CD14<sup>+</sup> peripheral monocytes or from CD34<sup>+</sup> hematopoietic precursor cells. A number of cytokines can contribute to expansion, differentiation, and terminal maturation of dendritic cells, but GM-CSF appears to be the most important factor for all of these functions. The professional antigen-presenting cells can be loaded with tumor-associated antigen in a number of ways. These include peptide pulsing, gene transfection, tumor cell-dendritic cell heterokaryon formation, and exposure to cells undergoing apoptosis. Dendritic cell immunizations have been used in a number of clinical studies ( [457](#) , [462](#) ). The experience with idiotypic-pulsed dendritic cells in patients with follicular lymphoma ( [419](#) , [420](#) , [421](#) and [422](#) ) and multiple myeloma ( [204](#) , [423](#) , [424](#) , [425](#) and [426](#) ) have been discussed in the earlier section [Active Immunization Against Idiotypes](#).

## OUTLOOK FOR THE FUTURE

Although this chapter has historically, and once again, taken a T-cell-centric approach to tumor immunotherapy, the last 5 years can certainly be called the triumph of passive humoral immunity in the treatment of lymphoid malignancies (and solid tumors). The approval and widespread use of rituximab has changed the standard of care for lymphoma. Other therapeutic monoclonal antibodies alone and conjugated to cytotoxic payloads will surely be developed over the next few years. In some instances, these products will face competition from small molecule inhibitors of key components of malignant transformation [like gefitinib ( [463](#) ) and imatinib mesylate ( [464](#) )] ( [465](#) ). Harnessing the power of dendritic cells, while avoiding the difficulties of patient specific therapy, will be a major challenge for immunotherapy in the years to come. An increasing number of clinical triumphs have proven the potential of immunotherapy, but many challenges lie ahead if this form of treatment is to become widespread. Once again, the roller coaster history of immunotherapy investigation should provide a sobering perspective against which the next wave of clinical results will be judged. The next few years should be interesting for investigators in the field, and, more important, beneficial to patients.

## REFERENCES

1. Ehrlich P. Ueber den jetzigen stand der karzinomforschung. *Ned Tijdschr Geneesk* 1909;5:273–290.
2. Thomas L. Discussion. In: Lawrence H, ed. *Cellular and humoral aspects of the hypersensitivity state*. New York: Hoeber, 1959:529.
3. Burnet F. The concept of immunological surveillance. *Prog Exp Tumor Res* 1970;13:1–27.
4. Moller G, Moller E. The concept of immunological surveillance against neoplasia. *Transplant Rev* 1976;28:3.
5. Penn I. Tumors of the immunocompromised patient. *Annu Rev Med* 1988;39:63–73.
6. Fefer A, McCoy J, Glynn J. Induction and regression of primary Moloney sarcoma virus-induced tumor in mice. *Cancer Res* 1967;27:962–967.
7. Old L, Boyse E. Antigens of tumors and leukemias induced by viruses. *Fed Proc* 1965;24:1009–1017.
8. Stutman O. Tumor development after 3-methylcholanthrene in immunologically deficient athymic nude mice. *Science* 1979;183:534–536.
9. Groopman J. Neoplasms in the acquired immune deficiency syndrome: the multidisciplinary approach to treatment. *Semin Oncol* 1987;14:1–6.
10. Woglom W. Immunity to transplantable tumors. *Cancer Res* 1929;4:129–214.
11. Gorer P. Some recent work on tumor immunity. *Adv Cancer Res* 1956;4:149–186.
12. Snell G. Studies in histocompatibility. *Science* 1981;213:172–178.
13. Prehn R, Main J. Immunity to methylcholanthrene-induced sarcomas. *J Natl Cancer Inst* 1957;18:769–778.
14. Old L, et al. Antigenic properties of chemically induced tumors. *Ann N Y Acad Sci* 1962;101:80–106.
15. Mitchison N. Passive transfer of transplantation immunity. *Proc R Soc Lond* 1954;B142:72–87.
16. Rouse B, Rollinghoff M, Warner N. Anti-F serum-induced suppression of the cellular transfer of tumour-specific immunity to syngeneic plasma cell tumour. *Nat New Biol* 1972;238:116–117.
17. Kohler G, Milstein C. Continuous cultures of fused cells secreting antibody of pre-defined specificity. *Nature* 1975;256:495–497.
18. Wiedenfeld E, et al. Evidence for selection against human lung cancers bearing p53 missense mutations which occur within the HLA A\*0201 peptide consensus motif. *Cancer Res* 1994;54:1175–1177.
19. Dranoff G. Tumour immunology: immune recognition and tumor protection. *Curr Opin Immunol* 2002;14:161–164.
20. Dighe AS, et al. Enhanced in vivo growth and resistance to rejection of tumor cell expressing dominant negative IFN  $\gamma$  receptors. *Immunity* 1994;1:447–456.
21. Kaplan DH, et al. Demonstration of an interferon  $\gamma$ -dependent tumor surveillance system in immunocompetent mice. *Proc Natl Acad Sci U S A* 1998;95:7556–7561.
22. Smyth M, et al. Perforin-mediated cytotoxicity is critical for surveillance of spontaneous lymphoma. *J Exp Med* 2000;192:755–760.
23. Davidson W, Giese T, Fredrickson T. Spontaneous development of plasmacytoid tumors in mice with defective fas-fas ligand interactions. *J Exp Med* 1998;187:1825–1838.
24. Shankaran V, et al. IFN $\gamma$  and lymphocytes prevent primary tumour development and shape tumour

immunogenicity. *Nature* 2001;410:1107–1111.

25. Smyth MJ, Godfrey DI, Trapani JA. A fresh look at tumor immunosurveillance and immunotherapy. *Nat Immunol* 2001;2:293–299.
26. Cohn J, Sessa G, Martin GB. Innate immunity in plants. *Curr Opin Immunol* 2001;13:55–62.
27. Iwaga S. The molecular basis of innate immunity in the horseshoe crab. *Curr Opin Immunol* 2002;14:87–95.
28. Janeway CA, Medzhitov R. Innate immune recognition. *Annu Rev Immunol* 2002;20:197–216.
29. Ezekowitz RAB, Hoffman J. The blossoming of innate immunity. *Curr Opin Immunol* 1998;10:9–11.
30. Godfrey DI, et al. NKT cells: facts, functions, and fallacies. *Immunol Today* 2000;21:573–583.
31. Smyth MJ, et al. NKT cells—conductors of tumor immunity? *Curr Opin Immunol* 2002;14:165–171.
32. Gallucci S, Matzinger P. Danger signals: SOS to the immune system. *Curr Opin Immunol* 2001;13:114–119.
33. Matzinger P. Tolerance, danger, and the extended family. *Annu Rev Immunol* 1994;12:991–1045.
34. Medzhitov R. Toll-like receptors and innate immunity. *Nat Rev Immunol* 2001;1:135–145.
35. Krieg AM. CpG motifs in bacterial DNA and their immune effects. *Annu Rev Immunol* 2002;20:709–760.
36. Whiteside TL, Herberman RB. The role of natural killer cells in immune surveillance of cancer. *Curr Opin Immunol* 1995;7:704–710.
37. Vilches C, Parham P. KIR: diverse, rapidly evolving receptors of innate and adaptive immunity. *Annu Rev Immunol* 2002;20:217–251.
38. Natarajan K, et al. Structure and function of natural killer cell receptors: multiple molecular solutions to self, nonself discrimination. *Annu Rev Immunol* 2002;20:853–885.
39. Diefenbach A, et al. Ligands for the murine NKG2D receptor: expression by tumor cells and activation of NK cells and macrophages. *Nat Immunol* 2000;1:119–126.
40. Cerwenka A, et al. Retinoic acid early inducible genes define a ligand family for the activating NKG2D receptor in mice. *Immunity* 2000;12:721–727.
41. Bauer S, et al. Activation of NK cells and T cells by NKG2D, a receptor for stress-inducible MICA. *Science* 1999;285:727–729.
42. Vivier E, Tomasello E, Paul P. Lymphocyte activation via NKG2D: towards a new paradigm in immune recognition? *Curr Opin Immunol* 2002;14:306–311.
43. Long EO. Regulation of immune responses through inhibitory receptors. *Annu Rev Immunol* 1999;17:875–904.
44. Soloski MJ. Recognition of tumor cells by the innate immune system. *Curr Opin Immunol* 2001;13:154–162.
45. Farag SS, et al. Natural killer cell receptors: new biology and insights into the graft-versus-leukemia effect. *Blood* 2002;100:1935–1947.
46. Srivastava P. Interaction of heat shock proteins with peptides and antigen presenting cells: chaperoning of the innate and adaptive immune responses. *Annu Rev Immunol* 2002;20:395–425.
47. Kusunoki Y, et al. NK-mediated elimination of mutant lymphocytes that have lost expression of MHC

class I molecules. *J Immunol* 2000;165:3555–3563.

48. Boon T, et al. Tumor antigens recognized by T lymphocytes. *Annu Rev Immunol* 1994;12:337–365.
49. Germain R, Marguiles D. The biochemistry and cell biology of antigen processing and presentation. *Annu Rev Immunol* 1993;11:403–450.
50. Englehard V. Structure of peptides associated with class I and class II MHC molecules. *Annu Rev Immunol* 1994;12:181–207.
51. Busch R, Mellins E. Developing and shedding inhibitions: how MHC class II molecules reach maturity. *Curr Opin Immunol* 1996;8:51–58.
52. Lennon-Dumenil A, et al. A close look at proteolysis and MHC-class-II-restricted antigen presentation. *Curr Opin Immunol* 2002;14:15–21.
53. Sant A, Miller J. MHC class II antigen processing; biology of invariant chain. *Curr Opin Immunol* 1994;6:57–63.
54. Williams D, Watts T. Molecular chaperones in antigen presentation. *Curr Opin Immunol* 1995;7:77–84.
55. Van Kaer L. Accessory proteins that control the assembly of MHC molecules with peptides. *Immunol Res* 2001;23:205–214.
56. Brocke P, et al. HLA-DM, HLA-DO and tapasin: functional similarities and differences. *Curr Opin Immunol* 2002;14:22–29.
57. Lehner P, Cresswell P. Processing and delivery of peptides presented by MHC class I molecules. *Curr Opin Immunol* 1996;8:59–67.
58. Goldberg A, Rock K. Proteolysis, proteasomes and antigen presentation. *Nature* 1992;357:375–379.
59. Howard J. Supply and transport of peptides presented by class I MHC molecules. *Curr Opin Immunol* 1995;7:69–76.
60. Selinger B, Maeurer MJ, Ferrone S. Antigen-processing machinery breakdown and tumor growth. *Immunol Today* 2000;21:455–464.
61. van den Eynde B, et al. The gene coding for a major tumor rejection antigen of tumor P815 is identical to the normal gene of syngeneic DBA/2 mice. *J Exp Med* 1991;173:1373–1384.
62. van der Bruggen P, et al. A gene encoding an antigen recognized by cytolytic T lymphocytes on a human melanoma. *Science* 1991;254:1643–1650.
63. Boon T, van der Bruggen P. Human tumor antigens recognized by T lymphocytes. *J Exp Med* 1996;183:725–729.
64. Traversari C, et al. Transfection and expression of a gene coding for a human melanoma antigen recognized by autologous cytolytic T lymphocytes. *Immunogenetics* 1992;35:145–152.
65. Wallny H, et al. Identification and quantification of a naturally presented peptide as recognized by cytotoxic T lymphocytes specific for an immunogenic tumor variant. *Int Immunol* 1992;4:1085–1090.
66. Mandelboim O, et al. The tumor-associated antigen of a murine lung carcinoma: CTL induction by an endogenous octapeptide(s). *Nature* 1994;369:67–71.
67. Henderson R, et al. Direct identification of an endogenous peptide recognized by multiple HLA-A2.1-specific cytotoxic T cells. *Proc Natl Acad Sci U S A* 1993;90:10275–10279.
68. Cox A, et al. Identification of a peptide recognized by five melanoma-specific human cytotoxic T-cell lines. *Science* 1994;264:716–719.

69. Pardoll D. Tumour antigens; a new look for the 1990s. *Nature* 1994;369:357–358.
70. Lethe B, et al. Mouse tumor rejection antigens P815A and P815B: two epitopes carried by a single peptide. *Eur J Immunol* 1992;22:2283–2288.
71. van den Eynde B, et al. Localization of two cytotoxic T lymphocyte epitopes and three anchoring residues on a single nonameric peptide that binds to H-2L<sup>d</sup> and is recognized by cytotoxic T lymphocytes against mouse tumor P815. *Eur J Immunol* 1994;24:2740–2745.
72. Traversari C, et al. A nonapeptide encoded by human gene MAGE-1 is recognized on HLA-A1 by cytolytic T lymphocytes directed against tumor antigen MZ2-E. *J Exp Med* 1992;176:1453–1457.
73. van der Bruggen P, et al. Autologous cytolytic T lymphocytes recognize a MAGE-1 nonapeptide on melanomas expressing HLA-Cw\*1601. *Eur J Immunol* 1994;24:2134–2140.
74. Wolfel T, et al. Two tyrosinase nonapeptides recognized on HLA-A2 melanomas by autologous cytolytic T lymphocytes. *Eur J Immunol* 1994;24:759–764.
75. Robbins P, et al. Recognition of tyrosinase by tumor-infiltrating lymphocytes from a patient responding to immunotherapy. *Cancer Res* 1994;54:3124–3126.
76. Topalian S, et al. Human CD4+ T cells specifically recognize a shared melanoma-associated antigen encoded by the tyrosinase gene. *Proc Natl Acad Sci U S A* 1994;91:9461–9465.
77. Kawakami Y, et al. Identification of a human melanoma antigen recognized by tumor-infiltrating lymphocytes associated with in vivo tumor rejection. *Proc Natl Acad Sci U S A* 1994;91:6458–6462.
78. Kawakami Y, et al. Recognition of multiple epitopes in the human melanoma antigen gp100 by tumor-infiltrating T lymphocytes associated with in vivo tumor regression. *J Immunol* 1995;54:3961–3968.
79. Kawakami Y, et al. Identification of the immunodominant peptides of the MART-1 human melanoma antigen recognized by the majority of HLA-A2-restricted tumor infiltrating lymphocytes. *J Exp Med* 1994;180:347–352.
80. Castelli C, et al. Mass spectrometric identification of a naturally processed melanoma peptide recognized by CD8+ cytotoxic T lymphocytes. *J Exp Med* 1995;181:363–368.
81. Toes REM, et al. CD4 T cells and their role in antitumor immune responses. *J Exp Med* 1999;189:753–756.
82. Rosenberg SA, et al. Immunologic and therapeutic evaluation of a synthetic tumor-associated peptide vaccine for the treatment of patients with metastatic melanoma. *Nat Med* 1998;4:321–327.
83. Nestle FO, et al. Vaccination of melanoma patients with peptide- or tumor lysate-pulsed dendritic cells. *Nat Med* 1998;4:328–332.
84. Marchand M, et al. Tumor regressions observed in patients with metastatic melanoma treated with an antigenic peptide encoded by gene MAGE-3 and presented by HLA-A1. *Int J Cancer* 1999;80:219–230.
85. Hung K, et al. The central role of CD4(+) T cells in the antitumor immune response. *J Exp Med* 1998;188:2357–2368.
86. Toes REM, et al. CD4+ T cells and their role in antitumor immune responses. *J Exp Med* 1999;189:753–756.
87. Cohen PA, et al. CD4+ T cells in adoptive immunotherapy and the indirect mechanism of tumor rejection. *Crit Rev Immunol* 2000;20:17–56.
88. Wang RF, et al. Cloning genes encoding MHC class II-restricted antigens: mutated CDC27 as a tumor antigen. *Science* 1999;284:1351–1354.
89. Wang RF. The role of MHC class II-restricted tumor antigens and CD4+ T cells in antitumor immunity.



Trends Immunol 2001;22:269–276.

90. Cheever M, et al. Immunity to oncogenic proteins. *Immunol Rev* 1995;145:33–59.
91. Weinstein IB. Addiction to oncogenes—the Achilles heel of cancer. *Science* 2002;297:63–64.
92. Peace D, et al. Lysis of ras oncogene-transformed cells by specific cytotoxic T lymphocytes elicited by primary in vitro immunization with mutated ras peptide. *J Exp Med* 1994;179:473–479.
93. Peace D, et al. T cell recognition of transforming proteins encoded by mutated ras onco-proteins. *J Immunol* 1991;14:2059–2065.
94. Fenton R, et al. Cytotoxic T-cell response and in vivo protection against tumor cells harboring activated ras protooncogenes. *J Natl Cancer Inst* 1993;85:1294–1302.
95. Fossum B, et al. A K-ras 13Gly-Asp mutation is recognized by HLA-DQ7 restricted T cells in a patient with colorectal cancer. Modifying effect of DQ7 on established cancers harboring this mutation? *Int J Cancer* 1994;58:506–511.
96. Gedde-Dahl T, et al. T cell epitopes encompassing the mutational hot spot position 61 of p21 ras. Promiscuity in ras peptide binding to HLA. *Eur J Immunol* 1994;24:410–414.
97. Disis M, et al. Existent T cell and antibody immunity to HER-2/neu protein in patients with breast cancer. *Cancer Res* 1994;54:16–20.
98. Ioannides C, et al. Cytotoxic T cells isolated from ovarian malignant ascites recognize a peptide derived from the HER-2/neu proto-oncogene. *Cell Immunol* 1993;151:225–234.
99. Chen W, et al. T-cell immunity to the joining region of p210<sup>BCR-ABL</sup> protein. *Proc Natl Acad Sci U S A* 1992;89:1468–1472.
100. Bocchia M, et al. Specific human cellular immunity to bcr-abl oncogene-derived peptides. *Blood* 1996;87:3587–3592.
101. Gambacorti-Passerini, C, et al. Human CD4+ lymphocytes specifically recognize a peptide representing the fusion region of the hybrid protein PML/RARα present in acute promyelocytic cells. *Blood* 1993;81:1369–1375.
102. Yanuck T, et al. A mutant p53 tumor suppressor protein is a target for peptide induced CD8+ cytotoxic T-cells. *Cancer Res* 1993;53:3257–3261.
103. Old LJ, Chen YT. New paths in human cancer serology. *J Exp Med* 1998;187:1163–1167.
104. Sahin U, Tureci O, Pfreundschuh M. Serological identification of human tumor antigens. *Curr Opin Immunol* 1997;9:709–716.
105. Sahin U, et al. Human neoplasms elicit multiple immune responses in the autologous host. *Proc Natl Acad Sci U S A* 1995;92:11810–11813.
106. Tureci O, et al. The SSX2 gene, which is involved in the t(X,18) translocation of synovial sarcomas, codes for the human tumor antigen HOM-Mel-40. *Cancer Res* 1996;56:4766–4772.
107. Allison J, McIntyre B, Bloch D. Tumor-specific antigen of murine T lymphoma defined with monoclonal antibody. *J Immunol* 1982;129:2293–2300.
108. Meuer S, et al. Clonotypic structures involved in antigen specific human T cell function: relationship to the T3 molecular complex. *J Exp Med* 1983;157:705–719.
109. Haskins K, et al. The major histocompatibility complex-restricted antigen receptor on T cells. I. Isolation with a monoclonal antibody. *J Exp Med* 1983;157:1149–1169.
110. Kaye J, et al. Both a monoclonal antibody and antisera specific for determinants unique to individual cloned helper T cell lines can substitute for antigen and antigen-presenting cells in the activation of T cells.

J Exp Med 1983;158:836–856.

111. Yanagi Y, et al. A human T cell-specific cDNA clone encodes a protein having extensive homology to immunoglobulin chains. *Nature* 1984;308:145–149.

112. Hedrick S, et al. Isolation of cDNA clones encoding T cell-specific membrane-associated proteins. *Nature* 1984;308:149–153.

113. Hedrick S, et al. Sequence relationships between putative T-cell receptor polypeptides and immunoglobulins. *Nature* 1984;308:153–158.

114. Zinkernagel R, Doherty P. Restriction of in vitro T cell-mediated cytotoxicity in lymphocytic choriomeningitis within a syngeneic or semiallogeneic system. *Nature* 1974;248:701–702.

115. Fremont D, Rees W, Kozono H. Biophysical studies of T-cell receptors and their ligands. *Curr Opin Immunol* 1996;8:93–100.

116. Dustin M, Spring T. Role of lymphocyte adhesion receptors in transient interactions and cell locomotion. *Annu Rev Immunol* 1991;9:27–66.

117. van der Merwe PA. Formation and function of the immunological synapse. *Curr Opin Immunol* 2002;14:293–298.

118. Viola A, Lanzavecchia A. T cell activation determined by T cell receptor number and tunable thresholds. *Nature* 1996;273:104–106.

119. Maniatis N, et al. Pairwise, cooperative and inhibitory interactions describe the assembly and probable structure of the T-cell antigen receptor. *EMBO J* 1991;10:1643–1651.

120. Reth M. Antigen receptor tail clue. *Nature* 1989;338:383–384.

121. June C, et al. Increases in tyrosine phosphorylation are detectable before phospholipase C activation after T cell receptor stimulation. *J Immunol* 1990;144:1591–1599.

122. Burkhardt A, et al. Temporal regulation of non-transmembrane protein tyrosine kinase enzyme activity following T cell antigen receptor engagement. *J Biol Chem* 1994;269:23642–23647.

123. Veillette A, et al. Signal transduction through the CD4 receptor involves the activation of the internal membrane tyrosine-protein kinase p56lck. *Nature* 1989;338:257–259.

124. Samelson L, et al. Association of the fyn protein-tyrosine kinase with the T-cell antigen receptor. *Proc Natl Acad Sci U S A* 1990;87:4358–4362.

125. Gauen L, et al. p59fyn tyrosine kinase associates with multiple T cell receptor subunits through its unique amino-terminal domain. *Mol Cell Biol* 1992;12:5438–5446.

126. Sicheri F, Kuriyan J. Structures of Src-family tyrosine kinases. *Curr Opin Struct Biol* 1997;7:777.

127. Chow L, Veillette A. The Src and Csk families of tyrosine protein kinases in hemopoietic cells. *Semin Immunol* 1995;7:207.

128. Thomas M, Brown E. Positive and negative regulation of Src-family membrane kinases by CD45. *Immunol Today* 1999;20:406.

129. Chan A, et al. ZAP-70: a 70 kD protein tyrosine kinase that associates with the TCR zeta chain. *Cell* 1992;71:649–662.

130. Isakov N, et al. ZAP-70 binding specificity to T cell receptor tyrosine based activation motifs: the tandem SH2 domains of ZAP-70 bind distinct tyrosine-based activation motifs with varying affinity. *J Exp Med* 1995;181:375–380.

131. Hatada M, et al. Molecular basis for interaction of the protein tyrosine kinase ZAP-70 with the T-cell

receptor. *Nature* 1995;377:32–38.

132. Kolanus W, Romeo C, Seed B. T cell activation by clustered tyrosine kinases. *Cell* 1993;74:171–183.

133. Elder M, et al. Human severe combined immunodeficiency due to a defect in ZAP–70, a T cell tyrosine kinase. *Science* 1994;264:1596.

134. Yang W, et al. The role of TEC protein tyrosine kinase in T cell signaling. *J Biol Chem* 1999;274:607.

135. Schaeffer E, et al. Requirement for Tec kinases RLK and ITK in T cell receptor signaling and immunity. *Science* 1999;284:638.

136. Chan A, Shaw A. Regulation of antigen receptor signal transduction by protein tyrosine kinases. *Curr Opin Immunol* 1996;8:394–401.

137. Burack WR, Cheng AM, Shaw AS. Scaffolds, adaptors, and linkers of TCR signaling: theory and practice. *Curr Opin Immunol* 2002;14:312–316.

138. Werlen G, Palmer E. The TCR signalsome: a dynamic structure with expanding complexity. *Curr Opin Immunol* 2002;14:299–305.

139. Sieh M, et al. Grb–2 and phospholipase C– $\gamma$ –1 associate with 36– and 38–kilodalton phosphotyrosine protein after T–cell receptor stimulation. *Mol Cell Biol* 1994;14:4435–4442.

140. Exley M, et al. Association of phosphatidylinositol 3–kinase with a specific sequence of the T cell receptor  $\zeta$  chain is dependent on T cell activation. *J Biol Chem* 1994;269:15140–15146.

141. Kanner S, Aruffo A, Chan P. Lymphocyte antigen receptor activation of a focal adhesion kinase–related tyrosine kinase substrate. *Proc Natl Acad Sci U S A* 1994;91:10484–10487.

142. Buday L, et al. A complex of Grb2 adaptor protein, Sos exchange factor and a 36 kDa membrane bound tyrosine phosphoprotein is implicated in Ras activation in T cells. *J Biol Chem* 1994;269:9019–9023.

143. Reif K, et al. SH3 domains of the adapter molecule Grb2 complex with two proteins in T cells; the guanine nucleotide exchange protein SOS and a 75–kDa protein that is a substrate for T cell antigen receptor–activated tyrosine kinases. *J Biol Chem* 1994;269:14081–14087.

144. Katzav S, et al. The protein tyrosine kinase ZAP–70 can associate with the SH2 domain of proto–Vav. *J Biol Chem* 1994;269:32579–32585.

145. Fournel M, et al. Association of tyrosine protein kinase Zap–70 with the protooncogene product p120–cbl in T lymphocytes. *J Exp Med* 1996;183:301–306.

146. Zhang W, et al. LAT: the ZAP–70 tyrosine kinase substrate that links T cell receptor to cellular activation. *Cell* 1998;92:83.

147. Samelson LE. Signal transduction mediated by the T cell antigen receptor: the role of adapter proteins. *Annu Rev Immunol* 2002;20:371–394.

148. Finco T, et al. LAT is required for TCR–mediated activation of PLC– $\gamma$  and Ras pathway. *Immunity* 1998;9:617.

149. Zhang W, et al. Essential role of LAT in T cell development. *Immunity* 1999; 10:323.

150. Yablonski D, Kadlecsek T, Weiss A. Identification of a phospholipase C– $\gamma$ 1 (PLC– $\gamma$ 1) SH3 domain–binding site in SLP–76 required for T–cell receptor–mediated activation of PLC– $\gamma$ 1 and NFAT. *Mol Cell Biol* 2001;21:4208–4218.

151. Secrist J, Karnitz L, Abraham R. T–cell antigen receptor ligation induces tyrosine phosphorylation of phospholipase C– $\gamma$ 1. *J Biol Chem* 1991;266: 12135–12139.

152. Altman A, Coggeshall K, Mustelin T. Molecular events mediating T cell activation. *Adv Immunol*

1990;48:227-360.

153. Lewis RS. Calcium signaling mechanisms in T lymphocytes. *Annu Rev Immunol* 2001;19:497-521.

154. Arendt CW, et al. Protein kinase C- $\alpha$ : signaling from the center of the T-cell synapse. *Curr Opin Immunol* 2002;14:323-330.

155. Monks C, et al. Selective modulation of protein kinase C- $\theta$  during T-cell activation. *Nature* 1997;385:83-86.

156. Sun Z, et al. PCK- $\alpha$  is required for TCR-induced NK- $\beta$  activation in mature but not immature T lymphocytes. *Nature* 2000;404:402-407.

157. Eder A, et al. Phosphoinositide 3-kinase regulation of T cell receptor-mediated interleukin-2 gene expression in normal T cells. *J Biol Chem* 1998;273:28025.

158. Wymann M, Pirola L. Structure and function of phosphoinositide 3-kinases. *Biochim Biophys Acta* 1998;1436:127.

159. Wymann M, et al. Lipids on the move: phosphoinositide 3-kinases in leukocyte function. *Immunol Today* 2000;21:260.

160. Lewis CM, et al. Tec kinases: modulators of lymphocyte signaling and development. *Curr Opin Immunol* 2001;13:317-325.

161. Sosinowski T, Killeen N, Weiss A. The Src-like adaptor protein down regulates the T cell receptor on CD4+CD8+ thymocytes and regulates positive selection. *Immunity* 2001;15:457-466.

162. Sosinowski T, et al. Src-like adaptor protein (SLAP) is a negative regulator of T cell receptor signaling. *J Exp Med* 2000;191:463-474.

163. McCormick F. Signal transduction: how receptors turn ras on. *Nature* 1993;363:15-16.

164. Izquierdo M, et al. Role of protein kinase C in T-cell antigen receptor regulation of p21ras: evidence that two p21ras regulatory pathways coexist in T cells. *Mol Cell Biol* 1992;12:3305-3312.

165. Downward J, et al. Stimulation of p21ras upon T-cell activation. *Nature* 1990;346:719-723.

166. Su B, Karin M. Mitogen-activated protein kinase cascades and regulation of gene expression. *Curr Opin Immunol* 1996;8:402-411.

167. Hill C, Treisman R. Transcriptional regulation by extracellular signals: mechanisms and specificity. *Cell* 1995;80:199-211.

168. Wu J, et al. Vav and SLP-76 interact and functionally cooperate in IL-2 gene activation. *Immunity* 1996;4:593-602.

169. Tarakhovskiy A, et al. Defective antigen receptor-mediated proliferation of B and T cells in the absence of Vav. *Nature* 1995;347:467-470.

170. Zhang R, et al. Defective signaling through the T and B cell antigen receptors in lymphoid cells lacking the vav proto-oncogene. *Nature* 1995;374:470-473.

171. Stewart S, et al. Activation of phospholipase D: a signaling system set in motion by perturbation of the T lymphocyte antigen receptor/CD3 complex. *Cell Regul* 1991;2:841-850.

172. Stewart S, Cunningham G, House F. Activation of phospholipase D following perturbation of the human T lymphocyte antigen receptor/CD3 complex is dependent upon protein kinase C. *Cell Signal* 1995;5:315-323.

173. Baldwin A. The NF- $\kappa$ B and I $\kappa$ B proteins: new discoveries and insights. *Annu Rev Immunol* 1996;14:649-681.

174. Izquierdo M, et al. The role of protein kinase C in the regulation of extracellular signal-related kinase by the T cell antigen receptor. *Eur J Immunol* 1994;24:3462-3468.
175. Clipstone N, Crabtree G. Identification of calcineurin as a key signaling enzyme in T-lymphocyte activation. *Nature* 1992;357:695-697.
176. Sharma V, et al. Which way for drug-mediated immunosuppression? *Curr Opin Immunol* 1994;6:784-790.
177. Neilson J, Stankunas K, Crabtree GR. Monitoring the duration of antigen-receptor occupancy by calcineurin/glycogen-synthase-kinase-3 control of NF-AT nuclear shuttling. *Curr Opin Immunol* 2001;13:346-350.
178. Rozdzial M, Malissen B, Finkel T. Tyrosine-phosphorylated T cell receptor z chain associates with the actin cytoskeleton upon activation of mature T lymphocytes. *Immunity* 1995;3:623-633.
179. Cantrell D. T cell antigen receptor signal transduction pathways. *Annu Rev Immunol* 1996;14:259-274.
180. Rao A. NF-ATp: a transcription factor required for the coordinate induction of several cytokine genes. *Immunol Today* 1994;15:274-281.
181. Viellette A, Latour S, Davidson D. Negative regulation of immunoreceptor signaling. *Annu Rev Immunol* 2002;20:669-707.
182. Rudd C. Upstream-downstream: CD28 cosignaling pathways and T cell function. *Immunity* 1996;4:527-534.
183. Whiteside TL. Review: signaling defects in T lymphocytes of patients with malignancy. *Cancer Immunol Immunother* 1999;48:346-352.
184. Reichert TE, et al. Signaling abnormalities, apoptosis, and reduced proliferation of circulating and tumor-infiltrating lymphocytes in patients with oral carcinoma. *Clin Cancer Res* 2002;8:3137-3145.
185. Gastman BR, et al. Caspase-mediated degradation of T-cell receptor z-chain. *Cancer Res* 1999;59:1422-1427.
186. Wieckowski E, et al. Granzyme B-mediated degradation of T-cell receptor z chain. *Cancer Res* 2002;62:4884-4889.
187. Nadler L, et al. Serotherapy of a patient with a monoclonal antibody directed against a human lymphoma-associated antigen. *Cancer Res* 1980;40:3137-3154.
188. Ritz J, et al. Serotherapy of acute lymphoblastic leukemia with monoclonal antibody. *Blood* 1981;58:141-152.
189. Miller R, Levy R. Response of cutaneous T cell lymphoma to therapy with hybridoma monoclonal antibody. *Lancet* 1981;2:226-229.
190. Longo D. Immunotherapy for non-Hodgkin's lymphoma. *Curr Opin Oncol* 1996;8:353-359.
191. Glennie MJ, Johnson PWM. Clinical trials of antibody therapy. *Immunol Today* 2000;21:403-410.
192. Riley JK, Sliwkowski MX. CD20: a gene in search of a function. *Semin Oncol* 2000;27:17-24.
193. McLaughlin P, et al. Rituximab chimeric anti-CD20 monoclonal antibody therapy for relapsed indolent lymphoma: half of patients respond to a four-dose treatment program. *J Clin Oncol* 1998;16:2825-2833.
194. Byrd JC, et al. Rituximab therapy in hematologic malignancy patients with circulating blood tumor cells: association with increased infusion-related side effects and rapid blood tumor clearance. *J Clin Oncol* 1999;17:791-795.

195. Kunkel L, et al. Optimizing the use of rituximab for treatment of B-cell non-Hodgkin's lymphoma: a benefit-risk update. *Semin Oncol* 2000;27:53-61.
196. Piro LD, et al. Extended rituximab (anti-CD20 monoclonal antibody) therapy for relapsed or refractory low-grade or follicular non-Hodgkin's lymphoma. *Ann Oncol* 1999;10:655-661.
197. Davis TA, et al. Single-agent monoclonal antibody efficacy in bulky non-Hodgkin's lymphoma: results of a phase II trial of rituximab. *J Clin Oncol* 1999;17:1851-1857.
198. Davis TA, et al. Rituximab anti-CD20 monoclonal antibody therapy in non-Hodgkin's lymphoma: safety and efficacy of re-treatment. *J Clin Oncol* 2000;18:3135-3143.
199. Hainsworth JD. Rituximab as first-line systemic therapy for patients with low-grade lymphoma. *Semin Oncol* 2000;27:25-29.
200. Vose JM, et al. Phase II study of rituximab in combination with CHOP chemotherapy in patients with previously untreated, aggressive non-Hodgkin's lymphoma. *J Clin Oncol* 2001;19:389-397.
201. Coiffier B, et al. CHOP chemotherapy plus rituximab compared with CHOP alone in elderly patients with diffuse large B-cell lymphoma. *N Engl J Med* 2002;346:235-242.
202. Cheson BD. CHOP plus rituximab—balancing facts and opinion. *N Engl J Med* 2002;346:280-281.
203. Fisher RI, et al. Comparison of a standard regimen (CHOP) with three intensive chemotherapy regimens for advanced non-Hodgkin's lymphoma. *N Engl J Med* 1993;328:1002-1006.
204. Ruffini PA, Kwak LW. Immunotherapy of multiple myeloma. *Semin Hematol* 2001;38:260-267.
205. Hussein MA, et al. Biological and clinical evaluation of rituxan in the management of newly diagnosed multiple myeloma patients. *Blood* 1999;94:313a.
206. Treon SP, et al. Phase II study of single agent rituximab in previously treated multiple myeloma patients: patients with CD20+ BM plasma cells may derive benefit from rituximab. *Blood* 2000;96:164a.
207. Weng W, Levy R. Expression of complement inhibitors CD46, CD55, and CD59 on tumor cells does not predict clinical outcome after rituximab treatment in follicular non-Hodgkin's lymphoma. *Blood* 2001;98:1352-1357.
208. Reff ME, et al. Depletion of B cells in vivo by a chimeric mouse human monoclonal antibody to CD20. *Blood* 1994;83:435-445.
209. Clynes RA, et al. Inhibitory Fc receptors modulate in vivo cytotoxicity against tumor targets. *Nat Med* 2000;6:443-446.
210. Cartron G, et al. Therapeutic activity of humanized anti-CD20 monoclonal antibody and polymorphism in IgG Fc receptor Fc $\gamma$ RIIIa gene. *Blood* 2002;99:754-758.
211. Wilson WH. Chemotherapy sensitization by rituximab: experimental and clinical evidence. *Semin Oncol* 2000;27:30-36.
212. Shan D, Ledbetter JA, Press OW. Apoptosis of malignant human B cell by ligation of CD20 with monoclonal antibodies. *Blood* 1998;91:1644-1652.
213. Mathas S, et al. Anti-CD20- and B-cell receptor-mediated apoptosis: evidence for shared intracellular signaling pathways. *Cancer Res* 2000;15:7170-7176.
214. Alas S, Bonavida B. Rituximab inactivates signal transducer and activation of transcription 3 (STAT3) activity in B-non-Hodgkin's lymphoma through inhibition of the interleukin-10 autocrine/paracrine loop and results in down-regulation of Bcl-2 and sensitization to cytotoxic drugs. *Cancer Res* 2001;61:5137-5144.
215. Alas S, Emmanouilides C, Bonavida B. Inhibition of IL-10 by rituximab results in downregulation of

- Bcl-2 and sensitization of B cell non-Hodgkin's lymphoma to apoptosis. *Clin Cancer Res* 2001;7:709-723.
216. Alas S, Bonavida B, Emmanouilides C. Potentiation of fludarabine cytotoxicity on non-Hodgkin's lymphoma by pentoxifylline and rituximab. *Anticancer Res* 2000;20:2961-2966.
217. Press OW, et al. Immunotherapy of non-Hodgkin's lymphomas. *Hematology* 2001;221-240.
218. Keating MJ, et al. Therapeutic role of alemtuzumab (Campath-1H) in patients who have failed fludarabine: results of a large international study. *Blood* 2002;99:3554-3561.
219. Wing MG, et al. Mechanism of first-dose cytokine-release syndrome by CAMPATH-1H: involvement of CD16 (Fc $\gamma$ RIII) and CD11a/CD18 (LFA-1) on NK cells. *J Clin Invest* 1996;98:2819-2826.
220. Kennedy B, et al. CAMPATH-1H in CLL: immune reconstitution and viral infections during and after therapy. *Blood* 2000;96:164a.
221. Leonard JP, Link BK. Immunotherapy of non-Hodgkin's lymphoma with hLL2 (epratuzumab, and anti-CD22 monoclonal antibody) and HuD10 (apolizumab). *Semin Oncol* 2002;29:81-86.
222. Sirisinha S, Eisen H. Autoimmune-like antibodies to the ligand-binding sites of myeloma proteins. *Proc Natl Acad Sci U S A* 1971;68:3130-3135.
223. Lynch R, et al. Myeloma proteins as tumor specific transplantation antigens. *Proc Natl Acad Sci U S A* 1972;69:1540-1544.
224. Levy R, Miller R. Therapy of lymphoma directed at idiotypes. *Monogr Natl Cancer Inst* 1990;10:61-68.
225. Thielemans K, et al. Strategies for production of monoclonal antiidiotypic antibodies against human B cell lymphomas. *J Immunol* 1984;133:495-501.
226. Miller R, et al. Treatment of B-cell lymphoma with monoclonal anti-idiotypic antibody. *N Engl J Med* 1982;306:517-522.
227. Meeker T, et al. A clinical trial of anti-idiotypic therapy for B cell malignancy. *Blood* 1985;65:1349-1363.
228. Meeker T, et al. Emergence of idiotypic variants during treatment of B-cell lymphoma with anti-idiotypic antibodies. *N Engl J Med* 1985;312:1658-1665.
229. Cleary M, et al. Clustering of extensive somatic mutations in the variable region of an immunoglobulin heavy chain gene from a human B cell lymphoma. *Cell* 1986;44:97-106.
230. Carroll W, et al. Idiotypic variant cell populations in patients with B cell lymphoma. *J Exp Med* 1986;164:1566-1580.
231. Levy S, et al. Mutational hot spots in Ig V region genes of human follicular lymphomas. *J Exp Med* 1988;168:475-489.
232. Maloney D, et al. Monoclonal anti-idiotypic antibody therapy of B-cell lymphoma: the addition of a short course of chemotherapy does not interfere with the antitumor effect nor prevent the emergence of idiotypic-negative variant cells. *Blood* 1992;80:1502-1510.
233. Vuist W, Levy R, Maloney D. Lymphoma regression induced by monoclonal anti-idiotypic antibodies correlates with their ability to induce Ig signal transduction and is not prevented by tumor expression of high levels of Bcl-2 protein. *Blood* 1994;83:899-906.
234. Press OW, Rasey J. Principles of radioimmunotherapy for hematologists and oncologists. *Semin Oncol* 2000;27:62-73.
235. Dillman RO. Radiolabeled anti-CD20 monoclonal antibodies for the treatment of B-cell lymphoma. *J Clin Oncol* 2002;20:3545-3557.
236. Chanan-Khan A, Czuczman MS. Radioimmunotherapy in non-Hodgkin's lymphoma. *Curr Opin Oncol*



2002;14:484-489.

237. Cheson B. Radioimmunotherapy of non-Hodgkin's lymphomas. *Blood* 2003;101:391-398.
238. Witzig TE, et al. Randomized controlled trial of yttrium-90-labeled ibritumomab tiuxetan radioimmunotherapy versus rituximab immunotherapy for patients with relapsed or refractory low-grade, follicular, or transformed B-cell non-Hodgkin's lymphoma. *J Clin Oncol* 2002;20:2453-2463.
239. Witzig TE, et al. Treatment with ibritumomab tiuxetan radioimmunotherapy in patients with rituximab-refractory follicular non-Hodgkin's lymphoma. *J Clin Oncol* 2002;20:3262-3269.
240. Kaminski MS, et al. Pivotal study of iodine I 131 tositumomab for chemotherapy-refractory low-grade or transformed low-grade B-cell non-Hodgkin's lymphomas. *J Clin Oncol* 2001;19:3918-3928.
241. Davis TA, et al. Results of a randomized trial of Bexxar (tositumomab plus iodine I 131 tositumomab) vs. unlabeled tositumomab in patients with relapsed or refractory low-grade or transformed non-Hodgkin's lymphoma. *Blood* 2001;98:843a.
242. Horning SJ, et al. Iodine-131 tositumomab for non-Hodgkin's lymphoma patients who progressed after treatment with rituximab: results of a multicenter phase II study. *Blood* 2000;96:508a.
243. Press OW. Radiolabeled antibody therapy of B-cell lymphomas. *Semin Oncol* 1999;26:58-65.
244. Press O, et al. Phase II trial of 131-I-B1 (anti-CD20) antibody therapy with autologous stem cell transplantation for relapsed B cell lymphomas. *Lancet* 1995;346:336-340.
245. Press OW, et al. A phase I/II trial of iodine-131-tositumomab (anti-CD20), etoposide, cyclophosphamide, and autologous stem cell transplantation for relapsed B-cell lymphomas. *Blood* 2000;96:2934-2942.
246. Ghetie MA, Vitetta E. Recent developments in immunotoxin therapy. *Curr Opin Immunol* 1994;6:707-714.
247. Kreitman RJ. Immunotoxins in cancer therapy. *Curr Opin Immunol* 1999;11:570-578.
248. Zein N, et al. Calicheamicin gamma II and DNA: molecular recognition process responsible for site-specificity. *Science* 1989;244:697-699.
249. Sievers EL, et al. Efficacy and safety of gemtuzumab ozogamicin in patients with CD33-positive acute myeloid leukemia in first relapse. *J Clin Oncol* 2001;19:3244-3254.
250. Vallera D. Immunotoxins: will their clinical promise be fulfilled? *Blood* 1994;83:309-317.
251. May R, et al. Evaluation of ricin A chain-containing immunotoxins directed against different epitopes on the delta chain of sIgD on murine B cells. *J Immunol* 1990;144:3637-3642.
252. Olsnes S, et al. Immunotoxins: entry into cells and mechanisms of action. *Immunol Today* 1989;10:291-295.
253. Lamber J, et al. The galactose-binding sites of the cytotoxic lectin ricin can be chemically blocked in high yield with reactive ligands prepared by chemical modification of glycopeptides containing triantennary N-linked oligosaccharides. *Biochemistry* 1991;30:3234-3247.
254. Casellas P, et al. Kinetics of cytotoxicity induced by immunotoxins: enhancement by lysosomotropic amines and carboxylic ionophores. *J Biol Chem* 1984;259:9359-9364.
255. Ramakrishnan S, Houston L. Inhibition of human acute lymphoblastic leukemia cells by immunotoxins: potentiation by chloroquine. *Science* 1984;223:58-61.
256. Sandvig K, Tnnessen T, Olsnes S. Ability of inhibitors of glycosylation and protein synthesis to sensitize cells to abrin, ricin, Shigella toxin, and Pseudomonas toxin. *Cancer Res* 1986;46:6418-6422.

257. Pappenheimer A. Diphtheria toxin. *Annu Rev Biochem* 1977;46:69–94.
258. Endo Y, et al. The mechanism of action of ricin and related toxic lectins on eukaryotic ribosomes. *J Biol Chem* 1984;262:5908–5912.
259. Grossbard M, Fidas P. Prospects for immunotoxin therapy on non-Hodgkin's lymphoma. *Clin Immunol Immunopathol* 1995;76:107–114.
260. Uckun F, Reaman G. Immunotoxins for treatment of leukemia and lymphoma. *Leuk Lymphoma* 1995;18:195–201.
261. Amlot P, et al. A phase I study of an anti-CD22-deglycosylated ricin A chain immunotoxin in the treatment of B-cell lymphomas resistant to conventional therapy. *Blood* 1993;82:2624–2633.
262. Vitetta E, et al. Phase I immunotoxin trial in patients with B-cell lymphoma. *Cancer Res* 1991;51:4052–4058.
263. Grossbard M, et al. Adjuvant immunotoxin therapy with anti-B4-blocked ricin after autologous bone marrow transplantation for patients with B-cell non-Hodgkin's lymphoma. 1993;81:2262–2271.
264. Grossbard M, et al. Anti-B4-blocked ricin: a phase-I trial of 7-day continuous infusion in patients with B-cell neoplasms. *J Clin Oncol* 1993;11:726–737.
265. Scadden DT, et al. Immunotoxin combined with chemotherapy for patients with AIDS-related non-Hodgkin's lymphoma. *Cancer* 1998;83:2580–2587.
266. Multani PS, et al. Phase II clinical trial of bolus infusion anti-B4 blocked ricin immunoconjugate in patients with relapsed B-cell non-Hodgkin's lymphoma. *Clin Cancer Res* 1998;4:2599–2604.
267. Soler-Rodriguez A, et al. Ricin A-chain and ricin A-chain immunotoxins rapidly damage human endothelial cells: implications for vascular leak syndrome. *Exp Cell Res* 1993;206:227–234.
268. Senderowicz AM, et al. Complete sustained response of a refractory, post-transplantation, large B-cell lymphoma to anti-CD22 immunotoxin. *Ann Intern Med* 1997;126:882–885.
269. Kreitman RJ, et al. Efficacy of the anti-CD22 recombinant immunotoxin BL22 in chemotherapy-resistant hairy-cell leukemia. *N Engl J Med* 2001;345:241–247.
270. Hamann PR, et al. Anti-Cd33 calicheamicin hybrid conjugates for the treatment of acute myelogenous leukemia. *Proc Am Assoc Cancer Res* 1996;37:471.
271. Sievers EL, et al. Selective ablation of acute myeloid leukemia using antibody-targeted chemotherapy: a phase I study of anti-CD33 calicheamicin immunoconjugate. *Blood* 1999;93:3678–3684.
272. Sievers EL, et al. Efficacy and safety of gemtuzumab ozogamicin in patients with CD33-positive acute myeloid leukemia in first relapse. *J Clin Oncol* 2001;19:3244–3254.
273. Kreitman R, Pastan I. Recombinant single-chain immunotoxins against T and B cell leukemias. *Leuk Lymphoma* 1994;13:1–10.
274. Apisarnthanarax N, Talpur R, Duvic M. Treatment of cutaneous T cell lymphoma: current status and future directions. *Am J Clin Dermatol* 2002;3:193–215.
275. Olsen E, et al. Pivotal phase III trial of two dose levels of denileukin diftitox for the treatment of cutaneous T-cell lymphoma. *J Clin Oncol* 2001;19:376–388.
276. Duvic M, Cather J. Immunotoxin DAB389-interleukin 2 (Ontak) in the management of cutaneous T cell lymphoma. *Curr Pract Med* 1999;2:7–9.
277. Renner C, Pfreundschuh M. Tumor therapy by immune recruitment with bispecific antibodies. *Immunol Rev* 1995;145:179–209.

278. Weiner LM. Bispecific antibodies in cancer therapy. *Cancer J* 2000;6:S265–S271.
279. van Spriël AB, van Ojik HH, van de Winkel JGJ. Immunotherapeutic perspective for bispecific antibodies. *Immunol Today* 2000;21:391–397.
280. Demanet C, et al. Treatment of murine B cell lymphoma with bispecific monoclonal antibodies (anti-idiotype x anti-CD3). *J Immunol* 1991;147:1091–1097.
281. Brissink J, et al. Treatment of mice bearing BCL1 lymphoma with bispecific antibodies. *J Immunol* 1991;147:4019–4026.
282. Weiner G, Hillstrom J. Bispecific anti-idiotype/anti-CD3 antibody therapy of murine B cell lymphoma. *J Immunol* 1991;147:4035–4044.
283. DeGast GC, et al. Clinical experience with CD3 x CD19 bispecific antibodies in patients with B cell malignancies. *J Hematother* 1995;4:433–437.
284. DeGast G, et al. CD8 T cell activation after intravenous administration of CD3 CD19 bispecific antibody in patients with non-Hodgkin's lymphoma. *Cancer Immunol Immunother* 1995;40:390–396.
285. Koon HB, Junghans RP. Anti-CD30 antibody-based therapy. *Curr Opin Oncol* 2000;12:588–593.
286. Hartmann F, et al. Treatment of refractory Hodgkin's disease with an anti-CD16/CD30 bispecific antibody. *Blood* 1997;89:2042–2047.
287. Hartmann F, et al. Anti-CD16/CD30 bispecific antibody treatment for Hodgkin's disease: role of infusion schedule and co-stimulation with cytokines. *Clin Cancer Res* 2001;7:1873–1881.
288. Darnell J, Kerr I, Stark G. Jak-STAT pathways and transcriptional activation in response to IFNs and other extracellular signaling proteins. *Science* 1994;264:1415–1421.
289. Sen G, Lengyár P. The interferon system: a bird's eye view of its biochemistry. *J Biol Chem* 1992;267:5017–5020.
290. Cohen B, et al. Enhancer-like interferon responsive sequences of the human and murine (2'-5') oligoadenylate synthetase gene promoters. *EMBO J* 1988;7:1411–1419.
291. Gresser I, et al. Interferon and murine leukemia: V. Effect of interferon preparations on the evolution of Rauscher disease in mice. *J Natl Cancer Inst* 1968;41:505–522.
292. Gresser I, Bourali C. Exogenous interferon and inducers of interferon in the treatment of BALB/c mice inoculated with RC19 tumour cells. *Nature* 1969;223:844–845.
293. Talpaz M, et al. Hematological remission and cytogenetic improvement induced by recombinant human interferon alpha A in chronic myelogenous leukemia. *N Engl J Med* 1986;314:1065–1069.
294. Talpaz M, et al. Clinical investigation of human alpha interferon in chronic myelogenous leukemia. *Blood* 1987;69:1280–1288.
295. Alimena G, et al. Interferon alpha-2b as therapy for Ph1-positive chronic myelogenous leukemia. A study of 82 patients treated with intermittent or daily administration. *Blood* 1988;72:642–647.
296. Ozer H, et al. Prolonged subcutaneous administration of recombinant a2b interferon in patients with previously untreated Philadelphia chromosome-positive chronic-phase chronic myelogenous leukemia: effect on remission duration and survival: Cancer and Leukemia Group B study 8583. *Blood* 1993;82:2975–2984.
297. Freund M, et al. Recombinant human interferon alpha-2b in chronic myelogenous leukemia: dose dependency of response and frequency of neutralizing anti-interferon antibodies. *Br J Haematol* 1989;72:350–356.
298. Tura S, et al. Interferon alfa-2a as compared with conventional chemotherapy for the treatment of

chronic myeloid leukemia. *N Engl J Med* 1994;330:820–825.

299. Kalidas M, Kantarjian H, Talpaz M. Chronic myelogenous leukemia. *JAMA* 2001;286:895–898.
300. Appelbaum FR. Perspectives on the future of chronic myeloid leukemia treatment. *Semin Hematol* 2001;38:35–42.
301. Helhlmann R, et al. Randomized comparison of interferon–alpha with busulfan and hydroxyurea in chronic myelogenous leukemia. *Blood* 1994;84:4064–4077.
302. Chronic Myeloid Leukemia Trialists' Collaborative Group. Interferon alpha versus chemotherapy for chronic myeloid leukemia: a meta–analysis of seven randomized trials. *J Natl Cancer Inst* 89:1616–1620.
303. Quesada J, et al. Alpha interferon for induction of remission in hairy cell leukemia. *N Engl J Med* 1984;310:15–18.
304. Worman C, et al. The U.K. experience with human lymphoblastoid interferon in HCL. *Leukemia* 1987;1:320–322.
305. Damasio E, et al. Human lymphoblastoid interferon for hairy cell leukemia: results from the Italian cooperative group. *Leukemia* 1987;1:331–333.
306. Foon K, et al. Recombinant leukocyte A interferon therapy for advanced hairy cell leukemia: therapeutic and immunologic results. *Am J Med* 1986;80:351–356.
307. Golomb H, et al. Alpha–2 interferon therapy for hairy cell leukemia: a multicenter study of 64 patients. *J Clin Oncol* 1986;4:900–905.
308. Paganelli K, et al. B cell growth factor–induced proliferation of hairy cell lymphocytes and inhibition by type I interferon in vitro. *Blood* 1986;67:937–942.
309. Baldini L, et al. Human recombinant interferon alpha–2c enhances the expression of class II HLC antigens on hairy cells. *Blood* 1986;67:458–464.
310. Gressler V, et al. Modulation of the expression of major histocompatibility antigens on splenic hairy cells: differential effect upon in vitro treatment with alpha–2b interferon, gamma–interferon, and interleukin–2. *Blood* 1988;72:1048–1053.
311. vander Molen L, et al. Low–versus high–dose interferon alfa–2a in relapsed indolent non–Hodgkin's lymphoma. *J Natl Cancer Inst* 1990;82:235–238.
312. Solai–Celigny P. GELF studies of intron A in follicular lymphomas: an update on the clinical data. *Ann Oncol* 1996;7:229.
313. Greipp P, Witzig T. Biology and treatment of myeloma. *Curr Opin Oncol* 1996;8:20–27.
314. Kirkwood J. Cancer immunotherapy: the interferon–a experience. *Semin Oncol* 2002;29:18–26.
315. Oken M. New agents for the treatment of multiple myeloma and non–Hodgkin's lymphoma. *Cancer* 1992;70:946–948.
316. Ludwig H, et al. Interferon–alpha for induction and maintenance in multiple–myeloma: results of 2 multicenter randomized trials and summary of other studies. *Ann Oncol* 1995;6:467–476.
317. Salmon S, et al. Combination chemotherapy, glucocorticoids, and interferon alfa in the treatment of multiple myeloma: a Southwest Oncology Group study. *J Clin Oncol* 1994;12:2405–2414.
318. Cooper M, et al. A randomized clinical trial comparing melphalan/prednisone with or without interferon–alfa–2b in newly diagnosed patients with multiple myeloma: a Cancer and Leukemia Group B study. *J Clin Oncol* 1993;11:155–160.
319. Alexanian R, Dimopoulos M. Management of multiple myeloma. *Semin Hematol* 1995;32:20–30.

320. Tomiyama J, et al. Clinical study of multiple myeloma in the elderly. *Oncol Rep* 1995;2:669–673.
321. Morgan D, Ruscetti F, Gallo R. Selective in vitro growth of T lymphocytes from normal human bone marrows. *Science* 1976;192:1007–1008.
322. Ruscetti F, Morgan D, Gallo R. Functional and morphological characterization of human T cells continuously grown in vitro. *J Immunol* 1977;119:131–138.
323. Gillis S, Smith K. Long-term culture of cytotoxic T-lymphocytes. *Nature* 1977;268:154–156.
324. Baker P, Gillis S, Smith K. Monoclonal cytolytic T-cell lines. *J Exp Med* 1979;149:273–278.
325. Gillis S, et al. The in vitro generation and sustained culture of nude mouse cytolytic T lymphocytes. *J Exp Med* 1979;149:1460–1476.
326. Lotze M, et al. Lysis of fresh and cultured autologous tumor by human lymphocytes cultured in T-cell growth factor. *Cancer Res* 1981;41:4420–4425.
327. Taniguchi T, et al. Structure and expression of a cloned cDNA for human interleukin-2. *Nature* 1983;302:305–310.
328. Smith K. The interleukin 2 receptor. *Annu Rev Cell Biol* 1989;5:397–425.
329. Wang HM, Smith K. The interleukin 2 receptor: functional consequences of its biomolecular structure. *J Exp Med* 1987;166:1055–1069.
330. Smith K. Interleukin-2 immunotherapy. In: Strom T, ed. *Therapeutic immunology*. Cambridge: Blackwell Science, 1996:264–268.
331. Siegel J, Puri R. Interleukin-2 toxicity. *J Clin Oncol* 1991;9:694–704.
332. Caligiuri M, et al. Selective modulation of human natural killer cells in vivo following prolonged infusion of low-dose recombinant interleukin 2. *J Clin Invest* 1993;91:123–132.
333. Maraninchi D, et al. High-dose recombinant interleukin-2 and acute myeloid leukemias in relapse. *Blood* 1991;78:2182–2187.
334. Foa R, et al. Treatment of acute myeloid leukaemia patients with recombinant interleukin 2: a pilot study. *Br J Haematol* 1991;77:491–496.
335. Lim S, et al. Continuous intravenous infusion of high-dose recombinant interleukin-2 for acute myeloid leukaemia: a phase II study. *Cancer Immunol Immunother* 1992;347:337–342.
336. Meloni G, et al. Interleukin-2 may induce prolonged remissions in advanced acute myelogenous leukemia. *Blood* 1994;84:2158–2163.
337. Benyunes M, et al. Immunotherapy with interleukin-2 after autologous bone marrow transplantation for hematologic malignancies. *Prog Clin Biol Res* 1994;389:229–238.
338. Wiernik P, et al. Polyethylene glycosylated interleukin-2 as maintenance therapy for acute myelogenous leukemia in second remission. *Am J Hematol* 1994;47:41–44.
339. Cortes JE, et al. A pilot study of interleukin-2 for adult patients with acute myelogenous leukemia in first complete remission. *Cancer* 1999;85:1506–1513.
340. Sznol M, Parkinson D. Interleukin-2 in therapy of hematologic malignancies. *Blood* 1994;83:2020–2022.
341. Gisselbrecht C, et al. Interleukin-2 treatment in lymphoma: a phase II multicenter study. *Blood* 1994;83:2081–2085.

342. Ogata K, Yokose N, Nomura T. Interleukin-2 therapy for myelodysplastic syndrome: does it work? *Leuk Lymphoma* 1995;17:411-415.
343. Barnes D, Loutit J. Treatment of murine leukaemia with x-rays and homologous bone marrow. *Br J Haematol* 1957;3:241-252.
344. Mathe G, et al. Adoptive immunotherapy of acute leukemia: experimental and clinical results. *Cancer Res* 1965;25:1525-1531.
345. Fefer A, et al. Graft versus leukemia effect in man: the relapse rate of acute leukemia is lower after allogeneic than after syngeneic marrow transplantation. In: Bortin M, ed. *Cellular immunotherapy of cancer*. New York: Alan R Liss, 1987:401-408.
346. Antin J. Graft-versus-leukemia: no longer an epiphenomenon. *Blood* 1993;82:2273-2277.
347. Porter D, Antin J. Graft-versus-leukemia effect in bone-marrow transplantation. In: Sheridan W, ed. *Cell therapy: stem cell transplantation, gene therapy, and cellular immunotherapy*. Cambridge: Cambridge University Press, 1996:568-585.
348. Odom L, et al. Remission of relapsed leukaemia during a graft-versus-host reaction. A "graft-versus-leukemia reaction" in man? *Lancet* 1978;2:357-340.
349. Collins R, et al. Hematologic relapse of chronic myelogenous leukemia following allogeneic bone marrow transplantation: apparent graft-versus-leukemia effect following abrupt discontinuation of immunosuppression. *Bone Marrow Transplant* 1992;10:391-395.
350. Gale R, Champlin R. How does bone-marrow transplantation cure leukaemia? *Lancet* 1984;2:28-30.
351. Gale R, et al. Identical-twin bone marrow transplants for leukemia. *Ann Intern Med* 1994;120:646-652.
352. Horowitz M, et al. Graft-versus-leukemia reactions after bone marrow transplantation. *Blood* 1990;75:555-562.
353. Barrett J, Malkovsk V. The graft-versus-leukemia effect. *Curr Opin Oncol* 1996;8:89-95.
354. Jones R, et al. Evidence of a graft-versus-lymphoma effect associated with allogeneic bone marrow transplantation. *Blood* 1991;77:649-653.
355. Goulmy E. Minor histocompatibility antigens and their role in transplantation. *Transplant Rev* 1988;2:29-53.
356. den Haan J, et al. Identification of a graft-versus-host disease-associated minor histocompatibility antigen. *Science* 1995;268:1476-1479.
357. Porter DL, Antin JH. The graft-versus-leukemia effects of allogeneic cell therapy. *Annu Rev Med* 1999;50:369-386.
358. Kessels HWHG, Wolkers MC, Schumacher NM. Adoptive transfer of T-cell immunity. *Trends Immunol* 2002;23:264-269.
359. Marijt W, et al. Multiple minor histocompatibility antigen-specific cytotoxic T lymphocyte clones can be generated during graft rejection after HLA identical bone marrow transplantation. *Bone Marrow Transplant* 1995;16:125-132.
360. van der Harst D, et al. Recognition of minor histocompatibility antigens on lymphocytic and myeloid leukemic cell lines by cytotoxic T-cell clones. *Blood* 1994;83:1060-1066.
361. Fontaine P, et al. Adoptive transfer of minor-histocompatibility-antigen-specific T lymphocytes eradicates leukemia cells without causing graft-versus-host disease. *Nat Med* 2001;7:789-794.
362. Disis M, Cheever M. Oncogenic proteins as tumor antigens. *Curr Opin Immunol* 1996;8:637-642.

363. ten Bosch G, et al. Recognition of BCR-ABL positive leukemic blasts by human CD4<sup>+</sup> T cells elicited by primary in vitro immunization with a BCR-ABL breakpoint peptide. *Blood* 1996;88:3522-3527.
364. Maraninchi D, et al. Impact of T-cell depletion on outcome of allogeneic bone-marrow transplantation for chronic myeloid leukemia. *Lancet* 1987;2:175-178.
365. Hercend T, et al. Characterization of natural killer cells with antileukemic activity following allogeneic bone marrow transplantation. *Blood* 1986;67:722-730.
366. Nimer S, et al. Selective depletion of CD8<sup>+</sup> cells for prevention of graft-versus-host disease after bone marrow transplantation: a randomized controlled trial. *Transplantation* 1994;57:82-88.
367. Giralt S, et al. CD8<sup>+</sup>-depleted donor lymphocyte infusion as treatment for relapsed chronic myelogenous leukemia after allogeneic bone marrow transplantation: graft vs. leukemia without graft vs. host disease. *Blood* 1995;86:4337-4343.
368. Korngold R, Leighton C, Manser T. Graft-versus-myeloid responses following syngeneic and allogeneic bone marrow transplantation. *Transplantation* 1994;15:278-287.
369. Faber L, et al. Generation of CD4<sup>+</sup> cytotoxic T-lymphocytes clones from a patient with severe graft-versus-host disease after allogeneic bone marrow transplantation: implications for graft-versus-leukemia reactivity. *Blood* 1995;86:2821-2828.
370. Fowler DH, Gress RE. Th2 and Tc2 cells in the regulation of GVHD, GVL, and graft rejection: considerations for the allogeneic transplantation therapy of leukemia and lymphoma. *Leuk Lymphoma* 2000;38:221-234.
371. Altman JD, et al. Phenotypic analysis of anti-specific T lymphocytes. *Science* 1996;274:94-96.
372. Mutis T, et al. Tetrameric HLA class I minor histocompatibility antigen peptide complexes demonstrate minor-histocompatibility-antigen-specific cytotoxic T lymphocytes in patients with graft-versus-host disease. *Nat Med* 1999;5:839-842.
373. Morecki S, Slavin S. Toward amplification of a graft-versus-leukemia effect while minimizing graft-versus-host disease. *J Hematother Stem Cell Res* 2000;9:355-366.
374. Johnson B, Truitt R. Delayed infusion of immunocompetent donor cells after bone marrow transplantation breaks graft-host tolerance and allows for persistent antileukemic reactivity without severe graft-versus-host disease. *Blood* 1995;85:3302-3312.
375. Tiberghien P, et al. Ganciclovir treatment of herpes simplex thymidine kinase-transduced primary T lymphocytes: an approach for specific in vivo donor T-cell depletion after bone marrow transplantation. *Blood* 1994;84:1333-1341.
376. Litvinova E, et al. Graft-versus-leukemia effect after suicide-gene-mediated control of graft-versus-host disease. *Blood* 2002;100:2020-2025.
377. Sykes M, et al. Interleukin-2 inhibits graft-versus-host disease-promoting activity of CD4<sup>+</sup> cells while preserving CD4<sup>-</sup> and CD8-mediated graft-versus-leukemia effects. *Blood* 1994;82:2560-2569.
378. Cavazzana-Calvo M, et al. Attenuation of graft-versus-host disease and graft rejection by ex-vivo immunotoxin elimination of alloreactive T cells in an H-2 haplotype disparate mouse combination. *Blood* 1994;83:288-298.
379. Datta A, et al. Distinct T-cell populations distinguish chronic myeloid leukemia cells from lymphocytes in the same individual: a model for separating GVHD from GVL reactions. *Bone Marrow Transplant* 1994;14:517-524.
380. Falkenberg J, et al. Generation of donor-derived antileukemic cytotoxic T-lymphocyte responses for treatment of relapsed leukemia after allogeneic HLA-identical bone marrow transplantation. *J Immunother* 1993;14:305-309.



381. Shimoni A, et al. Allogeneic hematopoietic transplantation for acute and chronic myeloid leukemia: non-myeloablative preparative regimens and induction of the graft-versus-leukemia effect. *Curr Oncol Rep* 2000;2:132-139.
382. Carella AM, et al. Mini-allografts: ongoing trials in humans. *Bone Marrow Transplant* 2000;25:345-350.
383. Kolb H, et al. Graft-versus-leukemia effect of donor lymphocyte transfusions in marrow grafted patients. *Blood* 1995;86:2041-2050.
384. Kolb H, et al. Donor leukocyte transfusions for treatment of recurrent chronic myelogenous leukemia in marrow transplant patients. *Blood* 1990;76:2462-2465.
385. Dazzi F, Goldman JM. Adoptive immunotherapy following allogeneic bone marrow transplantation. *Annu Rev Med* 1998;49:329-340.
386. Giralt S, Kolb H. Donor lymphocyte infusion. *Curr Opin Oncol* 1996;8:96-102.
387. Collins R, et al. Donor leukocyte infusions in 140 patients with relapsed malignancy after allogeneic bone marrow transplantation. *J Clin Oncol* 1997;15:433-444.
388. Soiffer R. Donor lymphocyte infusions: the door is open. *J Clin Oncol* 1997;15:416-417.
389. van Rhee F, et al. Relapse of chronic myeloid leukemia after allogeneic bone marrow transplant: the case for giving donor leukocyte transfusions before the onset of hematologic relapse. *Blood* 1994;83:3377-3383.
390. van Rhee F, Goldman J. Donor lymphocyte therapy in bone-marrow transplantation. In: Sheridan W, ed. *Cell therapy: stem cell transplantation, gene therapy, and cellular immunotherapy*. Cambridge: Cambridge University Press, 1996:550-567.
391. Bar B, et al. Donor leukocyte infusions for chronic myeloid leukemia relapsed after allogeneic bone marrow transplantation. *J Clin Oncol* 1993;11:513-519.
392. Drobyski W, et al. Salvage immunotherapy using donor leukocyte infusions as treatment for relapsed chronic myelogenous leukemia after allogeneic bone marrow transplantation: efficacy and toxicity of a defined T-cell dose. *Blood* 1993;82:2310-2318.
393. Rosenberg S, et al. Observations on the systemic administration of autologous lymphokine-activated killer cells and recombinant interleukin-2 to patients with metastatic cancer. *N Engl J Med* 1985;313:1485-1492.
394. Rosenberg S, et al. Use of tumor-infiltrating lymphocytes and interleukin-2 in the immunotherapy of patients with metastatic melanoma: a special report. *N Engl J Med* 1988;319:1676-1680.
395. Lotze M, et al. In vitro growth of cytotoxic human lymphocytes. IV. Lysis of fresh and cultured autologous tumor by lymphocytes cultured in T cell growth factor (TCGF). *Cancer Res* 1981;41:4420-4425.
396. Rayner A, et al. Lymphokine-activated killer (LAK) cell phenomenon: analysis of factors relevant to the immunotherapy of human cancer. *Cancer* 1985;55:1327-1333.
397. Rosenstein M, et al. Lymphokine activated killer cells: lysis of fresh syngeneic NK-resistant murine tumor cells by lymphocytes cultured in interleukin-2. *Cancer Res* 1984;44:1946-1953.
398. Grimm E, et al. Lymphokine-activated killer cell phenomenon. II. The precursor phenotype is serologically distinct from peripheral T lymphocytes, memory CTL, and NK cells. *J Exp Med* 1983;157:884-897.
399. Phillips J, Lanier L. Dissection of the lymphokine activated killer phenomenon. Relative contribution of peripheral blood natural killer cells and T lymphocytes to cytolysis. *J Exp Med* 1986;164:814-825.
400. Rosenberg S, et al. A progress report on the treatment of 157 patients with advanced cancer using lymphokine activated killer cells and interleukin-2 or high dose interleukin-2 alone. *N Engl J Med*

1987;316:889–897.

401. Rosenberg S, et al. Experience with the use of high-dose interleukin-2 in the treatment of 652 cancer patients. *Ann Surg* 1989;210:474–485.
402. Carson W, Caligiuri M. Cellular adoptive immunotherapy with natural killer cells. In: Sheridan W, ed. *Cell therapy: stem cell transplantation, gene therapy, and cellular immunotherapy*. Cambridge: Cambridge University Press, 1996:451–474.
403. Rosenberg S, Spiess P, Lafreniere R. A new approach to the adoptive immunotherapy of cancer with tumor-infiltrating lymphocytes. *Science* 1986;223:1318–1321.
404. Fisher B, et al. Tumor localization of adoptively transferred indium-111 labeled tumor infiltrating lymphocytes in patients with metastatic melanoma. *J Clin Oncol* 1989;7:250–261.
405. Griffith K, et al. In vivo distribution of adoptively transferred indium-111 labeled tumor infiltrating lymphocytes and peripheral blood lymphocytes in patients with metastatic melanoma. *J Natl Cancer Inst* 1989;81:1709–1717.
406. Rosenberg S, Yannelli J, Yang J. Treatment of patients with metastatic melanoma with autologous tumor infiltrating lymphocytes and interleukin-2. *J Natl Cancer Inst* 1994;86:1159.
407. Riddell S, et al. Restoration of viral immunity in immunodeficient humans by the adoptive transfer of T cell clones. *Science* 1992;257:238–241.
408. Riddell S, Greenberg P. Principles for adoptive T cell therapy of human viral disease. *Annu Rev Immunol* 1995;13:545–586.
409. Walter EA, et al. Reconstitution of cellular immunity against cytomegalovirus in recipients of allogeneic bone marrow by transfer of T-cell clones from the donor. *N Engl J Med* 1995;333:1038–1044.
410. Yee C, Riddell SR, Greenberg PD. Prospects for adoptive T cell therapy. *Curr Opin Immunol* 1997;9:702–708.
411. Rosenberg SA. Progress in human tumour immunology and immunotherapy. *Nature* 2001;411:380–384.
412. Timmerman JM, Levy R. The history of the development of vaccines for the treatment of lymphoma. *Clin Lymphoma* 2000;1:129–139.
413. Campbell M, et al. Idiotypic vaccination against murine B cell lymphoma. Humoral and cellular responses elicited by tumor-derived immunoglobulin M and its molecular subunits. *J Immunol* 1987;139:2825.
414. Kwak L, et al. Induction of immune responses in patients with B-cell lymphoma against the surface immunoglobulin idiotype expressed by their tumors. *N Engl J Med* 1992;327:1209–1215.
415. Hsu FJ, et al. Tumor-specific idiotype vaccines in the treatment of patients with B-cell lymphoma—long-term results of a clinical trial. *Blood* 1997;89:3129–3135.
416. Bendandi M, et al. Complete molecular remissions induced by patient-specific vaccination plus granulocyte-monocyte colony-stimulating factor against lymphoma. *Nat Med* 1999;5:1171–1177.
417. Tao MH, Levy R. Idiotype/granulocyte-macrophage colony-stimulating factor fusion protein as a vaccine for B-cell lymphoma. *Nature* 1993;362:755–758.
418. Syrengelas A, Chen T, Levy R. DNA immunization induces protective immunity against B-cell lymphoma. *Nature* 1996;2:1038–1041.
419. Hsu F, et al. Vaccination of patients with B-cell lymphoma using autologous antigen-pulsed dendritic cells. *Nature* 1996;2:52–58.
420. Timmerman JM, et al. Idiotype-pulsed dendritic cell vaccination for B-cell lymphoma: clinical and

immunological responses in 26 patients. *Blood* 1999;94:385a.

421. Timmerman JM, Levy R. Linkage of foreign carrier protein to a self-tumor antigen enhances the immunogenicity of a pulsed dendritic cell vaccine. *J Immunol* 2000;164:4797-4803.

422. Timmerman JM, et al. Regressions of follicular lymphoma following vaccination with idiotypic-protein coupled to keyhole limpet hemocyanin (Id-KLH) and idiotypic-pulsed dendritic cells. *Blood* 2000;96:508a.

423. Reichardt VL, et al. Idiotypic vaccination using dendritic cells after autologous peripheral blood stem cell transplantation for multiple myeloma—a feasibility study. *Blood* 1999;93:2411-2419.

424. Reichardt VL, et al. Specific immunotherapy of multiple myeloma patients using idiotypic pulsed serum free generated dendritic cells. *Blood* 2000;96:163a.

425. Titzer S, et al. Vaccination of multiple myeloma patients with idiotypic pulsed dendritic cells: immunological and clinical aspects. *Br J Hematol* 2000;108:805-816.

426. MacKenzie M, et al. Immunotherapy of advanced refractory multiple myeloma with idiotypic-pulsed dendritic cells. *Blood* 2000;96:166a.

427. Pardoll D. Paracrine cytokine adjuvants in cancer immunotherapy. *Annu Rev Immunol* 1995;13:399-415.

428. Tepper R, Pattengale P, Leder P. Murine interleukin-4 displays potent anti-tumor activity in vivo. *Cell* 1989;57:503-512.

429. Tepper R, Coffman R, Leder P. An eosinophil-dependent mechanism for the antitumor effect of interleukin-4. *Science* 1992;257:548-551.

430. Fearon E, et al. Interleukin-2 production by tumor cells bypasses T helper function in the generation of an antitumor response. *Cell* 1990;60:397-403.

431. Golubek P, et al. Treatment of established renal cell cancer by tumor cells engineered to secrete interleukin-4. *Science* 1991;254:713-716.

432. Dranoff G, et al. Vaccination with irradiated tumor cell engineered to secrete murine granulocyte-macrophage colony-stimulating factor stimulates potent, specific, and long-lasting anti-tumor immunity. *Proc Natl Acad Sci U S A* 1993;90:3539-3543.

433. Mach N, Dranoff G. Cytokine-secreting tumor cell vaccines. *Curr Opin Immunol* 2000;12:571-575.

434. Cavallo F, et al. Antitumor efficacy of adenocarcinoma cells engineered to produce interleukin-12 (IL-12) or other cytokines compared with exogenous IL-12. *J Natl Cancer Inst* 1997;89:1049-1058.

435. Dunussi-Joannopoulos K, et al. Vaccines with interleukin-12-transduced acute myeloid leukemia cells elicit very potent therapeutic and long-lasting protective immunity. *Blood* 1999;94:4263-4273.

436. Levitsky H, et al. Immunization with granulocyte-macrophage colony-stimulating factor-transduced, but not B7-1-transduced, lymphoma cells primes idiotypic-specific T cells and generates potent systemic antitumor immunity. *J Immunol* 1996;156:3858-3865.

437. Stewart S, Forbes J, House F. Cytokine-driven tumor elimination and induction of resistance to challenge in a murine model of indolent B-cell lymphoma. *Proc Am Assoc Cancer Res* 1996;37:456.

438. Jaffee E, et al. High efficiency gene transfer into primary human tumor explants without cell selection. *Cancer Res* 1993;53:2221-2226.

439. Simons JW, et al. Bioactivity of autologous irradiated renal cell carcinoma vaccines generated by ex vivo granulocyte-macrophage colony-stimulating factor gene transfer. *Cancer Res* 1997;57:1537-1546.

440. Soiffer R, et al. Vaccination with irradiated autologous melanoma cells engineered to secrete human granulocyte-macrophage colony-stimulating factor generates potent antitumor immunity in patients with

metastatic melanoma. *Proc Natl Acad Sci U S A* 1998;95:13141–13146.

441. Golumbek P, et al. Controlled release, biodegradable cytokine depots: a new approach in cancer vaccine design. *Cancer Res* 1993;53:5841–5844.

442. Chambers CA. The expanding world of co-stimulation: the two-signal model revisited. *Trends Immunol* 2001;22:217–223.

443. Chen L, et al. Costimulation of antitumor immunity by the B7 counterreceptor for the T lymphocyte molecules CD28 and CTLA-4. *Cell* 1992;71:1093–1102.

444. Townsend S, Allison J. Tumor rejection after direct costimulation of CD8+ T cells by B7-transfected melanoma cells. *Science* 1993;259:368–370.

445. Baskar S, et al. Constitutive expression of B7 restores immunogenicity of tumor cells expressing truncated major histocompatibility complex class II molecules. *Proc Natl Acad Sci U S A* 1993;90:5687–5690.

446. Townsend S, et al. Specificity and longevity of antitumor immune responses induced by B7-transfected tumors. *Cancer Res* 1994;54:6477–6483.

447. Baskar S, et al. Major histocompatibility complex class II+B7-1+ tumor cells are potent vaccines for stimulating tumor rejection in tumor-bearing mice. *J Exp Med* 1995;181:619–629.

448. Li Y, et al. Costimulation of tumor-reactive CD4+ and CD8+ T lymphocytes by B7, a natural ligand for CD28, can be used to treat established mouse melanoma. *J Immunol* 1994;153:421–428.

449. Allison J, Hurwitz A, Leach D. Manipulation of costimulatory signals to enhance antitumor T-cell responses. *Curr Opin Immunol* 1995;7:682–686.

450. Walunas T, et al. CTLA-4 can function as a negative regulator of T cell activation. *Immunity* 1994;1:405–413.

451. Krummel M, Allison J. CD28 and CTLA-4 deliver opposing signals which regulate the response of T cells to stimulation. *J Exp Med* 1995;182:459–465.

452. Allison J, Krummel M. The yin and yang of T cell costimulation. *Science* 1995;270:932.

453. Leach D, Krummel M, Allison J. Enhancement of antitumor immunity by CTLA-4 blockade. *Science* 1996;271:1734–1736.

454. Egen JG, Kuhns MS, Allison JP. CTLA-4: new insights into its biological function and use in tumor immunotherapy. *Nat Immunol* 2002;3:611–618.

455. Waterhouse P, et al. Lymphoproliferative disorders with early lethality in mice deficient in CTLA-4. *Science* 1995;270:985–988.

456. Baggers J, Ratzinger G, Young JW. Dendritic cells as immunologic adjuvants for the treatment of cancer. *J Clin Oncol* 2000;18:3879–3882.

457. Timmerman JM, Levy R. Dendritic cell vaccines for cancer immunotherapy. *Annu Rev Med* 1999;50:507–529.

458. Reid CDL. Review: dendritic cells and immunotherapy for malignant disease. *Br J Hematol* 2001;112:874–887.

459. Nestle FO. Dendritic cell vaccination for cancer therapy. *Oncogene* 2000;19:6673–6679.

460. Brossart P, et al. Dendritic cells in cancer vaccines. *Exp Hematol* 2001;29:1247–1255.

461. Caux C, et al. CD34+ hematopoietic progenitors from human cord blood differentiate along two independent dendritic cell pathways in response to GM-CSF + TNF alpha. *J Exp Med* 1996;184:695–706.

462. Jager E, Jager D, Knuth A. Clinical cancer vaccine trials. *Curr Opin Immunol* 2002;14:178–182.
463. Ranson M, Mansoor W, Jayson G. ZD1839 (IRESSA): a selective EGFR-TK inhibitor. *Expert Rev Anticancer Ther* 2002;2:161–168.
464. Druker BJ. STI571 (Gleevec) as a paradigm for cancer therapy. *Trends Mol Med* 2002;8:S14–18.
465. Sawyers CL. Finding the next Gleevec: FLT3 targeted kinase inhibitor therapy for acute myeloid leukemia. *Cancer Cell* 2002;1:413–415.

2004 Lippincott Williams & Wilkins  
John P. Greer, John Foerster, John N. Lukens  
George M. Rodgers, Frixos Paraskevas, Bertil Glader  
Wintrobe's Clinical Hematology

**APPROACH TO INFECTION IN THE IMMUNOCOMPROMISED HOST****Patient Evaluation and Assessment of Risk****Changing Epidemiology of Infections****Diagnostic Techniques****Empirical Antimicrobial Therapy: Current Guidelines and Regimens****Role of Granulocyte Transfusions and Growth Factors****Common Organ-Specific Febrile Syndromes****INFECTIONS IN THE STEM CELL TRANSPLANT RECIPIENT****General Principles****Early and Late Bacterial Infections****Cytomegalovirus****Other Viral Pathogens****Fungal Infections****Protozoal Infections****STRATEGIES FOR THE PREVENTION OF INFECTION****Reduction of Nosocomial Pathogen Acquisition****Decreasing Microbial Colonization of the Patient****Augmentation of Host Defenses****PREVENTION AND TREATMENT OF CHEMOTHERAPY-RELATED CYTOPENIAS****Use of Hematopoietic Growth Factors****Anemia****Myelosuppression and Colony-Stimulating Factors****Thrombocytopenia****Risks and Toxicities of Growth Factors****COMMON COMPLICATIONS OF CHEMOTHERAPY****Dermatologic Toxicity****Mucositis****Urinary Tract Toxicity****Cardiotoxicity****Pulmonary Toxicity****NONINFECTIOUS ISSUES IN HEMATOPOIETIC STEM CELL TRANSPLANTATION****Conditioning Regimen Toxicity****Venoocclusive Disease****Acute Lung Injury and Alveolar Hemorrhage****MANAGEMENT OF NAUSEA AND VOMITING****Emesis Response****Characteristics of Emesis That Is Induced by Chemoradiotherapy****Control and Prevention of Nausea****SELECTION AND CARE OF VASCULAR ACCESS DEVICES****General Considerations****Types of Access Devices****Selection of Catheters****Catheter Care****Complications****PHARMACOLOGIC MANAGEMENT OF CANCER PAIN****Types of Cancer Pain****Obstacles to Pain Management****Pain Assessment****Analgesic Agents**

[Routes of Administration and Dosing Considerations](#)

[Prevention and Management of Side Effects](#)

[Adjuvant Therapy](#)

**MISCELLANEOUS ISSUES**

[Infertility and Sexual Dysfunction](#)

[Pregnancy](#)

[Psychosocial Support](#)

[Palliative and Terminal Care](#)

**NUTRITIONAL SUPPORT**

[Hypermetabolism](#)

[Protein-Calorie Malnutrition](#)

[Nutritional Assessment](#)

[Enteral Nutrition](#)

[Parenteral Nutrition](#)

[Nutrition in Transplant Hematology](#)

**CONCLUSION**

**ACKNOWLEDGMENT**

**REFERENCES**

Several advances have been made over the past few decades in the supportive care of patients undergoing therapy for hematologic malignancies. This has resulted in improved survival as well as better quality of life in such patients. Use of new treatment modalities, such as monoclonal antibodies, radioimmunotherapy, and reduced intensity stem cell transplants (SCT), has changed the infectious risk, the spectrum of infections, and, thereby, the complications in this patient population. Intensive treatment strategies, such as high-dose chemotherapy and hematopoietic SCT, are being increasingly used with curative intent in these diseases and are associated with significant morbidity. The challenges for the clinician who cares for these patients include management of infections in the immunocompromised host, toxic effects of chemoradiotherapy, nausea and vomiting, bleeding complications, and pain. In addition, the psychosocial impact on the patient of a cancer diagnosis, lengthy hospitalizations, the long-term sequelae of therapy, and treatment failure must not be overlooked. For patients who receive palliative treatment, quality-of-life issues assume paramount importance. Careful attention to supportive measures is therefore essential to achieve therapeutic goals.

This chapter provides an overview of current recommendations as well as recent advances in the management of common problems that are encountered during the treatment of patients with hematologic malignancies. Specific complications of the malignancies and their treatments are discussed elsewhere in the text.

## APPROACH TO INFECTION IN THE IMMUNOCOMPROMISED HOST

Infection continues to be a significant cause of morbidity and mortality in patients who undergo antineoplastic chemotherapy. Despite improved diagnostic tools, better understanding of infectious etiologies, and the advent of several new antimicrobials, infections continue to be a major problem. An appreciation of the factors that predispose these patients to infection is the key to appropriate antimicrobial therapy, as well as the rational development of preventive strategies ( [Table 75.1](#) ) ( [1](#) ).

**TABLE 75.1. Factors Predisposing to Infection**

| Disease-Related and Other Host Factors |                                 | Therapy-Related Factors |
|--|---------------------------------|-------------------------|
| Cellular                               | T- and B-lymphocyte dysfunction | Granulocytopenia        |



|                |   |  |
|----------------|---|--|
|                | Hodgkin disease, non-Hodgkin lymphoma, acquired immunodeficiency syndrome, hairy cell leukemia  | Bactericidal and chemotactic defects   |
|                | Granulocytopenia (acute leukemia, myelodysplastic syndromes, myelofibrosis)   | T- and B-cell dysfunction (cyclosporine A, steroids, total body irradiation)<br>Deferoxamine therapy                                 |
| Humoral        | Hypogammaglobulinemia (multiple myeloma, chronic lymphocytic leukemia, acquired immunodeficiency syndrome)  | Suppression of antibody, complement, and nonspecific humoral mediators (lactoferrin, tuftsin)  |
| Mechanical     | Hyposplenism (hemoglobinopathies)   | Splenectomy or autosplenectomy   |
|                | Mass obstruction of a normally patent viscus  | Disruption of integument by venous access devices or chemotherapy  |
|                | Ciliary dysfunction<br>Impaired micturition   | Ciliary dysfunction<br>Chemotherapy-induced nausea, vomiting, and mucositis  |
|                | Impaired cough or gag reflex<br><br>Alteration of microbial colonization  | Suppression or inhibition of cough, gag reflex<br><br>Alteration of normal flora by antimicrobial use<br>Gastric acid neutralization |
| Multifactorial | Protein-calorie malnutrition<br>Zinc and vitamin B <sub>6</sub> deficiency<br>Uremia<br>Diabetes mellitus<br>Chronic hemolysis<br>Transfusion dependence<br>Chronic lung disease<br>Alcoholism<br>Impaired mobility<br>Reactivation of herpesviral infections (Epstein-Barr virus, herpes simplex viruses, varicella-zoster virus, cytomegalovirus) |  |

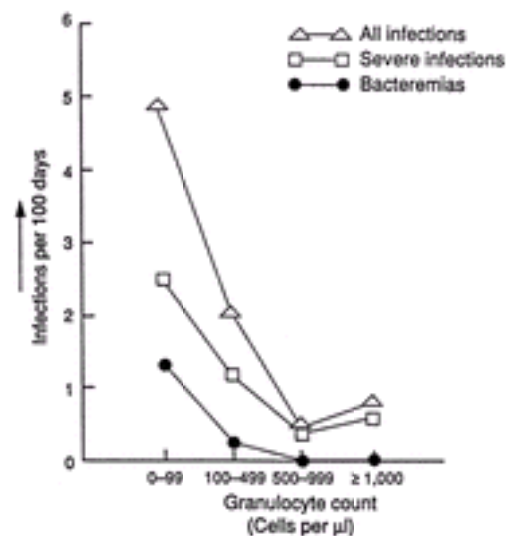
Adapted from Hathorn JW. Critical appraisal of antimicrobials for prevention of infection in immunocompromised hosts. *Hematol Oncol Clin North Am* 1993;7:1051-1099.

---

### Patient Evaluation and Assessment of Risk

The immunocompromised state may occur due to one or several defects in the host defense mechanism. Factors that are responsible for compromise of the host defense system could be due to the underlying malignancy [myelodysplastic syndrome (MDS), aplastic anemia, chronic lymphocytic leukemia (CLL), and tumor infiltration of the marrow], the therapy of the hematologic malignancy (myelosuppressive agents, steroids, monoclonal antibodies) or a breach in the normal physical barriers (mucositis, indwelling intravenous catheters). Absolute neutropenia remains the single most important risk factor for infection in patients with hematologic diseases, which could be a result of

myelosuppressive therapy, primary bone marrow failure, or marrow infiltration by tumor ( [Fig. 75.1](#)) ( [2](#), [3](#)). The definition of absolute neutropenia is variable, but an absolute neutrophil count (ANC) of less than  $500/\text{mm}^3$  is considered standard. The risk of infection correlates closely with the degree, as well as the duration of neutropenia; it is highest when neutropenia is prolonged (more than 10 to 14 days) and profound (ANC of less than  $100/\text{mm}^3$ ) and when the ANC falls sharply as the result of antecedent chemotherapy ( [3](#), [4](#), [5](#) and [6](#)). Bodey, in 1966, demonstrated this phenomenon for the first time and reported that the risk of infection was 14% if the ANC fell to less than 500 to  $1000/\text{mm}^3$  but rose to 24 to 60% if the ANC fell to less than  $100/\text{mm}^3$  ( [2](#)). The risk of infection is almost 100% if the host remains neutropenic for greater than 5 weeks.



**Figure 75.1.** Relationship between neutrophil (granulocyte) count and risk of infection. (From Schimpff SC. Infections in the cancer patient: diagnosis, prevention and treatment. In: Mandell GL, Douglas RG, Bennett JE, eds. Principles and practice of infectious diseases, 4th ed. New York: Churchill Livingstone, 1995:2667–2675, with permission.)

All neutropenic patients are clearly not similar ( [7](#)). Patients with aplastic anemia and hypoplastic MDS may remain free of bacterial infection, despite long periods of neutropenia, and may die principally of invasive aspergillosis ( [8](#)). Several investigators have attempted to stratify neutropenic patients into low- and high-risk groups for the purpose of tailoring antibiotic therapy and assessing the need for hospitalization ( [9](#), [10](#) and [11](#)). Although there are no strict criteria for risk-assessment, certain prediction rules help stratify these patients into high- and low-risk groups ( [12](#)). Patients who receive chemotherapy for solid tumors, clinically stable patients, and those with a short duration of neutropenia ( $< 7$  days) could be considered low-risk and are candidates for early discontinuation of parenteral antibiotics and discharge from the hospital before achieving complete neutrophil recovery ( [13](#), [14](#), [15](#) and [16](#)).

More than 80% of infections in immunocompromised patients are acquired from colonizing microbial flora rather than from exogenous sources ( [17](#)). Approximately 50% of these are hospital acquired. The virulence factors involved in the conversion of colonizing microorganisms into invasive pathogens are still incompletely characterized but are thought to include the alteration or exposure of mucosal attachment sites and changes in cell-surface fibronectin content in addition to the absence of functional granulocytes and

damage to anatomic defenses ( 18, 19 and 20). The normal flora of chronically debilitated or hospitalized patients is rapidly dominated by gram-negative and antibiotic-resistant organisms ( 21, 22). It has been shown, for example, that less than 10% of patients who are newly diagnosed with acute leukemia are colonized with *Pseudomonas* before entering the hospital, in contrast to more than 50% of patients who are hospitalized for as long as 4 weeks ( 23, 24). The composition of the resident flora varies between institutions as a result of different patterns of microbial distribution and antibiotic usage ( 3, 21). The usual portals of entry for microbial pathogens are small breaks in the skin [increasingly via central venous catheters (CVCs)] and gastrointestinal (GI) (oropharyngeal and perirectal) mucosa ( 25, 26).

The initial assessment of a febrile immunocompromised host is dependent on the underlying hematologic condition and other associated risk factors. Fever is defined as a single oral temperature of greater than or equal to 38.8° C (101° F) or a temperature of greater than or equal to 38.0° C (100.4° F) for more than 1 hour. Although fever remains the most important clue to an infectious process, it is necessary to remember that the characteristic signs and symptoms of infection may be absent in more than one-half of infected neutropenic patients, and routine cultures are often negative ( 27, 28). Because no known factors predict accurately which patients with fever and neutropenia are most likely to have bacteremia, a careful history and screening physical examination should be undertaken in every case, with special attention to the most common sites of infection: skin, oropharynx, nares, sinuses, lungs, GI tract (including perianal area), soft tissues, and indwelling catheter devices ( 3). [Table 75.2](#) reviews important aspects of an initial evaluation of a febrile immunocompromised patient ( 29). Blood cultures, a urinalysis and urinary Gram's stain, and baseline chest radiograph should be obtained, as well as cultures of aspirated or biopsy material from accessible body sites that appear infected. In patients with an indwelling vascular catheter, blood cultures should be obtained from a peripheral vein and from each catheter port. Although some investigators believe that cultures from peripheral vein are not necessary, the current Infectious Disease Society of America (IDSA) guidelines recommend that blood samples be obtained from the vascular device and peripheral vein ( 30). Quantitative blood cultures are not routinely recommended. Aggressive diagnostic workup is warranted if any localizing signs or symptoms are elicited (e.g., biopsy and culture of a tender subcutaneous nodule). Patients who are unable to undergo invasive diagnostic procedures to determine an infectious etiology should be treated with antibiotics empirically until they can safely undergo diagnostic workup or until the neutropenia resolves. Additional tests, such as cerebrospinal fluid examination and computed tomography (CT) scans of the sinuses, chest, and abdomen, may be necessary based on individual patient evaluation. Speed is critical in the evaluation of the febrile neutropenic patient, and early administration of broad-spectrum antibiotics to cover gram-positive and gram-negative organisms is of utmost importance. Choice of antibiotics (combination therapy or monotherapy) varies between treating physicians. These guidelines are somewhat arbitrary and do not take into account individual risk factors, but their adoption has decreased infectious morbidity and mortality in neutropenic patients.

#### **TABLE 75.2. General Management of the Febrile Neutropenic Patient**

---

Instruct patients and families to seek medical help if they develop a fever when their neutrophil count is falling or low.

Initiate prompt broad-spectrum antibiotics when a neutropenic patient

(polymorphonuclear leukocytes =500/mm<sup>3</sup>) becomes febrile (single oral-equivalent elevation =38.5° C or three elevations >38° C during a 24-hour period).



|  |    |                 |                 |    |    |    |    |    |    |
|--|----|-----------------|-----------------|----|----|----|----|----|----|
| Hematologic                                  |    |                 |                 |    |    |    |    |    |    |
| Complete blood cell and differential counts  | +  | +               | +               | +  | +  | +  | +  | ±  | ±  |
| Platelets                                    | +  | +               | ±               | ±  | ±  | ±  | ±  | ±  | ±  |
| Coagulation studies                          | -  | ±               | +               | ±  | +  | ±  | ±  | ±  | -  |
| Microbiologic                                |    |                 |                 |    |    |    |    |    |    |
| Nose and throat                              | Sx | Sx              | Sx              | Sx | Sx | Sx | Sx | -  | -  |
| Urine  | +  | +               | +               | +  | ±  | ±  | ±  | -  | Sx |
| Stool  | -  | -               | -               | -  | -  | -  | -  | -  | Sx |
| Blood  | +  | +               | +               | +  | +  | +  | +  | +  | +  |
| Cytomegalovirus antigen                      | -  | -               | +               | +  | +  | +  | +  | -  | Sx |
| Epstein-Barr virus polymerase chain reaction | -  | -               | Sx              | Sx | Sx | Sx | Sx | -  | Sx |
| Cerebrospinal fluid                          | -  | -               | -               | -  | -  | -  | -  | ±  | ±  |
| Radiologic                                   |    |                 |                 |    |    |    |    |    |    |
| Chest  | Sx | +               | +               | +  | +  | +  | +  | +  | +  |
| Sinus  | -  | ±               | ±               | -  | -  | ±  | ±  | -  | Sx |
| Special studies                              | Sx | Sx <sup>d</sup> | Sx <sup>b</sup> | Sx | Sx | Sx | Sx | Sx | Sx |

<sup>c</sup>

+, indicated; -, not necessary; ±, may be necessary; Sx, when symptoms are present.

<sup>a</sup> An evaluation of cerebrospinal fluid is especially important in patients with persistent fever.

<sup>b</sup> Lung computed tomography to detect pulmonary aspergillosis should be performed in patients with persistent fever and neutropenia and who have had more than 1 week of empirical therapy with antibiotics.

<sup>c</sup> Special studies include computed tomography and magnetic resonance imaging.

<sup>d</sup> Abdominal computed tomography or magnetic resonance imaging to detect hepatosplenic candidiasis should be performed in patients who are recovering from neutropenia who have new or persistent fever. From Pizzo PA. Fever in immunocompromised patients. *N Engl J Med* 1999;341:893-900, with permission.

The clinical benefit of routine surveillance cultures for bacteria from asymptomatic body sites in neutropenic patients and those who are already receiving antibiotic treatment is minimal. They do not appear to be cost-effective or helpful in guiding antimicrobial therapy because of delays in becoming positive in these patients and because multiple organisms are derived from any one body site (<sup>31</sup>). On the other hand, positive surveillance cultures (from urine, stool, and oropharynx) for *Candida tropicalis* are highly predictive of systemic infection but are not true for *Candida albicans*. Negative surveillance cultures for *C. tropicalis* and *C. albicans* have a high negative predictive value (95 to 99%) (<sup>32</sup>, <sup>33</sup>). It has been suggested that surveillance nasal swabs for *Aspergillus* may help identify high-risk patients in centers that have had an increased incidence of *Aspergillus* infection, but this has not been consistently confirmed (<sup>34</sup>). Stool cultures may aid in the prospective identification of drug-resistant organisms (vancomycin-resistant enterococci, methicillin-resistant staphylococci) in patients who are in protective isolation and who are receiving prophylactic antibiotics (<sup>35</sup>, <sup>36</sup>).

Surveillance cultures may provide useful epidemiologic information regarding resistance patterns in specific patient populations and are used at some institutions solely for this purpose. In patients who are being treated for catheter-associated infection, bacterial or fungal surveillance blood cultures via a CVC are also performed frequently during therapy to assess the need for catheter removal. Surveillance cultures may be useful in monitoring microbial suppression in patients who are receiving selective intestinal decontamination. Surveillance for cytomegalovirus (CMV) has significantly reduced the incidence of CMV disease due to early use of preemptive therapy with ganciclovir or foscarnet. CMV surveillance using antigen detection assays or quantitative polymerase chain reaction (PCR) assays has become the standard of care in the management of allogeneic SCT patients.

## Changing Epidemiology of Infections

The etiology of neutropenic fevers has changed constantly over the past few decades, and this change has been one of the challenges faced by the treating clinicians ( [Table 75.4](#) ) ( [37](#), [38](#) ). In the late 1960s and early 1970s, aerobic gram-negative bacilli (particularly *Escherichia coli*, *Klebsiella pneumoniae*, and *Pseudomonas aeruginosa*) emerged as predominant organisms causing infection in neutropenic patients, with *P. aeruginosa* being the leading organism in that era. In the middle 1980s, the trend of infections changed, and the incidence of gram-positive bacterial infections began to rise. An inexplicable decline in infections that were caused by *P. aeruginosa* [except in specific patient subgroups, such as children with human immunodeficiency virus (HIV) infection and indwelling catheters] and an increase in the number of non *aeruginosa Pseudomonas* isolates were noted. An increase in gram-positive infections could in part be explained due to the widespread use of intravascular Hickman and Broviac catheters over the past decade. Staphylococci ( *Staphylococcus aureus* and *Staphylococcus epidermidis*) were the most common gram-positive organisms that were isolated. Along with the emergence of staphylococcal infections, several other “rare” gram-positive bacteria were found to be etiologically relevant. These include the  $\alpha$ -hemolytic (viridans) streptococci ( *Streptococcus mitis*, *Streptococcus oralis*, *Streptococcus salivarius*, and *Streptococcus milleri*) and group D enterococci. These streptococci have emerged as serious pathogens in patients with severe oral mucositis, in those who receive treatment with high-dose cytarabine and H<sub>2</sub>-receptor antagonists, and in bone marrow transplant recipients ( [38](#), [39](#) and [40](#) ). These organisms are capable of causing a fatal febrile illness that results in a toxic shocklike syndrome (fever, hypotension, and diffuse rash with subsequent desquamation) and the adult respiratory distress syndrome (ARDS) in the immunocompromised patients ( [41](#), [42](#), [43](#) and [44](#) ). Approximately 10% of patients who are infected with these bacteria develop this syndrome, but the mortality rate ranges from 6 to 30%. There has been an increasing incidence of resistance to penicillins, second and third generation cephalosporins ( [45](#), [46](#) ). The enterococci are emerging as an important cause of nosocomial infections in the hospitalized patients, *Enterococcus faecium* being more predominant than *Enterococcus faecalis* in several health care facilities. There has been an increasing incidence of infections, as well as colonization with vancomycin-resistant enterococci ( [47](#), [48](#) and [49](#) ). There has been an increase in resistance of gram-negative bacteria to the current antibiotics. Approximately 10% of *P. aeruginosa* isolates are noted to be resistant to the third generation cephalosporins, imipenem and ciprofloxacin. The incidence of resistance of gram-negative bacilli to ciprofloxacin may be as high as 25% at some centers ( [50](#) ). Some other less frequent gram-negative bacteria that have been responsible for infections in neutropenic patients are *Stenotrophomonas maltophilia*, *Legionella* species, *Burkholderia cepacia*, and *Alcaligenes xylosoxidans*. A recent study from Europe suggested that there might be an increase again in the rate of gram-negative bacteremias in neutropenic febrile patients, although the reasons are unclear ( [Fig. 75.2](#) ) ( [51](#) ).

**TABLE 75.4. Changing Epidemiology of Opportunistic Infections**

|                  | Traditional   | Increasingly Recognized  |
|------------------|---|--|
| Bacteria<br>(nh) | <i>Staphylococcus aureus</i>  | Alpha-hemolytic (group D) streptococci   |
|                  | <i>Staphylococcus epidermidis</i>   | Enterococci  |
|                  | <i>Streptococcus pneumoniae</i> (s)   |  |
|                  | <i>Listeria monocytogenes</i> (c)   |  |
|                  | <i>Escherichia coli</i>   | <i>Propionibacterium acnes</i>   |
|                  | <i>Klebsiella pneumoniae</i>  | <i>Xanthomonas maltophilia</i>   |
|                  | <i>Pseudomonas aeruginosa</i>   | <i>Pseudomonas cepacia</i> and <i>Pseudomonas putida</i>   |
|                  | <i>Haemophilus influenzae</i> (s)   | Other Enterobacteriaceae ( <i>Citrobacter</i> , <i>Serratia</i> , <i>Acinetobacter</i> , <i>Providencia</i> , <i>Morganella</i> , and <i>Enterobacter</i> species) |
|                  | <i>Legionella</i> species   |  |
|                  | <i>Neisseria</i> species  |  |
|                  | <i>Salmonella</i> species (s)   | <i>Corynebacterium JK</i> .  |
|                  |   | <i>Bacillus</i> species  |
|                  |   | <i>Capnocytophaga</i> species and DF-2 (s)   |
|                  |   | <i>Clostridium tertium</i>   |
|                  |   | <i>Clostridium septicum</i>  |
|                  |   | <i>Clostridium difficile</i>   |
|                  | Oral anaerobes ( <i>Peptococcus</i> , <i>Peptostreptococcus</i> , <i>Veillonella</i> , <i>Fusobacterium</i> , <i>Eubacterium</i> , and <i>Bifidobacterium</i> ) |  |
| Atypical<br>(c)  | <i>Mycobacterium tuberculosis</i>   | <i>M. tuberculosis</i> (multidrug-resistant)   |
|                  | <i>Nocardia</i> species   | Atypical mycobacteria ( <i>Mycobacterium chelonae</i> , <i>Mycobacterium kansasii</i> , and <i>Mycobacterium fortuitum</i> )                                       |
| Fungi (cn)       | <i>Candida albicans</i>   | Other <i>Candida</i> species ( <i>Candida neoformans</i> , <i>Candida krusei</i> )   |
|                  | <i>Candida tropicalis</i>   | <i>Torulopsis glabrata</i>   |
|                  | <i>Aspergillus flavus</i>   | Other <i>Aspergillus</i> species ( <i>A. niger</i> , <i>A. terreus</i> )   |
|                  | <i>Aspergillus fumigatus</i>  | <i>Pseudoallescheria boydii</i>  |
|                  | <i>Pneumocystis carinii</i>   | <i>Drechslera</i> species  |
|                  | <i>Cryptococcus neoformans</i>  | <i>Trichosporon beigeli</i>  |
|                  | <i>Histoplasma capsulatum</i>   | <i>Scedosporium</i> species  |
|                  | <i>Coccidioides immitis</i>   | <i>Pityrosporum</i> species ( <i>Malassezia furfur</i> )   |
|                  | Zygomycetes ( <i>Mucor</i> , <i>Rhizopus</i> )  | <i>Fusarium</i> species  |
|                  | <i>Blastomyces hominis</i>  |  |



|                             |                                  |                                    |
|-----------------------------|----------------------------------|------------------------------------|
| Viruses<br>(ch)             | Cytomegalovirus                  | Respiratory syncytial virus        |
|                             | Epstein–Barr virus               | Adenovirus                         |
|                             | Varicella–zoster virus           | Human herpesvirus 6                |
|                             | Herpes simplex virus             | Human immunodeficiency virus       |
|                             |                                  | Polyomaviruses (BK and JC viruses) |
|                             |                                  | Enteroviruses                      |
| Influenza and parainfluenza |                                  |                                    |
| Other<br>(ch)               | <i>Toxoplasma gondii</i>         | <i>Babesia</i> (s)                 |
|                             | <i>Strongyloides stercoralis</i> |                                    |
|                             | <i>Giardia lamblia</i>           | <i>Cryptosporidium</i>             |
|                             |                                  |                                    |

NOTE: Associated immune defects are given in parentheses: c, T–cellular; h, humoral; s, asplenia; n, neutropenia.

Adapted from Hathorn JW. Critical appraisal of antimicrobials for prevention of infection in immunocompromised hosts. *Hematol Oncol Clin North Am* 1993;7:1051–1099.

---



**Figure 75.2.** *Fusarium* sepsis, manifesting as fever and a nodular, erythematous skin rash in an autologous bone marrow transplant recipient. See [Color Plate](#). (Photograph courtesy of S. Antony.)

With the changing host immunity, the nature of nonbacterial infections has also changed in the past few decades. Atypical fungi that are relatively or absolutely resistant to amphotericin B therapy have also been isolated more often; these include *Fusarium*, *Drechslera*, and *Trichosporon* species, *Pseudallescheria boydii*, and some *Candida* species ( [52](#), [53](#), [54](#) and [55](#) ). Routine use of fluconazole has resulted in emergence of resistant *Candida* species, such as *Candida krusei* and *Candida glabrata*. Mycobacterial exit site or tunnel infections ( *Mycobacterium chelonae* and *Mycobacterium fortuitum* ) have been reported, as have multidrug–resistant strains of *Mycobacterium tuberculosis* ( [47](#), [56](#) ). Trends in viral infection are more difficult to trace. Infections with herpes viruses remain problematic in patients who undergo chemotherapy for leukemia and lymphoma, with herpes simplex virus (HSV), varicella–zoster virus (VZV), and CMV being the most common. Human herpesvirus 6 (HHV6) has recently emerged as an important etiologic agent in posttransplant pneumonitis ( [57](#), [58](#) ). Acyclovir– and ganciclovir–resistant herpesviral infections have been reported ( [59](#), [60](#) ). Many other common viruses have also been associated with serious illness in hematologic cancer patients: respiratory syncytial virus (RSV), adenovirus, rotavirus, echovirus, coxsackievirus, measles virus, influenza, and parainfluenza viruses ( [1](#), [61](#) ). Finally, protozoal and parasitic infections may reactivate in

bone marrow transplant recipients and other abnormal hosts, especially in the setting of corticosteroid therapy. Well-described and emerging opportunistic pathogens in the immunocompromised patient population are listed in [Table 75.4](#).

## Diagnostic Techniques

Lysis centrifugation and constant-detection blood culture techniques for bacteria and fungi (such as BacT/Alert, Organon Teknika Corp., Durham, NC), shell vial cultures for viruses, immunofluorescent and enzyme-linked immunosorbent assays (ELISA) for antigen detection, and the PCR ([62](#), [63](#) and [64](#)) have all been added to the diagnostic armamentarium over the past 10 to 15 years. However, despite the clinician's best efforts, the source of fever in two-thirds of febrile neutropenic patients remains unknown or undiagnosed.

One of the problems with the management of fungal infections, especially aspergillosis, is late diagnosis. New diagnostic tools are now available that might help with the diagnosis of fungal infections early on in the disease process, especially in high-risk patients. Some of these tools, such as Galactomannan antigen testing of blood with ELISA methodology, help diagnose invasive aspergillosis before the appearance of clinical or radiologic signs.

Other nonspecific fungal assays include the G-test, which is a specific test for ([1](#), [3](#))- $\beta$ -D-glucan, a component of the fungal cell wall. This test is sensitive but has low specificity and a high number of false positives. The most sensitive and specific test available for early diagnosis of fungal infections is PCR analysis. Although these tests are being routinely used in some centers in Europe, they are still considered experimental in the United States and are not a part of a routine diagnostic armamentarium ([65](#)).

Cryptococcal antigen testing of serum, urine, or cerebrospinal fluid and *Histoplasma* antigen testing of urine are helpful in the diagnosis of these opportunistic infections. The cryptococcal latex agglutination test has been useful in the diagnosis of infections that are caused by *Trichosporon beigeli*, which shares antigens with *Cryptococcus* ([26](#)). Specific antigen tests (pp65) and PCR assays are available for diagnosis of CMV infection and direct preemptive therapy before development of CMV disease ([66](#)).

Imaging techniques to pinpoint the source of an occult infection, such as indium 111-labeled immunoglobulin (Ig) G tagging of leukocytes, CT scanning, and magnetic resonance imaging ([67](#)), have proved disappointing and might also be expected to have less usefulness in patients with neutropenia or diminished numbers of fully functional phagocytes. Spiral CT scanning of the chest has proved to be valuable in evaluating patients who are suspected to have fungal (especially *Aspergillus*) infections, as it can often detect pulmonary infiltrates that are not readily apparent on chest radiographs ([68](#)).

Bronchoalveolar lavage and protected brush specimens from the lung in conjunction with immunohistochemical staining methods have been particularly useful in establishing an infectious etiology of pulmonary infiltrates in immunocompromised hosts. The Gram's stain of an adequate (more than 25 neutrophils per high-power field) sputum specimen, although often discredited as nonspecific, is significant when more than ten organisms are noted per high-power field and is helpful in guiding initial therapy. The Gram's stain and cultures may be difficult to interpret in patients who are neutropenic or who are receiving antimicrobial therapy. Pathogens that do not normally inhabit the respiratory tract (*Legionella*, *Mycobacterium*, and *Histoplasma* species and RSV) may be identified by special stains of the sputum or by antigen tests, but most fungal organisms require invasive methods of detection ([69](#)). Although quantitative culture methods add sensitivity and specificity to the diagnosis of bacterial pneumonias, they are time consuming, costly, and often dependent on the growth rate of the organism. The optimal specimens and available diagnostic tests for many common opportunistic pulmonary pathogens are

summarized in [Table 75.5](#) ([70](#)). When bronchoalveolar lavage is nondiagnostic, open lung or percutaneous needle biopsy may be performed in selected patients who do not have a prohibitive risk of bleeding. However, the role of routine open lung biopsy in the evaluation of diffuse pulmonary infiltrates is controversial, as it is risky and is not better than empiric antimicrobial therapy ([71](#)). Several studies have demonstrated the feasibility of open lung biopsy in immunocompromised patients, but the results of the biopsy rarely resulted in a change in patient management ([72](#)).

**TABLE 75.5. Detection of Common Opportunistic Pulmonary Pathogens**

| Organism                     | Specimen          | Direct Stain   | Antigen or Nucleic Acid   | Culture/Incubation Time  |
|------------------------------|-------------------|--|---|--|
| Routine bacteria             | <b>1, 4, 5</b>    | Gram's stain   | Not available   | Routine methods, 3 to 4 d  |
| <i>Legionella</i> species    | 1, 4, 5           | Direct FAB   | PCR, <sup>a</sup> urine antigen (radioimmunoassay)  | Special <i>Legionella</i> media, 2 to 7 d (buffered charcoal yeast extract)              |
| Fungi                        | 1, 4, 5           | Wet mount or calcofluor white  | Serum cryptococcal antigen  | Mycologic media, 6 to 8 wk (Sabouraud, brain-heart infusion agar)                        |
| <i>Pneumocystis</i> species  | <b>2, 4, 5</b>    | FAB, Giemsa stain, toluidine blue  | PCR <sup>b</sup>  | Nonculturable  |
| <i>Mycobacterium</i> species | <b>1, 2, 4, 5</b> | Acid-fast stain  | Chemiluminescent DNA probes, PCR <sup>b</sup>   | Mycobacterial media, =8 wk (Middlebrook 7H 10/11)  |
| <i>Nocardia</i> species      | 1, 2, 4, 5        | Modified acid-fast stain   | Not available   | Blood agar, Sabouraud, 4 to 6 wk   |
| Viruses                      | 1, 3, 4, 5        | FAB for respiratory syncytial virus, cytomegalovirus, herpes simplex virus, varicella-zoster virus | Enzyme immunoassay <sup>b</sup> for respiratory syncytial virus, influenza A              | Traditional tissue, =2 wk  |
| <i>Chlamydia</i> species     | 3, 4, 5           | None <sup>d</sup>  | FAB for cytomegalovirus, herpes simplex virus, varicella-zoster virus<br>PCR <sup>b</sup> | Shell vial culture, <sup>c</sup> 2 to 5 d<br>HL or human laryngeal tumor cells, 3 to 5 d |
| Mycoplasma                   | 1, 3, 4, 5        | None   | PCR <sup>b</sup>  | Selective media, 7 to 10 d   |

NOTE: Bold indicates preferred.

1, expectorated sputum; 2, sodium chloride-induced sputum; 3, nasopharyngeal washings or swab; 4, bronchoalveolar lavage, brushings, biopsies; 5, percutaneous needle aspiration or open-lung biopsy; FAB, fluorescent antibody; PCR, polymerase chain reaction.

<sup>a</sup> The polymerase chain reaction assay is not widely available.

<sup>b</sup> Research technique.

<sup>c</sup> Influenza A and B; parainfluenza 1, 2, and 3; respiratory syncytial virus; cytomegalovirus; herpes simplex virus; and varicella-zoster virus are widely available.

<sup>d</sup> None for *Chlamydia pneumoniae*.

Adapted from Shelhamer JH, Gill VJ, Quinn TC, et al. NIH conference: the laboratory evaluation of opportunistic pulmonary infections. *Ann Intern Med* 1996;124:585–599.

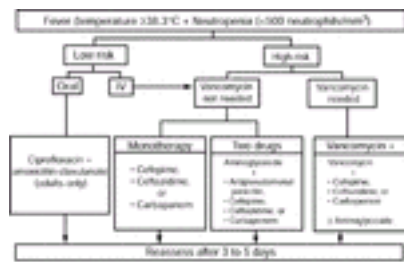
---

## Empirical Antimicrobial Therapy: Current Guidelines and Regimens

Once the neutropenic febrile patient has been assessed, evaluated, and risk stratified, antimicrobial therapy should be promptly initiated. The use of empirical antibiotic therapy in febrile neutropenic patients before the culture documentation of an organism has resulted in decreased infectious morbidity and mortality. The rationale for early administration of broad-spectrum antibiotics has been the prevention of death from rapidly evolving gram-negative sepsis while providing coverage for gram-positive or mixed infections. The choice of antimicrobials (monotherapy or combination), the route of administration (oral or intravenous), and the need for inpatient admission depend on the assessment of the patient. The initial choice of the antibiotic regimen should also be based on the type, frequency, and antibiotic susceptibility patterns of the bacterial isolates in individual centers. Until recent years, all neutropenic patients were admitted to the hospital for broad-spectrum antimicrobials, which were continued until recovery of the neutrophil count (greater than  $500/\text{mm}^3$  in high-risk patients or greater than  $100/\text{mm}^3$  in low-risk patients), to prevent recrudescence of fever, septic complications, and breakthrough infections by resistant organisms ( [73](#), [74](#) ).

To date, no single empirical antimicrobial regimen has been proven to be superior to another. Just like the epidemiology of the infections in neutropenic patients has changed over the years, the initial empirical antimicrobial regimen of choice has changed too. Combination regimens incorporating two or three additive or synergistic drugs were used in the early 1970s; for example, a combination of an anti-*Pseudomonas* penicillin (such as piperacillin or ticarcillin) and an aminoglycoside (such as gentamicin, amikacin, tobramycin). Soon followed the  $\beta$ -lactam and  $\beta$ -lactamase inhibitor combinations, such as ticarcillin-clavulanic acid and piperacillin-tazobactam. With the advent of third generation cephalosporins and carbapenems in the 1980s, monotherapy became the regimen of choice ( [Fig. 75.3](#) ). The monobactam antibiotic aztreonam is most useful in patients with severe  $\beta$ -lactam allergies. Owing to its lack of its efficacy against gram-positive organisms, it may be used in combination with vancomycin. Several prospective studies have now shown monotherapy with imipenem-cilastatin or ceftazidime to be an effective initial regimen, especially in patients with only mild to moderate neutropenia (an ANC of greater than  $100/\text{mm}^3$ ) and with fever as the only manifestation of infection ( [75](#), [76](#), and [77](#) ). The use of fluoroquinolones (ciprofloxacin) as monotherapy in empiric regimens is controversial and is not recommended because of their poor activity against streptococci and anaerobes and the increasingly reported emergence of resistant organisms ( [30](#), [78](#), [79](#) ). These agents are also to be avoided in children younger than 18 years of age or in pregnant or nursing women because of potential adverse effects on cartilage and bone development ( [76](#) ). The newer fluoroquinolones, levofloxacin, moxifloxacin, and sparfloxacin, are superior to ciprofloxacin against *Streptococcus pneumoniae*, including strains that are highly resistant to penicillin. They are also moderately active against

anaerobes ( 80, 81 ).

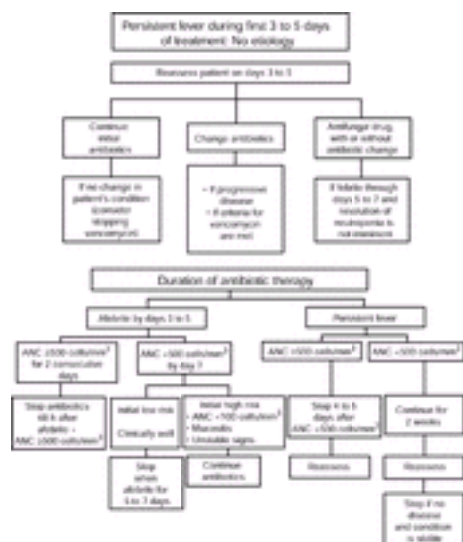


**Figure 75.3.** Empirical antibiotic regimens in febrile neutropenia. (Adapted from Hughes WT, Armstrong D, Bodey GP, et al. 2002 Guidelines for the use of antimicrobial agents in neutropenic patients with cancer. Clin Infect Dis 2002;34:730–751.)

The IDSA published new guidelines for the use of antimicrobial agents in neutropenic patients with cancers in 2002 ( 30 ). Patients who are determined to be low-risk (absent focus of bacterial infection and no other systemic signs like hypotension, rigors) should be considered for treatment with oral antibiotic regimens (combination ciprofloxacin and amoxicillin-clavulanate) ( 12, 13, 30, 82 ). If the clinician chooses to treat the patient with intravenous antibiotics, the guidelines offer three choices as follows: monotherapy, two-drug therapy without vancomycin, and two- or three-drug therapy with vancomycin. Monotherapy with a broad-spectrum antibiotic, such as cefepime or ceftazidime (third generation cephalosporins), or a carbapenem (imipenem-cilastatin or meropenem) has been found to be equally effective as multidrug combinations in several studies. Compared to the carbapenems and cefepime, ceftazidime has a restricted gram-positive activity, and the addition of vancomycin may become necessary when using ceftazidime. The addition of other antimicrobials to the monotherapy becomes necessary if the patient remains febrile or develops secondary infections. Aminoglycosides and fluoroquinolones are not currently recommended for monotherapy. Two-drug regimens that exclude vancomycin include an aminoglycoside in combination with a third generation cephalosporin (cefepime, ceftazidime) or carbapenem or an antipseudomonal penicillin (e.g., ticarcillin-clavulanic acid and piperacillin-tazobactam). The benefits of combination therapy include synergy and prevention of emergence of resistant bacteria. The disadvantages include increased renal toxicity and frequent drug administrations. A combination that uses quinolones is an option but needs to be further evaluated. Inclusion of vancomycin in the initial empirical regimen is controversial, as studies have failed to show a clear survival advantage with this approach ( 83, 84 ). At this time, initial empirical use of vancomycin is recommended for a subgroup of patients with the following findings: clinically suspected serious catheter-related infection (cellulitis, bacteremia), known colonization with penicillin- and cephalosporin-resistant pneumococci or methicillin-resistant *S. aureus*, positive blood cultures for gram-positive organisms before final identification, and hypotension or other cardiovascular compromise. Patients who are undergoing high-dose chemoradiotherapy, with or without stem cell rescue, who have severe mucositis may also benefit from early vancomycin therapy, although this remains unclear.

Modifications of the initial drug regimen are made based on new physical findings, microbiologic data, or persistent fever that indicates a resistant organism ( Fig. 75.4 ). It requires on an average 3 to 5 days to determine the efficacy of the initial antibiotic regimen. Low-risk patients may become afebrile as early as 2 days, and high-risk patients may take as long as 7 days to have a response to the antibiotics. The current guidelines suggest that if a patient becomes afebrile within 3 to 5 days of initiation of therapy, and

no etiology is identified, low-risk patients can be switched to oral combination therapy, including ciprofloxacin and amoxicillin-clavulanate (cefixime in children), and high-risk patients can continue the same antibiotics. If a source of infection is found, adjust the antibiotics to the most appropriate treatment. Antibiotics should be continued for a minimum of 7 days or until the documented infection has been eradicated. It is preferable to have neutrophil recovery (ANC >500/mm<sup>3</sup>) before discontinuing therapy. If the patient continues to be febrile 3 to 5 days after the initiation of empiric antibiotics, one of the following three choices can be made: Continue the same antibiotics if patient is stable and no source of infection has been found; change or add antibiotics if the patient develops a new complication or if the finding on evaluation or appears to worsen clinically; or add an antifungal drug. Amphotericin B had been the antifungal of choice for a long time, but, with the advent of several less toxic antifungals, such as caspofungin, voriconazole, and lipid formulations of amphotericin B (although more expensive). After 7 to 10 days of neutropenic fever that is associated with profound neutropenia, the risk of fungal infection (*Aspergillus* and *Candida*) rises precipitously, and the institution of empirical antifungal therapy is appropriate. Withholding antifungals until a fungal source is established by culture allows time for dissemination to occur and often proves catastrophic. Randomized clinical trials show that empirical antifungal therapy reduces infectious mortality in patients with new or persistent fever occurring after 1 week of antibiotic therapy (85, 86 and 87). Fluconazole is highly effective in the treatment of oropharyngeal and esophageal candidiasis and may be as effective as amphotericin B for systemic candidiasis (88, 89). However, it should not be used empirically in place of amphotericin B because of its absent or poor activity against *Aspergillus*, atypical fungi, and several clinically relevant *Candida* species (*C. krusei*, *C. tropicalis*, *Candida lusitanae*, and *Torulopsis glabrata*) (90, 91, 92 and 93). The empirical use of antivirals in the treatment of neutropenic fevers is less defined. Antiviral drugs, such as acyclovir, valacyclovir, and famciclovir, are indicated in the treatment of neutropenic fevers only if there is clinical and laboratory evidence of a viral infection (herpetic lesions of the skin or mucous membranes) (94).



**Figure 75.4.** Common modifications of empirical antimicrobial therapy in the febrile neutropenic patient. ANC, absolute neutrophil count. (Adapted from Hughes WT, Armstrong D, Bodey GP, et al. 2002 Guidelines for the use of antimicrobial agents in neutropenic patients with cancer. Clin Infect Dis 2002;34:730-751.)

The next important decision is when to discontinue the antibiotics. The determining



factors that help make that decision include neutrophil recovery, resolution of the fevers, and presence or absence of a source of infection. If a patient is afebrile for more than 48 hours, no source of infection is identified, and the ANC is more than 500/mm<sup>3</sup>, it is appropriate to discontinue the antibiotics. If the patient is still neutropenic but afebrile, the decision to discontinue antibiotics is less clear. If the patient is low risk at the initiation of treatment and is clinically stable, it may be appropriate to discontinue the antibiotics after 5 to 7 days of treatment, despite persistent neutropenia. If the patient continues to be febrile despite neutrophil recovery, reassess the patient for a source of infection that is not covered by the current antimicrobial regimen (e.g., fungal, viral, or protozoal infections) or other noninfectious sources of fever (e.g., drug fever, engraftment syndrome). The duration of antifungal therapy is determined by the type and extent of fungal infection.

## Role of Granulocyte Transfusions and Growth Factors

The role of granulocyte transfusions in the management of neutropenic fevers is poorly defined. The published literature includes small nonrandomized studies that show the safety and feasibility of the procedure in the recipients and the donors. Although some studies have shown the benefit of granulocyte transfusions in profoundly neutropenic patients with documented severe bacterial and fungal infections, others have failed to show any benefit ( [95](#), [96](#), [97](#) and [98](#)). Adverse reactions to granulocyte transfusions include febrile reactions, alloimmunization, pulmonary toxicity, and transmission of infection, particularly CMV ( [99](#), [100](#) and [101](#)). Some investigators have administered a combination of granulocyte colony-stimulating factor (G-CSF) and steroids (dexamethasone, prednisolone) to the donor before harvesting the granulocytes, but there is no evidence to show that this approach is more efficacious ( [102](#)). Transfusion of elutriated monocytes that are activated by macrophage colony-stimulating factor (M-CSF) is another strategy that is under investigation ( [103](#)).

The 2001 American Society of Clinical Oncology (ASCO) guidelines recommend against routine use of hematopoietic growth factors [G-CSF, filgrastim or granulocyte-macrophage colony-stimulating factor (GM-CSF), and sargramostim] in patients with uncomplicated neutropenic fevers. Several randomized controlled trials have failed to show any beneficial impact of growth factors on the duration of fever, the use of antimicrobials, or infection-related mortality. On the other hand, use of these growth factors is indicated in a certain subgroup of neutropenic febrile patients: those with profound and protracted neutropenia with documented infections, sepsis, systemic fungal infections, and cardiovascular compromise ( [104](#)).

## Common Organ-Specific Febrile Syndromes

**FEVER AND PULMONARY SYMPTOMS** Pneumonia is the most common infectious cause of death in immunocompromised patients. Pulmonary infiltrates may occur as a primary focus of infection or as a complication of septicemia and the ARDS or systemic inflammatory response syndrome. The most important role of the clinician is in deciding when to initiate empirical antimicrobial therapy and how best to use invasive diagnostic modalities to establish a diagnosis without exposing the patient to undue risk ( [105](#)). The differential diagnosis of pulmonary infiltrates in patients with hematologic malignancies is shown in [Table 75.6](#) ( [106](#)). Noninfectious causes of interstitial pneumonitis (IP) in the febrile patient are diagnosed by exclusion of an infectious etiology.

### TABLE 75.6. Differential Diagnosis of Pulmonary Infiltrates in the Immunosuppressed Patient

---



## Infectious causes

Conventional bacterial pneumonia

*Legionella* and *Legionella*-like infection

Nocardial infection

Tuberculosis

Fungal infection

Viral infection (cytomegalovirus, herpes simplex virus, adenovirus, human herpesvirus 6, and influenza or parainfluenza)

Protozoan infection ( *Pneumocystis carinii*, *Toxoplasma gondii*)

## Noninfectious causes

Tumor

Radiation pneumonitis

Drug-induced pneumonitis (bleomycin, busulfan, methotrexate, and cyclophosphamide)

Leukoagglutinin reaction

Pulmonary hemorrhage

Pulmonary emboli

Congestive heart failure

Postlymphangiography pulmonary embolization

Adapted from Rubin RH. Infection in the immunosuppressed host. In: Dale DC, Federman DD, eds. Scientific American Medicine, vol. 2. New York: Scientific American, 1997:1–23.

---

**SEPSIS SYNDROME** The clinical signs and symptoms of sepsis syndrome, which is typically associated with aerobic gram-negative infection, are well described, although none are pathognomonic. Shock occurs in at least one-third of cases of gram-negative sepsis, but it is also being seen more commonly in gram-positive bacteremias ( [107](#), [108](#) ). Common sequelae include ARDS and multisystem organ failure, which account for the high mortality of this syndrome. The source of bacteremia or fungemia is not apparent in 30% of cases, despite positive identification of an organism, and the prognosis is poor unless neutropenia resolves, and the underlying malignancy is controlled.

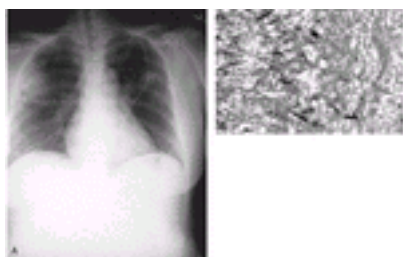
**FEVER AND CUTANEOUS LESIONS** Skin rash caused by infection must be distinguished from a nonspecific drug eruption, a reaction to radiation or chemotherapy (such as high-dose cytarabine), pyoderma gangrenosum, tumor, and GVHD. Biopsy of suspicious skin lesions may be the simplest or the only rapid means of diagnosing a disseminated bacterial or fungal process (such as *Neisseria meningitidis*, *Candida*, *Fusarium*) ( [Fig. 75.2](#) ). Sites of cutaneous necrosis may be clues to infectious endocarditis, catheter-related septic thromboembolism, *Pseudomonas* septicemia (ecthyma gangrenosum), or vascular invasion by *Aspergillus*.

**OROPHARYNGEAL AND FACIAL SITES** Severe mucositis, gingivostomatitis, and periodontal infection are common in patients during the course of therapy for hematologic malignancy. Mucositis may extend into the esophagus, causing retrosternal chest discomfort. Mucosal lesions are usually caused by HSV or *Candida* species, or both, but they are occasionally caused by CMV infection or fungal ( *Histoplasma* ) or bacterial pathogens, the most common of which are *Pseudomonas* species. Endoscopy with or without mucosal biopsy is often helpful in distinguishing these entities when there is no response to empiric antifungal or antiviral therapy or if clinical deterioration follows initial response to therapy. In acquired immunodeficiency syndrome and neutropenic cancer patients who are severely immunocompromised, and in patients with recurrent perineal candidiasis or refractory proven oropharyngeal candidiasis, systemic azole or amphotericin B therapy is preferred ( [88](#), [106](#) ). Localized tenderness of the face, particularly when associated with periorbital inflammation or cranial nerve palsy, is a particularly ominous sign, as it often heralds invasive fungal sinusitis (such as

rhinocerebral mucormycosis or *Aspergillus*). A black eschar in the nares or on the soft palate may be the first sign of such an infection. Aggressive surgical débridement, in addition to antifungal therapy, is usually mandatory to optimize the chances of recovery ( [109](#)). Bacterial sinus infections are generally treated more successfully. Odontogenic abscess may occur rarely even in edentulous patients, if tooth fragments are retained in the gingiva.

**FEVER AND LOWER GASTROINTESTINAL TRACT SYMPTOMS** Perianal cellulitis with or without abscess formation, acute abdominal pain, and diarrheal syndromes may be associated with fever, especially in patients with acute monocytic or myelomonocytic leukemia. These complications have decreased in frequency because of improved antibacterial prophylaxis in neutropenic patients. Typhlitis should be suspected if right lower quadrant pain and bloody diarrhea are present. Surgical intervention may be required in the event of an intraabdominal catastrophe. Pseudomembranous enterocolitis that is caused by *Clostridium difficile* may occur as a complication of antibiotic therapy, and stool should be assayed for the *C. difficile* toxin ( [110](#)). Empiric therapy for *C. difficile* enterocolitis should be instituted, despite a negative stool evaluation, if suspicion remains high, and other causes of diarrhea have been excluded. Focal hepatosplenic candidiasis has been reported to occur in patients who are recovering from myelosuppressive therapy ( [111](#)). The characteristic presentation is one of fever that recrudesces as the neutrophil count recovers, nonspecific GI symptoms (such as diarrhea), an elevated alkaline phosphatase level, and hepatomegaly. Bull's-eye hepatosplenic lesions are the classic finding on imaging studies. Treatment is difficult, and eradication of candidal microabscesses requires prolonged, high-dose antifungal therapy. Hepatosplenic lesions may become transiently undetectable on CT scans during recurrent periods of chemotherapy-induced neutropenia. This has been accomplished with amphotericin B (with a total dose of 2 to 9 g). Lipid formulations of amphotericin B may permit treatment with reduced toxicity. Responses to fluconazole therapy have been reported after failure of amphotericin B therapy, thus suggesting a synergism between the two drugs ( [112](#), [113](#)). Amphotericin B remains the drug of choice for this condition, however. Other fungi ( *Aspergillus*, *Fusarium*, and *Trichosporon*) may rarely cause a syndrome that is similar to hepatosplenic candidiasis.

**FEVER AND ALTERED MENTAL STATUS** Meningeal infections and cerebral abscesses present with fever, headache, or subtle behavioral changes, or a combination of these. Occasionally, seizures may be the first manifestation of a life-threatening infection of the central nervous system (CNS). Cerebrospinal fluid analysis may not be feasible if there is a bleeding propensity, and empirical therapy is based on the nature and duration of the immune dysfunction. Although immunosuppressed patients may develop conventional forms of meningitis, it is uncommon in the neutropenic setting, and more than 90% of cases in nonneutropenic patients are caused by *Cryptococcus neoformans* and *Listeria monocytogenes* ( [106](#)). CNS infection by *Toxoplasma gondii* or *Aspergillus* may occur in patients who are heavily immunosuppressed for GVHD after hematopoietic SCT ( [Fig. 75.5](#)). Rarely, viral pathogens have been reported to cause chronic meningoencephalitis (echovirus, coxsackievirus) ( [1](#)). The prognosis of *Aspergillus* infection of the CNS in neutropenic patients is dismal; early detection, rapid institution of high-dose amphotericin B therapy with or without 5-FC, and reversal of immunosuppression are key to optimizing the chances of recovery.



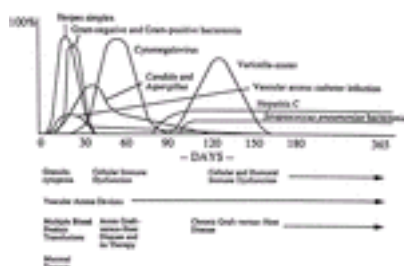
**Figure 75.5. A:** Chest radiograph of a patient with acute leukemia who developed

pulmonary *Aspergillus* infection after prolonged chemotherapy-induced neutropenia. **B:** Photomicrograph of the characteristic 45-degree-angle branching of septate hyphal forms of *Aspergillus* that invades lung parenchyma. Gomori methenamine silver stain, × 400. See [Color Plate](#). (Courtesy of M. Scott.)

## INFECTIONS IN THE STEM CELL TRANSPLANT RECIPIENT

### General Principles

Preparative regimens for autologous or allogeneic SCT consist of high-dose chemoradiotherapy, which causes short-term cytopenias as well as profound immunosuppression after engraftment. Reconstitution of cellular and humoral immunity in allogeneic transplant patients occurs gradually over a period of 12 to 24 months and may take much longer in those with chronic GVHD ( [114](#) ). GVHD, its prophylaxis and treatment, T-cell depletion of the graft, and CMV infection all contribute to delayed immune recovery in these patients, as compared to autologous transplant recipients ( [115](#) ). Evidence suggests that patients who receive autologous peripheral blood stem cell grafts undergo more rapid immune reconstitution than those who receive autologous marrow ( [116](#) ). The interplay of these factors results in characteristic periods of risk for infection with specific pathogens that form the basis for antimicrobial prophylaxis during the first year ( [Fig. 75.6](#) ). Before engraftment, the risk of bacterial infection, CVC infection, and reactivation of herpes simplex is highest. Prolonged neutropenia and antibiotic therapy leads to a steady rise in the risk of invasive fungal infection, which decreases after engraftment but remains significant if continued immunosuppression is required for GVHD. Reactivation of latent CMV infection is unusual before day 20 after transplant. Cellular immune dysfunction peaks at approximately day 40 after engraftment and the typical onset of GVHD. Varicella-zoster reactivation peaks at approximately day 120 but may occur any time within the first year. Long-term venous access catheters continue to give rise to infection as long as the access is maintained. Continuation of prophylactic antimicrobials beyond 1 year depends on the individual patient's infection history and the ability to wean immunosuppressive therapy ( [147](#) ).



**Figure 75.6.** Periods of risk for infections after allogeneic transplantation. (From Schimpff SC. Infections in the cancer patient: diagnosis, prevention and treatment. In: Mandell GL, Douglas RG, Bennett JE, eds. Principles and practice of infectious diseases, 4th ed. New York: Churchill Livingstone, 1995:2667–2675, with permission.)

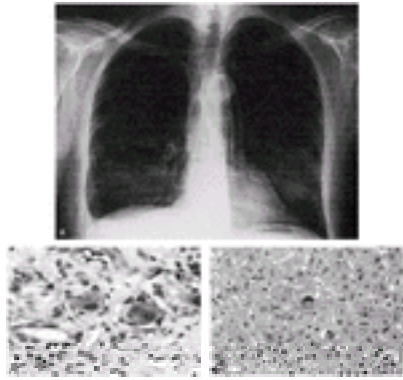
### Early and Late Bacterial Infections

The management of bacterial infections in the early neutropenic phase of the transplant is similar to the management of febrile neutropenia in patients who do not undergo transplant. The source of infection is usually the gut and oral flora, although the

increasing use of CVCs has increased the risk of gram-positive bacteremias from the skin flora. Streptococcal infections may be seen in patients with severe mucositis, and a comprehensive dental evaluation before transplant may reduce the incidence of such infections. The risk of late bacterial infections (those that occur after engraftment) depends on the immune status of the patient. It is extremely rare to see bacterial infections in patients who undergo autologous SCT after engraftment. On the other hand, patients who undergo allogeneic SCT are at risk for bacterial infections with encapsulated organisms (*S. pneumoniae*, *Haemophilus influenzae*, and *N. meningitidis*) if they develop chronic GVHD or develop profound hypogammaglobulinemia (117). Prophylactic fluoroquinolones have been used until marrow engraftment at most transplant centers, but the data are limited to suggest routine use of these drugs for bacterial prophylaxis. An oral penicillin or trimethoprim-sulfamethoxazole (TMP-SMZ) is recommended until discontinuation of immunosuppressive therapy in allogeneic transplant recipients or until 6 months after transplant.

### Cytomegalovirus

CMV infection causes a host of clinical syndromes and has been a major source of morbidity and mortality in stem cell and solid organ transplant recipients (Fig. 75.7). The virus may be acquired by primary infection via transfusion of blood products from a seropositive donor or by reactivation of the latent virus. With the increasing use of leukofiltered blood products, the incidence of primary infection has decreased. *CMV infection* is defined as the reactivation of the virus and the detection of the virus in the blood or other body fluids in the absence of organ-specific abnormalities (pneumonitis, hepatitis, colitis, and retinitis). *CMV disease* is defined as the isolation of the virus from body fluids or tissues in a symptomatic patient or the histopathologic evidence of CMV on tissue biopsy. Recent data also indicate that certain CMV serotypes may be more apt than others to cause myelosuppression (118). The incidence of CMV reactivation in allogeneic transplant recipients who are seropositive before transplant is approximately 70%, as compared to 15 to 20% in seronegative recipients with a seropositive donor (119). Although approximately 30% of seropositive recipients of autologous bone marrow transplants (ABMTs) also reactivate CMV, CMV disease occurs in fewer than 10%, and serious clinical consequences are rare (115, 120). The incidence of CMV disease is higher in patients who receive CD34 selected autografts (120a). CMV IP, the most imminently life-threatening form of CMV disease, occurred in approximately 17% of allogeneic bone marrow transplantation (BMT) patients, with ensuing mortality in 85%, before the use of ganciclovir. Mortality from CMV IP, when it occurs, remains at 30 to 50%, despite the combined use of ganciclovir and CMV-specific immune globulin (121). Risk factors for the development of CMV disease include older recipient age, pretransplant seropositivity of the recipient or donor, or both, and severe acute GVHD (115, 122). T-cell depletion of the stem cell graft or treatment of the recipient with antithymocyte globulin for GVHD also increases the likelihood of CMV reactivation, probably as a result of delayed reconstitution of CMV-immune T-cell clones (123).



**Figure 75.7.** The spectrum of cytomegalovirus (CMV) disease in the abnormal human host. **A:** Chest radiograph demonstrating diffuse interstitial infiltrates in a patient 30 days after allogeneic bone marrow transplant. **B:** CMV inclusion disease of the colon. Typical infected cells show cellular ballooning with dense primary nuclear inclusions that are surrounded by a thin, cleared rim; secondary inclusions appear as cytoplasmic granules after the nucleus has filled with virions. **C:** CMV hepatitis demonstrated on liver biopsy. Viral cytopathic effect may be difficult to establish, but rare viral inclusions with surrounding parenchymal changes are diagnostic of CMV. Hematoxylin and eosin stain,  $\times 400$ . See [Color Plate](#). (Photo-micrographs courtesy of M. Scott.)

The prevention of CMV disease in allogeneic BMT is complex and is evolving. Administration of seronegative or leukofiltered blood products is recommended to all seronegative autologous and allogeneic SCT recipients to prevent primary CMV infection ([124](#), [125](#) and [126](#)). Also, CMV seronegative transplant recipients should use caution and protection during sexual intercourse and in caring for children, as these might be other mechanisms of transmission. In instances of recipient or donor CMV seropositivity, or both, CMV surveillance, starting at the time of engraftment, is recommended. Techniques of CMV surveillance include CMV pp65 antigenemia assay, DNA PCR detection methods or CMV blood cultures (shell vial culture) ([66](#), [127](#), [128](#) and [129](#)). Detection of CMV in the blood is the strongest predictor of CMV disease ([130](#)). However, 12 to 20% of patients with negative surveillance cultures still develop CMV disease.

There are two current recommended strategies for prevention of CMV disease. One strategy is prophylaxis with ganciclovir or valganciclovir, starting from engraftment until day 100, or even longer if the patient remains at risk for CMV reactivation (active GVHD, high-dose steroids, low CD4 count) ([115](#), [131](#), [132](#)). The other strategy is close surveillance and preemptive therapy with ganciclovir or foscarnet if ganciclovir is contraindicated when CMV reactivation is detected. In a few randomized and nonrandomized studies, high-dose intravenous acyclovir significantly reduced the incidence of all forms of CMV disease or delayed the onset of CMV infection, but it did not prevent CMV viremia ([133](#), [134](#)). Use of high-dose acyclovir has been abandoned by most centers with improved surveillance tools.

In several studies that evaluated preemptive therapy for patients with positive CMV surveillance cultures (blood, urine, throat, or bronchoalveolar lavage fluid), survival at 100 and 180 days was improved in ganciclovir recipients, as compared to placebo recipients, although 12% of patients with negative cultures developed CMV disease ([135](#)). CMV infection and disease were significantly reduced, if not prevented, by ganciclovir administration to all seropositive patients in three other studies ([136](#), [137](#) and [138](#)). There was no impact on survival because of infectious complications of ganciclovir-related neutropenia, but hematopoietic growth factors were not used. A study by Boeckh et al. also suggested a trade-off: A higher incidence of CMV disease before day 100 was noted



in transplant recipients who were treated with ganciclovir only at the time of high-grade antigenemia, but more invasive fungal infections and late-onset CMV disease developed in those who received ganciclovir prophylaxis continuously through day 100 ( [129](#) ). Other problems with protracted ganciclovir prophylaxis are the emergence of resistant strains of the virus that were reported in some immunocompromised patients and the failure of natural immunity against CMV to develop, thus resulting in late recrudescences of the disease ( [139](#) , [140](#) and [141](#) ). The selective transfer of CMV-immune donor T lymphocytes into the transplant recipient has been advocated as one solution to this problem ( [142](#) ). The optimal duration of preemptive therapy appears to be 1 to 2 weeks of twice-a-day induction followed by maintenance until PCR negativity.

Although ganciclovir is the drug of choice for CMV infection and disease, its major toxicity of cytopenias precludes its use in patients with significant pancytopenia. Foscarnet, an equally effective alternative against CMV can be used to treat ganciclovir-refractory CMV infections or those with significant cytopenias. Although not myelosuppressive, this drug is associated with renal toxicity and electrolyte imbalances ( [143](#) , [144](#) ). Cidofovir is another nephrotoxic antiviral with efficacy against CMV, but there are few data on its use in the stem cell transplant patient population ( [145](#) ).

### Other Viral Pathogens

Testing all transplant recipients for HSV exposure (HSV IgG) is recommended. Reactivation of HSV occurs in as much as 80% of seropositive allogeneic transplant recipients, causing mucocutaneous oral or genital lesions, esophagitis, and, occasionally, pneumonia or encephalitis. Prophylaxis with acyclovir or valacyclovir is recommended to all seropositive patients until the time of engraftment. Although its use is not recommended past 1 month after transplant, some patients with recurrent lesions might benefit from longer use of the prophylaxis ( [146](#) , [147](#) ).

Current recommendations are to test every transplant patient for VZV serostatus (IgG). VZV reactivation may occur any time after engraftment in autologous and allogeneic transplant recipients, and the virus disseminates in as much as 30% of cases with ensuing high mortality. Many transplant centers administer oral acyclovir or valacyclovir for approximately 12 months after transplant to VZV-seropositive patients ( [147](#) ). Seronegative patients should be given varicella-zoster immune globulin within 96 hours of exposure to a VZV vaccine or on contact with active infection.

Infections with the Epstein-Barr virus (EBV), human herpesvirus 6, adenovirus, JC and BK viruses, RSV, parainfluenza, rotavirus, and other common viruses are also seen occasionally in transplant recipients ( [57](#) , [58](#) , [61](#) , [148](#) , [149](#) and [150](#) ), but effective prophylaxis has not yet been developed. High-risk patients (T-cell-depleted transplant recipients) for EBV may benefit from preemptive therapy if the quantitative PCR is rising, with rituximab (an anti-CD20 antibody) ( [151](#) ). Another strategy is prophylactic use of EBV-specific donor T lymphocytes in high-risk patients ( [152](#) ).

### Fungal Infections

Fungal infections in the transplant patient continue to be a significant cause of mortality. Greater than 90% of the fungal infections in the SCT population are due to *Candida* or *Aspergillus*. The etiologic agents in the remaining less than 10% of infections are uncommon fungi, such as *Fusarium*, *Scedosporium*, *Blastomyces*, and *Histoplasma*. Prevention of fungal infections in these patients is of utmost importance. One way that this can be achieved is by preventing exposure to invasive fungal species by protective

isolation during the periods of neutropenia (i.e., high-efficiency particulate air filtration in patient rooms, avoidance of construction areas, and good hand washing) ( [153](#) , [154](#) ). Effective control of GVHD can also reduce the incidence of fungal infections. As for prophylaxis, fluconazole at a dose of 400 mg/day, beginning at the time of transplant and until the time of engraftment, provides adequate protection against invasive yeast infections ( [155](#) , [156](#) and [157](#) ). Failure of fluconazole prophylaxis against *Candida* is usually due to emergence of resistant yeast forms ( *C. krusei*, *C. glabrata* ). To date, no antifungal regimen has been shown to be clearly effective as prophylaxis against invasive mold infections in SCT patients. There are several studies that have studied intravenous amphotericin, inhaled amphotericin, and itraconazole ( [158](#) , [159](#) and [160](#) ).

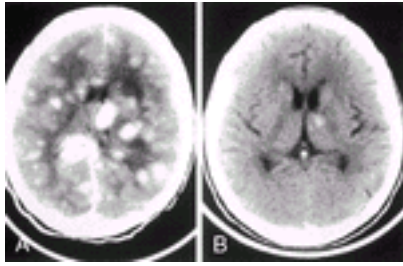
Preemptive therapy and empiric therapy for fungal infections are currently being practiced at several institutions. Empiric therapy in febrile neutropenic patients is considered the standard of care, and several studies are under way that are examining the preemptive approach ( [161](#) , [162](#) and [163](#) ). Until recently, amphotericin B was the only broad-spectrum antifungal available for the treatment of invasive molds and resistant invasive yeast infections. The toxicity of intravenous amphotericin B is substantial and has been one of the reasons why its use has been abandoned for prophylaxis. The lipid formulations of the drug (Abelcet, Amphotec, AmBisome) have lesser renal and infusional toxicities. Two new antifungals have been approved by the U.S. Food and Drug Administration (FDA) in the past 2 years, which may change the practice of management of fungal infections in SCT patients. Caspofungin (Cancidas; Merck & Co., Inc., Whitehouse Station, NJ) is the first echinocandin available with a broad spectrum of activity against several species of *Candida* and *Aspergillus* ( [164](#) ). The other drug is a triazole, Voriconazole (Vfend; Pfizer Inc., New York, NY) with excellent activity against *Aspergillus* and a wide variety of yeasts and molds ( [165](#) ).

## Protozoal Infections

Although *Pneumocystis carinii* pneumonia (PCP) in this section of protozoal infections, there is now evidence that this organism is not a protozoan but rather resembles the fungi, based on molecular studies, although it lacks ergosterol, the main fungal cell wall component ( [106](#) ). Prophylaxis against PCP is recommended in all allogeneic SCT recipients from the time of engraftment until 6 months after transplant or even longer if the patient is on high doses of immunosuppressive drugs for chronic GVHD. Oral TMP-SMZ is the preferred drug of choice, but aerosolized pentamidine, dapsone, dapsone in combination with trimethoprim or pyrimethamine, pyrimethamine and sulfadoxine, and atovaquone can be used as alternatives ( [157](#) , [166](#) , [167](#) , [168](#) and [169](#) ). Patients who are prescribed dapsone should be tested for glucose-6-phosphate dehydrogenase deficiency before initiation of the drug. Guidelines for PCP prophylaxis in autologous SCT patients is less clear and should be considered in patients who are considered high risk, that is, those who receive fludarabine or cladribine, who have manipulated grafts, or who have had prolonged steroid use before transplant.

Toxoplasmosis reactivation or, less commonly, infection is rare but life threatening in the posttransplant period and usually occurs within the first 6 months ( [Fig. 75.8](#) ). Oral TMP-SMZ is the prophylactic agent of choice, but pyrimethamine-sulfadoxine (Fansidar) prophylaxis can be used ( [170](#) , [171](#) ). Duration of prophylaxis is similar to that for PCP. It is worth noting, however, that pyrimethamine does not eradicate the cyst form of *T. gondii*. The organism can be acquired by ingestion of undercooked meat or through contact with cat feces.





**Figure 75.8.** Central nervous system toxoplasmosis: magnetic resonance imaging study of the brain before therapy (A) and after therapy (B) with pyrimethamine and sulfadiazine.

## STRATEGIES FOR THE PREVENTION OF INFECTION

The saying, “an ounce of prevention is worth a pound of cure,” holds true in the management of infections in immunocompromised patients.

### Reduction of Nosocomial Pathogen Acquisition

- Avoid hospitalization when possible and if appropriate.
- Avoid overcrowding and unnecessary through-traffic on the hematology and transplant wards and intensive care units.
- Enforce strict hand washing among the hospital personnel who care for patients.
- Segregate patients with communicable diseases.
- Consider protective isolation for high-risk patients.
- Ensure proper construction and frequent upkeep of ventilation systems.
- Provide serial monitoring of hospital water supply and cooling and heating systems for microbial contamination.

**PREVENTION OF PATHOGEN ACQUISITION** The simplest and most effective means of preventing transmission of infection has proven to be meticulous hand washing by physicians, nurses, and others who are in close contact with patients ( [172](#), [173](#) ). A meticulous screening history, review of systems, and physical examination are important to identify any preexisting sites of infection before initiating myelosuppressive therapy. A cooked food diet that excludes fresh fruits and vegetables and nonprocessed dairy products during periods of neutropenia is advocated by some (these foods are often contaminated with gram-negative bacteria and fungal spores), but there is unclear evidence to support this practice. Some institutions practice low-bacteria diets for neutropenic patients, but, again, there is a lack of scientific basis for such food restrictions ( [174](#), [175](#) ). Interventional strategies to prevent acquisition of infectious agents by the immunocompromised host can be classified into two categories: isolation techniques and the use of prophylactic antimicrobial agents.

**ISOLATION** Reverse isolation has not been shown to significantly reduce the acquisition of nosocomial pathogens beyond what can be accomplished by strict hand washing practices. The value of a total protected environment (TPE) has also been studied extensively in patients undergoing aggressive chemotherapy ( [1](#), [176](#), [177](#) ). The TPE incorporates laminar airflow rooms that are equipped with high-efficiency particle air (HEPA) filters, aggressive decontamination of all surfaces and objects that enter the room, decontamination of the patient with topical antiseptics and oral nonabsorbable antibiotics (ONAs), and a nearly sterile diet. Enthusiasm for the TPE waned rapidly when it was found that maintaining the sterile environment was cumbersome and costly and that definite improvement in overall remission rates or long-term patient survival could not be demonstrated ( [177](#) ). Better management of infection, including the use of CSFs to shorten the duration of neutropenia, has largely supplanted the TPE in the support of neutropenic patients. Laminar airflow rooms and HEPA filtration are still considered

important, if not essential, for certain high-risk patients, such as those undergoing BMT, as their use has decreased the incidence of *Aspergillus* infections at some institutions ( [178](#), [179](#) ).

### Decreasing Microbial Colonization of the Patient

- Provide prompt treatment of prior active sites of infection.
- Use immunosuppressive drugs judiciously.
- Avoid invasive procedures, except when absolutely necessary, and remove such devices as soon as possible.
- Change intravenous needles and tubing at least daily.
- Monitor serologies and clinical course in patients with known history of tuberculosis or fungal disease, and consider prophylactic isoniazid for those with radiographic or skin test findings that are indicative of old tuberculosis.
- Consider prophylactic antimicrobials in high-risk patients.

**ORAL NONABSORBABLE ANTIBIOTICS** ONA regimens (such as vancomycin, neomycin, gentamicin, nystatin, and polymyxin B) were used in combination with total reverse isolation for prevention of infections in patients with high infection risk. This combination has been reported to reduce the incidence of infections by almost 75% ( [180](#) ). Regimens of nonabsorbable antibiotics are effective in eliminating the vast majority of bacteria from the stool, and, because the GI tract is one of the most common routes of acquisition of infectious organisms, elimination of bacterial from the gut reduces risk of infection. Decreased infectious morbidity and mortality with ONA regimens was reported by several investigators ( [181](#), [182](#) ), but no consistent overall survival benefit was shown. Major problems with ONA regimens were the trend toward severe infections in patients who abruptly discontinued these antibiotics, their poor palatability, and the development of drug-resistant pathogens ( [1](#) ). Use of ONA was abandoned in neutropenic patients when the concept of *colonization resistance* was adapted. Antibiotics, such as TMP-SMZ, suppress the pathogenic bacteria but leave the anaerobic bacteria intact, which in turn prevent colonization by newly acquired organisms ( [183](#) ).

### **SELECTIVE GASTROINTESTINAL DECONTAMINATION AND SYSTEMIC**

**PROPHYLAXIS** The selective reduction of enteric aerobes while leaving anaerobic gut flora intact has been called *selective decontamination*. Clinical trials have used combinations of absorbable and nonabsorbable antibiotics ( [184](#), [185](#) ) or, more commonly, TMP-SMZ alone. In pediatric and adult patients with acute leukemia, TMP-SMZ prophylaxis decreased the frequency of bacteremias and infections ( [185](#), [186](#), [187](#) and [188](#) ). However, follow-up studies failed to show improvement in remission rates and overall survival, and there was no clear decrease in empiric antibiotic use, the number of febrile episodes, or gram-negative infections. Other disadvantages of the prophylactic use of TMP-SMZ in patients with hematologic malignancies, including prolonged bone marrow suppression, allergic reactions, nephrotoxicity, the emergence of resistant organisms, and an increase in oropharyngeal candidiasis, were noted in some series ( [187](#), [188](#), [189](#) and [190](#) ).

**ANTIBACTERIAL PROPHYLAXIS** The key to antimicrobial prophylaxis is to know the spectrum of infection-causing pathogens at the individual clinical center. TMP-SMZ has been used for many years for prophylaxis against bacterial infections. Initial studies using this drug showed its efficacy in preventing PCP ( [191](#) ). Later studies demonstrated its benefit in reducing the incidence of bacterial infections in patients with hematologic malignancies ( [192](#), [193](#) ). Since the advent of fluoroquinolones, TMP-SMZ for antibacterial prophylaxis has fallen out of favor. The fluoroquinolones are broad-spectrum derivatives of nalidixic acid that are orally bioavailable with a broader spectrum of activity, preserve colonization resistance ( [1](#) ), and are extremely well tolerated. Quinolone-based prophylaxis has been successful in reducing the risk of aerobic gram-negative infections in neutropenic patients who undergo cytotoxic chemotherapy for acute leukemia and BMT

([194](#), [195](#), [196](#) and [197](#)). However, an increased frequency of breakthrough gram-positive bacteremias, which are caused predominantly by viridans streptococci (*S. mitis*, *Streptococcus sanguis*) and coagulase-negative staphylococci, was noted by several investigators, particularly with the older quinolones ([198](#)). The newer fluoroquinolones (ciprofloxacin, levofloxacin) have broader gram-positive activity, and the coadministration of roxithromycin, amoxicillin-clavulanate, vancomycin, or rifampin has been variably effective in preventing infection with  $\alpha$ -hemolytic streptococci ([199](#), [200](#)). As with other prophylactic antibiotics, however, emergence of secondary resistance remains a problem with these augmented regimens. Gram-negative bacteremias in patients who receive fluoroquinolone prophylaxis are often caused by resistant *P. aeruginosa*, but infections that are caused by non-*aeruginosa* *Pseudomonas* species, especially *E. coli*, and *Enterobacter* species, are being increasingly reported ([201](#), [202](#)). Levofloxacin has somewhat greater *in vitro* activity than ciprofloxacin against *S. pneumoniae*, *Enterococcus*, and *S. aureus* ([203](#)) but may be inferior to ciprofloxacin against *P. aeruginosa*, although studies are suggestive of equal efficacy against *P. aeruginosa* ([204](#), [205](#)). Studies using prophylaxis with fluoroquinolones alone or in combination with other antibiotics have failed to demonstrate any significant improvement in survival or remission rates but have shown a definite reduction in the incidence of gram-negative infections ([206](#), [207](#), [208](#) and [209](#)). Most prophylactic trials have also failed to show decreased empiric parenteral antibiotic use. In fact, the recently published IDSA guidelines do not recommend routine prophylaxis with antimicrobials in neutropenic patients due to concerns about development of antimicrobial resistance ([30](#), [210](#)).

**ANTIFUNGAL PROPHYLAXIS** Risk factors for fungal infections in patients with hematologic malignancies include prolonged and profound neutropenia, immunosuppressive therapy, use of broad-spectrum antibiotics, use of parenteral nutrition, and use of indwelling vascular devices. Preventive efforts toward the reduction of fungal infections in this patient population have focused primarily on *Candida* and *Aspergillus* species, as they have traditionally been the most common causes of fungal disease in immunocompromised patients ([211](#)). Nosocomial aspergillosis had been an uncommon problem at most institutions but may be increasing in frequency because of changes in drug usage patterns; it remains a serious threat to patients who require prolonged immunosuppressive (especially corticosteroid) therapy, such as recipients of bone marrow transplants ([Fig. 75.5](#)). Hospital outbreaks of *Aspergillus* are more likely to occur during periods of construction or renovation. HEPA filtration, regular maintenance of ventilation systems, and floor-to-ceiling barriers around construction sites are important measures in reducing the risk of invasive aspergillosis. When possible, patients should be counseled to avoid dust or soil exposure when traveling to areas that are endemic for organisms such as *Blastomyces dermatitidis*, *Coccidioides immitis*, and *Histoplasma capsulatum*, but most other pathogens, such as *Aspergillus* species, *C. neoformans*, and the Mucorales order (Phycomycetes class), are ubiquitous in the environment. Before the development of the imidazole class of drugs, few effective antifungal agents other than amphotericin B were available. Randomized trials using oral polyenes (nystatin and oral amphotericin B) have failed to demonstrate a reduced incidence of systemic fungal infections, primarily because they are poorly tolerated at effective doses and are not orally bioavailable ([1](#), [212](#)). Nystatin and clotrimazole prevent oropharyngeal candidiasis, but it is not well tolerated in patients with severe mucositis. Miconazole and ketoconazole are seldom clinically useful because of their toxicity profiles and erratic absorption. Inhaled amphotericin B has shown promise in preventing colonization and infection with *Aspergillus* in uncontrolled trials but may be poorly tolerated in some patients with cancer ([213](#), [214](#)). Low-dosage prophylactic intravenous amphotericin B (0.15 to 0.25 mg/kg/day) has been demonstrated in one historically controlled study to significantly reduce mortality from invasive *Aspergillus* in allogeneic transplant recipients and may be indicated in patients who have a history of fungal infection ([158](#)). The newer lipid formulations of amphotericin B are less nephrotoxic and have been therapeutically effective in some cases of amphotericin

B-resistant *Aspergillus* ( [215](#), [216](#) ). Fluconazole prophylaxis at a dosage of 400 mg/day in several randomized trials in patients with leukemia and patients who were undergoing allogeneic SCT reduced the incidence of superficial and invasive candidal infections, except those caused by *C. krusei* ( [155](#), [217](#) ). There was no difference in the incidence of infections with *Aspergillus* in these studies, because fluconazole is ineffective against the molds. Low-dosage fluconazole is also effective, but studies in the acquired immunodeficiency syndrome population indicate increased risk of fluconazole resistance at lower dosages of 50 to 100 mg/day ( [218](#) ). Itraconazole has also been evaluated, but its efficacy in preventing colonization or invasive infection with *Aspergillus* has been shown in small studies ( [219](#) ). It has known activity against *Aspergillus* and has been effective in treating *Aspergillus* infections in patients who have failed with or are intolerant to amphotericin B ( [220](#), [221](#) ). It is available in parenteral and oral forms. It is recommended that the parenteral form should not be administered for more than 14 days owing to toxicity. The oral form is available as liquid and capsules. The capsules are poorly absorbed in the presence of chemotherapy-induced mucositis and gastric achlorhydria, but the absorption of the liquid formulation appears to be better. Histamine blockers and proton pump inhibitors, such as omeprazole, should be avoided, and serum itraconazole levels must be monitored during therapy to ensure bioavailability. Several newly developed antifungal agents with *in vitro* activity against *Aspergillus* are in clinical trials for prevention and treatment of fungal infections. These include the new class of drugs that are called *echinocandins*, with caspofungin being the only approved agent at this time. The other echinocandins that are being tested are micafungin and anidulafungin. The newer triazoles with activity against *Aspergillus* include voriconazole, posaconazole, and ravuconazole; of these drugs, only voriconazole is FDA approved ( [222](#), [223](#) ).

**ANTIVIRAL PROPHYLAXIS** Acquisition of opportunistic viral disease may occur by primary infection or by reactivation of latent infection. Herpesviruses, including CMV, VZV, and HSV-1 and -2, are by far the most common infection-causing viruses. Administration of oral or intravenous acyclovir prevents HSV reactivation (gingivo-stomatitis, esophagitis) in patients who are receiving intensive chemotherapy for acute leukemia or BMT ( [224](#), [225](#) ). Prophylaxis of HSV in these patients is prudent, because morbidity from infection is high, toxicity from acyclovir is low, and the development of resistance is unlikely ( [226](#) ). There is evidence of development of acyclovir resistance in HIV and transplant patients. Treatment with foscarnet or cidofovir is recommended for resistant infections. Foscarnet-resistant HSV strains have been recently reported in allogeneic stem cell transplant patients; such patients have been treated with cidofovir ( [227](#) ). The incidence of acyclovir-resistant HSV has remained stable between 4 to 7% over the past few decades. Data to support the prophylaxis of VZV are limited, as the natural history of varicella-zoster infections in patients who are treated with conventional chemotherapy is poorly defined. Newer nucleoside analogs (such as BV-ara U, Brovavir) and acyclovir-related prodrugs (valacyclovir, famciclovir) are as effective as acyclovir for HSV and VZV prophylaxis ( [228](#), [229](#), [230](#) and [231](#) ). Avoidance of close contact with infected or exposed individuals, especially small children in daycare, is advisable for severely immunocompromised seronegative patients.

### Augmentation of Host Defenses

Despite several advances in antimicrobial prophylaxis, efforts to prevent infections in immunocompromised patients with cancer have been disappointing. One of the possible ways to reduce infection risk may be to bolster the immune status of the host. There are several ways of boosting the immune status of the host and a few such strategies are outlined in this section.

**ACTIVE IMMUNIZATION** Patients with hematologic neoplasms often manifest impaired T-cell, granulocyte, and reticuloendothelial cell function and defective antibody responses

that put them at increased risk of infection with polysaccharide-encapsulated bacteria, viruses, and fungi. This susceptibility may persist for several months after antineoplastic therapy has been completed, because preexisting protective antibody titers often decline below protective levels after therapy ( 232 ). Patients with Hodgkin disease, depending on the nature of prior therapy and spleen status, may have a greatly increased susceptibility to infections that are caused by encapsulated bacteria ( 233 , 234 and 235 ). Immunization as a means of preventing infectious morbidity has been best studied in children with acute lymphocytic leukemia (ALL) or solid tumors, patients with Hodgkin disease with or without splenectomy, and marrow transplant recipients. Although the optimal timing of immunizations in these patients and specific recommendations for each type of cancer are still unclear, general guidelines have been established ( Table 75.7 ) ( 236 , 237 ).

**TABLE 75.7. Recommendations for Active Immunization of Adults with Malignancies**

| Vaccine   | Persons Who Should Receive Vaccine  | Timing with Relation to Chemotherapy  | Regimen <sup>a</sup>   |
|---|---|---|--|
| <i>Haemophilus influenzae</i> type b                                      | Lymphoma patients   | Before staging splenectomy, >10 d before initiation of chemotherapy, or 3 mo after completion of chemotherapy.  | Single dose  |
| Hepatitis B <sup>b</sup>  | Cancer patients with hepatitis B surface antigen (+) household contacts                             | Not during immunosuppressive therapy.   | 3 doses: second dose 1–2 mo after the first, third dose 4–6 mo after the first   |
| Influenza   | All cancer patients   | >2 wk before initiation or between cycles of intermittent chemotherapy.   | Annually each fall/winter  |
| Measles, mumps, rubella   | Nonimmune leukemic patients in remission and household contacts of all immunosuppressed individuals | For leukemic patients in remission, >3 mo after completion of therapy otherwise contraindicated in patients with leukemia, lymphoma, or those undergoing immunosuppressive therapy. | Once   |
| Meningococcal ( <i>Neisseria meningitides</i> )                           | Lymphoma patients   | Before staging splenectomy.   | 2 doses; second dose 3–5 yr after the first                                      |
| Poliomyelitis (inactivated poliovirus vaccine only) <sup>c</sup>          | Adults at increased risk of infection; all susceptible household contacts of cancer patients        | No data available; recommend each dose >10 d before initiating chemotherapy.  | 3 doses; second dose 4–8 wk after the first, third dose 6–12 mo after the second |
| 23-Valent polysaccharide pneumococcal ( <i>Streptococcus pneumoniae</i> ) | Any nonimmune cancer patient, especially lymphoma and multiple myeloma patients                     | Before staging splenectomy, >10 d before initiation of chemotherapy, or 3 mo after completion of chemotherapy.  | 2 doses; second dose at least 5 yr after the first                               |



|   |   |  |  |
|---|---|--|--|
| Tetanus and diphtheria toxoids combined | All cancer patients                             | No data available; recommend administration >10 d before initiating chemotherapy.                                  | Primary 3-dose series if not previously immunized; second dose 4–8 wk after the first, third dose 6–12 mo after the second; booster doses at 10-yr intervals throughout life or with dirty wound if >5 yr since last dose. |
| Varicella                               | Nonimmune household contacts of cancer patients | Not applicable—contraindicated in patients with leukemia, lymphoma, or those undergoing immunosuppressive therapy. | For persons >13 yr of age, 2 doses separated by 4–8 wk.  |

<sup>a</sup> Adapted from the Centers for Disease Control and Prevention.

<sup>b</sup> May be used in conjunction with hepatitis B immunoglobulin prophylaxis.

<sup>c</sup> Live oral polio vaccine is no longer available for general use in the United States and is contraindicated in immunosuppressed persons or their household contacts.

The risk of *Haemophilus influenzae* type B (Hib) infection is probably highest in asplenic patients. Owing to the current Centers for Disease Control and Prevention (CDC) recommendations that require all infants to be vaccinated for Hib, almost all adults have adequate immunity against this organism. Siber et al. ( 238 ) reported immune response to Hib vaccine in patients with Hodgkin disease who were undergoing chemotherapy. The study showed that patients who received antineoplastic therapy had significantly greater decrease in Hib titer at a 6- to 12-month period after the primary vaccination (given before starting chemotherapy) as compared to normal controls ( 239 ). Most children who receive maintenance chemotherapy for leukemia or lymphoma are able to generate protective antibody responses to a single dose of conjugate polysaccharide Hib vaccine, although responses are less than those that are seen in healthy children ( 240 , 241 ). Recommendations for children are therefore to continue the primary series of Hib-conjugate vaccinations during chemotherapy treatment and to administer a booster immunization 1 year after completion of chemotherapy ( 236 ). As for adults with cancer, it is recommended that a dose of Hib vaccine be given before initiation of chemotherapy or before splenectomy, if one is planned. The need for a booster in adults is yet to be determined, and further studies are warranted. The Advisory Committee on Immunization Practices of the CDC recommends that the 23-valent polysaccharide pneumococcal vaccine be given to all severely immunocompromised children and adults (i.e., patients with lymphoma, leukemia, multiple myeloma, aplastic anemia, or disseminated malignancy and patients who are being treated with cytotoxic chemotherapy, high-dose steroids, or radiation) ( 237 ). Complete protection might not be achieved if the vaccine is given within 3 years after antineoplastic therapy, although some immunity is seen ( 242 , 243 and 244 ). A newer, more immunogenic pneumococcal-conjugate vaccine is likely to have superior efficacy but remains investigational at this time ( 245 ). Attempts to develop an antipseudomonal vaccine are also under way ( 246 ). Immunization for *N. meningitidis* by using a polysaccharide vaccine is recommended in some cancer patients before

splenectomy, as splenectomized patients are at increased risk of infection, which can result in significant morbidity ( [247](#) ). This vaccine offers no protection from serogroup B (which is responsible for one-third of the cases). Children who undergo chemotherapy and who have not completed all of the diphtheria-tetanus (DT) (or diphtheria, pertussis, and tetanus; pertussis is included if the child is less than 7 years of age) and polio immunization series should complete the boosters as scheduled, although aggressive and prolonged chemotherapy may blunt the response. Only the inactivated polio vaccine (IPV) should be given to immunocompromised patients because of the risk of acquiring polio from the live-attenuated oral polio vaccine. Booster doses of DT or diphtheria, pertussis, and tetanus and the IPV should then be administered 1 year after chemotherapy completion. There are some data that suggest that patients with lymphoid malignancies are more likely to lose their immunity to DT after chemotherapy, as compared to patients with myeloid disorders ( [248](#) ). The current recommendations for adult patients with cancer is to administer DT immunization boosters in the same dose and schedule as for healthy individuals, as most immunocompromised patients have some response to this vaccine ( [236](#) ). The influenza vaccine is generally recommended in immunocompromised patients on a yearly basis. There are several studies that have evaluated the efficacy of this vaccine in cancer patients; there is definite efficacy of this vaccine in patients with solid tumors, and the response is somewhat blunted in the patients with hematologic malignancies ( [249](#) ). Despite a lack of a clear-cut benefit in immunocompromised patients, the likelihood of some protection against the infection has urged physicians to vaccinate all cancer patients with the influenza vaccine. The live-attenuated measles, mumps, and rubella (MMR) vaccine may be considered in previously unimmunized children with leukemia who are in remission, who have been off chemotherapy, and who will not receive chemotherapy for at least 3 months; it is otherwise contraindicated in immunocompromised individuals ( [236](#) , [237](#) ). The recently developed live-attenuated varicella vaccine has been used safely in children with ALL and has had approximately 90% efficacy in leukemic children in the Japanese experience ( [250](#) ). It is not recommended for use in immunocompromised patients, except in seronegative children with HIV ( [251](#) , [252](#) and [253](#) ). The response of asplenic patients to polysaccharide vaccines is controversial. Most healthy asplenic adults have antibody responses to polysaccharides that are normal or close to normal; splenectomized children also respond ( [254](#) , [255](#) ). Patients should be immunized before planned splenectomy, when possible, but postsplenectomy immunization is still effective in otherwise healthy patients. The situation in patients with lymphoproliferative disorders, such as CLL, is less clear; studies in small numbers of patients with CLL show poor antibody responses to polysaccharide vaccines that are given before splenectomy ( [256](#) ). Immune-reconstitution after bone marrow and peripheral blood SCT is dependent on several factors: type of transplant, graft manipulation, intensity of the conditioning regimen, the severity of GVHD, donor immune status, graft function, and ongoing immunosuppressive therapy. Recently, the CDC and the European Group for Bone Marrow Transplantation issued specific immunization recommendations for patients undergoing SCT ( [257](#) , [258](#) ). Patients who undergo autologous transplants recover their immunity faster than patients who undergo allogeneic transplants; in the allogeneic setting, mismatched and haploidentical transplant recipients have extreme delays in immune recovery. Graft manipulation techniques, such as T-cell depletion and CD34 selection, result in impaired immune recovery, as does the presence of chronic GVHD ( [259](#) ). Protective antibodies to the common childhood diseases (polio, tetanus, diphtheria, mumps, measles) wane after ablative therapy and autologous or allogeneic transplantation, thus necessitating revaccination. Increased susceptibility to polysaccharide-encapsulated organisms (pneumococcus, meningococci, *H. influenzae*) also results from a combination of splenic hypofunction, loss of protective antibody, and defective B- and T-cell responses after transplant. All BMT patients should be vaccinated with combined tetanus-diphtheria toxoids at 12, 14, and 24 months after transplant ( [260](#) , [261](#) , [262](#) and [263](#) ). Vaccinating adults against pertussis is not recommended,



as it is an unusual infection in adults. Antibody levels against *H. influenzae* gradually decline after transplant, and revaccination by using the Hib conjugate vaccine is recommended at 12, 14, and 24 months after transplant to regain immunity. The oral polio vaccine is contraindicated in all immunocompromised individuals. IPV and hepatitis B vaccines are recommended at 12, 14, and 24 months after transplant owing to the loss of immunity against the virus by 1 year after transplant in the majority of transplant recipients ( 264 , 265 ). Routine vaccination against *Meningococci*, rabies, and hepatitis A is not recommended. Annual seasonal administration of influenza vaccine is recommended, starting 6 months after transplant ( 266 ). The MMR vaccine, a live-attenuated vaccine, may be given approximately 2 years after transplant to BMT patients and may be administered to household contacts before then. Patients with GVHD who are continuing to receive immunosuppressive therapy should not be given the MMR vaccine ( 267 ). The CDC recommends the use of the 23-valent polysaccharide pneumococcal vaccine at 12 and 24 months after transplant. The varicella vaccine, another live-attenuated vaccine, is contraindicated in all transplant recipients. Use of the bacille Calmette-Guérin vaccine is contraindicated before 2 years posttransplant. There is evidence that donor immunization with conjugate vaccines before bone marrow harvest significantly enhances antibody responses to vaccination in the recipient after transplant ( 268 ). This is true for Hib immunity. Transfer of antigen-specific B cells and memory B and T cells from the donor is believed to confer this booster effect. A similar benefit is not seen after donor immunization with the unconjugated pneumococcal vaccine, but different results may be obtained with the investigational conjugated vaccine that is currently in trials. A significant, but smaller, benefit is noted in autologous BMT patients to whom the Hib-conjugate vaccine was given before bone marrow harvest ( 269 ). Pretransplant donor immunization against CMV and VZV or adoptive transfer of immune cells from the donor to the recipient may be effective in preventing viral disease in allogeneic transplant recipients in the future ( 142 , 270 , 271 ). Immunocompromised patients should be discouraged from traveling to areas that are endemic for typhoid, cholera, or yellow fever. The currently available live-attenuated vaccines for typhoid and yellow fever are contraindicated, and the inactivated typhoid vaccine has unknown efficacy in these patients ( 257 , 258 , 272 ). The newer oral recombinant cholera vaccine is potentially useful for immunocompromised patients ( 273 ). Patients must be particularly careful to avoid local water exposure and insect bites, particularly mosquitoes, in areas that are endemic for malaria. Asplenic patients are also at risk for babesiosis and should avoid tick exposure when traveling to the New England states ( 274 ).

**PASSIVE IMMUNIZATION** IVIG therapy for prevention of infection has been evaluated primarily in patients with lymphoproliferative disorders and multiple myeloma and stem cell transplant recipients. Currently available IVIG preparations are safe and well tolerated and consist primarily of IgG, although small amounts of IgA and IgM are present. They differ with respect to the various IgG subclasses and titers to several infectious organisms ( 275 ). IgA-poor preparations must be used in patients with known or suspected congenital IgA deficiency or those with high anti-IgA titers to prevent anaphylaxis. Polyvalent IgM-enriched preparations have been available for some time, but a role for them has not been defined. IVIG (400 mg/kg given every 3 weeks) has been shown in a double-blinded, randomized trial to reduce the frequency of moderately severe bacterial infections in patients with CLL and Ig levels that are less than 50% of normal or with a history of recurrent infections ( 276 , 277 ). However, a cost-benefit analysis in the same multicenter trial failed to prove that such therapy was cost-effective, as it neither prolonged survival nor demonstrably improved the quality of life of patients with CLL ( 278 , 279 ). Several subsequent studies have confirmed the benefit of IVIG infusions in reducing infection rates in hypogammaglobulinemic patients with CLL who have had recurrent infections ( 280 and 281 ). Reduction in the number of symptomatic and life-threatening infections has also been reported in patients with multiple myeloma who are given monthly infusions of IVIG, despite accelerated Ig metabolism in these patients ( 282 , 283 , 284 and 285 ). The optimal

dosage and schedule of administration of IVIG and the patient subgroups that are most apt to benefit from such prophylaxis are less clearly defined. Several small studies in allogeneic bone marrow transplant patients have reported fewer episodes of gram-negative septicemia or local infections in those receiving weekly IVIG followed by monthly IVIG to day 360 ( [286](#) , [287](#) ). A metaanalysis of all these studies that was published in 1993 showed that transplant recipients who received IVIG had fewer episodes of CMV pneumonia, fatal CMV infections, non-CMV interstitial pneumonia and reduced transplant-related mortality ( [288](#) ). A randomized multicenter trial, which compared different doses of IVIG (100 mg/kg, 250 mg/kg, and 500 mg/kg) that were given weekly until day 90 or later and then monthly until 1 year, failed to show any difference in the infection rates in the three groups ( [289](#) ). Owing to the high costs of IVIG and the availability of better antimicrobials, use of IVIG should be considered in selected patients who undergo allogeneic transplants. Autologous transplant recipients do not appear to benefit from prophylactic globulin therapy, and at least one study has linked its use in these patients to a higher incidence of fatal hepatic venoocclusive disease (VOD) ( [290](#) , [291](#) ). Although IVIG and CMV hyperimmune globulin confer some passive immunity against CMV infection, CMV disease, or IP, other, more cost-effective methods of CMV prophylaxis, such as leukofiltration of blood products and avoidance of granulocyte transfusions, may be more cost-effective ( [292](#) , [293](#) ). The best-established indication for prophylactic IVIG in allogeneic transplantation is prevention of acute GVHD (grades II through IV) ( [294](#) , [295](#) and [296](#) ). Passive immunization with varicella-zoster immune globulin, if it can be given within 72 to 96 hours of the exposure, is indicated in seronegative patients who are immunosuppressed ( [297](#) ). Patients who are exposed to measles, mumps, or rubella may benefit from passive Ig prophylaxis if it is given within 6 days of exposure ( [298](#) ). Intramuscular Ig is recommended for patients who travel to areas that are endemic for hepatitis A or for postexposure prophylaxis ( [299](#) ). Two doses of hepatitis B Ig, given 1 month apart, are recommended for postexposure prophylaxis. Other biologic agents that have been studied include polyclonal and monoclonal antibodies, cytokines, growth factors, interferons, interleukins (ILs), and interleukin-receptor or tumor necrosis factor (TNF)- $\alpha$  antagonists ( [300](#) ). Polyclonal antibodies against the core glycolipid of the family Enterobacteriaceae (J5 antiserum), although shown to reduce mortality in some patients with sepsis syndrome caused by gram-negative infection, have not been observed to benefit neutropenic patients ( [301](#) ). Similarly, human monoclonal antiendotoxin (HA-IA) antibodies have not proven beneficial in neutropenic patients with or without gram-negative infection and may cause serious toxicity ( [302](#) ). The role of interferon- $\gamma$  in combination with cytokines, such as macrophage CSF, and traditional modalities in bolstering host defenses against certain types of infections (especially fungal) appears promising ( [303](#) ). Despite promising initial results in animal models of sepsis by using anti-TNF- $\alpha$  and anti-IL-1 receptor, clinical trials have not demonstrated any benefit ( [304](#) ).

## PREVENTION AND TREATMENT OF CHEMOTHERAPY-RELATED CYTOPENIAS

### Use of Hematopoietic Growth Factors

The most common dose-limiting toxicity of several systemic chemotherapeutic regimens remains myelosuppression. Myelosuppression has long been a major obstacle to the delivery of effective doses of chemotherapy. Since the 1980s, tremendous progress in the understanding of hematopoiesis and its regulation has led to the identification, cloning, and large-scale production of numerous cytokines, several with clinical applications. Several distinct growth-stimulating and inhibitory cytokines (individually known as *growth* or *CSFs*, *ILs*, or *interferons*) are known, each of which acts through a specific cell-surface

receptor ( 305 ). A wide array of early- and late-acting CSFs and ILs regulate the differentiation of pluripotent stem cells into committed progenitors and their subsequent lineage-specific growth and differentiation ( 306 , 307 ). In the past decade, several recombinant hematopoietic growth factors have been approved for clinical use ( 308 , 309 , 310 and 311 ). These are G-CSF [filgrastim (Neupogen)], GM-CSF [sargramostim (Leukine)], erythropoietin (EPO) (Procrit), IL-11 [oprelvekin (Neumega)], pegylated G-CSF [pegfilgrastim (Neulasta)], and darbepoetin alfa (Aranesp). The approved clinical indications for their use include shortening the duration of cytopenias that result from standard or high-dose chemoradiotherapy, treating congenital or acquired bone marrow failure states, mobilizing peripheral blood progenitor cells (PBPCs), treating the anemia of chronic disease, and facilitating autologous blood donation ( Table 75.8 ).

**TABLE 75.8. Potential Uses of Hematopoietic Growth Factors in Supportive Care**

| Clinical Indication for Hematopoietic Growth Factor  | Evidence of Benefit | Evidence of Harm | Cost-Effectiveness                                 |
|--|---------------------|------------------|--|
| Supporting dose intensity in standard dose regimens for solid tumors                       | Limited             | No               | Unknown  |
| Primary prevention of febrile neutropenia in solid tumors                                  | Yes                 | No               | Yes, if risk of febrile neutropenia is high (=40%) |
| Secondary prevention of febrile neutropenia in solid tumors                                | Limited             | No               | Unknown  |
| Treatment of established febrile neutropenia in solid tumors                               | Limited             | No               | No   |
| Mobilization of progenitor cells   | Yes                 | No               | Yes  |
| Postrescue in high-dose therapy: bone marrow or peripheral blood stem cell transplantation | Yes                 | No               | Likely   |
| Cell cycling in leukemias  | No                  | Unclear          | Unknown  |
| Promotion of myeloid recovery in acute leukemia  | Yes                 | Unclear          | Unknown  |

Adapted from Bociek RG, Armitage JO. Hematopoietic growth factors. *CA Cancer J Clin* 1996;46:165-184.

## Anemia

Anemia is a frequent hematologic manifestation in patients with cancer that is due to the underlying malignancy or as a result of its treatment. Anemia in turn manifests as fatigue in such patients, causing worsening in quality of life as well as other physiologic impairments owing to reduced oxygen carrying capacity. Until the advent of erythropoietic agent, epoetin alfa, blood transfusions and iron replacement were the primary treatments for symptomatic anemia. Epoetin alfa (Epoen, Procrit) is a glycoprotein hormone with multilineage activity that promotes the survival and proliferation of committed erythroid progenitors and their terminal differentiation into mature red blood cells ( 312 ). Recombinant human EPO is effective in the treatment of anemia that is caused by hematologic malignancy or chemotherapy, although the origin of the anemia in most such patients is multifactorial ( 313 , 314 , 315 and 316 ). Recently published evidence-based clinical practice guidelines by ASCO and American Society of Hematology help clear some of the

uncertainty regarding dosing and patient selection ( 317 ). In several randomized, double-blind, placebo-controlled trials, EPO increased the mean weekly hematocrit in cancer patients, irrespective of their chemotherapy status ( 316 , 318 ). The current guidelines recommend the use of EPO in all patients with chemotherapy-associated anemia with a hemoglobin level of less than 10 g/dl. There is less clear evidence to support its use in patients with hemoglobin greater than 10 g/dl but less than 12 g/dl, and use should be based on clinical situation. The current recommended dosage of EPO is 150 U/kg three times a week or 40,000 U once a week, with the later dosing regimen being based on common clinical practice ( 319 ). In the absence of a response despite dose escalation at 6 to 8 weeks after therapy, use of EPO should be discontinued. In the absence of response, iron deficiency should be ruled out. More recent data suggest that the use of EPO significantly decreases overall transfusion requirements and delays the onset of anemia in patients with cancer who are undergoing chemotherapy ( 320 ). Significant improvement in quality of life has also been reported by responding patients ( 320 , 321 ). The administration of EPO after ABMT has been evaluated in randomized prospective trials, but no trial to date has shown reduced time to transfusion independence or a decreased total red blood cell transfusion requirement between patients with ABMT who receive EPO and those who receive placebo ( 322 , 323 and 324 ). In contrast, erythroid reconstitution is accelerated by the use of EPO in allogeneic transplant recipients ( 325 , 326 ). Median time to red blood cell transfusion independence was reduced by 8 days in allogeneic transplant recipients who were randomized to receive EPO after transplant at 150 U/kg/day versus placebo in a study by Lin et al. ( 327 ). The use of EPO to boost the hematocrit before or during courses of chemotherapy has been helpful in managing patients whose religious or other beliefs preclude the transfusion of blood products ( 327 , 328 ).

Although EPO levels are generally increased in MDS, the degree of increase may not be proportionate to the degree of anemia ( 329 ). Erythroid responses to EPO alone, which are defined as a greater than 50% decrease in transfusion requirement or a greater than 1 g/dl rise in hemoglobin, are seen in only 10 to 28% of patients with MDS, even when EPO is used at doses that are considerably higher than those used in chronic renal failure (100 to 200 U/kg three times per week, with dose escalation as needed to achieve response) ( 330 , 331 ). Baseline EPO levels do not appear to predict response to EPO alone ( 332 ). High-dosage EPO alone (more than 1000 U/kg/week) or dosages exceeding 150 U/kg daily in combination with a myeloid growth factor, such as G-CSF, result in durable responses in 35% and 48% of patients, respectively ( 330 , 331 and 332 ). In the study by Negrin et al. ( 330 ), a response to combined therapy was significantly more likely in patients with EPO levels less than 500 U/L and in those with higher basal reticulocyte counts and normal cytogenetics. Approximately 50% of responders require G-CSF and EPO to maintain the erythroid response, suggesting an *in vivo* synergy between these cytokines in myelodysplastic erythropoiesis. There is no demonstrable effect by EPO on granulocyte counts or platelet production. A trend toward greater responses to EPO in low-risk MDS subtypes (refractory anemia and refractory anemia with ringed sideroblasts) has been noted by some investigators ( 333 ). Cost constraints preclude the routine use of EPO or combination EPO-G-CSF therapy in support of MDS patients.

Darbepoetin alfa, a newer erythropoietic molecule, stimulates erythropoiesis by the same mechanism as EPO. The biochemical structure of darbepoetin alfa differs from that of EPO (darbepoetin alfa contains two additional *N*-linked carbohydrate chains, conferring more sialic acid, which prolongs its serum half life). Darbepoetin alfa, at a dosage of 3 µg/kg subcutaneously every 2 weeks, when compared to a placebo in a randomized clinical trial, was statistically more effective in reducing the number of blood transfusions as well as increasing the total hemoglobin. There was also improvement in quality of life in

patients who received darbepoetin alfa ( 334 , 335 ).

## Myelosuppression and Colony–Stimulating Factors

Neutropenia continues to be the most significant dose–limiting toxicity of systemic chemotherapy. Discovery of the recombinant human growth factors has been revolutionary in the management of chemotherapy–induced neutropenia. Recombinant human G–CSF is a nonglycosylated protein that is derived from *E. coli* and regulates neutrophil production and function. In contrast, glycosylated (Chinese hamster ovary or yeast–derived) and nonglycosylated (*E. coli*–derived) forms of recombinant GM–CSF are available. In conjunction with other cytokines, such as G–CSF and EPO, GM–CSF stimulates the production, growth, and activity of several hematopoietic cell lineages. It acts on granulocyte–macrophage colony–forming unit and on colonies that are made up of committed granulocytic, erythroid, and monomegakaryocytic progenitors and enhances various aspects of phagocyte and cytotoxic cell function ( 308 ).

Several large randomized clinical trials have shown that the prophylactic administration of G–CSF or GM–CSF after conventional–dose chemotherapy reduces the incidence of febrile neutropenia by 50% in patients with a 40% or greater incidence of febrile neutropenia than the control group ( 307 , 308 , 336 ). No trials have demonstrated any significant impact of growth factors on infectious mortality, response rates, or overall survival ( 104 ). Economic analyses suggest that prophylactic cytokines are cost–effective only in chemotherapy regimens that are associated with a greater than 40% incidence of febrile neutropenia or when febrile neutropenia has occurred with previous cycles of chemotherapy ( 104 ). Comprehensive, evidence–based practice guidelines that are set forth by the ASCO ( 104 ). The use of myeloid growth factors in addition to antibiotics to treat episodes of febrile neutropenia is less well substantiated in the literature and is not recommended by the ASCO guidelines unless certain clinical features are present. Febrile neutropenic patients who are at risk for clinical deterioration and who should receive growth factors include those with fungal infections, pneumonia, cardiovascular compromise, or multiorgan dysfunction. Collective results of eight randomized trials indicate a lack of evidence to support the use of growth factors in febrile neutropenic patients with none of the previously stated risk factors ( 104 , 337 , 338 ). The ASCO guidelines do not recommend that hematopoietic cytokines be used in patients who become neutropenic but remain afebrile after chemotherapy, and this has been substantiated by a more recently published study ( 339 ). Use of growth factors is currently recommended in patients older than 50 years of age with acute myeloid leukemias who are receiving induction chemotherapy. There are randomized clinical trials that show the safety and benefit of use of CSFs in this setting when started a few days after completion of the chemotherapy ( 104 , 340 , 341 and 342 ). Current ASCO guidelines recommend the use of CSFs to reduce the duration of neutropenia in patients with ALLs who are receiving chemotherapy ( 343 , 344 and 345 ). Few studies that directly compare G–CSF and GM–CSF have been performed ( 346 , 347 ), but the limited data suggest that these growth factors have equal efficacy in chemotherapy–induced neutropenia at currently recommended doses (5 µg/kg/day or 250 µg/m<sup>2</sup>/day, respectively). GM–CSF and G–CSF have been evaluated (GM–CSF more extensively) in the setting of high–dose therapy and hematopoietic SCT. Significant reductions in hospitalization and neutrophil engraftment times and in the incidence of infection have been demonstrated in autologous, as well as allogeneic, transplant recipients. There appears to be no increase in the incidence of graft rejection or acute GVHD in allogeneic transplant recipients who receive G–CSF or GM–CSF ( 348 , 349 , 350 , 351 and 352 ). An overall reduction in the cost of transplantation has also been demonstrated ( 353 ).



The administration of G-CSF or GM-CSF to patients with MDS and neutropenia results in significantly increased neutrophil counts in most patients ( [354](#) ). Some patients have also shown improvements in platelet count and hematocrit in trials of GM-CSF or maintenance therapy with G-CSF, but these effects are unpredictable ( [331](#), [355](#) ). As in the case of EPO, response to myeloid growth factors persists only as long as therapy is maintained ( [356](#) ). Dosage-ranging studies for GM-CSF suggest that an initial dosage of 10 to 40  $\mu\text{g}/\text{m}^2$  daily is reasonable, and responses to G-CSF have been noted at dosages of 0.1 to 3.0  $\mu\text{g}/\text{kg}$  daily. Limited evidence from follow-up cytogenetic studies suggests the possibility that the granulocyte response is caused by the activity of the abnormal clone rather than by normal granulopoiesis ( [331](#) ). Even though there is a theoretical likelihood of transformation of MDS to leukemia with the use of CSFs, randomized trials have shown that the incidence of transformation in patients with MDS who received G-CSF was no greater than that of untreated controls ( [356](#) ). A phase III trial that compared G-CSF versus observation in neutropenic MDS patients showed a benefit toward the use of G-CSF with clinical improvement in infections ( [355](#) ). The current ASCO guidelines do not support the continuous use of CSFs in patients with MDS, but a subset of patients with neutropenia and infections does benefit from intermittent use of CSFs.

The use of G-CSF and GM-CSF has permitted intensification of chemoradiotherapy, although nonmyeloid toxicities are still limiting. Retrospective studies suggest increased response rates with the use of high-dose chemotherapy to minimize the development of tumor resistance in leukemias and lymphomas ( [357](#) ). Evidence from prospective trials now also suggests that dose intensification and SCT can improve response rates and treatment outcomes in selected patients with hematologic malignancies ( [358](#), [359](#), [360](#) and [361](#) ). Phase I dose escalation trials using growth factor support with intensified standard chemotherapy regimens for lymphoma, such as the combination of cyclophosphamide, hydroxydaunomycin, Oncovin (vincristine), and prednisone, suggest improved response and survival rates without the need for stem cell rescue ( [362](#) ). Nevertheless, the use of growth factors to maximize dose intensity within standard-dose chemotherapy regimens has not translated into improved overall or disease-free survival. Because of the way in which some of these studies were conducted and their occasionally conflicting results, the impact of dose intensity on survival in lymphoid malignancies remains in question. Intermittent administration of G-CSF or GM-CSF has also permitted maintenance of dose intensity in patients who undergo chemotherapy for Hodgkin disease. The current body of literature does not support the routine use of CSFs for dose intensification, and such use should be done in the context of clinical trials.

*In vitro* studies show that myeloid growth factors can render leukemic cell lines more susceptible to cell cycle specific cytotoxic agents, such as cytarabine, by recruitment of blasts into S phase, and the potential clinical benefit of this phenomenon has been investigated in patients with acute leukemia ( [363](#), [364](#) and [365](#) ). However, there is no evidence to date that growth factor priming to recruit leukemic cells into a cycling state before antileukemic therapy results in improved remission rates or prolonged remission duration and is not recommended per ASCO guidelines. In general, CSFs should not be administered simultaneously with chemoradiotherapy because of the potential for increased thrombocytopenia, as has been evidenced in a randomized trial in small cell lung cancer patients ( [366](#) ); however, one recent study in patients with ALL indicated that treatment-related morbidity, and thus treatment delays, could be prevented by the use of G-CSF in patients who are undergoing multimodality therapy. Current ASCO guidelines suggest avoiding the use of CSFs when patients are treated with concomitant chemotherapy and radiation.

Mobilization of hematopoietic PBPCs into the peripheral blood has become the standard of care at most transplant centers for stem cell collection for autologous transplantation. Treatment with G-CSF or GM-CSF effectively increases the number of circulating progenitors available for transplantation; indeed, graft priming may be as important as the source of the graft ( [367](#), [368](#) ). Other potential advantages to the use of PBPC over bone marrow include ease of collection, immunomodulatory antitumor effects, decreased tumor contamination ( [369](#), [370](#) ), and more rapid hematopoietic and immunologic recovery ( [371](#), [372](#) ). G-CSF and GM-CSF are effective in increasing the yield of PBPC during leukapheresis, and, when used in combination, they are more effective than either growth factor alone, but increased cost becomes the inhibitory factor. Allogeneic peripheral blood stem cell transplants are being increasingly done and are being studied in the unrelated setting too ( [373](#) ). The current trend towards use of peripheral blood stem cells in the allogeneic setting has raised concern about potential long-term toxicity of use of CSFs in normal donors. Studies have failed to show any long-term risk for the use of CSFs in normal donors ( [374](#) ).

### Thrombocytopenia

Thrombocytopenia remains a challenge in the treatment of patients who undergo aggressive chemotherapy. Several cytokines have been developed and tested for treatment and prevention of chemotherapy-induced thrombocytopenia ( [375](#), [376](#), [377](#) and [378](#) ). The most promising results are from recombinant human IL-11 (Neumega), which, when tested in a randomized placebo-controlled study in breast cancer patients receiving chemotherapy, reduced the number of platelet transfusions required, and a smaller proportion of patients who received the drug needed platelet transfusions ( [379](#) ). In this study, recombinant human IL-11 also reduced the time to platelet recovery. This is the only current FDA-approved drug for chemotherapy-induced thrombocytopenia at a dosage of 50 µg/kg subcutaneously daily, starting a day after completion of chemotherapy until a platelet count of greater than 50,000/µl is reached.

### Risks and Toxicities of Growth Factors

In general, the later-acting hematopoietic cytokines have been associated with fewer side effects than those that act earlier and on multiple cell lineages. EPO causes little or no toxicity when used in patients with normal renal function and intravascular volume regulation. Toxicity with G-CSF is usually mild, bone pain being the most common symptom 1 to 2 days before neutrophil recovery. Recombinant yeast-derived GM-CSF has been reported to have a better side-effect profile than *E. coli*-derived GM-CSF (less fever, rash, and myalgias), although a randomized trial that compared them revealed no statistically significant differences ( [380](#) ). GM-CSF also has diverse toxicities involving many organ systems that are poorly understood, but elevated levels of TNF-α and IL-6 may be partly responsible. GM-CSF at high doses has been associated with hepatic transaminase elevation, serositis, fluid retention, venous thrombosis, and reactivation of autoimmune disease. A syndrome of hypoxemia, flushing, cardiovascular instability, musculoskeletal pain, nausea, and vomiting has also been described with intravenous GM-CSF at doses greater than 1 µg/kg ( [381](#) ). Recombinant human IL-11, when used for prevention of chemotherapy-induced thrombocytopenia, has been associated with increased fluid retention, capillary leak syndrome, and occasional pulmonary edema and should be used with caution in patients with cardiac disease. IL-11 use is also associated with hypersensitivity and anaphylactic reactions in some patients, as are anemia and tachycardia ( [375](#), [379](#) ).



It is likely that broader-acting cytokines, such as IL-1, IL-3, PIXY-321, IL-6, and stem cell factor (SCF), more often cause systemic toxicity (fever, chills, rash, hypotension) than the growth factors that have already been discussed. SCF may cause symptoms similar to those of mast cell activation in some patients ( [382](#) ). M-CSF causes a dose-dependent thrombocytopenia ( [383](#) ).

## COMMON COMPLICATIONS OF CHEMOTHERAPY

### Dermatologic Toxicity

Alopecia and pigmentary skin changes (usually hyperpigmentation) occur with a number of chemotherapeutic drugs ( [391](#) ). Resolution of alopecia may take several weeks or months, and patients should be referred to a reliable source for wigs, such as the American Cancer Society or the Alopecia Areata Foundation, before commencing treatment. Skin hyperpigmentation also resolves in most cases but can occasionally be permanent and of considerable cosmetic significance to the patient.

Certain chemotherapeutic agents, such as bleomycin, doxorubicin, and methotrexate, are associated with enhancement of radiation effects that can increase toxicity to target tissues, areas of exposed skin, and other mitotically active organs. This effect is dependent on drug dose and has the greatest potential to occur if chemotherapy is given within 1 week of radiation therapy. Skin changes include edema, erythema with or without bullae, or necrotic ulceration. Treatment consists of cool, wet compresses; débridement, if necessary; the use of topical occlusive dressings; and monitoring for infection ( [392](#) , [393](#) ).

Radiation recall reactions, in contrast, are characterized by recurrent inflammation in previously irradiated tissue (skin, lung, heart, and GI tract), usually within a few weeks of radiation therapy. A number of drugs (bleomycin, doxorubicin, etoposide, vinca alkaloids, and hydroxyurea), most notably anthracyclines, are associated with radiation recall ( [391](#) ). Photosensitivity and sunburn are infrequent side effects of chemotherapy and may be prevented by avoidance of skin exposure ultraviolet light and by withholding methotrexate for at least 1 week after sunburn, respectively ( [394](#) ). Sunscreens are not helpful in preventing photosensitivity but are recommended in transplant recipients who receive total body irradiation (TBI) to prevent flares of GVHD. Specific types of skin eruptions are noted with individual chemotherapeutic drugs. Tender erythematous plaques in acral areas (palms and soles) may be seen with cytarabine and 5-fluorouracil ( [395](#) , [396](#) and [397](#) ). More generalized erythematous macules suggest neutrophilic eccrine hidradenitis, which was first described in association with cytarabine in acute leukemia patients but may also occur with other drugs ( [398](#) , [399](#) ). Dermatologic side effects are increasingly being reported in patients who receive thalidomide, with most being minor skin eruptions and dermatitis, but few cases of erythema multiforme and toxic epidermal necrolysis have been reported ( [400](#) ).

### Mucositis

The rapid proliferation of mucosal epithelial cells makes the oropharyngeal and GI mucosa particularly vulnerable to cytotoxic chemotherapy and local radiotherapy effects. Incidence of mucositis varies from 40% in patients who receive standard chemotherapy to as high as 75% in stem cell transplant patients ( [401](#) ). Combined-modality chemoradiotherapy increases the potential for serious gut toxicity that is caused by concomitant myelosuppression and local mucosal damage. The use of methotrexate

further potentiates mucositis, despite folinic acid rescue. Mucositis usually begins as erythema of the soft palate, of the buccal mucosa, on the ventral surface of the tongue, and in the floor of the mouth. Buccal edema, desquamation, and frank ulceration follow in severe cases, and superficial bleeding may occur. Edema and scalloping of the lateral borders of the tongue may be noted if teeth are present. The severity of mucositis is dependent on therapy-related and host factors. The type of chemotherapy that is used, dose and field of radiation, cumulative dose, and treatment schedules of therapy are important determining factors. The presence of poor oral hygiene has been associated with a higher incidence of mucositis in transplant patients (402). Routine assessment of dental and oral soft tissue health before initiation of high-dose chemotherapy or radiotherapy to this region is therefore an important part of prevention of mucositis and secondary infection.

If handling of oral secretions due to pharyngeal mucositis is significantly impaired, the patient should be provided with a stiff catheter for suctioning, and evaluation of the airway by an otolaryngologist or even elective intubation may be prudent in severe cases. In addition to causing acute mucositis, radiation to the head or neck may lead to salivary gland dysfunction, bony and soft tissue changes, dental caries, and periodontal disease (403). Meticulous oral hygiene must continue once therapy begins, but, because of lack of patient motivation, nausea, mucositis pain, and general debility, this may be a difficult task. Multiple daily oral rinses with chlorhexidine, a salt and soda solution, or a topical antifungal are believed to reduce the risk of mucosal and systemic infection. Simultaneous pain control is also essential, and the use of topical anesthetics (viscous lidocaine) has limited success. Systemic analgesia with narcotics, which are delivered via patient-controlled analgesia pump, is often necessary. When natural teeth are present, the use of a soft toothbrush or chlorhexidine-saturated foam brush assists in maintaining oral hygiene.

Several agents have been studied to reduce the incidence and degree of mucositis. A randomized, placebo-controlled study using prophylactic oral rinses with sucralfate did not prevent oral ulcerative mucositis that was caused by radiation (404). Similarly, studies of the protective effects of the drug azelastine in combination with other antioxidants, such as vitamins C and E, in patients with solid tumors have failed to show any clear benefit (405). Vitamin E in topical form has been reported to be effective in treating chemotherapy-induced oral mucositis as compared with placebo in one randomized study (406). Prechemotherapy topical administration of transforming growth factor- $\beta$ , which has been shown to reduce the turnover of basal epithelial cells *in vitro* and *in vivo*, significantly decreased the incidence, severity, and duration of oral mucositis in one study and may be a promising avenue to prevention (407). The cytoprotectant amifostine has been reported in small, randomized, clinical trials to significantly reduce mucositis in patients who undergo chemoradiotherapy for head and neck cancers and also in patients who undergo stem cell transplant using melphalan as a conditioning regimen (408). Prostaglandin E<sub>2</sub> has been reported in healing mucositis in bone marrow transplant patients (409). In patients receiving 5-fluorouracil and high-dose melphalan, cryotherapy using ice-cold mouthwashes or ice pops immediately before and at least 30 minutes after melphalan administration may be helpful in reducing the incidence of mucositis, even when melphalan is not used as a single agent (410). The mechanism is thought to be local vasoconstriction and a decrease in temperature-dependent melphalan cytotoxicity. Keratinocyte growth factor, an epithelial-specific tissue growth factor, has been shown in preclinical and phase I and II studies to have cytoprotective properties (411). There are several ongoing clinical trials in patients who receive chemoradiotherapy as well as SCT.

Radiation-related mucositis occurs 10 to 14 days after the initiation of radiation therapy and heals within 2 to 3 weeks. It may be patchy or confluent. Topical anesthetic

suspensions, topical antifungals, and frequent daily saline or sodium bicarbonate lavages are helpful in maintaining hygiene and reducing microbial colonization; topical vancomycin may be of benefit prophylactically in patients who receive TBI ( 412 , 413 ). Acute sialadenitis, a common and often painful complication of TBI and of localized irradiation, is usually transient; stimulation of salivation with hard candy often provides relief in the interim. Chronic hyposalivation and xerostomia are more difficult to treat, as artificial saliva substitutes are unsatisfactory; systemic sialogogues (such as pilocarpine and bethanechol) have been efficacious in preliminary trials ( 403 , 414 ).

Diarrhea is a common occurrence after TBI or bowel irradiation; it can also result from chemotherapy with several chemotherapy agents. Noninfectious mild diarrhea can be controlled with opioid drugs, such as loperamide and diphenoxylate and atropine, and by lowering the fiber content of food. Loperamide may be superior to diphenoxylate and atropine for acute nonspecific diarrhea ( 415 ). Bile acid-binding resins (such as cholestyramine) may be effective in preventing and controlling diarrhea but at dosages that are unpalatable to most patients. Anecdotal reports have shown salicylates to be successful in refractory cases ( 416 ). There are preliminary reports of success with sucralfate ( 417 ) and glutathione ( 418 ) in prevention of radiation-induced diarrhea. Octreotide (0.1 mg subcutaneously) is an effective antidiarrheal against chemotherapy-induced diarrhea ( 419 , 420 ). This agent has been used extensively in GVHD of the gut after BMT and may lead to adynamic ileus, although immunosuppressive therapy remains the mainstay of treatment of GVHD ( 421 , 422 and 423 ). In immunocompromised patients, infectious causes, such as *Shigella*, *E. coli*, and *C. difficile*, must be ruled out as cause of diarrhea.

### Urinary Tract Toxicity

Acute and chronic nephrotoxicity is a common and dose-limiting complication of cancer chemotherapy. The most well-known nephrotoxic agents are ifosfamide and platinum drugs, which are used often in childhood and adult hematologic malignancies. Risk factors for ifosfamide renal toxicity that emerge from the pediatric literature include high cumulative dose, young patient age, prior nephrectomy, concomitant therapy with a platinum agent, and preexisting renal abnormalities ( 424 ). Continuous infusion may be less toxic than bolus infusion. Mesna is effective in protecting against bladder toxicity that is caused by the 4-hydroxy metabolites of cyclophosphamide, acrolein, and 4-hydroxy cyclophosphamide; it is widely used to reduce the risk of hemorrhagic cystitis that is caused by high-dose or daily low-dose cyclophosphamide ( 425 ). The efficacy of mesna in blocking the action of toxic ifosfamide metabolites appears to be considerably less ( 424 , 426 , 427 ), although it may exert some protective effect. In the event of bladder hemorrhage, support with blood products and continuous irrigation of the bladder with saline or hydrocortisone are needed. More extreme measures, such as intravesical formalin instillation, urinary diversion, or cystectomy, may be performed for refractory cases, but with generally disappointing results.

Cisplatin nephrotoxicity is well described but poorly understood. An autopsy study found significant correlation between tissue levels of the drug and the dose of cisplatin per course, the concomitant use of metoclopramide and phenytoin, and the renal cortical platinum level. The investigators suggest that the protective effect that is observed with hydration may not be caused by reduced cortical platinum concentrations ( 428 ). There is some evidence that prospective determinations of urinary tubular enzyme and retinol-binding protein excretion may be useful in predicting later decline in creatinine clearance in adults who receive cisplatin ( 429 ). Several other strategies, most of which entail the use of certain drugs before cisplatin administration, remain investigational at

this time: chelation or inactivation of platinum metabolites (amifostine, sodium thiosulfate, mesna, glutathione, and selenium), inhibition of tubular cisplatin secretion and accumulation (probenecid), renal vasodilation (captopril and verapamil), and removal of cisplatin from DNA adducts (diethyldithiocarbamate) ( [430](#), [431](#) ). The primary means of minimizing cisplatin toxicity is aggressive saline diuresis (2 to 3 L over 8 to 12 hours on the day of chemotherapy), with or without mannitol.

Dosage modification for renal or hepatic insufficiency is required for many chemotherapeutic agents (see [Chapter 73](#)).

### Cardiotoxicity

Several chemotherapeutic drugs can cause cardiac toxicity, some reversible and some irreversible. Anthracycline antibiotics (doxorubicin and daunomycin) may lead to acute supraventricular tachyarrhythmias within hours of bolus administration in as much as 40% of patients who receive bolus doxorubicin, but this is usually transient and asymptomatic. Chronic dose- and schedule-related toxicity is of more concern, as it is usually irreversible. Cumulative doses of greater than 400 mg/m<sup>2</sup> are associated with a significant increase in risk, and the incidence of clinical congestive heart failure is probably higher than was previously reported. Additional risk factors that have been identified are exposure to ionizing radiation to the chest, an age of older than 70 years, prior exposure to anthracyclines, and preexisting cardiac disease or coronary risk factors, but the relative importance of these risk factors has not been established ( [432](#), [434](#) ). Prolongation of the QTc interval may correlate with cumulative anthracycline dose and risk for long-term cardiac sequelae ( [433](#) ).

The major advance in prevention of anthracycline-induced cardiac toxicity is the development of the cardioprotectant dexrazoxane, which protects against free radical myocardial damage that is induced by anthracyclines. Randomized, placebo-controlled trials of this compound in patients with breast cancer and sarcomas show conclusively that dexrazoxane at a dose ratio of 10:1 or 20:1 dramatically reduces doxorubicin cardiotoxicity without diminished antitumor activity ( [435](#), [436](#) ). Patients in a New York University Medical Center study were able to tolerate significantly more cycles of anthracycline-based therapy for breast cancer (fluorouracil, doxorubicin, and cyclophosphamide at doses of 500, 50, and 500 mg/m<sup>2</sup>, respectively) and higher cumulative doxorubicin doses (with a median cumulative dose of 500 mg/m<sup>2</sup> versus 441 mg/m<sup>2</sup>, with a range to as high as 1000 mg/m<sup>2</sup>) with a decreased incidence of cardiac toxicity ( [437](#) ). The median fall in left ventricular ejection fraction was 1 to 3% in the dexrazoxane group versus 15 to 16% in the control group. ASCO published guidelines for use of dexrazoxane for patients who receive anthracyclines in 1999 ( [438](#) ).

High-dose cyclophosphamide, especially in the transplant setting, has also been associated with transient congestive heart failure, hemorrhagic myocarditis and pericarditis, and death, but these are uncommon complications ( [439](#) ). Finally, the infusion of autologous stem cells or marrow that is cryopreserved with dimethyl sulfoxide causes transient arrhythmias that are usually asymptomatic; slowing the rate of infusion and administering a diuretic immediately after infusion decreases the likelihood of this problem ( [440](#) ).

### Pulmonary Toxicity

Many chemotherapeutic agents may result in pulmonary toxicity ( [Table 75.9](#) ). Careful

attention to risk factors when designing therapeutic regimens and monitoring lung function is key to preventing such toxicity. Risk factors for toxicity that is caused by bleomycin, the most notable offender, are a total dose of greater than 400 U; older patient age; concomitant therapy with anthracyclines, cyclophosphamide, vincristine, dexamethasone, or methotrexate; radiotherapy; preexisting pulmonary function abnormalities; and high-dose oxygen exposure. Bleomycin should be discontinued for a greater than 10 to 15% decline in the measured parameters of pulmonary function (441). Another common offender that is seen often in the stem cell transplant setting is carmustine, which can cause pulmonary toxicity as late as 8 weeks after transplant. If diagnosed early, carmustine toxicity of the lung can be reversible with systemic steroid therapy.

**TABLE 75.9. Pulmonary Toxicity of Chemotherapeutic Agents**

| Drug             | Toxic Dose Range <sup>a</sup>  | Toxicity   |
|------------------|--------------------------------|--|
| Bleomycin        | Total dose =400 U              | Interstitial pneumonitis and fibrosis<br>Dyspnea and cough (early symptoms)<br>Fine rales (early signs)<br>Decreased vital capacity and lung volumes; toxicity is dose and age related |
| Busulfan         | Conventional dose              | Bronchopulmonary dysplasia and fibrosis<br>Onset delayed for months or years   |
| Carmustine       | Total dose =1 g/m <sup>2</sup> | Interstitial pneumonitis; delayed pulmonary fibrosis   |
| Chlorambucil     | Conventional dose              | Interstitial pneumonitis and fibrosis  |
| Cyclophosphamide | High dose                      | Pulmonary edema  |
| Cytarabine       | Conventional dose              | Interstitial pneumonitis and fibrosis  |
| Melphalan        | High dose                      | Interstitial pneumonitis   |
| Methotrexate     | Conventional dose              | Interstitial pneumonitis   |
| Mitomycin        | Conventional dose              | Interstitial pneumonitis   |
| Thiotepa         | High dose                      | Interstitial pneumonitis   |

<sup>a</sup> Route of administration is intravenous, unless otherwise indicated. The conventional dose is the commonly accepted therapeutic range.

Adapted from Page R, Rhodes V, Pazdur R. Cancer chemotherapy. In: Cancer management: a multidisciplinary approach. Medical, surgical and radiation oncology. Huntington, NY: PRR, 1996:541–580.

## NONINFECTIOUS ISSUES IN HEMATOPOIETIC STEM CELL

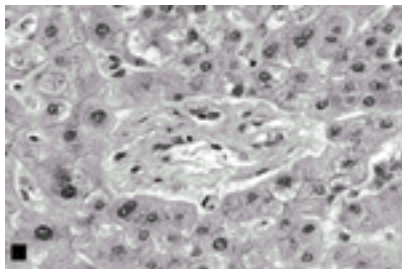
# TRANSPLANTATION

## Conditioning Regimen Toxicity

Regimen-related toxicity (RRT) is a major cause of early mortality after myeloablative SCT for hematologic malignancies. Hepatic VOD and acute lung injury are the two principal components of RRT. The specific risk factors, proposed pathophysiology, and management of these disorders are discussed fully in [Chapter 25](#). The source of stem cells for transplantation may significantly affect the risk of RRT ([442](#)).

## Venoocclusive Disease

VOD of the liver is the most common regimen-related toxicity that is seen after SCT when high-dose chemoradiotherapy is used as the conditioning regimen. Differentiation of VOD from other liver abnormalities, such as GVHD, drug-induced liver toxicity, or infectious hepatitis, may be difficult ([Fig. 75.9](#)) ([443](#), [444](#) and [445](#)). Imaging studies, such as CT scanning or ultrasound of the right upper quadrant, are nonspecific but are occasionally useful for documenting ascites and for excluding extrahepatic biliary obstruction. In selected patients, transvenous liver biopsy and measurement of the hepatic venous pressure gradient may be considered, but these procedures require a skilled and experienced operator. Noninvasive tests, such as magnetic resonance imaging and color Doppler ultrasound, have been found to be useful in the diagnosis of VOD, with the later test being exceptionally specific and sensitive ([446](#), [447](#)). One study suggests that an elevated plasminogen activator inhibitor-1 level in hyperbilirubinemic transplant recipients is a sensitive and specific marker for distinguishing VOD from GVHD and other causes of hepatic injury, but the plasminogen activator inhibitor-1 assay is not available to clinicians ([448](#)).



**Figure 75.9.** Regimen-related organ toxicity. Vasoocclusive disease of the liver with nonthrombotic fibrous occlusion of central veins and small venules. Hematoxylin and eosin stain,  $\times 400$ . See [Color Plate](#). (Photomicrograph courtesy of M. Scott.)

The pathogenesis of VOD is unclear and appears to be multifactorial. Recent studies have implicated low levels of von Willebrand factor cleaving-protease activity that lead to high levels of large von Willebrand factor multimers as a possible factor in development of VOD ([449](#)). At present, no consistent effective options exist for preventing fatal VOD. Several agents, including heparin, ursodiol, *N*-acetyl glucosamine, and L-glutamine, have been studied for prevention of VOD. Heparin and ursodiol were found in randomized studies to reduce the incidence of VOD but not the incidence of fatal VOD nor was there any survival benefit ([450](#)). Similarly, several treatment approaches toward VOD have been reported, but all have been in small studies. The drugs that have been found to be effective for the treatment of VOD are tissue plasminogen activator, antithrombin III,



defibrotide, and high-dose corticosteroids ( 451, 452 ). Some investigators believe that there is no significant benefit with thrombolytic therapy over standard supportive care ( 452 ), and large prospective randomized trials are needed to properly evaluate this strategy. *Trans*-jugular intrahepatic portosystemic shunt has been tried in some patients with significant portal hypertension as a result of VOD, but it is associated with long-term sequelae, such as encephalopathy ( 453 ). Fluid overload requires cautious diuresis with a loop diuretic or spironolactone because of frequent intravascular volume depletion and the risk of precipitation of the hepatorenal syndrome. Albumin and fresh frozen plasma are rarely of benefit and may ultimately worsen fluid overload. Hemodialysis and mechanical ventilation are mainstays of supportive care in patients with renal failure, pulmonary edema, and hypoxemia, but the need for hemodialysis portends a poor prognosis ( 454 ). Patients with VOD are also at high risk for developing subsequent pulmonary complications, possibly as a result of toxic lung injury ( 455 ). Although a combination of clinical and laboratory parameters may aid in the assessment of severity, predicting the course and reversibility of VOD in the individual patient remains a challenge ( 456 ).

### Acute Lung Injury and Alveolar Hemorrhage

Idiopathic IP occurs in as much as 35% of marrow transplant recipients, most commonly between 30 and 100 days after transplantation. The development of diffuse, patchy pulmonary infiltrates, with fever, dyspnea, and nonproductive cough, necessitates bronchoalveolar lavage to exclude an infectious etiology, such as CMV. The risk of true idiopathic pneumonitis is clearly greater in allogeneic than in autologous transplant recipients for reasons that are not entirely obvious, although acute GVHD and the use of methotrexate for GVHD prophylaxis are among the known risk factors for IP ( 365, 366 ). There is evidence that supports the hypothesis that dysregulated cytokine effects that are akin to those seen in the systemic inflammatory response syndrome and acute GVHD may play an important role in the pathogenesis of IP in these patients ( 367, 368, 369 and 370 ). Therapy is primarily supportive, but mortality remains extremely high in patients with this complication who require mechanical ventilation. A trial of corticosteroids is indicated early in the course of IP, once infection has been excluded, as some patients respond to this therapy. Combination cytokine (IL-10) and anticytokine (anti-TNF and IL-1R antagonist) therapy may prove useful in ameliorating the inflammatory response ( 371 ).

Diffuse alveolar hemorrhage occasionally occurs in the early posttransplant period in patients with severe mucositis, infection, and thrombocytopenia ( 365, 372, 373 ). It also tends to occur at the time of engraftment for reasons that are not entirely clear, but neutrophilic influx into the lung has been demonstrated, and proinflammatory cytokines may play a role. This entity usually presents as patchy consolidation on chest radiograph in association with hemoptysis, dyspnea, and evolving hypoxemia. If the diagnosis is established or suspected, immediate treatment with high-dose corticosteroids is indicated to reverse lung inflammation ( 374 ), and any bleeding tendency should be aggressively treated with platelet transfusions or plasma. Improvement is often noted within 24 to 48 hours.

## MANAGEMENT OF NAUSEA AND VOMITING

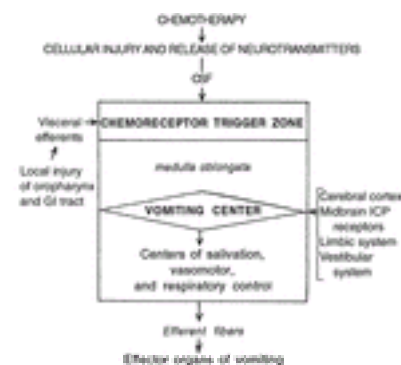
Two of the most common and most dreaded side effects of chemotherapy are nausea and vomiting. Nausea and vomiting, which occur in as much as 80% of patients with cancer, profoundly affect quality of life and, if poorly controlled, may lead to patient noncompliance ( 466, 467 ). An improved understanding of the neural pathways and neurotransmitter receptors that are involved in chemotherapy-induced emesis has led to



the development of better drugs for treatment and prophylaxis. The availability of these drugs in a variety of formulations has also broadened their clinical usefulness and has reduced the need for prolonged hospitalizations for chemotherapy.

## Emesis Response

Since the initial neuronal ablation and electrical stimulation studies that were performed by Borison and Wang in the 1950s, several pathways have been proposed for the emetic reflex ( 468 , 469 and 470 ). According to the current model ( Fig. 75.10 ), cellular injury that is induced by chemotherapy leads to the local or systemic release of neurotransmitters that generate a vomiting signal. The major excitatory neurotransmitters that are involved in emesis are 5-hydroxytryptamine (5-HT<sub>3</sub>, also known as *serotonin*) and dopamine, although corticosteroids, acetylcholine, substance P, endorphins, and histamine also appear to play a role ( 471 , 472 and 473 ). The role of opiates is unclear, as they may block or stimulate emesis ( 475 ). Receptors for 5-HT<sub>3</sub> and dopamine D2 are present in the chemoreceptor trigger zone (CTZ), which lies outside the blood-brain barrier in the *area postrema* of the fourth ventricle and in the GI mucosa; serotonin receptors are also located in the vomiting center in the medulla ( 471 , 476 , 477 ). Transmission of the signal to the vomiting center occurs via three principal routes: the CTZ, the cerebral cortex, and the visceral afferent nerve fibers from the pharynx and GI tract. The vomiting center also receives emetogenic input from the vestibular apparatus, thalamus and hypothalamus (limbic system), and midbrain receptors of intracranial pressure ( 468 , 478 ). Limbic input may be especially important in evoking anticipatory emesis. Cranial nerve nuclei and other medullary centers in control of vasomotor responses, salivation, and respiration are in turn stimulated by the vomiting center to initiate the motor events of emesis. Most of the available antiemetic drugs act on a single pathway, and, hence, a combination of antiemetic drugs is required to get the best antiemetic response.



**Figure 75.10.** Proposed mechanisms of emesis. CSF, cerebrospinal fluid; GI, gastrointestinal; ICP, intracranial pressure. (Adapted from Ettinger D. Preventing chemotherapy-induced nausea and vomiting: an update and a review of emesis. *Semin Oncol* 1995;22:6–18; and Grunberg SM, Hesketh PJ. Control of chemotherapy-induced emesis. *N Engl J Med* 1993;329:1790–1796.)

## Characteristics of Emesis That Is Induced by Chemoradiotherapy

Nausea and vomiting in patients with hematologic malignancies is multifactorial. All factors that are potentially responsible for causing nausea and vomiting should be considered when treating such patients. Other than chemotherapy-induced nausea and vomiting (CINV), reasons for emesis could be constipation that is caused by prolonged inactivity

and narcotic analgesic use, bowel obstruction or CNS metastasis, metabolic derangements (such as hypercalcemia), peptic ulcer disease, and other nonchemotherapeutic medications. Radiation therapy to the GI tract (especially the small bowel) or the brain has the highest potential for inducing nausea, with the risk increasing with increases in total dose and the amount of tissue that is irradiated (479). Patients who receive TBI as conditioning for SCT are especially prone to severe nausea.

Several patterns of nausea are recognized in cancer patients who are receiving chemotherapy. *Acute-onset CINV* is defined as nausea and vomiting that occur within the first 24 hours after chemotherapy administration and within a few minutes to several hours after administration of the drug, reaching peak intensity by 5 to 6 hours. This pattern of nausea is generally seen with moderately or highly emetogenic agents, such as doxorubicin and cisplatin. Younger patients, female patients, and patients with history of motion sickness are at greatest risk for acute emesis. Previous history of nausea, the environment in which the chemotherapy is given, the dose and method of administration of the drug (bolus vs. continuous infusion), and the type of antiemetic premedication that is given are also determining factors for acute CINV (471, 480, 481). Chronic heavy alcohol consumption has been reported to reduce the risk (482). *Delayed-onset CINV*, by definition, occurs more than 24 hours after administration of chemotherapy, with a peak at 48 to 72 hours, and may last for weeks. Morbidity is greatest with this type of nausea, because it is particularly hard to control, tends to prolong hospitalization, and can lead to anxiety and depression if it is not promptly addressed (483). Female gender, a history of motion sickness, high-dose intensity of chemotherapy, and prior severe acute emesis are risk factors (483, 484). Delayed-onset nausea probably involves mechanisms that are different from those that are involved in acute nausea. It is not uncommon after the administration of cyclophosphamide, ifosfamide, doxorubicin, and cisplatin. *Anticipatory CINV* is usually a result of a conditioned response from previous chemotherapy experience and more often affects younger patients, although this may be more a reflection of the aggressive chemotherapy that is given to these patients. Motion sickness is a predisposing factor (483, 485). Compliance with subsequent courses of therapy may be seriously hindered by such negative experiences, and early prevention of chemotherapy-induced nausea and emesis is therefore essential (486).

The intrinsic emetogenicity, dose, and method of administration of the chemotherapeutic agent are the most consistent predictors of nausea and vomiting. Antineoplastic drugs have been categorized according to their emetogenic potential (471); many of these drugs exhibit a dose-dependent increase in emetogenicity. In general, bolus injections of drug are less well tolerated than extended intravenous infusions (480). Nausea that is caused by continuous infusions peaks in the first 24 hours and then gradually diminishes. The duration of chemotherapy-induced emesis is also a function of the chemotherapeutic agent. Most antineoplastic drugs are emetogenic for a 12- to 24-hour period after administration. Cyclophosphamide may cause emesis after 24 hours, and mitomycin may still be emetogenic 48 to 72 hours after administration.

## Control and Prevention of Nausea

When designing an effective antiemetic regimen, the schedule of administration, duration, and site of action of the antiemetic are as important to consider as the pattern of emesis that is caused by the chemotherapy agent. Maximal efficacy is achieved if antiemetics are initiated before chemotherapy administration and scheduled throughout the period of emetic activity of the chemotherapeutic agent. Other important considerations in the selection of an antiemetic regimen are the route, the ease of administration, the potential adverse effects, and the patient's preference. An intravenous route is preferable in hospitalized patients who receive continuous or intensive chemotherapy or radiation and

who have severe mucositis. Oral or rectal formulations are appropriate for patients in the outpatient setting and for those with mild to moderate, intermittent nausea.

Antiemetics that have been found to be effective in patients with hematologic malignancies include the dopamine (D<sub>2</sub>)–receptor antagonists (phenothiazines, substituted benzamides, and butyrophenones), the serotonin (5-HT<sub>3</sub>) antagonists (ondansetron, granisetron, and dolasetron), and miscellaneous agents (corticosteroids, antihistamines, benzodiazepines, anticholinergic drugs, and cannabinoids). Agents that act directly on the CTZ and on peripheral receptors are the most effective in preventing chemotherapy–induced emesis. Combinations of synergistic drugs are generally used for optimum efficacy and reduction of adverse effects ( [Table 75.10](#)). Drugs that are useful for enhancing the efficacy and tolerability of other antiemetics in combination include benzodiazepines, antihistamines, corticosteroids, and anticholinergic drugs, such as scopolamine (transdermal). The early antiemetic agents that were studied formally in clinical trials included the dopamine receptor antagonists, which at standard doses were found to be ineffective against highly emetogenic cisplatin. The use of higher doses of metoclopramide in combination with corticosteroids increased the antiemetic response ( [487](#)). The development of the specific serotonin receptor antagonist (SSRA) class of antiemetics revolutionized the management of acute CINV ( [488](#), [489](#)). Ondansetron, dolasetron, and granisetron are the SSRAs that are approved for use in the United States. Clinical trials have demonstrated superior antiemetic efficacy with oral or intravenous ondansetron over metoclopramide in the control of acute–onset nausea and emesis ( [490](#)). The efficacy of ondansetron is further enhanced by the addition of dexamethasone (20 mg orally) to the regimen ( [491](#)). Single–dose oral (32 mg) or every–8–hour intravenous doses (0.15 mg/kg) of ondansetron were also effective in preventing and controlling emesis that was caused by high– or moderate–dose cisplatin in 68% and 78% of patients, respectively ( [492](#)). Similarly, granisetron at a dosage of 0.01 mg/kg intravenously once within 30 minutes before chemotherapy, or 2 mg orally within 1 hour before and 12 hours after chemotherapy administration is effective for cisplatin–induced emesis ( [493](#)). The combination of oral granisetron and intravenous dexamethasone significantly delays the onset of nausea and vomiting and achieves complete prevention of emesis in 65 to 90% of patients ( [494](#)). Dosage recommendations for delayed nausea are 100 mg by mouth (PO) twice a day (BID) of dolasetron, 1 mg PO BID of granisetron, and 8 mg PO BID of ondansetron in combination with oral dexamethasone. Side effects that are associated with SSRAs are usually mild and transient; headache is the most common. Other side effects that are reported infrequently are diarrhea, constipation, asthenia, and abdominal discomfort. Dysphoria, dystonia, and akathisia, which are seen with some traditional antiemetics, are not problematic with the SSRAs. Single–dose granisetron is more cost–effective in emesis control than multiple, round–the–clock doses of ondansetron, and a statistically significant difference in patient preference in favor of granisetron has been shown in one randomized study ( [495](#)). The most recently FDA–approved class of antiemetics is the neurokinin–1 receptor antagonists. These drugs have a unique mechanism of action by inhibition of substance P. In several randomized trials, addition of these drugs to standard antiemetic regimens was found to result in moderate reduction in acute CINV and a significant prevention of delayed emesis ( [496](#)). The current available drug in this class is aprepitant (MK–869, Emend) and is available for oral dosing.

**TABLE 75.10. Rationale of Combination Antiemetic Therapy**

| Primary Agent | Effective Secondary Agent |
|---------------|---------------------------|
|---------------|---------------------------|

|  |   |
|--|---|
| Specific serotonin receptor antagonist | Corticosteroid (E), phenothiazine (E), and butyrophenone (E)      |
| Substituted benzamide                  | Corticosteroid (E, T), anticholinergic (E), and antihistamine (T) |
| Phenothiazine                          | Corticosteroid (E) and antihistamine (T)                          |
| Butyrophenone                          | Corticosteroid (E) and antihistamine (T)                          |
| Cannabinoid                            | Phenothiazine (T)   |
| Corticosteroid                         | Benzodiazepine (E)  |

E, improves the efficacy of the primary drug; T, reduces the adverse effects of the primary drug.

Adapted from Grunberg SM, Hesketh PJ. Control of chemotherapy-induced emesis. *N Engl J Med* 1993;329:1790-1796.

Modification of the antiemetic regimen is necessary when there is a determination of *treatment failure*, which is generally defined as the occurrence of three or more vomiting episodes within 24 hours of chemotherapy administration or continued nausea that is bothersome to the patient. If delayed CINV is anticipated, prophylaxis with lower-dose SSRAs in combination with 4 to 8 mg of dexamethasone daily orally or intravenously for 2 to 4 days, with the addition of metoclopramide (20 mg orally) and diphenhydramine to prevent dystonia, if the patient is younger than 35 years of age, is often successful ( [Table 75.11](#) ). These medications should be administered at the expected time of onset of nausea (e.g., 12 hours after cyclophosphamide or 18 to 20 hours after cisplatin infusion). Chemotherapy of low emetogenicity usually requires only the administration of a phenothiazine antiemetic orally or intravenously before drug infusion and on an as-needed basis every 6 to 8 hours thereafter. Satisfactory control and prevention of nausea and emesis ultimately depend on good communication with the patient and serial evaluation of the efficacy of the antiemetic regimen being used. The ASCO has published evidence-based guidelines for the use of antiemetics ( [497](#) ).

**TABLE 75.11. General Guidelines for Selection of Antiemetic Agents**

| Low                            | Moderate to Severe<br>(Cisplatin-Containing) | Moderate to Severe<br>(Non-Cisplatin-Containing) |
|--------------------------------|--|--|
| Acute emesis                   |  |  |
| Phenothiazine or butyrophenone | Specific serotonin receptor antagonist       | Specific serotonin receptor antagonist           |
| ± benzodiazepine               | ± corticosteroids                            | ± corticosteroids                                |
| ± substituted benzamide        | ± benzodiazepine                             | ± benzodiazepine                                 |
| ± antihistamine                | (failure)                                    | Butyrophenone                                    |
|                                | Substituted benzamide                        | ± antihistamine                                  |
|                                | ± antihistamine                              | ± corticosteroid                                 |
|                                | ± corticosteroid                             | ± benzodiazepine                                 |
|                                | ± benzodiazepine                             |  |
|                                | (failure)                                    |  |
|                                | Phenothiazine                                |  |
| Delayed emesis                 | ± benzodiazepine                             |  |

|                         |                                   |
|-------------------------|-----------------------------------|
| Corticosteroid          | ± substituted benzamide           |
| ±                       | ± corticosteroid                  |
| benzamide/antihistamine |                                   |
| ± benzodiazepine        | ± antihistamine or<br>cannabinoid |

Adapted from Ettinger D. Preventing chemotherapy-induced nausea and vomiting: an update and a review of emesis. *Semin Oncol* 1995;22:6–18.

---

## SELECTION AND CARE OF VASCULAR ACCESS DEVICES

### General Considerations

Intravascular devices (IVDs) have become one of the most essential features in the current care of patients with hematologic malignancies. Reliable long-term venous access is often necessary in these patients for safe delivery of vesicant chemotherapy agents, multiple incompatible intravenous drugs, blood products, and hyperalimentation. Central access also promotes patient comfort when frequent phlebotomy is required and helps infusion of large volumes over shorter periods, when required. However, the IVDs are associated with increased risk of infections with bacteria and fungi.

### Types of Access Devices

CVCs can be short term or long term, depending on the duration for which they can remain in the patient. The typical short-term catheters are noncuffed, single or multiple lumen and are usually inserted into a subclavian, intrajugular, and, occasionally, femoral vein. These catheters need to be changed frequently, as often as every 3 to 5 days. Long-term CVCs are of two general types: those that have external access (Hickman, Broviac, Groshong, and Quinton catheters) and those that are accessed through one or more subcutaneous ports (LifePort, Port-A-Cath). Hickman- and Broviac-style catheters are anchored with a subcutaneous Dacron cuff, which becomes ingrown by host tissue, creating a mechanical barrier and tunnel subcutaneously into the central venous system, most commonly via the subclavian or internal jugular vein. The number and diameter of the lumens that are available with these catheters are variable. Subcutaneous and externalized catheters are placed surgically, but only the latter may be removed at the bedside or in the office setting. Peripherally inserted central catheters (P.A.S. peripheral access system) have recently gained popularity, because they may be placed at the bedside by trained personnel; however, peripherally inserted central catheters may not provide a sufficient number of lumens for patients who receive complex chemotherapy regimens. Finally, dual-purpose vascular catheters that can be used for leukapheresis or dialysis as well as chemotherapy are also available (Neostar catheter). They are of shorter length, have larger lumens, and are noncollapsible at high flow rates but have an increased tendency to kink near the exit site.

### Selection of Catheters

Several factors should be kept in mind while making a choice of IVD for a certain patient. Factors to be considered include the type of therapy that is planned (multiagent vs. single-agent chemotherapy) and whether vesicating agents are to be given; the frequency and duration of therapy; the frequency of blood draws; the need for blood transfusions, total parenteral nutrition (TPN), and other supportive infusions; whether the catheter may be used for hemodialysis, plasmapheresis, stem cell collection, or bone marrow reinfusion;

and, last but not the least, patient preference and ability to care for the catheter ( [497](#), [498](#) ).

The risk of infection increases with lumen number. A recent prospective observational study that compared Hickman catheters to central ports in cancer patients showed that the risk of infections might be lower with ports in patients who need intermittent access ( [499](#), [500](#) ).

## Catheter Care

To reduce the incidence of bloodstream infections that arise from IVDs, guidelines have been issued regarding the care of such devices. These guidelines were issued by the Hospital Infection Control Practices Advisory Committee in 1996 and were recently updated in 2001 ( [501](#) ). General measures include use of aseptic techniques while inserting, manipulating, or removing IVDs. Dedicated intravenous teams are strongly recommended to care for the IVDs. Daily cutaneous antisepsis is recommended with chlorhexidine, iodophor, or alcohol, followed by a sterile gauze or semipermeable polyurethane film dressing. The use of prophylactic systemic antibiotics without the presence of infection is strongly discouraged. Hickman–Broviac catheters must be flushed with 2 to 3 ml of heparin solution (100 U/ml) through all ports daily or after each use. The protective caps on each port should be replaced twice per week. Groshong catheters require flushing only once per week with 5 ml of sterile saline. Subcutaneous ports should be flushed with 2 to 3 ml of heparin solution (100 U/ml) monthly and after each use. Percutaneous access is achieved by using a noncoring (Huber) needle, and the needle should be replaced every 3 to 5 days during continuous access.

Any difficulty in withdrawing blood or flushing the ports of a CVC should be investigated to see if there is potential for extravasation of a vesicant drug or suspicion of catheter malposition. Patients and their caregivers should be instructed in advance of hospital discharge in heparin flushing, dressing changes, and changing the Luer Lok cap. Damage to the external portion of the catheter should be addressed immediately; repair kits may be used to replace the damaged portion in many cases.

## Complications

**INFECTION** Complications that are related to insertion of the catheter itself are rare (approximately 1%) and are not covered here. After placement, CVCs constitute a nidus for thrombus formation and infection. Systemic prophylactic antibiotics have not been consistently effective in averting infectious complications ( [497](#) ). Use of “antibiotic lock” solutions is a technique in which an antibiotic solution (ciprofloxacin or vancomycin, or both, at dose of 25 µg/ml) is instilled into the catheter lumen for 6 to 12 hours after which it is removed. Recently published randomized studies that use this technique for prevention of infections of CVCs show a reduction in risk of bacteremia with long-term IVDs ( [502](#) ). Neutropenic and nonneutropenic patients with indwelling venous catheters are at increased risk of bacteremia ( [503](#) ). Coagulase–negative staphylococci are the most common etiologic agents that are isolated, but *S. aureus*, gram–negative bacteria, corynebacteria, bacillus species, and mycobacterial and fungal organisms are also reported. Simultaneous cultures from peripheral sites and through all catheter ports are helpful in distinguishing infection of the catheter itself from infection arising from another source. Successful treatment of catheter–associated bacteremias that are caused by coagulase–negative staphylococcal or even gram–negative organisms does not always require catheter removal, even in the presence of neutropenia. Infections of the skin pocket of an implanted port also resolve in approximately 70% of patients without removal of the device ( [504](#) ). Intravenous antibiotics should be administered for 1 to 3 weeks and



should be rotated through all lumens; if clinical improvement is noted, and surveillance cultures from all lumens remain negative after 3 days of antibiotic therapy, the catheter can probably be sterilized. This is also true of uncomplicated exit-site infections, which usually resolve with aggressive local care and systemic antibiotic therapy. It may not be possible to treat some bacterial infections successfully, even when the organism is sensitive (e.g., *S. aureus*, some *Bacillus* species, corynebacterium group JK, and *Stenotrophomonas* species), and the catheter must then be removed. Other indications for immediate removal of the catheter are evidence of complicating endocarditis, septic thrombosis, and septic pulmonary embolism. Certain organisms, such as *Candida* and fungi, are extremely difficult to eradicate because of their attachment properties and necessitate prompt catheter removal to avoid the complications of disseminated infection. Fungemia that is caused by *Malassezia furfur* (*Pityrosporum orbiculare*) tends to occur in patients who receive parenteral lipids and may be resistant to amphotericin B. This infection often manifests as fever, pulmonary infiltrates, and thrombocytopenia; discontinuation of the lipid, as well as removal of the catheter, is needed ( 505 ).

**OCCLUSION AND VENOUS THROMBOSIS** Occlusion due to a fibrous sheath or a thrombus should be suspected if difficulty withdrawing from or infusing through a catheter happens. Fibrin blockage is common, and simple repositioning of the patient and a Valsalva maneuver may allow blood to be withdrawn. If this strategy fails, catheter position should be confirmed by chest radiograph after injection of contrast dye through the catheter. Patients in whom there is no contraindication to thrombolytic therapy may be given an infusion of urokinase at 200 U/kg/hour for as long as 12 hours to reopen the catheter. Otherwise, 5000 units of urokinase (in 2 ml of sterile water) may be injected into the catheter, and a blood draw may be attempted again in 30 minutes; this procedure may be repeated twice in 24 hours if necessary. Recombinant tissue plasminogen activator (alteplase) at a dose of 2 mg/2 ml, which is instilled for 30 minutes, results in restoration of function in occluded venous catheters ( 506 ). The incidence of catheter-related venous thrombosis is probably underestimated, because many cases are asymptomatic; however, pain, ipsilateral extremity edema, and superficial venous dilation require evaluation with venography or noninvasive contrasted imaging techniques. In one prospective, randomized placebo-controlled study, low-dosage warfarin (1 mg/day) was shown to reduce significantly the incidence of catheter-associated venous thrombosis without prolongation of the clotting times or an increase in bleeding complications ( 507 ). The catheter should be removed if it is no longer needed or if treatment with systemic anticoagulation fails. Prophylactic use of urokinase (5000 IU/ml) every 1 to 2 weeks into long-term IVDs has shown reduced incidence of thrombosis and also catheter-related infections ( 508 ).

**DRUG EXTRAVASATION** Incorrect needle placement in an implanted port, catheter tip migration, or forcible flushing of an occluded catheter may result in extravasation of vesicant chemicals into the skin. A burning sensation, pain, or swelling at the site suggests this complication, and cellulitis, ulceration, necrosis, and sloughing of soft tissue may result. Conservative therapy, which includes following specific measures for individual drugs, stopping the infusion, and withdrawing the needle, is usually effective ( 509 ). Anthracycline extravasations may progress to ulceration more often, and one uncontrolled study suggests that topical application of dimethyl sulfoxide can prevent this complication ( 510 , 511 ).

## PHARMACOLOGIC MANAGEMENT OF CANCER PAIN

Control of cancer-related pain is one of the most important aspects of supportive care for patients who receive antineoplastic therapy or for those with an advanced stage of cancer. Other coexistent conditions, such as depression, malaise, fatigue, anorexia or cachexia, dyspnea, and weakness, also influence the perception of pain by the patient and must be addressed simultaneously. Knowledge of the pathogenesis of cancer pain, pain assessment techniques, and various analgesics is important for appropriate pain management. Satisfactory pain relief depends on the ability to treat the primary source of



the pain, to alter the central perception of pain, or to block the transmission of pain to the CNS. Ideally, this is done while preserving performance and cognition. Invasive procedures are rarely necessary, and pain control is achieved in 85 to 95% of patients through integrated pharmacologic, nonpharmacologic, and anticancer therapy ( [512](#), [513](#) and [514](#) ).

## Types of Cancer Pain

Several types of cancer-related pain are recognized. The manner in which pain is described often gives a clue to the source and etiology of the pain. Pain may result from tumor pressure on adjacent structures (70%), from anticancer therapy (approximately 20%), or from cancer-induced syndromes, such as paraneoplastic syndromes (<10%), or it may be unrelated to the cancer (3 to 5%) ( [515](#), [516](#) ). The concept of a pain threshold is highly subjective and is dependent on the complex interplay between emotional, spiritual, and cultural factors, in addition to the physical effects of malignancy. Pain is often classified as nociceptive, neuropathic, or sympathetically maintained. *Nociceptive pain*, as the name describes, is due to the activation of somatic or visceral nociceptors, with the common example being pain due to bony metastasis. *Neuropathic pain* is typically due to injury to the nervous system structure and is described by patients as a burning type of pain. *Sympathetically maintained pain* is less commonly seen in cancer patients and is associated with brawny edema, burning discomfort, allodynia, and hyperpathia.

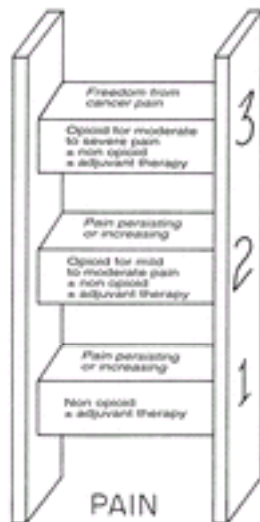
## Obstacles to Pain Management

Studies show that approximately 50% of patients with cancer receive inadequate analgesia ( [515](#) ). Several factors lead to pain undertreatment; a discrepancy between patients and physicians in judging the severity of pain, ignorance about types of pain and lack of pain assessment skills in the health care providers, and an unfounded fear of opioid addiction and tolerance among health care professionals and patients. The perception that opioid analgesia is to be used only in the advanced or terminal stages of malignancy, fear of scrutiny by regulatory agencies, and cost and drug procurement considerations are among the other reasons ( [515](#), [517](#), [518](#) and [519](#) ). True psychological addiction rarely occurs in patients with hematologic and other malignancies, and there is no reason for hesitation in prescribing narcotic analgesics at effective doses for patients with cancer pain ( [520](#) ). When given for long periods, physical dependence on opioids may occur, but this should not be taken to imply drug dependence in a global sense and can be managed by gradual tapering of narcotic analgesics, if the source of the pain has been eliminated, or pain transmission has been blocked.

## Pain Assessment

A detailed history of pain is an essential component of pain assessment. Many instruments have been developed to assess pain, because pain is subjective, and the patient can best guide therapy. When possible, using one of a number of simple pain rating scales (verbal or numeric), such as the Wisconsin Brief Pain Inventory or the Memorial Pain Assessment Card, which have been shown to be remarkably reliable indicators of pain intensity ( [521](#), [522](#) and [523](#) ). A modified pictorial version of the Wisconsin Brief Pain Inventory has been used in patients who cannot read or comprehend the written scale. Responses are then interpreted according to a three-step analgesic ladder ( [Fig. 75.11](#) ), which was developed by the World Health Organization, to decide the level of analgesic therapy that is required. Mild pain is given a rating of 1 to 4, moderate pain is given a rating of 5 to 6, and severe pain is given a rating 7 to 10. Pain that is rated as 5 or greater is considered substantial and interferes with the quality of life ( [524](#) ). Other available tools for pain assessment include the Hopkins pain rating instrument, which is a

modification of the visual analog scale, and the Edmonton staging system for cancer pain, which uses several patient characteristics to assess the likelihood of response to therapy ( 519 , 525 ). After a thorough history and physical, laboratory testing and noninvasive radiographic techniques might help determine the etiology of pain and better direct therapy.



**Figure 75.11.** Three-step analgesic ladder of the World Health Organization. (Adapted with permission of the publisher.)

## Analgesic Agents

The inflammatory and mechanical effects of tumor growth in surrounding tissues can lead to the release of several cytokines, such as bradykinin, prostaglandins, and serotonin, which can trigger pain in patients with cancer. Nonsteroidal antiinflammatory drugs (NSAIDs) exert their analgesic and antiinflammatory effects by blocking prostaglandin synthesis. According to World Health Organization guidelines, the treatment of patients with mild to moderate pain should begin with a nonopioid (step 1) analgesic drug, and, as long as pain persists, the dose should be titrated upward until the maximal dose has been reached. Step 1 agents include NSAIDs, such as aspirin, naproxen, ibuprofen, and acetaminophen. A step 2 opioid analgesic may also then be added to the regimen, and the dose is titrated accordingly. Only one drug from each of the groups should be used at the same time, and doses should be given on a regular schedule, so as to maintain continuous pain relief. Included in the step 2 group of drugs are codeine, dihydrocodeine, hydrocodone and oxycodone (in combination with acetaminophen), and propoxyphene. If pain of level 5 or greater persists, and further increase in the dose of the step 2 agent is impractical, change to a step 3 opioid is indicated. The dose of the step 3 opioid is increased if mild to moderate pain persists. Single-agent oxycodone, hydromorphone, fentanyl, and morphine are step 3 opioids ( 526 , 527 ). These guidelines have demonstrated efficacy in improving pain control in cancer patients ( 528 , 529 ) ( [Table 75.12](#) ). The toxicities and dosage threshold of nonopioid analgesics limit their role in cancer analgesia. For example, the total dosage of acetaminophen, for example, should not exceed 6 g/day, and dosages between 4 and 6 g/day may be hepatotoxic in patients with underlying liver dysfunction. NSAIDs carry the risk of GI distress, bleeding, and renal toxicity. Availability of the selective COX-2 inhibitors with reduced GI toxicity and antiplatelet effects may help override this problem with the NSAIDs. However, reports of some degree of GI toxicity with the COX-2 inhibitors demand caution when using these drugs in cancer

patients ( 530 ).

**TABLE 75.12. Guidelines for Adjuvant Drug Use in Cancer-Related Pain**

| Drugs  | Oral Dose (mg/day)                             | Indication/Type of Cancer Pain   |
|--|--|--|
| <b>Nonsteroidal antiinflammatory drugs</b>   |  |  |
| Choline magnesium trisalicylate  | 3000   | Bony metastases, soft-tissue infiltration, serositis, arthritis  |
| Ibuprofen  | 2400   | —  |
| Naproxen sodium  | 1100 to 1650                                   | —  |
| Sulindac   | 300 to 400                                     | —  |
| Indomethacin   | 150 to 200                                     | Postoperative pain   |
| Ketorolac  | 60 to 120 IV<br>(give for no more than 5 days) | —  |
| <b>Corticosteroids</b>   |  |  |
| Prednisone   | 40 to 120                                      | Perineuronal edema, lymphedema, soft-tissue infiltration, nerve compression, visceral distention, <sup>b</sup> and intracranial pressure |
| Dexamethasone  | 8 to 24  | —  |
| Methylprednisolone (=40 to 80 mg dexamethasone equivalent IV for severe acute <sup>b</sup> ICP or spinal cord compression) | 32 to 96                                       | —  |
| <b>Tricyclic antidepressants <sup>a</sup> <sup>b</sup></b>   |  |  |
| Amytriptyline  | 50 to 150                                      | Neuropathic (dysesthetic pain)   |
| Nortriptyline  | 50 to 150                                      | Rectal tenesmus  |
| Desipramine  | 50 to 200                                      | —  |
| Chlorimipramine  | 25 to 100                                      | Postherpetic pain  |
| Trazodone  | 150  | —  |
| Fluvoxamine  | 100 to 300                                     | Depression   |
| Fluoxetine   | 20   | Depression, diabetic neuropathy  |
| <b>Neuroleptics</b>  |  |  |
| Chlorpromazine   | 10 to 25                                       | Rectal tenesmus, vomiting  |
| Haloperidol  | 2.5 to 5.0                                     | Vomiting   |
| Prochlorperazine   | 5 to 10  | Vomiting   |
| <b>Anticonvulsants <sup>a</sup> <sup>b</sup></b>   |  |  |
| Carbamazepine  | 400 to 1600                                    | Neuropathic pain (including nerve compression and infiltration)  |
| Sodium valproate   | 400 to 600                                     | —  |
| Phenytoin  | 300  | —  |
| <b>Benzodiazepines</b>   |  |  |
| Diazepam   | 10   | Anxiety  |
| Clonazepam <sup>b</sup>  | 0.5 to 3.0                                     | Muscle spasm   |

|                      |  |                                     |
|----------------------|--|-------------------------------------|
| Triazolam            | 0.25   | Insomnia                            |
| Oxazepam             | 20   | Insomnia                            |
| Local anesthetics    |  |                                     |
| Mexiletine           | 10/kg  | Diabetic neuropathy                 |
| Tocainide            | 20/kg  | Cranial neuralgia, neuropathic pain |
| Miscellaneous        |  |                                     |
| Disodium pamidronate | 60 to 90 IV<br>every 2 to 4 wk                     | Bony metastases                     |
| Calcitonin           | 200 IU IV or<br>intranasally BID                   | Bony metastases                     |
| Octreotide           | 50 to 100 µg SQ<br>BID to TID                      | Bowel spasm                         |
| Bupivacaine          | 4 to 18 ml<br>(0.125 to 0.25%)<br>per h epidurally | Neuropathic pain                    |
| Clonidine            | 30 µg/h<br>epidurally                              | Neuropathic pain                    |
| Baclofen             | 5 to 30 µg BID<br>to TID                           | Neuropathic pain                    |

<sup>a</sup> Serum drug levels should be monitored.

<sup>b</sup> Start at 50% of lowest dose, titrate up every few days.

Adapted from Ripamonti C, Bruera E. Pain and symptom management in palliative care. *Cancer Control* 1996;3:204–213 and Levy MH. Pharmacologic treatment of cancer pain. *N Engl J Med* 1996;335:1224–1232.

---

Opioid drugs are the mainstay of cancer pain therapy. Many of the step 2 opioids are problematic because of undesirable dose-limiting side effects or a long half-life, or because their combination with nonopioid analgesics precludes adequate dose titration. Hydrocodone and oxycodone, when combined with acetaminophen, cannot be given at dosages greater than 15 mg every 4 hours, or the acetaminophen dosage exceeds 6 g/day. The side effects of codeine limit its use at higher doses, and it may also be ineffective in patients who are taking drugs that inhibit its hepatic conversion to morphine (such as fluoxetine). The partial opioid agonists (such as buprenorphine) and mixed opioid agonists (such as pentazocine) are not effective analgesics and may be toxic at higher dose ranges. These drugs may also paradoxically aggravate pain in patients who are receiving full opioid agonists, such as morphine, and are therefore not recommended for routine treatment of cancer pain ( [521](#), [531](#) ). Patients who are given NSAIDs and opioids should be observed carefully for increased central opioid toxicity because of NSAID-induced renal and hepatic effects that may lead to the accumulation of opioid metabolites. The drug tramadol, a new centrally acting analgesic, has been recently approved in the United States for patients with moderate or moderately severe pain. A 50-mg dose of tramadol is as effective as 60 mg of codeine in patients with cancer ( [532](#) ), but tramadol may cause nausea, dizziness, constipation, sedation, or headache. It acts by binding to U-opioid receptors and by inhibiting serotonin and norepinephrine reuptake. It may be considered in patients with mild to moderate pain who are intolerant of NSAIDs and who wish to avoid opioid analgesics.

The opioid analgesic of choice in chronic cancer pain is morphine, because it is available in immediate- and sustained-release formulations and is easily titrated and consistently

effective. Patients with chronic, stable pain do well on a regimen of twice-daily sustained-release morphine, with immediate-release morphine as needed for breakthrough pain. A small number of patients may require long-acting morphine every 8 hours. Oxycodone is also available in sustained-release form. In general, when switching to a different opioid, the equianalgesic dose of the new drug should be reduced by one-third to one-half to account for incomplete cross-tolerance between drugs, unless the reason for the switch is poor pain control. An exception to this rule is methadone, which should be reduced in dose by eight- to tenfold during the titration phase, as stated by clinicians who are experienced in its use ( 512 ). For moderate to severe pain in patients who are simply intolerant to morphine, a trial of an alternative opioid, such as methadone, hydromorphone, oxycodone, fentanyl, or levorphanol, is now recommended ( 522 ). Optimal methadone dosing is controversial, because it shows considerable interindividual variability in pharmacokinetics. Although methadone and morphine have similar potency, methadone must be given at lower doses and longer intervals and requires closer monitoring for redistribution from the tissues, accumulation, and toxicity; hence, the reluctance of most clinicians to use it routinely. Hydromorphone given orally exerts its peak effect more rapidly than morphine but has a shorter duration of action, often necessitating frequent administration every 2 or 3 hours. Fentanyl citrate is a highly potent synthetic opioid analgesic that has considerable epidermal absorption. Transdermal fentanyl is contraindicated in small children, in patients with generalized edema, and in the treatment of acute or postoperative pain.

There is no ceiling on the dose of an opioid analgesic; the appropriate dose is that which completely relieves pain over the entire dosing interval. Pain can usually be controlled with 240 mg or less per day of oral morphine, but those with severe cancer pain may need as much as 1800 mg/day, and, rarely, 4.5 g of parenteral morphine per hour may be required ( 512 ). Variation in the required dose is to be expected between individuals. However, accumulation of active metabolites of these drugs may be responsible for the late toxicity that is seen when using high doses for prolonged periods. Opioid rotation may be useful in combating adverse effects while ensuring adequate long-term pain control in these instances ( 533 ). Preterminal patients are often unable to communicate, but this does not necessarily imply adequate pain relief; grimacing or moaning should prompt an increase in the dose of opioid medication.

## Routes of Administration and Dosing Considerations

The oral route of administration is the most optimal and least expensive, but patients who are unable to swallow tablets or liquids require other modes of administration. Subcutaneous or intravenous morphine or hydromorphone via patient-controlled analgesia pumps allows for continuous pain relief, smooth dose titration, and rapid relief of breakthrough pain in patients who require a parenteral route. Routine rectal administration of pain medication is inconvenient and unappealing to patients, but rectal morphine or hydromorphone suppositories may be used for short-term pain control in patients with advanced cancer who cannot take oral medication; buccal and sublingual formulations of morphine are also available for this purpose. Transdermal fentanyl citrate acts for 72 hours and is effective in controlling chronic, stable cancer pain; however, dose titration is difficult. Buccal fentanyl can be used for episodic breakthrough pain. The short dosing intervals that are required for buccal and sublingual opioids preclude their use for long-term pain control ( 534 , 535 ). It is important to note that the bioavailability of most opioids is different by enteral and parenteral routes, thus necessitating a change in dosage when switching from one route to the other.

Acute pain or pain exacerbations that last less than 24 hours are best managed with medication on an as-needed basis. Sustained analgesia for persistent cancer pain is provided with round-the-clock or delayed-release medication. The primary goal is to

prevent pain recurrence. Supplemental doses of opioid analgesics should always be made available to prevent and to treat pain that is apt to vary in intensity because of progressive disease, stress, or activity. The total dose of this rescue medication over a specific time interval should be equal to the regular dose that is given during that interval. For example, a patient on a regimen of 90 mg of delayed-release morphine every 12 hours should be given roughly 30 mg of immediate-release morphine to take every 4 hours as needed for breakthrough pain ( [521](#), [529](#), [536](#) ). The optimal dosing interval for analgesic drugs is determined by the type of drug that is used and the route of administration. Pain relief from controlled-release opioid formulations should last throughout the dosing interval, and, if many rescue doses are needed, the long-acting dose should be increased. The exception to this rule occurs when an increased number of rescue doses is needed, only in special instances, and when raising the standing dose would cause undesirable side effects. The opioid dose should be increased by 50 to 100% every 24 hours in patients with severe unrelenting pain or by 25 to 50% in those with moderate unrelieved pain. Similarly, a decrease in dose titration by 25 to 50% each day is indicated in patients whose pain is resolving ( [512](#) ).

### Prevention and Management of Side Effects

Opioid analgesics have many adverse side effects, and adjuvant therapies should be used whenever possible to minimize them. Neuropsychiatric effects of opioids include myoclonus, grand mal seizures, delirium, hyperalgesia or hyperexcitability, and cognitive impairment. Others include nausea, constipation, sedation, and respiratory depression. Respiratory depression, myoclonus, and seizures are rarely seen, unless the dose is inappropriately high, especially in opioid-naïve patients. Other causes of these symptoms must be sought, as well. The clearance of morphine is decreased in patients who are older than 50 years of age, and dose reductions are often required. Centrally acting antiemetics, such as phenothiazines, haloperidol or droperidol, and metoclopramide, are useful in preventing and treating opioid-related nausea ( [537](#) ). Relief of constipation, which is required in all patients on chronic opioid therapy, may also help nausea in these patients. A prophylactic laxative regimen is essential in patients who receive these drugs. Urinary retention is not uncommon in older men, and Foley catheterization may be needed. Problems with sedation and cognitive impairment may be handled by allowing tolerance to take place, by using opioid-sparing analgesic drugs along with the opioid, by rotating opioids, and by treating the patient with psychostimulants (caffeine or methylphenidate). Dose reduction by 50 to 75% after withholding one or two doses is sometimes necessary. Circadian rhythms in the dose requirement may also allow for dose reductions at certain times of day. Although sedation is generally an unwelcome side effect of analgesic therapy in patients, it may be used intentionally to promote comfort in preterminal cancer pain as an adjunct to other measures. Naloxone may be given by intravenous bolus (20 to 40 µg) or by continuous infusion ( [538](#) ) to reverse severe respiratory depression that is caused by opioids if supportive measures are unsuccessful, but careful titration is necessary to avoid severe rebound pain. Delirium and confusion often respond to a low-dose neuroleptic agent, such as haloperidol (0.5 to 1 mg two to three times a day). Finally, preliminary evidence indicates that several other agents, such as baclofen, valproic acid, midazolam, and lorazepam, may be helpful in reducing hyperexcitability effects, but little of this evidence comes from controlled studies. Other strategies for overcoming opioid neurotoxicity include hydration, opioid rotation, dose reduction, and the use of adjuvant therapies ( [512](#), [539](#), [540](#) and [541](#) ).

For the minority of patients who fail standard pharmacologic management, formal consultation with an anesthesia or neurosurgical pain specialist may be necessary. Inability to tolerate oral or parenteral opioid analgesics at adequate doses may be an indication for spinal or epidural catheterization to reduce opioid dose requirements, but this costly and function-limiting method of analgesic delivery clearly must not be



overused. In such cases, pain control may be achieved with minimally invasive procedures, such as anesthetic nerve blocks for well-localized pain and implantable epidural catheters to administer opioid analgesia via an external or subcutaneous pump for more diffuse pain ( 542 ). Although most useful in patients with metastatic solid tumors, it has been suggested that early use of an anesthetic approach may be considered in patients with refractory abdominal, pelvic, or rectal pain, localized severe chest wall pain, perineal pain with urinary diversions, and unilateral lower body pain.

## Adjuvant Therapy

Opioid therapy alone may be inadequate for some types of malignancy-associated pain syndromes, and the use of adjuvant drugs has the advantage of reducing opioid requirements in specific circumstances ( Table 75.12 ). Corticosteroids are helpful in pain that is caused by increased intracranial pressure, epidural metastasis, nerve compression, and soft-tissue and visceral infiltration, and they may be administered in pulses to minimize adverse side effects. A few controlled studies have documented their efficacy in cancer patients ( 512 , 521 , 543 , 544 ). The NSAIDs are effective in treatment of the inflammatory component of soft-tissue infiltration, bony metastases, arthritis, and serositis. Pain that is caused by malignant bone involvement may also respond to therapy with agents that inhibit osteoclast activity, such as bisphosphonates (pamidronate) or calcitonin. Neuropathic pain that is caused by chemotherapy (vinca alkaloids, paclitaxel) is a challenging problem and can be especially distressing to patients; treatment with tricyclic antidepressants relieves pain in some but not all patients in 2 to 4 weeks. Nortriptyline and desipramine are the preferred drugs in this class, because they have fewer side effects than amitriptyline at higher doses. They are initially begun at a low dose (10 to 25 mg) and are titrated upward to 100 to 150 mg for effect. Antidepressant effects are seen in the higher dose range, may boost pain tolerance at the same time, and also help with insomnia in some patients. Other drugs that are effective in neuropathic pain include mexiletine, baclofen, and certain anticonvulsants (carbamazepine and clonazepam), which may be used alone or in combination with full-dose antidepressants. Careful monitoring for myelosuppression and other side effects is necessary ( 512 ).

## MISCELLANEOUS ISSUES

### Infertility and Sexual Dysfunction

Sexual dysfunction after treatment of cancer may be seen in a large number of patients and may be underreported. A recent review reported an incidence of sexual dysfunction that ranged from 40% to almost 100% ( 545 ). More patients are surviving aggressive therapy for hematologic malignancies that develop during childhood or the early reproductive years. Long-term chemotherapy and radiation effects on fertility and sexual function are therefore major quality-of-life considerations for many patients and their families. These issues should be discussed with patients during initial counseling sessions when deciding on the timing and nature of the treatment regimen. The chemotherapeutic agents that are most apt to affect fertility are alkylating agents (such as nitrogen mustard and cyclophosphamide) and cisplatin. Single-agent melphalan may be more fertility sparing in women of reproductive age ( 546 ). The patients that are best studied are those that undergo BMT ( 547 , 548 ) or therapy for Hodgkin disease ( 549 , 550 ).

Patient age, sex, the total dose and schedule of drugs administered, and the inclusion of radiotherapy are the most important factors that determine the long-term effects of therapy on sexual development and fertility ( 551 ). The addition of high-dosage busulfan (16 mg/kg) to cyclophosphamide as a preparative regimen may impair pubertal development and gonadal function in adolescents, thus necessitating sex hormone



replacement. Adolescent girls who undergo radiation therapy as conditioning for BMT often experience delayed menarche or primary amenorrhea and require sex hormone replacement. In contrast, boys usually recover Leydig cell function, unless they receive radiation to the testicles, and rarely need testosterone replacement. Prophylactic cranial irradiation for ALL may also retard pubertal development ( 552 ). Among adults, conditioning with chemotherapy results in infertility only in some patients, the reversibility of which is age and dose dependent. Sterility is to be anticipated after TBI-based preparative regimens. Spontaneous recovery of ovarian function and spermatogenesis is uncommon but has been reported in patients after TBI ( 553 ).

Potency and libido are usually unaffected by chemotherapy in men ( 554 ), whereas secondary amenorrhea is often associated with menopausal symptoms, decreased libido, and dyspareunia in women ( 555 ). Clearly, the systemic effects of chemoradiotherapy; other medications, such as narcotics; and the alterations in body image that occur in cancer patients can profoundly affect the expression of sexuality ( 556 , 557 ).

There is considerable controversy among health professionals regarding the usefulness of sperm banking for male patients before initiating antineoplastic therapy. Physicians may be reluctant to recommend sperm banking for a variety of reasons, including concern about delaying chemotherapy to accommodate semen collection, discomfort in discussing issues of a sexual nature, and the perception that the quality of cryopreserved semen that is obtained from patients with cancer is generally poor ( 557 , 558 , 559 and 560 ). Significant treatment delays may result if specimen volume and quality are low, and as many as eight collections that are obtained 2 to 3 days apart are needed ( 561 ). Although cryopreservation and some malignancies, such as Hodgkin disease, decrease sperm viability, several studies report a reasonable success rate in inducing pregnancy by using cryopreserved semen ( 554 , 562 ). Banking is feasible if the sperm count is at least 20 million/ml, and motility is 60%, but these numbers are not known before a collection attempt ( 563 ). Sperm banking should therefore be offered to most patients before initiation of therapy if the required delay is not deemed harmful.

A satisfactory method of oocyte preservation has not yet been developed. Implantation of embryos that are generated from *in vitro*-fertilized autologous ova has resulted in at least one successful pregnancy after allogeneic BMT ( 564 ). This technique is feasible in women whose disease permits time for ovarian hyperstimulation pretransplant and whose risk of subsequent infertility is high.

## Pregnancy

Fortunately, the diagnosis of a hematologic malignancy in pregnancy is rare. Whereas pregnancy itself is not known to alter the prognosis of leukemia, it greatly complicates treatment of the mother and the pregnancy. Fetal anomalies are unlikely, provided that teratogenic chemotherapy is begun after the first trimester of gestation ( 565 ). The risk of preterm delivery, perinatal complications, and birth defects is increased whenever alkylating agents or folic acid antagonists are used, however, and the patient should be so advised. Most physicians recommend termination of a first-trimester pregnancy if treatment of the mother's disease cannot be postponed. If a leukemic patient still wishes to continue the pregnancy, leukapheresis may be a helpful temporizing measure, but definitive therapy may be unavoidable ( 566 ). In patients with non-Hodgkin lymphoma (NHL) or Hodgkin disease, therapy is delayed, unless there is rapid disease progression ( 567 ). Radiation therapy should be avoided altogether in the first trimester and to fields below the diaphragm thereafter. The anticipated fetal dose can be calculated before

therapy; doses greater than 10 rads require termination of the fetus ( 568 ). Modified radiation fields and doses and abdominal shielding can be used if radiation is to be given to fields above the diaphragm ( 569 ).

## Psychosocial Support

Initial discussions with patients who are diagnosed with a hematologic malignancy necessarily focus on prognosis and therapeutic options. However, a diagnosis of cancer has huge personal, social, and economic ramifications for patients and their families ( 570, 571 ). The coping skills of individual patients and families vary widely. Anxiety disorders, clinical depression, and cognitive impairment are among the most common psychological complications in patients with cancer, the recognition and treatment of which can also alleviate suffering considerably ( 572, 573, 574, 575 and 576 ). It is therefore important to anticipate these problems, when possible, and to marshal the help of a dedicated social worker, counselors, nursing staff, and, when indicated, a psychiatrist who is knowledgeable about cancer therapy. Preexisting psychiatric problems should be explored before embarking on major therapeutic maneuvers. Patients who undergo BMT experience considerable psychological stress and need special support ( 577 ). Assessments of how the patient and his or her family are dealing with the disease should be made at regular intervals from the time therapy is initiated through its completion and particularly when therapy fails ( 578 ). Unrelieved pain, depression, delirium, a family history of suicide, lack of psychosocial support, and substance abuse are risk factors for suicide in patients with cancer ( 579, 580 ). Prognostic information should be imparted in a consistent manner by members of the health care team who are directly responsible for management decisions and who have rapport with the patient and family. Furthermore, spouses, relatives, and patients alike should be strongly encouraged to be as open as possible about the illness. Efforts to protect a person by withholding unpleasant information generally fail; they also deprive patients of the opportunity to participate in their care and discuss their fears. However, direct patient involvement in discussions about disease and death is alien to some cultures, and these differences should also be respected ( 581, 582 ). Some patients ask pointed questions about how and when death occurs and should receive a candid answer; others may not wish to discuss these issues at all ( 583 ). It is therefore necessary to tailor one's approach to the individual patient ( 584 ). Such an approach clearly requires a significant commitment of time to detailed and, above all, unhurried discussion with the patient and family, often with repetition of facts that may seem obvious. Facilitating the practice of religious and cultural beliefs can also be therapeutic. Existential concerns that transcend religious faith are common in terminally ill patients and may be handled by consultation with a chaplain who is experienced in this area ( 585, 586 ).

One must be alert to the special needs of family members and spouses in caring for ill patients, so that substantive help in the form of a home health or hospice nurse may be arranged. Special counseling should be offered to young children when a parent is critically ill or dying and to pediatric patients with hematologic malignancies, as serious behavioral problems and learning disabilities may be averted ( 587, 588 ). Encouraging self-care and limited work or exercise, as tolerated, can contribute greatly to the sense of well-being ( 589 ).

## Palliative and Terminal Care

**ADVANCE DIRECTIVES, ESCALATION OF CARE, AND WITHDRAWAL OF LIFE SUPPORT** Quality of life is an uncommon endpoint in supportive care trials, in part because it is hard to measure ( 590 ). Ongoing discussion of the goals of treatment and

quality-of-life issues is particularly important in palliative care and reaffirms the ethic of patient self-determination and autonomy in decision making ( 591 , 592 , 593 and 594 ). It includes discussion of advance directives, living wills; assignment of a health care proxy or durable power of attorney; or documentation of the circumstances under which a “do not resuscitate” order should prevail. Preferences regarding resuscitation should be investigated (and documented) after the patient has had ample time to assimilate information about the disease and prognosis but before the development of complications that impair competence ( 595 , 596 ). Physicians often hesitate to discuss the possibility of treatment failure, serious complications, or death, even in patients whose deterioration is predictable ( 597 ), but these physician attitudes appear to be changing ( 598 , 599 ). Clarification of the patient’s wishes and expectations at the outset relieves the burden on family members, who may be called on to act as surrogates without knowledge of the patient’s wishes. Greater emphasis on communication should obviate legalization of physician-assisted suicide or euthanasia ( 600 ). The decision to escalate care in patients with hematologic malignancies may be straightforward, as in the case of a patient with single-organ dysfunction who is being treated with curative intent. It is not so clear-cut in elderly patients with multiple medical problems and in patients who have recurrent or persistent disease after therapy. In such instances, factors that contribute to the acute decline and the overall potential for meaningful recovery must be weighed carefully and discussed with the patient (if possible) or a surrogate before deciding how to proceed ( 601 ). Treatment of depression, nausea and vomiting, and pain may significantly alter patient choices ( 602 , 603 ). When the patient is incompetent, and the efficacy of further treatments is uncertain or controversial, prior directives should be exercised fully ( 604 , 605 ). If the reversibility of the problem is unclear, or the patient’s wishes regarding resuscitation are uncertain, it is prudent to provide maximal support for 24 to 72 hours, allowing time for clarification of the prognosis before withdrawal of support ( 606 ). The statistical likelihood of recovery, which is extremely small when there is failure of more than two organ systems, may be estimated by using the multiorgan dysfunction score. The multiorgan dysfunction score is a useful objective parameter to consider in conferences between the health care team and the family ( 607 ). Involvement of an impartial medical ethics committee is rarely necessary. Life-prolonging measures, including mechanical ventilation, the use of pressor medications, chest compressions, and cardiac defibrillation should not be allowed to delay death when death is deemed inevitable. Withdrawal of life-sustaining measures that have already been instituted requires education of the family in what to expect and, when properly performed, causes no discomfort ( 608 ). The practice of medicine is founded on the principle of preserving all human life, but patient comfort and quality of life become paramount when medical therapy has little to offer. The physician’s primary role then is to assist the patient, family, and other caregivers in specific interventions that provide comfort and as much control over their lives as possible. The pace of hematologic malignancies may not afford patients time to plan their final days, but the patient should make choices whenever possible. Those patients who wish to die in the hospital should be allowed to do so. Most studies do not show that terminal care that is performed in the home with skilled nursing is more cost-effective than in-hospital care. The optimal arrangement for outpatient care depends on the nature and extent of further therapy to be provided. The feasibility of home care must be assessed in each case. Enrollment in a hospice program is only one of several options for the terminally ill ( 609 ). Other alternatives include using family support systems that are already in place, often with added training and assistance by a home health nurse in the initial phase of home care. Patients should be informed that no decision is irrevocable and that hospitalization for comfort remains an option if attempts to care for the patient at home are unsuccessful. Most patients are much more fearful of the conditions that lead up to death—the symptoms of advancing disease—than of death itself. They need to be given some idea of what to expect (death from infection being the most common) but should be reassured that pain, nausea, dyspnea, and other discomfort can be relieved effectively. Overt hemorrhage is a rare occurrence in end-stage hematologic disease.

## NUTRITIONAL SUPPORT

Patients with hematologic malignancies are extremely heterogeneous with respect to their nutritional status and requirements. Malnutrition appears to be multifactorial in these patients and could be due to a combination of several factors, such as underlying disease, complications of treatment of the disease (e.g., nausea and vomiting, anorexia, mucositis, diarrhea, esophagitis, and gastritis) and altered metabolism. In few situations, multiorgan toxicity (skin, lungs, liver, and kidneys) may be an important contributing factor. Patients who receive intensive combination therapy for aggressive leukemias and lymphomas are at particularly high risk of becoming malnourished ( [610](#), [611](#) and [612](#) ). Serial evaluations of the nutritional status by a multidisciplinary team, which includes a physician, a nurse, pharmacist, dietitian, and, sometimes, a speech therapist, is therefore essential in all patients with a hematologic malignancy.

### Hypermetabolism

Children and adults with leukemia exhibit greatly accelerated resting energy consumption and protein turnover and reduced resting energy expenditure during the first few days of chemotherapy, which then becomes stable. Such an effect has been shown in some lymphoma patients too, not during their initial chemotherapy cycle (first cycle), but more so in the subsequent cycle (third cycle) ( [613](#), [614](#) and [615](#) ). Fever, opportunistic infection, and other stresses once again increase metabolic rate and protein loss during the neutropenic period ( [615](#), [616](#) ). Moreover, the cytokine mediators of tumor cachexia and sepsis (TNF- $\alpha$ , IL-1, IL-2, IL-6, and interferons) promote anorexia and weight loss due to hypocaloric intake ( [617](#), [618](#) ).

### Protein-Calorie Malnutrition

Protein-calorie malnutrition is uncommon at presentation; weight loss of more than 10% occurs in only a minority of patients in the 6 months preceding diagnosis ( [619](#) ). It is most likely to occur in bone marrow transplant recipients, patients with high-risk acute nonlymphoblastic leukemia (ANLL) and ALL, and patients who are undergoing chemotherapy for NHL that involves the GI tract. The resulting impaired cell-mediated and humoral immunity leads to alterations in the normal flora, diminished levels of secretory IgA antibody, and reduced resistance to all types of infection ( [620](#), [621](#) and [622](#) ). Gram-negative bacteremias that arise because of invasion of microorganisms across a damaged enteric mucosa are also potentiated by mucositis. Preexisting malnutrition has been known to adversely affect survival in patients with NHL ( [623](#) ). The impact of nutritional deficits on growth and psychomotor development in children is well recognized. Overly aggressive nutritional supplementation should be avoided in severely malnourished patients, because it may lead to refeeding edema, possibly as a result of carbohydrate effects on renal sodium handling when protein stores are low ( [618](#) ).

### Nutritional Assessment

The assessment of nutritional status and needs during chemotherapy must take into account the extent and duration of prior weight loss and dietary deficiency. The serum albumin, prealbumin, and transferrin levels may be unreliable measures of true nutritional status in patients who are undergoing aggressive chemotherapy ( [624](#) ). Energy expenditure may be estimated in patients who are not severely ill or may be calculated in severely ill patients by using the Harris-Benedict equations, with adjustments for periods of stress,

such as sepsis ( [Table 75.13](#) ) ( [625](#) ). Free water needs are modified by the presence of cardiac, respiratory, or renal dysfunction and GI or insensible losses. Care must be taken to avoid negative nitrogen balance, especially in critically ill patients who experience protein catabolism to meet increased energy requirements. Nitrogen needs are estimated from urinary nitrogen excretion and usable dietary protein content. No more than 60% of calories should come from carbohydrates in patients with respiratory failure, because carbohydrates increase carbon dioxide production and ventilatory demand. A daily record of caloric intake that is obtained by a dietitian is useful in serial evaluation, especially in critically ill patients whose weight may not accurately reflect nutritional adequacy because of organ dysfunction or hypervolemia. Indirect calorimetry, when available, may be extremely helpful in ensuring adequate nutritional therapy in severely ill and mechanically ventilated patients while preventing the metabolic complications of overfeeding ( [625](#) ). In pediatric patients, the use of growth charts and serial weight to height ratios yields valuable information regarding early or chronic malnutrition and the need for urgent intervention. Children who fall below the tenth percentile in weight to height ratio and adults with more than a 10% weight loss over 10 months usually require nutritional supplements in conjunction with the treatment of symptoms that interfere with intake. Pediatric or adolescent patients who are receiving TBI, cranial irradiation, or transplant conditioning chemotherapy also exhibit slowed height velocity, and a fall below the fifth percentile for height according to a standardized chart signals the need for further evaluation ( [626](#) , [627](#) and [628](#) ).

**TABLE 75.13. Effect of Critical Illness on Resting Energy Expenditure**

| Patient's Condition              | Stress Factor | Estimated Daily Energy Expenditure (kcal/kg) |
|----------------------------------|---------------|--|
| Minimal illness or minor surgery | 1.2           | 25   |
| Moderate stress or trauma        | 1.35          | 35   |
| Sepsis or severe trauma          | 1.6           | 45   |
| Severe burns                     | 2.1           | 80   |

Adapted from Zakko W, Van Dam J. Techniques for nutritional assessment. Tips for designing an effective enteral feeding regimen. *J Crit Illness* 1996;11:405–412.

## Enteral Nutrition

Use of the oral route for nutritional support prevents mucosal atrophy and is clearly the most physiologic way to nourish patients. Vigorous treatment of nausea and emesis, diarrhea, metabolic disturbances, and other compromising conditions facilitates oral intake. However, most patients who receive aggressive chemotherapy regimens experience dysgeusia and varying degrees of mucositis that necessitate nutritional supplementation by other routes. Consultation and follow-up by a trained dietitian facilitate nutritional supplementation that is palatable and best meets the needs of the individual patient. Use of continuous drip, in contrast to intermittent or bolus feedings, and enteral formulas that are lower in fat, lactose, and tonicity may be appropriate if malabsorption is a problem ( [625](#) , [629](#) ). If persistent anorexia, gastric dysfunction, or severe dysphagia is present, the use of alternative enteral routes may be justified. These options include the placement of a percutaneous gastrostomy or jejunostomy tube (if more than 6 weeks of enteral supplementation is anticipated). Nasoenteric tube feeding is favored over



gastrostomy if significant gastric dysfunction or aspiration is present.

Several legitimate concerns regarding tube feeding have discouraged its use in patients with hematologic neoplasms. Delivery of tube feeding in a volume that is sufficient to meet caloric needs is difficult in patients with diarrhea, nausea and vomiting, and mucositis. Bleeding and discomfort that are caused by irritation by the tube and aspiration may occur. Second, increased rates of bacterial and yeast colonization of the gut and bacteremias have been reported in patients who are immunosuppressed and who are receiving peptic ulcer prophylaxis ( [630](#), [631](#) and [632](#)). The use of a closed, sterile feeding system, sterile formulations, and restricted infusion times (less than 8 hours at room temperature) are important safeguards against infection ( [632](#), [633](#)). Tube feedings should be withheld and cultured if diarrhea or fever develops.

## Parenteral Nutrition

Patients who are unable to eat are usually given TPN with follow-up by a hospital nutrition service. Malnutrition in children with acute leukemia and advanced NHL has been reversed by the use of TPN ( [634](#)). Significantly improved long-term survival with TPN in bone marrow transplant recipients has been demonstrated in one large-scale, randomized study, although no impact on engraftment times, bacteremias, or incidence of GVHD was noted, and smaller studies have had conflicting results ( [635](#)). Hematopoietic recovery after chemotherapy of ANLL and in transplant recipients may be accelerated by TPN administration ( [636](#), [637](#)), but improved survival in ANLL or lymphoma patients has not been documented.

Various TPN solutions are available. Whether modulating the content of micronutrients or the composition of protein in TPN is helpful in reducing muscle catabolism or hepatic encephalopathy is controversial ( [638](#), [639](#) and [640](#)). Certainly, requirements for specific electrolytes, vitamins, and minerals vary considerably among patients. Adjustments must often be made to account for impending tumor lysis, insensible losses, and medication effects on the kidney, liver, and gut. The addition to TPN of certain nonessential amino acids that are normally absent from adult parenteral formulations (such as taurine and glutamine) may be of benefit in ameliorating liver dysfunction or mucositis in marrow or blood stem cell transplant recipients ( [641](#), [642](#)). Insulin is added to TPN in patients with diabetes mellitus or steroid-induced glucose intolerance. Finally, patients with significant sloughing of skin or hemolysis should receive folate supplementation.

Lipid requirements are generally 25 to 30% of total calories. Intravenous lipid emulsions should be infused over at least 12 hours to minimize potential adverse effects on reticuloendothelial cell function and inflammatory responses that have been reported with bolus administration ( [643](#)). Marrow transplant recipients who receive standard versus low daily doses of lipid have not been found to differ with respect to the incidence of bacterial or fungal infections ( [644](#)).

## Nutrition in Transplant Hematology

The factors that affect nutrition in marrow transplant recipients are extremely complex. Failure to thrive and chronic malnutrition are not uncommon in allogeneic transplant recipients, who are usually catabolic because of prolonged corticosteroid therapy. In the early posttransplant period, a capillary leak syndrome that results from hepatic VOD or sepsis may lead to third-space edema, intravascular volume depletion, and renal hypoperfusion. If urinary output is normal in VOD, restriction of total sodium and fluid intake (as with concentrated TPN) and spironolactone may be beneficial ( [645](#)). When renal

failure necessitates hemodialysis, the levels of fat-soluble vitamins and serum triglycerides must be monitored to avert toxicity that is caused by decreased clearance of these nutrients ( [646](#), [647](#) ).

Protein and electrolyte losses are particularly high in acute GVHD that involves the lower GI tract, which manifests as a secretory diarrhea that contains varying amounts of mucus, blood, and sloughed epithelium. The diarrhea is exacerbated in hepatic GVHD by steatorrhea that is caused by derangements in bile salt synthesis and enterohepatic circulation ( [648](#), [649](#) ). Magnesium supplementation, which is needed to replace renal losses that are caused by cyclosporine, should be given via the intravenous route because of bloating and diarrhea that is associated with oral forms. Complete bowel rest and TPN support are necessary, with close monitoring of stool volumes until the diarrhea responds to immunosuppressive therapy. When abdominal cramping, distention, and diarrhea subside, oral intake is gradually resumed. Initially, isoosmolar liquids are introduced, followed by foods that are low in fat, lactose, fiber, and acidity ( [650](#) ). Even after overt healing of the intestinal mucosa, however, mucosal absorptive capacity may remain abnormal ( [651](#), [652](#) ). Severe acute GVHD that involves the skin leads to large fluid and protein losses that must be replaced, depending on the percentage of skin surface that is involved. Significant cholestasis that is caused by acute GVHD of the liver or other causes requires elimination of copper and manganese from TPN, because these substances are normally excreted in bile. Pretransplant protein restriction may help to prevent azotemia but is inadvisable in most transplant recipients, whose protein needs are high, and it does not reduce the risk of acute GVHD through limitation of antigenic exposure, as was once proposed ( [653](#) ). Chronic GVHD has profound effects on all aspects of nutrition ( [654](#) ).

## CONCLUSION

Supportive care is clearly an essential component in the management of patients with hematologic malignancies. There have been several advances in this field that have resulted in improved quality of life in these patients. It is hoped that more studies in this rapidly evolving area will include quality of life as an endpoint and cost-benefit analyses to aid the clinician in choosing the appropriate prophylactic and therapeutic interventions.

## ACKNOWLEDGMENT

I wish to thank Dr. Asha Khallianpur, who created the format of this chapter in the previous edition; the same format was used with some modifications in the current edition.

## REFERENCES

1. Hathorn JW. Critical appraisal of antimicrobials for prevention of infection in immunocompromised hosts. *Hematol Oncol Clin North Am* 1993;7:1051-1099.
2. Bodey GP, Buckley M, Satha YS, et al. Quantitative relationships between circulating leukocytes and infections in patients with acute leukemia. *Ann Intern Med* 1966;4:328-340.
3. Schimpff SC. Infections in the cancer patient: diagnosis, prevention and treatment. In: Mandell GL, Douglas RG, Bennett JE, eds. *Principles and practice of infectious diseases*, 4th ed. New York: Churchill Livingstone, 1995:2667-2675.
4. van der Meer JWM. Defects in host-defense mechanisms. Clinical approach to infection in the compromised host, 3rd ed. In: Rubin RH, Young LS, eds. *New York: Plenum*, 1994:33-66.



5. Dale DC, Guerry D, Wewerka JR, et al. Chronic neutropenia. *Medicine* 1979;58:128–144.
6. Pizzo PA, Robichaud KJ, Wesley R, et al. Fever in the pediatric and young adult patient with cancer: a prospective study of 1001 episodes. *Medicine* 1982;61:153–165.
7. Talcott JA, Finberg R, Mayer RJ, et al. The medical course of cancer patients with fever and neutropenia. *Ann Intern Med* 1988;148:2561–2568.
8. Weinberger M, Elattar I, Marshall D, et al. Patterns of infection in patients with aplastic anemia and the emergence of *Aspergillus* as a major cause of death. *Medicine* 1992;71:24–43.
9. Klaasseeen RJ, Goodman R, Pharm BA, et al. “Low-risk” prediction rule for pediatric oncology patients presenting with fever and neutropenia. *J Clin Oncol* 2000;18:1012–1019.
10. DiNubile MJ. Stopping antibiotic therapy in neutropenic patients. *Ann Intern Med* 1988;108:289–292.
11. Griffin TC, Buchanan GR. Hematologic predictors of bone marrow recovery in neutropenic patients hospitalized for fever: implications for discontinuation of antibiotics and early hospital discharge. *J Pediatr* 1992;121:28–33.
12. Klastersky J, Paesmans M, Rubenstein E, et al. The MASCC Risk Index: a multinational scoring system to predict low-risk febrile neutropenic cancer patients. *J Clin Oncol* 2000;18:3038–3051.
13. Malik IA, Khan WA, Karim M, et al. Feasibility of outpatient management of fever in patients with cancer with low-risk neutropenia: results of a prospective randomized trial. *Am J Med* 1995;98:224–231.
14. Rubenstein EB, Rolston KV, Benjamin RS, et al. Outpatient treatment of febrile episodes in low-risk neutropenic patients with cancer. *Cancer* 1993;71:3640–3646.
15. Rolston KVI, Rubenstein EB, Elting LS, et al. Ambulatory management of febrile episodes in low-risk neutropenic patients... an acceptable alternative to hospital based therapy. In: *Programs and Proceedings of the 6th International Symposium Supportive Care in Cancer*. 1994:21(abst).
16. Manzullo EF, Rubenstein EB, Rolston KVI. Outpatient management of the febrile neutropenic patient with cancer. *Infect Med* 1996;13:357–369.
17. Schimpff SC, Young VM, Greene WH, et al. Origin of infection in acute nonlymphocytic leukemia: significance of hospital acquisition of potential pathogens. *Ann Intern Med* 1972;77:707–714.
18. Beachey EH. Bacterial adherence: adhesin-receptor interactions mediating the attachment of bacteria to mucosal surfaces. *J Infect Dis* 1981;143:325–345.
19. Mackowiak PA. The normal microbial flora. *N Engl J Med* 1982;307:83–93.
20. Proctor RA. Fibronectin: a brief overview of its structure, functions, and physiology. *Rev Infect Dis* 1987;9:S317–S321.
21. Johanson WG, Pierce AK, Sanford JP. Changing pharyngeal bacterial flora in hospitalized patients. Emergence of Gram-negative bacilli. *N Engl J Med* 1969;281:1137–1140.
22. Kurrie E, Bhaduri S, Krieger D, et al. Risk factors for infections of the oropharynx and the respiratory tract in patients with acute leukemia. *J Infect Dis* 1981;144:128–136.
23. Wade JC. Epidemiology and prevention of infection in the compromised host. In: Rubin RH, Young LS, eds. *Clinical approach to infection in the compromised host*, 3rd ed. New York: Plenum, 1994:5–31.
24. Young LS. Management of infections in leukemia and lymphoma. In: Rubin RH, Young LS, eds. *Clinical approach to infection in the compromised host*, 3rd ed. New York: Plenum, 1994:551–579.
25. Vartivarian SE. Virulence properties and nonimmune pathogenetic mechanisms of fungi. *Clin Infect Dis* 1992;14[Suppl 1]:S30–S36.

26. Lee JW, Pizzo PA. Management of the cancer patient with fever and prolonged neutropenia. *Hematol Oncol Clin North Am* 1993;7:937–960.
27. Sickles EA, Green WH, Wiernik PH. Clinical presentation of infection in granulocytopenic patients. *Arch Intern Med* 1975;135:715–719.
28. Pizzo PA. Management of fever in patients with cancer and treatment-induced neutropenia. *N Engl J Med* 1993;328:1323–1332.
29. Pizzo PA. Fever in immunocompromised patients. *N Engl J Med* 1999;341:893–900.
30. Hughes WT, Armstrong D, Bodey GP, et al. 2002 Guidelines for the use of antimicrobial agents in neutropenic patients with cancer. *Clin Infect Dis* 2002;34:730–751.
31. Fainstein V, Rodriguez V, Turck M, et al. Patterns of oropharyngeal and fecal flora in patients with acute leukemia. *J Infect Dis* 1981;144:10–18.
32. Walsh TJ. Role of surveillance cultures in prevention and treatment of fungal infections. *NCI Monogr* 1990;(9):43–45.
33. Pfaller M, Cabezudo I, Koontz F, et al. Predictive value of surveillance cultures for systemic infection due to *Candida* species. *Eur J Clin Microbiol* 1987;6:628–633.
34. Nucci M, Biasoli I, Barreiros G, et al. Predictive value of a positive nasal swab for *Aspergillus* sp. in the diagnosis of invasive aspergillosis in adult neutropenic cancer patients. *Diagn Microbiol Infect Dis* 1999;35:193–196.
35. Riley DK, Pavia AT, Beatty PG, et al. Surveillance cultures in bone marrow transplant recipients: worthwhile or wasteful? *Bone Marrow Transplant* 1995;15:469–473.
36. Schimpff SC. Surveillance cultures. *J Infect Dis* 1981;144:81–84.
37. Zinner SH. New pathogens in neutropenic patients with cancer: an update for the new millennium. *Int J Antimicrob Agents* 2000;16:97–101.
38. Zinner SH. Changing epidemiology of infections in patients with neutropenia and cancer: emphasis on gram-positive and resistant bacteria. *Clin Infect Dis* 1999;29:490–494.
39. Giamarellou H, Antoniadou A. Infectious complications of febrile leucopenia. *Infect Dis Clin North Am* 2001;15:457–482.
40. Oppenheim BA. The changing pattern of infection in neutropenic patients. *J Antimicrob Chemother* 1998;41[Suppl D]:7–11.
41. Cohen J, Donnelly JP, Worsley AM, et al. Septicemia caused by viridans streptococci in neutropenic patients with leukemia. *Lancet* 1983;2:1452–1454.
42. Kern W, Jurrie E, Schmeiser T. Streptococcal bacteremia in adult patients with leukemia undergoing aggressive chemotherapy. A review of 55 cases. *Infection* 1990;18:138–145.
43. Peters WG, Willemze R, Colly LP. Results of induction and consolidation treatment with intermediate and high-dose cytosine arabinoside and m-AMSA of patients with poor-risk acute myelogenous leukemia. *Eur J Haematol* 1988;40:198–204.
44. Dybedal I, Lamvik J. Respiratory insufficiency in acute leukemia following treatment with cytosine arabinoside and septicemia with *Streptococcus viridans*. *Eur J Haematol* 1989;42:405–406.
45. Doern GV, Ferraro MJ, Brueggemann A, et al. Emergence of high rates of antimicrobial resistance among viridans group streptococci in the United States. *J Antimicrob Chemother* 1996;40:891–894.
46. Pfaller MA, Marshall SA, Jones RN. In vitro activity of cefepime and ceftazidime against 197 nosocomial blood stream isolates of streptococci: a multicenter sample. *Diagn Microbiol Infect Dis*

1997;29:273–276.

47. Gold HS, Moellering RC Jr. Drug therapy: antimicrobial resistance. *N Engl J Med* 1996;335:1445–1453.

48. Shay DK, Maloney SA, Montecalvo M, et al. Epidemiology and mortality risk of vancomycin-resistant enterococcal bloodstream infections. *J Infect Dis* 1995;172:993–1000.

49. Edmond MB, Ober JF, Weinbaum DL, et al. Vancomycin-resistant *Enterococcus faecium* bacteremia: risk factors for infection. *Clin Infect Dis* 1995;20:1126–1133.

50. Jones RN. Contemporary antimicrobial susceptibility patterns of bacterial pathogens commonly associated with febrile patients with neutropenia. *Clin Infect Dis* 1999;29:495–502.

51. Viscoli C, Castagnola E. Treatment of febrile neutropenia: what is new? *Curr Opin Infect Dis* 2002;15:377–382.

52. Boutati EI, Anaissie EJ. *Fusarium*, a significant emerging pathogen in patients with hematologic malignancy: ten years' experience at a cancer center and implications for management. *Blood* 1997;90:999–1008.

53. Wingard JR. Infections due to resistant *Candida* species in patients with cancer who are receiving chemotherapy. *Clin Infect Dis* 1994;19[Suppl]:S49–S53.

54. Segal BH, Bow EJ, Menichetti F. Fungal infections in nontransplant patients with hematologic malignancies. *Infect Dis Clin North Am* 2002;16:935–964.

55. Jahagirdar BN, Morrison VA. Emerging fungal pathogens in patients with hematologic malignancies and marrow/stem-cell transplant recipients. *Semin Respir Infect* 2002;17:113–120.

56. Villarino ME, Geiter LJ, Simone PM. The multidrug-resistant tuberculosis challenge to public health efforts to control tuberculosis. *Public Health Rep* 1992;107:616–625.

57. Singh N, Carrigan DR. Human herpesvirus-6 in transplantation: an emerging pathogen. *Ann Intern Med* 1996;124:1065–1071.

58. Clark DA, Emery VC, Griffiths PD. Cytomegalovirus, human herpesvirus-6, and human herpesvirus-7 in hematological patients. *Semin Hematol* 2003;40:154–162.

59. Chakrabarti S, Pillay D, Ratcliffe D, et al. Resistance to antiviral drugs in herpes simplex virus infections among allogeneic stem cell transplant recipients: risk factors and prognostic significance. *J Infect Dis* 2000;181:2055–2058.

60. Chou S, Marousek G, Guentzel S, et al. Evolution of mutations conferring multidrug resistance during prophylaxis and therapy for cytomegalovirus disease. *J Infect Dis* 1997;176:786–789.

61. Hiemenz JW, Greene JN. Special considerations for the patient undergoing allogeneic or autologous bone marrow transplantation. *Hematol Oncol Clin North Am* 1993;7:961–1002.

62. Walsh TJ, Hathorn JW, Sobel JD, et al. Detection of circulating candida enolase by immunoassay in patients with cancer and invasive candidiasis. *N Engl J Med* 1991;324:1026–1031.

63. Peter JB. The polymerase chain reaction: amplifying our options. *Rev Infect Dis* 1991;13:166–171.

64. Rubin RH, Ferraro M. Understanding and diagnosing infectious complications in the immunocompromised host: current issues and trends. *Hematol Oncol Clin North Am* 1993;7:795–812.

65. Stevens DA. Diagnosis of fungal infections: current status. *J Antimicrob Chemother* 2002;49[Suppl 1]:11–19.

66. Li H, Dummer JS, Estes WR, et al. Measurement of human cytomegalovirus loads by quantitative real-time PCR for monitoring clinical intervention in transplant recipients. *J Clin Microbiol* 2003;41:187–191.

67. Barloon TJ, Galvin JR, Mori M, et al. High-resolution ultrafast chest CT in the clinical management of

- febrile bone marrow transplant patients with normal or nonspecific chest roentgenograms. *Chest* 1991;99:928–933.
68. Caillot D, Casasnovas O, Bernard A, et al. Improved management of invasive pulmonary aspergillosis in neutropenic patients using early thoracic computed tomographic scan and surgery. *J Clin Oncol* 1997;15:139–147.
69. Dichter JR, Levine SJ, Shelhamer JH. Approach to the immunocompromised host with pulmonary symptoms. *Hematol Oncol Clin North Am* 1993;7:887–912.
70. Shelhamer JH, Gill VJ, Quinn TC, et al. NIH conference: the laboratory evaluation of opportunistic pulmonary infections. *Ann Intern Med* 1996;124:585–599.
71. Browne MJ, Potter D, Gress J, et al. A randomized trial of open lung biopsy versus empiric antimicrobial therapy in cancer patients with diffuse pulmonary infiltrates. *J Clin Oncol* 1990;8:222–229.
72. White DA, Wong PW, Downey R. The utility of open lung biopsy in patients with hematologic malignancies. *Am J Respir Crit Care Med* 2000;161:723–729.
73. Pizzo PA, Robichaud KJ, Gill FA, et al. Duration of empiric antibiotic therapy in granulocytopenic patients with cancer. *Am J Med* 1979;67:194–200.
74. Freifeld A, Pizzo P. Use of fluoroquinolones for empirical management of febrile neutropenia in pediatric cancer patients. *Pediatr Infect Dis J* 1997;16:140–146.
75. DePauw BE, Deresinski SC, Feld R, et al. Ceftazidime compared with piperacillin and tobramycin for the empiric treatment of fever in neutropenic patients with cancer: a multicenter randomized trial. *Ann Intern Med* 1994;120:834–844.
76. Ramphal R. Is monotherapy for febrile neutropenia still a viable alternative? *Clin Infect Dis* 1999;29:508–514.
77. Raad II, Abi-Said D, Rolston KV, et al. How should imipenem–cilastatin be used in the treatment of fever and infection in neutropenic cancer patients? *Cancer* 1998;82:2449–2458.
78. Carratala J, Fernandez-Sevilla A, Tubau F, et al. Emergence of quinolone-resistant *Escherichia coli* bacteremia in neutropenic patients with cancer who have received prophylactic norfloxacin. *Clin Infect Dis* 1995;20:557–561.
79. Winston DJ, Lazarus HM, Beveridge RA, et al. Randomized, double-blind, multicenter trial comparing clinafloxacin with imipenem as empirical monotherapy for febrile granulocytopenic patients. *Clin Infect Dis* 2001;32:381–390.
80. Talan DA. Clinical perspectives on new antimicrobials: focus on fluoroquinolones. *Clin Infect Dis* 2001;32[Suppl 1]:S64–S71.
81. Trautmann M, Ruhnke M, Borner K, et al. Pharmacokinetics of sparfloxacin and serum bactericidal activity against pneumococci. *Antimicrob Agents Chemother* 1996;40:776–779.
82. Shenep JL, Flynn PM, Baker DK, et al. Oral cefixime is similar to continued intravenous antibiotics in the empirical treatment of febrile neutropenic children with cancer. *Clin Infect Dis* 2001;32:36–43.
83. Feld R. Vancomycin as part of initial empirical antibiotic therapy for febrile neutropenia in patients with cancer: pros and cons. *Clin Infect Dis* 1999;29:503–507.
84. Ramphal R, Bolger M, Oblon DJ, et al. Vancomycin is not an essential component of the initial treatment regimen for febrile neutropenic patients receiving ceftazidime: a randomized prospective study. *Antimicrob Agents Chemother* 1992;36:1062–1067.
85. EORTC International Antimicrobial Therapy Cooperative Group. Empirical antifungal therapy in febrile granulocytopenic patients. *Am J Med* 1989;86:6668–6672.
86. Wingard JR, White MH, Anaissie E, et al. A randomized, double-blind comparative trial evaluating the safety of liposomal amphotericin B versus amphotericin B lipid complex in the empirical treatment of febrile

neutropenia. L Amph/ABLC Collaborative Study Group. Clin Infect Dis 2000;31:1155–1163.

87. Boogaerts M, Winston DJ, Bow EJ, et al. Intravenous and oral itraconazole versus intravenous amphotericin B deoxycholate as empirical antifungal therapy for persistent fever in neutropenic patients with cancer who are receiving broad-spectrum antibacterial therapy. A randomized, controlled trial. Ann Intern Med 2001;135:412–422.

88. Anaissie EJ, Darouiche RO, Abi-Said D, et al. Management of invasive candidal infections: results of a prospective, randomized multicenter study of fluconazole versus amphotericin B and review of the literature. Clin Infect Dis 1996;23:964–972.

89. Lain L, Dretler RH, Conteas CN, et al. Fluconazole compared with ketoconazole for the treatment of candida esophagitis in AIDS: a randomized trial. Ann Intern Med 1992;117:655–660.

90. Viscoli C, Castagnola E, VanLint MT, et al. Fluconazole versus amphotericin B as empirical antifungal therapy of unexplained fever in granulocytopenic cancer patients. Eur J Cancer 1996;32A:814–820.

91. Walsh TJ. Management of the immunocompromised patient who develops evidence of an invasive mycosis. Hematol Oncol Clin North Am 1993;7:1003–1026.

92. Wingard JR, Merz WG, Rinaldi MG, et al. Increase in *Candida krusei* infection among patients with bone marrow transplantation and neutropenia treated prophylactically with fluconazole. N Engl J Med 1991;325:1274–1277.

93. Wingard JR, Merz WG, Rinaldi MG, et al. Association of *Torulopsis glabrata* infections with fluconazole prophylaxis in neutropenic bone marrow transplant patients. Antimicrob Agents Chemother 1993;37:1847–1849.

94. Baglin TP, Gray JJ, Marcus RI, et al. Antibiotic resistant fever associated with herpes simplex virus infection in neutropenic patients with haematological malignancy. J Clin Pathol 1989;42:1255–1258.

95. Winston DJ, Ho WG, Gale RP. Therapeutic granulocytic transfusions for documented infections. A controlled trial in ninety-five infectious granulocytopenic episodes. Ann Intern Med 1982;97:509–515.

96. Cesaro S, Chinello P, Silvestro GD, et al. Granulocyte transfusions from G-CSF-stimulated donors for the treatment of severe infections in neutropenic pediatric patients with onco-hematological diseases. Support Care Cancer 2003;11:101–106.

97. Hubel K, Dale DC, Engert A, et al. Current status of granulocyte (neutrophil) transfusion therapy for infectious diseases. J Infect Dis 2001;183:321–328.

98. Strauss RG. Clinical perspectives of granulocyte transfusion: efficacy to date. J Clin Apheresis 1995;10:114–118.

99. Schiffer CA, Aisner J, Daly PA, et al. Alloimmunization following prophylactic granulocyte transfusion. Blood 1979;54:766–774.

100. Wright DG, Robichaud KJ, Pizzo PA, et al. Lethal pulmonary reactions associated with the combined use of amphotericin B and leukocyte transfusions. N Engl J Med 1981;304:1185–1189.

101. Hersman J, Meyers JD, Thomas ED, et al. The effect of granulocyte transfusions on the incidence of cytomegalovirus infection after allogeneic marrow transplantation. Ann Intern Med 1982;96:149–152.

102. Price TH, Bowden RA, Boeckh M, et al. Phase I/II trial of neutrophil transfusions from donors stimulated with G-CSF and dexamethasone for treatment of patients with infections in hematopoietic stem cell transplantation. Blood 2000;95:3302–3309.

103. Nemunaitis J, Meyers JD, Buckner D, et al. Phase I trial of recombinant human macrophage colony-stimulating factor in patients with invasive fungal infections. Blood 1991;78:907–913.

104. Ozer H, Armitage JO, Bennett CL, et al. 2000 Update of recommendations for the use of hematopoietic colony-stimulating factors: evidence-based, clinical practice guidelines. American Society of Clinical Oncology Growth Factors Expert Panel. J Clin Oncol 2000;18:3558–3585.

105. Peckham D, Elliott MW. Pulmonary infiltrates in the immunocompromised: diagnosis and management. *Thorax* 2002;57[Suppl 2]:II3-II7.
106. Rubin RH. Infection in the immunosuppressed host. In: Dale DC, Federman DD, eds. *Scientific American Medicine*. New York: Scientific American, 1997;2:1-23.
107. Sriskandan S, Cohen J. Gram-positive sepsis. Mechanisms and differences from gram-negative sepsis. *Infect Dis Clin North Am* 1999;13:397-412.
108. Bodey GP, Jadeja L, Elting L. Pseudomonas bacteremia: retrospective analysis of 410 episodes. *Arch Intern Med* 1985;145:1621-1629.
109. Goering P, Berlinger SNST, Weisdorf DJ. Aggressive combined modality treatment of progressive sinonasal fungal infections in immunocompromised patients. *Am J Med* 1988;85:619-623.
110. McFarland LV, Mulligan ME, Kwok RYY, et al. Nosocomial acquisition of *Clostridium difficile* infection. *N Engl J Med* 1989;320:204-210.
111. Thaler M, Pastakia B, Shahtker RH, et al. Hepatic candidiasis in cancer patients: the evolving picture of the syndrome. *Ann Intern Med* 1988;108:98-100.
112. Kauffman CA, Bradley SF, Ross SC, et al. Hepatosplenic candidiasis: successful treatment with fluconazole. *Am J Med* 1991;91:137-141.
113. Anaissie E, Bodey GP, Kantarjian H, et al. Fluconazole therapy for chronic disseminated candidiasis in patients with leukemia and prior amphotericin B therapy. *Am J Med* 1991;91:142-150.
114. Lum LG. The kinetics of immune reconstitution after bone marrow transplantation. *Blood* 1987;69:369-380.
115. Momin F, Chandrasekar PH. Antimicrobial prophylaxis in bone marrow transplantation. *Ann Intern Med* 1995;123:205-215.
116. Ottinger HD, Beelen DW, Scheulen B, et al. Improved immune reconstitution after allotransplantation of peripheral blood stem cells instead of bone marrow. *Blood* 1996;88:2775-2779.
117. Kulkarni S, Powles R, Treleaven J, et al. Chronic graft-versus-host disease is associated with long-term risk for pneumococcal infections in recipients of bone marrow transplants. *Blood* 2000;95:3683-3686.
118. Torok-Storb B, Boeckh M, Hoy C, et al. Association of specific cytomegalovirus genotypes with death from myelosuppression after marrow transplantation. *Blood* 1997;90:2097-2102.
119. Wingard JR, Piantadosi S, Burns WH, et al. Cytomegalovirus infections in bone marrow transplant recipients given intensive cytoreductive therapy. *Rev Infect Dis* 1990;12[Suppl 7]:S793-S804.
120. Pecego R, Hill R, Appelbaum FR, et al. Interstitial pneumonitis following autologous bone marrow transplantation. *Transplantation* 1986;42:515-517.
- 120a. Holmberg LA, Boeckh M, Hooper H, et al. Increased incidence of cytomegalovirus disease after autologous CD34-selected peripheral blood stem cell transplantation. *Blood* 1999;94:4029.
121. Reed EC, Bowden RA, Dandliker PS, et al. Treatment of cytomegalovirus pneumonia with ganciclovir and intravenous cytomegalovirus immunoglobulin in patients with bone marrow transplants. *Ann Intern Med* 1988;109:783-788.
122. Wingard JR. Viral infections in leukemia and bone marrow transplant patients. *Leukemia Lymphoma* 1993;11:115-125.
123. Reusser P, Riddell SR, Meyers JD, et al. Cytotoxic T-lymphocyte response to cytomegalovirus after human allogeneic bone marrow transplantation: pattern of recovery and correlation with cytomegalovirus

infection and disease. *Blood* 1991;78:1373–1380.

124. Zaia JA. Prevention and treatment of cytomegalovirus pneumonia in transplant recipients. *Clin Infect Dis* 1993;17[Suppl 2]:S392–S399.

125. Bowden RA, Slichter SJ, Sayers M, et al. A comparison of filtered leukocyte-reduced and cytomegalovirus (CMV)-seronegative blood products for the prevention of transfusion-associated CMV infection after marrow transplant. *Blood* 1995;86:3598–3603.

126. Forman SJ, Zaia JA. Treatment and prevention of cytomegalovirus pneumonia after bone marrow transplantation: where do we stand? *Blood* 1994;83:2392–2398.

127. Gleaves CA, Smith TF, Shuster EA, et al. Comparison of standard tube and shell vial culture techniques for the detection of cytomegalovirus in clinical specimens. *J Clin Microbiol* 1985;21:217–221.

128. Gerna G, Revello MG, Percivalle E, et al. Comparison of different immunostaining techniques and monoclonal antibodies to the lower matrix phosphoprotein (pp65) for optimal quantitation of human cytomegalovirus antigenemia. *J Clin Microbiol* 1992;30:1232–1237.

129. Boeckh M, Gooley TA, Myerson D, et al. Cytomegalovirus pp65 antigenemia-guided early treatment with ganciclovir versus ganciclovir at engraftment after allogeneic marrow transplantation. A randomized double blind study. *Blood* 1996;88:4063–4071.

130. Meyers JD, Ljungman P, Fisher LD. Cytomegalovirus excretion as a predictor of cytomegalovirus disease after marrow transplantation: importance of CMV viremia. *J Infect Dis* 1990;162:373–380.

131. Boeckh M, Gooley TA, Myerson D, et al. Cytomegalovirus pp65 antigenemia-guided early treatment with ganciclovir versus ganciclovir at engraftment after allogeneic marrow transplantation: a randomized double-blind study. *Blood* 1996;88:4063–4071.

132. Ljungman P, de La Camara R, Milpied N, et al. Randomized study of valacyclovir as prophylaxis against cytomegalovirus reactivation in recipients of allogeneic bone marrow transplants. *Blood* 2002;99:3050–3056.

133. Meyers JD, Reed EC, Shepp DH, et al. Acyclovir for the prevention of cytomegalovirus infection and disease after allogeneic marrow transplantation. *N Engl J Med* 1988;318:70–75.

134. Prentice HG, Gluckman E, Powles RL, et al. Impact of long-term acyclovir on cytomegalovirus infection and survival after allogeneic bone marrow transplantation. European Acyclovir for CMV prophylaxis study group 1994;343:749–753.

135. Goodrich JM, Mori M, Gleaves CA, et al. Early treatment with ganciclovir to prevent cytomegalovirus disease after allogeneic bone marrow transplantation. *N Engl J Med* 1991;325:1601–1607.

136. Goodrich JM, Bowden RA, Fisher LD, et al. Ganciclovir prophylaxis to prevent cytomegalovirus disease after allogeneic marrow transplant. *Ann Intern Med* 1993;118:173–178.

137. Schmidt GM, Horak DA, Niland JC, et al. A randomized controlled trial of prophylactic ganciclovir for cytomegalovirus pulmonary infection in recipients of allogeneic bone marrow transplants: The City of Hope-Stanford-Syntex CMV Study Group. *N Engl J Med* 1991;324:1005–1011.

138. Winston DJ, Ho WG, Bartoni K, et al. Ganciclovir prophylaxis of cytomegalovirus infection and disease in allogeneic bone marrow transplant recipients. Results of a placebo-controlled, double-blind trial. *Ann Intern Med* 1993;118:179–184.

139. Boeckh M, Leisenring W, Riddell SR, et al. Late cytomegalovirus disease and mortality in recipients of allogeneic hematopoietic stem cell transplants: importance of viral load and T-cell immunity. *Blood* 2003;101:407–414.

140. Hamprecht K, Eckle T, Prix L, et al. Ganciclovir-resistant cytomegalovirus disease after allogeneic stem cell transplantation: pitfalls of phenotypic diagnosis by in vitro selection of an UL97 mutant strain. *J Infect Dis* 2003;187:139–143.

141. Erice A, Chou S, Biron KK, et al. Progressive disease due to ganciclovir-resistant cytomegalovirus in



immunocompromised patients. *N Engl J Med* 1989;320:289–293.

142. Riddell SR, Walter BA, Gilbert MJ, et al. Selective reconstitution of CD 8+ cytotoxic T-lymphocyte responses in immunodeficient bone marrow transplant recipients by the adoptive transfer of T cell clones. *Bone Marrow Transplant* 1994;14:S78–S84.

143. Moretti S, Zikos P, Van Lint MT, et al. Foscarnet vs ganciclovir for cytomegalovirus (CMV) antigenemia after allogeneic hemopoietic stem cell transplantation (HSCT): a randomized study. *Bone Marrow Transplant* 1998;22:175–180.

144. Reusser P, Einsele H, Lee J, et al. Randomized multicenter trial of foscarnet versus ganciclovir for preemptive therapy of cytomegalovirus infection after allogeneic stem cell transplantation. *Blood* 2002;99:1159–1164.

145. Per Ljungman, Giorgio Lambertenghi Delilieri, Uwe Platzbecker, et al. Cidofovir for cytomegalovirus infection and disease in allogeneic stem cell transplant recipients. *Blood* 2001;97:388–392.

146. Liesveld JL, Abboud CN, Ifthikharuddin JJ, et al. Oral valacyclovir versus intravenous acyclovir in preventing herpes simplex virus infections in autologous stem cell transplant recipients. *Biol Blood Marrow Transplant* 2002;8:662–665.

147. Sullivan KM, Dykewicz CA, Longworth DL, et al. Preventing opportunistic infections after hematopoietic stem cell transplantation: the Centers for Disease Control and Prevention, Infectious Diseases Society of America, and American Society for Blood and Marrow Transplantation Practice Guidelines and Beyond. *Hematology (Am Soc Hematol Educ Program)* 2001:392–421.

148. Flomenberg P, Babbitt J, Drobyski WR, et al. Increasing incidence of adenovirus disease in bone marrow transplant recipients. *J Infect Dis* 1994;169:775–781.

149. Chan PK, Ip KW, Shiu SY, et al. Association between polyomaviruria and microscopic haematuria in bone marrow transplant recipients. *J Infect Dis* 1994;29:139–146.

150. Fouillard L, Mouthon L, Laporte JP, et al. Severe respiratory syncytial virus pneumonia after autologous bone marrow transplantation: a report of three cases and review. *Bone Marrow Transplant* 1992;9:97–100.

151. Kuehnle I, Huls MH, Liu Z, et al. CD20 monoclonal antibody (rituximab) for therapy of Epstein-Barr virus lymphoma after hemopoietic stem-cell transplantation. *Blood* 2000;95:1502–1505.

152. Bollard CM, Rooney CM, Huls MH, et al. Long-term follow-up of patients who received EBV specific CTLs for the prevention of treatment of EBV lymphoma. *Blood* 2000;96[Suppl]:478a(abst2057).

153. Hahn T, Cummings KM, Michalek AM, et al. Efficacy of high-efficiency particulate air filtration in preventing aspergillosis in immunocompromised patients with hematologic malignancies. *Infect Control Hosp Epidemiol* 2002;23:525–531.

154. Cornet M, Levy V, Fleury L, et al. Efficacy of prevention by high-efficiency particulate air filtration or laminar airflow against Aspergillus airborne contamination during hospital renovation. *Infect Control Hosp Epidemiol* 1999;20:508–513.

155. Goodman JL, Winston DJ, Greenfield RA, et al. A controlled trial of fluconazole to prevent fungal infections in patients undergoing bone marrow transplantation. *N Engl J Med* 1992;326:845–851.

156. Marr KA, Seidel K, Slavin MA, et al. Prolonged fluconazole prophylaxis is associated with persistent protection against candidiasis-related death in allogeneic marrow transplant recipients: long-term follow-up of a randomized, placebo-controlled trial. *Blood* 2000;96:2055–2061.

157. Guidelines for preventing opportunistic infections among hematopoietic stem cell transplant recipients. Recommendations of CDC, The Infectious Disease Society of America and the American Society of Blood and Marrow Transplantation. *MMWR Morb Mortal Wkly Rep* 2000;49:1–125.

158. Rousey SR, Russler S, Gottlieb M, et al. Low-dose amphotericin B prophylaxis against invasive Aspergillus infections in allogeneic marrow transplantation. *Am J Med* 1991;91:484–492.

159. Hertenstein B, Kern WV, Schmeiser T, et al. Low incidence of invasive fungal infections after bone marrow transplantation in patients receiving amphotericin B inhalations during neutropenia. *Ann Hematol* 1994;68:21–26.
160. Boyle BM, McCann SR. The use of itraconazole as prophylaxis against invasive fungal infection in blood and marrow transplant recipients. *Transpl Infect Dis* 2000;2:72–79.
161. Walsh TJ, Finberg RW, Arndt C, et al. Liposomal amphotericin B for empirical therapy in patients with persistent fever and neutropenia. National Institute of Allergy and Infectious Diseases Mycoses Study Group. *N Engl J Med* 1999;340:764–771.
162. Walsh TJ, Pappas P, Winston DJ, et al. Voriconazole compared with liposomal amphotericin B for empirical antifungal therapy in patients with neutropenia and persistent fever. *N Engl J Med* 2002;346:225–234.
163. Hebart H, Löffler J, Reitze H, et al. Prospective screening by a panfungal polymerase chain reaction assay in patients at risk for fungal infections: implications for the management of febrile neutropenia. *Br J Haematol* 2000;111:635–640.
164. Letscher-Bru V, Herbrecht R. Caspofungin: the first representative of a new antifungal class. *J Antimicrob Chemother* 2003;51:513–521.
165. Herbrecht R, Denning DW, Patterson TF, et al. Voriconazole versus amphotericin B for primary therapy of invasive aspergillosis. *N Engl J Med* 2002;347(6):408–415.
166. Bozzette SA, Finkelstein DM, Spector SA, et al. A randomized trial of three antipneumocystis agents in patients with advanced human immunodeficiency virus infection. *N Engl J Med* 1995;332:693–699.
167. Maltezou HC, Petropoulos D, Choroszy M, et al. Dapsone for *Pneumocystis carinii* prophylaxis in children undergoing bone marrow transplantation. *Bone Marrow Transplant* 1997;20:879–881.
168. Colby C, McAfee S, Sackstein R, et al. A prospective randomized trial comparing the toxicity and safety of atovaquone with trimethoprim/sulfamethoxazole as *Pneumocystis carinii* pneumonia prophylaxis following autologous peripheral blood stem cell transplantation. *Bone Marrow Transplant* 1999;24:897–902.
169. Marras TK, Sanders K, Lipton JH, et al. Aerosolized pentamidine prophylaxis for *Pneumocystis carinii* pneumonia after allogeneic marrow transplantation. *Transpl Infect Dis* 2002;4:66–74.
170. Derouin F, Devergie A, Auber P, et al. Toxoplasmosis in bone marrow transplant recipients: report of seven cases and review. *Clin Infect Dis* 1992;15:267–270.
171. Foot AB, Garin YJ, Ribaud P, et al. Prophylaxis of toxoplasmosis infection with pyrimethamine/sulfadoxine (Fansidar) in bone marrow transplant recipients. *Bone Marrow Transplant* 1994;14:241–245.
172. Larson EL. APIC guideline for hand washing and hand antisepsis in health care settings. *Am J Infect Control* 1995;23:251–269.
173. Albert RK, Condie F. Hand washing patterns in medical intensive care units. *N Engl J Med* 1981;304:1465–1466.
174. Wilson BJ. Dietary recommendations for neutropenic patients. *Semin Oncol Nurs* 2002;18:44–49.
175. Smith LH, Besser SG. Dietary restrictions for patients with neutropenia: a survey of institutional practices. *Oncol Nurs Forum* 2000;27:515–520.
176. Levine AS, Siegel SE, Schriebar AD, et al. Protected environments and prophylactic antibiotics: a prospective controlled study of their utility in the therapy of acute leukemia. *N Engl J Med* 1973;288:477–483.
177. Pizzo PA. The value of protective isolation in preventing nosocomial infections in high risk patients.

Am J Med 1981;70:631–637.

178. Hahn T, Cummings KM, Michalek AM, et al. Efficacy of high-efficiency particulate air filtration in preventing aspergillosis in immunocompromised patients with hematologic malignancies. *Infect Control Hosp Epidemiol* 2002;23:525–531.

179. Barnes RA, Rogers TR. Control of an outbreak of nosocomial aspergillosis by laminar air-flow isolation. *J Hosp Infect* 1989;14:89–94.

180. Schimpff SC. Infection prevention during profound granulocytopenia. New approaches to alimentary canal microbial suppression. *Ann Intern Med* 1980;93:358–361.

181. Yates JW, Holland JF. A controlled study of isolation and endogenous microbial suppression in acute myelocytic leukemia patients. *Cancer* 1973;32:1490–1498.

182. Gluckman E, Roudet C, Hirsch I, et al. Prophylaxis of bacterial infections after bone marrow transplantation. A randomized prospective study comparing oral broad-spectrum nonabsorbable antibiotics (vancomycin-tobramycin-colistin) to absorbable antibiotics (ofloxacin-amoxicillin). *Chemotherapy* 1991;37[Suppl 1]:33–38.

183. Hargadon MT, Young VM, Schimpff SC, et al. Selective suppression of alimentary tract microbial flora as prophylaxis during granulocytopenia. *Antimicrob Agents Chemother* 1981;20:620–624.

184. Guiot HFL, Van den Broek, van der Meer JW, et al. Selective antimicrobial modulation of the intestinal flora of patients with acute nonlymphocytic leukemia: a double-blind, placebo-controlled study. *J Infect Dis* 1983;147:615–623.

185. Verhoef J, Verhage EA, Visser MR. A decade of experience with selective decontamination of the digestive tract as prophylaxis for infections in patients in the intensive care unit: what have we learned? *Clin Infect Dis* 1993;17:1047–1054.

186. Gualtieri RJ, Donowitz GR, Kaiser DL, et al. Double-blind randomized study of prophylactic trimethoprim-sulfamethoxazole in granulocytopenic patients with hematological malignancies. *Am J Med* 1983;74:934–940.

187. Wilson JM, Guiney DG. Failure of oral trimethoprim/sulfamethoxazole prophylaxis in acute leukemia. Isolation of resistant plasmids from strains of Enterobacteriaceae causing bacteremia. *N Engl J Med* 1982;306:16–20.

188. Hughes WT, Kuhn LI, Chaudhary SC, et al. Successful chemoprophylaxis for *Pneumocystis carinii* pneumonitis. *N Engl J Med* 1977;297:1419–1426.

189. Wade JC, de Jongh CA, Newman KA, et al. Selective antimicrobial modulation as prophylaxis against infection during granulocytopenia: trimethoprim-sulfamethoxazole vs. nalidixic acid. *J Infect Dis* 1983;147:624–634.

190. Pizzo PA, Robichaud KJ, Edwards BK, et al. Oral antibiotic prophylaxis in patients with cancer: a double-blind, randomized placebo-controlled trial. *J Pediatr* 1983;102:125–133.

191. Hughes WT, Rivera GK, Schell MJ, et al. Successful intermittent chemoprophylaxis for *Pneumocystis carinii* pneumonitis. *N Engl J Med* 1987;316:1627–1632.

192. De Pauw BE, Novakova IR, Ubachs E, et al. Co-trimoxazole in patients with haematological malignancies: a review of 10-years' clinical experience. *Curr Med Res Opin* 1988;11:64–72.

193. Enno A, Catovsky D, Darrell J, et al. Co-trimoxazole for prevention of infection in acute leukaemia. *Lancet* 1978;2(8086):395–397.

194. Lew MA, Kehoe K, Ritz J, et al. Prophylaxis of bacterial infections with ciprofloxacin in patients undergoing bone marrow transplantation. *Transplantation* 1991;51:630–636.

195. Bow EJ, Rayner E, Louie TJ. Comparison of norfloxacin with co-trimoxazole for infection prophylaxis in acute leukemia. The trade-off for reduced Gram-negative sepsis. *Am J Med* 1988;84:847–854.

196. Cruciani M, Rampazzo R, Malena M, et al. Prophylaxis with fluoroquinolones for bacterial infections in neutropenic patients: a meta-analysis. *Clin Infect Dis* 1996;23:795–805.
197. Engels EA, Lau J, Barza M. Efficacy of quinolone prophylaxis in neutropenic cancer patients: a meta-analysis. *J Clin Oncol* 1998;16(3):1179–1187.
198. Horvathova Z, Spanik S, Sufliarsky J, et al. Bacteremia due to methicillin-resistant staphylococci occurs more frequently in neutropenic patients who received antimicrobial prophylaxis and is associated with higher mortality in comparison to methicillin-sensitive bacteremia. *Int J Antimicrob Agents* 1998;10(1):55–58.
199. Fanci R, Leoni F, Bosi A, et al. Chemoprophylaxis of bacterial infections in granulocytopenic patients with ciprofloxacin vs ciprofloxacin plus amoxicillin. *J Chemother* 1993;5:119–123.
200. Kerr KG, Armitage HT, McWhinney PH. Activity of quinolones against viridans group streptococci isolated from blood cultures of patients with haematological malignancy. *Support Care Cancer* 1999;7:28–30.
201. Gomez L, Garau J, Estrada C, et al. Ciprofloxacin prophylaxis in patients with acute leukemia and granulocytopenia in an area with high prevalence of ciprofloxacin-resistant *Escherichia coli*. *Cancer* 2003;97:419–424.
202. Ball P. Editorial response: is resistant *Escherichia coli* bacteremia an inevitable outcome for neutropenic patients receiving a fluoroquinolone as prophylaxis? *Clin Infect Dis* 1995;20:561–563.
203. Eliopoulos GM. In vitro activity of fluoroquinolones against Gram-positive bacteria. *Drugs* 1995;49:48–57.
204. D'Antonio D, Piccolomini R, Iacone A, et al. Comparison of ciprofloxacin, ofloxacin, and pefloxacin for the prevention of the bacterial infection in neutropenic patients with haematological malignancies. *J Antimicrob Chemother* 1994;33:837–844.
205. Segatore B, Setacci D, Perilli M, et al. Bactericidal activity of levofloxacin and ciprofloxacin on clinical isolates of different phenotypes of *Pseudomonas aeruginosa*. *Int J Antimicrob Agents* 2000;13(3):223–226.
206. Winston DJ, Ho WG, Bruckner DA, et al. Ofloxacin versus vancomycin/poly-myxin for prevention of infections in granulocytopenic patients. *Am J Med* 1990;88:36–42.
207. The GIMEMA Infection Program: prevention of bacterial infection in neutropenic patients with hematologic malignancies. A randomized multicenter trial comparing norfloxacin with ciprofloxacin. *Ann Intern Med* 1991;115:7–12.
208. Bow EJ, Loewen R, Vaughan D. Reduced requirement for antibiotic therapy targeting Gram-negative organisms in febrile, neutropenic patients with cancer who are receiving antibacterial chemoprophylaxis with oral quinolones. *Clin Infect Dis* 1995;20:907–912.
209. Peterson F, Thornquist M, Buckner C, et al. The effects of infection prevention regimens on early infectious complications in marrow transplant patients: a four arm randomized study. *Infection* 1988;16:199–208.
210. DePauw BE, Connelly JP, DeWitte T, et al. Options and limitations of long term oral ciprofloxacin as antibacterial prophylaxis in allogeneic bone marrow transplant recipients. *Bone Marrow Transplant* 1990;5:179–182.
211. Bow EJ, Laverdiere M, Lussier N, et al. Antifungal prophylaxis for severely neutropenic chemotherapy recipients: a meta analysis of randomized-controlled clinical trials. *Cancer* 94:3230–3246.
212. Menichetti F, Del Favero A, Martino P, et al. Preventing fungal infection in neutropenic patients with acute leukemia: fluconazole compared with oral amphotericin B. The GIMEMA Infection Program. *Ann Intern Med* 1994;120:913–918.
213. Jeffery GM, Beard MEJ, Ikram RB, et al. Intranasal amphotericin B reduces the frequency of invasive

aspergillosis in neutropenic patients. *Am J Med* 1991;90:685–692.

214. Behre GF, Schwartz S, Lenz K, et al. Aerosol amphotericin B inhalations for prevention of invasive pulmonary aspergillosis in neutropenic cancer patients. *Ann Hematol* 1995;71:287–291.

215. Wingard JR. Efficacy of amphotericin B lipid complex injection (ABLC) in bone marrow transplant recipients with life-threatening systemic mycoses. *Bone Marrow Transplant* 1997;19:343–347.

216. Lopez-Berenstein G. Liposomal amphotericin B in the treatment of fungal infections. *Ann Intern Med* 1986;105:130–131.

217. Winston DJ, Chandrasekar PH, Lazarus HM, et al. Fluconazole prophylaxis of fungal infections in patients with acute leukemia. Results of a randomized, placebo-controlled, double-blind, multicenter trial. *Ann Intern Med* 1993;118:495–503.

218. Lopez J, Pernot C, Aho S, et al. Decrease in *Candida albicans* strains with reduced susceptibility to fluconazole following changes in prescribing policies. *J Hosp Infect* 2001;48(2):122–128.

219. Bohme A, Just-Nubling G, Bergmann L, et al. Itraconazole for prophylaxis of systemic mycoses in neutropenic patients with haematological malignancies. *J Antimicrob Chemother* 1996;38(6):953–961.

220. Caillet D, Bassaris H, McGeer A, et al. Intravenous itraconazole followed by oral itraconazole in the treatment of invasive pulmonary aspergillosis in patients with hematologic malignancies, chronic granulomatous disease, or AIDS. *Clin Infect Dis* 2001;33:e83–e90.

221. van't Wout JW, Novakova I, Verhagen CA, et al. The efficacy of itraconazole against systemic fungal infections in neutropenic patients: a randomized comparative study with amphotericin B. *J Infect Dis* 1991;22(1):45–52.

222. Steinbach WJ, Perfect JR. Newer antifungal therapy for emerging fungal pathogens. *Int J Infect Dis* 2003;7:5–10.

223. Hoffman HL, Ernst EJ, Klepser ME. Novel triazole antifungal agents. *Expert Opin Investig Drugs* 2000;9:593–605.

224. Saral R, Ambinder RF, Burns WH, et al. Acyclovir prophylaxis against herpes simplex virus infection in patients with leukemia. A randomized, double-blind, placebo-controlled study. *Ann Intern Med* 1983;99(6):773–776.

225. Selby PJ, Powles RL, Easton D, et al. The prophylactic role of intravenous and long term oral acyclovir after allogeneic bone marrow transplantation. *Br J Cancer* 1989;59:434–438.

226. Anderson H, Scarffe JH, Sutton RN, et al. Oral acyclovir prophylaxis against herpes simplex virus in non-Hodgkin lymphoma and acute lymphoblastic leukaemia patients receiving remission induction chemotherapy. A randomized double blind, placebo controlled trial. *Br J Cancer* 1984;50(1):45–49.

227. Chen Y, Scieux C, Garrait V, et al. Resistant herpes simplex virus type 1 infection: an emerging concern after allogeneic stem cell transplantation. *Clin Infect Dis* 2000;31(4):927–935.

228. Reusser P. Challenges and options in the management of viral infections after stem cell transplantation. *Support Care Cancer* 2002;10(3):197–203.

229. Stein GE. Pharmacology of new antiherpes agents: famciclovir and valacyclovir. *J Am Pharm Assoc* 1997;37:157–163.

230. Griffiths PD. Tomorrow's challenges for herpesvirus management: potential applications of valacyclovir. *J Infect Dis* 2002;186[Suppl 1]:S131–S137.

231. Wutzler P. Antiviral therapy of herpes simplex and varicella-zoster virus infections. *Intervirology* 1997;40(5–6):343–356.

232. Molrine DC, Ambrosino DM. Immunizations in immunocompromised cancer patients. *Infect Med*

1996;13:259–280.

233. Ravry M, Maldonado M, Velez–Garcia E, et al. Serious infection after splenectomy for the staging of Hodgkin's disease. *Ann Intern Med* 1972;77:11–14.

234. Notter DT, Grossman PL, Rosenberg SA, et al. Infections in patients with Hodgkin's disease. A clinical study of 300 consecutive adult patients. *Rev Infect Dis* 1980;2:761–800.

235. Weitzman SA, Aisenberg AC, Siber GR, et al. Impaired humoral immunity in treated Hodgkin's disease. *N Engl J Med* 1977;297:245–248.

236. Arrowood JR, Hayney MS. Immunization recommendations for adults with cancer. *Ann Pharmacother* 2002;36(7–8):1219–1229.

237. Recommended adult immunization schedule—United States, 2002–2003. *MMWR Morb Mortal Wkly Rep* 2002;51(40):904–908.

238. Siber GR, Weitzman SA, Aisenberg AC. Antibody response of patients with Hodgkin's disease to protein and polysaccharide antigens. *Rev Infect Dis* 1981;3[Suppl];S144–S159.

239. Siber GR, Gorham C, Martin P, et al. Antibody response to pretreatment immunization and post-treatment boosting with bacterial polysaccharide vaccines in patients with Hodgkin's disease. *Ann Intern Med* 1986;104(4):467–475.

240. Ridgway P, Wolff LJ, Deforest A. Immunization response varies with intensity of acute lymphoblastic leukemia therapy. *Am J Dis Child* 1991;145:887–891.

241. Feldman S, Gigliotti F, Shenep JL, et al. Risk of *Haemophilus influenzae* type B disease in children with cancer and response of immunocompromised leukemic children to a conjugate vaccine. *J Infect Dis* 1990;161:926–931.

242. Molrine DC, George S, Tarbell N, et al. Antibody responses to polysaccharide and polysaccharide–conjugate vaccines after treatment of Hodgkin's disease. *Ann Intern Med* 1995;123:828–834.

243. Donaldson SS, Vosh KL, Berberich FR, et al. Response to pneumococcal vaccine among children with Hodgkin's disease. *Rev Infect Dis* 1981;3(S):S133–S143.

244. Siber GR, Weitzman SA, Aisenberg AC, et al. Impaired antibody response to pneumococcal vaccine after treatment for Hodgkin's disease. *N Engl J Med* 1978;299:442–448.

245. Chan CY, Molrine DC, George S, et al. Pneumococcal conjugate vaccine primes for antibody responses to polysaccharide pneumococcal vaccine after treatment of Hodgkin's disease. *J Infect Dis* 1996;173:256–258.

246. von Specht BU, Lucking HC, Blum B, et al. Safety and immunogenicity of a *Pseudomonas aeruginosa* outer membrane protein I vaccine in human volunteers. *Vaccine* 1996;14:1111–1117.

247. Prevention and control of meningococcal disease. Recommendations of the Advisory Committee on Immunization Practices (ACIP). *MMWR Recomm Rep* 2000;49(RR–7):1–10.

248. Hamarstrom V, Pauksen K, Svensson H, et al. Tetanus immunity in patients with hematological malignancies. *Support Care Cancer* 1998;6(5):469–472.

249. Ortvals DW, Liebhaber H, Presant CA, et al. Influenza immunization of adult patients with malignant diseases. *Ann Intern Med* 1977;87:552–557.

250. Gershon AA. Human immune responses to live attenuated varicella vaccine. *Rev Infect Dis* 1991;13[Suppl 11]:S957–S959.

251. Arbeter AM, Granwetter L, Starr SE, et al. Immunization of children with acute lymphoblastic leukemia with live–attenuated varicella vaccine without complete suspension of chemotherapy. *Pediatrics* 1990;85:338–344.

252. Hardy J, Gershon AA, Steinberg SP, et al. The incidence of zoster after immunization with live attenuated varicella vaccine. *N Engl J Med* 1991;325:1545–1577.
253. Kamiya H, Ito M. Update on varicella vaccine. *Curr Opin Pediatr* 1999;11(1):3–8.
254. Ruben FL, Hankins WA, Zeigler Z, et al. Antibody responses to meningococcal polysaccharide vaccine in adults without a spleen. *Am J Med* 1984;76:115–121.
255. Giebink GS, Foker JE, Kim Y, et al. Serum antibody and opsonic responses to vaccination with pneumococcal capsular polysaccharide in normal and splenectomized children. *J Infect Dis* 1980;3:404–412.
256. Stein RS, Pinson RD, Rothstein LB, et al. Limited response to pneumococcal vaccine in chronic lymphocytic leukemia. *Proceedings AACR and ASCO* 1981;142(abst).
257. Guidelines for preventing opportunistic infections among hematopoietic stem cell transplant recipients. *Biol Blood Marrow Transplant* 2000;6(6a):659–713.
258. Goldberg SL, Cicogna CE, Rowley SD, et al. Vaccinations against infectious diseases in hematopoietic stem cell transplant recipients. *Oncology* 2003;17:539–560.
259. Storek J, Dawson MA, Storer B, et al. Immune reconstitution after allogeneic marrow transplantation compared with blood stem cell transplantation. *Blood* 2001;97:3380–3389.
260. Somani J, Larson RA. Reimmunization after allogeneic bone marrow transplantation. *Am J Med* 1995;98:389–398.
261. Barra A, Cordonnier C, Preziosi MP, et al. Immunogenicity of *Haemophilus influenzae* type B conjugate vaccine in allogeneic bone marrow recipients. *J Infect Dis* 1992;166:1021–1028.
262. Ljungman P, Duraj V, Magnus L. Response to immunization against polio after allogeneic bone marrow transplantation. *Bone Marrow Transplant* 1991;7:89–93.
263. Ljungman P, Wiklund-Hammarsten M, Duraj V, et al. Response to tetanus toxoid immunization after allogeneic bone marrow transplantation. *J Infect Dis* 1990;162:496–500.
264. Parkkali T, Stenvik M, Ruutu T, et al. Randomized comparison of early and late vaccination with inactivated poliovirus vaccine after allogeneic BMT. *Bone Marrow Transplant* 1997;20:663–668.
265. Nagler A, Ilan Y, Adler R, et al. Successful immunization of autologous bone marrow transplantation recipients against hepatitis B virus by active vaccination. *Bone Marrow Transplant* 1995;15:475–478.
266. Engelhard D, Nagler A, Hardan I. Antibody response to a two-dose regimen of influenza vaccine in allogeneic T-depleted and autologous BMT recipients. *Bone Marrow Transplant* 1993;11:1–5.
267. Ljungman P, Fridell E, Lonquist B, et al. Efficacy and safety of vaccination of marrow transplant recipients with a live attenuated measles, mumps and rubella vaccine. *J Infect Dis* 1989;159:610–615.
268. Molrine DC, Guinan EC, Antin JH, et al. Donor immunization with *Haemophilus influenzae* type B (HIB)-conjugate vaccine in allogeneic bone marrow transplantation. *Blood* 1996;87:3012–3018.
269. Molrine DC, Guinan EC, Antin JH, et al. *Haemophilus influenzae* type b (HIB)-conjugate immunization before bone marrow harvest in autologous bone marrow transplantation. *Bone Marrow Transplant* 1996;17:1149–1155.
270. Kato S, Yabe H, Yabe M, et al. Studies on transfer of varicella-zoster virus specific T-cell immunity from bone marrow donor to recipient. *Blood* 1990;75:806–809.
271. Gottlieb DJ, Cryz SJ Jr, Furer E, et al. Immunity against *Pseudomonas aeruginosa* adoptively transferred to bone marrow recipients. *Blood* 1990;76:2470–2475.
272. Mannheimer S, Armstrong D. Vaccinations for the immunocompromised traveler. *Infect Med*



1995;12:415–419.

273. Jertborn M, Svennerholm AM, Holmgren J. Safety and immunogenicity of an oral recombinant cholera B subunit–whole cell vaccine in Swedish volunteers. *Vaccine* 1992;10:130–132.

274. Fielding AK. Prophylaxis against late infection following splenectomy and bone marrow transplant. *Blood Rev* 1994;8:179–191.

275. Todd AAM, Yap PL. Applications of intravenous immunoglobulin in haematology. *Blood Rev* 1992;6:105–117.

276. Cooperative group for the study of immunoglobulin in chronic lymphocytic leukemia: intravenous immunoglobulin for the prevention of infection in chronic lymphocytic leukemia. *N Engl J Med* 1988;319:902–907.

277. Chapel H, Griffiths H, Lee M. IVIG indication in patients with low grade B–cell tumours. In: Imbach P, ed. *Immunotherapy with intravenous immunoglobulins*. London: Academic Press, 1991;1651–1675.

278. Weeks JC, Tierney MR, Weinstein MC. Cost effectiveness of prophylactic intravenous immunoglobulin in chronic lymphocytic leukemia. *N Engl J Med* 1991;325:81–86.

279. Besa EC, Klumpe D. Prophylactic immune globulin in chronic lymphocytic leukemia [Letter]. *N Engl J Med* 1991;326:13.

280. Boughton BJ, Jackson N, Lim S, et al. Randomized trial of intravenous immunoglobulin prophylaxis for patients with chronic lymphocytic leukaemia and secondary hypogammaglobulinaemia. *Clin Lab Haematol* 1995;17(1):75–80.

281. Molica S, Musto P, Chiurazzi F, et al. Prophylaxis against infections with low–dose intravenous immunoglobulins (IVIG) in chronic lymphocytic leukemia. Results of a crossover study. *Haematologica* 1996;81:121–126.

282. Chapel HM, Lee M, Hargreaves R, et al. Randomized trial of intravenous immunoglobulin as prophylaxis against infection in plateau phase multiple myeloma. *Lancet* 1994;343:1059–1063.

283. Musto P, Brugiattelli M, Carotenuto M. Prophylaxis against infections with intravenous immunoglobulins in multiple myeloma. *Br J Haematol* 1995;89(4):945–946.

284. Berkman S, Lee ML, Gale RP. Clinical uses of intravenous immunoglobulins. *Ann Intern Med* 1990;112:278–292.

285. Chapel HM, Lee M. The use of intravenous immune globulin in multiple myeloma. *Clin Exp Immunol* 1994;97[Suppl 1]:21–24.

286. Sullivan KM, Kopecky KH, Jocum J, et al. Immunomodulatory and antimicrobial efficacy of intravenous immunoglobulin in bone marrow transplantation. *N Engl J Med* 1990;323:705–712.

287. Petersen FB, Bowden RA, Thornquist M, et al. The effect of prophylactic intravenous immune globulin on the incidence of septicemia in marrow transplant recipients. *Bone Marrow Transplant* 1987;2:141–148.

288. Bass EB, Powe NR, Goodman SN, et al. Efficacy of immune globulin in preventing complications of bone marrow transplantation: a meta–analysis. *Bone Marrow Transplant* 1993;12:273–282.

289. Winston DJ, Antin JH, Wolff SN, et al. A multicenter, randomized, double–blind comparison of different doses of intravenous immunoglobulin for prevention of graft–versus–host disease and infection after allogeneic bone marrow transplantation. *Bone Marrow Transplant* 2001;28:187–196.

290. Wolff SN, Fay JW, Herzig RH et al. High dose intravenous immunoglobulin to prevent infections in patients undergoing autologous bone marrow transplantation or severe myelosuppressive therapy. *Ann Intern Med* 1993;118:937–942.

291. Klaesson S, Rinden O, Ljungman P, et al. Does high–dose intravenous immune globulin treatment after bone marrow transplantation increase mortality in veno–occlusive disease of the liver? *Transplant*

1995;60:1225–1230.

292. Bowden RA, Fisher LD, Roders K, et al. Cytomegalovirus (CMV)–specific intravenous immunoglobulin for the prevention of primary CMV infection and disease after marrow transplant. *J Infect Dis* 1991;164:483–487.

293. Zikos P, Van Lint MT, Lamparelli T, et al. A randomized trial of high dose polyvalent intravenous immunoglobulin (HDIgG) vs. Cytomegalovirus (CMV) hyperimmune IgG in allogeneic hemopoietic stem cell transplants (HSCT). *Haematologica* 1998;83(2):132–137.

294. Sullivan KM. Immunomodulation in allogeneic marrow transplantation: use of intravenous immune globulin to suppress acute graft-versus-host disease. *Clin Exp Immunol* 1996;104[Suppl 1]:43–48.

295. Sullivan KM, Storek J, Kopecky KJ, et al. A controlled trial of long-term administration of intravenous immunoglobulin to prevent late infection and chronic graft-vs-host disease after marrow transplantation: clinical outcome and effect on subsequent immune recovery. *Biol Blood Marrow Transplant* 1996;2(1):44–53.

296. Sokos DR, Berger M, Lazarus HM. Intravenous immunoglobulin: appropriate indications and uses in hematopoietic stem cell transplantation. *Biol Blood Marrow Transplant* 2002;8(3):117–130.

297. Varicella-zoster immune globulins for the prevention of chickenpox: recommendations of the Immunization Practices Advisory Committee (ACIP). *MMWR CDC Surveill Summ* 1984;33:84–100.

298. Kay HEM, Rankin A. Immunoglobulin prophylaxis of measles in acute lymphoblastic leukaemia [Letter]. *Lancet* 1984;1:901–902.

299. Lemon SM, Thomas DL. Vaccines to prevent viral hepatitis. *N Engl J Med* 1997;336:196–204.

300. Roilides E, Pizzo PA. Biologicals and hematopoietic cytokines in prevention or treatment of infection in immunocompromised hosts. *Hematol Oncol Clin North Am* 1993;7:841–864.

301. Ziegler EJ, McCutchan JH, Fierer J, et al. Treatment of Gram-negative bacteremia and septic shock with human antiserum to a mutant *Escherichia coli*. *N Engl J Med* 1982;307:1225–1230.

302. Ziegler EJ, Fisher CJ Jr, Sprung CL, et al. Treatment of Gram-negative bacteremia and septic shock with HA-IA human monoclonal antibody against endotoxin: a randomized, double-blind, placebo-controlled trial. *N Engl J Med* 1991;324:429–436.

303. Roilides E, Pizzo PA. Modulation of host defenses by cytokines: evolving adjuncts in prevention and treatment of serious infections in immunocompromised hosts. *Clin Infect Dis* 1992;15:508–524.

304. Warren HS. Strategies for the treatment of sepsis. *N Engl J Med* 1997;336:952–953.

305. Arai KI, Lee F, Miyajima A, et al. Cytokines: coordinators of immune and inflammatory responses. *Ann Rev Biochem* 1990;59:783–836.

306. Walker F, Nicola NA, Metcalf D, et al. Hierarchical down-modulation of hematopoietic growth factor receptors. *Cell* 1985;43:269–276.

307. Bociek RG, Armitage JO. Hematopoietic growth factors. *CA Cancer J Clin* 1996;46:165–184.

308. Vose JM, Armitage JO. Clinical applications of hematopoietic growth factors. *J Clin Oncol* 1995;13:1023–1035.

309. Curran MP, Goa KL. Pegfilgrastim. *Drugs* 2002;62:1207–1213.

310. Pirker R, Smith R. Darbepoetin alfa: potential role in managing anemia in cancer patients. *Expert Rev Anticancer Ther* 2002;2(4):377–384.

311. Demetri GD. Targeted approaches for the treatment of thrombocytopenia. *Oncologist* 2001;6[Suppl 5]:15–23.

312. Krantz SB. Erythropoietin. *Blood* 1991;77:419–434.
313. Ludwig H, Fritz E, Kotzmann H, et al. Erythropoietin treatment of anemia associated with multiple myeloma. *N Engl J Med* 1990;322:1693–1699.
314. Cazzola M, Messinger D, Battistel V, et al. Recombinant human erythropoietin in the anemia associated with multiple myeloma or non-Hodgkin's lymphoma: dose finding and identification of predictors of response. *Blood* 1993;86:4446–4453.
315. Campos E, Radford J, Steward W, et al. Clinical and *in vitro* effects of recombinant human erythropoietin in patients receiving intensive chemotherapy for small cell lung cancer. *J Clin Oncol* 1995;13:1623–1631.
316. Henry DH, Abels RI. Recombinant human erythropoietin in the treatment of cancer and cancer-related anemia: results of double-blind and open-label follow-up studies. *Semin Oncol* 1994;21[Suppl 3]:21–28.
317. Rizzo JD, Lichtin AE, Woolf SH, et al. Use of epoetin in patients with cancer: evidence-based clinical practice guidelines of the American Society of Clinical Oncology and the American Society of Hematology. *J Clin Oncol* 2002;20:4083–4107.
318. Cella D, Zagari MJ, Vandoros C, et al. Epoetin alfa treatment results in clinically significant improvements in quality of life in anemic cancer patients when referenced to the general population. *J Clin Oncol* 2003;21:366–373.
319. Gabrilove JL, Cleeland CS, Livingston RB, et al. Clinical evaluation of once-weekly dosing of epoetin alfa in chemotherapy patients: improvements in hemoglobin and quality of life are similar to three-times-weekly dosing. *J Clin Oncol* 2001;19:2875–2882.
320. Glaspy J, Bukowski R, Steinberg D, et al. Impact of therapy with epoetin alfa on clinical outcome in patients with nonmyeloid malignancies during cancer chemotherapy in community oncology practice. *J Clin Oncol* 1997;15:1218–1234.
321. Demetri GD, Kris M, Wade J, et al. Quality-of-life benefit in chemotherapy patients treated with epoetin alfa is independent of disease response or tumor type: results from a prospective community oncology study. Procrit Study Group. *J Clin Oncol* 1998;16(10):3412–3425.
322. Link H, Boogaerts MA, Fauser AA, et al. A controlled trial of human erythropoietin after bone marrow transplantation. *Blood* 1994;84:3327–3335.
323. Chao NJ, Schriber JR, Long GD, et al. A randomized study of erythropoietin and granulocyte colony-stimulating factor (G-CSF) versus placebo and G-CSF in patients with Hodgkin's and non-Hodgkin's lymphoma undergoing autologous bone marrow transplantation. *Blood* 1994;83:2823–2828.
324. Vannucchi AM, Bosi A, Ieri A, et al. Combination therapy with G-CSF and erythropoietin after autologous bone marrow transplantation for lymphoid malignancies: a randomized trial. *Bone Marrow Transplant* 1996;17:527–531.
325. Steegmann IL, Lopez J, Otero MJ, et al. Erythropoietin treatment in allogeneic BMT accelerates erythroid reconstitution: results of a prospective controlled randomized trial. *Bone Marrow Transplant* 1992;10:541–546.
326. Biggs JC, Atkinson KA, Booker V, et al. Prospective randomized double-blind trial of the *in vivo* use of recombinant human erythropoietin in bone marrow transplantation from HLA-identical sibling donors. The Australian Bone Marrow Transplant Study Group. *Bone Marrow Transplant* 1995;15(1):129–134.
327. Lin CP, Huang MJ, Liu HJ, et al. Successful treatment of acute promyelocytic leukemia in a pregnant Jehovah's Witness with all-trans-retinoic acid, rh-G-CSF, and erythropoietin. *Am J Hematol* 1996;51:251–252.
328. Ballen KK, Ford PA, Waitkus H, et al. Successful autologous bone marrow transplant without the use of blood product support. *Bone Marrow Transplant* 2000;26(2):227–229.

329. Jacobs A, Janowska-Wieczorek A, Caro J, et al. Circulating erythropoietin in patients with myelodysplastic syndromes. *Br J Haematol* 1989;73:36–39.
330. Negrin RS, Stein R, Doherty K, et al. Maintenance treatment of the anemia of myelodysplastic syndromes with recombinant human granulocyte colony-stimulating factor and erythropoietin: evidence for *in vivo* synergy. *Blood* 1996;87:4076–4081.
331. Thompson JA, Gilliland DG, Prchal JT, et al. Effect of recombinant human erythropoietin combined with granulocyte/macrophage colony-stimulating factor in the treatment of patients with myelodysplastic syndrome. GM/EPO MDS Study Group. *Blood* 2000;95:1175–1179.
332. Stein RS. Clinical use of growth factors in the myelodysplastic syndromes. *Am J Med Sci* 1994;307:360–367.
333. Rose EH, Abels RI, Nelson RA, et al. The use of rHuEPO in the treatment of anaemia related to myelodysplasia (MDS). *Br J Haematol* 1995;89:831–837.
334. Pirker R, Smith R. Darbepoetin alfa: potential role in managing anemia in cancer patients. *Expert Rev Anticancer Ther* 2002;2(4):377–384.
335. Vansteenkiste J, Pirker R, Massuti B, et al. Double-blind, placebo-controlled, randomized phase III trial of darbepoetin alfa in lung cancer patients receiving chemotherapy. *J Natl Cancer Inst* 2002;94(16):1211–1220.
336. Pettengell R, Gurney H, Radford JA, et al. Granulocyte colony-stimulating factor to prevent dose-limiting neutropenia in non-Hodgkin's lymphoma: a randomized controlled trial. *Blood* 1992;80:1430–1436.
337. Maher DW, Lieschke GJ, Green M, et al. Filgrastim in patients with chemotherapy-induced febrile neutropenia. A double-blind, placebo-controlled trial. *Ann Intern Med* 1994;121:492–501.
338. Vellenga E, Uyl-de Groot CA, de Wit R, et al. Randomized placebo-controlled trial of granulocyte-macrophage colony-stimulating factor in patients with chemotherapy-related febrile neutropenia. *J Clin Oncol* 1996;14(2):619–627.
339. Hartmann LC, Tschetter LK, Habermann TM, et al. Granulocyte colony-stimulating factor in severe chemotherapy-induced afebrile neutropenia. *N Engl J Med* 1997;336(25):1776–1780.
340. Ganser A, Karthaus M. Clinical use of hematopoietic growth factors. *Curr Opin Oncol* 1996;8:265–269.
341. Rowe JM, Andersen J, Mazza J, et al. A randomized placebo-controlled phase III study of granulocyte-macrophage colony-stimulating factor in adult patients (>55 to 70 years of age) with acute myelogenous leukemia: a study of the Eastern Cooperative Oncology Group (E 1490). *Blood* 1995;86:457–462.
342. Geller RB. Use of cytokines in the treatment of acute myelocytic leukemia: a critical review. *J Clin Oncol* 1996;14:1371–1382.
343. Larson RA, Dodge RK, Linker CA, et al. A randomized controlled trial of filgrastim during remission induction and consolidation chemotherapy for adults with acute lymphoblastic leukemia: CALGB study 9111. *Blood* 1998;92(5):1556–1564.
344. Pui CH, Boyett JM, Hughes WT, et al. Human granulocyte colony-stimulating factor after induction chemotherapy in children with acute lymphoblastic leukemia. *N Engl J Med* 1997;336(25):1781–1787.
345. Ottmann OG, Hoelzer D. Growth factors in the treatment of acute lymphoblastic leukemia. *Leuk Res* 1998;22(12):1171–1178.
346. Beveridge RA, Miller JA, Kales AN, et al. A comparison of efficacy of sargramostim (yeast-derived RhuGM-CSF) and filgrastim (bacteria-derived RhuG-CSF) in the therapeutic setting of chemotherapy-induced myelosuppression. *Cancer Invest* 1998;16(6):366–373.

347. Beveridge RA, Miller JA, Kales AN, et al. Randomized trial comparing the tolerability of sargramostim (yeast-derived RhuGM-CSF) and filgrastim (bacteria-derived RhuG-CSF) in cancer patients receiving myelosuppressive chemotherapy. *Support Care Cancer* 1997;5:289-298.
348. Trigg ME, Peters C, Zimmerman MB. Administration of recombinant human granulocyte-macrophage colony-stimulating factor to children undergoing allogeneic marrow transplantation: a prospective, randomized, double-masked, placebo-controlled trial. *Pediatr Transplant* 2000;4(2):123-131.
349. Godder KT, Henslee-Downey PJ. Colony-stimulating factors in stem cell transplantation: effect on quality of life. *J Hematother Stem Cell Res* 2001;10(2):215-228.
350. Bishop MR, Tarantolo SR, Geller RB, et al. A randomized, double-blind trial of filgrastim (granulocyte colony-stimulating factor) versus placebo following allogeneic blood stem cell transplantation. *Blood* 2000;96(1):80-85.
351. Schwartzberg L, Birch R, Weaver C, et al. The effect of varying durations of granulocyte colony stimulation factor on neutrophil engraftment and supportive care following peripheral blood progenitor cell infusion. *Blood* 1994;84:91a.
352. Klumpp TR, Mangan KF, Goldberg SL, et al. Granulocyte colony-stimulating factor accelerates neutrophil engraftment following peripheral-blood stem-cell transplantation: a prospective, randomized trial. *J Clin Oncol* 1995;13(6):1323-1327.
353. Bennett CL, Armitage JL, Armitage GO, et al. Costs of care and outcomes for high-dose therapy and autologous transplantation for lymphoid malignancies: results from the University of Nebraska 1987 through 1991. *J Clin Oncol* 1995;13(4):969-973.
354. Saba HI. Myelodysplastic syndromes in the elderly: the role of growth factors in management. *Leuk Res* 1996;20:203-219.
355. Negrin RS, Haeuber DH, Nagler A, et al. Maintenance treatment of patients with myelodysplastic syndromes using recombinant human granulocyte colony-stimulating factor. *Blood* 1990;76:36-43.
356. Greenberg P, Taylor K, Larson R, et al. Phase III randomized multicenter trial of G-CSF vs. observation for myelodysplastic syndromes. *Proc Am Soc Hematol* 1993;82:196a.
357. Pettengell R, Crowther D. Haemopoietic growth factor and dose intensity in high-grade and intermediate-grade lymphoma. *Ann Oncol* 1994;5[Suppl 2]:133-141.
358. Philip T, Guglielmi C, Hagenbeek A, et al. Autologous bone marrow transplantation as compared with salvage chemotherapy in relapses of chemotherapy-sensitive non-Hodgkin's lymphoma. *N Engl J Med* 1995;333:1540-1545.
359. Attal M, Harsousseau JL, Stoppa AM, et al. High-dose therapy in multiple myeloma: final analysis of a prospective randomized study of the Intergrroupe Francais du Myelome (IFM90). *Blood* 1995;86:124a(abst).
360. Philip T, Guglielmi C, Hagenbeek A, et al. Autologous bone marrow transplantation as compared with salvage chemotherapy in relapses of chemotherapy-sensitive non-Hodgkin's lymphoma. *N Engl J Med* 1995;333:1540-1545.
361. Philip T, Chauvin F, Armitage J, et al. Parma international protocol: pilot study of DHAP followed by involved-field radiotherapy and BEAC with autologous bone marrow transplantation. *Blood* 1991;77:1587-1592.
362. Shipp MA, Neuberg D, Janicek M, et al. High-dose CHOP as initial therapy for patients with poor-prognosis aggressive non-Hodgkin's lymphoma: a dose-finding pilot study. *J Clin Oncol* 1995;13:2916-2923.
363. Lowenberg G, Suci S, Archimbaud E, et al. Use of recombinant granulocyte-macrophage colony-stimulating factor during and after remission induction chemotherapy in patients aged 61 years and older with acute myeloid leukemia (AML): final report of AML-11, a phase III randomized study of the Leukemia Cooperative Group of European Organization for the Research and Treatment of Cancer (EORTC-LCG) and the Dutch Belgian Hemato-Oncology Cooperative Group (HOVON). *Blood*

1997;90:2952-2961.

364. Zittoun R, Suci S, Mandelli F, et al. Granulocyte-macrophage colony-stimulating factor associated with induction treatment of acute myelogenous leukemia: a randomized trial by the European Organization for Research and Treatment of Cancer Leukemia Cooperative Group. *J Clin Oncol* 1996;14(7):2150-2159.

365. Ohno R, Naoe T, Kanamaru A, et al. A double-blind controlled study of granulocyte colony-stimulating factor started two days before induction chemotherapy in refractory acute myeloid leukemia. *Blood* 1994;83:2086-2092.

366. Bunn PA, Crowley J, Kelly K, et al. Chemoradiotherapy with or without granulocyte-macrophage colony-stimulating factor in the treatment of limited-stage small-cell lung cancer: a prospective phase III randomized study of the Southwest Oncology Group. *J Clin Oncol* 1995;13:1632-1641.

367. Meisenberg B, Brehm T, Schmeckel A, et al. A combination of low-dose cyclophosphamide and colony-stimulating factors is more cost-effective than granulocyte-colony-stimulating factors alone in mobilizing peripheral blood stem and progenitor cells. *Transfusion* 1998;38:209-215.

368. Weisdorf D, Miller J, Verfaillie C, et al. Cytokine-primed bone marrow stem cells vs. peripheral blood stem cells for autologous transplantation: a randomized comparison of GM-CSF vs. G-CSF. *Biol Blood Marrow Transplant* 1997;3:217-223.

369. Sharp JG, Kessinger A, Mann S, et al. Detection and clinical significance of minimal tumor cell contamination of peripheral blood stem cell harvests. *Int J Cell Cloning* 1992;10[Suppl 1]:92-94.

370. Craig JI, Langlands K, Parker AC, et al. Molecular detection of tumor contamination in peripheral blood stem cell harvests. *Exp Hematol* 1994;22:898-902.

371. Henon PR, Liang H, Beck-Wirth G, et al. Comparison of hematopoietic and immune recovery after autologous bone marrow or blood stem cell transplants. *Bone Marrow Transplant* 1992;9:285-291.

372. Talmadge JE, Reed E, Ino K, et al. Rapid immunologic reconstitution following transplantation with mobilized peripheral blood stem cells as compared to bone marrow. *Bone Marrow Transplant* 1997;19:161-172.

373. Schmitz N, Bacigalupo A, Hasenclever D, et al. Allogeneic bone marrow transplantation vs filgrastim-mobilized peripheral blood progenitor cell transplantation in patients with early leukaemia: first results of a randomized multicentre trial of the European Group for Blood and Marrow Transplantation. *Bone Marrow Transplant* 1998;21(10):995-1003.

374. De Silvestro G, Marson P, Cesaro S, et al. Legislative and ethical aspects of administering granulocyte colony-stimulating factor to normal donors. *Haematologica* 2002;87[Suppl 8]:28-34.

375. Lok S, Kaushansky K, Holly RD, et al. Cloning and expression of murine thrombopoietin cDNA and stimulation of platelet production *in vivo*. *Nature* 1994;369:565-568.

376. Kaye JA. The clinical development of recombinant human interleukin 11 (NEUMEGA rhIL-11 growth factor). *Stem Cells* 1996;14[Suppl 1]:256-260.

377. Schuster MW, Beveridge R, Frei-Lahr D, et al. The effects of pegylated recombinant human megakaryocyte growth and development factor (PEG-rHuMGDF) on platelet recovery in breast cancer patients undergoing autologous bone marrow transplantation. *Exp Hematol* 2002;30(9):1044-1050.

378. McDonald TP. Thrombopoietin. Its biology, clinical aspects, and possibilities. *Am J Pediatr Hematol Oncol* 1992;14(1):8-21.

379. Isaacs C, Robert NJ, Bailey FA, et al. Randomized placebo-controlled study of recombinant human interleukin-11 to prevent chemotherapy-induced thrombocytopenia in patients with breast cancer receiving dose-intensive cyclophosphamide and doxorubicin. *J Clin Oncol* 1997;15(11):3368-3377.

380. Beveridge RA, Miller JA. Impact of colony-stimulating factors on the practice of oncology. *Oncology* 1993;7:43-48.

381. Lieschke GJ, Cebon J, Morstyn G. Characterization of the clinical effects after the first dose of

bacterially synthesized recombinant human granulocyte-macrophage colony-stimulating factor. *Blood* 1989;74:2634-2643.

382. Crawford J, Lau D, Erwin R, et al. A phase I trial of recombinant methionyl human stem cell factor (SCF) in patients with advanced non-small cell lung carcinoma (NSCLC). *Clin Oncol* 1993;2:338a(abst).

383. Nemunaitis J, Shannon-Dorcy K, Appelbaum FR, et al. Long-term follow-up of patients with invasive fungal disease who received adjunctive therapy with recombinant human macrophage colony-stimulating factor. *Blood* 1993;82:1422-1427.

384. Reference deleted.

385. Reference deleted.

386. Reference deleted.

387. Reference deleted.

388. Reference deleted.

389. Reference deleted.

390. Reference deleted.

391. DeSpain JD. Dermatologic toxicity of chemotherapy. *Semin Oncol* 1992;19:501-507.

392. Phillips TL, Fu KF. Acute and late effects of multimodal therapy on normal tissues. *Cancer* 1977;40:489-494.

393. Margolin SG, Breneman JC, Denman DL, et al. Management of radiation-induced moist skin desquamation using hydrocolloid dressing. *Cancer Nurs* 1990;13:71-80.

394. Korossy KS, Hood AF. Methotrexate reactivation of sunburn reaction. *Arch Dermatol* 1981;117:310-311.

395. Lokich JJ, Moore C. Chemotherapy associated palmar-plantar erythrodysesthesia syndrome. *Ann Intern Med* 1984;101:798-800.

396. Oksenhendler E, Landais P, Cordonnier C, et al. Acral erythema and systemic toxicity related to CHA induction therapy. *Eur J Cancer Clin Oncol* 1989;25:1181-1185.

397. Baack BR, Burgdorf HC. Chemotherapy-induced acral erythema. *J Am Acad Dermatol* 1991;24:457-461.

398. Flynn TC, Harrist TJ, Murphy GF, et al. Neutrophilic eccrine hidradenitis: a distinctive rash associated with cytarabine therapy and acute leukemia. *J Am Acad Dermatol* 1984;11:584-590.

399. Beutner KR, Packman CH, Markowitch W. Neutrophilic eccrine hidradenitis associated with Hodgkin's disease and chemotherapy. *Arch Dermatol* 1986;122:809-811.

400. Hall VC, El-Azhary RA, Bouwuis S, et al. Dermatologic side effects of thalidomide in patients with multiple myeloma. *J Am Acad Dermatol* 2003;48(4):548-552.

401. Sonis ST. Oral complications of cancer therapy. In: De Vita VT, Hellman S, Rosenberg, eds. *Cancer* 1993.

402. Seto BG, Kim M, Wolinsky L, et al. Oral mucositis in patients undergoing bone marrow transplantation. *Oral Surg Oral Med Oral Pathol* 1985;60:493-497.

403. Carl W. Oral complications of local and systemic cancer treatment. *Curr Opin Oncol* 1995;7:320-324.

404. Epstein JB, Wong FLW. The efficacy of sucralfate suspension in the prevention of oral mucositis due



to radiation therapy. *Int J Radiat Oncol Biol Phys* 1994;28:693–698.

405. Osaki T, Ueta E, Yoneda K, et al. Prophylaxis of oral mucositis associated with chemoradiotherapy for oral carcinoma by azelastine hydrochloride (azelastine) with other antioxidants. *Head Neck* 1994;4:331–339.
406. Wadleigh RG, Redman RS, Graham ML, et al. Vitamin E in the treatment of chemotherapy-induced mucositis. *Am J Med* 1992;92:481–484.
407. Sonis ST, Linnquist L, Van Vugt A, et al. Prevention of chemotherapy-induced ulcerative mucositis by transforming growth factor beta 3. *Cancer Res* 1994;54:1135–1138.
408. Thieblemont C, Dumontet C, Saad H, et al. Amifostine reduces mucosal damage after high-dose melphalan conditioning and autologous peripheral blood progenitor cell transplantation for patients with multiple myeloma. *Bone Marrow Transplant* 2002;30(11):769–775.
409. Labar B, Mrcic M, Pavletic Z, et al. Prostaglandin E2 for prophylaxis of oral mucositis following BMT. *Bone Marrow Transplant* 1993;11:379–382.
410. Meloni G, Capria S, Proia A, et al. Ice pops to prevent melphalan-induced stomatitis. *Lancet* 1996;347:1691–1692.
411. Fillicko J, Lazarus HM, Flomenberg N. Mucosal injury in patients undergoing hematopoietic progenitor cell transplantation: new approaches to prophylaxis and treatment. *Bone Marrow Transplant* 2003;31(1):1–10.
412. Nicolaou N. Prevention and management of radiation toxicity. In: Pazdur R, Coia LR, Hoskins WJ, et al., eds. *Cancer management: a multidisciplinary approach. Medical, surgical, and radiation oncology*. Huntington, New York: PRR, 1996:655–687.
413. Bondi E, Baroni C, Prete A, et al. Local antimicrobial therapy of oral mucositis in pediatric patients undergoing bone marrow transplantation. *Oral Oncol* 1997;33:322–326.
414. Atkinson JC, Wu AS. Salivary gland dysfunction: causes, symptoms, treatment. *J Am Dent Assoc* 1994;125:409–416.
415. Cornett JWD, Aspelng RL, Mallegol D. A double-blind placebo controlled trial of loperamide in acute diarrhea. *J Drug Res* 1976;2:54–57.
416. Mennie AJ, Dalley V. Aspirin in radiation induced diarrhea. *Lancet* 1973;1:1131–1133.
417. Henriksson R, Franzen L, Littbrand B. Prevention and therapy of radiation-induced bowel discomfort. *Scand J Gastroenterol* 1992;191:7–11.
418. De Maria D, Falchi AM, Venturino P. Adjuvant radiotherapy of the pelvis with or without reduced glutathione: a randomized trial in patients operated on for endometrial cancer. *Tumor* 1992;78:374–376.
419. Cascinu S, Fedeli A, Luzi Fedili S, et al. Control of chemotherapy-induced diarrhea with octreotide. A randomized trial with placebo in patients receiving cisplatin. *Oncology* 1994;51:70–73.
420. Pro B, Lozano R, Ajani JA. Therapeutic response to octreotide in patients with refractory CPT-11 induced diarrhea. *Invest New Drugs* 2001;19(4):341–343
421. Ely P, Dunitz J, Rogosheske J, et al. Use of a somatostatin analogue octreotide acetate in the management of acute gastrointestinal graft-versus-host disease. *Am J Med* 1991;90:707–710.
422. Geller RB, Gilmore CE, Dix SP, et al. Randomized trial of loperamide versus dose escalation of octreotide acetate for chemotherapy-induced diarrhea in bone marrow transplant and leukemia patients. *Am J Hematol* 1995;50:167–172.
423. Ippoliti C, Champlin R, Bugazia N, et al. Use of octreotide in the symptomatic management of diarrhea induced by graft-versus-host disease in patients with hematologic malignancies. *J Clin Oncol*

1997;15:3350–3354.

424. Skinner R. Strategies to prevent nephrotoxicity of anticancer drugs. *Curr Opin Oncol* 1995;7:310–315.

425. Stillwell TJ, Benson RC. Cyclophosphamide-induced hemorrhagic cystitis. A review of 100 patients. *Cancer* 1988;61:451–457.

426. Elias AD, Eder JP, Shea T, et al. High-dose ifosfamide with mesna uroprotection: a phase I study. *J Clin Oncol* 1990;8(1):170–178.

427. Fukuoka M, Negoro S, Masuda N, et al. Placebo-controlled double-blind comparative study on the preventive efficacy of mesna against ifosfamide-induced urinary disorders. *J Cancer Res Clin Oncol* 1991;117(5):473–478.

428. Stewart DJ, Dulberg C, Molepu JM, et al. Factors affecting human autopsy kidney-cortex and kidney-medulla. *Cancer Chemother Pharmacol* 1994;34:14–22.

429. Verplanke AJW, Herber RFM, de Wit R, et al. Comparison of renal function parameters in the assessment of cis-platin induced nephrotoxicity. *Nephron* 1994;66:267–272.

430. Treskes M, van der Vijgh WJF. WR2721 as a modulator of cisplatin- and carboplatin-induced side effects in comparison with other chemoprotective agents: a molecular approach. *Cancer Chemother Pharmacol* 1993;33:93–106.

431. Pinzani V, Bressole F, Haug IJ, et al. Cisplatin-induced renal toxicity and toxicity-modulating strategies: a review. *Cancer Chemother Pharmacol* 1994;35:1–9.

432. Von Hoff D, Rozenzweig M, Layard M, et al. Daunomycin-induced cardiotoxicity in children and adults: a review of 110 cases. *Am J Med* 1977;62:200–208.

433. Schwartz C, Hobbie W, Truesdell S, et al. Corrected QT interval prolongation in anthracycline-treated survivors of childhood cancer. *J Clin Oncol* 1993;11:1906–1910.

434. Ali M, Ewer M, Gibbs H, et al. Late doxorubicin-associated cardiotoxicity in children. *Cancer* 1994;74:182–188.

435. Hochster H, Wasserheit C, Speyer J. Cardiotoxicity and cardioprotection during chemotherapy. *Curr Opin Oncol* 1995;7:304–309.

436. Swain SM, Whaley FS, Gerber MC, et al. Cardioprotection with dexrazoxane for doxorubicin-containing therapy in advanced breast cancer. *J Clin Oncol* 1997;15(4):1318–1332.

437. Speyer J, Green M, Kramer E, et al. Protective effect of the bispiperazine ICRF-187 against doxorubicin induced cardiac toxicity in women with advanced breast cancer. *N Engl J Med* 1988;319:745–752.

438. Hensley ML, Schuchter LM, Lindley C, et al. American Society of Clinical Oncology clinical practice guidelines for the use of chemotherapy and radiotherapy protectants. *J Clin Oncol* 1999;17(10):3333–3355.

439. Gottdeiner J, Appelbaum, Ferrans V, et al. Cardiotoxicity associated with high-dose cyclophosphamide therapy. *Arch Intern Med* 1981;141:758–763.

440. Lopez-Jimenez J, Cervero C, Munoz A, et al. Cardiovascular toxicities related to the infusion of cryopreserved grafts: results of a controlled study. *Bone Marrow Transplant* 1994;13:789–793.

441. Perry MC. Toxicity of chemotherapy. *Semin Oncol* 1992;19:453–609.

442. Gordon B, Haire W, Ruby E, et al. Factors predicting morbidity following hematopoietic stem cell transplantation. *Bone Marrow Transplant* 1997;19:497–501.

443. Bearman SI, Appelbaum FR, Buckner CD, et al. Regimen-related toxicity in patients undergoing bone

marrow transplantation. *J Clin Oncol* 1988;6:1562–1568.

444. Bearman SI. The syndrome of hepatic veno-occlusive disease after marrow transplantation. *Blood* 1995;85:3005–3019.

445. Bearman SI. Avoiding hepatic veno-occlusive disease: what do we know and where are we going? *Bone Marrow Transplantation* 2001;27:1113–1120.

446. Yoshimoto K, Ono N, Okamura T, et al. Recent progress in the diagnosis and therapy for veno-occlusive disease of the liver. *Leuk Lymphoma* 2003;44(2): 229–234.

447. Mortelet KJ, Van Vlierberghe H, Wiesner W, et al. Hepatic veno-occlusive disease: MRI findings. *Abdom Imaging* 2002;27(5):523–526.

448. Salat C, Holler E, Kolb H-J, et al. Plasminogen activator inhibitor-1 confirms the diagnosis of hepatic veno-occlusive disease in patients with hyperbilirubinemia after BMT. *Blood* 1997;89:2184–2188.

449. Park YD, Yoshioka A, Kawa K, et al. Impaired activity of plasma von Willebrand factor-cleaving protease may predict the occurrence of hepatic veno-occlusive disease after stem cell transplantation. *Bone Marrow Transplant* 2002;29(9):789–794.

450. Attal M, Huguet F, Rubie H, et al. Prevention of hepatic veno-occlusive disease after bone marrow transplantation by continuous infusion of low-dose heparin: a prospective, randomized trial. *Blood* 1992;79:2834–2840.

451. Richardson PG, Murakami C, Jin Z, et al. Multi-institutional use of defibrotide in 88 patients after stem cell transplantation with severe veno-occlusive disease and multisystem organ failure: response without significant toxicity in a high-risk population and factors predictive of outcome. *Blood* 2002;15;100(13):4337–4343.

452. Bearman SI, Lee JL, Baron AE, et al. Treatment of hepatic veno-occlusive disease with recombinant human tissue plasminogen activator and heparin in 42 marrow transplant patients. *Blood* 1997;5:1501–1506.

453. Azoulay D, Castaing D, Lemoine A, et al. Transjugular intrahepatic portosystemic shunt (TIPS) for severe veno-occlusive disease of the liver following bone marrow transplantation. *Bone Marrow Transplant* 2000;25(9):987–992.

454. Gruss E, Bernis C, Tomas JF, et al. Acute renal failure in patients following bone marrow transplantation: prevalence, risk factors and outcome. *Am J Nephrol* 1995;15(6):473–479.

455. Quabeck K. The lung as a critical organ in marrow transplantation. *Bone Marrow Transplant* 1994;14:S19–S28.

456. Bearman SI, Anderson GL, Mori M, et al. Venooocclusive disease of the liver: development of a model for predicting fatal outcome after marrow transplantation. *J Clin Oncol* 1993;11:1729–1736.

457. Weiner RS, Bortin MM, Gale RP, et al. Interstitial pneumonitis after bone marrow transplantation. *Ann Intern Med* 1986;104:168–175.

458. Shankar G, Cohen DA. Idiopathic pneumonia syndrome after bone marrow transplantation: the role of pre-transplant radiation conditioning and local cytokine dysregulation in promoting lung inflammation and fibrosis. *Int J Exp Pathol* 2001;82(2):101–113.

459. Holler E, Kolb HJ, Hintermeier-Knabe R, et al. Role of tumor necrosis factor-alpha in acute GVHD and complications following allogeneic bone marrow transplantation. *Transplant Proc* 1993;25:1234–1236.

460. Milburn HJ, Du Bois RM, Prentice HG, et al. Pneumonitis in bone marrow transplant recipients results from a local immune response. *Clin Exp Immunol* 1990;81:232–237.

461. Piguet PF, Grau GE, Callart MA, et al. Pneumopathies of the graft-vs-host reaction. Alveolitis associated with an increased level of tumor necrosis factor mRNA and chronic interstitial pneumonitis. *Lab Invest* 1989;61:37–45.

462. Parkman R. Reducing cytokine-associated complications of marrow transplantation. *Transplant Rev*

1993-1994;3:142-143.

463. Ho VT, Weller E, Lee SJ, et al. Prognostic factors for early severe pulmonary complications after hematopoietic stem cell transplantation. *Biol Blood Marrow Transplant* 2001;7(4):223-229.

464. Afessa B, Tefferi A, Litzow MR, et al. Outcome of diffuse alveolar hemorrhage in hematopoietic stem cell transplant recipients. *Am J Respir Crit Care Med* 2002;166(10):1364-1368.

465. Raptis A, Mavroudis D, Suffredini A, et al. High-dose corticosteroid therapy for diffuse alveolar hemorrhage in allogeneic bone marrow stem cell transplant recipients. *Bone Marrow Transplant* 1999;24(8):879-883.

466. Morran C, Smith DC, Anderson DA, et al. Incidence of nausea and vomiting with cytotoxic chemotherapy: a prospective randomized trial of antiemetics. *BMJ* 1979;1:1323-1324.

467. Richardson JL, Marks G, Levine A. The influence of symptoms of disease and side effects of treatment on compliance with cancer therapy. *J Clin Oncol* 1988;6:1746-1752.

468. Borison HL, Wang SC. Physiology and pharmacology of vomiting. *Pharmacol Rev* 1953;5:193-230.

469. Borison HL, McCarthy LE. Neuropharmacology of chemotherapy-induced emesis. *Drugs* 1983;25[Suppl]:8-17.

470. Carpenter DO. Neural mechanisms of emesis. *Can J Physiol Pharmacol* 1990;68:230-236.

471. Ettinger D. Preventing chemotherapy-induced nausea and vomiting: an update and a review of emesis. *Semin Oncol* 1995;22:6-18.

472. Diemunsch P, Grelot L. Potential of substance P antagonists as antiemetics. *Drugs* 2000;60(3):533-546.

473. Grunberg SM, Hesketh PJ. Control of chemotherapy-induced emesis. *N Engl J Med* 1993;329:1790-1796.

474. Golembiewski JA, O'Brien D. A systematic approach to the management of postoperative nausea and vomiting. *J Perianesth Nurs* 2002;17(6):364-376.

475. Kobrinsky NL. Regulation of nausea and vomiting in cancer chemotherapy: a review with emphasis on opiate mediators. *Am J Pediatr Hematol Oncol* 1988;10:209-213.

476. Stefanini E, Clement-Cormier Y. Detection of dopamine receptors in the area postrema. *Eur J Pharmacol* 1981;74:257-260.

477. Fozard JR. Neuronal 5-HT<sub>3</sub> receptors in the periphery. *Neuropharmacology* 1984;23:1473-1486.

478. Siegel LJ, Longo DL. The control of chemotherapy-induced emesis. *Ann Intern Med* 1981;95:352-359.

479. Maranzano E. Radiation-induced emesis: a problem with many open questions. *Tumori* 2001;87(4):213-218.

480. Pollera CF, Ginnarelli D. Prognostic factors influencing cisplatin-induced emesis: definition and validation of a predictive logistic model. *Cancer* 1989;64:1117-1122.

481. Gralla RJ, Tyson LB, Kris MG, et al. The management of chemotherapy-induced nausea and vomiting. *Med Clin North Am* 1987;71:289-301.

482. Sullivan JR, Leyden MJ, Bell R. Decreased cisplatin-induced nausea and vomiting with chronic alcohol ingestion [Letter]. *N Engl J Med* 1982;309:796.

483. Kris MG, Gralla RJ, Clark RA, et al. Incidence, course and severity of delayed nausea and vomiting following the administration of high-dose cisplatin. *J Clin Oncol* 1985;3:1379-1384.

484. Morrow GR. The effect of a susceptibility to motion sickness on the side effects of cancer chemotherapy. *Cancer* 1985;55:2766–2770.
485. Morrow GR. Clinical characteristics associated with the development of anticipatory nausea and vomiting in cancer patients undergoing chemotherapy treatment. *J Clin Oncol* 1984;2:1170–1176.
486. Mertens WC, Higby DJ, Brown D, et al. Improving the care of patients with regard to chemotherapy-induced nausea and emesis: the effect of feedback to clinicians on adherence to antiemetic prescribing guidelines. *J Clin Oncol* 2003;21(7):1373–1378.
487. Allan SG, Cornbleet MA, Warrington PS, et al. Dexamethasone and high dose metoclopramide: efficacy in controlling cisplatin induced nausea and vomiting. *BMJ* 1984;289:878–879.
488. Hesketh PJ, Gandara DR. Serotonin antagonists: a new class of antiemetic agents. *J Natl Cancer Inst* 1991;83:613–620.
489. Morrow GR, Hickok JT, Rosenthal SN. Progress in reducing nausea and emesis. Comparisons of ondansetron (Zofran), granisetron (Kytril), and tropisetron (Navoban). *Cancer* 1995;746:343–357.
490. Bonnetierre J, Chevallier B, Metz R, et al. A randomized double-blind comparison of ondansetron and metoclopramide in the prophylaxis of emesis induced by cyclophosphamide, fluorouracil, and doxorubicin or epirubicin chemotherapy. *J Clin Oncol* 1990;8:1063–1069.
491. Smith DB, Newlands ES, Rustin GJS, et al. Comparison of ondansetron and ondansetron plus dexamethasone as antiemetic prophylaxis during cisplatin-containing chemotherapy. *Lancet* 1991;338:487–490.
492. Grunberg SM, Stevenson LL, Russell CA, et al. Dose ranging phase I study of the serotonin antagonist GR 38032F for prevention of cisplatin-induced nausea and vomiting. *J Clin Oncol* 1989;7:1137–1141.
493. Bleiberg HH, Spielmann M, Falkson G, et al. Antiemetic treatment with oral granisetron in patients receiving moderately emetogenic chemotherapy: a dose-ranging study. *Clin Ther* 1995;17:38–51.
494. Latrielle J, Stewart D, Laberge F, et al. Dexamethasone (DEX) improves the efficacy of granisetron (GRAN) in the first 24 hours following high-dose cisplatin (HDGP) chemotherapy. *Proc Am Soc Clin Oncol* 1993;12:132(abst).
495. Noble A, Bremer K, Goedhals L, et al. A double-blind, randomized crossover comparison of granisetron and ondansetron in 5-day fractionated chemotherapy: assessment of efficacy, safety and patient preference. *Eur J Cancer* 1994;3A:1083–1088.
496. Chawla SP, Grunberg SM, Gralla RJ, et al. Establishing the dose of the oral NK1 antagonist aprepitant for the prevention of chemotherapy-induced nausea and vomiting. *Cancer* 2003;97(9):2290–2300.
497. Gralla RJ, Osoba D, Kris MG, et al. Recommendations for the use of antiemetics: evidence-based, clinical practice guidelines. American Society of Clinical Oncology. *J Clin Oncol* 1999;17:2971–2994.
498. Paz BI. Long-term venous access. In: Pazdur R, Coia LR, Hoskins WJ, et al., eds. *Cancer management: a multidisciplinary approach. Medical, Surgical, and Radiation Oncology*. Huntington, New York: PRR, 1996:762–771.
499. Mueller BU, Skelton J, Callender DP, et al. A prospective randomized trial comparing the infectious and noninfectious complications of an externalized catheter versus a subcutaneously implanted device in cancer patients. *J Clin Oncol* 1992;10:1943–1948.
500. Groeger JS, Lucas AB, Thaler HT, et al. Infectious morbidity associated with long-term use of venous access devices in patients with cancer. *Ann Intern Med* 1993;119:1168–1174.
501. O’Grady NP, Alexander M, Dellinger EP, et al. Guidelines for the prevention of intravascular catheter-related infections. The Hospital Infection Control Practices Advisory Committee, Centers for Disease Control and Prevention. *Pediatrics* 2002;110(5):e51.

502. Henrickson KJ, Axtell RA, Hoover SM, et al. Prevention of central venous catheter-related infections and thrombotic events in immunocompromised children by the use of vancomycin/ciprofloxacin/heparin flush solution: a randomized, multicenter, double-blind trial. *J Clin Oncol* 2000;18(6):1269-1278.
503. Howell PB, Walters PE, Donowitz GR, et al. Risk factors for infection of adult patients with cancer who have tunneled central venous catheters. *Cancer* 1995;75:1367-1375.
504. Lokich JJ, Bothe A Jr, Benotti P, et al. Complications and management of implanted venous access catheters. *J Clin Oncol* 1985;3:710-717.
505. Klotz S. *Malassezia furfur*. *Infect Dis Clin North Am* 1988;85:203-206.
506. Shen V, Li X, Murdock M, et al. Recombinant tissue plasminogen activator (alteplase) for restoration of function to occluded central venous catheters in pediatric patients. *J Pediatr Hematol Oncol* 2003;25(1):38-45.
507. Bern MM, Likich JJ, Wallach SR, et al. Very low doses of warfarin can prevent thrombosis in central venous catheters. A randomized prospective trial. *Ann Intern Med* 1990;112:423-428.
508. Ray CE Jr, Shenoy SS, McCarthy PL, et al. Weekly prophylactic urokinase instillation in tunneled central venous access devices. *J Vasc Interv Radiol* 1999;10(10):1330-1334.
509. Bertelli G. Prevention and management of extravasation of cytotoxic drugs. *Drug Saf* 1995;12:245-255.
510. Olver IN, Aisner J, Hament A, et al. A prospective study of topical dimethyl sulfoxide for treating anthracycline extravasation. *J Clin Oncol* 1988;6:1732-1735.
511. Bertelli G, Gozza A, Forno GB, et al. Topical dimethylsulfoxide for the prevention of soft tissue injury after extravasation of vesicant cytotoxic drugs: a prospective clinical study. *J Clin Oncol* 1995;13:2851-2855.
512. Levy MH. Pharmacologic management of cancer pain. *Semin Oncol* 1994;21:718-739.
513. Portenoy RK. Adjuvant analgesic agents. *Hematol Oncol Clin North Am* 1996;10:103-120.
514. Loscalzo M. Psychological approaches to the management of pain in patients with advanced cancer. *Hematol Oncol Clin North Am* 1996;10:139-156.
515. Ripamonti C, Bruera E. Pain and symptom management in palliative care. *Cancer Control* 1996;3:204-213.
516. Caraceni A. Clinicopathologic correlates of common cancer pain syndromes. *Hematol Oncol Clin North Am* 1996;10:57-78.
517. von Roenn JH, Cleeland CS, Gonin R, et al. Physician attitudes and practice in cancer pain management: a survey from the Eastern Cooperative Oncology Group. *Ann Intern Med* 1993;119:121-126.
518. Ward SE, Goldberg SN, Miller-McCauley V, et al. Patient-related barriers to management of cancer pain. *Pain* 1993;52:319-324.
519. Rimer BK, Kedziera P, Levy MH. The role of patient education in cancer pain control. *Hosp J* 1992;8:171-191.
520. Porter J, Jick H. Addiction rare in patients treated with narcotics. *N Engl J Med* 1980;302:123.
521. Levy MH. Pharmacologic treatment of cancer pain. *N Engl J Med* 1996;335:1224-1232.
522. Cleeland CS. Assessment of pain in cancer. In: Foly KM, Bonica JJ, Ventafridda V, eds. *Advances in pain research and therapy*, Vol 6. New York: Raven Press, 1990:47-55.
523. Fishman B, Pasternak S, Wallenstein SL, et al. The Memorial Pain Assessment Card: a valid

instrument for the evaluation of cancer pain. *Cancer* 1987;60:1151–1158.

524. Dalton JA, Youngblood R. Clinical application of the World Health Organization analgesic ladder. *J Intraven Nurs* 2000;23:118–124.

525. Bruera E, MacMillan K, Hanson J, et al. The Edmonton staging system for cancer pain: preliminary report. *Pain* 1989;37:203–209.

526. McGrath PA. Development of the World Health Organization guidelines on cancer pain relief and palliative care in children. *J Pain Symptom Manage* 1996;12:87–92.

527. Cancer pain relief and palliative care: report of a WHO expert committee. WHO Technical Report Series. Geneva Afr 1990;804:1–73.

528. Zech DF, Grond S, Lynch J, et al. Validation of World Health Organization guidelines for cancer pain relief: a 10-year prospective study. *Pain* 1995;64: 65–76.

529. Cherny NI, Portenoy RK. The management of cancer pain. *CA Cancer J Clin* 1994;44:263–303.

530. Deviere J. Do selective cyclo-oxygenase inhibitors eliminate the adverse events associated with nonsteroidal anti-inflammatory drug therapy? *Eur J Gastroenterol Hepatol* 2002;14[Suppl 1]:S29–S33.

531. Jacox A, Carr DB, Payne R, et al. Management of cancer pain: clinical practice guideline. No. 9. Rockville, MD: Agency for Health Care Policy and Research, 1994. (AHCPR publication no. 94–0592).

532. Wilder-Smith CH, Schimke J, Osterwalder B, et al. Oral tramadol, a mu-opioid agonist and monoamine reuptake-blocker, and morphine for strong cancer-related pain. *Ann Oncol* 1994;5:141–146.

533. de Stoutz ND, Bruera E, Suarez-Almazor M. Opioid rotation for toxicity reduction in terminal cancer patients. *J Pain Symptom Manage* 1995;10:378–384.

534. Fine PG, Marcus M, De Boer AJ, et al. An open label study of oral transmucosal fentanyl citrate (OTFC) for the treatment of breakthrough cancer pain. *Pain* 1991;45:149–153.

535. Payne R. Transdermal fentanyl: suggested recommendations for clinical use. *J Pain Symptom Manage* 1992;7[Suppl]:S40–S44.

536. Portenoy RK, Hagan NA. Breakthrough pain: definition, prevalence, and characteristics. *Pain* 1990;41:273–282.

537. Twycross R. Pain relief in advanced cancer. London: Churchill Livingstone, 1994.

538. Bradberry JC, Raebel MA. Continuous infusion of naloxone in the treatment of narcotic overdose. *Drug Intell Clin Pharm* 1981;15:945–950.

539. Bruera E, Brenneis C, Paterson AH, et al. Use of methylphenidate as an adjuvant to narcotic analgesics in patients with advanced cancer. *J Pain Symptom Manage* 1989;4:3–6.

540. Sawynok J, Yaksh TL. Caffeine as an analgesic adjuvant: a review of pharmacology and mechanisms of action. *Pharmacol Rev* 1993;45:43–85.

541. Fainsinger RL, Bruera E. When to treat dehydration in a terminally ill patient? *Support Care Cancer* 1997;5:205–211.

542. Cherny NI, Arbit E, Jain S. Invasive techniques in the management of cancer pain. *Hematol Oncol Clin North Am* 1996;10:121–138.

543. Bruera E, Roca E, Cedaro L, et al. Action of oral methylprednisolone in terminal cancer patients: a prospective randomized double-blind study. *Cancer Treat Rep* 1985;69:751–754.

544. Della Cuna GR, Pellegrini A, Piazzini M. Effect of methylprednisolone sodium succinate on quality of life in preterminal cancer patients: a placebo-controlled, multicenter study. *Eur J Cancer Clin Oncol*



1989;25:1817-1821.

545. Derogatis LR, Kourlesis SM. An approach to evaluation of sexual problems in the cancer patient. *CA Cancer J Clin* 1981;31:46-50.

546. Singhal S, Powles R, Treleaven J, et al. Melphalan alone prior to allogeneic bone marrow transplantation from HLA-identical sibling donors for hematologic malignancies: allo-engraftment with potential preservation of fertility in women. *Bone Marrow Transplant* 1996;18:1049-1055.

547. Chatterjee R, Goldstone AH. Gonadal damage and effects on fertility in adult patients with haematological malignancy undergoing stem cell transplantation. *Bone Marrow Transplant* 1996;17:5-11.

548. Apperley JF, Reddy N. Mechanism and management of treatment-related gonadal failure in recipients of high dose chemoradiotherapy. *Blood Rev* 1995;9:93-116.

549. Aisner J, Wiernik PH, Pearl P. Pregnancy outcome in patients treated for Hodgkin's disease. *J Clin Oncol* 1993;11:507-512.

550. Clark ST, Radford JA, Crowther D, et al. Gonadal function following chemotherapy for Hodgkin's disease: a comparative study of MVPP and a seven-drug hybrid regimen. *J Clin Oncol* 1995;13:134-139.

551. Sanders JE, The Seattle Marrow Transplant Team. The impact of marrow transplant preparative regimens on subsequent growth and development. *Semin Hematol* 1991;28:244-249.

552. Siimes MA, Lie SO, Andersen O, et al. Prophylactic cranial irradiation increases the risk of testicular damage in adult males surviving ALL in childhood. *Med Pediatr Oncol* 1993;21:117-121.

553. Sanders JE, Hawley J, Levy W, et al. Pregnancies following high-dose cyclophosphamide with or without high-dose busulfan or total-body irradiation and bone marrow transplantation. *Blood* 1996;87:3045-3052.

554. Milligan DW, Hughes R, Lindsay KS. Semen cryopreservation in men undergoing cancer chemotherapy: a UK survey. *Br J Cancer* 1989;60:966-967.

555. Young-McCaughan S. Sexual functioning in women with breast cancer after treatment with adjuvant therapy. *Cancer Nurs* 1996;19:308-319.

556. Smith DB. Sexual rehabilitation of the cancer patient. *Cancer Nurs* 1989;12:10-15.

557. Smith DB, Babaian RJ. The effects of treatment for cancer on male fertility and sexuality. *Cancer Nurs* 1992;15:271-275.

558. Koepfel KM. Sperm banking and patients with cancer: issues concerning patients and healthcare professionals. *Cancer Nurs* 1995;18:306-312.

559. Rhodes EA, Hoffman DJ, Kaempfer SH. Ten years of experience with semen cryopreservation by cancer patients: follow-up and clinical considerations. *Fertil Steril* 1985;44:512-516.

560. Shekarriz M, Tolentino MV, Ayzman I, et al. Cryopreservation and semen quality in patients with Hodgkin's disease. *Cancer* 1995;76:2732-2736.

561. Sanger WG, Olson JH, Sherman JK. Semen cryobanking for men with cancer—criteria change. *Fertil Steril* 1992;58:1024-1027.

562. Tournaye H, Camus M, Bollen N, et al. *In vitro* fertilization techniques with frozen-thawed sperm: a method for preserving the progenerative potential of Hodgkin's patients. *Fertil Steril* 1991;55:443-445.

563. Kaempfer SH, Hoffman DJ, Wiley FM. Sperm banking: a reproductive option in cancer therapy. *Cancer Nurs* 1983;6:31-38.

564. Lipton JH, Virro M, Solow H. Successful pregnancy after allogeneic bone marrow transplant with embryos isolated before transplant. *J Clin Oncol* 1997;15:3347-3349.

565. Rohatiner A, Lister TA. The general management of the patient with leukemia. In: Henderson ES, Lister TA, Greaves MF, eds. *Leukemia*, 6th ed. Philadelphia: WB Saunders, 1996:247–255.
566. Caplan SN, Coco FV, Berkman EM. Management of chronic myelocytic leukemia in pregnancy by cell pheresis. *Transfusion* 1978;18:120–124.
567. Doll DC, Ringenberg QS, Yarbrow JW. Management of cancer during pregnancy. *Arch Intern Med* 1988;148:2058–2064.
568. Wallack MK, Wolf JA Jr, Bedwinek J, et al. Gestational carcinoma of the female breast. *Curr Probl Cancer* 1983;7:1–58.
569. Woo SY, Fuller LM, Cundiff JH, et al. Radiotherapy during pregnancy for clinical stages IA–IIA Hodgkin's disease. *Int J Radiat Oncol Biol Phys* 1992;23:407–412.
570. Hinds C. Suffering: a relatively unexplored phenomenon among family caregivers of noninstitutionalized patients with cancer. *J Adv Nurs* 1992;17:918–925.
571. Bascom PB, Tolle SW. Care of the family when the patient is dying. *West J Med* 1995;163:292–296.
572. Jacobsen PB, Breitbart W. Psychosocial aspects of palliative care. *Cancer Control* 1996;3:214–222.
573. Massie MJ, Holland JC. Depression and the cancer patient. *J Clin Psychiatry* 1990;51:12–17.
574. Spiegel D. Effects of psychosocial support on patients with metastatic breast cancer. *Psycho Oncology* 1992;10:113–120.
575. Clark RL. Psychologic reactions of patients and health care professionals to cancer. *Cancer: The behavioral dimensions*. In: Cullen JW, ed. New York: Raven, 1976:1–10.
576. Derogatis LR, Morrow GR, Fetting J, et al. The prevalence of psychiatric disorders among cancer patients. *JAMA* 1983;249:751–759.
577. Lesko M. Bone marrow transplantation: support of the patient and his/her family. *Support Care Cancer* 1994;2:35–49.
578. Cull A, Stewart M, Altman DG. Assessment of and intervention for psychosocial problems in routine oncology practice. *Br J Cancer* 1995;72:229–235.
579. Roth AJ, Breitbart W. Psychiatric emergencies in terminally ill cancer patients. *Hematol Oncol Clin North Am* 1996;10:235–259.
580. Breitbart W, Bruera E, Chochinov H, et al. Neuropsychiatric and psychological symptoms in patients with advanced cancer. *J Pain Symptom Manage* 1995;10:131–141.
581. Tung TM. Death, dying and hospice: an Asian–American view. *Am J Hospice Palliat Care* 1990;23–26.
582. Rhymes JA. Barriers to palliative care. *Cancer Control* 1996;3:230–235.
583. Blumenfeld M, Levy NB, Kaufman D. Do patients want to be told? [Letter] *N Engl J Med* 1978;299:1138.
584. Girgis A, Sansonfisher RW. Breaking bad news: consensus guidelines for medical practitioners. *J Clin Oncol* 1995;13:2449–2456.
585. Speck PW. Spiritual issues in palliative care. In: Doyle D, Hanks GW, MacDonald N, eds. *Oxford textbook of palliative medicine*. New York: Oxford University Press, 1993:517–525.
586. Cohen RS, Mount BM, Tomas JJN, et al. Existential well-being is an important determinant of quality of life: evidence from the McGill Quality of Life Questionnaire. *Cancer* 1996;77:576–586.

587. Leonard RC, Gregor A, Coleman RE, et al. Strategy needed for adolescent patients with cancer [Letter]. *BMJ* 1995;311:387.
588. Yellen SB, Cella DF. Social well-being, parenthood status, and decision-making in oncology. *J Clin Oncol* 1995;13:1255-1264.
589. Klagsbrun SC. Cancer, emotions, and nurses. *Am J Psychiatry* 1970;126:1237-1244.
590. Warr D, Feld R. The role of supportive care in quality of life. *Curr Opin Oncol* 1996;8:279-283.
591. Cox DM, Sachs GA. Advance directives and the patient self-determination act. *Clin Geriatr Med* 1994;10:431-443.
592. Blumer BJ, Stine CL. Advance directives for health care. *Minn Med* 1994;77:25-28.
593. Singer PA, Siegler M. Advancing the cause of advance directives. *Arch Intern Med* 1992;152:22-24.
594. Gillick MR. A broader role for advance medical planning. *Ann Intern Med* 1995;123:621-624.
595. Wenger NS, Halpern J. The physicians role in completing advance directives: ensuring patients capacity to make health care decisions in advance. *J Clin Ethics* 1994;5:320-323.
596. Cassell CK. Case commentary. *Hosp Pract* 1996;31:89-90.
597. SUPPORT principal investigators. A controlled trial to improve care for seriously ill hospitalized patients: the study to understand prognoses and preferences for outcomes and risks of treatment (SUPPORT). *JAMA* 1995;274:1591-1598.
598. Oken D. What to tell cancer patients: a study of medical attitudes. *JAMA* 1961;175:1120-1128.
599. Novack DH, Plumer R, Smith L, et al. Changes in physicians toward telling the cancer patient. *JAMA* 1979;249:897-900.
600. Foley KM. Competent care of the dying patient instead of physician-assisted suicide. *N Engl J Med* 1997;336:54-58.
601. Gelder MS. Life and death decisions in the intensive care unit. *Cancer* 1995;76:2171-2175.
602. Doyle D, Hans G, Macdonald N, eds. *Oxford textbook of palliative medicine*. New York: Oxford Medical, 1993.
603. Ganzini L, Lee MA, Heintz RT, et al. The effect of depression treatment on elderly patients preferences for life-sustaining medical therapy. *Am J Psychiatry* 1994;151:1631-1636.
604. McIntyre KM. Implementation of advance directives. For physicians, a legal dilemma becomes an ethical imperative. *Arch Intern Med* 1992;152: 925-929.
605. Solomon MZ, O'Donnell L, Jennings B, et al. Decisions near the end of life: professional views on life sustaining treatments. *Am J Public Health* 1993;83:14-23.
606. Rubenfeld GD, Crawford SW. Withdrawing life support from mechanically ventilated recipients of bone marrow transplants: a case for evidence-based guidelines. *Ann Intern Med* 1996;125:625-633.
607. Marshall JC, Nathens AB. Multiorgan dysfunction syndrome. In: Wilmore DW, Cherung LY, Harken AH, et al., eds. *Scientific American Surgery. II*. New York: Scientific American, 1996:1-22.
608. Brody H, Campbell ML, Faber-Langendoen K, et al. Withdrawing intensive life-sustaining treatment: recommendations for compassionate clinical management. *N Engl J Med* 1997;336:652-657.
609. Walsh D. Palliative care: management of the patient with advanced cancer. *Semin Oncol*

1994;21[Suppl 7]:100-106.

610. Lobato-Mendizabal E, Lopez-Martinez B, Ruiz-Arguelles GJ. A critical review of the prognostic value of the nutritional status at diagnosis in the outcome of therapy of children with acute lymphoblastic leukemia. *Rev Invest Clin* 2003;55(1):31-35.

611. Holmes S, Dickerson JW. Malignant disease: nutritional implications of disease and treatment. *Cancer Metastasis Rev* 1987;6:357-381.

612. Parnes HL, Aisner J. Protein calorie malnutrition and cancer therapy. *Drug Saf* 1992;7(6):404-416.

613. Lerebours E, Tilly H, Rimbert A, et al. Change in energy and protein status during chemotherapy in patients with acute leukemia. *Cancer* 1988;61:2412-2417.

614. Delarue J, Lerebours E, Tilly H, et al. Effect of chemotherapy on resting energy expenditure in patients with non-Hodgkin's lymphoma. Results of a sequential study. *Cancer* 1990;65(11):2455-2459.

615. Chamouard Cogoluenhes V, Chambrier C, Michallet M, et al. Energy expenditure during allogeneic and autologous bone marrow transplantation. *Clin Nutr* 1998;17(6):253-257.

616. McGeer AJ, Detsky AS, O'Rourke K. Parenteral nutrition in cancer patients undergoing chemotherapy: a meta-analysis. *Nutrition* 1990;6:233-240.

617. Charuhas PM, Aker SN. Nutritional implications of antineoplastic chemotherapeutic agents. *J Appl Nutr* 1992;2:20-33.

618. Rubin H. Cancer cachexia: its correlations and causes. *Proc Natl Acad Sci U S A* 2003;100:5384-5389.

619. DeWys WD, Begg C, Lavin PT, et al. Prognostic effect of weight loss prior to chemotherapy in cancer patients. *Am J Med* 1980;69:491-497.

620. Reynolds JV, Shou JA, Sigal R, et al. The influence of protein malnutrition on T cell, natural killer cell, and lymphokine-activated killer cell function, and on biological responsiveness to high-dose interleukin-2. *Cell Immunol* 1990;128:569-577.

621. Deitch EA, Ma WJ, Ma L, et al. Protein malnutrition predisposes to inflammation-induced gut-origin septic states. *Ann Surg* 1990;211:560-567.

622. Chandra RK, Kumari S. Nutrition and immunity: an overview. *J Nutr* 1994;124[Suppl 8]:1433S-1435S.

623. Reynolds JV, O'Farrelly C, Feighery C, et al. Impaired gut barrier function in malnourished patients. *Br J Surg* 1996;83(9):1288-1291.

624. Muscaritoli M, Conversano L, Cangiano C, et al. Biochemical indices may not accurately reflect changes in nutritional status after allogeneic bone marrow transplantation. *Nutrition* 1995;11:433-436.

625. Zakko W, Van Dam J. Techniques for nutritional assessment. Tips for designing an effective enteral feeding regimen. *J Crit Illn* 1996;11:405-412.

626. Mauer AM, Burgess JB, Donaldson SS, et al. Special nutritional needs of children with malignancies: a review. *J Parenter Enteral Nutr* 1990;14:315-324.

627. Wells RJ, Foster MB, D'Ercole AJ, et al. The impact of cranial irradiation on the growth of children with acute lymphocytic leukemia. *Am J Dis Child* 1983;137:37-39.

628. Wingard JR, Plotnick LP, Freemer CS, et al. Growth in children after bone marrow transplantation: busulfan plus cyclophosphamide versus cyclophosphamide plus total body irradiation. *Blood* 1992;79:1068-1073.

629. Frankmann CB. Nutritional care in neoplastic disease. In: Mehan LK, Escott-Stump S, eds. *Krauses food, nutrition and diet therapy*, 9th ed. Philadelphia: WB Saunders, 1996:805-827.

630. Mulder POM, Bouman JG, Gietema JA, et al. Hyperalimentation in autologous bone marrow transplantation for solid tumors. Comparison of total parenteral versus partial parenteral plus enteral nutrition. *Cancer* 1989;64:2045-2052.
631. Szeluga DJ, Stuart RK, Brookmeyer R, et al. Nutritional support of bone marrow transplant recipients: a prospective randomized clinical trial comparing total parenteral nutrition to an enteral feeding program. *Cancer Res* 1987;47:3309-3316.
632. Anderton A. Microbiological aspects of the preparation and administration of naso-gastric and naso-enteric tube feeds in hospitals: a review. *Hum Nutr Appl Nutr* 1983;37A:426-440.
633. Fagerman KE, Paauw JD, McCamish MA, et al. Effects of time, temperature and preservation on bacterial growth in enteral nutrient solutions. *Am J Hosp Pharm* 1984;41:1122-1126.
634. Rickard KA, Grosfeld JL, Kirksey A, et al. Reversal of protein-energy malnutrition in children during treatment of neoplastic disease. *Ann Surg* 1979;190:771-781.
635. Weisdorf SA, Lysne J, Wlind D, et al. Positive effect of prophylactic total parenteral nutrition on long-term outcome of bone marrow transplantation. *Transplantation* 1987;43:833-838.
636. Weisdorf S, Hofland C, Sharp HL. Total parenteral nutrition in bone marrow transplantation: a clinical evaluation. *J Pediatr Gastroenterol Nutr* 1994;3:95-100.
637. Hays DM, Merritt RJ, White L, et al. Effect of total parenteral nutrition on marrow recovery during induction therapy for acute nonlymphocytic leukemia in childhood. *Med Pediatr Oncol* 1983;11:134-140.
638. Lenssen P, Spencer GD, McDonald GB. A randomized trial of FreAmine versus HepatAmine versus placebo in acute hepatic coma. *Gastroenterology* 1987;92:1749.
639. Brennan MF, Cerra F, Daly J, et al. Report of a research workshop: branched chain amino acids in stress and injury. *JPEN J Parenter Enter Nutr* 1986;10:446-452.
640. Lenssen P, Cheney CL, Aker SN, et al. Intravenous branched chain amino acid trial in marrow transplant recipients. *JPEN J Parenter Enter Nutr* 1987;11:112-118.
641. Desai RK, Maliakkal J, Kinzie JL, et al. Taurine deficiency after intensive chemotherapy and/or radiation. *Am J Clin Nutr* 1992;55:708-711.
642. Ziegler TR, Young LS, Benfell K, et al. Clinical and metabolic efficacy of glutamine-supplemented parenteral nutrition after bone marrow transplantation. A randomized double-blind controlled study. *Ann Intern Med* 1992;116:821-828.
643. Skeie B, Ashkanazi J, Rothkopf MM, et al. Intravenous fat emulsions and lung function; a review. *Crit Care Med* 1988;16:183-194.
644. Lenssen P, Bruemmer B, Aker S, et al. Relationship between IV lipid dose and incidence of bacteremia and fungemia in 492 marrow transplant patients. *JPEN J Parenter Enter Nutr* 1994;18:225.
645. Shulman HM, Hinterberger W. Hepatic venoocclusive disease: liver toxicity syndrome after bone marrow transplantation. *Bone Marrow Transplant* 1992;10:197-214.
646. Gleghorn EE, Eisenberg LD, Hack S, et al. Observations of vitamin A toxicity in three patients with renal failure receiving parenteral alimentation. *Am J Clin Nutr* 1986;44:107-112.
647. Druml W, Fischer M, Sertl S, et al. Fat elimination in acute renal failure: long-chain versus medium chain triglycerides. *Am J Clin Nutr* 1992;55:468-472.
648. McDonald GB, Shulman HM, Sullivan KM, et al. Intestinal and hepatic complications of human bone marrow transplantation. I. *Gastroenterology* 1986;90:460-477.
649. McDonald GB, Shulman HM, Sullivan KM, et al. Intestinal and hepatic complications of human bone

marrow transplantation. II. Gastroenterology 1986;90:770-784.

650. Gauvreau JM, Lenssen P, Cheney C, et al. Nutritional management of patients with acute gastrointestinal graft-versus-host disease. J Am Diet Assoc 1981;79:673-677.

651. Guyotat D, Vu Van H, Pigeon R, et al. Intestinal absorption tests after bone marrow transplantation. Exp Hematol 1984;12[Suppl 5]:118-119.

652. Chatti N, Jobin C, Perreault C, et al. Protein losing enteropathy and malabsorption in patients undergoing allogeneic marrow transplantation. Gastroenterology 1984;86:1045.

653. Cheney CL, Weiss NS, Fisher LD, et al. Oral protein intake and the risk of acute graft-versus-host disease after allogeneic marrow transplantation. Bone Marrow Transplant 1991;8:203-210.

654. Deeg HJ, Storb R. Acute and chronic graft-versus-host disease: clinical manifestations, prophylaxis and treatment. J Natl Cancer Inst 1986;76:1325-1328.

2004 Lippincott Williams & Wilkins  
John P. Greer, John Foerster, John N. Lukens  
George M. Rodgers, Frixos Paraskevas, Bertil Glader  
Wintrobe's Clinical Hematology

[TRANSLATIONS INVOLVING TRANSCRIPTIONAL REGULATORS](#)[Transcriptional Regulation](#)[Retinoic Acid Receptor Translocations](#)[Core Binding Factor Translocations](#)[Transcription Therapy with Histone Deacetylase Inhibitors](#)[Mixed Lineage Leukemia: 11q23 Translocations](#)[E2A Translocations](#)[TAL1/SCL Translocations](#)[HOX Gene Dysregulation](#)[TRANSLATIONS AND MUTATIONS INVOLVING TYROSINE KINASES](#)[BCR-ABL: Philadelphia Chromosome+ Acute Lymphoblastic Leukemia](#)[FLT3 Mutations](#)[MICROARRAY ANALYSIS OF ACUTE LEUKEMIA](#)[SUMMARY](#)[ACKNOWLEDGMENTS](#)[REFERENCES](#)

Molecular genetic analysis of acute leukemia has been at the forefront of research into the pathogenesis of cancer because the presence of recurring chromosomal translocations provides immediate clues to the genetic events leading to leukemia and the means to clone and identify the dysregulated oncogenes. On the other hand, the classification of acute leukemia has until recently been on the basis of morphology (FAB classification) and immunophenotype [acute myelogenous leukemia (AML) vs. acute lymphoblastic leukemia (ALL)]. The recognition of distinctive morphologies that correlate with specific translocations and the development of treatments that are based on specific genetic defects has led to acknowledgment of the importance of these recurring translocations in the classification of acute leukemia. A subset of the new World Health Organization classification of AML is entitled “acute myeloid leukemia with recurrent genetic abnormalities”<sup>(1)</sup>, as is described in detail in [Chapter 77](#).

In this chapter, the focus is on a description of the more common genetic abnormalities found in acute leukemias, with special emphasis on what these genetic defects indicate about the pathogenesis of acute leukemias. Specific examples are given when this basic science information has led or is leading to development of molecular inhibitors as specific therapies with far fewer side effects than traditional chemotherapy. This is truly an exciting time for hematologic oncology when the bench and the bedside have finally met.

In the majority of childhood acute leukemia and 54 to 78% of adult AML, cytogenetic abnormalities are detected on karyotype analysis of peripheral blood or bone marrow<sup>(2)</sup>. Large clinical studies of both AML and ALL have demonstrated that the pretreatment diagnostic cytogenetics is one of the most valuable prognostic indicators for acute leukemia. Results from these studies are routinely used to classify a leukemia as favorable or unfavorable, as listed in [Table 76.1](#) and [Table 76.2](#) for adult AML and pediatric B-ALL, respectively.



**TABLE 76.1. Cytogenetic Risk Groups in Adult Acute Myelogenous Leukemia**

| Risk Group   | Cytogenetic Abnormality   |
|--------------|---|
| Favorable    | t(8;21)<br>t(15;17)<br>inv(16)  |
| Intermediate | Normal<br>+8, +21, +22<br>del(7q), del(9q)<br>11q23 abnormality<br>Other structural/numeric abnormalities |
| Adverse      | -5, -7<br>del(5q)<br>Abnormal 3q<br>Complex karyotype   |

From Grimwade D, Walker H, Oliver F, et al. The importance of diagnostic cytogenetics on outcome in AML: analysis of 1,612 patients entered into the MRC AML 10 trial. *Blood* 1998;92:2322–2333, with permission.

**TABLE 76.2. Cytogenetic Risk Groups in Pediatric Precursor B–Cell Acute Lymphoblastic Leukemia**

| Risk Group  | Cytogenetic Abnormality                       |
|-------------|---|
| Favorable   | t(12;21)<br>Hyperdiploid >50                  |
| Unfavorable | t(9;22)<br>t(4;11)<br>t(1;19)<br>Hypodiploidy |

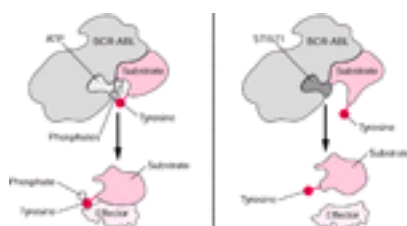
Adapted from Jaffe ES, Harris NL, Stein H, et al., eds. *Pathology and genetics of tumors of haematopoietic and lymphoid tissues. World Health Organization classification of tumours.* Lyon, France: IARC Press, 2001; and Pui C–H, Evans WE. Acute lymphoblastic leukemia. *N Engl J Med* 1998;339:605–615.

A theme in the translocations found in acute leukemia is that the majority of these translocation events produce a fusion gene that encodes an aberrant protein in which the 5' end of one translocation partner encodes the N-terminal protein sequence of the fusion protein, and the 3' end of the other translocation partner encodes the C-terminal protein sequence of the fusion protein. This is in contrast to many of the balanced translocations found in non-Hodgkin lymphoma, in which the intact coding sequence of an oncogene is translocated into a region where it is under the abnormal regulation of enhancer sequences highly active in lymphoid cells.

The fusion genes produced by the translocation event in leukemia encode aberrant proteins that have altered functional properties. Presumably, these altered properties are the pathogenetic basis of the leukemia. A large percentage of these aberrant proteins are transcriptional regulatory proteins that often preserve the original DNA binding specificity of one of the fusion partners but have altered properties of transcriptional activation or repression. The search to understand these altered properties has led investigators to basic discoveries of how transcriptional regulatory proteins modify chromatin structure to open up or inhibit the transcription of target genes. The search for the sets of genes targeted by these altered transcriptional regulators that are most directly involved in leukemogenesis has proven difficult. The majority of this chapter describes recurrent translocations that encode aberrant transcription factors. Additional functional categories of fusion proteins produced by recurrent translocations include kinases, inhibitors of apoptosis, and nuclear pore proteins.

Another theme that emerges from the study of leukemia with recurring translocations is that usually more than one genetic hit is necessary for the development of leukemia (3). This principle has been repeatedly demonstrated by animal models in which introduction of the fusion gene found in acute leukemia into mice via transgenic technology or retroviral transduction results in mice with a predisposition to acute leukemia with long latency, unless the accumulation of additional genetic hits is facilitated by treatment with a mutagenic agent. The discovery of frequent FLT3 mutations in leukemias with recurring translocations supports the hypothesis that multiple genetic defects are involved in leukemogenesis.

Finally, the breakthroughs in understanding of the molecular genetics of leukemia in the 1990s have had a direct and major impact on clinical treatment. The paradigm for the translation of basic research knowledge to clinical treatment has been chronic myelogenous leukemia (CML). The first leukemia to be associated with a recurrent translocation, the Philadelphia chromosome (4), CML was also the first leukemia in which the product of the translocation, BCR-ABL, was characterized (5). That BCR-ABL is directly involved in the pathogenesis of CML has been shown in mouse models in which efficient retroviral transduction of murine bone marrow stem cells results in induction of a CML-like disease in 100% of recipient mice (6). The constitutive tyrosine kinase activity of BCR-ABL is necessary for transformation as demonstrated by mutational analysis (7). This knowledge provided the basis for designing a specific inhibitor of the active site of the ABL kinase, STI571 [also called *imatinib* or *Gleevec* (8)]. STI571 blocks access of adenosine triphosphate (ATP) to the kinase pocket, inhibiting the ability of the kinase to phosphorylate substrates (Fig. 76.1). Current results of phase 2 trials demonstrate a complete hematologic remission in 95% of patients in chronic phase of CML and a major cytogenetic response in 60% of patients using a drug with many fewer side effects than conventional treatment (9). In the following discussion of the recurring translocations in acute leukemia, the pathogenesis of leukemia and the possibilities for development of molecular therapies are emphasized.



**Figure 76.1.** Inhibition of the active site of BCR-ABL by STI571. The BCR-ABL

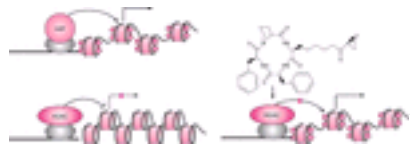
oncprotein is shown (A) with a molecule of adenosine triphosphate (ATP) in the kinase pocket. The substrate is phosphorylated on a tyrosine residue using the phosphate group donated by the ATP. The phosphorylated substrate then interacts with downstream effector molecules. When STI571 occupies the kinase pocket (B), ATP cannot enter, and the substrate is not phosphorylated. (From Goldman JM, Melo JV. Targeting the BCR-ABL tyrosine kinase in chronic myeloid leukemia N Engl J Med 2001;344:1084-1086, with permission.)

## TRANSLOCATIONS INVOLVING TRANSCRIPTIONAL REGULATORS

### Transcriptional Regulation

In the majority of recurring translocations in acute leukemia, at least one of the genes involved encodes a transcription factor so that the fusion protein product is an aberrant transcriptional regulatory protein. In this section, the major classes of transcription factors involved in translocations are discussed. Structure-function studies of the properties of aberrant fusion proteins have elucidated fundamental mechanisms of transcriptional regulation. These are briefly summarized before the description of individual models of transcriptional deregulation.

DNA is packaged into chromatin as nucleosomes, consisting of 146 bp of DNA wrapped around a histone core comprised of two molecules each of histones H2A, H2B, H3, and H4 ( [10](#) ). Interaction of the histones and DNA is such that histone tails reach to the exterior of the nucleosome and contact DNA to add to the stability of the complex. One way in which transcription factors can act as activators and repressors of transcription is to regulate the tightness of the DNA-histone interaction ( [11](#) ). If the available lysine residues in the histone tails are acetylated, the negatively charged acetyl group is repelled from the negatively charged DNA backbone, and the histone-DNA interaction is destabilized ( [Fig. 76.2A](#) ) ( [12](#) ). This results in more access of the gene promoter DNA to transcription factors and the transcriptional machinery. Conversely, if the lysines of the histone tails are deacetylated, then the histone-DNA interaction is stabilized, and the promoter is less accessible ( [Fig. 76.2B](#) ). Therefore, transcriptional activators generally are associated with coactivator proteins, such as p300/CBP and pCAF, which have histone acetylase activity themselves or recruit histone acetyltransferases ( [13](#) , [14](#) ). Conversely, transcriptional repressors generally are associated with co-repressor proteins, such as N-CoR (nuclear receptor co-repressor), SMRT (silencing mediator of retinoid and thyroid receptor), and mSin3, which bind to histone deacetylases (HDACs) ( [15](#) , [16](#) ).



**Figure 76.2.** The effect of histone-modifying enzymes on chromatin structure. **A:** The oval represents an intact transcription factor contacting a coactivator with histone acetyltransferase (HAT) activity. Histone acetylation ( *small sphere* ) leads to a relaxed chromatin structure, allowing transcription of target genes ( *straight arrow* ). **B:** The altered transcription factor is a repressor, binding a co-repressor complex containing histone deacetylases (HDACs). Histone deacetylation results in condensation of the chromatin and transcriptional repression of the target gene (X). **C:** HDAC inhibitors, such as trapoxin, block HDAC activity and thereby allow acetylation of histones to occur.

Therefore, the relaxed chromatin structure permits transcription of the target gene (*straight arrow*). (From Kramer OH, Gottlicher M, Heinzel T. Histone deacetylase as a therapeutic target. Trends Endocrinol Metab 2001;12:294–300, with permission.)

There are three classes of HDACs: class I (HDACs 1, 2, 3, and 8), class II (HDACs 4 to 7, 9, and 10), and class III (sirtuins 1 to 7). These are based on homology to three yeast deacetylases, rpd3, hda1, and sir2a, respectively ( [17](#) ). Class I deacetylases are more ubiquitously expressed than class II deacetylases ( [18](#) ). The role of class III sirtuins in leukemia is least understood. The above-mentioned co-repressors are associated with specific HDACs: N-CoR/SMRTs associate with HDACs 3, 4, 5, and 7 ( [19](#) ), whereas mSin3 associates with HDACs 1 and 2 ( [20](#) ).

Recently, additional complexities of the “histone code” have been decoded. First, DNA methyltransferases 1 and 3a (DNMT1 and DNMT3a) may interact with HDACs, conferring a more permanent mark of repression, DNA methylation, to the promoter targeted by the transcriptional repressor ( [21](#) ). Second, it appears that modification of histone lysines by methylation is also important in transcriptional regulation. Whether histone methylation results in transcriptional repression or activation depends on the specific lysine residues methylated and the specific transcriptional regulatory protein interaction ( [22](#), [23](#) ).

## Retinoic Acid Receptor Translocations

One of the most elegant examples of the interaction between clinical and molecular advances in the treatment of acute leukemia is acute promyelocytic leukemia (APL). The association between the t(15;17)(q22;q21) translocation and the characteristic morphology of APL (hypergranular blasts with frequent Auer rods or microgranular variant with dumbbell shaped nuclei) has been known for a long time. The ability to treat APL with retinoic acid (RA) and the understanding of the molecular basis for this treatment is a stunning example of the power of molecular medicine. The initial report from China ( [24](#) ) that all *trans*-RA (ATRA) could induce complete remission in APL patients actually preceded the discovery that the t(15;17) translocation involved the RA receptor gene (*RAR $\alpha$* ) on chromosome 17 ( [25](#), [26](#) and [27](#) ).

Of four translocations associated with APL, the most common is t(15;17)(q22;q21), in which the 5' portion of the fusion protein is encoded by the *PML* (promyelocytic leukemia) gene from 15q22, and the 3' portion is encoded by the *RAR $\alpha$*  gene from 17q21. The *RAR $\alpha$*  gene is a ligand-dependent steroid receptor that mediates the effects of the ligand, RA, on the cell. The breakpoint is invariant in intron 2, yielding the C-terminal portion of the fusion protein that includes the DNA-binding, ligand-binding, dimerization, and repression domains of *RAR $\alpha$* . There are three major breakpoints in the *PML* gene. The most common generates PML(L)-*RAR $\alpha$* , which includes the first six exons of *PML* encoding 554 amino acids of PML ( [28](#) ).

The wild-type *RAR $\alpha$*  is a nuclear receptor that acts as a transcription factor and binds to RA response elements (RAREs) in the promoters of many genes, including genes important in myeloid differentiation. *RAR $\alpha$*  binds as a heterodimer with retinoid X receptor protein (RXR) and acts as a transcriptional repressor until ligand (RA) binding occurs, changing the conformation of the protein and resulting in transcriptional activation ( [29](#) ). Target genes important for myeloid differentiation include granulocyte colony-stimulating factors (G-CSFs), G-CSF receptors (G-CSFRs), neutrophil granule proteins (leukocyte alkaline phosphatase and lactoferrin), cell surface adhesion molecules (CD11b and CD18), regulators of the cell cycle, regulators of apoptosis (Bcl-2), and transcription factors

(RARs, STATs, HOX genes) (reviewed in reference 30). Expression of a dominant negative RAR $\alpha$  in either a murine hematopoietic cell line or primary murine bone marrow cells, followed by stimulation with granulocyte-macrophage CSF (GM-CSF), results in arrest of granulocytic differentiation at the promyelocyte stage ( 31 ).

In the absence of RA, the wild-type RAR $\alpha$ , present as a heterodimer with RXR on the RARE, binds to the co-repressor proteins SMRT, N-CoR, mSin3, and HDACs. Deacetylation of the histones at the target gene promoter results in transcriptional repression. Ligand binding at physiologic concentrations of ATRA causes a conformational change that results in release of co-repressors and recruitment of a coactivator complex (SRC-1) that associates with histone acetyltransferases ( Fig. 76.3A ) ( 32 ). Acetylation of the histones at the target gene promoter is associated with transcriptional activation (reviewed in reference 30).



**Figure 76.3.** Model for the role of nuclear co-repressors and retinoic acid receptor  $\alpha$  (RAR $\alpha$ ) fusion proteins in the pathogenesis and treatment of acute promyelocytic leukemia. **A:** In the absence of all *trans*-retinoic acid (ATRA), RAR $\alpha$ , PML-RAR $\alpha$ , and promyelocytic leukemia zinc finger (PLZF)-RAR $\alpha$  associate with N-CoR/sin3A/HDAC1 co-repressor complex, which deacetylates histone tails, resulting in a compressed chromatin and transcriptional repression. Binding of ATRA at a physiologic concentration induces a conformational change in RAR $\alpha$ , causing release of the co-repressor complex and binding of coactivator (SRC-1) with histone acetyltransferase activity. Acetylation (Ac) of histone tails opens up the chromatin, facilitating transcriptional activation. **B:** In the case of PML-RAR $\alpha$  protein, pharmacologic doses of ATRA are required to achieve dissociation of the N-CoR repressor complex. **C:** Because of additional interactions of the PLZF moiety of PLZF-RAR $\alpha$  fusion protein with co-repressors, they do not dissociate even in the presence of pharmacologic doses of ATRA. Therefore, the chromatin still remains in the repressed state. RXR, retinoid X receptor protein. (From Guidez F, Ivins S, Jhu J, et al. Reduced retinoic acid-sensitivities of nuclear receptor corepressor binding to PML- and PLZF-RAR $\alpha$  underlie molecular pathogenesis and treatment of acute promyelocytic leukemia. *Blood* 1998;91:2634-2642, with permission.)

Wild-type PML protein is normally localized in subnuclear PML oncogenic domains, also called *nuclear bodies* (NBs) in which other nuclear factors co-localize ( 33 ). PML may act as a tumor suppressor protein and is involved in growth suppression as well as in induction of apoptosis (reviewed in reference 30). Although it does not bind DNA directly, it influences transcription by interacting with both CBP ( 34 ), a transcriptional activator, and HDACs, transcriptional repressors, possibly within the NBs. The protein encoded by the PML-RAR $\alpha$  fusion transcript resulting from the t(15;17) translocation is delocalized

from the NBs to a microspeckled nuclear pattern ( [35](#) ).

In APL, the PML-RAR $\alpha$  protein binds to RAREs with similar affinity to the RAR $\alpha$  protein and is able to heterodimerize with RXR. It acts in a dominant negative manner, competing with wild-type RAR $\alpha$  for binding to the RAREs. It binds co-repressor proteins in the absence of ligand (via the RAR $\alpha$  portion of the protein). However, physiologic levels of ATRA [ $10^{-8}$  Molar (M)] are not able to convert PML-RAR $\alpha$  into a transcriptional activator; pharmacologic concentrations are required ( $10^{-6}$  M; [Fig. 76.3B](#)) ( [32](#) , [36](#) ). This provides the mechanistic basis for the efficacy of treatment of APL patients with ATRA to induce differentiation of the promyelocytes.

Understanding of the mechanism of the response of APL to ATRA was furthered by studies on an alternative translocation, t(11;17)(q23;q21), documented in only eight patients with APL ( [37](#) ). Patients with this translocation are resistant to treatment with pharmacologic doses of ATRA. The fusion partner gene on chromosome 11q23 encodes promyelocytic zinc finger (PLZF), a transcriptional repressor. The N-terminal portion of the fusion protein encoded by PLZF includes the N-terminal POZ-BTB protein-interaction domain, transcriptional activation and repression domains, and a various number of zinc fingers important for protein and DNA interactions (reviewed in references [30](#) and [32](#)). PLZF interacts with NCoR, SMRT, mSin3A, and HDAC1 via the POZ/BTB domain ( [38](#) , [39](#) ) and therefore contributes a second binding site for co-repressor proteins. Therefore, although pharmacologic doses of ATRA induce release of co-repressors from the RAR $\alpha$  portion of the fusion protein, the co-repressors binding to PLZF are unaffected ( [Fig. 76.3C](#)) ( [30](#) , [40](#) ). Significantly, concomitant treatment of cells with HDAC inhibitors, such as Trichostatin A (TSA), restores ATRA sensitivity, as TSA inhibits the deacetylase activity of the co-repressors on the PLZF moiety ( [36](#) , [38](#) ).

Comparison of the ATRA-sensitive and ATRA-resistant PML-RAR $\alpha$  and PLZF-RAR $\alpha$  fusion proteins has demonstrated the pivotal role of HDACs in transcriptional repression and has triggered interest in the use of HDAC inhibitors as therapeutic agents in acute leukemia. In addition, recent experiments demonstrate that PML-RAR $\alpha$  may recruit DNA methyltransferases to the RARE. Binding of PML-RAR $\alpha$  to the target promoter of the *RARB2* gene induced hypermethylation of the promoter ( [41](#) ). Chromatin immunoprecipitation analysis demonstrated the presence of the DNA methyltransferases Dnmt1 and Dnmt3a at the promoter, along with PML-RAR $\alpha$ . Treatment with RA reduced methylation of the promoter, but concomitant treatment with RA, TSA, and 5-azacytidine (a drug that causes demethylation) relieved repression more completely than RA alone. This is the first example of recruitment of DNA methylases as well as HDACs to a promoter by a leukemic transcription factor, and it raises the possibility of using demethylating agents in conjunction with HDAC inhibitors as therapeutic agents.

A further insight into the pathogenesis of leukemia has come from study of transgenic mice expressing the PLZF-RAR $\alpha$  variant. Although transgenic mice expressing PML-RAR $\alpha$  develop a leukemia with similar features to APL, transgenic mice expressing PLZF-RAR $\alpha$  develop a chronic leukemia similar to CML, which lacks the promyelocytic block of APL. Likewise, transgenic mice expressing the reciprocal translocation RAR $\alpha$ -PLZF develop a myeloproliferative disorder. However, mutants produced by crossing of these mice ( *PLZF-RAR $\alpha$ <sup>+</sup>/RAR $\alpha$ -PLZF<sup>+</sup>* ) develop acute leukemia with a block in promyelocytic differentiation ( [42](#) ). Therefore, in APL there may be a synergistic role of the reciprocal product of translocation in leukemogenesis.

Finally, two additional alternative translocations are associated with APL, both of which are ATRA responsive. In the t(5;17)(q35;q21) translocation, nucleophosmin is fused with



RAR $\alpha$ , contributing an oligomerization domain (43). In the t(11;17)(q13;q21) translocation, the nuclear mitotic apparatus (NuMA) gene is fused to RAR $\alpha$ . The NuMA protein is involved in the mitotic process and also contributes a coiled-coil dimerization domain (44). Therefore, all of the translocation partners of RAR $\alpha$  encode proteins with multimerization domains.

### Core Binding Factor Translocations

The t(8;21) translocation is present in approximately 15% of patients with AML (45, 46), and the *AML-1* gene, cloned from the t(8;21)(q22;q22) breakpoint (47, 48), is mutated in another 3% of AML. In addition, the t(12;21) translocation implicates disruption of *AML-1* in the pathogenesis of B-ALL (49, 50). The activity of the murine counterpart of *AML-1* was first described as part of the core binding factor (CBF), which binds to a core enhancer sequence of the Molony leukemia virus long terminal repeat (51). Another component of CBF, the non-DNA binding CBF $\beta$  was found to be associated with inversion 16 in M4 AML (52). Finally, the fusion partner of *AML-1* in t(8;21), named *eight-twenty-one* (*ETC*), also is a transcriptional regulator (53). A gene related to *ETC*, *MTG16*, is involved in yet another translocation involving *AML-1*, t(16;21) (54). The structure of the fusion proteins resulting from these CBF translocations is shown in Figure 76.4.



**Figure 76.4.** Schematic diagram of the t(8;21), t(16;21), t(12;21), and inv(16) with known co-repressor contacts. **A:** t(8;21) *AML-1*/*ETO*. The *AML-1* portion is shown in light red, with the DNA binding domain indicated. The *ETO* portion is the dark red box with domains conserved between *ETO* and its *Drosophila* homolog in light grey boxes. Known contacts with co-repressors and histone deacetylases are shown. **B:** t(16;21) *AML-1*-*MTG16*. *AML-1* is shown as a red box, and *MTG16* is shown in a similar manner to *ETO* in **A**. **C:** t(12;21) *TEL-AML-1*. *TEL* is in the dark red box, with the conserved pointed (PNT) domain indicated. The *AML-1* portion is in the light red box. Interactions with co-repressors and HDACs are shown. **D:** inv(16) *CBF $\beta$* -*SMMHC*. The *CBF $\beta$*  portion, which interacts with *AML-1*, is light red, and the *SMMHC* is dark red, with the coiled-coil domain indicated and the C-terminal portion, which is necessary for interaction with mSin3A and HDAC8 (82). HHR, hydrophobic heptad repeat; ND, nery domain; TAF110, a domain with homology to the TAF110 coactivator; ZF, zinc finger domain. [From Hiebert SW, Lutterbach B, Amann J. Role of co-repressors in transcriptional repression mediated by the t(8;21), t(16;21), t(12;21), and inv(16) fusion proteins. *Curr Opin Hematol* 2001;8:197-200, with permission.]

*AML-1* is located on chromosome 21q22.3 and is encoded by 12 exons over 260 kilobases



(kb) of DNA. Alternative splicing yields four different transcripts ( [55](#) ). In the N-terminal portion of the protein is the runt homology domain (RHD), which is homologous to the *Drosophila* runt protein ( [56](#) ) and is responsible for the official HUGO name for AML-1, RUNX1. This is the DNA-binding domain, and it is mutated in familial platelet disorder (FPD) and in AML associated with *AML-1* mutations ( [57](#), [58](#) ). C/EBP $\beta$  interacts via this domain and changes the conformation of AML-1 to increase DNA-binding affinity ( [59](#) ). C-terminal to the RHD are potential MAP kinase phosphorylation sites, followed by three weak activation domains, a nuclear matrix target signal, a dimerization domain, and sequences that are recognized by co-repressor proteins (reviewed in reference 60).

The C/EBPs are essential for hematopoietic development. Gene deletion of either *AML-1* ( [61](#) ) or *C/EBP $\beta$*  ( [62](#) ) in mice results in fetal death at E11.5–12.5. These embryos lack all fetal hematopoiesis. Further transgenic experiments have demonstrated that AML-1 is essential for development of hematopoietic stem cells in the aorta/gonadal/mesodermal region, source of definitive hematopoiesis ( [63](#) ). The essential role of AML-1 in hematopoietic development appears to be through its function as a transcriptional activator. It regulates lymphoid genes such as B-cell tyrosine kinase ( [64](#) ) and T-cell receptor  $\alpha$  and  $\beta$  ( [65](#) ), cytokines (interleukin-3) ( [66](#) ), GM-CSF ( [67](#) ), and granulocyte-specific genes [MPO and neutrophil elastase ( [68](#) )], to name a few. In addition, AML-1 acts as a transcriptional repressor of genes such as *p21<sup>Waf1/Cip1</sup>* via interactions with the mSin3a co-repressor ( [69](#) ). AML-1 also influences T-cell development by repressing CD4 expression in double negative CD4<sup>-</sup>CD8<sup>-</sup> thymocytes ( [70](#) ).

The *ETC* gene, cloned from the t(8;21) fusion ( [48](#) ), is the mammalian homologue of the *Drosophila nervy* gene ( [71](#) ). The four homology domains shared with the *Drosophila* protein include a region of similarity to TAF110, a hydrophobic heptad repeat (HHR), an ND domain of undetermined function, and two zinc finger motifs that may be a protein-protein interaction domain ( [Fig. 76.4A](#) ) ( [60](#) ). ETO does not appear to bind DNA specifically on its own. However, it may act as a co-repressor protein ( [72](#) ). It associates with N-CoR and mSin3A and directly binds to the class I HDACs, HDAC-1, HDAC-2, and HDAC-3 ( [Fig. 76.4A](#) ) ( [73](#) ).

In the t(8;21) translocation, the *AML-1* gene is fused to the *ETC* gene on chromosome 8. The breakpoint in the *AML-1* locus is between exons 5 and 6 ( [74](#) ), yielding a fusion protein with the N-terminal 177aa of AML-1 ( [48](#) ). In this fusion protein, the DNA-binding domain is present, but the C-terminal activation domains, co-repressor interaction sites, and nuclear localization signals of the wild-type AML-1 are not present ( [Fig. 76.4A](#) ) ( [60](#) ). The breakpoint in the *ETC* gene occurs in the introns between the first two alternative exons of *ETC*, resulting in the inclusion of almost all of the coding region for *ETC* in the fusion transcript ( [48](#) ). Unlike APL, a transcript of the reciprocal *ETC/AML-1* fusion is not usually present ( [60](#) ).

The AML-1/ETO protein specifically binds to the same DNA binding site as AML-1 and can heterodimerize with C/EBP $\beta$  ( [75](#) ). Therefore, the AML-1/ETO protein can act as a dominant negative inhibitor of wild-type AML-1. However, co-transfection experiments demonstrated that AML-1/ETO can also function as an active transcriptional repressor, not only inhibiting activation of a reporter gene containing the GM-CSF promoter by co-transfected AML-1, but also reducing the expression of the reporter gene below baseline ( [76](#) ). The ability of AML-1/ETO to act as a transcriptional repressor depends on

its association with HDACs (via ETO; [Fig. 76.4A](#)), as the HDAC inhibitor TSA can abrogate effects of AML-1/ETO on the cell cycle ([73](#)). Targets of AML-1/ETO repression are presumed to include genes important for granulocyte differentiation. In addition, AML-1/ETO represses p14<sup>ARF</sup> ([77](#)). p14<sup>ARF</sup> stabilizes p53 by antagonizing MDM2, an inhibitor of p53 ([78](#)). Therefore, repression of p14<sup>ARF</sup> reduces the checkpoint control path of p53 and may be a key event in t(8;21) leukemogenesis. The promoter of p14<sup>ARF</sup> has eight AML-1 DNA binding sites, and wild-type AML-1 can activate p14<sup>ARF</sup>. However, transfection of AML-1/ETO into cells that have only low levels of AML-1 and high endogenous levels of p14<sup>ARF</sup> results in repression of p14<sup>ARF</sup>. Samples of bone marrow from patients with t(8;21) leukemia have low levels of p14<sup>ARF</sup> transcript by quantitative polymerase chain reaction analysis.

Surprisingly, expression of AML-1/ETO in myeloid progenitor cells inhibits cell cycle progression. However, this may contribute to leukemogenesis by allowing time for accumulation of mutations in a cell immune from p53-induced apoptosis due to inactivation of p14<sup>ARF</sup> ([77](#)).

AML-1 is also involved in a translocation that is present in 25% of pediatric B-acute lymphoblastic leukemia, t(12;21)(p13;q22). This translocation is associated with a good prognosis, although it is often missed by standard karyotype analysis. In this translocation, the N-terminus of *TEL* (translocation-ETS-leukemia) is fused to most of the coding region of *AML-1* ([49](#)). *TEL* contains a DNA-binding ETS domain and a “pointed” domain homologous to the *Drosophila* development protein, pointed ([79](#)). *TEL* is a transcriptional repressor, and as such it contains a DNA-binding ETS domain and domains that interact with mSin3A (pointed domain), NCoR, and HDAC-3 ([Fig. 76.4C](#)) ([80](#)). The functional significance of these interactions with HDACs was demonstrated by the ability of TSA to inhibit two properties of 3T3 fibroblast cells transformed with *TEL* and Ras: expression of the stromelysin-1 gene and aggregation ([80](#)).

Finally, inversion 16, present in approximately 8% of AML cases, involves the CBF complex member *CBFB* and is associated with a morphologically distinct subset of AML, M4Eo, a myelomonocytic leukemia with abnormal eosinophils that have dark purple as well as orange granules. This cytogenetic abnormality in which the *CBFB* gene is fused to the smooth muscle myosin heavy chain gene, *MYH11*, results in fusion of the first 165aa of *CBFB* to the C-terminal coiled-coil region of smooth-muscle myosin heavy chain protein (SMMHC; [Fig. 76.4D](#)) ([81](#)). A C-terminal region of SMMHC is necessary for the activity of *CBFB*/SMMHC as a transcriptional co-repressor, and this region also associates with mSin3a and HDAC8. Presumably, *CBFB*/SMMHC, which cannot bind DNA on its own, interacts with AML-1 to form a transcriptional repressor complex ([82](#)).

A number of experiments demonstrate that the CBF translocations are necessary but not sufficient for induction of leukemia. To determine whether expression of AML-1/ETO is sufficient to produce leukemia, mice were generated with a conditional AML-1/ETO knock-in allele using the Lox-Cre system. This obviates the embryonic lethality that results when AML-1/ETO is introduced into transgenic mice (recapitulating the phenotype of the AML-1 null mouse). No leukemia developed in 20 *AML-1/ETO*<sup>+</sup> mice in 11 months, and no hematologic abnormality was detected except for a slight increase in the number of hematopoietic colony forming cells. Expression of AML-1/ETO did not cause a significant block in differentiation of hematopoietic precursors. When the mice were mutagenized with the DNA alkylating agent, ENU, 31% of the mice developed granulocytic sarcoma or AML ([83](#)) This supports the hypothesis that several genetic “hits” are necessary for the development of leukemia. Similarly, chimeric mice created

with *Cbfb*<sup>+/Cbfb-MYH11</sup> embryonic stem cells fail to have a high rate of acute leukemia unless they are treated with ENU ( [84](#) ).

Another study used retroviral transduction of CD34<sup>+</sup> human hematopoietic progenitor cells to investigate the effect of AML-1/ETO on proliferation and differentiation ( [85](#) ).

Expression of AML-1/ETO in primitive CD34<sup>+</sup> cells slows differentiation and promotes progenitor cell self-renewal. Expression of AML-1/ETO in more mature progenitor cells results in growth arrest. Similar *in vivo* results were obtained with mice reconstituted with AML-1/ETO expressing hematopoietic stem cells. In these mice, there was an expansion of the hematopoietic stem cell population and immature myeloid cell populations, although the mice did not develop acute leukemia ( [86](#) ). Therefore, the expression of AML-1/ETO promotes accumulation of immature cells and prolongs the period during which progenitor cells may accumulate additional mutations.

Further support for the hypothesis that genetic mutations besides a mutant *AML-1* locus are necessary for development of acute leukemia comes from the study of patients with FPD with propensity to develop AML (FPD/AML). These patients have mutations in one allele of *AML-1* ( [87](#) ). They have defective platelets, progressive pancytopenia, and develop myelodysplasia and a high incidence of AML with age. However, second mutations appear to be necessary before progression to AML occurs. Similarly, syngeneic twins who have identical *TEL/AML-1* t(12;21) translocations at birth may develop ALL at different times later in life ( [88](#), [89](#) ). This implies that acquisition of additional mutations is necessary for development of leukemia.

### Transcription Therapy with Histone Deacetylase Inhibitors

Each CBF translocation results in fusion of AML-1 (AML-1/ETO, TEL-AML-1) or CBF $\beta$  with a protein that efficiently recruits HDACs either directly or via co-repressor complexes. The presence of these HDACs appears to be important in repression of target genes and therefore in leukemogenesis. Likewise, the function of the RA-responsive and RA-insensitive RAR $\alpha$  translocations depends on how tightly they bind to HDACs and co-repressors. These data have triggered much discussion of the possibility of treatment of acute leukemia with HDAC inhibitors. The rationale is that if the aberrant transcription factors involved in leukemia repress target promoters via deacetylation of histones, then treatment with HDAC inhibitors will overcome this repression by keeping the target promoter DNA in the open acetylated configuration ( [Fig. 76.2C](#) ). This relief of repression of target genes, therefore, should slow proliferation and induce differentiation of the leukemic cells.

Several HDAC inhibitors are available that vary in specificity, potency, and ease of administration (reviewed in reference 17). The oldest of these is butyrate; however, butyrates have low specificity, low potency, and fairly high toxicity at the dose necessary for treatment. Valproic acid is less toxic and is already used in medicine for neuropsychiatric illnesses. It is more active on class I HDACs than class II HDACs. Other newer HDAC inhibitors are suberoylanilide hydroxamic acid (SAHA), MS-275, and depsipeptide. An HDAC inhibitor used in laboratory experiments but not yet in clinical trials is TSA.

Cell culture results are promising as far as the ability of HDAC inhibitors to reverse transcriptional repression brought about by the CBF translocations or RAR $\alpha$  translocations. In transient transfection assays, TSA blocks repression of the stromelysin-1 promoter by TEL ( [80](#) ). In experiments in which either INV-16 or ETO are fused to the GAL4 DNA-binding protein and cotransfected with a reporter plasmid

containing GAL4 binding sites, repression is abrogated by treatment with TSA ( [82](#) ). In addition, TSA and butyrate block repression of reporter genes by PLZF-RAR $\alpha$  ( [38](#) ). In cell culture experiments, HDAC inhibitors induce partial differentiation or apoptosis in leukemic cell lines ( [90](#), [91](#) ).

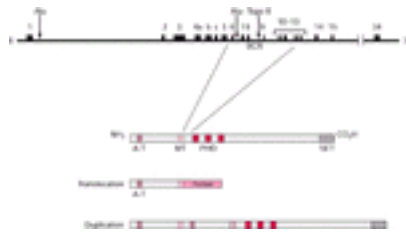
Phase 1 and phase 2 trials are ongoing investigating the use of butyrates, valproic acid, MS-275, depsipeptide, and SAHA in hematologic malignancies (reviewed in reference 17). The first successful treatment with HDAC inhibitors (HDIs) occurred with the use of phenyl butyrate on a patient with APL with the PML-RAR $\alpha$  fusion in her third relapse, having failed ATRA and chemotherapy, allogeneic bone marrow transplant, and arsenic trioxide. Phenylbutyrate was added to ATRA, and the patient achieved a molecular remission that has lasted longer than 6 months ( [92](#) ). However, most early results from trials report stabilization of disease or partial remissions but not complete remissions (reviewed in reference 17).

A theoretical concern about treatment of patients with HDAC inhibitors is that global derepression of genes might occur, leading to untoward expression of oncogenes. In differential display analysis of the global effects of HDI treatment on gene expression, only 2 to 5% of genes were induced ( [93](#) ). The “histone code” is complex enough that global hyperacetylation of DNA does not directly translate to global gene overexpression ( [22](#) ). The complexity of effects that HDAC inhibitors may produce is compounded by the fact that important transcription factor and regulatory proteins are acetylated as well as histones ( [94](#) ). In addition, up-regulation of genes besides those that are targeted by the aberrant transcription factors may occur and be responsible for the effect of HDIs. For example, experiments demonstrate that up-regulation of a protease may be the cause of HDI-mediated apoptosis ( [95](#) ). Therefore, many of the effects of treatment with HDIs may be unrelated to de-repression of the genes targeted by the specific leukemic transcription factor. Therefore, *in vitro* studies on leukemic cell lines or analysis of bone marrow from patients treated with HDIs should include analysis of the acetylation state of promoters targeted by the leukemic transcription factor using chromatin immunoprecipitation assays ( [17](#) ). Finally, an additional layer of complexity is emerging with the discovery of the importance of histone methylation ( [22](#) ) and the influence of modified histones on DNA methylation ( [21](#) ). Therefore, demethylation agents, such as 5-azacitidine, and histone methyltransferase inhibitors may emerge as important adjuncts in “transcription therapy.”

### Mixed Lineage Leukemia: 11q23 Translocations

A transcriptional activator that is characteristically rearranged in infant leukemia, therapy-related leukemia, and mixed lineage leukemia is mixed lineage leukemia gene ( *MLL* ), which maps to chromosome 11q23 (reviewed in references 96 and 97). Other names for this locus are *HRX* or *ALL-1*. The *MLL* gene consists of 34 exons over 100 kb encoding a 3969 aa protein ( [98](#) ) ( [Fig. 76.5](#) ). *MLL* bears homology regions with *trithorax*, a *Drosophila* transcriptional regulator that positively regulates homeobox ( *HOX* ) genes ( [99](#) ). *HOX* genes are a large family of genes named for a shared homeobox sequence motif, which are developmental regulators essential for growth and differentiation. They were first identified in *Drosophila* during the study of genes whose mutations led to developmental abnormalities involving misassignment of body segment identity ( [100](#) ). The mammalian homologs consist of 39 *HOX* genes, which are important in mammalian development and cell fate determination ( [101](#) ). Wild-type *MLL* appears to be responsible for the maintenance of *HOX* gene expression during development ( [102](#), [103](#) ). Recent evidence suggests that it may perform this transcriptional regulation via histone

methyltransferase activity conferred by the SET domain in its carboxyl terminus ([104](#)). The SET domain is a protein domain shared by a number of transcriptional regulators that have histone methyltransferase activity ([22](#)). However, the SET domain is truncated in most of the fusion proteins resulting from translocations involving MLL ([98](#)).



**Figure 76.5.** Organization of the mixed lineage leukemia (MLL) gene, protein, and products of MLL rearrangements. **Top:** Exon/intron structure of the *MLL* locus at 11q23. Topo II sites shown with arrows correspond to the BCR (breakpoint cluster region). **Middle:** The full length protein is shown, with the A–T hook domain (A–T), a second DNA binding domain (MT), a zinc finger domain used for protein interaction (PHD), and the SET domain that has histone methyltransferase activity. **Bottom:** The schematic of translocations and duplications demonstrate conservation of the A–T and MT domains but loss of the SET domain in the fusion protein. (From DiMartino J, Cleary M. MLL rearrangements in haematological malignancies: lessons from clinical and biological studies. *Br J Haematol* 1999;106:614–626.)

*MLL* rearrangements involve 5 to 10% of chromosomal rearrangements overall in patients with ALL, AML, and myelodysplastic syndrome (MDS), and are associated with poor prognosis ([105](#)). In a study of 550 cases of acute leukemia and MDS with acquired 11q23 rearrangements, 16% involved additions, duplications, and inversions at the *MLL* locus ([106](#)). Of the remaining reciprocal translocations, 30 different partner loci were identified ([107](#)). The three most common partners are the *AF4* gene at 4q21 in t(4;11), the *AF9* gene at 9p21–22 in t(9;11), and the *ENL* or *ELL* genes at 19p13.3 and 19p13.1, respectively, in t(11;19). t(4;11) is associated with ALL, whereas t(9;11) is associated with AML ([108](#)). As the name implies, MLL is associated with mixed lineage leukemias, in which blasts express both myeloid and lymphoid markers. This association and the presence of MLL rearrangements in both ALL and AML cases suggest that the recombination event may take place in an uncommitted hematopoietic stem cell. The most common leukemia associated with MLL is M4/M5 AML ([106](#)).

The breakpoints of 11q23 usually occur between exons 5 and 11 ([Fig. 76.5](#)) ([109](#)), leaving approximately the N-terminal 1400 amino acids of the MLL protein ([97](#)). The retained protein contains AT-hook sequences thought to bind DNA at the minor groove ([110](#)), two regions mediating subnuclear localization, and a conserved DNA methyl-transferase region; the SET domain is routinely lost ([Fig. 76.5](#)) ([98](#)). Domain-swapping experiments have been performed to determine the properties of the 3' fusion partner necessary for the hybrid protein to immortalize cells. These experiments demonstrate that two transcriptional activating domains are necessary for immortalization ([98](#), [111](#)). This suggests that as a result of the translocation, the *MLL* fusion gene becomes a stronger or constitutive transcriptional activator. A possible result of this activity would be abnormally sustained *HOX* gene expression. If *MLL-ENL* is transduced into bone marrow of mice lacking *HOXA9* or *HOXA7*, no immortalization of hematopoietic precursors occurs ([97](#)). This suggests that overexpression of these genes is necessary for leukemogenesis.



Microarray analysis of *MLL* supports this hypothesis, as high levels of *HOXA9*, *HOXA5*, and *HOXA4* are found in the group of leukemias with *MLL* translocations ( [112](#)).

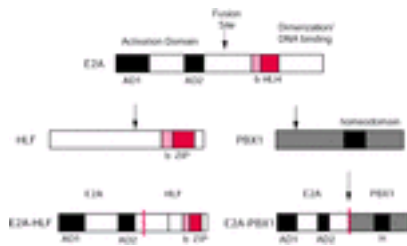
*MLL* rearrangements are associated with several unique types of leukemia. First, in infant acute leukemia (birth to 1 year) there is a 60 to 80% incidence of 11q23 rearrangement ( [113](#)). Second, in acute leukemias related to treatment with DNA topoisomerase II inhibitors, there is a 70 to 90% incidence of *MLL* rearrangements, particularly t(4;11)(q21;q23) and t(9;11)(p21–22;q23) ( [107](#), [114](#)). Topoisomerase II is an enzyme involved in unwinding of DNA during replication and transcription. It does so by producing double-stranded nicks in the DNA after which the ends are rejoined by a ligase activity of topoisomerase II. Topoisomerase II inhibitors, such as epidophyllotoxins, inhibit this ligase function so DNA-free ends accumulate, triggering apoptotic events. In *MLL*, there are 11 sites similar to topoisomerase II consensus-binding sites in the breakpoint cluster areas ( [115](#)). Therefore, if DNA-free ends created by the topoisomerase II are incorrectly relegated, translocations in *MLL* are likely to occur. Infant leukemia with *MLL* translocations has a similar distribution of breakpoints, whereas sporadic cases of acute leukemia have more random breakpoints ( [116](#)). This observation has triggered speculation that *in utero* exposure to environmental topoisomerase II inhibitors, such as flavonoids, may have a role in the etiology of infant leukemia ( [117](#)).

The latency of development of leukemia appears to be shorter for *MLL* rearrangements than for other leukemogenic rearrangements. In studies of twins who develop infant leukemia, those bearing a shared *MLL* rearrangement have a concordance of nearly 100% in the first year of life, whereas in twins sharing another rearrangement, the concordance is 25%, and the time to development may be years instead of months ( [118](#), [119](#)). Similarly, therapy-related leukemias based on *MLL* rearrangement occur sooner after therapy than those occurring after alkylating agents or radiation, usually 7q- or 5q- ( [114](#), [120](#)). This suggests that the oncogenic fusion protein produced by the *MLL* rearrangement can deregulate the cell without the accumulation of many secondary mutations. However, in genetic experiments in mice in which the *MLL-AF9* fusion gene is knocked-in, there is still a latency of 6 months before development of acute leukemia, suggesting that some secondary mutations are necessary ( [121](#)). An additional reflection of the potency of *MLL* rearrangements is that they are a poor prognostic indicator in infant leukemia, ALL, and most AML cases ( [113](#)).

## **E2A Translocations**

In acute lymphoblastic leukemia, most of the common translocations involve transcription factors that are members of common classes of transcription factors known to be involved in regulation of tissue-specific gene expression during development. A common translocation in childhood B-ALL, present in 5% of pre B-ALL cases ( [122](#)), is the t(1;19)(q23;p13.3) translocation, which fuses the *E2A* gene on chromosome 19p13.3 with the *PBX1* gene on chromosome 1q23 ( [Fig. 76.6](#)) ( [123](#), [124](#)). Presence of this translocation usually indicates a poor prognosis ( [125](#)). The *E2A* locus encodes three transcripts, E12, E47, and E2-5, which are generated by alternative splicing ( [126](#)). They belong to class I of the basic helix-loop-helix (bHLH) family of transcription factors. bHLH transcription factors bind to specific E-box (CANNTG) sequences in promoters and enhancers, the first of which were identified in the enhancer regions of the immunoglobulin heavy-chain and kappa-chain genes ( [126](#)). Usually, the ubiquitous E2A proteins heterodimerize through the HLH domain with members of the class II bHLH proteins, most of which are tissue specific in expression. These heterodimers are crucial in transcriptional regulation of tissue-specific genes during development. Although E2A proteins are ubiquitous, they are

preferentially expressed in B lymphocytes ( [127](#) ), and E27 forms homodimers exclusively in B cells ( [128](#) ). The requirement for E2A proteins in B-cell development is demonstrated by *E2A*<sup>-/-</sup> null mice, which exhibit a complete block in B-cell differentiation at the pro-B-cell stage before immunoglobulin gene rearrangement, as well as defective thymocyte differentiation ( [129](#), [130](#) ). These mice have an increased frequency of T-lymphoblastic lymphoma ( [130](#) ).



**Figure 76.6.** Structural features of E2A fusion proteins. The N-terminus of the E2A gene encodes a transcriptional activation domain that is translocated to hepatic leukemia factor (HLF) or pre-B-cell leukemic homeoboX1 (PBX1) by chromosome translocations in acute lymphocytic leukemia. In the case of E2A-HLF, the DNA binding and dimerization domains of E2A are replaced by similar domains in HLF. For E2A-PBX1, the same DNA binding and dimerization domains of E2A are replaced with the DNA-binding homeodomain of PBX1. AD, activation domain; bHLH, basic helix-loop-helix; bZIP, basic leucine zipper domain; H, homeodomain.

*PBX1* (pre-B-cell leukemic homeoboX1), identified as the fusion partner of *E2A* in t(1;19) ( [131](#) ), encodes another transcription factor that is a member of the homeodomain family of transcription factors encoded by *HOX* genes. The *PBX* gene is the mammalian homologue of the *Drosophila* gene *Extradenticle* whose protein product cooperates with other homeodomain proteins during development ( [132](#) ). Likewise, PBX1 forms heterodimers with other homeodomain proteins via the homeo-domain and the C-terminal HOX cooperativity motif (HCM) ( [133](#) ). Co-transfection experiments with reporter genes containing DNA binding sites for PBX1 have demonstrated that PBX1 is not a strong transcriptional activator ( [134](#) ). The *PBX1*<sup>-/-</sup> mice have late embryonic lethality associated with multiple organ abnormalities ( [135](#) ), supporting the hypothesis that PBX1 interactions regulate homeodomain protein function. PBX1 is not normally expressed in lymphocytes.

In the t(1;19) translocation, the breakpoint on chromosome 19 occurs within the intron between exons 13 and 14 of *E2A*, so that the N-terminal two-thirds of E2A, aa1-483, are included in the fusion protein ( [124](#) ). This includes both of the transcriptional activation domains (AD1 and AD2), but excludes the bHLH DNA-binding and dimerization domains ( [Fig. 76.6](#) ). Therefore, the E2A-PBX1 fusion protein depends on the homeo-domain of PBX1 for DNA-binding specificity. Two alternatively spliced forms of PBX1 result in two possible fusion proteins, E2A-PBX1a and E2A-PBX1b, which differ in the C-terminal end. Both forms join E2A at aa89 of PBX1 and contain the DNA-binding homeodomain and the HCM protein-interaction domain ( [124](#) ). The translocation is usually imbalanced, so that the reciprocal PBX1-E2A is not expressed ( [136](#) ).

Several hypotheses exist for how expression of the E2A-PBX fusion protein results in the development of leukemia. The most straightforward model is that fusion of the E2A



activation domains onto PBX1 sequence results in abnormally strong *trans*-activation of target genes recognized by the PBX1 homeo-domain ( [137](#) ). These target genes would be activated in lymphocytes, in which PBX1 is usually not expressed. Evidence for this model comes from the study of the ability of deletion mutants of E2A-PBX1 to transform fibroblasts and lymphocytes and to *trans*-activate reporter genes. Mapping experiments demonstrate that the activation domains AD1 and AD2 of E2A are necessary for *trans*-activation of reporter genes containing PBX1 binding sites, and they are also necessary for transformation of NIH 3T3 cells ( [138](#) ). In primary murine bone marrow, the homeodomain and HCM are both required for immortalization and differentiation blockade ( [139](#) ). However, using a fibroblast transformation assay, the only part of PBX1 that is necessary is the HCM ( [133](#) ). Based on these results, an alternative model of oncogenicity is that interaction between the E2A-PBX1 and homeodomain proteins via the HCM alters homeodomain protein function in development ( [133](#) ). Finally, E2A-PBX may alter wild-type E2A function in cells by a dominant negative effect or by sequestering coactivator proteins from E2A in cells that already are haploinsufficient for E2A due to the translocation event ( [137](#), [140](#) ).

Another translocation involving E2A occurs in approximately 1% of pediatric ALL, t(17;19)(q22;p13), which fuses *E2A* to hepatic leukemia factor ( *HLF* ) ( [141](#), [142](#) ). Clinically, these patients are adolescents and may present with disseminated intravascular coagulation and hypercalcemia. *HLF* encodes a transcription factor of the basic leucine zipper (bZIP) family, in which the basic region is the DNA-binding region and the leucine zipper refers to an amphipathic alpha helical domain through which HLF can homodimerize or heterodimerize with other bZIP proteins. HLF is usually expressed in liver, kidneys, and CNS neurons, but not in hematopoietic cells ( [143](#) ).

The E2A-HLF fusion protein is homologous to the E2A-PBX1 fusion protein in that the N-terminal 483 amino acids of E2A, contributing the activation domains AD1 and AD2, are fused to the C-terminal portion of HLF, which contains the bZIP DNA-binding and dimerization domains ( [Fig. 76.6](#) ) ( [144](#) ). Unlike PBX1, wild-type HLF is a strong *trans*-activator, but the alteration in cell-type expression and alterations in DNA-binding affinity and protein interactions by virtue of fusion to E2A may contribute to the transforming properties of E2A-HLF ( [145](#) ). In addition, as with the t(1;19) translocation, loss of one *E2A* allele and sequestration of coactivators from the wild-type E2A protein may be contributory factors ( [137](#) ).

The possibility that a mechanism of E2A-HLF-induced leukemogenesis is inhibition of apoptosis was raised by experiments in which expression of a dominant negative mutant of E2A-HLF in cells harboring t(17;19) resulted in apoptotic cell death ( [146](#) ). Representational difference analysis experiments to identify transcriptional targets of t(17;19) have strengthened this hypothesis. Pools of RNA were obtained before and after induction from a t(17;19) leukemic cell line that had been stably transfected with an inducible dominant negative E2A-HLF. One of the genes identified in the representational difference analysis screen was *SLUG*, the human homolog of the *Caenorhabditis elegans* gene *ces-1* involved in programmed cell death during neuronal development ( [147](#) ). *Ces-1* is regulated by *Ces-2* in *C. elegans*, and *Ces-2* has homology with *E2A-HLF* ( [147](#) ). SLUG may inhibit the cytochrome c/Apaf-1/caspase-9 apoptotic pathway by transcriptionally repressing members of the Bax family. Therefore, induction of SLUG by E2A-HLF inhibits apoptosis and promotes cell survival ( [148](#) ).

## **TAL1/SCL Translocations**

Alterations in expression of another member of the HLH family of transcription factors, *TAL1/SCL* (T-cell acute lymphoblastic leukemia 1/stem cell leukemia) are the most common molecular abnormalities in childhood T-cell ALL (T-ALL). The *TAL1/SCL* gene was originally cloned from a translocation, t(1;14)(p34;q11) present in 3% of patients with T-ALL ( [149](#)). In the translocation, the breakpoint is 5' to the coding region of *TAL1/SCL* on chromosome 1, and the translocation places *TAL1/SCL* under the regulation of the T-cell receptor  $\alpha/\beta$  gene on chromosome 14 ( [150](#), [151](#)). A second series of rearrangements that occurs in 12 to 26% of patients with T-ALL results in deletion of 90 to 100 kb of DNA from the 5' upstream region of *TAL1/SCL*, placing the gene under the control of the upstream *SIL* promoter, which is constitutively active ( [152](#)). In both cases, the coding region of *TAL1/SCL* is usually intact, unlike the fusion proteins that are usually expressed in acute leukemia. In addition, in some cases of T-ALL, overexpression occurs when there is no evident gene rearrangement by Southern blot analysis, suggesting a mutation in regulatory sequence ( [153](#)).

During development, *TAL1/SCL* is expressed in early hematopoietic elements, in both the yolk sac blood islands and the definitive blood cells of the aorta/gonadal/mesodermal and fetal liver ( [154](#)). Postnatally, it is expressed in erythroid, megakaryocyte, and mast cell lineages, but not in T cells. In nonerythroid cells, *TAL1/SCL* is expressed in stem cells but is not expressed as the cells differentiate; however, in erythroid cells, *TAL1* expression increases with early erythroid differentiation but decreases with terminal differentiation ( [155](#)). The essential role of *TAL1/SCL* in hematopoietic development is demonstrated by mice made null for *TAL1/SCL*; embryonic lethality occurs due to a total deficiency in hematopoietic progenitors ( [156](#), [157](#)). Conditional gene-targeting experiments using the *Lox-Cre* system to delete *TAL1/SCL* in adult mice demonstrates that continued expression of *TAL1/SCL* is not necessary for maintenance of hematopoietic stem cells, but it is necessary for erythrocyte and megakaryocyte differentiation ( [158](#)).

*TAL1/SCL* is a bHLH transcription factor and as a heterodimer with E2A proteins can bind to E-box DNA sequences. It also participates in multi-protein complexes with E2A, LMO2, GATA-1, and Ldb-1 ( [159](#), [160](#)). LMO-2 can be co-precipitated with *TAL1* from T-ALL cell lines ( [161](#)), and mice overexpressing both *TAL1* and LMO2 develop a T-ALL-like illness faster than transgenic mice overexpressing either gene alone ( [162](#)). *TAL1-BCL* also associates with transcriptional activators p300 and pCAF ( [163](#)), but also can interact with transcriptional co-repressors mSin3A and HDAC1 ( [164](#)). The transcriptional targets of activation or repression that are important for generating T-ALL are not known. However, recently it has been shown that a multiprotein complex involving *TAL1/SCL* regulates c-kit receptor expression ( [165](#)). *TAL1/SCL* is expressed in early hematopoietic cells along with c-kit, and co-transfection experiments demonstrated a role for *TAL1/SCL* in transcriptionally inducing expression of a reporter gene containing the c-kit promoter. Interestingly, c-kit is expressed in a subset of T-ALL cases ( [166](#)). Inappropriate expression of c-kit or another growth-promoting gene that *TAL1* usually regulates in early hematopoiesis may contribute to development of T-ALL when expressed in immature T-cells. Another hypothesis is that *TAL1/SCL* acts as a dominant negative inhibitor of the E2A transcription factors with which it can heterodimerize.

## HOX Gene Dysregulation

As discussed in the section [Mixed Lineage Leukemia: 11q23 Translocations](#), homeobox genes, or *HOX* genes, encode homeodomain proteins, homeodomain-containing transcription factors that are involved in cell fate determination during development ( [100](#)).

They are involved in several of the less frequent recurring translocations, and microarray analysis of T-ALL ( [167](#) ) and AML ( [168](#) ) have demonstrated overexpression of *HOX* genes in additional cases of leukemia that do not have a recurring translocation. *HOX11*, on chromosome 10q24, is involved in two translocations found in T-ALL: t(10;14)(q24;q11) and t(7;10)(q34;q24); in each of these translocations an intact *HOX11* gene is placed under the control of a T-cell receptor gene (T-cell receptor  $\alpha$  on 14q11 or T-cell receptor  $\beta$  on 7q34) ( [169](#) ). The abnormal recombination events involving the T-cell receptor gene loci may occur early in T-cell development as a result of faulty attempts at rearrangement of the T-cell receptor locus ( [170](#) ). By cytogenetic analysis, 4 to 7% of pediatric T-ALL cases have a rearrangement involving *HOX11*; in addition, by reverse-transcriptase polymerase chain reaction, 4 of 12 T-ALL and 0 of 56 B-ALL samples overexpressed *HOX11* messenger RNA ( [171](#) ). Yet another *HOX* gene, *Hox11L2*, is involved in the recently described t(5;14)(q35;q32) translocation that occurs in up to 25% of T-ALL cases ( [172](#) ).

Finally, a series of translocations associated with AML, MDS, and blast crisis of CML produce fusions of the *NUP98* gene on chromosome 11p15, with *HOXA9* [t(11;7)(p15;p15)], *PMX1* [t(1;11)(q24;p15)], or *HOXD13* [t(2;11)(q31;p15)] ( [173](#), [174](#) ). In each of these cases, the N-terminal portion of NUP98, a nucleoporin protein, is fused to the C-terminal portion of the homeodomain protein. Nucleoporins participate in the nuclear side of the nuclear pore complex necessary for transport of proteins in and out of the nucleus. Presumably, the nucleoporin portion of the fusion protein ensures nuclear expression of the NUP98-HOX fusion protein. Transduction of NUP98-HOXA9 into murine bone marrow cells induces AML after a shorter latency than transduction of HOXA9 alone ( [175](#) ). Expression of NUP98-HOXA9 in marrow progenitor cells in culture immortalizes the cells, preventing differentiation in response to GM-CSF and promoting proliferation in response to stem cell factor ( [176](#) ). The transcriptional targets of the NUP98-HOXA9 fusion protein that are involved in leukemogenesis are not known; however, in cells overexpressing NUP98-HOXA9, expression of several other *HOX* genes is induced ( [176](#) ).

## TRANSLOCATIONS AND MUTATIONS INVOLVING TYROSINE KINASES

### BCR-ABL: Philadelphia Chromosome+ Acute Lymphoblastic Leukemia

The Philadelphia chromosome is the result of the t(9;22)(q34;q11) translocation in which the 5' domains of the breakpoint cluster region (BCR) gene from chromosome 22 are fused with the 3' tyrosine kinase domain of the ABL gene from chromosome 9 ( [177](#), [178](#) ). The Philadelphia chromosome is the resultant shortened chromosome 22. It is the most frequent recurring translocation in adult ALL, occurring in 15 to 30% of patients ( [179](#) ), and also is present in 5% of pediatric B-ALL ( [180](#) ). It is an adverse prognostic factor in children and adults.

The *BCR-ABL* fusion gene is associated most commonly with CML. The pathogenesis of CML is discussed in [Chapter 84](#). A lymphoid blast crisis arising from CML may be difficult to distinguish from a Philadelphia chromosome-positive (Ph+) ALL. The size of the BCR-ABL fusion protein and whether it is restricted in expression to lymphoid cells may be helpful in making this distinction. The most common breakpoint region, the major breakpoint cluster region (M-bcr) spans almost 6 kb between exons 12 and 16 of *BCR* and results in a fusion protein of 210 kd, referred to as p210<sup>bcr-abl</sup> ( [5](#) ). A minor breakpoint, the m-bcr, is farther 5', after exon 2 of *BCR*, resulting in a truncated fusion protein of 190 kd, which contains only the first two exons of *BCR* (p190<sup>bcr-abl</sup>) ( [181](#) ).

p210<sup>bcr-abl</sup> is much more common in CML and CML with lymphoid blast crisis, whereas p190<sup>bcr-abl</sup> is much more commonly expressed in Ph+ ALL. p190<sup>bcr-abl</sup> is present in 80–90% of pediatric Ph+ ALL and 50% of adult Ph+ ALL ( [179](#) ). However, some cases of Ph+ ALL contain both p190<sup>bcr-abl</sup> and p210<sup>bcr-abl</sup>. Transgenic mice expressing p190<sup>bcr-abl</sup> develop an aggressive leukemia restricted to pre-B cells, whereas transgenic mice expressing p210<sup>bcr-abl</sup> develop a more chronic disease involving B and T cells and myeloid lineages ( [182](#) ). In some cases of Ph+ ALL, the aberrant fusion gene is present in lymphoid and myeloid marrow cells, whereas in other cases the aberrant fusion gene, usually p190<sup>bcr-abl</sup>, is restricted to lymphoid cells. Those cases in which p210<sup>bcr-abl</sup> is present in both lymphoid and myeloid cells are most likely to represent a CML lymphoid blast crisis ( [183](#) ).

Studies of BCR-ABL expression in CML have demonstrated the leukemogenic properties of BCR-ABL as a constitutive tyrosine kinase ( [184](#) ). This constitutive kinase activates by phosphorylation multiple downstream signal transduction intermediates, including ras (via grb2), PLC $\beta$ , and PI3 kinase ( [185](#) ). Activation of these pathways results in proliferation and resistance to apoptosis ( [186](#) ). Presumably, similar mechanisms are at work in Ph+ ALL. Restriction of expression of BCR-ABL to the lymphoid lineage would explain the development of ALL. However, in those cases of Ph+ ALL in which BCR-ABL is expressed in the stem cell compartment, it is unclear why ALL has resulted instead of CML.

Treatment of Ph+ ALL remains problematic. Initial response to chemotherapy is similar in Ph+ ALL and Ph-ALL, but remissions tend to be short-lived. Transplantation appears to be the best means of attaining a lasting remission. In a phase 2 trial of imatinib in relapsed or refractory Ph+ ALL, 60% of patients achieved a hematologic response, but it was usually short-lived ( [187](#) ). Development of resistance to imatinib occurs due to acquisition of mutations in the ATP-binding pocket of BCR-ABL that is targeted by imatinib ( [188](#) ).

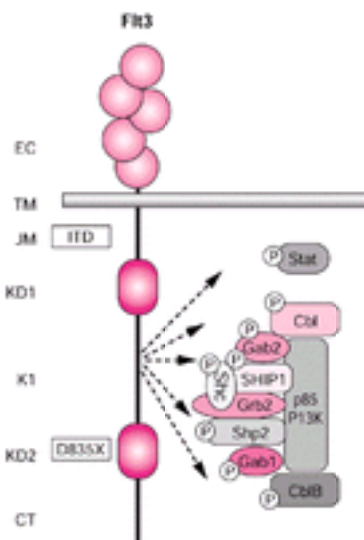
### FLT3 Mutations

*FLT3* may be the single most commonly mutated gene in AML (reviewed in reference [189](#)). Originally cloned from CD34<sup>+</sup> hematopoietic stem cells, it encodes a type III receptor tyrosine kinase. FLT3 ligand (FL) is a type I *trans*-membrane protein that is expressed on the surface of support and hematopoietic cells in the bone marrow, and it normally stimulates growth of immature myeloid cells and stem cells ( [190](#) ). When FL ligand binds to the FLT3 receptor, FLT3 dimerizes and autophosphorylates intracytoplasmic tyrosine residues. The phosphorylated, activated FLT3 then activates downstream signal transduction pathways. Two types of mutations in *FLT3* have been cloned from leukemic cells. The most common are internal tandem repeat (ITD) mutations, in which head-to-tail duplications of various lengths and positions occur in the juxtamembrane (JM) portion of the molecule ( [Fig. 76.7](#) ) ( [191](#) ). These elongation mutations may occur due to DNA replication errors as a result of a potential palindromic intermediate that may form at that site ( [192](#) ). The JM domain is an autoinhibitory domain whose inhibitory function is usually relieved by autophosphorylation after ligand binding ( [189](#) ). The in-frame insertions in the JM domain produce mutant proteins that are constitutively activated; they are able to dimerize and autophosphorylate in the absence of ligand ( [192](#) ). The second type of mutations are activation loop mutations, usually an Asp825Tyr substitution resulting from a point mutation. Usually, the activation loop inhibits access of ATP and substrate to the kinase domain until phosphorylation occurs as a result of ligand binding. The activation

loop mutations again produce a constitutively active FLT3 (189). Not only is the kinase constitutively active, but its effect on downstream signal transduction intermediates is altered. Ligand-activated, wild-type FLT3 stimulates proliferation via activation of the Ras/Raf/MAP kinase pathway (Fig. 76.8). In contrast, FLT3-ITD only weakly activates MAP kinase and Akt, but strongly activates STAT5 via phosphorylation (193).



**Figure 76.7.** Schematic of the internal tandem repeat (ITD) and activation loop FLT3 mutations in acute myelogenous leukemia (AML). The structure of the FLT3 receptor tyrosine kinase is shown, with the position of the transmembrane domain (TM), the juxtamembrane domain (JM), the kinase domains (TK1 and TK2), kinase insert (KI), and activation loop (AL). The amino acid sequence of the wild-type JM domain is listed, and underneath are the tandem duplication sequences found in individual patients with AML. These are always in-frame insertions. The position of the amino acid that is commonly substituted in activation loop mutations is indicated above the schematic of the protein domains. (Adapted from Mizuki M, Fenski R, Halfter H, et al. FLT3 mutations from patients with acute myeloid leukemia induce transformation of 32d cells mediated by the ras and stat5 pathways. *Blood* 2000;96:3907–3914; and Kelly LM, Liu Q, Kutok JL, et al. FLT3 internal tandem duplication mutations associated with human acute myeloid leukemias induce myeloproliferative disease in a murine bone marrow transplant model. *Blood* 2002;99:310–318.)



**Figure 76.8.** Hypothetical interactions of signaling molecules with FLT3. The model of FLT3 protein demonstrates the five immunoglobulin-like domains in the extracellular (EC) region of the receptor, followed by a transmembrane (TM) and juxtamembrane (JM) domain, a split kinase domain (KD1 and KD2) containing a kinase insert (KI) region, and a C-terminal tail (CT). The internal tandem repeat (ITD) in the JM domain and the site of activation loop mutations at D835 are indicated. The dashed arrows indicate phosphorylation of substrates at phosphotyrosine sites, and the potential adaptor and effector substrate proteins are portrayed. (From Scheijen B, Griffin JD. Tyrosine kinase oncogenes in normal hematopoiesis and hematological disease. *Oncogene* 2002;21:3314–3333, with permission.)



The overall frequency of FLT3-ITD in adult AML is 24% of patients, whereas in pediatric AML the frequency is somewhat lower at 10 to 15% (reviewed in reference 189). The frequency is very low in MDS and ALL. In contrast, the FLT3 activation loop mutation is reported in 7% of AML, 3% of MDS, and 3% of ALL patients (194). FLT3-ITD is detected most frequently in the M3 FAB subtype of AML, but has been detected in all FAB subtypes (189). The role of the FLT3-ITD in leukemogenesis has been investigated by retroviral transduction of murine bone marrow stem cells followed by transplantation into mice. These mice develop a myeloproliferative disease with predominantly maturing myeloid elements, but they do not develop acute leukemia (195). Therefore, the FLT3 mutations may confer the proliferative signal in patients with acute leukemia, whereas a concomitant balanced translocation or other genetic defect confers the block in differentiation necessary for development of acute leukemia (189).

The expression of FLT3 may be the most significant independent prognostic factor for poor outcome in patients younger than 60 years old. In a study of 91 pediatric AML patients on Children's Cancer Group protocol, the remission induction rate was 40% in patients with FLT3-ITD, compared to 74% with wild-type FLT3. The difference in event-free survival at 8 years was even more striking, at 7% for patients with FLT3-ITD compared to 44% for patients with wild-type FLT3 (196). In a study of patients with AML in the age range of 16 to 60 years with otherwise normal cytogenetics, the presence of the FLT3-ITD mutation also significantly decreased the length of remission and overall survival (197).

As with BCR-ABL for CML, the implication of a mutant constitutively active tyrosine kinase receptor in the pathogenesis of AML opens up the possibility of identifying a selective kinase inhibitor as a specific treatment for AML patients with a mutant FLT3. At this time, several kinase inhibitors have been identified by inhibition of interleukin-3-independent growth of cell lines expressing FLT3-ITD in culture (198, 199). These inhibitors bind to the ATP recognition domain of the enzyme and have differing degrees of specificity for the mutant FLT3 versus other kinases. They also prevent development of leukemia in mice transplanted with marrow transduced with a FLT3-ITD-expressing retrovirus. Clinical trials will soon indicate whether these inhibitors will be effective clinically (200).

## MICROARRAY ANALYSIS OF ACUTE LEUKEMIA

This chapter focuses on analysis of translocations present in acute leukemia, the majority of which produce a fusion protein encoding an abnormal transcriptional regulator. It is assumed that the aberrant regulation of the targets of this protein is directly relevant to leukemogenesis, but in only a few cases have a handful of putative targets been identified. Development of the technology of microarray analysis has made it possible to examine the global changes in gene expression that occur in leukemic cells. Microarray analysis of leukemic blasts from patients bearing recurring mutations, as well as controlled experiments in which gene expression profiles of hematopoietic stem cells transduced with a retrovirus encoding the aberrant fusion product are compared to profiles of hematopoietic stem cells transduced with retroviral vector only, will lead to a better understanding of the transcriptional targets involved in leukemogenesis.

Gene expression profiling, or microarray analysis, is a technique that has emerged as a powerful way to glimpse a large proportion of the genes being transcribed in a tissue at any one time. This provides a more global and unbiased view of gene expression than the

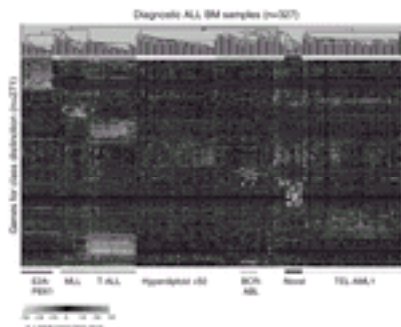
traditional Northern blot, which assays for the expression of a handful of candidate genes. The potential goals of this approach to study acute leukemia are several-fold: (a) discovery of previously unidentified subsets of ALL or AML that may have prognostic significance; (b) discovery of novel markers or groups of genes that allow class prediction, and thus aid in diagnosis of a case that is indeterminate by traditional morphologic and flow cytometric grounds; and (c) discovery of sets of genes that are instructive as to the pathogenesis of acute leukemia. These goals have been met to some degree by several recently published studies.

Microarray analysis involves preparing RNA from tumor samples that is then reverse transcribed to complementary DNA (cDNA), labeled with a fluorochrome, and hybridized to oligonucleotide arrays (Affymetrix) containing sequence from greater than 5000 genes. cDNA arrays can also be used, in which case the cDNA from the test sample is hybridized along with reference cDNA labeled with a different fluorochrome onto cDNA spotted on a micro-grid. However, most of the published studies on leukemia have been performed on Affymetrix oligonucleotide arrays. The normalized expression value for each gene is expressed as a number and visualized as a color representing expression higher or lower than the mean of all the samples.

In the first microarray experiment performed using leukemia samples, 38 bone marrow samples, 27 ALL and 11 AML, were analyzed using an oligonucleotide grid containing probes for 6817 genes ([168](#)). Neighborhood analysis was performed to determine a subset of genes that would be “class predictors,” assigning a given specimen to ALL or AML. The validity of this set was tested by cross-validation on the initial data set and then by the use of the predictive genes to categorize a new test set of samples. In 29 of 34 new samples, strong predictions were made with 100% accuracy. Among the genes identified in this group of predictors were membrane markers such as CD33 and CD11c. However, other genes involved in cell cycle progression, chromatin remodeling, adhesion, transcription, and oncogenesis were defined. Among cases from patients with treatment failure, the homeobox gene *HOXA9* was the single most highly correlated gene.

Further validation of the efficacy of microarray analysis in the subtyping of acute leukemia was demonstrated in a study of 367 bone marrow samples from pediatric patients with ALL ([201](#)). These samples were initially analyzed using Affymetrix-oligonucleotide microarray containing 12,600 probe sets. Analysis of the data using an unsupervised, two-dimensional, hierarchical clustering algorithm to group the leukemic samples having the most similar patterns of gene expression identified six major subtypes that corresponded to known subtypes of ALL: T-ALL and B-ALL with the following cytogenetic abnormalities: E2A-PBX1, MLL, hyperdiploid >50, BCR-ABL, and TEL-AML-1 ([Fig. 76.9](#)). That clustering of cases based on gene expression patterns corresponds to known cytogenetically defined subsets of ALL validates the significance of the gene expression patterns. A seventh group consisting of a somewhat more heterogeneous gene expression pattern corresponded to cases with a mixture of normal and abnormal cytogenetics (14 of 327 cases). However, the manner in which this study extended the understanding of ALL was in its ability to predict prognosis in a limited manner. Using supervised learning algorithms within the T-ALL and hyperdiploid >50 subgroups, gene expression profiles identified cases that went on to relapse with an accuracy of 97% and 100%, respectively, by cross-validation methods. In addition, in the TEL-AML-1 subtype, a distinct profile of 20 genes characterized those patients who developed therapy-related AML. The goal of this diagnostic approach would be to predict those patients likely to relapse to tailor the strength of the chemotherapy regimen appropriately.





**Figure 76.9.** Microarray analysis of pediatric acute lymphoblastic leukemia (ALL). Hierarchical clustering of 327 diagnostic ALL samples (columns) versus 271 genes (rows). The genes used in this analysis are the top 40 genes chosen by a chi-square statistic that are most highly correlated with the seven specific class distinctions. The normalized expression value for each gene is indicated by a color, with red representing high expression and green representing low expression, with the scale shown at the bottom. See [Color Plate](#). (From Yeoh E-J, Ross ME, Shurtleff SA, et al. Classification, subtype discovery, and prediction of outcome in pediatric acute lymphoblastic leukemia by gene expression profiling. *Cancer Cell* 2002;1:133–143, with permission.)

An additional aspect of microarray analysis of acute leukemias is the identification of new subcategories of leukemias based on pathogenesis. Identification of genes whose expression is uniformly altered in these subcategories advances the understanding of pathogenesis and may suggest novel therapeutic targets. For instance, subsets of T-ALL and B-ALL that harbor an MLL translocation also overexpress several *HOX* genes, *HOXA5*, *HOXA10*, and *HOXC6*, as well as the *MEIS1 HOX* co-regulator ([112](#)). Because *MLL* appears to be a *HOX* gene regulator, ([103](#), [104](#)) these genes may be aberrantly regulated by the mutant MLL. In another study, microarray analysis was used to subdivide 59 pediatric T-ALL cases into five groups that correspond to overexpression of different T-cell oncogenes (*HOX11*, *TAL1/SCL*, *LYL1*, *LMO1*, and *LMO2*) ([167](#)). The gene expression pattern associated with three of these categories appears to correlate with stages of thymocyte differentiation. High levels of Lyl1 expression were associated with a gene expression pattern characteristic of an undifferentiated thymocyte (CD34<sup>+</sup>, L-selectin<sup>+</sup>, BCL-2<sup>+</sup>, and LSP1). Similarly, high levels of HOX11 correlated with a gene expression pattern of early cortical thymocytes, whereas TAL1/SCL expression correlated with a gene expression pattern of late cortical thymocytes. This supports the long-standing notion that stage-specific developmental arrest of leukocytes occurs in leukemia. These studies demonstrate that microarray analysis may allow subclassification of leukemia into meaningful groups with unique prognosis and pathogenesis.

## SUMMARY

This chapter has reviewed the major translocations found in acute leukemia with a focus on understanding the function of the fusion protein encoded by the translocated genes. A major theme has been alteration of transcriptional regulation. Study of the aberrant transcription factors resulting from translocations has increased the understanding of the importance of histone acetylation and deacetylation in transcriptional regulation. This in turn has led to trials of HDAC inhibitors as potential transcription therapy agents. Study of mutated tyrosine kinases present in leukemia led to the first specifically engineered kinase inhibitor for the therapy of CML and Ph<sup>+</sup> ALL. Kinase inhibitors are being developed for the relatively common mutant FLT3 proteins present in AML. This is a truly exciting time for hematologic oncology, in which increased understanding of the pathogenesis of acute leukemia is leading to development of new therapeutic agents. However, mouse models demonstrating that several genetic events are necessary for the

development of acute leukemia underscore the complexity of the process.

## ACKNOWLEDGMENTS

I thank Drs. Stephen Brandt, Scott Hiebert, and Katherine Hamilton for critical review of the manuscript and Ms. Brenda Miller for assistance with the manuscript.

## REFERENCES

1. Jaffe ES, Harris NL, Stein H, et al., eds. Pathology and genetics of tumors of haematopoietic and lymphoid tissues. World Health Organization classification of tumours. Lyon, France: IARC Press, 2001.
2. Mrozek K, Heinonen K, Bloomfield CD. Clinical importance of cytogenetics in acute myeloid leukemia. *Best Pract Res Clin Haematol* 2001;14:19–47.
3. Kelly LM, Gilliland DG. Genetics of myeloid leukemias. *Annu Rev Genomics Hum Genet* 2002;3:179–198.
4. Nowell PC, Hungerford DA. A minute chromosome in human chronic granulocytic leukemia. *Science* 1960;132:1497.
5. Kurzrock R, Gutterman JU, Talpaz M. The molecular genetics of Philadelphia chromosome-positive leukemias. *N Engl J Med* 1988;319:990–998.
6. Zhang X, Ren R. BCR-ABL efficiently induces a myeloproliferative disease and production of excess interleukin-3 and granulocyte-macrophage colony-stimulating factor in mice: A novel model for chronic myelogenous leukemia. *Blood* 1998;92:3829–3840.
7. Cortez D, Kadlec L, Pendergast AM. Structural and signaling requirements for BCR-ABL-mediated transformation and inhibition of apoptosis. *Mol Cell Biol* 1995;15:5531–5541.
8. Druker BJ, Talpaz M, Resta DJ, et al. Efficacy and safety of a specific inhibitor of the BCR-ABL tyrosine kinase in chronic myeloid leukemia. *N Engl J Med* 2001;344:1031–1037.
9. Kantarjian HM, Sawyers C, Hochhaus A, et al. Hematologic and cytogenetic responses to imatinib mesylate in chronic myelogenous leukemia. *N Engl J Med* 2002;346:645–652.
10. Luger K, Mader AW, Richmond RK, et al. Crystal structure of the nucleosome core particle at 2.8 Å resolution. *Nature* 1997;389:251–260.
11. Redner RL, Wang J, Liu JM. Chromatin remodeling and leukemia: New therapeutic paradigms. *Blood* 1999;94:417–428.
12. Ura K, Kurumizaka H, Dimitrov S, et al. Histone acetylation: Influence on transcription, nucleosome mobility and positioning, and linker histone-dependent transcriptional repression. *EMBO J* 1997;16:2096–2107.
13. Martinez-Balbas MA, Bannister AJ, Martin K, et al. The acetyltransferase activity of CBP stimulates transcription. *EMBO J* 1998;17:2886–2893.
14. Blanco JC, Muinucci S, Lu J, et al. The histone acetylase PCAF is a nuclear receptor coactivator. *Genes Dev* 1998;12:1638–1651.
15. Heinzl T, Lavinsky RM, Mullen TM, et al. A complex containing N-CoR, mSin3 and histone deacetylase mediates transcriptional repression. *Nature* 1997;387:43–48.
16. Alland L, Muhle R, Hou HJ, et al. Role of N-CoR and histone deacetylase in sin3-mediated transcriptional repression. *Nature* 1997;387:49–55.
17. Melnick A, Licht J. Histone deacetylases as therapeutic targets in hematologic malignancies. *Curr Opin Hematol* 2002;9:322–332.

18. Grozinger CM, Hassig CA, Schreiber SL. Three proteins define a class of human histone deacetylases related to yeast *hda1p*. *Proc Natl Acad Sci U S A* 1999;96:4868–4873.
19. Huang EV, Zhang J, Miska EA, et al. Nuclear receptor corepressors partner with class II histone deacetylases in a *sin3*-independent repression pathway. *Genes Dev* 2000;14:45–54.
20. Zhang Y, Iratni R, Erdjument-Bromage H. Histone deacetylases and *sap18*, a novel polypeptide, are components of a human *sin3* complex. *Cell* 1997;89:357–364.
21. Fuks F, Burgers WA, Godin N, et al. *Dmrt3a* binds deacetylases and is recruited by a sequence-specific repressor to silence transcription. *EMBO J* 2001;20:2536–2544.
22. Jenuwein T, Allis CD. Translating the histone code. *Science* 2001;293:1074–1080.
23. Rice JC, Allis CD. Histone methylation versus histone acetylation: new insights into epigenetic regulation. *Curr Opin Hematol* 2001;13:263–273.
24. Huang ME, Ye YC, Chen SR, et al. Use of all trans retinoic acid in the treatment of acute promyelocytic leukemia. *Blood* 1988;72:567–572.
25. Borrow J, Goddard AD, Sheer D, et al. Molecular analysis of acute promyelocytic leukemia breakpoint cluster region on chromosome 17. *Science* 1990;249:1577–1580.
26. de The H, Chomienne C, Lanotte M, et al. The t(15;17) translocation of acute promyelocytic leukemia fuses the retinoic acid receptor  $\alpha$  gene to a novel transcribed locus. *Nature* 1990;347:558–561.
27. Longo L, Pandolfi PP, Biondi A, et al. Rearrangements and aberrant expression of the *RAR $\alpha$*  gene in acute promyelocytic leukemia. *J Exp Med* 1990;172:1571–1575.
28. Geng JP, Tong JH, Dong S, et al. Localization of the chromosome 15 breakpoints and expression of multiple PML-RAR  $\alpha$  transcripts in acute promyelocytic leukemia: A study of 28 Chinese patients. *Leukemia* 1993;7:20–26.
29. Schulman IG, Juguilon H, Evans RM. Activation and repression by nuclear hormone receptors—hormone modulates an equilibrium between active and repressive states. *Mol Cell Biol* 1996;16:3807–3813.
30. Melnick A, Licht JD. Deconstructing a disease: *RAR $\alpha$*  its fusion partners, and their roles in the pathogenesis of acute promyelocytic leukemia. *Blood* 1999;93:3167–3215.
31. Tsai S, Collins SJ. A dominant negative retinoic acid receptor blocks neutrophil differentiation at the promyelocyte stage. *Proc Natl Acad Sci U S A* 1993;90:7153–7157.
32. Guidez F, Ivins S, Zhu J, et al. Reduced retinoic acid-sensitivities of nuclear receptor co-repressor binding to PML- and PLZF-RAR $\alpha$  underlie molecular pathogenesis and treatment of acute promyelocytic leukemia. *Blood* 1998;91:2634–2642.
33. Zhong S, Muller S, Ronchetti S, et al. Role of SUMO-1-modified PML in nuclear body formation. *Blood* 2000;95:2748–2752.
34. Doucas V, Tini M, Egan DA, et al. Modulation of CREB binding protein function by the promyelocytic (PML) oncoprotein suggests a role for nuclear bodies in hormone signaling. *Proc Natl Acad Sci U S A* 1999;96:2627–2632.
35. Weis K, Rambaud S, Lavau C et al. Retinoic acid regulates aberrant nuclear localization of PML-RAR $\alpha$  in acute promyelocytic leukemia cells. *Cell* 1994;76:345–356.
36. Lin RJ, Nagy L, Inoue S, et al. Role of the histone deacetylase complex in acute promyelocytic leukemia. *Nature* 1998;391:811–814.
37. Licht J, Chomienne C, Goy A, et al. Clinical and molecular characterization of a rare syndrome of

acute promyelocytic leukemia associated with translocation (11;17). *Blood* 1995;85:1083.

38. Grignani F, De Merteis S, Nervi C, et al. Fusion proteins of the retinoic acid receptor—a recruit histone deacetylase in promyelocytic leukemia. *Nature* 1998;391:815–818.

39. David G, Alland L, Hong SH, et al. Histone deacetylase associated with mSin3a mediates repression by the acute promyelocytic leukemia-associated PLZF protein. *Oncogene* 1998;16:2549–2556.

40. He L-Z, Guidez F, Triboli C, et al. Distinct interactions of PML-RARα and PLZF-RARα with co-repressors determine differential responses to RA in APL. *Nat Genet* 1998;18:126–135.

41. DiCroce L, Raker V, Corsaro M, et al. Methyltransferase recruitment and DNA hypermethylation of target promoters by an oncogenic transcription factor. *Science* 2002;295:1079–1082.

42. He L, Bhaumik M, Triboiolo C, et al. Two critical hits for promyelocytic leukemia. *Mol Cell* 2000;6:1131–1141.

43. Redner RL, Rush EA, Faas S, et al. The t(5;17) variant of acute promyelocytic leukemia expresses a nucleophosmin-retinoic acid receptor fusion. *Blood* 1996;87:882–886.

44. Wells RA, Catzavelos C, Kamel-Reid S. Fusion of retinoic acid receptor alpha to NUMA, the mitotic apparatus protein, by a variant translocation in acute promyelocytic leukemia. *Nat Genet* 1997;17:109–113.

45. Look AT. Oncogenic transcription factors in the human acute leukemias. *Science* 1997;278:1059–1064.

46. Rowley JD. The role of chromosome translocations in leukemogenesis. *Semin Hematol* 1999;36:59–72.

47. Miyoshi H, Kozu T, Shimizu K, et al. The t(8;21) translocation in acute myeloid leukemia results in production of an AML1-MTG8 fusion transcript. *EMBO J* 1993;12:2715–2721.

48. Erickson P, Gao J, Chang KS, et al. Identification of breakpoints in t(8;21) acute myelogenous leukemia and isolation of a fusion transcript, AML1/ETO with similarity to *Drosophila* segmentation gene, runt. *Blood* 1992;80:1825–1831.

49. Golub TR, Barker GF, Bohlander SK, et al. Fusion of the TEL gene on 12p13 to the AML1 gene on 21q22 in acute lymphoblastic leukemia. *Proc Natl Acad Sci U S A* 1995;92:4917–4921.

50. Romana SP, Mauchauffe M, Le Coniat M, et al. The t(12;21) of acute lymphoblastic leukemia results in a TEL-AML1 gene fusion. *Blood* 1995;85:3662–3670.

51. Golemis EA, Speck NA, Hopkins N. Alignment of U3 region sequences of mammalian type c viruses: Identification of highly conserved motifs and implications for cancer design. *J Virol* 1990;64:534–542.

52. Liu P, Tarle SA, Hajra A, et al. Fusion between transcription factor CBFbeta/PEPB2 beta and a myosin heavy chain in acute myeloid leukemia. *Science* 1993;261:1041–1044.

53. Erickson P, Robinson M, Owens G, et al. The ETO portion of acute myeloid leukemia t(8;21) fusion transcript encodes a highly evolutionarily conserved, putative transcription factor. *Cancer Res* 1994;54:1782–1786.

54. Gamou T, Kitamura E, Hosoda F, et al. The partner gene of AML1 in t(16;21) myeloid malignancies is a novel member of the MTG8(ETO) family. *Blood* 1998;91:4028–4037.

55. Miyoshi H, Ohira M, Shimizu K, et al. Alternative splicing and genomic structure of the AML1 gene involved in acute myeloid leukemia. *Nucleic Acids Res* 1995;23:2762–2769.

56. Levanon D, Negreanu V, Bernstein Y, et al. AML1, AML2, and AML3, the human members of the runt domain gene family: cDNA structure, expression, and chromosomal location. *Genomics* 1994;23:425–432.

57. Osato M, Asou N, Abdalla E et al. Biallelic and heterozygous point mutations in the runt domain of the aml1/pebp2alpha gene associated with myeloblastic leukemias. *Blood* 1999;93:1817–1824.

58. Michaud J, Wu F, Osato M, et al. In vitro analyses of known and novel RUNX1/AML1 mutations in

dominant familial platelet disorder with predisposition to acute myelogenous leukemia: implications for mechanisms of pathogenesis. *Blood* 2002;99:1364–1372.

59. Tahirov TH, Inoue-Bungo T, Morii H, et al. Structural analysis of DNA recognition by the AML/RUNX-1 runt domain and its allosteric control by CBFβ. *Cell* 2001;104:755–767.

60. Licht J. AML1 and the AML1-ETO fusion protein in the pathogenesis of t(8;21) AML. *Oncogene* 2001;20:5660–5679.

61. Okuda T, Van Deursen V, Hiebert SW, et al. AML1, the target of multiple chromosomal translocations in human leukemia, is essential for normal fetal liver hematopoiesis. *Cell* 1996;84:321–330.

62. Wang Q, Stacy T, Miller JD, et al. The CBF beta subunit is essential for CBFalpha2 (AML1) function in vivo. *Cell* 1996;87:697–708.

63. North T, Gu TL, Stacy T, et al. CBFA2 is required for the formation of intra-aortic hematopoietic clusters. *Development* 1999;126:2563–2575.

64. Liebermann TA, Pan Z, Akbarali Y, et al. AML1 (CBFalpha2) cooperates with B cell-specific activating protein (BSAP/PAX5) in activation of the B cell specific BLK gene promoter. *J Biol Chem* 1999;274:24671–24676.

65. Bruhn L, Munnerlyn A, Grosschedl LR. Aly, a context-dependent coactivator of LEF-1 and AML1-1 is required for TCR alpha enhancer function. *Genes Dev* 1997;11:640–653.

66. Uchida H, Zhang J, Nimer SD. AML1a and AML1b can transactivate the human IL-3 promoter. *J Immunol* 1997;158:2251–2258.

67. Takahashi A, Satake M, Yamaguchi-Iwai Y, et al. Positive and negative regulation of granulocyte-macrophage colony stimulating factor promoter activity by AML1 related transcription factor PEBP2. *Blood* 1995;86:607–616.

68. Nuchprayoon I, Meyers S, Scott LM, et al. PEBP2/CBF, the murine homolog of the human myeloid AML1 and PEBP2 beta /CBFbeta proto-oncoproteins regulates the murine myeloperoxidase and neutrophil elastase genes in immature myeloid cells. *Mol Cell Biol* 1994;14:5558–5568.

69. Lutterbach B, Westendorf JJ, Linggi B, et al. A mechanism of repression by acute myeloid leukemia-1, the target of multiple chromosomal translocations in acute leukemia. *J Biol Chem* 2000;275:651–656.

70. Taniuchi I, Osato M, Egawa T, et al. Differential requirements for RUNX proteins in CD4 repression and epigenetic silencing during T lymphocyte development. *Cell* 2002;111:521–633.

71. Feinstein PG, Kornfeld K, Hogness DS, et al. Identification of homeotic target genes in *Drosophila melanogaster* including nervy, a proto-oncogene homologue. *Genetics* 1995;140:573–586.

72. Melnick A, Westendorf JJ, Polinger G, et al. The ETO protein disrupted in t(8;21)-associated acute myeloid leukemia is a corepressor for the promyelocytic leukemia zinc finger protein. *Mol Cell Biol* 2000;20:2075–2086.

73. Amann JM, Nip J, Strom D, et al. ETO, a target of t(8;21) in acute leukemia, makes distinct contacts with multiple histone deacetylases and binds mSin3a through its oligomerization domain. *Mol Cell Biol* 2001;21:6470–6483.

74. De Greef GE, Hagemeijer A, Morgan R, et al. Identical fusion transcript associated with different breakpoints in the AML1 gene in simple and variant t(8;21) acute myeloid leukemia. *Leukemia* 1995;9:282–287.

75. Meyers S, Downing Jr, Hiebert SW. Identification of AML1 and the (8;21) translocation protein (AML1/ETO) as sequence-specific DNA-binding proteins: the runt homology domain is required for DNA binding and protein-protein interactions. *Mol Cell Biol* 1993;13:6336–6345.

76. Frank R, Zhang J, Uchida H, et al. The AML1/ETO fusion protein blocks transactivation of the GM-CSF promoter by AML1b. *Oncogene* 1995;11:2667–2674.

77. Linggi B, Muller-Tidow C, Van De Locht L, et al. The t<sup>(8;21)</sup> fusion protein, AML1-ETO, specifically represses the transcription of the p14arf tumor suppressor in acute myeloid leukemia. *Nat Med* 2002;8:743-750.
78. Zhang Y, Xiong Y, Yarbrough WG. Arf promotes mdm2 degradation and stabilizes p53: Arf-ink4a locus deletion impairs both the Rb and p53 tumor suppression pathways. *Cell* 1998;92:725-734.
79. Scholz H, Deatrick J, Klaes A, et al. Genetic dissection of pointed, a *Drosophila* gene encoding two ets-related proteins. *Genetics* 1993;135:455-468.
80. Wang L, Hiebert SW. Tel contacts multiple co-repressors and specifically associates with histone deacetylase-3. *Oncogene* 2001;20:3716-3725.
81. Liu P, Tarle Sa, Hajra A, et al. Fusion between transcription factor CBFbeta/PEPB2 beta and a myosin heavy chain in acute myeloid leukemia. *Science* 1993;261:1041-1044.
82. Durst KL, Lutterbach B, Kummalue T, et al. The inv(16) fusion protein associates with corepressors via a smooth muscle myosin heavy-chain domain. *Mol Cell Biol* 2003;23:607-619.
83. Higuchi M, O'Brien D, Kumaravelu P, et al. Expression of a conditional AML1-ETO oncogene bypasses embryonic lethality and establishes a murine model of human t(8;21) acute myeloid leukemia. *Cancer Cell* 2002;1:63-74.
84. Castilla L, Garrett L, Adya N, et al. The fusion gene CBF-MYH11 blocks myeloid differentiation and predisposes mice to acute myelomonocytic leukemia. *Nat Genet* 1999;23:144-146.
85. Mulloy JC, Cammenga J, Mackenzie KL, et al. The AML1-ETO fusion protein promotes the expansion of human hematopoietic stem cells. *Blood* 2002;99:15-23.
86. De Guzman CG, Warren AJ, Zhang Z, et al. Hematopoietic stem cell expansion and distinct myeloid developmental abnormalities in a murine model of the aml1-eto translocation. *Mol Cell Biol* 2002;22:5506-5517.
87. Song W-J, Sullivan MG, Legare RD, et al. Haploinsufficiency of CBFa2 causes familial thrombocytopenia with propensity to develop acute myelogenous leukemia. *Nat Genet* 1999;23:166-175.
88. Ford AM, Bennett CA, Price CM, et al. Fetal origins of the TEL1-AML1 fusion gene in identical twins with leukemia. *Proc Natl Acad Sci U S A* 1998;95: 4584-4588.
89. Wiemels JL, Daniotti M, et al. Prenatal origin of acute lymphoblastic leukemia in children. *Lancet* 1999;354:1499-1503.
90. Ferrara F, Fazi F, Bianchini A, et al. Histone deacetylase-targeted treatment restores retinoic acid signaling and differentiation in acute myeloid leukemia. *Cancer Res* 2001;61:2-7.
91. Wang J, Sauntharajah Y, Redner RL, et al. Inhibitors of histone deacetylase relieve ETO-mediated repression and induce differentiation of AML1-ETO leukemia cells. *Cancer Res* 1999;59:2766-2769.
92. Warrell RP, He L-Z, Richon V, et al. Therapeutic targeting of transcription in acute promyelocytic leukemia by use of an inhibitor of histone deacetylase. *J Natl Cancer Inst* 1998;90:1621-1625.
93. Van Lint C, Emiliani S, Verdin E. The expression of a small fraction of cellular genes is changed in response to histone hyperacetylation. *Gene Expr* 1996;5:245-253.
94. Luo J, Su F, Chen D, et al. Deacetylation of p53 modulates its effect on cell growth and apoptosis. *Nature* 2000;408:377-381.
95. Ruefli AA, Ausserlechner MJ, Bernhard D, et al. The histone deacetylase inhibitor and chemotherapeutic agent suberoylanilide hydroxamic acid (SAHA) induces a cell-death pathway characterized by cleavage of Bid and production of reactive oxygen species. *Proc Natl Acad Sci U S A* 2001;98: 10833-10838.

96. Dimartino JF, Cleary ML. MLL rearrangements in haematological malignancies: lessons from clinical and biological studies. *Br J Haematol* 1999;106:614–626.
97. Ernst P, Wang J, Korsmeyer SJ. The role of MLL in hematopoiesis and leukemia. *Curr Opin Hematol* 2002;9:282–287.
98. Ayton PM, Cleary ML. Molecular mechanisms of leukemogenesis mediated by MLL fusion proteins. *Oncogene* 2001;20:5695–5707.
99. Ingham PW. Trithorax and the regulation of homeotic gene expression in *Drosophila*: a historical perspective. *Int J Dev Biol* 1998;42:423–429.
100. Gehring WJ, Affolter M, Burglin T. Homeodomain proteins. *Annu Rev Biochem* 1994;63:487–526.
101. Maconochie M, Nonchev S, Morrison A, et al. Paralogous HOX genes: function and regulation. *Annu Rev Genet* 1996;30:529–556.
102. Yu BD, Hanson RD, Hess JL, et al. MLL, a mammalian trithorax-group gene, functions as a transcriptional maintenance factor in morphogenesis. *Proc Natl Acad Sci U S A* 1998;95:10632–10636.
103. Yu BD, Hess JL, Horning SE, et al. Altered HOX expression and segmental identity in MLL-mutant mice. *Nature* 1995;378:505–508.
104. Milne TA, Briggs SD, Brock HW, et al. MLL targets SET domain methyltransferase activity to HOX gene promoters. *Mol Cell* 2002;10:1107–1117.
105. Heim S, Mitelman F. *Cancer cytogenetics: chromosomal and molecular aberrations of tumor cells*, 2nd ed. New York: Wiley, 1995.
106. Harrison CJ, Cuneo A, Clark R, et al. Ten novel 11q23 chromosomal partner sites. *Leukemia* 1998;12:811–822.
107. Secker-Walker LM. General report on the European Union Concerted Action Workshop on 11q23, UK. *Leukemia* 1998;12:776–778.
108. Johansson B, Moorman AV, Hass OA, et al. Hematologic malignancies with t(4;11)(q21;q23): a cytogenetic, morphologic, immunophenotypic and clinical study of 183 cases. *Leukemia* 1998;12:779–787.
109. Gu Y, Nakamura T, Adler H, et al. The t(4;11) chromosome translocation of human acute leukemias fuses the ALL-1 gene, related to *Drosophila* trithorax, to the AF-4 gene. *Cell* 1992;71:701–708.
110. Tkachuk DC, Kohler S, Cleary ML. Involvement of a homology of *Drosophila* trithorax by 11q23 chromosomal translocations in acute leukemias. *Cell* 1992;71:691–700.
111. So CW, Cleary ML. Common mechanism for oncogenic activation of MLL by forkhead family proteins. *Blood* 2003;101:633–639.
112. Ferrando AA, Armstrong SA, Neuberg DS, et al. Gene expression signatures in MLL-rearranged T-lineage and B-precursor acute leukemias: dominance of HOX dysregulation. *Blood* 2003;101:1–31.
113. Rubnitz JE, Link MP, Shuster JJ, et al. Frequency and prognostic significance of HRX rearrangements in infant acute lymphoblastic leukemia: a pediatric oncology group study. *Blood* 1994;84:570–573.
114. Hunger SP, Tkachuk DC, Amylon MD, et al. HRX involvement in de novo and secondary leukemias with diverse chromosome 11q23 abnormalities. *Blood* 1993;81:3197–3203.
115. Strissel PL, Strick R, Rowley JD, et al. An in vivo topoisomerase II cleavage site and a DNase I hypersensitive site colocalize near exon 9 in the MLL breakpoint cluster region. *Blood* 1998;92:3793–3803.
116. Cimino G, Rapanotti MC, Biondi A, et al. Infant acute leukemias show the same biased distribution of



- ALL1 gene breaks as topoisomerase II related secondary leukemias. *Cancer Res* 1997;57:2879–2883.
117. Ross JA, Potter JD, Reaman GH, et al. Maternal exposure to potential inhibitors of DNA topoisomerase II and infant leukemia (United States): a report from the Children's Cancer Group. *Cancer Causes Control* 1996;7:581–590.
118. Ford AM, Bennett CA, Price CM, et al. Fetal origins of the TEL-AML1 fusion gene. *Proc Natl Acad Sci U S A* 1998;95:4584–4588.
119. Ford AM, Ridge SA, Cabrera ME, et al. In utero rearrangements in the trithorax-related oncogene in human leukemias. *Nature* 1993;363:358–360.
120. Super HJ, McCabe NR, Thirman MI, et al. Rearrangements of the MLL gene in therapy-related acute myeloid leukemia in patients previously treated with agents targeting DNA-topoisomerase II. *Blood* 1993;82:3705–3711.
121. Dobson CL, Warren AJ, Pannell R, et al. The MLL-AF9 gene fusion in mice controls myeloproliferation and specifies acute myeloid leukemogenesis. *EMBO J* 1999;19:3564–3574.
122. Pui C-H, Evans WE. Acute lymphoblastic leukemia. *N Engl J Med* 1998;339:605–615.
123. Hunger SP, Galili N, Carroll AJ, et al. The t(1;19)(q23;p13) results in consistent fusion of the E2A and PBX1 coding sequence in acute lymphoblastic leukemia. *Blood* 1991;15:687–693.
124. Kamps MP, Look AT, Baltimore D. The human t(1;19) translocation in pre-B ALL produces multiple nuclear E2A-PBX1 fusion proteins with differing transforming potentials. *Genes Dev* 1991;5:358–368.
125. Crist WM, Carroll AJ, Shuster JJ, et al. Poor prognosis of children with pre-B acute lymphoblastic leukemia is associated with the t(1;19)(q23;p13): a Pediatric Oncology Group study. *Blood* 1990;76:117–122.
126. Murre C, McCaw PS, Baltimore D. A new DNA binding and dimerization motif in immunoglobulin enhancer binding, daughterless, myoD, and myc proteins. *Cell* 1989;56:777–783.
127. Rutherford MN, Lebrun DP. Restricted expression of E2A protein in primary human tissues correlates with proliferation and differentiation. *Am J Pathol* 1998;153:165–173.
128. Shen CP, Kadesch T. B-cell specific DNA binding by an E47 homodimer. *Mol Cell Biol* 1995;15:4518–4524.
129. Zhuang Y, Soriano P, Weintraub H. The helix-loop-helix gene E2A is required for B cell formation. *Cell* 1994;79:875–884.
130. Bain F, Engel I, Robanus EC, et al. E2a deficiency leads to abnormalities in  $\alpha\beta$  T-cell development and to rapid development of T-cell lymphomas. *Mol Cell Biol* 1997;17:4782–4791.
131. Nourse J, Mellentin JD, Galili N, et al. Chromosomal translocation t(1;19) results in synthesis of a homeobox fusion mRNA that codes for a potential chimeric transcription factor. *Cell* 1990;60:535–545.
132. Rauskolb C, Peifer M, Weischaus E. Extradenticle, a regulator of homeotic gene activity, is a homolog of the homeobox-containing human proto-oncogene PBX1. *Cell* 1993;74:1101–1112.
133. Chang CP, Devivo I, Cleary ML. The HOX cooperativity motif of the chimeric oncoprotein E2A-PBX1 is necessary and sufficient for oncogenesis. *Mol Cell Biol* 1997;17:81–88.
134. Van Dijk MA, Voorhoeve PM, Murre C. PBX1 is converted into a transcriptional activator upon acquiring the N-terminal region of E2A in pre-B cell acute lymphoblastoid leukemia. *Proc Natl Acad Sci U S A* 1993;90:6061–6065.
135. Selleri L, Depew MI, Jacobs Y, et al. Requirement for PBX1 in skeletal patterning and programming chondrocyte proliferation and differentiation. *Development* 2001;128:3543–3557.
136. Secker-Walker LM, Berger R, Fenaux P, et al. Prognostic significance of the balanced t(1;19) and

- unbalanced der(19)t(1;19) translocations in acute lymphoblastic leukemia. *Leukemia* 1992;6:363-369.
137. Lebrun DP. E2a basic helix-loop-helix transcription factors in human leukemia. *Front Biosci* 2003;8:s206-s222.
138. Monica K, Lebrun DP, Dedera DA, et al. Transformation properties of the E2A-PBX1 chimeric oncoprotein: fusion with E2A is essential, but the PBX1 homeodomain is dispensable. *Mol Cell Biol* 1994;14:8304-8314.
139. Kamps MP, Wright DD, Lu Q. DNA-binding by oncoprotein E2A-PBX1 is important for blocking differentiation but dispensable for fibroblast transformation. *Oncogene* 1996;12:19-30.
140. Aspland SE, Bendall HH, Murre C. The role of E2A-PBX1 in leukemogenesis. *Oncogene* 2001;20:5708-5717.
141. Raimondi SC, Privitera E, Williams DL, et al. New recurring chromosomal translocations in childhood acute lymphoblastic leukemia. *Blood* 1991;77:2016-2022.
142. Inaba T, Roberts WM, Shapiro LH, et al. Fusion of the leucine zipper gene HLF to the E2A gene in human acute B-lineage leukemia. *Science* 1992;257:531-534.
143. Hunger SP, Ohyashiki K, Toyama K, et al. HLF, a novel hepatic bZIP protein, shows altered DNA-binding properties following fusion to E2A in t(17;19) acute lymphoblastic leukemia. *Genes Dev* 1992;6:1608-1620.
144. Yoshihara T, Inaba T, Shapiro LH, et al. E2A-HLF-mediated cell transformation requires both the trans-activation domain of E2A and the leucine zipper dimerization domain of HLF. *Mol Cell Biol* 1995;15:3247-3255.
145. Inaba T, Shapiro LH, Funabiki T, et al. DNA-binding specificity and trans-activating potential of the leukemia-associated E2A-hepatic leukemia factor fusion protein. *Mol Cell Biol* 1994;14:3403-3413.
146. Inaba T, Inukai T, Yoshihara T, et al. Reversal of apoptosis by the leukemia-associated E2A-HLF chimaeric transcription factor. *Nature* 1996;382:541-544.
147. Inukai T, Inoue A, Kurosawa H, et al. SLUG, a Ces-1-related zinc finger transcription factor gene with anti-apoptotic activity, is a downstream target of the E2A-HLF oncoprotein. *Mol Cell* 1999;4:343-352.
148. Seidel MG, Look AT. E2A-HLF usurps control of evolutionarily conserved survival pathways. *Oncogene* 2001;20:5718-5725.
149. Carroll AJ, Crist WM, Link MP, et al. The t(1;14)(p34;q11) is nonrandom and restricted to T-cell acute lymphoblastic leukemia: a Pediatric Oncology Group study. *Blood* 1990;76:1220-1224.
150. Bernard OA, Guglielmi P, Jonveaux P, et al. Two distinct mechanisms for the SCL gene activation in the t(1;14) translocation of T-cell leukemias. *Genes Chromosomes Cancer* 1990;1:194-208.
151. Chen Q, Cheng J-T, Tsai L-H, et al. The TAL gene undergoes chromosome translocation in T cell leukemia and potentially encodes a helix-loop-helix protein. *EMBO J* 1990;9:415-424.
152. Brown L, Cheng J-T, Chen Q, et al. Site-specific recombination of the TALI-1 gene is a common occurrence in human T cell leukemia. *EMBO J* 1990;9:3343-3351.
153. Xia Y, Brown L, Tsan JT, et al. The translocation (1;14)(p34;q11) in human T-cell leukemia: Chromosome breakage 25 kilobase pairs downstream of the TAL1 proto-oncogene. *Genes Chromosomes Cancer* 1992;4:211-216.
154. Labastie MC, Cortes F, Romeo PH, et al. Molecular identity of hematopoietic precursor cells emerging in the human embryo. *Blood* 1998;92:3624-3635.
155. Cheng T, Shen H, Giokas D, et al. Temporal mapping of gene expression levels during the differentiation of individual primary hematopoietic cells. *Proc Natl Acad Sci U S A* 1996;93:13158-13163.

156. Robb L, Lyons I, Li R, et al. Absence of yolk sac hematopoiesis from mice with a targeted disruption of the SCL gene. *Proc Natl Acad Sci U S A* 1995;92:7075-7079.
157. Shivdasani RA, Mayer EL, Orkin SH. Absence of blood formation in mice lacking the T-cell leukemia oncoprotein TAL-1/SCL. *Nature* 1995;373:432-434.
158. Mikkola H, Klintman J, Yang H, et al. Haematopoietic stem cells retain long-term repopulating activity and multipotency in the absence of stem-cell leukemia SCL/TAL-1 gene. *Nature* 2003;421:547-551.
159. Osada H, Grutz GG, Axelson H, et al. Association of erythroid transcription factors: complexes involving the lim-protein rbtn2 and the zinc-finger protein GATA1. *Proc Natl Acad Sci U S A* 1995;92:9585-9589.
160. Grutz GG, Bucher K, Lvenir I, et al. The oncogenic T cell lim-protein Lmo2 forms part of a DNA-binding complex specifically in immature T cells. *EMBO J* 1998;17:4594-4605.
161. Valge-Archer VE, Forster A, Rabbitts TH. The Lmo1 and Ldb1 proteins interact in human T cell acute leukemia with the chromosomal translocation t(1;14)(p15;q11). *Oncogene* 1998;17:3199-3202.
162. Larson RC, Lavenir I, Larson TA, et al. Protein dimerization between Lmo2(rbtn2) TAL1 alters thymocyte development and potentiates T cell tumorigenesis in transgenic mice. *EMBO J* 1996;15:1021-1027.
163. Huang S, Qiu Y, Stein RW, et al. P300 functions as a transcriptional co-activator for the TAL1/SCL oncoprotein. *Oncogene* 1999;18:4958-4967.
164. Huang S, Brandt SJ. MSin3a regulates murine erythroleukemia cell differentiation through association with the TAL1/SCL transcription factor. *Mol Cell Biol* 2000;20:2248-2259.
165. Lecuyer E, Herblot S, Saint-Denis M, et al. The SCL complex regulates c-kit expression in hematopoietic cells through functional interaction with sp1. *Blood* 2002;100:2430-2440.
166. Tomeczkowski J, Frick D, Schwinzer B, et al. Expression and regulation of c-kit receptor and response to stem cell factor in childhood malignant T-lymphoblastic cells. *Leukemia* 1998;12:1221-1229.
167. Ferrando AA, Neuberg DS, Staunton JE, et al. Gene expression signatures define novel oncogenic pathways in T cell acute lymphoblastic leukemia. *Cancer Cell* 2002;1:75-88.
168. Golub TR, Slonim KD, Tamayo P, et al. Molecular classification of cancer: Class discovery and class prediction by gene expression monitoring. *Science* 1999;286:531-537.
169. Kennedy MA, Gonzalez-Sarmiento R, Kees UR, et al. HOX11, a homeobox-containing T-cell oncogene on human chromosome 10q24. *Proc Natl Acad Sci U S A* 1991;88:8900-8904.
170. Lichty BD, Ackland-Snow J, Noble L, et al. Dysregulation of HOX11 by chromosome translocations in T-cell acute lymphoblastic leukemia: A paradigm for homeobox gene involvement in human cancer. *Leuk Lymphoma* 1995;16:209-215.
171. Salvati PD, Ranford PR, Ford J, et al. HOX11 expression in pediatric acute lymphoblastic leukemia is associated with T-cell phenotype. *Oncogene* 1995;11:1333-1338.
172. Bernard OA, Busson-Leconiat M, Ballerini P, et al. A new recurrent and specific cryptic translocation t(5;14)(q35;q32) is associated with expression of the HOX11l2 gene in T acute lymphoblastic leukemia. *Leukemia* 2001;15:1495-1504.
173. Borrow J, Shearman AM, Stanton VP, et al. The t(7;11)(p15;p15) translocation in acute myeloid leukemia fuses the genes for nucleoporin NUP98 and class I homeoprotein HOXA9. *Nat Genet* 1996;12:159-167.
174. Nakamura T, Largaespada DA, Lee MP, et al. Fusion of the nucleoporin gene NUP98 to HOXA9 by the chromosome translocation t(7;11)(p15;p15) in human myeloid leukemia. *Nat Genet* 1996;12:154-158.

175. Kroon E, Thorsteinsdottir U, Mayotte N, et al. NUP98–HOXA9 expression in stem cells induces chronic and acute myeloid leukemias in mice. *EMBO J* 2001;20:350–361.
176. Calvo KR, Sykes DB, Pasillas MP, et al. NUP98–HOXA9 immortalizes myeloid progenitors, enforces expression of HOXA9, HOXA7, and Meis1, and alters cytokine–specific responses in a manner similar to that induced by retroviral co–expression of HOXA9 and Meis1. *Oncogene* 2002;21:4247–4256.
177. Bartram CR, De Klein A, Hagemeijer A, et al. Translocation of c–abl oncogene correlates with the presence of a Philadelphia chromosome in chronic myelocytic leukemia. *Nature* 1983;243:290–293.
178. Groffen J, Stephenson JR, Heisterkamp N, et al. Philadelphia chromosomal breakpoints are clustered within a limited region, bcr, on chromosome 22. *Cell* 1984;36:93–99.
179. Secker–Walker LM, Craig JM, et al. Philadelphia positive acute lymphoblastic leukemia in adults: age distribution, bcr breakpoint and prognostic significance. *Leukemia* 1991;5:196–199.
180. Uckun FM, Nachman JB, Sather HN, et al. Clinical significance of Philadelphia chromosome–positive pediatric acute lymphoblastic leukemia in the context of contemporary intensive therapies: a report from the Children’s Cancer Group. *Cancer* 1998;83:2030–2039.
181. Kurzrock R, Shtalid M, Romero P, et al. A novel c–abl protein product in Philadelphia–positive acute lymphoblastic leukemia. *Nature* 1987;325:631–635.
182. Voncken JW, Kaartinen V, Pattengale PK, et al. BCR/ABL p210 and p190 cause distinct leukemia in transgenic mice. *Blood* 1995;86:4603–4611.
183. Radich JP. Philadelphia chromosome–positive acute lymphocytic leukemia. *Hematol Oncol Clin North Am* 2001;15:21–36.
184. Laneuville, P. Abl tyrosine protein kinase. *Semin Immunol* 1995;74:255–266.
185. Pendergast AM, Quilliam LA, Cripe LD, et al. BCR–ABL–induced oncogenesis is mediated by direct interaction with the sh2 domain of the grb–2 adaptor protein. *Cell* 1993;75:175–185.
186. Faderl S, Talpaz M, Estrov X, et al. The biology of chronic myeloid leukemia. *N Engl J Med* 1999;341:164–172.
187. Ottmann OG, Druker BJ, Sawyers CL, et al. A phase 2 study of imatinib in patients with relapsed or refractory Philadelphia chromosome–positive acute lymphoid leukemias. *Blood* 2002;100:1965–1971.
188. Hofmann WK, Jones LC, Lemp NA, et al. Ph(+) acute lymphoblastic leukemia resistant to the tyrosine kinase inhibitor STI571 has a unique BCR–ABL gene mutation. *Blood* 2002;99:1860–1862.
189. Gilliland DG, Griffin JD. The roles of FLT3 in hematopoiesis and leukemia. *Blood* 2002;100:1532–1542.
190. Brasel K, Escobar S, Anderberg R, et al. Expression of the FLT3 receptor and its ligand on hematopoietic cells. *Leukemia* 1995;9:1212–1218.
191. Nakao M, Yokota S, Iwai T, et al. Internal tandem duplication of the FLT3 gene found in acute myeloid leukemia. *Leukemia* 1996;10:1911–1918.
192. Kiyoi H, Towatari M, Yokota S, et al. Internal tandem duplication of the FLT3 gene is a novel modality of elongation mutation which causes constitutive activation of the product. *Leukemia* 1998;12:1333–1337.
193. Mizuki M, Fenski R, Halfter H, et al. FLT3 mutations from patients with acute myeloid leukemia induce transformation of 32d cells mediated by the ras and stat5 pathways. *Blood* 2000;96:3907–3914.
194. Yamamoto Y, Kiyoi H, Nakano Y, et al. Activating mutation of D835 within the activation loop of FLT3 in human hematologic malignancies. *Blood* 2001;97:2434–2439.
195. Kelly LM, Liu Q, Kutok JL, et al. FLT3 internal tandem duplication mutations associated with human acute myeloid leukemias induce myeloproliferative disease in a murine bone marrow transplant model. *Blood*

2002;99:310–318.

196. Meshinchi S, Woods WG, Stirewalt DL, et al. Prevalence and prognostic significance of FLT3 internal tandem duplication in pediatric acute myeloid leukemia. *Blood* 2001;97:89–94.

197. Frohling S, Schlenk RF, Breitbruch J, et al. Prognostic significance of activating FLT3 mutations in younger adults (16 to 60 years) with acute myeloid leukemia and normal cytogenetics: a study of the AML study group Ulm. *Blood* 2002;100:4372–4380.

198. Kelly LM, Yu JC, Boulton CL, et al. Ct53518, a novel selective FLT3 antagonist for the treatment of acute myelogenous leukemia (AML). *Cancer Cell* 2002;1:421–432.

199. Weisberg E, Boulton CL, Kelly LM, et al. Inhibition of mutant FLT3 receptors in leukemia cells by the small molecule tyrosine kinase inhibitor pkc412. *Cancer Cell* 2002;1:433–443.

200. Sawyers CL. Finding the next Gleevec, FLT3-targeted kinase inhibitor therapy for acute myeloid leukemia. *Cancer Cell* 2002;1:413–415.

201. Yeoh EJ, Ross ME, Shurtleff SA, et al. Classification, subtype discovery, and prediction of outcome in pediatric acute lymphoblastic leukemia by gene expression profiling. *Cancer Cell* 2002;1:133–143.

2004 Lippincott Williams & Wilkins  
John P. Greer, John Foerster, John N. Lukens  
George M. Rodgers, Frixos Paraskevas, Bertil Glader  
Wintrobe's Clinical Hematology

## Classification and Differentiation of the Acute Leukemias

### DIAGNOSTIC EVALUATION

[Clinical Features](#)

[Morphology](#)

[Cytochemistry](#)

[Electron Microscopy](#)

[Immunophenotyping](#)

[Aberrant Antigen Expression in Acute Leukemia](#)

[Enzyme Markers](#)

[Genetic Abnormalities](#)

### FRENCH/AMERICAN/BRITISH PHENOTYPIC DESCRIPTIONS

[Acute Lymphoblastic Leukemia](#)

[Acute Myeloid Leukemia](#)

### DIFFERENTIAL DIAGNOSIS OF ACUTE MYELOID LEUKEMIA AND ACUTE LYMPHOBLASTIC LEUKEMIA

### WORLD HEALTH ORGANIZATION CLASSIFICATION OF THE ACUTE LEUKEMIAS

[Acute Myeloid Leukemia](#)

[Acute Lymphoblastic Leukemia](#)

[Acute Leukemia of Ambiguous Lineage](#)

### SUMMARY

### ACKNOWLEDGMENT

### REFERENCES

The acute leukemias are a heterogeneous group of neoplasms arising from transformation of uncommitted or partially committed hematopoietic stem cells (<sup>1</sup>). The retained partial capacity of differentiation was the basis for phenotypic classification that evolved throughout the twentieth century. Acute leukemias are divided into myeloid (or nonlymphocytic) and lymphoid. These differ somewhat in clinical presentation and differ substantially in response to therapy and course. Therefore, differentiation of acute lymphoblastic leukemia (ALL) from acute myeloid leukemia (AML) is fundamental to therapeutic decisions. Further subclassification of each group has become essential, as treatment is evolving for specific genetic and pathogenetic groups of disease. The initial diagnostic workup of acute leukemia is critical, and requires a variety of sophisticated laboratory techniques, some of which are currently available only in specialized centers.

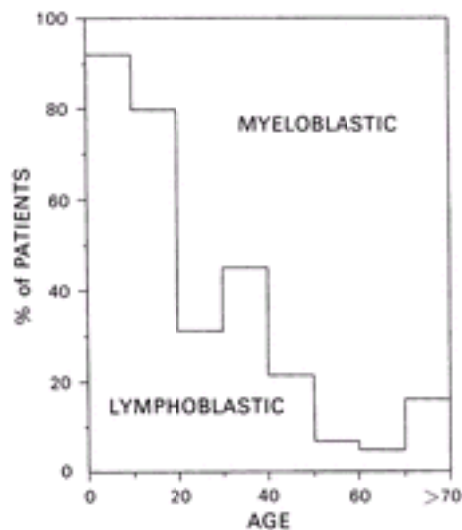
Acute leukemias are currently classified pragmatically by a combination of differentiation (AML vs. ALL, precursor B vs. precursor T-lymphoblastic leukemia/lymphoma), pathogenesis (myelodysplasia-related vs. *de novo* AML), and genetic abnormalities [e.g., acute promyelocytic leukemia (APL) with t(15;17)]. Lineage assignment is based on morphologic features, cytochemistry, and immunophenotyping. Correlation between experienced observers in classification increases from approximately 70% to greater than 95% when morphologic criteria alone are supplemented with cytochemistry and immunophenotyping (<sup>4</sup>). Obtaining accurate morphologic, cytochemical, immunophenotypic, and genetic data are critical for guiding treatment decisions. The clinical features of ALL and AML are considered in [Chapter 78](#), [Chapter 79](#), [Chapter 80](#), [Chapter 81](#) and [Chapter 82](#), respectively.

## DIAGNOSTIC EVALUATION

An adequate sample is critical for accurate diagnosis and classification of acute leukemia. Obtaining a proper sample for complete evaluation (i.e., microscopy, immunophenotyping, cytogenetics, and molecular genetics) must be emphasized before initiation of definitive therapy. Initiation of any definitive therapy before this, including corticosteroids, compromises accurate diagnosis, and hence proper treatment, of the patient.

### Clinical Features

Clinical features are not definitive for differentiation of ALL and AML. The age profiles of the acute leukemias differ, but overlap completely. ALL is predominant in childhood and AML in adults ( [Fig. 77.1](#) ) ( [2](#) , [3](#) ). Massive lymph node enlargement (diameter exceeding 2 or 3 cm) is suggestive of ALL. Widening of the mediastinum as a result of thymic enlargement is encountered most often in ALL of the T-cell type. Solid masses of leukemic cells (i.e., myeloid sarcoma, also known as *chloroma* or *granulocytic sarcoma*), often involving facial or intracranial structures, may occur in AML. Extensive involvement of the gums is common in acute monocytic leukemia ( [2](#) ).



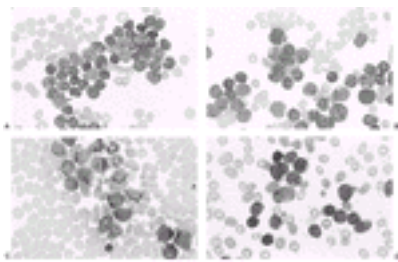
**Figure 77.1.** Relative frequencies of acute lymphoblastic leukemia and acute myeloid leukemia at different ages (based on data compiled from two series). (Adapted from Boggs DR, Wintrobe MM, Cartwright GE. The acute leukemias. Analysis of 322 cases and review of the literature. *Medicine* 1962;41:163–225; and Freireich EJ, Gehan EA, Sulman, et al. The effect of chemotherapy on acute leukemia in the human. *J Chronic Dis* 1962;14:593–608.)

### Morphology

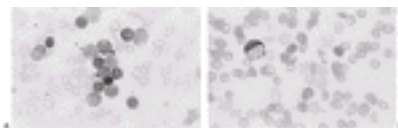
The morphologic and cytochemical features of the acute leukemias are illustrated in [Figure 77.2](#), [Figure 77.3](#), [Figure 77.4](#), [Figure 77.5](#), [Figure 77.6](#), [Figure 77.7](#), [Figure 77.8](#) and [Figure 77.9](#), and in texts ( [5](#) , [6](#) and [7](#) ). Even experienced morphologists can accurately classify only 70 to 80% of acute leukemias as ALL or AML on Romanovsky–stained smears. Helpful features are chromatin (fine in myeloblasts, often clumped in lymphoblasts), nucleoli (distinct in myeloblasts, variable in lymphoblasts), and cytoplasm



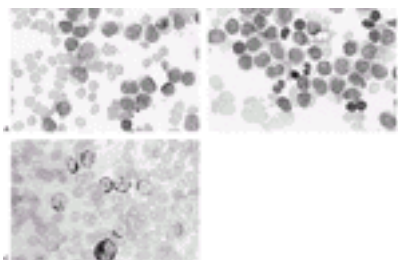
(moderate or abundant, often with granules in myeloblasts; scant to moderate, granules uncommon in lymphoblasts) ( [Fig. 77.2](#) and [Fig. 77.4](#)). The granules of standard APL are large and reddish violet; in the microgranular variant of APL, they are indistinct ( [Fig. 77.5](#)). ALL demonstrates cytoplasmic granules in approximately 10% of cases; the granules are usually larger and less abundant than those seen in AML ( [8](#), [9](#) and [10](#)) ( [Fig. 77.2D](#)). Auer rods, refractile needlelike crystalline inclusions in azurophilic granules, are diagnostic of myeloid blasts ( [Fig. 77.4B](#)). Auer rods may be single or multiple (faggots) and are seen in 60 to 70% of AML cases. The appearance of more differentiated myeloid cells in the marrow may provide a clue to myeloid lineage, particularly if the marrow is arising out of myelodysplasia. Erythroid and maturing myeloid precursors may be megaloblastoid in AML, but normal in ALL. Ring sideroblasts may be present.



**Figure 77.2.** Acute lymphoblastic leukemia (ALL) cytologic appearance, Wright stain. **A:** French/American/British (FAB) L1 lymphoblasts, marrow. The blasts are small with folded or clefted nuclei, fine to condensed chromatin, and scant cytoplasm. Nucleoli are inconspicuous. **B:** FAB L2 lymphoblasts, marrow. The blasts are larger with more cytoplasm. Most nuclei are irregular or folded and chromatin is dispersed. Nucleoli are prominent. **C:** FAB L3 lymphoblasts, marrow. The blasts are medium to large with abundant vacuolated basophilic cytoplasm. The nuclei are round with dispersed chromatin and prominent nucleoli. **D:** ALL with cytoplasmic granules, marrow. These granules were Sudan black negative with this stain and had a typical ALL immunophenotype (CD19<sup>+</sup>, CD10<sup>+</sup>, CD34<sup>+</sup>, TdT<sup>+</sup>). See [Color Plate](#).

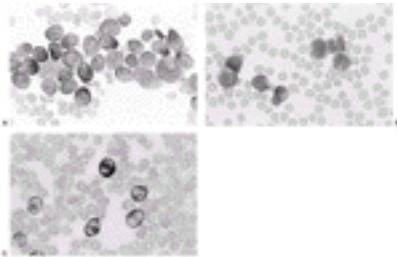


**Figure 77.3.** Acute lymphoblastic leukemia (ALL) cytochemical studies. **A:** Precursor B ALL. Blasts have coarse granular and block periodic acid-Schiff positivity. **B:** Precursor B ALL. Blasts are Sudan black negative. A residual normal myeloid cell is positive. See [Color Plate](#).

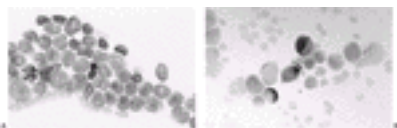


**Figure 77.4.** Acute myeloid leukemia, minimally differentiated [French/American/British (FAB) M1] and differentiated (FAB M2), marrow. Wright stain and cytochemical studies. **A:**

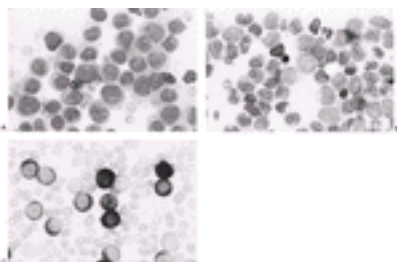
FAB M1. Myeloblasts predominate with few maturing myeloid elements. **B:** FAB M2. Blasts show maturation beyond the blast stage. Numerous Auer rods are present. **C:** FAB M2. Blasts are Sudan black positive. See [Color Plate](#).



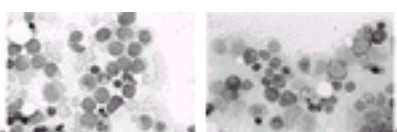
**Figure 77.5.** Acute promyelocytic leukemia (APL), French/American/British (FAB) M3, M3v. Wright stain and cytochemical studies ( **A**, marrow; **B** and **C**, blood). **A:** Typical hypergranular APL (FAB M3h) has hypergranulated promyelocytes. **B:** The microgranular variant, FAB M3v, has promyelocytes with folded, indented, or U-shaped nuclei and abundant cytoplasm with scant, fine, pink granules. These may be confused with myelomonoblasts. **C:** FAB M3v. The promyelocytes are strongly Sudan black positive. See [Color Plate](#).



**Figure 77.6.** Acute myelomonocytic leukemia, French/American/British (FAB) M4, marrow. Wright stain and cytochemical studies. **A:** The blasts have myeloid and monocytic differentiation. **B:** Combined esterase stains show chloroacetate esterase reactivity ( *rea*) in myeloblasts and nonspecific esterase reactivity ( *black*) in monoblasts. See [Color Plate](#).

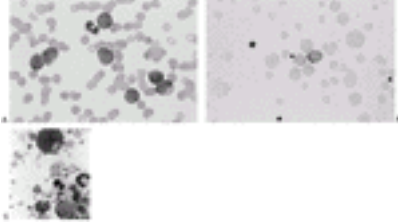


**Figure 77.7.** Acute monocytic leukemia, French/American/British (FAB) M5, marrow. Wright stain and cytochemical studies. **A:** FAB M5a. Predominant cell is a monoblast. **B:** FAB M5b. Blasts show differentiation to promonocytes and monocytes. **C:** FAB M5a. Nonspecific esterase is strongly positive. The reaction is inhibitable with fluoride treatment (not shown). See [Color Plate](#).



**Figure 77.8.** Erythroleukemia, French/American/British (FAB) M6, marrow. Wright stain and cytochemical studies. **A:** FAB M6 has a mixture of myeloblasts and erythroid

precursors. Auer rods are present. Erythroid cells have dysplastic features, including megaloblastic change, lobated nuclei, and cytoplasmic vacuolization. **B:** The pronormoblasts have strong, coarse, blocklike periodic acid–Schiff staining, and later stage erythroids are diffusely positive. See [Color Plate](#).



**Figure 77.9.** Megakaryocytic leukemic French/American/British (FAB) M7, marrow. Wright stain and immunoalkaline phosphatase staining. **A:** Megakaryoblasts often have dense chromatin and little cytoplasm, as shown here. **B:** Some megakaryoblasts have cytoplasmic blebs. **C:** The megakaryoblastic origin is confirmed by demonstrating CD41 expression using immunoalkaline phosphatase staining. See [Color Plate](#).

## Cytochemistry

Cytochemical stains may be used to demonstrate myeloid differentiation in leukemic blasts. Useful stains are myeloperoxidase (MPO), Sudan black B (SBB), and nonspecific esterase (NSE) ( [Fig. 77.3](#), [Fig. 77.4](#), [Fig. 77.5](#), [Fig. 77.6](#), [Fig. 77.7](#) and [Fig. 77.8](#)). Periodic acid–Schiff (PAS) and specific esterase (SE) stains are less helpful. The cytochemistry of the acute leukemias has been reviewed extensively ( [10](#), [11](#), [12](#), [13](#), [14](#) and [15](#)).

The MPO reaction is positive in cells of the granulocytic series and may be weakly positive in monocytes. MPO is located in the azurophilic granules of neutrophils and monocytes and specific granules of eosinophils. The reaction may be positive in poorly differentiated myeloblasts that lack azurophilic granules on Wright stain. Staining may be most pronounced in the Golgi region. Lymphocytes and erythroid precursors are negative. MPO is useful for distinguishing AML from ALL; demonstration of MPO activity in leukemic blasts establishes a diagnosis of AML ( [16](#), [17](#)). In cases of ALL, residual normal MPO–positive immature myeloid precursors are present in small numbers. A threshold of 3% positivity is frequently used to separate these from lymphoblasts, but regardless of threshold, lymphoblasts themselves are MPO negative.

SBB stains granule membranes ( [Fig. 77.4C](#)). The pattern of staining closely parallels MPO, but SBB positivity is usually stronger than MPO. Monocytes may contain sudanophilic granules, and monocytic leukemias may be SBB positive. Erythroid precursors are negative, and lymphoblasts are negative for myeloid–type intense positivity. SBB is useful for distinguishing AML from ALL, but ALL (especially granular ALL) may have weak SBB positivity ( [18](#), [19](#)), so it is important to compare reactivity to residual normal differentiating myeloid precursors. Auer rods are both MPO and SBB positive. As with MPO, a threshold of 3% positivity is frequently used to accommodate normal residual myeloid precursors in ALL, but regardless of threshold, lymphoblasts are negative for MPO–type SBB positivity.

NSE activity is found in monocytes ( [Fig. 77.6B](#) and [Fig. 77.7C](#)). Several substrates are available, but the most commonly used are alpha naphthyl butyrate (ANB) and alpha naphthyl acetate (ANA). Reactivity in monocytes is granular or diffuse, dependent on the color developer used. Monocytic NSE is inhibited by sodium fluoride (NaF). This is

generally unnecessary with the ANB stain, but the ANA stain also reacts with megakaryoblasts with a coarse granular pattern. In megakaryoblasts, the NSE activity is partially resistant to NaF inhibition. Megakaryoblasts are negative with ANB staining. These features may be used to identify megakaryoblasts, although if possible this should be corroborated with immunophenotyping. Twenty-five percent of APL cases are NSE positive (20). Lymphoblasts may be positive for NSE, with variable inhibition by NaF.

The substrate for SE staining is naphthol AS-D chloroacetate. SE is present in neutrophils and their precursors, but may also be present in monoblasts and monocytes. In the neutrophil series, it is only found in specific granules; hence, the reaction is typically negative in poorly differentiated AML, and the stain is not very useful for leukemia classification. SE has been used to demonstrate myeloid precursors in tissue sections (Leder stain). Monoblasts may have diffuse cytoplasmic staining, and lymphoblasts (especially granular lymphoblasts) may be positive with a granular pattern.

PAS reacts primarily with glycogen. ALL lymphoblasts often have prominent PAS staining in the form of coarse granules or blocks (Fig. 77.3A). Myeloblasts may also be positive, so the stain is of limited utility in diagnosis of acute leukemia. Maturing neutrophils are diffusely PAS positive. Monocytic precursors may show prominent granular PAS staining. Erythroid precursors are normally PAS negative. A coarsely granular staining pattern may be seen in pronormoblasts and basophilic normoblasts in myelodysplastic syndrome (MDS)-related AML (Fig. 77.8B). Diffuse PAS staining may be present in later stage erythroid precursors in MDS and MDS-related AML. Megakaryoblasts may show some PAS staining.

Other enzyme stains, such as acid phosphatase, are not useful in diagnosis of acute leukemia.

## Electron Microscopy

Ultrastructural studies have contributed substantially to the understanding of the cellular morphology of the acute leukemias (13, 21, 22 and 23) but have been supplanted by immunophenotyping and genetic studies for clinical diagnosis and characterization of patient material.

## Immunophenotyping

Immunophenotyping greatly facilitates diagnosis of the acute leukemias (24, 25, 26, 27, 28, 29, 30 and 31). The antibodies used recognize surface and cytoplasmic antigens expressed by human hematopoietic cells and their leukemic counterparts (Table 77.1). Most of the antigens are lineage associated, rather than lineage specific, but expression of groups of antigens is accurate in assignment of lineage. In difficult cases, a limited number of cytoplasmic antigens are currently considered lineage specific [cytoplasmic CD22 (cCD22) or cCD79a for B differentiation, cCD3 for T, cCD41 or cCD61 for megakaryoblastic, and cMPO for myeloid]. With immunophenotyping, morphology, and cytochemical tests, the lineage of differentiation (ALL or AML) can be reproducibly identified in more than 95% of acute leukemias, and ALL can be further subclassified based on T versus B precursor differentiation (32, 33, 34, 35, 36 and 37).

**TABLE 77.1. Immunologic Markers Commonly Used in Classification of Acute Leukemia**

| Lineage | Antigen |
|---------|---------|
|---------|---------|

|   |  |
|---|--|
| B cell                                      | CD19, CD20, CD22, CD79a, cCD22*, cCD79a*                         |
| T cell                                      | CD1, CD2, CD3, CD4, CD5, CD7, CD8, cCD3*                         |
| Lymphoid                                    | TdT  |
| Myeloid                                     | CD13, CD33, CD11b, CD15, CD4(CD2 <sup>-</sup> ),<br>CD117, cMPO* |
| Monocytic                                   | CD14, CD11b  |
| Erythroid                                   | Glycophorin A  |
| Megakaryocytic                              | CD41, CD61, cCD41*, cCD61*                                       |
| Lineage-independent antigens                |  |
| HLA class II                                | HLA-DR   |
| Leukocyte common antigen                    | CD45   |
| Stem cell antigen                           | CD34   |
| Common acute lymphoblastic leukemia antigen | CD10   |

NOTE: Antigens marked with an asterisk are currently considered lineage specific.

Immunophenotyping is usually performed by flow cytometry and interpreted in the context of panels of antibodies ( [Table 77.1](#) ) ( [38](#), [39](#) ). Paraffin immunohistochemistry on tissue sections can partially substitute for flow cytometry if a cell suspension is not available (i.e., dry tap and extramedullary sites), but the panel of available antibodies is limited and interpretation is more difficult ( [40](#), [41](#) ).

The immunophenotypic characteristics of leukemic cells are generally not unique to leukemia but reflect normal differentiation stages of cells sometimes with asynchronous antigen expression ( [32](#), [42](#), [43](#), [44](#) and [45](#) ). A discussion of lymphoid differentiation appears in [Chapter 18](#), [Chapter 19](#) and [Chapter 20](#) and myeloid differentiation in [Chapter 13](#). This discussion considers only use of myeloid and lymphoid differentiation antigens that are pertinent to the classification of acute leukemias.

**B-CELL MARKERS** The B-cell antigen receptor complex consists of an antigen-recognition structure [membrane immunoglobulin (Ig)] and two associated proteins, Ig- $\alpha$  and Ig- $\beta$ . In addition to the antigen receptor complex, B cells express a variety of other cell-surface proteins useful for diagnostic purposes. Some of these molecules function as receptors for signals that trigger B-cell maturation and activation; others, such as CD10 (common ALL antigen, a neutral endopeptidase), have cell-surface enzymatic activity ( [46](#) ). Antigens are expressed in an orderly sequence that reflects maturation ( [47](#) ). The earliest B precursor expresses nuclear terminal deoxynucleotidyl transferase (TdT) and class II HLA-DR antigens (neither lineage specific). CD19 and cytoplasmic CD22 appear early and are expressed in virtually all cases of B-precursor ALL. The same is true for CD79a (mb-1), the Ig- $\alpha$  portion of the B-cell antigen complex ( [48](#) ). Other antigens less useful for recognition of B-precursor blasts in ALL are CD20, cytoplasmic Ig (cIg), and surface Ig (sIg). Expression of TdT coincides with Ig heavy chain gene rearrangement. Expression of CD10 and CD19 precede rearrangement of Ig light chain. Precursors that are CD10, CD19, CD34, and TdT positive are designated early pre-B; their normal counterpart constitutes less than 1% of nucleated marrow cells. This phenotype accounts for approximately two-thirds of B-precursor ALL ( [49](#) ). The next stage, pre-B, has CD20 expression, cIg, and absence of sIg ( [50](#) ). Rearrangement of ? light

chain follows, then ? ( 51, 52, 53 and 54). Light chain gene rearrangement, in contrast to the heavy chain, is more lineage restricted, but light chain rearrangement has been reported in some cases of T-lymphoblastic disease ( 55, 56). A transitional stage may follow in which the lymphoblasts express cIg and sIg without ? or ? light chains ( 57). The last acute leukemic stage, the B-cell stage, has surface Ig, has often lost CD10, and is typically TdT negative; this stage corresponds to a leukemic phase of Burkitt lymphoma and is a counterpart of a germinal center cell rather than a marrow cell ( 58, 59 and 60). The frequency of B-cell-specific or B-cell-associated antigen expression in ALL is summarized in Table 77.2 ( 34).

**TABLE 77.2. Relative Frequency of B-Lymphoblastic Antigen Expression in Precursor B Acute Lymphoblastic Leukemia**

| Antigen  | Cases Positive (%) |
|--|--------------------|
| Ia/HLA-DR  | 99.8               |
| CD19   | 98                 |
| CD24   | 97                 |
| CD10 (common acute lymphoblastic leukemia antigen) | 92                 |
| CD9  | 90                 |
| CD22   | 74                 |
| CD34   | 64                 |
| CD20   | 36                 |
| CD21   | 4                  |

Adapted from Borowitz MJ. Immunological markers in childhood acute lymphoblastic leukemia. *Hematol Oncol Clin North Am* 1990;4:743-765.

Hematogones are early B-lineage cells that comprise up to 5% of nucleated cells in normal marrow. Their number may increase in adults or children after chemotherapy, stem cell transplantation, or with cytopenias of multiple causes ( 58, 59). Their immunophenotype (TdT, CD19, CD10, CD34 positive) is similar to B-precursor ALL ( 60).

**T-CELL MARKERS** T cells are recognized with monoclonal antibodies and by rearrangement of the T-cell receptor (TCR) genes ( 61, 62 and 63). TCR genes rearrange during T-cell differentiation to form a functional antigen with immunologic diversity. Two types of heterodimeric TCR are expressed on peripheral blood T cells. Receptors composed of  $\alpha$  and  $\beta$  subunits are expressed on most T cells, those composed of  $\gamma$  and  $\delta$  subunits on a small fraction ( 64). Both types of TCR are noncovalently associated with CD3, a complex of proteins involved in signal transduction. Rearrangement of the TCR- $\delta$  gene is followed by relatively synchronous rearrangement of the  $\gamma$  and  $\beta$  genes, followed by a  $\delta$  gene rearrangement. The TCR- $\delta$  gene is usually modified in T-precursor ALL, but the  $\gamma$ ,  $\beta$ , and  $\alpha$  genes may remain in germ-line configuration ( 65, 66 and 67). The TCR genes may also be rearranged in B-lineage ALL ( 62, 67, 68, 69 and 70) and AML ( 71).

Thymic stem cells are thought to arise from precursors in the marrow ( 45). The putative thymic precursor expresses nuclear TdT and membrane CD7. Some myeloid cells, but none of B-cell lineage, also express CD7 ( 72). Prethymocytes also express cytoplasmic CD3 ( 73). Rearrangement of the TCR- $\beta$  gene follows expression of CD7 ( 74). CD2, CD5, and CD7 antigens are expressed early and persist through T-cell development. CD2 is the sheep erythrocyte rosette receptor. CD4 and CD8 are expressed as T cells mature in the thymus, and CD3 is present on the cell surface in more differentiated cells. CD2 and CD7 are expressed in 5 to 30% of AML ( 75, 76). Most cases of T-ALL are HLA-DR negative,



whereas most AML cases, except APL, are HLA-DR positive.

**MYELOID LINEAGE** Many surface antigens expressed by myeloid cells have been identified, some of which are listed in [Table 77.1](#). Several antigens are expressed by both neutrophils and monocytes, whereas others are expressed by monocytes alone. Red cell precursors and platelets, as well as monocytes, express CD36. Other red cell and megakaryocyte antigens include glycoprotein A and CD41 and CD61, respectively. CD33 is expressed on normal myeloblasts, promyelocytes, myelocytes, and monocytes as well as on approximately 80 to 90% of AML blasts ([25](#), [77](#)). CD13 shows a similar distribution to CD33 in normal cells and is present in approximately 70 to 80% of AML. Monoclonal antibodies to CD11b, CD14, and CD36 react primarily with monocytic variants. CD11b is expressed in 5 to 10% of ALL, but CD14 is present in less than 1%. HLA-DR is expressed by 80% of AML; of the approximately 20% that are negative, most are APL. CD4 positivity in the absence of CD2 staining is a useful marker of myeloid lineage seen in 65% of AMLs ([78](#)). CD15 is more associated with differentiated leukemias. Glycoprotein A is expressed in erythroblasts but not until the colony-forming unit erythrocyte stage. CD41 (platelet glycoprotein IIb/IIIa) and CD61 (platelet glycoprotein IIIa) are present on megakaryoblasts ([79](#)). APL usually lacks CD34 and HLA-DR. CD2 is expressed in microgranular APL ([80](#)). CD56, the neural cell adhesion molecule, is an antigen expressed on natural killer cells and a subset of T cells often with cytolytic features. CD56 has been detected in 13 to 41% of AMLs ([81](#), [82](#) and [83](#)). CD56 expression is associated with monocytic differentiation, t(8;21), and trisomy 8 ([81](#)). Correlation with extramedullary location has been reported by some ([83](#)) but not by others ([81](#)). CD56 expression has been noted in a subset (approximately 5%) of AML with cytologic features of M3v ([84](#)). These myeloid/natural killer cell leukemias are HLA-DR and CD34 negative, CD33, CD13, CD56, and CD11a positive, and CD16 negative. Analysis for t(15;17) and PML/RARa has been negative in some cases ([84](#)) and positive in others ([85](#)).

**LINEAGE-INDEPENDENT MARKERS** CD10 (common ALL antigen) is present on B-precursor (>90%) and T-precursor ALL (10 to 40%), AML (1 to 5%), and mature neutrophils ([36](#), [47](#)). CD34 is a marker of primitive progenitor cells; it is seen in 40 to 60% of AML and 70 to 80% of B-precursor ALL ([86](#), [87](#)). HLA-DR is present on B cells, monocytes, and activated T cells; most acute leukemias are HLA-DR positive with the exception of T-ALL and APL. CD45, leukocyte common antigen, is present on all hematopoietic cells except erythrocytes and platelets ([88](#)); most leukemic blasts express CD45, but it is absent in some cases ([89](#)).

### Aberrant Antigen Expression in Acute Leukemia

Myeloid antigen expression (e.g., CD13, CD33, CD14, and CD15) is seen in 5 to 40% of adult and childhood ALL ([28](#), [90](#), [91](#), [92](#), [93](#) and [94](#)), higher in adults in most series. Some of the most commonly expressed myeloid-associated antigens are CD13 (6 to 16%) and CD33 (3 to 10%). In most ALL series, myeloid antigen expression has no significant independent effect on outcome ([94](#)). CD15-positive B-precursor ALL associates with 11q23/MLL rearrangements; other myeloid antigen-positive ALLs associate with t(9;22) ([90](#), [95](#)). CD4 is normally present on monocytes.

Lymphoid antigen expression is seen in 20 to 30% of AML. The most commonly expressed lymphoid-associated antigens are TdT (5 to 15%), CD7 (11 to 28%), CD2 (5 to 21%), and CD19 (3 to 14%). Others include surface CD3 (1%), CD10 (1 to 5%), and CD20 (6%) ([25](#), [77](#), [79](#), [96](#), [97](#)). Lymphoid antigen expression in AML correlates with neither TdT positivity nor presence of gene rearrangements ([96](#), [97](#)). AML with t(8;21) frequently expresses CD19 and CD56, and CD2 expression is frequent in the microgranular variant of APL ([96](#)). AML with lymphoid antigen expression or lymphoid gene rearrangement more often has t(9;22)



or 11q23 rearrangements ( [98](#) ). Lymphoid antigen expression in AML has no consistent prognostic significance beyond karyotypic associations ( [25](#) , [96](#) , [99](#) ).

## Enzyme Markers

The DNA polymerase TdT participates in rearrangement of Ig genes by inserting nucleotides at recombination junctions ( [100](#) ). It can be detected in individual cells by immunofluorescence or immunohistochemistry. TdT exists in high concentration in normal cortical thymocytes and in a small percentage of normal bone marrow cells, but not in blood lymphocytes. Expression is common in ALL, especially in blasts that are CD10 positive or of early B- or T-cell origin ( [101](#) , [102](#) ). Enzyme activity is usually absent in B/Burkitt ALL ( [103](#) ). TdT-negative ALL has been described in a small group of patients with high tumor burden and a poor response to therapy ( [104](#) , [105](#) ). In a small percentage of AML, blasts are TdT positive ( [106](#) , [107](#) and [108](#) ).

## Genetic Abnormalities

The known genetic abnormalities in the acute leukemias are discussed in detail in the preceding chapter. Presumably, genetic alterations are present and causative in all acute leukemias. The known abnormalities have led to an understanding of at least some of the events that transform precursor stem cells into acute leukemia, are now used in subclassification of the acute leukemias, and are increasingly the targets of directed therapy aimed at specific molecular genetic abnormalities in subsets of leukemia. This trend will continue and expand for the foreseeable future. It is imperative that new cases of acute leukemia receive thorough cytogenetic and directed molecular genetic evaluation to obtain sufficient information for accurate classification and appropriate direction of treatment.

## FRENCH/AMERICAN/BRITISH PHENOTYPIC DESCRIPTIONS

The acute leukemias mimic substantially the differentiation tree of hematopoietic/lymphoid cells. This capacity formed the basis for a morphologic/cytochemical classification system that evolved over the twentieth century, commencing with the description of myelomonocytic leukemia by Naegeli in 1900. In an important effort, in 1976 a group of French, American, and British investigators standardized this classification, with several subsequent modifications ( [16](#) , [109](#) , [110](#) , [111](#) , [112](#) , [113](#) and [114](#) ) ( [Fig. 77.2](#) , [Fig. 77.3](#) , [Fig. 77.4](#) , [Fig. 77.5](#) , [Fig. 77.6](#) , [Fig. 77.7](#) , [Fig. 77.8](#) and [Fig. 77.9](#) ). As treatment results for leukemia improved and the underlying genetic basis of leukemic transformation was elaborated in ensuing decades, comparisons with the FAB classification concluded that this historical classification approach had little predictive value for treatment outcome and compared poorly with biologic data. It is therefore of no continuing use as a clinical classification of disease per se, but it remains a useful shorthand descriptor for the varying morphology of acute leukemia and is described below for this purpose.

## Acute Lymphoblastic Leukemia

There are three FAB subtypes of blasts in ALL. Two are distinguished on the basis of size, nuclear shape, nucleoli, and amount of cytoplasm ( [Fig. 77.2](#) ) ( [109](#) ). L1 blasts are small with little cytoplasm, a regular nucleus, and small, inconspicuous nucleoli. L2 blasts are larger with irregular nuclear membranes, finer chromatin, one or more distinct nucleoli, and more abundant cytoplasm. L2 blasts are more common in adults (67% of adult cases),

and L1 blasts are more common in children (79% of pediatric cases) ( [115](#), [116](#) ). These two subgroups have no current clinical significance beyond recognition by the morphologist as ALL. L2 blasts can be confused with myeloblasts; reliable differentiation requires cytochemical stains and immunophenotyping ( [Fig. 77.3](#) and [Fig. 77.4](#) ) ( [24](#) ). The third type, L3 blasts, the leukemic counterpart of Burkitt lymphoma, are large regular cells with round to oval nuclei, fine or slightly coarse nuclear chromatin, prominent nucleoli, and intensely basophilic, often vacuolated, cytoplasm; the vacuoles are lipid and negative with PAS staining. Azurophilic granules are seen in 10% of L1 and L2 ALL ( [8](#), [9](#) and [10](#) ) ( [Fig. 77.2D](#) ), usually larger than granules in myeloblasts, often with a halo. The granules are negative for MPO, may be faintly PAS positive, are often positive for SE and NSE, and may stain weakly with SBB ( [9](#) ).

## Acute Myeloid Leukemia

FAB variants of AML are based on cell lineage and degree of differentiation ( [Fig. 77.4](#), [Fig. 77.5](#), [Fig. 77.6](#), [Fig. 77.7](#), [Fig. 77.8](#) and [Fig. 77.9](#) ). Three have granulocytic differentiation and differ from one another in extent of maturation (M0: undifferentiated by light microscopy; M1: poorly differentiated with demonstrable SBB/NSE positivity; M2: more differentiated). M3 (APL) demonstrates dysplastic promyelocytic morphology (M3h: hypergranular promyelocytes with a reddish color shift of granules, Auer rods, and faggot cells; M3v with inapparent or fine granules with light morphology, intense SBB/MPO positivity, and characteristic grooved bilobed nuclei; and M3a, less hypergranular blasts lacking features of M3h or M3v). M4 has both granulocytic and monocytic differentiation, a subtype having dysplastic eosinophils (M4Eo). M5 has monocytic differentiation with NSE positivity, predominantly blasts (M5a) or with differentiation to promonocytes and monocytes (M5b). M6 has myeloblasts with background dysplastic erythroid precursors, or in uncommon cases is comprised of erythroblasts. M7 has megakaryoblastic differentiation with surface blebs, binucleation, a clumping tendency of blasts, and ANA positivity with NaF resistance; it typically also has associated reticulin fibrosis. M0, M1, and M2 account for approximately 50% of AML; M4 for 25%; M3 for 10%; M5a and M5b for 10%; M6 for 5%; and M7 for 3 to 5% ( [117](#), [118](#) ). The exact distribution varies somewhat with age.

## DIFFERENTIAL DIAGNOSIS OF ACUTE MYELOID LEUKEMIA AND ACUTE LYMPHOBLASTIC LEUKEMIA

Separation of AML and ALL remains of fundamental importance for treatment of acute leukemia. It is based on a combination of morphology, cytochemistry, and immunophenotyping. With the exception of Auer rods and dysplastic promyelocytes, morphology alone is insufficient for reliable separation of the two entities, even in expert hands. Cytochemistry and immunophenotyping are somewhat redundant for diagnosis of leukemia. When offered on site, immunophenotyping is frequently available before cytochemistry. Immunophenotyping instrumentation is in increasingly widespread use, but rapid immunophenotyping is still not readily available in many areas of the world. Cytochemistry can contribute only negative information for diagnosis of ALL. Nevertheless, cytochemistry still contributes valuable information in some subsets of AML, is still useful for separation of AML and ALL in conjunction with immunophenotyping (or if immunophenotyping is unavailable), and is of great help for recognition of biphenotypic leukemias, in which small subsets of blasts with myeloid differentiation may be overlooked with immunophenotype gating.

## WORLD HEALTH ORGANIZATION CLASSIFICATION OF THE ACUTE LEUKEMIAS

In 2001, a group convened by the World Health Organization (WHO) published a new classification of hematopoietic and lymphoid neoplasms, including the acute leukemias (119) (Table 77.3). The directive for the classification was that it be up to date, incorporate genetic and immunophenotypic as well as morphologic information, and that it also be usable throughout the world, not just in Western academic medical centers. The AML classification includes four groups: AML with recurrent cytogenetic abnormalities, AML with multilineage dysplasia, therapy-related AML and MDS, and AML not otherwise specified, the latter being a modification of the FAB AML classification. The WHO classification does not group the acute lymphoid leukemias together, but separates them under three broader categories of lymphoid disease: precursor B-cell and precursor T-cell neoplasms, and mature B-cell neoplasms. Additionally, in each case it lumps predominantly leukemic disease with predominantly lymphomatous disease, based on similar biologic and genetic characteristics of disease rather than clinical presentation. Burkitt leukemia (previously L3/B-ALL) is lumped with Burkitt lymphoma and placed biologically correctly under mature B-cell neoplasms. However, because of its similarity to, and differential diagnostic problems with, precursor B-cell and T-cell ALL, Burkitt leukemia/lymphoma is also discussed in this chapter.

**TABLE 77.3. Classification of Acute Leukemias**

---

Acute myeloid leukemias

AMLs with recurrent cytogenetic abnormalities

AML with t(8;21)(q22;q22), (*AML1/ETO*)

AML with inv(16)(p13q22) or t(16;16)(p13;q22), (*CBFB/MYH11*)

Acute promyelocytic leukemia (AML with t(15;17)(q22;q12), (*PML/RAR $\alpha$* )

AML with 11q23 (*MLL*, abnormalities

AML with multilineage dysplasia

With prior myelodysplastic syndrome

Without prior myelodysplastic syndrome

AML and myelodysplastic syndrome, therapy related

Alkylating agent related

Topoisomerase II inhibitor related

AML, not otherwise categorized

AML, minimally differentiated

AML without maturation

AML with maturation

Acute promyelocytic leukemia lacking *RAR $\alpha$*  rearrangement

Acute myelomonocytic leukemia

Acute monoblastic and monocytic leukemia

Acute erythroid leukemia

Acute megakaryoblastic leukemia

Acute basophilic leukemia

Acute panmyelosis with myelofibrosis

Myeloid sarcoma

Acute lymphoblastic leukemias

Precursor B-lymphoblastic leukemia/lymphoma <sup>a</sup>

Precursor T-lymphoblastic leukemia/lymphoma <sup>a</sup>

Burkitt lymphoma/leukemia <sup>b</sup>

Acute leukemias of ambiguous lineage

Biphenotypic acute leukemia

Undifferentiated acute leukemia

AML, acute myeloid leukemia.

<sup>a</sup> Listed in World Health Organization (WHO) classification under precursor B-cell and T-cell neoplasms.

<sup>b</sup> Listed in WHO classification under mature B-cell neoplasms.

Modified from the World Health Organization Classification of Tumours, Pathology and Genetics: Tumours of Haematopoietic and Lymphoid Tissues.

---

## Acute Myeloid Leukemia

### ACUTE MYELOID LEUKEMIA WITH RECURRENT CYTOGENETIC ABNORMALITIES

Acute myeloid leukemias with recurrent cytogenetic abnormalities are characterized by recurring balanced translocations and inversions; have an approximately flat incidence throughout life after infancy, with median age in the 30s; lack multilineage background dysplasia; tend to have polyclonal background and remission hematopoiesis; tend to respond favorably to cytotoxic chemotherapy; and are unrelated pathogenetically to MDS ([120](#), [121](#) and [122](#)). They comprise approximately 85% of AML in young patients but only a small percent of cases in the elderly. Four specific groups are recognized in the classification, but others exist in smaller numbers. Each has morphologic correlates, though none are exact. All may be caused in a minor percent of cases by insertional events rather than translocations, and thus be cytogenetically inapparent, requiring fluorescence *in situ* hybridization or reverse transcriptase-polymerase chain reaction analysis for recognition. If these genetic abnormalities are encountered in a patient with symptomatic myeloproliferative disease, this diagnosis should be made regardless of the blast percent in peripheral blood or marrow ([122](#)).

- AML with t(8;21)(q22;q22);( *AML1/ETC*). Most typically, AML with differentiation (FAB M2 morphology). Blasts typically have prominent secondary granulation, an orange color to the Golgi zone with Wright-Giemsa staining, frequent Auer rods, and in some cases large granules similar to Chédiak-Higashi anomaly. Approximately 10 to 15% of AML.
- AML with inv(16)(p13q22) or t(16;16)(p13;q22);( *CBFb/MYH11*). Typically, AML with myelomonocytic differentiation and dysplastic eosinophils (FAB M4Eo morphology). The dysplastic eosinophils contain large purple granules, and may be positive for SE and PAS (normal eosinophils are negative). Other morphology is frequent, including lack of dysplastic eosinophils and M2 or M5 morphology. Approximately 6 to 8% of AML.
- APL (AML) with t(15;17)(q22;q12)( *PML/RARa*) and variants. High correlation with M3h or M3v (approximately 20% of cases) morphology; however, 2 to 3% of cases have M1 or M2 morphology. The uncommon variant translocation t(11;17)(q23;q12) ( *PLZF/RAR a*) usually has M3a morphology. Other translocation variants are t(5;17)(q32;q12) and t(11;17)(q13;q12). Approximately 8 to 10% of AML.
- AML with 11q23 ( *MLL*) abnormalities. Numerous translocation partners have been identified, the most frequent being t(9;11)(p21;q23);( *MLL/AF9*). Most frequently, AML with FAB M5 morphology, but there is considerable variation from case to case, including M2, M4, and M7 morphology. Approximately 5 to 8% of AML.

### ACUTE MYELOID LEUKEMIA WITH MULTILINEAGE DYSPLASIA MDS-type dysplastic

features should be present in at least two cell lines ( [120](#) ). AML leukemias with multilineage dysplasia are characterized by cytogenetic abnormalities shared with MDS; an exponentially increasing incidence with advancing age (similar to MDS), with median age in the 70s; tend to have multilineage background dysplasia; tend to have clonal background and remission hematopoiesis; respond poorly to cytotoxic chemotherapy, with resistant disease and sensitive background hematopoiesis; and are related pathogenetically to MDS ( [121](#) ). Cytogenetic abnormalities include  $-7/\text{del}(7q)$ ,  $-5/\text{del}(5q)$ ,  $+8$ ,  $+9$ ,  $+11$ ,  $\text{del}(11q)$ ,  $\text{del}(12p)$ ,  $-18$ ,  $+19$ ,  $\text{del}(20q)$ ,  $+21$ ; less frequently,  $t(2;11)$ ,  $t(1;7)$ ,  $t(3;3)(q21;q26)$ , and  $\text{inv}(3)(q21q26)$ . If these genetic abnormalities are encountered in a patient with AML and absent one of the recurring translocations found in the first category (AML with recurring cytogenetic abnormalities), this diagnosis should be made ( [122](#) ). Cases with a history of MDS should also be placed in this category. AML with multilineage dysplasia comprises approximately 15% of AML in young patients, and the vast majority of cases in the elderly. Further subclassification of this category is uncertain at this time, but may be based on specific genetic abnormalities (e.g.,  $-7$ ,  $+8$ ) and the complexity of abnormalities.

**ACUTE MYELOID LEUKEMIA, THERAPY RELATED** Some cytotoxic chemotherapy and radiation therapy are leukemogenic. Two patterns of therapy-related leukemia have been identified ( [120](#) ).

- Alkylating agent-related AML. Agents that cause interstrand cross-link DNA damage, such as alkylating agents, and radiation cause secondary leukemia morphologically and genetically similar to AML with multilineage dysplasia. Peak incidence is approximately 5 years after exposure. It is often preceded by MDS.
- Topoisomerase II inhibitor-related AML. Inhibitors of topo-isomerase II cause an increased incidence of the recurring translocations seen in the first category (AML with recurring cytogenetic abnormalities). The distribution of translocations varies with the agents used. Epipodophyllotoxins cause predominantly 11q23/MLL-type translocations, and to a lesser extent 21q22/AML1 translocations. Anthracyclines and complex therapeutic regimens are associated with an increased incidence of all translocations found in the first category. Peak incidence is earlier than for alkylating agent-related disease.

**ACUTE MYELOID LEUKEMIA NOT OTHERWISE CATEGORIZED** AML cases should be placed in one of the first three categories if possible, rather than in four ( [120](#) ). If placement in the first three categories is not possible for technological reasons or because of nondefinitive data, the modified FAB-type classification below is retained, with the understanding that treatment decisions will be based on other parameters than this classification, such as patient age.

- AML, minimally differentiated (FAB M0). No myeloid differentiation with Romanovsky morphology and cytochemistry, with differentiation confirmed by immunophenotyping or other means (e.g., electron microscopy).
- AML without maturation (FAB M1). Minimal myeloid differentiation confirmed by morphology and cytochemistry.
- AML with maturation (FAB M2). Maturing myeloid precursors beyond blasts comprise at least 10% of marrow cells.
- APL lacking an RARa translocation. Although not included in the WHO classification, APL occurs lacking an RARa translocation; it usually has M3a morphology, and has treatment response and course similar to other non- $t(15;17)$  AML. It does not respond to all- *trans*-retinoic acid therapy.
- Acute myelomonocytic leukemia (FAB M4). Mixed myeloid and monocytic differentiation in blasts demonstrated by morphology, cytochemistry, and immunophenotyping.
- Acute monoblastic leukemia (FAB M5a and M5b). Monoblastic differentiation predominates ( $>80\%$  of myeloid cells), demonstrated by morphology, cytochemistry,

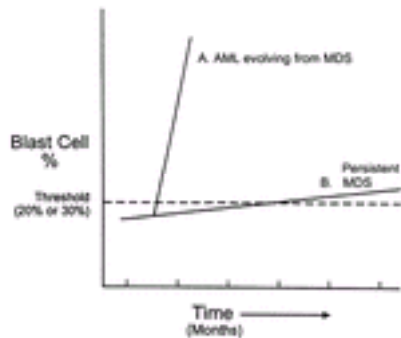


and immunophenotyping, with minimal further differentiation (M5a) or differentiation to promonocytes and monocytes (M5b).

- Acute erythroid leukemia.
  - Erythroleukemia (erythroid/myeloid). Myeloblastic leukemia with a major background component of maturing erythroid precursors.
  - Pure erythroid leukemia. Neoplastic proliferation of erythroid precursors with no myeloblastic component.
- Acute megakaryoblastic leukemia (FAB M7). Megakaryoblasts are characterized by surface blebs resembling budding platelets, a tendency to clump together, binucleation, ANA positivity partially resistant to NaF inhibition, and cytoplasmic immunopositivity for CD41 or CD61. Factor VIII expression is insensitive for diagnosis. Often associated with reticulin fibrosis of marrow. A variant in infants has t(1;22)(p13;q13) and presents with abdominal organomegaly.
- AML/transient myeloproliferative disorder (TMD) in Down syndrome (DS) variant of acute megakaryoblastic leukemia. DS patients have a striking increased incidence of AML younger than the age of 3 years; most is acute megakaryoblastic leukemia, but has an excellent prognosis with appropriate therapy. A similar but spontaneously remitting process (TMD) also occurs in DS, especially in the neonatal period. A substantial percent of patients with TMD later develop acute megakaryoblastic leukemia.
- Acute basophilic leukemia. Rare leukemia with predominant basophilic differentiation.
- Acute panmyelosis with myelofibrosis (acute myelofibrosis). Rare disorder characterized by rapidly progressive marrow fibrosis.
- Myeloid sarcoma. A tumor mass of myeloblasts may occur in association with other subtypes of AML, but rarely an isolated tumor mass is the first presenting manifestation of AML, with no discernible marrow disease.

**COMMENTS ABOUT ACUTE MYELOID LEUKEMIA CLASSIFICATION** The first three categories in the preceding AML classification are ultimately based on pathogenesis of disease ( [121](#) ). The fourth category is morphologic and descriptive. Thus, the classification is inconsistent in its premises. Several factors were important in dictating this inconsistency. If the second category, AML with multilineage dysplasia, is viewed as a surrogate for MDS-related disease, then most cases of AML appear to fall into the first two categories. However, there is no way currently to definitively assign all cases in these two categories. Because of this, it is also possible that there are other pathogenetic categories, as yet undescribed, encompassing small numbers of patients. Finally, the classification is intended for worldwide use, yet requisite technology for recognition of these categories of disease is not universally available. Therefore, the fourth category was necessary. If possible, given technological limitations, cases should be assigned in the first three categories, with fallback to the fourth group only if this is not possible.

***Differential Diagnosis of Myelodysplastic Syndrome versus Acute Myeloid Leukemia with Multilineage Dysplasia*** Traditionally, a 30% blast threshold in marrow has been used to separate AML and MDS. The proposal by the WHO working group to lower this threshold to 20% has stirred controversy. Rather than using variation of blast percent around a threshold, diagnosis of AML is better reserved for disease characterized by blast proliferation and tumor burden (AML), as opposed to ineffective hematopoiesis (MDS). Cases of MDS-related disease with blasts in the 20 to 35% range may behave as either AML or MDS clinically, and comparison to a fixed threshold cannot reliably discriminate between the two possibilities. When possible, it is advisable to delay definitive therapeutic intervention for several weeks in such cases and repeat a marrow examination to document the rate of rise of the blast percent. If the rise is gradual, persistent MDS is the better diagnosis; if rapid, AML should be the diagnosis ( [123](#) ) ( [Fig. 77.10](#) ).



**Figure 77.10.** In myelodysplastic syndrome (MDS)-related disease with a marrow blast percent from 20 to 35%, diagnosis of acute myeloid leukemia (AML) is best done with serial marrow examination. AML should show a rapid rise in blast percent, whereas persistent MDS has a stable blast percent or a slow rise. (Adapted from Head DR. Proposed changes in the definitions of acute myeloid leukemia and myelodysplastic syndrome: are they helpful? *Curr Opin Oncol* 2002;14:19-23.)

**FLT-3** To transform blasts to grow *in vivo* as acute leukemia appears to require at least two genetic events, one to block differentiation and a second to drive proliferation. As discussed in the preceding chapter, the genetic defects in AML with recurrent cytogenetic abnormalities all appear to block differentiation. Flt-3 is a member of the platelet-derived growth factor family of membrane receptors with cytoplasmic tyrosine kinase domains. Internal tandem duplications and point mutations that lead to constitutive activation of flt-3 are found in a percent of most subtypes of AML with recurrent cytogenetic abnormalities, as well as in some cases of AML with multilineage dysplasia, and appear to drive blast proliferation. Flt-3 is thus an example of an additional set of mutations that appear to cooperate in leukemia pathogenesis with genetic errors that block differentiation. Specific inhibitors of flt-3 activity are under development. Their clinical use will require identification and reporting of such defects. There is no provision as yet to incorporate this information as part of the WHO classification, but when available such information should become part of the complete descriptive pathologic report of a case.

### Acute Lymphoblastic Leukemia

**PRECURSOR B-LYMPHOBLASTIC LEUKEMIA/LYMPHOMA** Precursor B-lymphoblastic leukemias and lymphomas have demonstrable B-lineage differentiation in blasts by immunophenotyping ( [124](#) ). The most commonly used antibodies are for CD19, CD20, CD22, and CD79a. In difficult or ambiguous cases, cCD22 and cCD79a are considered lineage specific for B differentiation. They are also usually positive for CD10, HLA-DR, and TdT, and may be positive for CD34. They may have FAB L1, L2, or mixed blast morphology. The leukemias and lymphomas presumably differ in homing mechanisms for marrow versus lymph nodes, but share immunophenotype, genetic abnormalities, and response to therapy. They may be further subclassified by genetics into good risk [t(12;21)(p13;q22), hyperdiploidy >50], poor risk [t(9;22)(q34;q11.2), and average risk] groups.

**PRECURSOR T-LYMPHOBLASTIC LEUKEMIA/LYMPHOMA** Precursor T-lymphoblastic leukemias and lymphomas have demonstrable T-lineage differentiation in blasts by immunophenotyping ( [125](#) ). The most commonly used antibodies are for CD2, CD3, CD5, and CD7. In difficult or ambiguous cases, cCD3 is considered lineage specific for T differentiation. They are usually positive for TdT, negative for HLA-DR, and may express CD34. They may have FAB L1, L2, or mixed blast morphology. The leukemias and lymphomas presumably differ in homing mechanisms for marrow versus lymph nodes, but share overlapping immunophenotypes, genetic abnormalities, and response to therapy. A large number of recurring translocations have been described, but currently are not used for subclassification of cases for treatment purposes.



**BURKITT LYMPHOMA/LEUKEMIA** Burkitt lymphomas and leukemias are not technically precursor lymphoid neoplasms, but rather are derived from follicular center cells (small noncleaved lymphocytes). In the WHO classification, they are classified as mature B-cell neoplasms ([126](#)). However, because of similarities to, and differential diagnostic problems with, precursor B- and T-lymphoblastic disease, they are included here. Blasts have FAB L3 morphology, express clonal sIg, and are positive for CD19, CD20, CD22, and HLA-DR. They may express CD10, but are TdT negative. They have dysregulation of MYC by translocation into the promoter region of an Ig gene; most commonly, t(8;14)(q24;q32) (IgH) and less frequently t(2;8)(q11;q24) (? light chain) or t(8;22)(q24;q11) (? light chain). In pediatric disease, the genetics, L3 morphology, and clonal sIg are found together in most cases, but of the three the translocation is the most reliable marker, and morphology second. Clonal sIg is found in a small percent of cases of precursor B-lymphoblastic leukemia/lymphoma, a small percent of Burkitt lymphoma/leukemia is sIg negative, and occasional Burkitt-like cases lack typical FAB L3 morphology.

### Acute Leukemia of Ambiguous Lineage

There are two categories of acute leukemia of ambiguous lineage; cases with apparent differentiation to more than one lineage, usually T/myeloid or B/myeloid (biphenotypic acute leukemia), and cases with no discernible further differentiation beyond hematopoietic stem cells using current techniques (undifferentiated acute leukemia) ([127](#)).

**BIPHENOTYPIC ACUTE LEUKEMIA** Two morphologic populations of blasts are usually present; large blasts demonstrating differentiation as myeloblasts (SBB and MPO positive, often with Auer rods) and smaller blasts with FAB L1 lymphoblast morphology. The latter may have hand-mirror morphology. The blasts express a mixture of T and myeloid or B and myeloid antigens. Antigen expression may differ or overlap between the two morphologic populations. T/myeloid cases have no specific genotype, although both sets of blasts appear to share the same genotype. B/myeloid cases often have t(9;22)(q34;q11.2) or 11q23 translocations ([128](#)). Biphenotypic acute leukemia comprises 1 to 2% of acute leukemia cases ([129](#)).

**UNDIFFERENTIATED ACUTE LEUKEMIA** Blasts usually have FAB L2 morphology and lack any evidence of lineage differentiation. The incidence of this group is low but varies partially with the sophistication of techniques used to demonstrate lineage differentiation.

## SUMMARY

Acute leukemia is a marrow-based neoplasm arising in stem cells and composed predominantly of minimally or partially differentiated hematopoietic/lymphoid precursors. It is broadly classified into myeloid and lymphoid cell types, and currently subdivided using a combination of biologic, genetic, and pathogenetic features. Optimal diagnosis and classification require a variety of sophisticated immunophenotyping, cytogenetic, and molecular biologic techniques, when possible best performed in tertiary referral centers. The WHO classification forms the basis for current classification and treatment. The understanding of the pathogenesis of these diseases will continue to evolve rapidly, will result in further dramatic innovations in treatment targeted to specific genetic aberrations ([130](#)), and will predictably require further evolution of classification in the coming years.

## ACKNOWLEDGMENT

The author wishes to thank M.C. Kenney and I.N. Lukens for photomicrographs used in this chapter.

## REFERENCES

1. Haase D, Feuring-Buske M, Konemann S, et al. Evidence for malignant transformation in acute myeloid leukemia at the level of early hematopoietic stem cells by cytogenetic analysis of CD34<sup>+</sup> subpopulations. *Blood* 1995;86:2906-2912.
2. Boggs DR, Wintrobe MM, Cartwright GE. The acute leukemias. Analysis of 322 cases and review of the literature. *Medicine* 1962;41:163-225.
3. Freireich EJ, Gehan EA, Sulman D, et al. The effect of chemotherapy on acute leukemia in the human. *J Chronic Dis* 1962;14:593-608.
4. Bowman GP, Neame PB, Soamboonsrup P, et al. The contribution of cytochemistry and immunophenotyping to the reproducibility of the FAB classification in acute leukemia. *Blood* 1986;68:900-905.
5. Zucker-Franklin D, Greaves MF, Grossi CE, Marmont AM. Atlas of blood cells: function and pathology, vol 1, 2, 2nd ed. Philadelphia: Lea & Febiger, 1988:214-239,457-472.
6. Brunning RD, McKenna RW. Tumors of the bone marrow. Atlas of tumor pathology. Fascicle 9, Third series. Armed Forces Institute of Pathology, Washington: 1994:19-142.
7. Foucar K. Bone marrow pathology. Chicago: ASCP Press, 1995:189-227; 379-405.
8. Cerezo L, Shuster JJ, Pullen DJ, et al. Laboratory correlates and prognostic significance of granular acute lymphoblastic leukemia in children. A Pediatric Oncology Group study. *Am J Clin Pathol* 1991;95:526-531.
9. Stein P, Peiper S, Butler D, et al. Granular acute lymphoblastic leukemia. *Am J Clin Pathol* 1983;79:426-430.
10. Behm FG. Morphologic and cytochemical characteristics of childhood lymphoblastic leukemia. *Hematol Oncol Clin North Am* 1990;4:715-741.
11. Bennett JM. The classification of the acute leukemias: cytochemical and morphologic considerations. In: Wiernik PH, Canellos GP, Kyle RA, Schiffer CA, eds. Neoplastic diseases of the blood. New York: Churchill Livingstone, 1991:169-181.
12. Hayhoe FGJ, Quaglini D. Haematological cytochemistry. Edinburgh: Churchill Livingstone, 1980:259-308.
13. Polliack A, Leizerowitz R. Cytochemistry and ultrastructure in lymphoma and leukemia: utility in the diagnosis of different leukemias and the recognition of subtypes of lymphoproliferative disorders. *Hematol Oncol* 1983;1:101-126.
14. Sun T, Li CY, Yam LT. Atlas of cytochemistry and immunochemistry of hematologic neoplasms. Chicago: American Society of Clinical Pathologists Press, 1985.
15. Kass L. Leukemia cytology and cytochemistry. Philadelphia: JB Lippincott, 1982:245-272.
16. Bennett JM, Catovsky D, Daniel MT, et al. Proposals for the classification of the acute leukemias. *Br J Haematol* 1976;33:451-458.
17. Cheson BD, Cassileth PA, Head DR, et al. Report of the National Cancer Institute-sponsored workshop on definitions of diagnosis and response in acute myeloid leukemia. *J Clin Oncol* 1990;8:813-819.
18. Ngan M, Chien K, Lee S. Sudan black B positivity in acute lymphoblastic leukemia. *Mod Pathol* 1992;5:68-70.
19. Charak BS, Advani SH, Karandikar SM, et al. Sudan black B positivity in acute lymphoblastic leukemia.

Acta Haematol (Basel) 1988;80:199–202.

20. Davey FR, Davis RB, MacCallum JM, et al. Morphologic and cytochemical characteristics of acute promyelocytic leukemia. *Am J Hematol* 1989;30:221–227.

21. Huhn D, Thiel E, Rodt H, Andreewa P. Cytochemistry and membrane markers in acute lymphatic leukaemia (ALL). *Scand J Haematol* 1981;26:311–320.

22. Glick AD. Acute leukemia: electron microscopic diagnosis. *Semin Oncol* 1976;3:229–241.

23. Glick AD, Paniker K, Flexner JM, et al. Acute leukemia of adults. Ultrastructural, cytochemical and histologic observations in 100 cases. *Am J Clin Pathol* 1980;73:459–470.

24. Krause JR, Penchansky L, Contis L, Kaplan SS. Flow cytometry in the diagnosis of acute leukemia. *Am J Clin Pathol* 1988;89:341–346.

25. Robertson MJ, Ritz J. Prognostic significance of the surface antigens expressed by leukemic cells. *Leuk Lymphoma* 1994;13[Suppl 1]:15–22.

26. Casanovas RO, Solary E, Campos L. Prognostic relevance of surface markers in adult de novo acute myeloblastic leukemias: a prospective study of the Groupe d'Etude Immunologique des Leucemies (G.E.I.L.). *Leuk Lymphoma* 1994;13[Suppl 1]:7–10.

27. Dubosc-Marchenay N, Lacombe F, Dumain P, et al. Role of blast cell immunophenotyping for the diagnosis and prognosis of acute myeloid leukemia. *Hematol Oncol* 1992;10:235–249.

28. Borowitz MJ, Carroll AJ, Shuster JJ, et al. Use of clinical and laboratory features to define prognostic subgroups in B-precursor acute lymphoblastic leukemia: experience of the Pediatric Oncology Group. *Recent Results Cancer Res* 1993;131:257–267.

29. Bradstock KF. The diagnostic and prognostic value of immunophenotyping in acute leukemia. *Pathology* 1993;25:367–374.

30. Bradstock KF, Matthews J, Benson E, et al. Prognostic value of immunophenotyping in acute myeloid leukemias. *Blood* 1994;84:1220–1225.

31. Traweek ST. Immunophenotypic analysis of acute leukemia. *Am J Clin Pathol* 1993;99:504–512.

32. Greaves MF. Analysis of the clinical and biological significance of lymphoid phenotypes in acute leukemia. *Cancer Res* 1981;41:4752–4766.

33. Bowman WP, Melvin SL, Aur RJ, Mauer AM. A clinical perspective on cell markers in acute lymphocytic leukemia. *Cancer Res* 1981;41:4794–4801.

34. Borowitz MJ. Immunological markers in childhood acute lymphoblastic leukemia. *Hematol Oncol Clin North Am* 1990;4:743–765.

35. Crist WM, Grossi CE, Pullen DJ, Cooper MD. Immunologic markers in childhood acute lymphocytic leukemia. *Semin Oncol* 1985;12:105–121.

36. Foon KA, Todd RF III. Immunologic classification of leukemia and lymphoma. *Blood* 1986;68:1–31.

37. Foon KA. Laboratory and clinical applications of monoclonal antibodies for leukemias and non-Hodgkin's lymphomas. *Curr Probl Cancer* 1989;13(2):57–128.

38. Knapp W, Strobl H, Majdic O. Flow cytometric analysis of cell-surface and intracellular antigens in leukemia diagnosis. *Cytometry* 1994;18:187–198.

39. Slaper-Cortenback ICM, Admiraal LG, Kerr JM, et al. Flow cytometric detection of terminal deoxynucleotidyl transferase and other intracellular antigens in combination with membrane antigens in acute lymphocytic leukemias. *Blood* 1988;72:1639–1644.

40. Arber DA, Jenkins KA. Paraffin section immunophenotyping of acute leukemias in bone marrow

specimens. *Am J Clin Pathol* 1996;106:462-468.

41. Roth MJ, Medeiros LJ, Elenitoba-Johnson K, et al. Extramedullary myeloid cell tumors. An immunohistochemical study of 29 cases using routinely fixed and processed paraffin-embedded tissue sections. *Arch Pathol Lab Med* 1995;119:790-798.
42. Greaves MF. Differentiation-linked leukemogenesis in lymphocytes. *Science* 1986;234:697-704.
43. Uckun FM. Regulation of human B-cell ontogeny. *Blood* 1990;76:1908-1923.
44. Hurwitz CA, Gore SD, Stone KD, Civin CI. Flow cytometric detection of rare normal human marrow cells with immunophenotypes characteristic of acute lymphoblastic leukemia cells. *Leukemia* 1992;6:233-239.
45. Le Bien TW, Villablanca JG. Ontogeny of normal B-cell and T-cell precursors and its relation to leukemogenesis. *Hematol Oncol Clin North Am* 1990;4:835-847.
46. Le Bien TW, McCormack RT. The common acute lymphoblastic leukemia antigen (CD10)—emancipation from a functional enigma. *Blood* 1989;73:625-635.
47. Pui CH, Behm FG, Crist WM. Clinical and biologic relevance of immunologic marker studies in childhood acute lymphoblastic leukemia. *Blood* 1993;82:343-362.
48. Buccheri V, Mihaljevic B, Matutes E, et al. mb-1: A new marker for B-lineage lymphoblastic leukemia. *Blood* 1993;82:853-857.
49. Hurwitz CA, Loken MR, Graham ML, et al. Asynchronous antigen expression in B lineage acute lymphoblastic leukemia. *Blood* 1988;72:299-307.
50. Gathings WE, Lawton AR, Cooper MD. Immunofluorescent studies on the development of pre-B cells, B lymphocytes, and immunoglobulin isotope diversity in humans. *Eur J Immunol* 1977;7:804-810.
51. Korsmeyer SJ. Antigen receptor genes as molecular markers of lymphoid neoplasms. *J Clin Invest* 1987;79:1291-1295.
52. Korsmeyer SJ, Arnold A, Bakhshi A, et al. Immunoglobulin gene rearrangement and cell surface expression in acute lymphocytic leukemias of T cell and B cell precursor origins. *J Clin Invest* 1983;71:301-313.
53. Korsmeyer SJ, Hieter PA, Ravetch JV, et al. Developmental hierarchy of immunoglobulin gene rearrangements in human leukemic pre-B cells. *Proc Natl Acad Sci U S A* 1981;78:7096-7100.
54. Waldmann TA. The arrangement of immunoglobulin and T cell receptor genes in human lymphoproliferative disorders. *Adv Immunol* 1987;40:247-321.
55. Sheibani K, Wu A, Ben-Ezra J, et al. Rearrangement of  $\gamma$ -chain and T-cell receptor  $\beta$ -chain genes in malignant lymphomas of "T-cell" phenotype. *Am J Pathol* 1987;129:201-207.
56. Hanson CA, Thamilarasan M, Ross CW, et al. Kappa light chain gene rearrangement in T-cell acute lymphoblastic leukemia. *Am J Clin Pathol* 1990;93:563-568.
57. Koehler M, Behm FG, Shuster J, et al. Transitional pre-B-cell acute lymphoblastic leukemia of childhood is associated with favorable prognostic clinical features and an excellent outcome: a Pediatric Oncology Group study. *Leukemia* 1993;7:2064-2068.
58. Davis RE, Longacre TA, Cornbleet PJ. Hematogones in the bone marrow of adults. Immunophenotypic features, clinical settings and differential diagnosis. *Am J Clin Pathol* 1994;102:202-211.
59. Caldwell CW, Poje E, Helikson MA. B-cell precursors in normal pediatric bone marrow. *Am J Clin Pathol* 1991;95:816-823.
60. Longacre TA, Foucar K, Crago S. Hematogones: a multiparameter analysis of bone marrow precursor

cells. *Blood* 1989;73:543-552.

61. Flug F, Pelicci PG, Bonetti F, et al. T-cell receptor gene rearrangements as markers of lineage and clonality in T cell neoplasms. *Proc Natl Acad Sci U S A* 1985;82:3460-3464.
62. Minden MD, Mak TW. The structure of the T cell antigen receptor genes in normal and malignant T cells. *Blood* 1986;68:327-336.
63. Raulet DH, Garman RD, Saito H, Tonegawa S. Developmental regulation of T-cell receptor gene expression. *Nature* 1985;314:103-107.
64. Mak T, Toyonaga B. Genes of the T-cell antigen receptor in normal and malignant T cells. *Annu Rev Immunol* 1987;5:585-620.
65. Biondi A, Champagne E, Rossi V, Guidici G. T-cell receptor delta gene rearrangement in childhood T-cell acute lymphoblastic leukemia. *Blood* 1989;73:2133-2138.
66. de Villartay JP, Pullman AB, Andrade R, et al. Lineage relationship within a consecutive series of human precursor T-cell neoplasms. *Blood* 1989;74:2508-2518.
67. Foroni L, Laffan M, Boehm T, et al. Rearrangement of the T-cell receptor  $\delta$  genes in human T-cell leukemia. *Blood* 1989;73:559-565.
68. Felix CA, Wright JJ, Poplack DG, et al. T-cell receptor  $\alpha$ -,  $\beta$ -, and  $\delta$ -genes in T-cell and pre-B cell acute lymphoblastic leukemia. *J Clin Invest* 1987;80:545-556.
69. Hara J, Benedict SH, Mak TW, Gelfand EW. T cell receptor  $\alpha$ -chain rearrangements in B-precursor leukemia are in contrast to the findings in T cell acute lymphoblastic leukemia: comparative study of T cell receptor gene rearrangement in childhood leukemia. *J Clin Invest* 1987;80:1770-1777.
70. Tawa A, Benedict SH, Hara J, et al. Rearrangement of the T-cell receptor  $\delta$ -chain gene in childhood acute lymphoblastic leukemia. *Blood* 1987;70:1933-1939.
71. Cheng GY, Minden MD, Toyonaga B, et al. T cell receptor and immunoglobulin gene rearrangements in acute myeloblastic leukemia: evidence of lineage infidelity. *J Exp Med* 1986;163:414-424.
72. Vodinelich L, Tax W, Bai Y, et al. A monoclonal antibody (WT1) for detecting leukemias of T-cell precursors. *Blood* 1983;62:1108-1113.
73. Campana D, Janossy G, Coustan-Smith E, et al. The expression of T-cell receptor-associated proteins during T-cell ontogeny in man. *J Immunol* 1989;142:57-66.
74. Pittaluga S, Raffeld M, Lipford EH, Cossman J. 3A1(CD7) expression precedes T $\beta$  gene rearrangements in precursor T (lymphoblastic) neoplasms. *Blood* 1986;68:134-139.
75. Mirro J, Antoun GR, Zipf TF, et al. The E rosette-associated antigen of T cells can be identified on blasts from patients with acute myeloblastic leukemia. *Blood* 1985;65:363-367.
76. Kita K, Miwa H, Nakase K, et al. Clinical importance of CD7 expression in acute myelocytic leukemia. The Japan Cooperative Group of Leukemia/Lymphoma. *Blood* 1993;81:2399-2405.
77. Del Vecchio L, Schiavone EM, Ferrara F, et al. Immunodiagnosis of acute leukemia displaying ectopic antigens: proposal for a classification of promiscuous phenotypes. *Am J Hematol* 1989;31:173-180.
78. Larson RS, McCurley TL. CD4 predicts nonlymphocytic lineage in acute leukemia. Insights from analysis of 125 cases using two color flow cytometry. *Am J Clin Pathol* 1995;104:204-211.
79. Orfao A, Vidriales B, Gonzalez M, et al. Diagnostic and prognostic importance of immunophenotyping in adults with acute myeloid leukemia. *Recent Results Cancer Res* 1993;131:369-379.
80. Sato T, Abe R, Kawaguchi M, et al. Expression of monocytic and T-lymphocytic phenotype in a variant form of acute promyelocytic leukaemia (M3). *Scand J Haematol* 1986;37:151-153.

81. Seymour JF, Pierce SA, Kantarjian HM, et al. Investigation of karyotypic, morphologic and clinical features in patients with acute myeloid leukemia blast cells expressing the neural cell adhesion molecule (CD56). *Leukemia* 1994;8:823-826.
82. Vidriales MB, Orfao A, Gonzalez M, et al. Expression of NK and lymphoid-associated antigens in blast cells of acute myeloblastic leukemia. *Leukemia* 1993;7:2026-2029.
83. Iizuka Y, Aiso M, Oshimi K, et al. Myeloblastoma formation in acute myeloid leukemia. *Leuk Res* 1992;16:665-671.
84. Scott AA, Head DR, Kopecky KJ, et al. HLA-DR-, CD33+, CD56+, CD16-myeloid/natural killer cell acute leukemia: a previously unrecognized form of acute leukemia potentially misdiagnosed as French-American-British acute myeloid leukemia-M3. *Blood* 1994;84:244-255.
85. Paietta, Gallagher RE, Wiernik PH. Myeloid/natural killer cell acute leukemia: a previously unrecognized form of acute leukemia potentially misdiagnosed as FAB M3. *Blood* 1994;84:2824-2825.
86. Borowitz MJ, Shuster JJ, Civin CI, et al. Prognostic significance of CD34 expression in childhood B-precursor acute lymphocytic leukemia: a Pediatric Oncology Group study. *J Clin Oncol* 1990;8:1389-1398.
87. Pui CH, Hancock ML, Head DR, et al. Clinical significance of CD34 expression in childhood acute lymphoblastic leukemia. *Blood* 1993;82:889-894.
88. Thomas ML. The leukocyte common antigen family. *Annu Rev Immunol* 1989;7:339-369.
89. Behm FG, Raimondi SC, Schell MJ, et al. Lack of CD45 antigen on blast cells in acute lymphoblastic leukemia is associated with chromosomal hyperdiploidy and other favorable prognostic features. *Blood* 1992;79:1011-1016.
90. Garand R, Bene MC. A new approach of acute lymphoblastic leukemia immunophenotypic classification: 1984-1994 the GEIL experience. Groupe d'Etude Immunologique des Leucemies. *Leuk Lymphoma* 1994;13:1-5.
91. Sobel RE, Mick R, Royston I, et al. Clinical importance of myeloid antigen expression in adult acute lymphoblastic leukemia. *N Engl J Med* 1987;316:1111-1117.
92. Wiermsa SR, Ortega J, Sobel E, Weinberg KI. Clinical importance of myeloid-antigen expression in acute lymphoblastic leukemia of childhood. *N Engl J Med* 1991;324:800-808.
93. Pui CH, Behm FG, Singh B, et al. Myeloid-associated antigen expression lacks prognostic value in childhood acute lymphoblastic leukemia treated with intensive multiagent chemotherapy. *Blood* 1990;75:198-202.
94. Drexler HG, Thiel E, Ludwig WD. Review of the incidence and clinical relevance of myeloid antigen-positive acute lymphoblastic leukemia. *Leukemia* 1991;5:637-645.
95. Nakase K, Kita K, Shiku H, et al. Myeloid antigen, CD13, CD14, and/or CD33 expression is restricted to certain lymphoid neoplasms. *Am J Clin Pathol* 1996;105:761-768.
96. Ball ED, Davis RB, Griffin JD, et al. Prognostic value of lymphocyte surface markers in acute myeloid leukemia. *Blood* 1991;77:2242-2250.
97. Launder TM, Bray RA, Stempora L, et al. Lymphoid-associated antigen expression by acute myeloid leukemia. *Am J Clin Pathol* 1996;106:185-191.
98. Cuneo A, Ferrant A, Michaux JL, et al. Clinical review on features and cytogenetic patterns in adult acute myeloid leukemia with lymphoid markers. *Leuk Lymphoma* 1993;9:285-291.
99. Schaison GS. Childhood myeloid leukemias expressing lymphoid-associated antigens. *Pediatr Hematol Oncol* 1995;12:413-415.

100. Desiderio SV, Yancopoulos GD, Paskind M, et al. Insertion of N regions into heavy-chain genes is correlated with expression of terminal deoxytransferase in B cells. *Nature* 1984;311:752-755.
101. Hoffbrand AV, Ganeshaguru K, Janosy G, et al. Terminal deoxynucleotidyl-transferase levels and membrane phenotypes in diagnosis of acute leukemia. *Lancet* 1977;2:520-523.
102. Hutton JJ, Coleman MS. Terminal deoxynucleotidyl transferase measurements in the differential diagnosis of adult leukemias. *Br J Haematol* 1976; 34:447-456.
103. Coleman MS, Greenwood MF, Hutton JJ, et al. Adenosine deaminase, TdT and cell surface markers in childhood acute leukemia. *Blood* 1978;52:1125-1131.
104. Brusamolino E, Isernia P, Lazzarino M, et al. Clinical utility of terminal deoxynucleotidyl transferase and adenosine deaminase determinations in adult leukemia with a lymphoid phenotype. *J Clin Oncol* 1984;2:871-880.
105. Shurin SB, Scillian JJ. Absence of terminal transferase may predict failure of remission induction in childhood ALL. *Blood* 1983;62:81-84.
106. Benedetto P, Mertelsmann R, Sztatowski TH, et al. Prognostic significance of terminal deoxynucleotidyl transferase activity in acute nonlymphoblastic leukemia. *J Clin Oncol* 1986;4:489-495.
107. Jani P, Verbi W, Greaves MF, et al. Terminal deoxynucleotidyl transferase in acute myeloid leukaemia. *Leuk Res* 1983;7:17-29.
108. McCurley TL, Greer JP, Glick AD. Terminal deoxynucleotidyl transferase (TdT) in acute nonlymphocytic leukemia: a clinical, morphologic, cytochemical, immunologic, and ultrastructural study. *Am J Clin Pathol* 1988;90:421-430.
109. Bennett JM, Catovsky D, Daniel MT, et al. The morphologic classification of acute lymphoblastic leukaemia: concordance among observers and clinical correlations. *Br J Haematol* 1981;47:553-561.
110. Miller DR, Leikin S, Albo V, et al. Prognostic importance of morphology (FAB classification) in childhood acute lymphoblastic leukaemia (ALL). *Br J Haematol* 1981;48:199-206.
111. Bennett JM, Catovsky D, Daniel MT, et al. Criteria for the diagnosis of acute leukemia of megakaryocytic lineage (M7). *Ann Intern Med* 1985;103:460-462.
112. Lee EJ, Pollak A, Leavitt RD, et al. Minimally differentiated acute nonlymphocytic leukemia: a distinct entity. *Blood* 1987;70:1400-1406.
113. Bennett JM, Catovsky D, Daniel MT, et al. A variant form of hypergranular promyelocytic leukaemia (M3). *Br J Haematol* 1980;44:169-170.
114. Bennett JM, Catovsky D, Daniel MT, et al. Proposal for the classification of minimally differentiated acute myeloid leukaemia (AML-M0). *Br J Haematol* 1991;78:325-329.
115. Groupe Francais de Morphologie Hematologique: French registry of acute leukemia and myelodysplastic syndromes. Age distribution and hemogram analysis of the 4496 cases recorded during 1982-1983 and classified according to FAB criteria. *Cancer* 1987;60:1385-1394.
116. Brearley RL, Johnson SA, Lister TA. Acute lymphoblastic leukaemias in adults: clinicopathological correlations with the French-American-British (FAB) co-operative group classification. *Eur J Cancer* 1979;15:909-914.
117. Bennett JM, Begg CB. Eastern Cooperative Oncology Group study of the cytochemistry of adult acute myeloid leukemia by correlation of subtypes with response and survival. *Cancer Res* 1981;41:4833-4837.
118. Argyle JC, Benjamin DR, Lampkin B, Hammond D. Acute nonlymphocytic leukemias of childhood: inter-observer variability and problems in the use of the FAB classification. *Cancer* 1989;63:295-301.



119. Jaffe ES, Harris NL, Stein H, Vardiman JW, eds. World Health Organization classification of tumours, pathology and genetics: tumours of haematopoietic and lymphoid tissues. Lyon: IARC Press, 2001.
120. Brunning RD, Matutes E, Harris NL, et al. Acute myeloid leukaemia. In: Jaffe ES, Harris NL, Stein H, Vardiman JW, eds. World Health Organization classification of tumours, pathology and genetics: tumours of haematopoietic and lymphoid tissues. Lyon: IARC Press, 2001:75–105.
121. Head D. Revised classification of acute myeloid leukemia. *Leukemia* 1996;10:1826–1831.
122. Chan CF, Wang WC, Raimondi SC, et al. Myelodysplastic syndrome in children: differentiation from acute myeloid leukemia with a low blast count. *Leukemia* 1997;11:206–211.
123. Head DR. Proposed changes in the definitions of acute myeloid leukemia and myelodysplastic syndrome: are they helpful? *Curr Opin Oncol* 2002;14:19–23.
124. Brunning RD, Borowitz M, Matutes E, et al. Precursor B lymphoblastic leukaemia/lymphoblastic lymphoma. In: Jaffe ES, Harris NL, Stein H, Vardiman JW, eds. World Health Organization classification of tumours, pathology and genetics: tumours of haematopoietic and lymphoid tissues. Lyon: IARC Press, 2001:111–114.
125. Brunning RD, Borowitz M, Matutes E, et al. Precursor T lymphoblastic leukaemia/lymphoblastic lymphoma. In: Jaffe ES, Harris NL, Stein H, Vardiman JW, eds. World Health Organization classification of tumours, pathology and genetics: tumours of haematopoietic and lymphoid tissues. Lyon: IARC Press, 2001:115–117.
126. Diebold J, Jaffe ES, Raphael M, Warnke RA. Burkitt lymphoma/leukaemia. In: Jaffe ES, Harris NL, Stein H, Vardiman JW, eds. World Health Organization classification of tumours, pathology and genetics: tumours of haematopoietic and lymphoid tissues. Lyon: IARC Press, 2001:181–184.
127. Brunning RD, Matutes E, Borowitz M, et al. Acute leukaemias of ambiguous lineage. In: Jaffe ES, Harris NL, Stein H, Vardiman JW, eds. World Health Organization classification of tumours, pathology and genetics: Tumours of haematopoietic and lymphoid tissues. Lyon: IARC Press, 2001:106–107.
128. Carbonell F, Swansbury J, Min T, et al. Cytogenetic findings in acute biphenotypic leukaemia. *Leukemia* 1996;10:1283–1287.
129. Pui CH, Raimondi SC, Head DR, et al. Characterization of childhood acute mixed-lineage leukemia at diagnosis and at relapse. *Blood* 1991;78:1327.
130. Gilliland DG. Molecular genetics of human leukemias: new insights into therapy. *Semin Hematol* 2002;39:6–11.

2004 Lippincott Williams & Wilkins  
John P. Greer, John Foerster, John N. Lukens  
George M. Rodgers, Frixos Paraskevas, Bertil Glader  
Wintrobe's Clinical Hematology

**HISTORICAL BACKGROUND****PATHOPHYSIOLOGY**[Epidemiology](#)[Etiology](#)[Molecular Pathogenesis](#)**CLINICAL FEATURES****LABORATORY FEATURES**[Routine Laboratory Evaluation](#)[Lumbar Puncture](#)[Bone Marrow Evaluation](#)**DIFFERENTIAL DIAGNOSIS****PROGNOSTIC FACTORS**[Clinical Features](#)[Laboratory Features](#)[Response to Therapy](#)**PRIMARY THERAPY**[General Principles](#)[Adult Precursor B-Cell and T-Cell Acute Lymphoblastic Leukemia](#)[Adult Mature B-Cell Acute Lymphoblastic Leukemia](#)[Philadelphia Chromosome-Positive Acute Lymphoblastic Leukemia](#)[Acute Lymphoblastic Leukemia in Elderly Patients](#)**SALVAGE THERAPY**[Chemotherapy](#)[Bone Marrow Transplantation](#)**SUMMARY AND FUTURE DIRECTIONS****REFERENCES**

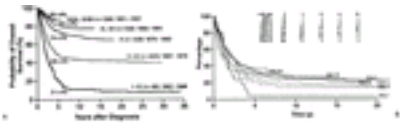
Acute lymphoblastic leukemia (ALL) is a neoplastic disorder that is rapidly fatal if untreated. In children, ALL is the most common leukemia, and considerable advances have resulted in most being cured of their disease. Similar progress in the treatment of ALL in adults has lagged behind. However, recent progress in understanding the molecular basis of the disease has led to improved prognostic stratification and may result in more rational, risk-adapted therapeutic approaches as well as the development of novel therapies.

The clinical onset of ALL is rarely insidious, and presenting signs and symptoms reflect bone marrow as well as extramedullary involvement by leukemia. Examination of the peripheral blood smear is often sufficient to establish the diagnosis of ALL, but additional clinical and laboratory tests are essential for formulating a treatment plan and provide important prognostic information. Current therapy for adults involves a scheduled sequence that starts with remission induction chemotherapy, followed by one or more cycles of intensification, prophylaxis of the central nervous system (CNS), and prolonged maintenance lasting 2 to 3 years. With this multiagent, multicycle approach, between 25 and 40% of adults with ALL are cured of their disease. Modifications to this general scheme, based on an appreciation of the high risk for disease relapse, have improved outcome for adult ALL patients who have the mature B-cell phenotype as well as those with the Philadelphia (Ph) chromosome. Age remains a significant limitation to treatment intensity as one-third of adults with ALL are over the age of 60 years.

Most adult patients with ALL experience relapse of their disease. Successful treatment options for relapsed or refractory ALL are few.

## HISTORICAL BACKGROUND

Only a few decades ago, ALL was an incurable disease in all but a small minority of patients. Progress in the treatment of pediatric ALL has been substantial. This is clearly illustrated in the results reported from a series of successive clinical protocols from St. Jude Children's Research Hospital ( [1](#), [2](#) ). Sequential treatment modifications in successive cohorts of children show a steady improvement in survival outcome as shown in [Figure 78.1A](#). The initial clinical trials from 1962 to 1969 introduced multiagent chemotherapy regimens into pediatric ALL therapy. This proved superior to single agent therapy, but, still, few children experienced long-term survival. The next era, from 1967 to 1979, saw effective prevention of leukemia relapse in sanctuary sites in the CNS through the use of cranial irradiation and intrathecal chemotherapy. Intensification of postremission therapy with administration of non-cross-resistant drugs was responsible for improving survival in subsequent cohorts. With further refinements, as well as general improvement in supportive care, approximately 85% of children with ALL are now cured of the disease.



**Figure 78.1.** Overall survival in successive acute lymphoblastic leukemia patient cohorts. **A:** Childhood acute lymphoblastic leukemia patients treated at the St. Jude Children's Research Hospital ( [2](#) ). **B:** Adult acute lymphoblastic leukemia patients treated by the UKALL collaborative study group ( [3](#) ).

The success demonstrated in the pediatric ALL trials led to similar approaches in the treatment of adults. As shown in [Figure 78.1B](#), outcomes in consecutive cohorts of adults with ALL treated by a collaborative study group gradually improved as treatment was intensified and extended. Compared with the success in treating childhood ALL, however, the degree of improvement is only modest. The British Medical Research Council initiated the United Kingdom Acute Lymphoblastic Leukemia (UKALL) trials in 1971 ( [3](#) ). The first trial, UKALL I, evaluated CNS prophylaxis but only enrolled 16 adults. Subsequent trials examined both the addition of active agents and more sustained intensive postremission therapy, and participation of adult patients progressively expanded. Survival for adults with ALL was still only 20% at the time the UKALL IX trial opened for patient accrual in 1980. It was the first trial in the series to enroll adults separately from children. UKALL IX and the subsequent trial, UKALL XA, saw further, although minor, incremental improvement in the survival rate but provided important systematic analyses of prognostic indicators based on clinical, immunophenotypic, and cytogenetic characteristics. The results from this trial are representative of outcomes expected with current therapy. The complete remission (CR) rate was 88%, disease-free survival at 5 years was 28%, and overall survival at 5 years was 34% ( [4](#) ). The current generation study, UKALL XII, opened for accrual in 1993. This study, along with efforts from many other collaborative study groups, will prospectively evaluate what may be the best approach to improving outcome for adults with ALL, tailored postremission therapy adapted

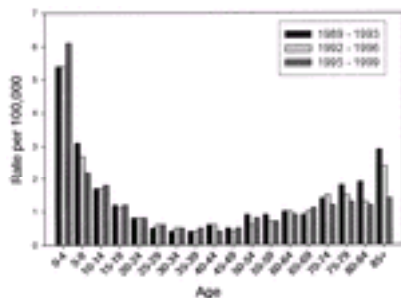
individually to each patient on the basis of anticipated relapse risk.

## PATHOPHYSIOLOGY

The cause of ALL is essentially unknown, and few clues can be derived from epidemiologic studies. The molecular pathogenesis of ALL is reviewed in [Chapter 76](#). Points relevant to adult ALL concerning these issues are briefly highlighted here.

### Epidemiology

The overall age-adjusted incidence of ALL in the United States based on the most recent National Cancer Institute report is 1.4 in 100,000 ([5](#)). The incidence of ALL in blacks is approximately one-half the incidence rate in whites. There is a slight male predominance with a male to female ratio of 1.3:1.0. The majority of the approximately 4000 new cases each year in the United States are diagnosed in persons younger than 15 years old with a peak between the ages of 2 and 5 years ([6](#)). A bimodal age-specific incidence pattern then ensues with a continuously decreasing incidence rate through young adulthood until age 50 when the incidence rate again rises ([Fig. 78.2](#)). A second minor peak observed in those over the age of 80 years was less pronounced during the most recent observation period between 1995 and 1999. Geographic differences in the incidence of ALL are reflected by higher rates in North America and Europe and lower rates in African and Asian populations ([7](#)).



**Figure 78.2.** Age-specific incidence rates for acute lymphoblastic leukemia by observation period. Data are based on Surveillance, Epidemiology, and End Results Program Cancer Statistics Review. (Data from Ries LAG, Eisner MP, Kosary CL, et al., eds. SEER Cancer Statistics Review, 1973–1999. Bethesda, MD: National Cancer Institute, 2002.)

### Etiology

The cause of ALL in adults is largely unknown ([8](#)). Inherited factors and genetic predisposition syndromes are more relevant to childhood ALL. Survivors of the nuclear fallout from the atomic bombing in Hiroshima and Nagasaki have an overall relative risk of 9.1 for ALL, greater among those exposed in childhood, with the peak incidence occurring 6 to 7 years after radiation exposure ([9](#)). Somewhat more relevant to adult ALL is the association between occupational exposure to low-dose ionizing radiation among nuclear workers in the United States and Europe and a slightly increased risk for leukemia, although findings were inconsistent across populations ([10](#), [11](#) and [12](#)).

Among chemical environmental exposure, high level benzene exposure that occurred before contemporary occupational standards is generally accepted as a cause of bone

marrow aplasia, chromosome damage, and leukemia ( [13](#), [14](#)). Cigarette smoking was linked to a small increase in risk for ALL among persons older than 60 years in one report ( [15](#)). Secondary acute leukemias occurring after exposure to chemotherapeutic agents are usually myeloid, although rare cases of therapy-related ALL have been observed ( [16](#), [17](#) and [18](#)).

## Molecular Pathogenesis

Molecular abnormalities can be grouped according to the functional consequence of oncogenic mutation. Acquired constitutive activation of the ABL protein kinase by rearrangement with the *BCR* gene is an example of a mutation that confers a proliferative advantage ( [19](#)). The fusion gene is the consequence of the t(9;22)(q34;q11) balanced chromosomal translocation, which is the most common cytogenetic abnormality in adult ALL. ABL is a nonreceptor tyrosine protein kinase that enzymatically transfers phosphate molecules to substrate proteins, thereby activating downstream signal transduction pathways important in regulating cell growth and proliferation ( [20](#)). Other gene rearrangements result in loss- or gain-of-function mutations involving transcription factors that are important for normal hematopoietic development ( [21](#)). An example is the t(12;21)(p13;q22) chromosomal translocation, which juxtaposes the *TEL* and *AML1* genes ( [22](#)). Excluding numerical aberrations, *TEL-AML1* is the most frequent cytogenetic abnormality in childhood ALL, although it is uncommon in adults. Another general mechanism of cancer formation involves loss or inactivation of tumor-suppressor genes, many of which have key regulatory functions in controlling cell cycle progression ( [23](#)). Examples are p16( *INK4A*) and p15( *INK4B*). Stock et al. investigated the incidence of cell cycle regulatory gene abnormalities in adult patients with *de novo* ALL treated by the Cancer and Leukemia Group B (CALGB) study group ( [24](#)). Deletions, microdeletions, and gene rearrangements involving p16( *INK4A*) and p15( *INK4B*) were common occurrences. Even more frequent was aberrant expression of *Rb* and *p53*, two other tumor-suppressor genes. Concurrent abnormalities involving two or more of these genes were found in one-third of adult ALL patients.

## CLINICAL FEATURES

Although the clinical presentation is variable and may develop insidiously, virtually all adults diagnosed with ALL present with symptoms of only a few weeks duration. The symptoms generally reflect bone marrow failure or involvement of extramedullary sites by leukemia ( [Table 78.1](#)). Up to one-half of patients with ALL have fever or documented infections. One-third have bleeding symptoms at diagnosis, which is less frequent than in patients presenting with acute myeloid leukemia. Severe hemorrhage is uncommon ( [25](#)). Fatigue, lethargy, dizziness, or even dyspnea and cardiac angina may reflect anemia in adults with ALL. Marrow expansion by leukemic blasts may produce bone pain and arthralgias, but marrow necrosis is much less frequently found in adults as compared with children who have ALL ( [26](#)). Approximately one-half of adult patients have hepatomegaly, splenomegaly, or lymphadenopathy at diagnosis that can be appreciated on physical examination. Mediastinal masses are detected by chest radiographs or computed tomography scans primarily in patients with T-lineage ALL, who also frequently have pleural involvement and may complain of chest pain ( [27](#)). The fewer than 10% of ALL patients who have CNS involvement infrequently present with referable symptoms, such as headache, vomiting, neck stiffness, alteration in mental status, and focal neurologic abnormalities. Other sites of extramedullary involvement include testis, retina, and skin, although virtually any organ can be infiltrated by leukemic blast cells.

**TABLE 78.1. Clinical Findings at Diagnosis in Adults with Acute Lymphoblastic Leukemia**

| Findings                        | Patients (%) |
|---------------------------------|--------------|
| Male                            | 59–63        |
| Symptoms                        |              |
| Fever/infection                 | 3–56         |
| Bleeding                        | 33           |
| Lymphadenopathy                 | 40–57        |
| Hepatomegaly                    | 24–47        |
| Splenomegaly                    | 31–56        |
| Mediastinal mass                | 10–15        |
| Central nervous system leukemia | 1–7          |
| Other organ involvement         |              |
| Pleura                          | 2.9          |
| Pericardium                     | 1.0          |
| Retina                          | 1.0          |
| Skin                            | 0.6          |
| Tonsils                         | 0.6          |
| Testis                          | 0.3          |

NOTE: Data are based on collaborative trials reported by the CALGB (n = 197; reference [53](#)); MRC (n = 617; reference [59](#)); GIMEMA (n = 778; reference [64](#)); and GMALL (n = 1273; reference [28](#)).

## LABORATORY FEATURES

In addition to a complete medical history and physical examination, patients with ALL should have a battery of diagnostic laboratory tests to confirm the diagnosis, subcategorize the patient's disease for prognostic classification, and plan for appropriate therapy ( [Table 78.2](#)). These studies include a complete blood count with examination of the peripheral blood smear, electrolyte measurements, creatinine, hepatic enzymes, uric acid, calcium, and albumin. Therapy-related declines in anticoagulation factors, including fibrinogen, occur with L-asparaginase, a drug commonly used in the treatment of ALL, and baseline levels should therefore be obtained. A mediastinal mass may be detected with a chest radiograph. A lumbar puncture for examination of the CSF to assess for leukemic involvement should be performed if patients present with neurologic symptoms. A bone marrow examination is mandatory and should include a complete cytogenetic assessment and immunologic phenotyping. Morphologic, cytogenetic, and immunophenotypic characteristics of ALL are detailed in [Chapter 77](#). This section emphasizes features pertinent to adults diagnosed with the disease.

**TABLE 78.2. Diagnostic Approach for Adult Acute Lymphoblastic Leukemia**

|                      |
|----------------------|
| Medical history      |
| Physical examination |
| Laboratory studies   |

Complete blood count, peripheral smear, coagulation studies, fibrinogen level, serum chemistry, ABO and Rh blood group, HLA typing  
 Chest radiograph or computed tomography  
 Lumbar puncture  
 Bone marrow aspiration and biopsy  
 Cytochemical stains, cytogenetic analysis, immunophenotype analysis, *BCR-ABL* molecular analysis

---

### Routine Laboratory Evaluation

Routine laboratory evaluation reveals that a substantial number of adult patients with ALL have normal or only modestly elevated white blood cell (WBC) counts at the time of diagnosis ( [Table 78.3](#)). Hyperleukocytosis ( $>100,000 \times 10^6/L$ ) occurs in approximately 15% of patients and may exceed  $200,000 \times 10^6/L$ . Some degree of anemia is present in the majority of adults. Approximately one-third of patients have a platelet count less than  $25,000 \times 10^6/L$ , which is approximately the same proportion that present with bleeding symptoms. Circulating leukemic blasts may not be evident on examination of the peripheral smear in a significant number of patients. Coagulation parameters are typically normal, and disseminated intravascular coagulation is rarely observed ( [28](#)). Metabolic abnormalities, including hyperuricemia, can occur, especially in patients with rapidly dividing leukemia cells and high tumor burden.

**TABLE 78.3. Laboratory Findings at Diagnosis in Adults with Acute Lymphoblastic Leukemia**

| Laboratory Finding                         | Patients (%) |
|--|--------------|
| White blood cell count ( $\times 10^6/L$ ) |              |
| <10,000                                    | 41           |
| <30,000                                    | 66           |
| 50,000–100,000                             | 10–13        |
| >100,000                                   | 14–16        |
| >200,000                                   | 6            |
| Hemoglobin (g/dl)                          |              |
| <5   | 11           |
| <10  | 55–62        |
| =10  | 38–45        |
| Platelet ( $\times 10^6/L$ )               |              |
| <25,000                                    | 30           |
| <50,000                                    | 41–55        |
| =50,000                                    | 48–59        |
| >150,000                                   | 15           |
| Blast cells in peripheral blood            |              |
| Present                                    | 92           |
| None                                       | 8            |
| Blast cells in bone marrow (%)             |              |
| <90  | 28–29        |



=90  
100

71-72  
7

NOTE: Data are based on collaborative trials reported by the CALGB (n = 197; reference [53](#)); MRC (n = 617; reference [59](#)); GIMEMA (n = 778; reference [64](#)); and GMALL (n = 1273; reference [28](#)).

## Lumbar Puncture

A lumbar puncture is often performed at the time of diagnosis to examine the cerebrospinal fluid (CSF). CNS involvement is traditionally defined as greater than 5 WBC/ $\mu$ L of CSF with morphologically unequivocal leukemic blasts on the cytocentrifuged specimen ([29](#)). Patients at risk for bleeding complications due to thrombocytopenia should be transfused to an adequate platelet count before the procedure. Whether to perform a lumbar puncture in patients with a high circulating blast count is controversial. This is due to concerns of iatrogenic “seeding” of the CNS with leukemic cells. Studies in pediatric ALL have shown that when the procedure is complicated by a traumatic tap, the finding of blast cells in the CSF occurs more frequently in children with higher presenting WBC count ([30](#)). Among the patients who had traumatic lumbar punctures, those with leukemic blasts in the CSF were more likely to have subsequent CNS relapse.

## Bone Marrow Evaluation

All patients with ALL should undergo a bone marrow aspiration and core biopsy procedure. The specimens must be submitted for histologic, cytogenetic, and immunophenotypic analysis. Morphologically, the marrow space is usually densely packed with leukemic blasts, which account for greater than 90% of nucleated cells in most adult ALL patients. As a result, the marrow biopsy sections are generally hypercellular, and, in 7% of adult patients with ALL, the normal marrow is completely replaced by leukemic blasts. This may prevent a successful aspiration, and a touch imprint of the biopsy tissue then becomes useful in evaluating cytologic features. Although increased reticulin deposits are common, marrow fibrosis is rarely present ([31](#), [32](#)).

**CYTOGENETICS** Historically, poor chromosomal morphology in ALL made banding studies challenging, and karyotypic abnormalities were not reliably detected in early studies ([33](#)). The implementation of modern metaphase spreading, banding, and molecular cytogenetic techniques now reveals prognostically significant abnormal karyotypes in the majority of adult patients with ALL ([34](#)). These molecular techniques include fluorescent *in situ* hybridization using chromosome- and gene-specific probes for gene rearrangements that are difficult to identify, such as the t(12;21) chromosomal translocation ([35](#)). Application of these sensitive methods has revealed, for instance, that the t(12;21) translocation is much less common in adults with ALL than in children ([36](#), [37](#)). Other age-related differences include fewer occurrences of numerical chromosome abnormalities and a higher incidence of the Ph chromosome in adults ([Table 78.4](#)).

**TABLE 78.4. Chromosomal Abnormalities at Diagnosis in Acute Lymphoblastic Leukemia**

| Chromosomal Abnormalities | Patients (%) |          |
|---------------------------|--------------|----------|
|                           | Adults       | Children |
| Normal karyotype          | 16-34        | 9        |

|                                     |       |      |
|-------------------------------------|-------|------|
| Numerical abnormalities             |       |      |
| Hypodiploid                         | 4–9   | 1    |
| Hyperdiploid (>50 chromosomes)      | 2–9   | 25   |
| Structural abnormalities            |       |      |
| t(9;22)                             | 11–30 | 4    |
| t(4;11)                             | 3–7   | 6    |
| t(10;14)                            | 4–6   | 4    |
| t(8;14)                             | 4     | 2    |
| t(1;19)                             | 3     | 5    |
| 9p abnormality                      | 5–16  | 7–13 |
| 6q abnormality                      | 2–6   | 4–6  |
| 12p abnormality, including t(12;21) | 4–5   | 22   |

NOTE: Data on adult acute lymphoblastic leukemia are from the Third International Workshop on Chromosomes in Leukemia (n = 329; reference [80](#)) and from collaborative trials reported by the CALGB (n = 256; reference [55](#)), MRC (n = 350; reference [82](#)), and GFCH (n = 443; reference [81](#)). Data on childhood acute lymphoblastic leukemia and t(8;14) are from reference [2](#).

---

Because of the profound prognostic implication of the Ph chromosome, molecular testing for the *BCR-ABL* gene rearrangement should be performed for all patients diagnosed with ALL ([38](#)). The Ph chromosome was originally identified in a patient with chronic myeloid leukemia, in whom the *BCR* and *ABL* genes juxtaposed within the so-called major breakpoint region ([19](#)). This transcribes a 7-kb messenger RNA that is expressed as a 210-kd fusion protein, or p210<sup>bcr-abl</sup>. In ALL, a variant breakpoint location, which results in the smaller p190<sup>bcr-abl</sup> oncoprotein, is commonly found ([39](#)). A polymerase chain reaction (PCR)-based laboratory test capable of detecting both the p210<sup>bcr-abl</sup> and p190<sup>bcr-abl</sup> gene transcripts is now readily available to most clinicians.

**IMMUNOPHENOTYPE** The primary basis of initial treatment strategies for ALL depends on antigenic parameters, and, hence, all patients should have their leukemic blasts characterized by immunophenotypic analysis. By current World Health Organization classifications, approximately 70% of adult ALL cases are precursor B-cell ALL, 25% are precursor T-cell ALL, and 5% are mature B-cell (Burkitt cell) ALL ([40](#), [41](#)). Compared with adults, children less often present with T-lineage ALL. There is also a slightly higher incidence of myeloid antigen expression in adult ALL patients, with reported incidences ranging from 15 to 54% compared with 4 to 35% in children ([42](#), [43](#)). Commonly detected myeloid antigens include CD13, CD15, and CD33. Rare cases with coexpression of multiple lymphoid and myeloid antigens may be considered acute biphenotypic leukemia according to criteria suggested by a European group ([44](#)). The clinical course appears to be poor; however, there is no uniform consensus on whether to manage these cases as acute myeloid or lymphoid leukemia ([45](#)). The Royal Marsden Hospital group identified 25 acute biphenotypic leukemia patients whom they treated over a 7-year period ([46](#), [47](#)). The patients variably underwent remission induction with ALL-like regimens, AML-like regimens, or hybrid regimens containing elements of both with equal success, except for an excess of treatment-related mortality with the latter. Overall survival was 39.4% at 2 years. They observed a high incidence of the Ph chromosome (41%), which partially accounted for the unfavorable outcome and emphasized the importance of aggressive risk-adapted therapy for these cases.

## DIFFERENTIAL DIAGNOSIS

The differential diagnosis of ALL in adult patients is rarely difficult. Most commonly, patients are diagnosed after an acute symptomatic presentation. ALL can be distinguished from the lymphocytosis, lymphadenopathy, and hepatosplenomegaly associated with viral infections and lymphoma by finding leukemic blasts in peripheral blood or bone marrow specimens. This is followed by definitive diagnosis with immunophenotypic studies.

Difficulty may arise when patients present with an antecedent or overlapping period of pancytopenia before developing ALL, as has been sporadically reported ([48](#), [49](#), [50](#) and [51](#)). It may be impossible to distinguish “aleukemic” pancytopenic ALL from aplastic anemia based on examination of the peripheral blood smear. Bone marrow evaluation and vigilant watch of the patient’s clinical course are mandatory in these instances.

Patients in lymphoid blast crisis of chronic myeloid leukemia are usually initially diagnosed in the chronic phase. Characterization of the breakpoint region for Ph-positive ALL patients is of no use in distinguishing *de novo* ALL from chronic myeloid leukemia lymphoid blast crisis, as both p190<sup>bcr-abl</sup> and p210<sup>bcr-abl</sup> are found in even distribution in patients with Ph-positive ALL ([52](#)).

## PROGNOSTIC FACTORS

Many clinical and biologic characteristics previously identified as prognostic factors for adult patients with ALL have lost predictive value as therapy has evolved and become more intensive. In contrast, age, WBC count at presentation, and initial response to therapy have remained strong predictors of outcome, as have immunophenotypic and cytogenetic features ([Table 78.5](#)). As noted above, the laboratory tests providing this information must be obtained for all patients who are diagnosed with ALL. New tests based on an assessment of the response to therapy, such as detection of minimal residual disease, may add refinement to known prognostic subtypes.

**TABLE 78.5. Prognostic Factors for Remission Duration in Adults with Acute Lymphoblastic Leukemia (ALL)**

| Patient Features                            | Prognostic Factor |
|---|-------------------|
| Age (yr)                                    |                   |
| <30   | Favorable         |
| =30   | Unfavorable       |
| White blood cell count ( $\times 10^6$ /ml) |                   |
| <30,000                                     | Favorable         |
| =30,000 (>100,000 for T cell)               | Unfavorable       |
| Immunophenotype                             |                   |
| T-cell ALL                                  | Favorable         |
| Mature B-cell ALL; early T-cell ALL         | Unfavorable       |
| Cytogenetics                                |                   |
| 12p abnormality; t(10;14)(q24;q11)          | Favorable         |
| Normal; hyperdiploid                        | Intermediate      |

|  |             |
|--|-------------|
| t(9;22), t(4;11), t(1;19), hypodiploid, -7, +8 Unfavorable |             |
| Response to therapy  |             |
| Complete remission within 4 wk                             | Favorable   |
| Persistent minimal residual disease                        | Unfavorable |

---

## Clinical Features

Advanced age and high WBC count at the time of diagnosis have held up as significant adverse prognostic factors in all modern adult ALL multicenter collaborative trials ( [4](#), [53](#), [54](#), [55](#), [56](#), [57](#), [58](#), [59](#), [60](#), [61](#), [62](#), [63](#), [64](#) and [65](#) ). Both advanced age and high WBC count were each inversely correlated with more frequent occurrences of CR, longer duration of CR, or better overall survival in either the majority or all of the collaborative studies. Advanced age was variably defined as greater than 30 or 35 years. When included in multivariate analysis as a continuous variable, increasing age predicted worse outcome across the entire age range, making it difficult to choose a cut-off separating standard-risk from high-risk patients. The cut-off for high WBC count was either  $30,000 \times 10^6/L$  or  $50,000 \times 10^6/L$ . In the trial conducted by the CALGB study group, patients with advanced age (30 to 59 years) and high WBC count had an overall survival of 39% and 34%, respectively, compared with 69% and 59% for patients without these adverse prognostic factors ( [53](#) ).

## Laboratory Features

**IMMUNOPHENOTYPE** The major immunophenotypic feature with prognostic value and therapeutic importance is the mature B-cell ALL subclassification. Mature B-cell ALL is characterized by expression of surface immunoglobulin, either kappa or lambda, in addition to other markers common to B-lineage ALL, including CD10, CD19, CD20, and CD22 ( [44](#) ). These patients respond poorly to standard ALL therapy, and outcome was dismal until brief, dose-intensified treatment programs were established as standard therapy ( [66](#), [67](#) ). The substantial improvement in survival that resulted has negated the adverse prognostic value of this feature if patients are optimally managed. T-cell ALL is another formerly unfavorable prognostic feature that, due to changes in treatment approach, is no longer a poor risk feature ( [68](#) ). In fact, with many modern treatment programs, the T-cell immunophenotype has become prognostically favorable ( [53](#), [58](#), [69](#) ). High WBC count does not adversely affect outcome in T-cell ALL if the greater than  $30,000 \times 10^6/L$  cut-off is used; however, a higher threshold ( $>100,000 \times 10^6/L$ ) may still identify patients who will have inferior survival ( [56](#), [57](#) ). Additionally, more detailed examination of prospective immunophenotypic data collected by the CALGB identified a subset characterized by expression of fewer than three T-cell markers that had an unfavorable prognosis ( [70](#) ). Leukemic blasts from these patients also infrequently expressed mature T-cell surface markers such as CD1, CD2, CD3, CD4, and CD8, and, hence, would be consistent with the “early” T-cell ALL immunophenotype also reported to be unfavorable by the German study group ( [71](#), [72](#) ). Other immunophenotypic markers have variably been shown to have prognostic value but are less well established. CD34 is expressed more frequently in adults with B-lineage ALL and was reported to adversely affect outcome by the CALGB ( [70](#) ). However, CD34 expression overlapped with both a high WBC and the presence of the Ph chromosome, and findings from other smaller series have yielded conflicting results ( [73](#), [74](#), [75](#), [76](#) and [77](#) ). From recent series, expression of myeloid antigen markers was slightly more frequent in B-lineage ALL than in T-lineage ALL but had no prognostic

value in either instance ( [54](#), [70](#), [78](#) ).

**CYTOGENETICS** Unfavorable cytogenetic abnormalities in adult ALL include t(9;22), t(4;11)(q21;q23), t(1;19)(q23;p13), and a hypodiploid karyotype. Translocations involving chromosomal band 14q11 and abnormalities of the short arm of chromosome 12, including t(12;21), are favorable cytogenetic abnormalities. Results from collaborative studies providing karyotypic data generally indicate disease-free survival rates less than 25% for patients with unfavorable abnormalities, as opposed to greater than 75% for those with favorable cytogenetic findings ( [52](#), [55](#), [79](#), [80](#), [81](#), [82](#) and [83](#) ). Additional reports from single institutions have provided similar outcome data ( [84](#), [85](#) ). Cytogenetic findings commonly identified in adult ALL with an intermediate prognosis include normal karyotype, hyperdiploidy, and abnormalities at 6q or 9p. The t(8;14)(q24;q32) and other *MYC* gene rearrangements are associated with the mature B-cell ALL subtype and are not prognostically unfavorable markers with optimal treatment. Adult Ph-positive patients achieve CR rates comparable to Ph-negative ALL patients, but the remissions are short and survival poor with standard therapy. The most frequent translocation in adults involving the *MLL* gene, located at chromosome band 11q23, is t(4;11) and is also associated with poor survival ( [83](#) ). The t(1;19) translocation results in the *E2A-PBX* gene rearrangement, and patients with this abnormality were found to have a 3-year disease-free survival rate of only 20% ( [81](#) ). Patients with hypodiploidy ranging from 30 to 39 chromosomes have a disease-free interval of only 2 to 4 months from the start of treatment ( [81](#) ). Deletions and translocations involving 12p include the *TEL-AML1* gene rearrangement. *TEL* gene rearrangements are much less frequent in adults than in children but are prognostically favorable in both. Translocations involving the *TCR-α* and *-δ* genes at chromosome 14q11 most frequently result in rearrangement with the *HOX11* gene at 10q24 ( [86](#) ). Adult ALL patients with t(10;14)(q24;q11) experience long survival, but this may reflect an association with T-cell ALL subtypes ( [55](#), [81](#) ).

## Response to Therapy

Response to therapy can be assessed by determination of time to attainment of CR, quantitation of early leukemic blast clearance, or detection of minimal residual disease. These measurements provide a direct assessment of biologic susceptibility to antileukemic agents, and, as such, prognostic factors based on them have inherently high heuristic power. In addition, prospective evaluation of their utility as predictors of outcome in clinical trials has established that they also have high explanatory power. However, virtually all of the clinical studies measuring these outcomes have been performed in pediatric ALL. Modest variation in results among pediatric studies, likely a reflection of differences in the techniques used to measure treatment response, further limit the adoption of these methodologies for practical patient management in adults. Nonetheless, a survey of current results suggests that such assessments of response to therapy may become crucial prognostic factors. These should aid in refining prognostic models with the goal of improving outcome with risk-adapted therapy.

**EARLY COMPLETE REMISSION** Failure to achieve CR within 4 weeks of starting treatment or after one course of induction chemotherapy is an unfavorable prognostic factor in most adult ALL studies ( [53](#), [65](#) ). When significant, early CR held predictive value for standard ALL programs as well as for newer, dose-intensified treatment protocols ( [4](#), [57](#), [69](#), [87](#), [88](#) and [89](#) ). Patients requiring greater than 4 weeks to achieve CR were at least twice as likely to relapse, depending on the study. In one study, patients who did not achieve CR by week 4 of induction had a 5-year disease-free survival of 0% as compared with 46% for the remainder of the complete responders ( [69](#) ). In this study, the number of weeks required to achieve CR was only marginally worse than the Ph chromosome as an unfavorable variable.

**EARLY LEUKEMIC BLAST CLEARANCE** Evaluation for persistence of leukemic blasts at



even earlier time points, between days 7 and 21 of induction, has been firmly established as an important prognostic indicator for outcome in pediatric ALL ( [90](#), [91](#) and [92](#) ). Early persistence of leukemic blasts at 7 days after starting induction is thought to represent corticosteroid resistance ( [93](#) ). In contrast, persistence at time points after 21 days is considered a reflection of cytotoxic chemotherapy resistance. Numerous prospective studies in pediatric ALL have shown that a substantial unfavorable influence on outcome is associated with the morphologic detection of blood or marrow leukemic blasts persisting during induction therapy at day 7, day 21, or at other time points in between. Persistence of leukemia was usually defined as the finding of greater than  $1000 \times 10^6/L$  blast cells in a peripheral blood sample or leukemic blasts greater than 5% of normal cells in a marrow specimen. Although pediatric protocols already incorporate early treatment response assessment by a day 7 or day 14 bone marrow examination into risk classification, similar data in adult ALL are only beginning to appear ( [94](#) ). Results from the few studies reported thus far agree with findings from the pediatric experience. Sebban et al. prospectively evaluated persistence of marrow blasts, defined as greater than 5% of nucleated cells, at day 15 of induction for influence on outcome ( [88](#) ). Among 437 adult ALL patients, one-third were found to have persistent blast cells. These patients were less likely to achieve CR after 4 weeks of therapy. Even among only the patients who achieved CR within 4 weeks, an otherwise favorable feature, those who had persistent blasts at day 15 fared significantly worse. Among all complete remitters, the 5-year disease-free survival was 34% for those who cleared marrow blasts at day 15, compared with 19% for those who did not. Annino et al. and the Italian collaborative study group evaluated the early corticosteroid response by giving a 7-day course of prednisone immediately before induction ( [64](#) ). The preinduction response was previously shown to have strong prognostic value in pediatric ALL ( [95](#), [96](#) ). In the adult ALL study, prednisone response was defined by reduction of peripheral blood blasts to less than or equal to  $1000 \times 10^6/L$ . Lack of a prednisone response was found to negatively affect overall survival, as it did in the pediatric ALL studies, and, among CR patients, it also adversely influenced remission duration.

**MINIMAL RESIDUAL DISEASE** *Minimal residual disease* refers to the postremission persistence of leukemia that cannot be detected by histomorphologic assessment. Immunophenotypic, cytogenetic, or molecular techniques can be used to detect minimal residual disease ( [97](#) ). Samples from peripheral blood are generally one log<sub>10</sub> less sensitive than bone marrow but may have comparable sensitivity in T-lineage ALL ( [98](#), [99](#) and [100](#) ). Fluorescence *in situ* hybridization is better than conventional banding analysis for detecting chromosomal translocations and numerical abnormalities, but both are limited by low sensitivity ( [101](#), [102](#), [103](#) and [104](#) ). The most sensitive assays for detecting minimal residual disease are based on PCR techniques, which can detect one leukemic blast in up to  $10^6$  normal cells. PCR targets using fusion gene transcripts such as *BCR-ABL*, *TEL-AML1*, *MLL-AF4*, and *E2A-PBX* are relatively standardized, but each alone can only be used for patient subsets ( [105](#), [106](#) ). PCR targets based on immunoglobulin and T-cell receptor gene rearrangements can be used to detect minimal residual disease in theoretically all patients but lose sensitivity if consensus rather than patient-specific primers are used ( [105](#), [107](#) ). Generating patient allele-specific primers requires DNA sequencing capability, and accurate quantitation is difficult without *real-time* PCR analyses. Flow cytometry, used in 4-color combinations and taking advantage of new reagents, can unambiguously distinguish one leukemic blast among more than  $10^4$  normal cells in 90% of all patients ( [108](#), [109](#) ). This level of sensitivity is sufficient for prognostically significant minimal residual disease detection ( [110](#) ). Additionally, flow cytometry is rapid, reliable, and allows accurate quantitation, and the technical requirements for the assay are already in place at most centers. Information from ongoing pediatric ALL trials using PCR and flow cytometry in tandem may help determine the role of each for evaluating

minimal residual disease ( [111](#) ). Many studies evaluating the prognostic utility of minimal residual disease detection have been reported ( [90](#), [105](#), [112](#) ). Virtually all were conducted in children with ALL. Three of the pediatric studies stand out for having large patient numbers, inclusion of both B- and T-lineage ALL, and for including patients with poor risk features ( [110](#), [113](#), [114](#) ). The European studies were multicentered and used PCR detection of patient-specific antigen receptor gene rearrangement, whereas Coustan-Smith et al. used multicolor flow cytometry in an unselected patient cohort treated at the St. Jude Children's Research Hospital. Minimal residual disease was determined at the end of induction and at various time points thereafter. The testing was technically challenging, as 1254 of 1914 (66%) combined patients treated during the study period did not have suitable PCR targets, did not have serial PCR performed, or did not have an immunophenotype suitable for minimal residual disease assessment. Nonetheless, all three studies demonstrated an unfavorable influence of persistent minimal residual disease on relapse-free survival. By multivariate analyses in the St. Jude study, sequential detection of persistent minimal residual disease remained a poor prognostic marker after controlling for age, WBC count, and adverse cytogenetics including the Ph chromosome and *MLL* gene rearrangement ( [110](#) ). Detection of minimal residual disease during maintenance therapy tended to have the strongest positive predictive value for relapse. Conversely, absence of minimal residual disease at the end of induction negated the unfavorable influence of persistent leukemic blasts at day 7 as a prognostic factor. Issues related to technique remain to be resolved. For instance, threshold values of minimal residual disease were suggested to be prognostically significant by the clinical studies ( [113](#), [114](#) ). Quantitation of leukemia-specific residual disease with the PCR assay, however, is technically demanding, and little is mentioned about efforts to ensure standardization of assay sensitivity between testing facilities. Quantitative real-time PCR may aid substantially in this regard ( [115](#) ). Efforts to study the predictive value of minimal residual disease in adult ALL have been considerably more limited, but the findings have been similar ( [116](#), [117](#) and [118](#) ). Mortuza et al. reported results for 66 Ph-negative adult B-lineage ALL patients treated at a single institution, for whom minimal residual disease was assessed with PCR using consensus immunoglobulin heavy chain gene primers ( [116](#) ). Detection of residual leukemia at the  $10^{-3}$  level, the limit of sensitivity of the assay, independently correlated with inferior disease-free survival. Ongoing prospective minimal residual disease assessment in trials being conducted by major cooperative groups will help clarify the extent to which the substantial pediatric data can be extrapolated to adult ALL ( [119](#), [120](#) ).

## PRIMARY THERAPY

Current management strategies for adult patients with ALL require a careful assessment of relapse risk at the time treatment is initiated. Most adult ALL patients have the precursor B-cell or T-cell subtype and can be managed with established treatment programs that start with remission induction, followed by blocks of intensification, CNS relapse prophylaxis, and prolonged maintenance therapy. With modern multiagent regimens, up to 90% of patients achieve CR, and 25 to 40% can be cured. The disease-free survival figure obviously needs improvement, and, hence, therapy should be tailored for patients who have an adverse prognostic profile. Risk-adapted therapy has proven remarkably effective for certain poor-risk groups, such as brief dose-intensive protocols for adult patients with mature B-cell ALL. Other patient groups known to have high risk for disease relapse should undergo allogeneic bone marrow transplantation (BMT) in first remission, given an available donor and eligibility status. Considerable clinical data suggest that this strategy has been effective, particularly with Ph-positive patients. Elderly ALL patients pose special treatment considerations, which are discussed in this chapter. General issues relating to supportive care of the patient with leukemia are



discussed in [Chapter 75](#).

## General Principles

On presentation, certain pretreatment considerations should be attended to before initiating therapy. Leukemia therapy is guided by an estimate of relapse risk, although there is no formal risk assessment tool for adult ALL. In reviewing the list of agents used to induce remission and protect against relapse, it can be appreciated that the individual superiority of one drug over another in many instances has not been established. Complicating management decisions are similarly conflicting outcome results for BMT in first remission for high-risk patients, although the general consensus is that allogeneic BMT from a sibling donor is best therapy.

**PRETREATMENT CONSIDERATIONS** Attention should be paid to metabolic, infectious, and hematologic matters before starting leukemia-specific therapy. Hyper-uricemia, hyperphosphatemia, and secondary hypocalcemia may be pronounced with high leukemic cell burden and require intravenous hydration, alkalization, and administration of allopurinol. In addition to myelosuppression during intensive treatment blocks, ALL therapy suppresses cell-mediated immunity, and some protocols have provisions for prophylaxis against herpesvirus and *Pneumocystis carinii* infections ([87](#)). The clinical consequences of hyperleukocytosis ( $=100,000 \times 10^6/L$ ) in adult ALL patients are not well understood. Patients with *MLL* gene rearrangements and the mature B-cell ALL subtype are at higher risk for hyperleukocytosis at presentation ([52](#)). In children, pronounced hyperleukocytosis involving lymphoid blasts are better tolerated than myeloid blasts, as reflected by fewer complications attributable to leukostasis or hemorrhage ([121](#)). In one series, leukapheresis for pediatric ALL patients having blast counts greater than or equal to  $200,000 \times 10^6/L$  led to outcomes equivalent to those for children who did not have this degree of hyperleukocytosis ([122](#)). A similar policy is reasonable for adult ALL patients. Alternatively, immediate administration of prednisone or vincristine can rapidly reduce the circulating blast count. In an adult series, the WBC count dropped from greater than  $100,000 \times 10^6/L$  to less than  $1000 \times 10^6$  in 39% of patients given a 7-day course of prednisone immediately preceding remission induction chemotherapy ([64](#)).

**RISK ASSESSMENT MODEL** There are no useful clinical staging or prognostic scoring systems for adult ALL patients as there are for other hematologic malignancies, and there are no agreed-on uniform risk criteria as there are for pediatric ALL ([123](#), [124](#), [125](#), [126](#) and [127](#)). A prognostic model based on CALGB data suggested an additive effect of multiple adverse prognostic features on outcome, and, conversely, those without any poor prognostic factors did exceptionally well with few relapses ([53](#)). Others have described similar analyses ([57](#), [69](#)). Based on these models and the current clinical evidence, a general framework for risk assessment may consider placing adults with ALL in high-risk and standard-risk prognostic categories ([Fig. 78.3](#)). All patients with at least one established poor prognosis factor based on clinical, immunophenotypic, or cytogenetic features and morphologic response to induction therapy should be considered at high risk for relapse. Adding response to therapy, based on early blast clearance and minimal residual disease detection, as a risk criterion for adapting therapy awaits prospective validation of these prognostic factors in adult ALL studies.



**Figure 78.3.** Risk assessment for adult acute lymphoblastic leukemia (ALL). Clinical,

immunophenotypic, and cytogenetic features may be combined with the initial response criteria to classify patients at high risk or low risk for disease relapse. CR, complete remission; WBC, white blood cell.

**REMISSION INDUCTION** The goal of remission induction therapy is hematologic CR, as defined by the eradication of morphologically detectable leukemia cells in blood and bone marrow and the return of normal hematopoiesis. Remission induction chemotherapy for adults with ALL is most commonly built around a backbone of vincristine and prednisone. Remission induction with these two drugs in combination produces CR in approximately one-half of patients with *de novo* ALL. The CR rate improves to 70 to 85% when an anthracycline is added, which was proven in a landmark CALGB trial to be superior to vincristine and prednisone alone ( [128](#) ). Induction failures are evenly divided between refractory disease and toxicity-related mortality ( [4](#), [53](#), [56](#), [64](#), [69](#) ). The efficacy of various anthracyclines in adults has been similar, including daunorubicin, doxorubicin, zorubicin, and mitoxantrone ( [68](#), [129](#), [130](#) and [131](#) ). Many alterations to the basic induction regimen have been evaluated ( [72](#), [132](#), [133](#), [134](#) and [135](#) ). A critical evaluation of the individual merits of these modifications is challenging. Improvement to CR rates that already exceed 80% would be difficult to detect at a satisfactory level of significance. Modern treatment protocols are complex, and it is difficult to attribute outcome results to any one component or to make comparisons of significant findings between any two trials. For example, most modern induction protocols also incorporate L-asparaginase, cyclophosphamide, or both, although neither has been proven by controlled trials to be beneficial in adult ALL when added to initial induction regimens. The one randomized trial with L-asparaginase found no improvement in frequency or duration of CR with the addition of L-asparaginase to doxorubicin, vincristine, and prednisone during induction ( [136](#) ). Nonetheless, L-asparaginase has a mechanism of action that is close to being ALL-specific and causes minimal myelosuppression, and efficacy data can be found in the pediatric ALL experience ( [137](#) ). An Italian Gruppo Italiano Malattie Ematologiche dell'Adulto (GIMEMA) trial randomized adult ALL patients to induction with daunorubicin, vincristine, prednisone, and L-asparaginase with or without cyclophosphamide ( [64](#) ). The rate and durability of remission, as well as overall survival, did not differ between the two randomized treatment groups or for any subtype analyzed. In contrast, other studies have suggested a benefit with the inclusion of cyclophosphamide during induction, especially for patients with T-cell ALL, and, conversely, worse outcome with its omission ( [53](#), [138](#) ). Dose-intensified anthracycline and high-dose cytarabine induction regimens are being evaluated as alternatives to traditional induction protocols. These treatment programs were intended to improve outcome by inducing rapid reduction of leukemic cell mass to achieve early CR ( [139](#) ). Todeschini et al. generated considerable interest with reports from two sequential trials showing that dose escalation of daunorubicin to 225 mg/m<sup>2</sup> and, subsequently, to 270 mg/m<sup>2</sup> significantly improved disease-free survival ( [140](#), [141](#) and [142](#) ). Multicentered implementation of this protocol by the GIMEMA group, however, failed to reproduce the earlier experience based on an interim analysis of 460 of 501 total patients enrolled ( [143](#) ). Weiss et al. investigated a different approach using high-dose mitoxantrone given with high-dose cytarabine during induction ( [144](#), [145](#) ). Compared with historical controls, this regimen yielded an improvement in the remission rate as well as the time to CR and is currently being explored in an expanded randomized trial at six study sites in the United States. Patients with mature B-cell ALL have poor initial responses to these conventional regimens and require special dose-intensified remission induction programs that are discussed below ( [66](#), [67](#), [146](#), [147](#) ). Granulocyte colony-stimulating factor started after completion of the first few days of ALL induction chemotherapy did not improve CR rates in randomized trials. It did shorten the duration of neutropenia by 5 to 6 days and appears to decrease the incidence of associated complications, particularly infections ( [54](#), [148](#), [149](#) and [150](#) ).

**INTENSIFICATION THERAPY** Postremission intensification or consolidation therapy after the attainment of CR is standard treatment for adult patients with ALL. This therapy refers to the administration of non-cross-resistant drugs aimed at eliminating residual leukemia to prevent relapse as well as the emergence of drug-resistant cells. Variably myelosuppressive doses of different drugs are given according to various schedules depending on the protocol. Due to the heterogeneity of approaches, it is difficult to assess the effect of any individual drug, and only a general assessment of the overall value of intensification can be made. A randomized trial in childhood ALL clearly demonstrated that administration of both early (given immediately after CR) and late (week 20) intensification therapy was better than either early or late intensification alone and better than no intensification at all ( [151](#) ). Two other pediatric trials confirmed the benefit of intensification ( [152](#), [153](#) ). Results from comparative trials in adults have been less clear and again highlight the difficulty of comparing findings from discordantly designed studies. The childhood study was conducted by the British UKALL study group, which also enrolled adult patients in a concurrent trial using essentially identical treatment regimens ( [4](#) ). There was a significant decrease in relapse incidence for patients who received the early intensification block, but this was not reflected by a statistically significant improvement in disease-free survival, possibly due to an increased number of deaths during remission. Likewise, two GIMEMA studies randomizing adult ALL patients to intensive versus standard consolidation and maintenance saw no advantage in disease-free survival for intensified postremission treatment ( [63](#), [64](#) ). No benefit was observed with extending consolidation started early in the postremission period from 1 month to 4 consecutive months ( [154](#) ). Adding two myelosuppressive consolidation courses patterned after acute myeloid leukemia, “3 + 7” cytarabine and daunorubicin, to maintenance alone made no difference in the duration of remission ( [155](#) ). Last, very late intensification given at 6 months or 11 months after CR, in two separate trials, led to no reduction in relapse compared with standard postremission therapy alone ( [156](#), [157](#) ). In contrast, clinical data from nonrandomized trials provide evidence that adult ALL patients benefit from intensification ( [53](#), [56](#), [57](#) ). In the CALGB study, patients who achieved CR received two blocks of early intensification in addition to an 8-week late intensification therapy ( [53](#) ). The reported medians of remission duration and survival, 29 months and 36 months, respectively, were substantially better than those observed in prior CALGB trials that did not use intensification blocks. Outcomes better than historical comparison groups were reported by German Multicenter Acute Lymphoblastic Leukemia (GMALL) studies that consolidated remission patients with a late “re-induction” of drugs identical to initial therapy given 21 weeks after starting treatment ( [56](#), [57](#) ).

**MAINTENANCE THERAPY** Like postremission intensification, the value of long-term, continuous maintenance therapy for adult ALL has not been established by randomized trials as it has for pediatric ALL ( [158](#) ). Patterned after the childhood ALL experience, maintenance therapy usually consists of daily 6-mercaptopurine and weekly methotrexate for a total treatment period of 2 to 3 years. There is no information from adult ALL trials regarding the proper duration of maintenance therapy, but children who receive less than 18 months of therapy have worse outcome. The addition of monthly pulses of vincristine and prednisone reduced relapses in controlled childhood ALL studies and has been adopted in some adult maintenance therapy regimens. From a mechanism-of-action perspective, it may be that long-term drug exposure is required to eradicate residual slowly dividing or drug-resistant ALL clones ( [159](#) ). This could explain why maintenance is not necessary for optimally treated patients with mature B-cell ALL, which is a highly mitotically active leukemia ( [2](#), [66](#), [67](#), [146](#), [147](#) ). Relatively strong evidence that adult ALL patients benefit from maintenance therapy comes from a number of studies showing inferior outcome when prolonged maintenance was completely omitted ( [129](#), [160](#), [161](#) and [162](#) ). The CALGB study was intended to evaluate the efficacy of mitoxantrone during induction and consolidation given over a 7- to 9-month period without maintenance ( [129](#) ). Patient accrual on this trial was terminated at interim analysis because the median

duration of remission (11 months) was much shorter than in previous protocols. Similarly, another American cooperative study group investigated high-dose cytarabine intensification followed by 8 cycles of multiagent consolidation (161). Without maintenance, the median duration of remission was 10 months, and the disease-free survival at 4 years was only 13%.

**CENTRAL NERVOUS SYSTEM THERAPY** CNS prophylaxis is essential in the treatment of ALL. Approximately one-third of adult patients will eventually have CNS involvement at relapse without prophylactic therapy (163, 164). The advantage of CNS prophylaxis in adult ALL was established by the Southeastern Cancer Group in a randomized trial comparing cranial irradiation plus intrathecal methotrexate versus no prophylaxis (165). CNS prophylaxis may involve combinations of intrathecal chemotherapy, cranial irradiation, and systemic administration of drugs with high CNS bioavailability, such as high-dose methotrexate and high-dose cytarabine. Although the best combination of modalities and the preferred timing have not been established in controlled trials, a number of different approaches have all proved equally effective. Intrathecal chemotherapy alone or high-dose chemotherapy alone, however, has been associated with poor protection from CNS relapse (166, 167). On the other hand, more aggressive approaches combining all three modalities do not yield clearly superior results (56). Cranial irradiation between 1800 and 2400 cGy plus intrathecal methotrexate started after achievement of CR has been used as CNS prophylaxis in several studies with CNS relapse rates between 0 and 11% (53, 60, 69, 138). Similar results were achieved in other studies that were able to omit cranial irradiation by starting intrathecal chemotherapy concurrent with induction and incorporating high-dose methotrexate, high-dose cytarabine, or both (63, 87, 155). Adult ALL patients with CNS involvement at diagnosis require additional CNS-directed therapy. Up to 10% of adults present with CNS leukemia at the time of diagnosis (53, 57, 131, 167). Patients with mature B-cell ALL are at high risk for both CNS disease at presentation and subsequent CNS relapse (66, 67). The treatment of CNS leukemia has generally involved early and repeated dosing of intrathecal chemotherapy started during induction therapy (57, 69, 87). Kantarjian et al. gave twice weekly alternating intrathecal methotrexate and cytarabine until the CSF showed no leukemic blasts, followed by the standard intrathecal prophylaxis regimen (87). Linker et al. gave intrathecal methotrexate injections weekly for 10 weeks, then monthly for the remainder of the first year (69). The cranial irradiation dose was also increased to 2800 or 3000 cGy when included as CNS prophylaxis during the treatment protocol (57, 69). With either approach, the presence of CNS leukemia did not adversely affect subsequent outcome.

**BONE MARROW TRANSPLANTATION** Allogeneic BMT in first remission improves outcome for adult ALL patients with high-risk features and should be pursued for all eligible patients. Outcome data from most uncontrolled individual trials indicate disease-free survival between 40 and 60% with matched sibling allogeneic BMT (168, 169, 170, 171, 172, and 173). Some centers reported exceptionally impressive results. In a transplant study performed by Stanford University and the City of Hope National Cancer Center, high-risk inclusion criteria were defined as age greater than 30 years, a WBC count greater than  $25,000 \times 10^6/L$ , failure to achieve CR within 6 weeks of starting induction, or the presence of unfavorable cytogenetic abnormalities. Blume et al. initially reported a disease-free survival rate of 63%, which held up at 61% with longer follow-up of an expanded patient cohort, as reported by Chao et al. (168, 169). Registry data from the International Bone Marrow Transplant Registry (IBMTR) provide additional information. Registry data are useful in limiting the influence of selection bias and heterogeneity between patient groups at different institutions, especially when based on large patient numbers. Reporting on 243 adult patients with high-risk ALL undergoing sibling donor allogeneic BMT, the 5-year estimate of disease-free survival was 39% (174). Treatment-related mortality (37%) exceeded disease relapse (30%) as the cause of treatment failure. In additional analyses by the IBMTR, patients were found to be half as



likely to relapse if they developed either acute or chronic graft-versus-host disease ( [175](#) ). Others have also described similar evidence for a significant graft-versus-leukemia effect, which may have contributed to the relatively low relapse rate ( [176](#) ). Several comparisons of IBMTR data with outcome after standard therapy have been reported ( [177](#) , [178](#) and [179](#) ). In these indirect comparisons with historical control groups, allogeneic BMT in first CR proved superior for survival due to protection from relapse. Only one study providing controlled outcome data for allogeneic BMT versus standard therapy has been completed, and long-term results were recently reported ( [61](#) , [62](#) , [131](#) ). The French Leucémie Aiguë Lymphoblastique de l'Adulte (LALA) study group genetically randomized adult patients with ALL to sibling donor allogeneic BMT in first CR versus consolidation and maintenance chemotherapy, regardless of risk category. Risk categorization was based on criteria set by the German study group ( [57](#) , [58](#) ). Allogeneic BMT was found to be significantly superior to standard therapy but only for high-risk patients. Disease-free survival at 10 years for these patients was 44% with allogeneic BMT versus 11% for conventional therapy. For standard-risk patients, disease-free survival with allogeneic BMT was similar (49%) but no better than conventional therapy (43%). The preliminary results of an Italian multicenter randomized trial evaluating a similar study design also appeared to favor allogeneic BMT over standard chemotherapy only for high-risk patients ( [180](#) ). Allogeneic BMT from unrelated donors for adults in first CR can be successfully performed. Various individual trials have been reported, but the most relevant outcome results are recently updated registry data from the National Marrow Donor Program ( [181](#) , [182](#) and [183](#) ). Sixty-four patients with high-risk features, including the t(4;11) and t(1;19) translocations, received matched unrelated donor allogeneic BMT in first remission. Transplant-related mortality was 54%, but relapse at 4 years was only 19%, and only 1 of 17 patients surviving beyond the first year had relapsed at the time of last follow-up. The role for autologous BMT as an option for postremission therapy in high-risk ALL patients is difficult to evaluate. The French LALA group performed a trial, parallel to the allogeneic BMT study, that randomly assigned patients younger than 50 years who did not have a matched sibling donor to autologous BMT versus standard therapy, once again regardless of disease risk ( [62](#) , [131](#) ). Conventional therapy was found to be equivalent to autologous BMT for standard-risk patients. For high-risk patients, autologous BMT and conventional therapy both proved equally ineffective, with 10-year disease-free survival rates of 10% and 16%, respectively. Patients on the BMT arm were transplanted after three consolidation courses, and the autografts were purged with monoclonal antibodies and complement or mafosfamide. Many autologous transplant studies compare individual trials with registry data and report significantly better results. These trials differ considerably from one another and from the French randomized study with respect to timing of transplant, purging method, intensity of preparative regimen, and whether posttransplant maintenance therapy is given ( [184](#) , [185](#) ). Taken together, disease-free survival for autologous BMT in first CR from individual trials ranges from 26 to 65%, a wide degree of variability likely reflecting the above considerations ( [173](#) , [186](#) ). In some studies, transplant-related mortality approached 20% and seems high relative to contemporary experience with autologous BMT ( [187](#) , [188](#) and [189](#) ). A trial genetically randomizing adult patients in first CR to sibling donor allogeneic versus autologous BMT found the former superior by a substantial margin ( [190](#) ). These results suggest that sibling donor and, probably, matched unrelated donor allogeneic BMT is preferable to autologous BMT in first CR.

### **Adult Precursor B-Cell and T-Cell Acute Lymphoblastic Leukemia**

Adult ALL patients with the precursor B-cell or T-cell immunophenotype should enter into chemotherapy treatment programs that start with multiagent remission induction chemotherapy. Prophylaxis against CNS relapse is indicated for all patients. Standard-risk

patients who achieve remission, who are the majority, should continue with intensification and maintenance therapy. Patients at high risk for relapse are best managed with allogeneic BMT in first CR.

Modern adult ALL treatment regimens that have been established by major collaborative study groups are illustrated in [Figure 78.4](#) ([4](#), [53](#), [56](#), [57](#), [64](#)). Clinical outcome results from these trials, which were conducted by American, German, British, and Italian study groups, are summarized in [Table 78.6](#). Almost all modern multiagent, multiphasic adult ALL treatment protocols are variations on the basic treatment theme ([65](#), [68](#), [69](#), [131](#), [136](#), [155](#), [191](#), [192](#)). Two exceptions are the GMALL B-NHL 86 and hyper-CVAD (hyperfractionated cyclophosphamide, vincristine, doxorubicin, and dexamethasone) protocols, which are brief, intensive treatment regimens that have improved outcome for adult mature B-cell ALL. They are discussed later in this chapter ([66](#), [67](#)).



**Figure 78.4.** Established treatment protocols for adult acute lymphoblastic leukemia (ALL). Protocols for patients with precursor B-cell or T-cell ALL shown are adapted from (A) CALGB 8811 trial ([53](#)); (B) GMALL 02/84 trial ([56](#)); (C) UKALL XA trial ([4](#)); and (D) GIMEMA 0288 ([64](#)). Protocols for patients with mature B-cell ALL shown are adapted from (E) GMALL B-NHL 86 ([66](#)); and (F) Hyper-CVAD from the M.D. Anderson Cancer Center (MDACC) ([67](#)). Time line drawn to semilogarithmic scale. CNS, central nervous system.

**TABLE 78.6. Multicenter Trials in Adults with Acute Lymphoblastic Leukemia**

| Trial        | Treatment Period     | Patients (no.) | Median Age (yr) | Complete Remission (%) | Median Remission Duration (mo) | Overall Survival | Disease-Free Survival | Reference                               |
|--------------|----------------------|----------------|-----------------|------------------------|--------------------------------|------------------|-----------------------|---|
| GMALL 01/81  | July 1981–June 1983  | 368            | 25              | 74                     | 24.3                           | 33% (11 yr)      | 35% (10 yr)           | <a href="#">57</a> , <a href="#">58</a> |
| GMALL 02/84  | July 1983–June 1987  | 562            | 28              | 75                     | 27                             | 36% (5 yr)       | 39% (7 yr)            | <a href="#">56</a>                      |
| CALGB 8811   | Sept. 1988–June 1991 | 197            | 32              | 85                     | 29                             | 36 mo            | 46% (3 yr)            | <a href="#">53</a>                      |
| MRC-UKALL XA | April 1985–Dec. 1992 | 618            | >15             | 82                     | —                              | 27 mo            | 28% (5 yr)            | <a href="#">4</a>                       |

|                |                            |     |    |    |    |       |            |                    |
|----------------|----------------------------|-----|----|----|----|-------|------------|--------------------|
| GIMEMA<br>0288 | Jan.<br>1988–April<br>1996 | 794 | 28 | 82 | 29 | 26 mo | 29% (9 yr) | <a href="#">64</a> |
|----------------|----------------------------|-----|----|----|----|-------|------------|--------------------|

---

The remission induction regimens are built around the four-drug combination of vincristine, prednisone, L-asparaginase, and an anthracycline, most commonly daunorubicin. The American CALGB 8811 and Italian GIMEMA 0288 protocols added cyclophosphamide to the induction regimen. For those who achieve remission, induction is followed by various intensification or consolidation treatment blocks, generally completed within 6 months of starting treatment. Prolonged maintenance with 6-mercaptopurine and methotrexate is continued for a total of 2 years of scheduled therapy. Intermittent pulses of vincristine and prednisone are also given during maintenance in the CALGB, GIMEMA, and the British UKALL protocols. Cranial irradiation is administered early in the German GMALL treatment program, during interim maintenance in the CALGB and UKALL programs, and omitted in the GIMEMA trial.

The CALGB 8811 trial was conducted between September 1988 and June 1991 at 25 institutions in the United States. Larson et al. reported the results of this study, which showed an 85% CR rate, median remission duration of 27 months, and disease-free survival of 46% but with relatively short median follow-up of 43 months ([53](#)). Six percent failed therapy due to death during induction, and an additional 7% due to refractory disease. Intensification of standard induction with cyclophosphamide was felt to contribute to favorable outcome with T-cell ALL but contributed to myelosuppression, requiring dose reduction in patients older than 60 years and hospital stays averaging 26 days during the induction phase. Prospective karyotype and immunophenotypic data were collected from patients on this and subsequent CALGB protocols for analysis of prognostic markers and were reported separately ([55](#), [70](#)).

The German GMALL 02/84 trial evaluated sequential blocks of intensive induction and consolidation therapy that extended for nearly a year before beginning maintenance. CNS therapy was aggressive and incorporated intrathecal chemotherapy and cranial irradiation, as well as systemic high-dose cytarabine and methotrexate. International application of this treatment protocol confirmed the high CR rate and disease-free survival of 39% that was reported by Hoelzer et al. ([56](#), [57](#), [166](#), [190](#), [193](#), [194](#) and [195](#)).

The British UKALL XA trial was designed to evaluate the benefit of postremission therapy with early and late intensification blocks, and results were reported by Durrant et al. ([4](#)). CR was achieved in 88% of adult patients, and disease-free survival at 5 years was 28%. As previously mentioned, there was a reduction in relapse for patients randomized to receive the early intensification block, but this did not lead to a superior disease-free survival rate. Additional analyses of this patient cohort describing clinical, immunophenotypic, and cytogenetic prognostic factors were detailed in separate reports ([59](#), [82](#)).

The GIMEMA 0288 trial tested the prognostic value of response to preinduction prednisone and the efficacies of cyclophosphamide inclusion during induction followed by intensification of postremission therapy. An 82% CR rate was observed in 794 adult patients with ALL, which was not better among patients randomized to receive cyclophosphamide during induction ([64](#)). The response to prednisone was shown to have prognostic significance. Prednisone responders had an overall survival rate of 33% at 8 years compared with 17% among nonresponders. The disease-free survival rate was 29%, which was no better for patients who were randomized to an additional eight-drug



consolidation after intensification, as opposed to proceeding directly to maintenance therapy.

### Adult Mature B-Cell Acute Lymphoblastic Leukemia

The mature B-cell phenotype is found in 5% of adult ALL cases, and most are not cured with conventional ALL regimens such as those just described. Diagnosis is made by morphologic and immunophenotypic features, as has been discussed. Compared with other ALL subtypes, there is a more pronounced male predominance and higher incidence of extramedullary disease, including CNS involvement ( [196](#), [197](#) and [198](#) ). As is the case with other high-grade malignancies, the blast cells have a rapid doubling time, and vigorous supportive care must be pursued to prevent or treat tumor lysis syndrome ( [199](#) ). The high proliferative rate exhibited by the leukemic cells served as the rationale for a treatment strategy based on repeated administration (hyperfractionation) of high-dose cyclophosphamide plus methotrexate, also given at high dose, which proved highly successful in pediatric studies ( [146](#), [200](#) ).

Studies performed by German, French, and American groups have established that these brief, cyclical, dose-intensive protocols are the preferred approach to treating adult patients with mature B-cell ALL ( [66](#), [67](#), [201](#) ). Adapted from the pediatric regimens, the B-NHL 86 protocol used by the German study group and the hyper-CVAD treatment program evaluated at the M.D. Anderson Cancer Center are illustrated in [Figure 78.4](#). Both use alternating blocks of intensive chemotherapy given monthly for a total of 6 or 8 months without subsequent maintenance. The hyper-CVAD regimen rotated fractionated high-dose cyclophosphamide with high-dose methotrexate. The B-NHL 86 protocol gave high-dose methotrexate with every treatment block and alternated cyclophosphamide with ifosfamide. CNS prophylaxis with intrathecal chemotherapy was started early, but cranial irradiation was omitted in the hyper-CVAD protocol. Similar outcome was reported by both studies ( [Table 78.7](#) ). Remarkably similar results were also reported by the CALGB, which implemented the German protocol in a study involving 24 adult patients, with the exception that excess neurotoxicity was reported by the CALGB ( [202](#) ).

**TABLE 78.7. Dose-Intensive Therapy in Adults with Mature B-Cell Acute Lymphoblastic Leukemia**

| Trial      | Year | Patients (no.) | Median Age (yr) | Complete Remission (%) | Induction Death (%) | Overall Survival (%) | Disease-Free Survival (%) | Reference           |
|------------|------|----------------|-----------------|------------------------|---------------------|----------------------|---------------------------|---------------------|
| LMB 84/86  | 1995 | 24             | 30              | 79                     | 8                   | 58 (3 yr)            | 57 (3 yr)                 | <a href="#">201</a> |
| B-NHL 86   | 1996 | 35             | 36              | 74                     | 9                   | 51 (4 yr)            | 71 (4 yr)                 | <a href="#">66</a>  |
| Hyper-CVAD | 1999 | 26             | 58              | 81                     | 19                  | 49 (3 yr)            | 61 (3 yr)                 | <a href="#">67</a>  |
| CALGB 9251 | 2001 | 24             | 45              | 75                     | 4                   | 44 (3 yr)            | 53 (3 yr)                 | <a href="#">202</a> |

There are currently no effective treatment options for mature B-cell ALL patients who have refractory or relapsed disease. From the recent studies, predictors for relapse were

high WBC count ( $>50,000 \times 10^6/L$ ), severe anemia, older age, and poor performance status ( [66](#), [67](#), [201](#) ). In the report by Thomas et al., nine patients relapsed in CR, for whom the median remission duration was only 7 months. Progression after relapse was rapid, with two deaths occurring before treatment could be initiated. The remaining patients were resistant to salvage therapy that included retreatment with hyper-CVAD. After relapse, the median survival for the group was 1 month.

### Philadelphia Chromosome-Positive Acute Lymphoblastic Leukemia

Ph-positive ALL accounts for at least 20% of adult cases ( [52](#), [203](#), [204](#) ). Patients tend to be older and have a higher WBC count and are more likely to present with hepatosplenomegaly and lymphadenopathy. Virtually all have the precursor B-cell immunophenotype. Most achieve CR with standard ALL induction chemotherapy, but few are long-term survivors due to relapse. The median duration of survival ranges from 8 to 16 months, and disease-free survival did not exceed 10% ( [55](#), [80](#), [81](#) and [82](#), [205](#) ). Incorporation of maintenance therapy to the hyper-CVAD regimen yielded interesting results for subtypes of adult ALL other than mature B-cell ALL but had no impact on survival for the 32 Ph-positive patients in the series reported by Kantarjian et al. ( [87](#) ).

Patients with Ph-positive ALL should undergo allogeneic BMT in first CR. Results vary from center to center, but 30 to 65% of Ph-positive patients can expect long-term survival with allogeneic BMT ( [206](#), [207](#), [208](#) and [209](#) ). Registry data from the IBMTR show rates at 2 years of 38% for disease-free survival and 34% for relapse ( [210](#) ). There are no comparative trials, but a large retrospective review of children who were Ph-positive, an equally unfavorable marker in pediatric ALL, suggested that allogeneic BMT substantially improved survival compared with chemotherapy alone ( [211](#) ). Too few Ph-positive adult ALL patients have been treated with autologous BMT in first CR to properly assess the value of this approach.

### Acute Lymphoblastic Leukemia in Elderly Patients

One-third of adults diagnosed with ALL are older than 60 years according to United States prevalence data ( [5](#) ). Advanced age is itself an adverse prognostic factor for ALL, and survival decreases continuously with increasing age. Although older age is independently predictive of inferior outcome, a number of factors can be identified that may account for the poor prognosis ( [212](#), [213](#), [214](#), [215](#) and [216](#) ). Elderly ALL patients tend to have worse performance status, in part, reflecting comorbid medical conditions. As a result, these patients have limited tolerance for intensive therapy, which may contribute to a high rate of treatment-related mortality. Additionally, aspects reflecting the underlying biology of the leukemia likely have an influence as well. Elderly patients are more likely to be Ph-positive, be underrepresented in the favorable T-cell subgroup, and have disease refractory to standard chemotherapy drugs used to treat ALL.

At present, there is no satisfactory approach for managing elderly patients with ALL. Several groups have described treatment outcome for these patients, and the results are summarized in [Table 78.8](#). Elderly ALL patients given no therapy may not survive more than a few weeks ( [217](#) ). Palliative therapy, usually moderate-dose prednisone and intermittent vincristine, has been used ( [218](#) ). Modest responses were observed, with survival extending to a few months. A retrospective review of one cooperative group member institution's 13-year experience revealed that only one-half of their ALL patients older than 60 years were enrolled in their active study protocol ( [213](#) ). In these instances, risk-adapted therapy often meant limiting treatment intensity on a case-by-case basis.

Many of these elderly patients were given ad hoc induction regimens of variably dosed vincristine and prednisone, with or without a third drug ( [219](#), [220](#) and [221](#) ). Complete responses were reported in up to 40%, but median survival remained only several months. Several groups uniformly treated fairly large cohorts (40 to 60) of elderly patients with “age-adjusted” chemotherapy programs ( [222](#), [223](#) and [224](#) ). Impressive CR rates were sometimes observed, and median survival extended to 12 to 14 months. The patient numbers were still small, and it is difficult to evaluate the influence of patient selection bias, as conflicting results have been reported by the same institution treating patients with essentially the same protocol ( [222](#), [223](#) ). Data from major collaborative groups treating selected, elderly ALL patients suggest that up to one-half may achieve CR with intensive therapy ( [225](#), [226](#) ). Resistant disease and toxic deaths were frequent, but a median survival of 10 months may be reasonably expected.

**TABLE 78.8. Treatment Outcome in Elderly Patients with Acute Lymphoblastic Leukemia**

| Study                 | Treatment Period | Patient (no.) | Median Age (yr) | Complete Remission (%) | Refractory (%) | Toxic Death (%) | Median Survival (mo) | Reference           |
|-----------------------|------------------|---------------|-----------------|------------------------|----------------|-----------------|----------------------|---------------------|
| Delannoy et al.       | 1980–1989        | 18            | 70              | 44                     | 28             | 28              | 3                    | <a href="#">218</a> |
| Taylor et al.         | 1982–1991        |               |                 |                        |                |                 |                      | <a href="#">217</a> |
| Curative              |                  | 19            | 68              | 32                     | 47             | 21              | 3                    |                     |
| Palliative            |                  | 22            | 74              | 14                     | 73             | 0               | 1                    |                     |
| No therapy            |                  | 5             | 83              | 0                      | NA             | NA              | <1                   |                     |
| Spath–Schwalbe et al. | 1983–1992        | 28            | 65              | 43                     | Not specified  | 37              | 5                    | <a href="#">221</a> |
| Ferrari et al.        | 1969–1993        |               |                 |                        |                |                 |                      | <a href="#">220</a> |
| Curative              |                  | 13            | 66              | 77                     | 0              | 23              | 4                    |                     |
| Palliative            |                  | 36            | 73              | 53                     | 25             | 22              | 10                   |                     |
| Kantarjian et al.     | 1983–1994        | 52            | >60             | 65                     | 23             | 12              | 10                   | <a href="#">214</a> |
| Mandelli et al.       | 1988–1994        | 80            | 65              | 47                     | 11             | 42              | 19% (2 yr)           | <a href="#">226</a> |
| Delannoy et al.       | 1992–1995        | 40            | 67              | 85                     | 7.5            | 7.5             | 14.2                 | <a href="#">223</a> |
| Delannoy et al.       | 1997–1999        | 58            | 65              | 58                     | 29             | 12              | 9.2                  | <a href="#">222</a> |
| Goekbuget et al.      | 1996–2000        | 63            | 69              | 46                     | 24             | 22              | 11                   | <a href="#">225</a> |

NA, not applicable.

At present, there is little reason to be optimistic about improving outcomes in elderly patients with ALL. The accumulated literature is still sparse, and much remains to be learned about treating these patients. Improvements in supportive care have certainly benefited elderly patients undergoing therapy. Some study centers are likely to evaluate newer, less toxic therapies, such as monoclonal antibodies or small molecule-based targeted approaches. Elderly patients should be referred for such investigational protocols whenever practical.

## SALVAGE THERAPY

The prospect of salvage therapy for refractory or relapsing disease will eventually have to be considered for most adult ALL patients. Primary resistance to induction chemotherapy reported by collaborative trials ranges from 8 to 15% ( [4](#), [53](#), [56](#), [64](#), [65](#), [69](#) ). Although most patients achieve a first CR, only 20 to 40% become long-term survivors, and the principal cause of treatment failure is disease relapse. Although a second or salvaged CR can be obtained for a slight majority with chemotherapy, the durability of remission is likely short unless an allogeneic BMT is subsequently performed, and, even then, remission duration is limited for most patients.

Recent studies yield some insight into the biologic and clinical features of disease relapse in adult ALL patients. Thomas et al. reviewed the presenting characteristics at relapse in patients referred for therapy at a single institution over a 17-year period ( [227](#) ). The duration of CR was less than 1 year in 61%. Essentially all patients had marrow relapses, although one-third had concurrent extramedullary involvement, including CNS leukemia in 16%. In other studies, the cytogenetic, immunophenotypic, and molecular changes at relapse compared with initial presentation were examined ( [228](#), [229](#) ). Clonal cytogenetic changes were the most common finding. One-half of the cytogenetic findings were believed to represent clonal evolution, and the remainder were karyotypic changes. Two entirely different abnormal karyotypes were never found. Immunophenotypic changes were twice as likely in patients with T-cell versus B-cell ALL and were marked by gain or loss of one or two antigens but no complete shift from B- to T-lineage ALL, or vice versa. Neither the presence of a karyotypic shift nor an immunophenotypic shift adversely influenced survival from the time of relapse.

## Chemotherapy

Reinduction of remission, or attainment of a first CR for refractory patients, can be expected in slightly more than one-half of patients with salvage chemotherapy. However, in the majority, remissions do not extend beyond 3 to 6 months, and long-term survival is well below 10% whether or not postremission therapy is given. The numerous reports describing generally single-institution studies involving small numbers of patients have been exhaustively catalogued in excellent reviews ( [230](#), [231](#) and [232](#) ). In general, single-agent chemotherapy is inferior to multiagent protocols. Two or three drugs have been added to L-asparaginase or an anthracycline with good responses, but the best results are produced by combinations based on intermediate- to high-dose cytarabine. In one of the larger patient series, doxorubicin combined with vincristine and dexamethasone induced CR in 39% of 64 refractory patients ( [233](#) ). Treatment failure was due to resistant disease in 41%, whereas induction mortality was only 6%, reflective of an inverse correlation between toxicity-related death and antileukemic activity.

Much more extensively studied have been salvage regimens based on high-dose cytarabine, which produce CR rates that vary widely but have occasionally exceeded 70%. Additional drugs have included an anthracycline, mitoxantrone, and fludarabine. The hyper-CVAD regimen, which incorporates doxorubicin and high-dose cytarabine in addition to fractionated cyclophosphamide, was used to salvage 66 relapsed patients and induced remissions in 44% ( [234](#) ). Hiddemann et al. reported a 50% CR rate in 24 refractory patients with the mito-xantrone and high-dose cytarabine two-drug combination ( [235](#) ). Other studies with these two drugs have reported CR rates of 17 to 80%. Fludarabine is a purine analog that enhances bioavailability of the active metabolite of cytarabine, and, as a salvage regimen, the combination yields CR in 30 to 83%, with the higher response rates reported when cytarabine was used at high rather than intermediate dose ( [236](#), [237](#) and [238](#) ).

In a large single-institution review, Thomas et al. described treatment outcome for 314 adult patients with relapsed or refractory ALL who received various salvage therapy regimens. Overall CR was achieved in 31% ( [227](#) ). Patients with long first remissions received the customary front-line study salvage regimen, which varied depending on the study period, whereas patients resistant to or relapsing on therapy were treated with new drug combinations. This approach to treatment regimen selection, based on timing of relapse and prior induction programs, can be regarded as reasonable recommendations for all adult ALL patients requiring salvage therapy. Patients with primary refractory disease and those with relapsed disease were found to achieve CR equally well. Death occurred without achieving remission in 21%. Patients with long first CR duration (>2 years) were more likely to achieve CR and have longer durations of second remission, a finding confirming observations made by other investigators ( [239](#) , [240](#) ). For the entire group, the median durations of remission and survival from the start of salvage therapy were 6 months and 5 months, respectively.

### **Bone Marrow Transplantation**

Given the dismal outlook, allogeneic BMT should be attempted for all eligible adult ALL patients as soon as possible after second or salvaged remission is achieved. The logistics may be difficult given the narrow window before impending relapse. This was examined by Davies et al., who describe finding matched related donors for only 35% of 115 consecutive relapsed ALL referrals to a single institution over a 2-year period ( [241](#) ). An unrelated marrow donor search was initiated in most of the remainder, which was successful in another one-third but required a median of 10 weeks before a donor was identified. Overall, allogeneic BMT was not performed in the majority of the patients, and the reason in 19% was death before transplant despite all efforts to expedite BMT. This point was highlighted by a study at 12 GIMEMA institutions, which reinduced CR in 56% of adult ALL patients in first relapse with a combination of idarubicin and intermediate-dose cytarabine ( [242](#) ). This was to be followed by a scheduled BMT that could not be performed in 44% due to relapse and in another 26.5% due to persistent infection acquired during induction.

Even if a patient is transplanted, the available data suggest that few will be effectively salvaged with allogeneic BMT. Outcome reported from individual trials indicates long-term disease-free survival in 15 to 45% after sibling donor allogeneic BMT in second or greater CR ( [171](#) , [243](#) , [244](#) ). Registry data from the IBMTR show a 5-year disease-free survival estimate of 26% ( [245](#) ). Unlike allogeneic BMT for adult ALL in first remission, however, relapse (52%) outranked treatment-related mortality (36%) as the cause of treatment failure.

Allogeneic BMT for active disease appears to yield inferior results. Results for individual trials reporting sibling-donor allogeneic BMT for untreated refractory or relapsed disease indicate disease-free survival of 12 to 43% ( [244](#) , [246](#) ). The IBMTR reported a 4-year disease-free survival of 13% with 71% of patients relapsing ( [245](#) ).

Unrelated donor BMT is associated with a very high transplant-related mortality, compounding the difficulties of finding a matched donor. Based on registry data from the National Marrow Donor Program, transplant-related mortality was 75% for patients transplanted in second or greater CR and 64% for patients transplanted in relapse ( [181](#) ). Recent advances in histocompatibility antigen matching based on molecular typing techniques may improve outcome by selecting better-matched donors ( [247](#) ).

A benefit from autologous BMT for patients in second or subsequent CR is difficult to determine. There are many individual studies, generally with short follow-up, reporting disease-free survival ranging from 10 to 31% ([182](#), [187](#), [248](#), [249](#) and [250](#)). Almost all failures are due to treatment relapse, however, and no study has demonstrated a disease-free survival plateau. Based on the available data, it appears that, as compared with standard therapy, remissions may be extended with autologous BMT for select patients. On that basis, autologous BMT can be considered an option in the salvage setting, particularly as part of an investigational protocol when available.

## SUMMARY AND FUTURE DIRECTIONS

Considerable progress has been made in the management of ALL in adult patients. Multiagent induction chemotherapy induces CR in over 85% of adult ALL patients. With the institution of postremission therapy and prophylaxis against CNS relapse, up to 40% may be cured of the disease. There is no compelling reason to believe, however, that further modification of modern multiagent regimens with the addition of currently available chemotherapy drugs will lead to a substantial improvement in outcome for these patients.

On the immediate horizon is the prospect of tailored therapy adapted for each individual patient on the basis of anticipated relapse risk. This approach has proved to be remarkably successful for two adult ALL subgroups, namely, those with mature B-cell ALL and those with Ph-positive ALL. Ongoing prospectively randomized trials will establish the role of risk-adapted therapy for patients with high-risk features according to other criteria. Ongoing trials will also help define the role of new technologies, such as minimal residual disease assessment, in refining and improving the ability to accurately evaluate relapse risk.

The success with improving outcome for Ph-positive ALL, while satisfying, highlights the fact that, at present, the only viable intervention for intensifying therapy for high-risk patients is allogeneic BMT. Newer approaches with allogeneic BMT using dose-attenuated nonmyeloablative recipient conditioning are promising and can extend the procedure to patients who might otherwise not be eligible for conventional transplantation. Clinical outcome data are not mature, however, and, at present, the procedure is still investigational.

Targeted therapy, such as monoclonal antibodies directed against surface antigens expressed by malignant cells, has proven extremely effective for other lymphoproliferative disorders. Targeted molecular therapy, such as the small molecule inhibitor of the *BCR-ABL* tyrosine kinase, is beginning to significantly affect care of patients with chronic myeloid leukemia. The addition of both approaches can be immediately evaluated for adult patients with ALL. Additional state-of-the-art novel therapies, based on a progressive understanding of the biology of the disease and the mechanisms of drug resistance, are needed and remain to be developed.

## REFERENCES

1. Rivera GK, Pinkel D, Simone JV, et al. Treatment of acute lymphoblastic leukemia. 30 years' experience at St. Jude Children's Research Hospital. *N Engl J Med* 1993;329:1289-1295.
2. Pui CH, Evans WE. Acute lymphoblastic leukemia. *N Engl J Med* 1998;339:605-615.
3. Durrant IJ, Richards SM, Prentice HG, Goldstone AH. The Medical Research Council trials in adult acute lymphoblastic leukemia. *Hematol Oncol Clin North Am* 2000;14:1327-1352.



4. Durrant IJ, Prentice HG, Richards SM. Intensification of treatment for adults with acute lymphoblastic leukaemia: results of U.K. Medical Research Council randomized trial UKALL XA. Medical Research Council Working Party on Leukaemia in Adults. *Br J Haematol* 1997;99:84–92.
5. Ries LAG, Esiner MP, Kosary CL, et al., eds. SEER Cancer Statistics Review, 1973–1999. Bethesda, MD: National Cancer Institute, 2002.
6. Gurney JG, Davis S, Severson RK, et al. Trends in cancer incidence among children in the U.S. *Cancer* 1996;78:532–541.
7. Parkin DM, Muir CS. Cancer incidence in five continents. Comparability and quality of data. *IARC Sci Publ* 1992;120:45–173.
8. Sandler DP, Collman GW. Cytogenetic and environmental factors in the etiology of the acute leukemias in adults. *Am J Epidemiol* 1987;126:1017–1032.
9. Preston DL, Kusumi S, Tomonaga M, et al. Cancer incidence in atomic bomb survivors. Part III. Leukemia, lymphoma and multiple myeloma, 1950–1987. *Radiat Res* 1994;137:S68–S97.
10. Wilkinson GS, Dreyer NA. Leukemia among nuclear workers with protracted exposure to low-dose ionizing radiation. *Epidemiology* 1991;2:305–309.
11. Kendall GM, Muirhead CR, MacGibbon BH, et al. Mortality and occupational exposure to radiation: first analysis of the National Registry for Radiation Workers. *BMJ* 1992;304:220–225.
12. Schubauer-Berigan MK, Wenzl TB. Leukemia mortality among radiation-exposed workers. *Occup Med* 2001;16:271–287.
13. Sole F, Caballin MR, Coll MD, et al. Acute lymphoblastic leukemia with t(4;11) in a patient previously exposed to a carcinogen. *Cancer Genet Cytogenet* 1990;49:133–136.
14. Cronkite EP. Chemical leukemogenesis: benzene as a model. *Semin Hematol* 1987;24:2–11.
15. Sandler DP, Shore DL, Anderson JR, et al. Cigarette smoking and risk of acute leukemia: associations with morphology and cytogenetic abnormalities in bone marrow. *J Natl Cancer Inst* 1993;85:1994–2003.
16. Pagano L, Pulsoni A, Tosti ME, et al. Acute leukemia following a previous malignancy: do acute lymphoid leukemia and acute myeloid leukemia have common risk factors? *Hematol J* 2000;1:329–332.
17. Andersen MK, Christiansen DH, Jensen BA, et al. Therapy-related acute lymphoblastic leukaemia with MLL rearrangements following DNA topo-isomerase II inhibitors, an increasing problem: report on two new cases and review of the literature since 1992. *Br J Haematol* 2001;114:539–543.
18. Bigoni R, Cuneo A, Roberti MG, et al. Therapy-related adult acute lymphoblastic leukemia with t(4;11)(q21; q23): MLL rearrangement, p53 mutation and multilineage involvement. *Leukemia* 1999;13:704–707.
19. de Klein A, van Kessel AG, Grosveld G, et al. A cellular oncogene is translocated to the Philadelphia chromosome in chronic myelocytic leukaemia. *Nature* 1982;300:765–767.
20. Druker BJ, Lydon NB. Lessons learned from the development of an abl tyrosine kinase inhibitor for chronic myelogenous leukemia. *J Clin Invest* 2000;105:3–7.
21. Look AT. Oncogenic transcription factors in the human acute leukemias. *Science* 1997;278:1059–1064.
22. Golub TR, Barker GF, Bohlander SK, et al. Fusion of the TEL gene on 12p13 to the AML1 gene on 21q22 in acute lymphoblastic leukemia. *Proc Natl Acad Sci U S A* 1995;92:4917–4921.
23. Sherr CJ. Cancer cell cycles. *Science* 1996;274:1672–1677.
24. Stock W, Tsai T, Golden C, et al. Cell cycle regulatory gene abnormalities are important determinants



of leukemogenesis and disease biology in adult acute lymphoblastic leukemia. *Blood* 2000;95:2364–2371.

25. Beutler E. Platelet transfusions: the 20,000/microL trigger. *Blood* 1993;81:1411–1413.
26. Pui CH, Stass S, Green A. Bone marrow necrosis in children with malignant disease. *Cancer* 1985;56:1522–1525.
27. Hoelzer D, Gokbuget N, Digel W, et al. Outcome of adult patients with T-lymphoblastic lymphoma treated according to protocols for acute lymphoblastic leukemia. *Blood* 2002;99:4379–4385.
28. Hoelzer D. Diagnosis and treatment of adult acute lymphoblastic leukemia. In: Wiernik PH, Canellos GP, Dutcher JP, Kyle RA, eds. *Neoplastic diseases of the blood*, 3rd ed. New York: Churchill Livingstone, 1996:295–319.
29. Mastrangelo R, Poplack D, Bleyer A, et al. Report and recommendations of the Rome workshop concerning poor-prognosis acute lymphoblastic leukemia in children: biologic bases for staging, stratification, and treatment. *Med Pediatr Oncol* 1986;14:191–194.
30. Gajjar A, Harrison PL, Sandlund JT, et al. Traumatic lumbar puncture at diagnosis adversely affects outcome in childhood acute lymphoblastic leukemia. *Blood* 2000;96:3381–3384.
31. Yokoyama K, Amamiya T, Kawai Y, et al. Acute lymphoblastic leukemia associated with severe myelofibrosis. *Keio J Med* 1997;46:196–204.
32. Wallis JP, Reid MM. Bone marrow fibrosis in childhood acute lymphoblastic leukaemia. *J Clin Pathol* 1989;42:1253–1254.
33. Third International Workshop on Chromosomes in Leukemia. Chromosomal abnormalities and their clinical significance in acute lymphoblastic leukemia. *Cancer Res* 1983;43:868–873.
34. Harrison CJ, Martineau M, Secker-Walker LM. The Leukaemia Research Fund/United Kingdom Cancer Cytogenetics Group Karyotype Database in acute lymphoblastic leukaemia: a valuable resource for patient management. *Br J Haematol* 2001;113:3–10.
35. Raynaud S, Cave H, Baens M, et al. The 12;21 translocation involving TEL and deletion of the other TEL allele: two frequently associated alterations found in childhood acute lymphoblastic leukemia. *Blood* 1996;87:2891–2899.
36. Kwong YL, Wong KF. Low frequency of TEL/AML1 in adult acute lymphoblastic leukemia. *Cancer Genet Cytogenet* 1997;98:137–138.
37. Raynaud S, Mauvieux L, Cayuela JM, et al. TEL/AML1 fusion gene is a rare event in adult acute lymphoblastic leukemia. *Leukemia* 1996;10:1529–1530.
38. Radich JP, Kopecky KJ, Boldt DH, et al. Detection of BCR-ABL fusion genes in adult acute lymphoblastic leukemia by the polymerase chain reaction. *Leukemia* 1994;8:1688–1695.
39. Kurzrock R, Shtalrid M, Romero P, et al. A novel c-abl protein product in Philadelphia-positive acute lymphoblastic leukaemia. *Nature* 1987;325:631–635.
40. Harris NL, Jaffe ES, Diebold J, et al. The World Health Organization classification of neoplasms of the hematopoietic and lymphoid tissues: report of the Clinical Advisory Committee meeting—Airlie House, Virginia, November, 1997. *Hematol J* 2000;1:53–66.
41. Riley RS, Massey D, Jackson-Cook C, et al. Immunophenotypic analysis of acute lymphoblastic leukemia. *Hematol Oncol Clin North Am* 2002;16:245–299, v.
42. Den Boer ML, Kapaun P, Pieters R, et al. Myeloid antigen co-expression in childhood acute lymphoblastic leukaemia: relationship with in vitro drug resistance. *Br J Haematol* 1999;105:876–882.
43. Pui CH, Rubnitz JE, Hancock ML, et al. Reappraisal of the clinical and biologic significance of myeloid-associated antigen expression in childhood acute lymphoblastic leukemia. *J Clin Oncol*

1998;16:3768–3773.

44. Bene MC, Castoldi G, Knapp W, et al. Proposals for the immunological classification of acute leukemias. European Group for the Immunological Characterization of Leukemias (EGIL). *Leukemia* 1995;9:1783–1786.
45. Legrand O, Perrot JY, Simonin G, et al. Adult biphenotypic acute leukaemia: an entity with poor prognosis which is related to unfavourable cytogenetics and P-glycoprotein over-expression. *Br J Haematol* 1998;100:147–155.
46. Killick S, Matutes E, Powles RL, et al. Outcome of biphenotypic acute leukemia. *Haematologica* 1999;84:699–706.
47. Matutes E, Morilla R, Farahat N, et al. Definition of acute biphenotypic leukemia. *Haematologica* 1997;82:64–66.
48. Sturgeon P. Leukemia presenting as aplastic anemia. *J Pediatr* 1972;80:159.
49. Nakamori Y, Takahashi M, Moriyama Y, et al. The aplastic presentation of adult acute lymphoblastic leukemia. *Br J Haematol* 1986;62:782–783.
50. Dalton RG. Aplastic presentation of acute lymphoblastic leukemia. *J R Soc Med* 1987;80:465.
51. D'Alessio A, Invernizzi R, Bernuzzi S, et al. Transient aplasia preceding adult acute lymphoblastic leukemia. *Haematologica* 1993;78:127–128.
52. Faderl S, Kantarjian HM, Talpaz M, Estrov Z. Clinical significance of cytogenetic abnormalities in adult acute lymphoblastic leukemia. *Blood* 1998;91:3995–4019.
53. Larson RA, Dodge RK, Burns CP, et al. A five-drug remission induction regimen with intensive consolidation for adults with acute lymphoblastic leukemia: cancer and leukemia group B study 8811. *Blood* 1995;85:2025–2037.
54. Larson RA, Dodge RK, Linker CA, et al. A randomized controlled trial of filgrastim during remission induction and consolidation chemotherapy for adults with acute lymphoblastic leukemia: CALGB study 9111. *Blood* 1998;92:1556–1564.
55. Wetzler M, Dodge RK, Mrozek K, et al. Prospective karyotype analysis in adult acute lymphoblastic leukemia: the cancer and leukemia group B experience. *Blood* 1999;93:3983–3993.
56. Hoelzer D, Thiel E, Ludwig WD, et al. Follow-up of the first two successive German multicentre trials for adult ALL (01/81 and 02/84). German Adult ALL Study Group. *Leukemia* 1993;7[Suppl 2]:S130–S134.
57. Hoelzer D, Thiel E, Loffler H, et al. Prognostic factors in a multicenter study for treatment of acute lymphoblastic leukemia in adults. *Blood* 1988;71:123–131.
58. Hoelzer D, Thiel E, Loffler H, et al. Intensified therapy in acute lymphoblastic and acute undifferentiated leukemia in adults. *Blood* 1984;64:38–47.
59. Chessells JM, Hall E, Prentice HG, et al. The impact of age on outcome in lymphoblastic leukaemia; MRC UKALL X and XA compared: a report from the MRC Paediatric and Adult Working Parties. *Leukemia* 1998;12:463–473.
60. Durrant IJ, Richards SM. Results of Medical Research Council trial UKALL IX in acute lymphoblastic leukaemia in adults: report from the Medical Research Council Working Party on Adult Leukaemia. *Br J Haematol* 1993;85:84–92.
61. Sebban C, Lepage E, Vernant JP, et al. Allogeneic bone marrow transplantation in adult acute lymphoblastic leukemia in first complete remission: a comparative study. French Group of Therapy of Adult Acute Lymphoblastic Leukemia. *J Clin Oncol* 1994;12:2580–2587.
62. Thiebaut A, Vernant JP, Degos L, et al. Adult Acute Lymphoblastic Leukemia study testing chemotherapy and autologous and allogeneic transplantation. A follow-up report of the French protocol

LALA 87. *Hematol Oncol Clin North Am* 2000;14:1353–1366.

63. Mandelli F, Annino L, Rotoli B. The GIMEMA ALL 0183 trial: analysis of 10-year follow-up. GIMEMA Cooperative Group, Italy. *Br J Haematol* 1996;92:665–672.

64. Annino L, Vegna ML, Camera A, et al. Treatment of adult acute lymphoblastic leukemia (ALL): long-term follow-up of the GIMEMA ALL 0288 randomized study. *Blood* 2002;99:863–871.

65. Hussein KK, Dahlberg S, Head D, et al. Treatment of acute lymphoblastic leukemia in adults with intensive induction, consolidation, and maintenance chemotherapy. *Blood* 1989;73:57–63.

66. Hoelzer D, Ludwig WD, Thiel E, et al. Improved outcome in adult B-cell acute lymphoblastic leukemia. *Blood* 1996;87:495–508.

67. Thomas DA, Cortes J, O'Brien S, et al. Hyper-CVAD program in Burkitt's-type adult acute lymphoblastic leukemia. *J Clin Oncol* 1999;17:2461–2470.

68. Schauer P, Arlin ZA, Mertelsmann R, et al. Treatment of acute lymphoblastic leukemia in adults: results of the L-10 and L-10M protocols. *J Clin Oncol* 1983;1:462–470.

69. Linker CA, Levitt LJ, O'Donnell M, et al. Treatment of adult acute lymphoblastic leukemia with intensive cyclical chemotherapy: a follow-up report. *Blood* 1991;78:2814–2822.

70. Czuczman MS, Dodge RK, Stewart CC, et al. Value of immunophenotype in intensively treated adult acute lymphoblastic leukemia: cancer and leukemia group B study 8364. *Blood* 1999;93:3931–3939.

71. Ludwig WD, Reiter A, Loffler H, et al. Immunophenotypic features of childhood and adult acute lymphoblastic leukemia (ALL): experience of the German Multicentre Trials ALL-BFM and GMALL. *Leuk Lymphoma* 1994;13[Suppl 1]:71–76.

72. Gokbuget N, Hoelzer D. Recent approaches in acute lymphoblastic leukemia in adults. *Rev Clin Exp Hematol* 2002;6:114–141.

73. Thomas X, Archimbaud E, Charrin C, et al. CD34 expression is associated with major adverse prognostic factors in adult acute lymphoblastic leukemia. *Leukemia* 1995;9:249–253.

74. Vanhaeke DR, Bene MC, Garand R, Faure GC. Expression and long-term prognostic value of CD34 in childhood and adult acute lymphoblastic leukemia. *Leuk Lymphoma* 1995;20:137–142.

75. Cascavilla N, Musto P, D'Arena G, et al. Adult and childhood acute lymphoblastic leukemia: clinico-biological differences based on CD34 antigen expression. *Haematologica* 1997;82:31–37.

76. Fruchart C, Lenormand B, Bastard C, et al. Correlation between CD34 expression and chromosomal abnormalities but not clinical outcome in acute myeloid leukemia. *Am J Hematol* 1996;53:175–180.

77. Cacciola E, Guglielmo P, Stagno F, et al. CD34 expression in adult acute lymphoblastic leukemia. *Leuk Lymphoma* 1995;18[Suppl 1]:31–36.

78. Lauria F, Raspadori D, Martinelli G, et al. Increased expression of myeloid antigen markers in adult acute lymphoblastic leukaemia patients: diagnostic and prognostic implications. *Br J Haematol* 1994;87:286–292.

79. Ferrando AA, Look AT. Clinical implications of recurring chromosomal and associated molecular abnormalities in acute lymphoblastic leukemia. *Semin Hematol* 2000;37:381–395.

80. Bloomfield CD, Secker-Walker LM, Goldman AI, et al. Six-year follow-up of the clinical significance of karyotype in acute lymphoblastic leukemia. *Cancer Genet Cytogenet* 1989;40:171–185.

81. Cytogenetic abnormalities in adult acute lymphoblastic leukemia: correlations with hematologic findings outcome. A Collaborative Study of the Group Francais de Cytogenetique Hematologique. *Blood* 1996;87:3135–3142.

82. Secker-Walker LM, Prentice HG, Durrant J, et al. Cytogenetics adds independent prognostic

information in adults with acute lymphoblastic leukaemia on MRC trial UKALL XA. MRC Adult Leukaemia Working Party. *Br J Haematol* 1997;96:601–610.

83. Mancini M, Cimino G, Vegna ML, et al. An integrated molecular–cytogenetic classification is highly predictive of outcome in adult acute lymphoblastic leukemia (ALL): analysis of 395 cases enrolled in the GIMEMA 0496 trial. *Blood* 2001;98:3492a.

84. Fenaux P, Lai JL, Morel P, et al. Cytogenetics and their prognostic value in childhood and adult acute lymphoblastic leukemia (ALL) excluding L3. *Hematol Oncol* 1989;7:307–317.

85. Walters R, Kantarjian HM, Keating MJ, et al. The importance of cytogenetic studies in adult acute lymphoblastic leukemia. *Am J Med* 1990;89:579–587.

86. Hatano M, Roberts CW, Minden M, et al. Deregulation of a homeobox gene, HOX11, by the t(10;14) in T cell leukemia. *Science* 1991;253:79–82.

87. Kantarjian HM, O'Brien S, Smith TL, et al. Results of treatment with hyper–CVAD, a dose–intensive regimen, in adult acute lymphoblastic leukemia. *J Clin Oncol* 2000;18:547–561.

88. Sebban C, Browman GP, Lepage E, Fiere D. Prognostic value of early response to chemotherapy assessed by the day 15 bone marrow aspiration in adult acute lymphoblastic leukemia: a prospective analysis of 437 cases and its application for designing induction chemotherapy trials. *Leuk Res* 1995;19:861–868.

89. Kantarjian HM, Walters RS, Keating MJ, et al. Results of the vincristine, doxorubicin, and dexamethasone regimen in adults with standard– and high–risk acute lymphoblastic leukemia. *J Clin Oncol* 1990;8:994–1004.

90. Donadieu J, Hill C. Early response to chemotherapy as a prognostic factor in childhood acute lymphoblastic leukaemia: a methodological review. *Br J Haematol* 2001;115:34–45.

91. Lilleyman JS. Clinical importance of speed of response to therapy in childhood lymphoblastic leukaemia. *Leuk Lymphoma* 1998;31:501–506.

92. Gaynon PS, Desai AA, Bostrom BC, et al. Early response to therapy and outcome in childhood acute lymphoblastic leukemia: a review. *Cancer* 1997;80:1717–1726.

93. Kaspers GJ, Pieters R, Klumper E, et al. Glucocorticoid resistance in childhood leukemia. *Leuk Lymphoma* 1994;13:187–201.

94. Pui CH, Sallan S, Relling MV, et al. International Childhood Acute Lymphoblastic Leukemia Workshop: Sausalito, CA, 30 November–1 December 2000. *Leukemia* 2001;15:707–715.

95. Dordelmann M, Reiter A, Borkhardt A, et al. Prednisone response is the strongest predictor of treatment outcome in infant acute lymphoblastic leukemia. *Blood* 1999;94:1209–1217.

96. Riehm H, Reiter A, Schrappe M, et al. Corticosteroid–dependent reduction of leukocyte count in blood as a prognostic factor in acute lymphoblastic leukemia in childhood (therapy study ALL–BFM 83). *Klin Padiatr* 1987;199:151–160.

97. Campana D, Pui CH. Detection of minimal residual disease in acute leukemia: methodologic advances and clinical significance. *Blood* 1995;85:1416–1434.

98. Coustan–Smith E, Sancho J, Hancock ML, et al. Use of peripheral blood instead of bone marrow to monitor residual disease in children with acute lymphoblastic leukemia. *Blood* 2002;100:2399–2402.

99. Brisco MJ, Sykes PJ, Hughes E, et al. Monitoring minimal residual disease in peripheral blood in B–lineage acute lymphoblastic leukaemia. *Br J Haematol* 1997;99:314–319.

100. Martin H, Atta J, Bruecher J, et al. In patients with BCR–ABL–positive ALL in CR peripheral blood contains less residual disease than bone marrow: implications for autologous BMT. *Ann Hematol* 1994;68:85–87.

101. El–Rifai W, Ruutu T, Vetterranta K, et al. Follow–up of residual disease using metaphase–FISH in

patients with acute lymphoblastic leukemia in remission. *Leukemia* 1997;11:633–638.

102. Heerema NA, Argyropoulos G, Weetman R, et al. Interphase in situ hybridization reveals minimal residual disease in early remission and return of the diagnostic clone in karyotypically normal relapse of acute lymphoblastic leukemia. *Leukemia* 1993;7:537–543.

103. Kasprzyk A, Secker–Walker LM. Increased sensitivity of minimal residual disease detection by interphase FISH in acute lymphoblastic leukemia with hyperdiploidy. *Leukemia* 1997;11:429–435.

104. White DM, Crolla JA, Ross FM. Detection of minimal residual disease in childhood acute lymphoblastic leukaemia using fluorescence in-situ hybridization. *Br J Haematol* 1995;91:1019–1024.

105. Foroni L, Harrison CJ, Hoffbrand AV, Potter MN. Investigation of minimal residual disease in childhood and adult acute lymphoblastic leukaemia by molecular analysis. *Br J Haematol* 1999;105:7–24.

106. Morgan GJ, Pratt G. Modern molecular diagnostics and the management of haematological malignancies. *Clin Lab Haematol* 1998;20:135–141.

107. Gleissner B, Thiel E. Detection of immunoglobulin heavy chain gene rearrangements in hematologic malignancies. *Expert Rev Mol Diagn* 2001;1:191–200.

108. Chen JS, Coustan–Smith E, Suzuki T, et al. Identification of novel markers for monitoring minimal residual disease in acute lymphoblastic leukemia. *Blood* 2001;97:2115–2120.

109. Campana D, Coustan–Smith E. The use of flow cytometry to detect minimal residual disease in acute leukemia. *Eur J Histochem* 1996;40[Suppl 1]:39–42.

110. Coustan–Smith E, Sancho J, Hancock ML, et al. Clinical importance of minimal residual disease in childhood acute lymphoblastic leukemia. *Blood* 2000;96:2691–2696.

111. Neale GA, Coustan–Smith E, Pan Q, et al. Tandem application of flow cytometry and polymerase chain reaction for comprehensive detection of minimal residual disease in childhood acute lymphoblastic leukemia. *Leukemia* 1999;13:1221–1226.

112. Stock W, Estrov Z. Studies of minimal residual disease in acute lymphoblastic leukemia. *Hematol Oncol Clin North Am* 2000;14:1289–1305.

113. Cave H, van der Werff ten Bosch J, Suci S, et al. Clinical significance of minimal residual disease in childhood acute lymphoblastic leukemia. European Organization for Research and Treatment of Cancer–Childhood Leukemia Cooperative Group. *N Engl J Med* 1998;339:591–598.

114. van Dongen JJ, Seriu T, Panzer–Grumayer ER, et al. Prognostic value of minimal residual disease in acute lymphoblastic leukaemia in childhood. *Lancet* 1998;352:1731–1738.

115. Verhagen OJ, Willems MJ, Breunis WB, et al. Application of germline IGH probes in real-time quantitative PCR for the detection of minimal residual disease in acute lymphoblastic leukemia. *Leukemia* 2000;14:1426–1435.

116. Mortuza FY, Papaioannou M, Moreira IM, et al. Minimal residual disease tests provide an independent predictor of clinical outcome in adult acute lymphoblastic leukemia. *J Clin Oncol* 2002;20:1094–1104.

117. Brisco J, Hughes E, Neoh SH, et al. Relationship between minimal residual disease and outcome in adult acute lymphoblastic leukemia. *Blood* 1996;87:5251–5256.

118. Foroni L, Coyle LA, Papaioannou M, et al. Molecular detection of minimal residual disease in adult and childhood acute lymphoblastic leukaemia reveals differences in treatment response. *Leukemia* 1997;11:1732–1741.

119. Bruggemann M, Droese J, Raff T, et al. The prognostic significance of minimal residual disease in adult standard risk patients with acute lymphoblastic leukemia. *Blood* 2001;98:1327a(abstr).

120. Krampera M, Vitale A, Vincenzi C, et al. Relapse prediction by immunophenotypic monitoring of minimal residual disease in adult T-ALL patients treated according to the GIMEMA 0496 protocol. *Blood*

2001;98:2449a(abstr).

121. Bunin NJ, Pui CH. Differing complications of hyperleukocytosis in children with acute lymphoblastic or acute nonlymphoblastic leukemia. *J Clin Oncol* 1985;3:1590-1595.
122. Eguiguren JM, Schell MJ, Crist WM, et al. Complications and outcome in childhood acute lymphoblastic leukemia with hyperleukocytosis. *Blood* 1992;79:871-875.
123. Greenberg P, Cox C, LeBeau MM, et al. International scoring system for evaluating prognosis in myelodysplastic syndromes. *Blood* 1997;89:2079-2088.
124. Durie BG, Salmon SE. A clinical staging system for multiple myeloma. Correlation of measured myeloma cell mass with presenting clinical features, response to treatment, and survival. *Cancer* 1975;36:842-854.
125. The International Symposium on Genetic Factors in Predictive and Preventive Oncology-Cofactor Interactions and Cancer Prevention, 8th International Symposium on Prevention and Detection of Cancer. Nice, France, March 1993. *Cancer Detect Prev* 1993;17:1-260(abstr).
126. Hasenclever D, Diehl V. A prognostic score for advanced Hodgkin's disease. International Prognostic Factors Project on Advanced Hodgkin's Disease. *N Engl J Med* 1998;339:1506-1514.
127. Smith M, Arthur D, Camitta B, et al. Uniform approach to risk classification and treatment assignment for children with acute lymphoblastic leukemia. *J Clin Oncol* 1996;14:18-24.
128. Gottlieb AJ, Weinberg V, Ellison RR, et al. Efficacy of daunorubicin in the therapy of adult acute lymphoblastic leukemia: a prospective randomized trial by cancer and leukemia group B. *Blood* 1984;64:267-274.
129. Cuttner J, Mick R, Budman DR, et al. Phase III trial of brief intensive treatment of adult acute lymphoblastic leukemia comparing daunorubicin and mitoxantrone: a CALGB Study. *Leukemia* 1991;5:425-431.
130. Peterson BA, Bloomfield CD, Bosl GJ, et al. Intensive five-drug combination chemotherapy for adult acute non-lymphocytic leukemia. *Cancer* 1980;46:663-668.
131. Fiere D, Lepage E, Sebban C, et al. Adult acute lymphoblastic leukemia: a multicentric randomized trial testing bone marrow transplantation as post-remission therapy. The French Group on Therapy for Adult Acute Lymphoblastic Leukemia. *J Clin Oncol* 1993;11:1990-2001.
132. Laport GF, Larson RA. Treatment of adult acute lymphoblastic leukemia. *Semin Oncol* 1997;24:70-82.
133. Cortes JE, Kantarjian HM. Acute lymphoblastic leukemia. A comprehensive review with emphasis on biology and therapy. *Cancer* 1995;76:2393-2417.
134. Copelan EA, McGuire EA. The biology and treatment of acute lymphoblastic leukemia in adults. *Blood* 1995;85:1151-1168.
135. Hoelzer D. Treatment of acute lymphoblastic leukemia. *Semin Hematol* 1994;31:1-15.
136. Nagura E, Kimura K, Yamada K, et al. Nation-wide randomized comparative study of doxorubicin, vincristine and prednisolone combination therapy with and without L-asparaginase for adult acute lymphoblastic leukemia. *Cancer Chemother Pharmacol* 1994;33:359-365.
137. Muller HJ, Boos J. Use of L-asparaginase in childhood ALL. *Crit Rev Oncol Hematol* 1998;28:97-113.
138. Radford JE Jr, Burns CP, Jones MP, et al. Adult acute lymphoblastic leukemia: results of the Iowa HOP-L protocol. *J Clin Oncol* 1989;7:58-66.
139. Bassan R, Lerede T, Rambaldi A, et al. The role of anthracyclines in adult acute lymphoblastic leukaemia. *Leukemia* 1996;10[Suppl 2]:s58-s61.
140. Todeschini G, Meneghini V, Pizzolo G, et al. Relationship between daunorubicin dosage delivered

during induction therapy and outcome in adult acute lymphoblastic leukemia. *Leukemia* 1994;8:376–381.

141. Todeschini G, Tecchio C, Meneghini V, et al. Estimated 6-year event-free survival of 55% in 60 consecutive adult acute lymphoblastic leukemia patients treated with an intensive phase II protocol based on high induction dose of daunorubicin. *Leukemia* 1998;12:144–149.

142. Todeschini G. High-dose anthracycline induction in adult acute lymphoblastic leukemia. *Hematol Oncol Clin North Am* 2001;15:9–20.

143. Mandelli MF, Annino L, Vegna ML, et al. Interim analysis of the GIMEMA ALL0496 trial for adult acute lymphoblastic leukemia (ALL). *Hematol J* 2001;1:629a.

144. Weiss M, Maslak P, Feldman E, et al. Cytarabine with high-dose mitoxantrone induces rapid complete remissions in adult acute lymphoblastic leukemia without the use of vincristine or prednisone. *J Clin Oncol* 1996;14:2480–2485.

145. Weiss M. Induction therapy of adult acute lymphoblastic leukemia without the use of vincristine or prednisone. *Hematol Oncol Clin North Am* 2001;15:1–7.

146. Murphy SB, Bowman WP, Abromowitch M, et al. Results of treatment of advanced-stage Burkitt's lymphoma and B cell (SIg+) acute lymphoblastic leukemia with high-dose fractionated cyclophosphamide and coordinated high-dose methotrexate and cytarabine. *J Clin Oncol* 1986;4:1732–1739.

147. Patte C, Michon J, Frappaz D, et al. Therapy of Burkitt and other B-cell acute lymphoblastic leukaemia and lymphoma: experience with the LMB protocols of the SFOP (French Paediatric Oncology Society) in children and adults. *Baillieres Clin Haematol* 1994;7:339–348.

148. Geissler K, Koller E, Hubmann E, et al. Granulocyte colony-stimulating factor as an adjunct to induction chemotherapy for adult acute lymphoblastic leukemia—a randomized phase-III study. *Blood* 1997;90:590–596.

149. Ottmann OG, Hoelzer D, Gracien E, et al. Concomitant granulocyte colony-stimulating factor and induction chemoradiotherapy in adult acute lymphoblastic leukemia: a randomized phase III trial. *Blood* 1995;86:444–450.

150. Ozer H, Armitage JO, Bennett CL, et al. 2000 Update of recommendations for the use of hematopoietic colony-stimulating factors: evidence-based, clinical practice guidelines. American Society of Clinical Oncology Growth Factors Expert Panel. *J Clin Oncol* 2000;18:3558–3585.

151. Chessells JM, Bailey C, Richards SM. Intensification of treatment and survival in all children with lymphoblastic leukaemia: results of UK Medical Research Council trial UKALL X. Medical Research Council Working Party on Childhood Leukaemia. *Lancet* 1995;345:143–148.

152. Ortega JJ, Ribera JM, Oriol A, et al. Early and delayed consolidation chemotherapy significantly improves the outcome of children with intermediate risk acute lymphoblastic leukemia. Final results of the prospective randomized PETHEMA ALL-89 TRIAL. *Haematologica* 2001;86:586–595.

153. Kamps WA, Veerman AJ, van Wering ER, et al. Long-term follow-up of Dutch Childhood Leukemia Study Group (DCLSG) protocols for children with acute lymphoblastic leukemia, 1984–1991. *Leukemia* 2000;14:2240–2246.

154. Stryckmans P, De Witte T, Marie JP, et al. Therapy of adult ALL: overview of 2 successive EORTC studies: (ALL-2 & ALL-3). The EORTC Leukemia Cooperative Study Group. *Leukemia* 1992;6[Suppl 2]:199–203.

155. Ellison RR, Mick R, Cuttner J, et al. The effects of postinduction intensification treatment with cytarabine and daunorubicin in adult acute lymphoblastic leukemia: a prospective randomized clinical trial by Cancer and Leukemia Group B. *J Clin Oncol* 1991;9:2002–2015.

156. Omura GA, Vogler WR, Martelo O, et al. Late intensification therapy in adult acute lymphoid leukemia: long-term follow-up of the Southeastern Cancer Study Group experience. *Leuk Lymphoma* 1994;15:71–78.

157. Ribera JM, Ortega JJ, Oriol A, et al. Late intensification chemotherapy has not improved the results



of intensive chemotherapy in adult acute lymphoblastic leukemia. Results of a prospective multicenter randomized trial (PETHEMA ALL-89). Spanish Society of Hematology. *Haematologica* 1998;83:222-230.

158. Duration and intensity of maintenance chemotherapy in acute lymphoblastic leukaemia: overview of 42 trials involving 12,000 randomised children. Childhood ALL Collaborative Group. *Lancet* 1996;347:1783-1788.

159. Pui CH, Crist WM. Biology and treatment of acute lymphoblastic leukemia. *J Pediatr* 1994;124:491-503.

160. Dekker AW, van't Veer MB, Sizoo W, et al. Intensive postremission chemotherapy without maintenance therapy in adults with acute lymphoblastic leukemia. Dutch Hemato-Oncology Research Group. *J Clin Oncol* 1997;15:476-482.

161. Cassileth PA, Andersen JW, Bennett JM, et al. Adult acute lymphoblastic leukemia: the Eastern Cooperative Oncology Group experience. *Leukemia* 1992;6[Suppl 2]:178-181.

162. Wernli M, Tichelli A, von Flidner V, et al. Intensive induction/consolidation therapy without maintenance in adult acute lymphoblastic leukaemia: a pilot assessment. Working Party on Leukaemia of the Swiss Group for Epidemiologic and Clinical Cancer Research (SAKK). *Br J Haematol* 1994;87:39-43.

163. Cortes J. Central nervous system involvement in adult acute lymphoblastic leukemia. *Hematol Oncol Clin North Am* 2001;15:145-162.

164. Gokbuget N, Hoelzer D. Meningeosis leukaemica in adult acute lymphoblastic leukaemia. *J Neurooncol* 1998;38:167-180.

165. Omura GA, Moffitt S, Vogler WR, Salter MM. Combination chemotherapy of adult acute lymphoblastic leukemia with randomized central nervous system prophylaxis. *Blood* 1980;55:199-204.

166. Lluesma-Gonalons M, Pavlovsky S, Santarelli MT, et al. Improved results of an intensified therapy in adult acute lymphoblastic leukemia. *Ann Oncol* 1991;2:33-39.

167. Cortes J, O'Brien SM, Pierce S, et al. The value of high-dose systemic chemotherapy and intrathecal therapy for central nervous system prophylaxis in different risk groups of adult acute lymphoblastic leukemia. *Blood* 1995;86:2091-2097.

168. Blume KG, Forman SJ, Snyder DS, et al. Allogeneic bone marrow transplantation for acute lymphoblastic leukemia during first complete remission. *Transplantation* 1987;43:389-392.

169. Chao NJ, Forman SJ, Schmidt GM, et al. Allogeneic bone marrow transplantation for high-risk acute lymphoblastic leukemia during first complete remission. *Blood* 1991;78:1923-1927.

170. Vernant JP, Marit G, Maraninchi D, et al. Allogeneic bone marrow transplantation in adults with acute lymphoblastic leukemia in first complete remission. *J Clin Oncol* 1988;6:227-231.

171. Wingard JR, Piantadosi S, Santos GW, et al. Allogeneic bone marrow transplantation for patients with high-risk acute lymphoblastic leukemia. *J Clin Oncol* 1990;8:820-830.

172. De Witte T, Awwad B, Boezeman J, et al. Role of allogenic bone marrow transplantation in adolescent or adult patients with acute lymphoblastic leukaemia or lymphoblastic lymphoma in first remission. *Bone Marrow Transplant* 1994;14:767-774.

173. Vey N, Blaise D, Stoppa AM, et al. Bone marrow transplantation in 63 adult patients with acute lymphoblastic leukemia in first complete remission. *Bone Marrow Transplant* 1994;14:383-388.

174. Barrett AJ, Horowitz MM, Gale RP, et al. Marrow transplantation for acute lymphoblastic leukemia: factors affecting relapse and survival. *Blood* 1989;74:862-871.

175. Passweg JR, Tiberghien P, Cahn JY, et al. Graft-versus-leukemia effects in T lineage and B lineage acute lymphoblastic leukemia. *Bone Marrow Transplant* 1998;21:153-158.

176. Appelbaum FR. Graft versus leukemia (GVL) in the therapy of acute lymphoblastic leukemia (ALL).

Leukemia 1997;11[Suppl 4]:S15–S17.

177. Oh H, Gale RP, Zhang MJ, et al. Chemotherapy vs HLA-identical sibling bone marrow transplants for adults with acute lymphoblastic leukemia in first remission. *Bone Marrow Transplant* 1998;22:253–257.

178. Zhang MJ, Hoelzer D, Horowitz MM, et al. Long-term follow-up of adults with acute lymphoblastic leukemia in first remission treated with chemotherapy or bone marrow transplantation. The Acute Lymphoblastic Leukemia Working Committee. *Ann Intern Med* 1995;123:428–431.

179. Horowitz MM, Messerer D, Hoelzer D, et al. Chemotherapy compared with bone marrow transplantation for adults with acute lymphoblastic leukemia in first remission. *Ann Intern Med* 1991;115:13–18.

180. Bernasconi C, Lazzarino M, Morra E, et al. Early intensification followed by allo-BMT or auto-BMT or a second intensification in adult ALL: a randomized multicenter study. *Leukemia* 1992;6[Suppl 2]:204–208.

181. Cornelissen JJ, Carston M, Kollman C, et al. Unrelated marrow transplantation for adult patients with poor-risk acute lymphoblastic leukemia: strong graft-versus-leukemia effect and risk factors determining outcome. *Blood* 2001;97:1572–1577.

182. Weisdorf DJ, Billett AL, Hannan P, et al. Autologous versus unrelated donor allogeneic marrow transplantation for acute lymphoblastic leukemia. *Blood* 1997;90:2962–2968.

183. Busca A, Anasetti C, Anderson G, et al. Unrelated donor or autologous marrow transplantation for treatment of acute leukemia. *Blood* 1994;83:3077–3084.

184. Gorin NC. Autologous stem cell transplantation in acute lymphoblastic leukemia. *Stem Cells* 2002;20:3–10.

185. Martin TG, Linker CA. Autologous stem cell transplantation for acute lymphoblastic leukemia in adults. *Hematol Oncol Clin North Am* 2001;15:121–143.

186. Simonsson B, Burnett AK, Prentice HG, et al. Autologous bone marrow transplantation with monoclonal antibody purged marrow for high risk acute lymphoblastic leukemia. *Leukemia* 1989;3:631–636.

187. Doney K, Buckner CD, Fisher L, et al. Autologous bone marrow transplantation for acute lymphoblastic leukemia. *Bone Marrow Transplant* 1993;12:315–321.

188. Tiley C, Powles R, Treleaven J, et al. Feasibility and efficacy of maintenance chemotherapy following autologous bone marrow transplantation for first remission acute lymphoblastic leukaemia. *Bone Marrow Transplant* 1993;12:449–455.

189. Blume KG, Thomas ED. A review of autologous hematopoietic cell transplantation. *Biol Blood Marrow Transplant* 2000;6:1–12.

190. Attal M, Blaise D, Marit G, et al. Consolidation treatment of adult acute lymphoblastic leukemia: a prospective, randomized trial comparing allogeneic versus autologous bone marrow transplantation and testing the impact of recombinant interleukin-2 after autologous bone marrow transplantation. BGMT Group. *Blood* 1995;86:1619–1628.

191. Bassan R, Pogliani E, Lerede T, et al. Fractionated cyclophosphamide added to the IVAP regimen (idarubicin–vincristine–L-asparaginase–prednisone) could lower the risk of primary refractory disease in T-lineage but not B-lineage acute lymphoblastic leukemia: first results from a phase II clinical study. *Haematologica* 1999;84:1088–1093.

192. Ribera JM, Ortega JJ, Oriol A, et al. Prognostic value of karyotypic analysis in children and adults with high-risk acute lymphoblastic leukemia included in the PETHEMA ALL-93 trial. *Haematologica* 2002;87:154–166.

193. Scherrer R, Geissler K, Kyrle PA, et al. Granulocyte colony-stimulating factor (G-CSF) as an adjunct to induction chemotherapy of adult acute lymphoblastic leukemia (ALL). *Ann Hematol* 1993;66:283–289.

194. Bosco I, Teh A. Outcome of treatment in adult acute lymphoblastic leukaemia in an Asian population:

- comparison with previous multicentre German study. *Leukemia* 1995;9:951–954.
195. Chim CS, Kwong YL, Chu YC, et al. Improved treatment outcome in adult acute lymphoblastic leukemia using the intensive German protocol, a preliminary report. *Hematol Oncol* 1997;15:19–26.
196. Fenaux P, Lai JL, Miaux O, et al. Burkitt cell acute leukaemia (L3 ALL) in adults: a report of 18 cases. *Br J Haematol* 1989;71:371–376.
197. Bernasconi C, Brusamolino E, Pagnucco G, et al. Burkitt's lymphoma/leukemia: a clinicopathologic study on 24 adult patients. *Leukemia* 1991;5[Suppl 1]:90–94.
198. Gill PS, Meyer PR, Pavlova Z, Levine AM. B cell acute lymphoblastic leukemia in adults. Clinical, morphologic, and immunologic findings. *J Clin Oncol* 1986;4:737–743.
199. Schiffer CA. Treatment of high-grade lymphoid malignancies in adults. *Semin Hematol* 2001;38:22–26.
200. Patte C, Philip T, Rodary C, et al. Improved survival rate in children with stage III and IV B cell non-Hodgkin's lymphoma and leukemia using multi-agent chemotherapy: results of a study of 114 children from the French Pediatric Oncology Society. *J Clin Oncol* 1986;4:1219–1226.
201. Soussain C, Patte C, Ostronoff M, et al. Small noncleaved cell lymphoma and leukemia in adults. A retrospective study of 65 adults treated with the LMB pediatric protocols. *Blood* 1995;85:664–674.
202. Lee EJ, Petroni GR, Schiffer CA, et al. Brief-duration high-intensity chemotherapy for patients with small noncleaved-cell lymphoma or FAB L3 acute lymphoblastic leukemia: results of cancer and leukemia group B study 9251. *J Clin Oncol* 2001;19:4014–4022.
203. Faderl S, Kantarjian HM, Thomas DA, et al. Outcome of Philadelphia chromosome-positive adult acute lymphoblastic leukemia. *Leuk Lymphoma* 2000;36:263–273.
204. Faderl S, Garcia-Manero G, Thomas DA, Kantarjian HM. Philadelphia chromosome-positive acute lymphoblastic leukemia—current concepts and future perspectives. *Rev Clin Exp Hematol* 2002;6:142–160.
205. Secker-Walker LM, Craig JM, Hawkins JM, Hoffbrand AV. Philadelphia positive acute lymphoblastic leukemia in adults: age distribution, BCR breakpoint and prognostic significance. *Leukemia* 1991;5:196–199.
206. Snyder DS, Nademanee AP, O'Donnell MR, et al. Long-term follow-up of 23 patients with Philadelphia chromosome-positive acute lymphoblastic leukemia treated with allogeneic bone marrow transplant in first complete remission. *Leukemia* 1999;13:2053–2058.
207. Sierra J, Radich J, Hansen JA, et al. Marrow transplants from unrelated donors for treatment of Philadelphia chromosome-positive acute lymphoblastic leukemia. *Blood* 1997;90:1410–1414.
208. Dunlop LC, Powles R, Singhal S, et al. Bone marrow transplantation for Philadelphia chromosome-positive acute lymphoblastic leukemia. *Bone Marrow Transplant* 1996;17:365–369.
209. Stockschrader M, Hegewisch-Becker S, Kruger W, et al. Bone marrow transplantation for Philadelphia-chromosome-positive acute lymphoblastic leukemia. *Bone Marrow Transplant* 1995;16:663–667.
210. Barrett AJ, Horowitz MM, Ash RC, et al. Bone marrow transplantation for Philadelphia chromosome-positive acute lymphoblastic leukemia. *Blood* 1992;79:3067–3070.
211. Arico M, Valsecchi MG, Camitta B, et al. Outcome of treatment in children with Philadelphia chromosome-positive acute lymphoblastic leukemia. *N Engl J Med* 2000;342:998–1006.
212. Thomas X, Olteanu N, Charrin C, et al. Acute lymphoblastic leukemia in the elderly: The Edouard Herriot Hospital experience. *Am J Hematol* 2001;67:73–83.
213. Legrand O, Marie JP, Marjanovic Z, et al. Prognostic factors in elderly acute lymphoblastic leukaemia. *Br J Haematol* 1997;97:596–602.
214. Kantarjian HM, O'Brien S, Smith T, et al. Acute lymphocytic leukaemia in the elderly: characteristics and outcome with the vincristine-adriamycin-dexamethasone (VAD) regimen. *Br J Haematol*

1994;88:94–100.

215. Taylor PR, Reid MM, Proctor SJ. Acute lymphoblastic leukaemia in the elderly. *Leuk Lymphoma* 1994;13:373–380.

216. Virgilio JF, Moscinski LC, Ballester OF, et al. Acute lymphoblastic leukemia (ALL) in elderly patients. *Hematol Oncol* 1993;11:121–126.

217. Taylor PR, Reid MM, Bown N, et al. Acute lymphoblastic leukemia in patients aged 60 years and over: a population-based study of incidence and outcome. *Blood* 1992;80:1813–1817.

218. Delannoy A, Ferrant A, Bosly A, et al. Acute lymphoblastic leukemia in the elderly. *Eur J Haematol* 1990;45:90–93.

219. Pagano L, Mele L, Casorelli I, et al. Acute lymphoblastic leukemia in the elderly. A twelve-year retrospective, single center study. *Haematologica* 2000;85:1327–1329.

220. Ferrari A, Annino L, Crescenzi S, et al. Acute lymphoblastic leukemia in the elderly: results of two different treatment approaches in 49 patients during a 25-year period. *Leukemia* 1995;9:1643–1647.

221. Spath-Schwalbe E, Heil G, Heimpel H. Acute lymphoblastic leukemia in patients over 59 years of age. Experience in a single center over a 10-year period. *Ann Hematol* 1994;69:291–296.

222. Delannoy A, Cazin B, Thomas X, et al. Treatment of acute lymphoblastic leukemia in the elderly: an evaluation of interferon alpha given as a single agent after complete remission. *Leuk Lymphoma* 2002;43:75–81.

223. Delannoy A, Sebban C, Cony-Makhoul P, et al. Age-adapted induction treatment of acute lymphoblastic leukemia in the elderly and assessment of maintenance with interferon combined with chemotherapy. A multicentric prospective study in forty patients. French Group for Treatment of Adult Acute Lymphoblastic Leukemia. *Leukemia* 1997;11:1429–1434.

224. Bassan R, Di Bona E, Lerede T, et al. Age-adapted moderate-dose induction and flexible outpatient postremission therapy for elderly patients with acute lymphoblastic leukemia. *Leuk Lymphoma* 1996;22:295–301.

225. Goekbuget N, de Wit M, Gerhardt A, et al. Results of a shortened, dose reduced treatment protocol in elderly patients with acute lymphoblastic leukemia (ALL). *Blood* 2000;96:718.

226. Mandelli F, Annino L, Ferrari A. ALL in elderly: the GIMEMA trials. *Ann Hematol* 1995;70:105–113.

227. Thomas DA, Kantarjian H, Smith TL, et al. Primary refractory and relapsed adult acute lymphoblastic leukemia: characteristics, treatment results, and prognosis with salvage therapy. *Cancer* 1999;86:1216–1230.

228. Chucrallah AE, Stass SA, Huh YO, et al. Adult acute lymphoblastic leukemia at relapse. Cytogenetic, immunophenotypic, and molecular changes. *Cancer* 1995;76:985–991.

229. Guglielmi C, Cordone I, Boecklin F, et al. Immunophenotype of adult and childhood acute lymphoblastic leukemia: changes at first relapse and clinico-prognostic implications. *Leukemia* 1997;11:1501–1507.

230. Welborn JL. Impact of reinduction regimens for relapsed and refractory acute lymphoblastic leukemia in adults. *Am J Hematol* 1994;45:341–344.

231. Bassan R, Lerede T, Barbui T. Strategies for the treatment of recurrent acute lymphoblastic leukemia in adults. *Haematologica* 1996;81:20–36.

232. Garcia-Manero G, Thomas DA. Salvage therapy for refractory or relapsed acute lymphoblastic leukemia. *Hematol Oncol Clin North Am* 2001;15:163–205.

233. Kantarjian HM, Walters RS, Keating MJ, et al. Experience with vincristine, doxorubicin, and dexamethasone (VAD) chemotherapy in adults with refractory acute lymphoblastic leukemia. *Cancer*

1989;64:16–22.

234. Koller CA, Kantarjian HM, Thomas D, et al. The hyper-CVAD regimen improves outcome in relapsed acute lymphoblastic leukemia. *Leukemia* 1997;11:2039–2044.

235. Hiddemann W, Buchner T, Heil G, et al. Treatment of refractory acute lymphoblastic leukemia in adults with high dose cytosine arabinoside and mitoxantrone (HAM). *Leukemia* 1990;4:637–640.

236. Suki S, Kantarjian H, Gandhi V, et al. Fludarabine and cytosine arabinoside in the treatment of refractory or relapsed acute lymphoblastic leukemia. *Cancer* 1993;72:2155–2160.

237. Visani G, Tosi P, Zinzani PL, et al. FLAG (fludarabine, cytarabine, G-CSF) as a second line therapy for acute lymphoblastic leukemia with myeloid antigen expression: in vitro and in vivo effects. *Eur J Haematol* 1996;56:308–312.

238. Montillo M, Tedeschi A, Centurioni R, Leoni P. Treatment of relapsed adult acute lymphoblastic leukemia with fludarabine and cytosine arabinoside followed by granulocyte colony-stimulating factor (FLAG-GCSF). *Leuk Lymphoma* 1997;25:579–583.

239. Giona F, Testi AM, Amadori S, et al. Idarubicin and high-dose cytarabine in the treatment of refractory and relapsed acute lymphoblastic leukemia. *Ann Oncol* 1990;1:51–55.

240. Freund M, Diedrich H, Ganser A, et al. Treatment of relapsed or refractory adult acute lymphoblastic leukemia. *Cancer* 1992;69:709–716.

241. Davies SM, Ramsay NK, Weisdorf DJ. Feasibility and timing of unrelated donor identification for patients with ALL. *Bone Marrow Transplant* 1996;17:737–740.

242. Giona F, Annino L, Rondelli R, et al. Treatment of adults with acute lymphoblastic leukaemia in first bone marrow relapse: results of the ALL R-87 protocol. *Br J Haematol* 1997;97:896–903.

243. Blume KG, Schmidt GM, Chao NJ, Forman SJ. Bone marrow transplantation from histocompatible sibling donors for patients with acute lymphoblastic leukemia. *Haematol Blood Transfus* 1990;33:636–637.

244. Doney K, Fisher LD, Appelbaum FR, et al. Treatment of adult acute lymphoblastic leukemia with allogeneic bone marrow transplantation. Multivariate analysis of factors affecting acute graft-versus-host disease, relapse, and relapse-free survival. *Bone Marrow Transplant* 1991;7:453–459.

245. Report from the International Bone Marrow Transplant Registry. Advisory Committee of the International Bone Marrow Transplant Registry. *Bone Marrow Transplant* 1989;4:221–228.

246. Forman SJ, Schmidt GM, Nademanee AP, et al. Allogeneic bone marrow transplantation as therapy for primary induction failure for patients with acute leukemia. *J Clin Oncol* 1991;9:1570–1574.

247. Petersdorf EW, Hansen JA, Martin PJ, et al. Major-histocompatibility-complex class I alleles and antigens in hematopoietic-cell transplantation. *N Engl J Med* 2001;345:1794–1800.

248. Santos GW, Yeager AM, Jones RJ. Autologous bone marrow transplantation. *Annu Rev Med* 1989;40:99–112.

249. Meloni G, De Fabritiis P, Pulsoni A, et al. Results of two different conditioning regimens followed by ABMT in refractory acute lymphoblastic leukemia. *Haematologica* 1989;74:67–70.

250. Granena A, Castellsague X, Badell I, et al. Autologous bone marrow transplantation for high risk acute lymphoblastic leukemia: clinical relevance of ex vivo bone marrow purging with monoclonal antibodies and complement. *Bone Marrow Transplant* 1999;24:621–627.

2004 Lippincott Williams & Wilkins  
John P. Greer, John Foerster, John N. Lukens  
George M. Rodgers, Frixos Paraskevas, Bertil Glader  
Wintrobe's Clinical Hematology

HISTORICAL PERSPECTIVEEPIDEMIOLOGYCLINICAL PRESENTATIONLABORATORY FINDINGSBIOLOGIC FEATURESColony Assays and Growth FactorsCell Growth StudiesLeukemogenesisCLASSIFICATION OF ACUTE MYELOID LEUKEMIAMorphologic SubtypesImmunophenotypic ClassificationCytogeneticsCLINICOPATHOLOGIC SYNDROMESMinimally Differentiated Acute Myeloid LeukemiaAcute Myeloid Leukemia without MaturationAcute Myeloid Leukemia with Maturation and with t(8:21)Acute Promyelocytic LeukemiaAcute Myelomonocytic Leukemia with Abnormal Eosinophils and Inversion of Chromosome 16Acute Monocytic Leukemia (FAB M5a and M5b)Erythroleukemia (FAB M6)Acute Megakaryocytic Leukemia (FAB M7)Other Clinicopathologic SyndromesPROGNOSISTHERAPYSingle Agent ChemotherapyInduction TherapyPostremission (Consolidation/ Intensification) TherapyMonoclonal Antibody TherapySTEM CELL TRANSPLANTATIONSPECIAL ISSUESRelapsed and Refractory Acute Myeloid LeukemiaAcute Myeloid Leukemia in the ElderlyAcute Myeloid Leukemia in PregnancyHypocellular Acute Myeloid LeukemiaGrowth Factors and Biologic Response ModifiersGene and Antisense TherapySUMMARY AND FUTURE DIRECTIONSREFERENCES

The terms *acute myeloid leukemia* (AML), *acute myelogenous leukemia*, and *acute nonlymphocytic leukemia* (ANLL) refer to a group of marrow-based neoplasms that have clinical similarities but distinct morphologic, immunophenotypic, and cytogenetic features. AML should be distinguished from acute lymphoblastic leukemia (ALL) ([Chapter 77](#)) and may follow myelodysplasia (MDS) ([Chapter 83](#)). AML occurs at any age but is more common in adults, with increased frequency as age advances. Clinical features are similar at all ages and are the result of replacement or suppression of normal marrow elements by malignant blasts, generally resulting in impaired hematopoiesis manifested by cytopenias. [Chapter 81](#) addresses the diagnosis and therapy of AML in children.

The malignant cell in AML is a blast that most often shows myeloid or monocytic

differentiation. In approximately 5 to 10% of patients, blasts have erythroid or megakaryocytic differentiation; for this reason, *ANLL* has been considered a more precise term, but *AML* is used more commonly and is the recommended term ( [1](#) ). The myeloid blast can be identified by the presence of Auer rods or by Sudan black, myeloperoxidase (MPO), chloroacetate esterase, or nonspecific esterase positivity on cytochemical stains. In addition to morphology and cytochemical evidence of lineage, flow cytometry is used to classify acute leukemia based on the presence of myeloid and lymphoid antigens ( [1](#) , [2](#) ). Surface marker analysis has shown that AML is heterogeneous and may have patterns of antigen expression varying from those seen on stem cells to those present on more mature myeloid cells. Expression of lymphoid antigens is not uncommon in subtypes of AML. Biphenotypic or mixed lineage features have been described in 5 to 20% of acute leukemias. Electron microscopy may also be used to identify and subclassify AML ( [3](#) ).

The pathogenesis of AML is uncertain, but chromosome abnormalities are present in most patients ( [4](#) ). Cytogenetic translocations result in the formation of fusion proteins, which are a common pathway in leukemogenesis. New diagnostic tools, including fluorescence *in situ* hybridization, polymerase chain reaction (PCR), comparative genomic hybridization, and microarray analysis have improved the sensitivity of detection of genetic abnormalities and the ability to subclassify AML and to detect minimal residual disease. Because of the importance of cytogenetics in diagnosis and prognosis in AML, the World Health Organization (WHO) has incorporated cytogenetic findings into a new classification. Genetic syndromes and toxic exposures contribute to the pathogenesis in some patients.

Advances in therapy have changed the cure rates in AML from less than 20% in 1960 to 1980 to 40 to 70% for selected groups in the 2000s. In fact, the cure rate of acute promyelocytic leukemia (APL) is more than 70% with the addition of all-*trans*-retinoic acid (ATRA) to chemotherapy ( [Chapter 82](#) ). For other types of AML, the highest cure rates have resulted from allogeneic stem cell transplantation (alloSCT) in first remission; however, the improved survival in patients receiving high-dose cytosine arabinoside (ara-C) chemotherapy has kept the question of what is the best initial therapy in AML unanswered. In this chapter, epidemiologic, clinical, biologic, and cytogenetic features of adult AML are addressed in the context of therapeutic principles and prognosis.

## HISTORICAL PERSPECTIVE

Virchow recognized leukemia as a distinct disease in 1845 when he used the term *weisses Blut* to describe the findings in an autopsy in which the ratio of red corpuscles to “colorless (in mass white)” was reversed ( [5](#) , [6](#) ). He used the term *leukämie* for the first time in 1847 and, subsequently, described lymphatic and splenic forms ( [7](#) ). Friedreich recognized acute and chronic types in 1857 ( [8](#) ), and Neumann in 1868 identified the bone marrow as the origin of leukemia and used *myelogenous* as a provisional term that has been validated over time ( [5](#) , [9](#) ). In 1876, Mosler introduced bone marrow puncture as a method to diagnose leukemia ( [10](#) ).

At the beginning of the twentieth century, Naegli distinguished acute myelomonocytic leukemia (AMMoL) from acute myeloblastic leukemia ( [11](#) ); and Ehrlich used morphology and aniline dyes to diagnose and categorize leukemia ( [12](#) ). During the first half of the century, most of the subcategories of AML were identified by light microscopy with the aid of cytohistochemical stains and were described based on the resemblance to normal hematopoietic precursors. Reschad and Schilling described acute monoblastic leukemia in 1913 ( [13](#) ); DiGugliermo described acute erythroleukemia in 1917 ( [14](#) ); Von Boros and Karenyi described acute megakaryocytic leukemia (AMgL) in 1931 ( [15](#) ); and Hilstad

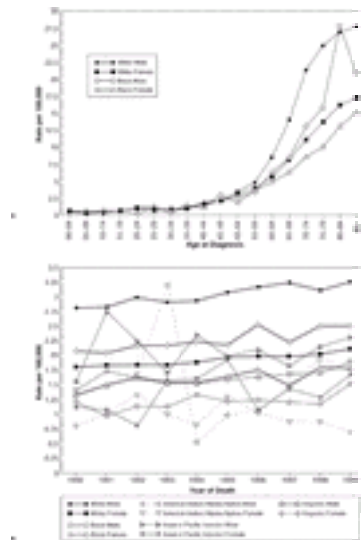


described APL in 1957 ( [16](#) ). The morphologic approach to AML culminated in the development of standard criteria beginning in 1976 by the French/American/British (FAB) working group, in what became known as the FAB classification of AML ( [17](#) ). Modifications of the FAB classification were made with recognition of new morphologic subsets of AML, such as minimally differentiated disease with myeloid antigen expression ( [18](#) ).

Nevertheless, the weaknesses of the FAB classification include interobserver variability, the failure to incorporate cytogenetic data into diagnosis, and poor correlation with clinical outcome. The recognition of the Philadelphia chromosome in chronic myeloid leukemia (CML) by Nowell and Hungerford in 1960 was the first demonstration of a recurring chromosomal abnormality ( [19](#) ). In the latter half of the twentieth century, numerous cytogenetic abnormalities, including specific translocations, were identified in subtypes of AML and have led to changes in classification, as proposed in 1997 by the WHO ( [20](#), [21](#) ). The WHO subdivides AML into true *de novo* AML occurring predominantly in young to middle-aged adults with recurring cytogenetic translocations or inversions and MDS-related AML occurring in elderly adults often with complex chromosomal abnormalities ( [21](#), [22](#) ). The WHO recognizes therapy-related AML and retains the morphologic subcategories of the FAB in cases not otherwise classified ( [21](#), [22](#) ). The category of acute leukemia of ambiguous lineage is also added.

## EPIDEMIOLOGY

Findings in epidemiologic studies suggest that environmental, occupational, and genetic factors play a role in the pathogenesis of AML ( [23](#), [24](#) and [25](#) ). Incidence rates are greater in developed countries and in industrialized cities. Studies reveal an increased risk for Eastern European Jews and a decreased risk for Asian populations ( [24](#) ). The overall annual incidence is 3.4/100,000 ( [26](#) ). The incidence of AML increases with age, with a median of 68 years ( [26](#) ). It is less than 1/100,000/year for persons younger than 30 years of age, but it reaches 17/100,000 for persons 75 years of age; the incidence is higher in males than in females and in whites than in blacks ( [Fig. 79.1](#) ) ( [26](#), [27](#) ). There is an increasing incidence of AML in the elderly, which is probably related to improved diagnosis, the recognition of AML after MDS, and longer life expectancy, resulting in increased environmental exposures ( [28](#) ). AML accounts for less than 15% of cases of leukemia in children younger than 10 years of age and 25 to 30% of cases between 10 and 15 years of age ( [25](#), [26](#) ); in adults, AML accounts for 80 to 90% of cases of acute leukemia. Paradoxically, congenital leukemia is usually AML rather than ALL and is often monocytic, with a high incidence of extramedullary disease, particularly involving the skin and the central nervous system (CNS).



**Figure 79.1. A:** Age-specific incidence rates for acute myeloid leukemia (AML) by race (black/white) and sex for nine areas evaluated by the Surveillance, Epidemiology, and End Results (SEER) program of the National Cancer Institute, 1973–1999. **B:** Age-adjusted mortality rates for AML by expanded race and sex by the SEER program, 1990–1999. Males predominate over females among all races, with the highest rate in white males (3.27/100,000 in 1999) and the lowest rate in Native-American/Alaskan females (0.73/100,000 in 1999). (Adapted from Ries LAG, Eisner MP, Kosary CL. SEER cancer statistics review, 1973–1999. Bethesda, MD: National Cancer Institute, 2002.)

Genetic factors are implicated in the pathogenesis of AML by virtue of its high incidence in patients with syndromes characterized by chromosomal abnormalities or instability or defective DNA repair ( [29](#) ). These disorders can be separated into congenital defects and marrow failure syndromes ( [Table 79.1](#) ) ( [30](#) ). They are usually recognized in childhood AML discussed in [Chapter 81](#) . Children with Down syndrome (trisomy 21) may have a transient leukemoid reaction and are also at a 20 times greater risk for development of acute leukemia, with a similar ratio of ALL to AML (4:1) as in other children ( [30](#) , [31](#) and [32](#) ). Acute leukemia in Down syndrome tends to occur 2 to 3 years earlier than the median age of 5 to 6 years in other children, and children with Down syndrome and AML often have acute megakaryoblastic leukemia (FAB M7) ( [30](#) , [31](#) and [32](#) ). Bloom syndrome is a rare autosomal-recessive disorder with excessive chromosomal breakage, including quadriradial formation and increased sister chromatid exchanges. Like the other syndromes with defective DNA repair, ataxia telangiectasia and xeroderma pigmentosum, Bloom syndrome is characterized by unique clinical features (telangiectatic erythema, photosensitivity, growth retardation, and immunodeficiency with or without mental retardation) and a predisposition to a variety of cancers ( [33](#) ). The gene for Bloom syndrome has been localized to chromosome 15q26.1 and encodes a protein with helicase activity that is central to DNA repair ( [33](#) ). Infantile monosomy 7 syndrome is a unique myelodysplastic syndrome of childhood that overlaps with juvenile CML and can evolve into aplastic anemia or AML ( [34](#) , [35](#) and [36](#) ). Both Klinefelter syndrome (XXY) and Turner syndrome (XO) are rarely associated with AML ( [37](#) , [38](#) ).

**TABLE 79.1. Genetic Disorders Implicated in the Pathogenesis of Acute Myeloid Leukemia**

| Congenital Defects | Marrow Failure Syndromes |
|--------------------|--------------------------|
|--------------------|--------------------------|

|                                 |                                  |
|---------------------------------|----------------------------------|
| Down syndrome                   | Fanconi anemia                   |
| Bloom syndrome                  | Dyskeratosis congenita           |
| Monosomy 7 syndrome             | Shwachman–Diamond syndrome       |
| Klinefelter syndrome            | Amegakaryocytic thrombocytopenia |
| Turner syndrome                 | Blackfan–Diamond syndrome        |
| Neurofibromatosis               | Kostmann agranulocytosis         |
| Congenital dysmorphic syndromes | Familial aplastic anemia         |

---

Neurofibromatosis has unique phenotypic features (café-au-lait patches, benign neurofibromata, freckling in intertriginous areas, skeletal abnormalities) and abnormalities of a specific gene, NF1, on the long arm of chromosome 17 at 17q11.2, which acts as a tumor-suppressor gene ( [30](#), [39](#) ). Patients with neurofibromatosis have a predisposition to cancer, including malignant nerve sheath tumors, optic nerve gliomas, and myeloid leukemias, which tend to develop in the second decade of life ( [40](#), [41](#) ). Other rare congenital syndromes associated with acute leukemia have unique dysmorphic features, usually in conjunction with a specific cytogenetic abnormality. Rubinstein–Taybi (broad thumbs and great toes, mental retardation, abnormal facies) is associated with breakpoints on chromosome 16p13.3 ( [30](#), [42](#) ); Treacher–Collins syndrome (mandibulofacial dysostosis) has been associated with abnormalities of chromosome 5q31–34 ( [30](#), [43](#) ), and Klippel–Feil syndrome (fusion of cervical vertebrae) and Goldenhar syndrome (hemifacial microsomia, radial defects) have autosomal-dominant inheritance. The latter is associated with abnormalities of chromosome 7 ( [30](#), [44](#) ).

Marrow failure syndromes are addressed in [Chapter 44](#) and [Chapter 83](#) and include disorders listed in [Table 79.1](#). Fanconi anemia (FA) is the most common disorder and also confers the highest risk of developing AML (approximately 9% risk) ( [30](#), [45](#), [46](#) ). FA was first described in 1927 ( [45](#) ); its association with leukemia was not reported until more than 30 years later ( [47](#) ). FA is an autosomal-recessive disorder with a slightly higher incidence in males ( [30](#) ). Four-fifths of cases are diagnosed between the ages of 2 and 13 years, with a median age of 7 years at diagnosis ( [30](#), [48](#) ). Clinical factors are variable but often include café-au-lait spots, skeletal abnormalities with absent thumbs, short stature, microcephaly, mental retardation, and renal abnormalities ( [30](#), [48](#) ). The cells in FA tend to exhibit spontaneous chromosome breaks. Karyotypes of bone marrow cells are often abnormal; monosomy 7 and rearrangements involving chromosome 1 are the most common findings ( [47](#), [48](#) ). The diagnosis of FA can be confirmed by an increased frequency of chromosome breaks when the cells are exposed to clastogens such as mitomycin C or diepoxybutane ( [30](#), [46](#) ). The best survival in FA is with marrow transplantation, but the preparative regimens must be modified because of excess toxicity in these patients ( [Chapter 25](#) ).

Dyskeratosis congenita (Zinsser–Cole–Engman syndrome) is predominantly X-linked, with approximately one-half of patients developing marrow aplasia at a mean age of 10 years ( [30](#) ). Shwachman–Diamond syndrome is autosomal recessive, with pancreatic insufficiency, skeletal abnormalities, and a median age of onset for leukemia of approximately 8 years ( [30](#), [49](#) ). Amegakaryocytic thrombocytopenia, which may be X-linked, and Blackfan–Diamond syndrome, a constitutional pure red cell aplasia, rarely precede AML ( [30](#) ). Patients with Kostmann syndrome and other congenital neutropenias have been treated with growth factor support, and data indicate that this intervention may promote

leukemogenesis ( 50 ). Familial aplastic anemia may precede AML in a minority of cases. Acquired diseases with an increased risk for developing AML include myelodysplastic syndromes ( Chapter 83 ), chronic myeloproliferative disorders ( Chapters 84 to 87 ), aplastic anemia ( Chapter 44 ), and paroxysmal nocturnal hemoglobinuria ( Chapter 37 ).

Familial studies have demonstrated an increased risk of leukemia in family members of patients with leukemia but may be flawed by biases in reporting and methodologic weaknesses. No consistent mendelian pattern has been identified in most reports; however, the Li-Fraumeni syndrome, described in 1969, is an autosomal-dominant cancer family syndrome with an increased risk for sarcomas, breast cancer, and other neoplasms, including leukemia, caused by mutations in the p53 gene ( 51 , 52 ). The risk of familial leukemia may be increased with consanguinity or inherited chromosomal instability syndromes (e.g., FA). It is probably caused by one of two factors: a genetic predisposition within a family or a common environmental exposure ( 30 ). Constitutional chromosome abnormalities associated with AML include t(7;20) ( 53 ) and t(3;6), both of which are rare ( 54 ). Anticipation (onset at earlier age with each generation) has been recognized in rare autosomal-dominant AML; possible candidate genes are located at 21q22, 11q23, or 16q22 ( 55 ).

The classic method for determining inheritability of a disease is through twin studies and evaluation of human lymphocyte antigen (HLA) associations ( 30 ). Leukemia in twins was first reported in 1928, and further studies have demonstrated an increased risk in monozygotic twins ( 56 ). The clinical presentation is atypical, with leukemia usually occurring before 2 years of age, indicating the probability of an intrauterine event ( 57 ). Transfer of leukemia cells from one twin to the other through a common placental blood vessel is generally accepted as the explanation for neonatal leukemia in monozygotic twins ( 30 ). Although there are conflicting data about the risk of leukemia in association with specific HLA types, there is a suggestion of nonrandom genetic associations between HLA-C locus alleles and acute leukemia ( 23 , 30 ). Prospective studies of HLA associations using molecular genetic analysis in selected populations are needed to identify whether HLA typing can be used as a surrogate marker for risk of leukemia ( 30 ).

Environmental factors have also been implicated in the pathogenesis of AML ( Table 79.2 ) ( 5 ). A possible link between solvents and leukemia was suggested by Vigliani ( 58 ) and confirmed by observations by Aksoy in shoe factory workers ( 59 , 60 ). Similar increases in incidence of leukemia have been reported in workers involved in organic synthesis and in rubber and paint manufacturing ( 61 , 62 ). Benzene is a solvent that can be absorbed through the skin and lungs and can accumulate in the body fat and neurologic tissues ( 60 ). Toxicity is related to cumulative dosage, and the risk of leukemia was high before safety controls were put into place in the workplace ( 60 ). Chromosome damage can occur at 1 to 10 ppm, and leukemogenic risk is considerable at 124 to 200 ppm ( 60 , 63 ). In surveys of factories in China, the leukemogenic risk was four to seven times higher in workers exposed to benzene than in the general population, and the average latency was 11.4 years ( 60 , 62 , 64 ). A dose response pattern was suggested with the highest risk in Chinese workers exposed at constant levels of 25 ppm or higher ( 64 ).

**TABLE 79.2. Environmental Factors Contributing to Acute Myeloid Leukemia**

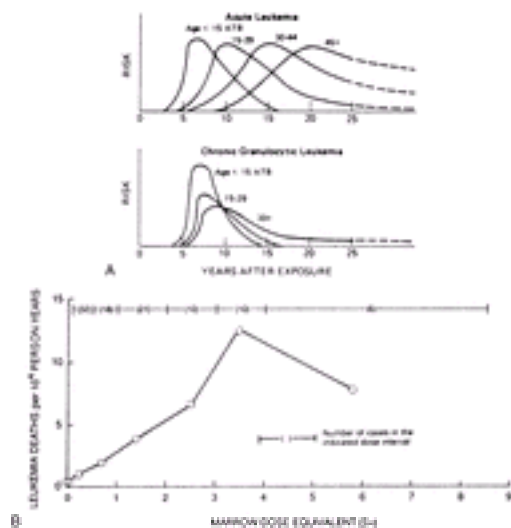
**Solvents (benzene)**

- Smoking
- Ionizing radiation
  - Atomic bomb exposure
  - Nuclear power exposure
  - Medical radiation
- Nonionizing radiation (?)
- Chemotherapy
  - Alkylating agents
  - Topoisomerase II inhibitors
- Other drugs
  - Chloramphenicol
  - Phenylbutazone

---

Smoking has been weakly associated with leukemia. Metaanalyses have estimated a relative risk for AML of 1.3 to 1.5 in smokers ( [65](#), [66](#) ). This association could be partially caused by exposure to benzene in cigarettes ( [60](#) ). Tobacco smoke also contains other potentially leukemogenic chemicals, including urethane, nitrosamines, and radioactive compounds ( [60](#) ). Studies from the American Cancer Society, the Veterans Administration, and Seventh Day Adventists have identified an increase in the incidence of myeloid leukemia in smokers ( [67](#), [68](#) ). The risk of developing AML is two to three times higher in male smokers who have exceeded 20 pack-years ( [60](#), [67](#), [69](#) ). Smokers of more than 40 cigarettes/day who develop AML have an increased incidence of unfavorable cytogenetic abnormalities, including -7/7q- and -5/5q- ( [60](#), [70](#) ).

The leukemogenic effect of ionizing radiation was established in the early twentieth century: Roentgen discovered X rays in 1895; the first cancer was reported on the hand of a radiologist in 1902; and leukemia caused the death of Marie Curie in 1934 ( [71](#) ). Subsequently, an increased prevalence of leukemia was recognized in radiologists in the 1940s ( [72](#) ). Atomic bombs were released over Hiroshima and Nagasaki in 1945; the first report of leukemia appeared in 1952 ( [73](#) ), and long-term follow-up has indicated a latency period of 5 to 21 years ( [60](#), [74](#), [75](#) ). The primary carcinogenic effects of ionizing radiation are breaks in double-stranded DNA. The risk of leukemia correlates with radiation dosage and age at exposure, with a more rapid peak early in life (<15 years), as well as a more rapid decline than in those exposed at older ages ( [Fig. 79.2](#) ) ( [60](#), [76](#) ). Fallout from atomic tests and exposure to nuclear reactors have been a concern in the second half of the twentieth century. Whereas little radioactivity was released into the environment at Three Mile Island, there was extensive exposure to radioactivity after Chernobyl ( [77](#) ). Although there are conflicting data on the impact of Chernobyl, there does appear to be an increased risk of leukemia associated with isolated events in which large amounts of radiation have been released into the atmosphere ( [77](#), [78](#), [79](#) and [80](#) ).



**Figure 79.2.** Risk of leukemia among atomic bomb survivors. **A:** Effect of age at exposure and the temporal pattern of developing leukemia according to cell type (acute vs. chronic granulocytic leukemia). [From Okada S, Hamilton HB, Egami N, et al., eds. A review of thirty years of Hiroshima and Nagasaki atomic bomb survivors. *J Radiation Res* 1975;16(Suppl):1–164.] **B:** Dose–response relationship among atomic bomb survivors. The leukemic risk increased with radiation dose except that a downturn was suggested after 4 Gy, possibly caused by killing of stem cells ( [56](#) ). ATB, at time of bomb. [From National Academy of Science. Health effects of exposure to low levels of ionizing radiation (Beir V). Washington, DC: National Academy Press, 1990. Reprinted with permission from Health Effects of Exposure to Allow Levels of Ionizing Radiation. Copyright 1990 by the National Academy of Sciences. Courtesy of the National Academy Press, Washington, DC.]

Radiation used for medical purposes was leukemogenic in the early twentieth century, when the carcinogenic effects of radiation were less well known. Diagnostic radiology, radiotherapy for benign and malignant diseases, and radionuclide exposure have been associated with leukemia ( [77](#) ). Although diagnostic radiographs are no longer considered to be associated with an increased risk, most studies of exposure during pregnancy have shown an increased risk of childhood leukemia ( [77](#), [81](#) ). Smith and Doll reported a fivefold increased risk of leukemia in patients with ankylosing spondylitis receiving a single dose of pelvic radiation; the risk peaked 3 to 5 years after radiotherapy ( [82](#) ). A twofold increased risk has been reported after pelvic radiation for menorrhagia, a treatment commonly used during the 1930s and 1940s ( [83](#) ). Small increases in risk have also been reported after radiation for tinea capitis ( [84](#) ) and peptic ulcer disease ( [85](#), [86](#) ).

Although radiation therapy is less leukemogenic than chemotherapy, leukemia has followed radiation and radioisotope therapy given for a variety of cancers. The risk of leukemia (latency period of 2 to 11 years) is approximately two times higher in patients who have received either radium implants or external beam radiation for cervical, ovarian, or endometrial cancer ( [60](#), [86](#), [87](#) ). Similarly, a twofold increase in risk has been reported in breast cancer patients receiving adjuvant radiotherapy compared to a tenfold increase in risk after chemotherapy; combined radiation and chemotherapy resulted in a 17–fold risk ( [77](#), [88](#) ). Radiation therapy has been associated with only a small increase in risk of leukemia in patients with Hodgkin and non–Hodgkin lymphomas, unless the radiation is extensive and encompasses a large volume of bone marrow ( [89](#), [90](#) and [91](#) ). Although there has been no increase in the risk of leukemia in patients treated with radioactive iodine (



<sup>131</sup>I) for hyperthyroidism, there have been reports of an increased incidence of leukemia in patients receiving higher <sup>131</sup>I dosages for thyroid cancer ( [92](#) ). In a randomized clinical trial, radioactive phosphorus ( <sup>32</sup>P ) administered to patients with polycythemia vera resulted in a 6% incidence of leukemia, compared to a 1% incidence after phlebotomy alone and an 11% incidence in patients treated with chlorambucil ( [93](#) ). Thorotrast, a radioactive contrast agent containing thorium ( <sup>232</sup>Th ), has also been associated with an increased risk of leukemia ( [94](#) ).

Radon, cosmic radiation, and nonionizing radiation have been implicated as possible etiologic factors in AML but are unlikely to contribute a major risk. Although radon exposure has been linked to AML in some studies ( [95](#) ), there has been no association in other studies ( [96](#) ); moreover, there has not been an increased incidence of leukemia in underground miners who are exposed to large amounts of radon ( [97](#) ). Cockpit crew members with a long flying history were observed to have an increased risk of AML, suggesting a possible leukemogenic role for cosmic radiation ( [98](#) ). Nonionizing radiation from the electromagnetic fields of household appliances and electrical power lines has generated public concern, but there are insufficient data to confirm any link to acute leukemia ( [77](#) ).

Drugs have been linked to AML, with the most convincing evidence pertaining to the antineoplastic agents, particularly alkylating agents and topoisomerase II inhibitors ( [99](#), [100](#) ). Alkylating agents cause point mutations, which result in activation of oncogenes such as RAS, as well as chromosomal deletions and unbalanced translocations involving chromosomes 5 and 7 ( [99](#), [101](#) ). Topoisomerase II inhibitors result in loss of a critical enzyme involved in DNA replication, leading to balanced chromosomal translocations involving 11q23 or 21q22, with the formation of chimeric fusion genes ( [102](#) ). Most therapy-related leukemias occur 3 to 10 years after initial therapy, with a longer latency for alkylating agents (5 to 9 years) than for topoisomerase II inhibitors (6 months to 5 years) ( [99](#) ). A third syndrome of therapy-related leukemias has been described in patients who develop AML with prognostically favorable cytogenetics, including t(15;17) and inv(16). These patients have received either alkylating agents or topoisomerase II inhibitors often with radiation, have a short latency period (22 to 29 months, median), and have chemosensitivity similar to that of *de novo* patients ( [103](#) ). Therapy-related ALL has also been described and usually involves an 11q23 translocation ( [104](#) ).

The best described and most common therapy-related leukemias are associated with alkylating agents. The most extensively studied disease is Hodgkin lymphoma ( [101](#), [105](#), [106](#), [107](#), [108](#), [109](#) and [110](#) ), but leukemia has occurred after therapy of multiple neoplasms treated with alkylating agents, including breast cancer ( [100](#), [111](#) ), multiple myeloma ( [112](#) ), ovarian cancer ( [113](#) ), and non-Hodgkin lymphoma. Similarly, MDS or acute leukemia may develop in myeloproliferative disorders, particularly polycythemia rubra vera, as well as nonneoplastic disorders such as collagen vascular diseases treated with alkylating agents. With the increased use of autologous transplants as salvage therapy for hematologic neoplasms, secondary MDS and AML are being recognized and are associated with a poor prognosis ( [114](#) ). In Hodgkin lymphoma, radiation can be a contributing factor, but the risk in patients who have received radiation only is usually less than 1.0%, compared to 1.5 to 5.0% for those who received both types of therapy, particularly when chemotherapy is administered as salvage therapy for relapse after radiation ( [115](#), [116](#) ). The risk of leukemia after Hodgkin lymphoma ranges from an 11- to a 136-fold increase over that in the



normal population ( [116](#) ).

The time of leukemia onset after alkylating agent exposure has ranged from 1 to 28 years and is most commonly in the 5- to 9-year range ( [100](#) , [117](#) ). The risk is greater and the latency is shorter in older patients with Hodgkin lymphoma (>50 years of age) ( [100](#) , [107](#) ). Splenectomy has been suggested as a contributing factor to leukemia in some, but not all, studies ( [107](#) , [117](#) ). Elevation in the mean corpuscular volume may be an early sign of development of myelodysplastic changes, and up to two-thirds of patients who develop leukemia have a preceding myelodysplastic phase that lasts approximately 6 months ( [100](#) ). In secondary MDS, there may be more hypoplasia and fibrosis than are observed in *de novo* MDS ( [117](#) ). When there is evolution to acute leukemia, Auer rods are rare, and assignment of FAB subtype is difficult ( [100](#) ). Clonal cytogenetic abnormalities are often complex; the most common single abnormality is monosomy 7(-7), followed by del(5q) and -5 ( [100](#) , [116](#) , [117](#) and [118](#) ).

Topoisomerase II inhibitors, particularly etoposide and teniposide, were recognized as leukemogenic agents in survivors of lung cancer ( [119](#) , [120](#) ), germ cell cancer ( [121](#) , [122](#) , [123](#) and [124](#) ), acute lymphocytic leukemia ( [125](#) , [126](#) ), neuroblastoma ( [127](#) ), and osteosarcoma ( [128](#) ) in the 1980s. Large cumulative dosages and prolonged courses have been implicated as increasing the risk of leukemia. The latency period was short, with most cases occurring between 6 months and 5 years after initial therapy. There was no myelodysplastic phase, and the majority of cases were myelomonocytic (FAB M4) or monoblastic (FAB M5). The cytogenetic abnormality usually consists of a translocation involving 11q23 or, less commonly, 21q22 ( [99](#) , [100](#) , [117](#) ). Patients with AML and 11q23 abnormalities after topoisomerase II inhibitors tend to be chemosensitive but are rarely long-term survivors because of a high relapse rate ( [117](#) ).

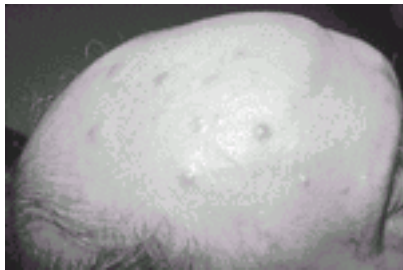
Other drugs and chemicals as well as parental and occupational exposures have been suggested as leukemogenic ( [24](#) , [117](#) ). Maternal alcohol consumption during pregnancy has been associated with an increased risk of AML, particularly in young children ( [129](#) ). Additionally, it has been suggested that maternal exposure to topoisomerase II inhibitors in the environment [flavonoids, catechins, caffeine, quinolones, thiram (agricultural fungicide), and podophyllin (used to treat genital warts)] may be associated with an increased risk of infant leukemia with abnormalities involving the mixed lineage leukemia (MLL) gene at chromosome band 11q23 ( [24](#) , [130](#) , [131](#) ). Antibiotics, including chloramphenicol ( [132](#) , [133](#) ) and analgesic agents, including phenylbutazone and derivatives such as sulfinpyrazone ( [134](#) ), have been associated with marrow suppression, aplastic anemia, agranulocytosis, and, more rarely, AML ( [5](#) ). The leukemia tends to follow marrow suppression, similar to what is seen with benzene and radiation-induced leukemia ( [117](#) , [132](#) ). Chloroquine, methoxypsoralen, and lysergic acid diethylamide have also been reported to be associated with AML ( [24](#) ). AML has been reported in workers exposed to rubber, paint, embalming fluids, pesticides, ethylene oxide, gasoline, poultry, and electrical wiring ( [24](#) , [117](#) ); however, many of these associations are difficult to substantiate because of small numbers and problems in epidemiologic reporting.

## CLINICAL PRESENTATION

Symptoms related to AML are caused by failure of normal hematopoiesis, resulting in anemia and increased risk of infection and bleeding ( [Chapter 72](#) ). The most common complaint is nonspecific fatigue or malaise that usually has been present for several

months. Pallor and weakness are caused by anemia. Fever is common and is the presenting feature in 15 to 20% of patients; it is often associated with sweats and results from infection secondary to neutropenias or from leukemia itself. Hemorrhagic signs and symptoms, including petechiae, epistaxis, and easy bruising, may be found in up to one-half of patients at diagnosis and correlate with the severity of thrombocytopenia or the presence of disseminated intravascular coagulation (DIC), most commonly observed in APL. Up to 50% of patients experience weight loss, but it is usually not severe. Bone pain occurs in less than 20% of patients. Although organomegaly and adenopathy have been reported in up to one-half of patients with AML, these signs are more common in ALL.

Leukemia skin infiltration, or leukemia cutis, occurs in up to 13% of patients with AML during the course of the disease and is associated with involvement of other extramedullary sites, including the CNS ( [135](#) ). The lesions are often violaceous and nodular and are more common in patients with a monocytic component to the AML ( [Fig. 79.3](#) ). The skin lesions may precede the diagnosis of AML. They are radiosensitive, but patients should usually be treated with systemic chemotherapy ( [135](#) ). Gum infiltration is also characteristic of acute monocytic leukemia (AMoL) ( [Fig. 79.4](#) ). Approximately one-half of children with congenital leukemia have gray-blue nodular skin lesions whose appearance is reminiscent of a blueberry muffin ( [136](#) ). Benign skin lesions associated with AML include Sweet syndrome ( [137](#) ) and pyoderma gangrenosum ( [138](#) ); these are generally painful and responsive to steroids.



**Figure 79.3.** Leukemia cutis manifesting as subcutaneous nodules. See [Color Plate](#). (Courtesy of Dr. Michael Smith, Division of Dermatology, Vanderbilt University Medical Center.)



**Figure 79.4.** Swollen and spongy gums in a patient with acute leukemia. See [Color Plate](#). (Courtesy of Dr. Stuart Salmon, Division of Hematology/Oncology, Vanderbilt University Medical Center.)

The incidence of CNS disease at diagnosis is difficult to determine because lumbar puncture is not always performed ( [139](#) , [140](#) , [141](#) , [142](#) , [143](#) and [144](#) ). Meningeal disease has

been reported to develop in 5 to 20% of children ( [142](#) , [143](#) ) and up to 16% of adults ( [144](#) ) with AML. The increased use of HiDAC lessens the risk of CNS leukemia in AML, as evidenced by a 2.2% incidence in a review of 410 patients from a single institution ( [145](#) ). CNS disease is associated with young age (<2 years), hyperleukocytosis, and the AMoL variants ( [139](#) , [140](#) ). It is often asymptomatic but may be associated with headache or cranial nerve palsies, particularly V and VII. Ocular involvement may result in blindness and suggests meningeal involvement. Intracerebral masses rarely coexist with leukemia meningitis but have been reported in FAB M4Eo in association with inv(16)(p13q22) ( [141](#) ). Prophylactic CNS therapy is not given routinely to patients with AML; however, some clinicians advocate prophylaxis, particularly in children and in patients with AMoL or with white cell counts greater than 100,000 cells/mm<sup>3</sup> ( [143](#) ).

*Myeloid (granulocytic) sarcoma, or myeloblastoma*, is an extramedullary tumor that occurs in 2 to 14% of cases of AML ( [146](#) , [147](#) , [148](#) , [149](#) , [150](#) and [151](#) ). These tumors are called *chloromas* because some appear green or turn green in dilute acid secondary to expression of MPO ( [149](#) , [150](#) and [151](#) ). The tumors are usually localized; they often involve bone, periosteum, soft tissues, lymph nodes, or skin. Common sites are the orbit and the paranasal sinuses, but other sites reported include the gastrointestinal tract, genitourinary tract, breast, cervix, salivary glands, mediastinum, pleura, peritoneum, and bile duct ( [147](#) , [151](#) ). Granulocytic sarcomas may occur at diagnosis of AML or may precede the diagnosis; they have also been seen in association with myelodysplastic syndromes or myeloproliferative disorders and usually predict transformation to acute leukemia ( [150](#) , [151](#) ). The diagnosis may be missed but should be suspected if eosinophilic myelocytes are present in hematoxylin and eosin-stained biopsy sections. Imprint preparations can be helpful. The diagnosis can be made if Auer rods are detected or if myeloid origin is confirmed by cytochemical or immunohistochemical methods ( [149](#) ). Although granulocytic sarcomas are radiosensitive, systemic chemotherapy is warranted in most cases ( [149](#) ). Testicular infiltration is less common in AML than in ALL, with an incidence of 1 to 8%; the management of testicular involvement includes bilateral testicular irradiation and systemic chemotherapy ( [151](#) , [152](#) and [153](#) ). Neutropenia is common in patients with granulocytic sarcoma; the marrow may be hypocellular and often reveals increased blasts.

Other organ systems may be involved with AML. Cardiac abnormalities are usually related to electrolyte imbalances, particularly hypokalemia, but may result from direct involvement of the conduction system or infiltration of vessel walls ( [151](#) , [154](#) ). Pulmonary symptoms occur in patients with leukostasis, infections related to neutropenia, or hemorrhage due to thrombocytopenia ( [151](#) ). Gastrointestinal symptoms also include infections, particularly perirectal abscesses and typhlitis, a necrotizing colitis related to leukemia infiltration of the bowel wall. Management of typhlitis is controversial and has included supportive care with antibiotics and nasogastric suction as well as surgical intervention ( [155](#) , [156](#) ). Obstructive jaundice has occurred secondary to granulocytic sarcoma, and patients with AML rarely present with hepatic failure ( [151](#) , [157](#) ).

## LABORATORY FINDINGS

Blood counts vary widely among patients with AML ( [158](#) ). The leukocyte count is elevated in more than one-half of patients but is more than 100,000 cells/mm<sup>3</sup> in less than 20%. Blasts usually are identified on peripheral smear; Auer rods and Phi bodies are considered pathognomonic of AML. *Phi bodies* are fusiform or spindle-shaped rods similar to Auer rods and require special stains for hydroperoxidases ( [159](#) ). Aleukemic leukemia (no blasts

in the peripheral smear) is rare, particularly if buffy coat smears are examined.

Cytopenias result from hematopoietic failure and contribute to symptoms and signs. Neutropenia is present in most AML patients. Galton et al. indicated that a normal neutrophil count is more common in patients with monocytic variants of AML and suggested that a correlation exists between the normal neutrophil count and maturation of the leukemia cells in AMoL ( [160](#) ). Giant lysosomes are rarely noted in neutrophils of patients with AML; their presence has been called a *pseudo-Chédiak-Higashi syndrome* ( [161](#) ). Anemia is common in AML and is predominantly normochromic and normocytic. Nucleated red cells and reticulocytopenia are often present. Erythroid precursors in the marrow are often megaloblastic, particularly in acute erythroleukemia or in AML that has evolved from a myelodysplastic syndrome. Thrombocytopenia, which may be severe at diagnosis, can be associated with DIC. Thrombocytosis is rarely identified, but large bizarre platelets may be found; megakaryocytes are usually decreased in number and may have abnormal nuclear morphology, including monolobate and hyperlobate forms.

DIC is more common in AML than in ALL; it is most common in APL, as initially described by Hillstad ( [Chapter 82](#) ) ( [16](#), [162](#) ). The cause of DIC is thought to be release of tissue factor-like procoagulants from the azurophilic granules within the leukemia cells. DIC is typically seen at presentation or during induction chemotherapy for APL ( [163](#), [164](#) ). Other mechanisms such as excessive fibrinolysis and secretion of interleukin (IL)-1 by the leukemia cells may contribute to bleeding in these patients ( [165](#), [166](#) ). DIC is manifested clinically by diffuse oozing of blood and is characterized by thrombocytopenia, hypofibrinogenemia, elevated fibrin split products, and deficiency of coagulation factors, including factor V and factor VIII ( [167](#) ).

Hyperuricemia has been noted in up to 50% of patients with AML and can also be associated with tumor lysis, although the latter is more common in ALL ( [168](#) ). Appropriate hydration and administration of allopurinol can prevent complications of tumor lysis, which may occur during induction chemotherapy, most often in the setting of hyperleukocytosis. Serum lactate dehydrogenase levels may be elevated, particularly in monocytic (M4/M5) subtypes, but to a lesser degree than is observed in ALL ( [169](#) ).

Levels of lysozyme are elevated, particularly in variants of AML with a predominantly monocytic component, including AMoL and AMMoL. Excess lysozyme (muramidase) may cause proximal renal tubular damage, which results in hypokalemia. Pickering et al. recorded hypokalemia in 12 of 50 patients with AML; all 12 had either AMoL or AMMoL, and 10 had lysozymemia ( [170](#) ). Other factors that can contribute to hypokalemia in AML include potassium uptake by rapidly proliferating cells, as well as drugs, particularly antibiotics and diuretics. Hyperkalemia can occur in association with hyperuricemia and tumor lysis. Patients with AML may have hypercalcemia ( [171](#) ), but hypocalcemia is more common and may rarely be caused by acceleration of bone formation by leukemia cells ( [172](#) ).

*Hyperleukocytosis*, arbitrarily defined as a blood blast count greater than 100,000/mm<sup>3</sup>, is rare in AML without a monocytic component; it occurs more commonly in cases of AMoL and AMMoL ( [150](#), [173](#), [174](#) ). Hyperleukocytosis is associated with leukostasis in the lung, CNS, or genitourinary tract ( [175](#), [176](#) ). Pulmonary leukostasis is manifested by dyspnea, tachypnea, rales, interstitial infiltrates, and respiratory failure and is associated with a poor prognosis ( [176](#), [177](#) and [178](#) ). Symptoms of CNS leukostasis are headaches and blurred vision. Fatal intracerebral hemorrhage may occur ( [139](#) ). Priapism, enlarged

kidneys, hyperuricemia, and renal failure are features of genitourinary involvement ( [151](#) ). Cardiovascular involvement may result in congestive heart failure and myocardial infarction ( [151](#), [176](#) ). Spurious laboratory data associated with hyperleukocytosis include a falsely elevated platelet count (because white cell fragments are counted as platelets), pseudohypoxemia caused by oxygen consumption by leukemia cells, falsely prolonged coagulation tests, pseudohyperkalemia, and pseudohypoglycemia ( [179](#), [180](#) and [181](#) ). Artifactual lowering of the PO<sub>2</sub> and glucose may be averted by placing blood samples on ice and performing the tests without delay ( [150](#) ).

Hyperleukocytosis is associated with a less favorable prognosis because of its association with CNS hemorrhage, respiratory failure, CNS involvement, and a higher relapse rate ( [139](#), [175](#), [182](#), [183](#) ). Therapeutic options to decrease the risks of leukostasis in patients with hyperleukocytosis include leukapheresis, administration of large doses of hydroxyurea, and immediate initiation of induction chemotherapy ( [150](#), [174](#), [183](#) ). Red cell transfusions should be minimized initially because increases in blood viscosity may worsen leukostasis. However, platelet transfusions are needed to decrease the risk of hemorrhage, because leukapheresis exacerbates thrombocytopenia. No controlled clinical trials have defined the optimal management of hyperleukocytosis. Leukapheresis is advocated if symptoms of leukostasis are present ( [178](#) ). Moreover, leukapheresis is advocated to decrease the risk of leukostasis in patients with hyperleukocytosis, as the onset of leukostasis may be abrupt, and, once initiated, it may be fulminant and irreversible ( [150](#) ). Recent studies suggest leukapheresis is associated with decreased early mortality and improved complete remission (CR) rates, but not with improved survival ( [182](#), [183](#) ). Because leukapheresis is only a temporary measure to decrease the risk of leukostasis, chemotherapy should also be initiated as rapidly as possible ( [150](#) ).

## BIOLOGIC FEATURES

AML is a marrow-based neoplasm composed of immature or blast cells, the nonlymphoid differentiation of which can be demonstrated by morphology, cytochemical and immunologic studies, and electron microscopy ( [184](#), [185](#) ). Cytogenetic analysis ( [186](#) ), isoenzyme studies ( [187](#) ), and restriction fragment length polymorphism analysis ( [188](#), [189](#) ) have confirmed the clonal nature of AML. The neoplastic cells in AML, in contrast to CML, usually show only limited maturation, presumably because of abnormalities in the regulation of growth and differentiation that inhibit the cells from becoming fully differentiated and functionally competent. Cells appear to be blocked or “frozen” in early stages of maturation. Glucose-6-phosphate dehydrogenase analysis of leukemia cells from female heterozygotes demonstrates clonal abnormalities in either a single cell line or more than one cell line (e.g., myeloid and erythroid or myeloid and megakaryocytic), indicating that the leukemia events can involve either restricted lineage or multipotential stem cells ( [190](#), [191](#), [192](#), [193](#) and [194](#) ). The former pattern is more common in patients younger than 45 years of age, whereas the latter has been identified primarily in patients older than 60 years of age ( [187](#), [194](#) ).

AML is a complex and heterogeneous disease in all respects (cytologic features, stage of differentiation, antigen expression, chromosome abnormalities, gene expression, growth regulation, and response to treatment). Prior classification systems are inadequate because they do not reflect this biologic heterogeneity. Recently, the WHO has attempted to develop an improved classification system ( [20](#), [21](#) and [22](#) ). The development of *in vitro* bone marrow culture systems, the recognition of specific oncogenes, and the increasing sophistication of clinical and research techniques should allow improved classification of AML, along with more effective means of therapy. The next section is a brief overview of



the characteristics of leukemia colony growth, response to soluble factors, cell growth parameters, and gene expression.

## Colony Assays and Growth Factors

*In vitro* colony assays have been useful in studying growth and differentiation of normal and neoplastic cells ( [195](#), [196](#), [197](#) and [198](#) ). Murine multipotent progenitor cells can be identified as colony-forming units spleen. In mice and humans, a progenitor cell common to granulocytes, erythrocytes, monocytes, and megakaryocytes (colony-forming unit granulocyte-erythrocyte-monocyte-megakaryocyte) is similar to colony-forming unit spleen but has little or no self-renewal capacity, suggesting that the colony-forming unit granulocyte-erythrocyte-monocyte-megakaryocyte is at a later point in differentiation. Cells that have undergone further differentiation are committed to one or two lineages. These include burst-forming unit erythroid, colony-forming unit erythroid, colony-forming unit granulocyte-monocyte (CFU-GM), or colony-forming unit megakaryocyte. Leukemia cells also form clusters or colonies; early clonogenic assays measuring leukemia cell growth in leukocyte feeder layer systems varied from 30 to 98% cloning efficiency ( [199](#), [200](#) and [201](#) ). Moore et al. described five patterns of growth: no growth, small clusters, large clusters, an abnormally high ratio of clusters to colonies, and rare colonies with normal cluster to colony ratio ( [202](#), [203](#) ). No growth, large clusters, and an abnormally high ratio of clusters to colonies are associated with a poor response to chemotherapy; however, subsequent studies suggest different prognostic correlations, with a favorable response for no growth and small cluster growth and an unfavorable prognosis for the large cluster growth ( [201](#), [204](#), [205](#) ). The use of improved culture systems with the addition of soluble factors has shown a higher yield, with growth of clonogenic cells in 80 to 90% of cases ( [206](#), [207](#) ). The *in vitro* growth pattern of leukemia cells is a parameter that is not used clinically at present.

Leukemia cells, like normal cells, generally require growth factors for survival and proliferation ( [208](#), [209](#) ). Early studies showed improved colony growth with the addition of phytohemagglutinin or phytohemagglutinin-conditioned medium from peripheral blood leukocytes. In recent years, numerous growth factors for hemopoietic cells have been identified, and many have been cloned. These factors include granulocyte-macrophage colony-stimulating factor (GM-CSF), granulocyte colony-stimulating factor (G-CSF), multiple ILs, Steel factor (KIT ligand), thrombopoietin (TPO) (c-mpl ligand), erythropoietin, and Fms-like tyrosine kinase 3 (FLT-3)/FLT-3 ligand ( [210](#), [211](#), [212](#), [213](#) and [214](#) ). Growth factor action is complex; it may be restricted or may affect multiple lineages at multiple stages of differentiation. Growth factors may act synergistically with each other and with other soluble substances. These factors may be supplied exogenously in a paracrine fashion by stromal cells, or, in the case of leukemia cells, autocrine growth factor production may be present ( [215](#) ). Transfection of normal mouse marrow cells with the IL-3 gene also produces autonomous growth ( [216](#) ). The effect of growth factors is predominantly proliferative, although G-CSF can induce differentiation ( [217](#) ), and FLT-3 ligand can prevent apoptosis of AML cells ( [218](#) ). The antiapoptotic effects of FLT-3 ligand are augmented when it is combined with G-CSF or GM-CSF and correlate with low bax and high bcl-2 levels ( [218](#) ).

Numerous other growth factors may be important in leukemogenesis and may have an impact on therapy. Steel factor (also known as *KIT ligand* and *stem cell factor*) is a restricted growth factor that cannot drive hematopoietic progenitor cells into cell cycle but may play a role in chemotherapy resistance by preventing apoptotic cell death ( [219](#) ). Inhibitory factors include transforming growth factor (TGF)- $\beta$ 1 and tumor necrosis factor (TNF), but their effects are often difficult to interpret because of their induction of other

regulatory molecules ( [220](#), [221](#) ). TGF- $\beta$ 1 suppresses growth factor-dependent colony formation in normal and *de novo* AML cells; however, it does not inhibit colony formation in AML after MDS because of a reduction in TGF- $\beta$ 1 binding sites on AML cells arising from MDS ( [222](#) ). Theoretically, this loss of TGF- $\beta$ 1 inhibition results in dysregulation of proliferation and could contribute to the chemoresistance of MDS-related AML.

Coculture experiments indicate that normal CFU-GM are inhibited by leukemia blasts ( [223](#) ). Inhibition correlates at least in part with the production of a soluble factor with leukemia inhibitory activity produced by small, nonadherent, light-density cells isolated from patients with several types of leukemia ( [224](#), [225](#) ). Leukemia inhibitory activity is cytotoxic to normal CFU-GM in the S-phase of the cell cycle, but CFU-GM from the marrow of patients with AML are resistant, possibly because of a shift of CFU-GM out of cycle. A second distinct substance, leukemia-associated inhibitor, has also been described and is produced by Fc receptor-positive medium-density cells ( [226](#), [227](#) ). Leukemia-associated inhibitor reversibly inhibits S-phase CFU-GM and reduces the tritiated thymidine labeling index of leukemia blasts ( [227](#) ). A long-term culture system simulates the microenvironment of marrow and includes stromal fibroblasts, endothelial cells, and macrophages—all of which can produce cytokines affecting leukemia growth ( [228](#) ). Increased bone marrow vascularization measured by microvessel density occurs in AML and correlates with vascular endothelial growth factor (VEGF) and VEGF receptor levels on AML blasts ( [229](#) ). Understanding the microenvironment and the diverse effects of growth factors and inhibitors on leukemia cells should lead to improved therapy.

## Cell Growth Studies

Multiple parameters, including a decreased thymidine labeling index, a lower mitotic rate, and a low proportion of cells in S and G<sub>2</sub> + M phases in DNA cell cycle analysis, indicate that leukemia cells often proliferate more slowly than their normal counterparts ( [230](#) ). One explanation for these findings is the existence of proliferative and nonproliferative pools of neoplastic cells. Autoradiographic and ultrastructural studies show that most labeled, proliferative blasts are large, whereas small blasts are not proliferating ( [231](#), [232](#), [233](#) and [234](#) ). When large marrow blasts divide, they give rise predominantly to small nondividing cells that are released preferentially into the peripheral blood ( [233](#), [235](#) ). The small blasts are capable of reentering the cycle and transforming into larger cells to replenish the proliferative compartment. An increase in cell mass is seen when the number of small cells reentering the cycle outnumbers those lost to cell differentiation and death.

Investigators have attempted to correlate kinetic parameters (e.g., percentage S-phase, total cycling time, and cell production rate), measured by flow cytometric analysis, *in vitro* uptake of tritiated thymidine, or *in vivo* bromodeoxyuridine infusion, with attainment of remission and remission duration ( [230](#), [236](#), [237](#), [238](#), [239](#), [240](#) and [241](#) ). The results have been conflicting. Leukemias with a high percentage of cells in S-phase often are more responsive to chemotherapy, but some patients with rapidly cycling leukemias not only achieve marrow aplasia quickly after chemotherapy, but also have rapid repopulation of the marrow by leukemia blasts ( [238](#) ). Patients whose leukemia cells have low levels of proliferative activity have better survival than those with high levels ( [205](#), [230](#) ). The presence of longer S-phases and total cycling times in relapsed rather than in newly diagnosed AML suggests that resistance to chemotherapy may result from selection of slowly cycling clones ( [239](#) ). Recent data correlate a lower CR rate with the presence of



increased AML cells in G<sub>0</sub>-phase at day 9 after the start of chemotherapy ( [241](#) ).

## Leukemogenesis

*Leukemogenesis* is a heterogeneous, multistep process that results in a block of differentiation, increased proliferation, and inhibition of apoptosis through genetic dysregulation. There is evidence for at least a “two-hit” model of leukemogenesis ( [242](#) ). Fusion genes [AML1/ETO, CBF/SMMHC, and promyelocytic leukemia (PML)/retinoic acid receptor (RAR)-α] involved in specific structural chromosomal abnormalities [t(8;21), inv(16), and t(15;17), respectively] impair differentiation and apoptosis, whereas another class of genetic changes, mutations in FLT-3 and N-RAS, promotes proliferation. Neither class of genetic changes is sufficient to cause leukemia by itself, and genetic changes may be mutually exclusive in that two translocations or inversions or two genetic mutations rarely occur in the same case of leukemia ( [242](#), [243](#) ).

Supporting evidence for the cooperation of the two classes of mutations in leukemogenesis stems from the finding of FLT-3 gene mutations in 30 to 40% of APL patients ( [242](#), [244](#) ). FLT-3 mutations are predominantly small tandem duplications within the gene, resulting in the duplication of amino acids within the juxtamembrane domain of the receptor. These duplications cause loss of autoinhibition and result in constitutive tyrosine kinase activity ( [242](#) ). FLT-3 mutations are also commonly found in cases of AML patients with normal cytogenetics and likely represent “second-hit” genetic changes that impair hematopoiesis ( [242](#) ). FLT-3 mutations in these patients are associated with a poor prognosis (see section [Prognosis](#) ).

A common component of leukemogenesis and drug resistance is inhibition of apoptosis. There are two pathways for apoptosis, both of which result in caspase activation: (a) the receptor-mediated pathway, which involves the TNF family of death receptors, and (b) the mitochondrial-mediated pathway regulated by the bcl-2 family of proteins ( [245](#) ). Resistance to apoptosis is often mediated by aberrant genes; BCR-ABL, fusion genes resulting from MLL translocations, and PML/RAR-α all inhibit apoptosis ( [245](#) ). The tyrosine kinase inhibitor STI 571 (Gleevec, Novartis) serves as the model for specifically targeting a gene blocking apoptosis. Classic chemotherapy kills malignant cells through activation of apoptosis; however, resistance often develops in the apoptotic pathways. Ongoing investigations are directed at developing new agents to target the molecular biologic processes involved in preventing apoptosis of leukemia cells.

## CLASSIFICATION OF ACUTE MYELOID LEUKEMIA

The WHO classification of acute leukemias and MDS has evolved away from the FAB classification, which is based on morphology, to include not only morphology, but also clinical, immunophenotypic, and cytogenetic features ( [20](#), [21](#) ). There are five major categories recognized by the WHO: (a) AML with recurrent genetic abnormalities; (b) AML with multilineage dysplasia; (c) AML and MDS, therapy related; (d) AML not otherwise categorized; and (e) acute leukemia of ambiguous lineage ( [Table 79.3](#) ). In the WHO, the refractory anemia with excess blasts in transformation (20 to 30% blasts) category of MDS has been eliminated based on evidence that the survival pattern of patients with marrows with 20% or more blasts is similar to those of patients with marrows with 30% or more blasts ( [246](#) ).

**TABLE 79.3. Classification of Acute Myeloid Leukemia (AML)**

---

|   |
|---|
| AML with recurrent genetic abnormalities  |
| AML with t(8;21)(q22;q22); (AML1/ETO)   |
| AML with abnormal bone marrow eosinophils inv(16)(p13;q22) or t(16;16)(p13;q22); (CBFB/MYH11) |
| Acute promyelocytic leukemia (AML with t(15;17)(q22;q12) (PML/RAR- $\alpha$ ) and variants    |
| AML with 11q23 (mixed lineage leukemia) abnormalities   |
| AML with multilineage dysplasia   |
| After a myelodysplastic syndrome or myelodysplastic syndrome/myeloproliferative disorder      |
| Without antecedent myelodysplastic syndrome   |
| AML and myelodysplastic syndromes, therapy-related  |
| Alkylating agent-related  |
| Topoisomerase type II inhibitor-related (some may be lymphoid)                                |
| Other types   |
| AML not otherwise categorized   |
| AML minimally differentiated  |
| AML without maturation  |
| AML with maturation   |
| Acute myelomonocytic leukemia   |
| Acute monoblastic and monocytic leukemia  |
| Acute erythroid leukemia  |
| Acute megakaryoblastic leukemia   |
| Acute basophilic leukemia   |
| Acute panmyelosis with myelofibrosis  |
| Myeloid sarcoma   |
| Acute leukemia of ambiguous lineage   |

---

AML with recurrent genetic abnormalities includes AML with t(8;21)(q22;q22), inv(16)(p13;q22) or t(16;16)(p13;q22), t(15;17)(q22;q12), or translocations or structural abnormalities involving 11q23. The first three variants occur in younger people and have a more favorable response to therapy. Two clinical subgroups of patients have translocations involving 11q23: AML in infants and therapy-related leukemia usually occurring after treatment with DNA topoisomerase II inhibitors. AML with recurrent genetic abnormalities is discussed in the section [Clinicopathologic Syndromes](#) in the context of the FAB morphologic subtype with which the abnormalities correlate.

AML with multilineage dysplasia is associated with unfavorable cytogenetics, including -7/del(7q), -5/del(5q), +8, +9, +11, del(11q), del(12p), -18, +19, del(20q) +21, and, less often, translocations t(2;q11) and t(1;7) and those involving 3q21 and 3q26 ([20](#), [21](#)). Abnormalities in the 3q26 region may be associated with increased platelet production. It is more common in older patients and has a poor response to therapy. Dysplasia must be present in 50% or more of the cells of at least two lineages. There is frequent aberrant expression of CD56, CD7, or both.

AML not otherwise categorized includes AML that does not fulfill criteria for the other groups and essentially reflects the morphologic and cytochemical features and degree of maturation used in the FAB classification with the exception that 20% (rather than 30%) or more blasts in the marrow is sufficient for diagnosis of acute leukemia; the abnormal

promyelocytes in APL and the promonocytes in AML with monocytic differentiation are also considered blast equivalents. This category includes, in addition, acute basophilic leukemia, acute panmyelosis with myelofibrosis, and myeloid sarcoma (see section [Clinical Presentation](#)).

AML and myelodysplastic syndromes, therapy related, are discussed in the section [Epidemiology](#). Acute leukemia of ambiguous lineage is diagnosed when blasts lack sufficient lineage-specific antigen expression to classify them as myeloid or lymphoid and is discussed in the section [Immunophenotypic Classification](#).

## Morphologic Subtypes

The FAB classification identified eight subtypes of AML based on morphology and cytochemical staining, with immunophenotypic data in some instances ([Chapter 77](#)) ([17](#), [181](#), [247](#), [248](#), [249](#) and [250](#)). Four types (M0, M1, M2, M3) are predominantly granulocytic and differ according to the extent of maturation. M4 is both granulocytic and monocytic, with at least 20% monocytic cells, whereas M5 is predominantly monocytic (at least 80% monocytic cells). M6 shows primarily erythroid differentiation with dysplastic features including megaloblastic changes, and M7 is AMgL identified by the presence of megakaryocyte antigens demonstrated by flow cytometry or immunohistochemistry, the presence of platelet peroxidase, or a demarcation membrane system on ultrastructural studies. Problems with the FAB classification include interobserver variability, lack of definitive criteria for some cases of AML, and poor correlation with survival ([250](#), [251](#)). Additionally, correlations with immunophenotyping, cytogenetics, and molecular diagnosis have not been fully defined. There are morphologic subtypes that are not precisely defined by the FAB, including hypocellular AML and mixed lineage acute leukemia ([252](#), [253](#), [254](#) and [255](#)). Eosinophilic leukemia, basophilic leukemia, and mast cell leukemia are rare, overlap with myeloproliferative disorders, and are also not recognized by the FAB classification. The WHO classification recognizes chronic eosinophilic leukemia with the overlapping hypereosinophilic syndrome, and acute basophilic leukemia and the spectrum of mast cell disease, including mast cell leukemia ([Chapter 87](#)) ([21](#)).

## Immunophenotypic Classification

The nonlymphoid derivation of AML is confirmed by the presence of antigens expressed during myelomonocytic differentiation, including CD13 (My7), CD14 (Mo2), CD15 (My1, LeuM1), CD33 (My9), CD117 (c-kit), and MPO; erythroid antigens (glycophorin A, CD71); and megakaryocytic antigens, including CD41 (platelet glycoprotein IIb/IIIa), CD42b (platelet glycoprotein Ib), CD61 (platelet glycoprotein IIIa), and factor VIII antigen ([256](#)). The stem cell marker CD34 (My10, HPCA-1) is present on blasts in 40 to 65% of cases of AML ([257](#)). Surface markers in most cases have not correlated well with the FAB classification or with prognosis ([258](#), [259](#)). More than 90% of cases of AML express CD33 or CD13, 80 to 90% express HLA-DR, and less than 25% express CD15; CD11b and CD14 are more variably expressed but tend to be present in monocytic (M4/M5) subtypes ([257](#)). Some antigens have also been associated with morphologic and cytogenetic subsets: CD2 with M4Eo (abnormal 16q22) ([260](#), [261](#)); absence of HLA-DR (major histocompatibility complex class II) and of CD34 with M3 [t(15;17)] ([262](#)); and presence of CD19, CD34, and CD56 with M2 [t(8;21)] ([263](#), [264](#)).

The morphologic associations and prognostic significance of surface markers have been variable; antigen expression should be interpreted only in the context of other clinicopathologic features. CD34 is expressed more often in less differentiated subtypes

(M0, M1; M5, poorly differentiated) in many series ( [265](#), [266](#) and [267](#) ); it has also been described as more common in monocytic (M4/M5) than in granulocytic (M1, M2, M3) subtypes ( [260](#) ). CD34 is generally a poor prognostic marker, particularly when observed in the elderly, after MDS, or in association with expression of the multidrug resistance gene (MDR-1) ( [266](#), [268](#), [269](#) ); however, CD34 is also commonly expressed in FAB M2 AML with the t(8;21) chromosomal translocation ( [270](#) ) and in FAB M4Eo with inv(16) ( [260](#) ), both of which have a favorable prognosis.

Lymphoid antigens are expressed on blasts in 10 to 30% of cases of AML, and their expression has often been implicated as having prognostic significance, but their presence should be interpreted in the context of all available information ( [267](#) ). Terminal deoxynucleotidyl transferase (TdT) is a DNA polymerase normally expressed in early lymphoid cells of the bone marrow and the thymus. The reported incidence of TdT positivity in AML varies widely (0 to 55%; average, 18%) in part because of the use of different methods and because of different cut-off values for positivity ( [271](#) ). In approximately one-half of studies of adult patients with AML, TdT expression is correlated with a poor prognosis, but usually in the setting of poorly differentiated AML and often in association with CD34 expression ( [271](#), [272](#), [273](#) and [274](#) ). Expression of the lymphoid antigens, CD2 (T cell) and CD19 (B cell), has been associated with a good prognosis ( [275](#) ), but CD19 expression has also been associated with a poor prognosis ( [276](#) ). CD19 is associated with a good prognosis when present in AML with t(8;21) ( [275](#) ) and a poor outcome when coexpressed with CD34 in the absence of favorable cytogenetics findings ( [276](#) ). CD7, which is present on most mature T and natural killer lymphocytes, is present in 15 to 20% of cases of adult AML and has been associated with a poor prognosis, usually with less differentiated subtypes (M0/M1) and expression of CD34, MDR-1, or TdT ( [277](#), [278](#) ). CD56, a cell-surface glycoprotein identical to the neural cell adhesion molecule, is more commonly observed in patients with AMoL, t(8;21), and trisomy 8 and with expression of CD11b, CD14, and CD19 ( [278](#) ). CD56 expression is also present in rare leukemias that have a precursor myeloid/natural killer cell phenotype ( [279](#) ). The lymphocyte activation antigens CD25 and CD30 are often observed in AML after MDS ( [222](#) ). Immunophenotyping is important in confirming the nonlymphoid nature of the leukemia and in recognizing subsets of AML; its prognostic impact can be interpreted only in the context of other factors and, ideally, in large prospective series.

The WHO classification includes a category of acute leukemias of ambiguous lineage in which blasts lack sufficient evidence to classify as myeloid or lymphoid ( [21](#) ). The reported incidence of these unclassifiable acute leukemias is highly variable because of lack of uniform diagnostic criteria, the use of different monoclonal antibody panels, and the failure to recognize the lack of lineage specificity of antibodies ( [252](#), [253](#), [254](#) and [255](#) ). Although up to 20% of patients with acute leukemia may have biphenotypic or mixed lineage features as detected by immunologic and molecular genetic techniques, the actual unclassifiable acute leukemia should be less than 4% of AML ( [21](#) ).

Acute leukemias of ambiguous lineage are divided into three groups. Undifferentiated acute leukemias, the first group, lack morphologic or immunologic differentiating features. The blasts often express HLA-DR, CD34, and CD38 and may express TdT and CD7. Bilineal acute leukemia, the second group, has two populations of blasts expressing distinct lineage markers of myeloid or lymphoid origin or, less frequently, B- and T-cell lineage. These leukemias may evolve into biphenotypic acute leukemia. In the third group, biphenotypic acute leukemia, blasts coexpress myeloid and lymphoid (B- or T-cell) antigens. Blasts very rarely express myeloid, B-, and T-cell antigens. Leukemia cells may reflect normal early multipotential or pluripotential stem cells that have a limited capacity

to express antigens of multiple lineages (“lineage promiscuity”), or the leukemia cell may have aberrant lineage differentiation (“lineage infidelity”) ( [253](#), [280](#) ). Rearrangements of the T-cell receptor or the immunoglobulin chain genes are usually absent in AML with lymphoid antigen expression ( [281](#), [282](#) ), although they have been described, usually in association with karyotypic abnormalities such as t(9;22), 11q23, or 14q32 translocations ( [283](#), [284](#), [285](#), [286](#) and [287](#) ).

The clinical significance and therapeutic implications of biphenotypic antigen expression remain undefined because uniform criteria for the diagnosis of biphenotypic leukemia have not been established. The expression of at least one cross-lineage marker is common in AML (20 to 30% of cases) and in ALL (5 to 46% of cases). For this reason, the diagnosis of biphenotypic leukemia should be reserved for cases in which there is ambiguity of lineage assignment. Scoring systems have been proposed to more precisely define biphenotypic leukemia ( [254](#), [288](#) ). A morphologic “tip-off” to the presence of a bilineal or biphenotypic acute leukemia is the presence of a mixed population of small blasts resembling lymphoblasts and large blasts. Biphenotypic acute leukemias respond less favorably to therapy than either AML or ALL; their prognosis is usually related to an association with other adverse features ( [255](#) ).

## Cytogenetics

Nonrandom acquired chromosome abnormalities are present in most patients with AML and correlate with prognosis ( [Chapter 4](#) ). The first descriptions of karyotypic changes in AML occurred in the 1950s; approximately one-half of patients with AML were found to have cytogenetic abnormalities in the 1970s when studies using banding were reported. With technical improvements, recent series have reported abnormal karyotypes in 55 to 78% of adults and 79 to 85% of children with AML ( [289](#), [290](#), [291](#), [292](#), [293](#), [294](#), [295](#), [296](#), [297](#), [298](#) and [299](#) ). Approximately 55% of patients with AML have only a single cytogenetic abnormality (15 to 20% have a gain or loss of a single chromosome as the only change); the remaining 45% have two or more changes ( [289](#) ). The most common recurring cytogenetic abnormalities in AML include t(15;17), t(8;21), inv(16), +8, +21, del(5q), -7, -8, 11q23 translocations, and 12p11-13 abnormalities ( [296](#), [297](#), [298](#) and [299](#) ).

Correlation of cytogenetics and clinicopathologic data has led to the recognition of distinct subtypes of AML and has helped to identify prognostic groups ( [Table 79.4](#) ) ( [236](#), [290](#), [291](#), [296](#), [297](#), [298](#), [299](#), [300](#) and [301](#) ). Techniques such as PCR, fluorescence *in situ* hybridization, and comparative genomic hybridization have improved the ability to recognize molecular lesions that involve oncogenes and tumor-suppressor genes and have further defined subtypes of AML ( [Chapter 76](#) ). The best described subtypes of AML have recurring genetic abnormalities, which primarily consist of balanced translocations, occur in younger patients, tend to correlate with morphology, and have a favorable prognosis. These include t(8;21), inv(16) or t(16;16), and t(15;17) and its variants. AML with t(8;21) tends to have blasts with maturation, often with azurophilic granules and occasionally with very large granules (pseudo-Chédiak-Higashi granules) ( [21](#) ). AML with inv(16) or t(16;16) usually is associated with monocytic differentiation and abnormal marrow eosinophils ( [21](#), [141](#) ). APL with t(15;17) and its variants are suggested by the presence of hypergranular promyelocytes in association with DIC, but it is also present in a microgranular (hypogranular) subtype ( [Chapter 82](#) ) ( [302](#), [303](#) ). Other cytogenetic abnormalities associated with morphology in AML include translocations of 11q23 with monoblastic features ( [21](#), [304](#) ); t(6;9) and del(12p) with marrow basophilia ( [305](#), [306](#) ); abnormalities of 3q21-26 with abnormal platelets and thrombocytosis ( [307](#), [308](#) ); and



t(9;22), 14q32, or 11q23 with MLLs ( [274](#) , [275](#) , [304](#) , [309](#) , [310](#) ).

**TABLE 79.4. Primary Chromosome Aberrations in Acute Myeloid Leukemia**

| Type of Rearrangement               | Genes Involved           | Hematologic Clinical Features  | Prognosis            |
|-------------------------------------|--------------------------|--|----------------------|
| t(1;3)(p36;q21)                     |                          | Preceded by MDS, M1, M4, dysmegakaryocytopoiesis                           | Poor                 |
| t(1;7)(q10;q10)                     |                          | Preceded by MDS, M1, M4, genotoxic exposure                                | Poor                 |
| t(1;11)(p32;q23)                    | AF1p, MLL                | M0, M5   | Poor                 |
| t(1;11)(q21;q23)                    | AF1q, MLL                | M4, M5, infants  | Poor                 |
| t(1;22)(p13;q13)                    |                          | M7, thrombocytopenia, hepatosplenomegaly, bone marrow fibrosis             | Poor                 |
| inv(3)(q21;q26);<br>t(3;3)(q21;q26) | EVI1, ribophorin 1       | Preceded by MDS, M1, M4, M6, abnormal megakaryocytopoiesis, thrombocytosis | Poor                 |
| t(3;5)(q25, 1;q35)                  | MLF1, NPM                | M6, megakaryocytosis, Sweet syndrome                                       | Intermediate to poor |
| t(3;21)(q26;q22)                    | EVI1, MDS1, or EAP; AML1 | No FAB preference, genotoxic exposure                                      | Poor                 |
| +4                                  |                          | M1, M2, M4; subcutaneous tumors  | Poor                 |
| 5/del(5q)                           |                          | No FAB preference, genotoxic exposure                                      | Poor                 |
| t(5;17)(q35;q12)                    | NPM, RAR <sup>-a</sup>   | M3   | Poor                 |
| t(6;9)(p23;q34)                     | DEK, CAN                 | Preceded by MDS; M2 and M4, bone marrow basophilia                         | Poor                 |
| t(6;11)(q27;q23)                    | AF6, MLL                 | M4 and M5; localized infections  | Poor                 |
| t(7;11)(p15;p15)                    | HOXA9, NuP98             | M2 with Auer rods  | Intermediate         |
| -7/del(7q)                          |                          | No FAB preference; genotoxic exposure                                      | Poor                 |
| +8                                  |                          | M2, M4, and M5; preceded by MDS  | Intermediate to poor |
| t(8;16)(p11;q13)                    | MOZ, CBP                 | M5, erythrophagocytosis  | Poor                 |
| t(8;21)(q22;q22)                    | ETO, AML1                | M2 with Auer rods, eosinophilia, myeloblastoma                             | Good                 |
| t(9;11)(p21-22;q23)                 | AF9, MLL                 | M5   | Intermediate         |
| t(9;22)(q34;q11)                    | ABL, BCR                 | M1 and M2; biphenotypic, rare  | Poor                 |
| t(10;11)(p11-15;q13-23)             | AF10, MLL                | M5   | Poor                 |
| +11                                 | MLL                      | M1, M2   | Poor                 |
| t(11;16)(q23;p13)                   | MLL, CBP                 | M4, M5, infants  | Poor                 |
| t(11;17)(q23;q25)                   | MLL, AF17                | M2, M4, and M5   | Poor                 |
| t(11;17)(q23;q21)                   | PLZF, RAR <sup>-a</sup>  | M3   | Intermediate         |
| t(11;19)(q23;p13)                   | MLL, ENL, ELL            | M4 and M5; biphenotypic  | Poor                 |

|   |                    |                                       |              |
|---|--------------------|---------------------------------------|--------------|
| t/del(11q23)                                      | MLL                | M5, biphenotypic, genotoxic exposure  | Poor         |
| t/del(12p)  |                    | No FAB preference, genotoxic exposure | Poor         |
| i(12)(p10)  |                    | Concurrent germ cell tumors           | Poor         |
| t(12;22)(p13;q11)                                 | TEL, MN1           | Preceded by MDS, M1, M4, M7           | Poor         |
| +13   |                    | No FAB preference                     | Poor         |
| t(15;17)(q22;q11)                                 | PML, RAR- $\alpha$ | M3, M3v, DIC                          | Good         |
| inv(16)(p13;q22), t(16;16)(p13;q22), del(16)(q22) | MYH11, CBF $\beta$ | M4Eo, central nervous system disease  | Good         |
| t(16;22)(p11;q22)                                 | FUS, ERG           | No FAB preference                     | Poor         |
| i(17)(q10)  |                    | Preceded by MDS, no FAB preference    | Poor         |
| del(20q)  |                    | No FAB preference                     | Poor         |
| +21   |                    | No FAB preference                     | Intermediate |
| +22   |                    | M4                                    | Intermediate |

FAB, French/American/British; MDS, myelodysplasia.

NOTE: See [Chapter 76](#) for description of the genes and Mitelman F, Johansson B, Mertens F, eds. Mitelman database of chromosome aberrations in cancer.

<http://cgap.nci.nih.gov/chromosomes/mitelman>.

Adapted from Heim S, Mitelman F. Cancer cytogenetics, 2nd ed. New York: Wiley, 1995:74–75.

Certain chromosomal abnormalities have been associated with MDS and secondary or treatment-related AML. In general, they do not correlate well with specific subtypes of MDS ([Chapter 83](#)) ([311](#), [312](#), [313](#) and [314](#)). Cytogenetic abnormalities have most often been associated with refractory anemia with excess blasts (RAEB) and RAEB in transformation, which are the subtypes most likely to transform to acute leukemia ([314](#)). As noted, RAEB in transformation is now grouped in AML by the WHO. MDS or AML after administration of alkylating agents has a high frequency of involvement of chromosomes 5 and 7 and of complex cytogenetic abnormalities ([100](#), [116](#), [117](#) and [118](#)). Topoisomerase II inhibitor administration is associated with AMoLs with 11q23 and, less commonly, 21q22 translocations ([99](#), [100](#), [117](#)). As MDS progresses to leukemia, there is often clonal chromosomal evolution. The most common secondary changes involve chromosomes 5, 7, 8, 9, 21, 22, X, and Y ([289](#), [296](#)).

## CLINICOPATHOLOGIC SYNDROMES

The WHO classification ([Table 79.3](#)) recognizes four major categories of AML defined by specific genetic abnormalities, prior MDS, prior cytotoxic therapy, and a not otherwise categorized group that retains the morphology-based FAB classification. In addition, acute leukemia of ambiguous lineage is included. In the subsequent paragraphs, clinicopathologic syndromes are briefly described with an emphasis on morphologic, clinical, and genetic features.

### Minimally Differentiated Acute Myeloid Leukemia

Although minimally differentiated AML was recognized earlier, criteria for FAB M0 were



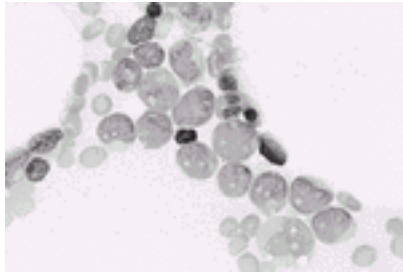
developed in 1991 ( [18](#), [248](#), [315](#) ). The blasts in these cases cannot be recognized as myeloid based on morphology and cytochemistry, but immunophenotyping demonstrates myeloid antigens. These cases are agranular and lack Auer rods. By definition, the diagnosis of AML M0 requires less than 3% of MPO-positive and Sudan black B-positive cells but more than 20% of leukemia cells expressing myeloid antigens (CD13, 33, 117) ( [248](#), [315](#) ). Of note, lymphoid-associated antigens (CD2, 7, 19) and TdT are commonly expressed in AML M0 ( [315](#), [317](#) ). Although no specific cytogenetic abnormality has been associated with AML M0, it often has a complex karyotype with abnormalities of chromosome 5 or 7, similar to MDS and secondary leukemia; trisomies of chromosomes 8 and 13 are also commonly recognized ( [316](#), [317](#) ). AML M0 tends to occur in older patients (median age, 60 years), and there is often a stem cell pattern of antigen expression, with CD34 and TdT positivity ( [318](#) ). The CR rate and survival in AML M0 are poor due in part to the association with adverse prognostic factors, particularly unfavorable karyotypes ( [316](#), [317](#), [318](#) and [319](#) ).

### Acute Myeloid Leukemia without Maturation

AML (FAB M1) is defined by a predominance (>90%) of myeloblasts without evidence of maturation (<10% promyelocytes or other, more mature cells). The presence of Auer rods is variable. At least 3% of the blasts are reactive with Sudan black or MPO. The blasts express myeloid antigens, including CD13, CD14, or CD33. Like AML M0, AML M1 must be distinguished from other types of acute leukemia, including ALL (FAB L2), acute monoblastic leukemia (M5a), acute megakaryoblastic leukemia (M7), and acute basophilic leukemia ( [21](#), [251](#) ). AML M1 makes up 10 to 20% of cases of AML ( [320](#), [321](#) ) and is more common in adults than in children; the median age is 45 to 50 years ( [21](#), [251](#) ). Constitutional symptoms are common, and hepatosplenomegaly and lymphadenopathy occur in up to one-third of patients ( [21](#) ). Approximately one-half of patients present with leukocytosis, and one-fourth have leukopenia; most patients are anemic and thrombocytopenic ( [21](#), [251](#), [321](#) ). There has been no specific cytogenetic marker associated with AML M1, but it generally is regarded as chemosensitive and prognostically favorable unless adverse features, such as hyperleukocytosis, are present.

### Acute Myeloid Leukemia with Maturation and with t(8;21)

The t(8;21)(q22;q22) is reported in 29 to 40% of cytogenetically abnormal cases of AML with maturation (FAB M2) ( [21](#), [251](#), [322](#) ). Between 5 and 12% of all AML patients have this syndrome; most are children and young adults ( [300](#) ). Clinical features include splenomegaly, an association with chloromas, and, often, anemia and thrombocytopenia at diagnosis. First described in 1973, t(8;21) may be predicted by typical morphology, including prominent Auer rods, marrow eosinophilia with salmon-colored granules, cytoplasmic globules, and vacuoles ( [Fig. 79.5](#) ) ( [322](#) ). Immunophenotypic markers include the presence of myeloid antigens, increased expression of the natural killer cell-associated antigen CD56, and, less commonly, the B-cell antigen CD19 ( [323](#) ). CD34 is also expressed in t(8;21) with coexpression of CD19 and CD56; CD2 and CD7 are usually absent ( [252](#), [270](#), [323](#) ).



**Figure 79.5.** Wright-stained marrow smear from acute myeloid leukemia–M2 with t(8;21). Blasts are associated with maturing myeloid elements and numerous eosinophils with salmon-colored granules. See [Color Plate](#).

The two genes involved in t(8;21) are AML1 (also known as RUNX1) at 21q22 and ETO (also called CDR and MTG8) at 8q22 ([324](#), [325](#)) ([Chapter 76](#)). They form a fusion gene on the derivative 8 chromosome that is best recognized by reverse transcriptase PCR (RT-PCR) ([326](#)). The fusion transcript can be detected even in patients in long-term remission and, therefore, cannot be used as a marker to predict relapse ([326](#), [327](#)). The AML1 gene is also involved in t(3;21)(q26;q22), a rare balanced translocation observed in blast crisis of CML and therapy-related AML ([328](#), [329](#)), in t(12;21) with the TEL gene in ALL ([330](#)), and in a variety of other rare translocations seen in patients with AML or MDS, including t(1;21)(p36;q22), t(5;21)(q13;q22), and t(17;21)(q11;q22) ([289](#)).

The t(8;21) usually occurs in *de novo* AML and generally predicts an excellent response to chemotherapy, with a high remission rate and a long survival, particularly after HiDAC intensification therapy ([331](#), [332](#)). However, some patients, particularly children and patients with granulocytosis (>2000 cells/mm<sup>3</sup>) or extramedullary disease, have high relapse rates and a poor survival ([297](#), [333](#), [334](#)). Paraspinal masses may result in spinal cord compression with irreversible neurologic sequelae and should be treated with radiation therapy ([334](#)). Expression of the CD56 antigen on AML cells with t(8;21) is also associated with a shorter disease-free survival (DFS) ([335](#)). For the most part, t(8;21) is regarded as a favorable prognostic factor. These patients are generally not treated with allogeneic transplantation in first remission.

### Acute Promyelocytic Leukemia

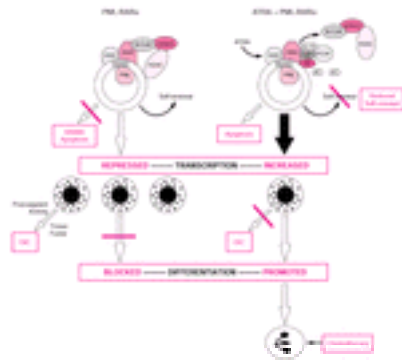
Between 5 and 10% of patients with AML present with APL, which is characterized by a reciprocal translocation involving chromosomes 15 and 17 ([Chapter 82](#)) ([336](#)). These patients are usually young, with a median age of 30 to 38 years, although APL rarely occurs before age 10 ([251](#)). The disease was recognized in the 1950s and was associated with early mortality often caused by intracranial hemorrhage ([162](#), [337](#)). Up to 90% of patients present with hemorrhagic manifestations secondary to DIC ([251](#)). Leukopenia is usually present in the more common hypergranular APL, whereas leukocytosis tends to occur in the microgranular variant ([21](#), [251](#)). The leukemia cells characteristically have numerous prominent granules, which may obscure the nucleus along with bundles of Auer rods (“faggot cells”). The microgranular variant of APL, which represents approximately 20% of APL cases, has granules that are small and more difficult to recognize by light microscopy but can be identified by electron microscopy or cytochemical stains ([302](#), [303](#)). The immunophenotype of APL is distinct from those of other AML subtypes; the myeloid antigens CD13 and CD33 are present, but HLA-DR is absent. The microgranular variant

commonly expresses CD34<sup>+</sup> and the T-cell antigen CD2 ( [262](#), [338](#) ).

The genes involved in the t(15;17) of APL are the RAR- $\alpha$  gene on chromosome 17q12 and the PML gene, initially called myl, on chromosome 15q22 ( [339](#), [340](#) ). Two fusion genes are formed: PML/RAR- $\alpha$  on 15q+ and its reciprocal, RAR- $\alpha$ /PML, on 17q-. The former is found in all patients, and the latter occurs in approximately two-thirds of patients. There are three different genomic breakpoints in the PML gene on chromosome 15: bcr1 (approximately 55% of cases), or long form; bcr2 (approximately 5%), or variable form; and bcr3 (approximately 40%), or short form. Data indicate that the short form is associated with pediatric APL, higher leukocyte counts, the microgranular variant, and a worse prognosis ( [338](#), [341](#), [342](#) and [343](#) ). Whereas cells with the long and short forms are responsive to ATRA, cells with the variable form have reduced sensitivity to ATRA and also more commonly have additional cytogenetic abnormalities ( [344](#) ). Other cytogenetic variants of APL involving fusion of genes with RAR- $\alpha$  include t(11;17)(q23;q11) [promyelocytic leukemia zinc finger (PLZF) gene], t(5;17)(q23;q11) [nucleophosmin (NPM) gene], and t(11;17)(q13;q11) [nuclear matrix-associated (NuMA) gene] ( [345](#), [346](#) and [347](#) ). APL with t(11;17)(q23;q11) is resistant to ATRA, whereas AML with t(5;17)(q23;q11) is responsive ( [344](#) ). Molecular studies using RT-PCR can confirm the presence of t(15;17) in virtually all cases of APL; its absence after therapy appears essential for long-term remission ( [347](#), [348](#), [349](#) and [350](#) ).

The therapy of APL dramatically changed with the introduction of ATRA into clinical trials in Shanghai in 1986 ( [351](#), [352](#) ). In early trials using ATRA, patients with t(15;17) had a 95% CR rate ( [335](#), [353](#), [354](#) and [355](#) ). ATRA is given orally, usually at doses of 45 mg/m<sup>2</sup>/day, and induces hematologic remission without aplasia within 1 to 3 months, but it does not induce a molecular remission, so that chemotherapy remains essential in induction and the postremission phase. There is a body of data indicating that aggressive anthracycline therapy improves the cure rate of APL and that HiDAC may even have a detrimental effect ( [356](#) ).

ATRA works, in part, through terminal differentiation of APL blasts; its effectiveness is strictly correlated with the expression of the PML/RAR- $\alpha$  fusion transcript ( [Fig. 79.6](#) ) ( [335](#), [347](#), [348](#) ). ATRA improves DIC parameters often within 48 hours. The main complication associated with ATRA is the retinoic acid syndrome, which occurs in up to one-fourth of patients, particularly in those with high leukocyte counts ( [357](#) ). It is characterized by a capillary leak syndrome with fever, respiratory failure, renal impairment, and, in some patients, cardiac failure ( [Chapter 82](#) ). The retinoic acid syndrome can be treated or prevented with high-dose steroids or chemotherapy, either hydroxyurea or induction chemotherapy ( [357](#), [358](#) ). The mechanisms by which ATRA prevents DIC are not fully understood but probably relate to protection of endothelium from procoagulants such as tissue factor ( [359](#) ).



**Figure 79.6.** Modulation of promyelocytic leukemia/retinoic acid receptor- $\alpha$  (PML/RAR- $\alpha$ ) by pharmacologic doses of all- *trans*-retinoic acid (ATRA). On the left, the leukemia model of acute promyelocytic leukemia involves PML/RAR- $\alpha$  interacting with corepressor (CoR) complex and repressing transcription. CoR is composed of three types of proteins: the nuclear receptor corepressor (N-CoR), the mSin3A or mSin3B, and histone deacetylase (HDAC). On the right, pharmacologic dosing of ATRA leads to release of CoR and recruitment of coactivator (CoA) complex, which promotes transcription. CoA is a multiprotein complex and includes the nuclear receptor coactivator (ACTR), the CREB binding protein (CBP)/adenoviral E1A-associated protein p300 (P300), P300/CBP-associated factor (P/CAF), and transcriptional intermediary factor (TIF-1). P/CBF, P/CAF, and ACTR have histone acetylase activity. In the absence of ATRA, RAR/retinoic X receptor (RXR) is associated with CoR, which represses transcription through deacetylation of histones. On binding of ATRA to retinoic acid, CoR is dissociated from RAR/RXR, and CoA binds to the receptor heterodimer, acetylates nucleosomes, and promotes transcription. AC, acetylated histones; DIC, disseminated intravascular coagulation; RARE, retinoic acid response element.

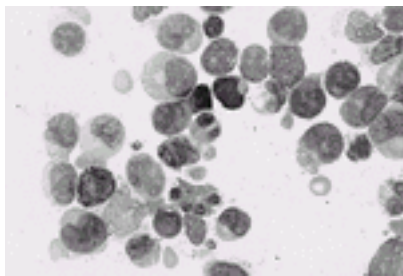
Although APL had a poor prognosis in early reports, in part because of its association with DIC, more recent data indicate an excellent response to therapy, with an overall good prognosis ( [335](#), [336](#), [355](#), [360](#) ). The management of the hemorrhagic diathesis associated with APL has always been controversial but has become less so with the use of ATRA, which shortens the period of time for bleeding and lessens the degree of risk ( [361](#) ). Heparin had been advocated to control DIC in APL, but no controlled trials are available to prove its efficacy ( [361](#), [362](#), [363](#) and [364](#) ). Others have advocated the use of antifibrinolytic agents (e-aminocaproic acid, tranexamic acid, aprotinin) if fibrinolysis is present, as evidenced by a decrease in a  $2$ -plasmin inhibitor ( [365](#), [366](#) ), but their efficacy, like that of heparin, has not been verified. If fibrinogen is low, transfusion support with platelets, fresh frozen plasma, and cryoprecipitate is indicated for patients with APL and DIC.

Chinese investigators have also identified arsenic trioxide ( $As_2O_3$ ) as effective therapy for APL ( [367](#) ). Western studies have confirmed CR rates of 90% in relapsed or refractory APL ( [368](#) ). Although the mechanisms have not been completely described,  $As_2O_3$  at different concentrations induces partial differentiation and apoptosis of APL cells and also causes histone acetylation ( [369](#) ). Because  $As_2O_3$  works by a different mechanism and may be synergistic with other agents, present studies are evaluating its role in APL regimens using ATRA and chemotherapy ( [369](#) ). Monoclonal antibodies, HuM 195 and gemtuzumab ozogamicin, have also been effective in APL ( *vide infra* ) ( [370](#), [371](#) ).

#### Acute Myelomonocytic Leukemia with Abnormal Eosinophils and Inversion of

## Chromosome 16

In approximately 5 to 10% of patients with AML, eosinophil precursors with abnormal morphology, cytochemical reactivity, and ultrastructure are present in association with monocytosis and a myeloblastic/monoblastic infiltration in the bone marrow. The median age is 40 to 45 years; organomegaly is common, and leukocytosis is present in most patients with hyperleukocytosis ( $>100,000$  cells/mm<sup>3</sup>) in 20 to 25% ( [141](#), [251](#) ). CNS disease and leukemia cutis are common. The immature eosinophils have a monocytoid nucleus and a mixture of eosinophilic and large atypical basophilic granules ( [Fig. 79.7](#) ). Staining with Sudan black, periodic acid–Schiff (PAS), and chloroacetate esterase with nonspecific esterase can identify the neoplastic cell. Well–formed central crystalloids characteristic of eosinophilic granules are absent on ultrastructural examination. By flow cytometry, all cases of AML M4Eo express the panmyeloid marker CD13 and the stem cell antigen CD34, but there is variable expression of other myeloid/monocytic markers, including CD11b, CD11c, CD14, and CD33. There is also frequent expression of the T–lymphoid marker CD2, along with HLA–DR ( [261](#) ).



**Figure 79.7.** Wright–stained marrow smear from patient with M4Eo and an inv(16). Myeloblasts, monoblasts, and abnormal eosinophils with large basophilic granules, as illustrated here, are typically present in this variant. See [Color Plate](#).

The syndrome was first described in 1983 in five patients with a deletion of the long arm of chromosome 16 ( [372](#) ). In subsequent reports, almost all patients have had a pericentric inversion of chromosome 16 [inv(16)(p13;q22)], whereas a minority of patients have had a balanced translocation between the two copies of chromosome 16 [t(16;16)(p13.1;q22)] ( [373](#) ). Cloning of the 16p and 16q breakpoints has identified the two genes involved: MYH11, which codes for smooth muscle myosin heavy chain, and core–binding factor (CBF)  $\beta$  (also known as PEBP2 $\beta$ ), which codes for the  $\beta$  subunit of CBF, a heterodimeric transcription factor involved in murine leukemogenesis and in T–cell receptor gene expression ( [374](#), [375](#) ). CBF $\alpha$  (?PEBP2 $\alpha$ ), which dimerizes with CBF $\beta$  to form CBF, is identical to AML1, which binds directly to DNA and is involved in the t(8;21) in AML M2; CBF $\beta$  does not bind DNA but increases the DNA–binding affinity of AML1. Thus, two of the most prevalent karyotypic abnormalities detected in *de novo* AML, t(8;21) and inv(16), result in the disruption of a single transcription factor, CBF ( [Chapter 76](#) ). CBF $\beta$ –MYH11 fusion transcripts are detected by RT–PCR in typical AML M4Eo, but also in approximately 10% of patients with AML M4 without eosinophilia ( [375](#), [376](#) and [377](#) ).

The CR rate of AML with inversion of chromosome 16 to chemotherapy has been higher than for most other subtypes of AML, and its prognosis for DFS is good, so allogeneic transplantation is often considered after relapse rather than as therapy in first remission ( [378](#) ). AML with inversion 16 has a higher risk of CNS relapse, but the use of HiDAC intensification therapy decreases the incidence of CNS disease and may serve as CNS prophylaxis ( [378](#) ). As with AML/ETO, the absence of CBF $\beta$  may not be required for



prolonged clinical remission ( [375](#) ), but residual disease may be monitored by quantitative RT-PCR ( [377](#) ).

### Acute Monocytic Leukemia (FAB M5a and M5b)

AMoL accounts for 2 to 10% of AML cases ( [300](#) , [379](#) ). M5 is subdivided into M5a, poorly differentiated (>80% monocytic cells including monoblasts), and M5b, well differentiated (80% monocytic, predominantly promonocytes and monocytes) ( [380](#) ). Patients with M5a tend to be younger (75% <25 years of age) than those with M5b, but both include a wide age range ( [251](#) ). Monocytic precursors are recognized by their fluoride-inhibitable nonspecific esterase positivity and expression of CD14 and CD4 (dim expression) but not CD2. Monoblasts may be recognized by staining with antibodies to lysozyme and to CD68 (KP1) ( [251](#) ). Cytogenetic abnormalities in M5 are not specific but often consist of chromosome 11 and 9 or 19 translocations. Balanced translocations involving 11q23 occur in both *de novo* and secondary AML, primarily as myelomonocytic (M4) or monocytic (M5) subtypes. The gene involved on chromosome 11 is called *mixed lineage leukemia* and has homology to the *Drosophila trithorax* gene ( [381](#) ). More than 25 different partner genes for MLL have been identified ( [21](#) ). In t(9;11) and t(11;19), the amino terminus of the MLL gene is fused to either of two homologous genes, AF9 or ENL, from chromosomes 9q21 and 19p13, respectively ( [382](#) ).

Extramedullary disease is more common in AMoL than in other subtypes of AML and includes cutaneous lesions, gum infiltration, and CNS disease ( [383](#) ); CNS involvement has been reported in 3 to 22% of patients. Leukocytosis is a common finding, present in 10 to 30% of patients. The frequency of DIC is second only to that in APL, and DIC may be exacerbated when therapy begins. Elevated levels of lysozyme are found in more than two-thirds of patients and may contribute to renal insufficiency or proteinuria. Although some disagreement exists about the prognosis of AMoL in relation to other subtypes of AML, results of several studies suggest that AMoL is associated with poor prognostic factors and has a shorter duration of response ( [380](#) , [383](#) ). Although 11q23 translocations are often associated with a poor prognosis, t(9;11) is more favorable than the others ( [290](#) , [297](#) ).

### Erythroleukemia (FAB M6)

Erythroleukemia accounts for less than 5% of cases of AML and is characterized by a prominent component of erythroblasts. Erythroid/myeloid leukemia (M6a) has 50% or more erythroid precursors in the nucleated population and 20% or more myeloblasts in the nonerythroid population. In pure erythroid leukemia (M6b), 80% of the marrow cells are immature erythroblasts without a significant number of myeloblasts. Erythroid precursors commonly have cytoplasmic vacuolization, nuclear abnormalities, and megaloblastoid features. PAS may stain erythroid elements in a diffuse or globular pattern. Auer rods are present in myeloblasts in up to two-thirds of patients ( [251](#) ).

Erythroleukemia usually occurs in patients 50 years of age or older and is more common in men ( [380](#) ). Aneuploidy is found in nearly two-thirds of patients, and cytogenetic abnormalities, particularly in association with secondary erythroleukemia, often involve chromosome 5 or 7 ( [301](#) , [384](#) ). The presenting complaints are constitutional, including fatigue, malaise, and other complaints related to anemia, but in approximately one-third of patients, bone pain may be a major symptom ( [380](#) ). Hypergammaglobulinemia and positive tests for rheumatoid factor, antinuclear antibody, and Coombs may be found in patients

with bone pain ( [385](#) ). Data are conflicting regarding prognosis in erythroleukemia, but in general, it appears to be less favorable than that of other subtypes of AML. The inferior prognosis is related in part to the associations with older patient age and with secondary leukemia.

### Acute Megakaryocytic Leukemia (FAB M7)

AMgL was added to the FAB classification in 1985 and represents 5 to 10% of cases of AML ( [251](#), [380](#), [386](#), [387](#) ). Morphologically, AMgL can be confused with the L2 subtype of ALL or with AML M1. Cytoplasmic blebs suggestive of megakaryocyte differentiation may be present on the blasts. Myeloid surface markers CD13 or CD33 may be positive, and CD34 is often absent. The diagnosis depends on the expression of at least one platelet antigen (CD41, CD42b, CD61, or factor VIII–related antigen) on the leukemia cells. The bone marrow may be difficult to aspirate and may have significant fibrosis. AMgL may present as *de novo* leukemia, secondary leukemia after chemotherapy, or transformed myeloproliferative disorders and myelodysplastic syndromes. Cytogenetic abnormalities are heterogeneous but include abnormalities of chromosome 8 and chromosome 21; secondary leukemias usually have abnormalities of chromosomes 5 and 7 ( [301](#), [380](#) ). A subset of AMgL is found in infants who present with extensive organomegaly and have a nonrandom chromosome abnormality, t(1;22)(p13;q13) ( [388](#) ). The two genes involved are one twenty-two (OTT), which is related to the *Drosophila* split-end family of proteins, and megakaryocytic acute leukemia (MAL), which is involved in chromatin organization ( [389](#) ).

Although data are limited, the clinical presentation of AMgL is not substantially different from that of other subtypes of AML. Fever is common, and organomegaly is noted infrequently. Cytopenias are usually present, but approximately 30% of patients have platelet counts that exceed 100,000/ $\mu$ l ( [380](#) ). Platelet function studies usually indicate impaired aggregation responses. Serum lactate dehydrogenase levels are often elevated. Osteosclerotic and osteolytic lesions have been demonstrated radiographically ( [380](#), [390](#) ).

Prognosis in AMgL appears to be poor, although systematic information is limited. Some cases of M7 are probably included in the description of acute myelosclerosis, which was reported in 1979 before the establishment of the criteria for AMgL ( [391](#) ). Acute myelosclerosis was associated with a fulminant clinical course and survival of less than 1 year. Patients with AMgL may have either a transient illness, as in neonates with Down syndrome, or a slowly progressive disease that follows a myeloproliferative disorder ( [392](#) ). Patients with Down syndrome who develop AML usually have either M6 or M7 subtype and have a good prognosis with therapy ( [Chapter 81](#) ) ( [393](#) ).

### Other Clinicopathologic Syndromes

Acute panmyelosis with myelofibrosis in the WHO classification has replaced acute myelosclerosis or acute myelofibrosis noted in the section [Acute Megakaryocytic Leukemia \(FAB M7\)](#) ( [21](#) ). This is a very rare form of AML and is not well defined. Patients have pancytopenia and constitutional symptoms. There is no or minimal splenomegaly. Marrow is hypercellular with various degrees of hyperplasia of the three cell lineages; clusters of late-stage erythroids may be prominent. Dysplastic changes, including hypolobated megakaryocytes with dispersed chromatin, are present. Clusters of immature cells are present, and the degree of marrow fibrosis is variable. If the proliferative process is predominantly myeloblasts and fibrosis is present, the leukemia should be classified as AML of the appropriate cell types with “myelofibrosis.”

Acute basophilic leukemia is very rare. Cutaneous disease, organomegaly, lytic bone



lesions, and symptoms of hyperhistaminemia may be present. Blast nuclei are oval, round, or bilobed, and there are variable numbers of coarse basophilic cytoplasmic granules that on electron microscopy have features of basophils or mast cell granules. The characteristic cytochemical stain is metachromatic positivity with toluidine blue and, in addition, diffuse acid phosphatase positivity and, in some cases, block PAS positivity. Blasts are often negative for Sudan black B, MPO, and nonspecific esterase. Blasts express myeloid antigen CD13, CD33, and CD34 and also HLA-DR; CD9 is usually present. Involvement of 12p or t(6;9), which occurs in some AML with increased basophils, has not been described. Some cases may represent blast crisis of CML or *de novo* Ph<sup>+</sup> acute leukemia, and prognosis is uniformly poor ( [394](#) ).

The t(6;9)(p21;q34) is a rare variant of AML (<1%) that was initially described in a young age group (20 to 30 years of age) with basophilia and a poor response to therapy. It is usually of the FAB M2 or M4 subtype and is often preceded by MDS ( [395](#) ). The genes involved in this translocation are the DEK gene on chromosome 6p23 and the CAN gene on chromosome 9p34 ( [Chapter 76](#) ).

AML presenting with a normal platelet count or thrombocytosis may involve abnormalities of the long arm of chromosome 3: inv(3)(q21q26) and t(3;3)(q21;q26) ( [307](#) , [396](#) , [397](#) and [398](#) ). The critical gene involved at 3q26 is EVI1 (ecotropic viral integration site 1) ( [399](#) , [400](#) ). Clinically, the patients have a young median age and may have preceding MDS. Morphologically, these cases are difficult to subtype and have included M1, M4, and M6 ( [252](#) ). Abnormal megakaryocytes are characteristic, and the prognosis is poor.

More clinicopathologic syndromes of AML are being recognized in conjunction with the discovery of genes involved in specific translocations. For example, AML with t(3;5)(q25.1;q35) has been difficult to subclassify by FAB, but approximately one-fourth of patients have erythroleukemia (M6), and the marrow often has trilineage dysplasia and abnormal megakaryocytes. Unlike patients with inv(3), patients with t(3;5) do not have thrombocytosis, and they may have an increased risk of Sweet syndrome ( [401](#) , [402](#) and [403](#) ). The genes involved in the t(3;5) are the NPM gene on chromosome 5 and a gene named *myelodysplasia/myeloid leukemia factor 1* (MLF1) on chromosome 3 ( [404](#) ).

Molecular cloning of translocations in AML continues to identify genes that contribute to leukemogenesis ( [405](#) ). The t(5;11)(q35;p15.5) and t(9;11)(p22;p15) result in NUP98/NSD1 and NUP98/LEDGF rearrangements, respectively; both result in fusion gene proteins involving components of the nuclear pore ( [406](#) , [407](#) ). New fusion partner genes are being identified in translocations with the MLL gene, usually in secondary or therapy-related leukemias with monocytic features ( [408](#) , [409](#) , [410](#) and [411](#) ). MOZ/p300 and MORF/CBP fusions were cloned in AML with t(8;22)(p11;p13) and t(10;16)(q22;p13), respectively, and contribute to leukemogenesis through transcriptional coactivators and remodeling of chromatin ( [412](#) , [413](#) ). Recognition of the genes involved in AML translocations will lead to a better understanding of leukemogenesis and, ultimately, to more specific therapies.

## PROGNOSIS

Clinical features, morphology, surface markers, and cytogenetics are combined to describe clinicopathologic syndromes in AML, and prognosis is usually determined by a combination of specific factors ( [Table 79.5](#) ) ( [298](#) , [299](#) , [414](#) , [415](#) , [416](#) , [417](#) , [418](#) and [419](#) ). A single factor cannot reliably predict prognosis but must be correlated with all available information. Age is an important prognostic factor, with elderly and very young (infants <2 years of age) patients having the worst prognoses ( [420](#) ). The clinical state of the patient,

as reflected in performance status or the serum albumin, affects outcome ( 421 ). Patients with a preceding bone marrow disorder, including MDS or myeloproliferative syndrome, or with a history of chemotherapy have an inferior response and survival compared to those with *de novo* AML ( 422 , 423 ). The presence of infection or thrombocytopenia has become less important because of improvements in supportive care. Although hyperleukocytosis correlates with a poor prognosis in some series, the correlation is not as strong in AML as it is in ALL ( 424 , 425 ).

**TABLE 79.5. Prognostic Factors in Acute Myeloid Leukemia**

| Factor  | Favorable   | Unfavorable  |
|---|---|--|
| <b>Clinical</b>                               |   |  |
| Age   | <45 yr  | <2 yr, >60 yr  |
| ECOG performance status                       | 0, 1  | >1   |
| Leukemia                                      | <i>De novo</i>  | Antecedent hematologic disorder: myelodysplasia, myeloproliferative disorder |
| Infection                                     | Absent  | Present  |
| Prior chemotherapy                            | No  | Yes  |
| Leukocytosis                                  | <25,000/mm <sup>3</sup>                                   | >100,000/mm <sup>2</sup>   |
| Serum lactate dehydrogenase                   | Normal  | Elevated   |
| Extramedullary disease                        | Absent  | Present  |
| Central nervous system disease                | Absent  | Present  |
| Cytoreduction                                 | Rapid   | Delayed  |
| <b>Morphology</b>                             |   |  |
| Auer rods                                     | Present   | Absent   |
| Eosinophils                                   | Present   | Absent   |
| Megaloblastic erythroids                      | Absent  | Present  |
| Dysplastic megakaryocytes                     | Absent  | Present  |
| FAB type                                      | M2, M3, M4  | M0, M6, M7   |
| <b>Surface/enzyme markers</b>                 |   |  |
| Myeloid                                       | CD34 <sup>-</sup> , CD14 <sup>-</sup> , CD13 <sup>-</sup> | CD34 <sup>+</sup> <sup>a</sup>   |
| HLA-DR  | Negative  | Positive   |
| Terminal deoxynucleotidyl transferase         | Absent  | Present  |
| Lymphoid                                      | CD2 <sup>+</sup>  | CD56 <sup>+</sup><br>Biphenotypic (=2 lymphoid markers)                      |
| MDR-1   | Absent  | Present  |
| Cytogenetics                                  | t(15;17), t(8;21), inv(16)                                | -7, del(7q), -5del(5q), 3q21 and 3q26 abnormalities, complex karyotype       |
| <b>Molecular markers</b>                      |   |  |
| Fms-related tyrosine kinase-3 mutations       | Absent  | Present  |
| Vascular endothelial growth factor expression | Absent  | Present  |

|  |        |         |
|--|--------|---------|
| Ectropic viral integration site 1 expression       | Absent | Present |
| Mixed lineage leukemia partial tandem duplications | Absent | Present |

FAB, French/American/British.

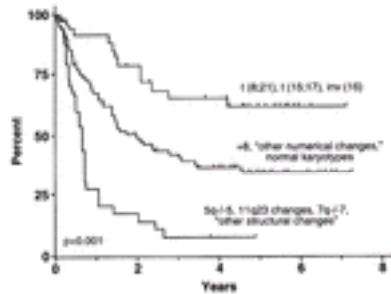
<sup>a</sup> Except when accompanied by favorable cytogenetics [i.e., FAB-M2 with t(8;21) or FAB-M4Eo with inv(16)].

Favorable morphologic features include Auer rods (M1–M4) and eosinophils (M2 and M4Eo), whereas megaloblastic features that may be seen in erythroleukemia (M6), acute megakaryoblastic leukemia (M7), or AML evolving from MDS are unfavorable ( [416](#), [417](#), [423](#) ). The eosinophils in M2 show only minor abnormalities such as faint green–blue/yellow granules, whereas in M4Eo, they are dysplastic and often have large, irregular, deeply purple granules ( [Fig. 79.7](#) ); their presence is favorable because of the association with good prognostic cytogenetics—t(8;21) in M2 and inv(16) in M4Eo ( [426](#) ). In regard to FAB morphology, results of studies are inconsistent, but they generally indicate that patients with M0, M6, M7, and, possibly, M5 have lower survival rates. Extramedullary disease, common in M5, is also associated with a worse prognosis. The speed of cytoreduction (how quickly aplasia is achieved) also correlates with survival, except in APL (M3), which may be difficult to assess because of the lack of aplasia after ATRA or chemotherapy. Although the usual time of evaluation of the marrow for aplasia is 2 weeks after start of therapy, some studies indicate a better prognosis if aplasia is achieved within the first week ( [427](#), [428](#) ).

The effect of surface markers on prognosis is variable and is interdependent with other factors; moreover, antigen expression often changes at relapse ( [405](#), [429](#), [430](#) and [431](#) ). Although CD34 has often been reported as an adverse factor, in some studies, it has had little impact on outcome ( [432](#) ). CD34 expression is a poor prognostic factor when coexpressed with CD7 ( [278](#) ), but it is probably more important when associated with adverse cytogenetics, including abnormalities of chromosome 5 (–5/5q–) and 7 ( [433](#) ), or with the multidrug resistance gene (MDR–1) ( [434](#) ). CD34 is also expressed in favorable AML subtypes, including all cases with t(8;21) and inv(16) ( [435](#) ). The absence of some markers, including CD34, CD14, and CD13, can be associated with a good prognosis ( [265](#), [419](#), [429](#), [434](#) ). Similarly, the lack of HLA–DR reactivity as observed in APL (M3) is associated with a good prognosis. An association between early death (<2 months) and the coexpression of leukocyte function antigens (CD16b and 11c) on leukemia cells has been reported ( [436](#) ). CD56, a cell adhesion molecule, has been implicated in the development of extramedullary disease ( [335](#), [437](#) ). The presence of lymphoid markers, particularly when they are multiple, is often associated with a poor prognosis; however, they have not predicted a poor prognosis when present in children ( [438](#) ) or when associated with a good cytogenetic group ( [275](#) ).

Cytogenetic subgroups identify prognosis better than any other factor ( [290](#), [291](#), [298](#), [299](#), [439](#), [440](#) and [441](#) ). Three abnormalities, t(8;21), t(15;17), and inv(16), are regarded as favorable ( [Fig. 79.8](#) ). Even favorable cytogenetics can be associated with an adverse clinical factor surface marker or cytogenetic abnormality. For example, when t(8;21) is associated with extramedullary disease, CD56, or del(9q), the overall prognosis worsens (

334, 335, 442). In early series, patients with t(15;17) did not do well because of hemorrhagic deaths, the number of which has decreased with better transfusion support and with the introduction of ATRA therapy (Chapter 82). The inv(16) has been associated with a high CR rate, but an increased incidence of CNS involvement resulted in an intermediate prognosis in some reports; the use of HiDAC may lessen the risk of CNS disease.



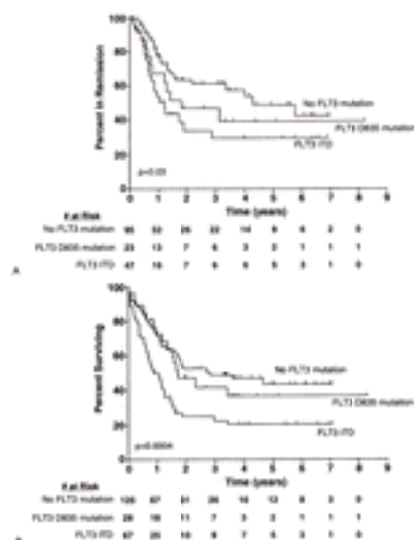
**Figure 79.8.** Probabilities of continuous complete remission of previously untreated patients with acute myeloid leukemia according to chromosomal groups. (From Dastague N, Payen C, Lafage-Pachitaloff M, et al. Prognostic significance of karyotype in *de novo* adult acute myeloid leukemia. The BGMT group. *Leukemia* 1995;9:1491–1498.)

The main disagreements about prognosis among groups are in the identification of cytogenetic abnormalities that constitute an intermediate risk (298, 439, 441). Poor cytogenetic groups include those defined by abnormalities of chromosomes 5 and 7, 3q26, and complex karyotypes and often include patients with prior chemotherapy or MDS (289, 443). 11q23 abnormalities are often associated with a poor prognosis but have been considered intermediate risk, especially in young patients with a *de novo* presentation with t(9;11) (290, 298). Trisomy 8 is the most common numerical abnormality in AML and, by itself, may be associated with an intermediate risk, but it often occurs in complex karyotypes that are prognostically unfavorable (444). A normal karyotype is generally associated with an intermediate prognosis; however, molecular techniques such as RT-PCR can detect molecular changes in AML with a normal karyotype that may have prognostic significance, including FLT-3 and MLL internal tandem duplications (244, 445, 446).

Expression of MDR genes has been identified as adverse prognostic markers in AML (269, 447, 448, 449, 450, 451, 452, and 453). The best described MDR gene is MDR-1 whose gene product, P-glycoprotein (Pgp), is a 170-kd membrane glycoprotein that functions as a drug efflux pump for naturally occurring substances, including anthracyclines, vinca alkaloids, taxanes, and epipodophyllotoxins (447, 453). Pgp expression can be detected by flow cytometry using specific antibodies such as MRK16 and can be correlated with functional efflux of fluorescent dyes by leukemia blasts (269, 449). Expression of MDR-1/Pgp is more commonly found in older patients, often in conjunction with adverse cytogenetics, and is associated with a lower CR rate (269, 449). Other transport proteins that may confer drug resistance include multidrug resistance-associated protein-1, lung resistance protein (LRP), and breast cancer resistance protein (BRCP) (449, 450, 451, and 452).

Prognosis in AML may also be assessed by evaluating molecular markers, particularly genes encoding growth factors and their receptors (453, 454, 455, and 456). The best-studied

receptor and its impact on prognosis is FLT-3, also known as stem cell kinase 1 or fetal liver kinase 2 ( [454](#), [455](#), [456](#), [457](#) and [458](#)). FLT-3 mutations predominantly occur by internal tandem duplication of the juxtamembrane region and, less commonly, through an “activation” loop involving an aspartic acid residue at amino acid position 835 ( [458](#)). They can be detected by genomic PCR amplification and gel electrophoresis in 20 to 34% of patients with AML ( [454](#), [455](#), [456](#), [457](#) and [458](#)). FLT-3 gene mutations have been associated with higher peripheral blast counts, normal cytogenetics, t(15;17), and FAB M5 disease. Although presence of FLT-3 mutations does not correlate with CR rate, they have predicted relapse and poor survival and may be useful in stratifying patients with normal cytogenetics into risk groups ( [Fig. 79.9](#)) ( [454](#), [456](#), [458](#)). RAS mutations occur in 20 to 44% of AML patients but rarely with FLT-3 mutations and have not consistently predicted prognosis ( [457](#), [459](#)). Although TP53 mutations are less common than either RAS or FLT-3 mutations, they have been associated with abnormalities in both chromosomes 5 and 7 and a worse overall survival in the elderly ( [457](#)). Increased expression of the protein EVI1 is associated not only with AML involving 3q26, but also with other unfavorable karyotypes (e.g., -7/7q- and 11q23 aberrations) and a poor prognosis ( [460](#)).

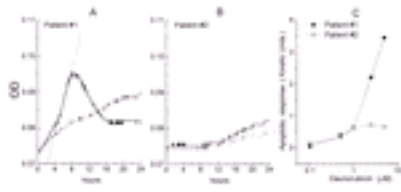


**Figure 79.9.** Survival for patients with normal cytogenetics according to Fms-like tyrosine kinase (FLT3) mutation status. **A:** Remission duration (  $p = .03$ ). **B:** Overall survival (  $p = .0004$ ). [FLT D835, Asp835 (three-letter amino acid code); FLT3 ITD, internal tandem duplication.] [From Frohling S, Schenk RF, Beitruck J, et al. Prognostic significance of activating FLT3 mutations in younger adults (16 to 60 years) with acute myeloid leukemia and normal cytogenetics: a study of the AML Study Group Ulm. *Blood* 2002;100:4372-4380.]

*In vitro* assays to measure proliferation or chemosensitivity have been of uncertain value but continue to be investigated. Clonogenic assays indicate that growth in small (as compared to large) clusters is associated with a better response to therapy ( [461](#)). *In vitro* sensitivity to ara-C and daunorubicin has been correlated with *in vivo* responses using clonogenic assays ( [462](#), [463](#)). Patients whose leukemia cells readily phosphorylate ara-C *in vitro* and retain it in its active form (ara-CTP) have had a longer response than those with low ara-CTP retention ( [464](#)). Bromodeoxyuridine has been used for *in vitro* assessment of cell cycling, and patients with a high S-phase index and longer cell cycling times have had longer remission durations ( [238](#)). Correlations between cytogenetics and

bone marrow cultures indicate an absence of autonomous growth *in vitro* in patients with favorable cytogenetics compared to partial or full autonomous growth in 50% of patients with intermediate-risk and 73% of patients with poor-risk cytogenetics ( $p = .0004$ ) (465). Cytokine-induced proliferation *in vitro* may also subdivide intermediate-risk patients into good and poor prognosis groups (466).

A major problem in leukemia is the inability to consistently predict chemosensitivity to a specific drug in an individual patient. Several types of *in vitro* assays that measure leukemia cell survival after exposure to chemotherapeutic agents have been evaluated for their ability to predict clinical responses (463, 467, 468, 469 and 470). The tests for chemosensitivity have included long-term assays based on clonal growth of leukemia colony-forming cells, short-term assays of the total cell population measuring loss of cell viability, and a rapid microculture kinetic assay that determines the extent of apoptosis in leukemia cells after exposure to cytotoxic agents (Fig. 79.10). The results of these assays have been variable in their ability to predict response and survival.



**Figure 79.10.** Determination of chemosensitivity to daunorubicin using the microculture kinetic (MiCK) assay of apoptosis. Myeloblasts from a patient with responsive acute myeloid leukemia (AML) (A) and a patient with resistant AML (B) are shown. The MiCK assay monitors the optical density (OD) of cell cultures exposed to antitumor drugs. Plotting OD against time provides a kinetic representation of responses to drugs. Serial OD readings are shown from untreated control cultures (thin lines) and cultures with 5  $\mu\text{m}$  daunorubicin (thick lines). Autonomous cell growth causes the slow OD increase in control cultures. The steep increases in the OD in (A) induced by daunorubicin are caused by increased side scattering of light from cells undergoing apoptosis. The slope [dotted line in (A)] of this steep increase, expressed as kinetic units, correlates directly with the percentage of apoptotic cells. The absence of any steep increase above controls in (B) indicates negligible apoptosis in response to 5  $\mu\text{m}$  daunorubicin. C: The dose-response relationship for the two leukemias is shown over a range of daunorubicin concentrations that can be achieved *in vivo*. (Courtesy of Drs. Vladimir Kravtsov and Mark Koury, Vanderbilt University, Division of Hematology/Oncology, Nashville, TN.)

Decreased apoptosis and increased angiogenesis can contribute to leukemogenesis and poor prognosis in AML. Increased bcl-2 protein expression exerts an antiapoptotic effect on leukemia cells, but studies correlating bcl-2 expression with known prognostic factors have yielded mixed results (471, 472). Overexpression of VEGF correlates with increased angiogenesis and has been associated with a worse response and survival in AML (473, 474). Ongoing studies correlating markers for apoptosis and angiogenesis with known prognostic factors in AML may further delineate prognosis in AML and identify targets for therapy.

## THERAPY

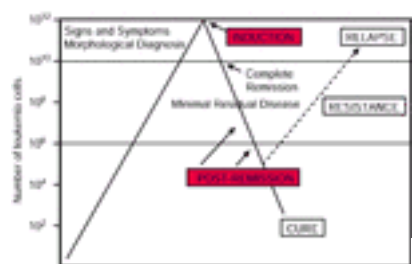
Therapy is instituted after differentiating AML from ALL (Chapter 77). Therapy for AML consists of cytotoxic chemotherapy alone or marrow/stem cell transplantation (SCT) after chemotherapy. Immunotherapy, which formerly included bacillus Calmette-Guérin



scarification, is reemerging as a therapeutic modality in AML with the development of monoclonal antibodies directed toward antigens on blast cells ( [Chapter 74](#) ) ( [475](#) , [476](#) , [477](#) and [478](#) ).

Administration of ara-C, usually in conjunction with an anthracycline, has been the cornerstone of chemotherapy in AML for more than 30 years. Choices of dosage, schedule, and methods of administration of ara-C differ among studies and play a role in determining outcome ( [479](#) , [480](#) , [481](#) , [482](#) and [483](#) ). SCT for selected patients in first remission appears to be superior to chemotherapy alone; however, intensification therapy with high doses of ara-C with or without anthracyclines has improved results of chemotherapy, so that the question of what is the best therapy for AML in first remission remains unanswered ( [483](#) , [484](#) , [485](#) and [486](#) ). Because of the heterogeneity of AML, therapy should probably be stratified according to clinical and cytogenetic features and possibly to other biologic data.

Therapy can be divided into two phases: induction and post-remission ( [Fig. 79.11](#) ). The initial goal of therapy is induction of a CR, which usually requires a period of aplasia (except in APL). CR is attained in 60 to 85% of patients. Better response rates (70 to 85%) are common in patients younger than 60 years of age without a prior myelodysplastic syndrome. Rarely, brief spontaneous remissions have occurred without therapy ( [487](#) ). As defined in a workshop sponsored by the National Cancer Institute, CR is the normalization of neutrophil counts (at least  $1.5 \times 10^9/L$ ) and platelet counts ( $>100 \times 10^9/L$ ), and a marrow aspirate and biopsy that demonstrate at least 20% cellularity, less than 5% blasts, and no Auer rods, as well as absence of extramedullary leukemia ( [1](#) ). Moreover, these criteria should be sustained for at least 4 weeks or until initiation of intensification therapy, if earlier than 4 weeks. Partial remissions defined by 5 to 25% blasts are of value only in phase I and II trials. Submicroscopic residual leukemia has been demonstrated after CR is achieved with induction therapy ( [488](#) ). Randomized trials that involve no postremission therapy have cure rates approaching 0%, so postremission therapy is essential to eliminate residual disease and to achieve cure ( [489](#) ).



**Figure 79.11.** Phases of therapy. The diagnosis of acute myeloid leukemia can be made when the leukemia cell number is greater than  $10^{10}$ . Induction therapy achieves a clinical complete remission and is followed by postremission therapy with a goal of cure. If cells develop mechanisms of resistance, relapse occurs.

Postremission therapy may consist of maintenance, consolidation, or intensification therapy. Maintenance therapy is less intensive and less myelosuppressive than induction; consolidation involves regimens similar to those used in induction; and intensification involves the use of drugs at higher dosages than in induction ( [483](#) , [490](#) ). Maintenance therapy is not as important in AML as it is in ALL. Randomized trials show that maintenance therapy may prolong initial remissions ( [491](#) , [492](#) ), but they also show no



benefit of maintenance in improving the cure rate of AML ( [493](#) , [494](#) ). Maintenance therapy is probably not warranted in AML if the postremission therapy is of adequate intensity ( [493](#) , [494](#) and [495](#) ). There does appear to be a role for maintenance in APL ( [Chapter 82](#) ), and maintenance therapy could be considered in the elderly due to difficulty in delivering intensive consolidation chemotherapy. Additionally, randomized trials evaluating the role of intensive consolidation therapy have not shown an improvement in survival of the elderly.

The cure rate of adult AML by chemotherapy is usually reported as 10 to 50% and depends on a number of factors, including age, prior MDS, rapidity of obtaining a CR, and cytogenetics. Recent studies with the use of high-dose cytarabine (HiDAC) in intensification or ATRA and anthracyclines in APL indicate that selected groups of patients have a cure rate of above 50%, which approaches the cure rates achieved with alloSCT. Both postremission high-dose chemotherapy consolidation and alloSCT have better results in younger patients, but alloSCT remains superior as antileukemic therapy because relapse occurs less often after transplantation (<25% relapse). However, because of morbidity and mortality from infections and graft-versus-host disease, the cure rate with alloSCT in first CR has ranged from 45 to 75%. With the improvements in chemotherapy results, some authorities are advocating alloSCT in early relapse, with salvage rates of 15 to 30% in these patients, so that the cure rate of chemotherapy along with alloSCT at early relapse may be equivalent to that of alloSCT in first remission ( [496](#) , [497](#) , [498](#) and [499](#) ).

The evaluation of both chemotherapy and transplantation should include not only the CR and cure rates, but also the reasons for failure. The two basic reasons for failure in chemotherapy-treated patients are resistant leukemia and death from infection or hemorrhage. With improvements in transfusion support, empiric antibacterial and antifungal therapy, and availability of growth factors, the latter reason has become less significant. Preisler emphasized the importance of recognizing different types of failures in the therapy of AML ( [Table 79.6](#) ) ( [500](#) ). Complete, or classic, drug resistance is complex and is characterized by the failure to significantly reduce the leukemia cell burden ( [501](#) ). Different mechanisms of drug resistance may be involved. Overexpression of the MDR-1 gene is the most commonly reported abnormality in chemotherapy-resistant AML, but overexpression of other proteins, such as LRP, which alters intracellular drug distribution, have also been described ( [447](#) ). Many of the failures previously attributed to relative drug resistance more accurately represent regrowth failures, in that there is substantial leukemia cell kill, but the leukemia cells regrow before additional therapy is given ( [501](#) ). Regeneration failures are rare in the era of growth factors. Hypoplastic deaths and inadequate chemotherapy trials include patients who die before the response can be assessed. Hematologic remission can be achieved, but other markers of disease may persist, including MDS in patients with AML evolving from MDS, extramedullary disease, or persistence of abnormal cytogenetic or molecular markers. Persistence of abnormal karyotypes, as well as some molecular markers such as PML/RAR- $\alpha$ , tends to predict disease recurrence, but other molecular markers, such as AML/ETO1, may not correlate with clinical disease.

**TABLE 79.6. Types of Failure in Therapy of Acute Myeloid Leukemia**

---

Drug resistance: no response based on absence of hypocellularity in posttreatment marrow biopsy, usually day 14

Relative drug resistance: partial response with subsequent regrowth of leukemia within 4 wk

Regeneration failure: marrow remains hypocellular for >4 wk  
 Hypoplastic death (within 4 wk)  
 Inadequate trial (death within 2 wk of initiating therapy)  
 Hematologic remission but persistent disease (myelodysplasia, extramedullary disease, cytogenetic or molecular abnormalities)

---

Because chemotherapy is the initial therapy for all patients and alloSCT is not readily available to most patients, the primary focus of the remainder of this chapter is on chemotherapy in AML: single agent data, remission–induction combinations, and postremission therapy. Special issues in AML therapy addressed at the end of the chapter are relapsed/refractory AML, AML in the elderly, AML during pregnancy, hypocellular AML, and the role of growth factors and biologic response modifiers.

### Single Agent Chemotherapy

[Table 79.7](#) outlines active agents in AML and includes their cell cycle specificity, major toxicities, response rates, and clinical uses. Cytarabine and anthracyclines have been the subject of most intense study. Cytarabine is effective in cells in the S–phase of the cell cycle and is not active in cells that are out of cycle or in other phases of the cell cycle. Anthracyclines do not depend on the cell cycle and appear to be the most active single agents. Synergy exists between agents with different mechanisms of action, and combination chemotherapy is warranted for optimal results in AML. Still, single agent data constitute the basis for therapy and the development of new agents in phase I and II trials. Data from new single agent studies are difficult to assess because new drugs are often administered with known active agents, and the trials are in heavily pretreated patients. Results depend on how extensive prior therapy has been; for example, in initial studies involving amsacrine, the response rate was 47% in patients who had received one prior regimen, 25% in patients who had received two prior regimens, and 0% in patients treated with three or more prior regimens ([502](#), [503](#)).

**TABLE 79.7. Standard Single Agents in Acute Myeloid Leukemia**

| Agent      | Class of Agent    | Route of Delivery | Cell Cycle Specificity | Mechanism of Action  | Plasma Half–Life (hr) | Main Route of Excretion | Response Rates (%) |
|------------|-------------------|-------------------|------------------------|--|-----------------------|-------------------------|--------------------|
| Cytarabine | Pyrimidine analog | IV, SC            | S                      | Active form ara-CTP inhibits DNA polymerase and is incorporated in DNA (S–phase) | 1–2                   | Renal                   | 15–35              |

|   |                           |        |    |   |       |                 |         |
|---|---------------------------|--------|----|---|-------|-----------------|---------|
| Daunorubicin, doxorubicin, idarubicin, epirubicin | Anthracycline antibiotics | IV     | NS | Inhibit DNA replication by intercalation of base pairs; inhibition of topoisomerase II        | 15-30 | Hepatic         | 40-50   |
| 6-Thioguanine                                     | Purine analog             | PO, IV | S  | Ribonucleotide form is incorporated in DNA, leading to strand breaks                          | 6-12  | Renal, hepatic  | 10      |
| Mitoxantrone                                      | Anthraquinone             | IV     | NS | Intercalates into DNA; induces topoisomerase II-mediated damage                               | 25-50 | Hepatic > renal | > 25-50 |
| VP-16 (etoposide)                                 | Epipodophyllotoxin        | IV, PO | S  | Forms complex with DNA and topoisomerase II, leading to strand breaks (G <sub>2</sub> -phase) | 6-12  | Renal > hepatic | 10-30   |
| Amsacrine (m-AMSA)                                | Acridine derivative       | IV     | NS | Intercalates into DNA, produces strand breaks (G <sub>2</sub> -phase)                         | 7-8   | Hepatic > renal | > 30-50 |
| 5-Azacytidine                                     | Pyrimidine analog         | IV, SC | S  | Phosphorylated form incorporates into RNA and DNA   | 3-6   | Renal           | 10-20   |

|                                      |                 |    |    |   |                                |                |       |
|--------------------------------------|-----------------|----|----|---|--------------------------------|----------------|-------|
| Carboplatinum                        | Platinum analog | IV | NS | Covalent binding to DNA   | 2–6                            | Renal          | 20–28 |
| Fludarabine, cladribine, pentostatin | Purine analogs  | IV | NS | Inhibit DNA polymerase, incorporation into DNA and RNA, nicotinamide adenine dinucleotide depletion | Biphasic: a <30 min; β 6–20 hr | Hepatic, renal | 5–25  |

ara-CTP, active form of cytosine arabinoside; NS, nonspecific; S, specific.

The antileukemic effect of cytarabine depends on dosage and schedule. Cytarabine is effective at both high and standard dosages. HiDAC (3 g/m<sup>2</sup> every 12 hours for 4 to 12 doses), usually in conjunction with an anthracycline, etoposide, mitoxantrone, or L-asparaginase, is particularly effective as intensification therapy or as therapy for relapsed disease ([504](#), [505](#), [506](#), [507](#), [508](#), [509](#) and [510](#)). HiDAC can cross the blood-brain barrier and help prevent CNS leukemia; however, cerebellar toxicity may develop, particularly in patients 50 years of age or older. Lengthening the time of administration from 1 hour to 3 hours or decreasing the dose from 3.0 g/m<sup>2</sup> to 1.5 g/m<sup>2</sup> may lessen the risk of cerebellar toxicity and is common practice in patients older than 50 years of age. Conjunctivitis and a painful, blistering erythematous rash involving the palms and soles are common side effects after HiDAC. Low-dose cytarabine (10 to 20 mg/m<sup>2</sup> every 12 to 24 hours) occasionally is effective in AML and myelodysplastic syndromes ([511](#), [512](#), [513](#) and [514](#)). The mechanism of low-dose cytarabine was thought to involve promotion of myeloid differentiation ([515](#)); however, it usually results in a period of aplasia similar to that produced by conventional and high-dose regimens and is now rarely used.

The anthracyclines used to treat AML are idarubicin, daunorubicin, and doxorubicin ([516](#)). Idarubicin may be the preferred anthracycline in AML, based on randomized studies that generally indicate a better response and survival than with daunorubicin ([517](#), [518](#), [519](#), [520](#) and [521](#)). New anthracyclines, including rubidazole and epidoxorubicin, are probably equivalent to the older compounds, although aclarubicin has been effective in patients whose leukemia was resistant to conventional anthracyclines. Amsacrine and mitoxantrone are efficacious agents that are nearly equivalent to the anthracyclines; mitoxantrone causes less alopecia, less gastrointestinal toxicity, and, possibly, less cardiac toxicity than the anthracyclines ([522](#), [523](#), [524](#), [525](#) and [526](#)).

After early reports indicated efficacy in AMoL of infancy, the role of epipodophyllotoxins in the therapy of AML has expanded. In 1984, Odom and Gordon reported sustained clinical remission in four of five infants treated with epipodophyllotoxins ([527](#)). Subsequently, etoposide more than teniposide has been used in combination chemotherapy for patients of all ages ([528](#), [529](#), [530](#), [531](#), [532](#) and [533](#)). As with other agents,

response depends on dosage and schedule of administration and the interaction with other agents, all of which continue to be investigated. Although the addition of etoposide to an anthracycline and cytarabine has not consistently improved CR rates, data from the Australian Leukemia Study Group indicate improved survival ( 529 ).

The mainstays of chemotherapy in AML are cytarabine, anthracyclines, mitoxantrone, and etoposide, but new agents are under development and investigation in clinical trials ( 534 ). In addition to cytarabine, nucleoside analogs with antileukemic activity used in clinical practice include fludarabine, gemcitabine, 2-chlorodeoxyadenosine, and 2-deoxycytosine ( 535 , 536 , 537 , 538 and 539 ). Fludarabine has been given with HiDAC and G-CSF [FLAG (fludarabine, ara-C, and G-CSF)] as a salvage regimen with good efficacy and without cardiotoxicity ( 540 ). Troxacitabine is a novel agent in an L configuration, unlike the D configuration of the other nucleoside analogs. Troxacitabine undergoes phosphorylation and is a complete DNA chain terminator. Unlike cytarabine and fludarabine, troxacitabine is not dependent on nucleotide-specific membrane transporters, which can contribute to resistance. Additionally, troxacitabine does not inhibit ribonucleotide reductase, so it could be combined with new agents that do inhibit the enzyme ( 534 , 541 ). Response rates to troxacitabine in relapsed AML in phase I-II trials have been in the 13 to 18% range ( 541 ).

Topotecan is a topoisomerase I-acting drug with activity in refractory anemia with excess blasts, chronic myelomonocytic leukemia, and AML ( 542 , 543 ). Its greatest efficacy has been in conjunction with cytarabine in patients with MDS and poor prognosis cytogenetics (i.e., -5, -7) ( 544 , 545 ). Carboplatinum causes DNA intrastrand cross-links, has relatively low response rates in AML as a single agent, and has mainly been used with cytarabine-based regimens ( 546 ). Other antineoplastic agents that have been used as single agents in AML with response rates of 15% or less include corticosteroids, L-asparaginase, cyclophosphamide, vinca alkaloids, methotrexate, and tubulin-interactive agents paclitaxel and docetaxel; however, the efficacy of any of these agents may improve by synergistic interactions with other drugs ( 547 and 548 ). Homoharringtonine is a plant alkaloid that has minimal activity as a single agent in AML and MDS ( 549 ). Other anthraquinones, diaziquone and bisantrene, are less active than mitoxantrone ( 550 ).

New agents under study are directed at molecular pathogenetic mechanisms of leukemogenesis and include inhibition of DNA methylation, modulation of angiogenesis, inhibition of the ubiquitin-proteasome pathway, and inhibition of farnesyl transferase ( 534 ). DNA methylation may contribute to leukemogenesis by silencing tumor-suppressor genes ( 534 ). Cytosine analogs, such as 5-azacytidine and decitabine, and other agents, such as phenylbutyrate and depsipeptide, inhibit DNA methylation and have activity in phase I-II trials of patients with MDS and AML ( 534 , 551 , 552 , 553 and 554 ). SU5416 (semaxanib; SUGEN) is an example of a small molecule receptor tyrosine kinase inhibitor directed at the VEGF pathway; early trials with SU5416 indicate activity in AML ( 555 ). PS341 [bortezomib (Velcade), Millenium Pharmaceuticals] is a small molecule proteasome inhibitor whose antileukemia activity may involve inhibition of cell growth signaling, induction of apoptosis, and inhibition of adhesion molecule expression ( 534 , 556 ). R115777 [tipifarnib (Zarnestra), Johnson and Johnson] is a nonpeptidomimetic enzyme-specific inhibitor of farnesyl protein transferase, an enzyme that promotes RAS processing and transduction of proliferative signals ( 557 ). In a phase I trial of R115777, 34 patients with refractory and relapsed acute leukemias had a response rate of 29% ( 557 ).

## Induction Therapy

At the time of diagnosis, numerous steps should be reviewed in the evaluation and preparation of the patient ( [Table 79.8](#)). If transplantation is being considered as an option, HLA typing of patient and siblings and screening for cytomegalovirus antibodies should be performed. As with other potentially curable malignancies, patients with AML are treated with combinations of effective agents ( [558](#), [559](#) and [560](#)). The most common regimens in AML involve the use of cytarabine and an anthracycline. Other agents, including 6-thioguanine and etoposide, have been added to the combination ( [529](#), [561](#)). Ara-C usually is administered as a continuous infusion of 100 mg/m<sup>2</sup>/day for 7 days, with an anthracycline given by intravenous push on the first 3 days of therapy. This combination is called *7 and 3*, and the anthracycline and the daily dose vary among studies: daunorubicin, 45 to 60 mg/m<sup>2</sup>; doxorubicin, 25 mg/m<sup>2</sup>; or idarubicin, 12 mg/m<sup>2</sup>.

**TABLE 79.8. Management of Acute Myeloid Leukemia at Diagnosis**

---

|  |
|--|
| Patient history  |
| Review preceding myelodysplasia, prior diagnosis of cancer, previous chemotherapy, occupational exposure, family history   |
| Physical examination   |
| Assess performance status  |
| Screen for infection: dental, nasopharyngeal, lung, perirectal   |
| Search for extramedullary disease: skin examination, neurologic, adenopathy, organomegaly, testicular examination  |
| Baseline laboratory  |
| Complete blood count with differential; type and screen for crossmatch   |
| Bone marrow examination: include cytogenetics and save sample for molecular diagnostics if applicable  |
| Screen electrolyte, liver and renal function, tumor lysis parameters   |
| Screen for DIC   |
| Viral serologies, particularly HSV, cytomegalovirus, hepatitis, and human immunodeficiency virus   |
| Determine HLA-A, -B, -DR type  |
| Chest radiograph: rule out pneumonia, leukostasis, mediastinal mass  |
| Cardiac status: ejection fraction by echocardiogram or MUGA  |
| Supportive care  |
| Transfusions: platelets, packed red blood cells (unless hyperleukocytosis); fresh frozen plasma with or without cryoprecipitate in DIC   |
| Central line placement (unless severe DIC)   |
| Hydration  |
| Allopurinol or other agent to prevent lysis  |
| Treat ongoing infections   |
| Infection prophylaxis: acyclovir (if HSV positive), antifungal agents (fluconazole or voriconazole), antibacterial agents  |
| If hyperleukocytosis, hydroxyurea, leukapheresis, or both  |
| Therapy  |
| Induction chemotherapy: cytarabine and anthracycline; use etoposide or mitoxantrone instead of anthracycline if cardiac status compromised; possible role for high-dose cytarabine |

All- *trans*-retinoic acid if acute promyelocytic leukemia with anthracycline  
 Monitor for DIC and tumor lysis, infection, drug toxicities

DIC, disseminated intravascular coagulation; HSV, herpes simplex virus; MUGA, multigated acquisition scan.

When daunorubicin was the primary anthracycline used, the CR rate after one cycle was usually 40 to 50%, and a second cycle could be given to the remaining patients for an overall CR rate of 60 to 75%. In randomized trials, however, idarubicin plus ara-C had a higher CR rate than daunorubicin with ara-C, more often required only one cycle to achieve remission, and was associated with a better survival in two of the trials ( [Table 79.9](#)) ( [518](#), [519](#) and [520](#), [562](#)). *In vitro* studies have also demonstrated that idarubicin is less of a substrate for Pgp than is daunorubicin ( [563](#)). Although some investigators have questioned whether biologically equivalent doses were used in the trials, “7 and 3” ara-C with idarubicin has become the preferred induction regimen in many centers. Randomized trials show little benefit of the addition of 6-thioguanine to induction therapy ( [503](#)). Similarly, the addition of etoposide to “7 and 3” at 75 mg/m<sup>2</sup>/day for 7 days (“7 + 3 + 7”) did not improve CR rates and was associated with more mucositis; however, it did improve overall survival when compared to “7 and 3” ( [529](#)). The anthraquinone derivative mitoxantrone has been extensively used with ara-C and occasionally with etoposide as part of an effective induction regimen. Mitoxantrone has been used more often at relapse and in the elderly and reportedly has less cardiotoxicity than the anthracyclines ( [532](#), [564](#), [565](#)).

**TABLE 79.9. Clinical Trials Comparing Idarubicin with Daunorubicin during Induction**

| Source                                 | Regimen | No. of Patients | Median Age (yr) | Complete Remission Rate (%) |                  | Percent of Patients Requiring More Than One Cycle to Achieve Complete Remission | Comments   |
|--|---------|-----------------|-----------------|-----------------------------|------------------|---|--|
|  |         |                 |                 | All Patients                | Patients Age <60 |   |  |
| Berman et al. ( <a href="#">520</a> )  | IA      | 60              | 36              | 80                          | 80               | 25  | Variable consolidation; overall survival for IA arm was 19.5 mo compared to 13.5 mo in the DA arm ( $p = .025$ ).                  |
|  | DA      | 60              | 41              | 58                          | 58               | 51  |  |
| Wiernik et al. ( <a href="#">518</a> ) | IA      | 97              | 56              | 70                          | 83               | 22  | Consolidation was 5 and 2 of same drugs; some went to transplant. Survival was 12.9 mo for IA versus 8.7 mo for DA ( $p = .038$ ). |
|  | DA      | 111             | 55              | 59                          | 68               | 35  |  |



|                     |    |     |    |           |    |    |   |
|---------------------|----|-----|----|-----------|----|----|---|
| Vogler et al. (519) | IA | 105 | 60 | 71        | 79 | 23 | Median survival was not different between the two arms, but it was improved if patient received late intensification. |
|                     |    |     |    | $p = .03$ | NS | NS |   |
|                     | DA | 113 | 61 | 58        | 63 | 22 |   |

DA, daunorubicin and cytosine arabinoside; IA, idarubicin and cytosine arabinoside.

Many studies of AML have evaluated the optimal dosage and schedules of administration of ara-C during induction (503, 566). “7 and 3” has been shown to be superior to the same drugs given over 5 days and 2 days, respectively (567), and appears equivalent to “10 and 3” (568). The continuous infusion of ara-C at a dosage of 100 mg/m<sup>2</sup> has been shown to be superior to pulse doses of 100 mg/m<sup>2</sup> every 12 hours (503, 567). Increasing the ara-C dose in “7 and 3” from 100 mg/m<sup>2</sup>/day to 200 mg/m<sup>2</sup>/day and prolonging the infusion to 10 days, in combination with daunorubicin, produced fatal gastrointestinal toxicity (568, 569). The optimal dosage and schedule for cytarabine may depend on individual metabolism and measurement of drug levels and continues to be the subject of investigation (569, 570 and 571).

Although HiDAC (1 to 3 g/m<sup>2</sup> every 12 to 24 hours, up to 12 doses) has most often been given as therapy for relapsed disease or as intensification, pilot data indicated some of the highest initial CR rates (up to 90%) when HiDAC was given during induction (572); however, randomized studies have not confirmed a definite advantage of HiDAC as induction therapy when compared to “7 and 3” or “7 + 3 + 7” (Table 79.10) (573, 574). The German AML Cooperative Group reported in a randomized trial an advantage to HiDAC with mitoxantrone over standard therapy on day 21 in patients with a poor prognosis defined as 40% or more blasts on day 16, unfavorable cytogenetics, and an elevated lactate dehydrogenase (575). Because there has been longer DFS with HiDAC than with conventional ara-C in persons younger than 50 years of age, the National Comprehensive Cancer Network advocates considering HiDAC during induction therapy for young patients if they are not participating in a clinical trial (576). Another strategy is to use HiDAC after “7 and 3” on days 8 through 10 (3 + 7 + 3), again achieving a high CR rate (89%) (577). The impact of HiDAC on improving survival in AML has been considerable, but the optimal dose, schedule, and timing during therapy (i.e., induction vs. post-remission) remain unresolved issues (578, 579 and 580).

**TABLE 79.10. Clinical Trials Evaluating Role of High-Dose Cytosine Arabinoside (HiDAC) for Induction**

| Source | Regimen | No. of Patients | Median Age | CR Rate (%) | 5-Yr Disease-Free Survival (%) | Comments |
|--------|---------|-----------------|------------|-------------|--------------------------------|----------|
|--------|---------|-----------------|------------|-------------|--------------------------------|----------|

|  |           |     |    |    |        |    |          |  |
|--|-----------|-----|----|----|--------|----|----------|--|
| Australia<br>Leukemia<br>Study Group<br>( 573) | HiDAC-3-7 | 149 | 43 | 71 | 41 ± 5 | NS | p = .007 | 5-yr survival was 31% for HiDAC-3-7 versus 25% for 7-3-7 ( p = .44). Patients received two consolidations with standard doses (5 and 2-5) or bone marrow transplantation (N = 61). |
|  | 7-3-7     | 152 | 39 | 74 | 23 ± 4 |    |          |  |

| Source                                | Regimen                         | No. of Patients | Median Age | CR Rate (%) |           |          |           | 4-Yr Relapse-Free Survival  |           | Comments |
|---------------------------------------|---------------------------------|-----------------|------------|-------------|-----------|----------|-----------|---|-----------|----------|
|                                       |                                 |                 |            | Age <50     | Age 50-64 | Age <50  | Age 50-64 | Age <50   | Age 50-64 |          |
| Southwest<br>Oncology<br>Group ( 574) | HiDAC (3 g/m <sup>2</sup> )/DNM | 58              | 32         | 59          | —         | 33       | 21        | No difference in CR rate or survival. Greater toxicities occurred with HiDAC arm. |           |          |
|                                       | HiDAC (2 g/m <sup>2</sup> )/DNM | 172             | 50         | 55          | 45        | p = .049 |           |   |           |          |
|                                       | 7 and 3                         | 493             | 45         | 58          | 53        | 21       | 9         |   |           |          |

| Source                                    | Regimen | No. of Patients | Median Age | CR Rate (%) |           | 5-Yr Relapse-Free Survival |   | Comments |
|---|---------|-----------------|------------|-------------|-----------|----------------------------|---|----------|
|   |         |                 |            | Age <50     | Age 50-64 | Age <50                    | Age 50-64   |          |
| German AML<br>Cooperative<br>Group ( 575) | TAD-TAD | 360             | 44         | 65          |           | 29                         | No advantage to HAM except in poor prognosis subgroup: CR = 65% versus 49% ( p = .004), and 5-yr event-free survival = 17% versus 12% ( p = .012) |          |
|   | TAD-HAM | 365             | 44         | 71          |           | 35                         |   |          |

CR, complete remission; DNM, daunomycin; HAM, HiDAC plus mitoxantrone; TAD, thioguanine, cytosine arabinoside, daunomycin.

### Postremission (Consolidation/ Intensification) Therapy

Although additional therapy clearly is required beyond induction therapy, minor modifications of consolidation therapy with drugs at similar doses to those used in induction therapy, with or without maintenance therapy, have not had a major impact on survival in AML ( 503). With a CR rate of 60 to 75%, 15 to 25% of adults and 20 to 30% of children could be expected to have prolonged survivals after consolidation or maintenance therapy administered through 1980. Pilot studies involving the use of HiDAC at different dosages and schedules as part of postremission therapy suggested that survival in AML could be improved by dosage escalation ( Table 79.11) ( 504, 581, 582, 583, 584, 585, and 586).

One of the earliest reports was by Vaughan et al., who used ara-C and daunorubicin based on cytokinetic models. Initially, one cycle of therapy as induction without additional therapy resulted in a projected cure rate of 12%; however, with a second cycle as consolidation therapy, the projected cure rate was 44% of patients in first remission (507, 583). In a randomized trial, Preisler et al. compared a form of HiDAC as consolidation to postremission therapy with modifications of “7 and 3” that also included amsacrine (568). Although no statistically significant differences were found between the arms, the projected survival was 45% for all patients and was 65% for patients 45 years of age and younger. Additionally, unfavorable cytogenetics, low percentage of cells in S-phase, and high initial white blood cell count were associated with a prognosis that was less favorable than that for patients without these features. Wolff et al. reported the use of HiDAC/daunomycin intensification in AML with a projected 49% survival that was age dependent (83%, 50%, and 23% for age groups 25 years or younger, 26 to 45 years, and older than 45 years, respectively) (585).

**TABLE 79.11. Trials Evaluating High-Dose Cytarabine (HiDAC) in Intensification**

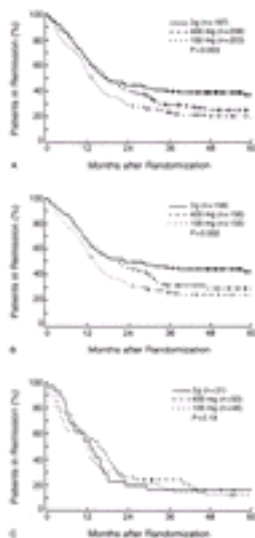
| Source                   | Remission Induction | Postremission                                       |               | CR (%) | No. of Patients in Remission | Median Age (yr) | Median Follow-Up (mo) | Median Duration of CR (mo) <sup>a</sup> | Complete Responding Patients in Continuous Remission after 24 mo (%) |
|--------------------------|---------------------|---|---------------|--------|------------------------------|-----------------|-----------------------|---|--|
|                          |                     | Regimen   | Duration (mo) |        |                              |                 |                       |   |  |
| <b>Uncontrolled</b>      |                     |   |               |        |                              |                 |                       |   |  |
| Vaughan (583)            | Ara-C, DNR, ara-C   | Ara-C, DNR, ara-C                                   | 3             | 76     | 25                           | 35              | 35                    | 30                                      | 44   |
| Preisler (568)           | 7 + 3 or 10 + 3     | Ara-C, Dox, Amsa, or HiDAC                          | 4             | 58     | 123                          | 55              | 20                    | 22                                      | 47   |
| Tricot (584)             | 10 + 3              | HiDAC, ara-C, DNR                                   | 4             | 72     | 44                           | 36              | 14                    | Not reached                             | 62   |
| Champlin (479)           | DAT                 | HiDAC, DNR; Ara-C, DNR                              | 2             | 63     | 70                           | 47              | 55                    | 23                                      | 40   |
| Wolff (585)              | 7 + 3 or 10 + 3     | HiDAC, DNR  | 3             | 87     | 87                           | 38              | 42                    | 36                                      | 49   |
| Harousseau Z/ara-C (586) |                     | Ara-C/DNR; HiDAC/Amsa BCNU, ara-C, cyclo, etoposide | 2             | 76     | 57                           | 44              | 60                    | 43                                      | 40   |
| <b>Controlled</b>        |                     |   |               |        |                              |                 |                       |   |  |
| Cassileth (587)          |                     | HiDAC/Amsa  | 1             |        | 99                           |                 |                       | N/A                                     | 28   |
|                          | DAT                 |   |               | 68     |                              | 44              | 48                    |   | $p = .047$   |
|                          |                     | Ara-C, 6-TG   | 24            |        | 94                           |                 |                       | N/A                                     | 15   |
| Mayer (589)              | 3 + 7               | HiDAC   |               |        | 187                          | 43              |                       |   | 44   |

|                                 |   |    |     |    |    |     |                 |
|---------------------------------|---|----|-----|----|----|-----|-----------------|
| Ara-C, 400<br>mg/m <sup>2</sup> | 4 | 64 | 206 | 49 | 37 | N/A | 29              |
| Ara-C, 100<br>mg/m <sup>2</sup> |   |    | 203 | 48 |    |     | 24              |
|                                 |   |    |     |    |    |     | <i>p</i> = .002 |

Amsa, amsacrine; ara-C, cytarabine; BCNU, carmustine; cyclo, cyclophosphamide; CR, complete remission; DNR, daunorubicin; Dox, doxorubicin; N/A, not available; 6-TG, 6-thioguanine; Z, zorubicin.

<sup>a</sup> CR duration data for controlled studies presented for patients younger than 60 years of age.

Randomized trials were performed to confirm the value of HiDAC consolidation ( 587, 588 and 589 ). In an Eastern Cooperative Oncology Group trial of 143 patients in first CR after daunorubicin, cytarabine, 6-thioguanine (DAT), patients were randomized to 24 months of low-dose maintenance therapy or one course of HiDAC (3 g/m<sup>2</sup> every 12 hours for 6 days) plus amsacrine ( 587 ). Although HiDAC caused more toxic deaths, the 4-year DFS in patients younger than 60 years of age was 28%, compared to 15% for those receiving maintenance therapy ( *p* = .047). The Leukemia Group for the Swiss Society for Cancer randomized 137 patients in first CR after ara-C, daunomycin, VP-16, and AMSA to standard-dose ara-C at 100 mg/m<sup>2</sup>/day 7 or to HiDAC at 3 g/m<sup>2</sup>/day every 12 hours for 6 days and found no differences in DFS ( 588 ). The Cancer and Leukemia Group B (CALGB) randomized 596 patients in first CR after “7 and 3” to one of three different dose schedules: HiDAC at 3 g/m<sup>2</sup> over 3 hours every 12 hours on days 1, 3, and 5 (six doses); intermediate-dose ara C at 400 mg/m<sup>2</sup>/day for 5 days by continuous infusion; or lower-dose ara-C at 100 mg/m<sup>2</sup> for 5 days by continuous infusion ( 589 ). The estimated probabilities of remaining in CR at 4 years for the 47 patients younger than 61 years of age were 44%, 29%, and 24% for the three treatments, respectively ( Fig. 79.12; *p* = .002). There were no differences among the arms in patients older than 60 years of age, with a probability of 16% or less of remaining in CR.



**Figure 79.12.** The effect of different doses of cytarabine on disease-free survival for all patients (A), patients 60 years of age or younger (B), and patients older than 60 years of

age (C). Only patients who underwent randomization are included. The *p* values are for the differences among the three treatment groups. Tic marks indicate surviving patients in continuous complete remission. Median follow-up was 52 months. (From Mayer RJ, Davis RB, Schiffer CA, et al. Intensive postremission chemotherapy in adults with acute myeloid leukemia. *N Engl J Med* 1994;331:896–903.)

Thus, consolidation with HiDAC improves the DFS in first CR in young patients. Multiple cycles may be required to obtain the maximum benefit of HiDAC consolidation ( 574 , 589 ). The National Comprehensive Cancer Network recommends anthracyclines as consolidation only for APL and stratifies consolidation according to age and cytogenetic risk group ( 576 ). For patients younger than 60 years of age, the choices are HiDAC consolidation alone (four cycles using CALGB doses and schedule) or one to two cycles followed by autologous transplantation or allogeneic transplantation. For patients older than 60 years of age not participating in a clinical trial, two cycles of standard-dose ara-C plus an anthracycline are recommended ( 576 ). For elderly patients with good performance status, normal renal function, and normal or favorable cytogenetics, a modified HiDAC regimen can be considered ( 576 ).

The roles of growth factors have been evaluated throughout the therapy of AML. They are used commonly in both induction and consolidation without evidence of adverse effects in most studies, albeit also without evidence of improved treatment outcome ( *vide infra* ).

### Monoclonal Antibody Therapy

Monoclonal antibody therapy for hematologic malignancies has been under clinical trials for the past two decades. The antibodies can be unconjugated, or “naked,” or conjugated to cytotoxic agents or radioisotopes ( Chapter 74 ). In early studies in AML, unconjugated antibodies targeting CD14, CD15, and CD33 achieved low response rates (<10%) ( 477 , 590 ). Consequently, investigators turned to conjugated antibody therapy, with CD33 being the best-studied target. CD33 is present on most AML cells and is not on hematopoietic stem cells; however, its presence on normal mature hematopoietic cells contributes to significant myelosuppression.

The best-studied anti-CD33 antibody conjugate is gemtuzumab ozogamicin (CMA-676, Mylotarg), which uses a recombinant humanized anti-CD33 monoclonal antibody to deliver calicheamicin, an antibiotic that binds to the minor grooves of DNA, causing double-strand breaks and apoptosis ( 591 ). In a phase I dose escalation trial, complete disappearance of blasts was observed in 8 of 40 patients, and gemtuzumab ozogamicin was reasonably well tolerated at the highest doses of 9 mg/m<sup>2</sup> ( 371 ). In three subsequent phase II trials, two doses of 9 mg/m<sup>2</sup> were given over 4 hours 14 days apart to 142 patients with CD33<sup>+</sup> AML in untreated first relapse ( 592 , 593 ). The overall response rate was 30% and included patients with CR and CR without full platelet recovery. There was no difference in response rates based on age (<60 years of age vs. =60 years of age) or length of first remission (<1 year vs. =1 year). Overall survival was 31% at one year with a median survival of 5.9 months ( 592 ). An infusion-related syndrome (chills, fever, rigors, nausea, pain, hypotension) and severe myelosuppression were common. Elevated liver functions [hyperbilirubinemia (23%) and transaminases (18%)] were usually transient ( 592 ).

Gemtuzumab ozogamicin was approved on May 17, 2000, by the United States Food and Drug Administration under the accelerated approval regulations. Postmarketing reports of

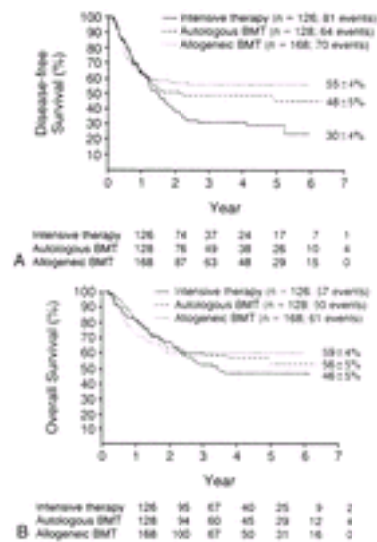
fatal anaphylaxis, tumor lysis, adult respiratory distress syndromes, and hepatic venoocclusive disease have required labeling revisions and the initiation of a surveillance program ( 593 ). Tumor lysis and adult respiratory distress syndrome were primarily observed in patients with leukocytes above 30,000/ml, so the present recommendation is to reduce the counts to below 30,000 before starting gemtuzumab ozogamicin. Venooclusive disease has been observed after SCT as well as without SCT ( 593 , 594 ).

Radioimmunotherapy has been investigated in AML, usually in the setting of SCT. CD33, CD45, and CD66 have been the main target antigens investigated, and the radioisotopes conjugated to antibodies directed at these antigens have included  $^{213}\text{Bi}$ ,  $^{131}\text{I}$ ,  $^{90}\text{Y}$ , and  $^{88}\text{Re}$  ( 595 , 596 , 597 , 598 and 599 ). Radioimmunotherapy offers the advantages of delivering larger doses of radiation to the marrow and less to normal tissues, in relation to standard total body irradiation (TBI) preparative regimens. Increasing the dose of TBI from 12.0 to 15.75 Gy reduced the risk of posttransplant relapse but was associated with increased organ toxicity and regimen-related mortality ( 600 ). A phase I trial using  $^{131}\text{I}$  anti-CD45 (BC8) antibody with cyclophosphamide plus 12 Gy TBI in relapsed acute leukemia patients resulted in delivering approximately 20 Gy to the marrow and a projected 30% long-term survival ( 597 ). A phase II trial of  $^{131}\text{I}$ -BC8 combined with busulfan and cyclophosphamide as the preparative regimen in patients with AML in first CR has a projected 70% DFS and a relapse rate of only 15% ( 598 ).

## STEM CELL TRANSPLANTATION

Although results of studies using chemotherapy alone demonstrate a gradual improvement in survival, alloSCT continues to be the best antileukemia therapy based on the lowest relapse rates ( Fig. 79.13 ) ( 496 , 601 , 602 ). Primary problems with alloSCT are lack of suitable donors and a high early mortality caused by organ toxicity, infections, and graft-versus-host disease ( Chapter 25 ). The donor pool is expanding with the increased availability of unrelated donors and umbilical cord transplants ( 603 , 604 and 605 ). Trends indicate a decrease in early mortality and an associated increase in leukemia-free survival in allogeneic transplantation, probably because of patient selection, timing of transplant, use of peripheral blood stem cells, and improved supportive care ( 606 ). Along with improvements and increased use of allogeneic transplants, there has been an increase in the use of autologous transplants ( 607 , 608 , 609 , 610 and 611 ). In a randomized trial comparing autologous bone marrow transplantation to no further therapy after four cycles of chemotherapy, the autologous bone marrow transplantation had better DFS at 7 years (53% vs. 40%;  $p = .04$ ) ( 612 ). Autologous transplantation is associated with a lower mortality than allogeneic transplantation, but it is associated with higher relapse rates. The role of purging remains controversial. Other controversies in transplantation for AML include the optimal preparative regimen, the best prophylaxis for graft-versus-host disease, and the role of T-cell depletion in allografts.





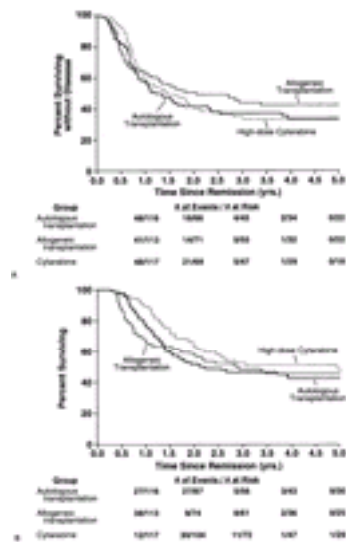
**Figure 79.13.** Impact of different postremission therapies on survival. **A:** Disease-free survival (DFS): Allogeneic bone marrow transplantation (BMT) has the best DFS, whereas randomization between autologous BMT and chemotherapy favored autologous BMT ( $p = .05$ ). **B:** Overall survival (OS): There were no differences in OS among the three treatment groups. The number of patients at risk is shown below each time point. (From Zittoun RA, Mandelli F, Willemze R, et al. Autologous or allogeneic bone marrow transplantation compared with intensive chemotherapy in acute myelogenous leukemia. *N Engl J Med* 1995;332:217–223, with permission.)

Patient selection and timing of transplantation determine the expected results. In most trials, DFS is 45 to 65% in patients in first CR undergoing alloSCT from an HLA-matched family donor ( 601 , 613 , 614 ). For patients in early relapse or second CR, the DFS rate is 20 to 35%, and for patients with refractory or advanced AML the rate is 5 to 15% ( 601 , 615 , 616 ). Patients who are unsuccessful with induction and proceed to allogeneic transplantation can have prolonged DFS of 21 to 43% ( 617 , 618 ). For autografts in first CR, the DFS is 34 to 57% with unpurged transplants and 40 to 76% with purged transplants ( 610 , 611 and 612 ). For patients in second or third CR, the results of autografts are usually in the 20 to 40% range ( 610 , 611 , 619 , 620 ). The optimal timing and type of transplant remain unresolved issues. Choices should be determined by prognostic factors and by the availability of clinical trials comparing efficacy. Unfavorable cytogenetics, preceding MDS, FAB M5–7 disease, and high white count at diagnosis have been suggested as adverse factors favoring early allogeneic transplantation; however, these factors confer a worse prognosis with transplantation as well as with chemotherapy ( 621 ).

Prospective trials have attempted to answer the question of the optimal therapy in AML ( [Table 79.12](#) ) ( 496 , 601 , 622 , 623 , 624 , 625 , 626 , 627 , 628 , 629 , 630 , 631 and 632 ). Although the studies tend to favor transplantation over chemotherapy and allografting slightly over autografting, they do not account for inherent selection biases for transplantation and usually do not reflect the use of the more intensive chemotherapy regimens now available ( [Fig. 79.14](#) ). There has been a concern that time delay favored transplant arms, because patients were censored if they relapsed before going to transplant. Compliance and differences among protocol designs have further confounded interpretation of results ( 625 ). In four major prospective trials (2687 patients in first CR), only 71% of eligible patients received allogeneic transplants, and only 47% of the remainder were randomized; 66% received their assigned autograft, and 93% received chemotherapy ( 625 ). To overcome some of the problems, an intent to treat analysis comparing survival between donor versus no donor has been performed in many of the trials. Although the results vary, the



risk of relapse is less and the DFS is better with transplantation, but the overall survival has not consistently been better for any one modality due to improved responses with chemotherapy, the procedural mortality associated with transplantation, and the ability to salvage patients relapsing after chemotherapy.



**Figure 79.14. A:** Disease-free survival according to postre-mission therapy was not statistically significant at 4 years: autologous bone marrow transplantation (autoBMT),  $35 \pm 9\%$ ; allogeneic bone marrow transplantation (alloBMT),  $43 \pm 10\%$ , high-dose cytarabine,  $35 \pm 9\%$ . **B:** Overall survival at 4 years was better for high-dose cytarabine,  $52 \pm 9\%$ , than for either alloBMT,  $46 \pm 10\%$  ( $p = .04$ ), or autoBMT,  $43 \pm 9\%$  ( $p = .05$ ). (From Cassileth PA, Harrington DP, Appelbaum FR, et al. Chemotherapy compared with autologous or allogeneic bone marrow transplantation in the management of acute myeloid leukemia in first remission. *N Engl J Med* 1998;339: 1649-1656.)

**TABLE 79.12. Trials Comparing Allogeneic Bone Marrow Transplantation (BMT) to Chemotherapy, Autologous BMT, or Both**

| Site; First Author (Reference)    | Modality | No. Patients | DFS (%) | $p$   | OS (%) | $p$ | Relapse Rate (%) | $p$    | Comments   |
|-----------------------------------|----------|--------------|---------|-------|--------|-----|------------------|--------|--|
| Seattle (FHCRRC); Appelbaum (622) | Allo     | 33           | 48      | .03   |        |     |                  |        | Higher early mortality with allo ( $p = .002$ ); no differences in survival on an intent to treat analysis |
|                                   | Chemo    | 43           | 21      |       |        |     |                  |        |  |
| MD Anderson; Zander (627)         | Allo     | 11           |         |       | 36     | NS  | 9                | <.01   | Marked decrease in relapse with allo but no difference in survival   |
|                                   | Chemo    | 27           |         |       | 15     |     | 85               |        |  |
| France; Reiffers (631)            | Allo     | 20           | 66      |       |        |     | 18               | <.0002 | Significant decrease in relapse as well as improved DFS in allo  |
|                                   | Auto     | 12           | 41      | <.004 |        |     | 50               |        |  |
|                                   | Chemo    | 20           | 16      |       |        |     | 83               |        |  |

|  |       |     |    |      |       |     |       |       |   |
|--|-------|-----|----|------|-------|-----|-------|-------|---|
| Netherlands;<br>Löwenberg ( <a href="#">628</a> )  | Allo  | 23  | 51 | NS   | 66    | .05 | 34    | .03   | Relapse rate ( $p = .03$ ) and OS ( $p = .05$ ) favored allo  |
|  | Auto  | 32  | 35 |      | 37    |     | 60    |       |   |
| UCLA; Schiller ( <a href="#">629</a> )   | Allo  | 28  | 45 | NS   | 45    | NS  | 32    | .05   | Lower relapse ( $p = .05$ ) but higher early mortality (32% vs. 6%; $p = .002$ ) with allo                                    |
|  | Chemo | 54  | 38 |      | 53    |     | 60    |       |   |
| UK MRC AML 10; Burnett ( <a href="#">612</a> , <a href="#">624</a> , <a href="#">625</a> ) | Allo  | 257 | 50 |      | 53    |     | 33    |       | Only 60% underwent BMT; comparisons are made on an intent to treat analysis; allo benefited only standard risk                |
|  | Auto  | 200 | 50 | <.05 | 52    | NS  | 35    | <.001 |   |
|  | Chemo | 661 | 40 |      | 46/53 |     | 51/53 |       |   |
| GOELAM; Harousseau ( <a href="#">626</a> )   | Allo  | 73  | 50 |      | 55    |     | 37    |       | No differences in survival on a donor versus no donor analysis  |
|  | Auto  | 75  | 48 | NS   | 52    | NS  | 45    | NR    |   |
|  | Chemo | 71  | 42 |      | 58    |     | 55    |       |   |
| EORTC/GIMEMA; Zittoun ( <a href="#">496</a> )  | Allo  | 168 | 55 |      | 59    |     | 27    |       | DFS favored either type transplant over chemo; OS was not different because of ability to salvage relapses after chemotherapy |
|  | Auto  | 128 | 48 | .05  | 56    | NS  | 41    | NR    |   |
|  | Chemo | 126 | 30 |      | 46    |     | 57    |       |   |
| US Intergroup; Cassileth ( <a href="#">632</a> )   | Allo  | 113 | 43 |      | 46    | .04 | 29    |       | OS favored chemotherapy (52%) over both auto (43%, $p = .05$ ) and alloBMT (46%, $p = .04$ ); allo benefited only poor risk   |
|  | Auto  | 116 | 35 | NS   | 43    | .05 | 48    | NR    |   |
|  | Chemo | 117 | 35 |      | 52    |     | 62    |       |   |

allo, allogeneic bone marrow transplantation; auto, autologous bone marrow transplantation; chemo, chemotherapy; DFS, disease-free survival; EORTC, European Organization for Research and Treatment of Cancer; FHCR. Fred Hutchinson Cancer Research Center; GIMEMA, Gruppo Italiano Malattie Ematologiche dell' Adulto; GOELAM, Groupe Ouest Est Leucemies Aigues Myeloblastiques; NR, not reported; NS, not significant; OS, overall survival; UCLA, University of California, Los Angeles; UK MRC, United Kingdom Medical Research Council.

Deciding if a patient in first CR should be transplanted outside a clinical trial remains a controversial issue. Patients with APL are not allografted due to the success of chemotherapy with ATRA in first CR and of autologous transplantation in a second molecular CR. Because of improved DFS after HiDAC intensification in patients with the other good-risk karyotypes [t(8;21) and inv16], allogeneic transplantation is usually

recommended only if the patient relapses ( 625 ). The latter recommendation remains controversial in children because a randomized trial favored allogeneic transplant over chemotherapy in all risk groups; chemotherapy had equivalent survival to autografting in first CR ( 630 ). A more difficult decision is the use of alternative donors for patients in first CR, whose prognosis is considered so poor that the high mortality associated with an unrelated donor transplant is an acceptable risk. Poor-risk cytogenetics or FLT-3 mutations in patients with normal cytogenetics are factors that could influence the decision to proceed with an early high-risk transplant.

Despite the above reservations regarding transplantation and the trend to risk-stratify therapy according to cytogenetic risk groups, alloSCT remains the best antileukemia therapy. Additionally, overall survival after allografts is gradually improving because of a slight decrease in early mortality, the use of peripheral blood stem cells in preference to marrow, and the availability of donor lymphocyte infusions or second transplants for relapsed patients ( 633 ). The development of nonablative SCT is expanding the upper age limits of allogeneic transplants and lessens the early mortality ( 634 , 635 ). Strategies to decrease the incidence of relapse after autologous transplants include immunotherapy, positive stem cell selection, and methods to develop autologous graft versus leukemia ( 636 ).

## SPECIAL ISSUES

### Relapsed and Refractory Acute Myeloid Leukemia

Between 40 and 80% of patients with AML relapse, and 10 to 20% of patients have refractory AML (i.e., never obtain a CR) ( 637 , 638 and 639 ). Patients with therapy-related AML may have transient responses to chemotherapy, but because almost all relapse, they should be considered for transplantation early in the course of their disease ( 640 , 641 , 642 , 643 , 644 and 645 ). Highly resistant AML includes not only refractory AML but also leukemia that relapses within 6 months after attainment of CR and leukemia that fails to go into a second remission ( 646 ). Allogeneic SCT is superior to chemotherapy for the patient with relapsed or refractory disease, but many patients either do not have a donor or are too old for transplantation ( 647 ). Autologous SCT is also an alternative for patients in second remission, but it is probably inferior to allografting.

Second remissions can be obtained in 30 to 50% of patients who had an initial first remission, are achieved more readily in patients with initial remissions longer than 1 year, and are generally shorter in duration than first remissions ( 648 , 649 and 650 ). Dose escalation and use of non-cross-resistant regimens have been helpful in inducing second remissions ( 651 ). Single agents have been used in phase I and II studies in patients after relapse but probably are inferior to combination regimens. HiDAC alone resulted in a CR rate of 40% compared to 56% in patients receiving the combination of an anthracycline and HiDAC ( 652 ). Other agents including L-asparaginase, amsacrine, mitoxantrone, etoposide, and fludarabine have been used in combination with HiDAC, with CR rates between 40 to 70% ( 653 , 654 , 655 and 656 ).

Despite the ability to induce a second remission with chemotherapy, most patients cannot be cured with chemotherapy because of drug resistance ( 657 , 658 ). Mechanisms of drug resistance include altered metabolism of drugs because of changes in enzymes ( 659 , 660 ) and enhanced expression of MDR genes ( 447 , 448 , 449 , 450 , 451 , 452 and 453 ). Levels of topoisomerase II may correlate with drug efficacy, as suggested by the presence of lower

levels in doxorubicin-resistant P-833 leukemia cells compared to the sensitive parental lines ( [660](#) ). The best described MDR gene is MDR-1; its gene product, p-glycoprotein, is a 170-kd membrane glycoprotein that functions as a drug efflux pump ( [447](#) , [448](#) , [449](#) and [450](#) ). Elevated levels of mRNA encoded by the MDR-1 gene are found in 13 to 71% of untreated patients with AML and in 50 to 85% of patients with secondary AML and after relapse, and they appear to correlate with prognosis ( [447](#) , [449](#) , [661](#) ).

Reversal of drug resistance may be accomplished through the use of calcium channel antagonists such as verapamil or the immunosuppressive agent cyclosporine. The mechanism does not depend on intracellular calcium content or immunosuppression; rather, the drugs appear to compete with chemotherapy agents for binding sites on p-glycoprotein. Additionally, cyclosporine and PSC-833, a more potent and selective analog, can increase levels of chemotherapy metabolites by altering the hepatobiliary elimination of bilirubin and the chemotherapy drugs. A randomized trial comparing cyclosporine with chemotherapy versus chemotherapy alone in poor-risk AML favored the cyclosporine arm ( [662](#) ); however, trials evaluating PSC-833 have been disappointing ( [663](#) , [664](#) ). Other proteins are also associated with drug resistance, including the 110-kd major vault protein called the LRP, which may alter intracellular drug distribution; its expression has also been associated with a poor prognosis ( [451](#) , [665](#) ).

### Acute Myeloid Leukemia in the Elderly

Older patients with AML, usually defined as those 60 years of age or older, have a worse outcome than younger patients ( [666](#) , [667](#) ). Reasons for the poorer prognosis in older patients include differences in biology, cytogenetics, comorbid illnesses, and drug resistance ( [666](#) , [667](#) ). The biology of AML may differ in older patients, with the malignant cell originating at an earlier stage of development than in younger patients ( [187](#) ). Prior MDS and treatment-related leukemia are more common ( [666](#) ). Unfavorable cytogenetic abnormalities are more common in the elderly, whereas the favorable core-binding factor abnormalities are less common ( [666](#) ). Drug resistance, as defined by an increased expression of the MDR-1 gene or lower CR rate, is more commonly found in elderly patients ( [447](#) , [448](#) and [449](#) ). In addition, older patients are more likely to have defects in the MSH2 protein, which is involved in DNA repair and is associated with microsatellite instability and p53 mutations ( [668](#) ).

Although the overall prognosis in AML patients older than 60 years of age is poor, CR rates approaching those of younger patients can be observed, so chemotherapy should not be withheld on the basis of age alone ( [666](#) , [667](#) , [669](#) ). Still, because of a high treatment-related mortality in the elderly (15 to 30%) and poor long-term DFS (5 to 15%), it is important to emphasize the poor prognosis and to give consideration to supportive care alone ( [667](#) ). CR rates in the elderly are usually in the 35 to 60% range, but median remission duration is less than 1 year regardless of the type of consolidation ( [666](#) , [667](#) ). With aging, vital organs may be compromised, requiring modifications in the agents used to treat AML. For example, a decrease in anthracycline dose has been advocated to reduce gastrointestinal and cardiac toxicity, but excessive dose reductions may compromise remission rates ( [669](#) ).

Early studies comparing low-dose chemotherapy or a watchful waiting approach to standard induction therapy in the elderly indicated a marginal benefit to standard therapy but with a high treatment-related mortality ( [670](#) , [671](#) ). Mitoxantrone plus etoposide has been advocated for use in the elderly; however, a randomized trial comparing this

combination to cytarabine plus daunorubicin showed no improvement ( [672](#)). Intermediate to HiDAC has also not improved the survival of elderly patients with AML ( [589](#), [673](#)). The use of growth factors may lessen the toxicity of therapy in the elderly, but their impact on survival has not been proven ( [666](#)). Gemtuzumab ozogamicin (Mylotarg) has been used primarily in the setting of relapse ( [592](#), [593](#) and [594](#)). Autologous transplantation is of uncertain benefit in the elderly, and allogeneic transplantation is usually considered too toxic, although studies are evaluating nonablative transplantation in the elderly ( [634](#)). The main strategies to improve survival of older AML patients are to improve tolerability without losing efficacy and to overcome drug resistance ( [667](#)).

### Acute Myeloid Leukemia in Pregnancy

Development of AML during pregnancy is rare, occurring in less than 1 in 75,000 pregnancies. Nonetheless, it is a major issue ( [674](#), [675](#), [676](#), [677](#) and [678](#)). Transmission of leukemia from mother to fetus is extremely unusual ( [679](#), [680](#)). Diagnosis of AML is less common in the first trimester than in the second or third trimesters, occurring in 14% in a series of 59 patients ( [677](#)). Teratogenic effects of chemotherapy are more common in the first trimester and appear to be minimal in the second or third trimester ( [678](#), [681](#)). Some authorities advocate therapeutic abortion in the first trimester, and others suggest supportive therapy until the second trimester. Chemotherapy with intensive supportive care can result in a successful outcome for the fetus and mother with leukemia, particularly in the second or third trimester ( [676](#), [678](#)). Fetuses exposed to antileukemia therapy *in utero* may have slight fetal growth restriction and transient myelosuppression if treatment is given near delivery but generally have normal growth and development in childhood ( [682](#), [683](#)).

### Hypocellular Acute Myeloid Leukemia

Hypocellular AML occurs in 5 to 10% of patients with AML and is defined by a decreased percentage of hematopoietic elements in the marrow biopsy; the definition of hypocellularity varies between 5 and 40% cellularity ( [684](#)). Hypocellular AML typically is seen in patients 50 years of age or older and should be distinguished from myelodysplastic syndromes and aplastic anemia. Although results of some studies suggest that supportive care alone can result in prolonged survival, Howe et al. demonstrated a CR rate of 73% in a series of 29 patients with hypocellular AML ( [685](#)). Although hypocellularity alone should not exclude a patient from receiving chemotherapy, caution should be exercised in treating these patients, and transplantation strategies should be considered.

### Growth Factors and Biologic Response Modifiers

A variety of purified monokines and lymphokines, including colony-stimulating factors (CSFs), ILs, interferons, and TNFs, have been investigated as modifiers of cytopenias and of leukemia growth *in vitro* and *in vivo* ( [686](#), [687](#)). The best studied are the myeloid growth factors GM-CSF and G-CSF. There have been differences in manufacturing the myeloid growth factors; there are glycosylated yeast-derived GM-CSF (sargramostim), nonglycosylated *Escherichia coli*-derived GM-CSF (molgrastim), glycosylated Chinese hamster ovary-derived G-CSF (lenograstim), and nonglycosylated *E. coli*-derived G-CSF (filgrastim). Use of the myeloid growth factors in AML was questioned due to *in vitro* data demonstrating increased growth of leukemia blasts in their presence. This effect on leukemia cells was used to attempt to recruit cells into S-phase, in which they would be more chemosensitive to S-phase-specific agents such as cytarabine. Other possible

beneficial effects of cytokines on leukemia cells include enhancement of chemotherapy-induced apoptosis, increase in topoisomerase II levels, and down-regulation of MDR-1 ( 687 ).

Despite the concerns about the effect of the CSFs on leukemia cell growth, studies were initiated in the 1990s to determine their efficacy. Two of the early reports were by Ohno et al. and Büchner et al., evaluating *E. coli*-derived G-CSF in patients with relapsed or refractory leukemia and yeast-derived GM-CSF in elderly patients with *de novo* AML, respectively. Both reports indicated the CSFs could be administered safely, with a statistically significant reduction in the duration of neutropenia and in early deaths, and trends toward an improvement in the CR rate, but not in survival ( 688 , 689 ). Subsequently, there have been numerous phase III trials ( Table 79.13 ) ( 690 , 691 , 692 , 693 , 694 , 695 , 696 , 697 and 698 ). These studies are difficult to compare because of variable patient populations, different induction and consolidation therapies, different growth factors and timing of their use, and variable documentation of marrow hypoplasia ( 687 ). For the most part, the studies consistently show improved neutrophil recovery, which usually results in fewer infections and shorter hospitalizations, but they rarely show improved CR rates, relapse rates, or survival.

**TABLE 79.13. Phase III Trials of Colony-Stimulating Factors in Patients with *De Novo* Acute Myeloid Leukemia**

| Author (Reference) | Product               | No. of Patients | Age (yr) | Recruitment into Cell Cycle | Leukemia Stimulation | Neutrophil Recovery | Complete Remission | Survival |
|--------------------|-----------------------|-----------------|----------|-----------------------------|----------------------|---------------------|--------------------|----------|
| Stone ( 690 )      | <i>E. coli</i> GM-CSF | 388             | =60      | Day 8                       | -                    | +                   | -                  | -        |
| Witz ( 691 )       | <i>E. coli</i> GM-CSF | 226             | 55-75    | Yes                         | -                    | +                   | -                  | -        |
| Zittoun ( 692 )    | <i>E. coli</i> GM-CSF | 102             | 15-60    | Variable                    | +                    | -                   | ?                  | -        |
| Lowenberg ( 693 )  | <i>E. coli</i> GM-CSF | 316             | >60      | Yes                         | -                    | +                   | -                  | -        |
| Rowe ( 694 )       | Yeast GM-CSF          | 117             | 55-70    | No                          | -                    | +                   | -                  | ?        |
| Büchner ( 695 )    | Yeast GM-CSF          | 96              | 16-75    | Yes                         | -                    | +                   | -                  | -        |
| Dombret ( 696 )    | G-CSF                 | 173             | =65      | Day 8                       | -                    | +                   | ?                  | -        |
| Heil ( 697 )       | G-CSF                 | 521             | Adults   | Day 8                       | -                    | +                   | -                  | -        |
| Godwin ( 698 )     | G-CSF                 | 193             | >55      | No                          | -                    | +                   | -                  | -        |

-, no significant difference; +, ?, ?, significance noted; *E. coli*, *Escherichia coli*; G-CSF, granulocyte colony-stimulating factor; GM-CSF, granulocyte-macrophage colony-stimulating factor.

Adapted from Geller RB. Use of cytokines in the treatment of acute myelocytic leukemia: a critical review. *J Clin Oncol* 1996;14:1371-1382.

For now, the CSFs are generally regarded as safe and useful primarily as supportive care



to decrease infections ( [687](#) ). Their use after chemotherapy during induction may make marrow examinations more difficult to interpret because of difficulty in distinguishing early recovery of myeloid cells from leukemia blasts. Some advocate using growth factors in induction only after aplasia has been documented or as part of a clinical trial. Their role in consolidation has not been studied as extensively as in induction.

Growth factors to stimulate platelet production have not been as successful as those for myelopoiesis and erythropoiesis. IL-2 was cloned in 1990; despite its nonspecific and modest effect on megakaryocytes, it can reduce platelet transfusion requirements in approximately one-third of patients undergoing standard chemotherapy ( [699](#) , [700](#) ). IL-2 is associated with mild peripheral edema, dyspnea, injected conjunctiva, and a low incidence of syncope and atrial arrhythmias, and it is not routinely used in therapy for acute leukemia.

TPO, the c-mpl ligand, is the specific regulator of megakaryocyte development and platelet production and was purified in 1994 ( [699](#) , [700](#) ). Two forms of TPO, recombinant human TPO and pegylated recombinant human megakaryocyte growth and development factor, have undergone clinical investigation. Although both stimulate megakaryocytes and platelet production and have improved platelet recovery after moderate intensity chemotherapy, they have demonstrated little benefit in improving the severe thrombocytopenia associated with induction and consolidation chemotherapy of AML ( [700](#) ).

Whereas the above cytokines appear to have a supportive role in lessening the duration of cytopenias, other cytokines are being evaluated for their antileukemia effects. Phase I-II clinical trials of IL-2 in patients with relapsed AML identified responses, particularly in those with low percentages of blasts ( [701](#) , [702](#) ), and ongoing trials are evaluating its use in eradicating minimal residual disease after chemotherapy or transplantation ( [703](#) , [704](#) and [705](#) ). Cytokines are being used to modify leukemia cells into efficient antigen-presenting cells to stimulate an antileukemic immune response ( [706](#) , [707](#) ). Although different cocktails of cytokines have been used, GM-CSF and IL-4 in combination with an immunomodulator (soluble CD40L) or TNF- $\alpha$  converted AML cells into dendritic cells that could stimulate a T-cell immune response ( [707](#) ).

Leukemia cells release proangiogenic cytokines as well as proinflammatory cytokines, including IL-1, TNF, and basic fibroblast growth factor ( [708](#) ). Angiogenic factors include direct and indirect angiogens and integrins ( [709](#) ). Indirect angiogens promote vascular formation by paracrine stimulation of direct angiogens, whereas integrins interact between new blood vessels and the extracellular matrix ( [709](#) ).

VEGF is a direct angiogen that can be released by leukemia cells and promote vasculogenesis by binding to one of three receptors (VEGFR-1, -2, or -3) ( [709](#) ). Endothelial cells produce VEGF-C in response to proinflammatory cytokines and can promote leukemogenesis by interacting with its receptor VEGFR-3 (FLT-4), which is present in one-third of AML cases ( [708](#) , [710](#) ). VEGF-C blocks chemotherapy-induced apoptosis of FLT-4+ leukemia by induction of bcl-2 with increased bcl-2 to bax ratios ( [709](#) ). Potential antileukemia therapy will be directed at blocking VEGF pathways by antibodies that neutralize VEGF or by small molecules that inhibit the receptor tyrosine kinase activity of VEGF receptors ( [709](#) ).



## Gene and Antisense Therapy

Gene-marking studies have been used in the autologous transplant setting to document that harvested autologous marrow cells contribute to stem cell recovery (711). The clinical applicability of gene therapy in leukemia is uncertain, but it offers novel therapeutic strategies (Chapter 26). Therapeutic applications under investigation include augmentation of the immune response against leukemia cells through transfection of cytokine genes, genetic modification of marrow stem cells for resistance to chemotherapy through transfection of MDR genes, and direct modifications of the leukemia cells to enhance chemosensitivity (712, 713 and 714). Current phase I trials of antisense oligonucleotides in hematologic malignancies, including AML, are aimed at abrogating the expression of tumor-suppressor genes and promoting leukemia cell death (712, 713 and 714). More than likely, gene therapy will be additive to other therapies currently in use and have its greatest impact when the tumor burden is low.

## SUMMARY AND FUTURE DIRECTIONS

Descriptions of clinicopathologic syndromes and correlations with immunophenotype, cytogenetics, and molecular genetics will continue to define subsets of AML as advocated in the WHO classification. Leukemogenesis will be best understood through the recognition of genes and their molecular interactions that promote cancer cell survival. In addition, gene expression analysis using microarrays will identify gene profiles that correlate with prognosis and promote more precise classification (715).

Therapeutically, patients will be stratified according to prognostic factors and genetic markers, and clinical trials will continue to define the roles of both chemotherapy and transplantation. Monoclonal antibody therapy is an effective new treatment currently under investigation. A better understanding of the mechanisms of tumor resistance and apoptosis is also needed to improve therapy. New agents in clinical trials are directed at molecular biologic targets involved in leukemia, including DNA methylation, angiogenesis, farnesyl transferase, and FLT-3. The detection of minimal residual disease is an ongoing area of study and can be a target for novel agents, monoclonal antibodies, and gene therapy.

## REFERENCES

1. Cheson BD, Cassileth PA, Head DR, et al. Report of the National Cancer Institute-sponsored workshop on definitions of diagnosis and response in acute myeloid leukemia. *J Clin Oncol* 1990;8:813-819.
2. Todd WM. Acute myeloid leukemia and related conditions. *Hematol Oncol Clin North Am* 2002;16:301-319.
3. Glick AD, Paniker K, Flexner JM, et al. Acute leukemia of adults: ultrastructural, cytochemical, and histologic observations in 100 cases. *Am J Clin Pathol* 1980;3:459-470.
4. Yunis JJ, Bloomfield CD, Ensrud K. All patients with acute nonlymphocytic leukemia may have a chromosomal defect. *N Engl J Med* 1981;305:135-139.
5. Henderson ES, Lister TA, Greaves MF. History of leukemia. In: Henderson ES, Lister TA, Greaves MF, eds. *Leukemia*. Philadelphia: Saunders, 2002:1-7.
6. Virchow RLK. *Wiesses Blut*. *N Notiz Geb Natur u Heilk* 1845;36:151.
7. Virchow R. *Weisses Blut und Milztumoren*. I. *Med Z* 1846;15:157; II. *Med Z* 1847;16:9.

8. Friedreich N. Ein neue Fall von Leukämie. *Virchows Arch Path Anat* 1857;12:37.
9. Neumann E. Ein Fall von Leukämie mit Erkrankung des Knochenmarkes. *Arch Heilk* 1870;11:1.
10. Mosler F. Klinische Symptome und Therapie des medullaren Leukämia. *Berliner Klin Wschr* 1876:702.
11. Naegli O. Ueber rotes Knochenmark und Myeloblasten. *Dtsch Med Wochenschr* 1900;26:287.
12. Ehrlich P, Lazarus P, Pinkus F. *Leukemia, Pseudoleukemia, Haemoglobinemia*. Vienna: 1901.
13. Reschad H, Schilling-Torgau V. Ueber eine neue Leukämie durch echte Uebergangsformen (Splenozyten-Leukämie) und ihre Bedeutung für die Selbständigkeit dieser Zellen. *Munch Med Wochenschr* 1913;60:1981.
14. DiGuglielmo G. Ricerche di hematologia: I. una casa di eritroleucemia. *Folia Med* 1917;13:386.
15. Von Boros J, Karenyi A. Über einem Fall von akuter Megakaryoblastenleukämie, zugleich einige Bemerkungen zum Problem der akuten Leukämie. *Z Klin Med* 1931;118:697.
16. Hilstad LK. Acute promyelocytic leukemia. *Acta Med Scand* 1947;159:189.
17. Bennett JM, Catovsky D, Daniel MT, et al. Proposals for the classification of the acute leukemias. *Br J Haematol* 1976;33:451-458.
18. Lee EJ, Pollak A, Leavitt RD, et al. Minimally differentiated acute nonlymphocytic leukemia: a distinct entity. *Blood* 1987;70:1400-1406.
19. Nowell PC, Hungerford DA. A minute chromosome in human chronic granulocytic leukemia. *Science* 1960;132:1497-1500.
20. Vardiman JW, Harris NL, Brunning RD. The World Health Organization (WHO) classification of the myeloid neoplasms. *Blood* 2002;100:2292-2302.
21. Brunning RD, Vardiman J, Matutes E, et al. Acute myeloid leukemia. In: *World Health Organization classification of tumors: tumors of haematopoietic and lymphoid tissues*. Lyon: IARC Press, 2001:75-107.
22. Head DR. Proposed changes in the definitions of acute myeloid leukemia and myelodysplastic syndrome: are they helpful? *Curr Opin Oncol* 2002;14:19-23.
23. Linet MS. *The leukemias: epidemiologic aspects*. New York: Oxford University Press, 1985.
24. Sandler DP, Ross JA. Epidemiology of acute leukemia in children and adults. *Semin Oncol* 1997;24:3-16.
25. Linet MS, Devesa SS. Epidemiology of leukemia: overview and patterns of occurrence. In: *Leukemia*. Philadelphia: WB Saunders, 2002:131-151.
26. Ries LAG, Eisner MP, Kosary CL. *SEER Cancer statistics review, 1973-1999*. Bethesda, MD: National Cancer Institute, 2002.
27. Hernandez JA, Land KJ, McKenna RW. Leukemias, myeloma, and other lymphoreticular neoplasms. *Cancer* 1995;75:381-394.
28. Kinlen LJ. Leukemia. In: *Trends in cancer incidence and mortality; Cancer surveys 1994*. New York: Cold Spring Harbor Laboratory Press, 1994:475-491.
29. Schwartz CL, Cohen HJ. Preleukemic syndromes and other syndromes predisposing to leukemia. *Pediatr Clin North Am* 1988;35:853-871.
30. Taylor GM, Birch JM. The hereditary basis of human leukemia. In: *Leukemia*. Philadelphia: WB Saunders, 2002:131-151.

MF, eds. Leukemia. Philadelphia: WB Saunders, 1996:210–245.

31. Miller RW. Neoplasia and Down's syndrome. *Acad Sci* 1970;171:637–644.
32. Fong CT, Brodeur GM. Down's syndrome and leukemia: epidemiology, genetics, cytogenetics and mechanisms of leukemogenesis. *Cancer Genet Cytogenet* 1987;28:55–76.
33. Ellis N, Groden J, Ye TZ, et al. The Bloom's syndrome gene product is homologous to RecQ helicases. *Cell* 1995;83:655–666.
34. Paul B, Reid MM, Davison EV, et al. Familial myelodysplasia: progressive disease associated with emergence of monosomy 7. *Br J Haematol* 1987;65:321–323.
35. Shannon KM, Turhan AG, Chang SSY, et al. Familial bone marrow monosomy 7. Evidence that the predisposing locus is not on the long arm of chromosome 7. *J Clin Invest* 1989;84:984–989.
36. Passmore SJ, Hann IM, Stiller CA, et al. Pediatric myelodysplasia: a study of 68 children and a new prognostic scoring system. *Blood* 1980;85:1742–1750.
37. Geraedts JP, Mol A, Briet E, et al. Klinefelter syndrome: predisposition to acute non-lymphocytic leukaemia? *Lancet* 1980;1:774.
38. Wertelecki W, Shapiro JR. 45,XO Turner's syndrome and leukaemia. *Lancet* 1970;1:789–790.
39. Gutmann DH, Wood DL, Collins FS. Identification of the neurofibromatosis gene product. *Proc Natl Acad Sci U S A* 1991;88:9658–9662.
40. Bader JL, Miller RW. Neurofibromatosis and childhood leukemia. *J Pediatr* 1978;92:925–929.
41. Blatt J, Jaffe R, Deutsch M, Adkins JC. Neurofibromatosis and childhood tumors. *Cancer* 1986;57:1225–1229.
42. Jonas DM, Heilbron DC, Ablin AR. Rubinstein–Taybi syndrome and acute leukemia. *J Pediatr* 1978;92:851–852.
43. Miller RW. Childhood cancer and congenital defects. A study of U.S. death certificates during the period 1960–1966. *Pediatr Res* 1969;3:389–397.
44. Mann JR, Dodd HE, Draper GJ, et al. Congenital abnormalities in children with cancer and their relatives: results for a case-control study (IRESCC). *Br J Cancer* 1993;68:357–363.
45. Fanconi G. Familiare infantile peniziosaartige anaemie (pernizioses blutbild und konstitution). *Jahrbuch Kinderheilkunde* 1927;117:257–280.
46. Alter BP, Young NS. The bone marrow failure syndromes. In: Nathan DG, Oski FA, eds. *Hematology of infancy and childhood*. Philadelphia: WB Saunders, 1998:237–335.
47. Garriga S, Crosby WH. The incidence of leukemia in families of patients with hypoplasia of the marrow. *Blood* 1959;14:1008–1014.
48. Auerbach AD, Allen RG. Leukemia and preleukemia in Fanconi anemia patients: a review of the literature and report of the International Fanconi Anemia Registry. *Cancer Genet Cytogenet* 1991;51:1–12.
49. Shwachman H, Diamond LK, Oski FA, Khaw KT. The syndrome of pancreatic insufficiency and bone marrow dysfunction. *J Pediatr* 1964;65:645–663.
50. Dong F, Dale DC, Bonilla MA, et al. Mutations in the granulocyte colony-stimulating factor receptor gene in patients with severe congenital neutropenia. *Leukemia* 1997;11:120–125.
51. Li FP, Fraumeni JF, Jr. Soft tissue sarcomas, breast cancer, and other neoplasms: a familial syndrome. *Ann Intern Med* 1969;71:747–752.
52. Malkin D, Li FP, Strong LC, et al. Germ line p53 mutations in a familial syndrome of breast cancer,

sarcomas and other neoplasms. *Science* 1990;250:1233–1238.

53. Riccardi VM, Humbert J, Peakman D. Familial cancer, reciprocal translocation [t(7p;20p)] and trisomy 8. *Am J Hum Genet* 1997;65:933–940.
54. Markkanen A, Ruutu T, Rasi V, et al. Constitutional translocation t(3;6)(p14;p11) in a family with hematologic malignancies. *Cancer Genet Cytogenet* 1987;25:87–95.
55. Horwitz M, Goode EL, Jarvik GP. Anticipation in familial leukemia. *Am J Hum Genet* 1996;59:990–998.
56. Keith L, Brown E. Epidemiologic study of leukemia in twins (1928–1969). *Acta Genet Med Gemellol* 1971;29:9–22.
57. MacMahon B, Levy MA. Prenatal origin of childhood leukemia: evidence from twins. *N Engl J Med* 1964;270:1082.
58. Vigliani EC, Sarta G. Benzene and leukemia. *N Engl J Med* 1964;271:872–876.
59. Aksoy M. Benzene as a leukemogenic and carcinogenic agent. *Am J Indust Med* 1985;8:9–20.
60. Sullivan AK. Classification, pathogenesis, and etiology of neoplastic diseases of the hematopoietic system. In: Lee GR, Bithell TC, Foerster J, et al., eds. *Wintrobe's clinical hematology*. Philadelphia: Lea & Febiger, 1993:1725–1791.
61. Rinsky RA, Smith AB, Hornung R, et al. Benzene and leukemia. An epidemiologic risk assessment. *N Engl J Med* 1987;316:1044–1050.
62. Yin SN, Li GL, Tain FD, et al. Leukaemia in benzene workers: a retrospective cohort study. *Br J Ind Med* 1987;44:124–128.
63. Holmberg B, Lundberg P. Benzene: standards, occurrence, and exposure. *Am J Indust Med* 1985;7:375–383.
64. Hayes RB, Yin SN, Dosemeci M, et al. Benzene and the dose-related incidence of hematologic neoplasms in China. Chinese Academy of Preventive Medicine–National Cancer Institute Benzene Study Group. *J Natl Cancer Inst* 1997;89:1065–1071.
65. Brownson RC, Novotny TE, Perry MC. Cigarette smoking and adult leukemia: a meta-analysis. *Arch Intern Med* 1993;153:469–475.
66. Doll R. Cancers weakly related to smoking. *Br Med Bull* 1996;52:35–49.
67. Garfinkel L, Boffetta P. Association between smoking and leukemia in two American Cancer Society prospective studies. *Cancer* 1990;65:2356–2360.
68. Mills PK, Newell GR, Beeson WL, et al. History of cigarette smoking and risk of leukemia and myeloma: results from the Adventist health study. *J Natl Cancer Inst* 1990;82:832–836.
69. Severson RK, Davis S, Heuser L, et al. Cigarette smoking and acute nonlymphocytic leukemia. *Am J Epidemiol* 1990;132:418–422.
70. Crane MM, Strom SS, Halabi, et al. Correlation between selected environmental exposures and karyotype in acute myelocytic leukemia. *Cancer Epidemiol Biomarkers Prev* 1996;5:639–644.
71. National Academy of Science. Health effects of exposure to low levels of ionizing radiation (Beir V). Washington, DC: National Academy Press, 1990.
72. March HC. Leukemia in radiologists. *Radiology* 1944;43:275–278.
73. Folley J, Borges W, Yamawaki T. Incidence of leukemia in survivors of the atomic bomb in Hiroshima and Nagasaki, Japan. *Am J Med* 1952;13:311–321.
74. Kato H, Schull WJ. Studies of the mortality of A-bomb survivors. 7. Mortality, 1950–1978: Part I.

Cancer mortality. *Radiat Res* 1982;90:395–432.

75. Kodama K, Mabuchi K, Shigematsu I. A long-term cohort study of the atomic bomb survivors. *J Epidemiol* 1996;6[Suppl 3]:S95–105.

76. Pierce DA, Shimizu Y, Preston DL, et al. Studies of the mortality of atomic bomb survivors. report 13, part 1. *Radiat Res* 1996;146:1–27.

77. Boice JD, Jr. Radiation-induced leukemia. In: Henderson ES, Lister TA, Greaves MF, eds. *Leukemia*. Philadelphia: Saunders, 2002:152–169.

78. Caldwell GG, Kelley D, Zack M, et al. Mortality and cancer frequency among military nuclear test (SMOKY) participants. 1957 through 1979. *JAMA* 1983;250:620–624.

79. United Nations Scientific Committee on the effects of atomic radiation. Sources and effects of ionizing radiation. New York: United Nations, 1972.

80. Noshchenko AG, Zamostyan PV, Bondar OY, et al. Radiation-induced leukemia risk among those aged 0–20 at the time of the Chernobyl accident: a case-control study in the Ukraine. *Int J Cancer* 2002;99:609–618.

81. Bithell JF, Stewart AM. Pre-natal irradiation and childhood malignancy: a review of British data from the Oxford Survey. *Br J Cancer* 1975;31:271–287.

82. Smith PG, Doll R. Mortality among patients with ankylosing spondylitis after a single treatment course with X-rays. *BMJ* 1982;284:449–460.

83. Inskip PD, Kleinerman RA, Stovall M, et al. Leukemia, lymphoma, and multiple myeloma after pelvic radiotherapy for benign disease. *Radiat Res* 1993;135:108–124.

84. Ron E, Modan B, Boice JD, Jr. Mortality after radiotherapy for ringworm of the scalp. *Am J Epidemiol* 1988;127:713–725.

85. Griem ML, Kleinerman RA, Boice JD, Jr., et al. Cancer following radiotherapy for peptic ulcer. *J Natl Cancer Inst* 1994;86:842–849.

86. Boice JD, Jr., Blettner M, Kleinerman RA, et al. Radiation dose and leukemia risk in patients treated for cancer of the cervix. *J Natl Cancer Inst* 1987;79:1295–1311.

87. Curtis RE, Boice JD, Jr., Stovall M, et al. Relation of leukemia risk to radiation dose after cancer of the uterine corpus. *J Natl Cancer Inst* 1994;86:1315–1324.

88. Curtis RE, Boice JD, Jr., Stovall M, et al. Risk of leukemia after chemotherapy and radiation treatment for breast cancer. *N Engl J Med* 1992;326:1745–1751.

89. Greene MH, Young RC, Merrill JM, et al. Evidence of a treatment dose response in acute nonlymphocytic leukemias which occur after therapy of non-Hodgkin's lymphoma. *Cancer Res* 1983;43:1891–1898.

90. Kaldor JM, Day NE, Clarke EA, et al. Leukemia following Hodgkin's disease. *N Engl J Med* 1990;322:7–13.

91. Swerdlow AJ, Douglas AJ, Hudson GV, et al. Risk of second primary cancers after Hodgkin's disease by type of treatment: analysis of 2846 patients in the British national lymphoma investigation. *BMJ* 1992;304:1137–1143.

92. Hall P, Holm LE, Lundell G, et al. Cancer risks in the thyroid cancer patients. *Br J Cancer* 1991;64:159–163.

93. Berk PD, Goldberg JD, Silverstein MN, et al. Increased incidence of acute leukemia in polycythemia vera associated with chlorambucil therapy. *N Engl J Med* 1981;304:441–447.

94. Andersson M, Cartensen B, Visfeldt J. Leukemia and other related hematological disorders among

Danish patients exposed to Thorotrast. *Radiat Res* 1993;134:224–233.

95. Eatough JP, Henshaw DL. Radon and monocytic leukaemia in England. *J Epidemiol Community Health* 1991;47:506–707.

96. Muirhead CR, Butland BK, Green BM, et al. Childhood leukaemia and natural radiation. *Lancet* 1993;337:503–504.

97. Tomasek L, Darby SC, Swerdlow AJ, et al. Radon exposure and cancer other than lung cancer among uranium miners in West Bohemia. *Lancet* 1993;341:919–923.

98. Gundestrup M, Storm HH. Radiation-induced acute myeloid leukaemia and other cancers in commercial jet cockpit crew: a population-based cohort study. *Lancet* 1999;354:2029–2031.

99. Karp JE, Smith MA. The molecular pathogenesis of treatment-induced (secondary) leukemias: foundations for treatment and prevention. *Semin Oncol* 1997;24:103–113.

100. Pedersen-Bjergaard J, Philip P, Larsen SO, et al. Therapy-related and de novo acute myeloid leukemia. *Cancer Genet Cytogenet* 1991;55:19–124.

101. Thirman MJ, Larsen RA. Therapy-related myeloid leukemia. *Hematol Oncol Clin North Am* 1996;10:293–320.

102. Olney HJ, Mitelman F, Johansson B, et al. Unique balanced chromosome abnormalities in treatment-related myelodysplastic syndromes and acute myeloid leukemia: report from an international workshop. *Genes Chromosomes Cancer* 2002;33:413–423.

103. Andersen MK, Larson RA, Mauritzson N, et al. Balanced chromosome abnormalities inv(16) and t(15;17) in therapy-related myelodysplastic syndromes and acute leukemia: report from an international workshop. *Genes Chromosomes Cancer* 2002;33:395–400.

104. Bloomfield CD, Archer KJ, Mrozek K, et al. 11q23 balanced chromosome aberrations in treatment-related myelodysplastic syndromes and acute leukemia: report from an international workshop. *Genes Chromosomes Cancer* 2002;33:362–378.

105. Pedersen-Bjergaard J, Larsen SO. The incidence of acute nonlymphocytic leukemia, preleukemia, and acute myeloproliferative syndrome up to 10 years after treatment of Hodgkin's disease. *N Engl J Med* 1982;307:965–971.

106. Pedersen-Bjergaard J, Sprecht L, Larsen SO. Risk of therapy-related leukemia and preleukemia after Hodgkin's disease. Relation to age, cumulative dose of alkylating agents, and time from chemotherapy. *Lancet* 1987;2:83–88.

107. Wolden SL, Lamborn KR, Cleary SF, et al. Second cancers following pediatric Hodgkin's disease. *J Clin Oncol* 1998;16:536–544.

108. Green DM, Hyland A, Barcos MP, et al. Second malignant neoplasms after treatment for Hodgkin's disease in childhood or adolescence. *J Clin Oncol* 2000;18:1492–1499.

109. Swerdlow AJ, Barber JA, Hudson GV, et al. Risk of second malignancy after Hodgkin's disease in a collaborative British cohort: the relation to age at treatment. *J Clin Oncol* 2000;18:498–509.

110. Ng AK, Bernardo MP, Weller E, et al. Long-term survival and competing causes of death in patients with early-stage Hodgkin's disease treated at age 50 or younger. *J Clin Oncol* 2002;20:2101–2108.

111. Chaplain G, Milan C, Sgro C, et al. Increased risk of acute leukemia after adjuvant chemotherapy for breast cancer: a population-based study. *J Clin Oncol* 2000;18:2836–2842.

112. Bergsagel DE, Bailey AJ, Langley GR, et al. The chemotherapy on plasma-cell myeloma and the incidence of acute leukemia. *N Engl J Med* 1979;301:743–748.

113. Greene MH, Boice JD, Jr., Greer BE, et al. Acute nonlymphocytic leukemia after therapy with alkylating agents for ovarian cancer: a study of five randomized clinical trials. *N Engl J Med*

1982;307:1416–1421.

114. Micallef INM, Lillington DM, Apostolidis J, et al. Therapy-related myelodysplasia and secondary acute myelogenous leukemia after high-dose therapy with autologous hematopoietic progenitor-cell support for lymphoid malignancies. *J Clin Oncol* 2000;18:947–955.

115. VanLeeuwen FE, Somers R, Taal BG, et al. Increased risk of lung cancer, non-Hodgkin's lymphoma, and leukemia following Hodgkin's disease. *J Clin Oncol* 1989;7:1046–1058.

116. Henry-Amar M, Dietrich PY. Acute leukemia after the treatment of Hodgkin's disease. *Hematol Oncol Clin North Am* 1993;7:369–387.

117. Pedersen-Bjergaard J. Chemicals and leukemia. In: Henderson ES, Lister TA, Greaves MF, eds. *Leukemia*. Philadelphia: Saunders, 2002:171–199.

118. LeBeau MM, Albain KS, Larson RA, et al. Clinical and cytogenetic correlations in 63 patients with therapy-related myelodysplastic syndromes and acute nonlymphocytic leukemia: further evidence for characteristic abnormalities of chromosomes no. 5 and 7. *J Clin Oncol* 1986;4:325–345.

119. Johnson DH, Porter LL, List AF, et al. Acute nonlymphocytic leukemia after treatment of small cell lung cancer. *Am J Med* 1986;81:962–968.

120. Ratain MJ, Kaminer LS, Bitran JD, et al. Acute nonlymphocytic leukemia following etoposide and cisplatin combination chemotherapy for advanced non-small-cell carcinoma of the lung. *Blood* 1987;70:1412–1417.

121. Redman JR, Vugrin D, Arlin ZA, et al. Leukemia following treatment of germ cell tumors in men. *J Clin Oncol* 1984;2:1080–1087.

122. DeVore R, Whitlock J, Hainsworth JD, et al. Therapy-related acute nonlymphocytic leukemia with monocytic features and rearrangement of chromosome 11q. *Ann Intern Med* 1989;110:740–742.

123. Whitlock JA, Greer JP, Lukens JN. Epipodophyllotoxin-related leukemia: identification of a new subset of secondary leukemia. *Cancer* 1991;68:600–604.

124. Pedersen-Bjergaard J, Daugaard G, Hansen SW, et al. Increased risk of myelodysplasia and leukaemia after etoposide, cisplatin, and bleomycin for germ cell tumors. *Lancet* 1991;338:359–363.

125. Pui CH, Raimondi SC, Behm FG, et al. Shifts in blast cell phenotype and karyotype at relapse of childhood lymphoblastic leukemia. *N Engl J Med* 1989;68:1306–1310.

126. Pui CH, Behm FG, Raimondi SC, et al. Secondary acute myeloid leukemia in children treated for acute lymphoid leukemia. *N Engl J Med* 1989;321:136–142.

127. Weh HJ, Kabisch H, Landbeck G, et al. Translocation (9;11)(p21;q23) in a child with acute monoblastic leukemia following 2–1/2 years after successful chemotherapy for neuroblastoma. *J Clin Oncol* 1986;4:1518–1520.

128. Fenaux P, Jouet JP, Bauters F, et al. Translocation t(9;11)(p23;q23) with acute myelomonocytic leukemia after chemotherapy for osteosarcoma: good response to antileukemic drugs. *J Clin Oncol* 1987;5:1304–1305.

129. Shu XO, Ross JA, Reaman GH, et al. Are parental alcohol consumption and cigarette smoking associated with risk of infant leukemia? A report from the Children's Cancer Group. *J Natl Cancer Inst* 1996;88:24–31.

130. Ross JA, Potter JD, Robison LL. Infant leukemia, topoisomerase II inhibitors, and the MLL gene. *J Natl Cancer Inst* 1994;86:1678–1680.

131. Strick R, Strissel PL, Borgers S, et al. Dietary bioflavonoids induce cleavage in the MLL gene and may contribute to infant leukemia. *Proc Natl Acad Sci U S A* 2000;97:4790–4795.

132. Brauer MJ, Dameshek W. Hypoplastic anemia and myeloblastic leukemia following chloramphenicol



therapy: report of three cases. *N Engl J Med* 1967;277:1003–1005.

133. Bloomfield CD, Brunning RD. Acute leukemia as a terminal event in nonleukemic hematopoietic disorders. *Semin Oncol* 1976;3:297–317.
134. Jensen MK, Roll K. Phenylbutazone and leukaemia. *Acta Med Scand* 1965;178:505–513.
135. Baer MR, Barcos MP, Farrell H, et al. Acute myelogenous leukemia with leukemia cutis: eighteen cases seen between 1969 and 1986. *Cancer* 1989;63:2192–2200.
136. Reimann DL, et al. Congenital acute leukemia–skin nodules, a first sign. *J Pediatr* 1949;54:691.
137. Cohen PR, Talpaz M, Kurzrok R. Malignancy–associated Sweet’s syndrome: review of the world literature. *J Clin Oncol* 1988;6:1887–1897.
138. Schwaegerle SM, Bergfeld WF, Senitzer D, Tidrick RT. Pyoderma gangrenosum: a review. *J Am Acad Dermatol* 1988;18:559–568.
139. Cassileth PA, Sylvester LS, Bennett JM, Begg CB. High peripheral blast count in adult acute myelogenous leukemia is a primary risk factor for CNS leukemia. *J Clin Oncol* 1988;6:495–498.
140. Dekker AW, Elderson A, Punt K, Sixma JJ. Meningeal involvement in patients with acute nonlymphocytic leukemia. Incidence, management, and predictive factors. *Cancer* 1985;56:2078–2082.
141. Holmes R, Keating MJ, Cork A, et al. A unique pattern of central nervous system leukemia in acute myelomonocytic leukemia associated with inv(16)(p13q2). *Blood* 1985;65:1071–1078.
142. Lampkin BC, Masterson M, Sambrano JE, et al. Current chemotherapeutic treatment strategies in childhood acute nonlymphocytic leukemia. *Semin Oncol* 1987;14:397–406.
143. Golub TR, Arceci RJ. Acute myelogenous leukemia. In: Pizzo P, Poplack D, eds. *Principles and practice of pediatric oncology*. Philadelphia: Lippincott Williams & Wilkins, 2002:545–590.
144. Peterson BA, Brunning RD, Bloomfield CD, et al. Central nervous system involvement in acute nonlymphocytic leukemia. *Am J Med* 1987;83:464–470.
145. Castagnola C, Nozza A, Corso A, Bernasconi C. The value of combination therapy in adult acute myeloid leukemia with central nervous system involvement. *Haematologica* 1997;82:577–580.
146. Muller S, Sangster G, Crocker J, et al. An immunohistochemical and clinicopathological study of granulocytic sarcoma (chloroma). *Hematol Oncol* 1986;4:101–112.
147. Neiman RS, Barcos MP, Berard C, et al. Granulocytic sarcoma: a clinicopathologic study of 61 biopsied cases. *Cancer* 1981;48:1426–1437.
148. Abe R, Umezumi H, Uchida T, et al. Myeloblastoma with an 8;21 chromosome translocation in acute myeloblastic leukemia. *Cancer* 1986;58:1260–1264.
149. Welch P, Grossi C, Carroll A, et al. Granulocytic sarcoma with an indolent course and destructive skeletal disease: tumor characterization with immunologic markers, electron microscopy, cytochemistry, and cytogenetic studies. *Cancer* 1986;57:1005–1010.
150. Baer MR. Management of unusual presentations of acute leukemia. *Hematol Oncol Clin North Am* 1993;7:275–292.
151. Wiernik PH. Extramedullary manifestations of adult leukemia. In: *American cancer society atlas of clinical oncology adult leukemias*. London: BC Decker Inc, 2001:275–305.
152. Furman WL, Fontanesi J, Hustu O, et al. Testicular relapse in children with acute nonlymphoblastic leukemia. *Cancer* 1990;66:2095–2098.
153. Ferry JA, Snigley JR, Young RH. Granulocytic sarcoma of the testis: a report of two cases of a

neoplasm prone to misinterpretation. *Mod Pathol* 1997;10:320–325.

154. Wiernik PH, Sutherland JC, Stechmiller BK, Wolff J. Clinically significant cardiac infiltration in acute leukemia, lymphocytic lymphoma, and plasma cell myeloma. *Med Pediatr Oncol* 1976;2:75–85.
155. Keidan R, Fanning J, Gatenby RA, Weese JL. Recurrent typhlitis. A disease resulting from aggressive chemotherapy. *Dis Colon Rectum* 1989;32:206–209.
156. Kunkel JM, Rosenthal D. Management of the ileocecal syndrome. Neutropenic enterocolitis. *Dis Colon Rectum* 1986;29:196–199.
157. Hess CE, Joyce RA. Acute myeloblastic leukemia presenting as progressive hepatic failure. *South Med J* 1981;74:1028–1029.
158. Boggs DR, Wintrobe MM, Cartwright GE. The acute leukemias. *Medicine* 1962;41:163–225.
159. Hanker JS, Laszlo J, Moore JO. The light microscopic demonstration of hydroperoxidase-positive Phi bodies and rods in leukocytes in acute myeloid leukemia. *Histochemistry* 1978;58:241–252.
160. Medical Research Council Leukaemia Committee. The relation between morphology and other features of acute myeloid leukemia, and their prognostic significance. *Br J Haematol* 1975;31(Suppl):165–180.
161. Tulliez M, Vernant JP, Breton-Gorius J, et al. Pseudo-Chediak-Higashi anomaly in a case of acute myeloid leukemia: electron microscopic studies. *Blood* 1979;54:863–871.
162. Gralnick HR, Marchesi S, Givelber H. Intravascular coagulation in acute leukemia: clinical and subclinical abnormalities. *Blood* 1972;40:709–718.
163. Goad KF, Gralnick HR. Coagulation disorders in cancer. *Hematol Oncol Clin North Am* 1996;10:457–484.
164. Kubota T, Andoh K, Sadakata H, et al. Tissue factor released from leukemic cells. *Thromb Haemost* 1991;65:59–63.
165. Bennett B, Booth NA, Croll A, Dawson AA. The bleeding disorder in acute promyelocytic leukaemia: fibrinolysis due to u-PA rather than defibrination. *Br J Haematol* 1989;71:511–517.
166. Cozzolino F, Torcia M, Miliani A, et al. Potential role of interleukin-1 as the trigger for diffuse intravascular coagulation in acute nonlymphoblastic leukemia. *Am J Med* 1988;84:240–250.
167. Ribeiro RC, Pui CH. The clinical and biological correlates of coagulopathy in children with acute leukemia. *J Clin Oncol* 1986;4:1212–1218.
168. O'Regan S, Carson S, Chesney RW, Drummond KN. Electrolyte and acid-base disturbances in the management of leukemia. *Blood* 1977;49:345–353.
169. Wiernik PH. Diagnosis and treatment of adult acute myelocytic leukemia. In: Wiernik PH, Canellos GP, Dutcher JP, Kyle RA, eds. *Neoplastic diseases of the blood*. New York: Churchill Livingstone, 1996:331–351.
170. Pickering TG, Catovsky D. Hypokalaemia and raised lysozyme levels in acute myeloid leukaemia. *QJM* 1973;42:677–682.
171. Gewirtz AM, Stewart AF, Vignery A, et al. Hypercalcemia and complicating acute myelogenous leukemia: a syndrome of multiple etiologies. *Br J Haematol* 1983;54:133–141.
172. Schenkein DP, O'Neill C, Shapiro JR, et al. Accelerated bone formation causing profound hypocalcemia in acute leukemia. *Ann Intern Med* 1986;105:375–378.
173. Bunin NJ, Pui CH. Differing complications of hyperleukocytosis in children with acute lymphoblastic or acute nonlymphoblastic leukemia. *J Clin Oncol* 1985;3:1590–1595.
174. Lichtman MA, Rowe JM. Hyperleukocytic leukemias. Rheological, clinical, and therapeutic

considerations. *Blood* 1982;60:279–283.

175. Cuttner J. Hyperleukocytosis in adult leukemias. In: Bloomfield CD, ed. *Chronic and acute leukemias in adults*. Boston: Martinus Nijhoff, 1985.

176. McKee LC, Jr., Collins RD. Intravascular leukocyte thrombi and aggregates as a cause of morbidity and mortality in leukemia. *Medicine (Baltimore)* 1974;53:463–478.

177. Creutzig U, Ritter J, Budde M, et al. Early deaths due to hemorrhage and leukostasis in childhood acute myelogenous leukemia. Associations with hyperleukocytosis and acute monocytic leukemia. *Cancer* 1987;60:3071–3079.

178. Lester TJ, Johnson JW, Cuttner J. Pulmonary leukostasis as the single worst prognostic factor in patients with acute myelocytic leukemia and hyperleukocytosis. *Am J Med* 1985;79:43–48.

179. Fox MJ, Brody JS, Weintraub LR. Leukocyte larceny: a cause of spurious hypoxemia. *Am J Med* 1979;67:742–746.

180. Field JB, Williams HE. Artifactual hypoglycemia associated with leukemia. *N Engl J Med* 1961;265:946–948.

181. Hess CE, Nichols AB, Hunt WB, et al. Pseudohypoxemia secondary to leukemia and thrombocytosis. *N Engl J Med* 1979;301:361–363.

182. Giles FJ, Shen Y, Kantarjian HM, et al. Leukapheresis reduces early mortality in patients with acute myeloid leukemia with high white cell counts but does not improve long-term survival. *Leuk Lymph* 2001;42:67–73.

183. Thiebaut A, Thomas X, Belhabri A, et al. Impact of pre-induction therapy leukapheresis on treatment outcome in adult acute myelogenous leukemia presenting with hyperleukocytosis. *Ann Hematol* 2000;79:501–506.

184. Messner HA, Griffin JD. Biology of acute myeloid leukemia. *Clin Haematol* 1986;15:641–667.

185. Greaves MF. The new biology of leukemia. In: Henderson ES, Lister TA, Greaves MF, eds. *Leukemia*. Philadelphia: WB Saunders, 1996:34–45.

186. Reid MM, Tantravahi R, Grier HE, et al. Detection of leukemia-related karyotypes in granulocyte/macrophage colonies from a patient with acute myelomonocytic leukemia. *N Engl J Med* 1983;308:1324–1328.

187. Fialkow PJ, Singer JW, Raskind WH, et al. Clonal development, stem-cell differentiation, and clinical remissions in acute nonlymphocytic leukemia. *N Engl J Med* 1987;317:468–473.

188. Vogelstein B, Fearon ER, Hamilton SR, et al. Clonal analysis using recombinant DNA probes from the X-chromosome. *Cancer Res* 1987;47:4806–4813.

189. Vogelstein B, Fearon ER, Hamilton SR, Feinberg AP. Use of restriction fragment length polymorphisms to determine the clonal origin of human tumors. *Science* 1985;227:642–645.

190. Ferraris AM, Raskind WH, Bjornson BH, et al. Heterogeneity of B cell involvement in acute nonlymphocytic leukemia. *Blood* 1985;66:342–344.

191. Ferraris AM, Broccia G, Meloni T, et al. Clonal origin of cells restricted to monocytic differentiation in acute nonlymphocytic leukemia. *Blood* 1984;64:817–820.

192. Jacobson RJ, Temple MJ, Singer JW, et al. A clonal complete remission in a patient with acute nonlymphocytic leukemia originating in a multipotent stem cell. *N Engl J Med* 1984;310:1513–1517.

193. Keinanen M, Griffin JD, Bloomfield CD, et al. Clonal chromosomal abnormalities showing multiple-cell-lineage involvement in acute myeloid leukemia. *N Engl J Med* 1988;318:1153–1158.

194. Singer JW, Fialkow PJ. Clonal remissions in acute nonlymphocytic leukemia: implications for

curability. *Semin Hematol* 1991;28[3 Suppl 4]:1-4.

195. Griffin JD, Lowenberg B. Clonogenic cells in acute myeloblastic leukemia. *Blood* 1986;68:1185-1195.

196. McCulloch EA, Curtis JE, Messner HA, et al. The contribution of blast cell properties to outcome variation in acute myeloblastic leukemia. *Blood* 1982;59:601-608.

197. Miller CW, Koeffler HP. In vivo and in vitro differentiation of myeloid leukemia cells. In: Mauer AM, ed. *The biology of human leukemia*. Baltimore: The Johns Hopkins University Press, 1990.

198. Vellenga E, Griffin JD. The biology of acute myeloblastic leukemia. *Semin Oncol* 1987;14:365-371.

199. Moore MAS. Prediction of relapses and remissions in AML by marrow culture criteria. *Nouv Rev Fr Hematol Blood Cells* 1976;2:109-124.

200. Morley A, Higgs D. Abnormal differentiation of leukemic cells in vitro. *Cancer* 1974;33:716-720.

201. Spitzer G, Dicke KA, Gehan EA, et al. The use of the Robinson in vitro agar culture assay in adult acute leukemia. *Nouv Rev Fr Hematol Blood Cells* 1976;17:139-148.

202. Moore MAS, Spitzer G, Williams N, et al. Agar culture studies in 127 cases of untreated acute leukemia: the prognostic value of reclassification of leukemia according to in vitro growth characteristics. *Blood* 1974;44:1-18.

203. Moore MAS, Williams N, Metcalf D. In vitro colony formation by normal and leukemic human hematopoietic cells: characterization of the colony forming cells. *J Natl Cancer Inst* 1973;50:603-623.

204. Browman G, Goldberg J, Gottlieb AJ, et al. The clonogenic assay as a reproducible in vitro system to study predictive parameters of treatment outcome in acute nonlymphoblastic leukemia. *Am J Hematol* 1983;15:227-235.

205. Brons PP, Haanen C, Boezeman JB, et al. Proliferation patterns in acute myeloid leukemia: leukemic clonogenic growth and in vivo cell cycle kinetics. *Ann Hematol* 1993;66:225-233.

206. Marie JP, Zittoun R, Thevenin D, et al. In vitro culture of clonogenic leukaemic cells in acute myeloid leukaemia: growth pattern and drug sensitivity. *Br J Haematol* 1983;55:427.

207. Swart K, Hagemeijer A, Lowenberg B. Acute myeloid leukemia colony growth in vitro: differences of colony-forming cells in PHA-supplemented and standard leukocyte feeder cultures. *Blood* 1982;59:816-821.

208. Oster W, Mertelsmann R, Herrmann F. Role of colony-stimulating factors in the biology of acute myelogenous leukemia. *Int J Cell Cloning* 1989;7:13-29.

209. Quesenberry PJ, Temels DS. The clonal culture of leukemic cells. In: Mauer AM, ed. *The biology of human leukemia*. Baltimore: The Johns Hopkins University Press, 1990.

210. Kelleher C, Miyauchi J, Wong G, et al. Synergism between recombinant growth factors, GM-CSF and G-CSF, acting on the blast cells of acute myeloblastic leukemia. *Blood* 1987;69:1498-1503.

211. Miyauchi J, Kelleher CA, Yang YC, et al. The effects of three recombinant growth factors, IL-3, GM-CSF, and G-CSF, on the blast cells of acute myeloblastic leukemia maintained in short-term suspension culture. *Blood* 1987;70:657-663.

212. Visani G, Manfroi S. G-CSF in the biology and treatment of acute myeloid leukemias. *Leuk Lymph* 1995;18:423-428.

213. Lyman SD, James L, VandenBos T, et al. Molecular cloning of a ligand for the flt3/flk-2 tyrosine kinase receptor: a proliferative factor for primitive hematopoietic cells. *Cell* 1993;75:1157-1167.

214. Brannan CI, Lyman SD, Williams DE, et al. Steel-Dickie mutation encodes a c-Kit ligand lacking transmembrane and cytoplasmic domains. *Proc Natl Acad Sci U S A* 1991;88:4671-4674.

215. Young DC, Griffin JD. Autocrine secretion of GM-CSF in acute myeloblastic leukemia. *Blood*

1986;68:1178–1181.

216. Jirik FR, Burstein SA, Treger L, Sorge JA. Transfection of a factor-dependent cell line with the murine interleukin-3 (IL-3) cDNA results in autonomous growth and tumorigenesis. *Leuk Res* 1987;11:1127–1134.
217. Souza LM, Boone TC, Gabrilove J, et al. Recombinant human granulocyte colony-stimulating factor: effects on normal and leukemic myeloid cells. *Science* 1986;232:61–65.
218. Lisovsky M, Estrov Z, Zhang X, et al. Flt3 ligand stimulates proliferation and inhibits apoptosis of acute myeloid leukemia cells: regulation of Bcl-2 and Bax. *Blood* 1996;88:3987–3997.
219. Hassan HT, Zander A. Stem cell factor as a survival and growth factor in human normal and malignant hematopoiesis. *Acta Haematol* 1996;95:257–262.
220. Munker R, Koeffler HP. In vitro action of tumor necrosis factor on myeloid leukemia cells. *Blood* 1987;69:1102–1108.
221. Tobler A, Munker R, Heitjan D, Koeffler HP. In vitro interaction of recombinant tumor necrosis factor alpha and all-trans-retinoic acid with normal and leukemic hematopoietic cells. *Blood* 1987;70:1940–1946.
222. Masuya M, Kita K, Shimizu N, et al. Biologic characteristics of acute leukemia after myelodysplastic syndrome. *Blood* 1993;81:3388–3394.
223. Morris TCM, McNeill TA, Bridges JM. Inhibition of normal human in vitro colony forming cells by cells from leukaemic patients. *Br J Cancer* 1975;31:641–648.
224. Broxmeyer HE, Ralph P, Margolis VB, et al. Characteristics of bone marrow and blood cells in human leukemia that produce leukemia inhibitory activity (LIA). *Leuk Res* 1979;3:193–203.
225. Cukrova V, Hrkal Z, Koprivova H, Neuwirt J. Identification of leukemia cell-derived inhibitory activity (LIA) in conditioned media from human myeloid leukemic cell line ML-2. *Blut* 1986;52:51–58.
226. Olofsson T, Olsson I. Suppression of normal granulopoiesis in vitro by a leukemia-associated inhibitor (LAI) of acute and chronic leukemia. *Blood* 1980;55:975–982.
227. Olofsson T, Nilsson E, Olsson I. Characterization of the cells in myeloid leukemia that produce leukemia associated inhibitor (LAI) and demonstration of LAI-producing cells in normal bone marrow. *Leuk Res* 1984;8:387–396.
228. Andreoni C, Moreau I, Rigal D. Long-term culture of human bone marrow. I. characterization of adherent cells in flow cytometry. *Exp Hematol* 1990;18:431–437.
229. de Bont ES, Rosati S, Kamps JS, Vellenga E. Increased bone marrow vascularization in patients with acute myeloid leukaemia: a possible role for vascular endothelial growth factor. *Br J Haematol* 2001;113:296–304.
230. Löwenberg B, VanPutten WL, Touw IP, et al. Autonomous proliferation of leukemic cells in vitro as a determinant of prognosis in adult acute myeloid leukemia. *N Engl J Med* 1993;328:614–619.
231. Gavosto F, Pileri A, Gabutti V, Masera P. Non-self-maintaining kinetics of proliferating blasts in human acute leukaemia. *Nature* 1967;216:188–189.
232. Greenberg ML, Chanana AD, Cronkite EP, et al. The generation time of human leukemic myeloblasts. *Lab Invest* 1972;26:245–252.
233. Mauer AM, Fisher V. Characteristics of cell proliferation in four patients with untreated acute leukemia. *Blood* 1966;28:428–445.
234. Ozawa K, Miura Y, Suda T, et al. In vitro differentiation of leukemic progenitor cells in various types of acute nonlymphocytic leukemia. *Cancer Res* 1983;43:2334–2338.
235. Killmann SA, Cronkite EP, Robertson JS, et al. Estimation of phases of the life cycle of leukemic

- cells from labeling in human beings in vivo with tritiated thymidine. *Lab Invest* 1968;12:671–684.
236. Hiddemann W, Wormann B, Gohde W, Buchner T. DNA aneuploidies in adult patients with acute myeloid leukemia. Incidence and relation to patient characteristics and morphologic subtypes. *Cancer* 1986;57:2146–2152.
237. Preisler H. Prediction of response to chemotherapy in acute myelocytic leukemia. *Blood* 1980;56:361–357.
238. Raza A, Preisler HD, Day R, et al. Direct relationship between remission duration in acute myeloid leukemia and cell cycle kinetics: a Leukemia Intergroup study. *Blood* 1990;76:2191–2197.
239. Raza A, Maheshwari Y, Preisler HD. Differences in cell cycle characteristics among patients with acute nonlymphocytic leukemia. *Blood* 1987;69:1647–1653.
240. Riccardi A, Danova M, Dionigi P, et al. Cell kinetics in leukaemia and solid tumours studied with in vivo bromodeoxyuridine and flow cytometry. *Br J Cancer* 1989;59:898–903.
241. Kamikubo KH, Ogata K, An E, Dan K. Low proportion of G<sub>0</sub>-phase cells during induction chemotherapy correlates with subsequent remission in acute myeloid leukemia. *Int J Hematol* 2000;71:249–255.
242. Gilliland DG, Griffin JD. The roles of FLT3 in hematopoiesis and leukemia. *Blood* 2002;100:1532–1542.
243. Castilla LH, Garrett L, Adya N, et al. The fusion gene CBFβ blocks myeloid differentiation and predisposes mice to acute myelomonocytic leukemia. *Nat Genet* 1999;23:144–146.
244. Kiyoi H, Naoe T, Hokata S, et al. Internal tandem duplication of FLT3 associated with leukocytosis in acute promyelocytic leukemia. Leukemia Study Group of the Ministry of Health and Welfare (Kohseisho). *Leukemia* 1997;11:1447–1452.
245. Schimmer AD, Hedley DW, Penn LS, Minden MD. Receptor- and mitochondrial-mediated apoptosis in acute leukemia: a translational view. *Blood* 2001;98:3541–3553.
246. Estey E, Thall P, Beran M, et al. Effect of diagnosis (refractory anemia with excess blasts, refractory anemia with excess blasts in transformation, or acute myeloid leukemia [AML]) on outcome of AML-type chemotherapy. *Blood* 1997;90:2969–2977.
247. Bennett JM, Catovsky D, Daniel MT, et al. Proposed revised criteria for the classification of acute myeloid leukemia. a report of the French-American-British cooperative group. *Ann Intern Med* 1985;103:620–625.
248. Bennett JM, Catovsky D, Daniel MT, et al. Proposal for the recognition of minimally differentiated acute myeloid leukaemia (AML-MO). *Br J Haematol* 1991;78:325–329.
249. Mufti GJ, Flandrin G, Schaefer HE, et al. An atlas of malignant haematology, cytology, histology and cytogenetics. Lippincott-Raven, 1996.
250. Argyle JC, Benjamin DR, Lampkin B, Hammond D. Acute nonlymphocytic leukemias of childhood. Inter-observer variability and problems in the use of the FAB classification. *Cancer* 1989;63:295–301.
251. Brunning RD, McKenna RW. Acute leukemias. In: Atlas of tumor pathology. Tumors of the bone marrow. Washington: Armed Forces Institute of Pathology, 1994:19–142.
252. Sulak LE, Clare CN, Morale BA, et al. Biphenotypic acute leukemia in adults. *Am J Clin Pathol* 1990;94:54–58.
253. Hanson CA, Abaza M, Sheldon S, et al. Acute biphenotypic leukaemia: immunophenotypic and cytogenetic analysis. *Br J Haematol* 1993;84:49–60.
254. Matutes E, Morilla R, Farahat N, et al. Definition of acute biphenotypic leukemia. *Haematologica* 1997;82:64–66.

255. Legrand O, Perrot JY, Simonin G, et al. Adult biphenotypic acute leukaemia: an entity with poor prognosis which is related to unfavourable cytogenetics and P-glycoprotein over-expression. *Br J Haematol* 1998;100:147-155.
256. Jennings CD, Foon KA. Recent advances in flow cytometry: application to the diagnosis of hematologic malignancy. *Blood* 1997;90:2863-2892.
257. Robertson MJ, Ritz J. Prognostic significance of the surface antigens expressed by leukemic cells. *Leuk Lymph* 1994;13:15-22.
258. Weir EG, Borowitz MJ. Flow cytometry in the diagnosis of acute leukemia. *Semin Hematol* 2001;38:124-138.
259. Kaleem Z, Crawford E, Pathan MH, et al. Flow cytometric analysis of acute leukemias. Diagnostic utility and critical analysis of data. *Arch Pathol* 2003;127:42-48.
260. Adriaansen HJ, teBoekhorst PAW, Hagemeyer AM, et al. Acute myeloid leukemia M4 with bone marrow eosinophilia (M4Eo) and inv(16)(p13q22) exhibits a specific immunophenotype with CD2 expression. *Blood* 1993;82:3043-3051.
261. Paietta E, Wiernik PH, Andersen J, et al. Acute myeloid leukemia M4 with inv(16)(p13q22) exhibits a specific immunophenotype with CD2 expression. *Blood* 1993;82:2595.
262. Paietta E, Andersen J, Gallagher R, et al. The immunophenotype of acute promyelocytic leukemia (APL): an ECOG study. *Leukemia* 1994;8:1108-1112.
263. Kita K, Nakase K, Miwa H, et al. Phenotypical characteristics of acute myelocytic leukemia associated with the t(8;21)(q22;q22) chromosomal abnormality: frequent expression of immature B-cell antigen CD19 together with stem cell antigen CD34. *Blood* 1992;80:470-477.
264. Reading L, Estey E, Huh YO, et al. Expression of unusual immunophenotype combinations in acute myelogenous leukemia. *Blood* 1993;81:3083-3090.
265. Campos L, Guyotat D, Archimbaud E, et al. Surface marker expression in adult acute myeloid leukemia: correlations with initial characteristics, morphology, and response to therapy. *Br J Haematol* 1989;72:161-166.
266. Geller RB, Zahurak M, Hurwitz CA. Prognostic importance of immunophenotyping in adults with acute myelocytic leukemia: the significance of the stem-cell glycoprotein CD34 (MY10). *Br J Haematol* 1990;76:340-347.
267. Lee EJ, Yang J, Leavitt RD, et al. The significance of CD34 and TdT determination in patients with untreated de novo acute myeloid leukemia. *Leukemia* 1992;6:1203-1209.
268. Borowitz MJ, Gockerman JP, Moore JO, et al. Clinicopathologic and cytogenetic features of CD34 (My 10)-positive acute nonlymphocytic leukemia. *Am J Clin Pathol* 1989;91:265-270.
269. Leith CP, Kopecky KJ, Godwin J, et al. Acute myeloid leukemia in the elderly: assessment of multidrug resistance (MDR1) and cytogenetics distinguishes biologic subgroups with remarkably distinct response to standard chemotherapy: a Southwest Oncology Group study. *Blood* 1997;89:3323-3329.
270. Porwit-MacDonald A, Janosy G, Ivory K, et al. Leukemia-associated changes identified by quantitative flow cytometry. iv. CD34 overexpression in acute myelogenous leukemia M2 with t(8;21). *Blood* 1996;87:1162-1169.
271. Drexler HG, Sperling C, Ludwig WD. Terminal deoxynucleotidyl transferase (TdT) expression in acute myeloid leukemia. *Leukemia* 1993;7:1142-1150.
272. Benedetto P, Mertelsmann R, Szatrowski TH, et al. Prognostic significance of terminal deoxynucleotidyl transferase activity in acute nonlymphoblastic leukemia. *J Clin Oncol* 1986;4:489-495.
273. McCurley TL, Greer JP, Glick AD. Terminal deoxynucleotidyl transferase (TdT) in acute nonlymphocytic leukemia. A clinical, morphologic, cytochemical, immunologic, and ultrastructural study. *Am*



J Clin Pathol 1988;90:421–430.

274. Ball ED, Davis RD, Griffin JD, et al. Prognostic value of lymphocyte surface markers in acute myeloid leukemia. *Blood* 1991;77:2242–2250.

275. Solary E, Casasnovas RO, Campos L, et al. Surface markers in adult acute myeloblastic leukemia: correlation of CD19+, CD34+ and CD14+/DR phenotypes with shorter survival. *Leukemia* 1992;6:393–399.

276. Jensen AW, Hokland M, Jorgensen H, et al. Solitary expression of CD7 among T-cell antigens in acute myeloid leukemia: identification of a group of patients with similar T-cell receptors  $\beta$  and  $\gamma$  rearrangements and course of disease suggestive of poor prognosis. *Blood* 1991;78:1292–1300.

277. Kita K, Miwa H, Nakase K, et al. Clinical importance of CD7 expression in acute myelocytic leukemia: the Japan Cooperative Group of Leukemia/Lymphoma. *Blood* 1993;81:2399–2405.

278. Seymour JF, Pierce SA, Kantarjian HM, et al. Investigation of karyotypic, morphologic and clinical features in patients with acute myeloid leukemia blast cells expressing the neural cell adhesion molecule (CD56). *Leukemia* 1994;8:823–826.

279. Suzuki R, Nakamura S. Malignancies of natural killer (NK) cell precursor myeloid/NK cell precursor acute leukemia and blastic NK cell lymphoma/leukemia. *Leuk Res* 1999;23:615–624.

280. Greaves MF, Chan LC, Furley AJ, et al. Lineage promiscuity in hemopoietic differentiation and leukemia. *Blood* 1986;67:6:1–11.

281. Farhi DC, Luckey CN. Prospective gene rearrangement studies and multiparameter analysis of acute myeloid leukemia. *Am J Clin Pathol* 1991;95:702–708.

282. Rovigatti U, Mirro J, Kitchingman G, et al. Heavy chain immunoglobulin gene rearrangement in acute nonlymphocytic leukemia. *Blood* 1984;63:1023–1027.

283. Moscinski LC, Nowell PC, Hoxie JA, et al. Surface marker analysis and karyotype distinguish acute biphenotypic leukemia from acute myelogenous leukemia expressing terminal deoxynucleotidyl transferase. *Cancer* 1991;68:2161–2168.

284. Hamaguchi H, Nakamura Y, Nagata K, et al. Philadelphia–chromosome–positive, monosomy 7 biphenotypic acute mixed lineage leukemia in adults: a pluripotent stem cell disorder. *Leukemia* 1993;7:1752–1758.

285. Buccheri V, Matutes E, Dyer MJ, Catovsky D. Lineage commitment in biphenotypic acute leukemia. *Leukemia* 1993;7:919–927.

286. Carter R, Dube I, McKeithan T, et al. Translocation (14;19) in acute biphenotypic leukemia. *Cancer Genet Cytogenet* 1991;53:67–73.

287. Kawakubo K, Ohyashiki K, Ohyashiki JH, et al. Acute myeloid leukemia with concomitant expression of T–/B–lymphoid antigens and immunogenotypic alterations exhibiting t(7;12)(q32;q24). *Leukemia* 1993;7:909–911.

288. Catovsky D, Matutes E, Buccheri V, et al. A classification of acute leukaemia for the 1990s. *Ann Hematol* 1991;62:16–21.

289. Heim S, Mitelman F. *Cancer cytogenetics*, 2nd ed. New York: Wiley–Liss, 1995.

290. Mrozek K, Heinonen K, Lawrence D, et al. Adult patients with de novo acute myeloid leukemia and t(9;11)(p22;q23) have a superior outcome to patients with other translocations involving band 11q23: a Cancer and Leukemia Group B study. *Blood* 1997;90:4532–4538.

291. Marosi C, Koller U, Koller–Weber E, et al. Prognostic impact of karyotype and immunologic phenotype in 125 adult patients with de novo AML. *Cancer Genet Cytogenet* 1992;61:14–25.

292. Stasi R, DelPoeta G, Masi M, et al. Incidence of chromosome abnormalities and clinical significance

of karyotype in de novo acute myeloid leukemia. *Cancer Genet Cytogenet* 1993;67:28–34.

293. Sandberg A. *The chromosomes in human cancer and leukemia*. 2nd ed. New York: Elsevier Science, 1990.

294. Yunis JJ, Lobell M, Arnesen MA, et al. Refined chromosome study helps define prognostic subgroups in most patients with primary myelodysplastic syndrome and acute myelogenous leukaemia. *Br J Haematol* 1988;68:189–194.

295. Yunis JJ, Brunning RD, Howe RB, Lobell M. High-resolution chromosomes as an independent prognostic indicator in adult acute nonlymphocytic leukemia. *N Engl J Med* 1984;311:812–818.

296. Mrozek K, Heinonen K, delaChapelle A, Bloomfield CD. Clinical significance of cytogenetics in acute myeloid leukemia. *Semin Oncol* 1997;24:17–31.

297. Martinez-Climent JA, Lane NJ, Rubin CM, et al. Clinical and prognostic significance of chromosomal abnormalities in childhood acute myeloid leukemia de novo. *Leukemia* 1995;9:95–101.

298. Grimwade D, Walker H, Oliver F, et al. The importance of diagnostic cytogenetics on outcome in AML: analysis of 1,612 patients entered into the MRC AML 10 trial. *Blood* 1998;92:2322–2333.

299. Grimwade D, Walker H, Harrison G, et al. The predictive value of hierarchical cytogenetic classification in older adults with acute myeloid leukemia (AML): analysis of 1065 patients entered into the United Kingdom Medical Research Council AML11 trial. *Blood* 2001;98:1312–1320.

300. Koeffler HP. Syndromes of acute nonlymphocytic leukemia. *Ann Intern Med* 1987;107:748–758.

301. Rowley JD, Alimena G, Garson OM, et al. A collaborative study of the relationship of the morphological type of acute nonlymphocytic leukemia with patient age and karyotype. *Blood* 1982;59:1013–1022.

302. Golomb HM, Rowley JD, Vardiman JW, et al. “Microgranular” acute promyelocytic leukemia: a distinct clinical, ultrastructural, and cytogenetic entity. *Blood* 1980;55:253–259.

303. McKenna RW, Parkin J, Bloomfield CD, et al. Acute promyelocytic leukaemia: a study of 39 cases with identification of a hyperbasophilic microgranular variant. *Br J Haematol* 1982;50:201–214.

304. Mirro J, Kitchingman G, Williams D, et al. Clinical and laboratory characteristics of acute leukemia with the 4;11 translocation. *Blood* 1986;67:689–697.

305. Pearson MG, Vardiman JW, Le Beau MM, et al. Increased numbers of marrow basophils may be associated with a t(6;9) in ANLL. *Am J Hematol* 1985;18:393–403.

306. Berger R, Bernheim A, le Coniat M, et al. Abnormalities of the short arm of chromosome 12 in acute nonlymphocytic leukemia and dysmyelopoietic syndrome. *Cancer Genet Cytogenet* 1986;19:281–289.

307. Bernstein R, Pinto MR, Behr A, Mendelow B. Chromosome 3 abnormalities in acute nonlymphocytic leukemia (ANLL) with abnormal thrombopoiesis: report of three patients with a new inversion anomaly and a further dose of homologous translocation. *Blood* 1982;60:613–617.

308. Bloomfield CD, Garson OM, Volin L, et al. t(1;3)(p36;q21) in acute nonlymphocytic leukemia: a new cytogenetic-clinicopathologic association. *Blood* 1985;66:1409–1413.

309. Hayashi Y, Pui CH, Behm FG, et al. 14q32 translocations are associated with mixed-lineage expression in childhood acute leukemia. *Blood* 1990;76:150–156.

310. Abe S, Sandberg A. Chromosomes and causation of human cancer and leukemia. XXXII. unusual features of PH-1-positive acute myeloblastic leukemia (AML), including a review of the literature. *Cancer* 1979;43:2352–2364.

311. Hawkins JM, Bain B, Mehta AB, Moorman AV. Complex hypodiploidy in acute myeloid leukaemia: a United Kingdom Cancer Cytogenetics Group study. *Leuk Res* 1995;19:905–913.

312. Taylor KM, Rodwell RL, Taylor DL, Seeley GO. Myelodysplasia. *Curr Opin Oncol* 1994;6:32-40.
313. Rowley JC, Golomb HM, Vardiman JW. Nonrandom chromosome abnormalities in acute leukemia and dysmyelopoietic syndromes in patients with previously treated malignant disease. *Blood* 1981;58:759-767.
314. List AF, Garewal HS, Sandberg AA. The myelodysplastic syndromes: biology and implications for management. *J Clin Oncol* 1990;8:1424-1441.
315. Venditti A, DelPoeta G, Stasi R, et al. Minimally differentiated acute myeloid leukemia (AML-MO): cytochemical, immunophenotypic and cytogenetic analysis of 19 cases. *Br J Haematol* 1994;88:784-793.
316. Venditti A, DelPoeta G, Buccisano F, et al. Minimally differentiated acute myeloid leukemia (AML-MO): comparison of 25 cases with other French-American-British subtypes. *Blood* 1997;89:621-629.
317. Cuneo A, Ferrant A, Michaux JL, et al. Cytogenetic profile of minimally differentiated (FAB MO) acute myeloid leukemia: correlation with clinicobiologic findings. *Blood* 1995;85:3688-3694.
318. Stasi R, DelPoeta G, Venditti A, et al. Analysis of treatment failure in patients with minimally differentiated acute myeloid leukemia. *Blood* 1994;83:1619-1625.
319. Amadori S, Venditti A, DelPoeta G, et al. Minimally differentiated acute myeloid leukemia (AML-MO): a distinct clinico-biologic entity with poor prognosis. *Ann Hematol* 1996;72:208-215.
320. Groupe Francais de Morphologie Hematologique. French registry of acute leukemia and myelodysplastic syndromes: age distribution and hemogram analysis of the 4496 cases recorded during 1982-1983 and classified according to FAB criteria. *Cancer* 1987;60:1385-1394.
321. Stanley M, McKenna RW, Ellinger G, Brunning RD. Classification of 358 cases of acute myeloid leukemia by FAB criteria: analysis of clinical morphologic features. In: Bloomfield CD, ed. *Chronic and acute leukemias in adults*. Boston: Martinus Nijhoff, 1985:147-174.
322. Nucifora G, Rowley JD. AML1 and the 8;21 and 3;21 translocations in acute and chronic myeloid leukemia. *Blood* 1995;86:1-14.
323. Hurwitz CA, Raimondi SC, Head DR, et al. Distinctive immunophenotypic features of t(8;21)(q22;q22) acute myeloblastic leukemia in children. *Blood* 1992;80:3182-3188.
324. Miyoshi H, Shimizu K, Kozu T, et al. The t(8;21) breakpoints on chromosome 21 in acute myeloid leukemia are clustered within a limited region of a novel gene, AML1. *Proc Natl Acad Sci U S A* 1991;88:10431-10434.
325. Nisson PE, Watkins PC, Sacchi N. Transcriptionally active chimeric gene derived from the fusion of the AML1 gene and a novel gene on chromosome 8 in t(8;21) leukemic cells. *Cancer Genet Cytogenet* 1992;63:81-88.
326. Nucifora G, Larson RA, Rowley JD. Persistence of the t(8;21) in AML-M2 long-term remission patients. *Blood* 1993;82:712-715.
327. Kusec R, Laczika K, Knobl P, et al. AML1/ETO fusion mRNA can be detected in remission blood samples of all patients with t(8;21) acute myeloid leukemia after chemotherapy or autologous bone marrow transplant. *Leukemia* 1994;8:735-739.
328. Rubin CM, Larson RA, Anastasi J, et al. Association of chromosomal translocation with the blast phase of chronic myelogenous leukemia. *Blood* 1987;70:1338-1342.
329. Rubin CM, Larson RA, Anastasi J, et al. t(8;21)(q26;q22): a recurring chromosomal abnormality in therapy-related myelodysplastic syndrome and acute myeloid leukemia. *Blood* 1990;76:2594-2598.
330. Golub TR, Barker GF, Bohlander SK, et al. Fusion of the TEL gene on 12p13 to the AML1 gene on 21q22 in acute lymphoblastic leukemia. *Proc Natl Acad Sci U S A* 1995;92:4917-4921.
331. Swansbury GJ, Lawler SD, Alimena G, et al. Long-term survival in acute myelogenous leukemia: a

second follow-up of the Fourth International Workshop on Chromosomes in Leukemia. *Cancer Genet Cytogenet* 1994;73:1-7.

332. Byrd JC, Dodge RK, Carroll A, et al. Patients with t(8;21)(q22;q22) and acute myeloid leukemia have superior failure-free and overall survival when repetitive cycles of high-dose cytarabine are administered. *J Clin Oncol* 1999;17:3767-3775.

333. O'Brien S, Kantarjian HM, Keating M, et al. Association of granulocytosis with poor prognosis in patients with acute myelogenous leukemia and translocation of chromosomes 8 and 21. *J Clin Oncol* 1989;7:1081-1086.

334. Byrd JC, Weiss RB, Arthur DC, et al. Extramedullary leukemia adversely affects hematologic complete remission rate and overall survival in patients with t(8;21)(q22;q22): results from Cancer and Leukemia Group B 8461. *J Clin Oncol* 1997;15:466-475.

335. Baer MR, Stewart CC, Lawrence D, et al. Expression of the neural cell adhesion molecule CD56 is associated with short remission duration and survival in acute myeloid leukemia with t(8;21)(q22;q22). *Blood* 1997;90:1643-1648.

336. Grignani F, Fagioli M, Alcalay M, et al. Acute promyelocytic leukemia: from genetics to treatment. *Blood* 1994;83:12-25.

337. Cordonnier C, Vernant JP, Brun B, et al. Acute promyelocytic leukemia in 57 previously untreated patients. *Cancer* 1985;55:18-25.

338. Foley R, Soamboonsrup P, Bengner A, et al. CD34-positive acute promyelocytic leukemia is associated with leukocytosis, microgranular/hypogranular morphology, expression of CD2 and bcr3 isoform. *Am J Hematol* 2001;67:34-41.

339. Grimwade D, Solomon E. Characterization of the PML/RAR alpha rearrangement associated with t(15;17) acute promyelocytic leukemia. *Curr Top Microbiol Immunol* 1997;220:81-112.

340. deThe H, Chomienne C, Lanotte M, et al. The t(15;17) translocation of acute promyelocytic leukemia fuses the retinoic acid receptor gene to a novel transcribed locus. *Nature* 1990;347:558-561.

341. Vahdat L, Maslak P, Miller WH, et al. Early mortality and the retinoic acid syndrome in acute promyelocytic leukemia: impact of leukocytosis, low-dose chemotherapy, PML/RAR-a isoform, and CD13 expression in patients treated with all-trans retinoic acid. *Blood* 1994;84:3843-3849.

342. Degos L, Dombret H, Chomienne C, et al. All-trans retinoic acid as a differentiating agent in the treatment of acute promyelocytic leukemia. *Blood* 1995;85:2643-2653.

343. Huang W, Sun GL, Li XS, et al. Acute promyelocytic leukemia: clinical relevance of two major PML/RAR-a isoforms and detection of minimal residual disease by retrotranscriptase/polymerase chain reaction to predict relapse. *Blood* 1993;82:1264-1269.

344. Gallagher RE, Li YP, Rao S, et al. Characterization of acute promyelocytic leukemia cases with PML/RAR-a break/fusion sites in PML exon 6: identification of a subgroup with decreased in vitro responsiveness to all-trans retinoic acid. *Blood* 1995;86:1540-1547.

345. Licht JD, Chomienne C, Goy A, et al. Clinical and molecular characterization of a rare syndrome of acute promyelocytic leukemia associated with translocation (11;17). *Blood* 1995;85:1083-1094.

346. Corey SJ, Locker J, Oliveri DR, et al. A non-classical translocation involving 17q12 (retinoic acid receptor a) in acute promyelocytic leukemia (APML) with atypical features. *Leukemia* 1994;8:1350-1353.

347. Melnick A, Licht JD. Deconstructing a disease: RAR-alpha, its fusion partners, and their roles in the pathogenesis of acute promyelocytic leukemia. *Blood* 1999;93:3167-3215.

348. Miller WH, Levine K, DeBlasio A, et al. Detection of minimal residual disease in acute promyelocytic leukemia by a reverse transcription polymerase chain reaction assay for the PML/RAR-fusion mRNA. *Blood* 1993;82:1689-1694.

349. Diverio D, Pandolfi PP, Biondi A, et al. Absence of reverse transcription-polymerase chain reaction

detectable residual disease in patients with acute promyelocytic leukemia in long-term remission. *Blood* 1993;82:3556-3559.

350. Zhao L, Chang KS, Estey EH, et al. Detection of residual leukemic cells in patients with acute promyelocytic leukemia by the fluorescence in situ hybridization method: potential for predicting relapse. *Blood* 1995;85:495-499.

351. Huang ME, Ye YC, Chen SR, et al. All-trans retinoic acid with or without low dose cytosine arabinoside in acute promyelocytic leukemia: report of 6 cases. *China Med J* 1987;100:949-953.

352. Huang ME, Ye YC, Chen SR, et al. Use of all-trans retinoic acid in treatment of acute promyelocytic leukemia. *Blood* 1988;72:567-572.

353. Fenaux P, leDeley MC, Castaigne S, et al. Effect of all transretinoic acid in newly diagnosed acute promyelocytic leukemia: results of a multicenter randomized trial. *Blood* 1993;82:3241-3249.

354. Kanamaru A, Takemoto Y, Tanimoto M, et al. All-trans retinoic acid for the treatment of newly diagnosed acute promyelocytic leukemia. *Blood* 1995;85:1202-1206.

355. Frankel SR, Eardley A, Heller G, et al. All-trans retinoic acid for acute promyelocytic leukemia. Results of the New York study. *Ann Intern Med* 1994;120:278-286.

356. Head D, Kopecky J, Weick J, et al. Effects of aggressive daunomycin therapy on survival in acute promyelocytic leukemia. *Blood* 1995;86:1717-1728.

357. Frankel SR, Eardley A, Lauwers, et al. The retinoic acid syndrome in acute promyelocytic leukemia. *Ann Intern Med* 1992;117:292-296.

358. Fenaux P, Castaigne S, Dombret H, et al. All-trans-retinoic acid followed by intensive chemotherapy gives a high complete remission rate and may prolong remissions in newly diagnosed acute promyelocytic leukemia: a pilot study on 26 cases. *Blood* 1992;80:2176-2181.

359. Falanga A, Maarchetti M, Giovanelli S, Barbui T. All-trans-retinoic acid counteracts endothelial cell procoagulant activity induced by a human promyelocytic leukemia-derived cell line (NB4). *Blood* 1996;87:613-617.

360. Fenaux P, Chomienne C, Degos L. Acute promyelocytic leukemia: biology and treatment. *Semin Oncol* 1997;24:92-102.

361. Tallman MS, Kwaan HC. Reassessing the hemostatic disorder associated with acute promyelocytic leukemia. *Blood* 1992;79:543-553.

362. Daly PA, Schiffer CA, Wiernik PH. Acute promyelocytic leukemia—clinical management of 15 patients. *Am J Hematol* 1980;8:347-359.

363. Drapkin RL, Gee TS, Dowling MD, et al. Prophylactic heparin therapy in acute promyelocytic leukemia. *Cancer* 1978;41:2484-2490.

364. Goldberg MA, Ginsburg D, Mayer RJ, et al. Is heparin administration necessary during induction chemotherapy for patients with acute promyelocytic leukemia? *Blood* 1987;69:187-191.

365. Schwartz BS, Williams EC, Conlan MG, Mosher DF. Epsilon-aminocaproic acid in the treatment of patients with acute promyelocytic leukemia and acquired alpha-2-plasmin inhibitor deficiency. *Ann Intern Med* 1986;105:873-877.

366. Rodighiero F, Avvisati G, Castaman G, et al. Early deaths and anti-hemorrhagic treatments in acute promyelocytic leukemia: a GIMEMA retrospective study in 268 consecutive patients. *Blood* 1990;75:2112-2117.

367. Chen Z, Chen GQ, Shen ZX, et al. Treatment of acute promyelocytic leukemia with arsenic compounds: in vitro and in vivo studies. *Semin Hematol* 2001;38:26-36.

368. Soignet SL, Maslak P, Wang ZG, et al. Complete remission after treatment of acute promyelocytic

leukemia with arsenic trioxide. *N Engl J Med* 1998;339:1341–1348.

369. Rambaldi A, Biondi A. Acute promyelocytic leukemia. In: Henderson E, Lister TA, Greaves MF, eds. *Leukemia* 2002:529–543.
370. Jurcic JG, DeBlasio T, Dumont L, et al. Molecular remission induction with retinoic acid and anti-CD33 monoclonal antibody HuM195 in acute promyelocytic leukemia. *Clin Cancer Res* 2000;6:372–380.
371. Sievers EL, Appelbaum FR, Spielberger RT, et al. Selective ablation of acute myeloid leukemia using antibody-targeted chemotherapy: a phase I study of an anti-CD33 calicheamicin immunoconjugate. *Blood* 1999;93:3678–3684.
372. Arthur DC, Bloomfield CD. Partial deletion of the long arm of chromosome 16 and bone marrow eosinophilia in acute nonlymphocytic leukemia: a new association. *Blood* 1983;61:994–998.
373. LeBeau MM, Larson RA, Bitter MA, et al. Association of an inversion of chromosome 16 with abnormal marrow eosinophils in acute myelomonocytic leukemia. *N Engl J Med* 1983;309:630–636.
374. Liu PP, Hajra A, Wijmenga C, Collins FS. Molecular pathogenesis of the chromosome 16 inversion in the M4Eo subtype of acute myeloid leukemia. *Blood* 1995;85:2289–2302.
375. Poirel H, Raford-Weiss I, Rack, et al. Detection of the chromosome 16 CBF  $\beta$ -MYH11 fusion transcript in myelomonocytic leukemias. *Blood* 1995;85:1313–1322.
376. VanDerReijden BA, Lombardo M, Dauwerse HG, et al. RT-PCR diagnosis of patients with acute nonlymphocytic leukemia and inv(16)(p13q22) and identification of new alternative splicing of CBF $\beta$ -MYH11 transcripts. *Blood* 1995;86:277–282.
377. Buonamici S, Ottoviani E, Testoni N, et al. Real-time quantitation of minimal residual disease in inv(16)-positive acute myeloid leukemia may indicate risk for clinical relapse and may identify patients in a curable state. *Blood* 2002;99:443–449.
378. Larson RA, Williams SF, LeBeau MM, et al. Acute myelomonocytic leukemia with abnormal eosinophils and inv(16) or t(16;16) has a favorable prognosis. *Blood* 1986;68:1242–1249.
379. Tobelem G, Jacquillat C, Chastang C, et al. Acute monoblastic leukemia: a clinical and biologic study of 74 cases. *Blood* 1980;55:71–76.
380. Peterson BA, Levine EG. Uncommon subtypes of acute nonlymphocytic leukemia: clinical features and management of FAB M5, M6 and M7. *Semin Oncol* 1987;14(4):425–434.
381. Tkachuk DC, Kohler S, Cleary ML. Involvement of a homolog of *Drosophila thorax* by 11q23 chromosomal translocations in acute leukemias. *Cell* 1992;71:691–700.
382. Nakamura T, Alder H, Gu Y, et al. Genes on chromosomes 4, 9 and 19 involved in 11q23 abnormalities in acute leukemia share sequence homology and/or common motifs. *Proc Natl Acad Sci U S A* 1993;20:4632–4635.
383. Scott CS, Stark AN, Limbert HJ, et al. Diagnostic and prognostic factors in acute monocytic leukaemia: an analysis of 51 cases. *Br J Haematol* 1988;69:247–252.
384. Stamberg J. Chromosome abnormalities in erythroleukemia. *Cancer* 1987;60:2649–2653.
385. Hetzel P, Gee TS. A new observation in the clinical spectrums of erythroleukemia. *Am J Med* 1978;64:765–772.
386. Huang M, Li CY, Nicholes WL, et al. Acute leukemia with megakaryocytic differentiation: a study of 12 cases identified immunocytochemically. *Blood* 1984;64:427–439.
387. Koike T. Megakaryoblastic leukemia: the characterization and identification of megakaryoblasts. *Blood* 1984;64:683–692.
388. Carroll A, Civin C, Schneider N, et al. The t(1;22)(p13;q13) is nonrandom and restricted to infants

with acute megakaryoblastic leukemia: a Pediatric Oncology Group study. *Blood* 1991;78:748–752.

389. Mercher T, Coniat MB, Monni R, et al. Involvement of a human gene related to the *Drosophila* *spen* gene in the recurrent t(1;22) translocation of acute megakaryocytic leukemia. *Proc Natl Acad Sci U S A* 2001;98:5776–5779.
390. Dharmasena F, Wickham N, McHugh PJ, et al. Osteolytic tumors in acute megakaryoblastic leukemia. *Cancer* 1986;58:2273–2277.
391. Bearman RM, Pangalis GA, Rappaport H. Acute (“malignant”) myelosclerosis. *Cancer* 1979;43:279–293.
392. Simon JH, Tebbi CK, Freeman AI, et al. Acute megakaryoblastic leukemia associated with mosaic Down’s syndrome. *Cancer* 1987;60:2515–2520.
393. Taub JW, Matherly LH, Stout ML, et al. Enhanced metabolism of 1-beta-D-arabinofuranosylcytosine in Down syndrome cells: a contributing factor to the superior event free survival of Down syndrome children with acute myeloid leukemia. *Blood* 1996;87:3395–3403.
394. Peterson LC, Parkin JL, Arthur DC, Brunning RD. Acute basophilic leukemia. A clinical, morphologic, and cytogenetic study of eight cases. *Am J Clin Pathol* 1991;96:160–170.
395. Soekarman D, VonLindern M, Daenen S, et al. The translocation (6;9)(p23;q34) shows consistent rearrangement of two genes and defines a myeloproliferative disorder with specific clinical features. *Blood* 1992;79:2990–2997.
396. Bitter MA, Neilly ME, LeBeau MM, et al. Rearrangements of chromosome 3 involving bands 3q21 and 3q26 are associated with normal or elevated platelet counts in acute nonlymphocytic leukemia. *Blood* 1985;66:1362–2370.
397. Jenkins RB, Tefferi A, Solberg LA, Jr., Dewald GW. Acute leukemia with abnormal thrombopoiesis and inversions of chromosome 3. *Cancer Genet Cytogenet* 1989;39:167–179.
398. Jotterand-Bellomo M, Parlier V, Muhlematter D, et al. Three new cases of chromosome 3 rearrangement in bands q21 and q26 with abnormal thrombopoiesis bring further evidence to the existence of a 3q21q26 syndrome. *Cancer Genet Cytogenet* 1992;59:138–160.
399. Fichelson S, Dreyfus F, Berger R, et al. Evi-1 expression in leukemic patients with rearrangements of the 3q25–q28 chromosomal region. *Leukemia* 1992;6:93–99.
400. Levy ER, Parganas E, Morishita K, et al. DNA rearrangement proximal to the EVI1 locus associated with the 3q21q26 syndrome. *Blood* 1994;83:1348–1354.
401. Raimondi SC, Dube ID, Valentine MB, et al. Clinicopathologic manifestations and breakpoints of the t(3;5). *Leukemia* 1989;3:42–47.
402. McCarthy CMT, Cobcroft RG, Harris MG, Scott DC. Sweet’s syndrome, acute leukemia, and t(3;5). *Cancer Genet Cytogenet* 1987;28:87–91.
403. Mijovic A, Novak A, Medenica L. Sweet’s syndrome associated with inversion of chromosome 3q in a patient with refractory anemia. *Eur J Haematol* 1992;49:156–157.
404. Yoneda-Kato N, Look AT, Kirstein MN. The t(3;5)(q25.1;q34) myelodysplastic syndrome and acute myeloid leukemia produces a novel fusion gene, NPM-MF1. *Oncogene* 1996;12:265–275.
405. Kelly L, Clark J, Gilliland DG. Comprehensive genotypic analysis of leukemia: clinical therapeutic implications. *Curr Opin Oncol* 2002;14:10–18.
406. Jaju RJ, Fidler C, Haas OA, et al. A novel gene, NSD1, is fused to NUP98 in the (5;11)(q35;p15.5) in de novo childhood acute myeloid leukemia. *Blood* 2001;98:1264–1267.
407. Ahuja HG, Hong J, Aplan PD, et al. t(9;11)(p22;p15) in acute myeloid leukemia results in a fusion between NUP98 and the gene encoding transcriptional coactivators p52 and p75-lens epithelium-derived



growth factor (LEDGF). *Cancer Res* 2000;60:6227–6228.

408. Daheron L, Veinstein A, Brizard F, et al. Human LPP gene is fused to MLL in a secondary acute leukemia with a t(3;11)(q28;q23). *Genes Chromosomes Cancer* 2001;31:382–389.

409. Kuwada N, Kimura F, Matsumura T, et al. t(11;14)(q23;q24) generates an MLL–human gephyrin fusion gene along with a de facto truncated MLL in acute monoblastic leukemia. *Cancer Res* 2001;61:2665–2669.

410. Hayette S, Tigaud I, Vanier A, et al. AF15q14, a novel partner gene fused to the MLL gene in an acute myeloid leukaemia with a t(11;15)(q23;q14). *Oncogene* 2000;19:4446–4450.

411. Borkhardt A, Bojesen S, Haas OA, et al. The human GRAF gene is fused to MLL in a unique t(5;11)(q31;q23) and both alleles are disrupted in cases of myelodysplastic syndrome/acute myeloid leukemia with a deletion 5q. *Proc Natl Acad Sci U S A* 2000;97:9168–9173.

412. Kitabayashi I, Aikawa Y, Yokoyama A, et al. Fusion of MOZ and p300 histone acetyltransferases in acute monocytic leukemia with a t(8;22)(p11;q13) chromosome translocation. *Leukemia* 2001;15:89–94.

413. Panagopoulos I, Fioretos T, Isaksson M, et al. Fusion of the MORF and CBP genes in acute myeloid leukemia with the t(10;16)(q22;p13). *Hum Mol Genet* 2001;10:395–404.

414. Baer MR, Bloomfield CD. The clinical significance of biological characteristics of the cells in acute myeloid leukemia. *Annu Rev Med* 1991;42:381–389.

415. Buchner T, Heinecke A. The role of prognostic factors in acute myeloid leukemia. *Leukemia* 1996;10:528–529.

416. Kahl C, Florschütz A, Müller G, et al. Prognostic significance of dysplastic features of hematopoiesis in patients with de novo acute myelogenous leukemia. *Ann Hematol* 1997;75:1–94.

417. Billström R, Nilsson PG, Mitelman F. Chromosomes, Auer rods and prognosis in acute myeloid leukaemia. *Eur J Haematol* 1988;40:273–278.

418. Estey E. Prognostic factors in acute myelogenous leukemia. *Leukemia* 2001;15:670–672.

419. Schwarzingger I, Valent P, Koller U, et al. Prognostic significance of surface marker expression on blasts of patients with de novo acute myeloblastic leukemia. *J Clin Oncol* 1990;8:423–430.

420. Brincker H. Estimate of overall treatment results in acute nonlymphocytic leukemia based on age-specific rates of incidence and of complete remission. *Cancer Treat Rep* 1985;69:5–11.

421. Swirsky DM, DeBastos M, Parish SE, et al. Features affecting outcome during remission induction of acute myeloid leukaemia in 619 adult patients. *Br J Haematol* 1986;64:435–453.

422. Hoyle CF, de Bastos M, Wheatley K, et al. AML associated with previous cytotoxic therapy, MDS or myeloproliferative disorders: results from the MRC's 9th AML trial. *Br J Haematol* 1989;72:45–53.

423. Mertelsmann R, Tzvi TH, To L, et al. Morphological classification, response to therapy, and survival in 263 adult patients with acute nonlymphoblastic leukemia. *Blood* 1980;56:773–781.

424. Vernant JP, Brun B, Mannoni P, Dreyfus B. Respiratory distress of hyperleukocytic granulocytic leukemias. *Cancer* 1979;44:264–268.

425. Hug V, Keating MJ, McCredie K, et al. Clinical course and response to treatment of patients with acute myelogenous leukemia presenting with a high leukocyte count. *Cancer* 1983;52:773–779.

426. Löffler H, Gassmann W, Haferlach T. AML M1 and M2 with eosinophilia and AML M4Eo: diagnostic and clinical aspects. *Leuk Lymph* 1995;18:61–63.

427. Peters WG, Willemze R, Zwaan FE, Colly LP. Day 6 bone marrow aspirate for the prediction of response to remission induction therapy for acute myelogenous leukaemia. *Blut* 1988;47:91–95.

428. Estey E, Shen Y, Thall P. Effect of time to complete remission on subsequent survival and

disease-free survival time in AML, RAEB-t, and RAEB. *Blood* 2000;95:72-77.

429. Griffin JD, Davis R, Nelson DA, et al. Use of surface marker analysis to predict outcome of adult acute myeloblastic leukemia. *Blood* 1986;68:1232-1241.

430. Lanza F, Gigolin GM, Moretti S, et al. Prognostic value of immunophenotypic characteristics of blast cells in acute myeloid leukemia. *Leuk Lymph* 1994;13:81-85.

431. Baer MR, Stewart CC, Dodge RK, et al. High frequency of immunophenotype changes in acute myeloid leukemia relapse: implications for residual disease detection (Cancer and Leukemia Group B study 8361). *Blood* 2001;97:3574-3580.

432. Ciolli S, Leoni F, Caporale R, et al. CD34 expression fails to predict the outcome in adult acute myeloid leukemia. *Haematologica* 1993;78:151-155.

433. Fagioli F, Cuneo A, Caarli A, Bardi A. Chromosome aberrations in CD34-positive acute myeloid leukemia. Correlations with clinicopathologic features. *Cancer Genet Cytogenet* 1993;7:119-124.

434. teBoekhorst PAW, deLeeuw K, Schoester M, et al. Predominance of functional multidrug resistance (MDR-1) phenotype in CD34+ acute myeloid leukemia cells. *Blood* 1993;82:3157-3162.

435. Willman CL. Immunophenotyping and cytogenetics in older adults with acute myeloid leukemia: significance of expression of the multidrug resistance gene-1 (MDR1). *Leukemia* 1996;10:533-535.

436. Tucker J, Dorey E, Gregory WM, et al. Immunophenotype of blast cells in acute myeloid leukemia may be a useful predictive factor for outcome. *Hematol Oncol* 1990;8:47-58.

437. Iizuka Y, Aiso M, Oshimi K, et al. Myeloblastoma formation in acute myeloid leukemia. *Leuk Res* 1992;16:665-671.

438. Kawai S, Xha Z, Yamamoto Y, et al. Clinical significance of childhood acute myeloid leukemias expressing lymphoid-associated antigens. *Hematol Oncol* 1995;12:463-469.

439. Byrd JC, Mrozek K, Dodge RK, et al. Pretreatment cytogenetic abnormalities are predictive of induction success, cumulative incidence of relapse, and overall survival in adult patients with de novo acute myeloid leukemia: results from Cancer and Leukemia Group B (CALGB 8461). *Blood* 2002;100:4325-4336.

440. Taylor CG, Stasi R, Bastianelli C, et al. Diagnosis and classification of the acute leukemias: recent advances and controversial issues. *Hematopathol Mol Hematol* 1996;10:1-38.

441. Slovak ML, Kopecky KJ, Cassileth P, et al. Karyotypic analysis predicts outcome of preremission and postremission therapy in adult acute myeloid leukemia: a Southwest Oncology Group/Eastern Cooperative Oncology Group study. *Blood* 2000;96:4075-4083.

442. Schoch C, Haase D, Haferlach T, et al. Fifty-one patients with acute myeloid leukemia and translocation t(8;21)(q22;q22): an additional deletion in 9q is an adverse prognostic factor. *Leukemia* 1996;10:1288-1295.

443. Tashiro S, Kyo T, Oguma N, et al. The prognostic value of cytogenetic analyses in patients with acute nonlymphocytic leukemia treated with the same intensive chemotherapy. *Cancer* 1992;37:2809-2815.

444. Pedersen B. MDS and AML with trisomy 8 as the sole chromosome aberration show different sex ratios and prognostic profiles: a study of 115 published cases. *Am J Hematol* 1997;56:224-229.

445. Yu M, Honoki K, Andersen J, et al. MLL tandem duplication and multiple splicing in adult acute myeloid leukemia with normal karyotype. *Leukemia* 1996;10:774-780.

446. Schnittger S, Kinkelin U, Schoch C, et al. Screening for MLL tandem duplication in 387 unselected patients with AML identify a prognostically unfavorable subset of AML. *Leukemia* 2000;14:796-804.

447. List AF. Role of multidrug resistance and its pharmacologic modulation in acute myeloid leukemia. *Leukemia* 1996;10:937-942.

448. Legrand O, Simonin G, Perrot JY, et al. Pgp and MRP activities using calcein-AM are prognostic factors in adult acute myeloid leukemia patients. *Blood* 1998;91:4480-4488.
449. Leith CP, Kopecky KJ, Chen IM, et al. Frequency and clinical significance of the expression of the multidrug resistance proteins MDR1/P-glycoprotein, MRP1, and LRP in acute myeloid leukemia: a Southwest Oncology Group Study. *Blood* 1999;94:1086-1099.
450. van den Heuvel-Eibrink MM, Wiemer EA, de Boevere MJ, et al. MDR1 gene-related clonal selection and P-glycoprotein function and expression in relapsed or refractory acute myeloid leukemia. *Blood* 2001;97:3605-3611.
451. Filipits M, Pohl G, Stranzl T, et al. Expression of the lung resistance protein predicts poor outcome in de novo acute myeloid leukemia. *Blood* 1998;91:1508-1513.
452. van der Kolk DM, Vellenga E, Scheffer GL, et al. Expression and activity of breast cancer resistance protein (BCRP) in de novo and relapsed acute myeloid leukemia. *Blood* 2002;99:3763-3770.
453. Murren JR. Modulating multidrug resistance: can we target this therapy? *Clin Cancer Res* 2002;8:633-635.
454. Kiyoi H, Naoe T, Nakano Y, et al. Prognostic implication of FLT3 and N-RAS gene mutations in acute myeloid leukemia. *Blood* 1999;93:3074-3080.
455. Thiede C, Steudel C, Mohr B, et al. Analysis of FLT3-activating mutations in 979 patients with acute myelogenous leukemia: association with FAB subtypes and identification of subgroups with poor prognosis. *Blood* 2002;99:4326-4335.
456. Kottaridis PD, Gale RE, Frew ME, et al. The presence of a FLT3 internal tandem duplication in patients with acute myeloid leukemia (AML) adds important prognostic information to cytogenetic risk group and response to the first cycle of chemotherapy: analysis of 854 patients from the United Kingdom Medical Research Council AML 10 and 12 trials. *Blood* 2001;98:1752-1759.
457. Stirewalt DL, Kopecky KJ, Meshinchi S, et al. FLT3, RAS, and TP53 mutations in elderly patients with acute myeloid leukemia. *Blood* 2001;97:3589-3595.
458. Fröhling S, Schlenk RF, Breitnick J, et al. Prognostic significance of activating FLT3 mutations in younger adults (16 to 60 years) with acute myeloid leukemia and normal cytogenetics: a study of the AML Study Group ULM. *Blood* 2002;100:4372-4380.
459. Beaupre DM, Kurzrock R. RAS and leukemia: from basic mechanisms to gene-directed therapy. *J Clin Oncol* 1999;17:1071-1079.
460. van Doorn-Khosrovani SBvW, Erpelinck C, van Putten WLJ, et al. High *EVI1* expression predicts poor survival in acute myeloid leukemia: a study of 319 de novo AML patients. *Blood* 2003;101:837-845.
461. Beran M, Reizenstein P, Uden AM. Response to treatment in acute nonlymphocytic leukaemia: prognostic value of colony forming and colony stimulating capacities of bone marrow and blood cells compared to other parameters. *Br J Haematol* 1980;44:39-50.
462. Lihou MG, Smith PF. Quantitation of chemosensitivity in acute myelocytic leukaemia. *Br J Cancer* 1983;48:559-567.
463. Park CH, Amare M, Savin MA, et al. Prediction of chemotherapy response in human leukemia using an in vitro chemotherapy sensitivity test on the leukemic colony-forming cells. *Blood* 1980;55:595-601.
464. Preisler HD, Rustum Y, Priore RL. Relationship between leukemic cell retention of cytosine arabinoside triphosphate and the duration of remission in patients with acute non-lymphocytic leukemia. *Eur J Cancer Clin Oncol* 1985;21:23-30.
465. Ohler L, Berer A, Aletaha D, et al. Cytogenetic risk groups in acute myeloblastic leukaemia differ greatly in their semi-solid colony growth. *Br J Haematol* 2001;113:120-125.
466. Rombouts WJ, Lowenberg B, van Putten WL, Ploemacher RE. Improved prognostic significance of

cytokine-induced proliferation in vitro in patients with de novo acute myeloid leukemia of intermediate risk: impact of internal tandem duplications in the Flt3 gene. *Leukemia* 2001;15:1046–1053.

467. Pieters R, Huismans DR, Leyva A, Veerman AJ. Comparison of the rapid automated MTT-assay with a dye exclusion assay for chemosensitivity testing in childhood leukaemia. *Br J Cancer* 1989;59:217–220.

468. Veerman AJ, Pieters R. Drug sensitivity assays in leukaemia and lymphoma. *Br J Haematol* 1990;74:381–384.

469. Kravtsov VD, Fabian I. Automated monitoring of apoptosis in suspension cell cultures. *Lab Invest* 1996;74:557–570.

470. Kravtsov VD, Greer JP, Whitlock JA, Koury MJ. Use of the microculture kinetic assay of apoptosis to determine chemosensitivities of leukemias. *Blood* 1998;92:968–980.

471. Banker DE, Groudine M, Norwood T, Appelbaum FR. Measurement of spontaneous and therapeutic agent-induced apoptosis with BCL-2 protein expression in acute myeloid leukemia. *Blood* 1997;89:243–255.

472. Kornblau SM, Thall PF, Estrov Z, et al. The prognostic impact of BCL2 protein expression in acute myelogenous leukemia varies with cytogenetics. *Clin Cancer Res* 1999;5:1758–1766.

473. Aguayo A, Estey E, Kantarjian H, et al. Cellular vascular endothelial growth factor is a predictor of outcome in patients with acute myeloid leukemia. *Blood* 1999;94:3717–3721.

474. Aguayo A, Kantarjian H, Manshoury T, et al. Angiogenesis in acute and chronic leukemias and myelodysplastic syndromes. *Blood* 2000;96:2240–2245.

475. Gahrton G. Treatment of acute leukemia—advances in chemotherapy, immunotherapy, and bone marrow transplantation. *Adv Cancer Res* 1983;40:255–329.

476. Hayat M, Jehn U, Willemze R, et al. A randomized comparison of maintenance treatment with androgens, immunotherapy, and chemotherapy in adult acute myelogenous leukemia. A Leukemia-Lymphoma Group Trial of the EORTC. *Cancer* 1986;58:617–623.

477. Caron PC, Jurcic JG, Scott AM, et al. A phase 1B trial of humanized monoclonal antibody M195 (anti-CD33) in myeloid leukemia: specific targeting without immunogenicity. *Blood* 1994;83:1760–1768.

478. Sievers EL, Larson RA, Stadtmauer EA, et al. Efficacy and safety of gemtuzumab ozogamicin in patients with CD33-positive acute myeloid leukemia in first relapse. *J Clin Oncol* 2001;19:3244–3254.

479. Champlin R, Gajewski J, Nimer S, et al. Post remission chemotherapy for adults with acute myelogenous leukemia: improved survival with high-dose cytarabine and daunorubicin consolidation treatment. *J Clin Oncol* 1990;8:1199–1206.

480. Schiller G. Dose-intensive treatment of acute myelogenous leukemia: improved survival [letter]. *J Clin Oncol* 1995;13:1828–1830.

481. Berman E. Chemotherapy in acute myelogenous leukemia: high-dose, higher expectations [Editorial]. *J Clin Oncol* 1994;12:671–678.

482. Lowenberg B. Post-remission treatment of acute myelogenous leukemia [Editorial]. *N Engl J Med* 1995;332:260–262.

483. Stone RM. Postremission therapy in adults with acute myeloid leukemia. *Semin Hematol* 2001;38[3 Suppl 6]:17–23.

484. Mayer RJ. Allogeneic transplantation versus intensive chemotherapy in first-remission acute leukemia: is there a “best choice”? *J Clin Oncol* 1988;6:1532–1536.

485. Hertenstein B, Heil G, Heimpel H. Allogeneic bone marrow transplantation or chemotherapy for patients with acute myeloid leukemia in first complete remission: a decision analysis approach. *Ann Hematol* 1996;72:223–230.

486. Buckner CD, Clift RA. Allogeneic transplantation in acute myelogenous leukemia: are we stuck? *Leuk Lymphoma* 1993;11[Suppl 2]:25-28.
487. Ifrah N, James JM, Viguie F, et al. Spontaneous remission in adult acute leukemia. *Cancer* 1985;56:1187-1195.
488. Gale RE, Foon KA. Therapy for acute myelogenous leukemia. *Semin Hematol* 1987;24:40-54.
489. Cassileth PA, Begg CB, Bennett JM, et al. A randomized study of the efficacy of consolidation therapy in adult acute nonlymphocytic leukemia. *Blood* 1984;63:843-847.
490. Bloomfield CD. Postremission therapy in acute myeloid leukemia. *J Clin Oncol* 1985;3:1570-1572.
491. Cassileth PA, Harrington DP, Hines JD, et al. Maintenance chemotherapy prolongs remission duration in adult acute nonlymphocytic leukemia. *J Clin Oncol* 1988;6:583-587.
492. Dutcher JP, Wiernik PH, Marcus S, et al. Intensive maintenance therapy improves survival in adult acute nonlymphocytic leukemia: an eight-year follow-up. *Leukemia* 1988;2:413-419.
493. Volger WR, Weiner RS, Moore JO, et al. Long-term follow-up of a randomized post-induction therapy trial in acute myelogenous leukemia (a Southeastern Cancer Study Group trial). *Leukemia* 1995;9:1456-1460.
494. Sauter C, Berchtold W, Fopp M, et al. Acute myelogenous leukaemia: maintenance chemotherapy after early consolidation treatment does not prolong survival. *Lancet* 1984;1:379-382.
495. Champlin R, Jacobs A, Gale RP, et al. Prolonged survival in acute myelogenous leukemia without maintenance chemotherapy. *Lancet* 1984;1:894-896.
496. Zittoun R, Mandelli F, Willemze R, et al. Autologous or allogeneic bone marrow transplantation compared with intensive chemotherapy in acute myelogenous leukemia. *N Engl J Med* 1995;332:217-223.
497. Stockerl-Goldstein KE, Blume KG. Allogeneic hematopoietic cell transplantation for adult patients with acute myeloid leukemia. In: Thomas ED, Blume KG, Forman SJ, eds. *Hematopoietic cell transplantation*, 2<sup>nd</sup> ed. London: Blackwell Science, 1999:823-834.
498. Fung HC, Forman SJ. Allogeneic hematopoietic cell transplantation for adult patients with acute myelogenous leukemia. In: Laughlin MS, Lazarus HM, eds. *Current clinical oncology: allogeneic stem cell transplantation*. Totowa: Humana Press, 2003:13-27.
499. Clift RA, Buckner CD, Thomas ED, et al. The treatment of acute non-lymphoblastic leukemia by allogeneic marrow transplantation. *Bone Marrow Transplant* 1987;2:243-258.
500. Preisler H. An integrated approach to the study and treatment of acute myelocytic leukemia. In: Bloomfield CD, ed. *Adult leukemias*. Martinus Nijhoff, 1982.
501. Preisler H. Poor prognosis acute myelogenous leukemia. *Leuk Lymphoma* 1993;9:273-283.
502. Legha SS, Keating MJ, Zander AR, et al. 4'-(9-Acridinylamino) methanesulfon-m-anisidide (AMSA): a new drug effective in the treatment of adult acute leukemia. *Ann Intern Med* 1980;93:17-21.
503. Stein RS. Advances in the therapy of acute nonlymphocytic leukemia. *Am J Med Sci* 1989;297:26-34.
504. Bolwell BJ, Cassileth PA, Gale RP. High dose cytarabine: a review. *Leukemia* 1988;2:253-260.
505. Capizzi RL, Davis R, Powell B, et al. Synergy between high-dose cytarabine and asparaginase in the treatment of adults with refractory and relapsed acute myelogenous leukemia—a Cancer and Leukemia Group B Study. *J Clin Oncol* 1988;6:499-508.
506. Cassileth PA, Begg CB, Silber R, et al. Prolonged unmaintained remission after intensive

- consolidation therapy in adult acute nonlymphocytic leukemia. *Cancer Treat Rep* 1987;71:137-140.
507. Shpilberg O, Haddad N, Sofer O, et al. Postremission therapy with two different dose regimens of cytarabine in adults with acute myelogenous leukemia. *Leuk Res* 1995;19:893-897.
508. Heil G, Mitrou PS, Hoelzer D, et al. High-dose cytosine arabinoside and daunorubicin postremission therapy in adults with de novo acute myeloid leukemia. Long-term follow-up of a prospective multicenter trial. *Ann Hematol* 1995;71:219-225.
509. Whitlock JA, Wells RJ, Hord JD, et al. High-dose cytosine arabinoside and etoposide: an effective regimen without anthracyclines for refractory childhood acute non-lymphocytic leukemia. *Leukemia* 1997;11:185-189.
510. Karanes C, Kopecky KJ, Head DR, et al. A phase III comparison of high dose ARA-C (HIDAC) versus HIDAC plus mitoxantrone in the treatment of first relapsed or refractory acute myeloid leukemia Southwest Oncology Group Study. *Leuk Res* 1999;23:787-794.
511. Bolwell BJ, Cassileth PA, Gale RP. Low dose cytosine arabinoside in myelo-dysplasia and acute myelogenous leukemia: a review. *Leukemia* 1987;1:575-579.
512. Tilly H, Castaigne S, Bordessoule D, et al. Low-dose cytosine arabinoside treatment for acute nonlymphocytic leukemia in elderly patients. *Cancer* 1985;55:1633-1636.
513. Wisch JS, Griffin JD, Kufe DW. Response of preleukemic syndromes to continuous infusion of low-dose cytarabine. *N Engl J Med* 1983;309:1599-1602.
514. Venditti A, Stasi R, Del Poeta G, et al. All-trans retinoic acid and low-dose cytosine arabinoside for the treatment of 'poor prognosis' acute myeloid leukemia. *Leukemia* 1995;9:1121-1125.
515. Castaigne S, Daniel MT, Tilly H, et al. Does treatment with ARA-C in low dosage cause differentiation of leukemic cells? *Blood* 1983;62:85-86.
516. Yates J, Glidewell O, Wiernik P, et al. Cytosine arabinoside with daunorubicin or adriamycin for therapy of acute myelocytic leukemia: a CALGB study. *Blood* 1982;60:454-462.
517. Arlin ZA. Idarubicin in acute leukemia: an effective new therapy for the future. *Semin Oncol* 1989;16[1 Suppl 2]:35-36.
518. Wiernik PH, Banks PL, Case DC, Jr., et al. Cytarabine plus idarubicin or daunorubicin as induction and consolidation therapy for previously untreated adult patients with acute myeloid leukemia. *Blood* 1992;79:313-319.
519. Vogler WR, Velez-Garcia E, Weiner RS, et al. A phase III trial comparing idarubicin and daunorubicin in combination with cytarabine in acute myelogenous leukemia: a Southeastern Cancer Study Group Study. *J Clin Oncol* 1992;10:1103-1111.
520. Berman E, Heller G, Santorsa J, et al. Results of a randomized trial comparing idarubicin and cytosine arabinoside with daunorubicin and cytosine arabinoside in adult patients with newly diagnosed acute myelogenous leukemia. *Blood* 1991;77:1666-1674.
521. Reiffers J, Huguet F, Stoppa AM, et al. A prospective randomized trial of idarubicin vs. daunorubicin in combination chemotherapy for acute myelogenous leukemia of the age group 55 to 75. *Leukemia* 1996;10:389-395.
522. Bezwoda WR, Bernasconi C, Hutchinson RM, et al. Mitoxantrone for refractory and relapsed acute leukemia. *Cancer* 1990;66:418-422.
523. Kaminer LS, Choi KE, Daley KM, Larson RA. Continuous infusion mito-xantrone in relapsed acute nonlymphocytic leukemia. *Cancer* 1990;65:2619-2623.
524. MacCallum PK, Rohatiner AZ, Davis CL, et al. Mitoxantrone and cytosine arabinoside as treatment for acute myeloblastic leukemia in older patients. *Ann Hematol* 1995;71:35-39.
525. Bjorkholm M, Liliemark J, Gahrton G, et al. Mitoxantrone, etoposide and ara-C vs. doxorubicin-DNA,

ara-C, thioguanine, vincristine and prednisolone in the treatment of patients with acute myelocytic leukaemia. A randomized comparison. *Eur J Haematol* 1995;55:19–23.

526. Keskin A, Tombuloglu M, Atamer MA, Buyukkececi F. Mitoxantrone and standard dose cytosine arabinoside therapy in refractory or relapsed acute leukemia. *Acta Haematol* 1994;92:14–17.

527. Odom LF, Gordon EM. Acute monoblastic leukemia in infancy and early childhood: successful treatment with an epipodophyllotoxin. *Blood* 1984;64(4):875–882.

528. Bern MM, Wallach SR, Arkin CF, et al. Etoposide in combination with cytarabine, doxorubicin, and 6-thioguanine for treatment of acute nonlymphoblastic leukemia in a protocol adjusted for age. *Cancer Treat Rep* 1987;71:201–203.

529. Bishop JF, Lowenthal RM, Joshua D, et al. Etoposide in acute nonlymphocytic leukemia. Australian Leukemia Study Group. *Blood* 1990;75:27–32.

530. Kalwinsky D, Mirro J, Jr., Schell M, et al. Early intensification of chemotherapy for childhood acute nonlymphoblastic leukemia: improved remission induction with a five-drug regimen including etoposide. *J Clin Oncol* 1988;6:1134–1143.

531. Bassan R, Barbui T. Remission induction therapy for adults with acute myelogenous leukemia: towards the ICE age? *Haematologica* 1995;80:82–90.

532. Stein RS, Greer JP, Flexner JM, et al. Etoposide and mitoxantrone as a second cycle of consolidation therapy following high dose cytosine arabinoside and daunorubicin in patients with acute non-lymphocytic leukemia in remission: a pilot study. *Leuk Lymphoma* 1996;23:93–98.

533. Brown RA, Herzig RH, Wolff SN, et al. High-dose etoposide and cyclophosphamide without bone marrow transplantation for resistant hematologic malignancy. *Blood* 1990;76:473–479.

534. Giles FJ. Novel agents for the therapy of acute leukemia. *Curr Opin Oncol* 2002;14:3–9.

535. Estey EH, Thall PF, Pierce S, et al. Randomized phase II study of fludarabine + cytosine arabinoside + idarubicin +/- all-trans retinoic acid +/- granulocyte colony-stimulating factor in poor prognosis newly diagnosed acute myeloid leukemia and myelodysplastic syndrome. *Blood* 1999;93:2478–2484.

536. Gandhi V, Plunkett W, Du M, et al. Prolonged infusion of gemcitabine: clinical and pharmacodynamic studies during a phase I trial in relapsed acute myelogenous leukemia. *J Clin Oncol* 2002;20:665–673.

537. Rizzieri DA, Bass AJ, Rosner GL, et al. Phase I evaluation of prolonged-infusion gemcitabine with mitoxantrone for relapsed or refractory acute leukemia. *J Clin Oncol* 2002;20:674–679.

538. Krance RA, Hurwitz CA, Head DR, et al. Experience with 2-chlorodeoxy-adenosine in previously untreated children with newly diagnosed acute myeloid leukemia and myelodysplastic diseases. *J Clin Oncol* 2001;19:2804–2811.

539. Niitsu N, Yamamoto-Yamaguchi Y, et al. Antileukemic efficacy of 2-deoxycoformycin in monocytic leukemia cells. *Blood* 2000;96:1512–1516.

540. Estey E, Thall P, Andreeff M, et al. Use of granulocyte colony-stimulating factor before, during, and after fludarabine plus cytarabine induction therapy of newly diagnosed acute myelogenous leukemia or myelodysplastic syndromes: comparison with fludarabine plus cytarabine without granulocyte colony-stimulating factor. *J Clin Oncol* 1994;12:671–678.

541. Giles FJ, Garcia-Manero G, Cortes JE, et al. Phase II study of troxacitabine, a novel dioxolane nucleoside analog, in patients with refractory leukemia. *J Clin Oncol* 2002;20:656–664.

542. Kantarjian HM, Beran M, Ellis A, et al. Phase I study of Topotecan, a new topoisomerase I inhibitor, in patients with refractory or relapsed acute leukemia. *Blood* 1993;81:1146–1151.

543. Furman WL, Baker SD, Pratt CB, et al. Escalating systemic exposure of continuous infusion topotecan in children with recurrent acute leukemia. *J Clin Oncol* 1996;14:1504–1511.

544. Estey EH. New agents for the treatment of acute myelogenous leukemia: focus on topotecan and



retinoids. *Leukemia* 1998;12[Suppl 1]:S13-S15.

545. Beran M, Estey E, O'Brien S, et al. Topotecan and cytarabine is an active combination regimen in myelodysplastic syndromes and chronic myelomonocytic leukemia. *J Clin Oncol* 1999;17:2819-2830.

546. Ferra C, Berlanga JJ, Gallardo D, et al. Mitoxantrone, etoposide, carboplatinum and ara-C combination therapy (MECA) in refractory and relapsed acute leukemia. *Leuk Lymph* 2002;39:583-590.

547. Guthrie TH, Jr. High-dose, continuous-infusion cyclophosphamide, cytarabine, vincristine, and prednisone for remission induction in refractory adult acute leukemia. *Cancer* 1987;59:1255-1257.

548. Consolini R, Pui CH, Behm FG, et al. In vitro cytotoxicity of docetaxel in childhood acute leukemias. *J Clin Oncol* 1998;16:907-913.

549. Feldman EJ, Seiter KP, Ahmed T, et al. Homoharringtonine in patients with myelodysplastic syndrome (MDS) and MDS evolving to acute myeloid leukemia. *Leukemia* 1996;10:40-42.

550. Lee EJ, Van Echo DA, Egorin MJ, et al. Diaziquone given as a continuous infusion is an active agent for relapsed adult acute nonlymphocytic leukemia. *Blood* 1986;67:182-187.

551. Lubbert M. DNA methylation inhibitors in the treatment of leukemias, myelodysplastic syndromes and hemoglobinopathies: clinical results and possible mechanisms of action. *Curr Top Microbiol Immunol* 2000;249:135-164.

552. Zhu WG, Lakshmanan RR, Beal MD, Otterson GA. DNA methyltransferase inhibition enhances apoptosis induced by histone deacetylase inhibitors. *Cancer Res* 2001;61:1327-1333.

553. Silverman LR, Demakos EP, Peterson BL, et al. Randomized controlled trial of azacitidine in patients with the myelodysplastic syndrome: a study of the cancer and leukemia group B. *J Clin Oncol* 2002;20:2429-2440.

554. Wijermans P, Lubbert M, Verhoef G, et al. Low-dose 5-aza-2'-deoxycytidine, a DNA hypomethylating agent, for the treatment of high-risk myelodysplastic syndrome: a multicenter phase II study in elderly patients. *J Clin Oncol* 2000;18:956-962.

555. Mesters RM, Padro T, Bieker R, et al. Stable remission after administration of the receptor tyrosine kinase inhibitor SU5416 in a patient with refractory acute myeloid leukemia. *Blood* 2001;98:241-243.

556. Wright J, Hillsamer VL, Gore-Langton RE, Cheson BD. Clinical trials referral resource. Current clinical trials for the proteasome inhibitor PS-341. *Oncology (Huntingt)* 2000;14:1589-1590, 1593-1594, 1597.

557. Karp JE, Lancet JE, Kaufmann SH, et al. Clinical and biologic activity of the farnesyltransferase inhibitor R115777 in adults with refractory and relapsed acute leukemias: a phase 1 clinical-laboratory correlative trial. *Blood* 2001;97:3361-3369.

558. Stone RM, Mayer RJ. Treatment of the newly diagnosed adult with de novo acute myeloid leukemia. *Hematol Oncol Clin North Am* 1993;7:47-64.

559. Burnett AK. Tailoring the treatment of acute myeloid leukemia. *Curr Opin Oncol* 1999;11:14-19.

560. Tallman MS. Therapy of acute myeloid leukemia. *Cancer Control* 2001;8:62-78.

561. Wiernik PH, Glidewell OJ, Hoagland HC, et al. A comparative trial of Daunorubicin, cytosine arabinoside, and thioguanine, and a combination of the three agents for the treatment of acute myelocytic leukemia. *Med Pediatr Oncol* 1979;6:261-277.

562. Mandelli F, Petti MC, Ardia A, et al. A randomized clinical trial comparing idarubicin and cytarabine to daunorubicin and cytarabine in the treatment of acute non-lymphoid leukaemia. A multicentric study from the Italian Co-operative Group GIMEMA. *Eur J Cancer* 1991;27:750-755.

563. Smeers ME, Raymakers RA, Vierwinder G, et al. Idarubicin DNA intercalation is reduced by MRP1

and not Pgp. *Leukemia* 1999;13:1390–1398.

564. MacCallum PK, Davis CL, Rohatiner AZ, et al. Mitoxantrone and cytosine arabinoside as treatment for acute myelogenous leukemia (AML) at first recurrence. *Leukemia* 1993;7:1496–1499.
565. Lowenberg B, Suci S, Archimbaud E, et al. Mitoxantrone versus daunorubicin in induction–consolidation chemotherapy—the value of low–dose cytarabine for maintenance of remission, and an assessment of prognostic factors in acute myeloid leukemia in the elderly: final report. European Organization for the Research and Treatment of Cancer and the Dutch–Belgian Hemato–Oncology Cooperative Hovon Group. *J Clin Oncol* 1998;16:872–881.
566. Mayer RJ, Schiffer CA, Peterson BA, et al. Intensive postremission therapy in adults with acute nonlymphocytic leukemia using various dose schedules of ara–C: a progress report from the CALGB. Cancer and Leukemia Group B. *Semin Oncol* 1987;14[2 Suppl 1]:25–31.
567. Rai KR, Holland JF, Glidewell OJ, et al. Treatment of acute myelocytic leukemia: a study by cancer and leukemia group B. *Blood* 1981;58:1203–1212.
568. Preisler H, Davis RB, Kirshner J, et al. Comparison of three remission induction regimens and two postinduction strategies for the treatment of acute nonlymphocytic leukemia: a cancer and leukemia group B study. *Blood* 1987;69:1441–1449.
569. Rowe JM, Tallman MS. Intensifying induction therapy in acute myeloid leukemia: has a new standard of care emerged? *Blood* 1997;90:2121–2126.
570. Capizzi RL, White JC, Powell BL, Perrino F. Effect of dose on the pharmacokinetic and pharmacodynamic effects of cytarabine. *Semin Hematol* 1991;28[3 Suppl 4]:54–69.
571. Estey E, Plunkett W, Dixon D, et al. Variables predicting response to high dose cytosine arabinoside therapy in patients with refractory acute leukemia. *Leukemia* 1987;1:580–583.
572. Phillips GL, Reece DE, Shepherd JD, et al. High–dose cytarabine and daunorubicin induction and postremission chemotherapy for the treatment of acute myelogenous leukemia in adults. *Blood* 1991;77:1429–1435.
573. Bishop JF, Matthews JP, Young GA, et al. A randomized study of high–dose cytarabine in induction in acute myeloid leukemia. *Blood* 1996;87:1710–1717.
574. Weick JK, Kopecky KJ, Appelbaum FR, et al. A randomized investigation of high–dose versus standard–dose cytosine arabinoside with daunorubicin in patients with previously untreated acute myeloid leukemia: a Southwest Oncology Group study. *Blood* 1996;88:2841–2851.
575. Buchner T, Hiddemann W, Wormann B, et al. Double induction strategy for acute myeloid leukemia: the effect of high–dose cytarabine with mitoxantrone instead of standard–dose cytarabine with daunorubicin and 6–thioguanine: a randomized trial by the German AML Cooperative Group. *Blood* 1999;93:4116–4124.
576. Appelbaum FR, Baer M, Byrd J, et al. Practice guidelines for Acute Myelogenous Leukemia (AML). National Comprehensive Cancer Network. 2002, [www.nccn.org/physician\\_gls/f\\_guidelines.html](http://www.nccn.org/physician_gls/f_guidelines.html).
577. Mitus AJ, Miller KB, Schenkein DP, et al. Improved survival for patients with acute myelogenous leukemia. *J Clin Oncol* 1995;13:560–569.
578. Bishop JF. Intensified therapy for acute myeloid leukemia. *N Engl J Med* 1994;331:941–942.
579. Bishop JF. The treatment of adult acute myeloid leukemia. *Semin Oncol* 1997;24:57–69.
580. Preisler HD, Raza A, Barcos M, et al. High–dose cytosine arabinoside as the initial treatment of poor–risk patients with acute nonlymphocytic leukemia: a Leukemia Intergroup Study. *J Clin Oncol* 1987;5:75–82.
581. Champlin R, Gajewski J, Nimer S, et al. Post remission chemotherapy for adults with acute myelogenous leukemia: improved survival with high–dose cytarabine and daunorubicin consolidation

treatment. *J Clin Oncol* 1990;8:1199-1206.

582. Vaughan WP, Karp JE, Burke PJ. Two-cycle timed-sequential chemotherapy for adult acute nonlymphocytic leukemia. *Blood* 1984;64:975-980.

583. Vaughan WP, Karp JE, Burke PJ. Long chemotherapy-free remissions after single-cycle timed-sequential chemotherapy for acute myelocytic leukemia. *Cancer* 1980;45:859-865.

584. Tricot G, Boogaerts MA, Vlietinck R, et al. The role of intensive remission induction and consolidation therapy in patients with acute myeloid leukaemia. *Br J Haematol* 1987;66:37-44.

585. Wolff SN, Herzig RH, Fay JW, et al. High-dose cytarabine and daunorubicin as consolidation therapy for acute myeloid leukemia in first remission: long-term follow-up and results. *J Clin Oncol* 1989;7(9):1260-1267.

586. Harousseau JL, Milpied N, Briere J, et al. Double intensive consolidation chemotherapy in adult acute myeloid leukemia. *J Clin Oncol* 1991;9:1432-1437.

587. Cassileth PA, Lynch E, Hines JD, et al. Varying intensity of postremission therapy in acute myeloid leukemia. *Blood* 1992;79:1924-1930.

588. Fopp M, Schatzmann E, Fey MF, et al. Randomized trial of post-remission high-dose (HIDAC) versus standard-dose (SDAC) cytosine arabinoside in adult acute myeloid leukemia (AML). *Proc Am Soc Clin Oncol* 1993;12:A999.

589. Mayer RJ, Davis RB, Schiffer CA, et al. Intensive postremission chemotherapy in adults with acute myeloid leukemia. Cancer and Leukemia group B. *N Engl J Med* 1994;331:896-903.

590. Scheinberg DA, Lovett D, Divgi CR, et al. A phase I trial of monoclonal antibody M195 in acute myelogenous leukemia: specific bone marrow targeting and internalization of radionuclide. *J Clin Oncol* 1991;9:478-490.

591. van Der Velden V, te Marvelde JG, Hoogeveen PG, et al. Targeting of the CD33-calicheamicin immunoconjugate Mylotarg (CMA-676) in acute myeloid leukemia: in vivo and in vitro saturation and internalization by leukemic and normal myeloid cells. *Blood* 2001;97:3197-3204.

592. Larson RA. Current use and future development of gemtuzumab ozogamicin. *Semin Hematol* 2001;38[3 Suppl 6]:24-31.

593. Bross PF, Beitz J, Chen G, et al. Approval summary: gemtuzumab ozogamicin in relapsed acute myeloid leukemia. *Clin Cancer Res* 2001;7:1490-1496.

594. Tack DK, Letendre L, Kamath PS, Tefferi A. Development of hepatic veno-occlusive disease after Mylotarg infusion for relapsed acute myeloid leukemia. *Bone Marrow Transplant* 2001;28:895-897.

595. Appelbaum FR, Matthews DC, Eary JF, et al. The use of radiolabeled anti-CD33 antibody to augment marrow irradiation prior to marrow transplantation for acute myelogenous leukemia. *Transplantation* 1992;54:829-833.

596. Sgouros G, Ballangrud AM, Jurcic JG, et al. Pharmacokinetics and dosimetry of an alpha-particle emitter labeled antibody: 213Bi-HuM195 (anti-CD33) in patients with leukemia. *J Nucl Med* 1999;40:1935-1946.

597. Matthews DC, Appelbaum FR, Eary JF, et al. Phase I study of (131)I-anti-CD45 antibody plus cyclophosphamide and total body irradiation for advanced acute leukemia and myelodysplastic syndrome. *Blood* 1999;94:1237-1247.

598. Ruffner KL, Matthews DC. Current uses of monoclonal antibodies in the treatment of acute leukemia. *Semin Oncol* 2000;27:531-539.

599. Bunjes DW, Buchmann I, Duncker C, et al. Using radiolabeled monoclonal antibodies to intensify the conditioning regimen for patients with high-risk AML and MDS: a single centre experience of 36 transplants. *Blood* 2000;96:1667.

600. Clift RA, Buckner CD, Appelbaum FR, et al. Allogeneic marrow transplantation in patients with acute myeloid leukemia in first remission: a randomized trial of two irradiation regimens. *Blood* 1990;76:1867–1871.
601. Appelbaum FR. Allogeneic hematopoietic stem cell transplantation for acute leukemia. *Semin Oncol* 1997;24:114–123.
602. Jourdan E, Maraninchi D, Reiffers J, et al. Early allogeneic transplantation favorably influences the outcome of adult patients suffering from acute myeloid leukemia. *Societe Francaise de Greffe de Moelle (SFGM). Bone Marrow Transplant* 1997;19:875–1981.
603. Schiller G, Feig SA, Territo M, et al. Treatment of advanced acute leukaemia with allogeneic bone marrow transplantation from unrelated donors. *Br J Haematol* 1994;88:72–78.
604. Beatty PG, Hansen JA, Longton GM, et al. Marrow transplantation from HLA-matched unrelated donors for treatment of hematologic malignancies. *Transplantation* 1991;51:443–447.
605. Kurtzberg J, Laughlin M, Graham ML, et al. Placental blood as a source of hematopoietic stem cells for transplantation into unrelated recipients. *N Engl J Med* 1996;335:157–166.
606. Fassoni F, Labopin M, Gluckman E, et al. Results of allogeneic bone marrow transplantation for acute leukemia have improved in Europe with time—a report of the Acute Leukemia Working Party of the European Group for Blood and Marrow Transplantation (EBMT) *Bone Marrow Transplant* 1996;17:13–18.
607. Stein AS, O'Donnell MR, Chai A, et al. In vivo purging with high-dose cytarabine followed by high-dose chemoradiotherapy and reinfusion of unpurged bone marrow for adult acute myelogenous leukemia in first complete remission. *J Clin Oncol* 1996;14:2206–2216.
608. Miggiano MC, Gherlinzoni F, Rosti G, et al. Autologous bone marrow transplantation in late first complete remission improves outcome in acute myelogenous leukemia. *Leukemia* 1996;10:402–409.
609. Selvaggi KJ, Wilson JW, Mills LE, et al. Improved outcome for high-risk acute myeloid leukemia patients using autologous bone marrow transplantation and monoclonal antibody-purged bone marrow. *Blood* 1994;83:1698–1705.
610. Gorin NC, Aegerter P, Auvert B, et al. Autologous bone marrow transplantation for acute myelocytic leukemia in first remission: a European survey of the role of marrow purging. *Blood* 1990;75:1606–1614.
611. Ball ED, Rybka WB. Autologous bone marrow transplantation for adult acute leukemia. *Hematol Oncol Clin North Am* 1993;7:201–231.
612. Burnett AK, Goldstone AH, Stevens RM, et al. Randomized comparison of addition of autologous bone-marrow transplantation to intensive chemotherapy for acute myeloid leukaemia in first remission: results of MRC AML 10 trial. *UK Medical Research Council Adult and Children's Leukaemia Working Parties. Lancet* 1998;51:700–708.
613. McGlave PB, Haake RJ, Bostrom BC, et al. Allogeneic bone marrow transplantation for acute nonlymphocytic leukemia in first remission. *Blood* 1988;72:1512–1517.
614. Blume KG, Forman SJ, O'Donnell MR, et al. Total body irradiation and high-dose etoposide: a new preparatory regimen for bone marrow transplantation in patients with advanced hematologic malignancies. *Blood* 1987;69:1015–1020.
615. Brown RA, Wolff SN, Fay JW, et al. High-dose etoposide, cyclophosphamide, and total body irradiation with allogeneic bone marrow transplantation for patients with acute myeloid leukemia in untreated first relapse: a study by the North American Marrow Transplant Group. *Blood* 1995;85:1391–1395.
616. Gorin NC, Labopin M, Fouillard L, et al. Retrospective evaluation of autologous bone marrow transplantation vs. allogeneic bone marrow transplantation from an HLA identical related donor in acute myelocytic leukemia. A study of the European Cooperative Group for Blood and Marrow Transplantation (EBMT). *Bone Marrow Transplant* 1996;18:111–117.
617. Forman SJ, Schmidt GM, Nademanee AP, et al. Allogeneic bone marrow transplantation as therapy

- for primary induction failure for patients with acute leukemia. *J Clin Oncol* 1991;9:1570–1574.
618. Biggs JC, Horowitz MM, Gale RP, et al. Bone marrow transplants may cure patients with acute leukemia never achieving remission with chemotherapy. *Blood* 1992;80:1090–1093.
619. Ball ED, Mills LE, Cornwell GG III, et al. Autologous bone marrow transplantation for acute myeloid leukemia using monoclonal antibody-purged bone marrow. *Blood* 1990;75:1199–1206.
620. Yeager AM, Kaizer H, Santos GW, et al. Autologous bone marrow transplantation in patients with acute nonlymphocytic leukemia, using ex vivo marrow treatment with 4-hydroperoxycyclophosphamide. *N Engl J Med* 1986;315(3):141–147.
621. Christiansen NP. Allogeneic bone marrow transplantation for the treatment of adult acute leukemias. *Hematol Oncol Clin North Am* 1993;7:177–200.
622. Appelbaum FR, Fisher LD, Thomas ED. Chemotherapy v marrow transplantation for adults with acute nonlymphocytic leukemia: a five-year follow-up. *Blood* 1988;72:179–184.
623. Champlin RE, Ho WG, Gale RP, et al. Treatment of acute myelogenous leukemia. A prospective controlled trial of bone marrow transplantation versus consolidation chemotherapy. *Ann Intern Med* 1985;102:285–291.
624. Burnett AK, Wheatley K, Goldstone AH, et al. The value of allogeneic bone marrow transplant in patients with acute myeloid leukaemia at differing risk of relapse: results of the UK MRCAML 10 trial. *Br J Haematol* 2002;118:385–400.
625. Burnett AK. Current controversies: which patients with acute myeloid leukaemia should receive a bone marrow transplantation? An adult treater's view. *Br J Haematol* 2002;118:357–364.
626. Housseau JL, Cahn JY, Pignon B, et al. Comparison of autologous bone marrow transplantation and intensive chemotherapy as postremission therapy in adult acute myeloid leukemia. *Blood* 1997;90:2978–2986.
627. Zander AR, Keating M, Dicke K, et al. A comparison of marrow transplantation with chemotherapy for adults with acute leukemia of poor prognosis in first complete remission. *J Clin Oncol* 1988;6:1548–1557.
628. Lowenberg B, Verdonck LJ, Dekker AW, et al. Autologous bone marrow transplantation in acute myeloid leukemia in first remission: results of a Dutch prospective study. *J Clin Oncol* 1990;8:287–294.
629. Schiller GJ, Nimer SD, Territo MC, et al. Bone marrow transplantation versus high-dose cytarabine-based consolidation chemotherapy for acute myelogenous leukemia in first remission. *J Clin Oncol* 1992;10:41–46.
630. Woods WG, Neudorf S, Gold S, et al. A comparison of allogeneic bone marrow transplantation autologous bone marrow transplantation, and aggressive chemotherapy in children with acute myeloid leukemia in remission: a report from the Children's Cancer Group. *Blood* 2000;97:56–62.
631. Reiffers J, Gaspard MH, Maraninchi D, et al. Comparison of allogeneic or autologous bone marrow transplantation and chemotherapy in patients with acute myeloid leukaemia in first remission: a prospective controlled trial. *Br J Haematol* 1989;72:57–63.
632. Cassileth PA, Harrington DP, Appelbaum FR, et al. Chemotherapy compared with autologous or allogeneic bone marrow transplantation in the management of acute myeloid leukemia in first remission. *N Engl J Med* 1998;339:1649–1656.
633. Kumar L. Leukemia: management of relapse after allogeneic bone marrow transplantation. *J Clin Oncol* 1994;12:1710–1717.
634. Giralt S, Anagnostopoulos A, Shahjahan M, et al. Nonablative stem cell transplantation for older patients with acute leukemias and myelodysplastic syndromes. *Semin Hematol* 2002;39:57–62.
635. McSweeney PA, Niederwieser D, Shizuru JA, et al. Hematopoietic cell transplantation in older patients with hematologic malignancies: replacing high-dose cytotoxic therapy with graft-versus-tumor

effects. *Blood* 2001;97:3390–3400.

636. Jones RJ, Vogelsang GB, Hess AD, et al. Induction of graft-versus-host disease after autologous bone marrow transplantation. *Lancet* 1989;1:754–757.

637. Kantarjian HM, Keating MJ, Walters RS, et al. The characteristics and outcome of patients with late relapse acute myelogenous leukemia. *J Clin Oncol* 1988;6:232–238.

638. Keating MJ, Kantarjian H, Smith TL, et al. Response to salvage therapy and survival after relapse in acute myelogenous leukemia. *J Clin Oncol* 1989;7:1071–1080.

639. Schiffer CA, Lee EJ. Approaches to the therapy of relapsed acute myeloid leukemia. *Oncology (Huntingt)* 1989;3:23–27.

640. Beltran G, Stuckey WJ. Therapy of secondary acute nonlymphocytic leukemia. *N Engl J Med* 1983;308:1295–1296.

641. Duane SF, Peterson BA, Bloomfield CD, et al. Response of therapy-associated acute nonlymphocytic leukemia to intensive induction chemotherapy. *Med Pediatr Oncol* 1985;13:207–213.

642. Gajewski JL, Ho WG, Nimer SD, et al. Efficacy of intensive chemotherapy for acute myelogenous leukemia associated with a preleukemic syndrome. *J Clin Oncol* 1989;7:1637–1645.

643. Kantarjian HM, Keating MJ, Walters RS, et al. Therapy-related leukemia and myelodysplastic syndrome: clinical, cytogenetic, and prognostic features. *J Clin Oncol* 1986;4:1748–1757.

644. Larson RA, Wernli M, Le Beau MM, et al. Short remission durations in therapy-related leukemia despite cytogenetic complete responses to high-dose cytarabine. *Blood* 1988;72:1333–1339.

645. Preisler HD, Early AP, Raza A, et al. Therapy of secondary acute nonlymphocytic leukemia with cytarabine. *N Engl J Med* 1983;308:21–23.

646. Estey EH, Keating MJ, McCredie KB, et al. Causes of initial remission induction failure in acute myelogenous leukemia. *Blood* 1982;60:309–315.

647. Gale RP, Horowitz MM, Rees JK, et al. Chemotherapy versus transplants for acute myelogenous leukemia in second remission. *Leukemia* 1996;10:13–19.

648. Letendre L, Kiely JM, Hoagland HC. Reinduction chemotherapy for acute nonlymphocytic leukemia. *Mayo Clin Proc* 1984;59:618–621.

649. Peterson BA, Bloomfield CD. Re-induction of complete remissions in adults with acute non-lymphocytic leukemia. *Leuk Res* 1981;5:81–88.

650. Welborn JL, Lewis JP, Meyers FJ. Impact of reinduction regimens on the clinical course of adult acute nonlymphocytic leukemia. *Leukemia* 1988;2:711–716.

651. Tschopp L, von Flidner VE, Sauter C, et al. Efficacy and clinical cross-resistance of a new combination therapy (AMSA/VP16) in previously treated patients with acute nonlymphocytic leukemia. *J Clin Oncol* 1986;4:318–324.

652. Herzig RH, Lazarus HM, Wolff SN, et al. High-dose cytosine arabinoside therapy with and without anthracycline antibiotics for remission reinduction of acute nonlymphoblastic leukemia. *J Clin Oncol* 1985;3:992–997.

653. Evans C, Winkelstein A, Rosenfeld CS, et al. High-dose cytosine arabinoside and L-asparaginase therapy for poor-risk adult acute nonlymphocytic leukemia. A retrospective study. *Cancer* 1990;65:2624–2630.

654. Hines JD, Oken MM, Mazza JJ, et al. High-dose cytosine arabinoside and m-AMSA is effective therapy in relapsed acute nonlymphocytic leukemia. *J Clin Oncol* 1984;2:545–549.

655. Tallman MS, Appelbaum FR, Amos D, et al. Evaluation of intensive postre-mission chemotherapy for

- adults with acute nonlymphocytic leukemia using high-dose cytosine arabinoside with L-asparaginase and amsacrine with etoposide. *J Clin Oncol* 1987;5:918-926.
656. Vogler WR, Preisler HD, Winton EF, et al. Randomized trial of high-dose cytarabine versus amsacrine in acute myelogenous leukemia in relapse: a Leukemia Intergroup Study. *Cancer Treat Rep* 1986;70:455-459.
657. Holmes JA. Multidrug resistance in leukaemia. *Leuk Lymph* 1990;1:163-168.
658. Holmes J, Jacobs A, Carter G, et al. Multidrug resistance in haemopoietic cell lines, myelodysplastic syndromes and acute myeloblastic leukaemia. *Br J Haematol* 1989;72:40-44.
659. Dedhar S, Hartley D, Fitz-Gibbons D, et al. Heterogeneity in the specific activity and methotrexate sensitivity of dihydrofolate reductase from blast cells of acute myelogenous leukemia patients. *J Clin Oncol* 1985;3:1545-1552.
660. Deffie AM, Batra JK, Goldenberg GJ. Direct correlation between DNA topoisomerase II activity and cytotoxicity in adriamycin-sensitive and -resistant P388 leukemia cell lines. *Cancer Res* 1989;49:58-62.
661. Samdani A, Vijapurkar U, Grimm MA, et al. Cytogenetics and P-glycoprotein (PGP) are independent predictors of treatment outcome in acute myeloid leukemia (AML). *Leuk Res* 1996;20:175-180.
662. List AF, Kopecky KJ, Willman CL, et al. Benefit of cyclosporine modulation of drug resistance in patients with poor-risk acute myeloid leukemia: a Southwest Oncology Group study. *Blood* 2001;98:3212-3220.
663. Greenberg P, Advani R, Tallman M, et al. Treatment of refractory/relapsed AML with PSC833 plus mitoxantrone, etoposide, cytarabine (PSC-MEC) vs. MEC: randomized phase III trial (E2995). *Blood* 1999;94:1703.
664. Baer MR, George SL, Dodge RK, et al. Phase 3 study of the multidrug resistance modulator PSC-833 in previously untreated patients 60 years of age and older with acute myeloid leukemia: Cancer and Leukemia Group B Study 9720. *Blood* 2002;100:1224-1232.
665. List AF, Spier CS, Grogan TM, et al. Overexpression of the major vault transporter protein lung-resistance protein predicts treatment outcome in acute myeloid leukemia. *Blood* 1996;87:2464-2469.
666. Sekeres MA, Stone RM. The challenge of acute myeloid leukemia in older patients. *Curr Opin Oncol* 2002;14:24-30.
667. Lowenberg B. Managing therapy in older adult patients with acute myeloid leukemia. *Semin Hematol* 2001;38[3 Suppl 6]:10-16.
668. Zhu YM, Das-Gupta EP, Russell NH. Microsatellite instability and p53 mutations are associated with abnormal expression of the MSH2 gene in adult acute leukemia. *Blood* 1999;94:733-740.
669. Kahn SB, Begg CB, Mazza JJ, et al. Full dose versus attenuated dose daunorubicin, cytosine arabinoside, and 6-thioguanine in the treatment of acute nonlymphocytic leukemia in the elderly. *J Clin Oncol* 1984;2:865-870.
670. Tilly H, Castaigne S, Bordessoule D, et al. Low-dose cytarabine versus intensive chemotherapy in the treatment of acute nonlymphocytic leukemia in the elderly. *J Clin Oncol* 1990;8:272-279.
671. Lowenberg B, Zittoun R, Kerkhofs H, et al. On the value of intensive remission-induction chemotherapy in elderly patients of 65+ years with acute myeloid leukemia: a randomized phase III study of the European Organization for Research and Treatment of Cancer Leukemia Group. *J Clin Oncol* 1989;7:1268-1274.
672. Anderson JE, Kopecky KJ, Willman CL, et al. Outcome after induction chemotherapy for older patients with acute myeloid leukemia is not improved with mitoxantrone and etoposide compared to cytarabine and daunorubicin: a Southwest Oncology Group study. *Blood* 2002;100:3869-3876.
673. Stone RM, Berg DT, George SL, et al. Postremission therapy in older patients with de novo acute myeloid leukemia: a randomized trial comparing mitoxantrone and intermediate-dose cytarabine with



standard-dose cytarabine. *Blood* 2001;98:548-553.

674. Caligiuri MA, Mayer RJ. Pregnancy and leukemia. *Semin Oncol* 1989;16:388-396.

675. Juarez S, Cuadrado Pastor JM, et al. Association of leukemia and pregnancy: clinical and obstetric aspects. *Am J Clin Oncol* 1988;1:159-165.

676. Reynoso EE, Shepherd FA, Messner HA, et al. Acute leukemia during pregnancy: the Toronto Leukemia Study Group experience with long-term follow-up of children exposed in utero to chemotherapeutic agents. *J Clin Oncol* 1987;5:1098-1106.

677. Feliu J, Juarez S, Ordonez A, et al. Acute leukemia and pregnancy. *Cancer* 1988;61:580-584.

678. Brell J, Kalaycio M. Leukemia in pregnancy. *Semin Oncol* 2000;27:667-677.

679. Dildy GA III, Moise KJ, Jr., Carpenter RJ, Jr., Klima T. Maternal malignancy metastatic to the products of conception: a review. *Obstet Gynecol Surv* 1989;44:535-540.

680. Honore LH, Brown LB. Intervillous placental metastasis with maternal myeloid leukemia. *Arch Pathol Lab Med* 1990;114:450.

681. Doll DC, Ringenberg QS, Yarbrow JW. Antineoplastic agents and pregnancy. *Semin Oncol* 1989;16:337-346.

682. Aviles A, Diaz-Maqueo JC, Talavera A, et al. Growth and development of children of mothers treated with chemotherapy during pregnancy: current status of 43 children. *Am J Hematol* 1991;36:243-248.

683. Resnik R. Cancer during pregnancy. *N Engl J Med* 1999;341:120-121.

684. Hoelzer D, Ganser A, Heimpel H. "Atypical" leukemias: preleukemia, smoldering leukemia and hypoplastic leukemia. *Recent Results Cancer Res* 1984;93:69-101.

685. Howe RB, Bloomfield CD, McKenna RW. Hypocellular acute leukemia. *Am J Med* 1982;72:391-395.

686. Buchner T, Hiddemann W, Wormann B, et al. Hematopoietic growth factors in acute myeloid leukemia: supportive and priming effects. *Semin Oncol* 1997;24:124-131.

687. Geller RB. Use of cytokines in the treatment of acute myelocytic leukemia: a critical review. *J Clin Oncol* 1996;14:1371-1382.

688. Ohno R, Tomonaga M, Kobayashi T, et al. Effect of granulocyte colony-stimulating factor after intensive induction therapy in relapsed or refractory acute leukemia. *N Engl J Med* 1990;323:871-877.

689. Buchner T, Hiddemann W, Koenigsmann M, et al. Recombinant human granulocyte-macrophage colony-stimulating factor after chemotherapy in patients with acute myeloid leukemia at higher age or after relapse. *Blood* 1991;78:1190-1197.

690. Stone RM, Berg DT, George SL, et al. Granulocyte-macrophage colony-stimulating factor after initial chemotherapy for elderly patients with primary acute myelogenous leukemia. *Cancer and Leukemia Group B. N Engl J Med* 1995;332:1671-1677.

691. Witz F, Harousseau JL, Sadoun D, et al. GM-CSF during and after remission induction treatment for elderly patients with acute myeloid leukemia (AML). *Haematol Blood Trans* 1997;40:852-856.

692. Zittoun R, Suci S, Mandelli F, et al. Granulocyte-macrophage colony-stimulating factor associated with induction treatment of acute myelogenous leukemia: a randomized trial by the European Organization for Research and Treatment of Cancer Leukemia Cooperative Group. *J Clin Oncol* 1996;14:2150-2159.

693. Löwenberg B, Suci S, Archimbaud E, et al. Use of recombinant GM-CSF during and after remission induction chemotherapy in patients aged 61 years and older with acute myeloid leukemia: final report of AML-II, a phase III randomized study of the Leukemia Cooperative Group of European Organization for the Research and Treatment of Cancer and the Dutch Belgium Hemato-Oncology Cooperative Group. *Blood*

1997;90:2952–2961.

694. Rowe JM, Andersen JW, Mazza JJ, et al. A randomized placebo-controlled phase III study of granulocyte-macrophage colony-stimulating factor in adult patients (> 55 to 70 years of age) with acute myelogenous leukemia: a study of the Eastern Cooperative Oncology Group (E1490). *Blood* 1995;86:457–462.

695. Buchner T, Hiddemann W, Wormann B, et al. GM-CSF multiple course priming and long-term administration in newly diagnosed AML hematologic and therapeutic effects (Abstract). *Blood* 1994;84:A27.

696. Dombret H, Chastang C, Fenaux P, et al. A controlled study of recombinant human granulocyte colony-stimulating factor in elderly patients after treatment for acute myelogenous leukemia. AML Cooperative Study Group. *N Engl J Med* 1995;332:1678–1683.

697. Heil G, Hoelzer D, Sanz MA, et al. A randomized, double-blind, placebo-controlled, phase III study of filgrastim in remission induction and consolidation therapy for adults with de novo acute myeloid leukemia. The International Acute Myeloid Leukemia Study Group. *Blood* 1997;90:4710–4718.

698. Godwin JE, Kopecky KJ, Head DR, et al. A double-blind placebo-controlled trial of granulocyte colony-stimulating factor in elderly patients with previously untreated acute myeloid leukemia: a Southwest Oncology Group study (9031). *Blood* 1998;91:3607–3615.

699. Kaushansky K. Use of thrombopoietic growth factors in acute leukemia. *Leukemia* 2000;14:505–508.

700. Kuter DJ, Begley CG. Recombinant human thrombopoietin: basic biology and evaluation of clinical studies. *Blood* 2002;100:3457–3469.

701. Mandelli F, Vignetti M, Tosti S, et al. Interleukin 2 treatment in acute myelogenous leukemia. *Stem Cells* 1993;11:263–268.

702. Maraninchi D, Blaise D, Viens P, et al. High-dose recombinant interleukin-2 and acute myeloid leukemias in relapse. *Blood* 1991;78:2182–2187.

703. Foa R, Meloni G, Tosti S, et al. Treatment of acute myeloid leukaemia patients with recombinant interleukin 2: a pilot study. *Br J Haematol* 1991;77:491–496.

704. Meloni G, Foa R, Vignetti M, et al. Interleukin-2 may induce prolonged remissions in advanced acute myelogenous leukemia. *Blood* 1994;84:2158–2163.

705. Slavin S, Or R, Kapelushnik Y, et al. Immunotherapy of minimal residual disease in conjunction with autologous and allogeneic bone marrow transplantation (BMT). *Leukemia* 1992;6[Suppl 4]:164–166.

706. Stripecke R, Levine AM, Pullarkat V, Cardoso AA. Immunotherapy with acute leukemia cells modified into antigen-presenting cells: ex vivo culture and gene transfer methods. *Leukemia* 2002;16:1974–1983.

707. Choudhury BA, Liang JC, Thomas EK, et al. Dendritic cells derived in vitro from acute myelogenous leukemia cells stimulate autologous, antileukemic T-cell responses. *Blood* 1999;93:780–786.

708. Dias S, Choy M, Alitalo K, Rafii S. Vascular endothelial growth factor (VEGF)-C signaling through FLT-4 (VEGFR-3) mediates leukemic cell proliferation, survival, and resistance to chemotherapy. *Blood* 2002;99:2179–2184.

709. List AF. Vascular endothelial growth factor signaling pathway as an emerging target in hematologic malignancies. *Oncologist* 2001;6[Suppl 5]:24–31.

710. Fielder W, Graeven U, Ergun S, et al. Expression of FLT4 and its ligand VEGF-C in acute myeloid leukemia. *Leukemia* 1997;11:1234–1237.

711. Brenner MK, Rill DR, Holladay MS, et al. Gene marking to determine whether autologous marrow infusion restores long-term haemopoiesis in cancer patients. *Lancet* 1993;342:1134–1137.

712. Bishop MR, Iversen PL, Bayever E, et al. Phase I trial of an antisense oligonucleotide OL(1)p53 in

hematologic malignancies. *J Clin Oncol* 1996;14:1320–1326.

713. Wierda WG, Kipps TJ. Gene therapy of hematologic malignancies. *Semin Oncol* 2000;27:502–511.

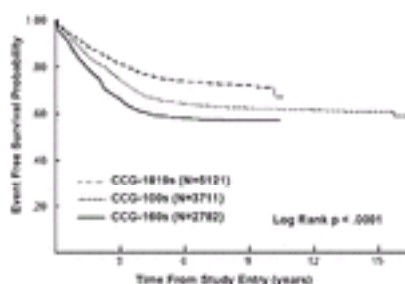
714. Marcucci G, Caligiuri MA. Antisense and gene transfer as therapeutic strategies in acute and chronic leukemia. In: Henderson ES, Lister TA, Greaves MF, eds. *Leukemia*. Philadelphia: Saunders, 2002:449.

715. Willman CL. Targeted AML therapy: new biologic paradigms and therapeutic opportunities. *Leukemia* 2001;15:690–694.

2004 Lippincott Williams & Wilkins  
John P. Greer, John Foerster, John N. Lukens  
George M. Rodgers, Frixos Paraskevas, Bertil Glader  
Wintrobe's Clinical Hematology

- [CLINICAL FEATURES](#)
- [LABORATORY FEATURES](#)
- [DIAGNOSIS AND DIFFERENTIAL DIAGNOSIS](#)
- [CLASSIFICATION AND ASSESSMENT OF RISK](#)
- [Immunophenotype](#)
- [Cytogenetic Markers](#)
- [Gene Expression Profiling](#)
- [Drug Sensitivity](#)
- [Minimal Residual Disease](#)
- [Other Biologic Markers](#)
- [Clinical Features Having Prognostic Significance](#)
- [Prognostic Stratification](#)
- [TREATMENT](#)
- [Primary Treatment](#)
- [Maintenance Therapy](#)
- [Relapse](#)
- [Bone Marrow Transplantation](#)
- [Outcomes](#)
- [REFERENCES](#)

Acute lymphoblastic leukemia (ALL) is the most common malignant disease affecting children, accounting for approximately 30% of childhood cancers (<sup>1</sup>). Recent data from the National Cancer Institute's Surveillance, Epidemiology, and End Results (SEER) program place the incidence of childhood ALL at 26 per million person years in the United States (<sup>2</sup>). Within this cohort, approximately 75% are children younger than 10 years of age, and 50% are younger than 5 years of age. Before the advent of effective chemotherapy in the 1960s, ALL was invariably fatal. Within 20 years, however, more than 50% of children with the disease were in complete remission 5 years from diagnosis (<sup>3</sup>), with most of these patients considered cured ( Fig. 80.1). Further progress followed the use of effective post-induction intensification based on L-asparaginase, intermediate dose methotrexate, and/or multi-agent reinduction and re-consolidation. Over 80% of children with ALL are expected to be cured in the 2000s.



**Figure 80.1.** Event-free survival in Children's Cancer Group (CCG) acute lymphoblastic leukemia trials over 17 years, 1978–1995 (CCG-160s: 1978–1983; CCG-100s: 1983–1988;

CCG-1819s: 1989–1995). (Courtesy of Dr. Harland N. Sather and the Children’s Cancer Group, Arcadia, CA.)

Currently, new patients are stratified into prognostic groups on the basis of presenting clinical and laboratory features and initial response to therapy. Patients with favorable features can be expected to respond satisfactorily to standard therapy, whereas those with adverse features achieve better outcome with more aggressive therapeutic strategies. Increasing evidence implies that novel chemotherapy approaches and better supportive care mitigate many disease characteristics previously associated with a poor prognosis.

The diagnosis and characterization of ALL are discussed in [Chapter 77](#). The molecular genetics of ALL are discussed in [Chapter 76](#). This chapter is concerned with the clinical characteristics, treatment, and late sequelae.

## CLINICAL FEATURES

Although it affects all age groups, ALL has its highest incidence in children between the ages of 1 and 5 years, with a peak at 3 to 4 years ([4](#), [5](#)). Curiously, this early peak is not seen in blacks, and as a result, ALL is more common in whites ([3](#), [6](#)). A slight male predominance (57%) has been noted in all demographic analyses of the disease.

Symptoms may be insidious and slowly progressive over weeks to months, or they may be acute and explosive. In general, the more indolent the onset, the better the outcome. Symptoms and signs result from either bone marrow failure or the involvement of extramedullary sites by leukemia ([Table 80.1](#)) ([7](#), [8](#)). Easy fatigue, lethargy, fever, and bone and joint pain are the most common presenting complaints. Fatigue and lethargy correlate with the presence and severity of anemia ([7](#)). No infectious basis for fever is found in most patients, especially if the neutrophil count exceeds  $0.2 \times 10^9/L$  ([9](#)). The leukemic process itself may be responsible for fever because fever resolves in most patients after the institution of chemotherapy ([10](#)). However, the risk of infection is still substantial at presentation, and prompt intravenous antibiotic therapy is the standard of care. Bone pain results from bone erosion or leukemic involvement of the periosteum. Young children, in particular, often present with gait disturbances or a refusal to walk. Vertebral compression fractures may complicate generalized osteoporosis. Prominent skeletal symptoms occur primarily in children with no lymphadenopathy, organomegaly, or leukocytosis, and as a result, the diagnosis of leukemia often is delayed ([11](#), [12](#) and [13](#)). Less commonly, bone pain is caused by recurring episodes of bone marrow necrosis ([14](#), [15](#) and [16](#)). Marrow necrosis also is associated with a small leukemic burden and an aleukemic blood picture. Approximately 2% of children present with marrow findings consistent with aplastic anemia; overt leukemia follows within weeks to months ([17](#), [18](#)); the majority of these children are females younger than 10 years old ([19](#)). Weight loss rarely is severe and is seen only in patients with longstanding symptoms. Central nervous system (CNS) involvement by leukemia occurs in approximately 2% of patients at diagnosis and may be manifested by headaches and vomiting or cranial nerve palsy ([20](#)). Cerebrospinal fluid (CSF) involvement is usually asymptomatic. Physical findings include various combinations of pallor, petechiae or purpura, mucous membrane bleeding, fever, lymphadenopathy, splenomegaly, hepatomegaly, tenderness over the sternum and other bones, and fundic hemorrhages. Abdominal organomegaly rarely is symptomatic. Skin involvement is rare; when it occurs, it is associated with the pre-B-cell phenotype ([21](#)). Infants 24 months of age or younger present with a constellation of features that portend

an unfavorable outcome. They are more likely to have massively enlarged livers and spleens, hyperleukocytosis, chromosomal changes involving 11q23, involvement of spinal fluid by leukemic cells, and a slow response to therapy ( [22](#) ).

**TABLE 80.1. Frequency of Clinical and Laboratory Findings at Diagnosis in 178 Children and Adults with Acute Lymphoblastic Leukemia**

| Clinical Features       | Percentage | Laboratory Features                    | Percentage |
|-------------------------|------------|--|------------|
| Symptoms                | —          | White blood cells ( $\times 10^9/L$ )* | —          |
| Fatigue                 | 92         | <10                                    | 40         |
| Bone or joint pain      | 79         | 10–49                                  | 34         |
| Fever without infection | 71         | 50–99                                  | 15         |
| Weight loss             | 66         | =100                                   | 11         |
| Abnormal masses         | 62         | Neutrophils ( $\times 10^9/L$ )        | —          |
| Purpura                 | 51         | >1                                     | 73         |
| Other hemorrhage        | 27         | 1–2                                    | 9          |
| Infection               | 17         | >2                                     | 18         |
| Physical findings       | —          | Packed cell volume (L/L)               | —          |
| Splenomegaly            | 86         | <30                                    | 65         |
| Lymphadenopathy         | 76         | >30                                    | 35         |
| Hepatomegaly            | 74         | Platelets ( $\times 10^9/L$ )          | —          |
| Sternal tenderness      | 69         | >50                                    | 62         |
| Purpura                 | 50         | 50–150                                 | 30         |
| Fundic hemorrhage       | 14         | >150                                   | 8          |

From Boggs DR, Wintrobe MM, Cartwright GE. The acute leukemias. *Medicine* 1962;41:163.

## LABORATORY FEATURES

The white blood cell (WBC) count is elevated in 60% of patients ( [Table 80.1](#) ). Because the number of normal leukocytes is reduced, the WBC count generally mirrors the number of circulating blast cells. Although obvious in smears of patients with high counts, leukemic blasts may be found only after careful review of blood smears from patients with decreased leukocyte counts. Occasionally, no lymphoblasts can be identified with certainty, despite extensive bone marrow involvement (aleukemic leukemia). A WBC count in excess of  $50 \times 10^9/L$  is frequently associated with prominent lymphadenopathy, hepatosplenomegaly, and the T-cell immunophenotype. Unlike the situation in acute nonlymphoblastic leukemia (ANLL), hyperleukocytosis in ALL rarely is complicated by intracerebral hemorrhages or pulmonary insufficiency ( [23](#) ).

Although occurring less frequently than in ANLL, coagulopathies may lead to both hemorrhagic and thrombotic complications ( [24](#) ). The coagulopathy usually is mediated by thrombin activation rather than by primary fibrinolysis ( [25](#) ).

Bone marrow aspiration is the standard method of establishing the diagnosis and provides

cells for immunophenotypic, histochemical, and cytogenetic analysis. Bone marrow lymphoblasts are more homogenous with respect to both morphologic and biologic characteristics than those in the blood. When cell density or marrow reticulum prevents marrow aspiration, a biopsy should be performed. The marrow is hypercellular with replacement of fat spaces and normal marrow elements by leukemic cells. In contrast to ANLL, residual myeloid and erythroid precursors appear morphologically normal. Megakaryocytes are decreased or absent.

A large leukemic cell burden having a high rate of cell turnover may produce several metabolic disturbances. Chief among these is elevation of the serum uric acid level. Although gout is a rare complication of hyperuricemia ([26](#)), urate nephropathy is not. Acute renal failure resulting from urate nephropathy may be a presenting feature, even in the absence of a large leukemic cell burden ([27](#)). Increased cell destruction also is responsible for hyperphosphatemia and hypocalcemia ([28](#)). As with hyperuricemia, these abnormalities are most likely to pose problems after the institution of chemotherapy. The management of these metabolic complications is discussed in [Chapter 72](#). Serum levels of lactic dehydrogenase (LDH) are increased because of an increased turnover of leukemic cells.

Radiographic examination of the chest demonstrates an anterior mediastinal mass in 5 to 10% of newly diagnosed patients. The thymic mass may be associated with pleural effusions, which on thoracentesis are found to be malignant. Skeletal lesions can be demonstrated radiographically in more than 50% of patients ([29](#)). The most common abnormalities include transverse metaphyseal radiolucent lines adjacent to the zone of provisional calcification at the end of long bones, generalized rarefaction of bones, cortical and trabecular osteolytic lesions, and periosteal new bone formation.

Lumbar puncture provides evidence of CNS involvement by leukemia in approximately 3% of children at diagnosis ([30](#)). Cytocentrifugation of CSF enhances diagnostic sensitivity by concentrating leukemic cells. Histochemical staining and determination of the immunophenotype of cells from suspicious or equivocal CSF may help to establish the presence or absence of leukemic involvement ([31](#)). Patients with symptomatic CNS involvement may have increased CSF pressure, elevated levels of CSF protein, and decreased glucose values.

## DIAGNOSIS AND DIFFERENTIAL DIAGNOSIS

The diagnosis of ALL is based on the demonstration of lymphoblasts in the bone marrow. By convention, the minimum number of bone marrow lymphoblasts required for diagnosis is set at 25%. In practice, patients with acute leukemia are found to have far more than 25% blasts. Characterization of the leukemia as lymphoblastic rather than nonlymphoblastic is based on morphologic, cytochemical, immunophenotypic, cytogenetic, and molecular biologic observations that are reviewed in [Chapter 77](#).

Occasionally, solid tumors that involve the bone marrow may be confused with lymphoblasts. In the pediatric age group, this confusion occurs most frequently with neuroblastoma ([32](#)). Although tumor cells tend to occur in clumps, they may replace marrow elements diffusely. Differentiation from leukemia is readily accomplished with immunohistochemistry, cytogenetic analysis, and electron microscopy. Involvement of the bone marrow by non-Hodgkin lymphoma cannot be differentiated by morphologic features or immunophenotype alone; differentiation rests on knowledge of the distribution of disease at initial presentation.



Diagnosis is not difficult once the possibility of acute leukemia is considered. Because of the variety of nonspecific symptoms caused by ALL, however, more common disorders often assume priority in the differential diagnosis. Fever, joint symptoms, and mild anemia are readily mistaken for juvenile rheumatoid arthritis or systemic lupus erythematosus ( 33 ). Further diagnostic confusion is assured if a test for antinuclear antibody is positive ( 34 ). An abnormal leukocyte differential, leukopenia, thrombocytopenia, or failure to respond to salicylate should prompt consideration of leukemia ( 35 ). Some infections, notably infectious mononucleosis, toxoplasmosis, and cytomegalovirus infection, also are characterized by fever, lymphadenopathy, hepatosplenomegaly, and abnormal blood lymphocytes. These infectious disorders are distinguished from acute leukemia by the distinctive morphology of reactive lymphocytes and lymphoblasts. In addition, the lymph nodes and abnormal organs associated with viral disease are usually (but not always) soft and ill defined, in contrast to the firm and discrete nature of the nodes, liver, and spleen in acute leukemia. Aplastic anemia may be impossible to distinguish from aleukemic leukemia on both clinical and hematologic grounds without a bone marrow biopsy. The serum uric acid and LDH levels characteristically are low in the former and elevated in the latter. Like ALL, idiopathic thrombocytopenic purpura occurs with greatest frequency in children between 3 and 5 years of age. The presence of symptoms other than those that can be attributed to purpura, or the detection of splenomegaly, an abnormal WBC count, or an abnormal leukocyte differential are clues that thrombocytopenia is not on an immune basis. Thrombocytopenia in the absence of other physical or hematologic manifestations occurs rarely, if at all in ALL ( 36 ). Acute disseminated Langerhans cell histiocytosis, like ALL, is associated with fever, purpura, hepatosplenomegaly, and pancytopenia (see Chapter 66). Unlike ALL, the skin also is frequently involved. The disorders are differentiated readily by histopathology.

## CLASSIFICATION AND ASSESSMENT OF RISK

ALL is a heterogeneous group of disorders comprising subtypes that differ with respect to their pathogenesis, biology, and clinical features. Some subtypes are characterized by a small leukemic burden and indolent clinical course, whereas others have extramedullary involvement and a rapid progression. The ability to identify biologic and clinical features that influence prognosis has led to the use of different treatment regimens for different risk groups, which in turn has resulted in both improved overall outcomes and decreased toxicities for selected subsets of patients. Currently utilized schemes for classification of risk rely primarily on clinical, immunophenotypic, and cytogenetic and response features ( Table 80.2). However, these features do not account for much of the variability in prognosis in childhood ALL ( 37 ). Advances in the understanding of the molecular genetic features of ALL promise to lead to an improved laboratory-based classification that will ultimately result in more precise risk assignment and will direct targeted therapies.

**TABLE 80.2. Prognostic Factors in Acute Lymphoblastic Leukemia**

| Determinants                    | Favorable                | Unfavorable               |
|---------------------------------|--------------------------|---------------------------|
| White blood cell count          | <10 × 10 <sup>9</sup> /L | >200 × 10 <sup>9</sup> /L |
| Age                             | 3–7 yr                   | <1, >10 yr                |
| Gender                          | Female                   | Male                      |
| Ethnicity                       | White                    | Black                     |
| Node, liver, spleen enlargement | Absent                   | Massive                   |
| Testicular enlargement          | Absent                   | Present                   |

|                                 |   |  |
|---------------------------------|---|--|
| Central nervous system leukemia | Absent  | Overt (blasts + pleocytosis)           |
| FAB morphologic features        | L1  | L2                                     |
| Ploidy                          | Hyperdiploidy                                     | Hypodiploidy < 45                      |
| Cytogenetic markers             | Trisomies 4, 10, and/or 17<br>t(12;21) (tel aml1) | t(9;22) [bcr abl]<br>t(4;11) [mll af4] |
| Time to remission               | <14 d   | >28 d                                  |
| Minimal residual disease        | <10 <sup>-4</sup>                                 | >10 <sup>-3</sup>                      |

---

## Immunophenotype

The immunophenotypic classification of ALL is based primarily on the surface marking characteristics of leukemic blasts and recognizes two lineages of lymphocytes (T and B cells), each of which can be subclassified into several maturational stages ( 38, 39). Leukemic T cells differ from those of B-cell lineage in that they less frequently express CD10 (the “common ALL antigen” or CALLA) ( 40) and HLA-DR, they more often are PAS negative, and they may have an increased amount of acid phosphatase ( 41). Mature B-cell ALL is distinguished by surface immunoglobulin (Ig) expression, whereas so-called pre-B cells express cytoplasmic, but not surface, Ig ( 42). Precursor B-cells, although lacking both membrane and cytoplasmic immunoglobulin (cIg), express surface antigens that are shared by more mature B-lymphocytes. Commitment to B-cell differentiation may be identified by rearrangement of one or more immunoglobulin genes.

Early pre-B cell ALL comprises approximately two-thirds of cases of childhood ALL ( 43, 44) and is associated with a favorable prognosis ( 44). Although most early pre-B lymphoblasts are CALLA positive, CALLA expression does not appear to have independent prognostic significance ( 45, 46).

Pre-B cell ALL accounts for approximately 20% of childhood ALL ( 44, 47) and has been associated with a poorer outcome compared to early pre-B cell ALL ( 48). Expression of cIg in ALL is associated with a nonrandom cytogenetic abnormality, t(1;19)(q23;q13) ( 49). The presence of this translocation, which is identified at the cytogenetic level in 20 to 30% of pre-B ALL patients ( 49) is the primary determinant of adverse prognosis in pre-B ALL ( 50, 51). Patients without this lesion have a survival rate similar to that of patients with early pre-B ALL.

Mature B-cell ALL is uncommon, accounting for only 1 to 2% of ALL cases in children ( 44, 45, 52). Both B-cell ALL and Burkitt lymphoma are characterized by FAB L3 morphology ( 53), an (8;14) or related translocations ( 54), and overexpression of the *c-myc* oncogene ( 55). Children with B-cell ALL are older than those with other B-lineage subtypes and have a higher incidence of CNS involvement. Children with B-cell ALL have a poor response to, and abbreviated survival after, standard ALL therapeutic regimens ( 56); however, dose-intensive regimens of brief duration used for Burkitt lymphoma have led to cure rates of 75% or higher ( 57, 58 and 59).

Transitional pre-B ALL, characterized by expression of cytoplasmic and surface  $\mu$  heavy chains without Ig light chain expression, occurs in a small (approximately 1%) subset of childhood ALL ( 60). These cases lack FAB L3 morphology or the chromosomal

translocations associated with mature B-cell ALL and have a favorable outcome.

T-cell ALL accounts for approximately 15% of ALL in children ( [43](#), [44](#) ). It is rare in infants younger than 1 year of age ( [61](#), [62](#) ). T-cell ALL occurs more frequently in males and is frequently associated with a high WBC count at diagnosis ( [45](#), [52](#), [63](#), [64](#) ). A mediastinal mass is present in 50 to 60% of patients, and the incidence of CNS involvement is higher than in other types of ALL. Although T-cell ALL was previously associated with a poor prognosis ( [65](#) ), the recent use of more intensive therapeutic regimens has resulted in a survival approaching that of non-T cell ALL ( [66](#), [67](#) and [68](#) ). The prognostic significance of T-cell ALL is related to clinical features associated with a poor prognosis, such as high initial WBC count, age older than 15 years, massive splenomegaly, FAB L2 blast morphology, and abnormal karyotype ( [63](#), [64](#) ); however, some investigators have found that clinical and laboratory prognostic factors are not as predictive for outcome in T-cell ALL as in B-precursor ALL ( [69](#) ). By multivariate analysis, the T-cell immunophenotype per se does not appear to be an independent prognostic variable ( [45](#), [70](#) ). Among T-cell ALL patients, those with the least mature immunophenotype have a significantly worse outcome than those with more mature immunophenotypes ( [71](#) ). A subset of ALL characterized by expression of the T-cell-associated CD7 surface antigen in the absence of either CD4 or CD8 is associated with resistance to conventional chemotherapy and poor survival ( [72](#), [73](#) and [74](#) ). Absence of CD2 expression identifies a group of T-cell patients with a worse outcome ( [75](#) ).

Approximately 10 to 20% of children with ALL express myeloid-associated antigens such as CD13 and CD33 ( [76](#), [77](#), [78](#) and [79](#) ). Although initial reports suggested that ALL with myeloid marker expression was associated with a poorer outcome ( [76](#), [79](#) ), expression of myeloid antigens had no adverse prognostic significance in subsequent clinical trials of childhood ALL ( [78](#), [80](#), [81](#) ).

Other immunophenotypic markers may have prognostic significance as well. Expression of the stem-cell-associated surface antigen CD34 exerts an independent favorable effect on the outcome of B-lineage, but not T-lineage, childhood ALL ( [82](#), [83](#) ). Lack of expression of CD45 antigen, which is uniformly expressed in T-lineage childhood ALL but only a proportion of B-lineage ALL, was associated with lower WBC count, lower serum LDH, and hyperdiploidy in one study ( [84](#) ).

## Cytogenetic Markers

Both chromosome number (ploidy) and chromosomal structural alterations have prognostic significance that is independent of other disease characteristics ( [85](#), [86](#) and [87](#) ). Patients with “normal” cytogenetics may have clonal abnormalities by molecular fluorescent *in situ* hybridization or reverse transcriptase-polymerase chain reaction assay, or both.

**CHROMOSOME NUMBER** Children whose blasts demonstrate a hyperdiploid karyotype (modal number of chromosomes greater than 50) experience longer remissions and better survival rates than other cytogenetic groups ( [87](#), [88](#), [89](#), [90](#) and [91](#) ). Children whose blasts by flow cytometry are judged to have 53 or more chromosomes have a relapse rate only one-third that of children with blasts with lower DNA content ( [46](#) ). Hyperdiploidy in association with trisomies of chromosomes 4, 10, and/or 17 is associated with a particularly favorable prognosis ( [92](#), [93](#) and [94](#) ). The adverse prognostic significance of a

DNA index less than 1.16 persists after cessation of treatment ( [95](#) ). The adverse prognostic significance of near hyperdiploid (47 to 50 chromosomes) seen in earlier studies has improved with the use of more effective therapy ( [96](#), [97](#) ). Near-tetraploidy (82 to 94 chromosomes) constitutes an exception to the generally favorable impact of hyperdiploidy. This rare anomaly is associated with a high frequency of treatment failure ( [98](#) ). The prognosis for children whose blasts contain 47 to 50 chromosomes is comparable to that of children with a normal chromosome number ( [54](#), [91](#) ). Children with pseudodiploidy (i.e., structural rearrangement without change in total chromosome number) have short remissions and poor survival ( [87](#), [89](#), [90](#) and [91](#), [99](#) ). Hypodiploidy confers adverse risk ( [97](#), [100](#), [101](#) ), which persists despite intensification of therapy ( [102](#) ); near-haploidy is associated with a particularly dismal outcome ( [101](#), [103](#), [104](#) ). Chromosome classification adds significant prognostic information to the WBC count at diagnosis, age, FAB classification, and cell immunotype ( [89](#), [90](#) and [91](#), [99](#), [105](#) ). Ploidy was the strongest predictor of outcome in one analysis of B-precursor ALL ( [106](#) ) and the only variable that added significant prognostic information to the leukocyte count in another ( [91](#) ).

**STRUCTURAL CHROMOSOMAL AND GENETIC CHANGES** Clonal chromosomal translocations are strong predictors of adverse treatment outcome in ALL ( [88](#), [107](#) ). The t(9;22)(q32;q11), or Philadelphia (Ph) chromosome, is present in approximately 20% of adults and 5% of children with ALL at the cytogenetic level ( [99](#), [108](#), [109](#), [110](#) and [111](#) ); molecular analysis to detect the *bcr-abl* fusion messenger RNA (mRNA) product identifies additional cases that are missed by standard cytogenetics ( [112](#), [113](#) ). Unlike many other nonrandom translocations, the t(9;22) is not associated with a specific immunophenotype. Features associated with the Ph chromosome include high WBC count, older age, male predominance, and FAB L2 blast morphology ( [110](#) ). Although the strong adverse prognostic significance of the Ph chromosome persists after adjustment for other prognostic features ( [88](#), [99](#), [105](#), [114](#), [115](#) ), an international review concluded that some children with Ph-positive ALL and favorable prognostic features can be cured with intensive chemotherapy alone ( [111](#) ). The t(4;11)(q21;q23) is also associated with high-risk features, most notably a high WBC count and age younger than 1 year ( [116](#), [117](#) ). The association of t(4;11) with leukemia in infants is particularly striking ( [117](#), [118](#) ) and is associated with a poor outcome in multivariate analyses, in contrast to involvement of other 11q23 rearrangements ( [119](#) ). Leukemic blasts with t(4;11) may express early myeloid as well as B-lymphoid markers, suggesting that they may be pluripotent stem cells ( [117](#), [120](#) ). Molecular analysis of the *MLL* gene at 11q23 ( [121](#), [122](#) and [123](#) ) has demonstrated that *MLL* alterations constitute a significant independent adverse prognostic risk factor in infants with ALL and that infants who lack this alteration have a good outcome with current therapies ( [124](#), [125](#), [126](#), [127](#) and [128](#) ). Even when infants are excluded, *MLL* alterations are associated with poor outcome in childhood ALL ( [129](#) ). The t(1;19)(q23;p13) is found in one-fourth of patients with the pre-B (cIg+) immunophenotype ( [49](#), [130](#) ). The t(1;19) is associated with a high WBC count and DNA index <1.16, and accounts for the poor prognosis previously associated with the pre-B immunophenotype ( [50](#), [130](#), [131](#) ). This translocation represents fusion of the *E2A* and *PBX1* genes on chromosomes 1 and 19, respectively ( [132](#) ). Expression of the *E2A-PBX1* fusion gene is associated with the t(1;19) in cIg+, but not cIg-, cases of childhood ALL ( [131](#) ); its detection allows more precise identification of those cases at high risk for treatment failure ( [133](#) ). Patients whose leukemias bear the unbalanced, or derivative, form of the t(1;19)(q23;p13) have an outcome similar to those with the balanced translocation ( [131](#), [134](#) ). Translocations involving the *c-myc* locus at 8q24, together with one of the Ig loci at 14q32, 2p12, or 22q11, are characteristic of B-cell ALL, or Burkitt leukemia, and are indistinguishable from the t(8;14) and related translocations that occur in Burkitt

lymphoma ( [105](#), [135](#) ). Treatment with dose-intensive chemotherapy regimens appropriate for Burkitt lymphoma has abrogated the adverse prognosis previously associated with this translocation in patients with B-cell ALL ( [57](#), [58](#) and [59](#) ). Although abnormalities of 12p occur in approximately 10% of cases of childhood ALL ( [87](#), [104](#), [136](#) ), their prognostic significance is unclear ( [136](#), [137](#) ). The cryptic t(12;21) is the most common cytogenetic abnormality yet recognized in childhood ALL, occurring in approximately 25% of B-precursor cases ( [138](#), [139](#) and [140](#) ), with involvement in up to one-half of the cases involving 12p abnormalities ( [141](#), [142](#) ). This translocation joins the *TEL* (or *ETV6*) gene on chromosome 12p with the *AML1* (or *CBFA2*) gene on chromosome 21 and is associated with an early pre-B immunophenotype, a younger childhood population, and nonhyperdiploidy ( [138](#), [143](#), [144](#) and [145](#) ). Although initial reports indicated that the presence of *TEL-AML1* transcripts were associated with a favorable prognosis in childhood ALL ( [128](#), [138](#), [143](#), [144](#), [145](#), [146](#) and [147](#) ), other groups subsequently reported that the prognostic significance of *TEL-AML1* was related to intensity of therapy ( [148](#), [149](#) ), confirming yet again the interaction of treatment with other prognostic variables and suggesting that this group of patients may not be ideal candidates for reduction of therapy ( [150](#) ). Deletions or translocations involving chromosome 9p occur in approximately 10% of childhood ALL and are associated with high WBC count at diagnosis, mediastinal mass, T-cell immunophenotype, and an increased risk of relapse ( [151](#), [152](#) ). The cyclin-dependent kinase 4 inhibitor ( *CDKN2* or p16<sup>ink4</sup> ) gene, which maps to 9p21, is deleted in 20% or more of ALL and other lymphoid malignancies ( [153](#), [154](#) and [155](#) ). Although deletion of the p16<sup>ink4a</sup> gene and the tandemly linked p15<sup>ink4b</sup> gene are associated with T-cell immunophenotype, nonhyperdiploid karyotype, poor event-free survival (EFS), and disease progression ( [156](#), [157](#), [158](#), [159](#) and [160](#) ), prognostic significance of loss of these genes has not been established in prospective studies ( [128](#) ).

## Gene Expression Profiling

Gene expression profiling through microarray analysis has emerged as a powerful tool in advancing the understanding of the biology of acute leukemias ( [161](#), [162](#), [163](#) and [164](#) ). Gene expression profiling has independently confirmed traditional classifications of acute leukemias ( [161](#), [164](#) ), identified biologically distinct categories of ALL not defined by conventional biologic analyses ( [162](#), [163](#) and [164](#) ), and identified novel genes whose expressions are altered in ALL ( [162](#), [164](#) ). Importantly, gene expression profiling also identifies patients at high risk of treatment failure independently of other prognostic factors ( [162](#), [164](#) ) and is likely to supplement or even replace currently used forms of risk classification and assignment in the future ( [165](#) ).

However, differences in gene expression predict outcome within subsets. At the present time, there is no pan-ALL “good” or “bad” prognosis gene.

## Drug Sensitivity

A primary cause of treatment failure in ALL is inherent or acquired resistance of leukemic blasts to chemotherapeutic agents. Drug sensitivity as determined by the *in vitro* methyl-thiazole-tetrazolium assay ( [166](#), [167](#) ) correlates with induction failure, early relapse, and disease-free survival (DFS) ( [168](#), [169](#) ). The level of glutathione in ALL blasts has been demonstrated to be of independent prognostic value in a multivariate analysis controlling for WBC, age, gender, and immunophenotype, presumably due to an association



with resistance to chemotherapeutic agents ( [170](#) ).

### Minimal Residual Disease

Patients who meet the criteria for clinical remission may nevertheless bear up to  $10^{10}$  leukemic cells ( [171](#) ). The ability to detect small numbers of leukemic cells in bone marrow samples from patients in clinical remission using highly sensitive methods, such as polymerase chain reaction (PCR) ( [172](#), [173](#), [174](#), [175](#) and [176](#) ) or multiparametric flow cytometry ( [171](#) ), has enabled the monitoring of minimal residual disease, with the possibility of intensifying therapy for patients at higher risk of relapse. A number of studies have demonstrated the ability to identify impending relapse in subsets of patients based on correlation of detection of minimal residual disease during or after completion of therapy ( [172](#), [173](#), [174](#) and [175](#), [177](#), [178](#) ). Variations in the sensitivity and specificity of the methods used to detect and to quantify minimal residual disease, as well as questions raised by the unexpected finding of persistent genetic abnormalities related to the leukemic clone in patients in apparent sustained remissions ( [175](#), [179](#), [180](#) ), have complicated the use of minimal residual disease for treatment allocation; nevertheless, recent studies using improved methodologies have shown that detection by either multiparametric flow cytometry analysis of leukemia-associated antigens ( [181](#), [182](#), [183](#), [184](#) and [185](#) ) or PCR detection of leukemia-specific Ig and T-cell receptor rearrangements ( [186](#), [187](#), [188](#) and [189](#) ) have prognostic power and the likely potential to improve identification of good and poor responders ( [Table 80.3](#) ).

**TABLE 80.3. Response and Outcome**

| Study/Risk Measure <sup>a</sup>        | Percent of Patients in Poor Response Subset | Percent of Total Events in Poor Response Subset | Relative Hazard  |
|--|---|---|------------------|
| CCG-105/AR<br>Day 14 marrow            | 117/1320 (9%)<br>M2/M3                      | 12  | 1.6              |
| CCG-123/HR<br>Day 14 marrow            | 30/205 (15%)<br>M2/M3                       | 27  | 2.8              |
| CCG-1881/LR<br>Day 14 marrow           | 64/711 (9%)<br>M2/M3                        | 18  | 2.5              |
| CCG-123/HR<br>Day 7 marrow             | 86/220 (39%)<br>M3                          | 58  | 2.7              |
| CCG-1891/AR<br>Day 7 marrow            | 525/1074 (49%)<br>M3                        | 60  | 1.7              |
| CCG-1882/HR<br>Day 7 marrow            | 732/1353 (54%)                              | 62  | 1.5 <sup>b</sup> |
| Coustan-Smith et al.<br>Flow cytometry | 30/128 (23%)<br>+ end induction             | 49  | 3.1              |
| Goulden et al.<br>PCR                  | 38/66 (58%)<br>+ end induction              | —   | —                |
| Cave et al.<br>PCR                     | 63/151 (42%)<br>+ end induction             | 82  | 3.4              |
| Van Dongen<br>PCR                      | 98/169 (58%)<br>+ end induction             | 78  | 5.7              |
|  |   | 95  | 14.5             |

PCR, polymerase chain reaction.

<sup>a</sup> Gaynon PS, Desai AA, Bostrom BC, et al. Early response to therapy and outcome in childhood acute lymphoblastic leukemia: a review. *Cancer* 1997;80:1717–1726.

<sup>b</sup> Some patients with a poor response on CCG-1882 received an effective rescue regimen (augmented intensive therapy).

---

The presence of a resistant subclone concealed in the midst of a generally sensitive blast population is one potential confounder of assays of chemosensitivity and response ( [190](#) ). A marrow sample might not reflect the true leukemic burden if the marrow sample is dilute or if blasts are distributed in an anatomically heterogeneous manner throughout the marrow compartment ( [191](#) ). Malignant cells may be difficult to identify in a day 7 or day 14 marrow by light microscopy. Multiparameter flow cytometry has been proposed as a superior strategy for blast identification ( [192](#) ). However, cells may share a clonotypic features or fingerprint and not themselves be fully leukemogenic. Clonotypic features may be subject to oligoclonality or clonal evolution ( [193](#) , [194](#) and [195](#) ). In one study, immunophenotype changed between diagnosis and relapse in 29 of 40 cases studied ( [196](#) ). In another study, changes in Ig heavy chain or T-receptor gene were found in 25 of 40 cases studied ( [197](#) ). Following multiple markers per patient may minimize the impact of oligoclonality or clonal evolution. In PCR-based assays, focusing on downstream D–N–J junctional sequences instead of the more variable upstream VH–D sequences limits oligoclonality ( [198](#) ).

### Other Biologic Markers

Inoculation of human leukemic cells into mice with severe combined immunodeficiency provides a model system for the study of human leukemias ( [199](#) ). Growth of leukemic blasts in severe combined immunodeficiency mice inoculated with cells from patients with both B- and T-lineage ALL has been shown to correlate with patient outcome ( [200](#) , [201](#) ).

### Clinical Features Having Prognostic Significance

**WHITE BLOOD CELL COUNT** The total WBC count at the time of diagnosis is the single most powerful clinical determinant of remission induction, remission duration, and long-term survival for all age groups ( [8](#) , [45](#) , [202](#) , [203](#) , [204](#) and [205](#) ). The inverse relationship between remission duration and WBC or blast count is linear. A WBC count in excess of  $100 \times 10^9/L$  at diagnosis is particularly devastating ( [206](#) ). Patients with high WBC counts often have bulky extramedullary disease at diagnosis and are at high risk for relapse in the CNS or testes after attainment of bone marrow remission. As with other prognostic factors (except for gender), the significance of the WBC count diminishes with time, so that by 24 months from diagnosis, it is no longer predictive of outcome ( [207](#) ).

**AGE** The second most significant clinical prognostic factor is age at diagnosis ( [5](#) , [8](#) , [205](#) , [208](#) , [209](#) ). In the age group 2 to 6 years, long-term survival is more than one-and-a-half times that of children younger than 2 years or older than 10 years treated in an identical manner ( [210](#) ). Infants younger than 1 year of age have an especially poor prognosis, in part because of the concurrence of multiple high-risk factors, such as high WBC counts and extramedullary disease at diagnosis, which in turn are a consequence of an increased frequency of chromosomal alterations involving the *MLL* locus on chromosome 11q23 ( [22](#) ,



62, 118, 124, 125, 211). Adolescents in the age group 10 to 20 years are also at higher risk than younger children (212, 213), and they may be at higher risk than adults 20 to 50 years of age (214). Leukemia in adolescents, as in infants, is frequently associated with adverse prognostic factors, including high WBC counts at diagnosis, T-cell immunophenotype, FAB L2 blast morphology, a low DNA index, and ploidy other than hyperdiploidy. Despite these associations, age 10 to 20 years at diagnosis of ALL has independent adverse prognostic significance (212, 213).

**GENDER** A difference in prognosis between boys and girls did not become apparent until the introduction of CNS-directed therapy and the emergence of a population of long-term survivors (8, 205, 215). Gender has little, if any, impact on the success of remission induction (at least in children) and relapse frequency during the first months of treatment. By 6 to 12 months, however, a higher relapse rate in boys is evident—a pattern that persists thereafter. The difference in DFS and survival is seen in all prognostic groups and cannot be attributed to the male prevalence of T-cell ALL (209, 216, 217). Notable is the observation that gender, unlike WBC count and age, fails to lose its prognostic significance with time (207, 218). After discontinuation of therapy, boys continue to experience a higher incidence of relapse, which can be explained only in part by relapse in the testis, as the rate of bone marrow relapse also is higher (207, 217, 218). Intensified therapy with contemporary treatment regimens, together with stratification for other prognostic factors such as immunophenotype and DNA index, has mitigated the effect of gender on survival in some studies (219).

**ETHNICITY** In many studies in which investigators examined the effect of race on prognosis, a poorer outcome for blacks was noted (6, 204, 220, 221, 222 and 223). Multivariate analysis indicates that this finding in part relates to different biologic characteristics of the disease in whites and blacks. Blacks more frequently present with a high WBC count, significant adenopathy, mediastinal mass, and FAB L2 blast morphology (222). These adverse features are not explained by an increased proportion of the pre-B cell and T-cell phenotypes (204). A recent analysis of SEER data found that black males younger than 4 years of age had a poorer survival than other childhood ALL populations, supporting the hypothesis that pharmacogenetic or other as-yet unidentified biologic differences exist among populations that contribute to outcome (2). Like blacks, Native Americans have high WBC counts at diagnosis (224). The use of intensified therapy for ALL has abrogated the prognostic significance of race in some (95, 225) but not other (226, 227) studies. Asians receiving contemporary therapies have outcomes comparable to Europeans receiving similar treatment (228).

**TIME TO REMISSION** The percentage of marrow blasts on days 7 and 14 of induction therapy identifies groups with disparate treatment outcomes (Table 80.3). In one Children's Cancer Group (CCG) study, 39% of children had >5% blasts on day 7 of therapy. Almost all achieved remission by day 28, but retained 2.7-fold increased risk of relapse (229). CCG has used early marrow response for treatment allocation. Higher risk patients with greater than 25% marrow blasts on day 7 of therapy and standard risk patients with greater than 25% marrow blasts on day 14 of therapy may be "rescued" with the "augmented regimen" (230, 231 and 232). The Berlin Frankfurt Munster (BFM) Group has used peripheral blood response to intrathecal methotrexate and oral prednisone to identify patients at very high risk of treatment failure (233). Examination of peripheral blood response has identified heterogeneity within cytogenetic subgroups like t(9;22) or t(4;11) (234, 235 and 236).

**LYMPHADENOPATHY AND HEPATOSPLENOMEGALY** The size of peripheral lymph nodes, liver, and spleen provide an indirect measurement of leukemic cell burden. Not surprisingly, therefore, several studies demonstrated that massive lymphadenopathy (58, 237), hepatomegaly, and/or splenomegaly (210, 238) impact adversely on remission duration and survival. However, in multivariate analysis, the prognostic significance of these

features is diminished by the level of WBC at diagnosis, early response to therapy, and other factors ( [239](#) ).

**MEDIASTINAL MASS** By univariate analysis, the presence of a mediastinal mass at diagnosis is a prominent poor prognostic feature. When considered with other variables, however, its prognostic significance varies among studies ( [66](#) , [209](#) , [210](#) , [237](#) ). Mediastinal masses are strongly associated with increased WBC count, older age, male gender, massive splenomegaly, hemoglobin concentration greater than 10 g/dl, decreased IgM levels, and slow response to therapy.

**CENTRAL NERVOUS SYSTEM LEUKEMIA** Involvement of the CNS by leukemia is typically defined as 5 or more WBC/ $\mu$ l with the presence of blast cells on cytospin preparations or the presence of cranial nerve palsy ( [240](#) ). CNS leukemia, present in approximately 5% of children at diagnosis, is associated with a significantly lower rate of remission induction, a higher risk of relapse, and a shorter survival ( [205](#) , [210](#) ). Although CNS disease is more common in T-cell ALL, its prognostic significance persists when adjustments are made for associated high risk factors. Recently, the use of different therapeutic strategies for childhood ALL have led to varying findings regarding the prognostic significance of less than 5 WBC/ $\mu$ l with blasts in the CSF at diagnosis. Both St. Jude's ( [241](#) ) and Pediatric Oncology Group (POG) ( [242](#) ) investigators observed a higher risk of CNS relapse in this group, in contrast to results obtained by the CCG ( [243](#) , [244](#) ). To establish uniform criteria for identifying CNS disease, the following revised definitions regarding CNS involvement at diagnosis were proposed at a consensus workshop: CNS-1 (no blast cells), CNS-2 (<5 WBC/ $\mu$ l with blast cells), and CNS-3 (=5 WBC/ $\mu$ l with blasts or cranial nerve involvement) ( [245](#) ). Adoption of these criteria will allow comparison of outcomes across varying therapeutic strategies used by different cooperative groups conducting clinical trials for childhood ALL.

**BLAST MORPHOLOGY FAB** morphologic classification has demonstrated strong prognostic significance in many analyses of childhood ALL ( [204](#) , [246](#) , [247](#) , [248](#) , [249](#) , [250](#) and [251](#) ) but not in others ( [252](#) , [253](#) and [254](#) ). FAB L1 morphologic features are associated with a more favorable prognosis than L2 in childhood ALL, whereas the L3 subtype was historically predictive of remission induction failure and short survival ( [210](#) ) when patients with this morphology were treated with standard ALL regimens. Because L1 and L2 morphology bear no relationship to immunologic subtype or other prognostic factors ( [45](#) , [249](#) ), these morphologic subtypes were predicted to have independent prognostic significance. This theory has been borne out by multivariate analysis ( [205](#) ). In a more recent study conducted by the Nordic ALL group ( [255](#) ), L2 morphology was again found to be an adverse risk factor, independent of other prognostic factors, in the setting of contemporary intensified therapy.

**HEMOGLOBIN CONCENTRATION AND PLATELET COUNT** Patients who presented with a hemoglobin concentration less than 10 or 11 g/dl had a higher remission induction rate, a lower relapse rate, and a longer survival rate than those with no anemia in early analyses ( [205](#) , [210](#) , [256](#) ). The hemoglobin level appears to be an indirect gauge of the biologic aggressiveness of leukemia. With explosive disease, symptoms evolve before anemia has time to develop, whereas with indolent leukemia, disordered bone marrow function becomes clinically apparent before anemia. Normal hemoglobin levels are associated with bulky extramedullary involvement and a high percentage of blasts in the proliferative (S) phase of the cell cycle ( [257](#) ). An association between low platelet count (less than  $30 \times 10^9$ /L) and shorter remission duration has been noted in some studies ( [258](#) ). Leukemic seeding associated with petechial hemorrhages may predispose patients to testicular and CNS relapse ( [259](#) ). Both the hemoglobin level and the platelet count lose much of their independent predictive power in multivariate analyses due to other risk factors with which they are associated ( [239](#) ).

**SERUM IMMUNOGLOBULINS** Approximately 30% of children have reduced levels of one

or more Igs at diagnosis ( [260](#) ). Low levels of IgG and IgA were historic predictors of induction failure ( [205](#) , [260](#) ). Although by multivariate analysis the concentrations of IgG, IgA, and IgM all had prognostic significance for survival duration ( [205](#) , [260](#) ), the identification of powerful new prognostic factors, such as early response to therapy, has rendered determination of serum Igs largely irrelevant in regard to prognostic stratification.

**DOWN SYNDROME** Children in whom ALL is associated with Down syndrome have a significantly lower rate of remission, a higher mortality rate during the induction phase, and a poorer long-term survival rate in many studies ( [261](#) , [262](#) , [263](#) , [264](#) and [265](#) ) in contrast to children with acute myelogenous leukemia and Down syndrome ( [266](#) ). The adverse influence of Down syndrome is not explained by a higher incidence of associated poor prognostic features ( [267](#) ). Rather, it may be explained in part by a greater incidence of toxicity related to intensive treatment ( [262](#) , [264](#) , [267](#) ) and in part by failure to distinguish acute megakaryocytic leukemia (AMeGL) and ALL. AMeGL is the most common type of acute leukemia occurring in Down syndrome children younger than 4 years of age ( [268](#) ). Platelet-specific monoclonal antibodies and examination for platelet peroxidase may be required to differentiate AMeGL and ALL. Intensification of therapy abrogates the adverse affect of Down syndrome in some studies but is attended by greater serious toxicity ( [267](#) , [269](#) ).

## Prognostic Stratification

Because treatment is the single most important prognostic factor, the relative prognostic power of disease characteristics varies from study to study. Consequently, different sets of prognostic variables have been found to be useful by those conducting clinical trials for childhood ALL. These include the WBC count, age, race, and karyotype ploidy ( [204](#) ); WBC count and size of liver and spleen ( [270](#) ); and WBC count and age alone ( [30](#) ). The CCG used the latter two variables to identify three prognostic groups within a large population of patients younger than 21 years of age treated in a uniform fashion ( [205](#) ). Children with an initial WBC count less than  $10 \times 10^9/L$  and between 3 and 7 years of age had a 4-year continuous remission rate of nearly 90%. This good prognosis group accounted for 27% of the study population. Average risk patients were defined as those of all ages with an initial WBC count between  $10$  and  $50 \times 10^9/L$  and those younger than 3 years or older than 7 years with a WBC count less than  $10 \times 10^9/L$ . This group constituted 54% of the total and had a 4-year continuous remission rate of approximately 60%. High-risk patients, identified by a WBC count in excess of  $50 \times 10^9/L$ , made up 19% of the population and had a median survival of only 2 years. This stratification was used prospectively to evaluate different therapeutic strategies for different prognostic groups ( [30](#) ). The CCG subsequently used the WBC count at diagnosis, age, gender, extent of extramedullary disease, FAB morphologic classification, and platelet count to stratify patients into five groups that differ with respect to prognosis, relapse patterns, and therapeutic priorities ( [239](#) , [271](#) ). Other groups adopted similar, but slightly different, approaches ( [22](#) , [272](#) , [273](#) ).

Differences among the risk classification criteria used in clinical trials of childhood ALL by various groups conducting clinical trials in this population made accurate comparisons of outcomes across groups difficult, if not impossible. To overcome this obstacle, an international workshop held in Rome in 1985 developed a proposal for uniform criteria for risk-based treatment assignment ( [240](#) ); however, these recommendations were not widely adopted. A subsequent consensus workshop, sponsored by the U.S. National Cancer Institute (NCI) in collaboration with representatives from major U.S. organizations involved

in the design and conduct of therapeutic trials for childhood ALL, led to the development of risk-based criteria similar to those recommended by the Rome workshop ( [245](#) ). The so-called Rome/NCI criteria define two risk groups: standard risk and high risk. The standard-risk group includes those patients with B-precursor ALL ages 1 to 9 years with a WBC count less than 50,000/ $\mu$ l, estimated to comprise approximately 75% of B-lineage ALL patients; these patients were estimated to have EFS of approximately 80%; the remaining high-risk patients were estimated to have EFS of approximately 65%. As different treatment strategies have yielded varying conclusions regarding the prognostic significance of the T-cell phenotype, some groups classify T-cell patients according to WBC count and age, whereas others classify all T-cell ALL patients as high-risk; uniform data collection will facilitate analysis of T-cell phenotype using different treatment strategies. Other prognostic factors obtained in all patients include DNA index, cytogenetics, early response to treatment, immunophenotype, and CNS status.

Although the Rome/NCI criteria represented a major advance in risk classification of childhood ALL, the criteria did not adequately take into account more current biologic features such as molecular genetic alterations, early response to therapy, minimal residual disease, and leukemic blast sensitivity to chemotherapeutic agents. Identification of these and other prognostic factors have led to continued discussion and refinement of risk classification strategies among those conducting clinical trials for childhood ALL ( [274](#) , [275](#) ).

The successful intensification of therapy for high-risk ALL has weakened the power of many previously useful adverse predictive factors. Many examples illustrate the potential of newer treatment strategies to offset the negative impact of clinical and biologic variables, including high WBC counts and splenomegaly ( [270](#) , [276](#) ), myeloid-associated antigen expression by ALL blasts ( [78](#) , [80](#) ), t(1;19) in pre-B-cell ALL ( [130](#) ), pseudodiploidy and hypodiploidy ( [277](#) ), and the T-cell immunophenotype ( [278](#) , [279](#) and [280](#) ).

## TREATMENT

Perhaps four in five children with ALL may be cured with current therapies ( [281](#) , [282](#) , [283](#) and [284](#) ). Challenging popular wisdom and linear assumptions, modest, rational changes in complex therapy have had significant clinical benefit. Outcome remains poor for infants, especially those with leukemic cells bearing the translocation t(4;11) or expressing MLL-AF4 fusion mRNA by reverse transcriptase-PCR ( [285](#) , [286](#) ) and for children and adolescents with leukemia cells bearing the translocation t(9;22) (Ph chromosome) or expressing BCR-ABL fusion mRNA ( [287](#) ). Of note, adolescents or young adults age 16 to 21 years have had better outcomes when treated by pediatric oncologists on pediatric protocols than by adult hematologists on adult protocols ( [288](#) ).

The road to cure passes through complete remission. New techniques allow supplementation of traditional microscopic marrow assessment with more sensitive laboratory measures. Remission induction in ALL is facilitated by the availability of three very active drugs in ALL with minimal myelotoxicity; namely, vincristine, a glucocorticoid (usually prednisone), and L-asparaginase. Although clinically detectable CNS leukemia is rare at diagnosis, the high frequency of subsequent "isolated" CNS relapse despite continuing marrow remission in patients who had received no CNS-directed therapy suggests that submicroscopic CNS disease is common. Thus, CNS-directed therapy is also required for cure.

Conventionally, remission has been defined by microscopic criteria (i.e., fewer than 5% blasts in a cellular marrow, recovery of peripheral neutrophils and platelets, and absence

of detectable extramedullary leukemia). Should therapy halt with remission, leukemia invariably returns. Recent studies using PCR-based ( [289](#), [290](#) ) or other ( [291](#) ) methodologies have uniformly demonstrated residual leukemic cells or cells sharing clonotypic features with the leukemic clone in patients in first remission.

Treatment is generally divided into phases: induction, intensification, and maintenance. The goal of induction is remission, or the eradication of all microscopically detectable leukemia. The goal of intensification is improvement in the quality of remission. Postinduction intensification has been a productive strategy for enhancing cure rates since the 1980s. The goal of maintenance is the preservation of remission. ALL, and childhood ALL in particular, is unique in its requirement for prolonged, 2- to 3-year moderate therapy. Other chemosensitive cancers, such as testicular cancer and Hodgkin disease, have no need for prolonged therapy after remission.

Outcome is usually described in terms of survival, EFS, DFS, and leukemia- or relapse-free survival. Survival is simply the cumulative percentage of living patients, with or without leukemic relapse or second malignant neoplasm. EFS is the cumulative fraction or percentage of patients surviving from time of diagnosis with no intervening adverse event such as failure to achieve remission, death, relapse, or second malignant neoplasm. DFS includes only patients who achieve remission and describes the cumulative fraction or percentage of patients surviving with no intervening adverse event such as death, relapse, or second malignant neoplasm. Leukemia- or relapse-free survival describes the cumulative fraction or percentage of patients in remission who survive with no intervening relapse. Patients with adverse events, such as death or second malignant neoplasm, are excluded. Currently, attention has broadened to include potential late effects of therapy that may have a lasting impact on quality of life such as neurocognitive damage, anthracycline cardiotoxicity, secondary malignant neoplasms, or avascular necrosis of bone.

## Primary Treatment

**REMISSION INDUCTION** In childhood ALL, a three-drug induction, using vincristine, prednisone, and doxorubicin, proved superior to vincristine and prednisone alone more in terms of long-term EFS (63% vs. 37%) than in terms of remission induction (93% vs. 100%) ( [292](#) ). The UKALL VIII trial examined the addition of daunomycin (D) to vincristine, prednisone, and L-asparaginase (VPL) in 630 children. Patients who received daunomycin (VPLD) had an increased treatment mortality and a somewhat lower relapse rate with no statistically significant overall improvement in EFS or survival ( [293](#) ). The CCG 105 study similarly found no clear benefit for intermediate-risk patients in an intensive VPLD induction with daunorubicin, 25 mg/m<sup>2</sup> weekly × 4, prednisone at 60 mg/m<sup>2</sup>/day, and cyclophosphamide, cytosine arabinoside, and 6-mercaptopurine (6-MP) consolidation compared to a VPL induction with prednisone at 40 mg/m<sup>2</sup>/day in induction and daily oral 6-MP in consolidation. The relative event rate was 0.85 (N = 804, *p* = .19) ( [294](#) ). Current practice uses three or four drugs in induction for lower-risk children and four to seven drugs for higher-risk children ( [295](#) ). Dexamethasone may be substituted for prednisone. Dexamethasone is known to provide better CNS penetration ( [296](#) ) and has been reported to be 16 times more active against ALL blasts *in vitro* ( [297](#) ). Compared to historical controls who received prednisone, the Dutch ALL VI trial showed 80% versus 66% 3-year EFS advantage for dexamethasone for standard-risk patients ( [298](#) ). The CCG 1922 study examined the same question in a randomized trial. Accrual was completed in 1995, and results favor dexamethasone over prednisone in terms of both CNS relapse rate and EFS ( [299](#) ). The UKALL '97 trial also compared dexamethasone and prednisone with similar findings ( [300](#) ). Concerns have been raised about unacceptable toxicity when



dexamethasone is used as part of a four-drug induction ( 301 ). Recent trials call attention to L-asparaginase and asparagine depletion. Asselin et al. ( 302 ) describe the differing pharmacokinetics of different asparaginase preparations, such as native *Escherichia coli* asparaginase, *Erwinia* asparaginase, and polyethylene glycol-modified *E. coli* (PEG) asparaginase. Native *Erwinia* asparaginase is known to have a shorter half-life than native *E. coli* asparaginase (0.65 days vs. 1.28 days in naïve patients) ( 302 , 303 ). The European Organization for Research on the Treatment of Cancer (EORTC) compared *E. coli* and *Erwinia* asparaginase at 10,000 IU/m<sup>2</sup> twice weekly in induction and intensification in EORTC 58881, a schedule that may have exaggerated pharmacologic differences more than the thrice-weekly schedule. A total of 652 patients were randomized. At 4 years, the EFS was 75% for *E. coli* and 62% for *Erwinia* asparaginase ( *p* <.001) ( 304 ). Unit/unit substitution of *Erwinia* asparaginase for native *E. coli* asparaginase also adversely impacted EFS on the Dana Farber Cancer Institute (DFCI) 95-01 trial ( 305 ). Asparagine depletion may fail because of pharmacology or because of the presence of neutralizing antibodies without clinical allergy (i.e., silent hypersensitization). Several groups have reported that conventional doses and schedules of *Erwinia* asparaginase fail to provide the expected continuous asparagine depletion for an increasing fraction of patients with repeated exposures ( 306 , 307 ). Cheung et al. report that patients may develop high-titer antibodies to native *E. coli* asparaginase after a single course without anaphylaxis ( 308 ). Patients with antibodies were more likely to relapse ( 308 ) and appeared less likely to respond to asparaginase-containing regimens in subsequent therapy ( 309 , 310 ). Intensive therapy, including alkylating agents, may prevent emergence of antibodies ( 308 ).

**PRESYMPTOMATIC CENTRAL NERVOUS SYSTEM THERAPY** Although overt CNS leukemia is rare at diagnosis, prevention of later CNS relapse was a major barrier to cure. Conventional criteria for CNS leukemia require pleocytosis (5 or more cells/μl) and the unambiguous identification of blasts in the CSF ( 311 ). The incidence of CNS leukemia at diagnosis is less than 5%. However, in the absence of CNS-directed therapy, 50 to 70% of children have their first leukemic relapse in the CNS while in marrow remission ( 312 ). Isolated CNS relapse is most commonly followed by marrow relapse despite apparently successful eradication of CSF blasts. Between 1967 and 1968, Simone et al. at St. Jude's Children's Research Hospital treated 31 children with no evidence of CNS leukemia at diagnosis with 24 Gy presymptomatic cranial irradiation and intrathecal methotrexate in Study V. Only three had a subsequent CNS relapse, and more than one-half were long-term, disease-free survivors. Between 1968 and 1971, Simone et al. demonstrated the effectiveness of 24 Gy presymptomatic craniospinal irradiation in preventing CNS relapse and subsequent marrow relapse compared to no presymptomatic CNS directed treatment in Study VI and a similar benefit for 24 Gy craniospinal irradiation and 24 Gy cranial irradiation with intrathecal methotrexate in Study VII. In striking contrast to prior experience, more than one-half of patients were and remain long-term, disease-free survivors ( 313 , 314 ). In 1980, Green et al. compared three regimens using different strategies for presymptomatic CNS therapy: 2400 Gy cranial irradiation and six doses of intrathecal methotrexate, intermediate-dose intravenous methotrexate with six doses of intrathecal methotrexate, and six doses of intrathecal methotrexate alone ( 315 ). Intrathecal therapy was limited to the first 2 to 3 months of treatment rather than extended throughout therapy. Cranial irradiation and intrathecal methotrexate provided the lowest rate of CNS relapse overall. However, the regimen with intravenous and intrathecal methotrexate provided the best overall DFS for lower-risk patients. The regimen with cranial irradiation and intrathecal methotrexate provided the best DFS in higher-risk patients. Subsequently, the dose of cranial irradiation was reduced to 18 Gy with no loss of efficacy in CCG trials ( 316 ). Dosage of intrathecal therapy is usually based on age rather than body surface area ( 317 ). Concerns about neurocognitive side effects ( 318 , 319 ) and secondary brain tumors ( 320 ) after cranial irradiation have led to its inexorable replacement for patients without overt CNS disease at diagnosis by improved

systemic therapy and intrathecal therapy extended through at least the first 7 months of treatment ( [321](#) , [322](#) , [323](#) , [324](#) , [325](#) and [326](#) ) or by very-high-dose parenteral methotrexate ( [327](#) , [328](#) ). Craniospinal irradiation remains an important therapeutic modality for children with overt CNS disease at diagnosis. In CCG trials, children with overt CNS disease at diagnosis received craniospinal irradiation and had outcomes similar to other children without overt CNS disease matched by WBC and age ( [329](#) ). The CCG 161 trial showed that intrathecal therapy extended through the 2- to 3-year duration of systemic therapy could replace cranial irradiation and limited intrathecal therapy for lower-risk patients ages 2 to 10 years with WBC less than 10,000/ $\mu\text{l}$  ( [322](#) ). The CCG 105 trial extended this observation to intermediate-risk children between the ages of 1 and 9 years with WBC below 50,000/ $\mu\text{l}$  but only when patients received intensified systemic therapy ( [324](#) ). When patients received only “standard” systemic therapy, cranial irradiation and limited intrathecal therapy were superior to extended intrathecal methotrexate with no irradiation. In CCG 1882, higher-risk patients, either older than 10 years of age or with WBC  $\geq$ 50,000/ $\mu\text{l}$  or higher and a rapid initial response to induction therapy received either 18 Gy cranial irradiation and extended intrathecal methotrexate or additional intrathecal methotrexate with no whole-brain irradiation. All received intensive systemic therapy. The cumulative incidence of isolated CNS relapse was 3.6% for patients not receiving cranial irradiation and 2.3% for patients receiving cranial irradiation. However, patients receiving additional intrathecal methotrexate had somewhat fewer bone marrow relapses, and the ultimate DFS was similar. Thus, cranial irradiation could be replaced with aggressive intrathecal methotrexate for this population also in the presence of effective systemic therapy ( [330](#) ). Others have used intrathecal triple therapy—that is, methotrexate, cytosine arabinoside, and hydrocortisone—in place of single-agent methotrexate and successfully omitted cranial irradiation ( [323](#) , [325](#) ). In the absence of cranial irradiation, Pullen and POG co-workers showed that extended intrathecal triple therapy better prevented CNS relapse than extended intermediate-dose intravenous methotrexate and more limited intrathecal methotrexate. The cumulative CNS relapse rates were 4.7% and 10.9% overall ( [323](#) ). Conter et al. from the *Associazione Italiana di Ematologia ed Oncologia Pediatrica* (AIEOP) found that extended intrathecal triple therapy every 8 weeks with no cranial irradiation limited the incidence of CNS relapse to 5% ( [325](#) ). Stork et al. recently reported a randomized comparison of intrathecal triple and single agent methotrexate therapy with more than 2000 randomized patients ( [331](#) ). Although intrathecal triple therapy halved the CNS relapse rate, EFS was similar at 5 years, and survival was actually statistically inferior due to inferior salvage from the excess of bone marrow relapses ( [331](#) ).

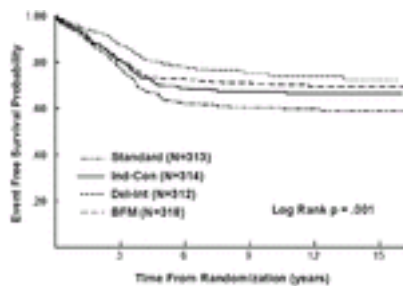
**POSTINDUCTION INTENSIFICATION** The observation of Freeman et al. ( [332](#) , [333](#) ) that postinduction intensification with parenteral intermediate-dose methotrexate and leucovorin rescue yielded lower marrow and testicular relapse rates than cranial irradiation and limited intrathecal methotrexate has led to continuing examination of postinduction intensification with prolonged 24- to 36-hour intravenous methotrexate infusions with leucovorin rescue in a number of trials ( [327](#) , [328](#) , [334](#) , [335](#) , [336](#) , [337](#) and [338](#) ).

More recently, oral methotrexate, 25 to 30 mg/m<sup>2</sup> every 6 hours  $\times$  four doses, and intravenous methotrexate by 4-hour infusion have been proposed as outpatient alternatives to inpatient, prolonged, intermediate-dose intravenous methotrexate infusions ( [339](#) , [340](#) ). Value has been shown for additional methotrexate in the form of intermediate-dose intravenous methotrexate with leucovorin rescue and for substitution of intravenous methotrexate with no leucovorin rescue for oral methotrexate in randomized trials. The POG 9404 study showed an advantage of additional intermediate-dose methotrexate with leucovorin rescue over no methotrexate for T-cell patients ( [341](#) ). Two trials show an advantage for parenteral methotrexate with no leucovorin rescue over conventional weekly oral methotrexate ( [342](#) , [343](#) ). Demonstration of an advantage in overall DFS for postinduction intensification limited to parenteral methotrexate with leucovorin rescue over oral methotrexate has been more elusive. In St.



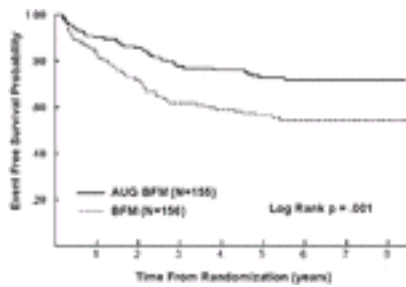
Jude's Study X, Abromowitch et al. ( [335](#), [336](#) ) compared one regimen that added parenteral methotrexate, 1 g/m<sup>2</sup>, to daily oral 6-MP to a second regimen, including cranial irradiation and rotating drug pairs: 6-MP-methotrexate, cyclophosphamide-doxorubicin, and teniposide-cytosine arabinoside. The 4-year DFS was 67% for the first regimen and 56% for the second (  $p = .049$  ). Differences were more striking for lower-risk patients ( [335](#), [336](#) ). BFM investigators claim advantage for intermediate-dose methotrexate, 5 g/m<sup>2</sup>, for T-cell patients in BFM 86 ( [344](#), [345](#) ). On the other hand, CCG-144 compared very-high-dose parenteral methotrexate (33.6 g/m<sup>2</sup>) with no intrathecal therapy to cranial irradiation and limited intrathecal methotrexate and found no advantage in overall DFS, although parenteral methotrexate provided adequate CNS prophylaxis ( [328](#) ). The German COALL 82 trial replaced cyclophosphamide with three 3-g/m<sup>2</sup> methotrexate infusions with folinic acid rescue, 15 mg/m<sup>2</sup> every 6 hours  $\times$  10. Patient entry was halted when outcome was found inferior to the previous trial, which did not include parenteral methotrexate ( [334](#) ). CCG-139 found no benefit for the addition of parenteral methotrexate, 500 mg/m<sup>2</sup>, three times during consolidation and every 6 weeks during maintenance compared to a regimen that included no intravenous methotrexate for intermediate-risk patients. All patients received extended intrathecal methotrexate ( [338](#) ). No benefit was found for intravenous methotrexate and rescue in a British study ( [346](#) ). Benefit is claimed in one subset but not overall in the French FRALLE93 study ( [346a](#), [346b](#) ). German COALL investigators comment on the inimical effects on outcome of "too early" or excess folinic acid rescue ( [347](#) ). Given the abiding interest in parenteral methotrexate, intensive scheduled oral methotrexate, 25 to 30 mg/m<sup>2</sup> every 6 hours  $\times$  4, has been proposed as an outpatient alternative to parenteral methotrexate, which might provide similar drug exposure ( [339](#) ). When intensive scheduled oral methotrexate was administered with no leucovorin, 16 out of 111 patients had one or more seizures, and six additional patients had transient episodes of weakness with unilateral paresthesias, generally 2 weeks after the last of a series of biweekly courses. After leucovorin, 5 mg/m<sup>2</sup>, was added 24 and 36 hours after the last dose of each course of oral methotrexate, no further neurologic toxicity was seen in the next 24 patients ( [348](#) ). More recently, oral methotrexate, 30 mg/m<sup>2</sup> every 6 hours  $\times$  4, was compared to intravenous methotrexate, 1 g/m<sup>2</sup> over 24 hours, for lower-risk patients in a randomized POG trial. All patients received intravenous leucovorin, 5 mg/m<sup>2</sup> every 6 hours  $\times$  5. At 3 years, the EFS was 78% for oral methotrexate versus 89% for parenteral methotrexate ( [340](#) ). Moderate to severe neurotoxicity, most commonly generalized or focal seizures, occurred in 7.2% of patients receiving parenteral methotrexate and 3.7% of patients receiving scheduled oral methotrexate ( [349](#) ). Other postinduction intensification strategies have shown benefit. Researchers from DFCI introduced an effective program, including extended use of weekly L-asparaginase ( [350](#), [351](#) ). Extended asparaginase strategies have been tested in a number of other current trials. No advantage was found for additional asparaginase in Italian or German studies ( [337](#), [352](#) ). POG also found no advantage for additional intramuscular L-asparaginase, 25,000 U/m<sup>2</sup>/week  $\times$  24 for standard-risk B-precursor patients ( [353](#) ). However, advantage was shown in another POG trial for T-cell disease ( [354](#) ). In 1970, investigators from the BFM Group introduced a 3-month intensive induction/consolidation phase called *protocol I*, which added pulses of cyclophosphamide, cytosine arabinoside, and 6-MP to a VPLD induction. No striking benefit followed ( [355](#) ). In 1976, they added a second intensive phase after consolidation, variously called *protocol II* in Europe and *delayed intensification* in North America. Protocol II included a reinduction segment of vincristine, dexamethasone, L-asparaginase, and doxorubicin followed by a reconsolidation segment of cyclophosphamide, cytosine arabinoside, and 6-thioguanine (6-TG). Outcomes improved compared to historical

controls, and advantages were most striking for higher-risk patients (356). Between 1983 and 1989, the CCG 106 and CCG 123 studies compared therapy based on the BFM '76 trial for higher-risk patients with then-current CCG therapy and demonstrated an unambiguous improvement in EFS for BFM-based therapy. The 7-year EFSs were 63% and 42% in CCG 106 (357, 358) and 67% and 50% in CCG 123 (359). Advantages were apparent in survival as well as EFS. CCG 105 extended this finding to intermediate-risk patients, 73% versus 61% (Fig. 80.2) (global  $p = .006$ ). Of great interest, outcome with protocol II alone with no intensive induction/consolidation (protocol I) was superior to "standard" therapy and similar in outcome as treatment with both protocols I and II, quite contrary to a "more is better" popular wisdom. Omission of protocol I avoided the short- and long-term morbidity of daunorubicin, 100 mg/m<sup>2</sup>, and cyclophosphamide, 2 g/m<sup>2</sup>, and 8.4 days of hospitalization per patient (294). The BFM '81 trial ultimately confirmed the benefit of postinduction intensification for lower-risk patients, 84% versus 62% (360). This finding was confirmed in a putative lowest-risk population in CCG 1881, in which patients who received delayed intensification had a 4-year EFS of 88%, compared to 82% for patients who had not (361). Patients on the standard arm in the CCG trial received vincristine and prednisone pulses q4wk and intrathecal methotrexate q12wk in maintenance (not received in the BFM trial). Lower-risk patients tend to have a prolonged period of risk of relapse, and any differences between regimens may emerge only later.



**Figure 80.2.** Impacts of intensive induction/consolidation (Ind-Con) and delayed intensification (Del-Int) on the event-free survival of children with average risk acute lymphoblastic leukemia. BFM, both intensive induction consolidation and delayed intensification based on the Berlin Frankfurt Munster 76/79 study; standard, neither intensive induction consolidation nor delayed intensification. (Children's Cancer Group-105 study; chair Dr. David G. Tubergen.) (Courtesy of Dr. Harland N. Sather and the Children's Cancer Group, Arcadia, CA.)

A further CCG modification of this therapy, the "augmented regimen," posited that more resistant cells responsible for relapse might need a stronger and more prolonged postinduction intensification. The "augmented regimen" provided two applications of delayed intensification and four 2-week courses of nonmyelosuppressive vincristine and L-asparaginase during the periods of myelosuppression that invariably follow the cyclophosphamide, cytosine arabinoside, and thiopurine pulses in consolidation (protocol Ib) and reconsolidation (protocol IIb). Two courses of five Capizzi I pulses (362, 363) of vincristine, parenteral methotrexate, and L-asparaginase replace the two 2-month courses of oral 6-MP and methotrexate between consolidation and delayed intensification #1 and delayed intensification #1 and delayed intensification #2. Higher-risk patients with a poor initial response to therapy (i.e., greater than 25% marrow blasts on day 7 of therapy) comprised the study population. At 5 years, DFS was 75% for the "augmented regimen" and 55% for standard intensive therapy (Fig. 80.3) (84). The "augmented regimen" was shown to be helpful for slower response, standard-risk patients with more than 25% marrow blasts on day 14 of induction (365).



**Figure 80.3.** Benefit of longer and stronger postinduction intensification (AUG BFM) therapy on the event-free survival of children and adolescents with higher risk acute lymphoblastic leukemia and a poor day 7 marrow response. BFM, standard post-induction intensification based on the Berlin Frankfurt Munster 76/79 study. (Children’s Cancer Group–1882 study; chair Dr. James B. Nachman.) (Courtesy of Dr. Harland N. Sather and the Children’s Cancer Group, Arcadia, CA.)

Subsequently, two delayed intensification phases proved superior to one delayed intensification phase for standard-risk patients (366). Double delayed intensification was shown advantageous overall, but the benefit was greater for slower response patients, with more than 5% marrow blasts on day 7 of therapy, and less for faster response patients, with fewer than 5% blasts. Recently, Italian investigators found benefit for two delayed intensification phases among “prednisone poor response” patients (366a). The current CCG higher-risk trial examines the effects of the length and strength of postinduction intensification in higher-risk, rapid, day 7 response patients (CCG 1961). The current standard risk trial examines the value of one or two delayed intensification phases for patients who received dexamethasone in induction and reexamines the relation between early response and optimal length of postinduction intensification (CCG–1991). The Childhood ALL Collaborative Group compiled data from seven randomized trials that examined the role of postinduction intensification on outcome (367). Only trials that included an intensification block believed to be strong enough and long enough to induce remission in a patient at diagnosis or relapse were considered. More than 2600 patients were included in the metaanalysis. Intensification, however constituted, provided an overall 8.2 percentage point advantage in EFS ( $p < .00001$ ) and a 4.2 percentage point advantage in survival ( $p = .01$ ). Overall, marrow relapse was decreased by 36%, CNS relapse by 41%, and testicular relapse by 31%. Remission deaths were increased to 4.9% versus 3.3% ( $p = .08$ ). On the other hand, 15 trials examining additional agents or higher doses of conventional agents after induction in 3133 patients found no advantage in EFS or survival.

## Maintenance Therapy

Daily oral 6-MP and weekly oral methotrexate with an extended periodic intrathecal therapy comprise the most common maintenance or continuation regimens. Ratios of weekly cumulative doses of 6-MP and methotrexate range from 8 to 26. Outcome with half-dose therapy is less effective than full dose (368). However, no advantage has been shown for increased-intensity oral 6-MP and methotrexate (369) or the addition of cytosine arabinoside or cyclophosphamide to this basic platform (368). Intramuscular methotrexate is no more effective than oral methotrexate (370). However, every-2-week or every-4-week intravenous methotrexate may be more effective than conventional weekly oral methotrexate (342, 343).

Vincristine and prednisone pulses may be useful in maintenance in preventing relapse, but demonstration of any impact on survival is less compelling. The Childhood ALL Collaborative Group compiled five randomized trials examining vincristine and prednisone pulses in maintenance for 1251 children (367). The overall difference in lifetable EFS was

10.5 percentage points ( $p < .0003$ ), and the difference in survival was 4.5 percentage points ( $p = .1$ ). Pulses resulted in a 36% reduction in bone marrow relapse ( $p = .0003$ ) and a 59% reduction in testicular relapse ( $p = .0003$ ). The reduction in deaths was 16%, however, and not statistically significant by conventional criteria.

Of course, this type of analysis cannot determine the value of vincristine and prednisone pulses in other specific contexts. Interventions may be useful in one context and redundant in another. The role of vincristine and dexamethasone pulses is under study in a current International BFM Study Group protocol in which all patients receive effective postinduction intensification.

Variations in the common continuation therapy program are found in the DFCI studies ([284](#), [350](#), [351](#)), the NY I and NY II protocols ([371](#), [372](#)), and Japanese studies ([343](#)). The Japanese Children's Cancer and Leukemia Study Group compared 6-MP, 175 mg/m<sup>2</sup>/day days 0 to 4, and intravenous methotrexate, 225 mg/m<sup>2</sup> day 14, with daily oral 6-MP, 50 mg/m<sup>2</sup>, and weekly oral methotrexate, 20 mg/m<sup>2</sup>. All patients received vincristine and prednisone pulses every 4 weeks and intrathecal methotrexate every 12 weeks. The 5-year EFS was 73% for the intermittent alternating regimen and 50% for the conventional regimen. The conventional regimen had more infections and late marrow, CNS, and testicular relapses ([343](#)).

Interpatient variations in 6-MP absorption are well known ([373](#)). Several laboratories have found an association between levels of erythrocyte TG nucleotides and freedom from relapse ([374](#), [375](#)). This observation encouraged attempts to improve outcome by enhancing intracellular TG nucleotide accumulation. Strategies include replacement of oral 6-MP by parenteral 6-MP ([376](#)) or by oral or parenteral 6-TG ([377](#), [378](#) and [379](#)).

Intravenous 6-MP provides less interpatient variability and more predictable plasma levels ([380](#), [381](#)). A number of randomized outcome comparisons were undertaken. Thus far, intravenous 6-MP has provided no clinical advantage over oral 6-MP in any study ([299](#), [382](#)).

Oral 6-TG is known to provide levels of erythrocyte thioguanine nucleotides four to six times higher than equitoxic doses of oral 6-MP ([377](#), [378](#)). *In vitro*, 6-TG is approximately tenfold more potent and provides potentially therapeutic levels in the CSF ([379](#)). Stork et al. have reported an advantage for 6-TG for standard-risk patients in terms of CNS relapse and EFS, but at a cost of sinusoidal obstruction syndrome ([331](#)). The 5-year EFS was 84% for 6-TG and 77% for 6-MP. A smaller German COALL trial has shown no advantage for 6-TG ([383](#)).

Continuation therapy for 2 to 3 years is most usual in childhood ALL. Despite effective postinduction intensification, the BFM Group found that 18 months of treatment was inferior to 24 months (83% vs. 77%) ([384](#)). The Childhood ALL Collaborative Group compiled 16 randomized trials that compared shorter and longer therapy in a metaanalysis that included 3861 patients ([367](#)). Longer therapy provided a small but statistically significant 3.3 percentage point improvement in EFS and a statistically not significant 0.8 percentage point improvement in survival. An advantage for longer therapy was found in the 24- versus 18-month and 36- versus 24-month comparisons but not in the 60- versus 36-month comparisons. Longer therapy provided statistically significant reductions in bone marrow relapse (26%) and testicular relapse (36%), but patients on longer therapy were more likely to die in remission (2.7% vs. 1.2%). Contrary to popular memory, boys and

girls derived similar, small benefit from longer therapy. Of course, this type of analysis cannot determine the value of duration of continuation therapy in regimens not studied, but cross-study consistency lends weight to its conclusions. The debate continues whether more effective postinduction intensification will allow briefer maintenance therapy or, conversely, will add value to longer therapy as more patients are brought to 24 months in remission. Optimal duration of therapy may differ among subsets, being more important in standard-risk patients and less important in older or T-cell patients.

## Relapse

Population-based SEER data found a 69% 5-year survival for children ages 0 to 14 years diagnosed with ALL in the United States between 1978 and 1986 (385). More recent data have raised this number to 79% for children diagnosed between 1986 and 1992, an increase of 10 percentage points relative to 1983 to 1985 (386). EFS may be a better measure of ultimate outcome than survival because relapsed patients carry a high risk of subsequent relapse and death after an initial relapse.

Despite improvements in the treatment of childhood ALL, relapsed ALL makes a major contribution to the morbidity and mortality of childhood cancer. SEER data estimate a 5-year survival of 69% for children diagnosed between 1983 and 1987 (385). The corresponding death rate is 31%. If the incidence of childhood ALL is  $31/10^6$  per year (387), then the incidence of death from childhood ALL is approximately  $10/10^6$  per year. More children die from ALL than are diagnosed with non-Hodgkin lymphoma, Wilms' tumor, Hodgkin disease, CNS primitive neuroectodermal tumor, acute myeloid leukemia, and rhabdomyosarcoma (387). Only newly diagnosed astrocytomas/gliomas and perhaps neuroblastoma are more common.

Relapse remains the principal barrier to cure. Between 1983 and 1989, 3712 eligible patients were enrolled in the CCG 100 series trials (Table 80.4); 1363 patients had an adverse event (388). Of these, 191 did not achieve remission or died from toxicity (14% of adverse events; 5% overall). Twenty-eight had a second malignant neoplasm (2% of adverse events). A total of 1144 had a relapse (84%) at one or more sites. Marrow, CNS, and testicular relapses were most common. Rare sites included isolated leukemic infiltration of the lymph nodes, eyes, and bone in CCG and other studies (388, 389 and 390).

**TABLE 80.4. Survival after Relapse: Children's Cancer Group 100 Series**

|   | N   | 6-Year Second Event-Free Survival (%) | 6-Year Survival (%) |
|---|-----|---------------------------------------|---------------------|
| Isolated marrow relapse                 | 642 | 16                                    | 20                  |
| <18 mo                                  | 233 | 5                                     | 6                   |
| 18–35 mo                                | 194 | 10                                    | 11                  |
| ≥36 mo                                  | 215 | 33                                    | 43                  |
| Isolated central nervous system relapse | 220 | 37                                    | 48                  |
| <18 mo                                  | 102 | 24                                    | 33                  |
| 18–35 mo                                | 84  | 44                                    | 59                  |
| ≥36 mo                                  | 34  | 59                                    | 72                  |
| Isolated testicular relapse             | 112 | 64                                    | 70                  |
| <18 mo                                  | 22  | 48                                    | 52                  |



|                         |     |    |    |
|-------------------------|-----|----|----|
| 18–35 mo                | 24  | 44 | 57 |
| =36 mo                  | 66  | 76 | 81 |
| Combined marrow relapse | 120 | 29 | 29 |
| <18 mo                  | 34  | 9  | 9  |
| 18–35 mo                | 26  | 11 | 11 |
| =36 mo                  | 60  | 48 | 49 |

NOTE: Other sites of relapse include lymph node (seven), eye (five), bone (four), and liver, skin, kidney, uterus, nasal mucosa, and ear (one each).

From Walters R, Kantarjian HM, Keating MJ, et al. The importance of cytogenetic studies in adult acute lymphocytic leukemia. *Am J Med* 1990;89:579–587, with permission.

Overall, fewer than one in four patients with relapse achieve long-term survival. Among patients with marrow relapse before 3 years from diagnosis, long-term survival is rare (below 10%). [Table 80.4](#) depicts data from the CCG 100 series by site and time to relapse. Combined marrow and CNS relapse may have a better outcome than isolated marrow relapse ([391](#)). Survival is better for later marrow relapse and for extramedullary relapse, but Wheeler et al. noted that patients who relapse and survive also bear additional risk of long-term morbidity ([392](#)). Inability to provide effective therapy after relapse maintains the imperative to prevent relapse at almost any cost and motivates the exposure of all children to the increased morbidity of ever more intensive therapy, when less intensive therapy would suffice for a growing majority of children.

**TREATMENT OF MARROW RELAPSE** Treatment of relapse begins with an attempt to obtain a second remission. This is usually successful with agents similar to those used at initial presentation, both in children and adults. In pediatric series, remission induction rates range from 71 to 97% ([393](#), [394](#), [395](#), [396](#) and [397](#)). One study used the same treatment for adults and children; 71% of children achieved remission compared to 55% of adults ([398](#)). Retreatment of the CNS appears critical even in isolated bone marrow relapse ([399](#)). Some sort of postinduction therapy is generally pursued, ranging from conventional chemotherapy intensification and maintenance to marrow ablative therapy and stem cell rescue (see [Bone Marrow Transplantation](#)). Outcomes improve with an increasing duration of first remission ([388](#), [389](#)), with protocol as opposed to ad hoc therapy ([400](#)), and less certainly with increasing intensity of otherwise somewhat effective therapy ([392](#), [396](#)). A substantial number of patients with an initial relapse after 3 years achieve long-term DFS with chemotherapy without bone marrow transplant (BMT). In some series, this fraction exceeds 50% ([396](#), [401](#)). Sensitivity to chemotherapy often decreases between presentation and relapse and between first and subsequent relapse, as seen in decreasing remission induction rates. The *in vitro* 3-[4,5-dimethyl-thiazole-2,5-] tetrazolium diphenyl bromide (methyl-thiazole-tetrazolium) assay shows a more than 100-fold increase in prednisolone LC<sub>50</sub> between presentation and initial early relapse, and more than 800-fold between presentation and multiple relapse ([402](#)). Patients with loss of p53 function (i.e., abnormal p53 or amplified mdm-2) tend to have earlier relapses and less satisfactory responses to subsequent therapy. Although usually intact at diagnosis, diminished p53 function is associated with a very high risk of early treatment failure ([403](#)). Function may be present at diagnosis but lost at relapse ([404](#), [405](#) and [406](#)). Loss of p53 function may protect leukemia cells from apoptosis and produce resistance to radiation and a variety of anticancer drugs ([407](#)). However, sensitivity to some interventions, such as asparagine depletion, may be preserved, as shown by Abshire et al.'s demonstration that weekly PEG asparaginase was superior to biweekly PEG asparaginase in patients with ALL in first

remission ( [310](#) ).

**TREATMENT OF ISOLATED EXTRAMEDULLARY RELAPSE** Isolated extramedullary relapses are rarely truly isolated to the apparent site of involvement. Three of six patients with apparently isolated testicular relapse had more widespread nodal disease on laparotomy ( [408](#) ). PCR-based assays usually show the presence of marrow cells sharing the clonotypic Ig or T-receptor rearrangement found in the leukemic blasts at presentation ( [409](#) , [410](#) , [411](#) ). The principal clinical challenge of isolated extramedullary relapse is prevention of subsequent marrow relapse. Local control of CNS or testicular sites can usually be obtained and maintained with chemotherapy and radiation therapy. Thus, isolated extramedullary relapse often or even usually represents a failure of systemic therapy, not only local therapy.

**ISOLATED CENTRAL NERVOUS SYSTEM RELAPSE** CNS disease may present with signs of increased intracranial pressure, such as headache or vomiting (especially morning vomiting). Because all patients receive maintenance intrathecal therapy, most CNS relapses are discovered incidentally. CNS relapses tend to occur between 1 and 3 years after diagnosis. CNS blasts may be cleared with weekly or twice weekly intrathecal therapy. Three-agent methotrexate, hydrocortisone, and cytosine arabinoside therapy was no more effective than two-agent methotrexate and hydrocortisone therapy in one trial ( [412](#) ). Cranial irradiation and intrathecal maintenance therapy were less effective in maintaining CNS remission than craniospinal irradiation ( [413](#) ). Patients undergo systemic reinduction therapy, and cranial or craniospinal irradiation is administered 1 month ( [414](#) ) to 6 months ( [396](#) , [415](#) , [416](#) ) from relapse. Radiation may be delayed to preserve marrow reserve for aggressive systemic therapy. The dose of cranial irradiation is generally 18 to 24 Gy. The spinal dose is 6 to 15 Gy ( [396](#) , [415](#) , [416](#) ). Steinherz et al. obtained excellent results with neuraxis dose between 6 and 9 Gy with subsequent intraventricular and intrathecal chemotherapy ( [417](#) ). Overall, at least 50% of patients may achieve long-term DFS after CNS relapse. The marrow is the principal site of treatment failure. In the past, most children received cranial irradiation as part of their initial presymptomatic CNS therapy and treatment after CNS relapse represented a second radiation exposure and higher cumulative dose. Mulhern et al. ( [418](#) ) found an average of more than 10 points decline in full-scale intelligence quotient (IQ) compared to population norms in 40 children 6 years after CNS relapse. Eight children were labeled mentally retarded and were receiving special education assistance. Younger children and those with seizures or structural brain abnormalities had the poorest cognitive outcomes ( [418](#) ). Winick et al. ( [414](#) ) studied 120 patients with isolated CNS relapse of whom 14 had received prior cranial irradiation. Of these, 17% had signs or symptoms of leukoencephalopathy, presenting with seizure in 85%, and ataxia, memory loss, and motor and cranial nerve deficits in others. Of children with prior cranial irradiation, 27% had significant neurotoxicity compared to 15% of children who did not (  $p = .33$  ). Twelve patients had progressive neurologic deterioration despite the cessation of intrathecal therapy. Eight had mild, stable symptoms and, of these, four had learning disabilities ( [414](#) ). Prevention of subsequent relapse and preservation of neurocognitive function remain dual challenges for patients with CNS relapse.

**ISOLATED TESTICULAR RELAPSE** Testicular leukemia presents with unilateral or bilateral painless testicular enlargement. At least one-half of cases occur longer than 3 years from diagnosis. Outcomes appear better for patients with overt disease after completion of therapy than for patients with overt disease while still on therapy ( [419](#) ). In two trials, approximately 10% of boys had occult testicular relapse on elective biopsy at 3 years from diagnosis. However, no advantage could be shown for early diagnosis, and 25 of 839 boys with negative initial biopsies had subsequent testicular relapse ( [420](#) , [421](#) ). CCG has reported a series of patients with overt isolated testicular relapse on or shortly after initial therapy. Patients received salvage chemotherapy as per the NY I ( [422](#) ) or CCG BFM-based ( [423](#) , [424](#) ) regimens and bilateral testicular irradiation. Intrathecal methotrexate was used for presymptomatic CNS therapy. Among 57 boys, the 5-year



EFS was 43% ( [424](#) ). This result is similar to that obtained in a POG series with somewhat different chemotherapy ( [425](#) ). For patients with an earlier or later overt testicular relapse, POG investigators obtained 4-year EFS of 53% or 84% ( [426](#) ). In adults, testicular irradiation doses greater than 4 to 6 Gy may result in persistent azoospermia. Even scatter from spinal irradiation may cause elevation of follicle-stimulating hormone or decreased testicular volume in some patients. Leydig cell function is generally spared. However, testicular irradiation doses greater than 20 Gy may compromise Leydig cell function in children, resulting in elevated luteinizing hormone, decreased testosterone, and delayed puberty ( [427](#) ). Doses greater than 20 Gy are generally used in the treatment of testicular relapse.

## Bone Marrow Transplantation

The potential benefit of allogeneic BMT derives from the opportunity for marrow ablative therapy—that is, high-dose chemotherapy with or without total body irradiation (TBI)—and from the possible graft-versus-leukemia effect. The success of match-related donor (MRD) BMT for some patients and a frequent lack of compatible family donors has led to consideration of other stem cell sources, such as purged or unpurged autologous marrow or peripheral blood stem cells ( [428](#), [429](#) and [430](#) ), matched but unrelated donor (MUD) ( [431](#), [432](#) and [433](#) ), or peripheral blood or cord blood ( [434](#), [435](#) ) stem cells, and related but partially mismatched marrow ( [436](#) ), peripheral blood, or cord blood stem cells.

Definition of the role of BMT in childhood ALL has been an ongoing challenge. Interpretation of reported BMT outcomes is complicated by the preponderance of small series, selection bias, waiting-time bias, and lack of adequate controls. Even in aggregate, small series may not be representative of the total experience. Small numbers quickly erode statistical power and obscure possibly important differences. Selection biases may also complicate comparisons. In “treatment-received” reports, patients who relapse before a BMT may be performed are excluded from the “treatment-received” experience. Such patients are included in a chemotherapy control. Patients deemed clinically unfit for BMT because of organ dysfunction or deep-seated infection are excluded from the BMT arm but may be included in the chemotherapy control. Their outcome is likely worse than average. Various statistical techniques can adjust for waiting-time bias, but selection bias proves more intractable. Intent-to-treat analysis is the best response.

Comparisons also are statistically challenging. The value of BMT may not be uniform among the various patient subsets that are conglomerated to form a very-high-risk group. The literature is replete with small trials for which large differences are required for any chance for statistical significance. Real differences may be modest, though important, and less than hoped. BMT and chemotherapy have differing patterns of failure. Transplant outcomes suffer from early mortality, whereas chemotherapy patients tend to survive early and relapse later. Graphic representations of EFS curves often cross. This violation of proportional hazards undermines the often-used log rank statistic and argues for a cure model ( [437](#), [438](#) ).

Interpretation of BMT results is also complicated by differences in therapy before BMT, in marrow ablative therapy, in graft-versus-host disease prophylaxis, and in supportive care. Comparisons depend on the detailed treatments studied. The superiority of a particular transplant regimen over a particular chemotherapy regimen does not imply that the same or a second transplant regimen will necessarily be superior to a second chemotherapy regimen.

To minimize possible biases, several studies have attempted to compare outcomes after MRD BMT and continued chemotherapy based on donor availability and intent to treat

with less than definitive conclusions. Physician and patient compliance with highly controversial treatment allocation schemes may be inconsistent and an additional source of bias. Multicenter BMT registries have made a major contribution to what knowledge is available. Proctor commented that more has been learned in this arena from such trials with constructed controls than from methodologically superior but clinically unfeasible classic randomized trials ([439](#)).

In a rare prospective trial, Wheeler et al. ([440](#)) in the British Medical Research Council designated as “very high risk” on the basis of presenting clinical and cytogenetic features 473 of 3676 children diagnosed between 1985 and 1997. Two hundred eighty-eight patients were tissue typed. Ninety-nine patients had a MRD, and 76 underwent BMT in first remission. One hundred eighty-nine patients had no MRD, and 25 underwent BMT from a MUD, contrary to protocol. At 10 years, the adjusted EFS was 45% for 101 children receiving first-remission BMT versus 39% for 351 children receiving chemotherapy. In contrast, in an intent-to-treat analysis, the 10-year EFS was 50% for children without an MRD, compared to 40% for children with an MRD ([440](#)). A near population-based retrospective review of 326 children and adolescents with t(9;22) showed a significant advantage for MRD BMT but not MUD BMT ([287](#)). No similar advantage was seen in a similar study of infants and children with 11q23 abnormalities ([286](#)). An ongoing European cooperative trial is expected to contribute greatly to this question ([441](#)).

Bone marrow relapse is the principal failing for chemotherapy. Treatment-related mortality (TRM) poses a major challenge for BMT. In first remission, Uderzo et al. reported 13% TRM for MRD BMT and 30% for MUD BMT ([442](#)).

Second-remission BMT remains an option for some patients treated with chemotherapy initially. However, when first-remission BMT is deferred, patients may not achieve second remission or may experience toxicity or deep-seated infection, precluding subsequent BMT. Second remissions may be too transient to allow BMT in second remission.

For children in second marrow remission, matched family donor allogeneic transplant has been recommended ([443](#)). International Bone Marrow Transplant Registry data suggest that MRD BMT is superior to chemotherapy for both early and late marrow relapse (using an historical POG control). Using matched controls, the 5-year DFS was estimated at 40% for 255 BMT patients and 17% for 255 matched chemotherapy patients, excluding patients who failed to achieve or maintained remission long enough to have received a transplant had they had a donor. Comparisons of BMT and chemotherapy outcomes for initial remissions before 18 months, at 18 to 36 months, and at 36 months or later were 29% versus 14%, 41% versus 7%, and 53% versus 32%, respectively. For 51 patients in second remission, Dopfer et al. ([444](#)) reported an overall 7-year DFS of 52%. Comparisons of BMT and chemotherapy outcomes for early and late relapse were 56% versus 22% and 47% versus 41% ([444](#)). Uderzo et al. ([445](#)) compared 57 patients after matched family donor BMT and 230 patients after chemotherapy. At 5 years, the DFS rates were 41% and 22%. Differences were significant after correction for time to transplant or waiting time bias and most striking for children with early relapse before 30 months ([445](#)). Hoogerbrugge et al. ([446](#)) compared 25 MRD BMT patients with 97 chemotherapy patients in second remission in a case-control study. The 4-year DFS was 44% for the BMT patients and 24% for chemotherapy patients (not significant) ([446](#)).

The British Medical Research Council has undertaken two prospective trials in patients after relapse. Wheeler et al. studied 489 children who relapsed from the UKALL X trial ([447](#)). Harrison et al. studied 256 relapsed children enrolled in the UKALL R1 trial ([448](#)). In

adjusted comparisons, BMT improved 5-year EFS from 26% to 41% in UKALL X ( $p = .05$ ). The 5-year EFS was only 3% for patients with marrow relapse before 2 years, whatever therapy was pursued. The 5-year EFS was 66% for late extramedullary relapse. On the UKALL R1 study, 67 children had MRD BMT, and 139 had no MRD. Sixty-three of 67 patients with MRDs underwent BMT. However, contrary to protocol, 41 of 139 patients with no MRD underwent MUD BMT! Six of 41 MUD patients died from TRM (15%). Within the power of the comparison, no statistically significant difference was apparent in intent-to-treat comparisons of patients with MRD versus patients with no MRD or in adjusted treatment-received comparisons of patients undergoing BMT versus patients receiving chemotherapy.

CCG undertook a prospective trial for children with ALL and early marrow relapse, CCG-1941. Two hundred fifteen patients enrolled. One hundred sixty-five achieved remission (77%). Forty-two refused postinduction allocation. Fifty-one patients had MRDs. Forty of 51 underwent BMT in second remission. Subsequently, eight died from TRM (20%) and 19 relapsed. Seventy-two patients had no MRD and were allocated to alternative-donor BMT or chemotherapy. Of 37 patients allocated to alternative-donor BMT, 20 underwent BMT (19 MUD BMTs and one autologous BMT) in second remission. Subsequently, eight died from TRM (40%) and six relapsed. Of 35 patients allocated to chemotherapy, ten patients underwent alternative-donor BMT anyway! Of these ten, four died from TRM and three relapsed. Twenty-five patients received only chemotherapy; two died from TRM and 16 relapsed. The 2-year EFS for MRD BMT and alternative BMT was 40% and 23%. By intent-to-treat from the end of induction, the 3-year DFS was 29%, 18%, and 28% for MRD BMT, alternative BMT, and chemotherapy, respectively. Censoring the chemotherapy patients who underwent BMT, the DFS is 36%. Differences were not significant ( [449](#) ).

The lesson is drawn that clinical outcomes are disappointing after marrow relapse despite reasonable transplant outcomes. Likely differences between BMT outcomes and chemotherapy outcomes are minor compared to the number of patients who fail to achieve a durable remission, die from TRM, or relapse despite BMT or chemotherapy. Improving BMT or chemotherapy outcomes, or both, is a greater imperative than continued “apples and oranges” comparisons that seek to define more precisely relatively minor differences between continually changing BMT and chemotherapy regimens.

BMT outcomes might be improved by bringing patients to transplant with less disease, better conditioning, less TRM, and/or enhancement of the graft-versus-leukemia effect. Increasing data link post-BMT outcomes to submicroscopic pre-BMT minimal residual disease ( [450](#) , [451](#) ). Proof that one ablation regimen is better than another has been elusive. Cyclophosphamide/TBI regimens may be superior to busulfan/cyclophosphamide regimens ( [452](#) ). Outcomes with TBI/cytosine arabinoside, cyclophosphamide/TBI, or hyperfractionated TBI/cyclophosphamide ablations were similar ( [453](#) ). Dopfer et al. advocated an etoposide/TBI regimen ( [444](#) ). Limitation of post-BMT graft-versus-host disease prophylaxis may enhance graft-versus-leukemia effect ( [454](#) ).

Future progress may come from better understanding of the agents that already contribute to cure and development of strategies that add to this therapeutic platform. Despite the complexity of current multidrug chemotherapy, thoughtful modifications have resulted in continuing improvements in outcome for newly diagnosed patients with ALL. The augmented BFM regimen rescues many standard and higher risk slow-response patients ( [364](#) , [365](#) ). As predicted by laboratory observations, dexamethasone is superior to prednisone ( [299](#) ), and 6-TG is superior to 6-MP despite important concerns about the sinusoidal obstruction syndrome ( [331](#) ). More is not always better ( [294](#) ). Monoclonal antibodies, such as rituximab ( [455](#) , [456](#) ), and immunotoxins, such as BL22 ( [457](#) ), have

already shown promise in adult malignancies and may prove suitable additions to current therapy in ALL.

## Outcomes

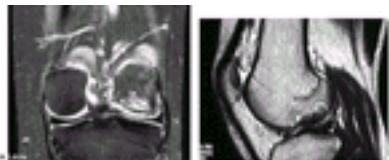
**QUALITY OF LIFE** The strikingly improved DFS of children with ALL and the availability of a variety of useful therapeutic strategies compel a careful consideration of the long-term sequelae of treatment. One therapy may be superior to another on the basis of the long-term health-related quality of life of survivors and not simply on the basis of transient morbidity or EFS. Barr et al. proposed to measure the global health status of leukemia survivors in terms of sensation (i.e., sight, hearing, and speech), mobility, emotion, cognition, self-care, pain, and fertility ( [458](#), [459](#) and [460](#) ). The Canadian General Social Survey examined the areas of vision, hearing, speech, ambulation, dexterity, emotion, cognition, and pain for 15- to 19-year-olds and found that 45%, 31%, and 24% had difficulties in zero, one, and two or more domains, respectively. Corresponding data for three populations of children with ALL ranged from 30 to 60%, 32 to 47%, and 8 to 26%, respectively. Three of 25 patients (12%) with standard-risk ALL were found to have deficits in the emotional domain compared to 139 of 662 teenagers (21%) in the Canadian population. Five of 25 patients (20%) were found to have deficits in the cognitive domain compared to 159 of 662 teenagers (24%). Neither comparison reached statistical significance ( [460](#) ). Study populations are scanty, and instruments are evolving, but careful evaluation of the health status and health concerns of long-term survivors is critical. Neither bland reassurance nor alarming anecdotes suffice.

**NEUROPSYCHOLOGICAL SEQUELAE** The neurotoxicity of brain irradiation, parenteral methotrexate, and intrathecal therapy has evoked ongoing concern. Jankovic et al. evaluated 203 children over 6 years in a multicenter European study ( [319](#) ). They found that 18-Gy brain irradiation resulted in a gradual decline in full-scale IQ score, approaching 4 points per year, first apparent 3 to 7 years after diagnosis. A similar decline was not seen in patients who received parenteral methotrexate and no brain irradiation. The risk appeared to be largely confined to children younger than 3 years at the time of diagnosis. However, biweekly parenteral methotrexate may have short-term and long-term neurotoxicity. The POG comparison of parenteral methotrexate and intensive scheduled oral methotrexate found moderate to severe short-term neurotoxicity in 7.1% of patients receiving parenteral methotrexate and 3.7% in patients receiving intensive oral methotrexate. Generalized or focal seizures were the most common toxicity (present in 86% of patients with neurotoxicity). Recurrent events occurred in 25% of patients who received parenteral methotrexate. Leukoencephalopathy with or without microangiopathic calcifications were found in 75% of patients who had clinical neurotoxicity after parenteral methotrexate ( [349](#) ). No patient received cranial irradiation. Although the long-term neurocognitive outcomes of infants ( [461](#) ) and older children ( [462](#) ) treated with very-high-dose methotrexate are excellent, others have found that children who receive parenteral and intrathecal methotrexate show decreases in IQ similar to those found for children treated with 18-Gy cranial irradiation and intrathecal methotrexate. Mulhern et al. found that 22 to 30% of patients exhibited a “clinically significant” decrease of 15 or more points in full-scale IQ, whether they had received cranial irradiation or intensive intravenous methotrexate ( [463](#) ). Testing 6 years after completion of treatment found that 60% of patients who received intrathecal therapy and cranial irradiation or parenteral methotrexate had more than 15-point decreases on one or more neuropsychological measures ( [464](#) ). Administration of a memory battery found losses in short-term and long-term recall of correct order with visual or auditory presentation. School performance was similarly affected ( [465](#) ). Recently, the acute neurotoxicity of intermediate-dose methotrexate regimens raised questions about long-term neurocognitive damage ( [349](#) ). Waber et al. have raised concerns about the potential neurocognitive effects of dexamethasone ( [466](#) ). The clinical impact of numeric differences in test scores is hard for

physicians to interpret and communicate to families. Haupt et al. compared 593 adult survivors of ALL and 409 sibling controls and looked at more tangible endpoints ( 467 ). Whereas patients were approximately 3.4 times more likely than their siblings to enter a special education program, they were just as likely to enter a gifted and talented program. The risk of school difficulties increased with decreasing age at diagnosis and increasing dose of cranial irradiation. However, patients were just as likely as controls to graduate from high school, enter college, or earn a bachelor's degree. These observations provide a clinical context for the isolated results of neuropsychological tests.

**SECONDARY MALIGNANT NEOPLASMS** Secondary malignant neoplasms have been seen in childhood ALL, especially associated with cranial irradiation and epipodophyllotoxin therapy. In 1991, Neglia et al. reported a retrospective cohort study of 9720 children with ALL treated between 1972 and 1988 ( 320 ). With median follow-up of 4.7 years (2 months to 16 years), 43 secondary neoplasms were identified, seven times more than among age-matched controls. The cumulative incidence of secondary neoplasms was 2.5% at 15 years. They found 24 brain tumors, ten leukemias or lymphomas, and nine other tumors. The incidence of brain tumors was 22 times higher than among age-matched controls. All brain tumors arose in children younger than 5 years of age at diagnosis who had received cranial irradiation. Brain tumors included glioblastomas or high-grade astrocytomas (58%); primitive neuroectodermal tumors, including medulloblastoma (17%); meningioma (8%); low-grade astrocytomas (8%); brainstem glioma (4%); and ependymoma (4%). Only two patients had secondary acute nonlymphocytic leukemia. No patient received epipodophyllotoxins. The low incidence of secondary malignancies has been confirmed in more recent reports ( 468 ). Epipodophyllotoxins (teniposide and etoposide) have been associated with a higher rate of secondary acute nonlymphocytic leukemia ( 469 , 470 and 471 ). These cases often involve a chromosomal abnormality at 11q23. Pui et al. ( 469 ) found secondary acute nonlymphocytic leukemia as a first adverse event in 17 of 734 patients or 3.8% at 6 years. Among patients who had received weekly or semiweekly epipodophyllotoxins, the cumulative incidence was 12% ( 469 ). Winick et al. ( 470 ) reported a cumulative 4-year incidence of 5.9% for secondary acute nonlymphocytic leukemia for children who had received semiweekly etoposide, three doses during consolidation therapy followed by 2 doses every 9 weeks during continuation therapy ( 470 ). Katz and POG co-workers found a 20% cumulative incidence of acute nonlymphocytic leukemia for children with T-cell ALL who had received semiweekly teniposide ( 471 ).

**AVASCULAR NECROSIS OF BONE** Avascular necrosis of bone has been recognized with increasing frequency in the greater number of surviving older children and adults with ALL after chemotherapy ( 472 , 473 and 474 ) or after BMT ( Fig. 80.4 ) ( 410 ). Prolonged administration of glucocorticoids, such as prednisone or dexamethasone, is the most likely cause. Involvement is often multifocal. Avascular necrosis of a weight-bearing joint, such as the hip, can be a source of life-long pain and disability and demonstrates the inadequacy of outcome measures such as EFS. Therapeutic options are limited.



**Figure 80.4.** Coronal (A) and sagittal (B) T2 images from a magnetic resonance imaging scan demonstrating corticosteroid-induced avascular necrosis of the right medial femoral condyle in a 15-year-old white girl. (Courtesy of Dr. Leonard A. Mattano, Michigan State University/Kalamazoo Center for Medical Studies.)

**CARDIAC TOXICITY** Anthracyclines are commonly used in the treatment of ALL in adults and children. Lipschultz et al. studied 115 children 1 to 15 years after completion of treatment on DFCI protocols between 1972 and 1987 ( 475 ). Cumulative anthracycline



exposures ranged from 45 mg/m<sup>2</sup> to 550 mg/m<sup>2</sup>. Doxorubicin was the anthracycline used, which milligram per milligram may be more cardiotoxic than daunorubicin. Eleven patients had clinical congestive heart failure within 1 year of the completion of therapy (10%), which seems extraordinarily high compared to other less thoroughly evaluated patient populations ( [281](#) , [282](#) and [283](#) ). No other patient has subsequently developed clinical congestive heart failure. However, 17% of patients who had received only 45 mg/m<sup>2</sup> of doxorubicin had slightly elevated, age-adjusted, left-ventricular load, as measured by end-systolic wall stress. Of patients who received more than 228 mg/m<sup>2</sup>, 65% had increased afterload and 23% had decreased left-ventricular contractility as measured by stress-velocity index. Overall, fractional shortening more than 2 SD below normal occurred in 28% of patients, but values normalized in 19 of 32 patients on subsequent follow-up. Among patients who had received at least 228 mg/m<sup>2</sup>, increased afterload was related to age younger than 4 years at time of treatment, and decreased contractility was related to cumulative dose.

**ENDOCRINOLOGIC DISTURBANCES** Treatment, including cranial irradiation without gonadal irradiation, may lead to primary germ-cell dysfunction, as manifest by elevated levels of follicle-stimulating hormone in boys and girls. Testicular volume is decreased ( [427](#) , [476](#) ). Puberty may be precocious or premature for girls ( [476](#) , [477](#) ). The data for boys are mixed ( [427](#) , [477](#) ). Cranial or craniospinal irradiation may lead to short stature. Among children younger than 12 years old at the time of diagnosis, 74% were more than 1 SD below norms for height, and 37% were more than 2 SD ( [478](#) ). Rappaport and Brauner found that 56% of children with ALL who had received 24-Gy cranial irradiation had growth hormone deficiency ( [479](#) ). Growth hormone replacement may be useful ( [480](#) ). However, some concerns remain about a modest increase in the rate of secondary neoplasms ( [481](#) ). The increasingly limited role of presymptomatic cranial irradiation will probably limit the clinical impact of these problems.

**MELANOCYTIC NEVI** An increased number of melanocytic nevi have been found among survivors of childhood leukemia and other cancers ( [482](#) , [483](#) and [484](#) ). Neglia et al. found only one case of melanoma among 9720 survivors of ALL, but median follow-up was less than 5 years ( [320](#) ). The total number of melanocytic nevi is the most powerful predictor for the development of melanoma ( [485](#) , [486](#) ), and further study is warranted.

## REFERENCES

1. Young YL, Miller RW. Incidence of malignant tumors in U.S. children. *J Pediatr* 1975;86:254-258.
2. McNeil DE, Coté TR, Clegg L, et al. SEER update of incidence and trends in pediatric malignancies: acute lymphoblastic leukemia. *Med Pediatr Oncol* 2002;39:554-557.
3. Mauer AM. Therapy of acute lymphoblastic leukemia in childhood. *Blood* 1980;56:1-10.
4. Miller RW. Fifty-two forms of childhood cancer: United States mortality experience, 1960-1966. *J Pediatr* 1969;75:685-689.
5. Sather HN. Age at diagnosis in childhood acute lymphoblastic leukemia. *Med Pediatr Oncol* 1986;14:166-172.
6. Macdougall LG. Acute childhood leukemia in Johannesburg: ethnic differences in incidence, cell type, and survival. *Am J Pediatr Hematol Oncol* 1986;8:43-51.
7. Boggs DR, et al. The acute leukemias. *Medicine* 1962;41:163.
8. Simone JV, Verzosa MS, Rudy JA. Initial features and prognosis in 363 children with acute lymphocytic leukemia. *Cancer* 1975;36:2099-2108.

9. Peng LH, Keng TC, Sinniah D. Fever in children with acute lymphocytic leukemia. *Cancer* 1981;47:583-587.
10. Freeman AI, Pantazopoulos N, DeCastro L, et al. Infections in children with acute leukemia. *Med Pediatr Oncol* 1975;1:67-73.
11. Blatt J, Martini SL, Penchansky L. Characteristics of acute lymphoblastic leukemia in children with osteopenia and vertebral compression fractures. *J Pediatr* 1984;105:280-282.
12. Jonsson OG, Sartain P, Ducore JM, et al. Bone pain as an initial symptom of childhood acute lymphoblastic leukemia: association with nearly normal hematologic indexes. *J Pediatr* 1990;117:233-237.
13. Ribeiro RC, Pui CH, Schell MJ. Vertebral compression fractures as a presenting feature of acute lymphoblastic leukemia in children. *Cancer* 1988;61:589-592.
14. Bevilacqua G, Abadessa A, Consolini R, et al. Bone marrow necrosis foreshadowing acute lymphoid leukemia. *Am J Pediatr Hematol Oncol* 1985;7:228-233.
15. Niebrugge DL, Benjamin DR. Bone marrow necrosis preceding acute lymphoblastic leukemia in childhood. *Cancer* 1983;52:2162-2164.
16. Pui CH, Stass S, Green A. Bone marrow necrosis in children with malignant disease. *Cancer* 1985;56:1522-1525.
17. Breatnach F, Chessells JM, Greaves MF. The aplastic presentation of childhood leukaemia: a feature of common-ALL. *Br J Haematol* 1981;49:387-393.
18. Homans AC, Cohen JL, Barker BE, et al. Aplastic presentation of acute lymphoblastic leukemia: evidence of cellular inhibition of normal hematopoietic progenitors. *Am J Pediatr Hematol Oncol* 1989;11:456-462.
19. Matloub YH, Brunning RD, Arthur DC, et al. Severe aplastic anemia preceding acute lymphoblastic leukemia. *Cancer* 1993;71:264-268.
20. Ingram LC, Fairclough DL, Furman WL, et al. Cranial nerve palsy in childhood acute lymphoblastic leukemia and non-Hodgkin's lymphoma. *Cancer* 1991;67:2262-2268.
21. Link MP, Roper M, Dorfman RF, et al. Cutaneous lymphoblastic lymphoma with pre-B markers. *Blood* 1983;61:838-841.
22. Crist W, Pullen J, Boyett J, et al. Clinical and biologic features predict a poor prognosis in acute lymphoid leukemias in infants: a Pediatric Oncology Group study. *Blood* 1986;67:135-140.
23. Bunin NJ, Pui CH. Differing complications of hyperleukocytosis in children with acute lymphoblastic or acute nonlymphoblastic leukemia. *J Clin Oncol* 1985;3:1590-1595.
24. Sarris AH, Kempin S, Berman E, et al. High incidence of disseminated intravascular coagulation during remission induction of adult patients with acute lymphoblastic leukemia. *Blood* 1992;79:1305-1310.
25. Abshire TC, Gold SH, Odom LF, et al. The coagulopathy of childhood leukemia: thrombin activation or primary fibrinolysis? *Cancer* 1990;66:716-721.
26. Whitaker JA, et al. Gout in childhood leukemia. *J Pediatr* 1963;63:961.
27. Jones DP, Stapleton FB, Kalwinsky D, et al. Renal dysfunction and hyperuricemia at presentation and relapse of acute lymphoblastic leukemia. *Med Pediatr Oncol* 1990;18:283-286.
28. Zusman J, Brown DM, Nesbit ME. Hyperphosphatemia, hyperphosphaturia and hypocalcemia in acute leukemia. *N Engl J Med* 1973;289:1335-1340.
29. Rosenfield NS. *The radiology of childhood leukemia and its therapy*. St. Louis: Warren H. Green, 1982.



30. Coccia PF, et al. Development and preliminary findings of Children's Cancer Study Group protocols (#161,162,163) for low, average, and high risk acute lymphoblastic leukemia in children, in *Leukemia Research*. In: Murphy SB, Gilbert JR, eds. *Advances in cell biology and treatment*. New York: Elsevier Science, 1983.
31. Homans AC, Forman EN, Barker BE. Use of monoclonal antibodies to identify cerebrospinal fluid lymphoblasts in children with acute lymphoblastic leukemia. *Blood* 1985;66:1321-1325.
32. Raney RB, Lyon GM, Porter FS. Neuroblastoma simulating acute leukemia. *J Pediatr* 1976;89:433-435.
33. Shaller J. Arthritis as a presenting manifestation of malignancy in children. *J Pediatr* 1972;81:793-797.
34. Saulsbury FT, Sabio H, Conrad D, et al. Acute leukemia with features of systemic lupus erythematosus. *J Pediatr* 1984;105:57-59.
35. Ostrov BE, Goldsmith DP, Athreya BH. Differentiation of systemic juvenile rheumatoid arthritis from acute leukemia near the onset of disease. *J Pediatr* 1993;122:595-598.
36. Dubansky AS, Boyett JM, Faletta J. Isolated thrombocytopenia in children with acute lymphoblastic leukemia: a rare event in a Pediatric Oncology Group study. *Pediatrics* 1989;84:1068-1071.
37. Donadieu J, Auclerc MF, Baruchel A, et al. Critical study of prognostic factors in childhood acute lymphoblastic leukaemia: differences in outcome are poorly explained by the most significant prognostic variables. *Br J Haematol* 1998;102:729-739.
38. Foon KA, Todd RF. Immunologic classification of leukemia and lymphoma. *Blood* 1986;68(1):1-31.
39. Pui CH, Behm FG, Crist WM. Clinical and biologic relevance of immunologic marker studies in childhood acute lymphoblastic leukemia. *Blood* 1993;82:343-362.
40. Ritz J, Nadler LM, Bhan AK, et al. Expression of common acute lymphoblastic leukemia antigen (CALLA) by lymphomas of B-cell and T-cell lineage. *Blood* 1981;58(3):648-652.
41. Moretta L, Mingari MC, Moretta A, et al. Human lymphocyte surface markers. *Semin Hematol* 1982;19:273-284.
42. Vogler LB, Crist WM, Bockman DE, et al. Pre-B-cell leukemia: a new phenotype of childhood lymphoblastic leukemia. *N Engl J Med* 1978;298:872-878.
43. Crist WM, Grossi CE, Pullen DJ, et al. Immunologic markers in childhood acute lymphocytic leukemia. *Semin Oncol* 1985;12:105-121.
44. Pullen DJ, Boyett JM, Crist WM, et al. Pediatric Oncology Group utilization of immunologic markers in the designation of acute lymphocytic leukemia (ALL) subgroups. Influence on treatment response. *Ann N Y Acad Sci* 1984;428:26-48.
45. Greaves MF, Janossy G, Peto J, et al. Immunologically defined subclasses of acute lymphoblastic leukaemia in children: their relationship to presentation features and prognosis. *Br J Haematol* 1981;48:179-197.
46. Look AT, Roberson P, Williams D. Prognostic importance of blast cell DNA content in childhood acute lymphoblastic leukemia. *Blood* 1985;65:1079-1086.
47. Crist W, Boyett J, Roper M, et al. Pre-B cell leukemia responds poorly to treatment: a Pediatric Oncology Group study. *Blood* 1984;63:407-414.
48. Crist W, Boyett J, Jackson J, et al. Prognostic importance of the pre-B-cell immunophenotype and other presenting features in B-lineage childhood acute lymphoblastic leukemia: a Pediatric Oncology Group study. *Blood* 1989;74:1252-1259.
49. Carroll AJ, Crist WM, Parmley RT, et al. Pre-B cell leukemia associated with chromosome

translocation 1;19. *Blood* 1984;63:721–724.

50. Crist WM, Carroll AJ, Shuster JJ, et al. Poor prognosis of children with pre-B acute lymphoblastic leukemia is associated with the t(1;19)(q23;q13): a Pediatric Oncology Group study. *Blood* 1990;76:117–122.

51. Pui CH, Williams DL, Kalwinsky DK, et al. Cytogenetic features and serum lactic dehydrogenase level predict a poor treatment outcome for children with pre-B-cell leukemia. *Blood* 1986;67:1688–1692.

52. Brouet J, Valensi F, Daniel MT, et al. Immunological classification of acute lymphoblastic leukaemias: evaluation of its clinical significance in a hundred patients. *Br J Haematol* 1976;33:319–328.

53. Preud'homme JL, Brouet JC, Danon F, et al. Acute lymphoblastic leukemia with Burkitt's lymphoma cells: membrane markers and serum immunoglobulin. *J Natl Cancer Inst* 1981;66:261–264.

54. Secker-Walker LM. The prognostic implications of chromosomal findings in acute lymphoblastic leukemia. *Cancer Genet Cytogenet* 1984;11:233–248.

55. Croce CM, Nowell PC. Molecular basis of human B cell neoplasia. *Blood* 1985;65:1–7.

56. Sullivan MP, Pullen DJ, Crist WM, et al. Clinical and biologic heterogeneity of childhood B cell acute lymphocytic leukemia: implications for clinical trials. *Leukemia* 1990;4:6–11.

57. Patte C, Philip T, Rodary C, et al. High survival rate in advanced-stage B-cell lymphomas and leukemias without CNS involvement with a short intensive polychemotherapy: results from the French Pediatric Oncology Society of a randomized trial of 216 children. *J Clin Oncol* 1991;9(1):123–132.

58. Schwenn MR, Blattner SR, Lynch E, et al. HiC-COM: a 2-month intensive chemotherapy regimen for children with stage III and IV Burkitt's lymphoma and B-cell acute lymphoblastic leukemia. *J Clin Oncol* 1991;9(1):133–138.

59. Reiter A, Schrappe M, Ludwig WD, et al. Favorable outcome of B-cell acute lymphoblastic leukemia in childhood: a report of three consecutive studies of the BFM group. *Blood* 1992;80(10):2471–2478.

60. Koehler M, Behm F, Shuster J, et al. Clinical significance of the transitional pre-B-cell immunophenotype in acute lymphoblastic leukemia of childhood: a Pediatric Oncology Group study. *Leukemia* 1993;7:2064–2068.

61. Greaves MF, Pegram SM, Chan LC. Collaborative group study of the epidemiology of acute lymphoblastic leukaemia subtypes: background and first report. *Leuk Res* 1985;9:715–733.

62. Reaman G, Zeltzer P, Bleyer WA, et al. Acute lymphoblastic leukemia in infants less than one year of age: a cumulative experience of the Children's Cancer Study Group. *J Clin Oncol* 1985;3:1513–1521.

63. Pui CH, Behm FG, Singh B, et al. Heterogeneity of presenting features and their relation to treatment outcome in 120 children with T-cell acute lymphoblastic leukemia. *Blood* 1990;75:174–179.

64. Shuster JJ, Falletta JM, Pullen DJ, et al. Prognostic factors in childhood T-cell acute lymphoblastic leukemia: a Pediatric Oncology Group study. *Blood* 1990;75:166–173.

65. Sallan SE, Ritz J, Pesando J, et al. Cell surface antigens: prognostic implications in childhood acute lymphoblastic leukemia. *Blood* 1980;55:395–402.

66. Henze G, Langermann HJ, Kaufmann U, et al. Thymic involvement and initial white blood count in childhood lymphoblastic leukemia. *Am J Pediatr Hematol Oncol* 1981;3:369–376.

67. Pullen DJ, Sullivan MP, Falletta JM, et al. Modified LSA2-L2 treatment in 53 children with E-rosette-positive T-cell leukemia: results and prognostic factors. *Blood* 1982;60:1159–1168.

68. Uckun FM, Reaman G, Steinherz PG, et al. Improved clinical outcome for children with T-lineage acute lymphoblastic leukemia after contemporary chemotherapy: a Children's Cancer Group study. *Leuk Lymphoma* 1996;24:57–70.

69. Pullen J, Shuster JJ, Link M, et al. Significance of commonly used prognostic factors differs for

children with T cell acute lymphocytic leukemia (ALL), as compared to those with B-precursor ALL. A Pediatric Oncology Group study. *Leukemia* 1999;13(11):1696-1707.

70. Hann HL, Lustbader ED, Evans AE, et al. Lack of influence of T-cell marker and importance of mediastinal mass on the prognosis of acute lymphocytic leukemias of childhood. *J Natl Cancer Inst* 1981;66:285-290.

71. Uckun FM, Gaynon PS, Sensel MG, et al. Clinical features and treatment outcome of childhood T-lineage acute lymphoblastic leukemia according to the apparent maturational stage of T-lineage leukemic blasts: a Children's Cancer Group study. *J Clin Oncol* 1997;15(6):2214-2221.

72. Kurtzberg J, Waldmann TA, Davey MP, et al. CD7+, CD4-, CD8- acute leukemia: a syndrome of malignant pluripotent lymphohematopoietic cells. *Blood* 1983;73:381-390.

73. Yumura-Yagi K, Hara J, Kurahashi H, et al. Clinical significance of CD7-positive stem cell leukemia: a distinct subtype of mixed lineage leukemia. *Cancer* 1991;68:2273-2280.

74. Katsuno M, Abe Y, Taguchi F, et al. CD7+ stem cell leukemia/lymphoma: features of a subgroup without circulating blast cells. *Cancer* 1993;72:99-104.

75. Uckun FM, Steinherz PG, Sather H, et al. CD2 antigen expression on leukemic cells as a predictor of event-free survival after chemotherapy for T-lineage acute lymphoblastic leukemia: a Children's Cancer Group study. *Blood* 1996;88(11):4288-4295.

76. Kurec AS, Belair P, Stefanu C, et al. Significance of aberrant immunophenotypes in childhood acute lymphoid leukemia. *Cancer* 1991;67:3081-3086.

77. Mirro J, Zipf TF, Pui CH, et al. Acute mixed lineage leukemia: clinicopathologic correlations and prognostic significance. *Blood* 1985;66:1115-1123.

78. Pui CH, Raimondi SC, Head DR, et al. Characterization of childhood acute leukemia with multiple myeloid and lymphoid markers at diagnosis and at relapse. *Blood* 1991;78(5):1327-1337.

79. Wiersma SR, Ortega J, Sobel E, et al. Clinical importance of myeloid-antigen expression in acute lymphoblastic leukemia of childhood. *N Engl J Med* 1991;324:800-808.

80. Pui CH, Behm FG, Singh B, et al. Myeloid-associated antigen expression lacks prognostic value in childhood acute lymphoblastic leukemia treated with intensive multiagent chemotherapy. *Blood* 1990;75:198-202.

81. Uckun FM, Sather HN, Gaynon PS, et al. Clinical features and treatment outcome of children with myeloid antigen positive acute lymphoblastic leukemia: a report from the Children's Cancer Group. *Blood* 1997;90(1):28-35.

82. Borowitz MJ, Shuster JJ, Civin CI, et al. Prognostic significance of CD34 expression in childhood B-precursor acute lymphocytic leukemia: a Pediatric Oncology Group study. *J Clin Oncol* 1990;8:1389-1398.

83. Pui CH, Hancock ML, Head DR, et al. Clinical significance of CD34 expression in childhood acute lymphoblastic leukemia. *Blood* 1993;82:889-894.

84. Behm FG, Raimondi SC, Schell MJ, et al. Lack of CD45 antigen on blast cells in childhood acute lymphoblastic leukemia is associated with chromosomal hyperdiploidy and other favorable prognostic features. *Blood* 1992;79:1011-1016.

85. Pui CH, Crist WM, Look AT. Biology and clinical significance of cytogenetic abnormalities in childhood acute lymphoblastic leukemia. *Blood* 1990;76:1449-1463.

86. Rubin CM, LeBeau MM. Cytogenetic abnormalities in childhood acute lymphoblastic leukemia. *Am J Pediatr Hematol Oncol* 1991;13:202-216.

87. Raimondi SC. Current status of cytogenetic research in childhood acute lymphoblastic leukemia. *Blood* 1993;81:2237-2251.

88. Bloomfield CD, Goldman AI, Alimena G, et al. Chromosomal abnormalities identify high-risk and low-risk patients with acute lymphoblastic leukemia. *Blood* 1986;67:415-420.
89. Secker-Walker LM, Swansbury GJ, Hardisty RM, et al. Cytogenetics of acute lymphoblastic leukaemia in children as a factor in the prediction of long-term survival. *Br J Haematol* 1982;52:389-399.
90. Swansbury GJ, Secker-Walker LM, Lawler SD, et al. Chromosomal findings in acute lymphoblastic leukaemia of childhood: an independent prognostic factor [Letter]. *Lancet* 1981;2:249-250.
91. Williams DL, Tsiatis A, Brodeur GM, et al. Prognostic importance of chromosome number in 136 untreated children with acute lymphoblastic leukemia. *Blood* 1982;60:864-871.
92. Jackson JF, Boyett J, Pullen J, et al. Favorable prognosis associated with hyperdiploidy in children with acute lymphocytic leukemia correlates with extra chromosome 6. *Cancer* 1990;66:1183-1189.
93. Harris MB, Shuster JJ, Carroll A, et al. Trisomy of leukemic cell chromosomes 4 and 10 identifies children with B-progenitor cell acute lymphoblastic leukemia with a very low risk of treatment failure: a Pediatric Oncology Group study. *Blood* 1992;79:3316-3324.
94. Heerema NA, Sather HN, Sensel MG, et al. Prognostic impact of trisomies of chromosomes 10, 17, and 5 among children with acute lymphoblastic leukemia and high hyperdiploidy (>50 chromosomes). *J Clin Oncol* 2000;18(9): 1876-1887.
95. Pui CH, Dodge RK, Look AT, et al. Risk of adverse events in children completing treatment for acute lymphoblastic leukemia: St. Jude Total Therapy studies VIII, IX, and X. *J Clin Oncol* 1991;9:1341-1347.
96. Raimondi SC, Roberson PK, Pui CH, et al. Hyperdiploid (47-50) acute lymphoblastic leukemia in children. *Blood* 1992;79:3245-3252.
97. Forestier E, Gustafsson G, Heideman AV, et al. Prognostic impact of bone marrow karyotype in childhood acute lymphoblastic leukaemia: Swedish experiences 1986-91. *Acta Paediatr* 1997;86(8):819-825.
98. Pui CH, Carroll AJ, Head D, et al. Near triploid and near-tetraploid acute lymphoblastic leukemia of childhood. *Blood* 1990;76:590-596.
99. Chromosome abnormalities and their clinical significance in acute lymphoblastic leukemia. *Cancer Res* 1983;43:868-873.
100. Pui CH, Williams DL, Raimondi SC, et al. Hypodiploidy is associated with a poor prognosis in childhood acute lymphoblastic leukemia. *Blood* 1987;70:247-253.
101. Pui CH, Carroll AJ, Raimondi SC, et al. Clinical presentation, karyotypic characterization, and treatment outcome of childhood acute lymphoblastic leukemia with a near-haploid or hypodiploid <45 line. *Blood* 1990;75:1170-1177.
102. Heerema NA, Nachman JB, Sather HN, et al. Hypodiploidy with less than 45 chromosomes confers adverse risk in childhood acute lymphoblastic leukemia: a report from the Children's Cancer Group. *Blood* 1999;94(12):4036-4046.
103. Brodeur GM, Williams DL, Look AT, et al. Near-haploid acute lymphoblastic leukemia: a unique subgroup with a poor prognosis? *Blood* 1981;58(1):14-19.
104. Chessells JM, Swansbury GJ, Reeves B, et al. Cytogenetics and prognosis in childhood acute lymphoblastic leukaemia: results of MRC UKALL X. Medical Research Council Working Party in Childhood Leukaemia. *Br J Haematol* 1997;99(1):93-100.
105. Clinical significance of chromosomal abnormalities in acute lymphoblastic leukemia. *Cancer Genet Cytogenet* 1981;4:111-137.
106. Trueworthy R, Shuster J, Look T, et al. Ploidy of lymphoblasts is the strongest predictor of treatment outcome in B-progenitor cell acute lymphoblastic leukemia of childhood: a Pediatric Oncology

Group study. *J Clin Oncol* 1992;10:606–613.

107. Williams DL, Harber J, Murphy SB, et al. Chromosomal translocations play a unique role in influencing prognosis in childhood acute lymphoblastic leukemia. *Blood* 1982;68:205–212.

108. Walters R, Kantarjian HM, Keating MJ, et al. The importance of cytogenetic studies in adult acute lymphocytic leukemia. *Am J Med* 1990;89:579–587.

109. Ribeiro RC, Abromowitch M, Raimondi SC, et al. Clinical and biologic hallmarks of the Philadelphia chromosome in childhood acute lymphoblastic leukemias. *Blood* 1987;70:948–953.

110. Crist W, Carroll A, Shuster J, et al. Philadelphia chromosome–positive childhood acute lymphoblastic leukemia: clinical and cytogenetic characteristics and treatment outcome. *Blood* 1990;76:489–494.

111. Arico M, Valsecchi M, Camitta B, et al. Outcome of treatment in children with Philadelphia chromosome–positive acute lymphoblastic leukemia. *N Engl J Med* 2000;342(14):998–1006.

112. Suryanarayan K, Hunger SP, Kohler S, et al. Consistent involvement of the BCR gene by 9;22 breakpoints in pediatric acute leukemias. *Blood* 1991;77:324–330.

113. Westbrook CA, Hooberman AL, Spino C, et al. Clinical significance of the BCR–ABL fusion gene in adult acute lymphoblastic leukemia: a Cancer and Leukemia Group B study (8762). *Blood* 1992;80:2983–2990.

114. Fletcher JA, Lynch EA, Kimball VM, et al. Translocation (9;22) is associated with extremely poor prognosis in intensively treated children with acute lymphoblastic leukemia. *Blood* 1991;77:435–439.

115. Uckun FM, Nachman JB, Sather HN, et al. Clinical significance of Philadelphia chromosome positive pediatric acute lymphoblastic leukemia in the context of contemporary intensive therapies: a report from the Children's Cancer Group. *Cancer* 1998;83(9):2030–2039.

116. Arthur DC, Bloomfield CD, Lindquist LL, et al. Translocation 4;11 in acute lymphoblastic leukemia: clinical characteristics and prognostic significance. *Blood* 1982;59:96–99.

117. Pui CH, Frankel LS, Carroll AJ, et al. Clinical characteristics and treatment outcome of childhood acute lymphoblastic leukemia with the t(4;11)(q21;q23): a collaborative study of 40 cases. *Blood* 1991;77(3):440–447.

118. Heerema NA, Arthur DC, Sather H, et al. Cytogenetic features of infants less than 12 months of age at diagnosis of acute lymphoblastic leukemia: impact of the 11q23 breakpoint on outcome: a report of the Children's Cancer Group. *Blood* 1994;83:2274–2284.

119. Heerema NA, Sather HN, Ge J, et al. Cytogenetic studies of infant acute lymphoblastic leukemia: poor prognosis of infants with t(4;11)—a report of the Children's Cancer Group. *Leukemia* 1999;13(5):679–686.

120. Mirro J, Kitchingman G, Williams D, et al. Clinical and laboratory characteristics of acute leukemia with the 4;11 translocation. *Blood* 1986;67:689–697.

121. Ziemin–VanDerPoel S, McCabe NR, Gill HJ, et al. Identification of a gene, MLL, that spans the breakpoint in 11q23 translocations associated with human leukemias. *Proc Natl Acad Sci U S A* 1991;88:10735–10739.

122. Cimino G, Moir DT, Canaani O, et al. Cloning of ALL–1, the locus involved in leukemias with the t(4;11)(q21;q23), t(9;11)(p22;q23), and t(11;19)(q23;p13) chromosome translocations. *Cancer Res* 1991;51:6712–6714.

123. Tkachuk DC, Kohler S, Cleary ML. Involvement of a homolog of *Drosophila trithorax* by 11q23 chromosomal translocations in acute leukemias. *Cell* 1992;71:691–700.

124. Chen CS, Sorensen PHB, Domer PH, et al. Molecular rearrangements on chromosome 11q23 predominate in infant acute lymphoblastic leukemia and are associated with specific biologic variables and poor outcome. *Blood* 1993;81:2386–2393.

125. Pui CH, Behm FG, Downing JR, et al. 11q23/MLL rearrangement confers a poor prognosis in infants with acute lymphoblastic leukemia. *J Clin Oncol* 1994;12:909-915.
126. Cimino G, Rapanotti MC, Rivolta A, et al. Prognostic relevance of ALL-1 gene rearrangement in infant acute leukemias. *Leukemia* 1995;9(3):391-395.
127. Taki T, Ida K, Bessho F, et al. Frequency and clinical significance of the MLL gene rearrangements in infant acute leukemia. *Leukemia* 1996;10:1303-1307.
128. Rubnitz JE, Behm FG, Pui CH, et al. Genetic studies of childhood acute lymphoblastic leukemia with emphasis on p16, MLL, and ETV6 gene abnormalities: results of St. Jude Total Therapy Study XII. *Leukemia* 1997; 11(8):1201-1206.
129. Behm FG, Raimondi SC, Frestedt JL, et al. Rearrangement of the MLL gene confers a poor prognosis in childhood acute lymphoblastic leukemia, regardless of presenting age. *Blood* 1996;87(7):2870-2877.
130. Raimondi SC, Behm FG, Roberson PK, et al. Cytogenetics of pre-B-cell acute lymphoblastic leukemia with emphasis on prognostic implications of the t(1;19). *J Clin Oncol* 1990;8:1380-1388.
131. Hunger SP. Chromosomal translocations involving the E2A gene in acute lymphoblastic leukemia: clinical features and molecular pathogenesis. *Blood* 1996;87(4):1211-1224.
132. Hunger SP, Galili N, Carroll AJ, et al. The t(1;19)(q23;p13) results in consistent fusion of E2A and PBX1 coding sequences in acute lymphoblastic leukemias. *Blood* 1991;77:687-693.
133. Privitera E, Kamps MP, Hayashi Y, et al. Different molecular consequences of the 1;19 chromosomal translocation in childhood B-cell precursor acute lymphoblastic leukemia. *Blood* 1992;79:1781-1788.
134. Pui CH, Raimondi SC, Hancock ML, et al. Immunologic, cytogenetic and clinical characterization of childhood acute lymphoblastic leukemia with the t(1;19)(q23;p13) or its derivative. *J Clin Oncol* 1994;12(12):2601-2606.
135. Lai JL, Fenaux P, Zandecki M, et al. Cytogenetic studies in 30 patients with Burkitt's lymphoma or L3 acute lymphoblastic leukemia with special reference to additional chromosome abnormalities. *Ann Genet* 1989;32:26-32.
136. Heerema NA, Sather HN, Sensel MG, et al. Prognostic significance of cytogenetic abnormalities of chromosome arm 12p in childhood acute lymphoblastic leukemia: a report from the Children's Cancer Group. *Cancer* 2000; 88(8):1945-1954.
137. Mahmoud H, Carroll AJ, Behm F, et al. The non-random dic(9;12) translocation in acute lymphoblastic leukemia is associated with B-progenitor phenotype and an excellent prognosis. *Leukemia* 1992;6(7):703-707.
138. Shurtleff SA, Buijs A, Behm FG, et al. TEL/AML1 fusion resulting from a cryptic t(12;21) is the most common genetic lesion in pediatric ALL and defines a group of patients with an excellent prognosis. *Leukemia* 1995;9:1985-1989.
139. Cayuela JM, Baruchel A, Orange C, et al. TEL-AML1 fusion RNA as a new target to detect minimal residual disease in pediatric B-cell precursor acute lymphoblastic leukemia. *Blood* 1996;88:302-308.
140. Raynaud S, Cavé H, Baens M, et al. The 12;21 translocation involving TEL and deletion of the other TEL allele: two frequently associated alterations found in childhood acute lymphoblastic leukemia. *Blood* 1996;87(7):2891-2899.
141. Takeuchi S, Seriu T, Bartram CR, et al. TEL is one of the targets for deletion on 12p in many cases of childhood B-lineage acute lymphoblastic leukemia. *Leukemia* 1997;11:1220-1223.
142. Raimondi SC, Shurtleff SA, Downing JR, et al. 12p abnormalities and the TEL gene (ETV6) in childhood acute lymphoblastic leukemia. *Blood* 1997;90(11):4559-4566.
143. McLean TW, Ringold S, Neuberg D, et al. TEL/AML-1 dimerizes and is associated with a favorable

outcome in childhood acute lymphoblastic leukemia. *Blood* 1996;88:4252–4258.

144. Rubnitz JE, Shuster JJ, Land VJ, et al. Case-control study suggests a favorable impact of TEL rearrangement in patients with B-lineage acute lymphoblastic leukemia treated with antimetabolite-based therapy: a Pediatric Oncology Group study. *Blood* 1997;89:1143–1146.

145. Rubnitz JE, Downing JR, Pui CH, et al. TEL gene rearrangement in acute lymphoblastic leukemia: a new genetic marker with prognostic significance. *J Clin Oncol* 1997;15:1150–1157.

146. Borkhardt A, Cazzaniga G, Viehmann S, et al. Incidence and clinical relevance of TEL/AML1 fusion genes in children with acute lymphoblastic leukemia enrolled in the German and Italian multicenter therapy trials. *Blood* 1997;90(2):571–577.

147. Maloney KW, McGavran L, Murphy JR, et al. TEL-AML1 fusion identifies a subset of children with standard risk acute lymphoblastic leukemia who have an excellent prognosis when treated with therapy that includes a single delayed intensification. *Leukemia* 1999;13:1708–1712.

148. Takahashi Y, Horibe K, Kiyoi H, et al. Prognostic significance of TEL/AML1 fusion transcript in childhood B-precursor acute lymphoblastic leukemia. *J Pediatr Hematol Oncol* 1998;20(3):190–195.

149. Avigad S, Kuperstein G, Zilberstein J, et al. TEL-AML1 fusion transcript designates a favorable outcome with an intensified protocol in childhood acute lymphoblastic leukemia. *Leukemia* 1999;13(3):481–498.

150. Rubnitz JE, Pui CH, Downing JR. The role of TEL fusion genes in pediatric leukemias. *Leukemia* 1999;13:6–13.

151. Chilcote RR, Brown E, Rowley JD. Lymphoblastic leukemia with lymphomatous features associated with abnormalities of the short arm of chromosome 9. *N Engl J Med* 1985;313:286–291.

152. Murphy SB, Raimondi SC, Rivera GK, et al. Nonrandom abnormalities of chromosome 9p in childhood acute lymphoblastic leukemia: association with high-risk clinical features. *Blood* 1989;74:409–415.

153. Ogawa S, Hirano N, Sato N, et al. Homozygous loss of the cyclin-dependent kinase 4-inhibitor (p16) gene in human leukemias. *Blood* 1994;84:2431–2435.

154. Stranks G, Height SE, Mitchell P, et al. Deletions and rearrangement of CDKN2 in lymphoid malignancy. *Blood* 1995;85:893–901.

155. Rasool O, Heyman M, Brandter LB, et al. p15ink4B and p16ink4 gene inactivation in acute lymphocytic leukemia. *Blood* 1995;85:3431–3436.

156. Okuda T, Shurtleff SA, Valentine MB, et al. Frequent deletion of p16INK4a/MTS1 and p15INK4b/MTS2 in pediatric acute lymphoblastic leukemia. *Blood* 1995;85:2321–2330.

157. Heyman M, Rasool O, Brandter LB, et al. Prognostic importance of p15INK4B and p16INK4 gene inactivation in childhood acute lymphocytic leukemia. *J Clin Oncol* 1996;14:1512–1520.

158. Kees UR, Burton PR, Lü C, et al. Homozygous deletion of the p16/MTS1 gene in pediatric acute lymphoblastic leukemia is associated with unfavorable clinical outcome. *Blood* 1997;89(11):4161–4166.

159. Maloney KW, McGavran L, Odom LF, et al. Acquisition of p16 INK4A and p15 INK4B gene abnormalities between initial diagnosis and relapse in children with acute lymphoblastic leukemia. *Blood* 1999;93(7):2380–2385.

160. Carter TL, Watt PM, Kumar R, et al. Hemizygous p16 INK4A deletion in pediatric acute lymphoblastic leukemia predicts independent risk of relapse. *Blood* 2001;97(2):572–574.

161. Golub TR, Slonim DK, Tamayo P, et al. Molecular classification of cancer: class discovery and class prediction by gene expression monitoring. *Science* 1999;286:531–537.

162. Ferrando AA, Neuberg DS, Staunton J, et al. Gene expression signatures define novel oncogenic



pathways in T cell acute lymphoblastic leukemia. *Cancer Cell* 2002;1:75–87.

163. Armstrong SA, Staunton JE, Silverman LB, et al. MLL translocations specify a distinct gene expression profile that distinguishes a unique leukemia. *Nat Genet* 2002;30:41–47.
164. Yeoh EJ, Ross ME, Shurtleff SA, et al. Classification, subtype discovery, and prediction of outcome in pediatric acute lymphoblastic leukemia by gene expression profiling. *Cancer Cell* 2002;1:133–143.
165. Staudt LM. It's ALL in the diagnosis. *Cancer Cell* 2002;1:109–110.
166. Pieters R, Loonen AH, Huismans DR, et al. In vitro sensitivity of cells from children with leukemia using the MTT assay with improved culture conditions. *Blood* 1990;76:2327–2336.
167. Hongo T, Fujii Y, Igarashi Y. An in vitro chemosensitivity test for the screening of anti-cancer drugs in childhood leukemia. *Cancer* 1990;65:1263–1272.
168. Kaspers GJL, Veerman AJP, Pieters R, et al. In vitro cellular drug resistance and prognosis in newly diagnosed childhood acute lymphoblastic leukemia. *Blood* 1997;90(7):2723–2729.
169. Hongo T, Yajima S, Sakurai M, et al. In vitro drug sensitivity testing can predict induction failure and early relapse of childhood acute lymphoblastic leukemia. *Blood* 1997;89(8):2959–2965.
170. Kearns PR, Pieters R, Rottier MMA, et al. Raised blood glutathione levels are associated with an increased risk of relapse in childhood acute lymphocytic leukemia. *Blood* 2001;97(2):393–398.
171. Campana D, Pui CH. Detection of minimal residual disease in acute leukemia: methodologic advances and clinical significance. *Blood* 1995;85:1416–1434.
172. Neale GAM, Menarguez J, Kitchingman GR, et al. Detection of minimal residual disease in T-cell acute lymphoblastic leukemia using polymerase chain reaction predicts impending relapse. *Blood* 1991;78:739–747.
173. Wasserman R, Galali N, Ito Y, et al. Residual disease at the end of induction therapy as a predictor of relapse during therapy in childhood B-lineage acute lymphoblastic leukemia. *J Clin Oncol* 1992;10:1879–1888.
174. Nizet Y, Daele SV, Lewalle P, et al. Long-term follow-up of residual disease in acute lymphoblastic leukemia patients in complete remission using clonogenic IgH probes and the polymerase chain reaction. *Blood* 1993;82:1618–1625.
175. Roberts WR, Estrov Z, Ouspenskaia MV, et al. Measurement of residual leukemia during remission in childhood acute lymphoblastic leukemia. *N Engl J Med* 1997;336:317–323.
176. Mayer SP, Giamelli J, Sandoval C, et al. Quantification of leukemia clone-specific antigen gene rearrangements by a single-step PCR and fluorescence-based detection method. *Leukemia* 1999;13:1843–1852.
177. Brisco MJ, Condon J, Hughes E, et al. Outcome prediction in childhood acute lymphoblastic leukemia by molecular quantification of residual disease at the end of induction. *Lancet* 1994;343:196–199.
178. Dibenedetto SP, Nigro LL, Mayer SP, et al. Detectable molecular residual disease at the beginning of maintenance therapy indicates poor outcome in children with T-cell acute lymphoblastic leukemia. *Blood* 1997;90(3):1226–1232.
179. Negrin RS, Blume KG. The use of the polymerase chain reaction for the detection of minimal residual malignant disease. *Blood* 1991;78:255–258.
180. Ito Y, Wasserman R, Galili N, et al. Molecular residual disease status at the end of chemotherapy fails to predict subsequent relapse in children with B-lineage acute lymphoblastic leukemia. *J Clin Oncol* 1993;11:546–553.
181. Farahat N, Morilla A, Owusu-Ankomah K, et al. Detection of minimal residual disease in B-lineage

- acute lymphoblastic leukaemia by quantitative flow cytometry. *Br J Haematol* 1998;101(1):158-164.
182. Coustan-Smith E, Behm FG, Sanchez J, et al. Immunologic detection of minimal residual disease in children with acute lymphoblastic leukaemia. *Lancet* 1998;351:550-554.
183. Gruhn B, Hongeng S, Yi H, et al. Minimal residual disease after intensive induction therapy in childhood acute lymphoblastic leukemia predicts outcome. *Leukemia* 1998;12(5):675-681.
184. Ciudad J, Miguel JFS, López-Berges MC, et al. Prognostic value of immunophenotypic detection of minimal residual disease in acute lymphoblastic leukemia. *J Clin Oncol* 1998;16(12):3774-3781.
185. Coustan-Smith E, Sancho J, Hancock ML, et al. Clinical importance of minimal residual disease in childhood acute lymphoblastic leukemia. *Blood* 2000;96(8):2691-2696.
186. Jacquy C, Delepaut B, Daele SV, et al. A prospective study of minimal residual disease in childhood B-lineage acute lymphoblastic leukaemia: MRD level at the end of induction is a strong predictive factor of relapse. *Br J Haematol* 1997;98:140-146.
187. Cavé H, van der Werff ten Bosch J, Suciú S, et al. Clinical significance of minimal residual disease in childhood acute lymphoblastic leukemia. *N Engl J Med* 1998;339(9):591-598.
188. von Dongen JJ, Seriu T, Panzer-Grümayer ER, et al. Prognostic value of minimal residual disease in acute lymphoblastic leukaemia in childhood. *Lancet* 1998;352:1731-1738.
189. Goulden NJ, Knechtli CJ, Garland RJ, et al. Minimal residual disease analysis for the prediction of relapse in children with standard-risk acute lymphoblastic leukaemia. *Br J Haematol* 1998;100:235-244.
190. Brisco M, Hughes E, Neoh S, et al. In childhood acute lymphoblastic leukemia, a small population of highly drug-resistant cells is present at diagnosis in many patients. *Blood* 1996;88:667a.
191. Martens AC, Schultz FW, Hagenbeek A. Nonhomogeneous distribution of leukemia in the bone marrow during minimal residual disease. *Blood* 1987;70:1073-1078.
192. Thomson B, Green C, Loken M, et al. Minimal residual disease detection during induction therapy in pediatric acute lymphoblastic leukemia with multi-dimensional flow cytometry (MDF). *Proc Am Soc Clin Oncol* 1998;17:530a.
193. Steward CG, Goulden NJ, Katz F, et al. A polymerase chain reaction study of the stability of Ig heavy-chain and T-cell receptor delta gene rearrangements between presentation and relapse of childhood B-lineage acute lymphoblastic leukemia. *Blood* 1994;83:1355-1362.
194. Steenbergen EJ, Verhagen OJ, van Leeuwen EF, et al. Frequent ongoing T-cell receptor rearrangements in childhood B-precursor acute lymphoblastic leukemia: implications for monitoring minimal residual disease. *Blood* 1995;86:692-702.
195. Steenbergen EJ, Verhagen OJ, Nibbering CP, et al. Clonal evolution of immunoglobulin heavy chain rearrangements in childhood B-precursor acute lymphoblastic leukemia after engraftment in SCID mice. *Leukemia* 1996;10:1471-1478.
196. van Wering ER, Beishuizen A, Roeffen ET, et al. Immunophenotypic changes between diagnosis and relapse in childhood acute lymphoblastic leukemia. *Leukemia* 1995;9:1523-1533.
197. Beishuizen A, Verhoeven MA, Hahlen K, et al. Differences in immunoglobulin heavy chain gene rearrangement patterns between bone marrow and blood samples in childhood precursor B-acute lymphoblastic leukemia at diagnosis [corrected and republished with original paging, article originally printed in *Leukemia* 1992 Jan;6(1):60-63]. *Leukemia* 1993;7:60-63.
198. Feroni L, Harrison C, Hoffbrand A, Potter M. Investigation of minimal residual disease in childhood and adult acute lymphoblastic leukaemia by molecular analysis. *Br J Haematol* 1999;105:7-24.
199. Uckun FM. Severe combined immunodeficient mouse models of human leukemia. *Blood* 1996;88(4):1135-1146.
200. Uckun FM, Sather H, Reaman G, et al. Leukemic cell growth in SCID mice as a predictor of relapse in

high-risk B-lineage acute lymphoblastic leukemia. *Blood* 1995;85:873-878.

201. Yan Y, Salomon O, McGuirk J, et al. Growth pattern and clinical correlation of subcutaneously inoculated human primary acute leukemias in severe combined immunodeficiency mice. *Blood* 1996;88:3137-3146.

202. Amadori S, Meloni G, Baccarani M, et al. Long-term survival in adolescent and adult acute lymphoblastic leukemia. *Cancer* 1983;52:30-34.

203. Baccarani M, Corbelli G, Amadori S, et al. Adolescent and adult acute lymphoblastic leukemia: prognostic features and outcome of therapy. A study of 293 patients. *Blood* 1982;60:677-684.

204. Kalwinsky DK, Rivera G, Dahl GV, et al. Variation by race in presenting clinical and biologic features of childhood acute lymphoblastic leukaemia: implications for treatment outcome. *Leuk Res* 1985;9:817-823.

205. Miller DR, Leiken S, Albo V, et al. Use of prognostic factors in improving the design and efficiency of clinical trials in childhood leukemia. *Cancer Treat Rep* 1980;64:381-392.

206. Harousseau J, Tobelem G, Schaison G, et al. High risk acute lymphocytic leukemia: a study of 141 cases with initial white blood cell counts over 100,000/cu mm. *Cancer* 1980;46:1996-2003.

207. Sather H, Coccia P, Nesbit M, et al. Disappearance of the predictive value of prognostic variables in childhood acute lymphoblastic leukemia. *Cancer* 1981;48:370-376.

208. George SL, Fernbach DJ, Vietti TJ, et al. Factors influencing survival in pediatric acute leukemia: the SWCCSG experience. 1958-1970. *Cancer* 1973;32:1542-1553.

209. Gustafsson G, Kreuger A. Sex and other prognostic factors in acute lymphoblastic leukemia in childhood. *Am J Pediatr Hematol Oncol* 1983;5:243-250.

210. Miller DR, Leikin S, Albo V, et al. Prognostic factors and therapy in acute lymphoblastic leukemia of childhood. *Cancer* 1983;51:1041-1049.

211. Biondi A, Cimino G, Pieters R, et al. Biological and therapeutic aspects of infant leukemia. *Blood* 2000;96(1):24-33.

212. Crist W, Pullen J, Boyett J, et al. Acute lymphoid leukemia in adolescents: clinical and biologic features predict a poor prognosis: a Pediatric Oncology Group study. *J Clin Oncol* 1988;6:34-43.

213. Santana VM, Dodge RK, Crist WM, et al. Presenting features and treatment outcome of adolescents with acute lymphoblastic leukemia. *Leukemia* 1989;4:87-90.

214. Hussein KK, Dahlberg S, Head D, et al. Treatment of acute lymphoblastic leukemia in adults with intensive induction, consolidation, and maintenance chemotherapy. *Blood* 1989;73:57-63.

215. Sather HS, Miller D, Nesbit M, et al. Differences in prognosis for boys and girls with acute lymphoblastic leukemia. *Lancet* 1981;1:739-743.

216. Chessells JM. Acute lymphoblastic leukemia. *Semin Hematol* 1982;19:155-171.

217. Chessells JM, Richards SM, Bailey CC, et al. Gender and treatment outcome in childhood lymphoblastic leukaemia: report from the MRC UKALL trials. *Br J Haematol* 1995;89:364-372.

218. Shuster JJ, Wacker P, Pullen J, et al. Prognostic significance of sex in childhood B-precursor acute lymphoblastic leukemia: a Pediatric Oncology Group study. *J Clin Oncol* 1998;16(8):2854-2863.

219. Pui CH, Boyett JM, Relling MV, et al. Sex differences in prognosis for children with acute lymphoblastic leukemia. *J Clin Oncol* 1999;17(3):818-824.

220. George SL, Aur RJ, Mauer AM, et al. A reappraisal of the results of stopping therapy in childhood leukemia. *N Engl J Med* 1979;300:269-273.

221. Pendergrass TW, Hoover R, Godwin JD. Prognosis of black children with acute lymphocytic leukemia.

Med Pediatr Oncol 1975;1:143–148.

222. Sather H, et al. Differences in the presentation of acute lymphoblastic leukemia and non-Hodgkin's lymphoma in black children and white children. In: Magrath IT, O'Connor GT, Ramot B, eds. Pathogenesis of leukemias and lymphomas: environmental influences. New York: Raven Press, 1984.

223. Szklo M, Gordis L, Tonascia J, et al. The changing survivorship of white and black children with leukemia. *Cancer* 1978;42:59–66.

224. Foucar K, Duncan MH, Stidley CA, et al. Survival of children and adolescents with acute lymphoid leukemia. A study of American Indians and Hispanic and Non-Hispanic whites treated in New Mexico (1969 to 1986). *Cancer* 1991;67:2125–2130.

225. Pui CH, Boyett JM, Hancock ML, et al. Outcome of treatment for childhood cancer in black as compared with white children. The St. Jude Children's Research Hospital experience, 1962 through 1992. *J Am Med Assoc* 1995; 273(8):633–637.

226. Bhatia S, Sather H, Zhang J, et al. Ethnicity and survival following childhood acute lymphoblastic leukemia (ALL): follow-up of the Children's Cancer Group (CCG) cohort. *Proc Am Soc Clin Oncol* 1999;18:568a.

227. Pollock BH, DeBaun MR, Camitta BM, et al. Racial differences in the survival of childhood B-precursor acute lymphoblastic leukemia: a Pediatric Oncology Group study. *J Clin Oncol* 2000;18(4):813–823.

228. Shing MMK, Li CK, Chik KW, et al. Outcomes and prognostic factors of Chinese children with acute lymphoblastic leukemia in Hong Kong: preliminary results. *Med Pediatr Oncol* 1999;32(2):117–123.

229. Steinherz PG, Gaynon PS, Breneman JC, et al. Cytoreduction and prognosis in acute lymphoblastic leukemia—the importance of early marrow response: report from the Children's Cancer Group. *J Clin Oncol* 1996;14:389–398.

230. Nachman J, Sather HN, Gaynon PS, et al. Augmented Berlin–Frankfurt–Munster therapy abrogates the adverse prognostic significance of slow early response to induction chemotherapy for children and adolescents with acute lymphoblastic leukemia and unfavorable presenting features: a report from the Children's Cancer Group. *J Clin Oncol* 1997;15:2222–2230.

231. Nachman JB, Sather HN, Sensel MG, et al. Augmented post-induction therapy for children with high-risk acute lymphoblastic leukemia and a slow response to initial therapy. *N Engl J Med* 1998;338:1663–1671.

232. Stork L, Sather H, Nachman J, et al. Intensive therapy 'rescues' children with standard risk ALL (SR-ALL) and slow early response to induction: CCG-1952 results. *Blood* 2000;96:466a(abst).

233. Riehm H, Reiter A, Schrappe M, et al. Corticosteroid-dependent reduction of leukocyte count in blood as a prognostic factor in acute lymphoblastic leukemia in childhood (therapy study ALL-BFM 83). *Klin Padiatr* 1987;199:151–160.

234. Dordelmann M, Reiter A, Borkhardt A, et al. Prednisone response is the strongest predictor of treatment outcome in infant acute lymphoblastic leukemia. *Blood* 1999;94:1209–1217.

235. Schrappe M, Viehmann S, Dordelmann M, et al. Translocation t(4;11)(q21;q23): is it an independent risk factor in childhood ALL? *Blood* 1999;94:500a.

236. Schrappe M, Arico M, Harbott J, et al. Philadelphia chromosome-positive (Ph+) childhood acute lymphoblastic leukemia: good initial steroid response allows early prediction of a favorable treatment outcome. *Blood* 1998;92:2730–2734.

237. Chilcote RR, Coccia P, Sather HN, et al. Mediastinal mass in acute lymphoblastic leukemia. *Med Pediatr Oncol* 1984;12:9–16.

238. Fitzpatrick J, Lieberman N, Sinks LF. Staging of acute leukemia and the relationship to CNS involvement: staging of ALL and CNS disease. *Cancer* 1974;33:1376–1381.

239. Hammond D, Sather H, Nesbit M, et al. Analysis of prognostic factors in acute lymphoblastic leukemia. *Med Pediatr Oncol* 1986;14:124–134.
240. Mastrangelo R, Poplack D, Bleyer A, et al. Report and recommendations of the Rome workshop concerning poor-prognosis acute lymphoblastic leukemia in children: biologic bases for staging, stratification, and treatment. *Med Pediatr Oncol* 1986;14:191–194.
241. Mahmoud HH, Rivera GK, Hancock ML, et al. Low leukocyte counts with blast cells in cerebrospinal fluid of children with newly diagnosed acute lymphoblastic leukemia. *N Engl J Med* 1993;329:314–319.
242. Lauer S, Shuster J, Kirchner P, et al. Prognostic significance of cerebrospinal fluid lymphoblasts at diagnosis in children with acute lymphoblastic leukemia. *Proc Am Soc Clin Oncol* 1994;13:317(abst).
243. Gilchrist GS, Tubergen DG, Sather HN, et al. Low numbers of CSF blasts do not predict for the development of CNS leukemia in children with intermediate-risk acute lymphoblastic leukemia: a Children's Cancer Group report. *J Clin Oncol* 1994;12:2594–2600.
244. Tubergen DG, Cullen JW, Boyett JM, et al. Blasts in CSF with a normal cell count do not justify alteration of therapy for acute lymphoblastic leukemia in remission: a Children's Cancer Group study. *J Clin Oncol* 1994;12:273–278.
245. Smith M, Arthur D, Camitta B, et al. Uniform approach to risk classification and treatment assignment for children with acute lymphoblastic leukemia. *J Clin Oncol* 1996;14(1):18–24.
246. Hann IM, Evans DI, Palmer MK, et al. The prognostic significance of morphological features in childhood acute lymphoblastic leukaemia. *Clin Lab Haematol* 1979;1:215–226.
247. Miller DR, Krailo M, Bleyer WA, et al. Prognostic implications of blast cell morphology in childhood acute lymphoblastic leukemia: a report from Children's Cancer Study Group. *Cancer Treat Rep* 1985;69:1211–1221.
248. Miller DR, Leikin S, Albo V, et al. Prognostic importance of morphology (FAB classification) in childhood acute lymphoblastic leukemia (ALL). *Br J Haematol* 1981;48:199–206.
249. Palmer MK, Hann IM, Jones PM, et al. A score at diagnosis for predicting length of remission in childhood acute lymphoblastic leukemia. *Br J Cancer* 1980;42:841–849.
250. Viana MB, Maurer HS, Ferenc C. Subclassification of acute lymphoblastic leukemia in children: analysis of the reproducibility of morphologic criteria and prognostic implications. *Br J Haematol* 1980;44:383–388.
251. Wagner VM, Baehner RL. Correlation of the FAB morphologic criteria and prognosis in acute lymphoblastic leukemia of childhood. *Am J Pediatr Hematol Oncol* 1979;1:103–106.
252. Eys JV, Pullen J, Head D, et al. The French–American–British (FAB) classification of leukemia: the Pediatric Oncology Group experience with lymphocytic leukemia. *Cancer* 1986;57:1046–1051.
253. Pui CH. Childhood leukemias. *N Engl J Med* 1995;332:1618–1630.
254. Lilleyman JS, Hann IM, Stevens RF, et al. Cytomorphology of childhood acute lymphoblastic leukaemia: a prospective study of 2000 patients. United Kingdom Medical Research Council's Working Party on Childhood Leukaemia. *Br J Haematol* 1992;81(1):52–57.
255. Kanerva J, Saarinen-Pihkala UM, Riikonen P, et al. Reemphasis on lymphoblast L2 morphology as a poor prognostic factor in childhood acute lymphoblastic leukemia. *Med Pediatr Oncol* 1999;33:388–394.
256. Robison LL, Sather HN, Coccia P, et al. Assessment of the interrelationship of prognostic factors in childhood acute lymphoblastic leukemia. *Am J Pediatr Hematol Oncol* 1980;2:5–13.
257. Hann IM, Scarrfe JH, Palmer MK, et al. Haemoglobin and prognosis in childhood acute lymphoblastic leukaemia. *Arch Dis Child* 1981;56:684–686.

258. Zippen C, Cutler SJ, Reeves WJ, et al. Variation in survival among patients with acute lymphocytic leukemia. *Blood* 1971;37:59–72.
259. Eden OB, Rankin A, Kay HE. Isolated testicular relapse in acute lymphoblastic leukaemia of childhood. Report on behalf of the Medical Research Council's working party on leukaemia in childhood. *Arch Dis Child* 1978;58:128–132.
260. Leikin S, Miller D, Sather H, et al. Immunologic evaluation in the prognosis of acute lymphoblastic leukemia. *Blood* 1981;58:501–508.
261. Robison LL, Nesbit ME, Sather HN, et al. Down syndrome and acute leukemia in children: a 10-year retrospective study from Children's Cancer Study Group. *J Pediatr* 1984;105:235–242.
262. Kalwinsky DK, Raimondi SC, Bunin NJ, et al. Clinical and biologic characteristics of acute lymphocytic leukemia in children with Down syndrome. *Am J Med Genet* 1990;7:S267–271.
263. Levitt GA, Stiller CA, Chessells JM. Prognosis of Down's syndrome with acute leukemia. *Arch Dis Child* 1990;65:212–216.
264. Dördelmann M, Schrappe M, Reiter A, et al. Down's syndrome in childhood acute lymphoblastic leukemia: clinical characteristics and treatment outcome in four consecutive BFM trials. *Leukemia* 1998;12:645–651.
265. Chessells JM, Harrison G, Richards SM. Down's syndrome and acute lymphoblastic leukaemia: clinical features and response to treatment. *Arch Dis Child* 2001;85:321–325.
266. Ravindranath Y, Abella E, Krischer JP, et al. Acute myeloid leukemia (AML) in Down's syndrome is highly responsive to chemotherapy: experience on Pediatric Oncology Group AML Study 8498. *Blood* 1992;80:2210–2214.
267. Pui CH, Raimondi SC, Borowitz MJ, et al. Immunophenotypes and karyotypes of leukemic cells in children with Down syndrome and acute lymphoblastic leukemia. *J Clin Oncol* 1993;11:1361–1367.
268. Kojima S, Matsuyama T, Sato T, et al. Down's syndrome and acute leukemia in children: an analysis of phenotype by use of monoclonal antibodies and electron microscopic platelet peroxidase reaction. *Blood* 1991;76:2348–2353.
269. Ragab AH, Abdel-Mageed A, Shuster JJ, et al. Clinical characteristics and treatment outcome of children with acute lymphocytic leukemia and Down's syndrome: a Pediatric Oncology Group study. *Cancer* 1991;67:1057–1063.
270. Lampert F, Henze G, Langermann HJ, et al. Acute lymphoblastic leukemia: current status of therapy in children. *Recent Results Cancer Res* 1984;93:159–181.
271. Bleyer WA. Acute lymphoid leukemia. *Pediatr Ann* 1983;12:277–292.
272. Lilleyman J, Eden O. United Kingdom Medical Research Council acute lymphoblastic leukaemia (UKALL) trials I–VIII: clinical features and results of treatment in four groups of children with adverse prognostic features. *Med Pediatr Oncol* 1986;14:182–186.
273. Pui CH, Crist WM. Biology and treatment of acute lymphoblastic leukemia. *J Pediatr* 1994;124:491–503.
274. Pui CH, Evans WE, Gilbert JR. Meeting report: International Childhood ALL Workshop: Memphis, TN, 3–4 December 1997. *Leukemia* 1998;12:1313–1318.
275. Pui CH, Evans WE. Acute lymphoblastic leukemia. *N Engl J Med* 1998;339(9):605–615.
276. Gaynon PS, et al. Modified BFM therapy for children with previously untreated acute lymphoblastic leukemia and unfavorable prognostic features. *Am J Pediatr Hematol Oncol* 1988;10:42.
277. Fletcher JA, Kimball VM, Lynch E, et al. Prognostic implications of cytogenetic studies in an

- intensively treated group of children with acute lymphoblastic leukemia. *Blood* 1989;74:2130–2135.
278. Clavell LA, et al. Four-drug induction and intensive asparaginase therapy for treatment of childhood acute lymphoblastic leukemia. *N Engl J Med* 1986;315:657.
279. Steinherz P, et al. Improved disease-free survival of children with acute lymphoblastic leukemia at high risk for early relapse with the New York regimen, a new intensive therapy protocol. *J Clin Oncol* 1986;4:744.
280. Uckun FM, Sensel MG, Sun L, et al. Biology and treatment of childhood T-lineage acute lymphoblastic leukemia. *Blood* 1998;91(3):735–746.
281. Schrappe M, Reiter A, Zimmermann M, et al. Long-term results of four consecutive trials in childhood ALL performed by the ALL-BFM study group from 1981 to 1995. *Berlin-Frankfurt-Munster. Leukemia* 2000;14:2205–2222.
282. Pui CH, Boyett JM, Rivera GK, et al. Long-term results of Total Therapy studies 11, 12 and 13A for childhood acute lymphoblastic leukemia at St. Jude Children's Research Hospital. *Leukemia* 2000;14:2286–2294.
283. Gaynon PS, Trigg ME, Heerema NA, et al. Children's Cancer Group trials in childhood acute lymphoblastic leukemia: 1983–1995. *Leukemia* 2000;14:2223–2233.
284. Silverman LB, Declerck L, Gelber RD, et al. Results of Dana-Farber Cancer Institute Consortium protocols for children with newly diagnosed acute lymphoblastic leukemia (1981–1995). *Leukemia* 2000;14:2247–2256.
285. Heerema NA, Arthur DC, Sather H, et al. Cytogenetic features of infants less than 12 months of age at diagnosis of acute lymphoblastic leukemia: impact of the 11q23 breakpoint on outcome: a report of the Children's Cancer Group. *Blood* 1994;83:2274–2284.
286. Pui CH, Gaynon P, Boyett J, et al. Outcome of treatment in childhood acute lymphoblastic leukaemia with rearrangements of the 11q23 chromosomal region. *Lancet* 2002;359:1909–1915.
287. Arico M, Valsecchi M, Camitta B, et al. Outcome of treatment in children with Philadelphia chromosome-positive acute lymphoblastic leukemia. *N Engl J Med* 2000;342:998–1006.
288. Stock W, Sather H, Dodge R, et al. Outcome of adolescents and young adults with ALL: a comparison of Children's Cancer Group (CCG) and Cancer and Leukemia Group B (CALGB) regimens. *Blood* 2000;96:467a.
289. Cave H, van der Werff ten Bosch J, Suci S, et al. Clinical significance of minimal residual disease in childhood acute lymphoblastic leukemia. European Organization for Research and Treatment of Cancer-Childhood Leukemia Cooperative Group. *N Engl J Med* 1998;339:591–598.
290. van Dongen JJ, Seriu T, Panzer-Grumayer ER, et al. Prognostic value of minimal residual disease in acute lymphoblastic leukaemia in childhood. *Lancet* 1998;352:1731–1738.
291. Coustan-Smith E, Behm FG, Sanchez J, et al. Immunological detection of minimal residual disease in children with acute lymphoblastic leukaemia. *Lancet* 1998;351:550–554.
292. Hitchcock Bryan S, Gelber R, Cassady JR, Sallan SE. The impact of induction anthracycline on long-term failure-free survival in childhood acute lymphoblastic leukemia. *Med Pediatr Oncol* 1986;14:211–215.
293. Eden OB, Lilleyman JS, Richards S, et al. Results of Medical Research Council Childhood Leukaemia Trial UKALL VIII (report to the Medical Research Council on behalf of the Working Party on Leukaemia in Childhood). *Br J Haematol* 1991;78:187–196.
294. Tubergen D, Gilchrist G, O'Brien A, et al. Improved outcome with delayed intensification for children with acute lymphoblastic leukemia and intermediate presenting features. *J Clin Oncol* 1993;11:527–537.
295. O'Reilly R, Pui CH, Kernan N, et al. NCCN pediatric acute lymphoblastic leukemia practice guidelines.



The National Comprehensive Cancer Network. *Oncology* 1996;10:1787–1794.

296. Balis FM, Lester CM, Chrousos GP, et al. Differences in cerebrospinal fluid penetration of corticosteroids: possible relationship to the prevention of meningeal leukemia. *J Clin Oncol* 1987;5:202–207.
297. Kaspers GJ, Veerman AJ, Popp Snijders C, et al. Comparison of the antileukemic activity in vitro of dexamethasone and prednisolone in childhood acute lymphoblastic leukemia. *Med Pediatr Oncol* 1996;27:114–121.
298. Veerman AJ, Hahlen K, Kamps WA, et al. Dutch Childhood Leukemia Study Group: early results of study ALL VI (1984–1988). *Hamatol Bluttransfus* 1990;33:473–477.
299. Bostrom BC, Sensel MR, Sather HN, et al. Dexamethasone versus prednisone and daily oral versus weekly intravenous mercaptopurine for patients with standard-risk acute lymphoblastic leukemia: a report from the Children's Cancer Group. *Blood* 2003;16:16.
300. Mitchell C, Kinsey S, Vora A, et al. MRC ALL97/99—a randomized comparison of dexamethasone versus prednisone and thioguanine versus mercaptopurine in the treatment of childhood acute lymphoblastic leukemia. *Blood* 2002;100:156a.
301. Hurwitz CA, Silverman LB, Schorin MA, et al. Substituting dexamethasone for prednisone complicates remission induction in children with acute lymphoblastic leukemia. *Cancer* 2000;88:1964–1969.
302. Asselin BL, Whitin JC, Coppola DJ, et al. Comparative pharmacokinetic studies of three asparaginase preparations. *J Clin Oncol* 1993;11:1780–1786.
303. Asselin BL. The three asparaginases. Comparative pharmacology and optimal use in childhood leukemia. *Adv Exp Med Biol* 1999;457:621–629.
304. Duval M, Suci S, Ferster A, et al. Comparison of *Escherichia coli*-asparaginase with *Erwinia*-asparaginase in the treatment of childhood lymphoid malignancies: results of a randomized European Organization for Research and Treatment of Cancer—Children's Leukemia Group phase 3 trial. *Blood* 2002;99:2734–2739.
305. Silverman L, Kimball Dalton V, Zou G, et al. *Erwinia* asparaginase is less toxic than *E. coli* asparaginase in children with acute lymphoblastic leukemia (ALL): results from the Dana-Farber Cancer Institute ALL Consortium. *Blood* 1999;94:290a.
306. Boos J, Werber G, Ahlke E, et al. Monitoring of asparaginase activity and asparagine levels in children on different asparaginase preparations. *Eur J Cancer* 1996;32A:1544–1550.
307. Rizzari C, Zucchetti M, Conter V, et al. L-asparagine depletion and L-asparaginase activity in children with acute lymphoblastic leukemia receiving i.m. or i.v. *Erwinia c.* or *E. coli* L-asparaginase as first exposure. *Ann Oncol* 2000;11:189–193.
308. Cheung NK, Chau IY, Coccia PF. Antibody response to *Escherichia coli* L-asparaginase. Prognostic significance and clinical utility of antibody measurement. *Am J Pediatr Hematol Oncol* 1986;8:99–104.
309. Kurtzberg J, Asselin B, Pollack B, et al. PEG-L-asparaginase (PEGasp) vs native *E. coli* asparaginase (asp) for reinduction of relapsed acute lymphoblastic leukemia (ALL): Pediatric Oncology Group (POG) 8866 Phase II trial. *Proc Annu Meet Am Soc Clin Oncol* 1993;12:A1079.
310. Abshire TC, Pollock BH, Billett AL, et al. Weekly polyethylene glycol conjugated L-asparaginase compared with biweekly dosing produces superior induction remission rates in childhood relapsed acute lymphoblastic leukemia: a Pediatric Oncology Group study. *Blood* 2000;96:1709–1715.
311. Mastrangelo R, Poplack D, Bleyer A, et al. Report and recommendations of the rome workshop concerning poor-prognosis acute lymphoblastic leukemia in children: biologic bases for staging, stratification, and treatment. *Med Pediatr Oncol* 1986;14:191–194.
312. Hustu HO, Aur RJ, Verzosa MS, et al. Prevention of central nervous system leukemia by irradiation. *Cancer* 1973;32:585–597.
313. Simone J, Aur RJ, Hustu HO, Pinkel D. "Total therapy" studies of acute lymphocytic leukemia in

children. Current results and prospects for cure. *Cancer* 1972;30:1488-1494.

314. Simone JV, Aur RJ, Hustu HO, et al. Combined modality therapy of acute lymphocytic leukemia. *Cancer* 1975;35:25-35.

315. Green DM, Freeman AI, Sather HN, et al. Comparison of three methods of central-nervous-system prophylaxis in childhood acute lymphoblastic leukemia. *Lancet* 1980;1:1398-1402.

316. Nesbit ME, Robison LL, Littman PS, et al. Presymptomatic central nervous system therapy in previously untreated childhood acute lymphoblastic leukaemia: comparison of 1800 rad and 2400 rad. A report for Children's Cancer Study Group. *Lancet* 1981;8218:461-466.

317. Bleyer WA, Coccia PF, Sather HN, et al. Reduction in central nervous system leukemia with a pharmacokinetically derived intrathecal methotrexate dosage regimen. *J Clin Oncol* 1983;1:317-325.

318. Stehbens JA, Kaleita TA, Noll RB, et al. CNS prophylaxis of childhood leukemia: what are the long-term neurological, neuropsychological, and behavioral effects? *Neuropsychol Rev* 1991;2:147-177.

319. Jankovic M, Brouwers P, Valsecchi MG, et al. Association of 1800 cGy cranial irradiation with intellectual function in children with acute lymphoblastic leukaemia. ISPAAC. International Study Group on Psychosocial Aspects of Childhood Cancer [see comments]. *Lancet* 1994;344:224-227.

320. Neglia JP, Meadows AT, Robison LL, et al. Second neoplasms after acute lymphoblastic leukemia in childhood. *N Engl J Med* 1991;325:1330-1336.

321. Sullivan MP, Chen T, Dyment PG, et al. Equivalence of intrathecal chemotherapy and radiotherapy as central nervous system prophylaxis in children with acute lymphatic leukemia: a Pediatric Oncology Group study. *Blood* 1982;60:948-958.

322. Bleyer WA, Sather HN, Nickerson HJ, et al. Monthly pulses of vincristine and prednisone prevent bone marrow and testicular relapse in low-risk childhood acute lymphoblastic leukemia: a report of the CCG-161 study by the Children's Cancer Study Group. *J Clin Oncol* 1991;9:1012-1021.

323. Pullen J, Boyett J, Shuster J, et al. Extended triple intrathecal chemotherapy trial for prevention of CNS relapse in good-risk and poor-risk patients with B-progenitor acute lymphoblastic leukemia: a Pediatric Oncology Group study. *J Clin Oncol* 1993;11:839-849.

324. Tubergen DG, Gilchrist GS, O'Brien RT, et al. Prevention of CNS disease in intermediate-risk acute lymphoblastic leukemia: comparison of cranial radiation and intrathecal methotrexate and the importance of systemic therapy: a Children's Cancer Group report. *J Clin Oncol* 1993;11:520-526.

325. Conter V, Arico M, Valsecchi MG, et al. Extended intrathecal methotrexate may replace cranial irradiation for prevention of CNS relapse in children with intermediate-risk acute lymphoblastic leukemia treated with Berlin-Frankfurt-Munster-based intensive chemotherapy. *The Associazione Italiana di Ematologia ed Oncologia Pediatrica* [see comments]. *Comment in: SS J Clin Oncol* 1995 Oct;13(10):2480-2482. *J Clin Oncol* 1995;13:2497-2502.

326. Nachman J, Sather HN, Cherlow JM, et al. Response of children with high-risk acute lymphoblastic leukemia treated with and without cranial irradiation: a report from the Children's Cancer Group. *J Clin Oncol* 1998;16:920-930.

327. Poplack D, Reaman G, Bleyer W, et al. Central nervous system (CNS) preventive therapy with high dose methotrexate (HDMTX) in children with high risk acute lymphoblastic leukemia (ALL): a preliminary report. *Proc Am Soc Clin Oncol* 1984;3:204.

328. Poplack D, Reaman G, Bleyer W, et al. Successful prevention of central nervous system (CNS) leukemia without cranial radiation in children with high risk acute lymphoblastic leukemia (ALL): a preliminary report. *Proc Am Soc Clin Oncol* 1989;8:213.

329. Cherlow JM, Sather H, Steinherz P, et al. Craniospinal irradiation for acute lymphoblastic leukemia with central nervous system disease at diagnosis: a report from the Children's Cancer Group [see comments]. *Int J Radiat Oncol Biol Phys* 1996;36:19-27.

330. Nachman J, Sather HN, Cherlow JM, et al. Response of children with high-risk acute lymphoblastic

leukemia treated with and without cranial irradiation: a report from the Children's Cancer Group. *J Clin Oncol* 1998;16:920-930.

331. Stork L, Sather H, Hutchinson R, et al. Comparison of mercaptopurine (MP) with thioguanine (TG) and IT methotrexate (ITM) with IT "Triples" in children with SR-ALL: results of CCG-1952. *Blood* 2002;100:156a.

332. Freeman AI, Weinberg V, Brecher ML, et al. Comparison of intermediate-dose methotrexate with cranial irradiation for the post-induction treatment of acute lymphocytic leukemia in children. *N Engl J Med* 1983;308:477-484.

333. Brecher ML, Weinberg V, Boyett JM, et al. Intermediate dose methotrexate in childhood acute lymphoblastic leukemia resulting in decreased incidence of testicular relapse. *Cancer* 1986;58:1024-1028.

334. Janka GE, Winkler K, Juergens H, Goebel U. early intensification therapy in high-risk childhood acute lymphocytic leukemia: lack of benefit from high-dose methotrexate. *Hamatol Bluttransfus* 1987;30:456-460.

335. Abromowitch M, Ochs J, Pui CH, et al. High-dose methotrexate improves clinical outcome in children with acute lymphoblastic leukemia: St. Jude Total Therapy Study X. *Med Pediatr Oncol* 1988;16:297-303.

336. Abromowitch M, Ochs J, Pui CH, et al. Efficacy of high-dose methotrexate in childhood acute lymphocytic leukemia: analysis by contemporary risk classifications. *Blood* 1988;71:866-869.

337. Schrappe M, Reiter A, Sauter S, et al. Concept and interim results of the ALL-BFM 90 therapy study in treatment of acute lymphoblastic leukemia in children and adolescents: the significance of initial therapy response in blood and bone marrow. *Klin Padiatr* 1994;206:208-221.

338. Lange BJ, Blatt J, Sather HN, Meadows AT. Randomized comparison of moderate-dose methotrexate infusions to oral methotrexate in children with intermediate risk acute lymphoblastic leukemia: a Children's Cancer Group study. *Med Pediatr Oncol* 1996;27:15-20.

339. Winick N, Shuster JJ, Bowman WP, et al. Intensive oral methotrexate protects against lymphoid marrow relapse in childhood B-precursor acute lymphoblastic leukemia [see comments]. Comment in: *SS J Clin Oncol* SS 1997 Aug;15(8):3024-3026. *J Clin Oncol* 1996;14:2803-2811.

340. Mahoney DH Jr., Shuster J, Nitschke R, et al. Intermediate-dose intravenous methotrexate with intravenous mercaptopurine is superior to repetitive low-dose oral methotrexate with intravenous mercaptopurine for children with lower-risk B-lineage acute lymphoblastic leukemia: a Pediatric Oncology Group phase III trial [see comments]. *J Clin Oncol* 1998;16:246-254.

341. Asselin B, Shuster J, Amylon M, et al. Improved event-free survival (EFS) with high dose methotrexate (HDM) in T-cell lymphoblastic leukemia and advanced lymphoblastic lymphoma (T-NHL): a Pediatric Oncology Group (POG) study. *Proc Am Soc Clin Oncol* 2001;20:367a.

342. Wehinger H, Gutjahr P, Hofweber K, et al. Randomisierte Studie zur Methotrexatapplikation in der Erhaltungstherapie der akuten lymphoblastischen Leukämie im Kindesalter. *Klin Padiatr* 1982;194:214-218.

343. Koizumi S, Fujimoto T, Takeda T, et al. Comparison of intermittent or continuous methotrexate plus 6-mercaptopurine in regimens for standard-risk acute lymphoblastic leukemia in childhood (JCCLSG-S811). The Japanese Children's Cancer and Leukemia Study Group. *Cancer* 1988;61:1292-1300.

344. Reiter A, Schrappe M, Ludwig WD, et al. Chemotherapy in 998 unselected childhood acute lymphoblastic leukemia patients. Results and conclusions of the multicenter trial ALL-BFM 86. *Blood* 1994;84:3122-3133.

345. Feickert HJ, Bettoni C, Schrappe M, et al. Event-free survival of children with T-cell acute lymphoblastic leukemia after introduction of high-dose methotrexate in multicenter trial ALL-BFM 86. Proceedings, annual meeting of the American Society of Clinical Oncology 1993;12:317(abst).

346. Hill F, Gibson B, Eden T, Richards S. Comparison of high dose methotrexate with continuing intrathecal methotrexate versus intrathecal methotrexate alone in low white blood count childhood acute lymphoblastic leukemia: preliminary results from the UKALLXI randomized trial. *Blood* 1998; 92[Suppl 1]:398a.

- 346a. Leblanc T, Auclerc M-F, Landman-Parker J, et al. Impact of HD-MTX on the outcome of children with intermediate-risk ALL: results from the FRALLE93: a randomized study. *Blood* 1998;92(Suppl 1):399a.
- 346b. Leblanc T, Auclerc M, Landman-Parker J, et al. High-dose methotrexate (8 g/m<sup>2</sup>) is beneficial to children with standard-risk acute lymphoblastic leukemia treated with daunorubicin. A result from the FRALLE 93B randomized study. *Blood* 2000;96:466a.
347. Jurgens H, Janka G, Ibrahim M, et al. Prognostic significance of exposure to intermediate dose methotrexate in children with standard risk ALL: the COALL 82/85 experience. *Haematol Blood Transfus* 1992;34:338-342.
348. Winick NJ, Bowman WP, Kamen BA, et al. Unexpected acute neurologic toxicity in the treatment of children with acute lymphoblastic leukemia. *J Natl Cancer Inst* 1992;84:252-256.
349. Mahoney DH Jr, Shuster JJ, Nitschke R, et al. Acute neurotoxicity in children with B-precursor acute lymphoid leukemia: an association with intermediate-dose intravenous methotrexate and intrathecal triple therapy—a Pediatric Oncology Group study. *J Clin Oncol* 1998;16:1712-1722.
350. Clavell LA, Gelber RD, Cohen HJ, et al. Four-agent induction and intensive asparaginase therapy for treatment of childhood acute lymphoblastic leukemia. *N Engl J Med* 1986;315:657-663.
351. Schorin MA, Blattner S, Gelber RD, et al. Treatment of childhood acute lymphoblastic leukemia: results of Dana-Farber Cancer Institute/Children's Hospital Acute Lymphoblastic Leukemia Consortium Protocol 85-01. *J Clin Oncol* 1994;12:740-747.
352. Rizzari C, Valsecchi MG, Arico M, et al. Effect of protracted high-dose L-asparaginase given as a second exposure in a Berlin-Frankfurt-Munster-based treatment: results of the randomized 9102 intermediate-risk childhood acute lymphoblastic leukemia study—a report from the Associazione Italiana Ematologia Oncologia Pediatrica. *J Clin Oncol* 2001;19:1297-1303.
353. Harris MB, Shuster JJ, Pullen DJ, et al. Consolidation therapy with antimetabolite-based therapy in standard-risk acute lymphocytic leukemia of childhood: a Pediatric Oncology Group study. *J Clin Oncol* 1998;16:2840-2847.
354. Amylon M, Shuster J, Pullen J, et al. Intensive high-dose asparaginase consolidation improves survival for pediatric patients with T cell acute lymphoblastic leukemia: a Pediatric Oncology Group study. *Leukemia* 1999;13:335-342.
355. Riehm H, Langermann HJ, Gadner H, et al. The Berlin Childhood Acute Lymphoblastic Leukemia Therapy Study, 1970-1976. *Am J Pediatr Hematol Oncol* 1980;2:299-306.
356. Henze G, Langermann HJ, Bramswig J, et al. The BFM 76/79 acute lymphoblastic leukemia therapy study. *Klin Padiatr* 1981;193:145-154.
357. Gaynon PS, Steinherz PG, Bleyer WA, et al. Intensive therapy for children with acute lymphoblastic leukaemia and unfavourable presenting features. Early conclusions of study CCG-106 by the Children's Cancer Study Group. *Lancet* 1988;2:921-924.
358. Gaynon PS, Steinherz PG, Bleyer WA, et al. Improved therapy for children with acute lymphoblastic leukemia and unfavorable presenting features: a follow-up report of the Children's Cancer Group Study CCG-106. *J Clin Oncol* 1993;11:2234-2242.
359. Steinherz P, Gaynon P, Breneman J, et al. Treatment of acute lymphoblastic leukemia with bulky extramedullary disease and T-cell phenotype or other poor prognostic features: randomized control trial from the Children's Cancer Group. *Cancer* 1998;82:600-612.
360. Henze G, Fengler R, Reiter A, et al. Impact of early intensive reinduction therapy on event-free survival in children with low-risk acute lymphoblastic leukemia. *Hamatol Bluttransfus* 1990;33:483-488.
361. Hutchinson R, Neerhout R, Bertolone S, et al. Should therapy be intensified for patients with good risk ALL? *Blood* 1996;88:668a.
362. Capizzi R. Schedule-dependent synergism and antagonism between methotrexate and asparaginase.

Biochem Pharmacol 1974;23[Suppl 2]:151.

363. Baum E, Nachman J, Ramsay N, et al. Prolonged second remissions in childhood acute lymphocytic leukemia: a report from the Children's Cancer Study Group. *Med Pediatr Oncol* 1983;11:1-7.

364. Nachman JB, Sather HN, Sensel MG, et al. Augmented post-induction therapy for children with high-risk acute lymphoblastic leukemia and a slow response to initial therapy. *N Engl J Med* 1998;338:1663-1671.

365. Stork L, Sather H, Nachman J, et al. Intensive therapy 'rescues' children with standard risk ALL (SR-ALL) and slow early response to induction: CCG-1952 results. *Blood* 2000;96:466a(abst).

366. Lange B, Bostrom B, JM C, et al. Double-delayed intensification improves event free survival for children with intermediate-risk acute lymphoblastic leukemia: a report from the Children's Cancer Group. *Blood* 2002;99:825-833.

366a. Arico M, Valsecchi MG, Conter V, et al. Improved outcome in high-risk childhood acute lymphoblastic leukemia defined by prednisone-poor response treated with double Berlin-Frankfurt-Muenster protocol II. *Blood* 2002;100:420-426.

367. Group CAC. Duration and intensity of maintenance chemotherapy in acute lymphoblastic leukaemia: overview of 42 trials involving 12,000 randomized children. *Lancet* 1996;347:1783-1788.

368. Simone J. Childhood leukemia as a model for cancer research: the Richard and Hilda Rosenthal Foundation Award Lecture. *Cancer* 1979;39:4301-4307.

369. van Eys J, Berry D, Crist W, et al. Treatment intensity and outcome for children with acute lymphocytic leukemia of standard risk: a Pediatric Oncology Group study. *Cancer* 1989;63:1466-1471.

370. Chessells J, Leiper A, Tiedemann K, et al. Oral methotrexate is as effective as intramuscular methotrexate in maintenance therapy of acute lymphoblastic leukaemia. *Arch Dis Child* 1987;62:172-176.

371. Steinherz PG, Gaynon P, Miller DR, et al. Improved disease-free survival of children with acute lymphoblastic leukemia at high risk for early relapse with the New York regimen—a new intensive therapy protocol: a report from the Children's Cancer Study Group. *J Clin Oncol* 1986;4:744-752.

372. Steinherz PG, Redner A, Steinherz L, et al. Development of a new intensive therapy for acute lymphoblastic leukemia in children at increased risk of early relapse. The Memorial Sloan-Kettering-New York-II protocol. *Cancer* 1993;72:3120-3130.

373. Zimm S, Collins J, Riccardi R, et al. Variable bioavailability of oral mercaptopurine. *N Engl J Med* 1983;308:1005-1009.

374. Bostrom B, Erdmann GR. Association of relapse with mercaptopurine (6MP) cellular pharmacokinetics (CPK) in children with acute lymphoblastic leukemia (ALL) (meeting abstract). *Proc Am Soc Clin Oncol* 1992;11.

375. Lilleyman JS, Lennard L. Mercaptopurine metabolism and risk of relapse in childhood lymphoblastic leukaemia. *Lancet* 1994;343:1188-1190.

376. Camitta B, Leventhal B, Lauer S, et al. Intermediate-dose intravenous methotrexate and mercaptopurine therapy for non-T, non-B acute lymphocytic leukemia of childhood: a Pediatric Oncology Group study [see comments]. *J Clin Oncol* 1989;7:1539-1544.

377. Lennard L, Davies HA, Lilleyman JS. Is 6-thioguanine more appropriate than 6-mercaptopurine for children with acute lymphoblastic leukaemia? *Br J Cancer* 1993;68:186-190.

378. Janka-Schaub G, Erb N, Harms D. Randomized comparison of 6-mercaptopurine (6-MP) vs. 6-thioguanine (6-TG) in maintenance treatment of childhood acute lymphoblastic leukemia (ALL): differing metabolism and hematologic toxicity. *Med Pediatr Oncol* 1994;23:197.

379. Adamson PC, Poplack DG, Balis FM. The cytotoxicity of thioguanine vs mercaptopurine in acute lymphoblastic leukemia [see comments]. *Leuk Res* 1994;18:805-810.

380. Zimm S, Ettinger L, Holcenberg J, et al. Phase I and clinical pharmacological study of mercaptopurine administered as a prolonged intravenous infusion. *Cancer Res* 1985;45:1869–1873.
381. Adamson P, Zimm S, Ragab A, et al. A phase II trial of continuous-infusion 6-mercaptopurine for childhood leukemia. *Cancer Chemother Pharmacol* 1992;30:155–157.
382. Vilmer E, Suci S, Ferster A, et al. Long-term results of three randomized trials (58831, 58832, 58881) in childhood acute lymphoblastic leukemia: a CLCG-EORTC report. *Children Leukemia Cooperative Group. Leukemia* 2000;14:2257–2266.
383. Janka G, Harms D, Escherich G, et al. Thioguanine offers no advantage over mercaptopurine in maintenance therapy (MT) of childhood ALL. *Med Pediatr Oncol* 1999;33:217.
384. Riehm H, Gadner H, Henze G, et al. Results and significance of six randomized trials in four consecutive ALL-BFM studies. *Hamatol Bluttransfus* 1990;33:439–450.
385. Miller RW, Young JL Jr, Novakovic B. Childhood cancer. *Cancer* 1995;75: 395–405.
386. Parker SL, Tong T, Bolden S, Wingo PA. Cancer statistics, 1997. *CA Cancer J Clin* 1997;47:5–27.
387. Gurney JG, Severson RK, Davis S, Robison LL. Incidence of cancer in children in the United States. Sex-, race-, and 1-year age-specific rates by histologic type. *Cancer* 1995;75:2186–2195.
388. Gaynon P, Qu R, Chappell R, et al. Survival after relapse in childhood acute lymphoblastic leukemia: impact of site and time to first relapse, the Children's Cancer Group experience. *Cancer* 1998;82:1387–1395.
389. Chessells JM. Relapsed lymphoblastic leukaemia in children: a continuing challenge. *Br J Haematol* 1998;102:423–438.
390. Bunin NJ, Pui CH, Hustu HO, Rivera GK. Unusual extramedullary relapses in children with acute lymphoblastic leukemia. *J Pediatr* 1986;109:665–668.
391. Buhner C, Hartmann R, Fengler R, et al. Superior prognosis in combined compared to isolated bone marrow relapses in salvage therapy of childhood acute lymphoblastic leukemia. *Med Pediatr Oncol* 1993;21:470–476.
392. Wheeler K, Leiper A, Jannoun L, Chessells J. Medical cost of curing childhood acute lymphoblastic leukaemia. *Br Med J* 1988;296:162–166.
393. Feig SA, Ames MM, Sather HN, et al. Comparison of idarubicin to daunomycin in a randomized multidrug treatment of childhood acute lymphoblastic leukemia at first bone marrow relapse: a report from the Children's Cancer Group. *Med Pediatr Oncol* 1996;27:505–514.
394. Gaynon P, Harris R, Stram D, et al. Asparagine (ASN) depletion and treatment response in childhood acute lymphoblastic leukemia (ALL) after an early marrow relapse: a children's Cancer Group trial (CCG-1941). *Blood* 1999;94:628a.
395. Leahey AM, Bunin NJ, Belasco JB, et al. Novel multiagent chemotherapy for bone marrow relapse of pediatric acute lymphoblastic leukemia. *Med Pediatr Oncol* 2000;34:313–318.
396. Henze G, Fengler R, Haertmann R, et al. Six-year experience with a comprehensive approach to the treatment of recurrent childhood acute lymphoblastic leukemia (ALL-REZ BFM 85). A relapse study of the BFM Group. *Blood* 1991;78:1166–1172.
397. Chessells JM, Leiper AD, Richards SM. A second course of treatment for childhood acute lymphoblastic leukaemia: long-term follow-up is needed to assess results. *Br J Haematol* 1994;86:48–54.
398. Giona F, Testi AM, Annino L, et al. Treatment of primary refractory and relapsed acute lymphoblastic leukaemia in children and adults: the GIMEMA/AIEOP experience. Gruppo Italiano Malattie Ematologiche Maligne dell'Adulto. Associazione Italiana Ematologia ed Oncologia Pediatrica. *Br J Haematol* 1994;86:55–61.

399. Buhner C, Hartmann R, Fengler R, et al. Importance of effective central nervous system therapy in isolated bone marrow relapse of childhood acute lymphoblastic leukemia. BFM (Berlin–Frankfurt–Munster) Relapse Study Group. *Blood* 1994;83:3468–3472.
400. Lawson SE, Harrison G, Richards S, et al. The UK experience in treating relapsed childhood acute lymphoblastic leukaemia: a report on the medical research council UKALLR1 study. *Br J Haematol* 2000;108:531–543.
401. Rivera GK, Hudson MM, Liu Q, et al. Effectiveness of intensified rotational combination chemotherapy for late hematologic relapse of childhood acute lymphoblastic leukemia. *Blood* 1996;88:831–837.
402. Klumper E, Pieters R, Veerman AJ, et al. In vitro cellular drug resistance in children with relapsed/refractory acute lymphoblastic leukemia. *Blood* 1995;86:3861–3868.
403. Marks DI, Kurz BW, Link MP, et al. Altered expression of p53 and mdm-2 proteins at diagnosis is associated with early treatment failure in childhood acute lymphoblastic leukemia. *J Clin Oncol* 1997;15:1158–1162.
404. Diccianni MB, Yu J, Hsiao M, et al. Clinical significance of p53 mutations in relapsed T-cell acute lymphoblastic leukemia. *Blood* 1994;84:3105–112.
405. Kawamura M, Kikuchi A, Kobayashi S, et al. Mutations of the p53 and ras genes in childhood t(1;19)-acute lymphoblastic leukemia. *Blood* 1995;85:2546–2552.
406. Zhou M, Gu L, Abshire TC, et al. Incidence and prognostic significance of MDM2 oncoprotein overexpression in relapsed childhood acute lymphoblastic leukemia. *Leukemia* 2000;14:61–67.
407. Harris C. Structure and function of the p53 tumor suppressor gene: clues for rationale cancer therapeutic strategies. *J Natl Cancer Inst* 1996;88:1442–1445.
408. Baum E, Heyn R, Nesbit M, et al. Occult abdominal involvement with apparently isolated testicular relapse in children with acute lymphocytic leukemia. *Am J Pediatr Hematol Oncol* 1984;6:343–346.
409. Goulden N, Langlands K, Steward C, et al. PCR assessment of bone marrow status in ‘isolated’ extramedullary relapse of childhood B-precursor acute lymphoblastic leukaemia. *Br J Haematol* 1994;87:282–285.
410. Neale GA, Pui CH, Mahmoud HH, et al. Molecular evidence for minimal residual bone marrow disease in children with ‘isolated’ extra-medullary relapse of T-cell acute lymphoblastic leukemia. *Leukemia* 1994;8:768–775.
411. Murray JC, Gmoser DJ, Barnes DA, et al. Isolated bone relapse during hematologic remission in childhood acute lymphoblastic leukemia: report of a metatarsal relapse and review of the literature. *Med Pediatr Oncol* 1994;23:153–157.
412. Sullivan M, Moon T, Trueworthy R, et al. Combination intrathecal therapy for meningeal leukemia: two versus three drugs. *Blood* 1977;50:471–479.
413. Land V, Thomas P, Boyett J, et al. Comparison of maintenance treatments for first central nervous system relapse in children with acute lymphocytic leukemia. *Cancer* 1985;56:81–87.
414. Winick NJ, Smith SD, Shuster J, et al. Treatment of CNS relapse in children with acute lymphoblastic leukemia: a Pediatric Oncology Group study [see comments]. Comment in: *SS J Clin Oncol* 1993 Nov;11(11):2286. *J Clin Oncol* 1993;11:271–278.
415. Ritchey A, Pollack B, Lauer S, et al. Improved survival of children with isolated CNS relapse of acute lymphoblastic leukemia: a Pediatric Oncology Group study. *J Clin Oncol* 1999;17:3745–3752.
416. Ribeiro RC, Rivera GK, Hudson M, et al. An intensive re-treatment protocol for children with an isolated CNS relapse of acute lymphoblastic leukemia. *J Clin Oncol* 1995;13:333–338.
417. Steinherz P, Jereb B, Galicich J. Therapy of CNS leukemia with intraventricular chemotherapy and



low-dose neuraxis radiotherapy. *J Clin Oncol* 1985;3:1217-1226.

418. Mulhern RK, Ochs J, Fairclough D, et al. Intellectual and academic achievement status after CNS relapse: a retrospective analysis of 40 children treated for acute lymphoblastic leukemia. *J Clin Oncol* 1987;5:933-940.

419. Russo A, Schiliro G. The enigma of testicular leukemia: a critical review. *Med Pediatr Oncol* 1986;14:300-305.

420. Miller DR, Leikin SL, Albo VC, et al. The prognostic value of testicular biopsy in childhood acute lymphoblastic leukemia: a report from the Children's Cancer Study Group. *J Clin Oncol* 1990;8:57-66.

421. Nachman J, Palmer NF, Sather HN, et al. Open-wedge testicular biopsy in childhood acute lymphoblastic leukemia after two years of maintenance therapy: diagnostic accuracy and influence on outcome—a report from Children's Cancer Study Group. *Blood* 1990;75:1051-1055.

422. Steinherz P, Redner A, Steinherz L, et al. Intensive therapy for acute lymphoblastic leukemia (ALL) in children at increased risk of early relapse: the MSK-NY-II protocol. Proceedings, annual meeting of the Am Soc Clin Oncol 1993;12:A1047(abst).

423. Gaynon PS, Bleyer WA, Steinherz PG, et al. Modified BFM therapy for children with previously untreated acute lymphoblastic leukemia and unfavorable prognostic features. Report of Children's Cancer Study Group study CCG-193p. *Am J Pediatr Hematol Oncol* 1988;10:42-50.

424. Finklestein JZ, Miller DR, Feusner J, et al. Treatment of overt isolated testicular relapse in children on therapy for acute lymphoblastic leukemia. A report from the Children's Cancer Group. *Cancer* 1994;73:219-223.

425. Buchanan GR, Boyett JM, Pollock BH, et al. Improved treatment results in boys with overt testicular relapse during or shortly after initial therapy for acute lymphoblastic leukemia. A Pediatric Oncology Group study. *Cancer* 1991;68:48-55.

426. Wofford MM, Smith SD, Shuster JJ, et al. Treatment of occult or late overt testicular relapse in children with acute lymphoblastic leukemia: a Pediatric Oncology Group study. *J Clin Oncol* 1992;10:624-630.

427. Sklar CA, Robison LL, Nesbit ME, et al. Effects of radiation on testicular function in long-term survivors of childhood acute lymphoblastic leukemia: a report from the Children Cancer Study Group. *J Clin Oncol* 1990;8:1981-1987.

428. Takaue Y, Watanabe A, Murakami T, et al. High-dose chemotherapy and blood stem cell autografts for children with first relapsed acute lymphoblastic leukemia: a pilot study of the Children's Cancer and Leukemia Study Group of Japan (CCLSG). *Med Pediatr Oncol* 1994;23:20-25.

429. Borgmann A, Schmid H, Hartmann R, et al. Autologous bone-marrow transplants compared with chemotherapy for children with acute lymphoblastic leukaemia in a second remission: a matched-pair analysis. The Berlin-Frankfurt-Munster Study Group. *Lancet* 1995;346:873-876.

430. Parsons SK, Castellino SM, Lehmann LE, et al. Relapsed acute lymphoblastic leukemia: similar outcomes for autologous and allogeneic marrow transplantation in selected children. *Bone Marrow Transplant* 1996;17:763-768.

431. Kernan NA, Bartsch G, Ash RC, et al. Analysis of 462 transplantations from unrelated donors facilitated by the National Marrow Donor Program. *N Engl J Med* 1993;328:593-602.

432. Balduzzi A, Gooley T, Anasetti C, et al. Unrelated donor marrow transplantation in children. *Blood* 1995;86:3247-3256.

433. Casper J, Gamitta B, Truitt R, et al. Unrelated bone marrow donor transplants for children with leukemia or myelodysplasia. *Blood* 1995;85:2354-2363.

434. Kurtzberg J. State of the art in umbilical cord transplantation. *Oncology (Huntingt)* 1996;10:1086, 1091.

435. Kurtzberg J, Martin P, Chao N, et al. Unrelated placental blood in marrow transplantation. *Stem Cells* 2000;18:153–154.
436. Handgretinger R, Lang P, Schumm M, et al. Immunological aspects of haploidentical stem cell transplantation in children. *Ann N Y Acad Sci* 2001;938:340–57; discussion 357–358.
437. Cox DR. Regression models and life tables. *J R Stat Soc B* 1972;34:187–220.
438. Breslow N. Analysis of survival data under the proportional hazards model. *Int Stat Rev* 1975;43:45–58.
439. Proctor SJ. Acute lymphoblastic leukaemia in adults: the case for a strategic shift in study approach. *Br J Haematol* 1994;88:229–233.
440. Wheeler KA, Richards SM, Bailey CC, et al. Bone marrow transplantation versus chemotherapy in the treatment of very high-risk childhood acute lymphoblastic leukemia in first remission: results from Medical Research Council UKALL X and XI. *Blood* 2000;96:2412–2418.
441. Uderzo C, Balduzzi A. Allogeneic bone marrow transplantation versus chemotherapy in childhood very high risk acute lymphoblastic leukemia in first complete remission: a controversial issue. *Haematologica* 2002;87:47–50.
442. Uderzo C, Balduzzi A, De Lorenzo P, et al. Prospective study on allogeneic bone marrow transplantation (allo BMT) versus chemotherapy (chemo) for very high-risk (VHR) childhood acute lymphoblastic leukemia in first complete remission. *Bone Marrow Transplant* 2001;28:S22–24.
443. Barrett AJ, Horowitz MM, Pollock BH, et al. Bone marrow transplants from HLA-identical siblings as compared with chemotherapy for children with acute lymphoblastic leukemia in a second remission. *N Engl J Med* 1994;331:1253–1258.
444. Dopfer R, Henze G, Bender-Gotze C, et al. Allogeneic bone marrow transplantation for childhood acute lymphoblastic leukemia in second remission after intensive primary and relapse therapy according to the BFM- and CoALL-protocols: results of the German Cooperative Study. *Blood* 1991;78:2780–2784.
445. Uderzo C, Valsecchi MG, Bacigalupo A, et al. Treatment of childhood acute lymphoblastic leukemia in second remission with allogeneic bone marrow transplantation and chemotherapy: ten-year experience of the Italian Bone Marrow Transplantation Group and the Italian Pediatric Hematology Oncology Association. *J Clin Oncol* 1995;13:352–358.
446. Hoogerbrugge PM, Gerritsen EJ, vd Does-van den Berg A, et al. Case-control analysis of allogeneic bone marrow transplantation versus maintenance chemotherapy for relapsed ALL in children. *Bone Marrow Transplant* 1995;15:255–259.
447. Wheeler K, Richards S, Bailey C, Chessells J. Comparison of bone marrow transplant and chemotherapy for relapsed childhood acute lymphoblastic leukaemia: the MRC UKALL X experience. Medical Research Council Working Party on Childhood Leukaemia. *Br J Haematol* 1998;101:94–103.
448. Harrison G, Richards S, Lawson S, et al. Comparison of allogeneic transplant versus chemotherapy for relapsed childhood acute lymphoblastic leukaemia in the MRC UKALL R1 trial. *Ann Oncol* 2000;11:999–1006.
449. Gaynon P, Harris R, Trigg M, Stram D. Chemotherapy (CT) vs BMT for children (pts) with acute lymphoblastic leukemia (ALL) and early marrow relapse (MR):CCG-1941. *Blood* 2000;96:418a.
450. Knechtli CJ, Goulden NJ, Hancock JP, et al. Minimal residual disease status as a predictor of relapse after allogeneic bone marrow transplantation for children with acute lymphoblastic leukaemia. *Br J Haematol* 1998;102:860–871.
451. Eckert C, Biondi A, Seeger R, et al. Prognostic value of minimal residual disease in relapsed childhood acute lymphoblastic leukaemia. *Lancet* 2001;358:1239–1241.
452. Davies SM, Ramsay NK, Klein JP, et al. Comparison of preparative regimens in transplants for

children with acute lymphoblastic leukemia. *J Clin Oncol* 2000;18:340–347.

453. Weisdorf DJ, Woods WG, Nesbit ME Jr, et al. Allogeneic bone marrow transplantation for acute lymphoblastic leukaemia: risk factors and clinical outcome. *Br J Haematol* 1994;86:62–69.

454. Locatelli F, Zecca M, Rondelli R, et al. Graft versus host disease prophylaxis with low-dose cyclosporine-A reduces the risk of relapse in children with acute leukemia given HLA-identical sibling bone marrow transplantation: results of a randomized trial. *Blood* 2000;95:1572–1579.

455. Coiffier B, Lepage E, Briere J, et al. CHOP chemotherapy plus rituximab compared with CHOP alone in elderly patients with diffuse large-B-cell lymphoma. *N Engl J Med* 2002;346:235–242.

456. Cheson BD. Rituximab: clinical development and future directions. *Expert Opin Biol Ther* 2002;2:97–110.

457. Kreitman RJ, Wilson WH, Bergeron K, et al. Efficacy of the anti-CD22 recombinant immunotoxin BL22 in chemotherapy-resistant hairy-cell leukemia. *N Engl J Med* 2001;345:241–247.

458. Feeny D, Furlong W, Barr R, et al. A comprehensive multiattribute system for classifying the health status of survivors of childhood cancer. *J Clin Oncol* 1992;10:923–928.

459. Barr R, Furlong W, Dawson S, et al. An assessment of the global health status in survivors of acute lymphoblastic leukemia in childhood. *Am J Pediatr Hematol Oncol* 1993;15:284–290.

460. Feeny D, Leiper A, Barr R, et al. The comprehensive assessment of health status in survivors of childhood cancer: application to high-risk acute lymphoblastic leukemia. *Br J Cancer* 1993;67:1047–1053.

461. Kaleita TA, Reaman GH, MacLean WE, et al. Neurodevelopmental outcome of infants with acute lymphoblastic leukemia: a Children's Cancer Group report. *Cancer* 1999;85:1859–1865.

462. Brouwers P, Moss H, Reaman G, et al. Central nervous system preventive therapy with systemic high dose methotrexate versus cranial radiation and intrathecal methotrexate: longitudinal comparison of effects of treatment on intellectual function of children with acute lymphoblastic leukemia. *Proc Am Soc Clin Oncol* 1987;6:158.

463. Mulhern R, Fairclough D, Ochs J. A prospective comparison of neuropsychologic performance of children surviving leukemia who received 18-Gy, 24-Gy, or no cranial irradiation. *J Clin Oncol* 1991;9:1348–1356.

464. Ochs J, Mulhern R, Fairclough D, et al. Comparison of neuropsychological functioning and clinical indicators of neurotoxicity in long-term survivors of childhood leukemia given cranial radiation or parenteral methotrexate: a prospective study. *J Clin Oncol* 1991;9:145–151.

465. Mulhern RK, Wasserman AL, Fairclough D, Ochs J. Memory function in disease-free survivors of childhood acute lymphocytic leukemia given CNS prophylaxis with or without 1,800 cGy cranial irradiation. *J Clin Oncol* 1988;6:315–320.

466. Waber DP, Carpentieri SC, Klar N, et al. Cognitive sequelae in children treated for acute lymphoblastic leukemia with dexamethasone or prednisone. *J Pediatr Hematol Oncol* 2000;22:206–213.

467. Haupt R, Fears T, Robison L, et al. Educational attainment in long-term survivors of childhood acute lymphoblastic leukemia. *JAMA* 1994;272:1427–1432.

468. Bhatia S, Sather HN, Pabustan OB, et al. Low incidence of second neoplasms among children diagnosed with acute lymphoblastic leukemia after 1983. *Blood* 2002;99:4257–4264.

469. Pui C, Ribeiro R, Hancock M, et al. Acute myeloid leukemia in children treated with epipodophyllotoxins for acute lymphoblastic leukemia. *N Engl J Med* 1991;325:1882–1887.

470. Winick N, Buchanan GR, Kamen BA. Secondary acute myeloid leukemia in Hispanic children. *J Clin Oncol* 1993;11:1433.

471. Katz JA, Shuster JJ, Ravindranath Y, et al. Secondary acute myelogenous leukemia (AML) following intensive treatment for childhood T-cell acute lymphoblastic leukemia (T-ALL) and advanced stage

lymphoblastic lymphoma (LL) treated with teniposide (VM-26): a Pediatric Oncology Group (POG) study. Proceedings of the annual meeting of Am Soc Clin Oncol 1995;14:A1040(abst).

472. Ojala AE, Lanning FP, Paakko E, Lanning BM. Osteonecrosis in children treated for acute lymphoblastic leukemia: a magnetic resonance imaging study after treatment. *Med Pediatr Oncol* 1997;29:260-265.

473. Korholz D, Bruder M, Engelbrecht V, et al. Aseptic osteonecrosis in children with acute lymphoblastic leukemia. *Pediatr Hematol Oncol* 1998;15:307-315.

474. Mattano LA Jr., Sather HN, Trigg ME, Nachman JB. Osteonecrosis as a complication of treating acute lymphoblastic leukemia in children: a report from the Children's Cancer Group. *J Clin Oncol* 2000;18:3262-3272.

475. Lipshultz S, Colan S, Gelber R, et al. Late cardiac effects of doxorubicin therapy for acute lymphoblastic leukemia in childhood. *N Engl J Med* 1991;324:808-815.

476. Quigley C, Cowell C, Jimenez M, et al. Normal or early development of puberty despite gonadal damage in children treated for acute lymphoblastic leukemia. *N Engl J Med* 1989;321:143-151.

477. Leiper AD, Stanhope R, Preece MA, et al. Precocious or early puberty and growth failure in girls treated for acute lymphoblastic leukaemia. *Horm Res* 1988;30:72-76.

478. Schriock EA, Schell MJ, Carter M, et al. Abnormal growth patterns and adult short stature in 115 long-term survivors of childhood leukemia. *J Clin Oncol* 1991;9:400-405.

479. Rappaport R, Brauner R. Growth and endocrine disorders secondary to cranial irradiation. *Pediatr Res* 1989;25:561-567.

480. Leung W, Rose SR, Zhou Y, et al. Outcomes of growth hormone replacement therapy in survivors of childhood acute lymphoblastic leukemia. *J Clin Oncol* 2002;20:2959-2964.

481. Sklar CA, Mertens AC, Mitby P, et al. Risk of disease recurrence and second neoplasms in survivors of childhood cancer treated with growth hormone: a report from the Childhood Cancer Survivor Study. *J Clin Endocrinol Metab* 2002;87:3136-3141.

482. Hughes B, Cunliffe W, Bailey C. Excess benign melanocytic naevi after chemotherapy for malignancy in childhood. *Br Med J* 1989;299:88-91.

483. Baird E, McHenry P, MacKie R. Effect of maintenance chemotherapy in childhood on numbers of melanocytic naevi. *Br Med J* 1992;305:799-801.

484. Naldi L, Adamoli L, Donetella F, et al. Number and distribution of melanocytic nevi in individuals with a history of childhood leukemia. *Cancer* 1996;77:1402-1408.

485. Grob J, Gouvernet J, Aymar D, et al. Count of benign melanocytic nevi as a major indicator of risk for nonfamilial nodular and superficial spreading melanoma. *Cancer* 1990;66:387-395.

486. Garbe C, Buttner P, Weiss J, et al. Risk factors for developing cutaneous melanoma and criteria for identifying persons at risk: multicenter case-control study of the Central Malignant Melanoma Registry of the German Dermatological Society. *J Invest Dermatol* 1994;102:695-699.

2004 Lippincott Williams & Wilkins  
John P. Greer, John Foerster, John N. Lukens  
George M. Rodgers, Frixos Paraskevas, Bertil Glader  
Wintrobe's Clinical Hematology

[HISTORICAL BACKGROUND](#)[EPIDEMIOLOGY](#)[CELLULAR AND MOLECULAR ORIGINS OF ACUTE MYELOGENOUS LEUKEMIA: HEMATOPOIETIC HIERARCHIES](#)[PREDISPOSING FACTORS AND PATHOPHYSIOLOGY](#)[Inherited Predisposition Syndromes](#)[Acquired Predisposition](#)[PRESENTATION](#)[DIFFERENTIAL DIAGNOSIS](#)[ACUTE MYELOGENOUS LEUKEMIA SUBTYPES](#)[THERAPY FOR PATIENTS WITH NEWLY DIAGNOSED ACUTE MYELOGENOUS LEUKEMIA](#)[Background](#)[Induction Therapy](#)[Hematopoietic Stem Cell Transplantation](#)[Intensification and Maintenance Therapy](#)[Summary of De Novo Therapy](#)[THERAPY FOR PATIENTS WITH RELAPSED/REFRACTORY DISEASE](#)[SUPPORTIVE CARE](#)[LATE EFFECTS OF THERAPY](#)[MANAGEMENT OF PATIENTS WITH DOWN SYNDROME](#)[MANAGEMENT OF INFANTS WITH CONGENITAL ACUTE MYELOGENOUS LEUKEMIA](#)[MANAGEMENT OF ACUTE PROMYELOCYTIC LEUKEMIA](#)[MANAGEMENT OF PATIENTS WITH INHERITED SYNDROMES CHARACTERIZED BY DNA REPAIR DEFECTS OR CYTOPENIAS](#)[OR BOTH](#)[PROGNOSTIC FACTORS](#)[FUTURE THERAPEUTIC CHALLENGES](#)

## HISTORICAL BACKGROUND

Acute myelogenous leukemia (AML) represents a heterogeneous group of hematologic malignancies arising from the transformation and expansion of an early myeloid stem cell. The term *leukemia* originated from Virchow, who, in 1845, recognized a clinical entity characterized by too many white blood cells, leading him to name the condition *white blood*, or leukemia (<sup>1</sup>). Of some historical interest is that Dr. John Hughes Bennett's report of a case of leukemia preceded Virchow's description by approximately 6 weeks (<sup>1</sup>). However, Bennett had concluded that the condition was secondary to an infection and referred to it as *pyemia*. The term *myelogenous*, or *myeloia*, derives from the terms *myelos*, meaning marrow, and *genesis*, meaning birth.

The original cases of Virchow and Bennett probably represented what we now know to be either chronic lymphocytic or myelogenous leukemia. The first likely case of acute leukemia was reported by Friedreich and was believed to be lymphocytic (<sup>2</sup>). It would take the definition of the myeloblast as a precursor cell for granulocytes by Naegeli in 1900 to set the stage for the identification of the first cases of AML or what was originally termed *acute nonlymphocytic leukemia* (<sup>3</sup>). Even during the first half of the twentieth century, reports describing different types of myeloid leukemia made it clear that this was not one but a variety of distinct disorders, all deriving from a bone marrow precursor myeloblast. Initially, cases of monocytic leukemia were described followed by myelomonocytic leukemia (<sup>3, 4</sup>). Cases of erythroleukemia, megakaryoblastic leukemia,

and acute promyelocytic leukemia (APL) were subsequently described in 1917, 1931, and 1957, respectively ( [5](#), [6](#) and [7](#)). During the mid-1970s, the French/American/British (FAB) classification system was agreed on and defined the major categories of AML as M1 through M7 ( [8](#)).

The description and classification of AML moved more rapidly than the development of effective treatments. During the mid-1800s, Virchow used diet therapies, ferric iodide, and application of abdominal and foot baths ( [1](#)). In 1865, Lissauer used arsenic (Fowler solution) to treat patients with leukemia but with little success ( [1](#)). Radiation therapy was used in the late 1800s, mostly as a form of palliation for chronic leukemias ( [1](#)). In 1938, Forkner stated, “although leukemia is a fatal disease much can be done to add to the comfort, and promote the general health of sufferers from the chronic forms of the disease. Unfortunately acute leukemia does not respond satisfactorily to any form of treatment” ( [1](#)). In 1948, Farber demonstrated that the use of the antimetabolite aminopterin could produce transient remissions in children with acute lymphocytic leukemia (ALL) ( [9](#)). The pioneering work resulted in the National Cancer Institute developing screening programs for other possible antitumor therapies during the 1950s. During the 1960s, several chemotherapeutic agents, particularly cytarabine and anthracyclines, were developed and used in the treatment of AML. During the 1970s, clinical trials demonstrated that combining these two agents would result in long-term remissions for 10 to 15% of patients with AML. The subsequent introduction of more intensive remission induction regimens and postremission therapy increased attention to supportive concerns, and the development of bone marrow transplantation has led to current cure rates of approximately 50% ( [10](#), [11](#)).

This chapter focuses on AML in pediatric patients, with an emphasis on the development of clinical trials and outcomes and some of the unique types of AML observed during childhood, as well the issue of late effects and future directions. Information that is similar in both adults and children, such as the classification of *de novo* AML and cytogenetics, may be found in [Chapter 79](#).

## EPIDEMIOLOGY

Approximately 6500 children younger than 20 years of age develop acute leukemia annually in the United States, and AML represents approximately 15%, resulting in just fewer than 1000 cases/year ( [12](#)). The remaining cases of acute leukemia in children and adolescents are lymphoblastic leukemia. Essentially the opposite ratios exist for adults, with AML accounting for approximately 80% of acute leukemia and lymphoblastic the remaining 20%. SEER ( Surveillance, Epidemiology, and End Results) program data indicate that there has been no significant increase in AML in childhood over the past two decades ( [12](#)).

The incidence of AML in children remains stable during childhood, except for a slight increase during adolescence and a peak during the neonatal period ( [12](#)). The incidence of AML in adults continues to increase throughout life and particularly beyond 55 years of age, during which time secondary AML and myelodysplastic syndromes (MDSs) with evolution to AML both increase dramatically ( [12](#)). There does not appear to be a sex predilection.

Some variation in the incidence of AML in children has been reported among different racial and ethnic groups. For example, black children have an incidence of 5.8 cases/million compared to 4.8 cases/million in white children ( [13](#), [14](#)). Children of

Hispanic background have the highest incidence ( [15](#), [16](#), [17](#) and [18](#)). This difference is primarily due to APL having a higher incidence in Hispanic and Latin populations. A higher incidence of AML in Asia has also been reported ( [15](#)). The increasing incidence of secondary leukemia, resulting from chemotherapy and radiation treatment for other malignancies, is a growing problem in pediatrics ( [19](#), [20](#), [21](#), [22](#), [23](#) and [24](#)).

## CELLULAR AND MOLECULAR ORIGINS OF ACUTE MYELOGENOUS LEUKEMIA: HEMATOPOIETIC HIERARCHIES

The determination of the AML stem cell is not solely of biologic interest but has profound significance for understanding the causes of leukemia and the development of curative therapies. This section discusses the cellular and molecular determinants of AML, and the implications for therapeutic intervention are covered in the section Future Therapeutic Challenges.

Normal hematopoiesis occurs through a series of complex changes that facilitate multipotential hematopoietic stem cells both to expand and to differentiate into various mature blood cell types. Because AML is derived from an abnormal immature hematopoietic precursor cell, these leukemias also have the capacity to expand and to show characteristics of limited differentiation. Thus, myeloid leukemias retain many of the molecular and cellular phenotypic characteristics of their normal hematopoietic origins, providing the means to distinguish subtypes of the disease and define potential leukemic stem cell compartments. For example, although most myeloid leukemia cells often express growth, survival, and differentiation receptors for specific cytokines such as the c-kit, the FLT-3 receptor, and granulocyte-macrophage colony-stimulating factor receptor, some subtypes express more lineage-specific surface receptors and proteins, such as for granulocyte colony-stimulating factor (G-CSF) and erythropoietin. The same is true for the expression of differentiation markers, including cytoplasmic enzymes such as myeloperoxidase and esterases, as well as surface markers characteristic of various myeloid lineages such as megakaryoblastic, erythroid, or monocytic. These diverse phenotypic characteristics of different subtypes suggest significant heterogeneity of both the genetic changes and the cell of origin in AML.

Some of the earliest biologic tools used to define the cellular compartment in which leukemic stem cells arise included the use of X-linked glucose-6-phosphate dehydrogenase isoenzyme analysis in female patients with chronic myelogenous leukemia (CML) and then AML ( [25](#), [26](#)). Subsequently, karyotypic abnormalities were examined in the maturing colony-forming units to evaluate which lineage (colony-forming unit stem, colony-forming unit granulocyte-macrophage, colony-forming unit megakaryocyte, colony-forming unit granulocyte, colony-forming unit eosinophil, and so forth) contained the aberrant chromosomal marker ( [27](#)). These studies revealed that although CML arises in a very early pluripotential hematopoietic stem cell, there are cases of AML that arise in more mature pluri- and unipotential progenitor cells ( [27](#)). For example, in adults, it has been estimated that approximately one-third of *de novo* AML may arise from erythroid and megakaryoblastic lineage-committed progenitors, and the remainder show clonality in the granulocytic or monocytic lineages ( [28](#), [29](#)). Similar analyses have not been done in pediatric patients to any great extent.

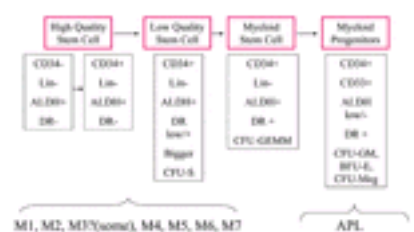
Immunophenotypic analysis of aberrant cell-surface antigen expression as a marker of lineage clonogenicity has more recently been applied to this question. The results have estimated that approximately one-third of cases are derived from less mature pluripotential progenitors and up to two-thirds from more lineage-restricted progenitors, such as from the colony-forming unit granulocyte-macrophage stage ( [27](#), [30](#), [31](#)). This type of work led to the conclusion that the AML stem cell frequently arises from different



stages of maturing myeloid progenitors, resulting in the heterogeneity of various AML subtypes. Furthermore, this conclusion would predict that the genetic changes that contribute to AML would also occur at that stage of maturation.

This view has been substantially challenged in the last several years by work focused on more accurately defining and purifying the self-renewing AML stem cell. By depleting samples of different AML subtypes using antibodies directed to lineage-specific surface antigens, a very small percentage of lineage-negative ( $\text{Lin}^-$ ) cells were isolated that had the capacity to generate AML when transferred to immunodeficient mice. These leukemogenic  $\text{CD34}^+$ ,  $\text{CD38}^-$ ,  $\text{Lin}^-$  cells (termed *self-renewing leukemia-initiating cell*) were rare, having a frequency of as few as 0.2 to 200/10<sup>6</sup> mononuclear cells from patient AML samples (32, 33 and 34). Of further significance was that the frequency of the self-renewing leukemia-initiating cell did not correlate with age, sex, or FAB classification, with the exception of some cases of APL (32). In the case of APL, a significant portion of cases appeared to be derived from a more committed progenitor cell (32, 35). Other studies have determined whether specific molecular abnormalities (detected by fluorescence *in situ* hybridization or polymerase chain reaction) are present or absent in sorted primitive cells; the results have in most instances confirmed these conclusions as to the more primitive nature of the AML stem cell (36). Subsequent investigations identified both  $\text{CD34}^+$  and  $\text{CD34}^-$  lineage-negative self-renewing leukemia-initiating cell populations that were present at extremely low frequency, demonstrating that the AML stem cell is in most cases derived from a very immature hematopoietic precursor cell (37).

The recognition that certain fluorescent dyes could be differentially taken up or excluded from primitive hematopoietic and leukemic stem cells has provided yet another important tool to investigate the origins of AML. Using Hoechst 33342 blue and red fluorescent dyes along with flow cytometry, a “side population” of cells was demonstrated that was characterized by being  $\text{CD34}^{\text{low}}$  to negative,  $\text{Thy-1}^-$ , and  $\text{Lin}^-$  (38, 39). This “side population” of very immature cells was found primarily, if not exclusively, in the bone marrow and was observed in both pediatric and adult AML; it was also capable of generating more mature myeloid precursors containing cytogenetic abnormalities characteristic of the AML clone. These results have provided further support for the conclusion that, in most cases of AML, the leukemic stem cell is represented by a very immature self-renewing phenotype with limited differentiation capability (Fig. 81.1).



**Figure 81.1.** Myeloid cell differentiation and leukemogenesis. The lineage stage from which the leukemic stem cell in different subtypes of acute myelogenous leukemia originates is estimated based on several recent manuscripts (32, 34, 35, 37, 38 and 39) and discussions with Dr. Rick Jones, Johns Hopkins. ALDH, aldehyde dehydrogenase; APL, acute promyelocytic leukemia; BFU-E, burst-forming unit erythroid; CFU-GEMM, colony-forming unit granulocyte-erythroid-monocyte-macrophage; CFU-GM, colony-forming unit granulocyte-macrophage; CFU-Meg, colony-forming unit megakaryocyte; CFU-S, colony-forming unit stem; DR, major histocompatibility class II

antigens; Lin<sup>-</sup>, cells depleted of common differentiation antigens.

When these results are placed into the context of the hematopoietic differentiation schema, the conclusion can be made that there must be primary genetic changes that occur in a very primitive self-renewing stem cell and that the nature of those genetic changes in part determine the subtype of AML. For example, a t(8;21) abnormality may lead to M1 AML with minimal differentiation, whereas an inv(16) abnormality may result in an M4eo subtype. The initiating events may primarily affect the ability of the leukemic stem cell to differentiate but retain the ability to self-replicate (40). Subsequent genetic changes, such as mutation pathways regulating apoptosis, cell survival, and proliferation, may further change the phenotype of the leukemia as well as provide the proliferative potential of the leukemia. This latter type of genetic change involves mostly secondary mutations that affect the function of growth and survival factor receptors, such as FLT-3 or c-kit (41). By themselves, the different types of mutations are insufficient to cause leukemia. However, when present together in the same cell, they can cooperate and lead to the development of AML (42).

These results have important implications not only for understanding the etiology and pathogenesis of AML, but also for the development of more effective treatments. The causes of generating genetic mutations contributing to AML involve both inherited and environmental factors. In pediatrics, the former class of factors is particularly important.

## PREDISPOSING FACTORS AND PATHOPHYSIOLOGY

### Inherited Predisposition Syndromes

**ABNORMAL CHROMOSOMAL NUMBER** Trisomy 21, or Down syndrome (DS), represents the most common inherited condition that predisposes to the development of leukemia (17, 43, 44 and 45). The overall risk of developing leukemia has been estimated to be approximately 14-fold above that of the general population (17, 43, 44 and 45). Although older children with DS have a similar frequency of ALL and AML, within the first 3 years of life, AML, and particularly acute megakaryoblastic leukemia (AMKL), predominates (46, 47 and 48). Patients with DS also have an increased predisposition to develop a condition known as *preleukemia* or *transient myeloproliferative disorder* (TMD). Approximately 10% of newborns with DS develop TMD. Although clinically indistinguishable from congenital leukemia, TMD, as the name suggests, is usually self-resolving. Importantly, even children who are mosaic for trisomy 21 but phenotypically normal share the increased risk of developing TMD and subsequent leukemia (49). However, approximately 20 to 30% of children whose TMD resolves still develop AMKL (50). The close association of trisomy 21 with TMD and AMKL suggests that predisposing genetic events exist. AML-1, which is located on chromosome 21 and known to be involved in some subtypes of AML, has been etiologically implicated, but no definitive evidence has yet demonstrated a specific mutation or gene dosage effect leading to AML (51, 52 and 53). However, other investigations have demonstrated the interesting finding that TMD and AMKL are both characterized by mutations of the GATA-1 gene that result in the introduction of a premature stop codon, truncating GATA-1 before the amino-terminal activation domain and reducing its transcriptional activation ability (54). The same GATA-1 mutation has been observed in the blasts from TMD as well as in AMKL (54, 55, 56, 57 and 58). These results strongly argue that mutations in the GATA-1 hematopoietic transcription factor are an early event in the development of TMD and AMKL in children with DS. It remains unclear why a majority of children with DS and TMD show regression of their disease. An

increased risk of developing AML in patients with Klinefelter syndrome (XXY) and Turner syndrome (XO) has also been reported, but the numbers of such cases are quite low ( [59](#), [60](#) ).

**INHERITED MARROW FAILURE AND CHROMOSOME INSTABILITY SYNDROMES** There are several important inherited syndromes characterized by progressive marrow failure and cytopenias with a high frequency of AML. Fanconi anemia (FA) is an autosomal-recessive inherited disorder with common congenital abnormalities including skeletal abnormalities, short stature, microcephaly, cardiac abnormalities, genitourinary tract abnormalities, café-au-lait spots, and mental retardation. Patients with FA have an estimated 15,000 times greater risk than the general population for developing AML and an actuarial risk of MDS or AML of approximately 52% by 40 years of age ( [61](#), [62](#), [63](#) and [64](#) ). There are multiple gene defects that give rise to FA and affect distinct but functionally related proteins that regulate cell cycle progression and DNA repair; the mutations result in a hypersensitivity to genotoxic agents such as mitomycin C or diepoxybutane and chromosomal instability ( [65](#), [66](#) ). Somatic mutations in several of the FA genes have also been observed in AML outside the setting of FA, thus further strengthening the link of these genes with predisposition for AML ( [67](#), [68](#) ). Dyskeratosis congenita is a primarily X-linked DNA repair syndrome characterized by skin pigmentation, nail dystrophy, and mucosal leukoplakia, as well as a predisposition to developing marrow aplasia, MDS, and AML ( [69](#) ). Mutations have been reported in the DKC1 gene that encodes dyskerin, a catalytic subunit of nucleolar RNA particles and a component of the telomerase complex ( [70](#), [71](#) ). Thus, dyskeratosis congenita may be considered a premature aging and an AML predisposition syndrome ( [72](#) ). Other DNA repair/chromosome instability syndromes that can lead to leukemia, although more commonly ALL, include Bloom syndrome, secondary to an inherited defect in the *blm* helicase gene, and ataxia telangiectasia, due to defects in the ATM gene ( [73](#), [74](#), [75](#), [76](#), [77](#) and [78](#) ).

**DEFECTS IN GENES REGULATING DIFFERENTIATION AND CELL PROLIFERATION PATHWAYS** The familial platelet disorder with a propensity to develop AML has been described that involves the transcription factor CFFA2 ( [79](#), [80](#), [81](#), [82](#), [83](#), [84](#), [85](#) and [86](#) ). Congenital amegakaryocytic thrombocytopenia is caused by inherited mutations in the thrombopoietin receptor (*c-mpl*) and may develop into MDS/AML ( [87](#), [88](#) ). There have also been acquired forms of amegakaryocytic thrombocytopenia ( [89](#), [90](#) and [91](#) ). Severe congenital neutropenia (Kostmann syndrome) represents an important inherited cytopenia of the granulocytic lineage with an increased risk of MDS/AML that increases with age ( [92](#), [93](#), [94](#) and [95](#) ). Introduction of G-CSF for the treatment of patients with Kostmann syndrome has been linked to the development of AML. However, it is possible that patients on G-CSF may survive for longer periods, raising the possibility that the development of AML is secondary to an intrinsically increased risk of leukemia in patients with Kostmann syndrome or a combination of this predisposition and G-CSF stimulation. Mutations in the elastase gene have been associated with both cyclic neutropenias as well as Kostmann syndrome ( [96](#) ). However, an attempt to generate a mouse model of Kostmann syndrome by homologous recombination of the elastase gene did not result in a neutropenia, raising the possibility that elastase is not responsible for Kostmann syndrome or that the murine system has alternative, compensatory pathways ( [97](#), [98](#) ). The detection of somatic activating mutations of the G-CSF receptor has been observed before the development of overt AML in patients with Kostmann syndrome ( [99](#), [100](#) ). Thus, when a rising WBC count is observed in a patient with Kostmann syndrome who was previously stable on G-CSF, one should consider that auto-activating mutations of G-CSF have occurred and that the patient has developed AML. Shwachman-Diamond syndrome, inherited in an autosomal-recessive fashion, is characterized by pancreatic insufficiency, skeletal abnormalities, neutropenia, and an increased incidence of MDS and AML ( [101](#), [102](#) ). Diamond-Blackfan anemia (DBA) is another inherited syndrome characterized by congenital anemia, skeletal and urogenital abnormalities, and an

increased risk of developing MDS and AML ( [65](#), [103](#) ). An association of mutations in the RPS19 gene, encoding a ribosomal protein product and located at chromosome 19q13.2, has been reported. Mutations in the RPS19 gene have been reported to occur in approximately 25% of cases ( [104](#), [105](#), [106](#) and [107](#) ). Another potential locus leading to DBA, representing another 25 to 30% of cases, has been localized on chromosome 8 ( [108](#) ). There are clearly other genetic defects that must account for the remaining cases. In addition to showing an increased frequency of AML, patients with DBA also appear to have a predisposition to other cancers, making DBA a true cancer predisposition syndrome ( [103](#), [109](#) ). Neurofibromatosis type 1 and Noonan syndrome represent two distinct but related disorders that are caused by different molecular lesions leading to increased activation of the RAS gene pathways and a predisposition for developing myeloid leukemias, including juvenile myelomonocytic leukemia (JMML), MDS, and AML ( [110](#), [111](#) ). Neurofibromatosis type 1 results from mutations in the gene encoding a guanosine triphosphatase, called *neurofibromin* ( [111](#), [112](#) ). This guanosine triphosphatase converts activated guanosine triphosphate–RAS to inactive guanosine diphosphate–RAS but, when mutated, leads to the accumulation of activated guanosine triphosphate–RAS. Increased activated guanosine triphosphate–RAS leads to persistent stimulation and proliferation with an increased likelihood of developing leukemia ( [112](#), [113](#) ). In a murine model of neurofibromatosis type 1, exposure of mice with hematopoietic cells of a null phenotype for neurofibromin to alkylating agents increased the incidence of leukemia, suggesting that mutations in neurofibromin are necessary but not sufficient in causing leukemia ( [114](#) ). Recently, defects in the gene encoding the PTPN11 phosphatase have been shown to account for approximately one-third of the cases of Noonan syndrome ( [115](#), [116](#) ). Germline mutations of PTPN11 have been shown to lead to Noonan syndrome and JMML, whereas somatic gain-of-function mutations of PTPN11 may account for approximately one-third of acquired JMML and a smaller percentage of patients with MDS or AML, or both ( [117](#) ). Thus, alteration of the PTPN11 phosphatase increases activity of downstream RAS-activated pathways and links different genetic defects to both the development of inherited disorders and a predisposition to myeloid leukemia. The discovery of these genetic pathways led to the elucidation of somatically acquired genetic defects that contribute to leukemia, similar to what has been observed in the case of FA genes.

**TWINS AND FAMILIAL CASES** The increased frequency of both AML and ALL in siblings of patients with leukemia has been recognized since the early 1920s ( [118](#), [119](#) ). The risk for identical twins is high when leukemia first develops during infancy; in most cases, transmission has been shown to be the result of transplacental transfer. Transmission rates have been reported to be approximately 20 to 30%, although other investigators have concluded transmission rates may approach 100% ( [120](#) ). There is also a high concordance of timing of the onset of leukemia. Molecular studies have demonstrated that identical molecular defects characterized the leukemia in both twins ( [121](#), [122](#), [123](#), [124](#), [125](#) and [126](#) ). Clinical follow-up is therefore essential in identical twins when one of them is diagnosed with acute leukemia. These normal twins should be followed approximately every 1 to 2 months until approximately 2 years of age with physical examinations and peripheral blood cell counts. Bone marrow examinations should only be done when clinically indicated. The risk of developing acute leukemia for nonidentical twins has been estimated to be a two- to fourfold increase until approximately 6 years of age, after which the risk becomes similar to that of the general population. Relatively rare occurrences of familial leukemia strongly suggest other hereditary contributions to the development of AML ( [127](#), [128](#) and [129](#) ). Familial cases have been reported to be associated with constitutional translocations involving t(7;20)(p13;p12) ( [130](#) ) and t(3;6)(p14;p11) ( [131](#) ). Familial monosomy 7 is also reported to be linked to the development of MDS or AML, or both ( [132](#) ).

## Acquired Predisposition

A variety of acquired AML predisposition disorders exist. Up to 20% of patients with severe aplastic leukemia treated with immunosuppressive agents may develop MDS or AML ( [133](#), [134](#) and [135](#) ). Similarly, paroxysmal nocturnal hemoglobinuria, an acquired pancytopenic condition, may evolve to MDS/AML ( [136](#) ). The development of MDS can also be considered an acquired, predisposing condition for AML ( [137](#) ). As noted in the section Defects in Genes Regulating Differentiation and Cell Proliferation Pathways, amegakaryocytic thrombocytopenia is another condition with an increased incidence of AML. Acquired monosomy 7 may predispose individuals to developing MDS and AML ( [138](#) ). The acquisition of predisposing conditions or chromosomal abnormalities is often linked to environmental exposures.

**ENVIRONMENTAL FACTORS** A wide variety of genotoxic environmental exposures can predispose individuals to AML. For example, in the period after the dropping of atomic bombs on Nagasaki and Hiroshima during World War II, an approximately 20-fold increase in myeloid leukemia was documented, with a peak in incidence between 6 and 8 years ( [139](#), [140](#), [141](#) and [142](#) ). The absence of a documented increase in leukemia in children exposed prenatally to the radiation of the atomic bombs has been reported ( [143](#) ) and may be consistent with the absence of definitive evidence that prenatal exposure to x-rays increases leukemia risk ( [144](#), [145](#) ). There remains no convincing evidence that ultrasound or the effects of living near high-voltage power lines predisposes individuals to leukemia, although reports differ in their conclusions ( [146](#), [147](#) and [148](#) ). Prenatal exposure to chemical genotoxic agents has been reported to increase postnatal incidence of myeloid leukemia. For example, maternal alcohol consumption has been associated with an increased risk of AML in offspring ( [149](#), [150](#) and [151](#) ). A significant dose response of prenatal alcohol consumption and the development of AML in offspring was documented ( [149](#) ). However, not all reports have concluded such strong associations ( [152](#) ). There has been an association of maternal ingestion of topoisomerase II inhibitors and the development of AML with malignant lymphoblastic lymphoma rearrangements in offspring ( [153](#), [154](#) and [155](#) ). Parental smoking of tobacco or marijuana has also been associated with an increased incidence of AML in offspring ( [156](#) ), although there are reports with dissenting conclusions ( [157](#), [158](#) ). Some reports have linked cigarette smoking in adults to an increased incidence of AML, making antismoking, preventive counseling important—particularly during teenage years ( [151](#), [159](#), [160](#), [161](#), [162](#) and [163](#) ). Exposure of individuals to environmentally derived genotoxic agents is quite substantial, and several specific examples of such exposures have been shown to be etiologically related to the development of AML. Such exposures include petroleum products, benzene, pesticides, and herbicides ( [164](#), [165](#), [166](#), [167](#) and [168](#) ). Interestingly, in some instances, such as with organophosphate pesticides, children may be at greater risk for accumulating higher levels of the chemicals ( [169](#) ). This represents an important example of age-dependent differences that may contribute to increased susceptibility of AML. An increasingly worrisome group of patients are those who develop AML as a result of chemotherapeutic exposures for treatment of their primary cancer or even nonmalignant conditions. For example, exposure to alkylating agents, commonly used to treat brain tumors, lymphomas, and other solid tumors, results in an increased incidence of secondary AML, with a peak incidence at 4 to 5 years, but with an at-risk period extending 12 years ( [170](#), [171](#), [172](#), [173](#) and [174](#) ). Exposure to topoisomerase I inhibitors, including anthracyclines, and topoisomerase II inhibitors, including epipodophyllotoxins such as etoposide, is also etiologically linked to the development of AML ( [24](#), [171](#), [175](#) ). Whereas cumulative dose and



schedule of drug delivery may play important roles in the development of AML ( [22](#), [176](#) ), nearly any exposures to such genotoxic agents can result in secondary AML, as demonstrated in a child initially treated for neuroblastoma ( [177](#), [178](#) ). The development of secondary AML in patients treated first for primary cancers may be one of the most compelling reasons to develop alternative and less genotoxic approaches to therapy.

## PRESENTATION

The clinical presentation of AML varies greatly, although in general, systemic symptoms and severity of illness are proportional to the leukemic cell burden. The systemic symptoms presenting at diagnosis stem from more than  $10^{12}$  leukemia cells crowding out normal hematopoietic cells in the marrow and invading extramedullary sites such as soft tissues, skin (leukemia cutis), gingivae, orbit, and brain. Patients typically present with signs and symptoms of diminished numbers of normal white blood cells, red blood cells, and platelets. On occasion, other organ systems may be involved at presentation, as in the case of coagulopathy seen most commonly in APL or end-organ damage due to hyperleukocytosis.

Marrow replacement may cause neutropenia, anemia, and thrombocytopenia. Neutropenia places patients at risk for opportunistic bacterial infections, which may be either gram-positive cocci or gram-negative rods. Typical sites of infection at diagnosis include bacteremias with or without septicemia, pneumonia, sinusitis, typhlitis, and perirectal abscesses. Invasive fungal infections are rarely seen at diagnosis in the pediatric patient, although the risk for these infections increases as the patient's duration of hospital stay and immunosuppression increases. Approximately 50% of patients have hepatosplenomegaly and lymphadenopathy. Gingival hyperplasia and leukemia cutis are less frequent but particularly characteristic of myeloid leukemia with monocytic differentiation.

Patients may also present with anemia, which gives rise to fatigue, pallor, and, in extreme cases, hemodynamic instability. The anemia is typically normocytic and normochromic, although evidence of red cell fragmentation may be seen in severe cases of disseminated intravascular coagulation (DIC). The median hemoglobin is approximately 7 g/dl with a range of 2.5 to 14.0 g/dl ( [179](#) ).

Nearly 75% of patients present with a platelet count less than 100,000 platelets/ml ( [180](#) ). Thrombocytopenia may cause petechiae, purpura, mucosal bleeding, and, rarely, central nervous system (CNS) and pulmonary hemorrhage. Thrombocytopenia is exacerbated by coagulopathy, especially in the M3 and M5 AML subtypes. Although the mechanism for DIC is not known in M5 AML, there is convincing evidence that expression of annexin II, a receptor for fibrinolytic proteins, facilitates plasminogen activation by associating plasminogen and its activator, tissue plasminogen activator, at the APL (M3) leukemic blast cell surface ( [181](#) ).

Patients with peripheral blast counts greater than  $200,000/\text{mm}^3$  are at risk for CNS stroke due to hyperviscosity, and benefit from leukapheresis to drop the blast count rapidly ( [182](#) ). Similarly, pulmonary insufficiency may occur in patients with very high leukemia blast counts. Approximately 5% of patients with AML have CNS disease at diagnosis, and a smaller percentage presents with CNS chloromas ( [183](#) ). These patients may have headaches, cranial nerve palsies, focal neurologic deficits, or, rarely, seizures.

## DIFFERENTIAL DIAGNOSIS

Whereas the diagnosis of acute myeloid leukemia is generally straightforward, the differential diagnosis is broad, including both malignant and nonmalignant conditions. Juvenile rheumatoid arthritis, infectious mononucleosis, aplastic anemia, congenital and acquired cytopenias, and the transient myeloproliferative syndrome of DS infants may all mimic AML. AML may be mistaken for MDS or chronic leukemias, including CML, chronic myelomonocytic leukemia, and JMML. Undifferentiated leukemia or FAB L2 ALL may be morphologically difficult to distinguish from megakaryoblastic AML. Metastatic rhabdomyosarcoma may appear like megakaryoblastic or monoblastic AML, as may metastatic neuroblastoma, especially in the neonate.

The diagnosis of AML is typically made on bone marrow aspirate examination, with special stains, flow cytometry, and cytogenetics providing additional data. On occasion, definitive diagnosis is difficult either because of technical difficulties in obtaining an adequate specimen or because of conflicting data. Repeat marrow aspirate and biopsy may provide a specimen adequate for diagnosis. Touch preparations of the bone marrow biopsy may be used in cases in which bone marrow aspiration is difficult.

## ACUTE MYELOGENOUS LEUKEMIA SUBTYPES

In general, the FAB classification system for acute myeloid leukemia applies equally well to pediatric and adult myeloid leukemias. Some important differences, however, occur in the epidemiology of certain FAB and cytogenetic subtypes. These differences are summarized here, and a complete description of the FAB classification system can be found in [Chapter 79](#). FAB subtypes M0, M1, M2, and M3 are more common in older rather than younger children ( [184](#), [185](#) ), with frequencies in children 10 to 15 years of age very similar to reported adult frequencies ( [186](#) ). On the other hand, FAB subtypes M5 and M7 are significantly more common in younger children ( [184](#), [185](#) ), although an increase in the frequency of M5 has been reported in older adult cases of AML ( [187](#) ). Several cytogenetic abnormalities parallel FAB frequencies and are summarized in [Table 81.1](#). Younger children are less likely to have t(8;21) and t(15;17) but more frequently have chromosome abnormalities involving 11q23. Likewise, the increased frequency of M7 AML in young patients is due to the high rate of M7 in DS patients ( [184](#), [185](#), [188](#) ).

**TABLE 81.1. Cytogenetic Abnormalities in Pediatric Acute Myelogenous Leukemia (AML)**

| Karyotype            | Gene           | French/ American/ British Classification | Children (%) | Adults (%) |
|----------------------|----------------|--|--------------|------------|
| Normal               |                |  | 15–31        | 40–46      |
| t(8;21)(q22;q22)     | ETO;<br>AML-1  | M1, M2                                   | 8–16         | 6–7        |
| inv(16)(p13;q22)     | MYH11;<br>CBFB | M4, M2                                   | 3–12         | 3–8        |
| t(16;16)             |                | M4                                       |              |            |
| t(15;17)(q22;q12-21) | PML; RARA      | M3                                       | 4–11         | 4–13       |
| 11q23 rearrangements | MLL; varied    | M4/M5                                    | 6–11         | 3–7        |
| t(6;9)(p23;q24)      | DEK; CAN       | M4, M2                                   | 0–1          | <2         |
| t(1;22)(p13;q13)     | Not known      | M7                                       | 0–3          | <1         |
| -7/del(7q)           | Not known      | —  | 4–6          | 6–8        |



-5/del(5q)

Not known M1, M2, M4, M6

0-2

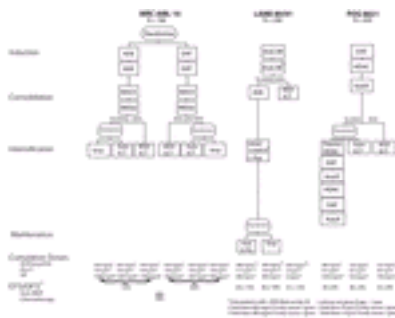
4-6

From Raimondi SC, Chang MN, Ravindranath Y, et al. Chromosomal abnormalities in 478 children with acute myeloid leukemia: clinical characteristics and treatment outcome in a cooperative pediatric oncology group study-POG 8821. *Blood* 1999;94(11):3707-3716, with permission.

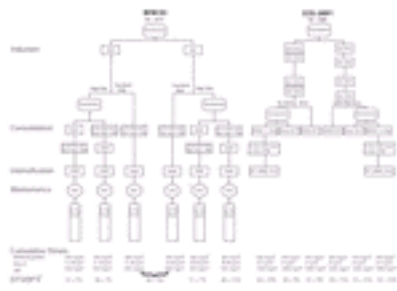
## THERAPY FOR PATIENTS WITH NEWLY DIAGNOSED ACUTE MYELOGENOUS LEUKEMIA

### Background

Pediatric AML protocols begin with a remission induction regimen, followed by a course of consolidation therapy and, subsequently, an intensification course, which may include hematopoietic stem cell transplantation (HSCT). This relatively brief but intensive approach has yielded an approximately 50% chance of cure across different cooperative group protocols ( [189](#), [190](#) and [191](#) ). The most recent cooperative group AML trial schemas and results that have been reported in peer-reviewed publications are shown in [Figure 81.2](#) and [Figure 81.3](#). Although there is general agreement that pediatric AML therapy should be based on the use of anthracyclines and cytarabine, pediatric cooperative groups differ in their induction regimens and use of HSCT transplant in intensification ( [192](#), [193](#) ). The major pediatric cooperative groups are also presently evaluating varied risk stratification methods as well as the use of novel agents.



**Figure 81.2.** Medical Research Council (MRC) acute myelogenous leukemia (AML) 10, Leucamie Aique Myeloide Enfant (LAME) 89/91, and Pediatric Oncology Group (POG)-8821 treatment schema ( [190](#), [204](#), [206](#), [212](#), 351,352). \*\*MRC reported 5-year disease-free survival (DFS) (relapse or death). LAME reported 6-year DFS (relapse or death). POG reported 3-year event-free survival (EFS) (treatment failure or death). ADE, cytarabine, daunorubicin, etoposide; AraC, cytarabine; AraC/M, cytarabine, mitoxantrone; AutoSCT, autologous stem cell transplant; Aza/E, azacitidine, cytarabine; DAT, daunorubicin, cytarabine, thioguanine; HDAC, high-dose cytarabine; MACE, amsacrine, cytarabine, etoposide; mAMSA, amsacrine; MiDac, mitoxantrone, etoposide; MSD, matched sibling donor; Rx, therapy; SCT, stem cell transplant; L-Asp, L-asparaginase; 6-TG, 6-thioguanine.



**Figure 81.3.** Children's Cancer Group (CCG)-2891 and Berlin-Frankfurt-Munster (BFM) 93 treatment schema. \*BFM reported 6-year event-free survival (EFS) (death, relapse, resistant disease, second malignancy). CCG reported 6-year disease-free survival (DFS) (death, relapse, induction failure). ADE, cytarabine, daunorubicin, etoposide; AIE, cytarabine, idarubicin, etoposide; AraC, cytarabine; Auto SCT, autologous stem cell transplant; 5-Aza, azacitidine; CPM, cyclophosphamide; DCTER, dexamethasone, cytarabine, thioguanine, etoposide, rubidomycin; DNM, daunomycin; Dox, doxorubicin; HAM, high-dose cytarabine, mitoxantrone; HDAC, high-dose cytarabine; L-Asp, L-asparaginase; MSD, matched sibling donor; Pred, prednisone; SCT, stem cell transplant; 6-TG, thioguanine; VCR, vincristine; VP, etoposide; XRT, radiotherapy.

### Induction Therapy

Induction therapy has two goals: first, to reduce the malignant blast bone marrow percentage to less than 5% or to eliminate overt extramedullary disease, or both, and second, to restore normal hematopoiesis. Current pediatric cooperative group approaches are based on the standard “7 and 3” induction regimen of 7 days of cytarabine at 100 mg/m<sup>2</sup> and 3 days of daunorubicin at 45 to 60 mg/m<sup>2</sup>. The most recent published induction regimens and results are listed in [Table 81.2](#).

**TABLE 81.2. Pediatric Acute Myelogenous Leukemia Induction Regimens**

| Study             | Patients | Cytosine Arabinoside (mg/m <sup>2</sup> ) | DNR (mg/m <sup>2</sup> ) | DNR Equivalent (mg/m <sup>2</sup> ) | Other Agents  | Complete Remission Rate (%) | Reference         |
|-------------------|----------|---|--------------------------|-------------------------------------|---------------|-----------------------------|-------------------|
| UK MRC-10         | 286      | 1000                                      | 150                      | —                                   | 6-Thioguanine | 89                          | <a href="#">a</a> |
| LAME 89/91        | 171      | 5000                                      | 225                      | 60 (Mitoxantrone)                   | Etoposide     | 93                          | —                 |
| POG-8821          | 649      | 700                                       | 135                      | —                                   | 6-Thioguanine | 85                          | <a href="#">c</a> |
| CCG-213 (7 and 3) | 597      | 700                                       | 135                      | —                                   | —             | 79                          | <a href="#">d</a> |
| CCG 2891          |          |   |                          |                                     | Etoposide     | —                           | <a href="#">e</a> |
| Standard          | 294      | 800                                       | 80                       | —                                   | 6-Thioguanine | 74                          | —                 |
| Intensive         | 295      | 1600                                      | 60                       | —                                   | Dexamethasone | 78                          | —                 |
| BFM '87           | 210      | 1400                                      | 180                      | —                                   | Etoposide     | 78                          | <a href="#">f</a> |
| BFM '93           | 471      | 1600                                      | 90                       | —                                   | Etoposide     | 82                          | <a href="#">g</a> |
|                   | —        | 1600                                      | —                        | 144 (Idarubicin)                    | Etoposide     | —                           | —                 |

BFM, Berlin–Frankfurt–Munster; CCG, Children’s Cancer Group; DNR, daunorubicin; LAME, Leucamie Aigue Myeloide Enfant; MRC, Medical Research Council; POG, Pediatric Oncology Group.

<sup>a</sup> Hann IM, Stevens RF, Goldstone AH, et al. Randomized comparison of DAT versus ADE as induction chemotherapy in children and younger adults with acute myeloid leukemia. Results of the Medical Research Council’s 10th AML trial (MRC AML 10). Adult and Childhood Leukaemia Working Parties of the Medical Research Council. *Blood* 1997;89:2311–2318.

<sup>b</sup> Michel G, Leverger G, Leblanc T, et al. Allogeneic bone marrow transplantation vs aggressive post–remission chemotherapy for children with acute myeloid leukemia in first complete remission. A prospective study from the French Society of Pediatric Hematology and Immunology (SHIP). *Bone Marrow Transplant* 1996;17:191–196.

<sup>c</sup> Ravindranath Y, Yeager AM, Chang MN, et al. Autologous bone marrow transplantation versus intensive consolidation chemotherapy for acute myeloid leukemia in childhood. *N Engl J Med* 1996;334:1428–1434.

<sup>d</sup> Wells RJ, Woods WG, Buckley JD, et al. Treatment of newly diagnosed children and adolescents with acute myeloid leukemia: a Children’s Cancer Group study. *J Clin Oncol* 1994;12:2367–2377.

<sup>e</sup> Woods WG, Kobrinsky N, Buckley JD, et al. Timed–sequential induction therapy improves postremission outcome in acute myeloid leukemia: a report from the Children’s Cancer Group. *Blood* 1996;87:4979–4989.

<sup>f</sup> Ritter J, Creutzig U, Schellong G. Treatment results of three consecutive German childhood AML trials: BFM–78, –83, and –87. AML–BFM–Group. *Leukemia* 1992;6(Suppl 2):59–62.

<sup>g</sup> Creutzig U, Ritter J, Zimmermann M, et al. Improved treatment results in high–risk pediatric acute myeloid leukemia patients after intensification with high–dose cytarabine and mitoxantrone: results of Study Acute Myeloid Leukemia–Berlin–Frankfurt–Munster 93. *J Clin Oncol* 2001;19:2705–2713.

---

Despite the different approaches taken by the cooperative groups, several important conclusions can be gained from these studies. First, remission quality modifies relapse risk, and more intensive induction regimens may provide deeper (less minimal residual disease) remissions with lower relapse rates. This is best shown in Children’s Cancer Group (CCG)–2891 study, in which the intensively timed DCTER (dexamethasone, cytarabine, thioguanine, etoposide, and rubidomycin) arm had a similar induction success rate compared to the standard timing regimen, but the relapse rate for the intensively timed arm was lower irrespective of postinduction therapy ([190](#)). However, more intensive induction regimens also carry greater treatment–related morbidity and mortality that can diminish the net benefit of such intensive therapy. In general, each trial using a very intensive induction regimen has noted an initial toxic death rate of approximately 10 to 15%, which decreases with acquired treatment experience ([194](#)).

This high induction mortality rate has been reduced in several studies by mandated supportive care guidelines (see section [Supportive Care](#)). Although escalating the economic cost of AML therapy, these supportive care guidelines are critical for improved outcomes. In the CCG, these guidelines mandate early initiation of broad–spectrum antibiotics, including vancomycin at the first febrile episode, early initiation of treatment doses of amphotericin after 3 days of persistent fevers, hospitalization until granulocyte recovery, strict hand washing, and use of high–efficiency particulate air–filtered rooms

whenever possible. Institution of these guidelines lowered toxic mortality to approximately 5% across cooperative group trials ( [194](#) ).

Recent cooperative group AML trials have also sought to answer three additional remission induction questions. First, what are the optimal dose and schedule of cytarabine? Second, what agents can be added to the cytarabine and anthracycline backbone? Third, is mitoxantrone a better anthracycline than daunorubicin? Although dose intensification of cytarabine has not been demonstrated to improve remission induction rates, higher doses appear to confer lower rates of leukemia relapse ( [195](#) , [196](#) ). This overall gain in patient survival with higher-dose cytarabine is diminished by increased toxicity, although some subgroups, such as those having core-binding factor AML [e.g., t(8;20)], experience an improved outcome ( [197](#) ).

Whereas the addition of other agents to the “7 and 3” backbone has helped increase induction rates from 70 to 85%, no randomized trial has demonstrated superiority of a particular agent, or combination of agents, over any other combination. Specifically, the Medical Research Council (MRC)-10 trial tested 6-thioguanine versus etoposide with daunomycin and cytarabine and found no statistically significant difference between the two induction regimens ( [191](#) ).

Finally, debate continues over the optimal anthracycline choice in induction. The Berlin-Frankfurt-Munster (BFM) group showed evidence that idarubicin was superior to daunomycin in induction ( [198](#) ), and a metaanalysis by MRC/Institute for Cancer Research of randomized idarubicin/daunomycin comparisons suggested that idarubicin is superior ( [199](#) ). The MRC AML-12 trial, which randomized daunorubicin versus mitoxantrone on a backbone of cytarabine and etoposide, showed no benefit of idarubicin. The mitoxantrone arm, however, experienced substantially more toxicity ( [200](#) ). The CCG-2941 trial showed that idarubicin was too toxic to be used in sequential courses of intensively timed IdaDCTER therapy ( [201](#) , [202](#) ).

In summary, present-day pediatric AML induction regimens successfully induce remission in approximately 85% of patients using a variety of induction strategies. The improvements in induction remission rates have come primarily from intensification of therapy, either by adding additional agents to the “7 and 3” backbone or from dose intensification. Although successful, it appears unlikely that further dose escalation or intensification will significantly improve remission rates. Thus, a central remission induction question now centers on the selection and safe integration of novel agents, such as gemtuzumab ozogamicin (Mylotarg), which may increase antileukemic activity with less toxicity than conventional chemotherapy ( [203](#) ).

## Hematopoietic Stem Cell Transplantation

All pediatric cooperative groups agree that intensive cytarabine-based postremission induction therapy is required to minimize relapse risk if a matched sibling donor (MSD) is not available. However, substantial debate exists over the use of an appropriately matched MSD. The various cooperative groups agree that allogeneic HSCT reduces the risk of leukemia relapse, but they differ in their assessment of the impact of transplant-related mortality and lower salvage of relapse after HSCT on the overall outcome of patients ( [192](#) , [193](#) ). Randomized trials in the United States and France have demonstrated that matched related donor (MRD) HSCT significantly improves both event-free survival (EFS) and overall survival (OS) over intensive chemotherapy or

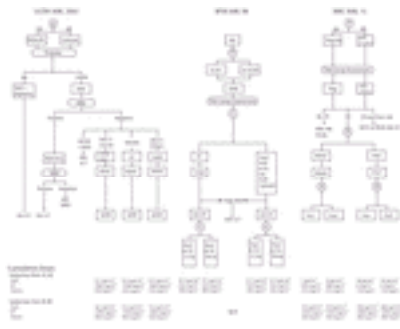
autologous hematopoietic stem cell transplant (auto HSCT) ( [204](#), [205](#) and [206](#) ).

Based on these trials, American and French cooperative groups offer MRD HSCT to all patients with appropriately MRDs in first complete remission (CR). The MRC and BFM groups, however, do not offer MRD HSCT in first CR to all patients because the AML-10 ( [207](#) ) and BFM trials ( [189](#), [208](#) ) did not show a statistically significant advantage for MRD bone marrow transplant for patients with “standard risk” AML as defined by each group. The discordant results of these trials may stem from the different patient populations and treatment protocols of each cooperative group and the statistical limitations of relatively small numbers, as well as the biases of parents, guardians, and physicians regarding postinduction therapies. Difficulties performing randomized trials testing HSCT questions and the strongly held opinions on the role of HSCT make it unlikely that the role of HSCT in pediatric AML will be definitively addressed in a randomized trial.

Several studies have sought to evaluate the role of HSCT with either a metaanalysis or a decision analysis approach. The metaanalysis by Bleakley et al. demonstrated that MSD HSCT decreased relapse risk while improving both disease-free and overall survival. However, the analyzed data were inadequate to evaluate individual risk groups (i.e., favorable vs. unfavorable cytogenetics) ( [209](#) ). A decision analysis by Hertenstein et al. also reached the conclusion that MSD HSCT improved disease-free survival over chemotherapy alone. However, this decision analysis did not evaluate the role of stratification based on leukemia cytogenetics ( [210](#) ). Sung et al. recently published a decision analysis that evaluated three treatment strategies: all HSCT, no HSCT, or HSCT for patients without favorable leukemia cytogenetics [i.e., without t(8;21), t(15;17), or inv(16)] ( [211](#) ). In this analysis, the strategy of cytogenetic testing and offering MSD HSCT to patients without favorable leukemia cytogenetics was the most optimal one ( [211](#) ). Completion of a metaanalysis with individual patient data, as well further refinement in outcome measure of decision analysis, may enable these methods to provide guidance to the selection of HSCT for pediatric AML patients.

### **Intensification and Maintenance Therapy**

If MRD HSCT is not available or selected, then chemotherapy-based consolidation and intensification regimens should follow induction therapy. Several cooperative group trials have addressed the role of auto HSCT in postremission therapy. CCG, the Pediatric Oncology Group, and Leucemie Aigue Myeloide Enfant studies showed no benefit from auto HSCT when compared to varied chemotherapy courses ( [204](#), [205](#) and [206](#) ). However, the combined pediatric and adult experience in MRC AML-10 demonstrated a significant disease-free benefit for auto HSCT compared to no further therapy after four courses of intensive chemotherapy, although OS was not improved ( [212](#) ). Current protocols from the MRC, BFM, and St. Jude Children’s Research Hospital ( [Fig. 81.4](#) ) do not use auto HSCT; it appears unlikely that auto HSCT will play a prominent role in pediatric AML therapy in the future.



**Figure 81.4.** St. Jude's Children's Research Hospital (SJCRH) acute myelogenous leukemia (AML) 2002, Berlin-Frankfurt-Munster (BFM) 98, and Medical Research Council (MRC) AML 15 treatment schema. ADE, cytarabine, daunorubicin, etoposide; AI, cytarabine, mitoxantrone; AIE, cytarabine, idarubicin, etoposide; Allo SCT, allogeneic stem cell transplant; AraC, cytarabine; 2CDA, cladribine; CE, cytarabine, etoposide; CR, complete responder/response; Dauno, daunorubicin; Flag, fludarabine; Flag-Ida, fludarabine, idarubicin; GCSF, granulocyte colony-stimulating factor; Gy, Gray; HAM, high-dose cytarabine, mitoxantrone; HDAC, high-dose cytarabine; HDACDE, high-dose cytarabine, daunorubicin, etoposide; HD/VP, high-dose cytarabine, etoposide; HR/SR, high risk/standard risk; Ida, idarubicin; idAM, intermediate-dose cytarabine, mitoxantrone; LDACDE, low-dose cytarabine, daunorubicin, etoposide; MACE, amsacrine, cytarabine, etoposide; MFD SCT, matched family donor stem cell transplant; MidAC, mitoxantrone, etoposide; MRD, minimal residual disease; MSD, matched sibling donor; MUD SCT, matched unrelated donor stem cell transplant; NR, nonresponder; PR, partial responder; Pred, prednisone; 6-TG, thioguanine; SCT, stem cell transplant; VCR, vincristine.

Although agreement exists on the role of cytarabine-based intensification therapy, especially for core-binding factor myeloid leukemias in which additional courses of cytarabine appear to significantly decrease relapse risk, the optimal number of cycles of intensification chemotherapy is not known ( 190, 213, 214 ). The published pediatric AML trials have used either two or three courses of consolidation therapy, for a total of four or five courses of therapy ( 198, 206, 212, 215 ). The MRC AML-10 randomized patients to either auto HSCT transplant or no further therapy and demonstrated a decreased relapse risk in patients receiving auto HSCT. However, the addition of auto HSCT was associated with significant morbidity and mortality, thus abrogating any OS advantage ( 212 ). MRC AML-12 randomized patients in all risk categories to either two or three consolidation cycles ( 216 ). These results, however, have not yet been reported in a peer-reviewed setting.

Debate also exists about the role of ALL-like maintenance therapy. Presently, only the BFM group uses a maintenance phase of chemotherapy. The BFM group bases this choice on the results of BFM-87, in which a maintenance phase was beneficial to a low-risk group of patients not receiving HSCT ( 208 ). Other cooperative groups, however, have shown that maintenance therapy is associated with a decrease in both EFS and OS when compared to shorter, more intensive regimens ( 204, 217, 218 ).

### Summary of *De Novo* Therapy

Despite differences in the use of anthracyclines, HSCT, and maintenance therapy, pediatric cooperative groups share a common treatment approach based on anthracyclines and cytarabine as the primary chemotherapy agents. This common backbone, as well as differences, can be seen in currently ongoing clinical trials within the MRC-15, BFM-98, and St. Jude's Children's Research Hospital AML 2002 protocols, illustrated in [Figure 81.4](#). These trials focus on evaluating cooperative group-specific risk



stratification methods as well as the use of novel agents, primarily gemtuzumab ozogamicin. Although potentially limited by small numbers of patients in subgroups, these trials will provide important information about the success of implementing risk-stratified approaches to AML therapy. With careful long-term follow-up of enrolled patients, important data on the risks and severity of late effects may also be obtained. These data may enable more precise determination of the overall risks and benefits of each therapeutic approach.

## THERAPY FOR PATIENTS WITH RELAPSED/REFRACTORY DISEASE

Despite AML treatment intensification, refractory disease and relapse remain the major causes of treatment failure. Reinduction regimens typically use high-dose cytarabine, even if prior therapy has included substantial cytarabine exposure. With the addition of such agents as mitoxantrone, etoposide, fludarabine, or 2-chlorodeoxyadenosine to cytarabine, a substantial percentage of relapsed or refractory patients achieve CR ([219](#), [220](#) and [221](#)). There is evidence that the combination of fludarabine, idarubicin, and cytarabine (FLAG-Ida) has a high remission induction rate, which may be of longer duration. However, the toxicity associated with this regimen is also substantial ([222](#), [223](#)). The combination of mitoxantrone and high-dose cytarabine used in the CCG-2951 study achieved a 76% overall remission rate ([224](#)). One adult trial has demonstrated that gemtuzumab ozogamicin, an anti-CD-33 antibody covalently linked to calicheamicin, in combination with idarubicin and cytarabine, is effective in the relapsed or refractory setting ([203](#)), and pediatric trials are presently under way.

Generally, patients with refractory or relapsed AML undergo allogeneic HSCT with either a related or an unrelated donor ([225](#)). Conditioning regimens vary widely. Despite, or perhaps because of, this wide variation, no randomized trial has evaluated the optimal HSCT conditioning regimen in the relapse setting. Because many investigators are reluctant to give conditioning regimens that include total body irradiation to young children, the balance between risks and benefits of total body irradiation-containing regimens for relapsed AML is unknown. Unrelated donor sources may include cord blood as well as haplo-identical grafts ([204](#), [206](#), [226](#), [227](#)). Although the use of cord blood units and haplo-identical grafts makes alternative donors available for almost every patient, both of these stem cell sources have disadvantages over fully matched unrelated donors. Cord blood grafts may have less of a graft-versus-leukemia effect, and the small number of stem cells can delay engraftment or increase graft failure ([228](#)). Haplo-identical grafts are associated with higher rates of graft-versus-host disease ([229](#)), as well as higher rates of viral infections and posttransplant lymphoproliferative disease due to the intensive immunosuppressive transplant regimens used ([230](#)).

Despite the increased risks of toxicity, infectious complications, and graft-versus-host disease associated with the allogeneic transplant typically used for relapsed or refractory AML, between 20 and 50% of patients may be salvaged ([231](#), [232](#)). Salvage rates are significantly affected by the duration of first CR, with shorter CR-1 (e.g., <6 months or while on therapy) being associated with lower salvage rates ([233](#)). Leukemia karyotype may also modify the probability of achieving CR in the relapsed or refractory setting ([234](#)). Overall, poor prognosis patients have a 3-year survival of less than 20%, whereas patients with initial CR lasting longer than 1 year may have a 30 to 40% 3-year survival.

## SUPPORTIVE CARE

Current AML protocols are among the most intensive chemotherapy protocols and cause



a wide variety of severe complications. AML treatment-related morbidity and mortality significantly affect OS of patients, both through treatment delays and toxic deaths. Thus, AML patients should be cared for by physicians and nurses experienced in AML therapy in institutions with appropriate laboratory, radiology, blood-banking, and surgical services. These necessary support services are expensive and require substantial commitment and resources from the patient's family and health care systems.

Standardization of supportive care, as shown by Riley et al., may reduce treatment-related mortality by 50% ( [194](#) ). AML supportive care guidelines typically focus on infection prophylaxis and treatment, although hematologic support is also critical. Fever and neutropenia in AML patients constitute a medical emergency ( [235](#) , [236](#) ). After obtaining blood cultures, broad-spectrum antibiotic therapy should be instituted rapidly. Coverage for penicillin-resistant *Streptococcus viridans* and gram-negative organisms should be given, and anaerobic coverage should be added if clinically indicated. Local microbial resistance patterns dictate selection of initial antibiotics, although vancomycin and ceftazidime are typically included in the initial antibiotic selection. Patients should remain on broad-spectrum coverage until their neutropenia shows signs of resolution. Vancomycin use may be limited to 24 to 48 hours until a resistant *S. viridans* infection has been excluded. Although patients with AML are at risk for a wide range of bacterial infections, gram-negative organisms occur frequently at diagnosis, and a-hemolytic streptococcus is often seen after intensive consolidation regimens ( [237](#) ).

Empiric antifungal therapy should begin if fever persists for more than 3 to 5 days after initiation of antibiotic therapy or with recurrent fever. Amphotericin B has been the first-line choice for antifungal coverage, although recently, voriconazole has been shown to be superior against *Aspergillus* in a randomized clinical trial ( [238](#) ). Selection of the appropriate antifungal agent is guided by culture results, which may require biopsy, radiographic findings of lesions difficult to biopsy, and the side effect profiles of the various antifungal agents. Importantly, strict hand-washing guidelines, mandated hospitalization until neutrophil recovery, and use of high-efficiency particulate air-filtered rooms whenever possible all significantly decrease the incidence, morbidity, and mortality of infections in pediatric AML patients.

Multiple studies in children and adults have demonstrated that G-CSF may decrease the length of neutropenia and the length of hospital stay, but it does not alter severe toxicity or infection rates ( [239](#) , [240](#) , [241](#) and [242](#) ). Unlike studies in adults, G-CSF treatment in patients with hypercellular day 7 bone marrows on CCG-2891 had a statistically significantly improved remission rate and OS ( [239](#) ).

Prophylaxis against opportunistic infections is also an important supportive care issue. Although *Pneumocystis carinii* is rare in pediatric patients with AML, prophylaxis with trimethoprim-sulfamethoxazole is often given. *S. viridans* sepsis may be prevented by penicillin prophylaxis in centers where *S. viridans* remains penicillin sensitive. Penicillin resistance, however, is becoming common. High-efficiency particulate air filtration has been shown to diminish *Aspergillus* infection in marrow transplant patients and likely benefits AML patients who experience prolonged periods of neutropenia and immunosuppression ( [243](#) ).

Patients undergoing AML therapy also require substantial blood product support. In MRC-10, approximately 20% of all pediatric deaths were due to hemorrhage, with two patients dying before initiation of therapy and five patients dying during induction therapy ( [194](#) ). Whereas the typical platelet transfusion threshold is conventionally 10,000 to 20,000 ( [244](#) ), AML patients often present with DIC and infections that markedly increase the risks of severe hemorrhage, even at platelet counts that would otherwise be

considered safe. Thus, patients at increased risk for hemorrhagic complications should have their platelet counts maintained at a higher level, and hemostatic factor replacement by fresh frozen plasma or clotting factors should be judiciously used ( [245](#) ). Standard hemoglobin transfusion thresholds for pediatric AML patients range from 7 to 9 mg/dl ( [246](#) ), although moderately higher hemoglobin levels may be sought in situations in which maximal oxygen-carrying capacity and intravascular volume expansion are needed. Prospective randomized trials to determine the potential advantage of maintaining higher hemoglobin levels in children have not been reported.

## LATE EFFECTS OF THERAPY

Although intensive AML protocols cure a substantial fraction of children with AML, the late effects of these therapies are significant. Several investigators have reported on AML late effects, but population-based follow-up studies of recent intensive therapies are lacking and remain a critically needed area of research ( [247](#) , [248](#) , [249](#) and [250](#) ). Leung et al., reporting on 77 patients surviving more than 10 years from diagnosis, observed that increasing radiation dose as well as younger age at diagnosis and initiation of radiation therapy were risk factors for growth delay, infertility, academic difficulties, cataracts, and hypothyroidism. Patients receiving total body irradiation had lower cumulative anthracycline doses (204 mg/m<sup>2</sup> vs. 335 mg/m<sup>2</sup>) but did not have a lower rate of cardiomyopathy ( [250](#) ). Patients who survive AML therapy also have a significantly increased rate of secondary malignancies ( [173](#) ). However, primary disease relapse and therapy-related morbidity decrease EFS significantly more than secondary AML.

## MANAGEMENT OF PATIENTS WITH DOWN SYNDROME

The majority of leukemias in children with DS are lymphoid, although DS children comprise 10% of pediatric AML patients, with the M7 FAB subtype being most common ( [251](#) ). The elevated risk of AML in DS children is first seen in the neonatal period: Up to 10% of newborns with DS experience TMD. TMD is very similar to M7 AML, except that trisomy 21 is usually the only karyotypic abnormality and that the leukemia nearly always regresses by 2 to 3 months of age without therapy ( [252](#) ). However, some patients with TMD require low-dose cytarabine therapy due to severe hepatic infiltration or other complications ( [252](#) , [253](#) ). On occasion, TMD may be fatal due to hepatic fibrosis, DIC, or other organ dysfunction due to leukemic cell infiltration ( [252](#) , [253](#) ).

All infants with DS, including those who have had TMD, should be considered at risk for developing AML ( [252](#) ). This risk is highest between the first and third year of life. DS patients who develop AML are more at risk for fatal toxicity but have significantly more chemotherapy-responsive leukemia ( [251](#) , [254](#) ). DS patients older than 4 years of age have significantly inferior survival than younger patients and may require more intensive therapies. Even accounting for these high-risk patients, children with DS have better outcomes than non-DS children when less-intensive therapies are used ( [46](#) , [48](#) , [254](#) , [255](#) ).

## MANAGEMENT OF INFANTS WITH CONGENITAL ACUTE MYELOGENOUS LEUKEMIA

Approximately 120 patients with congenital AML have been reported in case reports and reviews ( [256](#) , [257](#) , [258](#) and [259](#) ). Congenital leukemia is defined by (a) presentation in the first month of life, (b) presence of inappropriate numbers of immature myeloid, lymphoid, or erythroid cells, (c) infiltrations of immature cells into nonhematopoietic tissues, and (d)

absence of other etiologies ( [260](#) ). Approximately two-thirds of patients present with leukemia cutis, giving a “blueberry muffin” baby appearance that may also be seen in metastatic neuroblastoma or rhabdomyosarcoma and histiocytosis ( [261](#) ). Hepatosplenomegaly is also typically present, but lymphadenopathy less so; CNS involvement is present in 50% of cases that included performance of a lumbar puncture ( [261](#) ). The WBC count is typically elevated, and the majority of reported congenital myeloid leukemias have been of the M5 subtype. A majority of congenital AML cases have abnormal cytogenetic findings, with approximately one-fourth of cases having 11q23 abnormalities ( [261](#) ). Although spontaneous remissions have been reported ( [262](#) ), OS tends to be poor, with an OS of 24% at 2 years in the most comprehensive review ( [261](#) ).

## MANAGEMENT OF ACUTE PROMYELOCYTIC LEUKEMIA

The therapy for pediatric and adult APL is essentially identical for pediatric and adult patients. Thus, pediatric patients have usually been enrolled in various adult APL cooperative group trials. APL therapy is now based on the use of all- *trans*-retinoic acid (ATRA), a differentiating agent that induces remission in a majority of patients with APL when used as a single agent (see [Chapter 79](#) on adult AML) ( [263](#), [264](#) ). Importantly, patients with FAB M3 natural killer cells and t(11;17) do not respond to ATRA ( [265](#), [266](#) ). Whereas a majority of patients enter remission with ATRA, disease recurrence uniformly occurs within 3 to 4 months without additional therapy ( [266](#) ). Multiple trials have demonstrated a benefit to ATRA/chemotherapy combinations ( [267](#), [268](#), [269](#) and [270](#) ), with recent evidence suggesting that anthracyclines play a more important role in APL therapy than cytosine arabinoside ( [271](#), [272](#) ). To date, two reports have described treating APL with gemtuzumab ozogamicin, both alone ( [273](#) ) and in combination with ATRA ( [274](#) ).

Children with the t(15;17) respond equally well to ATRA, as do adults with AML. Both children and adults appear to have an induction mortality rate of 10% due to hemorrhagic complications ( [275](#) ). This complication rate has not significantly been altered by ATRA therapy. The risk of retinoic acid syndrome, or acute pulmonary failure, appears to be equal in children and adults ( [276](#) ). However, pediatric patients have an increased risk for pseudotumor cerebri ( [277](#) ). Treatment of retinoic acid syndrome centers on discontinuation of ATRA and initiation of dexamethasone therapy ( [276](#) ).

Arsenic trioxide has also shown efficacy as a differentiating agent in APL ( [278](#) ). Arsenic does not appear to be cross resistant with ATRA and, thus, has an important role in relapsed APL in which remission induction rates are approximately 85% ( [278](#), [279](#) and [280](#) ). Arsenic has been associated with sudden cardiac death in APL patients due to prolonged cardiac repolarization ( [281](#), [282](#) ). Arsenic should be used with caution in patients with known prolonged QT or in those taking medications known to prolong the QT interval. A significant challenge for future clinical trials is how to incorporate arsenic into treatment regimens for newly diagnosed patients alone or in combination with ATRA or chemotherapy, or both.

## MANAGEMENT OF PATIENTS WITH INHERITED SYNDROMES CHARACTERIZED BY DNA REPAIR DEFECTS OR CYTOPENIAS, OR BOTH

Patients with inherited syndromes characterized by DNA repair defects usually are not able to tolerate the effects of chemotherapy or radiation treatment as well as other

children with AML. For example, patients with FA require substantial dose reductions in chemotherapeutic drugs as well as bone marrow transplantation regimens, but such patients can be sometimes cured of their AML ( [283](#) ). Reduced-intensity regimens are therefore recommended for such patients ( [283](#) , [284](#) and [285](#) ).

Patients with Kostmann syndrome who develop AML can also be cured. Because of their severely compromised ability to generate granulocytes, these patients can have significant problems with infections. However, bone marrow transplantation has been successfully used ( [286](#) , [287](#) ).

Aside from case reports and small case series, few data have been reported on the therapy and outcome of patients with constitutional abnormalities or conditions with a predisposition for developing AML.

## PROGNOSTIC FACTORS

With the improved survival of pediatric patients with AML, prognostic factors that predict treatment outcome gain importance, and the number of patients required to develop and evaluate prognostic models increases. At this time, prognostic factors may be grouped into three general categories: host factors, disease factors, and treatment response. As illustrated in [Figure 81.5](#), these factors interact to determine patient outcome.



**Figure 81.5.** Relationship of prognostic factors in pediatric acute myelogenous leukemia. See text for details. FAB, French/American/British classification; MRD, minimal residual disease; PCR, polymerase chain reaction; WBC, white blood cell.

Of the host factors, patient age, race, and select constitutional abnormalities are most strongly correlated with outcome. In general, patient age is inversely related to treatment outcome. This relationship was best demonstrated in the MRC AML-10 trial and was confirmed in MRC AML-12, in which infants, despite worse toxicity, had higher survival rates than older children ( [225](#) , [288](#) ). The CCG-2891 trial has also demonstrated a benefit of young age ( [190](#) ).

Although patient gender is not usually included in risk models, girls generally have marginally better outcomes than boys. In CCG studies, race has consistently been a predictor of outcome, specifically with blacks having a poorer outcome than whites ( [289](#) ). This difference was statistically significant only for patients treated with chemotherapy alone. The reasons for this difference in outcome are not known but may be related to pharmacogenetic differences in the host or characteristics of the leukemia. As AML therapy is primarily inpatient hospital based, it is unlikely that access to medical care or issues of treatment compliance are involved.

Whereas the pharmacogenetic basis of treatment response is poorly understood, homozygous deletions of the GST theta gene, a detoxifying phase II enzyme, are associated with decreased survival (52% vs. 40%,  $p = .05$ ) ( [290](#) ). This difference in survival is due to an excess of toxicity in patients who are GST theta null (24% vs. 12%,  $p = .05$ ) and has been replicated in separate patient populations ( [222](#) ).

Patients with constitutional abnormalities also have altered risk of treatment response. Most notably, patients with trisomy 21 experience more therapy-related toxicity but have higher survival rates than patients with a normal constitutional karyotype when less-intensive regimens are used ( [251](#) ). Interestingly, age also prognosticates outcome for patients with trisomy 21, with older patients having a worse prognosis than younger ones. Patients with other constitutional abnormalities such as FA, Shwachman syndrome, or Kostmann syndrome also have increased toxicity with standard AML therapy. The underlying cytopenias in the patients also limit their ability to recover normal hematopoiesis after AML therapy. As a result, these patients are generally excluded from standard AML protocols.

Several characteristics of leukemia are also associated with outcome. These characteristics include initial WBC count, FAB morphology, and cytogenetics. Like age, initial WBC blast count is inversely related to outcome. An initial WBC count less than 20,000 WBCs/ml<sup>3</sup> is associated with a favorable prognosis, whereas an initial WBC count greater than 100,000 WBCs/ml<sup>3</sup> has been associated with an unfavorable prognosis in both the MRC and BFM trials ( [291](#) ). In CCG-2891, patients with a WBC count greater than 330,000 WBCs/ml<sup>3</sup> had an unfavorable prognosis, with an EFS of 7%, due to early death, induction failure, and relapse.

Whereas FAB group has been associated with treatment outcome, different studies have found different associations. The BFM group reported that patients with FAB M1-M4 had improved survival over patients with either M0 or M5-7 ( [292](#) ). However, in both MRC-10 and CCG-2891, the M5 FAB subtype was associated with favorable prognosis ( [184](#), [190](#) ). FAB M7 in non-trisomy 21 patients has also been associated with poor survival in CCG studies ( [251](#) ).

The cytogenetics karyotype of the leukemia blasts is a robust predictor of outcome. Patients with  $t(15;17)$ ,  $t(8;21)$ , and  $inv(16)$  fare better than patients with other cytogenetic findings ( [188](#), [255](#) ). Patients with monosomy 7 or 5 do poorly, as do patients with complex karyotypes ( [293](#), [294](#) ).

Much present work is focused on defining molecular prognostic factors for AML treatment response. To date, the most robust predictor is the presence of the FLT-3 internal tandem duplication (FLT-3/ITD), which is present in 10 to 30% of leukemic blasts ( [295](#), [296](#) ). The presence of the FLT-3/ITD is strongly correlated with poorer outcome, and recent work has shown that the number of internal tandem duplications is critical ( [297](#) ). Patients with a high FLT-3/ITD mutant allele ratio define an even higher risk group. Recent work has also focused on using RNA expression arrays to predict treatment outcome ( [298](#) ). Although technically and analytically more complex, these expression arrays may yield new prognostic variables and stratification schemas in the future.

Treatment response, in addition to host and disease characteristics, also predicts outcome. Currently, treatment response is measured by morphology, multiparameter flow



cytometry (MFC), or molecular techniques. Although morphology is less sensitive than either molecular methods or MFC, it is readily available and is the most technically straightforward. Studies across cooperative groups have demonstrated that patients who do not achieve remission after two induction cycles have a survival rate of less than 10%, and patients whose bone marrow blast counts are between 5 to 25% at day 14 also have decreased EFS and OS ( [190](#), [288](#), [291](#) ).

Cytogenetic evaluation of bone marrow specimens is another molecular method for evaluating treatment response. Detection of residual, nonrandom, abnormal karyotypes strongly predicts later morphologic relapse. This method is limited by difficulties in growing sufficient numbers of cells from heavily treated bone marrow samples, although fluorescence *in situ* hybridization of interphase chromosomes partially overcomes this limitation ( [299](#) ). The relatively large percentage of patients with normal karyotypes significantly limits this approach.

Polymerase chain reaction–based approaches are also available for monitoring treatment response. Persistent detection of the t(15;17) fusion gene is associated with a high risk of relapse, although the most sensitive assays can detect residual t(15;17) products in patients in remission ( [300](#), [301](#) and [302](#) ). The t(8;21) translocation may remain positive on polymerase chain reaction assays in patients who are in long–term remission, indicating that this translocation may be necessary but not sufficient for leukemic cell transformation. Development of assays to detect inv(16) and t(11q23) abnormalities are limited by the heterogeneous nature of these chromosomal changes ( [303](#) ).

Whereas both *ras* mutations and the Wilms' tumor gene ( *wt1* ) have been evaluated as predictors of treatment outcome, both markers have significant limitations that require further evaluation. Mutations in *ras* are present in approximately 25% of AML cases, although the mutations are not uniformly stable between diagnostic and subsequent specimens ( [304](#), [305](#) ). The same type of instability is observed for mutations in cytokine receptor genes, such as FLT–3 ( [297](#), [306](#) ). When one considers the group of pediatric patients with AML that includes a combination of mutations involving *ras*, c–kit, and FLT–3, an overall decrease in survival is observed ( [307](#) ). The WT1 gene is present in a majority of AML blasts, and persistent detection of WT1 transcripts has been associated with poorer outcome ( [308](#) ). However, less than 50% of FAB M5 blasts express WT1, thus limiting its universal applicability.

Multiparameter flow cytometry (MFC) can detect patient–specific blast flow signatures on up to 85% of samples with a detection sensitivity of approximately  $10^{-3}$  ( [309](#) ). Wormann et al. first described the use of MFC to detect residual AML blasts in 45 adult patients ( [310](#) ). Sievers et al. applied MFC in 39 pediatric patients and then validated this approach in 252 patients treated in CCG–2941 and CCG–2961 ( [309](#), [311](#) ). In the validation cohort, patients with residual disease by MFC had a 41% OS at 3 years, whereas patients without residual disease had a 69% OS (  $p = .0058$  ). In Cox proportional hazard analysis, MFC was the strongest predictor of outcome.

Despite some differences in risk group definition, the pediatric cooperative groups generally agree on the factors most predictive of treatment response. The development of more sensitive and universally applicable measures of treatment response may further refine the risk stratification process. Likewise, incorporation of pharmacogenetic patient information and leukemic blast gene expression data may also improve the predictive abilities of current risk stratification schemes. Finally, treatment stratification may be possible based on specific genetic lesions that have targeted therapies available. For example, activating *ras* mutations are potential targets for roughly 25% of pediatric AML.

Farnesyl transferase inhibitors are currently in phase I testing in children and adults ( [312](#), [313](#) ). Compounds with substantial preclinical activity with FLT-3/ITD-positive AML are also being introduced into clinical trials ( [314](#), [315](#), [316](#) and [317](#) ).

## FUTURE THERAPEUTIC CHALLENGES

Although dose intensification with chemotherapy with or without bone marrow transplantation has significantly improved the outcome of patients with AML, the associated morbidity and mortality preclude similar approaches from being pursued in the future. Instead, future therapeutic advances need to deliver greater leukemic cell killing but without additional collateral toxicity to normal tissues. These advances have been focused on developing targeted therapies directed toward specific molecular pathways that lead to increased leukemic cell survival, proliferation, and drug resistance ( [318](#) ). In part because of the tremendous advances in understanding the genetic defects and their molecular consequences in AML, there are many potential therapeutic targets that are being explored ( [318](#) ).

Ideally, molecularly targeted therapies should be tumor specific. Such approaches would be directed at blocking a molecular abnormality expressed by the leukemic cells but not by normal cells. Examples of this approach include strategies targeting the unique fusion proteins that result from distinctive chromosomal translocations or the use of agents that would specifically exploit a mutation in a cytokine receptor such as FLT-3/ITD or activating amino acid changes of FLT-3 or c-kit ( [314](#), [317](#), [319](#), [320](#) ). Differentiation therapies such as ATRA for APL are specifically targeted treatment. Other differentiation therapies directed at demethylation and histone deacetylase pathways may be less specific but are still intended to reexpress critical proliferation, survival, or antiapoptotic gene products whose expression has been repressed through tumor-specific epigenetic silencing ( [321](#), [322](#), [323](#), [324](#) and [325](#) ).

A second approach would be to target pathways or molecular targets that were shared by tumor cells and some normal cells but on which leukemic cells are more dependent in terms of their survival and proliferation. Such strategies include the antisense inhibition of antiapoptotic pathways dependent on bcl-2 expression ( [326](#), [327](#) ), the inhibition of farnesyl transferase activation of proteins such as RAS ( [312](#), [313](#) ), and immunotherapy directed toward differentiation antigens such as CD33 ( [203](#), [328](#), [329](#), [330](#) and [331](#) ). Although this latter approach may not be leukemia specific, its selective action may be less toxic than traditional chemotherapeutic drugs.

Both specific and selective targeted therapies are currently being tested in both adult and pediatric patients with AML. However, recent data have demonstrated that even molecularly targeted therapies are not often as specific as initial results would suggest and that leukemia resistance can develop. These points are especially evident for imatinib (Gleevec), initially developed as a specific inhibitor of the bcr-abl fusion kinase ( [332](#), [333](#), [334](#) and [335](#) ). However, subsequent reports have demonstrated that imatinib also can inhibit receptors such as c-kit and platelet-derived growth factor ( [336](#) ). Whereas imatinib may not be specific for bcr-abl, its ability to inhibit different mutations of the c-kit receptor is quite variable. For example, activating mutations of c-kit involving the juxtamembrane domain, which are commonly observed in gastrointestinal stromal cell tumors, are particularly sensitive to imatinib ( [337](#) ). However, activating mutations of c-kit that involve amino acid changes in the kinase domain are quite resistant to the action of imatinib ( [338](#) ). These observations point out that such small molecule inhibitors may be less specific in some situations while exquisitely specific in terms of their ability to detect different



structural motifs. A third critical lesson that imatinib has provided is that multiple forms of tumor cell resistance mechanisms can rapidly develop to molecularly targeted therapies. In the case of imatinib, up-regulation of adenosine triphosphate-dependent multidrug resistance transporters, increased expression of bcr-abl, and point mutations of bcr-abl abrogating imatinib binding have all been described as playing an important role in leukemic cell resistance ( [339](#), [340](#) and [341](#) ). Reports are also now showing that some patients with CML who are being treated with imatinib have developed clonal evolution of their CML and MDS/AML ( [342](#), [343](#) ). This last point raises the important issue of whether a therapy, molecularly targeted or not, is actually having an impact on the leukemic stem cell and not only on downstream progeny.

The AML stem cell, as discussed in the section Cellular and Molecular Origins of Acute Myelogenous Leukemia: Hematopoietic Hierarchies, commonly arises from an early point in the myeloid lineage. This appears to be true for most subtypes of AML, with the notable exception of some cases of APL. A major question for molecularly targeted therapies, then, is what impact do they have on the leukemic stem cell? This is no small task to ask of any therapy because so little is known about the physiology or mechanisms of drug resistance and survival. Experimental work involving leukemic stem cells has been slow in coming because, like their normal hematopoietic counterparts, they are usually quiescent, have a relatively long lifespan, and are extremely rare in terms of the entire population of leukemic progeny.

As pointed out by Reya and Weisman, the fundamentally critical target in treating leukemia, and all forms of cancer, is the eradication of the malignant stem cell ( [344](#) ). Most therapeutic agents are cytoreductive but do not necessarily target the leukemic stem cell compartment. Such treatments usually produce rapid early responses but are too often doomed to eventual failure due to relapse—a situation commonly observed in the majority of patients with AML who achieve an initial remission but then relapse. Targeting the leukemic stem cell would be predicted to show a slow rather than rapid response rate; that is, if the self-replicating leukemic stem cell were targeted, then the progeny with limited replicative potential would gradually be eliminated through apoptosis or senescence.

A critical question, then, is what targeted therapies that are being developed truly target the leukemic stem cell or are directed toward a more cytoreductive role that targets leukemic cell progeny with limited replicative potential? Thus far, most data would support the conclusion that most of the currently targeted therapies are more likely to be primarily cytoreductive. For example, at least some of the cytokine receptor mutations appear to be acquired and possibly second or third mutations ( [297](#), [306](#), [345](#) ). Similarly, most altered signal transduction pathways often represent secondary changes leading to increased proliferation and decreased apoptosis, such as mutations in RAS or altered bcl-2 expression ( [41](#) ). Vaccine-based treatments for AML remain potentially important but currently are relatively crude in that they usually represent whole cell vaccines ( [346](#), [347](#), [348](#) and [349](#) ). There are few data on what specific immunogenic antigens on leukemic stem cells would be good targets for more directed vaccine therapies. Differentiation therapies may provide a more leukemic stem cell-directed therapy, especially those directed toward “first hit” molecular lesions, possibly such as some of the known translocations observed in AML ( [350](#) ). But these approaches are also still relatively nonspecific in that approaches of genomic demethylation and histone deacetylase inhibition are currently not directed in terms of their effect on specific genes.

Although targeted therapies hold significant hope for improved antileukemic activity and for potentially sparing normal tissues from damage, there are clearly significant hurdles to overcome, including learning how to optimize such agents alone and in combination with

other drugs. Some of these challenges include those we have not yet conquered for even conventional therapy. A greater focus on the biology of the leukemic stem cell and whether a therapeutic target is relevant to the physiology and survival of that cell should take on an increasingly important role in future studies.

2004 Lippincott Williams & Wilkins  
John P. Greer, John Foerster, John N. Lukens  
George M. Rodgers, Frixos Paraskevas, Bertil Glader  
Wintrobe's Clinical Hematology

[EPIDEMIOLOGY](#)[CLINICAL PRESENTATION](#)[LABORATORY ANALYSIS](#)[Coagulation Studies](#)[Morphology, Cytochemistry, and Immunophenotype](#)[Differential Diagnosis](#)[Cytogenetics and Molecular Biology](#)[THERAPY OF ACUTE PROMYELOCYTIC LEUKEMIA](#)[General Principles of Management](#)[Assessment of Response](#)[Current Therapy](#)[SUMMARY](#)

*Acute myeloid leukemia* (AML) is a malignant disorder of the bone marrow in which a maturational arrest in blood cell progenitors results in failure of normal hematopoiesis. *Acute promyelocytic leukemia* (APL) is a subtype of AML with a defined clinical course and a biology that is distinct from the other forms of AML. Morphologically, the most common form of APL can have a striking appearance, as the bone marrow is effaced by heavily granulated cells with folded, twisted nuclei. Biologically, the cytogenetic changes define the syndrome, and the molecular consequences of the chromosomal changes found in APL are crucial in leukemogenesis. Clinically, patients typically display symptoms associated with cytopenias. The hemorrhagic complications are, however, often out of proportion to the degree of thrombocytopenia, reflecting the underlying biologic properties of the transformed promyelocyte. Historically, recognition of this form of AML as a separate entity was important for the clinician, not because the chemotherapy used as treatment differed substantially from that used for the other subtypes of AML, but because the relatively common occurrence of life-threatening coagulopathy mandated special supportive maneuvers, including the use of low-dose heparin and aggressive blood product support. Yet, despite prompt diagnosis and attention to potential complications associated with the institution of therapy, periinduction mortality was often significant, with some older series reporting an incidence approaching 50% ([1](#), [2](#), [12](#)). Hence, APL came to typify the worst features associated with leukemia: a fulminant disorder that struck primarily young people, had devastating effects on an individual's life, and resulted in death for a large number of patients during the initial phases of treatment.

The last two decades have seen a fundamental shift from this paradigm, with APL now recognized as one of the most curable forms of acute leukemia. In part, this change has been accomplished because supportive care has been refined. The most dramatic event, however, has been the introduction of therapy with all-*trans*-retinoic acid (ATRA). Subsequent laboratory investigations into the mechanism of the differentiating effect of ATRA have led to an understanding of the basic biology of APL, making the disease a model for the development of new therapies with possible applications across the entire field of oncology.

## EPIDEMIOLOGY

AML is, in itself, a rare disease. In 2001, there were approximately 10,000 new cases of AML in the United States ( [3](#) ). AML affects slightly more males than females, and the median age of these patients is 64 years. APL comprises approximately 8 to 13% of adult AML cases. In contrast to the other AML subtypes, APL tends to occur in younger patients ( [4](#) ). An increased incidence has been reported in Hispanic populations ( [5](#) ). One group has reported an association with obesity ( [6](#) ). Although relatively uncommon in children, clustering of cases in pediatric populations has been described, raising the issue of possible environmental exposure ( [7](#) ). APL generally is not preceded by a myelodysplastic syndrome. The disease may, however, result as a consequence of prior therapy for an unrelated malignancy ( [8](#) ). In such cases, the clinical characteristics are determined by the karyotype, and these patients do as well as individuals who present with *de novo* disease. This is in marked contrast to other secondary myeloid leukemias that result from exposure to radiation, topoisomerase therapy, or alkylating agents, in which the prognosis is significantly worse.

## CLINICAL PRESENTATION

Like any acute leukemia, the symptoms associated with APL may be relatively nonspecific. Most patients complain of fatigue, with a significant decrease in their previous level of activity. The manifestations of hemorrhage are often the most dramatic findings in the physical examination. There may be prominent petechiae or extensive ecchymotic involvement of the skin. Visual changes may result from retinal hemorrhages, and subconjunctival hemorrhage may follow episodes of coughing or vomiting. Overt hemorrhage from the gums, nose, mouth, or other bodily orifices can occur.

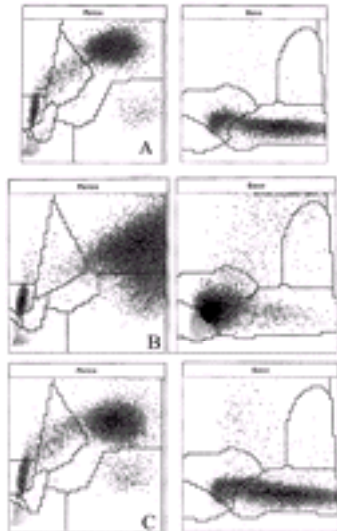
Frank infiltration of extramedullary sites [i.e., skin, central nervous system (CNS), and gums] is rare in newly diagnosed patients, although such findings have been described in patients who relapse after therapy ( [9](#) , [10](#) ).

## LABORATORY ANALYSIS

The clinical laboratory plays an important role in the diagnosis of APL and serves to focus nonspecific complaints and signs toward a hematologic origin. A complete blood count is among the first laboratory tests obtained and is almost always abnormal. Cytopenias of all three lineages are the most common findings. The white blood cell count (WBC) may be elevated in 10 to 30% of patients and has been associated with a morphologic variant of APL (see below) ( [11](#) , [12](#) , [13](#) , [14](#) , [15](#) and [16](#) ). Early recognition of this entity is important, as such patients have a higher incidence of periinduction morbidity/mortality and may warrant more aggressive management.

Quantitative abnormalities mandate that the peripheral smear be reviewed by an experienced morphologist. The peripheral blood often contains heavily granulated cells that are characteristic of the disease, but these are more likely to be found in the bone marrow. Direct examination of the blood smear also serves to verify any abnormalities and avoid spurious values such as thrombocytopenia secondary to platelet clumping. In addition, many of the standard Coulter counter instruments that rely solely on changes in electric impedance to generate blood cell differentials are unable to differentiate the heavily granulated promyelocytes from granulocytes, causing a false reading on the machine-generated differential. Some of the newer blood analyzers rely on a combination of light scatter and flow cytochemistry (detecting myeloperoxidase content) to

differentiate between peripheral blood cell types. The high myeloperoxidase content of the abnormal promyelocytes produces a characteristic scatterplot ( [Fig. 82.1](#) ), which can aid in the confirmation of the diagnosis ( [17](#), [18](#) ). This finding is particularly useful in identifying patients with the microgranular variant because the cytochemical properties of the cell are unchanged and detected by flow cytometry, whereas the morphology may be problematic.



**Figure 82.1.** Representative cytograms from an automated blood analyzer that plots cell volume ( *y-axis* ) versus peroxidase (Perox) activity ( *x-axis* ) to generate a blood cell differential. **A:** Normal cytogram shows a cluster of cells in the upper right of the peroxidase channel ( *left pane* ) typical for granulocytes. **B:** Untreated acute promyelocytic leukemia. The granulocyte cluster is now shifted to the extreme right, reflecting the high myeloperoxidase content of the abnormal promyelocytes. This pattern is characteristic of acute promyelocytic leukemia and is preserved in the microgranular variant. **C:** Treated acute promyelocytic leukemia. The same patient approximately 35 days after receiving all- *trans*-retinoic acid, idarubicin, and cytarabine. The normal pattern has been restored. Baso, basophil channel; perox, peroxidase channel.

The other blood tests obtained at the time of diagnosis generally serve to screen for complications that can be associated with the leukemia. Serum electrolyte abnormalities need to be corrected, particularly before the institution of cytotoxic chemotherapy ( [19](#) ). Adequate renal function is extremely important, as aggressive blood product replacement can be anticipated in this disorder, and the management of extreme fluid overload may complicate care.

### Coagulation Studies

Because the recognition and management of coagulopathy is of the utmost importance in treating patients with APL, the initial laboratory evaluation may include a platelet count, prothrombin time, activated partial thromboplastin time, D-dimer or fibrin split products, and fibrinogen ( [20](#) ). This disease-related coagulopathy represents a major source of morbidity, and, despite the effective antileukemia therapy presently available, it remains the leading cause of periinduction mortality. The mechanism underlying the coagulopathy is complex and has been the subject of intensive investigation. Historically, the coagulopathy was ascribed to disseminated intravascular coagulation, which resulted as the abnormal promyelocytes lysed and liberated the procoagulant contents of their

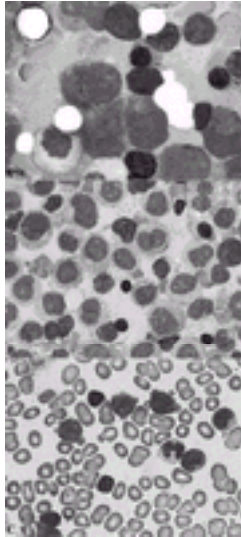
granules ( [22](#) ). Evidence for disseminated intravascular coagulation as the underlying mechanism includes the finding that APL cells release increased levels of tissue factor ( [23](#), [24](#) ). Tissue factor may serve to promote interaction between factor VII and other circulating procoagulants, resulting in a widespread generation of thrombin. The coagulopathy can occur in the absence of chemotherapy as the neoplastic cells undergo autolysis, and it is found in approximately 80% of APL patients at the time of diagnosis. The coagulopathy may be exacerbated by the institution of chemotherapy that results in the massive lysis of abnormal promyelocytes, amplifying the already existing activation of the coagulation pathway. Both the prothrombin time and partial thromboplastin time are abnormally elevated, whereas the fibrinogen is low, reflecting an ongoing consumption. In addition, a number of other coagulation parameters, such as the thrombin time and the level of fibrin split products, are elevated, reflecting widespread disruption of the normal coagulation cascade. It is important to note that a fibrinogen in the low range of normal is still cause for concern, given that it is an acute phase reactant and ordinarily would be elevated in an ill patient. Serial measurements (approximately 6 to 12 hours apart) often reveal the developing hypofibrinogenemia indicative of consumption and help guide replacement therapy with blood products.

More recently, another explanation for the underlying coagulopathy has attributed the bleeding diathesis to primary fibrinolysis ( [25](#) ). An ongoing unchecked process results in a low fibrinogen, producing a clinical picture in which hemorrhage is the primary sequelae. Evidence for this hypothesis has been provided by the finding that low plasma levels of plasminogen, a  $\alpha_2$ -plasmin inhibitor, and plasminogen-activator inhibitor 1 are found in fibrinolytic states and are also found in APL. In addition, annexin II, a cell-surface receptor for plasminogen and tissue plasminogen activator, is expressed at abnormally high levels on APL cells but not on blasts from other forms of acute leukemia ( [26](#) ). The increased expression of annexin II may lead to overproduction of plasmin, which results in dysregulated fibrinolysis. The potential for hemorrhage is further amplified by the depletion of the main inhibitor of plasmin, a  $\alpha_2$ -plasmin inhibitor, which is consumed in an effort to counter the increased production of plasmin. The clinical manifestations of the coagulopathy are controlled, and some of the coagulation parameters progressively improve within days after the institution of therapy with either ATRA or arsenic trioxide (ATO) ( [19](#), [21](#) ).

### **Morphology, Cytochemistry, and Immunophenotype**

Examination of the bone marrow aspirate and biopsy are the standard tests by which the diagnosis of acute leukemia is made. The morphologic features of the cells in the blood and the bone marrow may be different, underscoring the importance of sampling the bone marrow. The various morphologic subtypes of APL and their defining features are summarized in [Table 82.1](#) ( [13](#), [14](#) and [15](#), [27](#), [28](#) ). Characteristic examples of the morphology are provided in [Figure 82.2](#). In the classic hypergranular variety of APL, the bone marrow aspirate is generally hypercellular, and the abnormal promyelocytes constitute the predominant population. Blasts may be increased, but their number alone may not meet the minimal criteria by which classification systems like the French-American-British (FAB) and World Health Organization define AML. The malignant promyelocytes need to be considered in total to establish a diagnosis of AML. The malignant promyelocytes may be slightly larger than their normal counterparts. Such cells are heavily granulated; the granules often obscure the nucleus, making the nucleocytoplasmic border somewhat indistinct. In addition, the nucleus may be folded or bilobed. The cytoplasm often contains vacuoles, and distinctive Auer rods are frequently visible. *Auer rods* are coalesced primary granules and may be abundant. Multiple Auer rods clustered together within a single cell resemble a bundle of sticks or twigs, and such cells have been labeled *Faggot cells* (after the French term for *bundle of sticks*). Globular cytoplasmic inclusions (pseudo-Chédiak-Higashi inclusions) have also been described. The term *flaming*

*promyelocyte* has been coined to describe cells that appear to be “breaking apart,” taking on a vibrant reddish purple hue with the apparent liberation of granules into the surrounding cellular matrix.



**Figure 82.2.** Morphologic subtypes of acute promyelocytic leukemia. **A:** “Classic” M<sub>3</sub> is characterized by heavily granulated promyelocytes with abundant Auer rods. **B:** Microgranular variant (M<sub>3v</sub>) has fine granulation with a bilobed, folded nucleus. **C:** Hyperbasophilic variant has few granules, intense basophilia, and small cytoplasmic projections or buds reminiscent of micromegakaryocytes (100×, MacNeal Tetrachrome). See [Color Plate](#).

**TABLE 82.1. Morphologic Subtypes of Acute Promyelocytic Leukemia**

|           | Hypergranular<br>(Classic M <sub>3</sub> ) | Microgranular<br>(M <sub>3v</sub> )    | Hyperbasophilic   | Promyelocytic<br>Leukemia Zinc<br>Finger/Retinoic Acid<br>Receptor-α (M <sub>3r</sub> ) |
|-----------|--|--|---|---|
| Nucleus   | Folded, lobulated granules obscure borders | Irregular, folded                      | High nucleocytoplasmic ratio                                      | Regular; condensed chromatin pattern; Pelgerlike cells                                  |
| Cytoplasm | Prominent azurophilic granules             | Fine, small granules; dusky appearance | Granules sparse; strongly basophilic; cytoplasmic “budding” noted | Granularity: midway between classic M <sub>3</sub> and FAB M <sub>2</sub>               |
| Auer rods | Frequent; Faggot cells                     | Rare                                   | Not seen  | Rare; Faggot cells absent   |

Identification of the microgranular variant (M<sub>3v</sub> according to the FAB classification system) may be more problematic ([13](#), [14](#)). This entity generally constitutes approximately 20 to 30% of APL cases. It was first recognized because it shares some clinical features as well as the typical t(15;17) with the hypergranular form of APL. The granules in the microgranular variant are less prominent, somewhat dispersed, and may be difficult to



visualize using light microscopy. Instead, the granulation may be fine, and the cells may appear dusky. The shape of the nucleus, which has a characteristic bilobed, folded appearance, is often the key to identifying this disorder. Auer rods may be present but are generally less plentiful than in the hypergranular variety. Another clue to diagnosis is the finding of the more typical hypergranulated forms in the bone marrow. The peripheral WBC may be higher than in the classic variety, and any hypergranulated promyelocytes are less likely to be found in the peripheral blood. The characteristic cytogram found via flow cytometry ( [Fig. 82.1B](#) ) is preserved in the microgranular variant, providing useful rapid confirmation of the diagnosis before the cytogenetic or molecular results are available ( [18](#) ).

A third morphologic form of APL, the hyperbasophilic variant, has been described ( [15](#) ). This is a relatively uncommon form of APL, which some experts group within the M<sub>3v</sub> category. However, the morphologic features are distinct enough to warrant separate consideration. The cells in this disorder have few, if any, granules. Instead, the cytoplasm is deeply basophilic and may have small blebs, buds, or projections, making the appearance reminiscent of micromegakaryocytes. The nucleus tends to occupy most of the cell and has an irregular, lobulated appearance. Both the microgranular and hyperbasophilic variants can be mistaken for an acute monocytic leukemia. A variant form of AML associated with CD56 expression and natural killer cell lineage has been confused with M<sub>3v</sub> but lacks the defining t(15;17) cytogenetic abnormality ( [29](#) ). More recently, a European consensus group has described distinctive morphologic features of APL variants associated with the promyelocytic leukemia zinc finger gene (PLZF)/RA receptor- $\alpha$  (RARA) fusion products (see below) and has proposed a new morphologic category, M<sub>3r</sub>. These leukemias have a regular nuclear outline, rarely have Auer rods, and have a cytoplasmic granularity that is intermediate between the M3 and M2 varieties of AML ( [28](#) ).

Although not diagnostic for APL, cytochemistry and immunophenotyping may help characterize APL. The cytochemical properties of the abnormal promyelocytes are consistent with a diagnosis of AML ( [13](#), [14](#) and [15](#), [27](#), [30](#) ). The hypergranular variety stains intensely with Sudan black, myeloperoxidase, or chlor-acetate esterase. The microgranular variant retains this staining pattern, although the degree of positivity may be less intense. As discussed above, the high myeloperoxidase content of abnormal promyelocytes may be detected in the peripheral blood using modern blood analyzers. Less useful is the observation that nonspecific esterase activity has been noted in some abnormal promyelocytes, further confusing the differentiation between acute monocytic leukemia and some forms of APL ( [31](#) ). These reactions are weaker than those found in monocytes, and some forms of the isoenzymes found in monocytes are absent in the abnormal promyelocytes. Metachromatic staining with toluidine blue has been reported in cases of APL with basophilic differentiation.

Immunophenotyping is also useful in confirming the diagnosis of APL ( [30](#), [32](#) ).

*Promyelocytes* are partially differentiated cells that are reflected in the immunophenotype. The cells express the early myeloid marker CD33 but lack HLA-DR, a marker often associated with some earlier progenitor cells. It is important to emphasize that this immunophenotypic profile is characteristic, but not diagnostic, of APL. Up to 20% of other types of AML may express CD33 but not HLA-DR. The marker CD9 is expressed in APL but not in other AML subtypes ( [33](#) ). However, the utility of this finding is practically nil, as few screening panels used for diagnosis contain CD9 as part of the initial workup. The stem cell marker, C34, is generally not expressed, whereas the myeloid lineage marker CD 13 is occasionally observed and possibly associated with the development of retinoic acid syndrome (RAS) ( [34](#) ). The T-cell marker CD7 is negative as are the myelomonocytic markers CD11b and CD14. CD11b is also an indicator of myeloid

maturation and, along with CD16, a surface marker found on granulocytes, can be induced with differentiation therapy. The aberrant expression of the T-cell marker CD2 has been correlated with the microgranular variant. Reports of a correlation with the short form of the promyelocytic leukemia (PML)/RARA fusion transcripts have been mixed ( [35](#), [36](#), [37](#) and [38](#)). Expression of the P-glycoprotein associated with the MDR phenotype is generally not found in APL. The natural killer marker, CD56, has been reported in true APL (as opposed to natural killer-AML) and has been associated with a poor prognosis ( [39](#), [40](#)).

## Differential Diagnosis

As discussed above, the morphologic appearance of APL can be quite striking given the characteristic appearance of the most common variety, the hypergranular form. The differential diagnosis of APL includes reactive disorders of the bone marrow as well as other subtypes of acute leukemia. Recovery from an insult that produces relative aplasia can result in increased myeloid activity with a left shift in the myeloid series. Therapy with the myeloid growth factors, granulocyte colony-stimulating factor or granulocyte-macrophage colony-stimulating factor, can result in a hypercellular bone marrow with prominent toxic granulations. Maturation, however, is preserved, and Auer rods are not found. Other marrow elements, such as erythroid and megakaryocytic precursors, are present, although the relative number appears somewhat diminished. Chronic myelogenous leukemia may appear with a hypercellular marrow containing a predominant myeloid component that appears heavily granulated. In this disorder, all stages of maturation are present and accompanied by increased eosinophils, basophils, or both. Acute myeloid leukemia with maturation (FAB M2) may contain blasts as well as cells that contain too many granules to be considered blasts but are not mature enough to be classified as promyelocytes. Auer rods are also found in this AML subtype, but these occur as single structures and not as clusters. Faggot cells are generally not found. Abnormal promyelocytes can be seen, but these cells do not constitute the predominant population in the bone marrow. A monocytic component may be present in less than 20% of the nonerythroid elements. The microgranular and hyperbasophilic variants may be mistaken for monocytic leukemia because of the deeply staining cytoplasm, lack of granules, and folded, convoluted nuclei. Other rare forms of leukemia, such as mast-cell leukemia or basophilic leukemia, may, at first, be confused with APL but lack characteristic features such as Auer rods and the nuclear folding pattern and present with granules, which can be readily distinguished from those of the promyelocyte using conventional histochemical stains.

## Cytogenetics and Molecular Biology

Despite the minor variations in phenotype discussed above, APL as a clinical syndrome is defined by its cytogenetics. The balanced translocation between chromosomes 15 and 17 characterizes over 95% of cases of APL ( [41](#), [42](#)). The breakpoints for the translocation usually occur at q22 loci on chromosome 15 and at q21 on chromosome 17. The t(15;17) is generally detected by conventional cytogenetic techniques and provides definitive evidence of the diagnosis of APL. The molecular consequences of this translocation result in a fusion of a portion of the gene for RARA on chromosome 17 to part of the PML gene on chromosome 15 ( [43](#), [44](#), [45](#) and [46](#)). Although the break within the RAR gene is invariably within the second intron of the gene, the point of rearrangement within the PML gene can occur at two major breakpoints, resulting in three isoforms of the transcript. Breakpoints within PML intron 3 (bcr3) generally yield a shorter messenger RNA transcript, whereas breakpoints within intron 6 (bcr1) result in the long form of the transcript ( [47](#)). Breakpoints within intron 6 of PML can also occur at a second site (bcr2) and result in a transcript of variable length. The site of the breakpoint has been reported to have prognostic implications, as newly diagnosed patients with the short isoform appear to have a shorter disease-free survival (DFS) and overall survival (OS) compared

to patients with the long isoform in some series ( [34](#), [48](#)). Other authors have correlated the isoform with various other prognostic factors but discount an independent effect on outcome ( [49](#)). In all cases, the chimeric gene products that result from this translocation have fundamental implications for the cell and are believed to be causative in producing the malignant phenotype. Variations of this translocation exist and, in some instances, have profound clinical implications.

Although the t(15;17) is the defining cytogenetic abnormality in APL, other additional chromosomal abnormalities can be found in 30 to 40% of patients with APL ( [50](#), [51](#)). The most common of these are trisomy 8 and isochromosome 17. Additional chromosomal abnormalities do not have a negative effect on the overall prognosis ( [51](#), [52](#)). Complex translocations involving other chromosomes in addition to 15 and 17 can occur.

Masked translocations, in which pieces of chromosome 15 and 17 are transposed but escape detection by conventional techniques, have been reported ( [53](#), [54](#)). In most of these cases, the molecular abnormality, either the PML-RARa or the reciprocal RARa-PML transcript, can be detected. Expression of the fusion gene product ultimately results in the clinical syndrome identified with APL despite the lack of gross chromosomal changes.

Variant translocations also exist and are rare as clinical entities but are instructive in helping to define the biology of APL. The most common variants involve translocations between chromosome 17 and either chromosome 5 or 11 ( [55](#), [56](#), [57](#), [58](#) and [59](#)). These variant translocations retain the same break within the RARa intron but differ in the molecular partner gene (X gene), which may account for some of the differences regarding their functional effects on the cell. The individual variants are summarized in [Table 82.2](#). The structural changes within these genes may affect the normal function of the wild-type product, resulting in the phenotypic abnormality, which is expressed as the leukemia. Most notable among the variants is the t(11;17) (q23q21) because this entity is resistant to the differentiation effects of ATRA. This chromosomal translocation results in a fusion of the RAR gene with PLZF. PLZF is similar to PML in that it has profound implications for the cell with regard to regulation of transcription of target genes resulting in differentiation. However, PLZF is distinctly different from PML in that properties of this gene product interact differently with RA, rendering it ineffective ( [60](#)). In addition, this form of APL also has a poor response to standard chemotherapy, underscoring the multiple differences in biology between these two entities.

**TABLE 82.2. Acute Promyelocytic Leukemia: Chromosomal Translocations and Fusion Products**

| Translocation     | Frequency (%) | Molecular Fusion Product (X-RARa) | Function "X" Gene                          | Retinoid Sensitive | Chemotherapy Sensitive |
|-------------------|---------------|-----------------------------------|--|--------------------|------------------------|
| (15;17) (q22,q21) | 95            | PML-RARa                          | Transcriptional                            | +                  | +                      |
| (11;17) (q23,q21) | <5            | PLZF-RARa                         | Developmental/differentiation control      | -                  | -                      |
| (5;17) (q35,q21)  | <1            | NPM-RARa                          | Ribonucleoprotein maturation and transport | +                  | +                      |

|                      |    |              |  |   |   |
|----------------------|----|--------------|--|---|---|
| (11;17)<br>(q13,q21) | <1 | NuMA-RARa    | Structural role in mitosis, apoptosis, and interphase nuclear matrix | ± | ± |
| (17;17)<br>(q11,q21) | <1 | STAT 5b-RARa | Signal transduction, transcriptional factor                          | - | ? |

+, sensitive; -, not sensitive; ±, may be sensitive; NPM, nucleophosmin; NuMA, nuclear mitotic apparatus; PLZF, promyelocytic leukemia zinc finger; PML, promyelocytic leukemia; RARa, retinoic acid receptor- $\alpha$ ; STAT 5b, signal transducer and activator of transcription 5b; "X," RARa partner gene.

---

Based on experimental data generated in cell lines, transgenic mice, and correlations with clinical treatment data, a model for leukemogenesis in APL has been developed ([61](#), [62](#), [63](#), [64](#) and [65](#)). On the most basic level, this hypothesis states that APL results from transcriptional dysregulation of differentiation produced by the PML-RARa gene product. In the normal cell, RARa plays an important role in modulating myeloid differentiation by virtue of its ability to recruit various nuclear corepressors like SMRT/N-CoR and mSin3. These transcription corepressors, in turn, bind various histone deacetylases, affecting chromatin conformation resulting in repression of transcription of target genes fundamental to the differentiation process. Under physiologic conditions, binding of RA causes dissociation of the corepressor complex, recruits transcriptional activators, and "opens" the chromatin, facilitating the transcription of the various target genes and allowing normal maturation. The PML-RARa fusion protein has an increased affinity for the N-CoR corepressor complex, such that physiologic doses of RA ( $<10^{-8}$  M) fail to produce a dissociation of the complex, resulting in continued transcriptional repression and a maturational block. Instead, supraphysiologic doses achieved by the administration of ATRA are required to recapitulate the behavior of the wild-type receptor. In the PLZF-RARa variant, there is a second binding site for the corepressor proteins within the PLZF portion of the fusion protein that is not sensitive to RA. Hence, even supraphysiologic doses are unable to free the corepressor complex and permit the conformational changes in the histones necessary for permitting differentiation to occur. This may be an explanation for the clinical resistance of t(11;17) to ATRA and has led investigators to explore compounds like histone deacetylase inhibitors that bypass corepressor binding as defined by the activity of RA receptors and directly effect transcriptional activation.

Although the model of transcriptional repression through chromatin remodeling may rest on the interaction of the aberrant RARa fusion protein with key regulatory genetic elements, the primary partners in the molecular fusion proteins, namely PML and PLZF, may also serve to amplify dysregulation of transcription ([60](#), [62](#)). PML does not directly bind DNA but has been found to regulate transcription through interaction with a number of transcription factors and repressors ([66](#), [67](#) and [68](#)). In the normal cell, PML is localized in discreet subnuclear structures called *PML oncogenic domains* or *PML nuclear bodies* (PNBs). These PNBs may functionally regulate transcription either by providing an environment where the various regulatory factors can interact or be modified or by binding various transcription activators/repressors or sequestering them from circulating in the nucleoplasm, thereby preventing any interaction with other regulatory elements. This function, in turn, may affect fundamental cellular process, such as growth, senescence, and apoptosis. PML-RAR disrupts the organization and function of the PNBs and displaces PML, forming a microspeckled pattern in the nucleus. Treatment with RA causes the PNBs to reorganize and, presumably, restores not only the structure but the

functional activity.

Less is known about the function of PLZF. It also modulates transcriptional repression through multiple interactions with SMRT/N-CoR/mSin3/HDAC complexes and may localize in structures similar to the PNBs. Some of the mediators with which PLZF interacts are insensitive to modulation by RA, and these properties are retained in the PLZF-RAR fusion product, resulting in clinical ATRA resistance.

In addition to providing an understanding of the underlying biology of leukemia with possible application to cancer as a whole, the molecular genetics of APL also provide a useful tool for the clinician in confirming the diagnosis and planning therapy. As discussed above, the vast majority of APL cases are characterized by the t(15;17), resulting in a PML-RAR fusion product. These genetic changes are specific for APL, and, using the modern molecular technique of reverse transcriptase polymerase chain reaction (RT-PCR), they are easily detectable ( [69](#), [70](#) and [71](#) ). RT-PCR has become a standard tool in the management of APL. It is now readily available in commercial laboratories, and there is usually a rapid turnaround time. RT-PCR is useful in confirming the diagnosis of APL, particularly in cases in which morphology is problematic. In addition, this unique molecular “signature” can be used to monitor response and test for minimal residual disease (MRD) ( [48](#), [69](#), [70](#), [71](#), [72](#) and [73](#) ). This ability to use an effective method to detect MRD is in sharp contrast to the other forms of AML, in which response is assessed primarily through morphologic examination of the bone marrow and blood. Therefore, in APL, the concept of remission can be redefined to include a molecular response. Molecular relapse can be detected before it is clinically apparent, and this information can be used to guide therapy. An effective treatment regimen renders the RT-PCR assay for PML-RAR negative. Conversion from a negative result to a positive result that is reproducible on two sequential assays is predictive of clinical relapse. Some groups have reported highly successful results by treating the disease in molecular relapse before the occurrence of the full-blown clinical syndrome ( [74](#) ). This has led to the standard recommendation that patients with APL be serially monitored for PML-RAR via RT-PCR every 3 months during the first 2 years after remission is achieved, when the risk of relapse is the greatest ( [48](#) ).

## THErapy OF ACUTE PROMYELOCYTIC LEUKEMIA

### General Principles of Management

The primary life-threatening complications of acute leukemia are infection and hemorrhage ( [75](#) ). The key to the successful management of the patient with APL is anticipating the complications and instituting therapy early enough to limit toxicity. The available therapies, including ATRA, ATO, and conventional chemotherapy, all have potent antileukemia effects. The main challenge lies in supporting the patient through the 3 to 5 weeks of therapy necessary to achieve remission.

Stabilizing the patient requires interpretation of the history, clinical presentation, and initial laboratory data to correctly diagnose the underlying condition as APL. Many patients present to medical attention with fever, and, because infection in the setting of neutropenia can be rapidly fatal, empiric antibiotics are promptly started after an initial attempt at identifying a source of infection ( [76](#) ). This empiric antibiotic coverage can be altered based on the sensitivities of any organism isolated from the various cultures. Continued fever despite broad-spectrum antibiotics may require empiric therapy with an antifungal, such as amphotericin or a liposomal amphotericin preparation.

Approximately 80% of patients with APL present with coagulopathy in addition to



thrombocytopenia. As discussed above, laboratory tests that are useful as indicators of coagulopathy include the platelet count, prothrombin time, partial thromboplastin time, and fibrinogen levels. Other coagulation parameters, such as thrombin time, ethanol gelation test, and protamine sulfate test, may also be obtained but add little to the clinical decision-making process besides confirming the presence of a coagulopathy. Management of this coagulopathy requires treating the underlying leukemia. However, the administration of conventional cytotoxic chemotherapy may, at first, exacerbate the coagulopathy. The use of a continuous infusion of low-dose heparin (7 to 10 U/kg/hr) gradually evolved as a strategy to support patients through the initial phases of the chemotherapy until the leukemia burden had been decreased and the coagulopathy resolved. Although the rationale for such a strategy was, at best, unclear, some early studies reported a decreased rate of morbidity/mortality when heparin was used prophylactically when compared with historical controls with no heparin. Subsequently, a randomized study examining the use of heparin in APL patients failed to show any advantage when compared with aggressive blood product support (<sup>77</sup>). In addition, the introduction of RA changed the clinical scenario because this therapy does not cause an immediate, massive cell lysis and does not worsen the coagulopathy. Instead, the clinical coagulopathy typically abates after approximately 5 to 8 days of therapy.

Therefore, the initial therapy for the coagulopathy before the onset of the stabilizing effect seen with the retinoid is primarily supportive and based on aggressive platelet and blood product support. Frequent monitoring is the cornerstone of this management strategy. Intervention may be based on a worsening trend in a laboratory value such as the fibrinogen level. Platelets and fresh frozen plasma may be transfused multiple times per day to maintain a platelet count above 50,000/ $\mu$ l and fibrinogen levels above 100 mg/dl (<sup>20</sup>). In rare instances when the fresh frozen plasma is ineffective at supporting fibrinogen levels, cryoprecipitate may be administered to treat a fibrinogen level below 100 mg/dl. Others have advocated the use of low-dose heparin in cases in which the fibrinogen is unable to be maintained by replacement therapy alone.

Despite aggressive blood product support and early administration of either ATRA or arsenic, patients can and do experience catastrophic hemorrhage or thrombosis. In these instances, it may be appropriate to institute life-support measures, after discussion with the patient's health care proxy, in an effort to stabilize the patient while continuing to administer the leukemia therapy. Hemorrhage in the lung may require mechanical ventilation to support the airways, whereas a limited CNS hemorrhage may require measures to reduce intracranial pressure. The use of the antifibrinolytic  $\epsilon$ -aminocaproic acid has been advocated by some for use with CNS bleeding to inhibit fibrinolysis and help stabilize any clot formation (<sup>78</sup>). Underlying such heroic measures is the recognition that APL is ultimately a curable disease in the modern era. Primary resistance to either ATRA or ATO is rare, and most of the patients who do not respond to these therapies do so because they are unable to be supported through the acute phases of the illness.

### **Assessment of Response**

The traditional therapy for AML has relied on the strategy of using cytotoxic chemotherapy to induce bone marrow aplasia and clear the bone marrow of the malignant clone, allowing subsequent regrowth of normal progenitor cells with the restoration of normal hematopoiesis. A standard method for assessing whether aplasia has been achieved is to perform a bone marrow examination on approximately day 14 of therapy. The finding of persistent blasts on this day 14 bone marrow examination may prompt retreatment with a second course of induction therapy.

This paradigm does not apply to APL. The day 14 bone marrow examination after the

initial course of induction chemotherapy may reveal persistent abnormal promyelocytes, yet the patients are able to achieve remission at week 4 or 5 without further chemotherapy ( [79](#) ). Therefore, finding these abnormal promyelocytes should not automatically trigger a second course of chemotherapy. The pattern of response of APL to standard induction therapy is atypical and once again underscores that this disease is biologically distinct from other forms of AML. Some have interpreted these findings to mean that standard chemotherapy has a differentiating effect on the abnormal promyelocytes, whereas still others have cited a differential effect of cytotoxic therapy on the replicating abnormal progenitors with relative sparing of the quiescent, partially differentiated promyelocytes.

The introduction of ATRA and ATO as agents that accomplish remission by inducing differentiation/apoptosis has further modified the ways in which response is determined. The standard definitions of *complete remission* (CR) established by National Cancer Institute consensus criteria still remain useful ( [80](#) ). With the widespread availability of RT-PCR, the definition of CR has been further refined to include molecular remission. Often, the first sign that a patient is responding to therapy is the resolution of the coagulopathy with progressive improvement in the various coagulation parameters ( [81](#) ). The transfusion requirements for platelets may decrease, and fresh frozen plasma may no longer be needed to maintain the fibrinogen level. Leukocytosis, which can occur with either ATRA or ATO, may represent evidence of the abnormal clone's biologic response to therapy. Peripheral blood leukocytes undergo progressive morphologic changes, which include nuclear condensation and lobulation accompanied by cytoplasmic vacuolization ( [82](#) ). Granulocytic forms with persistent azurophilic granules may appear and have been labeled "intermediate" cells, as they retain features of promyelocytes but display some morphologic characteristics of neutrophils. These cells may also display an intermediate immunophenotype with the coexpression of CD33, a marker associated with immature myeloid cells, and CD16 or CD11b cell-surface markers, which are found on granulocytes and maturing myeloid elements ( [83](#) ). Various sources have also described the occurrence of polymorphonuclear leukocytes with Auer rods, another anomalous finding resulting from differentiation of the abnormal clone. Techniques such as fluorescence *in situ* hybridization (FISH) and premature chromosomal condensation have been used to verify that morphologically maturing cells are derived from the original malignant clone ( [84](#) ).

Although there may be a variety of clinical and morphologic changes that occur with therapy, the process of achieving CR is gradual. After approximately 4 to 6 weeks of treatment, the standard definition of CR should apply: adequate cellularity as determined by bone marrow biopsy and normal maturation of all cell lines with less than 5% blasts. No cells with Auer rods should be visualized. Restoration of normal hematopoiesis should be evidenced by a peripheral blood neutrophil count greater than or equal to  $1.5 \times 10^9/L$ , and the platelet count should be greater than  $100 \times 10^9/L$ . To meet criteria for CR, these findings should be present for at least 4 weeks ( [80](#) ).

Despite fulfilling the morphologic criteria for CR, approximately 90% of patients treated with ATRA alone and 25% of patients treated with ATO alone still have molecular evidence of disease as detected by RT-PCR. The addition of chemotherapy to ATRA increases the proportion of patients who become negative for molecular evidence of the disease. Repeated cycles of ATO may be needed to achieve this molecular remission. Given the importance of the RT-PCR assay results, it is recommended that the bone marrow be sampled and examined for both morphologic and molecular evidence of remission at least every 3 months for the first 2 years postremission ( [48](#) ). Patients whose RT-PCR result converts from a negative to a positive should have the bone marrow examination repeated within 1 month to verify this result. Patients tend to relapse within 6 months of completing therapy, so it is imperative that monitoring continue during this



critical time. Despite relatively intensive molecular monitoring, some patients relapse with overt clinical disease, raising questions regarding the predictive nature of the test as well as the sensitivity and standardization of the assay ( [85](#), [86](#) ).

### Current Therapy

APL was first recognized as a distinct subtype of AML in the 1950s ( [87](#) ). Until the late 1980s, patients with APL were treated with the standard therapy used for all subtypes of AML, consisting of a combination of an anthracycline and cytosine arabinoside. Using this approach, investigators reported CR rates in the 50 to 60% range, but with improvement in the management of infections and APL-related coagulopathy, CR rates increased to as much as 80% ( [88](#), [89](#), [90](#) and [91](#) ). The likely reasons for failure of this treatment included mortality related to sepsis, catastrophic hemorrhage, or, less frequently, primary drug resistance ( [92](#), [93](#) ). However, despite this high CR rate, long-term DFS in patients with APL was approximately 30 to 40% ( [94](#), [95](#) and [96](#) ), clearly reflecting a need for improvement in the existing approach. See [Table 82.3](#) for representative therapies for APL.

**TABLE 82.3. Representative Therapies for Newly Diagnosed Acute Promyelocytic Leukemia**

| Study   | Therapy   | Number (N)  | Complete Remission (%)   | EFS or DFS (%)                        | Relapse Rate (%)        |
|---|---|-------------|--------------------------|---------------------------------------|-------------------------|
| Marty et al. ( <a href="#">96</a> )                 | Daunorubicin  | 83          | 64                       | —                                     | —                       |
| Avvisati et al. ( <a href="#">101</a> )             | Idarubicin  | 131         | 76                       | —                                     | —                       |
| Warrell et al. ( <a href="#">108</a> )              | ATRA followed by chemotherapy   | 49          | 85                       | —                                     | —                       |
| Avvisati et al. ( <a href="#">110</a> )             | Idarubicin and ATRA (elimination of cytarabine)   | 480         | 93                       | —                                     | —                       |
| Sanz et al. ( <a href="#">121</a> )                 | Idarubicin and ATRA (elimination of cytarabine)   | 123         | 89                       | 2-yr DFS: 92 ± 3                      | —                       |
| Tallman et al. ( <a href="#">111</a> ) (randomized) | ATRA followed by chemotherapy vs. chemotherapy  | 172 vs. 174 | 72 vs. 69 (NS)           | 3-year DFS: 67 vs. 32 ( $p < .001$ )  | —                       |
| Burnett et al. ( <a href="#">123</a> ) (randomized) | ATRA × 5 d followed by chemotherapy vs. ATRA daily until complete remission plus chemotherapy | 119 vs. 120 | 70 vs. 87 ( $p < .001$ ) | DFS: 59 vs. 72 ( $p = .07$ )          | 36 vs. 20 ( $p = .04$ ) |
| Fenaux et al. ( <a href="#">112</a> ) (randomized)  | ATRA followed by chemotherapy vs. chemotherapy  | 54 vs. 47   | 91 vs. 81 (NS)           | 4-year EFS: 63 vs. 17 ( $p = .0001$ ) | 31 vs. 78 ( $p = .03$ ) |

ATRA, all- *trans*-retinoic acid; DFS, disease-free survival; EFS, event-free survival; NS, not significant.

**CHEMOTHERAPY** Anthracyclines are among the most important cytotoxic agents used in

treating AML. Several studies have specifically demonstrated the sensitivity of APL to this class of agents ( [95](#), [96](#) ). However, whether there is a clinical advantage of one anthracycline compared to another remains controversial. Three prospective randomized trials conducted in the early 1990s compared daunorubicin to idarubicin in adults with newly diagnosed AML. All three studies showed an improved remission rate in patients treated with idarubicin, and two suggested improved survival ( [97](#) ). When the survival data were updated in 1996, however, only one of these studies suggested an advantage in the idarubicin arm ( [98](#) ). Several investigators argued that the dose of daunorubicin used in these trials was not equivalent in intensity to that of idarubicin, which could be the explanation for the observed differences. However, no prospective randomized trial has compared daunorubicin to idarubicin in APL. Although cytosine arabinoside is the backbone of treatment for AML in general, the importance of this drug in the treatment of APL specifically remains unclear. In APL patients, monotherapy using either daunorubicin or idarubicin achieves a CR rate in the 55 to 88% range ( [99](#), [100](#) and [101](#) ). A retrospective analysis of 62 patients with APL treated with either single-agent daunorubicin or daunorubicin in combination with cytosine arabinoside for induction therapy showed no difference in CR rates ( [100](#) ). Similarly, in a randomized prospective study in untreated APL patients comparing idarubicin to the combination of idarubicin plus cytosine arabinoside, no difference in CR rate or event-free survival was observed ( [101](#) ). Considering the exquisite sensitivity of APL to anthracyclines, dose-intense single-agent anthracycline may be more beneficial than and a less toxic alternative to standard combination therapy. Despite this reasoning, the “7+3” regimen (cytosine arabinoside, 100 mg/m<sup>2</sup>/day continuous intravenous infusion on days 1 through 7, and daunorubicin, 50 mg/m<sup>2</sup>/day intravenously on days 1 through 3) continues to be widely used in clinical practice.

**ALL- TRANS-RETINOIC ACID-BASED STRATEGIES** The introduction of ATRA into the treatment strategy of APL fundamentally changed the management and outcome of this disease. The first series of patients treated with ATRA was reported by Huang et al. in 1987 ( [102](#) ). Less than 10 years later, more than 3000 APL patients worldwide had been treated with ATRA. Data published from Chinese, French, American, Italian, and Japanese investigators point toward a median CR response greater than 85% ( [81](#), [83](#), [102](#), [103](#) and [104](#) ). Doses up to 100 mg/m<sup>2</sup> have been used, but no particular dose-effect correlation has emerged. Most clinical experience has been obtained with a dose of 45 mg/m<sup>2</sup>/day administered as a single daily dose or as two equally divided doses given approximately 12 hours apart. In a multicenter study conducted in APL patients by Castaigne et al. ( [105](#) ), a dose of 25 mg/m<sup>2</sup>/day of ATRA produced similar results in terms of CR rates and pharmacokinetic parameters to ATRA at 45 mg/m<sup>2</sup>/day. The incidence of hyperleukocytosis and RAS was also the same. Therefore, the only clinical advantage of a lower dose of ATRA is a possible lower incidence of RA side effects such as headache and cheilitis. The long-term therapeutic effects of a lower dose have not been established, and, therefore, lower doses should not be used routinely as standard of care. The clinical response to ATRA is correlated with the presence of the 15;17 chromosomal translocation assessed by conventional cytogenetics or by RT-PCR ( [69](#), [70](#), [73](#) ). This translocation involves the molecular rearrangement of RAR $\alpha$ , which appears to be the link to the clinical responsiveness to ATRA. Some patients with equivocal cellular morphology and normal karyotypes have shown typical rearrangements of RAR $\alpha$  by molecular testing, and these patients are clinically responsive to ATRA ( [70](#) and [71](#) ). However, patients who are negative for PML-RAR $\alpha$  by RT-PCR or who do not exhibit the karyotypic t(15;17) do not respond to ATRA ( [69](#), [70](#) ). Therefore, it is critical to note that patients with acute leukemia with cytogenetic or molecular findings other than the common t(15;17) or PML-RAR $\alpha$  that is distinctly found in APL do not respond to ATRA and should be immediately treated with standard antileukemic therapy. In the initial phase II studies with ATRA in APL, two important clinical observations became evident. The first was that up

to one-half of the patients developed what is now known as RAS, which often proved to be fatal in the preliminary experience (see discussion below). Gradually, a number of treatment strategies emerged that resulted in decreasing the associated morbidity/mortality of this syndrome. Currently, as the result of vigilant monitoring and initiation of high-dose dexamethasone with the first presenting sign or symptom, few patients die as a result of RAS. The other observation was that remissions induced and maintained solely by ATRA are brief in duration. In the initial New York series, the median remission duration was 3.5 months ( [107](#), [108](#) ). In fact, few patients in this and other series maintained a remission greater than 1 year ( [17](#), [21](#), [51](#), [52](#) ). Subsequently, both randomized ( [108](#), [109](#) ) and nonrandomized ( [110](#) ) studies revealed that, by combining standard induction therapy with ATRA, followed by consolidation treatments using several cycles of anthracycline-based regimens, remissions were not only durable but superior to those achieved by chemotherapy alone. In the initial trials incorporating ATRA into the treatment for APL, the drug was given as a single agent until CR was achieved; then, patients were consolidated with chemotherapy. However, the optimal schedule and duration of ATRA therapy needed to be determined to obtain the best clinical outcome. In the U.S. Intergroup Study ( [111](#) ), 346 newly diagnosed APL patients were randomized to receive either ATRA or daunorubicin plus cytosine arabinoside for remission induction. Patients who obtained CR received two cycles of consolidation therapy; the first cycle of treatment was identical to the induction chemotherapy, and the second cycle of consolidation consisted of high-dose cytosine arabinoside plus daunorubicin. Patients who remained in remission after completing consolidation therapy were randomized to either observation only or maintenance treatment with ATRA. Therefore, the majority of patients in this trial received ATRA either as induction therapy, maintenance, or both. Although there was no significant difference in the CR rate between the ATRA (72%) and chemotherapy (69%) induction groups, the 3-year DFS was statistically improved in the patients treated with ATRA compared to those treated with standard antileukemic therapy (72% vs. 32%;  $p < .001$ ). This trial clearly showed the benefit of ATRA in the management of APL, particularly when ATRA was incorporated into the induction therapy. The group of patients who received no ATRA had a 3-year DFS of only 18%, which was consistent with the historical survival rate of APL patients. A large European study ( [112](#) ) addressed the issue of scheduling the ATRA and chemotherapy by prospectively randomizing 413 untreated APL patients between concurrent ATRA plus chemotherapy (daunorubicin and cytosine arabinoside) and sequential ATRA followed by the same chemotherapy. Induction therapy was stratified based on both age ( $>$  or  $=65$  years) and on presenting WBC ( $>$  or  $=5000/\mu\text{l}$ ). Patients with WBC greater than 5000 per  $\mu\text{l}$  and younger than 65 years old (163 patients) were not randomized but were treated with concurrent ATRA and chemotherapy starting on day 1, and patients who were older than 65 years old (66 patients) were not randomized but were treated with ATRA followed sequentially by chemotherapy. Patients who achieved CR, irrespective of their induction regimen, received one to two additional courses of consolidation chemotherapy (one course if older than 65) and were then randomized to receive either 2 years of maintenance chemotherapy consisting of (a) ATRA alone, (b) methotrexate plus 6-mercaptopurine (6-MP), or (c) ATRA plus methotrexate and 6-MP, or no maintenance chemotherapy (observation only). The proportion of patients achieving CR in these two induction groups was no different, with an overall CR rate of 92%. However, the event-free survival at 2 years was estimated at 84% in the concurrent ATRA plus chemotherapy group versus 77% in the ATRA followed by chemotherapy group (  $p = .1$  ). This benefit appears to occur from a reduction in the risk of relapse, which at 2 years was 6% in the concurrent arm and 16% in the sequential arm (  $p = .04$  ). Another possible advantage from the concurrent ATRA plus chemotherapy treatment approach appears to be a greater than 50% reduction in the incidence of the potentially fatal RAS ( [113](#) ). The Italian cooperative group [Gruppo Italiano Malattie Ematologiche Maligne dell'Adulto (GIMEMA)] took a slightly different approach by eliminating cytosine arabinoside from induction therapy and using the combination of ATRA and idarubicin (referred to as "AIDA" for ATRA plus idarubicin) for remission induction in newly diagnosed APL ( [114](#) ). In this multicenter trial, 253 patients with positive

cytogenetics for t(15;17), a molecularly positive result by RT-PCR for the PML-RARa fusion gene, or both were treated with ATRA until CR. Intravenous idarubicin (12 mg/m<sup>2</sup>/day) was given concurrently with ATRA on days 2, 4, 6, and 8. Patients who achieved CR were consolidated with three cycles of combination cytotoxic chemotherapy. Using this induction regimen, 229 of 240 (95%) patients who were able to be evaluated achieved CR. There were 11 deaths related to early complications. The molecular conversion rate from PCR-positive to PCR-negative for PML-RARa after induction therapy was 60.5%, which increased to 95% after completion of the third cycle of consolidation therapy. The estimated actuarial event-free survival for all 253 patients was 83% and 79% at 1 and 2 years, respectively. These are among the best results reported for treating adults with acute leukemia.

**Duration of All-*trans*-Retinoic Acid Therapy** Currently, ATRA is recommended as part of the induction regimen and as maintenance therapy, which is initiated after the completion of consolidation chemotherapy. There is no benefit to continuous treatment with ATRA once patients have achieved CR. Generally, patients who relapse while taking ATRA or shortly after discontinuing ATRA do not respond to further treatment with standard- or high-dose ATRA therapy (102, 108). It would be particularly unusual for patients with a molecular diagnosis of APL who are retinoid naïve to be resistant to ATRA. Given the limited duration of remission with ATRA as a single agent, acquired resistance to ATRA could theoretically result from genetic or epigenetic events (115). Although acquired resistance in HL-60, a retinoid-sensitive leukemic cell line, has been associated with point mutations in the RARa fusion gene (116, 117), clinical specimens collected from patients before treatment with ATRA and at the time of relapse have not shown additional mutations in PML-RARa (118). It appears that multiple mechanisms are likely involved in the development of resistance. Continuous daily treatment with ATRA is associated with a marked decrease in plasma drug concentrations occurring as early as 1 to 2 weeks after initiation of therapy (119). The mechanisms by which this occurs include induction of cytochrome P-450 catabolic enzymes, increased expression of oxidative cofactors, up-regulation of cellular RA binding proteins, or all three (119, 120). These biologic mechanisms function cooperatively to modulate intracellular retinoid concentrations. Therefore, it is conceivable that prolonged administration of ATRA could result in the development of clinical resistance due to an inability to sustain effective concentrations *in vivo* that would be required to achieve cytodifferentiation.

**POSTREMISSION CONSOLIDATION THERAPY** As discussed above, treatment of APL with ATRA alone or in combination with chemotherapy yields a complete clinical remission rate as high as 85 to 95%. However, MRD detected by a positive RT-PCR for the PML-RARa transcript is present in 80 to 90% and in 50% of patients after induction therapy with ATRA alone (48) and ATRA plus chemotherapy (121), respectively. Invariably, patients with positive cytogenetics for t(15;17) or MRD determined by RT-PCR will clinically relapse (69, 70, 71, 72 and 73, 122). The proportion of patients with MRD is significantly reduced by the administration of postremission chemotherapy, which translates into a higher percentage of patients cured (70, 72, 121). The Memorial Sloan-Kettering group performed serial PCR analysis on the bone marrow of 47 patients with untreated APL who received ATRA induction therapy followed by consolidation treatment with chemotherapy, RA, and biologic agents (48). Forty of 47 patients (85%) had MRD detectable by RT-PCR after ATRA induction, and only four patients (10%) had detectable MRD after completing three cycles of consolidation therapy. Although several groups have incorporated high-dose cytosine arabinoside as part of the consolidation strategy (111, 123, 124), there have been no substantial data to support the benefit of dose-intense cytosine arabinoside in either induction or consolidation. Instead, dose intensification of the anthracycline appears to be of primary importance. In a 1999 nonrandomized prospective study conducted by the Spanish Programa para el Tratamiento de Hemopatías Malignas group, 123 newly diagnosed molecularly confirmed APL patients were treated with a modified AIDA regimen for induction and consolidation



(cytosine arabinoside and etoposide were eliminated from consolidation) (121). After the completion of consolidation therapy, patients who remained in remission received maintenance therapy with mercaptopurine, methotrexate, and, intermittently, ATRA. CR was obtained in 89% (109) and resulted in a molecular remission in 51% of patients after induction therapy and in 93% after the completion of consolidation treatment. The 2-year DFS and OS estimates were 92% and 82%, respectively. These results are similar to those obtained in the German AML Cooperative Group study (CR, 92%; DFS, 96%; OS, 88%) (72), in which intensified double-induction therapy with high-dose cytosine arabinoside with ATRA was administered. Similar results were observed in other trials that used dose-intense cytosine arabinoside (124). Therefore, for previously untreated patients, most groups use a combination of ATRA and chemotherapy (anthracycline-based) for remission induction. Once remission is achieved, ATRA is discontinued, and two cycles of an anthracycline-based regimen are generally administered as consolidation therapy with the goal of eliminating MRD. As previously noted, this approach has been extremely effective, with 80 to 85% of patients achieving long-term DFS and, in all likelihood, cured (108, 122). However, patients in remission should be monitored for evidence of MRD by RT-PCR. The experience to date shows that patients who remain positive during remission or those who convert from negative to positive inevitably relapse (69, 70). Such patients should be considered candidates for additional therapy during remission, in particular allogeneic bone marrow or stem cell transplantation.

**MAINTENANCE THERAPY** Traditionally, maintenance therapy has not been a critical component of the “state of the art” management of AML. However, in APL, there are several small studies that have suggested a possible benefit of maintenance chemotherapy (106, 125). In an early trial conducted at the MD Anderson Cancer Center, 39 of 70 patients with APL who received 6-MP and methotrexate as maintenance therapy had a sustained 3-year remission rate that was almost twice as high as that of patients who did not receive maintenance therapy (56% vs. 30%;  $p < .01$ ) (106). Subsequently, results of two randomized trials (111, 112) and one nonrandomized trial (121) have shown a reduction in the risk of relapse in patients treated with ATRA, chemotherapy, or both as maintenance. In the European APL 93 trial (112), the largest of these three studies, 289 patients who had completed consolidation therapy were randomized to no maintenance or to maintenance with (a) ATRA (45 mg/m<sup>2</sup>/day for 15 days every 3 months), (b) continuous low-dose chemotherapy with 6-MP (90 mg/m<sup>2</sup>/day) plus methotrexate (50 mg/m<sup>2</sup> given weekly), or (c) to both ATRA and continuous low-dose chemotherapy. The 2-year relapse incidence was 13% in patients who received ATRA compared to 25% in those who did not receive ATRA ( $p = .2$ ) and 11% in patients who received chemotherapy as maintenance compared to 27% in those who did not receive chemotherapy as maintenance ( $p = .0003$ ). However, the relapse rate (6 of 74 patients, 8%) was lowest in those patients who were randomized to receive both ATRA and low-dose chemotherapy. In addition, there was an improvement in OS ( $p = .01$ ) in those patients who received chemotherapy maintenance, and a similar trend appeared in those patients who received ATRA maintenance ( $p = .22$ ). Interestingly, high-risk patients (presenting WBC >5000 and >60 years of age) who received both ATRA and low-dose chemotherapy seemed to benefit the most from such therapy. Currently, two large ongoing randomized trials will help define the dose, schedule, and role of ATRA and chemotherapy maintenance in APL. The GIMEMA Cooperative Group is randomizing newly diagnosed APL patients to either no maintenance or to maintenance therapy using the same dose and schedules of maintenance therapy used in the APL 93 study: ATRA or continuous low-dose chemotherapy with 6-MP plus methotrexate or both ATRA and continuous low-dose chemotherapy. The North American Intergroup is evaluating ATRA given alone every other week versus ATRA given every other week with continuous low-dose 6-MP plus weekly methotrexate.

**ADVERSE EFFECTS OF RETINOIC ACID** The toxicity profile of ATRA is comparable to that of other retinoids. APL patients, however, are uniquely prone to the development of

hyperleukocytosis and RAS ( [126](#) ). RAS is characterized by fever, respiratory distress, radiographic pulmonary infiltrates, pleural or pericardial effusions, weight gain due to fluid overload, episodic hypotension, and acute renal failure. RAS has a reported incidence as high as 50% ( [126](#) ). The clinical diagnosis can be challenging because this patient population is at risk to develop pneumonia, sepsis, and congestive heart failure because of the disease and complications of cytotoxic chemotherapy. The first sign or symptom of RAS has been reported to occur anytime within the first few days to weeks after initiating ATRA therapy ( [118](#) ). It is interesting that there have been reports of RAS occurring in patients who were maintained on ATRA and whose marrow was recovering after myelosuppressive doses of chemotherapy ( [125](#) ). Although hyperleukocytosis is frequently observed preceding RAS, the reaction may occur with a normal leukocyte count in up to one-third of cases ( [34](#) , [107](#) , [126](#) ). Clinically, RAS gives the impression of a “capillary leak syndrome.” Postmortem examinations performed on patients who had progressive hypoxemia and multiorgan failure revealed extensive infiltration of maturing myeloid cells into lung, skin, kidney, liver, and lymph nodes ( [126](#) ). The cause of RAS is unknown, although several mechanisms have been proposed, including release of vasoactive cytokines, increased expression of adhesion molecules on myeloid cell surfaces, and attainment of migratory capabilities by the malignant promyelocytes as they undergo differentiation ( [34](#) , [126](#) ). ATRA increases the expression of the surface integrin intracellular adhesion molecule-1 in certain cell lines. Of clinical importance, this effect can be blocked by treatment with dexamethasone ( [127](#) , [128](#) ). Development of this reaction is also correlated with expression of CD13 (aminopeptidase N) ( [34](#) ), which has been associated with a poor outcome in patients with acute myeloid leukemia. These observations suggest a link to the clinical experience of extravascular adhesion and migration of differentiating cells in this reaction. The progression of RAS can be terminated by early intervention with a short course of high-dose dexamethasone (10 mg twice per day for 3 days), and, as a result, the mortality from this adverse event has decreased significantly ( [129](#) ). However, the importance of immediate recognition and appropriate intervention cannot be overemphasized. The development of any unexplained sign or symptom, particularly fluid retention, hectic fevers, and pulmonary infiltrates, should prompt immediate dexamethasone treatment. Fully established RAS has proved especially difficult to manage and often results in significant morbidity and, frequently, death. Therefore, the benefits of empiric steroid therapy far outweigh the risk of complications associated with inappropriate use in leukemic patients with infections. In a nonrandomized prospective study, the Australian Study Group treated patients with prophylactic corticosteroids (prednisone, 75 mg/day) and reported a lower incidence of pulmonary toxicity and RAS ( [130](#) ). Most groups have not adopted this as a standard approach given the risks/benefits of corticosteroids but instead administer dexamethasone at the earliest appearance of any of the signs or symptoms suggestive of RAS. Although APL is generally associated with leukopenia at the time of presentation, leukocytosis ( $=10,000$  cells/mm<sup>3</sup>) frequently occurs in APL patients treated with ATRA alone. In general, it was recognized that patients who developed leukocytosis while receiving ATRA fared as well as patients who developed the RAS. In addition, it has been suggested that the development of leukocytosis and RAS is associated with a higher risk of extramedullary relapse ( [131](#) ). The prevention and management of leukocytosis involve using full-dose chemotherapy along with ATRA. The concurrent administration of these agents also appears to result in a lower incidence of RAS. With ATRA alone, the incidence of RAS is approximately 25%, and, when ATRA is given concurrently with chemotherapy, the GIMEMA Trial, the Japanese Adult Leukemia Study Group, and the European APL study reported an incidence of RAS of 10%, 6%, and 15%, respectively ( [111](#) , [112](#) , [121](#) ).

**MANAGEMENT OF RELAPSED ACUTE PROMYELOCYTIC LEUKEMIA** The incorporation of ATRA into the treatment regimen for newly diagnosed APL has significantly improved the remission rate and has more than doubled the survival of newly diagnosed patients over that achieved with chemotherapy alone ( [83](#) , [111](#) , [132](#) ). Nonetheless, despite these

improvements, 15 to 20% of these patients relapse and are often resistant to further treatment with ATRA ( [83](#), [103](#), [122](#) ). However, some patients who have relapsed more than 6 months after completing their last ATRA therapy have achieved a second CR when retreated with ATRA ( [92](#) ). This relative “reversal of resistance” may be related, in part, to the metabolism of ATRA. The plasma levels of ATRA have been shown to decline over time in pharmacokinetics studies in which ATRA was given continuously, in part, as a result of autoinduction as discussed earlier. Clinically, this could result in a subtherapeutic plasma level and, thereby, give the appearance of drug resistance. The up-regulation of the respective metabolic enzymes reverses after a defined period from discontinuation of therapy ( [133](#), [134](#) ). Therefore, when reinstating therapy with standard doses of ATRA, the therapeutic levels needed clinically to induce myeloid differentiation are once again obtained. Patients who achieve a second CR, irrespective of agent(s) used, need additional curative therapy. Salvage therapy often entails high doses of cytotoxic chemotherapy followed by either autologous or allogeneic transplantation. Such an approach carries a risk of significant morbidity and mortality and may not be appropriate for some patients, an important consideration in treating very young or elderly patients. Also, an allograft is contingent on finding an HLA-identical donor, which only occurs for a subset of patients. Since the incorporation of ATRA as part of standard first-line therapy, there have been limited clinical data available reviewing the role of dose-intense chemotherapy followed by transplantation in relapsed patients. In the European APL 91 trial ( [112](#) ) and the Italian GIMEMA Group study ( [114](#) ), 4 of 5 patients and 6 of 15 patients, respectively, in second CR who underwent allografts obtained a prolonged CR. Thomas et al. ( [135](#) ) reported treating 50 patients with APL in first relapse with single agent ATRA until CR, followed by sequential EMA chemotherapy ( etoposide, 200 mg/m<sup>2</sup>/day for 3 days; mitoxantrone, 12 mg/m<sup>2</sup>/day for 3 days; and cytosine arabinoside, 500 mg/m<sup>2</sup>/day for two sequences of 3 days). Forty-five patients (90%) achieved a second CR; 37 of these 45 patients had ATRA as part of their first remission regimen when newly diagnosed. While in second CR, 11 patients underwent HLA-identical allogeneic transplant and had a median DFS of 8.2 months; 22 patients underwent autologous transplants and had a 3-year DFS rate of 77%. These results suggest that transplantation effectively cures a large proportion of these patients in first relapse at the risk of significant but acceptable toxicity. For patients undergoing an autologous transplantation, an important consideration is the RT-PCR status for PML-RARa, which is indicative of MRD. Meloni et al. ( [136](#) ) reported the results of 15 relapsed APL patients who underwent autologous transplantation in second CR. Seven of these patients' cells used in the graft were positive for PML-RARa, and all relapsed less than 9 months after the transplant. In comparison, only one of eight patients whose cells were RT-PCR-negative for PML-RARa relapsed.

**Arsenic Trioxide** Abandoned 30 years ago as an anticancer medicine, arsenic has recently attracted renewed attention as a treatment for relapsed APL. Based on impressive results from China ( [137](#), [138](#) and [139](#) ), a pilot trial in 12 patients with relapsed APL was conducted at Memorial Sloan-Kettering Cancer Center that demonstrated the effectiveness of ATO. Eleven patients (92%) achieved CR ( [140](#) ). Subsequently, a U.S. multicenter study ( [141](#) ) was performed to evaluate the efficacy of ATO for remission induction and consolidation in a population of patients with APL who had relapsed from prior retinoid- and anthracycline-based chemotherapy. In this study, 40 patients were treated with a daily 1-hour infusion of 0.15 mg/kg of ATO until obvious leukemic cells in the bone marrow were eliminated. Patients who achieved CR were eligible for one additional consolidation course of ATO, consisting of 25 doses. Thirty-four patients (85%) achieved CR. The median time to bone marrow remission (i.e., elimination of all visible leukemic cells on bone marrow aspirate review) was 35 days (range, 20 to 61 days), which was the determining factor to discontinue the ATO. The median time to clinical CR was 59 days (range, 28 to 85 days). An indicator of the efficacy of this agent was the observation that 78% of these patients converted from RT-PCR-positive to -negative for the PML-RARa transcript by the completion of their consolidation therapy. Subsequently,



18 patients received one to four additional cycles of ATO as maintenance on a different protocol, and 12 patients underwent allogeneic (N = 9) or autologous (N = 3) transplant post-ATO treatment while in CR. When the data from the 12 patients treated in the original single-institution study of ATO are combined with results from the 40 patients treated in this multicenter study, the Kaplan-Meier 18-month estimates of OS and relapse-free survival are 66% and 50%, respectively ( [141](#) ). Of note, over one-half of these 52 patients were alive at the 18-month follow-up, irrespective of age or number of prior relapses. No difference in survival as a function of time from last ATRA therapy was noted. The most common adverse events observed with ATO in the U.S. multicenter study included leukocytosis ( $>10,000$  WBC/mm<sup>3</sup>) during induction therapy, mild hyperglycemia, and fatigue. Also, ten patients developed signs or symptoms suggestive of RAS and were effectively treated with dexamethasone. A potentially life-threatening side effect was Q-T prolongation on electrocardiogram, which was observed in 63% of patients. Although all of these patients were asymptomatic, including one patient that developed a brief episode of torsades de pointes, there have been more recent reports of sudden cardiac death ( [142](#), [143](#) ) associated with ATO therapy in APL patients. Therefore, close monitoring, including aggressive management of electrolytes, particularly potassium and magnesium, is undertaken in conjunction with ATO therapy. Both intravenous and oral supplements are liberally provided to maintain the serum potassium at greater than 4.0 mEq/L and the magnesium level at greater than 1.8 mg/dl. In addition, every effort is made to limit the concomitant use of other agents known to prolong Q-T intervals or induce ventricular arrhythmias. Based on these results, ATO (Trisenox) is used as standard therapy in patients who have had a second relapse and is now more frequently used in patients in first relapse, particularly in those patients whose first CR lasted less than 12 months. However, the best treatment strategy for patients who achieve CR with arsenic remains to be determined. Although 10 of 21 patients treated in the U.S. multicenter study who received only ATO were without evidence of either clinical or molecular recurrence at a median of 18 months of follow-up, there are little data on the long-term outcome. Therefore, patients who relapse and are candidates for either allogeneic or autologous transplants should be managed accordingly. The use of ATO is currently being explored in newly diagnosed patients as part of induction or consolidation therapy in the United States and in Europe.

**Gemtuzumab Ozogamicin** Other agents that may be of benefit in patients with relapsed APL include liposomal ATRA and gemtuzumab ozogamicin (Mylotarg). Douer et al. ( [144](#) ) conducted a trial using a liposomal formulation of ATRA and administering it intravenously in 69 patients: 32 with newly diagnosed APL, 35 with relapsed APL, and two patients who had not responded to oral ATRA. CR was achieved in 62% of newly diagnosed patients and in 70% of patients with first relapse who were ATRA-naïve or off oral ATRA for 1 year or more. In those patients who were in first relapse and off oral ATRA for less than 1 year or in at least their second relapse, 20% achieved CR. However, the proportion of patients responding may be no different than expected in the same population treated with oral ATRA. This agent may be more important in a patient population in which oral ATRA is not ideal, such as patients who are not able to tolerate or absorb the oral formulation.

*Gemtuzumab ozogamicin* is an engineered human anti-CD33 antibody linked with the potent antitumor antibiotic calicheamicin. This agent binds to the CD33 antigen that is found on the surface of more than 80% of patients with AML, including APL. Clinical remissions have been observed with gemtuzumab ozogamicin, including a clinical and molecular remission in a patient with multiple relapsed APL ( [145](#) ). This drug is currently

approved to treat patients who are at least 60 years old in first relapse with CD33<sup>+</sup> AML.

**EXTRAMEDULLARY RELAPSE** Extramedullary disease (EMD) occurs in approximately 5 to 10% of adult patients with AML, most commonly in the myelomonocytic and monocytic subtypes ( [146](#) ). In general, the incidence of EMD in patients with APL has been

considered rare ( [147](#), [148](#) ). However, since the early 1990s, there have been numerous reported cases in patients with APL at the time of relapse, mostly involving the skin and CNS ( [148](#), [149](#), [150](#) and [151](#) ). In the Italian GIMEMA Group study, 13 of 97 patients with

relapsed APL had EMD, and, in the European APL 93 trial, 3 of 75 relapsed patients had documented EMD. Specchia et al. ( [152](#) ) analyzed the incidence of EMD involvement in their series of APL patients who were treated with either chemotherapy alone or with ATRA and idarubicin (AIDA regimen) and subsequently relapsed. Accounting for all relapses, there were no conclusive data to support a higher incidence of EMD in patients treated with ATRA. However, the proportion of patients with EMD that had CNS involvement was significantly higher in the group that received ATRA as part of their induction therapy compared to those who received only chemotherapy. One explanation for this observation is that ATRA therapy induces the expression of adhesion molecules such as CD11c, CD13, and CD56 in the malignant promyelocytes and, thereby, may facilitate CNS infiltration ( [153](#) , [154](#) and [155](#) ). Of note, there was no comparative difference in the incidence of other sites of EMD. It is clinically important that 14 of the 16 patients on the AIDA trial with EMD found at relapse also had hematologic or molecular evidence of disease. Treatment for CNS relapse requires systemic reinduction along with four to six cycles of intrathecal methotrexate or cytosine arabinoside. Some patients may benefit from additional cranial–spinal radiation. To date, there is no specific risk factor identified to predict CNS relapse. In addition, CNS prophylaxis with either intrathecal chemotherapy alone or combined with cranial irradiation has not been shown to improve DFS in adults with AML in general. This is probably because the majority of patients have systemic relapse in addition to CNS relapse or EMD.

## SUMMARY

APL represents a model for modern cancer therapy. It is unique in that the identification of the specific genotype that is used for diagnosis, monitoring MRD, and detection of early relapse has also resulted in a greater understanding of the fundamental biology of this disease, which serves as template for the development of targeted therapies. Transgenic mice models ( [146](#) ) that stably carry the t(15;17) genotype and express a malignant phenotype have been developed and are currently used to test potential novel therapies and identify new targets in the preclinical setting. APL is the first known disease that is clinically sensitive to differentiation therapy, and, as a result, the paradigm for the treatment of leukemia has been irrevocably altered. As medicine moves through the era of genomics, proteomics, and rationale drug design, the models of pathogenesis based on interactions between the PML–RARA fusion products, corepressor binding proteins, and histone deacetylase may be instrumental in the understanding and treatment of other forms of malignancy.

2004 Lippincott Williams & Wilkins  
John P. Greer, John Foerster, John N. Lukens  
George M. Rodgers, Frixos Paraskevas, Bertil Glader  
Wintrobe's Clinical Hematology

[CLASSIFICATION AND DIAGNOSIS](#)[CLINICAL MANIFESTATIONS](#)[LABORATORY FINDINGS](#)[PATHOGENESIS](#)[BIOLOGIC FEATURES](#)[MOLECULAR AND CYTOGENETIC ABNORMALITIES](#)[Cytogenetic Changes That Are Associated with Clinical Subtypes of Myelodysplastic Syndrome: 5q- Syndrome](#)[Refractory Anemia](#)[Refractory Anemia with Ringed Sideroblasts](#)[Refractory Anemia with Excess Blasts and Refractory Anemia with Excess Blasts in Transformation](#)[Chronic Myelomonocytic Leukemia](#)[Some Aspects of Common Cytogenetic Abnormalities in Myelodysplastic Syndrome: Partial Trisomy of 1q](#)[Rearrangements of 3q26](#)[Other 5q Deletions](#)[Deletion of 7q \(7q-\) and -7](#)[11q23 in Myelodysplastic Syndrome](#)[12p Deletions \(12p-\)](#)[17p Deletions \(17p-\)](#)[Deletions of \(20q\)](#)[X Chromosome Changes](#)[Trisomy 8 \(+8\)](#)[Other Trisomies in Myelodysplastic Syndrome](#)[Gene Amplification in Myelodysplastic Syndrome](#)[Secondary and Therapy-Related Myelodysplastic Syndrome](#)[Molecular Changes in Myelodysplastic Syndrome](#)[Comment](#)[PROGNOSTIC FEATURES](#)[MANAGEMENT](#)[Low- and Intermediate-1-Risk Myelodysplastic Syndrome](#)[Intermediate-2- and High-Risk Myelodysplastic Syndrome](#)

The diagnosis and management of patients with myelodysplastic syndrome (MDS) remain challenges that are distinct from those for most other hematologic malignancies. Therapeutic goals vary among individuals and are influenced by hematologic presentation, prognosis, and age. No single treatment is uniformly effective or addresses the clinical needs of all patients. The standard of care ranges from amelioration of hematologic deficits with blood product transfusions and administration of recombinant growth factors to aggressive chemotherapy and stem cell transplantation for younger individuals with more aggressive disease. Given that the median age of patients with MDS exceeds 65 years, broad application of more aggressive therapeutic approaches is limited.

The MDSs represent a spectrum of stem cell malignancies that manifest dysplastic and ineffective hematopoiesis, which is associated with a variable risk of transformation to acute leukemia ( [1](#), [2](#), [3](#) and [4](#) ). Although generally arising *de novo*, with the risk increasing proportionate to age, MDS may also occur years after exposure to mutagenic chemotherapy ( [5](#) ). Although uniform morphologic classifications for MDS have emerged

only recently, descriptions of the disease have existed for more than 70 years. In 1938, Rhoades and Barker ( [6](#) ) described 60 patients with refractory anemia (RA), which was unrelated to any associated systemic melee. Hamilton–Paterson ( [7](#) ) later proposed the term *preleukemic anemia* to describe cases of RA that antedated the development of acute myelogenous leukemia. The term *preleukemia* was applied by Block et al. ( [8](#) ) in 1953 to describe patients with one or more refractory cytopenias whose natural history of disease included the potential for leukemia transformation.

Although these nosologic references persist to date, case studies raised awareness that the hematologic presentation and natural history of the preleukemic states vary.

Bjorkman ( [9](#) ) chronicled cases of RA that were associated with ringed sideroblasts in the bone marrow (BM), in which leukemic conversion represents a rare event. In 1963, Rheingold et al. ( [10](#) ) described a leukemia variant that was characterized by a subacute clinical course and a variable percentage of marrow blasts; the authors called this variant *smoldering acute leukemia*.

In the 1970s, chronic myelomonocytic leukemia (CMML) was recognized as a distinct preleukemic syndrome ( [11](#), [12](#) and [13](#) ). Dreyfus' ( [14](#) ) seminal observation that patients who presented with a RA and higher than normal BM blast percentage experienced more rapid hematologic deterioration proved to be a reproducible measure to gauge differences in clinical behavior and continues to be applied even today in prognostic staging systems. In 1976, the French/American/British (FAB) Cooperative Group first adopted diagnostic criteria for the preleukemic syndromes of refractory anemia with excess blasts (RAEB) and CMML ( [15](#) ). Three additional subtypes were added 6 years later to complete the current FAB classification scheme within the unifying diagnostic category of *MDS* ( [16](#) ). The terms that were previously applied to describe the preleukemic states in the hematology literature are summarized in [Table 83.1](#). The World Health Organization recently proposed modifications to the FAB criteria to strengthen the prognostic usefulness of the classification system.

**TABLE 83.1. Chronology and Terminology of the Myelodysplastic Syndromes**

| Term                                       | Year | Author                                      |
|--|------|---|
| Refractory anemia                          | 1938 | Rhoades and Barker ( <a href="#">6</a> )    |
| Preleukemic anemia                         | 1949 | Hamilton–Paterson ( <a href="#">7</a> )     |
| Preleukemia                                | 1953 | Block et al. ( <a href="#">8</a> )          |
| Refractory anemia with ringed sideroblasts | 1956 | Bjorkman ( <a href="#">9</a> )              |
| Refractory normoblastic anemia             | 1959 | Dacie et al. ( <a href="#">417</a> )        |
| Smoldering acute leukemia                  | 1963 | Rheingold et al. ( <a href="#">10</a> )     |
| Chronic erythremic myelosis                | 1969 | Dameshek ( <a href="#">418</a> )            |
| Preleukemic syndrome                       | 1973 | Saarni and Linman ( <a href="#">419</a> )   |
| Subacute myelomonocytic leukemia           | 1974 | Sexauer et al. ( <a href="#">420</a> )      |
| Chronic myelomonocytic leukemia            | 1974 | Miescher and Farguet ( <a href="#">11</a> ) |
| Hypoplastic acute myelogenous leukemia     | 1975 | Beard et al. ( <a href="#">421</a> )        |
| Refractory anemia with excess myeloblasts  | 1976 | Dreyfus ( <a href="#">14</a> )              |
| Hematopoietic dysplasia                    | 1978 | Linman and Bagby ( <a href="#">422</a> )    |
| Subacute myeloid leukemia                  | 1979 | Cohen et al. ( <a href="#">423</a> )        |
| Dysmyelopoietic syndrome                   | 1980 | Streuli et al. ( <a href="#">424</a> )      |
| Myelodysplastic syndromes                  | 1982 | Bennett et al. ( <a href="#">16</a> )       |

## CLASSIFICATION AND DIAGNOSIS

Based on peripheral blood and BM findings of unexplained hematopoietic dysplasia in two or more lineages, the FAB Cooperative Group (16) distinguishes five morphologic subtypes of MDS (Table 83.2), which include RA, refractory anemia with ringed sideroblasts (RARS), RAEB, refractory anemia with excess blasts in transformation (RAEB-t), and CMML. The presence of more than 15% of ringed sideroblasts in the BM accompanied by an increase in myeloblasts (>5%) or monocytosis is regarded as RAEB or CMML, respectively (17). These patients have a more unfavorable clinical course and a shorter survival than patients with RARS (18). Although the validity of the FAB classification has been questioned, it remains the most widely applied classification because of its reproducibility and usefulness as a reference for case comparison. Among 1640 cases that have been classified according to this scheme (19, 20, 21, 22, 23, 24, 25, 26, 27, 28, 29 and 30), 346 (21%) fulfilled the criteria for RA, 303 (17%) fulfilled the criteria for RARS, 219 (13%) fulfilled the criteria for CMML, 614 (37%) fulfilled the criteria for RAEB, and 159 (12%) fulfilled the criteria for RAEB-t. Despite its usefulness, some cases of MDS are not readily categorized by the FAB criteria. This is particularly true for patients with therapy-related MDS (t-MDS) (31). In such cases, the terms *unclassifiable MDS* (32) or *RA with multilineage dysplasia* have been applied (33).

**TABLE 83.2. French/American/British Classification of the Myelodysplastic Syndromes**

| Classification                          | Blast Cells (%) |                  | Ringed Sideroblasts (%) | Monocytes > 1 × 10 <sup>9</sup> /L |
|---|-----------------|------------------|-------------------------|------------------------------------|
|   | Bone Marrow     | Peripheral Blood |                         |                                    |
| RA                                      | <5              | <1               | <15                     | –                                  |
| RA with ringed sideroblasts             | <5              | <1               | >15                     | –                                  |
| RA with excess blasts                   | 5 to 20         | <5               | Variable                | –                                  |
| Chronic myelo-monocytic leukemia        | <20             | <5               | Variable                | +                                  |
| RA with excess blasts in transformation | 21 to 30        | ± 1              | Variable                | ±                                  |

RA, refractory anemia.

CMML is distinguished by an absolute monocytosis that exceeds 1000/μl, increased marrow myelomonocytic precursors, and single- or multilineage cytologic dysplasia. Circulating blasts should not exceed 5%, accompanied by fewer than 20% BM blasts (16). Controversy remains concerning the inclusion of CMML among the MDSs because of its characteristic proliferative features that are akin to chronic myelogenous leukemia (CML). Indeed, retrospective studies of Philadelphia (Ph) chromosome-negative CML indicate

that many cases fulfill the criteria for CMML or other MDS subtypes ( 34, 35 ). Molecular screening for the bcr/abl fusion gene, which is characteristic of CML, by polymerase chain reaction of fluorescence *in situ* hybridization (FISH) is necessary to assure discrimination among these entities ( 36 ). Nonetheless, rare patients display features of CMML and CML and lack the Ph chromosome or its gene rearrangement. The FAB group recently proposed the term *atypical CML* with specific diagnostic criteria to distinguish this particular subset of patients ( 37, 38 ).

A recognized limitation of the FAB classification is that anemia, per se, cannot be characterized morphologically, and the term *RA* may not apply when other deficits predominate. Recently, the World Health Organization (WHO) proposed a new classification system for MDS, which is summarized in Table 83.3 ( 39 ). The new schema lowers the diagnostic threshold for MDS to include one or more dysplastic lineages, while creating new subtypes that are distinguished by the number of dysplastic lineages and by smaller increments in marrow blast percentage. The subtype of RAEB-t is eliminated to lower the boundary for acute myeloid leukemia (AML) to 20% myeloblasts. The WHO system incorporates one cytogenetic abnormality, that is, an isolated interstitial deletion of chromosome 5q31-33, as a diagnostic requisite for the new category of *5q- syndrome*. MDS cases with nonerythroid, single-lineage dysplasia are regarded as *MDS unclassifiable*. Retrospective application of the WHO system suggests that it offers improved prognostic discrimination but lacks power when the FAB system is applied with the recently adopted International Prognostic Scoring System (IPSS) ( 40, 41 and 42 ). Finally, the WHO proposal creates a new diagnostic category, which is termed *myelodysplastic/myeloproliferative diseases*, that recognizes disorders with overlapping dysplastic and proliferative features, including CMML, atypical CML, and juvenile myelomonocytic leukemia (JMML). The diagnostic criteria for CMML require leukocytosis of greater than 13,000/ $\mu$ l, and three prognostically distinct subgroups are proposed, distinguished by blast percentage and associated eosinophilia ( Table 83.4 ). The latter subgroup characteristically displays a rearrangement of the platelet-derived growth factor (PDGF)- $\beta$  receptor gene ( *PDGF  $\beta$  F* ) on chromosome 5q33, resulting in constitutive receptor activation ( 43 ).

**TABLE 83.3. World Health Organization Classification of the Myelodysplastic Syndromes**

| Classification                                   | Peripheral Blood  | Bone Marrow   |
|--|---|---|
| Refractory anemia                                | Anemia<br>No or rare blasts   | Erythroid dysplasia only<br><5% blasts<br><15% ringed sideroblasts  |
| Refractory anemia with ringed sideroblasts       | Anemia<br>No blasts   | >15% ringed sideroblasts<br>Erythroid dysplasia only<br><5% blasts  |
| Refractory cytopenia with multilineage dysplasia | Cytopenias (bicytopenia or pancytopenia)<br>No or rare blasts<br>No Auer rods<br><1 $\times$ 10 <sup>9</sup> /L monocytes | Dysplasia in >10% of the cells of two or more myeloid lines<br><5% blasts in the marrow<br>No Auer rods<br><15% ringed sideroblasts |



|  |  |  |
|--|--|--|
| Refractory cytopenia with multilineage dysplasia and ringed sideroblasts | Cytopenias (bicytopenia or pancytopenia)<br>No or rare blasts<br>No Auer rods<br><1 × 10 <sup>9</sup> /L monocytes | Dysplasia in >10% of the cells of two or more myeloid lines<br><5% blasts in the marrow<br>>15% ringed sideroblasts<br>No Auer rods      |
| Refractory anemia with excess blasts 1                                   | Cytopenias<br><5% blasts<br>No Auer rods<br><1 × 10 <sup>9</sup> /L monocytes                                      | Unilineage or multilineage dysplasia<br>5 to 9% blasts<br>No Auer rods   |
| Refractory anemia with excess blasts 2                                   | Cytopenias<br>5 to 19% blasts<br>Auer rods present<br><1 × 10 <sup>9</sup> /L monocytes                            | Unilineage or multilineage dysplasia<br>10 to 19% blasts<br>Auer rods present  |
| Myelodysplastic syndrome, unclassified                                   | Cytopenias<br>No or rare blasts<br>No Auer rods  | Unilineage dysplasia: one myeloid cell line<br><5% blasts<br>No Auer rods  |
| 5q- syndrome   | Anemia<br><br>Usually normal or increased platelet count<br><5% blasts   | Normal to increased megakaryocytes with hypolobated nuclei<br><5% blasts<br><br>Isolated del(5q) cytogenetic abnormality<br>No Auer rods |

**TABLE 83.4. Diagnostic Criteria for Chronic Myelomonocytic Leukemia According to the World Health Organization**

Persistent peripheral blood monocyto-sis is >1 × 10<sup>9</sup>/L.

Absence of Philadelphia chromosome or BCR/ABL rearrangement.

Blasts <sup>a</sup> are <20% in peripheral blood or bone marrow.

Dysplasia in one or more myeloid lineages, or, in the absence of dysplasia, CMML can be diagnosed, if all other criteria are met, together with either of the following:

Presence of a clonal cytogenetic abnormality.

Monocytosis has been persistent for at least 3 months and all other causes of monocytosis have been excluded.

Subgroups

CMML-1: Blasts <5% in peripheral blood and <10% in bone marrow.

CMML-2: Blasts 5 to 19% in peripheral blood, 10 to 19% in bone marrow, or Auer rods are present and blasts are <20% in peripheral blood or bone marrow.



CMML-1 or CMML-2 with eosinophilia: Criteria for CMML-1 and CMML-2 are present, and the eosinophil count in peripheral blood is  $>1.5 \times 10^9/L$ .

CMML, chronic myelomonocytic leukemia.

<sup>a</sup> Blasts include myeloblasts, monoblasts, and promonocytes.

---

A diagnosis of MDS should be considered in any individual with unexplained, persistent cytopenias or monocytosis. Careful inspection of the peripheral blood smear and BM is necessary to document the requisite dysplastic cytologic features in one or more hematopoietic lineages ( 4, 16). The presence of nuclear hyposegmentation of granulocytes, that is, pseudo-Pelger-Huët anomaly, mononuclear or micromegakaryocytes ( 26), hypogranular neutrophils or megakaryocytes ( 44, 45), macroovalocytes, and acanthocytes ( 46), may be evident. Because these findings alone are not diagnostic of MDS, possible contributing conditions must be excluded. The preponderance of macrocytic anemia in MDS necessitates exclusion of vitamin B<sub>12</sub> and folate deficiency. Nutritional status, alcohol and drug use, occupational exposure to petrochemicals and other toxins, prior treatment with antineoplastics or radiotherapy, and risk factors for human immunodeficiency virus (HIV) should be elicited. Dysplastic hematopoiesis is a common finding that accompanies HIV infection ( 47, 48, 49, 50 and 51). Hematopoietic dysplasia in such patients may result from medications, opportunistic infection, or a direct effect of HIV on hematopoietic progenitors ( 52, 53). Serologic screening for HIV should be considered in patients who are at risk for virus exposure with unexplained cytopenia or myelo-dysplasia. Cytogenetic analysis ( 54), BM progenitor colony-forming capacity ( 55), trephine biopsies ( 56, 57, 58 and 59), flow cytometry ( 60, 61 and 62), and immunohistochemical studies ( 59, 63, 64) may be helpful, particularly in cases in which morphologic findings are equivocal. The identification of clonal cytogenetics may, in some cases, prove diagnostic ( 54).

In addition to its importance in the assessment of BM cellularity, the trephine biopsy may provide confirmatory or diagnostic information. Immature myeloid elements, for example, may be displaced from their normal paratrabecular location to aggregates in central marrow spaces ( 56, 57). This displacement of granulocyte precursors is termed *abnormal localization of immature precursors (ALIP)* ( 56, 57) and may be detected in any, but often a more advanced, FAB subtype, thus providing morphologic evidence for the imminent risk of leukemia transformation ( 32). Evidence of dysplastic thrombopoiesis, reticulin fibrosis, presence of lymphoid aggregates or lymphocytic infiltration, and immunohistochemical studies can be discerned from biopsy and clot sections ( 32, 43, 44, 48).

The diagnosis of MDS may be enhanced by the application of cytochemical stains and immunophenotyping studies ( 17, 32, 59, 63, 64). The former include iron stains for identification of ringed sideroblasts and periodic acid-Schiff-reactive erythroblasts to assess dyserythropoiesis, peroxidase or Sudan black B to confirm the myeloid lineage of blasts, and nonspecific or double esterase stains to discern abnormal granulocyte and monocyte forms ( 17, 64). Immunocytochemistry ( 65) may be necessary to exclude a lymphoid origin of primitive blasts, whereas erythroid precursors may be distinguished by a glycophorin-A expression; myeloid precursors may be quantified by using antibodies to CD13, CD14, and CD33 ( 66). Dysplastic or immature megakaryocytes may be detected by antibodies with specificity for factor VIII ( 67) or CD41 ( 68) or the HPI-ID monoclonal

antibody ( [64](#) ).

Although most patients with MDS have normal or increased BM cellularity, in 8 to 28% of patients, the cellularity is less than 25% and is lower than expected for the patient's age ( [56](#), [59](#), [69](#), [70](#), [71](#) and [72](#) ). The distinction between aplastic anemia and hypocellular MDS is important, because the clinical course differs and may impact patient management. The presence of a clonal chromosomal abnormality confirms a diagnosis of MDS ( [73](#) ).

Myelofibrosis, an abnormal increase in the number and caliber of reticulin fibers in the BM biopsy, may be detected by a silver impregnation stain ( [74](#) ). Mild to moderate myelofibrosis is reported in as much as 50% of MDS cases, and marked fibrosis is demonstrable in 10 to 15% ( [75](#), [76](#), [77](#) and [78](#) ). Myelofibrosis may accompany any morphology but is most common in t-MDS ( [31](#) ). Patients with hyperfibrotic variants are often pancytopenic, with trilineage dysplasia, absent organomegaly, and atypical megakaryocytic hyperplasia ( [75](#), [76](#), [77](#) and [78](#) ). The intense fibroblastic proliferation is believed to arise from the liberation of soluble effectors, such as transforming growth factor- $\beta$  and PDGF from dysplastic megakaryocytes ( [76](#) ). The absence of splenomegaly and the often rapidly progressive clinical course offer discrimination of this MDS variant from idiopathic myelofibrosis. Despite these differences, distinguishing this variant from other disorders, such as primary myelofibrosis, the accelerated phase of chronic myeloid leukemia, and acute megakaryocytic leukemia, may, in some cases, be problematic ( [32](#) ).

## CLINICAL MANIFESTATIONS

The precise incidence of *de novo* MDS is not known; however, estimates indicate that it probably exceeds the incidence for AML in the elderly. It remains clear, nonetheless, that the risk increases with age. In one study, the annual incidence per 100,000 was estimated at 0.5 for people younger than 50 years of age, compared to 5.3 for ages 50 to 59 years, 15 for ages 60 to 69 years, 49 for ages 70 to 79 years, and 89 for ages older than 80 years ( [79](#) ). Aul et al. ( [80](#) ) report a crude annual incidence of 4.1 per 100,000 for MDS and 2.1 per 100,000 for AML. The median age in most series approximates 65 years, and, in the majority of cases, there is a male predominance ( [1](#), [2](#), [3](#) and [4](#), [19](#), [20](#), [21](#), [22](#), [23](#), [24](#), [25](#), [26](#), [27](#), [28](#), [29](#) and [30](#) ). Onset of the disease before 50 years of age is unusual ( [81](#) ), with the specific exception of mutagen-induced MDS ( [30](#), [31](#) ).

Although rare in childhood, MDS occurs with a median age at onset of 6 years of age ( [82](#), [83](#), [84](#), [85](#) and [86](#) ). Two ill-defined syndromes predominate: JMML and the monosomy 7 syndrome ( [84](#), [85](#), [86](#), [87](#) and [88](#) ). These disorders share considerable clinical and hematologic overlap, making their distinction somewhat arbitrary. The characteristic features, which include splenomegaly, leukocytosis with monocytosis, frequent skin involvement, anemia, thrombocytopenia, and polyclonal gammopathy, correspond to those of adult CMML. Elevation in hemoglobin F and a natural history that is punctuated by progressive marrow failure serve to distinguish JMML from the monosomy 7 syndrome, in which susceptibility to bacterial infection, a familial tendency, and transformation to acute leukemia predominate ( [85](#), [86](#), [88](#), [89](#), [90](#), [91](#) and [92](#) ). Although the FAB classification does not recognize these childhood syndromes, it can, nonetheless, be applied successfully in the pediatric population with the majority of cases classified as CMML, RAEB, and RAEB-t, whereas RARS, a common category in adults, is rare ( [84](#), [85](#) and [86](#), [89](#), [93](#) ). A recent consensus panel recommended a revised classification scheme that incorporates elements of the adult WHO and FAB criteria. These include the category of *myelodysplastic and myeloproliferative disease*, which includes CMML, secondary CMML,

and Ph-negative CML, and the category of *MDS*, which includes a consolidation of FAB subtypes of RA and RARS as *refractory cytopenias*, as well as RAEB and RAEB-t ( 93 ).

Clinical signs and symptoms at presentation generally relate to peripheral cytopenias and are not necessarily disease specific. Many patients are asymptomatic, with a diagnosis that is established fortuitously on routine laboratory screening. Others present with fatigue, weakness, exercise intolerance, angina, dizziness, or an altered sense of well-being as a result of unrecognized anemia ( 1 , 2 and 3 ). Less commonly, infection ( 13 , 19 , 94 ), easy bruising, or bleeding precipitates laboratory investigation ( 1 , 2 and 3 , 19 , 20 ). Although neutropenia is largely responsible for the high incidence of infection in MDS, granulocyte dysfunction, which is manifested by impaired chemotaxis and microbial killing, also contributes to this high incidence ( 94 , 95 ). Bacterial infections predominate, with the skin representing the most common recurring site of infection ( 94 ). Infections may be occult, respond poorly to antibiotics, and resolve slowly ( 96 ). Indeed, infection remains the principal cause of mortality in patients with MDS ( 14 , 19 , 94 ). Although fungal, viral, and mycobacterial infections may occur, they are rare in the absence of concurrent treatment with systemic immunosuppressants ( 94 , 97 ).

Autoimmune abnormalities, although uncommon, may complicate the disease course in some patients ( 98 , 99 , 100 , 101 and 102 ). Among 221 cases in one series, 14% of patients experienced autoimmune disorders ( 98 ). The most common manifestations included cutaneous vasculitis and monoarticular arthritis ( 98 ). An acute clinical syndrome that is characterized by cutaneous vasculitis, fever, arthritis, peripheral edema, and pulmonary infiltrates was reported in seven patients. Other autoimmune abnormalities included pericarditis, pleural effusions, skin ulcerations, iritis, myositis, and peripheral neuropathy ( 98 ). Although connective tissue disorders, such as relapsing polychondritis, polymyalgia rheumatica, Raynaud disease, Sjögren syndrome, inflammatory bowel disease, pyoderma gangrenosum, and glomerulonephritis, have been reported in association with MDS ( 98 , 99 , 100 , 101 , 102 and 103 ), a causal relationship has not been established. These so-called paraneoplastic autoimmune complications generally respond to immunosuppressive agents ( 98 ). However, in less responsive cases ( 98 , 103 ), such autoimmune syndromes may contribute to early mortality.

Although cutaneous manifestations of MDS are uncommon, two syndromes occur with sufficient frequency to merit description. Sweet syndrome, or acute febrile neutrophilic dermatosis, when complicating the course of MDS ( 104 , 105 and 106 ), often heralds transformation to acute leukemia ( 104 ). Paracrine and autocrine elaboration of cytokines, such as interleukin (IL)-6 and granulocyte colony-stimulating factor (G-CSF), have been implicated in the pathogenesis of this condition ( 106 ). Granulocytic sarcoma ( 104 , 105 , 106 and 107 ), like Sweet syndrome, may herald disease acceleration ( 107 , 108 , 109 and 110 ).

Physical findings in patients with MDS reflect the underlying hematologic disturbance. Sixty percent of patients have pallor, and 26% have petechiae or purpura ( 20 ). Unlike the myeloproliferative syndromes or lymphoid leukemias, hepatomegaly, splenomegaly, and lymphadenopathy are uncommon ( 2 ). The singular exception is CMML. Splenomegaly may be massive in as much as 25% of patients with this disease type and, not uncommonly, is accompanied by hepatomegaly or nodular cutaneous leukemic infiltrates ( 12 , 111 , 112 , 113 and 114 ). Pleural and pericardial effusions and ascites may occur in CMML patients with exceedingly high or uncontrolled monocytosis ( 115 ) but often resolve with antileukemic therapy. Systemic symptoms of fever and weight loss are uncommon but generally

represent late manifestations of the disease or its attendant complications ( [20](#) ).

## LABORATORY FINDINGS

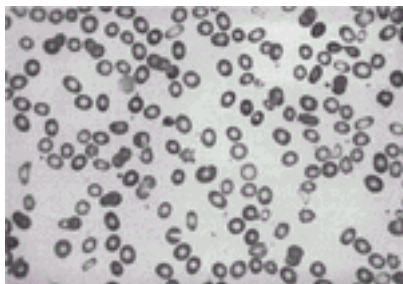
The hematologic manifestations in MDS are protean ( [Table 83.5](#) ). Nevertheless, hematologic deficits that involve one or more lineages with cytologic dysplasia represent the hallmark of the disease ( [1](#), [2](#), [3](#) and [4](#), [16](#), [17](#), [20](#), [21](#), [22](#) and [23](#) ). Anemia is almost uniformly present and is associated with an inappropriately low reticulocyte response. Pancytopenia may be present in as much as 50% of patients at the time of diagnosis; however, anemia may represent the only cytopenia or is accompanied by thrombocytopenia or neutropenia. Fewer than 5% of patients present with an isolated cytopenia or monocytosis in the absence of anemia ( [2](#) ).

**TABLE 83.5. Morphologic Abnormalities in Myelodysplastic Syndromes**

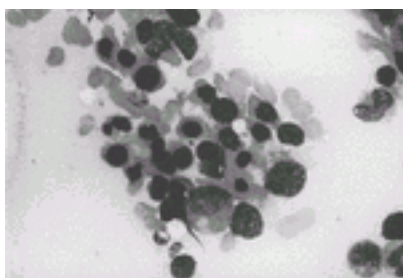
| Lineage            | Peripheral Blood                    | Bone Marrow                                  |
|--------------------|-------------------------------------|--|
| Erythroid          | Ovalomacocytes                      | Megaloblastoid erythropoiesis                |
|                    | Elliptocytes                        | Nuclear budding                              |
|                    | Acanthocytes                        | Ringed sideroblasts                          |
|                    | Stomatocytes                        | Internuclear bridging                        |
|                    | Teardrops                           | Karyorrhexis                                 |
|                    | Nucleated erythrocytes              | Nuclear fragments                            |
|                    | Basophilic stippling                | Cytoplasmic vacuolization                    |
|                    | Howell–Jolly bodies                 | Multinucleation                              |
|                    | Myeloid                             | Pseudo–Pelger–HuHuët anomaly                 |
| Auer rods          |                                     | Maturation arrest at myelocyte stage         |
| Hypogranulation    |                                     | Increase in monocytoid forms                 |
| Nuclear sticks     |                                     | Abnormal localization of immature precursors |
| Hypersegmentation  |                                     |  |
| Ring-shaped nuclei |                                     |  |
| Megakaryocyte      | Giant platelets                     | Micromegakaryocytes                          |
|                    | Hypogranular or agranular platelets | Hypogranulation                              |
|                    |                                     | Multiple small nuclei                        |

Erythrocyte morphology is usually normocytic or macrocytic ( [14](#), [116](#), [117](#) ), although patients with RARS may present with microcytic or hypochromic erythrocytes as an isolated or dimorphic population ( [118](#) ). Reticulocytosis may be indicative of a superimposed autoimmune hemolytic anemia ( [119](#), [120](#) ) or may be a marker of delayed reticulocyte maturation, so-called pseudoreticulocytosis ( [121](#), [122](#) ). Ovalomacrotosis is the best recognized erythrocyte abnormality. In extreme cases, elliptocytes ( [123](#), [124](#) ), teardrops, schistocytes, stomatocytes, or acanthocytes ( [46](#) ) may predominate ( [Fig. 83.1](#) ), reflecting intrinsic alterations in cytoskeletal proteins ( [124](#), [125](#) ). Basophilic stippling, Howell–Jolly bodies, and megaloblastoid nucleated red cells may also be found in the peripheral smear. The peripheral blood findings in MDS represent a peripheral extension of

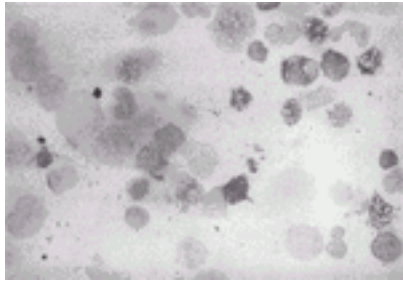
the dyserythropoietic features in marrow precursors that characteristically display delayed and distorted nuclear and cytoplasmic maturation. These findings include erythroid hyperplasia with megaloblastoid features, nuclear budding, multinucleation, karyorrhexis, and cytoplasmic vacuole formation ( [Fig. 83.2](#) ) ( [14](#), [116](#) ). Pathologic sideroblasts that contain more than five iron granules per cell may be evident ( [Fig. 83.3](#) ). Sideroblasts in which iron granules occupy more than one-third of the nuclear rim are referred to as *ringed sideroblasts* ( [126](#) ). Ringed sideroblasts and increased storage iron may be found in any of the FAB subtypes, but the former is characteristic of RARS. In RARS, a population of ragged, poorly hemoglobinized normoblasts may be identified, often accompanied by coarse stippling ( [127](#) ). Although erythroid hyperplasia generally accompanies ineffective erythropoiesis, red cell aplasia or hypoplasia may manifest in other cases, representing a defining feature of the *5q- syndrome* ( [128](#) ). Internuclear bridging, which is characterized by chromatin threads that tether dissociated nuclei, reflects impaired mitosis and may compound the addition or deletion of genetic material ( [129](#) ). Finally, abnormalities of erythrocyte glycolytic enzymes ( [130](#), [131](#) ), elevation in hemoglobin F content ( [132](#) ), alterations in blood group antigens ( [133](#) ), increased susceptibility to complement cytolysis ( [116](#) ), and paroxysmal nocturnal hemoglobinuria (PNH)-like antigenic effects ( [134](#), [135](#) and [136](#) ) have been described. Acquired hemoglobin H disease has been documented in rare cases of MDS ( [137](#) ) and results in a spectrum of red cell morphology that is analogous to thalassemia, including ghosted erythrocytes with profound hypochromia.



**Figure 83.1.** Oval macrocytes, hypochromic cells, and acanthocytes in refractory anemia with ringed sideroblasts (hematoxylin and eosin stain  $\times 1250$ ). See [Color Plate](#).



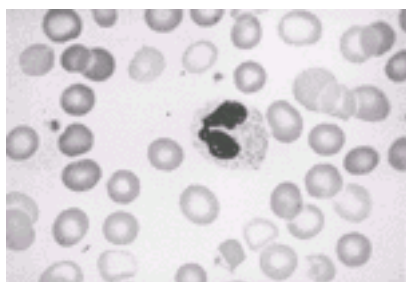
**Figure 83.2.** Dyserythropoiesis with nuclear budding and megaloblastoid erythropoiesis in refractory anemia (Wright-Giemsa stain  $\times 1250$ ). See [Color Plate](#).



**Figure 83.3.** Ringed sideroblasts in refractory anemia with ringed sideroblasts (Prussian blue stain  $\times 1250$ ). See [Color Plate](#).

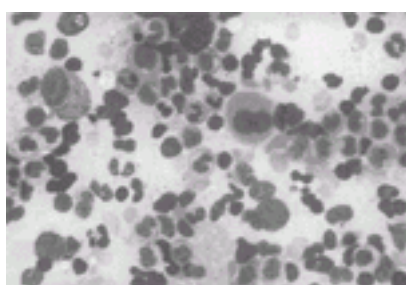
Leukopenia, which results from absolute neutropenia, is detected in as much as 50% of patients at the time of diagnosis ([30](#)). Circulating myelocytes and myeloblasts may be identified but generally constitute fewer than 5% of the leukocyte differential. Auer rods are rare, but their presence serves to identify the FAB category of RAEB-t ([16](#), [138](#)). Granulocytes commonly display reduced segmentation ([Fig. 83.4](#)), the so-called pseudo-Pelger-Huët anomaly ([26](#)), which is often accompanied by reduced or absent granulation ([44](#), [139](#)). Whether neutrophil hyposegmentation represents perturbed differentiation or excess chromatin condensation from accelerated apoptosis is unknown ([140](#)). Occasionally, granulocytes manifest a clumped chromatin pattern in which blocks of chromatin are separated by a void in nuclear material, creating an appearance of nuclear fragmentation that is associated with a loss of segmentation ([141](#), [142](#)). This granulocytic feature is linked to a specific karyotypic abnormality, (del 14) ([141](#), [142](#)). Ring-shaped nuclei and nuclear sticks may be identified ([143](#)), particularly in t-MDS. Ring-shaped granulocyte nuclei are believed to represent a transitional stage to the band form (acquired Pelger-Huët formation) and are considered a cytologic feature of abnormal myeloid maturation ([17](#)). Pseudo-Chédiak-Higashi anomaly and myelokathexis-like features are rarely evident. Myeloperoxidase ([95](#)) and alkaline phosphatase ([116](#)) activities may be diminished in myeloid elements, whereas monocyte-specific esterase may be increased ([144](#)). As a consequence, granulocytes may be dysfunctional and display defective phagocytosis, bactericidal activity, adhesion, and chemotaxis ([95](#)), leading to impaired resistance to bacterial infections. These features may have a common cytogenetic basis that is linked to complete or partial deletion of chromosome 7 ([88](#), [145](#)). Abnormal patterns of myeloid maturation antigen expression are common, providing further diagnostic and prognostic discrimination ([146](#), [147](#)). Impaired myeloid maturation is often apparent on inspection of the BM aspirate. The percentage of myeloblasts may be increased, and a maturation arrest may be apparent at the myelocyte stage ([4](#)). As with erythroid precursors, maturation of the cytoplasm may progress more rapidly than the nucleus ([81](#)). In addition, clusters of immature cells may coalesce centrally in the marrow space rather than along the endosteal surface ([57](#)).





**Figure 83.4.** Pseudo-Pelger-Huët anomaly in a patient with refractory anemia (hematoxylin and eosin stain  $\times 1250$ ). See [Color Plate](#).

Varying severity of thrombocytopenia is present in 25% of patients with MDS ([30](#)) and rarely represents an isolated early manifestation of the disease ([148](#)). Thrombocytosis is less common but occurs in association with a specific cytogenetic abnormality, that is, an interstitial deletion of the long arm of chromosome 5 or the *5q- syndrome* ([54](#)). Giant platelets or circulating megakaryocyte fragments, hypogranular forms, and dwarf or micromegakaryocytes may be present ([149](#)). These morphologic abnormalities can be accompanied by an increased bleeding tendency, despite the presence of apparent adequate platelet number ([150](#)). Prolongation of the bleeding time has been ascribed to intrinsic platelet dysfunction, as evidenced by decreased collagen- or epinephrine-induced platelet aggregation ([151](#)). Megakaryocytes are usually normal or increased and sometimes occur in clusters. Rarely, amegakaryocytosis is noted. Abnormal megakaryocytes, including micromegakaryocytes, large mononuclear forms, megakaryocytes with multiple dispersed nuclei, and hypogranular megakaryocytes, are common BM findings ([16](#), [26](#), [45](#)) ([Fig. 83.5](#)). Nonlobulated or mononuclear megakaryocytes may be identified, particularly in association with the *5q-* syndrome ([54](#)). Kuriyama et al. ([26](#)) proposed that the finding of micromegakaryocytes that are detected in the BM when coupled with pseudo-Pelger-Huët anomaly in the peripheral smear is the most specific morphologic feature that supports the diagnosis of MDS.

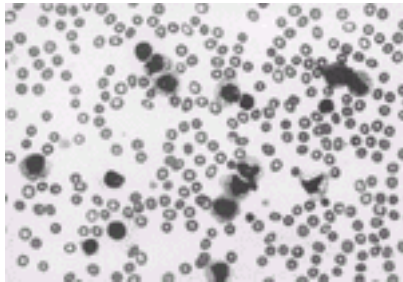


**Figure 83.5.** Micromegakaryocytes in a patient with refractory anemia with excess blasts (Wright-Giemsa stain  $\times 1250$ ). See [Color Plate](#).

In FAB categories other than CMML, relative elevations in monocyte count are common. In CMML, however, absolute monocytosis (i.e.,  $>1000/\mu\text{l}$ ) is a prerequisite and is often accompanied by atypical cytologic features and granulocytosis ([Fig. 83.6](#)) ([12](#)). The BM is uniformly hypercellular with pronounced granulocytic hyperplasia and mononuclear cells that exhibit cytologic features that are intermediate between myelocytes and monocytes; these cells are aptly termed *paramyeloid cells* ([12](#)). Discrete nodules of immature monocytic elements may be present on the trephine biopsy and can be distinguished from



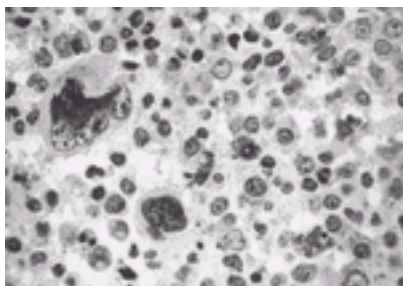
myeloid precursors by using a combined esterase stain. Muramidase (lysozyme) activity may be increased in the blood or urine ( [152](#) ), reflecting heightened monocyte generation.



**Figure 83.6.** Monocytes in a patient with chronic myelomonocytic leukemia (hematoxylin and eosin stain  $\times 1250$ ). See [Color Plate](#).

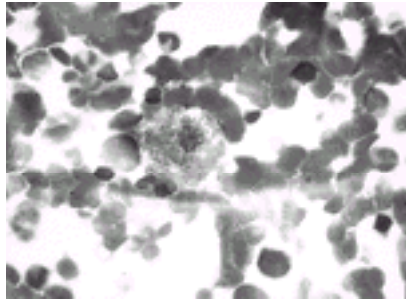
Abnormalities of the immune system may be demonstrable, but, in the majority of cases, lymphocytes are not derived from the malignant clone ( [153](#) ). Lymphopenia, accounted for largely by a reduced number of CD4<sup>+</sup> cells, inversely relates to the number of transfusions received ( [146](#), [154](#) ). Quantitative decreases in natural killer (NK) cells are routine, but CD8<sup>+</sup> cells are normal or slightly increased ( [155](#) ). Immunoglobulin production is variably affected, with hypogammaglobulinemia, polyclonal hypergammaglobulinemia, and monoclonal gammopathy reported in 13%, 30%, and 12% of patients, respectively ( [156](#) ). Serologic abnormalities are found in greatest frequency in CMML, with polyclonal gammopathy reported in 47% of patients in one series ( [111](#) ). Indeed, autoantibodies, antiplatelet antibodies, erythrocyte autoantibodies, and positive antiglobulin tests may be detected in this and other morphologic subtypes ( [156](#) ). Rarely, coexistent clonal lymphocyte or plasma cell populations may be identified ( [157](#), [158](#) and [159](#) ).

The BM in MDS is usually hypercellular and is accompanied by single-lineage or multilineage dysplasia ( [56](#), [57](#) and [58](#) ) ( [Fig. 83.7](#) ). The classic paradox of pancytopenia, despite the presence of a hypercellular marrow, reflects accelerated intramedullary cell death ( [160](#), [161](#), [162](#), [163](#), [164](#) and [165](#) ). Although hypocellularity is uncommon, it is found with greatest frequency in t-MDS ( [31](#) ). Marrow cells in these patients are, as a rule, morphologically and karyotypically abnormal, thereby facilitating distinction from aplastic anemia. Eosinophilia ( [166](#) ), an increase in mast cells ( [167](#) ), plasmacytosis, and sea blue histiocytosis ( [Fig. 83.8](#) ) ( [168](#) ) may also be apparent in the BM aspirate.



**Figure 83.7.** Hypercellular core biopsy with trilineage dysplasia in refractory anemia with excess blasts in transformation. Note the atypical megakaryocytes (periodic acid-Schiff

stain × 1250). See [Color Plate](#).



**Figure 83.8.** Sea-blue histiocyte in refractory anemia (Wright–Giemsa stain × 1250). See [Color Plate](#).

## PATHOGENESIS

The cytopenias that characterize MDS represent a late manifestation of the malignant transformation of primitive hematopoietic progenitors. Evidence from interphase cytogenetics, X chromosome inactivation, and analysis of polymorphic alleles indicates that these disorders derive from the clonal expansion of a multipotent hematopoietic progenitor that is capable of granulocyte, monocyte, erythrocyte, and megakaryocyte differentiation ([169](#), [170](#), [171](#), [172](#), [173](#) and [174](#)). Although initial studies suggested occasional involvement of B lymphocytes ([169](#)), more recent investigations indicate that this is rarely the case ([172](#), [173](#), [174](#) and [175](#)). The persistence of polyclonal hematopoiesis in a variable fraction of BM cells suggests that chromosome aberrations are a secondary event in the neoplastic process.

Like the disease itself, the factors that contribute to its development are heterogeneous. The high incidence of MDS in the elderly and the strong age dependence for development of t-MDS imply that factors inherent to *hematopoietic senescence* are important in the disease pathogenesis. There is accumulating evidence that environmental and heritable factors modify a person's cumulative risk. Exposure to genotoxic agents that are used in cancer therapy is by far the best characterized risk. Case control studies of patients who are treated with alkylating agents for Hodgkin disease, non-Hodgkin lymphoma, or other malignancies show an excess risk of t-MDS and AML that becomes apparent immediately after completion of therapy and reaches its peak at 5 years ([176](#), [177](#), [178](#), [179](#), [180](#), [181](#), [182](#) and [183](#)). Indeed, a myelodysplastic phase is observed in at least 70% of patients who develop secondary leukemia. The cumulative risk is greatest for patients who are treated with alkylator-based chemotherapy, but it is directly related to the cumulative dose and the duration of exposure, alkylator type, and treatment intensity ([176](#), [177](#), [180](#), [182](#)). Treatment with radiotherapy is associated with a low, but measurable, risk of myeloid malignancy that may compound the risk that is attributed to chemotherapy alone ([176](#), [184](#), [185](#)). The risk is greatest in patients older than 40 years of age with relapsed disease and in patients who were treated with extended courses of chemotherapy ([177](#), [182](#), [184](#), [186](#), [187](#)). The actuarial risk for t-MDS ranges from 3 to 4% at 10 years after alkylator therapy, after which the risk sharply diminishes. After salvage therapy for Hodgkin disease, however, the cumulative risk may approach 10%. A male predominance is evident in *de novo* and t-MDS, reflecting possible sexual disparity in patterns of environmental exposure or the hematopoietic stimulatory effects of androgens. Splenectomy has also

been implicated as a contributing risk factor in some, but not all, studies ( [176](#), [188](#) ).

The risk of developing t-MDS or AML is amplified in long-term survivors of autologous stem cell transplantation for lymphoid malignancies. In registry and published single institution experiences, the cumulative risk reaches 8 to 20% at 10 years' follow-up ( [189](#), [190](#), [191](#) and [192](#) ). Cumulative risk increases with a lower autograft CD34<sup>+</sup> cell yield, the type and duration of pretransplant salvage therapy, the use of dose-intensive chemotherapy for progenitor mobilization, the inclusion of high-intensity total body irradiation pretransplant conditioning (>12 Gy), and the use of a peripheral blood, versus BM, progenitor cell source. In the majority of cases, karyotypic abnormalities in t-MDS and AML are demonstrable in pretransplant marrow or autograft specimens, implicating the mutagenic effects of conventional dose therapy in the initiation of the myelodysplastic clone, which often antedates administration of the transplant conditioning regimen ( [193](#) ).

The cytotoxic agents that are implicated in the pathogenesis of t-MDS extend beyond the classic alkylators. Treatment with the  $\beta$ -emitter phosphorus-32 for polycythemia vera heightens the incidence of t-MDS to 10 to 15%, far exceeding the low intrinsic propensity that is attributed to the disease itself (less than 5%) ( [182](#), [194](#), [195](#) ). The latent interval from treatment to emergence of MDS is much longer (11 years) than that observed after treatment with alkylating agents. Less commonly, topo-isomerase II (Topo II)-interactive agents, such as the anthracyclines and the epipodophyllotoxin, etoposide, may be associated with the development of secondary myeloid malignancy ( [196](#), [197](#) and [198](#) ). In the vast majority of cases, the MDS phase is brief or absent with rapid conversion to AML, which generally occurs within 1 to 3 years after completion of therapy. Unlike radiation- or alkylator-induced myeloid malignancies, those malignancies that are related to anthracycline or epipodophyllotoxin treatment often harbor a balanced chromosome translocation or abnormality that affects chromosome 11q23.

With the exception of Topo II-associated malignancies, 60 to 80% of t-MDSs harbor numerical or structural deletions of chromosomes 5 or 7 ( [31](#), [199](#), [200](#), [201](#) and [202](#) ). Although deletions of these particular chromosomes are common in *de novo* MDS, their frequency is far greater in treatment-related cases. These similarities in cytogenetic pattern have heightened concern that *de novo* and secondary MDS (s-MDS) share pathogenetic features. Although fewer than 15% of patients with MDS have a history of treatment with cytotoxic agents, occupational or environmental exposure to potentially genotoxic chemicals has been implicated in the disease pathogenesis. People who are exposed to benzene for prolonged periods have a 5- to 20-fold excess risk of myeloid malignancy, which includes MDS ( [203](#), [204](#) ). Like therapeutic alkylators, the leukemia risk in exposed workers rises in direct proportion to the duration and intensity of cumulative exposure ( [203](#), [204](#), [205](#) and [206](#) ). Epidemiologic studies indicate that other agents, including solvents, petrochemicals, and insecticides, may contribute to an excess risk of MDS or AML ( [207](#), [208](#) ). Indeed, in case-controlled studies, a greater frequency and intensity of exposure to petrochemicals and other solvents is demonstrable in patients with *de novo* MDS ( [209](#) ). This association is not evident in all studies ( [210](#), [211](#) and [212](#) ). Tobacco smoke, which contains a number of leukemogens, including nitrosamines, benzene, and polonium-210, has not been addressed in the pathogenesis of MDS. Case-controlled studies support an association between cigarette smoking and adult AML and therefore imply a similar relationship for MDS ( [213](#), [214](#), [215](#), [216](#) and [217](#) ).

Genetic polymorphisms that predispose to differences in capacity to detoxify chemical mutagens may contribute to individual differences in MDS susceptibility ( [218](#) ). The genes that encode glutathione-S-transferases, for example, which conjugate glutathione to

DNA-reactive electrophiles, show considerable genetic and corresponding functional polymorphisms in humans ( [219](#) ). Case-controlled studies suggest that the *GST*-theta1 null genotype, alone or when associated with the *GST*-mu-1 null phenotype, is associated with a fourfold or greater excess risk of MDS in some populations ( [218](#), [220](#), [221](#) ). However, this association has not been confirmed in all studies ( [222](#), [223](#) ). Recent investigations suggest that null polymorphisms of two or more glutathione- *S*-transferases increase susceptibility to the mutagenic effects of breast cancer chemotherapy or environmental toxins ( [224](#), [225](#) ). Similarly, high- and low-activity polymorphisms of the microsomal epoxide hydrolase ( *HYL1* ) and nicotinamide adenine dinucleotide phosphate-quinine oxidoreductase ( *NQO1* ) genes, respectively, have been linked to greater risk of and specific chromosome abnormalities in AML ( [226](#), [227](#) ). Observations such as these suggest that heritable deficiencies of enzymes that are involved in mutagen detoxification may heighten the risk of MDS, raising hope that chemoprevention may modify disease risk in the future.

Reports of t-MDS or AML harboring chromosome 5 and 7 abnormalities that emerge after treatment with dose-intensive anthracyclines and all- *trans*-retinoic acid for acute promyelocytic leukemia suggest that the mutagenic effects of Topo II inhibitors may be modified by interaction with non-DNA-targeted antineoplastics ( [228](#), [229](#) and [230](#) ). Indeed, emergence of Ph chromosome-negative myelodysplastic clones in CML patients who achieve complete Ph suppression with imatinib (Gleevec) has raised consideration that such clones reflect the reemergence of genetically unstable clones that preceded acquisition of the *BCR/ABL* translocation ( [231](#), [232](#) ).

For the majority of adults, there is no family history or identifiable genetic predisposition. Although MDS is uncommon in people younger than 50 years of age, the prevalence of familial disease is greatest in this age group. In one series of 550 adults with *de novo* MDS, fewer than 7% of patients were younger than 50 years of age ( [233](#) ). Familial MDS clusters accounted for 14% of patients in the younger cohort, a frequency that is 35 times greater than that estimated for older patients. Although MDS is rare in childhood, approximately one-third of cases result from a genetic predisposition ( [Table 83.6](#) ) ( [85](#), [86](#) ). The most important heritable condition is trisomy 21 ( [86](#) ). Children with Down syndrome are 10 to 30 times more likely to develop acute megakaryoblastic leukemia, which is estimated to occur in 1% of affected children overall ( [234](#) ). As much as 50% of cases are preceded by MDS that is associated with the acquired chromosome abnormalities trisomy 8 or monosomy 7 ( [235](#) ). Other, less common, constitutional karyotypic abnormalities include trisomy 8 mosaicism and familial monosomy 7 ( [85](#), [88](#), [236](#), [237](#) and [238](#) ). The precise molecular disturbance that is responsible for the excess myeloid malignancy risk in the latter constitutional abnormalities remains unknown. In an investigation of children with monosomy 7-associated malignancy, loss of paternal alleles was evident in the majority of cases, suggesting that a simple gene dosage effect may contribute to the risk ( [239](#) ). Other heritable conditions include the DNA repair deficiency syndromes Fanconi anemia, ataxia-telangiectasia, and Bloom syndrome. Congenital disorders, such as neurofibromatosis 1 (NF1) and the congenital neutropenia syndromes, Kostmann agranulocytosis and Shwachman-Diamond syndrome, may antedate development of MDS ( [240](#), [241](#) and [242](#) ). The identification of activating point mutations of the G-CSF receptor gene in myeloid progenitors of patients who experienced the malignant transformation of Kostmann syndrome raised concern that treatment with this cytokine may increase the risk of malignant transformation.

**TABLE 83.6. Predisposing Factors and Epidemiologic Associations**

---

## Heritable predisposition

### Constitutional genetic disorders

- Down syndrome (trisomy 21)

- Trisomy 8 mosaicism

- Familial monosomy 7

### Neurofibromatosis 1

### Germ cell tumors (embryonal dysgenesis)

### Congenital neutropenia (Kostmann syndrome or Shwachman–Diamond syndrome)

### DNA repair deficiencies

- Fanconi anemia

- Ataxia telangiectasia

- Bloom syndrome

- Xeroderma pigmentosum

### Mutagen detoxification (GSTq1–null)

## Acquired

### Senescence

### Mutagen exposure

- Genotoxic therapy

  - Alkylators

  - Topoisomerase II interactive agents

  - β-emitters (phosphorus-32)

  - Autologous bone marrow transplantation

- Environmental or occupational exposure (e.g., benzene)

  - Tobacco

### Aplastic anemia

### Paroxysmal nocturnal hemoglobinuria

### Polycythemia vera

---

Other BM disorders that are known to affect stem cell development may predispose to MDS and AML. The best characterized of these disorders include PNH and aplastic anemia ( [243](#), [244](#) and [245](#) ). In either disorder, hematopoietic clones are deficient in glycosyl phosphatidyl inositol–anchored membrane proteins in approximately 20% of affected patients and associate with a specific major histocompatibility complex (MHC) phenotype, HLA–DR15 ( [135](#), [246](#), [247](#) ). The high predisposition for MDS development and MHC association suggests that a disturbance that is intrinsic to the PNH clone per se or a common immune pathogenesis may be responsible. Indeed, the incomplete hematologic recovery that is observed in patients with aplastic anemia who are treated with immunosuppressive therapy implies persistence of an intrinsic stem cell defect. The incidence of secondary myeloid malignancy, MDS in particular, ranges from 13 to 25% at 10–year observation; frequencies that exceed the prevalence of the PNH defect in aplastic anemia ( [248](#), [249](#) ). Multipotential differentiation of malignant germ cells may explain the association between extragonadal germ cell tumors and hematologic malignancies, which include MDS. The latter may occur concurrently or may succeed clinical recognition of yolk sac malignancies, but they typically harbor the same karyotypic abnormality isochromosome (12p) ( [250](#), [251](#), [252](#) and [253](#) ).

## BIOLOGIC FEATURES



The hematologic features in patients with MDS reflect an uncoupling of proliferation and differentiation programs within hematopoietic progenitors. As a result, ineffective hematopoiesis prevails, evidenced by BM hypercellularity, excess intramedullary cell death, and peripheral blood cytopenias ( [254](#), [255](#), [256](#), [257](#) and [258](#) ). Appropriate activation of growth arrest signals is a requisite for terminal differentiation of hematopoietic precursors. Evidence to date indicates that unimpaired cell cycle transition represents an inherent disturbance in MDS that contributes in part to the disease pathobiology. Cellular homeostasis in MDS is profoundly disturbed and is characterized by a high proportion of cells proliferating and undergoing programmed cell death ( [160](#), [161](#) ). This kinetic imbalance represents a dynamic continuum, such that the apoptotic index exceeds the proliferative rate in lower-risk MDS, whereas, in more advanced disease, apoptotic escape emerges despite a sustained elevation in proliferative fraction ( [259](#) ). Up-regulation of antiapoptotic proteins, such as Bcl-2 and Bcl-X<sub>L</sub>, occurs with apoptotic suppression, creating a milieu that is favorable for leukemia transformation ( [259](#), [260](#) ). Compared to *de novo* AML, the apoptotic index is higher in RAEB and RAEB-t, providing a biologic distinction between these related disease entities ( [261](#), [262](#) ).

In patients with pure sideroblastic anemia (RARS), dyserythropoiesis predominates, and impairment of progenitor growth is often restricted to the erythroid lineage ( [23](#), [263](#), [264](#) ). Ferrokinetic studies indicate that ineffective erythropoiesis is greatest in this FAB category, which may account for the erythroid hyperplasia characteristic on BM examination ( [254](#), [255](#) ). The profound disturbance in erythropoiesis may be compounded by abnormalities in mitochondrial iron metabolism. Multiple, but generally inconsistent, mitochondrial cytochrome defects are demonstrable in RARS that may contribute to or result from deposition of insoluble ferritin iron, the biochemical hallmark of this specific MDS subtype ( [23](#), [265](#), [266](#) and [267](#) ). This finding is associated with impaired cell cycle transition, which limits entry of erythroid progenitors into S phase, impaired protein synthesis, and accelerated cell death. Aberrant internuclear junctions that are evident on cytologic examination may add to intramedullary red cell loss ( [129](#), [268](#) ).

Clonogenic growth of multipotent and primitive erythroid progenitors, as well as long-term culture-initiating cells, is nearly uniformly deficient ( [269](#), [270](#), [271](#) and [272](#) ). With the exception of CMML, MDS progenitors exhibit impaired response to growth factor stimulation, despite normal cytokine receptor display, intact ligand binding capacity, and appropriate receptor signal activation ( [271](#), [273](#), [274](#), [275](#) and [276](#) ). *In vitro* proliferative response of erythroid precursors to erythropoietin (EPO) appears normal; however, excessive apoptosis supersedes with terminal differentiation, corresponding to maturation-dependent overexpression of fas ligand ( [276](#) ). As a consequence, the proportion of apoptotic cells is greater in differentiating erythroid precursors compared to the progenitor population ( [161](#) ). Susceptibility to fas ligand-induced programmed cell death varies with cytogenetic abnormality and disease stage. Fas (CD95) expression and susceptibility to ligand-induced apoptosis are increased in CD34<sup>+</sup> cells that are derived from patients with trisomy 8, whereas the opposite is true for monosomy 7 or isolated 5q interstitial deletions ( [277](#) ). CD95 receptor density on CD34<sup>+</sup> cells inversely correlates with blast percentage, whereas fas ligand density remains preserved, indicating that fas-resistant myeloblast populations emerge with disease progression ( [278](#), [279](#) ). Investigations that demonstrate improved cloning efficiency and reduced apoptosis with fas blockade support an effector role for death receptor-mediated apoptosis in lower-risk patients ( [280](#), [281](#) ). Membrane expression of the tumor necrosis factor (TNF)-related apoptosis-inducing ligand receptors and corresponding susceptibility to cell death that is induced by TNF-related apoptosis-inducing ligand are similarly increased in MDS

compared to normal CD34<sup>+</sup> progenitors ( [282](#) ).

Accumulating evidence indicates that regulation of apoptosis and death receptor/ligand display arises from a complex interaction between the myelodysplastic clone and the microenvironment. Medullary apoptosis often occurs in cellular clusters that encompass hematopoietic and stromal elements, implicating local generation of aptogenic molecules ( [160](#), [283](#) ). TNF- $\alpha$  and interferon- $\gamma$  cooperate to up-regulate CD95 in normal marrow CD34<sup>+</sup> cells and to restore fas ligand susceptibility ( [284](#), [285](#) and [286](#) ). As described previously, fas receptor and ligand display are up-regulated in myelodysplastic CD34<sup>+</sup> cells, permitting autocrine and paracrine triggering of the cell death program ( [278](#), [287](#), [288](#) ). Overproduction of aptogenic cytokines, including TNF- $\alpha$ , macrophage inhibitory protein-1a, transforming growth factor- $\beta$ , IL-1 $\beta$ , and interferon- $\gamma$ , is demonstrable in the BM microenvironment and the plasma of patients with MDS ( [160](#), [284](#), [285](#), [289](#), [290](#) and [291](#) ). *In vitro* neutralization of TNF- $\alpha$  enhances the outgrowth of hematopoietic progenitors in MDS ( [287](#) ). Similarly, elevations in plasma TNF- $\alpha$  correlate with oxidative DNA injury and depletion of cellular glutathione in the CD34<sup>+</sup> compartment, as well as caspase-3 activity, thus supporting an effector or potentiating role for these cytokines in the ineffective hematopoiesis of MDS ( [291](#), [292](#) ). Monocytes, macrophages, and stromal elements have been identified as the cellular origin of medullary aptogenic cytokine production ( [283](#), [290](#), [293](#) ). Accelerated loss of hematopoietic precursors may also occur through cellular immune-mediated cytotoxicity in selected patients, illustrating overlap with aplastic anemia. Oligoclonal hematopoietic inhibitory T lymphocytes with class I MHC antigen restriction act as cellular effectors of ineffective hematopoiesis ( [294](#) ). In approximately 11% of patients, clonal expansion of an NK-like cell population with a phenotype (CD8<sup>+</sup>, CD57<sup>+</sup>, CD56<sup>+</sup>) that is analogous to large granular lymphocytes is demonstrable, suggesting pathogenetic overlap with large granular lymphocytic leukemia ( [295](#) ).

Recent investigations indicate that autocrine production of angiogenic molecules promotes expansion of the leukemic clone while fostering the generation of aptogenic cytokines. Vascular endothelial growth factor (VEGF), in particular, the principal regulator of neovascularity in solid tumors, is overexpressed concordantly with its high affinity receptors (VEGFR-1 or VEGFR-2, or both) by myeloblasts and malignant monocytes ( [296](#) ). BM neovascularity increases in proportion to marrow blast percentage, implicating myeloblasts per se as the principal source of angiogenic molecules ( [297](#), [298](#), [299](#) and [300](#) ). VEGF neutralization suppresses *in vitro* leukemia colony formation in advanced MDS, whereas recombinant human VEGF stimulates leukemia colony formation, supporting an autocrine role in expansion of the leukemic clone ( [296](#), [301](#) ). Central medullary clusters of myeloblasts (i.e., ALIP) display VEGF competence, overexpressing VEGF and VEGFR-1, providing the first biologic insight into the pathogenesis of this morphologic and prognostic feature. Paracrine induction of inflammatory cytokines from receptor-competent endothelial cells and macrophages may augment ineffective hematopoiesis. *In vitro* neutralization of VEGF suppresses the generation of TNF- $\alpha$  from MDS BM stroma while promoting recovery of multipotent and erythroid progenitors ( [296](#) ). Such findings implicating autocrine production of VEGF as a potentially important feature of the malignant phenotype in MDS have facilitated development of novel therapeutic strategies for these disorders.

Although impaired progenitor growth is the hallmark of MDS, two distinct syndromes, CMML and JMML, represent distinct exceptions. Both disorders are characterized by exuberant and spontaneous proliferation of granulocyte-macrophage (colony-forming unit-granulocyte-macrophage) progenitors in clonogenic assays ( [23](#), [302](#), [303](#) ). Autocrine



and paracrine production of a number of cytokines, including IL-6, granulocyte-macrophage colony-stimulating factor (GM-CSF), IL-1, and TNF $\alpha$ , have been implicated in the propagation of myeloid colonies ( 304, 305, 306, 307 and 308). GM-CSF neutralization extinguishes spontaneous colony formation in CMML and JMML, implicating selective hypersensitivity to this growth factor in this unique biologic feature ( 304, 306, 307, 309). Although our understanding of the biology of these disorders derives largely from investigations of JMML, both disorders share overlapping biologic features. Mitogenic response to GM-CSF requires RAS activation ( 310), and constitutive activation that results in expanded RAS-guanosine triphosphate (GTP) pools is demonstrable in the majority of patients. Constitutive Ras signaling is demonstrable in 40 to 70% of cases of adult CMML, resulting from activating point mutations of *RAS* alleles or from reciprocal chromosome translocations that deregulate receptor tyrosine kinases (RTKs) ( 43, 311, 312). Although *RAS* mutations are detected in fewer than 20% of cases of JMML ( 313), 30% of patients harbor inactivating mutations of the neurofibromin 1 gene (*NF1*), which encodes a GTP hydrolase (GTPase) activating protein (GAP) that negatively regulates RAS by accelerating GTP hydrolysis ( 314). Reciprocal translocations that involve chromosomes 5q33 or 8p11 create novel fusion genes that involve the PDGF- $\beta$  and Fibroblast growth factor receptor V (FGFR1) RTKs, respectively, and corresponding constitutive RTK signaling ( 43, 315, 314, 315, 316, 317, 318 and 319). Although a number of chromosomes and genes may partner in the gene rearrangements ( Table 83.7), the clinical phenotype is distinct and is recognized by the WHO classification as CMML with eosinophilia. Transgenic mouse models have confirmed that these novel RTK fusion genes, which activate PDGFRB, are singularly responsible for these myeloproliferative disorders and are selectively responsive to RTK inhibitors ( 315, 320, 321).

**TABLE 83.7. Tyrosine Kinase Fusion Genes in Chronic Myelomonocytic Leukemia with Eosinophilia**

| Fusion Gene  | Translocation    |
|--------------|------------------|
| ZNF198-FGFR1 | t(8;13)(p11;q12) |
| FOP-FGFR1    | t(6;8)(q27;p11)  |
| CEP110-FGFR1 | t(8;9)(p11;q33)  |
| BCR-FGFR1    | t(8;22)(p11;q22) |
| ETV6-PDGFRB  | t(5;12)(q33;p13) |
| HIP1-PDGFRB  | t(5;7)(q33;q11)  |
| H4-PDGFRB    | t(5;10)(q33;q21) |
| RAB5-PDGFRB  | t(5;17)(q33;p13) |

## MOLECULAR AND CYTOGENETIC ABNORMALITIES

Epigenetic events, such as methylation silencing of the cyclin-dependent kinase inhibitor, p15, may override or compound genetic aberrations to heighten the risk for leukemia transformation. Aberrant methylation of promoter CpG islands contributes to repression of gene transcription in human malignancies and, in MDS in particular, has been implicated in the epigenetic silencing of the p15 protooncogene ( 322, 323). Methylation silencing of p15 is rare in patients with MDS and low leukemia burden but is detected in more than 75% of cases with excess blasts and occurs uniformly with progression to AML.

In keeping with the approach in the present chapter, the classification of MDS according to the FAB group ( <sup>16</sup> ) ( [Table 83.2](#) ) is followed, because cytogenetic results in MDS that are based on the WHO classification ( <sup>39</sup> ) ( [Table 83.3](#) ) are too sparse for consideration.

Even though MDS progresses not infrequently to AML, specific changes that are seen in this leukemia, such as t(8;21) in M2, t(15;17) in M3, and inv(16) in M4, although encountered, are rare in MDS. However, the overall karyotypic similarity between MDS and AML strongly emphasizes the pathogenetic relationship between these two disorders. The cytogenetic data support the view that at least some MDSs represent a continuum of early preleukemia phases. Thus, a patient may progress from RA through RAEB and RAEB-t to reach the end stage of overt AML. It is uncertain whether the transition from MDS to AML always requires additional genomic changes. At the cytogenetic level, it is common not to see secondary aberrations during the transition of MDS to AML, although examples to the contrary also exist.

More than 3500 karyotypes, appearing in more than 800 publications, have been described in MDS ( <sup>425</sup> ). Although there exists considerable heterogeneity among these karyotypes, which may be complex in a significant number of cases, some of the MDS subtypes are characterized by recurrent cytogenetic (karyotypic, chromosomal) abnormalities, and some of the chromosomal changes occur nonrandomly among the various MDS subtypes. These areas and some other facets of the cytogenetics of MDS are addressed in the following paragraphs. Space limitations and other considerations preclude an exhaustive review of the large literature on the cytogenetics and molecular genetics in MDS, and, hence, only the salient aspects of these areas, with appropriate references, are presented in this chapter.

Clonal chromosome abnormalities occur in 30 to 50% of successfully karyotyped cases of *de novo* MDS and in approximately 80% of s-MDS and t-MDS ( <sup>425</sup> , <sup>426</sup> ). The cytogenetic abnormalities that are seen in MDS strongly support the view that MDSs are of truly neoplastic nature, and the nonrandom distribution of these abnormalities has helped classify the cytogenetic changes that are probably primary and others that represent karyotypic evolution as the disease progresses toward an increasingly aggressive phenotype. The characteristic chromosomal changes that are encountered in MDS include a large number of rearrangements (translocations, deletions, inversions, and insertions) and a lesser number of numerical changes (monosomies and trisomies).

### **Cytogenetic Changes That Are Associated with Clinical Subtypes of Myelodysplastic Syndrome: 5q- Syndrome**

Although deletions of 5q may be observed in a whole spectrum of *de novo* and therapy-related AML and MDS, the *5q- syndrome* has a rather narrow definition. A deletion of 5q in patients with RA was first reported by Van den Berghe et al. ( <sup>427</sup> ) in 1974, and the clinical state associated with it is now known as the *5q- syndrome*. This syndrome occurs primarily in elderly women and is associated with therapy-resistant macrocytic anemia, a normal or elevated platelet count, and an increased number of megakaryocytes with characteristic morphologic abnormalities (e.g., hypolobulated nuclei) ( <sup>428</sup> ). The clinical course is usually mild, and transformation to AML is rare, especially in patients with 5q- as the only cytogenetic change. There is general consensus that the deletion of 5q in this syndrome is interstitial, with the breakpoints that are most frequently cited being 5q31-q33, although some heterogeneity of the breakpoints may exist, ranging from bands 5q12 to 5q35.

The molecular basis of the 5q- syndrome has been the subject of much investigation,

although the putative tumor-suppressor gene for the syndrome remains undetermined. The common deleted region of the 5q- syndrome has been narrowed to an approximately 1.5-megabase interval at 5q32 flanked by D5S413 and the *GLRA1* gene ( [429](#)). This region contains 40 genes, 33 of which are expressed in CD34<sup>+</sup> cells and therefore represent candidate genes, because they are expressed within the hematopoietic stem and progenitor cell compartment. Good candidates for the 5q- syndrome include *MEGF1* and *G3BF*, among others. The common deleted region in the 5q- syndrome is distinct from that of the del(5)(q31) in AML and some other more aggressive forms of MDS ( [430](#), [431](#)).

## Refractory Anemia

More than 500 cases of RA with karyotypic changes have been reported; generally, the changes are less extensive than they are in other subtypes of MDS (1.7 aberrations per RA case vs. 1.9 aberrations for unselected MDS) ( [432](#)). The most common chromosomal changes in RA are del(5q), -7, and +8. The del(5q) is found in at least 50% of RA cases, is clearly the most common change in MDS, and is often a sole abnormality ( [433](#)).

## Refractory Anemia with Ringed Sideroblasts

Approximately 20% of RARS cases have clonal cytogenetic changes that are similar to the percentages that are seen in RA ( [27](#), [338](#), [339](#)), in contrast to almost 40% in MDS as a whole. The types of karyotypic changes that are seen in RARS are not markedly different from those in other MDS subgroups ( [432](#), [433](#)). The nonrandom changes include trisomy 8 (+8), the most common change, which occurs in one-third to one-fourth of all abnormal RARS cases, followed by del(5q), which is seen in 50% of RA but only in approximately 25% of RARS, a frequency that is similar for MDS overall. Next in frequency are -7, del(11q23), and del(20q), each of which is seen in approximately 10% of RARS cases. Increased iron stores in the marrow have been reported in RARS with del(11q23) ( [434](#)); the latter may be associated with therapeutic exposure to epipodophyllotoxins ( [198](#), [435](#)). Translocations with 11q23 may involve a number of different partners, such as 2p22, 19p13.3, 19p13.1, 4q21, 6q27, 1p32, 16p13.1, 10p13, and 17q25 (in decreasing order of frequency). In a significant number of the cases with 11q23 involvement, the *MLL* gene is affected.

Although deletion of 20q may occur in a number of myeloid disorders, it is not uncommonly seen in RARS. These deletions appear to be interstitial in nature (apparently always encompassing 20q11.2-q12). The nature of the genes that are affected by these deletions has not been established with certainty.

## Refractory Anemia with Excess Blasts and Refractory Anemia with Excess Blasts in Transformation

RAEB and RAEB-t are more frequently associated with chromosomal changes than RA and RARS, with the frequency of these associations ranging from 45 to 60% versus 20 to 30%, respectively. Thus, the incidence and the extent of cytogenetic changes in MDS seem to be roughly proportional to the number of myeloblasts in the marrow ( [426](#)). The same karyotypic aberrations that are seen in other MDS subgroups are also seen in RAEB and RAEB-t. Thus, a deletion of 5q is the most frequent structural anomaly (25% of cases). Monosomy 5 (-5) is relatively common (10% of cases) but is rare in this subgroup, as in other *de novo* MDSs, as a solitary aberration. Monosomy 7 (-7) is more common (25% or more of cases) in RAEB-t than in any other subtype of MDS. Among other abnormalities, such as del(11q), it is more common in s-MDS than in the *de novo* variety of disease. Del(7q), like monosomy 7, is more commonly found with other karyotypic aberrations than as the only change. The extent of del(7q) varies among cases. Trisomy 8

(+8) is another common change in RAEB-t, as it is in other subtypes of MDS, occurring in approximately 15 to 20% of cases.

### Chronic Myelomonocytic Leukemia

Although CMML is not included among the MDS in the WHO classification, it has been included in most of the studies on chromosome changes in MDS and hence is discussed in this section. Cytogenetic changes occur in approximately one-third of the cases, with monosomy 7 (-7) and +8 being the most common and, often, the sole abnormality. Loss of the Y chromosome in males is seen more frequently in CMML than in other MDS subgroups, and may possibly be related to the age of the patient, and may not be involved in the neoplastic process. A specific translocation t(5;12)(q13;p13) has been reported in CMML ( [436](#) ) that leads to a fusion gene *TEL-PDGFB* ( [43](#) ). Some of the molecular consequences of this translocation are mentioned in the section on Molecular Changes in Myelodysplastic Syndrome. Other translocations that result in tyrosine kinase fusion genes in CMML are shown in [Table 83.7](#). The infrequent occurrence of 5q- in CMML sets this leukemia somewhat apart from other MDS forms and has been used as an indicator that CMML may not belong to the MDS group of disorders ( [39](#) ).

### Some Aspects of Common Cytogenetic Abnormalities in Myelodysplastic Syndrome: Partial Trisomy of 1q

Involvement of 1q is not uncommon in MDS (and AML) and can take the form of partial trisomy of this arm through a number of different translocations, such as der(Y;1)(q12;q12), der(1;7)(q10;p10)(p10), der(1;15)(q10;q10), der(16)t(1;16)(q11;q11), der(1;18)(q10;q10), der(1;19)(q21~q23;p13.3), and dic(1;10)(p11;p11) ( [437](#) , [438](#) , [439](#) , [440](#) and [441](#) ).

### Rearrangements of 3q26

Generally, patients with rearrangements at 3q26 have received prior therapy with an alkylating agent for an unrelated disease. Dysmegakaryopoiesis is present in 90% of cases that carry an inv(3)(q21q26) or t(3;3)(q21;q36). An activated or inappropriate expression of the *ETV1* oncogene that is located at 3q26 is observed. However, *ETV1* is also activated in 30% of MDS without 3q rearrangements ( [442](#) ). Patients with a t(3;21)(q26;q22) ( [Fig. 83.9](#) ) usually exhibit thrombocytopenia. This translocation has also been observed in CML and leads to a fusion between *ETV1* at 3q26 and *AML1* at 21q22 ( [443](#) ). The involved genes in the t(3;5)(q25;q34) are *MLF1* and *NPA*, respectively ( [444](#) ).



**Figure 83.9.** Karyotype of a bone marrow cell from a patient with myelodysplastic syndrome (MDS) that contains some of the common changes that are seen in this disease: 45,XY,t(3;21)(q26.3;q22), del(5)(q13q33), and -7. These changes are compatible with those seen in secondary MDS or therapy-related MDS.

## Other 5q Deletions

The 5q<sup>-</sup> anomaly is found in all myeloid-derived cells, including megakaryocytes, monocytic cells, erythroblastic-derivative cells, and, in rare cases, even in B cells ( [445](#), [446](#) ) in MDS, including the 5q<sup>-</sup> syndrome. Deletions of the long (q) arm of chromosome 5 are generally interstitial ( [Fig. 83.9](#)), often with a proximal breakpoint between bands 5q13 and 5q22 and a distal breakpoint between bands 5q32 and 5q35, although deletions may be seen outside these regions ( [447](#), [448](#) and [449](#) ). The type of deletion is often correlated with clinical features. For example, the most common type of deletion, del(5)(q13q33), is predominant in women, shares clinical features with the 5q<sup>-</sup> syndrome, and carries a relatively good prognosis. Efforts are still in progress to determine the molecular events in 5q deletions because of the highly complex and heterogeneous genetic features that result from deletion of the 5q region, which suggest that more than one gene is responsible. Many growth factors and growth factor receptors have been localized to 5q31–q33, such as GM-CSF, IL-3, IL-4, IL-5, and IL-9. Other genes within the same region have also been investigated, such as *ERG1* tumor-suppressor genes; *CDC25C*, a G2 checkpoint gene; *IRF1*, which encodes an interferon regulatory factor ( [450](#) ); *FMS*, the gene that encodes the receptor for *CSF1*; and the *ETF1* gene at 5q31 ( [451](#) ). At present, one is led to the conclusion that the role of oncogene and tumor-suppressor gene changes at the causative level and subsequent progression in MDS with 5q<sup>-</sup> (including the 5q<sup>-</sup> syndrome), remains uncertain.

## Deletion of 7q (7q<sup>-</sup>) and -7

Changes of chromosome 7 are common in MDS, especially in RAEB, RAEB-t, and CMML; these changes are particularly evident in s-MDS or t-MDS and are associated with a shorter survival than in MDS cases with other cytogenetic changes ( [426](#) ). In 80% of cases with chromosome 7 involvement, deletions of the long arm occur mainly in two important regions: proximal breakpoints in 7q11–q22 and distal breakpoints in 7q31–q36. In the remaining cases, deletions are observed in the 7q32–q33 region ( [452](#) ). The smallest overlapping region that is deleted is 7q22, which contains genes that are involved in DNA repair mechanisms (i.e., *EPC*, *PLANH1*, and *ASNS*). Their role in the pathogenesis of MDS is still unclear.

Monosomy 7 is frequently observed as an isolated chromosome aberration in adults with MDS who are younger than 50 years of age ( [233](#) ), whereas, in older patients, it is associated with other chromosome abnormalities ( [453](#) ). It can be readily detected by FISH analysis. It is the most frequent chromosome change that is seen as the sole abnormality in MDS in children who are younger than 4 years of age. Monosomy 7 syndrome occurs predominantly in boys with splenomegaly, thrombocytopenia, and a poor prognosis and may not be readily separated from JMML, which also shows monosomy 7 in 25% of cases ( [88](#) ). Monosomy 7 is also found in childhood preleukemic disorders that may evolve to MDS and AML, such as Fanconi anemia, Kostmann syndrome, Shwachman-Diamond syndrome, NF1, and a rare type of the so-called familial MDS ( [454](#) ). Because cells with -7 (as well as those with +8) have a proliferative advantage *in vitro*, it has been recommended that, to more accurately quantify the exact incidence of -7 in the marrow, FISH or other similar approaches on interphase nuclei should be used to determine the true incidence of -7 rather than that obtained by conventional cytogenetic techniques ( [453](#), [455](#) ). Deletion of 7q in MDS may progress to complete loss (monosomy) of this chromosome, an event that is usually associated with clinical progression of the disease.



Paradoxically, progression of 5q<sup>-</sup> to -5 is seldom seen.

The familial occurrence of complete (-7) or partial monosomy 7 (7q<sup>-</sup>) in association with MDS (or AML) has been reported. Although a hypothesis of a germ-line mutation of a tumor-suppressor gene on chromosome 7 as a first step in the pathogenesis of these cases had been advanced ( [456](#) ), the fact that -7 may be of different parental origin ( [456a](#) ) argues against such a hypothesis and points to an inherited mutation in any of a group of mutator genes as a more likely cause of familial -7 in the absence of a recognized mendelian disease.

A significant association of -7 with expression of the multidrug resistance P-170 glycoprotein has been observed ( [457](#) ). *RAS* gene mutations or loss of the *NF1* gene are thought to be critical events in the pathogenesis of MDS with 7q<sup>-</sup>.

### 11q23 in Myelodysplastic Syndrome

Translocations that involve 11q23 are well established changes in acute leukemia, as well as in t-MDS and s-MDS, usually affecting the *MLL* gene at 11q23. Recurring translocation partners are 9p22, 19p13.3, 19p13.1, 4q21, 6q27, 1p32, 16p13.1, 10p13, and 17q25, in order of frequency. These translocations are relatively rare in primary MDS ( [426](#) ). Breakpoints at 11q outside the *MLL* gene have been reported in *de novo* MDS, that is, t(11;21)(q24;q11), which is frequently associated with 5q<sup>-</sup> ( [458](#) ) and inv(11)(p15q22), resulting in fusion between the nucleoporin gene ( *NU98* ) and an RNA helicase gene ( *DDX10* ) whose transcript is thought to interfere with hematopoietic differentiation ( [459](#) ). For clinical involvement and a variety of other aspects of involvement of 11q23, see the report of a special workshop ( [460](#) ). Band 11q23 translocation breakpoints are DNA Topo II cleavage sites and involve the *MLL* gene in translocation processes ( [461](#) , [462](#) ).

### 12p Deletions (12p<sup>-</sup>)

Deletions of 12p may occur as sole cytogenetic events in MDS or may be part of a more complicated karyotype ( [463](#) , [464](#) ). These deletions are usually interstitial between 12p11 and 12p13, with the latter being most commonly affected and quite unstable ( [465](#) , [466](#) ); both *TEL* ( *ETV6* ) and *CDKN1B* genes are generally deleted ( [467](#) , [468](#) ). However, FISH studies have revealed that some of these deletions have hidden rearrangements of *TEL* ( *ETV6* ) that are located at 12p13.1. Although the t(5;12)(q33;p13) was first described in patients with CMML ( [469](#) ), it has been observed in other MDS types and is frequently associated with eosinophilia and monocytosis ( [436](#) , [470](#) ). The translocation results in a fusion transcript between the genes *TEL* ( *ETV6* ) at 12p13 and *PDGFRβ* at 5q33 ( [43](#) ). Variant translocations that involve chromosomal regions, such as 1p36, 3q26, 5q31, 6p21, 9q22, and 10q24, have been described as fusion partners of *TEL* ( *ETV6* ) in MDS ( [470](#) , [471](#) , [472](#) and [473](#) ).

It has been suggested that the fusion *ETV6/PDGFRβ* gene leads to high tyrosine kinase activity of *PDGFRβ*, with malignant transformation due to an altered *RAS* signal transduction pathway ( [43](#) ). In the *TEL/PDGFRβ* fusion, *TEL* contributes to the amino-terminal oligomerization domain, which is critical for the activation of *PDGFRβ* ( [468](#) ). Inversions of chromosome 12, paracentric and pericentric—for example, inv(12)(p13p15) and inv(12)(p15q24)—have been described in some cases of MDS, with the abnormality

occurring as the sole karyotypic change in some of the cases ( [474](#), [475](#) and [476](#) ).

### 17p Deletions (17p-)

Unbalanced rearrangements of chromosome 17 may result in 17p deletions, such as t(5;17)(p11;p11), t(7;17)(p11;p11), or i(17)(q10). Generally, del(17p) is associated with other chromosome abnormalities. A particular type of dysgranulopoiesis, which combines pseudo-Pelger-Huët hypolobulation of the nucleus and small vacuoles in neutrophils, is seen in some cases of MDS with 17p-. Of interest, the same type of dysgranulopoiesis is seen in CML in blast crisis that exhibits an i(17)(q10) ( [477](#) ). These patients usually have point mutations in *TP53* with a poor response to chemotherapy and short survival ( [341](#) ). The 17p anomaly is found in *de novo* MDS but more frequently in patients who received chemotherapy or radiation therapy, or both ( [478](#) ). The *TP53* gene acts as a tumor-suppressor gene that is involved in the control of the cell cycle, DNA repair, and apoptosis. The incidence of *TP53* mutations in MDS is 2 to 5% of the cases ( [479](#) ).

### Deletions of (20q)

Deletions of interstitial nature in the long arm of chromosome 20 (20q) are seen in approximately 5% of MDS, primarily affecting the erythrocytic and megakaryocytic lineages ( [480](#) ). The crucial region that is lost in MDS has been delineated (between D20S174 and D20S17) at which a number of tumor-suppressor genes may be located ( [175](#) ).

### X Chromosome Changes

Loss of an X chromosome in some female patients with MDS has been shown with FISH to affect blast cells, as well as myeloid elements of the marrow ( [481](#) ). A typical structural rearrangement (isodicentric chromosome X) with a breakpoint at Xq13 has been proposed for some cases of RARS ( [482](#) ). Xq13 may be involved in translocations in MDS without sideroblasts ( [483](#) ).

### Trisomy 8 (+8)

Trisomy 8 is a frequent aberration in MDS, and is the most common among trisomies ( [484](#) ), and appears to be confined to the myeloid elements of the marrow, as is shown by FISH studies ( [485](#) ). In rare and unusual cases, lymphocytes may show +8 ( [486](#) ). Trisomy 8 may be present as the sole cytogenetic change in MDS or with other chromosome abnormalities. The molecular basis for the effects of +8 in MDS and AML remains undetermined ( [487](#) ). The incidence of +8 as a sole cytogenetic change in MDS and related conditions varies in relation to gender, age, prior genotoxic exposure, and cell morphology ( [488](#) ). Clonal evolution from +8 to tetrasomy 8 (+8,+8) may be associated with development of AML from MDS ( [489](#) ). An interesting observation is the presence of a constitutional mosaicism for +8 in 15 to 20% of cases of MDS and AML ( [490](#) ). Functional impairment of the CD34<sup>+</sup>/CD38<sup>-</sup>Thy-1<sup>+</sup> hematopoietic stem cell pool in patients with trisomy 8 (+8) has been reported ( [491](#) ). It is associated with an intermediate prognosis.

### Other Trisomies in Myelodysplastic Syndrome

Trisomy of whole chromosomes, besides the +8, may be seen in various subtypes of MDS,



as well as in AML. Trisomy 14 may occur as a sole abnormality ( [492](#) ) or as part of a more complicated karyotype. This trisomy may be seen in several subtypes of MDS ( [493](#) ) and carries with it a rather poor prognosis ( [492](#) ).

Trisomy 15, with or without sex chromosome loss, may be present as a sole change in MDS or as part of a more complicated karyotype ( [494](#) , [495](#) ). The anomaly tends to occur in elderly patients. Rare trisomies in MDS involve chromosomes 11 (+11) ( [496](#) ), 13 (+13) ( [497](#) , [498](#) ), 19 (+19) ( [499](#) ), and 21 (+21) ( [500](#) ). Although these trisomic changes are seen more often in acute leukemia, and their significance in MDS is relatively uncertain, they may play a part in the leukemic transformation of MDS.

Trisomy 6 appears to be a nonrandom karyotypic change that may be helpful to differentiate between true aplastic anemia and rare MDS with aplastic BM ( [501](#) ).

### Gene Amplification in Myelodysplastic Syndrome

Gene amplification, which is usually associated with resistance to chemotherapy, may be identified cytogenetically as double-minute chromosomes (dmins) and as homogeneously staining regions ( [426](#) ). Although rare in MDS, such changes have been found in all subgroups of MDS ( [502](#) , [503](#) ). They may represent the only karyotypic change but are more often associated with 5q<sup>-</sup>, +4 (associated with *C-MYC* amplification), or trisomy 6 (+6) ( [502](#) , [503](#) , [504](#) and [505](#) ). Overexpression of the multidrug resistance gene ( *MDR-1* ) leads to the accumulation of a glycoprotein that is named P-170, which acts as a transmembrane drug efflux pump. High expression of P-170 may be seen at diagnosis of MDS, mainly in cells with an immature phenotype, CD34<sup>+</sup> or, in early committed myeloid cells, CD13<sup>+</sup> and CD33<sup>+</sup> ( [388](#) , [457](#) ). A high risk of leukemic evolution exists in these cases. Monosomy 7 (-7) is a karyotypic change that has been related to P-170 expression ( [457](#) ). Amplification of the *MLL* gene in cases of MDS with dmin or homogeneously staining regions has been reported ( [506](#) ).

### Secondary and Therapy-Related Myelodysplastic Syndrome

s-MDS is an entity in which a toxic cause for the disease can be established with some certainty. It is possible that a still unknown and possibly significant portion of *de novo* MDS is in fact of so-called secondary nature, particularly those MDSs with changes of chromosomes 5 and 7 (i.e., 5q<sup>-</sup>, -5, 7q<sup>-</sup>, and -7) ( [426](#) ). s-MDS (and AML) may also develop after exposure to genotoxins, besides those related to therapy of specific diseases. Such genotoxins include occupational exposure to chemical solvents, insecticides, and petroleum products. These exposures are frequently associated with loss of material from chromosomes 5 and 7 ( [432](#) ).

Generally, t-MDSs are much more aggressive clinically than *de novo* MDS and demonstrate recurrent cytogenetic changes, depending on the therapy that is administered. Therapy-related hematologic disease follows treatment of malignancies in 0 to 20% of patients, depending on the patient population, the treatment strategies used, and the follow-up time. Balanced translocations after topoisomerase inhibitors, affecting especially bands 11q23 and 21q22, have been described ( [197](#) ).

s-MDS or t-MDS is more often associated not only with cytogenetic changes (80 to 85% vs. 45% of cases) but also with more aberrations than *de novo* MDS ( [507](#) ). Complex and

hypodiploid karyotypes are more common in t-MDS than in *de novo* MDS. Furthermore, s-MDS and t-MDS more frequently evolve into AML than *de novo* MDS with or without additional cytogenetic abnormalities that accompany or cause the transformation. Thus, the cytogenetic information on secondary AML is relevant to s-MDS and t-MDS, and, in fact, such information shows considerable overlap ( [426](#) ).

The most frequent cytogenetic abnormalities in s-MDS and t-MDS are -7 (41%), 5q- (28%), and -5 (13%), followed by der(21q), +8, 7q-, der(12p), t(1;7), -12, -17, der(17p), der(3p), der(6p), and -18. Clones with single aberrations were seen in nearly 50% of the cases. Monosomy 7 (-7) was found to be more common in t-MDS after chemotherapy with alkylating agents, whereas 5q- was associated with exposure to ionizing radiation ( [507](#) ).

An international workshop dealt with balanced rearrangements that were seen in 20 to 30% of MDS ( [508](#) ) after therapy for other disorders ( [509](#) ). The crucial role of DNA Topo II inhibitors in the development of these t-MDS was stressed, that is, balanced translocations that involved 11q23 (and the *MLL* gene), inv(16)(p13q22) (and rearrangements of the *CBFB* and *MYH11* genes), t(15;17)(q22;q12) (and the *PML* and *RARA* genes), and t(8;21)(q22;q22) (and the *ETC* and *AML1* genes), as well as a number of rare balanced aberrations, some of which were rather unique in nature. The occurrence of these changes, which was generally thought to be specific for some *de novo* AML subtypes, in t-MDS was addressed at the workshop. The reader is referred to the full report of this workshop for correlations of the previously mentioned cytogenetic changes in t-MDS with clinical and prognostic parameters, as well as more complete cytogenetic data. For example, the data suggested that involvement of the *MLL* gene may be more closely associated with epipodophyllotoxins, whereas the anthracyclines were associated more often with 21q22 aberrations ( [509](#) ).

Some *MLL* breakpoints that are induced by Topo II inhibitors *in vitro* map to preferred sites ( [462](#) ). The 3' portion of the *MLL* bcr is one of these sites, and, in one series of t-AML patients, *MLL* breakpoints mapped close to this site. A new target gene in t-MDS and AML, *NUP98*, in chromosome band 11p15 has been implicated because of its recurrent involvement in several different chromosome rearrangements, such as inv(11)(p13q22), t(11;17)(p15;q21), t(11;12)(p15;p13), t(7;11)(p15;p15), t(11;20)(p15;q11), t(2;11)(q31;p15), and t(4;11)(q21;p15). The mechanisms that underlie these translocations are unclear. A role of DNA Topo II in the generation of the 11p15 translocations has been suggested because of the finding of 4-base pair (bp) microduplications at the breakpoints of derivative chromosomes, which implies that these translocations were initiated by a 4-bp staggered DNA break.

## Molecular Changes in Myelodysplastic Syndrome

Not all molecular genetic changes in MDS are reflected in the cytogenetic abnormalities that are encountered in these disease states, nor have all the cytogenetic abnormalities been translated into defined molecular genetic events. A number of genes has been reported to be affected or involved in MDS, with the possibility that some of these changes may play a primary role in the pathogenesis of these diseases, whereas others may be secondarily affected.

*RAS* mutations may be an early or late change in MDS, but the relation to transformation to AML remains uncertain ( [510](#) , [511](#) , [512](#) , [513](#) , [514](#) and [515](#) ), although some studies point to *RAS* mutations in MDS as being associated with disease progression and poor survival (

[511](#), [516](#), [517](#)).

Acquired *RAS* gene mutations (mainly *N-RAS*) are found in 20 to 40% of MDS and AML cases ([512](#)). Although some correlation of *N-RAS* mutations with the cytogenetic changes in MDS (5q-, -7, and +8) may exist, such mutations may be seen in the cells of MDS cases with normal karyotypes ([512](#), [518](#)). As a consequence of mutation, the active RAS-GTP is not inactivated to its guanosine diphosphate counterpart with consequent up-regulation of a signal transduction pathway. *N-RAS* mutations have been preferentially associated with the monocytic component of MDS and an increased risk of progression to AML ([511](#)). An overexpression of the p21 product of *RAS* has been found in nearly 30% of MDS ([519](#)). Involvement of *N-RAS* (located on chromosome 2), *H-RAS* (located on chromosome 11), and *K-RAS* (located at 12p12) does not correlate with the karyotypic rearrangements of these chromosomes in MDS. However, a case of MDS with a typical t(5;12) and *K-RAS* overexpression has been reported ([469](#)).

In addition to oncogenic point mutations, two other mechanisms in which *RAS* may be deregulated have been implicated in myeloid disorders. As mentioned previously, a specific translocation t(5;12)(q33;p13) has been described in CMML, leading to a fusion gene *TEL-PDGFB* ([43](#)), which is assumed to be oncogenic owing to constitutive receptor activation and, therefore, increased *RAS* activation ([520](#)). This event appears equivalent to constitutive activation of the c- *FMS* receptor, which is also known to occur in MDS and AML.

The neurofibromatosis gene *NF1* encodes a GAP that is responsible for inactivating *RAS* ([521](#)), and, thus, children with defects of *NF1* have deregulated *RAS* activation that may possibly be related to their predisposition to MDS and AML ([319](#)). However, in adult cases, inactivating *NF1* mutations are uncommon ([522](#), [523](#), [524](#) and [525](#)). It appears that the most common method of *RAS* activation in adult MDS (and AML) is by point mutations of the *N-RAS* and, to a lesser extent, the *K-RAS* genes ([512](#)).

The protein product of the gene *NF1*, neurofibromin, has extensive homology with the catalytic domain of GAPs, such as p120<sup>GAP</sup>, which are known to accelerate the intrinsic GTPase activity of p21<sup>ras</sup> proteins. Hence, the loss of *NF1* may mimic the effect of oncogenic *RAS* point mutations that cause high constitutive RAS-GTP levels ([526](#), [527](#)). Decreased levels of NF1 protein have been found in the BM of patients with MDS ([528](#)).

Involvement or loss of the *FMS* gene (located at 5q33) in the 5q- anomaly ([529](#)) remains uncertain in view of mutations that are seen in MDS that have also been found in normal individuals ([530](#)). The core-binding factor (CBF) complex is a heterodimeric transcription factor that is composed of two subunits, CBF $\alpha$  (located at 21q22) and CBF $\beta$  (located at 16q22), that play a major role in hematopoiesis. Both members are frequently altered by translocations or inversions. In contrast to *AML1* gene mutations in t-MDS and t-AML, none of CBF $\beta$  was seen in these states ([531](#), [532](#)).

The role played by cell cycle regulators, such as the cyclin-dependent kinase inhibitor genes (located at 9p21), which produce p15 and p16, has not been elucidated in MDS ([322](#), [533](#)). The *DCC* gene (located at 18q21) appears not to be affected in MDS ([534](#)). The hypermethylation of the calcitonin gene (located at 11p15) has been a controversial finding in MDS ([535](#), [536](#)).

Apoptosis (programmed cell death) is an active cellular process that regulates cell population size by decreasing cell survival ( [162](#) ). Increased apoptosis may play an important role in the early pathogenesis of MDS, a mechanism that may be responsible for the paradox of marrow hypercellularity and peripheral blood pancytopenia in MDS ( [537](#) ). Involvement of mitochondria and mutations of their DNA in MDS remains to be more clearly elucidated ( [538](#) , [539](#) ).

### Comment

In all probability, gene expression profiling of MDS, as has been done in some leukemias, will reveal hitherto unrecognized genetic changes ( [540](#) , [541](#) and [542](#) ) that will be of aid in the classification, prognosis, and understanding of MDS. FISH and spectral karyotyping ( [447](#) , [543](#) , [544](#) ), as well as comparative genomic hybridization, have revealed chromosomal changes in some MDSs, including RA, that are not seen with G-banding ( [545](#) ), including the demonstration that a substantial number of MDS cases with del(5q) are, in fact, der(5) as a result of unbalanced translocations. In more advanced stages of MDS, del(5q) has been shown to be associated with dmin (representing gene amplification) that originate from the deleted long arm of chromosome 5.

Although much has been learned about some of the genetic pathways leading to *de novo* and t-MDS ( [546](#) ) and the impact of cytogenetic changes on the prognosis of these syndromes ( [Table 83.8](#) and [Table 83.9](#) ) ( [162](#) , [497](#) , [547](#) ), the basic events underlying MDS remain essentially unknown ( [262](#) ).

**TABLE 83.8. Survival and Leukemic Transformation According to French/American/British (FAB) Subtype**

| FAB Subtype (%)  | Median Survival in Months (Range) | Percent of Leukemic Transformation (Range) |
|--|-----------------------------------|--|
| RA ( <a href="#">25</a> )                                      | 37 (19 to 64)                     | 11 (0 to 20)                               |
| RA with ringed sideroblasts ( <a href="#">18</a> )             | 49 (21 to 76)                     | 5 (0 to 15)                                |
| RA with excess blasts ( <a href="#">28</a> )                   | 9 (7 to 15)                       | 23 (11 to 50)                              |
| RA with excess blasts in transformation ( <a href="#">12</a> ) | 6 (5 to 12)                       | 48 (11 to 75)                              |
| Chronic myelomonocytic leukemia ( <a href="#">17</a> )         | 22 (8 to 60 <sup>+</sup> )        | 20 (3 to 55)                               |
| All patients   |                                   | 19   |

RA, refractory anemia.

NOTE: Based on data relating to 1914 patients compiled from nine reports (references [20](#) , [24](#) , [287](#) , [288](#) , [289](#) , [290](#) and [291](#) , [293](#) , [361](#) ).

From Sanz GF, Sanz MA. Prognostic factors in myelodysplastic syndromes. *Leuk Res* 1992;16:77, with permission.

**TABLE 83.9. Prognosis in Myelodysplastic Syndrome According to Cytogenetic Findings**

| Prognostic Category | Karyotypic Change         | Median Survival (Mo) |
|---------------------|---------------------------|----------------------|
| Good                | Normal                    | >24                  |
|                     | del(5q) alone             |                      |
|                     | del(20q) alone            |                      |
| Intermediate        | +8                        | 18                   |
|                     | Single karyotypic anomaly |                      |
|                     | Double abnormalities      |                      |
|                     | Other changes             |                      |
| Poor                | Complex karyotypes        | <12                  |
|                     | Chromosome 3 changes      |                      |
|                     | Chromosome 7 changes      |                      |

## PROGNOSTIC FEATURES

The MDSs display remarkable clinical, pathologic, and cytogenetic heterogeneity, thereby necessitating careful scrutiny of prognostic features to optimize treatment decisions. The FAB classification enjoyed widespread acceptance because of its prognostic usefulness, owing almost entirely to the impact of graded differences in blast percentage on leukemia transformation and cytopenic complications ( [20](#), [324](#), [325](#), [326](#), [327](#), [328](#), [329](#), [330](#) and [331](#) ). Despite this, prognostic distinctions are readily discernible within each of the three ranges of blast percentage: less than 5% (RA and RARS), 5 to 20% (RAEB), and 21 to 30% (RAEB-t) ( [Table 83.10](#) ). For example, although the FAB classification includes Auer rods as a diagnostic criterion for RAEB-t, inclusion of cases harboring fewer than 20% blasts does not carry the same prognostic connotation. In one large series of patients, RAEB-t cases classified solely by the presence of Auer rods had a median survival that was approximately 41 weeks longer than that of patients whose marrow blast percentage exceeded 20% ( [138](#) ). There remains considerable heterogeneity within other FAB types, indicating that factors other than leukemia load impact survival within morphologically defined subgroups. These features can be segregated into four categories that reflect leukemia burden, lineage penetrance and severity of the maturation defect, genetic and molecular abnormalities, and clinical and pathologic features ( [Table 83.10](#) ). Independent of blast percentage, an increased fraction of CD34<sup>+</sup> cells in the BM or peripheral blood, a leukemic pattern of growth progenitor, and ALIP are recognized surrogate markers of survival and leukemic potential ( [24](#), [59](#), [332](#), [333](#) ). The number of cytopenias and lineages displaying cytologic dysplasia, as well as the severity of cytopenias, provides an index of the penetrance and severity of the maturation disturbance. In RARS, for example, patients with hematologic abnormalities that are restricted to the erythroid lineage have a median survival of approximately 76 months, compared to 24 months for patients with a multilineage disturbance ( [264](#) ). For this reason, the term *pure sideroblastic anemia* has been adopted by the WHO to distinguish such patients from those with a multilineage hematopoietic disturbance.

**TABLE 83.10. Prognostic Factors in Myelodysplastic Syndrome**

|  |
|--|
| Leukemia burden                              |
| French/American/British type                 |
| Abnormal localization of immature precursors |

- In vitro* culture pattern
- Lineage penetrance and severity of maturation impairment
  - Number of cytopenias
  - Number of dysplastic lineages
  - Cytopenia severity
  - Fraction CD34<sup>+</sup> cells
- Genetic abnormalities
  - Cytogenetic pattern
  - DNA ploidy
  - Protooncogene mutations
- Clinical and pathologic features
  - De novo* versus therapy-related myelodysplastic syndrome
  - Myelofibrosis
  - Abnormal localization of immature precursors
  - Granulocytic sarcoma

---

Cytogenetic abnormalities offer additional prognostic discrimination ([29](#), [334](#), [335](#), [336](#), [337](#), [338](#), [339](#) and [340](#)). Although the presence of one or more chromosome abnormalities is generally associated with an inferior survival compared to a normal karyotype, three specific abnormalities, when present as a simple chromosome abnormality, are associated with a more favorable clinical course. These include del(5q), del(20q), and monosomy Y. Other karyotypic abnormalities that are associated with rapid progression of disease and an otherwise unfavorable clinical course include monosomy 7 and del(7q), trisomy 8, abnormalities of 3q26, del(12p), iso(17q), and complex cytogenetic abnormalities. DNA aneuploidy and the presence of point mutations affecting *ras* and the p53 protooncogenes adversely affect the risk of leukemic conversion and overall survival in most series ([61](#), [341](#), [342](#)). Clinical and pathologic features are also informative. s-MDS or t-MDS exhibits trilineage hematopoietic dysplasia that is associated with rapid conversion to acute leukemia and short overall survival ([5](#)). Granulocytic sarcomas occur in 5% of patients, a frequency that approaches the incidence in myeloproliferative disorders ([107](#), [110](#)). The most common sites of extramedullary involvement include the skin, lymph nodes, and nasal sinuses. Emergence of a granulocytic sarcoma is a harbinger of leukemic transformation that may precede medullary progression by months. Finally, the presence of excessive medullary fibrosis, or so-called hyperfibrotic MDS, is associated with an inferior survival that approximates that for RAEB ([75](#), [77](#), [78](#), [343](#), [344](#)). To what extent any of these prognostic factors are independent predictors of disease outcome is not clear, and, for this reason, scoring systems that incorporate hematologic, cytogenetic, and clinical features have been constructed that serve as reproducible and validated prognostic models ([42](#), [326](#), [327](#), [328](#) and [329](#)). The IPSS was developed and has been accepted as a consensus risk-adapted model for MDS since its inception in 1997 ([42](#)). The IPSS represents the culmination of data analysis from more than 800 patients with *de novo* MDS and nonproliferative CMML (i.e., white blood cell =12,000/ $\mu$ l). This prognostic model applies a score that is weighted according to statistical power for each of three features: BM blast percentage, cytogenetic pattern, and the number of cytopenias ([Table 83.11](#)). The cumulative score enables discrimination of patients into four subgroups with varying expectations for survival and risk of and interval to AML progression ([Table 83.12](#)). Although age offers further survival discrimination in lower-risk patients (i.e., low and intermediate-1 risk), it has no correlation with risk for leukemia evolution and therefore is not included in the prognostic model. Proliferative CMML was excluded from the IPSS model; however, a number of disease specific prognostic variables



have been identified from retrospective analyses, including blast percentage as recognized by the WHO classification, white blood cell or monocyte count, anemia, thrombocytopenia, lactate dehydrogenase, and spleen size ( 112, 345, 346 ). The M. D. Anderson Prognostic Score was developed as a prognostic model specific for CMML based on data that were collated from more than 200 consecutive patients ( 347 ). Variables with independent prognostic significance include hemoglobin, absolute lymphocyte count, circulating immature myelomonocytic cells, and BM blast percentage. Grading of these variables permits stratification of patients with CMML into four prognostic categories, with an expected median survival ranging from 5 to 24 months ( Table 83.13 ).

**TABLE 83.11. International Prognostic Scoring System**

| Prognostic Variable          | 0    | 0.5          | 1        | 1.5      | 2        |
|------------------------------|------|--------------|----------|----------|----------|
| Bone marrow blast percentage | <5   | 5 to 10      | 11 to 20 | 21 to 30 | 31 to 40 |
| Karyotype <sup>a</sup>       | Good | Intermediate | Poor     | —        | —        |
| Cytopenias                   | 0/1  | 2/3          | —        | —        | —        |

<sup>a</sup> Good, normal, -Y, del(5q), del(20q); poor, complex (= three abnormalities) or chromosome 7 anomalies; intermediate, other abnormalities.

Adapted from Greenberg P, Cox C, Le Beau M, et al. International scoring system for evaluating prognosis in myelodysplastic syndromes. Blood 1997;89:2079–2088.

**TABLE 83.12. Survival and Risk of Acute Myeloid Leukemia Evolution by International Prognostic Scoring System Score**

|                                      | International Prognostic Scoring System Risk Group |                |                |      |
|--------------------------------------|--|----------------|----------------|------|
|                                      | Low  | Intermediate-1 | Intermediate-2 | High |
| Score                                | 0  | 0.5 to 1.0     | 1.5 to 2.0     | ≥2.5 |
| Acute myeloid leukemia evolution (%) | 19   | 30             | 33             | 45   |
| Median (yr)                          | 9.4  | 3.3            | 1.1            | 0.2  |
| Median survival (yr)                 | 5.7  | 3.5            | 1.2            | 0.4  |

**TABLE 83.13. Prognostic Scoring System for Chronic Myelomonocytic Leukemia**

| Risk Group     | Adverse Features (N) | Number of Patients (%) | Median Survival (Mo) |
|----------------|----------------------|------------------------|----------------------|
| Low            | 0 to 1               | 35 ( 18 )              | 24                   |
| Intermediate-1 | 2                    | 60 ( 32 )              | 15                   |
| Intermediate-2 | 3                    | 75 ( 39 )              | 8                    |
| High           | 4                    | 20 ( 11 )              | 5                    |



NOTE: Variables (1.0 point each): hemoglobin < 12g/dl, lymphocyte count > 2500/ $\mu$ l, circulating immature myeloid cells and bone marrow blast >10%.

Adapted from Onida F, Kantarjian HM, Smith TL, et al. Prognostic factors and scoring systems in chronic myelomonocytic leukemia: a retrospective analysis of 213 patients. *Blood* 2002;99:840–849.

---

## MANAGEMENT

To date, no treatment other than hematopoietic stem cell transplantation offers significant curative potential in MDS; however, an improved understanding of disease biology has led to development of novel therapeutics that may alter the natural history of the disease. Management recommendations should be guided by the risks imposed by the disease itself, the patient's age, morphologic type, and performance status. Selection of treatment reflects the intended therapeutic goal as judged by prognostic category and patient preference. To ensure that new therapeutics are judged by uniformly accepted measures of benefit, an international working group proposed criteria for hematologic, BM, and cytogenetic response to be applied to all MDS clinical trials ([348](#)). Implicit in these recommendations is the notion that patients with low- or intermediate-1-risk IPSS categories experience longer survival, and therefore, amelioration of hematologic deficits should represent the principal therapeutic goal, whereas, in higher risk patients, extending survival is of immediate priority, allowing incorporation of complete pathologic and cytogenetic remission as an early surrogate milestone for survival extension.

### Low- and Intermediate-1-Risk Myelodysplastic Syndrome

In lower-risk MDS, treatment with recombinant human EPO (rhu-EPO) may improve anemia and reduce transfusion requirements in 15% of unselected patients ([349](#), [350](#)). The potential for benefit with rhu-EPO that is administered alone or in combination with a myeloid growth factor, such as G-CSF, inversely correlates with EPO level and red blood cell (RBC) transfusion burden. Those patients with suboptimal endogenous EPO response to anemia (i.e., pretransfusion serum EPO < 100 mU/ml) and moderate to low transfusion requirement ( $\leq 2$  U packed RBCs per month) have a response probability that exceeds 70%, whereas greater transfusion burden or EPO level, or both, substantially diminish response expectation ( $\approx 23\%$ ) (50a,50b). A recent report suggests that response rate to rhu-EPO may be improved by the addition of intermittent oral all-*trans*-retinoic acid ([351](#)), which merits further investigation. A younger individual (younger than 55 years of age) with lower-risk disease that fails traditional hematopoietic promoting therapy may be considered for allogeneic stem cell transplantation. Recognizing that the latter has an inherently high procedure-related mortality (15 to 35%), novel disease-targeted therapies with the potential for durable erythropoietic remitting activity should be considered before proceeding to hematopoietic stem cell allografting.

Innovative approaches to restore effective blood cell production in lower-risk disease have targeted biologic effectors of ineffective hematopoiesis. In nearly all circumstances, ineffective erythropoiesis represents the most pervasive and responsive hematopoietic deficit. Such targeted therapeutics include immunosuppressive therapy with antithymocyte globulin (ATG) or cyclosporin A, or both; the phosphoaminothiol amifostine; angiogenesis inhibitors, such as thalidomide or one of its structural analogs; and TNF- $\alpha$  inhibitors. Recognition that immunologic suppression of progenitor growth may contribute to impairment of hematopoiesis in hypocellular variants led to recent trials using immunosuppressive therapy. Earlier studies using corticosteroids were complicated by an unacceptable risk of infection ([352](#)). Nevertheless, clinical response correlated with the

capacity of corticosteroids to enhance *in vitro* growth of myeloid colonies. Treatment with cyclosporin A or ATG offers high response rates in appropriately selected candidates with lower-risk disease ( [353](#), [354](#), [355](#), [356](#) and [357](#) ). Approximately one-third of patients with RBC transfusion-dependent MDS and low leukemia burden (<15% blasts) were successfully managed with a single course of ATG (40 mg/kg for 4 days) in a National Institutes of Health trial, restoring transfusion-independence that was sustained in 87% of responders beyond 2.5 years ( [357](#) ). Although results of randomized comparative trials are not as yet mature, single institution series suggest that erythropoietic response is associated with longer survival and time to disease progression compared to nonresponders. Many patients who are responsive to immunosuppressive therapy harbor hematopoietic-inhibitory T lymphocytes, and can be identified prospectively through clinical and biologic features ( [283](#), [294](#) ). Indeed, four or more of the following features, including hypocellularity, age younger than 60 years, RA morphologic category, normal karyotype, PNH antigenic phenotype, or HLA class II DR2/15 MHC expression, yielded a 90% major erythropoietic response probability in the National Institutes of Health trial ( [247](#), [357](#) ). In unselected patients, the response rate is low, with significant treatment-associated morbidity ( [358](#) ).

Organic thiols neutralize oxygen free radicals generated in response to apoptotic signals and improve apoptotic defense in hematopoietic progenitors ( [359](#) ). Amifostine is a phosphorylated aminothiol developed as a radioprotectant that augments MDS progenitor colony-forming capacity while preserving maturation capacity ( [360](#) ). In a phase I and II clinical trial ( [361](#) ), amifostine administered intravenously three times per week yielded a more than 50% increase in neutrophil count in 78% of subjects and improved erythropoiesis or thrombocytopenia in 33% and 43% of patients, respectively. Subsequent phase II trials, using more stringent response criteria, suggest that response rates are lower when amifostine is used as a single agent ( [362](#), [363](#) and [364](#) ). Administration of this cytoprotectant in combination with other antiapoptotic agents may be a potentially more effective means to ameliorate ineffective erythropoiesis and represents a fertile avenue for further investigation ( [365](#) ).

Strategies intended to suppress the generation of apopto-genic cytokines or to inhibit the action of angiogenic molecules have shown considerable promise. Thalidomide displays antiangiogenic and anti-TNF- $\alpha$  properties and represents the most extensively investigated antiangiogenic agent ( [366](#) ). In a phase II trial of thalidomide in MDS, 15 of 51 evaluable patients (29%) who completed 12 weeks of treatment experienced RBC transfusion independence or a more than 50% decrease in transfusion burden after a median interval of 16 weeks, whereas responses in other lineages were uncommon ( [367](#) ). The erythropoietic potential of thalidomide in MDS is currently under investigation in a national, randomized, placebo-controlled trial. Nevertheless, other institutional studies have confirmed its erythropoietic activity ( [368](#) ). Although an active agent, cumulative neurotoxicity limits the necessary prolonged drug administration or significant dose escalation. Novel, more potent thalidomide analogs that are devoid of neurological toxicity are currently completing phase II investigation ( [369](#), [370](#) ). Preliminary results of a clinical trial investigating the immunomodulatory analog, CC5013 (Celgene Inc, Warren, NJ) indicate a greater than 50% erythropoietic remitting activity (i.e., transfusion-independence) in lower-risk MDS with fewer side effects than the parent compound ( [371](#) ). Treatment with TNF- $\alpha$  selective agents, such as soluble cytokine receptors [etanercept (Enbrel)] or neutralizing humanized monoclonal antibody (infliximab), have demonstrated only modest erythropoietic benefit ( [372](#), [373](#) and [374](#) ).

Primary management for many patients remains largely supportive, including

administration of RBC transfusions for symptomatic anemia, platelet transfusions for bleeding, and the judicious use of hematopoietic cytokines. Particular attention must be given to the potential for iron overload, which may ensue when the cumulative transfusion burden exceeds 30 U, but it can be delayed by the administration of an iron chelator, such as desferrioxamine ( 375 ). Empiric treatment with hematinic supplements, such as folate, is generally not beneficial unless vitamin deficiency is present. Rare patients with RARS may experience hematologic improvement with pyridoxine supplementation. In view of its low cost and tolerance, an empiric trial is warranted in symptomatic patients. Androgens and corticosteroids seldom yield sustained hematologic benefit ( 376 , 377 ).

The recombinant myeloid growth factors G-CSF and GM-CSF restore granulocyte production in 75 to 90% of neutropenic patients ( 378 ). Initial concerns that such cytokines might accelerate leukemia transformation restricted their application to patients with low leukemic burden. In one of the few randomized trials performed in MDS, treatment with GM-CSF significantly reduced the frequency of infection, without adversely affecting disease progression, in neutropenic patients who were treated for 90 days ( 379 ). Nevertheless, given the excessive cost of these cytokines and the necessity for continuous administration, their use has been relegated to the management of neutropenic patients with intercurrent infection.

### Intermediate-2- and High-Risk Myelodysplastic Syndrome

Given the limited life expectancy of patients with higher-risk MDS, management takes on greater urgency, with the immediate goal of extending survival by suppression of the malignant clone. Although allogeneic stem cell transplantation is potentially curative in 25 to 50% of younger (younger than 55 years of age) individuals, alternate strategies for the more infirm, elderly population range from low- and high-intensity chemotherapy to DNA methyltransferase inhibitors (DMTIs), reduced-intensity stem cell allografting, and investigational studies. Chemotherapy regimens applied in AML, which include cytarabine and an anthracycline, appear less active in advanced MDS and generally are not curative ( 380 , 381 ). Randomized trials comparing induction chemotherapy to supportive care are lacking; however, intensive chemotherapy offers the potential to suppress leukemia burden, to provide interim improvement in cytopenias, and to yield sustained complete remissions in some patients. Topotecan and cytarabine combinations, popularized in recent years, offer no significant advantage over standard anthracycline-containing regimens and may have inferior remission durability ( 381 , 382 ). Younger patients with RAEB-t are more likely to benefit from intensive chemotherapy, prompting recommendations that such patients may be more accurately regarded as oligoblastic presentations of *de novo* AML, as recognized by the WHO classification. Despite a comparatively high remission rate in this disease category, fewer than 10 to 20% of patients can be expected to remain in remission beyond 2 years. For this reason, selection of patients for intensive treatment should be based on features that are predictive of response to intensive chemotherapy. These include a normal karyotype, the presence of Auer rods, and younger age. Using these criteria, complete remission rates ranging from 70 to 85% can be expected in patients who are younger than 55 years of age, compared to remission rates of 25 to 45% in older patients ( 383 , 384 and 385 ).

Strategies targeting an important mechanism of chemotherapy resistance in advanced MDS and secondary AML have emerged as a promising strategy for intensive induction therapy. P-glycoprotein (P-gp) is a highly conserved plasma membrane glycoprotein encoded by the *MDR1* gene that functions as an adenosine triphosphate-dependent multidrug exporter with broad specificity for natural product-derived antineoplastics ( 386 , 387 ). P-gp is natively overexpressed by myeloblasts in RAEB-t, and secondary AML and is associated with a lower probability of complete remission and inferior disease-free

survival ( 388 , 389 and 390 ). A randomized phase III trial performed by the Southwest Oncology Group showed that concurrent treatment with the P-gp inhibitor cyclosporin A and infusional daunorubicin after cytarabine significantly reduces induction resistance in high-risk patients and significantly prolongs not only the duration of remission, but also overall survival ( 391 ). Similar results were reported in a French Cooperative Group study that used quinine as a P-gp modulator ( 392 ), indicating that this targeted induction strategy may significantly extend survival for selected individuals who are candidates for more intensive therapy. Low-dose cytarabine or melphalan monotherapy offers an outpatient alternative to intensive remission induction therapy with reduced treatment-related morbidity but may result in prolonged myelosuppression while inducing remissions in fewer than 30% of patients ( 393 , 394 , 395 and 396 ). Low-dose cytarabine has received the most scrutiny, yielding response rates ranging from 10 to 25% in phase II trials but offering no benefit compared to supportive care in a National Cancer Institute-sponsored intergroup study that involved all FAB types ( 393 ). Nevertheless, selected higher-risk patients may benefit from low-intensity chemotherapy, necessitating scrutiny of predictive variables ( 394 ).

Stem cell allografting after high-dose chemotherapy and radiotherapy conditioning remains the standard of care for younger individuals. Patients with lower-risk features (e.g., IPSS intermediate-1), normal or more favorable cytogenetics, and a histocompatible related or volunteer donor have a probability for sustained remission and possible cure that ranges between 40 and 60% ( 397 , 398 and 399 ). Despite its obvious benefits, allogeneic hematopoietic stem cell transplantation remains a high-risk procedure with a mortality of 25 to 40% that rises directly with age. A number of factors influence the outcome of stem cell allografting by impacting the probability of relapse or the risk of procedure-related complications. Variables, such as the percentage of blasts, cytogenetic pattern, IPSS risk category, and treatment-related MDS versus *de novo* MDS, affect the probability of relapse after transplantation, whereas age, duration of disease, platelet count, and donor MHC compatibility impact treatment-related mortality. Knowing this, early allogeneic BM transplantation is justified within the first year of diagnosis to optimize procedure outcome in younger patients with limiting cytopenias or other risk factors. Autologous SCT after high-intensity conditioning offers greater safety; however, the risk of relapse is much higher and appears to be of limited value in older individuals ( 400 ). Reduced-intensity conditioning regimens that rely on donor immune response to eradicate the malignant clone carry lower procedure-related mortality, but conclusions as to long-term benefit and expectations for sustained donor engraftment are premature ( 401 ).

Less aggressive approaches targeting biologic features implicated in evolution of disease in MDS have shown considerable promise. DMTIs, 5-azacytidine (5-aza), and 5-aza-2'-deoxycytidine (decitabine), have undergone the most extensive clinical investigation ( 402 , 403 , 404 , 405 and 406 ). Aberrant methylation of promoter CpG islands promotes recruitment of transcriptional corepressors and histone deacetylases, with consequent chromatin condensation and repression of gene expression in human malignancies. In MDS in particular, DNA hypermethylation has been implicated in the epigenetic silencing of the p15 protooncogene that is linked to leukemia transformation ( 322 , 323 ). Global genomic hypomethylation induced by DMTIs results in derepression of previously silenced genes and, *in vitro*, differentiation of leukemia cell lines ( 407 ). A phase III trial performed by the Cancer and Leukemia Group B comparing subcutaneous treatment with 5-aza to best supportive care revealed a significant advantage in hematologic response rate (60% vs. 5%), time to leukemia transformation or death (21 months vs. 13 months), and frequency of AML transformation (11% vs. 31%), favoring 5-aza, with accompanying improvement in quality of life parameters ( 405 , 408 ). A

randomized trial of similar design evaluating decitabine is nearing completion. Nonetheless, results of phase II investigations have provided proof of principle that this agent effectively restores p15 expression with a corresponding high rate of remitting activity ( [406](#) ).

Arsenic trioxide (ATO) (Trisenox, Cell Therapeutics Incorporated, Seattle, WA), recently received orphan drug designation from the Food and Drug Administration for the treatment of MDS. Arsenicals have a long history of application in human leukemia but only recently gained renewed recognition by virtue of activity in acute promyelocytic leukemia. ATO has multiple biologic effects that include apoptosis induction via disruption of survival signals, suppression of angiogenesis, and promotion of cellular differentiation ( [409](#) ). Phase II multicenter trials are ongoing in the United States and Europe to delineate its potential in advanced MDS. Preliminary results of the U.S. trial indicate that approximately one-third of patients treated with ATO may benefit by multilineage hematopoietic improvement or reduction in BM blast percentage, or both ( [410](#) ).

Activating point mutations of the *RAS* protooncogene are detected in fewer than 20% of unselected patients with MDS but are common in CMML. The *RAS* gene superfamily encodes GTPases that serve as critical regulatory elements in signal transduction, cellular proliferation, and maintenance of the malignant phenotype. Farnesylation represents the first posttranslational modification of Ras-GTPases that is necessary for plasma membrane association and transforming activity ( [411](#) ). The farnesyl protein transferase inhibitors are potent, orally bioavailable inhibitors of Ras activation and other prenylation-dependent molecules. These agents, as a class, are able to modulate multiple signaling pathways that have been implicated in the pathobiology or progression of CMML and MDS. Preliminary results of phase I and II studies in MDS and CMML indicate promising hematopoietic promoting activity that extends to nonerythroid lineages ( [412](#) , [413](#) ).

Perhaps the most important therapeutic discovery in the management of CMML in recent years is the activity of imatinib (Gleevec) in those patients harboring a reciprocal chromosome translocation involving chromosome 5q33 ( [321](#) ). These translocations are associated with the clinical phenotype of CMML with eosinophilia, as described by the WHO classification, and arise from the generation of novel fusion genes involving the PDGF- $\beta$  receptor with constitutive RTK signaling ( [43](#) , [315](#) , [319](#) ). Imatinib binds to the adenosine triphosphate binding pocket of the PDGF- $\beta$  receptor, analogous to its interaction with BCR/ABL, to act as a potent inhibitor of receptor kinase activity ( [315](#) ). Among the five patients reported to date, each achieved rapid hematologic control and sustained complete cytogenetic remission with imatinib monotherapy ( [321](#) , [414](#) ).

The retinoids have not yielded the hematologic potential hoped for in MDS but may have a role in selected patients, such as in those patients with the pediatric syndrome of JMML. Isotretinoin attenuates the spontaneous *in vitro* proliferation of myeloid progenitors that are characteristic of this disease ( [415](#) ). In one report, six of ten JMML patients treated with isotretinoin experienced a complete or partial remission characterized by normalization of the white blood cell count and resolution of organomegaly ( [415](#) ). Although treatment was well-tolerated, and responses were sustained, all patients had a normal karyotype and otherwise favorable prognostic features. It remains to be seen whether isotretinoin has remitting activity in high-risk patients. A variety of other agents have been tested in small numbers of patients without consistent benefit. In one series, the attenuated, synthetic androgen danazol ameliorated thrombocytopenia in as much as one-third of patients. However, responses were observed only in patients with antiplatelet antibodies and moderate thrombocytopenia

(greater than 20,000/ $\mu$ l), indicating that patients with severe thrombocytopenia are least likely to benefit ( [416](#) ).

Since the 1980s, the number of patients diagnosed with MDS has steadily risen owing to the extended survival of the aging population. With current advances in the understanding of the pathobiology of MDS and with prognostic models to appropriately guide therapy, patients have access to an array of promising novel therapeutics with greater expectation for benefit. The identification of relevant biologic targets in MDS has raised expectations for the development of effective disease-specific therapies. Enrollment in clinical trials should be encouraged for patients in whom standard therapy offers the prospect for low probability of success.

2004 Lippincott Williams & Wilkins  
John P. Greer, John Foerster, John N. Lukens  
George M. Rodgers, Frixos Paraskevas, Bertil Glader  
Wintrobe's Clinical Hematology



**HISTORY****INCIDENCE AND RELATIONSHIP TO OTHER MYELOPROLIFERATIVE DISORDERS****CLINICAL PRESENTATION****CLINICAL COURSE****DIAGNOSIS**

## Chronic Phase

## Transformation to Terminal Phase (Blast Crisis or Accelerated Phase)

## Juvenile Chronic Myelogenous Leukemia

**CELLULAR AND MOLECULAR PATHOGENESIS**

## Disease Initiation

## Disease Progression

**THERAPY**

## Hydroxycarbamide

## Busulfan

 $\alpha$ -Interferon

## Imatinib (Gleevec)

## Other Drugs

## Marrow Transplantation

**APPROACH TO A NEWLY DIAGNOSED PATIENT WITH CHRONIC MYELOID LEUKEMIA****WEB SITES****HISTORY**

*Chronic myeloid leukemia* (CML) is a clonal stem cell disorder characterized by increased proliferation of myeloid elements at all stages of differentiation (<sup>1</sup>). Its incidence increases steadily with age. In the United States, the disease most commonly occurs in middle-aged adults. CML is characterized by two distinct clinical phases. The first (chronic) phase is marked by a proliferation of myeloid cells showing a full range of maturation. Eventually, a decrease in myeloid differentiation generally occurs, and the disease enters an advanced state (accelerated phase or blast crisis/phase) with a very poor prognosis.

CML was first described in the nineteenth century (<sup>2</sup>, <sup>3</sup>, <sup>4</sup>, <sup>5</sup> and <sup>6</sup>), and research over the next 100 years focused on its clinical and morphologic features. In 1960, Nowell and Hungerford (<sup>7</sup>) documented an abnormal G-group chromosome in cells from patients with CML. This was the first time that a consistent chromosome abnormality had been documented in a human malignancy. The new marker was named the *Philadelphia chromosome* (Ph) in honor of the city in which it was discovered. In 1960, it was not possible to determine which of the small G-group chromosomes were involved in the formation of the Ph chromosome. However, with the advent of chromosomal banding in the 1970s, it was demonstrated that the Ph chromosome was actually a translocation between chromosomes 9 and 22, t(9;22)(p34.1;q11.21) (<sup>8</sup>, <sup>9</sup>). In a small proportion of patients with CML, complex translocations have also been shown to occur, of which chromosome 22 is universally and chromosome 9 is usually involved (<sup>1</sup>, <sup>10</sup>, <sup>11</sup> and <sup>12</sup>).



During the 1980s, a series of investigators showed that the *ABL* protooncogene on chromosome 9 was reciprocally translocated near the *BCR* gene on chromosome 22 ( [Fig. 84.1](#)) ( [11](#), [13](#), [14](#), [15](#) and [16](#)). This genetic alteration resulted in the formation of a chimeric protein, BCR–ABL. The fusion product is generally expressed as a chimeric protein of 210,000 d molecular weight (called *p210*). *p210* has tyrosine kinase activity and is overexpressed in freshly isolated cells and cell lines derived from patients with CML ( [17](#), [18](#) and [19](#)). Subsequent investigators have demonstrated that *p210* acts by releasing controls on stem cell proliferation or by blocking programmed cell death in ways that lead to CML. More recently, investigators have shown additional BCR–ABL breakpoints and novel fusion proteins of different sizes.



**Figure 84.1.** Breakpoints of BCR and ABL genes on chromosomes 9 and 22. mRNA, messenger RNA.

The continued growth in our understanding of the role of BCR–ABL chimeric protein in oncogenesis during the 1980s and 1990s has made CML a potentially curable disease. In addition, a wide variety of diagnostic tests, novel therapeutic interventions, and sensitive measures of therapeutic efficacy have evolved, all of which are discussed in this chapter.

## INCIDENCE AND RELATIONSHIP TO OTHER MYELOPROLIFERATIVE DISORDERS

CML is principally a disease of adults, with a yearly incidence of 1 in 100,000 in Western countries ( [20](#)). There is an increasing frequency with age, and the peak age of incidence is 53 years. Men are affected more often than women (3:2) ( [21](#), [22](#)). It is uncommon in children and accounts for less than 5% of all childhood leukemias ( [23](#)). The etiology of CML is unknown in most cases, although CML may develop after radiation exposure. Other environmental factors have not been well documented.

CML is one of several chronic myeloproliferative diseases (CMPDs; [Table 84.1](#)) ( [24](#), [25](#)). *CMPDs* are distinct, but closely related, clonal disorders of pluripotential hematopoietic stem cells in the marrow. In all *CMPDs*, the proliferative capacity of the neoplastic stem cell is not properly controlled, and excessive hematopoiesis occurs initially. The

neoplastic stem cell retains its ability to undergo complete differentiation, and, as a result, a marked increase in the number of mature and immature cells in the blood and bone marrow occurs. These differentiated neoplastic cells generally have few, if any, morphologic or functional abnormalities.

**TABLE 84.1. Classification of Myeloproliferative Disorders**

---

|   |
|---|
| Typical chronic myeloid leukemia                    |
| Morphologic variants                                |
| Chronic eosinophilic leukemia                       |
| Chronic basophilic leukemia                         |
| Chronic neutrophilic leukemia                       |
| Essential thrombocythemia                           |
| Polycythemia vera                                   |
| Idiopathic myelofibrosis                            |
| Chronic myelomonocytic leukemia, proliferative type |
| Atypical chronic myeloid leukemia                   |

---

CMPDs are distinguished from each other by the predominant type of differentiation that the neoplastic stem cell undergoes [such as the myeloid line in CML or megakaryocytes in essential thrombocythemia (ET)]. Furthermore, CMPDs are progressive and may change from a disease with excessive production of well-formed and functioning cells to a disorder associated with bone marrow failure or transformation to acute leukemia. Despite the similar cell and tissue of origin, it is not possible to group and treat all CMPDs as one disease because there are differences in the prognosis and optimal treatment of CMPDs. Thus, proper diagnosis and distinction of these entities are imperative.

The most common CMPDs include CML, ET, idiopathic myelofibrosis, and polycythemia vera ( [Table 84.1](#) ) ( [24](#), [25](#) ). CML, ET, and polycythemia vera represent excessive proliferation and differentiation, predominantly along myeloid, megakaryocytic, and erythroid lineages, respectively. Idiopathic myelofibrosis has also been called *myelosclerosis with myeloid metaplasia* or *agnogenic myeloid metaplasia* and is characterized by excessive marrow fibrosis. Chronic neutrophilic leukemia (CNL) is uncommon and identified by excessive neutrophil production without the myeloid precursors seen in CML ( [26](#), [27](#) ). Recent findings indicate that most cases of CNL may actually be a subset of CML because a novel Ph chromosome may be detected in CNL resulting from a novel breakpoint of the *BCR* gene. Chronic myelomonocytic leukemia is generally viewed as a myelodysplastic syndrome; however, there is at least a subset of this disease that has clinical, histologic, and pathogenetic characteristics more consistent with a myeloproliferative disease ( [28](#) ). A small minority of cases of the hypereosinophilic syndrome have clinical and pathologic findings that allow classification as a CMPD and are sometimes called *chronic eosinophilic leukemia* ( [29](#), [30](#), [31](#), [32](#), [33](#) and [34](#) ).

CML may occur in children and is called *adult form CML*. On the other hand, juvenile CML, now referred to as *juvenile myelomonocytic leukemia* (JMML), and a related or identical process, *monosomy 7 syndrome*, have traditionally been classified as CMPDs, but more recent studies show that they are probably best thought of as myelodysplastic or preacute leukemic states ( [35](#), [36](#) ). JMML is morphologically, cytogenetically, and clinically distinct from adult CML ( [37](#) ). It is clinically aggressive and more similar in its

course to acute myeloid leukemia (AML). Furthermore, in contrast to adult CML that occurs more often in adolescents, juvenile CML occurs more often in very young children. However, JMML is discussed in this chapter to distinguish it from CML.

Because CMPDs arise from a pluripotential stem cell that differentiates along all cell lines with only varying predominance along one or another cell line, it is not surprising that the clinical and morphologic features occasionally overlap, and classification and diagnosis are difficult. Fortunately, our understanding and ability to test for these disorders have grown, and most cases can be precisely defined. In particular, the advent of cytogenetics and molecular techniques has allowed for documentation of a simple or complex translocation between chromosomes 9 and 22, a finding required for diagnosis of CML. Despite the availability of these new techniques, there are some cases that clinically and histologically appear to be CML, but a t(9:22) cannot be demonstrated. Although these tumors are not related to CML pathogenetically or biologically, the World Health Organization has retained the term *atypical CML* or *Ph(-) CML* (37). These cases are quite heterogeneous and probably represent other myeloproliferative/myelodysplastic disorders or chronic myelomonocytic leukemia (38, 39 and 40).

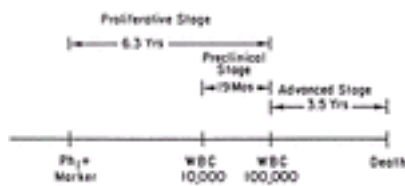
## CLINICAL PRESENTATION

The onset of symptoms in CML is usually insidious, with most patients presenting in chronic phase. In the past, symptoms of vigorous hematopoiesis (fever, sweats, bone pain, weight loss, and fatigue) or signs of extramedullary hematopoiesis (splenomegaly and left upper quadrant discomfort) caused patients to seek medical attention (Table 84.2) (41, 42, 43, 44 and 45). Occasionally, more unusual symptoms, such as bleeding, thrombosis, arthralgia, leukemic infiltration in sites such as the skin, peptic ulceration, spinal cord compression, and priapism, may be the primary presentation (46). However, with current medical practice, it is becoming more common for patients to be diagnosed before the development of any symptoms because of periodic routine medical evaluation with physical examination and laboratory testing. Estimates now indicate that 10 to 30% of patients are diagnosed before the development of symptoms (21). Approximately 10% of patients present in accelerated phase, and another 10% of patients present in blast phase.

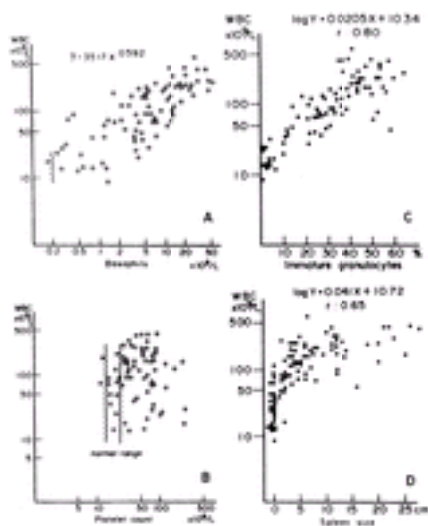
**TABLE 84.2. Symptoms and Signs of Chronic Phase Chronic Myeloid Leukemia at Presentation**

| Presentation of Chronic Myeloid Leukemia Patients Experiencing Sign or Symptom (%) |    |
|--|----|
| <b>Symptoms</b>  |    |
| Fatigue  | 83 |
| Weight loss  | 61 |
| Abdominal fullness and anorexia  | 38 |
| Easy bruising or bleeding  | 35 |
| Abdominal pain   | 33 |
| Fever  | 11 |
| <b>Signs</b>   |    |
| Splenomegaly   | 95 |
| Sternal tenderness   | 78 |
| Lymphadenopathy  | 64 |
| Hepatomegaly   | 48 |
| Purpura  | 27 |

By following multiple clinical parameters in untreated patients, previous investigators have constructed regression curves describing the chronology of clinical events in CML (47). These observations indicate that approximately 6 years elapse from the time of the initial chromosomal translocation until patients become symptomatic. Once a leukocytosis is present, it takes approximately 19 months (range, 7 to 24 months) for the white blood cell (WBC) count to reach 100,000/ $\mu$ l (Fig. 84.2). The median survival of patients with CML after diagnosis is approximately 4 to 5 years (1, 48, 49 and 50). Thus, the total duration of CML from its initiation appears to be approximately 10 years in the typical case. Increased absolute numbers of basophils are present in most patients early in the disease, even before the WBC count is elevated (Fig. 84.3). Anemia is not an early finding, but thrombocytosis is often noted. The leukocyte alkaline phosphatase (LAP) level generally is low, even when the WBC count is less than 20,000/ $\mu$ l, and falls further as the disease develops. The spleen rarely is palpable until the number of WBCs exceeds 40,000/ $\mu$ l, and symptoms usually appear when the WBC count reaches levels between 30,000 and 90,000/ $\mu$ l.



**Figure 84.2.** Putative phases and timing of chronic myeloid leukemia progression. Ph, Philadelphia chromosome; WBC, white blood cell count.



**Figure 84.3.** Relationship of leukocytosis to various clinical and laboratory parameters. WBC, white blood cell count.

At the time of presentation, the spleen varies in size, ranging from just a palpable tip to a mass filling the abdomen. Approximately 50% of patients have splenomegaly extending

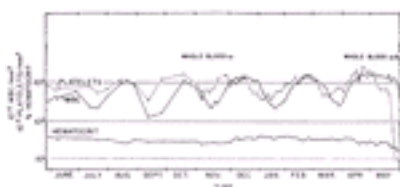
more than 10 cm below the costal margin at the time of diagnosis. Spleen size correlates reasonably well with the magnitude of the leukocyte count. The spleen is quite firm and usually nontender (unless splenic infarction is present), and the notch may be palpable. Hepatomegaly is less common. Splenic infarct is common and can herald the presentation of the illness. Sternal tenderness is a reliable sign of disease and usually is limited to a small area, most commonly the midbody (fifth intercostal space) of the sternum. If true sternal tenderness is present, the patient withdraws or complains spontaneously when firm pressure is applied to the tender area. Lymph nodes are palpable in most patients but rarely are greater than 1 cm in largest diameter.

In chronic phase, the distinction must be made with reactive leukocytosis ( 51 ). The distinction between CML presenting in lymphoid blast crises and Ph(+) acute lymphocytic leukemia (ALL) may be clinically difficult, and additional diagnostic procedures are necessary. CML may also present in myeloid blast crisis, which may be distinguished from *de novo* AML using ancillary testing. Diagnostic procedures to distinguish between these possibilities are discussed later in this chapter.

## CLINICAL COURSE

The chronic phase is characterized by robust marrow proliferation and maturation, with the increased WBC usually not leading to clinical complications. Thus, emergent treatment for leukocytosis is not generally required. Sequelae of leukostasis are uncommon, although cases of papilledema, blindness, and stroke have been reported with extreme WBC elevations (above 250,000/ $\mu$ l) even when an excess of blasts is not present ( 52 ). On the other hand, blast crisis often causes leukostatic syndromes, as do other variants of AML, in which efforts to rapidly control the WBC count are mandatory.

In most untreated patients, a steady, progressive increase in the leukocyte count is observed. In some untreated patients and, occasionally, in patients receiving therapy, cyclic WBC variations occurring at 2- to 4-month peak-to-peak intervals may be noted ( Fig. 84.4 ) ( 53 , 54 , 55 , 56 and 57 ). These cycles may be extreme, ranging from a normal count at the nadir to more than 200,000/ $\mu$ l. These WBC cycles represent an actual change in total body leukocytes rather than some form of leukocyte redistribution because cyclic changes in the size of the spleen and levels of serum B<sub>12</sub> and lysozyme coincide with changes in leukocyte count ( 56 ). Reticulocytes and platelets may also cycle, although out of phase with neutrophils and myeloid precursors. Some evidence exists of in-phase cycling of basophils, eosinophils, monocytes, and nucleated red blood cells. Neutrophil LAP levels cycle in inverse relation to the leukocyte count ( 53 ). Because cytotoxic therapy usually is initiated as soon as the diagnosis has been established, the true frequency of cyclic leukocytosis in patients with CML is difficult to estimate. In defining clinical situations or in making therapeutic decisions, the possibility of a periodic fluctuating WBC, as opposed to poorly controlled blood counts, must be considered.



**Figure 84.4.** Cyclic variations in blood counts in chronic myeloid leukemia. WBC, white blood cell count.

Adverse clinical consequences of abnormal myeloproliferation are usually not seen during chronic phase ( 58, 59 and 60). Patients with CML do not suffer from an increase in bacterial or fungal infections (which are normally prevented by adequate levels of neutrophils) until an advanced state of blast crisis. Platelet dysfunction is common in CML, and many patients present with some mild bleeding tendencies ( 61, 62 and 63). Marked elevation of the platelet count to over 1,000,000/ $\mu$ l occasionally can be associated with an increased likelihood of thrombosis and warrants therapy to lower the platelet count ( 64). To avoid thrombosis, care should be taken to control the platelet count or to administer antiplatelet agents before splenectomy ( 65).

Patient performance status and quality of life are not altered in the chronic phase, especially if excellent blood count control is achieved. Unfortunately, chronic phase inexorably progresses to the more advanced states of disease. This progression to blast phase occurs at an approximate rate of 5% in the first year and 20 to 25% in each year thereafter ( 48, 49). Once the blast phase is entered, long-term survival is uncommon, with most patients expiring within 3 to 6 months. Thus, in describing the natural history of CML, it is appropriate to denote either the development of blast crisis or overall survival as the important terminal outcome.

Subgroups of patients with different survival curves have been defined using multivariate analysis and Cox proportionate hazards models of presenting clinical features. Various parameters that have been included are the magnitude of initial elevation of the WBC count, extreme basophilia, massive hepatosplenomegaly, thrombocytopenia, thrombocytosis, multiple chromosomal abnormalities, male sex, poor performance status, black ethnicity, marrow fibrosis, and increasing patient age. Unfortunately, not all of these features have consistently affected survival, and recent attempts to use molecular sites of the BCR-ABL translocation have not led to improved prediction of survival ( 66, 67).

Sokal et al. evaluated 813 patients with CML and found a median survival of 47 months, representing a good-risk group of patients ( 68). Features significant in this analysis include spleen size and the percentage of circulating blasts. These, along with age, behaved as a continuous variable. Other meaningful features included a platelet count above 700,000/ $\mu$ l, more than 15% basophils plus eosinophils, marrow blasts above 5%, and additional karyotypic abnormalities aside from the Ph chromosome. In a Cox proportionate hazards model, blast percentage, spleen size, platelet count, and age were developed into a model. Figure 84.5 demonstrates distinct survival curves, with median survival from 28 to 67 months.

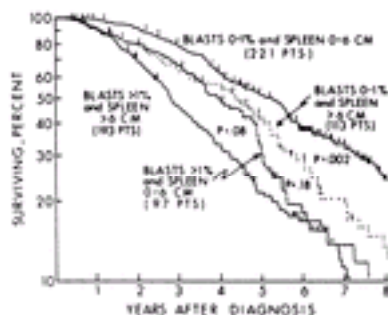


Figure 84.5. Survival curves of prognostic subgroups. PTS, patients.



Mosaicism, both Ph(+) and Ph(-) cells in direct marrow preparations, has been considered indicative of a good prognosis in most, but not all, series ( [69](#), [70](#), [71](#), [72](#), [73](#) and [74](#) ). Sokal described 22 patients with CML who had a mixture of Ph(+) and Ph(-) cells at the time of diagnosis ( [69](#) ). The survival of this group did not differ significantly from that in the total population of 195 patients with Ph(+) CML from which they were drawn ( [75](#) ).

Progression from chronic phase to the more advanced states is made by both clinical and laboratory features ( [76](#), [77](#) ). Clinical features indicating a more difficult-to-control marrow proliferative state suggest progression to accelerated phase. These include a rapidly rising WBC count that is more difficult to lower with antiproliferative agents, increasing organomegaly, fever, bone pain, and weight loss. Laboratory features include more immature cells in the bloodstream or marrow, increasing eosinophils or basophils, and the appearance of more chromosome anomalies, including additional Ph chromosomes. Not all forms of chromosome clonal evolution are associated with rapid disease progression ( [78](#) ). The clinical features of transformation from chronic phase are found in [Table 84.3](#).

**TABLE 84.3. Definitions of Accelerated Phase (AP) or Blastic Phase (BP) Chronic Myeloid Leukemia**

| Symptoms of AP                   | Signs and Laboratory Features of AP                                     |
|----------------------------------|---|
| Fever                            | Increasing peripheral basophilia to >20%                                |
| Night sweats                     | Peripheral blood blasts >10%  |
| Weight loss                      | —   |
| Refractory splenomegaly          | Marrow blasts >10%  |
| Bone pain                        | Cytogenetic clonal evolution  |
|                                  | Difficult to control white blood cells with antiproliferative treatment |
|                                  | Marrow reticulin or collagen fibrosis                                   |
|                                  | Thrombocytopenia (<100,000/ $\mu$ l) unrelated to treatment             |
| Symptoms of BP                   | Signs and Laboratory Features of BP                                     |
| Similar to AP                    | Peripheral blood blasts >20%  |
| lymphadenopathy                  |   |
| Extramedullary blastic chloromas | Marrow blasts >20%  |
|                                  | Clumps of blasts on marrow examination                                  |
|                                  | Extramedullary blastic chloroma   |

Not all patients transform from chronic phase to accelerated phase to blast phase in a systematic fashion. The blast phase can occur rather abruptly and without substantial warning. Compared to accelerated phase, blast phase is more easily defined as meeting the strict definition of acute leukemia. In this case, either the marrow is composed of large clumps of blasts or the percentage of blasts and promyelocytes is so high as to confer the diagnosis of acute leukemia. Blast phase CML has particular features, including a high prevalence of central nervous system involvement and lymph node chloromas. If suspected, biopsy of the involved tissue is required along with genetic and phenotypic analysis to identify the blast population. Blast crisis, as the obvious cause of death in



CML, has been reported to occur in 60 to 90% of patients in studies ( [79](#), [80](#) and [81](#) ). Patients not succumbing to blast transformation have had marrow failure states similar to advanced myelofibrosis as their cause of death ( [79](#), [82](#), [83](#) and [84](#) ).

For all practical purposes, any change from the expected clinical course of CML should raise the suspicion that blast crisis is beginning ( [85](#) ). The appearance of fibrosis in the bone marrow is considered an ominous sign. Fever without explanation when CML appears to be under moderately good control may herald blast crisis; however, fever may be associated with typical CML when the disease is untreated ( [79](#), [86](#) ). The development of anemia or splenomegaly of a degree disproportionate to the WBC count may precede the onset of obvious blast crisis. Development of thrombocytopenia may herald blast crisis, as may the unexpected development of thrombocytosis ( [64](#) ). Clinically evident invasion of organs other than the marrow, spleen, and liver is somewhat unusual in typical chronic phase CML. Evidence of such invasion, particularly the sudden enlargement of lymph nodes, often signals blast crisis.

A substantial proportion of patients have evidence of blast crisis at one localized site while the marrow and blood still appear typical of chronic stage. Such cases are noted frequently (12 of 73 in one series) ( [87](#) ). Lymph nodes probably are the most common site for localized blast crisis, although it may develop in bone and be associated with destruction of bone or other tissues ( [88](#) ). In some patients, new chromosome abnormalities are present in the local site but not in the marrow ( [89](#), [90](#) and [91](#) ). A case of recurrent blast crisis after allogeneic marrow transplantation was distinguished from posttransplant lymphoproliferative syndrome by genetic studies ( [92](#) ). This case and others indicate that evaluation of localized tumors in patients with chronic phase CML requires morphologic, immunologic, and genetic studies. As blast crisis supervenes, other chromosomal abnormalities, in addition to the Ph chromosome, often appear (60 to 90%) ( [74](#), [77](#), [79](#), [80](#), [93](#), [94](#) and [95](#) ). As with most of the other changes that have been discussed, the development of additional chromosomal abnormalities is not specific for blast crisis; some patients, including those with duplication of the Ph chromosome, have remained in the chronic phase for prolonged periods ( [79](#), [95](#) ).

A number of patients have been described in whom chromosome abnormalities in addition to the Ph chromosome were detected in the spleen or lymph nodes before they were present in marrow, in a higher proportion in the spleen, or in different anatomic sites. These observations led to the belief that blast crisis clones may originate in the spleen before frank blast crisis and formed part of the rationale for the extensive and unsuccessful trials of splenectomy in patients with CML. Systemic treatment of localized blast crisis is justified because localized crisis rapidly becomes widespread.

Blast phase is characterized by all of the morbid manifestations of acute leukemia. Patients suffer from severe bacterial or fungal infections and hemorrhage caused by neutropenia and thrombocytopenia, respectively. These complications inexorably lead to death within 3 to 6 months.

## DIAGNOSIS

### Chronic Phase

The diagnosis of CML rests on the examination of a peripheral blood smear and marrow biopsy. The documentation of either a Ph chromosome by karyotypic analysis or the presence of the BCR-ABL translocation by Southern blot or polymerase chain reaction

(PCR) assays confirms the diagnosis.

**PERIPHERAL BLOOD FINDINGS** The most important histologic finding in the peripheral blood is a neutrophilic leukocytosis and basophilia ( [Table 84.4](#)). The leukocytosis ranges from 20,000/ $\mu$ l to more than 500,000/ $\mu$ l, with a mean range of 134,000 to 225,000/ $\mu$ l in most studies ( [45](#), [96](#), [97](#)). A decreased LAP is present as an early manifestation in almost all cases ( [98](#)).

**TABLE 84.4. Morphologic Abnormalities in Blood Smears of 50 Untreated Patients with Chronic Myeloid Leukemia**

| Abnormality  | Patients Exhibiting Abnormality (%) |
|--|-------------------------------------|
| Nucleated erythrocytes                             | 98                                  |
| Dyserythropoietic (binucleate)                     | 12                                  |
| Target cells                                       | 2                                   |
| Giant platelets                                    | 2                                   |
| Megakaryocytic nucleoli                            | 24                                  |
| Binucleate of lobular leukocyte nuclei             |                                     |
| Blasts   | 2                                   |
| Promyelocytes                                      | 2                                   |
| Myelocytes   | 6                                   |
| Hypogranular leukocytes                            |                                     |
| Myelocytes   | 8                                   |
| Segmented neutrophils                              | 2                                   |
| Basophils  | 12                                  |
| Eosinophils  | 4                                   |
| Cells in mitosis                                   | 14                                  |
| Giant metamyelocytes                               | 24                                  |
| Pelger-Huet cells                                  | 4                                   |
| Hypersegmented neutrophils                         | 12                                  |
| Leukocytes with mixed basophil-eosinophil granules | 8                                   |

The leukocytosis is predominantly neutrophilic, with all stages of neutrophilic maturation represented, from myeloblast to segmented neutrophil. The myelocyte and segmented neutrophil usually predominate, and all the neutrophilic precursors appear morphologically normal by light and electron microscopy ( [99](#), [100](#)). Pelger-Huet abnormalities may exist late in the disease. Myeloblasts do not usually exceed 3% of the total WBC count. An absolute basophilia is invariably present and of critical importance; the diagnosis should be questioned without a documented Ph chromosome or BCR-ABL fusion product ( [46](#), [98](#), [100](#)). Basophilia may also precede clinical manifestations by many years ( [47](#), [98](#)). There may be an eosinophilia as well, but its presence does not carry the diagnostic significance of the basophilia and neutrophilic leukocytosis ( [17](#), [46](#), [98](#)). Occasional hybrid cells with mixed basophil-eosinophil granulation or mixed basophilic-mast cell granulation are found ( [101](#), [102](#) and [103](#)). The marked leukocytosis in cases of CML typically is associated with an absolute monocytopenia but relative monocytopenia ( [38](#), [45](#)). The mean percentage of monocytes is approximately 2% or less of the WBC count, although the relative number of monocytes may increase with evolution to blast crisis. The absence of a marked monocytosis in the early phases of CML is helpful in distinguishing some cases from chronic myelomonocytic leukemia. Absolute lymphocyte counts are variable, although a lymphocytosis is common. Thrombocytosis is present in approximately one-half of cases,

occasionally above 1,000,000/ $\mu$ l. Platelet counts of under 100,000/ $\mu$ l are very uncommon (45,63,96,104). The platelets may vary in appearance, occasionally being of large size or diminished or absent granulation. Megakaryocytes are seen in the peripheral blood in approximately one-fourth of cases (45, 63, 96, 104). Most patients have a normochromic/normocytic anemia at the time of diagnosis, although normal or elevated hemoglobin levels are reported (45, 97). As may be expected in proliferative, marrow-based processes, the severity of the anemia is directly proportional to the degree of leukocytosis. Minimal anisocytosis and poikilocytosis with occasional nucleated red blood cells are seen in most cases. A coincidental hemolytic anemia is rarely present. Significant abnormalities in red blood cell morphology should suggest an underlying red blood cell disorder or a part of the evolution to blast crisis.

**BONE MARROW FINDINGS** Marrow examination can be useful in distinguishing CML from other CMPDs and reactive processes. The bone marrow is markedly hypercellular, predominantly because of a proliferation of neutrophilic precursors from myeloblasts to segmented neutrophils (99, 104, 105). The maturation sequence and morphology at each stage are normal, although the relative increase in myelocytes seen in the peripheral blood is also seen in the bone marrow. Myeloblasts do not usually exceed 5% of the marrow elements. The myeloid precursors usually are located in a periosteal location as seen in normal marrow. Increased numbers of basophils, eosinophils, hybrid cells, and their precursors as seen in the peripheral blood are also present. Megakaryocytes are typically increased in number and occasionally clustered in groups of three or more in central intertrabecular regions (104, 105). The megakaryocyte clustering is not as pronounced as it is in ET. The megakaryocytes of CML are slightly smaller than normal megakaryocytes, and occasional micromegakaryocytes are present. Some cases of CML present with a decreased number of megakaryocytes (104, 106, 107), and some authors propose a subdivision of CML based on the number of megakaryocytes (104, 108, 109). *Common or granulocytic CML* has a decreased, normal, or slightly increased number of megakaryocytes, whereas a marked increase in megakaryocytes may be called *megakaryocytic CML*. The clinical significance of this division has not been demonstrated. Macrophages with coarse, granular, periodic acid-Schiff (PAS)-positive, cytoplasmic material (pseudo-Gaucher cells) are present in approximately one-third of patients (110, 111). These inclusions are the result of increased lipid turnover from granulocytic membranes and are of three types: blue birefringent inclusions, the most common (Gaucher-like); blue nonbirefringent, sea-blue histiocytes; and gray-green with birefringent. Iron stores in macrophages as detected by Prussian blue staining are decreased in virtually all cases to amounts lower than in normal subjects. Erythroid precursors may be present in increased, normal, or decreased numbers, although the myeloid to erythroid ratio is invariably increased (35, 97). Erythroid precursors may be distributed unevenly as well, with virtually no erythroid cells in some microscopic fields and numerous cells in others. Deposition of connective tissue as detected by reticulin or PAS stains is not noted in most cases (83, 84, 112, 113). Nevertheless, in some cases, deposition of connective tissue ranging from an increased number and thickness of fibers to multifocal areas of acellular connective tissue deposition reminiscent of idiopathic myelosclerosis. The deposition is typically around vessels and near megakaryocytes. Connective tissue deposition is associated with larger spleen sizes, increased blast percentages in the peripheral blood, decreased hemoglobin levels, and additional karyotypic abnormalities. As a result, it is not surprising that most studies have indicated that reticulin fiber deposition is associated with a worse prognosis, although a small set of patients with marked fibrosis and early stage CML has been reported to have a prolonged course.

**CYTOGENETIC FINDINGS** Karyotypic analysis is usually best performed from the bone marrow material, although peripheral blood may be used. The finding of a simple or complex translocation between chromosomes 9 and 22, generally the t(9;22)(q34;q11), confirms the diagnosis, and 5 to 10% of the cases have a variant translocation leading to rearrangement of the BCR gene (114). Patients with variant and classic Ph-producing

translocations are clinically and hematologically identical and distinct from Ph(-) cases. Typically, the Ph chromosome remains the sole chromosomal abnormality throughout most of the chronic phase. In a small number of cases with clinical and morphologic features of CML, a t(9;22) or some variant thereof is not identified by karyotypic analysis but may be demonstrated by molecular techniques such as Southern blot or PCR. The variant Ph chromosomes fall into two subgroups: simple and complex. In simple variant translocations, the segment from 22q is translocated onto a chromosome other than 9. Three or more chromosomes are involved in complex variant translocations. Although the disease appears identical among patients with classic and variant Ph chromosomes, there is controversy as to whether the chromosomal breakpoints and other molecular features are identical ( [114](#), [115](#), [116](#) and [117](#) ). Although t(9;22) is the hallmark of CML, it is not exclusive to CML. ALL may be accompanied by a t(9;22) in 10 to 20% of adult and in 2 to 5% of childhood cases. In addition, a t(9;22) appears to be found in some bona fide cases of *de novo* AML as well as in very rare cases of lymphoma and myeloma. Recently, Ph(+) CNL has also been added to this group.

**MOLECULAR DIAGNOSIS AND CLINICAL CORRELATE** All patients with CML and a demonstrable classic Ph chromosome by cytogenetics have molecular fusion of the BCR and ABL genes. This chromosomal translocation may also be demonstrated by Southern blot analysis ( [11](#) ), or the transcribed messenger RNA (mRNA) fusion product may be detected by reverse transcriptase PCR (RT-PCR) ( [118](#) ). Although Southern blot analysis and RT-PCR may not detect complex translocations, Southern blot can detect a translocation in a small minority of cases of CML reported as falsely negative using cytogenetic analysis ( [119](#), [120](#) ). The clinical and hematologic features of this small cohort of cases that are falsely karyotypically normal but have BCR rearrangement detected by Southern blot are comparable with cases having karyotypically obvious Ph chromosomes ( [121](#), [122](#) ). Using both cytogenetic and molecular techniques, a Ph chromosome can be demonstrated in all but approximately 1% of cases. These cases have been called *Ph(-) CML* or *atypical CML* by some. However, they probably represent another type of CMPD, so it is not surprising that these behave more aggressively than CML ( [38](#), [39](#) ). RT-PCR detects different length products corresponding to chimeric BCR-ABL proteins of 190 kd, 210 kd, and 230 kd. The breakpoint as detected by RT-PCR may be helpful in distinguishing ALL, CML, AML, and CNL. In the vast majority of cases of CML in adults and in virtually all cases in children, a p210 fusion protein is present. Cases of Ph(+) ALL are associated with the p190 protein, although rare cases of CML and AML with the smaller fusion protein have been reported. A large p230 fusion protein is present in cases of CNL. The p230 transcript has also been reported in cases of CML, but review of these reports suggests that these cases may actually represent CNL. There are also two types of p210 transcripts: b2a2 and b3a2. Although definitive prognostic differences between these groups are controversial, patients with b3a2 transcripts are likely to have higher platelet counts. In addition, the relative frequency of b2a2 and b3a2 is different in childhood and adult CML, with two-thirds of adults having b3a2 transcripts and the overwhelming majority of children with CML having b2a2 transcripts.

**ULTRASTRUCTURAL ANALYSIS AND IMMUNOPHENOTYPIC FINDINGS** Flow cytometric analysis does not have a significant role in the diagnosis of the chronic phase of CML because the phenotype of the cells in CML is the same as that of normal cells. The ultrastructural appearance of the majority of mature granulocytes of CML is the same as that of normal granulocytes ( [100](#), [103](#) ). The neutrophil precursors show some differences from their normal counterparts, although none of the findings is diagnostic. Bundles of microfilaments, deep nuclear folds, and mitochondria in the perinuclear hof are seen in myeloblasts and promyelocytes. Mixed-granule populations appreciated histologically are present by electron microscopy as well ( [123](#) ).

**EXTRAMEDULLARY DISEASE** During the chronic phase, the cells of CML infiltrate the spleen and liver. In the spleen, the pulp cords are predominantly infiltrated, and the malpighian corpuscles diminish in prominence as the disease progresses. Foci of myelopoiesis may be seen in the sinusoids ( [123](#) ). This latter finding probably represents

secondary extramedullary hematopoiesis and is not part of the primary disease process. Collections of infiltrating leukemic cells may also be seen in hepatic sinuses. Lymphadenopathy should be worrisome as an indication of transformation to the terminal phase.

### Transformation to Terminal Phase (Blast Crisis or Accelerated Phase)

CML usually transforms to a more aggressive disease after 2 to 4 years and occurs in at least two clinical manifestations: accelerated phase and blast crisis. Histologic, cytogenetic, and molecular findings accompany this transformation ( [71](#), [72](#), [73](#), [74](#), [75](#) and [76](#) ).

**HISTOPATHOLOGY** The transformation process may be abrupt, with a rapidly increasing percentage of blasts with a clinical course similar to *de novo* acute leukemia (blast crisis), or slower and more progressive, with marrow failure resulting in anemia and thrombocytopenia (accelerated phase). Blast crisis, an obvious cause of death, represents the transformation of CML to the equivalent of acute leukemia and is generally defined as more than 20% blasts in the peripheral blood or bone marrow aspirate smear ( [1](#), [123](#) ) or by microscopic identification of a large cluster of blasts in a marrow biopsy or extramedullary site biopsy ( [1](#), [87](#), [123](#), [124](#), [125](#), [126](#), [127](#), [128](#), [129](#), [130](#), [131](#), [132](#) and [133](#) ). In approximately two-thirds of cases of CML in blast transformation, the blasts are myeloid by traditional cytologic and immunophenotypic analysis. These myeloid cases can represent the spectrum of nonlymphocytic leukemias, resembling myeloid (M1–2), myelomonocytic (M4–5), erythroblastic (M6), or megakaryoblastic (M7) leukemias. Auer rods are very rarely, if ever, observed. Cytochemical reactions with Sudan black and myeloperoxidase are markedly decreased and often absent, so negativity does not exclude the diagnosis of acute myeloblastic leukemia. Flow cytometric analysis demonstrates the presence of nonlymphocytic markers, whereas electron microscopy demonstrates ultrastructural features (i.e., granules) consistent with nonlymphocytic differentiation. These cases are usually negative for terminal deoxynucleotidyl transferase, although a significant number of terminal deoxynucleotidyl transferase-positive myeloblastic cases have been reported. In one-third of the cases of transformation, the blasts have morphologic, immunophenotypic, and ultrastructural features of lymphoblasts ( [87](#), [125](#), [128](#), [129](#), [130](#), [131](#), [132](#) and [133](#) ). These blasts may exhibit the cytologic features of all types of ALL, most commonly L1 or L2. Similar to the blasts in *de novo* ALL, Sudan black, myeloperoxidase, and chloroacetate esterase are negative. However, the blasts may have block PAS positivity. Lymphoid antigens, usually B-cell antigens, are expressed on the cell surface. T lymphoblasts arising in CML have been described, although they are very rare. The lymphoblasts are terminal deoxynucleotidyl transferase-positive in the majority of cases and have characteristics of B-cell precursor lymphoblasts. The majority are CD10 (CALLA) and CD19 without surface immunoglobulins. Cytoplasmic  $\mu$  heavy chains may be seen in some cases. Although the majority of cases of blast transformation are characterized by an increase of blasts in marrow and blood, a number of patients present with extramedullary manifestations. The cytologic, immunologic, and cytogenetic features of these cases are similar to those of other cases of blast transformation of CML occurring in the marrow. Because the detection of transformation at an earlier stage might lead to more effective treatment, criteria that might indicate an earlier phase or different clinical behavior of transformation (accelerated phase) have also been proposed ( [123](#), [132](#), [134](#) ). These include myelofibrosis, basophilia in excess of 20%, hemoglobin of less than 7 g/dl, platelets less than 100,000/ $\mu$ l, karyotypic evolution, and a number of blasts that is increased but less than 20%. Although it is well documented that cases of CML proceed through a chronic phase to a phase with a low blast count to a phase with higher blast counts, the difficulty with the additional criteria for accelerated phase is that it is unclear whether all these cases represent an earlier phase of blast crisis or simply variants of CML with a slightly worse prognosis. In addition, the use of one or the other of



these terms to distinguish patients with high or low blast counts does not alter prognosis or treatment.

**LEUKOCYTE ALKALINE PHOSPHATE** LAP values are often increased when CML transforms to blast crisis or accelerated phase. However, LAP values are quite variable and are influenced by frequent coincident processes such as infection. Several other serum or urinary proteins have been reported to increase with the onset of terminal phase, including cationic leukocyte antigen, erythrocyte membrane proteins, and fucosyl transferase. The clinical relevance of these latter tests is not established.

**CYTOGENETIC FINDINGS** The evolution of chronic phase CML to accelerated or blast phase is accompanied by cytogenetic changes in 70 to 80% of cases ( [114](#), [135](#), [136](#) ). The most common abnormalities in addition to the Ph chromosome are (in order of frequency): an additional Ph chromosome, trisomy, isochromosome 17, and +19. The second Ph seems to result from duplication of the first because additional abnormal chromosome 9 is not observed. The prognostic significance of additional chromosomal abnormalities without histologic changes may indicate a poor prognosis because these chromosome changes usually precede the hematologic manifestations by several months. Nevertheless, the development of additional chromosomal abnormalities alone is not specific for evolution to the terminal phase, as some patients have remained in chronic phase for prolonged periods.

**MOLECULAR FINDINGS** Two molecular tests that detect the size or amount of the BCR-ABL mRNA transcript may be useful in evaluating transformation of CML: quantitative PCR and the size of the BCR-ABL gene product. Two sizes of BCR-ABL fusion mRNA message have been detected that correspond to proteins with molecular weights of 190 kd and 210 kd. Generally, cases of blast transformation in CML express the 210-kd form, whereas cases of *de novo* ALL with a Ph chromosome express the 190-kd form ( [137](#) ). Because some cases of blast transformation of CML present without a previously diagnosed chronic phase, the underlying CML is suggested by the presence of a 210-kd product. In addition, the presence of a 190-kd form in conjunction with a 210-kd product suggests evolution to terminal phase. The emergence of a p190 transcript in the background of p210 CML has been used as a suggestion of transformation to terminal phase. Although this may be the case, low levels of p190 products may also be generated through alternative splicing of the p210 fusion transcript and do not indicate transformation universally. Quantitation of the amount of BCR-ABL message may be documented by quantitative PCR. Although not widely used, this test can semiquantitate the level of BCR-ABL mRNA transcript in patients with CML. Although the absolute level is not predictive of transformation, an increase from a previously documented baseline for that patient is predictive of impending transformation, usually 6 months later ( [138](#) ).

### Juvenile Chronic Myelogenous Leukemia

Myeloproliferative disorders occurring in children may have similar or identical features to adult Ph(+) CML ( [1](#) ). However, it has become clear that at least two entities are represented by these processes: an adult form of CML occurring in juveniles and a juvenile type of CML (JMML) ( [35](#), [139](#), [140](#), [141](#) and [142](#) ). The adult form of CML has the same clinical, morphologic, and cytogenetic findings as adult Ph(+) CML and represents the same disease in a younger age group. The juvenile form represents a distinct disease that is hematologically similar and accounts for 2% of childhood leukemias ( [35](#), [142](#) ). However, JMML is Ph(-) and clinically aggressive, with a course similar to that of AML. Juvenile CML is also much more common in young children, whereas the adult form is more common in adolescents. Although JMML and monosomy 7 have distinct cytogenetic findings, some investigators suggest that JMML and monosomy 7 syndrome represent the same spectrum of disease ( [36](#) ). In addition, the aggressive nature of JMML and monosomy 7 syndrome, their occasional overt progression to acute leukemia, and the demonstration of excessive myelomonocytic proliferation in the marrow have led some

investigators to suggest the encompassing term *JMML* ( [35](#), [36](#), [143](#) ).

In *JMML*, LAP levels are generally reduced as they are in the adult form. However, in contrast to the adult form, fetal hemoglobin is increased in approximately one-half of cases. The elevated fetal hemoglobin may be useful in distinguishing *JMML* from other entities. In addition, levels of several red blood cell enzymes and proteins are reduced, including hemoglobin A<sub>2</sub> and erythrocyte carbonic anhydrase, whereas glucose-6-phosphate is increased. *JMML* has a prominent monocytic component with excessive monocyte proliferation in the absence of growth factors and suppression of normal hematopoietic colony formation ( [139](#), [140](#) and [141](#) ), findings that have been shown consistently. Polyclonal elevation of immunoglobulins is common. If cases of monosomy 7 syndrome are excluded, consistent chromosomal abnormalities are not found ( [36](#), [144](#), [145](#) ).

The leukocyte count is usually elevated in *JMML* but less than in the adult form ( [139](#), [140](#), [141](#), [142](#) and [143](#) ). Thrombocytopenia is usually present. The leukocyte differential shows a higher proportion of immature myeloid precursors than in the adult form. Basophilia may be present but is not a consistent feature as in the adult form. Nucleated red blood cells, occasional plasma cells, and immunoblasts may also be noted. The marrow is hypercellular and contains increased blasts, immature monocytes, and monocytes. Megakaryocytes are usually decreased.

The differential diagnosis may be difficult because of differing concepts of the disease and overlap with monosomy 7 syndrome ( [36](#) ). Monosomy 7 syndrome usually occurs before the age of 2 years and typically presents with rash, hepatomegaly, and lymphadenopathy. Although monosomy 7 syndrome usually presents with anemia, thrombocytopenia, monocytosis, and erythroid precursors in the blood similar to *JMML*, monosomy 7 syndrome has normal or only slightly increased fetal hemoglobin levels. Furthermore, the demonstration of monosomy 7 in the myeloid cells confirms the diagnosis.

Children with Epstein-Barr virus infection may have hematologic findings similar to those of *JMML*, including leukocytosis, thrombocytopenia, hepatomegaly, and elevated levels of fetal hemoglobin. Serologic testing may assist in the diagnosis of these cases.

## CELLULAR AND MOLECULAR PATHOGENESIS

Hematopoiesis in CML is clonal, derives from a pluripotent stem cell, and is fairly normal with respect to cellular maturation and function ( [146](#) ). However, there is a relentless rise in the WBC count. The Ph chromosome is the hallmark of CML, and its acquisition, presumably during a division of a pluripotent stem cell, is part of the molecular and cellular defects that ultimately produce CML. The unequivocal demonstration of Ph chromosomes in all blood cell types, including B and T cells, is widely accepted as evidence that the neoplastic clone originates in a very primitive pluripotent stem cell. However, these findings do not exclude the possibility that expression of BCR-ABL fusion protein may affect lineage commitment. To understand how expression of BCR-ABL protein causes CML, it is necessary to define in what ways hematopoiesis in CML is abnormal and in what manner these hematopoietic abnormalities change over time with progression of the disease from a chronic to an acute form.

### Disease Initiation

The cardinal feature of chronic phase CML is myeloproliferation, predominantly leading to an excess of myeloid precursors and mature forms. To understand the relationship among



the t(9;22), the clinical course of CML, and therapies, such as  $\alpha$ -interferon, and how this relationship affects the disease progression, it is necessary to define the cellular and molecular defects in CML.

The clinical phases of CML are manifestations of three distinct pathogenetic phases:

Phase 1: *preclinical stage*. Clonal proliferation of pluripotent Ph(-) bone marrow cells. These cells are genetically unstable and have a growth advantage over normal stem cells. Very little is known about the pathogenetic mechanisms of this stage.

Phase 2: *acquisition of the Ph chromosome or some variant leading to the production of a BCR-ABL gene product*. It is not known whether the acquisition of the Ph chromosome leads inexorably to CML. However, in the right genetic background, the acquisition of t(9;22) is clinically manifested as the chronic phase of the disease. It is characterized by an abnormal proliferation of marrow elements, predominantly myeloid precursors. This seems to occur because of two interrelated abnormalities. One is a subtle imbalance in cell maturation, the consequence of which is that CML progenitor cells undergo a few more divisions than their normal counterparts. The second abnormality is that immature CML precursor cells seem less responsive to molecules or stromal cell-precursor cell interactions that inhibit growth of their normal counterparts. Consequently, CML cells continue dividing even when normal cells cease doing so. Because hematopoiesis and granulocyte production are hierarchical and ampliative, the net effect is to produce billions of excess granulocytes.

Phase 3: *accelerated phase or blast crisis in which the increased genetic instability leads to additional chromosomal abnormalities, leading to increasing malignant subclones*. The accelerated or blast phase is characterized by the loss of differentiation and additional cytogenetic abnormalities. This biologic event corresponds to a histologic appearance and clinical behavior identical to those of acute leukemia.

Information concerning the preclinical stage of CML comes from small cohorts of patients who were medically followed before the development of symptoms or diagnosis. The largest series of this type is that of Kamada and Uchino, who reported 20 cases (16 survivors of the Hiroshima atomic bombing) (47). Assessment occurred at least twice yearly from a normal state to the development of early CML and through the symptomatic phase of the disease. Data were added from four other patients in whom a diagnosis was made when the WBC count was less than 42,000/ $\mu$ l. Once these 20 patients became symptomatic, the disease pattern did not differ from that seen in other bomb survivors with CML or from those patients not exposed to excessive radiation who developed CML. In all 20 patients, the Ph chromosome was present at diagnosis. In 17 cases, all marrow metaphases examined were Ph(+). In three cases, a minor population of metaphases (3 to 12%) were Ph(-) but abnormal, suggesting that the Ph(+) clone replaces normal myeloid cells before the WBC count becomes abnormal. The leukemic clone may actually develop before the translocation of the c-abl oncogene from chromosome 9 to chromosome 22, thus explaining the presence of Ph(-) B lymphocytes derived from the same clonal stem cell as the leukemic clone of myeloid cells (i.e., glucose-6-phosphate dehydrogenase type A or B only) in glucose-6-phosphate dehydrogenase heterozygous patients with CML (147). In ten patients, the diagnosis was made when the WBC count was less than 14,000/ $\mu$ l by detecting the presence of the Ph chromosome.

**ROLE OF BCR-ABL** The translocation of genetic material between chromosomes 9 and 22 ultimately results in the production of a chimeric molecule composed partly of the ABL gene and partly of the BCR gene (137). Understanding how the chimeric BCR-ABL fusion product causes the proliferation abnormalities that result in excess granulocyte production requires knowledge of the normal ABL and BCR genes. In normal individuals, BCR and ABL proteins are expressed in virtually all cells. In CML, a t(9;22) results in a hybrid BCR-ABL gene in which exon 1 of ABL is replaced by 5' exons of BCR (Fig. 84.1)

([137](#)). The breakpoint in the BCR gene occurs in an approximately 5.8-kb intronic region called the *major breakpoint cluster region* (M-bcr), spanning five exons named *b1* to *b5*, now known to be exons 12 to 16 of the BCR gene. The breakpoint in the ABL gene can occur anywhere within a 300-kb or larger segment at the 5' end of the gene. The fusion mRNA product is translated into a chimeric protein whose molecular weight is usually 210 kd. Because this BCR-ABL protein occurs in all cases of CML, it is reasonable to assume that it is critical to the pathogenesis of the disease. Indeed, studies using transgenic mice expressing BCR-ABL protein develop a disease similar to chronic phase CML in humans ([148](#)). In addition, antisense oligomers to the BCR-ABL mRNA junction may suppress leukemia colony formation but not normal colony formation ([13](#)). There is variation in the BCR-ABL fusion transcripts and proteins formed in CML and among other diseases with a t(9;22) ([148](#), [149](#), [150](#), [151](#) and [152](#)). Three different breakpoint areas in the BCR gene have been described: major (M-bcr), minor (m-bcr), and  $\mu$ -bcr. A translocation occurs between one of the exons in one of these three areas in the *BCR* gene and the second exon of *ABL*. A nomenclature has been developed to describe these different breakpoints. For instance, fusion junctions are called b3a2, e1a2, e19a2, and so on. The first alphanumeric pair refers to the exon used in the *BCR* gene that fuses with the second exon of *ABL* (a2). The M-bcr exons are called b1 to b5; e1, e2, e1', and e2' are exons used in the m-bcr; and the  $\mu$ -bcr has exons e19 and e20. Generally, the BCR-ABL hybrid results from a b3a2 or b2a2 junction encoding a p210 BCR-ABL fusion protein. Taken together, the data so far suggest that one can distinguish at least three clinicopathologic entities among the chronic (p210 CML, p190 CML, and p230 CNL) and two acute Ph(+) myeloid leukemias (p210 AML and p190 ALL) ([137](#), [148](#), [149](#), [150](#), [151](#), [152](#), [153](#) and [154](#)). The overwhelming majority of CML cases result from a b2a2 or b3a2 fusion leading to the formation of a p210 BCR-ABL protein. In two-thirds of ALL cases and in rare cases of CML and AML, exons among the m-bcr form an e1a2 junction and lead to a smaller mRNA transcript and a p190 BCR-ABL fusion protein. In rare cases of CML and in cases of CNL, exons e19 and e20 are used, forming an e19a2 mRNA transcript and a larger p230 BCR-ABL chimeric protein. It is also worth noting that BCR breakpoints outside the three characterized breakpoint regions have also been identified in rare cases of CML and ALL. In addition, t(9;22) using the minor and major breakpoint cluster regions have been rarely found in other hematopoietic neoplasms, including myeloma, ET, and B-cell lymphomas ([148](#), [155](#), [156](#), [157](#), [158](#), [159](#) and [160](#)). The clinical significance of different breakpoints in CML is not well defined. However, some intriguing correlations have been observed. Both childhood and adult CML are almost always of the p210 type. However, in contrast to adults, in whom two-thirds of cases have the b3a2 transcript, children with CML have a predominance of b2a2 fusion junctions ([161](#)). Furthermore, two different groups report that the b3a2 transcript is associated with higher platelet counts than the b2a2 in p210 CML ([162](#), [163](#)). However, a third group and a CML trial in the United Kingdom have not been able to show a correlation. Investigations into how the normal *ABL* and *BCR* genes regulate growth suggest several ways in which this chimeric molecule may promote uncontrolled growth ([134](#), [137](#)). The protooncogene *ABL* has been more widely studied of the two and acts primarily as a protein that phosphorylates tyrosine residues on itself and other proteins. The protein structure of *ABL* is complex. *ABL* has at least three functional domains: the domain responsible for phosphorylation and two other domains, SH2 and SH3, that regulate the activity of the former domain. The ability of *ABL* to transform cells is proportional to its ability to phosphorylate tyrosine residues. Currently, it is believed that *ABL* binds to a protein target. The SH2 domain up-regulates *ABL* activity and increases kinase activity, which promotes cellular transformation. Alternatively, the SH3 domain down-regulates kinase and transformation activity. In addition, it has been suggested that the SH3 region may also be responsible for regulating guanosine triphosphatase activity, a signal pathway known to be involved in the signal transduction pathway of another protooncogene, *ras*, whose abnormal expression is associated with cancer development. There are two other important functional domains in the *ABL* protein. First, there is a domain that binds specific

nucleotide sequences of DNA. These structural data and other data suggest that ABL may also be a transcription factor. Second, there is a region that facilitates binding to f-actin in the cytoplasm. Compared to the *ABL* gene, considerably less is known about the structure and functional activities of the *BCR* gene ( [125](#), [137](#) ). BCR protein may be a serine/threonine kinase rather than a tyrosine kinase like ABL. Some researchers suggest that BCR is a serine/threonine kinase, whereas others indicate that BCR is homologous to the cyclins, which regulate the cell cycle. A BCR-ABL fusion protein is produced that contains the N-terminus of the BCR protein and the C-terminus of the ABL protein. Mutation studies indicate that loss of the normal N-terminal region of ABL leads to increased tyrosine phosphorylation activity relative to its normal counterparts, increased f-actin binding, and decreased nuclear translocation. Presumably, these changes result in the proliferation defects seen in myeloid precursors in CML. Finally, some evidence indicates that ABL kinase activity is not the sole abnormality in CML. Other researchers suggest that BCR-ABL fusion protein may interact or interfere with other protooncogene pathways, such as the signaling pathways involving *ras*, *myc*, or *myb*, indicating the possibility that a cascade of protooncogene abnormalities may ultimately be found to be involved in BCR-ABL-mediated transformation.

**ROLE OF CELL CONTACTS AND SOLUBLE MEDIATORS** In addition to the signaling defects caused by BCR-ABL fusion protein, CML precursor cells are not inhibited by stromal cell contacts and soluble molecule mediators in the bone marrow microenvironment. CML precursor cells do not appear to adhere as well to stromal cell and extracellular matrix components of the marrow compartment as their normal counterparts ( [164](#), [165](#) and [166](#) ). So-called juxtacrine signaling, the interplay between adhesion and soluble factors, inhibits cellular growth; decreased adherence leads to an increased proliferation rate of CML precursors compared to their normal counterparts.  $\alpha$ -Interferon enhances the interaction of CML precursor cells with the stroma and decreases the proliferative activity of CML precursor cells, leading to a return to normal hematopoiesis. This antiproliferative effect of  $\alpha$ -interferon appears to be the result of modulation of *BCR-ABL* gene expression of CML precursor cells as well as enhanced cell-cell contacts in the marrow microenvironment ( [164](#), [165](#) and [166](#) ). In addition, stem cell colony formation assays show that the leukemic stem cell population in the marrow can be rather small, but it may be markedly elevated in the blood.

## Disease Progression

Progression of CML to the accelerated or blast phase is associated with the acquisition of additional chromosomal and genetic abnormalities. Chromosomal instability of the malignant clone is a fundamental characteristic of disease progression in CML. The t(9;22) remains the sole chromosome abnormality throughout the chronic phase, and its expression continues during blast crisis. However, 70 to 80% of patients develop additional chromosomal abnormalities with disease progression. These chromosomal changes may be detected in extramedullary tissue before the hematologic and clinical manifestations of blast crisis. Secondary chromosomal changes have been reported in more than 1500 patients with CML. Although there is no single pathway of progression, chromosomes 8, 17, 19, and 22 are most commonly involved in disease progression.

A number of oncogenes have been implicated in disease progression. Several groups suggest that the site of the intronic breakpoint affects prognosis, but the results have not been confirmed by others. Alterations in p53 correlate with progression to blast crisis or accelerated phase in one-fourth to one-third of patients with CML. In addition, structural abnormalities of the *Rb*, *myc*, and *ras* genes have been associated with progression in small cohorts of patients (114,135,136,167). Evidence of aberrant growth factor production or secretion in disease progression has also been reported. These factors include interleukin-1b, interleukin-6, and granulocyte-macrophage colony-stimulating factor, all of which may be involved in adherence to stromal cells.

In summary, there is now a wealth of information that supports an essential role for chimeric BCR-ABL protein in the initiation of CML. An assortment of forces seems to drive disease progression and transformation to an aggressive acute leukemic phenotype (blast crisis). These factors include chromosomal abnormalities, oncogene alteration, cytokine secretion, and alteration in cellular adherence. The precise nature of all of these events remains unclear.

## THERAPY

The initial therapy for patients presenting in chronic phase requires controlling the elevated WBC count, reducing the symptoms of concomitant splenomegaly, and treating any metabolic complications caused by the profound marrow proliferation. Hyperuricemia and gout can occur before therapy and can worsen with cytotoxic treatment. All patients should be placed on agents, such as allopurinol, to lower uric acid and prevent gout and renal damage. These agents should be continued at least until control of the excessive hematopoiesis is obtained. Fictitious elevations of serum potassium with a markedly elevated WBC count can be noted because of cell lysis after collection of blood samples. On the other hand, fictitious decrease in blood glucose can result from glucose metabolism in the blood-collecting tube by the elevated WBC. Careful blood collection, rapid performance of analyses, and collection in blood tubes with antimetabolizing agents, such as fluoride salts, may be required to distinguish spurious laboratory values. Criteria for a complete hematologic response (CHR) include a WBC count of less than 10,000/ $\mu\text{l}$ , a platelet count of less than 450,000/ $\mu\text{l}$ , no immature cells in the peripheral blood, and no palpable splenomegaly. A cytogenetic response is determined by assessing the percentage of Ph(+) cells in metaphase in the bone marrow. Complete, partial, and minor cytogenetic responses are defined as 0%, 1 to 34%, and 35 to 65% Ph(+) cells, respectively. A major response is defined as either a complete or partial cytogenetic response.

Rapid lowering of the WBC count is not generally required because symptoms of leukostasis are an uncommon manifestation of chronic phase CML. Rapid lowering can also lead to tumor lysis syndrome. Patients should undergo emergent leukapheresis and initiation of cytotoxic chemotherapy only if symptoms of leukostasis are believed to be present as manifested by central nervous system, pulmonary, or hemorrhagic events. Cranial radiation, although used for central nervous system leukostasis associated with AML and blast phase CML, is not generally performed for CML in chronic phase ([168](#)).

### Hydroxyurea

Hydroxyurea has a modest side-effect profile and rapid onset of action. This drug, acting as an inhibitor of ribonucleotide reductase, can lower blood counts within 1 to 2 days, especially if higher than standard doses are used. The advantages of hydroxyurea are the rapid onset, the lack of serious side effects, and the rapid recovery of counts if excessive lowering of the WBC count occurs ([169](#), [170](#), and [171](#)). The side effects of hydroxyurea are mild nausea and skin rash. Unlike busulfan (BU), hydroxyurea requires fastidious management. Blood counts should be measured weekly until a stable dose is determined. The usual dosage of hydroxyurea is between 500 and 3000 mg/day; greater dosages may be required initially. Hydroxyurea must be given daily and continually because the WBC rises rapidly after the drug is discontinued. With the use of hydroxyurea, most patients have excellent control of their blood counts, although most show persistent presence of the Ph chromosome. Compared to BU, hydroxyurea has been associated with a lower incidence of posttransplant complications, such as interstitial pneumonia, and can be used in pregnant patients because it is not mutagenic ([172](#)).

## Busulfan

Despite having a lower efficacy than hydroxyurea or  $\alpha$ -interferon, BU has certain advantages that continue to sustain its use ( [173](#) ). BU has a predictable dose, gradually lowers the blood counts, and does not require as frequent WBC measurements as hydroxyurea. However, BU can cause severe side effects, consisting of pulmonary fibrosis, rash, hypoadrenalism, and severe and prolonged lowering of blood counts, especially if  $\alpha$ -interferon is subsequently used ( [174](#) ). Severe and prolonged marrow aplasia has been described after BU therapy. Once therapy is stopped, BU-associated leukopenia can require many weeks to resolve. Patients with profound BU myelosuppression can achieve substantial cytogenetic remissions, although the consequences of severe cytopenias do not warrant the deliberate use of dose-intensive BU without some form of stem cell rescue ( [175](#) ).

BU can be started at a dosage of 6 to 10 mg, which can be reduced to 2 to 4 mg/day once the WBC reaches 20,000/ $\mu$ l ( [176](#) , [177](#) ). If blood counts are stable and less than 20,000/ $\mu$ l, BU can be discontinued. Evaluation of the WBC should be maintained every month. BU can be intermittently restarted with rising WBC or can be continued at low dosage. However, prolonged use can be associated with side effects. BU should be limited to patients who are intolerant of other therapies or who cannot maintain close and frequent medical supervision. BU should not be used in patients expected to undergo bone marrow transplantation (BMT) because adverse effects on transplantation outcome are reported ( [178](#) ).

## $\alpha$ -Interferon

$\alpha$ -Interferon was the treatment of choice in patients with CML who were not candidates for allogeneic BMT before the introduction of imatinib. The mechanism of action of  $\alpha$ -interferon is not known. Its pleiotropic effects include antiproliferative effects, immune modulation, antiangiogenesis, and modulation of the cytoadhesion between stromal cells and hematopoietic progenitors.  $\alpha$ -Interferon is considerably more effective during early chronic phase ( [179](#) ). CHRs of more than 70% occur when  $\alpha$ -interferon is used in early chronic phase ( [180](#) , [181](#) , [182](#) and [183](#) ). The standard dose used is 5 million units (MU)/m<sup>2</sup> daily by subcutaneous administration. In addition to the clinical response, more than 50% of patients have some cytogenetic response characterized by partial reemergence of Ph(-) hematopoiesis, as determined by karyotype or by fluorescence *in situ* hybridization analysis ( [184](#) , [185](#) ).

A number of biologic variables may predict  $\alpha$ -interferon-induced cytogenetic responses in patients with CML. A major cytogenetic response with  $\alpha$ -interferon was associated with high interferon regulatory factor 4 expression ( [186](#) ), a high interferon consensus sequence binding protein ( [187](#) ), a high interferon- $\alpha$ 2c/glucose-6-phosphate dehydrogenase H ratio ( [188](#) ), and a high ratio of interferon regulatory factor 1/interferon regulatory factor 2 expression ( [189](#) ). Clinical variables can be used to predict patient risk categories and the expected benefit of  $\alpha$ -interferon at diagnosis ( [68](#) , [190](#) ) ( [Table 84.5](#) ). The Hasford score was developed to predict the survival of patients being treated with  $\alpha$ -interferon. Patients at low risk treated with  $\alpha$ -interferon had a median survival of 100 months, whereas patients at high risk had a median survival of 45 months ( [190](#) ). Low-risk cases, which account for 50% of CML patients, would thus be good candidates for  $\alpha$ -interferon treatment. The *in vivo* response to  $\alpha$ -interferon is an important treatment prognostic factor. Patients experiencing reduction of Ph(+) cells and, especially, those having a major



cytogenetic response [below 35% Ph(+) cells in marrow examination] have been shown to have superior survival, estimated to be above 80% at 5 years ( [180](#), [183](#), [191](#), [192](#) and [193](#) ). Thus, there are clinical variables determined before and after initiating therapy that can help predict which patients may derive meaningful clinical benefit from  $\alpha$ -interferon therapy.

**TABLE 84.5. Hasford Risk Score for Patients with Chronic Myeloid Leukemia**

|  |  |
|--|--|
| Calculation of total score                     |  |
| Age (yr)                                       | 0.6666 when age =50; 0 when <50              |
| Spleen size <sup>a</sup> (cm)                  | 0.042 × spleen size below left costal margin |
| Platelets ( × 10 <sup>3</sup> /μl)             | 1.0956 when =1500/μl; 0 when <1500/μl        |
| Myeloblasts <sup>b</sup> (%)                   | 0.0584 × % myeloblasts                       |
| Eosinophils <sup>b</sup> (%)                   | 0.0413 × % eosinophils                       |
| Basophils <sup>b</sup> (%)                     | 0.2039 when basophils >3%                    |
| Assessment of relative risk                    |  |
| Relative risk = total × 1000                   |  |
| Low, <780; intermediate, 781–1479; high, =1480 |  |

<sup>a</sup> Spleen measured below left costal margin.

<sup>b</sup> Peripheral blood %.

Many patients require large doses of  $\alpha$ -interferon for maximal benefit. However, because of its predictable early side effects, the drug should be started at lower doses and gradually increased once side-effect tachyphylaxis occurs. A standard initial dose is 1 to 3 MU subcutaneously given 3 to 7 days per week. Doses can be gradually increased to a final daily dose of 5 MU/m<sup>2</sup>. It is recommended to start hydroxyurea to decrease the WBC to 10,000 to 20,000/μl before initiating  $\alpha$ -interferon. Patients having flulike side effects can be treated with acetaminophen or nonsteroidal antiinflammatories, and those with insomnia can be treated with amitriptyline (12.5 to 50.0 mg) or with a temporary dosage reduction. Many patients administer their  $\alpha$ -interferon before bedtime to lessen their awareness of constitutional symptoms. Patients using  $\alpha$ -interferon should be warned about side effects, as in randomized trials more than 25% of patients are intolerant of high-dose  $\alpha$ -interferon and must decrease their dosage or choose alternative agents. The dose of  $\alpha$ -interferon should be reduced for a patient with a WBC count less than 2,000/μl or a platelet count less than 50,000/μl. The  $\alpha$ -interferon dose should also be reduced for grade 3 to 4 toxicity. Older patients often have decreased tolerance to  $\alpha$ -interferon ( [194](#) ).

The optimal dosage of  $\alpha$ -interferon remains unclear. Various dosages have been used, and many patients require down-adjustment from higher dosages. In general, higher dosages have been shown to improve efficacy, but with more side effects ( [195](#) ). A recent trial suggests that a lower dosage (2 MU/m<sup>2</sup>) administered three times per week (approximately one-sixth of standard weekly dosing) was as effective as the standard

dosage (5 MU/m<sup>2</sup>) given daily ( [196](#) ). However, these results have not been confirmed.

Four major trials have compared  $\alpha$ -interferon to either hydroxyurea or BU ( [173](#), [182](#), [197](#), [198](#), [199](#) and [200](#) ). A fifth trial compared hydroxyurea to hydroxyurea and  $\alpha$ -interferon ( [201](#) ). These trials support the observation that CHR and cytogenetic responses are more common with  $\alpha$ -interferon. Although not universally noted, survival appears to be improved with  $\alpha$ -interferon, which is especially correlated with achievement of a cytogenetic response. A summary of these trials is included in [Table 84.6](#). A metaanalysis of all the randomized trials provided conclusive evidence of  $\alpha$ -interferon's superiority in overall survival (57% at 5 years) compared with conventional single-agent therapy (42% at 5 years) ( [200](#) ).

**TABLE 84.6. Results of Randomized Trials of  $\alpha$ -Interferon (IFN)**

| Study    | Therapy Used | Patients (No.) | Daily Median $\alpha$ -IFN Dose Administered (MU/m <sup>2</sup> ) | Complete Hematologic Response Noted (%) | Major Cytogenetic Response Noted (%) | Complete Cytogenetic Response Noted (%) | Median Survival (mo) | $\rho$ -Value for Survival <sup>a</sup> |
|----------|--------------|----------------|---|---|--------------------------------------|---|----------------------|---|
| Italian  | IFN          | 218            | 4.3   | 62                                      | 55                                   | 8                                       | 72                   | .002                                    |
|          | HU or BU     | 104            | —   | 53                                      | 34                                   | —                                       | 52                   |   |
| German   | IFN          | 133            | 2.0   | 31                                      | 18                                   | 7                                       | 66                   | .44                                     |
|          | BU           | 186            | —   | 23                                      | 4                                    | —                                       | 45                   |   |
|          | HU           | 194            | —   | 39                                      | 5                                    | —                                       | 56                   |   |
| British  | IFN          | 293            | 3.2   | 68                                      | 22                                   | 5                                       | 61                   | <.001                                   |
|          | HU or BU     | 294            | —   | —                                       | —                                    | —                                       | 41                   |   |
| Japanese | IFN          | 80             | 4.0   | 39                                      | 44                                   | —                                       | 65                   | <.03                                    |
|          | BU           | 79             | —   | 54                                      | 29                                   | —                                       | 50                   |   |

BU, busulfan; HU, hydroxyurea; MU, million units.

<sup>a</sup> Comparing other therapy to  $\alpha$ -IFN.

Preclinical ( [202](#) ) and phase II studies ( [203](#) ) suggested the benefit of combining cytosine arabinoside (ara-C) with  $\alpha$ -interferon. Two randomized trials have tested whether adding ara-C to  $\alpha$ -interferon improves clinical outcomes. A national French study of 721 patients demonstrated that ara-C (20 mg/m<sup>2</sup>/day for 10 days per month), when added to  $\alpha$ -interferon (5 MU/m<sup>2</sup>/day), improved cytogenetic response and survival ( [204](#) ). The major cytogenetic response at 12 months was 35% and 21% and the 5-year survival was 70% and 62% for the combination and  $\alpha$ -interferon arms, respectively. However, an Italian study of 538 patients using a similar protocol confirmed that the combination produced an improved major cytogenetic response (28% vs. 18% at 24 months) but failed to demonstrate a significant survival advantage between the two treatment arms (5-year survival, 68% vs. 65%) ( [205](#) ). The toxicity of the combination arm was greater in both studies than with  $\alpha$ -interferon alone ( [Table 84.7](#) ).



**TABLE 84.7. Complete Hematologic Response, Major Cytogenetic Response, and 5-Year Survival of Interferon (IFN)- and IFN/Cytosine Arabinoside (ara-C)-Treated Patients**

|                                       | French Trial |               |         | Italian Trial |               |         |
|---------------------------------------|--------------|---------------|---------|---------------|---------------|---------|
|                                       | IFN (%)      | IFN/ara-C (%) | p-Value | IFN (%)       | IFN/ara-C (%) | p-Value |
| Complete hematologic response at 6 mo | 55           | 66            | .003    | 55            | 62            | .11     |
| Major cytogenetic response at 12 mo   | 21           | 35            | .001    | 13            | 21            | .012    |
| 5-Yr survival                         | 62           | 70            | .02     | 65            | 68            | .77     |

Two retrospective analyses have been performed comparing  $\alpha$ -interferon therapy and HLA-identical sibling allogeneic bone marrow transplant. In the first analysis, 548 transplant patients from the International Bone Marrow Transplant Registry were compared to 121 patients who received hydroxyurea and 75 patients who received  $\alpha$ -interferon on a randomized German CML Study Group trial (206). In this study, patients treated with  $\alpha$ -interferon and hydroxyurea were evaluated as one group. Thus, the results of this trial need to be interpreted with caution. For the first 18 months, mortality was higher in the transplant group. From 18 to 56 months, the survival of both groups was similar, and, after 56 months, there was a survival advantage for the transplant group. For patients in the low-risk Sokal group, a statistically significant survival for the transplant cohort was only seen after almost 8 years. In a second study by the Italian Cooperative Study Group on CML, 840 patients younger than 56 years and entered on prospective trials were analyzed (207). Although there was a trend for improved survival for allogeneic BMT compared with  $\alpha$ -interferon in all groups, this was only statistically significantly superior in patients younger than 32 years and with a high-risk Sokal score (Table 84.8). A multicenter prospective trial in Japan compared  $\alpha$ -interferon in 175 patients with allogeneic BMT in 79 patients, of whom 50 received a transplant from an HLA-identical related donor and 29 from HLA-matched unrelated donors (208). At a median follow-up of 38 months, the 5-year survival rate was 79% for the  $\alpha$ -interferon group and 72% and 67% for the related and unrelated donor transplant groups, respectively. In subset analysis, transplantation resulted in improved survival only in the younger patient with a higher Sokal risk. Taken together, these studies suggest that allogeneic BMT results in a significantly improved survival, most notably in younger patients with higher risk Sokal scores.

**TABLE 84.8. Ten-Year Survival of Standard Allogeneic Bone Marrow Transplant Patients and  $\alpha$ -Interferon Therapy Patients**

|  | Sokal Score |     | Low Risk (<0.8) |     | High Risk (=0.8) |     |
|--|-------------|-----|-----------------|-----|------------------|-----|
|  | =32         | >32 | =32             | >32 | =32              | >32 |
| Standard allogeneic bone marrow transplant (%) | 62          | 50  | 65              | 47  |                  |     |
| $\alpha$ -Interferon therapy (%)               | 57          | 44  | 14              | 17  |                  |     |
| p-Value  | .74         | .15 | .008            | .50 |                  |     |

Modified from Monitoring treatment and survival in chronic myeloid leukemia. Italian Cooperative Study Group on Chronic Myeloid Leukemia and Italian Group for Bone Marrow Transplantation. *J Clin Oncol* 1999;17:1858–1868.

---

## Imatinib (Gleevec)

The 2-phenylaminopyrimidine derivative imatinib is an abl-specific tyrosine kinase inhibitor that inhibits the proliferation of CML cell lines by inhibiting BCR-ABL kinase activity ( [209](#) ). The drug is administered orally and is generally well tolerated. In a phase I study of patients resistant to or intolerant of  $\alpha$ -interferon, a dose-response relationship was demonstrated ( [210](#) ). A maximum tolerated dose was not established, but a dose of 400 mg/day was recommended for phase II study.

In a multicenter phase II trial, a total of 454 patients with confirmed chronic phase CML in whom previous therapy with  $\alpha$ -interferon had failed were treated with 400 mg of imatinib daily ( [211](#) ). Imatinib induced a CHR in 95% and a major cytogenetic response in 60% of patients. After a median follow-up of 18 months, CML had progressed to the accelerated or blast phase in 11% of patients, and 95% of the patients were alive. Only 2% of patients discontinued treatment because of drug-related adverse events, and no treatment-related deaths occurred. Supporting data have been reported in an Italian study in which 194 patients with CML resistant to  $\alpha$ -interferon were evaluated ( [212](#) ). A CHR was obtained in 93%, and the major cytogenetic response rate was 44% at 6 months.

In a study of CML patients in accelerated phase, 181 evaluable patients were treated with 400 mg or 600 mg of imatinib daily. The hematologic response rate was 82%. The rate of major cytogenetic response was 24%. The estimated 12-month progression-free and overall survival rates were 59% and 74%, respectively. Nonhematologic toxicity was usually mild or moderate, and hematologic toxicity was manageable. Imatinib at doses of 600 mg/day resulted in a higher cytogenetic response (28% compared with 16%), a longer time to disease progression (67% compared with 44% at 12 months), and increased overall survival (78% compared with 65% at 12 months) with no clinically relevant increase in toxicity ( [213](#) ). In a second trial, 75 patients in accelerated phase were treated with imatinib at a dose of 600 mg daily that could be escalated to 800 mg in the case of no response. The hematologic response was 86% at 3 months. The major cytogenetic response was 10% at 3 and 6 months ( [214](#) ).

Two studies have been reported using imatinib in patients with CML in blast crisis. In the first, a total of 260 patients with CML were enrolled of whom 229 had a confirmed diagnosis of CML in blast crisis ( [215](#) ). Patients were treated with imatinib in daily oral doses of 400 mg or 600 mg. Imatinib induced hematologic responses in 52% and cytogenetic responses in 16% of patients. Median survival time was 6.9 months. In the second trial, 75 patients, 65 with myeloid and 10 with lymphoid blast phase CML, were treated with imatinib at doses of 300 to 1000 mg/day ( [216](#) ). The objective response rate was 52%. Response rates were not different between myeloid and lymphoid groups. The cytogenetic response rate was 16%. The estimated median overall survival was 6.5 months. In 56 patients with relapsed or refractory Ph(+) acute lymphoblastic leukemia, imatinib was given once daily at 400 mg or 600 mg. Imatinib induced CHRs in 29% of patients. Median estimated time to progression and overall survival were 2.2 and 4.9 months, respectively ( [217](#) ). Given the data outlined above, the U.S. Food and Drug Administration has approved imatinib for CML in blast crisis, accelerated phase, or in

chronic phase after failure of  $\alpha$ -interferon therapy.

An interim analysis of a phase III trial in newly diagnosed chronic phase CML has been presented ([218](#)). This multicenter, randomized study, with 1106 patients, compares imatinib at 400 mg/day with  $\alpha$ -interferon (5 MU/m<sup>2</sup>/day) in combination with cytarabine (20 mg/m<sup>2</sup>/day for 10 days/month). At 6 months, the rates of major and complete cytogenetic response were 63% and 40%, respectively, in the imatinib arm versus 10% and 2% in the  $\alpha$ -interferon arm. The imatinib arm had a significantly better outcome for time to progression (1.4% vs. 10.3% events) and time to accelerated phase/blast crisis (1.1% vs. 4.7% events). Crossovers due to intolerance occurred in less than 1% of imatinib-treated patients and in 19% of  $\alpha$ -interferon-treated patients. The mature results of this study are eagerly awaited.

Approximately 30% of patients on imatinib with chronic phase CML experience grade 3 to 4 myelosuppression, most commonly neutropenia, followed by thrombocytopenia. Myelosuppression occurs more commonly in CML patients in accelerated phase and blast crisis, with rates of 50 to 60% in these patients. The WBC count begins to fall within the first 2 weeks and recovers within 4 to 6 weeks. The drop in the platelet count occurs in the first 3 to 4 weeks. Blood should be monitored weekly for the first month after initiating imatinib. In the chronic phase, it is recommended to withhold imatinib if the absolute neutrophil count falls below 1000/ $\mu$ l or if the platelets drop below 50,000/ $\mu$ l. Treatment may be restarted once the absolute neutrophil count has recovered to 1500/ $\mu$ l and the platelet count to 100,000/ $\mu$ l. Patients should be restarted on 400 mg/day unless they had profound myelosuppression or significantly delayed recovery. In these patients, restarting imatinib at 300 mg/day and then escalating to 400 mg/day in a few months is recommended. For patients with CML in accelerated phase or blast crisis, the decision to withhold imatinib should be weighed against the severity of their illness. A bone marrow biopsy may differentiate between bone marrow aplasia and persistent leukemia in these cases. Other common side effects include edema (50%), most commonly periorbital but also pleural or pericardial effusions, ascites, or anasarca; nausea (68%) and vomiting (50%); diarrhea (49%); muscle cramps (46%); skin rash (39%); and bone pain or arthralgias (20 to 40%). Edema should be managed with diuretics. In severe cases, imatinib treatment should be discontinued and restarted at reduced doses once edema is controlled. Nausea can be reduced by taking imatinib with food, dividing the dose, or using antiemetic medications. Muscle cramps may be alleviated with calcium and magnesium supplementation. The skin rash is usually a maculopapular rash that is manageable with antihistamines or topical steroids. A few patients may develop a desquamative rash that requires discontinuation of imatinib and steroid therapy. Hepatotoxicity occurs in less than 5% of patients at a median of 3 months from the onset of therapy. It is recommended that liver function tests be monitored every other week in the first month and monthly thereafter. Imatinib should be discontinued for significant elevations of aspartate aminotransferase or alanine aminotransferase and restarted at a reduced dose once the liver function tests have normalized. The dose may be increased if there is no further rise in the liver function tests. An evaluation for other causes of liver dysfunction should be undertaken, including viral studies, a serum ferritin, and an  $\alpha_1$ -antitrypsin level, and concurrent use of hepatotoxic drugs such as acetaminophen. Imatinib is metabolized by the CYP3A4/5 P-450 enzyme system. Thus, caution needs to be exercised when concurrent administration of drugs that affect or are affected by this system is used.

Drug resistance is associated with the reactivation of BCR-ABL signal transduction in all cases examined ([219](#), [220](#), [221](#), [222](#) and [223](#)). Resistance is associated with either a single amino acid substitution in the adenosine triphosphate-binding region of BCR-ABL or with progressive BCR-ABL gene amplification. *In vitro* studies have shown additive or synergistic activity of imatinib in combination with various cytotoxic agents, laying the groundwork for clinical studies using imatinib in combination with these agents ([224](#), [225](#)

and [226](#)).

## Other Drugs

*Homoharringtonine* (HHT) is a semisynthetic plant alkaloid. Phase II studies have shown activity in both chronic and more advanced phase CML. HHT has been used in combination with  $\alpha$ -interferon and ara-C with promising results. In one study of 47 patients, HHT in combination with  $\alpha$ -interferon produced a CHR rate of 85%, with major cytogenetic responses in 49% of patients and complete cytogenetic responses in 21% of patients. Myelosuppression was frequent but manageable ([227](#)). In a series of 100  $\alpha$ -interferon-resistant patients with chronic phase CML who received HHT and ara-C, the CHR rate in chronic phase was 72% and the cytogenetic response rate was 32% (major response, 15%; complete response, 5%). Toxicities were acceptable ([228](#)).

Decitabine, a hypomethylating agent, has been used to treat 31 patients with nonlymphoid blast crisis. The response rate was 26%, and the major toxicity was myelosuppression ([229](#)).

Polyethylene glycol interferon, a modified  $\alpha$ -interferon molecule that is covalently linked to polyethylene glycol, has a longer half-life than  $\alpha$ -interferon and can be administered once weekly. Based on the safety and tolerability profile in phase I studies, the dose of 6  $\mu\text{g}/\text{kg}/\text{week}$  was selected for further study in phase II and III trials. This dose has a safety profile that appears comparable with that associated with 3 to 5  $\text{MU}/\text{m}^2/\text{day}$  of  $\alpha$ -interferon. Of 27 patients, 13 (48%) who did not respond to  $\alpha$ -interferon therapy had either a CHR or improved cytogenetic response ([230](#), [231](#)).

Other tyrosine kinase inhibitors are under development. For example, a group of pyrido[2,3-d]pyrimidine src tyrosine kinase inhibitors has demonstrated profound inhibition of cell lines strictly dependent on BCR-ABL for growth as well as primary progenitor cells derived from patients with CML ([232](#)).

## Marrow Transplantation

First developed in the 1970s, allogeneic hematopoietic stem cell transplantation (HSCT) was initially characterized by poor overall survival because of several serious and fatal complications. These included organ toxicity from the cytoreductive regimen, acute and chronic graft-versus-host disease (GVHD), bacterial and fungal infections, cytomegalovirus infection, and disease relapse ([233](#), [234](#) and [235](#)). Currently, all of these issues are well studied and more effectively prevented or treated, resulting in better survival results. It is now estimated that patients younger than 50 years of age can expect more than a 50% likelihood of long-term disease-free survival after allogeneic HSCT performed in first chronic phase ([Fig. 84.6](#)). Individual centers present data demonstrating even better survival than in large-scale conglomerated series of patients ([236](#), [237](#), [238](#) and [239](#)).



**Figure 84.6.** Survival curves for chronic myeloid leukemia patients receiving HLA-compatible family transplants.

HSCT performed in blast phase is unsatisfactory, with survival of less than 10%. Intermediate long-term results with survival of 25 to 35% are reported for patients transplanted in accelerated phase or for those who enter a second chronic phase and then undergo transplantation. Variability in the results of transplantation for patients in accelerated phase may be caused by the difficulty of defining this phase and by patients with minimal evidence of transformation to accelerated phase such as those with minor additional chromosome abnormalities compared to those with overt manifestations ([76](#)).

Various clinical parameters influence the likelihood of long-term survival after allogeneic HSCT. Increasing patient age, increasing interval from diagnosis, prior BU therapy, and more advanced stage of disease negatively affect outcome ([179](#), [240](#), [241](#)). Cytomegalovirus serologic status of the patient has also been found to affect outcome in unrelated donors but not in sibling donors ([242](#), [243](#)). Neither hydroxyurea nor  $\alpha$ -interferon before allogeneic HSCT affects outcome ([244](#), [245](#)). In a retrospective analysis of 3142 patients treated with allogeneic HSCT for CML between 1989 and 1997 reported to the European Group for Blood and Marrow Transplantation, a risk score based on previously reported major pretransplant risk factors was developed ([242](#)). Histocompatibility, stage of disease at time of transplantation, age, sex of donor and recipient, and time from diagnosis to transplantation were found to be predictive variables ([Table 84.9](#)). Transplantation survival rates can exceed 70% and can be as low as 20% in patients with the best and worst prognostic features, respectively.

**TABLE 84.9.** Five-Year Probability of Leukemia-Free Survival, Transplant-Related Mortality, and Survival for Allogeneic Transplant Patients

| Risk Score <a href="#">a</a> | Leukemia-Free Survival (%) | Transplant-Related Mortality (%) | Survival (%) |
|------------------------------|----------------------------|----------------------------------|--------------|
| 0                            | 60                         | 20                               | 72           |
| 1                            | 60                         | 23                               | 70           |
| 2                            | 47                         | 31                               | 62           |
| 3                            | 37                         | 46                               | 48           |
| 4                            | 35                         | 51                               | 40           |
| 5                            | 19                         | 71                               | 18           |
| 6                            | 16                         | 73                               | 22           |

<sup>a</sup> The risk score was calculated as follows: (a) donor type: HLA-matched sibling = 0, matched unrelated donor = 1; (b) stage of disease: chronic phase = 0, accelerated phase = 1, blast crisis = 2; (c) age (yr): <20 = 0, 20–40 = 1, >40 = 2; (d) donor/recipient gender: other = 0, female donor/male recipient = 1; (e) interval from diagnosis to transplant: <12 mo = 0, >12 mo = 1.

Modified from Gratwohl A, Hermans J, Goldman JM, et al. Risk assessment for patients with chronic myeloid leukaemia before allogeneic blood or marrow transplantation. Chronic Leukemia Working Party of the European Group for Blood and Marrow Transplantation. *Lancet* 1998;352:1087–1092.

---

BU (16 mg/kg) with cyclophosphamide (120 mg/kg) is the most commonly used pretransplant cytoreductive regimen ( [246](#) ). Overall survival is similar and toxicity lower than for regimens that include total body irradiation ( [247](#) , [248](#) ). This is not true for acute leukemia, for which regimens containing total body irradiation appear superior ( [249](#) ). With the BU-cyclophosphamide regimen, virtually all patients enter a full molecular remission. Attempts to improve the cytotoxic regimen have yielded increased toxicity without better efficacy ( [250](#) ).

After HSCT, patients can be followed up by molecular evaluation of their marrow or peripheral blood for a rearranged BCR-ABL gene ( [251](#) , [252](#) and [253](#) ). Transient reemergence of rearranged BCR-ABL can be observed using sensitive fluorescence *in situ* hybridization or RT-PCR techniques. If the abnormality remains present or if quantitative evaluation indicates increasing amounts, relapse should be suspected ( [254](#) , [255](#) , [256](#) , [257](#) , [258](#) and [259](#) ).

Approximately 15 to 20% of allogeneically transplanted patients relapse with regrowth of host (recipient) cells. Patients experiencing GVHD have a lower rate of relapse than similar patients without GVHD. This phenomenon, known as the *graft-versus-leukemia reaction*, is best described in syngeneic HSCT, in which relapse is considerably higher than in allogeneic HSCT ( [260](#) , [261](#) ). Syngeneic HSCT eliminates the contribution of autologous reinfusion of malignant cells, eliminating all other parameters except GVHD. A few intriguing cases of relapse in donor cells have been noted, with implications for the pathogenesis and acquisition of the disease ( [262](#) , [263](#) ).

CML relapse after allogeneic HSCT can be reversed with discontinuation of GVHD therapy, treatment with  $\alpha$ -interferon, performance of a second marrow transplant, or infusion of donor-derived leukocytes ( [264](#) , [265](#) , [266](#) , [267](#) , [268](#) and [269](#) ). These approaches augment the immune mechanism of graft-versus-leukemia and may cause flaring of GVHD and marrow aplasia ( [270](#) , [271](#) ). Recent observations suggest that reinfusion of donor lymphocytes without additional cytotoxic treatment is the best method to combat relapse, with more than 75% of patients with chronic phase relapse reentering molecular remission ( [272](#) , [273](#) , [274](#) , [275](#) , [276](#) , [277](#) , [278](#) , [279](#) , [280](#) , [281](#) and [282](#) ). The estimated dosage of reinfused T cells needed to control relapse is approximately  $5 \times 10^7$  cells/kg. This dosage may reduce the risk of severe GVHD and still maintain the graft-versus-leukemia effect ( [283](#) , [284](#) ). Lower dosages may be less effective, and higher dosages cause more GVHD.

Adverse effects of donor lymphocyte infusion are marrow aplasia and GVHD ( [285](#) ). Marrow aplasia is more common when recipient cells (as opposed to donor cells) are the predominant source of hematopoiesis. The addition of  $\alpha$ -interferon or interleukin-2 after donor leukocyte infusion has not been shown to conclusively affect remission ( [261](#) , [286](#) ).



Results from infusion of donor lymphocytes are better during molecular or cytogenetic relapse than in overt relapse and are substantially inferior for advanced disease ( 287 ). Current strategies to improve results of donor lymphocyte infusion have concentrated on decreasing the risk of GVHD after infusion. These strategies include selective depletion of lymphocyte subsets ( 288 , 289 ), incremental doses of donor lymphocyte infusions ( 290 ), and gene modification of donor lymphocytes ( 291 , 292 ). The advanced disease group is the only subset in which second marrow transplantation (as opposed to infusion of donor leukocytes) should be initially considered, yielding a survival rate of approximately 25% ( 293 ). Imatinib has been used in patients with CML who have relapsed after both autologous ( 294 ) and allogeneic HSCT ( 295 ). Response rates, both hematologic and cytogenetic, are high, especially in patients with chronic phase relapse.

GVHD remains the most problematic complication after allogeneic HSCT ( 233 ). The usual practice to prevent GVHD is posttransplant immunosuppression with two agents such as cyclosporine and methotrexate ( 296 ). Other agents, such as tacrolimus, methylprednisolone, antithymocyte globulin, monoclonal T-cell antibodies, and photoactive therapy, can also be used ( 297 ). Despite prophylaxis, 40 to 50% of patients receiving matched-sibling HSCT still develop GVHD, with 10% of cases being severe, leading to patient death. Efforts to reduce GVHD have been attempted but, unfortunately, have generally caused concomitant deleterious effects on relapse by reducing the graft-versus-leukemia reaction ( 298 , 299 ). This sequence of events is best demonstrated with *ex vivo* T-cell depletion of the donor marrow, which leads to an increase in lymphocyte chimerism and residual leukemia ( 300 , 301 ). Although reducing overall morbidity and virtually eliminating severe GVHD, potent T-cell depletion causes a marked increase in CML relapse (50% or more), resulting in inferior overall survival. Modification of T-cell depletion with partial depletion, increased pre- and posttransplant immunosuppression, and periodic donor leukocyte or T-cell reinfusion is currently under investigation ( 302 ).

Unfortunately, only approximately 25% of patients have siblings who are genotypic matched donors, defined by identical inheritance on chromosome 6 of the major histocompatible complex. Typing between donor and recipient, now performed by serologic and DNA-based methods, routinely reports on alleles at both the A and B loci (class I) and the DR locus (class II). Thus, a *full sibling match* is defined as a six-antigen match. Siblings and extended family members having fewer than six matched antigens can serve as donors. Survival using minimally disparate (phenotypic six-antigen and five-antigen) matches may not be significantly different from that of genotypic matched donors, although the rate of allogeneic complications increases ( 303 , 304 and 305 ). These complications include graft rejection, failure of sustained marrow regeneration, and severe GVHD ( 306 ). Thus, in the absence of a sibling match, evaluation of the extended family should be pursued, especially if patient antigens are duplicated or one haplotype is uncommon and the other very common. Donors who are more disparate (less than a five-antigen match) are not routinely used. Haploidentical (three antigens matched) transplants are presently under investigation using a combination of more intense cytoreductive therapy and limited *ex vivo* T-cell depletion followed by long-term immunosuppression ( 307 , 308 ).

Transplantation using matched unrelated donors, fostered by the National Marrow Donor Program and other large national donor centers, is an alternative for patients without suitable matched related donors. Initial reports described results that were inferior to fully matched sibling donor HSCT ( 309 , 310 , 311 , 312 and 313 ). Increasing age of the patient and donor and increasing duration of chronic phase all reduced survival ( 314 , 315 and 316 ). Because of substantial GVHD, *ex vivo* T-cell depletion for unrelated HSCT may result in



satisfactory outcome ( [302](#) ). In the initial reports, donors were selected by serologic determination of HLA antigens ( [316](#) , [317](#) ). It is now known that DNA methods are more precise in determining DR, other class II antigens, and, more recently, class I antigens. Using donors selected by DNA methodology for class II HLA yielded results not dissimilar to those of similarly matched related donor HSCT ( [318](#) ). Further improved survival is likely with DNA-based methods to select class I as well as class II HLA combined with matching for other loci such as C, DP, and DQ ( [319](#) , [320](#) ). Despite these results, matched unrelated donor transplants are still associated with substantial allogeneic complications, especially GVHD and prolonged and pronounced immunodeficiency, limiting applicability to patients younger than 40 years old ( [321](#) , [322](#) ). Improved results and wider applicability will require more effective methods of prophylaxis and treatment of GVHD and of augmenting immune reconstitution.

With the current size of the pool of volunteer donors, approximately 75% of white patients can locate a suitable matched volunteer donor ( [323](#) ). Patients belonging to minority ethnic groups have lower rates of success in locating a fully matched donor. Blacks, because of their greater prevalence of uncommon HLA, have a success rate of finding matched donors one-half that of American whites. The success of finding donors for minority groups will be improved only by a substantial increase in their donor pool.

Peripheral blood stem cell transplantation (PBSCT) has emerged as an alternative to BMT. Nearly all studies have indicated faster engraftment and earlier hematopoietic recovery with PBSCT than with BMT ( [324](#) , [325](#) and [326](#) ). In some studies, the incidence of clinical extensive chronic GVHD in allogeneic recipients was higher with PBSCT than with BMT ( [327](#) , [328](#) ), but others have not confirmed these findings ( [324](#) , [329](#) ). Some studies have found improved overall survival using PBSCT ( [330](#) , [331](#) ), although this is not universal ( [329](#) ). Cord blood is a rich source of hematopoietic stem cells and has been used in allogeneic marrow transplantation ( [332](#) ). Most experience with cord blood cell transplantation has been limited to children ( [333](#) ), but recent reports have extended its promise to adults ( [334](#) , [335](#) and [336](#) ). Preliminary results suggest that GVHD may be much less common and less severe, thus permitting the use of more disparate donors ( [336](#) ). If true, this form of transplantation could extend allogeneic applicability to even more patients, especially those belonging to minority ethnic groups.

Much experience has been gained with nonmyeloablative HSCT, and the biology, indications, and limitations are becoming clearer ( [337](#) , [338](#) , [339](#) , [340](#) and [341](#) ). Nonmyeloablative conditioning allows consistent engraftment of allografts from matched related, matched unrelated, and even partially matched donors. Nonmyeloablative HSCT has been able to reduce the toxicity of allogeneic HSCT. A number of studies have reported remissions, including molecular remissions, in a significant number of patients. The major toxicity continues to be GVHD. This therapy is usually reserved for patients over the age of 60 years or younger patients with severe comorbidities.

It is well established that normal cells reside in CML marrow but are displaced by the proliferative abnormal cells ( [342](#) , [343](#) and [344](#) ). After intense cytotoxic therapy, the kinetics of recovery of hematopoiesis indicate that normal cells may proliferate faster than leukemic cells. Normal hematopoietic progenitor and stem cells are noted in the circulation during the early phase of count recovery after intense chemotherapy ( [345](#) , [346](#) ). Collection of these *in vivo* purged marrow cells by either marrow aspiration or leukapheresis can, depending on the timing of collection, result in a large quantity of presumed normal stem cells ( [347](#) ). Mobilization of Ph(-) stem cells can be obtained in a significant percentage of patients in early chronic phase CML ( [348](#) ), and a number of

patients can become Ph(-) after subsequent autologous HSCT ( 349, 350 ). However, genetic marking of the autologous hemopoietic stem cells has revealed that Ph(+) cells present in the autograft can contribute to relapse of CML ( 351 ). There are little long-term data on the results with autologous HSCT, and its role in the treatment of CML is not defined. Although potentially applicable to an older group of patients, the use of autologous HSCT remains an unproven therapeutic intervention that should be limited to well-designed studies for patients who are too old for allogeneic HSCT or those who do not have suitable HLA-compatible family or unrelated marrow donors.

Allogeneic HSCT in advanced stages of CML is far less successful than in the first chronic phase. Although patients can be cured in the blast phase, the 10% long-term survival suggests that transplantation should be performed before transformation. The results in accelerated phase are intermediate between chronic phase and blast phase but are significantly inferior to the former. Patients (predominantly with lymphoid phenotype) evolving into blast phase but reverting into a second chronic phase with chemotherapy can undergo allogeneic HSCT with results similar to those in the accelerated phase. Other forms of transplantation using autologous collected stem cells have not been proven to be beneficial when performed during advanced stages of CML.

In summary, allogeneic HSCT results in a 50 to 70% leukemia-free survival in a selected group of patients with chronic phase CML. This modality of therapy continues to improve with respect to diminishing toxicity. At the present time, allogeneic HSCT is the only treatment modality that produces a long-term leukemia-free survival in a significant number of patients. The role of allogeneic HSCT in CML is discussed below.

## **APPROACH TO A NEWLY DIAGNOSED PATIENT WITH CHRONIC MYELOID LEUKEMIA**

The treatment of CML has become more complex, with many options for individual patients ( 352, 353 ). Furthermore, as new therapies emerge and established therapies improve, it may become increasingly difficult to counsel newly diagnosed patients in a rapidly changing field. The treatment paradigm at the present time is whether or not to recommend transplantation to a patient. It is also conceivable that transplantation and conventional therapies may become complementary treatments in the future, rather than the "either/or" decision that patients are often faced with today. The analyses comparing transplant to nontransplant therapies are hampered not only by the limitations of the studies comparing  $\alpha$ -interferon to transplantation but also because of the (presumed) dramatically improved nontransplant therapies available with the advent of imatinib. Currently, there are no long-term data with imatinib. Based on preliminary results, at the very least, the hematologic and cytogenetic responses compare favorably with  $\alpha$ -interferon-based therapy ( 218 ). Although the relationship between a cytogenetic response and prognosis is well established with  $\alpha$ -interferon, one cannot automatically assume that this relationship will be true with imatinib. However, if hematologic and cytogenetic responses to imatinib are found to be durable, it may be reasonable to first treat every new patient with imatinib-based therapy. Patients in the appropriate age group in whom this therapy fails and who have an HLA-matched sibling or unrelated donor could subsequently be offered allogeneic HSCT. This approach has the advantage of avoiding the early mortality associated with allogeneic HSCT. There are no data to suggest that imatinib could adversely affect the outcome of allogeneic HSCT. However, it is conceivable that patients who do not respond adequately or who relapse after treatment with imatinib will inherently be a cohort of patients with a worse prognosis and, thus, have poorer transplantation outcomes. Given that one of the variables associated with improved outcome for allogeneic HSCT is transplantation within the first year, the above approach may reduce the chance of cure in patients who might otherwise have been offered transplantation early. Thus, another approach is to identify a subset of

patients for whom upfront transplantation could be recommended. This would be based on the presumptions that this cohort of patients has a low mortality with transplantation and that this risk is outweighed by the risk of delaying this potentially curative treatment. Given the data comparing  $\alpha$ -interferon with allogeneic HSCT, it seems reasonable to consider allogeneic HSCT for younger patients (<35–40 years) with an HLA-identical sibling donor and a high-risk Sokal or Hasford score. Despite the approximately 20% transplant-related mortality, transplantation seems to afford a significant survival benefit for this group compared to  $\alpha$ -interferon. For patients with a matched unrelated donor, the age group cut-off may be decreased by approximately 10 years (<25–30 years). Similarly, for patients with a low-risk Sokal or Hasford score, a similar adjustment may be considered. Clearly, this decision will ultimately need to be made by patients after careful and deliberate counseling by their physicians. Patients who present with accelerated phase or blast crisis should be treated initially with imatinib at the higher dose of 600 mg/day, and suitable patients should be referred for an allogeneic HSCT.

## WEB SITES

For calculations using the Sokal score, go to <http://www.nrhg.ncl.ac.uk/cgi-bin/cml/sokal.pl>

For calculations using the Hasford score, go to <http://www.pharmacoepi.de/cmlscore.html>

2004 Lippincott Williams & Wilkins  
John P. Greer, John Foerster, John N. Lukens  
George M. Rodgers, Frixos Paraskevas, Bertil Glader  
Wintrobe's Clinical Hematology

[DEFINITION AND HISTORY](#)[EPIDEMIOLOGY](#)[CLINICAL FEATURES](#)[Skin and Mucous Membranes](#)[Cardiovascular System](#)[Gastrointestinal System](#)[Splenomegaly](#)[Respiratory System](#)[Genitourinary System](#)[Neuromuscular System](#)[BLOOD AND LABORATORY FINDINGS](#)[Hematologic Findings](#)[Other Laboratory Findings](#)[Bone Marrow](#)[Cytogenetics](#)[PATHOGENESIS](#)[Clonality](#)[Hematopoietic Progenitor Studies](#)[Hematopoietic Growth Factor Signal Transduction](#)[DIAGNOSIS](#)[NATURAL HISTORY](#)[TREATMENT](#)[Phlebotomy](#)[Phlebotomy and Antiplatelet Agents](#)[Chemotherapy](#)[Other Modalities](#)[Special Topics](#)[Summary and Recommendations for Treatment](#)[REFERENCES](#)

## DEFINITION AND HISTORY

Polycythemia vera (PV), also commonly called *polycythemia rubra vera*, is a chronic, clonal, myeloproliferative disorder characterized by a striking, absolute increase in the number of red blood corpuscles and in the total blood volume, and usually by leukocytosis, thrombocytosis, and splenomegaly. The bone marrow is typically hypercellular and exhibits hyperplasia of myeloid, erythroid, and megakaryocyte lineages.

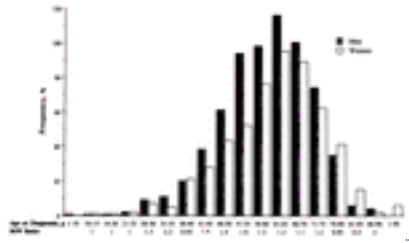
In 1892, Vaquez described persistent polycythemia, as distinguished from relative and transient forms, in a man whom he believed to have a congenital cardiac lesion even though no auscultatory signs were noted. At autopsy, 1 year after the patient was first examined, his heart was found to be normal (<sup>1</sup>). In 1903 and 1908, Osler further clarified the clinical picture of the disease (<sup>2</sup>) and Türk, in 1904, called attention to the occurrence of leukocytosis as well as to immature forms of cells of the red and white series, suggesting a hyperplastic disorder of blood formation involving the marrow as a tissue and not merely erythrocytes (<sup>3</sup>). Thus, the general clinical picture of the disease

was established in the earliest publications.

Synonyms less commonly used for PV include erythremia, splenomegalic polycythemia, Vaquez disease, Osler disease, polycythemia with chronic cyanosis, myelopathic polycythemia, erythrocytosis megalosplenica, and cryptogenic polycythemia.

## EPIDEMIOLOGY

The age- and sex-adjusted incidence rate of PV was 1.9 per 100,000 person years in Olmstead County, Minnesota during the years 1935 to 1989 (4), and 2.6 per 100,000 person years in Malmo, Sweden during 1980 to 1984. PV appears to be somewhat more common in men than in women, with reported male to female ratios ranging from 1.2 to 2.2 in various studies (4, 6, 7 and 8). PV in younger patients reportedly shows less of a male predominance (8). Some (5) but not all (4) studies have suggested that the incidence of PV is increasing with time. The frequency of PV according to age and sex is shown in Figure 85.1.



**Figure 85.1.** Frequency of diagnosis of polycythemia vera according to age and sex. Age at diagnosis of polycythemia vera for 671 men (55%) and 542 women (45%). M/W, ratio of men to women for diagnosis of polycythemia vera in each 5-year group. (From Gruppo Italiano Studio Policitemia. Polycythemia vera: the natural history of 1213 patients followed for 20 years. *Ann Intern Med* 1995;123:656–664, with permission.)

PV tends to be a disease of older individuals, with peak incidence observed at 60 to 80 years of age (6, 8), with maximum incidence exceeding 20 per 100,000 person years (4). The mean age at diagnosis has increased steadily since the 1920s (6, 9, 10, 11 and 12). Cases of PV have also been reported in patients younger than the age of 40 years (13, 14).

Racial and ethnic factors influence the incidence of PV. PV is significantly less common in blacks than in whites (7, 10, 15). In contrast, PV is more common in individuals of Jewish origin (an observation originally made by Türk) than in individuals not of Jewish origin (7, 10, 16, 17 and 18). Ashkenazi Jews in Northern Israel exhibit a higher incidence of PV than do their neighbors of Arab or Sephardic Jewish origins (18).

Familial occurrence of PV has been reported by 6% of patients enrolled in the protocols of the Polycythemia Vera Study Group and in intermittent sporadic cases (19, 20 and 21). It was previously claimed that PV affected primarily those of slender body habitus, but there is little evidence to support this statement (10).

## CLINICAL FEATURES

The symptoms and signs of PV can be attributed in large part to the expanded total blood volume and to the slowing of the blood flow as a result of increased blood viscosity, as discussed in [Chapter 50](#). It is evident from the history in most cases that the disorder probably has been present for a long time. Patients may complain of headache, dizziness, tinnitus, visual disturbances, dyspnea, lassitude, or weakness. Although the color of the skin often is acknowledged to have been abnormal for a long time, this complaint alone rarely brings the patient to the physician. Skin and mucous membrane hemorrhages are not uncommon; these, or a sense of weight or swelling in the abdomen owing to enlargement of the spleen, may be the initial symptoms. The lack of specificity of symptoms may in fact contribute to the delay in diagnosis. On the other hand, some patients have no complaints whatever, the polycythemia being discovered incidentally. [Table 85.1](#) lists the frequency of common symptoms and physical findings in patients with PV.

**TABLE 85.1. Physical Findings and Symptoms in Polycythemia Vera**

| Physical Findings                   | Frequency (%) |
|-------------------------------------|---------------|
| Splenomegaly                        | 70            |
| Skin plethora                       | 67            |
| Conjunctival plethora               | 59            |
| Engorged vessels in the optic fluid | 46            |
| Hepatomegaly                        | 40            |
| Systolic blood pressure >140 mm Hg  | 72            |
| Diastolic blood pressure >90 mm Hg  | 32            |
| Symptoms                            |               |
| Headache                            | 48            |
| Weakness                            | 47            |
| Pruritus                            | 43            |
| Dizziness                           | 43            |
| Diaphoresis                         | 33            |
| Visual disturbances                 | 31            |
| Weight loss                         | 29            |
| Paresthesias                        | 29            |
| Dyspnea                             | 26            |
| Joint symptoms                      | 26            |
| Epigastric discomfort               | 24            |

Data from Berlin NI. Diagnosis and classification of the polycythemias. *Semin Haematol* 1975;12:339–351.

### Skin and Mucous Membranes

The color of the face is not cyanotic but is rather “ruddy,” as might be produced by severe sunburn or a profound blush. The face also often appears swollen. This “rubor” may be so intense that it produces a startling appearance. The face, particularly the lips,

cheeks, tip of the nose, ears, and neck, show this color ( [Fig. 85.2](#)), but the skin of the trunk usually is not particularly affected. The distal portions of the extremities exhibit these changes more than the proximal portions and may be more truly cyanotic. The skin capillaries are distended, and the capillary loops are enlarged. The degree of red or blue coloration depends on the state of dilation of the peripheral vascular network and on the speed of circulation through these areas, because these factors determine the quantity of reduced hemoglobin present ( [22](#)). These findings are not unique to PV, but are also observed in patients with an elevated hematocrit from secondary erythrocytosis.



**Figure 85.2.** Photograph of a drawing (original in color) of one of Osler’s original patients.

Echymoses of various sizes are common as the disease progresses. Red or dark-violet spots or brownish pigmentation of the skin may be found, and a great variety of skin lesions ( [23](#), [24](#)) have been observed, including dry skin, eczema, acneiform or urticarial changes, acne rosacea, acne urticata ( [25](#)), urticaria pigmentosa ( [26](#)), and even a nodular eruption resembling leukemia cutis ( [27](#)). Purpura were observed in 13 of 163 PV patients in one series ( [28](#)). The eyes may appear bloodshot. The mucous membranes may be a deep raspberry-red, and epistaxis and/or gingival bleeding may occur.

A common complaint is intense itching after exposure to water (most typically in a bath or shower)—the so-called “aquagenic pruritus.” This may be the initial presentation of PV and is reported in up to 60% of PV patients younger than the age of 40 years ( [14](#), [29](#)). The itching may be so troublesome that bathing with hot or even warm water is avoided. The reaction is less frequent after the use of cold water. This complaint tends to disappear as the polycythemia is treated, but may require specific intervention. Reddening, swelling, and pain in the digits (erythromelalgia) may occur and are typically associated with extreme platelet elevations ( [30](#), [31](#)).

### Cardiovascular System

Cardiac symptoms are not particularly prominent, and cardiac hypertrophy is typically absent. The circulatory minute volume is reduced, and the velocity of blood flow is greatly lowered ( [32](#)), but the cardiac output and work are normal ( [33](#), [34](#)). When echocardiographic abnormalities are observed, they are typically associated with previous



thromboembolic events and consequent pulmonary hypertension ( 35 ). Whether PV increases the risk for myocardial infarction is unclear, because PV occurs in the population generally considered to be at highest risk for this disorder. Increased blood viscosity related to polycythemia, however, may contribute to symptoms in patients with atherosclerotic cardiovascular disease ( 36 , 37 ). Thrombotic events, in both the arterial and venous circulations, are common in patients with PV. Nineteen percent of the 1213 patients followed by the Gruppo Italiano Studio Policitemia experienced a thrombotic event. Of these, 50.5% of nonfatal thrombotic events occurred in the arterial circulation and 38.5% in the venous circulation; insufficient data were available to allow a determination to be made in the remaining 11%. More than 80% of fatal thromboses were arterial ( 8 ). Other abnormalities of the venous system include varicosities and phlebitis ( 38 ). Moderate or significant thickening of the peripheral arteries is found in patients with PV, and coronary thrombosis, claudication without occlusion, arterial occlusion with gangrene, acroparesthesia, Raynaud phenomenon, and thromboangiitis obliterans have been described ( 30 ).

As noted in [Table 85.1](#) and in other studies ( 39 , 40 ), hypertension is relatively common in patients with PV. It is unclear whether this reflects the increased incidence of hypertension in the middle aged and elderly or is a consequence of increased blood viscosity. Certainly, improvement of blood viscosity by reduction of the red cell volume aids in the control of blood pressure ( 40 ).

### Gastrointestinal System

In addition to nonspecific gastrointestinal symptoms experienced by everyone at some time, such as feelings of fullness, thirst, gas pains, and constipation, patients with PV have an increased frequency of peptic ulcer, gastrointestinal bleeding, or thrombosis of mesenteric vessels. Duodenal ulcer has been found in as many as 8% of patients with PV, almost four times more than in a control series ( 41 ). In another series of 125 patients, duodenal ulcer was found in 16% of patients, and gastric ulcer was found in 7% ( 42 ). It has been suggested that these ulcers follow thrombosis in the vessels of the first part of the duodenum and are produced by digestion of the area of local necrosis ( 43 ). The relationship of blood basophil concentration, histamine content, gastric acid secretion, and dyspepsia on peptic ulceration has also been examined in a small group of patients with PV ( 44 , 45 ). No convincing correlations were demonstrated. The relationship between PV and *Helicobacter pylori* infection has not been explored.

Massive hemorrhage from varices in the esophagus, stomach, or bowel may be observed ( 46 ). Thrombosis in the mesenteric veins and arteries may be mistaken for peritonitis or the perforation of an ulcer. Hepatomegaly is common ( [Table 85.1](#) ), and cirrhosis has also been reported ( 47 ). *Mosse syndrome* is a term applied by some to the coexistence of cirrhosis and PV ( 48 ). Budd–Chiari syndrome has also been reported ( 49 , 50 and 51 ).

### Splenomegaly

Clinically appreciable splenomegaly occurs in more than two-thirds of PV patients ( [Table 85.1](#) ) ( 9 , 12 ). The size of the spleen varies greatly in individual patients and occasionally may extend to the pelvic brim ( 39 ). It is usually hard and smooth. Patients may experience pain in the splenic region, and after infarction a friction rub can be heard in this area. The general assumption is that polycythemia antedates the enlargement of the spleen and that engorgement of this organ with blood and extramedullary hematopoiesis

are the major contributors to splenomegaly.

## Respiratory System

Dyspnea on severe exertion is common, and hoarseness is not unusual. Chest radiographs often reveal prominent vascular markings. Before the establishment of the Polycythemia Vera Study Group diagnostic criteria, which require a reasonably normal arterial oxygen saturation for the diagnosis of PV, it was noted that the vast majority of patients with PV had normal arterial oxygen saturation, even when the hemoglobin levels were high, indicating that the high viscosity of the blood does not prevent normal blood oxygenation; oxygen dissociation studies were also normal ( [52](#), [53](#) and [54](#) ). High diffusing capacities, which were reduced after phlebotomy, were also noted in a number of patients with PV ( [55](#) ). In another study, hypoxia, as evidenced by a low arterial oxygen tension and saturation, was observed in the absence of demonstrable coexistent cardiorespiratory disease ( [56](#) ). In these individuals, ventilation-perfusion ratios were altered, and the diffusing capacity was low. The authors postulated that these findings might be the result of an alteration of the pulmonary vasculature caused by unrecognized thromboembolism. They were probably correct in this assumption. Pulmonary hypertension is reported in patients with PV and other myeloproliferative disorders ( [35](#), [57](#) ).

## Genitourinary System

Vesical, vaginal, and uterine bleeding have been reported, as has nontraumatic perirenal hematoma ( [58](#) ). When hypertension is noted, albuminuria and signs of renal disease may be found.

## Neuromuscular System

Headache is the most common neurologic symptom ( [59](#) ), but lassitude, vertigo and giddiness, transitory syncope, insomnia, weakness, and a sensation of fullness in the head and numbness and tingling in the fingers (less often in the feet) are common.

Visual disturbances are common and include transitory dimness of vision, or even temporary blindness, scotomas, specks and bright points in front of the field of vision, diplopia, and temporary paralysis of one of the eye muscles. On examination of the eye grounds, the vessels may be engorged, tortuous, and irregular in diameter; the veins may be dark purple, and the retina deeply colored. Papilledema and embolism of the central retinal artery have been reported ( [60](#) ).

The cerebrospinal fluid pressure may be increased ( [24](#) ). Ringing and roaring in the ears are exceedingly common when the hematocrit is significantly elevated. Ménière syndrome has also been reported.

Vascular lesions of the brain constitute the most serious complication of PV. A variety of neurologic syndromes, ranging from hemiparesis to seizures to alteration of cerebral function, have been reported in patients with PV. All such symptoms and signs presumably are secondary to increased blood volume and/or decreased blood flow. Investigators have shown clearly that cerebral blood flow is greatly diminished at hematocrit levels between 0.53 and 0.62 ( [61](#) ), and that elevated hematocrit is a risk factor for cerebrovascular accidents ( [62](#), [63](#) ). Central nervous system vascular events represented 30% of the nonfatal thrombotic events observed in the Gruppo Italiano Study,

and 10.3% of deaths ( [63](#) ).

Pain in the limbs may be troublesome and severe. It has been attributed to pressure on the bone by swollen, hyperplastic bone marrow. Unusual paresthesias may be encountered, but anatomic evidence of spinal cord changes has not typically been found at autopsy.

## BLOOD AND LABORATORY FINDINGS

### Hematologic Findings

**ERYTHROCYTES** Hemoglobin concentration typically is in the range of 18 to 24 g/dl. Red cell counts of  $7$  to  $10 \times 10^{12}/L$  are common when patients with this disease are first evaluated, and values as high as 12 and even  $15 \times 10^{12}/L$  have been recorded ( [64](#) ). The highest hematocrit recorded is 0.92 in a patient with PV in whom the red cell count was  $10.37 \times 10^{12}/L$  ( [65](#) ). The individual erythrocytes usually appear normal. Slight anisocytosis may be evident, but poikilocytosis is unusual. Polychromatophilia and, occasionally, basophilic stippling may be found. An occasional normoblast may be observed in the blood smear and such a finding, in the presence of a relatively normal or definitely increased red cell count, should arouse suspicion of PV. The reticulocyte count, in percent, is not significantly increased. After hemorrhage, however, the reticulocytes may be increased, and a number of other immature forms of the red cell series may be encountered. If bleeding occurs repeatedly, iron-deficient erythropoiesis may develop. This raises an interesting semantic point: these patients are iron deficient in that iron stores are absent, but the total body iron content, including the iron present as hemoglobin in red cells, may be normal. Increased resistance to osmotic lysis has been reported for PV erythrocytes ( [66](#) , [67](#) ).

**LEUKOCYTES** Leukocyte counts of  $25.0 \times 10^9/L$  are not uncommon ( [68](#) ), and values above  $50.0 \times 10^9/L$  have been reported ( [69](#) , [70](#) ). The myeloid leukocytes are both relatively and absolutely increased, metamyelocytes are increased in number, and 1 or 2% of myelocytes, sometimes more, are found. Myeloblasts usually are not observed. Basophil, eosinophil, or monocyte concentrations may be increased and provide a marker of an underlying myeloproliferative disorder. Leukocytes from patients with PV exhibit increased metabolic activity ( [71](#) ). Neither Vaquez nor Osler appreciated the significance of the moderate or even marked leukocytosis, together with a “shift to the left” in the myeloid series of leukocytes, that often is present in this disease initially named after them. Türk, in 1904, called attention to this significant finding, which suggested that the whole bone marrow, rather than the erythropoietic tissue alone, was hyperactive. The leukocyte counts were greater than  $10.0 \times 10^9/L$  in 50% of Osler’s patients and greater than  $12.0 \times 10^9/L$  in 43% of the 325 Polycythemia Vera Study Group patients ( [32](#) ). In another series of 127 patients, the white cell count was elevated in 84% of patients ( [45](#) ).

**PLATELETS** The platelet count frequently is increased, usually in the  $500$  to  $1000 \times 10^9/L$  range, but counts as high as 3000 and even  $6000 \times 10^9/L$  have been reported ( [72](#) ). Bleeding time and conventional coagulation parameters usually are normal, but the clot may retract poorly. An artefactual elevation of protime and activated partial thromboplastin time may be observed in patients with erythrocytosis. The standard citrated tube used for coagulation studies contains a fixed quantity of anticoagulant for a fixed volume of blood. In polycythemia, there is a relative reduction of plasma, meaning that there will be excess anticoagulant for the volume of plasma. Functional assays of coagulation factors will thus be prolonged. This prolongation has no clinical significance, other than provoking panic on the part of the individual reviewing the laboratory results. The leukocyte and platelet counts are not always increased above normal in patients with

otherwise typical disease. Such normal values were found in 20% of the patients in one series ( [12](#) ). Morphologic and qualitative functional platelet abnormalities often are detectable. Platelets may appear to be abnormally large, and even bizarre shaped, and megakaryocyte fragments sometimes are seen in the blood smear. The hemorrhagic complications of this disease suggest that a hemostatic defect may be present, although physical distention of the vascular bed undoubtedly contributes to bleeding when it occurs. Platelet function defects reported in PV include shortened platelet survival in patients with erythromelalgia ( [73](#) ), altered von Willebrand factor multimers ( [74](#) ), deficient platelet-aggregating factor-induced aggregation ( [75](#) ), increased platelet thromboxane production ( [76](#) ), and platelet factor 3 deficiency ( [77](#) ). Plasminogen activator inhibitor-1 levels have been reported to be both elevated ( [78](#) ) or decreased ( [79](#) ) in patients with PV. Platelet glycoprotein IIIa expression has also been reported to be decreased in PV patients ( [80](#) ).

**TOTAL BLOOD VOLUME** The total blood volume characteristically is increased. The enormous increase in blood volume, which distends even the smaller vessels of the whole body, no doubt accounts for many of the symptoms of this disease. In a group of 30 patients in whom the hematocrit was 0.55 or greater, the total red cell volume, measured by the radioactive phosphorus (  $^{32}\text{P}$  )-labeled red cell method, was 38.8 to 91.9 ml/kg body weight as compared with the normal average of 29.9 ml/kg ( [81](#) ). In two-thirds of this patient group, the plasma volumes were below the lower limits of normal, and in none was the plasma volume above normal. Similar observations have been made using the chromium isotope method ( [6](#), [12](#) ). Because of variations in plasma volume, the packed cell volume (or hematocrit) gives only a rough indication of the size of the red cell mass.

**ERYTHROCYTE KINETICS** Erythrokinetic studies have shown active hemoglobin production, but otherwise, findings have been diverse. Erythrocyte survival may be normal ( [72](#) ) or shortened ( [82](#) ), and splenic sequestration may or may not be present. As measured by the 15 N-glycine method, the rate of hemoglobin production was approximately two times the normal rate. The plasma iron turnover rate was also increased ( [83](#) ). This value was not reduced to normal by oxygen administration, as occurs when polycythemia is caused by anoxia. Increased serum bilirubin ( [65](#), [67](#) ) and increased urine and stool urobilinogen ( [84](#) ) levels have been demonstrated in some patients with PV, but when allowance is made for the increase in the total amount of hemoglobin that must be degraded, fecal urobilinogen values rarely are increased above expected values and may, in fact, be somewhat reduced.

**NEUTROPHIL KINETICS** Studies of neutrophil kinetics in patients with PV in whom neutrophil counts ranged from normal to  $23.9 \times 10^9/\text{L}$  showed a blood neutrophil pool that ranged from normal to 12 times normal, with increased margination and a normal or slightly prolonged half disappearance time. The blood neutrophil turnover rate (effective neutrophil production) usually was increased and varied from normal to five times normal mean values ( [85](#) ). Increased polymorphonuclear leukocyte activation is also observed in PV patients, and is associated with evidence of endothelial damage ( [86](#) ).

**PLATELET KINETICS** Studies of platelet kinetics in five patients with PV in whom the platelet concentration was increased revealed effective production rates that ranged from 2 to 13 times normal. The marrow megakaryocyte mass was increased in all five patients studied ( [87](#) ).

**FIBRINOGEN TURNOVER** Results of studies involving three patients with erythremia indicated that fibrinogen was consumed in the course of chronic disseminated intravascular coagulation ( [88](#) ); similar findings were observed in several patients with erythrocytosis secondary to pulmonary insufficiency. No correlations between fibrinolytic parameters and thrombotic complications of PV has been reported ( [89](#) ).

## Other Laboratory Findings

The viscosity of the blood may be five to eight times greater than normal ( [65](#), [90](#) ). The specific gravity is 1.075 to 1.080, compared with the normal range of 1.055 to 1.065. The degree of abnormality varies with the relative quantity of red corpuscles. The viscosity and specific gravity of the serum were actually less than normal ( [91](#) ). The erythrocyte sedimentation rate of polycythemic blood is significantly increased. The urine may be normal, but albuminuria is found occasionally, and, less often, casts are present ( [68](#) ). The increased urobilinogenuria noted in some of the patients has been mentioned. Studies of renal hemodynamics suggested that glomerular filtration, despite the decreased fraction of plasma in the blood, is kept at almost normal values by an increase in renal blood flow and in the proportion of plasma filtered ( [92](#) ). The amount of uric acid in the serum may be normal or increased. Hyperuricemia was present in 70% of 127 patients in one series ( [45](#) ) and in 55% of 325 patients ( [6](#) ) in another series. Values ranged from 2.8 to 11.7 mg/dl (average, 6.6 mg) ( [68](#) ). Secondary gout occurs in 5% ( [10](#), [12](#) ) or more of these patients ( [12](#), [42](#), [45](#), [93](#) ), and symptoms often are atypical ( [64](#) ). The occurrence of hyperuricemia in association with PV is attributable to overproduction of uric acid ( [94](#), [95](#) ). A vitamin B<sub>12</sub>-binding protein, which may be an altered form ( [96](#) ) of transcobalamin I ( [Chapter 32](#) ), has been found in the plasma of patients with PV ( [97](#) ) and in a variety of conditions involving leukocytosis ( [96](#) ). The presence of this protein may explain the observation that, whereas serum B<sub>12</sub> content may be within the normal range or only moderately elevated, the capacity of the serum to bind additional vitamin B<sub>12</sub> added *in vitro* (unsaturated B<sub>12</sub>-binding capacity, UB<sub>12</sub>BC) is increased. Plasma homocysteine levels in polycythemic patients appear to be normal ( [98](#) ).

Spurious hyperkalemia has been noted when platelets are greatly increased in number ( [99](#) ). Hyperhistaminemia and hyperhistaminuria were reported in two-thirds of a series of patients with PV ( [100](#) ), which may explain, in part, the pruritus often present. The basal metabolic rate may be increased moderately ( [101](#) ). Gastric acidity ranges from absent to increased.

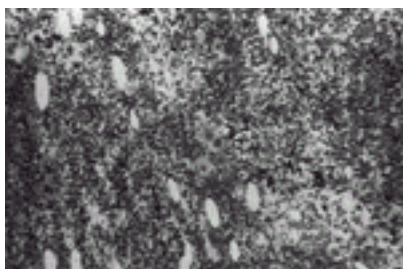
Patients with PV and thrombosis exhibit a greater frequency of procoagulant abnormalities in antithrombin III, protein C, protein S, and resistance to activated protein C, than do PV patients without thrombosis ( [102](#) ). Studies of prothrombin and factor V gene polymorphisms with a thrombotic diathesis showed no increased incidence of these abnormalities in PV patients ( [103](#) ). However, polymorphisms of the PI<sup>A2</sup> allele of platelet glycoprotein IIIa were associated with increased arterial thrombosis in PV and essential thrombocythemia patients ( [103](#) ).

## Bone Marrow

The value of bone marrow examination is debatable in the differentiation of PV from other myeloproliferative disorders, from secondary polycythemia, from spurious polycythemia, or from the normal state. Some investigators believe it to be an invaluable aid for making this differentiation ( [104](#), [105](#) ); others regard it as an important diagnostic tool but not one that is capable of definitively establishing the diagnosis ( [9](#) ). The Polycythemia Vera Study Group does not include the bone marrow among its diagnostic criteria for PV.



The marrow typically is hypercellular ( [106](#), [107](#) ) ( [Fig. 85.3](#) ), but normal cellularity is noted at the time of diagnosis in approximately 13% of cases ( [108](#) ). The hyperplasia involves all of the marrow elements and displaces marrow fat. Cellularity can be estimated with considerable accuracy by low-power examination of clot sections and needle or trephine biopsies. Planimetry or more detailed and time-consuming examination is not necessary ( [104](#) ), because comparative studies have shown good correlation between estimates and actual measurements of cellularity ( [103](#), [109](#) ). In several series, the mean cellularity of the marrow was 80 to 90% compared to approximately 30% in normal subjects and 40% in patients with secondary erythrocytosis ( [104](#), [105](#), [109](#) ). As mentioned, a few patients with untreated PV may have normal marrow cellularity ( [108](#), [109](#) ). Thus, the lack of hypercellularity does not exclude the diagnosis but should make it suspect.



**Figure 85.3.** Bone marrow biopsy from a patient with polycythemia vera, showing hypercellularity and hyperplasia of myeloid, erythroid, and megakaryocyte series (1000 ×).

An increase in megakaryocyte number and size is well documented in association with PV and was reported in 95% of 175 cases. When the number of megakaryocytes was expressed in terms of fat-free marrow, however, the megakaryocyte hyperplasia was shown to be proportional to overall marrow cellularity ( [109](#) ). The ratio of the different cell types in the marrow is not strikingly different from normal. Clumps of pronormoblasts and basophilic erythroblasts are seen ( [106](#) ), and the percentage of nucleated red cells may be moderately elevated ( [110](#) ). Myelocyte and myeloblast numbers may be greater than normal, and an increase in eosinophils ( [104](#) ) and basophils may be found ( [110](#) ).

Iron pigment is absent from the marrow in more than 90% of patients, even when phlebotomy has not been performed ( [104](#), [109](#) ). Increased marrow iron stores has been suggested as a morphologic hallmark favoring a secondary form of erythrocytosis over PV ( [111](#) ). An increase in marrow reticulin levels and/or fibrosis has often been reported, but an increase was observed in only 11 to 15% of patients studied early in the course of their disease ( [108](#), [109](#) ). The increase in reticulin correlates with the degree of marrow cellularity ( [109](#) ). It is slowly progressive but no increase occurs in association with a particular form of treatment or with the duration of the disease ( [108](#) ). Marrow vascularity may be increased in PV and other myeloproliferative disorders ( [112](#) ).

### Cytogenetics

In early studies of cytogenetic abnormalities associated with PV, aneuploidy was noted in some patients; however, many subjects had been treated previously and modern banding techniques were not used ( [113](#) ). In more modern studies, cytogenetic abnormalities were

observed in 20 to 43% of patients ( [112](#), [113](#) and [114](#)). The frequency of chromosomal abnormalities varied with the clinical picture. Results from two series are presented in [Table 85.2](#) ( [115](#), [116](#)). Fewer than 20% of patients studied at diagnosis had a cytogenetic abnormality. Patients evaluated during a clinical course not associated with progression had cytogenetic abnormalities in 25 to 35% of cases. However, patients who progressed to either myeloid metaplasia, myelofibrosis, or acute leukemia/myelodysplastic syndrome had abnormal cytogenetics in 75 to 100% of evaluations. The greater frequency of cytogenetic abnormalities in patients progressing to myelofibrosis in one of these series may reflect the greater utilization of <sup>32</sup>P therapy and alkylating agents among those patients ( [116](#)). The cytogenetic abnormalities most commonly observed were trisomy 8, trisomy 9, and deletions of Y, 5q, 6q, 7q, 11q, 13q, and 20q ( [115](#)). Although cytogenetics do not predict outcome, they appear to be correlated with disease stage and duration. Specific evaluation for trisomy 8, trisomy 9, and 20q- by fluorescent *in situ* hybridization may be a useful adjunct to conventional cytogenetics ( [117](#)).

**TABLE 85.2. Frequency of Abnormal Cytogenetics by Polycythemia Vera Disease Stage in Two Series**

| Reference           | Patient Number | Frequency (Expressed as Percentage of Patients) |                   |               |                    |                               |
|---------------------|----------------|---|-------------------|---------------|--------------------|-------------------------------|
|                     |                | At Diagnosis                                    | Polycythemia Vera | Myelofibrosis | Myeloid Metaplasia | Acute Leukemia/Myelodysplasia |
| <a href="#">116</a> | 64             | 17  | 32                | 85            | 75                 | 75                            |
| <a href="#">115</a> | 37             | 14  | 25                | 40            | 78                 | 100                           |

## PATHOGENESIS

The cause of PV is unknown. The early suggestion that this disease was the compensatory result of anoxemia of the bone marrow was based on the presence of capillary thickening and subintimal and adventitial fibrosis of small vessels in the bone marrow ( [17](#)). Direct measurements of bone marrow oxygen saturation, however, gave normal values ( [118](#), [119](#)), and the lack of elevated serum or urinary erythropoietin levels ( [120](#), [121](#)) is also contrary to this hypothesis.

### Clonality

In view of the increased production and turnover of erythrocytes, neutrophils, and platelets as well as the hypercellular marrow, a more likely possibility is that cell production in PV is abnormal at the stem cell level. Evidence supporting this hypothesis was provided by a study of two black female patients with PV who were heterozygous for X-linked glucose-6-phosphate dehydrogenase deficiency ( [122](#)). In these patients, tissues not affected by this disease (skin fibroblasts and lymphocytes) possessed both A and B type glucose-6-phosphate dehydrogenase isozymes, as expected. Red blood cells, granulocytes, and platelets contained only one isozyme (type A), however, thus demonstrating a probable clonal origin of this disorder at a pluripotent hematopoietic progenitor level. In one other patient, most B lymphocytes were also from the disease clone ( [123](#)), indicating involvement of an earlier hematopoietic progenitor that had differentiation potential for the lymphoid as well as the myeloid, erythroid, and

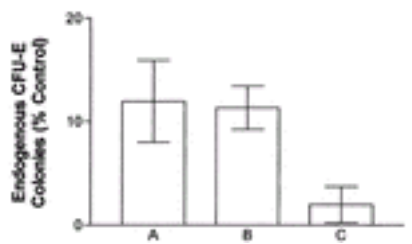


megakaryocytic series.

## Hematopoietic Progenitor Studies

The number of erythroid progenitors [burst-forming units erythroid (BFUs-E)] and erythroid colony-forming units erythroid (CFUs-E) detected in PV patients has been variously reported as either similar to that observed in normal persons or increased ( [124](#), [125](#) ). It has also been suggested that there is an increase in cycling of primitive BFUs-E, and that CFUs-E (typically observed only in marrow) are to be found in the peripheral blood of patients with PV ( [126](#), [127](#) ).

A hallmark of PV (and other myeloproliferative disorders as well) is erythroid progenitor colony formation *in vitro* without the addition of exogenous erythropoietin—the phenomenon called *endogenous erythroid colonies* or sometimes *erythropoietin-independent colony formation* ( [Fig. 85.4](#) ) ( [128](#), [129](#) ). This phenomenon has been observed with progenitors cultured from the marrow ( [124](#), [126](#), [130](#), [131](#), [132](#) and [133](#) ) or the blood ( [124](#), [126](#), [127](#), [133](#) ) of PV patients. This can be a consequence of true erythropoietin independence or of exquisite sensitivity to erythropoietin, which would permit a response to the extremely small quantities of erythropoietin present in the serum used in culture media. A variety of investigators, using either serum-free medium or neutralizing antibodies to erythropoietin in serum-containing medium, have provided data suggesting that endogenous erythroid colonies are a consequence of enhanced sensitivity to erythropoietin ( [132](#), [134](#), [135](#) and [136](#) ). Another group subsequently reported studies suggesting that endogenous erythroid colonies are a consequence of an altered response pattern induced by hypersensitivity to interleukin-3 ( [137](#) ). A more recent report, using antibodies capable of blocking the erythropoietin receptor, suggests that BFUs-E fall into two categories: those that exhibit a normal response to erythropoietin and those that are truly erythropoietin-independent ( [138](#) ).



**Figure 85.4.** Endogenous erythroid colony formation in polycythemia vera. Colony-forming unit erythroid ( *CFU-E* ) colony formation *in vitro* in the absence of exogenous erythropoietin by patients with polycythemia vera ( *A*, *B* ) and secondary polycythemia ( *C* ). Results are expressed as a percentage of colony formation in the presence of erythropoietin 1 U/ml.

In addition to interleukin-3 and erythropoietin, erythroid progenitors from PV patients have been reported to exhibit hypersensitivity to granulocyte-macrophage colony-stimulating factor, interleukin-1, stem cell factor, and insulin-like growth factor-1 ( [137](#), [139](#), [140](#), [141](#), [142](#) and [143](#) ).

## Hematopoietic Growth Factor Signal Transduction

The reported hypersensitivity of erythroid progenitors to erythropoietin in PV prompted evaluation of the erythropoietin receptor in this disease. The normal human erythropoietin receptor, although the product of a single gene, is expressed on CFU-E as a high- and low-affinity receptor ( [144](#), [145](#) ). In CFU-E generated from PV patients, only the low-affinity receptor is present ( [146](#) ). This differs from the finding in normal individuals, patients with hemolysis, or patients with secondary erythrocytosis. Studies of the erythropoietin receptor gene in PV have typically shown no mutations ( [147](#), [148](#) ), suggesting that the presence of only the low-affinity receptor class is the result of an alteration in posttranslational processing. Normal erythroid progenitors have been reported to express both a full-length erythropoietin receptor and a nonfunctional truncated version, which is believed to act as a dominant negative regulator of erythropoietin signal transduction. Expression of the truncated variant is reportedly decreased in PV patients, suggesting a mechanism for erythropoietin hypersensitivity ( [149](#) ).

The thrombopoietin receptor (Mpl) has been reported to be markedly decreased or absent on the platelets of PV patients and also of some individuals with myelofibrosis ( [150](#) ). These individuals exhibit decreased thrombopoietin-induced tyrosine phosphorylation ( [150](#) ). This decrease in phosphorylation appears to result from aberrant signaling through an abnormal Mpl characterized by decreased glycosylation ( [151](#), [152](#) ). It has been suggested that this abnormality in Mpl expression and function is both a marker for PV and, through suppression of apoptosis, a potential pathophysiologic contributor ( [152](#) ). Other investigators have questioned the usefulness of Mpl as a diagnostic marker of PV, as marked heterogeneity in its expression was observed in their laboratory, resulting in overlap with normal individuals ( [153](#) ).

The characteristic behavior of hematopoietic progenitors in PV may also reflect constitutive or deregulated activation of antiapoptotic mechanisms. Various investigators studying PV have reported constitutive activation of Stat 3 ( [154](#) ); deregulation of the anti-apoptotic protein Bcl-x ( [155](#) ); decreased expression of SHP-1 phosphatase, a negative regulator of hematopoietic growth factor-induced mitogenesis ( [156](#) ); increased protein tyrosine phosphatase activity ( [157](#) ); and decreased sensitivity of protein kinase C to the effects of inhibitors ( [158](#) ). The tumor-suppressor gene H19 has also been reported to be decreased in PV patients ( [159](#) ).

PRV-1 is a gene of the urokinase plasminogen activator receptor superfamily, which is highly expressed in granulocytes from PV patients but not from patients with other chronic myeloproliferative disorders or from normal individuals ( [160](#) ). Polymerase chain reaction-based techniques for detecting PRV-1 have been developed, and appear to be highly sensitive and specific for PV ( [161](#), [162](#) ). Genomic analysis suggests that PRV-1 is an allele of the gene encoding the neutrophil glycoprotein CD177 ( [163](#) ). It appears at present that PRV-1 is a marker of PV rather than a contributor to its pathogenesis.

## DIAGNOSIS

The approach to patients with elevated hemoglobin concentrations and hematocrit is outlined in [Chapter 50](#). The Polycythemia Vera Study Group developed a set of criteria that are useful clinically and conceptually ( [Table 85.3](#) ) (6). The diagnosis of PV requires the presence of all three major criteria (M) or the first two major criteria and two minor criteria (m). The first major criterion provides confirmation that the patient has actual

polycythemia, as indicated by an elevated red cell mass. The second major criterion rules out the most common etiology of secondary polycythemia, severe arterial hypoxemia, by demonstrating a normal or only moderately reduced arterial oxygen saturation. The third criterion, evidence of a myeloproliferative syndrome, is provided either by the third major criterion, splenomegaly appreciable on physical examination, or by two of the four minor criteria.

**TABLE 85.3. Polycythemia Vera Study Group Diagnostic Criteria: Significance and Proposed Alternatives/Additions**

| Significance   | Original Criteria   | Alternative/Additional Criteria   |
|--|---|---|
| M1. Identifies actual polycythemia vs. spurious polycythemia | M1. Increased RCM<br>Male >36 ml/mg<br>Female >32 ml/kg   | M1. RCM >125% of predicted  |
| M2. Rules out most common etiology of secondary polycythemia | M2. Arterial O <sub>2</sub> saturation >92%   | M2. Serum erythropoietin concentration not elevated   |
| M3. Evidence of a myeloproliferative state                   | M3. Clinical splenomegaly or two of the following:<br>m1. Thrombocytosis >400,000/μl<br>m2. Leukocytosis >12,000/μl<br>m3. Leukocyte alkaline phosphatase activity >100 (no fever or infection)<br>m4. Serum B <sub>12</sub> (>900 pg/ml) or unsaturated B <sub>12</sub> binding capacity (>2200 pg/ml) | M3. (additional minor criteria)<br>Splenomegaly apparent only on scans<br>Hypercellular marrow with trilineage hyperplasia<br>Characteristic hematopoietic colony response to growth factors<br>Evidence of clonal marrow cell population<br>PRV-1 gene expression in granulocytes<br>Decreased Mpl expression on platelets |

RCM, red cell mass.

It should, however, be remembered that the Polycythemia Vera Study Group's goal was to establish exclusive criteria, which would mean that all patients included in their protocols had clear-cut and inarguable PV. Although most PV patients meet the diagnostic criteria, some do not.

In the early phases of PV, the red cell mass may not be sufficiently elevated to meet the established criterion ( [Table 85.3](#) ). It has been proposed that a red cell mass >125% of predicted is a more appropriate diagnostic criterion for polycythemia ( [164](#) ). In other circumstances, blood loss may result in "auto-phlebotomy"—that is, the patient becomes iron deficient, and the hemoglobin and hematocrit fall into the normal range. A patient with an otherwise typical picture of PV would then appear to have either chronic

myelogenous leukemia (CML), essential thrombocytosis, or the early cellular phase of myelofibrosis. The diagnosis of essential thrombocytosis requires demonstration of reticuloendothelial iron stores ( [Chapter 56](#)), and myelofibrosis requires demonstration of marrow fibrosis ( [Chapter 86](#)), so that bone marrow examination would distinguish PV from both of these disorders. The major differential would be with CML. This question arises in 10 to 40% of PV patients ( [28](#), [45](#)). Testing for the Philadelphia chromosome or *bcr-ab1* gene rearrangement would permit CML to be diagnosed with considerable certainty. In addition, the leukocyte alkaline phosphatase score is normal or elevated in 80 to 100% of PV patients ( [45](#), [93](#), [165](#)) and typically low in CML patients.

As noted earlier, the majority of PV patients have normal arterial oxygen saturation. There is no intrinsic reason, however, why a patient with an underlying lung disease might not coincidentally have PV. In patients with a picture otherwise characteristic of PV but with arterial oxygen saturation below 92%, another marker for secondary polycythemia should be sought. The serum erythropoietin concentration is widely used by hematologists ( [166](#)). Although it is of arguable utility in the differential diagnosis of polycythemia (discussed in [Chapter 50](#)), failure to detect an elevated erythropoietin level in a polycythemic patient with reduced arterial oxygen saturation would be evidence against a secondary polycythemia. A decreased serum erythropoietin concentration has been proposed as an additional minor criterion ( [164](#)). Birgegard and Wide have reported that PV can be distinguished from secondary polycythemia by the erythropoietin response to phlebotomy: the erythropoietin concentration rises after phlebotomy in secondary erythrocytosis but remains unchanged in PV ( [167](#)).

It has been suggested that splenomegaly appreciated only by radiographic techniques should be considered a minor criterion ( [164](#)); experience suggests that most practitioners regard it as the equivalent of splenomegaly observed on physical examination. Absence of splenomegaly or of two minor criteria necessitates a search for other features of myeloproliferative syndromes. Likely possibilities would include a hypercellular bone marrow exhibiting hyperplasia of all cell lines, peripheral blood basophilia, or an assay for endogenous erythroid colonies. The drawback to the latter is that it is a specialized procedure that typically must be done in a research laboratory, and thus is of limited availability. It is, however, a useful method for identifying cases of PV “masked” by other concurrent conditions ( [168](#)). Other possibilities would include decreased platelet Mpl expression, detection of PRV-1 by polymerase chain reaction, or demonstration of a clonal population of marrow cells ( [164](#)).

## NATURAL HISTORY

The clinical picture of PV is characterized by the complications of polycythemia-induced hyperviscosity, expanded blood volume, and thrombosis. The occurrence of these complications is significantly affected by therapy and is discussed under specific therapeutic modalities.

Two other significant complications that may be observed late in the course of PV are the development of myeloid metaplasia with myelofibrosis and acute leukemia. In perhaps 25% of patients with PV, a progressive reduction in erythrocyte survival, decreased erythropoiesis, and myelofibrosis develop ( [169](#), [170](#)). Extramedullary hematopoiesis takes place in the spleen and liver. A rising leukocyte count with increased immature myeloid forms accompanies these changes. In addition, the teardrop and nucleated red cells characteristic of myelofibrosis and myeloid metaplasia appear in the blood ( [170](#)). The spleen may enlarge dramatically. A picture simulating that of acute myeloblastic leukemia develops in approximately one-third of these patients ( [170](#)). Others develop progressive

anemia and thrombocytopenia and die of a variety of intercurrent complications in the “spent” or “burnt-out” phase of myeloid metaplasia (171). It has been suggested that postpolycythemia myeloid metaplasia syndrome is related to the use of <sup>32</sup>P therapy (171), although it clearly occurs in patients who have never received this therapy. In still other patients (14 to 20% in most series) (8, 172), an acute leukemia-like picture develops without preceding evidence of myeloid metaplasia or myelofibrosis (170). It has been suggested that the small number of patients who have cytogenetic abnormalities at diagnosis are those who will eventually develop leukemia, but this is not observed in all series (115, 116, 170). The effect of therapy on the development of leukemia is discussed in the Chemotherapy section that follows.

A number of other diseases have been reported in association with PV. It is unclear whether these represent coincidence or an actual pathophysiologic relationship. These include hyperthyroidism (65), neurofibromatosis (von Recklinghausen disease) (173), paroxysmal nocturnal hemoglobinuria (174), agranulocytosis (175), chronic lymphocytic leukemia (176), lymphoma, multiple myeloma (177), osteosclerosis (70), as well as development of a marrow picture resembling aplastic anemia (178) or pernicious anemia (179).

The median survival of untreated PV patients is reported to be 18 months (180). Overall survival of PV patients appears decreased compared to age- and sex-matched controls (4). Table 85.4 gives the causes of death from two large series of PV patients (8, 181). Thrombotic events remained the leading cause of death (approximately 30% in both series), followed by acute leukemia and other malignancies, hemorrhage, and myelofibrosis/myeloid metaplasia, which represented 2 to 4% of patients.

**TABLE 85.4. Causes of Death in Polycythemia Vera Patients**

| Cause of Death                   | PVSG (%) | GISP (%) |
|----------------------------------|----------|----------|
| Thrombosis/thromboembolism       | 31       | 29.7     |
| Acute myeloid leukemia           | 19       | 14.6     |
| Other malignancy                 | 15       | 15.5     |
| Hemorrhage                       | 6        | 2.6      |
| Myelofibrosis/myeloid metaplasia | 4        | 2.6      |
| Other                            | 25       | 35.0     |

GISP, Gruppo Italiano Studio Policitemia (8); PVSG, Polychthemia Vera Study Group (181).

## TREATMENT

The object of therapy in PV is to produce a reduction in the red cell mass by methods that (a) permit the longest survival; (b) are associated with fewest significant complications, allowing the patient maximum quality of life; and (c) are least expensive and inconvenient for the patient.

## Phlebotomy

Phlebotomy offers prompt and effective reduction of the red cell mass and blood volume to normal values. Many patients can be maintained in an essentially normal state by phlebotomy together with a few simple adjuvants, when necessary, to control hyperuricemia or pruritus. The advantages of phlebotomy are that it is inexpensive, requires extremely limited technical support, and allows rapid control of symptoms. Criticisms of phlebotomy are the potential problem of venous access in elderly patients, that it does not address leukocytosis or thrombocytosis, and that erythropoiesis is stimulated by the blood loss ([120](#)). This last point is only a transient concern; the goal of phlebotomy is to induce a state of iron deficiency that will itself suppress erythropoiesis.

The Polycythemia Vera Study Group took patients who had been phlebotomized to maintain a normal hematocrit (less than 0.45) and then randomized patients to phlebotomy to maintain the hematocrit in this range, to therapy with  $^{32}\text{P}$ , or to therapy with chlorambucil ([182](#)). Median survival from study entry until death was 9.1 years for patients in the chlorambucil arm, 10.9 years for  $^{32}\text{P}$ -treated patients, and 12.6 years for phlebotomized patients ( $p = .008$ ). The survival differences did not become apparent until after 7 years into the study, indicating that the development of late events (principally leukemia) was responsible for these differences ([182](#)). Acute leukemia developed in 1.5% of phlebotomy patients, 14.2% of chlorambucil patients, and 9.6% of  $^{32}\text{P}$  patients. This complication was more frequent in patients with the “spent phase” of PV. Myelofibrosis was observed in 8.6%, 7.1%, and 7.7% of the phlebotomy, chlorambucil, and  $^{32}\text{P}$  patients, respectively ([182](#)).

The apparent advantage of phlebotomy was undercut by an increased risk of thrombosis. Thrombosis-free cumulative survival was significantly worse in the phlebotomy arm ( $p = .015$ ). This increased risk was predominantly limited to the first 3 years of therapy ([182](#)). Advanced age and history of previous thrombosis contributed to the relative risk of thrombosis in this and other studies ([8](#), [181](#)).

## Phlebotomy and Antiplatelet Agents

In an effort to reduce the thrombotic risk that impairs the otherwise excellent response to phlebotomy, the Polycythemia Vera Study Group randomized patients to phlebotomy with aspirin, 300 mg three times daily, and dipyridamole (Persantine), 75 mg three times daily, versus  $^{32}\text{P}$ . The study was stopped early because of excessive thrombosis, hemorrhage, and death in the phlebotomy/aspirin/dipyridamole arm ([182](#)). A subsequent study, however, found that total aspirin doses of 325 mg/day or less and phlebotomy resulted in no hemorrhagic or thrombotic complications in 69 patient years of follow-up ([183](#)). However, this latter study contained a preponderance of patients with known disease duration longer than 3 years; as discussed above, the thrombotic risk occurs predominantly in the first 3 years after diagnosis. A small placebo-controlled study performed by the Gruppo Italiano Studio Policitemia using an aspirin dose of 40 mg/day (112 patients followed for 1 year) reported similar results ([184](#)).

The goal of phlebotomy should be to maintain the hematocrit in the normal range (0.42 to 0.46). In elderly patients, patients with known cardiovascular disease, or hospitalized patients with severe symptoms, phlebotomy should be initiated cautiously, either using frequent small-volume phlebotomy (100 to 150 ml every day or on alternate days) or in



larger (500 ml) volumes using fluid replacement so that the patient remains isovolemic ( [185](#), [186](#) ). The hazards of excessively aggressive initial phlebotomy have been well described ( [187](#) ). After the hematocrit falls to less than 0.55, or more than 750 to 1000 ml of blood have been removed, phlebotomy of 250 to 500 ml can generally be carried out safely at weekly or less frequent intervals, as clinically indicated. Some advocate the administration of iron during phlebotomy to prevent the “symptoms” of iron deficiency. In many ways, this defeats the long-term purpose of phlebotomy: to establish a state of iron deficiency that will restrict red cell production. It has also been demonstrated that iron-deficient PV patients have no significant symptoms compared to other PV patients ( [188](#) ).

## Chemotherapy

**ALKYLATING AGENTS** A number of chemotherapeutic agents have been used for the treatment of PV. These include benzene ( [189](#) ), phenylhydrazine ( [190](#) ), Fowler’s solution (potassium arsenite) ( [191](#) ), nitrogen mustard ( [192](#) ), melphalan ( [193](#) ), triethylene melamine ( [194](#) ), thiotepa ( [195](#) ), pyrimethamine ( [196](#) ), Vercyte (a neutral piperazine compound) ( [197](#) ), and a variety of other agents ( [198](#), [199](#) and [200](#) ). For the most part, these agents have fallen into disuse in PV, typically through a poor toxicity to efficacy ratio. Busulphan, pipobroman, and chlorambucil are alkylating agents that were widely used in PV in the modern era, but the increased frequency of leukemia observed with alkylating agents led to a discontinuation of their first-line use ( [201](#), [202](#) ). They may have some utility in selected cases.

**HYDROXYUREA** The nonalkylating myelosuppressive agent hydroxyurea is the chemotherapeutic agent most widely used in PV at present. Its efficacy in controlling erythrocyte, leukocyte, and platelet counts in PV has been clearly demonstrated ( [203](#), [204](#) ). Thrombotic complications are less common than are observed in patients treated with phlebotomy only ( [182](#) ). Hydroxyurea permits rapid reduction of leukocyte and platelet counts; supplemental phlebotomy may occasionally be necessary to reduce the red cell mass ( [182](#) ). As a rule, neutropenia or thrombocytopenia corrects rapidly after cessation or reduction of hydroxyurea dose; for the same reason, however, missing a few days of therapy may be associated with recurrence of leukocytosis or thrombocytosis. The incidence of leukemia in patients treated long term with hydroxyurea appears to be low and similar to that observed in patients treated with phlebotomy alone ( [182](#), [205](#), [206](#) ), but requires further investigation. A study in which older PV patients initially treated with <sup>32</sup>P were randomized to maintenance with hydroxyurea or observation with phlebotomy showed a higher incidence of leukemia in the hydroxyurea arm. This suggests that there is at least some leukemogenic potential with this agent ( [207](#) ). The usual starting dose of hydroxyurea is 500 mg either once or twice daily and is adjusted according to clinical requirements.

**INTERFERON** Recombinant human interferon- $\alpha$  is an agent that has also demonstrated efficacy in PV ( [208](#), [209](#) and [210](#) ). In at least one study, interferon was more efficacious than phlebotomy ( [210](#) ). Another group found that only a subset of patients were responsive to interferon ( [209](#) ). In general, interferon appears to control leukocytosis and thrombocytosis and to reduce or eliminate the need for phlebotomy in a significant proportion of patients ( [211](#), [212](#) and [213](#) ). It also appears to improve pruritus ( [211](#), [212](#), [214](#) ). Reversal of marrow fibrosis has been reported in some, although not all, studies ( [211](#), [215](#) ). The precise role of interferon in PV, whether as therapy of first or later choice, remains to be firmly established, as does its optimum dose schedule. Many hematologists use interferon as first-line therapy in younger patients, particularly women of childbearing years.

**ANAGRELIDE** Anagrelide is a platelet-aggregating agent that is useful in the control of



thrombocytosis refractory to hydroxyurea or interferon in myeloproliferative disorders such as PV ( [216](#) ).

**RADIOACTIVE PHOSPHORUS** Whole-body or regional external beam irradiation is not especially useful ( [217](#) , [218](#) ). However, administration of  $^{32}\text{P}$  remains a technique of definite utility although limited applicability.  $^{32}\text{P}$  is typically provided as a dibasic sodium salt and administered intravenously ( [219](#) , [220](#) ). It passes to tissues that have a high phosphorus content and metabolize phosphorus rapidly. Its uptake by rapidly dividing cells is greater than that by normal cells. Because the physical half-life of this isotope is 14.3 days, steady irradiation of tissue takes place for several weeks ( [219](#) ). Its concentration in bone makes  $^{32}\text{P}$  valuable in the management of hematopoietic disorders, particularly PV. In patients with PV,  $^{32}\text{P}$  induces satisfactory clinical and hematologic remissions that may last years ( [40](#) , [220](#) ). The fall in the red cell count usually does not begin until 30 to 60 days from the time  $^{32}\text{P}$  is given. Therefore, initial phlebotomy may be indicated for symptomatic control. As with any myelosuppressive agent, care must be taken to avoid producing anemia, leukopenia, or thrombocytopenia. A usual dose is 3 to 5 mCi of  $^{32}\text{P}$  intravenously, or 2.3 mCi/m<sup>2</sup> ( [221](#) ). No additional  $^{32}\text{P}$  is given for 3 months to avoid cumulative effects. If the hematocrit rises above 0.46 in the interval, phlebotomy should be performed. If, after 3 months, the need for phlebotomy persists and leukopenia and thrombocytopenia are not present, a second injection of 1 to 4 mCi may be given. Examinations are repeated at 3-month intervals. Some patients do not require a second injection or further phlebotomies for 6 to 18 months or longer. A small minority, perhaps 10% of patients, need a third injection. After this third injection, no further injections are given for at least 12 to 18 months ( [222](#) ). An analysis of 300 courses administered to 139 patients showed that an average of 6.7 mCi had been given during the first 6 months of treatment ( [68](#) ). Most of these patients were re-treated within intervals of 6 to 10 months. In another series of 241 patients ( [223](#) ), the average dose required to produce remissions was 5.7 mCi in patients without leukocytosis or myeloid immaturity and as much as 8.3 mCi in others. The range of dose required was 3 to 21 mCi. As outlined above,  $^{32}\text{P}$  is effective and easily tolerated therapy. Survival after treatment is reported to be 10 to 14.5 years ( [68](#) , [172](#) , [220](#) , [224](#) ). The principal drawback to  $^{32}\text{P}$  therapy is the increased incidence of acute leukemia ( [170](#) , [182](#) , [224](#) ). As previously noted, the risk of leukemia (10 to 15%) develops after 7 or more years on treatment ( [182](#) ). In elderly patients (older than 75 years), the benefits of  $^{32}\text{P}$  may exceed the potential risks.  $^{32}\text{P}$  may be useful, therefore, in carefully selected patients, and obviously with a full explanation of the associated risks and benefits.

### Other Modalities

Splenectomy is useful only as a palliative measure in the late stages of the disease, when the spleen becomes massive and causes early satiety and weight loss, severe anemia, or thrombocytopenia ( [171](#) ). Hematopoietic stem cell transplantation has been reported in ten PV patients who had progressed to myelofibrosis or myelodysplastic syndrome/acute leukemia ( [225](#) ). Five of these patients had a complete response. There is also one report of a successful bone marrow transplant in an adolescent with PV ( [226](#) ).

### Special Topics

**PRURITUS** It has been reported that pruritus, upper gastrointestinal distress, and the urticarial manifestations of PV correlate with increased levels of whole blood histamine, which in turn is roughly related to the basophil leukocyte count ( [99](#) ) [although other

studies have questioned this model ( [227](#) ). These clinical manifestations were controlled by the administration of a potent antihistaminic agent, cyproheptadine (4 mg three or four times per day), in 12 of 18 patients so treated ( [99](#) ). More recent experience suggests a satisfactory response in less than one-third of patients with significant pruritus ( [20](#) ). Cimetidine ( [228](#) ) and hydroxyurea ( [229](#) ) have been useful in approximately 40% of patients with pruritus. Interferon has been used in intractable cases ( [214](#) ). Anecdotal experience suggests that aspirin (80 to 325 mg/day) also relieves pruritus in certain patients. As noted earlier, the most effective management of pruritus is establishing good hematologic control of PV.

**HYPERURICEMIA** Because of the excessive urinary load of uric acid excreted by patients with myeloproliferative disorders ( [230](#) ), urate may be precipitated in the kidneys, leading to stone formation or nephropathy. In one series, urolithiasis occurred in 40% of 44 patients with gout secondary to another disorder as compared to 20% of 937 patients with primary gout ( [231](#) ). An effective means of reducing uric acid production in patients with PV, other than by myelosuppression, is by the use of allopurinol, 300 mg/day ( [214](#) ). This agent is most useful during the short periods at the initiation of cytoreductive therapy when cell turnover is likely to be high and the avoidance of uric acid deposition is a major concern.

**SURGERY** Patients with poorly controlled PV are at increased risk for complications of elective surgery. In a series of 54 PV patients, a complication rate of 83% (46% morbidity, 37% mortality) was observed in poorly controlled patients, compared to a complication rate of 21% (16% morbidity, 5% mortality) in well-controlled patients ( [232](#) ). Fewer and less serious complications were observed in patients who had had stable, well-controlled counts for more than 4 months ( [232](#) ). It is recommended that PV patients undergoing elective surgery be in good hematologic control for at least 4 months. In more urgent surgery, control should be obtained as quickly as possible using phlebotomy with volume replacement, hydroxyurea, and cytapheresis if necessary, and should be maintained as long as possible pre- and postoperatively.

## Summary and Recommendations for Treatment

Although treatment with phlebotomy,  $^{32}\text{P}$ , or a variety of chemotherapeutic agents is effective and prolongs survival, no modality is clearly the best for everyone. The following recommendations represent a reasonable approach. More detailed recommendations have been published by the Polycythemia Vera Study Group ( [172](#), [233](#) ).

1. Most newly diagnosed patients should undergo phlebotomy to obtain symptomatic control of polycythemia. The rate and volume of phlebotomy is dictated by the patient's clinical status, as outlined in the section on phlebotomy above. The hematocrit should be reduced to the upper normal range (approximately 0.45).
2. The long-term therapy chosen to control PV varies according to the patient's clinical status. Young patients (younger than 50 years) with no history of thrombosis and without severe thrombocytosis (greater than 1,000,000/ $\mu\text{l}$ ) can probably be managed best with phlebotomy alone, with a target hematocrit of 0.45. The addition of aspirin, 325 mg per day or less, may be beneficial. Patients with a history of thrombosis who are older than 70 years or with severe thrombocytosis should be treated with myelosuppressive agents. Patients between the ages of 50 and 70 years with no history of thrombosis or severe thrombocytosis can be managed with myelosuppressive agents or phlebotomy, although the latter modality may increase their risk for thrombotic events.
3. The current myelosuppressive agent of first choice is hydroxyurea. Although the additional risk of leukemia with long-term hydroxyurea therapy appears to be small, it is probably not zero ( [234](#) ).  $^{32}\text{P}$  may be useful in a small number of carefully

selected elderly patients, in whom the potential leukemic risks are outweighed by ease of administration and limitations imposed by other clinical conditions. Interferon is clearly an effective agent in PV and should be considered a possible alternative to hydroxyurea. It may be particularly useful in younger patients and women of childbearing years.

## REFERENCES

1. Vaquez H. Sur une forme speciale de cyanose s'accompagnant d'hyperglobulie excessive et persistante. C R Soc Biol (Paris) 1892;4:384, and suppl note Bull Mem Soc Med Hôp Paris, 3 ser 1895;12:60.
2. Osler W. Chronic cyanosis with polycythemia and enlarged spleen; a new clinical entity. Am J Med Sci 1903;126:187.
3. Türk W. Beiträge zur Kenntnis des symptomensbildes Polyzythämie mit Milztumor und Zyanose. Wien Klin Wochenschr 1904;17:153.
4. Ania BJ, Suman VJ, Sobell JL, et al. Trends in the incidence of polycythemia vera among Olmstead County, Minnesota, residents, 1935–1989. Am J Hematol 1994;47:89–93.
5. Berglund S, Zettervall O. Incidence of polycythemia vera in a defined population. Eur J Haematol 1992;48:20–26.
6. Berlin NI. Diagnosis and classification of the polycythemias. Semin Hematol 1975;12:339–351.
7. Modan B. An epidemiological study of polycythemia vera. Blood 1965;26: 657.
8. Gruppo Italiano Studio Policitemia. Polycythemia vera: the natural history of 1213 patients followed for 20 years. Ann Intern Med 1995;123:656–664.
9. Calabresi P, Meyer OO. Polycythemia vera. Ann Intern Med 1959;50:1182.
10. Damon A, Holub DA. Host factors in polycythemia vera. Ann Intern Med 1958;49:43.
11. Osgood EE. Polycythemia vera: age relationships and survival. Blood 1965;26:243.
12. Szur L, et al. Polycythaemia vera and its treatment with radioactive phosphorus. QJM 1959;28:397.
13. Danish EH, Rasch CA, Harris JW. Polycythemia vera in childhood: case report and review of the literature. Am J Hematol 1980;9:421.
14. Najean Y, Mugnier P, Dresch C, et al. Polycythemia vera in young people: an analysis of 58 cases diagnosed before 40 years. Br J Haematol 1987;67:285–291.
15. Wasi P, Block M. Polycythemia vera in a Negro woman. Arch Intern Med 1961;107:260.
16. Modan B, Kallner H, Zemer D, et al. A note on the increased risk of polycythemia vera in Jews. Blood 1971;37:172.
17. Reznikoff P, et al. Etiologic and pathologic factors in polycythemia vera. Am J Med Sci 1935;189:753.
18. Chaitey Y, Brenner B, Aghai E, et al. High incidence of myeloproliferative disorders in Ashkenazi Jews in northern Israel. Leuk Lymphoma 1992;7:251–255.
19. Brubaker LH, Wasserman LR, Goldberg JD, et al. Increased prevalence of polycythemia vera in parents of patients on polycythemia vera study group protocols. Am J Hematol 1984;16:367–373.
20. Hoffman R, Wasserman LR. Natural history and management of polycythemia vera. Adv Intern Med 1979;24:255–285.
21. Inaba T, Shimazaki C, Hirai H, et al. Familial polycythemia vera in father and daughter [Letter]. Am J

Hematol 1996;51:172.

22. Lundsgaard C. Erythrosis or false cyanosis. *J Exp Med* 1919;30:295.
23. Pick E, Kaznelson P. Über eine eigenartige Dermatose bei Polycythämie. *Dermatol Monatsschr* 1925; abstracted in *Folia Haematol* 1927;24:266.
24. Bottner A. Zur und zur Einteilung der echten Polycythämieformen mit Berücksichtigung ihrer Augenhintergrundsveränderungen. *Dtsch Med Wochenschr* 1920;132:1.
25. Baxter DL, Lockwood JH. Acne urticata polycythemia. *Arch Dermatol* 1958;78:325.
26. Diamond JH, Gross L. Urticaria pigmentosa complicated by polycythemia vera. *Blood* 1966;27:253–257.
27. Gans O. Überspezifische Hautveränderungen bei Erythämie. *Virchows Arch* 1927;263:565.
28. Tinney WS, et al. Polycythemia vera. *Mayo Clin Proc* 1943;18:227; 1945;20:49 and 306.
29. Abdel-Nasser MB, Gollnick H, Orfanos CE. Aquagenic pruritus as a presenting symptom of polycythemia vera. *Dermatology* 1993;187:130–133.
30. Brown GE, Griffin HZ. Peripheral arterial disease in polycythemia vera. *Arch Intern Med* 1930;46:705.
31. van Genderen PJJ, Michiels JJ. Erythromelalgic, thrombotic, and haemorrhagic manifestations of thrombocythaemia. *Presse Med* 1994;23:73–77.
32. Blumgart HL, et al. Studies on the velocity of blood flow: XV. The velocity of blood flow and other aspects of the circulation in patients with “primary” and secondary anemia and in two patients with polycythemia vera. *J Clin Invest* 1930;9:679.
33. Altschule MD, et al. Cardiac and respiratory function at rest in patients with uncomplicated polycythemia vera. *Am J Med Sci* 1940;200:478.
34. Murray JF, et al. The circulatory effects of hematocrit variations in normo-volemic and hypervolemic dogs. *J Clin Invest* 1963;42:1150–1155.
35. Reisner SA, Rinkevich D, Markiewicz W, et al. Cardiac involvement in patients with myeloproliferative disorders. *Am J Med* 1992;93:498–504.
36. Venegoni P, Schroth G. Myocardial infarction and polycythemia vera: how should we treat it? *Cath Cardiovasc Diagn* 1994;32:259–261.
37. Piccirillo G, Fimongari FL, Valdivia JL, et al. Effects of phlebotomy on a patient with secondary polycythemia and angina pectoris. *Int J Cardiol* 1994;44:175–177.
38. Norman IL, Allen EV. The vascular complications of polycythemia. *Am Heart J* 1937;13:257.
39. Dameshek W, Kenstell HH. The diagnosis of polycythemia. *Ann Intern Med* 1940;13:1360.
40. Lawrence JH. The control of polycythemia by marrow inhibition. *JAMA* 1949;141:13.
41. Wilbur DL, Ochsner HC. The association of polycythemia vera and peptic ulcer. *Ann Intern Med* 1935;8:1667.
42. Videbaek A. Polycythemia vera. *Acta Med Scand* 1950;138:179.
43. Boyd W. The relationship of polycythemia to duodenal ulcer. *Am J Med Sci* 1934;187:589.
44. Gray AG, Boughton BJ, Burt DS, et al. Basophils, histamine, and gastric acid secretion in chronic myeloproliferative disorders. *Br J Haematol* 1982;51:117–123.
45. Perkins J, et al. Polycythemia vera: clinical studies on a series of 127 patients managed without

radiation therapy. *Q J Med* 1964;33:499.

46. Aufses AH, Jr. Bleeding varices associated with hematologic disorders. *Arch Surg* 1960;80:655.
47. Sohval AR. Hepatic complications in polycythemia vera. *Arch Intern Med* 1938;62:925.
48. Mosse M. Polyglobulie und Lebererkrankung. *Ztschr Klin Med* 1914;79:431.
49. Fitzgerald O, et al. Diagnosis and treatment of the Budd–Chiari syndrome in polycythemia vera. *Br Med J* 1956;2:1343.
50. Parker RGF. Occlusion of the hepatic veins in man. *Medicine* 1959;38:369.
51. Mitchell MC, Boitnott JK, Kaufman S, et al. Budd–Chiari syndrome: etiology, diagnosis and management. *Medicine* 1982;61:199–218.
52. Cassels DE, Morse M. The arterial blood gases, the oxygen dissociation curve, and the acid–base balance in polycythemia vera. *J Clin Invest* 1953;32:52.
53. Fisher JM, et al. Differentiation of polycythemia vera and secondary polycythemia by arterial oxygen saturation and pulmonary function tests. *J Lab Clin Med* 1957;50:455.
54. Wasserman LR, et al. Blood oxygen studies in patients with polycythemia and in normal subjects. *J Clin Invest* 1949;28:60.
55. Herbert SJ, et al. Pulmonary diffusing capacity in polycythemic states before and after phlebotomy. *Dis Chest* 1965;48:408.
56. Lertzman M, et al. Hypoxia in polycythemia vera. *Ann Intern Med* 1964;60:409.
57. Nand S, Orfei E. Pulmonary hypertension in polycythemia vera. *Am J Hematol* 1994;47:242–244.
58. MacKenzie DW. Perirenal hematoma primary with polycythemia. *J Urol* 1930;23:535.
59. Silverstein A, et al. Neurologic complications of polycythemia. *Ann Intern Med* 1962;57:909.
60. Eilschnig A, Nonnenbruch W. Polycythämie und Embolie der Arteria centralis retinae. *Klin Monatsbl Augenheilkd* 1932;88:433.
61. Thomas DJ, duBoulay GH, Marshall G, et al. Cerebral blood flow in polycythemia. *Lancet* 1977;2:1161–1163.
62. Jaillard AS, Hommel M, Mazetti P. Prevalence of stroke at high altitude (3380 m) in Cuzco, a town of Peru. A population–based study. *Stroke* 1995;26:562–568.
63. Niazi GA, Awada A, al Rajeh S, et al. Hematological values and their assessment as risk factors in Saudi patients with stroke. *Acta Neurol Scand* 1994;89:439–445.
64. Harrop GA, Jr. Polycythemia. *Medicine* 1928;7:291.
65. Zadek I. Die Polycythämien. *Ergeb Ges Med* 1927;10:355.
66. Isaacs R. Pathologic physiology of polycythemia vera. *Arch Intern Med* 1923;31:289.
67. Minot GR, Buchman TE. Erythremia (polycythemia rubra vera). *Am J Med Sci* 1923;166:469.
68. Lawrence JR, et al. The nature and treatment of polycythemia. *Medicine* 1953;32:323.
69. Cautley E. Chronic polycythemia. *Lancet* 1908;1:1204.

70. Rosenthal N, Bassen FA. Course of polycythemia. *Arch Intern Med* 1938;62:903.
71. Cooper MR, DeChatlet LR, McCall CE, et al. The activated phagocyte of polycythemia vera. *Blood* 1972;40:366–374.
72. London IM, et al. Heme synthesis and red blood cell dynamics in normal humans and in subjects with polycythemia vera, sickle cell anemia, and pernicious anemia. *J Biol Chem* 1949;179:463.
73. van Genderen RJ, Michiels JJ, van Strik R, et al. Platelet consumption in thrombocythemia complicated by erythromelalgia: reversal by aspirin. *Thromb Haemost* 1995;73:210–214.
74. Castaman G, Lattuada A, Ruggeri M, et al. Platelet von Willebrand factor abnormalities in myeloproliferative syndromes. *Am J Hematol* 1995;49:289–293.
75. LeBlanc K, Berg A, Palmblad J, et al. Stimulus-specific defect in platelet aggregation in polycythemia vera. *Eur J Haematol* 1994;53:145–149.
76. Landolfi R, Ciabattini G, Patrignani P, et al. Increased thromboxane biosynthesis in patients with polycythemia vera: evidence for aspirin suppressible platelet activation in vivo. *Blood* 1992;80:1965–1971.
77. Abraham JP, et al. A study of the defects in the blood coagulation mechanisms in polycythemia vera. *Am J Clin Pathol* 1961;36:7.
78. Cancelas JA, Garcia-Avello A, Garcia-Frade LJ. High levels of plasminogen activator inhibitor 1 (PAI-1) in polycythemia vera and essential thrombocythemia are associated with thrombosis. *Thromb Res* 1994;75:513–520.
79. Friedenberg WR, Roberts RC, David DE. Relationship of thrombohemorrhagic complications to endothelial cell function in patients with chronic myeloproliferative disorders. *Am J Hematol* 1992;40:283–289.
80. Le Blanc K, Berg A, Palmblad J, et al. Defective platelet aggregation in polycythaemia vera is not caused by impaired calcium signaling, phospholipase D activation or decreased amounts of focal adhesion proteins. *Eur J Haematol* 2000;65:322–330.
81. Berlin NI, et al. Blood volume in polycythemia as determined by <sup>32</sup>P labeled red blood cells. *Am J Med* 1950;9:747.
82. Polycove M, Winchel HS, Lawrence JH. Classification and evolution of patterns of erythropoiesis in polycythemia vera as studied by iron kinetics. *Blood* 1966;28:807–829.
83. Huff RL, et al. Plasma and red cell iron turnover in normal subjects and in patients having various hematopoietic disorders. *J Clin Invest* 1950;29:1041.
84. Paschkis K, Diamant M. Beitrage zur Pathologie der Erythramie. Zugleich 1. Mitteilung uber den urobilin Stoffwechsel. *Dtsch Arch Klin Med* 1930;169:180.
85. Athens JW, et al. Blood granulocyte kinetics in polycythemia vera, infection and myelofibrosis. *J Clin Invest* 1965;44:778.
86. Falanga A, Marchetti M, Evangelista V, et al. Polymorphonuclear leukocyte activation and hemostasis in patients with essential thrombocythemia and polycythemia vera. *Blood* 2000;96:4261–4266.
87. Harker LA, Finch CA. Thrombokinetics in man. *J Clin Invest* 1969;48:963–974.
88. Tytgat GN, Collen D, Vermeylen J. Metabolism and distribution of fibrinogen. II. Fibrinogen turnover in polycythemia, thrombocytosis, haemophilia A, congenital afibrinogenaemia and during streptokinase therapy. *Br J Haematol* 1972;22:701.
89. Lugassy G, Filin I. Study of fibrinolytic parameters in different types of polycythemia. *Am J Hematol* 1999;60:196–199.

90. Karaca M, Stefanini M. Thromboplastic activity and content in lipids and phospholipids of platelets in polycythemia vera with associated thrombopathy. *Am J Clin Pathol* 1967;48:320.
91. Orlowski W. Contribution à l'étude de la "polycythemia rubra." *Prog Med* 1912;10:117.
92. Wardener HE, et al. Renal haemodynamics in primary polycythemia. *Lancet* 1951;2:204.
93. Reed C. Polycythaemia rubra vera. *Med J Aust* 1965;2:654.
94. Shelburne SA, Hanzal RF. The endogenous uric acid metabolism in polycythemia vera. *J Clin Invest* 1932;11:865.
95. Yu TF, et al. On the biosynthesis of uric acid from glycine-N<sup>15</sup> in primary and secondary polycythemia. *Am J Med* 1956;21:901.
96. Carmel R. Vitamin B<sub>12</sub>-binding protein abnormality in subjects without myeloproliferative disease. *Br J Haematol* 1972;22:53-62.
97. Hall CA, Finkler AE. Vitamin B<sub>12</sub>-binding protein in polycythemia vera plasma. *J Lab Clin Med* 1969;73:60-69.
98. Bucalossi A, Marotta G, Bigazzi C, et al. Reduction of antithrombin III, protein C, and protein S levels and activated protein C resistance in polycythemia vera and essential thrombocythemia patients with thrombosis. *Am J Hematol* 1996;52:14-20.
99. Myerson RM, Frumin AM. Hyperkalemia associated with the myeloproliferative disorder. *Arch Intern Med* 1960;106:479.
100. Gilbert HS, Warner RR, Wasserman LR. A study of histamine in myeloproliferative disease. *Blood* 1966;28:795-806.
101. Bliss TL. Basal metabolism in polycythemia vera. *Ann Intern Med* 1929;2:1155.
102. Bucalossi A, Marotta G, Bigazzi C, et al. Reduction of antithrombin III, protein C, and protein S levels and activated protein C resistance in polycythemia vera and essential thrombocythemia patients with thrombosis. *Am J Hematol* 1996;52:14-20.
103. Afshar-Khargan V, Lopez JA, Gray LA, et al. Hemostatic gene polymorphisms and the prevalence of thrombohemorrhagic complications in polycythemia vera and essential thrombocythemia. *Blood* 2001;98[Suppl 1]:1967a(abst).
104. Kurnick JE, Warnock HP, Block MH. Bone marrow sections in the differential diagnosis of polycythemia. *Arch Pathol Lab Med* 1972;94:489-499.
105. Lundin PM, Ridell B, Weinfeld A. The significance of bone marrow morphology for the diagnosis of polycythemia vera. *Scand J Haematol* 1972;9:271-282.
106. Block M, Bethard WF. Bone marrow studies in polycythemia. *J Clin Invest* 1952;31:618.
107. Ellis ID, et al. Marrow iron. *Ann Intern Med* 1964;61:44.
108. Ellis JT, Peterson P, Geller SA, et al. Studies of the bone marrow in polycythemia vera and the evolution of myelofibrosis and second hematologic malignancies. *Semin Hematol* 1986;23:144-155.
109. Ellis JT, Silver RT, Coleman M, et al. The bone marrow in polycythemia vera. *Semin Hematol* 1975;12:433-444.
110. Wasserman LR, et al. The bone marrow picture in polycythemia vera before and after treatment with radioactive phosphorus. *Acta Med Scand* 1952;143:442.
111. Thiele J, Kvasnicka HM, Muehlhausen K, et al. Polycythemia vera versus secondary polycythemias. A



- clinicopathological evaluation of distinctive features in 199 patients. *Pathol Res Pract* 2001;197:77–84.
112. Lundberg LG, Lerner R, Sundelin P, et al. Bone marrow in polycythemia vera, chronic myelocytic leukemia, and myelofibrosis has an increased vascularity. *Am J Pathol* 2000;157:15–19.
113. Wurster–Hill D, et al. Cytogenetic studies in polycythemia vera. *Semin Hematol* 1976;13:13.
114. Berger R, Bernheim A, LeConiat M, et al. Chromosome studies in polycythemia vera patients. *Cancer Genet Cytogenet* 1984;12:217–223.
115. Diez–Martin JL, Graham DL, Petit RM, et al. Chromosome studies in 104 patients with polycythemia vera. *Mayo Clin Proc* 1991;66:287–299.
116. Swolin B, Weinfeld A, Westin J. A prospective long–term cytogenetic study in polycythemia vera in relation to treatment and clinical course. *Blood* 1988;72:386–395.
117. Westwood NB, Gruszka–Westwood AM, Pearson CE, et al. The incidences of trisomy 8, trisomy 9 and D20S108 deletion in polycythaemia vera: an analysis of blood granulocytes using interphase fluorescence in situ hybridization. *Br J Haematol* 2000;110:839–846.
118. Berk L, et al. Oxygen saturation of sternal marrow blood with special reference to pathogenesis of polycythemia vera. *Proc Soc Exp Biol Med* 1948;69:316.
119. Hecht HH, Samuels AJ. Observations on the oxygen content of sternal bone marrow with reference to polycythemic states. *Fed Proc* 1952;11:68.
120. Adamson JW. The erythropoietin hematocrit relationship in normal and polycythemic man: implications of marrow regulation. *Blood* 1968;32:597–609.
121. Alexanian R. Correlations between erythropoietin production and excretion. *J Lab Clin Med* 1969;74:614–622.
122. Adamson JW, Fialkow PJ, Murphy S, et al. Polycythemia vera: stem cell and probable clonal origin of the disease. *N Engl J Med* 1976;295:913–916.
123. Raskind WH, Jacobson R, Murphy S, et al. Evidence for the involvement of B lymphoid cells in polycythemia vera and essential thrombocythemia. *J Clin Invest* 1985;75:1388–1390.
124. Eridani S, Batten E, Sawyer B. Erythropoietic activity in primary proliferative polycythemia [Letter]. *Br J Haematol* 1983;55:557.
125. Eaves AC, Eaves CJ. Erythropoiesis in culture. *Clin Haematol* 1984;13:371–391.
126. Eaves AC, Henkelmann DH, Eaves CJ. Abnormal erythropoiesis in the myeloproliferative disorders: an analysis of underlying cellular and humoral mechanisms. *Exp Hematol* 1980;8[Suppl 8]:235–247.
127. Cashman J, Henkelmann D, Humphries K, et al. Individual BFU–E in polycythemia vera produce both erythropoietin dependent and independent progeny. *Blood* 1983;61:876–884.
128. Reid CDL, Fidler J, Kirk A. Endogenous erythroid colonies (EEC) in polycythaemia and their relationship to diagnosis and the response to treatment. *Br J Haematol* 1988;68:395–400.
129. Reid CDL. The significance of endogenous erythroid colonies in haematological disorders. *Blood Rev* 1987;1:133–140.
130. Eaves CJ, Eaves AC. Erythropoietin dose–response curves for three classes of erythroid progenitors in normal human marrow and in polycythemia vera. *Blood* 1978;52:1196–1210.
131. Prchal JF, Axelrad AA. Bone marrow responses in polycythemia vera. *N Engl J Med* 1974;290:1382.
132. Golde DW, Bersch N, Cline MJ. Polycythemia vera: hormonal modulation of erythropoiesis in vitro. *Blood* 1977;49:399–405.

133. Mladenovic J, Adamson JW. Characteristics of circulating erythroid colony-forming cells in normal and polycythaemic man. *Br J Haematol* 1982;51:377-384.
134. Zanjani ED, Lutton JD, Hoffman R, et al. Erythroid colony formation by polycythemia vera bone marrow in vitro. Dependence on erythropoietin. *J Clin Invest* 1977;59:841-848.
135. Prchal JF, Adamson JW, Murphy S, et al. Polycythemia vera. The in vitro response of normal and abnormal stem cell lines to erythropoietin. *J Clin Invest* 1978;61:1044-1047.
136. Casadevall N, Vainchecker W, LaCombe C, et al. Erythroid progenitors in polycythemia vera: demonstration of their hypersensitivity to erythropoietin using serum free cultures. *Blood* 1982;59:447-451.
137. Dai CH, Krantz SB, Means RT, et al. Polycythemia vera blood burst-forming units-erythroid are hypersensitive to interleukin-3. *J Clin Invest* 1991;87:391-396.
138. Fisher MJ, Prchal JF, Prchal JT, et al. Anti-erythropoietin (EPO) receptor monoclonal antibodies distinguish EPO-dependent and EPO-independent erythroid progenitors in polycythemia vera. *Blood* 1994;84:1982-1991.
139. Dai CH, Krantz SB, Dessypris EN, et al. Polycythemia vera. II. Hypersensitivity of bone marrow erythroid, granulocyte-macrophage, and megakaryocyte progenitor cells to interleukin-3 and granulocyte-macrophage colony stimulating factor. *Blood* 1992;80:891-899.
140. Muller EW, de Wolf JT, Hendriks DW, et al. Recombinant human mast cell growth factor supports erythroid colony formation in polycythemia vera in the presence and absence of erythropoietin and serum. *Exp Hematol* 1993;21:1353-1357.
141. de Wolf JT, Hendriks DW, Esselink MT, et al. The effects of IL-1 and IL-4 on the Epo-independent erythroid progenitor in polycythaemia vera. *Br J Haematol* 1994;88:242-246.
142. Mirza AM, Ezzat S, Axelrad AA. Insulin-like growth factor binding protein-1 is elevated in patients with polycythemia vera and stimulates erythroid burst formation in vitro. *Blood* 1997;89:1862-1869.
143. Michl P, Spoettl G, Engelhardt D, et al. Alterations of the insulin-like growth factor system in patients with polycythemia vera. *Mol Cell Endocrinol* 2001;181:189-197.
144. Sawada K, Krantz SB, Sawyer ST, et al. Quantitation of specific binding of erythropoietin to human erythroid colony-forming cells. *J Cell Physiol* 1988;137:337-345.
145. Sawyer ST, Penta K. Erythropoietin cell biology. *Hematol Oncol Clin North Am* 1994;8:895-911.
146. Means RT, Krantz SB, Sawyer ST, et al. Erythropoietin receptors in polycythemia vera. *J Clin Invest* 1989;84:1340-1344.
147. Hess G, Rose P, Gamm H, et al. Molecular analysis of the erythropoietin receptor system in patients with polycythaemia vera. *Br J Haematol* 1994;88:794-802.
148. Kralovics R, Indrak K, Stopka T, et al. Two new EPO receptor mutations: truncated EPO receptors are most frequently associated with primary familial and congenital polycythemias. *Blood* 1997;90:2057-2061.
149. Chiba S, Takahashi T, Takeshita K, et al. Selective expression of mRNA coding for the truncated form of erythropoietin receptor in hematopoietic cells and its decrease in patients with polycythemia vera. *Blood* 1997;90:97-104.
150. Moliterno AR, Hankins WD, Spivak JL. Impaired expression of the thrombopoietin receptor by platelets from patients with polycythemia vera. *N Engl J Med* 1998;338:572-580.
151. Moliterno AR, Williams DM, Spivak JL. Enhanced in vitro viability of polycythemia vera CD34+ cells is associated with abnormal thrombopoietin receptor expression and aberrant signal transduction. *Blood* 2001;98[Suppl]:1961a(abst).

152. Moliterno AR, Spivak JL. Posttranslational processing of the thrombopoietin receptor is impaired in polycythemia vera. *Blood* 1999;94:2555–2561.
153. Le Blanc K, Andersson P, Samuelsson J. Marked heterogeneity in protein levels and functional integrity of the thrombopoietin receptor c-mpl in polycythaemia vera. *Br J Haematol* 2000;108:80–85.
154. Roder S, Steimle C, Meinhardt G, et al. STAT3 is constitutively active in some patients with polycythemia rubra vera. *Exp Hematol* 2001;29:694–702.
155. Silva M, Richard C, Benito A, et al. Expression of Bcl-x in erythroid precursors from patients with polycythemia vera. *N Engl J Med* 1998;338:564–571.
156. Wickrema A, Chen F, Namin F, et al. Defective expression of the SHP-1 phosphatase in polycythemia vera. *Exp Hematol* 1999;27:1124–1132.
157. Sui X, Krantz SB, Zhao Z. Identification of increased protein tyrosine phosphatase activity in polycythemia vera erythroid progenitor cells. *Blood* 1997;90:651–657.
158. Kawada E, Tamura J, Kubota K, et al. Possible involvement of protein kinase C in the aberrant regulation of erythropoiesis in polycythemia vera. *Leuk Res* 1997;21:101–105.
159. Nunez C, Bashein AM, Brunet CL, et al. Expression of the imprinted tumour-suppressor gene H19 is tightly regulated during normal haematopoiesis and is reduced in haematopoietic precursors of patients with the myeloproliferative disease polycythaemia vera. *J Pathol* 2000;190:61–68.
160. Temerinac S, Klippel S, Strunck E, et al. Cloning of PRV-1, a novel member of the uPAR receptor superfamily, which is overexpressed in polycythemia rubra vera. *Blood* 2000;95:2569–2576.
161. Freuehauf S, Topaly J, Villalobos M, et al. Development of a new quantitative PCR-based assay for the polycythemia rubra vera-1 (PRV-1) gene: diagnostic and therapeutic implications. *Blood* 2001;98[Suppl]:2632a(abst).
162. Klippel S, Strunck E, Temerinac S, et al. Quantification of PRV-1 expression, a molecular marker for the diagnosis of polycythemia vera. *Blood* 2001;98[Suppl]:1965a(abst).
163. Caruccio L, Bettinotti MP, Olsen A, et al. Use of bioinformatics to identify the genomic structure of the gene encoding polycythemia rubra vera-1 (PRV-1). *Blood* 2001;98[Suppl]:1964a(abst).
164. Pearson TC, Messinezy M. The diagnostic criteria of polycythemia rubra vera. *Leuk Lymphoma* 1996;22[Suppl 1]:87–93.
165. Anstey L, et al. Leucocyte alkaline-phosphatase activity in polycythemia rubra vera. *Br J Haematol* 1963;9:91.
166. Strieff MB, Smith B, Spivak JL. The diagnosis and management of polycythemia vera in the era since the Polycythemia Vera Study Group: a survey of American Society of Hematology members' practice patterns. *Blood* 2002;99:1144–1149.
167. Birgegard G, Wide L. Serum erythropoietin in the diagnosis of polycythemia and after phlebotomy treatment. *Br J Haematol* 1992;81:603–606.
168. Shih LY, Lee CT. Identification of masked polycythemia vera from patients with idiopathic marked thrombocytosis by endogenous erythroid colony assay. *Blood* 1994;83:744–748.
169. Glasser RM, Walker RI. Transitions among the myeloproliferative disorders. *Ann Intern Med* 1969;71:285–307.
170. Lawrence JH, Winchell HS, Donald WG. Leukemia in polycythemia vera. Relationship to splenic myeloid metaplasia and therapeutic radiation dose. *Ann Intern Med* 1969;70:763–771.
171. Silverstein MN. The evaluation into and the treatment of late stage polycythemia vera. *Semin*

Hematol 1976;13:79–84.

172. Berk PD, Goldberg JD, Donovan PB, et al. Therapeutic recommendations in polycythemia vera based on Polycythemia Vera Study Group protocols. *Semin Hematol* 1986;23:132.

173. Van Baren N, Issa A, Delannoy A. Von Recklinghausen neurofibromatosis and hematologic malignancies: 2 case reports in adulthood. *Acta Clin Belg* 1993;48:164–170.

174. Pel PK. Paroxysmale Hämoglobinurie mit Hyperglobulie. *Folia Haematol* 1908;6:290(abst).

175. Schnetz H. Polycythaemia vera mit Ausgang in Agranulocytose und Thrombarteriitis pulmonalis. *Folia Haematol* 1937;57:110.

176. Bethard WF, et al. Coexistent chronic lymphatic leukemia and polycythemia vera. *Blood* 1953;8:934.

177. Heinle EW, Jr., Sarasti HO, Garcia D, et al. Polycythemia vera associated with lymphomatous diseases and myeloma. *Arch Intern Med* 1966;118:351–355.

178. Delhougne F, et al. Über Polyzythämie mit Ausgang in Anämie. *Dtsch Arch Klin Med* 1928;160:257.

179. Freund H. Polyzythämie mit Ausgang in perniziöse Anämie. *Munch Med Wochenschr* 1919;66:84.

180. Chievitz E, Thiede T. Complications and causes of death in polycythemia vera. *Acta Med Scand* 1962;172:513.

181. Wasserman LR, Balcerzak SP, Berk PD, et al. Influence of therapy on causes of death in polycythemia vera. *Trans Assoc Am Phys* 1981;94:30–38.

182. Berk PD, Wasserman LR, Fruchtman SM, et al. Treatment of polycythemia vera: a summary of trials conducted by the Polycythemia Vera Study Group. In: Wasserman LR, Berk PD, Berlin NI, eds. *Polycythemia vera and the myeloproliferative disorders*. Philadelphia: WB Saunders, 1995:166–194.

183. Gilbert HS, Hanna MM. Low-dose aspirin/low-hematocrit regimen: a safe and efficacious treatment for polycythemia vera. *Blood* 1986;68[Suppl 1]:223a(abst).

184. Gruppo Italiano Studio Policitemia (GISP). Low-dose aspirin in polycythaemia vera: a pilot study. *Br J Haematol* 1997;97:453–456.

185. Gardner FH. Treatment of polycythemia vera (P vera). *Semin Hematol* 1966;3:220.

186. Harrison B, et al. Exchange transfusion and dextran 40 in polycythaemia secondary to hypoxic lung disease. *BMJ* 1971;4:713.

187. Kiraly JF, Feldmann JE, Wheby MS. Hazards of phlebotomy in polycythemic patients with cardiovascular disease. *JAMA* 1976;236:2080–2081.

188. Rector WG, Jr., Fortuin NJ, Conley CL. Non-hematologic effects of chronic iron deficiency. A study of patients with polycythemia vera treated solely by phlebotomy. *Medicine* 1982;61:382–389.

189. v. Koranyi A. Die Beeinflussung der Leukämie durch Benzol. *Klin Wochenschr* 1912;49:1357.

190. Giffin HZ, Conner HM. The untoward effects of treatment by phenylhydrazine hydrochloride. *JAMA* 1929;92:1505.

191. Forkner CE, et al. Treatment of polycythemia vera (erythremia) with solution of potassium arsenite. *Arch Intern Med* 1933;51:616.

192. Spurr CL, et al. A clinical study of the use of nitrogen mustard therapy in polycythemia vera. *J Lab Clin Med* 1950;35:252.

193. Logue GL, Gutterman JU, McGinn TG, et al. Melphalan therapy of polycythemia vera. *Blood*

1970;36:70–86.

194. Rosenthal N, Rosenthal RL. Treatment of polycythemia vera with triethylene melamine. *Arch Intern Med* 1952;90:379.
195. Ehrhart H. Chemotherapie der Polycythaemia vera mit Triäthylthiophosphoramid (Thio-Tepa). *Folia Haematol NF* 1961;5:80.
196. Frost JW, et al. Pyrimethamine in the treatment of polycythemia vera. *South Med J* 1958;51:1260.
197. Monto RW, et al. A-8103 in polycythemia. *JAMA* 1964;190:833.
198. Deconti RC, Calabresi P. Treatment of polycythemia vera with azauridine and azaribine. *Ann Intern Med* 1970;73:575–579.
199. Najman A, Stachowiak J, Parlier Y, et al. Pipobroman therapy of polycythemia vera. *Blood* 1982;59:890–894.
200. Tura S, Baccarani M. The management of polycythaemia vera with dibromomannitol. *Haematologia* 1970;4:67–74.
201. Brodsky I. Busulphan treatment of polycythaemia vera. *Br J Haematol* 1982;52:1–6.
202. Berk PD, Goldberg JD, Silverstein MN, et al. Increased incidence of acute leukemia in polycythemia vera associated with chlorambucil therapy. *N Engl J Med* 1981;304:441–447.
203. Kaplan ME, Mack K, Goldberg JD, et al. Long-term management of polycythemia vera with hydroxyurea: a progress report. *Semin Hematol* 1986;23:167–171.
204. Donovan PB, Kaplan ME, Goldberg JD, et al. Treatment of polycythemia vera with hydroxyurea. *Am J Hematol* 1984;17:329–334.
205. West WO. Hydroxyurea in the treatment of polycythemia vera: a prospective study of 100 patients over 20 years. *South Med J* 1987;80:323–327.
206. Nand S, Stock W, Godwin J, et al. Leukemogenic risk of hydroxyurea therapy in polycythemia vera, essential thrombocythemia, and myeloid metaplasia with myelofibrosis. *Am J Hematol* 1996;52:42–46.
207. Najean Y, Rain JD. Treatment of polycythemia vera: use of <sup>32</sup>P alone or in combination with maintenance therapy using hydroxyurea in 461 patients greater than 65 years of age. *Blood* 1997;89:2319–2327.
208. Silver RT. A new treatment for polycythemia vera: recombinant interferon alfa. *Blood* 1990;76:664–665.
209. Foa P, Massaro P, Ribera S, et al. Role of interferon alpha-2a in the treatment of polycythemia vera. *Am J Hematol* 1995;48:55–57.
210. Sacchi S, Leoni P, Riccardi A, et al. A prospective comparison between treatment with phlebotomy alone and with interferon-alpha in patients with polycythemia vera. *Ann Hematol* 1994;68:247–250.
211. Lengfelder E, Berger U, Hehlmann R. Interferon alpha in the treatment of polycythemia vera. *Ann Hematol* 2000;79:103–109.
212. Elliott MA, Tefferi A. Interferon-alpha therapy in polycythemia vera and essential thrombocythemia. *Semin Thromb Hemost* 1997;23:463–472.
213. Heis N, Rintelen C, Gisslinger B, et al. The effect of interferon alpha on myeloproliferation and vascular complications in polycythemia vera. *Eur J Haematol* 1999;62:27–31.
214. Finelli C, Gugliotta L, Gamberi B, et al. Relief of intractable pruritus in polycythemia vera with

- recombinant interferon alpha. *Am J Hematol* 1993;43:316–318.
215. Kreft A, Nolde C, Busche G, et al. Polycythaemia vera: bone marrow histopathology under treatment with interferon, hydroxyurea and busulphan. *Eur J Haematol* 2000;64:32–41.
216. Anagrelide Study Group. Anagrelide, a therapy for thrombocythemic states: experience in 577 patients. *Am J Med* 1992;92:69–76.
217. Pack GT, Craver LF. Radiation therapy of polycythemia vera. *Am J Med Sci* 1930;180:609.
218. Sgalitzer M. Rontgentotalbestrahlung bei Polycythaemia. *Wien Klin Wochenschr* 1935;48:675.
219. Freidell HL, Storaasli JP. The therapeutic application of radioactive phosphorus with special reference to the treatment of primary polycythemia and chronic myeloid leukemia. *J Clin Invest* 1949;28:1308.
220. Harman JB, Ledlie EM. Survival of polycythaemia vera patients treated with radioactive phosphorus. *Br Med J* 1967;2:146–148.
221. Wasserman LR. The management of polycythemia vera. *Br J Haematol* 1971;21:371–376.
222. Reinhard EH, et al. Radioactive phosphorus as a therapeutic agent. *J Lab Clin Med* 1946;31:107.
223. Stroebel CF, et al. Evaluation of radiophosphorus therapy in primary polycythemia. *JAMA* 1951;146:1301.
224. Tubiana M, Flamant R, Attie E, et al. A study of hematological complications occurring in patients with polycythemia vera treated with <sup>32</sup>P. *Blood* 1968;32:536–548.
225. Jurado M, Deeg H, Gooley T, et al. Haemopoietic stem cell transplantation for advanced polycythaemia vera or essential thrombocythaemia. *Br J Haematol* 2001;112:392–396.
226. Stobart K, Rogers PC. Allogeneic bone marrow transplantation for an adolescent with polycythemia vera. *Bone Marrow Transplant* 1994;13:337–339.
227. Buchanan JG, Ameratunga RV, Hawkins RC. Polycythemia vera and water-induced pruritus: evidence against mast cell involvement. *Pathology* 1994;26:43–45.
228. Weick JK, et al. The use of cimetidine for the treatment of pruritus in polycythemia vera. *Arch Intern Med* 1982;142:241.
229. Wasserman LR, Donovan PB. Polycythemia vera and relative polycythemia. In: *Conn's current therapy*. Philadelphia: WB Saunders, 1984.
230. Yü TF, Gutman AB. Effect of allopurinol on serum and urinary uric acid in primary and secondary gout. *Am J Med* 1964;37:885.
231. Gutman AB. Urate urolithiasis in primary and secondary gout. *Ann Intern Med* 1963;58:741.
232. Wasserman LR, Gilbert HS. Surgery in polycythemia vera. *N Engl J Med* 1963;269:1226–1229.
233. Fruchtman SM, Wasserman LR. Therapeutic recommendations for polycythemia vera. In: Wasserman LR, Berk PD, Berlin NI, eds. *Polycythemia vera and the myeloproliferative syndromes*. Philadelphia: WB Saunders, 1995:337–350.
234. Weinfield A, Swolin B, Westin J. Acute leukaemia after hydroxyurea therapy in polycythemia vera and allied disorders: prospective study of efficacy and leukaemogenicity with therapeutic implications. *Eur J Haematol* 1994;52:134–139.

# Wintrobe's Clinical Hematology



**ETIOLOGY AND PATHOGENESIS**[Epidemiology](#)[Clonal Hematopoiesis](#)[Molecular Events](#)[Bone Marrow Fibrosis and Extramedullary Hematopoiesis](#)**FEATURES OF DISEASE AT DIAGNOSIS**[Symptoms](#)[Signs](#)[Laboratory Findings](#)**NATURAL HISTORY AND SURVIVAL****THERAPY**[Allogeneic Hematopoietic Stem Cell Transplantation](#)[Androgens and Corticosteroids](#)[Chemotherapy](#)[Irradiation](#)[Splenectomy](#)[Other Measures](#)**DIFFERENTIAL DIAGNOSIS**[Acute Myelofibrosis](#)[Other Chronic Myeloproliferative Disorders](#)[Secondary Forms of Myelofibrosis](#)**REFERENCES**

*Myelofibrosis* is a term referring to deposition of excess collagen in the bone marrow. It is a defining characteristic of a distinct clonal hematopoietic stem cell disorder, which is related to the other chronic myeloproliferative disorders (CMPDs). This uncommon disorder was first described in 1879 ([1](#)) and has been given more than 30 names, including primary myelofibrosis, osteomyelofibrosis, agnogenic myeloid metaplasia, idiopathic myelofibrosis, and most commonly, myelofibrosis with myeloid metaplasia (MMM) ([2](#)). MMM must be distinguished from other diseases in which myelofibrosis is a secondary phenomenon ([Table 86.1](#)) ([3](#)). In a rare familial disorder, primary hypertrophic osteoarthropathy, myelofibrosis may be a primary disorder of marrow fibroblast growth ([4](#)).

**TABLE 86.1. Conditions in Which Myelofibrosis May Occur**

## Neoplastic conditions

Chronic myeloproliferative disorders

Agnogenic myeloid metaplasia

Polycythemia rubra vera

Chronic myeloid leukemia

Other neoplastic conditions

Acute megakaryoblastic leukemia (M7)

Myelodysplasia with fibrosis

“Transitional” agnogenic myeloid metaplasia–myelodysplastic myeloproliferative syndrome

Other acute myeloid leukemias

Acute lymphoid leukemia

Hairy cell leukemia

Myeloma

Carcinoma

Systemic mastocytosis

Nonneoplastic conditions

Granulomatous disease

Paget disease

Hypoparathyroidism

Hyperparathyroidism

Osteoporosis

Renal osteodystrophy

Vitamin D deficiency

Gray platelet syndrome

Systemic lupus erythematosus

Systemic sclerosis

Adapted from references [2](#), [48](#), [160](#), [210](#), [212](#), [213](#), [245](#), [255](#), and [258](#), [259](#), [260](#) and [261](#).

---

## ETIOLOGY AND PATHOGENESIS

### Epidemiology

The cause of MMM is unknown. In most cases, no inciting factors are found, but epidemiologic studies have identified some associations. MMM may occur after exposure to toluene and benzene ([5](#), [6](#) and [7](#)). It may also occur after exposure to ionizing radiation ([8](#), [9](#)). A very high incidence of MMM was observed in patients given the thorium-based radiographic contrast material, Thorotrast ([8](#)), and victims of the atomic bombing of Hiroshima had a risk of MMM 18 times that of the remainder of the Japanese population, with symptoms appearing an average of 6 years after exposure ([9](#)). Tefferi measured a baseline annual incidence of 1.5 cases per 100,000 in a North American population ([3](#)).

### Clonal Hematopoiesis

In 1951, Dameshak grouped MMM with chronic myeloid leukemia (CML), polycythemia vera (PV), and essential thrombocythemia (ET) as a CMPD because of the clinical and morphologic similarity of these conditions ([10](#)). All display a hyperplastic bone marrow, hematopoiesis independent of physiologic stimuli, a phase of increased circulating blood cell concentrations, a tendency toward the development of marrow fibrosis, and a tendency to terminate in acute leukemia. All CMPDs arise as somatic mutations of a pluripotent hematopoietic stem cell. Several observations confirm that there is neoplastic clonal hematopoiesis in MMM. Various clonal cytogenetic abnormalities are present in half of patients at diagnosis ([11](#), [12](#), [13](#), [14](#), [15](#) and [16](#)). Other markers of clonality are observed in circulating neutrophils, red cells, platelets, lymphocytes, and their marrow precursors. These include the distribution of glucose-6-phosphate dehydrogenase isoenzymes, the

pattern of X chromosome inactivation in women, cell membrane defects, and mutations of the N-ras gene ( [17](#), [18](#), [19](#), [20](#), [21](#), [22](#), [23](#), [24](#), [25](#) and [26](#)). The circulating progenitor cell concentration in MMM is 10 to 20 times normal, and CD34<sup>+</sup> progenitor cells in circulation are increased 400 times above normal levels ( [27](#), [28](#), [29](#), [30](#), [31](#) and [32](#)). Progenitor cells from MMM patients are hypersensitive to cytokines and can proliferate *in vitro* without cytokine stimulation ( [33](#), [34](#)). This property is a consistent feature of all the CMPDs. Megakaryocyte progenitors from MMM patients may also differentiate independent of thrombopoietin (TPO), the physiologic stimulus ( [35](#), [36](#)).

## Molecular Events

Mutagens presumably initiate events that produce the clonal hemopathy in MMM. There is no consistent cytogenetic abnormality in this disease similar to the *bcr/ab* gene rearrangement in CML that calls attention to candidate genes important in pathogenesis. The molecular events leading to development of MMM have not been elucidated but are under investigation in several laboratories. Differential expression of a panel of candidate genes has been studied in cytokine-independent progenitor cells from MMM patients versus cytokine-dependent (and presumably normal) progenitors. The FKBP51 immunophilin is overexpressed in most patients studied, and its functioning appears to confer cytokine independence ( [37](#)). The GATA-1 transcription factor is active in normal megakaryocyte differentiation ( [38](#)). A genetically altered mouse has been created that has impaired expression of GATA-1 and develops a syndrome similar to MMM ( [39](#)). This observation suggests that events directed by GATA-1 may be important in the development of MMM. Other growth-related genes that have been examined include the retinoblastoma gene, which may be deleted or altered in expression ( [22](#), [23](#) and [24](#)), and the calcitonin gene, which may be methylated ( [24](#)). Disease progression in MMM may be associated with abnormalities of p53 or ras genes ( [26](#)).

## Bone Marrow Fibrosis and Extramedullary Hematopoiesis

Myelofibrosis in MMM is a secondary reaction to the clonal hemopathy ( [40](#)). Fibroblasts secrete the collagen, which accumulates; these cells are normal and polyclonal ( [41](#), [42](#), [43](#), [44](#), [45](#) and [46](#)). They are stimulated by cytokines released from neoplastic megakaryocytes and other clonally expanded hematopoietic cells ( [40](#), [47](#)). Both breakdown and synthesis of collagen are affected, but increased synthesis of collagen appears to be most important, as the concentration of procollagen cleavage products is a marker for new collagen synthesis and correlates with disease activity ( [48](#), [49](#), [50](#), [51](#), [52](#) and [53](#)). Collagen is deposited in the extracellular space and the vascular elements of the bone marrow. Four of the five types of collagen are normally present. The major components of the fibrosis in MMM are type 1 and 3 collagen, and collagen deposition increases with the duration of disease ( [48](#), [49](#) and [50](#)). In early stages of MMM, there is a high percentage of newly synthesized collagen (type 3); in later stages, a high percentage of a more stable, polymeric collagen (type 1) is found ( [48](#)). In addition, a smaller proportion of hexosamine-containing matrix molecules is found in MMM as compared with normal marrow, and the proportion decreases further with the duration of MMM. Bone marrow vascularity is consistently increased in MMM. The degree of neovascularity correlates with the extent of disease and may be important to the development of the fibrosis ( [52](#)).

Transforming growth factor (TGF)- $\beta$  is the principal mediator of collagen accumulation in MMM ( [46](#), [53](#), [54](#), [55](#), [56](#), [57](#), [58](#) and [59](#)). This cytokine is synthesized by megakaryocytes and endothelial cells as well as by the monocyte-macrophage system ( [57](#), [58](#)). It is more

potent in stimulating collagen secretion than either platelet-derived growth factor or epidermal growth factor ( 57 ) and may regulate the expression of these two cytokines ( 57 , 58 ). TGF- $\beta$  is also a potent stimulus of angiogenesis, acting in part through vascular endothelial growth factor ( 60 ). Elevated levels of TGF- $\beta$  are detected in the circulating platelets and megakaryocyte fragments of MMM patients, and circulating concentrations of TGF- $\beta$  are increased ( 61 , 62 ). Monocytes and macrophages arise from the neoplastic clone and may be another source of cytokines. TGF- $\beta$  is secreted in increased amounts by monocytes from patients with MMM as compared with normal controls, and its messenger RNA is expressed at elevated levels in blood mononuclear cells in MMM patients ( 55 , 56 , 57 , 58 and 59 ). Other growth factors are also believed to be stimulatory to fibroblasts in MMM. These include platelet-derived growth factor, which is present in elevated concentration in MMM megakaryocytes, epidermal growth factor, endothelial cell growth factor, interleukin-1, basic fibroblast growth factor, and calmodulin ( 55 , 56 , 61 , 62 , 63 , 64 , 65 and 66 ). Several mechanisms for release of increased levels of cytokines into the marrow environment have been proposed: simple secretion of  $\alpha$ -granules from the megakaryocytes, intramedullary death of dysplastic megakaryocytes with dissolution of their cytoplasm ( 67 ), and damage to megakaryocyte cytoplasm by engulfment of polymorphonuclear leukocytes ( 68 ).

Mice exposed to very high concentrations of TPO develop a syndrome similar to MMM. Mice injected repeatedly with polyethylene glycol-conjugated TPO or transfected to express the TPO gene exhibit megakaryocyte hyperplasia, thrombocytosis, bone marrow fibrosis, and extramedullary hematopoiesis ( 69 , 70 ). The syndrome remits in mice that are no longer injected and in genetically altered mice that are treated by bone marrow transplantation. However, the role of TPO in MMM is unclear. Circulating levels of TPO in MMM patients are elevated but do not correlate with the megakaryocyte mass ( 71 , 72 ). The apparent elevation of TPO levels in MMM may result from altered clearance mechanisms ( 73 , 74 ). Moreover, TPO inhibits proliferation of hematopoietic stem cells from MMM patients ( 35 , 75 ).

The distribution of extramedullary hematopoiesis in MMM approximates that in the fetus, and the liver and spleen are invariably involved ( 76 ). In a vascular injury model of myelofibrosis, ultrastructural studies reveal crowding of hematopoiesis out of the scarred marrow and early release of hematopoietic precursors. Extramedullary sites are colonized by the displaced hematopoietic cells ( 2 , 77 ). A similar abnormal release of marrow precursors from distorted sinusoids produces extramedullary hematopoiesis in metastatic cancer and may be a general mechanism ( 78 ).

## FEATURES OF DISEASE AT DIAGNOSIS

MMM affects mostly middle-aged and elderly patients. The median age at diagnosis is 60 years, and men and women are affected with equal frequency ( 2 , 76 , 79 , 80 , 81 , 82 , 83 , 84 , 85 , 86 , 87 and 88 ). MMM is less common in younger adults and rare in children, with boys affected twice as often as girls ( 89 , 90 ). A familial form has been reported in several kindreds ( 91 , 92 ).

### Symptoms

MMM is asymptomatic in 25% of patients at presentation, and the diagnosis is suggested by abnormal blood findings or incidentally discovered splenomegaly ( 2 ) ( [Table 86.2](#) ). Most

patients report fatigue, and weight loss is common (7 to 39%) ( [2](#), [76](#), [85](#)). Hypermetabolic symptoms, such as fever and night sweats, occur in 5 to 20% of patients, and bleeding and bruising occur in a similar proportion ( [2](#), [76](#), [85](#)). Patients may note a mass in the abdomen. Gout and renal colic affect 4 to 6% of patients, but tophi are unusual ( [2](#)). Another symptom noted by a few patients is diarrhea, the cause of which usually is obscure. Sternal tenderness is sometimes noted.

**TABLE 86.2. Clinical Findings at Diagnosis Among Patients with Myelofibrosis with Myeloid Metaplasia**

---

Very common findings (>50% of cases)

- Splenomegaly
- Hepatomegaly
- Fatigue
- Anemia
- Leukocytosis
- Thrombocytosis

Common findings (10–50% of cases)

- Asymptomatic
- Weight loss
- Night sweats
- Bleeding
- Splenic pain
- Leukocytopenia
- Thrombocytosis
- Thrombocytopenia

Uncommon findings (<10% of cases)

- Peripheral edema
- Portal hypertension
- Lymphadenopathy
- Jaundice
- Gout

Adapted from references [2](#), [76](#), and [79](#), [80](#), [81](#), [82](#), [83](#), [84](#), [85](#) and [86](#).

---

## Signs

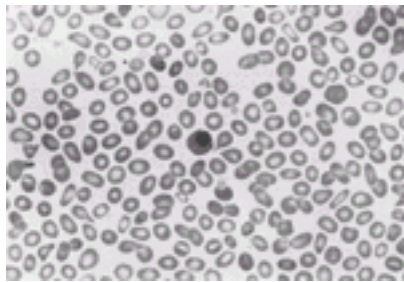
Splenomegaly is the only physical finding in the majority of patients at presentation, and the spleen may be quite large ( [2](#), [76](#), [79](#), [80](#), [81](#), [82](#), [83](#), [84](#), [85](#), [86](#), [87](#), and [88](#)) ( [Table 86.2](#)).

Absence of splenomegaly is rare ( [93](#)). Hepatomegaly is found in half of patients at diagnosis, and 2 to 6% also have portal hypertension, which may be complicated by ascites, esophageal varices, gastrointestinal bleeding, and hepatic encephalopathy ( [2](#), [76](#), [83](#), [85](#)). Petechiae, ecchymoses, and lymphadenopathy are detected in a few patients ( [81](#), [84](#)). Some exhibit neutrophilic dermatosis similar to Sweet syndrome, and a few have dermal extramedullary hematopoiesis ( [94](#), [95](#)). Many have osteosclerosis. In a few patients, osteosclerosis is associated with periostitis leading to bony pain ( [2](#), [76](#), [79](#), [80](#), [81](#), [82](#), [83](#), [84](#), [85](#), [86](#), [87](#), [88](#), [89](#), [90](#), [91](#), [92](#), [93](#), [94](#), [95](#)).

, [85](#), [86](#), [87](#) and [88](#)) or deafness ([76](#)). When serosal surfaces are involved by extramedullary hematopoiesis, there may be symptomatic pleural or pericardial effusions or ascites ([96](#), [97](#) and [98](#)). The central nervous system is a common site of symptomatic deposits. Associated neurologic complications include increased intracranial pressure, delirium, coma, subdural hemorrhage, motor and sensory impairment, and paralysis ([99](#), [100](#), [101](#), [102](#), [103](#), [104](#) and [105](#)).

## Laboratory Findings

**BLOOD** The characteristic peripheral blood finding in MMM is the presence of teardrop-shaped red cells associated with circulating nucleated red cells ([Fig. 86.1](#)), immature neutrophilic leukocytes, and abnormally large platelets ([2](#), [76](#)). Fragmented, target, and polychromatophilic red cells and increased numbers of reticulocytes are usually present. These morphologic abnormalities are the result of altered hematopoiesis, early release of cells from the marrow, and extramedullary hematopoiesis. Because the number of teardrop cells in circulation declines after splenectomy, these cells are believed to arise from extramedullary hematopoiesis. However, the mechanism by which this shape is induced is obscure ([106](#)).



**Figure 86.1.** Teardrop poikilocytes and nucleated red cell from the blood of a patient with myelofibrosis (Wright stain × 400 original magnification).

The concentration of circulating blood cells varies widely among MMM patients and with the course of the illness in any one patient. Anemia with a hemoglobin less than 10 g per dl develops in 60% of patients with MMM, and some degree is usually present at diagnosis ([2](#), [76](#)). There are dilutional effects from expanded plasma volume ([107](#)), and both marrow underproduction ([76](#), [82](#), [107](#), [108](#), [109](#), [110](#) and [111](#)) and hemolysis occur. Causes of hemolysis include hypersplenism ([76](#), [107](#), [112](#)), red cell autoantibodies ([76](#), [82](#), [113](#), [114](#)), acquired hemoglobin H ([115](#)), and membrane complement sensitivity similar to that in *de novo* paroxysmal nocturnal hemoglobinuria ([17](#), [18](#), [116](#)) (see [Chapter 37](#)). In one series, 10% of patients exhibited hemolysis due to a paroxysmal nocturnal hemoglobinuria-like defect, and the paroxysmal nocturnal hemoglobinuria phenotype may occasionally be the predominate clinical manifestation ([17](#)). Red cells are generally normochromic and normocytic, but classic nutritional deficiencies also occur. Depletion of folate may produce a macrocytic anemia ([117](#), [118](#)), and iron-deficient microcytic anemia due to gastrointestinal bleeding is sometimes observed. Leukocyte counts are increased in approximately 50% but are decreased in approximately 25% of MMM patients at the time of diagnosis ([76](#)). Eosinophilia and basophilia are often present, and the number of lymphocytes is usually normal. Some myeloblasts circulate in the peripheral blood and may not necessarily indicate conversion to acute leukemia. However, a concentration of myeloblasts above 1% may indicate a poor prognosis. Hypersegmented neutrophils may be seen, and levels of neutrophil enzymes may be altered ([80](#), [82](#), [119](#), [120](#), [121](#), [122](#), [123](#), [124](#) and [125](#)). The platelet concentration is increased at the time of diagnosis in 50% of patients. However, with disease progression, thrombocytopenia becomes common. Extreme



thrombocytosis in a few patients may make a distinction from ET difficult. Platelets are usually large, and intact or fragmented megakaryocytes circulate (79). Platelet function is often abnormal. Abnormal bleeding times and clot retraction, a reduced level of platelet factor 3, reduced platelet adhesiveness, and reduced lipoxygenase activity may be present (126, 127, 128 and 129). Alterations of soluble clotting factors also occur. Subclinical disseminated intravascular coagulation is found in 15% of patients with advanced MMM, and acquired factor V deficiency may be present (2, 130). Levels of uric acid and lactic dehydrogenase are increased in most patients, reflecting an expanded mass of hematopoietic cells, ineffective hematopoiesis, or both (76, 80). The level of serum alkaline phosphatase is increased in half the patients and is believed to be related to bone rather than liver disease (76). Levels of albumin, cholesterol, and lipoproteins are generally decreased (131). Increased serum levels of vitamin B<sub>12</sub> found in patients with leukocytosis reflect the increased neutrophil mass (132, 133).

**BONE MARROW** Aspiration of bone marrow may be unsuccessful (dry tap), and biopsy is required to diagnose MMM. A consensus conference was convened by the Italian Society of Hematology to develop diagnostic criteria. Morphologic and clinical data were combined to differentiate MMM from other CMPDs and from myelodysplastic syndromes with marrow fibrosis (134, 135). These criteria define marrow fibrosis and morphologic evidence for marrow hyperplasia and extramedullary hematopoiesis. All three elements must be present to sustain a diagnosis of MMM (Table 86.3). Fibrosis is present at some point in all cases of MMM, but its extent varies. Early in the disease, fibrosis may be minimal, and evidence of marrow hyperplasia may be more striking. This has been termed the *cellular phase* of MMM. If marrow fibrosis is not evident in a patient suspected of having MMM, a second specimen should be obtained from a different site, because it may not be uniformly distributed throughout the marrow. Fibrosis may be graded according to published systems, and histologic evidence of osteosclerosis may be noted (48, 136, 137) (Fig. 86.2). When there is massive fibrosis, overall cellularity may be decreased, but evidence of megakaryocytic hyperplasia remains (136). Bone marrow sinusoids are expanded, and there is intravascular hematopoiesis (Fig. 86.3B) (136). Increased numbers of mast cells may be observed in biopsies adjacent to fibrosis (138). Smears from successful aspirates may show no abnormality, but usually there is neutrophilic and megakaryocytic hyperplasia. Micromegakaryocytes and macromegakaryocytes are observed, and there is nuclear–cytoplasmic asynchrony. Increased polyploidy (64N cells) is often demonstrable (139, 140). Granulocytes may be hyper- or hypolobulated and may exhibit an acquired Pelger–Huët anomaly or nuclear–cytoplasmic asynchrony (141). Erythroid precursors may be normal or increased. Isotopic scanning of marrow with sulfur colloid (for reticuloendothelial cells) and with iron (for erythroid cells) reveals expansion of marrow into the normally inactive long bones (142, 143). Magnetic resonance scanning can also document expansion of marrow in MMM by a change in signal characteristics in long bones (144).

**TABLE 86.3. Italian Consensus Conference for Diagnosis of Myelofibrosis with Myeloid Metaplasia**

**Major criteria**

- Diffuse bone marrow fibrosis
- Absence of t9:22 chromosome or *bcr/abi* rearrangement in peripheral blood cells
- Splenomegaly

**Minor criteria**

- Anisopoikilocytosis with teardrop red cells
- Circulating immature myeloid cells
- Circulating nucleated red cells

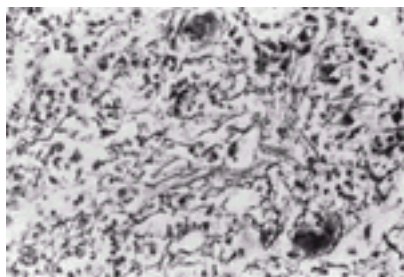


Clustered marrow megakaryoblasts and anomalous megakaryocytes  
Myeloid metaplasia

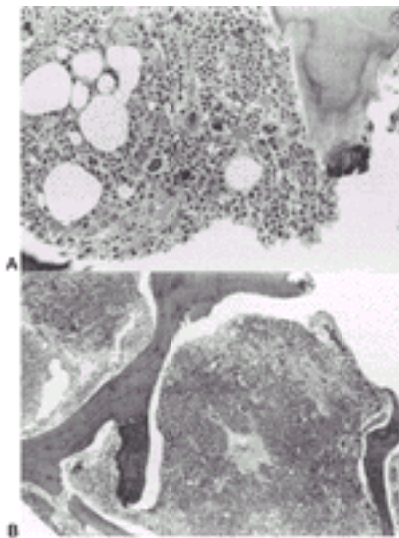
NOTE: All three major criteria plus any two minor criteria OR the first two major criteria plus any four minor criteria must be present to sustain a diagnosis of myelofibrosis with myeloid metaplasia.

Adapted from Barosi G, Ambreotti A, Finelli C, et al. The Italian consensus conference on diagnostic criteria for myelofibrosis with myeloid metaplasia. *Br J Haematol* 1999;104:730–737; and Barosi G. Myelofibrosis with myeloid metaplasia: diagnostic definition and prognostic classification for clinical studies and treatment guidelines. *J Clin Oncol* 1999;17:2954–2970.

---



**Figure 86.2.** Reticulin stain of a bone marrow biopsy specimen demonstrating increased collagen ( $\times 400$  original magnification).



**Figure 86.3.** Bone marrow biopsy sections from two patients with agnogenic myeloid metaplasia demonstrating a proliferative-phase bone marrow with hyperplasia involving all cell lines and relatively little fibrosis (hematoxylin and eosin,  $\times 200$  original magnification) (A) and intense fibrosis with new bone formation, dilated sinusoids, and residual megakaryocytes (hematoxylin and eosin,  $\times 100$  original magnification) (B).

**CHROMOSOME ABNORMALITIES** Half of MMM patients have clonal karyotypic abnormalities at diagnosis ([11](#), [12](#), [13](#), [14](#), [15](#) and [16](#), [145](#), [146](#), [147](#) and [148](#)). Only a minority demonstrate the abnormality in all metaphases examined, indicating that many MMM patients have residual normal hematopoietic cells ([145](#)). The most common findings are

deletion of a segment of the chromosome bearing the retinoblastoma gene, del 13(q13q21) and del 20q ( [146](#), [147](#) ). Other chromosomal defects are not random. Chromosomes 1, 5, 7, 8, 9, 13, 20, and 21 are most commonly affected. Monosomy and trisomy are common, and partial deletions and translocations also occur. Fibroblasts do not share the chromosomal abnormalities found in hematopoietic cells in MMM ( [36](#) ).

**IMMUNE DISORDERS** Clinically significant immunologic abnormalities are common in MMM, in contrast with the other CMPDs. B and T lymphocytes are directly affected by the stem cell defect in MMM in at least some patients, and functional defects of T or B cells may be demonstrated ( [22](#), [149](#) ). A variety of abnormalities of humoral immunity have been described. Depressed levels of C3 occur and may cause increased susceptibility to bacterial infection ( [150](#), [151](#) ). Circulating immune complexes have been found, and their concentration correlates with the state of disease activity ( [152](#) ). Pathologic autoantibodies that may occur include antierythrocyte autoantibodies ( [2](#), [150](#), [152](#), [153](#) and [154](#) ), antiplatelet antibodies ( [155](#) ), antinuclear antibodies ( [150](#), [156](#) ), antiimmunoglobulins ( [150](#), [156](#) ), and antiphospholipid antibodies ( [150](#), [157](#) ). Bone marrows in MMM often have lymphoid infiltrates ( [157](#), [158](#) ). Monoclonal gammopathy may occur in as many as 10% of MMM patients, and several cases of simultaneous MMM and plasma cell dyscrasia have been reported ( [154](#), [158](#), [159](#) ).

**PATHOLOGY** The characteristic features of MMM are fibrosis of the bone marrow, as described above, and extramedullary hematopoiesis. Bone marrow fibrosis is associated with osteosclerosis in 30 to 70% of patients ( [76](#) ). It is most common for the axial skeleton and proximal long bones to be affected. The bony cortex appears thickened, and the normal trabecular pattern is lost ( [160](#) ). Extramedullary hematopoiesis is present in the spleen and is responsible for the splenic enlargement. The liver is likewise involved in most patients. Any organ may be engaged in extramedullary hematopoiesis; it occurs, in approximate decreasing frequency, in lymph nodes, kidneys, adrenals, peritoneum, gut, pleura, lungs, fatty tissue, skin, breast, dura, ovaries, and thymus ( [76](#) ). The hematopoietic islands may contain any combination of myeloid precursor lineages and may be microscopic infiltrates or macroscopic tumors ( [161](#) ). The proportion of erythroid cells is higher in extramedullary sites than in the marrow, and extramedullary erythropoiesis tends to be associated with a lower mitotic index and a higher percentage of immature and megaloblastic cells than medullary erythropoiesis ( [162](#) ). Damage to target organs occurs by physical compression of adjacent normal tissue, but their normal architecture usually is preserved.

## NATURAL HISTORY AND SURVIVAL

MMM has a median survival of 3 to 7 years, and less than 20% of patients survive more than 10 years ( [2](#), [76](#), [79](#), [80](#), [81](#), [82](#), [83](#), [84](#) and [85](#), [163](#) ). This prognosis approximates the median time to development of blast crisis in CML and is considerably worse than survival in ET and PV ( [163](#) ). Patients with evidence of a greater disease burden at diagnosis experience shorter survival ( [76](#) ). Favorable prognostic factors include lack of constitutional symptoms, hemoglobin levels of 10 g per dl or more, platelet counts of  $100 \times 10^9$  per L or more, and absence of hepatomegaly ( [85](#) ). Younger patients have a better survival ( [15](#), [164](#), [165](#) ), as do those with a low concentration of circulating myeloblasts ( [164](#) ).

Some cytogenetic abnormalities, such as a single clone with translocation of chromosome 1, 5q-, trisomy 8, 13q-, or 20q-, may be associated with a better prognosis ( [166](#) ), but the overall subset of patients with any chromosome abnormality has been reported to have a poorer prognosis than patients with normal karyotypes ( [146](#) ). Additionally, patients with

increased plasma volume or increased plasma levels of soluble interleukin-2 receptor appear to have a poorer survival ( [107](#), [167](#) ). Several prognostic scores have been devised that use age, hemoglobin level, constitutional symptoms, and karyotype ( [15](#), [164](#), [165](#) ). Patients may be stratified with these systems into risk groups with life expectancies as short as 16 months and as long as 180 months ( [15](#) ).

Over time, the severity of symptoms and cytopenias in MMM progresses despite occasional spontaneous improvements ( [2](#) ). Weight loss becomes more troublesome, and edema of the lower extremities often develops. Infections, especially pneumonia, are frequent ( [76](#), [150](#) ). Most patients experience progressive splenic enlargement leading to pain, and bone pain is frequent with time ( [76](#), [168](#) ). Portal hypertension with esophageal varices eventually complicates the course of 17% of patients with MMM. It results from increased splenoportal blood flow, hepatic vein thrombosis, thrombosis of the portal vein, transfusion-induced hemochromatosis, and intrasinusoidal hematopoiesis ( [76](#), [161](#), [169](#), [170](#) ). Bleeding due to thrombocytopenia, platelet defects, disseminated intravascular coagulation, or factor deficiencies tends to develop ( [2](#) ). Over time, tumors composed of hematopoietic tissue become more common and may damage vital structures, especially in the central nervous system ( [99](#), [100](#), [101](#), [102](#), [103](#), [104](#) and [105](#), [171](#) ).

The causes of death in MMM are variable. Infection, hemorrhage, cardiac failure, and cerebrovascular accidents are common, and renal failure, hepatic failure, or thrombosis is also reported in most series ( [2](#), [76](#), [80](#), [81](#), [82](#), [83](#), [84](#) and [85](#), [163](#), [172](#), [173](#) and [174](#) ). Leukemic conversion has been reported in 5 to 20% of patients with MMM ( [80](#), [82](#), [172](#), [173](#) ). The onset of leukemia is usually abrupt, and most patients have had a rapidly fatal course ( [147](#) ). Many cases occur without exposure to cytotoxic therapy, and cases of acute lymphocytic leukemia as well as all classes of acute myeloid leukemia have occurred ( [22](#), [84](#), [174](#) ).

## THERAPY

MMM may be cured by hematopoietic stem cell transplantation (HSCT), but HSCT is generally reserved for younger individuals and carries a significant risk of mortality ( [Table 86.4](#) ). No other form of therapy has been shown to prolong survival or prevent progression of myelofibrosis; thus, there must be clear indications for intervention. Supportive therapy is directed toward specific complications. Many patients are asymptomatic and require only observation. Allopurinol is used to keep serum levels of uric acid within normal limits to avoid urate nephropathy and renal calculi and to prevent gout ( [2](#), [76](#) ). Anemia and thrombocytopenia may be present at diagnosis and usually progress to a point at which symptoms result. When therapeutic maneuvers fail to improve hematopoiesis, treatment consists of transfusions as needed to maintain adequate blood counts. Because of the frequency of hemolysis, folate supplementation is also given.

**TABLE 86.4. Therapy for Patients with Myelofibrosis with Myeloid Metaplasia**

| Indication  | Therapeutic Option  |
|---|---|
| Young ( $\leq 45$ yr) patient with $\geq 2$ adverse risk factors <sup>a</sup> | Consider allogeneic hematopoietic stem cell transplantation |
| Hyperuricemia or gout   | Allopurinol   |

|                                  |  |
|----------------------------------|--|
| Anemia                           | Trial of androgens and corticosteroids; transfusion; splenectomy for refractory hemolysis or excessive transfusion requirement |
| Severe thrombocytopenia          | Splenectomy  |
| Splenic pain                     | Splenectomy or irradiation   |
| Portal hypertension              | Splenectomy  |
| Symptomatic extramedullary focus | Irradiation  |
| Severe hypermetabolic symptoms   | Chemotherapy   |
| Hepatomegaly after splenectomy   | Chemotherapy   |
| Symptomatic thrombocytosis       | Chemotherapy   |

<sup>a</sup> Hemoglobin <10 g/dl, abnormal karyotype, constitutional symptoms, >1% circulating blasts ( [164](#)).

---

## Allogeneic Hematopoietic Stem Cell Transplantation

All of the CMPDs may be cured by allogeneic HSCT. The utility of this approach has been limited by the age and condition of many of the patients, by the availability of suitable donors, and by the morbidity and mortality associated with the procedure. However, donor procurement programs, conditioning regimens, and supportive care have continued to improve. The presence of marrow fibrosis and splenomegaly in MMM patients does not seem to be an obstacle to HSCT ( [175](#), [176](#)).

There are now several published series describing results in patients with MMM, including an international cooperative trial with 55 patients ( [177](#), [178](#) and [179](#) ). Most of these patients were young (median age, 42 years in the largest series) and had HLA-identical related donors. However, in the Seattle series, 8 of 19 donors were HLA-matched but unrelated, and 2 of 19 donors were one-antigen mismatches ( [178](#) ). Overall survival in the largest series was approximately 50% at 5 years. Abnormal karyotype, anemia, and older age were associated with poorer outcome in that series, and there was a 14% 5-year survival for MMM patients over the age of 45 ( [179](#) ). However, a recent communication from the Seattle group predicts a more favorable outcome of 50% in patients over age 45 ( [180](#) ). Lower intensity conditioning regimens that may be more tolerable for older MMM patients are being examined and show initially positive results in terms of engraftment and resolution of disease features ( [181](#), [182](#) ). It seems clear that younger patients with two or more adverse risk factors who have a poor predicted survival without curative treatment should be considered for HSCT shortly after diagnosis ( [179](#), [183](#) ). Older patients, who may have a poor outcome with HSCT, and those without adverse risk factors at diagnosis may be better served by delaying consideration of HSCT until adverse factors develop. However, data are still too limited to suggest a more definitive approach to this issue.

## Androgens and Corticosteroids

Androgens may be given to treat anemia associated with MMM. Response rates of 29 to 57% have been reported in various series ( [184](#), [185](#) and [186](#) ). Spontaneous improvement may occur in MMM, so apparent responses to therapy must be reviewed critically ( [184](#), [185](#) and [186](#) ). Young women with minimal splenomegaly and patients with normal karyotypes appear

to benefit most ( [109](#), [119](#), [184](#), [185](#) and [186](#) ). Men must be screened for prostate cancer with digital rectal examination and prostate-specific antigen determination, and women must be cautioned about virilizing effects before androgen therapy. Liver function tests should be monitored during therapy.

Several dosing schedules have been used successfully ( [2](#), [109](#), [119](#), [184](#), [185](#) and [186](#) ). A reasonable regimen is to give the oral synthetic androgen fluoxymesterone in doses of 10 mg two to three times daily. If no improvement is noted after 3 to 6 months, androgen therapy should be discontinued ( [2](#) ). Some patients who do not respond to one androgen preparation may respond to another ( [2](#) ). Because red cell survival is often shortened in MMM, adrenal corticosteroids may improve red cell survival and anemia. Oral prednisone at doses of 1 mg/kg daily produces responses in 25 to 50% of patients ( [2](#), [81](#) ). Again, the best responses have been observed in women ( [2](#) ). However, this dose of prednisone cannot be given indefinitely because of steroid toxicity. Patients with hemolysis should also receive folic acid supplementation. Androgens and corticosteroids are probably best given in combination. Therapy may be initiated with prednisone at 30 mg daily given in combination with fluoxy-mesterone at 10 mg twice daily. If a patient responds after a month, the prednisone may be withdrawn while fluoxymesterone is continued.

## Chemotherapy

Chemotherapy rarely induces a hematologic remission and does not alter the overall course of MMM, but it may be very useful for relief of symptoms ( [2](#), [3](#), [76](#), [79](#), [80](#), [81](#), [82](#), [83](#), [84](#), [85](#), [86](#), [87](#) and [88](#), [166](#), [187](#) ). Chemotherapy reduces the liver and spleen size and alleviates weight loss, fever, and night sweats in up to 70% of patients ( [2](#) ). It also reduces elevated leukocyte and platelet counts and occasionally may correct anemia ( [79](#), [81](#), [119](#), [187](#) ). Busulfan, melphalan, 6-thioguanine, and hydroxyurea have all been used successfully for these indications ( [166](#), [187](#), [188](#) ). Patients with MMM are especially prone to develop myelotoxicity, so chemotherapy must be used more cautiously than in the treatment of other CMPDs. For example, 2 to 4 mg/day of busulfan probably is the maximal dose that can be given with any degree of safety to patients with MMM. Patients must be monitored at frequent intervals, and late or prolonged cytopenias may occur. Hydroxyurea should probably be initiated at a reduced dose of 500 to 1000 mg every other day. Cautious dose adjustments should be based on clinical response and current blood counts.

## Irradiation

MMM patients with hypersplenism may respond to splenic irradiation when there is a contraindication to splenectomy. Most patients experience relief of pain and a 50% or more reduction in spleen size ( [189](#), [190](#) and [191](#) ). Splenic irradiation may produce life-threatening cytopenias, so the treatment must be administered in small fractions with close clinical monitoring ( [191](#) ). Fractions of 15 to 100 cGy are usually given 2 to 3 days per week. Total doses of 700 to 2400 cGy can give satisfactory results with tolerable toxicity ( [189](#), [190](#) and [191](#) ). However, the benefits often are temporary, lasting only a few months. Symptomatic extramedullary hematopoietic tumors also respond to radiation therapy. It is especially useful for bone pain from tumors or periostitis and for central nervous system deposits ( [103](#), [192](#), [193](#) ). Irradiation may also be administered as radiophosphate ( [2](#) ).

## Splenectomy



Splenectomy may be considered for treatment of refractory cytopenias, portal hypertension, or symptoms of hypersplenism ( [2](#), [107](#), [194](#), [195](#), [196](#), [197](#), [198](#), [199](#), [200](#), [201](#) and [202](#) ). Most patients benefit with resolution of hypersplenic symptoms and signs of portal hypertension (97% and 83%, respectively). The majority have improvement in anemia and thrombocytopenia (70% and 56%, respectively) ( [195](#) ). However, many of these benefits may not persist at 1 year postprocedure ( [200](#) ). Splenectomy is hazardous in MMM because of the size of the organ, its frequent adhesion to adjacent structures, its increased blood flow, and the compromised state of the patients. Low-grade disseminated intravascular coagulation, evidenced by elevated D-dimer levels, is also common in MMM and leads to increased bleeding risk if it is not sought and corrected preoperatively. Acute operative mortality up to 38% was reported in early series ( [195](#) ). Current mortality rates at experienced centers are better, usually less than 10% in hospital and 25% at 3 months ( [200](#) ).

Splenectomy has been criticized due to the fear of producing an aplastic crisis on the supposition that the spleen may be the sole site of hematopoiesis if the marrow is severely fibrotic ( [76](#) ). Even in advanced MMM, the marrow is usually the principal site of hematopoiesis ( [107](#) ), and in practice, aplastic crises are not usually observed. Concern has also been raised that splenectomy may precipitate leukemic transformation ( [202](#) ). However, analysis of histologic risk factors for leukemia in resected MMM spleens suggests that the progression of hypersplenism necessitating the procedure may often be the result of disease progression already in progress ( [203](#) ). Complications of splenectomy are significant and include intraabdominal infection, extreme thrombocytosis with thrombosis, and a rapidly enlarging liver ( [195](#), [200](#), [201](#) ). The latter two complications may require a postoperative course of chemotherapy ( [204](#) ).

## Other Measures

Small clinical trials and case reports have suggested the possible utility of a number of other therapies for MMM. Interferons have been studied because of their activity against TGF- $\beta$  and their efficacy in CML ( [61](#), [205](#) ). Interferon- $\alpha$  may diminish bone pain, thrombocytopenia, and splenic enlargement, but its efficacy is limited by severe flulike symptoms and, on occasion, worsened anemia ( [206](#), [207](#), [208](#), [209](#), [210](#) and [211](#) ). Vitamin D analogs suppress megakaryocyte proliferation and reverse myelofibrosis associated with rickets ( [48](#), [49](#), [212](#), [213](#) ). Vitamin D derivatives have thus been given to patients with MMM and have shown benefit in several cases ( [214](#), [215](#) and [216](#) ). Anagrelide reduces platelet counts in MMM but does not provide other clinical benefits ( [217](#) ). Small series of MMM patients with anemia have been treated with erythropoietin. Both positive ( [218](#) ) and negative ( [219](#) ) results have been reported. The effect of erythropoietin may be greater if it is administered in combination with interferon ( [220](#) ). The antiangiogenic agent thalidomide has been given to several series of patients with advanced MMM. Approximately 20% have had some benefit, with decrease in constitutional symptoms and spleen size and improvement in blood counts ( [221](#), [222](#) and [223](#) ). Serious side effects, including extreme leukocytosis and thrombocytosis and pericardial extramedullary hematopoiesis, have occurred, and a very low starting dose (50 mg daily) and cautious dose escalation are suggested ( [221](#) ). The soluble tumor necrosis factor receptor, etanercept, has been used to reverse constitutional symptoms and is active in approximately half the patients treated ( [224](#) ). Suramin and imatinib have been given to a

number of patients with MMM without apparent benefit ( [225](#), [226](#) ).

Mechanical curettage of small amounts (150 g) of fibrotic marrow from the iliac bone in MMM may be associated with an increased hematopoiesis and improvement in anemia ( [227](#), [228](#) ), but it is a complex procedure and is not successful in all patients ( [227](#), [228](#) ). Autologous HSCT after high-dose busulfan conditioning has been offered to a small series of patients with advanced MMM refractory to other maneuvers. Although there was a significant mortality (6 of 21 patients), most patients had improvement in hypersplenic symptoms, and approximately half had improvement in anemia and thrombocytopenia ( [229](#), [230](#) ).

## DIFFERENTIAL DIAGNOSIS

The diagnosis of MMM rests on the demonstration of the triad of bone marrow fibrosis, extramedullary hematopoiesis, and evidence of clonal hematopoiesis in the absence of some underlying disease. There are no pathognomonic findings, and evidence of clonal hematopoiesis is indirect if karyotypic abnormalities are not present. A bone marrow biopsy is essential to demonstrate fibrosis. It may also provide evidence for clonal hematopoiesis in the form of panhyperplasia and exclude an infiltrative process. The criteria developed by the Italian consensus conference provide considerable guidance but may not recognize all patients with early-phase MMM ( [Table 86.3](#) ). Consideration of the patient's clinical course and careful judgment may be required.

### Acute Myelofibrosis

MMM may be confused with acute myelofibrosis. In 1963, Lewis and Szur described five patients with bone marrow fibrosis, pancytopenia, fever, and a rapidly fatal course ( [231](#) ). They termed this syndrome "malignant myelosclerosis," and it has come to be called *acute myelosclerosis* or *acute myelofibrosis* ( [232](#), [233](#), [234](#), [235](#), [236](#), [237](#), [238](#), [239](#), [240](#) and [241](#) ). Published series have included patients with fibrosis complicating acute leukemia ( [233](#), [234](#), [235](#), [236](#), [237](#), [238](#), [239](#) and [240](#) ), with MMM in transition to acute leukemia ( [81](#), [82](#), [172](#), [173](#) ), and with fibrosis complicating myelodysplastic syndromes ( [242](#), [243](#), [244](#) and [245](#) ). However, it has become clear that most patients with this syndrome have experienced a rapidly developing aleukemic form of acute megakaryoblastic leukemia (French-American-British M7), and many consider the two diagnoses to be equivalent (see [Chapter 79](#)) ( [246](#), [247](#) and [248](#) ). Acute myelofibrosis must be distinguished from MMM, because the former is treated as an acute leukemia. Splenomegaly is absent in acute myelofibrosis, and there is usually a diagnostic increase in megakaryoblasts in the marrow.

### Other Chronic Myeloproliferative Disorders

MMM must sometimes be distinguished from CML, ET, and PV. When marrow fibrosis becomes a prominent feature of one of the other CMPDs, diagnosis may be difficult. PV terminates in an MMM-like syndrome in 15 to 20% of patients (see [Chapter 85](#)) ( [249](#) ). Myelofibrosis in PV most commonly occurs after years of disease. Because patients with postpolycythemic PV become symptomatic from the expanded red cell mass and come to medical attention early in their course, their diagnosis is usually made before marrow fibrosis develops. A patient with PV first encountered with myelofibrosis in the postpolycythemic phase usually pursues a more rapidly progressive course than an MMM patient ( [249](#) ). Fibrosis may be present in CML at diagnosis or develop as the disease progresses ( [250](#), [251](#) ). In most cases, differentiation of MMM and CML is straightforward on the basis of genetic analysis. A karyotype or a fluorescence *in situ* hybridization probe



for the *bcr/abl* gene rearrangement can usually be accomplished on bone marrow or peripheral blood. Approximately 95% of patients with typical CML have the t(9;22) Philadelphia (Ph1) chromosome abnormality, and most of the remainder exhibit molecular evidence of the *bcr/abl* gene rearrangement (see [Chapter 84](#)). In the rare instance in which neither the 9:22 translocation nor the *bcr/abl* can be detected in a patient suspected of having one of the two disorders, other factors may be considered. In CML, the size of the spleen is proportional to the white cell count. Thus, if the spleen is large, but the leukocyte count is less than  $100 \times 10^9$  per L, MMM rather than CML may be present. When bone marrow fibrosis is present in ET, this condition may resemble an early phase of MMM. In fact, making a clear distinction may not be possible ([245](#)), and the patient may require observation over time.

## Secondary Forms of Myelofibrosis

Myelofibrosis may occur as a reaction to malignancy, infections, and other diseases ([Table 86.1](#)). It may be associated with peripheral blood changes and extramedullary hematopoiesis that mimic MMM ([160](#)). In 50,277 consecutive blood smears in patients studied at the Mayo Clinic, there was a leukoerythroblastic picture in 215, or 0.4% ([252](#)). Two-thirds of these patients proved to have some form of neoplastic disease, and the remainder suffered from a wide range of illnesses.

The diagnosis of secondary myelofibrosis is based on identification of the underlying disease. Secondary myelofibrosis is a regular feature of some conditions, such as postpolycythemic PV ([245](#)), and an uncommon complication of others, such as systemic lupus erythematosus and rickets ([212](#), [213](#), [253](#), [254](#)). When myelofibrosis is due to infection, the infection usually is chronic, widespread, and easily diagnosed. Tuberculosis and fungal infections are now generally treated before secondary myelofibrosis develops ([255](#)). Most cases of secondary myelofibrosis are now due to metastatic malignancy ([253](#)). Tumor is not always demonstrable in the bone marrow when myelofibrosis develops, but in most cases, the malignancy is widely metastatic and easily recognized. Rarely, a malignancy is occult at presentation, and a mistaken diagnosis of MMM may be made ([78](#), [256](#)). Measurement of urinary hydroxyproline, a metabolite of collagen, can help to distinguish secondary myelofibrosis from MMM ([257](#)). Its excretion is normal in patients with MMM but increased in patients with cancer and secondary myelofibrosis ([257](#)). Therapy for secondary myelofibrosis consists of treating the underlying disease. Reversal of fibrosis has been well documented after successful treatment of PV, Hodgkin disease, and metastatic prostate and breast carcinoma ([258](#), [259](#), [260](#) and [261](#)).

## REFERENCES

1. Heuck G. Zwei Falle von Leukemie mit eigenthumlichen Blut-resp. Knochenmarksbefund. Arch Pathol Anat Physiol Virchows 1879;78:475-496.
2. Silverstein MN. Agnogenic myeloid metaplasia. Publishing Sciences Group. Acton: 1975.
3. Tefferi A, Silverstein MN, Noel P. Agnogenic myeloid metaplasia. Semin Oncol 1995;22:327-333.
4. Fontnay-Roupie M, Dupuy E, Berrou E, et al. Increased proliferation of marrow-derived fibroblasts in primitive hypertrophic osteoarthropathy with severe myelofibrosis. Blood 1995;85:3229-3238.
5. Honda Y, Delzell E, Cole P. An updated study of mortality among workers at a petroleum manufacturing plant. J Occup Environ Med 1995;37:194-200.

6. Hu H. Benzene-associated myelofibrosis. *Ann Intern Med* 1987;106:171-172.
7. Aksoy M, Erdem S, Dincol G. Two rare complications of chronic benzene poisoning: myeloid metaplasia and paroxysmal nocturnal hemoglobinuria. *Blut* 1975;30:255-260.
8. Visfeldt J, Andersson M. Pathoanatomical aspects of haematological disorders among Danish patients exposed to thorium dioxide. *APMIS* 1995;103:29-36.
9. Anderson RE, Hioshino T, Yammamoto T. Myelofibrosis with myeloid metaplasia in survivors of the atomic bomb in Hiroshima. *Ann Intern Med* 1964;60:1-18.
10. Dameshak W. Some speculations on the myeloproliferative syndromes (editorial). *Blood* 1951;6:372-375.
11. Reilly JT, Wilson G, Barnett D, et al. Karyotypic and ras gene mutational analysis in idiopathic myelofibrosis. *Br J Haematol* 1994;88:575-581.
12. Nowell P. Chromosome studies in "preleukemia." III. Myelofibrosis. *Cancer* 1976;38:1803-1810.
13. Van Slyck EJ, Weiss L, Dully M. Chromosomal evidence for the secondary role of fibroblastic proliferation in acute myelofibrosis. *Blood* 1970;36:729-735.
14. Werner M, Nolte M, Kaloutsi V, et al. Karyotype findings and molecular analysis of the bcr gene rearrangement supplementing the histologic classification of chronic myeloproliferative disorders. Evidence for pluripotent stem cell origin of idiopathic myelofibrosis: clonal analysis of myeloproliferative disorders. *Lab Invest* 1995;72:405-410.
15. Reilly JT, Snowden JA, Spearing RL, et al. Cytogenetic abnormalities and their prognostic significance in idiopathic myelofibrosis: a study of 106 cases. *Br J Haematol* 1997;98:96-102.
16. Tefferi A, Mesa RA, Schroeder G, et al. Cytogenetic findings and their clinical relevance in myelofibrosis with myeloid metaplasia. *Br J Haematol* 2001;113: 763-771.
17. Kou CY, Van Voolen GA, Morrison AN. Primary and secondary myelofibrosis. Its relationship to "PNH-like defect." *Blood* 1972;40:875-880.
18. Hansen NE, Killmann SA. Paroxysmal nocturnal hemoglobinuria in myelofibrosis. *Blood* 1970;36:428-431.
19. Croizat H, Amato D, McLeod DL, et al. Differences among myeloproliferative disorders in the behavior of their restricted progenitor cells in culture. *Blood* 1983;62:578-584.
20. Jacobson RJ, Salo A, Fialkow PJ. Agnogenic myeloid metaplasia: a clonal proliferation of hematopoietic stem cells with secondary myelofibrosis. *Blood* 1987;51:189-194.
21. Lucas GS, Padua RA, Masters GS, et al. The application of X chromosome gene probes to the diagnosis of myeloproliferative disease. *Br J Haematol* 1989;72:530-533.
22. Morris CM, Cochrane JM, Benjes SM, et al. Molecular definition of interstitial deletions of chromosome 13 in leukemic cells. *Genes Chromosomes Cancer* 1991;3:455-460.
23. Lebowitz P, Papac R, Ghosh PK. Impaired retinoblastoma susceptibility (Rb) gene in agnogenic myeloid metaplasia. *Blood* 1990;76[Suppl 1]:236a.
24. Buschle M, Janssen JW, Drexler H, et al. Evidence for pluripotent stem cell origin of idiopathic myelofibrosis: clonal analysis of a case characterized by N-ras gene mutation. *Leukemia* 1988;2:658-660.
25. Ihalainen J, Juvonen E, Savolainen ER, et al. Calcitonin gene methylation in chronic myeloproliferative disorders. *Leukemia* 1994;8(2):230-235.
26. Gaidano G, Guerrasio A, Serra A, et al. Mutations in the p53 and RAS family genes are associated

- with tumor progression of bcr/abl negative chronic myeloproliferative disorders. *Leukemia* 1993;7:946–953.
27. Chervenick PA. Increase in circulating stem cells in patients with myelofibrosis. *Blood* 1973;41:69–71.
  28. Wang JC, Cheung CP, Ahmed F, et al. Circulating granulocyte and macrophage progenitor cells in primary and secondary myelofibrosis. *Br J Haematol* 1983;54:301–307.
  29. Hibbin JA, Njoku OS, Matutes E, et al. Myeloid progenitor cells in the circulation of patients with myelofibrosis and other myeloproliferative disorders. *Br J Haematol* 1984;57:495–503.
  30. Carlo-Stella C, Cazzola M, Gasner A, et al. Effects of alpha and gamma interferon on in vitro growth of circulating hematopoietic progenitor cells (CFU-GEMM, CFU-MK, BFU-E, and CFU-GM) from patients with myelofibrosis with myeloid metaplasia. *Blood* 1987;70:1014–1019.
  31. Juvonen E. Megakaryocytic colony formation in chronic myeloid leukemia and myelofibrosis. *Leuk Res* 1988;12:751–756.
  32. Barosi G, Viarengo G, Pecci A, Rosti V. Diagnostic and clinical relevance of the number of circulating CD43(+) in myelofibrosis with myeloid metaplasia. *Blood* 2001;98:3249–3255.
  33. Ozaki S, Kosaka M, Ozaki K, et al. Thrombopoietin-responsive essential thrombocythemia with myelofibrosis. *Br J Haematol* 1997;97:449–452.
  34. Kobayashi S, Teramura M, Hoshino S, et al. Circulating megakaryocyte progenitors in myeloproliferative disorders are hypersensitive to interleukin-3. *Br J Haematol* 1993;83:539–544.
  35. Taksin AL, Couedic JP, Dusanter-Fourt I, et al. Autonomous megakaryocyte growth in essential thrombocythemia and idiopathic myelofibrosis is not related to a c-mpl mutation or to an autocrine stimulation by Mpl-L. *Blood* 1999;93:125–129.
  36. Battegay EJ, Thomssen C, Nissen C, et al. Endogenous megakaryocyte colonies from peripheral blood in precursor cell cultures of patients with myeloproliferative disorders. *Eur J Haematol* 1989;42:321–326.
  37. Giraudier S, Chagraoui H, Komura E, et al. Overexpression of FKBP51 in idiopathic myelofibrosis regulates the growth factor independence of megakaryocyte progenitors. *Blood* 2002;100:2931–2940.
  38. Orkin SH. Transcription factors that regulate lineage decisions. In: Stamatoyannopoulos G, Majerus PW, Perlmutter R, Varmus H, eds. *The molecular basis of blood diseases*. Philadelphia: WB Saunders, 2000:80–102.
  39. Vannucchi AM, Bianchi L, Cellai C, et al. Development of myelofibrosis in mice genetically impaired for GATA-1 expression (GATA-1 low mice). *Blood* 2002;100:1123–1132.
  40. Groopman JE. The pathogenesis of myelofibrosis in myeloproliferative disorders. *Ann Intern Med* 1980;92:857–858.
  41. Adamson JW, Fialkow PJ. The pathogenesis of myeloproliferative syndromes. *Br J Haematol* 1978;38:299–303.
  42. Golde DW, Hocking WG, Quan SG, et al. Origin of human bone marrow fibroblasts. *Br J Haematol* 1980;44:183–187.
  43. Carbone P, Barbaroa G, Murro S, et al. Cytogenetic studies in five patients with myelofibrosis and myeloid metaplasia. *Cancer Genet Cytogenet* 1984;12:209–215.
  44. McGlave PB, Arthur DC, Kim TH, et al. Successful allogeneic-bone marrow transplantation for patients in the accelerated phase of chronic granulocytic leukemia. *Lancet* 1982;2:625–627.
  45. Truong LD, Saleem A, Schwartz MR. Acute myelofibrosis—a report of four cases and review of the literature. *Medicine* 1984;63:182–187.
  46. Wang JC, Lang HD, Lichter S, et al. Cytogenetic studies of bone marrow fibroblasts cultured from

patients with myelofibrosis and myeloid metaplasia. *Br J Haematol* 1992;80:184–188.

47. Reilly JT. Pathogenesis of idiopathic myelofibrosis: present status and future directions. *Br J Haematol* 1994;88:1–8.
48. McCarthy DM. Fibrosis of the bone marrow: content and causes. *Br J Haematol* 1985;59:1–7.
49. Castro-Malspina H. Pathogenesis of myelofibrosis. *Prog Clin Biol Res* 1984;154:427–454.
50. Charron D, Robert L, Couty MC, Binet JL. Biochemical and histological analysis of bone marrow collagen in myelofibrosis. *Br Haematol* 1979;41:151–161.
51. Burstein SA, Malpass TE, Yee E, et al. Platelet factor-4 excretion in myeloproliferative disease: implication for the etiology of myelofibrosis. *Br J Haematol* 1984;57:383–392.
52. Barosi G, Costa A, Liberato LN, et al. Serum procollagen-III-peptide level correlates with disease activity in myelofibrosis with myeloid metaplasia. *Br J Haematol* 1989;72:16–20.
53. Hassalbalch H, Junker P, Horslev-Petersen K, et al. Procollagen type III aminoterminal peptide in serum in idiopathic myelofibrosis and allied conditions: relation to disease and effect of chemotherapy. *Am J Hematol* 1990;33:18–26.
54. Mesa RA, Hanson S, Rajkumar SV, et al. Evaluation and clinical correlations of bone marrow angiogenesis in myelofibrosis with myeloid metaplasia. *Blood* 2000;96:3374–3380.
55. Rameshwar P, Denny T, Stein D, Gascon P. Monocyte adhesion in patients with bone marrow fibrosis is required for the production of cytokines: potential role for interleukin-1 and TGF-beta. *J Immunol* 1994;153:2819–2828.
56. Rameshwar P, Chang VT, Gascon P. Implication of CD44 in adhesion-mediated overproduction of TGF-beta and IL-1 in monocytes from patients with bone marrow fibrosis. *Br J Haematol* 1996;93:22–29.
57. Martyre MC, Romquin N, Le Bousse-Kerdiles MC, et al. Transforming growth factor-beta and megakaryocytes in the pathogenesis of idiopathic myelofibrosis. *Br J Haematol* 1994;88:9–16.
58. Terui T, Niitsu Y, Mahra K, et al. The production of transforming growth factor-beta in acute megakaryoblastic leukemia and its possible implications in myelofibrosis. *Blood* 1990;75:1540–1548.
59. Kimura A, Katoh O, Kuramoto A. Effects of platelet derived growth factor, epidermal growth factor and transforming growth factor-beta on the growth of human fibroblasts. *Br J Haematol* 1988;69:9–12.
60. Berse B, Hunt JA, Diegel RJ, et al. Hypoxia augments cytokine (transforming growth factor-beta (TGF-beta) and IL-1-induced vascular endothelial growth factor secretion by human synovial fibroblasts. *Clin Exp Immunol* 1999;115:176–182.
61. Martyre MC, Magdelenat H, Bryckaert MC, et al. Increased intraplatelet levels of platelet-derived growth factor and transforming growth factor-beta in patients with myelofibrosis with myeloid metaplasia. *Br J Haematol* 1991;77:80–86.
62. Rameshwar P, Chang VT, Thacker UT, et al. Systemic transforming growth factor-beta in patients with bone marrow fibrosis: pathophysiological implication. *Am J Hematol* 1998;59:133–142.
63. Le Bousse-Kerdiles MC, Chevillard S, Charpetier A, et al. Differential expression of transforming growth factor-beta, basic fibroblast growth factor, and their receptors in CD34+ hematopoietic progenitor cells from patients with myelofibrosis with myeloid metaplasia. *Blood* 1996;88:4534–4546.
64. Reilly JT, Barnett D, Dolan G, et al. Characterization of an acute micromegakaryocytic leukemia: evidence for the pathogenesis of myelofibrosis. *Br J Haematol* 1993;83:58–62.
65. Kimura A, Katoh O, Hyodo H, Kuramoto A. Transforming growth factor-beta regulates growth as well as collagen and fibronectin synthesis of human fibroblasts. *Br J Haematol* 1989;72:486–491.
66. Thiele J, Rompik V, Wagner S, Fischer R. Vascular architecture and collagen type IV in primary

myelofibrosis and polycythemia vera. *Br J Haematol* 1992;80:227–234.

67. Thiele J, Kvasnicka HM, Zankovich R, Diehl V. Clinical and morphological criteria for the diagnosis of prefibrotic idiopathic (primary) myelofibrosis. *Ann Hematol* 2001;80:160–165.
68. Schmitt A, Jouault H, Guichard J, et al. Pathologic interaction between megakaryocytes and polymorphonuclear leukocytes in myelofibrosis. *Blood* 2000;96:1342–1347.
69. Ulich TR, del Castillo J, Senaldi G, et al. Systemic hematologic effects of PEG-rHuMGDF-induced megakaryocyte hyperplasia in mice. *Blood* 1996;87:5006–5215.
70. Yan XQ, Lacey D, Fletcher F, et al. Chronic exposure to retroviral vector encoded MGDF (mpl-ligand) induces lineage-specific growth and differentiation of megakaryocytes in mice. *Blood* 1995;86:4025–4033.
71. Wang JC, Chen C, Lou LH, Mora M. Blood thrombopoietin, IL-6 and IL-11 levels in patients with agnogenic myeloid metaplasia. *Leukemia* 1997;11:1827–1832.
72. Wang JC, Hashimi G. Thrombopoietin levels in patients with myelofibrosis may not be due to enhanced production of thrombopoietin by bone marrow. *Leuk Res* 2003;27:13–17.
73. Moliterno AR, Hankins WD, Spivak JL. Impaired expression of the thrombopoietin receptor by platelets from patients with polycythemia vera. *N Engl J Med* 1998;338:572–578.
74. Sasaki A, Katoh O, Kawaishi K, et al. Expression of c-Mpl and c-Mpl ligand gene in hematopoietic cells of individuals with and without myeloproliferative disorders and leukemia cell lines. *Int J Hematol* 1995;62:217–223.
75. Li Y, Hetet G, Kiladjian JJ, et al. Proto-oncogene c-mpl is involved in spontaneous megakaryocytopoiesis in myeloproliferative disorders. *Br J Haematol* 1996;92:60–66.
76. Ward HP, Block MH. The natural history of agnogenic myeloid metaplasia (AMM) and a critical evaluation of its relationship with the myeloproliferative syndrome. *Medicine* 1971;50:357–420.
77. Oberline F, Guerbaoui M, Sick H. Les evenements microvasculaires dans la moelle hematopoietique au cours des myeloscleroses experimentales. *Nouv Rev Fr Hematol* 1973;13:193–219.
78. O'Keane JC, Wolf BC, Neiman RS. The pathogenesis of splenic extramedullary hematopoiesis in metastatic carcinoma. *Cancer* 1989;63:1539–1543.
79. Korst DR, Clatanoff DV, Schilling RF. On myelofibrosis. *Arch Intern Med* 1956;97:169–183.
80. Leonard BJ, Israels MCG, Wilkinson JF. Myelosclerosis: a clinicopathological study. *QJM* 1957;26:131–147.
81. Bouroncle BA, Doan CA. Myelofibrosis, clinical, hematologic and pathologic study of 110 patients. *Am J Med Sci* 1962;243:697–715.
82. Nakai GS, Craddock CG, Figueroa WG. Agnogenic myeloid metaplasia: a survey of 29 cases and a review of the literature. *Ann Intern Med* 1962;57: 419–440.
83. Varki A, Lottenberg R, Griffith R, Reinhard E. The syndrome of idiopathic myelofibrosis: a clinicopathologic review with emphasis on the prognostic variables predicting survival. *Medicine* 1963;62:353–371.
84. Rosenthal DS, Moloney WC. Myeloid metaplasia: a study of 98 cases. *Postgrad Med* 1969;45:136–142.
85. Visani G, Finelli C, Castelli U, et al. Myelofibrosis with myeloid metaplasia: clinical and hematological parameters predicting survival in a series of 133 patients. *Br J Haematol* 1990;75:4–9.
86. Thiele J, Steinberg T, Zankovich R, Fischer R. Primary myelofibrosis–osteomyelosclerosis (agnogenic myeloid metaplasia). *Anticancer Res* 1989;9:429–435.

87. Smith RE, Chelmowski MK, Szabo EJ. Myelofibrosis. *Am J Hematol* 1988;29:174–180.
88. Hassalbalch H. Idiopathic myelofibrosis. *Am J Hematol* 1990;34:291–300.
89. Boxer LA, Camitta BM, Berenberg W, Fanning JP. Myelofibrosis–myeloid metaplasia in childhood. *Pediatrics* 1975;55:861–865.
90. Cohn SL, Cohn RA, Chou P, et al. Infantile myelofibrosis with nephromegaly secondary to myeloid metaplasia. *Clin Pediatr* 1991;30:59–61.
91. Kaufman S, Briere J, Bernard J. Syndromes myeloproliferatifs familiaux: etude a propos de six families at revue de la literature. *Nouv Rev Fr Hematol* 1978;20:1–15.
92. Mallouh AA, Sa'di AR. Agnogenic myeloid metaplasia in children. *Am J Dis Child* 1992;146:965–967.
93. Cheng DS. Idiopathic myelofibrosis without splenomegaly. *Cancer* 1979;43:1761–1765.
94. Caughman W, Stern R, Haynes H. Neutrophilic dermatosis of myeloproliferative disorders. *J Am Acad Dermatol* 1983;9:751–758.
95. Loewy G, Mathew A, Distenfeld A. Skin manifestations of agnogenic myeloid metaplasia. *Am J Hematol* 1994;45:167–170.
96. Wajima T. Agnogenic myeloid metaplasia and malignant pleural effusion caused by extramedullary hematopoiesis. *Chest* 1994;106(1):322–323.
97. Liote F, Yeni P, Teillet–Thibaud F, et al. Ascites revealing peritoneal and hepatic extramedullary hematopoiesis with peliosis in agnogenic myeloid metaplasia: case report and review of the literature. *Am J Med* 1991;90:111–117.
98. Nagler A, Brenner B, Argov S, Tatarsky J. Postsplenectomy pericardial effusion in two patients with myeloid metaplasia. *Arch Intern Med* 1986;146: 600–601.
99. Lundh B, Brandt L, Cronqvist S, Eyrich R. Intracranial myeloid metaplasia in myelofibrosis. *Scand J Haematol* 1982;28:91–94.
100. Cornfield DB, Shipkin P, Alavia A, et al. Intracranial myeloid metaplasia: diagnosis by CT and Fe52 scans and treatment by cranial irradiation. *Am J Hematol* 1983;15:273–278.
101. Ligumski M, Polliack A, Benbasset J. Metaplasia of the central nervous system in patients with myelofibrosis and agnogenic myeloid metaplasia. *Am J Med Sci* 1979;275:99–103.
102. Stahl SM, Ellinger G, Baringer JR. Progressive myelopathy due to extramedullary hematopoiesis. *Ann Neurol* 1979;5:485–489.
103. Price F, Bell H. Spinal cord compression due to extramedullary hematopoiesis: successful treatment in a patient with long–standing myelofibrosis. *JAMA* 1985;253:2876–2877.
104. Cook G, Sharp RA. Spinal cord compression due to haemopoiesis in myelofibrosis. *J Clin Pathol* 1994;47:464–465.
105. Koch BL, Bisset GS, Bisset RR, Zimmere MB. Intracranial extramedullary hematopoiesis: MR findings with pathologic correlation. *Am J Radiol* 1994;162:1419–1420.
106. Dibella NJ, Silverstein MN, Hoagland HC. Effect of splenectomy on teardrop–shaped erythrocytes in agnogenic myeloid metaplasia. *Arch Intern Med* 1977;137:380–381.
107. Njoku OS, Lewis SM, Catovsky D, Gordon–Smith EC. Anaemia in myelofibrosis: its value in prognosis. *Br J Haematol* 1983;54:79–89.
108. Fabich DR, Raich PC. Acute myelofibrosis. A report of three cases. *Am J Clin Pathol*

1977;67:334-348.

109. Gardner FH, Nathan DG. Androgens and erythropoiesis. III. Further evaluation of testosterone treatment of myelofibrosis. *N Engl J Med* 1966;274:420-426.

110. Najean Y, Cacchione R, Castro-Malaspina H, Dresch C. Erythrokinetic studies in myelofibrosis: their significance for prognosis. *Br J Haematol* 1978;40:205-217.

111. Szur L, Smith MD. Red cell production and destruction in myelosclerosis. *Br J Haematol* 1961;7:147-168.

112. Pettit JE, Lewis SM, Williams ED. Quantitative studies of splenic erythropoiesis in polycythaemia vera and myelofibrosis. *Br J Haematol* 1976;34:465-475.

113. Lewis CM, Pegrum GD. Immune complexes in myeloproliferative disorders. *Lancet* 1977;2:1151-1153.

114. Hasselbalch H, Berid D, Hansen OP. Red-cell sensitization in myelofibrosis. *Scand J Haematol* 1984;32:179-182.

115. Veer A, Kosciolk BA, Bauman AW, Rowley PT. Acquired hemoglobin H disease in idiopathic myelofibrosis. *Am J Hematol* 1979;6:199-206.

116. Lewis SM, Pettit JE, Tattersall MH. Myelosclerosis and paroxysmal nocturnal haemoglobinuria. *Scand J Haematol* 1971;8:451-460.

117. Forshaw J, Harwood L, Weatherall DJ. Folic-acid deficiency and megaloblastic erythropoiesis. *BMJ* 1964;1:671-672.

118. Hoffbrand AV, Chanarin I, Kremenchuzky S. Megaloblastic anemia in myelosclerosis. *QJM* 1968;837:493-516.

119. Silver RT, Jenkins DE, Engle RL. Use of testosterone and busulfan in the treatment of myelofibrosis with myeloid metaplasia. *Blood* 1964;23:341-353.

120. Valentine WM. Biochemical studies in chronic myelocytic leukemia, polycythemia vera and other idiopathic myeloproliferative disorders. *Blood* 1952;7:959-977.

121. El-Maalem H, Fletcher J. Impaired neutrophil function and myeloperoxidase deficiency in myeloid metaplasia. *Br J Haematol* 1977;37:323-329.

122. Marquetty C, Labro-Bryskier MT, Perianin A, Hakim J. Impaired metabolic activity of phagocytosing neutrophils in agnogenic osteomyelofibrosis with splenomegaly: a longitudinal study. *Am J Hematol* 1984;16:243-254.

123. Brown RD, Rickard KA, Kronenberg H. Lactoferrin in the myeloproliferative disorders: a search for granulopoietic regulator defects. *Br J Haematol* 1985;59:617-626.

124. Krauss S, Gilbert HS, Wasserman LR. Leukocyte histidine decarboxylase: properties and activity in myeloproliferative disorders. *Blood* 1968;31:699-709.

125. Athens JW, Haab OP, Raab SO. Leukokinetic studies. XI. Blood granulocyte kinetics in polycythemia vera, infection and myelofibrosis. *J Clin Invest* 1965;44:778-788.

126. Schafer AI. Deficiency of platelet lipoxigenase activity in myeloproliferative disorders. *N Engl J Med* 1982;306:381-386.

127. Didisheim P, Bunting D. Abnormal platelet function in myelofibrosis. *Am J Clin Pathol* 1966;45:566-573.

128. Karaca M, Stefanini M. Studies on platelets. XXV. Chemical analysis of platelets from patients with congenital and acquired thrombocytopathy, with special reference to phospholipids. *J Lab Clin Med* 1966;6:229-245.



129. Baker RI, Manoharan A. Platelet function in myeloproliferative disorders: characterization and sequential studies show multiple platelet abnormalities, and change with time. *Eur J Haematol* 1988;40:267-272.
130. Silverstein MN, Remine WH. Splenectomy in myeloid metaplasia. *Blood* 1979;53:515-518.
131. Gilbert HS, Ginsberg H, Fagerstrom R, Brown WV. Characterization of hypocholesterolemia in myeloproliferative disease: relation to disease manifestations and activity. *Am J Med* 1981;71:595-602.
132. Corcino J, Krauss S, Waxman S, Herbert V. Release of B12 binding protein by human leukocytes in vitro. *J Clin Invest* 1970;49:2250-2255.
133. Herbert V. Diagnostic and prognostic values of measurement of serum vitamin B 12-binding proteins. *Blood* 1968;32:305-312.
134. Barosi G, Ambreotti A, Finelli C, et al. The Italian consensus conference on diagnostic criteria for myelofibrosis with myeloid metaplasia. *Br J Haematol* 1999;104:730-737.
135. Barosi G. Myelofibrosis with myeloid metaplasia: diagnostic definition and prognostic classification for clinical studies and treatment guidelines. *J Clin Oncol* 1999;17:2954-2970.
136. Thiele J, Krech R, Vykoupil KF, Georgii A. Malignant (acute) myelosclerosis—a clinical and pathological study in 6 patients. *Scand J Haematol* 1984;33:95-109.
137. Thiele J, Georgii A, Vykoupil KF. Ultrastructure of chronic megakaryocytic-granulocytic myelosis. *Blut* 1976;32:433-438.
138. Thiele J, Ballard AC, Georgii A, Vykoupil KF. Chronic megakaryocyte-granulocytic myelosis—an electron microscopy study including freeze-fracture. *Virchows Arch(A)* 1977;375:129-146.
139. Wolf BC, Neiman RS. Myelofibrosis with myeloid metaplasia: pathophysiologic implications of the correlation between bone marrow changes and progression of splenomegaly. *Blood* 1985;65:803-809.
140. Bauermeister DE. Quantitation of bone marrow reticulin—a normal range. *Am J Clin Pathol* 1971;56:24-31.
141. Udoji WC, Razavi SA. Mast cells and myelofibrosis. *Am J Clin Pathol* 1975;63:203-209.
142. Raich PC, Sorenson JA, Tyson IB, Korst DR. Linear profile scanning of marrow in myelofibrosis. *J Reticuloendothel Soc* 1974;16:282-288.
143. Arrago JP, Pain JP, Vigneron N, et al. Diagnostic value of bone marrow imaging with 111indium-transferrin and 99 technetium-colloids in myelofibrosis. *Am J Hematol* 1985;18:275-282.
144. Mouloupoulos LA, Dimopoulos MA. Magnetic resonance imaging in myelofibrosis and essential thrombocythemia: contribution to differential diagnosis. *Br J Haematol* 1999;104:574.
145. Sandberg AA. The chromosomes in human cancer and leukemia. New York and Amsterdam: Elsevier Science, 1980.
146. Denory JL, Dupriez B, Feneaux P, et al. Cytogenetic studies and their prognostic significance in agnogenic myeloid metaplasia. *Blood* 1988;72:855-859.
147. Nakamura H, Sadamori N, Mine M, et al. Effects of short-term liquid culture of peripheral blood mononuclear cells with recombinant human granulocyte or granulocyte-macrophage colony-stimulating factor in cytogenetic studies of myelofibrosis with myeloid metaplasia. *Leukemia* 1992;6:853-855.
148. Jensen MK. Cytogenetic studies in myeloproliferative disorders during transformation into leukemia. *Scand J Haematol* 1970;7:330-335.
149. Selroos O, Skifvars B, Usastjerna C. Immunological deficiency in myelofibrosis. *Scand J Haematol*

1973;11:307–313.

150. Gordon B. Immunological abnormalities in myelofibrosis. *Prog Clin Biol Res* 1984;154:455–463.
151. Gordon BR, Coleman M, Kohen P, Day NK. Immune abnormalities in myelofibrosis with activation of the complement system. *Blood* 1981;58:904–910.
152. Vellenga E, Mulder N, The T. A study of the cellular and humoral immune response in patients with myelofibrosis. *Clin Lab Haematol* 1982;4:307–316.
153. Khumbanonda M, Horowitz HI, Eyster ME. Coombs' positive hemolytic anemia in myelofibrosis with myeloid metaplasia. *Am J Med* 1969;258:89–93.
154. Rondeau E, Solal-Celigny P, Dhermy D. Immune disorders in agnogenic myeloid metaplasia: relation to myelofibrosis. *Br J Haematol* 1983;53:467–475.
155. Seelen MA, de Meijer PH, Posthuma EF, Meinders AE. Myelofibrosis and idiopathic thrombocytopenic purpura. *Ann Hematol* 1997;75:129–131.
156. Lang JM, Oberling F, Mayer S. Autoimmunity in primary myelofibrosis. *Biomedicine* 1976;29:39.
157. Bernhardt B, Valleta M. Lupus anticoagulant in myelofibrosis. *Am J Med Sci* 1976;272:229–231.
158. Cappio FC, Vigliani R, Novarino A, et al. Idiopathic myelofibrosis: a possible role for immune complexes in the pathogenesis of bone marrow fibrosis. *Br J Haematol* 1981;49:17–21.
159. Humphrey CA, Morris TC. The intimate relationships of myelofibrosis and myeloma: effect of therapy. *Br J Haematol* 1989;73:269–270.
160. Roberts BE, Woods CG, Miller DW, Patterson CR. Bone changes in polycythaemia vera and myelosclerosis. *J Clin Pathol* 1969;22:696–700.
161. Glew RH, Haase WH, McIntyre PA. Myeloid metaplasia with myelofibrosis. The clinical spectrum of extramedullary hematopoiesis and tumor formation. *Johns Hopkins Med J* 1973;132:253–270.
162. Sjogren U. Different composition of the erythropoietic tissue in bone marrow, spleen and liver in myelofibrosis. *Acta Haematol (Basel)* 1978;59:231–236.
163. Rozman C, Giralt M, Feliu E, et al. Life expectancy of patients with chronic nonleukemic myeloproliferative disorders. *Cancer* 1991;67:2658–2663.
164. Dupriez B, Demory JL, Lai JL, et al. Prognostic classification of myelofibrosis with myeloid metaplasia. *Br J Haematol* 1989;73:136–137.
165. Cervante F, Pereira A, Esteve J, et al. Identification of 'short-lived' and 'long-lived' patients at presentation of idiopathic myelofibrosis. *Br J Haematol* 1997;97:635–640.
166. Manoharan A. Annotation—myelofibrosis: prognostic factors and treatment. *Br J Haematol* 1988;6:295–298.
167. Wang JC, Wang A. Plasma soluble interleukin-2 receptor in patients with primary myelofibrosis. *Br J Haematol* 1994;86:380–382.
168. Gunz FW. Myelofibrosis. In: Williams WJ, et al., eds. *Hematology*. New York: McGraw-Hill, 1972.
169. Rosenbaum DL, Murphy GW, Swisher SN. Hemodynamic studies of the portal circulation in myeloid metaplasia. *Am J Med* 1966;41:360–368.
170. Shaldon S, Sherlock S. Portal hypertension in the myeloproliferative syndrome and the reticuloses. *Am J Med* 1962;32:755–764.
171. Moore CV. Clinicopathologic Conference: Ascites and myelofibrosis with amyloid. *Am J Med*

1961;31:125–133.

172. Cehreli C, Ezdinli EZ, Li CY. Blastic phase of agnogenic myeloid metaplasia simulating malignant lymphoma. *Cancer* 1976;38:1297–1305.

173. Pitcock JA, Reinhard EH, Justus BW, Mendelsohn RS. A clinical and pathological study of 70 cases of myelofibrosis. *Ann Intern Med* 1962;57:73–84.

174. Silverstein MN, Brown AL, Linman JW. Idiopathic myeloid metaplasia—its evolution into acute leukemia. *Arch Intern Med* 1973;132:709–712.

175. Soll E, Massumoto C, Clift RA, et al. Relevance of marrow fibrosis in bone marrow transplantation: a retrospective analysis of engraftment. *Blood* 1995;86: 4667.

176. Li Z, Gooley T, Appelbaum FR, Deeg HJ. Splenectomy and hematopoietic stem cell transplantation for myelofibrosis (correspondence). *Blood* 2001;97:2180.

177. Guardiola P, Esperou H, Cazals-Hatem D, et al. Allogeneic bone marrow transplantation for agnogenic myeloid metaplasia. French Society of Bone Marrow Transplantation. *Br J Haematol* 1997;98:1004–1009.

178. Jurado M, Deeg HJ, Gooley T, et al. Haemopoietic stem cell transplantation for advanced polycythemia vera or essential thrombocythemia. *Br J Haematol* 2001;112:392–396.

179. Guardiola P, Anderson JE, Bandini G, et al. Allogeneic stem cell transplantation for agnogenic myeloid metaplasia: A European Group for Blood and Bone Marrow Transplantation, Societe Francasie de Greffe de Moelle, Gruppo Italiano per il Trapianto del Midollo Osseo, and Fred Hutchinson Cancer Research Center Collaborative Study. *Blood* 1999;93:2831–2838.

180. Deeg HJ, Appelbaum FR. Stem-cell transplantation for myelofibrosis [Letter]. *N Engl J Med* 2001;344:775.

181. Devine SM, Hoffman R, Verma A, et al. Allogeneic blood cell transplantation following reduced-intensity conditioning is effective therapy for older patients with myelofibrosis with myeloid metaplasia. *Blood* 2002;99:2255–2258.

182. Hessling J, Kroger N, Werner M, et al. Dose-reduced conditioning regimen followed by allogeneic stem cell transplantation in patients with myelofibrosis with myeloid metaplasia. *Br J Haematol* 2002;119:769–772.

183. Guardiola P, Anderson JE, Gluckman E. Myelofibrosis with myeloid metaplasia. *N Engl J Med* 2000;343:659–660.

184. Besa EC, Nowell PC, Geller NL, Gardner FH. Analysis of the androgen response of 23 patients with agnogenic myeloid metaplasia: the value of chromosomal studies in predicting response and survival. *Cancer* 1982;49:308–313.

185. Brubaker LH, Briere J, Laszlo J, et al. Treatment of anemia in myeloproliferative disorders: a randomized study of fluoxymesterone v transfusions only. *Arch Intern Med* 1982;142:1533–1537.

186. Branda RF, Anderson TW, Jacob HS. Randomized study of nandrolone therapy for anemias due to bone marrow failure. *Arch Intern Med* 1977;137:65–69.

187. Manoharan A, Pitney WR. Chemotherapy resolves symptoms and reverses marrow fibrosis in myelofibrosis. *Scand J Haematol* 1984;33:453.

188. Petti MC, Latgliata R, Spadea T, et al. Melphalan treatment in patients with myelofibrosis with myeloid metaplasia. *Br J Haematol* 2002;116:576–581.

189. Wagner H, McKJeough PG, DesForges J, Madoc-Jones H. Splenic irradiation in the treatment of patients with chronic myelogenous leukemia or myelofibrosis with myeloid metaplasia. *Cancer* 1986;58:1204–1207.

190. Sciascia R, Mazza P, Tondi L. Splenic radiation in the treatment of idiopathic myelofibrosis.

Retrospective study of 14 cases. *Radiol Med (Torino)* 1988;76:87.

191. Elliot MA, Chen MG, Silverstein MN, Tefferi A. Splenic irradiation for symptomatic splenomegaly associated with myelofibrosis with myeloid metaplasia. *Br J Haematol* 1998;103:505–511.
192. Beckman EN, Oehrle JS. Fibrous hemopoietic tumors arising in agnogenic myeloid metaplasia. *Hum Pathol* 1982;13:804–810.
193. Nicholls MD, Concannon AL, Bigs JC. Myelofibrosis associated with periostitis. *Aust N Z J Med* 1982;12:177–178.
194. Block M, Jacobson LO. Myeloid metaplasia. *JAMA* 1950;143:1390–1396.
195. Benbassat J, Penchas S, Ligumski M. Splenectomy in patients with agnogenic myeloid metaplasia: an analysis of 321 published cases. *Br J Haematol* 1979;42:207–214.
196. Silverstein MN, ReMine WH. Splenectomy in myeloid metaplasia. *Blood* 1979;53:515–518.
197. Brenner B, Nagler A, Tatarsky I, Hashmonai M. Splenectomy in agnogenic myeloid metaplasia and postpolycythemic myeloid metaplasia: a study of 34 cases. *Arch Intern Med* 1988;148:2501–2506.
198. Mulder H, Steenbergen J, Haanen C. Clinical course and survival after elective splenectomy in 19 patients with primary myelofibrosis. *Br J Haematol* 1977;35:419–427.
199. Barosi G, Ambrosetti A, Buratti A, et al. Splenectomy for patients with myelofibrosis with myeloid metaplasia: pretreatment variables and outcome prediction. *Leukemia* 1993;7:200–206.
200. Tefferi A, Mesa RM, Nagorney DM, et al. Splenectomy in patients with agnogenic myeloid metaplasia: a single institution experience with 223 patients. *Blood* 2000;95:2226–2233.
201. Akpek G, McAneny D, Weintraub L. Risks and benefits of splenectomy in myelofibrosis with myeloid metaplasia: a retrospective analysis of 26 cases. *J Surg Oncol* 2001;77:42–48.
202. Barosi G, Ambrosetti A, Centra A, et al. Splenectomy and risk of blast transformation in myelofibrosis with myeloid metaplasia. Italian Cooperative Study Group on Myelofibrosis with Myeloid Metaplasia. *Blood* 1998;91:3630–3636.
203. Mesa RA, Li CY, Schroeder G, Tefferi A. Clinical correlates of splenic histopathology and splenic karyotype in myelofibrosis with myeloid metaplasia. *Blood* 2001;97:3665–3667.
204. Tefferi A, Silverstein MN, Li CY. 2-Chlorodeoxyadenosine treatment after splenectomy in patients who have myelofibrosis with myeloid metaplasia. *Br J Haematol* 1997;99:352–357.
205. Kahari VM, Chen YQ, Su MW, et al. Tumor necrosis factor- $\alpha$  and interferon- $\gamma$  suppress the activation of human type I collagen gene expression by transforming growth factor- $\beta$  1. Evidence for two distinct mechanisms of inhibition at the transcriptional and posttranscriptional levels. *J Clin Invest* 1990;86:1489–1495.
206. Wickramashinghe SN, Pearl R, Gill DS. Alpha-interferon in primary idiopathic myelofibrosis. *Lancet* 1987;2:1524–1525.
207. Hasselbalch H. Interferon in myelofibrosis. *Lancet* 1988;1:355.
208. Seewan HL, Gastl G, Lang A, et al. Interferon- $\alpha$ -2 in the treatment of idiopathic myelofibrosis. *Blut* 1988;56:161–163.
209. Anthony RS, Craig JI, Parker AC. Circulating progenitor cells in myelofibrosis: the effect of recombinant alpha 2B interferon in vivo and in vitro. *Br J Haematol* 1991;78:155–160.
210. McCarthy D, Clark J, Giles F. The treatment of myelofibrosis with alpha-interferon. *Br J Haematol* 1991;78:590–591.
211. List AF, Doll DC. Alpha-interferon in the treatment of idiopathic myelofibrosis [Letter]. *Br J*

Haematol 1992;80:566–567.

212. Cooperberg AA, Singer OP. Reversible myelofibrosis due to vitamin D deficiency rickets. *Can Med Assoc J* 1966;94:392–395.
213. Yetgin S, Ozsoylu S. Myeloid metaplasia in vitamin D deficiency rickets. *Scand J Haematol* 1982;28:180–185.
214. Petrini M, Cecconi N, Azzara A, et al. 1,25-Dihydroxy-vitamin D on the treatment of idiopathic myelofibrosis. *Br J Haematol* 1986;62:399.
215. Richard C, Mazzora F, Iriundo A, et al. The usefulness of 1,25-dihydroxy-vitamin D3 in the treatment of idiopathic myelofibrosis. *Br J Haematol* 1986;62:399–400.
216. Eugster C, Brun-del-Re GP, Bucher U. The role of 1,25-dihydroxy-vitamin D3 (1,25(OH)2D3) in the treatment of idiopathic myelofibrosis [Letter]. *Br J Haematol* 1987;65:381.
217. Yoon SY, Li CY, Mesa RA, Tefferi A. Bone marrow effects of anagrelide therapy in patients with myelofibrosis with myeloid metaplasia. *Br J Haematol* 1999;106:682–688.
218. Aloe Spiriti M, Latagliata R, Avvisat G, et al. Erythropoietin treatment of idiopathic myelofibrosis. *Haematologica* 1993;78:371–373.
219. Tefferi A, Silverstein MN. Recombinant human erythropoietin therapy in patients with myelofibrosis with myeloid metaplasia. *Br J Haematol* 1994;86:893.
220. Hasselbalch HC, Clausen NT, Jensen BA. Successful treatment of anemia in idiopathic myelofibrosis with recombinant human erythropoietin. *Am J Hematol* 2002;70:92–99.
221. Elliot MA, Mesa RA, Li CY, et al. Thalidomide treatment in myelofibrosis with myeloid metaplasia. *Br J Haematol* 2002;117:288–296.
222. Merup M, Kutti J, Birgergard G, et al. Negligible clinical effects of thalidomide in patients with myelofibrosis with myeloid metaplasia. *Med Oncol* 2002;19:79–86.
223. Canepa L, Ballerini F, Varaldo R, et al. Thalidomide in agnogenic and secondary myelofibrosis. *Br J Haematol* 2001;115:313–315.
224. Steensma DP, Mesa RA, Li CY, Gray L, Tefferi A. Etanercept, a soluble tumor necrosis factor receptor, palliates constitutional symptoms in patients with myelofibrosis with myeloid metaplasia: results of a pilot study. *Blood* 2002;99:2252–2254.
225. Tefferi A, Silverstein MN, Plumhoff EA, et al. Suramin toxicity and efficacy in agnogenic myeloid metaplasia. *J Natl Cancer Inst* 1993;85:1520–1522.
226. Tefferi A, Mesa RA, Gray LA, et al. Phase 2 trial of imatinib mesylate in myelofibrosis with myeloid metaplasia. *Blood* 2002;99:3854–3856.
227. Matzner Y, Polliack A, Shenar E, et al. Sustained haematological remission after bone marrow curettage in a case of primary myelofibrosis. *Scand J Haematol* 1978;20:168–170.
228. Matzner Y, Polliack A. Bone marrow curettage in myelodysplastic disorders: A stimulus for regeneration in disturbed hematopoiesis. *JAMA* 1981;246:1926–1928.
229. Giuliani D, Nussbaum M, Morse BS. Trauma as a stimulus to marrow regeneration in the osteosclerotic mouse. *J Lab Clin Med* 1977;89:804–808.
230. Balfanz JR, Nesbit ME, Krivit W. Bone marrow curettage in childhood myelofibrosis. *J Pediatr* 1975;87:578–580.
231. Lewis SM, Szur L. Malignant myelosclerosis. *BMJ* 1963;7:472–477.
232. Bird T, Proctor SJ. Malignant myelosclerosis. Myeloproliferative disorder or leukemia? *Am J Clin*

Pathol 1977;67:512–520.

233. Bergsman KL, Van Slyck EJ. Acute myelofibrosis. *Ann Intern Med* 1971;74:232–235.
234. Evans DL. Acute myelofibrosis in children with Down's syndrome. *Arch Dis Child* 1975;50:458–462.
235. Patel AR, Shah PC, Rhee HL. Acute myelofibrosis and acute myeloblastic leukaemia. *BMJ* 1976;2:1232.
236. Truong LD, Saleem A, Schwartz MR. Acute myelofibrosis—a report of four cases and review of the literature. *Medicine* 1984;63:182–187.
237. Yeung KY, Trowbridge AA. Idiopathic acquired sideroblastic anemia terminating in acute myelofibrosis—case report and review of literature. *Cancer* 1977;39:359–365.
238. Fabich DR, Raich PC. Acute myelofibrosis. A report of three cases. *Am J Clin Pathol* 1977;67:334–338.
239. Manoharan A, Pitney WR. Acute myeloblastic leukaemia with marrow fibrosis (malignant myelosclerosis): acute leukaemia or malignant myelosclerosis? *Aust N Z J Med* 1977;7:638–641.
240. Bearman RM, Panglis GA, Rappaport H. Acute (“malignant”) myelosclerosis. *Cancer* 1979;43:279–293.
241. San Miguel JF, Gonzalez M, Canizo MC, et al. Leukemia with megakaryoblastic involvement: clinical hematologic and immunologic characteristics. *Blood* 1988;72:402–407.
242. Pagliuca A, Layton DM, Manoharan A, et al. Myelofibrosis in primary myelodysplastic syndromes: a clinico-morphological study of 10 cases. *Br J Haematol* 1989;71:499–504.
243. Lambertenghi-Delilieri G, Orazi A, Luksch R, et al. Myelodysplastic syndrome with increased marrow fibrosis: a distinct clinico-pathological entity. *Br J Haematol* 1991;78:161–166.
244. Dickstein JI, Vardiman JW. Issues in the pathology and diagnosis of the chronic myeloproliferative disorders and the myelodysplastic syndromes. *Am J Clin Pathol* 1993;99:513–525.
245. Dickstein JI, Vardiman JW. Hematopathologic findings in the myeloproliferative disorders. *Semin Oncol* 1995;22:355–373.
246. Bain BJ, Catovsky D, O'Brien M, et al. Megakaryoblastic leukemia presenting as acute myelofibrosis—a study of four cases with the platelet-peroxidase reaction. *Blood* 1981;58:206–213.
247. Den Ottlander GJ, Te Velde J, Brederoo P, et al. Megakaryoblastic leukemia (acute myelofibrosis): a report of three cases. *Br J Haematol* 1979;42:9–20.
248. List AF, Kummet TD, Kerr DM, et al. Acute myelofibrosis: response to recombinant interferon alpha 2a. *Leuk Res* 1990;14:321–326.
249. Silverstein MN. Evolution into and treatment of late stage polycythemia vera. *Semin Hematol* 1976;13:79–84.
250. Gralnick HR, Harbor J, Vogel C. Myelofibrosis in chronic granulocytic leukemia. *Blood* 1971;37:152–162.
251. Clough V, Geary CG, Hashimi K, et al. Myelofibrosis in chronic granulocytic leukemia. *Br J Haematol* 1979;42:515–526.
252. Weick JK, Hagedorn AB, Linman JW. Leukoerythroblastosis: diagnostic and prognostic significance. *Mayo Clin Proc* 1974;49:110–113.
253. Kaelin WG, Spivak JL. Systemic lupus erythematosus and myelofibrosis. *Am J Med* 1986;81:935–938.
254. Paquette RL, Meshinpour A, Rosen PJ. Autoimmune myelofibrosis. A steroid-responsive cause of

bone marrow fibrosis associated with systemic lupus erythematosus. *Medicine* 1994;73:145–152.

255. Andre J, Schwartz R, Dameshak W. Tuberculosis and myelosclerosis with myeloid metaplasia. *JAMA* 1961;178:1169–1174.

256. Kiely JM, Silverstein MN. Metastatic carcinoma simulating agnogenic myeloid metaplasia and myelofibrosis. *Cancer* 1969;24:1041–1044.

257. Wang JC, Aung MK, Tobin MS. Urinary hydroxyproline excretion in myelofibrosis. *Blood* 1980;55:383–385.

258. Eriksson S, Killander J, Wedman B. Leuco-erythroblastic anaemia in prostatic cancer—report of two cases with complete haematological remission. *Scand J Haematol* 1972;9:648–653.

259. Hann IM, Evans DL, Marsden HB, et al. Bone marrow fibrosis in acute lymphoblastic leukaemia of childhood. *J Clin Pathol* 1978;31:313–315.

260. Kiang DT, McKenna RW, Kennedy BJ. Reversal of myelofibrosis in advanced breast cancer. *Am J Med* 1978;64:173–176.

261. Pettit JE, Lewis SM, Goolden AW. Polycythaemia vera—transformation to myelofibrosis and subsequent reversal. *Scand J Haematol* 1978;20:63–69.

2004 Lippincott Williams & Wilkins  
John P. Greer, John Foerster, John N. Lukens  
George M. Rodgers, Frixos Paraskevas, Bertil Glader  
Wintrobe's Clinical Hematology



[HISTORICAL BACKGROUND](#)[PATHOPHYSIOLOGY](#)[CLINICAL FEATURES](#)[Cutaneous Mastocytosis](#)[Indolent Systemic Mastocytosis](#)[Systemic Mastocytosis with an Associated Hematologic Clonal Nonmast Cell Lineage Disorder](#)[Aggressive Systemic Mastocytosis](#)[Mast Cell Leukemia](#)[Mast Cell Sarcoma](#)[Extracutaneous Mastocytoma](#)[LABORATORY FINDINGS](#)[DIFFERENTIAL DIAGNOSIS](#)[MANAGEMENT](#)[WEB SITES](#)[REFERENCES](#)

## HISTORICAL BACKGROUND

Mastocytosis—a heterogeneous disease characterized by abnormal growth and accumulation of mast cells in one or more organs—has sparked the interest of the biomedical community for decades, though deeper understanding of the pathophysiology of this collective group of unusual disorders has only become manifest within the past several years. In 1878, Paul Ehrlich first identified the mast cell as a distinct cell type packed with meta-chromatic granules ([1](#)). Its role in the immune response was at that time unknown, as no disease or animal model could be identified from which a biologic role of mast cells could be inferred. The first case of mastocytosis was reported in 1869 by Nettleship and Tay under the heading of “rare forms of urticaria” and was described as “brown cutaneous lesions that whealed after scratching” ([2](#)). These lesions were termed *urticaria pigmentosa* (UP) 1 year after this initial description ([3](#)). The association between mast cells and mastocytosis was finally made in 1887, when Unna found that UP lesions were characterized by an increased number of mast cells in the dermis ([4](#)).

Subsequent appreciation of the full clinical spectrum of these disorders has identified forms of mastocytosis that also involve mast cell infiltration of visceral organs, and these forms of disease have collectively been termed *systemic mastocytosis* (SM) ([5](#)). The one unifying feature of this diverse group of disorders is a pathologic increase in mast cells in specific tissues. It is now known that SM can present with or without skin lesions and may show an indolent or aggressive clinical course; in some cases complicated by concomitant emergence of a clonal nonmast cell lineage disorder, such as one of the myeloproliferative disorders or myelodysplastic syndromes. This has led to further classification of mastocytosis based on hematologic findings, molecular markers, and serum levels of biomarkers such as tryptase, and the cluster designation (CD) markers CD2 and CD25; thereby prognosticating patients into better defined clinical categories than had been previously tenable. This updated reclassification of mastocytosis has been adopted by the World Health Organization (WHO) as the new classification scheme for

mastocytosis ( [6](#) ).

## PATHOPHYSIOLOGY

The current understanding of the etiology of mastocytosis has evolved from concentrated research efforts in the 1990s that have linked two key factors that control mast cell growth and activity—stem cell factor (SCF) and the SCF receptor, Kit. The two resultant hypotheses on the pathophysiology of mastocytosis that have thus emerged focus on disruption of the normal function of Kit or dysregulation of production of SCF, or both.

Mastocytosis is recognized in the majority of cases to represent a clonal disorder of the pluripotential hematopoietic progenitor cell that gives rise to B cells and monocytes, as well as mast cells ( [7](#), [8](#), [9](#) and [10](#) ). This precursor is believed to be more primitive than precursors committed to either the neutrophil/macrophage or erythroid cell lineages, with the affected clone showing variable expansion in these lineages in the peripheral blood of patients with SM ( [11](#) ). Thus, mastocytosis in such cases represents a somatic cell disorder that is confined to hematopoietic lineages. Although T and B cells of such mastocytosis patients carry a codon 816 mutation (such as Asp816Val), unlike mast cells, these cells do not express surface Kit when mature, and thus may be less susceptible to the biologic effects of constitutively activated Kit.

Early research efforts in the area of mast cell physiology concentrated on identifying the key biochemical pathways and mediators in these disorders that accounted for the various clinical sequelae seen in physiologic processes due to mast cell activation, including anaphylaxis and other allergic disease. Subsequent work by Kitamura and others ( [12](#), [13](#) and [14](#) ) focused on murine models of mast cell deficiency via studies on mice that exhibited either abnormal Kit ( $W/W^v$  mice) ( [12](#) ) or decreased production of SCF ( $Sl/Sl^d$  mice) ( [13](#) ) and laid the foundation for suggesting the pathophysiologic basis of human mastocytosis as comprising dysfunction at the *c-kit*–SCF locus. Two predominant hypotheses thus emerged regarding the etiology of mastocytosis: (a) mastocytosis as a result of local overproduction of soluble SCF and (b) mastocytosis as a result of mutations in Kit that lead to ligand-independent activation and proliferation. Irrespective of etiology, the pathologic sequelae of mastocytosis seen clinically largely reflects increased mast cell numbers at normal and abnormal sites.

Mast cells normally reside in tissue, generally located near epithelial surfaces, blood vessels, nerves, and glands. They are derived from  $CD34^+$  pluripotential progenitors (stem cells) ( [15](#), [16](#), [17](#) and [18](#) ), which give rise to mast cells, monocytes, and B cells ( [7](#), [11](#) ). Precommitted mast cell progenitors are  $CD34^+$ ,  $CD13^+$ , and  $CD117^+$  ( [17](#), [18](#), [19](#), [20](#) and [21](#) ). Except for a population of mast cells that reside in the bone marrow, mast cells complete their maturation in peripheral tissues. During maturation, mast cells down-regulate CD34 and several other receptors, but continue to express cell surface CD117 and CD13 ( [16](#), [17](#) and [18](#), [21](#) ). During terminal maturation, CD13 expression also decreases ( [20](#) ). Under normal physiologic conditions, mast cells and their progenitors do not or only minimally express CD2, CD25, or CD35 on their cell surface. This expression pattern, however, is altered in most patients with mastocytosis ( [22](#), [23](#) ).

Mast cells are heterogeneous in terms of their morphologic, biochemical, and functional characteristics. These differences appear to correlate with differences in their anatomic locations and, when perturbed in function, correlate with the specific signs and symptoms reported clinically. Clinical sequelae of mastocytosis are thus not only the result of organ infiltration but also the direct result of mast cell mediator release from spontaneous or

triggered mechanisms.

Mast cells are deemed to be long-lived cells, though it appears that at least some mast cells may proliferate locally in tissues in response to inflammatory or repair processes. In tissue sections, mast cells typically appear as either round or elongated cells, usually with a nonsegmented nucleus with moderate condensation of nuclear chromatin, and contain prominent cytoplasmic granules and lipid bodies. The cytoplasmic granules of mast cells contain heparin and chondroitin sulfate proteoglycans, consisting of sulfated glycosaminoglycans covalently linked to a protein core. Under appropriate conditions, the proteoglycans stain metachromatically with basic dyes. In humans, mast cells may be characterized as either mucosal or connective tissue mast cells; the former being located at mucosal locations, such as the lamina propria of the gastrointestinal (GI) tract, and containing a specific tryptase (thus a “T type” mast cell), the latter—more commonly found near the epithelial surface of the skin, and respiratory, GI, and genitourinary tracts and containing both tryptase and a chymotryptase (CT mast cells) ( [24](#) ). Human mast cell granules also contain tumor necrosis factor- $\alpha$ , histamine, acid hydrolases, cathepsin G, and carboxypeptidase ( [25](#) ). They may be activated by a number of stimuli that are both Fc<sub>ε</sub>RI dependent and Fc<sub>ε</sub>RI independent. After activation, mast cells may immediately release granule-associated mediators and generate lipid-derived substances that induce immediate allergic responses. Together, these mediators are deemed responsible for many of the clinical sequelae of the immediate hypersensitivity reaction, including pruritus, flushing, palpitations, and lightheadedness; also commonly reported in many patients with mastocytosis.

Major lipid mediators produced on appropriate activation via immunoglobulin E (IgE) or non-IgE stimuli include prostaglandin D<sub>2</sub> and leukotriene C<sub>4</sub> ( [24](#) ). Mast cell activation may be followed hours later by synthesis and release of additional chemokines and cytokines, and which may contribute to chronic inflammation. Cytokines reported to be synthesized and released from mast cells include macrophage inhibitory protein 1- $\alpha$ , basic fibroblast growth factor, vascular endothelial growth factor, interleukin-4 (IL-4), IL-5, IL-6, IL-8, IL-13, and IL-16 ( [24](#), [26](#) ).

Studies performed in rodents, nonhuman primates, and humans have shown that many aspects of mast cell development are critically regulated by SCF. SCF is produced by B-lymphoid cells, endothelial cells, fibroblasts, and mast cells. SCF promotes the *in vitro* growth, differentiation, and survival of mast cells derived from human CD34<sup>+</sup> cells from human bone marrow or peripheral blood via Kit dimerization ( [15](#), [26](#), [27](#) ) and has been shown to work in concert with other growth factors, such as IL-3, to induce optimal mast cell precursor proliferation ( [16](#) ). It has also been reported to be present in the lesional skin of patients with UP ( [28](#) ) but was not identified in blister fluids ( [29](#) ) and has been reported on the surface membrane of circulating neoplastic mast cells ( [30](#) ). SCF can also directly promote mast cell mediator release and, at low concentrations, appears to augment mast cell mediator release in response to stimulation by IgE and antigen. Cells bearing mutated Kit on their surface have been shown to have an increased chemotactic response toward SCF. SCF may influence the response of mast cells and lymphoid progenitor cells, which also bear Kit and thus contribute to the development of mast cell lesions ( [31](#) ). An immunohistochemical study of bone marrow lesions of patients with systemic indolent mastocytosis confirmed that SCF was present in lesional mast cells, with a granular staining pattern surrounded by lymphoid aggregates that were comprised of B and T cells—suggesting a potential feedback loop for growth and differentiation of mast cells and lymphoid progenitors ( [32](#) ). These findings support the autocrine or paracrine secretion of SCF hypothesis for the etiology of mastocytosis in which SCF may promote chemotaxis and proliferation of mast cells, in particular those mast cells and

lymphoid progenitors bearing mutated Kit.

The companion hypothesis for excessive mast cell numbers at various organ sites in mastocytosis is based on disordered signaling through Kit due to one of several somatic point mutations, most studied of which is the Asp816Val mutation (though other mutations at codon 816 with substitution of tyrosine and phenylalanine for aspartic acid have also been described in human subjects) and that favor ligand-independent activation and proliferation of mast cells.

Kit is present on mast cells and lymphoid progenitor cells and is critical for development of both lineages. Signaling through Kit is essential for the proliferation of CD34<sup>+</sup>CD117<sup>+</sup> mast cell precursors and their subsequent migration into tissues where they differentiate into mast cells. The binding of SCF to Kit induces dimerization, with activation of intrinsic tyrosine kinase activity and phosphorylation of the receptor. This in turn leads to exposure of specific recognition motifs for intracellular binding proteins containing Src homology (SH2) domains such as phospholipase C $\alpha$ -1, phosphatidylinositol-3' kinase, mitogen-activated kinase, and Ras protein ( [33](#), [34](#) ). Activating or gain-of-function mutations in Kit are associated with constitutive tyrosine kinase activation and ligand-independent autophosphorylation of the Kit; thereby giving affected mast cells a survival advantage over wild-type cells ( [34](#), [35](#) and [36](#) ).

The Asp816Val mutation was first reported in the peripheral blood mononuclear cells (PBMCs) of adult patients with mastocytosis with an associated hematologic disorder and in patients with persistent mastocytosis and extensive disease ( [37](#), [38](#) ) but codon 816 mutations (Asp816Phe, Asp816Tyr) have been shown to be present in UP lesions of all adults examined and in a subset of pediatric patients with more severe mastocytosis ( [38](#), [39](#) and [40](#) ). A Gly839Lys mutation has been reported in skin lesions of some pediatric patients with mastocytosis ( [10](#), [41](#) ) and, thus far, somewhat different mutation patterns appear to be emerging for adult versus pediatric-onset mastocytosis, which may explain the differences in presentation and clinical course for these two different patient populations ( [38](#), [41](#), [42](#) ).

All evidence to date indicates that the c-kit mutation occurs in a mast cell progenitor and then, as the clone expands, it initially becomes detectable in skin lesions ( [43](#) ). With greater clonal expansion and disease progression, the mutated clone may become detectable in peripheral blood cells as noted in earlier studies performed on CD34<sup>+</sup> cells isolated from mastocytosis patients, which showed that in the presence of the same amount of SCF, greater numbers of mast cells arose from hematopoietic progenitor cells of mastocytosis patients than from healthy volunteers ( [44](#) ).

Additional c-kit mutations have since been identified that may play a role in the etiology of mastocytosis in some patients ( [42](#) ). These mutations consist of substitutions of glycine for valine in codon 560 within the juxtamembrane domain of Kit and detected in the human mast cell leukemia (MCL) cell line HMC-1 ( [35](#) ). The downstream signal transduction pathways responsible for oncogenesis by these point mutations have yet to be fully elucidated, although impaired association of mutated Kit with the p85 subunit of phosphatidylinositol 3'-kinase appears to play a role in ligand-independent growth and suppression of apoptosis ( [31](#), [45](#) ).

Irrespective of effects on Kit, inhibition of mast cell apoptosis through other biologic pathways may also contribute to the pathogenesis of mastocytosis. IL-4 is known to promote apoptosis of mast cells ( [46](#), [47](#) ). A polymorphism in the gene for the IL-4

receptor a chain has been shown to be associated with less extensive mast cell involvement, with disease usually localized to the skin ( [48](#) ). In addition, the bone marrow cells of patients with mastocytosis have been found to constitutively express the antiapoptotic proteins Bcl-XL and Bcl-2 ( [49](#) , [50](#) ) and may explain the long survival of these cells and perhaps their resistance to chemotherapy-induced apoptosis.

In the genesis of mastocytosis, more aggressive forms of this disease may be characterized by other unique features that enhance the clonal expansion of mast cell populations bearing these changes. Thus, at least in some patients, one or more independent additional mutations in CD34<sup>+</sup> progenitor cells, mast cells, or an altogether different group of cells that have yet to be identified may comprise the underlying molecular basis for the mastocytosis phenotype.

It appears that consistent with the progressive genetic instability that is often described in other human tumors, increased chromosomal abnormalities that are unrelated to the c-kit locus have likewise been detected in patients with more malignant forms of mastocytosis, and new abnormalities may appear in a subset of such patients on disease progression ( [51](#) , [52](#) ). No recurrent patterns of chromosomal changes have been consistently reported in patients with SM. The implications of these findings are that, at least in some patients with mastocytosis, the etiology of their disease may extend beyond a specific mutation event in a DNA “hotspot” and may encompass a broader chromosomal problem of genetic instability, in which subsequent clonal abnormalities that are detected do not represent the primary genetic event.

Dysregulation of other cellular processes that control cell growth have likewise been described in malignant mast cells. Tumor mast cell lines appear to express persistently high telomerase activity throughout the cell cycle and do not appear to be subject to the normal regulatory feedbacks seen in nontumor-igenic mast cells ( [53](#) ). Maintenance of the high telomerase activity in tumor mast cell lines does not appear to be dependent on intracellular signals or cell replication, in contrast to normal human progenitor mast cells that experience transient induction of telomerase activity that is dependent on growth factor-mediated signals such as SCF-, IL-3-, and IL-6-mediated p38 mitogen-activated kinase and phosphatidylinositol-3' kinase ( [53](#) ).

## CLINICAL FEATURES

The clinical manifestations of mastocytosis are diverse and may be divided into those that are systemic or localized ( [54](#) , [55](#) , [56](#) , [57](#) , [58](#) , [59](#) and [60](#) ). Systemic effects of this disorder result from the release of significant amounts of mast cell mediators into the circulation. Clinical signs and symptoms that comprise systemic mediator release are those reported with anaphylaxis and include flushing, pruritus, hypotension, syncope, palpitations, and tachycardia ( [61](#) ). GI symptoms are commonly associated with mastocytosis and include nausea, vomiting, abdominal cramping, or bloating, and/or diarrhea. Peptic ulcer disease, which appears to reflect at least partially increased gastric acid secretion due to hyperhistaminemia, may occur in up to 50% of patients with systemic disease ( [60](#) ). Malabsorption, though less common, tends to be mild and may occur in those with progressive disease. Local sequelae of mastocytosis are largely due to the effects of mast cell collections at specific organ sites and may result in severe end-organ dysfunction due to infiltration of normal tissue with mast cells and subsequent fibrosis (e.g., cardiomyopathy, end-stage liver disease due to fibrosis, and bone marrow failure).

For some patients, in particular those with advanced disease or with an associated

hematologic disorder, the most bothersome complaints include severe and nonspecific constitutional symptoms of fatigue, weakness, anorexia, weight loss, low-grade fevers, night sweats, musculoskeletal pain, headaches, depression, and even subtle cognitive deficits such as mild memory loss. Clearly, some of these symptoms are attributable to ongoing chronic disease, whereas others (e.g., memory loss), may in part be a result of the central nervous system effects of histamine and other mast cell mediators.

Attacks may be precipitated by physical stimuli such as heat, cold, pressure, alcohol, and medications (e.g., opiates, nonsteroidal antiinflammatory agents, and estrogens), radiocontrast agents, and venoms. Patients with aggressive disease also often present with unexplained lymphadenopathy, splenomegaly, or hepatomegaly that may or may not be symptomatic. One of the most difficult clinical scenarios of mastocytosis from a management perspective is the treatment of severe musculoskeletal pain and/or pathologic fractures due to the osteoporosis that results from release of mast cell mediators and/or an expanding marrow compartment with active proliferation of mast cells. Besides local disruption of normal bone architecture, mast cell infiltration of bone may cause bone loss due to the secretion of heparin, IL-6, and other ill-defined mediators and from their paracrine effects on osteoclast function.

The most frequently involved organs in SM are the skin, bone marrow, lymph nodes, spleen, liver, and GI tract. The lungs are usually spared in mastocytosis. Atopy and airway hyperreactivity are not generally a feature of this disease.

The prognosis of patients with mastocytosis is dependent on the extent of disease and presence of an associated hematologic disorder. Patients with cutaneous disease or limited extracutaneous involvement tend to have an indolent course. Few, if any of these patients have been documented to progress to more aggressive forms of mastocytosis. Conversely, patients with peripheral blood c-kit mutation positivity by reverse transcriptase-polymerase chain reaction analysis, an associated hematologic disorder, or presence of a significant hematologic abnormality, late age of disease onset, and/or an elevated serum lactic dehydrogenase are more likely to have an aggressive disease course with shortened survival (62, 63).

Classification schemes for mastocytosis, as originally proposed by Travis et al. (63) and then modified by Metcalfe (59) (to include lymphadenopathic mastocytosis with eosinophilia), have been updated to reflect new information on the molecular, genetic, and clinical features of these disorders (64, 65 and 66). This current classification of mastocytosis was adopted by the WHO (6, 65) and is provided in Table 87.1. This classification differs from previous versions by including a smouldering mastocytosis category and other rare variants of mastocytosis, such as mast cell sarcoma (MCS) and extracutaneous mastocytoma, and by providing criteria for diagnosis of each disease category. Major and minor criteria for diagnosis of cutaneous and SM are provided in Table 87.2 and a listing of “B” and “C” findings, which are used to prognosticate patients are listed in Table 87.3.

**TABLE 87.1. Classification of Mastocytosis: Adapted from the World Health Organization**

| Variant Term                | Subvariants  |
|-----------------------------|--|
| Cutaneous mastocytosis (CM) | Urticaria pigmentosa (UP)<br>Maculopapular CM (MPCM)<br>Diffuse CM (DCM) |



|   |   |
|---|---|
| Indolent systemic mastocytosis (ISM)  | Cutaneous mastocytoma<br>Smouldering SM<br>Isolated bone marrow mastocytosis  |
| Systemic mastocytosis with an associated clonal hematologic nonmast cell lineage disease (SM-AHNMD) | Acute myeloid leukemia (SM-AML)<br>Myelodysplastic syndrome (SM-MDS)<br>Myeloproliferative disorders (SM-MPD)<br>Chronic myelomonocytic leukemia (SM-CMML)<br>Non-Hodgkin lymphoma (SM-NHL) |
| Aggressive systemic mastocytosis (ASM)  | Lymphadenopathic SM with eosinophilia   |
| Mast cell leukemia (MCL)  | Aleukemic MCL   |
| Mast cell sarcoma (MCS)   | —   |
| Extracutaneous mastocytoma  | —   |

NOTE: For details of the World Health Organization classification of mastocytosis, see Valent P, Horny HP, Li CY, et al. Mastocytosis. In: Jaffe ES, Harris NL, Stein H, Vardiman JW, eds. World Health Organization classification of tumours. Pathology and genetics of tumours of the haematopoietic and lymphoid tissues. Lyon: IARC Press, 2001:291–302.

---

**TABLE 87.2. Criteria Defining Systemic Mastocytosis**

---

**Major**

Multifocal dense infiltrates of MCs in bone marrow or other extracutaneous organ(s) (>15 MCs in aggregate) and confirmed by tryptase immunohistochemistry or other special stains

**Minor**

MCs in bone marrow or other extracutaneous organ(s) demonstrate abnormal morphologic features (>25%)

Detection of Kit mutation at codon 816 in peripheral blood, bone marrow, or other extracutaneous organs

MCs in blood, bone marrow, or other extracutaneous organs coexpress CD117 with CD2 or CD25

Serum total tryptase >20 ng/ml (not applicable in patients with systemic mastocytosis with an associated clonal hematologic nonmast cell lineage disease)

MCs, mast cells.

NOTE: The diagnosis of systemic mastocytosis is established if at least one major and one minor or at least three minor criteria are fulfilled (6).

---

**TABLE 87.3. World Health Organization Definition of “B” and “C” Findings**

---



B findings (indicative of a high burden of mast cells and expansion of the genetic defect into various myeloid lineages)

A >30% infiltration of the bone marrow by mast cells (focal, dense aggregates) or serum total tryptase >200 ng/ml

Histologic evidence of dysmyelopoiesis or myeloproliferative changes on bone marrow biopsy or in the peripheral blood, but not meeting criteria for a myelodysplastic syndrome or myeloproliferative disorder

Demonstration of organomegaly: hepatomegaly, splenomegaly, or lymphadenopathy (on computed tomography or ultrasound: >2 cm) without impairment of organ function

C findings (indicative of impaired organ function due to mast cell infiltration)

Bone marrow dysfunction as shown by =1 cytopenias: absolute neutrophil count <1000/ $\mu$ l or hemoglobin <10 g/dl or platelets <100,000/ $\mu$ L

Palpable hepatomegaly with impaired liver function, ascites, and/or portal hypertension

Skeletal involvement with large-sized osteolysis or/and severe osteoporosis causing pathologic fractures

Palpable splenomegaly with hypersplenism

Malabsorption with weight loss

Adapted from Valent P, Horny HP, Li CY, et al. Mastocytosis. In: Jaffe ES, Harris NL, Stein H, Vardiman JW, eds. World Health Organization classification of tumours. Pathology and genetics of tumours of the haematopoietic and lymphoid tissues. Lyon: IARC Press, 2001:291–302.

---

## Cutaneous Mastocytosis

Cutaneous mastocytosis comprises three distinct clinical variants: UP/maculopapular cutaneous mastocytosis (MPCM), solitary mastocytoma, and diffuse-erythrodermic disease also known as *diffuse cutaneous mastocytosis* (DCM). UP is further subcategorized into four subvariants: typical UP, a plaque form, a nodular form, and telangiectasia macularis eruptiva perstans (TMEP) ([6](#)).

The classic lesions of cutaneous mast cell disease are UP—reddish-brown macules, papules or plaques that urticate [i.e., form a wheal and erythema with a distinct border when stroked (a positive Darier sign)]. However, in a number of patients, cutaneous lesions are lacking, and other organs, particularly the bone marrow, must be biopsied to make the diagnosis.

UP lesions tend to occur in a generalized distribution, most commonly occurring over the trunk and generally sparing the face, scalp, palms, and soles. When abundant, they may form a cobblestone appearance. There appears to be no sex predilection or familial pattern of cutaneous disease, though mastocytosis of one form or another has been described in families, including several sets of twins ([24](#)).

Histologically, UP lesions are composed of a collection of mast cells within the papillary dermis with variable extension throughout the reticular dermis and into the subcutaneous fat. An increase in dermal mast cells =10 times that of normal skin, in the absence of other pathology is generally diagnostic of UP ([26](#), [67](#)). In or adjacent to UP lesions, petechiae, ecchymoses, or telangiectasias may be present. Blister formation and hemorrhage may also occur, particularly in infants and young children. This complication is presumed to occur due to high local levels of mediators released from mast cells, but why this younger age group is more adversely affected is unknown. After age 10 years,

vesicles do not generally occur, and UP lesions tend to be smaller and more numerous. UP lesions tend to follow a biphasic curve, with one peak at 2.5 months of age and another at 26.5 years ( [67](#), [68](#) ). Of pediatric patients in whom UP occurs, approximately half lose these lesions by adolescence. The remaining patients generally have lighter macular lesions at previous involved sites. Pruritus is the most common symptom that accompanies UP. Approximately 15 to 30% of pediatric patients whose skin lesions persist into adulthood progress to develop SM ( [69](#) ).

Although UP in adults may persist indefinitely, a subset of patients, estimated from 7 to 19% in published series, experience a fading or resolution of lesions over time ( [70](#) ). Regression of UP in patients with indolent SM (ISM) appears to parallel a decrease in disease severity (e.g., constitutional symptoms), although bone marrow findings of ISM remain. In contrast, disappearance of lesions in patients with an associated hematologic disorder may herald progression of disease, with more severe bone marrow pathology noted on follow-up biopsies. Hence, changes in the intensity of UP may have different clinical significance in patients with indolent versus more aggressive categories of mastocytosis such as SM with an associated hematologic nonmast cell disorder (SM-AHNMD). Conclusions from an analysis of 106 adult patients with SM followed for a minimum of 10 years indicated that remission of UP could not be predicted on the basis of the extent and distribution of UP or the extent of organ involvement; the severity and frequency of symptoms of mast cell mediator release, abdominal pain, or constitutional symptoms; or plasma tryptase levels ( [70](#) ). The absence or presence of the Asp816Val mutation in PBMCs did not predict the course of UP. Disease progression in patients with SM-AHNMD is therefore better monitored with bone marrow biopsy findings than with changes in the number, distribution, or intensity of skin lesions.

In addition to the presence of typical skin lesions on clinical examination, diagnosis of UP is based on histopathologic evidence of significant mast cell infiltrates in lesional skin, absence of signs of systemic involvement, and serum tryptase levels that are generally within normal limits (<20 ng/ml) ( [6](#) ). In adults with cutaneous mastocytosis, systemic disease is excluded by bone marrow examination ( [6](#) ).

DCM is a less frequent cutaneous manifestation of mastocytosis and generally presents before the age of 3 years ( [24](#), [26](#), [56](#) ). The entire skin is involved and may present as a yellow-red-brown discoloration with a peau d'orange appearance, or as a generalized erythroderma in which severe edema gives the skin a doughy appearance. Additionally, yellow-cream-colored papules have been described that resemble xanthomas and pseudoxanthoma elasticum ( [24](#), [71](#) ). Only rarely does skin appear normal in DCM. Dermatographism and formation of hemorrhagic blisters may occur. GI manifestations, such as diarrhea, flushing, and hypotension, may be associated, and such patients have an increased risk for more serious clinical sequelae such as shock, significant GI bleeding, and death. DCM may resolve spontaneously by age 5 to 15 months, but when persistent, the skin may remain thickened and doughy and recalcitrant to treatment.

Solitary mastocytomas are a fairly common cutaneous variant of mastocytosis that may present at birth or more commonly within the first 3 months of age, with spontaneous involution during childhood ( [72](#), [73](#) and [74](#) ). They are only rarely described in adults. They present as macules, plaques, or nodules and are formed by dermal collections of mast cells without cellular atypia. They are most commonly seen on the extremities and rarely involve the palms or soles. When systemic symptoms are present, they most commonly involve flushing.

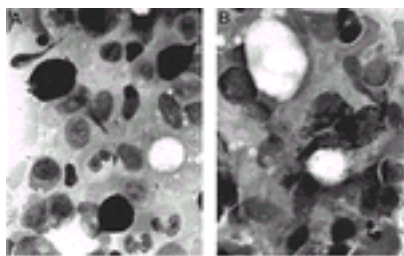
TMEP is another rare form of mastocytosis (<1% of cases) that is traditionally thought to be limited to the skin and only reported in adults. Select cases with concomitant

splenomegaly, increased mast cells in the bone marrow, and abnormal skeletal radiographs suggest that this form of cutaneous disease may have systemic features ( [75](#), [76](#) and [77](#) ). The characteristic skin lesion in TMEP is a telangiectatic, red macule on a tan-brown background. Individual lesions are 2 to 6 mm in diameter and are without sharply defined borders. Pruritus, purpura, and blister formation are not generally associated with TMEP, though lesions may become edematous when rubbed. Occasionally, these lesions are found to coexist with UP ( [24](#) ).

### Indolent Systemic Mastocytosis

ISM may be characterized by mast cell involvement at various organ sites, although significant organ dysfunction (C findings) is virtually always absent, and prognosis in these patients is generally good. The bone marrow is the most common site of extracutaneous mastocytosis, with as many as 90% of adult patients with indolent disease demonstrating bone marrow mast cell infiltration ( [63](#) ). The criteria for diagnosis of SM is provided in [Table 87.2](#) ( [6](#) ).

Characteristic bone marrow lesions of SM comprise focal or diffuse aggregates of mast cells. Focal infiltrates are frequently observed in paratrabecular and perivascular areas and are often associated with adjacent lymphoid or eosinophil aggregates, or both ( [77](#) ). Histologically, mast cells in these patients show characteristic cytologic abnormalities, including cytoplasmic surface projections, eccentric oval nuclei, and a hypogranulated cytoplasm (atypical mast cell type I) ( [6](#) ). A representative bone marrow aspirate from a patient with indolent SM with characteristic morphologic features compared with a control bone marrow aspirate is shown in [Figure 87.1](#). Clonal mast cells express CD2 or CD25, or both, on their cell surface, and the *c-kit* mutation Asp816Val ( [6](#) ). The bone marrow lesions of SM contain a mixed population of B and T cells, in addition to mast cells identified by antitryptase staining ( [32](#) ). The histopathology of these lymphoid aggregates is similar to benign lymphoid aggregates associated with reactive bone marrow ( [78](#) ) and not lymphoproliferative disease—the latter being highly uncommon in patients with adult-onset ISM. In bone marrow extensively involved by mast cell infiltration, the bony trabeculae may be moderately to markedly thickened.



**Figure 87.1.** Morphologic features of mast cells from normal versus mastocytosis bone marrow aspirate. Panel **A** shows staining of a control bone marrow aspirate from an individual with aplastic anemia using toluidine blue stain (magnification, 40 × ). Panel **B** shows a hematoxylin and eosin stain of a bone marrow aspirate acquired from a patient with indolent systemic mastocytosis and illustrates representative spindle-shaped mast cells with an eccentric nucleus (magnification, 40 × ). See [Color Plate](#). (Provided courtesy of Dr. Cem Akin, National Institute of Allergy and Infectious Diseases, National Institutes of Health.)

A number of hematologic abnormalities have been reported in patients with SM, including

cytopenias (e.g., anemia, thrombocytopenia, leukopenia, and lymphopenia) and increased white blood cell counts (e.g., leukocytosis, eosinophilia, basophilia, monocytosis, lymphocytosis, and thrombocytosis) ( [79](#) ). Hematologic abnormalities in children with mastocytosis are rare, with a normochromic normocytic anemia being the most common finding ( [41](#) ). Prolonged bleeding times have been reported in infants with mastocytosis due to abnormal thrombin clotting times. In published reports of rare pediatric mastocytosis patients who have developed an associated hematologic malignancy, these were most frequently acute myeloid leukemias and acute lymphoblastic leukemias ( [41](#), [80](#) ).

Isolated bone marrow mastocytosis is a rare subvariant of ISM that is distinctive in lacking cutaneous and multiorgan involvement ( [6](#) ). The tryptase level in this group of patients is usually >20 ng/ml. These patients generally require no specific therapy, but ISM must be differentiated from aggressive SM (ASM) or MCL, in which skin lesions are also absent.

Smouldering mastocytosis is another subvariant of ISM ( [81](#), [82](#), [83](#) and [84](#) ). Unlike typical ISM, these patients manifest two or more B findings (but no C findings) and have a higher mast cell burden [e.g., bone marrow infiltration grade >30% (dense infiltrates) and serum tryptase >200 ng/ml] with extension of a clonal disease process to several myeloid lineages ( [81](#) ). Although these patients have no overt myeloproliferative or myelodysplastic disease, they are at higher risk for progression to more aggressive forms of mastocytosis and carry a worse prognosis than those with indolent disease. Bone marrow lesions typically contain dense focal and diffuse mast cell infiltrates, and mast cells detected in such lesions may be immature. Markers of a poorer prognosis seen in this subvariant include a hypercellular bone marrow, hepatosplenomegaly or lymphadenopathy, and presence of the c-kit mutation in PBMCs ( [81](#) ).

In contrast to adults with SM, definitive marrow involvement in children is much less common ( [85](#), [86](#) ). In a study of 17 children with cutaneous or disseminated mastocytosis, only ten patients had small focal mast cell lesions on bone marrow biopsy, and only five demonstrated increased mast cells on bone marrow aspirate ( [86](#), [87](#) ). These aggregates were generally associated with eosinophils and early myeloid cells. Unlike the adult population, the mast cell lesions seen on bone marrow biopsy in children were found to be uniformly small and frequently located in perivascular sites ( [87](#) ).

The course of bone marrow involvement in mastocytosis is unknown. Although many patients, mostly adults and, less frequently, children, have stable or decreasing marrow involvement over time, the clinical significance of the extent of marrow involvement by mast cells remains elusive. Because studies in children have not involved large numbers of patients or followed them for extended time intervals, no conclusions can be made with regard to the significance of the progression of mast cell infiltration of the bone marrow in this population.

Lymphadenopathy is present in a subset of patients with mastocytosis and is more commonly seen in those with an associated hematologic disorder or in lymphadenopathic SM with eosinophilia. Travis and Li reported peripheral adenopathy in 26% of patients and central lymphadenopathy in 19% of patients with SM at the time of diagnosis ( [88](#) ). Hyperplasia of lymph nodes is the result of infiltration with mast cells and in approximately one-half of cases is associated with aggregates of eosinophils. Infiltrates are more commonly observed in the paracortex, follicles, medullary cords, and sinuses ( [26](#) ). Other histopathologic findings may include extramedullary hematopoiesis, small blood vessel proliferation in paracortical areas, and collagen fibrosis ( [89](#) ). On hematoxylin and eosin staining, mast cell infiltrates may resemble T-cell lymphomas in their paracortical

distribution, clear cytoplasm in some cases, and associated vascular proliferation. Or conversely, mast cell infiltration may resemble follicular hyperplasia or lymphoma when they replace lymphoid follicles.

The presence of lymphadenopathy by itself does not signal aggressive disease. However, patients who present with progressive lymphadenopathy, with or without hepatosplenomegaly, and especially if accompanied by peripheral blood abnormalities, should be closely monitored for evolution into a more aggressive systemic disorder. This latter patient population may be more likely to harbor mutations in the Kit receptor, as was demonstrated in a recent survey of patients with the Asp816Val mutation and an associated hematologic disorder ( [62](#) ).

Splenomegaly due to splenic infiltration with mast cells is likewise a not infrequent finding in systemic disease, with approximately 40 to 50% of such patients presenting with splenic involvement at the time of diagnosis ( [63](#) ). Splenomegaly has also been reported to occur in the absence of demonstrable mast cell infiltration on biopsy ( [90](#) ). A review of pathologic features of 16 spleens from patients with mastocytosis showed a paratrabecular distribution of mast cell infiltrates in 15 of 16 spleens. In addition, parafollicular, follicular, and diffuse infiltrates were noted in ten (64%), two (4%), and one (7%) patients, respectively ( [88](#) ). Varying degrees of trabecular and capsular fibrosis and eosinophilic hematopoiesis and plasmacytosis were seen, and 71% of all biopsies revealed extramedullary hematopoiesis. Disorders or conditions with similar histologic features to splenic mast cell involvement include T-cell lymphoma, myeloproliferative disorders, hairy cell leukemia, follicular hyperplasia or a granulomatous process, follicular lymphoma, and Kaposi sarcoma. The prognostic significance of splenomegaly is seen with markedly increased splenic weights (>700 g) that have been reported to correlate with SM-AHNMD or ASM ( [90](#) ) and may be a contributing factor to the hematologic abnormalities seen in such patients.

Mast cell infiltration of the liver is a common finding in SM, although severe liver disease and hepatomegaly are relatively uncommon except, again, in patients with more aggressive forms of disease. In a study of 41 patients with mastocytosis, liver disease was reported in 61% ( [91](#) ). Approximately one-half of the patients with liver disease in this series exhibited elevated liver function tests—either an elevated alkaline phosphatase, 5' nucleotidase, or  $\gamma$ -glutamyl transpeptidase. Hepatomegaly, infiltration of the liver by mast cells on liver biopsy, and hepatic fibrosis correlated with elevated levels of serum alkaline phosphatase. These findings were more commonly seen in patients with aggressive disease, ascites, or portal hypertension. As confirmed on liver biopsy, portal fibrosis and venopathy with subsequent veno-occlusive disease appear to be a direct result of vascular obstruction by mast cell infiltrates ( [91](#) ). Fibrosis, including that which affects the liver, often accompanies mast cell proliferation and mast cell release of such proinflammatory mediators as histamine and transforming growth factor- $\beta$ .

GI symptoms reported in both retrospective and prospective studies of SM include abdominal pain, cramping, nausea, vomiting, diarrhea, and peptic ulcer disease. Less commonly seen is a malabsorption syndrome due to mucosal mast cell infiltration ( [92](#), [93](#) ). A prospective study published by Cherner et al. revealed that 6 of 16 patients with SM had a significantly elevated basal acid secretion, with concomitantly low gastrin levels ( [92](#) ). These data were found to be consistent with the hypothesis that histamine secreted by mast cells is the primary cause of gastric hypersecretion. However, subsequent studies have shown that biopsy of gastric tissues in mastocytosis patients with acid hypersecretion symptoms did not always demonstrate increased mast cell infiltrates, thereby suggesting that the hyperhistaminemia observed in such patients may be due to oversecretion by all mast cells and not as a result of an increased mast cell burden in the



gastric tissues. GI disease is much less common in children, although GI bleeding is a potential complication with severe disease ( 41 ). Abdominal cramping and diarrhea have also been reported in patients with pediatric mastocytosis.

Musculoskeletal pain in patients with SM has been well documented but only recently has the pathophysiologic basis for this clinical manifestation begun to be understood. Bony infiltration with mast cells may result in osteopenia, with more aggravated cases leading to osteoporosis and pathologic fractures ( 94 , 95 ). In some cases, osteoporosis or pathologic fractures, or both, may be the only initial manifestation of mastocytosis, with back pain secondary to osteoporosis and vertebral compression fractures a classic presentation of systemic mast cell disease ( 96 ).

A comprehensive review of mastocytosis patient outcomes by Travis et al. found that approximately 16% and 70% of patients, respectively, had pathologic fractures and radiologic changes at initial diagnosis ( 63 ). As previously described, these clinical sequelae appear to be due to the release of mast cell mediators that have either a direct or indirect effect on bone cells (e.g., histamine, heparin, and tryptase) or are involved in the promotion of the inflammatory response (e.g., histamine, heparin, leukotrienes, and IL-6) ( 97 , 98 ). Bone scans may show focal or diffuse abnormalities, and the latter has been associated with more aggressive disease and a worse prognosis. The most commonly reported abnormalities are diffuse, poorly demarcated, sclerotic, and lucent areas involving the axial skeleton. In addition to bone loss, patients with mastocytosis may also exhibit concomitant abnormal bone formation, resulting in osteosclerosis. The finding of osteosclerosis was increasingly seen in patients harboring the Asp816Val mutation and an associated hematologic disorder ( 62 )—again portending a poorer long-term prognosis.

Occasionally, patients in whom bone involvement by mastocytosis is not seen on routine diagnostic evaluation and symptoms are not found to be attributable to any known cause may nonetheless report myalgias and arthralgias, often in concert with constitutional symptoms of fatigue, general weakness, and even depression. Management of this patient subset may be particularly challenging and may require behavior modification practices as well as therapeutic intervention. Patients may require both nonnarcotic and narcotic analgesics for adequate pain relief.

### **Systemic Mastocytosis with an Associated Hematologic Clonal Nonmast Cell Lineage Disorder**

A subset of patients with SM (20 to 30%) either present with or develop over time a second hematologic disease in association with mastocytosis. These patients are categorized as SM-AHNMD ( 6 , 65 ). The most common associated hematologic disorders that have been observed in retrospective series are the myeloproliferative disorders (e.g., chronic myelogenous leukemia), myelodysplastic syndromes (e.g., chronic myelomonocytic leukemia), acute myeloid leukemia, and the non-Hodgkin lymphomas ( 79 , 99 , 100 ). In these patients, WHO criteria to diagnose an AHNMD as well as ISM criteria should be applied ( 6 ). Management of these patients involves management of their underlying nonmast cell hematologic disorder either via close observation for stable disease, chemotherapy for progressive disease, or bone marrow (stem cell) transplantation in suitable candidates. The prognosis for such patients is variable and is dictated by the course of the associated nonmast cell lineage disorder.

Bone marrow findings that are more common with SM-AHNMD and have been associated with the Asp816Val c-kit mutation include a hypercellular bone marrow, dysplasia of myeloid or erythroid cell lineages, and an increased megakaryocyte number or

megakaryocyte atypia ( [62](#) ). Fibrosis may be seen and is more frequent in patients with an associated hematologic disorder. Mast cells with bilobed nuclei, if seen on biopsy, portend a poor prognosis.

### **Aggressive Systemic Mastocytosis**

ASM is a unique variant of mastocytosis characterized by abnormal myelopoiesis with mixed focal and diffuse mast cell infiltration of the bone marrow. These cells may be atypical and may be associated with other peripheral blood abnormalities (initially often presenting with eosinophilia), hepatosplenomegaly (due to mast cell infiltration), osteopenia and pathologic fractures, and life-threatening organ impairment ( [59](#) , [101](#) ). A subset of cases appear to be associated with a prior history of malignant germ cell tumors ( [63](#) , [102](#) , [103](#) ). In many respects, this disease has been described to resemble a “lymphomalike” illness with progressive infiltration of organs with mast cell infiltrates; the most commonly affected organs are the bone marrow, liver, spleen, and the GI tract. Cutaneous involvement is usually absent.

In some patients, bone marrow aspirates may reveal significant numbers of mast cells with bi- or multilobed nuclei (high-grade morphology). Metachromatic blasts may also be detected. The peripheral blood smear may show cytopenias, leukocytosis, eosinophilia, or monocytosis ( [104](#) ). Laboratory test abnormalities are frequently observed in such patients, with elevations in liver function, serum calcium, and alkaline phosphatase tests and prolonged prothrombin and partial thromboplastin times reported ( [63](#) ). As a result of impaired hepatic function and a propensity for spontaneous mast cell degranulation, ASM patients with more advanced disease may be at high risk for spontaneous hemorrhage during periods of mast cell activation. Serum tryptase levels may be very high and may also demonstrate wide fluctuations due to spontaneous mast cell degranulation ( [102](#) ).

### **Mast Cell Leukemia**

MCL is an exceedingly rare variant of mastocytosis, with a grave prognosis and poorly understood pathophysiology ( [105](#) , [106](#) ). MCL is defined by presence of mast cells as =10% of circulating peripheral white blood cells. The bone marrow typically shows a dense and diffuse infiltration (=20%) with mast cells that display an immature, blastlike morphology with bi- or multilobed nuclei. Many of these mast cells express CD2 or CD25, or both ( [107](#) , [108](#) ). Other peripheral blood abnormalities may be observed and include leukocytosis, anemia, and/or thrombocytopenia ( [108](#) ). In general, such patients manifest bone marrow and peripheral blood abnormalities that are insufficient to fulfill WHO criteria for SM-AHNMD ( [6](#) ). In the aleukemic variant of MCL, mast cells account for <10% of peripheral white blood cells, and patients develop pancytopenia ( [6](#) , [65](#) ). Similar to aggressive mastocytosis, MCL patients are prone to bleeding diatheses, with or without signs of consumption or hyperfibrinolysis.

### **Mast Cell Sarcoma**

MCS is a rare and ill-defined malignant mast cell neoplasm comprised of immature cells with a high nucleus to cytoplasm ratio, nucleoli, and a hypogranulated cytoplasm. It carries a highly unfavorable prognosis. The cellular atypia described in MCS is comparable to the high-grade cytologic abnormalities found in MCL. It is characterized by local, destructive, sarcomalike growth, with transformation to generalized involvement of multiple organ sites in its terminal phase. Thus far, the three cases described in the literature have included an MCS of the larynx, ascending colon, and an intracranial site ( [109](#) , [110](#) and [111](#) ). This



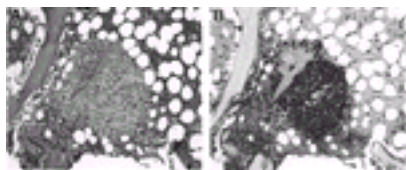
disorder often terminates as MCL, with no known life-prolonging or curative treatments available.

### Extracutaneous Mastocytoma

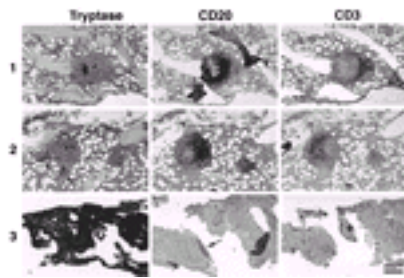
Extracutaneous mastocytoma is another rare variant of mast cell disease, with virtually all cases that have been reported in the literature occurring in the lungs ([112](#), [113](#) and [114](#)). They are generally considered benign due to their low-grade histology (mature mast cells) and lack of progression to aggressive disease or MCL. Because they may present similarly to MCS, they must be differentiated from the latter.

## LABORATORY FINDINGS

The diagnosis of mastocytosis is based on the finding of confluent clusters of mast cells in affected organ sites or diffuse infiltration with replacement of normal tissue by mast cells, coupled with clinical signs and symptoms and laboratory tests that are consistent with mast cell disease ([24](#), [26](#), [63](#), [115](#), [116](#)). Bone marrow biopsy in pediatric onset cutaneous disease is generally not recommended unless there is evidence of systemic disease—unexplained peripheral blood abnormalities, hepatosplenomegaly, or lymphadenopathy ([86](#)). Slight increases in mast cell numbers in target tissues (up to fourfold) are not diagnostic, as they may reflect normal variation or inflammatory or reactive processes ([26](#)). Examination of the bone marrow in patients with suspected mastocytosis should include an inspection of both the bone marrow biopsy and aspirate. Immunohistochemical staining of the bone marrow biopsy with antitryptase is the method of choice to visualize mast cells ([117](#), [118](#) and [119](#)), as shown in [Figure 87.2](#). The cellular composition of lymphoid collections is evaluated by using lineage-specific antibodies against CD3 and CD20, respectively ([32](#)), as seen in [Figure 87.3](#). Other stains commonly used to detect mast cell infiltrates include Wright-Giemsa and toluidine blue, along with reticulin staining to detect fibrosis and Masson trichrome staining to evaluate the extent of collagen deposition. Mast cells also stain positively for chloroacetate esterase and aminocaproate esterase ([24](#)). Although some patients with mastocytosis may exhibit increased bone marrow mast cells without discrete foci of mast cells, such patients are the exception, and the diagnosis of mastocytosis must incorporate other relevant clinical and laboratory findings.



**Figure 87.2.** Bone marrow histopathology showing focal mast cell infiltrates in a bone marrow biopsy taken from a patient with indolent systemic mastocytosis. Panel **A** shows staining of a representative mast cell lesion with hematoxylin and eosin stain (magnification, 10×), and panel **B** shows staining of the same section with antitryptase antibody (magnification, 10×). See [Color Plate](#). (Provided courtesy of Dr. Gem Akin, National Institute of Allergy and Infectious Diseases, National Institutes of Health.)



**Figure 87.3.** Immunohistochemical staining of lymphoid aggregates in two patients with a focal ( **1** and **2**) and one patient with a diffuse ( **3**) increase in mast cells. Antibodies are shown on top of each column. Nodular lesions shown in **1** and **2** contain a central core of mast cells ( *arrows*) surrounded by B cells (CD20) and a peripheral rim of T cells (CD3). Diffuse mast cell infiltrates ( **3**) are seen in association with a small B-cell collection ( *arrow*) and scattered single T cells. The bar represents 200  $\mu$ m. See [Color Plate](#). (From Akin C, Jaffe ES, Raffeld M, et al. An immunohistochemical study of the bone marrow lesions of systemic mastocytosis. *Am J Clin Pathol* 2002;118:242–247, by permission of Dr. Cem Akin, National Institute of Allergy and Infectious Diseases, National Institutes of Health and the *American Journal of Clinical Pathology*.)

The finding of clusters of confluent mast cells on bone marrow aspirate is consistent with SM, however not all patients demonstrate this finding. Therefore, underestimation of the degree of mast cell infiltration through examination of an aspirate may be more common than appreciated, with aspirates compromised because of underlying marrow fibrosis and a resultant inability to obtain adequate marrow aspirate or spicules at fibrotic marrow sites. Surrogate disease markers in mastocytosis include serum or plasma tryptase levels, serum histamine, urinary histamine metabolites, soluble CD117, soluble CD25, and CD2 ( [120](#) ).

Serum mast cell tryptase is the most commonly used surrogate marker for SM and is currently quantified using commercial enzyme-linked immunosorbent assays. It has both high sensitivity (approximately 0.2 ng/ml) and specificity ( [120](#) , [121](#) ). A total tryptase >20 ng/ml is suggestive of mastocytosis and has been included as a minor criterion in the diagnosis of SM as per the WHO classification scheme for mast cell disorders ( [6](#) , [65](#) ). Normal baseline levels in healthy individuals are generally =5 ng/ml. Tryptase levels =20 ng/ml have been detected in patients with cutaneous mastocytosis and in those with limited systemic disease ( [122](#) , [123](#) ). Thus, the tryptase level is an important parameter in evaluating patients with suspected mastocytosis and appears useful in assessing disease severity and monitoring disease activity.

Other mast cell mediators that are surrogate disease markers for mastocytosis are serum histamine and 24-hour urine sampling for the urinary histamine metabolites, N-methylhistamine, and methylimidazoleacetic acid. These tests are less commonly used with the availability of commercial tryptase assays. Disadvantages of using blood and urinary histamine levels for diagnosis and prognostication of patients with mastocytosis are the variability of histamine levels among healthy individuals and patients, difficulty in assay standardization, and the problem of false-positive results due to presumed synthesis of histamine by bacteria in the urinary tract. Other variables that can alter results of histamine assays (i.e., elevate histamine levels) are prior ingestion of foods rich in histamine and improper storage of the urine sample. Because basophils also contain histamine, hematologic disorders presenting with basophilia (e.g., certain myeloproliferative disorders) or allergic events that lead to basophil activation (e.g., during the collection process) result in elevated histamine levels.

Various metabolites of arachidonic acid are also elevated in patients with mastocytosis.

These include urinary PGD-M or 9 $\alpha$ ,11 $\beta$ -dihydroxy-15-oxo-2,2,18,19-tetranorprost-5-ene-1,20-dioic acid, as well as plasma thromboxane B<sub>2</sub> and its metabolites. Because the source of prostaglandins and thromboxanes in mastocytosis is not exclusively limited to mast cells, reliance on assays that measure these metabolites are unlikely to be sufficiently specific for diagnostic purposes. However, if measured, elevations in one or more mast cell mediators raise the suspicion of mastocytosis and warrant further diagnostic evaluation.

Use of genetic markers of mastocytosis, such as evaluation for the presence of point mutations of c-kit, most commonly the Asp816Val mutation, is helpful in identifying patients with SM with more severe disease (the relative clonal expansion of cells derived from the neoplastic progenitor is expressed more readily with more aggressive mastocytosis categories) and perhaps even more helpful in following disease progression by assessing the relative intensity of the reverse transcriptase-polymerase chain reaction complementary DNA bands over the patient's course (62). IL-6 levels may correlate with disease severity but are not currently recommended for diagnosis or monitoring of patients (29, 98). Their primary use is in the research setting.

Newer surrogate markers that may also be useful in assessing more severe forms of mastocytosis, such as SM-AHNMD, and in following disease severity are the soluble receptors CD117 (Kit) and CD25 (the  $\alpha$ -chain of the IL-2 receptor) (124). These receptors are expressed in both membrane-bound and soluble form—the latter a result of proteolytic cleavage. Soluble forms of these receptors are more readily detectable in the circulation in patients with an increased mast cell burden and correlate with disease severity and bone marrow pathology. Soluble CD117 levels are also found to be elevated in some patients with acute myeloid leukemias and advanced myelodysplastic syndromes. Elevated CD25 levels may be seen in patients with hairy cell leukemia, solid tumors, and a number of infectious and autoimmune diseases. A comparison of the plasma CD117 and tryptase levels for various categories of mastocytosis revealed that tryptase levels were more sensitive indicators of early disease, whereas elevated plasma CD117 levels demonstrated a stronger correlation with advanced disease (124).

Additional diagnostic studies that may be helpful in evaluating extent of systemic disease include bone scans or skeletal surveys, computed tomography scan of the abdomen, upper GI series, small-bowel radiography, and, when indicated, endoscopy to rule out peptic ulcer disease or esophageal reflux.

## DIFFERENTIAL DIAGNOSIS

The differential diagnostic list of disorders for mastocytosis comprises a number of other diseases that have a similar clinical presentation. These include hereditary or acquired angioedema, idiopathic flushing or anaphylaxis, carcinoid tumor, pheochromocytoma, and idiopathic capillary leak syndrome. Although hyper-IgE syndrome is listed in the differential for mastocytosis, such patients more often have distinct facial features (coarse facies), which set them apart from other similar, confounding clinical syndromes such as mastocytosis. Pheochromocytoma should be considered when episodic hypertension is a predominant clinical manifestation. Unexplained gastroduodenal disease should include evaluation for Zollinger-Ellison gastrinoma. *Helicobacter pylori* infection should be considered in all patients with gastric ulcers, even in those patients diagnosed with mastocytosis.

DCM should be included in the differential diagnosis of neonatal blister disorders such as pemphigoid (24). Extensive bullae with crusting may be the first presentation in an infant

who later develops DCM.

A number of nonmast cell hematologic disorders, such as the myeloproliferative disorders (e.g. chronic myelogenous leukemia) or lymphoma of the bone marrow, may present with an increased number of mast cells on bone marrow biopsy, though circumscribed lesions are generally lacking in these disorders ( [125](#), [126](#) ). Diseases with bone marrow lesions on biopsy that appear similar to SM on gross analysis include primary myelofibrosis, angioimmunoblastic lymphadenopathy, and eosinophilic fibrohistiocytoma ( [24](#) ). Close evaluation of histopathologic specimens differentiates these disorders from mastocytosis in part on the basis of a general absence of mast cell infiltrates. Myelofibrosis can resemble mastocytosis when fibrosis is extensive and the marrow is diffusely infiltrated with increased mast cells. The distinguishing feature between these two disorders is the overwhelming greater absolute number of mast cells on bone marrow biopsy in mastocytosis. Although differentiation of mastocytosis from angioimmunoblastic lymphadenopathy may be made on the basis of presence of plasma cells and immunoblasts in the latter and absence of neovascularity in mastocytosis, differentiation of mastocytosis from fibrohistiocytoma is more difficult. Large histiocytic cells noted in eosinophilic fibrohistiocytic lesions have a similar appearance to the large mast cells seen in many mast cell lesions ( [127](#) ). Some debate exists as to whether eosinophilic fibrohistiocytic lesions of the bone represent an indolent form of SM ( [127](#) ).

Conditions with secondary changes in mast cell numbers have been observed at sites of pathology in a number of autoimmune disorders, including systemic lupus erythematosus, rheumatoid arthritis, psoriatic arthritis, and scleroderma; with chronic liver or renal disease; and with a variety of infectious diseases, though in all cases, these increases are nominal ( [26](#) ). On resolution of the infection, mast cell numbers generally return to normal. At sites of allergic inflammation, increases of mast cells up to fourfold over normal have been described.

## MANAGEMENT

Treatment of all categories of mastocytosis is primarily based on control of symptoms by blocking the action of mast cell mediators, though several new therapeutic strategies may hold promise for more severe forms of disease by targeting mast cell growth and development ( [128](#), [129](#) and [130](#) ). Because of the heterogeneous nature of disease manifestations in this group of disorders, therapy should be individualized to each patient's clinical presentation and prognosis. A summary of treatment approaches for mastocytosis is provided in [Table 87.4](#).

**TABLE 87.4. Suggested Therapy for Mastocytosis**

---

|  |
|--|
| Hypotensive/anaphylactoid symptoms   |
| Epinephrine [intramuscular (e.g., Epi-Pen)]  |
| More severe, frequent episodes: consider prophylaxis with H <sub>1</sub> , H <sub>2</sub> antihistamines ± corticosteroids |
| Cutaneous disease  |
| Antihistamines: H <sub>1</sub> ± H <sub>2</sub>  |
| Corticosteroids  |
| Psoralen and ultraviolet A light: consider for recalcitrant disease  |
| Laser therapy: consider for telangiectasia macularis eruptiva perstans   |
| Gastrointestinal disease   |

Peptic ulcer disease/gastroesophageal reflux: H<sub>2</sub> antihistamines, omeprazole

Abdominal cramping: cromolyn sodium

Diarrhea: anticholinergics, cromolyn sodium, omeprazole

Malabsorption: corticosteroids

Ascites: corticosteroids, consider a portacaval shunt

#### Bone disease

Calcium supplementation ± vitamin D

Bisphosphonates

Consider estrogen therapy for postmenopausal women, testosterone replacement in men with low testosterone levels

Consider interferon-α2b in patients with severe bone disease and severe musculoskeletal pain

Radiotherapy: palliative therapy for severe, localized bone pain

#### Smouldering mastocytosis

Observe: if evidence of progressive hematologic disease, consider bone marrow transplantation, chemotherapy

Systemic mastocytosis with an associated nonmast cell lineage disorder

If indicated, consider treatment of the associated nonmast cell hematologic disorder

Interferon-α2b

Consider bone marrow transplantation if an appropriate HLA match is available

Splenectomy if patient has an enlarged spleen and/or cytopenias and if chemotherapy is to be considered

#### Aggressive systemic mastocytosis

Interferon-α2b

Cladribine

Consider bone marrow transplantation if an appropriate HLA match is available

Splenectomy if patient has an enlarged spleen and/or cytopenias and if chemotherapy is to be considered

#### Mast cell leukemia

Chemotherapy

Consider cladribine

Consider phase 1 or phase 2 investigational research studies, including bone marrow transplantation

---

The mainstay of treatment for most categories of mastocytosis is H<sub>1</sub> and H<sub>2</sub> antihistamine blockade for prophylaxis of hypotensive episodes; for control of cutaneous manifestations, such as pruritus and flushing; and for gastric hypersecretion and corticosteroids for control of malabsorption and ascites and for prevention or amelioration of anaphylaxis ([128](#), [131](#), [132](#), [133](#) and [134](#)). Ketotifen, an antihistamine with mast cell stabilizing properties, is of benefit in relieving pruritus and whealing associated with mastocytosis ([135](#), [136](#) and [137](#)) but appears to offer no advantage over classical H<sub>1</sub> antihistamines such as hydroxyzine ([138](#)). Although no double-blind, placebo-controlled trials have been conducted assessing the relative efficacy of the newer, nonsedating antihistamines (e.g., loratadine and fexofenadine), use of these drugs have utility when patient sedation is a key concern ([139](#)). Alternative approaches include administration of a nonsedating antihistamine during the day, with supplementation of one of the potent sedating antihistamines at bedtime for added symptom relief.

Addition of an H<sub>2</sub> antihistamine, such as ranitidine, cimetidine, or famotidine, may be beneficial in cases in which insufficient symptom control is afforded by use of an H<sub>1</sub> antihistamine alone ( [128](#), [140](#), [141](#), [142](#), [143](#) and [144](#) ). Neither chemotherapy nor splenectomy appear to have any role in the treatment of cutaneous or indolent forms of mastocytosis.

For cutaneous manifestations of mastocytosis, which may be quite diverse, other therapies may be beneficial in addition to antihistamines ( [128](#) ). UP and DCM have been shown to be responsive to topical (UP) or intravenous corticosteroids (DCM) ( [145](#), [146](#), [147](#), [148](#) and [149](#) ) and oral methoxypsoralen therapy with long-wave ultraviolet radiation—psoralen and ultraviolet A light has been used for both UP and DCM ( [150](#), [151](#), [152](#), [153](#), [154](#), [155](#), [156](#), [157](#) and [158](#) ). Photochemotherapy, however, should only be used in instances of extensive cutaneous disease unresponsive to other therapy. TMEP—a rare variant of cutaneous disease, is somewhat more complicated in that lesions are chronic and tend to be unresponsive to currently available therapies ( [128](#) ). Neither corticosteroids nor psoralen and ultraviolet A light have been shown to afford significant improvement in TMEP and in UP and DCM improvement is transient. A limited body of literature indicates that laser therapy may have some utility in the treatment of TMEP ( [76](#), [128](#) ). In children with mastocytomas with associated severe systemic symptoms due to massive mast cell mediator release, surgical excision of the mastocytoma may be considered ( [57](#), [58](#) ). An alternative approach used involves injection of the mastocytoma with corticosteroids to induce involution ( [159](#) ).

Management of GI symptoms should address the type and severity of symptoms. H<sub>2</sub> antihistamines are specifically used to treat gastric hypersecretion and peptic ulcer disease associated with mastocytosis. Omeprazole may be effective in decreasing diarrhea in addition to controlling gastric acid hypersecretion ( [160](#) ). Anticholinergics and orally administered cromolyn sodium may also be useful for control of diarrhea ( [161](#) ). Intestinal absorption of cromolyn is limited (=1%), and a number of weeks of therapy may be needed before clinical benefits are seen ( [139](#) ). The recommended adult dosage is 200 mg four times daily, and doses ranging from 60 mg daily to 100 mg four times daily have been used in children in published studies, even though none of these were double-blind, placebo-controlled trials ( [57](#), [58](#), [128](#) ).

In addition to its efficacy in treating GI symptoms, cromolyn has been reported to decrease musculoskeletal pain and headaches and improve cognitive abilities ( [128](#) ). Its purported mechanism of action is in decreasing mast cell degranulation. As such, its use would not be expected to alter the natural course of the disease.

Malabsorption is generally managed with corticosteroids ( [55](#), [162](#) ). In adults, oral prednisone (40 to 60 mg/day) usually results in a decrease in malabsorption over 10 to 20 days, after which steroids can usually be tapered to as low as 15 to 20 mg every other day ( [128](#), [129](#) ). A more difficult treatment dilemma, ascites, has been shown to improve with systemic corticosteroids ( [128](#), [129](#) ). Again, in adults, treatment with prednisone, 40 to 60 mg/day, with tapering to an every-other-day dose usually results in a decrease in ascites ( [128](#), [129](#) ). A subgroup of patients with mastocytosis who develop ascites may also develop portal hypertension, which may be exceedingly difficult to manage and indicates a poor prognosis ( [163](#) ). At least one patient with portal hypertension was shown to be successfully managed with a portacaval shunt ( [164](#) ).



Epinephrine is used to treat acute episodes of hypotension ( [128](#), [165](#) ). Treatment of refractory hypotension and shock requires fluid resuscitative measures along with additional pharmacologic intervention ( [61](#), [128](#), [165](#) ).

Osteoporosis in those with mastocytosis may be under detected and, hence, under treated. Recommended approaches to treatment include calcium supplementation and use of bisphosphonates ( [128](#) ). Narcotic analgesics should be used with care, as these, particularly at high doses or in susceptible patients, may potentiate mast cell degranulation. Radiotherapy may have a palliative role in decreasing bone pain in isolated areas ( [166](#) ). The literature indicates that interferon- $\alpha$ 2b may have some efficacy in decreasing musculoskeletal pain and improving bone mineralization in patients with extensive bony involvement ( [128](#) ). The decision to initiate treatment with interferon- $\alpha$ 2b therapy should take into consideration potentially debilitating side effects such as fever, malaise, nausea, and hypothyroidism, along with the small but well-described risk for anaphylaxis. Patients with mastocytosis who ultimately require joint replacement due to extensive bone loss generally tolerate these procedures well; however, such procedures do not obviate further decline in bone mass ( [102](#), [167](#) ).

Neither chemotherapy nor splenectomy have any role in the treatment of indolent mastocytosis. Interferon- $\alpha$ 2b, administered subcutaneously by injection has been used in the treatment of indolent disease with mixed success ( [128](#), [168](#), [169](#), [170](#), [171](#), [172](#), [173](#), [174](#) and [175](#) ). Although interferon- $\alpha$ 2b showed some efficacy in controlling mast cell-mediated symptoms, such as flushing and pruritus, and symptoms such as diarrhea and abdominal pain in some patients, it failed to influence the number or extent of UP lesions and in some cases where checked, the extent of mast cell infiltration of the bone marrow ( [170](#), [172](#) and [173](#) ).

Despite therapy with multiple drugs, many patients fail to obtain adequate symptom relief, especially of musculoskeletal pain, headaches, and flushing. It is possible that newer therapies that target mediators shown to be elevated in mastocytosis may improve patient quality of life, but data are lacking in this regard. All newer therapies, especially biotechnology products or those with significant toxicities, require an appropriate risk/benefit analysis with respect to the patient's disease category and morbidity.

Therapeutic options for patients with mastocytosis with an associated clonal hematologic nonmast cell lineage disease (SM-AHNMD), ASM, and MCL are at the present time based on treating associated medical conditions and, when associated, the underlying hematologic disorder ( [128](#), [176](#), [177](#), [178](#), [179](#), [180](#), [181](#), [182](#), [183](#), [184](#), [185](#), [186](#), [187](#), [188](#), [189](#), [190](#), [191](#), [192](#), [193](#), [194](#), [195](#) and [196](#) ). Various chemotherapeutic regimens have been tried with mixed success and are summarized in a recent review ( [128](#) ). Regardless of the regimens used, relatively short partial remissions were noted in the majority of patients treated.

Interferon- $\alpha$ 2b has been used to treat a number of patients with SM-AHNMD, but overall findings in these small case series are inconclusive ( [102](#), [128](#), [182](#), [188](#), [189](#) and [190](#) ). Although some patients noted marked clinical improvement in terms of symptomatology, little or no evidence of a decrease in mast cell infiltration was seen on bone marrow biopsy in the majority of patients. In the majority of these patients, interferon generally failed to have any effect in decreasing either the intensity or number of skin lesions ( [128](#), [183](#) ), as also seen in many patients with indolent disease ( [170](#) ).



Two recent case reports of the successful use of cladribine (2-chlorodeoxyadenosine), a purine nucleoside analog, in inducing clinical remissions in patients with more aggressive forms of mastocytosis suggests continued evolution in attempts to treat this disease ( [195](#) , [196](#) ). Cladribine may be a reasonable therapeutic approach in treating those with aggressive forms of mastocytosis who have interferon- $\alpha$ -resistant advanced disease ( [196](#) ). In this same vein, similar treatments that target CD25 expressed on progenitor cells of patients with mastocytosis may ultimately prove to be more selective therapeutic interventions in patients whose cells express this biomarker. In other patients, bone marrow transplantation has the potential of allowing long-term engraftment of healthy bone marrow progenitors along with provision for a graft-versus-leukemia effect. Here, too, limited published data are available ( [128](#) , [197](#) , [198](#) and [199](#) ).

In SM-AHNMD patients with significant cytopenias and splenomegaly, splenectomy may result in some amelioration of the cytopenia and thereby reduce a patient's transfusion requirement or risk of bleeding or infection ( [200](#) ). Such patients might also be better able to tolerate chemotherapy, as suggested by a study in which patients with more aggressive forms of mastocytosis who underwent splenectomy had a mean survival time of 34 months compared to 26 months in those who did not undergo splenectomy ( [200](#) ).

Therapies used in the management of ASM include initial treatment with corticosteroids and H<sub>1</sub> and H<sub>2</sub> blockers, with addition of cytoreductive therapy for progressive disease. One case report describes a successful trial of cyclosporin-A (50 to 100 mg/day) given to a patient with aggressive mastocytosis ( [201](#) ). This patient demonstrated significant improvement within several weeks of cyclosporin-A treatment, which further improved when methylprednisolone (4 mg/day) was added. Other approaches, including administration of interferon- $\alpha$ 2b, cytoreductive therapy with daunorubicin and cytosine arabinoside, or with cyclophosphamide, vincristine, and prednisone, have demonstrated mixed success and no sustained complete responses ( [128](#) , [176](#) , [177](#) , [178](#) , [179](#) , [180](#) , [181](#) , [182](#) , [183](#) , [184](#) , [185](#) , [186](#) , [187](#) , [188](#) , [189](#) , [190](#) , [191](#) , [192](#) , [193](#) and [194](#) ). Interferon- $\alpha$ 2b appears to be useful in decreasing symptoms in patients with ASM who are no longer adequately responsive to other therapies. However, similar to outcomes seen in patients with SM-AHNMD, there is no evidence to date that it alters the course of disease ( [128](#) , [186](#) , [202](#) ). Because most of these studies were designed to follow patients for a relatively short period, conclusions about long-term efficacy and response rate are lacking.

Control of bone pain due to extensive skeletal involvement is a management challenge. Such patients should empirically be placed on calcium supplementation, when indicated, and possibly bisphosphonates, though extensive experience with the latter is lacking ( [128](#) , [203](#) ). Radiotherapy or strontium-99 may have a palliative role in decreasing bone pain in isolated areas ( [166](#) , [204](#) ). A small number of case series also indicate that a trial of interferon- $\alpha$ 2b may have some efficacy in decreasing bone pain and improving bone mineralization in mastocytosis patients with extensive bony involvement ( [181](#) , [192](#) , [194](#) ). The decision to initiate treatment with interferon- $\alpha$ 2b therapy should take into consideration potentially debilitating side effects, such as fever, malaise, nausea, and hypothyroidism, along with the small but well-described risk for anaphylaxis, versus the patient's severity of disease ( [168](#) , [205](#) , [206](#) and [207](#) ).

Prognosis for MCL is poor, and such patients should be treated with corticosteroids for mild and early stage disease ( [104](#) , [208](#) , [209](#) ). Review of 16 published cases of MCL revealed that the clinical manifestations, complications, and survival do not vary significantly with the percentage of peripheral blood mast cells ( [105](#) ). Chemotherapy, including cladribine,

may be considered for advanced disease, but, thus far, most data are not compelling for most chemotherapeutic regimens with regard to long-term outcome ( [128](#) ). One published report showed that even aggressive, high-dose chemotherapy, which is routinely used in conditioning protocols before allogeneic bone marrow transplantation, might not be able to eradicate the dysplastic mast cells in these patients ( [208](#) , [209](#) and [210](#) ). A novel approach that used antibody against the high-affinity IgE receptor that was coupled to chlorambucil and adsorbed onto sheep IgG was likewise ineffective in slowing down progression of disease, though the number of circulating mast cells decreased ( [211](#) ).

Tyrosine kinase inhibitors have been under investigation as a potential therapeutic class that could be used to interfere with mast cell proliferation and survival ( [212](#) , [213](#) , [214](#) , [215](#) and [216](#) ). A report by Ma et al. ( [215](#) ) indicates that activation of the juxtamembrane domain Kit mutant was effectively suppressed by Imatinib (STI571), but additional studies on effects of these tyrosine kinase inhibitors, including STI571 and SU9529, on activation of the catalytic domain of Kit indicated that wild-type Kit was more effectively inhibited than Kit with a codon 816 mutation ( [215](#) , [216](#) ). These data indicate that the catalytic domain of Kit with a codon 816 mutation is characterized by a unique activation mechanism that is resistant to tyrosine kinase inhibitors and that appears to be localized to the activation loop portion of the catalytic domain. It is not unreasonable to postulate that the patient population with mastocytosis that is most likely to respond to tyrosine kinase inhibitors will comprise those that lack a codon 816 mutation.

Despite the intricacies of treating this diverse group of disorders, an important component of management of all categories of mastocytosis is patient avoidance of triggering factors such as alcohol; nonsteroidal antiinflammatory agents in sensitive patients; pressure, friction, or extremes of temperature; and agents to which the patient is specifically allergic ( [24](#) , [26](#) , [128](#) , [217](#) , [218](#) , [219](#) , [220](#) , [221](#) , [222](#) , [223](#) and [224](#) ). As with other syndromes in which patients may be at risk for severe type I hypersensitivity reactions, patients with mastocytosis should use great caution to avoid known potentiators, consider prophylactic H<sub>1</sub> and H<sub>2</sub> antihistamine treatment, and, when indicated, carry epinephrine-filled syringes and be skilled in self-administration ( [128](#) ).

## WEB SITES

The following web sites provide updated information on mastocytosis: [www.niaid.nih.gov/factsheets/masto.htm](http://www.niaid.nih.gov/factsheets/masto.htm), [www.mastocytosis.com](http://www.mastocytosis.com), and [www.rarediseases.org](http://www.rarediseases.org)

## REFERENCES

1. Ehrlich P. Beitrage zur kennntniss der quilinfarbunger und ihrer verivendung in der mikroskopischen technik. *Alch Mikros Anat* 1877;13:263-267.
2. Nettleship E, Tay W. Rare forms of urticaria. *BMJ* 1869;2:323-330.
3. Sanger A. An anomalous mottled rash, accompanied by pruritus, factious urticaria and pigmentation, "urticaria pigmentosa." *Trans Clin Soc Lond* 1878;11:161-163.
4. Unna PG. Beitrage zur anatomic und pathogenese der urticaria simplex und pigmentosa. *Mschr Prakt Dermatol, Suppl Dermatol Stud* 1887;3:9.
5. Ellis JM. Urticaria pigmentosa. A report of a case with autopsy. *AMA Arch Pathol* 1949;48:426-429.
6. Valent P, Horny HP, Li CY, et al. Mastocytosis. In: Jaffe ES, Harris NL, Stein H, Vardiman JW, eds. *World Health Organization classification of tumours. Pathology and genetics of tumours of the*

haematopoietic and lymphoid tissues. Lyon: IARC Press, 2001:291–302.

7. Yavuz AS, Lipsky PE, Yavuz S, et al. Evidence for the involvement of a hematopoietic progenitor cell in systemic mastocytosis from single-cell analysis of mutations in the c-kit gene. *Blood* 2002;100:661–665.
8. Sotlar K, Fridrich C, Mall A, et al. Detection of c-kit point mutation Asp-816?Val in microdissected pooled single mast cells and leukemic cells in a patient with systemic mastocytosis and concomitant myelomonocytic leukemia. *Leuk Res* 2002;26:979–984.
9. Longley BJ, Tyrrell L, Lu SZ, et al. Somatic c-KIT activating mutation in urticaria pigmentosa and aggressive mastocytosis: establishment of clonality in a human mast cell neoplasm. *Nat Genet* 1996;12:312–314.
10. Simpson JK, Akin C, Metcalfe DD. C-kit mutations and mastocytosis. *ACI International* 2002;14:60–63.
11. Akin C, Kirshenbaum AS, Semere T, et al. Analysis of the surface expression of the c-kit Asp816Val activating mutation in T cells, B cells, and myelomonocytic cells in patients with mastocytosis. *Exp Hematol* 2000;28:140–147.
12. Kitamura Y, Go S, Hatanaka S. Decrease in mast cells in W/W<sup>v</sup> mice and their increase by bone marrow transplantation. *Blood* 1978;52:447–452.
13. Kitamura Y, Go S. Decreased production of mast cells in Sl/Sl<sup>d</sup> mice. *Blood* 1979;53:492–497.
14. Sonoda T, Kitamura Y, Haku Y, et al. Mast cell precursors in various hematopoietic colonies of mice produced in vivo and in vitro. *Br J Hematol* 1983;53:611–620.
15. Galli SJ, Tsai M, Wershil BK. The c-kit receptor, stem cell factor and mast cells. What each is teaching us about the others. *Am J Pathol* 1993;142:965–974.
16. Kirshenbaum AS, Goff JP, Kessler SW, et al. Effects of IL-3 and stem cell factor on the appearance of human basophils and mast cells from CD34<sup>+</sup> pluripotent progenitor cells. *J Immunol* 1992;148:772–777.
17. Kirshenbaum AS, Goff JP, Semere T, et al. Demonstration that human mast cells arise from a progenitor cell population that is CD34<sup>+</sup>, c-kit<sup>+</sup>, and expresses aminopeptidase N (CD13). *Blood* 1999;94:2333–2342.
18. Kirshenbaum AS, Kessler SW, Goff JP, et al. Demonstration of the origin of human mast cells from CD34<sup>+</sup> bone marrow progenitor cells. *J Immunol* 1991;146:1410–1415.
19. Agis H, Willheim M, Sperr WR, et al. Monocytes do not make mast cells when cultured in the presence of SCF. Characterization of the circulating mast cell progenitor as a c-kit<sup>+</sup>, CD34<sup>+</sup>, Ly<sup>-</sup>, CD14<sup>-</sup>, CD17<sup>-</sup>, colony forming cell. *J Immunol* 1993;151:4221–4227.
20. Shimizu Y, Sakai K, Miura T, et al. Characterization of 'adult-type' mast cells derived from human bone marrow CD34<sup>+</sup> cells cultured in the presence of stem cell factor and interleukin-6. Interleukin-4 is not required for constitutive expression of CD54, Fc epsilon RI alpha and chymase, and CD13 expression is reduced during differentiation. *Clin Exp Allergy* 2002;32:872–880.
21. Valent P, Scherthaner GH, Sperr WR, et al. Variable expression of activation-linked surface antigens on human mast cells in health and disease. *Immunol Rev* 2001;179:74–81.
22. Escribano L, Orfao A, Diaz-Augustin B, et al. Indolent systemic mast cell disease in adults: immunophenotypic characterization of bone marrow mast cells and its diagnostic implication. *Blood* 1998;91:2731–2736.
23. Ghannadan M, Hauswirth A, Scherthaner GH, et al. Detection of novel CD antigens on the surface of human mast cells and basophils. *Int Arch Allergy Immunol* 2002;127:299–307.
24. Parker RI, Metcalfe DD. Basophils, mast cells and systemic mastocytosis. In: Hoffman R, Benz EJ, Jr., Shattil SJ, et al., eds. *Hematology: basic principles and practice*, 3rd ed. Philadelphia: Churchill Livingstone, 2000:830–846.

25. Metcalfe DD, Baram D, Mekori YA. Mast cells. *Physiol Rev* 1997;77:1033–1079.
26. Galli SJ, Metcalfe DD, Dvorak AM. Basophils and mast cells and their disorders. In: Beutler E, Coller BS, Lichtman MA, Kipps TJ, eds. *Williams hematology*, 6th ed. New York: McGraw–Hill, 2001:801–815.
27. Valent P. The riddle of the mast cell: c-kit ligand as missing link? *Immunol Today* 1994;15:111–114.
28. Longley BJ, Jr., Morganroth GS, Tyrrell L, et al. Altered metabolism of mast-cell growth factor (c-kit ligand) in cutaneous mastocytosis. *N Engl J Med* 1993;328:1302–1307.
29. Brockow KC, Akin C, Huber M, et al. Levels of mast cell growth factors in plasma and in suction blister fluid in adults with mastocytosis: correlation with dermal mast cell numbers and mast cell tryptase. *J Allergy Clin Immunol* 2002;109:82–88.
30. Castells MC, Friend DS, Bunnell CA, et al. The presence of membrane-bound stem cell factor on highly immature nonmetachromatic mast cells in the peripheral blood of a patient with aggressive systemic mastocytosis. *J Allergy Clin Immunol* 1996;98:831–840.
31. Taylor ML, Dastych J, Sehgal D, et al. The Kit-activating mutation D816V enhances stem cell factor-dependent chemotaxis. *Blood* 2001;28:140–147.
32. Akin C, Jaffe ES, Raffeld M, et al. An immunohistochemical study of the bone marrow lesions of systemic mastocytosis. *Am J Clin Pathol* 2002;118:242–247.
33. Taylor ML, Metcalfe DD. Kit signal transduction. *Hematol Oncol Clin North Am* 2000;14:517–535.
34. Linnekin D. Early signaling pathways activated by c-Kit in hematopoietic cells. *Int J Biochem and Cell Biol* 1999;31:1053–1074.
35. Furitsu T, Tsujimura T, Tono T, et al. Identification of mutations in the coding sequence of the proto-oncogene c-kit in a human mast cell leukemia cell line causing ligand-independent activation of c-kit product. *J Clin Invest* 1993;92:1736–1744.
36. Kitayama H, Kanakura Y, Furitsu T, et al. Constitutively activating mutations of c-kit receptor tyrosine kinase confer factor-independent growth and tumorigenicity of factor-dependent hematopoietic cell lines. *Blood* 1995;85:790–798.
37. Feger F, Ribadue Dumas A, Leriche L, et al. Kit and c-kit mutations in mastocytosis: a short overview with special reference to novel molecular and diagnostic concepts. *Int Arch Allergy Immunol* 2002;127:110–114.
38. Nagata H, Worobec AS, Oh CK, et al. Identification of a point mutation in the catalytic domain of the protooncogene c-kit in peripheral blood mononuclear cells of patients who have mastocytosis with an associated hematologic disorder. *Proc Natl Acad Sci U S A* 1995;92:10560–10564.
39. Longley BJ, Jr., Metcalfe DD, Tharp M, et al. Activating and dominant inactivation c-KIT catalytic domain mutations in distinct clinical forms of human mastocytosis. *Proc Natl Acad Sci U S A* 1999;96:1609–1614.
40. Longley BJ, Tyrrell L, Lu SZ, et al. Somatic c-kit activating mutation in urticaria pigmentosa and aggressive mastocytosis: establishment of clonality in a human mast cell neoplasm. *Nat Genet* 1996;12:312–314.
41. Carter MC, Metcalfe DD. Pediatric mastocytosis. *Arch Dis Child* 2002;86:315–319.
42. Buttner C, Henz BM, Welker P, et al. Identification of activating c-kit mutations in adult-, but not childhood-onset indolent mastocytosis: a possible explanation for divergent clinical behaviour. *J Invest Dermatol* 1998;111: 1227–1231.
43. Nagata N, Okada T, Worobec AS, et al. c-kit mutation in a population of patients with mastocytosis. *Int Arch Allergy Immunol* 1997;113:184–186.

44. Rottem M, Okada T, Goff JP, et al. Mast cells cultured from peripheral blood of normal donors and patients with mastocytosis originate from a CD34<sup>+</sup>/FceRI<sup>+</sup>-cell population. *Blood* 1994;84:2489–2496.
45. Hashimoto K, Matsumura I, Tsujimura T, et al. Necessity of tyrosine 719 and phosphatidylinositol 3'-kinase-mediated signal pathway in constitutive activation and oncogenic potential of *c-kit* receptor tyrosine kinase with the Asp814Val mutation. *Blood* 2003;101:1094–1102.
46. Shelburne CP, Ryan JJ. The role of Th2 cytokines in mast cell homeostasis. *Immunol Rev* 2001;179:82–93.
47. Oskeritzian CA, Wang Z, Kochan JP, et al. Recombinant human (rh) IL-4 mediated apoptosis and recombinant human IL-6 mediated protection of recombinant human stem cell factor-dependent human mast cells derived from cord blood mononuclear cell progenitors. *J Immunol* 1999;163:5105–5115.
48. Daley T, Metcalfe DD, Akin C. Association of the Q576R polymorphism in the interleukin-4 receptor alpha chain with indolent mastocytosis limited to the skin. *Blood* 2001;98:880–882.
49. Mekori YA, Gilfillan AM, Akin C, et al. Human mast cell apoptosis is regulated through Bcl-2 and Bcl-XL. *J Clin Immunol* 2001;21:171–174.
50. Cervero C, Escribano L, San Miguel JF, et al. Expression of Bcl-2 by human bone marrow mast cells and its overexpression in mast cell leukemia. *Am J Hematol* 1999;60:191–195.
51. Worobec AS, Akin C, Scott LM, et al. Cytogenetic abnormalities and their lack of relationship to the Asp816Val *c-kit* mutation in the pathogenesis of mastocytosis. *J Allergy Clin Immunol* 1998;102:523–524.
52. Gupt R, Bain BJ, Knight CL. Cytogenetic and molecular genetic abnormalities in systemic mastocytosis. *Acta Haematol* 2002;107:123–128.
53. Chaves-Dias C, Hundley TR, Gilfillan AM, et al. Induction of telomerase activity during development of human mast cells from peripheral blood CD34<sup>+</sup> cells: comparisons with tumor mast cell lines. *J Immunol* 2001;166:6647–6656.
54. Akin C, Metcalfe DD. Mastocytosis. In: Leung DYM, Greaves MW, eds. *Allergic skin diseases*. New York: Marcel Dekker, 2000:337–352.
55. Metcalfe DD. Mastocytosis syndromes. In: Middleton E, Jr., Ellis EF, Yunginger JW, et al., eds. *Allergy: principles and practice*, 5th ed. St. Louis: Mosby-Year Book, 1998:1093–1103.
56. Longley J, Duffy TP, Kohn S. The mast cell and mast cell disease. *J Am Acad Dermatol* 1995;32:545–561.
57. Kettelhut BV, Metcalfe DD. Pediatric mastocytosis. *Ann Allergy* 1994;73:197–202.
58. Kettelhut BV, Metcalfe DD. Pediatric mastocytosis. *J Invest Dermatol* 1991;96:15S–18S.
59. Metcalfe DD. Classification and diagnosis of mastocytosis: current status. *J Invest Dermatol* 1991;96:2S–4S.
60. Pauls JD, Brems J, Pockros PJ, et al. Mastocytosis: diverse presentations and outcomes. *Arch Intern Med* 1999;159:401–405.
61. Koide T, Nakajima T, Makifuchi T, et al. Systemic mastocytosis and recurrent anaphylactic shock. *Lancet* 2002;359:2084.
62. Worobec AS, Semere T, Nagata H, et al. Clinical correlates of the presence of the Asp816Val *c-kit* mutation in the peripheral blood mononuclear cells of patients with mastocytosis. *Cancer* 1998;83:2120–2129.
63. Travis WD, Li CY, Bergstrahl EF, et al. Systemic mast cell disease. Analysis of 58 cases and literature review. *Medicine* 1988;67:345–368.

64. Longley BJ, Metcalfe DD. A proposed classification of mastocytosis incorporating molecular genetics. *Hematol Oncol Clin North Am* 2000;14:697–701.
65. Valent P, Horny H, Escribano L, et al. Diagnostic criteria and classification of mastocytosis: a consensus proposal. *Leuk Res* 2001;25:603–625.
66. Metcalfe DD, Akin C. Mastocytosis: molecular mechanisms and clinical disease heterogeneity. *Leuk Res* 2001;25:577–582.
67. Soter NA. The skin in mastocytosis. *J Invest Dermatol* 1991;96:32S–38S.
68. Soter NA. Mastocytosis and the skin. *Hematol Oncol Clin North Am* 2000;14:537–555.
69. Caplan R. The natural course of urticaria pigmentosa. *Arch Dermatol* 1963;87:146–157.
70. Brockow K, Scott LM, Worobec AS, et al. Regression of urticaria pigmentosa in adult patients with systemic mastocytosis. *Arch Dermatol* 2002;138:785–790.
71. Roca Miralles M, Cambazard F, Castells Rodellas A. Bullous mastocytosis (diffuse cutaneous mastocytosis): report of a case and review of the literature. *An Esp Pediatr* 1993;39:69–73.
72. Kacker A, Huo J, Huang R, et al. Solitary mastocytoma in an infant—case report with review of literature. *Int J Pediatr Otorhinolaryngol* 2000;52:93–95.
73. Inoue T, Yoneda K, Kakurai M, et al. Alteration of mast cell proliferation/apoptosis and expression of stem cell factor in the regression of mastocytoma—report of a case and a serial immunohistochemical study. *J Cutan Pathol* 2002;29:305–312.
74. Lee HP, Yoon DH, Kin CW, et al. Solitary mastocytoma on the palm. *Pediatr Dermatol* 1998;15:386–387.
75. Sarkany RP, Monk BE, Handfield–Jones SE. Telangiectasia macularis eruptiva perstans: a case report and review of the literature. *Clin Exp Dermatol* 1998;23:38–39.
76. Cohn MS, Mahon MJ. Telangiectasia macularis eruptiva perstans. *J Am Osteopath Assoc* 1994;94:246–248.
77. Horny HP, Valent P. Histopathological and immunohistochemical aspects of mastocytosis. *Int Arch Allergy Immunol* 2002;127:115–117.
78. Bluth RF, Casey TT, McCurley TL. Differentiation of reactive from neoplastic small–cell lymphoid aggregates in paraffin–embedded marrow particle preparations using L–26 (CD20) and UCH–1 (CD45RO) monoclonal antibodies. *Am J Clin Pathol* 1993;99:150–156.
79. Lawrence JB, Friedman BS, Travis WD, et al. Hematologic manifestations of systemic mast cell disease: a prospective study of laboratory and morphologic features and their relation to prognosis. *Am J Med* 1991;91:612–624.
80. Longley BJ, Reguera MJ, Ma Y. Classes of c–kit activating mutations: proposed mechanisms of action and implications for disease classification and therapy. *Leuk Res* 2001;25:571–576.
81. Akin C, Scott LM, Metcalfe DD. Slowly progressive systemic mastocytosis with high mast–cell burden and no evidence of a non–mast cell hematologic disorder: an example of a smoldering case? *Leuk Res* 2001;25:635–638.
82. Hauswirth A, Sperr WR, Gannadan M, et al. A case of smouldering mastocytosis with peripheral blood eosinophilia and lymphadenopathy. *Leuk Res* 2002;26:601–606.
83. Valent P, Akin C, Sperr WR, et al. Smouldering mastocytosis: a new type of systemic mastocytosis with slow progression. *Int Arch Allergy Immunol* 2002;127:137–139.
84. Jordan JH, Fritsche–Polanz R, Sperr WR, et al. A case of ‘smouldering’ mastocytosis with high mast

cell burden, monoclonal myeloid cells, and C-KIT mutation Asp-816-Val. *Leuk Res* 2001;25:627-634.

85. Azana JM, Torreló A, Mediero IG, et al. Urticaria pigmentosa: a review of 67 pediatric cases. *Pediatr Dermatol* 1994;11:102-106.

86. Kettlehut BV, Parker RI, Travis WD, et al. Hematopathology of the bone marrow in pediatric cutaneous mastocytosis. A study of 17 patients. *Am J Clin Pathol* 1989;91:558-562.

87. Parker RI. Hematologic aspects of mastocytosis: bone marrow pathology in adult and pediatric systemic mast cell disease. *J Invest Dermatol* 1991;96:47S-51S.

88. Travis WD, Li CY. Pathology of the lymph node and spleen in systemic mast cell disease. *Mod Pathol* 1988;1:4-14.

89. Horny HP, Kaiserling E, Rarwaresch MR, et al. Lymph node findings in generalized mastocytosis. *Histopathology* 1992;21:439-446.

90. Horny HP, Ruck MT, Kaiserling E. Spleen findings in generalized mastocytosis. A clinicopathologic study. *Cancer* 1992;70:459-468.

91. Mican JM, DiBisceglie AM, Fong TL, et al. Hepatic involvement in mastocytosis: clinicopathologic correlations in 41 cases. *Hepatology* 1995;22:1163-1170.

92. Cherner JA, Jensen RT, Dubois A, et al. Gastrointestinal dysfunction in systemic mastocytosis. *Gastroenterology* 1988;95:657-667.

93. Jensen RT. Gastrointestinal abnormalities and involvement in systemic mastocytosis. *Hematol Oncol Clin North Am* 2000;14:579-623.

94. Chen CC, Andrich MP, Metcalfe DD, et al. A retrospective analysis of bone scan abnormalities in mastocytosis: correlation with disease category and prognosis. *J Nuclear Med* 1994;35:1471-1475.

95. Horan RF, Austen KF. Systemic mastocytosis: retrospective review of a decade's clinical experience at the Brigham and Women's Hospital. *J Invest Dermatol* 1991;96:5S-13S.

96. Lidor C, Frisch B, Gazit D, et al. Osteoporosis as the sole presentation of bone marrow mastocytosis. *J Bone Mineral Res* 1990;8:871-876.

97. Marshall A, Kavanagh RT, Crisp AJ. The effect of pamidronate on lumbar spine bone density and pain in osteoporosis secondary to systemic mastocytosis. *Br J Rheumatol* 1997;36:393-396.

98. Theoharides TC, Boucher W, Spear K. Serum interleukin-6 reflects disease severity and osteoporosis in mastocytosis patients. *Int Arch Allergy Immunol* 2002;128:344-350.

99. Travis WD, Li CY, Yam LT, et al. Significance of systemic mast cell disease with associated hematologic disorders. *Cancer* 1988;62:965-972.

100. Sperr WR, Horny HP, Lechner K, et al. Clinical and biological diversity of leukemias occurring in patients with mastocytosis. *Leuk Lymphoma* 2000;37:473-486.

101. Valent P, Akin C, Sperr WR, et al. Aggressive systemic mastocytosis and related mast cell disorders: current treatment options and proposed response criteria. *Leuk Res* 2003;27:635-641.

102. Worobec AS, Kirshenbaum AS, Schwartz AB, et al. Treatment of three patients with systemic mastocytosis with interferon alpha-2b. *Leuk Lymphoma* 1995;18:179-184.

103. Travis WD, Li CY, Bergstralh EJ. Solid and hematologic malignancies in 60 patients with systemic mast cell disease. *Arch Pathol Lab Med* 1989;113:365-368.

104. Valent P. Biology, classification and treatment of human mastocytosis. *Wien Klin Wschr* 1996;108:385-397.

105. Travis WD, Li CY, Hoagland HC, et al. Mast cell leukemia. Report of a case and review of the



literature. *Mayo Clin Proc* 1986;61:957-966.

106. Scherthaner GH, Jordan JH, Ghannadan M, et al. Expression, epitope analysis, and function role of the LFA-2 antigen detectable on neoplastic mast cells. *Blood* 2001;98:3784-3792.

107. Escribano L, Diaz-Agustin B, Bellas C, et al. Utility of flow cytometric analysis of mast cells in the diagnosis and classification of adult mastocytosis. *Leuk Res* 2001;25:563-570.

108. Sperr WR, Escribano L, Jordan JH, et al. Morphologic properties of neoplastic mast cells: delineation of stages of maturation and implication for cytological grading of mastocytosis. *Leuk Res* 2001;25:529-536.

109. Horny HP, Parwaresch MR, Kaiserling E, et al. Mast cell sarcoma of the larynx. *J Clin Pathol* 1986;39:596-602.

110. Kojima M, Nakamura S, Itoh H, et al. Mast cell sarcoma with tissue eosinophilia arising in the ascending colon. *Mod Pathol* 1999;12:739-743.

111. Guenther PP, Huebner A, Sobottka SB, et al. Intracranial mast cell sarcoma. *J Pediatr Hematol Oncol* 2001;23:134-138.

112. Simpson J, Metcalfe D. Mastocytosis and disorders of mast cell proliferation. *Clin Rev Allergy Immunol* 2002;22:175-188.

113. Kudo H, Morinaga S, Shimosata Y, et al. Solitary mast cell tumor of the lung. *Cancer* 1988;61:2089-2094.

114. Mylanos EAM, Wielinger EWJ, van de Nes JAP. A solitary manifestation of mastocytosis in the head and neck. *Eur Arch Otorhinolaryngol* 2000;257:270-272.

115. Schwartz LB. Clinical utility of tryptase levels in systemic mastocytosis and associated hematologic disorders. *Leuk Res* 2001;25:553-562.

116. Koide T, Nakajima T, Makifuchi T, et al. Systemic mastocytosis and recurrent anaphylactic shock. *Lancet* 2002;359:2084.

117. Horny HP, Sillaber C, Menke D, et al. Diagnostic utility of staining for tryptase in patients with mastocytosis. *Am J Surg Pathol* 1998;22:1132-1140.

118. Li WV, Kapadia SB, Sonmez-Alpan E, et al. Immunohistochemical characterization of mast cell disease in paraffin sections using tryptase, CD68, myeloperoxidase, lysozyme, and CD20 antibodies. *Mod Pathol* 1996;9:982-988.

119. Li CY. Diagnosis of mastocytosis: value of cytochemistry and immunohistochemistry. *Leuk Res* 2001;25:537-541.

120. Akin C, Metcalfe DD. Surrogate markers of disease in mastocytosis. *Int Arch Allergy Immunol* 2002;127:133-136.

121. Sperr WR, Jordan JH, Fiegl M, et al. Serum tryptase levels in patients with mastocytosis: correlation with mast cell burden and implication for defining the category of disease. *Int Arch Allergy Immunol* 2002;128:136-141.

122. Schwartz B, Sakai K, Bradford TR, et al. The alpha form of human tryptase is the predominant type present in blood at baseline in normal subjects and is elevated in those with systemic mastocytosis. *J Clin Invest* 1995;96:2702-2710.

123. Schwartz LB. Clinical utility of tryptase levels in systemic mastocytosis and associated hematologic disorders. *Leuk Res* 2001;25:553-562.

124. Akin C, Schwartz LB, Kitoh T, et al. Soluble stem cell factor receptor (CD117) and IL-2 receptor alpha chain (CD25) levels in the plasma of patients with mastocytosis: relationships to disease severity and bone marrow pathology. *Blood* 2000;96:1267-1273.

125. Prokocimer M, Pollack A. Increased bone marrow mast cells in preleukemic syndromes, acute leukemia, and lymphoproliferative disorders. *Am J Clin Pathol* 1981;75:34–38.
126. Valent P, Sperr WR, Samarapompichit P, et al. Myelomastocytic overlap syndromes: biology, criteria, and relationship to mastocytosis. *Leuk Res* 2001;25:595–602.
127. Te Velde J, Vismans FJFE, Leenheers–Binnendijk L, et al. The eosinophilic fibrohistiocytic lesion of the bone marrow: a mastocellular lesion in bone disease. *Virchows Arch Pathol Anat* 1978;377:279–285.
128. Worobec AS. Treatment of systemic mast cell disorders. *Hematol Oncol Clin North Am* 2000;14:659–687.
129. Marone G, Spadaro G, Genovese A. Biology, diagnosis, and therapy of mastocytosis. *Chem Immunol* 1995;62:1–21.
130. Marone G, Spadaro G, Granata F, et al. Treatment of mastocytosis: pharmacologic basis and current concepts. *Leuk Res* 2001;25:583–594.
131. Greaves MW. Antihistamines. *Dermatol Clin* 2001;19:53–62.
132. Gasior–Chrzan B, Falk ES. Systemic mastocytosis treated with histamine H1 and H2 receptor antagonists. *Dermatology* 1992;184:149–152.
133. Friedman BS, Santiago ML, Berkebile C, et al. Comparison of azelastine and chlorpheniramine in the treatment of mastocytosis. *J Allergy Clin Immunol* 1993;92:520–526.
134. Frieri M, Alling DW, Metcalfe DD. Comparison of the therapeutic efficacy of cromolyn sodium with that of combined chlorpheniramine and cimetidine in systemic mastocytosis. *Am J Med* 1985;78:9–14.
135. Czarnetzki BM. A double–blind cross–over study of the effect of ketotifen in urticaria pigmentosa. *Dermatologia* 1983;166:44–47.
136. Pova A, Ducla–Soares J, Fernandes A, et al. A case of systemic mastocytosis; therapeutic efficacy of ketotifen. *J Intern Med* 1991;229:475–477.
137. Velloso ED, Beitler B, Chamone DA. Benign systemic mastocytosis: report of 2 cases. *Rev Hosp Clin Fac Med Sao Paulo* 1991;46:94–98.
138. Kettelhut BV, Berkebile C, Bradley D, et al. A double–blind, placebo–controlled, crossover trial of ketotifen versus hydroxyzine in the treatment of pediatric mastocytosis. *J Allergy Clin Immunol* 1989;83:866–870.
139. Gruchalla RS. Southwestern internal medicine conference: Mastocytosis: developments over the past decade. *Am J Med Sci* 1995;309:328–338.
140. Berg MJ, Bernhard H, Schentag JJ. Cimetidine in systemic mastocytosis. *Drug Intell Clin Pharm* 1981;15:180–183.
141. Bredfeldt JE, O’Laughlin JC, Durham JB, et al. Malabsorption and gastric hyperacidity in systemic mastocytosis. Results of cimetidine therapy. *Am J Gastroenterol* 1980;74:133–137.
142. Hirschowitz BI, Groarke JF. Effect of cimetidine on gastric hypersecretion and diarrhea in systemic mastocytosis. *Ann Intern Med* 1979;90:769–771.
143. Johnson GJ, Silvis SE, Roitman B, et al. Long–term treatment of systemic mastocytosis with histamine H2 receptor antagonists. *Am J Gastroenterol* 1980;74:485–489.
144. Jensen RT, Collen MJ, McArther KE, et al. Comparison of the effectiveness of ranitidine and cimetidine in inhibiting acid secretion in patients with gastric hypersecretory states. *Am J Med* 1984;77:90–105.
145. Tebbe B, Stavropoulos PG, Krasagakis K, et al. Cutaneous mastocytosis in adults. Evaluation of 14

- patients with respect to systemic disease manifestations. *Dermatology* 1998;197:101–108.
146. Lavker RM, Schechter NM. Cutaneous mast cell depletion results from topical corticosteroid usage. *J Immunol* 1985;135:2368–2373.
147. Guzzo C, Lavker R, Roberts LJ III, et al. Urticaria pigmentosa: systemic evaluation and successful treatment with topical steroids. *Arch Dermatol* 1991;127:191–196.
148. Higgins EM, Humphreys S, Duvivier AW. Urticaria pigmentosa—response to topical steroids. *Clin Exp Dermatol* 1994;19:438–440.
149. Barton J, Lakver RM, Schechter NE, et al. Treatment of urticaria pigmentosa with corticosteroids. *Arch Dermatol* 1985;121:1516–1523.
150. Krutmann J. High-dose ultraviolet A1 (UVA1) phototherapy: does it work? *Photodermatol Photoimmunol Photomed* 1997;13:78–81.
151. Mackey S, Pride HB, Tyler WB. Diffuse cutaneous mastocytosis: treatment with oral psoralen plus UV-A. *Arch Dermatol* 1996;132:1429–1430.
152. Czarnetzki BM, Rosenbach T, Kolde G, et al. Phototherapy of urticaria pigmentosa: clinical response and changes of cutaneous reactivity, histamine, and chemotactic leukotrienes. *Arch Dermatol Res* 1985;277:105–113.
153. Abdullah AN, Keczek K. Cutaneous and ocular side-effects of PUVA photochemotherapy—a 10 year follow-up study. *Clin Exp Dermatol* 1989;14:421–424.
154. Christophers E, Honigsmann H, Wolff K, et al. PUVA-treatment of urticaria pigmentosa. *Br J Dermatol* 1978;98:701–702.
155. Kolde G, Frosch PJ, Czarnetzki BM, et al. Response of cutaneous mast cells to PUVA in patients with urticaria pigmentosa: histomorphometric, ultrastructural, and biochemical investigations. *J Invest Dermatol* 1984;83:175–178.
156. Smith ML, Orton PW, Chu H, et al. Photochemotherapy of dominant, diffuse, cutaneous mastocytosis. *Pediatr Dermatol* 1990;7:251–255.
157. Stege H, Schopf E, Ruzicka T, et al. High-dose UVA1 for urticaria pigmentosa. *Lancet* 1996;347:64.
158. Godt O, Proksch E, Streit V, et al. Short- and long-term effectiveness of oral and bath PUVA therapy in urticaria pigmentosa and systemic mastocytosis. *Dermatology* 1997;195:35–39.
159. Allison MA, Schmidt CP. Urticaria pigmentosa. *Int J Dermatol* 1997;36:321–325.
160. Buhl K, Clearfield HR. Omeprazole: a new approach to gastric acid suppression. *Am Fam Physician* 1990;41:1225–1227.
161. Achord JL, Langford H. The effect of cimetidine and propantheline on the symptoms of a patient with systemic mastocytosis. *Am J Med* 1980;69:610–614.
162. Friedman BS, Metcalfe DD. Effects of tixocortol pivalate on gastrointestinal disease in systemic mastocytosis: a preliminary study. *Clin Exp Allergy* 1991;21:181–188.
163. Fonga-Djimi HS, Gottrand F, Bonneville M, et al. A fatal case of portal hypertension complicating systemic mastocytosis in an adolescent. *Eur J Pediatr* 1995;154:819–821.
164. Bonnet P, Smadja C, Szekely AM. Intractable ascites in systemic mastocytosis treated by portal diversion. *Dig Dis Sci* 1987;32:209–213.
165. Worobec AS, Metcalfe DD. In: Fauci AS, Lichtenstein LB, eds. *Current therapy in allergy, immunology, and rheumatology*. St. Louis: Mosby-Year Book, 1996:170–177.
166. Johnstone PAS, Mican JM, Metcalfe DD, et al. Radiotherapy of refractory bone pain due to systemic

mast cell disease. *Am J Clin Oncol* 1994;17:328–330.

167. Moret H, Plihal E, Saudan Y. Case report of bone mastocytosis: total hip arthroplasty for osteoarthritis and open reduction for condylar fracture of the knee. *Clin Rheumatol* 1994;13:616–623.

168. Bletry O, Papo T. Interferons alpha and gamma: indications in systemic diseases. *Ann Med Intern (Paris)* 1993;144:557–562.

169. Chosidow O, Becherel PA, Piette JC, et al. Tripe palms associated with systemic mastocytosis: the role of transforming growth factor- $\alpha$  and efficacy of interferon- $\alpha$ . *Br J Dermatol* 1998;138:698–703.

170. Czarnetzki BM, Algermissen B, Jeep S, et al. Interferon treatment of patients with chronic urticaria and mastocytosis. *J Am Acad Dermatol* 1994;30:500–501.

171. Delaporte E, Pierard E, Wolthers BG, et al. Correspondence: Interferon- $\alpha$  in combination with corticosteroids improves systemic mast cell disease. *Br J Dermatol* 1995;132:479–482.

172. Granerus G, Lonnqvist B, Roupe G. Histamine metabolism in mastocytosis patients treated with interferon  $\alpha$ -2b. *Inflamm Res* 1996;45[Suppl 1]:S41–S43.

173. Kolde G, Sunderkotter C, Luger TA. Treatment of urticaria pigmentosa using interferon alpha. *Br J Dermatol* 1995;133:91–94.

174. Luger TA. Cytokine treatment of mast cell-mediated skin diseases. *Exp Dermatol* 1995;4:277–280.

175. Takasaki Y, Tsukasaki K, Jubashi T, et al. Systemic mastocytosis with extensive polypoid lesions in the intestines: successful treatment with interferon- $\alpha$ . *Intern Med* 1998;37:484–488.

176. Parker RI. Hematologic aspects of mastocytosis: II: management of hematologic disorders in association with systemic mast cell disease. *J Invest Dermatol* 1991;96:52S–53S, discussion 53S–54S.

177. Lortholary O, Casassus P, Laroche L, et al. Systemic mastocytosis and malignant mastocytosis. *Presse Med* 1990;19:125–128.

178. Wong KF, Chan JK, Chan JC, et al. Concurrent acute myeloid leukemia and systemic mastocytosis. *Am J Hematol* 1991;38:243–244.

179. Sartori PC, Taylor MH, Stevens MC, et al. Treatment of childhood acute myeloid leukaemia using the BFM-83 protocol. *Med Pediatr Oncol* 1993;21:8–13.

180. Conrad ME, Carpenter JT, Jr., Todd JN III, et al. Mithramycin in the treatment of systemic mastocytosis. *Ann Intern Med* 1975;83:659–660.

181. Brunel V, Tadrist Z, Cailleres S, et al. Interferon alpha and pamidronate: a useful combination in the treatment of osteoporosis and systemic mastocytosis [Letter]. *Presse Med* 1998;17:64.

182. Butterfield JH. Response of severe systemic mastocytosis to interferon alpha. *Br J Dermatol* 1998;138:489–495.

183. Cooper AJ, Winkelmann RK, Wiltsie JC. Hematologic malignancies occurring in patients with urticaria pigmentosa. *Am Acad Dermatol* 1982;7:215–220.

184. Harrison BD, Ashford RA, Hatton CS. Systemic mastocytosis—a case treated with interferon alpha and radiotherapy. *Clin Lab Haematol* 1994;16:291–294.

185. Cassasus P, Caillat-Vigneron N, Martin A, et al. Treatment of adult systemic mastocytosis with interferon alpha: results of a multi-centre phase trial on 20 patients. *Br J Haematol* 2002;119:1090–1097.

186. Kluijn-Nelemans HC, Jansen JH, Breukelman H, et al. Successful treatment of systemic mastocytosis with interferon- $\alpha$  2b. *Blood* 1991;78:120.

187. Kluijn-Nelemans HC, Jansen JH, Breukelman H, et al. Response to interferon  $\alpha$ -2b in a patient with

systemic mastocytosis. *N Engl J Med* 1992;326:619–623.

188. De las Nieves M, Poveda F, Queipo de Llano MP, et al. Systemic mastocytosis: presentation of a case evolving into myelofibrosis and no response to interferon alfa 2b [Letter]. *Sangre (Barc)* 1997;42:430–431.

189. Essner C, Thieflin G, Diebold MD, et al. Lymphocytic ascites revealing systemic mastocytosis. *Gastroenterol Clin Biol* 1995;19:948–951.

190. Sewell KL. Immunotherapy and other novel therapies, including biologic response modifiers, apheresis, and dietary modifications. *Curr Opin Rheumatol* 1993;5:293–298.

191. Petit A, Pulik M, Gaulier A, et al. Systemic mastocytosis associated with chronic myelomonocytic leukemia: clinical features and response to interferon alfa therapy. *J Am Acad Dermatol* 1995;32:850–853.

192. Weide R, Ehlenz K, Lorenz W, et al. Successful treatment of osteoporosis in systemic mastocytosis with interferon alpha-2b. *Ann Hematol* 1996;72:41–43.

193. Griesinger F, Bergmann L, Mitrou PS. Interferons in the treatment of malignant mastocytosis (MM) and CMMol. *Blut* 1987;55:309.

194. Lehmann T, Beyeler C, Lammler B, et al. Case Report: Severe osteoporosis due to systemic mast cell disease: successful treatment with interferon alpha-2b. *Br J Rheumatol* 1996;35:898–900.

195. Tefferi A, Chin-Yang L, Butterfield JH, Hoagland HC. Treatment of systemic mast cell disease with cladribine. *N Engl J Med* 2001;344:307–309.

196. Escribano L, Perez de Oteyza J, Nunez R, et al. Cladribine induces immunophenotypical changes in bone marrow mast cells from mastocytosis. Report of a case of mastocytosis associated with a lymphoplasmacytic lymphoma. *Leuk Res* 2002;26:1043–1046.

197. Przepiorka D, Giralt S, Khouri I, et al. Allogeneic marrow transplantation for myeloproliferative disorders other than chronic myelogenous leukemia: review of forty cases. *Am J Hematol* 1998;57:24–28.

198. Ronnov-Jessen D, Lovgreen Nielsen P, Horn T. Persistence of systemic mastocytosis after allogeneic bone marrow transplantation in spite of complete remission of the associated myelodysplastic syndrome. *Bone Marrow Transplant* 1991;8:413–415.

199. Van Hoof A, Criel A, Louwagie A, et al. Cutaneous mastocytosis after autologous bone marrow transplantation. *Bone Marrow Transplant* 1991;8:151–153.

200. Friedman B, Darling G, Norton J, et al. Splenectomy in the management of systemic mast cell disease. *Surgery* 1990;107:94–100.

201. Kurosawa M, Amano H, Kanbe N, et al. Response to cyclosporin and low-dose methylprednisolone in aggressive systemic mastocytosis. *J Allergy Clin Immunol* 1999;103(5 Pt 2):S412–S420.

202. Castellano GP, Barcia-Erce JN, Alegret AP, et al. Interferon alfa and systemic mastocytosis. Analysis of therapeutic efficacy in 6 cases. *Rev Clin Exp* 1998;198:345.

203. Cundy T, Beneton MNC, Darby JA, et al. Osteopenia in systemic mastocytosis: natural history and responses to treatment with inhibitors of bone resorption. *Bone* 1987;8:149–155.

204. Janjan NA, Conway P, Lundberg J, et al. Radiation therapy in a case of systemic mastocytosis: evaluation of histamine levels and mucosal effects. *Am J Clin Oncol* 1992;15:337–339.

205. Lippert Y, Henz BM. Long-term effect of interferon alpha treatment in mastocytosis. *Br J Anaesth* 1990;134:1164–1165.

206. Nabeshima M, Kumakiri M, Ohkawara A. Correspondence: Long-term effect of interferon alpha treatment in mastocytosis. *Br J Dermatol* 1996;134:1164.

207. Pardini S, Bosincu L, Bonfigli S, et al. Anaphylactic-like syndrome in systemic mastocytosis treated

with alpha-2 interferon [Letter]. *Acta Haematol* 1991;85:220.

208. Torrey E, Simpson K, Wilbur S, et al. Malignant mastocytosis with circulating mast cells. *Am J Hematol* 1990;34:283-286.
209. Sugita K, Kareko T, Sekire Y, et al. Mast cell leukemia evolved from RAEB-T (5q-syndrome) in a 12 year-old girl. *Rinsho Ketsueki* 1996;37:430-436.
210. Fodinger M, Fritsch G, Winkler K, et al. Origin of human mast cells: development from transplanted hematopoietic stem cells after allogeneic bone marrow transplantation. *Blood* 1994;84:2954-2959.
211. Clancy RL, Gaulde J, Vallieres M, et al. An approach to immunotherapy: antibody to IgE in mast cell leukemia. *Cancer* 1976;37:693-696.
212. Hartmann K, Bruns SB, Henz BM. Mastocytosis: review of clinical and experimental aspects. *J Invest Dermatol Symp Proc* 2001;6:143-147.
213. Longley BJ, Ma Y, Carter E, et al. New approaches to therapy for mastocytosis. A case for treatment with kit kinase inhibitors. *Hematol Oncol Clin North Am* 2000;14:689-695.
214. Heinrich MC, Blanke CD, Druker BJ, et al. Inhibition of KIT tyrosine kinase activity: a novel molecular approach to the treatment of KIT-positive malignancies. *J Clin Oncol* 2002;20:1692-1703.
215. Ma Y, Zeng S, Metcalfe DD, et al. The c-kit mutation causing human mastocytosis is resistant to STI571 and other kit kinase inhibitors; kinases with enzymatic site mutations show different inhibitor sensitivity profiles than wild-type kinases and those with regulatory-type mutations. *Blood* 2002;99:1741-1744.
216. Ueda S, Ikeda H, Mizuki M, et al. Constitutive activation of c-kit by the juxtamembrane but not the catalytic domain mutations is inhibited selectively by tyrosine kinase inhibitors STI571 and AG1296. *Int J Hematol* 2002;76:427-435.
217. Oude Elberink JN, de Monchy JG, Kors JW, et al. Fatal anaphylaxis after a yellow jacket sting, despite venom immunotherapy, in two patients with mastocytosis. *Allergy Clin Immunol* 1997;99:153-154.
218. Borgeat A, Ruetsch YA. Anesthesia in a patient with malignant systemic mastocytosis using a total intravenous anesthetic technique. *Anesth Analg* 1998;86:442-444.
219. Butterfield JH, Kao PC, Klee GC, et al. Aspirin idiosyncrasy in systemic mast cell disease: a new look at mediator release during aspirin desensitization. *Mayo Clin Proc* 1995;70:481-487.
220. Goins VA. Mastocytosis. Perioperative considerations. *AORN J* 1991;54:1227-1238.
221. Lerno G, Slaats G, Coenen E, et al. Anesthetic management of systemic mastocytosis. *Br J Anaesth* 1990;65:254-257.
222. Roberts LJ II, Turk JW, Oates JA. Shock syndrome associated with mastocytosis: pharmacologic reversal of the acute episode and therapeutic prevention of recurrent attacks. *Adv Shock Res* 1982;8:145-152.
223. Turk J, Oates JA, Roberts LJ II. Intervention with epinephrine in hypotension associated with mastocytosis. *J Allergy Clin Immunol* 1983;71:189-192.
224. Walton J. Mastocytosis/vasodilatory shock in a 25-year-old woman. *J Emerg Nurs* 1989;15:356-357.

2004 Lippincott Williams & Wilkins  
John P. Greer, John Foerster, John N. Lukens  
George M. Rodgers, Frixos Paraskevas, Bertil Glader  
Wintrobe's Clinical Hematology

## Diagnosis and Classification of Non-Hodgkin Lymphomas

### SPECIMEN EVALUATION

Tissue Sampling and Processing

Morphologic Examination

Immunophenotypic and Genotypic Analysis

Classification of Non-Hodgkin Lymphomas

### B-CELL LYMPHOMAS

Precursor B-Cell Lymphoblastic Lymphoma

Chronic Lymphocytic Leukemia and Small Lymphocytic Lymphoma

Lymphoplasmacytic Lymphoma

Mantle Cell Lymphoma

Nodal Marginal Zone B-Cell Lymphoma

Splenic Marginal Zone B-Cell Lymphoma

Extranodal Marginal Zone B-Cell Lymphoma of Mucosa-Associated Lymphoid Tissue

Follicular Lymphoma

Burkitt Lymphoma

Diffuse Large B-Cell Lymphoma

### T-CELL AND NATURAL KILLER-CELL LYMPHOMAS

Precursor T-Cell Lymphoblastic Lymphoma

Peripheral T-Cell Lymphoma, Unspecified

Angioimmunoblastic T-Cell Lymphoma

Anaplastic Large Cell Lymphoma

Adult T-Cell Leukemia/Lymphoma

Hepatosplenic T-Cell Lymphoma

Subcutaneous Panniculitis-Like T-Cell Lymphoma

Enteropathy-Type T-Cell Lymphoma

Extranodal Natural Killer/T-Cell Lymphoma, Nasal Type

### NATURAL KILLER-CELL LYMPHOMAS

### REFERENCES

## SPECIMEN EVALUATION

### Tissue Sampling and Processing

Precise assessment of hematopathologic specimens depends, in large part, on adequate sampling and proper handling of tissues, both of which may be influenced significantly by clinicians. Therefore, effective communication between the clinician and the pathologist is imperative for obtaining pertinent patient history and the proper specimen. The largest lymph node or mass lesion generally provides the most useful material for accurate diagnosis and should undergo surgical biopsy. Fresh tissue, moistened in a balanced solution, such as normal saline, should be sent intact to the surgical pathology laboratory without delay to maximize the immunophenotypic, genotypic, and karyotypic studies that are available and to minimize irreversible tissue artifacts. Frozen sections should be discouraged on small specimens, as lymphoid hyperplasias may appear indistinguishable from lymphomas, and freezing permanently distorts the tissue. Touch imprints are



generally satisfactory for initial evaluation and for directing specimen workup.

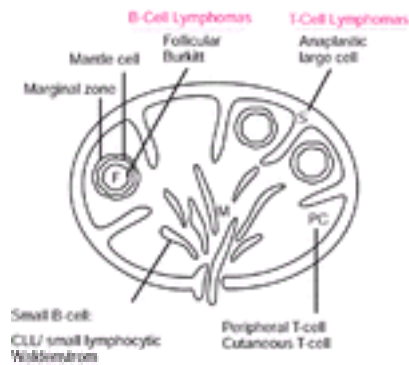
Needle biopsy and aspiration cytology is playing an expanded role in the primary diagnosis and monitoring of patients with malignant lymphomas. The major advantages of these techniques include: (a) their relatively noninvasive nature and (b) the rapidity with which morphology can be reviewed (minutes) and immunophenotyped (2 to 3 hours by flow cytometry). With computed tomography guidance, lesions in the mediastinum and retroperitoneum or in any highly vascular organ or tissue can be sampled with minimal morbidity. Further advances in flow cytometry and molecular biology have markedly reduced the amount of tissue required to provide immunophenotypic and genetic data.

Just as with lymph node and bone marrow biopsies, however, optimal information can be obtained only by close coordination between the clinician, the person performing the aspirate (radiologist or pathologist), and the hematopathologist providing ancillary diagnostic services. If the material is put into fixative, it cannot be used for flow cytometric phenotypic analysis or standard karyotypic studies.

The limitations of fine-needle aspiration include: (a) the possibility of missing focal lesions, (b) difficulty in making a primary diagnosis of malignant lymphoma in which the tumor cell is a minor population (e.g., Hodgkin lymphoma and T-cell-rich B-cell lymphoma), and (c) difficulty in precisely classifying many reactive processes in which architectural features are of prominent diagnostic importance. For example, in patients with mediastinal masses, it may be impossible to distinguish between normal thymus, thymoma, and precursor T-cell lymphoblastic lymphoma by the cytology of the lymphoid population. Furthermore, immunophenotypic studies may identify a common thymocyte phenotype that can be dominant in all three. Despite these limitations, fine-needle aspiration will play a major role in the diagnosis of many non-Hodgkin lymphomas (NHLs) in the future.

### **Morphologic Examination**

Morphologic examination starts at low magnification to evaluate tissue architecture and patterns of infiltration. Lymphomas may cause partial or complete destruction of the normal architectural features of the lymph node. Growth patterns are generally described as nodular or diffuse. Lymphomas are often distributed within specific anatomic compartments of the lymph node, such as follicle (germinal) centers, follicle mantles, or the paracortical and medullary areas. The low magnification pattern of neoplastic cell distribution within the lymph node suggests the type of lymphoma present ( [Fig. 88.1](#)). High magnification is then used to examine cytologic features, such as the neoplastic cell types [e.g., small cleaved cells (centrocytes), large transformed cells (centroblasts or immunoblasts), and plasmacytoid lymphocytes or plasma cells], because this information helps establish classification and grade of the tumor. In some lymphomas, the reactive cell constituents also may be of prognostic significance.



**Figure 88.1.** Sites of origin of malignant lymphomas in a lymph node according to anatomic and functional compartments of the immune system. CLL, chronic lymphocytic leukemia; F, follicles with germinal centers; MC, medullary cords; PC, paracortex, or interfollicular areas; S, sinuses. (Adapted from Mann RB, et al. Malignant lymphomas: a conceptual understanding of morphologic diversity. *Am J Pathol* 1979;94:1.)

### Immunophenotypic and Genotypic Analysis

Immunophenotypic analysis uses antibodies of variable specificity to detect cellular antigens (surface, cytoplasmic or nuclear) in cell suspensions (flow cytometry) or in frozen or paraffin-embedded tissue sections ( [Table 88.1](#)). These studies are often invaluable, because they help in distinguishing subtle lymphomatous infiltrates from reactive hyperplasias, can demonstrate the lineage of the neoplastic cell [e.g., B-cell, T-cell, and natural killer (NK) cell], can provide data necessary for precise classification of some lymphomas [e.g., mantle cell lymphoma vs. small lymphocytic lymphoma (SLL)] ( [Table 88.2](#)), can identify important nonlineage-related markers (e.g., CD15, CD30, and CD56), and can determine the proliferative rate of lymphomas. Immunoglobulin (Ig) light chain restriction is evidence of B-cell clonality, whereas aberrant B-cell or T-cell phenotypes infer clonality ( [1](#), [2](#)). As small monotypic (light chain-restricted) B-cell or genotypically clonal B-cell or T-cell populations may be seen in reactive processes, correlation of these studies with the morphologic features is essential to prevent misdiagnosis and clinical confusion ( [3](#), [4](#) and [5](#)).

**TABLE 88.1. Selected Antibodies That Are Useful in Immunophenotypic Analysis of Non-Hodgkin Lymphomas**

| Clusters of Differentiation (CD) Number | Antibodies                            | Reactivity  |
|---|---------------------------------------|---|
| CD1                                     | Leu-6, T6, and OKT6                   | Thymocytes, dendritic cells, and epidermal Langerhans cells |
| CD2                                     | Leu-5, T11, and OKT11                 | T cells and natural killer cells                            |
| CD3                                     | Leu-4, T3, OKT3, UCHT-1, and poly-CD3 | T cells   |
| CD4                                     | Leu-3, T4, and OKT4                   | Helper and inducer T cells, monocytes, and macrophages      |
| CD5                                     | Leu-1, T1, OKT1, and UCHT-2           | T cells and B-cell subset                                   |
| CD7                                     | Leu-9 and 3A1                         | T cells and natural killer cells                            |

|        |   |   |
|--------|---|---|
| CD8    | Leu-2, T8, OKT8, and UCHT-4               | T-cytotoxic and -suppressor cells and natural killer cells  |
| CD10   | CALLA, J5, and BA-3                       | Progenitor B lymphocytes and B-cell subset (follicular center cells)  |
| CD11b  | Leu-15 and Mo-1                           | Granulocytes, monocytes, natural killer cells, T-cell subset  |
| CD11c  | Leu-M5 and Ki-M1                          | Monocytes and macrophages, granulocytes, natural killer cells, and B-cell subset (hairy cell leukemia and monocytoid B cells) |
| CD14   | Leu-M3, Mo2, MY4, and UCHM-1              | Monocytes, granulocytes, and epidermal Langerhans cells   |
| CD15   | Leu-M1 and MY1                            | Granulocytes, monocytes, Reed-Sternberg cells, activated lymphocytes, and some epithelial cells                               |
| CD16   | Leu-11                                    | Natural killer cells, granulocytes, macrophages, and T-cell subset  |
| CD19   | Leu-12 and B4                             | B cells   |
| CD20   | Leu-16, B1, and L26                       | B cells   |
| CD21   | B2  | B-cell subset and follicular dendritic cells  |
| CD22   | Leu-14                                    | B-cell subset   |
| CD23   | Leu-20 and B6                             | Activated B cells and follicular mantle B cells   |
| CD24   | BA-1                                      | B cells and granulocytes  |
| CD25   | IL2R and Tac                              | Activated T and B cells and activated macrophages   |
| CD30   | Ki-1 and Ber-H2                           | Activated T and B cells and Reed-Sternberg cells  |
| CD38   | Leu-17 and T10                            | Plasma cells, thymocytes, and activated T cells   |
| CD43   | Leu-22, MT1, and DFT1                     | T cells, B-cell subset, granulocytes, and monocytes and macrophages   |
| CD45   | T29/33, HLe-1, and T200                   | Leukocytes  |
| CD45RA | Leu-18 and 4KB5                           | B cells, T-cell subset, granulocytes, and monocytes   |
| CD45RB | LCA and PD7/26/16                         | B cells, T-cell subset, granulocytes, and monocytes and macrophages   |
| CD45RO | UCHL1 and A6                              | T cells, B-cell subset, granulocytes, and monocytes and macrophages   |
| CD56   | Leu-19 and NKH1                           | Natural killer cells and T-cell subset  |
| CD57   | Leu-7 and HNK1                            | Natural killer cells and T-cell subset  |
| CD68   | KP1, Ki-M6, and KiM7                      | Monocytes and macrophages   |
| CD71   | T9 and OKT9                               | Activated T and B cells, macrophages, and proliferating cells   |
| CD74   | LN2                                       | B cells, monocytes and macrophages, and Reed-Sternberg cells  |
| CDw75  | LN1                                       | B cells and some epithelial cells   |
| CD79a  | mb-1                                      | B cells   |
| CD103  | HML-1                                     | Intestinal intraepithelial T cells  |
| CD138  | Syndecan                                  | Plasma cells and plasmablasts   |
|        | IgG, A, M, D, and E                       | Immunoglobulin heavy chains   |
|        | ?, ?                                      | Immunoglobulin light chains   |
|        | Anti-TCR $\alpha\beta$ , $\beta\text{F1}$ | $\alpha\beta$ T cells   |

|   |   |
|---|---|
| Anti-TCR $\alpha$ ; HLA-DR and LN3                      | $\alpha$ ; T cells<br>Activated T and B cells, monocytes, and macrophages   |
| Anti-TdT  | Lymphoblasts and some myeloblasts   |
| Anti-lysozyme   | Monocytes, macrophages, and granulocytes  |
| MAC 387   | Macrophage subset   |
| EMA   | Epithelial cells, plasma cells, and some lymphoid neoplasms, including lymphocyte predominant Hodgkin lymphoma and anaplastic large cell lymphoma |
| Ki-67, PCNA   | Nuclear proliferation antigens  |
| Antiperforin; antigranzymes A, B, and C; and anti-TIA-1 | Cytolytic granule-associated proteins in natural killer cells and cytotoxic T cells   |

**TABLE 88.2. Pathologic Features in the Differential Diagnosis of Small B-Cell Lymphomas**

|  | Growth Pattern                                | Cytology  | Immunophenotype |      |      | Surface Ig               | Genetics               |
|--|---|---|-----------------|------|------|--------------------------|------------------------|
|  |   |   | CD5             | CD23 | CD10 |                          |                        |
| B-cell chronic lymphocytic leukemia/small lymphocytic lymphoma | Diffuse effacement with proliferation centers | Small round nuclei, scant cytoplasm   | +               | +    | -    | Weak IgM and IgD         | Trisomy 12/20 to 30%   |
| Lymphoplasmacytic lymphoma                                     | Diffuse or interfollicular                    | Small lymphocytes, plasma cells, and plasmacytoid lymphocytes                 | -               | -    | -    | Moderate IgM             | t(9;14)(p13;q32)       |
| Mantle cell lymphoma   | Diffuse or vaguely nodular                    | Irregular nuclei, scant cytoplasm, and few large cells                        | +               | -    | -    | Moderate IgM and IgD     | t(11;14)(q13;q32)      |
| Follicular lymphoma  | Follicular                                    | Irregular cleaved nuclei (centrocytes) and admixed large cells (centroblasts) | -               | -    | +    | Bright<br>Lambda > kappa | t(14;18)(q32;q21) >85% |
|  |   |   |                 |      |      | IgM > IgG > IgA          |                        |

|   |                                    |   |   |   |   |                        |                            |
|---|------------------------------------|---|---|---|---|------------------------|----------------------------|
| Nodal marginal zone B-cell lymphoma   | Interfollicular and perisinusoidal | Small, round, and folded nuclei and abundant cytoplasm ± plasma cells | - | - | - | Moderate Trisomy 3 IgM |                            |
| Extranodal marginal zone B-cell lymphoma of mucosa-associated lymphoid tissue | Diffuse                            | Small, round, and folded nuclei and abundant cytoplasm ± plasma cells | - | - | - | IgM                    | Trisomy 3t(11;18)(q21;q21) |

Ig, immunoglobulin; +, positive; -, negative.

Each of the major immunologic techniques has its strengths and liabilities. Flow cytometry permits rapid analysis of large numbers of cells for virtually any surface or cytoplasmic antigen. Studies for coexpression of more than one marker are easily accomplished (e.g., CD5 on CD19<sup>+</sup> B-cells). Flow cytometry also allows correlation of phenotypic characteristics with cell cycle kinetics and other biological features of cells. Data storage in list mode permits retrospective off-line multiparameter analysis of lymphocyte subpopulations. However, for most analyses, flow cytometry requires viable cell populations. The quality of the information produced by flow cytometry is directly related to the quality of the communication between the flow cytometrist and the pathologist. The basic question is, "Is the cell population of interest to the pathologist the same cell population analyzed by flow cytometry?"

Immunohistochemical studies on paraffin-embedded tissue permit direct visualization of antigens on the cell of interest. Leukocyte common antigen (CD45) is a reliable marker for identifying most hematopoietic or lymphoid neoplasms but can be negative in acute leukemia, plasma cell neoplasms, and anaplastic large cell lymphoma (ALCL) (6, 7). Several markers that work well in paraffin, such as L-26 (CD20), polyclonal CD3, and UCHL-1 (CD45RO), are adequate to categorize most NHL as to their B-cell or T-cell lineage (8, 9, 10 and 11). Detection of light chain restriction is most easily achieved in B-cell lymphomas that have abundant cytoplasmic Ig (most lymphomas with plasmacytic differentiation and many large B-cell lymphomas). The major liability of paraffin immunohistochemistry is the loss of many lymphocyte antigens during tissue processing. Frozen section immunohistochemistry is performed on tissue frozen fresh or after transport in saturated ammonium chloride solution (e.g., Michel's Media and Zeus). This allows preservation of almost all membrane and cytoplasmic antigens, although morphology is suboptimal. Frozen tissue is also suitable for molecular genetic studies.

Genotypic analysis using the Southern blot technique provides a sensitive, but time-consuming and expensive, means of detecting clonal lymphoproliferations and their lineage. Polymerase chain reaction (PCR) is more sensitive than Southern blot for detecting clonality and also can be performed more rapidly. PCR is particularly helpful for establishing B-cell or T-cell clonality in lymphoproliferations present in paraffin-embedded small biopsies, such as those obtained by endoscopy (12). These methods are most useful when immunophenotypic studies are inconclusive and are the only practical way of proving T-cell clonality. Southern blot and PCR also can demonstrate significant chromosomal abnormalities (e.g., *BCL-1*, *BCL-2*, and *C-MYC* gene rearrangements) and viral nucleic acids that may be involved in lymphomagenesis [e.g.,

Epstein-Barr virus (EBV), human T-cell lymphotropic virus type 1 (HTLV-1), and human herpes virus 8]. PCR also is proving valuable in the detection of minimal amounts of residual disease in treated patients.

More recently, fluorescence *in situ* hybridization applied to paraffin-embedded tissue has allowed detection of critical translocations in lymphomas, such as mantle cell lymphoma, ALCL, Burkitt lymphoma, hepatosplenic T-cell lymphoma, and extranodal marginal zone B-cell lymphoma of mucosa-associated lymphoid tissue (MALT) type, with sensitivity that is much greater than classic cytogenetics on fresh tissue or PCR on fresh or fixed tissue ([13](#), [14](#), [15](#), [16](#), [17](#), and [18](#)).

## Classification of Non-Hodgkin Lymphomas

For the clinician, pathologist, and basic scientist working in lymphoid neoplasia, the classification of NHL is a persistent, confusing, and controversial problem. Several competing classification schemes have evolved, all with their supporters and detractors. In the 1950s, Rappaport developed a classification system based on growth pattern (nodular or diffuse) and cytology of lymphocytes (well differentiated, poorly differentiated, undifferentiated, or histiocytic) ([19](#), [20](#)). This scheme enjoyed enormous popularity because of its simplicity and reproducibility but was superseded by classification schemes that reflected advances in cellular immunology.

In the early 1970s, Lukes and Collins ([21](#)), in the United States, and Lennert ([22](#)), at the University of Kiel, Germany, proposed lymphoma classifications that related morphology to lymphocyte lineage. Both recognized follicular structures as a histologic correlate of B-cell differentiation. Each subdivided follicular lymphomas by the cytologic appearance of the predominant follicle center cell type: small and large cleaved cells in the Lukes-Collins Classification (centrocytes in Kiel classification) and small and large noncleaved (transformed) cells in the Lukes-Collins Classification (centroblasts in Kiel classification). For NHL with diffuse growth patterns, immunophenotypic studies facilitated and, in many cases, were essential for precise classification ([23](#), [24](#) and [25](#)).

In 1982, the Working Formulation (WF) was introduced in an attempt to provide a morphologic classification scheme with prognostic relevance ([26](#)). Although the WF was an improvement over the earlier Rappaport classification, it had the same limitations as all purely morphologic classification schemes, separating biologically closely related lymphomas and grouping together biologically unrelated entities. All consideration regarding immunophenotype was excluded, so that the WF did not foster recognition of new entities.

In 1994, the Revised European American Lymphoma (REAL) Classification ([27](#)) was developed for consensus of terminology and was based on the immunologic principles used by Lennert and Lukes and Collins. More recently, the World Health Organization (WHO) classification ([Table 88.3](#)) ([28](#)) built on the REAL Classification and corrected some of its deficiencies. Like all classifications, it was the product of political horse trading and is subject to erosion as advances in science refine clinically and biologically relevant disease entities. The WHO classification has many strengths and is comprehensive, including virtually all lymphoid malignancies described at the time of its publication in 2001. It defines diseases by four features: morphology, immunophenotype, genetics, and clinical information. Accordingly, the major diagnostic criteria for each of the major groups of NHL are presented in the following discussion.

**TABLE 88.3. World Health Organization Classification of Lymphoproliferative Disorders, Including Non-Hodgkin Lymphomas**

| B-Cell Neoplasms  | T-Cell and NK-Cell Neoplasms   |
|---|--|
| Precursor B-cell neoplasm<br>Precursor B-lymphoblastic leukemia/lymphoma  | Precursor T-cell neoplasm<br>Precursor T-lymphoblastic leukemia/lymphoma   |
| Mature B-cell neoplasms<br>Chronic lymphocytic leukemia/small lymphocytic lymphoma<br>B-cell prolymphocytic leukemia                              | Mature T-cell and NK-cell neoplasms<br>T-cell prolymphocytic leukemia<br><br>T-cell large granular lymphocytic leukemia  |
| Lymphoplasmacytic lymphoma<br>Splenic marginal zone B-cell lymphoma<br>Hairy cell leukemia  | Aggressive NK-cell leukemia<br>Adult T-cell leukemia/lymphoma<br>Extranodal NK/T-cell lymphoma, nasal type   |
| Plasma cell myeloma<br>Monoclonal gammopathy of undetermined significance<br>Solitary plasmacytoma of bone  | Enteropathy-type T-cell lymphoma<br>Hepatosplenic T-cell lymphoma  |
| Extraosseous plasmacytoma<br>Primary amyloidosis<br>Heavy chain diseases  | Subcutaneous panniculitis-like T-cell lymphoma<br>Mycosis fungoides<br>Sézary syndrome<br>Primary cutaneous anaplastic large cell lymphoma<br>Anaplastic large cell lymphoma |
| Extranodal marginal zone B-cell lymphoma of mucosa-associated lymphoid tissue<br>Nodal marginal zone B-cell lymphoma                              | Angioimmunoblastic T-cell lymphoma   |
| Follicular lymphoma   | Peripheral T-cell lymphoma, unspecified  |
| Mantle cell lymphoma  | T-cell proliferation of uncertain malignant potential<br>Lymphomatoid papulosis  |
| Diffuse large B-cell lymphoma<br>Mediastinal (thymic) large B-cell lymphoma   | Neoplasm of uncertain lineage and stage of differentiation<br>Blastic NK-cell lymphoma   |
| Intravascular large B-cell lymphoma<br>Primary effusion lymphoma<br>Burkitt lymphoma/leukemia   |  |
| B-cell proliferations of uncertain malignant potential<br>Lymphomatoid granulomatosis<br>Posttransplant lymphoproliferative disorder, polymorphic |  |

NK, natural killer.

## B-CELL LYMPHOMAS



## Precursor B-Cell Lymphoblastic Lymphoma

Lymphoblastic lymphoma is a malignant lymphoma of precursor lymphocytes. Approximately 5 to 15% of lymphoblastic lymphomas are of B-cell lineage. They are distinguished from extramedullary acute lymphoblastic leukemia (ALL) by (a) the absence of peripheral blood involvement at presentation, (b) absence or only patchy marrow involvement (<25%) by blast cells, and (c) a clinical picture dominated by extramedullary tumor. Although they may occur at any age, the majority of these rare lymphomas have been described in children and young adults. These neoplasms present frequently in cervical lymph nodes, bone, or the central nervous system or as skin tumors of the scalp and face ( [29](#), [30](#) and [31](#) ). They almost never present as mediastinal masses.

Histologically, they exhibit a diffuse growth pattern with frequent mitoses and a “starry sky” appearance. Capsular and interfollicular involvement of lymph nodes is characteristic. Cytologically, the tumor cells are small to intermediate in size with irregular nuclear borders, dispersed chromatin, and small nucleoli ( [29](#), [32](#) ).

Most B-cell lymphoblastic lymphomas are CD19, CD79a, CD10, and terminal deoxynucleotidyl transferase (TdT) positive with undetectable cytoplasmic Ig and variable expression of CD45 and CD20 ( [29](#), [32](#), [33](#) ). However, a few surface Ig-positive cases have been described ( [34](#) ). As lymphoblastic lymphomas may be quite difficult to distinguish from nonhematopoietic small cell undifferentiated tumors, such as Ewing sarcoma, rhabdomyosarcoma, and neuroblastoma, as well as T-cell lymphoblastic lymphomas and blastic variants of mantle cell lymphoma, immunohistochemical studies are essential in differential diagnosis. The expression of monotypic surface Ig on tumor cells that also have a CD5<sup>+</sup> and CD10<sup>-</sup> phenotype or the presence of areas in which tumor cell cytology is more characteristic of mantle cell lymphoma is helpful in identifying blastic variants of mantle cell lymphomas ( [35](#) ).

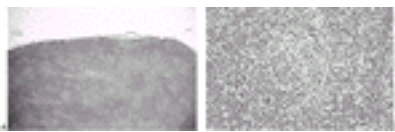
Studies of the genetics of B-cell lymphoblastic lymphoma are limited. It appears that hyperdiploidy or the presence of many of the translocations seen in pediatric ALL, such as t(9;22), t(1;19), and t(4;11), are uncommon. Chromosome 21 additions, including trisomy and tetrasomy, have been described ( [36](#) ).

## Chronic Lymphocytic Leukemia and Small Lymphocytic Lymphoma

B-cell chronic lymphocytic leukemia (CLL)/SLL is a neoplasm of small round B cells that usually have scant surface Ig and a CD5<sup>+</sup>, CD23<sup>+</sup> phenotype. *SLL* is the term used to describe the disease when lymph node involvement is the dominant feature. Usually, these lymphomas present in elderly patients with a leukemic phase and generalized lymphadenopathy on routine examination. Bone marrow involvement is often extensive. Occasionally, patients present with bacterial infection related to hypogammaglobulinemia or with signs and symptoms secondary to anemia or thrombocytopenia that may have an autoimmune basis ( [37](#) ).

Lymph node architecture is totally effaced with loss of lymphoid follicles and obliteration of sinuses by an infiltrate of small round lymphocytes with condensed chromatin and scant cytoplasm. Growth centers or proliferation centers (collections of intermediate-size round lymphocytes with open chromatin and small nucleoli called *paraimmunoblasts*) are dispersed throughout the lymph node and are thought to represent foci of cell proliferation ( [Fig. 88.2](#) ) ( [38](#) ). Morphologic features that correlate with a worse prognosis

include capsular invasion and increased numbers of large lymphocytes in the node or increased numbers (>10%) of prolymphocytes (intermediate size lymphocytes with prominent central nucleoli) in the blood ( [39](#) ). A clinically aggressive paraimmunoblastic variant of SLL has been described in which cells resembling those in growth centers predominate throughout the node ( [40](#) ). The WHO classification also includes cases corresponding to the lymphoplasmacytoid subtype of immunocytoma of the Kiel classification within the B-cell SLL group. These cases show minimal plasmacytic differentiation that is most easily recognized by the presence of cytoplasmic Ig on paraffin immunoperoxidase stains. The majority of these cases are CD23<sup>+</sup> and CD5<sup>+</sup> ( [41](#) ). The intensity of surface Ig is much brighter than the usual case of B-cell CLL/SLL ( [42](#) ).



**Figure 88.2.** Lymph node: small lymphocytic lymphoma/chronic lymphocytic leukemia. **A:** Low magnification showing diffuse alteration of architecture, with pale areas corresponding to proliferation centers. **B:** A higher power of a growth center that is composed of intermediate-sized cells with small nucleoli that are surrounded by small round lymphocytes. See [Color Plate](#).

Richter syndrome, which is the evolution of CLL/SLL to a large cell lymphoma, occurs in less than 5% of patients and may arise as transformation of the neoplastic small B cell or as an unrelated B-cell clone ( [43](#), [44](#) ). Less commonly, B-cell SLL may transform to prolymphocytic leukemia ( [45](#) ). Rarely, Hodgkin lymphoma complicates B-cell SLL ( [46](#) ). Of interest is a description of 13 cases of B-cell SLL with Reed-Sternberg-like cells that contained EBV RNA as detected by *in situ* hybridization. Three of these patients developed disseminated Hodgkin lymphoma ( [47](#) ).

On immunologic typing studies, neoplastic lymphocytes have weak or scant monotypic surface Ig, which usually is IgM associated with IgD. Neoplastic lymphocytes coexpress the nominal T-cell antigen CD5 with B-cell markers CD19, CD20 (weak); CD21, CD11c (weak); and CD23. The tumor cells are negative for FMC7, CD10, and cyclin D1. Phenotypically, B-cell SLL and CLL are identical ( [48](#) ). Admixed T cells are usually few in number. CD23 and FMC7 expression and cyclin D1 negativity are helpful in the phenotypic separation of B-cell CLL/SLL from mantle cell lymphoma, another CD5<sup>+</sup> small B-cell neoplasm ( [49](#) ). The coexpression of CD5 by B-cell CLL is a feature of intense interest, as CD5<sup>+</sup> B cells are only a small subpopulation of normal B cells but contain disproportionate numbers of cells making autoantibodies, such as rheumatoid factors ( [37](#), [50](#), [51](#) ).

Classic cytogenetic studies demonstrate specific chromosomal abnormalities in more than one-half of patients with B-cell CLL/SLL, most commonly, trisomy 12 and, less often, structural abnormalities of chromosomes 13 and 14. Trisomy 12 is correlated with mixed cell morphology, atypical immunophenotypes, and a more aggressive clinical course ( [52](#), [53](#) ). Recent molecular genetic studies suggest B-cell CLL/SLL can be divided into two major groups based on the presence or absence of somatic mutation. Mutation status of Ig heavy chain genes correlate with surface CD38 expression and cytoplasmic ZAP-70 expression. Deletion or inactivation of p53 and 11q deletions are poor prognostic features

in multivariate analysis ( [54](#) , [55](#) , [56](#) , [57](#) and [58](#) ).

## Lymphoplasmacytic Lymphoma

Lymphoplasmacytic lymphomas are uncommon B-cell neoplasms composed of small lymphocytes, plasmacytoid lymphocytes, plasma cells, and variable numbers of large lymphocytes. These lymphomas, like B-cell CLL/SLL, often have marrow involvement and a leukemic phase. They are often associated with high levels of an IgM paraprotein (Waldenström macroglobulinemia) or type II cryoglobulinemia ( [59](#) , [60](#) ). Some patients have antecedent systemic or localized abnormal immune reactions, such as Sjögren syndrome ( [61](#) ). Many patients have hepatitis C infection ( [62](#) ). These neoplasms must be differentiated from other small B-cell lymphomas that frequently exhibit plasmacytic differentiation, including nodal and extranodal marginal zone B-cell lymphomas.

Lymphoplasmacytic lymphomas are morphologically diverse and may cause diffuse or partial alteration of lymph node architecture. Many have an interfollicular distribution and abundant macrophages that may impart a mottled low-magnification appearance, resembling Hodgkin lymphoma. On high magnification, small lymphocytes are admixed with variable numbers of plasma cells, plasmacytoid lymphocytes, and admixed large lymphocytes. Other features indicating plasmacytic differentiation include Dutcher bodies (cytoplasmic Ig inclusions that appear to be intranuclear) and extracellular periodic acid-Schiff-positive material. Mast cells and hemosiderin-laden macrophages are often present. These lymphomas may transform to large cell lymphomas ( [41](#) , [63](#) , [64](#) and [65](#) ). These higher-grade lymphomas usually produce the same Ig heavy chains and light chains as the original tumor ( [66](#) ).

Plasmacytoid lymphocytes and plasma cells contain abundant intracellular Ig, which usually is monotypic IgM without IgD and can be detected using paraffin immunoperoxidase reactions. In cell suspension studies, neoplastic lymphocytes usually express more surface Ig than is usually seen in B-cell CLL/SLL ( [42](#) , [65](#) ). Tumor cells express pan-B-cell markers CD19 and CD20 and are usually CD5<sup>-</sup> ( [44](#) ). The presence of numerous follicular dendritic cells in neoplastic infiltrates, identified by immunoperoxidase studies, is reported to have favorable prognostic implications ( [67](#) ). As the tumor cells are actively secreting Ig, many patients have high levels of monoclonal IgM producing hyperviscosity (Waldenström macroglobulinemia). The IgM may have rheumatoid factor activity or function as cryoglobulin, or both ( [59](#) ). Less commonly, these neoplasms may be associated with production of other Ig heavy chain classes ( [68](#) ).

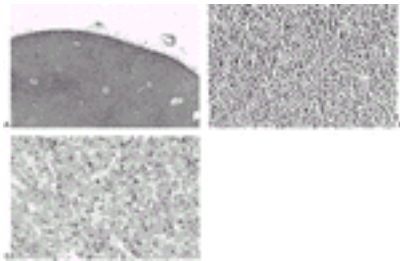
The t(9;14)(p13;q32) is associated with approximately 50% of lymphomas in this group. This translocation involves the PAX-5 gene on chromosome 9, which encodes a B-cell specific transcription factor ( [69](#) ). Somatic mutations of Ig genes are commonly found in Waldenström macroglobulinemia ( [70](#) , [71](#) ).

## Mantle Cell Lymphoma

Mantle cell lymphoma is B-cell lymphoma composed of small lymphocytes with irregular nuclear outlines that have a CD5<sup>+</sup> and CD23<sup>-</sup> phenotype and overexpress cyclin D1. These lymphomas are usually widespread at diagnosis with generalized adenopathy and extensive bone marrow involvement. They may involve extranodal sites, such as Waldeyer ring, or present as lymphomatous polyposis of the lower gastrointestinal tract ( [72](#) , [73](#) ). A few have a leukemic phase mimicking CLL, prolymphocytic leukemia, or acute leukemia

(blastic variants of mantle cell lymphoma) ( [74](#), [75](#) ). Recognition of mantle cell lymphoma is clinically important, as these lymphomas pursue a more aggressive clinical course than other small B-cell lymphomas ( [76](#), [77](#) ).

Mantle cell lymphomas are composed of small lymphocytes with irregular nuclear contours. Mitotic activity is brisk, but large transformed lymphocytes are usually few in number. They usually have a diffuse growth pattern ( [Fig. 88.3A](#), [Fig. 88.3B](#) ) or surround reactive germinal centers in a mantle zone pattern. Extension of the lymphoma into the capsule and perinodal fat is common ( [72](#), [73](#), [78](#) ). Transformation of mantle cell lymphoma, first recognized by Lennert as a blastic transformation of centrocytic lymphoma ( [79](#) ), is characterized morphologically by an increased cell size, frequent mitoses, and an aggressive clinical course. The differential diagnosis of blastic transformation of mantle cell lymphoma includes acute leukemia involving lymph nodes, lymphoblastic lymphoma, and transformed cutaneous T-cell lymphoma ( [35](#), [80](#) ).



**Figure 88.3.** Lymph node: mantle cell lymphoma **A:** Low magnification showing diffuse architectural effacement, which, on higher magnification in **B**, is composed of sheets of small irregular lymphocytes with few large cells. **C:** Small lymphocytes exhibit nuclear staining for cyclin D1. See [Color Plate](#).

The neoplastic cell shares immunophenotypic features with normal mantle zone lymphocytes, including moderate amounts of surface IgM, usually with IgD. Neoplastic cells are generally CD5<sup>+</sup> and CD10<sup>-</sup>, but a subset of mantle cell lymphomas has CD5<sup>-</sup> tumor cells ( [81](#) ). Mantle cell lymphomas usually mark with pan-B-cell antibodies CD19, CD20, and CD22. CD23 is negative, and FMC7 is positive in contrast to the tumor cells of B-cell CLL/SLL ( [49](#), [82](#) ). Overexpression of cyclin D1 is almost universal in mantle cell lymphoma ( [Fig. 88.3C](#) ) ( [83](#) ). Overexpression of cyclin D1 is not seen in follicular hyperplasia and is uncommon in other small B-cell malignancies, with the exception of plasmacytic neoplasms and hairy cell leukemia ( [84](#) ).

On classic cytogenetics, most cases of mantle cell lymphoma show evidence of t(11;14) with *BCL-1/PRAD1* gene rearrangements involving the cyclin D1 gene ( [85](#), [86](#) ). Fluorescence *in situ* hybridization analysis of paraffin-embedded tissue extends the sensitivity of t(11;14) (q13;q32) detection to greater than 90% and does not require fresh or frozen tissue ( [13](#) ). A subset of patients with p53 mutations and overexpression of the p53 protein appear to have a worse prognosis ( [87](#) ).

### Nodal Marginal Zone B-Cell Lymphoma

Nodal marginal zone B-cell lymphomas are uncommon lymphomas in which the tumor cells resemble the cytology of those in splenic and extranodal marginal zone B-cell

lymphomas of MALT, but there is no evidence for splenic or extranodal disease. Clinically, these lymphomas appear more extensive at presentation than MALT lymphomas. They have a tendency to early relapse, and a small minority transform to large cell lymphoma ( [88](#), [89](#) ).

Nodal marginal zone lymphomas characteristically involve the interfollicular areas of lymph nodes and are composed predominantly of “monocytoid” small- and medium-sized lymphocytes of uniform size with distinct cell membranes that surround an abundant amount of pale cytoplasm. Nuclei are bland and oval to coffee bean in shape. In some cases, plasma cells are prominent ( [90](#) ). Admixed large lymphocytes are present, and mitotic activity is variable ( [89](#) ).

Nodal marginal zone B-cell lymphomas express pan-B-cell antigens (CD19, CD20, CD79A) and monotypic Ig (IgM without IgD) and are negative for CD5, CD10, and cyclin D1. A variable number are positive for bcl-2 protein and CD43 ( [88](#), [91](#) ).

Genetic studies are limited and have not identified any common cytogenetic abnormalities. Somatic mutation of the Ig genes is usually (but not always) present ( [92](#) ).

### **Splenic Marginal Zone B-Cell Lymphoma**

Splenic marginal zone B-cell lymphoma is a small B-cell lymphoma of the white pulp of the spleen that often involves the splenic hilar lymph nodes, bone marrow, and peripheral blood. Patients with splenic marginal zone B-cell lymphoma characteristically present with splenomegaly, and many have B-symptoms (fever, weight loss, and night sweats) ( [93](#), [94](#) and [95](#) ).

The spleen has increased white pulp with nodular expansion of marginal zones and periarteriolar lymphoid sheaths. Adjacent neoplastic marginal zones merge with one another as the process extends into the red pulp. Germinal centers are often obliterated. Cytologically, neoplastic cells are small to medium sized with oval to round nuclei and moderate to abundant cytoplasm ( [95](#) ). Many cases have a lymphoplasmacytic component with monotypic cytoplasmic Ig in plasma cells and plasmacytoid lymphocytes ( [96](#) ). The mitotic rate is usually low. Lymph node involvement demonstrates a diffuse infiltrate with patent sinuses but no residual germinal centers. Bone marrow involvement is nodular or interstitial and frequently intrasinusoidal. Tumor cells in peripheral blood often have short villous projections ( [95](#) ). Transformation to large B-cell lymphoma is seen in as much as 15% of cases ( [97](#) ).

Neoplastic cells are CD45, CD20, and bcl-2 protein positive with monotypic IgM, with or without IgD. Tumor cells are negative for CD5, CD10, CD21, CD43, and cyclin D1 ( [95](#) ). Unlike hairy cell leukemia ( [93](#), [94](#) ), they are usually CD11c, CD103, and DBA.44 negative.

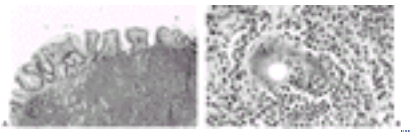
Allelic loss of 7q21-32 is seen in slightly less than one-half of patients. Chromosomal translocations that are seen in other small B-cell lymphomas involving *BCL-1*, *BCL-2*, and *MLT-1* are not present ( [98](#), [99](#) ). On molecular genetic studies, approximately one-half of cases show somatic mutation, and one-half have unmutated Ig genes. The latter group more frequently have deletions and allelic loss of 7q31-32 and may have a worse prognosis ( [100](#) ).



## Extranodal Marginal Zone B-Cell Lymphoma of Mucosa-Associated Lymphoid Tissue

Extranodal marginal zone B-cell lymphomas arise in normal sites for mucosal immunity (MALT), such as intestinal Peyer patches, or in sites of inflammation triggered by autoimmune disorders, such as Hashimoto thyroiditis or Sjögren syndrome, or by infection (*Helicobacter pylori*-associated chronic gastritis) ( [101](#), [102](#), [103](#), [104](#) and [105](#) ). MALT lymphomas, many of which were diagnosed previously as pseudolymphomas, tend to remain localized, and, when dissemination occurs, it is usually to other mucosal sites. Transformation to large cell lymphoma occurs in a minority of cases ( [106](#) ).

These lymphomas are composed of small- to medium-sized lymphocytes that exhibit variable cytologic features. In some cases, lymphocytes with irregular nuclear contours resembling follicular small cleaved cells or centrocytes may predominate. Other cases may be composed primarily of cells with abundant pale cytoplasm resembling monocytoid B cells. Cases with an abundance of small lymphocytes or plasma cells also may be seen. Regardless of the neoplastic cells' appearance, they produce a diffuse infiltrate that invades epithelial structures, producing lymphoepithelial lesions ( [Fig. 88.4A](#), [Fig. 88.4B](#) ) and subsequent epithelial disruption ( [107](#) ). Reactive lymphoid follicles are generally present, and the neoplastic lymphocytes may infiltrate and colonize them ( [108](#) ). Transformation to large cell lymphoma may occur ( [109](#) ).



**Figure 88.4.** Stomach: extranodal marginal zone B-cell lymphoma of mucosa-associated lymphoid tissue **A:** The submucosa contains a diffuse infiltrate of small lymphocytes. **B:** Centrocyte-like cells with moderate amounts of clear cytoplasm invade gastric glands, producing lymphoepithelial lesions. See [Color Plate](#).

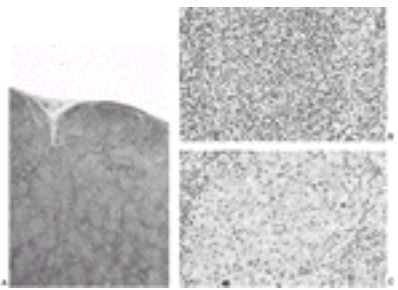
MALT lymphomas express B-cell antigens (CD19 and CD20) and monotypic surface Ig (usually IgM without IgD). They may be CD43<sup>+</sup> but usually lack other antigens expressed by small B-cell lymphomas, such as CD5, CD10, CD23, and cyclin D1. Cytoplasmic Ig is present in cases exhibiting plasmacytic differentiation ( [106](#) ).

These lymphomas demonstrate clonal Ig gene rearrangements and show extensive somatic mutations characteristic of postgerminal center B cells. The most common cytogenetic abnormality in this lymphoma is trisomy 3, seen in more than one-half of patients, but is not specific for this lymphoma ( [106](#) ). The t(11;18) chromosomal abnormality is more specific and involves fusion of the *API2* gene (an apoptosis inhibitor) on chromosome 11q21 and the *MLT1* gene (a caspase-like protease) on chromosome 18q21. It is found in 40% of patients with MALT lymphomas. Two, less common, translocations are t(1;14)(p22;q32) and t(14;18)(q32;q21) ( [110](#) ). These three translocations are not found in marginal zone B-cell lymphomas of spleen and lymph node ( [111](#) ). The t(14;18)(q32;q21) involves the Ig heavy chain gene locus and *MLT1* gene and is common in extragastric MALT lymphomas ( [110](#) ). T(11;18) identifies gastric MALT lymphomas that (a) present with advanced stage disease, (b) do not respond to *H. pylori* eradication, and (c) are unlikely to transform to large cell lymphoma ( [112](#), [113](#) ). In contrast, the t(11;18) negative cases frequently show one or more other genetic abnormalities, suggesting two

distinct pathways in the development of these lymphomas with similar morphologies ( [17](#), [114](#) ).

## Follicular Lymphoma

The WHO classification of follicular lymphomas requires that lymphomas in this category be at least partially follicular in its growth pattern ( [Fig. 88.5A](#) ). It excludes lymphomas, such as MALT lymphomas and mantle cell lymphomas, that also may have a nodular growth pattern. The incidence of follicular lymphomas is second only to DLBCL in the United States and western Europe. These usually indolent lymphomas commonly present as painless lymphadenopathy in middle-aged or elderly adults. They commonly involve the bone marrow early ( [28](#) ). Follicular lymphomas in young children and cutaneous follicular lymphomas may have a different clinical behavior than typical nodal cases ( [115](#), [116](#) ).



**Figure 88.5.** Lymph node: follicular lymphoma. **A:** Low magnification, demonstrating effacement of architecture by a nodular process. **B:** In a higher magnification, the nodules are composed almost entirely of small cleaved cells (follicular lymphoma, grade 1), whereas, in **C**, from another patient, the nodules are dominated by large noncleaved cells (follicular lymphoma, grade 3). See [Color Plate](#).

**BACKGROUND** The follicle center is the major site of B-lymphocyte differentiation and proliferation ( [117](#), [118](#) ). It may also serve as the site of lymphomagenesis of most B-cell lymphomas and Hodgkin lymphoma ( [119](#) ). B lymphocytes move into the follicle after they first encounter protein antigen in the paracortex to begin a series of steps that ultimately produces plasma cells with high-affinity Ig and memory B cells. Morphologically, the follicle center reflects this biologic transformation by frequent mitoses and by its range of cell types, including cleaved cells (or centrocytes) and large noncleaved cells (or centroblasts). Differentiation results in Ig heavy chain class switching from IgM to IgG, IgA, or IgE and in enhanced Ig synthesis. Proliferation produces the clonal expansion that is the basis of immunologic memory and an effective humoral immune response ( [117](#), [118](#) ). Somatic mutation in the Ig genes occurring during proliferation is followed by selection of B cells with surface Ig of higher affinity for antigen. Successful interaction of B cells with antigen-bearing follicular dendritic cells triggers B-cell expression of bcl-2 protein that saves the B cell from apoptotic cell death ( [120](#) ). Tingible body macrophages mark the passing via apoptosis of B cells not selected for survival. Somatic mutation may serve to identify those neoplasms that have arisen from B cells that have been exposed to antigen in the environment of the follicle, such as follicular lymphomas and multiple myeloma, versus those that have not, such as mantle cell lymphoma. Most B-cell NHLs and Hodgkin lymphomas have extensive somatic mutations ( [119](#), [121](#), [122](#) ). Somatic mutation of non-Ig genes, such as *BCL-6*, may participate in lymphomagenesis ( [123](#) ). The recognition of the contribution of somatic mutation, receptor editing, and class switching in lymphomagenesis supports a major role for the follicle in neoplastic transformation ( [119](#), [124](#), [125](#) ).



**GRADING** A major problem area within those lymphomas classified as follicular lymphoma is that of grading. Virtually all follicular lymphomas are composed of a mixture of cleaved (centrocytes) and large noncleaved cells (centroblasts). Numerous studies have correlated the number of centroblasts with prognosis. Most studies agree that follicular lymphomas composed predominantly of centrocytes have a more indolent course than those composed predominantly of centroblasts ( [126](#) , [127](#) , [128](#) and [129](#) ). The most popular scheme for subclassification of follicular lymphoma is a modified version of that proposed by Berard, which bases categorization on numbers of large noncleaved cells per standardized high-magnification field (HMF) with fewer than six per HMF classified as grade 1 follicular lymphomas, 6 to 15 per HMF as grade 2, and greater than 15 per HMF as grade 3 follicular lymphomas ( [130](#) ). In all of these schemes of grading, there is substantial subjectivity and often disappointing interinstitutional reproducibility ( [131](#) , [132](#) ).

**PATHOLOGY** Follicular lymphomas are recognized at low magnification by the effacement of nodal architecture by follicular nodules that crowd one another and fill the cortex and the medulla ( [Fig. 88.5A](#) ). Tingible body macrophages are not seen in contrast to reactive follicles. Mantle zones are usually thin or absent ( [133](#) ). A small number of follicular lymphomas show differentiation to marginal zone-like cells with a “halo-like” distribution around neoplastic follicles. These marginal zone cells, although often CD10 and bcl-2 protein negative, are genetically identical to the neoplastic cells of the follicles ( [134](#) ). On high magnification, low-grade (WHO grades 1 and 2) follicular lymphomas are composed of a relatively homogeneous population of small cleaved lymphocytes (smaller than, or the same size as the macrophage nucleus) with twisted nuclei, condensed chromatin, and inapparent nucleoli ( [Fig. 88.5B](#) ). Cleaved cells frequently infiltrate the interfollicular areas and capsule. A variable number of large noncleaved lymphocytes with oval to round nuclei (greater in size than a macrophage nucleus), dispersed chromatin, and one to three nucleoli that often abut the nuclear membrane also are present. Grade 3 follicular lymphomas, which by definition have an increased number of large noncleaved cells ( [Fig. 88.5C](#) ), have been provisionally subcategorized into 3a and 3b, with the former having a mix of cleaved and large noncleaved cells, and the latter having sheets or large clusters of large noncleaved cells ( [135](#) ). Areas of diffuse growth composed predominately of cleaved cells do not appear to affect prognosis ( [126](#) ). Small cleaved follicular lymphomas with a purely diffuse growth pattern are uncommon and may be difficult to separate morphologically from mantle cell lymphoma without immunophenotypic or cytogenetic studies. Large cleaved cell lymphoma with a follicular growth pattern is not recognized as a separate entity in the WHO classification. Large cleaved cells differ from small cleaved cells not only in nuclear size (larger than macrophage nucleus), but also in chromatin pattern, which is more open with occasional small nucleoli. The nuclei are elongated and twisted like the small cleaved cell. Because of the abundant cytoplasm of tumor cells, the follicles appear pale. A minority of large cleaved follicular lymphomas exhibit a predominantly diffuse growth pattern. Several studies suggest that large cleaved cell lymphomas have a course similar to that of low-grade follicular lymphomas composed predominantly of small cleaved cells ( [136](#) , [137](#) ). Follicular lymphomas, particularly those arising in the retroperitoneum, have a propensity for extranodal growth and interfollicular sclerosis ( [138](#) ). The sclerotic tissue is composed predominantly of type 1 collagen with variable amounts of type 3 collagen and fibronectin ( [139](#) ). Occasionally, follicular lymphomas present with massive nodal necrosis. Clonal Ig heavy chain gene rearrangements can sometimes be demonstrated in these necrotic lymph nodes without morphologically viable lymphocytes ( [140](#) , [141](#) ). A minority of follicular lymphomas contain plasma cells that may be polyclonal or monoclonal with the same Ig heavy chain and light chain of the cleaved cells ( [142](#) ). Rarely, accumulations of intracytoplasmic Ig give cells in follicular lymphomas a signet ring cell-like appearance ( [143](#) ). A leukemic phase may be present in as much as 10% of patients with cleaved follicular lymphomas. Circulating cells show nuclear irregularity and are immunophenotypically distinct from neoplastic cells of B-cell CLL/SLL or mantle cell lymphoma ( [144](#) ). Neoplastic transformation to a large

noncleaved cell lymphoma, usually with a diffuse growth pattern, occurs in approximately one-half of cases ( [145](#), [146](#), [147](#) and [148](#) ). Pathology reports should emphasize areas of diffuse growth of large cells, as they are sufficient for regarding the tumor as intermediate grade regardless of the grade of the tumor in follicular nodules ( [149](#) ). More recently, a rare form of transformation in which the tumor cells have a blastlike morphology has been recognized. These blastic variants of follicular lymphoma are aggressive clinically ( [150](#) ). Small cleaved follicular lymphomas express bright surface Ig fluorescence, usually IgM or IgM with IgD. Large cleaved and large noncleaved follicular lymphomas usually express IgM or IgG with approximately equal frequency. A minority of large cell follicular lymphomas are surface Ig negative but may be recognized as B-cell lymphomas by their expression of pan-B-cell markers, including CD19, CD20, and CD22 ( [1](#), [151](#) ). Most follicular cleaved lymphomas are CD10<sup>+</sup> (WHO grades 1 and 2) as are more than one-half of large noncleaved lymphomas (WHO grade 3) ( [152](#) ). Follicular lymphomas are almost always CD5<sup>-</sup>, but rare CD5<sup>+</sup>/CD10<sup>+</sup> cases have been described that often exhibit variant histopathology. This morphologic pattern may be confused with progressive transformation of germinal centers ( [153](#), [154](#) ). Expression of bcl-2 protein may be helpful in differentiating follicular hyperplasias from some cases of follicular lymphoma; however, overexpression of bcl-2 protein is not of help in differentiating follicular lymphomas from other NHLs ( [155](#) ). Overexpression of p53, detected by immunohistochemistry, may identify patients with increased risk for transformation ( [156](#), [157](#) ). Small cleaved follicular lymphomas differ from most other small B-cell lymphomas in having a significant admixture of T cells, and some authors have suggested that large numbers of T cells indicate a favorable prognostic feature ( [158](#) ). More than 85% of cleaved follicular lymphomas and 25 to 30% of DLBCLs have the t(14;18) translocation. Molecular genetic studies may identify additional cases not recognized by conventional cytogenetics ( [159](#), [160](#) ). Abnormalities of chromosomes 3q27, 5, 7, 12, and 13q are more common in a higher grade (WHO grade 3) or in transformation of follicular lymphoma. Abnormalities of chromosome 8q24 are associated with blastic or blastoid variants of follicular lymphoma ( [161](#), [162](#) ). The pattern of somatic mutation in follicular lymphomas suggests a role for antigen selection in their clonal evolution ( [121](#), [122](#) ).

## Burkitt Lymphoma

Burkitt lymphoma is a high-grade B-cell lymphoma composed of medium-sized, rapidly dividing lymphocytes. These lymphomas usually affect children and young adults and often present at extranodal sites. Less commonly, they have a leukemic phase. Three clinical forms are recognized: (a) endemic, which classically presents as jaw or facial masses in young boys in equatorial Africa; (b) sporadic, which may present at any age with frequent abdominal involvement; and (c) immunodeficiency associated, such as in patients who are human immunodeficiency virus positive. All subtypes are characterized by chromosomal rearrangements involving the *c-myc* oncogene that lead to its inappropriate expression in B cells. All three forms are associated with EBV infection, 100% in endemic Burkitt lymphomas and 20 to 40% in sporadic and immunodeficiency-associated Burkitt lymphomas ( [28](#), [163](#), [164](#) and [165](#) ).

Burkitt lymphomas typically have a diffuse growth pattern that is dominated on low magnification by the “starry sky” produced by tingible body macrophages ( [Fig. 88.6A](#) ). Tumor cells may home into residual follicles and often have a cohesive appearance at the interface of tumor and soft tissue. Nuclear size is equivalent to that of endothelial cells or macrophages. The nuclei are round to oval with small nucleoli and a moderate amount of amphophilic cytoplasm. Mitoses are frequent ( [Fig. 88.6B](#) ). On Wright-stained touch imprints, the neoplastic cells show remarkable nuclear homogeneity and the presence of

characteristic, vacuolated, basophilic cytoplasm. In some cases, there is more nuclear pleomorphism and numerous large cells with prominent nucleoli. A second variant shows plasmacytic differentiation with eccentric nuclei and more abundant basophilic cytoplasm. In cases with atypical histologic or immunophenotypic features, demonstration of *c-myc* gene dysregulation and translocations is essential to confirm the diagnosis ( [163](#), [166](#), [167](#) and [168](#) ).



**Figure 88.6.** Lymph node: Burkitt lymphoma. **A:** The architecture is totally effaced by a diffuse infiltrate with a “starry sky” appearance. **B:** High power, showing a monotonous population of small transformed or noncleaved lymphocytes with round to oval nuclei and variable cytoplasm. Mitotic figures are frequent. Numerous tingible body macrophages are present. See [Color Plate](#).

Immunophenotypically, these lymphomas have moderate amounts of monotypic surface Ig (usually IgM) and are CD10 positive but CD5 and TdT negative. The plasmacytic variants may contain intracellular Ig, and paraffin immunohistochemical staining with Ki-67 shows greater than 95% of tumor cells are positive, which is consistent with a high growth fraction ( [169](#), [170](#), [171](#) and [172](#) ).

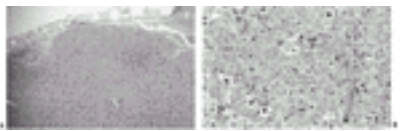
These tumors have reciprocal translocations involving the *C-MYC* oncogene mapped to chromosome 8q24, which is juxtaposed to the enhancer region of the Ig heavy chain gene on chromosome 14. The translocations less commonly involve the  $\kappa$ -light chain (chromosome 2) and  $\lambda$ -light chain (chromosome 22) genes ( [173](#) ). In endemic Burkitt lymphoma, the translocation breakpoints are located in the joining region of the Ig heavy chain gene, whereas, in sporadic or immunodeficiency-associated cases, the breakpoints are within the switch region. All forms show the presence of somatic mutation, which is ongoing in some cases of epidemic Burkitt lymphoma ( [174](#), [175](#) and [176](#) ).

### Diffuse Large B-Cell Lymphoma

DLBCLs are the most frequent lymphoma in North America and Europe and occur in all age groups. These lymphomas are often localized at presentation and frequently occur in extranodal sites. They may arise as a result of transformation of more indolent low-grade B-cell lymphomas. They are the most common lymphoma seen in patients with immunodeficiency ( [27](#), [177](#) ).

By definition, there is diffuse effacement of the architecture, usually with no residual normal nodal architecture remaining ( [Fig. 88.7A](#) ). Cytologically, the tumor cells most often resemble the large noncleaved cells or centroblasts of follicular lymphoma with nuclei two or more times larger than a macrophage nucleus, dispersed chromatin, and two to three small- to medium-sized nucleoli that may abut the nuclear membrane. Their cytoplasm is usually abundant. Mitotic activity is brisk ( [Fig. 88.7B](#) ). They often involve perinodal soft tissue and fat and may be associated with sclerosis. Several cytologic variants are described. Multilobated large B-cell lymphomas include lymphocytes in which more than 25% of the nuclei have mulberry or cloverleaf shapes with small nucleoli and dispersed chromatin ( [178](#), [179](#) ). Anaplastic variants have multiple large nuclei with bizarre pleomorphic features producing a cytologic resemblance to ALCL ( [180](#) ). Rare spindle cell

variants may mimic sarcoma ( [181](#) ). T-cell-rich large B-cell lymphoma is a type of DLBCL characterized by a diffuse or interfollicular growth pattern dominated by reactive, small T cells and histiocytes unlike the other variants of DLBCL. These lymphomas tend to be more widespread at presentation than the other members of this group. The neoplastic large B cells are in a minority ( [182](#) , [183](#) ). An immunoblastic cytology is characterized by cells that have a single prominent inclusionlike nucleolus and often have features of plasmacytic differentiation (cytoplasmic basophilia and nuclear eccentricity). Immunoblastic cytology may confer a worse prognosis when compared to tumors with centroblastic morphology and may be more common in patients with immunodeficiency ( [180](#) , [184](#) ). In addition, two subtypes of DLBCL with immunoblastic features are noteworthy. Plasmablastic lymphomas present as soft-tissue lesions of the airway in human immunodeficiency virus-positive patients. These lymphomas, which often are associated with EBV, lack CD45 and CD20 but do express plasma cell markers, such as CD138, and contain intracellular Ig ( [185](#) ). DLBCL with ALK expression have an immunoblastic cytology with prominent central nucleoli. They also have weak to absent CD20 and CD45 expression but contain monocytic IgA. These aggressive lymphomas are CD30 negative and do not harbor a t(2;5) ( [186](#) ). Finally, a controversial group in classification are the Burkitt-like lymphomas. They are B-cell lymphomas with a variable number of cytologic characteristics of Burkitt lymphoma, including a high mitotic rate, prominent cytoplasmic basophilia, and a “starry sky” pattern. The tumor cells are smaller than centroblasts but are somewhat larger and more pleomorphic than those typical of Burkitt lymphoma. In the WHO classification, cases with these features but lacking evidence of translocations causing *C-MYC* gene overexpression have been included in the DLBCL category. There is evidence to suggest that these “Burkitt-like” lymphomas have a worse prognosis than the usual DLBCL ( [187](#) ).



**Figure 88.7.** Lymph node: diffuse large B-cell lymphoma. **A:** On low magnification, the architecture is replaced by neoplastic process with a diffuse growth pattern. **B:** On high magnification, the tumor cells have large nuclei with dispersed chromatin, small nucleoli, and a variable amount of cytoplasm. Mitotic figures are easily identified. See [Color Plate](#).

The tumor cells of DLBCL usually have monocytic surface or cytoplasmic Ig, or both, on flow cytometry or frozen section immunoperoxidase. Monocytic Ig may be detected in less than one-third of cases by paraffin immunohistochemistry ( [188](#) ). The tumor cells are usually CD45, CD19, CD20, CD22, and CD79A positive with a significant number also CD10 positive and bcl-6 positive ( [189](#) , [190](#) ). CD30 expression is variable. A subset is CD5 positive, but this group does not appear to arise as a transformation of B-cell CLL/SLL or mantle cell lymphoma ( [191](#) ). Increased expression of Ki-67 (a marker of cell proliferation), bcl-2 protein, and CD44 (a lymphoid homing receptor) are associated with decreased survival, as is loss of the pan-B-cell markers CD20 and CD22 ( [190](#) , [192](#) , [193](#) and [194](#) ). Loss of HLA class I or class II antigens is not associated with a worse prognosis, as was originally reported ( [195](#) ).

A minority of DLBCLs have a t(14;18) ( [196](#) , [197](#) ). Many of these lymphomas arise as transformations of cleaved follicular lymphomas, as may be suggested by antecedent biopsy or the presence of admixed cleaved follicular lymphoma in the diagnostic biopsy or

at other sites (e.g., bone marrow). Overexpression of bcl-2 protein with or without an associated t(14;18) correlates with a poor prognosis ( [193](#), [198](#) ). Almost one-fourth of DLBCLs have rearrangements involving *BCL-6*, a gene on chromosome 3q27 that codes for a protein similar to zinc-finger transcription factors. The prognostic implications of *BCL-6* gene rearrangements are controversial, varying from study to study ( [199](#) ). Amplification of the *REL* protooncogene is seen in DLBCLs, particularly in those arising in extranodal sites, and may represent a progression-associated marker ( [200](#) ). Gene microarray analysis of tumor RNA in DLBCL has revealed two distinct patterns, germinal center B-cell-like and activated B-cell-like. The former appears to have a better prognosis than the latter ( [201](#) ).

**MEDIASTINAL (THYMIC) LARGE B-CELL LYMPHOMA** Mediastinal (thymic) large B-cell lymphomas often present in young adult women and are clinically aggressive. They appear to originate from thymic B cells. Mediastinal large B-cell lymphomas invade local structures (pleura, lung, and pericardium) and often produce compression of the superior vena cava and airways ( [202](#), [203](#) ). Mediastinal large B-cell lymphomas have a diffuse growth pattern and are frequently sclerotic. The neoplastic cells have a range of cytologic appearances from cells resembling centroblasts of the follicular center, to large cells with abundant clear cytoplasm, to cells with multilobated nuclei, and to pleomorphic variants that may appear similar to those in anaplastic carcinoma or Hodgkin lymphoma ( [204](#), [205](#) and [206](#) ). Admixed eosinophils and small lymphocytes in a sclerotic background may contribute to morphologic confusion with Hodgkin lymphomas. These lymphomas are often surface Ig negative with decreased expression of HLA class I and II antigens. They express the B-cell markers CD19, CD20, CD22, and CD79a ( [205](#) ). They are CD5 and CD10 negative. CD30 is often positive, but CD20 and CD45 positivity, along with CD15 negativity, allow distinction from syncytial variants of classical Hodgkin lymphoma and ALCL ( [205](#), [207](#) ). These lymphomas do not have translocations involving the *BCL-1*, *BCL-2*, or *BCL-6* gene loci ( [207](#) ). Point mutations of *C-MYC* and p53 are seen in a minority of cases ( [208](#), [209](#) ). Many have additions to the short arm of chromosome 9 (also seen in classic Hodgkin lymphoma), as well as abnormalities of the X chromosome and amplification of *REL1*. Somatic mutation in these lymphomas is extensive, but continuing mutation is infrequent ( [210](#) ).

**INTRAVASCULAR LARGE B-CELL LYMPHOMA** Rare intravascular large B-cell lymphomas are characterized by multifocal intravascular aggregates of pleomorphic cells. They have a predilection for small blood vessels in the skin and central nervous system, where they produce cutaneous plaques and focal or global neurologic signs. The tumor is often clinically unsuspected and can be easily overlooked on biopsy. The diagnosis is most commonly made at autopsy. The tumor cells have large nuclei with open chromatin, small nucleoli, and scant cytoplasm. They fill small veins and arteries, as well as capillaries. Unlike so-called angiocentric lymphomas (formerly called *lymphomatoid granulomatosis*), the neoplastic cells do not infiltrate vascular walls and are usually not associated with tissue necrosis ( [211](#), [212](#), [213](#), [214](#), [215](#), [216](#) and [217](#) ). Intravascular, or angiotropic, large B-cell lymphomas are CD20 and CD45 positive. Their peculiar intravascular location may be related to expression of CD44, a lymphocytic homing receptor. Almost all cases are bcl-2 protein positive, with a minority expressing CD5 or CD10 ( [216](#), [217](#) and [218](#) ). Genetic studies are limited but have detected extensive somatic mutation. These lymphomas do not show *BCL-2* gene rearrangements, and studies for EBV by *in situ* hybridization are negative ( [216](#), [219](#) ).

## T-CELL AND NATURAL KILLER-CELL LYMPHOMAS

T-cell and NK-cell lymphomas may be grouped together, because their normal counterparts apparently arise from a common progenitor cell that expresses CD3ε and is

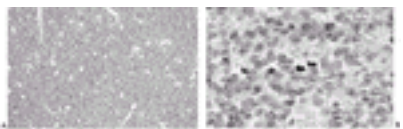


unable to develop into B cells ( [220](#) ). Furthermore, some lymphomas from these two lymphoid lineages have considerable morphologic, immunologic, and clinical overlap. Overall, T- and NK-cell lymphomas are less common than B-cell malignancies, as they comprise approximately 15% of the NHL in the United States and western Europe ( [221](#) ).

Classification of T- and NK-cell lymphomas has been problematic. The WF did not attempt to recognize T-cell or NK-cell lymphomas, although morphologic categories were available for lymphoblastic lymphoma and mycosis fungoides ( [26](#) ). Both of the updated early immunologically oriented schemes segregated T-cell lymphomas into particular morphologic subgroups that often were not distinct clinically ( [222](#), [223](#) ). The REAL Classification attempted to define “real” disease entities and considered T-cell and putative NK-cell neoplasms as a single group that was subdivided into *precursor* (phenotypically immature) and *peripheral* (phenotypically mature) categories ( [27](#) ). The peripheral T- and NK-cell neoplasms were further subdivided into definite and provisional entities, depending on the International Lymphoma Study Group’s experience with each proposed entity. The current WHO classification is built on the REAL Classification and divides definite T-cell and NK-cell neoplasms into *precursor* and *mature* categories. Provisional entities are not included. The *mature* T-cell and NK-cell neoplasms are subdivided into those that are leukemic, cutaneous and extranodal, and nodal in origin. Precursor and peripheral T- and NK-cell lymphomas are discussed in the following sections. Precursor T-cell ALL ( [Chapter 77](#) and [Chapter 78](#) ), T-cell prolymphocytic leukemia and T-cell large granular lymphocytic leukemia ( [Chapter 90](#) and [Chapter 92](#) ), and mycosis fungoides ( [Chapter 94](#) ) are discussed elsewhere in this text.

### Precursor T-Cell Lymphoblastic Lymphoma

T-cell lymphoblastic lymphomas are highly aggressive malignancies of immature (precursor) T cells that generally present in children and young adults who have anterior mediastinal masses, often accompanied by supradiaphragmatic lymphadenopathy. These lymphomas efface the thymic and nodal architecture in a diffuse pattern, and infiltrate the capsule and adjacent soft tissue. Numerous tingible body macrophages impart a “starry sky” appearance similar to small noncleaved cell (Burkitt and Burkitt-like) lymphomas ( [Fig. 88.8A](#) ). Monomorphic neoplastic lymphocytes are small to intermediate in size, contain scant cytoplasm, and have round to convoluted nuclei ( [Fig. 88.8B](#) ). The chromatin is dispersed and blastlike, and nucleoli are usually indistinct. Mitotic figures are abundant. These morphologic features are indistinguishable from disseminated precursor T-cell ALL ( [224](#) ) and the infrequent B-cell lymphoblastic lymphomas that were discussed previously.



**Figure 88.8.** Lymph node: precursor T-cell lymphoblastic lymphoma. **A:** The nodal architecture is completely effaced by a diffuse lymphoid infiltrate. The interspersed macrophages help impart a “starry sky” appearance. **B:** The neoplastic cells are intermediate in size and have delicate chromatin that are characteristic of blasts, indistinct nucleoli, and scant cytoplasm. Frequent mitoses are present (*center*). See [Color Plate](#).

T-cell lymphoblastic lymphomas express diverse T-cell antigens, but most are CD3<sup>+</sup> and CD7<sup>+</sup>. Some lesions correspond to early (CD1<sup>-</sup>, cytoplasmic CD3<sup>+</sup>, CD4<sup>-</sup>, and CD8<sup>-</sup>),

common (CD1<sup>+</sup>, cytoplasmic CD3<sup>+</sup>, CD4<sup>+</sup>, and CD8<sup>+</sup>), or late (CD1<sup>-</sup>, surface CD3<sup>+</sup>, CD4<sup>+</sup>, or CD8<sup>+</sup>) thymocytes ( [225](#)). Cytoplasmic CD3 expression is the most specific early marker of a T-cell phenotype and is also present in T-ALL ( [226](#), [227](#)). TdT is present in T-cell lymphoblastic lymphomas, and 25% of these lymphomas are CD10<sup>+</sup>. HLA-DR expression is absent in almost all cases unlike B-ALL and most nonlymphoid leukemias. CD34 expression is also uncommon in T-cell lymphoblastic lymphomas. Occasional T-cell lymphoblastic lymphomas express NK-cell-associated antigens (e.g., CD16, CD56, or CD57) and may be of true NK-cell lineage ( [228](#), [229](#) and [230](#)).

Because T-cell lymphoblastic lymphoma and T-ALL have considerable overlap of morphologic, immunologic, and clinical features, it may be impossible to distinguish between the two for individual precursor T-cell neoplasms. Extensive mediastinal and peripheral lymph node involvement with limited bone marrow and peripheral blood disease favors a diagnosis of T-cell lymphoblastic lymphoma, whereas the presence of greater than 25% T-cell lymphoblasts in the marrow is considered T-ALL ( [27](#)).

### Peripheral T-Cell Lymphoma, Unspecified

Several specific types of mature (peripheral) T-cell lymphomas are recognized by the WHO classification, as discussed separately in the following sections. However, approximately one-half of peripheral T-cell lymphomas (PTCLs) do not fit a distinctive type and are regarded as PTCL, unspecified. These lymphomas are postthymic T-cell malignancies that usually present in adults who have disseminated disease accompanied by B symptoms and poor performance status. There is generally a diffuse growth pattern, but rare cases may appear nodular ( [231](#), [232](#)). A variety of the following morphologic features may also be seen: neoplastic lymphocytes of varying size that often have clear cytoplasm; large tumor cells that may have hyperlobate nuclei, may be multinucleate, or may resemble Reed-Sternberg cells; frequent reactive epithelioid histiocytes; delicate connective tissue bands that segregate cells into clusters; and hypervascularity ( [231](#)). These lesions have diverse and often aberrant T-cell phenotypes ( [233](#)). Most express a/B T-cell receptors (TCRs) and demonstrate TCR gene rearrangements ( [234](#), [235](#), [236](#) and [237](#)).

*NK-cell-like T-cell lymphoma* is a general term that has been applied for a heterogeneous group of PTCLs that express NK-cell-associated antigens, such as CD16, CD56, or CD57, and have azurophilic cytoplasmic granules by light or electron microscopy ( [238](#), [239](#)). NK-cell-like T-cell lymphomas express surface CD3 or framework determinants of the TCR (a/B or ?/d chains), or both, and demonstrate TCR gene rearrangements unlike true NK-cell lymphomas ( [238](#)). Most NK-cell-like T-cell lymphomas are highly aggressive extranodal neoplasms. A leukemic phase is common that can be distinguished from large granular lymphocyte leukemias by the overall clinicopathologic features ( [238](#)). Hepatosplenic T-cell lymphoma, subcutaneous panniculitis-like T-cell lymphoma, and enteropathy-type T-cell lymphoma (discussed in detail later) may be regarded as specific subsets of NK-cell-like T-cell lymphomas, because most thoroughly studied cases express NK-cell-associated antigens and contain cytolytic-type cytoplasmic granules ( [240](#)). Many posttransplant PTCLs also fall within the spectrum of NK-cell-like T-cell lymphomas ( [238](#), [241](#)).

**T-ZONE LYMPHOMA** T-zone lymphoma, considered a specific entity in the updated Kiel classification, is recognized as a morphologic variant among the PTCL, unspecified in the WHO classification. The characteristic histopathologic feature is an interfollicular growth of primarily small neoplastic T-cells with clear cytoplasm that are associated with prominent high endothelial venules and spared secondary lymphoid follicles.

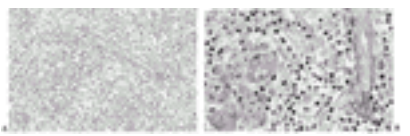


**LYMPHOEPITHELIOID CELL LYMPHOMA** Lymphoepithelioid cell (Lennert) lymphoma ( [242](#), [243](#) and [244](#) ), another specific entity in the updated Kiel classification, is also considered a morphologic variant among PTCL, unspecified in the WHO classification. The most striking histologic feature is the numerous clusters of epithelioid histiocytes that are relatively evenly dispersed throughout tissues obliterated by a lymphomatous infiltrate composed primarily of small neoplastic T-cells. This moderately aggressive lymphoma must be distinguished from some cases of Hodgkin lymphoma, B-cell lymphomas, and other PTCLs that are also accompanied by a high content of epithelioid histiocytes ( [64](#), [245](#), [246](#) and [247](#) ). Misinterpretation as a reactive process may occur when attention is focused on the histiocytes rather than on the lymphoid infiltrate that destroys tissue architecture. When localized, Lennert lymphoma tends to involve the head and neck region, particularly cervical lymph nodes and sometimes Waldeyer ring.

### Angioimmunoblastic T-Cell Lymphoma

Angioimmunoblastic T-cell lymphoma, a specific subtype of PTCL, accounts for approximately 15 to 20% of all PTCLs. It also incorporates angioimmunoblastic lymphadenopathy with dysproteinemia ( [248](#) ) and immunoblastic lymphadenopathy ( [249](#) ), because the clinicopathologic features are similar for each, and most cases of angioimmunoblastic lymphadenopathy with dysproteinemia and immunoblastic lymphadenopathy show T-cell clonality and nonrandom chromosomal abnormalities ( [250](#), [251](#), [252](#) and [253](#) ). Patients with this moderately aggressive lymphoma are typically adults who present with generalized lymphadenopathy, B-symptoms, polyclonal hypergammaglobulinemia, skin rash, and various autoimmune phenomena.

Lymph nodes are usually effaced by a diffuse lymphoproliferation that may extend beyond the capsule into the pericapsular soft tissue. Branching high endothelial venules with hyalinized walls proliferate throughout ( [Fig. 88.9A](#) ). The lymphoid infiltrate often appears hypocellular because of a meshwork of follicular dendritic cells around the vessels and in residual “burned-out” follicle centers ( [251](#) ). The lymphoid infiltrate consists of a mixture of small lymphocytes and immunoblasts, the latter often having clear cytoplasm ( [Fig. 88.9B](#) ). Epithelioid histiocytes, eosinophils, and plasma cells are present in variable proportions, with the latter likely contributing to the hypergammaglobulinemia ( [245](#), [254](#) ).



**Figure 88.9.** Lymph node: angioimmunoblastic T-cell lymphoma. **A:** There is a diffuse lymphoproliferation that is associated with prominent periodic acid-Schiff-staining high endothelial venules. **B:** Perivascular clusters of “clear cell” immunoblasts (*left*) are admixed with small lymphocytes and periodic acid-Schiff-staining high endothelial venules. See [Color Plate](#).

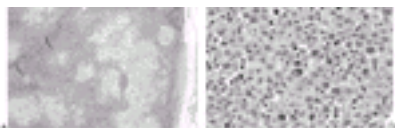
Most angioimmunoblastic T-cell lymphomas have a CD4<sup>+</sup> (helper T-cell) phenotype, and many cases have aberrant T-cell antigen expression. The neoplastic T cells frequently express CD10 ( [255](#) ). Most also demonstrate TCR gene rearrangements. EBV genomes have been detected in B cells and T cells in angioimmunoblastic T-cell lymphoma ( [256](#), [257](#) ). The presence of the EBV genome may be due to the decreased immunocompetence of

these patients ( [256](#) ) or it may be directly involved in lymphomagenesis ( [257](#) ).

## Anaplastic Large Cell Lymphoma

ALCL is typically characterized by an infiltrate of highly pleomorphic large lymphocytes that express strong reactivity with antibodies directed against CD30, a T-cell activation-associated antigen ( [258](#) ). Primary ALCL arises *de novo* and can be subdivided into nodal (systemic) and cutaneous forms ( [259](#) ). Secondary ALCL represents a morphologic (and immunologic) transformation of another T-cell lymphoma, such as mycosis fungoides ( [260](#) ).

Primary systemic ALCL is a moderately aggressive tumor that generally presents in young patients who have peripheral lymphadenopathy and extranodal disease that often includes the skin ( [259](#), [261](#) ). The lymphoma preferentially infiltrates nodal sinuses and extends into the paracortical region, often sparing secondary lymphoid follicles ( [Fig. 88.10A](#) ). The neoplastic large cells seem cohesive and usually have great variability in nuclear appearance, including some that are horseshoe- or doughnut-shaped (“hallmark” cells) or are multinucleate with a resemblance to Reed-Sternberg cells of Hodgkin lymphoma ( [Fig. 88.10B](#) ) ( [262](#) ). These features of the tumor cells are characteristic of the common variant of ALCL with pleomorphic cytology. The common variant, comprising approximately 70% of ALCL, also includes cases with monomorphic cytologic features in which the nuclei are round rather than pleomorphic ( [262](#) ). The chromatin pattern is dispersed (blastlike), and there are often prominent nucleoli. The cytoplasm is abundant, and the mitotic rate is often brisk. The common variant of ALCL may be misdiagnosed as metastatic carcinoma or malignant histiocytosis because of the pleomorphic cytologic features of the tumor cells ( [258](#), [263](#) ). Small cell and lymphohistiocytic variants have been described, each comprising approximately 10% of ALCL ( [264](#), [265](#) ). The latter two variants may be misdiagnosed as an inflammatory process.



**Figure 88.10.** Lymph node: anaplastic large cell lymphoma. **A:** Pale-staining tumor cell infiltrates with a cohesive appearance fill the sinuses. **B:** The lymphoma is composed of pleomorphic large lymphocytes, some of which have the horseshoe- or doughnut-shaped nuclei (*center*) that are characteristic of “hallmark” cells of anaplastic large cell lymphoma. See [Color Plate](#).

Although the tumor cells of ALCL are always CD30<sup>+</sup>, expression of CD30 is not synonymous with a diagnosis of ALCL as this antigen can be detected in some neoplastic cells of other T-cell and B-cell lymphomas and in Reed-Sternberg cells of Hodgkin lymphoma ( [258](#), [266](#) ). Embryonal carcinoma, seminoma, and pancreatic carcinoma may also have some CD30 positivity. ( [267](#), [268](#) and [269](#) ) Furthermore, CD30 is expressed in some florid immunoblastic reactions, such as in infectious mononucleosis ( [270](#), [271](#) ). Most ALCLs have a T-cell phenotype or genotype, but 10 to 15% express B-cell antigens and are included among the DLBCL category in the WHO classification. Another 10 to 20% lack T-cell and B-cell antigens (“null” cell type) but are still grouped with T-cell ALCL. Most ALCLs demonstrate cytotoxic granule-associated proteins that are suggestive of a

cytotoxic lymphocyte origin ( [272](#), [273](#)). Epithelial membrane antigen is frequently expressed by tumor cells of ALCL, particularly the primary systemic cases ( [259](#), [274](#)).

A t(2;5) (p23;q35) chromosomal abnormality is observed in approximately 60% of the primary systemic type of ALCL ( [275](#), [276](#), [277](#) and [278](#)). This translocation fuses the anaplastic lymphoma kinase gene ( *ALK*) on chromosome 2 and the nucleophosmin gene ( *NPM*) on chromosome 5 ( [279](#)). The fusion protein can be detected with a cytoplasmic and nuclear ALK staining pattern by immunohistochemistry ( [280](#)). Approximately 70 to 80% of ALK-positive ALCL have cytoplasmic and nuclear staining, whereas the remainder have cytoplasmic staining only indicating variant translocations involving *ALK* and partner genes other than *NPM* ( [281](#)). Variant *ALK* gene translocations include t(1;2) (q25;p23), which fuses the tropomyosin 3 ( *TPM3*) gene on chromosome 1 and *ALK*; t(2;3) (p23;q21), which involves the *TRK*-fused gene ( *TFG*) on chromosome 3 and *ALK*; inv ( [2](#)) (p23 q35), which involves the *AT1C* gene (encoding for 5-aminoimidazole-4-carboxamide-ribonucleotide) on chromosome 2 and *ALK*; and t(2;17) (p23;q11-qter), which fuses the clathrin heavy chain ( *CLTC*) gene on chromosome 17 and *ALK* ( [282](#), [283](#), [284](#) and [285](#)). The ALK-positive ALCLs have been shown to have a much better 5-year survival than ALK-negative ALCLs ( [286](#), [287](#)).

Primary cutaneous ALCL typically occurs in adults who have localized disease at the time of diagnosis ( [259](#)). This form of ALCL is often indolent and may be an extension of lymphomatoid papulosis type A. The tumor cells generally resemble those of the common variant of primary systemic ALCL and express T-cell antigens. Primary cutaneous ALCL is usually epithelial membrane antigen negative and lacks t(2;5) and ALK expression, suggesting it has a different pathogenetic mechanism than that of primary systemic ALCL ( [259](#), [277](#), [278](#)).

### Adult T-Cell Leukemia/Lymphoma

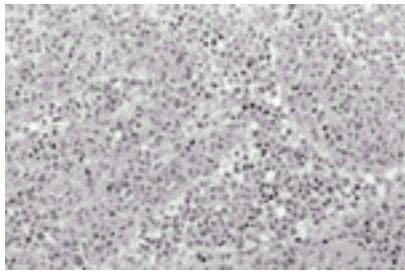
Adult T-cell leukemia/lymphoma (ATLL) is a peripheral T-cell neoplasm caused by HTLV-1 and has four clinical subtypes: acute, chronic, lymphomatous, and smoldering ( [288](#), [289](#), [290](#) and [291](#)). Bone marrow infiltrates are interstitial or diffuse and may be less impressive than the degree of peripheral blood involvement. Circulating tumor cells have hyperlobate nuclei, sometimes with a cloverleaf shape. Lymph nodes are generally effaced by a diffuse infiltrate of pleomorphic lymphocytes of variable size, an appearance that may be difficult to distinguish from some PTCL, unspecified by morphology alone ( [292](#)). Cutaneous infiltrates may be difficult to distinguish from mycosis fungoides, because ATLL can have epidermotropism with formation of Pautrier's microabscesses ( [288](#)). The neoplastic cells express T-cell antigens but often lack CD7. Most cases are CD4<sup>+</sup> and express the activation markers CD25 (interleukin-2 receptor) and HLA-DR. ATLL exhibits TCR gene rearrangements and clonal integration of HTLV-1 genomes ( [291](#)).

### Hepatosplenic T-Cell Lymphoma

Hepatosplenic T-cell lymphoma, an extranodal lymphoma, probably arises from the cytotoxic T<sub>H</sub>1 and a/β T cells of the splenic red pulp ( [293](#)). Despite the few descriptions of hepatosplenic T-cell lymphomas ( [294](#), [295](#), [296](#) and [297](#)), a fairly typical clinicopathologic picture has emerged for these neoplasms. Most cases involve young, adult men who present with B-symptoms, massive hepatosplenomegaly, no lymphadenopathy, moderate anemia, and marked thrombocytopenia. The disease is aggressive, and most patients die

within 2 years, even if a remission is achieved initially with therapy.

This lymphoma preferentially infiltrates the cords and sinuses of the splenic red pulp, hepatic sinusoids, and marrow interstitium ( [Fig. 88.11](#)). A leukemic phase may develop as the disease progresses ( [294](#), [295](#), [296](#) and [297](#)). Tumor cells are generally small to intermediate in size, but some cases may have a predominance of large cells. There are condensed chromatin, indistinct nucleoli, and scant eosinophilic cytoplasm. Circulating tumor cells are generally agranular, but cytoplasmic granules have been detected by electron microscopy in some cases ( [297](#)). There may be an associated hemophagocytosis by benign histiocytes ( [297](#)). The characteristic phenotype is CD2<sup>+</sup>, CD3<sup>+</sup>, CD4<sup>-</sup>, CD5<sup>-</sup>, CD7<sup>+</sup>, and CD8<sup>-</sup>. Most reported cases express TCR  $\gamma/\delta$  chains, but a subset has TCR  $\alpha/\beta$  chains ( [298](#)). The TCR  $\gamma/\delta$  cases are derived preferentially from the V $\delta$ 1 subset of  $\gamma/\delta$  T cells, whereas cases of  $\gamma/\delta$  subcutaneous panniculitis-like T-cell lymphoma appear to be derived from a different  $\gamma/\delta$  T-cell subset that expresses the V $\delta$ 2 gene ( [299](#)). NK-cell-associated antigens, such as CD16 and CD56, and cytotoxic granule-associated proteins are often expressed ( [295](#), [296](#) and [297](#)). TCR gene rearrangements are observed. Karyotypic studies often show isochromosome 7q that may be accompanied by trisomy 8 and loss of a sex chromosome ( [296](#), [297](#) and [298](#), [300](#)).

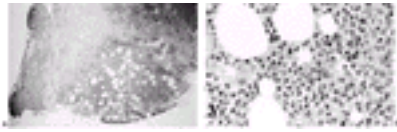


**Figure 88.11.** Spleen: hepatosplenic T-cell lymphoma. Intermediate-size lymphocytes are present throughout the splenic red pulp and markedly expand its sinuses. See [Color Plate](#).

### Subcutaneous Panniculitis-Like T-Cell Lymphoma

Subcutaneous panniculitis-like T-cell lymphoma usually presents as multiple erythematous subcutaneous nodules of variable size (0.5 to 12.0 cm) on the extremities or trunk, or both, of adults ( [301](#), [302](#) and [303](#)). This moderately aggressive lymphoma tends to remain localized to the subcutis throughout the clinical course that may be complicated by a severe, and often fatal, hemophagocytic syndrome.

The lymphoma primarily involves the subcutaneous adipose tissue, where there is a lobular panniculitic infiltrate of pleomorphic lymphocytes of variable size ( [Fig. 88.12](#)). There may be tumor in the deep dermis, but the upper dermis and epidermis are spared. Karyorrhexis and fat necrosis are always present, as are benign histiocytes that often exhibit phagocytosis of nuclear debris or red blood cells. The lymphoma cells express a T-cell phenotype that may be aberrant. Most cases have  $\alpha/\beta$  TCR, and there is heterogeneous expression of CD4 and CD8. The few cases that lack CD4 and CD8 have  $\gamma/\delta$  TCR ( [303](#), [304](#)). These lymphomas contain cytotoxic granule-associated proteins, and some also express NK-cell-associated antigens, usually CD56 ( [303](#)). TCR gene rearrangements have been identified ( [303](#), [305](#)).

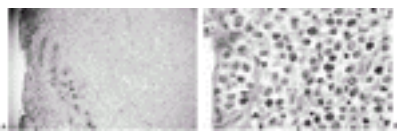


**Figure 88.12.** Skin: subcutaneous panniculitis-like T-cell lymphoma. **A:** There is a lobular panniculitic lymphocytic infiltrate that is confined to the subcutaneous tissue with complete sparing of the dermis. **B:** Pleomorphic tumor cells fill the interstitium and rim some of the fat spaces. See [Color Plate](#).

### Enteropathy-Type T-Cell Lymphoma

Primary intestinal T-cell lymphomas are rare ([306](#)), and most are considered enteropathy-type in the WHO classification. These lymphomas are regarded as *enteropathy-associated* if there is clinical evidence of malabsorption or if there is villous atrophy of the mucosa ([306](#), [307](#)). Most patients are middle-aged to elderly; it is unusual for these lymphomas to present before 40 years of age. The most common presenting symptoms are abdominal pain and weight loss. Diarrhea is present less often but is not infrequent. There may be signs of acute obstruction or spontaneous perforation. Some patients may have a history of celiac disease or other malabsorptive problem. These T-cell lymphomas are aggressive, and most patients die of their disease within 2 years of diagnosis.

The small intestine is primarily involved, with most cases being multifocal in the jejunum. The neoplastic cells always involve the mucosa ([Fig. 88.13](#)). There is often ulceration (*ulcerative jejunitis*), and there may be villous atrophy (*enteropathy-associated* T-cell lymphoma). Lymphoma cells also may infiltrate residual glandular structures producing lymphoepithelial lesions that must be distinguished from those associated with extranodal marginal zone B-cell lymphomas of MALT type. This epitheliotropism also is reminiscent of that seen in the skin in patients with mycosis fungoides ([308](#)). The lymphoma may extend through the bowel wall, resulting in perforation. Regional lymph nodes are often involved. Tumor cells are usually intermediate to large in size with oval to pleomorphic nuclei. There is generally abundant clear to eosinophilic cytoplasm, and azurophilic cytoplasmic granules are occasionally observed on touch imprints of the tumor ([308](#), [309](#) and [310](#)). Mitotic activity is usually brisk. The phenotype is variable but is often CD2<sup>+</sup>, CD3<sup>+</sup>, CD4<sup>-</sup>, CD5<sup>-</sup>, CD7<sup>+</sup>, CD8<sup>-/+</sup>, TCRα/β positive, and TCRγ/d negative. Some cases may be CD30<sup>+</sup> and must be distinguished from ALCL. NK-cell-associated antigen expression, such as CD56, has been described ([309](#), [310](#)). Many cases demonstrate TCR β-chain gene rearrangements. Comparative genomic hybridization has shown chromosomal imbalances in 87% of enteropathy-type T-cell lymphoma with gains at chromosome 9q being the most frequent, by far ([311](#)).



**Figure 88.13.** Small intestine: enteropathy-type T-cell lymphoma. **A:** The small intestinal features are markedly distorted by a lymphomatous infiltrate. There is also loss of the villous pattern at the luminal surface (*left*). **B:** Pleomorphic tumor cells with clear cytoplasm fill the mucosa and replace the glandular epithelium. See [Color Plate](#).



## Extranodal Natural Killer/T-Cell Lymphoma, Nasal Type

Nasal NK/T-cell lymphomas occur in the nasopharyngeal or sinonasal areas and include cases with morphologic features described previously as *polymorphic reticulosis* and *lethal midline granuloma*. These lymphomas are often angiocentric, angioinvasive, and angiodestructive lesions composed of a polymorphic infiltrate of small lymphocytes and immunoblasts with significant cytologic atypia ( [312](#), [313](#) ). The lymphoid infiltrate often occludes vessels producing areas of ischemic necrosis. The clinical course is typically aggressive. These lymphomas are observed most frequently in east Asia and are rare in the United States and Europe. Any age group can be affected.

Recent studies have shown these lymphomas are true NK-cell lymphomas or cytotoxic PTCL. Most cases express NK-cell-associated antigens, particularly CD56, and some contain azurophilic cytoplasmic granules on Romanowsky-type-stained smears or cytotoxic granule-associated proteins recognized by immunohistochemistry ( [312](#), [313](#), [314](#) and [315](#) ). The true NK-cell lymphomas lack TCR gene rearrangements, whereas the few well-defined T-cell cases demonstrate TCR gene rearrangements or transcripts ( [312](#), [313](#), [314](#) and [315](#) ). Most of these lymphomas are EBV associated ( [313](#), [315](#) and [316](#) ).

Nonnasal NK/T-cell lymphomas may be called *extranodal NK- and T-cell lymphomas, nasal type*, because they share many of the features of the more commonly occurring NK/T-cell lymphomas in the nasal region ( [317](#) ). Skin, soft tissue, gastrointestinal tract, and testis are the most frequent nonnasal extranodal sites involved by NK/T-cell lymphomas. Some cutaneous and subcutaneous NK/T-cell lymphomas may represent secondary spread from nasal NK/T-cell lymphomas. Cutaneous cases are generally true NK-cell lymphomas ( [318](#), [319](#), [320](#) and [321](#) ). Most express CD56, and azurophilic cytoplasmic granules are often present. There is also a high degree of association with EBV, particularly those of apparent, true NK-cell origin ( [322](#) ).

## NATURAL KILLER-CELL LYMPHOMAS

True NK-cell lymphomas are typically CD56<sup>+</sup> and express some T-cell antigens, including cytoplasmic CD3, the latter due to the presence of truncated CD3ε in the cytoplasm ( [323](#) ). NK-cell lymphomas lack surface CD3 and α/β and γ/d chains of the TCR and do not rearrange their TCR genes ( [323](#) ). NK-cell lymphomas are rare outside east Asia. Many are found in the nasal region or skin, as discussed previously. A few NK-cell neoplasms present as lymphoblastic lymphomas, as mentioned previously. Rare NK-cell neoplasms present as an aggressive nonlymphoblastic leukemia/lymphoma that often involve young adult men ( [324](#), [325](#) ). These patients generally have fever, moderate hepatosplenomegaly, variable lymphadenopathy, and pancytopenia that may precede the overt leukemic phase. The tumor cells are atypical large lymphocytes with azurophilic cytoplasmic granules on Romanowsky-type-stained touch imprints or smears of the tumor.

## REFERENCES

1. Picker LJ, Weiss LM, Medeiros LJ, et al. Immunophenotypic criteria for the diagnosis of non-Hodgkin's lymphoma. *Am J Pathol* 1987;128:181-201.
2. Jamal S, Picker LJ, Aquino DB, et al. Immunophenotypic analysis of peripheral T-cell neoplasms. *Am J*

Clin Pathol 2001;116:512–526.

3. Palutke M, Schnitzer B, Mirchandani I, et al. Increased numbers of lymphocytes with single class surface immunoglobulins in reactive hyperplasia of lymphoid tissue. *Am J Clin Pathol* 1982;78:316–323.
4. Chamberlain WD, Falta MT, Kotzin BL. Functional subsets within clonally expanded CD8+ memory T cells in elderly humans. *Clin Immunol* 2000;94(3):160–172.
5. Fishleder A, Tubbs R, Hesse B, et al. Uniform detection of immunoglobulin–gene rearrangement in benign lymphoepithelial lesions. *N Engl J Med* 1987;316:1118–1121.
6. Kurtin PJ, Pinkus GS. Leukocyte common antigen—a diagnostic discriminant between hematopoietic and nonhematopoietic neoplasms in paraffin sections using monoclonal antibodies: correlation with immunologic studies and ultrastructural localization. *Hum Pathol* 1985;16:353–365.
7. Weiss LM, Arber DA, Chang KL. CD45. A review. *Appl Immunohistochem Mol Morphol* 1993;1:166–181.
8. Cabeçadas JM, Isaacson PG. Phenotyping of T–cell lymphomas in paraffin sections— which antibodies? *Histopathology* 1991;19:419–424.
9. Segal GH, Stoler MH, Fishleder AJ, et al. Reliable and cost–effective paraffin section immunohistology of lymphoproliferative disorders. *Am J Surg Pathol* 1991;15:1034–1041.
10. Kurtin PJ, Roche PC. Immunoperoxidase staining of non–Hodgkin’s lymphomas for T–cell lineage associated antigens in paraffin sections. *Am J Surg Pathol* 1993;17:898–904.
11. Chadburn A, Knowles DM. Paraffin–resistant antigens detectable by antibodies L26 and polyclonal CD3 predict the B– or T–cell lineage of 95% of diffuse aggressive non–Hodgkin’s lymphomas. *Am J Clin Pathol* 1994;102:284–291.
12. Sukpanichnant S, Vnencak–Jones CL, McCurley TL. Determination of B–cell clonality in paraffin–embedded endoscopic biopsy specimens of abnormal lymphocytic infiltrates and gastrointestinal lymphoma by polymerase chain reaction. *Am J Clin Pathol* 1994;102:299–305.
13. Remstein ED, Kurtin PJ, Buño I, et al. Diagnostic utility of fluorescence *in situ* hybridization in mantle–cell lymphoma. *Br J Haematol* 2000;110:856–862.
14. Cataldo KA, Jalal SM, Law ME, et al. Detection of t(2;5) in anaplastic large cell lymphoma: comparison of immunohistochemical studies, FISH, and RT–PCR in paraffin–embedded tissue. *Am J Surg Pathol* 1999;23:1386–1392.
15. McClure R, Macon W, Remstein E, et al. Burkitt–like lymphoma and diffuse large B–cell lymphoma in adults form a continuum that is distinct from classical Burkitt lymphoma. *J Clin Pathol* 2002;55[Suppl 1]:A21–A22(abst).
16. Macon WR, Meyer RG, Levy NB, et al. Isochromosome 7q and/or trisomy 8 are commonly detected in hepatosplenic alpha–beta T–cell lymphomas by fluorescent *in situ* hybridization. *Mod Pathol* 2002;15(1):253A(abst).
17. Remstein ED, Kurtin PJ, James CD, et al. Mucosa–associated lymphoid tissue lymphomas with t(11;18) (q21;q21) and mucosa–associated lymphoid tissue lymphomas with aneuploidy develop along different pathogenetic pathways. *Am J Pathol* 2002;161:63–71.
18. Paternoster SF, Brockman SR, McClure RF, et al. A new method to extract nuclei from paraffin–embedded tissue to study lymphomas using interphase fluorescence *in situ* hybridization. *Am J Pathol* 2002;160:1967–1972.
19. Rappaport H, Winter WJ, Hicks EB. Follicular lymphoma: a re–evaluation of its position in the scheme of malignant lymphoma, based on a survey of 253 cases. *Cancer* 1956;9:792–821.
20. Rappaport H. Tumors of the hematopoietic system. Atlas of tumor pathology, Section 3, Fascicle 8. Washington, DC: US Armed Forces Institute of Pathology, 1966.
21. Lukes RJ, Collins RD. Immunologic characterization of human malignant lymphomas. *Cancer*



1974;34:1488–1503.

22. Lennert K, Mohri N, Stein H, et al. The histopathology of malignant lymphoma. *Br J Haematol* 1975;31[Suppl]:193–203.
23. Bloomfield CD, et al. Clinical utility of lymphocyte surface markers combined with the Lukes–Collins histologic classification in adult lymphoma. *N Engl J Med* 1979;301:512.
24. Doggett RS, et al. The immunologic characterization of 95 nodal and extranodal diffuse large cell lymphomas in 89 patients. *Am J Pathol* 1984;115:245.
25. Schuurman HJ, et al. Immunophenotyping of non–Hodgkin’s lymphoma: lack of correlation between immunophenotype and cell morphology. *Am J Pathol* 1987;129:140.
26. Non–Hodgkin’s lymphoma pathologic classification project. National cancer institute sponsored study of classifications of non–Hodgkin’s lymphomas: summary and description of a working formulation for clinical usage. *Cancer* 1982;49:2112–2135.
27. Harris NL, Jaffe ES, Stein H, et al. A revised European–American classification of lymphoid neoplasms: a proposal from the International Lymphoma Study Group. *Blood* 1994;84:1361–1392.
28. Jaffe ES, Harris NL, Stein H, et al, eds. World Health Organization classification of tumours. Pathology and genetics of tumours of haematopoietic and lymphoid tissues. Lyon: IARC Press, 2001.
29. Sheibani K, Nathwani BN, Winberg CD, et al. Antigenically defined subgroups of lymphoblastic lymphoma. *Cancer* 1987;60:183–190.
30. Sander CA, Medeiros LJ, Abruzzo LV, et al. Lymphoblastic lymphoma presenting in cutaneous sites. *J Am Acad Dermatol* 1991;25:1023–1031.
31. Picozzi VJ Jr, Coleman CN. Lymphoblastic lymphoma. *Semin Oncol* 1990;17:96–103.
32. Lin P, Jones D, et al. Precursor B–cell lymphoblastic lymphoma. *Am J Surg Pathol* 2000;24(11):1480–1490.
33. Maitra A, McKenna RW, et al. Precursor B–cell lymphoblastic lymphoma. *Am J Clin Pathol* 2001;115:868–875.
34. Stroup R, Sheibani K, Misset J–L, et al. Surface immunoglobulin–positive lymphoblastic lymphoma. A report of three cases. *Cancer* 1990;65:2559–2563.
35. Cheng A–L, Su I–J, Tien H–F, et al. Characteristic clinicopathologic features of adult B–cell lymphoblastic lymphoma with special emphasis on differential diagnosis with an atypical form probably of blastic lymphocytic lymphoma of intermediate differentiation origin. *Cancer* 1994;73:706–710.
36. Millot F, Robert A, et al. Cutaneous involvement in children with acute lymphoblastic leukemia or lymphoblastic lymphoma. *Pediatrics* 1997;100:60–64.
37. Rozman C, Montserrat E. Chronic lymphocytic leukemia. *N Engl J Med* 1995;333:1052–1057.
38. Lennert K, Feller AC. Histopathology of non–Hodgkin’s lymphomas (based on the updated Kiel Classification), 2nd ed. New York: Springer–Verlag, 1992:54–60.
39. Ben–Ezra J, Burke JS, Schwartz WG, et al. Small lymphocytic lymphoma: a clinicopathologic analysis of 268 cases. *Blood* 1989;73:579–587.
40. Pugh WC, Manning JT, Butler JJ. Paraimmunoblastic variant of small lymphocytic lymphoma/leukemia. *Am J Surg Pathol* 1988;12:907–917.
41. Lennert K, Tamm I, Hans–Heinrich W. Histopathology and immunocytochemistry of lymph node biopsies in chronic lymphocytic leukemia and immunocytoma. *Leuk Lymphoma* 1991;[Suppl]:147–160.
42. Ludescher C, Gattringer C, Weger AR, et al. Surface immunoglobulin density in the differential

- diagnosis of B-cell chronic lymphocytic leukemia and leukemic immunocytoma. *Leuk Res* 1992;16:191-196.
43. Foon KA, Thiruvengadam R, Saven A, et al. Genetic relatedness of lymphoid malignancies: transformation of chronic lymphocytic leukemia as a model. *Ann Intern Med* 1993;119:63-73.
  44. Robertson LE, Pugh W, O'Brien S, et al. Richter's syndrome: a report on 39 patients. *J Clin Oncol* 1993;11:1985-1989.
  45. Ghani AM, Krause JR, Brody JP. Polymphocytic transformation of chronic lymphocytic leukemia: a report of three cases and review of the literature. *Cancer* 1986;57:75-80.
  46. Choi H, Keller RH. Coexistence of chronic lymphocytic leukemia and Hodgkin's disease. *Cancer* 1981;48:48-57.
  47. Momose H, Jaffe ES, Shin SS, et al. Chronic lymphocytic leukemia/small lymphocytic lymphoma with Reed-Sternberg-like cells and possible transformation to Hodgkin's disease. *Am J Surg Pathol* 1992;16:859-867.
  48. Batata A, Shen B. Relationship between chronic lymphocytic leukemia and small lymphocytic lymphoma. *Cancer* 1992;70:625-632.
  49. Kilo MN, Dorfman DM. The utility of flow cytometric immunophenotypic analysis in the distinction of small lymphocytic lymphoma/chronic lymphocytic leukemia from mantle cell lymphoma. *Am J Clin Pathol* 1996;105:451-457.
  50. Caligaris-Cappio F. B-chronic lymphocytic leukemia: a malignancy of anti-self B cells. *Blood* 1996;87:2615-2620.
  51. Kipps TJ, Carson DA. Autoantibodies in chronic lymphocytic leukemia and related systemic autoimmune disease. *Blood* 1993;81:2475-2487.
  52. Juliusson G, Oscier DG, Fitchett M, et al. Prognostic subgroups in B-cell chronic lymphocytic leukemia defined by specific chromosomal abnormalities. *N Engl J Med* 1990;323:720-724.
  53. Finn WG, Thangavelu M, Yelavarthi KK, et al. Karyotype correlates with peripheral blood morphology and immunophenotype in chronic lymphocytic leukemia. *Am J Clin Pathol* 1996;105:458-467.
  54. Damle RN, Wasil T, et al. Ig V gene mutation status and CD38 expression as novel prognostic indicators in chronic lymphocytic leukemia. *Blood* 1999;6:1840-1847.
  55. Oscier DG, Gardiner AC, et al. Multivariate analysis of prognostic factors in CLL: clinical stage, IGVH gene mutational status, and loss or mutation of the P53 gene are independent prognostic factors. *Blood* 2002;100:1177-1184.
  56. Krober A, Seiler T, et al. Vh mutation status, CD38 expression level, genomic aberrations, and survival in chronic lymphocytic leukemia. *Blood* 2002;100: 1410-1416.
  57. Hamblin TJ, Davis Z, et al. Unmutated Ig Vh genes are associated with a more aggressive form of chronic lymphocytic leukemia. *Blood* 1999;94:1848-1854.
  58. Crespo M, Bosch F, Villamor N, et al. ZAP-70 expression as a surrogate for immunoglobulin-variable-region mutations in chronic lymphocytic leukemia. *N Engl J Med* 2003;348:1764-1775.
  59. Finkel HE, Raje N. Case 27-2001: Waldenström's macroglobulinemia. *N Engl J Med* 2002;346:784.
  60. Kyrtsolis MC, Vassilakopoulos TP, et al. Waldenström's macroglobulinemia: clinical course and prognostic factors in 60 patients. Experience from a single hematology unit. *Ann Hematol* 2001;80:722-727.
  61. McCurley TL, Collins RD, Ball E, et al. Nodal and extranodal lymphoproliferative disorders in Sjögren's syndrome: a clinical and immunopathologic study. *Hum Pathol* 1990;21:482-492.
  62. Silvestri F, Pipan C, Barillari G, et al. Prevalence of hepatitis C virus infection in patients with

lymphoproliferative disorders. *Blood* 1996;87:4296–4301.

63. Harris NL, Bhan AK. B-cell neoplasms of the lymphocytic, lymphoplasmacytoid, and plasma cell types: immunohistologic analysis and clinical correlation. *Hum Pathol* 1985;16:829–837.

64. Patsouris E, Noël H, Lennert K. Lymphoplasmacytic/lymphoplasmacytoid immunocytoma with a high content of epithelioid cells. *Am J Surg Pathol* 1990;14:660–670.

65. Andriko JA, Swerdlow SH, et al. Is lymphoplasmacytic lymphoma/immunocytoma a distinct entity? *Am J Surg Pathol* 2001;25(6):742–751.

66. Abe M, Takahashi K, Mori N, et al. “Waldenström’s macroglobulinemia” terminating in immunoblastic sarcoma: a case report. *Cancer* 1982;49:2580–2586.

67. Eisterer W, Hilbe W, Fend F, et al. Identification of a favorable subgroup of patients with generalized immunocytomas by follicular dendritic cells. *Leukemia* 1995;9:254–259.

68. Levine AM, Lichtenstein A, Gresik MV, et al. Clinical and immunologic spectrum of plasmacytoid lymphocytic lymphoma without serum monoclonal IgM. *Br J Haematol* 1980;46:225–233.

69. Iida S, Rao PH, Nallasivam P, et al. The t(9;14)(p13;q32) chromosomal translocation associated with lymphoplasmacytoid lymphoma involves the PAX-5 gene. *Blood* 1996;88:4110–4117.

70. Aoki H, Takishita M, Kosaka M, et al. Frequent somatic mutations in V and/or JH segments of Ig gene in Waldenström’s macroglobulinemia and chronic lymphocytic leukemia with Richter’s syndrome but not in common CLL. *Blood* 1995;85:1913–1919.

71. Sahota SS, Forconi F, et al. Typical Waldenström macroglobulinemia is derived from a B-cell arrested after cessation of somatic mutation but prior to isotype switch events. *Blood* 2002;100(4):1505–1507.

72. Banks PM, Chan J, Cleary ML, et al. Mantle cell lymphoma: a proposal for unification of morphologic, immunologic, and molecular data. *Am J Surg Pathol* 1992;16:637–640.

73. Raffeld M, Sander CA, Yano T, et al. Mantle cell lymphoma: an update. *Leuk Lymphoma* 1992;8:161–166.

74. Ott MM, Ott G, Kuse R, et al. The anaplastic variant of centrocytic lymphoma is marked by frequent rearrangements of the bcl-1 gene and high proliferation indices. *Histopathology* 1994;24:329–334.

75. Schlette E, Lai R, et al. Leukemic mantle cell lymphoma: clinical and pathologic spectrum of twenty-three cases. *Mod Pathol* 2001;14:1133–1140.

76. Weisenburger DD, Armitage JO. Mantle cell lymphoma—an entity comes of age. *Blood* 1996;87:4483–4494.

77. Yatabe Y, Suzuki R, et al. Significance of cyclin D1 overexpression for the diagnosis of mantle cell lymphoma: a clinicopathologic comparison of cyclin D1-positive MCL and cyclin D1-negative MCL-like B-cell lymphoma. *Blood* 2000;95(7):2253–2261.

78. Yatabe Y, Suzuki R, et al. Morphological spectrum of cyclin D1-positive mantle cell lymphoma: study of 168 cases. *Pathol Int* 2001;51:747–761.

79. Lennert K. Malignant lymphomas other than Hodgkin’s disease. Berlin, Germany: Springer-Verlag, 1978:284.

80. CBernard M, Gressin R, Lefrere F, et al. Blastic variant of mantle cell lymphoma: a rare but highly aggressive subtype. *Leukemia* 2001;15:1785–1791.

81. Liu Z, Dong HY, Gorczyca W, et al. CD5-mantle cell lymphoma. *Am J Clin Pathol* 2002;118:216–224.

82. Sanchez ML, Almeida J, Vidriales B, et al. Incidence of phenotypic aberrations in a series of 467 patients with B chronic lymphoproliferative disorders: basis for the design of specific four-color stainings to

be used for minimal residual disease investigation. *Leukemia* 2002;16(8):1460–1469.

83. Zukerberg LR, Yang WI, et al. Cyclin D1 expression in non-Hodgkin's lymphomas: detection by immunohistochemistry. *Am J Clin Pathol* 1995;103(6):756–780.

84. Swerdlow SH, Zukerberg LR, Yang W-I, et al. The morphologic spectrum of non-Hodgkin's lymphomas with BCL-1/Cyclin D1 gene rearrangements. *Am J Surg Pathol* 1996;20:627–640.

85. Williams ME, Zukerberg LR, Harris NL, et al. Mantle cell/centrocytic lymphoma: molecular and phenotypic analysis including analysis of the bcl-1 major translocation cluster by PCR. *Curr Top Microbiol Immunol* 1995;194:341–346.

86. Segal GH, Masih AS, Fox AC, et al. CD5-expressing B-cell non-Hodgkin's lymphomas with bcl-1 gene rearrangement have a relatively homogeneous immunophenotype and are associated with an overall poor prognosis. *Blood* 1995;85:1570–1579.

87. Greiner TC, Moynihan MJ, Chan WC, et al. p53 mutations in mantle cell lymphoma are associated with variant cytology and predict a poor prognosis. *Blood* 1996;87:4302–4310.

88. Nathwani BN, Drachenberg MR, et al. Nodal monocytoid B-cell lymphoma (nodal marginal-zone B-cell lymphoma). *Semin Hematol* 1999;36(2):128–138.

89. Ngan BY, Warnke RA, et al. Monocytoid B-cell lymphoma: a study of 36 cases. *Hum Pathol* 1991;22(5):409–421.

90. Davis GG, York JC, et al. Plasmacytic differentiation in parafollicular (monocytoid) B-cell lymphoma: a study of 12 cases. *Am J Surg Pathol* 1992;16:1066–1074.

91. Campo E, Miquel R, et al. Primary nodal marginal zone lymphomas of splenic and MALT type. *Am J Surg Pathol* 1999;23(1):59–68.

92. Conconi A, Bertoni F, et al. Nodal marginal zone B-cell lymphomas may arise from different subsets of marginal zone B lymphocytes. *Blood* 2001;98(3):781–786.

93. Schmid C, Kirkham N, Diss T, et al. Splenic marginal zone lymphoma. *Am J Surg Pathol* 1992;16:455–466.

94. Pawade J, Wilkins BS, Wright DH. Low-grade B-cell lymphomas of the splenic marginal zone: a clinicopathological and immunohistochemical study of 14 cases. *Histopathology* 1995;27:129–137.

95. Hammer RD, Glick AD, Greer JP, et al. Splenic marginal zone lymphoma: a distinct B-cell neoplasm. *Am J Surg Pathol* 1996;20:613–626.

96. Van Huyen JPD, Molina T, et al. Splenic marginal zone lymphoma with or without plasmacytic differentiation. *Am J Surg Pathol* 2000;24(12):1581–1592.

97. Camacho FI, Mollejo M, et al. Progression to large B-cell lymphoma in splenic marginal zone lymphoma. *Am J Surg Pathol* 2001;25(10):1268–1276.

98. Sole F, Woessner S, et al. Frequent involvement of chromosomes 1, 3, 7, and 8 in splenic marginal zone B-cell lymphoma. *Br J Haematol* 1997;98:446–449.

99. Mateo M, Mollejo M, et al. 7q31–32 allelic loss is a frequent finding in splenic marginal zone lymphoma. *Am J Pathol* 1999;154(5):1583–1589.

100. Algara P, Mateo M, et al. Analysis of the IgVh somatic mutations in splenic marginal zone lymphoma defines a group of unmutated cases with frequent 7q deletion and adverse clinical course. *Blood* 2002;99(4):1299–1304.

101. Isaacson PG. Lymphomas of mucosa-associated lymphoid tissue (MALT). *Histopathology* 1990;16:617.

102. Isaacson PG, Matutes E, Burke M, et al. The histopathology of splenic lymphoma with villous

lymphocytes. *Blood* 1994;84:3828–3834.

103. Harris N. Extranodal lymphoid infiltrates and mucosa-associated lymphoid tissue (MALT). A unifying concept. *Am J Surg Pathol* 1991;15:879–884.

104. Pelstring RJ, Essell JH, Kurtin PJ, et al. Diversity of organ site involvement among malignant lymphomas of mucosa-associated tissues. *Am J Clin Pathol* 1991;96:738–745.

105. Wotherspoon AC, Ortiz-Hidalgo C, Falzon MR, et al. *Helicobacter pylori*-associated gastritis and primary B-cell gastric lymphoma. *Lancet* 1991;338: 1175–1176.

106. Cavalli F, Isaacson PG, et al. MALT lymphomas. *Hematology* 2001;241(1):1–30.

107. Papadaki L, Wotherspoon AC, Isaacson PG. The lymphoepithelial lesion of gastric low-grade B-cell lymphoma of mucosa-associated lymphoid tissue (MALT): an ultrastructural study. *Histopathology* 1992;21:415–421.

108. Isaacson PG, Wotherspoon AC, Diss T, et al. Follicular colonization in B-cell lymphoma of mucosa-associated lymphoid tissue. *Am J Surg Pathol* 1991;15:819–828.

109. Chan JKC, Ng CS, Isaacson PG. Relationship between high-grade lymphoma and low grade B-cell mucosa-associated lymphoid tissue lymphoma (MALToma) of the stomach. *Am J Pathol* 1990;136:1153–1164.

110. Streubel B, Lamprecht A, et al. T(14;18)(q32;q21) involving IGH and MALT1 is frequent chromosomal aberration in MALT lymphoma. *Blood* 2003;101:2335–2339.

111. Remstein ED, James CD, et al. Incidence and subtype specificity of API2–MALT1 fusion translocations in extranodal, nodal, and splenic marginal zone lymphomas. *Am J Pathol* 2000;156:1183–1188.

112. Alpen B, Stolte M, et al. Translocation t(11;18) absent in early gastric marginal zone B-cell lymphomas of MALT type responding to eradication of *Helicobacter pylori* infection. *Blood* 2000;95(12):4014–4015.

113. Baens M, Maes B, et al. The product of the t(11;18), an API2–MLT fusion, marks nearly half of gastric MALT type lymphomas without large cell proliferation. *Am J Pathol* 2000;156:1433–1439.

114. Starostik P, Patzner J, et al. Gastric marginal zone B-cell lymphomas of MALT type develop along 2 distinct pathogenetic pathways. *Blood* 2002;99(1):3–9.

115. Lorsbach RB, Shay–Seymore D, et al. Clinicopathologic analysis of follicular lymphoma occurring in children. *Blood* 2002;99(6):1959–1964.

116. Goodlad JR, Krajewski AS, et al. Primary cutaneous follicular lymphoma: a clinicopathologic and molecular study of 16 cases in support of a distinct entity. *Am J Surg Pathol* 2002;26(6):733–741.

117. Liu Y–J, Johnson GD, Gordon J, et al. Germinal centers in T–cell–dependent antibody responses. *Immunol Today* 1992;13:17–21.

118. Liu Y–J, Banchereau J. The paths and molecular controls of peripheral B–cell development. *Immunologist* 1996;4:55–66.

119. Kupperts R, Klein U, et al. Cellular origin of human B–cell lymphomas. *N Engl J Med* 1999;341(20):1520–1529.

120. Korsmeyer SJ. Bcl–2 initiates a new category of oncogenes: regulators of cell death. *Blood* 1992;80:879–886.

121. Bahler DW, Levy R. Clonal evolution of a follicular lymphoma: evidence for antigen selection. *Proc Natl Acad Sci U S A* 1992;89:6770–6774.

122. Zhu D, Hawkins RE, Hamblin TJ, et al. Clonal history of a human follicular lymphoma as revealed in

the immunoglobulin variable region genes. *Br J Haematol* 1994;86:505–512.

123. Stamatopoulos K, Kosmas C, Belessi C, et al. Molecular insights into the immunopathogenesis of follicular lymphoma. *Immunol Today* 2000;21:298–305.

124. Brauninger A, Hansman ML, et al. Identification of common germinal center B-cell precursors in two patients with both Hodgkin disease and non-Hodgkin lymphoma. *N Engl J Med* 1999;340(16):1239–1282.

125. Kuppers R, Dalla-Favers R. Mechanisms of chromosomal translocations in B-cell lymphomas. *Oncogene* 2001;20:5580–5594.

126. Stein RS, Cousar J, Flexner JM, et al. Malignant lymphomas of follicular center cell origin in man. III. Prognostic features. *Cancer* 1979;44:2236–2243.

127. Martin AR, Weisenburger DD, Chan WC, et al. Prognostic value of cellular proliferation and histologic grade in follicular lymphoma. *Blood* 1995;85:3671–3678.

128. Paryani SB, Hoppe RT, Cox RS, et al. Analysis of non-Hodgkin's lymphomas with nodular and favorable histologies, stages I and II. *Cancer* 1983;52:2300–2307.

129. Bartlett NL, Rizeqi M, Dorfman RF, et al. Follicular large-cell lymphoma: intermediate or low grade? *J Clin Oncol* 1994;12:1349–1357.

130. Nathwani BN, Metter GE, Miller TP, et al. What should be the morphologic criteria for the subdivision of follicular lymphomas? *Blood* 1986;68:837–845.

131. Coiffier B, Bastion Y, Berger F, et al. Prognostic factors in follicular lymphomas. *Semin Oncol* 1993;20:89–95.

132. Metter GE, Nathwani BN, Burke JS, et al. Morphological subclassification of follicular lymphoma: variability of diagnoses among hematopathologists, a collaborative study between the repository center and pathology panel for lymphoma clinical studies. *J Clin Oncol* 1985;3:25–38.

133. Weisenburger DD, Chan WC. Lymphomas of follicles. Mantle cell and follicle center cell lymphomas. *Am J Clin Pathol* 1993;99:409–420.

134. Yegappan S, Schnitzer B, et al. Follicular lymphoma with marginal zone differentiation: microdissection demonstrates the t(14;18) in both the follicular and marginal zone components. *Mod Pathol* 2001;14:191–196.

135. Ott G, Katzenberger T, et al. Cytomorphologic, immunohistochemical, and cytogenetic profiles of follicular lymphoma: 2 types of follicular lymphoma grade 3. *Blood* 2002;99(10):3806–3812.

136. Strauchen JA, Young RC, DeVita VT Jr, et al. Clinical relevance of the histopathological subclassification of diffuse "histiocytic" lymphoma. *N Engl J Med* 1978;299:1382–1387.

137. Stein RS, Greer JP, Flexner JM, et al. Large-cell lymphomas: clinical and prognostic features. *J Clin Oncol* 1990;8:1370–1379.

138. Waldron JA, Newcomer LN, Katz ME, et al. Sclerosing variants of follicular center cell lymphomas presenting in the retroperitoneum. *Cancer* 1983;52:712–720.

139. McCurley TL, Gay RE, Gay S, et al. The extracellular matrix in "sclerosing" follicular center cell lymphomas: an immunohistochemical and ultrastructural study. *Hum Pathol* 1986;17:930–938.

140. Cleary KR, Osborne BM, Butler JJ. Lymph node infarction foreshadowing malignant lymphoma. *Am J Surg Pathol* 1982;6:435–442.

141. Laszewski MJ, Belding PJ, Feddersen RM, et al. Clonal immunoglobulin gene rearrangement in infarcted lymph node syndrome. *Am J Clin Pathol* 1991;96:116–120.

142. Keith TA, Cousar JB, Glick AD, et al. Plasmacytic differentiation in follicular center cell (FCC)

lymphomas. *Am J Clin Pathol* 1985;84:283–290.

143. Kim H, Dorfman RF, Rappaport H. Signet ring cell lymphoma: a rare morphologic and functional expression of nodular (follicular) lymphoma. *Am J Surg Pathol* 1978;2:119–131.

144. Hauptman SP, Mintzer DM. Lymphosarcoma cell leukemia and other non-Hodgkin's lymphomas in leukemic phase. *Am J Med* 1983;75:110–120.

145. Yuen AR, Kamel OW, Halpern J, et al. Long-term survival after histologic transformation of low-grade follicular lymphoma. *J Clin Oncol* 1995;13:1726–1733.

146. Cullen MH, Lister TA, Brearley RL, et al. Histological transformation of non-Hodgkin's lymphoma. A prospective study. *Cancer* 1979;44:645–651.

147. Hubbard SM, Chabner BA, DeVita VT Jr, et al. Histologic progression in non-Hodgkin's lymphoma. *Blood* 1982;258–264.

148. Horning SJ, Rosenberg SA. The natural history of initially untreated low-grade non-Hodgkin's lymphomas. *N Engl J Med* 1984;311:1471–1475.

149. Hans CP, Weisenburger DD, et al. A significant diffuse component predicts for inferior survival in grade 3 follicular lymphoma, but cytological subtypes do not predict survival. *Blood* 2003;101:2363–2367.

150. Natkunam Y, Warnke R, et al. Blastic/blastoid transformation of follicular lymphoma. *Am J Surg Pathol* 2000;24(4):525–534.

151. Harris NL, Nadler LM, Bhan AK. Immunohistologic characterization of two malignant lymphomas of germinal center type (centroblastic/centrocytic and centrocytic) with monoclonal antibodies. *Am J Pathol* 1984;117:262–272.

152. Esho C, Perkins S, et al. Decreased CD10 expression in grade III and in interfollicular infiltrates of follicular lymphomas. *Am J Clin Pathol* 2001;115:862–867.

153. Tiesinga JJ, Wu CD, et al. CD5+ follicle center lymphoma. *Am J Clin Pathol* 2002;114(6):912–921.

154. Barekman CL, Aguilera NSI, et al. Low-grade B-cell lymphoma with co-expression of both CD5 and CD10. *Arch Pathol Lab Med* 2001;125:951–953.

155. Gaulard P, d'Agay M-F, Peuchmaur M, et al. Expression of the bcl-2 gene product in follicular lymphoma. *Am J Pathol* 1991;140:1089–1095.

156. Sander CQ, Yano T, Clark HM, et al. p53 mutation is associated with progression in follicular lymphomas. *Blood* 1993;82:1994–2004.

157. Nguyen PL, Zukerberg LR, Benedict WF, et al. Immunohistochemical detection of p53, bcl-2 and retinoblastoma proteins in follicular lymphoma. *Am J Clin Pathol* 1996;105:538–543.

158. Swerdlow SH, Murray LJ, Habeshaw JA, et al. B- and T-cell subsets in follicular centroblastic/centrocytic (cleaved follicular center cell) lymphoma: an immunohistologic analysis of 26 lymph nodes and three spleens. *Hum Pathol* 1985;16:339–352.

159. Yunis JJ, Frizzera G, Oken MM, et al. Multiple recurrent genomic defects in follicular lymphoma. A possible model for cancer. *N Engl J Med* 1987;316:79–84.

160. Weiss LM, Warnke RA, Sklar J, et al. Molecular analysis of the t(14;18) chromosomal translocation in malignant lymphomas. *N Engl J Med* 1987;317:1185–1189.

161. Mohamed A, Margarita P, et al. Chromosomal analyses of 52 cases of follicular lymphoma with t(14;18), including blastic/blastoid variant. *Cancer Genet Cytogenet* 2002;126:45–51.

162. Martinez-Climent JA, Alizadeh AA, et al. Transformation of follicular lymphoma diffuse large cell lymphoma is associated with a heterogeneous set of DNA copy number and gene expression alterations.



Blood 2002;10:1182.

163. Raphael M, Gentilhomme O, et al. Histopathologic features of high-grade non-Hodgkin's lymphomas in acquired immunodeficiency syndrome. *Arch Pathol Lab Med* 1991;115:15-20.

164. Magrath IT. African Burkitt's lymphoma. *Am J Pediatr Hematol Oncol* 1991;13(2):222-246.

165. Sandlund JT, Downing JR, Crist WM. Non-Hodgkin's lymphoma in childhood. *N Engl J Med* 1996;334:1238-1248.

166. Pavlova Z, Parker JW, Taylor CR, et al. Small noncleaved follicular center cell lymphoma: Burkitt's and non-Burkitt's variants in the US. *Cancer* 1987;59:1892-1902.

167. Wilson JF, Kjeldsberg K, Sposto R, et al. The pathology of non-Hodgkin's lymphoma of childhood. II. Reproducibility and relevance of the histologic classification of "undifferentiated" lymphomas (Burkitt's versus non-Burkitt's). *Hum Pathol* 1987;18:1008-1014.

168. Hutchison RE, Murphy SB, Fairclough D, et al. Diffuse small noncleaved cell lymphoma in children, Burkitt's versus non-Burkitt's types. Results from the Pediatric Oncology Group and St. Jude Children's Research Hospital. *Cancer* 1989;64:23-28.

169. Gregory CD, Tursz T, Edwards CF, et al. Identification of a subset of normal B cells with a Burkitt's lymphoma (BL)-like phenotype. *J Immunol* 1987;139:313-318.

170. Mann RB, Jaffe ES, Braylan RC, et al. Non-endemic Burkitt's lymphoma: a B-cell tumor related to germinal centers. *N Engl J Med* 1976;295:685-691.

171. Oviatt DL, Cousar JB, Flexner JM, et al. Malignant lymphoma of follicular center cell origin in humans. IV. Small transformed (noncleaved) cell lymphoma of the non-Burkitt's type. *Cancer* 1983;52:1196-1201.

172. Mashal RD, Canellos GP. Small non-cleaved lymphoma in adults. *Am J Hematol* 1991;38:40-47.

173. Kornblau SM, Goodacre A, Cabanillas F. Chromosomal abnormalities in adult non-endemic Burkitt's lymphoma and leukemia: 22 new reports and a review of 148 cases from the literature. *Hematol Oncol* 1991;9:63-78.

174. Shiramizu B, Barriga F, Neequaye J, et al. Patterns of chromosomal breakpoint locations in Burkitt's lymphoma: relevance to geography and Epstein-Barr virus association. *Blood* 1991;77:1516-1526.

175. Chapman CJ, Mockridge CI, Rowe M, et al. Analysis of VH genes used by neoplastic B cells in endemic Burkitt's lymphoma shows somatic hypermutation and intraclonal heterogeneity. *Blood* 1995;85:2176-2181.

176. Hecht JL, Aster JC. Molecular biology of Burkitt's lymphoma. *J Clin Oncol* 2000;18(21):3707-3721.

177. Coiffier B. Diffuse large cell lymphoma. *Curr Opin Oncol* 2001;13:325-334.

178. Weinberg DS, Pinkus G. Non-Hodgkin's lymphoma of large multilobated cell type: a clinicopathologic study of ten cases. *Am J Clin Pathol* 1981;76:190-196.

179. O'Hara CJ, Said JW, Pinkus GS. Non-Hodgkin's lymphoma, multilobated B-cell type: report of nine cases with immunohistochemical and immunoultrastructural evidence for a follicular center cell derivation. *Hum Pathol* 1986;17:593-599.

180. Engelhard M, Brittinger G, et al. Subclassification of diffuse large B-cell lymphomas according to the Kiel classification: distinction of centroblastic and immunoblastic lymphomas is a significant prognostic risk factor. *Blood* 1997;89(7):2291-2297.

181. Wang J, Sun NCJ, et al. Histological and immunohistochemical characterization of extranodal diffuse large-cell lymphomas with prominent spindle cell features. *Histopathology* 2001;19:476-481.

182. Achten R, Verhoef G, et al. Histiocyte-rich T-cell-rich B-cell lymphoma: a distinct diffuse large

B-cell lymphoma subtype showing characteristic morphologic and immunophenotypic features. *Histopathology* 2002;40:31–45.

183. Lim MS, Beaty M, et al. T-cell/histiocyte-rich large B-cell lymphoma: a heterogeneous entity with derivation from germinal center B cells. *Am J Surg Pathol* 2002;26(11):1458–1466.
184. Diebold J, Anderson JR, et al. Diffuse large B cell lymphoma: a clinicopathologic analysis of 444 cases classified according to the updated Kiel classification. *Leuk Lymphoma* 2002;43:97–104.
185. Delecluse HG, Anagnostopoulos I, et al. Plasmablastic lymphomas of the oral cavity: a new entity associated with the human immunodeficiency virus infection. *Blood* 1997;89(4):1413–1420.
186. Delsol G, Lamant L, et al. A new subtype of large B-cell lymphoma expressing the ALK kinase and lacking the 2;5 translocation. *Blood* 1997;89(5):1483–1490.
187. Brazier RM, Arber DA, et al. The Burkitt-like lymphomas: a southwest oncology group study delineating phenotypic, genotypic, and clinical features. *Blood* 2001;97(12):3713–3720.
188. Stein RS, Cousar JB, Flexner JM, et al. Correlations between immunologic markers and histopathologic classifications: clinical implications. *Semin Oncol* 1980;7:244–253.
189. King BE, Chen C, et al. Immunophenotypic and genotypic markers of follicular center cell neoplasia in diffuse large B-cell lymphomas. *Mod Pathol* 2000;13:1219–1231.
190. Spier CM, Grogan TM, Lippman SM, et al. The aberrancy of immunophenotype and immunoglobulin status as indicators of prognosis in B cell diffuse large cell lymphoma. *Am J Pathol* 1988;133:118–126.
191. Yamaguchi M, Seto M, et al. De novo CD5+ diffuse large B-cell lymphoma: a clinicopathologic study of 109 patients. *Blood* 2002;99(3):815–821.
192. Slymen DJ, Miller TP, Lippman SM, et al. Immunobiologic factors predictive of clinical outcome in diffuse large-cell lymphoma. *J Clin Oncol* 1990;8:986–993.
193. Hermine O, Haioun C, Lepage E, et al. Prognostic significance of bcl-2 protein expression in aggressive non-Hodgkin's lymphoma. *Blood* 1996;87:265–272.
194. Shipp MA. Prognostic factors in aggressive non-Hodgkin's lymphoma: who has “high-risk” disease? *Blood* 1994;83:1165–1173.
195. Medeiros LJ, Gelb AB, Wolfson K, et al. Major histocompatibility complex class I and class II antigen expression in diffuse large cell and large cell immunoblastic lymphomas. *Am J Pathol* 1993;143:1086–1097.
196. Offit K, Wong G, Filippa DA, et al. Cytogenetic analysis of 434 consecutively ascertained specimens of non-Hodgkin's lymphoma: clinical correlations. *Blood* 1991;77:1508–1515.
197. Yunis JJ, Mayer MG, Arnesen MA, et al. Bcl-2 and other genomic alterations in the prognosis of large-cell lymphoma. *N Engl J Med* 1989;320:1047–1054.
198. Offit K, Lo Coco F, Louie DC, et al. Rearrangement of the bcl-2 gene as a prognostic marker in diffuse large-cell lymphoma. *N Engl J Med* 1994;331:74–80.
199. Barrans SL, O'Connor SJ, et al. Rearrangement of the BCL6 locus at 3q27 is an independent poor prognostic factor in nodal diffuse large B-cell lymphoma. *Br J Haematol* 2002;117(2):322–332.
200. Houldsworth J, Mathew S, Rao P, et al. REL proto-oncogene is frequently amplified in extranodal diffuse large lymphoma. *Blood* 1996;87:25–29.
201. Rosenwald A, Wright G, et al. The use of molecular profiling to predict survival after chemotherapy for diffuse large B-cell lymphoma. *N Engl J Med* 2002;346(25):1937–1947.
202. Aisenberg AC. Primary large-cell lymphoma of the mediastinum. *J Clin Oncol* 1993;11:2291–2294.
203. Lazzarino M, Orlandi E, Paulli M, et al. Primary mediastinal B-cell lymphoma with sclerosis: an

aggressive tumor with distinctive clinical and pathologic features. *J Clin Oncol* 1993;11:2306–2313.

204. Perrone T, Frizzera G, Rosai J. Mediastinal diffuse large-cell lymphoma with sclerosis. *Am J Surg Pathol* 1986;10:176–191.

205. Yousem SA, Weiss LM, Warnke RA. Primary mediastinal non-Hodgkin's lymphomas: a morphologic and immunologic study of 19 cases. *Am J Clin Pathol* 1985;83:676–680.

206. Suster S, Moran C. Pleomorphic large cell lymphomas of the mediastinum. *Am J Surg Pathol* 1996;20:224–232.

207. Suster S. Primary large-cell lymphomas of the mediastinum. *Semin Diagn Pathol* 1999;16(1):51–64.

208. Tsang P, Cesarman E, Chadburn A, et al. Molecular characterization of primary mediastinal B cell lymphoma. *Am J Pathol* 1996;148:2017–2025.

209. Scarpa A, Borgato, Chilosi M, et al. Evidence of c-myc gene abnormalities in mediastinal large B-cell lymphoma of young adult age. *Blood* 1991;78:780–788.

210. Barth TFE, Leithauser F, et al. Mediastinal (thymic) large B-cell lymphoma: where do we stand? *Lancet Oncol* 2002;3(4):229–234.

211. Bhawan J, Wolff SM, Ucci A, et al. Malignant lymphoma and malignant angioendotheliomatosis: one disease. *Cancer* 1985;55:570–576.

212. Kitagawa M, Matsubara O, Song S-Y, et al. Neoplastic angioendotheliosis: immunohistochemical and electron microscopic findings in three cases. *Cancer* 1985;56:1134–1143.

213. Ben-Ezra J, Sheibani K, Kendrick F, et al. Angiotropic large cell lymphoma of the prostate gland: an immunohistochemical study. *Hum Pathol* 1986;17:964–967.

214. Lie JT. Malignant angioendotheliomatosis (intravascular lymphomatosis) clinically simulating primary angiitis of the central nervous system. *Arthritis Rheum* 1992;35:831–834.

215. Sheibani K, Battifora H, Winberg CD, et al. Further evidence that “malignant angioendotheliomatosis” is an angiotropic large-cell lymphoma. *N Engl J Med* 1986;314:943–948.

216. Yegappan S, Coupland R, et al. Angiotropic lymphoma: an immunophenotypically and clinically heterogeneous lymphoma. *Mod Pathol* 2001;14:1147–1156.

217. Carroll TJ, Schelper RL, Goeken JA, et al. Neoplastic angioendotheliomatosis: immunopathologic and morphologic evidence for intravascular malignant lymphomatosis. *Am J Clin Pathol* 1986;85:169–175.

218. Ferry JA, Harris NL, Picker LJ, et al. Intravascular lymphomatosis (malignant angioendotheliomatosis): a B-cell neoplasm expressing surface homing receptors. *Mod Pathol* 1988;1:444–452.

219. Kanda M, Suzumiya J, et al. Analysis of the immunoglobulin heavy chain gene variable region of intravascular large B-cell lymphoma. *New York: Springer-Verlag*, 2001;439:540–546.

220. Spits H, Lanier LL, Phillips JH. Development of human T and natural killer cells. *Blood* 1995;85:2654–2670.

221. Harris NL, Jaffe ES, Stein H, et al. Lymphoma classification proposal: clarification. *Blood* 1995;85:857–860.

222. Lukes RJ. The immunologic approach to the pathology of malignant lymphomas. *Am J Clin Pathol* 1979;72:657–669.

223. Stansfeld AG, Diebold J, Noël H. Updated Kiel classification for lymphomas. *Lancet* 1988;1:292–293.

224. Nathwani BN, Diamond LW, Winberg CD. Lymphoblastic lymphoma: a clinicopathologic study of 95

patients. *Cancer* 1981;48:2347–2357.

225. Bernard A, Boumsell L, Reinherz L, et al. Cell surface characterization of malignant T cells from lymphoblastic lymphoma using monoclonal antibodies: evidence for phenotypic differences between malignant T cells from patients with acute lymphoblastic leukemia and lymphoblastic lymphoma. *Blood* 1981;57:1105–1110.

226. Mori N, Oka K, Yoda Y, et al. Leu-4 (CD3) antigen expression in the neoplastic cells from T-ALL and T-lymphoblastic lymphoma. *Am J Clin Pathol* 1988;90:244–249.

227. Weiss L, Bindl J, Picozzi V, et al. Lymphoblastic lymphoma: an immunophenotype study of 26 cases with comparison to T cell acute lymphoblastic leukemia. *Blood* 1986;67:474–478.

228. Swerdlow S, Habeshaw J, Richards M, et al. T lymphoblastic lymphoma with Leu-7 positive phenotype and unusual clinical course: a multiparameter study. *Leuk Res* 1985;9:167–173.

229. Sheibani K, Winberg C, Burke J. Lymphoblastic lymphoma expressing natural killer cell-associated antigens: a clinico-pathologic study of six cases. *Leuk Res* 1987;11:371–377.

230. Koita H, Suzumiya J, Ohshima K, et al. Lymphoblastic lymphoma expressing natural killer cell phenotype with involvement of the mediastinum and nasal cavity. *Am J Surg Pathol* 1997;21:242–248.

231. Waldron JA, Leech JH, Glick AD, et al. Malignant lymphoma of peripheral T-lymphocyte origin: immunologic, pathologic, and clinical features in six patients. *Cancer* 1977;40:1604–1617.

232. Macon WR, William ME, Greer JP, et al. Paracortical nodular T-cell lymphoma: identification of an unusual variant of T-cell lymphoma. *Am J Surg Pathol* 1996;19:297–303.

233. Hastrup N, Ralfkiaer E, Pallesen G. Aberrant phenotypes in peripheral T cell lymphomas. *J Clin Pathol* 1989;42:398–402.

234. Said J, Shintaku P, Parekh K, et al. Specific phenotyping of T-cell proliferations in formalin-fixed paraffin-embedded tissues. Use of antibodies to the T-cell receptor  $\beta\text{F1}$ . *Am J Clin Pathol* 1990;93:382–386.

235. Gaulard P, Bourquelot P, Kanavaros P. Expression of the alpha/beta and gamma/delta T-cell receptors in 57 cases of peripheral T-cell lymphomas: identification of a subset of  $\gamma/\delta$  T-cell lymphomas. *Am J Pathol* 1990;137:617–628.

236. Weiss L, Trela M, Cleary M, et al. Frequent immunoglobulin and T cell receptor gene rearrangement in “histiocytic” neoplasms. *Am J Pathol* 1985;121:369–373.

237. Weiss L, Picker L, Grogan T, et al. Absence of clonal beta and gamma T-cell receptor gene rearrangements in a subset of peripheral T-cell lymphomas. *Am J Pathol* 1988;130:436–442.

238. Macon WR, Williams ME, Greer JP, et al. Natural killer-like T cell lymphomas: aggressive lymphomas of T-large granular lymphocytes. *Blood* 1996;87:1474–1483.

239. Chan JKC, Tsang WYW, Wong KF. Classification of natural killer cell neoplasms. *Am J Surg Pathol* 1994;18:1177–1178.

240. Felgar RE, Macon WR, Kinney MC, et al. TIA-1 expression in lymphoid neoplasms: identification of subsets with cytotoxic T lymphocyte or natural killer cell differentiation. *Am J Pathol* 1997;150:1893–1900.

241. Hanson MN, Morrison VA, Peterson BA, et al. Posttransplant T-cell lymphoproliferative disorders—aggressive, late complication of solid-organ transplantation. *Blood* 1996;88:3626–3633.

242. Burke JS, Butler JJ. Malignant lymphoma with a high content of epithelioid histiocytes (Lennert's lymphoma). *Am J Clin Pathol* 1976;66:1–9.

243. Kim H, Jacobs C, Warnke R, et al. Malignant lymphoma with a high content of epithelioid histiocytes: a distinct clinicopathologic entity and a form of so-called “Lennert's lymphoma.” *Cancer* 1978;41:620–635.

244. Patsouris E, Noël H, Lennert K. Histological and immunohistological findings in lymphoepithelioid cell lymphoma (Lennert's lymphoma). *Am J Surg Pathol* 1988;12:341–350.
245. Patsouris E, Noël H, Lennert K. Angioimmunoblastic lymphadenopathy–type of T-cell lymphoma with a high content of epithelioid cells. Histopathology and comparison with lymphoepithelioid cell lymphoma. *Am J Surg Pathol* 1989;13:262–275.
246. Patsouris E, Noël H, Lennert K. Cytohistologic and immunohistochemical findings in Hodgkin's disease, mixed cellularity type, with a high content of epithelioid cells. *Am J Surg Pathol* 1989;13:1014–1022.
247. Kojima M, Nakamura S, Motoori T, et al. Centroblastic and centroblastic–centrocytic lymphomas associated with prominent epithelioid granulomatous response without plasma cell differentiation: a clinicopathologic study of 12 cases. *Hum Pathol* 1996;27:660–667.
248. Frizzera G, Moran E, Rappaport H. Angio-immunoblastic lymphadenopathy with dysproteinemia. *Lancet* 1974;1:1070–1073.
249. Lukes RJ, Tindle BH. “Immunoblastic lymphadenopathy,” a hyperimmune entity resembling Hodgkin's disease. *N Engl J Med* 1975;292:1–8.
250. Weiss L, Strickler J, Dorfman R, et al. Clonal T-cell populations in angioimmunoblastic lymphadenopathy and angioimmunoblastic lymphadenopathy–like lymphoma. *Am J Pathol* 1986;122:392–397.
251. Feller A, Griesser H, Schilling C, et al. Clonal gene rearrangement patterns correlate with immunophenotype and clinical parameters in patients with angioimmunoblastic lymphadenopathy. *Am J Pathol* 1988;133:549–556.
252. Kaneko Y, Larson RA, Variakojis D, et al. Nonrandom chromosome abnormalities in angioimmunoblastic lymphadenopathy. *Blood* 1982;60:877–887.
253. Schlegelberger B, Zhang Y, Weber–Matthiesen K, et al. Detection of aberrant clones in nearly all cases of angioimmunoblastic lymphadenopathy with dysproteinemia–type T-cell lymphoma by combined interphase and metaphase cytogenetics. *Blood* 1994;84:2640–2648.
254. Hsu S–M, Waldron JA, Fink L, et al. Pathogenic significance of interleukin–6 in angioimmunoblastic lymphadenopathy–type T-cell lymphoma. *Hum Pathol* 1993;24:126–131.
255. Attygalle A, Al–Jehani R, Diss TC, et al. Neoplastic T-cells in angioimmunoblastic T-cell lymphoma express CD10. *Blood* 2002;99:627–633.
256. Ohshima K, Takeo H, Kikuchi M, et al. Heterogeneity of Epstein–Barr virus infection in angioimmunoblastic lymphadenopathy type T-cell lymphoma. *Histopathology* 1994;25:569–579.
257. Kon S, Sato T, Onodera K, et al. Detection of Epstein–Barr virus DNA and EBV–determined nuclear antigen in angioimmunoblastic lymphadenopathy with dysproteinemia type T cell lymphoma. *Pathol Res Pract* 1993;189:1137–1144.
258. Stein H, Mason D, Gerdes J, et al. The expression of the Hodgkin's disease associated antigen Ki–1 in reactive and neoplastic lymphoid tissue: evidence that Reed–Stenberg cells and histiocytic malignancies are derived from activated lymphoid cells. *Blood* 1985;66:848–858.
259. de Bruin P, Beljaards R, van Heerde P, et al. Differences in clinical behavior and immunophenotype between primary cutaneous and primary nodal anaplastic large cell lymphoma of T-cell or null cell phenotype. *Histopathology* 1993;23:127–135.
260. Kaudewitz P, Stein H, Dallenbach F. Primary and secondary Ki–1+ (CD30+) anaplastic large cell lymphomas. *Am J Pathol* 1989;135:359–367.
261. Kadin ME, Sako D, Berliner N, et al. Childhood Ki–1 lymphoma presenting with skin lesions and peripheral lymphadenopathy. *Blood* 1986;68:1042–1049.
262. Chott A, Kaserer K, Augustin I. Ki–1 positive large cell lymphoma: a clinicopathologic study of 41

cases. *Am J Surg Pathol* 1990;14:439–448.

263. Wilson MS, Weiss LM, Gatter KC, et al. Malignant histiocytosis. a reassessment of cases previously reported in 1975 based on paraffin section immunophenotyping studies. *Cancer* 1990;66:530–536.

264. Kinney M, Collins R, Greer J, et al. A small-cell-predominant variant of primary Ki-1 (CD30)+ T-cell lymphoma. *Am J Surg Pathol* 1993;17:859–868.

265. Pileri S, Falini B, Delsol G, et al. Lymphohistiocytic T-cell lymphoma (anaplastic large cell lymphoma CD30+/Ki-1+) with a high content of reactive histiocytes. *Histopathology* 1998;16:383–391.

266. Piris M, Brown D, Gatter K, et al. CD30 expression in non-Hodgkin's lymphoma. *Histopathology* 1990;17:211–218.

267. Pallesen G, Hamilton-Dutoit SJ. Ki-1 (CD30) antigen is regularly expressed by tumor cells of embryonal carcinoma. *Am J Pathol* 1988;133:446–450.

268. Hittmair A, Rogatsch H, Hobisch A, et al. CD30 expression in seminoma. *Hum Pathol* 1996;27:1166–1171.

269. Schwarting R, Gerdes J, Dürkop H, et al. Ber-H2: a new anti-Ki-1 (CD30) monoclonal antibody directed at a formalin resistant epitope. *Blood* 1989;74:1678–1689.

270. Segal GH, Kjeldsberg CR, Smith GP, et al. CD30 antigen expression in florid immunoblastic proliferations. *Am J Clin Pathol* 1994;102:292–298.

271. Abbondanzo SL, Sato N, Straus SE, et al. Acute infectious mononucleosis. CD30 (Ki-1) antigen expression and histologic correlations. *Am J Clin Pathol* 1990;93:698–702.

272. Krenacs L, Wellman A, Sorbara L, et al. Cytotoxic cell antigen expression in anaplastic large cell lymphomas of T- and null-cell type and Hodgkin's disease: evidence for a distinct cellular origin. *Blood* 1997;89:980–989.

273. Felgar RE, Salhany KE, Macon WR, et al. The expression of TIA-1<sup>+</sup> cytotoxic-type granules and other cytolytic lymphocyte-associated markers in CD30<sup>+</sup> anaplastic large cell lymphomas (ALCL): correlation with morphology, immunophenotype, ultrastructure and clinical features. *Hum Pathol* 1999;30:228–236.

274. Delsol G, Al Saati T, Gatter K, et al. Co-expression of epithelial membrane antigen (EMA), Ki-1, and interleukin-2 receptor by anaplastic large cell lymphomas: diagnostic value in so-called malignant histiocytosis. *Am J Pathol* 1988;130:59–70.

275. Kaneko Y, Frizzera G, Edamura S. A novel translocation, t(2;5)(p23;q35), in childhood phagocytic large T-cell lymphoma mimicking malignant histiocytosis. *Blood* 1989;73:806–813.

276. LeBeau MM, Bitter MA, Larson RA, et al. The t(2;5)(p23;q35): a recurring chromosomal abnormality in Ki-1-positive anaplastic large cell lymphoma. *Leukemia* 1989;3:866–870.

277. Wellmann A, Otsuki T, Vogelbruch M, et al. Analysis of the t(2;5)(p23;q35) translocation by reverse transcription-polymerase chain reaction in CD30+ anaplastic large-cell lymphomas, in other non-Hodgkin's lymphomas of T-cell phenotype, and in Hodgkin's disease. *Blood* 1995;86:2321–2328.

278. DeCoteau JF, Butmarc JR, Kinney MC, et al. The t(2;5) chromosomal translocation is not a common feature of primary cutaneous CD30+ lymphoproliferative disorders: comparison with anaplastic large-cell lymphoma of nodal origin. *Blood* 1996;87:3437–3441.

279. Morris SW, Kirstein MN, Valentine MB, et al. Fusion of a kinase gene, ALK, to a nucleolar protein gene, NPM, in non-Hodgkin's lymphoma. *Science* 1994;263:1281–1284.

280. Pulford K, Lamant L, Morris SW, et al. Detection of anaplastic lymphoma kinase (ALK) and nucleolar protein nucleoplasmin (NPM)-ALK proteins in normal and neoplastic cells with the monoclonal antibody ALK1. *Blood* 1997;89:1394–1404.

281. Falini B, Pulford K, Pucciarini A, et al. Lymphomas expressing ALK fusion protein(s) other than NPM-ALK. *Blood* 1999;94:3509-3515.
282. Lamant L, Dastugue N, Pulford K, et al. A new fusion gene TPM3-ALK in anaplastic large cell lymphoma created by a (1;2)(q25;p23) translocation. *Blood* 1999;93:3088-3095.
283. Hernández L, Piniyol M, Hernández S, et al. TRK-fused gene (TFG) is a new partner of ALK in anaplastic large cell lymphoma producing two structurally different TFG-ALK translocations. *Blood* 1999;94:3265-3268.
284. Wlodarska I, De Wolf-Peeters C, Falini B, et al. The cryptic inv (2)(p23q35) defines a new molecular genetics subtype of ALK-positive anaplastic large-cell lymphoma. *Blood* 1998;92:2688-2695.
285. Touriol C, Greenland C, Lamant L, et al. Further demonstration of the diversity of chromosomal changes involving 2p23 in ALK-positive lymphoma: 2 cases expressing ALK kinase fused to CLTCL (clathrin chain polypeptide-like). *Blood* 2000;95:3204-3207.
286. Falini B, Pileri S, Zinzani PL, et al. ALK+ lymphoma: clinico-pathological findings and outcome. *Blood* 1999;93:2697-2706.
287. Gascoyne RD, Aoun P, Wu D, et al. Prognostic significance of anaplastic lymphoma kinase (ALK) protein expression in adults with anaplastic large cell lymphoma. *Blood* 1999;93:3913-3921.
288. Jaffe E, Blattner W, Blayney D, et al. The pathologic spectrum of adult T-cell leukemia/lymphoma in the United States. *Am J Pathol* 1984;8:263-275.
289. Swerdlow S, Habeshaw J, Rohatiner A, et al. Caribbean T-cell lymphoma/leukemia. *Cancer* 1984;54:687-696.
290. Shimoyama M. Diagnostic criteria and classification of clinical subtypes of adult T-cell leukaemia-lymphoma. *Br J Haematol* 1991;79:428-437.
291. Yoshida M, Seiki M, Yamaguchi K, et al. Monoclonal integration of human T-cell leukemia provirus in all primary tumors of adult T-cell leukemia suggests causative role of human T-cell leukemia virus in the disease. *Proc Natl Acad Sci U S A* 1984;81:2534-2537.
292. Suchi T, Lennert K, Tu L-Y. Histopathology and immunohistochemistry of peripheral T-cell lymphomas: a proposal for their classification. *J Clin Pathol* 1987;40:995-1015.
293. Falini B, Flenghi L, Pileri S, et al. Distribution of T-cells bearing different forms of the T-cell receptor  $\alpha/\delta$  in normal and pathological human tissue. *J Immunol* 1989;143:2480-2488.
294. Farcet J-P, Gaulard P, Marolleau J-P, et al. Hepatosplenic T-cell lymphoma: sinusal/sinusoidal localization of malignant cells expressing the T-cell receptor  $\alpha/\delta$ . *Blood* 1990;75:2213-2219.
295. Wong KF, Chan JKC, Matutes E, et al. Hepatosplenic  $\alpha/\delta$  T-cell lymphoma: a distinct aggressive lymphoma type. *Am J Surg Pathol* 1995;19:718-726.
296. Cooke CB, Krenacs L, Stetler-Stevenson M, et al. Hepatosplenic T-cell lymphoma: a distinct clinicopathologic entity of cytotoxic  $\alpha/\delta$  T-cell origin. *Blood* 1996;88:4265-4274.
297. Salhany KE, Feldman M, Peritt D, et al. Hepatosplenic  $\alpha/\delta$  T-cell lymphoma: ultrastructural, immunophenotypic and functional evidence for cytotoxic T lymphocyte (CTL) differentiation. *Hum Pathol* 1997;28:674-685.
298. Macon WR, Levy NB, Kurtin PJ, et al. Hepatosplenic  $\alpha\beta$  T-cell lymphomas. A report of 14 cases and comparison with hepatosplenic  $\gamma\delta$  T-cell lymphomas. *Am J Surg Pathol* 2000;25:285-296.
299. Przybylski GK, Wu H, Macon WR, et al. Hepatosplenic and subcutaneous panniculitis-like  $\gamma\delta$  T cell lymphomas are derived from different  $\gamma\delta$  subsets of  $\gamma\delta$  T lymphocytes. *J Mol Diagn* 2000;2:11-19.
300. Wang C-C, Tien H-F, Lin M-T, et al. Consistent presence of isochromosome 7q in hepatosplenic T



- ?/d lymphoma: a new cytogenetic-clinicopathologic entity. *Genes Chromosomes Cancer* 1995;12:161-164.
301. Gonzales CL, Medeiros LJ, Brazier RM, et al. T-cell lymphoma involving subcutaneous tissue: a clinicopathologic entity commonly associated with hemophagocytic syndrome. *Am J Surg Pathol* 1991;15:17-27.
302. Mehregan DA, Su WPD, Kurtin PJ. Subcutaneous T-cell lymphoma: a clinical, histopathologic, and immunohistochemical study of six cases. *J Cutan Pathol* 1994;21:110-117.
303. Salhany KE, Macon WR, Choi JK, et al. Subcutaneous panniculitis-like T-cell lymphoma: clinicopathologic, immunophenotypic, and genotypic analysis of alpha/beta and gamma/delta subtypes. *Am J Surg Pathol* 1998;22:881-893.
304. Burg G, Dummer R, Wilhelm M, et al. A subcutaneous delta-positive T-cell lymphoma that produces interferon gamma. *N Engl J Med* 1991;325:1078-1081.
305. Medeiros LJ, Greiner TG, Gonzalez CL, et al. T-cell lymphoma involving subcutaneous tissue: an update. *Mod Pathol* 1994;7:116A.
306. Chott A, Dragosics B, Radaszkiewicz T. Peripheral T-cell lymphomas of the intestine. *Am J Pathol* 1992;141:1361-1371.
307. O'Farrelly C, Feighery C, O'Briain DS, et al. Humoral response to wheat protein in patients with coeliac disease and enteropathy associated T-cell lymphomas. *Br Med J* 1986;293:908-910.
308. Foucar K, Foucar E, Mitros F, et al. Epitheliotropic lymphoma of the small bowel. Report of a fatal case with cytotoxic/suppressor T-cell immunotype. *Cancer* 1984;54:54-60.
309. Kanavaros P, Lavergne A, Galian A, et al. A primary immunoblastic T malignant lymphoma of the small bowel, with azurophilic intracytoplasmic granules: a histologic, immunologic and electron microscopy study. *Am J Surg Pathol* 1988;12:641-647.
310. Longacre TA, Listrom MB, Spigel JH, et al. Aggressive jejunal lymphoma of large granular lymphocytes: immunohistochemical, ultrastructural, molecular, and DNA content analysis. *Am J Clin Pathol* 1990;93:124-132.
311. Zettl A, Ott G, Makulik A, et al. Chromosomal gains at 9q characterize enteropathy-type T-cell lymphoma. *Am J Pathol* 2002;161:1635-1645.
312. Suzumiya J, Takeshita M, Kimura N, et al. Expression of adult and fetal natural killer cell markers in sinonasal lymphomas. *Blood* 1994;83:2255-2260.
313. Van Gorp J, De Bruin PC, Sie-Go DMDS, et al. Nasal T-cell lymphoma: a clinicopathologic and immunophenotypic analysis of 13 cases. *Histopathology* 1995;27:139-148.
314. Chiang AKS, Srivastava G, Lau PWF, et al. Differences in T-cell-receptor gene rearrangement and transcription in nasal lymphomas of natural killer and T-cell types: implications on cellular origin. *Hum Pathol* 1996;27:701-707.
315. Petrella T, Delfau-Larue M-H, Caillot D, et al. Nasopharyngeal lymphomas: further evidence for a natural killer cell origin. *Hum Pathol* 1996;27:827-833.
316. Chan JKC, Yip TTC, Tsang WYW, et al. Detection of Epstein-Barr viral RNA in malignant lymphomas of the upper aerodigestive tract. *Am J Surg Pathol* 1994;18:938-946.
317. Jaffe ES, Chan JKC, Su I-J, et al. Report of the workshop on nasal and related extranodal angiocentric T/natural killer cell lymphomas. Definitions, differential diagnosis and epidemiology. *Am J Surg Pathol* 1996;20:103-111.
318. Wong KF, Chan JKC, Ng CS, et al. CD56 (NKH-1)-positive hematolymphoid malignancies: an aggressive neoplasm featuring frequent cutaneous/mucosal involvement, cytoplasmic azurophilic granules, and angiocentricity. *Hum Pathol* 1992;23:798-804.
319. Nakamura S, Suchi T, Koshikawa T, et al. Clinicopathologic study of CD56 (NCAM)-positive

angiocentric lymphoma occurring in sites other than the upper and lower respiratory tract. *Am J Surg Pathol* 1995;19:284–296.

320. Takeshita M, Akamatsu M, Ohshima K, et al. Angiocentric immunoproliferative lesions of the skin show lobular panniculitis and are mainly disorders of large granular lymphocytes. *Hum Pathol* 1995;26:1321–1328.

321. Chan JKC, Ng CS, Ngan KC, et al. Angiocentric T-cell lymphoma of the skin. An aggressive lymphoma distinct from mycosis fungoides. *Am J Surg Pathol* 1988;12:861–876.

322. Tsang WYW, Chan JKC, Yip TTC, et al. In situ localization of Epstein-Barr virus encoded RNA in non-nasal/nasopharyngeal CD56-positive and CD56-negative T-cell lymphomas. *Hum Pathol* 1994;25:758–765.

323. Emile J-F, Boulland M-L, Haioun C, et al. CD5<sup>-</sup> CD56<sup>+</sup> T-cell receptor silent peripheral T-cell lymphomas are natural killer cell lymphomas. *Blood* 1996;87:1466–1473.

324. Imamura N, Kusunoki Y, Kawa-Ha K, et al. Aggressive natural killer cell leukaemia/lymphoma: report of four cases and review of the literature. Possible existence of a new clinical entity originating from the third lineage of lymphoid cells. *Br J Haematol* 1990;75:49–59.

325. Sun T, Brody J, Susin M, et al. Aggressive natural killer cell lymphoma/leukemia. A recently recognized clinicopathologic entity. *Am J Surg Pathol* 1993;17:1289–1299.

2004 Lippincott Williams & Wilkins  
John P. Greer, John Foerster, John N. Lukens  
George M. Rodgers, Frixos Paraskevas, Bertil Glader  
Wintrobe's Clinical Hematology

[SMALL NONCLEAVED CELL LYMPHOMA \(BURKITT\): cMYC](#)  
[LYMPHOPLASMACYTOID LYMPHOMA: PAX5](#)  
[MANTLE CELL LYMPHOMA: CCND1 \(CYCLIN D1\)](#)  
[FOLLICULAR LYMPHOMA: BCL2](#)  
[LYMPHOBLASTIC LYMPHOMA: TAL1, TAL2, LMO1, LMO2, HOX11, HOX11L2, LYL1, cMYC, NOTCH1, LCK, AND FUSION GENES INVOLVING FGFR1](#)  
[LARGE CELL LYMPHOMA: BCL6 AND FUSION GENES INVOLVING ALK](#)  
[MUCOSA-ASSOCIATED LYMPHOID TISSUE LYMPHOMA: API2-MALT1 AND BCL10](#)  
[VARIOUS NON-HODGKIN LYMPHOMA SUBTYPES: 1q21-q22 GENE LOCI \(BCL9, MUC1, FcγRIIB, IRTA1 AND -2\), AND BCL8-1q21-q22 Gene Loci \(BCL9, MUC1, FcγRIIB, IRTA1 and -2\)](#)  
[BCL8](#)  
[GENE EXPRESSION PROFILING IN NON-HODGKIN LYMPHOMA](#)  
[REFERENCES](#)

The non-Hodgkin lymphomas (NHLs) are a diverse collection of lymphoid malignancies with varied pathology, cell of origin, natural history, and response to treatment. The diversity of the NHLs is reflected by the numerous subtypes and classifications ([1](#), [2](#), [3](#), [4](#), [5](#), [6](#), [7](#), [8](#), [9](#), [10](#), [11](#), [12](#) and [13](#)), based primarily on morphology and immunophenotype, that have appeared over the years to describe them and that are discussed in detail in [Chapter 88](#). The histologic diagnosis of NHL is among the most difficult tasks that surgical pathologists are asked to undertake; although the diagnosis of NHL compared to other malignancies is accurate in roughly 90% of cases, consensus among pathologists regarding the identification of specific histologic subtypes occurs only slightly more than one-half of the time ([14](#), [15](#), [16](#), [17](#) and [18](#)). Despite their shortcomings, the morphologic and immunophenotypic classifications of NHL have been invaluable in providing the basis for our current approach to the therapeutic management of these malignancies by providing a framework to subdivide the disease into clinically meaningful subgroups. Refinements in these classification schemes are constantly ongoing as additional parameters are identified and are shown to permit the detection of subgroups that possess unique biologic features or that have a specific response to traditional therapies or are amenable to more directed forms of treatment, or both.

One set of features that are candidates for incorporation into NHL classification systems are the molecular genetic lesions that appear to be of pathogenic importance in selected forms of NHL. Progress in this area has come about over the past 20 years with the molecular analysis of structural chromosomal abnormalities, including translocations, deletions, inversions, amplifications, and base pair mutations, which alter critical genes that normally regulate growth or differentiation (oncogenes and tumor suppressor genes, or antioncogenes), or both ([19](#), [20](#), [21](#), [22](#), [23](#), [24](#) and [25](#)). With the currently available molecular methods, genetic abnormalities of various types can be identified in essentially all cases of NHL. The analysis of the genetic lesions present in NHL has tended to be in the vanguard of such studies in malignant diseases; indeed, the realization that characteristic chromosomal translocations, or rearrangements, tend to occur in specific types of lymphomas, consistently altering the function of a particular gene or subset of genes, provided the initial impetus for the analysis of such abnormalities in other tumors. For example, Burkitt lymphoma was the first human tumor in which a chromosomal translocation was demonstrated by molecular analysis to be involved in its pathogenesis (

[26](#), [27](#), [28](#) and [29](#)). Although the possibility of therapies aimed at malignancy-specific genetic lesions in NHL remains to be realized in the clinical setting, this issue promises to change significantly over the next decade with the current emphasis on the development of targeted therapeutic approaches for cancer ([30](#), [31](#)).

The identification of the genes involved in the pathogenesis of NHL has already had the practical benefit of allowing development of highly specific and sensitive molecular assays to detect these genetic “tags.” These assays can often resolve diagnostic ambiguities brought about by the more traditional classification methods and can be used to follow therapeutic responses, as well as for the early detection of recurrence ([32](#), [33](#)). In some instances, as described later in the chapter, the presence of specific genetic abnormalities may be of prognostic importance also. From a basic science standpoint, the isolation of lymphoma-associated and other oncogenic genes has led to the identification of proteins that not only promote the development of cancer, but that also have essential roles in normal cellular growth and development as well. The use of gene targeting methods in embryonic stem cells to create animals in which a specific gene is homozygously inactivated (e.g., knockout mice) ([34](#), [35](#)), as well as other gene inactivation techniques, such as RNA interference ([36](#), [37](#)), now allows investigators to unequivocally determine the essential functional roles that the gene plays.

A brief background regarding the mechanisms and consequences of malignancy-related chromosomal rearrangement and of normal lymphocyte development, with emphasis on the physiologic DNA rearrangements that assemble the antigen-specific immunoglobulin (Ig) and T-cell receptor (TCR) genes in B and T cells, is required before the discussion of individual genetic abnormalities in NHL. Two distinct consequences have been found to occur as a result of malignancy-related chromosomal translocations. In many cases, translocations have been shown to fuse sequences from one chromosome (often encoding a transcription factor, or a receptor or cytoplasmic tyrosine kinase) to those of a normally unrelated gene present on the other chromosome, producing a chimeric gene and a protein that possesses oncogenic capabilities. The other common mechanism by which these translocations deregulate gene function is by the relocation of the gene to the vicinity of highly active promoters or enhancers from other chromosomes (often within the Ig or TCR gene loci) that drive the expression, in an abnormal cell type or an abnormal amount, or both, of an otherwise unaltered gene product. Because the chimeric genes are unique to the cancer cells that contain them, diagnostic assays, such as fluorescence *in situ* hybridization (FISH) or RNA polymerase chain reaction (PCR), can specifically detect cases of a given translocation-containing tumor type ([38](#), [39](#), [40](#) and [41](#)). In those instances in which the expression of an otherwise unaltered gene is activated, the presence of the gene’s transcripts or its encoded protein within cells that do not normally express the gene is often also helpful in making or confirming a suggested diagnosis ([33](#)).

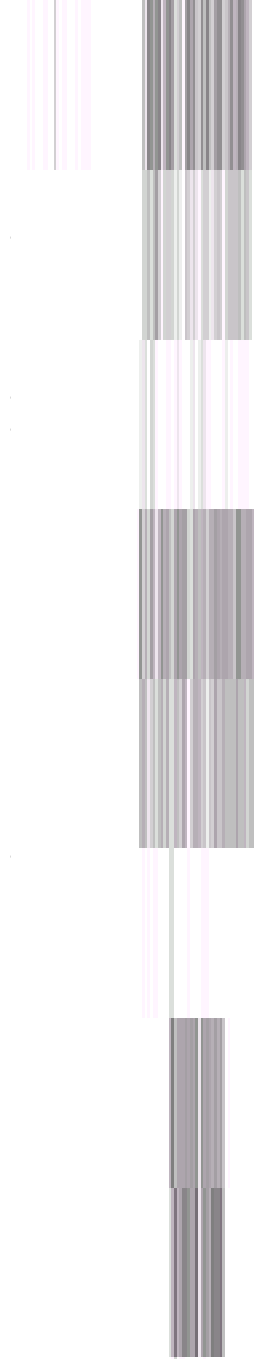
Lymphocytes arise in the developing liver and bone marrow from a pluripotent hematopoietic stem cell, with early T-cell differentiation occurring in the thymus and early B cells undergoing differentiation within the bone marrow ([42](#), [43](#) and [44](#)). Normal lymphoid cell populations undergo diverse, clonal rearrangements of their Ig or TCR antigen receptor genes during this developmental process to generate B cells and T cells with the specificities required to support a fully competent immune system ([45](#), [46](#) and [47](#)). Lymphomas arise from a single progenitor lymphoid cell that has undergone genetic damage that results in deregulated growth and clonal expansion, together with arrested differentiation at a discrete stage of development. Nevertheless, malignant lymphoid cells share many features with their normal counterparts, including Ig or TCR gene rearrangement ([48](#), [49](#) and [50](#)); indeed, the unicellular development of lymphoma cell populations can be demonstrated by the presence of uniform rearrangements of these

genes, as compared to the heterogeneous pattern of rearrangements found in populations of normal T and B cells ( [51](#), [52](#), [53](#), [54](#), [55](#), [56](#), [57](#) and [58](#) ).

A major advance in the characterization of the genetic abnormalities important in lymphomagenesis (and lymphoid leukemogenesis as well) was the realization that the Ig and TCR genes are common sites of illegitimate interchromosomal translocation. As mentioned, in the normal sequence of events, B and T cells rearrange their Ig or TCR gene subsegments to generate lymphoid cells with antigenic specificity ( [47](#) ). The Ig and the TCR genes are organized as discontinuous DNA segments in their embryonic or germline form that are assembled in this physiologic rearrangement process during lymphoid development. An initial sign of B-lineage commitment is the rearrangement of the Ig heavy chain locus at chromosome 14, band q32, which begins with the approximation of one of the more than 20 D<sub>H</sub> (diversity) segments with one of the six alternative J<sub>H</sub> (joining) segments to create a D<sub>H</sub>/J<sub>H</sub> region. Subsequently, the DJ segment on one allele is approximated with one of, potentially, several hundred V<sub>H</sub> (variable) segments to create a functional VDJ segment, which joins the C<sub>H</sub> (constant) portion of the molecule to generate the Ig heavy chain protein. Inserted extra nucleotides, called N sequences, are frequently found at the site of each junction and contribute to diversity, because they are located at the site at which the antibody molecule contacts antigen. Furthermore, a “somatic hypermutation” mechanism is activated at later stages of lymphoid development that alters selected VDJ sequences to improve antigen-binding affinity ( [59](#), [60](#), [61](#) and [62](#) ). Just as the physiologic process of Ig and TCR gene rearrangement can be subverted in malignancy, somatic hypermutation can also occur abnormally, resulting in the mutation of genes possessing oncogenic potential, such as BCL6 and cMYC, among others ( [59](#), [60](#), [61](#) and [62](#) ). The successful production of the μ-chain in the cytoplasm as a result of the rearrangement of the Ig heavy chain gene defines the so-called pre-B cell. Only if these rearrangements on the first chromosome are unsuccessful is the second allele rearranged beyond the DJ stage. Failure of this rearrangement sequence on the first allele can be of pathologic significance with regard to the development of lymphoid neoplasms. In the case of the t(14;18), as an example, instead of correctly recombining D and J segments of the Ig heavy chain locus, a broken BCL2 gene from 18q21 is introduced into these sites.

On successful rearrangement of one of the two heavy chain loci, κ-light chain gene rearrangement proceeds on chromosome 2p12. If κ gene rearrangement is unsuccessful, the λ gene on chromosome 22q11 alternatively rearranges. Illegitimate recombination of either of these gene loci with oncogenic genes can also occur in malignancy, as noted later with the examples of the small noncleaved cell lymphomas that contain the t(2;8)(p12;q24) or the t(8;22)(q24;q11) that activate cMYC and the large-cell lymphomas containing the t(2;3)(p12;q27) or t(3;22)(q27;q11) that result in the expression of BCL6. Once functional light chains are produced, they associate by disulfide linkages to the μ heavy chain, producing a complete Ig molecule that is expressed on the cell surface. The expression of surface Ig is the hallmark of the mature B cell. The final antibody molecule is composed of two identical heavy chains that are disulfide-linked to two identical light chains. The amino-terminal variable portions of each chain possess the antigen recognition sites, whereas the carboxy-terminal constant portion is invariant in sequence and performs effector functions. The earliest recognizable B cells display only surface IgM. Subsequently, an alternative splicing mechanism places the C<sub>μ</sub> or C<sub>d</sub> constant heavy chain region adjacent to the same unique VDJ region, and cells express IgM and IgD simultaneously. Heavy chain class switching may then occur, in which other C<sub>H</sub> segments (γ, ε, or α) are placed next to the VDJ segment, enabling the same antigen specificity to be associated with the different physiologic functions of an IgG, IgE, or IgA molecule.

Like the Ig gene loci, the genes encoding the α, β, γ, and δ TCR chains have been cloned and characterized ( [47](#) ). These genes are evolutionarily related but distinct from the Ig



go rearrangement of their V, D, and J regions to assemble the T-cell surface that demonstrate antigen-specific genes are located on chromosomes 7q34 and 7p15, the TCR gene is located within the alpha TCR locus on chromosome 6. Aberrant recombination of the TCR gene loci with genes that control growth or development, or both, can lead to the lymphomas, as described in the following discussion in the case of the lymphomas characteristically found in the lymphoblastic lymphomas. Thus, the identification of the Ig and TCR gene loci was the result that permitted the relatively easy identification of these

The molecular consequences of the most frequently occurring chromosomal translocations in the NHLs are described, grouped under the lymphoma subtype in which each is solely, or primarily, associated (Fig. 89.1). Anomalies that are aberrantly expressed owing to chromosomal translocations in NHL subtypes, rather than being associated typically with only one subtype, are also described. Genes that are functionally important, but less common, chromosomal translocations that have been characterized molecularly are described in Fig. 89.2. Last, the usefulness of recently developed microarray technology in the analysis of the global gene expression profile of NHL subtypes is

**Figure 89.1.** Molecular genetic aspects of non-Hodgkin lymphoma (NHL)-associated chromosomal translocations. The genes altered by the more commonly occurring chromosomal translocations in NHL are shown in italics, together with the lymphoma subtype in which they have pathogenic significance. The functional family to which each gene belongs is indicated in bold face. The percentages shown indicate the approximate representation of each histologic NHL subtype occurring in children or adults. The genes shown in this figure occur in a significant portion of (but not all) cases within each associated subtype. bHLH, basic helix-loop-helix; Ig, immunoglobulin.

**TABLE 89.1. Genes Involved in B-Cell Oncogenesis via Chromosomal Translocations**

| Cytogenetic Abnormality <sup>a</sup> | Disease (Predominant Subtypes)             | Involved or Presumed Target Genes (Aliases)                      | Presumed Function of Target Genes                  |
|--------------------------------------|--|--|--|
| t(1;14)(p22;q32)                     | Mucosa-associated lymphoid tissue lymphoma | <i>BCL11</i> (mE10, <i>CIPER</i> , <i>CARMEN</i> , <i>CLAF</i> ) | Antigen receptor-induced NF- $\kappa$ B activation |

|                  |  |   |   |
|------------------|--|---|---|
| t(1;14)(q21;q32) | B-cell precursor acute lymphoblastic leukemia, B-NHL | <i>BCL9</i>   | Required for Wnt signal transduction at the level of nuclear $\beta$ -catenin   |
| t(1;14)(q21;q32) | Myeloma, also BL with dup(1q)                        | <i>IRTA1/2</i>  | Immunoglobulin receptor superfamily   |
| t(1;14)(q21;q32) | DLBCL  | <i>MUC1</i> ( <i>EMA</i> , <i>CD227</i> , <i>PEM</i> , <i>PEM1</i> , <i>H23AG</i> , <i>PUM</i> )<br><i>MDC15</i> (ADAM15) | Mucin (episialin); cell surface transmembrane glycoprotein<br>Metalloproteinase-like disintegrin-like and cysteine-rich protein   |
| t(1;22)(q21;q11) | Transformed follicular B-NHL                         | <i>FCGR2B</i> ( <i>CD32E</i> )  | Low-affinity Fc $\gamma$ receptor IIB; immunoreceptor tyrosine-based inhibition motif-containing receptor for the Fc domain of immunoglobulin G; binds immunoglobulin G immune complexes; member of the immunoglobulin superfamily                                  |
| t(2;7) (p12;q21) | SLVL   | <i>CDK6</i> ( <i>PLSTIRE</i> )  | Cyclin-dependent protein kinase 6; interacts with D-type cyclins and phosphorylates Rb in G <sub>1</sub> phase  |
| t(2;14)(p13;q32) | B-CLL, immunocytoma, DLBL                            | <i>BCL11A</i> ( <i>EV19</i> )   | Zinc finger transcriptional repressor   |
| t(3;14)(q27;q32) | DLBCL and others                                     | <i>BCL6</i> ( <i>BCL5</i> , <i>LAZ3</i> )   | Zinc finger transcriptional repressor   |
| t(4;14)(p16;q32) | Myeloma  | <i>FGFR3</i> ( <i>CEK2</i> , <i>JTK4</i> )<br><br><i>MMSET</i> ( <i>WHSC1</i> )   | Fibroblast growth factor receptor 3; receptor tyrosine kinase that binds acidic and basic fibroblast growth factor; preferentially binds acidic fibroblast growth factor<br>Wolf-Hirschhorn syndrome candidate 1; contains a SET domain, an HMG box and PHD fingers |
| t(5;14)(q31;q32) | B-cell precursor acute lymphoblastic leukemia        | <i>IL3</i> ( <i>MCGF</i> )  | Interleukin-3 (colony-stimulating factor); hematopoietic growth factor  |
| t(6;14)(p25;q32) | Myeloma  | <i>IRF4</i> ( <i>NF-EM5</i> , <i>MUM1</i> , <i>LSIRF</i> )  | Interferon regulatory factor-4; transcription factor that stimulates B-cell proliferation   |
| t(6;14)(p21;q32) | DLBCL, myeloma, SLVL, marginal zone lymphoma         | <i>CCND3</i>  | Cyclin D3, essential for control of the cell cycle at the G <sub>1</sub> -S phase (start) transition; interacts with the CDC2 protein kinase  |
| t(8;14)(q24;q32) | BL, DLBCL, B-cell prolymphocytic leukemia, myeloma   | <i>cMYC</i>   | basic helix-loop-helix-zip transcription factor; activates or represses expression of multiple target genes   |
| t(9;14)(p13;q32) | Lymphoplasmacytoid lymphoma, myeloma                 | <i>PAX5</i> ( <i>BSAF</i> )   | Paired box 5; B-cell lineage-specific activator protein, transcription factor   |



|                      |   |  |   |
|----------------------|---|--|---|
| t(10;14)(q24;q32)    | DLBCL   | <i>NFKB2</i> ( <i>LYT10, H2TF1</i> )   | 49-kd DNA-binding subunit (p52/p100) of heterodimeric NF- $\kappa$ B transcription factor; complex regulates the expression of inflammatory and immune genes  |
| t(11;14)(q13;q32)    | Mantle cell lymphoma, B-cell prolymphocytic leukemia, SLVL, myeloma | <i>CCND1</i> ( <i>BCL1, PRAD1</i> )  | Cyclin D1; essential for control of the cell cycle at the G <sub>1</sub> -S phase (start) transition; interacts with the CDK4 and CDK6 protein kinases        |
| t(11;14)(q23;q32)    | Mediastinal B-NHL   | <i>PAFAH2</i>  | Platelet-activation factor acetylhydrolase  |
| t(11;14)(q23;q32)    | DLBCL   | <i>RCK</i> ( <i>HLR2, p54, DEAD/H BOX 6</i> )  | DEAD/H box adenosine triphosphate-dependent RNA helicase  |
| t(11;18)(q21;q21)    | Mucosa-associated lymphoid tissue lymphoma                          | <i>API2</i> ( <i>cIAP2, HIAP1, MIHC</i> )<br><i>MALT1</i> ( <i>ML1, hParacaspase</i> ) | <i>API2</i> —apoptosis inhibitor, <i>MALT1</i> —unclear, but possibly regulation of NF- $\kappa$ B activation; possesses homology with caspases               |
| t(12;14)(q23;q32)    | DLBCL, B-CLL  | <i>C4ST-1</i>  | Chondroitin-4-O-sulfotransferase 1  |
| t(12;14)(q24;q32)    | BL, myeloma   | <i>BCL7A</i>   | Unknown; shares homology with actin-binding protein caldesmon   |
| t(12;15)(q32;q11-13) | DLBCL   | <i>BCL6</i> ( <i>BCL8A</i> )   | Unknown; related <i>BCL8B</i> protein shares extensive homology to the RG <i>Drosophila</i> protein kinase A anchoring protein                                |
| t(12;22)(p13;q11)    | B-CLL   | <i>CCND2</i>   | Cyclin D2; essential for control of the cell cycle at the G <sub>1</sub> -S phase (start) transition; interacts with the CDC2 protein kinase                  |
| t(14;16)(q32;q23)    | Myeloma   | <i>MAF</i>   | Transcription factor; contains a leucine zipper motif   |
| t(14;18)(q32;q21)    | Follicular lymphoma, DLBCL  | <i>BCL2</i>  | Apoptosis inhibitor   |
| t(14;19)(q32;q13)    | B-CLL   | <i>BCL3</i> ( <i>BCL4</i> )  | Transcriptional activating factor subunit-specific inhibitor of the transcription factor NF- $\kappa$ B; contains seven tandem copies of the SWI6/cdd10 motif |
| t(14;20)(q32;q11)    | Myeloma   | <i>MAFB</i> ( <i>KRML</i> )  | Transcription factor; contains a leucine zipper motif   |

B-CLL, B-cell chronic lymphocytic leukemia; BL, Burkitt lymphoma; B-NHL, B-cell non-Hodgkin lymphoma; DLBCL, diffuse large B-cell lymphoma; NF- $\kappa$ B, nuclear factor- $\kappa$ B; SLVL, splenic lymphoma with villous lymphocytes.

NOTE: The information displayed in this table focuses on genes involved in the pathogenesis of the non-Hodgkin lymphomas; however, genes that are recurrently involved in the genesis of selected other B- or T-cell lymphoid malignancies are also shown.

<sup>a</sup> Variant translocations affecting other immunoglobulin or T-cell receptor, or nonimmunoglobulin or non-T-cell receptor loci than the one shown do occur less commonly for many of the translocations.

Functional data were obtained from the SOURCE database (<http://genome-www4.stanford.edu/cgi-bin/SMD/source/sourceSearch>), as available.

**TABLE 89.2. Genes Involved in T-Cell Oncogenesis via Chromosomal Translocations**

| Cytogenetic Abnormality <sup>a</sup> | Disease (Predominant Subtypes) | Involved or Presumed Target Genes (Aliases)              | Presumed Function of Target Genes  |
|--------------------------------------|--------------------------------|--|--|
| t(1;7)(p34;q34)                      | Lymphoblastic lymphoma         | <i>LCK</i> ( <i>p56-LCK</i> , <i>LSK</i> )               | Cytoplasmic tyrosine kinase; participates in antigen-induced T-cell activation; bound to cytoplasmic domains of either CD4 or CD8  |
| t(1;14)(p32;q11)                     | Lymphoblastic lymphoma         | <i>TAL1</i> ( <i>SCL</i> , <i>TCL5</i> )                 | bHLH DNA-binding transcription factor  |
| t(2;5)(p23;q35)                      | Anaplastic large cell lymphoma | <i>NPM-ALK</i>   | Anaplastic lymphoma kinase; receptor tyrosine kinase that binds the ligands pleiotrophin and midkine   |
| t(5;14)(q35;q32)                     | Lymphoblastic lymphoma         | <i>HOX11L2</i> ( <i>RNX</i> , <i>TLX-3</i> )             | Homeodomain transcription factor   |
| t(7;9)(q34;q34.3)                    | Lymphoblastic lymphoma         | <i>NOTCH1</i> ( <i>TAN1</i> )                            | Transmembrane protein that functions as receptor for membrane-bound ligands Jagged1, Jagged2, and Delta1; intracellular domain is proteolytically released on ligand binding, translocates to nucleus, and acts as a transcriptional activator |
| t(7;9)(q35;q34)                      | Lymphoblastic lymphoma         | <i>TAL2</i>  | bHLH DNA-binding transcription factor  |
| t(7;19)(q35;p13)                     | Lymphoblastic lymphoma         | <i>LYL1</i>  | bHLH DNA-binding transcription factor  |
| t(8;13)(p11;q12)                     | Lymphoblastic lymphoma         | <i>FGFR1</i> ( <i>bFGFR</i> , <i>CEK</i> , <i>FLT2</i> ) | Fibroblast growth factor receptor 1; receptor tyrosine kinase that binds basic fibroblast growth factor  |
| t(8;14)(q24;q11)                     | Lymphoblastic lymphoma         | <i>cMYC</i>  | bHLH-zip transcription factor; activates or represses expression of multiple target genes  |
| t(10;14)(q24;q11)                    | Lymphoblastic lymphoma         | <i>HOX11</i> ( <i>TCL3</i> , <i>TLX-1</i> )              | Homeodomain transcription factor   |

|                     |  |  |  |
|---------------------|--|--|--|
| t(11;14)(p13;q11)   | Lymphoblastic lymphoma   | <i>LMO2</i> ( <i>RBTN2</i> , <i>TTG2</i> ) | LIM-only protein 2; cysteine-rich LIM domain transcriptional regulator |
| t(11;14)(p15;q11)   | Lymphoblastic lymphoma   | <i>LMO1</i> ( <i>RBTN1</i> , <i>TTG1</i> ) | LIM-only protein 1; cysteine-rich LIM domain transcriptional regulator |
| t(14;14)(q11;q32.1) | T-cell chronic lymphocytic leukemia, T-cell prolymphocytic leukemia/lymphoma | <i>TCL1</i>                                | AKT kinase coactivator   |
| t(X;14)(q28;q11)    | T-cell chronic lymphocytic leukemia, T-cell prolymphocytic leukemia/lymphoma | <i>MTCP-1</i> ( <i>C6.1B</i> )             | AKT kinase coactivator   |

bHLH, basic helix-loop-helix.

NOTE: The information displayed in this table focuses on genes involved in the pathogenesis of the non-Hodgkin lymphomas; however, genes that are recurrently involved in the genesis of selected other B- or T-cell lymphoid malignancies are also shown.

<sup>a</sup> Variant translocations affecting other immunoglobulin or T-cell receptor, or nonimmunoglobulin or non-T-cell receptor loci than the one shown do occur less commonly for many of the translocations.

Functional data were obtained from the SOURCE database (<http://genome-www4.stanford.edu/cgi-bin/SMD/source/sourceSearch>), as available.

## SMALL NONCLEAVED CELL LYMPHOMA (BURKITT): cMYC

There are two types of lymphomas within the small noncleaved cell category: the Burkitt and the non-Burkitt types ( [63](#), [64](#), [65](#), [66](#), [67](#), [68](#), [69](#), [70](#), [71](#), [72](#), [73](#) and [74](#) ). The non-Burkitt lymphomas have a similar overall survival and response to therapy as the Burkitt type. In addition, the non-Burkitt and Burkitt lymphomas share essentially identical histologic features, with only subtle differences distinguishing the two, and both express mature B-cell surface markers. Despite their close similarities, the molecular pathogenesis of the Burkitt and non-Burkitt lymphomas is different in that the chromosomal abnormalities found in the Burkitt type that affect the *cMYC* gene are not usually considered a feature of non-Burkitt small noncleaved cell cases. In some cases, the non-Burkitt lymphomas contain the t(14;18) rearrangement that activates the expression of *BCL2*, whereas, in many, the molecular pathogenetic lesions remain to be defined ( [70](#), [75](#), [76](#) ).

The Burkitt-type lymphomas themselves classically comprise two subtypes: the endemic form that occurs primarily in Africa and the sporadic form that occurs throughout the world ( [77](#), [78](#) ). These two forms differ in terms of the frequency of their association with Epstein-Barr virus (EBV) infection and with regard to selected molecular aspects of the involvement of the *cMYC* gene in their pathogenesis ( *vide infra* ). Both of these forms affect men more often than women (with a male to female ratio of 2 to 3:1). The endemic form typically affects children between 5 and 10 years of age and usually presents with involvement of the maxilla and mandible, with abdominal and other extranodal sites also common, whereas the sporadic form occurs mainly in the adolescent and young adult age groups and usually presents as abdominal disease. These tumors, which are responsive to chemotherapy, have the highest growth rate of all lymphomas. Some 2 to 5% of patients

with acute lymphoblastic leukemia have a FAB L3 morphology, with cells that contain the typical Burkitt chromosomal translocations involving cMYC and that are thought to represent Burkitt lymphoma in leukemic phase (77). In addition to the two originally described classical subtypes of Burkitt-type lymphomas, it has more recently become evident that Burkitt lymphoma is also common in human immunodeficiency virus (HIV)-infected individuals (70, 79).

In endemic African Burkitt lymphoma, approximately 95% of tumors contain clonal EBV DNA, whereas only some 20% of tumors in the United States and Europe are EBV associated (70, 78, 80, 81, 82 and 83). Likewise, only a subset (approximately 40%) of HIV-associated Burkitt lymphomas are EBV associated (70, 79). The exact contributions of the EBV genome to the development of these lymphomas are not yet clear, but it is well known that EBV is capable of immortalizing B lymphocytes (and pre-B cells) as cell lines that proliferate indefinitely *in vitro* (77). The identification of clonal EBV genomes in Burkitt lymphomas indicates that EBV cell infection and immortalization is an early event that occurs before the development of frank malignant transformation, not after development of the transformed clone (84). Presumably, the activity of several specific EBV genome-encoded proteins expressed during acute infection is necessary for polyclonal lymphoproliferation, which is followed by the establishment of a monoclonal tumor population once the cMYC gene is activated (70, 77). The latent pattern of EBV-associated gene expression observed in established Burkitt lymphomas, which is more restricted than the expression pattern observed in acute infections that lead to polyclonal “lymphoblastoid” proliferation, is accompanied by the down-regulation of adhesion molecules, such as LFA-3 and intercellular adhesion molecule 1, HLA class I molecules, and immunogenic EBV proteins (e.g., Epstein-Barr nuclear antigen 2 and latent membrane protein 1), suggesting that EBV infection may facilitate escape of the lymphomas from normal immune surveillance mechanisms (83). Furthermore, Epstein-Barr nuclear antigen 1, which is one of the few EBV genes that continues to be expressed in established Burkitt tumors has been shown to induce B-cell lymphomas in transgenic mice (85), and the latently expressed Epstein-Barr-encoded RNA 1 and Epstein-Barr-encoded RNA 2, a pair of small EBV-specific RNA transcripts, exhibit oncogenic potential in cell lines experimentally (86, 87). Thus, an integrated model (which is yet unequivocally proven) of the role of EBV in the pathogenesis of Burkitt lymphoma supposes that the “lymphoblastoid” pattern of EBV gene expression initially drives a polyclonal B-cell expansion and that, on the stochastic acquisition of cMYC rearrangement and expression, a nascent tumor cell clone converts to the latent EBV gene expression pattern, which possibly enables escape from immune surveillance and helps sustain the fully transformed state. The EBV genome is also present in a high percentage of lymphomas associated with congenital (e.g., Wiskott-Aldrich syndrome and X-linked lymphoproliferative syndrome) or acquired [e.g., posttransplant immunosuppression and some acquired immunodeficiency syndrome (AIDS) patients] immunodeficiency states (77, 79, 81, 88, 89, 90, 91, 92, 93, 94, 95, 96, 97, 98 and 99), in which the impaired immune surveillance permits the expansion of an EBV-immortalized polyclonal lymphoid cell population. A more complete discussion of the role of EBV in lymphomagenesis, including in the congenital or acquired immunodeficiency diseases that predispose to NHL, and of other viruses associated with the development of NHL, is found in [Chapter 67](#), [Chapter 68](#) and [Chapter 69](#).

Roughly 80% of the Burkitt lymphomas contain a t(8;14)(q24;q32) rearrangement in which translocation of one allele of the prototypic basic helix-loop-helix (bHLH)-leucine zipper transcription factor gene cMYC, normally on chromosome 8, occurs into the Ig heavy chain locus on chromosome 14, adjacent to the coding sequences of the Ig constant region (28, 29, 70, 100, 101). The remaining cases have a t(2;8)(p12;q24) (found in 15% of cases) or a t(8;22)(q24;q11) (5% of cases) involving cMYC and the ? or ? Ig light chain loci

on chromosome 2 or 22, respectively ( [102](#), [103](#), [104](#), [105](#), [106](#), [107](#) and [108](#) ). In these two rearrangements, the cMYC gene remains on chromosome 8, and the involved light chain gene is translocated downstream of the cMYC locus. In spite of the large variation in their positions, the breakpoints on chromosome 8 in these translocations never disrupt the coding regions of the cMYC protein. Differences in the chromosome 8 breakpoint location have been noticed between endemic and sporadic Burkitt tumors ( [77](#), [109](#) ). The majority of endemic tumors possess breakpoints far upstream (with a smaller number far downstream) of cMYC, whereas sporadic tumors almost always have breakpoints within or close to the cMYC locus. In all instances of translocation, cMYC transcription is deregulated as a result of the juxtaposition of the locus with strong Ig gene enhancers, producing constitutive high-level expression. Because the positions of the chromosomal breakpoints in cMYC and the various Ig genes are widely dispersed, it has been difficult to design PCR-based tests to detect cMYC-Ig genes; as a result, these cMYC translocations are reliably identified only by karyotyping of metaphase chromosomes or FISH, which can be performed on metaphase chromosomes or interphase nuclei ( [110](#) ). Minimal information is available regarding the mechanisms underlying the chromosomal breaks in cMYC; for example, the breakpoints in the gene locus bear no significant homology to V(D)J or switch recombinase recognition sequences, suggesting that the breaks are not likely dependent on these activities. Interestingly, mice with genetic defects that impair the repair of double-strand DNA breaks develop pro-B-cell tumors with high frequency, all of which have chromosomal translocation involving cMyc and IgH ( [111](#) ), but the relevance of this observation to the mechanism of cMYC translocations in human Burkitt lymphomas remains to be determined.

It also appears that, in most, if not all, tumors, regardless of breakpoint location, mutations of the cMYC locus occur coincident with the translocations that can alter the transcription or other functional aspects of the gene, resulting in its deregulation ( [109](#), [112](#), [113](#) and [114](#) ). For example, point mutations near the 3' end of the first exon of cMYC (the gene consists of three exons, the first being noncoding, with the coding sequences present in exons 2 and 3) have been described that prevent the binding of a factor involved in suppressing the elongation of cMYC transcripts ( [115](#) ), whereas other mutations have been reported to impair the binding and suppression of the cMYC transcriptional activation domain by the Rb-related protein p107 ( [116](#) ). Another example of this mutational process occurs within exon 2 of the gene, in which amino acid substitutions that stabilize the cMYC protein occur ( [117](#), [118](#) ), thus increasing its cellular concentration and functional effects. One important amino acid in this regard is threonine 58, a site that normally targets the protein for proteasome-mediated degradation when phosphorylated ( [119](#), [120](#) ). The origin of these mutations is thought to be a consequence of the juxtaposition of the locus to Ig sequences and the exposure to the somatic mutation process that normally occurs in the variable (V) regions to contribute to diversification of the antibody response (so-called somatic hypermutation) ( [59](#), [60](#), [61](#) and [62](#) ).

Numerous studies have confirmed that cMYC is a transcription factor that promotes cell cycle progression and cell transformation, and inhibits differentiation ( [121](#), [122](#), [123](#) and [124](#) ). For example, enforced expression of cMYC in growth factor-deprived cells is sufficient to overcome cell cycle arrest and push cells into S phase ( [125](#), [126](#) and [127](#) ). Ablation of cMYC in cells using antisense oligonucleotides or expression constructs blocks entry into S phase, further indicating that cMYC function is essential for cell cycle progression ( [128](#), [129](#) and [130](#) ). *In vitro*, the pathogenesis of Burkitt lymphoma has been experimentally reproduced by demonstrating the tumorigenic conversion of EBV-infected B lymphoblasts on introduction of an activated cMYC gene into the cells ( [131](#) ). Enforced cMYC expression promotes *in vivo* transformation, as evidenced by the development of

lymphomas in mice bearing the gene driven by an Ig gene enhancer ( [132](#), [133](#) ). In this animal model of Burkitt lymphoma, mice initially develop a polyclonal pre-B-cell hyperplasia that progresses within a short period of time to monoclonal malignancies. The time course of tumor development suggests that cMYC overexpression alone is insufficient to produce transformation, requiring cooperating genetic abnormalities for the development of a full-fledged malignancy. A number of genes that cooperate with cMYC to enhance tumorigenesis have been identified, including BCL2, PIM-1, RAS, ABL, BMI-1, and RAF-1 ( [70](#), [121](#) ).

The exact mechanism by which cMYC acts to promote cellular transformation is not yet clear but is thought to involve the transcriptional regulation of relevant target genes. It is known that cMYC alone or as a homodimer does not efficiently exhibit sequence-specific DNA binding. Rather, the protein exists in cells as a heterodimer with another bHLH-leucine zipper protein called *MAX*; cMYC/MAX heterodimers exhibit efficient sequence-specific DNA binding and tend to activate gene transcription ( [134](#), [135](#) and [136](#) ). However, MAX can also heterodimerize with a number of other related bHLH-leucine zipper proteins including MAD ( [137](#) ), MXI-1 (MAD2) ( [138](#), [139](#) and [140](#) ), and MNT ( [141](#) ). MAX/MAX, MAX/MAD, and MAX/MXI-1 dimers repress transcription while retaining the ability to bind to the DNA sequences also bound by cMYC/MAX heterodimers. Thus, it is generally accepted that cells contain cMYC/MAX heterodimers and MAX/MAX homodimers (as well as the aforementioned MAX/MAD and MAX/MXI-1 heterodimers) that compete for binding to similar gene target sequences and activate or inhibit transcription, respectively ( [134](#), [135](#), [138](#), [142](#) ). Because the cMYC messenger RNA (mRNA) and protein are short lived, and MAX is relatively stable and abundant, the level of cMYC/MAX heterodimer largely depends on the cMYC concentration in the cell. Factors that result in the increased production of cMYC (like the chromosomal translocations characteristic of Burkitt lymphoma) are thought to favor the formation of cMYC/MAX complexes and the transactivation of a set of genes essential for the progression through the G<sub>1</sub> phase of the cell cycle ( [143](#) ). Overexpression of cMYC also effectively decreases the heterodimerization of MAX with its other dimerization partners, such as MAD and MXI1, the expression of which is associated with cellular differentiation ( [137](#), [139](#), [144](#), [145](#) ). This currently accepted model of cMYC regulation (and deregulation in cancer) would predict that underproduction of inhibitory bHLH-leucine zipper proteins might also produce consequences similar to cMYC up-regulation; support for this hypothesis is provided by the phenotype of Mxi-1 knockout mice, which have an increased susceptibility to the development of lymphoma ( [140](#) ).

Transcriptional activation of genes by cMYC/MAX heterodimers, like many oncogenic transcription factors, in part involves changes in the balance of histone acetylation and deacetylation, thereby altering chromatin structure ( [146](#), [147](#), [148](#) and [149](#) ). For example, MAD, MXI-1 and MNT all interact with a transcriptional repressor complex that possesses histone deacetylase (HDAC) activity; increased recruitment of this complex to promoter elements correlates with HDAC-dependent silencing of transcription and cellular growth arrest plus enhanced differentiation ( [138](#), [141](#), [150](#), [151](#), [152](#) and [153](#) ). By contrast, cMYC interacts with the transactivation-transformation domain-associated protein (TRRAP), which recruits GCN5, a known histone acetyltransferase, providing part of the explanation for transcriptional activation by cMYC/MAX heterodimers ( [154](#), [155](#), [156](#) and [157](#) ). The binding of TRRAP correlates with the oncogenic ability of cMYC, pointing out the critical importance of histone acetylase activity and alterations of chromatin structure in the cellular transformation process. This importance is also borne out by the current preclinical and clinical efforts to regulate oncogenic gene expression by alteration of chromatin structure using various compounds (e.g., HDAC inhibitors) that may have therapeutic potential ( [158](#) ). Additional modulation of transcriptional control by cMYC occurs through interactions of the protein with multiple other proteins. For example, in



addition to TRRAP, the N-terminus of cMYC interacts with p107, Bin1, MM1, PAM, and AMY1, and many of these interactions appear to be mediated throughout the functionally crucial “MYC box” sequences (MB1 and MB2) within the N-terminal cMYC transcriptional activation domain ( [122](#), [159](#) ). Likewise, the C-terminal portion of cMYC also interacts with a host of proteins implicated in the regulation of transcription, such as YY1, AP2, BRCA1, TFII-I, and MIZ1 ( [122](#), [159](#) ). The significance of these cMYC-interacting proteins in the cellular transformation process is a matter of ongoing study.

cMYC expression and its deregulation influence multiple cellular processes, including cell cycle progression, differentiation, metabolism, apoptosis, immortalization, and adhesion. For example, with respect to the cell cycle, analysis of cMyc-null fibroblasts has revealed a 12-fold reduction in the expression of cell cycle-promoting cyclin D1-cyclin-dependent kinase (CDK) 4 and -CDK6 complexes ( [160](#) ). Other cell cycle-important cMYC targets include the cell cycle inhibitors p21 and p27, both of which are down-regulated by cMYC, and Cdc25A, a protein phosphatase up-regulated by cMYC that activates CDK2 and CDK4 ( [161](#), [162](#) ). Because terminal cellular differentiation requires exit from the cell cycle, and given that cMYC promotes constant cycling, it follows that overexpression of the protein interferes with cellular maturation. Interestingly, recent studies examining mice engineered to express a regulated cMYC gene (allowing the gene to be turned off by administration of the antibiotic doxycycline to the mice) has shown that the majority of cMYC-induced hematopoietic and other lineage tumors undergo cell cycle arrest, terminal differentiation, and regression on down-regulation of the gene ( [163](#), [164](#) ). Thus, continued expression of cMYC is necessary for persistence of the tumor; an obvious correlate of these findings is that inhibition of cMYC might therefore hold therapeutic benefit. A number of metabolic pathways are affected by cMYC owing to its regulation of other target genes, including nucleotide synthesis, protein synthesis, and iron metabolism ( [70](#) ). In addition, lactate dehydrogenase A transcription is activated by cMYC ( [165](#) ). Lactate dehydrogenase A expression correlates with the ability of cells to participate in aerobic glycolysis and to grow more efficiently under hypoxic conditions. cMYC may also be able to maintain the expression of telomerase, an enzyme that contributes to the immortalization of cells by permitting the indefinite maintenance of the chromosomal ends (i.e., the telomeres), which normally shorten as aging occurs. This shortening process is thought to contribute to cellular senescence. cMYC can directly induce the catalytic subunit of telomerase, known as *telomerase reverse transcriptase*, at the level of transcription ( [166](#), [167](#) ). Enforced expression of telomerase reverse transcriptase has been demonstrated to immortalize rodent cells experimentally and to make cells susceptible to oncogenic transformation ( [167](#), [168](#) ).

A brief mention at this point of the importance of the function of the p53 gene in the development and progression of NHL is warranted. Abnormalities of the p53 tumor suppressor gene appear to play a pathogenic role in some Burkitt lymphomas, as well as in a number of other NHL subtypes ( *vide infra* ). Mutations of this gene locus have been identified in one-third of primary biopsies and almost two-thirds of Burkitt lymphoma-derived cell lines ( [169](#), [170](#) ). The p53 protein, encoded on chromosome 17p13, is the most commonly mutated protein identified in human cancer and is involved in programmed cell death as well as in cell cycle regulation and DNA repair ( [171](#), [172](#), [173](#), [174](#), [175](#), [176](#) and [177](#) ). This protein, which has been referred to as the *guardian of the genome*, monitors DNA repair, helping ensure that the repair process is completed before subsequent cell division occurs ( [178](#) ). By functioning as a transcription factor to increase the expression of the p21 protein, a universal inhibitor of cyclin-CDK complexes ( [179](#) ), normal p53 can turn off DNA replication, arresting cells in G<sub>1</sub> phase to allow extra time for repair ( [180](#), [181](#) ). In addition, if the repair process fails, p53 can trigger cell death by apoptosis. Cells bearing inactivated p53 are unable to undergo these checks and balances



and acquire mutations at an increased rate, allowing defective cells to replicate unrepaired DNA sequences that are passed on to their progeny and ultimately lead to the selection and outgrowth of clones with enhanced malignant potential. The tumor-suppressive effects of p53 are evident in mice lacking the protein as a result of gene targeting by homologous recombination; these animals develop normally but experience the early development of a variety of neoplasms ( [182](#), [183](#) ).

## LYMPHOPLASMACYTOID LYMPHOMA: PAX5

Roughly 50% of the low-grade NHLs that are known as *small lymphocytic lymphomas with plasmacytoid differentiation* or *lymphoplasmacytoid lymphomas* contain a t(9;14)(p13;q32) chromosomal rearrangement. Although rare, the t(9;14) is illustrative of the involvement in malignancy of a family of transcription factors, the PAX (for *paired homeobox*) proteins, that normally control embryonic development and organogenesis ( [184](#), [185](#) ). Members of this family contain two discrete DNA-binding domains—the paired box and the paired-type homeodomain—that display coordinate DNA binding specificity ( [186](#) ). The lymphomas that contain the t(9;14) comprise B cells with a plasma cell-like phenotype that possess cytoplasmic Ig, produce serum paraproteins, and typically follow an indolent clinical course followed by transformation into large-cell lymphoma ( [187](#) ). A number of other reciprocal chromosomal fusion partners with the 9p13 breakpoint have been identified cytogenetically in addition to chromosome 14q32, including 1q25, 3q27, 7q11, 12q13, 12q21, 10p13, and 9q13 ( [188](#) ). The t(9;14) results in the juxtaposition of the PAX5 (paired Homeobox-5) gene ( [189](#) ) with the Ig heavy chain locus on chromosome 14 ( [190](#) ).

PAX5 is normally expressed in fetal brain and liver during the embryonic period but is restricted to B lymphocytes and the testis after birth ( [189](#) ). PAX5 is transcribed throughout B-cell ontogeny but undergoes down-regulation during plasma cell differentiation. Knockout mice experiments have demonstrated that Pax5 is important for midbrain development and that loss of Pax5 function results in maturation arrest of lymphocytes at the pro-B-cell stage ( [191](#) ). Pax5 overexpression, by contrast, results in splenic B-cell proliferation ( [192](#), [193](#) ). Several genes important for B-cell development have been proposed to be PAX5 targets, including CD19, B-cell receptor component Ig alpha (mb-1), transcription factors N-MYC and LEF-1 (positively regulated by PAX5), and the cell surface protein PD-1 and the p53 tumor suppressor (which are down-regulated) ( [194](#), [195](#) and [196](#) ). In addition, the B-cell SRC family tyrosine kinase BLK, which transforms lymphoid progenitors in an activated form but is dispensable for B-cell development and activation, is up-regulated by PAX5 ( [197](#), [198](#), [199](#) and [200](#) ). Furthermore, PAX5 appears to be required for normal IgH VDJ recombination, given that V-to-DJ recombination is reduced approximately 50-fold in Pax5-deficient pre-B cells ( [196](#) ). In a series of elegant experiments, Busslinger and his group have shown that Pax5-null pro-B cells are incapable of B-cell-lineage differentiation and rather can actually give rise to all other hematopoietic cell types when cultured under appropriate conditions; reintroduction of the gene into pro-B cells lacking Pax5 restores their ability to differentiate into mature B cells but suppresses their differentiation into other blood lineages ( [201](#), [202](#) and [203](#) ). Pax5-null pro-B cells express genes of non-B-cell hematopoietic lineage-associated programs; restoration of Pax5 expression in these cells represses this lineage-promiscuous gene transcription while up-regulating genes critical for B-cell development. Thus, Pax5 plays an essential role in B-cell-lineage commitment by suppressing alternative hematopoietic lineage choices. The overexpression of PAX5, as a consequence of the t(9;14), down-regulates p53 ( [190](#), [204](#) ) and presumably also alters the expression of multiple B-cell-important target genes, thus contributing to malignant transformation.

Deregulation of PAX5 expression by a translocated IgH promoter has also been reported rarely in NHL subtypes other than lymphoplasmacytoid lymphoma and in myeloma ( [205](#) ). As noted previously, other PAX genes play a role in oncogenesis. For example, the PAX3 and PAX7 genes fuse to the forkhead domain transcription factor (FKHR) in the t(2;13)(q35;q14) and t(1;13)(p36;q14) translocations, respectively, in the skeletal muscle tumor rhabdomyosarcoma ( [206](#) ), and PAX8 forms a fusion oncoprotein, PAX8–PPAR $\gamma$ 1, in human thyroid follicular carcinomas ( [207](#) ). PAX5 itself is aberrantly expressed in some medulloblastomas and glioblastomas through an unknown mechanism of altered regulation ( [208](#) ).

## MANTLE CELL LYMPHOMA: CCND1 (CYCLIN D1)

Mantle cell lymphoma (MCL) is recognized under the Revised European American Lymphoma (REAL) and World Health Organization (WHO) classifications as a distinct clinicopathologic entity, which was referred to in the past as *centrocytic lymphoma* in the Kiel classification and *intermediately differentiated lymphoma* in the modified Rappaport classification ( [12](#), [13](#), [209](#), [210](#) ). The Working Formulation ( [8](#) ) failed to recognize MCL as a unique entity, and most of these lymphomas were considered to be diffuse small cleaved lymphoma (approximately 60%), follicular small cleaved lymphoma (approximately 25%), or small lymphocytic lymphoma (approximately 15%) ( [211](#) ). These B–cell lymphomas constitute roughly 6% of all NHL, predominate in men (male to female ratio, 4:1) older than 55 years of age, and are associated with an overall poor prognosis (worse than other small cell NHL subtypes), having a median survival of approximately 3 years, although some patients have an aggressive disease that leads to death in less than 1 year, whereas others manifest a rather indolent disease and may survive for more than 10 years ( [210](#), [212](#), [213](#) ). The so–called blastic variant morphology of MCL has been associated with a short survival in several reports ( [214](#), [215](#) ), and mutations of p53 ( [216](#), [217](#) and [218](#) ), as well as deletions of the INK4a/ARF tumor suppressor gene locus ( [219](#), [220](#) ), are thought to identify subsets of MCL with a particularly poor prognosis (see also the section [Gene Expression Profiling in Non–Hodgkin Lymphoma](#) at the end of this chapter for additional information regarding the diagnosis and prognosis of MCL).

MCL was not widely acknowledged as a discrete subtype of NHL until its association with a unique chromosome translocation. Almost all (>90%) cases of this lymphoma contain the translocation t(11;14)(q13;q32), which also occurs infrequently in other types of NHL, chronic lymphocytic and B–cell prolymphocytic leukemias, and multiple myeloma ( [221](#), [222](#) and [223](#) ). Although the breakpoint on chromosome 11 that is altered by the t(11;14) was cloned in 1984 ( [224](#), [225](#) ), CCND1, the chromosome 11 gene transcriptionally activated because of its juxtaposition near the enhancer region of the Ig heavy chain locus on 14q32, was not identified until 7 years later, because the major genomic breakpoint cluster region (designated BCL1 for B–cell lymphoma/leukemia 1) is located approximately 120 kilobases (kb) centromeric to the CCND1 coding sequences ( [226](#), [227](#) and [228](#) ). Because the breakpoints in the BCL1 genomic locus are not tightly clustered, most studies using Southern blot analysis or PCR detect the translocation in only 50 to 70% of patients ( [229](#), [230](#), [231](#) and [232](#) ). Thus, conventional cytogenetics or FISH ( [233](#), [234](#) ) are the most sensitive means to detect the t(11;14), although detection of overexpression of the CCND1 transcript or its encoded protein, cyclin D1, by *in situ* hybridization or immunostaining have recently been shown to be sensitive diagnostic methods, because B and T lymphocytes do not normally express the gene ( [33](#), [235](#), [236](#), [237](#), [238](#), [239](#), [240](#) and [241](#) ).

Cyclin D1, previously also known as *PRAD1* because of its involvement in parathyroid

adenoma-associated translocations in addition ( [227](#), [242](#) ), is overexpressed in nearly all cases of MCL but is only rarely expressed in other hematopoietic malignancies ( [227](#), [229](#), [231](#), [232](#), [243](#), [244](#) ). All 11;14 translocation breakpoints thus far characterized leave the CCND1 coding region intact structurally and result in increased protein expression ( [228](#), [245](#), [246](#) ). Cyclin D1 overexpression facilitates lymphomagenesis as a result of its role in the progression of cells through the G<sub>1</sub> to S phase transition of the cell cycle ( [247](#), [248](#) ). Cyclin D1, a member of the family of D-type cyclins, physically associates with and activates enzymes known as *cyclin-dependent kinases* (mainly CDK4 and CDK6). Cyclin D1-CDK complexes in turn bind to and hyperphosphorylate the retinoblastoma tumor suppressor protein (Rb) ( [249](#), [250](#) and [251](#) ), preventing Rb from interacting with and inhibiting the activity of transcription factors, such as E2F that promote S phase entry ( [252](#), [253](#) ). The growth inhibitory effects of Rb are thus removed, and cells undergo a shortened G<sub>1</sub> phase, followed by S phase entry ( [177](#), [254](#) ). Cyclin D1-CDK4 and -6 complexes also promote enhanced cell cycle progression by interacting with the CDK inhibitors (CKIs) p21 and p27KIP1 ( [255](#) ), titrating these proteins away from cyclin E-CDK2 complexes. Although p21 and p27KIP1 are potent inhibitors of cyclin E-CDK2 complexes, they do not inhibit cyclin D1-CDK4 and -6 complexes. Increased cyclin E-CDK2 activity can promote S-phase entry by phosphorylating Rb and can sustain cell cycle progression by the phosphorylation of p27KIP1, which leads to the proteasome-mediated degradation of the CKI ( [177](#) ).

Deletions of the INK4a/ARF gene locus are found in 20 to 30% of MCLs and, as mentioned previously, are associated with an inferior prognosis ( [219](#), [220](#), [256](#), [257](#) and [258](#) ). This locus encodes two structurally unrelated tumor suppressors, the p16INK4a protein, which is an inhibitor of CDK4 and CDK6 that prevents their ability to phosphorylate and inactivate the growth-suppressive Rb protein, and the human p14ARF protein, which is encoded in part from an alternative reading frame (from which it gets its name) of the INK4a locus and acts as an inhibitor of the p53 negative regulator, HDM2, to induce the tumor-suppressive functions of p53, which include the promotion of cell cycle arrest and apoptosis ( [177](#) ). Thus, loss of the INK4a and ARF proteins removes these tumor suppressor activities and cooperates with cyclin D1 overexpression to quantitatively increase MCL tumor cell proliferation and shorten patient survival ( [259](#) ).

The important role that cyclin D1 plays in oncogenesis is further highlighted by the observation that, in addition to MCL and parathyroid adenomas, the protein is overexpressed in a number of cases of breast cancer and squamous cell carcinomas of the head and neck ( [260](#), [261](#) ) as a result of gene amplification. Interestingly, a small percentage (approximately 9%) of otherwise typical MCLs lack cyclin D1 overexpression ( [262](#) ); some of these cases instead express high levels of cyclins D2 and D3, suggesting that the enhanced cell cycle progression mediated by cyclin D1 overexpression can be mimicked at least partly by these other D-type cyclins ( [258](#) ).

A number of cell culture-based, as well as transgenic mice, experimental studies have demonstrated the potential for cyclin D1 to contribute to oncogenesis ( [263](#), [264](#), [265](#), [266](#), [267](#), [268](#) and [269](#) ). Experiments with transgenic mice overexpressing CCND1 in their lymphoid compartment revealed subtle alterations in lymphocyte maturation and cell cycle progression ( [267](#), [268](#) ). Although CCND1 was not transforming by itself in these studies, the gene was shown to cooperate with MYC genes to produce B-cell lymphomas. Oncogenic cooperation of CCND1 with the Harvey RAS gene has also been reported in the transformation of primary rat embryo fibroblasts, whereas CCND1 alone or in combination with cMYC failed to transform cells in this system ( [266](#) ). These results are

consistent with the oncogenic contributions of cyclin D1 overexpression to lymphoma development and progression but suggest that the protein is relatively poor at initiating the lymphomagenic process ( [270](#) ). Experience from other cyclin D1 transgenic mice studies also points to the oncogenic capabilities of the protein; for example, mice overexpressing the gene driven by the mouse mammary tumor virus promoter develop breast hyperplasia and carcinoma ( [269](#) , [271](#) ).

It is appropriate at this point to note in greater detail that the alteration of CDKIs has been demonstrated in a variety of NHL and other cancers. Several of the CDKIs, which include p15<sup>INK4B/MTS2</sup>, p16<sup>INK4A/MTS1</sup>, p18<sup>INK4C</sup>, p19<sup>INK4D</sup>, p21<sup>CIP1,WAF1,SDI1,CAP20</sup>, p27<sup>KIP1</sup>, and p57<sup>KIP2</sup> (the various names that have been given to these proteins are shown in this paragraph as superscripts), are altered in a variety of solid and hematopoietic malignancies, including NHL ( [176](#) , [247](#) , [255](#) , [272](#) , [273](#) ). These factors normally bind to specific CDKs, inhibiting their kinase activities and preventing cell cycle progression ( [255](#) , [272](#) ). The inactivation of CDKI activity in cancer, usually by homozygous gene deletions but occasionally by point mutations or chromosomal rearrangements, or both, contributes to tumorigenesis because of the removal of this negative cell cycle regulation ( [273](#) ). Among the CDKIs, p16<sup>INK4A/MTS1</sup> (formally also known as *CDKN2*) and the closely linked p15<sup>INK4B/MTS2</sup>, which are located on chromosome 9p21 and are specific inhibitors of cyclin D-associated kinases, appear by far to be the most frequently altered ( [273](#) , [274](#) and [275](#) ). For example, in hematopoietic malignancies, a remarkable 75 to 80% of T-cell acute lymphocytic leukemias (ALLs) and 5 to 15% of B-cell ALLs have homozygous p16<sup>INK4A/MTS1</sup> deletion, making this the most frequently altered gene locus thus far reported in ALL ( [273](#) ). Deletion of the p15<sup>INK4B/MTS2</sup> gene, located only 25 kb from the p16<sup>INK4A/MTS1</sup> locus, accompanies the loss of p16<sup>INK4A/MTS1</sup> in most, but not all, cases. In addition, as noted previously, deletions of p16<sup>INK4A/MTS1</sup> also usually involve p14<sup>ARF</sup> as well. Interestingly, alteration of these genes is preferentially found in lymphoid cells, with only occasional myeloid malignancies possessing abnormalities (usually those cases that coexpress lymphoid lineage markers). Approximately 10% of NHL has been reported to contain cytogenetic abnormalities of 9p ( [188](#) ), and studies have revealed p15<sup>INK4B/MTS2</sup> and p16<sup>INK4A/MTS1</sup> alterations to result from some of these abnormalities, with cytogenetically occult alterations also common. In the NHLs other than MCL, abnormalities of these genes seem to be most common in (although not restricted to) diffuse large cell lymphomas (DLCLs), with 10 to 15% of cases reported to show alterations in most studies ( [176](#) , [276](#) , [277](#) , [278](#) , [279](#) , [280](#) and [281](#) ). Interestingly, abnormalities in NHL of some CDKIs (p18<sup>INK4C</sup>, p19<sup>INK4D</sup>, and p21<sup>CIP1,WAF1,SDI1,CAP20</sup>) are infrequent, whereas others (p27<sup>KIP1</sup> and p57<sup>KIP2</sup>) are often inactivated by various mechanisms to deregulate the cell cycle ( [176](#) , [262](#) , [263](#) , [264](#) , [265](#) , [266](#) , [267](#) , [268](#) , [269](#) , [270](#) , [271](#) , [272](#) , [273](#) , [274](#) , [275](#) , [276](#) , [277](#) , [278](#) , [279](#) , [280](#) , [281](#) , [282](#) , [283](#) , [284](#) and [285](#) ).

## FOLLICULAR LYMPHOMA: BCL2

From 80 to 90% of follicular lymphomas (FLs) (follicular small cleaved cell, follicular mixed, or follicular large cell) contain the t(14;18)(q32;q21), the most common chromosomal translocation in human lymphoid malignancy ( [286](#) , [287](#) and [288](#) ). The FLs occur almost exclusively in adults and are the most common human B-cell neoplasm, constituting approximately 45% of all NHLs and 80% of all indolent lymphomas ( [8](#) ). On the derivative 14 chromosome resulting from this translocation, the gene BCL2 (for B-cell leukemia and lymphoma 2), normally located on chromosome 18, is introduced into the Ig heavy chain

locus on chromosome 14 ( [289](#), [290](#) and [291](#) ). The great majority (slightly less than 70%) of breakpoints on chromosome 18 within the BCL2 locus occur in the 3' untranslated region of the gene (the major breakpoint region), and approximately 20% are found roughly 20 kb 3' to the gene locus (the minor cluster region) ( [292](#), [293](#) ). Both breakpoints leave the coding sequence of the gene intact. PCR-using primers that span each of these breakpoint regions can be used to identify the presence of the t(14;18) ( [293](#), [294](#), [295](#), [296](#), [297](#), [298](#) and [299](#) ). These studies have shown that cells positive for the t(14;18) persist in patients in prolonged complete clinical remission, but whether this predicts relapse remains uncertain. Insertion of BCL2 into the Ig heavy chain locus produces dysregulation of the transcription and RNA processing of the gene, resulting in the production of an inappropriately increased amount of the normal 25-kd BCL2 protein. Interestingly, lymphoid cells in the lymph nodes, tonsils, and peripheral blood of normal individuals have been demonstrated to contain BCL2-Ig rearrangement in nearly one-half of cases in some studies, suggesting that the t(14;18) could be a commonly occurring event during normal lymphocyte development and indicating that cells with the abnormality may not necessarily be committed by evolution to lymphoma ( [301](#) and [302](#) ).

BCL2 is a mitochondrial membrane-associated protein that is normally expressed in B cells on their activation with antigens and growth factors and that undergoes down-regulation with normal differentiation. A large number of studies performed since the mid-1980s have established the normal role of BCL2 as an inhibitor of apoptotic (programmed cell death) pathways ( [303](#), [304](#) ). This function of BCL2 is highly conserved in evolution, with the BCL2 homologue CED-9 of the nematode *Caenorhabditis elegans* repressing cell death during the development of the hermaphrodite worm ( [305](#), [306](#) ). BCL2 functions, at least partly, through protein-protein interactions with a number of BCL2 homologues, including the death-promoting 21-kd protein BAX ( [307](#), [308](#) ). BAX can heterodimerize with BCL2 and homodimerize with itself. When it is overexpressed in cells, BAX homodimerizes and accelerates apoptotic cell death; when BCL2 is overexpressed, it heterodimerizes with BAX and inhibits cell death. Thus, the ratio of BCL2 to BAX is critical in determining the susceptibility to apoptosis. BAK (BCL2 homologous antagonist/killer) is another BCL2 family member that can interact with BCL2 in a manner functionally similar to BAX, thus opposing the death-repressor activity of BCL2 ( [309](#), [310](#) and [311](#) ). Additional regulation of BCL2 activity is modulated by the protein BAD (BCL2/BCL-X<sub>L</sub>-associated death promoter) ( [312](#) ), another BCL2-interacting protein that negatively regulates BCL2 by displacing BAX from BCL2/BAX heterodimers in a concentration-dependent fashion, and BAG-1 ( [313](#) ), a protein that is not significantly homologous to the BCL2 family members but that can interact with BCL2 and enhance its death-repressor activity. Yet, additional BCL2 family members have been identified that may modulate BCL2 function or participate in the control of cell lineage-specific apoptosis ( [304](#) ).

Although BCL2 overexpression alone is insufficient to fully transform B cells, the survival advantage that overexpression provides allows time for the development of cooperating genetic mutations that produce frank lymphoma. For example, *in vitro* and *in vivo* studies have demonstrated that BCL2 can complement the cMYC protein, in part by inhibiting cMYC-induced apoptosis, to produce tumors ( [314](#), [315](#), [316](#), [317](#) and [318](#) ). Transgenic mice engineered to express BCL2 within their developing B-cell compartment develop an overabundance of small resting IgM- and IgD-positive polyclonal B cells ( [319](#), [320](#) ). With time, these cells, which demonstrate no proliferative advantage but exhibit prolonged survival, acquire secondary genetic abnormalities (frequently involving cMYC) that produce monoclonal, often highly aggressive malignancies ( [314](#), [321](#) ). This animal model is reminiscent of the course of human FL, which can often be indolent for years before progressing to aggressive diffuse large cell lymphoma (Richter transformation) ( [322](#) ).



Indeed, a substantial number of the approximately 20% diffuse B-cell lymphomas that contain the t(14;18) probably represent progression from typical FLs ( [323](#) ). Conversely, established diffuse large B-cell lymphomas (DLBCLs) can acquire BCL2 expression, due to the t(14;18) or other, unknown mechanisms, and the increased BCL2 expression in this setting has been associated with an inferior disease-free survival in several studies (reviewed in reference [324](#) ). These observations also correlate well with reports that indicate that patients whose lymphoma contains the t(14;18) as a solitary abnormality usually have an indolent course as compared to those patients whose tumors carry additional karyotypic abnormalities ( [288](#) , [322](#) , [325](#) , [326](#) ). For example, the ability to detect the t(14;18) by itself was found to have no impact on survival in FL patients ( [327](#) ), whereas the additional presence of structural breaks in chromosome 17 has been demonstrated to be a predictor of poor outcome ( [325](#) , [326](#) , [328](#) ). At least some of these chromosome 17 abnormalities affect the p53 gene locus at 17p13, the mutation of which has been associated with the histologic transformation of FL ( [329](#) ). The involvement of BCL2 and related proteins in NHL and many other cancers has made this family of apoptosis-regulatory proteins prime targets for therapeutic intervention using antisense and other approaches, and targeted therapies aimed at these molecules are likely to be available in the clinic in the near future ( [330](#) ).

## **LYMPHOBLASTIC LYMPHOMA: TAL1, TAL2, LMO1, LMO2, HOX11, HOX11L2, LYL1, CMYC, NOTCH1, LCK, AND FUSION GENES INVOLVING FGFR1**

These highly aggressive lymphomas, which are almost always of a T-cell phenotype, occur most often in adolescent and young adult men and comprise approximately 40% of NHL in children and 3 to 4% of the NHLs in adults in most series ( [24](#) , [331](#) , [332](#) , [333](#) , [334](#) and [335](#) ). Information regarding the molecular pathogenesis of lymphoblastic lymphoma is derived primarily from the large number of studies that have been performed on the T-cell leukemias, based on the belief held by most investigators that these two clinical diagnoses represent different manifestations of a single biologic entity. In contrast to most of the other major subtypes of NHL in which one or a few chromosomal rearrangements alter the function of a single gene locus (e.g., cMYC in Burkitt lymphomas and BCL2 in the FLs), a number of translocations altering various protooncogenes [TAL1, TAL2, LMO1, LMO2, HOX11, HOX11L2, LYL1, cMYC, NOTCH1, LCK, and fibroblast growth factor receptor-1 (FGFR1)] occur in lymphoblastic lymphoma. A unifying feature of these translocations, with the exception of those involving FGFR1, is that they cause deregulated expression of the involved protooncogene by placing it near enhancer sequences present in the TCR  $\beta$ -chain gene locus on chromosome 7, band q34, or the TCR  $\alpha$ /d locus on chromosome 14, band q11. With the exception of rare chromosomal rearrangements that involve LCK, a cytoplasmic tyrosine kinase involved in interleukin (IL)-2 receptor- and TCR-mediated cell signaling in T lymphocytes ( [336](#) , [337](#) , [338](#) , [339](#) , [340](#) , [341](#) , [342](#) and [343](#) ); NOTCH1 (formerly known as *TANI*), a transmembrane protein of the NOTCH gene family of membrane-spanning receptor proteins that normally play a role in the control of cell fate decisions during differentiation in a variety of tissues from flies to man ( [344](#) , [345](#) , [346](#) , [347](#) , [348](#) , [349](#) and [350](#) ); and the FGFR1 receptor tyrosine kinase, all of the genes altered by these rearrangements encode transcription factors.

Although NOTCH1 is a single-pass transmembrane receptor protein, the early observation that the T-cell acute lymphoblastic leukemia-associated t(7;9)(q34;q34.3) rearrangement results in the expression of truncated NOTCH1 polypeptides that localize primarily to the nucleus, together with subsequent data demonstrating that the cytoplasmic portions of the four mammalian NOTCH proteins interact with several transcription factors to control the activity of the factors, indicated that NOTCH1 also ultimately participates in the oncogenic process by regulating the expression of critical

target genes ( [344](#), [345](#) and [346](#), [348](#), [349](#), [351](#), [352](#) ). Normally, the NOTCH receptors and their ligands (five ligands have been identified in humans: Jagged1, Jagged2, Delta-like1, Delta-like3 and Delta-like4) are transmembrane proteins expressed on the surface of cells. The activation of NOTCH receptors by ligand binding triggers a series of proteolytic cleavages of the receptors that release the intracellular portion of the receptors from the membrane, allowing them to translocate to the cell nucleus [thus, the truncated NOTCH1 proteins expressed due to the t(7;9) represent activated versions of the protein] ( [353](#) ). In the nucleus, NOTCH proteins bind to a highly conserved transcription factor called *CSL* (for CBF1/RBP-Jk in mammals, suppressor of hairless in *Drosophila*, and Lag-1 in *C. elegans*). Binding of the intracellular portion of NOTCH proteins to CSL in the nucleus converts CSL from a transcriptional repressor into an activator of gene expression, and this activation is potentiated by the recruitment of coactivators, such as the protein known as *mastermind-like-1* (*MAML1*, as well as p300 ( [354](#) ). Interestingly, CSL is a target for several EBV proteins required for B-cell transformation and is likely deregulated in a number of human tumors ( [355](#), [356](#) and [357](#) ).

As of 2003, only a few of the target genes of NOTCH signaling have been identified; one frequent target for transcriptional up-regulation is the family of bHLH-type transcriptional repressors known as *hairy/enhancer of split* (*HES*, proteins that regulate embryonic patterning and cell differentiation, but it is not clear that the HES proteins are critical for oncogenic transformation by NOTCH signaling ( [358](#) ). Another possible target of NOTCH proteins that may contribute to oncogenicity includes E2A ( [359](#) ), a gene that encodes two bHLH transcription factors that are known as *E12* and *E47*, the lack of which in knockout mice produces an early block in B-cell development and a predilection to the formation of T-cell tumors ( [360](#) ). Interestingly, aberrant expression of TAL1, LMO1, or LMO2 ( *vide infra* ), the genes most commonly deregulated in human T-cell ALLs, also inhibits E2A activity. Activated NOTCH1 inhibits E2A-induced transcriptional activation, suggesting a common event linking various forms of T-cell malignancy. REL/nuclear factor- $\kappa$ B (NF- $\kappa$ B) transcription factors may also be involved in NOTCH-mediated oncogenesis; certain members of this family, such as *v-rel*, induce T-cell leukemias in animal models, and activated NOTCH1 is known to overcome CSL-mediated repression of the NF- $\kappa$ B2 gene promoter, suggesting that it too may activate REL factors ( [353](#) ).

The association of NOTCH1 abnormalities in T-cell malignancy parallels the importance of the protein in normal lymphoid development. For example, mouse models have demonstrated that NOTCH1 signaling is essential for normal T-cell development and that NOTCH1-mediated signals promote T-cell development at the expense of B-lymphoid development ( [351](#), [361](#), [362](#) ). Furthermore, mice engineered to express excess NOTCH signaling have been shown to develop T-cell malignancies ( [353](#) ). Enhanced NOTCH1 signaling also appears to promote tumor cell growth in human Hodgkin and anaplastic large cell lymphomas (ALCLs) ( [363](#) ).

The TAL1, TAL2, MYC, and LYL1 genes encode members of the bHLH class of transcription factors that are involved in translocations in the lymphoblastic malignancies ( [364](#), [365](#), [366](#), [367](#), [368](#), [369](#), [370](#), [371](#) and [372](#) ). The bHLH domains of these proteins mediate protein dimerization and sequence-specific binding to DNA sequences present in the promoter and enhancer regions of key target genes, most which have yet to be identified ( [373](#), [374](#), [375](#), [376](#), [377](#) and [378](#) ), that normally control events in cellular differentiation or proliferation. By far, the most commonly involved of these loci is TAL1 (also known as *SCL* or *TCL1*) ( [365](#), [366](#) and [367](#) ). Although few studies have examined lymphomas, involvement of this gene has been reported in as much as 30% of T-cell acute lymphoblastic leukemias. In 5% of T-cell ALL, the TAL1 locus on chromosome 1 is altered by the t(1;14)(p32-33;q11), whereas the remaining 25% of cases possess rearrangements



of the locus that are cytogenetically unapparent and that result in an intragenic deletion of the 5' side of the gene that brings TAL1 under the control of the promoter of another chromosome 1 gene called *SIL* ( [379](#), [380](#), [381](#), [382](#), [383](#), [384](#) and [385](#) ). TAL1 has also been reported to be overexpressed in approximately 50% of T-cell malignancies that do not contain these typical abnormalities at the gene locus ( [385](#) ), but these data are uncertain, given that a subsequent examination found the expression of TAL1 in many T-cell leukemias that lack rearrangements of the gene actually occurred in other, nonmalignant cells (e.g., erythroid cells) ( [386](#) ). The molecular genetic abnormalities that affect TAL1 result in the ectopic expression of the protein in T-lymphoid cells (normal expression of the TAL1 protein is restricted to myeloid and erythroid progenitors, megakaryocytes, mast cells, embryonic brain, and endothelial cells) ( [387](#), [388](#), [389](#), [390](#), [391](#), [392](#), [393](#), [394](#) and [395](#) ). Study of TAL1-null embryonic stem cells indicates that the function of the gene is essential for the development of all hematopoietic lineages, suggesting a role in early blood cell development before lineage commitment (i.e., in the genesis of hematopoietic stem cells) has taken place ( [396](#), [397](#), [398](#), [399](#), [400](#), [401](#), [402](#), [403](#), [404](#) and [405](#) ). The bHLH domain of TAL1 has been shown to bind with the so-called E-protein transcription factors that include the E2A bHLH transcription factor and related proteins (E12, E47, HEB, and E2-2) ( [364](#), [365](#), [366](#), [367](#), [368](#), [369](#), [370](#), [371](#), [372](#), [373](#), [374](#), [375](#), [376](#), [377](#), [378](#), [379](#), [380](#), [381](#), [382](#), [383](#), [384](#), [385](#), [386](#), [387](#), [388](#), [389](#), [390](#), [391](#), [392](#), [393](#), [394](#), [395](#), [396](#), [397](#), [398](#), [399](#), [400](#), [401](#), [402](#), [403](#), [404](#), [405](#), [406](#), [407](#), [408](#), [409](#) and [410](#) ) to form sequence-specific DNA-binding heterocomplexes ( [411](#), [412](#) and [413](#) ). The exact mechanism underlying the contribution of TAL1 to the development of T-cell malignancies is not fully clear, but one suggestion is that the overexpression of the protein may act as a dominant-negative regulator of transcription, preventing the normal function of the E-proteins, which play key roles in the developmental progression of a variety of cell lineages including brain, muscle, and lymphocytes ( [410](#), [414](#) ). This hypothesis is consistent with studies indicating that E-protein inactivation or inhibition can lead to T-cell leukemia/lymphoma development ( [415](#), [416](#) ). Transgenic mice engineered to express TAL1 develop T-cell malignancies ( [417](#), [418](#) and [419](#) ). TAL1-E2A heterodimers can physically interact in cells with the LMO1 and LMO2 proteins as well that are also activated in T-lymphoblastic malignancies by chromosomal translocations ( [420](#), [421](#) ). "Double" transgenic mice that express TAL1 and LMO1 or LMO2 in their T cells develop abnormalities of T-cell differentiation and tumors at a significantly faster rate than mice that express LMO1 or LMO2 only, indicating that TAL1 serves as a synergistic tumor promoter in this system ( [416](#), [422](#), [423](#) and [424](#) ).

As mentioned previously, two other transcription factor genes that are altered by translocations found in T-lymphoblastic malignancies encode the cysteine-rich LIM proteins LMO1 and LMO2 (for LIM only) ( [425](#), [426](#), [427](#) and [428](#) ). These two proteins, which were formerly known also as *rhombotin-1* (*RBTN1*) and *T-cell translocation gene 1* (*TTG1*), and *rhombotin-2* (*RBTN2*) and *T-cell translocation gene 2* (*TTG2*), respectively, each contain an amino-terminal transcriptional activation domain and two tandem LIM domains, the latter of which include zinc fingerlike regions ( [429](#), [430](#), [431](#) and [432](#) ). These LIM domains are structurally related to the DNA-binding zinc fingerlike domains of other transcriptional proteins, like the GATA factors ( [433](#), [434](#), [435](#), [436](#) and [437](#) ), but there is no evidence that they bind to DNA. In addition, the absence of a Homeobox DNA-binding domain, which is found in other LIM family members, suggests that these proteins modulate transcription through protein-protein interactions mediated via their LIM domains. Indeed, LMO1 and LMO2 have the ability to physically associate not only with the TAL1 bHLH protein, but also with the bHLH proteins TAL2 and LYL1 that are activated in rare (2%) cases of T-cell malignancy by chromosome rearrangements ( [368](#), [371](#), [420](#), [421](#) ). In turn, like TAL1, TAL2 and LYL1 also interact with E2A ( [438](#) ), and all three of the proteins can bind the same DNA sequences. These observations suggest that, in T

cells, the different E2A-TAL1, -TAL2, or -LYL1 heterodimers may functionally inactivate normal E2A activity or control the regulation, or both, of a common set of as-yet-unknown target genes to contribute to T-cell transformation. The LMO proteins are also involved in this process; for example, LMO2 is found in complexes in normal erythroid cells as well as T-cell lymphomas that include TAL1, E2A, GATA-1, and the ubiquitous nuclear adaptor protein Ldb1/NLI/CLIM2 (439, 440), whereas LMO1 is known to bind Ldb1 (441). TAL1, TAL2, LYL1, and the LMO proteins may possibly contribute to T-cell oncogenesis via other mechanisms as well. TAL1 has been reported to possess antiapoptotic properties that may play a role in the process (442, 443). In addition, TAL1, TAL2, and LYL1 can all physically interact with a novel guanosine triphosphate-binding protein named *DRG*, which has been shown to stimulate the cotransforming activity of MYC and RAS in an experimental model (444). Furthermore, LYL1, but not TAL1 or TAL2, interacts with NF- $\kappa$ B1 and reduces its transcriptional activity, perhaps contributing to oncogenic transformation when deregulated by aberrant expression of LYL1 (445). LMO2 can also bind several proteins in addition to those already mentioned, including Elf-2, an ETS family transcription factor, the retinoblastoma-binding protein 2—a protein that in turn binds Rb, p107, TATA-binding protein, and nuclear hormone receptors to modulate transcription—and AF6, a protein originally identified as a translocation partner of the MLL oncoprotein (446, 447, 448, 449 and 450). Gene targeting experiments in mice of LMO2 and TAL1 indicate that the function of each of these proteins is critical for erythroid cell development, with mice null for the individual genes showing a similar block in red blood cell development (396, 397, 451, 452). These observations suggest that there is a complicated interplay involving transcriptional complexes among the LMO and bHLH proteins altered in T-cell neoplasms (that also includes the GATA factors) (435, 437), which controls normal hematopoietic development (453). T-cell malignancies from some patients have been shown to contain rearrangement of LMO2 and TAL1 gene activation as a result of promoter deletion (421), providing further evidence for cooperation of these genes in tumor development. Although not as common as TAL1 alterations, activation of LMO2 is found in approximately 7% of patients with T-cell lymphoblastic malignancies as a result of the t(11;14)(p13;q11), whereas LMO1 activation by the t(11;14)(p15;q11) is seen in less than 1% of patients (429, 430 and 431, 454). The oncogenic potential of LMO2 overexpression has also been demonstrated recently by the unfortunate development of a monoclonal T-cell lymphoproliferative disorder due to inadvertent insertional mutagenesis of the LMO2 gene locus after treatment of a patient with X-linked severe combined immunodeficiency using retrovirally-mediated gene therapy (455).

The LMO proteins are normally not expressed in T cells or their progenitors (451, 456). Each of the t(11;14) rearrangements leads to the ectopic expression of a completely normal nonfusion transcript. Like TAL1, enforced expression of LMO1 or LMO2 induces T-cell tumors in transgenic mice but with relatively long latency periods that are probably required for the development of additional cooperating oncogenic “hits” (457, 458, 459, 460 and 461).

Two final examples of the group of transcription factors that are altered in T-cell lymphoid malignancies are the HOX11 and HOX11L2 Homeobox genes, located on chromosomes 10q24 and 5q35, respectively (462, 463, 464, 465, 466, 467, 468, 469 and 470). The Homeobox genes were first identified in *Drosophila melanogaster* as genes encoding factors (homeoproteins) that are involved in the determination of the basic body plan (471, 472 and 473). Mutations of the Homeobox genes in *Drosophila* cause one body part of the organism to develop with the characteristics of another part (e.g., the Antennapedia mutant fly possesses leg structures where antennae are normally found). Homeoproteins

have been identified in a wide variety of organisms and appear to play an evolutionarily conserved role as determinants of development, regulating the expression of genes in a spatial, temporal, and tissue-specific fashion. Roughly 50 mammalian Homeobox genes are present in a series of four clusters located on different chromosomes ( [474](#), [475](#) and [476](#) ). The expression of each individual gene coincides with its linear arrangement within its cluster, thus resulting in an expression gradient along the anterior-posterior axis of the organism. As noted previously in the case of PAX5, the role of HOX11 in oncogenesis is not unique among the Homeobox genes, with many other examples of homeoprotein involvement in malignancy and other human diseases known ( [190](#), [474](#), [477](#), [478](#), [479](#), [480](#), [481](#), [482](#) and [483](#) ).

Like all other homeoproteins, HOX11 localizes to the cell nucleus, binds to DNA in a sequence-specific manner, and transactivates the expression of specific target genes ( [484](#), [485](#) ). HOX11 is not normally expressed in adult tissues at levels detectable by routine Northern (RNA blot) hybridization analysis, although it can be detected in a variety of tissues (including normal T cells) by more sensitive PCR-based methods ( [462](#), [463](#) and [464](#), [486](#), [487](#) ). The mouse homolog, designated Tlx-1 (for T-cell leukemia Homeobox 1), is expressed in the embryo within branchial arch structures, portions of the peripheral and central nervous systems, the pancreas, the salivary glands, and the splanchnic mesoderm ( [488](#), [489](#) and [490](#) ). Knockout mice deleted for Tlx-1 are phenotypically normal, with the remarkable exception that splenic development is completely absent ( [489](#), [491](#) ). HOX11 thus appears to be a “master gene” that serves as a regulatory switch to control normal cellular growth and proliferation of splenic tissue.

HOX11 expression in T-cell lymphoblastic malignancies is found in 5 to 10% of patients, most often as a result of the t(10;14)(q24;q11) that involves the TCR  $\alpha$ /d-chain gene complex at 14q11 but, rarely, because of the variant translocation t(7;10)(q35;q24) that contains chromosome 7 breakpoints within the TCR  $\beta$ -chain gene locus ( [492](#), [493](#) ). In both instances, the HOX11 coding sequence is unaltered, but the gene becomes abundantly overexpressed in T cells. Although the exact role of HOX11 in malignant transformation remains to be elucidated, the high-level expression of the gene in T lymphocytes has been demonstrated to be lymphomagenic in transgenic mice ( [494](#) ). A mean age of tumor onset of 7.5 months, together with the fact that only approximately one-third of animals develop malignancy, indicate the necessity for additional genetic changes to cooperate with HOX11 to generate a fully transformed phenotype. This observation is congruous with the results of studies in which murine hematopoietic precursors were transduced with HOX11 retroviral expression vectors to produce immortalized and immature, but IL-3 factor-dependent, nonleukemogenic cell lines ( [495](#) ).

Expression of the HOX11L2 gene, located at human chromosome band 5q34-q35, is activated in T-cell malignancy by the frequently cryptic t(5;14)(q35;q32), which has been reported in 22% of children and adolescents with T-cell ALL ( [466](#) ), and by the less frequent t(5;14)(q34;q11) that results in recombination of the HOX11L2 region with the TCR delta gene locus ( [467](#) ). Other studies have reported that HOX11L2 expression may occur aberrantly in an even higher percentage of T-cell malignancies, suggesting it to be the most frequent abnormality identified in childhood T-cell acute lymphoblastic leukemia to date, and have associated the abnormal expression of the gene with a poor clinical prognosis ( [468](#), [469](#) and [470](#) ). HOX11L2 is similar to HOX11, and microarray analysis of T-cell malignancies aberrantly expressing either gene show marked similarities in the associated gene expression profiles ( [469](#) ); surprisingly, although HOX11L2 overexpression has been associated with a poor outcome, overexpression of HOX11 in T-cell acute lymphoblastic leukemia seems to denote a favorable prognosis, although more studies are required to confirm this observation. HOX11L2 (also called *Rrx* and *Tlx-3*) is normally

expressed in the nervous system, and studies in lower vertebrates have suggested at least partial functional redundancy of the gene with HOX11 ( [496](#), [497](#) ). However, the mouse knockout of Hox11L2 possesses a phenotype distinct from that of Hox11(Tlx-1)-null mouse, with absence of the gene causing a lethal central hypoventilation defect due to abnormal development of the ventral medullary respiratory center ( [498](#) ).

The so-called 8p11 myeloproliferative syndrome (EMS)/stem cell leukemia-lymphoma syndrome (SCLL), first described in 1995 ( [499](#), [500](#) ), is a rare chronic myeloproliferative disorder that is characterized by marked eosinophilia in 90% of patients, generalized lymphadenopathy, and frequent development of T-cell lymphoblastic lymphomas ( [501](#) ). Of the approximately 30 cases reported in the literature as of 2003, the median age at presentation was 32 years of age (with a range from 3 to 84 years of age). The appearance of the peripheral blood in EMS/SCLL at presentation resembles, in some respects, chronic myeloid leukemia, with marked leukocytosis present in almost all patients, and the predominant cell types being neutrophils, metamyelocytes, and myelocytes. Most patients rapidly progress to acute myeloid leukemia or, less commonly, B-cell-lineage ALL, with the median time to transformation, based on the available case reports, probably between only 6 and 9 months. In spite of aggressive chemotherapy with acute myelogenous leukemia and NHL treatment protocols, most patients with EMS/SCLL die from resistant disease or early relapse within 1.5 years of diagnosis, and only aggressive chemotherapy followed by allogeneic stem cell transplantation has thus far appeared to offer the hope of cure in a few patients. Lymphoblastic lymphoma, which is uncommonly observed in other myeloproliferative disorders, is seen in more than two-thirds of EMS/SCLL cases, suggesting that the cell targeted for malignant transformation in this disorder is a lymphoid-myeloid bipotential precursor cell. The lymphoma presents at diagnosis in some cases, whereas it appears during the course of the disease in others.

Several chromosomal translocations, all involving chromosome band 8p11, have been described in karyotypes of EMS/SCLL cases, with t(8;13)(p11;q12) being the most common. Molecular cloning of the t(8;13) in 1998 showed it to produce a fusion of approximately the N-terminal two-thirds of a novel protein encoded on 13q12 and named *ZNF198* that contains zinc-fingerlike motifs with the entire kinase catalytic domain of the FGFR1, starting immediately downstream of the transmembrane domain of this receptor tyrosine kinase ( [502](#), [503](#), [504](#) and [505](#) ). Several of the other translocations occurring in EMS/SCLL have also recently been molecularly cloned (reviewed in reference 501); all involve the FGFR1 gene located at 8p11 and form similar fusions but with N-terminal partners other than ZNF198. All of the described N-terminal partners of the FGFR1 contain putative dimerization domains that are important for causing the constitutive, unregulated activation of the catalytic function of the kinase, producing an unrelenting growth signal to the cells that express them. Such a mechanism of NHL causation is highly reminiscent of the involvement of the anaplastic lymphoma kinase (ALK) receptor tyrosine kinase by its truncation and the generation of various ALK fusions resulting from chromosomal rearrangements in the ALCLs, as described in the following section. The dramatically positive results recently observed for the adenosine triphosphate-competitive small molecule inhibitor STI-571, imatinib (Gleevec/Glivec, Novartis Pharmaceuticals, Basel, Switzerland), in the treatment of chronic myeloid leukemias ( [506](#) ), in which an identical mechanism of oncogenesis is operative (i.e., truncation and constitutive activation of the Abelson (ABL) tyrosine kinase due to its fusion with the N-terminus of the breakpoint cluster region (BCR) protein resulting from the t(9;22) chromosomal rearrangement), holds promise that analogous small molecule inhibitors of the FGFR1 could also be effective therapies for EMS/SCLL, although this remains to be determined.

## LARGE CELL LYMPHOMA: BCL6 AND FUSION GENES INVOLVING ALK

The large cell lymphomas account for 30 to 40% of newly diagnosed NHL and as much as 80% of NHL mortality ( [507](#) ). Before the 1990s, relatively little was known about the molecular pathogenesis of these lymphomas. Although studies had identified rearrangements of the *cMYC* and *BCL2* gene loci in 5 to 20% and 20%, respectively, of diffuse large cell cases ( [324](#), [508](#) ), these abnormalities are not specific to the large cell lymphomas, being most commonly associated with Burkitt lymphoma (*cMYC*) and FL (*BCL2*) ( [324](#), [509](#), [510](#), [511](#) and [512](#) ). In large cell cases with *BCL2* involvement, the abnormality may often reflect the histologic transformation from a prior FL ( [323](#) ). As detailed in the following discussion, the cloning in the early 1990s of the chromosomal junctions of translocations in the large cell lymphomas that involve band 3q27 ( [513](#), [514](#), [515](#), [516](#) and [517](#) ), together with the characterization of the t(2;5)(p23;q35) and other translocations that involve band 2p23 that are found in the ALCL subtype ( [518](#), [519](#) ), has added significantly to our knowledge of the genetics of these tumors.

Karyotypic analysis of the large cell lymphomas (including diffuse large cell, diffuse mixed cell, and immunoblastic) has identified chromosomal abnormalities affecting band 3q27 in 10 to 12% of cases ( [520](#), [521](#) ). These abnormalities involve reciprocal translocations between the 3q27 region and a number of alternative chromosomes (more than ten), but most commonly the Ig heavy (14q32) or light (2p12; 22q11) chain loci. The gene on 3q27 altered by these translocations encodes a transcription factor of the Kruppel-like subfamily of zinc finger proteins ( [522](#) ) and has been officially named BCL6 (formerly also called *LAZ3* or *BCL5*) ( [515](#), [517](#), [523](#), [524](#) ). The amino-terminal portion of BCL6 contains a POZ domain ( [525](#), [526](#) ), a protein-protein interaction motif found in some zinc finger transcription factors, including the *Drosophila* developmental regulatory genes tramtrack ( [527](#), [528](#) ) and broad complex ( [529](#) ) and the human PLZF gene that is involved in occasional cases of acute promyelocytic leukemia ( [530](#) ). The POZ domain of BCL6 has been shown to mediate homodimerization of the protein, to target its subcellular localization to discrete nuclear dots, and to function as an autonomous transcriptional repression domain ( [531](#), [532](#) and [533](#) ). The fact that POZ domains can mediate protein-protein heterodimerization ( [525](#), [526](#) ) raised the possibility that BCL6 could act in conjunction with other POZ domain-containing transcription factors, as well as other transcription-modulating proteins—a prediction that has proved correct ( *vide infra* ). A specific DNA sequence to which BCL6 binds has been identified; in addition, the protein has been experimentally shown to decrease the transcription from promoters linked to this sequence, suggesting that the normal function of BCL6 is to inhibit the expression of its target genes ( [531](#), [534](#), [535](#) and [536](#) ).

Normal BCL6 expression is tightly regulated during B-cell development, being expressed in mature B cells but not in their precursors or their more mature progeny (i.e., immunoblasts and plasma cells) ( [537](#), [538](#), [539](#), [540](#) and [541](#) ). Within the lymph nodes, BCL6 expression is present only within the germinal centers, the structures in which antigen-primed mature B cells are programmed to undergo apoptosis, to become memory B cells, or to undergo immunoblast and plasma cell differentiation ( [542](#), [543](#) ). BCL6 was therefore thought to be important for germinal center-associated functions ( [544](#) ); analysis of knockout mice has supported this hypothesis, with Bcl6-null mice exhibiting an inability of follicular B cells to proliferate and to form germinal centers ( [545](#), [546](#) and [547](#) ). As a consequence of this defect, these mice have defects in their T-cell-dependent antibody responses to antigenic challenge. Bcl6 knockout mice also experience an inflammatory



state characterized by myocarditis and pulmonary vasculitis with infiltrations of eosinophils and IgE-expressing B lymphocytes, due, at least in part, to an abnormal overproduction of Th2-like lymphokines, including IL-4, IL-5, IL-6, and IL-13 because of the release of transcriptional repression normally mediated by Bcl6.

The frequency of BCL6 gene rearrangement detected by molecular analysis significantly exceeds the 10 to 12% predicted by the cytogenetic study of 3q27 abnormalities in large cell lymphoma, indicating that rearrangements may also occur as a consequence of submicroscopic chromosomal abnormalities. Approximately one-third of large cell lymphomas have BCL6 gene rearrangement identified by Southern blot hybridization analysis; rearrangement of the locus occurs in as many as 45% of pure diffuse large cell cases and also, less often, in lymphomas with diffuse, mixed, small and large cell histology (10 to 20%) ( [548](#), [549](#), [550](#), [551](#) and [552](#) ). AIDS-associated DLCLs have been shown to contain BCL6 gene rearrangement in 20% of cases ( [553](#) ). BCL6 gene rearrangement is not uniquely restricted to large cell lymphoma, however, having also been identified in 5 to 14% of FLs ( [515](#), [548](#), [549](#), [551](#), [552](#) ). BCL6 rearrangements tend to occur exclusive of rearrangement of BCL2, suggesting that BCL6 is probably specifically involved in the pathogenesis of *de novo* large cell lymphoma as opposed to large cell tumors that result from the transformation of FL ( [531](#) ). Rearrangement of BCL6 has been associated with lymphomas characterized by the primary involvement of extranodal tissues and the lack of bone marrow involvement in a high percentage of cases ( [531](#) ). It has also been suggested that BCL6 alterations may be associated with lymphomas that have a favorable prognosis after chemotherapy ( [550](#) ), although this correlation has not been readily apparent in all studies ( [549](#) ).

All BCL6 breakpoints occur in or around the first exon, which is not translated, and leave the coding region of the gene intact but inserted downstream to heterologous sequences derived from the translocation partner chromosome. The BCL6 translocations that have been fully characterized thus far have been shown to result in the deregulated expression of a normal BCL6 protein because of promoter substitution ( [554](#), [555](#) and [556](#) ). The ultimate consequence of these alterations appears to be to prevent the physiologic down-regulation of BCL6 subsequent to B-cell differentiation into plasma cells ( [537](#), [538](#) and [539](#), [544](#) ).

In addition to chromosome translocation, involvement of BCL6 in large cell and FLs can occur as a result of somatic mutations that cluster in the same 5' noncoding region of the gene in which the 3q27 breakpoints occur ( [557](#) ). These mutations are often multiple and biallelic, are present in cases containing normal or rearranged BCL6 alleles, and therefore occur independently of mechanisms involved in chromosomal translocation. Similar high-frequency mutation (somatic hypermutation) ( [59](#), [60](#), [61](#) and [62](#) ) of cMYC and BCL2 has also been reported when these genes are translocated adjacent to Ig loci in lymphomas ( [109](#), [112](#), [113](#), [558](#), [559](#) ). Somatic hypermutation of the BCL6 locus presumably occurs by the same mechanisms operative in the cases of BCL2 and cMYC, but appears to be unique in that it can also occur in the absence of physical juxtaposition of Ig gene loci ( [557](#) ). Mutations of BCL6 were observed in almost three-fourths of diffuse large cell and one-half of FLs, indicating that this is a common form of genetic instability that may implicate BCL6 in the pathogenesis of a high percentage of NHL.

As noted previously, BCL6 functions as a transcriptional repressor; targets for BCL6-mediated repression have been reported to include the IL-4 and IL-5 Th2-type cytokines, the programmed cell death-2 (PDCD2) protein, and certain signal transducer and activator of transcription (STAT) protein transcriptional targets, among others ( [545](#) ),

[560](#), [561](#), [562](#), [563](#), [564](#), [565](#), [566](#) and [567](#)). Decreased expression of B-lymphocyte-induced maturation protein 1 (Blimp-1), a transcriptional repressor that plays a key role in the normal differentiation of B cells to mature plasma cells, and of the p27/Kip1 CDKI by BCL6 also appear important for lymphomagenesis ([562](#), [568](#)). Inhibition of gene expression by BCL6 is mediated by a protein complex containing the co-repressors SMRT and mSIN3A as well as HDACs ([569](#), [570](#) and [571](#)). BCL6-mediated transcriptional repression also likely involves physical interactions with other transcriptional regulators, including PLZF, BAZF, and BCL11A/Evi-9. PLZF is related to BCL6 and encodes a transcription factor also belonging to the POZ domain and Kruppel zinc finger family. BCL6 and PLZF heteroassociate and colocalize in the nuclei of cells; like BCL6, PLZF strongly represses transcription initiated from various promoters by recruiting a HDAC through SMRT-mSIN3-HDAC complexes ([572](#), [573](#)). BAZF (*Bcl6*- associated zinc finger protein) is another POZ domain and Kruppel-like zinc finger protein that physically interacts with BCL6; BAZF binds to the same DNA-binding sequence as BCL6 and also functions as a transcriptional repressor ([574](#), [575](#)). Recent studies suggest that BAZF itself does not bind to a repressor complex and that its transrepressor activity is actually mediated by recruiting an mSin3A-HDAC complex through association with BCL6 ([576](#)). BCL11A is a Kruppel zinc finger protein and is the human homolog of the mouse Evi-9 gene, which is deregulated in myeloid leukemias after proviral integration ([577](#)). BCL11A itself is the target gene deregulated in B-cell malignancies by a rare but recurrent t(2;14)(p13;q32) chromosomal rearrangement as well as by DNA coamplification with the REL gene locus at 2p13 ([578](#), [579](#) and [580](#)). BCL11A physically interacts with BCL6 and, like BCL6, represses transcription. BCL11a-null mice lack B cells and also have alterations in several types of T cells, pointing out the importance of the gene in the normal development of the lymphoid system ([581](#), [582](#)). The exact interplay among PLZF, BAZF, BCL11A, and BCL6 normally and during lymphomagenesis has not yet been clarified.

Taken together, the available data regarding normal BCL6 function permit the following explanation for the role of the protein in lymphomagenesis. Because the translocations in NHL that alter the BCL6 locus result in constitutive overexpression of the normal protein, they prevent the normal down-regulation of BCL6 that occurs on plasmacytic differentiation. Thus, lymphomas with BCL6 activation would maintain repression of BCL6 target genes, trapping the neoplastic lymphocytes at the germinal center stage of differentiation. As noted, repression of Blimp-1 by BCL6 may be especially important for malignant transformation, in part because Blimp-1 acts as a transcriptional repressor of cMYC; as such, Blimp-1 can cause growth arrest and terminal plasmacytic differentiation or apoptotic death ([568](#)). Repression of Blimp-1 by BCL6, which in turn allows cMYC expression, would permit continued cell growth and prevent differentiation. The repression of p27/KIP1 by BCL6 is likely also critical for malignant transformation given that this CDKI functions to arrest the cell cycle in response to extrinsic signals at the G<sub>1</sub> to S phase transition ([583](#), [584](#)). Thus, repression of p27/KIP1 by BCL6 would allow inappropriately regulated proliferation. BCL6 has also recently been demonstrated to override the senescence of cells downstream of p53 and to extend the replicative lifespan of primary B cells; these effects, which appear to require the induction of cyclin D1 expression, thus render cells unresponsive to antiproliferative signals produced by the p19 ARF-p53 pathway as well ([585](#)).

The t(2;5)(p23;q35) is the other commonly occurring nonrandom chromosomal rearrangement associated with large cell NHL. The t(2;5) was originally identified in karyotypic analyses of NHL as a recurrent cytogenetic abnormality found in a significant but uncertain percentage of ALCLs that express the Ki-1 (CD30) antigen ([586](#), [587](#), [588](#), [589](#), [590](#), [591](#) and [592](#)), a cytokine receptor for a ligand related to the tumor necrosis factor family ([593](#), [594](#)). ALCL itself was first described by Stein et al. ([595](#)) in 1985 and was



soon recognized as a distinct clinicopathologic entity in the revised Kiel ( 11 ) and REAL ( 12 ) classifications. More recently, as mentioned in a following discussion in detail, the so-called ALK-positive lymphomas, which comprise a distinct subset of ALCL that possesses unique biologic characteristics, have been recognized in the WHO classification of NHL ( 596 ). ALCL, which occurs with a bimodal age distribution that peaks in adolescents and again in older adults, constitutes approximately 2.5% of all NHL but accounts for as many as 30 to 40% of pediatric large cell lymphomas ( 591, 597, 598, 599, 600, 601, 602, 603, 604, and 605 ). These lymphomas are pathologically defined based on the presence of large malignant cells containing pleomorphic nuclei, clumped chromatin, prominent nucleoli, and abundant cytoplasm that preferentially involve the paracortical regions of the lymph nodes, with intrasinusoidal dissemination ( 598, 605 ). Because of their anaplastic features, ALCLs can often be misdiagnosed as other conditions, including Hodgkin disease, malignant histiocytosis, mycosis fungoides, malignant melanoma, poorly differentiated metastatic carcinoma to lymph nodes, or even lymphadenopathic viral infections ( 602, 606 ). In fact, the t(2;5) was actually first described in the tumor of a patient erroneously diagnosed with malignant histiocytosis ( 607 ). The diagnosis of ALCL can be further confounded by the existence of several variant pathologic forms, including monomorphic ( 608, 609 ), small cell ( 610 ), microvillous ( 611 ), lymphohistiocytic ( 612 ), and the “Hodgkin-like” ( 613, 614 ) variants. The characteristics of these variant pathologic forms have been nicely reviewed recently by Kinney and Kadin ( 615 ), Falini ( 616 ), and Morris et al. ( 617 ). Immunophenotypic analysis of ALCL reveals the majority of cases to express T-lymphoid markers (75%); less commonly, these neoplasms bear B-cell markers (approximately 15%) or have a null phenotype with neither B- nor T-antigen expression (approximately 10%).

Clinically, ALCLs typically behave as aggressive, high-grade lymphomas, with patients exhibiting peripheral lymphadenopathy and extranodal disease involving skin, bone, soft tissue, gastrointestinal tract, or lung, or a combination of these ( 591, 597, 601, 602, 604, 618, 619, 620, and 621 ). Despite their aggressive nature, these tumors are chemosensitive at diagnosis and relapse; however, 20 to 30% of patients do eventually succumb because of refractory disease ( 591, 592, 599, 600, 601, 602, 603, and 604, 622, 623 ). A primary cutaneous form of ALCL that is characterized by the absence of nodal or visceral involvement at presentation and an indolent course with spontaneous remission, low recurrence rate after therapy, and infrequent visceral dissemination has also been described ( 624, 625 ). Primary cutaneous ALCL is quite difficult to distinguish from lymphomatoid papulosis (LyP), a monoclonal proliferation of CD30<sup>+</sup> T cells involving the skin, that is likewise characterized by absent visceral involvement, spontaneous remission, and rare progression to frank malignant lymphoma ( 626, 627 ). The t(2;5) and other translocations affecting chromosomal band 2p23 are not, however, a feature of primary cutaneous CD30<sup>+</sup> lymphoproliferative disorders nor of the lymphomas resembling ALCL that have been reported in HIV-infected patients ( 606, 628, 629, 630, 631, 632, 633, and 634 ).

Molecular analysis of the ALCLs has suggested that cMYC is mutated in a relatively high percentage of cases (approximately one-third), especially in those of B-cell lineage and in those that are HIV-associated ( 635, 636 ). Activation of cMYC may also play a significant functional role in ALK-positive ALCLs, given that the NPM-ALK fusion protein ( *vide infra* ) appears to induce cMYC expression ( 637 ). The receptor for hematopoietic stem cell growth factor, c-KIT, also appears to be expressed in a high percentage of ALCL, although the functional significance of its presence remains to be defined ( 638 ). Other genes commonly altered in hematopoietic malignancy, including BCL2, the RAS family, p53, and Rb, are not often mutated in ALCL, however ( 635 ). Several studies have

suggested that human T-cell leukemia virus type 1 (639) or EBV (635, 640, 641), or both, may also be important in the pathogenesis of some ALCL cases. For example, approximately 30% of all ALCLs involving the skin are positive for human T-cell leukemia virus type 1, and 30 to 35% of all ALCLs contain EBV genomes and EBV-specific products (614, 642, 643). As the expression of an activated cMYC gene has been experimentally demonstrated to produce the malignant conversion of EBV-infected human B lymphoblasts (131), it is possible but not proven that these genetic abnormalities are of pathogenic importance in a subset of ALCL.

The molecular cloning of the t(2;5) in 1994 revealed that this chromosomal rearrangement produces a fusion gene, NPM-ALK, encoding the amino-terminal portion of nucleophosmin, a nucleolar phosphoprotein encoded on chromosome 5, linked to the cytoplasmic part of ALK, a receptor tyrosine kinase of the insulin receptor subfamily that is closely related to leukocyte tyrosine kinase, on chromosome 2 (Fig. 89.2A) (644, 645). NPM is a highly conserved and ubiquitously expressed 38-kd nonribosomal RNA-binding protein that shuttles ribosomal ribonucleoproteins between the nucleolus and the cytoplasm and is involved in the late stages of preribosomal particle assembly (646, 647, 648, 649, 650, 651 and 652); NPM has also recently been reported to control centrosome duplication initiated by CDK2-cyclin E-mediated phosphorylation of the protein and therefore to be critical for the normal progression through mitosis (653). It is presently unclear whether either of these normal functions of NPM (or alterations of them) play a significant role in the development of ALCL, but the fact that a number of other proteins with different normal functions are also known to form N-terminal fusion partners with ALK (vide infra) suggests that these NPM functions are dispensable for oncogenesis. ALK is normally expressed mainly in the central and peripheral nervous systems (654, 655), but the normal functions of this receptor tyrosine kinase remain unclear, and mice engineered to lack expression of the protein have a normal lifespan and no grossly evident abnormalities (645). The growth factors that bind and activate ALK normally are the small secreted proteins pleiotrophin and midkine (656, 657). Interestingly, the deregulation of each of these ALK ligands has been implicated in the genesis of a variety of solid tumors via mechanisms involving autocrine tumor growth loops, as well as the promotion of tumor-associated angiogenesis (for example, see reference 658); thus, the inappropriate activation of the full-length ALK receptor may be of pathogenic importance in these solid tumors, just as constitutively active ALK fusion proteins contribute to the genesis of ALCL.



**Figure 89.2. A:** Schematic of the anaplastic lymphoma kinase (ALK) receptor tyrosine kinase and the NPM-ALK fusion protein resulting from the t(2;5). Fusion of the chromosome 5 gene encoding nucleophosmin (NPM) to the chromosome 2 gene encoding ALK generates the chimeric tyrosine kinase, NPM-ALK. NPM contains an oligomerization domain (OD) (residues 1 to 117) a putative metal-binding domain (MB) (residues 104 to 115), two acidic amino acid clusters (AD) (aspartic acid/glutamic acid-rich acidic domain;

residues 120 to 132 and 161 to 188) that function as acceptor regions for nucleolar targeting signals, and two nuclear localization signals (NLSs) (residues 152 to 157 and 191 to 197). ALK contains a single MAM ( *Meprin*, *A5*, and protein tyrosine phosphatase *Mu*) domain, a region of approximately 170 amino acids present in the extracellular portions of a number of functionally diverse proteins that may have an adhesive function (residues 480 to 635). The ligand-binding site (LBS) for pleiotrophin and midkine (ALK residues 391 to 401) is indicated. **B:** ALK fusion proteins, the chromosomal rearrangements that generate them, their occurrence in ALK-positive lymphomas and inflammatory myofibroblastic tumors (IMTs), and their subcellular localizations. The frequency of the various ALK fusions expressed in IMT has not yet been determined. ATIC, 5-aminoimidazole-4-carboxamide ribonucleotide formyltransferase/IMP cyclohydrolase; C, cytosolic; CM, cell membrane; CLTC, clathrin heavy chain; MSN, moesin; N, nuclear; NM, nuclear membrane; RanBP2, Ran-binding protein 2; TFG, TRK-fused gene; TK, tyrosine kinase catalytic domain; TM, transmembrane domain; TPM3, non-muscle tropomyosin-3; TPM4, non-muscle tropomyosin-4.

As a result of the t(2;5), the transcription of the portion of the ALK gene encoding its kinase domain is driven by the strong NPM gene promoter, leading to its inappropriate expression in lymphoid cells (in which little or no ALK is normally expressed) ( [519](#), [644](#) ). In addition, as a result of NPM-ALK homooligomerization mediated by the NPM portion of the fusion (which contains a self-association domain), the ALK kinase catalytic function is constitutively activated and can engage and activate mitogenic signaling substrate proteins by their phosphorylation ( [645](#), [659](#), [660](#) ). The oncogenic ability of NPM-ALK can be readily demonstrated by *in vitro* transformation assays using immortalized rodent fibroblast lines, such as NIH-3T3 ( [659](#), [660](#) ). Furthermore, lethally irradiated mice transplanted with bone marrow that expresses NPM-ALK have been demonstrated to develop lymphomas after a 3- to 4-month latency period, leading to death ( [661](#) ), and transgenic mice engineered to express NPM-ALK in their lymphoid cells develop both T- and B-cell lymphoproliferative malignancies that are rapidly fatal (mean survival, 18 weeks) ( [662](#) ).

The cloning of the t(2;5)-associated NPM-ALK fusion permitted the development of RNA-PCR, DNA-PCR, FISH, and Southern blot hybridization assays for the diagnosis of NHL containing this abnormality ( [606](#), [629](#), [663](#), [664](#), [665](#), [666](#), [667](#) and [668](#) ). In addition, because ALK is not normally expressed at significant levels in lymphoid cells, immunohistochemical staining of biopsy samples with anti-ALK antibodies can be used to reliably detect expression of the NPM-ALK chimeric protein in ALCL ( [33](#), [623](#), [634](#), [669](#), [670](#) and [671](#) ). Because as much as one-third of ALCLs are initially misdiagnosed based on histologic morphology alone ( [602](#), [606](#) ), the use of these assays for NPM-ALK should be considered to clarify the diagnosis in those cases in which ALCL is considered in the differential diagnosis.

Anti-ALK immunohistochemical staining of NPM-ALK-expressing ALCL cases shows a typical staining pattern, in which the chimeric protein is present in the cytoplasm and the nucleus of the tumor cells (for example, see reference [672](#) ). The dual cytoplasmic and nuclear localization of NPM-ALK in tumor cells is due to its heterooligomerization with NPM, which includes among its normal functions the bidirectional shuttling of proteins between the cytoplasm and nucleus; thus, a portion of the NPM-ALK protein, which lacks any nuclear localization signals of its own, is transported to the nucleus ( [660](#), [673](#) ). However, approximately 20 to 25% of ALCLs that stain positively for ALK (the so-called ALK-positive lymphomas or ALKomas) exhibit anti-ALK staining in the cytoplasm of the tumor cells only, and, when examined, these cases have been shown to possess variant chromosomal translocations involving the ALK gene locus at chromosome 2p23 but not

the NPM gene from chromosome 5. In addition, immunoblotting with ALK- and NPM-specific antibodies has revealed variant ALK proteins that have different molecular masses as compared to the 80-kd NPM-ALK protein and that do not contain NPM ( [674](#) ). Over the past 5 years, a number of these variant ALK rearrangements have been molecularly cloned, and the ALK fusion partners have been identified. Included among these variant ALK fusion proteins are nonmuscle tropomyosin-3 (TPM3)-ALK, 5-aminoimidazole-4-carboxamide ribonucleotide formyltransferase/IMP cyclohydrolase (ATIC)-ALK, CLTC (clathrin heavy chain)-ALK, TRK-fused gene (TFG)-ALK, and moesin (MSN)-ALK, listed in the approximate order of their frequency in ALK-positive lymphomas ( [Fig. 89.2B](#) ) (see references [616](#) , [617](#) , and [645](#) for reviews). Interestingly, although ALK fusion proteins are found mainly in T- and null-cell NHLs, recent studies suggest that occasional DLBCLs can also be ALK positive, with CLTC-ALK and NPM-ALK fusions reported in such cases ( [675](#) , [676](#) , [676a](#) ).

The same basic cellular transforming mechanism appears to be operative for NPM-ALK and the variant ALK fusions. Specifically, the N-terminal portion of the particular ALK partner protein present in a given X-ALK fusion contains some form of oligomerization domain that mediates constitutive self-association of the X-ALK protein, which in turn mimics the receptor aggregation and kinase catalytic activation that normally occurs only on pleiotrophin or midkine binding to the full-length ALK receptor protein. Because these fusion proteins are constantly kinase active, they transmit unremitting mitogenic signals to cells that express them, resulting in uncontrolled proliferation. This mechanism for acquisition of oncogenic capabilities by tyrosine kinases is a commonly repeated one, not only for hematopoietic malignancies but for solid tumors as well ( [677](#) ). Indeed, ALK itself has recently been shown to participate in the genesis of a nonhematopoietic malignancy, the sarcoma known as *inflammatory myofibroblastic tumor (IMT)*, with some of the same ALK fusion proteins that occur in ALCL being of pathogenic importance in IMT as well ( [Fig. 89.2B](#) ). IMTs, which affect mainly children and young adults and are composed histopathologically of malignant myofibroblasts together with infiltrating normal reactive lymphocytes, eosinophils, and plasma cells, are typically indolent tumors and can be cured by surgical resection in most cases; however, cases of locally invasive and metastatic IMTs have been described ( [678](#) , [679](#) ). A recent study of IMTs has shown 44 of the 73 cases examined (60%) to aberrantly express ALK proteins ( [680](#) ); therefore, ALK deregulation appears to be of causative importance in a majority of IMTs. Thus, although the histologic appearance of IMT is not likely to be confused by an experienced pathologist, it is nonetheless important to remember that the expression of an ALK fusion protein in a malignant tumor does not invariably equate with a diagnosis of ALCL.

The molecular cloning of NPM-ALK and the variant ALK fusions and the ability to readily detect their presence in diagnostic samples using immunostaining, RNA-PCR, and other methodologies has now permitted a clear description of the clinicopathologic characteristics of the ALK-positive lymphomas. For example, it is clear that histologically defined ALCL is associated with the expression of ALK fusions in only approximately two-thirds of all cases, with NPM-ALK found in approximately 75% of ALK-positive cases and the variant ALK fusions comprising the remaining 25%. Although they are histologically indistinguishable from ALK-positive ALCLs, the molecular pathogenic mechanisms underlying the development of ALCLs that lack expression of ALK fusions ( *ALK-negative ALCLs* ) do not appear to involve the deregulation of tyrosine kinase activity ( [681](#) ) and remain unknown at this time. As it turns out, the expression of ALK fusions in ALCL defines a distinct clinicopathologic entity that is not strictly associated only with anaplastic morphology; rather, many cases are not anaplastic appearing at all, having instead a morphological spectrum that includes monomorphic diffuse large cell, small cell-predominant, and lymphohistiocytic types, among others ( [615](#) , [616](#) and [617](#) ). All of the described histologic variants of ALCL have been reported to express ALK fusions in a percentage of cases, including the common or classic large cell type of ALCL that can be

subdivided into pleomorphic (which itself contains multiple subtypes, including the giant cell, neutrophil-rich, sarcomatoid, and signet ring variants) or monomorphic categories, the small cell variant, the lymphohistiocytic variant, and the provisional entity that is known as *ALCL, Hodgkin-like*. However, the percentage of cases that contain ALK fusions varies markedly among the histologic variants, ranging from greater than 80% of monomorphic ALCLs and 75 to 100% of the small cell variant to less than 15% of the Hodgkin-like cases ( [615](#), [616](#) and [617](#)). ALK-positive ALCLs are primarily T- or null-cell tumors, with frequent expression of epithelial membrane antigen and cytolytic granule proteins. Overall, approximately 10 to 20% of ALCLs have a B-cell phenotype, but generally less than 15% (with a range from 0 to 25%, depending on the specific study) of B-cell ALCLs have been shown to be ALK positive ( [617](#)).

ALK-positive ALCLs occur predominately in children and young adults. For example, Pulford et al. ( [682](#)) identified ALK expression in 88.5% of 26 children, but in only 34% of 47 adults with CD30<sup>+</sup> ALCL. Similarly, Falini et al. ( [683](#)) examined 96 CD30<sup>+</sup> ALCLs (58 ALK-positive and 38 ALK-negative) and found the mean age of the ALK-positive cases to be 22.01 years of age (with a range from 3 to 52 years of age), whereas ALK-negative cases occurred at a mean age of 43.33 years. The tendency for ALK positivity in ALCL to be higher in children than adults reflects, at least in part, the significant number of secondary ALCLs (i.e., ALCLs that have evolved from lymphomas of other histologic subtypes) that occur uniquely in older patients. Most patients with ALK-positive lymphoma present with systemic nodal (with or without extranodal) disease, and the so-called primary systemic form of ALCL is the form specifically associated with the expression of ALK fusions ( *vide infra*). Carefully randomized trials of uniformly treated and age-matched patients comparing the prognosis of ALK-positive with ALK-negative ALCL have yet to be performed; however, large retrospective clinical trials examining overall and event-free survival of NHL patients have suggested that ALCL as a whole has a significantly better outcome than non-ALCL subtypes. Furthermore, in almost all studies published, ALK-positive ALCL patients have fared dramatically better than those with ALK-negative disease after conventional combination chemotherapy, with overall 5-year survival rates of 79 to 88% compared to 28 to 40%, respectively (summarized in reference [617](#)). It appears that the superior prognosis of ALK-positive ALCL occurs irrespective of the specific ALK fusion that is expressed, with the variant fusions being associated with an equally good outcome to that observed in the NPM-ALK-positive cases ( [684](#)). The reasons for the better outcome following therapy for ALK-positive patients are unknown. The superior prognosis of ALK-positive lymphomas may occur only in T- and null-cell disease, given that B-cell NHLs that expressed ALK fusions nonetheless appeared to carry a prognosis similar to ALK-negative disease in one study ( [685](#)).

In addition to the usefulness of ALK detection in establishing the diagnosis of ALK-positive primary systemic ALCL, the *absence* of ALK expression is similarly extremely useful in discriminating between this entity and its lymphoproliferative mimics, which have different natural histories. ALCL can be clinically subdivided based on sites of disease, immune status, and history of antecedent lymphoproliferative disease into primary systemic ALCL (nodal, with or without nodal involvement), primary cutaneous ALCL, HIV-related ALCL, or secondary ALCL (i.e., after LyP, Hodgkin disease or mycosis fungoides). The overall approximately 60% incidence of ALK positivity typically reported in ALCL refers specifically to the primary systemic type, with these other forms rarely, if ever, expressing ALK. Primary cutaneous ALCL typically occurs in older patients, with a median age of 60 years of age; in contrast to primary systemic ALCL, which is highly aggressive (although responsive to therapy), approximately 25% of primary cutaneous ALCLs spontaneously undergo partial or complete regression without treatment ( [624](#), [686](#), [687](#) and [688](#)). Except for those patients with generalized skin involvement, who appear to be at greater risk of developing extracutaneous involvement and may benefit from multiagent



systemic chemotherapy, primary cutaneous ALCL patients can be treated by excision of their lesions, with or without radiation. Thus, it is important, if possible, to discriminate between primary systemic ALCL with cutaneous involvement and primary cutaneous ALCL, which appear essentially identical histologically, for optimal treatment planning. Although the detection of ALK cannot be used to unequivocally distinguish between these two entities, ALK expression is clearly most consistent with a diagnosis of primary systemic ALCL, given that true ALK-positive-CD30<sup>+</sup> primary cutaneous ALCL is rare, if existent at all. ALCL occurring in the setting of HIV infection has uniformly tested negative for ALK expression; these lymphomas represent 2 to 15% of AIDS-related lymphomas and appear to be clearly different from ALCL in patients without HIV, because most have a B-cell phenotype and are positive for EBV gene products. The prognosis of patients with ALCL in the setting of HIV infection is usually poor and can be related in general to the immune status of the individual. Secondary ALCLs that evolve from other lymphomas or lymphoproliferative diseases usually occur in older patients and are ALK negative.

Other lymphoproliferative diseases that can mimic primary systemic ALCL, such as Hodgkin disease, LyP, and mycosis fungoides, are also ALK negative (reviewed in reference 617). Because ALCL and Hodgkin disease share a number of features in common, including CD30 expression, the presence of Reed-Sternberg-like cells in some cases of ALCL, and a similar bimodal age distribution, some investigators believed that these two lymphomas represented extremes of a continuous spectrum of malignancy (689). Although a few early studies performed shortly after the cloning of the t(2;5) suggested that NPM-ALK was expressed in a subset of Hodgkin disease cases, more thorough examinations of more than 800 individual cases of Hodgkin disease by multiple investigators have ruled out a role for ALK deregulation in the genesis of this malignancy. The results of these studies are consistent with the fact that the t(2;5) has not been reported in the more than 130 cases of Hodgkin disease in which karyotypes have been reported in the literature as showing chromosomal abnormalities and the observation that all nine established cell lines believed to be bona fide Hodgkin disease lines are ALK negative (668, 671, 690, 691, 692 and 693). Most probably, the studies in which ALK-positive Hodgkin disease cases had been reported were due to misdiagnosis (analysis of ALCL variants that are similar in histologic appearance to Hodgkin disease), sample contamination during PCR, or expression of ALK fusion transcripts in rare “normal” bystander cells [like other gene transcripts associated with malignant transformation, such as the IgH/BCL2 message associated with the t(14;18) in FLs and the t(9;22)-associated BCR-ABL fusion in chronic myeloid leukemias, the NPM-ALK fusion gene transcript can be detected by sensitive PCR-based methods in the peripheral blood of as much as 50% of healthy individuals, suggesting that the DNA recombination machinery involved in the genesis of these genetic lesions is continuously operative and that progression to malignancy likely involves the acquisition of additional, cooperating genetic mutations in affected individuals] (694). LyP is a clonal CD30<sup>+</sup> T-cell lymphoproliferative disorder in which recurrent crops of ulcerating papules regress with scar formation in a few weeks. In 5 to 20% of cases, LyP progresses to overt lymphomas, such as Hodgkin disease, ALCL, or mycosis fungoides. This observation, together with the presence of lesions with similar histologic features shared between LyP and ALCL, indicates that LyP and primary cutaneous ALCL represent a histopathologic continuum of CD30<sup>+</sup> lymphoproliferative disorders of the skin. A large number of studies have examined ALK expression in LyP and found no evidence for involvement of the gene in the genesis of the disorder (reviewed in reference 617).

Although the prognosis of patients with ALK-positive lymphoma is usually quite favorable after conventional multiagent chemotherapy, at least 20 to 30% of patients fail to respond to this treatment. Additional prognostic factors need to be identified and confirmed that permit detection of this “poor-outcome” group, so that they might be treated with

alternative approaches. For instance, Nagasaka et al. ( 695 ) have reported a poor prognosis for ALK-positive patients whose lymphomas arise in bone, and CD56, previously shown to be a marker of high risk in acute myeloid leukemia patients, has been suggested to be a strong negative prognostic factor in a study of 143 cases of ALCL by Suzuki et al. ( 696 ). Although not yet available, ALK-specific targeted therapies, including adenosine triphosphate-competitive small molecule ALK tyrosine kinase inhibitors analogous to imatinib (which is used for the treatment of BCR-ABL-induced chronic myeloid leukemia) ( 506 ) are under development and will likely be beneficial for the treatment of patients refractory to conventional chemotherapy (and perhaps ultimately as a component of initial therapy as well).

## MUCOSA-ASSOCIATED LYMPHOID TISSUE LYMPHOMA: API2-MALT1 AND BCL10

The REAL classification separates NHLs that arise from the marginal zone B cells into three distinct disorders—primary nodal marginal zone lymphomas, primary splenic marginal zone lymphomas, and extranodal lymphomas of the mucosa-associated lymphoid tissue (MALT) type ( 12 ). Although these disorders share a CD5<sup>-</sup> and CD10<sup>-</sup> B-cell phenotype, they have subtle morphologic differences and distinct clinical behaviors, suggesting that their pathogenesis differs ( 697 , 698 , 699 , 700 , 701 and 702 ). Marginal zone lymphomas of MALT are the most common type of lymphoma arising in extranodal locations and account for 5 to 10% of all NHLs ( 703 ). MALT lymphomas have frequent multicentric extranodal involvement including the gastrointestinal tract, lung, thyroid, and mammary, salivary, and lacrimal glands, and typically exhibit an indolent clinical course. These lymphomas usually originate in the setting of chronic inflammation triggered by infection or autoimmune disorders, including *Helicobacter pylori* gastritis, Sjögren syndrome, and Hashimoto thyroiditis. Abnormal B-cell proliferation in early, low-grade gastric MALT tumors is dependent in part on *H. pylori*-specific tumor-infiltrating T cells, and eradication of *H. pylori* by antibiotic treatment results in tumor regression in most, but not all, of these patients ( 704 ). Molecular genetic studies in the MALT lymphomas had lagged behind other subtypes of NHL until recently; in 1999, however, two recurrent chromosomal changes in these tumors—the t(11;18)(q21;q21) and the t(1;14)(p22;q32)—were characterized at the molecular level.

Three groups of investigators independently showed the t(11;18) rearrangement to produce a fusion of API2 (also known as *cIAP2*, *HIAP1*, or *MIHC*) at 11q21, which encodes an inhibitor of apoptosis protein (IAP), to a gene at 18q21 named *ML1* or *MALT1* (for *MALT* lymphoma-associated translocation) ( 705 , 706 and 707 ) ( Fig. 89.3A). MLT/MALT1 was also identified by an unrelated experimental approach to encode a caspase-related protein, leading to its alternative designation, *human paracaspase* (*hParacaspase*) ( 708 ). API2 belongs to a family of IAPs first identified in baculoviruses, in which they suppress host cell apoptotic responses to viral infection; five human IAPs have been identified—NIAP, API1 (also named *cIAP1*, *HIAP2*, and *MIHE*), API2, XIAP-hILP, and survivin ( 709 ). IAPs contain from one to three baculovirus inhibitor of apoptosis repeat (BIR) motifs, a caspase recruitment domain (CARD), and a C-terminal zinc-binding RING finger domain (the latter being found in all IAPs except NIAP and survivin) ( 710 , 711 ). IAP-1 and -2 were originally identified as proteins recruited to the tumor necrosis factor receptor (TNFR) II cytoplasmic domain via association with the TNFR-associated factors (TRAFs), TRAF-1 and -2. API2 is highly expressed in lymphoid cells in the spleen and thymus and suppresses apoptosis by binding and inhibiting caspases-3 and -7, as well as the cytochrome c-mediated activation of caspase-9 ( 709 ). Engineered mutant IAPs that contain only BIR domains can bind and inhibit caspases, emphasizing the importance of these motifs ( 712 ). The MLT/MALT1/hParacaspase gene is highly expressed in peripheral



blood mononuclear cells, at moderate to weak levels in bone marrow, thymus and lymph nodes, and at high levels in hematopoietic cell lines of T-cell, B-cell and myeloid lineages, suggesting a normal function in blood cell growth ( [705](#), [706](#) and [707](#) ).



**Figure 89.3. A:** Schematic of the normal MALT1 and IAP-2 proteins and two examples of the fusion proteins generated by the t(11;18)(q21;q21) in MALT lymphomas. Selected motifs found in MALT1 [also known as *MLT1* or *human paracaspase (hParacaspase)*] and IAP-2 (also known as *AIP2*, *HIAP1* or *MIHC*) are shown. The caspase recruitment domain (not shown) of IAP-2 is located between the baculovirus inhibitor of apoptosis repeat (BIR) and zinc-binding RING finger domain (RING) motifs. The segment of MALT1 at which binding to BCL10 occurs is illustrated. *Downward-pointing arrows* indicate the locations of breakpoints typically found in MALT1 or IAP-2 in MALT lymphomas containing the t(11;18). The two fusions shown (*case 1* and *case 2*) are representative of the chimeric proteins created by the t(11;18); note that they differ primarily in the presence or absence of the BCL10 interaction motif from MALT1. **B:** t(11;18) Fusion proteins strongly activate nuclear factor- $\kappa$ B (NF- $\kappa$ B). The bar graph shows the relative induction of cellular NF- $\kappa$ B activity due to the experimental expression of the MLT/MALT1/hParacaspase protein, IAP-2, the t(11;18)-encoded fusion proteins (*case 1* and *case 2*), or selected experimentally-produced mutants of each. Note that the cells used for these experiments exhibit minimal NF- $\kappa$ B activity normally (“vector” control) and that expression of the two normal proteins induces no additional activity (*hParacaspase* and *IAP-2*). Likewise, truncated proteins (labeled ? *hPC 127-824*, ? *hPC 321-824*, and *IAP-2 1-441*) that contain the portions of MLT/MALT1/hParacaspase or IAP-2 present in the two t(11;18) fusion proteins shown in this figure do not increase cellular NF- $\kappa$ B activity. By contrast, the t(11;18) fusion proteins (*case 1* and *case 2*) dramatically enhance NF- $\kappa$ B function and those fusions capable of interacting with BCL10 (as for *case 2*) show synergistic NF- $\kappa$ B activation. Note also that experimentally produced mutant fusion proteins (*case 1 mut* and *case 2 mut*) in which the conserved catalytic cysteine present in the caspase homology domain of MALT1 was changed to an alanine residue lose most of their NF- $\kappa$ B-activating potential, indicating the functional importance of this portion of MALT1. The relevance of NF- $\kappa$ B activation to oncogenic transformation is discussed in the text and in reference 748. DD, death domain; Ig, immunoglobulin-like motif; H C, conserved cysteine/histidine catalytic diad required for the activity of traditional caspases. (Modified from Uren GA, O’Rourke K, Aravind L, et al. Identification of paracaspases and metacaspases: two ancient families of caspase-like proteins, one of which plays a key role in MALT lymphoma. *Mol Cell* 2000;6:961–967, with permission.)

The t(11;18) breakpoints are heterogeneous among MALT lymphoma cases, and additional complexity is introduced by alternative MALT1 (because *MALT1* is the official HUGO Gene Nomenclature Committee designation for MLT/MALT1/hParacaspase, this name is used here subsequently to refer to the gene) splicing, resulting in different API2-MALT1 fusion transcripts. reverse transcriptase-PCR (RT-PCR) of the chimeric transcripts from a number of MALT tumors has revealed at least two breakpoints in API2 and three in MALT1, with at least four chimeric proteins predicted ( [713](#), [714](#) and [715](#) ). RT-PCR analysis has also revealed several differently sized fusion products in individual tumors, suggesting that alternative MALT1 splicing (in addition to different breakpoints) may also contribute to variable API2-MALT1 transcripts ( [713](#) ). In all cases described, however, the N-terminus of the fusions contains all three API2 BIR domains, and the RING finger is

eliminated (as noted, suggesting the fusion may liberate the BIR motifs from negative control by the RING finger) ( [Fig. 89.3A](#)). The presence of the CARD motif of API2 is variable, but it is excluded from most fusions; inclusion of the CARD could potentially alter the caspase-binding abilities of the chimeric protein, given that a number of caspases (and many other proteins important in apoptosis regulation) also contain this homophilic interaction motif ( [710](#)). The MALT1 sequences in the fusion vary significantly, with the only invariant portion present being the region of caspase-like homology in the C-terminus of the protein. The observation that the reciprocal MALT1-API2 fusion is expressed in only a subset of MALT lymphomas containing the t(11;18), together with cryptic deletions of 3' portions of API2 that would preclude expression of the reciprocal protein in other cases, suggests that the lymphomagenic properties of the t(11;18) reside solely in API2-MALT1. In addition to the use of RT-PCR, interphase and metaphase FISH seem to be robust diagnostic methods for detection of the t(11;18) ( [705](#), [706](#) and [707](#), [716](#)).

The incidence of API2-MALT1 in all extranodal lymphomas of the MALT type in various anatomic locations has ranged from 19 to 36% in various studies, but the fusion appears especially frequent in gastric MALT lymphomas that lack a high-grade (large cell) component, being present in roughly 50% of such tumors ( [713](#)). Despite the common origin of primary nodal, primary splenic, and extranodal MALT-type marginal zone lymphomas from the marginal zone B cells, only MALT lymphomas have been found to express API2-MALT1. In addition, no evidence for the t(11;18) has been found in any other type of NHL. API2-MALT1-containing MALT tumors have not been shown to possess a greater likelihood of transformation to large cell lymphoma, although the number of cases examined thus far is still relatively small. However, gastric MALT lymphomas that express API2-MALT1 appear capable of *H. pylori*-independent growth and thus do not regress on eradication of this infection after antibiotic therapy, as is the case in 75% or more of gastric MALT lymphoma patients ( [717](#), [718](#) and [719](#)). The API2-MALT1 fusion also has been reported in approximately 40% of pulmonary extranodal marginal zone B-cell lymphomas and may be associated especially with those tumors that occur in patients lacking autoimmune disease as a predisposing feature ( [720](#)).

The exact contributions of the API2-MALT1 fusion to the genesis of MALT lymphomas remain to be determined, but inhibition of normal proapoptotic responses in marginal zone B-cells is almost certainly part of the lymphomagenic mechanism. Truncation of API2 due to the t(11;18) at its C-terminus, leaving the BIR domains in the lymphoma-associated fusion protein, may release their antiapoptotic effects from negative regulation normally mediated by the CARD and RING domains (as noted previously, the BIR domain alone is sufficient for caspase inhibition and suppression of apoptosis) ( [712](#)), whereas overexpression of the RING domain alone increases cell death in a *Drosophila* experimental system ( [721](#)). As discussed in subsequent sections in detail, the MALT/MALT1/hParacaspase protein appears to participate together with BCL10 in a novel NF- $\kappa$ B activation pathway; thus, deregulation of this normal function, perhaps leading to inappropriate activation of NF- $\kappa$ B signaling (and resultant antiapoptotic and proliferation-enhancing effects), may occur due to the API2-MALT1 fusion ( [708](#), [722](#)). Consistent with these likely lymphomagenic mechanisms, a recent study examining API2-MALT1-positive MALT tumor cells revealed fourfold higher proliferation and survival *in vitro* compared to t(11;18)-negative MALT lymphoma B cells ( [723](#)).

The other recurrent chromosomal rearrangement observed in the MALT lymphomas is the t(1;14)(p22;q32), which is considerably less frequent than the t(11;18) ( [724](#)). MALT lymphomas that contain the t(1;14) appear to grow more readily *in vitro* than those lacking the abnormality and to be more clinically aggressive. Like the t(11;18), the presence of the t(1;14) is believed to contribute to the development of *H. pylori*-independent growth

of gastric MALT tumors.

In 1999, Willis et al. (725) and Zhang et al. (726) independently characterized the t(1;14), demonstrating a novel gene, BCL10, which encodes an NF- $\kappa$ B-activating protein, to be the 1p22 target of this genetic mutation. Intriguingly, like the *API2* gene altered in the t(11;18), *BCL10* encodes a CARD-containing protein. The CARD is a homotypic protein interaction motif of approximately 90 amino acids shared by proapoptotic (e.g., RAIDD/CRADD; CED4/Apaf-1; caspases-1, -2, -4, -5, -9, -11, and -12; CED3, and CARDIAK/RICK/RIP2) and antiapoptotic (e.g., cIAP1, cIAP2, and ARC) proteins (710). Many CARD-containing proteins are known to be essential for transducing death or survival signals. For example, CED3 and procaspase-9 associate with their regulatory proteins CED4 and Apaf-1, respectively, through CARD-mediated interactions that control activation of the caspase zymogens, thus leading to the induction of apoptotic cell death (727, 728).

The t(1;14) results in significant overexpression of BCL10 due to juxtaposition of the gene locus adjacent to the *IgH* enhancer (725, 726). BCL10 is ubiquitously expressed in normal tissues, although at relatively low abundance, as a single 2.8-kb transcript. The tissues exhibiting highest BCL10 expression are spleen, lymph node, and testis. *BCL10* is also expressed in B-cell lines transformed at all stages of differentiation, including pro-B-cell ALL, pre-B-cell ALL, Burkitt lymphoma, multiple myeloma, and EBV-immortalized lymphoblastoid lines. The 233-amino acid BCL10 protein contains a single CARD in its N-terminus and a serine-threonine-rich C-terminus. Human BCL10 shares 29% identity (35.5% similarity) with open reading frame E10 of the gamma herpesvirus equine herpesvirus 2, which is restricted to horses and causes pharyngitis and lymphadenopathy (729). Although not known to be lymphomagenic, equine herpesvirus 2 is highly related to herpesvirus saimiri, which causes fulminant T-cell lymphomas in primates and is only slightly less related to EBV and human herpesvirus 8 that are implicated in Burkitt lymphoma and lymphomas in immunocompromised patients.

Simultaneous with the cloning of the t(1;14), a number of research laboratories that study apoptosis regulation also published initial characterizations of BCL10 [referred to as *cE10* (cellular *E10*), *CIPER* (CED3/ACH-1 prodomain homologous *E10*-like regulator), *CLAP* (CARD-like apoptosis protein), *CARMEN* (CARD-containing molecule enhancing NF- $\kappa$ B), or *mE10* (mammalian *E10*)] (730, 731, 732, 733 and 734). These studies suggested enforced expression of BCL10 in most cell types (e.g., 293T, COS, HeLa, and MCF7) to induce modest or marked (depending on the particular experiment) apoptotic death. Contrary to the apparently proapoptotic effects of BCL10 in these epithelial cell types, stable BCL10 expression could be achieved in lymphoid cell lines without inducing a propensity to apoptotic death (725, 726), suggesting that the functional effects of BCL10 may depend in part on the cellular context. Cellular cues that result in BCL10 phosphorylation likely also regulate the effects of the protein on apoptosis; for example, phosphorylation of BCL10 has been reported to result in its dissociation from the apoptosis regulator, TRAF-2, and binding to cIAPs, which correlated with the promotion of apoptotic cell death (735, 736).

Functional evidence of the importance of BCL10 in lymphocyte development and MALT lymphomagenesis has come from recently described mouse models. Transgenic mice in which BCL10 expression is engineered specifically in the T and B cells develop splenomegaly due to a marked and specific expansion of their marginal zone B cells in a manner reminiscent of human splenic marginal zone lymphomas (737). Furthermore, studies from Bcl10-deficient mice indicate that, in addition to a role in neural tube closure, Bcl10 functions as a positive regulator of lymphocyte proliferation that specifically connects antigen receptor (the B-cell receptors and TCRs) signaling in lymphoid cells to NF- $\kappa$ B activation (738). An additional study of Bcl10-deficient mice has

shown the function of the gene to be essential not only for the normal development and function of marginal zone B cells, the normal cellular counterparts to MALT lymphoma tumor cells ( [739](#), [740](#) ), but also for the development and function of follicular and B1 B cells as well ( [741](#) ).

In view of the data showing BCL10 to be proapoptotic in most cell types, overexpression of the protein due to the t(1;14) appeared paradoxical. To examine this issue, BCL10 transcripts from t(1;14)-positive MALT lymphomas ( [725](#), [726](#) ), as well as from other NHLs and solid tumors lacking the translocation ( [725](#) ), were examined and reported to contain a variety of mutations. These data suggested that BCL10 might normally possess a tumor suppressor function, and that overexpression of loss-of-function BCL10 mutants or gain-of-function mutants (with respect to NF- $\kappa$ B activation, *vide infra*) might contribute to lymphomagenesis rather than overexpression of the normal protein. Prompted by these reports, a number of investigators subsequently examined various tumor types for mutations of BCL10 (see reference [742](#) for a review of these studies). Based on these studies, BCL10 mutations actually appear to occur rarely in nonlymphoid hematopoietic malignancies and solid tumors of all types and are thus unlikely to play a significant role in oncogenesis. The combined data suggest that, at most, 5 to 10% of B-cell NHLs may contain BCL10 mutations, whereas mutation in T-cell-lineage disease rarely, if ever, occurs. Therefore, the initially reported high frequency of BCL10 mutation in hematopoietic and solid tumors ( [725](#) ) has not been borne out by the additional data from a large number of studies. The contributions (if any) of BCL10 mutants to MALT lymphomas or other tumors are not currently clear and await further study, although a classic tumor suppressor role for the gene normally appears unlikely.

Unlike the controversy regarding the effects of BCL10 on apoptosis, essentially uniform agreement exists concerning the ability of the protein to activate NF- $\kappa$ B when overexpressed in cells. Dominant-negative forms of NF- $\kappa$ B-inducing kinase, I $\kappa$ B kinase (IKK) and I $\kappa$ B, but not dominant-negative TRAF-2, TRAF-6, or RIP, inhibit BCL10-mediated NF- $\kappa$ B activation, suggesting that BCL10 functions upstream of NF- $\kappa$ B-inducing kinase, IKK, and I $\kappa$ B and downstream or independent of TRAFs and RIP ( [730](#), [731](#) and [732](#) ). Suggestive evidence for a direct role of BCL10 in TNFR-induced NF- $\kappa$ B activation is the demonstration that engineered expression of normal BCL10 slightly enhances tumor necrosis factor  $\alpha$ -mediated NF- $\kappa$ B activation, whereas expression of the BCL10 CARD domain alone inhibits activation ( [732](#) ).

The exact mechanisms by which BCL10 normally activates NF- $\kappa$ B are still being clarified, but CARD-mediated interactions with a subfamily of membrane-associated guanylate kinase (MAGUK) proteins ( [743](#) ) that are called *CARD-MAGUKs* ( *CARMA*s), BCL10-interacting MAGUK proteins (BIMPs), or CARD10, CARD11, and CARD14 seem to be a critical component (for example, see reference [744](#) and the references cited therein). MAGUKs are scaffolding proteins containing several types of protein-protein interaction motifs that bind directly to the cytoplasmic portions of membrane-spanning and other signal transduction proteins, thus organizing specific signaling pathways originating from cell membrane receptors ( [743](#) ). On engineered overexpression in cells, CARMA1 (also called *CARD11* and *BIMP3*), CARMA2 (also known as *CARD14* and *BIMP2*), and CARMA3 (also known as *CARD10* and *BIMP1*) bind to BCL10, thereby activating the NF- $\kappa$ B pathway. Recent studies have shown that members of this MAGUK protein subfamily organize BCL10 and other signaling proteins in NF- $\kappa$ B-activating pathways emerging from certain cell surface receptors. For example, CARMA1 physically associates with the TCR and BCL10 on TCR stimulation, and a CARMA1 mutant defective for BCL10 binding has a dominant-negative effect on TCR-induced NF- $\kappa$ B activation ( [744](#) ).

Intriguingly, the two independent targets of the recurrent chromosomal rearrangements in MALT lymphoma, API2-MALT1 and BCL10, appear to converge functionally in the same novel NF- $\kappa$ B activation pathway (708, 722). The normal MLT/MALT1/hParacaspase and BCL10 proteins have been shown to physically interact and cooperate in NF- $\kappa$ B activation (708, 722). Although not yet completely elucidated, a mechanism in which BCL10 mediates oligomerization and activation of the MLT/MALT1/hParacaspase caspase-like domain, which in turn activates the IKK complex and eventually NF- $\kappa$ B, seems likely. MAGUK family proteins appear also to be involved in this activation pathway; for example, CARD10, BCL10, and MLT/MALT1/hParacaspase form a ternary complex in cells, with BCL10 serving as the bridge between the other two proteins (745). CARD10-mediated NF- $\kappa$ B activation requires BCL10 and IKK, indicating that the protein acts upstream of these signaling mediators. In addition, a dominant-negative CARD10 mutant protein inhibits NF- $\kappa$ B induction by TCR or protein kinase C activation, suggesting that the protein normally links cell surface receptor signaling downstream to BCL10 and MLT/MALT1/hParacaspase to activate NF- $\kappa$ B.

The BCL10 protein is normally localized to the cytoplasm of cells. For unknown reasons, MALT lymphomas that overexpress BCL10 owing to the t(1;14), as well as many MALT tumors (but not other subtypes of NHL) that do not contain this translocation, also express the protein in their nuclei (746). The presence of the t(11;18)-associated API2-MALT1 fusion is also associated with nuclear BCL10 expression (747), and MALT lymphomas bearing these two abnormal findings are more frequently aggressive and disseminated. The pathogenic significance of aberrant nuclear localization of BCL10 is not yet clear. However, the frequent association of API2-MALT1 expression with nuclear BCL10 in MALT lymphomas provides yet further suggestive evidence that the oncogenic properties of the two are interrelated.

The API2-MALT1 fusion and BCL10 can independently activate NF- $\kappa$ B when expressed in cells, but they markedly synergize when coexpressed (708, 722) (Fig. 89.3B). Therefore, the expression of the API2-MALT1 fusion or excess BCL10 would be predicted to significantly enhance NF- $\kappa$ B function, leading to up-regulation of NF- $\kappa$ B target genes, such as TRAF-1 and -2, cIAP-1 and -2, cMYC, and IL6, all of which should promote MALT B-cell growth (748). Such enhancement of NF- $\kappa$ B activation due to the API2-MALT1 fusion or BCL10 overexpression presumably substitutes for the requirement of early, low-grade MALT lymphomas for the sustained B-cell antigen receptor stimulation that occurs with *H. pylori* gastritis or chronic autoimmune diseases.

## **VARIOUS NON-HODGKIN LYMPHOMA SUBTYPES: 1q21-q22 GENE LOCI (BCL9, MUC1, Fc $\gamma$ RIIB, IRTA1 AND -2), AND BCL8**

### **1q21-q22 Gene Loci (BCL9, MUC1, Fc $\gamma$ RIIB, IRTA1 and -2)**

Abnormalities of the long arm of chromosome 1, particularly the 1q21-q22 region, occur in roughly 10 to 15% of B-cell NHLs, are usually secondary, and are associated with a poor prognosis, especially in the DLCLs (511, 749). Chromosomal breakpoints at 1q21-q22 show surprising heterogeneity and involve several target genes, as described in the following discussion.

In 1998, Willis et al. (750) reported the cloning of a t(1;14)(q21;q32) in a pre-B-cell acute lymphoblastic leukemia cell line, identifying the novel BCL9 gene. Increased transcript levels of BCL9, which encodes a 1394-amino acid protein that was noted to contain several pentapeptide repeats and a nuclear localization signal, were detectable in the cell



line. BCL9 expression levels appear normally to be low in B cells, but 50-fold higher expression was found in the cell line from which the gene was cloned (750). However, Southern blot hybridization and FISH analyses of a panel of 39 B-cell malignancies with 1q21 abnormalities revealed the BCL9 locus to be affected in only two cases (one MCL and FL each).

The normal function of BCL9 has been partially clarified by a report in 2002 that described its *Drosophila* homolog, a segment polarity protein named *legless* (*lgs*) that is required for the development of the legs and antennae of the fly (751). This report showed that BCL9/*lgs* can form a trimolecular complex with the Wnt/wingless signaling proteins  $\beta$ -catenin/*arm* and TCF/*pan*, and suggested that BCL9/*lgs* recruits another segment polarity gene known as *pygopus* (*pygo*) to  $\beta$ -catenin in the nucleus. Wnt signal transduction is mediated by the association of  $\beta$ -catenin with the nuclear TCF DNA-binding factors, and *lgs* and *pygo* were shown to be required for Wnt signaling at the level of  $\beta$ -catenin. These data suggest that the recruitment of *pygo* to  $\beta$ -catenin by *lgs* allows  $\beta$ -catenin to transcriptionally activate Wnt target genes, which include cMYC and cyclin D1 among others (751).

The normal proliferation and differentiation of pro-B cells require an intact Wnt signaling pathway, suggesting that Wnt signals may provide important mitogenic stimuli at certain developmental stages (752). In addition, Wnt3A has been shown to have a mitogenic effect on pro-B cells (753), whereas some pre-B-cell ALL blasts overexpress Wnt 16 (754). Thus, overexpression of BCL9 owing to genetic abnormalities may drive abnormal Wnt signaling to contribute to the oncogenic transformation of lymphoid cells.

Recently, two independent reports described the characterization of a t(1;14)(q21;q32) in the same case of large cell lymphoma, identifying dysregulation of the MUC1 gene (755, 756). MUC1, also called *epithelial membrane antigen*, is a glycoprotein that contains multiple copies of a tandemly repeated mucinlike domain. This glycoprotein was previously shown to be expressed in several lymphoid malignancies (75% of lymphocyte-predominant Hodgkin disease cases, 75% of plasmacytomas, and 50% of T-cell lymphomas, including essentially all ALCLs), as a result of unknown mechanisms other than 1q21-q22 rearrangements, and was shown to be involved in the progression of solid tumors (757, 758). The t(1;14) results in the dramatic up-regulation of expression of an intact MUC1 protein; none of six other genes located in an 85-kb region immediately centromeric to the MUC1 locus (CLK2, propin, COTE1, GBA, metaxin, or thrombospondin-3) were found to be overexpressed because of the translocation (756). Southern blot analysis of 72 B-cell NHLs containing a 1q21 rearrangement revealed MUC1 rearrangement in four cases (6%). In addition, increased copy number (four to six copies) of the MUC1 locus was identified in 18 (10%) of 178 B-cell NHLs (755). More recently three body-cavity-based-lymphoma cell lines have been reported to contain rearrangements near MUC1 and the physically linked metalloproteinase-like, disintegrin-like, and cysteine-rich protein (MDC15) (also known as *ADAM15*, for *a* disintegrin and metalloproteinase) gene loci, and to result in MDC15 overexpression in two of the three cell lines (759). Thus, rearrangements at this particular 1q21 region appear to be capable of producing overexpression of MUC1 or MDC15, both of which may contribute to the extranodal presentation of certain B-cell lymphomas because of the involvement of these proteins normally in cell-cell or cell-matrix interactions (758, 760).

By cloning the t(1;22)(q22;q11) in three FLs also containing t(14;18), Callanan et al. (761) showed FCGR2B, which encodes the immunoreceptor tyrosine-based inhibition motif-containing low-affinity IgG Fc receptor Fc $\gamma$ RIIB, to be the 1q22 target of this rearrangement. Fc $\gamma$ RIIB is an inhibitory coreceptor that effects negative regulation of

immune responses mediated by activating receptors such as B-cell antigen receptors ( [762](#) ). High levels of the Fc $\gamma$ RIIB receptor alternative splice isoform Fc $\gamma$ RIIb2 were specifically overexpressed in t(1;22)-positive cases, whereas b1 isoform levels were not elevated above normal. How high-level constitutive Fc $\gamma$ RIIb2 expression might contribute to B-cell tumorigenesis is not clear, but Fc $\gamma$  receptors can clearly affect B-cell growth; for example, activation of these receptors enhances the growth and differentiation of murine B-cell-lineage progenitors *in vitro*, and Fc $\gamma$ RII-deficient mice have an increased B-cell compartment ( [763](#) ).

The chromosomal region 1q21-q22 is remarkably rich in FCGR genes. Three Fc $\gamma$ RII genes and two Fc $\gamma$ RIIIB genes are located in an approximately 200-kb region in 1q22. Moreover, cloning of yet another t(1;14)(q21;q32) from the FR4 myeloma cell line has revealed an additional group of highly related Fc receptor-related genes that are involved in the pathogenesis of B-cell-lineage malignancies. Hatzivassiliou et al. ( [764](#) ) reported the presence of five adjacent genes (named *Ig superfamily receptor translocation-associated (IRTA)* genes) from a 300-kb region spanning the breakpoint in this cell line, all of which encode surface receptor molecules that are members of the Ig gene superfamily. All IRTA genes are expressed normally in the B-cell lineage with distinct developmental stage-specific patterns; for example, IRTA1 is expressed in a marginal zone B-cell pattern, and IRTA2 is found in centrocytes, marginal zone B cells, and immunoblasts ( [764](#) , [765](#) ). As a result of the translocation in the FR4 cell line, IRTA1 is interrupted and fused to the Ig Calpha locus, producing a chimeric IRTA1/Calpha protein. The IRTA2 gene, normally silent in centroblasts (the presumed normal cellular counterparts of Burkitt lymphoma tumor cells), is overexpressed in Burkitt lymphoma as well as multiple myeloma cell lines carrying 1q21 abnormalities. The pathologic mechanisms by which deregulation of the IRTA genes contributes to lymphocyte proliferation are not yet clear but presumably involve, in part, a disturbance of the physiologic homeostasis between activating and inhibitory antigen receptors.

## BCL8

Rearrangements affecting chromosomal bands 15q11-q13 and various partners occur in approximately 4% of DLCLs. In 1997, Dyomin et al. ( [766](#) ) identified a chromosome 15 genomic locus, which they named BCL8, at which at least some of these rearrangements occur. Transcripts from the BCL8 locus were found to be normally expressed as a major transcript of 2.6 kb and a less prominent 4.5-kb message due to differential polyadenylation, and their expression was restricted primarily to the testis and prostate, with no transcripts being found normally in hematopoietic tissues, such as the spleen, thymus, or blood leukocytes. The cloning of the corresponding BCL8 complementary DNA species revealed a 513-base pair open reading frame predicted to encode a 19-kd protein with a high degree of homology to the N-terminus of the *D. melanogaster* protein kinase A (PKA) anchoring protein RG ( [767](#) ). RT-PCR analysis of RNAs from DLCL samples and lymphoma cell lines identified BCL8 expression in all cases having abnormalities of chromosome 15q11-q13, as well as in four of nine randomly selected DLCL cases and 6 of 15 DLCL cell lines (but none of three hyperplastic lymph nodes). The mechanism of aberrant BCL8 expression in lymphomas lacking 15q11-q13 translocations has not yet been defined.

A recently published study has identified several additional chromosomal loci sharing homology with the originally described BCL8 complementary DNA (which has subsequently been renamed *BCL8A*) ( [768](#) ). BCL8A and three related loci (designated *BCL8C*, *BCL8D*, and *BCL8E*) found on other chromosomes were found to be truncated at the genomic level, suggesting that they may actually be pseudogenes, sterile transcripts that are not translated into proteins, or that they may possibly encode truncated



polypeptides of uncertain function. By contrast, a fifth related locus, *BCL8B*, which was expressed mainly in the brain, contained an uninterrupted open reading frame predicted to encode a 327-kd protein with extensive homology to the RG *Drosophila* PKA anchoring protein.

Involvement of PKA anchoring proteins in the phosphorylation and resultant inactivation of the proapoptotic BCL2 family member BAD has been identified (769), suggesting a potential role for some PKA anchoring proteins in oncogenesis. However, additional studies are required to determine what, if any, protein is translated from BCL8A and what function such a protein might possess.

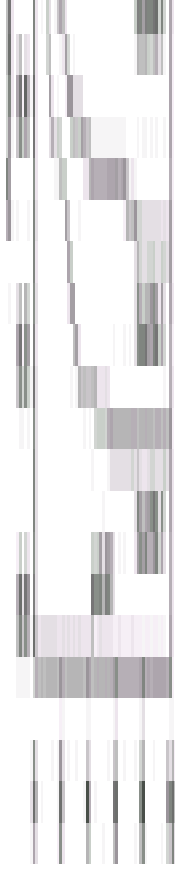
## GENE EXPRESSION PROFILING IN NON-HODGKIN LYMPHOMA

The previous sections of this chapter have, for the most part, highlighted characteristic genetic alterations associated with specific subtypes of NHL. The current WHO classification scheme for lymphomas incorporates these recurrent aberrations along with morphologic and immunophenotypic features of the tumor cells (770). However, many NHL subgroups defined in this fashion remain biologically and clinically heterogeneous and vary in their response to current therapeutic regimens. This variability is due, in large measure, to molecular differences between the tumors that are not included in the current classification criteria. The information provided by the Human Genome Project has paved the way toward a comprehensive molecular characterization of lymphomas and other cancer types. One genomics-based technology that has proven useful in lymphoma classification is gene expression profiling using DNA microarrays (25, 771). Using this technology, the mRNA expression levels of thousands of genes can be measured simultaneously in a tumor biopsy, thus creating a molecular portrait of the tumor. It is anticipated that, in the near future, comparison of the gene expression profiles of lymphoma samples from a large number of patients will lead to a new molecular definition of lymphoma subgroups that are more uniform in their biologic and clinical behavior. As an introduction to this technology, the following section focuses on efforts made as of 2003 concerning the expression profiling of B-cell NHL subtypes.

An initial gene expression profiling study of tumor samples from patients with DLBCL, FL, and chronic lymphocytic leukemia demonstrated that large sets of genes are characteristically and selectively expressed by each of these diagnostic subtypes (772). FLs, for example, display a gene expression phenotype that is characteristic of normal B cells at the germinal center stage of B-cell differentiation. By contrast, chronic lymphocytic leukemia cells share similarities in gene expression with normal peripheral blood B-cells (772).

Three major gene expression profiling studies have addressed the biologic and clinical heterogeneity of DLBCL (772, 773 and 774). In DLBCL, current chemotherapeutic regimens (e.g., cyclophosphamide, hydroxydaunomycin, vincristine, and prednisone) achieve durable remissions in less than 50% of the patients, and multiple attempts to improve clinical outcome in this disease have failed (775). The clinical relevance of the histopathologic subclassification of DLBCL cases into centroblastic, immunoblastic, and other variants has not been demonstrated conclusively (776). Despite the fact that the marked biologic and clinical heterogeneity of DLBCL is well recognized, it is still considered a single lymphoma entity in the most recent WHO classification of lymphoid malignancies (770).

In the initial gene expression profiling study in DLBCL, lymph node biopsy samples from previously untreated DLBCL patients were analyzed (772). Genes that define the germinal center stage of B-cell differentiation were used to define two prominent DLBCL



terminal center *B-cell-like* (GCB) DLBCL subgroup of normal germinal center B cells (e.g., CD10, BCL6, and *activated B-cell-like* (ABC) DLBCL subgroup expressed genes that activation of peripheral blood B cells (e.g., BCL-2, IRF-4, expression profiling study of DLBCL cases confirmed the subgroups but also identified another set of cases, termed resemble GCB or ABC DLBCLs and may represent additional DLBCL (774).

**Figure 89.4. A:** Subgroups of diffuse large B-cell lymphoma (DLBCL) defined by gene expression profiling. Hierarchic clustering of 188 lymph node biopsies from DLBCL patients, according to the gene expression levels of 100 selected genes. Shades of red indicate higher expression, shades of green indicate lower expression, and black indicates median expression. Each column represents one tumor sample, and each row represents a single gene. The germinal center B-cell-like DLBCLs (see text) show high expression of genes that are characteristically expressed in germinal center B cells (e.g., CD10 and BCL6), whereas activated B-cell-like DLBCLs express genes normally induced during *in vitro* activation of B cells (e.g., cyclin D2, IRF-4, and CD44). **B:** A gene expression-based outcome predictor in 240 DLBCL patients. Each case of DLBCL was assigned an outcome predictor score calculated from gene expression averages of the model components (see text for details). Patients were ranked according to their scores and divided into quartiles. The 5-year survival rates for these quartile groups are shown in the Kaplan-Meier plot. See [Color Plate](#). (Adapted from Rosenwald A, Wright G, Chan WC, et al. The use of molecular profiling to predict survival after chemotherapy for diffuse large-B-cell lymphoma. *N Engl J Med* 2002;346:1937-1947, with permission.)

These observations raised the possibility that the DLBCL subgroups represent pathogenetically distinct entities that are derived from cells at different stages of B-lymphoid differentiation. Support for this hypothesis has come from analysis of Ig gene mutations and oncogenic abnormalities in the DLBCL subgroups. Although DLBCLs in the GCB and ABC subgroups were found to have mutated Ig genes, only GCB DLBCLs had ongoing somatic hypermutation of the Ig locus within the tumor clone (777). Because somatic hypermutation of Ig genes is a hallmark of germinal center B cells, this finding suggests that the GCB DLBCL tumors retain some of the biologic characteristics of normal B cells at this stage of differentiation.

Two recurrent chromosomal alterations in DLBCL were detected exclusively in the GCB DLBCL subgroup (774, 778). The t(14;18)(q32;q21) translocation involving the BCL2 oncogene was detected in 23 to 35% of GCB DLBCL cases but never in ABC or type 3 DLBCL cases. Similarly, amplification of the cREL locus on chromosome 2p was detected in 15% of GCB DLBCLs but not in the other subgroups (774). By contrast, ABC DLBCLs

were found to have constitutive activity of the NF- $\kappa$ B pathway, which is not a feature of GCB DLBCLs (779). These findings suggest that the DLBCL subgroups use distinct oncogenic mechanisms, which may have implications for targeted therapy in the future. Indeed, interference with the NF- $\kappa$ B pathway was found to kill ABC DLBCL cells *in vitro*, suggesting that pharmacologic targeting of this pathway may be beneficial for patients with this type of DLBCL (779).

The DLBCL gene expression subgroups were found to have distinct overall survival rates after anthracycline-based multiagent chemotherapy (e.g, the regimen of cyclophosphamide, hydroxydaunomycin, vincristine, and prednisone) (772, 774). The 5-year survival rates for the GCB, ABC, and type 3 DLBCL subgroups were 60%, 35%, and 39%, respectively (774). However, the DLBCL subgroup distinction did not fully account for the variable response of these patients to chemotherapy, suggesting that further molecular differences among the lymphomas influence the response to chemotherapy.

To directly search for genes that influence the response of DLBCL patients to chemotherapy, clinical data were used to identify genes with expression patterns that correlated with survival (773, 774). This “supervised” analytic approach was used to create multivariate statistical models based on gene expression that strongly predicted survival. In one gene expression-based prognostic model, most of the genes reflected one of four biologic characteristics of the DLBCL tumors that independently influenced survival (774). The predictive genes in this model were classified functionally based on their membership in gene expression *signatures*. A gene expression signature is a set of genes that are selectively and coordinately expressed in a particular cell type, stage of differentiation, or cellular response (565).

Most of the genes that predicted poor survival when expressed belonged to the *proliferation gene expression signature* (774). This signature includes genes that are more highly expressed in dividing cells than in quiescent cells. This gene expression signature is a quantitative measure of proliferation rate, and its adverse prognostic influence is in accord with previous studies of tumor cell proliferation in DLBCL (780, 781). Many genes that predicted favorable survival when expressed belonged to the *germinal center B-cell signature*, a finding that mirrors the superior survival of the GCB DLBCL subgroup of patients that was mentioned previously. Other predictive genes in the prognostic model suggested that the host immune response to the lymphoma may be critical for a curative response to chemotherapy (774). Genes involved in antigen presentation to the immune system, including genes encoding major histocompatibility complex class II molecules and invariant chain, predicted favorable survival when expressed, in keeping with previous results (782). Other genes that predicted a favorable survival belonged to the *lymph node signature*, which corresponds to a fibrotic response to the lymphoma cells that is associated with an influx of macrophages and natural killer cells into the lymph node.

A multivariate model was created from 17 predictive genes that was shown to predict survival in an independent set of DLBCL cases, thus establishing the statistical validity of the model (774). Each DLBCL patient was assigned an *outcome predictor score* based on the expression of these 17 genes that was used to stratify the patients into four quartiles with 5-year survival rates of 73%, 71%, 36%, and 16% (Fig. 89.4B). This gene expression-based prognostic model functioned independently of a prognostic model based on clinical parameters, the International Prognostic Index (783). Because this gene expression-based prognostic model incorporates defined biologic features of DLBCL tumors, it may prove useful in identifying alternative therapies for patients who are not likely to be cured by conventional multiagent chemotherapy.

Gene expression profiling has also provided insights into the pathogenesis and clinical behavior of MCL (258). As noted earlier in this chapter, most cases of MCL are characterized by a common genetic alteration, the t(11;14) translocation, which juxtaposes the cyclin D1 gene to the Ig heavy chain locus (212). Cyclin D1 is a key regulator of the G<sub>1</sub> to S phase transition in the cell cycle, and its deregulation in MCL highlights the central role of abnormal proliferation in this disease. A set of *MCL signature genes* was defined by gene expression profiling that distinguished this lymphoma type from other NHLs (258). This gene expression signature was used to identify a novel subtype of MCLs that lack cyclin D1 expression but nevertheless express MCL signature genes and resemble cyclin D1-positive MCL morphologically and clinically (258). Some of these cyclin D1-negative cases express cyclin D2 or cyclin D3, suggesting that they may have developed alternative mechanisms to promote cell cycle progression.

The median length of survival of patients with cyclin D1-positive MCL is approximately 2.8 years, but some patients die within the first year of diagnosis, whereas others live for more than 10 years with this lymphoma (213). Much of this variable survival can be accounted for by differences in expression of the proliferation gene expression signature, with higher expression of this signature associated with shorter survival (258). Using this quantitative measure of tumor cell proliferation rate, MCL patients could be subdivided into quartiles with median survival times 0.8 years, 2.3 years, 3.3 years, and 6.7 years (258). Two oncogenic mechanisms were identified that accounted for some of this variability in proliferation and survival. Some of the more proliferative MCLs expressed higher levels of cyclin D1, and this was due to the preferential expression of a more stable isoform of cyclin D1 mRNA. In addition, deletions of the INK4a/ARF tumor suppressor locus were commonly observed among the highly proliferative MCLs. Both of these oncogenic events were independently associated with shorter survivals, but a statistical model that combined these two events did not predict length of survival as well as the proliferation gene expression signature. The proliferation signature thus acts as a quantitative integrator of multiple oncogenic events that affect the clinical course of MCL patients.

As these examples illustrate, gene expression profiling is able to identify lymphoma subtypes that are distinct pathogenetically and clinically. Furthermore, gene expression can be used to create quantitative prognostic indices that reflect biologic differences among lymphomas. In the future, it is possible that some of these prognostic differences may be used to stratify patients to more or less aggressive treatment regimens. Furthermore, the molecular diagnosis of a lymphoma subtype can provide information about the signaling pathways vital to the proliferation or survival, or both, of the lymphoma, which could prove increasingly valuable as more targeted treatments become available for NHL.

## REFERENCES

1. Rappaport H. Tumors of the hematopoietic system. Atlas of tumor pathology, Section III, Fascicle 8. Washington, DC: Armed Forces Institute of Pathology, 1966:97-161.
2. Dorfman RF. Classification of non-Hodgkin's lymphomas [Letter]. *Lancet* 1974;1:1295-1296.
3. Lukes RJ, Collins RD. Immunologic characterization of human malignant lymphomas. *Cancer* 1974;34[suppl]:1488-1503.
4. Lennert K, Stein H, Kaiserling E. Cytological and functional criteria for the classification of malignant lymphomata. *Br J Cancer* 1975;31:29-43.
5. Mann RB, Jaffe ES, Berard CW. Malignant lymphomas: a conceptual understanding of morphologic

diversity. A review. *Am J Pathol* 1979;94:105–191.

6. Aisenberg AC. Cell-surface markers in lymphoproliferative disease. *N Engl J Med* 1980;304:331–336.
7. Nathwani BN. The Rappaport classification of the non-Hodgkin's lymphomas: is it pertinent for the 1980's? In: Bennett JM, ed. *Lymphoma II: controversies in the management of lymphoma (including Hodgkin's disease), diagnosis and management*. Boston: Martinus Nijhoff, 1983:183–223.
8. National Cancer Institute sponsored study of classifications of non-Hodgkin's lymphomas: summary and description of a working formulation for clinical usage. The Non-Hodgkin's Lymphoma Pathologic Classification Project. *Cancer* 1982;49:2112–2135.
9. Nathwani BN, Brynes RK, Lincoln T, et al. Classifications of the non-Hodgkin's lymphomas. In: Knowles DM, ed. *Neoplastic hematopathology*. Baltimore: Williams & Wilkins, 1992:555–601.
10. Isaacson PG. The current status of lymphoma classification. *Br J Haematol* 2000;109:258–266.
11. Stansfeld AG, Diebold J, Noel H, et al. Updated Kiel classification for lymphomas [Letter]. *Lancet* 1988;1:292–293. [published erratum appears in *Lancet* 1988 Feb 13;1(8581):372.]
12. Harris NL, Jaffe ES, Stein H, et al. A revised European-American classification of lymphoid neoplasms: a proposal from the International Lymphoma Study Group. *Blood* 1994;84:1361–1392.
13. Jaffe ES, Harris NL, Diebold J, et al. World Health Organization classification of neoplastic diseases of the hematopoietic and lymphoid tissues. A progress report. *Am J Clin Pathol* 1999;111:S8–S12.
14. Jones SE, Butler JJ, Byrne GE Jr, et al. Histopathologic review of lymphoma cases from the Southwest Oncology Group. *Cancer* 1977;39:1071–1076.
15. Ezdinli EZ, Costello W, Wasser LP, et al. Eastern Cooperative Oncology Group experience with the Rappaport classification of non-Hodgkin's lymphomas. *Cancer* 1979;43:544–550.
16. Velez-Garcia E, Durant J, Gams R, et al. Results of a uniform histopathologic review system of lymphoma cases. A ten-year study from the Southeastern Cancer Study Group. *Cancer* 1983;52:675–679.
17. Bird CC, Lauder I, Kellett HS, et al. Yorkshire Regional Lymphoma Histopathology panel: analysis of five years' experience. *J Pathol* 1984;143:249–258.
18. Berard CW, Bloomfield C, Bonadonna G, et al. Classification of non-Hodgkin's lymphomas. Reproducibility of major classification systems. NCI non-Hodgkin's Classification Project Writing Committee. *Cancer* 1985;55:91–95.
19. Siebert R, Rosenwald A, Staudt LM, et al. Molecular features of B-cell lymphoma. *Curr Opin Oncol* 2001;13:316–324.
20. Dyer MJ. The pathogenetic role of oncogenes deregulated by chromosomal translocation in B-cell malignancies. *Int J Hematol* 2003;77(4):315–320.
21. Campo E. Genetic and molecular genetic studies in the diagnosis of B-cell lymphomas. I. Mantle cell lymphoma, follicular lymphoma, and Burkitt's lymphoma. *Hum Pathol* 2003;34(4):330–335.
22. Muller-Hermelink HK. Genetic and molecular genetic studies in the diagnosis of B-cell lymphomas: marginal zone lymphomas. *Hum Pathol* 2003;34(4):336–340.
23. Kadin ME. Genetic and molecular genetic changes in the diagnosis of T-cell malignancies. *Hum Pathol* 2003;34(4):322–329.
24. Goldsby RE, Carroll WL. The molecular biology of pediatric lymphomas. *J Pediatr Hematol Oncol* 1998;20(4):282–296.
25. Staudt LM. Molecular diagnosis of the hematologic cancers. *N Engl J Med* 2003;348(18):1777–1785.
26. Manolov G, Manolova Y. Marker band in one chromosome 14 from Burkitt lymphomas. *Nature*

1972;237:33.

27. Zech L, Haglund U, Nilsson K, et al. Characteristic chromosomal abnormalities in biopsies and lymphoid-cell lines from patients with Burkitt and non-Burkitt lymphomas. *Int J Cancer* 1976;17:47-56.
28. Taub R, Kirsch I, Morton C, et al. Translocation of the C-myc gene into the immunoglobulin heavy chain locus in human Burkitt lymphoma and murine plasmacytoma cell. *Proc Natl Acad Sci U S A* 1982;79:7837-7841.
29. Dalla-Favera R, Bregni M, Erikson J, et al. Human c-myc onc gene is located on the region of chromosome 8 that is translocated in Burkitt lymphoma cells. *Proc Natl Acad Sci U S A* 1982;79:7824-7827.
30. Felsher DW. Cancer revoked: oncogenes as therapeutic targets. *Nat Rev Cancer* 2003;3(5):375-380.
31. Traxler P. Tyrosine kinases as targets in cancer therapy--successes and failures. *Expert Opin Ther Targets* 2003;7(2):215-234.
32. Rowley JD, Aster JC, Sklar J. The clinical applications of new DNA diagnostic technology on the management of cancer patients. *J Am Med Assoc* 1993;270:2331-2337.
33. Falini B, Mason DY. Proteins encoded by genes involved in chromosomal alterations in lymphoma and leukemia: clinical value of their detection by immunocytochemistry. *Blood* 2002;99(2):409-426.
34. Zimmer A. Manipulating the genome by homologous recombination in embryonic stem cells. *Annu Rev Neurosci* 1992;15:115-137.
35. van der Weyden L, Adams DJ, Bradley A. Tools for targeted manipulation of the mouse genome. *Physiol Genomics* 2002;11(3):133-164.
36. McManus MT, Sharp PA. Gene silencing in mammals by small interfering RNAs. *Nat Rev Genet* 2002;3(10):737-747.
37. Paddison PJ, Hannon GJ. RNA interference: the new somatic cell genetics? *Cancer Cell* 2002;2:17-23.
38. Harris NL, Stein H, Coupland SE, et al. New approaches to lymphoma diagnosis. *Hematology (Am Soc Hematol Educ Program)* 2001;194-220.
39. Rowland JM. Molecular genetic diagnosis of pediatric cancer: current and emerging methods. *Pediatr Clin North Am* 2002;49(6):1415-1435.
40. Sen F, Vega F, Medeiros LJ. Molecular genetic methods in the diagnosis of hematologic neoplasms. *Semin Diagn Pathol* 2002;19(2):72-93.
41. FISH in cancer diagnosis and prognostication: from cause to course of disease. *Expert Rev Mol Diagn* 2002;2(2):109-119.
42. Reinherz EL, Schlossman SF. The differentiation and function of human T lymphocytes. *Cell* 1980;19:821.
43. Trinchieri G. The hematopoietic system and hematopoiesis. In: Knowles DM, ed. *Neoplastic hematopathology*. Baltimore: Williams & Wilkins, 1992:1-25.
44. Inghirami G, Knowles DM. The immune system: structure and function. In: Knowles DM, ed. *Neoplastic hematopathology*. Baltimore: Williams & Wilkins, 1992:27-72.
45. Tonegawa S. Somatic generation of antibody diversity. *Nature* 1983;302:575-581.
46. Leder P. The genetics of antibody diversity. *Sci Am* 1982;246:102-115.
47. Sklar J. Antigen receptor genes: structure, function, and techniques for analysis of their rearrangements. In: Knowles DM, ed. *Neoplastic hematopathology*. Baltimore: Williams & Wilkins, 1992:215-244.

48. Korsmeyer SJ, Hieter PA, Ravetch JV, et al. Developmental hierarchy of immunoglobulin gene rearrangements in human leukemic pre-B-cells. *Proc Natl Acad Sci U S A* 1981;78:70-96.
49. Korsmeyer SJ, Arnold A, Bakshi A, et al. Immunoglobulin gene rearrangement and cell surface antigen expression in acute lymphocytic leukemias of T-cell and B-cell precursor origins. *J Clin Invest* 1983;71:301.
50. Greaves MF. Differentiation-linked leukemogenesis in lymphocytes. *Science* 1986;234:697-704.
51. Toyonaga B, Yanagi Y, Suciú-Foca N, et al. Rearrangements of T-cell receptor gene YT35 in human DNA from thymic leukemia T-cell lines and functional T-cell clones. *Nature* 1984;311:385.
52. Pelicci PG, Knowles DM, Dalla-Favera R. Lymphoid tumors displaying rearrangements of both immunoglobulin and T cell receptor genes. *J Exp Med* 1985;162:1015-1024.
53. Waldmann TA, Davis MM, Bongioanni KF, et al. Rearrangements of genes for the antigen receptor on T-cell receptor in T-cell chronic lymphocytic leukemia and related disorders. *N Engl J Med* 1985;313:776.
54. Tawa A, Hozumi N, Minden M, et al. Rearrangement of T-cell receptor B-chain gene in non-T-cell, non-B-cell acute lymphoblastic leukemia of childhood. *N Engl J Med* 1985;313:1033-1037.
55. O'Connor NTJ, Weatherall DJ, Feller AC, et al. Rearrangement of the T cell-receptor beta-chain gene in the diagnosis of lymphoproliferative disorders. *Lancet* 1985;1:1295-1297.
56. Asou N, Matsuoka M, Hattori T, et al. T-cell gamma gene rearrangements in hematologic neoplasms. *Blood* 1987;69:968-970.
57. Waldmann TA. The arrangement of immunoglobulin and T-cell receptor genes in human lymphoproliferative disorders. *Adv Immunol* 1987;40:247.
58. Tkachuk DC, Griesser H, Takihara Y, et al. Rearrangement of T-cell delta locus in lymphoproliferative disorders. *Blood* 1988;72:353-357.
59. Kuppers R, Dalla-Favera R. Mechanisms of chromosomal translocations in B cell lymphomas. *Oncogene* 2001;20:5580-5594.
60. Storb U, Shen HM, Michael N, et al. Somatic hypermutation of immunoglobulin and non-immunoglobulin genes. *Philos Trans R Soc Lond B Biol Sci* 2001;356(1405):13-19.
61. Papavasiliou FN, Schatz DG. Somatic hypermutation of immunoglobulin genes: merging mechanisms for genetic diversity. *Cell* 2002;109[Suppl]:S35-S44.
62. Kuppers R. Somatic hypermutation and B cell receptor selection in normal and transformed human B cells. *Ann N Y Acad Sci* 2003;987:173-179.
63. Berard CW, O'Connor GT, Thomas LB, et al. Histopathological definition of Burkitt's tumor. *Bull WHO* 1969:40.
64. Grogan TM, Warnke RA, Kaplan HS. A comparative study of Burkitt's and non-Burkitt's "undifferentiated" malignant lymphoma: immunologic, cytochemical, ultrastructural, cytologic, histopathologic, clinical and cell culture features. *Cancer* 1982;49:1817-1828.
65. Miliauskas JR, Berard CW, Young RC, et al. Undifferentiated non-Hodgkin's lymphomas (Burkitt's and non-Burkitt's types). The relevance of making this histologic distinction. *Cancer* 1982;50:2115-2121.
66. Levine AM, Pavlova Z, Pockros AW, et al. Small noncleaved follicular center cell (FCC) lymphoma: Burkitt and non-Burkitt variants in the United States. I. Clinical features. *Cancer* 1983;52:1073-1079.
67. Pavlova Z, Parker JW, Taylor CR, et al. Small noncleaved follicular center cell lymphoma: Burkitt's and non-Burkitt's variants in the US. II. Pathologic and immunologic features. *Cancer* 1987;59:1892-1902.
68. Hutchison RE, Murphy SB, Fairclough DL, et al. Diffuse small noncleaved cell lymphoma in children, Burkitt's versus non-Burkitt's types. Results from the Pediatric Oncology Group and St. Jude Children's



Research Hospital. *Cancer* 1989;64:23–28.

69. Davi F, Delecluse HJ, Guiet P, et al. Burkitt-like lymphomas in AIDS patients: characterization within a series of 103 human immunodeficiency virus-associated non-Hodgkin's lymphomas—Burkitt's Lymphoma Study Group. *J Clin Oncol* 1998;16:3788–3795.
70. Hecht JL, Aster JC. Molecular biology of Burkitt's lymphoma. *J Clin Oncol* 2000;18(21):3707–3721.
71. Hutchison RE, Finch C, Kepner J, et al. Burkitt lymphoma is immunophenotypically different from Burkitt-like lymphoma in young persons. *Ann Oncol* 2000;11[Suppl 1]:35–38.
72. Brazier RM, Arber DA, Slovak ML, et al. The Burkitt-like lymphomas: a Southwest Oncology Group study delineating phenotypic, genotypic, and clinical features. *Blood* 2001;97(12):3713–3720.
73. Evens AM, Gordon LI. Burkitt's and Burkitt-like lymphoma. *Curr Treat Options Oncol* 2002;3(4):291–305.
74. Cairo MS, Sposto R, Perkins SL, et al. Burkitt's and Burkitt-like lymphoma in children and adolescents: a review of the Children's Cancer Group experience. *Br J Haematol* 2003;120(4):660–670.
75. Yano T, van Krieken JH, Magrath IT, et al. Histogenetic correlations between subcategories of small noncleaved cell lymphomas. *Blood* 1992;79:1282–1290.
76. MacPherson N, Lesack D, Klasa R, et al. Small noncleaved, non-Burkitt's (Burkitt-like) lymphoma: cytogenetics predict outcome and reflect clinical presentation. *J Clin Oncol* 1999;17(5):1558–1567.
77. Magrath I. The pathogenesis of Burkitt's lymphoma. *Adv Cancer Res* 1990;55:133–270.
78. Magrath IT. African Burkitt's lymphoma. History, biology, clinical features, and treatment. *Am J Pediatr Hematol Oncol* 1991;13:222–246.
79. Knowles DM, Chamulak GA, Subar M, et al. Lymphoid neoplasia associated with the acquired immunodeficiency syndrome (AIDS): The New York University Medical Center experience with 105 patients (1981–1986). *Ann Intern Med* 1988;108:744–753.
80. Purtilo DT, Stevenson M. Lymphotropic viruses as etiologic agents of lymphoma. *Hematol Oncol Clin North Am* 1991;5:901–923.
81. List AF, Greco FA, Vogler LB. Lymphoproliferative diseases in immunocompromised hosts: the role of Epstein-Barr virus. *J Clin Oncol* 1987;5:1673–1689.
82. Young L, Alfieri C, Hennesy K, et al. Expression of Epstein-Barr virus transformation-associated genes in tissues of patients with EBV lymphoproliferative disease. *N Engl J Med* 1989;321:1080–1085.
83. Lyons SF, Liebowitz DN. The roles of human viruses in the pathogenesis of lymphoma. *Semin Oncol* 1998;25:461–475.
84. Neri A, Barriga F, Inghirami G, et al. Epstein-Barr virus infection precedes clonal expansion in Burkitt's and acquired immunodeficiency syndrome-associated lymphoma. *Blood* 1991;77:1092–1095.
85. Wilson JB, Bell JL, Levine AJ, et al. Expression of Epstein-Barr virus nuclear antigen-1 induces B cell neoplasia in transgenic mice. *EMBO J* 1996;15:3117–3126.
86. Komano J, Maruo S, Kurozumi K, et al. Oncogenic role of Epstein-Barr virus-encoded RNAs in Burkitt's lymphoma cell line Akata. *J Virol* 1999;73:9827–9831.
87. Ruf IK, Rhyne PW, Yang H, et al. Epstein-Barr virus regulates c-MYC, apoptosis, and tumorigenicity in Burkitt lymphoma. *Mol Cell Biol* 1999;19:1651–1660.
88. Filipovich AH, Heinritz KJ, Robison LL, et al. The Immunodeficiency Cancer Registry. A research resource. *Am J Pediatr Hematol Oncol* 1987;9:183–184.
89. Grierson H, Purtilo DT. Epstein-Barr virus infections in males with the X-linked lymphoproliferative

syndrome. *Ann Intern Med* 1987;106:538–545.

90. Lai PK, Yasuda N, Purtilo DT. Immunoregulatory T cells in males vulnerable to Epstein–Barr virus with the X-linked lymphoproliferative syndrome. *Am J Pediatr Hematol Oncol* 1987;9:179–182.

91. Purtilo DT, Tatsumi E, Manolov G, et al. Epstein–Barr virus as an etiological agent in the pathogenesis of lymphoproliferative and aroliferative diseases in immune deficient patients. *Int Rev Exp Pathol* 1985;27:113–183.

92. Cleary ML, Sklar J. Lymphoproliferative disorders in cardiac transplant recipients are multiclonal lymphomas. *Lancet* 1984;2:489–493.

93. Cleary ML, Warnke R, Sklar J. Monoclonality of lymphoproliferative lesions in cardiac-transplant recipients. Clonal analysis based on immunoglobulin-gene rearrangements. *N Engl J Med* 1984;310:477–482.

94. Cleary ML, Nalesnik MA, Shearer WT, et al. Clonal analysis of transplant-associated lymphoproliferations based on the structure of the genomic termini of the Epstein–Barr virus. *Blood* 1988;72:349–352.

95. Swinnen LJ, Costanzo–Nordin MR, Fisher SG, et al. Increased incidence of lymphoproliferative disorder after immunosuppression with the monoclonal antibody OKT3 in cardiac-transplant recipients. *N Engl J Med* 1990;323:1723–1728.

96. d'Amore ES, Manivel JC, Gajl–Peczalska KJ, et al. B-cell lymphoproliferative disorders after bone marrow transplant. An analysis of ten cases with emphasis on Epstein–Barr virus detection by *in situ* hybridization. *Cancer* 1991;68:1285–1295.

97. Davey DD, Kamat D, Laszewski M, et al. Epstein–Barr virus-related lymphoproliferative disorders following bone marrow transplantation: an immunologic and genotypic analysis. *Mod Pathol* 1989;2:27–34.

98. Subar M, Neri A, Inghirami G, et al. Frequent c-myc oncogene activation and infrequent presence of Epstein–Barr virus genome in AIDS-associated lymphoma. *Blood* 1988;72:667–671.

99. Su IJ, Hsieh HC, Lin KH, et al. Aggressive peripheral T-cell lymphomas containing Epstein–Barr viral DNA: a clinicopathologic and molecular analysis. *Blood* 1991;77:799–808.

100. Adams JM, Gerondakis S, Webb E, et al. Cellular myc oncogene is altered by chromosome translocation to an immunoglobulin locus in murine plasmacytomas and is rearranged similarly in Burkitt lymphomas. *Proc Natl Acad Sci U S A* 1983;80:1982.

101. Marcu KB, Harris LJ, Stanton LW, et al. Transcriptionally active c-myc oncogene is contained within NIARD, a DNA sequence associated with chromosome translocations in B-cell neoplasia. *Proc Natl Acad Sci U S A* 1983;80:519–523.

102. Erikson J, Nishikura K, ar–Rushdi A, et al. Translocation of an immunoglobulin kappa locus to a region 3' of an unrearranged c-myc oncogene enhances c-myc transcription. *Proc Natl Acad Sci U S A* 1983;80:7581–7585.

103. Emanuel BS, Selden JR, Chaganti RSK, et al. The 2p breakpoint of a 2;8 translocation in Burkitt lymphoma interrupts the V kappa locus. *Proc Natl Acad Sci U S A* 1984;81:2444.

104. Croce CM, Thierfelder W, Erikson J, et al. Transcriptional activation of an unrearranged and untranslocated c-myc oncogene by translocation of a C lambda locus in Burkitt. *Proc Natl Acad Sci U S A* 1983;80:6922–6926.

105. Hollis GF, Mitchell KF, Battey J, et al. A variant translocation places the lambda immunoglobulin genes 3' to the c-myc oncogene in Burkitt's lymphoma. *Nature* 1984;307:752–755.

106. Rappold GA, Hameister H, Cremer T, et al. C-myc and immunoglobulin kappa light chain constant genes are on the 8q+ chromosome of three Burkitt lymphoma lines with t(2;8) translocations. *EMBO J* 1984;3:2951–2955.

107. Taub R, Kelly K, Battey J, et al. A novel alteration in the structure of an activated c-myc gene in a

variant t(2;8) Burkitt lymphoma. *Cell* 1984;37:511–520.

108. Rabbitts TH, Boehm T. Structural and functional chimerism results from chromosomal translocation in lymphoid tumors. *Adv Immun* 1991;50:119–146.

109. Pelicci PG, Knowles DM, Magrath I, et al. Chromosomal breakpoints and structural alterations of the c-myc locus differ in endemic and sporadic forms of Burkitt lymphoma. *Proc Natl Acad Sci U S A* 1986;83:2984–2988.

110. Davison JM, Morgan TW, Hsi BL, et al. Subtracted, unique-sequence, in situ hybridization: experimental and diagnostic applications. *Am J Pathol* 1998;153:1401–1409.

111. Gao Y, Ferguson DO, Xie W, et al. Interplay of p53 and DNA-repair protein XRCC4 in tumorigenesis, genomic stability and development. *Nature* 2000;404:897–900.

112. Rabbitts TH, Hamlyn PH, Baer R. Altered nucleotide sequences of a translocated c-myc gene in Burkitt lymphoma. *Nature* 1983;306:760–765.

113. Taub R, Moulding C, Battey J, et al. Activation and somatic mutation of the translocated c-myc gene in Burkitt lymphoma cells. *Cell* 1984;36:339–348.

114. Bhatia K, Spangler G, Gaidano G, et al. Mutations in the coding region of c-myc occur frequently in acquired immunodeficiency syndrome-associated lymphomas. *Blood* 1994;84:883–888.

115. Zajac-Kaye M, Gelmann EP, Levens D. A point mutation in the c-myc locus of a Burkitt lymphoma abolishes binding of a nuclear protein. *Science* 1988;240:1776–1780.

116. Gu W, Bhatia K, Magrath IT, et al. Binding and suppression of the myc transcriptional activation domain by p107. *Science* 1994;264:251–254.

117. Flinn EM, Busch CM, Wright AP. Myc boxes, which are conserved in myc family proteins, are signals for protein degradation via the proteasome. *Mol Cell Biol* 1998;18:5961–5969.

118. Salghetti SE, Kim SY, Tansey WP. Destruction of Myc by ubiquitin-mediated proteolysis: cancer-associated and transforming mutations stabilize Myc. *EMBO J* 1999;18:717–726.

119. Bahram F, von der Lehr N, Cetinkaya C, et al. c-Myc hot spot mutations in lymphomas result in inefficient ubiquitination and decreased proteasome-mediated turnover. *Blood* 2000;95:2104–2110.

120. Gregory MA, Hann SR. c-Myc proteolysis by the ubiquitin-proteasome pathway: stabilization of c-Myc in Burkitt's lymphoma cells. *Mol Cell Biol* 2000;20:2423–2435.

121. Packham G, Cleveland JL. c-Myc and apoptosis. *Biochim Biophys Acta* 1995;1242:11–28.

122. Dang CV. C-Myc target genes involved in cell growth, apoptosis, and metabolism. *Mol Cell Biol* 1999;19(1):1–11.

123. Dang CV, Resar LMS, Emison E, et al. Function of the c-Myc oncogenic transcription factor. *Exp Cell Res* 1999;253:63–77.

124. Gartel AL, Shchors K. Mechanisms of c-myc-mediated transcriptional repression of growth arrest genes. *Exp Cell Res* 2003;283:17–21.

125. Eilers M, Schirm S, Bishop JM. The MYC protein activates transcription of the alpha-prothymosin gene. *EMBO J* 1991;10:133–141.

126. Askew DS, Ashmun RA, Simmons BC, et al. Constitutive c-myc expression in an IL-3-dependent myeloid cell line suppresses cell cycle arrest and accelerates apoptosis. *Oncogene* 1991;6:1915–1922.

127. Evan GI, Wyllie AH, Gilbert CS, et al. Induction of apoptosis in fibroblasts by c-myc protein. *Cell* 1992;69:119–128.

128. Heikkila R, Schwab G, Wickstrom E, et al. A c-myc antisense oligodeoxynucleotide inhibits entry into

S phase but not progress from G0 to G1. *Nature* 1987;328:445-449.

129. Prochownik EV, Kukowska J, Rodgers C. c-myc antisense transcripts accelerate differentiation and inhibit G1 progression in murine erythroleukemia cells. *Mol Cell Biol* 1988;8:3683-3695.

130. Shibuya H, Yoneyama M, Ninomiya-Tsuji J, et al. IL-2 and EGF receptors stimulate the hematopoietic cell cycle via different signaling pathways: demonstration of a novel role for c-myc. *Cell* 1992;70:57-67.

131. Lombardi L, Newcomb EW, Dalla-Favera R. Pathogenesis of Burkitt lymphoma: expression of an activated c-myc oncogene causes the tumorigenic conversion of EBV-infected human B lymphoblasts. *Cell* 1987;49:161-170.

132. Adams JM, Harris AW, Pinkert CA, et al. The c-myc oncogene driven by immunoglobulin enhancers induces lymphoid malignancy in transgenic mice. *Nature* 1985;318:533-538.

133. Langdon WY, Harris AW, Cory S, et al. The C-myc oncogene perturbs B lymphocyte development in Emu-myc transgenic mice. *Cell* 1986;47:11-18.

134. Blackwood EM, Eisenman RN. Max: a helix-loop-helix zipper protein that forms a sequence-specific DNA-binding complex with Myc. *Science* 1991;251:1211-1217.

135. Prendergast GC, Lawe D, Ziff EB. Association of Myn, the murine homolog of Max, with c-Myc stimulates methylation-sensitive DNA binding and Ras cotransformation. *Cell* 1991;65:395-407.

136. Grandori C, Mac J, Siebelt F, et al. Myc-Max heterodimers activate a DEAD box gene and interact with multiple E box-related sites in vivo. *EMBO J* 1996;15:4344-4357.

137. Ayer DE, Kretzner L, Eisenman RN. Mad: a heterodimeric partner for Max that antagonizes Myc transcriptional activity. *Cell* 1993;72:211-222.

138. Schreiber-Agus N, Chin L, Chen K, et al. An amino-terminal domain of Mxi1 mediates anti-Myc oncogenic activity and interacts with a homolog of the yeast transcriptional repressor SIN3. *Cell* 1995;80:777-786.

139. Zervos AS, Gyuris J, Brent R. Mxi1, a protein that specifically interacts with Max to bind Myc-Max recognition sites. *Cell* 1993;72:223-232.

140. Foley KP, Eisenman RN. Two MAD tails: what the recent knockouts of Mad1 and Mxi1 tell us about the MYC/MAX/MAD network. *Biochim Biophys Acta* 1999;1423:M37-M47.

141. Hurlin PJ, Queva C, Eisenman RN. Mnt: a novel Max-interacting protein and Myc antagonist. *Curr Top Microbiol Immunol* 1997;224:115-121.

142. Ayer DE, Lawrence QA, Eisenman RN. Mad-Max transcriptional repression is mediated by ternary complex formation with mammalian homologs of yeast repressor Sin3. *Cell* 1995;80:767-776.

143. Amati B, Brooks MW, Levy N, et al. Oncogenic activity of the c-Myc protein requires dimerization with Max. *Cell* 1993;72:233-245.

144. Ayer DE, Eisenman RN. A switch from Myc: Max to Mad: Max heterocomplexes accompanies monocyte/macrophage differentiation. *Genes Dev* 1993;7:2110-2119.

145. Larsson LG, Pettersson M, Oberg F, et al. Expression of mad, mxi1, max and c-myc during induced differentiation of hematopoietic cells: opposite regulation of mad and c-myc. *Oncogene* 1994;9:1247-1252.

146. Fenrick R, Hiebert SW. Role of histone deacetylases in acute leukemia. *J Cell Biochem* 1998;31[Suppl]:194-202.

147. Redner RL, Wang J, Liu JM. Chromatin remodeling and leukemia: new therapeutic paradigms. *Blood* 1999;94:417-428.

148. Lehrmann H, Pritchard LL, Harel-Bellan A. Histone acetyltransferases and deacetylases in the

control of cell proliferation and differentiation. *Adv Cancer Res* 2002;86:41–65.

149. De Ruijter AJ, van Gennip AH, Caron HN, et al. Histone deacetylases (HDACs): characterization of the classical HDAC family. *Biochem J* 2003;370(3):737–749.

150. Harper SE, Qui Y, Sharp PA. Sin3 corepressor function in Myc-induced transcription and transformation. *Proc Natl Acad Sci U S A* 1996;93:8536–8540.

151. Alland L, Muhle R, Hou H Jr, et al. Role for N-CoR and histone deacetylase in Sin3-mediated transcriptional repression. *Nature* 1997;387:49–55.

152. Heinzel T, Lavinsky RM, Mullen TM, et al. A complex containing N-CoR, mSin3 and histone deacetylase mediates transcriptional repression. *Nature* 1997;387:43–48.

153. Sommer A, Hilfenhaus S, Menkel A, et al. Cell growth inhibition by the Mad/Max complex through recruitment of histone deacetylase activity. *Curr Biol* 1997;7:357–365.

154. Grant PA, Duggan L, Cote J, et al. Yeast Gcn5 functions in two multisubunit complexes to acetylate nucleosomal histones: characterization of an Ada complex and the SAGA (Spt/Ada) complex. *Genes Dev* 1997;11:1640–1650.

155. McMahon SB, van Buskirk HA, Dugan KA, et al. The novel ATM-related protein TRRAP is an essential cofactor for the c-Myc and E2F oncoproteins. *Cell* 1998;94:363–374.

156. Saleh A, Schieltz D, Ting N, et al. Tra1p is a component of the yeast Ada. Spt transcriptional regulatory complexes. *J Biol Chem* 1998;273:26559–26565.

157. McMahon SB, Wood MA, Cole MD, et al. The essential cofactor TRRAP recruits the histone acetyltransferase hGCN5 to c-Myc. *Mol Cell Biol* 2000;20:556–562.

158. Kelly WK, O'Connor OA, Marks PA. Histone deacetylase inhibitors: from target to clinical trials. *Expert Opin Investig Drugs* 2002;11(12):1695–1713.

159. Sakamuro D, Prendergast GC. New Myc-interacting proteins: a second Myc network emerges. *Oncogene* 1999;18:2942–2954.

160. Mateyak MK, Obaya AJ, Sedivy JM. C-Myc regulates cyclin D-Cdk4 and -Cdk6 activity but affects cell cycle progression at multiple independent points. *Mol Cell Biol* 1999;19:4672–4683.

161. Galaktionov K, Chen X, Beach D. Cdc25 cell-cycle phosphatase as a target of c-myc. *Nature* 1996;382:511–517.

162. Muller D, Bouchard C, Rudolph B, et al. Cdk2-dependent phosphorylation of p27 facilitates its Myc-induced release from cyclin E/cdk2 complexes. *Oncogene* 1997;15:2561–2576.

163. Felsher DW, Bishop JM. Reversible tumorigenesis by MYC in hematopoietic lineages. *Mol Cell* 1999;4:199–207.

164. Jain M, Arvanitis C, Chu K, et al. Sustained loss of a neoplastic phenotype by brief inactivation of MYC. *Science* 2002;297:102–104.

165. Shim H, Dolde C, Lewis BC, et al. c-Myc transactivation of LDH-A: implications for tumor metabolism and growth. *Proc Natl Acad Sci U S A* 1997;94:6658–6663.

166. Wang J, Xie LY, Allan S, et al. Myc activates telomerase. *Genes Dev* 1998;12:1769–1774.

167. Wu KJ, Grandori C, Amacker M, et al. Direct activation of TERT by c-MYC. *Nat Genet* 1999;21(2):220–224.

168. Wick M, Zubov D, Hagen G. Genomic organization and promoter characterization of the gene encoding the human telomerase reverse transcriptase (hTERT). *Gene* 1999;232:97–106.

169. Gaidano G, Ballerini P, Gong JZ, et al. p53 mutations in human lymphoid malignancies: association

- with Burkitt lymphoma and chronic lymphocytic leukemia. *Proc Natl Acad Sci U S A* 1991;88:5413–5417.
170. Farrell PJ, Allan GJ, Shanahan F, et al. p53 is frequently mutated in Burkitt's lymphoma cell lines. *EMBO J* 1991;10:2879–2887.
171. Harris CC, Hollstein M. Clinical implications of the p53 tumor-suppressor gene. *N Engl J Med* 1993;329:1318–1327.
172. Donehower LA, Bradley A. The tumor suppressor p53. *Biochim Biophys Acta* 1993;1155:181–205.
173. Nigro JM, Baker SJ, Preisinger AC, et al. Mutations in the p53 gene occur in diverse human tumour types. *Nature* 1989;342:705–708.
174. Hollstein M, Sidransky D, Vogelstein B, et al. p53 mutations in human cancers. *Science* 1991;253:49–53.
175. Mayo LD, Donner DB. The PTEN, Mdm2, p53 tumor suppressor-oncoprotein network. *Trends Biochem Sci* 2002;27(9):462–467.
176. Sanchez-Beato M, Sanchez-Aguilera A, Piris MA. Cell cycle regulation in B-cell lymphomas. *Blood* 2002;101(4):1220–1235.
177. Sherr CJ, McCormick F. The RB and p53 pathways in cancer. *Cancer Cell* 2002;2(2):103–112.
178. Lane DP. Cancer. p53, guardian of the genome. *Nature* 1992;358:15–16.
179. Sherr CJ, Roberts JM. Inhibitors of mammalian G1 cyclin-dependent kinases. *Genes Dev* 1995;9:1149–1163.
180. Kastan MB, Onyekwere O, Sidransky D, et al. Participation of p53 protein in the cellular response to DNA damage. *Cancer Res* 1991;51:6304–6311.
181. Hartwell LH, Kastan MB. Cell cycle control and cancer. *Science* 1994;266:1821–1828.
182. Donehower LA, Harvey M, Slagle BL, et al. Mice deficient in p53 are developmentally normal but susceptible to spontaneous tumours. *Nature* 1992;356:215–221.
183. Jacks T, Remington L, Williams BO, et al. Tumor spectrum analysis in p53-mutant mice. *Curr Biol* 1994;4:1–7.
184. Mansouri A, Goudreau G, Gruss P. Pax genes and their roles in organogenesis. *Cancer Res* 1999;59:1707s–1709s.
185. Chi N, Epstein JA. Getting your Pax straight: Pax proteins in development and disease. *Trends Genet* 2002;18(1):41–47.
186. Stuart ET, Gruss P. PAX genes: what's new in developmental biology and cancer? *Hum Mol Genet* 1995;4:1717–1720.
187. Offit K, Parsa NZ, Filippa D, et al. t(9;14)(p13;q32) denotes a subset of low-grade non-Hodgkin's lymphoma with plasmacytoid differentiation. *Blood* 1992;80:2594–2599.
188. Offit K, Parsa NZ, Jhanwar SC, et al. Clusters of chromosome 9 aberrations are associated with clinico-pathologic subsets of non-Hodgkin's lymphoma. *Genes Chromosomes Cancer* 1993;7:1–7.
189. Adams B, Dorfler P, Aguzzi A, et al. Pax-5 encodes the transcription factor BSAP and is expressed in B lymphocytes, the developing CNS, and adult testis. *Genes Dev* 1992;6:1589–1607.
190. Iida S, Rao PH, Nallasivam P, et al. The t(9;14)(p13;q32) chromosomal translocation associated with lymphoplasmacytoid lymphoma involves the PAX-5 gene. *Blood* 1996;88:4110–4117.
191. Urbanek P, Wang ZQ, Fetka I, et al. Complete block of early B cell differentiation and altered

- patterning of the posterior midbrain in mice lacking Pax5/BSAP. *Cell* 1994;79:901–912.
192. Wakatsuki Y, Neurath MF, Max EE, et al. The B cell-specific transcription factor BSAP regulates B cell proliferation. *J Exp Med* 1994;179:1099–1108.
193. Baker SJ, Reddy EP. B cell differentiation: role of E2A and Pax5/BSAP transcription factors. *Oncogene* 1995;11:413–426.
194. Kozmik Z, Wang S, Dorfler P, et al. The promoter of the CD19 gene is a target for the B-cell-specific transcription factor BSAP. *Mol Cell Biol* 1992;12:2662–2672.
195. Stuart ET, Haffner R, Oren M, et al. Loss of p53 function through PAX-mediated transcriptional repression. *EMBO J* 1995;14:5638–5645.
196. Morrison AM, Nutt SL, Thevenin C, et al. Loss- and gain-of-function mutations reveal an important role of BSAP (Pax-5) at the start and end of B cell differentiation. *Semin Immunol* 1998;10:133–142.
197. Zwollo P, Desiderio S. Specific recognition of the blk promoter by the B-lymphoid transcription factor B-cell-specific activator protein. *J Biol Chem* 1994;269:15310–15317.
198. Malek SN, Dordai DI, Reim J, et al. Malignant transformation of early lymphoid progenitors in mice expressing an activated Blk tyrosine kinase. *Proc Natl Acad Sci U S A* 1998;95:7351–7356.
199. Libermann TA, Pan Z, Akbarali Y, et al. AML1 (CBFalpha2) cooperates with B cell-specific activating protein (BSAP/PAX5) in activation of the B cell-specific BLK promoter. *J Biol Chem* 1999;274:24671–24676.
200. Texido G, Su IH, Mecklenbrauker I, et al. The B-cell-specific Src-family kinase Blk is dispensable for B-cell development and activation. *Mol Cell Biol* 2000;20:1227–1233.
201. Nutt SL, Heavey B, Rolink AG, et al. Commitment to the B-lymphoid lineage depends on the transcription factor Pax5. *Nature* 1999;401(6753):556–562.
202. Mikkola I, Heavey B, Horcher M, et al. Reversion of B cell commitment upon loss of Pax5 expression. *Science* 2002;297(5578):110–113.
203. Souabni A, Cobaleda C, Schebesta M, et al. Pax5 promotes B lymphopoiesis and blocks T cell development by repressing Notch1. *Immunity* 2002;17(6):781–793.
204. Ohno H, Ueda C, Akasaka T. The t(9;14)(p13;q32) translocation in B-cell non-Hodgkin's lymphoma. *Leuk Lymphoma* 2000;36(5–6):435–445.
205. Morrison AM, Jager U, Chott A, et al. Deregulated PAX-5 transcription from a translocated IgH promoter in marginal zone lymphoma. *Blood* 1998;92:3865–3878.
206. Barr FG. The role of chimeric paired box transcription factors in the pathogenesis of pediatric rhabdomyosarcoma. *Cancer Res* 1999;59:1712s–1715s.
207. Kroll TG, Sarraf P, Pecciarini L, et al. PAX8-PPARgamma1 fusion oncogene in human thyroid carcinoma. *Science* 2000;289(5483):1357–1360.
208. Kozmik Z, Sure U, Ruedi D, et al. Deregulated expression of PAX5 in medulloblastoma. *Proc Natl Acad Sci U S A* 1995;92:5709–5713.
209. Banks PM, Chan J, Cleary ML, et al. Mantle cell lymphoma. A proposal for unification of morphologic, immunologic, and molecular data. *Am J Surg Pathol* 1992;16:637–640.
210. Weisenburger DD, Armitage JO. Mantle cell lymphoma: an entity comes of age. *Blood* 1996;87:4483–4494.
211. Fisher RI, Dahlberg S, Nathwani BN, et al. A clinical analysis of two indolent lymphoma entities: mantle cell lymphoma and marginal zone lymphoma (including the mucosa-associated lymphoid tissue and



- monocytoid B-cell subcategories): a Southwest Oncology Group study. *Blood* 1995;85:1075–1082.
212. Campo E, Raffeld M, Jaffe ES. Mantle-cell lymphoma. *Semin Hematol* 1999;36:115–127.
213. Swerdlow SH, Williams ME. From centrocytic to mantle cell lymphoma: a clinicopathologic and molecular review of 3 decades. *Hum Pathol* 2002;33:7–20.
214. Argatoff LH, Connors JM, Klasa RJ, et al. Mantle cell lymphoma: a clinicopathologic study of 80 cases. *Blood* 1997;89:2067–2078.
215. Bosch F, Lopez-Guillermo A, Campo E, et al. Mantle cell lymphoma: presenting features, response to therapy, and prognostic factors. *Cancer* 1998;82:567–575.
216. Louie DC, Offit K, Jaslow R, et al. p53 overexpression as a marker of poor prognosis in mantle cell lymphomas with t(11;14)(q13;q32). *Blood* 1995;86:2892–2899.
217. Greiner TC, Moynihan MJ, Chan WC, et al. p53 mutations in mantle cell lymphoma are associated with variant cytology and predict a poor prognosis. *Blood* 1996;87:4302–4310.
218. Hernandez L, Fest T, Cazorla M, et al. p53 gene mutations and protein overexpression are associated with aggressive variant of mantle cell lymphoma. *Blood* 1996;87:3351–3359.
219. Dreyling MH, Bullinger L, Ott G, et al. Alterations of the cyclin D1/p16-pRB pathway in mantle cell lymphoma. *Cancer Res* 1997;57:4608–4614.
220. Pinyol M, Cobo F, Bea S, et al. p16(INK4a) gene inactivation by deletions, mutations, and hypermethylation is associated with transformed and aggressive variant of non-Hodgkin's lymphomas. *Blood* 1998;91:2977–2984.
221. Rimokh R, Berger F, Cornillet P, et al. Break in the BCL1 locus is closely associated with intermediate lymphocytic lymphoma subtype. *Genes Chromosomes Cancer* 1990;2:223–226.
222. Leroux D, Le Marc'Hadour F, Gressin R, et al. Non-Hodgkin's lymphomas with t(11;14)(q13;q32): a subset of mantle zone/intermediate lymphocytic lymphoma? *Br J Haematol* 1991;77:346–353.
223. Vandenberghe E, De Wolf Peeters C, Wlodarska I, et al. Chromosome 11q rearrangements in B non Hodgkin's lymphoma. *Br J Haematol* 1992;81:212–217.
224. Erikson J, Finan J, Tsujimoto Y, et al. The chromosome 14 breakpoint in neoplastic B cells with the t(11;14) translocation involves the immunoglobulin heavy chain locus. *Proc Natl Acad Sci U S A* 1984;81:4144–4148.
225. Tsujimoto Y, Yunis J, Onorato-Showe L, et al. Molecular cloning of the chromosomal breakpoint of B-cell lymphomas and leukemias with the t(11;14) chromosome translocation. *Science* 1984;224:1403–1406.
226. Lammie GA, Fantl V, Smith R, et al. D11S287, a putative oncogene on chromosome 11q13, is amplified and expressed in squamous cell and mammary carcinomas and linked to BCL-1. *Oncogene* 1991;6:439–444.
227. Rosenberg CL, Wong E, Petty EM, et al. PRAD1, a candidate BCL1 oncogene: mapping and expression in centrocytic lymphoma. *Proc Natl Acad Sci U S A* 1991;88:9638–9642.
228. Withers DA, Harvey RC, Faust JB, et al. Characterization of a candidate bcl-1 gene. *Mol Cell Biol* 1991;11:4846–4853.
229. Rimokh R, Berger F, Delsol G, et al. Rearrangement and overexpression of the BCL-1/PRAD-1 gene in intermediate lymphocytic lymphomas and in t(11q13)-bearing leukemias. *Blood* 1993;81:3063–3067.
230. de Boer CJ, Loyson S, Kluijn PM, et al. Multiple breakpoints within the BCL-1 locus in B-cell lymphoma: rearrangements of the cyclin D1 gene. *Cancer Res* 1993;53:4148–4152.
231. Hayashi T, Ohno H, Yamabe H, et al. Clinical aspects of B-cell malignancy involving the

BCL1/PRAD1 locus. *Int J Hematol* 1994;59:281–296.

232. Bosch F, Jares P, Campo E, et al. PRAD-1/cyclin D1 gene overexpression in chronic lymphoproliferative disorders: a highly specific marker of mantle cell lymphoma. *Blood* 1994;84:2726–2732.

233. Zucca E, Soldati G, Schlegelberger B, et al. Detection of chromosome 11 alterations in blood and bone marrow by interphase cytogenetics in mantle cell lymphoma. *Br J Haematol* 1995;89:665–668.

234. Bigoni R, Negrini M, Veronese ML, et al. Characterization of t(11;14) translocation in mantle cell lymphoma by fluorescent in situ hybridization. *Oncogene* 1996;13:797–802.

235. Yang WI, Zukerberg LR, Motokura T, et al. Cyclin D1 (Bcl-1, PRAD1) protein expression in low-grade B-cell lymphomas and reactive hyperplasia. *Am J Pathol* 1994;145:86–96.

236. Zukerberg LR, Yang WI, Arnold A, et al. Cyclin D1 expression in non-Hodgkin's lymphomas. Detection by immunohistochemistry. *Am J Clin Pathol* 1995;103:756–760.

237. Swerdlow SH, Yang WI, Zukerberg LR, et al. Expression of cyclin D1 protein in centrocytic/mantle cell lymphomas with and without rearrangement of the BCL1/cyclin D1 gene. *Hum Pathol* 1995;26:999–1004.

238. Kuroda H, Komatsu H, Nakamura S, et al. The positive nuclear staining observed with monoclonal antibody against PRAD1/cyclin D1 correlates with mRNA expression in mantle cell lymphoma. *Jpn J Cancer Res* 1995;86:890–898.

239. de Boer CJ, Schuurin E, Dreef E, et al. Cyclin D1 protein analysis in the diagnosis of mantle cell lymphoma. *Blood* 1995;86:2715–2723.

240. Delmer A, Ajchenbaum-Cymbalista F, Tang R, et al. Over-expression of cyclin D1 in chronic B-cell malignancies with abnormality of chromosome 11q13. *Br J Haematol* 1995;89:798–804.

241. Williams ME, Nichols GE, Swerdlow SH, et al. *In situ* hybridization detection of cyclin D1 mRNA in centrocytic/mantle cell lymphoma. *Ann Oncol* 1995;6:297–299.

242. Motokura T, Bloom T, Kim HG, et al. A novel cyclin encoded by a bcl1-linked candidate oncogene. *Nature* 1991;350:512–515.

243. Oka K, Ohno T, Kita K, et al. PRAD1 gene over-expression in mantle-cell lymphoma but not in other low-grade B-cell lymphomas, including extranodal lymphoma. *Br J Haematol* 1994;86:786–791.

244. de Boer CJ, van Krieken JH, Kluijn-Nelemans HC, et al. Cyclin D1 messenger RNA overexpression as a marker for mantle cell lymphoma. *Oncogene* 1995;10:1833–1840.

245. Rosenberg CL, Motokura T, Kronenberg HM, et al. Coding sequence of the overexpressed transcript of the putative oncogene PRAD1/cyclin D1 in two primary human tumors. *Oncogene* 1993;8:519–521.

246. Rimokh R, Berger F, Bastard C, et al. Rearrangement of CCND1 (BCL1/PRAD1) 3' untranslated region in mantle-cell lymphomas and t(11q13)-associated leukemias. *Blood* 1994;83:3689–3696.

247. Sherr CJ. The Pezcoller lecture: cancer cell cycles revisited. *Cancer Res* 2000;60:3689–3695.

248. Hall M, Peters G. Genetic alterations of cyclins, cyclin-dependent kinases, and Cdk inhibitors in human cancer. In: Vande Woude GF, Klein G, eds. *Advances in cancer research*. San Diego: Academic Press, 1996:67–108.

249. Goodrich DW, Lee WH. Molecular characterization of the retinoblastoma susceptibility gene. *Biochim Biophys Acta* 1993;1155:43–61.

250. Ewen ME. The cell cycle and the retinoblastoma protein family. *Cancer Metastasis Rev* 1994;13:45–66.

251. Wang JY, Knudsen ES, Welch PJ. The retinoblastoma tumor suppressor protein. *Adv Cancer Res*

1994;64:25–85.

252. Weinberg RA. The retinoblastoma protein and cell cycle control. *Cell* 1995;81:323–330.

253. Nevins JR. E2F: a link between the Rb tumor suppressor protein and viral oncoproteins. *Science* 1992;258:424–429.

254. Sherr CJ. G1 phase progression: cycling on cue. *Cell* 1994;79:551–555.

255. Sherr CJ, Roberts JM. CDK inhibitors: positive and negative regulators of G1–phase progression. *Genes Dev* 1999;13:1501–1512.

256. Pinyol M, Hernandez L, Cazorla M, et al. Deletions and loss of expression of p16INK4a and p21Waf1 genes are associated with aggressive variants of mantle cell lymphomas. *Blood* 1997;89:272–280.

257. Pinyol M, Hernandez L, Martinez A, et al. INK4a/ARF locus alterations in human non-Hodgkin's lymphomas mainly occur in tumors with wild-type p53 gene. *Am J Pathol* 2000;156:1987–1996.

258. Rosenwald A, Wright G, Wiestner A, et al. The proliferation gene expression signature is a quantitative integrator of oncogenic events that predicts survival in mantle cell lymphoma. *Cancer Cell* 2003;3:185–197.

259. Evans WE, Meyling C, Yang W, et al. Expression arrays illuminate a way forward for mantle cell lymphoma. *Cancer Cell* 2003;3:100–102.

260. Gillett C, Fantl V, Smith R, et al. Amplification and overexpression of cyclin D1 in breast cancer detected by immunohistochemical staining. *Cancer Res* 1994;54:1812–1817.

261. Bartkova J, Lukas J, Muller H, et al. Abnormal patterns of D-type cyclin expression and G1 regulation in human head and neck cancer. *Cancer Res* 1995;55:949–956.

262. Yatabe Y, Suzuki R, Tobinai K, et al. Significance of cyclin D1 overexpression for the diagnosis of mantle cell lymphoma: a clinicopathologic comparison of cyclin D1-positive MCL and cyclin D1-negative MCL-like B-cell lymphoma. *Blood* 2000;95:2253–2261.

263. Lammie GA, Smith R, Silver J, et al. Proviral insertions near cyclin D1 in mouse lymphomas: a parallel for BCL1 translocations in human B-cell neoplasms. *Oncogene* 1992;7:2381–2387.

264. Jiang W, Kahn SM, Zhou P, et al. Overexpression of cyclin D1 in rat fibroblasts causes abnormalities in growth control, cell cycle progression and gene expression. *Oncogene* 1993;8:3447–3457.

265. Hinds PW, Dowdy SF, Eaton EN, et al. Function of a human cyclin gene as an oncogene. *Proc Natl Acad Sci U S A* 1994;91:709–713.

266. Lovec H, Sewing A, Lucibello FC, et al. Oncogenic activity of cyclin D1 revealed through cooperation with Ha-ras: link between cell cycle control and malignant transformation. *Oncogene* 1994;9:323–326.

267. Bodrug SE, Warner BJ, Bath ML, et al. Cyclin D1 transgene impedes lymphocyte maturation and collaborates in lymphomagenesis with the myc gene. *EMBO J* 1994;13:2124–2130.

268. Lovec H, Grzeschiczek A, Kowalski MB, et al. Cyclin D1/bcl-1 cooperates with myc genes in the generation of B-cell lymphoma in transgenic mice. *EMBO J* 1994;13:3487–3495.

269. Wang TC, Cardiff RD, Zukerberg L, et al. Mammary hyperplasia and carcinoma in MMTV-cyclin D1 transgenic mice. *Nature* 1994;369:669–671.

270. Adams JM, Harris AW, Strasser A, et al. Transgenic models of lymphoid neoplasia and development of a pan-hematopoietic vector. *Oncogene* 1999;18:5268–5277.

271. Sutherland RL, Musgrove EA. Cyclin D1 and mammary carcinoma: new insights from transgenic mouse models. *Breast Cancer Res* 2002;4(1):14–17.

272. Sherr CJ, Roberts JM. Inhibitors of mammalian G1 cyclin-dependent kinases. *Genes Dev*

1995;9:1149–1163.

273. Hirama T, Koeffler HP. Role of the cyclin-dependent kinase inhibitors in the development of cancer. *Blood* 1995;86:841–854.

274. Kamb A, Gruis NA, Weaver-Feldhaus J, et al. A cell cycle regulator potentially involved in genesis of many tumor types. *Science* 1994;264:436.

275. Nobori T, Miura K, Wu DJ, et al. Deletions of the cyclin-dependent kinase-4 inhibitor gene in multiple human cancers. *Nature* 1994;368:753–756.

276. Koduru PR, Zariwala M, Soni M, et al. Deletion of cyclin-dependent kinase 4 inhibitor genes P15 and P16 in non-Hodgkin's lymphoma. *Blood* 1995;86:2900–2905.

277. Hangaishi A, Ogawa S, Imamura N, et al. Inactivation of multiple tumor suppressor genes involved in negative regulation of the cell cycle, MTS1/p16INK4A/CDKN2, MTS2/p15INK4B, p53, and Rb genes in primary lymphoid malignancies. *Blood* 1996;87:4949–4958.

278. Gombart AF, Morosetti R, Miller CW, et al. Deletions of the cyclin-dependent kinase inhibitor genes p16INK4A and p15INK4B in non-Hodgkin's lymphomas. *Blood* 1995;86:1534–1539.

279. Stranks G, Height SE, Mitchell P, et al. Deletions and rearrangement of CDKN2 in lymphoid malignancy. *Blood* 1995;85:893–901.

280. Uchida T, Watanabe T, Kinoshita T, et al. Mutational analysis of the CDKN2 (MTS1/p16ink4A) gene in primary B-cell lymphomas. *Blood* 1995;86:2724–2731.

281. Chaganti SR, Gaidano G, Louie DC, et al. Diffuse large cell lymphomas exhibit frequent deletions in 9p21–22 and 9q31–34 regions. *Genes Chromosomes Cancer* 1995;12:32–36.

282. Bhatia K, Fan S, Spangler G, et al. A mutant p21 cyclin-dependent kinase inhibitor isolated from a Burkitt's lymphoma. *Cancer Res* 1995;55:1431–1435.

283. Morosetti R, Kawamata N, Gombart AF, et al. Alterations of the p27KIP1 gene in non-Hodgkin's lymphomas and adult T-cell leukemia/lymphoma. *Blood* 1995;86:1924–1930.

284. Otsuki T, Jaffe ES, Wellmann A, et al. Absence of p18 mutations or deletions in lymphoid malignancies. *Leukemia* 1996;10:356–360.

285. Li Y, Nagai H, Ohno T, et al. Aberrant DNA methylation of p57(KIP2) gene in the promoter region in lymphoid malignancies of the B-cell phenotype. *Blood* 2002;100(7):2572–2577.

286. Fukuhara S, Rowley JD, Variakojis D, et al. Chromosome abnormalities in poorly differentiated lymphocytic lymphoma. *Cancer Res* 1979;39:3119–3128.

287. Yunis JJ, Oken MM, Kaplan ME, et al. Distinctive chromosomal abnormalities in histologic subtypes of non-Hodgkin's lymphoma. *N Engl J Med* 1982;307:1231–1236.

288. Yunis JJ, Frizzera G, Oken MM, et al. Multiple recurrent genomic defects in follicular lymphoma. A possible model for cancer. *N Engl J Med* 1987;316:79–84.

289. Bakhshi A, Jensen JP, Goldman P, et al. Cloning the chromosomal breakpoint of t(14;18) human lymphomas: clustering around JH on chromosome 14 and near a transcriptional unit on 18. *Cell* 1985;41:899–906.

290. Tsujimoto Y, Gorham J, Cossman J, et al. The t(14;18) chromosome translocations involved in B-cell neoplasms result from mistakes in VDJ joining. *Science* 1985;229:1390–1393.

291. Cleary ML, Smith SD, Sklar J. Cloning and structural analysis of cDNAs for bcl-2 and a hybrid bcl-2/immunoglobulin transcript resulting from the t(14;18) translocation. *Cell* 1986;47:19–28.

292. Tsujimoto Y, Finger LR, Yunis J, et al. Cloning of the chromosome breakpoint of neoplastic B cells

with the t(14;18) chromosome translocation. *Science* 1984;226:1097–1099.

293. Ngan BY, Nourse J, Cleary ML. Detection of chromosomal translocation t(14;18) within the minor cluster region of bcl-2 by polymerase chain reaction and direct genomic sequencing of the enzymatically amplified DNA in follicular lymphomas. *Blood* 1989;73:1759–1762.

294. Lee MS, Chang KS, Cabanillas F, et al. Detection of minimal residual cells carrying the t(14;18) by DNA sequence amplification. *Science* 1987;237:175–178.

295. Price CG, Meerabux J, Murtagh S, et al. The significance of circulating cells carrying t(14;18) in long remission from follicular lymphoma. *J Clin Oncol* 1991;9:1527–1532.

296. Meijerink JP, Smetsers TF, Raemaekers JM, et al. Quantitation of follicular non-Hodgkin's lymphoma cells carrying t(14;18) by competitive polymerase chain reaction. *Br J Haematol* 1993;84:250–256.

297. Gribben JG, Neuberg D, Barber M, et al. Detection of residual lymphoma cells by polymerase chain reaction in peripheral blood is significantly less predictive for relapse than detection in bone marrow. *Blood* 1994;83:3800–3807.

298. Johnson PW, Price CG, Smith T, et al. Detection of cells bearing the t(14;18) translocation following myeloablative treatment and autologous bone marrow transplantation for follicular lymphoma. *J Clin Oncol* 1994;12:798–805.

299. Hill ME, MacLennan KA, Cunningham DC, et al. Prognostic significance of BCL-2 expression and bcl-2 major breakpoint region rearrangement in diffuse large cell non-Hodgkin's lymphoma: a British National lymphoma investigation study. *Blood* 1996;88:1046–1051.

300. Limpens J, de Jong D, van Krieken JH, et al. Bcl-2/JH rearrangements in benign lymphoid tissues with follicular hyperplasia. *Oncogene* 1991;6:2271–2276.

301. Limpens J, Stad R, Vos C, et al. Lymphoma-associated translocation t(14;18) in blood B cells of normal individuals. *Blood* 1995;85:2528–2536.

302. Liu Y, Hernandez AM, Shibata D, et al. BCL2 translocation frequency rises with age in humans. *Proc Natl Acad Sci U S A* 1994;91:8910–8914.

303. Rathmell JC, Thompson CB. Pathways of apoptosis in lymphocyte development, homeostasis, and disease. *Cell* 2002;109[Suppl]:S97–S107.

304. Opferman JT, Korsmeyer SJ. Apoptosis in the development and maintenance of the immune system. *Nat Immunol* 2003;4(5):410–415.

305. Hengartner MO, Horvitz HR. *C. elegans* cell survival gene ced-9 encodes a functional homolog of the mammalian proto-oncogene bcl-2. *Cell* 1994;76:665–676.

306. Hengartner MO, Horvitz HR. Programmed cell death in *Caenorhabditis elegans*. *Curr Opin Genet Dev* 1994;4:581–586.

307. Yin XM, Oltval ZN, Korsmeyer SJ. BH1 and BH2 domains of Bcl-2 are required for inhibition of apoptosis and heterodimerization with Bax. *Nature* 1994;369:321–323.

308. Cheng EHA, Wei MC, Weiler S, et al. BCL-2, BCL-XL sequester BH3 domain-only molecules preventing BAX- and BAK-mediated mitochondrial apoptosis. *Mol Cell* 2001;8:705–711.

309. Chittenden T, Harrington EA, O'Connor R, et al. Induction of apoptosis by the Bcl-2 homologue Bak. *Nature* 1995;374:733–736.

310. Kiefer MC, Brauer MJ, Powers VC, et al. Modulation of apoptosis by the widely distributed Bcl-2 homologue Bak. *Nature* 1995;374:736–739.

311. Wei MC, Zong WX, Cheng EH, et al. Proapoptotic BAX and BAK: a requisite gateway to mitochondrial dysfunction and death. *Science* 2001;292(5517):727–730.

312. Yang E, Zha J, Jockel J, et al. Bad, a heterodimeric partner for Bcl-XL and Bcl-2, displaces Bax and promotes cell death. *Cell* 1995;80:285-291.
313. Townsend PA, Cutress RI, Sharp A, et al. BAG-1: a multifunctional regulator of cell growth and survival. *Biochim Biophys Acta* 2003;1603:83-98.
314. Strasser A, Harris AW, Bath ML, et al. Novel primitive lymphoid tumours induced in transgenic mice by cooperation between myc and bcl-2. *Nature* 1990;348:331-333.
315. Vaux DL, Cory S, Adams JM. Bcl-2 gene promotes haemopoietic cell survival and cooperates with c-myc to immortalize pre-B cells. *Nature* 1988;335:440-442.
316. Fanidi A, Harrington EA, Evan GI. Cooperative interaction between c-myc and bcl-2 proto-oncogenes. *Nature* 1992;359:554-556.
317. Bissonnette RP, Echeverri F, Mahboubi A, et al. Apoptotic cell death induced by c-myc is inhibited by bcl-2. *Nature* 1992;359:552-554.
318. Marin MC, Hsu B, Stephens LC, et al. The functional basis of c-myc and bcl-2 complementation during multistep lymphomagenesis in vivo. *Exp Cell Res* 1995;217:240-247.
319. McDonnell TJ, Deane N, Platt FM, et al. bcl-2-immunoglobulin transgenic mice demonstrate extended B cell survival and follicular lymphoproliferation. *Cell* 1989;57:79-88.
320. McDonnell TJ, Nunez G, Platt FM, et al. Deregulated Bcl-2-immunoglobulin transgene expands a resting but responsive immunoglobulin M and D-expressing B-cell population. *Mol Cell Biol* 1990;10:1901-1907.
321. McDonnell TJ, Korsmeyer SJ. Progression from lymphoid hyperplasia to high-grade malignant lymphoma in mice transgenic for the t(14;18). *Nature* 1991;349:254-256.
322. Richardson ME, Chen QG, Filippa DA, et al. Intermediate- to high-grade histology of lymphomas carrying t(14;18) is associated with additional nonrandom chromosome changes. *Blood* 1987;70:444-447.
323. Offit K, Koduru PR, Hollis R, et al. 18q21 rearrangement in diffuse large cell lymphoma: incidence and clinical significance. *Br J Haematol* 1989;72:178-183.
324. Sarris A, Ford R. Recent advances in the molecular pathogenesis of lymphomas. *Curr Opin Oncol* 1999;11:351-363.
325. Levine EG, Arthur DC, Frizzera G, et al. Cytogenetic abnormalities predict clinical outcome in non-Hodgkin lymphoma. *Ann Intern Med* 1988;108:14-20.
326. Schouten HC, Sanger WG, Weisenburger DD, et al. Chromosomal abnormalities in untreated patients with non-Hodgkin's lymphoma: associations with histology, clinical characteristics, and treatment outcome. The Nebraska Lymphoma Study Group. *Blood* 1990;75:1841-1847.
327. Pezzella F, Jones M, Ralfkiaer E, et al. Evaluation of bcl-2 protein expression and 14;18 translocation as prognostic markers in follicular lymphoma. *Br J Cancer* 1992;65:87-89.
328. Cabanillas F, Pathak S, Grant G, et al. Refractoriness to chemotherapy and poor survival related to abnormalities of chromosomes 17 and 7 in lymphoma. *Am J Med* 1989;87:167-172.
329. Lo Coco F, Gaidano G, Louie DC, et al. p53 mutations are associated with histologic transformation of follicular lymphoma. *Blood* 1993;82:2289-2295.
330. Bettaieb A, Dubrez-Daloz I, Launay S, et al. Bcl-2 proteins: targets and tools for chemosensitisation of tumor cells. *Curr Med Chem Anti-Canc Agents* 2003;3(4):307-318.
331. Knowles DM. Lymphoblastic lymphoma. In: Knowles DM, ed. *Neoplastic hematopathology*. Baltimore: Williams & Wilkins, 1992:715-747.

332. Wright D, McKeever P, Carter R. Childhood non-Hodgkin lymphomas in the United Kingdom: findings from the UK Children's Cancer Study Group. *J Clin Pathol* 1997;50(2):128-134.
333. Ozdemirli M, Fanburg-Smith JC, Hartmann DP, et al. Precursor B-lymphoblastic lymphoma presenting as a solitary bone tumor and mimicking Ewing's sarcoma: a report of four cases and review of the literature. *Am J Surg Pathol* 1998;22(7):795-804.
334. Soslow RA, Baergen RN, Warnke RA. B-lineage lymphoblastic lymphoma is a clinicopathologic entity distinct from other histologically similar aggressive lymphomas with blastic morphology. *Cancer* 1999;85(12):2648-2654.
335. Thomas DA, Kantarjian HM. Lymphoblastic lymphoma. *Hematol Oncol Clin North Am* 2001;15(1):51-95.
336. Hatakeyama M, Kono T, Kobayashi N, et al. Interaction of the IL-2 receptor with the src-family kinase p56lck: identification of novel intermolecular association. *Science* 1991;252:1523-1528.
337. Rudd CE, Trevillyan JM, Dasgupta JD, et al. The CD4 receptor is complexed in detergent lysates to a protein-tyrosine kinase (pp58) from human T lymphocytes. *Proc Natl Acad Sci U S A* 1988;85:5190-5194.
338. Veillette A, Bookman MA, Horak EM, et al. The CD4 and CD8 T cell surface antigens are associated with the internal membrane tyrosine-protein kinase p56lck. *Cell* 1988;55:301-308.
339. Rudd CE. CD4, CD8 and the TCR-CD3 complex: a novel class of protein-tyrosine kinase receptor. *Immunol Today* 1990;11:400-406.
340. Tycko B, Smith SD, Sklar J. Chromosomal translocations joining LCK and TCRB loci in human T cell leukemia. *J Exp Med* 1991;174:867-873.
341. Burnett RC, David JC, Harden AM, et al. The LCK gene is involved in the t(1;7)(p34;q34) in the T-cell acute lymphoblastic leukemia derived cell line, HSB-2. *Genes Chromosomes Cancer* 1991;3:461-467.
342. Wright DD, Sefton BM, Kamps MP. Oncogenic activation of the Lck protein accompanies translocation of the LCK gene in the human HSB2 T-cell leukemia. *Mol Cell Biol* 1994;14:2429-2437.
343. Zamoyska R, Basson A, Filby A, et al. The influence of the src-family kinases, Lck and Fyn, on T cell differentiation, survival and activation. *Immunol Rev* 2003;191:107-118.
344. Artavanis-Tsakonas S, Matsuno K, Fortini ME. Notch signaling. *Science* 1995;268:225-232.
345. Artavanis-Tsakonas S, Rand MD, Lake RJ. Notch signaling: cell fate control and signal integration in development. *Science* 1999;284:770-776.
346. Jarriault S, Brou C, Logeat F, et al. Signaling downstream of activated mammalian Notch. *Nature* 1995;377:355-358.
347. Ellisen LW, Bird J, West DC, et al. TAN-1, the human homolog of the *Drosophila* notch gene is broken by chromosomal translocations in T lymphoblastic neoplasms. *Cell* 1991;66:649-661.
348. Aster J, Pear W, Hasserjian R, et al. Functional analysis of the TAN-1 gene, a human homolog of *Drosophila* notch. *Cold Spring Harb Symp Quant Biol* 1994;59:125-136.
349. Pear WS, Aster JC, Scott ML, et al. Exclusive development of T cell neoplasms in mice transplanted with bone marrow expressing activated Notch alleles. *J Exp Med* 1996;183:2283-2291.
350. Hasserjian RP, Aster JC, Davi F, et al. Modulated expression of Notch 1 during thymocyte development. *Blood* 1996;88:970-976.
351. Allman D, Punt JA, Izon DJ, et al. An invitation to T and more: notch signaling in lymphopoiesis. *Cell* 2002;109:S1-S11.
352. Campese AF, Bellavia D, Gulino A, et al. Notch signaling at the crossroads of T cell development and



leukemogenesis. *Semin Cell Dev Biol* 2003;14:151–157.

353. Aster JC, Pear WS. Notch signaling in leukemia. *Curr Opin Hematol* 2001;8:237–244.

354. Wu L, Aster JC, Blacklow SC, et al. MAML1, a human homologue of *Drosophila* Mastermind, is a transcriptional co-activator for NOTCH receptors. *Nat Genet* 2000;26:484–489.

355. Robertson ES, Lin J, Kieff E. The amino-terminal domains of Epstein-Barr virus nuclear proteins 3A, 3B, and 3C interact with RBP(kappa). *J Virol* 1996;70:3068–3074.

356. Waltzer L, Perricaudet M, Sergeant A, et al. Epstein-Barr virus EBNA3A and EBNA3C proteins both repress RBP-J kappa-EBNA2-activated transcription by inhibiting the binding of RBP-J kappa to DNA. *J Virol* 1996;70:5909–5915.

357. Zimmer-Strobl U, Strobl LJ. EBNA2 and Notch signaling in Epstein-Barr virus mediated immortalization of B lymphocytes. *Semin Cancer Biol* 2001;11(6):423–434.

358. Kawamata S, Du C, Li K, et al. Overexpression of the Notch target genes Hes in vivo induces lymphoid and myeloid alterations. *Oncogene* 2002;21:3855–3863.

359. Ordentlich P, Lin A, Shen CP, et al. Notch inhibition of E47 supports the existence of a novel signaling pathway. *Mol Cell Biol* 1998;18:2230–2237.

360. Kee BL, Murre C. Transcription factor regulation of B lineage commitment. *Curr Opin Immunol* 2001;13:180–185.

361. MacDonald HR, Wilson A, Radtke F. Notch1 and T-cell development: insights from conditional knockout mice. *Trends Immunol* 2001;22(3):155–160.

362. Pear WS, Radtke F. Notch signaling in lymphopoiesis. *Semin Immunol* 2003;15:69–79.

363. Jundt F, Anagnostopoulos I, Forster R, et al. Activated Notch1 signaling promotes tumor cell proliferation and survival in Hodgkin and anaplastic large cell lymphoma. *Blood* 2002;99(9):3398–3403.

364. Murre C, McCaw PS, Baltimore D. A new DNA binding and dimerization motif in immunoglobulin enhancer binding, daughterless, MyoD, and myc proteins. *Cell* 1989;56:777–783.

365. Begley CG, Aplan PD, Davey MP, et al. Chromosomal translocation in a human leukemic stem-cell line disrupts the T-cell antigen receptor delta-chain diversity region and results in a previously unreported fusion transcript. *Proc Natl Acad Sci U S A* 1989;86:2031–2035.

366. Finger LR, Kagan J, Christopher G, et al. Involvement of the TCL5 gene on human chromosome 1 in T-cell leukemia and melanoma. *Proc Natl Acad Sci U S A* 1989;86:5039–5043.

367. Chen Q, Cheng JT, Tasi LH, et al. The tal gene undergoes chromosome translocation in T cell leukemia and potentially encodes a helix-loop-helix protein. *EMBO J* 1990;9:415–424.

368. Xia Y, Brown L, Yang CY, et al. TAL2, a helix-loop-helix gene activated by the (7;9)(q34;q32) translocation in human T-cell leukemia. *Proc Natl Acad Sci U S A* 1991;88:11416–11420.

369. McKeithan TW, Shima EA, Le Beau MM, et al. Molecular cloning of the breakpoint junction of a human chromosomal 8;14 translocation involving the T-cell receptor alpha-chain gene and sequences on the 3' side of MYC. *Proc Natl Acad Sci U S A* 1986;83:6636–6640.

370. Shima EA, Le Beau MM, McKeithan TW, et al. Gene encoding the alpha chain of the T-cell receptor is moved immediately downstream of c-myc in a chromosomal 8;14 translocation in a cell line from a human T-cell leukemia. *Proc Natl Acad Sci U S A* 1986;83:3439–3443.

371. Mellentin JD, Smith SD, Cleary ML. lyl-1, A novel gene altered by chromosomal translocation in T-cell leukemia, codes for a protein with a helix-loop-helix DNA binding motif. *Cell* 1989;58:77–83.

372. Bucher K, Sofroniew MV, Pannell R, et al. The T cell oncogene Tal2 is necessary for normal

development of the mouse brain. *Dev Biol* 2000;227:533–544.

373. Ono Y, Fukuhara N, Yoshie O. Transcriptional activity of TAL1 in T cell acute lymphoblastic leukemia (T-ALL) requires RBTN1 or -2 and induces TALLA1, a highly specific tumor marker of T-ALL. *J Biol Chem* 1997;272(7):4576–4581.

374. Cohen-Kaminsky S, Maouche-Chretien L, Vitelli L, et al. Chromatin immunoselection defines a TAL-1 target gene. *EMBO J* 1998;17(17):5151–5160.

375. Ono Y, Fukuhara N, Yoshie O. TAL1 and LIM-only proteins synergistically induce retinaldehyde dehydrogenase 2 expression in T-cell acute lymphoblastic leukemia by acting as cofactors for GATA3. *Mol Cell Biol* 1998;18(12):6939–6950.

376. Davenport J, Neale GA, Goorha R. Identification of genes potentially involved in LMO2-induced leukemogenesis. *Leukemia* 2000;14(11):1986–1996.

377. Kappel A, Schlaeger TM, Flamme I, et al. Role of SCL/Tal-1, GATA, and ets transcription factor binding sites for the regulation of flk-1 expression during murine vascular development. *Blood* 2000;96(9):3078–3085.

378. Lecuyer E, Herblot S, Saint-Denis M, et al. The SCL complex regulates c-kit expression in hematopoietic cells through functional interaction with Sp1. *Blood* 2002;100(7):2430–2440.

379. Brown L, Cheng JT, Chen Q, et al. Site-specific recombination of the tal-1 gene is a common occurrence in human T cell leukemia. *EMBO J* 1990;9:3343–3351.

380. Bernard O, Lecointe N, Jonveaux P, et al. Two site-specific deletions and t(1;14) translocation restricted to human T-cell acute leukemias disrupt the 5' part of the tal-1 gene. *Oncogene* 1991;6:1477–1488.

381. Aplan PD, Lombardi DP, Kirsch IR. Structural characterization of SIL, a gene frequently disrupted in T-cell acute lymphoblastic leukemia. *Mol Cell Biol* 1991;11:5462–5469.

382. Aplan PD, Lombardi DP, Reaman GH, et al. Involvement of the putative hematopoietic transcription factor SCL in T-cell acute lymphoblastic leukemia. *Blood* 1992;79:1327–1333.

383. Bash RO, Crist WM, Shuster JJ, et al. Clinical features and outcome of T-cell acute lymphoblastic leukemia in childhood with respect to alterations at the TAL1 locus: a Pediatric Oncology Group study. *Blood* 1993;81:2110–2117.

384. Breit TM, Mol EJ, Wolvers-Tettero IL, et al. Site-specific deletions involving the tal-1 and sil genes are restricted to cells of the T cell receptor alpha/beta lineage: T cell receptor delta gene deletion mechanism affects multiple genes. *J Exp Med* 1993;177:965–977.

385. Bash RO, Hall S, Timmons CF, et al. Does activation of the TAL1 gene occur in a majority of patients with T-cell acute lymphoblastic leukemia? A Pediatric Oncology Group study. *Blood* 1995;86:666–676.

386. Delabesse E, Bernard M, Meyer V, et al. TAL1 expression does not occur in the majority of T-ALL blasts. *Br J Haematol* 1998;102(2):449–457.

387. Begley CG, Aplan PD, Denning SM, et al. The gene SCL is expressed during early hematopoiesis and encodes a differentiation-related DNA-binding motif. *Proc Natl Acad Sci U S A* 1989;86:10128–10132.

388. Visvader J, Begley CG, Adams JM. Differential expression of the LYL, SCL and E2A helix-loop-helix genes within the hemopoietic system. *Oncogene* 1991;6:187–194.

389. Green AR, Lints T, Visvader J, et al. SCL is coexpressed with GATA-1 in hemopoietic cells but is also expressed in developing brain. *Oncogene* 1992;7:653–660.

390. Hwang LY, Siegelman M, Davis L, et al. Expression of the TAL1 proto-oncogene in cultured endothelial cells and blood vessels of the spleen. *Oncogene* 1993;8:3043–3046.

391. Mouthon MA, Bernard O, Mitjavila MT, et al. Expression of tal-1 and GATA-binding proteins during

human hematopoiesis. *Blood* 1993;81:647–655.

392. Kallianpur AR, Jordan JE, Brandt SJ. The SCL/TAL-1 gene is expressed in progenitors of both the hematopoietic and vascular systems during embryogenesis. *Blood* 1994;83:1200–1208.

393. Pulford K, Lecoite N, Leroy-Viard K, et al. Expression of TAL-1 proteins in human tissues. *Blood* 1995;85:675–684.

394. Liao EC, Paw BH, Oates AC, et al. SCL/Tal-1 transcription factor acts downstream of cloche to specify hematopoietic and vascular progenitors. *Genes Dev* 1998;12:621–626.

395. Visvader JE, Fujiwara Y, Orkin SH. Unsuspected role for the T-cell leukemia protein SCL/tal-1 in vascular development. *Genes Dev* 1998;12:473–479.

396. Shivdasani RA, Mayer EL, Orkin SH. Absence of blood formation in mice lacking the T-cell leukaemia oncoprotein tal-1/SCL. *Nature* 1995;373:432–434.

397. Robb L, Lyons I, Li R, et al. Absence of yolk sac hematopoiesis from mice with a targeted disruption of the scl gene. *Proc Natl Acad Sci U S A* 1995;92:7075–7079.

398. Porcher C, Swat W, Rockwell K, et al. The T cell leukemia oncoprotein SCL/tal-1 is essential for development of all hematopoietic lineages. *Cell* 1996;86:47–57.

399. Porcher C, Liao EC, Fujiwara Y, et al. Specification of hematopoietic and vascular development by the bHLH transcription factor SCL without direct DNA binding. *Development* 1999;126(20):4603–4615.

400. Robertson SM, Kennedy M, Shannon JM, et al. A transitional stage in the commitment of mesoderm to hematopoiesis requiring the transcription factor SCL/tal-1. *Development* 2000;127(11):2447–2459.

401. Endoh M, Ogawa M, Orkin S, et al. SCL/tal-1-dependent process determines a competence to select the definitive hematopoietic lineage prior to endothelial differentiation. *EMBO J* 2002;21(24):6700–6708.

402. Gottgens B, Nastos A, Kinston S, et al. Establishing the transcriptional programme for blood: the SCL stem cell enhancer is regulated by a multiprotein complex containing Ets and GATA factors. *EMBO J* 2002;21(12):3039–3050.

403. Ema M, Faloon P, Zhang WJ, et al. Combinatorial effects of Flk1 and Tal1 on vascular and hematopoietic development in the mouse. *Genes Dev* 2003;17(3):380–393.

404. Mikkola HK, Fujiwara Y, Schlaeger TM, et al. Expression of CD41 marks the initiation of definitive hematopoiesis in the mouse embryo. *Blood* 2003;101(2):508–516.

405. Mikkola HK, Klintman J, Yang H, et al. Haematopoietic stem cells retain long-term repopulating activity and multipotency in the absence of stem-cell leukemia SCL/tal-1 gene. *Nature* 2003;421(6922):547–551.

406. Murre C, McCaw PS, Vaessin H, et al. Interactions between heterologous helix-loop-helix proteins generate complexes that bind specifically to a common DNA sequence. *Cell* 1989;58:537–544.

407. Sun XH, Baltimore D. An inhibitory domain of E12 transcription factor prevents DNA binding in E12 homodimers but not in E12 heterodimers. *Cell* 1991;64:459–470.

408. Henthorn P, Kiledjian M, Kadesch T. Two distinct transcription factors that bind the immunoglobulin enhancer E5/E2 motif. *Science* 1990;247:467–470.

409. Henthorn P, McCarrick-Walmsley R, Kadesch T. Sequence of the cDNA encoding ITF-1, a positive-acting transcription factor. *Nucleic Acids Res* 1990;18:677.

410. Quong MW, Romanow WJ, Murre C. E protein function in lymphocyte development. *Annu Rev Immunol* 2002;20:301–322.

411. Hsu H, Cheng J, Chen Q, et al. Enhancer-binding activity of the tal-1 oncoprotein in association with

the E47/E12 helix-loop-helix proteins. *Mol Cell Biol* 1991;11:3037-3042.

412. Hsu HL, Huang L, Tsan JT, et al. Preferred sequences for DNA recognition by the TAL1 helix-loop-helix proteins. *Mol Cell Biol* 1994;14:1256-1265.

413. Hsu HL, Wadman I, Baer R. Formation of in vivo complexes between the TAL1 and E2A polypeptides of leukemic T cells. *Proc Natl Acad Sci U S A* 1994;91:3181-3185.

414. Murre C. Intertwining proteins in thymocyte development and cancer. *Nat Immunol* 2000;1(2):97-98.

415. Bain G, Engel I, Robanus Maandag EC, et al. E2A deficiency leads to abnormalities in alphabeta T-cell development and to rapid development of T-cell lymphomas. *Mol Cell Biol* 1997;17(8):4782-4791.

416. Herblot S, Steff AM, Hugo P, et al. SCL and LMO1 alter thymocyte differentiation: inhibition of E2A-HEB function and pre-T alpha chain expression. *Nat Immunol* 2000;1(2):138-144.

417. Condorelli GL, Facchiano F, Valtieri M, et al. T-cell-directed TAL-1 expression induces T-cell malignancies in transgenic mice. *Cancer Res* 1996;56(22):5113-5119.

418. Kelliher MA, Seldin DC, Leder P. Tal-1 induces T cell acute lymphoblastic leukemia accelerated by casein kinase IIalpha. *EMBO J* 1996;15(19):5150-5166.

419. O'Neil JO, Billa M, Oikemus S, et al. The DNA binding activity of TAL-1 is not required to induce leukemia/lymphoma in mice. *Oncogene* 2001;20:3897-3905.

420. Valge-Archer VE, Osada H, Warren AJ, et al. The LIM protein RBTN2 and the basic helix-loop-helix protein TAL1 are present in a complex in erythroid cells. *Proc Natl Acad Sci U S A* 1994;91:8617-8621.

421. Wadman I, Li J, Bash RO, et al. Specific in vivo association between the bHLH and LIM proteins implicated in human T cell leukemia. *EMBO J* 1994;13:4831-4839.

422. Larson RC, Lavenir I, Larson TA, et al. Protein dimerization between Lmo2 (Rbtn2) and Tal1 alters thymocyte development and potentiates T cell tumorigenesis in transgenic mice. *EMBO J* 1996;15:1021-1027.

423. Aplan PD, Jones CA, Chervinsky DS, et al. An scl gene product lacking the transactivation domain induces bony abnormalities and cooperates with LMO1 to generate T-cell malignancies in transgenic mice. *EMBO J* 1997;16(9):2408-2419.

424. Chervinsky DS, Zhao XF, Lam DH, et al. Disordered T-cell development and T-cell malignancies in SCL LMO1 double-transgenic mice: parallels with E2A-deficient mice. *Mol Cell Biol* 1999;19(7):5025-5035.

425. Baer R, Hwang LY, Bash RO. Transcription factors of the bHLH and LIM families: synergistic mediators of T cell acute leukemia? *Curr Top Microbiol Immunol* 1997;220:55-65.

426. Rabbitts TH. LMO T-cell translocation oncogenes typify genes activated by chromosomal translocations that alter transcription and developmental processes. *Genes Dev* 1998;12:2651-2657.

427. Rabbitts TH, Bucher K, Chung G, et al. The effect of chromosomal translocations in acute leukemias: the LMO2 paradigm in transcription and development. *Cancer Res* 1999;59:1794s-1798s.

428. Yamada Y, Pannell R, Forster A, et al. The oncogenic LIM-only transcription factor Lmo2 regulates angiogenesis but not vasculogenesis in mice. *Proc Natl Acad Sci U S A* 2000;97(1):320-324.

429. McGuire EA, Hockett RD, Pollock KM, et al. The t(11;14)(p15; q11) in a T-cell acute lymphoblastic leukemia cell line activates multiple transcripts, including *ttg-1*, a gene encoding a potential zinc finger protein. *Mol Cell Biol* 1989;9:2124-2132.

430. Boehm T, Foroni L, Kaneko Y, et al. The rhombotin family of cysteine-rich LIM-domain oncogenes: distinct members are involved in T-cell translocations to human chromosomes 11p15 and 11p13. *Proc Natl Acad Sci U S A* 1991;88:4367-4371.

431. Royer-Pokora B, Loos U, Ludwig WD. *TTG-2*, a new gene encoding a cysteine-rich protein with the

- LIM motif, is overexpressed in acute T-cell leukaemia with the t(11;14)(p13; q11). *Oncogene* 1991;6:1887–1893.
432. Sanchez-Garcia I, Axelson H, Rabbitts TH. Functional diversity of LIM proteins: amino-terminal activation domains in the oncogenic proteins RBTN1 and RBTN2. *Oncogene* 1995;10:1301–1306.
433. Omichinski JG, Clore GM, Schaad O, et al. NMR structure of a specific DNA complex of Zn-containing DNA binding domain of GATA-1. *Science* 1993;261:438–446.
434. Perez-Alvarado GC, et al. Structure of the carboxy-terminal LIM domain from the cysteine rich protein CRP. *Nat Struct Biol* 1994;1:388–398.
435. Pevny L, Simon MC, Robertson E, et al. Erythroid differentiation in chimaeric mice blocked by a targeted mutation in the gene for transcription factor GATA-1. *Nature* 1991;349:257–260.
436. Sanchez-Garcia I, Rabbitts TH. The LIM domain: a new structural motif found in zinc-finger-like proteins. *Trends Genet* 1994;10:315–320.
437. Osada H, Grutz G, Axelson H, et al. Association of erythroid transcription factors: complexes involving the LIM protein RBTN2 and the zinc-finger protein GATA1. *Proc Natl Acad Sci U S A* 1995;92:9585–9589.
438. Miyamoto A, Cui X, Naumovski L, et al. Helix-loop-helix proteins LYL1 and E2a form heterodimeric complexes with distinctive DNA-binding properties in hematolymphoid cells. *Mol Cell Biol* 1996;16(5):2394–2401.
439. Wadman IA, Osada H, Grutz GG, et al. The LIM-only protein Lmo2 is a bridging molecule assembling an erythroid DNA-binding complex which includes the TAL1, E47, GATA-1 and Ldb1/NL1 proteins. *EMBO J* 1997;16:3145–3157.
440. Grutz G, Bucher K, Lavenir I, et al. The oncogenic T cell LIM-protein Lmo2 forms part of a DNA-bonding complex specifically in immature T cells. *EMBO J* 1998;17:4594–4605.
441. Valge-Archer V, Forster A, Rabbitts TH. The LMO1 and LDB1 proteins interact in human T cell acute leukemia with the chromosomal translocation t(11;14)(p15;q11). *Oncogene* 1998;17(24):3199–3202.
442. Leroy-Viard K, Vinit MA, Lecoite N, et al. Loss of TAL-1 protein activity induces premature apoptosis of Jurkat leukemic T cells upon medium depletion. *EMBO J* 1995;14(10):2341–2349.
443. Condorelli GL, Tocci A, Botta R, et al. Ectopic TAL-1/SCL expression in phenotypically normal or leukemic myeloid precursors: proliferative and antiapoptotic effects coupled with a differentiation blockade. *Mol Cell Biol* 1997;17(5):2954–2969.
444. Mahajan MA, Park ST, Sun XH. Association of a novel GTP binding protein, DRG, with TAL oncogenic proteins. *Oncogene* 1996;12(11):2343–2350.
445. Ferrier R, Nougarede R, Doucet S, et al. Physical interaction of the bHLH LYL1 protein and NF- $\kappa$ B1 p105. *Oncogene* 1999;18:995–1005.
446. Mao S, Neale GAM, Goorha RM. T-cell proto-oncogene rhombotin-2 is a complex transcription regulator containing multiple activation and repression domains. *J Biol Chem* 1997;272(9):5594–5599.
447. Mao S, Neale GA, Goorha RM. T-cell oncogene rhombotin-2 interacts with retinoblastoma-binding protein 2. *Oncogene* 1997;14(13):1531–1539.
448. Wilkinson DA, Neale GA, Mao S, et al. Elf-2, a rhombotin-2 binding ets transcription factor: discovery and potential role in T cell leukemia. *Leukemia* 1997;11(1):86–96.
449. Chan SW, Hong W. Retinoblastoma-binding protein 2 (Rbp2) potentiates nuclear hormone receptor-mediated transcription. *J Biol Chem* 2001;276(30):28402–28412.
450. Begay-Muller V, Ansieau S, Leutz A. The LIM domain protein Lmo2 binds to AF6, a translocation

partner of the MLL oncogene. *FEBS Lett* 2002;521(1-3):36-38.

451. Warren AJ, Colledge WH, Carlton MBL, et al. The oncogenic cysteine-rich LIM domain protein Rbtl2 is essential for erythroid development. *Cell* 1994;78:45-57.

452. Yamada Y, Warren AW, Dobson C, et al. The T cell leukaemia LIM protein Lmo2 is necessary for adult mouse haematopoiesis. *Proc Natl Acad Sci U S A* 1998;95:3890-3895.

453. Shivdasani RA, Orkin SH. The transcriptional control of hematopoiesis. *Blood* 1996;87:4025-4039.

454. McGuire EA. Ttg-1: a paradigm for transcription factor deregulation in T-ALL. *Clin Immunol* 1994;14:48-51.

455. Hacein-Bey-Abina S, von Kalle C, Schmidt M, et al. A serious adverse event after successful gene therapy for X-linked severe combined immunodeficiency. *N Engl J Med* 2003;348(3):255-256.

456. Greenberg JM, Boehm T, Sofroniew MV, et al. Segmental and developmental regulation of a presumptive T-cell oncogene in the central nervous system. *Nature* 1990;344:158-160.

457. McGuire EA, Rintoul CE, Sclar GM, et al. Thymic overexpression of Ttg-1 in transgenic mice results in T-cell acute lymphoblastic leukemia/lymphoma. *Mol Cell Biol* 1992;12:4186-4196.

458. Fisch P, Boehm T, Lavenir I, et al. T-cell acute lymphoblastic lymphoma induced in transgenic mice by the RBTN1 and RBTN2 LIM-domain genes. *Oncogene* 1992;7:2389-2397.

459. Larson RC, Fisch P, Larson TA, et al. T cell tumours of disparate phenotype in mice transgenic for Rbtl2. *Oncogene* 1994;9:3675-3681.

460. Larson RC, Osada H, Larson TA, et al. The oncogenic LIM protein Rbtl2 causes thymic developmental aberrations that precede malignancy in transgenic mice. *Oncogene* 1995;11:853-862.

461. Neale GA, Rehg JE, Goorha RM. Ectopic expression of rhombotin-2 causes selective expansion of CD4-CD8-lymphocytes in the thymus and T-cell tumors in transgenic mice. *Blood* 1995;86:3060-3071.

462. Dube ID, Kamel-Reid S, Yuan CC, et al. A novel human homeobox gene lies at the chromosome 10 breakpoint in lymphoid neoplasias with chromosomal translocation t(10;14). *Blood* 1991;78:2996-3003.

463. Hatano M, Roberts CW, Minden M, et al. Deregulation of a homeobox gene, HOX11, by the t(10;14) in T cell leukemia. *Science* 1991;253:79-82.

464. Kennedy MA, Gonzalez-Sarmiento R, Kees UR, et al. HOX11, a homeobox-containing T-cell oncogene on human chromosome 10q24. *Proc Natl Acad Sci U S A* 1991;88:8900-8904.

465. Lu M, Gong ZY, Shen WF, et al. The tcl-3 proto-oncogene altered by chromosomal translocation in T-cell leukemia codes for a homeobox protein. *EMBO J* 1991;10:2905-2910.

466. Bernard OA, Busson-LeConiat M, Ballerini P, et al. A new recurrent and specific cryptic translocation, t(5;14)(q35;q32), is associated with expression of the Hox11L2 gene in T acute lymphoblastic leukemia. *Leukemia* 2001;15(10):1495-1504.

467. Hansen-Hagge TE, Schafer M, Kiyoi H, et al. Disruption of the RanBP17/Hox11L2 region by recombination with the TCRdelta locus in acute lymphoblastic leukemias with t(5;14)(q34;q11). *Leukemia* 2002;16(11):2205-2212.

468. Ballerini P, Blaise A, Busson-LeConiat M, et al. HOX11L2 expression defines a clinical subtype of pediatric T-ALL associated with poor prognosis. *Blood* 2002;100(3):991-997.

469. Ferrando AA, Neuberg DS, Staunton J, et al. Gene expression signatures define novel oncogenic pathways in T cell acute lymphoblastic leukemia. *Cancer Cell* 2002;1:75-87.

470. Mauvieux L, Leymarie V, Helias C, et al. High incidence of Hox11L2 expression in children with T-ALL. *Leukemia* 2002;16(12):2417-2422.

471. Gehring WJ. Homeoboxes in the study of development. *Science* 1987;236: 1245–1252.
472. McGinnis W, Krumlauf R. Homeobox genes and axial patterning. *Cell* 1992;68:283–302.
473. Hughes CL, Kaufman TC. Hox genes and the evolution of the arthropod body plan. *Evol Dev* 2002;4(6):459–499.
474. Lawrence HJ, Largman C. Homeobox genes in normal hematopoiesis and leukemia. *Blood* 1992;80:2445–2453.
475. Kappen C, Schughart K, Ruddle FH. Early evolutionary origin of major homeodomain sequence classes. *Genomics* 1993;18:54–70.
476. Zhao Y, Westphal H. Homeobox genes and human genetic disorders. *Curr Mol Med* 2002;2(1):13–23.
477. Blatt C. The betrayal of homeobox genes in normal development: the link to cancer. *Cancer Cells* 1990;2:186–189.
478. Perkins A, Kongsuwan K, Visvader J, et al. Homeobox gene expression plus autocrine growth factor production elicits myeloid leukemia. *Proc Natl Acad Sci U S A* 1990;87:8398–8402.
479. Kamps MP, Baltimore D. E2A-Pbx1, the t(1;19) translocation protein of human pre-B-cell acute lymphocytic leukemia, causes acute myeloid leukemia in mice. *Mol Cell Biol* 1993;13:351–357.
480. Dederer DA, Waller EK, LeBrun DP, et al. Chimeric homeobox gene E2A-PBX1 induces proliferation, apoptosis, and malignant lymphomas in transgenic mice. *Cell* 1993;74:833–843.
481. Chiba S. Homeobox genes in normal hematopoiesis and leukemogenesis. *Int J Hematol* 1998;68(4):343–353.
482. Abate-Shen C. Deregulated homeobox gene expression in cancer: cause or consequence? *Nat Rev Cancer* 2002;2(10):777–785.
483. Owens BM, Hawley RG. HOX and non-HOX homeobox genes in leukemic hematopoiesis. *Stem Cells* 2002;20(5):364–379.
484. Dear TN, Sanchez-Garcia I, Rabbitts TH. The HOX11 gene encodes a DNA-binding nuclear transcription factor belonging to a distinct family of homeobox genes. *Proc Natl Acad Sci U S A* 1993;90:4431–4435.
485. Tang S, Breitman ML. The optimal binding sequence of the Hox11 protein contains a predicted recognition core motif. *Nucleic Acids Res* 1995;23:1928–1935.
486. Yamamoto H, Hatano M, Iitsuka Y, et al. Two forms of Hox11, a T cell leukemia oncogene, are expressed in fetal spleen but not in primary lymphocytes. *Mol Immunol* 1995;32:1177–1182.
487. Lu M, Zhang N, Ho AD. Genomic organization of the putative human homeobox proto-oncogene HOX-11 (TCL-3) and its endogenous expression in T cells. *Oncogene* 1992;7:1325–1330.
488. Raju K, Tang S, Dube ID, et al. Characterization and developmental expression of Tlx-1, the murine homolog of HOX11. *Mech Dev* 1993;44:51–64.
489. Roberts CWM, Shutter JR, Korsmeyer SJ. Hox11 controls the genesis of the spleen. *Nature* 1994;368:747–749.
490. Roberts CW, Sonder AM, Lumsden A, et al. Development expression of Hox11 and specification of splenic cell fate. *Am J Pathol* 1995;146:1089–1101.
491. Dear TN, Colledge WH, Carlton MB, et al. The Hox11 gene is essential for cell survival during spleen development. *Development* 1995;121:2909–2915.
492. Dube ID, Raimondi SC, Pi D, et al. A new translocation, t(10;14)(q24;q11), in T-cell neoplasia. *Blood*



1986;67:1181.

493. Kees UR, Lukeis R, Ford J, et al. Establishment and characterization of a childhood T-cell acute lymphoblastic leukemia cell line, PER-255, with chromosome abnormalities involving 7q32-34 in association with T-cell receptor-beta gene rearrangement. *Blood* 1989;74:369-373.

494. Hatano M, Roberts CWM, Kawabe T, et al. Cell cycle progression, cell death and T cell lymphoma in HOX11 transgenic mice. *Blood* 1992;80:[Suppl]355a(abst).

495. Hawley RG, Fong AZ, Lu M, et al. The HOX11 homeobox-containing gene of human leukemia immortalizes murine hematopoietic precursors. *Oncogene* 1994;9:1-12.

496. Logan C, Wingate RJ, McKay IJ, et al. Tlx-1 and Tlx-3 homeobox gene expression in cranial sensory ganglia and hindbrain of the chick embryo: markers of patterned connectivity. *J Neurosci* 1998;18(14):5389-5402.

497. Patterson KD, Krieg PA. Hox11-family genes Xhox11 and Xhox11L2 in xenopus: Xhox11L2 expression is restricted to a subset of the primary sensory neurons. *Dev Dyn* 1999;214(1):34-43.

498. Shirasawa S, Arata A, Onimaru H, et al. Rnx deficiency results in congenital central hypoventilation. *Nat Genet* 2000;24:287-290.

499. Inhorn RC, Aster JC, Roach SA, et al. A syndrome of lymphoblastic lymphoma, eosinophilia, and myeloid hyperplasia/malignancy associated with t(8;13)(p11;q11): description of a distinctive clinicopathologic entity. *Blood* 1995;85:1881-1887.

500. MacDonald D, Aguiar RCT, Mason PJ, et al. A new myeloproliferative disorder associated with chromosomal translocations involving 8p11: a review. *Leukemia* 1995;9:1628-1630.

501. MacDonald D, Reiter A, Cross NCP. The 8p11 myeloproliferative syndrome: a distinct clinical entity caused by constitutive activation of FGFR1. *Acta Haematol* 2002;107:101-107.

502. Popovici C, Adelaide J, Ollendorff V, et al. Fibroblast growth factor receptor 1 is fused to FIM in stem-cell myeloproliferative disorder with t(8;13). *Proc Natl Acad Sci U S A* 1998;95:5712-5717.

503. Reiter A, Sohal J, Kulkarni S, et al. Consistent fusion of ZNF198 to the fibroblast growth factor receptor-1 in the t(8;13)(p11;q12) myeloproliferative syndrome. *Blood* 1998;92:1735-1742.

504. Smedley D, Hamoudi R, Clark J, et al. The t(8;13)(p11;q11-12) rearrangement associated with an atypical myeloproliferative disorder fuses the fibroblast growth factor receptor 1 gene to a novel gene RAMP. *Hum Mol Genet* 1998;7:637-642.

505. Xiao S, Nalabolu SR, Aster JC, et al. FGFR1 is fused with a novel zinc-finger gene, ZNF198, in the t(8;13) leukaemia/lymphoma syndrome. *Nat Genet* 1998;18:84-87.

506. Deininger MW, O'Brien SG, Ford JM, et al. Practical management of patients with chronic myeloid leukemia receiving imatinib. *J Clin Oncol* 2003;21(8):1637-1647.

507. Magrath IT. The non-Hodgkin's lymphomas: an introduction. In: Magrath IT, ed. *The non-Hodgkin's lymphomas*. London: Arnold, 1990:1.

508. Ladanyi M, Offit K, Jhanwar SC, et al. MYC rearrangement and translocations involving band 8q24 in diffuse large cell lymphomas. *Blood* 1991;77:1057-1063.

509. Chaganti RSK, Doucette LA, Offit K, et al. Specific translocations in non-Hodgkin's lymphoma: incidence, molecular detection, and histological and clinical correlations. *Cancer Cells* 1989;7:33-36.

510. Offit K, Chaganti RS. Chromosomal aberrations in non-Hodgkin's lymphoma. *Biologic and clinical correlations*. *Hematol Oncol Clin North Am* 1991;5:853-869.

511. Offit K, Wong G, Filippa DA, et al. Cytogenetic analysis of 434 consecutively ascertained specimens of non-Hodgkin's lymphoma: clinical correlations. *Blood* 1991;77:1508-1515.

512. Yunis JJ, Mayer MG, Arnesen MA, et al. *bcl-2* and other genomic alterations in the prognosis of large-cell lymphoma. *N Engl J Med* 1989;320:1047-1054.
513. Deweindt C, Kerckaert JP, Tilly H, et al. Cloning of a breakpoint cluster region at band 3q27 involved in human non-Hodgkin's lymphoma. *Genes Chromosomes Cancer* 1993;8:149-154.
514. Ye BH, Rao PH, Chaganti RS, et al. Cloning of *bcl-6*, the locus involved in chromosome translocations affecting band 3q27 in B-cell lymphoma. *Cancer Res* 1993;53:2732-2735.
515. Ye BH, Lista F, Lo Coco F, et al. Alterations of a zinc finger-encoding gene, *BCL-6*, in diffuse large-cell lymphoma. *Science* 1993;262:747-750.
516. Baron BW, Nucifora G, McCabe N, et al. Identification of the gene associated with the recurring chromosomal translocations *t*(3;14)(q27;q32) and *t*(3;22)(q27;q11) in B-cell lymphomas. *Proc Natl Acad Sci U S A* 1993;90:5262-5266.
517. Miki T, Kawamata N, Arai A, et al. Molecular cloning of the breakpoint for 3q27 translocation in B-cell lymphomas and leukemias. *Blood* 1994;83:217-222.
518. Morris SW, Kirstein MN, Valentine MB, et al. Fusion of a kinase gene, *ALK*, to a nucleolar protein gene, *NPM*, in non-Hodgkin's lymphoma. *Science* 1994;263:1281-1284.
519. Shiota M, Fujimoto J, Semba T, et al. Hyperphosphorylation of a novel 80 kDa protein-tyrosine kinase similar to *Ltk* in a human *Ki-1* lymphoma cell line, *AMS3*. *Oncogene* 1994;9:1567-1574.
520. Offit K, Jhanwar S, Ebrahim SA, et al. *t*(3;22)(q27;q11): a novel translocation associated with diffuse non-Hodgkin's lymphoma. *Blood* 1989;74:1876-1879.
521. Bastard C, Tilly H, Lenormand B, et al. Translocations involving band 3q27 and *Ig* gene regions in non-Hodgkin's lymphoma. *Blood* 1992;79:2527-2531.
522. Rosenberg UB, Schroder C, Preiss A, et al. Structural homology of the product of the *Drosophila* Kruppel gene with *Xenopus* transcription factor IIIA. *Nature* 1986;319:336-339.
523. Kerckaert JP, Deweindt C, Tilly H, et al. *LAZ-3*, a novel zinc-finger encoding gene, is disrupted by recurring chromosome 3q27 translocations in human lymphomas. *Nat Genet* 1993;5:66-70.
524. Miki T, Kawamata N, Hirosawa S, et al. Gene involved in the 3q27 translocation associated with B-cell lymphoma, *BCL5*, encodes a Kruppel-like zinc-finger protein. *Blood* 1994;83:26-32.
525. Bardwell VJ, Treisman R. The POZ domain: a conserved protein-protein interaction motif. *Genes Dev* 1994;8:1664-1677.
526. Albagli O, Dhordain P, Deweindt C, et al. The BTB/POZ domain: a new protein-protein interaction motif common to DNA- and actin-binding proteins. *Cell Growth Differ* 1995;6:1193-1198.
527. Harrison SD, Travers AA. The tramtrack gene encodes a *Drosophila* finger protein that interacts with the *ftz* transcriptional regulatory region and shows a novel embryonic expression pattern. *EMBO J* 1990;9:207-216.
528. Read D, Manley JL. Alternatively spliced transcripts of the *Drosophila* tramtrack gene encode zinc finger proteins with distinct DNA binding specificities. *EMBO J* 1992;11:1035-1044.
529. DiBello PR, Withers DA, Bayer CA, et al. The *Drosophila* broad-complex encodes a family of related proteins containing zinc fingers. *Genetics* 1991;129:385-397.
530. Chen Z, Brand NJ, Chen A, et al. Fusion between a novel Kruppel-like zinc finger gene and the retinoic acid receptor- $\alpha$  locus due to a variant *t*(11;17) translocation associated with acute promyelocytic leukaemia. *EMBO J* 1993;12:1161-1167.
531. Dalla-Favera R, Ye BH, Cattoretti G, et al. *BCL-6* in diffuse large-cell lymphomas. In: De Vita VT, Hellman S, Rosenberg SA, eds. *Important advances in oncology 1996*. Philadelphia: Lippincott-Raven,

1996:139–148.

532. Albagli O, Dhordain P, Bernardin F, et al. Multiple domains participate in distance-independent LAZ3/BCL6-mediated transcriptional repression. *Biochem Biophys Res Commun* 1996;220:911–915.
533. Dhordain P, Albagli O, Ansieau S, et al. The BTB/POZ domain targets the LAZ3/BCL6 oncoprotein to nuclear dots and mediates homoisomerisation in vivo. *Oncogene* 1995;11:2689–2697.
534. Baron BW, Stanger RR, Hume E, et al. BCL6 encodes a sequence-specific DNA-binding protein. *Genes Chromosomes Cancer* 1995;13:221–224.
535. Kawamata N, Miki T, Ohashi K, et al. Recognition DNA sequence of a novel putative transcription factor, BCL6. *Biochem Biophys Res Commun* 1994;204:366–374.
536. Chang C, Ye BH, Chaganti RSK, et al. BCL-6, a POZ/zinc-finger protein, is a sequence-specific transcriptional repressor. *Proc Natl Acad Sci U S A* 1996;93.
537. Cattoretti G, Chang CC, Cechova K, et al. BCL-6 protein is expressed in germinal-center B cells. *Blood* 1995;86:45–53.
538. Onizuka T, Moriyama M, Yamochi T, et al. BCL-6 gene product, a 92- to 98-kD nuclear phosphoprotein, is highly expressed in germinal center B cells and their neoplastic counterparts. *Blood* 1995;86:28–37.
539. Flenghi L, Ye BH, Fizzotti M, et al. A specific monoclonal antibody (PG-B6) detects expression of the BCL-6 protein in germinal center B cells. *Am J Pathol* 1995;147:405–411.
540. Falini B, Bigerna B, Pasqualucci L, et al. Distinctive expression pattern of the BCL-6 protein in nodular lymphocyte predominance Hodgkin's disease. *Blood* 1995;87:465–471.
541. Flenghi L, Bigerna B, Fizzotti M, et al. Monoclonal antibodies PG-B6a and PG-B6p recognize, respectively, a highly conserved and a formol-resistant epitope on the human BCL-6 protein amino-terminal region. *Am J Pathol* 1996;148:1543–1555.
542. MacLennan IC. Germinal centers. *Annu Rev Immunol* 1994;12:117–139.
543. Ma C, Staudt LM. Molecular definition of the germinal center stage of B-cell differentiation. *Philos Trans R Soc Lond B Biol Sci* 2001;356(1405):83–89.
544. Allman D, Jain A, Dent A, et al. BCL-6 expression during B-cell activation. *Blood* 1996;87:5257–5268.
545. Dent AL, Shaffer AL, Yu X, et al. Control of inflammation, cytokine expression, and germinal center formation by BCL-6. *Science* 1997;276(5312):589–592.
546. Fukuda T, Yoshida T, Okada S, et al. Disruption of the Bcl6 gene results in an impaired germinal center formation. *J Exp Med* 1997;186(3):439–448.
547. Ye BH, Cattoretti G, Shen Q, et al. The BCL-6 proto-oncogene controls germinal-centre formation and Th2-type inflammation. *Nat Genet* 1997;16(2):161–170.
548. Lo Coco F, Ye BH, Lista F, et al. Rearrangements of the BCL6 gene in diffuse large cell non-Hodgkin's lymphoma. *Blood* 1994;83:1757–1759.
549. Bastard C, Deweindt C, Kerckaert JP, et al. LAZ3 rearrangements in non-Hodgkin's lymphoma: correlation with histology, immunophenotype, karyotype, and clinical outcome in 217 patients. *Blood* 1994;83:2423–2427.
550. Offit K, Lo Coco F, Louie DC, et al. Rearrangement of the BCL-6 gene as a prognostic marker in diffuse large-cell lymphoma. *N Engl J Med* 1994;331:74–80.
551. Ohno H, Kerckaert JP, Bastard C, et al. Heterogeneity in B-cell neoplasms associated with rearrangement of the LAZ3 gene on chromosome band 3q27. *Jpn J Cancer Res* 1994;85:592–600.

552. Otsuki T, Yano T, Clark HM, et al. Analysis of LAZ3 (BCL-6) status in B-cell non-Hodgkin's lymphomas: results of rearrangement and gene expression studies and a mutational analysis of coding region sequences. *Blood* 1995;85:2877-2884.
553. Gaidano G, Lo Coco F, Ye BH, et al. Rearrangements of the BCL-6 gene in acquired immunodeficiency syndrome-associated non-Hodgkin's lymphoma: association with diffuse large-cell subtype. *Blood* 1994;84:397-402.
554. Ye BH, Chaganti S, Chang CC, et al. Chromosomal translocations cause deregulated BCL6 expression by promoter substitution in B cell lymphoma. *EMBO J* 1995;14:6209-6217.
555. Dallery E, Galiegue-Zouitina S, Collyn-d'Hooghe M, et al. TTF, a gene encoding a novel small G protein, fuses to the lymphoma-associated LAZ3 gene by t(3;4) chromosomal translocation. *Oncogene* 1995;10:2171-2178.
556. Galiegue-Zouitina S, Quief S, Hildebrand MP, et al. Fusion of the LAZ3/BCL6 and BOB1/OBF1 genes by t(3;11) (q27;q23) chromosomal translocation. *C R Acad Sci III Sci Vie* 1995;318:1125-1131.
557. Migliazza A, Martinotti S, Chen W, et al. Frequent somatic hypermutation of the 5' noncoding region of the BCL6 gene in B-cell lymphoma. *Proc Natl Acad Sci U S A* 1995;92:12520-12524.
558. Johnston JM, Yu MT, Carroll WL. c-myc hypermutation is ongoing in endemic, but not all Burkitt's lymphoma. *Blood* 1991;78:2419-2425.
559. Tanaka S, Louie DC, Kant JA, et al. Frequent incidence of somatic mutations in translocated BCL2 oncogenes of non-Hodgkin's lymphomas. *Blood* 1992;79:229-237.
560. Gupta S, Jiang M, Anthony A, et al. Lineage-specific modulation of interleukin 4 signaling by interferon regulatory factor 4. *J Exp Med* 1999;190(12):1837-1848.
561. Harris MB, Chang CC, Berton MT, et al. Transcriptional repression of Stat6-dependent interleukin-4-induced genes by BCL-6: specific regulation of epsilon transcription and immunoglobulin E switching. *Mol Cell Biol* 1999;19(10):7264-7275.
562. Shaffer AL, Yu X, He Y, et al. BCL-6 represses genes that function in lymphocyte differentiation, inflammation, and cell cycle control. *Immunity* 2000;3(2):199-212.
563. Toney LM, Cattoretti G, Graf JA, et al. BCL-6 regulates chemokine gene transcription in macrophages. *Nat Immunol* 2000;1(3):214-220.
564. Hartatik T, Okada S, Okabe S, et al. Binding of BAZF and Bcl6 to STAT6-binding DNA sequences. *Biochem Biophys Res Commun* 2001;284(1):26-32.
565. Shaffer AL, Rosenwald A, Hurt EM, et al. Signatures of the immune response. *Immunity* 2001;15(3):375-385.
566. Arima M, Toyama H, Ichii H, et al. A putative silencer element in the IL-5 gene recognized by Bcl6. *J Immunol* 2002;169:829-835.
567. Baron BW, Anastasi J, Thirman MJ, et al. The human programmed cell death-2 (PDCD2) gene is a target of BCL6 repression: implications for a role of BCL6 in the down-regulation of apoptosis. *Proc Natl Acad Sci U S A* 2002;99(5):2860-2865.
568. Shaffer AL, Lin KI, Kuo TC, et al. Blimp-1 orchestrates plasma cell differentiation by extinguishing the mature B cell gene expression program. *Immunity* 2002;17(1):51-62.
569. Dhordain P, Lin RJ, Quief S, et al. The LAZ3(BCL-6) oncoprotein recruits a SMRT/mSIN3A/histone deacetylase containing complex to mediate transcriptional repression. *Nucleic Acids Res* 1998;26(20):4645-4651.
570. Zhang H, Okada S, Hatano M, et al. A new functional domain of Bcl6 family that recruits histone

deacetylases. *Biochim Biophys Acta* 2001;1540(3):188–200.

571. Lemerrier C, Brocard MP, Puvion-Dutilleul F, et al. Class II histone deacetylases are directly recruited by BCL6 transcriptional repressor. *J Biol Chem* 2002;277(24):22045–22052.

572. David G, Alland L, Hong SH, et al. Histone deacetylase associated with mSin3A mediates repression by the acute promyelocytic leukemia-associated PLZF protein. *Oncogene* 1998;16(19):2549–2456.

573. Dhordain P, Albagli O, Honore N, et al. Colocalization and heteromerization between the two human oncogene POZ/zinc finger proteins, LAZ3 (BCL6) and PLZF. *Oncogene* 2000;19(54):6240–6250.

574. Okabe S, Fukuda T, Ishibashi K, et al. BAZF, a novel Bcl6 homolog, functions as a transcriptional repressor. *Mol Cell Biol* 1998;18(7):4235–4244.

575. Sakashita C, Fukuda T, Okabe S, et al. Cloning and characterization of the human BAZF gene, a homologue of the BCL6 oncogene. *Biochem Biophys Res Commun* 2002;291(3):567–573.

576. Takenaga M, Hatano M, Takamori M, et al. Bcl6-dependent transcriptional repression by BAZF. *Biochem Biophys Res Commun* 2003;303(2):600–608.

577. Nakamura T, Yamazaki Y, Saiki Y, et al. Evi9 encodes a novel zinc finger protein that physically interacts with BCL6, a known human B-cell proto-oncogene product. *Mol Cell Biol* 2000;20(9):3178–3186.

578. Satterwhite E, Sonoki T, Willis TG, et al. The BCL11 gene family: involvement of BCL11A in lymphoid malignancies. *Blood* 2001;98(12):3413–3420.

579. Dyer MJ, Oscier DG. The configuration of the immunoglobulin genes in B cell chronic lymphocytic leukemia. *Leukemia* 2002;16(6):973–984.

580. Martin-Subero JI, Gesk S, Harder L, et al. Recurrent involvement of the REL and BCL11A loci in classical Hodgkin lymphoma. *Blood* 2002;99(4):1474–1477.

581. Liu P, Keller JR, Ortiz M, et al. Bcl11a is essential for normal lymphoid development. *Nat Immunol* 2003;4:525–532.

582. Durum SK. Bcl11: sibling rivalry in lymphoid development. *Nat Immunol* 2003;4:512–514.

583. Polyak K, Kato JY, Solomon MJ, et al. p27Kip1, a cyclin-Cdk inhibitor, links transforming growth factor-beta and contact inhibition to cell cycle arrest. *Gene Dev* 1994;8:9–22.

584. Toyoshima H, Hunter T. p27, a novel inhibitor of G1 cyclin-Cdk protein kinase activity, is related to p21. *Cell* 1994;78:67–74.

585. Shvarts A, Brummelkamp TR, Scheeren F, et al. A senescence rescue screen identifies BCL6 as an inhibitor of anti-proliferative p19(ARF)-p53 signaling. *Genes Dev* 2002;16(6):681–686.

586. Kaneko Y, Frizzera G, Edamura S, et al. A novel translocation, t(2;5)(p23;q35), in childhood phagocytic large T-cell lymphoma mimicking malignant histiocytosis. *Blood* 1989;73:806–813.

587. Rimokh R, Magaud JP, Berger F, et al. A translocation involving a specific breakpoint (q35) on chromosome 5 is characteristic of anaplastic large cell lymphoma (“Ki-1 lymphoma”). *Br J Haematol* 1989;71:31–36.

588. Le Beau MM, Bitter MA, Larson RA, et al. The t(2;5)(p23;q35): a recurring chromosomal abnormality in Ki-1-positive anaplastic large cell lymphoma. *Leukemia* 1989;3:866–870.

589. Bitter MA, Franklin WA, Larson RA, et al. Morphology in Ki-1(CD30)-positive non-Hodgkin's lymphoma is correlated with clinical features and the presence of a unique chromosomal abnormality, t(2;5)(p23;q35). *Am J Surg Pathol* 1990;14:305–316.

590. Mason DY, Bastard C, Rimokh R, et al. CD30-positive large cell lymphomas (“Ki-1 lymphoma”) are associated with a chromosomal translocation involving 5q35. *Br J Haematol* 1990;74:161–168.

591. Sandlund JT, Pui CH, Roberts M, et al. Clinicopathologic features and treatment outcome of children with large cell lymphoma and the t(2;5)(p23;q35). *Blood* 1994;84:2467-2471.
592. Offit K, Ladanyi M, Gangi MD, et al. Ki-1 antigen expression defines a favorable clinical subset of non-B cell non-Hodgkin's lymphoma. *Leukemia* 1990;4:625-630.
593. Durkop H, Latza U, Hummel M, et al. Molecular cloning and expression of a new member of the nerve growth factor receptor family that is characteristic for Hodgkin's disease. *Cell* 1992;68:421-427.
594. Smith CA, Gruss HJ, Davis T, et al. CD30 antigen, a marker for Hodgkin's lymphoma, is a receptor whose ligand defines an emerging family of cytokines with homology to TNF. *Cell* 1993;73:1349-1360.
595. Stein H, Mason DY, Gerdes J, et al. The expression of the Hodgkin's disease associated antigen Ki-1 in reactive and neoplastic lymphoid tissue: evidence that Reed-Sternberg cells and histiocytic malignancies are derived from activated lymphoid cells. *Blood* 1985;66:848-858.
596. Jaffe ES. Anaplastic large cell lymphoma: the shifting sands of diagnostic hematopathology. *Mod Pathol* 2001;14:219-228.
597. Kadin ME. Ki-1/CD30+ (anaplastic) large-cell lymphoma: maturation of a clinicopathologic entity with prospects of effective therapy. *J Clin Oncol* 1994;12:884-887.
598. Kadin ME. Primary Ki-1-positive anaplastic large cell lymphoma: a distinct clinicopathologic entity. *Ann Oncol* 1994;5:S25-S30.
599. Sandlund JT, Pui CH, Santana VM, et al. Clinical features and treatment outcome for children with CD30+ large-cell non-Hodgkin's lymphoma. *J Clin Oncol* 1994;12:895-898.
600. Vecchi V, Burnelli R, Pileri S, et al. Anaplastic large cell lymphoma (Ki-1+/CD30+) in childhood. *Med Pediatr Oncol* 1993;21:402-410.
601. Shulman LN, Frisard B, Antin JH, et al. Primary Ki-1 anaplastic large-cell lymphoma in adults: clinical characteristics and therapeutic outcome. *J Clin Oncol* 1993;11:937-942.
602. Greer JP, Kinney MC, Collins RD, et al. Clinical features of 31 patients with Ki-1 anaplastic large-cell lymphoma. *J Clin Oncol* 1991;9:539-547.
603. Eden GJ, Evans AE. Anaplastic large cell lymphoma in childhood. *Med Pediatr Oncol* 1993;21:665-670.
604. Reiter A, Schrappe M, Tiemann M, et al. Successful treatment strategy for Ki-1 anaplastic large-cell lymphoma of childhood: a prospective analysis of 62 patients enrolled in three consecutive Berlin-Frankfurt-Munster group studies. *J Clin Oncol* 1994;12:899-908.
605. Stein H, Dallenbach F. Diffuse large cell lymphomas of B and T cell type. In: Knowles DM, ed. *Neoplastic hematopathology*. Baltimore: Williams & Wilkins, 1992:675-714.
606. Sarris AH, Luthra R, Papadimitracopoulou V, et al. Amplification of genomic DNA demonstrates the presence of the t(2;5) (p23;q35) in anaplastic large cell lymphoma, but not in other non-Hodgkin's lymphomas, Hodgkin's disease, or lymphomatoid papulosis. *Blood* 1996;88:1771-1779.
607. Morgan R, Hecht BK, Sandberg AA, et al. Chromosome 5q35 breakpoint in malignant histiocytosis [Letter]. *N Engl J Med* 1986;314:1322.
608. Chott A, Kaserer K, Augustin I, et al. Ki-1-positive large cell lymphoma: a clinicopathologic study of 41 cases. *Am J Surg Pathol* 1990;14:439-448.
609. Chan JKC, Ng CS, Leung TW, et al. Anaplastic large cell Ki-1 lymphoma. Delineation of two morphological types. *Histopathology* 1989;15:11-34.
610. Kinney MC, Collins RD, Greer JP, et al. A small-cell-predominant variant of primary Ki-1 (CD30)+

- T-cell lymphoma. *Am J Surg Pathol* 1993;17:859–868.
611. Chan JK, Buchanan R, Fletcher CD. Sarcomatoid variant of anaplastic large-cell Ki-1 lymphoma. *Am J Surg Pathol* 1990;14:983–988.
612. Pileri S, Falini B, Delsol G, et al. Lymphohistiocytic T-cell lymphoma (anaplastic large cell lymphoma CD30+/Ki-1+ with a high content of reactive histiocytes). *Histopathology* 1990;16:383–391.
613. Pileri S, Bocchia M, Baroni CD, et al. Anaplastic large cell lymphoma (CD30+/Ki-1+): results of a prospective clinico-pathological study of 69 cases. *Br J Haematol* 1994;86:513–523.
614. Stein H, Herbst H, Anagnostopoulos I, et al. The nature of Hodgkin and Reed–Sternberg cells, their association with EBV, and their relationship to anaplastic large-cell lymphoma. *Ann Oncol* 1991;2[Suppl 2]:33–38.
615. Kinney MC, Kadin ME. The pathologic and clinical spectrum of anaplastic large cell lymphoma and correlation with ALK gene dysregulation. *Am J Clin Pathol* 1999;111[Suppl 1]:S56–S67.
616. Falini B. Anaplastic large cell lymphoma: pathological, molecular and clinical features. *Br J Haematol* 2001;114(4):741–760.
617. Morris SW, Xue L, Ma Z, et al. ALK+ CD30+ lymphomas: a distinct molecular genetic subtype of non-Hodgkin's lymphoma. *Br J Hematol* 2001;113:275–295.
618. Agnarsson BA, Kadin ME. Ki-1 positive large cell lymphoma. A morphologic and immunologic study of 19 cases. *Am J Surg Pathol* 1988;12:264–274.
619. Nakamura S, Takagi N, Kojima M, et al. Clinicopathologic study of large cell anaplastic lymphoma (Ki-1-positive large cell lymphoma) among the Japanese. *Cancer* 1991;68:118–129.
620. Ebrahim SA, Ladanyi M, Desai SB, et al. Immunohistochemical, molecular, and cytogenetic analysis of a consecutive series of 20 peripheral T-cell lymphomas and lymphomas of uncertain lineage, including 12 Ki-1 positive lymphomas. *Genes Chromosomes Cancer* 1990;2:27–35.
621. Chan JK, Ng CS, Hui PK, et al. Anaplastic large cell Ki-1 lymphoma of bone. *Cancer* 1991;68:2186–2191.
622. Romaguera JE, Manning JT, Todriguez TJ, et al. Long term prognostic importance of primary Ki-1 (CD30) antigen expression and anaplastic morphology in adult patients with diffuse large-cell lymphoma. *Ann Oncol* 1994;5:317–322.
623. Shiota M, Nakamura S, Ichinohasama R, et al. Anaplastic large cell lymphomas expressing the novel chimeric protein p80NPM/ALK: a distinct clinicopathologic entity. *Blood* 1995;86:1954–1960.
624. Kaudewitz P, Stein H, Dallenbach F, et al. Primary and secondary cutaneous Ki-1+ (CD30+) anaplastic large cell lymphomas. Morphologic, immunohistologic, and clinical characteristics. *Am J Pathol* 1989;135:359–367.
625. Krishnan J, Tomaszewski MM, Kao GF. Primary cutaneous CD30-positive anaplastic large cell lymphoma. Report of 27 cases. *J Cutan Pathol* 1993;20(3):193–202.
626. Cabanillas F, Armitage J, Pugh WC, et al. Lymphomatoid papulosis: a T-cell dyscrasia with a propensity to transform into malignant lymphoma. *Ann Intern Med* 1995;122:210–217.
627. LeBoit PE. Hodgkin's disease, anaplastic large cell lymphoma, and lymphomatoid papulosis. Another scalpel blunted. *Am J Clin Pathol* 1995;104:3–4.
628. DeCoteau JF, Butmarc JR, Kinney MC, et al. The t(2;5) chromosomal translocation is not a common feature of primary cutaneous CD30+ lymphoproliferative disorders: comparison with anaplastic large-cell lymphoma of nodal origin. *Blood* 1996;87:3437–3441.
629. Wellmann A, Otsuki T, Vogelbruch M, et al. Analysis of the t(2;5)(p23;q35) translocation by reverse transcription-polymerase chain reaction in CD30+ anaplastic large-cell lymphomas, in other non-Hodgkin's



lymphomas of T-cell phenotype, and in Hodgkin's disease. *Blood* 1995;86:2321-2328.

630. Chadburn A, Cesarman E, Jagirdar J, et al. CD30 (Ki-1) positive anaplastic large cell lymphomas in individuals infected with the human immunodeficiency virus. *Cancer* 1993;72:3078-3090.

631. Gonzalez-Clemente JM, Ribera JM, Campo E, et al. Ki-1+ anaplastic large-cell lymphoma of T-cell origin in an HIV-infected patient. *AIDS* 1991;5:751-755.

632. Wood GS, Hardman DL, Boni R, et al. Lack of the t(2;5) or other mutations resulting in expression of anaplastic lymphoma kinase catalytic domain in CD30+ primary cutaneous lymphoproliferative disorders and Hodgkin's disease. *Blood* 1996;88:1765-1770.

633. Beylot-Barry M, Lamant L, Vergier B, et al. Detection of t(2;5)(p23;q35) translocation by reverse transcriptase polymerase chain reaction and in situ hybridization in CD30-positive primary cutaneous lymphoma and lymphomatoid papulosis. *Am J Pathol* 1996;149:483-492.

634. Pulford K, Lamant L, Morris SW, et al. Detection of ALK and NPM-ALK proteins in normal and neoplastic cells with the monoclonal antibody ALK1. *Blood* 1997;89:1394-1404.

635. Inghirami G, Macri L, Cesarman E, et al. Molecular characterization of CD30+ anaplastic large-cell lymphoma: high frequency of c-myc proto-oncogene activation. *Blood* 1994;83:3581-3590.

636. Ballerini P, Gaidano G, Gong JZ, et al. Multiple genetic lesions in acquired immunodeficiency syndrome-related non-Hodgkin's lymphoma. *Blood* 1993;81:166-176.

637. Raetz E, Perkins SL, Carlson MA, et al. The nucleophosmin-anaplastic lymphoma kinase fusion protein induces c-Myc expression in pediatric anaplastic large cell lymphomas. *Am J Pathol* 2002;161(3):875-883.

638. Pinto A, Gloghini A, Gattei V, et al. Expression of the c-kit receptor in human lymphomas is restricted to Hodgkin's disease and CD30+ anaplastic large cell lymphomas. *Blood* 1994;83:785-792.

639. Anagnostopoulos I, Hummel M, Kaudewitz P, et al. Detection of HTLV-I proviral sequences in CD30-positive large cell cutaneous T-cell lymphomas. *Am J Pathol* 1990;137:1317-1322.

640. Herbst H, Dallenbach F, Hummel M, et al. Epstein-Barr virus DNA and latent gene products in Ki-1 (CD30)-positive anaplastic large cell lymphomas. *Blood* 1991;78:2666-2673.

641. Ross CW, Schlegelmilch JA, Grogan TM, et al. Detection of Epstein-Barr virus genome in Ki-1 (CD30)-positive, large-cell anaplastic lymphomas using the polymerase chain reaction. *Am J Pathol* 1992;141:457-465.

642. Shimakage M, Nakamine H, Tamura S, et al. Detection of Epstein-Barr virus transcripts in anaplastic large-cell lymphomas by mRNA in situ hybridization. *Hum Pathol* 1997;28(12):1415-1419.

643. Agarwal S, Ramanathan U, Naresh KN. Epstein-Barr virus association and ALK gene expression in anaplastic large-cell lymphoma. *Hum Pathol* 2002;33(2):146-152.

644. Morris SW, Kirstein MN, Valentine MB, et al. Fusion of the tyrosine kinase gene ALK to the nucleolar phosphoprotein gene NPM in human t(2;5)-positive lymphomas. *Science* 1994;263:1281-1284.

645. Duyster J, Bai R-Y, Morris SW. Translocations involving anaplastic lymphoma kinase (ALK). *Oncogene* 2001;20(40):5623-5637.

646. Schmidt-Zachmann MS, Hugle-Dorr B, Franke WW. A constitutive nucleolar protein identified as a member of the nucleoplasmin family. *EMBO J* 1987;6:1881-1890.

647. Schmidt-Zachmann MS, Franke WW. DNA cloning and amino acid sequence determination of a major constituent protein of mammalian nucleoli. Correspondence of the nucleoplasmin-related protein NO38 to mammalian protein B23. *Chromosoma* 1988;96:417-426.

648. Chan WY, Liu QR, Borjigin J, et al. Characterization of the cDNA encoding human nucleophosmin and

studies of its role in normal and abnormal growth. *Biochem* 1989;28:1033–1039.

649. Borer RA, Lehner CF, Eppenberger HM, et al. Major nucleolar proteins shuttle between nucleus and cytoplasm. *Cell* 1989;56:379–390.

650. Feuerstein N, Mond JJ, Kinchington PR, et al. Evidence for DNA binding activity of numatrin (B23), a cell cycle-regulated nuclear matrix protein. *Biochim Biophys Acta* 1990;1087:127–136.

651. Dumbar TS, Gentry GA, Olson MOJ. Interaction of nucleolar phosphoprotein B23 with nucleic acids. *J Biochem* 1993;28:9495–9501.

652. Szebeni A, Herrera JE, Olson MO. Interaction of nucleolar protein B23 with peptides related to nuclear localization signals. *J Biochem* 1995;34:8037–8042.

653. Okuda M, Horn HF, Tarapore P, et al. Nucleophosmin/B23 is a target of CDK2/cyclin E in centrosome duplication. *Cell* 2000;103(1):127–140.

654. Iwahara T, Fujimoto J, Wen A, et al. Molecular characterization of ALK, a receptor tyrosine kinase expressed specifically in the nervous system. *Oncogene* 1997;14:439–449.

655. Morris SW, Naeve C, Mathew P, et al. ALK, the chromosome 2 gene locus altered by the t(2;5) in non-Hodgkin's lymphoma, encodes a neural receptor tyrosine kinase that is highly related to leukocyte tyrosine kinase (LTK). *Oncogene* 1997;14:2175–2188.

656. Stoica GE, Kuo A, Aigner A, et al. Identification of anaplastic lymphoma kinase as a receptor for the growth factor pleiotrophin. *J Biol Chem* 2001;276(20):16772–16779.

657. Stoica GE, Kuo A, Powers C, et al. Midkine binds to anaplastic lymphoma kinase (ALK) and acts as a growth factor for different cell types. *J Biol Chem* 2002;277(39):35990–35998.

658. Powers C, Aigner A, Stoica GE, et al. Pleiotrophin signaling through anaplastic lymphoma kinase is rate-limiting for glioblastoma growth. *J Biol Chem* 2002;277(16):14153–14158.

659. Fujimoto J, Shiota M, Iwahara T, et al. Characterization of the transforming activity of p80, a hyperphosphorylated protein in a Ki-1 lymphoma cell line with chromosomal translocation t(2;5). *Proc Nat Acad Sci U S A* 1996;93:4181–4186.

660. Bischof D, Pulford K, Mason DY, et al. Role of the nucleophosmin (NPM) portion of the non-Hodgkin's lymphoma-associated NPM-anaplastic lymphoma kinase fusion protein in oncogenesis. *Mol Cell Biol* 1997;23:2312–2325.

661. Kuefer MU, Look AT, Pulford K, et al. Retrovirus-mediated gene transfer of NPM-ALK causes lymphoid malignancy in mice. *Blood* 1997;90(8):2901–2910.

662. Chiarle R, Gong JZ, Guasparri I, et al. NPM-ALK transgenic mice spontaneously develop T-cell lymphomas and plasma cell tumors. *Blood* 2003;101(5):1919–1927.

663. ElMBERGER PG, Lozano MD, Weisenburger DD, et al. Transcripts of the NPM-ALK fusion gene in anaplastic large cell lymphoma, Hodgkin's disease, and reactive lymphoid lesions. *Blood* 1995;86:3517–3521.

664. Waggott W, Lo YM, Bastard C, et al. Detection of NPM-ALK DNA rearrangement in CD30 positive anaplastic large cell lymphoma. *Br J Haematol* 1995;89:905–907.

665. Downing JR, Shurtleff SA, Zielenska M, et al. Molecular detection of the (2;5) translocation of non-Hodgkin's lymphoma by reverse transcriptase-polymerase chain reaction. *Blood* 1995;85:3416–3422.

666. Bullrich F, Morris SW, Hummel M, et al. Nucleophosmin (NPM) gene rearrangements in Ki-1-positive lymphomas. *Cancer Res* 1994;54:2873–2877.

667. Mathew P, Sanger WG, Weisenburger DD, et al. Detection of the t(2;5)(p23;q35) and NPM-ALK fusion in non-Hodgkin's lymphoma by two-color fluorescence *in situ* hybridization. *Blood* 1997;89:1678–1685.

668. Weber-Matthiesen K, Deerberg-Wittram J, Rosenwald A, et al. Translocation t(2;5) is not a primary

event in Hodgkin's disease. *Am J Pathol* 1996;149:463-468.

669. Shiota M, Fujimoto J, Takenaga M, et al. Diagnosis of t(2;5)(p23; q35)-associated Ki-1 lymphoma with immunohistochemistry. *Blood* 1994;84:3648-3652.

670. Lamant L, Meggetto F, Al Saati T, et al. High incidence of the t(2;5)(p23;q35) translocation in anaplastic large cell lymphoma and its lack of detection in Hodgkin's disease. Comparison of cytogenetic analysis, reverse transcriptase-polymerase chain reaction, and P-80 immunostaining. *Blood* 1996;87:284-291.

671. Herbst H, Anagnostopoulos J, Heinze B, et al. ALK gene products in anaplastic large cell lymphomas and Hodgkin's disease. *Blood* 1995;86:1694-1700.

672. Benharroch D, Meguerian-Bedoyan Z, Lamant L, et al. ALK-positive lymphoma: a single disease with a broad spectrum of morphology. *Blood* 1998;1(6):2076-2084.

673. Mason DY, Pulford KA, Bischof D, et al. Nucleolar localization of the nucleophosmin-anaplastic lymphoma kinase is not required for malignant transformation. *Cancer Res* 1998;58(5):1057-1062.

674. Pulford K, Falini B, Cordell J, et al. Biochemical detection of novel anaplastic lymphoma kinase proteins in tissue sections of anaplastic large cell lymphoma. *Am J Pathol* 1999;154(6):1657-1663.

675. De Paepe P, Baens M, van Krieken H, et al. ALK activation by the CTLC-ALK fusion is a recurrent event in B-cell lymphoma. *Blood*, 2003 (*in press*).

676. Gascoyne RD, Lamant L, Martin-Subero JI, et al. ALK-positive diffuse large B-cell lymphoma is associated with Clathrin-ALK rearrangements: report of six cases. *Blood*, 2003 (*in press*).

676a. Onciu M, Behm FG, Downing JR, et al. ALK-positive plasmablastic B-cell lymphoma with expression of the NPM-ALK fusion transcript: report of two cases. *Blood* 2003 (*in press*).

677. Blume-Jensen P, Hunter T. Oncogenic kinase signaling. *Nature* 2001;411(6835): 355-365.

678. Coffin CM, Humphrey PA, Dehner LP. Extrapulmonary inflammatory myofibroblastic tumor: a clinical and pathologic survey. *Semin Diagn Pathol* 1998;15:85-101.

679. Coffin CM, Dehner LP, Meis-Kindblom JM. Inflammatory myofibroblastic tumor, inflammatory fibrosarcoma, and related lesions: an historical review with differential diagnostic considerations. *Semin Diagn Pathol* 1998;15:102-110.

680. Cook JR, Dehner LP, Collins MH, et al. Anaplastic lymphoma kinase (ALK) expression in the inflammatory myofibroblastic tumor: a comparative immunohistochemical study. *Am J Surg Pathol* 2001;25(11):1364-1371.

681. Pulford K, Delsol G, Roncador G, et al. Immunohistochemical screening for oncogenic tyrosine kinase activation. *J Pathol* 1999;187(5):588-593.

682. Pulford K, Lamant L, Morris SW, et al. Detection of anaplastic lymphoma kinase (ALK) and nucleolar protein nucleophosmin NPM-ALK proteins in normal and neoplastic cells with the monoclonal antibody ALK1. *Blood* 1997;89:1394-1404.

683. Falini B, Pileri S, Zinzani PL, et al. ALK+ lymphomas: clinico-pathological findings and outcome. *Blood* 1999;93(8):2697-2706.

684. Falini B, Pulford K, Pucciarini A, et al. Lymphomas expressing ALK fusion protein(s) other than NPM-ALK. *Blood* 1999;94:3509-3515.

685. Gascoyne RD, Aoun P, Wu D, et al. Prognostic significance of anaplastic lymphoma kinase (ALK) protein expression in adults with anaplastic large cell lymphoma. *Blood* 1999;93:3913-3921.

686. Beljaards RC, Kaudewitz P, Berti E, et al. Primary cutaneous CD30-positive large cell lymphoma: definition of a new type of cutaneous lymphoma with a favorable prognosis. A European Multicenter Study

of 47 patients. *Cancer* 1993;71(6):2097–2104.

687. MacGrogan G, Vergier B, Dubus P, et al. CD30-positive cutaneous large cell lymphomas. a comparative study of clinicopathologic and molecular features of 16 cases. *Am J Clin Pathol* 1996;105(4):440–450.

688. Demierre MF, Goldberg LJ, Kadin ME, et al. Is it lymphoma or lymphomatoid papulosis? *J Am Acad Dermatol* 1997;36:765–772.

689. Leoncini L, Del Vecchio MT, Kraft R, et al. Hodgkin's disease and CD30-positive anaplastic large cell lymphomas: a continuous spectrum of malignant disorders. A quantitative morphometric and immunohistologic study. *Am J Pathol* 1990;137:1047–1057.

690. Ladanyi M, Parsa NZ, Offit K, et al. Clonal cytogenetic abnormalities in Hodgkin's disease. *Genes Chromosomes Cancer* 1991;3:294–299.

691. Poppema S, Kaleta J, Hepperle B. Chromosomal abnormalities in patients with Hodgkin's disease: evidence for frequent involvement of the 14q chromosomal region but infrequent bcl-2 gene rearrangement in Reed-Sternberg cells. *J Natl Cancer Inst* 1992;84:1789–1793.

692. Downing JR, Ladanyi M, Raffeld M, et al. Large-cell anaplastic lymphoma-specific translocation in Hodgkin's disease. *Lancet* 1995;345:918.

693. Dirks WG, Zaborski M, Jager K, et al. The t(2;5)(p23;q35) translocation in cell lines derived from malignant lymphomas: absence of t(2;5) in Hodgkin-analogous cell lines. *Leukemia* 1996;10(1):142–149.

694. Basecke J, Griesinger F, Trumper L, et al. Leukemia- and lymphoma-associated genetic aberrations in healthy individuals. *Ann Hematol* 2002;81(2):64–75.

695. Nagasaka T, Nakamura S, Medeiros LJ, et al. Anaplastic large cell lymphomas presented as bone lesions: a clinicopathologic study of six cases and review of the literature. *Mod Pathol* 2000;13(10):1143–1149.

696. Suzuki R, Kagami Y, Takeuchi K, et al. Prognostic significance of CD56 expression for ALK-positive and ALK-negative anaplastic large-cell lymphoma of T/null phenotype. *Blood* 2000;96(9):2993–3000.

697. Campo E, Miquel R, Krenacs L, et al. Primary nodal marginal zone lymphomas of splenic and MALT type. *Am J Surg Pathol* 1999;23:59–68.

698. Nathwani BN, Anderson JR, Armitage JO, et al. Marginal zone B-cell lymphoma: a clinical comparison of nodal and mucosa-associated lymphoid tissue types. Non-Hodgkin's Lymphoma Classification Project. *J Clin Oncol* 1999;17:2486–2492.

699. Cavalli F, Isaacson PG, Gascoyne RD, et al. MALT lymphomas. *Hematology (Am Soc Hematol Educ Program)* 2001;241–258.

700. Arcaini L, Paulli M, Boveri E, et al. Marginal zone-related neoplasms of splenic and nodal origin. *Haematologica* 2003;88(1):80–93.

701. Franco V, Florena AM, Iannitto E. Splenic marginal zone lymphoma. *Blood* 2003;101(7):2464–2472.

702. Thieblemont C, Felman P, Callet-Bauchu E, et al. Splenic marginal-zone lymphoma: a distinct clinical and pathological entity. *Lancet Oncol* 2003;4(2):95–103.

703. Isaacson PG. Mucosa-associated lymphoid tissue lymphoma. *Semin Hematol* 1999;36:139–147.

704. Wotherspoon AC. Gastric lymphoma of mucosa-associated lymphoid tissue and *Helicobacter pylori*. *Annu Rev Med* 1998;49:289–299.

705. Akagi T, Mutsuhito M, Akiko T, et al. A novel gene, MALT1 at 18q21, is involved in t(11;18)(q21;q21) found in low-grade B-cell lymphoma of mucosa-associated lymphoid tissue. *Oncogene* 1999;18:5785–5794.

706. Dierlamm J, Baens M, Wlodarska I, et al. The apoptosis inhibitor gene API2 and a novel 18q gene,

- MLT, are recurrently rearranged in the t(11;18)(q21;q21) associated with mucosa-associated lymphoid tissue lymphomas. *Blood* 1999;93:3601–3609.
707. Morgan JA, Yin Y, Borowsky AD, et al. Breakpoints of the t(11;18)(q21;q21) in mucosa-associated lymphoid tissue (MALT) lymphoma lie within or near the previously undescribed gene MALT1 in chromosome 18. *Cancer Res* 1999;59:6205–6213.
708. Uren GA, O'Rourke K, Aravind L, et al. Identification of paracaspases and metacaspases: two ancient families of caspase-like proteins, one of which plays a key role in MALT lymphoma. *Mol Cell* 2000;6:961–967.
709. Salvesen GS, Duckett CS. IAP proteins: blocking the road to death's door. *Nat Rev Mol Cell Biol* 2002;3(6):401–410.
710. Hofmann K, Bucher P, Tschopp J. The CARD domain: a new apoptotic signaling motif. *Trends Biochem Sci* 1997;22:155–156.
711. Saurin AJ, Borden KI, Boddy MN, et al. Does this have a familiar RING? *Trends Biochem Sci* 1996;21:208–214.
712. Roy N, Deveraux Q, Takahashi R, et al. The c-IAP-1 and c-IAP-2 proteins are direct inhibitors of specific caspases. *EMBO J* 1997;16:6914–6925.
713. Baens M, Maes B, Steyls A, et al. The product of the t(11;18), and API2-MLT fusion, marks nearly half of gastric MALT type lymphomas without large cell proliferation. *Am J Pathol* 2000;156:1433–1439.
714. Motegi M, Yonezumi M, Suzuki H, et al. API2-MALT1 chimeric transcripts involved in mucosa-associated lymphoid tissue type lymphoma predict heterogeneous products. *Am J Pathol* 2000;156:807–812.
715. Remstein ED, James CD, Kurtin PJ. Incidence and subtype specificity of API2-MALT1 fusion translocations in extranodal, nodal, and splenic marginal zone lymphomas. *Am J Pathol* 2000;156:1183–1188.
716. Rosenwald A, Ott G, Stilgenbauer S, et al. Exclusive detection of the t(11;18)(q21;q21) in extranodal marginal zone B cell lymphomas (MZBL) of MALT type in contrast to other MZBL and extranodal large B cell lymphomas. *Am J Pathol* 1999;155:1817–1821.
717. Liu H, Ruskone-Fourmesttraux A, Lavergne-Slove A, et al. Resistance of t(11;18) positive gastric mucosa-associated lymphoid tissue lymphoma to *Helicobacter pylori* eradication therapy. *Lancet* 2001;357:39–40.
718. Liu H, Ye H, Ruskone-Fourmesttraux A, et al. t(11;18) is a marker for all stage gastric MALT lymphomas that will not respond to *H. pylori* eradication. *Gastroenterology* 2002;122(5):1286–1294.
719. Nakamura S, Matsumoto T, Nakamura S, et al. Chromosomal translocation t(11;18)(q21;q21) in gastrointestinal mucosa associated lymphoid tissue lymphoma. *J Clin Pathol* 2003;56:36–42.
720. Okabe M, Inagaki H, Ohshima K, et al. API2-MALT1 fusion defines a distinctive clinicopathologic subtype in pulmonary extranodal marginal zone B-cell lymphoma of mucosa-associated lymphoid tissue. *Am J Pathol* 2003;162(4):1113–1122.
721. Hay BA, Wassarman DA, Rubin GM. Drosophila homologs of baculovirus inhibitor of apoptosis proteins function to block cell death. *Cell* 1995;83:1253–1262.
722. Lucas PC, Yonezumi M, Inohara N, et al. Bcl10 and MALT1, independent targets of chromosomal translocation in MALT lymphoma, cooperate in a novel NF- $\kappa$ B signaling pathway. *J Biol Chem* 2001;276:19012–19019.
723. Knorr C, Amrehn C, Seeberger H, et al. Expression of costimulatory molecules in low-grade mucosa-associated lymphoid tissue-type lymphomas in vivo. *Am J Pathol* 1999;155:2019–2027.
724. Wotherspoon AC, Pan L, Diss TC, et al. Cytogenetic study of B-cell lymphoma of mucosa-associated lymphoid tissue. *Cancer Genet Cytogenet* 1991;58:35–38.

725. Willis TG, Jadayel DM, Du MQ, et al. Bcl10 is involved in t(1;14)(p22;q32) of MALT B cell lymphoma and mutated in multiple tumor types. *Cell* 1999;96:35–45.
726. Zhang Q, Siebert R, Yan M, et al. Inactivating mutations and overexpression of BCL10, a caspase recruitment domain-containing gene, in MALT lymphoma with t(1;14)(p22;q32). *Nat Genet* 1999;22:63–68.
727. Li P, Nijhawan D, Budihardjo I, et al. Cytochrome c and dATP-dependent formation of Apaf-1/caspase-9 complex initiates an apoptotic protease cascade. *Cell* 1997;91:479–489.
728. Yang X, Chang HY, Baltimore D. Essential role of CED-4 oligomerization in CED-3 activation and apoptosis. *Science* 1998;281:1355–1357.
729. Telford EAR, Watson MS, Aird HC, et al. The DNA sequence of equine herpesvirus 2. *J Mol Biol* 1995;249:520–528.
730. Costanzo A, Guet C, Vito P. c-E10 is a caspase-recruiting domain-containing protein that interacts with components of death receptors signaling pathway and activates nuclear factor- $\kappa$ B. *J Biol Chem* 1999;274:20127–20132.
731. Koseki T, Inohara N, Chen S, et al. CIPER, a novel NF $\kappa$ B-activating protein containing a caspase recruitment domain with homology to herpesvirus-2 protein E10. *J Biol Chem* 1999;274:9955–9961.
732. Srinivasula SM, Ahmad M, Lin JH, et al. CLAP, a novel caspase recruitment domain-containing protein in the tumor necrosis factor receptor pathway, regulates NF- $\kappa$ B activation and apoptosis. *J Biol Chem* 1999;274:17946–17954.
733. Thome M, Martinon F, Hofmann K, et al. Equine herpesvirus-2 E10 gene product, but not its cellular homologue, activates NF- $\kappa$ B transcription factor and c-Jun N-terminal kinase. *J Biol Chem* 1999;274:9962–9968.
734. Yan M, Lee J, Schilbach S, et al. mE10, a novel caspase recruitment domain-containing proapoptotic molecule. *J Biol Chem* 1999;274:10287–10292.
735. Yoneda T, Imaizumi K, Maeda M, et al. Regulatory mechanisms of TRAF2-mediated signal transduction by Bcl10, a MALT lymphoma-associated protein. *J Biol Chem* 2000;275:11114–11120.
736. Yui D, Yoneda T, Oono K, et al. Interchangeable binding of Bcl10 to TRAF2 and cIAPs regulates apoptosis signaling. *Oncogene* 2001;20(32):4317–4323.
737. Zhang Q, Cui X, Sangster MY, et al. Selective hyperexpansion of marginal zone (MZ) B cells in  $\mu$ -BCL10 mice. *Blood* 2000;96:822(abst).
738. Ruland J, Duncan GS, Elia A, et al. Bcl10 is a positive regulator of antigen receptor-induced activation of NF- $\kappa$ B and neural tube closure. *Cell* 2001;104:33–42.
739. Morse HC 3rd, Kearney JF, Isaacson PG, et al. Cells of the marginal zone—origins, function and neoplasia. *Leuk Res* 2001;25(2):169–178.
740. Martin F, Kearney JF. Marginal-zone B cells. *Nat Rev Immunol* 2002;2:323–335.
741. Xue L, Morris SW, Orihuela C, et al. Defective development and function of Bcl10-deficient follicular, marginal zone and B1 B cells. *Nat Immunol* 2003; 4(9):857–865.
742. MacIntyre E, Willerford D, Morris SW. Non-Hodgkin's lymphoma: molecular features of B cell lymphoma. *Hematology (Am Soc Hematol Educ Program)* 2000;180–204.
743. Dimitratos SD, Woods DF, Stathakis DG, et al. Signaling pathways are focused at specialized regions of the plasma membrane by scaffolding proteins of the MAGUK family. *Bioessays* 1999;21(11):912–921.
744. Gaide O, Favier B, Legler DF, et al. CARMA1 is a critical lipid raft-associated regulator of TCR-induced NF- $\kappa$ B activation. *Nat Immunol* 2002;3(9):836–843.

745. McAllister-Lucas LM, Inohara N, Lucas PC, et al. Bimp1, a MAGUK family member linking protein kinase C activation to Bcl10-mediated NF- $\kappa$ B induction. *J Biol Chem* 2001;276(33):30589-30597.
746. Ye H, Dogan A, Karran L, et al. BCL10 expression in normal and neoplastic lymphoid tissue. Nuclear localization in MALT lymphoma. *Am J Pathol* 2000;157(4):1147-1154.
747. Liu H, Ye H, Dogan A, et al. t(11;18)(q21;q21) is associated with advanced mucosa-associated lymphoid tissue lymphoma that expresses nuclear BCL10. *Blood* 2001;98(4):1182-1187.
748. Luque I, Gelinás C. Rel/NF- $\kappa$ B and I $\kappa$ B factors in oncogenesis. *Semin Cancer Biol* 1997;8:103-111.
749. Schlegelberger B, Zwingers T, Harder L, et al. Clinicopathogenetic significance of chromosomal abnormalities in patients with blastic peripheral B-cell lymphoma. Kiel-Wien-Lymphoma Study Group. *Blood* 1999;94:3114-3120.
750. Willis TG, Zalcborg IR, Coignet LJ, et al. Molecular cloning of translocation t(1;14)(q21;q32) defines a novel gene (BCL9) at chromosome 1q21. *Blood* 1998;91:1873-1881.
751. Kramps T, Peter O, Brunner E, et al. Wnt/Wingless signaling requires BCL9/Legless-mediated recruitment of Pygopus to the nuclear beta-catenin-TCF complex. *Cell* 2002;109:47-60.
752. van Es JH, Barker N, Clevers H. You Wnt some, you lose some: oncogenes in the Wnt signaling pathway. *Curr Opin Genet Dev* 2003;13(1):28-33.
753. Reya T, O'Riordan M, Okamura R, et al. Wnt signaling regulates B lymphocyte proliferation through a LEF-1 dependent mechanism. *Immunity* 2000;13:15-24.
754. McWhirter JR, Neuteboom ST, Wancewicz EV, et al. Oncogenic homeodomain transcription factor E2A-Pbx1 activates a novel WNT gene in pre-B acute lymphoblastoid leukemia. *Proc Natl Acad Sci U S A* 1999;96:11464-11469.
755. Dyomin VG, Palanisamy N, Lloyd KO, et al. MUC1 is activated in a B-cell lymphoma by the t(1;14)(q21;q32) and is rearranged and amplified in B-cell lymphoma subsets. *Blood* 2000;95:2666-2671.
756. Gilles F, Goy A, Remache Y, et al. MUC1 dysregulation as the consequence of a t(1;14)(q21;q32) translocation in an extranodal lymphoma. *Blood* 2000;95:2930-2936.
757. Spicer AP, Rowse GJ, Lidner TK, et al. Delayed mammary tumor progression in Muc-1 null mice. *J Biol Chem* 1995;270:30093-30101.
758. Wesseling J, van der Valk SW, Vos HL, et al. Episialin (MUC1) overexpression inhibits integrin-mediated cell adhesion to extracellular matrix components. *J Cell Biol* 1995;129:255-265.
759. Gilles F, Goy A, Remache Y, et al. MUC1 and MDC15 dysregulation in extranodal B-cell lymphomas. *Blood* 2000;96:159b(abst).
760. Wu E, Croucher PI, McKie N. Expression of members of the novel membrane linked metalloproteinase family ADAM in cells derived from a range of haematological malignancies. *Biochem Biophys Res Commun* 1997;235:437-442.
761. Callanan MB, Le Baccon P, Mossuz P, et al. The IgG Fc receptor, Fc $\gamma$ RIIB, is a target for deregulation by chromosomal translocation in malignant lymphoma. *Proc Natl Acad Sci U S A* 2000;97:309-314.
762. Daeron M. Fc receptor biology. *Annu Rev Immunol* 1997;15:203-234.
763. de Andres B, Mueller AL, Verbeek S, et al. A regulatory role for Fc gamma receptors CD16 and CD32 in the development of murine B cells. *Blood* 1998; 92:2823-2829.
764. Hatzivassiliou G, Miller I, Takizawa J, et al. IRTA1 and IRTA2, novel immunoglobulin superfamily receptors expressed in B cells and involved in chromosomal 1q21 abnormalities in B-cell malignancy.



Immunity 2001;14:277–289.

765. Miller I, Hatzivassiliou G, Cattoretti G, et al. IRTAs: a new family of immunoglobulinlike receptors differentially expressed in B cells. *Blood* 2002;99(8):2662–2669.
766. Dyomin VG, Rao PH, Dalla-Favera R, et al. BCL8, a novel gene involved in translocations affecting band 15q11–13 in diffuse large-cell lymphoma. *Proc Natl Acad Sci U S A* 1997;94:5728–5732.
767. Han JD, Baker NE, Rubin CS. Molecular characterization of a novel A kinase anchor protein from *Drosophila melanogaster*. *J Biol Chem* 1997;272:26611–26619.
768. Dyomin VG, Chaganti SR, Dyomina K, et al. BCL8 is a novel, evolutionarily conserved human gene family encoding proteins with presumptive protein kinase A anchoring function. *Genomics* 2002;80(2):158–165.
769. Harada H, Becknell B, Wilm M, et al. Phosphorylation and inactivation of BAD by mitochondria-anchored protein kinase A. *Mol Cell* 1999;3(4):413–422.
770. Jaffe ES, Harris NL, Stein H, et al. Tumours of haematopoietic and lymphoid tissues. Lyon: IARC Press, 2001.
771. Schulze A, Downward J. Navigating gene expression using microarrays—a technology review. *Nat Cell Biol* 2001;3:E190–E195.
772. Alizadeh AA, Eisen MB, Davis RE, et al. Distinct types of diffuse large B-cell lymphoma identified by gene expression profiling. *Nature* 2000;403:503–511.
773. Shipp MA, Ross KN, Tamayo P, et al. Diffuse large B-cell lymphoma outcome prediction by gene-expression profiling and supervised machine learning. *Nat Med* 2002;8:68–74.
774. Rosenwald A, Wright G, Chan WC, et al. The use of molecular profiling to predict survival after chemotherapy for diffuse large-B-cell lymphoma. *N Engl J Med* 2002;346:1937–1947.
775. Fisher RI. Diffuse large-cell lymphoma. *Ann Oncol* 2000;11[Suppl 1]:29–33.
776. Harris NL, Jaffe ES, Diebold J, et al. Lymphoma classification—from controversy to consensus: the R.E.A.L. and WHO classification of lymphoid neoplasms. *Ann Oncol* 2000;11(Suppl 1):3–10.
777. Lossos IS, Alizadeh AA, Eisen MB, et al. Ongoing immunoglobulin somatic mutation in germinal center B cell-like but not in activated B cell-like diffuse large cell lymphomas. *Proc Natl Acad Sci U S A* 2000;97:10209–10213.
778. Huang JZ, Sanger W, Greiner TC, et al. The t(14;18) defines a unique subset of diffuse large B-cell lymphoma with a germinal center B-cell gene expression profile. *Blood* 2002;99:2285–2290.
779. Davis RE, Brown KD, Siebenlist U, et al. Constitutive nuclear factor kappaB activity is required for survival of activated B cell-like diffuse large B cell lymphoma cells. *J Exp Med* 2001;194:1861–1874.
780. Grogan TM, Lippman SM, Spier CM, et al. Independent prognostic significance of a nuclear proliferation antigen in diffuse large cell lymphomas as determined by the monoclonal antibody Ki-67. *Blood* 1988;71:1157–1160.
781. Silvestrini R, Costa A, Boracchi P, et al. Cell proliferation as a long-term prognostic factor in diffuse large-cell lymphomas. *Int J Cancer* 1993;54:231–236.
782. Miller TP, Lippman SM, Spier CM, et al. HLA-DR (Ia) immune phenotype predicts outcome for patients with diffuse large cell lymphoma. *J Clin Invest* 1988;82:370–372.
783. The International non-Hodgkin's Lymphoma Prognostic Factors Project. A predictive model for aggressive non-Hodgkin's lymphoma. *N Engl J Med* 1993;329:987–994.

George M. Rodgers, Frixos Paraskevas, Bertil Glader  
Wintrobe's Clinical Hematology

HISTORICAL PERSPECTIVEEPIDEMIOLOGYAge, Race, and Gender DifferencesEnvironmental FactorsInfectious AgentsPRELYMPHOMATOUS CONDITIONSOrgan TransplantsAcquired Immunodeficiency SyndromeAutoimmune and Other Immunologic DisordersCLINICAL FEATURES AT PRESENTATIONSTAGINGPROGNOSTIC FACTORSTHERAPEUTIC PRINCIPLESINDOLENT LYMPHOMASSpecial Clinicopathologic FeaturesStages I and II Indolent LymphomaStages III and IV Indolent LymphomaImmunotherapyMANTLE CELL LYMPHOMAAGGRESSIVE LYMPHOMASDiffuse Large B-Cell LymphomasPeripheral T-Cell and Natural Killer-Cell LymphomasMature T-Cell and Natural Killer-Cell LeukemiasTHERAPY FOR LOCALIZED LARGE CELL LYMPHOMACHEMOTHERAPYSALVAGE CHEMOTHERAPYHIGHLY AGGRESSIVE LYMPHOMASSmall Noncleaved Cell LymphomaLymphoblastic LymphomaMANAGEMENT OF EXTRANODAL LYMPHOMASROLE OF STEM CELL TRANSPLANTATIONSPECIAL AREASTherapy in the ElderlyTherapy in PregnancyLong-Term SequelaeFUTURE DEVELOPMENTS AND SUMMARYREFERENCES**HISTORICAL PERSPECTIVE**

The recognition of lymphoma evolved from Thomas Hodgkin's 1832 paper entitled "On Some Morbid Appearances of the Absorbent Glands and Spleen" (<sup>1</sup>). Hodgkin was the first to realize that lymphadenopathy could occur as a primary disorder rather than a secondary disorder to infection or carcinoma. Since Hodgkin's initial description, there have been four historic phases in the study of non-Hodgkin lymphoma (NHL): (a) clinical features, 1832 to 1900; (b) histopathology, 1900 to 1972; (c) immunopathology, 1972 to the present; and (d) molecular genetics, 1982 to the present. These phases naturally overlap and all contribute to the understanding of NHL.

From 1863 to 1865, Virchow (<sup>2</sup>) introduced the terms *aleukemia* and *lymphosarcoma* to distinguish lymphoproliferative diseases from leukemia, and, in 1871, Billroth used the

term *malignant lymphoma* for a vague collection of primary lymphoid disorders ( 3 ). In 1893, Kundrat ( 4 ) proposed that the term *lymphosarcoma* was more specific than the term that was originally used by Virchow and that it should be reserved for sarcomatous tumors of lymph nodes.

At the turn of the century, Sternberg ( 5 ) and Reed ( 6 ) identified the giant cells that are characteristic of Hodgkin disease (HD) and introduced histopathology as an important method for diagnosis and classification of lymphoma. Brill et al. ( 7 ) and Symmers ( 8 ) first described follicular, or nodular, lymphoma in the 1920s and indicated that it was a malignant, albeit indolent, disorder. In 1930, Roulet ( 9 ) used the term *reticulum cell sarcoma* as another term for malignant lymphoma. In 1942, Gall and Mallory ( 10 ) developed a classification scheme on NHL that had clinical and histopathologic significance. The histopathologic phase of NHL culminated in the 1956 classic work of Rappaport ( 11 ), who developed a morphologic classification that was reproducible and relevant.

The complex interplay of environmental and host factors in the pathogenesis of lymphoma was recognized through Dennis Burkitt's description in 1958 of an aggressive tumor of young children that was characterized by frequent jaw and abdominal involvement ( Fig. 90.1A ). Using careful epidemiologic surveys, Burkitt ( 12 , 13 ) identified a tumor belt across equatorial Africa that was associated with temperature, rainfall, and elevation ( Fig. 90.1B ). Subsequently, the geographic distribution of this neoplasm was shown to correlate with that of endemic malaria.



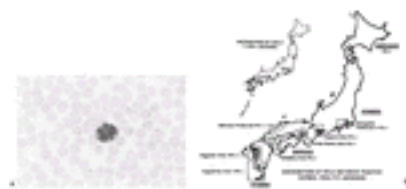
**Figure 90.1. A:** Burkitt lymphoma that involves the mandible, the maxilla, and the orbit. (From O'Connor GT. Significant aspects of childhood lymphomas in Africa. *Cancer Res* 1963;23:1514–1527, with permission.) **B:** Lymphoma belt of Africa: Burkitt lymphoma occurred only in the areas below 3000 ft (above sea level), with mean temperature of higher than 15.6° C and with an annual rainfall of more than 50 cm. The shaded area is the area in which Burkitt lymphoma would be expected to occur; the black squares indicate the sites of the cases that were identified by Burkitt. (From Haddow AJ. An improved map for study of Burkitt's lymphoma syndrome in Africa. *E Afr Med J* 1963;40:429–432, with permission.)

In 1961, pathologic studies by O'Connor ( 14 ) suggested that the tumor was a lymphoma—an observation that was confirmed later by the demonstration of monotypic immunoglobulin (Ig) on tumor cells by Klein. In 1964, Epstein et al. ( 15 ) found viral particles in tumor cell lines that were derived from Burkitt's patients. A direct causative role for the virus was subsequently questioned by its infrequency in Burkitt lymphoma that occurred outside of Africa; however, the Epstein–Barr virus (EBV) was shown to be trophic for B cells, to induce B-cell proliferation and differentiation, and to be the etiologic agent for infectious mononucleosis.

The identification of a 14q+ cytogenetic abnormality in Burkitt lymphoma by Manalov and Manolova ( [16](#) ) in 1971 led to the description of the 8;14 chromosomal translocation by Zech et al. ( [17](#) ) in 1976. Subsequent molecular genetic studies showed that this translocation juxtaposed the c-myc oncogene on chromosome 8 to the Ig heavy chain gene sequences on chromosome 14 ( [18](#) ). These observations suggest that the 8;14 translocation of endemic Burkitt NHL arises in a state of EBV-induced polyclonal B-cell proliferation in the setting of immunodeficiency that is associated with chronic malaria. Support for this theory has been derived by the role of EBV in lympho-proliferation in other immunodeficient conditions.

In 1967, Good and Finstad discussed, at an international conference on leukemia and lymphoma in Ann Arbor, Michigan, the relationship of B and T cells to lymphoid neoplasia ( [3](#) ), and Dameshek introduced the concepts that lymphoid neoplasms were aberrations of immunologically competent cells and that transformation of lymphocytes to “blast” forms (immunoblasts) could occur secondary to antigenic stimulation ( [3](#) ). In 1972, the immunologic origin of lymphoid neoplasia was confirmed by the presence of monotypic Ig on the cell surface (B cell) or by sheep erythrocyte rosette formation with neoplastic cells (T cell) ( [19](#), [20](#) and [21](#) ). Lymphoblastic lymphoma (LL) was determined to originate from thymocytes by Smith et al. ( [22](#) ) in 1973. Barcos and Lukes ( [20](#) ) described the clinicopathologic features of “convoluted lymphocytic lymphoma” of thymic origin and used the term LL, which was later preferred by Nathwani et al. ( [23](#) ) because of similarities to blasts of T-cell acute lymphocytic leukemia (ALL).

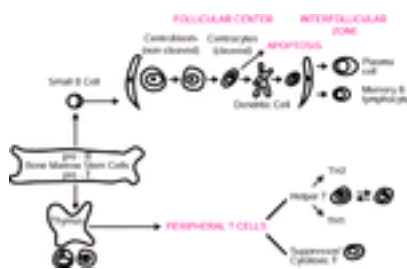
The importance of distinguishing a T cell from a B cell as a separate cell of origin for lymphoma accompanied the description of adult T-cell leukemia/lymphoma (ATLL) by Takatsuki et al. ( [24](#) ) and Uchiyama et al. ( [25](#) ) in 1977. The clinical course of ATLL was variable, but the majority of patients presented with an acute form, which was characterized by lymphadenopathy; organomegaly; skin lesions; an elevated white count with multilobated lymphocytes, which were referred to as *cloverleaf* or *flower* cells ( [Fig. 90.2A](#) ); and a rapidly fatal course. In 1980 and 1981, Gallo et al. ( [26](#) ), in the United States, and Hinuma et al. ( [27](#) ), in Japan, discovered a unique retrovirus, human T-cell leukemia virus type 1 (HTLV-1), as the etiologic agent of ATLL. HTLV-1 was shown to be endemic to certain geographic areas ( [Fig. 90.2B](#) ): southwestern Japan, in which 6 to 20% of the population is seropositive for HTLV-1; the Caribbean islands; New Guinea; and parts of Central Africa and South America ( [28](#), [29](#), [30](#), [31](#) and [32](#) ). Some early cases were reported in Europe and parts of the United States, particularly in the Southeast ( [33](#) ).



**Figure 90.2. A:** Peripheral blood, adult T-cell leukemia/lymphoma. A neoplastic lymphocyte shows the cloverleaf nuclear lobations that are characteristic of circulating adult T-cell leukemia/lymphoma cells. (Courtesy of William Macon, Mayo Clinic, Rochester, MN.) **B:** Comparison of the distribution of adult T-cell leukemia in Japan with the distribution of human T-cell leukemia virus (HTLV) type 1 antibody-positive healthy Japanese. See [Color Plate](#). [From Robert-Guroff M, Gallo RC. Establishment of an etiologic relationship between the human T cell leukemia/lymphoma virus (HTLV) and

adult T cell leukemia. Blut 1983;47:1–12, with permission.]

In 1974, Lennert et al. (34) and Lukes and Collins (35) classified NHL on the basis of the cell of origin within the immune system (Fig. 90.3). Subsequently, monoclonal antibodies to lymphocyte differentiation antigens have been able to detect sequential stages in the development of B and T cells and to identify subtypes of NHL. In the 1980s, the lymphoid origin of NHL was confirmed at the molecular level with the identification of specific Ig gene and T-cell receptor (TCR) gene rearrangements in B- and T-cell lymphomas, respectively (36, 37, 38 and 39).



**Figure 90.3.** B- and T-cell differentiation pathways. B and T cells originate in the marrow, where they are antigen independent. The follicular center is a normal site of antigen-dependent B cells, which go through different stages: (a) proliferation of centroblasts (large noncleaved cells), (b) selection of centrocytes (small cleaved cells) or cell death via apoptosis, and (c) differentiation into postgerminal center memory B lymphocytes or plasma cells, often in association with increased antigen affinity and an immunoglobulin isotope switch. The T cells depend on the thymus for early differentiation before becoming peripheral T cells, which are subdivided into helper and suppressor or cytotoxic subsets. T cells predominantly populate the interfollicular zone of lymph nodes. Subsets of T helper cells (TH<sub>2</sub>) regulate B-cell responses to antigens along with the dendritic cells, whereas others (TH<sub>1</sub>) recruit cells (macrophages) to sites of inflammation.

Because of the diverse terminology that is used in the multiple classifications of lymphomas, there have been attempts to develop uniform pathologic descriptions with clinical usefulness. In 1982, a Working Formulation (WF) of NHL separated diseases according to histologic grade (low, intermediate, and high) and made correlations with survival (40); however, classification was based on morphology without using immunophenotyping or molecular genetic techniques to define histologically similar processes. In 1994, a Revised European American Lymphoma (REAL) Classification was proposed to identify specific types of lymphomas of B- and T-cell origin (41). The REAL Classification dropped the grading schema of lymphomas and developed a diagnosis by identifying clinical features, morphology, immunophenotype, and genetic data, when available (42). The World Health Organization (WHO) has adopted the diagnostic principles of the REAL Classification, and the WHO classification is used as the schema for the diagnosis of all hematopoietic neoplasms (Chapter 88) (43, 44).

Progress in the last three decades has involved not only the recognition of the importance of immunopathology and molecular genetics in the definition of these diseases, but also the development of curative therapy for many patients with NHL. In this chapter, the areas that are reviewed include the epidemiology of NHL, a clinical approach, and therapeutic principles for adult NHL.

## EPIDEMIOLOGY

There is an epidemic of NHL worldwide ( [45](#) ). More than 60,000 new cases per year will be diagnosed in the United States in the 2000s. Part of the increase was attributed to the development of NHL in patients with the acquired immunodeficiency syndrome (AIDS); however, there are a large number of other possible contributing factors to the epidemic ( [Table 90.1](#) ). Even before the AIDS crisis, there was a steady increase of 3 to 4% per year since the 1970s until 1996, when there was a plateau and even drop-off in some subgroups of patients ( [Fig. 90.4](#) ). Part of the drop-off is attributed to the introduction of highly active antiretroviral therapy (HAART) for AIDS patients ( [46](#) , [47](#) and [48](#) ). The rise in NHL was faster than that of all other malignancies except lung cancer in women, melanoma, and prostate cancer ( [48](#) , [49](#) ).

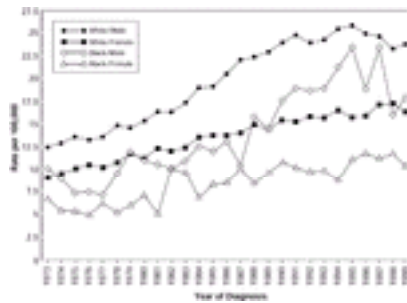
**TABLE 90.1. Epidemiologic Factors That Are Associated with an Increased Risk of Non-Hodgkin Lymphoma**

---

|   |
|---|
| Immunosuppression   |
| Infectious agents   |
| Epstein-Barr virus  |
| Human T-cell lymphotropic virus type 1                              |
| Helicobacter pylori   |
| Hepatitis C virus   |
| Human herpesvirus 8 (Kaposi sarcoma)                                |
| Human herpesvirus 6   |
| Human T-cell lymphotropic virus type 2                              |
| Male gender   |
| Increasing age  |
| Family history of non-Hodgkin lymphoma                              |
| Prior cancer history  |
| Drug history  |
| Immunosuppressive agents  |
| Phenytoin   |
| Methotrexate  |
| Occupational history  |
| Exposure to herbicides, pesticides, wood dust, epoxy glue, solvents |
| Jobs in farming, forestry, painting, carpentry, tanning             |
| Other possible etiologic factors                                    |
| Hair dye use  |
| Sunlight exposure   |
| Nutritional factors   |
| Blood transfusion   |

---



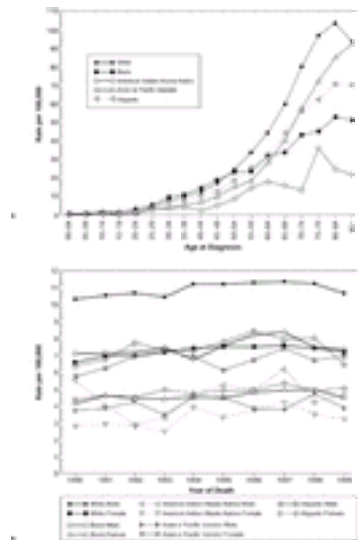


**Figure 90.4.** Age-adjusted incidence rates of non-Hodgkin lymphoma according to race and gender by year, 1973 to 1999. (From Ries LA, et al. SEER cancer statistics review, 1973–1999. Bethesda, MD: National Cancer Institute, 2002.)

The rise in NHL led to a symposium at the National Institutes of Health in 1991 to address whether the epidemic is real or due to changes in classification, improved diagnosis, or the AIDS crisis, or a combination of these. Although some NHL may have been previously diagnosed as HD, and new entities among NHL are being recognized, the consensus of the symposium was that the overwhelming majority of the increase in NHL was unexplained by changes in diagnosis or the development of AIDS ([50](#)).

### Age, Race, and Gender Differences

The frequency of various lymphoid neoplasms is age dependent, has a variable worldwide distribution, and is more common in men than women. Lymphomas represent approximately 10% of all childhood cancers in developed countries and are the third most common in relative frequency, behind acute leukemias and brain tumors. They are more common in adults than in children and have a steady increase in incidence from childhood through 80 years of age ([Fig. 90.5A](#)) ([48](#)). They are the fifth most common cancer in the United States and represent 4% of all cancers. The mean age at diagnosis is 45 to 55 years of age, and the median age is 60 to 65 years of age. The annual incidence rate of NHL from 1995 to 1999 was 19.1 cases per 100,000 population with a 50% higher incidence for men (23.6 per 100,000) than women (15.4 per 100,000) and a 35% higher incidence among whites (19.9 per 100,000) than blacks (14.7 per 100,000) ([48](#)). The highest age-adjusted mortality has been in white men (10.9 per 100,000), and the lowest mortality has been in Native American (Indian/Alaska) women (3.4 per 100,000) ([Fig. 90.5B](#)) ([48](#)).



**Figure 90.5. A:** Age-specific incidence rates of non-Hodgkin lymphoma according to race. **B:** Age-adjusted mortality rates by expanded race and gender, 1990 to 1999. (From Ries LA, et al. SEER cancer statistics review, 1973–1999. Bethesda, MD: National Cancer Institute, 2002.)

A comparison of NHL in children and adults is outlined in [Table 90.2](#). Lymphomas that involve peripheral lymph nodes are usually of B-cell origin in the West and are more common in adults than in children, who often present with gastrointestinal involvement [small noncleaved cell (SNC), B cell] or mediastinal widening (usually LL of T-cell origin). The histologic appearance of NHL is more variable in adults, who frequently have low-grade follicular patterns in which the majority of malignant cells are small, dormant lymphocytes; children predominantly have high-grade diffuse patterns in which the malignant cells have a “blastic” or transformed appearance and a high mitotic rate. A possible explanation of the differences between childhood and adult NHL is that most childhood lymphomas arise from early cells that are antigen independent, whereas many adult lymphomas arise from fully differentiated cells and are antigen dependent ([51](#)).

**TABLE 90.2. Clinicopathologic Differences between Childhood and Adult Non-Hodgkin Lymphomas**

|                                  | Children  | Adults   |
|----------------------------------|---|--|
| Incidence                        | Rare  | Common   |
| Median age                       | 10–15 yr  | 55–70 yr   |
| Presentation                     | Extranodal > nodal  | Nodal > extranodal   |
| Most common histologic diagnoses | B cell: small noncleaved cell (Burkitt)<br>T cell: lymphoblastic; Ki-1+ anaplastic large cell | B cell: small lymphocytic; small cleaved (follicular center) cell; diffuse large cell<br>T cell: peripheral T-cell |
| Immunophenotype                  | 50–70% B cell   | 70–90% B cell (United States, Europe); 40–70% T cell (Asia)  |
| Paraprotein                      | None  | Rare (<5%)   |
| Clinical course                  | Aggressive  | Variable—often indolent  |

Curability

70–90%

<30%, except 40–70% in intermediate to high grades, particularly large cell lymphomas

---

Extranodal presentation of NHL occurs in 15 to 25% of adult patients in the United States ( [52](#), [53](#) ) and in as much as 40 to 50% of adult patients in Europe and the Far East ( [54](#), [55](#) ). Clinicopathologic features of the epidemic of NHL include a faster rise in extranodal than nodal disease, an increase in diffuse pattern rather than nodular pattern, and an increase in intermediate- to high-grade NHL rather than low-grade disease ( [56](#), [57](#) ). NHL of the brain has risen four times as rapidly as other extranodal sites and is partly due to AIDS, but the upward trend began before the AIDS crisis and continues to rise in immunocompetent hosts of all ages and in both genders ( [56](#), [58](#) ). The most common extranodal sites are the gastrointestinal tract and nasopharynx; other common sites include brain, skin, bone, thyroid, salivary glands, and testis.

Familial aggregation of NHL plays a small role in the epidemic and accounts for a two- to fourfold increased risk for NHL in close relatives of patients with lymphoma or another hematopoietic neoplasm ( [59](#), [60](#) and [61](#) ). Some families have various immune function abnormalities, whereas others have no discernible immune dysfunction. There is an increased risk for NHL and HD in families with an autoimmune lymphoproliferative syndrome (also known as the *Canale-Smith syndrome*), which is characterized by chronic lymphadenopathy, splenomegaly, autoimmune features, and expanded T cells, which are negative for CD4 and CD8 ( [62](#) ). The lymphomas may occur decades after recognition of the syndrome and are associated with germline Fas mutations and defective lymphocyte apoptosis ( [62](#) ). A prior history of cancer, Jewish ancestry, and small-size families have been suggested as risk factors for lymphoma ( [63](#), [64](#) ). Patients who have a family history of hematologic cancer and occupational exposures to certain substances (e.g., gasoline or benzene) appear to have an increased risk for NHL ( [59](#), [60](#) ).

## Environmental Factors

Environmental associations that are implicated in the pathogenesis of NHL include infections, drug exposure, and toxic chemical exposure. Viruses, particularly EBV, play a critical role in lymphomagenesis in the immunodeficient host. Phenytoin (Dilantin) has been associated with pseudolymphoma and malignant lymphoma, with the former condition presenting with fever, rash, and adenopathy that regress after drug withdrawal ( [65](#), [66](#) ). Methotrexate and the tumor necrosis factor- $\alpha$  inhibitors (etanercept, infliximab, and adalimumab) have been associated with an increased risk of lymphoma in rheumatoid arthritis, which itself may have an increased risk (see the section [Prelymphomatous Conditions](#)) ( [67](#) ). Although epidemiologic studies are flawed by methodologic weaknesses, other implicated drugs include aspirin, antibiotics, steroids, digitalis, estrogen, and tranquilizers ( [63](#) ).

Occupational exposures have been suggested as factors in the epidemic. There appears to be a two- to threefold increased risk of NHL among people who are employed in agriculture, forestry, fishing, construction, and leather industries ( [68](#) ). Specific jobs that are at high risk include plant farmers and gardeners, painters and plasterers, carpenters, brick and stone masons, plumbers, and roofers. The chemicals that are implicated are chlorophenols and phenoxyacetic acids that are commonly found in herbicides ( [68](#), [69](#), [70](#), [71](#), [72](#) and [73](#) ). An excess risk has also been suggested for exposure to wood dust, epoxy

glues, pesticides, fertilizers, and solvents ( [63](#) ).

Hair dyes ( [74](#), [75](#) ), ultraviolet light ( [76](#), [77](#) and [78](#) ), and nutritional factors ( [79](#), [80](#) ) have been implicated in some epidemiologic studies and have been negated in others. Hair dye is more likely to be a factor in women than in men because of a greater use in women ( [56](#) ). Several studies noted an increase in NHL among patients with melanoma or squamous cell skin cancer and suggested a role for ultraviolet light in suppression of the immune system ( [76](#), [77](#) ); however, there was no correlation between NHL mortality and increased ultraviolet light exposure in the southern United States, as has been observed in skin cancer ( [78](#) ). Nutritional factors, including milk, butter, liver, meat, coffee, and cola consumption, have been identified as possible risk factors ( [50](#), [79](#), [81](#) ). In one study, a high-meat diet and a high intake of fat from animal sources were associated with an increased risk of NHL in older women; there was no association with milk consumption, and there was a decreased risk with increased ingestion of fruits ( [80](#) ).

Blood transfusion has been implicated as contributing to the increased incidence of NHL ( [82](#), [83](#), [84](#) and [85](#) ). The use of blood products, beginning in the 1950s, has coincided with the epidemic ( [84](#) ). Transmission of infectious agents through blood transfusion could suppress the immune system and make a patient susceptible to the development of lymphoma ( [83](#) ). Blood transfusion has been associated with all types of histologies ( [82](#), [85](#) ). Although cohort studies have supported the connection between blood transfusion and lymphoma, case-control studies have not consistently confirmed the association ( [84](#) ).

A number of other factors have been mentioned as possibly contributing to the epidemic, including ionizing radiation, electromagnetic fields, alcohol, tobacco, and chronic fatigue syndrome, but the data are weak to support an association of any of these factors with an increased risk of NHL ( [56](#), [86](#), [87](#), [88](#), [89](#), [90](#) and [91](#) ). The epidemiology of NHL is emerging and requires carefully designed studies with large cohorts and prolonged follow-up to determine the validity of an association between a factor and NHL.

## Infectious Agents

The lymphotropic viruses EBV and HTLV-1 have a pathogenetic role in predominantly B- and T-cell lymphoid neoplasias, respectively ( [92](#) ). These viruses have been well studied and continue to provide information regarding lymphomagenesis. The biology, epidemiology, and associated clinical diseases of EBV are reviewed in [Chapter 67](#). Dysfunction in T-cell immunity can lead to polyclonal EBV lymphoproliferation, which may become an oligoclonal or monoclonal malignant B-cell lymphoma. EBV has been implicated in African Burkitt lymphoma, AIDS-related lymphomas (ARLs) [many systemic and most central nervous system (CNS)], some HD, and in some T-cell and natural killer (NK)-cell lymphomas, including nasal lymphoma ( [93](#) ), posttransplant T-cell lymphoma, and several lymphomas that developed after chronic infectious mononucleosis ( [94](#), [95](#) ).

HTLV-1 is an RNA-containing type C retrovirus that infects a mature T cell, usually CD3<sup>+</sup>, CD4<sup>+</sup>, and HLA-DR<sup>+</sup>. T-cell dysregulation may initially involve an autocrine interleukin (IL)-2 loop, as well as paracrine effects from other cellular genes and cytokines, but, over time, clonal selection may result in T cells becoming IL-2 independent. Initially, the T-cell lymphoproliferation is polyclonal and is controlled by host defense mechanisms ( [96](#), [97](#) ); however, an oligoclonal or monoclonal T-cell proliferation may emerge, resulting in the clinical manifestations of ATLL. Mutations in tumor suppressor genes are associated with progression of ATLL ( [98](#), [99](#) ). Similar to EBV in lymphomagenesis, HTLV-1 may not have

direct oncogenic activity but contributes to a multistep process of worsening genetic instability by interfering with mitotic checkpoints or preventing DNA repair, or both ( [100](#), [101](#) ).

A phylogenetic scheme of HTLV-1 has identified five major molecular subtypes, which probably spread worldwide via the slave trade: South African, Japanese, West African, Central African, and Melanesian ( [102](#) ). HTLV-1 can be transmitted by blood transfusions, needle sharing, and sexual intercourse and from mother to child through breast milk or through the placenta. The virus can have a prolonged latency period of decades before clinical syndromes appear ( [96](#), [103](#), [104](#) ) (see the section [Mature T-Cell and Natural Killer-Cell Leukemias](#)). In areas in which the virus is endemic, ATLL occurs at a rate of two to four cases per 100,000 population per year, with a lifetime risk of approximately 1 to 5% for those persons who are seropositive for HTLV-1 antibodies ( [96](#) ).

HTLV-1 infection induces the production of antibodies to various viral core proteins, which can be used as serologic markers of infection ( [30](#), [32](#) ). The diagnosis is usually suggested by a screening enzyme-linked immunosorbent assay and is confirmed by Western blot test. Because of slow replication, seroconversion may take as long as 2 years in HTLV-1 infection compared to the 3 to 6 months for human immunodeficiency virus (HIV) ( [105](#) ). Polymerase chain reaction (PCR) uses primers and probes of the Pol (polymerase or reverse transcriptase) and Tax (transactivator) regions and is the most sensitive and specific assay for detecting HTLV-1 ( [105](#) ). HTLV-1 can lead to other diseases, including myelopathy, tropical spastic paraparesis, uveitis, bronchopneumopathy, and arthropathy ( [105](#), [106](#) ).

Other viruses have been implicated in lymphoid neoplasia and include human T-cell leukemia virus type 2, human herpesvirus (HHV) 6, HHV8 [also known as *Kaposi sarcoma-associated herpesvirus (KSHV)*], and hepatitis C. Human T-cell leukemia virus type 2 was isolated in 1982 by Kalyanaraman et al. ( [107](#) ) from a patient with an unusual T-cell variant of hairy cell leukemia. It has subsequently been isolated only rarely in lymphoid neoplasia and in HTLV-1-negative tropical spastic paraparesis, but it is prevalent in intravenous drug abusers ( [108](#) ). Salahuddin et al. ( [109](#) ) identified HHV6 in B lymphocytes from six patients with various lymphoproliferative disorders; it was identified subsequently as the etiologic agent for exanthema subitum (roseola infantum) and as a cause for pneumonia in immunocompromised hosts ( [110](#) ). The significance of both of these viruses in lymphoproliferation remains to be determined. KSHV, also referred to as *HHV8*, has been identified in AIDS-related body cavity-based B-cell lymphomas and multicentric Castleman disease (CD) and has been associated with the EBV genome in the absence of c-myc rearrangement ( [111](#), [112](#) ). Theoretically, KSHV acts synergistically with EBV to transform B cells and causes a unique clinical presentation.

Chronic hepatitis C virus (HCV) infection is often present in patients with type II cryoglobulin, and many of these patients have an underlying indolent B-cell lymphoma ( [113](#), [114](#), [115](#) and [116](#) ). A study found anti-HCV antibodies in 29 of 69 (42%) unselected patients with B-cell lymphoma who lacked an association with cryoglobulinemia ( [115](#) ). The role of HCV infection in lymphoma could be indirect or direct. Viral persistence could lead to clonal expansion of B cells, predisposing to neoplastic transformation, or, alternatively, lymphoproliferation could be the result of direct B-cell infection by HCV ( [116](#), [117](#) ). Rearrangement of the *BCL2* gene occurs in three-fourths of patients with hepatitis C and mixed cryoglobulinemia and regresses with antiviral therapy ( [116](#), [117](#) ).

One of the more important infections that is associated with lymphomas is *Helicobacter*

*pylori*. This gram-negative rod was discovered by Marshall and Warren (118) in 1983 and was shown to be associated with peptic ulcer disease and gastric carcinoma (119). Gastric lymphoma was found to have a high frequency in certain parts of Europe, such as the Veneto region of Italy, and was usually a low-grade B-cell lymphoma of mucosa-associated lymphoid tissue (MALToma) (120). Parsonnet et al. (121) recognized that *H. pylori* infection preceded the development of lymphoma, and Wotherspoon et al. (122) reported that antibiotic treatment for *H. pylori* caused regression of the lymphoma in most patients.

## PRELYMPHOMATOUS CONDITIONS

The mechanism of developing lymphomas has been best studied in those lymphomas that occur in immunodeficiency states (123, 124). These disorders can be subdivided into congenital, or primary, immunodeficiencies and acquired, or secondary, immunodeficiencies (Table 90.3). Common components to all of these disorders are defects in immunoregulation, particularly in T-cell immunity, which results in decreased cytokines, and uncontrolled B-cell growth in lymphoid tissue, often in association with the EBV genome. Since 1973, cases of malignant disease in children with immunodeficiency have been recorded by immunodeficiency cancer registries, and NHL constitutes the majority of the cases (125, 126). The median age of onset is 7 years of age, and there is a predominance in men rather than women due, in part, to the contribution of X-linked disorders (125). The importance of EBV in the pathogenesis of lympho-proliferation was suggested by Grierson and Purtilo (127) in 1974 when they described an X-linked disorder in which six boys in a single family died of infectious mononucleosis, agammaglobulinemia, or malignant lymphoma. The role of EBV in lymphomas that develop in patients with immunodeficiencies is addressed in Chapter 67, Chapter 68 and Chapter 69.

**TABLE 90.3. Prelymphomatous Conditions**

| Congenital                              | Acquired                           |
|---|------------------------------------|
| Ataxia telangiectasia                   | Immunodeficiency                   |
| Wiskott-Aldrich syndrome                | Organ transplants                  |
| Severe combined immunodeficiency        | Acquired immunodeficiency syndrome |
| Common variable immunodeficiency        |                                    |
| Hyper immunoglobulin M syndrome         | Autoimmune disorders               |
| X-linked hypogammaglobulinemia          | Sjögren syndrome                   |
| X-linked lymphoproliferative syndrome   | Hashimoto thyroiditis              |
| Autoimmune lymphoproliferative syndrome | Rheumatoid arthritis               |
|   | Inflammatory bowel disease         |
|   | Castleman disease                  |
|   | Hodgkin disease                    |
|   | Predisposition to T-cell lymphoma  |
|   | Nontropical sprue                  |
|   | Angioimmunoblastic lymphadenopathy |
|   | Lymphomatoid papulosis             |



## Organ Transplants

In the early 1980s, a range of lymphoproliferative lesions was described that occurred in patients who received chronic immunosuppressive therapy after solid organ transplantation. The clinical and pathologic spectrum of diseases included primary infectious mononucleosis, polymorphic B-cell hyperplasia, and intermediate- to high-grade B-cell lymphomas in which necrosis, cytologic atypia, monotypic Ig expression, and cytogenetic abnormalities were harbingers of neoplastic transformation and aggressive behavior ( [128](#), [129](#) ). Serologic and molecular studies linked many of these lymphoproliferations to primary or secondary EBV infection ( [130](#), [131](#) ). The risk of developing lympho-proliferation after transplantation is dependent on age, EBV status, type of transplant, and amount of immunosuppression ( [128](#), [129](#) ). A lower chance occurs in older, as opposed to younger, age; sibling, as opposed to cadaver, donor; and single, as opposed to multiple, transplants. Early reports from Stanford University indicated that as many as 40% of patients who survived cardiac transplantation developed a malignant lymphoma ( [132](#) ). With less immunosuppression, the incidence is 1 to 13% after solid organ transplants, which is a 30- to 60-fold increase in lymphomas compared to the general population ( [133](#) ). The diagnosis and management of posttransplant lymphoproliferative disease is described in [Chapter 67](#).

## Acquired Immunodeficiency Syndrome

AIDS was recognized as a disease in 1981, and the first case of lymphoma in an AIDS patient was reported in 1982 ( [134](#) ). This was followed by a series of 90 homosexual patients with NHL that was reported by Ziegler et al. ( [135](#) ) in 1984. In 1985, the diagnosis of NHL in association with positive serologic evidence for HIV became a criterion for the diagnosis of AIDS ( [136](#) ). In the series by Ziegler et al. ( [135](#) ), presenting features included generalized adenopathy and opportunistic infections in one-third of patients. Extranodal sites of disease and advanced stage occur in three-fourths of patients with ARL. The most common extranodal sites are the meninges, the gastrointestinal tract, the bone marrow, the liver, and the lungs and pleura; unusual sites include the rectum, the oral cavity, the heart and pericardium, the common bile duct, and the skin ( [137](#) ). NHL in AIDS patients is usually of B-cell origin and includes large B-cell (immunoblastic or large transformed) and small transformed B-cell histologies (Burkitt and Burkitt-like) ( [137](#) ). Unique presentations of ARL include plasmablastic lymphoma of the oral cavity ( [138](#) ) and primary effusion lymphoma ( [111](#) ). Differences in the histology of ARL have not impacted survival ( [139](#) ); however, they are likely to become more important with improved survival in AIDS.

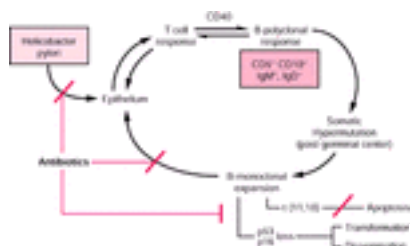
The prevalence of NHL in AIDS is 3 to 6%, and, before the era of HAART, there were projected increased risks over time ( [140](#), [141](#) ). The risk of lymphoma is 150- to 650-fold among HIV-infected patients compared to the general population and is associated with older age, severe immunodeficiency (defined by CD4 count and HIV viral load), and prolonged HIV infection ( [142](#), [143](#) and [144](#) ). Since the introduction of HAART, epidemiologic studies are finding a decreased incidence in ARL, particularly in primary brain NHL and in immunoblastic histology ( [143](#) ). Prognostic factors and therapy of ARL are addressed in [Chapter 69](#).

## Autoimmune and Other Immunologic Disorders



Chronic inflammation, immune hyperactivity, or immunosuppression, or a combination of these, are elements of autoimmune disorders that predispose patients to lymphoma (145). Many of these lymphomas arise in extranodal sites at which there is sparse lymphoid tissue; they are usually localized, low-grade B-cell MALTomas. Isaacson (146) initially recognized MALTomas in the gastrointestinal tract and indicated that they were a subset of immunoproliferative small intestinal disease (IPSID), or Mediterranean lymphoma; however, they subsequently identified similar lymphomas that occurred in the lung and salivary gland. Multiple other extranodal sites have been involved with MALTomas and include thyroid gland, thymus, breast, conjunctiva, gallbladder, skin, cervix, larynx, and trachea (146). Although the term *MALToma* is misleading owing to the fact that not all of the lesions arise in mucosal tissue, two common features are chronic inflammation and the presence of glandular epithelium that is destroyed by progressive lymphocytic infiltration (147).

MALToma of the stomach serves as a model for lymphomagenesis secondary to antigenic stimulation (Fig. 90.6) (148). Both B and T cells are recruited to the gastric mucosa following *H. pylori* infection. Proliferation of B cells is dependent on reactive T cells (149). There is a continuous spectrum of pathologic lesions during the transition from gastritis to low-grade MALToma (148). PCR may be helpful in identifying a malignant B-cell clone that may persist after histologic regression after antibiotic therapy (150). Somatic hypermutation is characteristic of the B-cell clone of MALToma and, along with the observation of plasmacytic differentiation, indicates a postgerminal center origin.



**Figure 90.6.** MALToma of the stomach: model for lymphomagenesis. *Helicobacter pylori* infects the epithelial cells, and there is recruitment of T and B cells. Contact-dependent T-cell help is mediated by CD40 and CD40 ligand interaction. B cells undergo a T-cell dependent polyclonal response that can develop into a postgerminal center monoclonal B-cell lymphoma. Antibiotics can eradicate *H. pylori* and cause regression of the lymphoma unless there is a clonal evolution that involves a specific translocation [i.e., t(11;18)] or a loss of tumor suppressor genes (i.e., p53, p16), which are associated with dissemination of disease.

The most common genetic abnormality in stomach MALT-oma is the t(11;18)(q21;q21), which is present in approximately one-third of cases and in as much as one-half of *H. pylori*-negative cases (151, 152). The genes that are involved at t(11;18) are an apoptosis inhibitor gene *API2* and a novel 18q gene, *MALT1*, and are less likely to undergo histologic transformation than other genetic abnormalities that are identified in MALTomas (153). Another nonrandom translocation, t(1;14)(p22;q32), which involves the *BCL10* gene, and trisomy 3 are other genetic abnormalities that are reported in MALToma and suggest the heterogeneity of lymphomagenesis in histologically similar lesions (148, 154, 155). *BCL1* and *BCL2* gene rearrangements are not present in MALTomas, and *BCL6* has only rarely been reported (148). There is controversy regarding whether the B-cell clones remain

dependent on antigen stimulation or expand through autonomous (antigen-independent) growth ( [148](#) ). The loss of tumor suppressor genes and the amplification of 3q27 have been associated with histologic progression and dissemination of MALTomas ( [153](#) , [156](#) , [157](#) ).

Lymphomas that are associated with Sjögren syndrome and Hashimoto thyroiditis tend to occur in elderly patients and are B-cell lymphomas. Unlike other NHLs, however, they have a female predominance. The presumed pathogenesis of lymphomas in these patients is associated with chronic antigenic stimulation that causes polyclonal B-cell growth with eventual development of a monoclonal B-cell lymphoma. Bunim and Talal ( [158](#) ) reported the first association of lymphoma and Sjögren syndrome in 1963, and Kassan et al. ( [159](#) ) subsequently reported a greater than 40-fold risk for lymphomas in these patients. The histologic lesion of Sjögren syndrome is a myoepithelial sialoadenitis that is characterized by lymphoid infiltration of the salivary gland along with acinar atrophy and proliferation of ductal cells to form myoepithelial islands ( [160](#) ). Although the initial clinical course of Sjögren syndrome usually is benign, clonally rearranged Ig genes can be detected uniformly by Southern blot analysis in the biopsy of myoepithelial sialoadenitis ( [161](#) ). Furthermore, the finding of light chain restriction in minor salivary glands of the lip by *in situ* hybridization techniques correlates with development of lymphoma ( [162](#) ). These findings suggest, as in many other prelymphomatous conditions, that the so-called benign lesion actually represents a monoclonal population of unknown significance or malignant lymphoma *in situ*. Clinically overt malignant lymphoma tends to occur in those lesions with extensive, confluent areas of monotypic B-cell proliferation, and the lymphomas that are seen most commonly are monocytoid B-cell, lymphoplasmacytic, or immunoblastic sarcoma of B cells ( [160](#) ). Salivary MALTomas arise from a restricted Ig *V<sub>H</sub>* gene repertoire, which can have rheumatoid factor activity ( [163](#) ).

Lindsay and Dailey ( [164](#) ) described an association between malignant lymphoma of the thyroid and Hashimoto thyroiditis in 1957. Subsequent studies indicate that more than 75% of thyroid lymphomas are preceded by Hashimoto thyroiditis, which is made evident by thyroiditis in the nonlymphomatous portion of the pathologic specimens ( [165](#) ) and by antithyroid antibodies in most patients ( [166](#) ). There is a 60- to 80-fold increase in thyroid lymphoma after thyroiditis, but the lifetime risk is only 1 to 2% ( [167](#) , [168](#) ). Unlike the lesion of Sjögren syndrome, which has Ig gene rearrangement, the lesion of Hashimoto thyroiditis does not usually have a clonal population of cells that is identified by DNA analysis ( [169](#) ). Most thyroid lymphomas express surface IgG rather than the IgM that is characteristic of follicular center cell (FCC) lymphomas, thus suggesting that thyroid lymphomas involve B-cell progenitors with the ability to differentiate further from IgM to IgG production ( [170](#) , [171](#) ).

Lymphomas have been reported in patients with other autoimmune disorders, including rheumatoid arthritis, systemic lupus erythematosus, scleroderma, inflammatory bowel disease, and dermatomyositis; however, the increased incidence in these disorders is complicated by the use of immunosuppressive therapy and by possible methodologic flaws of epidemiologic studies ( [123](#) , [172](#) , [173](#) ). The increased risk for lymphoma in rheumatoid arthritis varies from two- to 15-fold and is higher with methotrexate use and in patients with Felty syndrome ( [174](#) , [175](#) , [176](#) and [177](#) ). A wide spectrum of lesions has been described with methotrexate, ranging from lesions that resemble posttransplant polymorphous lymphoproliferation to large B-cell lymphomas and HD ( [176](#) , [178](#) ). EBV may be present in tumor cells, and the lymphoproliferations may regress with discontinuation of methotrexate ( [178](#) , [179](#) ). T-cell large granular lymphocytic (LGL) leukemia is often

associated with rheumatoid arthritis and neutropenia ( [180](#) ).

CD (giant lymph node hyperplasia, angiofollicular lymph node hyperplasia) was first recognized in the 1920s and was further described as a clinicopathologic entity in 1956 ( [181](#) ). It has two types of clinical presentations (localized and multicentric) and three types of histologic subtypes (hyaline vascular, plasma cell, and mixed) ( [182](#) , [183](#) and [184](#) ). The hyaline variant type is the most common subtype and presents as localized adenopathy often in the mediastinum. It can be amenable to surgical resection, and, although it was initially reported to be radioresistant, it has been successfully treated with radiation as well ( [185](#) ). The plasma cell variant is associated with systemic symptoms, anemia of chronic disease, hypergammaglobulinemia, and a variety of unusual syndromes, including myasthenia gravis, nephrotic syndrome, peripheral neuropathy, amyloidosis, and temporal arteritis ( [182](#) , [183](#) and [184](#) , [186](#) ). Increased expression of the gene coding for IL-6 has been identified in CD, and retroviral transduction of the gene into mice has reproduced histology and symptoms ( [187](#) ). Moreover, antibodies to IL-6 or its receptor have ameliorated the disease ( [188](#) ).

The plasma cell variant tends to be a local form, which occurs more commonly in young adults and is amenable to local therapy, or a multicentric form, which occurs in older adults or in HIV-infected patients with diffuse adenopathy and a variable, but often fatal, clinical course in which 20 to 30% of patients develop Kaposi sarcoma or B-cell lymphoma ( [186](#) , [189](#) ). Immunophenotyping and Ig gene rearrangements of the plasma cell variant in CD indicate that patients usually have polyclonal lesions ( [190](#) ); however, monoclonal Ig gene rearrangements have been identified in patients with the multicentric form and in patients who develop B-cell lymphoma ( [191](#) ). KSHV (HHV8) has been identified in HIV-associated multicentric CD cases ( [192](#) ). KSHV-positive plasmablasts have lambda light-chain restriction, are localized to the mantle zone of germinal centers, and can coalesce to form microscopic lymphomas ( [193](#) ). The lymphomas have had a variable histologic pattern, but they are usually of B-cell origin, with mantle cell being the most common subtype, and have a poor prognosis ( [189](#) , [194](#) ).

NHL may follow HD, with prior therapy and the cell-mediated immune defect characteristic of HD serving as possible contributing factors. Krikorian et al. ( [195](#) ) reported six cases from Stanford University of intermediate- to high-grade lymphoma that developed after HD. In subsequent series, authors have estimated that 1 to 5% of patients with HD develop NHL ( [196](#) ); some studies have indicated a greater risk in the nodular variant of lymphocyte predominant HD (LPHD), which, unlike other subtypes of HD, clearly has a B-cell immunophenotype ( [195](#) , [197](#) ). The large cell lymphomas that are associated with LPHD generally are regarded as a progression of LPHD rather than as secondary neoplasms. Single-cell analysis of the lymphocytic and histiocytic cells of LPHD have proven a clonal relation to large B-cell lymphoma that develops in the same patient ( [198](#) ). Most NHLs that occur after all subtypes of HD are of B-cell origin ( [197](#) , [199](#) ), but those of T-cell immunophenotype have followed HD as well ( [200](#) , [201](#) ). The EBV genome has been found in some cases of NHL that develop after HD ( [197](#) ). The prognosis of NHL secondary to HD is poor ( [195](#) , [199](#) ); however, responses to rituximab have occurred in large B-cell lymphoma after HD ( [202](#) ).

T-cell lymphomas commonly do not occur in the setting of immunodeficiencies, with the exception of ataxia telangiectasia; however, some disorders appear to predispose to peripheral T-cell lymphoma (PTCL), and as much as one-tenth of lymphomas in organ transplants are of T-cell origin. Posttransplant lymphoproliferative disease of T-cell origin

tends to occur late and has a poor prognosis ( 203 ). Angioimmunoblastic lymphadenopathy and angiocentric immunoproliferative syndromes usually represent early variants of PTCL ( 204 ). Patients with gluten-sensitive enteropathy or celiac disease have an increased incidence of lymphoma ( 205 ). Although Isaacson et al. ( 206 ) initially reported that these lymphomas were variants of malignant histiocytosis, subsequent studies with gene rearrangement techniques indicated a T-cell origin, and they are referred to as *enteropathy-associated T-cell lymphoma (EATL)*.

Skin disorders, particularly lymphomatoid papulosis, may also evolve into a malignant cutaneous T-cell lymphoma (CTCL) ( Chapter 94 ). Clonality, as evidenced by TCR gene rearrangements, has been detected in some patients with lymphomatoid papulosis ( 207 ), as well as in those with other cutaneous T-cell processes of uncertain malignant potential, such as pityriasis lichenoides et varioliformis acuta ( 208 ), granulomatous slack skin disease ( 209 ), and pagetoid reticulosis ( 210 ). The latter two disorders are now thought to represent variants of mycosis fungoides.

## CLINICAL FEATURES AT PRESENTATION

The majority of patients with NHL present with painless adenopathy, more commonly in the cervical or supraclavicular regions ( 211 ). Systemic symptoms occur in less than 25% of patients in most large series ( 211 , 212 ). When present, however, they usually are associated with advanced stages of disease and a poor prognosis. Significant cytopenias are rare, unless marrow involvement is extensive, or there are associated immune-mediated cytopenias, hypersplenism, or, rarely, hemophagocytosis.

The gastrointestinal tract and Waldeyer ring are the most common extranodal sites at presentation ( 53 , 213 ). Gastrointestinal symptoms are often nonspecific, with vague abdominal pain being the most common presenting symptom in intestinal lymphoma. Frank bleeding occurs in less than 30% of patients with gastrointestinal lymphomas and usually is from a gastric or large bowel source ( 214 ). Obstruction, specifically intussusception, or perforation is more commonly associated with aggressive small bowel lymphomas, particularly Burkitt lymphoma and intestinal T-cell lymphoma ( 214 , 215 ). Mantle cell lymphoma (MCL) presents with gastrointestinal symptoms in 20 to 30% of patients, and multiple polyposis may be found on colonoscopy. Although the mucosa often appears normal, abnormal histology is found in more than 80% of mantle cell patients ( 216 ). Dysphagia, airway obstruction, and eustachian tube blockage, with or without cervical adenopathy, are symptoms that suggest Waldeyer ring involvement. Epistaxis and nasal obstruction, usually with facial edema, are common signs of involvement of nasal lymphomas.

Hepatosplenomegaly is a common feature of advanced low-grade B-cell lymphoma, including small B-cell lymphocytic lymphoma, follicular lymphoma, and splenic marginal zone lymphoma (SMZL), and can be the predominant clinical feature of a rare PTCL, ?d hepatosplenic type. Primary NHL of the liver is extremely rare, usually is a large B-cell type, and can arise in immunodeficient hosts. Presenting features include right upper quadrant pain, anorexia, nausea, coagulopathy, and elevated liver enzymes without significant jaundice ( 217 ). Obstructive jaundice can occur in NHL secondary to periportal lymphadenopathy or primary to lymphoma of the bile duct or pancreas. Hypodense, nonenhancing masses on computed tomography (CT) imaging are characteristic of primary liver NHL. Solitary masses occur in approximately two-thirds of cases; multiple masses occur in one-third of cases, and diffuse infiltration is rare ( 217 ). Rarely, liver involvement

with NHL may present with hepatic failure ( [218](#) ).

The skin is another common extranodal presentation of NHL, and the most common primary cutaneous type is the cerebriform T cell of mycosis fungoides or Sézary syndrome ( [Chapter 94](#) ). Although mycosis fungoides tends to be confined to the skin with characteristic stages, B-cell lymphomas that involve the skin only represent 20% or less of primary cutaneous lymphomas and usually present as nodules that involve the head, neck, or trunk, and more often represent evidence of systemic disease ( [219](#) ). The major types of primary cutaneous B-cell lymphoma and their distinguishing immunotypes include marginal zone (MALToma type) (CD20<sup>+</sup>, CD5<sup>-</sup>, CD10<sup>-</sup>), primary cutaneous follicular lymphoma (PCFL) (CD20<sup>+</sup>, CD10<sup>+</sup>), and primary cutaneous large B-cell lymphoma (PCBCL) (CD20<sup>+</sup>, usually CD10<sup>-</sup>). Other T-cell lymphomas with unique skin involvement include anaplastic large cell lymphoma (ALCL), which can be a primary cutaneous type or a systemic disease ( [220](#) ), and subcutaneous panniculitis-like PTCL.

Neurologic symptoms and signs, including headache, confusion, lethargy, dysphasia, hemiparesis, seizures, and cranial nerve palsies, and, rarely, multifocal leukoencephalopathy, may be presenting features of CNS disease and are more commonly seen in CNS lymphoma in AIDS patients or in patients with high-grade lymphomas (small noncleaved B-cell and T-cell LL) ( [221](#), [222](#) ). Cognitive and personality changes are more common in primary CNS lymphoma (PCNSL) owing to a predilection for involvement in the frontal lobes, the corpus callosum, and the periventricular area ( [221](#) ).

The detection of a single lesion on magnetic resonance imaging (MRI) favors PCNSL, but multifocal lesions can occur in approximately one-third of normal hosts and more frequently in AIDS patients (see the section [Epidemiology](#)) ( [221](#) ). In AIDS patients with intracranial mass lesions, the differential includes not only CNS lymphoma, but also toxoplasmosis, progressive multifocal leukoencephalopathy, and other opportunistic infections. CT scanning of CNS lymphoma usually identifies a contrast-enhancing lesion or lesions with a mass effect and edema that may have ring enhancement, a common finding in toxoplasmosis. The definitive diagnostic procedure is CT-guided stereotactic biopsy. Positron emission tomography (PET) scanning may distinguish lymphoma and toxoplasmosis and may obviate the need for biopsy in some AIDS patients ( [223](#) ).

Lymphomatous sites with a risk for CNS disease include nasopharyngeal, testicular, and extensive marrow involvement with intermediate-grade (large B-cell) to high-grade (small noncleaved B-cell and T-cell lymphoblastic) histologies. Because of the risk of leptomeningeal disease in PCNSL, ARL, the high-grade histologies, and the specific sites that were noted previously, the cerebrospinal fluid should be examined and treated early in the course of these patients. Elevated lactate dehydrogenase (LDH) and more than one extranodal site have been associated with CNS disease in patients with intermediate- to high-grade histologies ( [221](#), [222](#), [224](#), [225](#) ). Symptoms of spinal cord compression may include back pain, paresthesias, weakness, and incontinence and require emergent recognition and therapy.

Primary ocular lymphoma is part of the spectrum of CNS lymphoma. Approximately 5 to 15% of PCNSLs have ocular involvement at diagnosis, whereas CNS involvement may follow isolated ocular lymphoma in 50 to 80% of patients ( [221](#) ). Ocular symptoms include blurred vision, loss of visual acuity, or “floaters,” but patients can be asymptomatic ( [221](#) ). Slit lamp examination is recommended for patients with CNS or ocular lymphoma. The external eye usually is normal, and the diagnosis can be confused with uveitis, vitritis, or



glaucoma ( [226](#) ).

Lymphomas of the extraocular space are more common than ocular lymphomas and can arise in the superficial conjunctiva or eyelids or deeper in the lacrimal gland or retrobulbar tissues ( [227](#) ). Blurred vision, ptosis, chemosis, epiphora, and proptosis can occur, depending on the orbital site that is involved. Most orbital lymphomas are of B-cell origin and are low grade, particularly in the conjunctiva or eyelids, but can be large B-cell lymphomas in the lacrimal gland or retrobulbar area ( [227](#) ). Bilateral involvement occurs in 10 to 15% of patients. CNS involvement rarely occurs, and the risk for distant spread is lower with conjunctival lesions ( [227](#) ).

Other symptoms and signs depend on unusual extranodal presentations. Bone pain is uncommon, unless the lymphoma has a leukemic component or the patient has extranodal bone lymphoma, which accounts for 3 to 5% of extranodal NHL ( [53](#), [227](#), [228](#) ). The long bones are most commonly affected, and there may be soft tissue swelling ( [229](#) ). The lesions may be lytic, sclerotic, or mixed with periosteal erosion and are best evaluated by MRI. Genitourinary presentations include renal mass, ureteral obstruction, testicular mass, ovarian mass, and vaginal bleeding. The most common cause of a testicular mass in an elderly man is NHL. Primary breast lymphoma is rare, accounts for 0.04 to 0.50% of all malignant breast tumors, and has a bimodal presentation ( [227](#) ). Breast lymphoma in young women is associated with pregnancy and lactation and often has diffuse involvement of both breasts ( [230](#) ). Older women tend to have discrete masses with unilateral involvement. Large B-cell lymphoma is the most common type of the previously mentioned extranodal NHL ( [227](#) ). Therapy of extranodal NHL is addressed in the section Management of Extranodal Lymphomas.

The lungs and, particularly, the heart are rarely involved in NHL, but patients commonly present with cardiopulmonary symptoms. Cough, dyspnea, and chest pain, usually of a short duration of a few weeks, may be the presenting symptoms of mediastinal nodal involvement. The superior vena cava syndrome can occur with T-cell LL or large B-cell lymphoma of the mediastinum. Pleural effusions require immunophenotyping by flow cytometry (FC) to determine if there is lymphomatous involvement. The most common primary lung lymphoma is the low-grade small B-cell bronchus-associated lymphoid tissue lymphoma, which more commonly presents as localized opacities ( [231](#) ). Bronchoscopy may reveal bronchial narrowing, and biopsy often identifies submucosal involvement ( [232](#) ). Open lung biopsy may be required if bronchoscopy is nondiagnostic. Primary lymphoma of the pleura has been associated with chronic tuberculosis pyothorax or empyema ( [233](#) ). Primary cardiac lymphoma is extremely rare, usually occurs as a large B-cell NHL in an immunocompromised host, and may present with heart failure, pericardial effusion, or arrhythmia, including heart block ( [234](#) ).

NHL occasionally presents with metabolic and endocrine problems that tend to be more prominent after introduction of therapy, particularly in the setting of large tumor volume or aggressive histologies ( [Chapter 72](#) ). Hypercalcemia, hyperuricemic renal failure, and severe hypoglycemia are unusual metabolic presentations. ATLL has approximately one-fifth of patients presenting with hypercalcemia at diagnosis ( [235](#) ). A few cases of primary adrenal lymphoma have been reported, and the initial presentation is usually due to the mass effect ( [236](#) ). Rarely, adrenal insufficiency may be the initial presentation of NHL and is rapidly fatal if it is unrecognized ( [237](#) ).

## STAGING

The Ann Arbor staging classification ( [Table 90.4](#)), which was developed for HD in 1971, has been the standard scheme for NHL ( [238](#)); however, it does not account for tumor burden and does not correlate well with prognosis. Other staging systems have been developed for NHL, particularly for NHL in children, specific pathologies (e.g., lymphoblastic, Burkitt, follicular), and extranodal sites of disease (e.g., cutaneous, gastrointestinal). Prognosis and therapy depend not only on stage, but also, more important, on the pathologic features of the lymphoma and a variety of clinical parameters that reflect tumor bulk and kinetics (e.g., size of mass, LDH level, number of extranodal sites) ( [239](#), [240](#)).

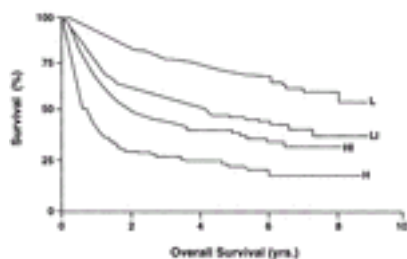
**TABLE 90.4. Staging of Non-Hodgkin Lymphoma**

| Staging System                                    | Stage               | Definition  |                  |                   |
|---|---------------------|---|------------------|-------------------|
| Ann Arbor   | I                   | Involvement of a single lymph node region or a single extranodal organ or site (stage I <sub>E</sub> ).   |                  |                   |
|   | II                  | Involvement of two or more node regions on the same side of the diaphragm or localized involvement of an extranodal site or organ (stage II <sub>E</sub> ) and one or more lymph node regions on the same side of the diaphragm.  |                  |                   |
|   | III                 | Involvement of lymph node regions on both sides of the diaphragm that may also be accompanied by localized involvement of an extranodal organ or site (stage III <sub>E</sub> ) or spleen (stage III <sub>S</sub> ), or both (stage III <sub>SE</sub> ).  |                  |                   |
|   | IV                  | Diffuse or disseminated involvement of one or more distant extranodal organs with or without associated lymph node involvement.   |                  |                   |
|   | B                   | Fever >38° C, night sweats, or weight loss >10% of body weight in the 6 mo preceding admission, or a combination of these, is defined as a systemic symptom.  |                  |                   |
| National Cancer Institute Modified Staging System | I                   | One or two nodal sites or one extranodal site of disease without poor prognostic features.  |                  |                   |
|   | II                  | More than two nodal sites of disease or one or more localized extranodal sites plus draining nodes with none of the following poor prognostic features: performance status =70, B symptoms, any mass >10 cm in diameter (particularly abdominal), serum lactate dehydrogenase >500 IU/dl, bone marrow involvement, three or more extranodal sites of disease. |                  |                   |
|   | III                 | Stage I or II plus any poor prognostic features.  |                  |                   |
| International Prognostic Index                    |                     | Adverse factors   | Risk group       | Number of factors |
|   |                     | Performance status =2 <sup>a</sup>  | Low              | 0, 1              |
|   |                     | Lactate dehydrogenase > normal <sup>a</sup>   | Low-intermediate | 2                 |
|   | Extranodal sites =2 | High-intermediate   | 3                |                   |



<sup>a</sup> Age-adjusted factors.

The international prognostic index (IPI) ( [Table 90.4](#) ) was developed to correlate clinical parameters with prognosis and appears to be more useful than the Ann Arbor staging system in predicting survival ( [Fig. 90.7](#) ) ( [241](#) ). When the REAL Classification was under evaluation for clinical usefulness, an early report indicated that a high IPI did not predict an adverse outcome for ALCL; however, subsequent studies have indicated that the IPI correlates with prognosis for all histologies ( [242](#) , [243](#) and [244](#) ). Additional biologic and genetic parameters, particularly genomic profiling, further subdivide prognostic groups in NHL (see the section [Prognostic Factors](#) ).



**Figure 90.7.** The International Prognostic Index subdivides patients with aggressive lymphoma into risk groups and correlates them with 5-year survival. L, low (73%); LI, low intermediate (51%); HI, high intermediate (43%); H, high (26%). (From Anonymous. A predictive model for aggressive non-Hodgkin’s lymphoma. *N Engl J Med* 1993;329:987–994, with permission.)

[Table 90.5](#) outlines the clinical evaluation and staging studies to consider when evaluating patients with NHL. Bone marrow evaluation detects disease in 20 to 40% of all patients with NHL and from 50 to 70% of patients with indolent lymphomas ( [245](#) ). FC can increase the overall percent involvement, but morphology can be positive when FC is negative, as well as vice versa ( [246](#) , [247](#) ). Immunoperoxidase techniques may identify isolated tumor cells that are not visualized on routine hematoxylin and eosin stains. Because NHL can have focal involvement, there may be a slight advantage in performing bilateral posterior iliac crest biopsies ( [248](#) ). MRI is a sensitive technique to identify marrow involvement in patients whose biopsies have been negative ( [249](#) ). Molecular studies, such as Southern blot analysis and PCR, are more sensitive than morphology and further increase the percentage of marrow involvement; however, there is an ongoing debate about the impact of molecular markers on prognosis in NHL ( [250](#) , [251](#) ).

**TABLE 90.5. Staging Studies in Non-Hodgkin Lymphoma**

Complete history and physical examination; inquiry about B symptoms, human immunodeficiency virus risk, infections, autoimmune diseases, immunosuppressive therapy

Complete blood cell count, including leukocyte count with differential; platelet count  
 Chemistry profile, particularly lactate dehydrogenase; also alkaline phosphatase, uric acid, creatinine, calcium, and albumin  
 Computed tomography of chest, abdomen, pelvis, and neck  
 Bone marrow aspiration and biopsy: cytogenetics and consider molecular tests (*BCL2* for follicular lymphoma, *BCL1* for mantle cell) and gene rearrangement studies in selected patients  
 Lumbar puncture with cytology in selected patients: all patients with small noncleaved cell and lymphoblastic lymphomas; patients with non-Hodgkin lymphoma in certain sites (i.e., nasopharynx, epidural space, testes, and large cell with marrow involvement); human immunodeficiency virus-positive patients  
 Gastrointestinal endoscopy for patients with Waldeyer ring involvement or abdominal symptoms  
 Cytologic assessment of third space fluids (pleura, peritoneum)  
 Immunophenotype of pathology specimen (cytogenetics and gene rearrangement data in selected patients)  
 Selected radiologic procedures as clinically appropriate (e.g., gallium, positron emission tomography scan, magnetic resonance imaging, ultrasound, bone scan)  
 Other blood evaluations: levels of  $\beta_2$ -microglobulin and cytokines (interleukin-2 receptor, tumor necrosis factor)

---

Gallium and PET scans are sensitive ways to diagnose disseminated disease and may be used to assess response, particularly when residual abnormalities are noted on CT scans after therapy. Patients with a tumor that remains gallium avid during therapy are more likely to develop progressive disease than those patients with lesions that become gallium negative ( [252](#), [253](#) ). Similarly, persistent abnormal fluorine 18 fluorodeoxyglucose by PET after therapy is predictive of relapse and may be more sensitive than gallium scans ( [254](#), [255](#) ).

## PROGNOSTIC FACTORS

[Table 90.6](#) outlines clinical, laboratory, and biologic features that affect prognosis in NHL. As part of the IPI, serum LDH represents a surrogate quantitative measure for tumor burden, and other serologic markers, particularly  $\beta_2$ -microglobulin ( $\beta_2m$ ), have been identified as prognostic factors.  $\beta_2m$  is a low-molecular-weight polypeptide that is noncovalently linked to the heavy chain of class I histocompatibility antigens that is shed with cell turnover ( [256](#) ). Combined with serum LDH,  $\beta_2m$  provides a reliable serologic system for predicting freedom from relapse and survival in large cell lymphoma ( [257](#) ). Patients at low risk for disease recurrence have normal levels of both markers, whereas elevations in levels of LDH and  $\beta_2m$  (more than 3 mg/L) predict shortened remission and survival ( [257](#) ). Quantitation of a soluble, truncated IL-2 receptor that is secreted by activated lymphocytes has been applied as a serologic marker for lymphoma burden ( [258](#), [259](#) ). Elevations of tumor necrosis factor and its soluble receptors (p55 and p75) ( [260](#) ), IL-6 ( [261](#) ), and basic fibroblast growth factor ( [262](#) ) have correlated with a poor prognosis, whereas other cytokines, such as IL-10, have not consistently predicted prognosis ( [263](#) ).

**TABLE 90.6. Clinical and Pathologic Features That Affect Treatment Outcome in**

## Non-Hodgkin Lymphoma

---

### Clinical features

Stage (I and II vs. III and IV)

Age ( =60 vs. >60 yr)

Performance status (Eastern Cooperative Oncology Group 0, 1 vs. =2)

B symptoms

Mass size (<10 cm vs. =10 cm)

Number of extranodal sites (<2 vs. =2)

Bone marrow involvement

Treatment courses to complete remission ( =3 vs. >3)

### Laboratory parameters

Lactate dehydrogenase

$\beta_2$ -microglobulin

Interleukin-2 receptor level

Tumor necrosis factor level

### Biologic characteristics

Histology

Lineage (B cell vs. T cell)

Proliferative rate

Tumor-infiltrating T-lymphocyte response

Karyotype

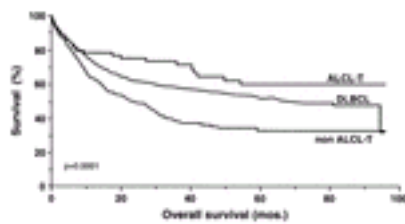
Genotype

---

Separation of NHL into three prognostic groups by histologic appearance formed the basis of the WF; however, it often combined separate entities, and it failed to recognize the impact of immunophenotyping. Although the WHO classification separates disorders into B- and T-cell neoplasms, it does not recognize the clinical grade of the disease. Clinical correlations are being recognized for the WHO classification, which combines all follicular lymphomas together, includes immunoblastic lymphoma as a subtype of diffuse large B-cell lymphoma (DLBCL), and introduces multiple types of PTCL. Although patients with a predominantly follicular lymphoma experience prolonged survival despite a continuous rate of relapse, there may be subtypes of follicular lymphoma (grade III and some types that were formerly called *nodular mixea*) without continuous relapses ( [264](#) , [265](#) and [266](#) ). Some, but not all, studies suggest that immunoblastic lymphoma is a subtype of DLBCL that is associated with immunodeficiency and with inferior outcome; however, there is difficulty in reproducing the diagnosis, and the diagnosis is rare if strict criteria are applied ( [267](#) ).

Since the initial recognition of T-cell lymphomas in the 1970s, there has been disagreement about the impact of recognizing the cell of origin on prognosis. Early series of PTCL disagreed about whether PTCL has an inferior survival to the more common DLBCL ( [268](#) , [269](#) ). Large, prospective trials have indicated a worse prognosis for PTCL than DLBCL, except for ALCL of T-cell origin, which has a survival that is equivalent or superior to DLBCL ( [Fig. 90.8](#) ) ( [270](#) , [271](#) ). Within all of the categories (PTCL, DLBCL, T-cell ALCL), there are clinical, immunophenotypic, and genetic markers that further predict prognosis. Randomized pediatric trials for the most aggressive lymphomas (Burkitt and T-cell lymphoblastic) have identified the impact of pathology and different therapies on outcome ( [272](#) ). The improved response and survival of monoclonal B-cell antibody (anti-CD20) plus chemotherapy compared to chemotherapy alone in DLBCL is additional

evidence that supports the importance of recognizing the cell of origin ( [273](#) ).



**Figure 90.8.** Overall survival of 228 peripheral T-cell lymphoma [non-T-cell anaplastic large cell lymphoma (ALCL-T)] and 60 ALCL-T compared to 1595 diffuse large B-cell lymphoma (DLBCL) patients. (From Grisselbrecht C, Gaulard P, LePage E, et al. Prognostic significance of T-cell phenotype in aggressive non-Hodgkin's lymphoma. *Blood* 1998;92:76–82, with permission.)

Advances in lymphoma biology have contributed to the understanding of tumor-specific variables that impact on clinical behavior. Cell kinetics (low growth vs. high growth fraction), T-cell immune responses ( $T4^+$  and  $T8^+$ ), and cell adhesion molecules are biologic parameters that contribute to lymphomagenesis and may correlate with prognosis. Cell proliferative fraction, as determined by S-phase percentage, thymidine labeling, or immunocytochemistry influences outcome in indolent and aggressive lymphomas ( [274](#) , [275](#) and [276](#) ). In DLBCL, a high proliferative fraction, as defined by expression of the nuclear proliferation antigen Ki-67 (more than 60% of malignant cells), has identified patients at risk for early relapse and short survival ( [276](#) ). Similarly, loss of immune recognition structures on malignant cells, such as the histocompatibility antigens (e.g., HLA-DR), is thought to be associated with deficient local suppressor and cytotoxic T-cell response—that is, tumor-infiltrating T lymphocytes ( [277](#) ). Patients with HLA-DR negative lymphomas were initially reported to have a shortened survival, but some studies have not confirmed the correlation and have identified a favorable prognosis in NHL with increased  $CD4^+$  memory T cells ( [278](#) , [279](#) , [280](#) and [281](#) ).

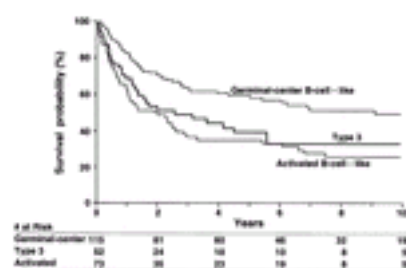
Cell adhesion molecules are involved in lymphocyte homing and belong to adhesion receptor families, including selectin, integrin, Ig, and CD44 ( [282](#) ). Weak expression of the integrin ligand intercellular adhesion molecule 1 has correlated with dissemination and a poor prognosis in some, but not all, studies ( [283](#) ). Alternatively, increased CD44 expression has frequently correlated with a poor survival in DLBCL, even with limited-stage disease ( [283](#) , [284](#) and [285](#) ). The variables of cell growth, T cells, and expression of cell adhesion molecules appear to have predictive prognostic value independent of clinical parameters and may be used to construct biologically relevant models of risk assessment ( [275](#) , [282](#) , [286](#) ).

Correlations between genetic abnormalities and disease entities are a central part of the WHO classification and the understanding of lymphomagenesis ( [Chapter 89](#) ). Immunoperoxidase stains can identify protein expression that correlates with a specific cytogenetic abnormality or prognosis, or both. Examples include cyclin D1 expression with  $t(11;14)$  of mantle cell NHL ( [287](#) ) and anaplastic lymphoma kinase (ALK) with the  $t(2;5)$  and its variants in T- or null-cell ALCL ( [288](#) ). Alternatively, BCL2 expression does not always coincide with the *BCL2* rearrangement [ $t(14;18)$ ] of follicular lymphoma but may predict an inferior prognosis in DLBCL ( [289](#) , [290](#) ). Although there is contradictory data on the impact of *BCL6* gene rearrangement on prognosis in DLBCL, increased BCL6

messenger RNA expression is associated with improved survival ( [291](#) ). Acquired chromosome 11q deletion involves the ataxia telangiectasia mutated ( *ATM* ) gene locus, is seen in a variety of NHL (B-cell, mantle cell, DLBCL, T-cell prolymphocytic leukemia), and is associated with a complex karyotype and a loss of tumor suppressor function ( [292](#) ).

Specific numerical abnormalities in NHL yield limited clinical data but should be correlated with pathology or other clinical factors. Favorable responses to therapy have been reported with normal metaphases and +3 or duplication of 3p, whereas chromosome breaks at 1q21–23, 1p32–36, 7, and 17p have been associated with a poor prognosis ( [293](#) , [294](#) , [295](#) and [296](#) ). Other correlations include 6q11–q16 with B symptoms, 11q13 with elevated LDH levels, and 3q21–q25 and 13q21–q24 with bulky disease ( [294](#) ). Inferior survival in follicular lymphoma was associated with deletions in 6q25–q27 or with complex karyotypes (two or more imbalanced chromosomal aberrations) ( [297](#) ). Trisomy 3 and normal metaphases were observed in less aggressive PTCL, whereas deletions in 6q, total or partial trisomy 7q, and monosomy 13 or changes in 13q14 were more common in the more aggressive PTCL ( [298](#) ). An increased number of chromosomal imbalances, gains of 3q or 12q, losses of 9p, and a loss of tumor suppressor genes are associated with an aggressive course in mantle cell NHL ( [299](#) , [300](#) ).

Gene expression profiling by using DNA microarrays is yielding prognostic information in NHL and has subdivided DLBCL into prognostic groups according to a molecular profile ( [301](#) , [302](#) ). Three gene expression subgroups, germinal center, activated B cell, and a third type, were identified and predicted prognosis independent of IPI ( [Fig. 90.9](#) ) ( [302](#) ). *BCL2* translocation and c-rel amplification were identified only in the germinal center subtype that had the best prognosis. Cell lines from the germinal center DLBCL have decreased activity of the nuclear factor- $\kappa$ B pathway, which blocks the apoptotic effects of chemotherapy and is increased in the poorer prognosis, activated B-cell type ( [302](#) ). Gene expression profiles have identified major differences between *de novo* DLBCL and transformation of follicular lymphoma to DLBCL with changes in expression of c-myc and its regulated genes in the latter ( [303](#) ).



**Figure 90.9.** Kaplan–Meier survival curves of subgroups of diffuse large B-cell lymphoma according to gene expression profiles. Three subgroups of diffuse large B-cell lymphoma were identified, with the best prognosis occurring in the germinal center B-cell-like type. (From Rosenwald A, Wright G, Chan W, et al. The use of molecular profiling to predict survival after chemotherapy for diffuse large B cell lymphoma. *N Engl J Med* 2002;346:1937–1947, with permission.)

Treatment-associated parameters can also be applied to assess the probability of sustained remission. The relative dose intensity of the chemotherapy that is administered and the interval to attainment of complete remission (CR) influence the duration of remission ( [304](#) , [305](#) , [306](#) and [307](#) ). In one series, rapidly responding patients (i.e., CR in three

or fewer treatment courses) had a risk of relapse that was one-half that of slower responders (307); however, slow responses in a later trial could not be used to accurately identify patients who could benefit from early transplantation (308). P-glycoprotein expression, which correlates with drug resistance, is uncommon (<5%) in untreated lymphoma patients but is often found in previously treated patients and can be a target for modifiers of drug resistance (309). Theoretically, therapy in the future will be directed at a drug-resistant phenotype that is defined by biologic parameters, specific genes, and protein expression.

## THERAPEUTIC PRINCIPLES

Therapy follows assessment of the patient, the pathology, and the stage of the disease. The ability of the patient to tolerate therapy is dependent on age, performance status, and, if present, immunodeficiency due to a prelymphomatous condition. How advanced age adversely affects outcome in therapy is controversial, but comorbid illnesses and biologic differences of lymphomas can contribute to higher mortality in the elderly. Treatment-related toxicities are greater in elderly patients, but deaths from unrelated causes are also increased (310). Biologic differences of NHL between young and old patients are implicated by a greater lymphoma-related mortality in some series of elderly patients compared to younger cohorts (311) (see the section [Therapy in the Elderly](#)).

The type of therapy is based on pathology. One of the clinical disadvantages of the WHO and REAL classifications was the deletion of the WF grading system. Clinical schemas are being proposed to recognize the biologic behavior along with the cell of origin of the lymphoid neoplasm ( [Table 90.7](#)).

**TABLE 90.7. Proposed Clinical Schema for Malignancies of the Lymphoid System**

| B-Cell Lineage   | T-Cell Lineage  |
|--|---|
| Indolent lymphomas/leukemia (untreated survival measured in years)         |   |
| Chronic lymphocytic leukemia and small lymphocytic lymphoma                | Large granular lymphocytic leukemia, T-cell and natural killer-cell types                               |
| Lymphoplasmacytic lymphoma, immunocytoma, Waldenström macroglobulinemia    | Mycosis fungoides and Sézary syndrome   |
| Hairy cell leukemia  | Primary cutaneous anaplastic large cell   |
| Splenic marginal zone lymphoma   | Smoldering and chronic adult T-cell leukemia/lymphoma (human T-cell lymphotropic virus type 1 positive) |
| Marginal zone B-cell lymphoma  |   |
| Extranodal (mucosa-associated lymphoid tissue B-cell lymphoma)             |   |
| Nodal (monocytoid)   |   |
| Follicle center lymphoma, follicular (small cell)—grade I                  |   |
| Follicle center lymphoma, follicular (mixed small and large cell)—grade II |   |
| Aggressive lymphomas (untreated survival measured in months)               |   |
| Plasmacytoma, multiple myeloma   | Prolymphocytic leukemia   |



|   |  |
|---|--|
| Mantle cell lymphoma  | Peripheral T-cell lymphoma, unspecified  |
| Follicle center lymphoma, follicular (large cell)—grade III   | Angioimmunoblastic lymphoma  |
| Diffuse large B-cell lymphoma (includes immunoblastic and diffuse large and centroblastic lymphoma) | Angiocentric lymphoma (nasal type natural killer-cell and T-cell lymphoma)       |
| Primary mediastinal (thymic) large B-cell lymphoma  | Intestinal T-cell lymphoma   |
|   | Anaplastic large cell lymphoma (T-cell and null-cell type)                       |
|   | Hepatosplenic ?d T-cell lymphomas (gamma delta)                                  |
|   | Subcutaneous panniculitis-like T-cell lymphoma                                   |
| Highly aggressive lymphomas and acute leukemias (untreated survival measured in weeks)              |  |
| Precursor B-lymphoblastic lymphoma/leukemia   | Precursor T-lymphoblastic lymphoma/leukemia                                      |
| High-grade B-cell lymphoma, Burkitt-like  | Adult T-cell lymphoma/leukemia (human T-cell lymphotropic virus type 1 positive) |
| Burkitt lymphoma and B-cell acute leukemia  |  |
| Plasma cell leukemia  |  |

Adapted from Hiddemann W, Longo DL, Coiffier B, et al. Lymphoma classification—the gap between biology and clinical management is closing. *Blood* 1996;88:4085–4089.

---

The intensity of therapy is based on pathology and stage of disease. Advanced stage, tumor bulk as reflected by size (usually larger than 10 cm) and LDH, and number of extranodal sites of involvement were recognized early as independent prognostic determinants in NHL and now contribute to the IPI ([239](#), [312](#), [313](#) and [314](#)). The IPI has correlated clinical features into prognostic groups for indolent and aggressive lymphomas ([241](#), [243](#), [315](#), [316](#)).

After therapy is instituted, response needs to be assessed according to standardized criteria that were developed in 1998 by an international workshop of lymphoma investigators ([Table 90.8](#)) ([317](#)). Nodal masses should be smaller than or equal in size to 1.5 cm to be considered normal but should be smaller than or equal in size to 1 cm if they are initially clinically abnormal in the range from 1.0 to 1.5 cm ([317](#)). A common problem, particularly in large cell NHL, is a residual mass after therapy. A designation of unconfirmed complete response is given if there is a greater than 75% reduction in tumor size after therapy ([317](#)). Persistently positive gallium or PET scans after therapy suggest residual disease, but biopsy should be considered if a therapeutic decision is going to be made. FC studies, cytogenetics, and molecular markers are not presently required in the assessment of clinical response but are areas of ongoing investigations. The endpoints of clinical trials should also be well defined, and their importance may vary according to type of lymphoma ([317](#)). For example, progression-free survival (PFS) is more important in aggressive lymphomas than in indolent lymphomas, for which the time to the next treatment is more relevant. The problem with the latter end point is that guidelines for initiation of treatment need to be standardized as well.



**TABLE 90.8. Response Criteria for Non-Hodgkin Lymphoma**

| Response Category             | Physical Examination              | Lymph Nodes      | Lymph Node Masses | Bone Marrow             |
|-------------------------------|-----------------------------------|------------------|-------------------|-------------------------|
| Complete response             | Normal                            | Normal           | Normal            | Normal                  |
| Complete response unconfirmed | Normal                            | Normal           | Normal            | Indeterminate           |
| Partial response              | Normal                            | Normal           | >75% decrease     | Normal or indeterminate |
|                               | Normal                            | =50% decrease    | =50% decrease     | Positive                |
|                               | Decrease in liver/spleen          | =50% decrease    | =50% decrease     | Irrelevant              |
| Relapse/progression           | Enlarging liver/spleen, new sites | New or increased | New or increased  | Reappearance            |

NOTE: See text for definitions of normal.

Adapted from Cheson BD, Horning SJ, Coiffier B, et al. Report of an international workshop to standardize response criteria for non-Hodgkin's lymphoma. *J Clin Oncol* 1999;17:1244.

## INDOLENT LYMPHOMAS

Indolent lymphomas are characterized by a long median survival and by a slow, but continuous, decline in survival. They are usually advanced in stage; respond to therapy, but relapse; may transform over time to a more aggressive course; and rarely spontaneously regress. With the availability of new chemotherapy agents and the advent of immunotherapy, the therapeutic options for indolent lymphomas are increasing in number ( [Table 90.9](#)). Although the expansion of therapies represents a major advancement, the decisions of when to initiate therapy and what type of therapy to select are often controversial and confusing for the individual patient.

**TABLE 90.9. Therapeutic Options for Indolent Lymphoma**

|   |
|---|
| Watchful waiting                          |
| Local radiation for limited stage disease |
| Chemotherapy                              |
| Alkylating agent                          |
| Nucleoside analog                         |
| Combination chemotherapy                  |
| Immunotherapy                             |
| Unconjugated monoclonal antibody          |
| Radioimmunotherapy                        |
| Interferons                               |
| Interleukins                              |
| Vaccines                                  |

- Combined modality
  - Chemotherapy and radiation
  - Chemotherapy and immunotherapy
- Transplantation
  - Autologous with or without purging
  - Allogeneic
    - Myeloablative
    - Nonmyeloablative
- Selected therapies
  - Antibiotics in gastric lymphoma of mucosa-associated lymphoid tissue
  - Splenectomy

---

Indolent B-cell lymphomas include follicular lymphoma, small lymphocytic lymphoma, lymphoplasmacytoid lymphoma and immunocytoma, and marginal zone lymphoma. Indolent T- and NK-cell lymphomas are less common and are less well recognized, other than CTCL ( [Chapter 94](#)). T- and NK-cell lymphomas and leukemias, which can have an indolent phase, include large granular T- and NK-cell leukemia, smoldering HTLV-1-positive ATLL, and, more controversially, some types of PTCL. Follicular lymphomas formerly included follicular small cleaved lymphoma (FSCL), follicular mixed lymphoma (FML), and follicular large cell lymphoma and roughly correlate with cytologic grades I, II, and III, respectively. Grades I and II follicular lymphoma are considered indolent, whereas grade III is an aggressive lymphoma that is similar to DLBCL.

Follicular lymphoma (grades I and II) is the most common indolent lymphoma in the West, usually comprising 25 to 35% of lymphomas compared to 5 to 12% in Asia ( [46](#), [318](#)). Most patients present with asymptomatic lymphadenopathy; B symptoms occur in approximately one-fourth of patients ( [265](#)). The disease occurs primarily in the elderly (median age, 55 to 65 years), has a near equal male to female ratio, and usually is disseminated at diagnosis (stages III and IV =70%) ( [265](#), [319](#), [320](#), [321](#) and [322](#)). Marrow involvement occurs in 40 to 60% of FSCL and in 25 to 35% of FML ( [319](#), [320](#), [321](#) and [322](#)). Evaluating the marrow or blood for the *BCL2* translocation often identifies occult disease and can upstage patients by molecular criteria ( [323](#)).

Before the recognition of different types of lymphomas by immunophenotyping and the prevalence of *BCL2* translocation in follicular lymphoma, extensive descriptions were made about pathologic differences among follicular lymphomas. The degree of nodularity in follicular lymphoma had been associated with a better prognosis in FSCL, but it was not of major significance without near complete absence of follicles, as in diffuse small cleaved cell lymphoma ( [321](#), [322](#)). With present-day immunophenotyping, most of diffuse small cleaved cell lymphomas are more aggressive than follicular lymphomas and include mantle cell NHL and PTCL.

Along with cytologic grading, identification of *BCL2* translocations may further subclassify follicular lymphomas. Approximately 70% of patients have translocations at the major breakpoint region that is located in the untranslated region 3' of the last exon of the *BCL2* gene, and 10 to 15% of patients have translocations in the minor cluster region that is 30 kilobases downstream of the *BCL2* gene ( [318](#), [324](#)). Lopez-Guillermo et al. ( [324](#)) correlated survival with *BCL2* rearrangements: The 3-year failure-free survivals (FFSs) for minor cluster region, major breakpoint region, and germline cases were 95%, 76%, and 57%, respectively (  $p < .001$ ). The impact of persistence of *BCL2* rearrangement in follicular

lymphomas after therapy is controversial, because there are data indicating that its presence adversely affects clinical progression after therapy, and, alternatively, other series indicate that it has no effect on long-term survival ( [251](#), [325](#), [326](#) ). Median survivals for follicular lymphomas have been in the range of 8 to 11 years ( [319](#), [320](#), [322](#) ). Although survival has not changed substantially over the past two decades, preliminary data suggest that survival may be improving with the addition of immunotherapy.

Small B-lymphocytic lymphoma (SLL) is part of the spectrum of diffuse small B-cell lymphomas that includes lymphoplasmacytoid lymphoma, marginal zone lymphomas, and MCL ( [Chapter 88](#) ) ( [327](#) ). There is extensive clinical overlap with chronic lymphocytic leukemia (CLL) ( [Chapter 92](#) ), although there is more prominent lymphadenopathy and less lymphocytosis in SLL than in CLL ( [328](#), [329](#) ). An initial lymphocyte count of greater than  $4 \times 10^9$  per L is considered diagnostic of CLL ( [327](#) ). Over time, 10 to 20% of patients develop a lymphocytosis that is consistent with CLL ( [327](#) ). SLL represents 4 to 6% of NHL in the West, is a disease of the elderly (median age, 55 to 65 years), and has a male to female ratio of approximately 2:1 ( [327](#), [328](#) and [329](#) ). Patients usually present with generalized adenopathy, and marrow involvement is found in most patients (70 to 80%) ( [328](#) ). Splenomegaly may be prominent, and SLL is often the underlying malignancy in primary splenic lymphoma ( [327](#) ). Median survivals have been variable, from a low of 4 to 6 years to more than 10 years, and probably depend on the criteria that are used to separate SLL from CLL ( [328](#), [329](#) and [330](#) ). Deletion at chromosome 6q is the most common cytogenetic abnormality in SLL but has had no effect on prognosis ( [331](#) ). Unmutated genes, as opposed to hypermutated genes, and expression of CD38 have been associated with a worse prognosis in CLL ( [332](#), [333](#) ). Between 1 and 15% of SLL and CLL evolve into an aggressive large cell process that is known as *Richter syndrome*, which is characterized by bulky retroperitoneal adenopathy, rising LDH, and a survival of less than 1 year ( [334](#), [335](#) ).

When SLL has plasmacytic differentiation, it is referred to as a *lymphoplasmacytic lymphoma (LPL)*, and can clinically overlap with Waldenström macroglobulinemia ( [Chapter 100](#) ). LPL represents 1 to 2% of NHL, usually occurs in the elderly (median age, 60 to 65 years), and presents with lymphadenopathy and marrow involvement in most patients and splenomegaly in as much as one-half of patients ( [336](#) ). A paraprotein is found in 29 to 50% of patients, with IgM being the most prevalent type, and can contribute to hyperviscosity, neuropathy, and glomerular disease ( [327](#), [336](#) ). A positive Coombs test, cold agglutinin disease, cryoglobulinemia, and positive hepatitis C serology are associated with LPL and Waldenström macroglobulinemia ( [337](#) ). Translocation (9;14) involving the *PAX5* gene is the most common cytogenetic abnormality in LPL. Early reports using alkylating agents resulted in a median survival of only 5 years, but the introduction of nucleoside analogs and monoclonal antibody therapy has improved response and survival ( [338](#), [339](#) and [340](#) ).

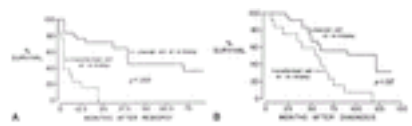
Marginal zone B-cell lymphomas (MZBL) include nodal-based disease (with or without monocytoid B cells), SMZL, and extranodal MALToma. Together, they represent 1 to 2% of NHL. Nodal MZBL occurs in the elderly (median age, 59 to 65 years), is the only indolent lymphoma in which women predominate (approximately a 2:1 female to male ratio), often presents with localized lymphadenopathy, and has less marrow involvement (29 to 43%) than other indolent lymphomas ( [327](#), [341](#), [342](#) and [343](#) ). Involvement of salivary glands and their adjacent nodes occurs in MZBL, usually in the setting of Sjögren syndrome ( [342](#), [344](#) ). Median survival has been variable owing to limited numbers of patients but has been recorded in the range from 9 to 12 years ( [343](#), [345](#) ). MALTomas are

discussed in the section Management of Extranodal Lymphomas.

SMZL, with or without villous lymphocytes, occurs in the elderly (median age, 61 to 70 years), has a slight female predominance, and usually presents owing to symptoms of splenomegaly ( 346 , 347 ). Cytopenias are common (46 to 60%), peripheral adenopathy is rare (10 to 15%), and marrow involvement is usually detected (73 to 100%) ( 114 , 347 , 348 and 349 ). A paraprotein may be present and is usually IgM. Despite disseminated disease, splenectomy plays a role in therapy by alleviating symptoms and improving cytopenias ( 346 , 347 and 348 ). Median survival has been recorded to be 10.5 years but is shorter in the presence of a paraprotein, elevated  $\beta_2m$ , or lymphocytosis ( $>9 \times 10^9$  per L) ( 349 , 350 ). Patients with a more aggressive course have been reported to have unmutated genes with 7q deletion or to have *p53* mutations ( 351 , 352 ).

### Special Clinicopathologic Features

Clinicopathologic features that are unique to indolent lymphomas are histologic transformation and spontaneous regression. The forerunner and counterpart of histologic transformation is Richter syndrome of CLL and SLL ( 334 , 335 ). Histologic transformation of indolent lymphomas usually is associated clinically with increasing adenopathy and LDH levels. All of the indolent lymphomas can undergo transformation, but the most common lymphoma to do so is FSCL; the transformation is characterized pathologically by a loss of a follicular pattern and an increase in the number of large noncleaved cells ( 353 , 354 and 355 ). The median time from initial diagnosis to transformation is 4 to 6 years ( 353 , 354 and 355 ). The incidence of histologic transformation is uncertain but has been estimated to be between 10 and 40% of indolent lymphomas, and the risk increases over time ( 356 ). Autopsy series of nodular lymphomas have identified diffuse morphologic changes, usually with increased large cells, in more than two-thirds of patients ( 357 ). Histologic transformation may involve the expression of additional cytogenetic abnormalities and oncogenes ( 303 , 354 , 358 , 359 and 360 ). The disease course usually progresses rapidly after transformation, with a median survival of less than 1 year ( Fig. 90.10 ) ( 353 ); occasionally, patients may attain a long remission after transformation ( 355 ). Patients with limited-stage disease and no prior chemotherapy at the time of histologic transformation are more likely to have prolonged survival ( 355 ).



**Figure 90.10.** Histologic transformation of follicular center cell lymphoma. **A:** For patients with small cleaved cell lymphoma who underwent rebiopsy, median survival after transformation to large cell lymphoma was 2.5 months compared to 37.5 months in patients who had persistent cleaved cell lymphoma. **B:** Overall median survival was 56.5 months in the patients who transformed versus 89.2 months in the patients who had persistent cleaved cells at rebiopsy. (From Oviatt DL, Cousar JB, Collins RD, et al. Malignant lymphomas of follicular center cell origin in humans. V. Incidence, clinical features, and prognostic implications of transformation of small cleaved cell lymphoma. *Cancer* 1984;53:1109–1114, with permission.)

Spontaneous regression has occurred in indolent lymphomas, but its exact incidence is

uncertain. Horning and Rosenberg reported regression in 19 (23%) of 83 untreated follicular lymphoma patients, including complete regression in six patients ( [356](#) ). Spontaneous regression occurs in approximately one-fourth of primary cutaneous ALCL cases (see the section [Ki-1+ Anaplastic Large Cell Lymphoma](#)). Spontaneous remission in diffuse large cell lymphoma (DLCL) has rarely been observed ( [361](#) ).

Additional clinicopathologic terms that are often misnomers are *discordant histology* and *composite lymphoma*. Both are related to the fact that lymphomas, particularly of FCC origin, are dynamic processes, and variations in morphology occur at different biopsy sites in patients. *Discordant histology* refers to the identification of different histologic grades of lymphoma in the same patient. The most commonly identified discordant histology is a peripheral node with predominantly large noncleaved cells and a marrow with small cleaved cells ( [362](#) ). Clinically, therapy should be directed at the higher histologic grade, although the risk of relapse may be higher ( [362](#) ). *Composite lymphoma* has also been used to describe a mixture of histologic grades but probably should be restricted to lymphomas that have two distinct histopathologic types—that is, two distinct diseases, preferably with immunophenotypic and molecular genetic differences ( [363](#) ).

### Stages I and II Indolent Lymphoma

Limited-stage disease in indolent lymphomas is infrequent and may be as low as 6%, as reported by the National Cancer Institute (NCI) series of pathologically staged patients ( [364](#) ); most series that involve clinical staging report between 10 and 20% of patients with limited-stage disease ( [322](#), [365](#) ). Immunophenotyping and molecular genetic studies may identify more advanced-stage disease, as well as predict the clinical course, but their impact on therapeutic decisions is controversial. Radiation therapy has achieved disease-free survival (DFS) in 31 to 85% of limited-stage patients with follow-up over 10 years, including a report from Stanford University of relapse-free survivals (RFSs) of 44% and 37% at 10 and 20 years, respectively ( [366](#), [367](#), [368](#) and [369](#) ). Although these reports suggest that some limited-stage patients may be curable, there is not a clear plateau on the survival curves. Most relapses have occurred outside the radiation field. The best results have been in young patients (younger than 50 years of age), in patients with a small amount of disease (less than 2.5 cm), and in stage I disease ( [365](#) ).

More extensive radiation (total lymphoid irradiation vs. involved field or extended field) has been associated with a better survival in a multivariate analysis, but no significant difference was noted in survival based on the extent of radiation in clinically or pathologically staged patients ( [367](#) ). Although extended field radiation is used frequently, no conclusive data are available to support more extensive radiation than involved field for localized low-grade lymphomas. The role of adjuvant chemotherapy for localized low-grade lymphomas has not been evaluated thoroughly. Results of small series have indicated fewer relapses in patients who receive combined chemotherapy and radiotherapy ( [370](#), [371](#) ), but adding chemotherapy has not improved survival in localized, indolent lymphomas ( [372](#) ).

Rituximab (anti-CD20 monoclonal antibody) was initially approved for relapsed indolent lymphomas with response rates in the 50% range but is now being used as front-line single-agent therapy, with response rates of 70 to 76% ( [373](#), [374](#) ). The rationale for its use in limited-stage patients includes its efficacy with low tumor burden, better PFS with molecular responses, and the fact that most limited-stage patients actually have advanced-stage disease.

## Stages III and IV Indolent Lymphoma

Many investigators advocate initial watchful waiting for the advanced-stage indolent lymphomas, because of a continual risk of relapse, and early chemotherapy has not improved overall survival (OS) ( [321](#), [367](#), [375](#), [376](#) ). Although stages III and IV usually are considered together, stage III has a tendency toward better survival than stage IV ( [322](#), [365](#) ). Radiation alone and combined modality therapy are associated with an RFS of more than 50% at 5 years in stage III patients, but there are continued relapses with longer follow-up ( [377](#), [378](#) ). Adverse prognostic factors in series that evaluate stage III patients include B symptoms, more than four sites of involvement, bulky disease, and elevated serum LDH levels ( [377](#), [378](#) ).

Among the most controversial aspects in the management of indolent lymphomas are the initiation of therapy and the selection of type of therapy ( [Table 90.9](#) ). The choices of therapy are multiple and vary widely from no initial therapy to various chemotherapy agents (single or combination), with or without monoclonal antibody therapy, to transplantation ( [319](#), [321](#), [367](#), [379](#) ). Clinical features that usually warrant therapy include B symptoms, bulky lymphadenopathy, nodal encroachment on vital organs, massive organomegaly, cytopenias, or transformation ( [319](#), [367](#) ). Age of the patient, performance status, comorbid illnesses, patient preference, and physician training and bias influence therapeutic decisions. Most studies that evaluate the therapy of indolent lymphoma are compromised owing to small patient numbers, the lack of randomized trials, the combination of different histologies and stages, and premature reporting. Because these diseases have long median survivals, long follow-up is required, and, ideally, randomized trials need to be developed to determine optimal therapy.

Prospective trials at Stanford University have evaluated different therapies in indolent lymphomas and the approach of watchful waiting before initiating therapy ( [367](#), [375](#) ). In a randomized series of 51 patients, no significant differences were noted in CR, RFS, or OS among three different treatments: chlorambucil; cyclophosphamide, vincristine, and prednisone (CVP); or irradiation ( [375](#) ). In a series of 83 patients with advanced disease who initially were not treated, a median actuarial survival of 11 years was reported; 61% of patients required therapy for progressive disease at a median time of 3 years ( [356](#) ). The median time to treatment was significantly shorter for FML (16.5 months) than for FSCL (48 months) or SLL (72 months), and the OS at 10 years was significantly poorer for FML (60%) as compared to FSCL (80%) ( [356](#) ).

Combination chemotherapy has been evaluated in randomized trials without evidence of superiority of any one regimen and without comparing therapy to watchful waiting, except in a single trial at the NCI. Although the Eastern Cooperative Oncology Group (ECOG) reported a better 5-year RFS in stages III and IV FSCL that received a combination of COPP (cyclophosphamide, vincristine, procarbazine, and prednisone) (57%) as opposed to a combination of BCOP (bischloroethylnitrosourea, cyclophosphamide, vincristine, and prednisone) (26%) and a combination of chlorambucil and prednisone (22%;  $p = .02$ ); no difference was noted in OS ( [380](#) ). The Southwest Oncology Group (SWOG) and Cancer and Leukemia Group B have similarly found no significant differences in response or OS in patients with indolent lymphomas when comparing the combination of CHOP [cyclophosphamide, hydroxydaunomycin, Oncovin (vincristine), and prednisone] with or without bleomycin to less aggressive regimens ( [381](#), [382](#) and [383](#) ); however, the M. D. Anderson Cancer Center (MDACC) group has advocated using doxorubicin in treating indolent lymphomas because of better CR and survival with CHOP when compared retrospectively to CVP ( [384](#) ). Using intensive non-cross-resistant regimens, the MDACC



group achieved CR rates of 65% in stage IV indolent lymphomas; some of these patients achieved molecular remissions with the loss of *BCL2* gene rearrangements by PCR analysis ( [385](#) ). CHOP plus rituximab has achieved response rates of 95% [55% CR plus 40% partial response (PR)] in indolent lymphomas and molecular remission in seven of eight patients who were previously positive for *BCL2* by PCR ( [386](#) ). Still, no randomized trial has shown a survival benefit of CHOP or other intensive regimens over less aggressive therapy in advanced-stage indolent lymphoma ( [383](#) , [387](#) ).

In an effort to answer the controversy between watchful waiting and initial combination chemotherapy, the NCI group prospectively randomized patients to a watch-and-wait arm with palliative involved field radiation or to an aggressive combined modality arm [ProMACE (prednisone, methotrexate, Adriamycin [doxorubicin], cyclophosphamide, and etoposide)] and MOPP [mustard, Oncovin (vincristine), procarbazine, and prednisone]; plus total lymphoid irradiation] ( [388](#) ). In a report of 104 patients, 83% were eligible for randomization, and 17% required therapy at diagnosis. No difference was noted in OS between the two groups (greater than 75% survival at 5 years), but there was a difference in DFS (51% vs. 12%;  $p < .01$ ), favoring initial therapy. Despite these results, no conclusive data support intensive chemotherapy as initial therapy for advanced-stage indolent lymphomas; however, patients, particularly those with poor prognostic features, can benefit from therapy and should continue to be evaluated in clinical trials.

Although alkylating agents have been the backbone of the early trials in indolent lymphomas, nucleoside analogs, particularly fludarabine, have been increasingly used because of high response rates in previously treated and subsequently untreated patients. Responses were reported in a range from 40 to 50% in previously treated patients with 10 to 20% CR and in a range from 60 to 90% in untreated patients with 37 to 50% CR ( [319](#) , [389](#) , [390](#) and [391](#) ). In general, these agents are well tolerated, with little gastrointestinal side effects and no alopecia, but cause prolonged decrease in T-cell immunity and contribute to immune-mediated cytopenias. In a phase III randomized trial of fludarabine versus CVP in patients with relapsed indolent lymphomas, there were no differences in response rates or OS; but fludarabine slightly improved PFS (11 months vs. 9.1 months;  $p = .03$ ) and treatment-free survival (15 months vs. 11 months;  $p = .02$ ) and had higher scores for social function (  $p = .0008$ ) ( [392](#) ).

Combinations of nucleoside analogs with other agents, particularly alkylating agents and the anthracenedione mitoxantrone, have been used in indolent lymphomas. In phase I and II trials of fludarabine plus cyclophosphamide in untreated indolent lymphomas and CLL, the response rates have been 92 to 100%, including CR rates of 47 to 89% ( [393](#) , [394](#) ). The estimated 5-year DFS and OS in an ECOG trial were 53% and 66%, respectively ( [394](#) ). Despite these encouraging results, opportunistic infections are increased with the combination, there may be an increased incidence of myelodysplasia, and phase III trials have not established the combination of cyclophosphamide and fludarabine as a superior regimen ( [393](#) ).

The combination of fludarabine, Novantrone (mitoxantrone), and dexamethasone (FND) has been established as an effective combination with response rates greater than 90% (CR, 43 to 67%) in treated and untreated indolent lymphoma ( [395](#) , [396](#) and [397](#) ). In previously untreated patients, the 2-year PFS was 63%, and the OS was 93% ( [396](#) ). Steroids that contribute to opportunistic infections may not increase efficacy and have been dropped by some investigators. In a randomized trial that involved patients with stage IV indolent lymphoma, FND was compared to an intensive alternating triple therapy (ATT) regimen. Maintenance therapy with interferon (IFN) and dexamethasone was given for 1 year to both arms. Although the 5-year FFS was better in ATT than in FND (50% vs. 41%;  $p = .02$ ),



there was no difference in OS (82% vs. 84%), and there were much higher grade III and IV toxicities with ATT ( 398 ). The controversy in indolent lymphoma is identifying an optimal treatment regimen that achieves high response rates, prolonged PFS, and mild toxicity.

## Immunotherapy

The role of IFN in indolent lymphomas has been mixed owing to conflicting data in randomized trials. In the 1980s, IFN- $\alpha$  as a single agent had response rates that varied from 30 to 50% in NHL, depending in part on the amount of prior therapy ( 399 , 400 ). No survival advantage was identified in most randomized trials that compared alkylator-based therapy to an alkylator with IFN- $\alpha$  ( 401 , 402 ); however, randomized trials with intensive regimens, often with anthracyclines, favored the IFN- $\alpha$  arm with better DFS and, usually, OS ( 403 ). Although other trials did not find a survival advantage to IFN- $\alpha$ , the U.S. Food and Drug Administration approved its use in combination with anthracyclines for aggressive follicular lymphomas in 1997 ( 404 ).

Rituximab (Rituxan) is an unconjugated antibody against the CD20 antigen and has emerged as an effective component in the therapy of all types of B-cell lymphomas. In a phase I dose-escalation trial, Maloney et al. ( 405 ) determined a dosage of 375 mg/m<sup>2</sup> weekly for four doses as the dosage for subsequent phase II trials ( 406 ). In a multicenter trial that involved 166 patients with relapsed indolent NHL, McLaughlin et al. reported a 48% response and a median time to progression of 13 months for responders ( 407 ). This study led to rituximab's approval by the U.S. Food and Drug Administration for relapsed follicular, indolent NHL in 1997. Humanized antibodies undergoing trials in B-cell NHL include epratuzumab and apolizumab, which are directed toward the CD22 receptor and a polymorphic determinant of HLA-DR, respectively ( 408 , 409 ).

Radioimmunotherapy has paralleled the development of unconjugated monoclonal antibody therapy and has led to the approval of two radioisotopes (yttrium 90 and iodine 131) that are conjugated to anti-CD20. The first radioimmunotherapy that was approved for the treatment of relapsed or refractory follicular and indolent or transformed NHL was yttrium 90 ibritumomab tiuxetan (Zevalin, IDEC Pharmaceuticals, San Diego, CA) ( 410 , 411 ). In a randomized trial that compared ibritumomab tiuxetan to rituximab, in relapsed and refractory follicular or CD20<sup>+</sup> transformed NHL, Witzig et al. ( 412 ) reported that the radioimmunotherapy arm had a higher response rate (80% vs. 56%,  $p = .002$ ; 30% vs. 16% for CR,  $p = .04$ ). Although there was no difference in the median duration of response (14.2 months vs. 12.1 months;  $p = .6$ ), durable responses of greater than or equal to 6 months were statistically more frequent with radioimmunotherapy (64% vs. 47%,  $p = .03$ ).

Iodine 131 tositumomab (Bexxar, Corixa, Seattle, WA; Glaxo Smith Kline, Philadelphia, PA) has been in clinical investigation since 1990 ( 413 ). Kaminski et al. ( 414 ) reported response rates of 65% in patients with chemorefractory indolent or transformed NHL compared to a 28% response after their last chemotherapy (  $p < .001$ ). The median duration of response was 6.5 months for iodine 131 tositumomab compared to 3.4 months after chemotherapy (  $p < .001$ ) ( 414 ). When used as initial therapy in patients with follicular lymphoma, the response rate was 97%, including 63% CR, and the median duration had not been reached ( 415 ).

Transient myelotoxicity has been the primary toxicity of radioimmunotherapy, but myelodysplasia has been reported in 5 to 7% of patients and remains a concern ( 410 , 414 ). Although new radioimmunoconjugates are under development, trials are ongoing to establish the optimal timing and use of radioimmunotherapy in NHL and whether

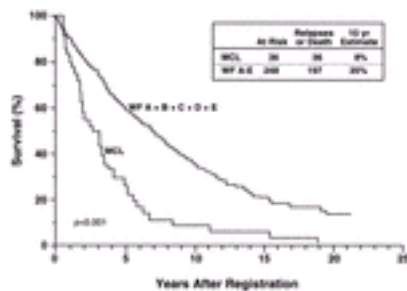
combining it with chemotherapy or transplantation may improve responses and survival ( [410](#), [416](#), [417](#) ). The ultimate form of immunotherapy for lymphoma is vaccination, which was pioneered in clinical trials by Levy et al. at Stanford University. Their studies and other aspects of immunotherapy are reviewed in [Chapter 74](#).

## MANTLE CELL LYMPHOMA

*MCL* has previously been referred to as *centrocytic*, *intermediate lymphocytic*, and *mantle zone lymphoma* and was given its present name in 1992 ( [418](#), [419](#) ). *MCL* represents approximately 2 to 8% of NHL in the West, occurs in the elderly (median age, 60 to 68 years), and has a male predominance (male to female ratio is 2 to 6:1) ( [420](#), [421](#) and [422](#) ). Most patients present with diffuse lymphadenopathy (75 to 100%), and splenomegaly is common (35 to 75%) ( [420](#), [421](#) and [422](#) ). B symptoms are present in 25 to 50% of patients, and 15 to 30% have or develop a unique gastrointestinal presentation with multiple lymphomatous polyposis ( [216](#), [420](#), [421](#) and [422](#) ). Bone marrow involvement is detected in 60 to 90% of patients, and as many as 25% have a leukemic phase ( [420](#), [422](#) ). CNS involvement has been documented in 9% of patients during the course of the illness ( [423](#) ).

*MCL* is considered a part of the spectrum of diffuse small B-cell lymphomas. They usually express CD5 (pan T marker) and are negative for CD10 (follicular center B cells). The classic cytogenetic marker, t(11;14)(q13;q32), is detected in 50 to 70% of cases by conventional chromosome analysis or fluorescence *in situ* hybridization, or both ( [424](#), [425](#) ). Overexpression of cyclin D1 RNA or protein, or both, is found in more than 90% of cases and is considered the most reliable pathologic marker in the diagnosis of *MCL* ( [426](#) ). Recent identification of a minimally deleted segment of 11q22–q23 that affects the *ATM* gene in 50% of *MCL* suggests that this could be the initial genetic event before the *BCL1* translocation to chromosome 14 ( [427](#) ). Loss of tumor suppressor genes, including *p53* and *CDKN2/p16*, is an ongoing genetic change that is associated with an aggressive course in *MCL* ( [299](#), [300](#), [428](#), [429](#) ).

*MCL* has features of an indolent NHL, because of the absence of a plateau on the survival curve, and aggressive NHL, because of short median survivals of 2.5 to 4.0 years ( [Fig. 90.11](#) ) ( [345](#), [420](#), [421](#) and [422](#) ). Although response rates are 50 to 90%, CRs are usually less than 50%, and median time to treatment failure is usually less than 18 months ( [330](#), [430](#) ). Although some investigators have recommended using anthracyclines in therapy ( [431](#) ), there is no randomized trial that proves the efficacy of anthracycline-based therapy over other regimens ( [432](#), [433](#) ). Similarly, there was no advantage to fludarabine plus idarubicin compared to fludarabine alone in a randomized trial that involved *MCL* patients ( [434](#) ). Cyclophosphamide and fludarabine and cladribine and mitoxantrone are other effective combinations for *MCL* in phase II trials ( [435](#), [436](#) ). Responses with rituximab have been in a range from 20 to 38% in relapsed *MCL*, and it is now being added to chemotherapy regimens ( [430](#), [437](#) ). CHOP plus rituximab resulted in a high response rate (96%: 48% CR and unconfirmed complete response and 48% PR) in 40 newly diagnosed *MCL* patients, but 28 (70%) relapsed or developed progressive disease with a median PFS of 16.6 months ( [438](#) ). Even patients who had achieved a molecular CR had no improvement in PFS ( [438](#) ).



**Figure 90.11.** The overall survival of 36 patients with mantle cell lymphoma (MCL) is significantly worse when compared to 248 patients with indolent lymphomas that are recognized by the Working Formulation (WF) as types A through E. [From Fisher RI, Dahlberg S, Nathwani BN, et al. A clinical analysis of two indolent lymphoma entities: mantle cell and marginal zone lymphoma (including the mucosa-associated lymphoid tissue and monocytoid B-cell subcategories): a Southwest Oncology Group Study. *Blood* 1995;85:1075–1082, with permission.]

More intensive regimens, often using stem cell transplantation (SCT), have had mixed results in MCL. The best published results are by Khouri et al. (439) from MDACC, who used hyper CVAD (cyclophosphamide, vincristine, doxorubicin, and dexamethasone) followed by autologous or allogeneic transplantation. For previously untreated patients, the 3-year event-free survival (EFS) and OS were 72% and 92%, respectively, compared to 17% ( $p = .007$ ) and 25% ( $p = .005$ ) in previously treated patients. Other autologous transplant series for MCL have not seen plateaus on survival curves even in first CR, and results approach zero survival in heavily treated patients (440, 441). Myeloablative radioimmunotherapy or allogeneic transplantation have been successful in resistant MCL (442, 443). The optimal chemotherapy and use of SCT have yet to be determined in MCL.

## AGGRESSIVE LYMPHOMAS

### Diffuse Large B-Cell Lymphomas

One of the problems of the WF was the heterogeneity of the neoplasms that were called *intermediate grade*. Subsets of intermediate-grade lymphomas, such as diffuse small cleaved, many of which are MCLs, behave clinically as low-grade neoplasms; that is, they have high relapse rates and have been difficult to cure. Intermediate-grade lymphomas that are curable with chemotherapy include DLBCL, B-cell immunoblastic lymphoma, and Ki-1+ ALCL (predominantly T cell in origin). Another subset of intermediate-grade lymphoma within the WF was diffuse mixed lymphoma (DML), which is also heterogeneous and generally has had a higher relapse rate than DLCL (444). The higher relapse rate in DML might be accounted for by the inclusion of low-grade lymphomas and some PTCL, which have generally been harder to cure than DLBCL (269, 270 and 271, 445).

Despite the recognition of DLBCL as a pathologic category within the WHO classification, it is heterogeneous. DLBCL constitutes as much as 20 to 25% of NHL in many series, and 40 to 50% of cases are curable in adults. Differences within the category of DLBCL include pathology and molecular genetics. Although B-cell immunoblastic lymphoma was categorized as high grade in the WF, it is generally regarded as intermediate grade in that no apparent differences in survival exist between it and other DLBCL in some series (446, 447). T-cell-rich B-cell lymphomas, many of which were previously within the DML category, are believed to represent a subset of large B-cell lymphoma in which the malignant large B cell is the minority cell (448). CD5<sup>+</sup> DLBCL is associated with a higher

IPI than the more common CD5<sup>-</sup> DLBCL and has a correspondingly worse survival ( 449 ). Within the category of DLBCL, there are molecular genetic differences that are associated with survival differences and probably are important in developing therapeutic strategies (see the section [Prognostic Factors](#)) ( 301 , 302 ).

Although studies are ongoing to identify different subgroups within DLBCL, therapy is directed at clinical features, pathology, and stage of disease (see the section [Therapeutic Principles](#)). Because DLBCL represents a group of potentially curable neoplasms, prognostic factors are important to recognize and can influence the type, intensity, and duration of therapy. Selecting the intensity of therapy based on prognostic factors is referred to as *risk stratification* and has been applied successfully in pediatrics in which the curability of all types and stages of NHL approaches 80% ( [Chapter 91](#) ).

Unique clinical presentations of DLBCL include large B-cell lymphoma of the leg, intravascular B-cell lymphoma, and mediastinal large B-cell lymphoma, the latter of which is recognized by the WHO classification. Large B-cell lymphoma of the leg is seen in the elderly and has a poorer prognosis than other cutaneous B-cell lymphomas ( 450 ). Intravascular B-cell lymphoma was recognized in 1959 and was known as *malignant angioendotheliomatosis* ( 451 , 452 ). It occurs in the elderly (median age, 65 to 70 years) and most commonly affects the skin and CNS. Symptoms are usually related to ischemia secondary to occlusion of blood vessels, and approximately one-half of cases are first detected at autopsy ( 452 ).

**MEDIASTINAL LARGE B-CELL LYMPHOMA** The WHO classification recognizes a distinct large B-cell lymphoma that probably arises from the thymus and that can be confused with LL, HD, thymomas, and extragonadal germ cell neoplasms ( 453 , 454 , 455 , 456 , 457 and 458 ). Primary mediastinal B-cell lymphomas (PMBL) constitute 2 to 3% of NHL and occur predominantly in women (female to male ratio is approximately 2:1) and young adults; three-fourths of patients are younger than 35 years of age ( 453 ). Gains in chromosome 9p have been recognized in as much as 50% of patients ( 459 ). *BCL2* and *BCL6* gene rearrangements rarely occur; overexpression of the *MAL* gene is common ( 460 ). Presenting features are usually of short duration, varying from a few weeks to several months, and include chest pain (73%), cough (60%), dyspnea (46%), and superior vena cava obstruction (30 to 57%) ( 454 , 457 ). More than two-thirds of patients have large masses ( $\geq 10$  cm). Local extension of the mass into the pericardium, chest wall, or lung is common, whereas distant involvement of peripheral nodes, marrow, or CNS is infrequent ( 453 , 454 , 458 ). Unusual extranodal sites of involvement include kidney, ovaries, and adrenal glands. Although early reports indicated a poor prognosis despite combination chemotherapy, more recent studies have had a good prognosis similar to other DLBCL ( 454 , 456 , 457 ). Some of the best results have added involved field radiation therapy ( 454 , 457 ), but some series have had equally good results without radiation; thus, the role of radiation remains controversial ( 456 ). As much as one-third of patients fail induction therapy, but the 3-year FFS ranges from 38 to 88% ( 458 ). Poor prognostic factors in PMBL have been the presence of pleural or pericardial effusion, multiple extranodal sites ( $\geq 2$ ) of disease, bulk ( $\geq 10$  cm), high LDH (more than three times the normal level), and a persistently positive gallium or PET scan posttherapy ( 453 , 457 , 458 ). Because the disease is usually localized and occurs in young people, the IPI may have limited value ( 453 , 457 ). SCT has been used in PMBL, and results vary according to remission status and chemosensitivity ( 461 , 462 ).

## Peripheral T-Cell and Natural Killer-Cell Lymphomas

The clinical significance and the management of PTCL are areas of controversy in part because of the relative infrequency as compared to B-cell lymphomas and the lack of controlled trials that evaluate the impact of immunophenotype on prognosis ( 270, 463, 464 ). PTCL and NK-cell neoplasms represent less than 15% of NHL in the West, and there are multiple subtypes, so that most represent less than 1% of NHL ( 465 ). PTCL often is associated with paraneoplastic phenomena, including skin rashes, autoimmune hemolytic anemia, hypergammaglobulinemia, eosinophilia, hypercalcemia, vasculitis, and hemophagocytosis, which may obscure the initial diagnosis ( 466 ).

Attempts have been made to separate postthymic T-cell neoplasms into low-grade and intermediate- to high-grade subcategories; however, the so-called low-grade T-cell lymphomas may have an aggressive course and can undergo histologic transformation similar to that seen in low-grade B-cell lymphomas ( 467 ). Cytogenetic differences have been used in an attempt to separate PTCL into low- and high-grade categories ( 298 ). PTCLs that have been described with an indolent course include angioimmunoblastic lymphadenopathy with dysproteinemia (AILD) (AILD-like T-cell lymphoma), T-zone lymphoma, and lymphoepithelioid lymphoma (Lennert lymphoma) ( 467, 468 and 469 ); only AILD is described in the WHO classification as a distinct entity (angioimmunoblastic T-cell lymphoma), whereas the latter two entities would be referred to as *PTCL, not otherwise specified*. Lennert lymphoma typically occurs in older patients, often with diffuse adenopathy and involvement of Waldeyer ring, and has a clinical course that is characterized by recurrent relapses ( 468, 469 ).

The WHO classification separates the mature T- and NK-cell neoplasms by site of involvement: nodal, extranodal, leukemic, and cutaneous. In the subsequent section, the focus is primarily on nodal and extranodal diseases, followed by a brief description of the leukemias. CTCLs are reviewed in [Chapter 94](#).

**KI-1+ ANAPLASTIC LARGE CELL LYMPHOMA** Since the original description of Ki-1+ (CD30) ALCL by Stein et al. in 1985, a type of ALCL has become a paradigm for the WHO classification for NHL ( 220, 470 ). In the past two decades, the clinical, morphologic, immunophenotypic, and genetic spectrum of ALK-positive ALCL has been defined. The first clinical description of ALCL was in a series by Kadin et al. ( 471 ) in six children, all of whom had skin lesions. Subsequent studies that included adults recognized a common lymphoma (2 to 8% of NHL) with a wide morphologic spectrum, young median age, peripheral adenopathy with relative sparing of the mediastinum, frequent extranodal disease, and a good prognosis ( 220, 472, 473 ). In 1989, a proportion of ALCLs were associated with a specific chromosomal translocation ( 474, 475 ), and, in 1994, Morris et al. ( 476 ) identified the genes that are involved in the t(2;5) ( [Chapter 89](#) ). *ALK* rearrangements are present in 50 to 70% of CD30<sup>+</sup> ALCL, and the t(2;5) occurs in approximately three-fourths of these patients ( 220, 477 ). Cytogenetic variants have been described, with t(1;2)(q25;p23) as the most common ( 477 ). Immunocytochemical stain for the ALK protein is usually present in cytoplasm and nuclei of the classic t(2;5)(p23;q35), whereas it is present only in the cytoplasm of the variants ( 220, 244 ). Because the variants are of T- or null-cell origin and occur in a similar age group as the t(2;5), Falini et al. ( 244 ) proposed the term *ALKoma* for all patients expressing the ALK protein. ALK expression subdivides ALCL into at least three clinical subtypes of ALCL: (a) ALK-positive systemic ALCL, (b) ALK-negative systemic ALCL, and (c) primary cutaneous ALCL (also ALK negative). ALK-positive ALCL occurs at a younger median age (15 to 30 years) than ALK negative (45 to 65 years), has a male predominance (male to female ratio is 2 to 6:1), and usually has advanced-stage disease with frequent B



symptoms (40 to 75%) and extranodal involvement (50 to 80%) ( [220](#), [244](#), [478](#) ). Skin (21 to 35%), soft tissue (17%), and bone (8 to 17%) are common extranodal sites, whereas the gastrointestinal tract and CNS are rarely involved ( [220](#) ). Bone marrow involvement in ALK-positive ALCL is identified in 10 to 15% with hematoxylin and eosin stains but in as much as 30% if immunohistochemistry stains are used to identify isolated ALCL cells ( [220](#), [479](#) ). Limited data indicate that ALK-positive ALCL is more chemosensitive than ALK-negative ALCL, with CR rates being greater than 75% for ALK-positive ALCL and 50 to 75% in ALK-negative ALCL ( [244](#), [478](#) ). Better responses have resulted in a twofold or higher increase in survival for ALK-positive ALCL (71 to 93% at 5 years), compared to ALK-negative ALCL (15 to 46%) in retrospective series ( [244](#), [478](#), [480](#) ); however, not all series have confirmed an improved survival for ALK-positive ALCL ( [481](#) ). Differences among studies could be due in part to the favorable younger age of ALK-positive ALCL, but an improved survival has been reported for ALK-positive ALCL over ALK-negative ALCL in patients who are younger than 30 years of age ( [480](#) ). Another problem with comparing ALK-positive ALCL to ALK-negative ALCL is the fact that the latter represents a heterogeneous group of diseases. ALK-negative ALCL may be considered as secondary ALCL when it follows mycosis fungoides, lymphomatoid papulosis, or HD ( [220](#) ). Hodgkin-like ALCL is formerly a provisional diagnosis of the WHO classification but is probably a variant of HD ( [482](#) ). ALK-negative ALCL can rarely be of B-cell origin either with an aggressive course or in the setting of AIDS ( [220](#), [483](#) ). Primary cutaneous ALCL is another ALK-negative ALCL, is part of the spectrum of CD30<sup>+</sup> cutaneous lymphoproliferative disease, and clinically overlaps with lymphomatoid papulosis ( [Chapter 94](#) ) ( [471](#), [484](#) ). It usually arises in the skin in an older patient (median age is approximately 60 years) as an isolated reddish-violet tumor, which may be ulcerated. Less commonly, it may present as multiple nodules in a circumscribed area or, rarely, with disseminated skin lesions. Treatment of localized lesions may include watchful waiting, because approximately one-fourth of patients regress, as well as local excision with or without radiation or radiation alone ( [220](#) ). Combination chemotherapy may be warranted with widespread skin disease or localized skin disease with adjacent nodal involvement, but these patients tend to relapse ( [485](#) ). Although therapy for adults has not been stratified according to prognostic factors in ALCL, pediatric groups have stratified therapy according to risk factors and have a 5-year EFS that is greater than 70% even for the ALCL patients with multiple adverse features ( [486](#) ). Some investigators have advocated a role of autologous transplant in first CR for adults with ALCL and report a greater than 90% DFS ( [487](#) ). They justified SCT based on the early data that the IPI did not correlate with prognosis in ALCL ( [488](#) ). Because prognosis does correlate with IPI and ALCL has a good response to chemotherapy, a policy of transplantation in first CR cannot be supported in most patients ( [244](#) ). In addition, preliminary data indicate that ALK-positive ALCL has a high salvage rate with SCT in chemosensitive relapse ( [489](#) ).

**NODAL PERIPHERAL T-CELL LYMPHOMA** The distribution of PTCL varies according to geography, viral associations, and referral patterns ( [270](#), [316](#), [490](#), [491](#), [492](#), [493](#), [494](#), [495](#) and [496](#) ). In the West, nodal disease predominates with PTCL, not otherwise specified; ALCL and AILD represent the largest groups, whereas in the Far East, there are increased numbers of extranodal disease, often of nasal origin with angiocentric features and an association with EBV ( [492](#) ). In HTLV-1 endemic areas, as much as one-half of the T- and NK-cell neoplasms are ATLL ( [493](#) ). Problems in management of PTCL include the fact that, unlike B-cell NHL, cell size does not correlate with prognosis, and there are sparse data regarding the impact of cytogenetics on diagnosis other than ALK expression in ALCL. The IPI does correlate with prognosis in PTCL, but only the low risk (0, 1) has prolonged survival that is greater than 50% ( [316](#), [494](#) ). Expression of chemokine receptors differs among PTCL and could contribute to biologic differences ( [497](#) ). Genomic profiling is likely

to identify different prognostic subsets among PTCL, as has been done in DLBCL ( 301 , 302 ). AILD-like T-cell lymphoma serves as a model for the problems with assigning grade and therapy to some PTCL. AILD usually occurs in older patients with a median age between 57 and 68 years of age; they frequently have B symptoms, generalized adenopathy, skin rash, organomegaly, anemia, and polyclonal hypergammaglobulinemia ( 498 ). The clinical course of AILD is variable, with spontaneous remissions occurring in as much as 10% of patients. Single agents, primarily steroids, but also alkylating agents, methotrexate, IFN, and cyclosporine can achieve responses, but many patients develop a progressive lymphoma. Although AILD can respond to single agents, combination chemotherapy is usually recommended once a diagnosis is confirmed. The CR rate with anthracycline-based regimens is in the range from 50 to 70%, but patients have frequent relapses or death due to infection, so that median survivals are short (11 to 30 months) ( 498 , 499 ). There is clonal evolution over time in AILD ( 500 ), and EBV may participate in lymphomagenesis ( 501 ). TCR gene rearrangements occur early in the course of AILD, thus indicating a clonal T-cell population; some patients have also had Ig gene rearrangements. Similar to posttransplant lymphoproliferation but unlike other NHL, unrelated or oligoclonal clones are commonly found in AILD ( 500 ). The most common cytogenetic abnormalities are trisomy 3, trisomy 5, and an additional X chromosome, but patients who develop complex aberrant clones and structural abnormalities in the short arm of chromosome 1 progress rapidly ( 500 , 502 ). EBV can be identified in B and T cells of AILD, and it may participate in the occasional B-cell immunoblastic lymphoma as well as the more common PTCL ( 503 ). Cytokines, particularly lymphotoxin and tumor necrosis factor- $\alpha$ , are primarily found in B cells and probably contribute to the clinicopathologic course of AILD ( 504 ). Because the clinical course is variable, and no single therapy has been shown to be better, optimal treatment for AILD-like T-cell lymphoma remains to be defined.

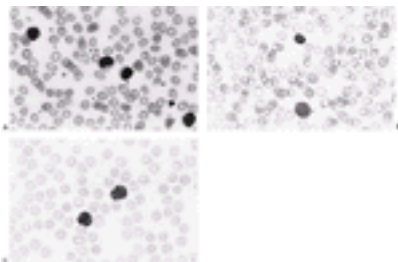
**EXTRANODAL T-CELL AND NATURAL KILLER-CELL LYMPHOMAS** Hepatosplenic ?d T-cell lymphoma was first described in 1990 as an aggressive illness with B symptoms and organomegaly in young adult men ( 505 ). The median age is 29 years of age, and patients have splenomegaly (98%), hepatomegaly (80%), minimal to no lymphadenopathy, anemia (84%), and severe thrombocytopenia (85%) ( 506 ). The bone marrow is involved in 72% of patients, and erythrophagocytosis may occur ( 506 ). Isochromosome 7q, which is often associated with trisomy 8, is a common cytogenetic abnormality ( 507 ). Most patients are refractory to anthracycline-based therapy, with CR rates that are less than 15% and median survival of 8 months ( 506 ). Because of the poor prognosis, there may be a role for allogeneic SCT ( 506 ). There is an  $\alpha\beta$  variant with similar features and prognosis ( 508 ). Subcutaneous panniculitis-like T-cell lymphoma presents with subcutaneous nodules, usually on the extremities, and is often associated with systemic symptoms and erythrophagocytosis ( 509 , 510 and 511 ). Median age is 43 years of age, and women predominate. There can be nodal dissemination, but a poor prognosis is usually due to fulminant hemophagocytosis. Median survival is usually less than 2 years, but occasional patients without hemophagocytosis have an indolent course, and some patients have had prolonged remissions after chemotherapy ( 509 , 510 and 511 ). EATL has an association with celiac disease but has occurred without it as well ( 512 , 513 and 514 ). The median age is 50 years of age, and men predominate ( 514 ). Abdominal pain and weight loss occur in more than four-fifths of patients at presentation, followed by diarrhea or vomiting in one-third of patients ( 514 ). Small bowel obstruction or perforation is common, and the diagnosis of EATL is usually made at laparotomy. Prognosis is poor, with a median survival of 7.5 months and a 1-year FFS of less than 20% ( 514 ). Nasal and nasal-type NK- and T-cell lymphomas are characterized by angiocentric and angiodestructive proliferation; LGL morphology; CD2<sup>+</sup>, CD3<sup>-</sup>, CD16<sup>-/+</sup>, CD56<sup>+</sup>, CD57<sup>-</sup> phenotype; and an aggressive



course ( 93, 515, 516 ). Only 10% express surface CD3<sup>+</sup>, have clonal TCR rearrangement, and have a similar course ( 517 ). Nasal NK- and T-cell lymphomas may present with facial swelling or mid-facial destruction and was formerly called *lethal midline granuloma* or *polymorphic reticulosis*. The disease occurs more commonly in men with a median age of 50 to 55 years of age ( 515, 516 ). Nasal NK- and T-cell lymphoma is localized stages I and II in 80% of patients at diagnosis but can disseminate early to skin, gastrointestinal tract, testis, orbit, and CNS. Although radiation alone can achieve CR in two-thirds of localized disease, local relapse occurs in one-half of patients, and disseminated disease develops in one-fourth of patients ( 515 ). Combined modality therapy and CNS prophylaxis are recommended. Prognosis is variable, with a long-term survival of 20 to 80%, usually only in the patients with stage I, nonbulky disease ( 515, 516 and 517 ). Nasal-type NK- and T-cell lymphoma is essentially disseminated nasal disease without obvious nasal involvement ( 518 ). Only one-fifth of patients have stage I disease ( 518 ). Despite anthracycline therapy, median survival is less than 1 year ( 518 ). Patients with cutaneous-only involvement have a better survival ( 519 ). A disseminated, leukemic form is usually fatal within weeks ( 520 ). Because of poor prognosis, there may be a role for transplant in some patients with nasal-type NK- and T-cell lymphomas ( 521 ).

### Mature T-Cell and Natural Killer-Cell Leukemias

The differential diagnosis of CLL in Chapter 92 includes the mature T- and NK-cell leukemias. LGL leukemia was associated with chronic neutropenia in 1977, was recognized as a clonal disorder in 1985, and was classified into T-cell (CD3<sup>+</sup>) and NK-cell (CD3<sup>-</sup>) types in 1993 ( Fig. 90.12A ) ( 180, 522, 523 ). The median age is 55 years of age, and there is an association with rheumatoid arthritis and autoimmune features ( 180, 524 ). Lymphocytosis is usually between 2 to 20 × 10<sup>9</sup> per L, and mild splenomegaly may be present, but the usual clinical presentation and problem is neutropenia or anemia ( 180 ). Pure red cell aplasia, autoimmune hemolytic anemia, aplastic anemia, idiopathic thrombocytopenic purpura, and myelodysplastic syndrome (MDS) may occur in LGL leukemia ( 180 ). Leukemic LGL cells express high levels of Fas and Fas ligand, but the cells are resistant to Fas-mediated death due to signal transducer and activator of transcription type 3 activation, which up-regulates an antiapoptotic protein ( 525, 526 ). LGL leukemia is an indolent disease, with a median survival of longer than 10 years in a series of 68 patients ( 527 ). Immunosuppressant drugs, which have been used in LGL leukemia, include methotrexate, cyclosporine, prednisone, and cyclophosphamide ( 527, 528 and 529 ). Prolonged treatment with methotrexate of 1 to 2 years has resulted in CR in as much as 50% of patients ( 528 ).



**Figure 90.12.** Mature T-cell and natural killer-cell leukemias. **A:** Peripheral blood, T-cell granular lymphocytic leukemia. Two lymphocytes that have oval-shaped nuclei, condensed chromatin, inconspicuous nucleoli, and abundant pale cytoplasm that contains azurophilic

granules are in the center of the field. These lymphocytes have the characteristic morphology of large granulocytes that are normal constituents of the peripheral blood or that can be seen in large granular lymphocytic leukemia or in some reactive states. **B:** Peripheral blood, peripheral T-cell lymphoma of cytotoxic (natural killer-like) T-cell phenotype. A neoplastic large lymphocyte that has clumpy chromatin, a discernible nucleolus, and a modest amount of basophilic cytoplasm that contains a few azurophilic granules is associated with a smaller peripheral blood lymphocyte. The lymphoma had a CD56<sup>+</sup> and perforin<sup>+</sup> T-cell phenotype. **C:** Peripheral blood, T-cell prolymphocytic leukemia, small (“knobby”) cell variant. Small lymphocytes with markedly irregular (“knobby”) nuclear profiles, coarse chromatin, variably discernible nucleoli, and scant agranular cytoplasm are characteristic of the small cell variant of T-cell prolymphocytic leukemia (“T-cell chronic lymphocytic leukemia”). See [Color Plate](#). (Courtesy of William Macon, Mayo Clinic, Rochester, MN.)

Aggressive NK- and T-cell leukemia is a rare disorder more common in Asia and often is associated with EBV, and some cases may represent the leukemic phase of nasal-type NK-cell lymphoma ([Fig. 90.12B](#)) ([530](#), [531](#), and [532](#)). Patients are usually teenagers to young adults, with slight male predominance, and present with a fulminant illness that is characterized by diffuse adenopathy, organomegaly, and circulating LGL cells that can have a blastic appearance ([531](#), [532](#)). Patients are usually chemoresistant and have median survivals of less than 3 months ([531](#), [532](#)). Rare NK-cell-like T-cell lymphomas present with B symptoms and organomegaly, have occurred in immunosuppressed hosts, and usually have a similar fatal course, which can include a leukemic phase ([203](#), [533](#)). Immature NK-cell neoplasms include myeloid and NK-cell precursor acute leukemia and blastic NK-cell lymphoma/leukemia ([534](#)).

T-prolymphocytic leukemia (T-PLL) represents approximately 2% of small lymphocytic leukemia in adults ([Fig. 90.12C](#)) ([535](#)). The median age is 57 to 69 years of age, and the male to female ratio is 1.5:1.0 ([536](#), [537](#)). Patients usually have a marked lymphocytosis ( $>100 \times 10^9$  per L in 75% of patients), splenomegaly (73%), and lymphadenopathy (53%), and approximately 20% of patients have skin infiltration ([535](#), [536](#)). Cell morphology is variable; the nuclei are irregular, include a “knobby” variant, and usually have prominent nucleoli; cytoplasmic protrusions are characteristic. Sixty percent of patients are CD4<sup>+</sup> and CD8<sup>-</sup>; 25% coexpress CD4<sup>+</sup> and CD8<sup>+</sup>; and 15% are CD4<sup>-</sup> and CD8<sup>+</sup> ([535](#), [536](#)). The most common cytogenetic abnormality, occurring in 80% of patients, is an inversion of chromosome 14 with breakpoints in q11 and q32; 10% have a reciprocal translocation t(14;14)(q11;132) ([535](#), [538](#)). These translocations juxtapose the locus of the *TCR*  $\alpha\beta$  gene with the *TCL1* and *TCL1t* genes at 14q32 ([539](#)). Deletions at 11q23, the locus for the *ATM* gene, and 12p13 and abnormalities of chromosome 8 are other common cytogenetic findings in T-PLL ([535](#), [540](#)). Response rates in T-PLL are 10 to 48%, with few CRs using chemotherapy, including CHOP or nucleoside analogs ([536](#), [537](#)). Median survival is usually 1 year, although as much as one-third of patients can have an indolent phase ([536](#), [537](#), [541](#)). The best responses have been reported with alemtuzumab (Campath 1H), and preliminary data recommend proceeding to an allogeneic transplant if a donor is available ([542](#), [543](#)).

The clinical course of ATLL is variable and takes four basic forms: (a) acute, (b) lymphoma, (c) chronic, and (d) smoldering. The male to female ratio is 1.3 to 2.2:1, and the median age is 47 to 65 years of age ([544](#), [545](#), and [546](#)). Between 55 and 65% of patients have the acute form, which is characterized by lymphadenopathy; organomegaly; skin

lesions; elevated white count with multilobed lymphocytes, often referred to as *cloverleaf* or *flower* cells ( [Fig. 90.2A](#)); hypercalcemia; elevated LDH level; and, usually, a rapidly fatal course ( [545](#), [546](#), [547](#) and [548](#) ). The cutaneous lesions have a diverse appearance, including papules, nodules, plaques, tumors, and ulcers. Histologically, dermal invasion predominates, although the lesions of ATLL may resemble primary CTCL with epidermotropism and Pautrier microabscesses. Anemia and thrombocytopenia are infrequent findings because of a low degree of marrow infiltration. CNS involvement may develop in as many as 10% of patients with ATLL ( [549](#) ).

Lymphoma is the second most common form of ATLL, represents 20 to 25% of cases, and is distinguished by prominent adenopathy without significant peripheral blood involvement. Primary extranodal lymphoma occurs in approximately 5% of lymphomatous presentations and has involved skin, Waldeyer ring, gastrointestinal tract, sinuses, and pleura ( [550](#) ). The chronic type is associated with an increased white blood cell count and occasionally with slight adenopathy and organomegaly. Patients with smoldering ATLL have few ATLL cells (0.5 to 3.0%) in the peripheral blood and may have skin lesions, as well as slight adenopathy, organomegaly, and marrow infiltration ( [551](#) ). Chronic or smoldering ATLL, or both, may evolve into an acute form after many years of indolent disease ( [552](#), [553](#) ).

No consistent cytogenetic abnormality has been identified in ATLL, but the most common abnormalities are trisomy 7,q-, and 14q+ ( [25](#), [554](#), [555](#) ). Aneuploidy, multiple chromosomal breaks, and loss of tumor suppressor genes are associated with an aggressive course ( [556](#) ).

Despite combination chemotherapy, which can yield brief responses, median survivals in the acute and lymphomatous forms of ATLL are less than 10 months ( [235](#), [557](#) ). Poor performance status, high LDH, age older than 40 years, tumor bulk, and hypercalcemia are adverse prognostic factors ( [235](#), [557](#) ). The chronic and smoldering forms have a longer survival rate regardless of therapy ( [552](#), [558](#) ). The major causes of death in ATLL are opportunistic pulmonary infections and progressive disease, often in association with hypercalcemia ( [547](#), [559](#) ). New chemotherapy agents have included nucleoside analogs and topoisomerase inhibitors, but response rates are 10 to 40% and are brief in duration ( [560](#), [561](#) and [562](#) ). Conjugated and unconjugated monoclonal antibodies directed at the IL-2 receptor have activity in ATLL and remain under investigation ( [563](#) ). There are data that indicate improved responses to a combination of IFN- $\alpha$  and zidovudine ( [564](#), [565](#) ). Because of the poor prognosis, there may be a role for early allogeneic transplantation.

## THERAPY FOR LOCALIZED LARGE CELL LYMPHOMA

Localized disease is defined by stage I or II disease that is nonbulky (no tumor mass  $\geq$ 10 cm; no mediastinal mass greater than one-third of the chest diameter) ( [566](#) ). Radiation therapy alone has resulted in 20 to 85% cure rates for limited-stage large cell lymphomas, with the best results in patients who have stage I disease after undergoing pathologic staging ( [567](#), [568](#) ). With clinical staging, cure rates with radiation alone have usually been less than 50%; therefore, most investigators are advocating chemotherapy, usually CHOP-type regimens, often followed by radiation, with cure rates of 70 to 90% ( [569](#), [570](#) and [571](#) ). Patients with stage I disease have generally done better than stage II patients, with cure rates greater than 90% in some series ( [571](#) ).

Recent clinical trials have addressed the issue of chemotherapy versus combined

modality therapy in limited-stage large cell lymphoma and have favored combined modality for adults ( 572, 573 ). In a SWOG study, patients with localized intermediate- or high-grade NHL were randomized to three cycles of CHOP followed by involved field radiation therapy (4000 to 5500 cGy) versus eight cycles of CHOP ( 573 ). Better PFSs (77% vs. 64%;  $p = .03$ ) and OS (82% vs. 72%;  $p = .02$ ) were observed in the combined modality arm, and there was a trend toward increased toxicity, particularly cardiac, in the chemotherapy-only arm ( 573 ). A subsequent follow-up report, however, indicates no difference in survival between the two arms ( 574 ). Similar randomized trials in children, as well as adults, have not shown a benefit to chemotherapy plus radiation over chemotherapy alone in limited-stage patients ( 575 ). Other concerns of the SWOG study are that eight cycles of CHOP are probably excessive for localized disease and that radiation contributes to the risk of long-term toxicities. Thus, although short-course chemotherapy (three to four cycles) followed by radiation is an accepted treatment for adults for localized large cell NHL, ongoing trials are still warranted to identify patients who can do well with chemotherapy alone.

## CHEMOTHERAPY

In the early 1970s, DeVita et al. at the NCI introduced a combination chemotherapy regimen, C-MOPP (cyclophosphamide replacing mechlorethamine, vincristine, procarbazine, and prednisone), which produced a CR rate in excess of 40% in patients with diffuse “histiocytic” lymphoma, a neoplasm that is generally equivalent to DLCL; approximately one-third of these patients were cured ( 566, 576 ) ( Table 90.10 ). By the middle 1970s, doxorubicin had been added to cyclophosphamide, vincristine, and prednisone to produce the CHOP regimen, which produced CR rates of 50 to 60% and a DFS of 30 to 40% ( 381, 577 ). CHOP remains the most extensively studied and used regimen in the therapy of large cell lymphoma. Other first generation regimens with similar cure rates include BACOP (bleomycin, doxorubicin, cyclophosphamide, vincristine, and prednisone) ( 578 ) and COMLA (cyclophosphamide, vincristine, methotrexate, leucovorin, and arabinosylcytosine) ( 579, 580 ). Important clinical observations were that rapid achievement of a CR was associated with a good prognosis ( 306, 577 ) and that relapses after 2 years of DFS were rare. Further follow-up for large cell lymphoma, however, has recorded relapses in 6 to 22% of patients after 2 years of CR ( 306, 581 ).

**TABLE 90.10. Chemotherapy Programs for Non-Hodgkin Lymphoma, Predominantly Large Cell Lymphoma**

| Regimen          | Institution (Reference)           | Number of Patients | Complete Remission (%) | Disease-Free Survival (%) | Comments   |
|------------------|-----------------------------------|--------------------|------------------------|---------------------------|--|
| First generation |                                   |                    |                        |                           |  |
| C-MOPP           | National Cancer Institute ( 576 ) | 27                 | 45                     | 37                        | Initial report of curative therapy.                              |
| CHOP             | Southwest Oncology Group ( 381 )  | 250                | 58                     | 34                        | Introduced anthracyclines; still the most commonly used therapy. |

|                            |   |     |    |    |  |
|----------------------------|---|-----|----|----|--|
| BACOP                      | National Cancer Institute and Dana Farber Cancer Institute ( <a href="#">590</a> )      | 99  | 48 | 34 | Introduced bleomycin.  |
| COMLA                      | Yale University and University of Chicago ( <a href="#">579</a> , <a href="#">580</a> ) | 54  | 44 | 32 | Introduced methotrexate and cytarabine.  |
| Second generation          |   |     |    |    |  |
| M-BACOD                    | Dana Farber Cancer Institute ( <a href="#">585</a> )                                    | 81  | 72 | 41 | High-dose methotrexate used; includes late relapses with 8-yr median follow-up.  |
| m-BACOD                    | Dana Farber Cancer Institute ( <a href="#">584</a> )                                    | 131 | 61 | 47 | Lower-dose methotrexate had similar results to high dose; identified prognostic categories.  |
| ProMACE-MOPP               | National Cancer Institute ( <a href="#">586</a> )                                       | 79  | 74 | 47 | Introduced flexible therapy concept; 10% mortality.  |
| COPBLAM                    | New York Hospital, Cornell Medical Center ( <a href="#">583</a> )                       | 48  | 73 | 55 | Introduced continuous infusions of vincristine and bleomycin.  |
| CAP-BOP                    | University of Nebraska ( <a href="#">310</a> )  | 51  | 73 | 54 | Continuous infusions of vincristine and bleomycin along with higher doses of cyclophosphamide and doxorubicin.   |
| Third generation and newer |   |     |    |    |  |
| MACOP-B                    | Cancer Control Agency, British Columbia ( <a href="#">589</a> )                         | 126 | 86 | 58 | Short (12-wk) therapy with antibiotic prophylaxis; new regimen (VACOP-B) replaces methotrexate with etoposide and has equivalent results with less toxicity. |

|                 |  |     |    |    |   |
|-----------------|--|-----|----|----|---|
| COPBLAM-III     | New York Hospital, Cornell Medical Center ( <a href="#">587</a> )  | 51  | 84 | 65 | Introduced continuous infusions into therapy.   |
| CODBLAM-IV      | New York Hospital, Cornell Medical Center ( <a href="#">583</a> )  | 61  | 88 | 64 | Introduced higher doses of cyclophosphamide and doxorubicin as consolidation.   |
| ProMACE-CytaBOM | National Cancer Institute ( <a href="#">590</a> )  | 94  | 86 | 69 | Better results than ProMACE-MOPP when compared in randomized trials.  |
| LNH regimens    | Groupe Francais d'Etude des Lymphomes Agressifs (GELA Group), France ( <a href="#">445</a> , <a href="#">588</a> , <a href="#">612</a> , <a href="#">613</a> ) |     |    |    | Dose-intensive regimen; T immunophenotype had inferior survival to B immunophenotype. Randomized arm to intensification and transplantation in LNH-84, LNH-87, and LNH-93 did not improve survival. LNH-93 stratifies patients according to age, IPI, and $\beta_2$ -microglobulin. |
| LNH-80          |  | 100 | 84 | 59 |   |
| LNH-84          |  | 737 | 75 | 48 |   |
| LNH-87          |  | 273 | 61 | 54 |   |
| LNH-93          |  | 181 | 64 | 52 |   |
| MEGA-III        | Vanderbilt University Medical Center ( <a href="#">609</a> )   | 36  | 75 | 58 | Phase II, short, dose-intensive therapy in poor prognosis patients.   |
| CHOP-B/CMED     | M. D. Anderson Cancer Center ( <a href="#">591</a> )   | 138 | 78 | 58 | Alternating non-cross-resistant regimens included involved field radiation in stage II and III patients and had better 5-yr survival than historic control of CHOP-B alone.   |



|                      |  |    |    |    |   |
|----------------------|--|----|----|----|---|
| High-dose CHOP       | Dana Farber Cancer Institute ( <a href="#">608</a> )       | 22 | 86 | 69 | Phase II study to determine maximum tolerated dose of CHOP (plus G-CSF) with short follow-up. |
| 200% ProMACE-CytaBOM | Eastern Cooperative Oncology Group ( <a href="#">610</a> ) | 74 | 69 | 71 | Phase II trial of dose intensity plus G/GM-CSF.   |
| EPOCH                | National Cancer Institute ( <a href="#">604</a> )          | 50 | 92 | 70 | Dose-adjusted phase II trial; 70% is progression-free survival.                               |

BACOP, bleomycin, doxorubicin, cyclophosphamide, vincristine, prednisone; CAP-BOP, cyclophosphamide, doxorubicin, procarbazine, bleomycin, vincristine, prednisone; CHOP, cyclophosphamide, doxorubicin, vincristine, prednisone; CMED, cyclophosphamide, methotrexate, etoposide, dexamethasone; C-MOPP, cyclophosphamide, vincristine, procarbazine, prednisone; COMLA, cyclophosphamide, vincristine, methotrexate, leucovorin, cytarabine; COP(D)/BLAM, cyclophosphamide, vincristine, prednisone (dexamethasone)/bleomycin, doxorubicin, procarbazine; CytaBOM, cytarabine, bleomycin, vincristine, methotrexate; EPOCH, etoposide, prednisone, vincristine, cyclophosphamide, doxorubicin; G-CSF, granulocyte colony-stimulating factor; GM-CSF, granulocyte-macrophage colony-stimulating factor; MACOP-B, methotrexate, doxorubicin, cyclophosphamide, vincristine, prednisone, bleomycin; M/m-BACOD, high dose (M) or low dose (m) methotrexate, bleomycin, doxorubicin, cyclophosphamide, vincristine, dexamethasone; ProMACE-MOPP, prednisone, methotrexate, doxorubicin, cyclophosphamide, etoposide/mechlorethamine, vincristine, procarbazine, prednisone.

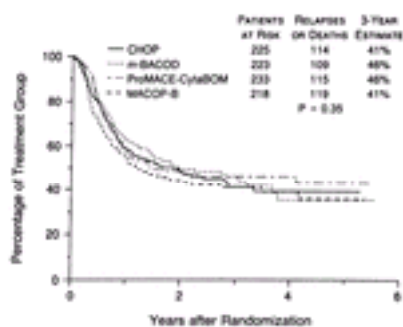
Subsequent regimens were developed in part on the concepts of Goldie and Coldman, who proposed that tumors develop drug resistance by spontaneous mutation soon after exposure to chemotherapy, and of Hryniuk and Bush, who proposed that increasing dose intensity could overcome drug resistance ( [582](#)). Thus, new regimens introduced as many non-cross-resistant chemotherapeutic agents as early as possible and at the highest doses that were tolerable. Some of the regimens, such as Pro-MACE-MOPP, used a non-cross-resistant regimen after a patient achieved a maximum response with the initial regimen. Second-generation regimens included COPBLAM (cyclophosphamide, vincristine, prednisone, bleomycin, doxorubicin, and procarbazine) ( [583](#)); m/M-BACOD [regular and moderate-dose methotrexate, bleomycin, Adriamycin (doxorubicin), cyclophosphamide, Oncovin (vincristine), and dexamethasone] ( [314](#), [584](#), [585](#)); and ProMACE-MOPP ( [586](#)), which produced CR rates of 70 to 76% and a DFS of 40 to 55% in patients with predominantly large cell lymphomas ( [582](#)).

Third-generation regimens, which included variations of COPBLAM ( [583](#), [587](#)); LNH 80/84 ( [445](#), [588](#)); MACOP-B [methotrexate-leucovorin, Adriamycin (doxorubicin), cyclophosphamide, Oncovin (vincristine), prednisone, and bleomycin] ( [589](#)); and ProMACE/CytaBOM [cytarabine, bleomycin, Oncovin (vincristine), methotrexate] ( [590](#)) were designed to further shorten and intensify therapy along with modifying delivery and schedules of drug. The CR rates of these regimens were 75 to 88% with a DFS of 50 to 65% in studies primarily at single institutions. Alternating regimens between different



combinations compared favorably with the third-generation regimens ( 591, 592 ). Many of these newer regimens had considerable toxicity, when they were used initially, and were associated with mortality rates of 5 to 10%; however, the rate of toxic deaths decreased over time with more experience and perhaps with better patient selection ( 581 ). Many of the series in which these regimens were used involved favorable prognostic groups, including patients with limited-stage disease and patients with a relatively young median age. Cooperative groups generally were not able to reproduce the results that were obtained at single institutions ( 593, 594 and 595 ).

One of the most important clinical trials for lymphoma was performed by an intergroup (SWOG and ECOG) study that compared CHOP with three of the newer and reportedly more intensive regimens, m-BACOD, MACOP-B, and ProMACE-CytaBOM ( 596 ). There were no differences in CR, PFS, or OS. The percentage of patients alive without progression at 3 years was 41% in the CHOP and MACOP-B groups and 46% in the m-BACOD and ProMACE-CytaBOM groups ( Fig. 90.13 ). The estimated OS was 52% of the entire group, 50% for ProMACE-CytaBOM and MACOP-B, 52% for m-BACOD, and 54% for CHOP (  $p = .90$  ). There were also no differences in fatal toxicities among the regimens: CHOP (1%), ProMACE-CytaBOM (3%), m-BACOD (5%), and MACOP-B (6%) (  $p = .09$  ). Similar cooperative group comparisons found no differences among these regimens ( 597, 598 and 599 ).

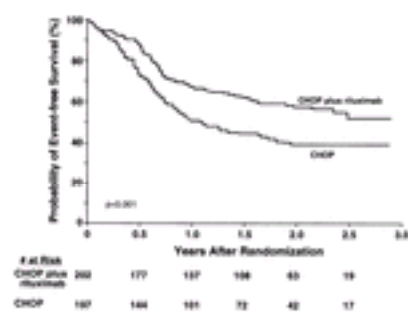


**Figure 90.13.** Intergroup study that compares CHOP, m-BACOD, MACOP-B, and ProMACE-CytaBOM in predominantly intermediate-grade working formulation lymphomas. There were no differences observed in time-to-treatment failure in the four groups. [From Fisher RI, Gaynor ER, Dahlberg S, et al. Comparison of a standard regimen (CHOP) with three intensive chemotherapy regimens for advanced non-Hodgkin's lymphoma. *N Engl J Med* 1993;328:1002-1006, with permission.]

Although the intergroup study reestablished CHOP as standard therapy for large cell lymphoma, it did not address the issue of dose intensity, and it did not emphasize how poorly these regimens do in patients with adverse prognostic factors. Although the newer regimens supposedly were more dose intensive than CHOP, there are little differences among the regimens with respect to the most active agents that were used (i.e., cyclophosphamide and doxorubicin). Although no differences were identified among the regimens in patients with adverse prognostic factors, none of them produced good results. Using these conventional regimens, CR rates of 55% and 44% and 5-year survivals of 43% and 26% were observed in the high-intermediate and high risk groups, respectively, in the IPI (see the section [Prognostic Factors](#)) ( 241, 600 ).

The intergroup trial was met with praise, as well as disappointment, because it indicated no improvement in survival for nearly two decades after the establishment of CHOP as an effective regimen. The first study to show an improvement in survival was a randomized

comparison of CHOP to CHOP plus rituximab in elderly patients (60 to 80 years of age) with DLBCL ( Fig. 90.14 ) ( 273 ). The rate of CR was higher for CHOP plus rituximab, compared to CHOP alone (76% vs. 63%;  $p = .005$ ). The EFS and OS were significantly higher in the CHOP-plus-rituximab arm: 57% versus 38% (  $p < .001$  ) and 70% versus 57% (  $p = .007$  ) ( 273 ). Potential concerns regarding the trial included the fact that 12.5% of patients had their diagnoses changed after central pathology review, the inclusion of stage II patients who could have received combined modality, and the use of eight cycles of CHOP, which could be excessive in an elderly population. Phase II trials have confirmed the efficacy of CHOP plus rituximab in a diverse group of B-cell lymphomas, and a similar intergroup phase III trial in the elderly in the United States has been completed but not reported ( 601 ). Despite these concerns, CHOP plus rituximab has become standard therapy for DLBCL in the elderly, and its use has been extended to most patients with DLBCL, as well as to other CD20<sup>+</sup> NHLs.



**Figure 90.14.** Event-free survival among 399 elderly patients who were randomized between CHOP plus rituximab (57% 2-year event-free survival) and CHOP (38% 2-year event-free survival). (From Coiffier B, Lepage E, Briere J, et al. CHOP chemotherapy plus rituximab compared with CHOP alone in elderly patients with diffuse large-B-cell lymphoma. *N Engl J Med* 2002;346:235–242, with permission.)

Although there is agreement about which clinical factors adversely affect prognosis, there is no consensus about how to improve CHOP-based therapy, except for the addition of rituximab for B-cell NHL. Strategies to improve response and survival in aggressive lymphomas have included using alternating non-cross-resistant regimens, infusion therapy, modifiers of multidrug resistance (MDR) genes, and dose intensification, including SCT. Phase II trials of non-cross-resistant regimens, such as ATT from the MDACC, appear to overcome adverse prognostic factors, but they have not been rigorously compared to CHOP in phase III trials ( 602 , 603 ). Similarly, a continuous infusion regimen, EPOCH (etoposide, prednisone, Oncovin, Cytosin, Adriamycin) with dose adjustments based on an individual's drug clearance, had a CR rate in large B-cell NHL of 92% and a 5-year PFS and OS of 70% and 73%, respectively; it overcame the IPI, but it has not been compared to CHOP ( 604 ). A phase II ECOG trial of infusion cyclophosphamide, doxorubicin, and etoposide in predominantly intermediate-grade NHL had a 2-year FFS of 50%, which was not significantly improved over historically IPI-matched controls ( 605 ). Phase II SWOG trials that evaluated infusion cyclophosphamide, vincristine, doxorubicin, and dexamethasone with or without modifiers of MDR (verapamil and quinine) also showed no advantage over historic trials that used CHOP therapy ( 606 ).

Dose escalation has been advocated as a means to improve response and survival in aggressive lymphomas, but phase III clinical trials have yet to prove the efficacy of dose intensity. Increased doses of doxorubicin in the regimen of bleomycin, doxorubicin, cyclophosphamide, vincristine, and prednisone failed to show improvement in response or

survival when compared in a randomized trial to the standard dose ( [607](#) ). In a small trial of 22 patients who were treated with high-dose CHOP, the CR rate was 86% with a 69% PFS but a short follow-up (median of 20 months) ( [608](#) ). In a trial of 70 patients with intermediate- to high-grade lymphoma, short-course (8 weeks), dose-intensive therapy, which is referred to as *MEGA*, produced an 81% CR rate and a 52% 5-year FFS ( [609](#) ). Another phase II trial that evaluated double-dose ProMACE-CytaBOM with growth factor support reported a CR of 69%, a PFS of 58%, and an OS at 73% at 4 years ( [610](#) ).

In one of the few phase III trials (LNH87-1) that compared a more intensive regimen—ACVBP [Adriamycin (doxorubicin), cyclophosphamide, vindesine, bleomycin, and prednisone] to a standard regimen (m-BACOD)—in a group of low-risk aggressive-lymphoma patients, there were no differences in FFS and OS (65% and 75% in ACVBP and 61% and 73% in m-BACOD) ( [611](#) ). In a multivariate analysis, ACVBP was associated with a better FFS in the patients with two or three age-adjusted IPI risk factors ( [611](#) ).

Some investigators advocate early SCT for selected patients with poor prognostic factors, but large randomized trials have failed to show a benefit for early transplantation (see the section [Role of Stem Cell Transplantation](#)) ( [308](#) , [612](#) , [613](#) ). CHOP with or without rituximab is the standard regimen for aggressive lymphomas for adults in the United States. European trials and pediatric studies, however, have indicated a role for more intensive therapy based on an increasing number of adverse features ( [611](#) ). It is likely that there are patients with such poor survival at diagnosis who still should be considered for early transplantation. Ongoing trials continue to address the issues of dose intensity and transplantation as front-line therapy for aggressive NHL.

## SALVAGE CHEMOTHERAPY

Although the role of transplantation in first remission remains uncertain, there is general agreement that transplantation can improve survival predominantly in patients with intermediate-grade NHL that responds to salvage chemotherapy (see the section [Role of Stem Cell Transplantation](#)). Chemotherapy regimens at relapse usually involve agents that are non-cross-resistant with, or at least different from, drugs that are used in initial therapy. Investigators at MDACC have developed multiple effective protocols: MIME [methylguazone, ifosfamide, methotrexate, and etoposide (VP-16)] ( [614](#) ); DHAP [dexamethasone, high-dose cytarabine (ara-C), and cisplatin (Platinol)] ( [615](#) ); ESHAP [etoposide, solumedrol (methylprednisolone), high-dose cytarabine (ara-C), and Platinol (cisplatin)] ( [616](#) ); MINE [mesna, ifosfamide, Novantrone (mitoxantrone), and etoposide] ( [617](#) ); and MINT [mesna, ifosfamide, Novantrone (mitoxantrone), and Taxol (paclitaxel)] ( [618](#) ). Various doses and schedules of ICE (ifosfamide, carboplatin, and etoposide) have been used in relapsed NHL and to mobilize peripheral blood stem cells before transplant ( [619](#) , [620](#) ).

The CR and PR rates for a variety of histologic types were 24 and 36% for MIME; 31 and 24% for DHAP; 37 and 27% for etoposide, solumedrol (methylprednisolone), and high-dose cytarabine (ara-C) with or without cisplatin; and 26 and 20% for MINT, but most of the responses were of short duration, with the median times to treatment failure usually being less than 1 year, particularly in the intermediate- to high-grade histologies. The response rate to an ICE regimen that was developed at Memorial Sloan-Kettering Cancer Center was 66%, with 89% of these patients going on to transplantation ( [619](#) ). Patients who achieved a CR to ICE before transplantation had a superior OS to patients who had a PR

(65% vs. 30%;  $p = .003$ ) ( [619](#) ).

Based on the premise that prolonged exposure to therapy may be more effective than bolus, a continuous infusion regimen, EPOCH, was developed at the NCI and produced a 24% CR and a 50% PR in relapsed and refractory NHL ( [621](#) ). With a median follow-up of 76 months, the OS and EFS were 17.5 and 7 months, respectively. In patients with chemosensitive disease with aggressive histologies, the EFS was 19% at 3 years ( [621](#) ). Investigators at Stanford University developed a regimen of cyclophosphamide, etoposide, procarbazine, and prednisone with or without bleomycin, which produced a 34% CR and a 22% PR in previously treated patients with intermediate- or high-grade histologies ( [622](#) ).

Combinations of regimens, such as MINT-ESHAP or MINE-ESHAP, have yielded response rates in a range from 49 to 69%, but there are no obvious differences in outcome among the combinations ( [623](#) , [624](#) ). In general, salvage chemotherapy regimens in aggressive lymphomas are used as a bridge to transplantations, because prolonged survivals without transplant are less than 15%. Single-agent therapy is rarely used in intermediate- to high-grade lymphoma, except in phase I and II studies or as palliation. Because of significant activity in relapsed disease, some of the agents are being used in combination with other drugs earlier in the course of NHL.

Doxorubicin-related compounds that are used as single agents and in combination chemotherapy for relapsed NHL include mitoxantrone ( [624](#) ), amsacrine ( [625](#) ), idarubicin ( [626](#) ), epirubicin ( [627](#) ), aclacinomycin ( [628](#) ), and esorubicin ( [629](#) ). No drug has had an advantage over doxorubicin, although mitoxantrone produces less alopecia, mucositis, nausea, vomiting, and cardiotoxicity. CHOP has been shown to be superior to a regimen of GNOP (cyclophosphamide, mitoxantrone, vincristine, and prednisone) in a randomized trial in elderly patients ( [630](#) ); however, an argument has been made that the study did not compare equivalent doses of doxorubicin and mitoxantrone ( [624](#) ). Ifosfamide, an alkylating agent analog, produced a 29% response in phase II trials ( [631](#) ) and is used in salvage combination chemotherapy ( [619](#) , [620](#) ).

Taxanes and camptothecins are agents with considerable activity in solid tumors and are being evaluated in the therapy of NHL. Paclitaxel (Taxol) and docetaxel (Taxotere) are tubulin-binding taxanes that have produced responses in 13 to 23% of heavily treated patients ( [632](#) , [633](#) , [634](#) , and [635](#) ). Camptothecins and type I topoisomerase inhibitors, including hycamptamine (Topotecan), irinotecan (CPT-11, Camptosar), and 9-aminocamptothecin (9-AC) have had responses of 25 to 35% ( [636](#) , [637](#) ). Combinations of paclitaxel plus hycamptamine appear to be synergistic, with a response rate of 48% and a median duration of 6 months ( [638](#) ).

Nucleoside analogs have primarily been used in indolent lymphomas, but gemcitabine, a pyrimidine antimetabolite, has had activity in relapsed intermediate-grade lymphomas. A response rate of 20% was observed in predominantly large B-cell NHL, and higher responses have been observed in PTCL ( [639](#) , [640](#) ). Combining gemcitabine with irinotecan in a phase I trial led to a 33% response for patients with NHL ( [641](#) ).

Vinca alkaloids with less neurotoxicity than vincristine have also been evaluated in NHL. Liposomal vincristine resulted in 41% response, with a median PFS of 5.5 months in responders ( [642](#) ). Infusion vinorelbine resulted in a 25% response, with a median PFS of 6 months in responders ( [643](#) ). Novel methods of drug delivery, including liposomal formulations, pegylation, different schedules of infusions, and oral formulations, may also

obtain responses in relapsed NHL ( [641](#), [644](#), [645](#) ). Incorporation of these and other new agents into combination regimens is an ongoing area of investigation.

Understanding mechanisms of drug resistance is also an area of investigation for the development of salvage regimens. Although the *MDF* gene and its gene product, P-glycoprotein, are expressed rarely in lymphomas at diagnosis, *MDF* expression often is detected in lymphoma cells at relapse. The *MDF*-inhibiting agents include verapamil and cyclosporine and its analog, PSC-833, and their use in conjunction with chemotherapy has been inconsistent in patients with relapsed lymphomas. ( [309](#), [646](#) ).

## HIGHLY AGGRESSIVE LYMPHOMAS

SNC lymphoma (Burkitt and Burkitt-like NHL) and LL, usually of T-cell origin, are rare NHLs in adults, each representing less than 3% of NHL. Because they are more common lymphomas in children, most of the advancement in therapy has evolved through phase III trials in pediatrics ( [Chapter 91](#) ) ( [272](#) ). The basic principles that are learned from pediatrics apply to the therapy of highly aggressive lymphoma in adults. In brief, short-course, dose-intensive cyclophosphamide therapy is used in SNC lymphoma, whereas therapy for ALL is the main approach to LL. Both types of highly aggressive NHL require CNS prophylaxis and have clinical overlap with adult ALL ( [Chapter 78](#) ).

### Small Noncleaved Cell Lymphoma

SNC lymphoma can be subdivided pathologically into Burkitt and Burkitt-like lymphoma (BLL), with the latter having more nuclear irregularity and also occurring more commonly in adults; however, they behave similarly clinically ( [647](#) ). Some have suggested combining BLL into DLBCL; however, the SWOG group delineated biologic and genetic differences between BLL and DLBCL ( [648](#) ). BLL had a higher proliferative rate, a greater expression of CD10, and a decreased expression of *BCL2*. Additionally, BLL had low cytotoxic T cells, an absence of one or more adhesion molecules, and an absence of the CD44 homing receptor ( [648](#) ). BLL had the t(8;14) translocation in 80% of patients and, most important, had a median survival of 1.2 years compared to 2.5 years for DLBCL ( [648](#) ).

In the United States, the Burkitt type of lymphoma tends to occur in younger adults, with more gastrointestinal presentations and less marrow involvement than BLL, but Burkitt lymphoma and BLL clinically overlap, have a risk for tumor lysis, and have been difficult to cure with conventional chemotherapy for adults. Two early reports in 1983 by Levine et al. ( [649](#) ) and Oviatt et al. ( [650](#) ) had CR rates of 29 to 40%, a continuous CR of 20 to 26%, and median survivals of 6 to 10 months ( [649](#), [650](#) ). With combination chemotherapy that was effective in large cell lymphoma, the Vancouver group reported only a 40% CR rate in SNC lymphoma that was treated with MACOP-B and no long-term survivors ( [651](#) ); however, the NCI reported a 61% DFS and a 35% OS with a ProMACE-based regimen ( [652](#) ).

More intensive regimens have improved results in SNC NHL and mature B-cell ALL ( [653](#), [654](#), [655](#), [656](#), [657](#), [658](#), [659](#) and [660](#) ). Results vary in part owing to differences in age, stage, number of HIV-positive patients, and intensity of therapy ( [Table 90.11](#) ). In general, the CR rates are in the range of greater than 80%, and survival is approximately 50% for the older adult and in the range from 60 to 80% for young adults. Relapses are usually confined to the first year after stopping therapy; there is no role for maintenance. Previously, intensity of therapy in HIV patients with NHL was reduced owing to risk of infections and poor survival; however, in the era of HAART and growth factor support, the



CR rate with hyper CVAD in HIV patients with Burkitt lymphoma/leukemia has reached 92% with a 2-year survival of 48% ( [Chapter 69](#) ) ( [661](#) ). In pediatric trials, there is usually a prephase with low-dose cyclophosphamide steroids to debulk and to lessen tumor lysis, followed by intensive therapy that is stratified according to prognostic factors ( [655](#) ). Previously, subsets of advanced-stage patients with CNS or marrow involvement had a survival of less than 30% and were considered candidates for early transplantation ( [662](#) ); however, with the present day regimens, DFS is in a range from 50 to 80% for advanced SNC lymphoma and Burkitt leukemia, thus obviating the need for early transplantation in most adult patients ( [663](#) ).

**TABLE 90.11. Chemotherapy in Adults with Small Noncleaved Cell Lymphoma**

| Author, Year (Reference)               | Number of Patients | Median Age (Yr) | HIV (%) | Bone Marrow (%) | Therapy                           | CR (%) | Survival    |                           |                                 | Comments  |
|--|--------------------|-----------------|---------|-----------------|-----------------------------------|--------|-------------|---------------------------|---------------------------------|---|
|  |                    |                 |         |                 |                                   |        | Overall (%) | Limited (%)               | Advanced (%)                    |   |
| Lopez, 1990 ( <a href="#">653</a> )    | 44                 | 32              | 27      | 16              | Variable, three rotating regimens | 80     | 63          | 95                        | 29                              | 83% CR and 36% overall survival in HIV.   |
| McMaster, 1991 ( <a href="#">654</a> ) | 26                 | 45              | 23      | 35              | MEGA                              | 81     | 55          | 88                        | 40                              | <30% DFS in patients older than 60 yr of age; lactate dehydrogenase >900 IU/L; marrow involvement; 33% DFS in HIV.  |
| Soussain, 1995 ( <a href="#">655</a> ) | 65                 | 26              | 0       | 43              | LMB regimens                      | 89     | 71          | 92                        | 76 (stage III)<br>57 (stage IV) | Pediatric protocol; includes 13 patients who were transplanted in first CR; 7 out of 12 patients with central nervous system disease have long DFS.           |
| Magrath, 1996 ( <a href="#">656</a> )  | 39                 | 24              | 0       | 28              | 77-04                             | 82     | 56          | 66 (stages I through III) | 19 (stage IV)                   | DFS includes children; there was no difference with adults. New regimen (89-C-41) added IVAC; no benefit to granulocyte-macrophage colony-stimulating factor. |
|  | 20                 | 25              | 0       | 15              | 89-C-41                           | 100    | 92          | 97 (stages I through III) | 80 (stage IV)                   |   |

|                                       |    |    |   |     |                     |    |    |               |    |  |
|---------------------------------------|----|----|---|-----|---------------------|----|----|---------------|----|--|
| Hoelzer, 1996 ( <a href="#">657</a> ) | 35 | 36 | 0 | 100 | B-NHL86             | 74 | 51 | —             | 51 | All patients had B-cell acute lymphocytic leukemia; 17% central nervous system relapses; 9% early deaths. 77% overall survival for patients younger than 60 yr of age compared to 17% for patients equal to or older than 60 yr of age ( <i>p</i> <.01). Median follow-up 5.1 yr; 19 patients excluded by path review. Uses Magrath regimen 89-C-41. |
| Thomas, 1999 ( <a href="#">658</a> )  | 26 | 58 | 0 | 100 | Hyper CVAD          | 81 | 49 | —             | 49 |  |
| Lee, 2001 ( <a href="#">659</a> )     | 54 | 44 | 0 | 80  | CALGB 9251          | 80 | 52 | Not available | 46 |  |
| Mead, 2002 ( <a href="#">660</a> )    | 52 | 35 | 0 | 48  | United Kingdom LY06 | 77 | 73 | 82            | 70 |  |

CR, complete remission; CVAD, cyclophosphamide, vincristine, Adriamycin (doxorubicin), dexamethasone; DFS, disease-free survival; HIV, human immunodeficiency virus; IVAC, ifosfamide, VP-16 (etoposide), Ara-C (cytarabine).

## Lymphoblastic Lymphoma

The immature T-cell origin of LL was confirmed by the presence of the intranuclear enzyme, terminal deoxynucleotidyl transferase, which is not detected in the mature or peripheral T-cell neoplasms. Although LL expresses less terminal deoxynucleotidyl transferase and tends to have a more mature phenotype than T-cell ALL, considerable overlap exists biologically and clinically between these entities ( [664](#) ). In the past decade, multiple oncogenes have been identified in the translocations that are associated with T-cell LL and ALL ( [Chapter 89](#) ). Rarely, T-cell LL is associated with eosinophilia, acute myelogenous leukemia (AML), and a specific cytogenetic abnormality, t(8;13)(p11;q11) ( [665](#) ), and it has been associated with prior epipodophyllotoxin chemotherapy and a cytogenetic translocation that involves the *MLL* gene, t(11;19)(q23;p23) ( [666](#) ). LL is occasionally of B-cell origin, which has different clinical features from T-cell disease, including cutaneous and bone involvement and less mediastinal disease ( [667](#) ).

Because LL is rare in adults, only a few series have addressed therapy, and some patients have received early transplantation, which compromises the assessment of the impact of chemotherapy. In 1978, Rosen et al. ( [668](#) ) described 12 adult patients with a median survival of 13 months and less than 20% DFS. Studies in the 1980s indicated a CR rate of 53 to 95% when using CHOP-like induction regimens, and a high CNS relapse (approximately 40%), if CNS prophylaxis was not given ( [669](#) , [670](#) and [671](#) ). ALL-like regimens with a maintenance phase that lasted 12 to 36 months resulted in 3- to 5-year survivals of 30 to 56% ( [669](#) , [670](#) and [671](#) ). Poor prognostic features included age (older than 30 years),



bone marrow involvement, elevated white cell count ( $>50 \times 10^9$  per L), CNS disease, elevated LDH, and slow response (670, 671). Coleman et al. (671) reported a 5-year survival of 94% in low-risk patients, compared to 19% ( $p < .001$ ), with high-risk features defined by bone marrow or CNS disease or elevated LDH ( $>1.5$  times normal). Short-course, dose-intensive regimens without maintenance have been tried in LL, but the relapses appear excessive, and the numbers are too small to use this approach (672).

Controversial management issues for LL include the optimal type of CNS prophylaxis, the role of radiation to the mediastinum, the type of maintenance therapy, and the role of transplantation. With present-day ALL regimens, the CR rates are 75 to 90%, with a prolonged DFS of 40 to 60% of responders (Table 90.12) (673, 674, 675, 676, 677 and 678). An option to consider for young adults is to use pediatric-based protocols, which have had better EFS when compared to adult ALL protocols (679). Because of poor survival with chemotherapy, high-risk patients may be candidates for early transplantation.

**TABLE 90.12. Chemotherapy in Adults with Lymphoblastic Lymphoma**

The most significant predictor of survival for patients who undergo SCT is the status of the disease at the time of transplant (680, 681, 682, 683, 684 and 685). The European Bone Marrow Transplantation Group retrospectively reviewed their experience in 214 patients with LL who underwent autologous transplantation; the 6-year DFS varied according to disease status: 63% in first CR, 31% in second CR, and 15% with resistant disease (682). In a randomized trial that compared early autologous SCT to conventional chemotherapy, Sweetenham et al. (684) reported a trend that favored autologous SCT (55% vs. 24%;  $p = .065$ ), but there was no improvement in OS. The role of allogeneic transplant in LL in first CR is even more controversial. In an International Bone Marrow Transplant Registry retrospective review of transplants for LL, there were fewer relapses with allogeneic SCT, compared to autologous SCT, but there was no survival advantage owing to higher treatment-related mortality (685). Recent randomized trials in adult ALL, which include LL, however, are favoring the allogeneic arm (686, 687).

## MANAGEMENT OF EXTRANODAL LYMPHOMAS

Sites of involvement and histologic type are important factors in the management of extranodal lymphomas. The Ann Arbor staging system has been used: Stage I<sub>E</sub> represents localized extranodal lymphoma; stage II<sub>E</sub> represents extranodal lymphoma with involvement of adjacent lymph nodes; subclassifications of stage II<sub>E</sub> separate involvement into contiguous nodes (stage II<sub>1E</sub>) and noncontiguous nodes (stage II<sub>2E</sub>) and have been used in gastric lymphomas; stages III and IV in extranodal lymphomas represent disseminated disease with little advantage in distinguishing the two stages. Extranodal lymphomas of the gastrointestinal tract, the nasopharynx, and the testes are generally more aggressive than those of the lung, the orbit, or the salivary gland. Therapy, however, depends not only on the site, but also on the histologic characteristics,

immunophenotype, and stage of the lymphoma ( [Table 90.13](#)).

**TABLE 90.13. Management Issues for Extranodal Lymphomas**

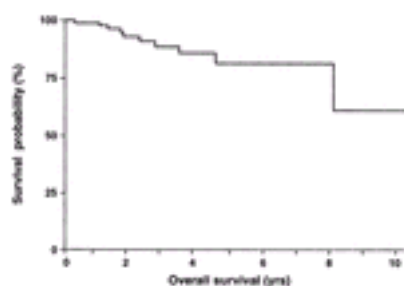
| Site   | Usual Pathology                                    | Clinical Associations  | Suggested Therapy <sup>a</sup>  |
|--|--|--|---|
| Stomach                                      | B-cell MALToma                                     | <i>Helicobacter pylori</i>   | Antibiotic trial, serial endoscopy; other therapy if t(11;18) or progressive disease      |
| Intestine<br>Ileum                           | Small noncleaved B cell                            | Obstruction  | High-dose cyclophosphamide combination chemotherapy with or without surgery               |
| Immunoproliferative small intestinal disease | B cell MALToma                                     | Malabsorption, immunoglobulin A heavy chain, Middle East                       | Antibiotics, steroids, with or without combination chemotherapy                           |
| Enteropathy associated T-cell lymphoma       | Peripheral T-cell lymphoma                         | Celiac disease, West, obstruction  | Combination chemotherapy with or without surgery  |
| Waldeyer ring                                | Large B cell                                       | Other gastrointestinal disease   | Combined modality   |
| Paranasal                                    | Large B cell                                       | CNS disease  | Combined modality, CNS prophylaxis  |
| Nasal  | Natural killer-cell and peripheral T-cell lymphoma | Epstein-Barr virus, angiocentric features, CNS disease, Far East               | Combined modality, CNS prophylaxis  |
| Salivary gland                               | B-cell MALToma                                     | Sjögren syndrome   | Single agent or radiation, or both  |
| Thyroid                                      | B cell   | Hashimoto thyroiditis  | Radiation or combined modality, depending on histology and stage                          |
| Lung   | Small B cell, B-cell MALToma                       | —  | Single agent, surgery, or radiation   |
| Orbital                                      | Small B cell, B-cell MALToma                       | —  | Radiation   |
| Primary CNS                                  | Large B cell                                       | Ocular involvement, leptomeningeal disease, acquired immunodeficiency syndrome | Steroids, high-dose methotrexate with or without radiation                                |
| Testis                                       | Large B cell                                       | Contralateral testicular disease, CNS disease, retroperitoneal spread          | Orchiectomy, combination chemotherapy, radiation to contralateral testis, CNS prophylaxis |

|           |   |                   |  |
|-----------|---|-------------------|--|
| Breast    | Large B cell  | Pregnancy         | Combination chemotherapy with or without radiation |
| Ovary     | Burkitt, large B cell                                 | Bilateral disease | Combination chemotherapy                           |
| Bone      | Large B cell  | —                 | Combination chemotherapy with or without radiation |
| Cutaneous | Mycosis fungoides                                     | —                 | Skin-directed                                      |
|           | B-cell MALToma, primary cutaneous follicular lymphoma |                   | Radiation if stage I E                             |
|           | Primary cutaneous B-cell lymphoma                     |                   | Combined modality                                  |

CNS, central nervous system; MALToma, lymphoma of mucosa-associated lymphoid tissue.

<sup>a</sup> Combined modality refers to combination chemotherapy and radiation. Combination chemotherapy refers to doxorubicin-based therapy. Rituximab can be added to therapy of most B-cell (CD20<sup>+</sup>) lymphomas.

The recognition of MALTomas has led to unique therapeutic options. MALTomas were previously called *pseudolymphomas*, but the latter term is probably no longer valid because MALTomas are monoclonal, can be associated with a higher-grade histology, and have cytogenetic abnormalities (688). Clinically, MALTomas are different from other low-grade lymphomas in that they tend to remain localized, rarely disseminate, and respond favorably to local therapy (Fig. 90.15) (688, 689).



**Figure 90.15.** Kaplan-Meier survival curve of overall survival for mucosa-associated lymphoid tissue lymphoma of the stomach in 93 patients who were diagnosed from 1986 to 1995 in northern Italy. Most patients presented with localized disease (82 stage I, four stage II, and seven stage IV). The 5-year projected overall survival was 82% (95% confidence interval, 76 to 91%) without any apparent differences from different therapies [antibiotics (49), gastrectomy plus other therapy (24), chemotherapy (12), radiotherapy (

10), and none (7)]. (From Pinotti G, Zucca E, Roggero E, et al. Clinical features, treatment and outcome in a series of 93 patients with low grade gastric MALT lymphoma. *Leuk Lymphoma* 1997;26:527–537, with permission.)

Management of gastric MALToma changed when antibiotic therapy for *H. pylori* resulted in regression of lymphoma (690, 691, 692 and 693). Ultrasound endoscopy and biopsies assist in the determination of the extent of disease and the depth of invasion, which correlate with spread to regional lymph nodes and response to antibiotics (694). CR rates to antibiotics are greater than 70% when the disease is confined to the mucosa and submucosa (693). Infiltration of the muscularis mucosa or nodal extension and the presence of t(11;18) do not respond well to antibiotics (692, 693, 695). Serial endoscopies are warranted to ensure eradication of *H. pylori* and gradual disappearance of the lymphoma over many months (690, 691, 692 and 693). Follow-up endoscopy is recommended 2 months after antibiotic therapy and, subsequently, at least twice a year for 2 years (694). B-cell clonality, as detected by PCR, may persist after histologic regression but is of uncertain clinical significance (150, 696). If there is evidence of a high-grade component or progressive disease, alternative therapies are usually warranted. Surgery can be curative in gastric lymphoma, particularly in stage I<sub>E</sub>, with cure rates greater than 80% (697, 698); however, radiation therapy or single-agent chemotherapy is also effective in low-grade MALToma and may prevent the morbidity of total gastrectomy (689, 699, 700). Preliminary data also indicate that MALToma can respond to rituximab (701).

With the recognition of MALToma and the effectiveness of other therapies, the role of surgery has become an area of controversy in the management of gastrointestinal lymphoma. Although many investigators advocate surgical resection in gastric and other intestinal lymphomas to debulk, to stage accurately, and to prevent perforation (214, 697, 698, 702, 703), some investigators have achieved good results with combination chemotherapy or combined modality without surgery, particularly for the higher-grade lesions (704, 705). Although a partial or subtotal gastrectomy may be justified in some cases, more extensive surgery, such as total gastrectomy, should not be routinely performed because of the increased morbidity and the curability with alternative therapies (703, 706, 707). Surgery was avoided in two series of patients with intermediate- to high-grade gastrointestinal lymphoma who achieved a 61% 4-year DFS and a 76% 6-year survival with combination chemotherapy alone (704, 708).

Similar surgical issues pertain to intestinal lymphomas as in gastric lymphomas, particularly if they present with obstruction; however, they usually are less amenable to total resection (709). Other B-cell tumors that have relatively unique presentations are SNC (Burkitt or Burkitt-like) in the ileocecal region, which is particularly common in the Middle East (710), and MCL, which can present with lymphomatous polyposis (216). IPSID can be considered a subtype of B-cell MALToma and is distinguished by its occurrence in young adults from low socioeconomic groups in the Middle East and North Africa and its association with the synthesis of an IgA heavy chain (711, 712). Although the prognosis is usually considered poor in IPSID, a combination of antibiotics (tetracycline), steroids, and anthracycline-based chemotherapy, along with aggressive supportive care with hyperalimentation, can achieve CRs in two-thirds of patients with survivals in more than one-half of the patients at 3.5 years (713). The only unique T-cell lymphoma of the gut is the EATL, which may require emergent surgery and responds poorly to chemotherapy (see the section [Extranodal T-Cell and Natural Killer-Cell Lymphomas](#)) (512, 513 and 514).

Lymphomas that involve Waldeyer ring account for as much as one-third of extranodal lymphomas and are second to gastric lymphoma as the most common extranodal site ( [52](#), [53](#) ). Prognosis depends on histologic findings, which are usually a large B-cell lymphoma, the size of the tonsillar mass, and the stage ( [714](#), [715](#) ). As much as one-half of patients have advanced disease, and simultaneous involvement of the gastrointestinal tract is detected in 10 to 15% of patients with Waldeyer ring lymphoma ( [716](#), [717](#) ). Because of the intermediate histologic grade and the advanced stage of many patients, chemotherapy, often in combination with radiation, is usually considered the therapy of choice ( [718](#) ). With combined modality therapy, 70 to 90% of clinical stage I<sub>E</sub> patients survive 5 years, along with 40 to 60% of patients with stage II<sub>E</sub> ( [719](#), [720](#) ).

Lymphomas of the nasal cavity and paranasal sinuses often are evaluated in series that include Waldeyer ring lymphomas, despite differences in presentation, diagnosis, and therapy. The primary lymphoma often is more advanced in nasal lymphomas with invasion of adjacent bones and an increased risk for CNS involvement. Although uncommon, cervical node involvement in nasal lymphomas is associated with a poor prognosis ( [719](#) ). Large B-cell lymphoma is the most common histology; but, in series from the Far East, NK and PTCL frequently originate from the nasal area, have angiocentric and angiodestructive features, and are associated with EBV (see the section [Extranodal T-Cell and Natural Killer-Cell Lymphomas](#)) ( [93](#), [515](#), [516](#) and [517](#) ). Some investigators advocate using the American Joint Committee TNM staging for carcinoma of the paranasal sinuses. In a series from MDACC, patients with T1 and T2 lesions had an 89% 5-year DFS compared to 25% for patients with T3 and T4 lesions ( [719](#) ). Patients with Ann Arbor stage III and IV disease usually die, despite chemotherapy ( [516](#) ). The best therapeutic results have tended to be in those series with combined modality therapy ( [516](#), [517](#), [719](#), [721](#) ).

Other rare extranodal lymphomas include salivary gland, thyroid, pulmonary, and orbital lymphomas; all have unique presentations and histopathologic features and may be associated with autoimmune disorders. Although somewhat variable according to series, the majority of salivary gland lymphomas are indolent and localized, have been treated with radiation, and have survivals of 70 to 80% at 5 years and 40 to 50% at 10 years ( [722](#), [723](#) ). Most patients with thyroid lymphomas have localized stage I<sub>E</sub> or II<sub>E</sub> disease and have been treated with radiation, with a 5-year DFS of 40 to 70% ( [724](#), [725](#) and [726](#) ). A worse prognosis occurs with penetration of the thyroid capsule, tumor bulk, advanced stage, and intermediate- to high-grade histologic types. Because of the frequency of these factors, many have advocated combined modality therapy for thyroid lymphoma, except in the patient with small stage I disease ( [725](#), [726](#) ).

Most primary pulmonary lymphomas are small B lymphocytic, with or without plasmacytic differentiation, and are considered a part of the spectrum of MALTomas. Therapy options include chemotherapy, single agent or a nonanthracycline combination; surgical resection; radiation; or rituximab, or a combination of these. The prognosis is good, with a 94% OS at 5 years without reaching a median survival at 10 years, and there is no advantage for a specific type of therapy ( [231](#), [727](#), [728](#) ). Other pulmonary lymphomas are heterogeneous but generally have a poor prognosis and include disseminated large B-cell lymphoma and lymphomatoid granulomatosis, which can be associated with PTCL ( [231](#), [729](#) ).

Orbital lymphomas, like the bronchus-associated lymphoid tissue lymphomas, usually involve small B lymphocytes, with or without plasmacytic differentiation, and need to be

distinguished from benign lymphoid hyperplasia. They tend to be localized, and 10 to 15% are bilateral. They respond to radiation, with a survival of 75 to 92% at 5 years and 70 to 80% at 10 years ( [227](#), [730](#), [731](#) ). Large B-cell lymphomas are less common, tend to involve the lacrimal gland or retroorbital area, and have a worse prognosis despite the recommended use of combined modality therapy ( [227](#) ).

CNS lymphomas are responsive to steroids, radiation, intrathecal or Ommaya reservoir therapy, and systemic chemotherapy, which crosses the blood-brain barrier. Standard treatment for PCNSL historically was whole-brain radiation therapy alone; the prognosis was poor, with a survival less than 6 months in AIDS patients and 1 to 2 years in immunocompetent hosts ( [732](#), [733](#) ). However, recent data that use early chemotherapy, particularly high-dose methotrexate or cytosine arabinoside, usually followed by whole-brain radiation therapy, have improved results in PCNSL, with median survivals from 30 to 60 months ( [221](#), [734](#), [735](#) and [736](#) ). Severe neurologic toxicity that is manifested as leukoencephalopathy secondary to radiation is common, particularly in the patient who is older than 60 years of age, and trials with chemotherapy alone and deferred radiation are being conducted ( [737](#), [738](#) and [739](#) ).

Testicular lymphoma, which represents approximately 5% of testicular neoplasms, is the most common testicular tumor in patients who are older than 60 years of age and is the most common bilateral testicular tumor ( [740](#), [741](#) ). It is associated with involvement of the contralateral testis in 20% of patients and involvement of the skin, Waldeyer ring, and CNS, each in approximately 10% of patients. The predominant histologic type is a DLCL, usually of B-cell origin. In most series, median survivals have been 1 to 2 years, and 5-year survivals have varied from 12 to 48%, depending in part on the extent of disease ( [740](#), [741](#), [742](#) and [743](#) ). Because of the poor prognosis and early systemic spread, anthracycline-based chemotherapy is warranted, usually with radiation to the involved testis, if unresected, as well as to the contralateral testis. Because of the CNS relapse rate of 15 to 31%, CNS prophylaxis should also be considered ( [740](#), [744](#) ).

Breast lymphomas usually manifest as a rapidly enlarging mass, may be multiple, and involve the opposite breast in 10 to 20% of patients ( [227](#), [230](#), [745](#), [746](#) and [747](#) ). The histologic type is variable, but it is more often a large B-cell lymphoma; low-grade lesions with MALToma features and an association with lymphocytic lobulitis have also been described ( [748](#) ). Massive bilateral breast involvement with SNC lymphoma has been described in pregnant or lactating women, predominantly those from Africa, and is characterized by rapid dissemination with ovarian and CNS disease ( [230](#) ). After simple biopsy and staging, radiation therapy can be considered for local control of low-grade lesions, but combination chemotherapy is warranted for aggressive histologies.

Primary ovarian lymphomas are rare, except in countries in which Burkitt lymphoma is endemic; however, the ovary is the most common site of female genital tract involvement by lymphoma at autopsy ( [749](#) ). Ovarian lymphomas may be associated with bilateral involvement in more than one-half of patients and have had a poor prognosis, with a 5-year survival of less than 25% ( [750](#) ). Prognosis depends on the extent of disease and the histologic type. Combination chemotherapy is warranted in most patients owing to aggressive histologies.

Primary bone lymphomas are usually intermediate- or high-grade B-cell NHL, and approximately one-third of cases have more than one bone involved ( [53](#), [227](#), [228](#) ). Prognosis depends on the bones that are involved, with the femur having the best prognosis and the spine having the worst prognosis; histologic type; stage; and the



presence of soft-tissue involvement ( [228](#), [751](#) ). Local radiation is usually given to the entire bone, with a boost to the tumor bed. Although combined modality has been recommended for aggressive histologies ( [752](#), [753](#) ), chemotherapy alone has been successful, particularly in children ( [754](#) ). For localized bone lymphoma, RFS exceeds 70% at 5 years ( [227](#) ).

Therapy of CTCL and the differential diagnosis of cutaneous lymphomas are addressed in [Chapter 94](#). Local radiation therapy is often adequate for localized (stage I<sub>E</sub>) cutaneous MALT-oma or PCFL, whereas multiple therapeutic options can be considered for advanced disease that is similar to other indolent lymphomas. Combined modality therapy is usually recommended for localized PCBCL. The majority of PCFL lack *BCL2* expression and the *BCL2* gene rearrangement and have a good prognosis ( [755](#) ). Alternatively, *BCL2* expression is often present in PCBCL of the leg, as opposed to other sites; is primarily seen in the elderly; and has a poor prognosis ( [756](#) ).

## ROLE OF STEM CELL TRANSPLANTATION

Transplantation is addressed in [Chapter 25](#) and has taken an expanded role in the therapy of NHL; its use has been noted in the preceding sections on individual diseases. In 1978, Appelbaum et al. ( [757](#) ) reported long-term DFS in three of nine patients with relapsed Burkitt lymphoma who underwent high-dose chemotherapy and autologous marrow transplantation. In subsequent series using autologous transplants, the OS rate has usually been 20 to 40% in relapsed NHL ( [758](#), [759](#), [760](#), [761](#) and [762](#) ). Patients who are in a sensitive relapse—that is, they are responding to additional chemotherapy—have 30 to 50% salvage rates with transplantation, compared to 0 to 15% in patients who are in a resistant relapse. Patient selection influences outcome, with the best results achieved in patients in first CR or who had minimal disease before the transplant ( [759](#), [763](#) ). Histologic grade and preparative regimen have not consistently influenced outcome. Mortality has been in the range from 5 to 25% but has decreased with the use of peripheral blood stem cells and improved supportive care. Relapse is the main reason for failure after autologous transplants. Hematopoietic growth factors lessen the length of neutropenia and hospitalization with autologous marrow transplantation and may decrease morbidity and mortality rates ( [764](#), [765](#) ).

An unresolved issue of SCT for NHL is the optimal timing of transplant. There is agreement that SCT is warranted in relapsed patients with intermediate- to high-grade histology based on the PARMA trial, which randomized patients to transplantation versus chemotherapy ( [Fig. 90.16](#) ) ( [766](#) ). Much disagreement surrounds which, if any, poor prognostic factors could be used to select patients with NHL for early SCT. Although several small series have had a DFS of greater than 75% in selected patients who were transplanted in good PR or first CR with intermediate- to high-grade histology ( [767](#), [768](#) and [769](#) ), most studies that have compared SCT to chemotherapy in first CR or in slow responders have shown no advantage to early transplantation ( [Table 90.14](#) ) ( [308](#), [612](#), [613](#), [770](#), [771](#), [772](#) and [773](#) ). Retrospective analysis of trials indicated a survival advantage for SCT in patients with an age-adjusted IPI that was greater than or equal to 2 ( [612](#) ); however, prospective randomized trials have not supported early transplantation over chemotherapy in first CR ( [774](#) ).





immunotherapy to eradicate minimal residual disease ( [788](#), [789](#) and [790](#) ).

## SPECIAL AREAS

### Therapy in the Elderly

Although lymphomas steadily increase in number with aging, and the prognosis tends to be poor in the older patient, the management of lymphomas, primarily intermediate- to high-grade types, in the elderly is controversial. Possible factors that contribute to poor prognosis in this group include poor performance status, reduced vital organ reserve, comorbid diseases, and biologic features of the lymphoma; however, physician biases and reduction of chemotherapy doses may also contribute to an inferior prognosis ( [791](#), [792](#) ). In a SWOG study with CHOP chemotherapy in which the dosage was reduced by 50% in patients who were older than 65 years of age, CR rates declined with advancing age; however, in a small subset of patients who were older than 65 years of age who did receive full doses, the CR rate approximated that of younger patients ( [793](#) ). Randomized clinical trials that have compared different regimens to doxorubicin-based therapy have usually shown equivalent or inferior results ( [630](#), [794](#), [795](#), [796](#) and [797](#) ). The randomized trial that favored CHOP plus rituximab over CHOP established a new standard for therapy of large B-cell lymphoma in the elderly ( [273](#) ). Despite anthracyclines being recommended in the elderly, close monitoring of cardiac function is essential, and a decline in ejection fraction requires substitution of another drug.

Although some studies have excluded older patients, as evidenced by a median age of younger than 52 years ( [585](#), [586](#) ), others have had unacceptable toxicity in the elderly population, with as high as a 23% mortality in patients who were older than 60 years of age who were treated with MACOP-B ( [589](#) ). In a University of Nebraska study of the chemotherapy regimen of CAP-BOP (cyclophosphamide, doxorubicin, procarbazine, bleomycin, vincristine, and prednisone), Vose et al. ( [310](#) ) noted that the CR rate for patients who were older than 60 years of age (61%) was not statistically different from the CR rate for patients who were younger than 60 years of age (76%;  $p = .18$  ). Moreover, although the overall 5-year survival rate was 34% in the elderly, compared to 62% in younger patients (  $p = .01$  ), no difference in survival by age was noted when elderly patients who died of unrelated causes (22%) were censored. Novel regimens have been developed for the elderly patient, not only to lessen toxicity, but also to maintain a high curability ( [798](#), [799](#), [800](#), [801](#) and [802](#) ). CR rates are usually 45 to 60%, and OS at 3 years is 25 to 42%, but most have not been compared to CHOP. Growth factors lessen the neutropenia of various regimens and allow the delivery of adequate doses on schedule ( [803](#) ). Age is a continuum, with tolerance to therapy and survival worsening in patients older than 70 years of age; however, performance status is the best predictor of treatment-related death ( [804](#) ). Autologous transplantation in the elderly can result in similar outcomes to those observed in younger patients ( [805](#) ). Elderly patients should not be excluded from clinical trials or curative therapy solely on the basis of age.

### Therapy in Pregnancy

The coincidence of NHL in pregnancy is unknown ( [806](#) ). More than 100 cases of NHL in pregnancy have been reported ( [806](#) ); therapy is based on the histologic type and the point of gestation at diagnosis. Staging studies are limited owing to concern for radiation exposure to the fetus. Most women who develop NHL during pregnancy have intermediate- to high-grade histologies and advanced-stage disease ( [806](#) ). There is an unusually high incidence of breast, ovarian, uterine, and cervix involvement that is

attributed to hormonal influences and increased blood flow to these organs ( 806 ). Placental involvement is rare, and transmission to the fetus is so uncommon that it is reportable ( 807 ).

Patients with aggressive lymphomas who present in the first trimester should be considered for a therapeutic abortion, unless the lymphoma is localized above the diaphragm and could be treated with involved field radiation plus abdominal shielding ( 808 ). As a rule, radiation should be avoided until the third trimester, whereas combination chemotherapy can be given successfully in the second or third trimester. Early delivery (by induction or cesarean section) can be considered to avoid myelosuppression of mother and fetus or to initiate intensive chemotherapy. Staging should be completed after delivery. Prognosis for mothers has been relatively poor, with a DFS of only 40 to 45%, probably owing to the aggressive histologies and the advanced stage ( 806 , 807 , 808 and 809 ). Although low-grade lymphomas constitute a minority of NHL in pregnancy, they generally can be observed until after delivery. If necessary, IFN can be used throughout pregnancy to control indolent hematologic disorders ( 810 ). Offspring who, as fetuses, received chemotherapy, even in the first trimester, have had normal growth and development and no increased risk of cancer ( 811 ).

### Long-Term Sequelae

The long-term complications of therapy in NHL are not as well described as those in HD, but they appear to be similar and depend on the therapy that is used, the age of the patient, and the comorbid illnesses. These problems include endocrine disorders (infertility, hypothyroidism, panhypopituitarism, growth retardation), vital organ toxicity, psychosocial issues, transfusion-induced viral infections, and second neoplasms ( Chapter 95 ) ( 812 , 813 ). Radiation is the main cause of endocrine and neurologic toxicities ( 812 ). Cardiotoxicity from anthracyclines is the most common chemotherapy-related toxicity ( 814 ). Although previous studies have suggested no increase in second neoplasms after therapy for NHL, the NCI's Surveillance, Epidemiology, and End Results Program identified an increased risk over time for AML; cancers of the bladder, kidney, and lung; malignant melanoma; and HD ( 812 , 813 ). As much as 10% of NHL patients who are treated with standard chemotherapy regimens or autologous transplantation, particularly in regimens that use total body irradiation, may develop MDS or AML within 10 years of their initial therapy ( 782 ).

## FUTURE DEVELOPMENTS AND SUMMARY

New drugs with unique activity are in phase I and II trials ( 815 ). Depsipeptide is a histone deacetylase inhibitor that causes cell cycle arrest at G<sub>0</sub> and G<sub>1</sub> and has activity in PTCL and CTCL ( 816 ). Other drugs that are directed at the cell cycle are flavopiridol, which inhibits cyclins and cyclin-dependent kinases, and UCN-01, which inhibits serine and threonine kinases and leads to the arrest of cells in G<sub>1</sub> ( 815 ). Bortezomib (Velcade, Millenium Pharmaceuticals, Inc., Cambridge, MA) is the first proteasome inhibitor in trials and has been approved for use in relapsed myeloma ( 817 ). G 3139 (oblimersen sodium, Genta Incorporated, Berkely Heights, NJ), the first antisense molecule in trials, targets *BCL2* messenger RNA and causes BCL2 protein expression reduction, which correlates with response in NHL ( 818 ). These and other new agents are synergistic with other chemotherapy and monoclonal antibodies and require phase III trials to establish their place in the expanding list of treatments for NHL.

Advances in NHL will involve molecular techniques to refine diagnosis, classification, and therapy. The classification of lymphoma will improve with genomic profiling in conjunction with clinical and pathologic factors. The application of PCR to detect minimal residual disease may identify patients who should be followed more closely or should receive additional therapy. The success of monoclonal antibody therapy in NHL has been remarkable, and the development of vaccines may be the ultimate goal of immunotherapy ([Chapter 74](#)). Continued trials that evaluate the role of dose intensification and the use of different types of transplantation are still warranted in NHL.

## REFERENCES

1. Hodgkin T. On some morbid appearances of the absorbent glands and spleen. *Trans R Med Chir Soc Glasgow* 1832;17:68–114.
2. Virchow R. *Die Krankhaften Geschwulste. Dreissig Vorlesungen gehalten während des Wintersemestes 1862–1863 an der Universität zu Berlin.* Berlin: A. Hirschwald, 1863–1867.
3. Robb-Smith AHT, Taylor CR. *Lymph node biopsy.* New York: Oxford University Press, 1981.
4. Kundrat H. Ueber Lympho-Sarkomatosis. *Wein Klin Wochenschr* 1893;6: 211–234.
5. Sternberg C. Über eine eigenartige unter dem Bilde der Pseudoleukämie verlaufende Tuberculose des lymphatischen Apparates. *Ztschr f Heilkd* 1898;19:21–90.
6. Reed DM. On the pathological changes in Hodgkin's disease, with especial reference to its relation to tuberculosis. *Johns Hopkins Med J* 1902;10:133–196.
7. Brill NF, Baehr G, Rosenthal N. Generalized giant lymph node hyperplasia of lymph nodes and spleen. A hitherto undescribed type. *JAMA* 1925;84:668–671.
8. Symmers D. Follicular lymphadenopathy with splenomegaly. A newly recognized disease of the lymphatic system. *Arch Pathol Lab Med* 1927;3:816–820.
9. Roulet F. Das primäre retothelsarkem der lymphknoten. *Virchows Arch Pathol Anat Physiol Klin Med* 1930;227:15–47.
10. Gall EA, Mallory TB. Malignant lymphoma: a clinico-pathological survey of 618 cases. *Am J Pathol* 1942;18:381–429.
11. Hicks EB, Rappaport H, Winter WJ. Follicular lymphoma: a re-evaluation of its position in the scheme of malignant lymphoma, based on a survey of 253 cases. *Cancer* 1956;9:792–821.
12. Burkitt DP. The discovery of Burkitt's lymphoma. *Cancer* 1983;51:1777–1786.
13. Burkitt DP. A sarcoma involving the jaws of African children. *Br J Surg* 1958;46:218.
14. O'Connor GT. Malignant lymphoma in African Children. II. A pathological entity. *Cancer* 1961;14:270.
15. Epstein MA, Achong BG. Discovery and general biology of the virus. In: Epstein MA, Achong BG, eds. *The Epstein-Barr virus.* Berlin: Springer-Verlag, 1979:1–22.
16. Manolov G, Manolova Y. A marker band in one chromosome No. 14 in Burkitt lymphoma. *Hereditas* 1971;69.
17. Zech L, Haglund U, Nilsson K, et al. Characteristic chromosomal abnormalities in biopsies and lymphoid-cell lines from patients with Burkitt and non-Burkitt lymphomas. *Int J Cancer* 1976;17:47–56.
18. Dalla-Favera R, Bregni M, Erikson J, et al. Human c-myc onc gene is located on the region of

- chromosome 8 that is translocated in Burkitt lymphoma cells. *Proc Natl Acad Sci U S A* 1982;79:7824–7827.
19. Aisenberg AC, Bloch KJ. Immunoglobulins on the surface of neoplastic lymphocytes. *N Engl J Med* 1972;287:272–276.
  20. Barcos MP, Lukes RJ. Malignant lymphomas of convoluted lymphocytes: a new entity of possible T-cell type. In: Sinks LF, Godden, JO, eds. *Conflicts in childhood cancer: an evaluation of current management*. New York: Alan R. Liss, 1975.
  21. Preud'homme JL, Seligmann M. Surface bound immunoglobulins as a cell marker in human lymphoproliferative diseases. *Blood* 1972;40:777–794.
  22. Smith JL, Clein GP, Barker CR, et al. Characterization of malignant mediastinal lymphoid neoplasm (Sternberg sarcoma) as thymic in origin. *Lancet* 1973;1:74–77.
  23. Nathwani BN, Diamond LW, Winberg CD, et al. Lymphoblastic lymphoma: a clinicopathologic study of 95 patients. *Cancer* 1981;48:2347–2357.
  24. Takatsuki K, Yamaguchi K, Hattori T. Adult T-cell leukemia/lymphoma. In: Gallo RC, Wong-Staal F, eds. *Retrovirus biology and human disease*. New York: Marcel Dekker, 1990:147–159.
  25. Uchiyama T, Yodoi J, Sagawa K, et al. Adult T-cell leukemia: clinical and hematologic features of 16 cases. *Blood* 1977;50:481–492.
  26. Poiesz BJ, Ruscetti FW, Gazdar AF, et al. Detection and isolation of type C retrovirus particles from fresh and cultured lymphocytes of a patient with cutaneous T-cell lymphoma. *Proc Natl Acad Sci U S A* 1980;77:7415–7419.
  27. Hinuma Y, Nagata K, Hanaoka M, et al. Adult T-cell leukemia: antigen in an ATL cell line and detection of antibodies to the antigen in human sera. *Proc Natl Acad Sci U S A* 1981;78:6476–6480.
  28. Catovsky D, Greaves MF, Rose M, et al. Adult T-cell lymphoma-leukemia in Blacks from the West Indies. *Lancet* 1982;1:639–643.
  29. Gibbs WN, Lofters WS, Campbell M, et al. Non-Hodgkin lymphoma in Jamaica and its relation to adult T-cell leukemia-lymphoma. *Ann Intern Med* 1987;106:361–368.
  30. Robert-Guroff M, Gallo RC. Establishment of an etiologic relationship between the human T-cell leukemia/lymphoma virus (HTLV) and adult T-cell leukemia. *Blut* 1983;47:1–12.
  31. de Oliveira MS, Matutes E, Famadas LC, et al. Adult T-cell leukemia/lymphoma in Brazil and its relation to HTLV-I. *Lancet* 1990;336:987–990.
  32. Robert-Guroff M, Nakao Y, Notake K, et al. Natural antibodies to human retrovirus HTLV in a cluster of Japanese patients with adult T cell leukemia. *Science* 1982;215:975–978.
  33. Blayney DW, Blattner WA, Robert-Guroff M, et al. The human T-cell leukemia-lymphoma virus in the southeastern United States. *JAMA* 1983;250:1048–1052.
  34. Lennert K, Stein H, Kaiserling E. Cytological and functional criteria for the classification of malignant lymphomata. *Br J Cancer* 1975;31[Suppl 2]:29–43.
  35. Lukes RJ, Collins RD. Immunologic characterization of human malignant lymphomas. *Cancer* 1974;34[Suppl]:1488–1503.
  36. Aisenberg AC, Krontiris TG, Mak TW, et al. Rearrangement of the gene for the beta chain of the T-cell receptor in T-cell chronic lymphocytic leukemia and related disorders. *N Engl J Med* 1985;313:529–533.
  37. Korsmeyer SJ, Hieter PA, Ravetch JV, et al. Developmental hierarchy of immunoglobulin gene rearrangements in human leukemic pre-B-cells. *Proc Natl Acad Sci U S A* 1981;78:7096–7100.
  38. Reis MD, Griesser H, Mak TW. T cell receptor and immunoglobulin gene rearrangements in

lymphoproliferative disorders. *Adv Cancer Res* 1989;52:45–80.

39. Waldmann TA, Davis MM, Bongiovanni KF, et al. Rearrangements of genes for the antigen receptor on T cells as markers of lineage and clonality in human lymphoid neoplasms. *N Engl J Med* 1985;313:776–783.

40. National Cancer Institute sponsored study of classifications of non-Hodgkin's lymphomas: summary and description of a working formulation for clinical usage. The Non-Hodgkin's Lymphoma Pathologic Classification Project. *Cancer* 1982;49:2112–2135.

41. Harris NL, Jaffe ES, Stein H, et al. A revised European-American classification of lymphoid neoplasms: a proposal from the International Lymphoma Study Group. *Blood* 1994;84:1361–1392.

42. Mason DY, Harris NL. Human lymphoma: clinical implications of the REAL classification. London: Springer Verlag, 1999.

43. Jaffe ES, Harris NL, Stein H, et al. Pathology & genetics: tumours of haematopoietic and lymphoid tissues. Lyon: IARC Press, 2001.

44. Harris NL, Jaffe ES, Diebold J, et al. World Health Organization classification of neoplastic diseases of the hematopoietic and lymphoid tissues: report of the Clinical Advisory Committee meeting–Airlie House, Virginia, November 1997. *J Clin Oncol* 1999;17:3835–3849.

45. Palackdharry CS. The epidemiology of non-Hodgkin's lymphoma: why the increased incidence? *Oncology (Huntingt)* 1994;8:67–73; discussion 73–68.

46. Devesa SS, Fears T. Non-Hodgkin's lymphoma time trends: United States and international data. *Cancer Res* 1992;52:5432s–5440s.

47. Clarke CA, Glaser SL. Changing incidence of non-Hodgkin lymphomas in the United States. *Cancer* 2002;94:2015–2023.

48. Ries LAG, Eisner MP, Kosary CL, et al. SEER cancer statistics review, 1973–1999. Bethesda, MD: National Cancer Institute, 2002.

49. Baris D, Zahm SH. Epidemiology of lymphomas. *Curr Opin Oncol* 2000;12:383–394.

50. Hartge P, Devesa SS. Quantification of the impact of known risk factors on time trends in non-Hodgkin's lymphoma incidence. *Cancer Res* 1992;52:5566s–5569s.

51. Magrath I. Historical perspective: the origins of modern concepts of biology and management. In: Magrath IT, ed. *The non-Hodgkin's lymphomas*. Baltimore: Williams & Wilkins, 1990:15–28.

52. Boddie AW Jr, Mullins JD, West G, et al. Extranodal lymphoma: surgical and other therapeutic alternatives. *Curr Probl Cancer* 1982;6:1–64.

53. Freeman C, Berg JW, Cutler SJ. Occurrence and prognosis of extranodal lymphomas. *Cancer* 1972;29:252–260.

54. Banfi A, Bonadonna G, Carnevali G, et al. Preferential sites of involvement and spread in malignant lymphomas. *Eur J Cancer* 1968;4:319–324.

55. Gurney KA, Cartwright RA. Increasing incidence and descriptive epidemiology of extranodal non-Hodgkin lymphoma in parts of England and Wales. *Hematol J* 2002;3:95–104.

56. Hartge P, Devesa SS, Fraumeni JF Jr. Hodgkin's and non-Hodgkin's lymphomas. In: Doll R, Fraumeni JF Jr, Muir CS, eds. *Cancer surveys. Trends in cancer incidence and mortality*. Cold Spring Harbor: Cold Spring Harbor Laboratory Press, 1994:423–545.

57. Groves FD, Linet MS, Travis LB, et al. Cancer surveillance series: non-Hodgkin lymphoma incidence by histologic subtype in the United States from 1978 through 1995. *J Natl Cancer Inst* 2000;92:1240–1251.

58. Olson JE, Janney CA, Rao RD, et al. The continuing increase in the incidence of primary central nervous system non-Hodgkin lymphoma: a surveillance, epidemiology, and end results analysis. *Cancer*

2002;95:1504–1510.

59. Linet MS, Pottern LM. Familial aggregation of hematopoietic malignancies and risk of non-Hodgkin's lymphoma. *Cancer Res* 1992;52:5468s–5473s.
60. Pottern LM, Linet M, Blair A, et al. Familial cancers associated with subtypes of leukemia and non-Hodgkin's lymphoma. *Leuk Res* 1991;15:305–314.
61. Paltiel O, Schmit T, Adler B, et al. The incidence of lymphoma in first-degree relatives of patients with Hodgkin's disease and non-Hodgkin's lymphoma: results and limitations of a registry-linked study. *Cancer* 2000;88:2357–2366.
62. Straus SE, Jaffe ES, Puck JM, et al. The development of lymphomas in families with autoimmune lymphoproliferative syndrome with germline Fas mutations and defective lymphocyte apoptosis. *Blood* 2001;98:194–200.
63. Bernstein L, Ross RK. Prior medication use and health history as risk factors for non-Hodgkin's lymphoma: preliminary results from a case-control study in Los Angeles County. *Cancer Res* 1992;52:5510s–5515s.
64. Cartwright RA, McKinney PA, O'Brien C, et al. Non-Hodgkin's lymphoma: case control epidemiological study in Yorkshire. *Leuk Res* 1988;12:81–88.
65. Hyman GA, Sommers SC. The development of Hodgkin's disease and lymphoma during anticonvulsant therapy. *Blood* 1966;28:416–427.
66. Abbondazo SL, Irey NS, Frizzera G. Dilantin-associated lymphadenopathy. Spectrum of histopathologic patterns. *Am J Surg Pathol* 1995;19:675–686.
67. Brown SL, Greene MH, Gershon SK, et al. Tumor necrosis factor antagonist therapy and lymphoma development: twenty-six cases reported to the Food and Drug Administration. *Arthritis Rheum* 2002;46:3151–3158.
68. Scherr PA, Hutchison GB, Neiman RS. Non-Hodgkin's lymphoma and occupational exposure. *Cancer Res* 1992;52:5503s–5509s.
69. Hoar SK, Blair A, Holmes FF, et al. Agricultural herbicide use and risk of lymphoma and soft-tissue sarcoma. *JAMA* 1986;256:1141–1147.
70. Wigle DT, Semenciw RM, Wilkins K, et al. Mortality study of Canadian male farm operators: non-Hodgkin's lymphoma mortality and agricultural practices in Saskatchewan. *J Natl Cancer Inst* 1990;82:575–582.
71. Vineis P, Faggiano F, Tedeschi M, et al. Incidence rates of lymphomas and soft-tissue sarcomas and environmental measurements of phenoxy herbicides. *J Natl Cancer Inst* 1991;83:362–363.
72. Zahm SH, Blair A. Pesticides and non-Hodgkin's lymphoma. *Cancer Res* 1992;52:5485s–5488s.
73. Rothman N, Cantor KP, Blair A, et al. A nested case-control study of non-Hodgkin lymphoma and serum organochlorine residues. *Lancet* 1997;350:240–244.
74. Correa A, Jackson L, Mohan A, et al. Use of hair dyes, hematopoietic neoplasms, and lymphomas: a literature review. II. Lymphomas and multiple myeloma. *Cancer Invest* 2000;18:467–479.
75. Zahm SH, Weisenburger DD, Babbitt PA, et al. Use of hair coloring products and the risk of lymphoma, multiple myeloma, and chronic lymphocytic leukemia. *Am J Public Health* 1992;82:990–997.
76. Hall P, Rosendahl I, Mattsson A, et al. Non-Hodgkin's lymphoma and skin malignancies—shared etiology? *Int J Cancer* 1995;62:519–522.
77. Adami J, Frisch M, Yuen J, et al. Evidence of an association between non-Hodgkin's lymphoma and skin cancer. *BMJ* 1995;310:1491–1495.



78. Hartge P, Devesa SS, Grauman D, et al. Non-Hodgkin's lymphoma and sunlight. *J Natl Cancer Inst* 1996;88:298-300.
79. Davis S. Nutritional factors and the development of non-Hodgkin's lymphoma: a review of the evidence. *Cancer Res* 1992;52:5492s-5495s.
80. Chiu BC, Cerhan JR, Folsom AR, et al. Diet and risk of non-Hodgkin lymphoma in older women. *JAMA* 1996;275:1315-1321.
81. Ursin G, Bjelke E, Heuch I, et al. Milk consumption and cancer incidence: a Norwegian prospective study. *Br J Cancer* 1990;61:456-459.
82. Brandt L, Brandt J, Olsson H, et al. Blood transfusion as a risk factor for non-Hodgkin lymphoma. *Br J Cancer* 1996;73:1148-1151.
83. Cerhan JR, Wallace RB, Folsom AR, et al. Transfusion history and cancer risk in older women. *Ann Intern Med* 1993;119:8-15.
84. Vamvakas EC. Allogenic blood transfusion as a risk factor for the subsequent development of non-Hodgkin's lymphoma. *Transfus Med Rev* 2000;14:258-268.
85. Cerhan JR, Wallace RB, Dick F, et al. Blood transfusions and risk of non-Hodgkin's lymphoma subtypes and chronic lymphocytic leukemia. *Cancer Epidemiol Biomarkers Prev* 2001;10:361-368.
86. Boice JD Jr. Radiation and non-Hodgkin's lymphoma. *Cancer Res* 1992;52:5489s-5491s.
87. Brown LM, Gibson R, Burmeister LF, et al. Alcohol consumption and risk of leukemia, non-Hodgkin's lymphoma, and multiple myeloma. *Leuk Res* 1992;16:979-984.
88. Chiu BC, Weisenburger DD, Cantor KP, et al. Alcohol consumption, family history of hematolymphoproliferative cancer, and the risk of non-Hodgkin's lymphoma in men. *Ann Epidemiol* 2002;12:309-315.
89. Zahm SH, Weisenburger DD, Holmes FF, et al. Tobacco and non-Hodgkin's lymphoma: combined analysis of three case-control studies (United States). *Cancer Causes Control* 1997;8:159-166.
90. Herrinton LJ, Friedman GD. Cigarette smoking and risk of non-Hodgkin's lymphoma subtypes. *Cancer Epidemiol Biomarkers Prev* 1998;7:25-28.
91. Miligi L, Seniori Costantini A, Crosignani P, et al. Occupational, environmental, and life-style factors associated with the risk of hematolymphopietic malignancies in women. *Am J Ind Med* 1999;36:60-69.
92. Purtilo DT, Stevenson M. Lymphotropic viruses as etiologic agents of lymphoma. *Hematol Oncol Clin North Am* 1991;5:901-923.
93. Kanavaros P, Lescs MC, Briere J, et al. Nasal T-cell lymphoma: a clinicopathologic entity associated with peculiar phenotype and with Epstein-Barr virus. *Blood* 1993;81:2688-2695.
94. van Gorp J, Doornewaard H, Verdonck LF, et al. Posttransplant T-cell lymphoma. Report of three cases and a review of the literature. *Cancer* 1994;73:3064-3072.
95. Jones JF, Shurin S, Abramowsky C, et al. T-cell lymphomas containing Epstein-Barr viral DNA in patients with chronic Epstein-Barr virus infections. *N Engl J Med* 1988;318:733-741.
96. Mannis A, Hisada M, La Grenade L. Human T-lymphotropic virus type I infection. *Lancet* 1999;353:1951-1958.
97. Tokudome S, Tokunaga O, Shimamoto Y, et al. Incidence of adult T-cell leukemia/lymphoma among human T-lymphotropic virus type I carriers in Saga, Japan. *Cancer Res* 1989;49:226-228.
98. Hatta Y, Hiramata T, Miller CW, et al. Homozygous deletions of the p15 (MTS2) and p16 (CDKN2/MTS1)

genes in adult T-cell leukemia. *Blood* 1995;85:2699–2704.

99. Yamada Y, Hatta Y, Murata K, et al. Deletions of p15 and/or p16 genes as a poor-prognosis factor in adult T-cell leukemia. *J Clin Oncol* 1997;15:1778–1785.

100. Itoyama T, Chaganti RS, Yamada Y, et al. Cytogenetic analysis and clinical significance in adult T-cell leukemia/lymphoma: a study of 50 cases from the human T-cell leukemia virus type-1 endemic area, Nagasaki. *Blood* 2001;97:3612–3620.

101. Arima N, Tei C. HTLV-I Tax related dysfunction of cell cycle regulators and oncogenesis of adult T cell leukemia. *Leuk Lymphoma* 2001;40:267–278.

102. Vidal AU, Gessain A, Yoshida M, et al. Phylogenetic classification of human T cell leukemia/lymphoma virus type I genotypes in five major molecular and geographical subtypes. *J Gen Virol* 1994;75(Pt12):3655–3666.

103. Blattner WA. Human T-lymphotropic viruses and diseases of long latency. *Ann Intern Med* 1989;111:4–6.

104. Saji F, Ohashi K, Tokugawa Y, et al. Perinatal infection of human T-lymphotropic virus type I, the etiologic virus of adult T-cell leukemia/lymphoma. DNA amplification of specific human T-lymphotropic virus type I sequences. *Cancer* 1990;66:1933–1937.

105. Poesz BJ. Etiology of acute leukemia: molecular genetics and viral oncology. In: Wiernik PH, Canellos, GP, et al., eds. *Neoplastic diseases of the blood*, 3rd ed. New York: Churchill Livingstone, 1996:159–175.

106. Yamaguchi K. Human T-lymphotropic virus type I in Japan. *Lancet* 1994;343:213–216.

107. Kalyanaraman VS, Sarngadharan MG, Robert-Guroff M, et al. A new subtype of human T-cell leukemia virus (HTLV-II) associated with a T-cell variant of hairy cell leukemia. *Science* 1982;218:571–573.

108. Rosenblatt JD, Plaeger-Marshall S, Giorgi JV, et al. A clinical, hematologic, and immunologic analysis of 21 HTLV-II-infected intravenous drug users. *Blood* 1990;76:409–417.

109. Salahuddin SZ, Ablashi DV, Markham PD, et al. Isolation of a new virus, HBLV, in patients with lymphoproliferative disorders. *Science* 1986;234:596–601.

110. Yamanishi K, Okuno T, Shiraki K, et al. Identification of human herpesvirus-6 as a causal agent for exanthem subitum. *Lancet* 1988;1:1065–1067.

111. Cesarman E, Chang Y, Moore PS, et al. Kaposi's sarcoma-associated herpesvirus-like DNA sequences in AIDS-related body-cavity-based lymphomas. *N Engl J Med* 1995;332:1186–1191.

112. Oksenhendler E, Boulanger E, Galicier L, et al. High incidence of Kaposi sarcoma-associated herpesvirus-related non-Hodgkin lymphoma in patients with HIV infection and multicentric Castleman disease. *Blood* 2002;99:2331–2336.

113. Pozzato G, Mazzaro C, Crovatto M, et al. Low-grade malignant lymphoma, hepatitis C virus infection, and mixed cryoglobulinemia. *Blood* 1994;84:3047–3053.

114. Franzin F, Efremov DG, Pozzato G, et al. Clonal B-cell expansions in peripheral blood of HCV-infected patients. *Br J Haematol* 1995;90:548–552.

115. Luppi M, Grazia Ferrari M, Bonaccorsi G, et al. Hepatitis C virus infection in subsets of neoplastic lymphoproliferations not associated with cryoglobulinemia. *Leukemia* 1996;10:351–355.

116. Zuckerman E, Zuckerman T, Levine AM, et al. Hepatitis C virus infection in patients with B-cell non-Hodgkin lymphoma. *Ann Intern Med* 1997;127:423–428.

117. Zignego AL, Ferri C, Giannelli F, et al. Prevalence of bcl-2 rearrangement in patients with hepatitis C virus-related mixed cryoglobulinemia with or without B-cell lymphomas. *Ann Intern Med* 2002;137:571–580.

118. Marshall BJ, Warren JR. Unidentified curved bacilli in the stomach of patients with gastritis and peptic ulceration. *Lancet* 1984;1:1311–1315.
119. Parsonnet J, Friedman GD, Vandersteen DP, et al. *Helicobacter pylori* infection and the risk of gastric carcinoma. *N Engl J Med* 1991;325:1127–1131.
120. Doglioni C, Wotherspoon AC, Moschini A, et al. High incidence of primary gastric lymphoma in northeastern Italy. *Lancet* 1992;339:834–835.
121. Parsonnet J, Hansen S, Rodriguez L, et al. *Helicobacter pylori* infection and gastric lymphoma. *N Engl J Med* 1994;330:1267–1271.
122. Wotherspoon AC, Doglioni C, Diss TC, et al. Regression of primary low-grade B-cell gastric lymphoma of mucosa-associated lymphoid tissue type after eradication of *Helicobacter pylori*. *Lancet* 1993;342:575–577.
123. Louie S, Daoust PR, Schwartz RS. Immunodeficiency and the pathogenesis of non-Hodgkin's lymphoma. *Semin Oncol* 1980;7:267–284.
124. Dunn BK, Longo DL. Lymphoma occurring in association with other diseases. In: Wiernik PH, Canellos GP, Dutcher JP et al., eds. *Neoplastic diseases of the blood*, 3rd ed. New York: Churchill Livingstone, 1996:963–997.
125. Filipovich AH, Mathur A, Kamat D, et al. Primary immunodeficiencies: genetic risk factors for lymphoma. *Cancer Res* 1992;52:5465s–5467s.
126. Vihinen M, Lehtvaslainen H, Cotton RGH. Immunodeficiency mutation databases. In: Ochs HD, Smith CIE, Puck JM, eds. *Primary immunodeficiency diseases: a molecular and genetic approach*. New York: Oxford University Press, 1999:443–447.
127. Grierson H, Purtilo DT. Epstein-Barr virus infections in males with the X-linked lymphoproliferative syndrome. *Ann Intern Med* 1987;106:538–545.
128. Penn I. Tumors after renal and cardiac transplantation. *Hematol Oncol Clin North Am* 1993;7:431–445.
129. Paya CV, Fung JJ, Nalesnik MA, et al. Epstein-Barr virus-induced posttransplant lymphoproliferative disorders. ASTS/ASTP EBV-PTLD Task Force and The Mayo Clinic Organized International Consensus Development Meeting. *Transplantation* 1999;68:1517–1525.
130. Cleary ML, Warnke R, Sklar J. Monoclonality of lymphoproliferative lesions in cardiac-transplant recipients. Clonal analysis based on immunoglobulin-gene rearrangements. *N Engl J Med* 1984;310:477–482.
131. Cleary ML, Nalesnik MA, Shearer WT, et al. Clonal analysis of transplant-associated lymphoproliferations based on the structure of the genomic termini of the Epstein-Barr virus. *Blood* 1988;72:349–352.
132. Krikorian JG, Anderson JL, Bieber CP, et al. Malignant neoplasms following cardiac transplantation. *JAMA* 1978;240:639–643.
133. Swerdlow AJ, Higgins CD, Hunt BJ, et al. Risk of lymphoid neoplasia after cardiothoracic transplantation. a cohort study of the relation to Epstein-Barr virus. *Transplantation* 2000;69:897–904.
134. Doll DC, List AF. Burkitt's lymphoma in a homosexual. *Lancet* 1982;1:1026–1027.
135. Ziegler JL, Beckstead JA, Volberding PA, et al. Non-Hodgkin's lymphoma in 90 homosexual men. Relation to generalized lymphadenopathy and the acquired immunodeficiency syndrome. *N Engl J Med* 1984;311:565–570.
136. Revision of the case definition of acquired immunodeficiency syndrome for national reporting—United States. Centers for Disease Control, Department of Health and Human Services. *Ann*

Intern Med 1985;103:402-403.

137. Levine AM, Seneviratne L, Espina BM, et al. Evolving characteristics of AIDS-related lymphoma. *Blood* 2000;96:4084-4090.
138. Delecluse HJ, Anagnostopoulos I, Dallenbach F, et al. Plasmablastic lymphomas of the oral cavity: a new entity associated with the human immunodeficiency virus infection. *Blood* 1997;89:1413-1420.
139. Gabarre J, Raphael M, Lepage E, et al. Human immunodeficiency virus-related lymphoma: relation between clinical features and histologic subtypes. *Am J Med* 2001;111:704-711.
140. Gail MH, Pluda JM, Rabkin CS, et al. Projections of the incidence of non-Hodgkin's lymphoma related to acquired immunodeficiency syndrome. *J Natl Cancer Inst* 1991;83:695-701.
141. Pluda JM, Venzon DJ, Tosato G, et al. Parameters affecting the development of non-Hodgkin's lymphoma in patients with severe human immunodeficiency virus infection receiving antiretroviral therapy. *J Clin Oncol* 1993;11:1099-1107.
142. Grulich AE, Wan X, Law MG, et al. B-cell stimulation and prolonged immune deficiency are risk factors for non-Hodgkin's lymphoma in people with AIDS. *AIDS* 2000;14:133-140.
143. Besson C, Goubar A, Gabarre J, et al. Changes in AIDS-related lymphoma since the era of highly active antiretroviral therapy. *Blood* 2001;98:2339-2344.
144. Kirk O, Pedersen C, Cozzi-Lepri A, et al. Non-Hodgkin lymphoma in HIV-infected patients in the era of highly active antiretroviral therapy. *Blood* 2001;98:3406-3412.
145. Isaacson P, Wright DH. Malignant lymphoma of mucosa-associated lymphoid tissue. A distinctive type of B-cell lymphoma. *Cancer* 1983;52:1410-1416.
146. Isaacson PG. Lymphomas of mucosa-associated lymphoid tissue (MALT). *Histopathology* 1990;16:617-619.
147. Parveen T, Navarro-Roman L, Medeiros LJ, et al. Low-grade B-cell lymphoma of mucosa-associated lymphoid tissue arising in the kidney. *Arch Pathol Lab Med* 1993;117:780-783.
148. Zucca E, Bertoni F, Roggero E, et al. The gastric marginal zone B-cell lymphoma of MALT type. *Blood* 2000;96:410-419.
149. Hussell T, Isaacson PG, Crabtree JE, et al. *Helicobacter pylori*-specific tumour-infiltrating T cells provide contact dependent help for the growth of malignant B cells in low-grade gastric lymphoma of mucosa-associated lymphoid tissue. *J Pathol* 1996;178:122-127.
150. Thiede C, Alpen B, Morgner A, et al. Ongoing somatic mutations and clonal expansions after cure of *Helicobacter pylori* infection in gastric mucosa-associated lymphoid tissue B-cell lymphoma. *J Clin Oncol* 1998;16:3822-3831.
151. Ye H, Liu H, Raderer M, et al. High incidence of t(11;18)(q21;q21) in *Helicobacter pylori*-negative gastric MALT lymphoma. *Blood* 2003;101:2547-2550.
152. Auer IA, Gascoyne RD, Connors JM, et al. t(11;18)(q21;q21) is the most common translocation in MALT lymphomas. *Ann Oncol* 1997;8:979-985.
153. Starostik P, Patzner J, Greiner A, et al. Gastric marginal zone B-cell lymphomas of MALT type develop along 2 distinct pathogenetic pathways. *Blood* 2002;99:3-9.
154. Willis TG, Jadayel DM, Du MQ, et al. Bcl10 is involved in t(1;14)(p22;q32) of MALT B cell lymphoma and mutated in multiple tumor types. *Cell* 1999;96:35-45.
155. Ott G, Kalla J, Steinhoff A, et al. Trisomy 3 is not a common feature in malignant lymphomas of mucosa-associated lymphoid tissue type. *Am J Pathol* 1998;153:689-694.
156. Du M, Peng H, Singh N, et al. The accumulation of p53 abnormalities is associated with progression

of mucosa-associated lymphoid tissue lymphoma. *Blood* 1995;86:4587-4593.

157. Neumeister P, Hoefler G, Beham-Schmid C, et al. Deletion analysis of the p16 tumor suppressor gene in gastrointestinal mucosa-associated lymphoid tissue lymphomas. *Gastroenterology* 1997;112:1871-1875.

158. Bunim JJ, Talal N. The association of malignant lymphoma with Sjögren's syndrome. *Trans Assoc Am Physicians* 1963;76:45.

159. Kassan SS, Thomas TL, Moutsopoulos HM, et al. Increased risk of lymphoma in sicca syndrome. *Ann Intern Med* 1978;89:888-892.

160. Schmid U, Helbron D, Lennert K. Development of malignant lymphoma in myoepithelial sialadenitis (Sjögren's syndrome). *Virchows Arch A Pathol Anat Histol* 1982;395:11-43.

161. Fishleder A, Tubbs R, Hesse B, et al. Uniform detection of immunoglobulin-gene rearrangement in benign lymphoepithelial lesions. *N Engl J Med* 1987;316:1118-1121.

162. Speight PM, Jordan R, Colloby P, et al. Early detection of lymphomas in Sjögren's syndrome by in situ hybridization for kappa and lambda light chain mRNA in labial salivary glands. *Eur J Cancer B Oral Oncol* 1994;30B:244-247.

163. Miklos JA, Swerdlow SH, Bahler DW. Salivary gland mucosa-associated lymphoid tissue lymphoma immunoglobulin V(H) genes show frequent use of V1-69 with distinctive CDR3 features. *Blood* 2000;95:3878-3884.

164. Lindsay S, Dailey ME. Malignant lymphoma of the thyroid gland and its relation to Hashimoto disease: a clinical and pathologic study of 8 patients. *J Clin Endocrinol* 1955;15:1332.

165. Maurer R, Taylor CR, Terry R, et al. Non-Hodgkin lymphomas of the thyroid. A clinico-pathological review of 29 cases applying the Lukes-Collins classification and an immunoperoxidase method. *Virchows Arch A Pathol Anat Histol* 1979;383:293-317.

166. Aozasa K, Inoue A, Tajima K, et al. Malignant lymphomas of the thyroid gland. Analysis of 79 patients with emphasis on histologic prognostic factors. *Cancer* 1986;58:100-104.

167. Holm LE, Blomgren H, Lowhagen T. Cancer risks in patients with chronic lymphocytic thyroiditis. *N Engl J Med* 1985;312:601-604.

168. Kato I, Tajima K, Suchi T, et al. Chronic thyroiditis as a risk factor of B-cell lymphoma in the thyroid gland. *Jpn J Cancer Res* 1985;76:1085-1090.

169. Ben-Ezra J, Wu A, Sheibani K. Hashimoto's thyroiditis lacks detectable clonal immunoglobulin and T cell receptor gene rearrangements. *Hum Pathol* 1988;19:1444-448.

170. Hyjek E, Isaacson PG. Primary B cell lymphoma of the thyroid and its relationship to Hashimoto's thyroiditis. *Hum Pathol* 1988;19:1315-1326.

171. Aisenberg AC. *Malignant lymphoma: biology, natural history and treatment*. Philadelphia: Lea & Febiger, 1991:337-338.

172. Miller DG. The association of immune disease and malignant lymphoma. *Ann Intern Med* 1967;66:507-521.

173. Greenstein AJ, Mullin GE, Strauchen JA, et al. Lymphoma in inflammatory bowel disease. *Cancer* 1992;69:1119-1123.

174. Gridley G, McLaughlin JK, Ekblom A, et al. Incidence of cancer among patients with rheumatoid arthritis. *J Natl Cancer Inst* 1993;85:307-311.

175. Gridley G, Klippel JH, Hoover RN, et al. Incidence of cancer among men with the Felty syndrome. *Ann Intern Med* 1994;120:35-39.

176. Georgescu L, Paget SA. Lymphoma in patients with rheumatoid arthritis: what is the evidence of a link with methotrexate? *Drug Saf* 1999;20:475-487.
177. Mariette X, Cazals-Hatem D, Warszawski J, et al. Lymphomas in rheumatoid arthritis patients treated with methotrexate: a 3-year prospective study in France. *Blood* 2002;99:3909-3915.
178. Salloum E, Cooper DL, Howe G, et al. Spontaneous regression of lymphoproliferative disorders in patients treated with methotrexate for rheumatoid arthritis and other rheumatic diseases. *J Clin Oncol* 1996;14:1943-1949.
179. Kamel OW, van de Rijn M, Weiss LM, et al. Brief report: reversible lymphomas associated with Epstein-Barr virus occurring during methotrexate therapy for rheumatoid arthritis and dermatomyositis. *N Engl J Med* 1993;328:1317-1321.
180. Loughran TP Jr. Clonal diseases of large granular lymphocytes. *Blood* 1993;82:1-14.
181. Castleman B, Iverson L, Menendez VP, et al. Localized mediastinal lymph node hyperplasia resembling thymoma. *Cancer* 1956;9:822-830.
182. Keller AR, Hochholzer L, Castleman B. Hyaline-vascular and plasma-cell types of giant lymph node hyperplasia of the mediastinum and other locations. *Cancer* 1972;29:670-683.
183. Herrada J, Cabanillas F, Rice L, et al. The clinical behavior of localized and multicentric Castleman disease. *Ann Intern Med* 1998;128:657-662.
184. Palestro G, Turrini F, Pagano M, et al. Castleman's disease. *Adv Clin Path* 1999;3:11-22.
185. Marti S, Pahissa A, Guardia J, et al. Multicentric giant follicular lymph node hyperplasia. Favorable response to radiotherapy. *Cancer* 1983;51:808-810.
186. Peterson BA, Frizzera G. Multicentric Castleman's disease. *Semin Oncol* 1993;20:636-647.
187. Brandt SJ, Bodine DM, Dunbar CE, et al. Dysregulated interleukin 6 expression produces a syndrome resembling Castleman's disease in mice. *J Clin Invest* 1990;86:592-599.
188. Nishimoto N, Sasai M, Shima Y, et al. Improvement in Castleman's disease by humanized anti-interleukin-6 receptor antibody therapy. *Blood* 2000;95:56-61.
189. Frizzera G, Peterson BA, Bayrd ED, et al. A systemic lymphoproliferative disorder with morphologic features of Castleman's disease: clinical findings and clinicopathologic correlations in 15 patients. *J Clin Oncol* 1985;3:1202-1216.
190. Soulier J, Grollet L, Oksenhendler E, et al. Molecular analysis of clonality in Castleman's disease. *Blood* 1995;86:1131-1138.
191. Hanson CA, Frizzera G, Patton DF, et al. Clonal rearrangement for immunoglobulin and T-cell receptor genes in systemic Castleman's disease. Association with Epstein-Barr virus. *Am J Pathol* 1988;131:84-91.
192. Soulier J, Grollet L, Oksenhendler E, et al. Kaposi's sarcoma-associated herpesvirus-like DNA sequences in multicentric Castleman's disease. *Blood* 1995;86:1276-1280.
193. Dupin N, Diss TL, Kellam P, et al. HHV-8 is associated with a plasmablastic variant of Castleman disease that is linked to HHV-8-positive plasmablastic lymphoma. *Blood* 2000;95:1406-1412.
194. Larroche C, Cacoub P, Soulier J, et al. Castleman's disease and lymphoma: report of eight cases in HIV-negative patients and literature review. *Am J Hematol* 2002;69:119-126.
195. Krikorian JG, Burke JS, Rosenberg SA, et al. Occurrence of non-Hodgkin's lymphoma after therapy for Hodgkin's disease. *N Engl J Med* 1979;300:452-458.
196. Jacquillat C, Khayat D, Desprez-Curely JP, et al. Non-Hodgkin's lymphoma occurring after Hodgkin's

disease. Four new cases and a review of the literature. *Cancer* 1984;53:459-462.

197. List AF, Greer JP, Cousar JB, et al. Non-Hodgkin's lymphoma after treatment of Hodgkin's disease: association with Epstein-Barr virus. *Ann Intern Med* 1986;105:668-673.

198. Ohno T, Huang JZ, Wu G, et al. The tumor cells in nodular lymphocyte-predominant Hodgkin disease are clonally related to the large cell lymphoma occurring in the same individual. Direct demonstration by single cell analysis. *Am J Clin Pathol* 2001;116:506-511.

199. Casey TT, Cousar JB, Mangum M, et al. Monomorphic lymphomas arising in patients with Hodgkin's disease. Correlation of morphologic, immunophenotypic, and molecular genetic findings in 12 cases. *Am J Pathol* 1990;136:81-94.

200. Gowitt GT, Chan WC, Brynes RK, et al. T-cell lymphoma following Hodgkin's disease. *Cancer* 1985;56:1191-1196.

201. Li FP, Gimbrere K, Ritz J, et al. Lymphoma with clonal T-cell receptor gene rearrangement in a 25-year survivor of Hodgkin's disease. *Cancer* 1987;60:2213-2218.

202. Kirchner EM, Ebsen M, Kirchner J, et al. Transformation of Hodgkin's disease to high-grade B-cell lymphoma: remission after Rituximab monotherapy. *Ann Oncol* 2001;12:1169-1171.

203. Macon WR, Williams ME, Greer JP, et al. Natural killer-like T-cell lymphomas: aggressive lymphomas of T-large granular lymphocytes. *Blood* 1996;87:1474-1483.

204. Lipford EH Jr, Margolick JB, Longo DL, et al. Angiocentric immunoproliferative lesions: a clinicopathologic spectrum of post-thymic T-cell proliferations. *Blood* 1988;72:1674-1681.

205. Loughran TP Jr, Kadin ME, Deeg HJ. T-cell intestinal lymphoma associated with celiac sprue. *Ann Intern Med* 1986;104:44-47.

206. Isaacson PG, O'Connor NT, Spencer J, et al. Malignant histiocytosis of the intestine: a T-cell lymphoma. *Lancet* 1985;2:688-691.

207. Weiss LM, Wood GS, Trela M, et al. Clonal T-cell populations in lymphomatoid papulosis. Evidence of a lymphoproliferative origin for a clinically benign disease. *N Engl J Med* 1986;315:475-479.

208. Weiss LM, Wood GS, Ellisen LW, et al. Clonal T-cell populations in pityriasis lichenoides et varioliformis acuta (Mucha-Habermann disease). *Am J Pathol* 1987;126:417-421.

209. LeBoit PE, Beckstead JH, Bond B, et al. Granulomatous slack skin: clonal rearrangement of the T-cell receptor beta gene is evidence for the lymphoproliferative nature of a cutaneous elastolytic disorder. *J Invest Dermatol* 1987;89:183-186.

210. Wood GS, Weiss LM, Hu CH, et al. T-cell antigen deficiencies and clonal rearrangements of T-cell receptor genes in pagetoid reticulosis (Woringer-Kolopp disease). *N Engl J Med* 1988;318:164-167.

211. Rosenberg SA, Diamond HD, Jaslowitz B, et al. Lymphosarcoma. *Medicine* 1961;40:31-84.

212. Jones SE, Fuks Z, Bull M, et al. Non-Hodgkin's lymphomas. IV. Clinicopathologic correlation in 405 cases. *Cancer* 1973;31:806-823.

213. Sutcliffe SB, Gospodarowicz MK. Localized extranodal lymphomas. In: Keating A, Armitage J, AB, eds. *Haematological oncology*. Cambridge: Cambridge University Press, 1992:189-222.

214. List AF, Greer JP, Cousar JC, et al. Non-Hodgkin's lymphoma of the gastrointestinal tract: an analysis of clinical and pathologic features affecting outcome. *J Clin Oncol* 1988;6:1125-1133.

215. Wright DH. Enteropathy associated T cell lymphoma. *Cancer Surv* 1997;30:249-261.

216. Romaguera JE, Medeiros LJ, Hagemeister FB, et al. Frequency of gastrointestinal involvement and its clinical significance in mantle cell lymphoma. *Cancer* 2003;97:586-591.



217. Ohsawa M, Aozasa K, Horiuchi K, et al. Malignant lymphoma of the liver. Report of five cases and review of the literature. *Dig Dis Sci* 1992;37:1105–1109.
218. Thompson DR, Faust TW, Stone MJ, et al. Hepatic failure as the presenting manifestation of malignant lymphoma. *Clin Lymphoma* 2001;2:123–128.
219. Zackheim HS, Vonderheid EC, Ramsay DL, et al. Relative frequency of various forms of primary cutaneous lymphomas. *Am Acad Dermatol* 2000;43:793–796.
220. Stein H, Foss HD, Durkop H, et al. CD30(+) anaplastic large cell lymphoma: a review of its histopathologic, genetic, and clinical features. *Blood* 2000;96:3681–3695.
221. Lister A, Abrey LE, Sandlund JT. Central nervous system lymphoma. *Hematology (Am Soc Hematol Educ Program)* 2002:283–296.
222. Hollender A, Kvaloy S, Nome O, et al. Central nervous system involvement following diagnosis of non-Hodgkin's lymphoma: a risk model. *Ann Oncol* 2002;13:1099–1107.
223. Pierce MA, Johnson MD, Maciunas RJ, et al. Evaluating contrast-enhancing brain lesions in patients with AIDS by using positron emission tomography. *Ann Intern Med* 1995;123:594–598.
224. van Besien K, Ha CS, Murphy S, et al. Risk factors, treatment, and outcome of central nervous system recurrence in adults with intermediate-grade and immunoblastic lymphoma. *Blood* 1998;91:1178–1184.
225. Haioun C, Besson C, Lepage E, et al. Incidence and risk factors of central nervous system relapse in histologically aggressive non-Hodgkin's lymphoma uniformly treated and receiving intrathecal central nervous system prophylaxis: a GELA study on 974 patients. *Groupe d'Etudes des Lymphomes de l'Adulte. Ann Oncol* 2000;11:685–690.
226. Corriveau C, Easterbrook M, Payne D. Lymphoma simulating uveitis (masquerade syndrome). *Can J Ophthalmol* 1986;21:144–149.
227. Sutcliffe S, Gospodarowicz MK. Primary extranodal lymphomas. In: Canellos GP, Lister TA, Sklar JL, eds. *The lymphomas*. Philadelphia: WB Saunders, 1998:449–479.
228. Ostrowski ML, Unni KK, Banks PM, et al. Malignant lymphoma of bone. *Cancer* 1986;58:2646–2655.
229. Bacci G, Ferraro A, Casadei R, et al. Primary lymphoma of bone: long term results in patients treated with vincristine--adriamycin--cyclophosphamide and local radiation. *J Chemother* 1991;3:189–193.
230. Hugh JC, Jackson FI, Hanson J, et al. Primary breast lymphoma. An immunohistologic study of 20 new cases. *Cancer* 1990;66:2602–2611.
231. Cordier JF, Chailleux E, Lauque D, et al. Primary pulmonary lymphomas. A clinical study of 70 cases in nonimmunocompromised patients. *Chest* 1993;103:201–208.
232. Eng J, Sabanathan S. Endobronchial non-Hodgkin's lymphoma. *J Cardiovasc Surg Torino* 1993;34:351–354.
233. Aozasa K, Ohsawa M, Iuchi K, et al. Prognostic factors for pleural lymphoma patients. *Jpn J Clin Oncol* 1991;21:417–421.
234. Zaharia L, Gill PS. Primary cardiac lymphoma. *Am J Clin Oncol* 1991;14:142–145.
235. Shimoyama M, Ota K, Kikuchi M, et al. Major prognostic factors of adult patients with advanced T-cell lymphoma/leukemia. *J Clin Oncol* 1988;6:1088–1097.
236. Choi CH, Durishin M, Garbadawala ST, et al. Non-Hodgkin's lymphoma of the adrenal gland. *Arch Pathol Lab Med* 1990;114:883–885.
237. Kuyama A, Takeuchi M, Munemasa M, et al. Successful treatment of primary adrenal non-Hodgkin's

lymphoma associated with adrenal insufficiency. *Leuk Lymphoma* 2000;38:203–205.

238. Carbone PP, Kaplan HS, Musshoff K, et al. Report of the Committee on Hodgkin's Disease Staging Classification. *Cancer Res* 1971;31:1860–1861.

239. Coiffier B, Gisselbrecht C, Vose JM, et al. Prognostic factors in aggressive malignant lymphomas: description and validation of a prognostic index that could identify patients requiring a more intensive therapy. *The Groupe d'Etudes des Lymphomes Agressifs. J Clin Oncol* 1991;9:211–219.

240. Rodriguez J, Cabanillas F, McLaughlin P, et al. A proposal for a simple staging system for intermediate grade lymphoma and immunoblastic lymphoma based on the 'tumor score.' *Ann Oncol* 1992;3:711–717.

241. A predictive model for aggressive non-Hodgkin's lymphoma. The International Non-Hodgkin's Lymphoma Prognostic Factors Project. *N Engl J Med* 1993;329:987–994.

242. Armitage JO, Weisenburger DD. New approach to classifying non-Hodgkin's lymphomas: clinical features of the major histologic subtypes. Non-Hodgkin's Lymphoma Classification Project. *J Clin Oncol* 1998;16:2780–2795.

243. Lopez-Guillermo A, Montserrat E, Bosch F, et al. Applicability of the International Index for aggressive lymphomas to patients with low-grade lymphoma. *J Clin Oncol* 1994;12:1343–1348.

244. Falini B, Pileri S, Zinzani PL, et al. ALK+ lymphoma: clinico-pathological findings and outcome. *Blood* 1999;93:2697–2706.

245. Moormeier JA, Williams SF, Golomb HM. The staging of non-Hodgkin's lymphomas. *Semin Oncol* 1990;17:43–50.

246. Duggan PR, Easton D, Luider J, et al. Bone marrow staging of patients with non-Hodgkin lymphoma by flow cytometry: correlation with morphology. *Cancer* 2000;88:894–899.

247. Hanson CA, Kurtin PJ, Katzmann JA, et al. Immunophenotypic analysis of peripheral blood and bone marrow in the staging of B-cell malignant lymphoma. *Blood* 1999;94:3889–3896.

248. Coller BS, Chabner BA, Gralnick HR. Frequencies and patterns of bone marrow involvement in non-Hodgkin lymphomas: observations on the value of bilateral biopsies. *Am J Hematol* 1977;3:105–119.

249. Hoane BR, Shields AF, Porter BA, et al. Detection of lymphomatous bone marrow involvement with magnetic resonance imaging. *Blood* 1991;78:728–738.

250. Gulley ML, Dent GA, Ross DW. Classification and staging of lymphoma by molecular genetics. *Cancer* 1992;69:1600–1606.

251. Price CG, Meerabux J, Murtagh S, et al. The significance of circulating cells carrying t(14;18) in long remission from follicular lymphoma. *J Clin Oncol* 1991;9:1527–1532.

252. Janicek M, Kaplan W, Neuberg D, et al. Early restaging gallium scans predict outcome in poor-prognosis patients with aggressive non-Hodgkin's lymphoma treated with high-dose CHOP chemotherapy. *J Clin Oncol* 1997;15:1631–1637.

253. Front D, Israel O. The role of Ga-67 scintigraphy in evaluating the results of therapy of lymphoma patients. *Semin Nucl Med* 1995;25:60–71.

254. Spaepen K, Stroobants S, Dupont P, et al. Prognostic value of positron emission tomography (PET) with fluorine-18 fluorodeoxyglucose ([<sup>18</sup>F]FDG) after first-line chemotherapy in non-Hodgkin's lymphoma: is [<sup>18</sup>F]FDG-PET a valid alternative to conventional diagnostic methods? *J Clin Oncol* 2001;19:414–419.

255. Kostakoglu L, Leonard JP, Kuji I, et al. Comparison of fluorine-18 fluorodeoxyglucose positron emission tomography and Ga-67 scintigraphy in evaluation of lymphoma. *Cancer* 2002;94:879–888.

256. Cresswell P, Springer T, Strominger JL, et al. Immunological identity of the small subunit of HL-A antigens and beta2-microglobulin and its turnover on the cell membrane. *Proc Natl Acad Sci U S A*

1974;71:2123–2127.

257. Swan F Jr, Velasquez WS, Tucker S, et al. A new serologic staging system for large-cell lymphomas based on initial beta 2-microglobulin and lactate dehydrogenase levels. *J Clin Oncol* 1989;7:1518–1527.

258. Pizzolo G, Chilosi M, Semenzato G. The soluble interleukin-2 receptor in haematological disorders. *Br J Haematol* 1987;67:377–380.

259. Pui CH, Ip SH, Kung P, et al. High serum interleukin-2 receptor levels are related to advanced disease and a poor outcome in childhood non-Hodgkin's lymphoma. *Blood* 1987;70:624–628.

260. Warzocha K, Salles G, Biennu J, et al. Tumor necrosis factor ligand-receptor system can predict treatment outcome in lymphoma patients. *J Clin Oncol* 1997;15:499–508.

261. Preti HA, Cabanillas F, Talpaz M, et al. Prognostic value of serum interleukin-6 in diffuse large-cell lymphoma. *Ann Intern Med* 1997;127:186–194.

262. Salven P, Teerenhovi L, Joensuu H. A high pretreatment serum basic fibroblast growth factor concentration is an independent predictor of poor prognosis in non-Hodgkin's lymphoma. *Blood* 1999;94:3334–3339.

263. Cortes JE, Talpaz M, Cabanillas F, et al. Serum levels of interleukin-10 in patients with diffuse large cell lymphoma: lack of correlation with prognosis. *Blood* 1995;85:2516–2520.

264. Longo DL, Young RC, Hubbard SM, et al. Prolonged initial remission in patients with nodular mixed lymphoma. *Ann Intern Med* 1984;100:651–656.

265. Johnson PW, Rohatiner AZ, Whelan JS, et al. Patterns of survival in patients with recurrent follicular lymphoma: a 20-year study from a single center. *J Clin Oncol* 1995;13:140–147.

266. Bartlett NL, Rizeq M, Dorfman RF, et al. Follicular large-cell lymphoma: intermediate or low grade? *J Clin Oncol* 1994;12:1349–1357.

267. Lennert K, Feller AC. *Histopathology of non-Hodgkin's lymphoma*, 2nd ed. New York: Springer-Verlag, 1992.

268. Horning SJ, Weiss LM, Crabtree GS, et al. Clinical and phenotypic diversity of T cell lymphomas. *Blood* 1986;67:1578–1582.

269. Lippman SM, Miller TP, Spier CM, et al. The prognostic significance of the immunotype in diffuse large-cell lymphoma: a comparative study of the T-cell and B-cell phenotype. *Blood* 1988;72:436–441.

270. Gisselbrecht C, Gaulard P, Lepage E, et al. Prognostic significance of T-cell phenotype in aggressive non-Hodgkin's lymphomas. *Groupe d'Etudes des Lymphomes de l'Adulte (GELA)*. *Blood* 1998;92:76–82.

271. Melnyk A, Rodriguez A, Pugh WC, et al. Evaluation of the Revised European-American Lymphoma classification confirms the clinical relevance of immunophenotype in 560 cases of aggressive non-Hodgkin's lymphoma. *Blood* 1997;89:4514–4520.

272. Anderson JR, Jenkin RD, Wilson JF, et al. Long-term follow-up of patients treated with COMP or LSA2L2 therapy for childhood non-Hodgkin's lymphoma: a report of CCG-551 from the Childrens Cancer Group. *J Clin Oncol* 1993;11:1024–1032.

273. Coiffier B, Lepage E, Briere J, et al. CHOP chemotherapy plus rituximab compared with CHOP alone in elderly patients with diffuse large-B-cell lymphoma. *N Engl J Med* 2002;346:235–242.

274. Witzig TE, Habermann TM, Kurtin PJ, et al. S-phase fraction by the labeling index as a predictive factor for progression and survival in low grade non-Hodgkin's lymphoma. *Cancer* 1995;76:1059–1064.

275. Grogan TM, Miller TP. New biologic markers in non-Hodgkin's lymphomas. *Hematol Oncol Clin North Am* 1991;5:925–933.

276. Miller TP, Grogan TM, Dahlberg S, et al. Prognostic significance of the Ki-67-associated proliferative

- antigen in aggressive non-Hodgkin's lymphomas: a prospective Southwest Oncology Group trial. *Blood* 1994;83:1460-1466.
277. Miller TP, Lippman SM, Spier CM, et al. HLA-DR (Ia) immune phenotype predicts outcome for patients with diffuse large cell lymphoma. *J Clin Invest* 1988;82:370-372.
278. Medeiros LJ, Gelb AB, Wolfson K, et al. Major histocompatibility complex class I and class II antigen expression in diffuse large cell and large cell immunoblastic lymphomas. Absence of a correlation between antigen expression and clinical outcome. *Am J Pathol* 1993;143:1086-1097.
279. Lippman SM, Spier CM, Miller TP, et al. Tumor-infiltrating T-lymphocytes in B-cell diffuse large cell lymphoma related to disease course. *Mod Pathol* 1990;3:361-367.
280. Medeiros LJ, Picker LJ, Gelb AB, et al. Numbers of host "helper" T cells and proliferating cells predict survival in diffuse small-cell lymphomas. *J Clin Oncol* 1989;7:1009-1017.
281. Ansell SM, Stenson M, Habermann TM, et al. Cd4+ T-cell immune response to large B-cell non-Hodgkin's lymphoma predicts patient outcome. *J Clin Oncol* 2001;19:720-726.
282. Drillenburg P, Pals ST. Cell adhesion receptors in lymphoma dissemination. *Blood* 2000;95:1900-1910.
283. Terol MJ, Lopez-Guillermo A, Bosch F, et al. Expression of the adhesion molecule ICAM-1 in non-Hodgkin's lymphoma: relationship with tumor dissemination and prognostic importance. *J Clin Oncol* 1998;16:35-40.
284. Drillenburg P, Wielenga VJ, Kramer MH, et al. CD44 expression predicts disease outcome in localized large B cell lymphoma. *Leukemia* 1999;13:1448-1455.
285. Horst E, Meijer CJ, Radaszkiewicz T, et al. Adhesion molecules in the prognosis of diffuse large-cell lymphoma: expression of a lymphocyte homing receptor (CD44), LFA-1 (CD11a/18), and ICAM-1 (CD54). *Leukemia* 1990;4:595-599.
286. Terol MJ, Lopez-Guillermo A, Bosch F, et al. Expression of beta-integrin adhesion molecules in non-Hodgkin's lymphoma: correlation with clinical and evolutive features. *J Clin Oncol* 1999;17:1869-1875.
287. Yatabe Y, Suzuki R, Tobinai K, et al. Significance of cyclin D1 overexpression for the diagnosis of mantle cell lymphoma: a clinicopathologic comparison of cyclin D1-positive MCL and cyclin D1-negative MCL-like B-cell lymphoma. *Blood* 2000;95:2253-2261.
288. Kutok JL, Aster JC. Molecular biology of anaplastic lymphoma kinase-positive anaplastic large-cell lymphoma. *J Clin Oncol* 2002;20:3691-3702.
289. Gascoyne RD, Adomat SA, Krajewski S, et al. Prognostic significance of Bcl-2 protein expression and Bcl-2 gene rearrangement in diffuse aggressive non-Hodgkin's lymphoma. *Blood* 1997;90:244-251.
290. Hill ME, MacLennan KA, Cunningham DC, et al. Prognostic significance of BCL-2 expression and bcl-2 major breakpoint region rearrangement in diffuse large cell non-Hodgkin's lymphoma: a British National Lymphoma Investigation Study. *Blood* 1996;88:1046-1051.
291. Lossos IS, Jones CD, Warnke R, et al. Expression of a single gene, BCL-6, strongly predicts survival in patients with diffuse large B-cell lymphoma. *Blood* 2001;98:945-951.
292. Gronbaek K, Worm J, Ralfkiaer E, et al. ATM mutations are associated with inactivation of the ARF-TP53 tumor suppressor pathway in diffuse large B-cell lymphoma. *Blood* 2002;100:1430-1437.
293. Offit K, Chaganti RS. Chromosomal aberrations in non-Hodgkin's lymphoma. Biologic and clinical correlations. *Hematol Oncol Clin North Am* 1991;5:853-869.
294. Schouten HC, Sanger WG, Weisenburger DD, et al. Chromosomal abnormalities in untreated patients with non-Hodgkin's lymphoma: associations with histology, clinical characteristics, and treatment outcome. The Nebraska Lymphoma Study Group. *Blood* 1990;75:1841-1847.
295. Cabanillas F, Pathak S, Grant G, et al. Refractoriness to chemotherapy and poor survival related to

- abnormalities of chromosomes 17 and 7 in lymphoma. *Am J Med* 1989;87:167-172.
296. Levine EG, Arthur DC, Frizzera G, et al. Cytogenetic abnormalities predict clinical outcome in non-Hodgkin lymphoma. *Ann Intern Med* 1988;108:14-20.
297. Viardot A, Moller P, Hogel J, et al. Clinicopathologic correlations of genomic gains and losses in follicular lymphoma. *J Clin Oncol* 2002;20:4523-4530.
298. Schlegelberger B, Himmler A, Godde E, et al. Cytogenetic findings in peripheral T-cell lymphomas as a basis for distinguishing low-grade and high-grade lymphomas. *Blood* 1994;83:505-511.
299. Bea S, Ribas M, Hernandez JM, et al. Increased number of chromosomal imbalances and high-level DNA amplifications in mantle cell lymphoma are associated with blastoid variants. *Blood* 1999;93:4365-4374.
300. Martinez-Climent JA, Vizcarra E, Sanchez D, et al. Loss of a novel tumor suppressor gene locus at chromosome 8p is associated with leukemic mantle cell lymphoma. *Blood* 2001;98:3479-3482.
301. Alizadeh AA, Eisen MB, Davis RE, et al. Distinct types of diffuse large B-cell lymphoma identified by gene expression profiling. *Nature* 2000;403:503-511.
302. Rosenwald A, Wright G, Chan WC, et al. The use of molecular profiling to predict survival after chemotherapy for diffuse large-B-cell lymphoma. *N Engl J Med* 2002;346:1937-1947.
303. Lossos IS, Alizadeh AA, Diehn M, et al. Transformation of follicular lymphoma to diffuse large-cell lymphoma: alternative patterns with increased or decreased expression of c-myc and its regulated genes. *Proc Natl Acad Sci U S A* 2002;99:8886-8891.
304. Kwak LW, Halpern J, Olshen RA, Horning SJ. Prognostic significance of actual dose intensity in diffuse large-cell lymphoma: results of a tree-structured survival analysis. *J Clin Oncol* 1990;8:963-977.
305. Meyer RM, Hryniuk WM, Goodyear MD. The role of dose intensity in determining outcome in intermediate-grade non-Hodgkin's lymphoma. *J Clin Oncol* 1991;9:339-347.
306. Haw R, Sawka CA, Franssen E, et al. Significance of a partial or slow response to front-line chemotherapy in the management of intermediate-grade or high-grade non-Hodgkin's lymphoma: a literature review. *J Clin Oncol* 1994;12:1074-1084.
307. Armitage JO, Weisenburger DD, Hutchins M, et al. Chemotherapy for diffuse large-cell lymphoma—rapidly responding patients have more durable remissions. *J Clin Oncol* 1986;4:160-164.
308. Verdonck LF, van Putten WL, Hagenbeek A, et al. Comparison of CHOP chemotherapy with autologous bone marrow transplantation for slowly responding patients with aggressive non-Hodgkin's lymphoma. *N Engl J Med* 1995;332:1045-1051.
309. Miller TP, Grogan TM, Dalton WS, et al. P-glycoprotein expression in malignant lymphoma and reversal of clinical drug resistance with chemotherapy plus high-dose verapamil. *J Clin Oncol* 1991;9:17-24.
310. Vose JM, Armitage JO, Weisenburger DD, et al. The importance of age in survival of patients treated with chemotherapy for aggressive non-Hodgkin's lymphoma. *J Clin Oncol* 1988;6:1838-1844.
311. Solal-Celigny P, Chastang C, Herrera A, et al. Age as the main prognostic factor in adult aggressive non-Hodgkin's lymphoma. *Am J Med* 1987;83:1075-1079.
312. Fisher RI, Hubbard SM, DeVita VT, et al. Factors predicting long-term survival in diffuse mixed, histiocytic, or undifferentiated lymphoma. *Blood* 1981;58:45-51.
313. Jagannath S, Velasquez WS, Tucker SL, et al. Tumor burden assessment and its implication for a prognostic model in advanced diffuse large-cell lymphoma. *J Clin Oncol* 1986;4:859-865.
314. Shipp MA, Harrington DP, Klatt MM, et al. Identification of major prognostic subgroups of patients with large-cell lymphoma treated with m-BACOD or M-BACOD. *Ann Intern Med* 1986;104:757-765.
315. Hermans J, Krol AD, van Groningen K, et al. International Prognostic Index for aggressive

non-Hodgkin's lymphoma is valid for all malignancy grades. *Blood* 1995;86:1460-1463.

316. Ansell SM, Habermann TM, Kurtin PJ, et al. Predictive capacity of the International Prognostic Factor Index in patients with peripheral T-cell lymphoma. *J Clin Oncol* 1997;15:2296-2301.
317. Cheson BD, Horning SJ, Coiffier B, et al. Report of an international workshop to standardize response criteria for non-Hodgkin's lymphomas. NCI Sponsored International Working Group. *J Clin Oncol* 1999;17:1244.
318. Biagi JJ, Seymour JF. Insights into the molecular pathogenesis of follicular lymphoma arising from analysis of geographic variation. *Blood* 2002;99:4265-4275.
319. Rohatiner A, Lister TA. Follicular lymphoma. In: Canellos GP, Lister TA, L SJ, eds. *The lymphomas*. Philadelphia: WB Saunders Company, 1998:371-387.
320. Horning SJ. Natural history of and therapy for the indolent non-Hodgkin's lymphomas. *Semin Oncol* 1993;20:75-88.
321. Portlock CS. Management of the low-grade non-Hodgkin's lymphomas. *Semin Oncol* 1990;17:51-59.
322. Stein RS, Greer JP, Cousar JB, et al. Malignant lymphomas of follicular centre cell origin in man. VII. Prognostic features in small cleaved cell lymphoma. *Hematol Oncol* 1989;7:381-391.
323. Lambrechts AC, Hupkes PE, Dorssers LC, et al. Translocation (14;18)-positive cells are present in the circulation of the majority of patients with localized (stage I and II) follicular non-Hodgkin's lymphoma. *Blood* 1993;82:2510-2516.
324. Lopez-Guillermo A, Cabanillas F, McDonnell TI, et al. Correlation of bcl-2 rearrangement with clinical characteristics and outcome in indolent follicular lymphoma. *Blood* 1999;93:3081-3087.
325. Rambaldi A, Lazzari M, Manzoni C, et al. Monitoring of minimal residual disease after CHOP and rituximab in previously untreated patients with follicular lymphoma. *Blood* 2002;99:856-862.
326. Lopez-Guillermo A, Cabanillas F, McLaughlin P, et al. The clinical significance of molecular response in indolent follicular lymphomas. *Blood* 1998;91:2955-2960.
327. Horning SJ. Diffuse small-cell lymphomas. In: Magrath IT, ed. *The non-Hodgkin's lymphomas*, 2nd ed. London: Arnold, 1997:853-866.
328. Ben-Ezra J, Burke JS, Swartz WG, et al. Small lymphocytic lymphoma: a clinicopathologic analysis of 268 cases. *Blood* 1989;73:579-587.
329. Morrison WH, Hoppe RT, Weiss LM, et al. Small lymphocytic lymphoma. *J Clin Oncol* 1989;7:598-606.
330. Berger F, Felman P, Sonet A, et al. Nonfollicular small B-cell lymphomas: a heterogeneous group of patients with distinct clinical features and outcome. *Blood* 1994;83:2829-2835.
331. Offit K, Louie DC, Parsa NZ, et al. Clinical and morphologic features of B-cell small lymphocytic lymphoma with del(6)(q21q23). *Blood* 1994;83:2611-2618.
332. Damle RN, Wasil T, Fais F, et al. Ig V gene mutation status and CD38 expression as novel prognostic indicators in chronic lymphocytic leukemia. *Blood* 1999;94:1840-1847.
333. Hamblin TJ, Davis Z, Gardiner A, et al. Unmutated Ig V(H) genes are associated with a more aggressive form of chronic lymphocytic leukemia. *Blood* 1999;94:1848-1854.
334. Robertson LE, Pugh W, O'Brien S, et al. Richter's syndrome: a report on 39 patients. *J Clin Oncol* 1993;11:1985-1989.
335. Richter MN. Generalized reticular cell sarcoma of lymph nodes associated with lymphatic leukemia. *Am J Med* 1928;68:539.
336. Richards MA, Hall PA, Gregory WM, et al. Lymphoplasmacytoid and small cell centrocytic

non-Hodgkin's lymphoma—a retrospective analysis from St Bartholomew's Hospital 1972–1986. *Hematol Oncol* 1989;7:19–35.

337. Izumi T, Sasaki R, Tsunoda S, et al. B cell malignancy and hepatitis C virus infection. *Leukemia* 1997;11[Suppl 3]:516–518.

338. Gertz MA. Waldenström's macroglobulinemia: a review of therapy. *Leuk Lymphoma* 2002;43:1517–1526.

339. Dimopoulos MA, Kantarjian H, Estey E, et al. Treatment of Waldenström macroglobulinemia with 2-chlorodeoxyadenosine. *Ann Intern Med* 1993;118:195–198.

340. Treon SP, Agus TB, Link B, et al. CD20-directed antibody-mediated immunotherapy induces responses and facilitates hematologic recovery in patients with Waldenström's macroglobulinemia. *J Immunother* 2001;24:272–279.

341. Traweek ST, Sheibani K. Monocytoid B-cell lymphoma. The biologic and clinical implications of peripheral blood involvement. *Am J Clin Pathol* 1992;97:591–598.

342. Nathwani BN, Anderson JR, Armitage JO, et al. Marginal zone B-cell lymphoma: a clinical comparison of nodal and mucosa-associated lymphoid tissue types. Non-Hodgkin's Lymphoma Classification Project. *J Clin Oncol* 1999;17:2486–2492.

343. Berger F, Felman P, Thieblemont C, et al. Non-MALT marginal zone B-cell lymphomas: a description of clinical presentation and outcome in 124 patients. *Blood* 2000;95:1950–1956.

344. Shin SS, Sheibani K, Fishleder A, et al. Monocytoid B-cell lymphoma in patients with Sjögren's syndrome: a clinicopathologic study of 13 patients. *Hum Pathol* 1991;22:422–430.

345. Fisher RI, Dahlberg S, Nathwani BN, et al. A clinical analysis of two indolent lymphoma entities: mantle cell lymphoma and marginal zone lymphoma (including the mucosa-associated lymphoid tissue and monocytoid B-cell subcategories): a Southwest Oncology Group study. *Blood* 1995;85:1075–1082.

346. Mollejo M, Menarguez J, Lloret E, et al. Splenic marginal zone lymphoma: a distinctive type of low-grade B-cell lymphoma. A clinicopathological study of 13 cases. *Am J Surg Pathol* 1995;19:1146–1157.

347. Hammer RD, Glick AD, Greer JP, et al. Splenic marginal zone lymphoma. A distinct B-cell neoplasm. *Am J Surg Pathol* 1996;20:613–626.

348. Chacon JI, Mollejo M, Munoz E, et al. Splenic marginal zone lymphoma: clinical characteristics and prognostic factors in a series of 60 patients. *Blood* 2002;100:1648–1654.

349. Franco V, Florena AM, Iannitto E. Splenic marginal zone lymphoma. *Blood* 2003;101:2464–2472.

350. Thieblemont C, Felman P, Berger F, et al. Treatment of splenic marginal zone B-cell lymphoma: an analysis of 81 patients. *Clin Lymphoma* 2002;3:41–47.

351. Algara P, Mateo MS, Sanchez-Beato M, et al. Analysis of the IgV(H) somatic mutations in splenic marginal zone lymphoma defines a group of unmutated cases with frequent 7q deletion and adverse clinical course. *Blood* 2002;99:1299–1304.

352. Baldini L, Guffanti A, Cro L, et al. Poor prognosis in non-villous splenic marginal zone cell lymphoma is associated with p53 mutations. *Br J Haematol* 1997;99:375–378.

353. Oviatt DL, Cousar JB, Collins RD, et al. Malignant lymphomas of follicular center cell origin in humans. Incidence, clinical features, and prognostic implications of transformation of small cleaved cell nodular lymphoma. *Cancer* 1984;53:1109–1114.

354. Lee JT, Innes DJ Jr, Williams ME. Sequential bcl-2 and c-myc oncogene rearrangements associated with the clinical transformation of non-Hodgkin's lymphoma. *J Clin Invest* 1989;84:1454–1459.

355. Yuen AR, Kamel OW, Halpern J, et al. Long-term survival after histologic transformation of



low-grade follicular lymphoma. *J Clin Oncol* 1995;13:1726-1733.

356. Horning SJ, Rosenberg SA. The natural history of initially untreated low-grade non-Hodgkin's lymphomas. *N Engl J Med* 1984;311:1471-1475.

357. Garvin AJ, Simon RM, Osborne CK, et al. An autopsy study of histologic progression in non-Hodgkin's lymphomas. 192 cases from the National Cancer Institute. *Cancer* 1983;52:393-398.

358. Sander CA, Yano T, Clark HM, et al. p53 mutation is associated with progression in follicular lymphomas. *Blood* 1993;82:1994-2004.

359. Tilly H, Rossi A, Stamatoullas A, et al. Prognostic value of chromosomal abnormalities in follicular lymphoma. *Blood* 1994;84:1043-1049.

360. Yunis JJ, Frizzera G, Oken MM, et al. Multiple recurrent genomic defects in follicular lymphoma. A possible model for cancer. *N Engl J Med* 1987;316:79-84.

361. Grem JL, Hafez GR, Brandenburg JH, et al. Spontaneous remission in diffuse large cell lymphoma. *Cancer* 1986;57:2042-2044.

362. Fisher DE, Jacobson JO, Ault KA, et al. Diffuse large cell lymphoma with discordant bone marrow histology. Clinical features and biological implications. *Cancer* 1989;64:1879-1887.

363. York JC 2nd, Cousar JB, Glick AD, et al. Morphologic and immunologic evidence of composite B- and T-cell lymphomas. A report of three cases developing in follicular center cell lymphomas. *Am J Clin Pathol* 1985;84:35-43.

364. Chabner BA, Johnson RE, Young RC, et al. Sequential nonsurgical and surgical staging of non-Hodgkin's lymphoma. *Cancer* 1978;42:922-925.

365. Gallagher CJ, Gregory WM, Jones AE, et al. Follicular lymphoma: prognostic factors for response and survival. *J Clin Oncol* 1986;4:1470-1480.

366. Paryani SB, Hoppe RT, Cox RS, et al. Analysis of non-Hodgkin's lymphomas with nodular and favorable histologies, stages I and II. *Cancer* 1983;52:2300-2307.

367. Horning SJ. Treatment approaches to the low-grade lymphomas. *Blood* 1994;83:881-884.

368. Hiddemann W, Unterhalt M. Current status and future perspectives in the treatment of low-grade non-Hodgkin's lymphomas. *Blood Rev* 1994;8:225-233.

369. MacManus MP, Hoppe RT. Is radiotherapy curative for stage I and II low-grade follicular lymphoma? Results of a long-term follow-up study of patients treated at Stanford University. *J Clin Oncol* 1996;14:1282-1290.

370. Monfardini S, Banfi A, Bonadonna G, et al. Improved five year survival after combined radiotherapy-chemotherapy for stage I-II non-Hodgkin's lymphoma. *Int J Radiat Oncol Biol Phys* 1980;6:125-134.

371. Nissen NI, Ersboll J, Hansen HS, et al. A randomized study of radiotherapy versus radiotherapy plus chemotherapy in stage I-II non-Hodgkin's lymphomas. *Cancer* 1983;52:1-7.

372. Kelsey SM, Newland AC, Hudson GV, et al. A British National Lymphoma Investigation randomized trial of single agent chlorambucil plus radiotherapy versus radiotherapy alone in low grade, localized non-Hodgkin's lymphoma. *Med Oncol* 1994;11:19-25.

373. Colombat P, Salles G, Brousse N, et al. Rituximab (anti-CD20 monoclonal antibody) as single first-line therapy for patients with follicular lymphoma with a low tumor burden: clinical and molecular evaluation. *Blood* 2001;97:101-106.

374. Hainsworth JD, Litchy S, Burris HA 3rd, et al. Rituximab as first-line and maintenance therapy for patients with indolent non-Hodgkin's lymphoma. *J Clin Oncol* 2002;20:4261-4267.

375. Hoppe RT, Kushlan P, Kaplan HS, et al. The treatment of advanced stage favorable histology non-Hodgkin's lymphoma: a preliminary report of a randomized trial comparing single agent chemotherapy, combination chemotherapy, and whole body irradiation. *Blood* 1981;58:592-598.
376. Brice P, Bastion Y, Lepage E, et al. Comparison in low-tumor-burden follicular lymphomas between an initial no-treatment policy, prednimustine, or interferon alfa: a randomized study from the Groupe d'Etude des Lymphomes Folliculaires. *Groupe d'Etude des Lymphomes de l'Adulte. J Clin Oncol* 1997;15:1110-1117.
377. McLaughlin P, Fuller LM, Velasquez WS, et al. Stage III follicular lymphoma: durable remissions with a combined chemotherapy-radiotherapy regimen. *J Clin Oncol* 1987;5:867-874.
378. Paryani SB, Hoppe RT, Cox RS, et al. The role of radiation therapy in the management of stage III follicular lymphomas. *J Clin Oncol* 1984;2:841-848.
379. Bierman PJ, Vose JM, Anderson JR, et al. High-dose therapy with autologous hematopoietic rescue for follicular low-grade non-Hodgkin's lymphoma. *J Clin Oncol* 1997;15:445-450.
380. Ezdinli EZ, Anderson JR, Melvin F, et al. Moderate versus aggressive chemotherapy of nodular lymphocytic poorly differentiated lymphoma. *J Clin Oncol* 1985;3:769-775.
381. Jones SE, Grozea PN, Metz EN, et al. Superiority of adriamycin-containing combination chemotherapy in the treatment of diffuse lymphoma: a Southwest Oncology Group study. *Cancer* 1979;43:417-425.
382. Dana BW, Dahlberg S, Nathwani BN, et al. Long-term follow-up of patients with low-grade malignant lymphomas treated with doxorubicin-based chemotherapy or chemoimmunotherapy. *J Clin Oncol* 1993;11:644-651.
383. Peterson BA, Petroni GR, Frizzera G, et al. Prolonged single-agent versus combination chemotherapy in indolent follicular lymphomas: a study of the cancer and leukemia group B. *J Clin Oncol* 2003;21:5-15.
384. Cabanillas F, Smith T, Bodey GP, et al. Nodular malignant lymphomas: factors affecting complete response rate and survival. *Cancer* 1979;44:1983-1989.
385. McLaughlin P, Hagemester FB, Swan F, et al. Intensive conventional-dose chemotherapy for stage IV low-grade lymphoma: high remission rates and reversion to negative of peripheral blood bcl-2 rearrangement. *Ann Oncol* 1994;5[Suppl 2]:73-77.
386. Czuczman MS, Grillo-Lopez AJ, White CA, et al. Treatment of patients with low-grade B-cell lymphoma with the combination of chimeric anti-CD20 monoclonal antibody and CHOP chemotherapy. *J Clin Oncol* 1999;17:268-276.
387. Kimby E, Bjorkholm M, Gahrton G, et al. Chlorambucil/prednisone vs. CHOP in symptomatic low-grade non-Hodgkin's lymphomas: a randomized trial from the Lymphoma Group of Central Sweden. *Ann Oncol* 1994;5 [Suppl 2]:67-71.
388. Young RC, Longo DL, Glatstein E, et al. The treatment of indolent lymphomas: watchful waiting vs aggressive combined modality treatment. *Semin Hematol* 1988;25:11-16.
389. Pott-Hoeck C, Hiddemann W. Purine analogs in the treatment of low-grade lymphomas and chronic lymphocytic leukemias. *Ann Oncol* 1995;6:421-433.
390. Piro LD. Cladribine in the treatment of low-grade non-Hodgkin's lymphoma. *Semin Hematol* 1996;33:34-39.
391. Solal-Celigny P, Brice P, Brousse N, et al. Phase II trial of fludarabine monophosphate as first-line treatment in patients with advanced follicular lymphoma: a multicenter study by the Groupe d'Etude des Lymphomes de l'Adulte. *J Clin Oncol* 1996;14:514-519.
392. Klasa RJ, Meyer RM, Shustik C, et al. Randomized phase III study of fludarabine phosphate versus cyclophosphamide, vincristine, and prednisone in patients with recurrent low-grade non-Hodgkin's

lymphoma previously treated with an alkylating agent or alkylator-containing regimen. *J Clin Oncol* 2002;20:4649-4654.

393. Flinn IW, Byrd JC, Morrison C, et al. Fludarabine and cyclophosphamide with filgrastim support in patients with previously untreated indolent lymphoid malignancies. *Blood* 2000;96:71-75.

394. Hochster HS, Oken MM, Winter JN, et al. Phase I study of fludarabine plus cyclophosphamide in patients with previously untreated low-grade lymphoma: results and long-term follow-up—a report from the Eastern Cooperative Oncology Group. *J Clin Oncol* 2000;18:987-994.

395. McLaughlin P, Hagemester FB, Romaguera JE, et al. Fludarabine, mitoxantrone, and dexamethasone: an effective new regimen for indolent lymphoma. *J Clin Oncol* 1996;14:1262-1268.

396. Velasquez W, Lew D, Miller TP, et al. SWOG 95-01: a phase II trial of a combination of fludarabine and mitoxantrone (FN) in untreated advanced low grade lymphoma: an effective, well-tolerated therapy (abstract). *Proc Am Soc Clin Oncol* 1999;18:9a.

397. Zinzani PL, Magagnoli M, Bendandi M, et al. Efficacy of fludarabine and mitoxantrone (FN) combination regimen in untreated indolent non-Hodgkin's lymphomas. *Ann Oncol* 2000;11:363-365.

398. Tsimberidou AM, McLaughlin P, Younes A, et al. Fludarabine, mitoxantrone, dexamethasone (FND) compared with an alternating triple therapy (ATT) regimen in patients with stage IV indolent lymphoma. *Blood* 2002;100:4351-4357.

399. Foon KA, Sherwin SA, Abrams PG, et al. Treatment of advanced non-Hodgkin's lymphoma with recombinant leukocyte A interferon. *N Engl J Med* 1984;311:1148-1152.

400. O'Connell MJ, Colgan JP, Oken MM, et al. Clinical trial of recombinant leukocyte A interferon as initial therapy for favorable histology non-Hodgkin's lymphomas and chronic lymphocytic leukemia. An Eastern Cooperative Oncology Group pilot study. *J Clin Oncol* 1986;4:128-136.

401. Arranz R, Garcia-Alfonso P, Sobrino P, et al. Role of interferon alfa-2b in the induction and maintenance treatment of low-grade non-Hodgkin's lymphoma: results from a prospective, multicenter trial with double randomization. *J Clin Oncol* 1998;16:1538-1546.

402. Hagenbeek A, Carde P, Meerwaldt JH, et al. Maintenance of remission with human recombinant interferon alfa-2a in patients with stages III and IV low-grade malignant non-Hodgkin's lymphoma. European Organization for Research and Treatment of Cancer Lymphoma Cooperative Group. *J Clin Oncol* 1998;16:41-47.

403. Solal-Celigny P, Lepage E, Brousse N, et al. Doxorubicin-containing regimen with or without interferon alfa-2b for advanced follicular lymphomas: final analysis of survival and toxicity in the Groupe d'Etude des Lymphomes Folliculaires 86 Trial. *J Clin Oncol* 1998;16:2332-2338.

404. Rohatiner AZS, Gregory W, Peterson BA, et al. A meta-analysis of randomized trials evaluating the role of interferon as treatment for follicular lymphoma. *Proc Am Soc Clin Oncol* 1998;17:4a(abst).

405. Maloney DG, Grillo-Lopez AJ, Bodkin DJ, et al. IDEC-C2B8: results of a phase I multiple-dose trial in patients with relapsed non-Hodgkin's lymphoma. *J Clin Oncol* 1997;15:3266-3274.

406. Davis TA, White CA, Grillo-Lopez AJ, et al. Single-agent monoclonal antibody efficacy in bulky non-Hodgkin's lymphoma: results of a phase II trial of rituximab. *J Clin Oncol* 1999;17:1851-1857.

407. McLaughlin P, Grillo-Lopez AJ, Link BK, et al. Rituximab chimeric anti-CD20 monoclonal antibody therapy for relapsed indolent lymphoma: half of patients respond to a four-dose treatment program. *J Clin Oncol* 1998;16:2825-2833.

408. Leonard JP, Coleman M, Schuster MW, et al. Epratuzumab, a new anti-CD22, humanized, monoclonal antibody for the therapy of non-Hodgkin's lymphoma (NHL): phase I/II trial results. *Blood* 1999;94:404(abst).

409. Link BD, Kahl B, Czuczman M, et al. A phase II study of Remitogen (Hu1D10), a humanized monoclonal antibody in patients with relapsed or refractory follicular, small lymphocytic, or marginal zone/MALT B-cell lymphoma. *Blood* 2001;98:2540a(abst).

410. Cheson BD. Radioimmunotherapy of non-Hodgkin lymphomas. *Blood* 2003;101:391-398.
411. Witzig TE, White CA, Wiseman GA, et al. Phase I/II trial of IDEC-Y2B8 radioimmunotherapy for treatment of relapsed or refractory CD20(+) B-cell non-Hodgkin's lymphoma. *J Clin Oncol* 1999;17:3793-3803.
412. Witzig TE, Gordon LI, Cabanillas F, et al. Randomized controlled trial of yttrium-90-labeled ibritumomab tiuxetan radioimmunotherapy versus rituximab immunotherapy for patients with relapsed or refractory low-grade, follicular, or transformed B-cell non-Hodgkin's lymphoma. *J Clin Oncol* 2002;20:2453-2463.
413. Kaminski MS, Estes J, Zasadny KR, et al. Radioimmunotherapy with iodine (131)I tositumomab for relapsed or refractory B-cell non-Hodgkin lymphoma: updated results and long-term follow-up of the University of Michigan experience. *Blood* 2000;96:1259-1266.
414. Kaminski MS, Zelenetz AD, Press OW, et al. Pivotal study of iodine I 131 tositumomab for chemotherapy-refractory low-grade or transformed low-grade B-cell non-Hodgkin's lymphomas. *J Clin Oncol* 2001;19:3918-3928.
415. Kaminski MS, Estes J, Tuck M, et al. Iodine I 131 tositumomab for previously untreated follicular lymphoma (FL). *Proc Am Soc Clin Oncol* 2000;19:5a(abst).
416. Press OW, Unger JM, Braziel RM, et al. A phase II trial of CHOP followed by Bexxar (tositumomab and iodine-131-tositumomab) for treatment of newly diagnosed follicular non-Hodgkin's lymphomas (SWOG 9911). *Blood* 2001;98:843a(abst).
417. Vose JM, Bierman PJ, Lynch JC, et al. Radioimmunotherapy with Bexxar combined with high-dose chemotherapy (HDC) followed by autologous hematopoietic stem cell transplantation (ASCT) for refractory non-Hodgkin's lymphoma (NHL): synergistic results with no added toxicity. *Proc Am Soc Clin Oncol* 2001;20:19a(abst).
418. Banks PM, Chan J, Cleary ML, et al. Mantle cell lymphoma. A proposal for unification of morphologic, immunologic, and molecular data. *Am J Surg Pathol* 1992;16:637-640.
419. Weisenburger DD, Armitage JO. Mantle cell lymphoma—an entity comes of age. *Blood* 1996;87:4483-4494.
420. Decaudin D. Mantle cell lymphoma: a biological and therapeutic paradigm. *Leuk Lymphoma* 2002;43:773-781.
421. Andersen NS, Jensen MK, de Nully Brown P, et al. A Danish population-based analysis of 105 mantle cell lymphoma patients: incidences, clinical features, response, survival and prognostic factors. *Eur J Cancer* 2002;38:401-408.
422. Velders GA, Kluin-Nelemans JC, De Boer CJ, et al. Mantle-cell lymphoma: a population-based clinical study. *J Clin Oncol* 1996;14:1269-1274.
423. Valdez R, Kroft SH, Ross CW, et al. Cerebrospinal fluid involvement in mantle cell lymphoma. *Mod Pathol* 2002;15:1073-1079.
424. Rimokh R, Berger F, Cornillet P, et al. Break in the BCL1 locus is closely associated with intermediate lymphocytic lymphoma subtype. *Genes Chromosomes Cancer* 1990;2:223-226.
425. Avet-Loiseau H, Garand R, Gaillard F, et al. Detection of t(11;14) using interphase molecular cytogenetics in mantle cell lymphoma and atypical chronic lymphocytic leukemia. *Genes Chromosomes Cancer* 1998;23:175-182.
426. de Boer CJ, Schuurig E, Dreef E, et al. Cyclin D1 protein analysis in the diagnosis of mantle cell lymphoma. *Blood* 1995;86:2715-2723.
427. Stilgenbauer S, Winkler D, Ott G, et al. Molecular characterization of 11q deletions points to a pathogenic role of the ATM gene in mantle cell lymphoma. *Blood* 1999;94:3262-3264.

428. Hernandez L, Fest T, Cazorla M, et al. p53 gene mutations and protein overexpression are associated with aggressive variants of mantle cell lymphomas. *Blood* 1996;87:3351–3359.
429. Dreyling MH, Bullinger L, Ott G, et al. Alterations of the cyclin D1/p16-pRB pathway in mantle cell lymphoma. *Cancer Res* 1997;57:4608–4614.
430. Rohatiner AZ, Lister TA. “Diffuse” low grade B-cell lymphomas. In: Canellos GP, Lister TA, Sklar JL, eds. *The lymphomas*. Philadelphia: WB Saunders, 1998:389–398.
431. Zucca E, Fontana S, Roggero E, et al. Treatment and prognosis of centrocytic (mantle cell) lymphoma: a retrospective analysis of twenty-six patients treated in one institution. *Leuk Lymphoma* 1994;13:105–110.
432. Teodorovic I, Pittaluga S, Kluijn-Nelemans JC, et al. Efficacy of four different regimens in 64 mantle-cell lymphoma cases: clinicopathologic comparison with 498 other non-Hodgkin’s lymphoma subtypes. European Organization for the Research and Treatment of Cancer Lymphoma Cooperative Group. *J Clin Oncol* 1995;13:2819–2826.
433. Meusers P, Engelhard M, Bartels H, et al. Multicentre randomized therapeutic trial for advanced centrocytic lymphoma: anthracycline does not improve the prognosis. *Hematol Oncol* 1989;7:365–380.
434. Zinzani PL, Magagnoli M, Moretti L, et al. Randomized trial of fludarabine versus fludarabine and idarubicin as frontline treatment in patients with indolent or mantle-cell lymphoma. *J Clin Oncol* 2000;18:773–779.
435. Cohen BJ, Moskowitz C, Straus D, et al. Cyclophosphamide/fludarabine (CF) is active in the treatment of mantle cell lymphoma. *Leuk Lymphoma* 2001;42:1015–1022.
436. Rummel MJ, Chow KU, Karakas T, et al. Cladribine (2-chlorodeoxyadenosine, 2-CdA) plus mitoxantrone in the treatment of progressive advanced low-grade non-Hodgkin’s and mantle cell lymphomas—preliminary results of a phase II study. *Blood* 1999;94[Suppl 1]:660a(abst).
437. Foran JM, Cunningham D, Coiffier B, et al. Treatment of mantle-cell lymphoma with Rituximab (chimeric monoclonal anti-CD20 antibody): analysis of factors associated with response. *Ann Oncol* 2000;11[Suppl 1]:117–121.
438. Howard OM, Gribben JG, Neuberg DS, et al. Rituximab and CHOP induction therapy for newly diagnosed mantle-cell lymphoma: molecular complete responses are not predictive of progression-free survival. *J Clin Oncol* 2002;20:1288–1294.
439. Khouri IF, Romaguera J, Kantarjian H, et al. Hyper-CVAD and high-dose methotrexate/cytarabine followed by stem-cell transplantation: an active regimen for aggressive mantle-cell lymphoma. *J Clin Oncol* 1998;16:3803–3809.
440. Jindra P, Koza V, Svojcova M, et al. Frontline transplantation of autologous CD34+ selected blood cells for advanced mantle cell lymphoma: no evidence of long-term cure: a single centre experience. *Bone Marrow Transplant* 2000;26:1138–1139.
441. Vose JM, Bierman PJ, Weisenburger DD, et al. Autologous hematopoietic stem cell transplantation for mantle cell lymphoma. *Biol Blood Marrow Transplant* 2000;6:640–645.
442. Gopal AK, Rajendran JG, Petersdorf SH, et al. High-dose chemo-radioimmunotherapy with autologous stem cell support for relapsed mantle cell lymphoma. *Blood* 2002;99:3158–3162.
443. Martinez C, Carreras E, Rovira M, et al. Patients with mantle-cell lymphoma relapsing after autologous stem cell transplantation may be rescued by allogeneic transplantation. *Bone Marrow Transplant* 2000;26:677–679.
444. Lawrence EH, et al. Follicular and diffuse mixed small-cleaved and large cell lymphoma—a clinicopathologic study. *J Clin Oncol* 1985;3:1183.
445. Coiffier B, Bryon PA, French M, et al. Intensive chemotherapy in aggressive lymphomas: updated results of LNH-80 protocol and prognostic factors affecting response and survival. *Blood*

1987;70:1394-1399.

446. Stein RS, Greer JP, Flexner JM, et al. Large-cell lymphomas: clinical and prognostic features. *J Clin Oncol* 1990;8:1370-1379.

447. Urba WJ, Duffey PL, Longo DL. Treatment of patients with aggressive lymphomas: an overview. *J Natl Cancer Inst Monogr* 1990;29-37.

448. Greer JP, Macon WR, Lamar RE, et al. T-cell-rich B-cell lymphomas: diagnosis and response to therapy of 44 patients. *J Clin Oncol* 1995;13:1742-1750.

449. Yamaguchi M, Seto M, Okamoto M, et al. De novo CD5+ diffuse large B-cell lymphoma: a clinicopathologic study of 109 patients. *Blood* 2002;99:815-821.

450. Pandolfino TL, Siegel RS, Kuzel TM, et al. Primary cutaneous B-cell lymphoma: review and current concepts. *J Clin Oncol* 2000;18:2152-2168.

451. DiGiuseppe JA, Nelson WG, Seifter EJ, et al. Intravascular lymphomatosis: a clinicopathologic study of 10 cases and assessment of response to chemotherapy. *J Clin Oncol* 1994;12:2573-2579.

452. Miller DC, Hochberg FH, Harris NL, et al. Pathology with clinical correlations of primary central nervous system non-Hodgkin's lymphoma. The Massachusetts General Hospital experience 1958-1989. *Cancer* 1994;74:1383-1397.

453. Aisenberg AC. Primary large cell lymphoma of the mediastinum. *Semin Oncol* 1999;26:251-258.

454. Jacobson JO, Aisenberg AC, Lamarre L, et al. Mediastinal large cell lymphoma. An uncommon subset of adult lymphoma curable with combined modality therapy. *Cancer* 1988;62:1893-1898.

455. Kirn D, Mauch P, Shaffer K, et al. Large-cell and immunoblastic lymphoma of the mediastinum: prognostic features and treatment outcome in 57 patients. *J Clin Oncol* 1993;11:1336-1343.

456. Cazals-Hatem D, Lepage E, Brice P, et al. Primary mediastinal large B-cell lymphoma. A clinicopathologic study of 141 cases compared with 916 non-mediastinal large B-cell lymphomas, a GELA ("Groupe d'Etude des Lymphomes de l'Adulte") study. *Am J Surg Pathol* 1996;20:877-888.

457. Lazzarino M, Orlandi E, Paulli M, et al. Treatment outcome and prognostic factors for primary mediastinal (thymic) B-cell lymphoma: a multicenter study of 106 patients. *J Clin Oncol* 1997;15:1646-1653.

458. van Besien K, Kelta M, Bahaguna P. Primary mediastinal B-cell lymphoma: a review of pathology and management. *J Clin Oncol* 2001;19:1855-1864.

459. Joos S, Otano-Joos MI, Ziegler S, et al. Primary mediastinal (thymic) B-cell lymphoma is characterized by gains of chromosomal material including 9p and amplification of the REL gene. *Blood* 1996;87:1571-1578.

460. Copie-Bergman C, Gaulard P, Maouche-Chretien L, et al. The MAL gene is expressed in primary mediastinal large B-cell lymphoma. *Blood* 1999;94:3567-3575.

461. Sehn LH, Antin JH, Shulman LN, et al. Primary diffuse large B-cell lymphoma of the mediastinum: outcome following high-dose chemotherapy and autologous hematopoietic cell transplantation. *Blood* 1998;91:717-723.

462. Popat U, Przepiork D, Champlin R, et al. High-dose chemotherapy for relapsed and refractory diffuse large B-cell lymphoma: mediastinal localization predicts for a favorable outcome. *J Clin Oncol* 1998;16:63-69.

463. Coiffier B, Brousse N, Peuchmaur M, et al. Peripheral T-cell lymphomas have a worse prognosis than B-cell lymphomas: a prospective study of 361 immunophenotyped patients treated with the LNH-84 regimen. The GELA (Groupe d'Etude des Lymphomes Aggressives). *Ann Oncol* 1990;1:45-50.

464. Cheng AL, Chen YC, Wang CH, et al. Direct comparisons of peripheral T-cell lymphoma with diffuse B-cell lymphoma of comparable histological grades—should peripheral T-cell lymphoma be considered

separately? *J Clin Oncol* 1989;7:725-731.

465. Greer JP, Kinney MC, Loughran TP Jr. T cell and NK cell lymphoproliferative disorders. *Hematology (Am Soc Hematol Educ Program)* 2001:259-281.

466. Brouet JC, Rabian C, Gisselbrecht C, et al. Clinical and immunological study of non-Hodgkin T-cell lymphomas (cutaneous and lymphoblastic lymphomas excluded). *Br J Haematol* 1984;57:315-327.

467. Armitage JO, Greer JP, Levine AM, et al. Peripheral T-cell lymphoma. *Cancer* 1989;63:158-163.

468. Nakamura S, Suchi T. A clinicopathologic study of node-based, low-grade, peripheral T-cell lymphoma. Angioimmunoblastic lymphoma, T-zone lymphoma, and lymphoepithelioid lymphoma. *Cancer* 1991;67:2566-2578.

469. Siegert W, Nerl C, Engelhard M, et al. Peripheral T-cell non-Hodgkin's lymphomas of low malignancy: prospective study of 25 patients with pleomorphic small cell lymphoma, lymphoepithelioid cell (Lennert's) lymphoma and T-zone lymphoma. The Kiel Lymphoma Study Group. *Br J Haematol* 1994;87:529-534.

470. Stein H, Mason DY, Gerdes J, et al. The expression of the Hodgkin's disease associated antigen Ki-1 in reactive and neoplastic lymphoid tissue: evidence that Reed-Sternberg cells and histiocytic malignancies are derived from activated lymphoid cells. *Blood* 1985;66:848-858.

471. Kadin ME, Sako D, Berliner N, et al. Childhood Ki-1 lymphoma presenting with skin lesions and peripheral lymphadenopathy. *Blood* 1986;68:1042-1049.

472. Greer JP, Kinney MC, Collins RD, et al. Clinical features of 31 patients with Ki-1 anaplastic large-cell lymphoma. *J Clin Oncol* 1991;9:539-547.

473. Shulman LN, Frisard B, Antin JH, et al. Primary Ki-1 anaplastic large-cell lymphoma in adults: clinical characteristics and therapeutic outcome. *J Clin Oncol* 1993;11:937-942.

474. Kaneko Y, Frizzera G, Edamura S, et al. A novel translocation, t(2;5)(p23;q35), in childhood phagocytic large T-cell lymphoma mimicking malignant histiocytosis. *Blood* 1989;73:806-813.

475. Rimokh R, Magaud JP, Berger F, et al. A translocation involving a specific breakpoint (q35) on chromosome 5 is characteristic of anaplastic large cell lymphoma ('Ki-1 lymphoma'). *Br J Haematol* 1989;71:31-36.

476. Morris SW, Kirstein MN, Valentine MB, et al. Fusion of a kinase gene, ALK, to a nucleolar protein gene, NPM, in non-Hodgkin's lymphoma. *Science* 1994;263:1281-1284.

477. Duyster J, Bai RY, Morris SW. Translocations involving anaplastic lymphoma kinase (ALK). *Oncogene* 2001;20:5623-5637.

478. Gascoyne RD, Aoun P, Wu D, et al. Prognostic significance of anaplastic lymphoma kinase (ALK) protein expression in adults with anaplastic large cell lymphoma. *Blood* 1999;93:3913-3921.

479. Fraga M, Brousset P, Schlaifer D, et al. Bone marrow involvement in anaplastic large cell lymphoma. Immunohistochemical detection of minimal disease and its prognostic significance. *Am J Clin Pathol* 1995;103:82-89.

480. Shiota M, Nakamura S, Ichinohasama R, et al. Anaplastic large cell lymphomas expressing the novel chimeric protein p80NPM/ALK: a distinct clinicopathologic entity. *Blood* 1995;86:1954-1960.

481. Greer JP, Flexner JM, Kallianpur AR, et al. Ki-1 anaplastic large cell lymphoma (ALCL): correlation of clinical features with p80(NPM/ALK) expression and histology. *Blood* 1996;224a(abst).

482. Jaffe ES. Anaplastic large cell lymphoma: the shifting sands of diagnostic hematopathology. *Mod Pathol* 2001;14:219-228.

483. Haralambieva E, Pulford KA, Lamant L, et al. Anaplastic large-cell lymphomas of B-cell phenotype are anaplastic lymphoma kinase (ALK) negative and belong to the spectrum of diffuse large B-cell



lymphomas. *Br J Haematol* 2000;109:584–591.

484. Kinney MC, Kadin ME. The pathologic and clinical spectrum of anaplastic large cell lymphoma and correlation with ALK gene dysregulation. *Am J Clin Pathol* 1999;111:S56–S67.

485. Paulli M, Berti E, Rosso R, et al. CD30/Ki-1–positive lymphoproliferative disorders of the skin—clinicopathologic correlation and statistical analysis of 86 cases: a multicentric study from the European Organization for Research and Treatment of Cancer Cutaneous Lymphoma Project Group. *J Clin Oncol* 1995;13:1343–1354.

486. Seidemann K, Tiemann M, Schrappe M, et al. Short-pulse B–non–Hodgkin lymphoma–type chemotherapy is efficacious treatment for pediatric anaplastic large cell lymphoma: a report of the Berlin–Frankfurt–Munster Group Trial NHL–BFM 90. *Blood* 2001;97:3699–3706.

487. Fanin R, Sperotto A, Silvestri F, et al. The therapy of primary adult systemic CD30–positive anaplastic large cell lymphoma: results of 40 cases treated in a single center. *Leuk Lymphoma* 1999;35:159–169.

488. A clinical evaluation of the International Lymphoma Study Group classification of non–Hodgkin's lymphoma. The Non–Hodgkin's Lymphoma Classification Project. *Blood* 1997;89:3909–3918.

489. Jagasia M, Stein R, Kinney M, et al. High dose chemotherapy and hematopoietic stem cell transplant in peripheral T–cell lymphomas. *J Clin Oncol* 2001;20:294a.

490. Lopez–Guillermo A, Cid J, Salar A, et al. Peripheral T–cell lymphomas: initial features, natural history, and prognostic factors in a series of 174 patients diagnosed according to the R.E.A.L. Classification. *Ann Oncol* 1998;9:849–855.

491. Ascani S, Zinzani PL, Gherlinzoni F, et al. Peripheral T–cell lymphomas. Clinico–pathologic study of 168 cases diagnosed according to the R.E.A.L. Classification. *Ann Oncol* 1997;8:583–592.

492. Lee SS, Cho KJ, Kim CW, et al. Clinicopathological analysis of 501 non–Hodgkin's lymphomas in Korea according to the revised European–American classification of lymphoid neoplasms. *Histopathology* 1999;35:345–354.

493. Vaccher E. The World Health Organization classification of malignant lymphomas in Japan: incidence of recently recognized entities. Lymphoma Study Group of Japanese Pathologists. *Pathol Int* 2000;50:696–702.

494. Arrowsmith ER, Macon WR, Kinney MC, et al. Peripheral T–cell lymphomas: clinical features and prognostic factors of 92 cases defined by the revised European American lymphoma classification. *Leuk Lymphoma* 2003;44:241–249.

495. Kim K, Kim WS, Jung CW, et al. Clinical features of peripheral T–cell lymphomas in 78 patients diagnosed according to the Revised European–American lymphoma (REAL) classification. *Eur J Cancer* 2002;38:75–81.

496. Pellatt J, Sweetenham J, Pickering RM, et al. A single–centre study of treatment outcomes and survival in 120 patients with peripheral T–cell non–Hodgkin's lymphoma. *Ann Hematol* 2002;81:267–272.

497. Jones D, O'Hara C, Kraus MD, et al. Expression pattern of T–cell–associated chemokine receptors and their chemokines correlates with specific subtypes of T–cell non–Hodgkin lymphoma. *Blood* 2000;96:685–690.

498. Freter CE, Cossman J. Angioimmunoblastic lymphadenopathy with dysproteinemia. *Semin Oncol* 1993;20:627–635.

499. Siegert W, Agthe A, Griesser H, et al. Treatment of angioimmunoblastic lymphadenopathy (AILD)–type T–cell lymphoma using prednisone with or without the COPBLAM/IMVP–16 regimen. A multicenter study. Kiel Lymphoma Study Group. *Ann Intern Med* 1992;117:364–370.

500. Schlegelberger B, Zhang Y, Weber–Matthiesen K, et al. Detection of aberrant clones in nearly all cases of angioimmunoblastic lymphadenopathy with dysproteinemia–type T–cell lymphoma by combined

interphase and metaphase cytogenetics. *Blood* 1994;84:2640–2648.

501. Ohshima K, Takeo H, Kikuchi M, et al. Heterogeneity of Epstein–Barr virus infection in angioimmunoblastic lymphadenopathy type T–cell lymphoma. *Histopathology* 1994;25:569–579.
502. Schlegelberger B, Zwingers T, Hohenadel K, et al. Significance of cytogenetic findings for the clinical outcome in patients with T–cell lymphoma of angioimmunoblastic lymphadenopathy type. *J Clin Oncol* 1996;14:593–599.
503. Anagnostopoulos I, Hummel M, Finn T, et al. Heterogeneous Epstein–Barr virus infection patterns in peripheral T–cell lymphoma of angioimmunoblastic lymphadenopathy type. *Blood* 1992;80:1804–1812.
504. Foss HD, Anagnostopoulos I, Herbst H, et al. Patterns of cytokine gene expression in peripheral T–cell lymphoma of angioimmunoblastic lymphadenopathy type. *Blood* 1995;85:2862–2869.
505. Farcet JP, Gaulard P, Marolleau JP, et al. Hepatosplenic T–cell lymphoma: sinusal/sinusoidal localization of malignant cells expressing the T–cell receptor gamma delta. *Blood* 1990;75:2213–2219.
506. Weidmann E. Hepatosplenic T cell lymphoma. A review on 45 cases since the first report describing the disease as a distinct lymphoma entity in 1990. *Leukemia* 2000;14:991–997.
507. Yao M, Tien HF, Lin MT, et al. Clinical and hematological characteristics of hepatosplenic T gamma/delta lymphoma with isochromosome for long arm of chromosome 7. *Leuk Lymphoma* 1996;22:495–500.
508. Macon WR, Levy NB, Kurtin PJ, et al. Hepatosplenic alphabeta T–cell lymphomas: a report of 14 cases and comparison with hepatosplenic gammadelta T–cell lymphomas. *Am J Surg Pathol* 2001;25:285–296.
509. Gonzalez CL, Medeiros LJ, Brazier RM, et al. T–cell lymphoma involving subcutaneous tissue. A clinicopathologic entity commonly associated with hemophagocytic syndrome. *Am J Surg Pathol* 1991;15:17–27.
510. Cho KH, Oh JK, Kim CW, et al. Peripheral T–cell lymphoma involving subcutaneous tissue. *Br J Dermatol* 1995;132:290–295.
511. Salhany KE, Macon WR, Choi JK, et al. Subcutaneous panniculitis–like T–cell lymphoma: clinicopathologic, immunophenotypic, and genotypic analysis of alpha/beta and gamma/delta subtypes. *Am J Surg Pathol* 1998;22:881–893.
512. Chott A, Dragosics B, Radaszkiewicz T. Peripheral T–cell lymphomas of the intestine. *Am J Pathol* 1992;141:1361–1371.
513. O'Farrelly C, Feighery C, O'Briain DS, et al. Humoral response to wheat protein in patients with coeliac disease and enteropathy associated T cell lymphoma. *BMJ (Clin Res Ed)* 1986;293:908–910.
514. Gale J, Simmonds PD, Mead GM, et al. Enteropathy–type intestinal T–cell lymphoma: clinical features and treatment of 31 patients in a single center. *J Clin Oncol* 2000;18:795–803.
515. Kim GE, Cho JH, Yang WI, et al. Angiocentric lymphoma of the head and neck: patterns of systemic failure after radiation treatment. *J Clin Oncol* 2000;18:54–63.
516. Liang R, Todd D, Chan TK, et al. Treatment outcome and prognostic factors for primary nasal lymphoma. *J Clin Oncol* 1995;13:666–670.
517. Liang R. Diagnosis and management of primary nasal lymphoma of T–cell or NK–cell origin. *Clin Lymphoma* 2000;1:33–37; discussion 38.
518. Chan JK, Sin VC, Wong KF, et al. Nonnasal lymphoma expressing the natural killer cell marker CD56: a clinicopathologic study of 49 cases of an uncommon aggressive neoplasm. *Blood* 1997;89:4501–4513.
519. Mraz–Gernhard S, Natkunam Y, Hoppe RT, et al. Natural killer/natural killer–like T–cell lymphoma, CD56+, presenting in the skin: an increasingly recognized entity with an aggressive course. *J Clin Oncol*

2001;19:2179–2188.

520. Kwong YL, Chan AC, Liang R, et al. CD56+ NK lymphomas: clinicopathological features and prognosis. *Br J Haematol* 1997;97:821–829.
521. Liang R, Chen F, Lee CK, et al. Autologous bone marrow transplantation for primary nasal T/NK cell lymphoma. *Bone Marrow Transplant* 1997;19:91–93.
522. McKenna RW, Parkin J, Kersey JH, et al. Chronic lymphoproliferative disorder with unusual clinical, morphologic, ultrastructural and membrane surface marker characteristics. *Am J Med* 1977;62:588–596.
523. Loughran TP Jr, Kadin ME, Starkebaum G, et al. Leukemia of large granular lymphocytes: association with clonal chromosomal abnormalities and autoimmune neutropenia, thrombocytopenia, and hemolytic anemia. *Ann Intern Med* 1985;102:169–175.
524. Gentile TC, Wener MH, Starkebaum G, et al. Humoral immune abnormalities in T-cell large granular lymphocyte leukemia. *Leuk Lymphoma* 1996;23:365–370.
525. Lamy T, Liu JH, Landowski TH, et al. Dysregulation of CD95/CD95 ligand–apoptotic pathway in CD3(+) large granular lymphocyte leukemia. *Blood* 1998;92:4771–4777.
526. Epling–Burnette PK, Liu JH, Catlett–Falcone R, et al. Inhibition of STAT3 signaling leads to apoptosis of leukemic large granular lymphocytes and decreased Mcl–1 expression. *J Clin Invest* 2001;107:351–362.
527. Dhodapkar MV, Li CY, Lust JA, et al. Clinical spectrum of clonal proliferations of T–large granular lymphocytes: a T–cell clonopathy of undetermined significance? *Blood* 1994;84:1620–1627.
528. Loughran TP Jr, Kidd PG, Starkebaum G. Treatment of large granular lymphocyte leukemia with oral low–dose methotrexate. *Blood* 1994;84:2164–2170.
529. Sood R, Stewart CC, Aplan PD, et al. Neutropenia associated with T–cell large granular lymphocyte leukemia: long–term response to cyclosporine therapy despite persistence of abnormal cells. *Blood* 1998;91:3372–3378.
530. Sun T, Brody J, Susin M, et al. Aggressive natural killer cell lymphoma/leukemia. A recently recognized clinicopathologic entity. *Am J Surg Pathol* 1993;17:1289–1299.
531. Mori N, Yamashita Y, Tsuzuki T, et al. Lymphomatous features of aggressive NK cell leukemia/lymphoma with massive necrosis, haemophagocytosis and EB virus infection. *Histopathology* 2000;37:363–371.
532. Chan JKC, Wong KF, Jaffe ES, et al. Aggressive NK–cell leukemia. In: Jaffe ES, Harris NL, Stein H, et al., eds. *Pathology & genetics: tumours of haematopoietic and lymphoid tissues*. Lyon: IARC Press, 2001:190–200.
533. Gentile TC, Uner AH, Hutchison RE, et al. CD3+, CD56+ aggressive variant of large granular lymphocyte leukemia. *Blood* 1994;84:2315–2321.
534. Suzuki R, Nakamura S. Malignancies of natural killer (NK) cell precursor: myeloid/NK cell precursor acute leukemia and blastic NK cell lymphoma/leukemia. *Leuk Res* 1999;23:615–624.
535. Catovsky D, Ralfkiaer E, Muller–Hermelink HK. T–cell prolymphocytic leukaemia. In: Jaffe ES, Harris NL, et al., eds. *Pathology & genetics: tumours of haematopoietic and Lymphoid tissues*. Lyon: IARC Press, 2001:195–196.
536. Matutes E, Brito–Babapulle V, Swansbury J, et al. Clinical and laboratory features of 78 cases of T–prolymphocytic leukemia. *Blood* 1991;78:3269–3274.
537. Hoyer JD, Ross CW, Li CY, et al. True T–cell chronic lymphocytic leukemia: a morphologic and immunophenotypic study of 25 cases. *Blood* 1995;86:1163–1169.
538. Maljaei SH, Brito–Babapulle V, Hiorns LR, et al. Abnormalities of chromosomes 8, 11, 14, and X in T–prolymphocytic leukemia studied by fluorescence in situ hybridization. *Cancer Genet Cytogenet*

1998;103:110-116.

539. Pekarsky Y, Hallas C, Isobe M, et al. Abnormalities at 14q32.1 in T cell malignancies involve two oncogenes. *Proc Natl Acad Sci U S A* 1999;96:2949-2951.

540. Stilgenbauer S, Schaffner C, Litterst A, et al. Biallelic mutations in the ATM gene in T-prolymphocytic leukemia. *Nat Med* 1997;3:1155-1159.

541. Garand R, Goasguen J, Brizard A, et al. Indolent course as a relatively frequent presentation in T-prolymphocytic leukemia. *Groupe Francais d'Hematologie Cellulaire. Br J Haematol* 1998;103:488-494.

542. Pawson R, Dyer MJ, Barge R, et al. Treatment of T-cell prolymphocytic leukemia with human CD52 antibody. *J Clin Oncol* 1997;15:2667-2672.

543. Dearden CE, Matutes E, BC, et al. Longer follow up of T-prolymphocytic leukemia patients treated with alemtuzumab (CAMPATH-1H) shows improved survival and higher response rates in previously untreated patients. *Blood* 2002;100:364a.

544. Kinoshita K. Adult T cell leukemia-lymphoma in the Nagasaki district. In: Hanaoka M, Takatsuki K, Shimoyama M, et al., eds. *Adult T cell leukemia and related diseases*. Tokyo: Scientific Societies Press, 1982.

545. Kinoshita K, Kamihira S, Yamada Y, et al. Clinical, hematological and pathological features of T-cell leukemia-lymphoma in the Nagasaki district. *Nippon Ketsueki Gakkai Zasshi* 1981;44:1431-1443.

546. Shih LY, Liang DC. Non-Hodgkin's lymphomas in Asia. *Hematol Oncol Clin North Am* 1991;5:983-1001.

547. Bunn PA Jr, Schechter GP, Jaffe E, et al. Clinical course of retrovirus-associated adult T-cell lymphoma in the United States. *N Engl J Med* 1983;309:257-264.

548. Lennert K, Kikuchi M, Sato E, et al. HTLV-positive and -negative T-cell lymphomas. Morphological and immunohistochemical differences between European and HTLV-positive Japanese T-cell lymphomas. *Int J Cancer* 1985;35:65-72.

549. Teshima T, Akashi K, Shibuya T, et al. Central nervous system involvement in adult T-cell leukemia/lymphoma. *Cancer* 1990;65:327-332.

550. Shimamoto Y, Yamaguchi M. HTLV-I induced extranodal lymphomas. *Leuk Lymphoma* 1992;7:37-45.

551. Shimoyama M, Minato K, Tobinai K, et al. Atypical adult T-cell leukemia-lymphoma: diverse clinical manifestations of adult T-cell leukemia-lymphoma. *Jpn J Clin Oncol* 1983;13[Suppl 2]:165-187.

552. Kawano F, Yamaguchi K, Nishimura H, et al. Variation in the clinical courses of adult T-cell leukemia. *Cancer* 1985;55:851-856.

553. Kinoshita K, Amagasaki T, Ikeda S, et al. Preleukemic state of adult T cell leukemia: abnormal T lymphocytosis induced by human adult T cell leukemia-lymphoma virus. *Blood* 1985;66:120-127.

554. Miyamoto K, Tomita N, Ishii A, et al. Chromosome abnormalities of leukemia cells in adult patients with T-cell leukemia. *J Natl Cancer Inst* 1984;73:353-362.

555. Sanada I, Tanaka R, Kumagai E, et al. Chromosomal aberrations in adult T cell leukemia: relationship to the clinical severity. *Blood* 1985;65:649-654.

556. Tsukasaki K, Krebs J, Nagai K, et al. Comparative genomic hybridization analysis in adult T-cell leukemia/lymphoma: correlation with clinical course. *Blood* 2001;97:3875-3881.

557. Major prognostic factors of patients with adult T-cell leukemia-lymphoma: a cooperative study. *Lymphoma Study Group (1984-1987). Leuk Res* 1991;15:81-90.

558. Yamaguchi K, Takatsuki K. Adult T cell leukemia-lymphoma. *Baillieres Clin Haematol* 1993;6:899-915.

559. Sato E. Autopsy findings of adult T cell Lymphoma-leukemia. In: Hanaoka M, Takatsuki K, Shimoyama M, et al., eds. Adult T cell leukemia and related diseases. Tokyo: Scientific Societies Press, 1982.
560. Dearden C, Matutes E, Catovsky D. Deoxycoformycin in the treatment of mature T-cell leukemias. *Br J Cancer* 1991;64:903-906.
561. Tsuda H, Takatsuki K, Ohno R, et al. Treatment of adult T-cell leukemia-lymphoma with irinotecan hydrochloride (CPT-11). CPT-11 Study Group on Hematological Malignancy. *Br J Cancer* 1994;70:771-774.
562. Pawson R, Mufti GJ, Pagliuca A. Management of adult T-cell leukemia/lymphoma. *Br J Haematol* 1998;100:453-458.
563. Waldmann TA, White JD, Goldman CK, et al. The interleukin-2 receptor: a target for monoclonal antibody treatment of human T-cell lymphotropic virus I-induced adult T-cell leukemia. *Blood* 1993;82:1701-1712.
564. Gill PS, Harrington W Jr, Kaplan MH, et al. Treatment of adult T-cell leukemia-lymphoma with a combination of interferon alfa and zidovudine. *N Engl J Med* 1995;332:1744-1748.
565. Hermine O, Bouscary D, Gessain A, et al. Brief report: treatment of adult T-cell leukemia-lymphoma with zidovudine and interferon alfa. *N Engl J Med* 1995;332:1749-1751.
566. Gaynor ER, Fisher RI. What is the best treatment for diffuse large cell lymphoma? In: Armitage J, Newland A, Keating A, et al., eds. *Haematological oncology*, 1995:119-133.
567. Lester JN, Fuller LM, Conrad FG, et al. The roles of staging laparotomy, chemotherapy, and radiotherapy in the management of localized diffuse large cell lymphoma: a study of 75 patients. *Cancer* 1982;49:1746-1753.
568. Ruijs CD, Dekker AW, van Kempen-Harteveld ML, et al. Treatment of localized non-Hodgkin's lymphomas of the head and neck. *Cancer* 1994;74:703-707.
569. Connors JM, Klimo P, Fairey RN, et al. Brief chemotherapy and involved field radiation therapy for limited-stage, histologically aggressive lymphoma. *Ann Intern Med* 1987;107:25-30.
570. Jones SE, Miller TP, Connors JM. Long-term follow-up and analysis for prognostic factors for patients with limited-stage diffuse large-cell lymphoma treated with initial chemotherapy with or without adjuvant radiotherapy. *J Clin Oncol* 1989;7:1186-1191.
571. Longo DL, Glatstein E, Duffey PL, et al. Treatment of localized aggressive lymphomas with combination chemotherapy followed by involved-field radiation therapy. *J Clin Oncol* 1989;7:1295-1302.
572. Glick J, Kim K, Earle JD, et al. An ECOG randomized phase III trial of CHOP vs CHOP + radiotherapy for intermediate grade early stage non-Hodgkin's lymphoma. *Proc Am Soc Clin Oncol* 1995;14:391.
573. Miller TP, Dahlberg S, Cassady JR, et al. Chemotherapy alone compared with chemotherapy plus radiotherapy for localized intermediate- and high-grade non-Hodgkin's lymphoma. *N Engl J Med* 1998;339:21-26.
574. Miller TP, LeBlanc M, Spier C, et al. CHOP alone compared to CHOP plus radiotherapy for early stage aggressive non-Hodgkin's lymphomas: update of the Southwest Oncology Group (SWOG) randomized trial. *Blood* 2001;98:724a.
575. Link MP, Shuster JJ, Donaldson SS, et al. Treatment of children and young adults with early-stage non-Hodgkin's lymphoma. *N Engl J Med* 1997;337:1259-1266.
576. DeVita VT Jr, Canellos GP, Chabner B, et al. Advanced diffuse histiocytic lymphoma, a potentially curable disease. *Lancet* 1975;1:248-250.
577. Armitage JO, Fyfe MA, Lewis J. Long-term remission durability and functional status of patients treated for diffuse histiocytic lymphoma with the CHOP regimen. *J Clin Oncol* 1984;2:898-902.

578. Skarin AT, Rosenthal DS, Moloney WC, et al. Combination chemotherapy of advanced non-Hodgkin lymphoma with bleomycin, adriamycin, cyclophosphamide, vincristine, and prednisone (BACOP). *Blood* 1977;49:759-770.
579. Gaynor ER, Ultmann JE, Golomb HM, et al. Treatment of diffuse histiocytic lymphoma (DHL) with COMLA (cyclophosphamide, oncovin, methotrexate, leucovorin, cytosine arabinoside): a 10-year experience in a single institution. *J Clin Oncol* 1985;3:1596-1604.
580. Sweet DL, Golomb HM, Ultmann JE, et al. Cyclophosphamide, vincristine, methotrexate with leucovorin rescue, and cytarabine (COMLA) combination sequential chemotherapy for advanced diffuse histiocytic lymphoma. *Ann Intern Med* 1980;92:785-790.
581. Armitage JO, Cheson BD. Interpretation of clinical trials in diffuse large-cell lymphoma. *J Clin Oncol* 1988;6:1335-1347.
582. DeVita VT Jr, Hubbard SM, Young RC, et al. The role of chemotherapy in diffuse aggressive lymphomas. *Semin Hematol* 1988;25:2-10.
583. Coleman M, Armitage JO, Gaynor M, et al. The COP-BLAM programs: evolving chemotherapy concepts in large cell lymphoma. *Semin Hematol* 1988;25:23-33.
584. Shipp MA, Yeap BY, Harrington DP, et al. The m-BACOD combination chemotherapy regimen in large-cell lymphoma: analysis of the completed trial and comparison with the M-BACOD regimen. *J Clin Oncol* 1990;8:84-93.
585. Skarin AT, Canellos GP, Rosenthal DS, et al. Improved prognosis of diffuse histiocytic and undifferentiated lymphoma by use of high dose methotrexate alternating with standard agents (M-BACOD). *J Clin Oncol* 1983;1:91-98.
586. Fisher RI, DeVita VT Jr, Hubbard SM, et al. Diffuse aggressive lymphomas: increased survival after alternating flexible sequences of proMACE and MOPP chemotherapy. *Ann Intern Med* 1983;98:304-309.
587. Boyd DB, Coleman M, Papish SW, et al. COPBLAM III: infusional combination chemotherapy for diffuse large-cell lymphoma. *J Clin Oncol* 1988;6:425-433.
588. Coiffier B, Gisselbrecht C, Herbrecht R, et al. LNH-84 regimen: a multicenter study of intensive chemotherapy in 737 patients with aggressive malignant lymphoma. *J Clin Oncol* 1989;7:1018-1026.
589. Klimo P, Connors JM. MACOP-B chemotherapy for the treatment of diffuse large-cell lymphoma. *Ann Intern Med* 1985;102:596-602.
590. Longo DL, DeVita VT Jr, Duffey PL, et al. Superiority of ProMACE-CytaBOM over ProMACE-MOPP in the treatment of advanced diffuse aggressive lymphoma: results of a prospective randomized trial. *J Clin Oncol* 1991;9:25-38.
591. Velasquez WS, McLaughlin P, Fuller LM, et al. Intermediate-grade lymphomas treated with cyclophosphamide-doxorubicin-vincristine-prednisone-bleomycin alternated with cyclophosphamide-methotrexate-etoposide-dexamethasone. Application of prognostic models to data analysis. *Cancer* 1994;73:2408-2416.
592. De Lena M, Ditunno P, Lorusso V, et al. CEOP-B alternated with VIMB in intermediate-grade and high-grade non-Hodgkin's lymphoma: a pilot study. *J Clin Oncol* 1995;13:953-960.
593. Miller TP, Dahlberg S, Weick JK, et al. Unfavorable histologies of non-Hodgkin's lymphoma treated with ProMACE-CytaBOM: a group wide Southwest Oncology Group study. *J Clin Oncol* 1990;8:1951-1958.
594. Schneider AM, Straus DJ, Schluger AE, et al. Treatment results with an aggressive chemotherapeutic regimen (MACOP-B) for intermediate- and some high-grade non-Hodgkin's lymphomas. *J Clin Oncol* 1990;8:94-102.
595. Weick JK, Dahlberg S, Fisher RI, et al. Combination chemotherapy of intermediate-grade and high-grade non-Hodgkin's lymphoma with MACOP-B: a Southwest Oncology Group study. *J Clin Oncol*

1991;9:748-753.

596. Fisher RI, Gaynor ER, Dahlborg S, et al. Comparison of a standard regimen (CHOP) with three intensive chemotherapy regimens for advanced non-Hodgkin's lymphoma. *N Engl J Med* 1993;328:1002-1006.

597. Gordon LI, Harrington D, Andersen J, et al. Comparison of a second-generation combination chemotherapeutic regimen (m-BACOD) with a standard regimen (CHOP) for advanced diffuse non-Hodgkin's lymphoma. *N Engl J Med* 1992;327:1342-1349.

598. Cooper IA, Wolf MM, Robertson TI, et al. Randomized comparison of MACOP-B with CHOP in patients with intermediate-grade non-Hodgkin's lymphoma. The Australian and New Zealand Lymphoma Group. *J Clin Oncol* 1994;12:769-778.

599. Sertoli MR, Santini G, Chisesi T, et al. MACOP-B versus ProMACE-MOPP in the treatment of advanced diffuse non-Hodgkin's lymphoma: results of a prospective randomized trial by the non-Hodgkin's Lymphoma Cooperative Study Group. *J Clin Oncol* 1994;12:1366-1374.

600. Shipp MA. Prognostic factors in aggressive non-Hodgkin's lymphoma: who has "high-risk" disease? *Blood* 1994;83:1165-1173.

601. Vose JM, Link BK, Grossbard ML, et al. Phase II study of rituximab in combination with chop chemotherapy in patients with previously untreated, aggressive non-Hodgkin's lymphoma. *J Clin Oncol* 2001;19:389-397.

602. Cabanillas F, Rodriguez-Diaz Pavon J, Hagemester FB, et al. Alternating triple therapy for the treatment of intermediate grade and immunoblastic lymphoma. *Ann Oncol* 1998;9:511-518.

603. Fridrik MA, Hausmaninger H, Linkesch W, et al. CEOP-IMVP-Dexa in the treatment of aggressive lymphomas: an Austrian multicenter trial. *J Clin Oncol* 1996;14:227-232.

604. Wilson WH, Grossbard ML, Pittaluga S, et al. Dose-adjusted EPOCH chemotherapy for untreated large B-cell lymphomas: a pharmacodynamic approach with high efficacy. *Blood* 2002;99:2685-2693.

605. Sparano JA, Weller E, Nazeer T, et al. Phase 2 trial of infusional cyclophosphamide, doxorubicin, and etoposide in patients with poor-prognosis, intermediate-grade non-Hodgkin lymphoma: an Eastern Cooperative Oncology Group trial (E3493). *Blood* 2002;100:1634-1640.

606. Gaynor ER, Unger JM, Miller TP, et al. Infusional CHOP chemotherapy (CVAD) with or without chemosensitizers offers no advantage over standard CHOP therapy in the treatment of lymphoma: a Southwest Oncology Group Study. *J Clin Oncol* 2001;19:750-755.

607. Meyer RM, Quirt IC, Skillings JR, et al. Escalated as compared with standard doses of doxorubicin in BACOP therapy for patients with non-Hodgkin's lymphoma. *N Engl J Med* 1993;329:1770-1776.

608. Shipp MA, Neuberg D, Janicek M, et al. High-dose CHOP as initial therapy for patients with poor-prognosis aggressive non-Hodgkin's lymphoma: a dose-finding pilot study. *J Clin Oncol* 1995;13:2916-2923.

609. Waits TM, Greco FA, Greer JP, et al. Effective therapy for poor-prognosis non-Hodgkin's lymphoma with 8 weeks of high-dose-intensity combination chemotherapy. *J Clin Oncol* 1993;11:943-949.

610. Gordon LI, Young M, Weller E, et al. A phase II trial of 200% ProMACE-CytaBOM in patients with previously untreated aggressive lymphomas: analysis of response, toxicity, and dose intensity. *Blood* 1999;94:3307-3314.

611. Tilly H, Mounier N, Lederlin P, et al. Randomized comparison of ACVBP and m-BACOD in the treatment of patients with low-risk aggressive lymphoma: the LNH87-1 study. Groupe d'Etudes des Lymphomes de l'Adulte. *J Clin Oncol* 2000;18:1309-1315.

612. Haioun C, Lepage E, Gisselbrecht C, et al. Benefit of autologous bone marrow transplantation over sequential chemotherapy in poor-risk aggressive non-Hodgkin's lymphoma: updated results of the prospective study LNH87-2. Groupe d'Etude des Lymphomes de l'Adulte. *J Clin Oncol* 1997;15:1131-1137.



613. Gisselbrecht C, Lepage E, Molina T, et al. Shortened first-line high-dose chemotherapy for patients with poor-prognosis aggressive lymphoma. *J Clin Oncol* 2002;20:2472-2479.
614. Cabanillas F, Hagemester FB, McLaughlin P, et al. Results of MIME salvage regimen for recurrent or refractory lymphoma. *J Clin Oncol* 1987;5:407-412.
615. Velasquez WS, Cabanillas F, Salvador P, et al. Effective salvage therapy for lymphoma with cisplatin in combination with high-dose Ara-C and dexamethasone (DHAP). *Blood* 1988;71:117-122.
616. Velasquez WS, McLaughlin P, Tucker S, et al. ESHAP--an effective chemotherapy regimen in refractory and relapsing lymphoma: a 4-year follow-up study. *J Clin Oncol* 1994;12:1169-1176.
617. Rodriguez MA, Cabanillas FC, Velasquez W, et al. Results of a salvage treatment program for relapsing lymphoma: MINE consolidated with ESHAP. *J Clin Oncol* 1995;13:1734-1741.
618. Romaguera JE, Rodriguez MA, Hagemester FB, et al. Phase II study of paclitaxel in combination with mitoxantrone and ifosfamide/mesna for patients with relapsed or refractory non-Hodgkin's lymphoma after failure to cytarabine/cisplatin combination. *Invest New Drugs* 1999;17:187-192.
619. Moskowitz CH, Bertino JR, Glassman JR, et al. Ifosfamide, carboplatin, and etoposide: a highly effective cytoreduction and peripheral-blood progenitor-cell mobilization regimen for transplant-eligible patients with non-Hodgkin's lymphoma. *J Clin Oncol* 1999;17:3776-3785.
620. Fields KK, Zorsky PE, Hiemenz JW, et al. Ifosfamide, carboplatin, and etoposide: a new regimen with a broad spectrum of activity. *J Clin Oncol* 1994;12:544-552.
621. Gutierrez M, Chabner BA, Pearson D, et al. Role of a doxorubicin-containing regimen in relapsed and resistant lymphomas: an 8-year follow-up study of EPOCH. *J Clin Oncol* 2000;18:3633-3642.
622. Chao NJ, Rosenberg SA, Horning SJ. CEPP(B): an effective and well-tolerated regimen in poor-risk, aggressive non-Hodgkin's lymphoma. *Blood* 1990;76:1293-1298.
623. Romaguera JE, Hagemester FB, McLaughlin P, et al. Ninety-six-hour paclitaxel infusion with mitoxantrone and ifosfamide/mesna and consolidation with ESHAP for refractory and relapsed non-Hodgkin's lymphoma. *Leuk Lymphoma* 1998;32:97-106.
624. Armitage JO. The role of mitoxantrone in non-Hodgkin's lymphoma. *Oncology (Huntingt)* 2002;16:490-502, 507-498.
625. Weick JK, Jones SE, Ryan DH. Phase II study of amsacrine (m-AMSA) in advanced lymphomas: a Southwest Oncology Group study. *Cancer Treat Rep* 1983;67:489-492.
626. Cheson BD. New chemotherapeutic agents for non-Hodgkin's lymphomas. *Hematol Oncol Clin North Am* 1991;5:1027-1051.
627. Zuckerman KS, Case DC Jr, Gams RA, et al. Chemotherapy of intermediate- and high-grade non-Hodgkin's lymphomas with an intensive epirubicin-containing regimen. *Blood* 1993;82:3564-3573.
628. Warrell RP Jr, Kempin SJ. Clinical evaluation of a new anthracycline antibiotic, aclacinomycin-A, in patients with advanced malignant lymphoma. *Am J Clin Oncol* 1983;6:81-84.
629. Zagonel V, Tirelli U, Sorio R, et al. 4'-Deoxydoxorubicin (esorubicin) in non-Hodgkin's lymphomas and plasma cell tumors: first evidence of activity. *Haematologica* 1987;72:97-99.
630. Sonneveld P, de Ridder M, van der Lelie H, et al. Comparison of doxorubicin and mitoxantrone in the treatment of elderly patients with advanced diffuse non-Hodgkin's lymphoma using CHOP versus CNOP chemotherapy. *J Clin Oncol* 1995;13:2530-2539.
631. Cabanillas F. Experience with ifosfamide combinations in malignant lymphomas. *Semin Oncol* 1989;16:78-81.
632. Younes A, Sarris A, Melnyk A, et al. Three-hour paclitaxel infusion in patients with refractory and

relapsed non-Hodgkin's lymphoma. *J Clin Oncol* 1995;13:583-587.

633. Wilson WH, Chabner BA, Bryant G, et al. Phase II study of paclitaxel in relapsed non-Hodgkin's lymphomas. *J Clin Oncol* 1995;13:381-386.

634. Press OW, LeBlanc M, O'Rourke TJ, et al. Phase II trial of paclitaxel by 24-hour continuous infusion for relapsed non-Hodgkin's lymphomas: Southwest Oncology Group trial 9246. *J Clin Oncol* 1998;16:574-578.

635. Budman DR, Petroni GR, Johnson JL, et al. Phase II trial of docetaxel in non-Hodgkin's lymphomas: a study of the Cancer and Leukemia Group B. *J Clin Oncol* 1997;15:3275-3279.

636. Wilson WH, Little R, Pearson D, et al. Phase II and dose-escalation with or without granulocyte colony-stimulating factor study of 9-aminocamptothecin in relapsed and refractory lymphomas. *J Clin Oncol* 1998;16:2345-2351.

637. Sarris AH, Romaguera J, Hagemeister FB, et al. Irinotecan in relapsed or refractory non-Hodgkin's lymphoma. *Oncology (Huntingt)* 2001;15:53-56.

638. Younes A, Preti HA, Hagemeister FB, et al. Paclitaxel plus topotecan treatment for patients with relapsed or refractory aggressive non-Hodgkin's lymphoma. *Ann Oncol* 2001;12:923-927.

639. Fossa A, Santoro A, Hiddemann W, et al. Gemcitabine as a single agent in the treatment of relapsed or refractory aggressive non-Hodgkin's lymphoma. *J Clin Oncol* 1999;17:3786-3792.

640. Zinzani PL, Baliva G, Magagnoli M, et al. Gemcitabine treatment in pretreated cutaneous T-cell lymphoma: experience in 44 patients. *J Clin Oncol* 2000;18:2603-2606.

641. Bass AJ, Gockerman JP, Hammett E, et al. Phase I evaluation of prolonged-infusion gemcitabine with irinotecan for relapsed or refractory leukemia or lymphoma. *J Clin Oncol* 2002;20:2995-3000.

642. Sarris AH, Hagemeister F, Romaguera J, et al. Liposomal vincristine in relapsed non-Hodgkin's lymphomas: early results of an ongoing phase II trial. *Ann Oncol* 2000;11:69-72.

643. Sarris AH, Psyrrri A, Hagemeister F, et al. Infusional vinorelbine in relapsed or refractory lymphomas. *Leuk Lymphoma* 2000;39:291-299.

644. Aviles A, Neri N, Castaneda C, et al. Pegylated liposomal doxorubicin in combination chemotherapy in the treatment of previously untreated aggressive diffuse large-B-cell lymphoma. *Med Oncol* 2002;19:55-58.

645. Hainsworth JD, Johnson DH, Frazier SR, et al. Chronic daily administration of oral etoposide in refractory lymphoma. *Eur J Cancer* 1990;26:818-821.

646. Sarris AH, Younes A, McLaughlin P, et al. Cyclosporin A does not reverse clinical resistance to paclitaxel in patients with relapsed non-Hodgkin's lymphoma. *J Clin Oncol* 1996;14:233-239.

647. Pavlova Z, Parker JW, Taylor CR, et al. Small noncleaved follicular center cell lymphoma: Burkitt's and non-Burkitt's variants in the US. II. Pathologic and immunologic features. *Cancer* 1987;59:1892-1902.

648. Braziel RM, Arber DA, Slovak ML, et al. The Burkitt-like lymphomas: a Southwest Oncology Group study delineating phenotypic, genotypic, and clinical features. *Blood* 2001;97:3713-3720.

649. Levine AM, Pavlova Z, Pockros AW, et al. Small noncleaved follicular center cell (FCC) lymphoma: Burkitt and non-Burkitt variants in the United States. I. Clinical features. *Cancer* 1983;52:1073-1079.

650. Oviatt DL, Cousar JB, Flexner JM, et al. Malignant lymphoma of follicular center cell origin in humans. IV. Small transformed (noncleaved) cell lymphoma of the non-Burkitt's type. *Cancer* 1983;52:1196-1201.

651. Connors JM, Klimo P. MACOP-B chemotherapy for malignant lymphomas and related conditions: 1987 update and additional observations. *Semin Hematol* 1988;25:41-46.

652. Longo DL, Duffey PL, Jaffe ES, et al. Diffuse small noncleaved-cell, non-Burkitt's lymphoma in

- adults: a high-grade lymphoma responsive to ProMACE-based combination chemotherapy. *J Clin Oncol* 1994;12:2153-2159.
653. Lopez TM, Hagemester FB, McLaughlin P, et al. Small noncleaved cell lymphoma in adults: superior results for stages I-III disease. *J Clin Oncol* 1990;8:615-622.
654. McMaster ML, Greer JP, Greco FA, et al. Effective treatment of small-noncleaved-cell lymphoma with high-intensity, brief-duration chemotherapy. *J Clin Oncol* 1991;9:941-946.
655. Soussain C, Patte C, Ostronoff M, et al. Small noncleaved cell lymphoma and leukemia in adults. A retrospective study of 65 adults treated with the LMB pediatric protocols. *Blood* 1995;85:664-674.
656. Magrath I, Adde M, Shad A, et al. Adults and children with small non-cleaved-cell lymphoma have a similar excellent outcome when treated with the same chemotherapy regimen. *J Clin Oncol* 1996;14:925-934.
657. Hoelzer D, Ludwig WD, Thiel E, et al. Improved outcome in adult B-cell acute lymphoblastic leukemia. *Blood* 1996;87:495-508.
658. Thomas DA, Cortes J, O'Brien S, et al. Hyper-CVAD program in Burkitt's-type adult acute lymphoblastic leukemia. *J Clin Oncol* 1999;17:2461-2470.
659. Lee EJ, Petroni GR, Schiffer CA, et al. Brief-duration high-intensity chemotherapy for patients with small noncleaved-cell lymphoma or FAB L3 acute lymphocytic leukemia: results of cancer and leukemia group B study 9251. *J Clin Oncol* 2001;19:4014-4022.
660. Mead GM, Sydes MR, Walewski J, et al. An international evaluation of CODOX-M and CODOX-M alternating with IVAC in adult Burkitt's lymphoma: results of United Kingdom Lymphoma Group LY06 study. *Ann Oncol* 2002;13:1264-1274.
661. Cortes J, Thomas D, Rios A, et al. Hyperfractionated cyclophosphamide, vincristine, doxorubicin, and dexamethasone and highly active antiretroviral therapy for patients with acquired immunodeficiency syndrome-related Burkitt lymphoma/leukemia. *Cancer* 2002;94:1492-1499.
662. Sweetenham JW, Pearce R, Taghipour G, et al. Adult Burkitt's and Burkitt-like non-Hodgkin's lymphoma—outcome for patients treated with high-dose therapy and autologous stem-cell transplantation in first remission or at relapse: results from the European Group for Blood and Marrow Transplantation. *J Clin Oncol* 1996;14:2465-2472.
663. Fenaux P, Bourhis JH, Ribrag V. Burkitt's acute lymphocytic leukemia (L3ALL) in adults. *Hematol Oncol Clin North Am* 2001;15:37-50.
664. Weiss LM, Bindl JM, Picozzi VJ, et al. Lymphoblastic lymphoma: an immunophenotype study of 26 cases with comparison to T cell acute lymphoblastic leukemia. *Blood* 1986;67:474-478.
665. Inhorn RC, Aster JC, Roach SA, et al. A syndrome of lymphoblastic lymphoma, eosinophilia, and myeloid hyperplasia/malignancy associated with t(8;13)(p11;q11): description of a distinctive clinicopathologic entity. *Blood* 1995;85:1881-1887.
666. Thandla S, Alashari M, Green DM, et al. Therapy-related T cell lymphoblastic lymphoma with t(11;19)(q23;p13) and MLL gene rearrangement. *Leukemia* 1999;13:2116-2118.
667. Cheng AL, Su IJ, Tien HF, et al. Characteristic clinicopathologic features of adult B-cell lymphoblastic lymphoma with special emphasis on differential diagnosis with an atypical form probably of blastic lymphocytic lymphoma of intermediate differentiation origin. *Cancer* 1994;73:706-710.
668. Rosen PJ, Feinstein DI, Pattengale PK, et al. Convolved lymphocytic lymphoma in adults: a clinicopathologic entity. *Ann Intern Med* 1978;89:319-324.
669. Levine AM, Forman SJ, Meyer PR, et al. Successful therapy of convolved T-lymphoblastic lymphoma in the adult. *Blood* 1983;61:92-98.
670. Slater DE, Mertelsmann R, Koziner B, et al. Lymphoblastic lymphoma in adults. *J Clin Oncol*

1986;4:57-67.

671. Coleman CN, Picozzi VJ Jr, Cox RS, et al. Treatment of lymphoblastic lymphoma in adults. *J Clin Oncol* 1986;4:1628-1637.

672. Kobayashi T, Tobinai K, Shimoyama M, et al. Long-term follow-up results of adult patients with acute lymphocytic leukemia or lymphoblastic lymphoma treated with short-term, alternating non-cross-resistant chemotherapy: Japan Clinical Oncology Group Study 8702. Lymphoma Study Group. *Jpn J Clin Oncol* 1999;29:340-348.

673. Thomas D, Kantarjian H, O'Brien S, et al. Outcome with the hyper-CVAD regimen in lymphoblastic lymphoma (LL). *Proc Am Soc Clin Oncol* 1999;18:11a (abst).

674. Morel P, Lepage E, Brice P, et al. Prognosis and treatment of lymphoblastic lymphoma in adults: a report on 80 patients. *J Clin Oncol* 1992;10:1078-1085.

675. Colgan JP, Andersen J, Habermann TM, et al. Long-term follow-up of a CHOP-based regimen with maintenance therapy and central nervous system prophylaxis in lymphoblastic non-Hodgkin's lymphoma. *Leuk Lymphoma* 1994;15:291-296.

676. Zinzani PL, Bendandi M, Visani G, et al. Adult lymphoblastic lymphoma: clinical features and prognostic factors in 53 patients. *Leuk Lymphoma* 1996;23:577-582.

677. Kaiser U, Uebelacker I, Havemann K. Non-Hodgkin's lymphoma protocols in the treatment of patients with Burkitt's lymphoma and lymphoblastic lymphoma: a report on 58 patients. *Leuk Lymphoma* 1999;36:101-108.

678. Hoelzer D, Gokbuget N, Digel W, et al. Outcome of adult patients with T-lymphoblastic lymphoma treated according to protocols for acute lymphoblastic leukemia. *Blood* 2002;99:4379-4385.

679. Bleyer WA. Cancer in older adolescents and young adults: epidemiology, diagnosis, treatment, survival, and importance of clinical trials. *Med Pediatr Oncol* 2002;38:1-10.

680. Thomas DA, Kantarjian HM. Lymphoblastic lymphoma. *Hematol Oncol Clin North Am* 2001;15:51-95, vi.

681. Chopra R, Goldstone AH, Pearce R, et al. Autologous versus allogeneic bone marrow transplantation for non-Hodgkin's lymphoma: a case-controlled analysis of the European Bone Marrow Transplant Group Registry data. *J Clin Oncol* 1992;10:1690-1695.

682. Sweetenham JW, Liberti G, Pearce R, et al. High-dose therapy and autologous bone marrow transplantation for adult patients with lymphoblastic lymphoma: results of the European Group for Bone Marrow Transplantation. *J Clin Oncol* 1994;12:1358-1365.

683. Bouabdallah R, Xerri L, Bardou VJ, et al. Role of induction chemotherapy and bone marrow transplantation in adult lymphoblastic lymphoma: a report on 62 patients from a single center. *Ann Oncol* 1998;9:619-625.

684. Sweetenham JW, Santini G, Qian W, et al. High-dose therapy and autologous stem-cell transplantation versus conventional-dose consolidation/maintenance therapy as postremission therapy for adult patients with lymphoblastic lymphoma: results of a randomized trial of the European Group for Blood and Marrow Transplantation and the United Kingdom Lymphoma Group. *J Clin Oncol* 2001;19:2927-2936.

685. Levine JE, Harris RE, Loberiza FR Jr, et al. A comparison of allogeneic and autologous bone marrow transplantation for lymphoblastic lymphoma. *Blood* 2003;101:2476-2482.

686. Rowe JM, Richards S, Wiernik PH, et al. Allogeneic bone marrow transplantation (BMT) for adults with acute lymphoblastic leukemia (ALL) in first complete remission (CR): early results from the international ALL trial (MRC UKALL/ECOG E2993). *Blood* 1999;94:732a.

687. Thiebaut A, Vernant JP, Degos L, et al. Adult acute lymphocytic leukemia study testing chemotherapy and autologous and allogeneic transplantation. A follow-up report of the French protocol LALA 87. *Hematol Oncol Clin North Am* 2000;14:1353-1366, x.

688. Isaacson PG, Spencer J. The biology of low grade MALT lymphoma. *J Clin Pathol* 1995;48:395–397.
689. Pinotti G, Zucca E, Roggero E, et al. Clinical features, treatment and outcome in a series of 93 patients with low-grade gastric MALT lymphoma. *Leuk Lymphoma* 1997;26:527–537.
690. Bayerdorffer E, Neubauer A, Rudolph B, et al. Regression of primary gastric lymphoma of mucosa-associated lymphoid tissue type after cure of *Helicobacter pylori* infection. MALT Lymphoma Study Group. *Lancet* 1995;345:1591–1594.
691. Roggero E, Zucca E, Pinotti G, et al. Eradication of *Helicobacter pylori* infection in primary low-grade gastric lymphoma of mucosa-associated lymphoid tissue. *Ann Intern Med* 1995;122:767–769.
692. Steinbach G, Ford R, Guber G, et al. Antibiotic treatment of gastric lymphoma of mucosa-associated lymphoid tissue. An uncontrolled trial. *Ann Intern Med* 1999;131:88–95.
693. Ruskone-Fourmestraux A, Lavergne A, Aegerter PH, et al. Predictive factors for regression of gastric MALT lymphoma after anti-*Helicobacter pylori* treatment. *Gut* 2001;48:297–303.
694. Cavalli F, Isaacson PG, Gascoyne RD, et al. MALT Lymphomas. *Hematology (Am Soc Hematol Educ Program)* 2001:241–258.
695. Liu H, Ye H, Ruskone-Fourmestraux A, et al. T(11;18) is a marker for all stage gastric MALT lymphomas that will not respond to *H. pylori* eradication. *Gastroenterology* 2002;122:1286–1294.
696. Savio A, Franzin G, Wotherspoon AC, et al. Diagnosis and posttreatment follow-up of *Helicobacter pylori*-positive gastric lymphoma of mucosa-associated lymphoid tissue: histology, polymerase chain reaction, or both? *Blood* 1996;87:1255–1260.
697. Schwarz RJ, Conners JM, Schmidt N. Diagnosis and management of stage IE and stage IIE gastric lymphomas. *Am J Surg* 1993;165:561–565.
698. Durr ED, Bonner JA, Strickler JG, et al. Management of stage IE primary gastric lymphoma. *Acta Haematol* 1995;94:59–68.
699. Taal BG, Burgers JM, van Heerde P, et al. The clinical spectrum and treatment of primary non-Hodgkin's lymphoma of the stomach. *Ann Oncol* 1993;4:839–846.
700. Hammel P, Haioun C, Chaumette MT, et al. Efficacy of single-agent chemotherapy in low-grade B-cell mucosa-associated lymphoid tissue lymphoma with prominent gastric expression. *J Clin Oncol* 1995;13:2524–2529.
701. Conconi A, Thieblemont C, Martinelli G, et al. An International Extranodal Lymphoma Study group phase II study of rituximab in extranodal marginal zone B-cell lymphomas (MZL). *Proc Am Soc Clin Oncol* 2001;20(part 1):296a(abst).
702. Paulson S, Sheehan RG, Stone MJ, et al. Large cell lymphomas of the stomach: improved prognosis with complete resection of all intrinsic gastrointestinal disease. *J Clin Oncol* 1983;1:263–269.
703. Sheridan WP, Medley G, Brodie GN. Non-Hodgkin's lymphoma of the stomach: a prospective pilot study of surgery plus chemotherapy in early and advanced disease. *J Clin Oncol* 1985;3:495–500.
704. Maor MH, Velasquez WS, Fuller LM, et al. Stomach conservation in stages IE and IIE gastric non-Hodgkin's lymphoma. *J Clin Oncol* 1990;8:266–271.
705. Gobbi PG, Dionigi P, Barbieri F, et al. The role of surgery in the multimodal treatment of primary gastric non-Hodgkin's lymphomas. A report of 76 cases and review of the literature. *Cancer* 1990;65:2528–2536.
706. Shimm DS, Dosoretz DE, Anderson T, et al. Primary gastric lymphoma. An analysis with emphasis on prognostic factors and radiation therapy. *Cancer* 1983;52:2044–2048.
707. Shiu MH, Nisce LZ, Pinna A, et al. Recent results of multimodal therapy of gastric lymphoma. *Cancer*

1986;58:1389–1399.

708. Salles G, Herbrecht R, Tilly H, et al. Aggressive primary gastrointestinal lymphomas: review of 91 patients treated with the LNH-84 regimen. A study of the Groupe d'Etude des Lymphomes Agressifs. *Am J Med* 1991;90:77–84.

709. Dragosics B, Bauer P, Radaszkiewicz T. Primary gastrointestinal non-Hodgkin's lymphomas. A retrospective clinicopathologic study of 150 cases. *Cancer* 1985;55:1060–1073.

710. Ladjaj Y, Philip T, Lenoir GM, et al. Abdominal Burkitt-type lymphomas in Algeria. *Br J Cancer* 1984;49:503–512.

711. Khojasteh A, Haghshenas M, Haghghi P. Current concepts immunoproliferative small intestinal disease. A "Third-World lesion." *N Engl J Med* 1983;308:1401–1405.

712. Price SK. Immunoproliferative small intestinal disease: a study of 13 cases with alpha heavy-chain disease. *Histopathology* 1990;17:7–17.

713. el Saghir NS. Combination chemotherapy with tetracycline and aggressive supportive care for immunoproliferative small-intestinal disease lymphoma. *J Clin Oncol* 1995;13:794–795.

714. Barton JH, Osborne BM, Butler JJ, et al. Non-Hodgkin's lymphoma of the tonsil. A clinicopathologic study of 65 cases. *Cancer* 1984;53:86–95.

715. Shirato H, Tsujii H, Arimoto T, et al. Early stage head and neck non-Hodgkin's lymphoma. The effect of tumor burden on prognosis. *Cancer* 1986;58:2312–2319.

716. Ree HJ, Rege VB, Knisley RE, et al. Malignant lymphoma of Waldeyer's ring following gastrointestinal lymphoma. *Cancer* 1980;46:1528–1535.

717. Saul SH, Kapadia SB. Primary lymphoma of Waldeyer's ring. Clinicopathologic study of 68 cases. *Cancer* 1985;56:157–166.

718. Uematsu M, Kondo M, Hiramatsu H, et al. Stage IA non-Hodgkin's lymphoma of the Waldeyer's ring. Limited chemotherapy and radiation therapy versus radiation therapy alone. *Acta Oncol* 1993;32:675–678.

719. Robbins KT, Kong JS, Fuller LM, et al. A comparative analysis of lymphomas involving Waldeyer's ring and the nasal cavity and paranasal sinuses. *J Otolaryngol* 1985;14:7–13.

720. Barista I, Tekuzman G, Gullu I, et al. Non-Hodgkin's lymphomas of the tonsil: a retrospective analysis of twenty-eight patients with primary tonsillary lymphoma. *Tumori* 1995;81:234–237.

721. Logsdon MD, Ha CS, Kavadi VS, et al. Lymphoma of the nasal cavity and paranasal sinuses: improved outcome and altered prognostic factors with combined modality therapy. *Cancer* 1997;80:477–488.

722. Gleeson MJ, Bennett MH, Cawson RA. Lymphomas of salivary glands. *Cancer* 1986;58:699–704.

723. Schmid U, Helbron D, Lennert K. Primary malignant lymphomas localized in salivary glands. *Histopathology* 1982;6:673–687.

724. Logue JP, Hale RJ, Stewart AL, et al. Primary malignant lymphoma of the thyroid: a clinicopathological analysis. *Int J Radiat Oncol Biol Phys* 1992;22:929–933.

725. Tsang RW, Gospodarowicz MK, Sutcliffe SB, et al. Non-Hodgkin's lymphoma of the thyroid gland: prognostic factors and treatment outcome. The Princess Margaret Hospital Lymphoma Group. *Int J Radiat Oncol Biol Phys* 1993;27:599–604.

726. Ha CS, Shadle KM, Medeiros LJ, et al. Localized non-Hodgkin lymphoma involving the thyroid gland. *Cancer* 2001;91:629–635.

727. L'Hoste RJ Jr, Filippa DA, Lieberman PH, et al. Primary pulmonary lymphomas. A clinicopathologic analysis of 36 cases. *Cancer* 1984;54:1397–1406.

728. Li G, Hansmann ML, Zwingers T, et al. Primary lymphomas of the lung: morphological, immunohistochemical and clinical features. *Histopathology* 1990;16:519-531.
729. Kennedy JL, Nathwani BN, Burke JS, et al. Pulmonary lymphomas and other pulmonary lymphoid lesions. A clinicopathologic and immunologic study of 64 patients. *Cancer* 1985;56:539-552.
730. Medeiros LJ, Harmon DC, Linggood RM, et al. Immunohistologic features predict clinical behavior of orbital and conjunctival lymphoid infiltrates. *Blood* 1989;74:2121-2129.
731. Pelloski CE, Wilder RB, Ha CS, et al. Clinical stage IEA-IIIEA orbital lymphomas: outcomes in the era of modern staging and treatment. *Radiother Oncol* 2001;59:145-151.
732. Nelson DF, Martz KL, Bonner H, et al. Non-Hodgkin's lymphoma of the brain: can high dose, large volume radiation therapy improve survival? Report on a prospective trial by the Radiation Therapy Oncology Group (RTOG): RTOG 8315. *Int J Radiat Oncol Biol Phys* 1992;23:9-17.
733. DeAngelis LM. Current management of primary central nervous system lymphoma. *Oncology (Huntingt)* 1995;9:63-71; discussion 71, 75-76, 78.
734. O'Brien P, Roos D, Pratt G, et al. Phase II multicenter study of brief single-agent methotrexate followed by irradiation in primary CNS lymphoma. *J Clin Oncol* 2000;18:519-526.
735. Blay JY, Bouhour D, Carrie C, et al. The C5R protocol: a regimen of high-dose chemotherapy and radiotherapy in primary cerebral non-Hodgkin's lymphoma of patients with no known cause of immunosuppression. *Blood* 1995;86:2922-2929.
736. DeAngelis LM, Seiferheld W, Schold SC, et al. Combination chemotherapy and radiotherapy for primary central nervous system lymphoma: Radiation Therapy Oncology Group Study 93-10. *J Clin Oncol* 2002;20:4643-4648.
737. Hochberg FH, Tabatabai G. Therapy of PCNSL at the Massachusetts General Hospital with high dose methotrexate and deferred radiotherapy. *Ann Hematol* 2001;80 [Suppl 3]:B111-B112.
738. Batchelor T, Carson K, O'Neill A, et al. Treatment of primary CNS lymphoma with methotrexate and deferred radiotherapy: a report of NABTT 96-07. *J Clin Oncol* 2003;21:1044-1049.
739. Ferreri AJ, Blay JY, Reni M, et al. Prognostic scoring system for primary CNS lymphomas: the International Extranodal Lymphoma Study Group experience. *J Clin Oncol* 2003;21:266-272.
740. Fonseca R, Habermann TM, Colgan JP, et al. Testicular lymphoma is associated with a high incidence of extranodal recurrence. *Cancer* 2000;88:154-161.
741. Zucca E, Conconi A, Mughal TI, et al. Patterns of outcome and prognostic factors in primary large-cell lymphoma of the testis in a survey by the International Extranodal Lymphoma Study Group. *J Clin Oncol* 2003;21:20-27.
742. Martenson JA Jr, Buskirk SJ, Ilstrup DM, et al. Patterns of failure in primary testicular non-Hodgkin's lymphoma. *J Clin Oncol* 1988;6:297-302.
743. Touroutoglou N, Dimopoulos MA, Younes A, et al. Testicular lymphoma: late relapses and poor outcome despite doxorubicin-based therapy. *J Clin Oncol* 1995;13:1361-1367.
744. Tondini C, Ferreri AJ, Siracusano L, et al. Diffuse large-cell lymphoma of the testis. *J Clin Oncol* 1999;17:2854-2858.
745. Schouten JT, Weese JL, Carbone PP. Lymphoma of the breast. *Ann Surg* 1981;194:749-753.
746. Smith MR, Brustein S, Straus DJ. Localized non-Hodgkin's lymphoma of the breast. *Cancer* 1987;59:351-354.
747. Wong WW, Schild SE, Halyard MY, et al. Primary non-Hodgkin lymphoma of the breast: the Mayo



Clinic experience. *J Surg Oncol* 2002;80:19–25; discussion 26.

748. Mattia AR, Ferry JA, Harris NL. Breast lymphoma. A B-cell spectrum including the low grade B-cell lymphoma of mucosa associated lymphoid tissue. *Am J Surg Pathol* 1993;17:574–587.

749. Ferry JA, Young RH. Malignant lymphoma, pseudolymphoma, and hematopoietic disorders of the female genital tract. *Pathol Annu* 1991;26:227–263.

750. Osborne BM, Robboy SJ. Lymphomas or leukemia presenting as ovarian tumors. An analysis of 42 cases. *Cancer* 1983;52:1933–1943.

751. Clayton F, Butler JJ, Ayala AG, et al. Non-Hodgkin's lymphoma in bone. Pathologic and radiologic features with clinical correlates. *Cancer* 1987;60:2494–2501.

752. Bacci G, Picci P, Bertoni F, et al. Primary non-Hodgkin's lymphoma of bone: results in 15 patients treated by radiotherapy combined with systemic chemotherapy. *Cancer Treat Rep* 1982;66:1859–1862.

753. Loeffler JS, Tarbell NJ, Kozakewich H, et al. Primary lymphoma of bone in children: analysis of treatment results with adriamycin, prednisone, Oncovin (APO), and local radiation therapy. *J Clin Oncol* 1986;4:496–501.

754. Lones MA, Perkins SL, Sposto R, et al. Non-Hodgkin's lymphoma arising in bone in children and adolescents is associated with an excellent outcome: a Children's Cancer Group report. *J Clin Oncol* 2002;20:2293–2301.

755. Mirza I, Macpherson N, Paposki S, et al. Primary cutaneous follicular lymphoma: An assessment of clinical, histopathologic, immunophenotypic, and molecular features. *J Clin Oncol* 2002;20:647–655.

756. Geelen FA, Vermeer MH, Meijer CJ, et al. bcl-2 protein expression in primary cutaneous large B-cell lymphoma is site-related. *J Clin Oncol* 1998;16:2080–2085.

757. Appelbaum FR, Deisseroth AB, Graw RG Jr, et al. Prolonged complete remission following high dose chemotherapy of Burkitt's lymphoma in relapse. *Cancer* 1978;41:1059–1063.

758. Phillips GL, Fay JW, Herzig RH, et al. The treatment of progressive non-Hodgkin's lymphoma with intensive chemoradiotherapy and autologous marrow transplantation. *Blood* 1990;75:831–838.

759. Vose JM, Anderson JR, Kessinger A, et al. High-dose chemotherapy and autologous hematopoietic stem-cell transplantation for aggressive non-Hodgkin's lymphoma. *J Clin Oncol* 1993;11:1846–1851.

760. Horning SJ, Negrin RS, Chao JC, et al. Fractionated total-body irradiation, etoposide, and cyclophosphamide plus autografting in Hodgkin's disease and non-Hodgkin's lymphoma. *J Clin Oncol* 1994;12:2552–2558.

761. Weaver CH, Petersen FB, Appelbaum FR, et al. High-dose fractionated total-body irradiation, etoposide, and cyclophosphamide followed by autologous stem-cell support in patients with malignant lymphoma. *J Clin Oncol* 1994;12:2559–2566.

762. Freedman AS, Takvorian T, Anderson KC, et al. Autologous bone marrow transplantation in B-cell non-Hodgkin's lymphoma: very low treatment-related mortality in 100 patients in sensitive relapse. *J Clin Oncol* 1990;8:784–791.

763. Nademanee A, Molina A, Dajis A, et al. Autologous stem-cell transplantation for poor-risk and relapsed intermediate-and high-grade non-Hodgkin's lymphoma. *Clin Lymphoma* 2000;1:46–54.

764. Brandt SJ, Peters WP, Atwater SK, et al. Effect of recombinant human granulocyte-macrophage colony-stimulating factor on hematopoietic reconstitution after high-dose chemotherapy and autologous bone marrow transplantation. *N Engl J Med* 1988;318:869–876.

765. Rabinowe SN, Neuberg D, Bierman PJ, et al. Long-term follow-up of a phase III study of recombinant human granulocyte-macrophage colony-stimulating factor after autologous bone marrow transplantation for lymphoid malignancies. *Blood* 1993;81:1903–1908.

766. Philip T, Guglielmi C, Hagenbeek A, et al. Autologous bone marrow transplantation as compared with

salvage chemotherapy in relapses of chemotherapy-sensitive non-Hodgkin's lymphoma. *N Engl J Med* 1995;333:1540-1545.

767. Gulati SC, Shank B, Black P, et al. Autologous bone marrow transplantation for patients with poor-prognosis lymphoma. *J Clin Oncol* 1988;6:1303-1313.

768. Nademanee A, Schmidt GM, O'Donnell MR, et al. High-dose chemoradiotherapy followed by autologous bone marrow transplantation as consolidation therapy during first complete remission in adult patients with poor-risk aggressive lymphoma: a pilot study. *Blood* 1992;80:1130-1134.

769. Freedman AS, Takvorian T, Neuberg D, et al. Autologous bone marrow transplantation in poor-prognosis intermediate-grade and high-grade B-cell non-Hodgkin's lymphoma in first remission: a pilot study. *J Clin Oncol* 1993;11:931-936.

770. Gianni AM, Bregni M, Siena S, et al. High-dose chemotherapy and autologous bone marrow transplantation compared with MACOP-B in aggressive B-cell lymphoma. *N Engl J Med* 1997;336:1290-1297.

771. Santini G, Salvagno L, Leoni P, et al. VACOP-B versus VACOP-B plus autologous bone marrow transplantation for advanced diffuse non-Hodgkin's lymphoma: results of a prospective randomized trial by the non-Hodgkin's Lymphoma Cooperative Study Group. *J Clin Oncol* 1998;16:2796-2802.

772. Kaiser U, Uebelacker I, Abel U, et al. Randomized study to evaluate the use of high-dose therapy as part of primary treatment for "aggressive" lymphoma. *J Clin Oncol* 2002;20:4413-4419.

773. Kluin-Nelemans HC, Zagonel V, Anastasopoulou A, et al. Standard chemotherapy with or without high-dose chemotherapy for aggressive non-Hodgkin's lymphoma: randomized phase III EORTC study. *J Natl Cancer Inst* 2001;93:22-30.

774. Hahn T, Wolff SN, Czuczman M, et al. The role of cytotoxic therapy with hematopoietic stem cell transplantation in the therapy of diffuse large cell B-cell non-Hodgkin's lymphoma: an evidence-based review. *Biol Blood Marrow Transplant* 2001;7:308-331.

775. Williams CD, Goldstone AH, Pearce RM, et al. Purging of bone marrow in autologous bone marrow transplantation for non-Hodgkin's lymphoma: a case-matched comparison with unpurged cases by the European Blood and Marrow Transplant Lymphoma Registry. *J Clin Oncol* 1996;14:2454-2464.

776. Hunault-Berger M, Ifrah N, Solal-Celigny P. Intensive therapies in follicular non-Hodgkin lymphomas. *Blood* 2002;100:1141-1152.

777. Weisdorf DJ, Andersen JW, Glick JH, et al. Survival after relapse of low-grade non-Hodgkin's lymphoma: implications for marrow transplantation. *J Clin Oncol* 1992;10:942-947.

778. Romaguera JE. Can we identify patients with low grade lymphoma for frontline ABMT? *Leuk Lymphoma* 1993;10[Suppl]:9-15.

779. Freedman AS, Gribben JG, Neuberg D, et al. High-dose therapy and autologous bone marrow transplantation in patients with follicular lymphoma during first remission. *Blood* 1996;88:2780-2786.

780. Vose JM, Sharp G, Chan WC, et al. Autologous transplantation for aggressive non-Hodgkin's lymphoma: results of a randomized trial evaluating graft source and minimal residual disease. *J Clin Oncol* 2002;20:2344-2352.

781. Jacquy C, Soree A, Lambert F, et al. A quantitative study of peripheral blood stem cell contamination in diffuse large-cell non-Hodgkin's lymphoma: one-half of patients significantly mobilize malignant cells. *Br J Haematol* 2000;110:631-637.

782. Armitage JO, Carbone PP, Connors JM, et al. Treatment-related myelodysplasia and acute leukemia in non-Hodgkin's lymphoma patients. *J Clin Oncol* 2003;21:897-906.

783. Jones RJ, Ambinder RF, Piantadosi S, et al. Evidence of a graft-versus-lymphoma effect associated with allogeneic bone marrow transplantation. *Blood* 1991;77:649-653.

784. van Besien KW, Khouri IF, Giralt SA, et al. Allogeneic bone marrow transplantation for refractory and

recurrent low-grade lymphoma: the case for aggressive management. *J Clin Oncol* 1995;13:1096-1102.

785. Ratanatharathorn V, Uberti J, Karanes C, et al. Prospective comparative trial of autologous versus allogeneic bone marrow transplantation in patients with non-Hodgkin's lymphoma. *Blood* 1994;84:1050-1055.

786. Branson K, Chopra R, Kottaridis PD, et al. Role of nonmyeloablative allogeneic stem-cell transplantation after failure of autologous transplantation in patients with lymphoproliferative malignancies. *J Clin Oncol* 2002;20:4022-4031.

787. Robinson SP, Goldstone AH, Mackinnon S, et al. Chemoresistant or aggressive lymphoma predicts for a poor outcome following reduced-intensity allogeneic progenitor cell transplantation: an analysis from the Lymphoma Working Party of the European Group for Blood and Bone Marrow Transplantation. *Blood* 2002;100:4310-4316.

788. Schenkein DP, Dixon P, Desforges JF, et al. Phase I/II study of cyclophosphamide, carboplatin, and etoposide and autologous hematopoietic stem-cell transplantation with posttransplant interferon alfa-2b for patients with lymphoma and Hodgkin's disease. *J Clin Oncol* 1994;12:2423-2431.

789. Grossbard ML, Gribben JG, Freedman AS, et al. Adjuvant immunotoxin therapy with anti-B4-blocked ricin after autologous bone marrow transplantation for patients with B-cell non-Hodgkin's lymphoma. *Blood* 1993;81:2263-2271.

790. Rapoport AP, Meisenberg B, Sarkodee-Adoo C, et al. Autotransplantation for advanced lymphoma and Hodgkin's disease followed by post-transplant rituxan/GM-CSF or radiotherapy and consolidation chemotherapy. *Bone Marrow Transplant* 2002;29:303-312.

791. Goss PE. Non-Hodgkin's lymphomas in elderly patients. *Leuk Lymphoma* 1993;10:147-156.

792. Bertini M, Boccomini C, Calvi R. The influence of advanced age on the treatment and prognosis of diffuse large-cell lymphoma (DLCL). *Clin Lymphoma* 2001;1:278-284.

793. Dixon DO, Neilan B, Jones SE, et al. Effect of age on therapeutic outcome in advanced diffuse histiocytic lymphoma: the Southwest Oncology Group experience. *J Clin Oncol* 1986;4:295-305.

794. Meyer RM, Browman GP, Samosh ML, et al. Randomized phase II comparison of standard CHOP with weekly CHOP in elderly patients with non-Hodgkin's lymphoma. *J Clin Oncol* 1995;13:2386-2393.

795. Kouroukis CT, Browman GP, Esmail R, et al. Chemotherapy for older patients with newly diagnosed, advanced-stage, aggressive-histology non-Hodgkin lymphoma: a systematic review. *Ann Intern Med* 2002;136:136-143.

796. Bastion Y, Blay JY, Divine M, et al. Elderly patients with aggressive non-Hodgkin's lymphoma: disease presentation, response to treatment, and survival—a Groupe d'Etude des Lymphomes de l'Adulte study on 453 patients older than 69 years. *J Clin Oncol* 1997;15:2945-2953.

797. Tirelli U, Errante D, Van Glabbeke M, et al. CHOP is the standard regimen in patients older or equal to 70 years of age with intermediate-grade and high-grade non-Hodgkin's lymphoma: results of a randomized study of the European Organization for Research and Treatment of Cancer Lymphoma Cooperative Study Group. *J Clin Oncol* 1998;16:27-34.

798. Mainwaring PN, Cunningham D, Gregory W, et al. Mitoxantrone is superior to doxorubicin in a multiagent weekly regimen for patients older than 60 with high-grade lymphoma: results of a BNLI randomized trial of PAdriaCEBO versus PMitCEBO. *Blood* 2001;97:2991-2997.

799. Goss P, Burkes R, Rudinkas L, et al. A phase II trial of prednisone, oral etoposide, and novantrone (PEN) as initial treatment of non-Hodgkin's lymphoma in elderly patients. *Leuk Lymphoma* 1995;18:145-152.

800. Zinzani PL, Storti S, Zaccaria A, et al. Elderly aggressive-histology non-Hodgkin's lymphoma: first-line VNCOP-B regimen experience on 350 patients. *Blood* 1999;94:33-38.

801. Rigacci L, Carpaneto A, Alterini R, et al. Treatment of large cell lymphoma in elderly patients with a mitoxantrone, cyclophosphamide, etoposide, and prednisone regimen: long-term follow-up results. *Cancer* 2003;97:97-104.

802. Martino R, Perea G, Caballero MD, et al. Cyclophosphamide, pegylated liposomal doxorubicin (Caelyx), vincristine and prednisone (CCOP) in elderly patients with diffuse large B-cell lymphoma: results from a prospective phase II study. *Haematologica* 2002;87:822–827.
803. Bertini M, Freilone R, Vitolo U, et al. P-VEBEC: a new 8-weekly schedule with or without rG-CSF for elderly patients with aggressive non-Hodgkin's lymphoma (NHL). *Ann Oncol* 1994;5:895–900.
804. Gomez H, Hidalgo M, Casanova L, et al. Risk factors for treatment-related death in elderly patients with aggressive non-Hodgkin's lymphoma: results of a multivariate analysis. *J Clin Oncol* 1998;16:2065–2069.
805. Gopal AK, Gooley TA, Golden JB, et al. Efficacy of high-dose therapy and autologous hematopoietic stem cell transplantation for non-Hodgkin's lymphoma in adults 60 years of age and older. *Bone Marrow Transplant* 2001;27:593–599.
806. Pohlman B, Macklis RM. Lymphoma and pregnancy. *Semin Oncol* 2000;27:657–666.
807. Catlin EA, Roberts JD Jr, Erana R, et al. Transplacental transmission of natural-killer-cell lymphoma. *N Engl J Med* 1999;341:85–91.
808. Ward FT, Weiss RB. Lymphoma and pregnancy. *Semin Oncol* 1989;16:397–409.
809. Aviles A, Diaz-Maqueo JC, Torras V, et al. Non-Hodgkin's lymphomas and pregnancy: presentation of 16 cases. *Gynecol Oncol* 1990;37:335–337.
810. Baer MR, Ozer H, Foon KA. Interferon-alpha therapy during pregnancy in chronic myelogenous leukaemia and hairy cell leukaemia. *Br J Haematol* 1992;81:167–169.
811. Aviles A, Neri N. Hematological malignancies and pregnancy: a final report of 84 children who received chemotherapy in utero. *Clin Lymphoma* 2001;2:173–177.
812. Travis LB, Curtis RE, Boice JD Jr, et al. Second cancers following non-Hodgkin's lymphoma. *Cancer* 1991;67:2002–2009.
813. Zarrabi MH. Association of non-Hodgkin's lymphoma and second neoplasms. *Semin Oncol* 1990;17:120–132.
814. Haddy TB, Adde MA, McCalla J, et al. Late effects in long-term survivors of high-grade non-Hodgkin's lymphomas. *J Clin Oncol* 1998;16:2070–2079.
815. Cheson BD. Hematologic malignancies: new developments and future treatments. *Semin Oncol* 2002;29:33–45.
816. Piekarczyk RL, Robey R, Sandor V, et al. Inhibitor of histone deacetylation, depsipeptide (FR901228), in the treatment of peripheral and cutaneous T-cell lymphoma: a case report. *Blood* 2001;98:2865–2868.
817. Orłowski RZ, Stinchcombe TE, Mitchell BS, et al. Phase I trial of the proteasome inhibitor PS-341 in patients with refractory hematologic malignancies. *J Clin Oncol* 2002;20:4420–4427.
818. Waters JS, Webb A, Cunningham D, et al. Phase I clinical and pharmacokinetic study of bcl-2 antisense oligonucleotide therapy in patients with non-Hodgkin's lymphoma. *J Clin Oncol* 2000;18:1812–1823.

2004 Lippincott Williams & Wilkins  
John P. Greer, John Foerster, John N. Lukens  
George M. Rodgers, Frixos Paraskevas, Bertil Glader  
Wintrobe's Clinical Hematology

[EPIDEMIOLOGY](#)  
[PATHOLOGIC SPECIMEN EVALUATION](#)  
[CLASSIFICATION](#)  
[Lymphoblastic Lymphoma](#)  
[Burkitt Lymphoma](#)  
[Large Cell Lymphoma](#)  
[Uncommon Pediatric Lymphomas](#)  
[CLINICAL FEATURES](#)  
[MANAGEMENT](#)  
[Initial Workup and Staging](#)  
[Initial Management](#)  
[Therapy](#)  
[RELAPSE](#)  
[LONG-TERM SEQUELAE](#)  
[FUTURE DIRECTIONS](#)  
[REFERENCES](#)

There have been significant clinical and laboratory advances over the last decade that add to our understanding of the non-Hodgkin lymphomas (NHLs) of childhood. These include the refinement of diagnosis and classification of clinically relevant histologic subtypes, the elucidation of various pathogenic mechanisms, and most importantly, improvements in therapy and supportive care, which have resulted in improved event-free and overall survival rates. Increased attention toward the reduction and elimination of concerning late effects of therapy, such as infertility, cardiotoxicity, and second cancers, is another important hallmark of clinical research in recent years. These advances and future directions are discussed in this chapter.

Malignant lymphomas, which comprise both Hodgkin disease and NHL, are the third most common type of childhood cancer, after acute lymphoblastic leukemia (ALL) and brain tumors ([1](#), [2](#), [3](#), [4](#), [5](#), [6](#), [7](#) and [8](#)). Among children between the ages of 15 and 18, there is a slight predominance of Hodgkin disease, whereas NHL is more common among those younger than 15 years of age ([4](#), [5](#), [8](#)).

It is important to note the distinction between the NHLs of adults and those of children ([9](#)). Children typically present with diffuse extranodal disease, in contrast to adults, among whom primary nodal disease is more common. Additionally, the pediatric NHLs are typically high-grade tumors as defined by the National Cancer Institute Working Formulation ([10](#)), in contrast to the low- and intermediate-grade tumors that are predominant among adults. Age-related differences in the immune system and associated susceptibility to malignant transformation are factors that likely contribute to these observed differences in histologic subtype ([2](#)).

## EPIDEMIOLOGY

There are approximately 500 cases of newly diagnosed pediatric NHL in the United States each year ([5](#), [6](#), [7](#) and [8](#)). Although there is no clear peak age, the median age in one

single-institution review was 10 years (range, 7 months to 19 years) ( [3](#) ). This disease is uncommon in very young children (i.e., younger than 3 years of age) ( [3](#), [11](#) ). NHL is two to three times more common in boys than in girls and is more common in black children than in white children ( [2](#), [3](#) ). The reasons for these differences have yet to be elucidated.

There are geographic differences with respect to frequency and distribution of histologic subtypes of NHL in children ( [4](#), [12](#), [13](#), [14](#), [15](#) and [16](#) ). For example, although NHL is very common in equatorial Africa, it is very rare in Japan ( [15](#) ). Among the NHL cases observed in equatorial Africa, Burkitt lymphoma is the most common type observed. Burkitt lymphoma is also the most frequent histologic subtype encountered in northeastern Brazil and in some areas of the Middle East ( [14](#) ). In contrast, lymphoblastic lymphoma is the predominant histologic subtype in southern India ( [14](#) ).

Burkitt lymphoma is also of interest with respect to the geographic variances (i.e., endemic vs. sporadic) in both clinical and biologic features ( [15](#) ). Those tumors that arise in children from equatorial Africa ( *endemic subtype* ) are characterized clinically by frequent involvement of jaw, abdomen, paraspinal area, and orbit and by a younger age at diagnosis ( [14](#), [15](#) and [16](#) ). Those Burkitt tumors that arise in children from Western Europe and the United States ( *sporadic subtype* ) are, in contrast, characterized by frequent involvement of the abdomen, nasopharynx, and bone marrow and by an older age at diagnosis ( [14](#), [15](#) and [16](#) ). The breakpoint in the c-myc protooncogene in Burkitt lymphomas has also been reported to vary with respect to geography; in sporadic cases, the breakpoint tends to occur within the c-myc gene, as compared to upstream of c-myc as tends to be the case in endemic cases ( [15](#) ).

An infectious agent was suspected to play a role in the pathogenesis of Burkitt lymphoma in equatorial Africa after it was noticed that the malaria belt overlapped with the lymphoma belt. Subsequently, Epstein-Barr virus (EBV) was shown to be associated with Burkitt lymphoma in equatorial Africa ( [15](#), [16](#) ). However, the association of EBV with Burkitt lymphoma has been shown to vary with geography. EBV association occurs in approximately 85% of endemic cases, in contrast to the 15% association in Western Europe and the United States ( [15](#), [16](#) ). An intermediate degree of EBV association has been observed in other parts of the world, such as northeastern Brazil ( [12](#) ). Although the evidence for a direct role for EBV in Burkitt lymphoma pathogenesis is relatively lacking, the circumstantial evidence is compelling. It was initially hypothesized that EBV, a B-cell mitogen, increases the target pool of cells that would be susceptible to a malignant transformation ( [15](#) ). This hypothesis is supported by the observation that the expression of the recombination activating gene can be induced by EBV and therefore potentially increases the chance that a chromosomal translocation may occur during immunoglobulin (Ig) gene rearrangement ( [17](#) ). That transgenic mice expressing Epstein-Barr nuclear antigen-1 develop lymphomas is also provocative ( [18](#) ). The observation that the EBV-positive cell line Akata loses its malignant phenotype with spontaneous loss of EBV, yet maintains the ability to regain its malignant phenotype with EBV reinfection, is suggestive of a more direct role for EBV in pathogenesis ( [19](#) ).

Children with certain immunodeficiency conditions are at increased risk for the development of NHL ( [1](#), [2](#) and [3](#) ). Examples of specific populations at risk include those with congenital immunodeficiency disorders such as ataxia-telangiectasia ( [20](#) ), X-linked lymphoproliferative syndrome, and Wiskott-Aldrich syndrome. It is important that these underlying conditions be recognized in children who present with NHL, so that appropriately designed therapy can be delivered. For example, in children with

ataxia–telangiectasia, involved field irradiation and the use of radiomimetics such as bleomycin should be avoided, and the judicious use of x-rays is advised. Children with ataxia–telangiectasia are also at increased risk for the development of severe hemorrhagic cystitis after the administration of alkylating agents such as cyclophosphamide and ifosfamide; therefore, vigorous hydration and administration of the uroprotectant mesna are recommended whenever these agents are delivered. Boys with X-linked lymphoproliferative syndrome are at increased risk for the development of both B-cell lymphomas and fatal infectious mononucleosis and are potential candidates for matched sibling allogeneic bone marrow transplantation. Therefore, the diagnosis of X-linked lymphoproliferative syndrome should be considered in (a) any boy who presents with a B-cell lymphoma and whose brother has had either B-cell lymphoma or fatal infectious mononucleosis, and (b) in any male who has had two primary B-cell lymphomas. There is also an increased risk for the development of NHL among children with acquired immunodeficiency conditions ([20](#), [21](#), [22](#), [23](#), [24](#), [25](#) and [26](#)). Specific populations at risk include those with the acquired immunodeficiency syndrome and those on immunosuppressive therapy after bone marrow or organ transplantation.

## PATHOLOGIC SPECIMEN EVALUATION

The NHLs of childhood are very rapidly growing neoplasms. It is therefore imperative that the diagnosis be established as soon as possible so that appropriate therapy can be started. The diagnosis can be established after a comprehensive characterization of the biologic features of the tumor. Optimally, sufficient tissue should be obtained to permit histologic, cytochemical, flow cytometric, cytogenetic, and molecular pathologic studies. Sufficient tissue for these studies is most readily obtained by open biopsy of an involved site. Bilateral bone marrow aspirates and biopsies should be performed before open biopsy, because the diagnosis may be established with these required staging examinations, thereby negating the need for a more invasive procedure such as an open biopsy. There may be some patients, such as those with a large anterior mediastinal mass, who are not candidates for general anesthesia. In these cases, the diagnosis may be established by examination of pleural fluid obtained by thoracentesis; alternatively, tissue may be obtained by parasternal core biopsy of the mass using local anesthesia with an anesthesiologist in attendance ([27](#)).

## CLASSIFICATION

The National Cancer Institute (NCI) Working Formulation, the Revised European–American Lymphoma (REAL) Classification, and the World Health Organization (WHO) Classification of Tumors of Haematopoietic and Lymphoid Tissues all recognize the three major subtypes of NHL in children: Burkitt, lymphoblastic, and large cell lymphoma. The more recent REAL and WHO systems incorporate genetic abnormalities and additional histopathologic features. Among the pediatric NHLs, these refinements have primarily influenced the classifications of the large cell lymphomas by designating anaplastic large cell lymphoma (ALCL) and mediastinal large B-cell lymphoma, which were not featured in the NCI Working Formulation. [Table 91.1](#) summarizes the pediatric NHLs according to the WHO system.

**TABLE 91.1. World Health Organization Classification of Pediatric Non-Hodgkin Lymphomas**

---

|   |
|---|
| Common pediatric lymphomas                  |
| B-cell lymphomas                            |
| Precursor B-lymphoblastic lymphoma/leukemia |



- Burkitt lymphoma
- Diffuse large B-cell lymphoma
- Mediastinal (thymic) large B-cell lymphoma
- T-cell lymphomas
  - Precursor T-lymphoblastic lymphoma/leukemia
  - Anaplastic large cell lymphoma
  - Peripheral T-cell lymphoma, unspecified
- Uncommon pediatric lymphomas
  - Follicular lymphoma (grade 1, 2, or 3)
  - Hepatosplenic T-cell lymphoma
  - Extranodal marginal zone B-cell lymphoma of mucosa-associated lymphoid tissue (MALT lymphoma)
- Rare pediatric lymphomas
  - Mycosis fungoides
  - Subcutaneous panniculitis-like T-cell lymphoma
  - Adult T-cell leukemia/lymphoma (human T-cell leukemia virus type 1-associated leukemia/lymphoma)
  - Primary cutaneous CD30<sup>+</sup> T-cell lymphoproliferative disorders
  - Extranodal natural killer cell/T-cell lymphoma

From Jaffe ES, Harris NL, Stein H, Vardiman JW, eds. World Health Organization classification of tumours. Pathology and genetics of tumours of haematopoietic and lymphoid tissues. Lyon: IARC Press, 2001, with permission.

---

## Lymphoblastic Lymphoma

ALL and lymphoblastic lymphoma (precursor B- and T-lymphoblastic lymphoma/leukemia) have overlapping morphologic, immunophenotypic, and cytogenetic features; thus, the distinction between these two processes is considered by many to be largely arbitrary ( [28](#) , [29](#) and [30](#) ). In keeping with this concept, the International Lymphoma Study Group and the WHO designate these malignancies *precursor B-* and *T-lymphoblastic leukemia/lymphoma* in the updated REAL and WHO classifications, respectively ( [31](#) , [32](#) ). However, less obvious etiologic or molecular genetic differences must exist to explain why some lymphoblastic processes remain relatively localized and others rapidly expand to involve distant sites. Future immunologic and molecular genetic investigations may reveal the underlying differences and possibly provide insight to new therapeutic approaches. The distinction between a leukemic phase of lymphoblastic lymphoma and extramedullary involvement of ALL is arbitrary. Lymphoblastic malignancy confined to an extramedullary site is considered lymphoblastic lymphoma. Regardless of the extent of extramedullary disease, the St. Jude criteria define *ALL* as greater than 25% lymphoblasts in the bone marrow or blood, whereas other criteria require only 10% lymphoblasts in the marrow ( [9](#) , [33](#) , [34](#) ).

Common presenting sites of precursor T-lymphoblastic lymphoma are mediastinum, lymph nodes, skin, bone, and soft tissues. Rarely, the presentation may be in kidney, lung, or orbit. By contrast, precursor B-lymphoblastic lymphoma more often presents in the lymph nodes, skin, bone, soft tissues, or breast, with mediastinal presentation being very uncommon ( [35](#) , [36](#) , [37](#) , [38](#) and [39](#) ). The most frequent location of skin lesions in children is the head ( [38](#) , [39](#) ). Patients with precursor B-lymphoblastic lymphoma may fare better

than those with T-lymphoblastic lymphoma, but this impression is tempered by the relative infrequency of the precursor B-lymphoblastic lymphoma ( [35](#), [36](#) and [37](#) ).

Although some patients with lymphoblastic lymphoma may appear to have localized disease by morphologic and clinical evaluations, sensitive flow cytometric and molecular studies frequently reveal submicroscopic involvement of bone marrow or blood. Precursor B- and T-lymphoblastic lymphomas show a diffuse pattern of tissue involvement by a uniform population of small to medium-sized blastic cells. Partially involved lymphoid tissues may show residual normal follicles and germinal centers. The malignant lymphoblasts characteristically have scant to moderate amounts of basophilic cytoplasm and finely dispersed chromatin with small indistinct nucleoli. The nuclei of B or T types may be markedly irregular or convoluted, although this is more commonly a feature of T-lymphoblastic lymphomas. Mitotic figures may be numerous and correspond to the rapid growth potential of these lymphomas. Large, actively phagocytosing histiocytes interspersed among the malignant lymphoblasts may impart a microscopic "starry-sky" appearance in some cases. A high mitotic rate and starry-sky pattern are characteristics of Burkitt lymphoma and, when present in lymphoblastic lymphoma, may make the morphologic distinction between these lymphomas very difficult. However, immunologic and genetic studies readily distinguish between these entities.

Immunophenotypic studies have revealed only minor antigen-expression differences between B- or T-lymphoblastic lymphomas and their ALL counterparts. Approximately 90% of lymphoblastic lymphomas are of T lineage, and the remaining 10% is of B lineage ( [40](#), [41](#), [42](#), [43](#) and [44](#) ). Rarely, one might encounter a case of lymphoblastic lymphoma derived from a natural killer (NK) cell of origin ( [43](#), [45](#), [46](#) ). Lymphoblastic lymphomas are usually Tdt ( terminal deoxynucleotidyl transferase)-positive, a marker that distinguishes this neoplastic process from all other types of lymphoma ( [47](#), [48](#), [49](#), [50](#) and [51](#) ). Previously, Tdt-positive cells were believed to be confined to the bone marrow and thymus, sites of normal B- and T-cell development, respectively. The presence of Tdt-positive cells in the peripheral blood or lymph nodes was considered to be evidence of lymphoblastic malignancy in these tissues. However, improved immunohistochemical and flow cytometric methodologies have allowed for the detection of small numbers of benign immature Tdt-positive lymphocytes in blood and lymph nodes ( [52](#) ). CD34 is expressed by the many lymphoblastic lymphomas and is also useful in distinguishing these malignancies from Burkitt lymphoma. Expression of Tdt and CD34 can be performed by flow cytometry of lymphoma cell suspensions or by immunohistochemical studies of fixed and paraffin-embedded tumor biopsies ( [53](#) ). Precursor B- and T-lymphoblastic lymphomas may express CD10 or the common ALL antigen. A favorable clinical outcome is associated with CD10<sup>+</sup> T-ALLs, but a similar association of CD10 expression with T-lymphoblastic lymphoma has not been described ( [43](#), [54](#) ).

The lymphoblastic lymphomas may be further subclassified by their apparent stage of bone marrow or intrathymic maturation in a manner analogous to ALL ( [Table 91.2](#) ) ( [55](#), [56](#), [57](#) and [58](#) ). Attempts at separating lymphoblastic lymphoma from ALL by immunophenotypic features and the identification of clinically significant immunologic subtypes have been largely unsuccessful. In our and others' experience, B-lymphoblastic lymphomas may correspond to any of the four subtypes listed in [Table 91.2](#). As compared to B-precursor ALL, a pre-B stage of maturation (i.e., cytoplasmic  $\mu$ -heavy chain expression without detectable  $\kappa$ - or  $\lambda$ -Ig light chains) appears to be more frequent ( [42](#), [59](#), [60](#) ). Rare cases of B-lymphoblastic lymphoma may express surface Ig without detectable Tdt and should not be confused with Burkitt lymphoma ( [43](#), [61](#) ). T-lymphoblastic malignancies can also be subdivided according to the corresponding stages of normal intrathymic T-cell maturation: early thymic stage (CD7<sup>+</sup>, cytoplasmic CD3<sup>+</sup>, CD5<sup>±</sup>, CD2

$\pm$ , CD1a<sup>-</sup>, CD4<sup>-</sup>, CD8<sup>-</sup>), mid-thymic stage (CD7<sup>+</sup>, CD5<sup>+</sup>, CD2<sup>+</sup>, cytoplasmic CD3<sup>+</sup>, surface CD3 <sup>$\pm$</sup> , CD1a <sup>$\pm$</sup> , CD4 <sup>$\pm$</sup> , CD8 <sup>$\pm$</sup> ), and late thymic stage (CD7<sup>+</sup>, CD5<sup>+</sup>, CD2<sup>+</sup>, surface CD3<sup>+</sup>, CD1a<sup>-</sup>, CD4<sup>+</sup> or CD8<sup>+</sup>). The majority of T-lymphoblastic lymphomas correspond to the late stage of intrathymic T-cell maturation (56, 57 and 58). Most lymphoblastic lymphomas retain the expression of pan-T-cell antigens (e.g., CD7, CD2, CD5, and CD6), whereas one or more of these are often undetectable in large T-cell lymphomas. A more frequent expression of T-cell receptor (TCR)  $\alpha$ - $\beta$  than  $\gamma$ - $\delta$  has been reported in T-lymphoblastic lymphoma as compared to T-precursor ALL (62). Some lymphoblastic lymphomas may aberrantly express myeloid-associated antigens (41, 63, 64). CD56, a marker of NK cells and cytotoxic T cells, is occasionally expressed by blasts of T-lymphoblastic lymphoma but does not appear to be of clinical significance. All relapses of T-lymphoblastic lymphomas should be restudied immunologically, as a small number of cases can undergo a phenotypic switch to acute myeloid leukemia (65, 66).

**TABLE 91.2. Immunophenotypic Features of Precursor B- and T-Lymphoblastic Lymphomas**

| Subtype                 | CD45           | CD34  | Tdt   | CD3 | CD5   | CD7 | CD19 | CD20  | CD22 | CD79a | CD10 | Immunoglobulin Expression   |
|-------------------------|----------------|-------|-------|-----|-------|-----|------|-------|------|-------|------|---|
| Early pre-B             | + <sup>b</sup> | +     | +     | -   | -     | -   | +    | $\pm$ | +    | +     | +    | cIg $\mu$ <sup>-</sup> , sIg $\mu$ <sup>-</sup> , ? <sup>-</sup> , ? <sup>-</sup>                               |
| Pre-B                   | +              | $\pm$ | +     | -   | -     | -   | +    | $\pm$ | +    | +     | +    | cIg $\mu$ <sup>+</sup> , sIg $\mu$ <sup>-</sup> , ? <sup>-</sup> , ? <sup>-</sup>                               |
| Late pre-B <sup>c</sup> | +              | $\pm$ | $\pm$ | -   | -     | -   | +    | $\pm$ | +    | +     | +    | cIg $\mu$ <sup>+</sup> , sIg $\mu$ <sup>+</sup> , ? <sup>-</sup> , ? <sup>-</sup>                               |
| Mature B <sup>d</sup>   | +              | $\pm$ | $\pm$ | -   | -     | -   | +    | $\pm$ | +    | +     | +    | cIg $\mu$ <sup>+</sup> , sIg $\mu$ <sup>+</sup> , ? <sup><math>\pm</math></sup> , ? <sup><math>\pm</math></sup> |
| T <sup>e</sup>          | +              | $\pm$ | $\pm$ | +   | $\pm$ | +   | -    | -     | -    | $\pm$ | -    | -   |

cIg $\mu$ , cytoplasmic immunoglobulin  $\mu$ ; ?, immunoglobulin light chain ?; ?, immunoglobulin light chain ?; sIg $\mu$ , surface immunoglobulin  $\mu$ ; Tdt, terminal deoxynucleotidyl transferase.

<sup>a</sup> Cytoplasmic antigen expression.

<sup>b</sup> 10% of cases may have very weak to no detectable CD45 antigen.

<sup>c</sup> Also termed *transitional pre-B*.

<sup>d</sup> Rare subtype not to be confused with Burkitt lymphoma.

<sup>e</sup> May be subclassified into early thymic stage (CD7<sup>+</sup>, cytoplasmic CD3<sup>+</sup>, CD5 <sup>$\pm$</sup> , CD2 <sup>$\pm$</sup> , CD1a<sup>-</sup>, CD4<sup>-</sup>, CD8<sup>-</sup>), mid-thymic stage (CD7<sup>+</sup>, CD5<sup>+</sup>, CD2<sup>+</sup>, cytoplasmic CD3<sup>+</sup>, surface CD3 <sup>$\pm$</sup> , CD1a <sup>$\pm$</sup> , CD4 <sup>$\pm$</sup> , CD8 <sup>$\pm$</sup> ), and late thymic stage (CD7<sup>+</sup>, CD5<sup>+</sup>, CD2<sup>+</sup>, surface CD3<sup>+</sup>, CD1a<sup>-</sup>, CD4<sup>+</sup> or CD8<sup>+</sup>).

Cytogenetic studies of pediatric lymphoblastic lymphomas are few and include small

numbers of patients ( [67](#), [68](#), [69](#) and [70](#) ). Additionally, some reports of the cytogenetics or molecular genetics of lymphoblastic lymphoma include cases of ALL with extramedullary spread. T-lymphoblastic lymphoma and T-precursor ALL share similar chromosomal abnormalities. Chromosome abnormalities of the TCR are relatively common and include chromosome abnormalities at 7q34–36, 7p15, and 14q11 ( [68](#), [69](#) ). The t(9;17) translocation is more common in T-lymphoblastic lymphoma than in T-precursor ALL ( [68](#) ). These patients often present with a mediastinal mass and have an aggressive disease course. The t(8;13)(p11;q11–14) has been described in rare cases of T-lymphoblastic lymphoma that present with myeloid hyperplasia and eosinophilia ( [71](#), [72](#) and [73](#) ). The t(10;11)(p13–14;q14–21) is an uncommon but recurring translocation associated with ALL, AML, and lymphoblastic lymphoma ( [74](#), [75](#) ). Cytogenetic abnormalities have not been shown to be of prognostic significance in lymphoblastic lymphoma. Gene expression profile (microarray) studies of lymphoblastic lymphoma may unveil clinically relevant subgroups similar to those reported for T-ALL ( [76](#), [77](#) ).

## Burkitt Lymphoma

The updated REAL and the WHO classifications replace the “small noncleaved cell lymphoma” of the Lukes–Collins and NCI Working Formulations with *Burkitt lymphoma* ( [Table 91.1](#) ) ( [10](#), [31](#), [32](#), [78](#) ). The REAL and WHO classifications also combine the L3–ALL of the French–American–British classification with Burkitt lymphoma. Indeed, most but not all L3–ALLs appear to be the leukemic phase of Burkitt lymphoma ( [79](#) ). Biologic and genetic differences between Burkitt lymphoma and primary Burkitt leukemia have not been reported.

Classic Burkitt lymphoma consists of a diffuse infiltrative pattern of uniform small to medium-sized cells with moderate amounts of basophilic cytoplasm ( [31](#), [32](#) ). The cells have round nuclei, clumped or condensed chromatin with clear parachromatin, and one to three nucleoli. Lukes and Collins called these cells “small noncleaved cells” because of their morphologic resemblance to cells in the reactive germinal center of normal lymph nodes. But unlike normal germinal center cells, Burkitt lymphoma cells characteristically have multiple small, clear, cytoplasm vacuoles. Frequent mitotic and apoptotic cells are present and reflect this lymphoma’s high proliferative rate and apoptotic index, respectively. Tingible body macrophages interspersed among the neoplastic cells impart a low-power microscopic starry-sky appearance. Burkitt lymphoma cells in malignant pleural effusions often are larger and more pleomorphic than their tissue or blood counterparts and may be confused with large cell lymphoma.

The WHO classification recognizes two morphologic variants of Burkitt lymphoma: Burkitt lymphoma with plasmacytoid differentiation and atypical Burkitt or Burkittlike lymphoma ( [32](#) ). The plasmacytoid variant contains many tumor cells with eccentrically placed nuclei and a single, central nucleolus—features of plasma cells ( [31](#), [32](#) ). This variant is more frequently found in immunodeficiency-related Burkitt lymphomas ( [80](#) ). No prognostic significance in children has been described for this variant.

The neoplastic cells of atypical Burkitt or Burkittlike lymphoma show a wider range of nuclear size and shape plus fewer and larger nucleoli ( [32](#), [81](#) ). These cellular features may lead to difficulties in differentiating this variant from large B-cell lymphoma. To be considered part of the Burkitt lymphoma family, these lymphomas must have evidence of a c- *MYC* translocation. However, c- *MYC* translocations may also be present in some large B-cell lymphomas. In classic Burkitt lymphoma, c- *MYC* deregulation results in almost 100% of the tumor cells being in cell cycle. This proliferative activity can be detected with Ki-67 antibodies, such that almost all of the Burkitt lymphoma cells show

positive nuclear reactivity with this antibody. The WHO committee suggests that a Burkittlike lymphoma diagnosis should be made for tumors with morphologic features intermediate between Burkitt lymphoma and diffuse large B-cell lymphoma (DLBCL) in which the Ki-67 fraction of viable cells is at least 99% or a *c-MYC* translocation is present (32, 82). Lymphomas with typical features of large cell lymphoma plus a *c-MYC* translocation or a very high Ki-67-positive fraction and Burkittlike lymphomas with a low Ki-67 index should be classified as *DLBCLs* (32, 82). Whether large cell lymphomas with a *c-MYC* translocation and high proliferative rate respond to the same therapy as that for Burkitt lymphoma is not known. The atypical Burkitt variant is more common in adults than in children, and controversy continues as to its clinical significance in children (83).

Burkitt lymphomas display a characteristic but not unique immunophenotype expression profile: CD19<sup>+</sup>, strong CD20<sup>+</sup>, CD22<sup>+</sup>, and CD79a<sup>+</sup>, and moderately strong expression of surface IgM or, less commonly, IgA or IgG with light chain ? or ? restriction (Table 91.3) (84). Nuclear Bcl-6 is present without evidence of *BCL6* rearrangement (85). Markers CD5, CD34, BCL2, and Tdt are negative. CD10 is expressed by over half of cases and is often cited as evidence of a germinal center of origin. CD21, the receptor for complement fragment C3 and EBV, is more frequently detected in the endemic than in the sporadic form. A small percentage of Burkitt lymphomas have cytoplasmic Ig-μ with no detectable surface Ig, and a rare case may have neither (86, 87). Cases with double ?-plus ?-Ig light chain expression may be encountered but are very rare. In contrast to B-lymphoblastic lymphomas, Burkitt lymphomas do not express CD34 or Tdt.

**TABLE 91.3. Immunohistochemical Markers of Lymphomas of Children**

|   | Tdt   | CD20 | CD79a | Ig  | CD5 | CD3            | CD30 | CD15 | ALK | CTA | MUM1 | BCL2 | BCL6 |
|---|-------|------|-------|-----|-----|----------------|------|------|-----|-----|------|------|------|
| T-lymphoblastic lymphoma                    | +(-)- | -    | -(+)  | -   | +/- | + <sup>a</sup> | -    | -    | -   | -   | -/+  | -    | +/-  |
| Burkitt lymphoma                            | -     | +    | +     | +   | -   | -              | -    | -    | -   | -   | -    | -    | +    |
| Anaplastic large cell lymphoma <sup>b</sup> | -     | -    | -     | -   | -   | -/+            | +    | -(+) | +   | +/- | +    | -    | +/-  |
| Peripheral T-cell lymphoma                  | -     | -    | -     | -   | +/- | +/-            | -/+  | -    | -   | -/+ | +/-  | -    | -/+  |
| Mediastinal large B-cell lymphoma           | -     | +    | +     | +/- | -   | -              | +/-  | -    | -   | -   | +/-  | -    | -    |
| Diffuse large B-cell lymphoma               | -     | +    | +     | +/- | -/+ | -              | +/-  | -    | -   | +/- | +/-  | +/-  | +/-  |
| Follicular lymphoma                         | -     | +    | +     | +/- | -   | -              | -    | -    | -   | -/+ | +/-  | +/-  | -/+  |
| Hepatosplenic lymphoma                      | -     | -    | -     | -   | -   | +              | -    | -    | -   | +   | -/+  | -    | +    |

+, positive; -, negative; (+), less than 15% of cases positive; +/-, commonly positive but may be negative; -/+, commonly negative but may be positive; (-), less than 15% of cases negative; ALK, anaplastic lymphoma kinase; CTA, cytotoxic antigen (e.g., TIA-1, perforin); Ig, immunoglobulin; MUM1, interferon regulatory factor-4; Tdt, terminal deoxynucleotidyl transferase.

<sup>a</sup> Cytoplasmic CD3.

<sup>b</sup> Marker features are for T-lineage anaplastic large cell lymphomas with ALK gene rearrangements. Rare ALK-positive cases may be B-lineage with CD20<sup>+</sup>/CD79a<sup>+</sup>/CD3<sup>-</sup> profile; anaplastic large cell lymphomas without ALK rearrangements are ALK-1-negative and may express BCL2 protein.

Data from Falini B, Mason DY. Proteins encoded by genes involved in chromosomal alterations in lymphoma and leukemia: clinical value of their detection by immunocytochemistry. *Blood* 2002;99:409-426.

---

All cases of Burkitt lymphoma have a chromosomal translocation t(8;14), t(2;8), or t(8;22) involving the *MYC* locus on chromosome 8 at band q24. The partner genes of these translocations involve the Ig heavy chain gene on chromosome 14 at band q32,  $\lambda$ -Ig light chain loci at 2q11, or the  $\kappa$ -Ig light loci at 22q11. Approximately 80% of Burkitt lymphomas have a t(8;14)(q24;q32) translocation ( [88](#) ). The breakpoint on chromosome 14 in endemic Burkitt lymphoma involves the heavy-chain joining region, whereas sporadic cases usually show translocation of *MYC* to the Ig gene switch region. As a result of these translocations, *MYC* comes under the influence of the promoter region of the Ig gene, resulting in constitutive expression of *MYC* ( [89](#) ). The deregulation of *MYC* drives cells through the cell cycle and activates genes involved in apoptosis. *MYC* translocations are not entirely specific for Burkitt lymphoma, having been reported in large B-cell lymphomas, follicular lymphomas, and precursor B-lymphoblastic transformation of follicular lymphoma. The translocations associated with Burkitt lymphoma are relatively easily detected by classical cytogenetic methods and, more recently, by fluorescence *in situ* hybridization of interphase nuclei ( [90](#) ).

## Large Cell Lymphoma

Large cell lymphomas are composed of lymphoid cells that are larger than the diameter of a histiocytic nucleus or two to three times the width of small, inactive-appearing lymphocytes. These lymphomas are of B-, T- or, rarely, NK-cell origin. The term *non-B*, *non-T*, or *null-cell large cell lymphoma* usually indicates incomplete laboratory characterization of the cell origin and should not be regarded as a lymphoma without lineage commitment. Large cell neoplasms of true monocytic/histiocytic or dendritic phenotype should not be considered lymphomas, as their clinical course and treatment differ. The revised REAL and recent WHO classifications recognize several types of large cell lymphoma, including diffuse large B-cell, mediastinal (thymic) B-cell, intravascular large B-cell, peripheral T-cell-undefined, angioimmunoblastic T-cell, and ALCL ( [32](#) ). Other lymphomas, including adult T-cell leukemia/lymphoma, extranodal nasal NK/T-cell lymphoma, enteropathy-type T-cell lymphoma, subcutaneous panniculitis-like T-cell lymphoma, and primary cutaneous CD30<sup>+</sup> T-cell disorders, may have prominent large cell components but are defined by other biologic or clinical features ( [32](#) ). ALCL of T/null type, DLBCL, and peripheral T-cell lymphoma (PTCL) comprise the majority of pediatric large cell lymphomas, although rare examples of other types of large cell lymphomas in this age group have been described. ALCLs account for 40 to 50% of pediatric large cell lymphomas, and DLBCLs comprise another 30 to 40%, with the remainder consisting of PTCL ( [91](#), [92](#) ). Although the morphologic and immunophenotypic features of large cell lymphomas of adults and children are for the most part identical, very few investigations of the laboratory and biologic features of pediatric large cell lymphomas other than the anaplastic large cell-type have been reported.

**ANAPLASTIC LARGE CELL LYMPHOMA** ALCL is rare in very young children and has a



peak incidence in adolescence ( [93](#) ). In children, ALCL tends to involve lymph nodes and extranodal sites, including skin, soft tissues, lungs, and bones ( [93](#) , [94](#) ). Approximately 20 to 25% of patients have bone marrow involvement at diagnosis that may not be obvious without special studies ( [95](#) ). The architecture of involved lymph nodes may be partially or totally effaced by malignant cells. A frequent pattern of early lymph node involvement consists of proliferation of lymphoma cells within the lymphoid sinuses, resulting in a cohesive appearance that mimics metastatic tumor. ALCL is typically comprised of variable numbers of small, medium-sized, and large neoplastic cells. The hallmark cells of ALCL are large cells with eccentrically placed, monocytoid or horseshoe-shaped nuclei with an eosinophilic Golgi region near the nucleus. Gigantic large cells with multiple nuclei forming a wreathlike appearance are common. The large cells often resemble Reed-Sternberg cells and their variant forms. The smaller cells usually have smaller amounts of cytoplasm and lack the nuclear characteristics of the large cells. ALCL includes several morphologic forms or variants, including the common, lymphohistiocytic, and small cell variants ( [32](#) , [96](#) ). The *common variant* accounts for over 70% of cases and features the hallmark large anaplastic tumor cells described above ( [97](#) ). Varying numbers of small and medium-sized lymphoid cells are also commonly present. Histiocytic erythrophagocytosis is a prominent feature in some cases. The *lymphohistiocytic variant* accounts for less than 20% of ALCL in children and consists of a mixture of small and larger lymphoid cells and many histiocytes ( [98](#) , [99](#) ). The histiocytes may be so numerous as to partially obscure the lymphoid cells. Not infrequently, there is evidence of active histiocytic erythrophagocytosis, simulating a hemophagocytic syndrome ( [100](#) , [101](#) ). Neutrophils and sometimes eosinophils can also be present. The *small cell variant* accounts for less than 10% of cases and may not be recognized if the hallmark large cells are scarce and immunophenotyping and cytogenetic studies are not performed ( [102](#) ). In the past, this variant in children and adults was often called *PTCL*. A neutrophil-rich form of ALCL has also been described but is not recognized as a variant form by the WHO classification ( [103](#) , [104](#) , [105](#) and [106](#) ). Other rare forms of ALCL include sarcomatoid, signet ring, and granulomatous forms ( [107](#) , [108](#) and [109](#) ). Most ALCLs express one or more T-cell-associated antigens, including CD2, CD3, CD4, CD7, and CD45RO ( [Table 91.3](#) ) ( [32](#) , [110](#) ). T-cell antigens CD5 and CD8 are usually negative. Some cases lack demonstrable T-cell antigens but have evidence of TCR gene rearrangements. These cases are similar to T-cell antigen-positive cases in every other way and may be referred to as *null/T ALCL* ( [32](#) ). Most ALCLs express cytoplasmic cytotoxic cell-associated proteins TIA-1, granzyme B, or perforin. A membranous plus Golgi pattern of CD30 expression is characteristic of the neoplastic cells of ALCL ( [111](#) ). The most intense reactivity to CD30 antibodies is seen in the large cells, whereas the smaller cells are weakly positive or, more often, negative. Most ALCLs are positive for the EMA ( epithelial membrane antigen ) in a manner analogous to CD30 ( [112](#) ). Myeloid-associated CD15 may be weakly expressed by some neoplastic cells in a minority of cases. Gene expression profiling studies show that clusterin is aberrantly expressed in systemic but not primary cutaneous anaplastic lymphoma kinase (ALK)-negative ALCL ( [113](#) ). B-cell-associated antigens CD19, CD20, CD22, and CD79a are not expressed by the ALCLs except for rare, controversial cases of B-cell ALCL. A t(2;5)(p23;q35) translocation is demonstrable in over 75% of ALCLs ( [114](#) , [115](#) ). Several other translocations of ALK have been described, including t(1;2)(q25;p23), t(2;3)(p23;q21), inv(2)(p23q35), t(2;22), t(2;17)(p23;q11), and t(2;19)(p23;p13) ( [116](#) , [117](#) , [118](#) and [119](#) ). With the t(2;5), *NPM* (nucleophosmin) on chromosome 5q35 is fused with *ALK* on chromosome 2p23, resulting in expression of a chimeric NPM-ALK protein ( [120](#) ). ALK protein is a transmembrane protein normally expressed by some cells of the brain but not by lymphoid or hematopoietic elements. The result of *ALK* translocations is up-regulation of ALK with resultant aberrant expression of a chimeric ALK protein in the lymphoma cells. ALCLs with the t(2;5) display a cytoplasmic plus nuclear ALK expression pattern,



whereas those with other *ALK* translocations display a cytoplasmic-only pattern ( [110](#), [111](#) ). Rare cases of ALCL with the t(2;17)(q23;q11) display granular cytoplasmic staining with ALK antibodies ( [121](#) ). Approximately 10% of ALCL cases do not have a detectable *ALK* translocation or express ALK ( [99](#) ). Conversely, rare lymphomas with a t(2;5) do not have the morphologic features of ALCL ( [93](#) ). The lymphoma cells of over 85% of ALCL cases express ALK proteins detectable with the p80 or ALK1 antibodies ( [120](#), [122](#), [123](#) ). Thus, tumor cell expression of ALK is a highly sensitive marker for ALCL and its variants having a translocation of *ALK*. Lymphomas with ALCL morphology and immunophenotype but no detectable *ALK* translocation or expression should be regarded as phenotypic variants of ALCL or as a different entity, because ALK positivity appears to have prognostic significance ( [32](#) ). Some mesenchymal tumors in children and adults can also express ALK, including neuroblastoma, inflammatory myofibroblastic tumor, rhabdomyosarcoma, and malignant peripheral nerve sheath tumor ( [124](#), [125](#) and [126](#) ). ALK expression in these tumors may be due to rearrangement of an *ALK* loci or other mechanisms that up-regulate ALK expression. Thus, ALK expression alone should not be used to distinguish between lymphoma and other tumors. ALCL can present as a leukemic process, or a leukemic phase may develop during the disease course ( [119](#), [127](#), [128](#), [129](#), [130](#) and [131](#) ). Lymphadenopathy or extranodal masses may not be present in patients presenting with a leukemic process. The circulating lymphoma cells are usually small to medium-sized with atypical nuclear features. White blood cell counts can be over  $100 \times 10^9$  per L. Tissue masses, when present, can show the typical histopathologic features of common ALCL, but most cases reported to date resemble the small cell variant. The bone marrow may contain lymphoma cells resembling those in the peripheral blood or may be comprised in part or largely of large anaplastic cells. The circulating cells have a T-cell phenotype profile. In contrast to precursor T-ALL, CD1a, CD34, and Tdt are negative. ALK- and EMA-expressing cells are usually demonstrated in the bone marrow. Cytogenetic or molecular studies for *ALK* translocations are necessary to confirm a primary diagnosis. A t(2;5)(p23;q35) is demonstrable in most cases. A novel t(2;19)(p23;p13) was found in an 18-month-old boy who presented with a leukemia process and hepatosplenomegaly but no overt bone marrow involvement, adenopathy, or other extranodal masses ( [119](#) ). Studies revealed an unusual immunophenotype: positive for CD45, CD13, CD30, CD33, CD16/56, ALK, perforin, and granzyme B and negative for CD3, CD34, Tdt, and myeloperoxidase. The phenotype of this leukemia was suggestive of a NK-cell origin and raises the possibility that some cases of null-ALCL may likewise arise from this cell lineage. In adults, ALK protein expression in ALCL is a favorable prognostic factor ( [132](#), [133](#) and [134](#) ). Treatment responses in adults are similar for patients with the t(2;5) or its variant translocations ( [110](#) ). A similar favorable outcome is found in children with immunohistochemically documented ALK-positive ALCL ( [93](#), [99](#), [135](#), [136](#) ). In multivariate analyses of childhood ALCL, mediastinal, visceral (lung, liver, spleen), and skin involvement are poor prognostic factors ( [137](#), [138](#) ).

**Diffuse Large Cell Lymphomas of B-Cell Lineage** The WHO classification recognizes four types of large cell lymphoma of B-cell lineage based on laboratory and clinical features: (a) DLBCL, (b) mediastinal large B-cell lymphoma (MLBCL), (c) intravascular large B-cell lymphoma, and (d) primary effusion lymphoma ( [32](#) ). The last two large cell lymphomas are very rare in adults and are very uncommon or have not been reported in the pediatric age group.

**Diffuse Large B-Cell Lymphoma** DLBCL includes four morphologic variants, including centroblastic, immunoblastic, T-cell/histiocyte-rich, and anaplastic variants ( [32](#) ). The variants are not recognized as clinical/pathologic entities in the WHO classification, in part because of difficulties with morphologic reproducibility among different observers and controversy over the clinical relevance of separating these lymphomas. Another not infrequently encountered problem is distinguishing among Burkitt, Burkittlike, and DLBCLs. In a recent study, the consensus for identifying Burkitt and DLBCL was 88% and

80%, respectively, and 42% for Burkittlike lymphoma ( [139](#) ). In many cases, the difficulty is a direct result of limited size or quality of the tissue obtained for examination. Additional biopsy tissue, if available, often results in recognition of the patient's lymphoma type. DLBCLs express one or more pan-B-associated markers, CD19, CD20, CD22, and CD79a. Surface or cytoplasmic Igs are expressed by 50% or more cases. Some cases may express CD5, CD10, BCL2, or BCL6 ( [Table 91.3](#) ). The proliferative index, as measured by nuclear Ki-67 expression, may be high in some DLBCLs but is less than in Burkitt lymphoma. Centroblastic lymphoma may be more common than the other DLBCL variants in children. These lymphomas are believed to arise from germinal center cells and express CD20, CD79a, CD10, and BCL6 but not MUM-1(interferon regulatory factor-4) and CD138. The immunoblastic variant is rare and consists of over 90% immunoblasts with single, large, centrally placed nucleoli, sometimes with a plasmacytoid appearance. Immunoblastic lymphomas express CD20 and CD79a, and, in some instances, CD30, MUM-1, or CD138. In adults, controversy exists as to whether patients with the immunoblastic variant fare less well than those with the centroblastic variant ( [140](#) ). The rarely encountered B-cell ALCL is characterized by cohesive large pleomorphic cells that initially occupy the sinuses of involved lymph nodes. These lymphomas can express CD30 but not ALK. In adults, full-length ALK protein is detected in a rare subtype of DLBCL that has plasmacytoid features but no rearrangement of the ALK gene ( [141](#) ). Rare cases of t(2;5) and ALK expressing DLBCL with plasmacytoid features can be found among DLBCLs of children ( [142](#) ). T-cell/histiocyte-rich large B-cell lymphomas are rare in children and may be confused with Hodgkin lymphoma or reactive processes ( [143](#) ). The large cells express CD20, CD79a, BCL-6, and sometimes CD30 and EMA but not CD15 or ALK ( [139](#) , [144](#) ). Information on the genetic lesions in childhood DLBCL is scanty. In a recent small study of pediatric DLBCL, expression of Bcl-6, c-myc, and Bcl-2 was detected in 66%, 100%, and 50% of cases, respectively ( [145](#) ). Approximately 30% of adult DLCLs express BCL2 or have a t(14;18) translocation, indicative of germinal center origin. Another 30% of cases may have abnormalities of the chromosome 3 band q27, the locus of *BCL6*. A small number of cases may have a t(8;14) translocation. Recent gene expression profiling studies reveal that adult DLBCL consists of three subgroups: germinal center B-cell-like, activated B-cell-like, and a third type not corresponding clearly to a stage of recognized B-cell differentiation ( [146](#) , [147](#) and [148](#) ). Another DNA-based gene expression profile study of adults with DLBCL delineated patients within International Prognostic Index risk categories who were likely to be cured or to die of their disease ( [149](#) ). Gene profiling studies of pediatric large cell lymphomas have not been reported.

**Mediastinal Large B-Cell Lymphoma** MLBCL is an uncommon subtype of DLBCL ( [32](#) , [150](#) , [151](#) , [152](#) , [153](#) , [154](#) and [155](#) ). Other names for this lymphoma include *mediastinal diffuse large cell lymphoma with sclerosis* and *mediastinal clear cell lymphoma of B-cell type*. MLBCLs comprise less than 10% of all large cell lymphomas in children. In contrast to a female prevalence in adults, this lymphoma may occur slightly more frequently in male children and adolescents. These neoplasms appear analogous to noncirculating thymic medullary B cells. Patients present with signs and symptoms of a large mediastinal mass, frequently with extension into adjacent structures, including lung, pericardium, chest wall, and superior vena cava. Extrathoracic extension at diagnosis is uncommon but, with disease progression, can involve kidneys, brain, soft tissue, skin, and adrenal glands. Previously, MLBCL was considered an aggressive neoplasm, but current chemotherapy treatments of children and adults with localized disease have resulted in greater than 80% overall survival ( [151](#) , [153](#) ). Pediatric patients presenting with extrathoracic disease fare less well ( [153](#) ). Under the microscope, MLBCLs typically show small clusters of large lymphoid cells surrounded by thin to thick dense fibrotic bands. The clusters of neoplastic cells can mimic the metastatic undifferentiated carcinoma. Remnant thymic epithelial cells expressing cytokeratin may also be present and may be confused with an epithelial tumor or thymoma in small biopsies. Not infrequently, intense fibrosis can obscure the neoplastic lymphocytes. The lymphoma may be comprised of a mixture of small, medium, or large

lymphoid cells or may consist primarily of large cells with ample amounts of clear and, less commonly, acidophilic or weakly basophilic cytoplasm ( [156](#) ). Small benign-appearing lymphocytes and eosinophils may be present and may create problems initially in differentiating MLBCL from Hodgkin lymphoma. Unlike classical Hodgkin lymphoma, the neoplastic cells of MLBCL express CD45 and B-cell-associated antigens CD19, CD20, CD22, and CD79a ( [Table 91.3](#) ). Expression of BCL-6 and CD10 by these lymphomas suggests a possible derivation from germinal center B cells ( [157](#) ). Ig expression may be weak but often is not detectable ( [158](#), [159](#) ). In contrast to lymphoblastic lymphoma, these tumors do not express Tdt or CD34. The CD30 antigen, a marker common to ALCL and classical Hodgkin disease, may be weakly to strongly expressed by a few or sometimes the majority of lymphoma cells ( [160](#) ). Molecular studies uniformly reveal clonal Ig gene rearrangements even when Igs are not demonstrable by immunologic techniques. The lymphoma cells show mutated Ig V region genes consistent with antigen-experienced or post-germinal center B cells ( [161](#) ). It is uncommon for evidence of clonal EBV genome to be present in the tumor cells. Relatively few cytogenetic studies have been reported, but those available show aneu-ploid tumor cells, often with gains of chromosome 9p or Xq ( [162](#), [163](#) ). The t(14;18) chromosomal translocation and its variants, common to adult large cell follicular lymphomas, are rare ( [163](#) ). The tumor cells may overexpress *REL* or *MAL* in a minority of cases ( [164](#) ). *BCL6*, p53, p16INK4 alterations, and *c-MYC* rearrangements may be present ( [162](#), [163](#), [164](#), [165](#) and [166](#) ).

### Uncommon Pediatric Lymphomas

**FOLLICULAR LYMPHOMA** *Follicular lymphoma* is a neoplasm of follicular center B cells that retains a follicular or nodular growth pattern. The WHO classification recognizes three morphologic grades of follicular lymphoma based on ratios of centroblasts or centrocytes (noncleaved and cleaved follicular center cells, respectively) ( [32](#) ). Follicular lymphomas comprise approximately 35% of adult NHLs and, in this age group, usually present in lymph nodes, spleen, and bone marrow ( [32](#) ). More than two-thirds of adult patients have disseminated disease at diagnosis and are not cured with chemotherapy. In contrast, follicular lymphoma comprises less than 3% of all pediatric lymphomas ( [167](#), [168](#), [169](#), [170](#), [171](#) and [172](#) ). Furthermore, in children, these lymphomas usually present with disease localized to tonsillar, cervical, and inguinal lymphoid tissues. Examples of localized testicular follicular large cell lymphomas in the pediatric age group have also been reported ( [172](#), [173](#), [174](#), [175](#) and [176](#) ). In striking contrast to adults, transformation to higher grade, diffuse lymphoma or leukemic phase is distinctly uncommon, and most children have prolonged remissions with or without therapy. The actuarial 5-year event-free survival was 94% in a series reported by Ribeiro ( [170](#) ). In another study, six of seven children were in complete remission, including three who had no chemotherapy ( [171](#) ). In a recent study of 23 pediatric patients, 15 of 19 patients had stage I disease, and 11 of 13 with sufficient follow-up achieved a durable clinical remission ( [172](#) ). Despite good morphologic criteria for follicular lymphoma, the rarity of this disease in children requires additional immunophenotypic and molecular studies to confirm a lymphoma diagnosis and to clearly separate it from the more frequent occurrence of benign follicular hyperplasia. Adult and pediatric follicular lymphomas do not differ morphologically, but recent studies reveal biologic differences in the lymphomas of these two age groups. Pediatric testicular follicular lymphomas express bcl-6 or have *BCL6* rearrangements but lack t(14;18)(q32;q21) chromosomal translocations and *bcl-2* and *p53* abnormalities ( [Table 91.3](#) ) ( [173](#), [174](#), [175](#) and [176](#) ). By contrast, the majority of adult follicular lymphomas express bcl-2, have a t(14;18) that involves rearrangement of *BCL2*, and progress despite chemotherapy ( [32](#) ). Bcl-2 is a mitochondrial protein that plays a central role in resistance to apoptosis. Bcl-2 is normally expressed by T cells and mantle zone B cells but not by

germinal center cells. Aberrant expression of bcl-2 by follicular lymphomas may influence the therapeutic response of the lymphomas. In two separate investigations of pediatric nontesticular follicular lymphomas, bcl-2 expression was detected in only 6 of 20 patients and BCL2 rearrangements by polymerase chain reaction in 2 of 16 patients ( [171](#), [172](#) ). In one of the latter studies, all four patients with lymphomas expressing bcl-2 presented with advanced disease stage or had disease refractory to therapy, whereas children with bcl-2-negative tumors had stage I disease, achieved complete remission, and had no relapses ( [172](#) ). Thus, bcl-2 expression does not appear to contribute to the pathogenesis of most pediatric follicular lymphomas. However, bcl-2 expression appears to identify a subset of pediatric patients in whom the lymphoma is often disseminated and more refractory to chemotherapy.

**HEPATOSPLENIC T-CELL LYMPHOMA** *Hepatosplenic T-cell lymphoma* is an aggressive extranodal malignancy of cytotoxic T cells usually of  $\gamma\delta$  and, less commonly,  $\alpha\beta$  TCR type ( [32](#), [177](#), [178](#), [179](#), [180](#), [181](#) and [182](#) ). Children and adults are rare victims of this systemic lymphoma, which has its peak incidence in adolescents and young adults ( [32](#), [178](#) ). Males are more frequently affected than females, although a female predisposition is reported for  $\alpha\beta$  hepatosplenic lymphomas ( [180](#), [181](#) ). Patients typically present with enlarged spleens and livers with no appreciable lymphadenopathy. Thrombocytopenia is common as is anemia. Circulating lymphoma cells are commonly present at diagnosis but may be difficult to distinguish from atypical lymphocytes. A more obvious leukemic phase may develop as the disease progresses ( [180](#), [181](#) ). Cases of  $\alpha\beta$  hepatosplenic lymphoma are histologically, cytogenetically, and clinically similar to the  $\gamma\delta$  form ( [181](#) ). A relatively high percentage of cases follow solid organ transplant, suggesting that an underlying immune problem predisposes to this neoplasm ( [183](#), [184](#), [185](#) and [186](#) ). The neoplastic cells are medium sized with scant to moderate amounts of cytoplasm. Azurophilic cytoplasmic granules have been described in a minority of cases. The nuclei may be round or convoluted with condensed chromatin and inconspicuous nucleoli. Mitotic cells are infrequent. With disease progression, a blast cell transformation with cells having prominent nucleoli may occur ( [183](#), [187](#), [188](#) ). The lymphoma cells may be difficult to appreciate in bone marrow aspirates, but bone marrow needle biopsies frequently show the presence of a characteristic sinusoidal infiltrate ( [181](#), [182](#), [188](#) ). The spleen and liver also show marked sinusoidal infiltrations by the neoplastic cells ( [181](#), [182](#) ).

Erythrophagocytosis may be evident in splenic and bone marrow sinusoids ( [181](#), [182](#), [189](#), [190](#) ). The lymphoma cells have a fairly consistent immunophenotypic expression pattern of CD2<sup>+</sup>, CD3<sup>+</sup>, CD4<sup>-</sup>, CD8<sup>±</sup>, CD5<sup>-</sup>, CD7<sup>+</sup>, CD16<sup>+</sup>, and CD56<sup>±</sup> ( [Table 91.3](#) ) ( [32](#), [180](#) ), although exceptions to this phenotype are not uncommon. The  $\alpha\beta$  hepatosplenic lymphomas have a similar immunophenotype except for a slightly more frequent expression of CD57 ( [181](#) ). TCR- $\gamma\delta$  or less common TCR- $\alpha\beta$  proteins can be detected by flow cytometric analyses ( [177](#), [182](#) ). Cytotoxic granular protein TIA-1 is detected in most cases, whereas granzyme B or perforin are detected in only a minority of cases ( [180](#), [181](#), [189](#), [191](#), [192](#) ). An isochromosome 7q, often with trisomy 8 and other random chromosomal abnormalities, is found in the majority of reported cases ( [181](#), [185](#), [187](#), [188](#), [193](#), [194](#), [195](#) and [196](#) ). TCR  $\gamma$ - and  $\beta$ -chain gene rearrangement studies show reciprocal findings between  $\alpha\beta$  and  $\gamma\delta$  types of hepatosplenic lymphomas and should not be used as a distinguishing test ( [180](#), [181](#) ). The majority of  $\gamma\delta$  cytotoxic T cells in the sinuses of normal spleens utilize V $\delta$  1. This splenic cell is cited as being the origin of  $\gamma\delta$  hepatosplenic T-cell lymphoma, because the majority of these lymphomas preferentially express V $\delta$  1 ( [180](#), [197](#) ). EBV genome may be present in the neoplastic cells of some patients, but there does not appear to be any causative relationship ( [181](#), [198](#) ). Hepatosplenic T-cell lymphoma in children may have been previously confused with a T-cell lymphoblastic malignancy or other forms of peripheral T-cell lymphomas. Reports of pediatric cases are limited to case discussions or are included in reports of adult investigations ( [177](#), [180](#), [181](#), [194](#), [196](#), [198](#) ).

). Children with aB hepatosplenic lymphoma tend to be younger than those with the ?d form of lymphoma ( [181](#), [199](#)). As in adults, the clinical course in children is aggressive. Initial responses to chemotherapy are followed shortly thereafter by relapse and death in the majority of patients. Bone marrow transplant with subsequent relapse has been mentioned in one report ( [181](#)).

**RARE PEDIATRIC LYMPHOMAS** Rare lymphomas of children and adolescents include mycosis fungoides ( [200](#), [201](#), [202](#), [203](#), [204](#), [205](#), [206](#) and [207](#)), mucosa-associated lymphoid tissue lymphoma ( [208](#)), panniculitis-like T-cell lymphoma ( [209](#), [210](#)), human T-cell leukemia virus type 1-associated leukemia/lymphoma ( [211](#), [212](#) and [213](#)), and NK lymphoma ( [214](#), [215](#) and [216](#)). For the most part, the clinical and biologic features of these lymphomas in children resemble their adult counterparts. However, because of their rarity in children, clinical and biologic features of these lymphomas can only be gleaned from compilations of case reports. The diagnosis of these rare lymphomas in children is often delayed or initially interpreted as a reactive process or as one of the more common pediatric lymphomas.

## CLINICAL FEATURES

The clinical presentation for children with NHL is quite varied ( [Table 91.4](#)) ( [1](#), [2](#) and [3](#)). The primary sites of disease, which vary according to histologic subtype, are the primary determinants for the signs and symptoms observed. Children with lymphoblastic lymphoma typically present with a mediastinal mass, whereas children with Burkitt lymphoma typically present with abdominal disease (usually arising from the terminal ileum and often serving as a trigger point for an intussusception). By way of contrast, children with large cell lymphoma may present with primary involvement of either mediastinum or abdomen.

**TABLE 91.4. Clinical and Biologic Characteristics of Non-Hodgkin Lymphoma in Children**

| Subtype       | Proportion of Cases (%) | Phenotype           | Primary Site                 | Translocation  | Affected Genes  |
|---------------|-------------------------|---------------------|------------------------------|--|---|
| Burkitt       | 39                      | B cell              | Abdomen or head and neck     | t(8;14)(q24;q32)<br>t(2;8)(p11;q24)<br>t(8;22)(q24;q11)  | IgH-c <i>MYC</i><br>Ig?-c <i>MYC</i><br>Ig? -c <i>MYC</i>   |
| Lymphoblastic | 28                      | T cell <sup>b</sup> | Mediastinum or head and neck | t(1;14)(p32;q11)<br>t(11;14)(p13;q11)<br>t(11;14)(p15;q11)<br>t(10;14)(q24;q11)<br>t(7;19)(q35;p13)<br>t(8;14)(q24;q11)<br>t(1;7)(p34;q34) | TCRad- <i>TAL1</i><br>TCRad- <i>RHOMB2</i><br>TCRad- <i>RHOMB1</i><br>TCRad- <i>HOX11</i><br>TCRB- <i>LYL1</i><br>TCRad- <i>MYC</i><br>TCRB- <i>LCK</i> |



|            |    |  |  |                 |                |
|------------|----|--|--|-----------------|----------------|
| Large cell | 26 | B cell, T cell, <sup>c</sup><br>indeterminate <sup>c</sup> | Mediastinum,<br>abdomen, head<br>and neck, or skin | t(2;5)(p23;q35) | <i>NPM-ALK</i> |
|------------|----|--|--|-----------------|----------------|

Ig, immunoglobulin; TCR, T-cell receptor.

<sup>a</sup> Proportion at St. Jude Children's Research Hospital; other histotypes account for approximately 7%.

<sup>b</sup> B-cell progenitor variants have also been described.

<sup>c</sup> Associated with the anaplastic large cell lymphoma subtype (approximately 10% of childhood non-Hodgkin lymphoma).

Children presenting with an abdominal mass may have associated nausea, vomiting, and abdominal pain. Abdominal distention secondary to obstruction and associated ascites may be present on physical examination. Extension of the mass into the pelvis may result in ureteral compression and hydronephrosis. The presence of an anterior mediastinal mass may result in some degree of respiratory distress, ranging from slight cough to severe respiratory compromise including arrest (<sup>2</sup>). The respiratory status may also be compromised by the presence of a pleural effusion. A mediastinal mass may obstruct venous return to the heart, resulting in a superior vena cava syndrome (<sup>2</sup>). This syndrome is characterized by swelling in the neck and shoulder region and prominent venous vasculature, a condition that may predispose the patient to the development of a deep venous thrombosis.

The degree of tumor burden at the time of diagnosis is quite variable. Some children present with isolated lymph node involvement, whereas others may present with more widespread disease. Involvement of the bone marrow may be associated with pancytopenia, pallor, and bruising. Blurred vision, headache, or the presence of a cranial nerve palsy on physical examination may be present when the central nervous system is involved. Skin lesions may be present at the time of diagnosis in approximately 4% of children; however, this is usually associated with the CD30<sup>+</sup>, ALK<sup>+</sup>, anaplastic subtype of large cell lymphoma (<sup>217</sup>, <sup>218</sup>). Involvement of bone may be associated with local swelling, pain, or limp. Boys may present with testicular enlargement secondary to tumor infiltration. Involvement of the ovary may be identified on diagnostic imaging studies.

## MANAGEMENT

### Initial Workup and Staging

Modern therapy for the NHLs of childhood is determined by both the histologic diagnosis and the disease stage. It is therefore imperative that an expeditious and comprehensive staging workup be performed after the diagnosis is established. This generally includes (a) computed tomography of the neck, chest, abdomen, and pelvis; (b) nuclear scans (e.g., bone scan, gallium scan); (c) bilateral bone marrow aspirates and biopsies for cell count and differential, flow cytometry if marrow overtly involved, cytogenetics, and molecular pathology; and (d) lumbar puncture for cerebrospinal fluid cytology (<sup>1</sup>, <sup>2</sup> and <sup>3</sup>). Positron emission tomography is commonly used among adults with either Hodgkin disease or NHL; however, it is not currently a standard staging modality for children with NHL (<sup>219</sup>). Further data on how positron emission tomography compares to conventional gallium and

bone scanning are needed. A complete blood count with differential and chemistry panel, including serum lactate dehydrogenase, should also be obtained. On completion of the workup described above, patients are designated with a disease stage, usually according to the St. Jude system described by Murphy ( [Table 91.5](#)) ( [9](#)). Those in stage I or II are considered to have limited stage disease, whereas those in stage III or IV are considered to have advanced stage disease.

**TABLE 91.5. Stages of Non-Hodgkin Lymphoma**

---

**Stage I**

A single tumor (extranodal) or involvement of a single anatomic area (nodal), with the exclusion of the mediastinum and abdomen.

**Stage II**

A single tumor (extranodal) with regional node involvement.

Two or more nodal areas on the same side of the diaphragm.

Two single (extranodal) tumors, with or without regional node involvement on the same side of the diaphragm.

A primary gastrointestinal tract tumor (usually in the ileocecal area), with or without involvement of associated mesenteric nodes, that is completely resectable.

**Stage III**

Two single tumors (extranodal) on opposite sides of the diaphragm.

Two or more nodal areas above and below the diaphragm.

Any primary intrathoracic tumor (mediastinal, pleural, or thymic).

Extensive primary intraabdominal disease.

Any paraspinous or epidural tumor, whether or not other sites are involved.

**Stage IV**

Any of the above findings with initial involvement of the central nervous system, bone marrow, or both.

Adapted from Murphy SB. Classification, staging and end results of treatment of childhood non-Hodgkin's lymphomas: dissimilarities from lymphoma in adults. *Semin Oncol* 1980;7:332-339.

---

## **Initial Management**

On expeditious completion of the diagnostic and staging workup, appropriate therapeutic options can be considered. Before chemotherapy is started, however, a number of issues must be considered. Some children are at high risk for tumor lysis syndrome. This primarily includes children with advanced stage Burkitt lymphoma and some children with lymphoblastic lymphoma who have a large tumor burden at diagnosis, which may be reflected by an elevated serum lactate dehydrogenase. Some of these children have metabolic abnormalities with some degree of renal dysfunction at diagnosis, which only worsen once chemotherapy is started (e.g., hyperkalemia, hyperuricemia, hyperphosphatemia, and so forth). Therefore, these children should have excellent intravenous access and vigorous hydration before starting chemotherapy. Hyperuricemia has historically been managed using hyperhydration coupled with allopurinol, a xanthine oxidase inhibitor. Uricolytics, such as uricozyme, which cleaves uric acid to the more soluble and readily cleared allantoin, have been used in France for decades. More recently, a recombinant form of this drug, rasburicase (SR29142), has become available



and has been shown to be very effective and well tolerated with a reduced risk of associated allergic reaction ( [220](#) ). The advantage of these agents is that they cause a precipitous drop in serum uric acid, which negates the need for alkalinization, thus facilitating phosphorus excretion. It is of note that a recent study of rasburicase in children at high risk for tumor lysis syndrome demonstrated preservation of renal function with no significant associated hyperphosphatemia or hyperkalemia ( [220](#) ).

## Therapy

There have been significant improvements in treatment outcome for children with newly diagnosed NHL over the past 20 years ( [1](#) ). This has been accomplished largely through incremental refinements in sequential multicenter trials that feature a stage and histology-directed or an immunophenotype-directed approach to treatment assignment. Two of the initial successful regimens for children with NHL were the multiagent LSA  $2L_2$  regimen ( [221](#), [222](#) and [223](#) ) designed for children with ALL and the COMP regimen (cyclophosphamide, vincristine, methotrexate, and prednisone) ( [221](#) ). A randomized trial by the Children's Cancer Group (CCG) comparing these two approaches validated a stage and histology-directed therapeutic approach to pediatric NHL ( [221](#) ). Specifically, children with limited stage disease did well regardless of treatment arm. In contrast, among those with advanced stage disease, those with Burkitt lymphoma had a better outcome with COMP, and those with lymphoblastic lymphoma had a better outcome with LSA  $2L_2$ ; there was no clear therapeutic advantage with either approach for children with advanced stage large cell lymphoma. Other trials validated and built on these observations ( [224](#), [225](#), [226](#), [227](#), [228](#), [229](#), [230](#), [231](#), [232](#), [233](#), [234](#), [235](#), [236](#), [237](#), [238](#), [239](#), [240](#), [241](#), [242](#), [243](#), [244](#), [245](#), [246](#), [247](#), [248](#), [249](#), [250](#), [251](#), [252](#), [253](#), [254](#), [255](#), [256](#), [257](#), [258](#), [259](#), [260](#), [261](#), [262](#), [263](#), [264](#), [265](#), [266](#), [267](#) and [268](#) ).

Subsequent to the CCG trial comparing LSA  $2L_2$  and COMP, the dominant theme of most trials for children with limited stage disease has been the reduction of treatment-related acute and late effects without compromising treatment outcome ( [226](#), [228](#), [229](#), [247](#), [250](#), [251](#) ). This has been attempted by shortening the duration of therapy, reducing the dose of certain agents, and eliminating involved field irradiation. In the first of two sequential trials performed by the Pediatric Oncology Group (POG) ( [229](#) ), it was demonstrated that involved field irradiation could safely be eliminated from a 33-week treatment plan that featured three courses of cyclophosphamide, doxorubicin, vincristine, and prednisone (CHOP) followed by a 24-week maintenance phase of 6-mercaptopurine and low-dose methotrexate. In the subsequent trial, it was shown that the 24-week maintenance phase could be safely eliminated for children with Burkitt or large cell lymphoma; however, the result was inferior for children with lymphoblastic lymphoma ( [229](#) ). Even with the 24-week maintenance phase, one-third of children with lymphoblastic lymphoma experience a recurrence; however, the majority is successfully salvaged, resulting in an overall survival similar to other histologic subtypes. Other groups have approached limited stage lymphoblastic lymphoma with a more intensive initial treatment regimen ( [246](#) ). For example, the French Pediatric Oncology Society (SFOP) cooperative group trial treats children with lymphoblastic lymphoma with the same regimen used for those with advanced stage disease ( [246](#) ). A somewhat intermediate-intensity approach is currently being studied by the Children's Oncology Group, in which patients with limited stage lymphoblastic lymphoma are receiving a regimen modeled after approaches used for low-risk ALL.

Treatment advances for children with advanced stage disease have primarily focused on improving histology- and immunophenotype-directed treatment strategies (United States and Europe, respectively) ( [224](#), [225](#), [226](#) and [227](#), [230](#), [231](#), [232](#), [233](#), [234](#), [235](#), [236](#), [237](#), [238](#), [239](#), [240](#),

[241](#), [242](#), [243](#), [244](#), [245](#), [246](#), [247](#), [248](#), [249](#), [250](#), [251](#), [252](#), [253](#), [254](#), [255](#), [256](#), [257](#), [258](#), [259](#) and [260](#)).

Intensification of therapy, addition of new active agents, and refinement in risk-adapted therapy have all been credited with improvement in outcome.

For children with advanced stage Burkitt lymphoma, initial improvements in treatment outcome beyond those achieved with COMP were attained by the incorporation of high-dose methotrexate and cytarabine ([Table 91.6](#)). Two-year event-free survival rates of approximately 80% for children with stage III Burkitt lymphoma were reported with the Total B regimen, which featured 1 g/m<sup>2</sup> methotrexate and sequentially escalating doses of continuous-infusion cytarabine; for those with bone marrow involvement, however, the outcome was inferior (approximately 20%) ([227](#)). The POG modified the Total B approach in the PG8617 protocol by incorporating high-dose pulses of cytarabine and intensified intrathecal therapy. This resulted in an improved treatment outcome for children with stage IV disease ([231](#)).

**TABLE 91.6. Treatment Outcome for Advanced Stage Burkitt Lymphoma**

| Protocol                | Stage        | Patients (No.) | EFS Rate                                | Reference           |
|-------------------------|--------------|----------------|---|---------------------|
| POG 8617                | IV           | 34             | 4-yr EFS = 79% ± 9%                     | <a href="#">231</a> |
|                         | B-ALL        | 47             | 4-yr EFS = 65% ± 8%                     |                     |
| LMB 89 <sup>a</sup>     | III          | 278            | 5-yr EFS = 91% (CI, 95%; range, 87–94%) | <a href="#">226</a> |
|                         | IV           | 62             | 5-yr EFS = 87% (CI, 95%; range, 77–93%) |                     |
|                         | B-ALL        | 102            | 5-yr EFS = 87% (CI, 95%; range, 79–92%) |                     |
| BFM 90                  | III          | 169            | 6-yr EFS = 86% ± 3%                     | <a href="#">251</a> |
|                         | IV           | 24             | 6-yr EFS = 73% ± 10%                    |                     |
|                         | B-ALL        | 56             | 6-yr EFS = 74% ± 6%                     |                     |
| CCG <sup>a</sup> Orange | III/IV/B-ALL | 43             | 12-mo EFS = 83%                         | <a href="#">236</a> |
| vs.<br>LMB 86           | III/IV/B-ALL | 42             | 12-mo EFS = 84%                         |                     |

B-ALL, B-cell acute lymphoblastic leukemia; CI, confidence interval; EFS, event-free survival.

<sup>a</sup> Includes patients with B-cell large cell non-Hodgkin lymphoma.

The optimal duration of therapy was examined in other trials. For example, the French SFOP ([232](#)) demonstrated that the duration of therapy could be reduced to 4 months; Schwenn et al. ([238](#)) reported an excellent result with a 2-month regimen for those with stage III disease. Further advances in therapy have been achieved over the last 10 years by dose intensification of cyclophosphamide, methotrexate, and cytarabine and by the incorporation of new active agents (e.g., etoposide). The German Berlin-Frankfurt-Munster (BFM) ([264](#)) and French SFOP ([226](#)) cooperative groups have reported among the best results, using risk-directed treatment assignment based on clinical features such as stage, degree of surgical resection, tumor burden, degree of bone

marrow involvement, and disease sites. For example, in the SFOP LMB-89 regimen ([226](#)), Group A treatment is restricted to those who have completely resected limited stage disease, whereas Group C, which is the most intensive arm, comprises those who have greater than 70% marrow blasts or central nervous system disease. Group B treatment is intermediate in intensity and is given to those with incompletely resected limited stage disease, stage III, and those with less than 70% bone marrow replacement. Approximately 85% of children with advanced stage B-cell lymphoma are cured with this approach.

Strategies to improve the outcome for children with lymphoblastic lymphoma have generally built on the results of the CCG trial, which demonstrated a superior result with an ALL-like treatment approach (i.e., LSA  $_2L_2$ ). The incorporation of high-dose methotrexate has been featured in a number of successful treatment regimens ([Table 91.7](#)) ([246](#), [255](#), [260](#)). For example, the SFOP modified the LSA  $_2L_2$  regimen by incorporating courses of high-dose methotrexate throughout the maintenance phase of therapy with an excellent treatment result ([246](#)). The BFM cooperative group achieved an outstanding result (i.e., 5-year event-free survival of 90%) with an approach that featured a high-dose methotrexate consolidation phase (5 g/m<sup>2</sup> every other week for a total of four courses) ([255](#)). The improved outcome with higher doses of methotrexate may be the result of higher levels of intracellular methotrexate polyglutamates achieved with dose escalation ([269](#)). The necessity of methotrexate in the treatment regimen has been questioned ([260](#)). In a randomized trial performed by the POG, it did not appear that high-dose methotrexate added to the treatment result for children with lymphoblastic lymphoma in the setting of an anthracycline- and asparaginase-rich backbone ([260](#)); however, the result for children with T-cell ALL entered on this trial was inferior in the arm without high-dose methotrexate. In light of the results of the POG trial, which questioned the need for high-dose methotrexate in children with lymphoblastic lymphoma, the Children's Oncology Group is currently performing another randomized trial to address this issue. Improvements in treatment outcome have also been attributed to other interventions, such as the incorporation of a delayed intensification phase (i.e., reinduction phase) ([255](#)), L-asparaginase ([265](#)), and new active agents ([240](#)).

**TABLE 91.7. Treatment Outcome for Advanced Stage Lymphoblastic Non-Hodgkin Lymphoma**

| Protocol                        | Stage  | Patients (No.) | EFS Rate                 | Reference           |
|---------------------------------|--------|----------------|--------------------------|---------------------|
| LSA $_2L_2$ (modified); CCG-551 | III/IV | 124            | 5-yr EFS = 64%           | <a href="#">221</a> |
| BFM 90                          | III    | 82             | 5-yr EFS = 90% ± 3%      | <a href="#">255</a> |
|                                 | IV     | 19             | 5-yr EFS = 95% ± 5%      |                     |
| X-H SJCRH                       | III/IV | 22             | 4-yr DFS = 73%           | <a href="#">240</a> |
| APO (Dana Farber)               | III/IV | 21             | 3-yr DFS = 58% ± 23%     | <a href="#">34</a>  |
| A-COP + (POG)                   | III    | 33             | 3-yr DFS = 54% ± 9%      | <a href="#">241</a> |
| SFOP LMT81                      | III    | 33             | 57-mo EFS = 79% (SE, 4%) | <a href="#">246</a> |

|                                       |                                 |     |                          |                     |
|---------------------------------------|---------------------------------|-----|--------------------------|---------------------|
|                                       | IV/acute lymphoblastic leukemia | 43  | 57-mo EFS = 72% (SE, 4%) |                     |
| CCG: LSA $2L_2$ (modified) vs. ADCOMP | I-IV                            | 243 | 5-yr EFS = 74%           | <a href="#">249</a> |
| POG8704: no extra Asp vs. Extra Asp   | I-IV                            | 138 | 5-yr EFS = 64%           |                     |
|                                       | III/IV                          | 83  | 4-yr CCR = 64% (SE, 6%)  | <a href="#">265</a> |
|                                       | III/IV                          | 84  | 4-yr CCR = 78% (SE, 5%)  |                     |

Asp, asparaginase; CCR, continuous complete remission; DFS, disease-free survival; EFS, event-free survival.

Determining the optimal treatment approach for children with advanced stage large cell lymphoma has been more of a challenge for various reasons. The CCG randomized trial comparing COMP and LSA  $2L_2$  did not show an advantage to either approach for children with advanced stage large cell lymphoma. Further complicating the picture is the fact that, historically, children with large cell lymphoma in the United States were treated on the basis of the histologic diagnosis (i.e., uniform therapy for all immunophenotypic subtypes), whereas in Europe, children with large cell lymphoma have been treated primarily according to immunophenotype (e.g., T-cell, B-cell, or CD30<sup>+</sup> ALCL) ([99](#), [135](#), [136](#), [261](#)). With histology-directed therapy, the 5-year event-free survival rates for children with advanced stage disease have generally been in the range of 60 to 75% ([221](#), [224](#), [244](#), [225](#), [235](#), [261](#), [262](#) and [263](#)) ([Table 91.8](#)). These results have been achieved largely by using CHOP-based therapy (cyclophosphamide, doxorubicin, vincristine, and prednisone). There is a general trend in the United States to move toward an immunophenotype-directed approach for children with large cell lymphoma, in part because of the excellent result achieved in Europe using this strategy. For example, in France (SFOP), children with advanced stage B-cell large cell lymphoma are treated according to the Burkitt lymphoma regimen (LMB89) with an excellent result (3-year event-free survival, >80%) ([256](#)). Most groups are now treating Burkitt lymphoma and B-cell large cell lymphoma similarly.

**TABLE 91.8. Treatment Outcome for Advanced Stage Large Cell Non-Hodgkin Lymphoma**

| Protocol            | Stage      | Patients (No.) | EFS Rate             | Reference           |
|---------------------|------------|----------------|----------------------|---------------------|
| CHOP                | III and IV | 21             | 3-yr EFS = 62% ± 11% | <a href="#">224</a> |
| MACOP-B             | III and IV | 11             | 3-yr EFS = 55% ± 16% | <a href="#">244</a> |
| COMP vs. LSA $2L_2$ | III and IV | 42             | 5-yr EFS = 52%       | <a href="#">221</a> |
| LSA $2L_2$          | III and IV | 18             | 5-yr EFS = 43%       |                     |
| APO vs. ACOP+       | III and IV | 62             | 3-yr EFS = 72% ± 6%  | <a href="#">263</a> |
|                     | III and IV | 58             | 4-yr EFS = 62% ± 7%  |                     |

EFS, event-free survival.

Quite varied approaches are still used for children with CD30<sup>+</sup> ALCL ( [99](#), [135](#), [136](#), [263](#) ). In SFOP trials, children with CD30<sup>+</sup> ALCL have been entered on regimens specific for that subtype ( [99](#) ). In the German BFM trials, children with CD30<sup>+</sup> ALCL have been treated with a B-cell approach (Burkitt lymphoma-like) with an outstanding result (3-year event-free survival of approximately 80%) ( [135](#), [136](#) ). In the United States, a comparable result was achieved using the APO regimen (doxorubicin, prednisone, and vincristine) ( [225](#) ). Current cooperative group trials in Europe and the United States are building on the BFM B-cell and APO strategies, respectively. Both studies are examining the benefit of adding vinblastine, an agent that has activity as a single agent in multiply relapsed ALCL patients ( [268](#) ).

## RELAPSE

Approximately 20 to 30% of children with NHL have a treatment failure with frontline therapy as manifested by either recurrent or, less commonly, refractory disease ( [1](#) ). The prognosis for children with recurrent or refractory NHL has generally been believed to be quite poor. Therefore, most oncologists consider either intensive or novel salvage chemotherapy regimens followed by an intensification phase including either autologous or allogeneic hematopoietic stem cell transplantation (HSCT) in the majority of cases. However, the role of HSCT in this setting is somewhat controversial, with a recent publication questioning the benefit of this salvage strategy ( [270](#) ).

There are a number of studies that feature HSCT ( [264](#), [271](#), [272](#), [273](#), [274](#), [275](#), [276](#), [277](#), [278](#), [279](#) and [280](#) ). For example, some children with Burkitt lymphoma who had a poor early response to therapy were successfully salvaged with high-dose intensive chemotherapy followed by autologous HSCT in European cooperative group trials ( [264](#), [273](#), [275](#), [276](#), [278](#) ). The Spanish Working Party for Bone Marrow Transplantation reported that 58% of the children who had either refractory/recurrent NHL or high risk disease in first complete remission were event-free survivors after HSCT ( [275](#) ). The French cooperative group SFOP reported that 8 of 24 children with refractory or recurrent NHL were long-term disease-free survivors using HSCT ( [276](#) ). In a St. Jude single-institution review of 20 children with recurrent or refractory NHL, approximately 45% were survivors after HSCT ( [280](#) ). Published studies featuring HSCT for pediatric NHL are relatively small in number and vary with respect to the type of HSCT (autologous vs. allogeneic), salvage therapy, preparative regimen, and histologic subtype, making direct comparisons difficult.

Histologic subtype of NHL should be considered in determining the appropriate type of HSCT (i.e., allogeneic vs. autologous) for those children who experience a failure after primary therapy. A number of studies have suggested that autologous HSCT is beneficial in the management of children with Burkitt lymphoma who have a poor early response to initial therapy ( [264](#), [271](#), [276](#) ). It is less clear which approach is optimal for those children with Burkitt lymphoma who relapse in the bone marrow, although many favor an allogeneic approach if a suitable donor is available. Autologous HSCT strategies have been shown to be efficacious in children with recurrent large cell lymphoma ( [274](#), [280](#) ), whereas the results of an autologous approach for those with recurrent lymphoblastic lymphoma have been generally less encouraging ( [270](#) ).

There is a spectrum of preparative regimens that have been studied in children with recurrent or refractory NHL ( [264](#), [271](#), [272](#), [273](#), [274](#), [275](#), [276](#), [277](#), [278](#), [279](#) and [280](#) ). Carmustine, etoposide, cytarabine, and melphalan (BEAM) and carmustine, cytarabine,

cyclophosphamide, and thioguanine (BACT) are two of the earliest drug combinations used successfully ( [271](#), [272](#), [279](#) ). The SFOP credited their excellent salvage rate in part to the inclusion of high-dose busulfan in the preparative regimen ( [276](#) ). Gordon et al. ( [274](#) ) reported excellent results for children with recurrent PTCL using a regimen that featured thiotepa.

At present, most would consider an autologous HSCT for children with Burkitt lymphoma who have a poor early response and for those with chemosensitive recurrent large cell lymphoma. An allogeneic HSCT is generally considered for children with lymphoblastic or Burkitt lymphoma that recurs in the bone marrow and is shown to be chemosensitive. Additional prospective clinical trials that examine HSCT strategies in children with recurrent or refractory NHL are clearly needed; it has been suggested by one group that the potential graft-versus-lymphoma effect of the allogeneic HSCT approach be studied ( [278](#) ).

## LONG-TERM SEQUELAE

Improvements in the cure rate for children with NHL have prompted investigators to more closely examine long-term treatment-related late effects. Areas of concern include second malignancies, second cancers, and effects on fertility. Attempts to reduce these unwanted sequelae include trials that have eliminated or reduced the doses of certain chemotherapeutic agents or involved field irradiation.

In the first of two sequential randomized trials for limited stage NHL, the POG demonstrated that involved field irradiation could be safely eliminated without compromising the excellent treatment outcome ( [229](#) ). The elimination of involved field irradiation was also shown to be possible without compromising outcome in a St. Jude study of patients with advanced stage disease ( [281](#) ). Involved field irradiation of primary tumor masses is not used in most current NHL trials. Cranial irradiation is considered in the management of children with lymphoblastic lymphoma who present with overt involvement of the central nervous system; however, its use for central nervous system prophylaxis in these children is controversial.

Alkylating agents, such as cyclophosphamide and ifosfamide, cause a dose-related depletion of germinal cells and tend to be more gonadotoxic in males. Studies suggest that fertility is generally maintained at a cumulative cyclophosphamide dose of less than 4 g/m<sup>2</sup>, whereas sterility is likely at doses greater than 7.5 g/m<sup>2</sup> ( [282](#) ). In this regard, various clinical trials have examined the possibility of eliminating or reducing the dose of cyclophosphamide in the treatment of certain NHL subtypes ( [263](#) ).

Pediatric NHL trials have also been influenced by the desire to avoid or limit anthracycline-related cardiac toxicity. Although adults have been shown to tolerate cumulative doxorubicin doses of 550 mg/m<sup>2</sup>, children treated with lower cumulative doses have been shown to have clinically significant abnormalities in ventricular contractility ( [283](#) ). Factors that have been shown to be predictive of cardiac dysfunction include higher anthracycline dose intensity, cumulative anthracycline dose, female sex, younger age at time of treatment, combined modality therapy that includes mediastinal irradiation, and time interval since completion of therapy ( [284](#), [285](#) ). In addition to trials that attempt to reduce the cumulative dose of anthracyclines ( [235](#) ), the study of cardioprotectants is also indicated.



## FUTURE DIRECTIONS

Although significant progress has been made in the treatment of children with NHL, 25 to 30% continue to have refractory or recurrent disease. Treatment-related late effects are of additional concern. Thus, the continued goal and challenge for the pediatric oncologist are to develop more effective treatment approaches that are not associated with significant late effects. This will require further refinement in risk-adapted treatment planning, which will be made possible by the identification of additional prognostic biologic and clinical factors.

Various strategies may contribute to further improvement in treatment outcome, such as the development of new active agents or new schedules for the delivery of current agents. One of the most promising novel approaches is the use of immunotherapeutic agents, such as the use of rituximab for adults with CD20<sup>+</sup> B-cell lymphomas ([286](#), [287](#)). Pediatric trials are currently under way. Small molecule inhibitors, which have been shown to be active in adults with chronic myelogenous leukemia, may have a role in some types of childhood NHL.

The continued molecular characterization of chromosomal abnormalities associated with pediatric NHL may prove helpful in refining the classification of clinically relevant histologic subtypes, evaluating response to therapy, and developing novel therapeutic approaches that target the molecular lesion directly.

## REFERENCES

1. Sandlund JT, Downing JR, Crist WM. Non-Hodgkin's lymphoma in childhood. *N Engl J Med* 1996;334:1238-1248.
2. Magrath IT. Malignant non-Hodgkin's lymphomas in children. In: Pizzo PA, Poplack DG, eds. *Principles and practice of pediatric oncology*, 2nd ed. Philadelphia: JB Lippincott, 1993:537-575.
3. Murphy S, Fairclough DL, Hutchison RE, Berard CW. Non-Hodgkin's lymphomas of childhood: an analysis of the histology, staging, and response to treatment of 338 cases at a single institution. *J Clin Oncol* 1989;7:186-193.
4. Robison LL. General principles of the epidemiology of childhood cancer. In: Pizzo PA, Poplack DG, eds. *Principles and practice of pediatric oncology*, 2nd ed. Philadelphia: JB Lippincott, 1993:3-10.
5. Young JL, Jr., Ries LG, Silverberg E, et al. Cancer incidence, survival and mortality for children younger than age 15 years. *Cancer* 1986;58:598-602.
6. Bleyer WA. The impact of childhood cancer on the United States and the world. *CA Cancer J Clin* 1990;40:355-366.
7. Parker SL, Tong T, Bolden S, Wingo PA. Cancer Statistics, 1996. *CA Cancer J Clin* 1996;65:5-27.
8. Ries LAG, Miller BA, Hankey BF, et al. *SEER Cancer Statistics Review, 1973-1991*. Bethesda, Maryland: NIH, 1994.
9. Murphy SB. Classification, staging and end results of treatment of childhood non-Hodgkin's lymphomas: dissimilarities from lymphoma in adults. *Semin Oncol* 1980;7:332-339.
10. National Cancer Institute sponsored study of classifications of non-Hodgkin's lymphoma. Summary and description of a working formulation for clinical usage. *Cancer* 1982;49:2112-2135.
11. Hutchison RE, et al. Non-Hodgkin's lymphoma in children younger than three years. *Cancer*



1988;62:1371.

12. Sandlund J, Fonseca T, Leimig T, et al. Predominance and characteristics of Burkitt lymphoma among children with non-Hodgkin lymphoma (NHL) in northeast Brazil. *Leukemia* 1997;11:743-746.
13. Madanat FF, Amr SS, Tarawneh MS, et al. Burkitt's lymphoma in Jordanian children: epidemiological and clinical study. *Trop Med Hyg* 1986;89:189-191.
14. Shad A, Magrath I. Non-Hodgkin's lymphoma. *Pediatric Oncology. Pediatr Clin North Am* 1997;44:863.
15. Magrath IT, Bhatia K. Pathogenesis of small noncleaved cell lymphomas (Burkitt's lymphoma). In: Magrath IT, ed. Chapter 16, pp 385-409.
16. Gutierrez MI, Bhatia K, Barriga F, et al. Molecular epidemiology of Burkitt's lymphoma from South America: differences in breakpoint location and Epstein-Barr virus association from tumors in other world regions. *Blood* 1992;79:3261-3266.
17. Kuhn-Hallek I, Sage DR, Stein L, et al. Expression of recombination activating genes (RAG-1 and RAG-2) in Epstein-Barr virus-bearing B-cells. *Blood* 1995;85:1289-1299.
18. Wilson JB, Levine AJ. The oncogenic potential of Epstein-Barr virus nuclear antigen 1 in transgenic mice. *Curr Top Microbiol Immunol* 1992;182:375-385.
19. Ruf IK, Rhyne PW, Yang H, et al. Epstein-Barr virus regulates c-MYC, apo-ptosis, and tumorigenicity in Burkitt lymphoma. *Mol Cell Biol* 1999; 19(3):1651-1660.
20. Taylor AMR, Metcalfe JA, Thick J, Mak YF. Leukemia and lymphoma in ataxia telangiectasia. *Blood* 1996;87:423-438.
21. Ellaurie M. Lymphoma in pediatric HIV infection. *Pediatr Res* 1989;25:884(abst).
22. Murphy SB, Jenson HB, McClain KL, et al. AIDS related tumors. *Med Pediatr Oncol* 1997;29:381.
23. McClain KL, Joshi VV, Murphy SB. Cancers in children with HIV infection. *Hematol Oncol Clin North Am* 1996;10:1189.
24. Pluda JM, Yarchoan R, Jaffe ES, et al. Development of non-Hodgkin lymphoma in a cohort of patients with severe human immunodeficiency virus (HIV) infection on long-term antiretroviral therapy. *Ann Intern Med* 1990;113:276.
25. Filipovich AH, Heinitz KJ, Robison LL, Frizzera G. The immunodeficiency cancer registry. A research resource. *Am J Pediatr Hematol Oncol* 1987;9:183-184.
26. Gatti RA, Good RA. Occurrence of malignancy in immunodeficiency disease. A literature review. *Cancer* 1971;28:89-98.
27. Garrett KM, Hoffer FA, Behm FG, et al. Interventional radiology techniques for the diagnosis of lymphoma or leukemia. *Pediatr Radiol* 2002;32:653-662.
28. Williams AH, Taylor CR, Higgins GR, et al. Childhood lymphoma-leukemia: I. Correlation of morphology and immunological studies. *Cancer* 1978;42:171-181.
29. Mitchell CD, Gordon I, Chessells JM. Clinical, haematological and radiological features in T-cell lymphoblastic malignancy in childhood. *Clin Radiol* 1986;37:257-261.
30. Head DR, Behm FG. Acute lymphoblastic leukemia and the lymphoblastic lymphomas of childhood. *Semin Diagn Pathol* 1995;12(4):325-334.
31. Harris NL, Jaffe ES, Stein H, et al. A revised European-American classification of lymphoid neoplasms: a proposal from the International Lymphoma Study Group. *Blood* 1994;84(5):1361-1392.
32. Jaffe ES, Harris NL, Stein H, Vardiman JW, eds. World Health Organization classification of tumours.

Pathology and genetics of tumours of haematopoietic and lymphoid tissues. Lyon: IARC Press, 2001.

33. Murphy SB. Childhood non-Hodgkin's lymphoma. *N Engl J Med* 1978;299:1446-1448.
34. Weinstein MJ, Cassidy JR, Levey R. Long-term results of the APO (vincristine, doxorubicin [adriamycin], and prednisone) protocol for treatment of mediastinal lymphoblastic lymphoma. *J Clin Oncol* 1983;1:537-541.
35. Maitra A, McKenna RW, Weinberg AG, et al. Precursor B-cell lymphoblastic lymphoma. A study of nine cases lacking blood and bone marrow involvement and review of the literature. *Am J Clin Pathol* 2001;115:868-875.
36. Lin P, Jones D, Dorfman DM, Medeiros LJ. Precursor B-cell lymphoblastic lymphoma: a predominantly extranodal tumor with low propensity for leukemic involvement. *Am J Surg Pathol* 2000;24:1480-1490.
37. Neth O, Seidemann K, Jansen P, et al. Precursor B-cell lymphoblastic lymphoma in childhood and adolescence: clinical features, treatment, and results in trials NHL-BFM 86 and 90. *Med Pediatr Oncol* 2000;35:20-27.
38. Millot F, Robert A, Bertrand Y, et al. Cutaneous involvement in children with acute lymphoblastic leukemia or lymphoblastic lymphoma. The Children's Leukemia Cooperative Group of the European Organization of Research and Treatment of Cancer (EORTC). *Pediatrics* 1997;100:60-64.
39. Kahwash SB, Qualman SJ. Cutaneous lymphoblastic lymphoma in children: report of six cases with precursor B-cell lineage. *Pediatr Dev Pathol* 2002;5:45-53.
40. Bernard A, Boumsell L, Reinherz EL, et al. Cell surface characterization of malignant T cells from lymphoblastic lymphoma using monoclonal antibodies: evidence for phenotypic differences between malignant T cells from patients with acute lymphoblastic leukemia and lymphoblastic lymphoma. *Blood* 1981;57:1105-1110.
41. Weiss LM, Bindl JM, Picozzi VJ, et al. Lymphoblastic lymphoma: an immunophenotype study of 26 cases with comparison to T cell acute lymphoblastic leukemia. *Blood* 1986;67:474-478.
42. Cossmann J, Chused T, Fisher R, et al. Diversity of immunological phenotypes of lymphoblastic lymphoma. *Cancer Res* 1983;43:4486-4490.
43. Sheibani K, Nathwani BN, Winberg CD, et al. Antigenically defined subgroups of lymphoblastic lymphoma. Relationship to clinical presentation and biologic behavior. *Cancer* 1987;60:183-190.
44. Grogan T, Spier C, Wirt DP, et al. Immunologic complexity of lymphoblastic lymphoma. *Diagn Immunol* 1986;4:81-88.
45. Swerdlow SH, Habeshaw JA, Richards MA, et al. T lymphoblastic lymphoma with LEU-7 positive phenotype and unusual clinical course: a multiparameter study. *Leuk Res* 1985;9:167-173.
46. Sheibani K, Winberg CD, Burke JS, et al. Lymphoblastic lymphoma expressing natural killer cell-associated antigens: a clinicopathologic study of six cases. *Leuk Res* 1987;11:371-377.
47. Brazier RM, Keneklis T, Donlan JA, et al. Terminal deoxynucleotidyl transferase in non-Hodgkin's lymphoma. *Am J Clin Pathol* 1983;80:655-659.
48. Kung PC, Long JC, McCaffrey RP, et al. Terminal deoxynucleotidyl transferase in the diagnosis of leukemia and malignant lymphoma. *Am J Med* 1978;64:788-794.
49. Murphy S, Jaffe ES. Terminal transferase activity and lymphoblastic neoplasm. *N Engl J Med* 1984;311:1373-1375.
50. Bearman RM, Winberg CD, Maslow WC, et al. Terminal deoxynucleotidyl transferase activity in neoplastic and nonneoplastic hematopoietic cells. *Am J Clin Pathol* 1981;75:794-802.
51. McCaffrey R, Smoler DF, Baltimore D. Terminal deoxynucleotidyl transferase in a case of childhood

acute lymphoblastic leukemia. *Proc Natl Acad Sci U S A* 1973;70:521–525.

52. Onciu M, Lorsbach RB, Henry C, Behm FG. Terminal deoxynucleotidyl transferase-positive lymphoid cells in reactive lymph nodes from children with malignant tumors: incidence, distribution pattern, and immunophenotype in 26 patients. *Am J Clin Pathol* 2002;118:248–254.
53. Soslow RA, Bhargava V, Warnke RA. MIC2 Tdt, bcl-2, and CD34 expression in paraffin-embedded high-grade lymphoma/acute lymphoblastic leukemia distinguishes between distinct clinicopathologic entities. *Hum Pathol* 1997;28:1158–1165.
54. Pui CH, Rivera GK, Hancock ML, et al. Clinical significance of CD10 expression in childhood acute lymphoblastic leukemia. *Leukemia* 1993;7:35–40.
55. Pui CH, Behm FG, Crist WM. Clinical and biological relevance of immunologic marker studies in childhood acute lymphoblastic leukemia. *Blood* 1993;82:343–362.
56. Roper M, Crist WM, Metzgar R, et al. Monoclonal antibody characterization of surface antigens in childhood T-cell lymphoid malignancies. *Blood* 1983;61:830–837.
57. MaGrath IT. Malignant non-Hodgkin's lymphomas in children. *Hematol Oncol Clin North Am* 1987;1:577–602.
58. Crist WM, Shuster JJ, Falletta J, et al. Clinical features and outcome of T-cell acute lymphoblastic leukemia in childhood with respect to alterations at the TAL1 locus: a Pediatric Oncology Group study. *Blood* 1993;81:2110–2117.
59. Link MP, Roper M, Dorfman RF, et al. Cutaneous lymphoblastic lymphoma with pre-B markers. *Blood* 1983;61:838–841.
60. Borowitz MJ, Croker BP, Metzgar RS. Lymphoblastic lymphoma with the phenotype of common acute lymphoblastic leukemia. *Am J Clin Pathol* 1983;79:387–391.
61. Stroup R, Sheibani K, Misset JL, et al. Surface immunoglobulin-positive lymphoblastic lymphoma. A report of three cases. *Cancer* 1990;65:2559–2563.
62. Gouttefangeas C, Bensussan A, Boumsell L. Study of the CD3-associated T-cell receptors reveals further differences between T-cell acute lymphoblastic lymphoma and leukemia. *Blood* 1990;75:931–934.
63. Childs CC, Chrystal CS, Strauchen, et al. Biphenotypic lymphoblastic lymphoma: an unusual tumor with lymphocytic and granulocytic differentiation. *Cancer* 1986;57:1019–1023.
64. Somers GR, Slater H, Rockman S, et al. Coexistent T-cell lymphoblastic lymphoma and an atypical myeloproliferative disorder associated with t(8;13)(p21;q14). *Pediatr Pathol Lab Med* 1997;17:141–158.
65. Thandla S, Alashari M, Green DM, et al. Therapy-related T cell lymphoblastic lymphoma with t(11;19)(q23;p13) and MLL gene rearrangement. *Leukemia* 1999;13:2116–2118.
66. Nagano M, Kimura N, Akiyoshi T, et al. T-stem cell leucemia/lymphoma with both myeloid lineage conversion and T-specific delta recombination. *Leuk Res* 1997;21(8):763–773.
67. Thomas DA, Kantarjian HM. Lymphoblastic lymphoma. *Hematol Oncol Clin North Am* 2001;15:51–95.
68. Shikano T, Ishikawa Y, Naito H, et al. Cytogenetic characteristics of childhood non-Hodgkin lymphoma. *Cancer* 1992;70:714–719.
69. Kaneko Y, Frizzera G, Shikano T, et al. Chromosomal and immunophenotypic patterns in T cell acute lymphoblastic leukemia (T ALL) and lymphoblastic lymphoma (LBL). *Leukemia* 1989;3:886–892.
70. Kaneko Y, Frizzera G, Maseki N, et al. A novel translocation, t(2;5)(p23;q35), in childhood phagocytic large T-cell lymphoma mimicking malignant histiocytosis. *Leukemia* 1988;2:745–748.
71. Naeem R, Singer S, Fletcher JA. Translocation t(8;13)(p11;q11–12) in stem cell leukemia/lymphoma of

- T-cell and myeloid lineages. *Genes Chromosomes Cancer* 1995;12:148–151.
72. Inhorn RC, Aster JC, Roach SA, et al. A syndrome of lymphoblastic lymphoma, eosinophilia, and myeloid hyperplasia/malignancy associated with t(8;13)(p11;q11): description of a distinctive clinicopathologic entity. *Blood* 1995;85:1881–1887.
73. Xiao S, Nalabolu SR, Aster JC, et al. FGFR1 is fused with a novel zinc-finger gene, ZNF198, in the t(8;13) leukaemia/lymphoma syndrome. *Nat Genet* 1998;18:84–87.
74. Narita M, Shimizu K, Hayashi Y, et al. Consistent detection of CALM–AF10 chimaeric transcripts in haematological malignancies with t(10;11)(p13;q14) and identification of novel transcripts. *Br J Haematol* 1999;105:928–937.
75. Bohlander SK, Muschinsky V, Schrader K, et al. Molecular analysis of the CALM/AF10 fusion: identical rearrangements in acute myeloid leukemia, acute lymphoblastic leukemia and malignant lymphoma patients. *Leukemia* 2000;14:93–99.
76. Yeoh EJ, Ross MB, Shurtleff S, et al. Classification, subtype discovery and prediction of outcome in pediatric acute lymphoblastic leukemia by gene expression profiling. *Cancer Cell* 2002;1:133–143.
77. Ferrando AA, Neuberg DS, Staunton J, et al. Gene expression signatures define novel oncogenic pathways in T cell acute lymphoblastic leukemia. *Cancer Cell* 2002;1:75–87.
78. Lukes R, Collins R. Immunologic characterization of human malignant lymphomas. *Cancer* 1974;34[4 Suppl]:1488–1503.
79. Bennett JM, Catovsky D, Daniel MT, et al. The morphologic classification of acute lymphoblastic leukemia: concordance among observers and clinical correlations. *Br J Haematol* 1981;41:553–561.
80. Raphael M, Gentihomme O, Tulliez M, et al. Histopathological features of high-grade non-Hodgkin's lymphoma in acquired immunodeficiency syndrome. The French Study Group of Pathology for Human Immunodeficiency Virus-Associated Tumors. *Arch Pathol Lab Med* 1991;115:15–20.
81. Hutchison RE, Finch C, Kepner J, et al. Burkitt lymphoma is immunophenotypically different from Burkitt-like lymphoma in young persons. *Ann Oncol* 2000;11[Suppl 1]:35–38.
82. Harris NL, Jaffe ES, Diebold J, et al. The World Health Organization classification of hematological malignancies report of the Clinical Advisory Committee Meeting. *J Clin Oncol* 1999;17:3835–3849.
83. Hutchison RE, Murphy SB, Fairclough DL, et al. Diffuse small noncleaved cell lymphoma in children, Burkitt's versus non-Burkitt's types. Results from the Pediatric Oncology Group and St. Jude Children's Research Hospital. *Cancer* 1989;64:23–28.
84. Behm FG, Campana D. Immunophenotyping. In: Pui CH, ed. *Childhood leukemias*. New York: Cambridge University Press, 1999:111–141.
85. Falini B, Fizzotti M, Pileri S, et al. Bcl-6 protein expression in normal and neoplastic lymphoid tissue. *Ann Oncol* 1997;8[Suppl 2]:101–104.
86. Navid F, Mosijczuk AD, Head DR, et al. Acute lymphoblastic leukemia with the (8;14)(q24;q32) translocation and FAB L3 morphology associated with a B-precursor immunophenotype: the Pediatric Oncology Group experience. *Leukemia* 1999;13(1):135–141.
87. Loh ML, Samson Y, Motte E, et al. Translocation (2;8)(p12;q24) associated with a cryptic t(12;21)(p13;q22) TEL/AML1 gene rearrangement in a child with acute lymphoblastic leukemia. *Cancer Genet Cytogenet* 2000;122(2):79–82.
88. Kornblau SM, Goodacre A, Cabanillas F. Chromosomal abnormalities in adult non-endemic Burkitt's lymphoma and leukemia: 22 new reports and a review of 148 cases from the literature. *Hematol Oncol* 1991;9:63–78.
89. Krolewski JJ, Dalla-Favera R. Molecular genetic approaches in the diagnosis and classification of lymphoid malignancies. *Hematol Pathol* 1989;3(2):45–61.

90. Nishida K, Ritterbach J, Repp R, et al. Characterization of chromosome 8 abnormalities by fluorescence in situ hybridization in childhood B-acute lymphoblastic leukemia/non-Hodgkin lymphoma. *Cancer Genet Cytogenet* 1995;79:8-14.
91. Mora J, Filippa DA, Thaler HT, et al. Large cell non-Hodgkin lymphoma of childhood: analysis of 78 consecutive patients enrolled in 2 consecutive protocols at the Memorial Sloan-Kettering Cancer Center. *Cancer* 2000;88(1): 186-197.
92. Wright D, McKeevr P, Carter R. Childhood non-Hodgkin lymphomas in the United Kingdom: findings from the UK Children's Cancer Study Group. *J Clin Pathol* 1997;50:128-134.
93. Sandlund J, Pui CH, Santana V, et al. Clinical features and treatment outcome for children with CD30+ large-cell non-Hodgkin's lymphoma. *J Clin Oncol* 1994;12:895-898.
94. Rubie H, Gladiëff L, Robert A, et al. Childhood anaplastic large cell lymphoma Ki-1/CD30 clinicopathologic features of 19 cases. *Med Pediatr Oncol* 1994;22:155-161.
95. Fraga M, Brousset P, Schlaifer D, et al. Bone marrow involvement in anaplastic large cell lymphoma. Immunohistochemical detection of minimal disease and its prognostic significance. *Am J Clin Pathol* 1995;103:82-89.
96. Benharroch D, Meguerian-Bedoyan Z, Lamant L, et al. ALK-positive lymphoma: a single disease with a broad spectrum of morphology. *Blood* 1998;91:2076-2084.
97. Stein H. Ki-1-anaplastic large cell lymphoma: is it a discrete entity? *Leuk Lymphoma* 1993;10:81-84.
98. Peleri S, Falini B, Delsol G, et al. Lymphohistiocytic T-cell lymphoma (anaplastic large cell lymphoma CD30+/Ki-1+ with a high content of reactive histiocytes). *Histopathology* 1990;16:383-391.
99. Brugieres L, Le Deley MC, Pacquement H, et al. CD30+ anaplastia large-cell lymphoma in children: analysis of 82 patients enrolled in two consecutive studies of the French Society of Pediatric Oncology. *Blood* 1998;92:3591-3598.
100. Sandlund JT, Roberts WM, Pui CH, et al. Systemic hemophagocytosis masking the diagnosis of large cell non-Hodgkin lymphoma. *Med Pediatr Oncol* 1997;29:167-169.
101. Blatt J, Weston B, Belhorn T, et al. Childhood non-Hodgkin lymphoma presenting as hemophagocytic syndrome. *Pediatr Hematol Oncol* 2002;19:45-49.
102. Kinney MC, Collins RD, Greer JP, et al. A small-cell-predominant variant of primary Ki-1 (CD30)+ T-cell lymphoma. *Am J Surg Pathol* 1993;17(9):859-868.
103. Mann KP, Hall B, Kamino H, et al. Neutrophil-rich, Ki-1-positive anaplastic large-cell malignant lymphoma. *Am J Surg Pathol* 1995;19(4):407-416.
104. McCluggage WG, Walsh MY, Bharucha H. Anaplastic large cell malignant lymphoma with extensive eosinophilic or neutrophilic infiltration. *Histopathology* 1998;32:110-115.
105. Simonart T, Kentos A, Renoirte C, et al. Cutaneous involvement by neutrophil-rich, CD30-positive anaplastic large cell lymphoma mimicking deep pustules. *Am J Surg Pathol* 199;23:244-246.
106. Burg G, Kempf W, Kazakov DV, et al. Pyogenic lymphoma of the skin: a peculiar variant of primary cutaneous neutrophil-rich CD30+ anaplastic large-cell lymphoma. Clinicopathological study of four cases and review of the literature. *Br J Dermatol* 2003;148(3):580-586.
107. Chan JK, Buchanan R, Fletcher CD. Sarcomatoid variant of anaplastic large-cell Ki1 lymphoma. *Am J Surg Pathol* 1990;14:983-988.
108. Falini B, Liso A, Pasqualucci L, et al. CD30+ anaplastia large cell lymphoma, null type, with signet-ring appearance. *Histopathology* 1997;30:90-92.
109. Piccaluga PP, Ascani S, Fraternali Orcioni G, et al. ALK expression as a marker of malignancy.

Application to a case of anaplastic large cell lymphoma with high granulomatous reaction. *Haematologica* 2000;85:978–981.

110. Falini B. Anaplastic large cell lymphoma: pathological, molecular and clinical features. *Br J Haematol* 2001;114:741–760.

111. Stein H, Foss HD, Durkop H, et al. CD30-positive anaplastic large cell lymphoma: a review of its histopathological, genetic, and clinical features. *Blood* 2000;96:3681–3695.

112. Delsol GA, Al Saati T, Gatter KC, et al. Coexpression of epithelial membrane antigen (EMA), Ki-1, and interleukin-2 receptor by anaplastic large cell lymphoma. Diagnostic value in so-called malignant histiocytosis. *Am J Pathol* 1998;130:59–70.

113. Wellmann A, Thieblemont C, Pittaluga S, et al. Detection of differentially expressed genes in lymphomas using cDNA arrays: identification of clusterin as a new diagnostic marker for anaplastic large-cell lymphomas. *Blood* 2000;96(2):398–404.

114. Kaneko Y, Frizzera G, Edamura S, et al. A novel translocation, t(2;5)(p23;q35), in childhood phagocytic large T-cell lymphoma mimicking malignant histiocytosis. *Blood* 1989;73:806–813.

115. Mason DY, Bastard C, Rimokh R, et al. CD30-positive large cell lymphomas (‘Ki-1 lymphoma’) are associated with a chromosomal translocation involving 5q35. *Br J Haematol* 1990;74:161–168.

116. Rosenwald A, Ott G, Pullford K, et al. t(1;2)(q21;p23) and t(2;3)(p23;q21): two novel variant translocations of the t(2;5)(p23;q35) in anaplastic large cell lymphoma. *Blood* 1999;94(1):362–364.

117. Lamant L, Dastugue N, Pullford K, et al. A new fusion gene TPM3-ALK in anaplastic large cell lymphoma created by a (1;2)(q25;p23) translocation. *Blood* 1999;93:3088–3095.

118. Colleoni GW, Bridge JA, Garicochea B, et al. ATIC-ALK: A novel variant ALK gene fusion in anaplastic large cell lymphoma resulting from the recurrent cryptic chromosomal inversion, inv(2)(p23q35). *Am J Pathol* 2000;156:781–789.

119. Meech SJ, McGavaran L, Odom LF, et al. Unusual childhood extramedullary hematologic malignancy with natural killer cell properties that contains tropomyosin 4-anaplastic lymphoma kinase gene fusion. *Blood* 2001;98:1209–1216.

120. Morris SW, Kirstein MN, Valentine MB, et al. Fusion of a kinase gene, ALK, to a nucleolar protein gene, NPM, in non-Hodgkin’s lymphoma. *Science* 1994;263:1281–1284.

121. Touriol C, Greenland C, Lamant L, et al. Further demonstration of the diversity of chromosomal changes involving 2p23 in ALK-positive lymphoma: 2 cases expressing ALK kinase fused to CLTCL (clathrin chain polypeptide-like). *Blood* 2000;95:3204–3207.

122. Lamant L, Meggetto F, Al Saati TA, et al. High incidence of the t(2;5)(p23;q35) translocation in anaplastic large cell lymphoma and its lack of detection in Hodgkin’s disease. Comparison of cytogenetic analysis, reverse transcriptase-polymerase chain reaction, and P-80 immunostaining. *Blood* 1996;87(1):284–291.

123. Pullford K, Lamant L, Morris SW, et al. Detection of anaplastic lymphoma kinase (ALK) and nucleolar protein (NPM)-ALK proteins in normal and neoplastic cells with the monoclonal antibody ALK1. *Blood* 1997;89:1394–1404.

124. Lamant L, Pullford K, Bischof D, et al. Expression of the ALK tyrosine kinase gene in neuroblastoma. *Am J Pathol* 2000;156:1711–1721.

125. Lawrence B, Perez-Atayde A, Hibbard MK, et al. TPM3-ALK and TPM4-ALK oncogenes in inflammatory myofibroblastic tumors. *Am J Pathol* 2000;157:377–384.

126. Cessna MH, Zhou H, Sanger WG, et al. Expression of ALK1 and p80 in inflammatory myofibroblastic tumor and its mesenchymal mimics: a study of 135 cases. *Mod Pathol* 2002;15:931–938.

127. van den Berg H, Noorduynd A, van Kullenburg ABP, et al. Leukaemic expression of anaplastic large cell lymphoma with 46,XX,ins(2;5)(p23;q15q35) in a child with dihydropyrimidine dehydrogenase deficiency.

Leukemia 2000(4):769–770.

128. Anderson MM, Ross CW, Singleton TP, et al. Ki-1 anaplastic large cell lymphoma with a prominent leukemic phase. *Hum Pathol* 1996;27:1093–1095.
129. Villamor N, Rozman M, Esteve J, et al. Anaplastia large-cell lymphoma with rapid evolution to leukemic phase. *Ann Hematol* 1999;78:478–482.
130. Bayle C, Charpentier A, Duchayne E, et al. Leukaemic presentation of small cell variant anaplastic large cell lymphoma: report of four cases. *Br J Haematol* 1999;104:680–688.
131. Chacnabhai M, Britten C, Klasa R, Gascoyne RD. t(2;5) positive lymphoma with peripheral blood involvement. *Leuk Lymphoma* 1998;28:415–422.
132. Siota M, Nakamura S, Ichinohasama R, et al. Anaplastic large cell lymphomas expressing the novel chimeric protein p80NPM/ALK: a distinct clinicopathologic entity. *Blood* 1995;86:1954–1960.
133. Faini B, Bigerna B, Pizzotti M, et al. ALK expression defines a distinct group of t/null lymphomas ('ALK lymphoma') with a wide morphologic spectrum. *Am J Pathol* 1998;153:875–886.
134. Gascoyne RD, Aoun P, Wu D, et al. Prognostic significance of anaplastic lymphoma kinase (ALK) protein expression in adults with anaplastic large cell lymphoma. *Blood* 1999;93(11):3913–3921.
135. Reiter A, Schrappe M, Tiemann M, et al. Successful treatment strategy for Ki-1 anaplastic large-cell lymphoma of childhood: a prospective analysis of 62 patients enrolled in three consecutive Berlin–Frankfurt–Munster group studies. *J Clin Oncol* 1994;12(5):899–908.
136. Reiter A, Tiemann M, Schrappe M, et al. A short pulse chemotherapy is an efficient treatment for anaplastic large cell lymphoma of childhood: report of the German–Austrian–Swiss trial NHL–BFM 90. *Med Pediatr Oncol* 1997;29:357.
137. Le Deley MC, Reiter A, Williams D, et al. Prognostic factors in childhood anaplastic large cell lymphoma: results of the European Intergroup Study. *Ann Oncol* 1999;10[Suppl 3]:28.
138. Williams DM, Hobson R, Imeson J, et al. Anaplastic large cell lymphoma in childhood: analysis of 72 patients treated on The United Kingdom Children's Cancer Study Group chemotherapy regimens. *Br J Haematol* 2002;117(4):812–820.
139. Lones MA, Auperin A, Raphael M, et al. Mature B-cell lymphoma/leucemia in children and adolescents: intergroup pathologist consensus with the revised European–American Lymphoma Classification. *Ann Oncol* 2000;11:47–51.
140. Salar A, Fernandez de Sevilla A, Romagnosa V, et al. Diffuse large B-cell lymphoma: is morphologic subdivision useful in clinical management? *Eur J Haematol* 1998;60:202–208.
141. Delsol G, Lamant L, Mariame B, et al. A new subtype of large B-cell lymphoma expressing the ALK kinase and lacking the 2;5 translocation. *Blood* 1997;89:1483–1490.
142. Oncin M (personal communication).
143. Lones MA, Cairo MS, Perkins SL. T-cell-rich large B-cell lymphoma in children and adolescents: a clinicopathologic report of six cases from the Children's Cancer Group Study CCG-5961. *Cancer* 2000;88(10):2378–2386.
144. Lim MS, Beaty M, Sorbara L, et al. T-cell/histiocyte-rich large B-cell lymphoma: a heterogeneous entity with derivation from germinal center B cells. *Am J Surg Pathol* 2002;26(11):1458–1466.
145. Hutchison RE, Fairclough DL, Holt H, et al. Clinical significance of histology and immunophenotype in childhood diffuse large cell lymphoma. *Am J Clin Pathol* 1991;95(6):787–793.
146. Alizadeh AA, Eisen MB, Davis RE, et al. Distinct types of diffuse large B-cell lymphoma identified by gene expression profiling. *Nature* 2000;405:503–511.



147. Rosenwald A, Wright G, Chang WC, et al. The use of molecular profiling to predict survival after chemotherapy for diffuse large B-cell lymphoma. *N Engl J Med* 2002;346:1937–1947.
148. Davis RE, Staudt LM. Molecular diagnosis of lymphoid malignancies by gene expression profiling. *Curr Opin Hematol* 2002;9:333–338.
149. Shipp MA, Ross KN, Tamayo P, et al. Diffuse large B-cell lymphoma outcome prediction by gene-expression profiling and supervised machine learning. *Nat Med* 2002;8(1):68–74.
150. Lazzarino M, Orlandi E, Paulli M, et al. Treatment outcome and prognostic factors for primary mediastinal (thymic) B-cell lymphoma: a multicenter study of 106 patients. *J Clin Oncol* 1997;15(4):1646–1653.
151. Zanzani PL, Bendandi M, Frezza G, et al. Primary mediastinal B-cell lymphoma with sclerosis: clinical and therapeutic evaluation of 22 patients. *Leuk Lymphoma* 1996;21:311–316.
152. Pauli M, Lazzarino M, Gianelli U, et al. Primary mediastinal B-cell lymphoma: update of its clinicopathologic features. *Leuk Lymphoma* 1997;26:115–123.
153. Lones MA, Perkins SL, Sposto R, et al. Large-cell lymphoma arising in the mediastinum in children and adolescents is associated with an excellent outcome: a Children's Cancer Group report. *J Clin Oncol* 2000;18:3845–3853.
154. Van Besien K, Kelta M, Bahaguna. Primary mediastinal B-cell lymphoma: a review of pathology and management. *J Clin Oncol* 2001;19:1855–1864.
155. Abou-Ellela AA, Weinburger DD, Vose JM, et al. Primary mediastinal large B-cell lymphoma: a clinicopathologic study of 43 patients from the Nebraska Lymphoma Study Group. *J Clin Oncol* 1999;17:784–790.
156. Pauli M, Strater J, Gianelli U, et al. Mediastinal B-cell lymphoma: a study of its histomorphologic spectrum based on 109 cases. *Hum Pathol* 1999;30:178–187.
157. de Leval L, Ferry JA, Falini B, et al. Expression of bcl-6 and CD10 in primary mediastinal large B-cell lymphoma: evidence for derivation from germinal center B cells? *Am J Surg Pathol* 2001;25:1277–1282.
158. Kanavaros P, Gaulard P, Charlotte F, et al. Discordant expression of immunoglobulin and its associated molecule mb-1/CD79a is frequently found in mediastinal large B cell lymphomas. *Am J Pathol* 1995;146:735–741.
159. Lamarre L, Jacobson JO, Aisenberg AC, et al. Primary large cell lymphoma of the mediastinum: a histologic and immunophenotypic study of 29 cases. *Am J Surg Pathol* 1989;13:730–739.
160. Higgins JP, Warnke RA. CD30 expression is common in mediastinal large B-cell lymphoma. *Am J Clin Pathol* 1999;112:241–247.
161. Kuppers R, Rajewsky K, Hansmann ML, et al. Diffuse large cell lymphomas are derived from mature B cells carrying V region genes with a high load of somatic mutation and evidence of selection for antibody expression. *Eur J Immunol* 1997;27:1398–1405.
162. Bentz M, Barth TF, Bruderlein S, et al. Gain of chromosome arm 9p is characteristic of primary mediastinal B-cell lymphoma (MBL): comprehensive molecular cytogenetic analysis and presentation of a novel MBL cell line. *Genes Chromosomes Cancer* 2001;30:393–401.
163. Palanisamy N, Abou-Ellella AA, Chaganti SR, et al. Similar patterns of genomic alterations characterize primary mediastinal large-B-cell lymphoma and diffuse large-B-cell lymphoma. *Genes Chromosomes Cancer* 2002;33:114–122.
164. Joos S, Otano-Joos MI, Ziegler S, et al. Primary mediastinal (thymic) B-cell lymphoma is characterized by gains of chromosomal material including 9p and amplification of the REL gene. *Blood* 1996;87:1571–1578.
165. Scarpa A, Moore PS, Riguid G, et al. Molecular features of primary mediastinal B-cell lymphoma:

involvement of p16INK4A, p53, and c-myc. *Br J Haematol* 1999;170:106–113.

166. Tsang P, Cesarman E, Chadburn A, et al. Molecular characterization of primary mediastinal B cell lymphoma. *Am J Pathol* 1996;148:2017–2025.

167. Frizzera G, Murphy SB. Follicular (nodular) lymphoma in childhood: a rare clinical–pathological entity. Report of eight cases from four cancer centers. *Cancer* 1979;44:2218–2235.

168. Murphy SB, Fairclough DL, Hutchison RE, Berard CW. Non-Hodgkin's lymphomas of childhood: an analysis of the histology, staging, and response to treatment of 338 cases at a single institution. *J Clin Oncol* 1989;7:186–193.

169. Pinto A, Hutchison RE, Grant LH, et al. Follicular lymphomas in pediatric patients. *Mod Pathol* 1990;3:308–313.

170. Ribeiro RC, Pui CH, Murphy SB, et al. Childhood malignant non-Hodgkin's lymphomas of uncommon histology. *Leukemia* 1992;6:761–765.

171. Atra A, Meller ST, Stevens RS, et al. Conservative management of follicular non-Hodgkin's lymphoma in childhood. *Br J Haematol* 1998;103:320–323.

172. Lorsbach RB, Shay-Seymore D, Moore J, et al. Clinicopathologic analysis of follicular lymphoma occurring in children. *Blood* 2002;99:1959–1964.

173. Moertel CL, Watterson J, McCormick SR, Simonton SC. Follicular large cell lymphoma of the testis in a child. *Cancer* 1995;75:1182–1186.

174. Finn LS, Viswanatha DS, Belasco JB, et al. Primary follicular lymphoma of the testis in childhood. *Cancer* 1999;85:1626–1635.

175. Lu D, Medeiros LJ, Eskenazi AE, Abruzzo LV. Primary follicular large cell lymphoma of the testis in a child. *Arch Pathol Lab Med* 2001;125:551–554.

176. Pakzad K, MacLennan GT, Elder JS, et al. Follicular large cell lymphoma localized to the testis in children. *J Urol* 2002;168:225–228.

177. Lai R, Larratt LM, Etches W, et al. Hepatosplenic T-cell lymphoma of alphabeta lineage in a 16-year-old boy presenting with hemolytic anemia and thrombocytopenia. *Am J Surg Pathol* 2000;24:45–63.

178. Weidmann E. Hepatosplenic T cell lymphoma. A review on 45 cases since the first report describing the disease as a distinct lymphoma entity in 1990. *Leukemia* 2000;14:991–997.

179. Suarez F, Wlodarska I, Rigal-Huguet F, et al. Hepatosplenic alpha-beta T-cell lymphoma: an unusual case with clinical, histologic, and cytogenetic features of gamma-delta hepatosplenic T-cell lymphoma. *Am J Surg Pathol* 2000;24:1027–1032.

180. Cooke CB, Krenacs L, Steltler-Stevenson M, et al. Hepatosplenic T-cell lymphoma: a distinct clinicopathologic entity of cytotoxic gamma delta T-cell origin. *Blood* 1996;88:4265–4274.

181. Macon WR, Levy NB, Kurtin PJ, et al. Hepatosplenic  $\alpha\beta$  T-cell lymphomas. *Am J Surg Pathol* 2001;25:285–296.

182. Farcet J, Gaulard P, Marolleau J, et al. Hepatosplenic T-cell lymphoma: sinusal/sinusoidal localization of malignant cells expressing the T-cell receptor  $\alpha\beta$ . *Blood* 1990;75:2213–2219.

183. Francosis A, Lesesve JF, Stamatoullas A, et al. Hepatosplenic gamma/delta T-cell lymphoma: a report of two cases in immunocompromised patients associated with isochromosome 7q. *Am J Surg Pathol* 1997;21:781–790.

184. Ross CW, Schnitzer B, Scheldon S, et al.  $\gamma\delta$  T-cell posttransplantation lymphoproliferative disorder primarily in the spleen. *Am J Clin Pathol* 1994;102:310–315.

185. Khan WA, Yu L, Eisenbrey AB, et al. Hepatosplenic gamma/delta T-cell lymphoma in

- immunocompromised patients. Report of two cases and review of literature. *Am J Clin Pathol* 2001;116(1):41–50.
186. Steurer M, Stauder R, Grunewald K, et al. Hepatosplenic gammadelta-T-cell lymphoma with leukemic course after renal transplantation. *Hum Pathol* 2002;33:253–258.
187. Wang CC, Tien HF, Kin MT, et al. Consistent presence of isochromosome 7q in hepatosplenic T gamma/delta lymphoma: a new cytogenetic-clinicopathologic entity. *Genes Chromosomes Cancer* 1995;12:161–164.
188. Vega F, Medeiros LJ, Bueso-Ramos C, et al. Hepatosplenic gamma/delta T-cell lymphoma in bone marrow. A sinusoidal neoplasm with blastic cytologic features. *Am J Clin Pathol* 2001;116(3):410–419.
189. Salhany KE, Feldman M, Kahn MJ, et al. Hepatosplenic gammadelta T-cell lymphoma: ultrastructural, immunophenotypic, and functional evidence for cytotoxic T lymphocyte differentiation. *Hum Pathol* 1997;28:674–685.
190. Nosari A, Oreste PL, Biondi A, et al. Hepato-splenic gammadelta T-cell lymphoma: a rare entity mimicking the hemophagocytic syndrome. *Am J Hematol* 1999;60(1):61–65.
191. Felger RE, Macon WR, Kinney MC, et al. TIA-1 expression in lymphoid neoplasm, identification of subsets with cytotoxic T lymphocyte or natural killer cell differentiation. *Am J Pathol* 1997;150:1893–1900.
192. Boulland ML, Kanavaros P, Wechsler J, et al. Cytotoxic protein expression in natural killer cell lymphomas and in alpha beta and gamma delta peripheral T-cell lymphomas. *J Pathol* 1997;183:432–439.
193. Joneaux P, Daniel MT, Martel V, et al. Isochromosome 7q and trisomy 8 are consistent primary, non-random chromosomal abnormalities associated with hepatosplenic T gamma/delta lymphoma. *Leukemia* 1996;10:1453–1455.
194. Coventry S, Punnett HH, Tomeczak EZ, et al. Consistency of isochromosome 7q and trisomy 8 in hepatosplenic gammadelta T-cell lymphoma: detection by fluorescence in situ hybridization of a splenic touch-preparation from a pediatric patient. *Pediatr Dev Pathol* 1999;2:478–483.
195. Wlodarska I, Martin-Garcia N, Achten R, et al. Fluorescence in situ hybridization study of chromosome 7 aberrations in hepatosplenic T-cell lymphoma: isochromosome 7q as a common abnormality accumulating in forms with features of cytologic progression. *Genes Chromosomes Cancer* 2002;33:243–251.
196. Rossbach HC, Chamizo W, Dumont DP, et al. Hepatosplenic gamma/delta T-cell lymphoma with isochromosome 7q, translocation t(7;21), and tetrasomy 8 in a 9-year-old girl. *J Pediatr Hematol Oncol* 2002;24:154–157.
197. Przybylski GK, Wu H, Macon WR, et al. Hepatosplenic and subcutaneous panniculitis-like gamma/delta T cell lymphomas are derived from different Vdelta subsets of gamma/delta T lymphocytes. *J Mol Diagn* 2000;2:11–19.
198. Ohshima K, Haraoka S, Harada N, et al. Hepatosplenic gammadelta T-cell lymphoma: relation to Epstein-Barr virus and activated cytotoxic molecules. *Histopathology* 2000;36:127–135.
199. Garcia-Sanchez F, Menarguez J, Cristobal E, et al. Hepatosplenic gamma-delta T-cell malignant lymphoma: report of the first case in childhood, including molecular minimal residual disease follow-up. *Br J Haematol* 1995;90:943–946.
200. Agnarrsson BA, Kadin ME. Peripheral T-cell lymphomas in children. *Semin Diagn Pathol* 1995;12:314–324.
201. El-Hoshy K, Hashimoto K. Adolescence mycosis fungoides: an unusual presentation with hypopigmentation. *J Dermatol* 1995;22:424–427.
202. Grunwald MH, Amichai B. Localized hypopigmented mycosis fungoides in a 12-year-old Caucasian boy. *J Dermatol* 1999;26:70–71.
203. Schmid H, Dummer R, Kempf W, et al. Mycosis fungoides with mucinous follicularis in childhood.

Dermatology 1999;198:284–287.

204. Garzon MC. Cutaneous T cell lymphoma in children. *Semin Cutan Med Surg* 1999;18:226–232.

205. Tan E, Tay YK, Giam YC. Profile and outcome of childhood mycosis fungoides in Singapore. *Pediatr Dermatol* 2000;17:352–356.

206. Neuhaus IM, Ramos-Caro FA, Hassanein AM. Hypopigmented mycosis fungoides in childhood and adolescence. *Pediatr Dermatol* 2000;17:403–406.

207. Whittam LR, Calonje E, Orchard G, et al. CD8-positive juvenile onset mycosis fungoides: an immunohistochemical and genotypic analysis of six cases. *Br J Dermatol* 2000;143:1199–1204.

208. Gold BD. Helicobacter pylori prevalence infection in children. *Curr Gastroentrol Rep* 2001;3:235–247.

209. Thomson AB, McKenzie KJ, Jackson R, Wallace WH. Subcutaneous panniculitic T-cell lymphoma in childhood: successful response to chemotherapy. *Med Pediatr Oncol* 2001;37:549–552.

210. Sen F, Rassidakis GZ, Jones D, et al. Apoptosis and proliferation in subcutaneous panniculitis-like T-cell lymphoma. *Mod Pathol* 2002;15:625–631.

211. Lewis JM, Vasef MA, Seabury Stone M. HTLV-I-associated granulomatous T-cell lymphoma in a child. *J Am Acad Dermatol* 2001;44:525–529.

212. Broniscer A, Ribeiro RC, Srinivas RV, et al. An adolescent with HTLV-I-associated adult T cell leukemia treated with interferon- $\alpha$  and zidovudine. *Leukemia* 1996;10:1244–1254.

213. Pombo-de-Oliveira MS, Dobbin JA, Loureiro P, et al. Genetic mutation and early onset of T-cell leukemia in pediatric patients infected at birth with HTLV-I. *Leuk Res* 2002;26:155–161.

214. Miyazaki M, Lin YW, Okiada M, et al. Childhood cutaneous natural killer/T-cell lymphoma successfully treated with only one course chemotherapy and incomplete tumor resection. *Haematologica* 2001;86(8):883–884.

215. Ohnuma K, Toyada Y, Nishihira H, et al. Aggressive natural killer (NK) cell lymphoma: report of a pediatric case and review of the literature. *Leuk Lymphoma* 1997;25:387–392.

216. Shaw PH, Cohn SL, Morgan ER, et al. Natural killer cell lymphoma: report of two pediatric cases, therapeutic options, and review of the literature. *Cancer* 2001;91:642–646.

217. Kadin ME. Ki-1-positive anaplastic large-cell lymphoma: a clinicopathologic entity? *J Clin Oncol* 1991;9:533–536.

218. Kadin ME. Ki-1/CD30+ (Anaplastic) large-cell lymphoma: maturation of a clinicopathologic entity with prospects of effective therapy. *J Clin Oncol* 1994;12:884–887.

219. Naumann R, Vaic A, Beuthien-Baumann B, et al. Prognostic value of positron emission tomography in the evaluation of post-treatment residual mass in patients with Hodgkin's disease and non-Hodgkin's lymphoma. *Br J Haematol* 2001;115(4):793–800.

220. Pui CH, Mahmoud HH, Wiley JM, et al. Recombinant urate oxidase for the prophylaxis or treatment of hyperuricemia in patients with leukemia or lymphoma. *J Clin Oncol* 2001;19:697–704.

221. Anderson JR, Jenkin RDT, Wilson JF, et al. Long-term follow-up of patients treated with COMP or LSA2-L2 therapy for childhood non-Hodgkin's lymphoma: a report of CCG-551 from the Childrens Cancer Group. *J Clin Oncol* 1993;11:1024–1032.

222. Wollner N, Burchenal JH, Liebermann PH. Non-Hodgkin's lymphoma in children: a comparative study of two modalities of therapy. *Cancer* 1976;37:123.

223. Sullivan MP, Boyett J, Pullen J, et al. Pediatric Oncology Group experience with modified LSA2-L2 therapy in 107 children with non-Hodgkin's lymphoma (Burkitt's lymphoma excluded). *Cancer*

1985;55:323–336.

224. Sandlund JT, Santana V, Abromowitch M, et al. Large cell non-Hodgkin lymphoma of childhood: clinical characteristics and outcome. *Leukemia* 1994;8:30–34.

225. Hutchison RE, Berard CW, Shuster JJ, et al. B-Cell Lineage Confers a Favorable Outcome Among Children and Adolescents With Large-Cell Lymphoma: A Pediatric Oncology Group Study. *J Clin Oncol* 1995;13:2023–2032.

226. Patte C, Auperin A, Michon J, et al. The Société Française d'Oncologie Pédiatrique LMB89 protocol: highly effective multiagent chemotherapy tailored to the tumor burden and initial response in 561 unselected children with B-cell lymphomas and L3 leukemia. *Blood* 2001;97:3370–3379.

227. Murphy SB, Bowman WP, Abromowitch M, et al. Results of treatment of advanced-stage Burkitt's lymphoma and B cell (SIg+) acute lymphoblastic leukemia with high-dose fractionated cyclophosphamide and coordinated high-dose methotrexate and cytarabine. *J Clin Oncol* 1986;4:1732–1739.

228. Murphy SB, Hustu HO, Rivera G, Berard CW. End results of treating children with localized non-Hodgkin's lymphomas with a combined modality approach of lessened intensity. *J Clin Oncol* 1983;1:326–330.

229. Link MP, Shuster JJ, Donaldson SS, et al. Treatment of children and young adults with early-stage non-Hodgkin's lymphoma. *N Engl J Med* 1997;337:1259–1266.

230. Brecher M, Schwenn MR, Coppes MJ, et al. Fractionated cyclophosphamide and back to back high dose methotrexate and cytosine arabinoside improves outcome in patients with stage III high grade small non-cleaved cell lymphomas (SNCCCL): a randomized trial of the Pediatric Oncology Group. *Med Pediatr Oncol* 1997;29:526–533.

231. Bowman WP, Shuster J, Cook B, et al. Improved survival for children with B-cell acute lymphoblastic leukemia and stage IV small noncleaved cell lymphoma: a Pediatric Oncology Group study. *J Clin Oncol* 1996;14:1252–1261.

232. Patte C, Philip T, Rodary C, et al. High survival rate in advanced-stage B-cell lymphomas and leukemias without CNS involvement with a short intensive polychemotherapy: results from the French Pediatric Oncology Society of a randomized trial of 216 children. *J Clin Oncol* 1991;9:123–132.

233. Patte C, Leverger G, Perel Y, et al. Updated results of the LMB86 protocol of the French Pediatric Oncology Society (SFOP) for B-cell non-Hodgkin's lymphomas (B-NHL) with CNS involvement (CNS+) and B-ALL. *Med Pediatr Oncol* 1990;18:397.

234. Reiter A, Schrappe M, Ludwig W. Favorable outcome of B-cell acute lymphoblastic leukemia in childhood: a report of three consecutive studies of the BFM Group. *Blood* 1992;80:2471.

235. Sposto R, Meadows AT, Chilcote RR, et al. Comparison of long-term outcome of children and adolescents with disseminated non-lymphoblastic non-Hodgkin lymphoma treated with COMP or daunomycin-COMP: a report from the Children's Cancer Group. *Med Pediatr Oncol* 2001;37:432–441.

236. Cairo MS, Krailo M, Hutchinson R, et al. Results of a phase II trial of "French" (F) (LMB-86) or "orange" (O) (CCG-hybrid) in children with advanced non-lymphoblastic non-Hodgkin's lymphoma: an improvement in survival. *Proc Am Soc Clin Oncol* 1994;13:392(abst).

237. Magrath IT, Janus C, Edwards BK, et al. An effective therapy for both undifferentiated (including Burkitt's) lymphomas and lymphoblastic lymphomas in children and young adults. *Blood* 1984;63:1102–1111.

238. Schwenn MR, Blattner SR, Lynch E, Weinstein HJ. HiC-COM: A 2-month intensive chemotherapy regimen for children with stage III and IV Burkitt's lymphoma and B-cell acute lymphoblastic leukemia. *J Clin Oncol* 1991;9:133–138.

239. Muller-Wehrich S, Henze G, Odenwald E. BFM trials for childhood non-Hodgkin's lymphomas. In: Cavalli F, Bonadonna G, Rozencweig M, eds. *Malignant lymphomas and Hodgkin's disease: experimental and therapeutic advances*. Boston: Martinus Nijhoff, 1985:633.

240. Dahl GV. A novel treatment of childhood lymphoblastic non-Hodgkin's lymphoma: early and

intermittent use of teniposide plus cytarabine. *Blood* 1985;66:1110–1114.

241. Hvizdala E. Lymphoblastic lymphoma in children—a randomized trial comparing LSA2L2 with the A-COP therapeutic regimen: a POG study. *J Clin Oncol* 1988;6:26–33.

242. Weinstein HJ, Lack EE, Cassady JR. APO therapy for malignant lymphoma of large cell histiocytic type of childhood: analysis of treatment results for 29 patients. *Blood* 1984;64:422–426.

243. Hvizdala EV, Berard C, Callihan T. Nonlymphoblastic lymphoma in children—histology and stage-related response to therapy: a POG study. *J Clin Oncol* 1991;9:1189–1195.

244. Santana VM, Abromowitch M, Sandlund JT, et al. MACOP-B treatment in children and adolescents with advanced diffuse large-cell non-Hodgkin's lymphoma. *Leukemia* 1993;7:187–191.

245. Reiter A, Schrappe M, Tiemann M, et al. Successful treatment strategy for Ki-1 anaplastic large-cell lymphoma of childhood: a prospective analysis of 62 patients enrolled in three consecutive Berlin-Frankfurt-Munster group studies. *J Clin Oncol* 1994;12:899–908.

246. Patte C, Kalifa C, Flamant F, et al. Results of the LMT81 protocol, a modified LSA2L2 protocol with high dose methotrexate, in 84 children with non-B-cell (lymphoblastic) lymphoma. *Med Ped Oncol* 1992;20:105–113.

247. Meadows A, Sposto R, Jenkin R, et al. Similar Efficacy of 6 and 18 Months of Therapy With Four Drugs (COMP) for Localized Non-Hodgkin's Lymphoma of Children: A Report From the Childrens Cancer Study Group. *J Clin Oncol* 1989;7:92–99.

248. Patte C, Philip T, Rodary C, et al. Improved survival rate in children with stage III and IV B cell non-Hodgkin's lymphoma and leukemia using multi-agent chemotherapy: results of a study of 114 children from the French Pediatric Oncology Society. *J Clin Oncol* 1986;4:1219–1226.

249. Tubergen DG, Krailo MD, Meadows AT, et al. Comparison of treatment regimens for pediatric lymphoblastic non-Hodgkin's lymphoma: a Childrens Cancer Group study. *J Clin Oncol* 1995;13:1368–1376.

250. Reiter A, Schrappe M, Parwaresch R, et al. Non-Hodgkin's lymphomas of childhood and adolescence: results of a treatment stratified for biologic subtypes and stage—a report of the Berlin-Frankfurt-Munster Group. *J Clin Oncol* 1995;13:359–372.

251. Reiter A, Schrappe M, Tiemann M, et al. Improved treatment results in childhood B-cell neoplasms with tailored intensification of therapy: a report of the Berlin-Frankfurt-Munster Group Trial NHL-BFM 90. *Blood* 1999;94:3294–3306.

252. Jansen P, Schrappe M, Zimmermann M, et al. Intraventricularly applied chemotherapy and intensive systemic therapy is effective for CNS positive patients with Burkitt-type lymphomas or acute B-cell leukemia (B-ALL). *SIOP XXIX Med Pediatr Oncol* 1997;29:359.

253. Magrath I, Adde M, Shad A, et al. Adult and children with small noncleaved cell lymphoma have a similar excellent outcome when treated with the same chemotherapy regimen. *J Clin Oncol* 1996;14:925–934.

254. Magrath I, Adde M, Venzon D, et al. Additional chemotherapy agents improve treatment outcome for children and young adults with B-cell lymphomas. *SIOP XXIX Med Pediatr Oncol* 1997;29:358.

255. Reiter A, Schrappe M, Ludwig WD, et al. Intensive ALL-type therapy without local radiotherapy provides a 90% event-free survival for children with T-cell lymphoblastic lymphoma: a BFM group report. *Blood* 2000;95:416–421.

256. Patte C, Michon J, Behrendt H, et al. B-cell large cell lymphoma in children, description and outcome when treated with the same regimen as Burkitt. SFOP experience with the LMB 89 protocol. *Ann Oncol* 1996;7.

257. Mann G, Yakan E, Schrappe M, et al. Diffuse large B-cell lymphomas in childhood and adolescence: favorable outcome with a Burkitt's lymphoma directed therapy in trial NHL-BFM 90—a report of the BFM group. *SIOP XXIX Med Pediatr Oncol* 1997;29:358.

258. Patte C. Non-Hodgkin's lymphoma. *Eur J Cancer* 1998;34:359-363.
259. Soussain C, Patte C, Ostronoff M, et al. Small noncleaved cell lymphoma and leukemia in adults. A retrospective study of 65 adults treated with the LMB pediatric protocols. *Blood* 1995;85:664-674.
260. Asselin B, Shuster J, Amylon M, et al. Improved event-free survival (EFS) with high dose methotrexate (HDM) in T-cell lymphoblastic leukemia (T-ALL) and advanced lymphoblastic lymphoma (T-NHL): a Pediatric Oncology Group (POG) study. *Pediatr Oncol* 2001;1464:367a.
261. Murphy SB. Pediatric lymphomas: recent advances and commentary on Ki-1-positive anaplastic large-cell lymphomas of childhood. *Ann Oncol* 1994;5[Suppl 1]:S31-S33.
262. Brugieres L, Le Deley MC, Pacquement H, et al. Anaplastic large cell lymphoma in children: analysis of 63 patients enrolled in two consecutive studies of the SFOP. *SIOP XXIX Med Pediatr Oncol* 1997;29:357.
263. Laver JH, Mahmoud H, Pick TE, et al. Results of a randomized phase III trial in children and adolescents with advanced stage diffuse large cell non-Hodgkin's lymphoma: a Pediatric Oncology Group study. *Leuk Lymphoma* 2002;43:105-109.
264. Reiter A, Schrappe M, Tiemann M, et al. Improved treatment results in childhood B-cell neoplasms with tailored intensification of therapy: a report of the Berlin-Frankfurt-Münster Group Trial NHL-BFM 90. *Blood* 1999;94:3294-3306.
265. Amylon MD, Shuster J, Pullen J, et al. Intensive high-dose asparaginase consolidation improves survival for pediatric patients with T cell acute lymphoblastic leukemia and advanced stage lymphoblastic lymphoma: a Pediatric Oncology Group study. *Leukemia* 1999;13:335-342.
266. Williams DM, Hobson R, Imeson J, et al. Anaplastic large cell lymphoma in childhood: analysis of 72 patients treated on The United Kingdom Children's Cancer Study Group chemotherapy regimens. *Br J Haematol* 2002;117:812-820.
267. Abromowitch M, Sposto R, Perkins S, et al. Outcome of Children's Cancer Group (CCG) 5941: A pilot study for the treatment of newly diagnosed pediatric patients with disseminated lymphoblastic lymphoma. *Proceedings of ASCO* 2000;19:583a #2295.
268. Brugières L, Quartier P, Le Deley MC, et al. Relapses of childhood anaplastic large-cell lymphoma: treatment results in a series of 41 children—a report from the French Society of Pediatric Oncology. *Ann Oncol* 2000;11:53-58.
269. Synold TW, Relling MV, Boyett JM, et al. Blast cell methotrexate-poly-glutamate accumulation in vivo differs by lineage, ploidy, and methotrexate dose in acute lymphoblastic leukemia. *J Clin Invest* 1994;94:1996-2001.
270. Korinsky NL, Sposto R, Shah NR, et al. Outcomes of treatment of children and adolescents with recurrent non-Hodgkin's lymphoma and Hodgkin's disease with dexamethasone, etoposide, cisplatin, cytarabine, and L-asparaginase, maintenance chemotherapy, and transplantation: Children's Cancer Group Study CCG-5912. *J Clin Oncol* 2001;19:2390-2396.
271. Philip T, Biron P, Philip I, et al. Massive therapy and autologous bone marrow transplantation in pediatric and young adults Burkitt's lymphoma (30 courses on 28 patients: a 5-year experience). *Eur J Cancer Clin Oncol* 1986;22:1015-1027.
272. Philip T, Armitage JO, Spitzer G, et al. High-dose therapy and autologous bone marrow transplantation after failure of conventional chemotherapy in adults with intermediate-grade or high-grade non-Hodgkin's lymphoma. *N Engl J Med* 1987;316:1493-1498.
273. Philip T, Hartmann O, Biron P, et al. High-dose therapy and autologous bone marrow transplantation in partial remission after first-line induction therapy for diffuse non-Hodgkin's lymphoma. *J Clin Oncol* 1988;6:1118-1124.
274. Gordon BG, Warkentin PI, Weisenburger DD, et al. Bone marrow transplantation for peripheral T-cell lymphoma in children and adolescents. *Blood* 1992;80(11):2938-2942.



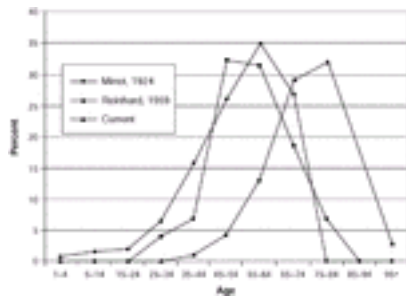
275. Bureo E, Ortega JJ, Muñoz A, et al. Bone marrow transplantation in 46 pediatric patients with non-Hodgkin's lymphoma. *Bone Marrow Transplant* 1995;15:353-359.
276. Avet Loiseau H, Hartmann O, Valteau D, et al. High-dose chemotherapy containing Busulfan followed by bone marrow transplantation in 24 children with refractory or relapsed non-Hodgkin's lymphoma. *Bone Marrow Transplant* 1991;8:465-472.
277. O'Leary M, Ramsay NKC, Nesbit ME, et al. Bone marrow transplantation for non-Hodgkin's lymphoma in children and young adults. *Am J Med* 1983;74:497.
278. Ladenstein R, Pearce R, Hartmann O, et al. High-dose chemotherapy with autologous bone marrow rescue in children with poor-risk Burkitt's lymphoma: a report from the European Lymphoma Bone Marrow Transplantation Registry. *Blood* 1997;90:2921-2930.
279. Appelbaum FR, Deisseroth AB, Graw RG, et al. Prolonged complete remission following high-dose chemotherapy of Burkitt's lymphoma in relapse. *Cancer* 1978;41:1059-1063.
280. Sandlund JT, Bowman L, Heslop HE, et al. Intensive chemotherapy with hematopoietic stem-cell support for children with recurrent or refractory NHL. *Cytotherapy* 2002;4:253-258.
281. Murphy SB, Hustu HO. A randomized trial of combined modality therapy of childhood non-Hodgkin's lymphoma. *Cancer* 1980;45:630-637.
282. Meistrich ML, Wilson G, Brown BW, et al. Impact of cyclophosphamide on long-term reduction in sperm count in men treated with combination chemotherapy for Ewing and soft tissue sarcomas. *Cancer* 1992;70:2703-2712.
283. Lipshultz SE, Colan SD, Gelber RD, et al. Late cardiac effects of doxorubicin therapy for acute lymphoblastic leukemia in childhood. *N Engl J Med* 1991;324:808-815.
284. Sorensen K, Levitt G, Bull C, et al. Anthracycline dose in childhood acute lymphoblastic leukemia: issues of early survival versus late cardiotoxicity. *J Clin Oncol* 1997;15:61-68.
285. Nysom K, Holm K, Lipsitz SR, et al. Relationship between cumulative anthracycline dose and late cardiotoxicity in childhood acute lymphoblastic leukemia. *J Clin Oncol* 1998;16:545-550.
286. Colombat P, Salles G, Brousse N, et al. Rituximab (anti-CD20 monoclonal antibody) as single first-line therapy for patients with follicular lymphoma with a low tumor burden: clinical and molecular evaluation. *Blood* 2001;97:101-106.
287. Coiffier B, Haioun C, Ketterer N, et al. Rituximab (anti-CD20 monoclonal antibody) for the treatment of patients with relapsing or refractory aggressive lymphoma: a multicenter phase II study. *Blood* 1998;92:1927-1932.

2004 Lippincott Williams & Wilkins  
John P. Greer, John Foerster, John N. Lukens  
George M. Rodgers, Frixos Paraskevas, Bertil Glader  
Wintrobe's Clinical Hematology

**PATHOPHYSIOLOGY**[Predisposing Factors](#)[Cell of Origin](#)[Abnormalities in Apoptosis](#)[Abnormalities in Cell Division](#)[Genomic Abnormalities](#)[Cytokines](#)**CLINICAL FINDINGS****LABORATORY FINDINGS**[Peripheral Blood](#)[Bone Marrow and Lymph Nodes](#)[Immunophenotyping](#)[Functional Immune Abnormalities](#)[Autoimmune Manifestations](#)**DIAGNOSIS****DIFFERENTIAL DIAGNOSIS**[Benign Causes](#)[Malignant Causes](#)**INVESTIGATIONS AND STAGING**[Investigations](#)[Staging](#)**PROGNOSIS**[Rai and Binet Staging](#)[Age and Sex](#)[Lymphocyte Characteristics](#)[Marrow Histology](#)[Serum Markers](#)**TREATMENT**[Response Criteria](#)[Chemotherapy](#)[Monoclonal Antibodies](#)[Bone Marrow Transplantation](#)[Radiotherapy](#)[Splenectomy](#)[Biologic Response Modifiers](#)[Systemic Complications Requiring Therapy](#)[Summary](#)**DISEASE COURSE****REFERENCES**

Chronic lymphocytic leukemia (CLL) is characterized by the accumulation of nonproliferating mature-appearing lymphocytes in the blood, marrow, lymph nodes, and spleen. The CLL cells are monoclonal B lymphocytes and are unique in being CD5<sup>+</sup> and CD23<sup>+</sup> ([1](#), [2](#) and [3](#)). Recent evidence suggests that these tumor cells are derived from memory B cells, and there is considerable heterogeneity in CLL in terms of cellular morphology, phenotype, biology, molecular genetics, and prognosis ([4](#), [5](#) and [6](#)). The incidence of CLL varies throughout the world, being highest in North America and rare in the Far East. In North America, CLL accounts for 22.6% of all leukemias, and the incidence is 3.35 to 3.69 per 100,000 per year for men and 1.61 to 1.92 per 100,000 per

year for women ( [7](#), [8](#)). Indeed, it has recently been suggested that the incidence of CLL is much higher than reported, as many patients are diagnosed by flow cytometry and do not require referral for treatment ( [9](#)). The disease is rare in young people, but the incidence rises in the fourth decade and continues to rise exponentially, with the mean age at diagnosis being 69.6 years and greater than 80% of patients being older than 60 years ( [7](#)) ( [Fig. 92.1](#)). However, in contrast with the non-Hodgkin lymphomas, the incidence of CLL has not increased over the past 30 years.



**Figure 92.1.** Age distribution in chronic lymphocytic leukemia. (From Diehl LF, Karnell LH, Menck HR. The National Cancer Data Base report on age, gender, treatment, and outcomes of patients with chronic lymphocytic leukemia. *Cancer* 1999;86:2684–2692, with permission.)

## PATHOPHYSIOLOGY

### Predisposing Factors

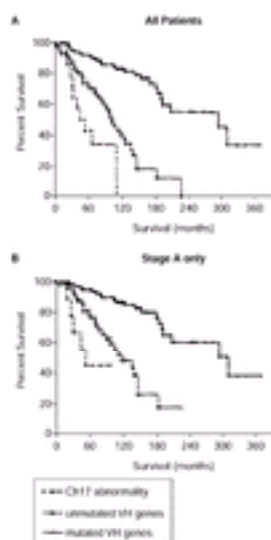
Unlike other leukemias, there is no firm evidence linking an environmental or occupational exposure with an increased incidence of CLL ( [8](#)). However, a family history of CLL or another lymphoproliferative disorder is a strong risk factor for CLL, and it is estimated that one in ten patients with CLL has a family history of CLL or another lymphoproliferative disorder ( [10](#)). There is a 30-fold increase in the risk of CLL in first-degree relatives of patients with CLL ( [8](#), [10](#), [11](#) and [12](#)), and 13.5% of first-degree relatives have peripheral blood lymphocytes with the typical CLL immunophenotype ( [13](#)). However, whether individuals with these abnormal cells will eventually develop CLL is presently unknown ( [13](#)). Patients with familial CLL are approximately 10 years younger than those with sporadic CLL ( [11](#)), and anticipation occurs in familial CLL, with affected children being 15 to 20 years younger than their parents at diagnosis ( [14](#), [15](#), [16](#) and [17](#)). The pattern of inheritance in this condition is unknown, but there is no linkage to HLA type ( [18](#)). As discussed in the section Cell of Origin, there are two forms of sporadic CLL: those with somatic hypermutations of the variable region of the immunoglobulin ( *IgV*) gene and those without. At the present time, there is controversy as to whether familial CLL differs from sporadic CLL with regard to the incidence of *IgV* gene mutations ( [19](#), [20](#)).

The *ataxia telangiectasia mutator* ( *ATM*) gene may induce DNA repair or apoptosis in response to the induction of DNA double-strand breaks, and at least part of these effects is mediated through p53, which is phosphorylated by ATM ( [21](#)). The *ATM* gene is particularly important in lymphocyte development, and patients with ataxia telangiectasia are predisposed to T-cell lymphoid malignancies ( [21](#), [22](#), [23](#) and [24](#)). It has recently been

demonstrated that up to one-third of CLL patients have mutations or deletions of the *ATM* gene in the leukemic cells ( [22](#), [23](#) ), and these cases do not have *IgV* gene mutations and are thus of pregerminal cell origin ( [24](#) ). As *ATM* mutations are also observed in the germ-line of these patients, it has been suggested that heterozygosity of the *ATM* gene may predispose an individual to CLL and explain the familial clustering seen in this disease ( [22](#), [23](#) and [24](#) ). However, more recent evidence indicates that this is unlikely ( [25](#) ).

## Cell of Origin

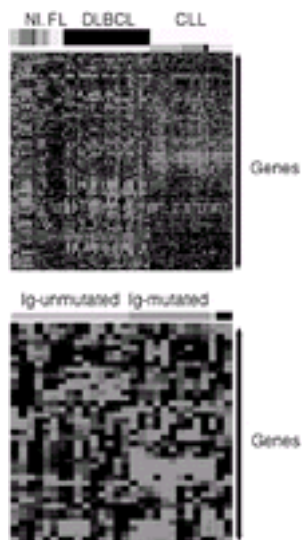
There has been controversy as to the normal counterpart of the CLL cell ( [26](#) ). As the CLL cell is CD5<sup>+</sup>, it was previously believed that the normal counterpart was the CD5<sup>+</sup> B lymphocyte, which is present in the mantle zone of lymph nodes and in small numbers in the peripheral blood ( [1](#), [26](#), [27](#) ). However, the CD5<sup>+</sup> B lymphocyte lacks mutations of the *IgV* gene ( [28](#) ), whereas the CLL cell has undergone mutations in approximately 50% of cases ( [29](#), [30](#) and [31](#) ). These data indicate that there are two forms of CLL, one arising from the pregerminal lymphocyte and lacking mutations of the *IgV* gene and the other having traversed the germinal center and containing mutations ( [32](#) ). It is interesting that these two forms of CLL have different genetic abnormalities (see [Genomic Abnormalities](#)) and prognoses ( [29](#), [30](#) and [31](#) ). Those with mutations are more likely to have deletions of 13q14 and a good prognosis, whereas those without mutations more frequently express trisomy 12 and have a poor prognosis ( [Fig. 92.2](#) ) ( [29](#), [31](#) ).



**Figure 92.2.** Overall survival of patients with loss or mutation of p53 regardless of *IgVH* gene status compared to patients with mutated or unmutated *IgVH* genes with no p53 abnormality. **A:** All patients. **B:** Stage A patients. The median survival of patients with mutated or unmutated *IgVH* genes or a p53 abnormality was 310, 119, and 47 months, respectively, for all patients, and 327, 115, and 54 months, respectively, for stage A patients. (From Oscier DG, Gardiner AC, Mould SJ, et al. Multivariate analysis of prognostic factors in CLL: clinical stage, IGVH gene mutational status, and loss or mutation of the p53 gene are independent prognostic factors. *Blood* 2002;100:1177–1184, with permission.)

More recently, the gene expression profile in CLL has been studied by DNA chip

microarrays ( [5](#), [6](#)). Twelve thousand genes were analyzed by Klein et al. ( [5](#)), and there was a common pattern of expression for most genes in the 16 mutated and 18 unmutated cases. However, there was a differential expression of 23 genes between the two groups. When compared to normal naïve B cells, germinal cells, CD5<sup>+</sup> cells, and memory cells, both mutated and unmutated CLL cells were most similar to the memory cell ( [5](#)). Using Lymphochip complementary DNA microarrays, Rosenwald et al. ( [6](#)) have reached similar conclusions in 37 CLL patients. In that study, *IgV* gene-mutated CLL cells could be differentiated from unmutated cells by the expressions of approximately 175 genes ( [Fig. 92.3](#)). Using 56 differentially expressed genes, they were able to accurately assign nine of ten patients to the mutated or unmutated group. The gene that could most accurately differentiate the two groups was ZAP-70, a kinase that is primarily expressed in T cells and is responsible for the transduction of signals from the T-cell receptor. Using reverse transcriptase-polymerase chain reaction, it was confirmed that cells without mutations had higher levels of ZAP-70 messenger RNA than cells with mutations.

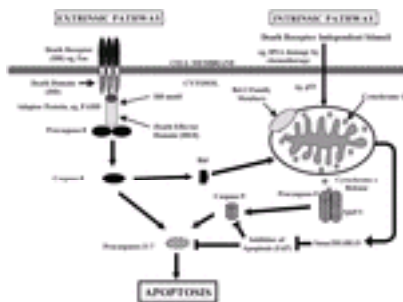


**Figure 92.3.** Microarray analysis in chronic lymphocytic leukemia (CLL). **A:** The expression of 247 “signature” genes differentiates CLL cells from diffuse large B-cell lymphoma (DLBCL), follicular lymphomas (FL), and most normal lymphocytes (NI). The “signature” genes are expressed by CLL cases with or without *IgV* gene mutations. **B:** CLL patients can be differentiated into those with or without mutations of the *IgV* gene by the expressions of 56 genes ( [6](#)). Ig, immunoglobulin. See [Color Plate](#). (From Staudt LM. Gene expression profiling of lymphoid malignancies. *Annu Rev Med* 2002;53:303–318, with permission.)

The results of these studies indicate that the CLL cell is not derived from the CD5<sup>+</sup> cell, a naïve B cell, or a follicle center cell, suggesting that the expressions of CD5 and CD23 on these cells are secondary changes, perhaps representing cell activation or nonspecific changes secondary to the malignancy. The cell of origin of the CLL cell appears to be the memory B cell, regardless of whether or not there are mutations of the *IgV* gene. This would explain why all CLL cells are CD27<sup>+</sup>, which is typically a marker of the memory B cell ( [33](#), [34](#), and [35](#)). Although most normal CD27<sup>+</sup> B cells have *IgV* gene mutations, a small fraction does not ( [36](#), [37](#)). It is thus possible that the CLL cell evolves from the two types of CD27<sup>+</sup> cell: one group with *IgV* gene mutations and the other without.

## Abnormalities in Apoptosis

Galton ( [38](#) ) and Dameshek ( [39](#) ) made the astute observation 35 years ago that the basic defect in CLL is one of cellular accumulation rather than proliferation. Since then, it has become clear that a defect in apoptosis typifies CLL, with the majority of cells being long-lived, noncycling, and in G<sub>0</sub>, with a small fraction of cells replicating and being responsible for the gradual increase in cell number. Chemotherapeutic agents induce apoptosis, and defects in apoptosis may also be responsible for drug resistance ( [40](#) , [41](#) and [42](#) ). Considerable knowledge has been obtained regarding the apoptotic pathways, and the major steps are shown in [Figure 92.4](#) (reviewed in references 40–42). Apoptosis occurs through the activation of caspases, which are cysteine proteases that cleave other caspases at aspartate acid residues, converting the inactive proforms to active enzymes. The downstream caspases, caspases 3, 6, and 7, cleave specific proteins leading to the typical morphologic changes of apoptosis. Apoptosis can be initiated through two main pathways, which interact and subsequently activate the same downstream caspases.



**Figure 92.4.** Apoptotic pathway in chronic lymphocytic leukemia.

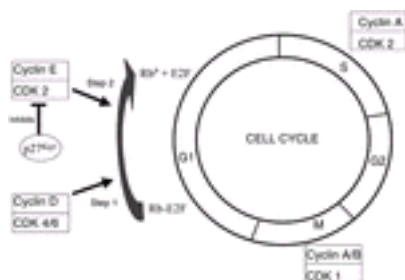
**TWO MAJOR APOPTOTIC PATHWAYS** The *mitochondria/cytochrome c (intrinsic) pathway* is typically initiated by DNA damage, which causes the up-regulation of p53, an increase in the bax:bc-2 ratio, and the release of cytochrome *c* from between the inner and outer mitochondrial membranes into the cytosol. Cytochrome *c* binds to and activates apoptosis-activating factor-1 (Apaf-1) in the cytosol in a process that requires deoxyadenosine triphosphate (dATP). The N-terminal of Apaf-1 binds to and causes the autoactivation of procaspase 9 and, subsequently, caspase 3 ( [43](#) ). The cytochrome *c*/mitochondrial system is important for the activity of chemotherapy, and a deficiency in Apaf-1 can cause drug resistance ( [44](#) ), although whether the variable levels of Apaf-1 in CLL influence sensitivity to chemotherapy is unknown ( [45](#) ). As discussed later, the triphosphate derivatives of fludarabine and 2-chlorodeoxyadenosine (CdA) can substitute for dATP, and part of their cytotoxic activities is related to the binding of Apaf-1 and direct activation of caspases 9 and 3 ( [46](#) , [47](#) ). Smac/DIABLO is also released from the mitochondria along with cytochrome *c* and induces apoptosis by binding to the inhibitor of apoptosis family of proteins, which normally inactivate a number of caspases, including caspase 3. The *tumor necrosis factor (TNF) death receptor (DR) (extrinsic) pathway* also plays a major role in apoptosis. There are presently six known DRs, and these include TNF, Fas (APO-1 or CD95) and DR4/DR5 [receptors for TNF-related apoptosis-inducing ligand (TRAIL)]. These receptors contain a cytosolic domain called the *death domain*, which recruits adaptor proteins such as Fadd/Mort-1 to the receptor complex after binding to ligand. The recruiter adaptor protein has a death domain end and a death effector domain (DED). Once bound to the TNF receptor, the DED binds to caspases 8 and 10, which then become activated by autoactivation ( [43](#) ). Apoptosis through this pathway is controlled by the presence of the receptor and a variety of inhibitors that can

bind to the DED in place of the caspases. One of these is FLICE inhibitory protein, which is a homolog of procaspase 8 and contains two DED domains but lacks proteolytic activity (48). There is cross-talk between the intrinsic and extrinsic pathways. Thus, caspase 8 can activate Bid, which causes the release of cytochrome *c* from the mitochondria (42, 49). Alternatively, activation of the intrinsic pathway in CLL cells by chemotherapy or irradiation also activates caspase 8 (50), possibly by activation of caspase 3 (51). Apoptosis through the TNF receptors plays an important role in controlling lymphoid cell populations, and defects either in Fas ligand or the receptor result in the autoimmune lymphoproliferative syndrome with lymphadenopathy, splenomegaly, and an increase in the risk of subsequent autoimmune diseases and lymphomas. Fas is normally up-regulated in activated lymphocytes, and CLL cells are not sensitive to Fas ligand, even if Fas (CD95) is increased through the use of *Staphylococcus aureus* protein A from Cowan I plus interleukin (IL)-2, CD40 ligation, or through  $\alpha$ - or  $\gamma$ -interferon (50, 51, 52 and 53). DR4 and DR5 receptors are present on CLL cells, but the extent of sensitivity of these cells to TRAIL is controversial (54, 55). CLL cells secrete both TRAIL (56) and Fas ligand (50, 56), which may suppress normal T cells and contribute to the immunosuppression seen with this disease. Apart from the direct induction of apoptosis through the interaction with TNF ligands, the TNF receptors may play a role in the activity of chemotherapeutic agents. Chemotherapeutic agents may up-regulate receptors for Fas (57, 58) or DR4/DR5 (59, 60), which could prime the cells to physiologic levels of Fas ligand or TRAIL. However, although fludarabine and chlorambucil increase Fas messenger RNA levels in CLL cells *in vitro*, they do not affect the levels of Fas protein (50). In contrast, irradiation does increase Fas protein levels, but none of these agents sensitizes CLL cells to Fas ligand (50). Fludarabine and chlorambucil increase the messenger RNA and cell-surface expression levels of DR4/DR5 in CLL cells, but it is not yet known whether this sensitizes the cells to TRAIL (55).

**MODULATORS OF THE APOPTOTIC PATHWAYS** The above pathways are modulated by a variety of proteins, which may be altered in CLL. The *bcl-2 family* consists of approximately 20 members that can either promote or inhibit apoptosis. These proteins are located in the cell membrane, nuclear membrane, and mitochondrial membrane and function by binding to other proteins or influencing cell permeability and the release of cytochrome *c* from the mitochondria. Some *bcl-2 family* members (e.g., bax, bcl-x<sub>S</sub>, bak, and bad) promote apoptosis, whereas others (e.g., bcl-2, bcl-x<sub>L</sub>, and mcl-1) inhibit apoptosis (61, 62, 63, 64, 65, 66 and 67). In addition, another group (e.g., bag-1) can influence the activities of the other family members (61, 62, 63, 64, 65, 66 and 67). CLL cells have high bcl-2, bax, and bak levels but have low levels of bcl-x<sub>L</sub> and bad (61, 62, 63, 64, 65, 66 and 67). The bcl-2 overexpression is related to hypomethylation of DNA, rather than to a translocation, and may contribute to the longevity of the CLL cell (61). CLL cells with high bcl-2 levels have more prolonged *in vitro* survival than those with low levels, and decreasing bcl-2 expression by antisense oligonucleotides can induce apoptosis (66). Whether the bax and bcl-2 levels or the bax:bcl-2 ratios are predictive of drug sensitivity in CLL is controversial (62, 63, 64, 65, 66 and 67). Mcl-1 protein levels are variable in CLL, and it has been suggested that patients with high levels are more resistant to chemotherapy (65). The transcription factor nuclear factor- $\kappa$ B (NF- $\kappa$ B) plays an important role in suppressing apoptosis by inducing the expression of a variety of antiapoptotic genes (68, 69). NF- $\kappa$ B is inactivated by I $\kappa$ B, which binds NF- $\kappa$ B and prevents its access to the nucleus; activation of NF- $\kappa$ B occurs by the phosphorylation of I $\kappa$ B, which leads to the coupling of I $\kappa$ B with ubiquitin. This complex is degraded by a protease called the *proteasome*. The levels of NF- $\kappa$ B are high in CLL and are increased further by stimulation with CD40 ligand, which, as discussed in the Cytokines section, plays an important role in preventing apoptosis and prolonging cell survival in CLL (70). In addition, inactivation of the proteasome by inhibitors such as lactacystin, MG132, and



PS-341 can induce death of CLL cells but not normal lymphocytes (71, 72 and 73). Cell death is mediated through the cytochrome *c*/mitochondrial pathway, and these agents may be useful in drug-resistant disease (71, 72 and 73). The protein kinase *Akt* is activated through phosphatidylinositol 3'-hydroxykinase and can suppress apoptosis by phosphorylating bad, caspase 9, and other proteins involved in apoptosis (74, 75). This pathway is activated by autologous plasma in CLL, which may explain the relative resistance of these cells to spontaneous apoptosis and chemotherapy when they are grown in autologous plasma (75). A number of other proteins play a key role in apoptosis, and their expressions can be affected by the chromosomal changes that occur in CLL (discussed further in Genomic Abnormalities). The tumor-suppressor gene, *p53*, is a transcriptional activator and is located on chromosome 17p13 (42, 76). *p53* protein is phosphorylated and stabilized after DNA damage, such as that produced by radiation or alkylating agents, through activation of ATM kinase and DNA-dependent kinase (76). Cell cycle blockage at G<sub>1</sub> or G<sub>2</sub> may occur, allowing the cell to repair the damage before entering S- or M-phase (76). However, *p53* may also induce apoptosis, and this occurs preferentially in tumor cells, a feature that may explain the relative tumor specificity of anticancer agents (77). *p53* mutations are typically associated with deletions of the second allele (deletion 17p13), and mutations or *p53* gene deletions are observed in 10 to 15% of CLL patients (see section [Genomic Abnormalities](#)); these abnormalities are associated with high lymphocyte counts, drug resistance to anticancer agents *in vitro* and *in vivo*, and poor patient survival (Fig. 92.2 and Fig. 92.5) (63, 64, 78, 79). In a longitudinal study of 181 patients, the percentage of leukemia cells with a *p53* mutation increased during the course of the disease, indicating that the mutation provided a survival advantage for the tumor cells (78).



**Figure 92.5.** Control of the cell cycle. Chronic lymphocytic leukemia cells are quiescent and in G<sub>0</sub>/G<sub>1</sub>. Both cyclins D2 and D3 are overexpressed in chronic lymphocytic leukemia cells, but the retinoblastoma (Rb) protein is not phosphorylated, perhaps related to overexpression of p27<sup>Kip1</sup>. CDK, cyclin-dependent kinase.

The *murine double minute-2* (*mdm-2*) gene is located on chromosome 12 and is transactivated by *p53* (76). The *mdm-2* protein enhances the binding of *p53* to ubiquitin, and *p53* is subsequently degraded (76). Thus, overexpression of *mdm-2* in cell lines reduces the capacity of *p53* to block the cell cycle in G<sub>1</sub> after irradiation and speculatively could also decrease *p53*-induced apoptosis and produce drug resistance (63). However, although the *mdm-2* protein has been found to be overexpressed in two-thirds of CLL cases, this does not correlate with disease stage, aggressiveness, or drug resistance (80). The *ATM* gene is located on chromosome 11q22-23 and is responsible for phosphorylation and activation of *p53* after DNA damage (21, 76). Approximately 30% of CLL patients have a mutation of *ATM*, and these patients have a defect in cellular response to irradiation similar to that observed in patients with a *p53* mutation (21, 81). This would explain the drug resistance and poor clinical outcome in patients with an *ATM* mutation (82, 83). It is interesting that *ATM* mutations are seen in patients with an unmutated *IgV* gene, and these patients are known to have a poor

prognosis ( [24](#), [29](#), [30](#) and [31](#) ).

## Abnormalities in Cell Division

Passage through the cell cycle is controlled by the interaction of the cyclins and the cyclin-dependent kinases (CDKs); the levels of the CDK remain constant, whereas the levels of the five different cyclins fluctuate and activate the appropriate CDK, leading the cell through the cycle ( [Fig. 92.5](#) ) ( [84](#) ). In addition, two classes of CDK inhibitors, the INK4 proteins and the Cip/Kip proteins, control the activity of the CDKs ( [85](#) ). Normally, when quiescent cells enter the cell cycle, the D cyclins (D1, D2, and D3) in conjunction with CDKs 4 and 6 bring the cell into the S-phase. The D cyclin/CDK4/6 initiates phosphorylation of the retinoblastoma (Rb) protein, which is then further phosphorylated by cyclin E/CDK2. Another function of the D cyclins/CDK4 is the sequestration of the Cip/Kip inhibitors p27<sup>Kip1</sup> and p21<sup>Cip1</sup>, which normally inhibit the activity of cyclin E/CDK2. Although the CLL cell is quiescent and in G<sub>0</sub>/G<sub>1</sub>, the expression of cyclins D2 and D3 is increased in these cells ( [86](#), [87](#) and [88](#) ). In addition, cyclin D1 is also detectable and increased in 25% of patients, although the levels are not as high as seen in mantle cell lymphoma ( [89](#) ). Despite these findings, the Rb protein is not phosphorylated in unstimulated CLL cells ( [90](#) ); this may be related to overexpression of p27<sup>Kip1</sup>, in which high levels are associated with high lymphocyte counts and poor patient survival ( [91](#) ).

## Genomic Abnormalities

Conventional cytogenetic studies were initially carried out in CLL in the 1980s, and these proved difficult as CLL cells have a very low proliferative index, and even with mitogens, metaphases are difficult to obtain ( [79](#), [92](#) ). When analysis is possible, clonal chromosomal abnormalities are detected in approximately 50% of cases ( [79](#), [92](#), [93](#), [94](#), [95](#), [96](#), [97](#), [98](#), [99](#), [100](#), [101](#), [102](#), [103](#), [104](#) and [105](#) ), and it is likely that the normal karyotyping in the remaining cases is due to analysis of contaminating normal T cells ( [79](#) ). Of the 50% of cases with clonal abnormalities, one-half have one clonal abnormality, and the remainder have two or three clones ( [94](#) ). With newer techniques, such as fluorescence *in situ* hybridization (FISH) and comparative genomic hybridization, which allow analysis of interphase cells (FISH) or isolated DNA (comparative genomic hybridization), respectively, abnormalities may be detected in over 80% of cases ( [79](#), [92](#) ). Most commonly, these abnormalities are deletions or aneuploidy, and in contrast to other low-grade lymphoid malignancies, translocations are infrequent. FISH is highly sensitive, but the specific abnormality to be studied needs to be known in advance, and this is therefore not a good technique to screen for new abnormalities. In contrast, comparative genomic hybridization has been used to screen for chromosome gain or loss (i.e., aneuploidy, gene amplification, or deletions not detected by conventional cytogenetics) ( [92](#) ). As more sophisticated techniques are being developed, such as allelotyping with microsatellite markers spaced throughout the genome, multiple new abnormalities are being detected and will hopefully provide insight into the pathogenesis of this disease ( [93](#) ).

**ANALYSIS BY CONVENTIONAL CYTOGENETICS** Using conventional cytogenetics, the International Working Party on Chromosomes in CLL reported in 1990 that clonal chromosomal abnormalities were obtained in 311 patients (51%) out of a total of 604 cytogenetically evaluable cases ( [Table 92.1](#) ) ( [98](#), [99](#) ). The most common clonal abnormality was trisomy 12 (36%, or 19% of all evaluable cases), either by itself or in combination with other cytogenetic changes. Other frequently observed alterations included structural abnormalities of chromosome 13 (20%, or 10% of all cases) and of

chromosome 14 (16%, or 8% of all cases) ( 98, 99 ). The 13q abnormalities usually involved a 13q14 deletion (site of the *Rb* gene) or translocations with a breakpoint at chromosome 13q14. The 14q abnormalities included translocations from a variety of chromosomes, usually involving chromosome 11. As t(11;14)(q13;q32) is classically seen in mantle cell lymphoma and rarely in CLL (see below), it is likely that these patients had mantle cell lymphoma and not CLL ( 106 ). Less than 5% of patients had an 11q deletion. The abnormalities of chromosomes 12 and 13 occurred with equal frequency in cases with a single clonal abnormality and in patients having more than one clonal abnormality ( 94, 98 ). In contrast, abnormalities of chromosome 14 occurred primarily in patients having more than one clonal abnormality ( 94, 98 ).

**TABLE 92.1. Incidence of Genomic Abnormalities and the Associated Clinical Features in Chronic Lymphocytic Leukemia**

| Genomic Abnormality               | Incidence (%)                       |  | Affected Genes | Clinical Features   |
|-----------------------------------|-------------------------------------|--|----------------|---|
|                                   | Classical Cytogenetics <sup>a</sup> | Fluorescence <i>In Situ</i> Hybridization <sup>b</sup> |                |   |
| Normal                            | 50 <sup>c</sup>                     | 20   | —              | —   |
| 13q deletion                      | 10                                  | 55   | <i>Rb</i>      | <i>IgV</i> gene mutations; good prognosis   |
| Alone                             | 5                                   | 36   |                |   |
| Combined with other abnormalities | 5                                   | 19   |                |   |
| 11q deletion                      | 8                                   | 18   | <i>ATM</i>     | No <i>IgV</i> gene mutations; bulky lymphadenopathy   |
| 12q trisomy                       | 13                                  | 16   | <i>mdm2</i>    | No <i>IgV</i> gene mutations; “atypical” morphology; end-stage disease                        |
| 17p deletion                      | 4                                   | 17   | <i>p53</i>     | No <i>IgV</i> gene mutations; chronic lymphocytic leukemia/prolymphocytic leukemia morphology |
| 6q deletion                       | 4                                   | 6  | —              | —   |

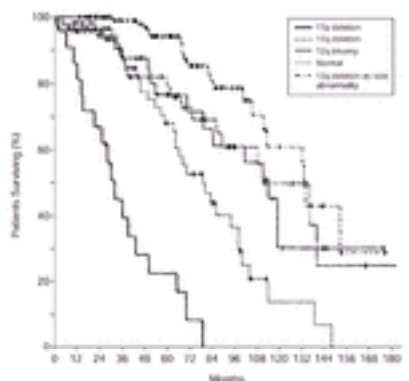
<sup>a</sup> From Juliusson G, Merup M. Cytogenetics in chronic lymphocytic leukemia. *Semin Oncol* 1998;25:192–196; Juliusson G, Oscier DG, Fitchett M, et al. Prognostic subgroups in B-cell-chronic lymphocytic leukemia defined by specific chromosome abnormalities. *N Engl J Med* 1990;323:720–724; and Juliusson G, Oscier D, Gahrton G, et al. Cytogenetic findings and survival in B-cell chronic lymphocytic leukemia. Second IWCLL compilation of data on 662 patients. *Leuk Lymphoma* 1991;5:21–25. Percentages refer to the number of cases with the abnormality compared with the total number of cases in which cytogenetic analysis was possible.

<sup>b</sup> From Döhner H, Stilgenbauer S, Benner A, et al. Genomic aberrations and survival in chronic lymphocytic leukemia. *N Engl J Med* 2000;343:1910–1916.

<sup>c</sup> In 50% of cases, clonal abnormalities were not obtained. As these studies were not carried out on purified chronic lymphocytic leukemia cells, some of the cases with normal cytogenetics reflect analysis of normal T cells.

In general, patients with abnormal karyotyping had a worse prognosis than those with normal cytogenetics, and the outlook was poorest for those with multiple clonal abnormalities ( [95](#), [96](#), [97](#), [98](#), [99](#), [100](#) and [101](#) ). In addition, the higher the percentage of cells at metaphase with a clonal chromosomal abnormality, the worse the prognosis. Of patients with a single clonal abnormality, those with trisomy 12 had the worst prognosis, and those with 13q<sup>+</sup> had a similar survival as cases with normal karyotyping ( [98](#), [99](#) ). It is interesting that trisomy 12 was usually seen in those 15% of cases with CLL variants, either CLL/prolymphocytic leukemia (CLL/PL) or “atypical” CLL (see [Laboratory Findings](#) for details of these variants), and this may explain the poor prognosis associated with these morphologic variants ( [101](#), [102](#) and [103](#) ). When all patients were considered, regardless of the number of clones, those with chromosome 14 abnormalities had the worst prognosis ( [98](#) ). As most of the chromosome 14 abnormality group had a t(11;14)(q13;q32), in retrospect, they likely had mantle cell lymphoma and not CLL. More recently, 11q deletions have been detected in 13% of patients by karyotyping, and these patients had disease progression and poor survival ( [104](#) ). The chromosome abnormalities identified in CLL occur early, and it is disputed as to whether additional chromosomal abnormalities develop with disease progression ( [98](#), [107](#), [108](#) ). Although Juliusson et al. ( [98](#) ) found little evidence for clonal evolution, others have noted a 16 to 39% incidence of new or additional chromosomal abnormalities, which develop over several years from initial diagnosis ( [107](#), [108](#) ). The acquisition of deletions of 11q or 6q is associated with disease progression ( [109](#), [110](#) ). The presence of multiple clones and subclones and the development of new clonal abnormalities have been taken as evidence that clonal evolution may be a common event in CLL ( [107](#), [108](#) ).

**ANALYSIS BY FLUORESCENCE *IN SITU* HYBRIDIZATION** Because of the limitations of conventional cytogenetics in CLL, most present day studies use FISH to identify and quantify the genetic defects in CLL. In a recent major study using FISH, Döhner et al. ( [79](#) ) evaluated 325 CLL patients for deletions of 6q21, 11q22–q23, 13q14, and 17p13; for trisomies of bands 3q26, 8q24, and 12q13; and for translocations involving the Ig heavy chain locus on 14q32. In these patients, 268 (82%) had abnormalities, with deletion 13q14 being most frequent (55%), followed by deletion 11q22–q23 (18%), trisomy 12q13 (16%), deletion 17p13 (7%), and deletion 6q21 (7%) ( [79](#) ). The frequency of the different abnormalities differed from the studies using conventional cytogenetics, presumably because classical cytogenetics only detect abnormalities in replicating cells, whereas interphase FISH detects abnormalities in the entire cell population. A comparison of the incidence of the different abnormalities, as detected by FISH and cytogenetics, is shown in [Table 92.1](#). In this FISH study, there was one abnormality in 175 patients, 67 patients had two aberrations, and 26 patients had more than two chromosomal changes. As shown in [Figure 92.6](#), there was a very good correlation between the presence of these abnormalities and survival: Patients with deletion 13q had a similar survival to those with normal chromosomes, and only one-third required therapy. Patients with 17p or 11q deletions had the poorest survival, had more marked lymphadenopathy and splenomegaly, and were more likely to be symptomatic with night sweats and weight loss.



**Figure 92.6.** Survival according to molecular genetic changes in chronic lymphocytic leukemia. (From Döhner H, Stilgenbauer S, Benner A, et al. Genomic aberrations and survival in chronic lymphocytic leukemia. *N Engl J Med* 2000;343:1910–1916, with permission.)

In addition to a correlation between genomic abnormalities and prognosis, FISH studies have also demonstrated a correlation between these abnormalities and the presence or absence of *IgV* gene mutations ( [29](#), [30](#) and [31](#) ) and alterations in cell morphology ( [29](#), [102](#), [103](#) ). Cases with trisomy 12 or deletions of 17p13 or 11q22–11q23 typically do not have mutations of the *IgV* gene, whereas those with deletions of 13q14 do have *IgV* gene mutations ( [29](#), [30](#) and [31](#) ). Trisomy 12 frequently occurs in “atypical” CLL or CLL/PL ( [102](#) ). However, not all the “atypical” cells in an individual patient contain trisomy 12, indicating that the chromosomal abnormality is not responsible for the atypical morphology ( [110](#), [111](#) ). In addition, although trisomy 12 connotes aggressive disease, it is unclear whether the proportion of cells with trisomy 12 increases over time ( [112](#), [113](#) ). Half the patients with CLL/PL have a p53 mutation, suggesting a role for the gene in the pathogenesis of this variant ( [114](#) ).

**EFFECTS OF CHROMOSOME CHANGES ON GENE EXPRESSION** The most frequent structural abnormality in CLL is a deletion at 13q14 ( [79](#), [92](#), [96](#), [98](#), [99](#) and [100](#) ). Cases with this abnormality usually have mutations of the *IgV* gene, classic CLL cell morphology, and good prognosis ( [29](#), [79](#) ). Approximately one-half of the abnormalities involve an interstitial deletion and almost invariably are associated with loss of the *Rb* gene ( [94](#), [98](#) ). Translocations involving 13q are found in the remaining one-half of cases, and most of these involve a breakpoint at 13q14, which is the site of the *Rb* gene, with translocations from a variety of other chromosomes ( [94](#), [98](#) ). Usually, the translocations are accompanied by submicroscopic deletions at 13q14 ( [100](#) ). The *Rb* gene plays a key role in controlling cellular proliferation ( [Fig. 92.5](#) ), and loss of *Rb* may lead to cell cycle progression and tumor development ( [90](#), [116](#) ). Inactivation of both *Rb* alleles is required for this effect, and this contrasts with p53 mutations, in which a mutation affecting one allele leads to a mutant protein that has a dominant effect ( [115](#), [116](#) ). Using conventional cytogenetic techniques, deletions of 13q14 are found to occur in 15 to 30% of CLL patients ( [98](#), [99](#) and [100](#) ), whereas monoallelic deletions of the *Rb* gene may be detected by FISH in approximately one-half of patients ( [79](#), [104](#) ). However, mutations of the remaining allele are uncommon ( [79](#), [104](#) ). The D13S25 probe, which identifies a region telomeric to the *Rb* gene on chromosome 13q, has been shown to be more frequently deleted than the *Rb* gene ( [99](#), [117](#), [118](#) ). Mapping of this region (reviewed in references 100 and 119) has been carried out by a number of groups to identify a putative tumor-suppressor gene, and three candidate genes include *Leu1*, *Leu2*, and *Leu3* ( [119](#), [120](#) and [121](#) ). However, whether they have a role in the pathogenesis of this disease is still unclear ( [119](#), [120](#) and [121](#) ). Garcia-Marco et al. ( [100](#) ) have provided evidence for a new tumor-suppressor locus at 13q12.3, which is more centromeric than the *Rb* locus. This area encompasses the breast cancer susceptibility gene, *BRCA2*, and using FISH, 80% of patients had either homozygous or heterozygous deletions of the gene; in most cases, there were two cell populations, one containing a heterozygous deletion and one a homozygous deletion ( [99](#) ). However, these findings have been disputed ( [122](#) ). A deletion of 11q22–q23 occurs in approximately 20% of cases, is seen in younger patients, and is associated with marked lymphadenopathy, rapid disease progression, and poor survival ( [79](#), [123](#), [124](#) and [125](#) ). The critical region for the deletion is a 3-Mb segment at 11q22.3–q23.1, and candidate genes in this region include radixin (RDX), which has homology to the neurofibromatosis-type 2 (NF2) tumor-suppressor gene and the ATM gene ( [124](#) ). However, mutations of the remaining *ATM* allele only occur in 20% of patients with a deletion ( [22](#) ). Although CLL



cells with a deletion of 11q22–q23 do not differ from other CLL cells in growth fraction, NF- $\kappa$ B expression, or response to mitogenic stimuli, they have reduced levels of a number of adhesion proteins, which may explain the marked lymphadenopathy observed in these cases ( [124](#) ). Complementary DNA microarray analysis has demonstrated that patients with a deletion of 11q22–11q23 have a distinct expression pattern, and the expressions of 16 genes could separate these patients from those without the deletion ( [125](#) ). Trisomy 12q13 occurs as a result of duplication of one homolog and is seen in 10 to 20% of CLL patients. Trisomy 12 is frequently associated with “atypical” CLL and CLL/PL. Patient survival is only minimally affected when trisomy 12 is detected by FISH, whereas survival is shortened if trisomy 12 is detected by classical cytogenetics ( [79](#) , [98](#) , [99](#) ). 12q13–15 contains the *mdm-2* gene, and overexpression of *mdm-2* could simulate a p53 mutation, as *mdm-2* binds and inactivates p53 ( [122](#) ). However, although *mdm-2* is overexpressed in two-thirds of patients, the increase does not correlate with disease stage, aggressiveness, or drug resistance ( [80](#) ). 14q32 is the site of the Ig heavy chain gene, and the most common translocation is with chromosome 11, but others have also been reported ( [93](#) ). The t(11;14) (q13;q32) occurs more typically in mantle cell lymphoma, and the rearrangement on chromosome 11 involves the *bcl-1* (*B-cell leukemia/lymphoma-1*) gene, a G<sub>1</sub> cyclin also called *CCND1* or *cyclin D1* ( [106](#) ). A t(14;18) (q32;q21) translocation is seen commonly in follicular lymphomas, and this rearrangement juxtaposes the Ig heavy chain locus on chromosome 14 to the 3' end of *bcl-2* on chromosome 18 ( [32](#) ). This rearrangement causes overexpression of *bcl-2* in the follicular lymphomas with inhibition of apoptosis; although the levels of *bcl-2* in CLL are equivalent to those in follicular lymphomas, the overexpression in CLL is related to *bcl-2* gene hypomethylation ( [61](#) , [63](#) ). The t(14;19) (q32;q13.1) is a rare event and involves the juxtapositioning of *bcl-3* on chromosome 19 with the Ig gene on chromosome 14. The candidate oncogene *bcl-3* is a member of the I $\kappa$ B family, and patients with this translocation have atypical morphology and progressive disease ( [126](#) ).

## Cytokines

As lymphocyte survival and growth are intimately related to growth factors, it has been suggested that alterations in the production of and response to cytokines may play major roles in the pathogenesis of CLL ( [127](#) , [128](#) ). Speculatively, these cytokines may decrease apoptosis or stimulate proliferation of CLL cells but inhibit survival of normal lymphoid and marrow cells, leading to the immunosuppression and myelosuppression seen in this disease.

CLL cells produce TNF- $\alpha$  *in vitro* ( [129](#) , [130](#) ), and TNF- $\alpha$  decreases apoptosis in these cells through the induction of *bcl-2* ( [129](#) , [131](#) , [132](#) and [133](#) ). In addition, TNF- $\alpha$  may induce the proliferation of CLL cells while suppressing the growth of normal lymphocytes and marrow cells ( [129](#) , [131](#) , [132](#) and [133](#) ). The serum level of TNF- $\alpha$  is increased in most patients with CLL, and the highest levels are observed in those with advanced disease ( [132](#) ). An increase in the serum levels of the soluble receptors for TNF- $\alpha$  has also been observed in CLL ( [134](#) ).

Transforming growth factor- $\beta$  is secreted by CLL cells ( [135](#) ) and marrow stromal cells in CLL ( [136](#) ). Transforming growth factor- $\beta$  inhibits DNA synthesis in both CLL and normal B cells, although the degree of inhibition can be quite low in CLL as a result of the loss of TGF- $\beta$  receptors ( [137](#) , [138](#) ). In contrast to normal B cells, CLL cells are consistently resistant to apoptosis induced by TGF- $\beta$  ( [139](#) ).

CLL cells differ from normal CD19<sup>+</sup> B cells in producing the lymphoid stem cell growth factor IL-7, suggesting that this cytokine might also be important in disease pathogenesis (140). IL-7 does not itself induce proliferation or prevent apoptosis of CLL cells *in vitro* (140). However, the prevention of apoptosis of CLL cells by co-culturing with endothelial cells appears to be related to the maintenance of intracellular IL-7 levels, which occurs by signaling through the cell-surface  $\beta$ 2-integrin (140). Both IL-2 and IL-15 stimulate the proliferation of CLL but not normal B cells (141). Moreover, IL-2 is sequestered by the CLL cells and by the increased serum levels of the IL-2 receptor (TAC receptor) seen in this disease, preventing its interaction with normal lymphocytes (142, 143). This may partly explain the immune dysfunction seen in CLL (143). A number of other cytokines (e.g.,  $\alpha$ - and  $\beta$ -interferon, IL-1, IL-2, IL-4, IL-6, and IL-8) can prevent CLL cells from undergoing spontaneous apoptosis (144); these ILs may be derived from the CLL cells (IL-1, -6, and -8) or from T cells (IL-2 and -4) (144).

CD40 is a glycoprotein of the TNF superfamily that is expressed on B-cell surfaces and is important for B-cell differentiation and function, whereas the CD40 ligand (CD40L) is expressed on activated T-cell surfaces. Stimulation of CD40 on CLL cells induces proliferation and the release of cytokines (145) and also prevents apoptosis induced by chemotherapy (146). In addition, CLL cells release CD40L, and the level of ligand is high in the plasma of CLL patients (147). As CLL cells have both CD40 and CD40L, it has been suggested that the cell may stimulate its own growth and survival (148). Moreover, the CD40L released by CLL cells may stimulate nonmalignant B cells to produce autoantibodies, and this may be a mechanism for the autoimmune phenomena in CLL (128). Finally, the CD40 on CLL cells can down-regulate the CD40L on activated T cells, protecting the cells from their cytolytic effect, and this may contribute to the T-cell dysfunction seen in this disease (128, 149). Thus, with early disease, the CD40 activation induces growth and survival of the CLL cells, and with continued growth of tumor, there is suppression of CD4<sup>+</sup> T cells (128, 149).

More recently, “nurselike” cells have been identified in CLL patients, which may produce survival factors for the leukemia cells (150). A subset of peripheral blood CD14<sup>+</sup> mononuclear cells develops into large adherent cells when grown in the presence of CLL cells, and these nurselike cells support the survival of the CLL cells. These cells share common antigens with myelomonocytic cells but differ from typical monocytes in having low CD14<sup>+</sup>, low CD33<sup>+</sup>, and higher CD68<sup>+</sup>. The putative cytokine produced by these cells is stromal-derived factor-1, although others have not found that stromal-derived factor-1 protects CLL cells from apoptosis *in vitro* (75).

## CLINICAL FINDINGS

Although most CLL patients are elderly, approximately 10% of patients are younger than 50 years old (151, 152). However, the presenting features are similar regardless of age (151, 152). Nowadays, approximately 50% of patients are asymptomatic at diagnosis, and most are found to have an isolated peripheral blood lymphocytosis during a routine blood test (2). Alternatively, lymphadenopathy, splenomegaly, or both may be detected during a regular physical examination. When symptomatic, the most frequent complaint is fatigue or a vague sense of being unwell. Less frequently, enlarged nodes or the development of an infection is the initial complaint, and the most frequent infections are bacterial



pneumonias. In contrast to lymphomas, fever and weight loss are uncommon.

Most symptomatic patients have enlarged lymph nodes, as well as splenomegaly. Enlargement of the cervical and supraclavicular nodes occurs more frequently than axillary or inguinal lymphadenopathy. The lymph nodes are usually discrete, freely movable, and nontender. Painful enlarged nodes usually indicate superimposed infection, and these can be bacterial or viral. There is usually only mild to moderate enlargement of the spleen, and splenic infarction is uncommon. Less common manifestations are enlargement of the tonsils, abdominal masses due to mesenteric or retroperitoneal lymphadenopathy, and skin infiltration. Patients can also present with the features of anemia, which may be related to marrow replacement or, more rarely, to autoimmune hemolysis or aplasia. Alternatively, patients may have bruising or bleeding, secondary to thrombocytopenia, acquired von Willebrand disease, or an acquired inhibitor to factor VIII. Rarely, patients may present with a paraneoplastic syndrome, such as nephrotic syndrome, paraneoplastic pemphigus, or angioedema (see [Autoimmune Manifestations](#)).

## LABORATORY FINDINGS

### Peripheral Blood

Although a persistent lymphocyte count of greater than  $10 \times 10^9/L$  was originally required for the diagnosis of CLL ([153](#)), the diagnosis is now made with a count of greater than  $5 \times 10^9/L$  and the presence of typical immunophenotypic markers ([1](#)). The median lymphocyte count at diagnosis is  $30 \times 10^9/L$ , and in most patients, there is a continuous increase in the lymphocyte count over time ([151](#), [152](#)). In half the patients, it takes more than 12 months for the lymphocyte count to double; cyclic fluctuations of up to  $50 \times 10^9/L$  can occur in the lymphocyte counts of untreated patients, and in others, the count may remain stable for years ([152](#)).

In most patients, the leukemia cells have the morphologic appearance of normal small to medium-sized lymphocytes with clumped chromatin, inconspicuous nucleoli, and a small ring of cytoplasm. Cytoplasmic inclusions occasionally may be observed in CLL cells and may be crystalline, globular, tubular, or rod-shaped ([154](#), [155](#)). Ruptured lymphocytes (“basket” or “smudge” cells) are commonly seen in the blood smear, and the number of these cells increases with the lymphocyte count. There can be variations in cell morphology, with some cells being prolymphocytes, whereas others are larger with abundant cytoplasm, and some are plasmoid or cleaved ([101](#), [102](#), [156](#)). The French/American/British classification system divides patients into three groups depending on the percentage of abnormal cells ([156](#)). In *classical CLL*, more than 90% of cells are small, and when 11 to 54% of the cells are prolymphocytes, it is termed *CLL/PL*. When more than 15% of the lymphocytes are plasmoid or cleaved and less than 10% are prolymphocytes, it is termed *atypical CLL* ([101](#), [102](#), [156](#)). Approximately 80% of patients have classical CLL, and 20% have CLL/PL or atypical CLL. If more than 55% of the cells are prolymphocytes, the patient has prolymphocytic leukemia.

As discussed in the section Differential Diagnosis, a number of other conditions can produce peripheral lymphocytosis, but a careful examination of the blood smear and immunophenotyping can differentiate these disorders ([2](#), [3](#), [101](#), [102](#), [156](#)).

### Bone Marrow and Lymph Nodes

There are four patterns of marrow involvement in CLL ( [157](#) ). The infiltration may be interstitial, nodular, mixed (nodular and interstitial), or diffuse, with mixed being the most common and nodular the least common. Diffuse involvement, in which there is effacement of the fat spaces by tumor, carries the worst prognosis ( [157](#) ). The marrow involvement is sporadic and contrasts with follicular lymphomas, in which paratrabeular involvement is the rule. In contrast to marrow, involvement of the lymph node is diffuse. Proliferation centers with prolymphocytes and paraimmunoblasts are commonly seen in both marrow and lymph nodes ( [101](#) ).

### Immunophenotyping

CLL is generally believed to develop by the malignant transformation of a single B lymphocyte and its subsequent clonal expansion ( [3](#), [5](#), [6](#), [26](#) ). It has been suggested that a small proportion of cases (<1%) may be of T-cell origin ( [158](#) ). However, these cases may be more accurately classified as a small-cell variant of T-cell prolymphocytic leukemia rather than as T-cell CLL ( [159](#) ). When viewed by electron microscopy, these cells have nucleoli and, like T-cell prolymphocytic leukemia, contain abnormalities of chromosomes 14 and 8 and strongly express CD7 ( [158](#), [159](#) ). In addition, both these T-cell leukemias may involve the skin and are aggressive and generally resistant to therapy ( [158](#), [159](#) ). In classical B-cell CLL, the cells have a number of distinct markers that help in its diagnosis and differentiation from other disorders ( [2](#), [101](#), [160](#), [161](#), [162](#) and [163](#) ) ( [Table 92.2](#) ). The leukemic cells have the B-cell markers CD19, CD20 (low), CD43, and CD79b (low) and, by definition, are also CD5<sup>+</sup>. In addition, the cells show clonal light chain restriction, weak expression of sIgM and sIgD, and are CD23<sup>+</sup> and CD10<sup>-</sup>. These cells are also CD27<sup>+</sup> ( [34](#), [35](#) ), consistent with the recent data suggesting that these cells are memory B cells ( [5](#) ). Alternatively, the presence of CD27, in addition to CD5 and CD23, could reflect the activated nature of the CLL cells, as these markers all increase with cellular activation ( [164](#) ). Based on the above, Matutes et al. ( [162](#), [165](#) ) have recommended the use of five markers to differentiate CLL from other B-cell malignancies ( [Table 92.3](#) ). Typical CLL should be surface Ig (weak), CD5<sup>+</sup>, CD23<sup>-</sup>, CD79b/CD22 (weak), and FMC7<sup>-</sup>.

**TABLE 92.2. Immunophenotypes of Chronic Lymphocytic Leukemia and Other Chronic B-Cell Disorders**

| Condition                                 | smIg | CD5 | CD10 | CD11c | CD19 | CD20 | CD22 | CD23 | CD25 | CD43 | CD79b | CD103' |
|---|------|-----|------|-------|------|------|------|------|------|------|-------|--------|
| Chronic lymphocytic leukemia              | Dim  | ++  | -    | -/+   | ++   | Dim  | -/+  | ++   | +/-  | +    | -     | -      |
| Waldenström macroglobulinemia             | ++   | -   | -    | -/+   | ++   | ++   | +    | -    | -/+  | +/-  | +     | -      |
| Prolymphocytic leukemia                   | +++  | -/+ | -/+  | -/+   | ++   | +++  | ++   | ++   | -/+  | +    | ++    | -      |
| HCL                                       | +++  | -   | -    | ++    | +++  | +++  | +++  | -    | +++  | +    | +     | +++    |
| HCL variant                               | +++  | -   | -    | ++    | +++  | +++  | +++  | -    | -    | +    | +     | +++    |
| Splenic lymphoma with villous lymphocytes | ++   | -/+ | -/+  | +/-   | ++   | ++   | ++   | +/-  | -/+  | +    | ++    | -/+    |

|                               |    |     |     |     |    |    |     |     |   |     |    |   |
|-------------------------------|----|-----|-----|-----|----|----|-----|-----|---|-----|----|---|
| Marginal zone B-cell lymphoma | ++ | -   | -   | +/- | ++ | ++ | +/- | +/- | - | -/+ | ++ | - |
| Mantle cell lymphoma          | ++ | ++  | -/+ | -   | ++ | ++ | ++  | -   | - | +   | ++ | - |
| Follicular lymphoma           | ++ | -/+ | ++  | -   | ++ | ++ | ++  | -/+ | - | -   | ++ | - |

-, not expressed; -/+, usually is not expressed; +/-, usually is expressed; + to +++, varying degrees of strength of expression; HCL, hairy cell leukemia; sIg, surface membrane immunoglobulin. Adapted from references [2](#) and [160](#), [161](#), [162](#) and [163](#).

**TABLE 92.3. Scoring System for Diagnosis of Chronic Lymphocytic Leukemia**

| Marker                 | Marker Intensity | Score | Marker Intensity | Score |
|------------------------|------------------|-------|------------------|-------|
| Surface immunoglobulin | Weak             | 1     | Strong           | 0     |
| CD5                    | +                | 1     | -                | 0     |
| CD23                   | +                | 1     | -                | 0     |
| CD22/CD79b             | Weak             | 1     | Strong           | 0     |
| FMC7                   | -                | 1     | +                | 0     |

+, present; -, absent.

NOTE: Diagnosis of chronic lymphocytic leukemia requires a score of 4 or 5.

Adapted from Matutes E, Polliack A. Morphological and immunophenotypic features of chronic lymphocytic leukemia. *Rev Clin Exp Hematol* 2000;4:22-47; and Moreau EJ, Matutes E, A'Hern RP, et al. Improvement of the chronic lymphocytic leukemia scoring system with the monoclonal antibody SN8 (CD79b). *Am J Clin Pathol* 1997;108:378-382.

To define the stage of maturation of the CLL cell, Damle et al. ([30](#)) measured CD38 levels in CLL. Approximately 50% of patients had greater than 30% CD38<sup>+</sup> cells, and these patients had a worse prognosis than those with less than 30% CD38<sup>+</sup> cells. Activation of CD38<sup>+</sup> cells, but not CD38<sup>-</sup> cells, through sIgM induces apoptosis and through IgD prolongs cell survival and induces differentiation ([166](#)).

One of the typical features of the CLL cell is the overexpression of membrane CD23, which is an activation marker and may play a role in the decreased apoptosis observed in this disease ([167](#)). The presence of CD23 is useful to differentiate CLL from mantle cell lymphoma, which is also CD5<sup>+</sup> ([163](#), [167](#)). Recently, it has been demonstrated that the increased expression of CD23 in CLL is related to deregulation of Notch2 signaling ([168](#)). Cell-surface CD23 undergoes spontaneous proteolysis, producing elevated serum levels of CD23, the level of which is a marker of disease stage and progression ([3](#)).

The B-cell antigen receptor complex is required for the proliferation of B cells after immune stimulation and is a complex formed by sIg and Iga/IgB (CD79a/CD79b) ([3](#)). CLL cells lack CD79b, which is related to overexpression of an alternatively spliced form of the gene ([169](#)). Very small numbers of CLL cells may be identified through the detection

of CD19<sup>+</sup>/CD5<sup>+</sup> cells that are CD79b<sup>-</sup>, and 3.5% of adults older than 40 years of age have small numbers of these cells in their peripheral blood (170). Whether these patients will eventually develop CLL is unknown, but the cells are monoclonal by surface Igs and are in the “good prognosis” group by being CD38<sup>-</sup> and showing mutations of the *IgV* gene. FMC7 is usually strongly expressed in hairy cell leukemia and prolymphocytic leukemia, and approximately 16% of CLL cases also stain positively (160). It has been shown recently that FMC7 reacts with an epitope of CD20; as CD20 staining is low in typical stable CLL, this explains the low positivity seen with FMC7 staining (171). In general, those patients who are FMC7<sup>+</sup> have high levels of surface IgM, low expression of CD23, and poor prognosis (160). Myelomonocytic antigens (CD11b, CD13) may also be expressed in CLL, and this is associated with diffuse marrow involvement, CD5 negativity, and poor survival (172).

The CD5 antigen is most commonly associated with mature T cells and is expressed weakly on thymocytes (3, 173). However, normal B cells carrying the CD5 marker are located in the mantle zone of the lymph node, and small numbers of these cells are also present in the peripheral blood (3, 173). The CD5 molecule has been cloned and appears to be involved in the activation of T lymphocytes. The function of CD5 on the B cell remains unknown, but its induction has been shown to be inhibited by the T cell-derived cytokine IL-4. CD5<sup>+</sup> B cells can be stimulated to secrete anti-DNA antibodies and rheumatoid factors *in vitro*, and increased numbers are found in the peripheral blood of patients with rheumatoid arthritis, systemic lupus erythematosus, and Sjögren syndrome (4). It has been suggested that the normal counterpart of the CLL cell is the CD5<sup>+</sup> B cell (3, 4), although a recent study using detailed immunophenotyping demonstrated significant differences between the two groups (3, 4, 164). Thus, the CD5<sup>+</sup> B cell appears to be a resting antigen-naïve cell, whereas the CLL cell is activated and antigen-experienced (164). Moreover, the specific activation marker expression pattern varies between cells that have *IgV* gene mutations and those that do not, with the unmutated group resembling B cells at an earlier state of activation (164). It has been shown that approximately 5% of patients with the morphologic features of CLL are CD5<sup>-</sup> (160, 162, 171). These cases are more likely to be FMC7<sup>+</sup>, CD23<sup>-</sup>, CD11b<sup>+</sup>, and CD13<sup>+</sup> and have a poorer prognosis than those with CD5<sup>+</sup> CLL (160, 162). However, it has more recently been suggested that these CD5<sup>-</sup> patients do not have CLL (174), and the National Cancer Institute-sponsored Working Group (NCI-WG) on CLL now includes CD5<sup>+</sup> as an essential criterion for the diagnosis of CLL (1).

Apart from having either  $\kappa$  or  $\lambda$  light chains on the cell-surface membrane (1, 3, 4), clonality is confirmed by the presence of unique idiotypic specificities of the Igs produced by CLL cells (175) and by Ig gene rearrangements (3, 4, 173). CLL cells have low to undetectable amounts of monoclonal polyreactive IgM autoantibodies, frequently of the rheumatoid factor type, on their surface (3, 4, 173). Thus, the same monoclonal autoantibody produced by a leukemia cell may react with a variety of antigens (e.g., IgG, cardiolipin, histones, or single- or double-stranded DNA) (173). Surface and cytoplasmic Igs contain either  $\kappa$  or  $\lambda$  light chains but never both. Most cells display a single heavy chain class, usually  $\mu$ , although some display  $\mu$  and d. Less commonly,  $\delta$ , a, or no heavy chain determinant is found. Although the CLL cell has traditionally been believed to be frozen at a particular stage in maturation, recent evidence has demonstrated that up to 50% of CLL patients have IgM<sup>+</sup> leukemia cells, which are able to undergo isotype switching to IgA (usually) or to IgG (176, 177). Rearrangements of Ig heavy and light chain

genes are readily demonstrated in patients with CLL ( [166](#), [178](#) ). Abnormal patterns, such as multiple cytoplasmic  $\mu$  bands, may correlate with advanced clinical stages of the disease ( [178](#) ). In addition, approximately 25% of patients with CLL appear to have rearrangements of the T-cell receptor  $\beta$  gene ( [179](#) ) but rarely, if ever, of the T-cell receptor  $\gamma$  gene ( [180](#), [181](#) ). In other T-cell malignancies, both  $\beta$ - and  $\gamma$ -genes are rearranged. Rearrangement of the T-cell receptor  $\beta$  gene may indicate transformation to prolymphocytic leukemia ( [180](#) ).

In more than half the cases, CLL cells can be induced to secrete monoclonal antibodies *in vitro* ( [3](#), [4](#), [166](#) ). Using sensitive techniques, monoclonal proteins can be detected in the serum of virtually all patients ( [182](#) ), although less than 5% of patients produce large enough quantities of monoclonal proteins to be detected by routine serum electrophoresis.

### Functional Immune Abnormalities

With disease progression, patients with CLL develop immunosuppression, partly as a result of their disease and partly because of chemotherapy, and 80% of patients have recurrent infections, with sepsis being the major cause of death ( [183](#) ). Apart from typical bacterial infections, CLL patients are also susceptible to opportunistic infections, particularly if they have received nucleoside analogs or monoclonal antibodies ( [184](#), [185](#), [186](#) and [187](#) ). The nucleoside analogs are highly toxic to T lymphocytes, whereas monoclonal antibodies may be cytotoxic to B cells, T cells, or both depending on the antibody used ( [186](#), [187](#) ). The major cause of infection is hypogammaglobulinemia, although CLL patients also have abnormalities in T cells, complement, and neutrophil function.

The characteristics of the CLL cells are described in other sections, but in essence, these cells have no useful immune function ( [183](#), [184](#) ). The cells show poor stimulatory activity in mixed lymphocyte culture ( [188](#) ) and in response to B-cell mitogens, such as pokeweed mitogen, lipopolysaccharide, and the Epstein-Barr virus ( [189](#), [190](#) ). However, phorbol esters, *Staphylococcus aureus* protein A from Cowan I, anti- $\mu$  antibodies, anti-CD40, and loxoribine have been shown to be potent mitogens ( [191](#), [192](#) ). Moreover, these cells are poor antigen-presenting cells and, as discussed below, can interfere with normal B- and T-cell function ( [193](#) ).

Hypogammaglobulinemia and agammaglobulinemia are usually observed in CLL, and the severity increases with the duration and stage of disease ( [183](#), [184](#), [194](#) ). The Ig levels are all decreased, and within the IgG class, reduced levels of IgG2 and IgG4 correlate best with the risk of infection; however, the decline in IgA levels is the most important predictor of infection ( [194](#), [195](#) ). Patients with CLL have reduced primary and secondary responses to immunization ( [183](#) ). Although patients with higher levels of gammaglobulin usually show better responses than those with low levels, the response of both groups is abnormal. The pathogenesis of the hypogammaglobulinemia is poorly understood. However, impaired B-cell function and regulatory abnormalities of T cells (including the reversal of normal helper/suppressor cell ratios) probably play a role. In addition, CLL-derived natural killer (NK) cells have been shown to suppress Ig secretion by normal B cells *in vitro* ( [196](#) ).

The absolute number of T cells may be increased in untreated B-cell CLL, but there are marked abnormalities in the surface markers, including inversion of the T-helper cell to

T-suppressor cell ratio, suggesting perturbations in T-cell function ( [183](#), [197](#), [198](#) ). The increase in the absolute number of T-suppressor cells may correlate with the degree of hypogammaglobulinemia ( [199](#) ). The T cells usually respond normally to mitogens, such as phytohemagglutinin, *in vitro* and produce IL-2 and  $\gamma$ -interferon ( [200](#) ), but their reactivity to allogeneic and autologous B cells is impaired ( [201](#), [202](#) ). Functional studies of the T cells have sometimes shown decreased T-helper functions ( [201](#), [202](#) ). Spontaneous and antibody-dependent cytotoxicity are reduced, suggesting an abnormality in the large granular lymphocyte population, including NK cells ( [203](#) ).

The cause of these abnormalities is unclear, but in some cases, there is clonal expansion of T-cell subsets, which has been ascribed to stimulation by CLL cells ( [183](#), [204](#) ). Alternatively, the B-, T-, and NK-cell functions may be suppressed by means of immunosuppressive factors produced by CLL B cells. One potential candidate is TGF- $\beta$ , which is secreted by CLL cells and marrow stromal cells in CLL, and has been shown to be a potent inhibitor of normal B and T cells ( [136](#), [137](#), [138](#) and [139](#) ). In addition, CLL cells express both CD40 and the CD40L (CD154), and these cells decrease CD154 expression by normal T cells with resultant effects on normal B-cell differentiation and isotype switching ( [205](#) ).

In addition to the above abnormalities, the levels of different complement components are decreased in CLL, particularly in patients with advanced disease ( [206](#) ). As well, multiple defects in neutrophil function have been described in CLL, and these are associated with an increased risk of infection ( [207](#) ).

### Autoimmune Manifestations

Although CLL patients are immune deficient, they have an increased incidence of autoimmune disorders, particularly of the hematopoietic system, and the incidence is highest in those with advanced disease who have undergone therapy ( [208](#), [209](#) and [210](#) ). Four percent to 25% of patients develop autoimmune hemolytic anemia, and this is usually associated with a warm-type antibody against the Rhesus system. The incidence of this disorder is higher in men, those with lymphocyte counts greater than  $60 \times 10^9/L$ , and those older than 60 years of age ( [208](#) ). Immune thrombocytopenia occurs in 2% of patients, and the diagnosis is based on an increase in platelet size in the peripheral blood and an increase in megakaryocytes in the marrow, although the latter is often difficult to ascertain as the marrow usually is heavily infiltrated with CLL cells. It is interesting that approximately one-third of these patients have a positive Coombs test ( [210](#) ). Whether autoimmune neutropenia occurs in CLL is unclear ( [210](#) ). Pure red cell aplasia occurs in approximately 1% of cases and may be caused by a T-cell mechanism rather than the formation of autoantibodies ( [209](#), [211](#) ). Apart from the autoimmune hematologic disorders, nephrotic syndrome, related to membranous or membranoproliferative glomerulonephritis, acquired angioedema, and autoimmune blistering skin diseases also occur in CLL ( [210](#) ). The glomerulonephritis is believed to be secondary to deposition of monoclonal Ig and remits with treatment of the CLL ( [210](#), [212](#) ). Acquired angioedema is associated with recurrent angioedema and abdominal pain and is related to inactivation of the inhibitor of the first component of complement by a paraprotein produced by the lymphoid malignancy ( [210](#) ). CLL is also a cause of paraneoplastic pemphigus, which produces painful mouth ulcers, conjunctivitis, and pruritic blistering skin lesions ( [210](#), [213](#) ). This disorder is diagnosed by distinct histologic changes in the skin and the presence of autoantibodies in



the blood directed against cutaneous epitopes ( [210](#), [213](#), [214](#) ).

Normal CD5<sup>+</sup> B cells can produce autoantibodies to IgG and single- and double-stranded DNA, as well as other autoantigens, and the number of these cells is increased in autoimmune disorders ( [3](#), [4](#), [172](#) ). CLL cells also can be induced to secrete IgM molecules that react with a comparable spectrum of antigens ( [172](#), [215](#) ). However, several observations suggest that the clinically significant autoantibodies are not produced by the leukemic clone. First, the antibodies are polyclonal and are usually IgG. Second, the autoimmune disorders may occur while the patient's disease is responding to therapy ( [208](#), [209](#), and [210](#), [216](#) ). This was initially observed during or after treatment with fludarabine ( [216](#) ), although subsequent studies in untreated patients have shown a similar incidence of this complication regardless of whether the patients received fludarabine or other agents ( [217](#), [218](#) ). It is therefore likely that the high incidence of autoimmune hemolytic anemia in the initial studies with fludarabine was associated with advanced and alkylator-resistant disease ( [208](#), [209](#), and [210](#), [216](#) ). It has been suggested that CLL cells act as antigen-presenting cells for either normal CD5<sup>+</sup> or CD5<sup>-</sup> antibody-producing B cells and that antibody production is increased after inhibition of T cells either with advancement of disease or because of therapy ( [4](#), [215](#) ). Alternatively, the CLL cells might be the source of antibody, as it has been demonstrated that IgM<sup>+</sup> CLL cells can undergo isotype class-switching to IgG<sup>+</sup> cells, which could be a source of the typical "warm reactive" antibodies normally seen with autoimmune disease ( [175](#), [176](#) ). Additional support for CLL cells being the source of autoantibody is provided by the association between autoimmune hemolytic anemia in CLL and the expression by the leukemia cells of specific Ig variable-region genes ( [219](#) ).

## DIAGNOSIS

The CLL working groups, the International CLL Workshop ( [153](#) ) and the NCI-WG ( [1](#) ), have summarized the diagnostic criteria for CLL.

The International CLL Workshop proposed the following criteria in 1989:

1. A sustained peripheral blood lymphocyte count of  $\geq 10 \times 10^9/L$ , with most of the cells being mature-appearing lymphocytes.
2. A bone marrow aspirate showing greater than 30% lymphocytes.
3. Peripheral blood lymphocytes that have a B-cell phenotype consistent with CLL (i.e., weak expression of surface Ig, CD5<sup>+</sup>, and rosette formation with mouse erythrocytes).

The diagnosis of CLL is confirmed if criterion 1 plus criterion 2 or 3 are present. If the peripheral blood lymphocyte count is less than  $10 \times 10^9/L$ , then both criteria 2 and 3 must be present.

The NCI-WG in 1996 recommended that the diagnosis of CLL require

1. A peripheral blood lymphocyte count of greater than  $5 \times 10^9/L$ , with less than 55% of the cells being atypical. The cells should have (a) B cell-specific differentiation antigens (CD19, CD20, and CD23) and be CD5<sup>+</sup>, without other pan-T-cell markers; (b) either  $\kappa$  or  $\lambda$  chain surface Ig, confirming monoclonicity; and (c) low-density



- surface Ig.
2. A bone marrow aspirate showing greater than 30% lymphocytes.

## DIFFERENTIAL DIAGNOSIS

In most patients, the diagnosis of CLL is easily made after a careful review of the peripheral smear and immunophenotyping, although other conditions must be considered ( [Table 92.4](#) ). On occasion, immunohistochemistry or gene rearrangement studies are required to exclude other diagnoses.

**TABLE 92.4. Differential Diagnosis of Chronic Lymphocytic Leukemia**

|                  |   |
|------------------|---|
| Benign causes    |   |
|                  | Bacterial (e.g., tuberculosis)                        |
|                  | Viral (e.g., infectious mononucleosis)                |
|                  | Persistent polyclonal B-cell lymphocytosis            |
|                  | Hyperreactive malarial splenomegaly                   |
| Malignant causes |   |
| B Cell           |   |
|                  | Prolymphocytic leukemia                               |
|                  | Leukemic phase of non-Hodgkin lymphomas               |
|                  | Mantle cell lymphoma                                  |
|                  | Follicular small cleaved cell lymphoma                |
|                  | Splenic lymphoma with circulating villous lymphocytes |
|                  | Marginal zone lymphomas                               |
|                  | Large cell lymphoma                                   |
|                  | Hairy cell leukemia                                   |
|                  | Waldenström macroglobulinemia                         |
| T Cell           |   |
|                  | Prolymphocytic leukemia                               |
|                  | Adult T-cell leukemia/lymphoma                        |
|                  | Sézary syndrome                                       |
|                  | Large granular lymphocytic leukemia                   |

### Benign Causes

**T-CELL-ASSOCIATED CAUSES** Chronic infections, such as tuberculosis or syphilis, may produce a lymphocytosis. Transient but fairly profound increases in the number of small lymphocytes in the blood may be seen in viral illnesses, such as pertussis, infectious lymphocytosis, or infectious mononucleosis. However, these are usually found in children or young adults and should be easily distinguished from CLL by the clinical features and the morphologic appearance of the cells.

**B-CELL-ASSOCIATED CAUSES** Persistent polyclonal B-cell lymphocytosis is a rare and benign condition seen typically in middle-aged female smokers with a familial tendency ( [220](#), [221](#) and [222](#) ). The lymphocytes are binucleated and have abundant cytoplasm. There is a polyclonal increase in Igs and a strong association with HLA-DR7, and an isochromosome 3q<sup>+</sup> (i3)(q10) is observed in some cases ( [220](#), [221](#) ). These cells show *IgV*

gene mutations and immunophenotypically are splenic marginal zone lymphocytes [i.e., CD27<sup>+</sup>, IgM (high), CD21 (high), CD5 (low)] ( 222 ). Delage et al. ( 221 ) have demonstrated multiple *bcl-2/Ig* gene rearrangements in this disease and described a family in which there was a high incidence of the gene rearrangements in first-degree relatives in association with a paternal HLA haplotype ( 221 ). These findings suggest that persistent polyclonal B-cell lymphocytosis can be a familial disorder and that the *bcl-2/Ig* gene rearrangements may represent the first abnormality before B-cell expansion ( 221 ). Tropical splenomegaly syndrome or hyperreactive malarial splenomegaly occurs in most countries in the malaria belt and may mimic CLL ( 223 , 224 ). This disease is believed to be a disordered response to malarial antigens leading to overproduction of B cells and is characterized by massive splenomegaly, an increase in IgM, and, in 10% of cases, an increase in the peripheral lymphocyte count. The disorder responds to proguanil (an antimalarial compound), and this is used to differentiate hyperreactive malarial splenomegaly from CLL.

## Malignant Causes

Malignant disorders that may be confused with CLL are discussed in detail later in this section, but their main clinical and laboratory features are summarized here for comparative purposes and as an aid in differential diagnosis ( Table 92.4 ). Over the past decade, the identification of new disorders has increased, partly as a result of greater attention to morphologic details, but also as a result of increasing sophistication in immunophenotyping and molecular genetic and cytogenetic studies ( 163 , 225 ).

Before flow cytometry became a routine investigation, many patients were diagnosed as having CLL but in fact had other disorders ( Table 92.2 ). Approximately 50% of cases of peripheral lymphocytosis seen in some referral centers are caused by CLL ( 226 ), and the most common malignancies to be confused with CLL are polymphocytic leukemia and the leukemic phase of non-Hodgkin lymphomas. Morphologically, these disorders may appear similar to CLL, particularly to atypical CLL.

## B-CELL-ASSOCIATED CAUSES

***B-Cell Prolymphocytic Leukemia*** B-cell prolymphocytic leukemia is characterized by larger, less mature-appearing cells than are seen in CLL, and the nucleus has condensed chromatin and prominent central nucleoli ( 227 , 228 ). Patients with CLL/PLL have 11 to 54% prolymphocytes, but in prolymphocytic leukemia, =55% of the cells are prolymphocytes ( 156 ). Prolymphocytic leukemia appearing *de novo* is an aggressive disease, and patients frequently are symptomatic with fever, weight loss, or abdominal discomfort and are found to have massive splenomegaly, minimal lymphadenopathy, and resistance to therapy ( 227 , 228 ). Leukocyte counts in excess of  $150 \times 10^9/L$ , consisting almost entirely of prolymphocytes, are common, as are anemia and thrombocytopenia. The cells have invariably intense staining for surface membrane Ig, FMC7, CD20, and CD79b, whereas this may or may not occur with CLL/PLL ( 156 ). One-third of cases have a deletion of 11q23, one-half a deletion of 13q14, and three-fourths a mutation of p53 ( 229 , 230 ). Although occasional patients may initially have stable disease, progression is the rule, and the median survival is 65 months ( 228 ).

***Leukemic Phase of Non-Hodgkin Lymphoma*** The leukemic phase of non-Hodgkin lymphoma used to be referred to as *lymphosarcoma cell leukemia* and includes the leukemic phase of mantle cell (intermediate cell) lymphoma, follicular lymphoma, splenic lymphoma with villous lymphocytes (splenic marginal zone lymphoma), other marginal zone lymphomas, and, rarely, large cell lymphomas. The lymphocytes in mantle cell lymphoma are larger than those seen in CLL and have more cytoplasm; in contrast to CLL and the other disorders, there is variation in cell morphology, with some cells looking like classical

CLL cells, others having irregular nuclei, and some looking like prolymphocytes ( [231](#), [232](#) ). Two-thirds of patients have marrow involvement and one-third leukemic involvement ( [231](#) ). Patients with a leukemic picture have aggressive disease. The cells strongly express surface Ig and are CD19<sup>+</sup>, CD20<sup>+</sup>, CD5<sup>+</sup>, CD23<sup>-</sup>, CD10<sup>-</sup>, and FMC7<sup>+</sup> ( [2](#), [163](#) ). These cells have the t(11;14)(q13;q32) and, by immunohistochemistry, stain strongly for cyclin D1. As the breakpoint for t(11;14)(q13;q32) covers a large area, PCR using only one set of primers misses many cases, and Southern blot analysis or FISH may be required ( [233](#), [234](#) ). The leukemic phase of follicular lymphomas may be confused with CLL; usually, the cells are small, the nuclear chromatin is smooth and not clumped, there is almost no cytoplasm, and the nucleus is indented ( [163](#), [235](#) ). Occasionally, large cells are seen, and, when possible, a lymph node biopsy should be carried out to type the follicular lymphoma. The cells are identified by immunophenotyping and are CD19<sup>+</sup>, CD20<sup>+</sup>, FMC7<sup>+</sup>, CD23<sup>-</sup>, CD5<sup>-</sup>, and CD10<sup>+</sup>. The diagnosis can be confirmed by demonstrating a t(14;18)(q32;q21). Approximately 10% of peripheral B-cell lymphocytosis is caused by splenic lymphoma with villous lymphocytes; these cells have characteristic filamentous projections and, frequently, a nucleolus ( [226](#), [236](#) ). The cells are usually SIg<sup>+</sup> (strong), CD19<sup>+</sup>, CD20<sup>+</sup>, CD23<sup>-</sup>, CD5<sup>-</sup>, CD79b<sup>+</sup>, and FMC7<sup>+</sup>. The other forms of marginal zone lymphomas, which include the mucosa-associated lymphoid tissue and monocytoid B-cell lymphomas, may also rarely involve the marrow and peripheral blood ( [225](#) ).

**Hairy Cell Leukemia** *Hairy cell leukemia* ( [Chapter 93](#) ) is so called because the leukemia cells have hairy cytoplasmic projections that are usually visible under light, phase, or electron microscopy. Almost always, this is a B-cell disorder, and the cells are of moderate size with eccentric oval nuclei and variable prominent nucleoli. The cells differ from CLL cells in being CD5<sup>-</sup> but FMC7<sup>+</sup>, CD11c<sup>+</sup>, CD25<sup>+</sup>, HC2<sup>+</sup>, and CD103<sup>+</sup> (B-ly-7<sup>+</sup>) ( [237](#) ). In contrast to classical hairy cell leukemia, in which the lymphocyte count is usually low, the variant form of hairy cell leukemia has a higher lymphocyte count, but the cells have prominent nucleoli, are tartrate-resistant acid-phosphatase negative, and are CD25<sup>-</sup> ( [238](#) ).

**Waldenström Macroglobulinemia** Waldenström macroglobulinemia ( [Chapter 100](#) ) is characterized by the proliferation of cells having plasmacytoid features and, frequently, abundant basophilic cytoplasm. Peripheral lymphocytosis is only moderate, the cells have surface and cytoplasmic IgM, and produce large quantities of monoclonal IgM ( [225](#) ).

**T-CELL-ASSOCIATED CAUSES** The chronic T-cell disorders are much less common than the B-cell disorders but can be classified into four groups ( [156](#) ).

**T-Cell Prolymphocytic Leukemia** T-cell prolymphocytic leukemia is morphologically identical to B-cell prolymphocytic leukemia, but lymphadenopathy and skin involvement are more common ( [239](#), [240](#) ). Most often, these cases are CD3<sup>+</sup>, CD4<sup>+</sup>, CD7<sup>+</sup>, and CD8<sup>-</sup>, but in one-third of patients, the cells are both CD4<sup>+</sup> and CD8<sup>+</sup> or, more rarely, CD4<sup>-</sup> and CD8<sup>+</sup> ( [239](#) ). Although the median survival for this disease is only 7.5 months, good responses have recently been observed with alemtuzumab (Campath-1H), a monoclonal antibody against CD52 ( [241](#) ).

**Adult T-Cell Leukemia/Lymphoma** Adult T-cell leukemia/lymphoma is most common in the Orient and has a variety of clinical presentations ( [242](#), [243](#) ). Patients may present acutely with lymphadenopathy or hepatosplenomegaly, although skin involvement, lytic bone lesions, hypercalcemia, and involvement of other organs have been described. Alternatively, there may be a chronic form of the disease with peripheral lymphocytosis and skin involvement, which may either resolve entirely or develop into the acute form of the disease ( [243](#) ). More recently, a prognostic classification has been developed based on the proliferative capacity of the peripheral blood leukemic cells ( [244](#) ). The cells are usually CD4<sup>+</sup> and are infected with human T-cell leukemia/lymphoma virus-1.

**Sézary Syndrome** Sézary syndrome is the leukemic form of mycosis fungoides, and

affected patients have diffuse skin involvement plus lymphadenopathy and splenomegaly, although peripheral lymphocytosis can occur in isolation ( 245 ). The cells are typically large with cerebriform nuclei, coarse chromatin, and inconspicuous nucleoli and are usually CD4<sup>+</sup> ( 245 ). The diagnosis of Sézary syndrome requires a peripheral blood Sézary cell count of greater than  $1 \times 10^9/L$  or that greater than 20% of the lymphocytes be identified as Sézary cells ( 245 ).

**Large Granular Lymphocytic Leukemia** Large granular lymphocytic (LGL) leukemia is characterized by moderate lymphocytosis ( $1$  to  $49 \times 10^9/L$ ) and the presence of cells that are bigger than CLL cells and have abundant cytoplasm containing azurophilic granules ( 246 , 247 and 248 ). However, there is considerable variation, even within the same patient, and in some cases, the lymphocytes may appear normal, and the granules may be coarse, fine, or absent ( 246 ). Large granular lymphocytes may be CD3<sup>-</sup> NK cells that mediate non-major histocompatibility complex-restricted cytotoxicity or CD3<sup>+</sup> cells that mediate non-major histocompatibility complex-restricted cytotoxicity ( 246 ). T-LGL leukemia is the most common form, making up 85% of cases, and is associated with neutropenia (which may be cyclical), red cell aplasia, and rheumatoid arthritis (25%), but this is a distinct entity from Felty syndrome ( 246 ). Recent evidence has suggested that the neutropenia is related to the expression of Fas ligand by LGL cells ( 249 ). The usual immunophenotyping of T-LGL leukemia is CD3<sup>+</sup>, CD4<sup>-</sup>, CD8<sup>+</sup>, CD16<sup>+</sup>, CD56<sup>-</sup>, CD57<sup>+</sup>, and TCR $\alpha\beta$ <sup>+</sup>, and T-cell receptor gene rearrangement studies confirm T-cell monoclonicity. If therapy is required, responses may be observed with cyclosporin or methotrexate ( 250 , 251 ). NK-LGL leukemia occurs most frequently in Japan and has an acute fulminant course with high fever, hepatosplenomegaly, and pancytopenia ( 247 ). However, chronic NK-cell leukemia can occur, with a clinical course similar to that of T-LGL leukemia ( 248 ). These cells are usually CD3<sup>-</sup>, CD4<sup>-</sup>, CD8<sup>-</sup>, CD16<sup>+</sup>, CD56<sup>+</sup>, and CD57<sup>-</sup> ( 246 ).

## INVESTIGATIONS AND STAGING

### Investigations

A complete blood count, review of the peripheral smear, and immunophenotyping are required for diagnosis and prognosis in CLL. A bone marrow aspirate/biopsy is not required for diagnosis but is useful to assess normal marrow reserve, and the pattern of involvement of the marrow by CLL is prognostically important ( 1 , 157 ). A reticulocyte count, Coombs test, renal and liver function tests [including lactate dehydrogenase (LDH)], serum protein electrophoresis and/or immunoelectrophoresis, and Ig levels are also required. Monoclonal proteins, if found, should be typed and measured in the serum and the urine. The plasma  $\beta_2$ -microglobulin level should also be measured, as this is a simple and important prognostic measure ( 252 ). If available, cytogenetic analysis and, particularly, FISH provide important prognostic information.

### Staging

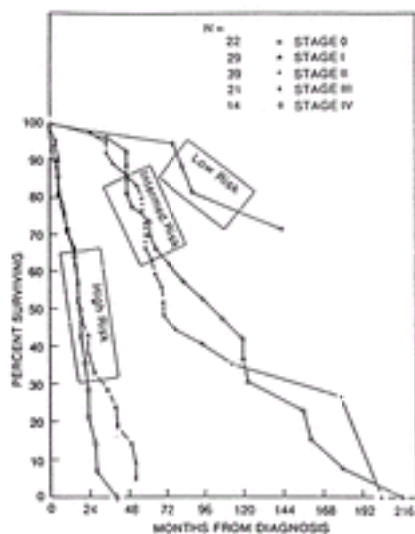
Two staging systems are in general use, and both are very useful for estimating disease severity and prognosis in CLL ( 253 , 254 ). The Rai staging system is generally used in North America, and the original system divided patients into five groups on the basis of the presence of lymphadenopathy, splenomegaly, and anemia or thrombocytopenia ( [Table 92.5](#) ) ( 253 ). A simplified three-stage version of this scheme is now generally accepted ( [Table 92.5](#) ) ( 1 ). Patients are classified into three groups with a significantly different

prognosis, making the classification useful in clinical decision making ( [Fig 92.7](#)).

**TABLE 92.5. Rai Classification System for Chronic Lymphocytic Leukemia**

| Stage | Modified Stage    | Description   | Median Survival (yr) |
|-------|-------------------|---|----------------------|
| 0     | Low risk          | Lymphocytosis   | >10                  |
| I     | Intermediate risk | Lymphocytosis <sup>a</sup> + lymphadenopathy  | 9                    |
| II    | Intermediate risk | Lymphocytosis + splenomegaly ± lymphadenopathy  | 7                    |
| III   | High risk         | Lymphocytosis + anemia <sup>a</sup> ± lymphadenopathy or splenomegaly                   | 5                    |
| IV    | High risk         | Lymphocytosis + thrombocytopenia <sup>a</sup> ± anemia ± splenomegaly ± lymphadenopathy | 5                    |

<sup>a</sup> Lymphocytosis, lymphocyte count  $>5 \times 10^9/L$  for  $>4$  weeks; anemia, hemoglobin  $<110$  g/L; and thrombocytopenia, platelets  $<100 \times 10^9/L$  ( [253](#), [257](#)).



**Figure 92.7.** Survival of patients with chronic lymphocytic leukemia staged according to the Rai system ( [Table 92.5](#)). Stages I and II are indistinguishable and are combined in the intermediate (Intermed)–risk group. Similarly, stages III and IV are combined in the high–risk group. (From Rai KR, Han T. Prognostic factors and clinical staging in chronic lymphocytic leukemia. *Hematol Oncol Clin North Am* 1990;4:447–456, with permission.)

The Binet staging system is most frequently used in Europe ( [254](#) ), and staging using this system is based on the number of involved areas, the level of hemoglobin, and the platelet count ( [Table 92.6](#) ). The five areas of involvement considered in this system include three lymph node areas (cervical, axillary, and inguinal, whether unilateral or bilateral), the spleen, and the liver. Most hematologists continue to use either the Rai or the Binet

system, but the International Workshop on CLL has recommended the integration of these two systems with special provisions for Rai stage 0 patients (153). This amalgamated system recognizes categories A(0), A(I), A(II), B(I), B(II), C(III), and C(IV) (1). The influence of the different stages on survival and the correlation with the other prognostic markers are discussed in Prognosis.

**TABLE 92.6. Binet Classification for Chronic Lymphocytic Leukemia**

| Stage | Blood Counts   | Involved Areas <sup>a</sup> | Median Survival (yr) |
|-------|--|-----------------------------|----------------------|
| A     | Hb >100 g/L and platelets >100 × 10 <sup>9</sup> /L          | <3                          | >10                  |
| B     | Hb >100 g/L and platelets >100 × 10 <sup>9</sup> /L          | >3                          | 7                    |
| C     | Hb <100 g/L, or platelets <100 × 10 <sup>9</sup> /L, or both | Any number                  | 5                    |

Hb, hemoglobin.

<sup>a</sup> The five areas of involvement include head and neck, axillae, groins, palpable spleen, and clinically enlarged liver (254, 257).

## PROGNOSIS

As indicated in the previous section, there is considerable variation in survival in CLL. Some patients may have a prolonged survival without treatment, and, indeed, an occasional patient can have a spontaneous remission (255). However, some patients suffer a rapid downhill course leading to death. The Rai or Binet clinical staging systems are simple and reliable prognostic measures (Fig 92.7) (253, 254). However, there is considerable variation in the prognosis of patients within any of these groups, and other prognostic measures must be used in conjunction with staging (Table 92.7). Some of these studies, such as lymphocyte morphology and doubling time, immunophenotyping, pattern of marrow involvement, serum LDH, and  $\beta_2$ -microglobulin levels, are routinely available, but others are either experimental or only available at specialized centers. Considerable effort is now being made to determine the association between these markers and to assess the relative importance of the individual markers by multivariate analysis (29, 31, 83). Clearly, the stratification of patients into different risk groups will allow for a more rational approach to treatment options and will identify specific patient groups to be studied in clinical trials.

**TABLE 92.7. Markers of Poor Prognosis in Chronic Lymphocytic Leukemia**

|   |
|---|
| Routine studies   |
| Advanced Rai or Binet stage   |
| “Atypical” morphology or chronic lymphocytic leukemia/prolymphocytic leukemia |
| Peripheral lymphocyte doubling time of <12 mo                                 |
| Immunophenotyping   |



High surface IgM, FMC7<sup>+</sup>, CD23<sup>-</sup>, CD11b<sup>+</sup>, CD13<sup>+</sup>  
CD38<sup>+</sup>

High  $\beta_2$ -microglobulin level

Diffuse marrow histology

High lactate dehydrogenase

Poor response to chemotherapy

Investigational studies

Lack of *IgV* gene mutations

Expression of ZAP-70 protein

Fluorescence *in situ* hybridization studies showing del 11q (loss of *ATM* gene), del 17p (loss of p53), or trisomy 12

Increased serum levels of CD23, tumor necrosis factor- $\alpha$ , and thymidine kinase

Ig, immunoglobulin.

---

### Rai and Binet Staging

The median survival of patients in the Rai staging *low-risk* group (31%), who have an isolated lymphocytosis, is more than 10 years and similar to that for the “normal” population, and therapy is therefore not indicated. Patients in the *intermediate-risk* group (61%), who have lymphadenopathy, splenomegaly, or both, have a median survival of 7 to 9 years. They carry a significantly greater tumor load and may develop signs and symptoms attributable to the presence of tumor masses. Patients in the *high-risk* group (8%) have anemia, thrombocytopenia, or both and have a median survival of approximately 5 years. The median survival of patients with Binet stage A (63%) is greater than 10 years, stage B (30%) is 7 years, and stage C (7%) is 5 years ( [256](#), [257](#) ).

Although both staging systems provide useful prognostic information, they do not correlate well with each other. Thus, there are twice as many patients with Binet stage A disease as in the Rai low-risk group, and the opposite is true for Binet stage B disease and the Rai intermediate-risk group. Although the median survival of patients with stage A disease or in the low-risk group is greater than 10 years, 40% of these patients will progress to a more advanced disease, and 50% of patients will require therapy at some point, with 25% dying from their disease ( [256](#), [257](#) ).

### Age and Sex

Approximately 10% of CLL patients are younger than 50 years old, and the clinical features and staging at presentation are similar in this group to those older than 50 years ( [151](#), [152](#) ). Survival of both groups of patients is the same, although the proportion of deaths that can be directly attributed to CLL is greater for the younger age group ( [152](#) ). These results indicate that a subgroup of younger patients have aggressive disease. In addition, the risk of a Richter transformation is fivefold higher in the younger age group ( [152](#) ). The male to female ratio for CLL is 2:1, and women are more likely to have early-stage disease. However, regardless of stage and age, women have a better prognosis than men ( [258](#) ).



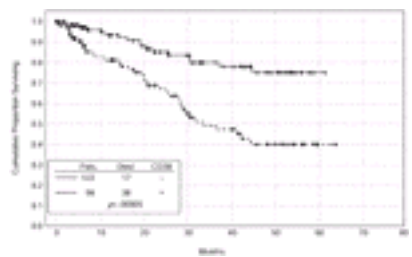
## Lymphocyte Characteristics

**MORPHOLOGY** Approximately 20% of patients have atypical CLL or CLL/PLL, and these patients have a more advanced stage, a higher proliferative index, and a poorer prognosis ( [101](#), [102](#), [113](#), [162](#)). Moreover, these patients are also more likely to have trisomy 12 or deletion of 17p13 (p53 mutation), to be CD38<sup>+</sup>, and not to have mutations of the *IgV* gene ( [102](#), [113](#), [162](#)). However, in a multivariate analysis, aberrant cell morphology was found to be an independent prognostic marker ( [259](#)).

**NUMBER** Survival decreases with increasing lymphocyte count ( [260](#)). The median survival is 8.6 years for a lymphocyte count =  $20 \times 10^9/L$  and 3.7 years if the count is greater than  $40 \times 10^9/L$ .

**DOUBLING TIME** The lymphocyte doubling time is a useful measure of disease aggressiveness. Indolent CLL is associated with a slow lymphocyte doubling time, whereas patients with a lymphocyte doubling time of less than 12 months have a significantly worse survival rate ( [261](#), [262](#)).

**IMMUNE MARKERS** Variations in immunophenotyping, such as an increase in surface Igs, FMC7<sup>+</sup>, and CD23<sup>-</sup> or increased intensity of CD20, may be associated with atypical morphology, trisomy 12, and poor prognosis ( [101](#), [160](#), [161](#), [263](#)). A number of studies have demonstrated the importance of CD38<sup>+</sup> as a prognostic marker ( [Fig. 92.8](#)) ( [29](#), [30](#) and [31](#), [84](#), [264](#), [265](#) and [266](#)). Although Damle et al. ( [30](#)) initially found a correlation between the presence of an *IgV* gene mutation and CD38<sup>-</sup> (<30% CD38<sup>+</sup> cells), this has not been confirmed by others ( [29](#), [31](#), [83](#)). In all of these studies, CD38<sup>+</sup> has been associated with shorter survival ( [29](#), [30](#) and [31](#), [84](#), [264](#), [265](#) and [266](#)) and correlates with increasing Rai stage, intrathoracic and -abdominal lymphadenopathy, short doubling time, increased  $\beta_2$ -microglobulin levels, and atypical morphology ( [Fig. 92.8](#)) ( [264](#), [265](#) and [266](#)). Moreover, the CD38 status is useful to predict which patients within a particular clinical stage will progress ( [265](#), [266](#)). When followed over time, CD38<sup>-</sup> patients may become CD38<sup>+</sup>, and this is associated with deletion of 17p13 (p53 mutation) and disease progression ( [266](#)).



**Figure 92.8.** Survival according to CD38 status. Patients (Pats) with greater than 20% CD38<sup>+</sup> chronic lymphocytic leukemia cells have a poorer survival than those with less than 20% CD38<sup>+</sup> cells. (From Ibrahim S, Keating M, Do K-A, et al. CD38 expression as an important prognostic factor in B-cell chronic lymphocytic leukemia. *Blood* 2001;98:181–186, with permission.)

A low CD4/CD8 ratio and a decreased number of NK cells are observed in advanced disease and are associated with hypogammaglobulinemia ( [267](#)). In addition, a low gammaglobulin level is associated with reduced survival ( [268](#)).

**MOLECULAR GENETICS AND CYTOGENETICS** As discussed previously, chromosomal analysis provides prognostic information about overall survival ( [Fig. 92.2](#) and [Fig. 92.6](#)) ( [91](#), [93](#), [96](#), [97](#), [98](#), [99](#) and [100](#)). Because of the difficulty in obtaining metaphases in CLL,

interphase FISH has become the standard technique in staging this disease and provides important prognostic information ( [Fig. 92.6](#)) ( [29](#), [31](#), [79](#), [84](#), [91](#)). Patients with deletions of 17p13 (p53 mutations) or 11q22–11q23 have very poor prognosis ( [29](#), [31](#), [79](#), [84](#), [266](#)). Patients with trisomy 12 have atypical morphology and immunophenotyping, advanced disease, and a poorer prognosis than those with normal molecular genetics or a deletion 13q14 ( [79](#), [101](#)).

**P53, ATAXIA TELANGIECTASIA MUTATION, RETINOBLASTOMA, AND P27<sup>Kip1</sup> Status**  
Mutations of p53 are present in 10 to 15% of patients and are predictive of resistance to chemotherapy, both *in vitro* ( [269](#)) and *in vivo* ( [79](#)). Mutations of p53 can be detected by a deletion of 17p13, as demonstrated by FISH, or by an increase in p53 protein, as assessed by immunohistochemistry ( [78](#), [79](#), [113](#)). The abnormality is associated with aberrant cell morphology and very poor survival ( [Fig. 92.2](#) and [Fig. 92.6](#)). ATM and Rb protein levels are reduced in 34 and 42% of patients, respectively, and these patients have advanced stage disease and reduced survival ( [83](#), [90](#)). Overexpression of p27<sup>Kip1</sup> is associated with a short lymphocyte doubling time and poor survival ( [91](#)).

**SOMATIC HYPERMUTATIONS OF THE IMMUNOGLOBULIN GENE** Approximately 50% of patients with CLL have somatic mutations of the *IgV* gene, and these patients have stable disease and normal cell morphology ( [Fig. 92.2](#)) ( [5](#), [6](#), [29](#), [30](#), [84](#)). In contrast, patients without *IgV* mutations are more likely to have atypical morphology, deletion of 11q23, advanced disease, and a poor prognosis ( [29](#)). Whether patients without *IgV* mutations have an increased incidence of p53 mutations or trisomy 12 is controversial ( [29](#), [31](#), [83](#)).

### **Marrow Histology**

Nodular and interstitial growth patterns in the marrow are associated with similar marrow tumor burdens and median survival times of 90 and 46 months, respectively, whereas diffuse infiltration or a “packed marrow” is associated with a greater marrow tumor burden and a median survival time of only 28 months ( [1](#), [157](#)). However, a more recent study has not shown that the pattern of marrow involvement adds additional information to staging alone ( [270](#)). Fibrosis of the marrow also indicates an aggressive clinical course ( [271](#)). There is more reproducibility in assessing the extent and type of marrow infiltration with the aspirate compared with the biopsy, but Montserrat et al. ( [272](#)) only found that the biopsy provided useful prognostic information.

The pattern of marrow involvement after chemotherapy is also prognostically important. Patients with persistent lymphoid nodules in the marrow after chemotherapy [nodular partial remission (PR)] have persistent leukemia and have a shorter time to relapse compared to those in complete remission (CR) ( [273](#)). However, the extent of involvement does not correlate with the rapidity of disease recurrence ( [274](#)).

### **Serum Markers**

Increased levels of the serum markers LDH ( [31](#)),  $\beta_2$ -microglobulin ( [252](#), [264](#), [265](#), [275](#)), CD23 ( [142](#), [167](#)), thymidine kinase ( [276](#)), and TNF- $\alpha$  ( [277](#)) can help identify patients who are at risk of disease progression. Serum LDH,  $\beta_2$ -microglobulin, and CD23 levels presumably reflect tumor burden, whereas thymidine kinase is involved in the “salvage pathway” for DNA synthesis and reflects the number of dividing cells.

## **TREATMENT**

In general, it is estimated that one-third of CLL patients never require therapy, one-third need treatment as soon as they are seen, and one-third have disease progression over the years and require therapy at some point ( 257 ). As all forms of treatment can carry some risk, it is important to ensure that the CLL patient really requires therapy before initiating treatment. Using the above prognostic indicators, it is possible to assess which patients do not require treatment. For example, patients with Binet stage A disease having a lymphocyte count of less than  $30 \times 10^9/L$ , a doubling time of more than 12 months, hemoglobin of more than 130 g/L, and a nondiffuse marrow morphology are classified as having “smoldering” CLL ( 278 , 279 ). These patients have a life expectancy no different from that of the age- and sex-matched population and definitely do not require treatment ( 278 , 279 and 280 ). In fact, premature treatment may actually cause harm. Thus, treatment of patients with Rai 0 or Binet A disease with chlorambucil may delay disease progression but does not improve survival and may increase the incidence of epithelial tumors and acute leukemia ( 256 ). Thus, treatment is reserved for patients with *low- or intermediate-risk* disease who are symptomatic or have progressive disease, as evidenced by increasing organomegaly or a lymphocyte doubling time of less than 12 months. Patients with *high-risk* disease are usually treated in an attempt to improve hemoglobin and platelet counts, although asymptomatic patients can be monitored and treatment initiated when there is clear evidence of disease progression. In addition, patients are usually treated if they have systemic symptoms, bulky lymphadenopathy or hepatosplenomegaly, autoimmune hemolytic anemia/thrombocytopenia, or a rapidly rising lymphocyte count.

## Response Criteria

To facilitate comparisons of results obtained in clinical trials, the NCI-WG ( 1 ) has established criteria for complete and partial responses to therapy in CLL, and the details of these definitions are outlined in Table 92.8. A *CR* was defined as including the resolution of systemic symptoms, lymphadenopathy, and hepatosplenomegaly with the normalization of blood counts (hemoglobin,  $>110$  g/L; neutrophils,  $>1.5 \times 10^9/L$ ; and platelets,  $>100 \times 10^9/L$ ). These criteria must be maintained for longer than 2 months, after which time a bone marrow aspiration and biopsy must contain less than 30% lymphocytes and no lymphoid nodules. In the original NCI-WG definitions and International Workshop, patients were considered to be in *CR* even if there were lymphoid nodules in the marrow, as these can occur normally ( 281 ). However, it was subsequently demonstrated that patients in *CR* achieved a shorter remission if there were nodules in the marrow, indicating that some of these nodules are malignant ( 282 ). Thus, patients with residual lymphoid nodules in the marrow are classified as *nodular PRs*. A *PR* includes a greater than 50% decrease in lymphocyte count and a greater than 50% reduction in lymphadenopathy, hepatosplenomegaly, or both, with normalization of the neutrophils, hemoglobin, and platelets ( 1 ). The use of more sophisticated techniques to confirm a *CR*, such as immunophenotyping, FISH, and assaying for clonal rearrangement of Ig genes, is being evaluated ( 1 , 282 , 283 ).

**TABLE 92.8. Criteria for Clinical Response in Chronic Lymphocytic Leukemia**

### CR

No constitutional symptoms

No hepatosplenomegaly or lymphadenopathy by physical examination or radiography

Normal complete blood count (hemoglobin, >110g/L; neutrophils, >1.5 × 10<sup>9</sup>/L; and platelets, 100 × 10<sup>9</sup>/L)

The above should be maintained for 2 mo, after which a normal marrow aspirate and biopsy (normocellular, with no lymphoid nodules and <30% lymphocytes) should be documented. If marrow is hypocellular, a repeat examination should be carried out in 4 wk. If the marrow contains lymphoid nodules, then the patient is not in CR but is classified as “nodular PR.”

If the patient remains anemic or thrombocytopenic but is otherwise in CR, they are considered to be in PR.

PR

>50% decrease in peripheral blood lymphocyte count and >50% decrease in lymphadenopathy and/or splenomegaly (or hepatomegaly)

The above should be maintained for 2 mo in conjunction with one or more of the features below

Hemoglobin >100 g/L or >50% improvement from baseline

Neutrophils >1.5 × 10<sup>9</sup>/L or >50% improvement from baseline

Platelets >100 × 10<sup>9</sup>/L or >50% improvement from baseline

PD

>50% increase in the sum of the products of >two nodes on at least two determinations carried out 2 wk apart, and/or

>50% in liver and/or spleen size, and/or

>50% increase in lymphocyte count to at least 5 × 10<sup>9</sup>/L, and/or

Transformation to a more aggressive histology

Stable disease

Patients who do not fit the criteria for CR, PR, or PD

CR, complete remission; PD, progressive disease; PR, partial remission.

Adapted from Cheson BD, Bennett JM, Grever M, et al. National Cancer Institute-sponsored working group guidelines for chronic lymphocytic leukemia: revised guidelines for diagnosis and treatment. *Blood* 1996;87:4990-4997.

---

## Chemotherapy

**ALKYLATING AGENTS** The most commonly used treatment for CLL is the alkylating agent chlorambucil, which likely produces its antitumor effect by binding covalently with DNA, RNA, and cellular proteins ( [284](#), [285](#)). Chlorambucil has been used in CLL for 50 years, but the interpretation of the early studies is difficult, as the strict criteria for the diagnosis of this disease and the definitions of response have only recently been formulated ( [1](#), [281](#)). Chlorambucil is usually administered continuously in a daily dosage of 0.1 mg/kg or intermittently as 0.4 mg/kg every 2 weeks, and these treatment schedules have equivalent efficacy, although the intermittent route may produce less myelosuppression ( [286](#), [287](#)). By the intermittent route, the dose is increased in increments of 0.1 mg/kg until the maximum tolerated dosage is reached (between 0.4 and 1.8 mg/kg). Overall, the response rate with these regimens is 40 to 60%, with 4 to 10% of patients achieving a CR ( [217](#), [286](#), [287](#), [288](#) and [289](#)). Cyclophosphamide has also been used in the treatment of CLL and differs little, if at all, from chlorambucil in its effectiveness ( [289](#)). Cyclophosphamide usually is given in a daily dose of 2 to 3 mg/kg or 20 mg/kg once every 2 to 3 weeks. To improve response rates, alkylating agents have been combined

with steroids or other agents, or the dose of the alkylating agents has been increased. The monthly administration of chlorambucil with prednisone increased the response rate (47%) and survival compared to daily chlorambucil plus prednisone (response rate, 37%) or prednisone alone (response rate, 11%) ( [286](#) ). In one study, the frequency of response and the number of patients alive at 2 years were higher when chlorambucil (6 mg/day) was combined with prednisone (30 mg/day) for 6 weeks than when chlorambucil was used alone; however, no difference in median survival was demonstrated between the two groups ( [291](#) ). In practice, prednisone is frequently combined with chlorambucil to produce a more rapid decrease in lymph node and spleen size, and this is usually accompanied by an initial increase in the peripheral lymphocyte count. It has become clear that the response rate to chlorambucil is highly dependent on the dose of drug used ( [290](#) ). Jaksic et al. ( [292](#), [293](#) ) have demonstrated that the CR rate could be increased in CLL using high-dose chlorambucil, and with this regimen, the continuous route appeared to be preferable to the intermittent. Chlorambucil was administered as 15 mg/day until CR or toxicity or for a maximum period of 6 months in comparison to 75 mg weekly for 6 weeks; the CR rate for the continuous route was 70% compared with 31% for the intermittent route, and those patients receiving continuous chlorambucil had a longer survival ( [292](#) ). In a subsequent multicenter randomized study in untreated patients comparing the continuous regimen with modified CHOP (cyclophosphamide, doxorubicin, vincristine, and prednisone), the CR rate with chlorambucil was 59.5% (CR and PR, 89.5%) ( [293](#) ). Nonrandomized studies initially reported excellent responses using intermittent cyclophosphamide, vincristine, and prednisone (COP) in patients with advanced CLL ( [294](#), [295](#) ), with approximately 44% of patients achieving a CR ( [294](#) ). However, a subsequent randomized study comparing COP to chlorambucil showed no difference in survival or disease progression at 9 ( [296](#) ) or 53 ( [297](#) ) months. When COP was compared with chlorambucil and prednisone therapy in untreated patients, the response and survival rates were identical ( [298](#) ). In a similar study, a significantly higher response rate was observed using COP (59%) compared to chlorambucil and prednisone (31%), but the CR and overall survival rates were similar for both groups ( [299](#) ). In other trials, the addition of low doses of doxorubicin to COP (CHOP) or CAP (cyclophosphamide, doxorubicin, and prednisone) or the use of multiple agents has been examined. The French Cooperative Group on CLL compared COP to CHOP in previously untreated patients with Binet stage C disease ( [300](#), [301](#) ). The 3-year survival rates were 28% with COP and 71% with CHOP, and the median survival times were 22 and 62 months, respectively ( [301](#) ). However, these results are controversial, as no survival advantage has been observed when CHOP is compared with standard chlorambucil and prednisone ( [302](#), [303](#) ). Indeed, higher doses of chlorambucil (15 mg/day continuously) produced a statistically higher response rate than CHOP (89.5% vs. 75.0%) and an improved survival (median, 68 months vs. 47 months) ( [293](#) ). Other combination regimens have been studied. Sixty-three patients with advanced or refractory disease were treated with the M2 program, consisting of cyclophosphamide, bischloroethylnitrosourea, melphalan, and prednisone, with a CR rate of only 17% and a PR rate of 44% ( [304](#) ). The median survivals were 47, 20, and 19 months for Rai stages II, III, and IV, respectively, which are not significantly different from survival rates achieved with less aggressive regimens. A CR rate of 30% was achieved with patients not previously treated ( [304](#) ). A combination protocol including prednisone, vincristine, cytosine arabinoside, cyclophosphamide, and doxorubicin (POACH) achieved response and survival rates not significantly different from those reported for chlorambucil and prednisone, with complete and overall response rates of 21 and 56%, respectively, for previously untreated patients and 6 and 21%, respectively, for previously treated patients ( [305](#) ). The Eastern Cooperative Oncology Group has examined VAD (vincristine, doxorubicin, and dexamethasone) in relapsed or refractory CLL ( [306](#) ). No CRs were observed, and although 21% had a PR, 33% had progressive disease. To determine whether aggressive multiagent therapy is better than standard chlorambucil (with or without prednisone) in CLL, a



metaanalysis of ten randomized studies involving 2035 patients, mostly with Binet stage B and C disease, was carried out comparing standard treatment with COP, CHOP, and chlorambucil/epirubicin (280). This analysis did not reveal an improvement in survival by using an anthracycline-containing regimen compared to standard chlorambucil, demonstrating that more aggressive treatment approaches are not required to make an impact on survival.

**NUCLEOSIDE ANALOGS** The nucleoside analogs have demonstrated significant activity in the low-grade lymphoproliferative disorders (Fig. 92.9) (307). 2'-Deoxycoformycin (dCF; pentostatin; Nipent) is an inhibitor of adenosine deaminase, which is responsible for the deamination of deoxyadenosine and adenosine to deoxyinosine and inosine, respectively. After therapy with dCF, deoxyadenosine and adenosine accumulate in the plasma; after uptake into cells, deoxyadenosine is phosphorylated to deoxyadenosine monophosphate, deoxyadenosine diphosphate, and dATP, and this occurs preferentially in lymphocytes (308). The intracerebral accumulation of deoxyadenosine and adenosine likely causes the nausea/vomiting that is a major toxicity with this agent (309). CdA (cladribine; Leustatin) and F-arabinosyladenine (F-ara-A) are halogenated derivatives of deoxyadenosine that are resistant to degradation by adenosine deaminase. For clinical use, F-ara-A is administered as the more water-soluble monophosphate, F-ara-adenosine monophosphate (fludarabine; Fludara); fludarabine is rapidly dephosphorylated in the plasma to F-ara-A (310, 311). Like deoxyadenosine, CdA and F-ara-A accumulate in lymphocytes as their phosphorylated derivatives and can kill lymphocytes in three ways (Fig. 92.10 and Fig. 92.11) (46, 312). First, the triphosphate forms can trigger DNA breaks, which result in the release of cytochrome *c* from the mitochondria; the released cytochrome *c* interacts with Apaf-1 and dATP causing the activation of caspase 9 and, subsequently, apoptosis. Second, the increased levels of the triphosphates can enhance the effects of endogenous dATP on the apoptosome, inducing apoptosis. Finally, CdA differs from the other two drugs in that it is phosphorylated by deoxyguanosine kinase in the mitochondria to CdATP, which is directly toxic to the mitochondria.

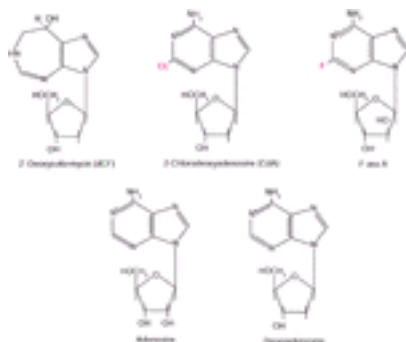


Figure 92.9. Structure of the nucleoside analogs. F-ara-A, F-arabinosyladenine.

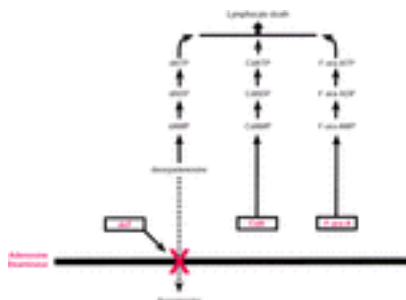
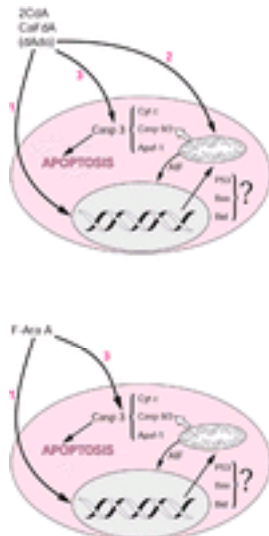


Figure 92.10. Metabolism of the nucleoside analogs. CdA, 2-chlorodeoxyadenosine; CdADP, 2-chlorodeoxyadenosine diphosphate; CdAMP, 2-chlorodeoxyadenosine monophosphate; CdATP, 2-chlorodeoxyadenosine triphosphate; dADP, deoxyadenosine

diphosphate; dAMP, deoxyadenosine monophosphate; dATP, deoxyadenosine triphosphate; dcF, 2'-deoxycoformycin; F-ara-A, F-arabinosyladenine; F-ara-ADP, F-arabinosyl-adenine diphosphate; F-ara-AMP, F-arabinosyladenine monophosphate; F-ara-ATP, F-arabinosyladenine triphosphate.



**Figure 92.11.** Mechanisms of action of the nucleoside analogs in chronic lymphocytic leukemia. AIF, inhibitor of apoptosis; Apaf, apoptosis-activating factor; CdA, 2-chlorodeoxyadenosine; CaFdA, 2-chloro-2'-ara-fluorodeoxyadenosine; Casp, caspase; Cyt c, cytochrome c; dAdo, deoxyadenosine; F-ara-A, F-arabinosyladenine. (From Genini D, Adachi S, Chao Q, et al. Deoxyadenosine analogs induce programmed cell death in chronic lymphocytic leukemia cells by damaging the DNA and by directly affecting the mitochondria. *Blood* 2000;96:3537–3543, with permission.)

Although dCF has demonstrated remarkable activity in hairy cell leukemia, producing CR in more than 90% of patients ( 307 ), it is much less impressive in CLL. CR and PR rates of 16 to 25% have been noted in previously treated patients, with an additional 20 to 30% of patients exhibiting other forms of clinical improvement ( 313 , 314 ). The standard dose is 4 mg/m<sup>2</sup> intravenously (IV) every other week ( 307 , 314 ). Toxicities include infection, myelosuppression, nausea/vomiting, and pruritus. Fludarabine has demonstrated significant activity in CLL. Although usually administered IV, the drug appears equally efficacious when administered orally, although a higher dose is required as absorption is approximately 50% ( 315 ). Using 25 to 30 mg/m<sup>2</sup> IV daily for 5 days, repeated monthly, the overall response rate is approximately 45% in previously treated patients, with the CR rate being 3 to 20% ( 315 , 316 , 317 and 318 ). In untreated patients, the response rate is approximately 70%, with the CR rate being 20 to 40% ( 217 , 218 , 318 , 319 ). The main toxicities with fludarabine are myelosuppression and infections, particularly when patients have been previously treated with alkylating agents. Nausea, vomiting, and neuropathy rarely occur. In an attempt to reduce toxicity, fludarabine has been administered as 30 mg/m<sup>2</sup> IV daily for 3 days, repeated every 4 weeks ( 320 ). Compared to the standard 5-day treatment schedule, the response rate was lower at 46% (CR, 10%), but there was a significant reduction in the infection rate and no difference in survival. The addition of prednisone to fludarabine therapy does not improve the response rate over fludarabine used alone and significantly increases the risk of unusual infections (i.e., *Pneumocystis carini*, pneumonia and *Listeria monocytogenes* sepsis) ( 321 ). Three major phase III studies have determined whether initial treatment with fludarabine could produce an increased remission rate compared with standard chemotherapy and whether this would translate



into improved survival ( [Table 92.9](#)) ( [217](#), [218](#), [318](#)). These are summarized as follows:

**TABLE 92.9. Phase III Studies Comparing Fludarabine and 2–Chlorodeoxyadenosine to Alkylating Agents**

| Reference  | Treatment                | Patients (No.) | Complete Remission (%) | Partial Remission (%) | Median Response (Mo) | Median Survival (Mo) |
|--|--------------------------|----------------|------------------------|-----------------------|----------------------|----------------------|
| European Cooperative Group ( <a href="#">318</a> ) | Fludarabine              | 52             | 23                     | 48                    | Not reached          | Not reached          |
|  | CAP                      | 48             | 17                     | 43                    | 208 d                | 1580 d               |
| French Cooperative Group ( <a href="#">218</a> )   | Fludarabine              | 341            | 40 <sup>a</sup>        | 31                    | 32.0                 | 69                   |
|  | CAP                      | 240            | 15 <sup>a</sup>        | 43                    | 28.0                 | 70                   |
|  | CHOP                     | 357            | 30 <sup>a</sup>        | 42                    | 29.5                 | 67                   |
| InterGroup ( <a href="#">217</a> )                 | Fludarabine              | 170            | 20                     | 43                    | 25.0                 | 66                   |
|  | Chlorambucil             | 181            | 4                      | 33                    | 14.0                 | 56                   |
|  | Fludarabine/Chlorambucil | 123            | 20                     | 41                    | Not reached          | 55                   |
| Polish group ( <a href="#">288</a> )               | 2–Chlorodeoxyadenosine   | 126            | 47                     | 40                    | 21.0                 | 78% <sup>b</sup>     |
|  | Chlorambucil             | 103            | 12                     | 45                    | 18.0                 | 82% <sup>b</sup>     |

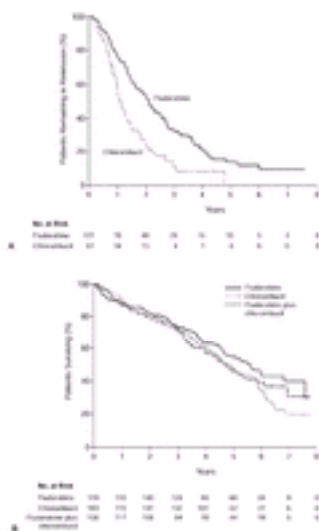
CAP, cyclophosphamide, doxorubicin, and prednisone; CHOP, cyclophosphamide, doxorubicin, vincristine, and prednisone.

<sup>a</sup> Actually denoted as *clinical remissions* as marrow studies were not carried out on many after therapy.

<sup>b</sup> At 24 mo.

- The European Cooperative Group study on CLL has compared six courses of fludarabine with CAP in 100 untreated and 96 treated patients with Binet B or C CLL ( [318](#)). In untreated patients, the responses with fludarabine (71%; CR, 23%) were similar to those for CAP (60%; CR, 17%), but the duration of responses was significantly longer with fludarabine. Although there was a tendency toward a longer survival of patients treated with fludarabine, the follow-up period has been too short to confirm this. In previously treated patients, a higher response rate was observed with fludarabine (48%; CR, 13%) compared to CAP (27%; CR, 6%), but there was no improvement in the median remission duration or survival between the two groups.
- In a French Cooperative Group study ( [218](#)), 938 untreated CLL patients with Binet stage B or C disease were randomized to a 6-month course of CHOP, CAP, or fludarabine ( [218](#)). The response rates were similar for CHOP and fludarabine, and both were better than those for CAP. However, time to relapse and survival rates were similar regardless of initial treatment.
- Finally, in a North American Inter-Group study ( [217](#)), 509 untreated CLL patients

were randomized to receive fludarabine (25 mg/m<sup>2</sup> IV daily × 5 days, repeated every 28 days), chlorambucil (40 mg/m<sup>2</sup> orally every 28 days), or a combination of fludarabine (20 mg/m<sup>2</sup> IV daily × 5 days, every 28 days) with chlorambucil (20 mg/m<sup>2</sup> orally every 28 days). Treatment was continued for a maximum of 12 months and was discontinued if a patient achieved a CR or if response plateaued for 2 months. Nonresponding patients receiving fludarabine or chlorambucil were switched to the other drug; patients off therapy who relapsed more than 6 months after discontinuation of treatment were started back on the same drug, whereas those who relapsed less than 6 months after discontinuation of drug were switched to the other drug. Accrual to the combination of fludarabine plus chlorambucil was discontinued when it was found that this arm was more myelotoxic and produced a similar response rate to the fludarabine only arm. There was a higher response rate, longer duration of response, and improved progression-free survival in patients treated with fludarabine. The CR and PR rates with fludarabine were 20 and 43%, respectively, whereas the corresponding responses with chlorambucil were 4 and 33%. The median remission for fludarabine was 25 months, and for chlorambucil, it was significantly shorter at 14 months ( Fig. 92.12A). For patients previously treated with chlorambucil, the response rate to subsequent fludarabine was 46%. In contrast, only 7% of patients who had become resistant to fludarabine responded to chlorambucil. However, regardless of which drug was used first, there was no significant difference in survival ( Fig. 92.12B).



**Figure 92.12. A:** Proportion of patients with an initial response to fludarabine or chlorambucil who continued in remission. Shown are the proportions of 107 patients assigned to fludarabine and 67 assigned to chlorambucil who had a response to treatment and remained in complete or partial remission. In both groups combined, 78% of patients (135 of 174) had relapses. The median duration of the response was significantly longer in the fludarabine group than in the chlorambucil group (25 vs. 14 months,  $p < .001$ ). **B:** Survival according to treatment group. Shown are the proportions of 178 patients assigned to fludarabine, 193 assigned to chlorambucil, and 136 assigned to fludarabine plus chlorambucil who were still alive during follow-up. Forty-seven percent, 57%, and 56% of the patients in the three groups, respectively, died. There was no statistically significant difference in overall survival among the three groups (median, 66 months, 56 months, and 55 months, respectively;  $p = .21$ ). (From Rai KR, Pererson BL, Appelbaum FR, et al. Fludarabine compared with chlorambucil as primary therapy for chronic lymphocytic leukemia. *N Engl J Med* 2000;343:1750–1757, with permission.)

CdA has been less extensively evaluated in CLL than fludarabine but probably has equivalent antitumor activity ( 288 , 307 , 322 , 323 , 324 , 325 , 326 and 327 ). The drug is given in monthly cycles, in doses of 0.1 mg CdA/kg/day by continuous infusion × 7 days ( 324 ), or 0.12–0.14 mg/kg/day over 2 hours × 5 days ( 322 , 325 ), or 10 mg/m<sup>2</sup>/day orally × 5 days ( 327 ). The results of studies with CdA have varied greatly ( 288 , 322 , 323 , 325 ), with response rates in previously treated patients varying from 48 to 72% and CR rates varying from 4 to 39% ( 307 , 322 ). In previously untreated patients, approximately 80% of patients respond, and the CR rate varies from 10 to 45% ( 288 , 307 , 322 , 323 , 324 , 325 and 326 ). In a multicenter study with patients randomized to receive initially either CdA or chlorambucil, and resistant patients being switched to the other drug, CdA produced a higher remission rate and more prolonged remissions than chlorambucil ( Table 92.9 ) ( 288 ). However, as with the randomized studies comparing fludarabine with alkylating agents ( 217 , 218 , 318 ), survival was similar whether the initial treatment was with CdA or chlorambucil ( 288 ). The variation in the response rates to CdA in previously treated patients may be related to the extent of prior therapy. *In vitro* studies have shown that CdA is more myelosuppressive than fludarabine ( 310 ), and in the clinical setting, repeated treatments with CdA can produce prolonged thrombocytopenia ( 288 , 322 , 323 , 324 , 325 , 326 and 327 ). Like fludarabine, CdA is very immunosuppressive, and infections are the major toxicity, particularly when given in conjunction with prednisone ( 184 , 288 , 326 ). Neither CdA nor fludarabine causes the accumulation of adenosine, which likely explains the lack of nausea/vomiting observed with these agents when compared to dCF. However, all these nucleoside analogs can produce neurotoxicity, and peripheral neuropathy is now being documented as a potential devastating toxicity of these drugs ( 328 ). The nucleoside analogs are all highly immunosuppressive, being both myelosuppressive and producing a marked fall in the CD4<sup>+</sup> cell count, which may persist for years ( 307 ). As these agents are now frequently combined with other immunosuppressive agents, such as monoclonal antibodies (see below), the number and variety of opportunistic infections observed in CLL are likely to increase ( 184 ). Although initial studies suggested that the nucleoside analogs could trigger autoimmune hemolytic anemias, the frequency of this complication appears no greater with the analogs than with other agents ( 217 , 218 , 288 ). Graft-versus-host disease has been observed in patients being treated with nucleoside analogs who receive blood transfusions, and it has been recommended that these patients receive only irradiated blood products ( 329 ). Reports have also indicated a higher incidence of acute myeloid leukemia/myelodysplasia in patients receiving nucleoside analogs ( 330 , 331 and 332 ), and this risk may be further increased in patients receiving a combination of chlorambucil and fludarabine ( 332 ). Recent studies have demonstrated that fludarabine can be toxic to the lung, apart from predisposing these patients to pneumonia ( 333 ). Once infections have been ruled out, these patients can respond to steroids ( 333 ). An *in vitro* study has demonstrated cross-resistance between fludarabine and CdA in the leukemic cells of 90% of patients ( 310 ), and clinical studies have confirmed that patients resistant to fludarabine are unlikely to respond to CdA, and vice versa ( 326 , 334 ). In a clinical trial of 28 patients who were resistant to fludarabine, only one patient had a PR with CdA ( 334 ). Thus, patients who are resistant to one of the nucleoside analogs should not be treated with another, particularly as such therapy increases the risk of infections secondary to myelosuppression and immunosuppression ( 334 ).

**COMBINATION THERAPY WITH NUCLEOSIDE ANALOGS** As the nucleoside analogs alone do not increase survival in CLL, these drugs have been combined with other agents in an attempt to improve antitumor activity. Combined therapy with steroids does not improve antitumor effect and markedly increases the risk of infection ( 321 , 325 ). However, the initial addition of steroids may be useful in selected patients to produce more rapid marrow clearing and to improve blood counts ( 290 ). *In vitro* studies have demonstrated

that the nucleoside analogs can inhibit DNA repair, which explains the synergistic antitumor activity seen between these agents and irradiation and alkylating agents ( [335](#), [336](#) and [337](#) ). Moreover, this effect is seen preferentially in CLL cells compared to normal marrow cells ( [336](#) ). Synergy has also been observed between fludarabine and cyclophosphamide in phase II clinical studies ( [337](#), [338](#) and [339](#) ). O'Brien et al. ( [338](#) ) combined fludarabine 30 mg/m<sup>2</sup> IV daily × 3 with cyclophosphamide 300, 350, or 500 mg/m<sup>2</sup> IV daily × 3 and demonstrated a 38% response rate in patients who were resistant to fludarabine alone. In previously untreated patients, more than 80% responded with a 35% CR. Moreover, the durations of response were longer than for fludarabine alone. Similar responses have been seen with other combinations of fludarabine and cyclophosphamide ( [338](#), [339](#) and [340](#) ), and these promising combinations are now being evaluated in phase III clinical trials. However, myelosuppression remains a significant problem, and there is concern that the combinations may be leukemogenic, as may be the case when fludarabine and chlorambucil are combined ( [332](#) ). There is thus considerable interest in combining monoclonal antibodies with the nucleoside analogs, regimens that theoretically should enhance antitumor activity without affecting the marrow (see [Monoclonal Antibodies](#)).

**STEROIDS** As steroids kill CLL cells with a p53 mutation ( [63](#) ), they can be useful for palliation in patients resistant to alkylating agents and nucleoside analogs ( [290](#), [341](#) ). A frequent starting dose is 50 or 100 mg prednisone/day to control symptoms and then maintaining the patient on alternate-day prednisone or gradually tapering the dose according to response. Methylprednisolone at 1 gm/m<sup>2</sup>/day × 5 days, repeated monthly, can be helpful in end-stage patients, who are drug resistant and have bulky disease, marrow failure, or both ( [341](#) ). These patients are at risk of all the complications of steroids. The management of CLL patients maintained on steroids is discussed in Systemic Complications Requiring Therapy.

## Monoclonal Antibodies

The chimeric monoclonal antibody rituximab (Rituxan) contains a human IgG1 immunoglobulin constant region and a murine variable region directed against the cell-surface antigen CD20, which plays an important role in the activation, proliferation, and differentiation of B cells ( [342](#) ). This agent has shown significant activity against low-grade lymphomas, which have high surface concentrations of CD20, and is believed to exert its antitumor activity through activation of complement (complement-mediated cytotoxicity), antibody-dependent cell-mediated cytotoxicity, or by the direct induction of apoptosis ( [342](#), [343](#) and [344](#) ). Each of these mechanisms likely plays a role, and in the blood, target cells may be lysed by high concentrations of complement (complement-mediated cytotoxicity mechanism), whereas circulating cells coated with Ig can be removed by Fc receptor-containing effector cells, such as NK cells, monocytes, and macrophages (antibody-dependent cell-mediated cytotoxicity mechanism) ( [342](#) ).

Using the standard rituximab regimen that is effective in follicular lymphomas (375 mg/m<sup>2</sup> IV weekly × 4), initial studies showed that rituximab had little activity in CLL (13% response rate), compared to a 50% response rate in the follicular lymphomas ( [345](#) ). This decreased activity was attributed to the low levels of CD20 on CLL cells and the high plasma CD20 levels observed in CLL; the high plasma CD20 levels are believed to divert rituximab from the cellular target and to reduce the half-life of the antibody ( [342](#), [346](#) ). The plasma CD20 is believed to be derived from cell breakdown, and the level correlates with disease stage but not the lymphocyte count ( [346](#) ). However, two more recent studies have shown that rituximab can rapidly, albeit transiently, reduce the peripheral

lymphocyte counts of CLL patients ( 347, 348 ). The treatment had little effect on lymphadenopathy and did not normalize blood counts, and this discrepancy has been related to the fact that the CLL CD20 levels are lower in the nodes and marrow than in the peripheral blood ( 349 ). In an attempt to increase the effectiveness of rituximab in CLL, the dose of rituximab has been escalated, using either a weekly or thrice weekly schedule, and response rates of 36 to 45% have been achieved without a significantly higher toxicity than is observed with the standard schedule ( 350, 351 ). Rituximab can cause allergic reactions (e.g., fevers/rigors, dyspnea, hypotension, and nausea/vomiting) as a result of the release of inflammatory cytokines (e.g., IL-6, IL-8, TNF- $\alpha$ , and  $\gamma$ -interferon) ( 347, 348, 350, 351 ). This usually occurs with the first treatment, and the likelihood of a reaction decreases with each subsequent treatment. Initial studies suggested that this complication occurred in patients with lymphocyte counts of greater than  $50 \times 10^9/L$  ( 347, 348 ), although this was not confirmed in a more recent study ( 351 ). Pretreatment with prednisone or “stepped-up dosing” decreases the severity or likelihood of a reaction ( 348 ).

Alemtuzumab (Campath-1H) is a humanized IgG1 antibody against CD52, with the antigen-binding site being of rodent origin. Both B and T lymphocytes are targets, and there is sparing of the normal hematopoietic stem cells. As with rituximab, alemtuzumab can kill tumor cells by complement-mediated cytotoxicity, antibody-dependent cell-mediated cytotoxicity, or the direct induction of apoptosis ( 352 ). Patients with CLL who were resistant to standard chemotherapy have received alemtuzumab 30 mg IV three times per week for 12 to 16 weeks, and the response rate was 33 to 53%, with most responses being PRs ( 352, 353, 354 and 355 ). Patients had infusion-related toxicities (i.e., nausea/vomiting, fevers, rigors, and rash) with the initiation of treatment and infections. Despite antibiotic therapy, infections, including opportunistic infections (most frequently cytomegalovirus), occurred later. Alemtuzumab has also been evaluated in untreated patients using the subcutaneous route, with the dose of alemtuzumab gradually increased to 30 mg three times per week for a maximum of 18 weeks ( 356 ). Of 41 patients, 38 received more than 1 week of treatment, and in this group, the CR rate was 19% and the PR rate 68%. Ninety percent of patients had local injection-site reactions, with erythema/edema, pruritus, and pain at the site of injection. In most cases, the reactions disappeared with continued treatments, usually within 2 weeks. However, the infusion-related toxicities described above with intravenous treatments were rarely seen. Infectious problems were much less severe than observed in previously treated patients.

There is interest in combining the monoclonal antibodies with chemotherapy to enhance antitumor activity without increasing myelosuppression. Moreover, as rituximab is effective for the treatment of autoimmune hemolytic anemia in CLL ( 357 ), the addition of rituximab might prevent the development of this complication, which can occur with chemotherapy ( 208, 209 and 210, 216 ). Synergy has been demonstrated between rituximab and chemotherapy *in vitro*, although the mechanisms underlying this phenomenon are unclear ( 343, 358, 359, 360 and 361 ). However, the synergy may be related to effects of rituximab on the levels of antiapoptotic proteins, as rituximab reduces the cellular levels of bcl-2 in lymphoma cell lines *in vitro* ( 358 ), and the levels of Mcl-1 and XIAP are decreased in the CLL cells of patients undergoing treatment with the antibody ( 343 ). Alternatively, fludarabine may down-regulate the expressions of CD46, CD55, and CD59 on the CLL cells, proteins that antagonize the effects of activated complement ( 362, 363 ).

Rituximab has been combined with fludarabine in the clinic ( 362, 363 ). In one study, 31 previously treated or untreated CLL patients received four monthly cycles of fludarabine ( $25 \text{ mg/m}^2$  IV daily  $\times$  5 days) combined with four monthly treatments with rituximab



(375 mg/m<sup>2</sup> IV), the first two rituximab treatments given with the last two cycles of fludarabine ( [362](#) ). The CR rate was 33%, the PR rate was 55%, and treatment was well tolerated. A second study compared concurrent versus sequential treatment with fludarabine and rituximab in untreated CLL patients ( [363](#) ). Fifty-one patients received six cycles of fludarabine followed by four weekly treatments with rituximab (sequential regimen), while 53 patients received six cycles of concurrent fludarabine and rituximab followed by consolidation with four weekly treatments with rituximab. In the concurrent regimen, there were 47% CR rates and 43% PR rates, whereas the sequential regimen appeared less effective with 28% CR and 49% PR. Treatment was generally well tolerated; infusion-related toxicity, myelosuppression, and infections were the major toxicities. The M. D. Anderson Cancer Center has combined fludarabine with cyclophosphamide and rituximab, and preliminary results on 60 patients showed a response rate of 95% with 66% CR ( [364](#) ). It is interesting that responses have been observed on combining fludarabine with alemtuzumab in six CLL patients treated previously with either fludarabine or alemtuzumab alone, suggesting that the combination might reverse drug resistance ( [365](#) ).

### Bone Marrow Transplantation

As CLL is not curable with standard therapy, there has been interest in bone marrow transplantation (BMT) in this disease, particularly in younger patients who are more able to withstand aggressive treatment. In addition, recent advances in the identification of biologic risk factors indicative of aggressive disease (i.e., those with unmutated *IgV* genes and those with deletions of 11q22-23 or 17p13) have permitted the recognition of patients who have a very poor prognosis with standard therapy and might benefit from BMT. As genomic abnormalities are known to develop over time in CLL, it would appear most reasonable to consider early transplantation in these patients before the development of drug resistance and more aggressive disease. However, this is a relatively recent treatment modality in CLL, and many of the studies are still only reported in abstract form. Several excellent reviews have been published on the subject ( [366](#) , [367](#) ).

Autologous BMT is an attractive option in CLL, as the mortality of this procedure is low and prolonged remissions may be obtained. However, at the present time, this is not a curative procedure, and there is no plateau in the survival curves of patients receiving this treatment ( [366](#) , [367](#) ). An update of patients followed by the European Group for Blood and Marrow Transplantation (EBMT) register showed that treatment-related mortality is 11% and that 79% of patients will be alive at 3 years, although 41% will relapse during this time ( [368](#) ). The prognosis is better for patients who are transplanted early in the course of their disease, have chemosensitive disease (as assessed by a CR before transplant), and receive total body irradiation (TBI) with the transplant ( [368](#) , [369](#) ). The risk of relapse correlates with the persistence of minimal residual disease ( [283](#) , [370](#) , [371](#) ). All these factors suggest that optimum CRs before transplantation and the purging of the harvested stem cells improve outcome. The optimum therapy before transplant is still unknown, and although fludarabine is highly effective in CLL, it is myelotoxic, and this may make it difficult to harvest marrow subsequently ( [372](#) ). However, as most patients receiving fludarabine before transplant have also received other drugs, it is unclear how much of the marrow toxicity can be attributed to fludarabine. Indeed, a recent study using fludarabine/cyclophosphamide in previously untreated patients showed that there was no difficulty in harvesting cells after treatment ( [339](#) ). Regardless, it has been suggested that harvesting should only be attempted more than 2 months after the last fludarabine treatment ( [372](#) ).

The monoclonal antibodies may also be useful before transplant, as they produce synergistic antitumor activity with chemotherapy, may reverse drug resistance, and are

not myelotoxic. Rituximab has been combined with fludarabine/cyclophosphamide for this purpose, and alemtuzumab has been used to produce further marrow clearing after a maximum response to fludarabine or dCF ( [364](#), [373](#) ). Elimination of tumor from the marrow harvests has also been carried out by “double purging” (i.e., CD19 depleting and CD34 enriching) ( [374](#) ). However, although remissions were prolonged, there was an increased risk of life-threatening infections. Although the morbidity and mortality associated with autologous BMT are relatively low, these patients have an increased risk of acute myeloid leukemia/myelodysplasia and second tumors ( [366](#) ). The cumulative incidence of acute myeloid leukemia/myelodysplasia for CLL patients 5 years post-autologous BMT is 6%, similar to that observed with autologous BMT in other lymphomas ( [366](#), [375](#) ).

Whereas autologous BMT is basically high-intensity chemotherapy, allogeneic BMT has the added advantage of cellular immune therapy, which explains the higher efficacy of this treatment, albeit at the cost of toxicity ( [376](#), [377](#), [378](#), [379](#), [380](#) and [381](#) ). Of 90 patients in the EBMT registry who have undergone allogeneic BMT for CLL and are evaluable for response, 40% died from causes related to the transplant, and at 3 years, 55% were alive, with the risk of relapse by that time being 25% ( [368](#) ). As with autologous BMT, patients do better if the transplant occurs soon after diagnosis. However, in contrast to autologous BMT, the outcome is less dependent on the sensitivity of the tumor to chemotherapy, and the survival curve plateaus posttransplant, suggesting that long-term survival might be possible ( [379](#), [380](#) ). The difference in responses with these two types of BMT is related to the graft-versus-leukemia effect, as the CLL cells disappear with the onset of graft-versus-host disease ( [382](#), [383](#) and [384](#) ). Patients transplanted with marrow from unrelated donors also have significant graft-versus-host disease, and out of 33 evaluable patients in one study, 64% achieved a CR and 15% a PR ( [381](#) ). The 3-year disease-free survival was 44%. However, the mortality of this procedure can be as high as 50%, in part related to the immune incompetence of these patients.

The demonstrated graft-versus-tumor effect associated with allogeneic transplantation has raised interest in nonmyeloablative transplantation in CLL ( [385](#), [386](#) ). The advantage of this approach is that end-organ damage and the profound pancytopenia and infections associated with intense induction chemotherapy are avoided, while the beneficial graft-versus-tumor effects are retained ( [385](#) ). McSweeney et al. ( [385](#) ) carried out nonmyeloablative BMT in 45 patients with a variety of hematologic malignancies, including seven patients with CLL. Patients received TBI followed by cyclosporin and mycophenolate mofetil to prevent host-versus-graft and graft-versus-host diseases. Donor lymphocyte infusions were given at 2-month intervals, depending on the absence of graft-versus-host disease, persistence of chimerism, and either persistent or progressive disease. Of the seven CLL patients, four achieved a CR, one a PR, and two had progressive disease. The treatment was relatively well tolerated, and half of all patients received their entire treatments as outpatients. However, acute graft-versus-host disease occurred in one-half of the patients, grade II in 36%, and grade III in 11%. Rejection occurred in 20% of patients, and as this developed primarily in patients who had not received prior intensive chemotherapy, the authors added fludarabine as part of the preparative regimen. It is interesting that molecular remissions occurred while patients were receiving immunosuppression to control their graft-versus-host disease, indicating the potency of the graft-versus-tumor effect. Of 63 patients followed by the EBMT, mortality related to the procedure was 19%, and with a median follow-up of 8 months, overall survival was 80% with the probability of relapse being 16% ( [386](#) ).

## Radiotherapy

As there are now a variety of treatment options for CLL, there is little need for



radiotherapy as primary treatment for this disease. However, for many decades, irradiation of the spleen was the primary treatment for CLL ( 387 , 388 , 389 , 390 , 391 , 392 and 393 ); irradiation of the mediastinum ( 394 , 395 ), extracorporeal irradiation of the blood ( 396 , 397 ), TBI ( 398 , 399 , 400 , 401 and 402 ), and hemibody irradiation ( 403 ) may also reduce the peripheral blood lymphocyte counts and the size of lymph nodes, spleen, and liver.

Splenic irradiation has produced survival rates comparable to those achieved with chlorambucil or COP in Rai stage III and IV patients ( 390 ). However, in general, splenic irradiation is reserved to treat patients with large painful spleens or those with cytopenias related to splenomegaly who are not medically fit for splenectomy. Although almost all patients experience a reduction in spleen size and relief from pain with irradiation, the effects on hemoglobin and platelets are more variable ( 389 , 391 ). It is likely that differences in therapeutic effect are related to the extent of prior treatments, as untreated patients respond much better to irradiation than those who have previously undergone therapy ( 387 ). High doses of splenic irradiation may cause neutropenia and thrombocytopenia, and it is thus recommended to initially use small fraction sizes (e.g., 0.25 to 0.50 Gy on alternate days, for three times per week) ( 387 , 389 ). The dose of irradiation is gradually increased according to response and toxicity, and the usual maximum dose is between 5 and 10 Gy.

TBI has been given alone ( 398 , 399 and 400 ) or in combination with chemotherapy ( 401 , 402 ). Patients treated with TBI plus cyclophosphamide and prednisone had higher response rates than those treated with TBI alone ( 401 ). Intermittent low doses of irradiation may also be effective ( 397 , 400 ). In one study, 48 patients with progressive disease received 5– to 10–rad TBI three to five times per week for a total of 100 to 400 rad ( 399 ). Eighty–eight percent of the patients responded, with one–third achieving a CR, although mild anemia and thrombocytopenia persisted in some individuals. The regimen was generally well tolerated, although significant myelosuppression occurred, and rest periods of weeks to months were intermittently required to allow marrow recovery. The Ig levels returned to normal in most of the patients who achieved a CR.

Splenic irradiation can produce systemic effects with a decrease in lymphadenopathy and a reduction in lymphocyte count and can induce CRs ( 387 , 393 ). The mechanism(s) underlying these phenomena is unclear, and many factors may be involved ( 387 ). CLL cells are highly sensitive to ionizing radiation *in vitro*, and a correlation has been observed between the radiosensitivity of CLL cells *in vitro* and the patients' clinical response to radiation therapy ( 404 ). However, irradiation may also produce its effects through the inhibition of CD8<sup>+</sup> T cells and the induction of cytokine release from CLL cells ( 387 , 405 ). Finally, radiation of the spleen can produce a “radiotherapeutic splenectomy,” thus decreasing “pooling” and improving normal blood counts.

## Splenectomy

Splenectomy is primarily carried out in CLL for the treatment of autoimmune hemolytic anemia or thrombocytopenia but may also be useful for patients with painful splenomegaly or in whom the leukemia is predominantly confined to the spleen ( 406 , 407 , 408 and 409 ). In addition, splenectomy may be considered when cytopenias are believed to be due to hypersplenism and have not responded to chemotherapy ( 406 , 407 , 408 and 409 ). Neal et al. ( 409 ) noted an improvement in the hemoglobin and platelet counts in two–thirds of patients with advanced–stage CLL who underwent splenectomy, and the improvement was maintained during the 1–year follow–up. In this study, neither the spleen size nor the

degree of marrow involvement was predictive of response, although others have observed a correlation between spleen size and the improvement in blood counts after splenectomy ( 406 ). Approximately 50% of patients have postoperative infections, and half of these require antibiotics ( 406 ). Moreover, the perioperative mortality from sepsis is 5 to 10%, and this is primarily in patients with advanced disease and poor performance status ( 406 ). Thus, in selected patients with good performance status, splenectomy may increase the blood counts sufficiently to permit aggressive chemotherapy.

### Biologic Response Modifiers

$\alpha$ -Interferon can decrease the lymphocyte count and produce PRs in patients with early-stage CLL ( 410 , 411 ). However,  $\alpha$ -interferon is less active against early-stage disease having features of an aggressive course, and it does not prolong progression-free survival or overall survival ( 412 ). Furthermore,  $\alpha$ -interferon is ineffective in patients with advanced disease who have received prior therapy ( 413 ).  $\alpha$ -Interferon has been evaluated as maintenance therapy in patients after treatment with chlorambucil ( 414 ) or fludarabine ( 415 , 416 ). However,  $\alpha$ -interferon did not influence residual disease after fludarabine and did not increase the duration of remission ( 415 , 416 ).

### Systemic Complications Requiring Therapy

Patients with CLL have an increased risk of infection, which is partly related to the effects of the disease and partly to the effects of chemotherapy. CLL can cause hypogammaglobulinemia, neutropenia, hypocomplementemia, and T-cell dysfunction, and the incidence of infections increases with disease stage and the degree of hypogammaglobulinemia ( 184 , 417 , 418 ). However, risk of infections, particularly opportunistic infections, is increased with the use of steroids, reduction in CD4<sup>+</sup> cells by nucleoside analogs, and lymphocytolytic effects of monoclonal antibodies ( 185 , 186 , 321 ). In general, vaccines are ineffective because of an impairment in the immune system ( 183 ).

High-dose Ig, administered as 400 mg/kg IV every 3 weeks, reduces the incidence of bacterial infections by 50%, particularly those caused by *Streptococcus pneumoniae* and *Haemophilus influenzae*, but the total number of severe bacterial infections and nonbacterial infections is not reduced, and this treatment does not prolong survival ( 419 ). A subsequent study using this regimen showed that the reduction in infections did not improve the patients' quality of life or survival and that the treatment was not cost effective, in part because of the high doses of Ig infused ( 420 ).

More recently, it has been shown that lower doses of gammaglobulin may be as effective, for instance, 250 mg/kg every 4 weeks or 10 g every 3 weeks ( 421 , 422 ). Molica et al. ( 423 ) randomized CLL patients with an IgG of less than 0.6 g/L and a serious infection in the previous 6 months to 300 mg/kg gammaglobulin every 4 weeks or to observation. Patients receiving gammaglobulin had a reduced number of infections, but the effectiveness did not correlate with restoration of the IgG levels. Thus, selected patients with hypogammaglobulinemia and frequent bacterial infections may benefit from prophylactic Ig, although the cost benefit of this treatment is questionable.

Granulocyte-macrophage colony-stimulating factor can increase the neutrophil count and function in CLL, although whether this reduces the incidence of infections remains unclear ( 424 , 425 ). However, the use of granulocyte colony-stimulating factor after fludarabine has been shown to reduce the risk of neutropenia and the incidence of

pneumonia ( [426](#) ). Prophylactic antibiotics may be of benefit, particularly when patients are receiving nucleoside analogs, monoclonal antibodies, and steroids, and frequently, antibiotics are incorporated into the newer and more immunosuppressive regimens. Thus, patients may be maintained on trimethoprim–sulfamethoxazole to prevent *F. carini* pneumonia, acyclovir to prevent herpes simplex, and fluconazole to prevent candidal infections.

Autoimmune hemolytic anemia occurs in 5 to 37% of patients, autoimmune thrombocytopenia in 1 to 3% of patients, and pure red cell aplasia is less frequent ( [208](#) , [209](#) ). These disorders usually occur late in the disease and may be provoked by chemotherapy, which can cause an imbalance in the lymphocyte subtypes, allowing emergence of an antibody–producing B–cell clone ( [208](#) , [209](#) ). Although pure red cell aplasia is rare in CLL, it may well be underreported, as there are usually other causes to explain the anemia, but the diagnosis should be considered in any patient who has a disproportionate anemia compared to the other blood counts ( [209](#) ). These immune disorders are generally treated initially with steroids, using prednisone 1 mg/kg/day, and 75% of patients respond to this therapy ( [208](#) ). A response may be seen within days, although it may take several weeks in some patients. Patients with hemolytic anemia should also be maintained on folic acid, 5 mg/day, and after the hemoglobin and reticulocyte counts have normalized (usually in 1 to 2 weeks), the prednisone can be tapered slowly over a period of 2 to 3 months. These patients should be watched for all the usual complications of prednisone, such as gastric irritation, diabetes mellitus, an increased risk of opportunistic infections, and osteoporosis. Thus, these patients may need to be maintained on an H<sub>2</sub>–blocker, may require oral hypoglycemics/insulin, and should be maintained on prophylaxis against *F. carini* [e.g., trimethoprim–sulfamethoxazole (one double–strength tablet orally twice a day on Saturdays and Sundays, or one double–strength tablet three times a week)] ( [427](#) ). They are also at risk of other infections, such as oral thrush or herpetic infections and may require therapy or prophylactic antibiotics. Many of these patients are elderly, and the prolonged course of prednisone increases the risk of osteoporosis and vertebral collapse. Thus, patients should be maintained on bisphosphonates. The author prefers an intravenous formulation to reduce the risk of gastric irritation, which may already be a problem because of prednisone (e.g., pamidronate 30 mg IV every 3 months) ( [428](#) ). It is important that patients with autoimmune hemolytic anemia and dangerously low hemoglobins are transfused, because, despite theoretical concerns, these patients rarely have severe transfusion reactions ( [429](#) ). In addition, any infection should be treated promptly, as sepsis can inhibit compensatory reticulocytosis and worsen anemia.

If the patient does not respond to prednisone within 7 to 10 days, intravenous Ig 0.4 g/kg/day × 5 days should be added ( [209](#) ). This can produce a rapid response, but the response is transient, and retreatments are generally required every 3 to 4 weeks ( [209](#) , [430](#) ). There is no standard therapy for patients who do not respond to this therapy or who cannot be weaned off prednisone without a relapse. Cyclosporin is a reasonable option and produces a major response in two–thirds of CLL patients with immune thrombocytopenia or anemia and is highly effective in red cell aplasia ( [208](#) , [431](#) , [432](#) and [433](#) ). In one study using cyclosporin 300 mg/day, the median time to initial response was 3 weeks (range, 1 to 13 weeks), and the median time to best response was 10.5 weeks (range, 1 to 48 weeks) ( [433](#) ). The median duration of response was 10 months (1+ to 39+ months), and some patients who had fludarabine–associated cytopenias were retreated effectively with fludarabine. Immune cytopenias also may be treated with other immunosuppressive drugs, such as 6–mercaptopurine or cyclophosphamide, although no controlled trials related to their use have been published ( [209](#) ).

Splenectomy may also be considered, although this is rarely carried out, as most patients with CLL are elderly and there is significant risk with this surgery, particularly in patients who are actively hemolyzing and are on steroids. Of 113 patients who underwent a splenectomy for immune hemolytic anemias, only four had underlying CLL ( 434 ). Thus, there is little information as to the benefit of this procedure in CLL or the long-term response rate. Splenic irradiation may be carried out in those who are not surgical candidates, but it may take up to 2 months to see a response; the responses last for approximately 1 year ( 209 , 389 ). Finally, rituximab may be useful in these immune cytopenias ( 357 , 435 ): Eight patients with heavily pretreated CLL who had steroid-resistant autoimmune hemolytic anemia were treated with a combination of rituximab, cyclophosphamide, and dexamethasone given at monthly intervals ( 357 ). All patients responded on a median of three cycles, with the time to maximum response ranging between 4 and 14 weeks. Five patients relapsed at a median of 13 months (range, 7 to more than 23). Three patients with immune thrombocytopenia had rapid and prolonged responses to four weekly cycles of rituximab at 375 mg/m<sup>2</sup> IV/week ( 435 ).

Anemia that is related to marrow involvement by leukemia and has not corrected with standard treatments may respond to erythropoietin ( 436 , 437 ). In one study, erythropoietin was injected at 150 U/kg subcutaneously three times per week, with a gradual escalation up to 300 U/kg if necessary to achieve a response. Seventy-seven percent of patients responded, and 50% achieved a stable hematocrit of greater than 0.38 L/L ( 437 ). Erythropoietin decreased transfusion requirements in the majority of patients and improved the quality of life in responding patients.

## Summary

The indications for treatment of patients with CLL differ somewhat between institutions; however, if the patient is not participating in a clinical trial, the following general guidelines are considered useful ( 1 ):

- Patients with stable *low-risk* “smoldering” CLL, or Binet stage A CLL, do not require therapy, and survival may actually be shortened with chemotherapy due to treatment-related complications.
- Many patients with *intermediate-risk* CLL, or Binet stage B CLL, do not require therapy, but treatment should be initiated with chlorambucil or fludarabine if there is evidence of progressive disease or uncomfortable organomegaly. Chemotherapy should be continued until the maximum response is obtained.
- Patients with *high-risk* CLL, or Binet stage C disease, should be treated with chlorambucil or fludarabine.
- Compared to chlorambucil, fludarabine produces a higher remission rate and more prolonged remissions in previously untreated patients. However, there is no evidence that survival is prolonged by treating patients initially with fludarabine. Increased response rates are observed on combining fludarabine with cyclophosphamide, and this may be further enhanced by the addition of a monoclonal antibody (rituximab or alemtuzumab). Furthermore, combination therapy may reverse drug resistance. Ongoing studies are determining the potential clinical utility of these combinations.
- The standard dose of chlorambucil is 4 to 8 mg orally OD, although higher remission rates may be obtained using higher doses. The standard dose of fludarabine is 25 mg/m<sup>2</sup>/day × 5 days IV monthly, or 25 mg/m<sup>2</sup>/day × 3 days IV monthly for older or frail patients. Patients not responding to fludarabine may be considered for one of the newer combination regimens or standard CHOP.
- Steroids should be avoided, if possible, as there is no evidence that they increase

the response rate obtained with alkylating agents or nucleoside analogs alone, and they increase the risk of infection. Steroids should be reserved to treat immune cytopenias. Alternatively, if used judiciously, prednisone may be combined with chlorambucil if a more rapid response is required, either to reduce organomegaly or to improve blood counts.

- Radiotherapy is reserved for local lesions that are particularly bulky and troublesome and is used only when chemotherapy is not required for control of more disseminated disease. The lowest dose of radiotherapy capable of shrinking the tumor mass should be used. Splenic irradiation may be helpful in patients who require a splenectomy but who are not surgical candidates.
- Splenectomy may be useful in patients with painful splenomegaly or who have cytopenias that are unresponsive to other therapies. Minimally invasive surgical techniques should be considered.
- Prophylactic gammaglobulin is useful in reducing the frequency of infections in patients with hypogammaglobulinemia and frequent episodes of sepsis. Prophylactic antibiotics (e.g., trimethoprim–sulfamethoxazole, fluconazole, or acyclovir) may also be useful to prevent recurrent bacterial, herpetic, or fungal infections and in high-risk patients receiving nucleoside analogs or steroids.
- Although not standard therapy, BMT may be considered for the younger patient with CLL, preferably in the setting of a clinical trial.

## DISEASE COURSE

Based on cytogenetic and molecular studies, it has been demonstrated that multiple clones may occur in CLL and that clonal evolution is a frequent occurrence ( [107](#) , [108](#) , [109](#) and [110](#) ). Rarely, the disease may convert to prolymphocytic leukemia, diffuse large cell lymphoma (Richter syndrome), Hodgkin disease, acute leukemia, or multiple myeloma ( [438](#) ).

Prolymphocytic transformation of CLL occurs slowly over several years and is associated with increasing anemia, thrombocytopenia, lymphadenopathy, splenomegaly, and resistance to treatment ( [438](#) , [439](#) and [440](#) ). However, an occasional excellent response to aggressive therapy is observed ( [439](#) ). Both typical CLL cells and an increasing number of prolymphocytes are observed in the circulation simultaneously. In most cases, the prolymphocytic transformation has likely developed from the CLL cells, as the leukemic cells have similar surface characteristics, including low-intensity surface Ig and the presence of CD5 ( [438](#) , [439](#) ). The clinical picture and immunophenotyping are thus quite different from those in *de novo* prolymphocytic leukemia.

Richter syndrome occurs in 3% of CLL patients and is characterized by increasing lymphadenopathy, splenomegaly, fever, and weight loss ( [441](#) , [442](#) , [443](#) , [444](#) and [445](#) ). In addition, these patients frequently have extranodal involvement with infiltration of kidneys, lungs, and the gastrointestinal tract; most patients die within 1 year. It is important to rule out opportunistic infections in these patients, and the definitive diagnosis is made by needle aspirate and cytology/flow cytometry of a node or a node biopsy ( [444](#) , [445](#) ). Eighty percent of patients have an increase in LDH, and it has been suggested that high-dose (7- to 10-mCi) gallium-67 scans may assist in the diagnosis by showing increased uptake into involved lymph nodes ( [442](#) ). However, a more recent study has not confirmed these findings ( [443](#) ). In 39 patients reported by the M. D. Anderson group ( [444](#) , [445](#) ), transformation occurred at a median time of 4 years from the diagnosis of CLL. Patients with all stages of disease were affected, and the incidence was not increased in patients treated with fludarabine or CdA. Response to standard chemotherapy is poor, with a median survival of 5 months, although responses may be obtained with standard and



nonmyeloablative allogeneic BMT ( [446](#) ). Some studies provide evidence for the clonal transformation of CLL cells into diffuse large cell lymphoma ( [444](#), [445](#), [446](#), [447](#), [448](#) and [449](#) ), whereas others suggest that some of these large cell lymphomas are an independent B-cell malignancy ( [449](#), [450](#) ). Foon et al. ( [438](#) ) have estimated that one-half of cases arise from the same clone as the CLL cell and one-half from a different B cell. Richter's transformation in CLL resembles the occurrence of large cell lymphomas in various immune deficiency states, even though there is no increase in the incidence of Richter's transformation in CLL patients treated with the highly immunosuppressive agents, fludarabine or CdA ( [444](#) ).

Occasionally, Hodgkin disease develops in CLL, and this is frequently called *Richter syndrome with features of Hodgkin disease*. Histologically, there may be classical Hodgkin disease or scattered Reed–Sternberg cells in a field of typical CLL cells ( [455](#) ). As with typical Richter syndrome, patients frequently present with fever, lymphadenopathy, and weight loss ( [445](#), [451](#), [452](#) ). Hodgkin disease develops approximately 4 years after the diagnosis of CLL, and in general, these patients have advanced Hodgkin disease and poor response to therapy with a median survival of 14 months ( [451](#) ). Using a variety of techniques, it has been demonstrated that the Reed–Sternberg cell evolves from the CLL cell, and in some cases, the Epstein–Barr virus has been found in the Reed–Sternberg cells, suggesting a pathogenetic role for the virus ( [453](#), [454](#) and [455](#) ). It is interesting that recent evidence suggests that Reed–Sternberg cells containing the Epstein–Barr virus have a different Ig gene rearrangement than the CLL cells, suggesting that in these cases, the Hodgkin disease did not evolve from the CLL clone but had a separate cell of origin ( [456](#) ). In contrast to Hodgkin disease, the Epstein–Barr virus does not appear to be important for the development of the diffuse large cell form of Richter syndrome ( [457](#) ).

Acute leukemia occurs in less than 1% of CLL patients, and this contrasts with the almost invariable progression of patients with chronic myeloid leukemia to acute leukemia ( [458](#) ). Of 31 cases of acute leukemia developing in patients with preexisting CLL, ten were lymphoblastic, seven myeloblastic, and one plasmacytic; in 13 cases, the cell type was not identified ( [458](#) ). As 29 of these 31 patients had received chemotherapy, it was assumed that many of the acute myeloid leukemia cases were attributable to therapy ( [458](#) ). However, acute myeloid leukemia was found in a patient who had recently been diagnosed as having CLL and who had not received chemotherapy ( [459](#) ). Both acute B- and T-cell lymphoblastic leukemias have been described in CLL ( [460](#), [461](#), [462](#), [463](#) and [464](#) ), and although this usually occurs after many years, the concomitant presentation of CLL and acute lymphoblastic leukemia also has been reported ( [460](#) ). In B-CLL, evidence of clonal evolution has been documented in some cases, whereas in T-cell cases, a common lymphoid progenitor precursor has been postulated as the source of both malignancies ( [460](#), [461](#), [462](#), [463](#) and [464](#) ).

Multiple myeloma may also develop in patients with CLL ( [465](#), [466](#), [467](#), [468](#) and [469](#) ). Some studies have suggested clonal evolution ( [467](#), [468](#) ), but Ig gene rearrangement studies have not confirmed this ( [469](#) ). It thus appears likely that, in some cases, the two diseases develop separately, whereas in others, multiple myeloma develops from the CLL clone.

There is an increased risk of second malignancies in CLL, and excluding non-Hodgkin lymphomas (which may arise from the CLL itself), the risk for Hodgkin disease is highest at 7.69%, but there is also an increased risk of melanomas, central nervous system tumors, and lung cancer ( [470](#) ). It has been suggested that the risk of second malignancies is not influenced by chemotherapy ( [152](#), [332](#) ), although recent evidence suggests that

chlorambucil, particularly if combined with fludarabine, increases the risk of myeloid malignancies ( [471](#) ). An analysis of 791 patients treated with fludarabine has not shown any increase in the incidence of second malignancies, although follow-up at the time of this report was very short (median, 1.1 years) ( [332](#) ).

## REFERENCES

1. Cheson BD, Bennett JM, Grever M, et al. National Cancer Institute-sponsored working group guidelines for chronic lymphocytic leukemia: revised guidelines for diagnosis and treatment. *Blood* 1996;87:4990-4997.
2. Rozman C, Montserrat E. Chronic lymphocytic leukemia. *New Engl J Med* 1995;333:1052-1057.
3. Caligaris-Cappio F, Hamblin TJ. B-cell chronic lymphocytic leukemia: a bird of a different feather. *J Clin Oncol* 1999;17:399-408.
4. Caligaris-Cappio F. B-chronic lymphocytic leukemia: a malignancy of anti-self B cells. *Blood* 1996;87:2615-2620.
5. Klein U, Tu Y, Stolovitzky GA, et al. Gene expression profiling of B cell chronic lymphocytic leukemia reveals a homogeneous phenotype related to memory B cells. *J Exp Med* 2001;194:1625-1638.
6. Rosenwald A, Alizadeh AA, Widhopf G, et al. Relation of gene expression phenotype to immunoglobulin lymphocytic leukemia. *J Exp Med* 2001;194:1639-1646.
7. Diehl LF, Karnell LH, Menck HR. The National Cancer Data Base report on age, gender, treatment, and outcomes of patients with chronic lymphocytic leukemia. *Cancer* 1999;86:2684-2692.
8. Sgambati MT, Linet MS, Devesa SS. Chronic lymphocytic leukemia: epidemiological, familial, and genetic aspects. In: Cheson BD, ed. *Chronic lymphoid leukemias*, 2nd ed. New York: Marcel Dekker Inc, 2001:33-62.
9. Zent CS, Kyasa MJ, Evans R, et al. Chronic lymphocytic leukemia incidence is substantially higher than estimated from tumor registry data. *Cancer* 2001;92:1325-1330.
10. Houlston RS, Catovsky D, Yuille MR. Genetic susceptibility to chronic lymphocytic leukemia. *Leukemia* 2002;16:1008-1014.
11. Ishibe N, Sgambati MT, Fontaine L, et al. Clinical characteristics of familial B-CLL in the National Cancer Institute Familial Registry. *Leuk Lymphoma* 2001;42:99-108.
12. Capalbo S, Trerotoli P, Ciancio A, et al. Increased risk of lymphoproliferative disorders in relatives of patients with B-cell chronic lymphocytic leukemia: relevance of the degree of familial linkage. *Eur J Haematol* 2000;65:114-117.
13. Rawstron AC, Yuille MR, Fuller J, et al. Inherited predisposition to CLL is detectable as subclinical monoclonal B-lymphocyte expansion. *Blood* 2002;100:2289-2290.
14. Wiernik PH, Ashwin M, Hu XP, et al. Anticipation in familial chronic lymphocytic leukaemia. *Br J Haematol* 2001;113:407-414.
15. Horwitz M, Goode EL, Jarvik GP. Anticipation in familial leukemia. *Am J Hum Genet* 1996;59:990-998.
16. Yuille MR, Houlston RS, Catovsky D. Anticipation in familial chronic lymphocytic leukaemia. *Leukemia* 1998;12:1696-1698.
17. Goldin LR, Sgambati M, Marti GE, et al. Anticipation in familial chronic lymphocytic leukemia. *Am J Hum Genet* 1999;65:265-269.
18. Bevan S, Catovsky D, Matutes E, et al. Linkage analysis for major histocompatibility complex-related genetic susceptibility in familial chronic lymphocytic leukemia. *Blood* 2000;96:3982-3984.
19. Pritsch O, Troussard X, Magnac C, et al. VH gene usage by family members affected with chronic



lymphocytic leukaemia. *Br J Haematol* 1999;107:616–624.

20. Sakai A, Marti GE, Caporaso N, et al. Analysis of expressed immunoglobulin heavy chain genes in familial B-CLL. *Blood* 2000;95:1413–1419.

21. Pettitt AR, Sherrington PD, Stewart G, et al. P53 dysfunction in B-cell chronic lymphocytic leukemia: inactivation of ATM as an alternative to TP53 mutation. *Blood* 2001;98:814–822.

22. Schaffner C, Stilgenbauer S, Rappold GA, et al. Somatic ATM mutations indicate a pathogenic role of ATM in B-cell chronic lymphocytic leukemia. *Blood* 1999;94:748–753.

23. Bullrich F, Rasio D, Kitada S, et al. ATM mutations in B-cell chronic lymphocytic leukemia. *Cancer Res* 1999;59:24–27.

24. Stankovic T, Stewart GS, Fegan C, et al. Ataxia telangiectasia mutated-deficient B-cell chronic lymphocytic leukemia occurs in pregerminal center cells and results in defective damage response and unrepaired chromosome damage. *Blood* 2002;99:300–309.

25. Yuille MR, Condie A, Hudson CD, et al. ATM mutations are rare in familial chronic lymphocytic leukemia. *Blood* 2002;100:603–609.

26. Dighiero G, Kipps HW, Schroeder N, et al. What is the CLL B-lymphocyte? *Leuk Lymphoma* 1996;22:13–39.

27. Schena M, Larsson LG, Gottardi D, et al. Growth- and differentiation-associated expression of bcl-2 in B-chronic lymphocytic leukemia cells. *Blood* 1992;79:2981–2989.

28. Brezinschek HP, Foster SJ, Brezinschek Dörner R, et al. Analysis of the human VH gene repertoire. Differential effects of selection and somatic hypermutation on human peripheral CD5+/IgM+ and CD5-/IgM+ B cells. *J Clin Invest* 1997;99:2488–2501.

29. Oscier DG, Gardiner AC, Mould SJ, et al. Multivariate analysis of prognostic factors in CLL: clinical stage, IGVH gene mutational status, and loss or mutation of the p53 gene are independent prognostic factors. *Blood* 2002;100:1177–1184.

30. Damle RN, Wasil T, Fais F, et al. IgV gene mutation status and CD38 expression as novel prognostic indicators in chronic lymphocytic leukemia. *Blood* 1999;94:1840–1847.

31. Kröber A, Seiler T, Benner A, et al. VH mutation status, CD38 expression level, genomic aberrations, and survival in chronic lymphocytic leukemia. *Blood* 2002;100:1410–1416.

32. Küppers R, Klein U, Hansmann ML, et al. Cellular origin of human B-cell lymphoma. *N Engl J Med* 1999;341:1520–1529.

33. Van Oers MHJ, Pals ST, Evers LM, et al. Expression and release of CD27 in human B-cell malignancies. *Blood* 1993;82:3430–3436.

34. Ranheim EA, Aversa G, Cocks BG, et al. Expression of CD27 and its ligand CD70, on chronic lymphocytic leukemia B cells. *Blood* 1995;85:3556–3565.

35. Agematsu K, Hokibara S, Nagumo H, et al. CD27: a memory B-cell marker. *Immunol Today* 2000;21:204–206.

36. Klein U, Rajewsky K, Küppers R. Human immunoglobulin (Ig)M+IgD+ peripheral blood B cells expressing the CD27 cell surface antigen carry somatically mutated variable region genes: CD27 as a general marker for somatically mutated (memory) cells. *J Exp Med* 1998;188:1679–1689.

37. Tangye SG, Leui YJ, Aversa G, et al. Identification of functional human splenic memory B cells by expression of CD148 and CD27. *J Exp Med* 1998;188:1691–1703.

38. Galton DAG. The pathogenesis of chronic lymphocytic leukemia. *Can Med Assoc J* 1966;94:1005–1010.

39. Dameshek W. Chronic lymphocytic leukemia—an accumulative disease of immunologically incompetent lymphocytes. *Blood* 1967;29:566–584.
40. Hentgartner MO. The biochemistry of apoptosis. *Nature* 2000;407:770–776.
41. Herr I, Debatin K-M. Cellular stress response and apoptosis in cancer therapy. *Blood* 2001;98:2603–2614.
42. Johnstone RW, Ruefli AA, Lowe SW. Apoptosis: a link between cancer genetics and chemotherapy. *Cell* 2002;108:153–164.
43. Salvesen GS, Dixit VM. Caspase activation: the induced-proximity model. *Proc Natl Acad Sci U S A* 1999;96:10964–10967.
44. Jia L, Srinivasula SM, Liu F-T, et al. Apaf-1 protein deficiency confers resistance to cytochrome c-dependent apoptosis in human leukemic cells. *Blood* 2001;98:414–421.
45. Leoni L, Chao Q, Cottam H. Induction of an apoptotic program in cell-free extracts by 2-chloro-2'-deoxyadenosine 5'-triphosphate and cytochrome c. *Proc Natl Acad Sci U S A* 1998;95:9567–9571.
46. Genini D, Adachi S, Chao Q, et al. Deoxyadenosine analogs induce programmed cell death in chronic lymphocytic leukemia cells by damaging the DNA and by directly affecting the mitochondria. *Blood* 2000;96:3537–3543.
47. Chandra J, Mansson E, Gogvadze V, et al. Resistance of leukemic cells to 2-chlorodeoxyadenosine is due to a lack of calcium-dependent cytochrome c release. *Blood* 2002;99:655–663.
48. Olsson A, Diaz T, Aguilar-Santelises M, et al. Sensitization to TRAIL-induced apoptosis and modulation of FLICE-inhibitory protein in B chronic lymphocytic leukemia by actinomycin D. *Leukemia* 2001;15:1868–1877.
49. Luo X, Budihardjo I, Zou H, et al. Bid, a bcl2 interacting protein, mediates cytochrome c release from mitochondria in response to activation of cell surface death receptors. *Cell* 1998;94:481–490.
50. Jones DT, Ganeshaguru K, Virchis AE, et al. Caspase 8 activation independent of Fas (CD95/APO-1) signaling may mediate killing of B-chronic lymphocytic leukemia cells by cytotoxic drugs or ? radiation. *Blood* 2001;98:2800–2807.
51. Wieder T, Essmann F, Prokop A, et al. Activation of caspase-8 in drug-induced apoptosis of B-lymphoid cells is independent of CD95/Fas receptor-ligand interaction and occurs downstream of caspase-3. *Blood* 2002;97:1378–1387.
52. Panayiotidis P, Ganeshaguru K, Foroni L, et al. Expression and function of the FAS antigen in B chronic lymphocytic leukemia and hairy cell leukemia. *Leukemia* 1995;9:1227–1232.
53. Wang D, Freeman GJ, Levine H, et al. Role of the CD40 and CD95 (APO-1/Fas) antigens in the apoptosis of human B-cell malignancies. *Br J Haematol* 1997;97:409–417.
54. Olsson A, Diaz T, Aguilar-Santelises M, et al. Sensitization to TRAIL-induced apoptosis and modulation of FLICE-inhibitory protein in B chronic lymphocytic leukemia by actinomycin D. *Leukemia* 2001;15:1868–1877.
55. Kabore AF, Johnston JB, Kropp D, et al. The TRAIL death signaling pathway plays a role in chlorambucil- and fludarabine-induced apoptosis in primary CLL cells. *Blood* 2002;100:595a.
56. Zhao S, Asgary Z, Wang Y, et al. Functional expression of TRAIL by lymphoid and myeloid tumour cells. *Br J Haematol* 1999;106:827–832.
57. Friesen C, Herr I, Krammer PH, et al. Involvement of the CD95 (APO-1/FAS) receptor/ligand system in drug-induced apoptosis in leukemia cells. *Nat Med* 1996;2:574–577.

58. Fulda S, Strauss G, Meyer E, et al. Functional CD95 ligand and CD95 death inducing signaling complex in activation-induced cell death and doxorubicin-induced apoptosis in leukemic T cells. *Blood* 2000;95:301–308.
59. Gibson SB, Oyer R, Spalding AC, et al. Increased expression of death receptors 4 and 5 synergizes the apoptosis response to combined treatment with etoposide and TRAIL. *Mol Cell Biol* 2000;20:205–212.
60. Wen J, Ramadevi N, Nguyen D, et al. Antileukemic drugs increase death receptor 5 levels and enhance Apo-2L-induced apoptosis of human acute leukemia cells. *Blood* 2000;96:3900–3906.
61. Hanada M, Delia D, Aiello A, et al. Bcl-2 gene hypomethylation and high-level expression in B-cell chronic lymphocytic leukemia. *Blood* 1993;82:1820–1828.
62. Robertson LE, Plunkett W, McConnell K, et al. Bcl-2 expression in chronic lymphocytic leukemia and its correlation with the induction of apoptosis and clinical outcome. *Leukemia* 1996;10:456–459.
63. Johnston JB, Daeninck P, Verburg L, et al. p53, mdm-2, bax and bcl-2 and drug resistance in chronic lymphocytic leukemia. *Leuk Lymphoma* 1997;26:435–449.
64. Christodoulopoulos G, Fotouhi N, Krajewski S, et al. Relationship between nitrogen mustard drug resistance in B-cell chronic lymphocytic leukemia (B-CLL) and protein expression of Bcl-2, Bax, Bcl-X and p53. *Cancer Lett* 1997;121:59–67.
65. Kitada S, Anderson J, Akar S, et al. Expression of apoptosis-regulating proteins in chronic lymphocytic leukemia: correlations with in vitro and in vivo chemo responses. *Blood* 1998;91:3379–3389.
66. Pepper C, Thomas A, Hoy T, et al. Antisense-mediated suppression of bcl-2 highlights its pivotal role in failed apoptosis in B-cell chronic lymphocytic leukaemia. *Br J Haematol* 1999;107:611–615.
67. Bellosillo B, Villamor N, Colomer D, et al. In vitro evaluation of fludarabine in combination with cytophosphamide and/or mitoxantrone in B-cell chronic lymphocytic leukemia. *Blood* 1999;94:2836–2843.
68. Stroka D, Badrichani A, Bach F, et al. Overexpression of A1, an NF- $\kappa$ B-inducible, anti-apoptotic BCL gene inhibits endothelial cell activation. *Blood* 1999;93:3803–3810.
69. Cheng G, Lee H, Dadgostar H, et al. NF- $\kappa$ B-mediated up-regulation of bcl-x and bfl-1/al is required for cd40 survival signaling in B lymphocytes. *Proc Natl Acad Sci U S A* 1999;96:9136–9141.
70. Furman RR, Asgary Z, Mascarebhas JO, et al. Modulation of NF- $\kappa$ B activity and apoptosis in chronic lymphocytic leukemia B cells. *J Immunol* 2000;164:2200–2206.
71. Chandra J, Niemer I, Gilbreath J, et al. Proteasome inhibitors induce apoptosis in glucocorticoid-resistant chronic lymphocytic leukemic lymphocytes. *Blood* 1998;92:4220–4229.
72. Almond JB, Snowden RT, Hunter A, et al. Proteasome inhibitor-induced apoptosis of B-chronic lymphocytic leukaemia cells involves cytochrome c release and caspase activation, accompanied by formation of an approximately 700 kDa Apaf-1 containing apoptosome complex. *Leukemia* 2001;15:1388–1397.
73. Adams J. Development of the proteasome inhibitor PS-341. *Oncologist* 2002;7:9–16.
74. Datta S, Brunet A, Greenberg M. Cellular survival: a play in three Acts. *Genes Dev* 1999;13:2905–2927.
75. Wickremasinghe RG, Ganeshaguru K, Jones DT, et al. Autologous plasma activates Akt/protein kinase B and enhances basal survival and resistance to DNA damage-induced apoptosis in B-chronic lymphocytic leukaemia cells. *Br J Haematol* 2001;114:608–615.
76. Vogelstein B, Lane, Levine AJ. Surfing the p53 network. *Nature* 2000;408:307–310.
77. Fisher DE. Apoptosis in cancer therapy: crossing the threshold. *Cell* 1994;78:539–542.
78. Cordone I, Masi S, Mauro FR, et al. p53 expression in B-cell chronic lymphocytic leukemia: a marker

of disease progression and poor prognosis. *Blood* 1998;91:4342–4349.

79. Döhner H, Stilgenbauer S, Benner A, et al. Genomic aberrations and survival in chronic lymphocytic leukemia. *N Engl J Med* 2000;343:1910–1916.

80. Watanabe T, Hotta T, Ichikawa A, et al. The MDM2 oncogene overexpression in chronic lymphocytic leukemia and low-grade lymphoma of B-cell origin. *Blood* 1994;84:3158–3165.

81. Stankovic T, Stewart GS, Fegan C, et al. Ataxia telangiectasia mutated-deficient B-cell chronic lymphocytic leukemia occurs in pregerminal center cells and results in defective damage response and unrepaired chromosome damage. *Blood* 2002;99:300–309.

82. Starostik P, Manshouri T, O'Brien S, et al. Deficiency of the ATM protein expression defines an aggressive sub-group of B-cell chronic lymphocytic leukemia. *Cancer Res* 1998;58:4552–4557.

83. Lin K, Sherrington PD, Dennis M, et al. Relationship between p53 dysfunction, CD38 expression, and IgVH mutation in chronic lymphocytic leukemia. *Blood* 2002;100:1404–1409.

84. Sherr CJ. G1 phase progression: cycling on cue. *Cell* 1994;79:551–555.

85. Sherr CJ, Roberts JM. CDK inhibitors: positive and negative regulators of G1-phase progression. *Genes Dev* 1999;13:1501–1512.

86. Delmer A, Ajchenbaum-Cymbalista F, Tang R, et al. Overexpression of cyclin D2 in chronic B-cell malignancies. *Blood* 1995;85:2870–2876.

87. Suzuki R, Kuroda H, Komatsu H, et al. Selective usage of D-type cyclins in lymphoid malignancies. *Leukemia* 1999;13:1335–1342.

88. Wolowiec D, Ciszak L, Kosmaczcwska A, et al. Cell cycle regulatory proteins and apoptosis in B-cell chronic lymphocytic leukemia. *Haematologica* 2001;86:1296–1304.

89. Korz C, Pscherer A, Benner A, et al. Evidence for distinct pathomechanisms in B-cell chronic lymphocytic leukemia and mantle cell lymphoma by quantitative expression analysis of cell cycle and apoptosis-associated genes. *Blood* 2002;99:4554–4561.

90. Kornblau S, Chen N, Del Giglio A, et al. Retinoblastoma protein expression is frequently altered in chronic lymphocytic leukemia. *Cancer Res* 1994;54:242–246.

91. Vrhovac R, Delmer A, Tang R, et al. Prognostic significance of the cell cycle inhibitor p27KIP1 in chronic lymphocytic leukemia. *Blood* 1998;91:4694–4700.

92. Stilgenbauer S, Bullinger L, Lichter P, et al. Genetics of chronic lymphocytic leukemia: genomic aberrations and VH gene mutation status in pathogenesis and clinical course. *Leukemia* 2002;16:993–1007.

93. Novak U, Oppliger Leibundgut E, Hager J, et al. A high-resolution allelotype of B-cell chronic lymphocytic leukemia (B-CLL). *Blood* 2002;100:1787–1794.

94. Juliusson G, Merup, M. Cytogenetics in chronic lymphocytic leukemia. *Semin Oncol* 1998;25:192–196.

95. Oscier DG, Stevens J, Hamblin TJ, et al. Correlation of chromosome abnormalities with laboratory features and clinical course in B-cell chronic lymphocytic leukaemia. *Br J Haematol* 1990;76:352–358.

96. Peterson LC, Lindquist LL, Church S, et al. Frequent clonal abnormalities of chromosome band 13q14 in B-cell chronic lymphocytic leukemia: multiple clones, subclones, and nonclonal alterations in 82 midwestern patients. *Genes Chromosomes Cancer* 1992;4:273–280.

97. Han T, Henderson ES, Emrich LJ, et al. Prognostic significance of karyotypic abnormalities in B-cell chronic lymphocytic leukemia: an update. *Semin Hematol* 1987;24:257–263.

98. Juliusson G, Oscier DG, Fitchett M, et al. Prognostic subgroups in B-cell-chronic lymphocytic leukemia defined by specific chromosome abnormalities. *N Engl J Med* 1990;323:720–724.

99. Juliusson G, Oscier D, Gahrton G, et al. Cytogenetic findings and survival in B-cell chronic lymphocytic leukemia. Second IWCLL compilation of data on 662 patients. *Leuk Lymphoma* 1991;5:21-25.
100. Garcia-Marco JA, Price CM, Catovsky D. Interphase cytogenetics in chronic lymphocytic leukemia. *Cancer Genet Cytogenet* 1997;94:52-58.
101. Geisler C, Philip P, Hansen M. B-cell chronic lymphocytic leukemia: clonal chromosome abnormalities and prognosis in 89 cases. *Eur J Haematol* 1989;43:397-403.
102. Matutes E, Oscier D, Garcia-Marco J, et al. Trisomy 12 defines a group of CLL with atypical morphology: correlation between cytogenetic, clinical and laboratory features in 544 patients. *Br J Haematol* 1996;92:382-388.
103. Criel A, Michaux L, de Wolf-Peters C. The concept of typical and atypical chronic lymphocytic leukemia. *Leuk Lymphoma* 1999;33:33-45.
104. Neilson JR, Auer R, White D, et al. Deletions at 11q identify a subset of patients with typical CLL who show consistent disease progression and reduced survival. *Leukemia* 1997;11:1929-1932.
105. Que T, Marco J, Ellis J, et al. Trisomy 12 in chronic lymphocytic leukemia detected by fluorescein in situ hybridization: analysis by stage, immunophenotype, and morphology. *Blood* 1993;82:571-575.
106. Weisenburger DD, Armitage JO. Mantle cell lymphoma—an entity comes of age. *Blood* 1996;87:4483-4494.
107. Kay NE, Ranheim EA, Peterson LC. Tumor suppressor genes and clonal evolution in B-CLL. *Leuk Lymphoma* 1995;18:41-49.
108. Oscier D, Fitchett M, Herbert T, et al. Karyotypic evolution in B-cell chronic lymphocytic leukaemia. *Genes Chromosomes Cancer* 1991;3:16-20.
109. Fegan C, Robinson H, Thompson P, et al. Karyotypic evolution in CLL. Identification of a new sub-group of patients with deletions of 11q and advanced or progressive disease. *Leukemia* 1995;9:2003-2008.
110. Finn WG, Kay NE, Kroft SH, et al. Secondary abnormalities of chromosome 6q in B-cell chronic lymphocytic leukemia: a sequential study of karyotypic instability in 51 patients. *Am J Hematol* 1998;59:223-229.
111. Hjalmar V, Kimby E, Matutes E, et al. Atypical lymphocytes in B-cell chronic lymphocytic leukemia and trisomy 12 studied by conventional staining combined with fluorescence in situ hybridization. *Leuk Lymphoma* 2000;37:571-576.
112. Garcia-Marco JA, Price CM, Catovsky D. Interphase cytogenetics in chronic lymphocytic leukemia. *Cancer Genetic Cytogenet* 1997;94:52-58.
113. Auer RL, Bienz N, Neilson J. The sequential analysis of trisomy 12 in B-cell chronic lymphocytic leukaemia. *Br J Haematol* 1999;104:742-744.
114. Lens D, Dyer MJ, Garcia-Marco JM, et al. p53 abnormalities in CLL are associated with excess of polymphocytes and poor prognosis. *Br J Haematol* 1997;99:848-857.
115. Yong-Ming Z, Haynes AP, Keith FJ, et al. Abnormalities of retinoblastoma gene expression in hematological malignancies. *Leuk Lymphoma* 1995;18:61-67.
116. Stilgenbauer S, Dohner H, Bulgay-Morschel M, et al. High frequency of monoallelic retinoblastoma gene deletion in B-cell chronic lymphoid leukemia shown by interphase cytogenetics. *Blood* 1993;81:2118-2124.
117. Hawthorn LA, Chapman R, Oscier D, et al. The consistent 13q14 translocation breakpoint seen in chronic B-cell leukaemia (BCLL) involves deletion of the D13S25 locus which lies distal to the

retinoblastoma predisposition gene. *Oncogene* 1993;8:1415–1419.

118. Liu Y, Szekely L, Grander D, et al. Chronic lymphocytic leukemia cells with allelic deletions at 13q14 commonly have one intact RB-1 gene: evidence for a role of an adjacent locus. *Proc Natl Acad Sci U S A* 1993;90:8697–8701.

119. Mertens D, Wolf S, Schroeter P, et al. Down-regulation of candidate tumor suppressor genes within chromosome band 13q14.3 is independent of the DNA methylation pattern in B-cell chronic lymphocytic leukemia. *Blood* 2002;99:4116–4121.

120. Migliazza A, Bosch F, Komatsu H, et al. Nucleotide sequence, transcription map, and mutation analysis of the 13q14 chromosomal region deleted in B-cell chronic lymphocytic leukemia. *Blood* 2001;97:2098–2104.

121. Bullrich F, Fujii H, Calin G, et al. Characterization of the 13q14 tumor suppressor locus in CLL: identification of ALT1, an alternative splice variant of the LEU2 gene. *Cancer Res* 2001;61:6640–6648.

122. Panayiotidis P, Ganeshaguru K, Rowntree C, et al. Lack of clonal BRCA2 gene deletion on chromosome 13 in chronic lymphocytic leukaemia. *Br J Haematol* 1997;97:844–847.

123. Monni O, Knuutila S. 11q deletions in hematological malignancies. *Leuk Lymphoma* 2001;40:259–266.

124. Sembries S, Pahl H, Stilgenbauer S, et al. Reduced expression of adhesion molecules and cell signaling receptors by chronic lymphocytic leukemia cells with 11q deletion. *Blood* 1999;93:624–631.

125. Aalto Y, EL-Rifa W, Vilpo L, et al. Distinct gene expression profiling in chronic lymphocytic leukemia with 11q23 deletion. *Leukemia* 2001;15:1721–1728.

126. Au WY, Horsman DE, Ohno H, et al. Bcl-3/IgH translocation (14;19)(q32;q13) in non-Hodgkin's lymphomas. *Leuk Lymphoma* 2002;43: 813–816.

127. Ghia P, Caligaris-Cappio F. The indispensable role of microenvironment in the natural history of low grade B cell neoplasma. *Adv Cancer Res* 2000;79:157–174.

128. Orsini E, Guarini A, Foa R. Accessory cells, cytokine loops and cell-to-cell interactions in chronic lymphocytic leukemia. *Rev Clin Exp Hematol* 2000;4:73–98.

129. Cordingley FT, Bianchi A, Hoffbrand AV, et al. Tumour necrosis factor as an autocrine tumour growth factor for chronic B-cell malignancies. *Lancet* 1988;1:969–971.

130. Digel W, Stefanic M, Schoniger W, et al. Tumor necrosis factor induces proliferation of neoplastic B cells from chronic lymphocytic leukemia. *Blood* 1989;73:1242–1246.

131. Tangye SG, Taison RL. Human cytokines suppress apoptosis of leukaemic CD5+ B cells and preserve expression of bcl-2. *Immunol Cell Biol* 1997;75:127–135.

132. Ferraioli A, Keating MJ, Manshouri T, et al. The clinical significance of tumor necrosis factor- $\alpha$  plasma level in patients having chronic lymphocytic leukemia. *Blood* 2002;100:1215–1219.

133. Michalevicz R, Porat R, Vcoropoulos M, et al. Restoration of in vitro hematopoiesis in chronic lymphocytic leukemia by antibodies to tumor necrosis factor. *Leuk Res* 1991;15:111–120.

134. Digel W, Porzsozt F, Schmid M, et al. High levels of circulating soluble receptors for tumour necrosis factor in hairy cell leukemia and type B chronic lymphocytic leukemia. *J Clin Invest* 1992;89:1690–1693.

135. Kremer JP, Reisbach G, Nerl C, et al. B-cell chronic lymphocytic leukaemia cells express and release transforming growth factor- $\beta$ . *Br J Haematol* 1992;80:480–487.

136. Lagneaux L, Delforge A, Dorval C, et al. Excessive production of transforming growth factor- $\beta$  by bone marrow stromal cells in B-cell chronic lymphocytic leukemia inhibits growth of hematopoietic precursors and interleukin-production. *Blood* 1993;82:2379–2385.

137. Israels LG, Israels SJ, Begleiter A, et al. Role of transforming growth factor- $\beta$  in chronic lymphocytic

leukemia. *Leuk Res* 1993;17:83–87.

138. DeCoteau JF, Knaus PI, Yankelev H, et al. Loss of functional cell surface transforming growth factor  $\beta$  (TGF- $\beta$ ) type I receptor correlates with insensitivity to TGF- $\beta$  in chronic lymphocytic leukemia. *Proc Natl Acad Sci U S A* 1997;94:5877–5881.

139. Douglas RS, Capocasale RJ, Lamb RJ, et al. Chronic lymphocytic leukemia B cells are resistant to the apoptotic effects of transforming growth factor- $\beta$ . *Blood* 1997;89:941–947.

140. Long BW, Witte PL, Abraham GN, et al. Apoptosis and interleukin 7 gene expression in chronic B-lymphocytic leukemia cells. *Proc Natl Acad Sci U S A* 1995;92:1416–1420.

141. Trentin L, Cerutti A, Zambello R, et al. Interleukin-15 promotes the growth of leukemic cells of patients with B-cell chronic lymphoproliferative disorders. *Blood* 1996;87:3327–3335.

142. Knauf WU, Langenmayer I, Ehlers B, et al. Serum levels of soluble CD23, but not soluble CD25, predict disease progression in early stage B-cell chronic lymphocytic leukemia. *Leuk Lymphoma* 1997;27:523–532.

143. Foa R, Fierro MT, Giovarelli M, et al. Immunoregulatory T-cell defects in B-cell chronic lymphocytic leukemia: cause or consequence of the disease? The contributory role of a decreased availability of interleukin 2 (IL2). *Blood Cells* 1987;12:399–412.

144. Aguilar-Santelises M, Gigliotti D, Osorio LM, et al. Cytokine expression in B-cell in relation to disease progression and in vitro activation. *Med Oncol* 1999;16:289–295.

145. Buhmann R, Nolte A, Westhaus D, et al. CD40-activated B-cell chronic lymphocytic leukemia cells for tumor immunotherapy: stimulation of allogeneic versus autologous T cells generates different types of effector cells. *Blood* 1999;93:1992–2002.

146. Kitada S, Zapata JM, Andreeff M, et al. Bryostatins and CD40-ligand enhance apoptosis resistance and induce expression of cell survival genes in B cell chronic lymphocytic leukaemia. *Br J Haematol* 1999;106:995–1004.

147. Romano MF, Lamberti A, Tassone P, et al. Triggering of CD40 antigen inhibits fludarabine induced apoptosis in B chronic lymphocytic leukemia cells. *Blood* 1998;92:990–995.

148. Younes A, Snell V, Consoli U, et al. Elevated levels of biologically active soluble CD40 ligand in the serum of patients with chronic lymphocytic leukaemia. *Br J Haematol* 1998;100:135–141.

149. Cantwell M, Hua T, Pappas J, et al. Acquired CD40-ligand deficiency in chronic lymphocytic leukemia. *Nat Med* 1997;3:984–989.

150. Tsukada N, Burger JA, Zvaifler NJ, et al. Distinctive features of “nurselike” cells that differentiate in the context of chronic lymphocytic leukemia. *Blood* 2002;99:1030–1037.

151. De Lima M, O'Brien S, Lerner S, et al. Chronic lymphocytic leukemia in the young patient. *Semin Oncol* 1998;25:107–116.

152. Mauro FR, Foa R, Giannarelli D, et al. Clinical characteristics and outcome of young chronic lymphocytic leukemia patients: a single institution study of 204 cases. *Blood* 1999;94:448–454.

153. International Workshop on chronic lymphocytic leukemia. Chronic lymphocytic leukemia: recommendations for diagnosis, staging and response criteria. *Ann Intern Med* 1989;110:236–238.

154. Feliu E, Rozman C, Montserrat E, et al. Cytoplasmic inclusions in lymphocytes of chronic lymphocytic leukaemia. *Scand J Haematol* 1983;31:510–512.

155. Escribano L, Heinrichs B, Villarrubia J, et al. Juvenile chronic lymphocytic leukemia with unusual intracisternal inclusions: an ultrastructural study. *Leuk Lymphoma* 1995;17:515–519.

156. Bennett JM, Catovsky D, Daniel MT, et al. Proposals for the classification of chronic (mature) B and



T lymphoid leukaemias. *J Clin Pathol* 1989;42:567–584.

157. Rozman C, Montserrat E, Rodriguez-Fernandez JM, et al. Bone marrow histologic pattern. The best single prognostic parameter in chronic lymphocytic leukemia. A multivariate analysis of 329 cases. *Blood* 1984;64:642–648.

158. Hoyer JD, Ross CW, Li C-Y, et al. True T-cell chronic lymphocytic leukemia: a morphologic and immunophenotypic study of 25 cases. *Blood* 1995;86:1163–1169.

159. Matutes E, Catovsky D. Similarities between T-cell chronic lymphocytic leukemia and the small-cell variant of T-prolymphocytic leukemia. *Blood* 1996;87:3520.

160. Geisler CH, Larsen JK, Hansen NE, et al. Prognostic importance of flow cytometric immunophenotyping of 540 consecutive patients with B-cell chronic lymphocytic leukemia. *Blood* 1991;78:1795–1802.

161. DiGiuseppen JA, Borowitz MJ. Clinical utility of flow cytometry in the chronic lymphoid leukemias. *Semin Oncol* 1998;25:6–10.

162. Matutes E, Polliack A. Morphological and immunophenotypic features of chronic lymphocytic leukemia. *Rev Clin Exp Hematol* 2000;4:22–47.

163. Gascoyne RD. Differential diagnosis of the chronic B-cell lymphoid leukemias. In: Cheson BD, ed. *Chronic lymphoid leukemias*, 2nd ed. New York: Marcel Dekker Inc, 2001:209–230.

164. Damle R, Ghiotto F, Valetto A, et al. B-cell chronic lymphocytic leukemia cells express a surface membrane phenotype of activated, antigen-experienced B lymphocytes. *Blood* 2002;99:4087–4093.

165. Moreau EJ, Matutes E, A'Hern RP, et al. Improvement of the chronic lymphocytic leukemia scoring system with the monoclonal antibody SN8 (CD79b). *Am J Clin Pathol* 1997;108:378–382.

166. Zupo S, Massara R, Dono M, et al. Apoptosis or plasma cell differentiation of CD38-positive B-chronic lymphocytic leukemia cells induced by cross-linking of surface IgM or IgD. *Blood* 2000;95:1199–1206.

167. DiRaimondo F, Albitar M, Huh Y, et al. The clinical and diagnostic relevance of CD23 expression in the chronic lymphoproliferative disease. *Cancer* 2002;94:1721–1730.

168. Hubmann R, Schwarzmeier JD, Shehata M, et al. Notch2 is involved in the overexpression of CD23 in B-cell chronic lymphocytic leukemia. *Blood* 2002;99:3742–3747.

169. Alfarano A, Indraccolo S, Circosta P, et al. An alternatively spliced form of CD79b gene may account for altered B-cell receptor expression in B-chronic lymphocytic leukemia. *Blood* 1999;93:2327–2335.

170. Rawstron AC, Green MJ, Kuzmicki A, et al. Monoclonal B lymphocytes with the characteristics of “indolent” chronic lymphocytic leukemia are present in 3.5% of adults with normal blood counts. *Blood* 2002;100:635–639.

171. Serke S, Schwaner I, Yordanova M, et al. Monoclonal antibody FMC7 detects a conformational epitope on the CD20 molecule: evidence from phenotyping after Rituxan therapy and transfectant cell analyses. *Cytometry* 2001;46:98–104.

172. Ikematsu W, Ikematsu H, Okamura S, et al. Surface phenotype and Ig heavy-chain gene usage in chronic B-cell leukemias: expression of myelomonocytic surface markers in CD5-chronic B-cell leukemia. *Blood* 1994;83:2602–2610.

173. Kipps TJ, Carson DA. Autoantibodies in chronic lymphocytic leukemia and related systemic autoimmune diseases. *Blood* 1993;81:2475–2487.

174. Huang JC, Finn WG, Goolsby CL, et al. CD5- small B-cell leukemias are rarely classifiable as chronic lymphocytic leukemia. *Am J Clin Pathol* 1999;111:123–130.

175. Giardina SL, Schroff RW, Kipps TJ, et al. The generation of monoclonal anti-idiotypic antibodies to

human B-cell derived leukemias and lymphomas. *J Immunol* 1985;135:653-658.

176. Fais F, Sellars B, Ghiotto F, et al. Examples of in vivo isotype class switching in IgM<sup>+</sup> chronic lymphocytic leukemic B cells. *J Clin Invest* 1995;98:7:1659-1666.

177. Dono M, Hashimoto S, Fais F, et al. Evidence for progenitors of chronic lymphocytic leukemia B cells that undergo intraclonal differentiation and diversification. *Blood* 1996;87:1586-1594.

178. Rechavi G, Mandel M, Katzir N, et al. Immunoglobulin heavy chain rearrangements in chronic lymphocytic leukemia: correlation with clinical stage. *Br J Haematol* 1989;72:524-529.

179. Perl A, DiVincenzo JP, Ryan DH, et al. Rearrangement of the T-cell receptor alpha, beta and gamma chain genes in chronic lymphocytic leukemia. *Leuk Res* 1990;14:131-137.

180. Norton JD, Pattinson J, Hoffbrand AV, et al. Rearrangement and expression of T cell antigen receptor genes in B cell chronic lymphocytic leukemia. *Blood* 1988;71:178-185.

181. O'Connor NT, Wainscoat JS, Weatherall DJ, et al. Rearrangement of the T cell receptor beta chain gene in the diagnosis of lymphoproliferative disorders. *Lancet* 1985;1:1295-1297.

182. Beaume A, Brizard A, Dreyfus B, et al. High incidence of serum monoclonal Igs detected by a sensitive immunoblotting technique in B-cell chronic lymphocytic leukemia. *Blood* 1994;84:1216-1219.

183. Bartik MM, Welker D, Kay NE. Impairments in immune cell function in B-cell chronic lymphocytic leukemia. *Semin Oncol* 1998;25:27-33.

184. Morrison VA. The infectious complications of chronic lymphocytic leukemia. *Semin Oncol* 1998;25:98-106.

185. Morrison VA, Rai KR, Peterson BL, et al. Impact of therapy with chlorambucil, fludarabine, or fludarabine plus chlorambucil on infections in patients with chronic lymphocytic leukemia: Intergroup Study Cancer and Leukemia Group B 9011. *J Clin Oncol* 2001;19:3611-3621.

186. Keating MJ, Flinn I, Jain V, et al. Therapeutic role of alemtuzumab (Campath-1H) in patients who have failed fludarabine: results of a large international study. *Blood* 2002;99:3554-3561.

187. Byrd JC, Peterson BL, Morrison VA, et al. Randomized Phase II study of fludarabine with concurrent versus sequential treatment with rituximab in symptomatic, untreated patients with B-cell chronic lymphocytic leukemia: results from CALGB 9712. *Blood* 2002.

188. Wolos JA, Davey FR. B lymphocyte function in B cell chronic lymphocytic leukemia. *Br J Haematol* 1981;49:395-403.

189. Fu SM, Chiorazzi N, Kunkel HG. Differentiation capacity and other properties of the leukemic cells of CLL. *Immunol Rev* 1979;48:23-44.

190. Johnstone AP, Jensenius JC, Millard RE, et al. Mitogen-stimulated immunoglobulin production by CLL lymphocytes. *Clin Exp Immunol* 1982;47:697-705.

191. Goodman MG, Wormsley SB, Spinosa JC, et al. Loxoribine induces chronic lymphocytic leukemia B cells to traverse cell cycle. *Blood* 1994;84:3457-3464.

192. Planken EV, Willemze R, Kluin-Nelemans JC. The role of the CD40 antigen on malignant B cells. *Leuk Lymphoma* 1996;22:229-235.

193. Kneitz C, Goller Wilhelm M, Mehringer C, et al. Inhibition of T cell/B cell interaction by B-CLL cells. *Leukemia* 1999;13:98-104.

194. Lacombe C, Gombert J, Dreyfus B, et al. Heterogeneity of serum IgG subclass deficiencies in B chronic lymphocytic leukemia. *Clin Immunol* 1999;90:128-132.

195. Aittoniemi J, Miettinen A, Laine S, et al. Opsonising immunoglobulins and mannan-binding lectin in

chronic lymphocytic leukemia. *Leuk Lymphoma* 1999;34:381–385.

196. Kay NE, Perri RT. Evidence that large granular lymphocytes from B-CLL patients down-regulate B cell immunoglobulin synthesis. *Blood* 1989;73:1016–1019.

197. Frolova EA, Richards SJ, Jones RA. Immunophenotypic and DNA genotypic analysis of T-cell and NK-cell subpopulations in patients with B-cell chronic lymphocytic leukaemia (B-CLL). *Leuk Lymphoma* 1995;16:307–318.

198. Scrivener S, Kaminski ER, Demaine A, et al. Analysis of the expression of critical activation/interaction markers on peripheral blood T cell in B-cell chronic lymphocytic leukaemia: evidence of immune dysregulation. *Br J Haematol* 2001;112:959–964.

199. Catovsky D, Lauria F, Matutes E, et al. Increase in T lymphocytes in B-cell CLL. *Br J Haematol* 1981;47:539–544.

200. Rossi JF, Commes T, Grenier J, et al. Production of B-cell growth factor interleukin 2 and gamma interferon by peripheral blood lymphocytes from patients with chronic lymphocytic leukemia of B cell type. *Am J Hematol* 1988;29:183–188.

201. Han T, Dadly B. In vitro functional studies of mononuclear cells in patients with CLL. *Cancer* 1979;43:109–117.

202. Han T, Bloom ML, Dadey B, et al. Lack of autologous mixed lymphocyte reaction in patients with CLL. *Blood* 1982;60:1075–1081.

203. Lauria F, Foa R, Mantovani V, et al. T cell functional abnormality in B-CLL: evidence of a defect of the T helper subset. *Br J Haematol* 1983;54:277–283.

204. Farace F, Orlanducci F, Dietrich PY, et al. T cell repertoire in patients with B chronic lymphocytic leukemia. *J Immunol* 1994;153:4281–4290.

205. Schattner EJ. CD40 ligand in CLL pathogenesis and therapy. *Leuk Lymphoma* 2000;37:461–472.

206. Schlesinger M, Broman I, Lugassy G. The complement system is defective in chronic lymphatic leukemia patients and in their healthy relatives. *Leukemia* 1996;10:1509–1513.

207. Itala M, Vainio O, Remes K. Functional abnormalities in granulocytes predict susceptibility to bacterial infections in chronic lymphocytic leukaemia. *Eur J Haematol* 1996;57:46–53.

208. Mauro FR, Foa R, Cerretti T, et al. Autoimmune hemolytic anemia in chronic lymphocytic leukemia: clinical therapeutic, and prognostic features. *Blood* 2000;95:2786–2792.

209. Diehl LF, Ketchum LH. Autoimmune disease and chronic lymphocytic leukemia: autoimmune hemolytic anemia, pure red cell aplasia, and autoimmune thrombocytopenia. *Semin Oncol* 1998;25:80–97.

210. Hamblin T. Autoimmune disease and its management in chronic lymphocytic leukemia. In: BD, ed. *Chronic lymphoid leukemias*, 2nd ed. New York: Marcel Dekker Inc, 2001:33–62.

211. Mangan KF, Chikkappa G, Farley PC. T gamma cells suppress growth of erythroid colony-forming units in vitro in the pure red cell aplasia of B-cell CLL. *J Clin Invest* 1982;70:1148–1156.

212. Moulin B, Ronco PM, Mougnot B, et al. Glomerulonephritis in chronic lymphocytic leukaemia and related B cell lymphomas. *Kidney Int* 1992;42:127–135.

213. Anhalt GJ, Kim SC, Stanley JR, et al. Paraneoplastic pemphigus. An autoimmune mucocutaneous disease associated with neoplasia. *N Engl J Med* 1990;323:1729–1735.

214. Joly P, Thomin E, Gilbert D, et al. Overlapping distribution of autoantibody specificities in paraneoplastic pemphigus and pemphigus vulgaris. *J Invest Dermatol* 1994;103:65–72.

215. Borche L, Lim A, Binet JL, et al. Evidence that chronic lymphocytic leukemia B lymphocytes are

frequently committed to production of natural autoantibodies. *Blood* 1990;76:562–569.

216. Weiss RB, Freiman J, Kweder SL, et al. Hemolytic anemia after fludarabine therapy for chronic lymphocytic leukemia. *J Clin Oncol* 1998;16:1885–1889.

217. Rai KR, Pererson BL, Appelbaum FR, et al. Fludarabine compared with chlorambucil as primary therapy for chronic lymphocytic leukemia. *N Engl J Med* 2000;343:1750–1757.

218. Lepage M, Chevret S, Cazin B, et al. Randomized comparison of fludarabine, CAP, and CHOP in 938 previously untreated stage B and C chronic lymphocytic leukemia patients. *Blood* 2001;98:2319–2325.

219. Efremov DG, Ivanovski M, Siljanovski N, et al. Restricted immunoglobulin VH region repertoire in chronic lymphocytic leukemia patients with autoimmune hemolytic anemia. *Blood* 1996;87:3869–3876.

220. Mossafa J, Malaure J, Maynadie M, et al. Persistent polyclonal B lymphocytosis with binucleated lymphocytes: a study of 25 cases. *Groupe Francais d'Hematologie Cellulaire. Br J Haematol* 1999;104:486–493.

221. Delage R, Jacques L, Massinga-Loembe M, et al. Persistent polyclonal B-cell lymphocytosis: further evidence for a genetic disorder associated with B-cell abnormalities. *Br J Haematol* 2001;114:666–670.

222. Salcedo I, Campos-Caro A, Sampalo A, et al. Persistent polyclonal B lymphocytosis: an expansion of cells showing IgVH gene mutations and phenotypic features of normal lymphocytes from the CD27+ marginal zone B-cell compartment. *Br J Haematol* 2002;116:662–666.

223. Bates I, Bedu-Addo G, Bevan DH, et al. Use of immunoglobulin gene rearrangements to show clonal lymphoproliferation in hyper-reactive malarial splenomegaly. *Lancet* 1991;337:505–507.

224. Bedu-Addo G, Bates I. Causes of massive tropical splenomegaly in Ghana. *Lancet* 2002;360:449–454.

225. Harris NL, Jaffe ES, Stein H, et al. A revised European-American classification of lymphoid neoplasms: a proposal from the International Lymphoma Study Group. *Blood* 1994;84:1361–1392.

226. Catovsky D, Matutes E. Splenic lymphoma with circulating villous lymphocytes/splenic marginal-zone lymphoma. *Semin Hematol* 1999;36:148–154.

227. Melo JV, Catovsky D, Galton DAG. The relationship between chronic lymphocytic leukaemia and prolymphocytic leukaemia. I. Clinical and laboratory features of 300 patients and characteristics of an intermediate group. *Br J Haematol* 1986;63:377–387.

228. Shvidel L, Shatalrid M, Bassous L, et al. B-cell prolymphocytic leukemia: a survey of 35 patients emphasizing heterogeneity, prognostic factors and evidence for a group with an indolent course. *Leuk Lymphoma* 1999;33:169–179.

229. Lens D, Matutes E, Catovsky D, et al. Frequent deletions at 11q23 and 13q14 in B-cell prolymphocytic leukemia (B-CLL). *Leukemia* 2000;14:427–430.

230. Lens D, de Schouwer PJ, Hamoudi RA, et al. p53 abnormalities in B-cell prolymphocytic leukemia. *Blood* 1997;89:2015–2023.

231. Argatoff LH, Connors JM, Klasa RJ, et al. Mantle cell lymphoma: a clinicopathologic study of 80 cases. *Blood* 1997;89:2067–2078.

232. Bosch F, Lopez-Guillermo A, Campo E, et al. Mantle cell lymphoma: presenting features, response to therapy, and prognostic factors. *Cancer* 1998;82: 567–575.

233. Fan H, Gulley RD, Gascoyne DE, et al. Molecular methods for detecting t(11;14) translocations in mantle-cell lymphomas. *Diagn Mol Pathol* 1998;7:209–214.

234. Matutes E, Carrara P, Coignet L, et al. FISH analysis for BCL-1 rearrangements and trisomy 12 helps the diagnosis of atypical B cell leukaemias. *Leukemia* 1999;13:1721–1726.

235. Melo JV, Robinson DSF, de Oliveira MP, et al. Morphology and immunology of circulating cells in

leukaemic phase of follicular lymphoma. *J Clin Pathol* 1988;41:951–959.

236. Troussard X, Valensi F, Duchayne E, et al. Splenic lymphoma with villous lymphocytes: clinical presentation, biology and prognostic factors in a series of 100 patients. *Groupe Francais d'Hematologie Cellulaire (GFHC). Br J Haematol* 1996;93:731–736.

237. Robbins BA, Ellison DJ, Spinosa JC, et al. Diagnostic application of two-color flow cytometry in 161 cases of hairy cell leukemia. *Blood* 1993;82:1277–1287.

238. Sainati L, Matutes E, Mulligan S, et al. A variant form of hairy cell leukemia resistant to alpha-interferon: clinical and phenotypic characteristics of 17 patients. *Blood* 1990;76:157–162.

239. Matutes E, Brito-Babapulle V, Swansbury J, et al. Clinical and laboratory features of 78 cases of T-prolymphocytic leukemia. *Blood* 1991;78:3269–3274.

240. Mallet RB, Matutes E, Catovsky D, et al. Cutaneous infiltration in T-cell prolymphocytic leukaemia. *Br J Dermatol* 1995;132:263–266.

241. Dearden CE, Matutes E, Cazin B, et al. High remission rate in T-cell prolymphocytic leukemia with CAMPATH-1H. *Blood* 2001;98:1721–1726.

242. Blayney DW, Jaffe ES, Fisher RI, et al. The human T cell leukemia/lymphoma virus, lymphoma, lytic bone lesions and hypercalcemia. *Ann Intern Med* 1983;98:144–151.

243. Ratner L, Griffith RC, Marselle L, et al. A lymphoproliferative disorder caused by human T-lymphotropic virus Type I. Demonstration of a continuum between acute and chronic adult T-cell leukemia/lymphoma. *Am J Med* 1987;83:953–958.

244. Shirono K, Hattori R, Takatsuki K. A new classification of clinical stages of adult T-cell leukemia based on prognosis of the disease. *Leukemia* 1994;8:1834–1837.

245. Youn H, Kim Y, Hoppe RT. Mycosis fungoides and Sézary syndrome. *Semin Oncol* 1999;26:276–289.

246. Loughran TP. Clonal diseases of large granular lymphocytes. *Blood* 1993;82:1–14.

247. Jaffe ES. Classification of natural killer (NK) cell and NK-like T-cell malignancies. *Blood* 1996;87:1207–1210.

248. Tefferi A, Li C-Y, Witzig TE, et al. Chronic natural killer cell lymphocytosis: a descriptive clinical study. *Blood* 1994;84:2721–2725.

249. Lamy T, Liu JH, Landowski TH, et al. Dysregulation of CD95/CD95 ligand-apoptotic pathway in CD3+ large granular lymphocyte leukemia. *Blood* 1998;92:4771–4777.

250. Sood R, Stewart CC, Aplan PD, et al. Neutropenia associated with T-cell large granular lymphocyte leukemia: long-term response to cyclosporin therapy despite persistence of abnormal cells. *Blood* 1998;91:3372–3378.

251. Loughran TP Jr, Kidd PG, Starkebaum G. Treatment of large granular lymphocyte leukemia with or low-dose methotrexate. *Blood* 1994;84:2164–2170.

252. Keating MJ, Lerner S, Kantarjian H, et al. The serum beta2-microglobulin (beta2M) level is more powerful than stage in predicting response and survival in chronic lymphocytic leukemia (CLL). *Blood* 1995;86:606a.

253. Rai JL, Sawitsky A, Cronkite EP, et al. Clinical staging of chronic lymphocytic leukemia. *Blood* 1975;46:219–234.

254. Binet JL, Auquier A, Dighiero G, et al. A new prognostic classification of chronic lymphocytic leukemia derived from a multivariate survival analysis. *Cancer* 1981;48:198–206.

255. Thomas R, Ribeiro I, Sheperd P, et al. Spontaneous clinical regression in chronic lymphocytic

leukaemia. *Br J Haematol* 2002;116:341–345.

256. Dighiero G, Maloum K, Desablens B, et al. Chlorambucil in indolent chronic lymphocytic leukemia. *N Engl J Med* 1998;338:1506–1514.

257. Dighiero G, Binet J-L. When and how to treat chronic lymphocytic leukemia. *N Engl J Med* 2000;343:1799–1801.

258. Catovsky D, Fooks J, Richards S. Prognostic factors in chronic lymphocytic leukaemia: the importance of age, sex and response to treatment in survival. *Br J Haematol* 1989;72:141–149.

259. Oscier DG, Matutes E, Copplestone A, et al. Atypical lymphocyte morphology: an adverse prognostic factor for disease progression in stage A CLL independent of trisomy 12. *Br J Haematol* 1997;98:934–939.

260. Lee JS, Dixon DO, Kantarjian HM, et al. Prognosis of chronic lymphocytic leukemia: a multivariate regression analysis of 325 untreated patients. *Blood* 1987;69:929–936.

261. Montserrat E, Sánchez-Bisonó J, Viñolas N, et al. Lymphocyte doubling time in chronic lymphocytic leukemia. Analysis of its prognostic significance. *Br J Haematol* 1986;62:567–575.

262. Molica S, Alberti A. Prognostic value of the lymphocyte doubling time in chronic lymphocytic leukemia. *Cancer* 1987;60:2712–2716.

263. Molica S, Levato D, Dattilo A, et al. Clinico-prognostic relevance of quantitative immunophenotyping in B-cell chronic lymphocytic leukemia with emphasis on the expression of CD20 antigen and surface immunoglobulins. *Eur J Haematol* 1998;60:47–52.

264. Del Poeta G, Maurillo L, Venditti A, et al. Clinical significance of CD38 expression in chronic lymphocytic leukemia. *Blood* 2001;98:2633–2639.

265. Ibrahim S, Keating M, Do K-A, et al. CD38 expression as an important prognostic factor in B-cell chronic lymphocytic leukemia. *Blood* 2001;98:181–186.

266. Chevallier P, Penther D, Avet-Loiseau H, et al. CD38 expression and secondary 17p deletion are important prognostic factors in chronic lymphocytic leukaemia. *Br J Haematol* 2002;116:142–150.

267. Apostolopoulos A, Symeonidis A, Zoumbvos N. Prognostic significance of immune function parameters in patients with chronic lymphocytic leukaemia. *Eur J Hematol* 1990;44:39–44.

268. Rozman C, Montserrat E, Vinolas N. Serum immunoglobulins in B-chronic lymphocytic leukemia. Natural history and prognostic significance. *Cancer* 1988;61:279–283.

269. El Rouby S, Thomas A, Costin D, et al. p53 gene mutation in B-cell chronic lymphocytic leukemia is associated with drug resistance and is independent of MDR1/MDR3 gene expression. *Blood* 1993;82:3452–3459.

270. Mauro FR, De Rossi G, Burgio VL, et al. Prognostic value of bone marrow histology in chronic lymphocytic leukemia. A study of 335 untreated cases from a single institution. *Haematologica* 1994;79:334–341.

271. Frisch B, Bartl R. Histologic classification and staging of chronic lymphocytic leukemia. A retrospective and prospective study of 503 cases. *Acta Haematol* 1988;79:140–152.

272. Montserrat E, Villamor N, Reverter JC, et al. Bone marrow assessment in B-cell chronic lymphocytic leukemia: aspirate or biopsy? A comparative study in 258 patients. *Br J Haematol* 1996;93:111–116.

273. Robertson LE, Huh YO, Butler JJ, et al. Response assessment in chronic lymphocytic leukemia after fludarabine plus prednisone: clinical, pathologic, immunophenotypic, and molecular analysis. *Blood* 1992;80:29–36.

274. Oudat R, Keating MJ, Lerner S, et al. Significance of the levels of bone marrow lymphoid infiltrate in chronic lymphocytic leukemia patients with nodular partial remission. *Leukemia* 2002;16:632–635.

275. Molica S, Levato D, Cascavilla N, et al. Clinico-prognostic implications of simultaneous increased serum levels of soluble CD23 and beta2-microglobulin in B-cell chronic lymphocytic leukemia. *Eur J Haematol* 1999;62:117-122.
276. Hallek M, Langenmayer I, Nerl C, et al. Elevated serum thymidine kinase levels identify a subgroup at high risk of disease progression in early, non-smoldering chronic lymphocytic leukemia. *Blood* 1999;93:1732-1737.
277. Ferrajoli A, Keating MJ, Manshouri T, et al. The clinical significance of tumor necrosis factor- $\alpha$  plasma level in patients having chronic lymphocytic leukemia. *Blood* 2002;100:1215-1219.
278. Montserrat E, Violas N, Reverter JC, et al. Natural history of chronic lymphocytic leukemia: on the progression and prognosis of early clinical stages. *Nouv Rev Fr Hematol* 1988;30:359-361.
279. French Cooperative Group on Chronic Lymphocytic Leukemia. Natural history of stage A chronic lymphocytic leukemia untreated patients. *Br J Haematol* 1990;76:45-57.
280. CLL Trialists Collaborative Group. Chemotherapeutic options in chronic lymphocytic leukemia: a meta-analysis of the randomized trials. *J Natl Cancer Inst* 1999;91:861-868.
281. Cheson BD, Bennett JM, Rai KR, et al. Guidelines for clinical protocols for chronic lymphocytic leukemia: recommendations of the NCI sponsored working groups. *Am J Hematol* 1988;29:152-163.
282. Noy A, Verma R, Glenn M, et al. Clonotypic polymerase chain reaction confirms minimal residual disease in CLL nodular PR: results from a sequential treatment CLL protocol. *Blood* 2001;97:1929-1936.
283. Rawstron AC, Kennedy B, Evans PA, et al. Quantitation of minimal disease levels in chronic lymphocytic leukemia using a sensitive flow cytometric assay improves the prediction of outcome and can be used to optimize therapy. *Blood* 2001;98:29-35.
284. Begleiter A, Mowat M, Israels LG, et al. Chlorambucil in chronic lymphocytic leukemia-mechanism of action. *Leuk Lymphoma* 1996;23:187-201.
285. Panasci L, Paiement J-P, Christodouloupoulos G, et al. Chlorambucil drug resistance in chronic lymphocytic leukemia: the emerging role of DNA repair. *Clin Cancer Res* 2001;7:454-461.
286. Sawitsky A, Rai KR, Glidewell O, et al. Comparison of daily versus intermittent chlorambucil and prednisone therapy in the treatment of patients with chronic lymphocytic leukemia. *Blood* 1977;50:1049-1059.
287. Knospe WH, Loeb V, Huguley CM. Bi-weekly chlorambucil treatment of chronic lymphocytic leukemia. *Cancer* 1974;33:555-562.
288. Robak T, Bloński JZ, Kasznicki M, et al. Cladribine with prednisone versus chlorambucil with prednisone as first-line therapy in chronic lymphocytic leukemia: report of a prospective, randomized, multicenter trial. *Blood* 2000;96:2723-2729.
289. Montserrat E, Rozman C. Chronic lymphocytic leukaemia treatment. *Blood Rev* 1993;7:164-175.
290. Robak T, Kasznicki M. Alkylating agents and nucleoside analogues in the treatment of B cell chronic lymphocytic leukemia. *Leukemia* 2002;16:1015-1027.
291. Han T, Ezdinli EZ, Shimaoka K, et al. Chlorambucil vs combined chlorambucil-corticosteroid therapy in chronic lymphocytic leukemia. *Cancer* 1973;31:502-508.
292. Jaksic B, Brugiatelli M. High dose continuous chlorambucil vs intermittent chlorambucil plus prednisone for treatment of B-CLL IGCI CLL-01 trial. *Nouv Rev Fr Hematol* 1988;30:437-442.
293. Jaksic B, Brugiatelli M, Krc I, et al. High dose chlorambucil versus Binet's modified cyclophosphamide, doxorubicin, vincristine, and prednisone regimen in the treatment of patients with advanced B-cell chronic lymphocytic leukemia: results of an international multicenter randomized trial.



International Society for Chemo-Immunotherapy, Vienna. *Cancer* 1997;79:2107-2114.

294. Liepman M, Votaw ML. Treatment of chronic lymphocytic leukemia with COP chemotherapy. *Cancer* 1978;41:2664-2669.
295. Oken MM, Kaplan ME. Combination chemotherapy with cyclophosphamide, vincristine and prednisone in the treatment of refractory CLL. *Cancer Treat Rep* 1979;63:441-447.
296. French Cooperative Group on Chronic Lymphocytic Leukemia. Prognostic and therapeutic advances in CLL management: the experience of the French Cooperative Group. *Semin Hematol* 1987;24:275-290.
297. French Cooperative Group on chronic lymphocytic leukemia. A randomized clinical trial of chlorambucil versus COP in stage B chronic lymphocytic leukemia. *Blood* 1990;75:1422-1425.
298. Raphael B, Anderson JW, Silber R, et al. Comparison of chlorambucil and prednisone versus cyclophosphamide, vincristine, and prednisone as initial treatment for chronic lymphocytic leukemia: long-term follow-up of an Eastern Cooperative Oncology Group randomized clinical trial. *J Clin Oncol* 1991;9:770-776.
299. Montserrat E, Alcalá A, Parody R, et al. Treatment of chronic lymphocytic leukemia in advanced stages. A randomized trial comparing chlorambucil plus prednisone versus cyclophosphamide, vincristine and prednisone. *Cancer* 1985;56:2369-2375.
300. French Cooperative Group on Chronic Lymphocytic Leukaemia. Benefit of 'CHOP' regimen in advanced untreated chronic lymphocytic leukemia: results from a randomized clinical trial. *Lancet* 1986;1:1346-1349.
301. French Cooperative Group on Chronic Lymphocytic Leukemia. Long-term results of the CHOP regimen in stage C chronic lymphocytic leukemia. *Br J Haematol* 1989;73:334-340.
302. Kimby E, Melstedt H. Chlorambucil/prednisone versus CHOP in symptomatic chronic lymphocytic leukemias of B-cell type: a randomized trial. *Leuk Lymphoma* 1991;5[Suppl]:93-96.
303. Hansen MM, Andersen E, Birgeus H, et al. CHOP versus prednisone + chlorambucil in chronic lymphocytic leukemia: preliminary results of a randomized multicenter study. *Nouv Rev Fr Hematol* 1998;30:433-436.
304. Kempin S, Lee BJ, Thaler HT, et al. Combination chemotherapy of advanced chronic lymphocytic leukemia: the M2 protocol (vincristine, BCNU, cyclophosphamide, melphalan and prednisone). *Blood* 1982;60:1110-1121.
305. Keating MJ, Scouros M, Murphy S, et al. Multiple agent chemotherapy (POACH) in previously treated and untreated patients with chronic lymphocytic leukemia. *Leukemia* 1988;2:157-164.
306. Friedenber g WR, Anderson J, Wolf BC, et al. Modified vincristine, doxorubicin and dexamethasone regimen in the treatment of resistant or relapsed chronic lymphocytic leukemia. *Cancer* 1993;71:2983-2989.
307. Tallman MS, Hakimian D. Purine nucleoside analogs: emerging roles in indolent lymphoproliferative disorders. *Blood* 1995;86:2463-2474.
308. Begleiter A, Glazer RI, Israels LG, et al. Induction of DNA strand breaks in chronic lymphocytic leukemia following treatment with 2'-deoxycoformycin in vivo and in vitro. *Cancer Res* 1987;47:2498-2503.
309. Major PP, Agarwal RP, Kufe DW. Clinical pharmacology of deoxycoformycin. *Blood* 1981;58:91-96.
310. Begleiter A, Verburg L, Ashique A, et al. Comparison of antitumor activities of 2-chlorodeoxyadenosine and 9-β-arabinosyl-2-fluoroadenine in chronic lymphocytic leukemia and marrow cells in vitro. *Leukemia* 1995;9:1875-1881.
311. Robertson LE, Chubb S, Meyn RE, et al. Induction of apoptotic cell death in chronic lymphocytic leukemia by 2-chloro-2'-deoxyadenosine and 9-β-D-arabinosyl-2-fluoroadenine. *Blood* 1993;81:143-150.
312. Genini D, Budihardjo I, Plunkett W, et al. Nucleotide requirements for the in vitro activation of the

- apoptosis protein-activating factor-1-mediated caspase pathway. *J Biol Chem* 2000;275:29-34.
313. Ho AD, Thaler J, Stryckmans P, et al. Pentostatin in refractory chronic lymphocytic leukemia: a phase II trial of the European Organization for Research and Treatment of Cancer. *J Natl Cancer Inst* 1990;82:1416-1420.
314. Dillman RO, Mick R, McIntyre OR. Pentostatin in chronic lymphocytic leukemia: a phase II trial of Cancer and Leukemia Group B. *J Clin Oncol* 1989;7:433-438.
315. Boogaerts MA, Van Hoof A, Catovsky D, et al. Activity of oral fludarabine phosphate in previously treated chronic lymphocytic leukemia. *J Clin Oncol* 2001;19:4252-4258.
316. Keating MJ, O'Brien S, Kantarjian H, et al. Long-term follow-up of patients with chronic lymphocytic leukemia treated with fludarabine as a single agent. *Blood* 1993;81:2878-2884.
317. Sorensen JM, Vena DA, Fallavollita A, et al. Treatment of refractory chronic lymphocytic leukemia with fludarabine phosphate via the group C protocol mechanism of the a National Cancer Institute: five-year follow-up report. *J Clin Oncol* 1997;15:458-465.
318. The French Cooperative Group on CLL, Johnson S, Smith AG, et al. Multicentre prospective randomized trial of fludarabine versus cyclophosphamide, doxorubicin, and prednisone (CAP) for treatment of advanced-stage chronic lymphocytic leukaemia. *Lancet* 1996;347:1432-1438.
319. Keating MJ, O'Brien S, Lerner S, et al. Long-term follow-up of patients with chronic lymphocytic leukemia (CLL) receiving fludarabine regimens as initial therapy. *Blood* 1998;92:1165-1171.
320. Robertson LE, O'Brien S, Kantarjian H, et al. A 3-day schedule of fludarabine in previously treated chronic lymphocytic leukemia. *Leukemia* 1995;9:1444-1449.
321. O'Brien S, Kantarjian H, Beran M, et al. Results of fludarabine and prednisone therapy in 264 patients with chronic lymphocytic leukemia with multivariate analysis-derived prognostic model for response to treatment. *Blood* 1993;82:1695-1700.
322. Juliusson G, Liliemark J. High complete remission rate from 2-chloro-2'-deoxyadenosine in previously treated patients with B-cell chronic lymphocytic leukemia: response predicted by rapid decrease of blood lymphocyte count. *J Clin Oncol* 1993;11:679-689.
323. Delannoy A, Martiat P, Gala JL, et al. 2-Chlorodeoxyadenosine (CdA) for patients with previously untreated chronic lymphocytic leukemia (CLL). *Leukemia* 1995;9:1130-1135.
324. Saven A, Lemon RH, Kasty M, et al. 2-Chlorodeoxyadenosine activity in patients with untreated chronic lymphocytic leukemia. *J Clin Oncol* 1995;13:570-575.
325. Robak T, Bloński JZ, Kasznicki M, et al. Cladribine with or without prednisone in the treatment of previously treated and untreated B-cell chronic lymphocytic leukemia--updated results of the multicenter study of 378 patients. *Br J Haematol* 2000;108:357-368.
326. Robak T. Cladribine in the treatment of chronic lymphocytic leukemia. *Leuk Lymphoma* 2001;40:551-564.
327. Juliusson G, Christiansen I, Hansen MM, et al. Oral cladribine as a primary therapy for patients with B-cell chronic lymphocytic leukemia. *J Clin Oncol* 1996;14:2160-2166.
328. Cheson BD, Vena DA, Foss FM, et al. Neurotoxicity of purine analogs: a review. *J Clin Oncol* 1994;12:2216-2228.
329. Schroeder M. Transfusion-associated graft-versus-host disease. *Br J Haematol* 2002;117:275-287.
330. Orchard JA, Bolam S, Oscier DG. Association of myelodysplastic changes with purine analogues. *Br J Haematol* 1998;100:677-679.
331. Van Den Neste E, Delannoy A, Feemans W, et al. Second primary tumors and immune phenomena

after fludarabine or 2-chloro-2-deoxyadenosine treatment. *Leuk Lymphoma* 2001;40:541-550.

332. Morrison VA, Rai KR, Peterson BL, et al. Therapy-related myeloid leukemias are observed in patients with chronic lymphocytic leukemia after treatment with fludarabine and chlorambucil: results of an intergroup study, cancer and leukemia group B 9011. *J Clin Oncol* 2002;20:3878-3884.

333. Helman DL, Byrd JC, Ales NC, et al. Fludarabine-related pulmonary toxicity: a distinct clinical entity in chronic lymphoproliferative syndromes. *Chest* 2002;122:785-790.

334. O'Brien, Kantarjian H, Estey E, et al. Lack of effect of 2-chlorodeoxyadenosine therapy in patients with chronic lymphocytic leukemia refractory to fludarabine therapy. *N Engl J Med* 1994;330:319-322.

335. Begleiter A, Pugh L, Israels LG, et al. Enhanced cytotoxicity and inhibition of DNA damage repair in irradiated murine L5178Y lymphoblasts and human chronic lymphocytic leukemia cells treated with 2'-deoxycoformycin and deoxyadenosine in vitro. *Cancer Res* 1988;48:3981-3986.

336. Begleiter A, Wang H, Verburg L, et al. In vitro cytotoxicity of 2-chlorodeoxyadenosine and chlorambucil in chronic lymphocytic leukemia. *Leukemia* 1996;10:1959-1965.

337. Yamauchi T, Nowak BJ, Keating MJ, et al. DNA repair initiated in chronic lymphocytic leukemia lymphocytes by 4-hydroperoxycyclophosphamide is inhibited by fludarabine and clofarabine. *Clin Cancer Res* 2001;7:3580-3589.

338. O'Brien SM, Kantarjian HM, Cortes J, et al. Results of the fludarabine and cyclophosphamide combination regimen in chronic lymphocytic leukemia. *J Clin Oncol* 2001;19:1414-1420.

339. Flinn IW, Byrd JC, Morrison C, et al. Fludarabine and cytophosphamide with filgrastim support in patients with previously untreated indolent lymphoid malignancies. *Blood* 2000;96:71-75.

340. Hallek M, Schmitt B, Wilhelm M, et al. Fludarabine plus cyclophosphamide is an efficient treatment for advanced chronic lymphocytic leukaemia (CLL): results of a phase II study of the German CLL study group. *Br J Haematol* 2001;114:342-348.

341. Thornton PD, Hamblin M, Treleaven JG, et al. High dose methyl prednisolone in refractory chronic lymphocytic leukaemia. *Leuk Lymphoma* 1999;34:167-170.

342. Maloney DG, Smith B, Rose A. Rituximab: mechanism of action and resistance. *Semin Oncol* 2002;29(Suppl 2):2-9.

343. Byrd JC, Kitada S, Flinn IW, et al. The mechanism of tumor cell clearance by rituximab in vivo in patients with B-chronic lymphocytic leukemia: evidence of caspase activation and apoptosis induction. *Blood* 2002;99:1038-1043.

344. Manches O, Lui G, Chaperot L, et al. In vitro mechanisms of action of rituximab on primary non-Hodgkin's lymphomas. *Blood (in press)*.

345. McLaughlin P, Grillo-López AJ, Link BK, et al. Rituximab chimeric anti-CD20 monoclonal antibody therapy for relapsed indolent lymphoma: half of patients respond to a four-dose treatment program. *J Clin Oncol* 1998;16:2825-2833.

346. Manshouri T, Do K-A, Wang X, et al. Circulating CD20 is detectable in the plasma of patients with chronic lymphocytic leukemia and is of prognostic significance. *Blood (in press)*.

347. Winkler U, Jensen M, Manzke O, et al. Cytokine release syndrome in patients with B-cell chronic lymphocytic leukemia and high lymphocyte counts after treatment with the anti-CD20 monoclonal antibody. *Blood* 1999;94:2217-2224.

348. Huhn D, von Schilling C, Wilhelm M, et al. Rituximab therapy of patients with B-cell chronic lymphocytic leukemia. *Blood* 2001;98:1326-1331.

349. Huh YO, Keating MJ, Saffer HL, et al. Higher levels of surface CD20 expression on circulating lymphocytes compared with bone marrow and lymph nodes in B-cell chronic lymphocytic leukemia. *Am J Clin Pathol* 2001;116:437-443.

350. Byrd JC, Murphy T, Howard RS, et al. Rituximab using a thrice weekly dosing schedule in B-cell chronic lymphocytic leukemia and small lymphocytic lymphoma demonstrates clinical activity and acceptable toxicity. *J Clin Oncol* 2001;19:2153–2164.
351. O'Brien SM, Kantarjian H, Thomas DA, et al. Rituximab dose-escalation trial in chronic lymphocytic leukemia. *J Clin Oncol* 2001;19:2165–2170.
352. Keating MJ, Flinn I, Jain V, et al. Therapeutic role of alemtuzumab (Campath-1H) in patients who have failed fludarabine: results of a large international study. *Blood* 2002;99:3554–3561.
353. Osterborg A, Dyer MJ, Bunjes D, et al. "Phase II multicenter study of human CD52 antibody in previously treated chronic lymphocytic leukemia." *J Clin Oncol* 1997;15:1567–1574.
354. Rai KR, Freter CE, Mercier RJ, et al. Alemtuzumab in previously treated chronic lymphocytic leukemia patients who also had received fludarabine. *J Clin Oncol* 2002;20:3891–3897.
355. McCune SL, Gockerman JP, Moore JO, et al. Alemtuzumab in relapsed or refractory chronic lymphocytic leukemia and prolymphocytic leukemia. *Leuk Lymphoma* 2002;43:1007–1011.
356. Lundin JL, Kimby E, Björkholm M, et al. Phase II trial of subcutaneous anti-CD52 monoclonal antibody alemtuzumab (Campath-1H) as first-line treatment for patients with B-cell chronic lymphocytic leukemia (B-CLL). *Blood* 2002;100:768–773.
357. Gupta N, Kavuru S, Patel D, et al. Rituximab-based chemotherapy for steroid-refractory autoimmune hemolytic anemia of chronic lymphocytic leukemia. *Leukemia* 2002;16:2092–2095.
358. Chow KU, Sommerlad WD, Boehrer S, et al. Anti-CD20 antibody (IDEC-C2B8, rituximab) enhances efficacy of cytotoxic drugs on neoplastic lymphocytes in vitro: role of cytokines, complement, and caspases. *Haematologica* 2002;87:33–43.
359. Alas S, Emmanouilides C, Bonavida B. Inhibition of interleukin 10 by rituximab results in down-regulation of bcl-2 and sensitization of B-cell non-Hodgkin's lymphoma to apoptosis. *Clin Cancer Res* 2001;7:709–723.
360. Alas S, Bonavida B, Emmanouilides C. Potentiation of fludarabine cytotoxicity on non-Hodgkin's lymphoma by pentoxifylline and rituximab. *Anticancer Res* 2000;20:2961–2966.
361. Di Gaetano N, Ziao Y, Erba E, et al. Synergism between fludarabine and rituximab revealed in a follicular lymphoma cell line resistant to the cytotoxic activity of either drug alone. *Br J Haematol* 2001;114:800–809.
362. Schulz H, Klein SK, Rehwald U, et al. Phase 2 study of a combined immunochemotherapy using rituximab and fludarabine in patients with chronic lymphocytic leukemia. *Blood* 2002;100:3115–3120.
363. Byrd JC, Peterson BL, Morrison VA, et al. Randomized Phase II study of fludarabine with concurrent versus sequential treatment with rituximab in symptomatic, untreated patients with B-cell chronic lymphocytic leukemia: results from CALGB 9712. *Blood* 2002;101:6–14.
364. Wierda W, O'Brien S, Albitar M, et al. Combined fludarabine, cyclophosphamide, and rituximab achieves a high complete remission rate as initial treatment for chronic lymphocytic leukemia. *Blood* 2001;98:771a.
365. Kennedy B, Rawstron A, Carter C, et al. Campath-1H and fludarabine in combination are highly active in refractory chronic lymphocytic leukemia. *Blood* 2002;99:2245–2247.
366. Dreger P, Montserrat E. Autologous and allogeneic stem cell transplantation for chronic lymphocytic leukemia. *Leukemia* 2002;16:985–992.
367. Van Besien K, Keralavarma B, Devine S, et al. Allogeneic and autologous transplantation for chronic lymphocytic leukemia. *Leukemia* 2001;15:1317–1325.
368. Michallet M, Brand R, Dreger P, et al. Analysis of prognostic factors on the outcome of autologous

- and allogeneic stem cell transplantations (SCT) for chronic lymphocytic leukemia (CLL). *Blood* 2001;98:859a.
369. Itala M, Pelliniemi TT, Rajamaki A, et al. Autologous blood cell transplantation in B-CLL: response to chemotherapy prior to mobilization predicts the stem cell yield. *Bone Marrow Transplant* 1997;19:647-651.
370. Esteve J, Villamor N, Colomer D, et al. Stem cell transplantation for chronic lymphocytic leukemia: different outcome after autologous and allogeneic transplantation and correlation with minimal residual disease status. *Leukemia* 2001;15:445-451.
371. Esteve J, Villamor N, Colomer D, et al. Different clinical value of minimal residual disease after autologous and allogeneic stem cell transplantation for chronic lymphocytic leukemia. *Blood* 2002;99:1873-1874.
372. Michallet M, Thiebaut A, Dreger P, et al. Peripheral blood stem cell (PBSC) mobilization and transplantation after fludarabine therapy in chronic lymphocytic leukemia (CLL): a report of the European Blood and Marrow Transplantation (EBMT) CLL subcommittee on behalf of the EBMT Chronic Leukemias Working Party. *Br J Haematol* 2000;108:595-601.
373. Dyer MJ, Kelsey SM, Mackay HJ, et al. In vivo 'purging' of residual disease in CLL with Campath-1H. *Br J Haematol* 1997;97:669-672.
374. Altés A, Sierra J, Esteve J, et al. CD34<sup>+</sup>-enriched-CD19<sup>+</sup>-depleted autologous peripheral blood stem cell transplantation for chronic lymphoproliferative disorders: high purging efficiency but increased risk of severe infections. *Exp Hematol* 2002;30:824-830.
375. Krishnan A, Bhatia S, Slovak ML, et al. Predictors of therapy-related leukemia and myelodysplasia following autologous transplantation for lymphoma: an assessment of risk factors. *Blood* 2000;95:1588-1593.
376. Michallet M, Archimbaud E, Rowlings PA, et al. HLA-identical sibling bone marrow transplants for chronic lymphocytic leukemia. *Ann Intern Med* 1996;124:311-315.
377. Pavletic ZS, Arrowsmith ER, Bierman PJ, et al. Outcome of allogeneic stem cell transplantation for B cell chronic lymphocytic leukemia. *Bone Marrow Transplant* 2000;25:717-722.
378. Khouri I, Przepiorka D, van Besien K, et al. Allogeneic blood or marrow transplantation for chronic lymphocytic leukaemia: timing of transplantation and potential effect of fludarabine on acute graft-versus-host disease. *Br J Haematol* 1997;97:466-473.
379. Khouri I, Keating M, Saliba R, et al. Long-term follow-up of patients with CLL treated with allogeneic hematopoietic transplantation. *Cytotherapy* 2002;4:217-221.
380. Doney K, Chauncey T, Applebaum F, et al. Allogeneic related donor hematopoietic stem cell transplantation for treatment of chronic lymphocytic leukemia. *Bone Marrow Transplant* 2002;29:817-823.
381. Pavletic S, Khouri I, King R, et al. HLA-matched unrelated donor (MUD) bone marrow transplantation for B-cell chronic lymphocytic leukemia (results from the CLL working group, national marrow donor program). *Am J Clin Oncol* 2000;19:4.
382. Rondón G, Giralt S, Huh Y, et al. Graft-versus-leukemia effect after allogeneic bone marrow transplantation for chronic lymphocytic leukemia. *Bone Marrow Transplant* 1996;18:669-672.
383. Mattsson J, Uzunel M, Remberger M, et al. Minimal residual disease is common after allogeneic stem cell transplantation in patients with B cell chronic lymphocytic leukemia and may be controlled by graft-versus-host disease. *Leukemia* 2000;14:247-254.
384. Dreger P, Glass B, Seyfarth B, et al. Reduced-intensity allogeneic stem cell transplantation as salvage treatment for patients with indolent lymphoma after failure of autologous SCT. *Bone Marrow Transplant* 2000;26:1361-1362.
385. McSweeney P, Niederwieser D, Shizuru J, et al. Hematopoietic cell transplantation in older patients with hematologic malignancies: replacing high-dose cytotoxic therapy with graft-versus-tumor effects. *Blood* 2001;97:3390-3400.
386. Dreger P, van Biezen A, Brand R, et al. Allogeneic stem cell transplantation (SCT) for chronic

lymphocytic leukemia (CLL) using intensity-reduced conditioning: a survey of the European Blood and Marrow Transplant Group (EBMT). *Blood* 2001;98:743a.

387. Weinmann M, Becker G, Einsele H, et al. Clinical indications and biological mechanisms of splenic irradiation in chronic leukaemias and myeloproliferative disorders. *Radiother Oncol* 2001;58:235-246.

388. Van Mook WN, Fickers MM, Verschueren TA. Clinical and immunological evaluation of primary splenic irradiation in chronic lymphocytic leukemia: a study of 24 cases. *Ann Hematol* 2001;80:216-223.

389. Guiney MJ, Liew KH, Quong GG, et al. A study of splenic irradiation in chronic lymphocytic leukemia. *Int J Radiat Oncol Biol Phys* 1989;16:225-229.

390. Catovsky D, Fooks J, Richards S. The UK Medical Research Council CLL trials 1 and 2. *Nouv Rev Fr Hematol* 1988;30:423-427.

391. Roncadin M, Arcicasa M, Trovo MG, et al. Splenic irradiation in chronic lymphocytic leukemia. A ten years experience in a single institution. *Cancer* 1987;60:2624-2628.

392. De Rossi G, Biagnin C, Lopez M, et al. Treatment by splenic irradiation in 22 chronic lymphocytic leukemia patients. *Tumori* 1982;68:511-514.

393. McCann SR, Whelan CA, Breslin B, et al. Lymphocyte sub-populations following splenic irradiation in patients with chronic lymphocytic leukemia. *Br J Haematol* 1982;50:225-229.

394. Richards F Jr, Spurr CL, Ferree C, et al. The control of chronic lymphocytic leukemia with mediastinal irradiation. *Am J Med* 1978;64:947-954.

395. Sawitsky A, Rai KR, Aral I, et al. Mediastinal irradiation for chronic lymphocytic leukemia. *Am J Med* 1976;61:892-896.

396. Field EO, Dawson KB, Peckham MJ, et al. The response of chronic lymphocytic leukemia to treatment by extracorporeal irradiation of the blood, assessed by isotope labeling procedures. *Blood* 1970;36:87-97.

397. Storb R, Epstein RB, Buckner CD, et al. Treatment of chronic lymphocytic leukemia by extracorporeal irradiation. *Blood* 1968;31:490-502.

398. Jacobs P, King HS. A randomized prospective comparison of chemotherapy to total body irradiation as initial treatment for the indolent lymphoproliferative diseases. *Blood* 1987;69:1642-1646.

399. Johnson RE. Total body irradiation of chronic lymphocytic leukemia. Relationship between therapeutic response and prognosis. *Cancer* 1976;37:2691-2696.

400. Rubin P, Bennet JM, Begg C, et al. The comparison of total body irradiation versus chlorambucil and prednisone for remission induction of active chronic lymphocytic leukemia: an ECOG study. Part I: total body irradiation-response and toxicity. *Int J Radiat Oncol Biol Phys* 1981;7:1623-1632.

401. Johnson RE. Treatment of chronic lymphocytic leukemia by total body irradiation alone and combined with chemotherapy. *Int J Radiat Oncol Biol Phys* 1979;5:159-164.

402. Roncadin M, Arcicasa M, Zagonel V, et al. Total body irradiation and pred-nimustine in chronic lymphocytic leukemia and low grade non-Hodgkin's lymphomas: a 9-year experience at a single institute. *Cancer* 1994;74:978-984.

403. Leporrier M, Reman O, Troussard X, et al. Double hemibody irradiation with GM-CSF as salvage therapy for refractory chronic lymphocytic leukemia. *Leuk Lymphoma* 1994;16:121-124.

404. Decaudin D, Delic J, Dumont J, et al. Clinical efficacy of irradiation in CLL patients: predictive value of in vitro radio-induced apoptosis. *Leuk Lymphoma* 2002;43:827-829.

405. Bessler H, Notti I, Cohen AM, et al. Inhibition of leukemic cell proliferation by factor(s) released from irradiated lymphocytes of B-chronic lymphocytic leukemia patients. *Am J Hematol* 1994;46:65-71.

406. Seymour JF, Cusack JD, Lerner SA, et al. Case/control study of the role of splenectomy in chronic lymphocytic leukemia. *J Clin Oncol* 1997;15:52-60.
407. Ferrant A, Michaux J-L, Sokal G. Splenectomy in advanced chronic lymphocytic leukemia. *Cancer* 1986;58:2130-2135.
408. Majumdar G, Singh AK. Role of splenectomy in chronic lymphocytic leukemia with massive splenomegaly and cytopenia. *Leuk Lymphoma* 1992;7:131-134.
409. Neal TF, Tefferi A, Witzig TE, et al. Splenectomy in advanced chronic lymphocytic leukemia: a single institution experience with 50 patients. *Am J Med* 1992;93:435-440.
410. Ziegler-Heitbrock HWL, Schlag R, Flieger D, et al. Favorable response of early stage B CLL patients to treatment with IFN- $\alpha$ 2. *Blood* 1989;73:1426-1430.
411. McSweeney EN, Giles FJ, Worman CP, et al. Recombinant interferon alfa 2a in the treatment of patients with early stage B chronic lymphocytic leukemia. *Br J Haematol* 1993;85:77-83.
412. Langenmayer I, Nerl C, Kanuf W, et al. Interferon-alpha 2b (IFN alpha) for early-phase chronic lymphocytic leukaemia with high risk for disease progression: results of a randomized multicentre study. *Br J Haematol* 1996;94:362-369.
413. Foon KA, Bottino GC, Abrams PG, et al. Phase II trial of recombinant leukocyte A interferon in patients with advanced chronic lymphocytic leukemia. *Am J Med* 1985;78:216-220.
414. Montserrat E, Villamor N, Urbano-Ispizua A, et al. Treatment of early stage-B chronic lymphocytic leukemia with alpha-2B interferon after chlorambucil reduction of the tumoral mass. *Ann Hematol* 1991;63:15-19.
415. O'Brien S, Kantarjian H, Robertson B, et al. Interferon maintenance therapy for patients with chronic lymphocytic leukemia in remission after fludarabine therapy. *Blood* 1995;86:1296-1300.
416. Zinzani PL, Bendandi M, Magagnoli M, et al. Results of a fludarabine induction and alpha-interferon maintenance protocol in pretreated patients with chronic lymphocytic leukemia and low-grade non-Hodgkin's lymphoma. *Eur J Haematol* 1997;59:82-88.
417. Itala M, Helenius H, Nikoskeolainen J, et al. Infections and serum IgG levels in patients with chronic lymphocytic leukemia. *Eur J Haematol* 1992;48:266-270.
418. Morra E, Nosari A, Montillo M. Infectious complications in chronic lymphocytic leukemia. *Hematol Cell Ther* 1999;41:145-151.
419. Cooperative Group for the study of immunoglobulin in chronic lymphocytic leukemia: intravenous immunoglobulin for the prevention of infection in chronic lymphocytic leukemia. A randomized control trial. *N Engl J Med* 1988;319:902-907.
420. Weeks JC, Tierney MR, Weinstein MC. Cost effectiveness of prophylactic intravenous immune globulin in chronic lymphocytic leukemia. *N Engl J Med* 1991;325:81-86.
421. Chapel H, Dicato M, Gamm H, et al. Immunoglobulin replacement in patients with chronic lymphocytic leukaemia: a comparison of two dose regimens. *Br J Haematol* 1994;88:209-212.
422. Jurlander J, Geisler CH, Hansen MM. Treatment of hypogammaglobulinaemia in chronic lymphocytic leukaemia by low-dose intravenous gammaglobulin. *Eur J Haematol* 1994;53:114-118.
423. Molica S, Musto P, Chiurazzu F, et al. Prophylaxis against infections with low-dose intravenous immunoglobulins (IVIG) in chronic lymphocytic leukemia. Results of a crossover study. *Haematologica* 1996;81:121-126.
424. Itala M, Pelliniemi TT, Remes S, et al. Long-term treatment with GM-CSF in patients with chronic lymphocytic leukemia and recurrent neutropenic infections. *Leuk Lymphoma* 1998;32:165-174.



425. de Nully Brown P, Hansen MM. GM-CSF treatment in patients with B-chronic lymphocytic leukemia. *Leuk Lymphoma* 1999;32:365-368.
426. O'Brien S, Kantarjian H, Beran M, et al. Fludarabine and granulocyte colony-stimulating factor (G-CSF) in patients with chronic lymphocytic leukemia. *Leukemia* 1997;11:1631-1635.
427. Kovacs JA, Gill VJ, Meshnick S, et al. New insights into transmission, diagnosis, and drug treatment of *Pneumocystis carinii* pneumonia. *JAMA* 2001;286:2450-2460.
428. Pfeilschifter J, Diel IJ. Osteoporosis due to cancer treatment: pathogenesis and management. *J Clin Oncol* 2000;18:1570-1593.
429. Jeffriess LC. Transfusion therapy in autoimmune hemolytic anemia. *Hematol Oncol Clin North Am* 1994;8:1087-1104.
430. Flores G, Cunningham-Rundels C, Newland AC, et al. Efficacy of intravenous immunoglobulin in the treatment of autoimmune hemolytic anemia: results in 73 patients. *Am J Haematol* 1993;44:237-242.
431. Chikkappa G, Pasquale D, Zarrabi MH, et al. Cyclosporine and prednisone therapy for pure red cell aplasia in patients with chronic lymphocytic leukemia. *Am J Hematol* 1992;41:5-12.
432. Yamada O, Yun-Hua W, Motoji T, et al. Clonal T-cell proliferation causing pure red cell aplasia in chronic B-cell lymphocytic leukaemia: successful treatment with cyclosporine following in vitro abrogation of erythroid colony-suppressing activity. *Br J Haematol* 1998;101:335-337.
433. Cortes J, O'Brien S, Loscetales J, et al. Cyclosporin A for the treatment of cytopenia associated with chronic lymphocytic leukemia. *Cancer* 2001;92:2016-2021.
434. Coon WW. Splenectomy in the treatment of hemolytic anemia. *Arch Surg* 1985;120:625-628.
435. Hegde UP, Wilson WH, White T, et al. Rituximab treatment of refractory fludarabine-associated immune thrombocytopenia in chronic lymphocytic leukemia. *Blood* 2002;100:2260-2262.
436. Pangalis GA, Poziopoulos C, Angelopoulou MK, et al. Effective treatment of disease-related anaemia in B-chronic lymphocytic leukaemia patients with recombinant human erythropoietin. *Br J Haematol* 1995;89:627-629.
437. Siakantaris MP, Angelopoulou MK, Vassilakopoutos TP, et al. Correction of disease related anaemia of B-chronic lymphoproliferative disorders by recombinant human erythropoietin: maintenance is necessary to sustain response. *Leuk Lymphoma* 2000;40:141-147.
438. Foon KA, Thiruvengadam R, Saven A, et al. Genetic relatedness of lymphoid malignancies: transformation of chronic lymphocytic leukemia as a model. *Ann Intern Med* 1993;19:63-73.
439. Enno A, Catovsky D, O'Brien M, et al. "Prolymphocytoid" transformation of chronic lymphocytic leukemia. *Br J Haematol* 1979;41:9-18.
440. Roberts JD, Tindle BH, MacPherson BR. Prolymphocytic transformation of chronic lymphocytic leukemia: a case report of lengthy survival after intensive chemotherapy. *Am J Hematol* 1989;31:131-132.
441. Trump DL, Mann RB, Phelps R, et al. Richter's syndrome: diffuse histiocytic lymphoma in patients with chronic lymphocytic leukemia. A report of five cases and review of the literature. *Am J Med* 1980;68:539-548.
442. Partyka S, O'Brien S, Podoloff D, et al. The usefulness of high dose (7-10 mCi) Gallium (67Ga) scanning to diagnose Richter's transformation. *Leuk Lymphoma* 1999;36:151-155.
443. Cobo F, Rosiñol L, Martínez A, et al. Limitations of Gallium-67 SPECT in histological transformation of chronic lymphocytic leukaemia: an analysis of 13 patients with clinically suspected Richter's syndrome. *Br J Haematol* 2002;119:484-487.
444. Robertson LE, Pugh W, O'Brien S, et al. Richter's syndrome: a report of 39 patients. *J Clin Oncol*

1993;11:1985–1989.

445. Giles FJ, O'Brien SM, Keating MJ. Chronic lymphocytic leukemia in (Richter's) transformation. *Semin Oncol* 1998;25:117–125.

446. Rodriguez J, Keating MJ, O'Brien S, et al. Allogeneic haematopoietic transplantation for Richter's syndrome. *Br J Haematol* 2000;110:897–899.

447. Bernard DJ, Bignon YJ, Pauchard J, et al. Genotypic analyses of Richter's syndrome. *Cancer* 1991;67:997–1002.

448. Michiels JJ, van Dongen JJ, Hagemeijer A, et al. Richter's syndrome with identical immunoglobulin gene rearrangements in the chronic lymphocytic leukemia and the supervening non-Hodgkin lymphoma. *Leukemia* 1989;3:819–824.

449. Bessudo A, Kipps TJ. Origin of high-grade lymphomas in Richter syndrome. *Hum Pathol* 1995;16:854–857.

450. Matolcsy A, Inghirami G, Knowles D. Molecular genetic demonstration of the diverse evolution of Richter's syndrome (chronic lymphocytic leukemia and subsequent large cell lymphoma). *Blood* 1994;83:1363–1372.

451. Fayad L, Robertson LE, O'Brien S, et al. Hodgkin's disease variant of Richter's syndrome: experience at a single institution. *Leuk Lymphoma* 1996;23:333–337.

452. Weisenberg E, Anastasi J, Adenyanju D, et al. Hodgkin's disease associated with chronic lymphocytic leukemia. *Am J Clin Pathol* 1995;103:479–484.

453. Rubin D, Hudnall SD, Aisenberg A, et al. Richter's transformation of chronic lymphocytic leukemia with Hodgkin's-like cells is associated with Epstein-Barr infection. *Mod Pathol* 1994;7:91–98.

454. Petrella T, Yaziji N, Collin F, et al. Implication of the Epstein-Barr virus in the progression of chronic lymphocytic leukaemia/small lymphocytic lymphoma to Hodgkin-like lymphomas. *Anticancer Res* 1997;17(5B):3907–3913.

455. Ohno T, Smir BN, Weisenburger DD, et al. Origin of the Hodgkin/Reed-Sternberg cells in chronic lymphocytic leukemia with "Hodgkin's transformation." *Blood* 1998;91:1757–1761.

456. Kanzler H, Kuppers R, Helmes S, et al. Hodgkin and Reed-Sternberg-like cells in B-cell chronic lymphocytic leukemia represent the out-growth of single germinal-center B-cell-derived clones: potential precursors of Hodgkin and Reed-Sternberg cells in Hodgkin's disease. *Blood* 2000;95:1023–1031.

457. Ansell SM, Li CY, Lloyd RV, et al. Epstein-Barr virus infection in Richter's transformation. *Am J Hematol* 1999;60:99–104.

458. Zarrabi MH, Grunwalk HW, Rosner F. Chronic lymphocytic leukemia terminating in acute leukemia. *Arch Intern Med* 1977;137:1059–1064.

459. Lawlor E, McCann SR, Whelan A, et al. Acute myeloid leukemia occurring in untreated chronic lymphatic leukemia. *Br J Haematol* 1979;43:369–373.

460. Archimbaud E, Charrin C, Gentilhomme O, et al. Initial clonal acute lymphoblastic transformation of chronic lymphocytic leukemia with (11;14) and (8;12) chromosome translocations and acquired homozygosity. *Acta Haematol* 1988;79:168–173.

461. Mohamed AN, Compean R, Dan ME, et al. Clonal evolution of chronic lymphocytic leukemia to acute lymphoblastic leukemia. *Cancer Genet Cytogenet* 1996;86:143–146.

462. Demiroglu H, Dundar S. T-cell acute lymphoblastic leukaemic transformation of B-cell chronic lymphocytic leukaemia. *Eur J Haematol* 1996;56:184–185.

463. Preudhomme C, Lepelley P, Lovi V, et al. T-cell acute lymphoblastic leukemia occurring in the

course of B cell chronic lymphocytic leukemia: a case report. *Leuk Lymphoma* 1995;18:361–364.

464. Demiroglu H, Dundar S. T-cell acute lymphoblastic leukaemic transformation of B-cell chronic lymphocytic leukaemia. *Eur J Haematol* 1996;56:184–185.

465. Brouet JC, Ferman J, Laurent G, et al. The association of chronic lymphocytic leukemia and multiple myeloma: a study of eleven patients. *Br J Haematol* 1985;59:55–66.

466. Paietta E, Tudoriu CD, Goldstein M, et al. Plasmacytoid blast crisis in B-cell chronic lymphocytic leukemia. *Leuk Res* 1985;9:19–29.

467. Ferman J, James JM, Herait P, et al. Associated chronic lymphocytic leukemia and multiple myeloma: origin from a single clone. *Blood* 1985;66:291–293.

468. Saltman DL, Ross JA, Banks RE, et al. Molecular evidence for a single clonal origin in biphenotypic concomitant chronic lymphocytic leukemia and multiple myeloma. *Blood* 1989;74:2026–2030.

469. Browett PJ, Lever BF, Coustan-Smith E, et al. Independent clonal origin of coexisting chronic lymphocytic leukaemia and multiple myeloma. *Br J Haematol* 1988;70:126–127.

470. Travis LB, Curtis RE, Hankey BF, et al. Second cancers in patients with chronic lymphocytic leukemia. *J Natl Cancer Inst* 1992;84:1422–1427.

471. Cheson BD, Vena DA, Barrett J, et al. Second malignancies as a consequence of nucleoside analog therapy for chronic lymphoid leukemias. *J Clin Oncol* 1999;17:2454–2460.

2004 Lippincott Williams & Wilkins  
John P. Greer, John Foerster, John N. Lukens  
George M. Rodgers, Frixos Paraskevas, Bertil Glader  
Wintrobe's Clinical Hematology

**INCIDENCE AND ETIOLOGY.****PATHOGENESIS.****Cytogenetics.****Oncogenes.****Cytokines.****CLINICAL FINDINGS.****Infections.****Autoimmune Disorders.****Unusual Manifestations.****LABORATORY FINDINGS.****Hairy Cells.****Bone Marrow.****Spleen and Liver.****DIAGNOSIS.****DIFFERENTIAL DIAGNOSIS.****TREATMENT.****Splenectomy.****Interferon- $\alpha$ .****Nucleoside Analogs.****Monoclonal Antibodies.****SUMMARY.****SECOND MALIGNANCIES.****PROGNOSIS.****REFERENCES.**

Hairy cell leukemia (HCL), or leukemic reticuloendotheliosis, is a chronic B-cell disorder that was initially described by Bouroncle et al. in 1958 ([1](#)). The disease is characterized by the presence of typical hairy cells in the peripheral blood and marrow, pancytopenia, and a variable degree of splenomegaly ([1](#), [2](#), [3](#), [4](#), [5](#) and [6](#)). The disease has always aroused interest, initially over the unique clinical features of this disorder and the origin of the hairy cell. More recently, there has been intense interest in the treatment of HCL after the observation that remissions could be readily obtained in this disease using interferon (IFN)- $\alpha$  or the nucleoside analogs 2'-deoxycoformycin (dCF) and 2-chlorodeoxyadenosine (CdA) ([5](#), [6](#)).

## INCIDENCE AND ETIOLOGY

HCL is a rare disorder, accounting for 2% of all leukemias, and occurs more frequently in men, with an incidence in the United States of 2.9 per million per year for men and 0.6 per million per year for women ([5](#), [7](#)). The etiology of HCL is unknown, and a possible relationship to radiation exposure remains controversial ([7](#), [8](#)). A familial predisposition is suggested by reports of the disorder in a father and son ([9](#)), a mother and daughter ([10](#)), a mother and son ([11](#)), two brothers ([12](#), [13](#)), and three siblings, all with the same haplotype—A1, B7 ([14](#)).

## PATHOGENESIS

Although the normal cellular counterpart of the hairy cell has not been identified, findings of multiple immunologic ( [15](#), [16](#), [17](#) and [18](#) ), molecular genetic ( [19](#), [20](#) ), and chromosomal ( [21](#), [22](#) ) studies indicate that the hairy cell is of B-cell origin. Although some T-cell features have been reported ( [23](#), [24](#), [25](#), [26](#), [27](#) and [28](#) ), including two cases in which the retrovirus human T-cell leukemia virus type II was isolated ( [29](#), [30](#) ), no instances of T-cell receptor gene rearrangements have been found. Fluctuations in the expression of T- and B-cell markers have been demonstrated both *in vivo* and under various *in vitro* culture conditions ( [31](#), [32](#), [33](#) and [34](#) ). In most instances, the alteration noted was between a surface immunoglobulin-positive (SIg<sup>+</sup>) CD2<sup>-</sup> phenotype and an SIg<sup>-</sup> CD2<sup>+</sup> phenotype. Other B-cell antigens, however, such as CD20, were retained, even with the loss of SIg and the appearance of CD2 ( [33](#) ).

The marginal zone B cell has been suggested as a likely normal counterpart of the hairy cell ( [35](#), [36](#) ). Hairy cells characteristically undergo high rates of somatic mutations within the variable regions of H- and L-chain Ig genes and are thus derived from a postgerminal center cell ( [37](#), [38](#) and [39](#) ). These cells are similar to a subset of normal circulating B prolymphocytes, as well as to "monocytoid" B cells that are a prominent cellular component of mucosa-based lymphoid tissue and that proliferate within the sinuses of some patients with nonneoplastic lymphadenopathy (e.g., in toxoplasmosis) ( [40](#), [41](#) and [42](#) ). From a developmental standpoint, marginal zone B cells appear to represent a stage just before the terminal differentiation of an activated B cell to a plasma cell (a preplasma cell) ( [43](#) ). These data, together with the evidence of multiple heavy chain classes detected on the surface of hairy cells ( [44](#) ) and their reactivity with a monoclonal antibody against PCA-1, a structure present only at an early stage of plasma cell differentiation ( [45](#) ), support the hypothesis that the marginal zone B cell may be the normal counterpart of the malignant hairy cell ( [36](#) ). Using single cell analysis in HCL, it has been demonstrated that individual cells are able to synthesize multiple isotypes and contain transcripts of preswitched (IgM/IgD) and postswitched (IgG/IgA) immunoglobulins ( [37](#) ). Thus, the hairy cell may be arrested at a point at which isotype switching is occurring. It has been suggested that the point of differentiation of the hairy cell is more distant to that of the normal counterpart of the B-chronic lymphocytic leukemia (CLL) cell. Thus, when CLL cells are stimulated with 12-O-tetradecanoylphorbol 13-acetate or the protein kinase C activator, Bryostatin 1, the cells develop the morphologic and immunologic features of hairy cells ( [46](#), [47](#) and [48](#) ). Interestingly, one patient has been described who had CLL that subsequently transformed to HCL *in vivo* ( [49](#) ). In addition, hybrid leukemias have been described that have immunologic features of both HCL and CLL, being CD11c<sup>+</sup> and CD5<sup>+</sup> ( [50](#), [51](#) ).

### Cytogenetics

Cytogenetic studies have been difficult to carry out in HCL, as the number of circulating hairy cells is small, and attempts at marrow aspiration are usually unsuccessful. In addition, until recently, it has been difficult to induce hairy cells to proliferate and to obtain hairy cells in metaphase. In early reports, the abnormalities observed in HCL tended to be nonclonal ( [52](#), [53](#) ). However, more recently, 15 of 19 patients were found to have an abnormal karyotype, and a 14q<sup>+</sup> marker involving the breakpoint q32 at the Ig heavy chain locus was the most frequent clonal abnormality ( [21](#) ). Abnormalities involving

the short arm of chromosome 12 have been observed in four patients (17). Haglund et al. (54) observed deletions and inversions in 67% of patients. Clonal abnormalities of chromosome 5 were found in 40% of cases (most commonly, trisomy 5, pericentric inversions, and interstitial deletions involving 5q13). The frequency with which these abnormalities occur is unique and is not found in other B-cell malignancies. Abnormalities in 5q13 thus occur in one-third of patients, and subsequent studies have identified three expressed sequences as candidates for a putative tumor-suppressor gene at 5q13.3 (55). Cytogenetic analysis has been carried out using monoclonal antibodies to CD40, as this appears to be the most effective way of inducing hairy cell proliferation (56). This technique allowed cytogenetic analysis in 42 of 43 cases and demonstrated that clonal abnormalities were present in 19% of cases and involved numeric or structural abnormalities in chromosomes 5, 7, and 14. In contrast, abnormalities of chromosome 5 were not observed in the HCL variant, and translocations more frequently involved either chromosome 2 or 14 (57).

More recently, a high incidence of p53 mutations has been observed in HCL (58, 59). Using fluorescence *in situ* hybridization, a deletion of 17p13 (site of the p53 gene) has been demonstrated in 75% of patients with typical HCL and 100% of patients with the variant form (59). However, others have not confirmed these findings (60). König et al. (58) have observed p53 mutations in 28% of 61 HCL patients, although the codons typically affected in other hematologic malignancies were not involved. These results are surprising, as p53 mutations are usually associated with drug resistance and an aggressive clinical course, whereas typical HCL is an indolent disease that is highly responsive to treatment.

## Oncogenes

To date, there has been little information regarding the role of oncogenes in CLL. It has been shown that *c-fms*, which encodes the receptor for macrophage colony-stimulating factor and is normally expressed in macrophages/monocytes, is highly expressed in hairy cells (61). The addition of macrophage colony-stimulating factor to hairy cells causes enhanced mobility of the cells, the extent of which depends on the underlying stratum, and this effect is mediated through alterations in the integrin  $\alpha_v\beta_4$  (62). More recently, it has been demonstrated that, compared to normal lymphocytes, hairy cells have markedly increased levels and activities of the protein tyrosine kinase pp60<sup>c-src</sup>, which is the product of the protooncogene *c-src* (63). This increase was not observed in CLL cells and was unrelated to the amplification or structural rearrangements of the gene (63). Cyclin D1 messenger RNA (mRNA) and protein levels are increased in HCL, but the increase is less than is seen in mantle cell lymphoma and is not related to t(11;14)(q13;q32), which is typically observed in mantle cell lymphoma (64, 65). Finally, because of the high frequency of abnormalities of chromosome 5 in classic HCL, it has been suggested that a transforming oncogene might be located at 5q13.3 (51, 55, 58).

## Cytokines

There has been great interest in the role of cytokines in the pathogenesis of HCL (66). Identified factors that may be involved include interleukin-2 (IL-2), tumor necrosis factor (TNF)- $\alpha$ , IL-4, IL-6, B-cell growth factor, and interferon (IFN)- $\alpha$  (66). Some of these factors may be produced by the hairy cells themselves or by normal T cells (66, 67). T-cell clones have been shown to produce cytokines that stimulate the growth of hairy

cells, but not normal B cells; this effect is prevented by the addition of IFN- $\alpha$  ( 67 ).

A feature of classic HCL is the reactivity of the hairy cells with anti-Tac (CD25), which detects the  $\alpha$ -chain of the IL-2 receptor ( 20 , 68 , 69 , 70 and 71 ). By immunofluorescence, these cells also can be shown to express the  $\beta$ -chain of the IL-2 receptor ( 58 , 59 ), although this has not been confirmed using other techniques ( 70 ). In contrast, the hairy cells of the HCL variant express the  $\beta$ - but not the  $\alpha$ -chain, and normal B cells do not express the receptor or only express it very weakly ( 66 , 68 ). Increased serum levels of IL-2 receptor have been found in untreated HCL patients, and there is evidence that the leukemic cells release the receptor ( 71 ). The serum levels of IL-2 receptor correlate with the extent of disease and decrease after effective therapy with IFN- $\alpha$  ( 72 , 73 ). Paradoxically, even though the IL-2 receptor is present on hairy cells, these cells do not respond to stimulation by IL-2 ( 20 ), and IL-2 probably does not play a major role in the pathogenesis of HCL ( 66 ).

It has been demonstrated that TNF- $\alpha$ , but not TNF- $\beta$ , stimulates the growth of hairy cells, whereas in CLL, both forms of TNF stimulate leukemic cell growth ( 74 , 75 ). Hairy cells can also produce TNF- $\alpha$  ( 76 , 77 ), and the serum level of TNF- $\alpha$  is increased in HCL, the level correlating with the tumor burden ( 77 ). The TNF- $\alpha$  receptor can also be detected in the serum of these patients, and the level of this receptor also decreases after treatment with IFN- $\alpha$  ( 78 , 79 ). These findings suggest that TNF- $\alpha$  production by the hairy cells may play an important role in the pathogenesis of HCL by stimulating further growth of hairy cells and producing pancytopenia through the inhibition of normal marrow function ( 74 , 76 , 77 ).

Hairy cells secrete low levels of IL-6, and the serum level of this cytokine is increased in HCL ( 66 , 80 ). The production of IL-6 mRNA and IL-6 secretion is markedly increased by incubating HCL cells with TNF ( 80 ). IL-6 antisense oligonucleotide can inhibit the effect of TNF on IL-6 secretion and DNA synthesis, suggesting that IL-6 mediates the activity of TNF in HCL ( 80 ).

Information regarding the role of other ILs is more fragmentary, but IL-4 has been shown to induce DNA synthesis in hairy cells, and B-cell growth factors can support the survival of hairy cells in long-term culture ( 66 ).

## CLINICAL FINDINGS

The median age of HCL patients is between 50 and 55 years, with a range of 22 to 85 years, and the male to female ratio is 4:1 ( 1 , 2 , 3 , 4 , 5 and 6 , 81 ). Classically, these patients present with weakness and easy fatigue, and the symptoms can usually be related to pancytopenia and splenomegaly ( Table 93.1 ) ( 1 , 2 , 3 , 4 , 5 and 6 , 81 ). Ninety percent of patients have a palpable spleen, which may be massive, and one-third of patients have hepatomegaly ( 1 , 2 , 3 , 4 , 5 and 6 , 81 ). Peripheral lymphadenopathy is uncommon ( 5 ), but with computed tomography scanning, significant abdominal lymphadenopathy may be observed ( 82 , 83 ). The degree of abdominal lymphadenopathy correlates with the duration and extent of disease. The incidence at presentation is 17% but increases to 56% at relapse after chemotherapy ( 82 ). Less frequently, mediastinal node enlargement may also be observed ( 84 ). Compared to 30 years ago, patients are now being diagnosed earlier and have less marked splenomegaly and anemia at



presentation (6).

**TABLE 93.1. Hairy Cell Leukemia: Clinical Manifestations**

| <b>Manifestation</b>                     | <b>Incidence (%)</b> |
|--|----------------------|
| Weakness, easy fatigue                   | 80                   |
| Fever, sweats, weight loss, anorexia     | 20–35                |
| Infection                                | 20–30                |
| Easy bruising, bleeding                  | 20–30                |
| Left upper quadrant abdominal discomfort | 25                   |
| Autoimmune disorders                     | 15–30                |
| Splenomegaly                             | 80–90                |
| Hepatomegaly                             | 30–40                |
| Ecchymoses, petechiae                    | 20–30                |

Most patients have pancytopenia, the etiology of which is multifactorial but is primarily related to marrow failure and splenomegaly. Marrow failure is related to replacement of marrow by hairy cells and the associated reticulin fibrosis and to the inhibition of myelopoiesis by cytokines, such as TNF- $\alpha$ , released by the hairy cells (74, 76, 77, 85). Splenomegaly in HCL may produce pancytopenia by three mechanisms. First, the major factor responsible for the cytopenias is pooling (sequestration, margination) of normal peripheral blood cells in the enlarged spleen (85, 86, 87, 88, 89 and 90). As much as 90% of the peripheral platelet mass (86, 91), 30% of the red cell mass (89, 91), and 65% of the granulocytes (87, 91) may pool in a massively enlarged spleen. These cellular elements often are not destroyed by the spleen at an increased rate but slowly reenter the circulation (91). Pooling occurs in the red pulp, Billroth cords, and venous sinuses. In HCL, apparently because of the formation of blood-filled pseudosinuses by the hairy cells, a greater proportion of the peripheral red cell volume (as much as 48%) may be pooled in a massively enlarged spleen (89). A second mechanism responsible for cytopenias with splenomegaly is the increased destruction of cells in the spleen. Finally, an expanded plasma volume contributes to the appearance of cytopenia with splenomegaly; this is particularly true for the observed anemia (85, 88, 91).

### Infections

Recurrent infections are a major problem and the leading cause of death for patients with HCL (5, 92, 93, 94 and 95). Fever is rarely a manifestation of the underlying HCL; when present, it should prompt a careful search for an infectious process. Approximately 30% of patients present with infection, and 70% have either documented or suspected infections during the course of the disease (81, 92). Pyogenic infections account for approximately 50% of infectious episodes; gram-negative and gram-positive bacteria are identified with approximately equal frequency (81, 92). However, nonpyogenic infections occur in more than 30% of patients (81, 92), and infections can occur with unusual organisms such as atypical mycobacteria, including *Mycobacterium kansasii*, which is a unique feature of HCL, in comparison to other lymphoproliferative disorders (81, 93, 96). Other common organisms include *Toxoplasma* (97), various fungi (81, 95, 98), *Legionella* (81, 99), *Listeria*

*monocytogenes* ( [100](#) ), *Pneumocystis carinii* ( [95](#) ), and viruses ( [95](#) ).

The high infection rate can be ascribed primarily to neutropenia, although several other immune defects have been described. Monocytopenia is often a prominent feature ( [101](#) , [102](#) ), and functional abnormalities of monocytes and granulocytes may occur ( [99](#) , [101](#) , [103](#) , [104](#) and [105](#) ). The defects in monocyte production and function may account for the unusual susceptibility of these patients to atypical mycobacterial and other fungal infections ( [94](#) , [95](#) ). Natural killer (NK) cell activity is also severely depressed and is probably related to an absolute decrease in the number of these cells in the peripheral blood ( [106](#) , [107](#) and [108](#) ). A depressed helper to suppressor T-cell ratio associated with a decrease in the number of T-helper cells and an increase in the number of T-suppressor cells also has been demonstrated ( [109](#) ). As expected, lymphocyte functional studies reveal impaired delayed-type hypersensitivity to recall antigens, as well as near-absent antibody-dependent cellular cytotoxicity ( [106](#) ). In contrast to CLL, the serum Ig levels are normal ( [110](#) ).

### Autoimmune Disorders

Clinical manifestations secondary to various autoimmune disorders are being recognized with increasing frequency in patients with HCL ( [95](#) , [111](#) , [112](#) , [113](#) , [114](#) and [115](#) ). In one series of patients, these complications were second only to infection as a cause of morbidity ( [95](#) , [112](#) ). The onset may occur any time during the course of the disease and is not related to the tumor burden. Infection, however, particularly with mycobacterial organisms, often coexists ( [95](#) ). Most frequently, patients present with arthritis, arthralgias, palpable purpura or nodular skin lesions resulting from cutaneous vasculitis, and low-grade fever ( [95](#) , [112](#) , [114](#) ). Occasionally, patients may have involvement of the lung, liver, intestine, and kidney, with a clinical picture that resembles poly-arteritis nodosa ( [95](#) , [112](#) , [113](#) , [115](#) ). These patients often have fever, malaise, and weight loss, and a coexistent infection must be ruled out ( [95](#) , [112](#) ). If skin lesions are present, the diagnosis can be confirmed by biopsy, which usually shows changes compatible with a diagnosis of polyarteritis nodosum or leukocytoclastic vasculitis; occasionally, a vasculitis related to the invasion of the vessel wall by hairy cells occurs; this may appear very similar to polyarteritis nodosa with the presence of aneurysms ( [114](#) ). In some organs, such as the lung, a granulomatous vasculitis may be found ( [95](#) , [112](#) ). Angiography may reveal peripheral aneurysms ( [112](#) , [115](#) ). Antinuclear antibodies, rheumatoid factor, immune complexes, and hepatitis B antigen are variably positive ( [105](#) ). Cryoglobulinemia has been detected in some patients ( [116](#) , [117](#) ). It has been postulated that the increased incidence of vasculitis in HCL may be related to infections with hepatitis B and other viruses, cross-reactivity of antibodies against hairy cells with epitopes on endothelial cells, and decreased clearance of immune complexes by the impaired immune system ( [114](#) ).

These autoimmune manifestations may be self-limited, but if therapy is required, a short course of corticosteroids is usually effective ( [95](#) , [114](#) ). Remissions have also been observed after splenectomy, IFN- $\alpha$ , and dCF therapy ( [95](#) , [112](#) , [114](#) , [115](#) ).

### Unusual Manifestations

**LYTIC BONE LESIONS** Although the immunophenotypic profile of hairy cells closely resembles that of B cells at a developmental stage just before terminal differentiation to plasma cells, lytic bone lesions are distinctly unusual ( [Table 93.2](#) ) ( [118](#) , [119](#) , [120](#) and [121](#) ). In

some patients with osteolytic lesions, HCL and multiple myeloma were thought to coexist ( [122](#), [123](#) ). However, several patients with classic HCL and without any evidence of plasma cell proliferation have been reported to develop osteolytic lesions ( [119](#), [120](#) and [121](#) ). These lesions have a predilection for the proximal femur and usually are associated with extensive bone marrow infiltration by hairy cells ( [120](#), [121](#) ). The lesions, like those seen in association with multiple myeloma, respond well to radiotherapy. The administration of corticosteroids can produce prompt relief of bone pain ( [119](#) ).

**TABLE 93.2. Hairy Cell Leukemia: Unusual Clinical Manifestations**

| Manifestation              | Incidence (%) |
|----------------------------|---------------|
| Peripheral lymphadenopathy | <5            |
| Lytic bone lesions         | 3             |
| Skin involvement           | 5             |
| Splenic rupture            | <5            |
| Other organ dysfunction    | <5            |

**SKIN INVOLVEMENT** Cutaneous lesions referable to thrombocytopenia (ecchymoses, petechiae), infection, or vasculitis are common during the course of HCL, but lesions caused by infiltration of the skin by hairy cells are unusual ( [124](#), [125](#) ). In a retrospective review of 600 cases, skin lesions thought to be due to infiltration by hairy cells were reported in 8.0% of cases, but histopathologic verification was present in only 1.3% ( [124](#) ). Infiltrative lesions usually are widely disseminated and consist of erythematous maculopapules. Biopsy shows the infiltrates to be perivascular, involving the dermis but not the epidermis ( [126](#) ).

**SPLENIC RUPTURE** Surprisingly, even with massive splenomegaly, spontaneous splenic rupture is rare in HCL, occurring in approximately 2% of cases ( [1](#), [95](#), [127](#) ).

**OTHER ORGAN DYSFUNCTION** Although hairy cell infiltration of multiple organs and tissues is a frequent finding at autopsy, clinically significant organ dysfunction is unusual ( [128](#) ). Infiltration of connective tissue and fat surrounding organs is common ( [128](#) ). Central nervous system involvement is unusual, and only a rare case of meningeal involvement has been documented ( [128](#), [129](#) ). Infection is by far the most frequent cause for neurologic complications ( [129](#) ). Pleural effusions, ascites, protein-losing enteropathy, and spinal cord compression may occur rarely in HCL and result from tissue infiltration by hairy cells ( [118](#) ).

## LABORATORY FINDINGS

The relative incidence of the most characteristic laboratory findings is listed in [Table 93.3](#). In a series of 725 cases studied by the Italian Cooperative Group, 80% of patients had pancytopenia at presentation, with one-third of all patients having a hemoglobin less than 85 g/L, neutrophils less than  $0.5 \times 10^9/L$ , and platelets less than  $50 \times 10^9/L$  ( [6](#) ). A careful inspection of the peripheral blood smear demonstrates the presence of typical hairy cells in more than 85% of patients ( [1](#), [6](#) ), and in 13% of cases, there are more than  $5 \times 10^9/L$  hairy cells ( [6](#) ). In Bouroncle's series of 82 patients, hairy cells accounted for 10% or more of the leukocytes in 80% of patients and 50% or more in 43% of patients ( [2](#) ). The total leukocyte count was elevated in 20%, but in only 4% did the count exceed  $50 \times 10^9/L$  ( [2](#) ).

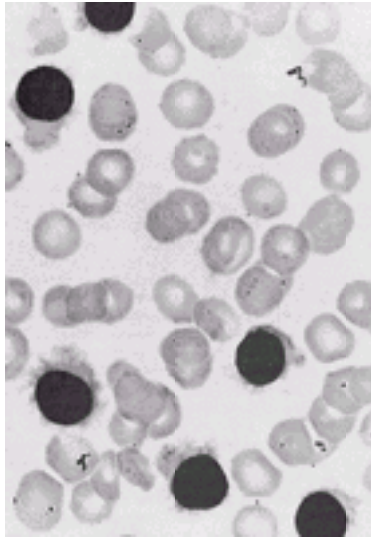
**TABLE 93.3. Hairy Cell Leukemia: Laboratory Manifestations**

| Manifestation                   | Incidence (%) |
|---------------------------------|---------------|
| Pancytopenia                    | 70            |
| Neutropenia                     | 80            |
| Thrombocytopenia                | 80            |
| Anemia                          | 75            |
| Monocytopenia                   | 98            |
| Leukocytosis                    | 15            |
| Hairy cells in peripheral blood | 85            |
| Hairy cells in bone marrow      | 99            |

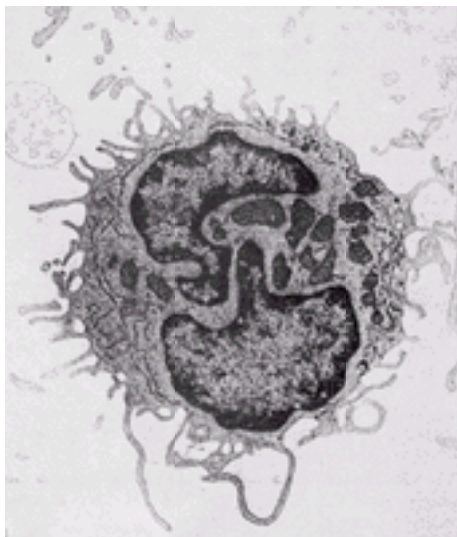
Abnormal liver function studies, usually with an isolated elevation of the serum alkaline phosphatase level, are obtained in 10 to 19% of individuals with HCL ( [4](#) ). The leukocyte alkaline phosphatase scores are high in most cases. Monoclonal gam-mopathy is rare, occurring in 1 to 3% of patients ( [3](#) , [4](#) ). It has been difficult to prove that the hairy cells are secreting the paraprotein ( [130](#) ); in other cases, the M band was thought to be related to a coexisting myeloma ( [120](#) , [122](#) , [123](#) ).

### Hairy Cells

The characteristic morphologic appearance of hairy cells on a Wright-stained peripheral blood smear is the single most important diagnostic finding ( [Fig. 93.1](#) ) ( [6](#) ). The cells are mononuclear with relatively abundant cytoplasm and a cell diameter in the range of 10 to 25  $\mu\text{m}$ . The cytoplasm is pale blue-gray and agranular with a variable number of elongated (hairy) projections. The nuclei are round, oval, reniform, or dumbbell-shaped with a nuclear chromatin pattern that is homogeneous and less clumped and lighter staining than that of normal mature lymphocytes and those seen in classic CLL and prolymphocytic leukemia ( [6](#) , [23](#) ). A prominent nucleolus is rarely seen. On both transmission and scanning electron microscopy, the cytoplasmic projections appear as elongated slender microvilli or broad-based ruffles or pseudopods ( [Fig. 93.2](#) ) ( [131](#) ). Other ultrastructural features include numerous mitochondria, polyribosomes, strands of rough endoplasmic reticulum, intermediate filaments, and some lysosomal granules ( [23](#) ). In 50% of cases, cytoplasmic inclusions known as *ribosome-lamellar complexes* are found ( [6](#) , [132](#) ). These complexes appear as rod-shaped structures under light microscopic analysis ( [132](#) ). Although seen most frequently in individuals with HCL, they are not pathognomonic, having been reported in association with other chronic B-cell lymphoproliferative disorders, acute monocytic leukemia, and even nonhematologic neoplasms ( [133](#) ). The characteristic filamentous projections can be seen readily in living hairy cells; using supravital dyes and phase-contrast microscopy, one can observe the cytoplasmic projections protruding and then retracting constantly ( [6](#) ).



**Figure 93.1.** Hairy cells from a peripheral blood smear (light microscopy). Cells have abundant agranular cytoplasm with multiple cytoplasmic projections. Nucleus is round, oval, or reniform with light-staining homogeneous nuclear chromatin (Wright stain,  $\times 1500$ ).



**Figure 93.2.** Hairy cells from the peripheral blood (transmission electron microscopy). The characteristic and delicate cytoplasmic projections are striking. Nucleus is irregular in shape with margined chromatin ( $\times 11,000$ ).

A useful diagnostic test for HCL is the presence of acid phosphatase isoenzyme 5 in the cytoplasm of hairy cells, but this can also be positive in other disorders ( [6](#), [134](#), [135](#), [136](#) and [137](#) ). Cytochemical staining procedures demonstrate that this isoenzyme, unlike other acid phosphatase isoenzymes, is not inhibited by tartrate ( [134](#), [135](#), [136](#) and [137](#) ). The enzyme concentrates primarily in the Golgi area and nuclear membrane ( [134](#) ). Even though a positive tartrate-resistant acid phosphatase (TRAP) stain is not pathognomonic for the diagnosis of HCL, it has stood the test of time as an important tool in the differential diagnosis of this disease ( [136](#) ). The test is positive in more than 95% of cases ( [4](#) ). In one report ( [136](#) ), the TRAP stain was positive in 76%, intermediate in 21%, and negative in only 3% of 29 patients with HCL. In contrast, in 37 patients with CLL and other

lymphoproliferative disorders, the test was positive in only 3%, intermediate in 32%, and negative in 65% (136). A limiting factor of the TRAP stain is that it cannot be carried out on paraffin-embedded tissue. This problem has been circumvented recently with the development of an immunohistochemical technique using 9C5, a monoclonal antibody to TRAP (137, 138). The majority of cases of HCL are detected using this antibody, although only 50% of the cells stain positively (138).

Immunophenotyping has proved very useful in assisting in the diagnosis of HCL and in differentiating it from variants and other B-cell malignancies (139, 140, 141 and 142). Using flow cytometry, hairy cells can be detected in the peripheral blood of 92% of patients, even if the hairy cells comprise less than 1% of the lymphocytes (140). Table 93.4 shows the immunophenotype of typical HCL in comparison to other chronic B-cell disorders that have "hairy" cells (i.e., the HCL variant and splenic lymphoma with villous lymphocytes).

In HCL, the leukemia cells have SIg (IgM <sup>+/-</sup>, IgG, IgD, or IgA) and B-cell associated antigens (CD19, CD20, and CD22); typically, the cells are positive for CD25, the IL-2 receptor. CD11c (leu-M5), which reacts with the  $\alpha$  subunit of p150/95, a member of the lymphocyte function-associated antigen subfamily of integrin molecules, is present on virtually all hairy cells, but it is also present on monocytes and neutrophils and on the cells of other lymphoid malignancies (6, 139, 140). A number of antibodies have been raised against hairy cells, although none is entirely specific for this leukemia. B-ly 7 reacts with a 144-kd antigen (mucosal lymphocyte antigen; CD103) on hairy cells and on a small number of normal lymphocytes, which have been postulated to be the normal hairy cell counterpart (139, 141). Like B-ly 7, the antibodies HML-1, Ber-ACT8, and LF61 can also recognize CD103 (141). Two further antibodies, RAB-I and anti-HC2, are also relatively specific for hairy cells (6). Important markers to help differentiate HCL from the other B-cell malignancies include CD5 <sup>-</sup>, CD10 <sup>-</sup>, CD23 <sup>-</sup>, CD25 <sup>+</sup> (strong), CD11c <sup>+</sup> (strong), FMC7 <sup>+</sup>, HC-2, and CD103 <sup>+</sup> (140, 141 and 142).

**TABLE 93.4. Hairy Cell Leukemia (HCL): Immunophenotypic Profile**

| Antigen       | Prototype Monoclonal Antibody             | HCL HCL Variant |   | Splenic Lymphoma with Villous Lymphocytes |
|---------------|---|-----------------|---|---|
| CD19, CD20    | B4, B1                                    | +               | + | +   |
| CD22          | Leu-14                                    | +               | + | +   |
| HLA-DR        | Anti-HLA-DR                               | +               | + | +   |
| Nonclustered  | FMC7                                      | +               | + | +   |
| Surface Ig    | Anti-Ig                                   | +               | ± | +   |
| CD11c         | Leu-M5                                    | +               | + | ±   |
| CD103         | B-ly-7                                    | +               | ± | ±   |
| CD25          | Anti-Tac (interleukin-2 receptor)         | +               | - | ±   |
| Nonclustered  | HC2                                       | +               | - | -   |
| CD23          | MHM6                                      | ±               | - | ±   |
| CD3, CD4, CD8 | Leu-4, Leu-3a, Leu-2a                     | -               | - | -   |
| CD5           | Leu-1                                     | -               | - | ±   |
| CD10          | Common acute lymphocytic leukemia antigen | -               | ± | ±   |



+, positive in nearly all cases; ±, positive in less than 50% of cases; –, less than 10% positive; CD, cluster of differentiation; Ig, immunoglobulin.

Adapted from Cornfield DB, Mitchell Nelson DM, Rimsza LM, et al. The diagnosis of hairy cell leukemia can be established by flow cytometric analysis of peripheral blood, even in patients with low levels of circulating malignant cells. *Am J Hematol* 2001;67:223–226; Frassoldati A, Lamparelli T, Federico M, et al. Hairy cell leukemia: a clinical review based on 725 cases of the Italian Cooperative Group (ICGHCL). *Leuk Lymph* 1994;13:307–316; Matutes E, Morilla R, Owusu–Ankomah K, et al. The immunophenotype of hairy cell leukemia (HCL). Proposal for a scoring system to distinguish HCL from B–cell disorders with hairy or villous lymphocytes. *Leuk Lymph* 1994;14(Suppl 1):57–61; and Robbins BA, Ellison DJ, Spinosa JC, et al. Diagnostic application of two–color flow cytometry in 161 cases of hairy cell leukemia. *Blood* 1993;82:1277–1287.

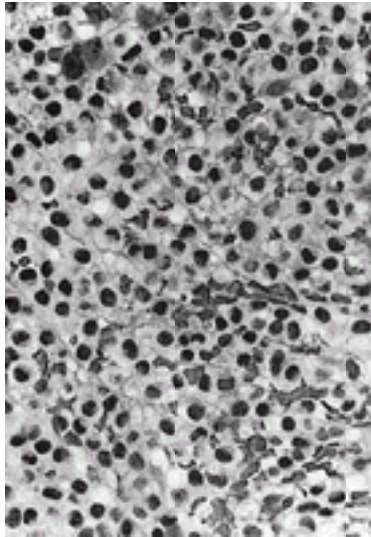
---

The above antibodies are primarily used on viable or frozen cells, but antibodies have also been developed that can recognize formalin–resistant hairy cell antigens. One of these is DBA.44, which strongly stains hairy cells fixed in formalin or Bouin solution and is thus useful for detecting residual disease in the marrow after chemotherapy ( [143](#) , [144](#) ). However, DBA.44 is not entirely specific for hairy cells and also stains mantle zone lymphocytes and a variety of low– and high–grade B–cell lymphomas ( [143](#) , [144](#) ). The specificity and sensitivity for the diagnosis of HCL by immunohistochemistry can be increased when DBA.44 staining is used in conjunction with the 9C5 antibody to detect TRAP and an anti–CD20 antibody to detect B cells ( [138](#) ).

## Bone Marrow

More than 99% of patients have marrow infiltration by biopsy, although the occasional patient can have isolated involvement of the spleen ( [3](#) , [145](#) ). The pattern of bone marrow involvement on biopsy specimens is near to pathognomonic for HCL ( [Fig. 93.3](#) ) ( [146](#) , [147](#) and [148](#) ). Classically, the infiltration is diffuse and has a “honeycomb” appearance with the nucleus of each hairy cell surrounded by a halo of cytoplasm ( [Fig. 93.3](#) ). The individual cells have been described as resembling a fried egg. This pattern of infiltration is quite different from that seen in other chronic lymphoproliferative disorders, such as CLL, well–differentiated lymphocytic lymphoma, and lymphoplasmocytic lymphoma in which the lymphocyte nuclei closely approximate each other ( [138](#) , [139](#) , [140](#) and [141](#) ). In polymorphous lymphocytic leukemia, monocytoid B–cell lymphoma, marginal zone lymphoma, and large granular lymphocytic (LGL) leukemia, in which the malignant lymphocytes are about the size of hairy cells with a low nuclear to cytoplasmic ratio, the infiltrates are similar to those seen in HCL. Bone marrow involvement in systemic mast cell disease and even in some nonhematologic neoplasms, such as mesenchymal chondrosarcoma, also may mimic HCL ( [149](#) ). The hairy cells may be more easily identified using immunohistochemistry with antibodies to CD20 (L26) or DBA.44.





**Figure 93.3.** Bone marrow biopsy (plastic embedded) in hairy cell leukemia. Pattern of the infiltration gives a “honeycomb” appearance with the nucleus of each hairy cell surrounded by a halo of cytoplasm. Nuclei are bland and round, oval, or indented (hematoxylin and eosin, × 600).

Silver staining demonstrates diffuse reticulin fibrosis, without a collagenous component; this likely explains the usual difficulty in obtaining a marrow by aspirate (“dry tap”) ([147](#), [148](#), [150](#)). Recently, it has been demonstrated that this feature is related to the ability of hairy cells to synthesize fibronectin ([151](#)). In addition, hairy cells contain the fibronectin receptor, very late antigen-5, and are able to assemble the fibronectin molecule into multimers ([151](#)). In some patients, the bone marrow is not diffusely involved by hairy cells; instead, focal (patchy) or interstitial infiltrates are seen ([146](#), [147](#) and [148](#)). The focal areas may be well-circumscribed nodules, or they may have irregular borders. Extravasation of red cells into areas of involvement is often present ([147](#)). Islands of normal hematopoiesis, particularly erythroid islands, are common. Increased numbers of plasma cells, lymphocytes, and mast cells may also be seen.

The overall marrow cellularity is increased in 55% of patients and normal in 38% of patients ([6](#)). However, in 7% of cases, the cellularity is decreased; this can lead to the erroneous diagnosis of aplastic anemia or hypoplastic myelofibrosis ([149](#), [150](#), [152](#), [153](#)). Patients with hypocellular marrows frequently do not have splenomegaly, suggesting that these patients may have an early stage of the disease ([95](#)).

### Spleen and Liver

The spleen is almost always involved in HCL, and the pattern of hairy cell involvement, like that in the bone marrow, is nearly pathognomonic for HCL ([146](#), [153](#), [154](#) and [155](#)). The infiltrates are confined to the red pulp, and, unlike other lymphoproliferative disorders, the white pulp is not expanded and is actually atrophic. Although a variable degree of red pulp involvement is seen in association with all leukemias, it is not a feature of most lymphomas until a leukemic transformation occurs. Blood-filled pseudosinuses lined by hairy cells are a characteristic feature, and, despite monocytopenia, the number of histiocytes is increased in the red pulp. Infiltration of the liver occurs in both portal areas and sinuses ([128](#)). Pseudosinuses, some resembling hemangiomas, may be present ([128](#)).

## DIAGNOSIS

The diagnosis of HCL usually is not difficult ( [1](#), [2](#), [3](#), [4](#), [5](#) and [6](#) ). Most patients have splenomegaly in the absence of peripheral lymphadenopathy, and a variable degree of pancytopenia with severe monocytopenia. Typical hairy cells are evident in the peripheral blood on a routine smear or on a buffy coat in more than 90% of cases, and the suspected hairy cells should be TRAP positive. The marrow aspirate is “dry,” and the bone biopsy should reveal the classic pattern of infiltration that may be diffuse, focal, or interstitial with increased reticulin. When hairy cells cannot be demonstrated in the peripheral blood, the bone marrow findings are critical for diagnosis. When the bone marrow findings are not typical, particularly in those patients in whom the TRAP stain is negative, immunophenotyping is helpful ( [Table 93.4](#) ). Analysis for Ig and T-cell receptor gene rearrangements occasionally may be necessary, particularly in individuals with one of the “variant forms” of the disease. Rarely, the diagnosis is confirmed only after splenectomy ( [145](#) ).

The HCL variant makes up 10% of all HCL cases and was originally described as having morphologic features intermediate between hairy cells and prolymphocytes ( [156](#), [157](#) ). However, there are other presentations of the HCL variant, including hybrid forms of HCL and prolymphocytic leukemia or CLL, a blastic form of HCL, and an HCL multilobular form ( [156](#), [157](#), [158](#), [159](#), [160](#), [161](#) and [162](#) ). These patients have many of the clinical and laboratory features of typical HCL ( [156](#), [157](#), [158](#), [159](#), [160](#), [161](#) and [162](#) ). Splenomegaly without peripheral lymphadenopathy is seen in all patients, and a pattern of exclusive red pulp infiltration in the spleen is evident in most. The HCL variant differs from typical HCL in the following ways ( [142](#), [157](#), [160](#), [163](#), [164](#) ):

- Patients are older, the median age being 71 years.
- The peripheral leukocyte count usually is higher (often  $>50 \times 10^9/L$ ).
- Hairy cells may or may not be TRAP <sup>+</sup>.
- The monocyte count is normal.
- Hairy cells show a higher nuclear to cytoplasmic ratio, and the nuclear chromatin is more condensed with more prominent nucleoli.
- Classic HCL is CD25 <sup>+</sup>, HC2 <sup>+</sup>, CD11c <sup>+</sup>, and CD103 <sup>+</sup>, whereas the HCL variant is CD25 <sup>-</sup> and HC2 <sup>-</sup> and may or may not be CD11c <sup>+</sup> and CD103 <sup>+</sup>.
- The marrow usually can be aspirated in the HCL variant, and there is an interstitial pattern of infiltration seen in the bone marrow with a variable degree of fibrosis.
- The HCL variant responds more poorly to IFN- $\alpha$  and the nucleoside analogs than classic HCL ( [157](#), [160](#), [163](#), [164](#) ) but may respond to splenectomy ( [157](#) ). In one report, none of the seven patients responded to IFN- $\alpha$ , and only two of three patients achieved a partial response (PR) to dCF ( [160](#) ). Of four patients treated with CdA, one achieved a complete response (CR), and two achieved a PR ( [163](#) ). Others have observed similarly poor responses ( [157](#) ).
- Survival is shorter than for typical HCL, with the median survival in one report being 9 years (vs.  $>12$  years for typical HCL) ( [157](#) ).

## DIFFERENTIAL DIAGNOSIS

Disorders to be considered in the differential diagnosis of HCL include lymphoid malignancies that present with splenomegaly in the absence of lymphadenopathy and are

listed in [Table 93.5](#) ( [165](#) ).

**TABLE 93.5. Hairy Cell Leukemia: Differential Diagnosis**

---

|  |
|--|
| Splenic lymphoma with villous lymphocytes                            |
| Marginal zone B-cell lymphoma  |
| Monocytoid B-cell lymphoma   |
| Small lymphocytic lymphoma   |
| Primary splenic chronic lymphocytic leukemia                         |
| Lymphoplasmacytoid lymphoma, including Waldenström macroglobulinemia |
| Chronic lymphocytic leukemia   |
| Mantle zone (intermediate) lymphoma                                  |
| Myeloproliferative disorders   |
| Malignant histiocytosis  |
| Primary lymphoma of spleen   |
| Chronic prolymphocytic leukemia                                      |
| Large granular lymphocytic leukemia                                  |
| Systemic mast cell disease   |
| Hairy B-cell lymphoproliferative disorder                            |

---

The normal cellular counterpart of the malignant lymphocyte in splenic lymphoma with villous lymphocytes ( [152](#), [153](#), [154](#) and [155](#) ), marginal zone B-cell lymphoma ( [39](#), [170](#) ), monocytoid B-cell lymphoma ( [171](#), [172](#) and [173](#) ), and HCL may be similar. Marginal zone B cells, found in the marginal zone of the normal spleen, are large mononuclear cells with abundant cytoplasm, a variable number of cytoplasmic projections, and condensed nuclear chromatin ( [39](#) ). Monocytoid B cells, initially identified and referred to as *sinus histiocytes* that proliferate in certain reactive lymph nodes (e.g., toxoplasmosis), are morphologically and immunologically similar to marginal zone lymphocytes ( [38](#), [39](#) ). A similar B cell is also found in the perifollicular areas of lymph nodes, particularly in the mucosa-based lymphoid tissue ( [173](#) ). The malignant cell in these disorders is a mononuclear cell with abundant cytoplasm, a variable degree of cytoplasmic projections, condensed nuclear chromatin, and usually a prominent nucleolus ( [39](#) ). In tissue sections, these lymphomas closely resemble hairy cell infiltrates, but the cytologic appearance of the malignant cells with the clumped nuclear chromatin and shorter and fewer cytoplasmic projections distinguishes them from the typical hairy cell. These disorders may be differentiated by immunophenotyping and by the TRAP stain, which is positive in HCL and usually negative or only weakly positive in the other disorders ( [171](#) ). The pattern of infiltration in the bone marrow and spleen also is different from that of HCL.

In splenic lymphoma with villous lymphocytes, previously known as *malignant lymphoma simulating leukemic reticuloendotheliosis* ( [166](#) ) and now considered to be one of the splenic marginal zone lymphomas ( [35](#) ), the white cell count is usually higher than in HCL, being 3 to  $38 \times 10^9/L$  ( [166](#), [168](#) ). Typically, these patients have prominent splenomegaly and no lymphadenopathy; they may have an IgM paraprotein and a Coombs-positive hemolytic anemia and respond to chlorambucil or splenectomy ( [168](#) ). The leukemia cell is smaller and frequently contains a nucleolus, and the villi are shorter, fewer, and more uneven than in a typical hairy cell and are frequently concentrated at one end of the cell.

A small monoclonal band is found in the serum or urine in two-thirds of patients. Marrow involvement is patchier without the “fried-egg” pattern or reticulin fibrosis; in the spleen, the white pulp is expanded, and there is a variable degree of red pulp expansion without pseudosinus formation ( [166](#), [167](#), [168](#) and [169](#) ). Immunophenotyping can also assist in differentiating these cells from hairy cells ( [166](#) ). Although these cells have many markers similar to those of hairy cells, only 25% of cases are CD25<sup>+</sup>, and these do not have the classic markers for HCL (CD11c, HC2<sup>+</sup>, and B-ly-7). In marginal zone B-cell lymphoma, the pattern of bone marrow infiltration also tends to be patchy or focal without reticulin fibrosis, but in the spleen, the infiltration is predominantly in the red pulp, such as occurs in HCL ( [170](#) ). In monocytoid B-cell lymphomas, the infiltrates resemble those of HCL, but the clinical presentation is different ( [171](#), [172](#) ). These patients usually have peripheral lymphadenopathy without splenomegaly and a high incidence of extranodal involvement ( [173](#) ). Bone marrow involvement is less frequent and usually is paratrabecular; peripheral blood involvement is rare ( [171](#) ). In lymph nodes, the infiltration is interfollicular and sinusoidal, often with preservation of some lymph follicles, a finding similar to that seen in hairy cell involvement of lymph nodes ( [171](#), [172](#) ).

Patients with small lymphocytic lymphoma (SLL) ( [174](#), [175](#) ), lymphoplasmacytic lymphoma ( [161](#) ), primary splenic CLL ( [176](#) ), typical CLL, and mantle cell lymphoma ( [177](#), [178](#) ) can have the same clinical presentation as HCL, but the laboratory features are quite different. The cytologic appearance of the malignant cells on Wright stain and the appearance and distribution of the infiltrates in the bone marrow, spleen, and lymph nodes distinguish these disorders from HCL. In SLL/CLL, the lymphocytes are small with scant cytoplasm and clumped nuclear chromatin. The bone marrow usually is diffusely involved in CLL, but a focal interstitial pattern may be evident early in the course of the disease. In SLL, the bone marrow may not be involved early in the course, and the pattern initially is more focal. Involved lymph nodes in SLL and CLL show diffuse infiltration with small mature lymphocytes that completely efface the nodal architecture. The spleen shows not only white pulp expansion, but also a variable degree of red pulp expansion. The malignant lymphocytes in both SLL and CLL are typically CD5<sup>+</sup> in contrast to hairy cells, which are CD5<sup>-</sup>. In the lymphoplasmacytic disorders, particularly Waldenström macroglobulinemia, splenomegaly, peripheral lymphadenopathy, and a variable degree of pancytopenia are a more common presentation. Like hairy cells, these malignant B cells are CD5<sup>-</sup>, but they are CD103<sup>-</sup> and usually CD11c<sup>-</sup> and CD25<sup>-</sup>. In addition, the cytologic appearance (plasmacytoid lymphocytes) and the frequent presence of a serum IgM monoclonal spike distinguish them from HCL. Although mantle cell lymphoma is usually associated with generalized lymphadenopathy, splenomegaly may be a prominent feature ( [177](#), [178](#) ). Again, this lymphoma can be differentiated from HCL by the cytologic appearance of the cells, immunophenotyping, and the pattern and nature of the infiltration in lymph nodes, spleen, and bone marrow. The malignant cells are small mature lymphocytes with scant cytoplasm, a round or cleft nucleus, and clumped nuclear chromatin. The bone marrow may demonstrate diffuse or patchy involvement. Lymph nodes are diffusely infiltrated and often show expansion of the mantle zone with residual isolated benign-looking germinal centers ( [177](#), [178](#) ). A similar pattern is seen in the expanded white pulp in the spleen with a variable degree of red pulp expansion ( [177](#), [178](#) ).

Various myeloproliferative disorders present with splenomegaly without peripheral lymphadenopathy, but the diagnosis is established easily by bone marrow biopsy and the findings on a peripheral blood smear.

Malignant histiocytosis occasionally is associated with splenomegaly as the predominant

manifestation ( [179](#) ). The characteristic cytologic and cytochemical features of the malignant histiocytes and the subsequent course of the disease make the process of differential diagnosis easy.

Rarely, a diagnosis cannot be made for a patient with symptomatic splenomegaly short of splenectomy; these patients may have primary lymphoma of the spleen ( [180](#) , [181](#) ) or, less commonly, primary splenic HCL ( [134](#) , [182](#) ).

Prolymphocytic leukemia may have a presentation very similar to that of HCL, with splenomegaly and minimal or no peripheral lymphadenopathy ( [183](#) ). Prolymphocytic leukemia can usually be distinguished from HCL in that the nuclear chromatin is more clumped than in hairy cells, the level of peripheral lymphocytosis is high, the TRAP stain is negative or only weakly positive, and expansion of the white pulp in the spleen is evident. The immunologic profile is slightly different; prolymphocytic leukemia cells are CD25<sup>-</sup>, CD11c<sup>-</sup>, and CD5<sup>+/-</sup> ( [165](#) , [183](#) ).

LGL leukemia frequently presents with splenomegaly without peripheral lymphadenopathy ( [184](#) ). The disease is characterized by the presence of cells that are bigger than CLL cells and have abundant cytoplasm containing azurophilic granules. Large granular lymphocytes may be CD3<sup>-</sup> NK cells that mediate non-major histocompatibility complex-restricted cytotoxicity, or they may be CD3<sup>+</sup> cells that mediate non-major histocompatibility complex-restricted cytotoxicity ( [185](#) ). T-LGL leukemia is associated with neutropenia (which may be cyclical), red cell aplasia, and rheumatoid arthritis but is a distinct entity from Felty syndrome ( [184](#) ). The usual immunophenotyping of T-LGL leukemia is CD3<sup>+</sup>, CD4<sup>-</sup>, CD8<sup>+</sup>, CD16<sup>+</sup>, CD56<sup>-</sup>, CD57<sup>+</sup>, and TCRαβ<sup>+</sup>. NK-LGL leukemia occurs most frequently in Japan and has an acute fulminant course with high fever, hepatosplenomegaly, and pancytopenia. However, chronic NK-LGL leukemia can occur with clinical features similar to those of T-LGL leukemia ( [184](#) ). These cells are usually CD3<sup>-</sup>, CD4<sup>-</sup>, CD8<sup>-</sup>, CD16<sup>+</sup>, CD56<sup>+</sup>, and CD57<sup>-</sup> ( [184](#) , [185](#) ).

Systemic mast cell disease, in which splenomegaly may be a prominent feature, rarely presents a problem in differential diagnosis, except for the appearance of the mast cell infiltrates in tissue sections that can closely mimic HCL ( [186](#) ).

More recently, a condition called *hairy B-cell lymphoproliferative disorder* (HBLD) has been described in five patients from Japan ( [187](#) , [188](#) ). All patients were middle-aged women who presented with clinical and laboratory features consistent with the HCL variant and had a polyclonal increase in IgG. However, the hairy cells were polyclonal. This condition is thus similar to persistent polyclonal B-cell lymphocytosis, a rare and benign condition seen typically in middle-aged female smokers with a familial tendency ( [189](#) , [190](#) and [191](#) ). The lymphocytes are binucleated and have abundant cytoplasm. There is a polyclonal increase in Igs and a strong association with HLA-DR7 ( [189](#) ). However, HBLD differs from persistent polyclonal B-cell lymphocytosis in that (a) the patients in HBLD are not smokers; (b) there is a polyclonal increase in IgG in HBLD as opposed to the polyclonal increase in IgM seen with persistent polyclonal B-cell lymphocytosis; (c) the cells in HBLD are not binucleated and are CD11c<sup>+</sup>; and (d) there is no association with HLA-DR7 in HBLD ( [187](#) , [188](#) , [189](#) , [190](#) and [191](#) ).

## TREATMENT



Although splenectomy used to be the standard treatment for HCL, therapy for this disease has been transformed over the past 20 years with the development of IFN- $\alpha$  and the nucleoside analogs ( [192](#), [193](#) and [194](#) ). Splenectomy and IFN- $\alpha$  may still be used for HCL under specific circumstances, but the standard therapy consists of the nucleoside analogs dCF or CdA, which produce complete and durable remissions in the majority of patients ( [192](#), [193](#) and [194](#) ). More recently, it has been demonstrated that the monoclonal antibody rituximab, which is directed against CD20, and the immunotoxins LMB-2 and BL22, which are directed against CD25 and CD22, respectively, have significant activity against nucleoside-resistant HCL ( [195](#), [196](#), [197](#), [198](#), [199](#) and [200](#) ).

## Splenectomy

Until the mid-1980s, the standard therapy for HCL was splenectomy ( [5](#), [195](#), [196](#), [197](#) and [198](#) ). The variable degree of pancytopenia in all patients during the course of their disease is to a great extent a direct result of splenomegaly ( [86](#), [87](#), [88](#), [89](#) and [90](#) ). An enlarged spleen may be responsible for the development of peripheral cytopenias by one or more of three mechanisms: increased sequestration or pooling, increased rate of peripheral destruction, or dilution of the cellular elements in the peripheral blood by an expanded plasma volume ( [88](#) ). Other clinical manifestations, such as hypermetabolism, weight loss, early satiety, and left upper quadrant abdominal discomfort, are also caused by splenomegaly ( [88](#) ). Occasional patients may achieve a CR with splenectomy, and these patients may have a pure “splenic” form of HCL ( [2](#), [145](#) ). Approximately two-thirds of patients have a hematologic response with splenectomy; this results in an improvement in the quality of their lives. In addition, splenectomy also alleviates early satiety, weight loss, and abdominal discomfort ( [5](#) ). However, it is unclear whether this procedure prolongs survival, as all the studies are retrospective, and, because of the obvious clinical benefit of splenectomy, randomized prospective trials have not been carried out ( [5](#) ). Early studies, with small numbers of patients, demonstrated no overall improvement in survival for patients after splenectomy ( [195](#), [196](#) ). However, in a large, multicenter retrospective analysis of 391 patients, a highly significant survival advantage (  $p < .0001$  ) was demonstrated for those patients who underwent splenectomy ( [197](#) ). In the multicenter analysis, a CR, defined as a postsplenectomy hemoglobin greater than 110 g/L, neutrophils greater than  $1 \times 10^9$ /L, and platelets greater than  $100 \times 10^9$ /L, was achieved in 40% of patients ( [197](#) ). An increase was noted in the hemoglobin in 92%, neutrophils in 84%, and platelets in 92% of patients ( [197](#) ). Jansen et al. ( [197](#) ) also reported that patients with larger spleens responded better than those with smaller spleens, but this has been disputed ( [198](#) ). The duration of response after splenectomy is variable, but some patients remain asymptomatic for years. Approximately one-third, however, achieves only a minimal response or relapse within a few months. In an analysis of prognostic variables after splenectomy in 194 patients, the most important were bone marrow cellularity and the platelet count ( [199](#) ). *Failure-free survival*, defined as time from splenectomy to death or the need for more therapy, was significantly worse if the postoperative bone marrow cellularity was greater than or equal to 85% or the platelet count was less than  $60 \times 10^9$ /L, or both ( [199](#) ).

Although splenectomy is now rarely required in HCL, it may be of value for (a) patients with splenic rupture; (b) patients with the pure “splenic” form of the disease; and (c) patients with splenomegaly and profound thrombocytopenia, having megakaryocytes in the marrow ( [5](#) ).

## Interferon- $\alpha$

IFN- $\alpha$ , both the natural form and the two recombinant forms (IFN- $\alpha$ 2a and IFN- $\alpha$ 2b), is effective in the treatment of HCL ( [192](#), [200](#), [201](#), [202](#), [203](#), [204](#), [205](#), [206](#), [207](#) and [208](#) ), and a recent study has provided insight into the mechanism for this activity ( [209](#) ). IFN- $\alpha$  has been shown to induce apoptosis in nonadherent hairy cells; this is related to an increase in the production of TNF by the hairy cells associated with sensitization of the hairy cells to TNF- $\alpha$  ( [209](#) ). The sensitization is due to a decrease in the levels of inhibitors of apoptosis by IFN- $\alpha$ . Interestingly, IFN- $\alpha$  does not induce apoptosis in hairy cells adhering to vitronectin or fibronectin, because IFN- $\alpha$  does not affect the inhibitors of apoptosis in adherent cells. The receptors for TNF- $\alpha$  are not changed by IFN- $\alpha$ . These results may explain why IFN- $\alpha$  can clear hairy cells rapidly from the bloodstream, but not from the tissues, in which the leukemic cells presumably are adherent.

After the observation that remissions could be obtained with IFN- $\alpha$ , it became necessary to define responses ( [192](#) ). A CR was defined as normalization of the peripheral blood counts (hemoglobin  $>120$  g/L, platelets  $>100 \times 10^9$ /L, and neutrophils  $>1.5 \times 10^9$ /L) with less than 5% hairy cells in the marrow ( [192](#) ). A PR was defined as the normalization of peripheral blood counts and the persistence of more than 5% hairy cells in the marrow; however, treatment must have produced a greater than 50% fall in the hairy cell infiltration in marrow ( [192](#) ). The aggregate results of 13 studies show that the overall response rate with IFN- $\alpha$  is approximately 80%, with 13% having a CR and 69% having a PR ( [192](#), [207](#), [208](#) and [209](#) ). Responding patients have a reduced incidence of infections, even if they remain neutropenic ( [200](#), [201](#) and [202](#), [205](#) ). The responses occur rapidly, regardless of whether the patients have previously had a splenectomy, with hairy cells disappearing from the peripheral blood within the first week; the platelet counts return to normal within 2 months, the hemoglobin level within 4 months, and the neutrophil counts within 4 to 6 months ( [200](#), [205](#) ). The percentage of hairy cells in the bone marrow decreases, but they rarely disappear completely, and the reticulin fibrosis persists ( [210](#), [211](#) ). Patients with CD5<sup>+</sup> hairy cells ( [212](#) ) and HCL-variant patients ( [160](#) ) respond poorly to IFN- $\alpha$ .

The optimal dose schedule to maximize response and prevent relapse has yet to be established. In most series, the dose is  $2$  to  $4 \times 10^6$  U/m<sup>2</sup> SC three to seven times weekly for 12 months. Higher doses do not appear to increase the response rate and are associated with more severe toxic reactions ( [204](#), [213](#) ). In addition, extending the treatment beyond 12 months does not improve the response rate, and the development of a chronic fatigue syndrome is more prevalent and severe ( [214](#) ). Doses 1 log lower ( $2 \times 10^5$  U/m<sup>2</sup> three times weekly) show activity, but the response is inferior to that achieved with higher IFN- $\alpha$  doses ( [215](#) ). However, the relapse rate is high (33 to 77%) after the discontinuation of IFN- $\alpha$ , usually 6 to 31 months after cessation of therapy ( [192](#), [206](#), [216](#) ). It has been demonstrated that maintenance low-dose IFN- $\alpha$  ( $1 \times 10^6$  U, three times/week, or  $3 \times 10^6$  U, once a week) can prolong remissions with minimal toxicity ( [209](#), [217](#), [218](#) ). In one study, patients received either no maintenance therapy or  $1 \times 10^6$  U IFN- $\alpha$  three times/week; 37 of the 56 patients who did not receive maintenance therapy relapsed in a median time of 19 months, whereas none of the 28 patients receiving maintenance therapy relapsed, with the median follow-up time being 30 months ( [217](#) ). When patients relapse after IFN- $\alpha$  therapy, a further remission can generally be obtained with IFN- $\alpha$  ( [217](#), [218](#) ) or the nucleoside analogs ( [192](#), [193](#) and [194](#) ). In addition, patients who relapse after therapy with the nucleoside analogs respond to IFN- $\alpha$ , confirming the lack of



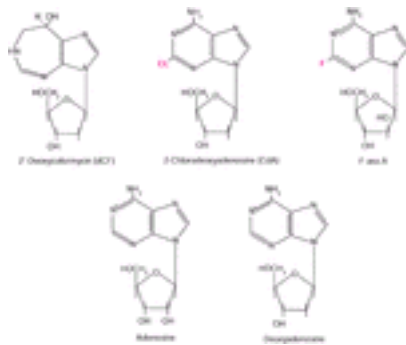
cross-reactivity between these agents ( [219](#) ).

Neutralizing anti-IFN antibodies appear to develop in one-third of patients treated with IFN- $\alpha$ 2a ( [220](#) ), but this does not occur with IFN- $\alpha$ 2b ( [221](#) ). The clinical significance of these neutralizing antibodies and their role in the induction of resistance to therapy are controversial. In 51 patients with HCL treated with IFN- $\alpha$ 2a, 31 (61%) developed antibodies after a median of 6 months of therapy, and in 16 of these, the antibodies neutralized the antiviral activity of recombinant IFN- $\alpha$ 2a *in vitro* but had no effect on natural IFN- $\alpha$  ( [220](#) ). Interestingly, six of the patients with antibodies were clinically resistant to IFN- $\alpha$ , whereas none of the patients without antibodies were resistant. However, in a follow-up study, no further patients were noted to have developed antibodies, and antibodies to IFN could no longer be detected in patients who previously had antibodies, although they continued to receive IFN- $\alpha$  ( [222](#) ).

Virtually all patients experience toxicity with IFN- $\alpha$  therapy, and the frequency and severity are dose and age related ( [192](#), [200](#), [201](#), [202](#), [203](#), [204](#), [205](#) and [206](#), [213](#) ). Flulike symptoms occur in most patients with the initiation of treatment; these symptoms can usually be controlled with acetaminophen or by reducing the IFN- $\alpha$  dosage, and symptoms usually resolve within 2 to 4 weeks. Less common symptoms include nausea and vomiting; diarrhea; central nervous system manifestations such as somnolence and confusion; cardiovascular disorders including hypotension and tachycardia; and skin changes such as rash and pruritus ( [213](#) ). With high doses, leukopenia, thrombocytopenia, and anemia may occur, but this is rare with the doses of IFN- $\alpha$  used for HCL. A worsening of preexisting autoimmune disorders, or the emergence of new autoimmune problems, has also been reported with IFN- $\alpha$  therapy; this appears to be related to the development of multiple autoantibodies ( [223](#) ). In most reports, patients developed thyroiditis, autoimmune thrombocytopenia, or anemia ( [224](#), [225](#) ). Kampmeier et al. ( [226](#) ) reported an increased incidence of second malignancies in HCL patients treated with IFN. Of 69 patients treated with IFN- $\alpha$ 2b for 12 to 18 months, 13 (19%) developed second malignancies; this incidence was substantially higher than predicted. Six of the tumors were hematologic, and seven were adenocarcinomas. The tumors developed 17 to 105 months after the initiation of IFN- $\alpha$ . However, these results have not been confirmed, and no increase in the incidence of second malignancies was observed in 200 HCL patients in another study, of which 147 had been treated with IFN- $\alpha$  ( [227](#) ).

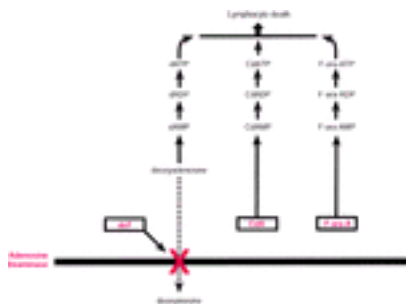
## Nucleoside Analogs

The nucleoside analogs dCF (pentostatin; Nipent, SuperGen, San Ramon, CA), CdA (cladribine; Leustatin, Ortho Biotech, Raritan, NJ), and fludarabine (F-ara-A AMP; Fludara, Berlex Laboratories, Richmond, CA) have significant activity in the low-grade lymphoid malignancies ( [Fig. 93.4](#) ) ( [192](#), [193](#) and [194](#) ). Both dCF and CdA have now replaced IFN- $\alpha$  as first-line therapy for HCL, and fludarabine is now one of the standard treatments for CLL.

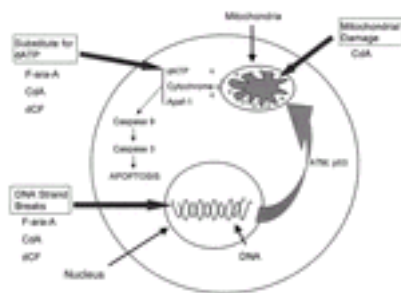


**Figure 93.4.** Structures of nucleoside analogs.

After therapy with dCF, deoxyadenosine and adenosine accumulate in the plasma; after uptake into cells, deoxyadenosine is phosphorylated to deoxyadenosine monophosphate, deoxyadenosine diphosphate, and deoxyadenosine triphosphate (dATP); this occurs preferentially in lymphocytes (228). The intracerebral accumulation of deoxyadenosine and adenosine likely causes the nausea and vomiting that are a major toxicity of this agent (229). CdA and F-ara-A are halogenated derivatives of deoxyadenosine that are resistant to degradation by adenosine deaminase. For clinical use, F-ara-A is administered as the more water-soluble monophosphate, F-ara-AMP (fludarabine), which is rapidly dephosphorylated in the plasma to F-ara-A (230, 231). Like deoxyadenosine, CdA and F-ara-A accumulate in lymphocytes as their phosphorylated derivatives and can kill lymphocytes in three ways (Fig. 93.5 and Fig. 93.6) (232, 233). First, the triphosphate forms can trigger DNA breaks, which result in the release of cytochrome *c* from the mitochondria; the released cytochrome *c* interacts with Apaf-1 and dATP, causing the activation of caspase 9 and, subsequently, apoptosis. Second, the increased levels of triphosphates can enhance the effects of endogenous dATP on the apoptosome, inducing apoptosis. Finally, CdA differs from the other two drugs in that it is phosphorylated by deoxyguanosine kinase in the mitochondria to CdATP, which is directly toxic to the mitochondria.



**Figure 93.5.** Metabolism of the nucleoside analogs. ADP, adenosine diphosphate; AMP, adenosine monophosphate; ATP, adenosine triphosphate; CdA, 2-chlorodeoxyadenosine; d, deoxy; dCF, 2'-deoxycofomycin.



**Figure 93.6.** Mechanism of action of the nucleoside analogs. CdA, 2-chlorodeoxyadenosine; dATP, deoxyadenosine triphosphate; dCF, 2'-deoxycofomycin. (Modified from Genini D, Adachi S, Chao Q, et al. Deoxyadenosine analogs induce programmed cell death in chronic lymphocytic leukemia cells by damaging the DNA and by directly affecting the mitochondria. *Blood* 2000;96:3537–3543, with permission.)

dCF is highly effective in HCL and produces a much higher rate of durable CR than is observed with IFN- $\alpha$  ( [Table 93.6](#) ) ( [234](#) ). dCF has been administered in a variety of different doses and schedules for HCL, but regardless of the mode of administration, it produces responses in most patients. Of 960 patients in nine studies, the CR rate ranged from 44 to 89% (median, 76%), and the PR rate varied from 0 to 52% (median, 16%) ( [234](#) , [235](#) , [236](#) , [237](#) , [238](#) , [239](#) , [240](#) , [241](#) and [242](#) ). Patients who relapse after splenectomy or who are resistant to IFN- $\alpha$  also respond to dCF, with a median CR rate of 42% and a PR rate of 45% ( [242](#) , [243](#) and [244](#) ). In two large studies, the response rates to dCF were similar in untreated patients and in patients treated with IFN- $\alpha$  ( [234](#) , [241](#) ). Moreover, these studies identified young age, initial high hemoglobin, high white cell count, and little or no splenomegaly as favorable prognostic features ( [234](#) , [241](#) ). The most commonly used treatment regimen is dCF 4 mg/m<sup>2</sup> every second week; the average number of treatments to CR is 8 (range, 4 to 15) ( [234](#) , [237](#) ). The peripheral blood lymphocyte count falls rapidly after the initiation of treatment, with the hairy cell count decreasing by 50 to 95% in the first week ( [245](#) ). Concomitantly, there is a rapid increase in platelets followed by recovery of neutrophils and hemoglobin; the median time to documented peripheral and marrow CR is 4 months ( [245](#) ). In contrast to IFN- $\alpha$ , there is resolution of the marrow fibrosis after therapy with dCF ( [245](#) , [246](#) ). Using immunophenotyping of peripheral blood or bone marrow, immunohistochemistry of the bone biopsy, or gene rearrangement studies, one can detect residual hairy cells in HCL patients who are in morphologic CR after dCF, suggesting that dCF cannot entirely eliminate the hairy cell population ( [246](#) , [247](#) ). In addition, relapses are observed after discontinuation of treatment without evidence of a plateau, although there is no correlation between the extent of residual disease and the time to relapse. However, the duration of remissions is considerably longer than for IFN- $\alpha$  ( [234](#) , [238](#) , [245](#) , [248](#) , [249](#) and [250](#) ).

**TABLE 93.6. Response Rates of Standard Treatments for Hairy Cell Leukemia**

| Drug                 | Author (Reference)                  | Dose and Schedule   | Number of Patients | Complete Response (CR) (%) | Partial Response (%) |
|----------------------|-------------------------------------|---|--------------------|----------------------------|----------------------|
| Interferon- $\alpha$ | Spielberger ( <a href="#">216</a> ) | $2 \times 10^6$ U/m <sup>2</sup> SC; 3 $\times$ /wk for 12 or 18 mo | 68                 | 13                         | 62                   |

|                        |                                   |   |     |    |    |
|------------------------|-----------------------------------|---|-----|----|----|
|                        | Grever ( <a href="#">234</a> )    | 3 × 10 <sup>6</sup> U SC;<br>3 × /wk for 12<br>mo                                 | 159 | 11 | 27 |
|                        | Rai ( <a href="#">208</a> )       | 2 × 10 <sup>6</sup> U SC;<br>3 × /wk for 12<br>mo                                 | 55  | 24 | 49 |
| 2'-Deoxycycoformycin   | Spiers ( <a href="#">236</a> )    | 5 mg/m <sup>2</sup> IV daily<br>× 2; repeated<br>every 14 days<br>until CR        | 27  | 59 | 37 |
|                        | Johnston ( <a href="#">235</a> )  | Cycles (4 mg/m <sup>2</sup><br>IV/wk × 3);<br>q8wk until CR +<br>2 further cycles | 28  | 89 | 11 |
|                        | Grever ( <a href="#">234</a> )    | 4 mg/m <sup>2</sup> IV<br>q2wk; until CR +<br>2 to max 12 mo                      | 154 | 76 | 3  |
|                        | Maloisel ( <a href="#">241</a> )  | 4 mg/m <sup>2</sup> IV<br>q2wk until max<br>response or<br>failure                | 230 | 79 | 16 |
| 2-Chlorodeoxyadenosine | Cheson ( <a href="#">264</a> )    | 0.1 mg/kg/day<br>cont IV × 7<br>days  | 861 | 50 | 37 |
|                        | Saven ( <a href="#">265</a> )     | 0.1 mg/kg/day<br>cont IV × 7<br>days  | 349 | 91 | 7  |
|                        | Juliusson ( <a href="#">276</a> ) | 3.4 mg/m <sup>2</sup> SC<br>daily × 7 days  | 73  | 81 | 14 |
|                        | Robak ( <a href="#">275</a> )     | 0.1 mg/kg/day IV<br>over 2 h × 5 or<br>7 days                                     | 23  | 83 | 17 |
|                        | Lauria ( <a href="#">279</a> )    | 0.15 mg/kg IV<br>over 2 h weekly<br>× 6   | 30  | 73 | 27 |

cont, continuous; max, maximum.

A number of studies have evaluated the long-term outcome of patients treated with dCF ( [240](#), [241](#), [249](#), [250](#), [251](#), [252](#) and [253](#) ) ( [Table 93.7](#) ). The longest follow-up is provided by the National Cancer Institute of Canada study, in which 28 patients have been followed for a median of 125 months (range, 61 to 137 months) ( [252](#) ). Nine (36%) of the 25 patients who achieved a CR have relapsed at a median time of 49 months (range, 15 to 122 months). The largest study was a phase III intergroup study, in which patients were randomized to receive dCF, 4 mg/m<sup>2</sup> IV every 2 weeks, or IFN- $\alpha$ , 3 × 10<sup>6</sup> U SC three times a week ( [234](#), [253](#) ). Patients not responding to one treatment were switched to the other agent. Two hundred and forty-one patients received dCF and have been followed for a median of 9.3 years; 154 received dCF as initial therapy, and 87 received dCF after failure with IFN- $\alpha$ . For all patients, the estimated 5- and 10-year survivals were 90 and 81%, similar to those

predicted for the general population. The survival was similar whether patients were treated initially with dCF or were crossed over to dCF after treatment with IFN- $\alpha$  ( [Fig. 93.7A](#)). Patients younger than 55 years of age did significantly better than patients 55 years of age or older, and the 10-year survivals for the two groups were 93 and 68%, respectively ( [Fig. 93.7B](#)). Similarly, in a large multicenter retrospective study from France, the estimated survivals at 5 and 10 years in 230 evaluable patients treated with dCF were both 89% ( [241](#)). In that study, a hemoglobin less than 100 g/L, a white cell count less than  $2 \times 10^9$ /L, and lymphadenopathy were associated with decreased survival.

**TABLE 93.7. Long-Term Follow-Up of Patients with Hairy Cell Leukemia**

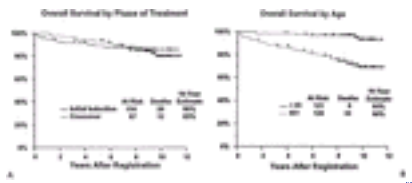
| Drug                   | Author (Reference)               | Number of Patients | Number Alive | Median Follow-Up Months (Range) | Number of Relapses after Complete Response (%) | Median Complete Response Duration for Relapsed Patients (Mo) |
|------------------------|----------------------------------|--------------------|--------------|---------------------------------|--|--|
| Interferon- $\alpha$   | Grever ( <a href="#">234</a> )   | 159                | 152          | 57 (19–82)                      | 12 (70)  | (9–27)   |
| 2'-Deoxycytosine       | Kraut ( <a href="#">249</a> )    | 24                 | 23           | 82 (54–104)                     | 11 (48)  | 30 (7–80)  |
|                        | Dearden ( <a href="#">251</a> )  | 165                | NA           | 71 (6–139)                      | 40 (24)  | 51.5 (14–105)  |
|                        | Johnston ( <a href="#">252</a> ) | 28                 | 23           | 125 (61–137)                    | 9 (36)   | 49 (15–122)  |
|                        | Flinn ( <a href="#">253</a> )    | 241                | 201          | 112 (19–139)                    | 32 (18)  | NA   |
| 2-Chlorodeoxyadenosine | Maloisel ( <a href="#">241</a> ) | 238 <sup>a</sup>   | 213          | 63.5 (0.39–138.4)               | 26 (14.3)                                      | 56 (11–89)   |
|                        | Hoffman ( <a href="#">266</a> )  | 49                 | NA           | 55                              | 6 (16)   | 19 (12–55)   |
|                        | Saven ( <a href="#">265</a> )    | 358 <sup>b</sup>   | 337          | 58 (1–134)                      | 76 (24)  | 30 (7–85)  |
|                        | Dearden ( <a href="#">251</a> )  | 45                 | NA           | 45 (9–72)                       | 13 (29)  | 23.5 (7–59)  |
|                        | Tallman ( <a href="#">271</a> )  | 52 <sup>c</sup>    | 48           | NA                              | 5 (12.5)                                       | 24 (12–34)   |
|                        | Lauria ( <a href="#">262</a> )   | 40                 | 40           | NA                              | 5 (17)   | 26 (12–36)   |

NA, not available.

<sup>a</sup> Only 230 evaluable for response.

<sup>b</sup> Only 349 evaluable for response.

<sup>c</sup> Only 50 evaluable for response.



**Figure 93.7. A:** Survival of patients treated initially with 2'-deoxycoformycin (dCF) or after crossover from interferon- $\alpha$ . Survival is similar in both groups ( $p = .59$ ). Figure shows estimated distributions of overall survival (Kaplan-Meier estimates) from date of registration for dCF therapy, by phase of treatment. **B:** Overall survival by age of patients treated with dCF. Survival is significantly better for patients younger than 55 years of age ( $p < .0001$ ). Figure shows estimated distributions of overall survival (Kaplan-Meier estimates) from date of registration for dCF therapy, by age at start of initial therapy. (From Flinn IW, Kopecky KJ, Foucar MK, et al. Long-term follow-up of remission duration, mortality, and second malignancies in hairy cell leukemia patients treated with pentostatin. *Blood* 2000;96:2981–2986, with permission.)

dCF is generally well tolerated, although nausea and vomiting and lethargy can occur ( 234 , 235 , 236 , 237 , 238 , 239 , 240 , 241 and 242 ). Drug-induced neutropenia with fever commonly occurs with initiation of treatment ( 235 , 248 ), and deaths from infection have occurred ( 248 ). However, for patients receiving 4 mg/m<sup>2</sup> dCF every 2 weeks, infections can be avoided by delaying the treatments if the white blood count is less than  $1.5 \times 10^9/L$  ( 237 ). dCF decreases the number of T cells to a greater extent than that of B cells, and CD4<sup>+</sup> cells are affected to a greater extent than CD8<sup>+</sup> cells or NK cells, whereas Ig levels are not affected ( 246 , 254 , 255 and 256 ). The CD4<sup>+</sup> and CD8<sup>+</sup> cell counts fall to less than  $0.2 \times 10^9/L$  during therapy ( 246 , 254 , 255 ); after discontinuation of dCF, the CD4<sup>+</sup> counts gradually recover and normalize in 3.0 to 49.5 months (median, 14.5 months) ( 246 ). The CD8<sup>+</sup> and B cells recover at the same rate ( 246 , 254 , 255 ). Associated with the decrease in T cells during therapy is an increase in the incidence of herpetic infections, which are easily treated with acyclovir, and there is a gradual decrease in the incidence after discontinuation of therapy ( 246 , 254 , 255 ). However, there is no increase in more unusual opportunistic infections, either during therapy or during long-term follow-up, and there is no evidence of a significant increase in second malignancies ( 249 , 250 ). Although neurotoxicity is a problem with high doses of dCF ( 257 ), the major neurologic problems encountered with the doses of dCF used in HCL are nausea and vomiting and somnolence ( 234 , 235 , 236 , 237 , 238 , 239 , 240 , 241 and 242 ).

CdA appears to have activity equivalent to that of dCF in HCL, and it has the advantage of rarely causing nausea and vomiting ( Table 93.6 ) ( 258 , 259 , 260 , 261 and 262 ). In initial studies, CdA was administered by continuous infusion, as *in vitro* studies indicated that a prolonged exposure to CdA was required for cytotoxic effect ( 263 ). Thus, most early clinical trials in HCL used CdA 0.1 mg/kg/day by continuous infusion for 7 days ( 263 ). From eight studies comprising 1552 patients, the CR rate ranged from 50 to 91% (median, 78%), and the PR rate varied from 0 to 37% (median, 16%) ( 258 , 259 , 260 , 261 and 262 , 264 , 265 and 266 ). As with dCF, there was a rapid recovery in blood counts, with the platelet count increasing almost immediately, followed by an increase in neutrophils and hemoglobin ( 258 , 259 , 260 , 261 and 262 ). Some patients achieved a CR with normal blood counts, whereas the marrows remained hypocellular ( 267 ). Technetium 99m sulfur colloid scans have demonstrated increased uptake in the distal appendicular skeleton in some of these patients, suggesting abnormal areas of hematopoiesis ( 267 ). Although hairy cells may not



be seen in the marrow 3 to 4 months after CdA treatment ( [262](#), [263](#) ), the leukemic cells can still be detected by immunostaining, using the monoclonal antibody, DBA.44 ( [267](#), [268](#) ), or by using the polymerase chain reaction with clonospecific probes for heavy-chain Ig genes ( [269](#) ). When marrows were intermittently examined by DBA.44 for 25 months after treatment with CdA, there was no increase in the number of hairy cells in the marrow in most cases, suggesting stabilization of residual disease ( [268](#) ). However, others have suggested that the presence of residual disease is predictive of relapse ( [270](#) ). As CdA was developed after dCF, there is less information related to the long-term effectiveness of CdA as compared to dCF ( [251](#), [262](#), [265](#), [266](#), [271](#) ) ( [Table 93.7](#) ). However, Dearden et al. ( [251](#) ) have found that relapses occur significantly earlier in patients treated with CdA compared to those treated with dCF ( [Table 93.7](#) ). In a large long-term study from the Scripps Clinic, 91% of patients achieved a CR with CdA, and these 349 patients were followed for a median of 52 months (range, 1 to 134 months) ( [265](#) ). Twenty-four percent of these patients relapsed at a median time of 30 months (range, 7 to 85 months). The overall survival at 48 months was 96%.

A number of patients who were resistant to dCF have obtained remissions with CdA, suggesting a possible lack of cross-resistance between these agents ( [241](#), [272](#) ). This may be related to the additional action of CdA on the mitochondria of the leukemia cells ( [232](#), [233](#) ).

There has been interest in investigating different modes of CdA administration to simplify the treatment and minimize toxicity. Liliemark et al. ( [273](#) ) demonstrated an identical “area under the curve” for drug concentration versus time using the same CdA concentration given by continuous infusion, as a 2-hour infusion, or given orally using twice the IV dose. Similar responses have been obtained with CdA in HCL using 0.1 mg/kg IV over 2 hours daily  $\times$  5 ( [274](#), [275](#) ) or 0.1 mg/kg SC daily  $\times$  7 ( [276](#), [277](#) ) and when the drug was administered as 0.1 mg/kg/day by continuous infusion  $\times$  7. In addition, lower doses of CdA (e.g., 2 mg/m<sup>2</sup> SC daily  $\times$  5) ( [278](#) ) or altered schedules (e.g., 0.15 mg/kg IV each week) ( [279](#), [280](#) ) appear to be as effective and less toxic than the traditional schedule of CdA ( [258](#), [259](#), [260](#), [261](#) and [262](#), [264](#), [265](#) and [266](#) ). In particular, the weekly regimen is associated with significantly less myelosuppression and risk of infection and hospitalization than the continuous infusion regimen, with efficacy equivalent to that of the standard regimen ( [279](#), [280](#) ).

CdA can be toxic and was implicated as the cause of deaths in the National Cancer Institute group C phase II study in 1.1% of 979 patients ( [264](#) ). The major CdA toxicity is marrow suppression, and one-third to one-half of patients develop severe neutropenia with infections and often required prolonged blood support after therapy ( [258](#), [259](#), [260](#), [261](#) and [262](#), [264](#), [265](#) and [266](#), [281](#) ). This problem is not prevented by prophylactic antibiotics, and, although an infectious cause for the fever is not found in most cases, affected patients usually require hospitalization for septic work-up and antibiotics ( [264](#), [278](#) ). The likelihood of this complication occurring increases with the severity of initial marrow involvement, and it has been suggested that these patients should initially be treated with IFN- $\alpha$  ( [281](#) ). Alternatively, to reduce the risk of infections, granulocyte colony-stimulating factor has been administered using 5  $\mu$ g/kg/day SC on days -3, -2, and -1 before a standard 7-day course of CdA, and then after CdA until the neutrophil count was above  $2 \times 10^9$ /L for 2 consecutive days ( [282](#) ). Although granulocyte colony-stimulating factor increased the neutrophil count before therapy and reduced the severity of neutropenia after CdA, there was no decrease in the number of febrile episodes and the number of hospitalizations for



antibiotics. An identical phenomenon is observed after treatment of HCL with dCF ( [235](#), [248](#) ), and it has been suggested that the fever is related to tumor lysis and the release of cytokines by the tumor ( [261](#) ). However, infections, sometimes opportunistic, do occur in some of these patients, and deaths have been reported ( [260](#), [278](#) ). Like dCF, CdA produces a profound fall in CD4<sup>+</sup> and CD8<sup>+</sup> cells after treatment, and although CD8<sup>+</sup> cell counts may recover within 3 months, the CD4<sup>+</sup> count may take longer than 3 years to normalize ( [283](#), [284](#) ). Despite this, there have, to date, been no long-term problems with opportunistic infections after therapy with CdA ( [256](#), [261](#) ). Significant neurotoxicity has also been observed with CdA and includes neuropathies affecting the legs or arms ( [264](#) ). Transfusion-associated graft-versus-host disease has been observed with multiple cycles of CdA or fludarabine in low-grade lymphomas and CLL ( [285](#), [286](#) ), but, to the author's knowledge, this has not yet been observed in HCL.

Fludarabine has not yet been evaluated extensively in HCL. However, complete and partial responses have been observed in the few patients treated so far ( [287](#), [288](#) ).

### Monoclonal Antibodies

Monoclonal antibody therapy is an attractive option for HCL, as many of these patients have significant neutropenia at the time of diagnosis; in contrast to chemotherapy, this should not be worsened by antibodies. The chimeric monoclonal antibody rituximab (Rituxan; Genentech, Inc., South San Francisco, and IDEC Pharmaceuticals, San Diego, CA) contains a human IgG1 Ig constant region and a murine variable region directed against the cell-surface CD20, an antigen that plays an important role in the activation, proliferation, and differentiation of B cells ( [289](#) ). This agent has shown significant activity against the low-grade lymphomas, which have high surface concentrations of CD20, and is believed to exert its antitumor activity through activation of complement (complement-mediated cytotoxicity), antibody-dependent cell-mediated cytotoxicity, or the direct induction of apoptosis ( [289](#), [290](#) and [291](#) ). In two preliminary studies, rituximab, 375 mg/m<sup>2</sup> IV once a week for 4 weeks, produces a response rate of approximately 50% in HCL patients with relapsed or progressive disease, with a variable number of these being CRs ( [292](#), [293](#) ).

Kreitman and colleagues have developed two immunotoxins, LMB-2 and BL22, directed against CD25 and CD22, respectively ( [294](#), [295](#) and [296](#) ). LMB-2 contains the variable heavy and light chain regions against CD25 linked to a truncated *Pseudomonas* exotoxin, and cell death is induced once the exotoxin is internalized ( [294](#), [295](#) ). Of four nucleoside-resistant HCL patients, one achieved a CR and three a PR with LMB-2 ( [294](#), [295](#) ). Sixteen CdA-resistant HCL patients were treated with BL22, and 11 achieved a CR and 2 a PR ( [296](#) ). Interestingly, 7 of the 11 complete responders had never achieved a CR with the nucleoside analogs, and none of the other 4 patients had achieved a CR longer than 6 months with CdA. Moreover, all three patients with the HCL variant achieved a CR with BL22. With a median follow-up of 16 months (range, 10 to 23 months), 3 of the 11 patients relapsed, and all had a second CR with retreatment.

**OTHER TREATMENTS** As HCL is now so easily and effectively treated with the nucleoside analogs, IFN- $\alpha$ , or the monoclonal antibodies, other treatments have become redundant. However, for completeness and interest, they are reviewed briefly.

Chlorambucil was most frequently used when the disease progressed after splenectomy ( [297](#), [298](#) ). Although some patients improved, the course in others was often worse, with

more myelosuppression. The best results were reported by Golomb et al. ( 298 ), who administered chlorambucil, 4 mg orally/day for at least 6 months, to 24 postsplenectomy patients with progressive disease. A reduction in the number of circulating hairy cells and an increase in one or more of the normal peripheral blood cellular elements occurred in most patients. Six deaths occurred, and time to response was 6 months or longer. Other chemotherapeutic agents, either alone or in combination, have demonstrated some benefit, but the toxic effects were often severe ( 299 , 300 ). These agents included doxorubicin ( 301 ), rubidazole ( 302 ), combinations of rubidazole, cytarabine, and cyclophosphamide, or cytarabine and cyclophosphamide ( 303 ). PRs also have been reported with androgens ( 304 , 305 ), as well as with a combination of lithium carbonate and immunotherapy with Calmette–Guérin bacillus ( 306 ). A transient increase in neutrophils can be obtained with granulocyte colony–stimulating factor and may be a useful adjunct to more definitive therapy ( 282 , 307 ). Steroids are ineffective and increase the risk of infection ( 4 ).

**BONE MARROW TRANSPLANTATION** One case of successful bone marrow transplantation from an identical twin has been reported ( 309 ).

**LEUKAPHERESIS** Clinical and hematologic improvements, lasting as long as 26 months, have been reported by using leukapheresis to reduce the number of hairy cells in the peripheral blood ( 309 , 310 ). However, others have found the responses less predictable and more transient ( 311 ).

**RADIATION THERAPY** Low-dose radiotherapy to the spleen can produce transient clinical and hematologic improvements, but the response is slow and unpredictable ( 312 ). However, radiation therapy can be effective for the treatment of massive retroperitoneal lymphadenopathy and lytic bone lesions ( 313 ).

## SUMMARY

Patients with HCL may not require therapy for many years but should be considered for treatment if they are symptomatic or if there is significant pancytopenia (hemoglobin <110 g/L, platelets <100 × 10<sup>9</sup>/L, or neutrophils <1 × 10<sup>9</sup>/L).

The standard therapy for HCL is with one of the nucleoside analogs, dCF or CdA, which appear to have equal efficacy and produce CRs in the majority of patients. The greatest experience has been with dCF, which is usually administered as 4 mg/m<sup>2</sup> IV every second week until CR, followed by two additional treatments for consolidation. The majority of patients achieve a CR with this drug, and the 5- and 10-year survivals are similar to those of the control population. CdA appears to have similar efficacy as dCF and traditionally has been administered as 0.1 mg/kg/day × 7, by continuous infusion. However, the drug appears to be equally effective when administered as daily 2-hour infusions or SC, or on a weekly schedule. Because of the effectiveness of dCF and CdA in HCL and the rarity of this disease, it is unlikely that there will be any prospective studies to compare the efficacy of these two agents and the different treatment regimens.

The major toxicity with the nucleoside analogs is myelosuppression and the risk of infections with initiation of treatment. This is most common in patients with severe marrow impairment; in such cases, it might be preferable to use IFN-α initially to obtain marrow clearing before treatment with a nucleoside analog. Alternatively, weekly CdA might be preferable to the standard 5- or 7-day schedule. The blood counts should be followed closely during and after therapy and with weekly CdA or biweekly dCF; treatments can be held until the neutrophil count has recovered from the previous treatment. Whereas the less-intensive induction regimens can significantly reduce the risk

of neutropenic sepsis with initiation of treatment, it is unknown whether these regimens reduce the likelihood of long-term remissions. A morphologic CR can be obtained in approximately 75% of patients and a PR in 15% of cases, although residual hairy cells can invariably be detected by immunostaining, even with a morphologic CR. Remissions are prolonged, and relapsing patients respond to a second cycle of therapy. It is unclear whether survival is longer for patients who achieve a CR or a PR. Response to CdA and dCF is poorer for patients with the HCL variant and for those with bulky abdominal lymphadenopathy (314). Prognosis for patients treated with dCF is worse for those older than 50 to 55 years of age and those with a hemoglobin less than 10 g/L and white cell counts less than  $2 \times 10^9/L$  (241, 253). Both dCF and CdA should be used with caution in the presence of renal or hepatic dysfunction.

IFN- $\alpha$  ( $3 \times 10^6$  U SC three times/week for 12 months) produces a lower response rate than the nucleoside analogs (8% CR and 74% PR), and relapses occur after discontinuation of the drug. However, IFN- $\alpha$  may be useful initially in patients with an active infection or severe neutropenia.

Initial studies with the monoclonal antibodies against CD20, CD22, and CD25 suggest that these agents may be useful for the treatment of patients refractory to the nucleoside analogs, for patients with a poor marrow reserve, and for patients with the HCL variant.

Two-thirds of patients benefit from splenectomy, but a CR is rare. Splenectomy is required for patients who have a splenic rupture and may be of value for patients with pure "splenic" HCL, as well as for patients who have severe thrombocytopenia with increased numbers of megakaryocytes in the marrow.

## SECOND MALIGNANCIES

There has been controversy as to whether patients with HCL have an increased incidence of malignancies and whether this may be related to therapy (241, 253, 264, 265, 315, 316, 317, 318, 319, and 320). A number of studies have demonstrated an increased incidence of second tumors in HCL, and the incidence appears to be highest in the first 2 years after diagnosis. However, the increase may occur before the diagnosis of HCL, or concurrently, suggesting that these patients have an inherent tendency to develop second malignancies (315, 316, and 317). Kampmeier et al. (316) demonstrated that 19% of 69 patients observed for a median of 91 months after treatment with IFN- $\alpha$  developed a second malignancy, and the authors suggested that the increased incidence was related to the more prolonged survival of these immunocompromised patients rather than an effect of the IFN- $\alpha$ . However, it has been observed more recently that the incidence of second malignancies is less when patients are treated with dCF or CdA than with IFN- $\alpha$ , suggesting that the second malignancies may be directly related to active HCL (319). In 349 patients treated with CdA and a median follow-up of 58 months, 8% developed a second malignancy (primarily solid tumors), a rate 1.8–1.9-fold higher than expected (265). However, Kurzrock et al. (319) observed a 7.4% incidence of second malignancies in 350 HCL patients after a mean follow-up of 7.1 years, and this incidence was not significantly greater than expected and was not influenced by treatment with IFN- $\alpha$  or the nucleoside analogs. Others have made similar observations (241, 253). In a large multicenter prospective crossover study with dCF and IFN- $\alpha$  and a median follow-up of 112 months, there was no increase in the number of second malignancies as compared to that of the control population (253).

## PROGNOSIS

Before the availability of IFN- $\alpha$  and the nucleoside analogs, the median survival of HCL patients followed by Bouroncle (2) was 4.6 years for nonsplenectomized patients and 6.9 years for splenectomized patients, although the range of survival was very broad, with a few patients surviving for a couple of decades from the time of diagnosis. However, prognosis for HCL patients has improved markedly with present therapies, and the predicted 5- and 10-year survival rates for patients treated with dCF are now similar to those of the general population (253). It appears likely that a similar survival benefit will be seen with CdA. However, long-term follow-up is required to determine the relapse rate, the percentage of patients who become resistant to the nucleoside analogs and, subsequently, the monoclonal antibodies, and whether there will be long-term complications from these treatments.

## REFERENCES

1. Bouroncle BA, Wiseman BK, Doan CA. Leukemic reticuloendotheliosis. *Blood* 1958;13:609-630.
2. Bouroncle BA. Leukemic reticuloendotheliosis (hairy cell leukemia). *Blood* 1979;53:412-436.
3. Flandrin G, Sigaux F, Sebahoun G, Boufette P. Hairy cell leukemia: clinical presentation and follow-up of 211 patients. *Semin Oncol* 1984;11:458-471.
4. Golomb HM, Catovsky D, Golde DW. Hairy cell leukemia: a clinical review based on 71 cases. *Ann Intern Med* 1978;89:677-683.
5. Bouroncle BA. Thirty-five years in the progress of hairy cell leukemia. *Leuk Lymphoma* 1994;14[Suppl 1]:1-12.
6. Frassoldati A, Lamparelli T, Federico M, et al. Hairy cell leukemia: a clinical review based on 725 cases of the Italian Cooperative Group (ICGHCL). *Leuk Lymphoma* 1994;13:307-316.
7. Ruiz-Arguelles GJ, Cantu-Rodriguez O, Gomez-Almaguer S, et al. Hairy cell leukemia is infrequent in Mexico and has a geographic distribution. *Am J Hematol* 1996;52:316-318.
8. Stewart DJ, Keating MJ. Radiation exposure as a possible etiologic factor in hairy cell leukemia (leukemic reticuloendotheliosis). *Cancer* 1980;46:1577-1580.
9. Ramseur WL, Golomb HM, Vardiman JW, et al. Hairy cell leukemia in father and son. *Cancer* 1981;48:1825-1829.
10. Mantovani G, Piso A, Santa Cruz G, et al. Familial chronic B-cell malignancy. Hairy cell leukemia in mother and daughter. *Haematologia (Budap)* 1988;21:205-218.
11. Begley CG, Tait B, Crapper RM, et al. Familial hairy cell leukemia. *Leuk Res* 1987;11:1027-1028.
12. Egli FL, Koller B, Furrer J. Hairy cell leukemia and glucose-6-phosphate dehydrogenase deficiency in two brothers. *N Engl J Med* 1990;322:1159.
13. Milligan DW, Stark AN, Bynoe AG. Hairy cell leukemia in two brothers. *Clin Lab Haematol* 1987;9:321-325.
14. Wylin RF, Greene MH, Palutke M, et al. Hairy cell leukemia in three siblings: an apparent HLA-linked disease. *Cancer* 1982;49:538-542.
15. Cordone I, Annino L, Masi S, et al. Diagnostic relevance of peripheral blood immunocytochemistry in hairy cell leukaemia. *J Clin Pathol* 1995;48(10):955-960.

16. Jansen J, Schuit HR, Meijer CJ, et al. Cell markers in hairy cell leukemia studied in cells from 51 patients. *Blood* 1982;59:52-60.
17. Jansen J, den Ottolander GJ, Schuit HRE, et al. Hairy cell leukemia: its place among the chronic B cell leukemias. *Semin Oncol* 1984;11:386-393.
18. Robbins BA, Ellison DJ, Spinosa JC, et al. Diagnostic application of two-color flow cytometry in 161 cases of hairy cell leukemia. *Blood* 1993;82:1277-1287.
19. Cleary ML, Wood GS, Warnke R, et al. Immunoglobulin gene rearrangements in hairy cell leukemia. *Blood* 1984;64:99-104.
20. Korsmeyer SJ, Greene WC, Cossman J, et al. Rearrangement and expression of immunoglobulin genes and expression of Tac antigens in hairy cell leukemia. *Proc Natl Acad Sci U S A* 1983;80:4522-4526.
21. Brito-Babapulle V, Pittman S, Melo JV, et al. The 14q<sup>+</sup> marker in hairy cell leukaemia. A cytogenetic study of 15 cases. *Leuk Res* 1986;10:131-138.
22. Ueshima Y, Alimena G, Rowley JD, Golomb HM. Cytogenetic studies in patients with hairy cell leukemia. *Hematol Oncol* 1983;1:215-226.
23. Naeim F. Hairy cell leukemia: characteristics of the neoplastic cells. *Hum Pathol* 1988;19:375-388.
24. Cawley JC, Burns GF, Nash TA, et al. Hairy cell leukemia with T-cell features. *Blood* 1978;51:61-69.
25. Hernandez D, Cruz C, Carnot J, et al. Hairy cell leukemia of T-cell origin. *Br J Haematol* 1978;40:504-506.
26. Saxon A, Stevens RH, Golde DW. T-lymphocyte variant of hairy cell leukemia. *Ann Intern Med* 1978;88:323-326.
27. Semenzato G, Basso G, Cartei G, et al. Hairy cell leukemia with T cell features. *Br J Haematol* 1980;46:491-492.
28. Wachsman W, Golde DW, Chen IS. Hairy cell leukemia and human T cell leukemia virus. *Semin Oncol* 1984;11:446-450.
29. Kalyanaraman VS, Sarngadharan MG, Robert-Guroff M, et al. A new subtype of human T-cell leukemia virus (HTLV-II) associated with a T-cell variant of hairy cell leukemia. *Science* 1982;218:571-573.
30. Rosenblatt JD, Golde DW, Wachsman W, et al. A second isolate of HTLV-II associated with atypical hairy cell leukemia. *N Engl J Med* 1986;315:372-377.
31. Armitage RJ, Worman CP, Galvin MC, Cawley JC. Hairy cell leukemia with hybrid B-T features: a study with a panel of monoclonal antibodies. *Am J Hematol* 1985;18:335-344.
32. Burns GF, Worman CP, Cawley JC. Fluctuations in the T and B characteristics of two cases of T cell hairy cell leukemia. *Clin Exp Immunol* 1980;39:76-82.
33. Divine M, Farcet JP, Gourdin MF, et al. Phenotype study of fresh and cultured hairy cells with the use of immunologic markers and electron microscopy. *Blood* 1984;64:547-552.
34. Worman CP, Beverley PC, Cawley JC. Alterations in the phenotype of hairy cells during culture in the presence of PHA: requirement for T cells. *Blood* 1982;59:895-899.
35. Harris NL, Jaffe ES, Stein H, et al. A revised European-American Classification of lymphoid neoplasms: a proposal from the International Lymphoma Study Group. *Blood* 1994;84:1361-1392.
36. van den Oord JJ, de Wolf-Peeters C, Desmet VJ. Hairy cell leukemia: a B-lymphocyte disorder derived from splenic marginal zone lymphocytes? *Blut* 1985;50:191-194.

37. Wagner SD, Martinelli V, Luzzatto L. Similar patterns of V kappa gene usage but different degrees of somatic mutation in hairy cell leukemia, prolymphocytic leukemia, Waldenstrom's macroglobulinemia, and myeloma. *Blood* 1994;83:3647-3653.
38. Maloum K, Magnac C, Azgui Z, et al. VH gene expression in hairy cell leukaemia. *Br Haematol* 1998;101:171-178.
39. Forconi F, Sahota SS, Raspadori D, et al. Tumor cells of hairy cell leukemia express multiple clonally related immunoglobulin isotypes via RNA splicing. *Blood* 2001;98:1174-1181.
40. Robinson DS, Posnett DN, Zola H, Catovsky D. Normal counterparts of hairy cells and B prolymphocytes in the peripheral blood. An ultrastructural study with monoclonal antibodies and immunogold method. *Leuk Res* 1985;9:335-348.
41. van den Oord JJ, de Wolf-Peeters C, de Vos R, Desmet VJ. Immature sinus histiocytosis. Light- and electron microscopic features, immunological phenotype and relationship with marginal zone lymphocytes. *Am J Pathol* 1985;118:266-277.
42. van Krieken JH, von Schilling C, Kluin PM, Lennert K. Splenic marginal zone lymphocytes and related cells in the lymph node: a morphologic and immunohistochemical study. *Hum Pathol* 1989;20:320-327.
43. Dobashi M, Terashima K, Imai Y. Electron microscopic study of differentiation of antibody-producing cells in mouse lymph nodes after immunization with horseradish peroxidase. *J Histochem Cytochem* 1982;30:67-74.
44. Burns GF, Cawley JC, Worman CP, et al. Multiple heavy chain isotypes on the surface of the cells of hairy cell leukemia. *Blood* 1978;52:1132-1147.
45. Anderson KC, Boyd AW, Fisher DC, et al. Hairy cell leukemia: a tumor of pre-plasma cells. *Blood* 1985;65:620-629.
46. Totterman TH, Nilsson K, Sundstrom C. Phorbol ester-induced differentiation of chronic lymphocytic leukaemia cells. *Nature* 1980;288:176-178.
47. Caligaris-Cappio F, Pizzolo G, Chilosi M, et al. Phorbol ester induces abnormal chronic lymphocytic leukemia cells to express features of hairy cell leukemia. *Blood* 1985;66:1035-1042.
48. al-Katib A, Mohammad RM, Dan M, et al. Bryostatins 1-induced hairy cell features on chronic lymphocytic leukemia cells in vitro. *Exp Hematol* 1993;21:61-65.
49. Duchayne E, Delsol G, Kuhlein E, et al. Hairy cell transformation of a B-cell chronic lymphocytic leukemia: a morphological, cytochemical, phenotypic and molecular study. *Leukemia* 1991;5:150-155.
50. Wormsley SB, Baird SM, Gadol N, et al. Characteristics of CD11c+CD5+ chronic B-cell leukemias and the identification of novel peripheral blood B-cell subsets with chronic lymphoid leukemia immunophenotypes. *Blood* 1990;76:123-130.
51. Hanson CA, Gribbin TE, Schnitzer B, et al. CD11c (LEU-M5) expression characterizes a B-cell chronic lymphoproliferative disorder with features of both chronic lymphocytic leukemia and hairy cell leukemia. *Blood* 1990;76:2360-2367.
52. Golomb HM, Lindgren V, Rowley JD. Chromosome abnormalities in patients with hairy cell leukemia. *Cancer* 1978;41:1374-1380.
53. Lele KP, Filippa DA, Chaganti RS. Cytogenetic studies of hairy cell leukemia. *Cancer Genet Cytogenet* 1981;4:325-330.
54. Haglund U, Juliusson G, Stellan B, Gahrton G. Hairy cell leukemia is characterized by clonal chromosome abnormalities clustered to specific regions. *Blood* 1994;83:2637-2645.
55. Wu X, Ivanova G, Merup M, et al. Molecular analysis of the human chromosome 5q13.3 region in patients with hairy cell leukemia and identification of tumor suppressor gene candidates. *Genomics*

1999;60:161–171.

56. Kluin-Nelemans HC, Beverstock GC, Mollevanger P, et al. Proliferation and cytogenetic analysis of hairy cell leukemia upon stimulation via the CD40 antigen. *Blood* 1994;84:3134–3141.
57. Brito-Babapulle V, Matutes E, Oscier D, et al. Chromosome abnormalities in hairy cell leukaemia variant. *Genes Chromosomes Cancer* 1994;10:197–202.
58. König EA, Kusser WC, Day C, et al. P53 mutations in hairy cell leukemia. *Leukemia* 2000;14:706–711.
59. Vallianatou K, Brito-Babapulle V, Matutes E, et al. P53 gene deletion and trisomy 12 in hairy cell leukemia and its variant. *Leuk Res* 1999;23:1041–1045.
60. Dierlamm J, Stefanova M, Woldarska I, et al. Chromosomal gains and losses are uncommon in hairy cell leukemia: a study based on comparative genomic hybridization and interphase fluorescence in situ hybridization. *Cancer Genet Cytogenet* 2001;128:164–167.
61. Till KJ, Lopez A, Slupsky J, Cawley JC. C-fms protein expression by B-cells, with particular reference to the hairy cells of hairy-cell leukaemia. *Br J Haematol* 1993;83:223–231.
62. Burthem J, Baker PK, Hunt JA, Cawley JC. The function of c-fms in hairy-cell leukemia: macrophage colony-stimulating factor stimulates hairy-cell movement. *Blood* 1994;83:1381–1389.
63. Lynch SA, Brugge JS, Fromowitz F, et al. Increased expression of the *src* proto-oncogene in hairy cell leukemia and a subgroup of B-cell lymphomas. *Leukemia* 1993;7:1416–1422.
64. Bosch F, Campo E, Jares P, et al. Increased expression of the PRAD-1/CCND1 gene in hairy cell leukaemia. *Br J Haematol* 1995;91:1025–1030.
65. Miranda RN, Briggs RC, Kinney MC, et al. Immunohistochemical detection of cyclin D1 using optimized conditions is highly specific for mantle cell lymphoma and hairy cell leukemia. *Mod Pathol* 2000;13:1308–1314.
66. Schmid M, Porzolt F. Autocrine and paracrine regulation of neoplastic cell growth in hairy cell leukemia. *Leuk Lymphoma* 1995;17:401–410.
67. Schmid M, Schrezenmeier H, Staib G, Porzolt F. Evidence for a paracrine pathway of B-cell stimulation in hairy cell leukemia. *Br J Haematol* 1995;90:156–162.
68. de Toter D, Carbone A, Tazzari PL, et al. Expression of the IL2 receptor  $\alpha$ ,  $\beta$  and  $\gamma$  chains in hairy cell leukemia. *Leuk Lymphoma* 1994;14[Suppl 1]:27–32.
69. de Toter D, Tazzari PL, Lauria F, et al. Phenotypic analysis of hairy cell leukemia: “variant” cases express the interleukin-2 receptor  $\beta$  chain, but not the  $\alpha$  chain (CD25). *Blood* 1993;82:528–535.
70. Bulger K, Murphy J, Janckila A, et al. Peripheral blood hairy cell leukemia cells express only low affinity IL-2 receptors. *Leuk Res* 1994;18:101–104.
71. Semenzato G, Trentin L, Zambello R, et al. Origin of the soluble interleukin-2 receptor in the serum of patients with hairy cell leukemia. *Leukemia* 1988;2:788–792.
72. Richards JM, Mick R, Latta JM, et al. Serum soluble interleukin-2 receptor is associated with clinical and pathologic disease status in hairy cell leukemia. *Blood* 1990;76:1941–1945.
73. Lauria F, Rondelli D, Raspadori D, et al. Serum soluble interleukin-2 receptor levels in hairy cell leukemia: correlation with clinical and hematological parameters and with  $\alpha$ -interferon treatment. *Leuk Lymphoma* 1992;7:103–107.
74. Cordingley FT, Bianchi A, Hoffbrand AV, et al. Tumour necrosis factor as an autocrine tumour growth factor for chronic B-cell malignancies. *Lancet* 1988;1:969–971.
75. Buck C, Digel W, Schöniger W, et al. Tumor necrosis factor- $\alpha$  but not lymphotoxin, stimulates growth



of tumor cells in hairy cell leukemia. *Leukemia* 1990;4:431-434.

76. Foa R, Guarini A, Francia di Celle P, et al. Constitutive production of tumor necrosis factor- $\alpha$  in hairy cell leukemia: possible role in the pathogenesis of the cytopenia(s) and effect of treatment with interferon- $\alpha$ . *J Clin Oncol* 1992;10:954-959.

77. Lindemann A, Ludwig WD, Oster W, et al. High-level secretion of tumor necrosis factor- $\alpha$  contributes to hematopoietic failure in hairy cell leukemia. *Blood* 1989;73:880-884.

78. Digel W, Porzolt F, Schmid M, et al. High levels of circulating soluble receptors for tumor necrosis factor in hairy cell leukemia and type B chronic lymphocytic leukemia. *J Clin Invest* 1992;89:1690-1693.

79. Trentin L, Pizzolo G, Zambello R, et al. Leukemic cells in hairy cell leukemia and B cell chronic lymphocytic leukemia release soluble TNF receptors. *Leukemia* 1995;9:1051-1055.

80. Barut B, Chauhan D, Uchiyama H, Anderson KC. Interleukin-6 functions as an intracellular growth factor in hairy cell leukemia in vitro. *J Clin Invest* 1993;92:2346-2352.

81. Lembersky BC, Golomb HM. Hairy cell leukemia: clinical features and therapeutic advances. *Cancer Metastasis Rev* 1987;6:283-300.

82. Mercieca J, Puga M, Matutes E, et al. Incidence and significance of abdominal lymphadenopathy in hairy cell leukaemia. *Leuk Lymphoma* 1994;14[Suppl 1]:79-83.

83. Hakimian D, Tallman MS, Hogan DK, et al. Prospective evaluation of internal adenopathy in a cohort of 43 patients with hairy cell leukemia. *J Clin Oncol* 1994;12:268-272.

84. Malik ST, Amess J, D'Ardenne AJ, Lister TA. Hairy cell leukemia—mediastinal involvement. A report of two cases and review of the literature. *Hematol Oncol* 1989;7:303-306.

85. Castro-Malaspina H, Najean Y, Flandrin G. Erythrokinetic studies in hairy-cell leukaemia. *Br J Haematol* 1979;42:189-197.

86. Aster RH. Splenic platelet pooling as a cause of "hypersplenic" thrombocytopenia. *Trans Assoc Am Phys* 1965;78:362-373.

87. Brubaker LH, Johnson CA. Correlation of splenomegaly and abnormal neutrophil pooling (margination). *J Lab Clin Med* 1978;92:508-515.

88. Hess CE, Ayers CR, Sandusky WR, et al. Mechanism of dilutional anemia in massive splenomegaly. *Blood* 1976;47:629-644.

89. Lewis SM, Catovsky D, Hows JM, Ardalan B. Splenic red cell pooling in hairy cell leukaemia. *Br J Haematol* 1977;35:351-357.

90. Schaffner A, Augustiny N, Otto RC, Fehr J. The hypersplenic spleen. A contractile reservoir of granulocytes and platelets. *Arch Intern Med* 1985;145:651-654.

91. Hess CE. Approach to patients with lymphadenopathy and splenomegaly. In: Thorup OA, Jr., ed. *Fundamentals in clinical hematology*, 5th ed. Philadelphia: WB Saunders, 1987.

92. Golomb HM, Hadad LJ. Infectious complications in 127 patients with hairy cell leukemia. *Am J Hematol* 1984;16:393-401.

93. Mackowiak PA, Demian SE, Sutker WL, et al. Infections of hairy cell leukemia. Clinical evidence of a pronounced defect in cell-mediated immunity. *Am J Med* 1980;68:718-724.

94. Stewart DJ, Bodey GP. Infections in hairy cell leukemia (leukemic reticuloendotheliosis). *Cancer* 1981;47:801-805.

95. Westbrook CA, Golde DW. Clinical problems in hairy cell leukemia: diagnosis and management. *Semin Oncol* 1984;11:514-522.

96. Weinstein RA, Golomb HM, Grumet G, et al. Hairy cell leukemia: association with disseminated atypical mycobacterial infection. *Cancer* 1981;48:380–383.
97. Knecht H, Rhyner K, Streuli RA. Toxoplasmosis in hairy-cell leukaemia. *Br J Haematol* 1986;62:65–73.
98. Kumar S, Kumar D, Gourley WK, Alperin JB. Sporotrichosis as a presenting manifestation of hairy cell leukemia. *Am J Hematol* 1994;46:134–137.
99. Nielsen H, Bangsberg J, Rechnitzer C, et al. Defective monocyte function in Legionnaires' disease complicating hairy cell leukaemia. *Acta Med Scand* 1986;220:381–383.
100. Salata RA, King RE, Gose F, Pearson RD. *Listeria monocytogenes* cerebritis, bacteremia, and cutaneous lesions complicating hairy cell leukemia. *Am J Med* 1986;81:1068–1072.
101. Janckila AJ, Wallace JH, Yam LT. Generalized monocyte deficiency in leukaemic reticuloendotheliosis. *Scand J Haematol* 1982;29:153–160.
102. Seshadri RS, Brown EJ, Zipursky A. Leukemic reticuloendotheliosis. A failure of monocyte production. *N Engl J Med* 1976;295:181–184.
103. Child JA, Cawley JC, Martin S, Ghoneim AT. Microbicidal function of the neutrophils in hairy-cell leukaemia. *Acta Haematol (Basel)* 1979;62:191–198.
104. Kjeldsberg CR. Leukocyte mobilization in leukemic reticuloendotheliosis. *Ann Intern Med* 1978;88:268–269.
105. Yam LT, Chaudhry AA, Janckila AJ. Impaired marrow granulocyte reserve and leukocyte mobilization in leukemic reticuloendotheliosis. *Ann Intern Med* 1977;87:444–446.
106. Hersh EM, Quesada J, Keating MJ, et al. Host defense factors and prognosis in hairy cell leukemia. *Leuk Res* 1982;6:625–637.
107. Ruco LP, Procopio A, Maccallini V, et al. Severe deficiency of natural killer activity in the peripheral blood of patients with hairy cell leukemia. *Blood* 1983;61:1132–1137.
108. Hooper WC, Barth RF, Shah NT. Lack of natural killer cell activity in hairy cell leukemia patients and partial restoration with interleukin-2. *Cancer* 1986;57:988–993.
109. Lauria F, Foa R, Matera L, et al. Membrane phenotype and functional behaviour of T lymphocytes in hairy cell leukemia (HCL). *Semin Oncol* 1984;11:409–412.
110. Hansen DA, Robbins BA, Bylund DJ, et al. Identification of monoclonal immunoglobulins and quantitative immunoglobulin abnormalities in hairy cell leukemia and chronic lymphocytic leukemia. *Am J Clin Pathol* 1994;102:580–585.
111. Dorsey JK, Penick GD. The association of hairy cell leukemia with unusual immunologic disorders. *Arch Intern Med* 1982;142:902–903.
112. Westbrook CA, Golde DW. Autoimmune disease in hairy-cell leukaemia: clinical syndromes and treatment. *Br J Haematol* 1985;61:349–356.
113. Komadina KH, Houk RW. Polyarteritis nodosa presenting as recurrent pneumonia following splenectomy for hairy-cell leukemia. *Semin Arthritis Rheum* 1989;18:252–257.
114. Hasler P, Kistler H, Gerber H. Vasculitides in hairy cell leukemia. *Semin Arthritis Rheum* 1995;25:134–142.
115. Carpenter MT, West SG. Polyarteritis nodosa in hairy cell leukemia: treatment with interferon-alpha. *J Rheumatol* 1994;21:1150–1152.
116. Douglas MF, Schwartz MM, Sharon Z. Cryoglobulinemia and immune-mediated glomerulonephritis in

- association with hairy cell leukemia. *Am J Kidney Dis* 1985;6:181-184.
117. Raju SF, Chapman SW, Dreiling B, Tavassoli M. Hairy-cell leukemia with the appearance of mixed cryoglobulinemia and vasculitis. *Arch Intern Med* 1984;144:1300-1302.
118. Bouroncle BA. Unusual presentations and complications of hairy cell leukemia. *Leukemia* 1987;1:288-293.
119. Arkel YS, Lake-Lewin D, Savopoulos AA, Berman E. Bone lesions in hairy cell leukemia. A case report and response of bone pains to steroids. *Cancer* 1984;53:2401-2403.
120. Demanes DJ, Lane N, Beckstead JH. Bone involvement in hairy-cell leukemia. *Cancer* 1982;49:1697-1701.
121. Lembersky BC, Ratain MJ, Golomb HM. Skeletal complications in hairy cell leukemia: diagnosis and therapy. *J Clin Oncol* 1988;6:1280-1284.
122. Catovsky D, Costello C, Loukopoulos D, et al. Hairy cell leukemia and myelomatosis: chance association or clinical manifestations of the same B-cell disease spectrum. *Blood* 1981;57:758-763.
123. Jansen J, Bolhuis RL, van Nieuwkoop JA, et al. Paraproteinemia plus osteolytic lesions in typical hairy-cell leukaemia. *Br J Haematol* 1983;54:531-541.
124. Arai E, Ikeda S, Itoh S, Katayama I. Specific skin lesions as the presenting symptom of hairy cell leukemia. *Am J Clin Pathol* 1988;90:459-464.
125. Carsuzaa F, Pierre C, Jaubert D, Viala JJ. Cutaneous findings in hairy cell leukemia. Review of 84 cases. *Nouv Rev Fr Hematol* 1994;35:541-543.
126. Murphy. GF, Mihm MC. Benign, dysplastic, and malignant lymphoid infiltrates of the skin: an approach based on pattern analysis. In: Murphy GF, Mihm MC, eds. *Lymphoproliferative disorders of the skin*. Boston: Butterworth, 1986.
127. Yam LT, Crosby WH. Spontaneous rupture of spleen in leukemic reticuloendotheliosis. *Am J Surg* 1979;137:270-273.
128. Vardiman JW, Golomb HM. Autopsy findings in hairy cell leukemia. *Semin Oncol* 1984;11:370-380.
129. Kimmel DW, Hermann RC, Jr., O'Neill BP. Neurologic complications of hairy cell leukemia. *Arch Neurol* 1984;41:202-203.
130. Newell DG, Sattar M, Hannam-Harris AC, et al. Hairy cell leukemia occurring with an unrelated paraproteinaemia. A biochemical and immuno-electron microscopic study. *Scand J Haematol* 1982;28:441-450.
131. Golomb HM, Braylan R, Polliack A. 'Hairy' cell leukaemia (leukaemic reticuloendotheliosis): a scanning electron microscopic study of eight cases. *Br J Haematol* 1975;29:455-460.
132. Merchant RE, Hofmann V, Moreillon MC, Arrenbrecht S. Hairy cell leukemia: ultrastructural and cytochemical evaluation of leukemic colonies grown in a semi-solid medium. *Eur J Cancer Clin Oncol* 1985;21:221-232.
133. Offerman MK, Golomb HM. Hairy cell leukemia. *Curr Probl Cancer* 1984;8:1-39.
134. Yam LT, Li CY, Lam KW. Tartrate-resistant acid phosphatase isoenzyme in the reticulum cells of leukemic reticuloendotheliosis. *N Engl J Med* 1971;284:357-360.
135. Boesen AM. Ultrastructural localization of acid phosphatase in immunologically defined neoplastic lymphocytic cells and hairy cells. A comparison between two different substrates. *Scand J Haematol* 1984;32:245-252.
136. Katayama I, Yang JP. Reassessment of a cytochemical test for differential diagnosis of leukemic

reticuloendotheliosis. *Am J Clin Pathol* 1977;68:268–272.

137. Janckila AJ, Cardwell EM, Yam LT, Li CY. Hairy cell identification by immunohistochemistry of tartrate-resistant acid phosphatase. *Blood* 1995;85:2839–2844.

138. Hoyer JD, Li CY, Yam LT, et al. Immunohistochemical demonstration of acid phosphatase isoenzyme 5 (tartrate-resistant) in paraffin sections of hairy cell leukemia and other hematologic disorders. *Am J Clin Pathol* 1997;108:308–315.

139. Visser L, Shaw A, Slupsky J, et al. Monoclonal antibodies reactive with hairy cell leukemia. *Blood* 1989;74:320–325.

140. Cornfield DB, Mitchell Nelson DM, Rimsza LM, et al. The diagnosis of hairy cell leukemia can be established by flow cytometric analysis of peripheral blood, even in patients with low levels of circulating malignant cells. *Am J Haematol* 2001;67:223–226.

141. Harris NL, Jaffe ES, Stein H, et al. A revised European–American classification of lymphoid neoplasms: a proposal from the International Lymphoma Study Group. *Blood* 1994;84:1361–1392.

142. Matutes E, Morilla R, Owusu-Ankomah K, et al. The immunophenotype of hairy cell leukemia (HCL). Proposal for a scoring system to distinguish HCL from B-cell disorders with hairy or villous lymphocytes. *Leuk Lymphoma* 1994;14[Suppl 1]:57–61.

143. Hounie H, Chittal SM, al Saati T, et al. Hairy cell leukemia. Diagnosis of bone marrow involvement in paraffin-embedded sections with monoclonal antibody DBA.44. *Am J Clin Pathol* 1992;98:26–33.

144. Pileri S, Sabattini E, Poggi S, et al. Bone-marrow biopsy in hairy cell leukaemia (HCL) patients. Histological and immunohistological analysis of 46 cases treated with different therapies. *Leuk Lymphoma* 1994;14[Suppl 1]:67–71.

145. Myers TJ, Ikeda Y, Schwartz S, et al. Primary splenic hairy cell leukemia—remission for 21 years following splenectomy. *Am J Hematol* 1981;11:299–303.

146. Burke JS, Rappaport H. The diagnosis and differential diagnosis of hairy cell leukemia in bone marrow and spleen. *Semin Oncol* 1984;11:334–346.

147. Bartl R, Frisch B, Hill W, et al. Bone marrow histology in hairy cell leukemia. Identification of subtypes and their prognostic significance. *Am J Clin Pathol* 1983;79:531–545.

148. Katayama I. Bone marrow in hairy cell leukemia. *Hematol Oncol Clin North Am* 1988;2:585–602.

149. Yam LT, Philyly RL, Li CY. Benign and neoplastic disorders simulating hairy cell leukemia. *Semin Oncol* 1984;11:353–361.

150. Brearley RL, Chapman RM, Brozovic B. Hairy cell leukemia presenting as aplastic anemia. *Ann Intern Med* 1979;91:228.

151. Burthem J, Cawley JC. The bone marrow fibrosis of hairy-cell leukemia is caused by the synthesis and assembly of a fibronectin matrix by the hairy cells. *Blood* 1994;83:497–504.

152. Lee WM, Beckstead JH. Hairy cell leukemia with bone marrow hypoplasia. *Cancer* 1982;50:2207–2210.

153. Winkler CF, Jennings CV. Hairy-cell leukemia and aplastic anemia. *Ann Intern Med* 1979;91:794–795.

154. Nanba K, Soban EJ, Bowling MC, Berard CW. Splenic pseudosinuses and hepatic angiomatous lesions. Distinctive features of hairy cell leukemia. *Am J Clin Pathol* 1977;67:415–426.

155. Pilon VA, Davey FR, Gordon GB, Jones DB. Splenic alterations in hairy-cell leukemia: II. An electron microscopic study. *Cancer* 1982;49:1617–1623.

156. Cawley JC, Burns GF, Hayhoe FJ. A chronic lymphoproliferative disorder with distinctive features: a

distinct variant of hairy-cell leukaemia. *Leuk Res* 1980;4:547-559.

157. Matutes E, Wotherspoon A, Brito-Babapulle V, Catovsky D. The natural history and clinico-pathological features of the variant form of hairy cell leukemia. *Leukemia* 2001;15:184-193.

158. Catovsky D, O'Brien M, Melo JV, et al. Hairy cell leukemia (HCL) variant: an intermediate disease between HCL and B prolymphocytic leukemia. *Semin Oncol* 1984;11:362-369.

159. Diez Martin JL, Li CY, Banks PM. Blastic variant of hairy-cell leukemia. *Am J Clin Pathol* 1987;87:576-583.

160. Sainati L, Matutes E, Mulligan S, et al. A variant form of hairy cell leukemia resistant to  $\alpha$ -interferon: clinical and phenotypic characteristics of 17 patients. *Blood* 1990;76:157-162.

161. Arber DA, Lopategui JR, Brynes RK. Chronic lymphoproliferative disorders involving blood and bone marrow. *Am J Clin Pathol* 1993;99:494-503.

162. Sun T, Dittmar K, Koduru P, et al. Relationship between hairy cell leukemia variant and splenic lymphoma with villous lymphocytes: presentation of a new concept. *Am J Hematol* 1996;51:282-288.

163. Tetreault SA, Robbins BA, Saven A. Treatment of hairy cell leukemia-variant with cladribine. *Leuk Lymphoma* 1999;35:347-354.

164. Robak T, Blasinska-Morawiec M, Blonski J, et al. 2-Chlorodeoxyadenosine (cladribine) in the treatment of hairy cell leukemia and hairy cell leukaemia variant: 7-year experience in Poland. *Eur J Haematol* 1999;62:49-56.

165. Bennett JM, Catovsky D, Daniel MT, et al. Proposals for the classification of chronic (mature) B and T lymphoid leukaemias. French-American-British (FAB) Cooperative Group. *J Clin Pathol* 1989;42:567-584.

166. Sun T, Susin M, Brody J, et al. Splenic lymphoma with circulating villous lymphocytes: report of seven cases and review of the literature. *Am J Hematol* 1994;45:39-50.

167. Neiman RS, Sullivan AL, Jaffe R. Malignant lymphoma simulating leukemic reticuloendotheliosis: a clinicopathologic study of ten cases. *Cancer* 1979;43:329-342.

168. Melo JV, Hegde U, Parreira A, et al. Splenic B cell lymphoma with circulating villous lymphocytes: differential diagnosis of B cell leukaemias with large spleens. *J Clin Pathol* 1987;40:642-651.

169. Matutes E, Morilla R, Owusu-Ankomah K, et al. The immunophenotype of splenic lymphoma with villous lymphocytes and its relevance to the differential diagnosis with other B-cell disorders. *Blood* 1994;83:1558-1562.

170. Palutke M, Eisenberg L, Narang S, et al. B lymphocytic lymphoma (large cell) of possible splenic marginal zone origin presenting with prominent splenomegaly and unusual cordal red pulp distribution. *Cancer* 1988;62: 593-600.

171. Sheibani K, Burke JS, Swartz WG, et al. Monocytoid B-cell lymphoma. Clinicopathologic study of 21 cases of a unique type of low-grade lymphoma. *Cancer* 1988;62:1531-1538.

172. Traweek ST, Sheibani K, Winberg CD, et al. Monocytoid B-cell lymphoma: its evolution and relationship to other low-grade B-cell neoplasms. *Blood* 1989;73:573-578.

173. Isaacson PG, Spencer J. Malignant lymphoma of mucosa-associated lymphoid tissue. *Histopathology* 1987;11:445-462.

174. Ben-Ezra J, Burke JS, Swartz WG, et al. Small lymphocytic lymphoma: a clinicopathologic analysis of 268 cases. *Blood* 1989;73:579-587.

175. Pangalis GA, Nathwani BN, Rappaport H. Malignant lymphoma, well differentiated lymphocytic: its relationship with chronic lymphocytic leukemia and macroglobulinemia of Waldenstrom. *Cancer* 1977;39:999-1010.

176. Dighiero G, Charron D, Debre P, et al. Identification of a pure splenic form of chronic lymphocytic leukaemia. *Br J Haematol* 1979;41:169–176.
177. Velders GA, Kluin-Nelemans JC, De Boer CJ, et al. Mantle-cell lymphoma: a population-based clinical study. *Blood* 1996;14:1269–1274.
178. Weisenburger DD, Armitage JO. Mantle cell lymphoma—an entity comes of age. *Blood* 1996;87:4483–4494.
179. Vardiman JW, Byrne GE, Jr., Rappaport H. Malignant histiocytosis with massive splenomegaly in asymptomatic patients. A possible chronic form of the disease. *Cancer* 1975;36:419–427.
180. Kraemer BB, Osborne BM, Butler JJ. Primary splenic presentation of malignant lymphoma and related disorders. A study of 49 cases. *Cancer* 1984;54:1606–1619.
181. Narang S, Wolf BC, Neiman RS. Malignant lymphoma presenting with prominent splenomegaly. A clinicopathologic study with special reference to intermediate cell lymphoma. *Cancer* 1985;55:1948–1957.
182. Ng JP, Hogg RB, Cumming RL, et al. Primary splenic hairy cell leukaemia: a case report and review of the literature. *Eur J Haematol* 1987;39:349–352.
183. Melo JV, Catovsky D, Galton DA. The relationship between chronic lymphocytic leukaemia and prolymphocytic leukaemia. I. Clinical and laboratory features of 300 patients and characterization of an intermediate group. *Br J Haematol* 1986;63:377–387.
184. Loughran TP, Jr. Clonal diseases of large granular lymphocytes. *Blood* 1993;82:1–14.
185. Tefferi A, Li CY, Witzig TE, et al. Chronic natural killer cell lymphocytosis: a descriptive clinical study. *Blood* 1994;84:2721–2725.
186. Lennert K, Papwaresch MR. Mast cells and mast cell neoplasia: a review. *Histopathology* 1979;3:349–365.
187. Matsue K, Nishi H, Onozawa S, et al. Polyclonal B cell chronic lymphoproliferative disease with hairy cell morphology: a case report and clonal studies. *Am J Hematol* 1996;51:141–146.
188. Machii T, Yamaguchi M, Inoue R, et al. Polyclonal B-cell lymphocytosis with features resembling hairy cell leukemia—Japanese variant. *Blood* 1997;89:2008–2014.
189. Mossafa J, Malaure J, Maynadie M, et al. Persistent polyclonal B lymphocytosis with binucleated lymphocytes: a study of 25 cases. *Groupe Francais d'Hematologie Cellulaire*. *Br J Haematol* 1999;104:486–493.
190. Delage R, Jacques L, Massinga-Loembe M, et al. Persistent polyclonal B-cell lymphocytosis: further evidence for a genetic disorder associated with B-cell abnormalities. *Br J Haematol* 2001;114:666–670.
191. Salcedo I, Campos-Caro A, Sampalo A, et al. Persistent polyclonal B lymphocytosis: an expansion of cells showing IgVH gene mutations and phenotypic features of normal lymphocytes from the CD27+ marginal zone B-cell compartment. *Br J Haematol* 2002;116:662–666.
192. Jaiyesimi IA, Kantarjian HM, Estey EH. Advances in therapy for hairy cell leukemia. A review. *Cancer* 1993;72:5–16.
193. Gollard R, Lee TC, Piro LD, Saven A. The optimal management of hairy cell leukaemia. *Drugs* 1995;49:921–931.
194. Tallman MS, Hakimian D. Purine nucleoside analogs: emerging roles in indolent lymphoproliferative disorders. *Blood* 1995;86:2463–2474.
195. Jansen J, Hermans J, Remme J, et al. Hairy cell leukaemia. Clinical features and effect of splenectomy. *Scand J Haematol* 1978;21:60–71.

196. Mintz U, Golomb HM. Splenectomy as initial therapy in twenty-six patients with leukemic reticuloendotheliosis (hairy cell leukemia). *Cancer Res* 1979;39:2366-2370.
197. Jansen J, Hermans J. Splenectomy in hairy cell leukemia: a retrospective multicenter analysis. *Cancer* 1981;47:2066-2076.
198. Golomb HM, Vardiman JW. Response to splenectomy in 65 patients with hairy cell leukemia: an evaluation of spleen weight and bone marrow involvement. *Blood* 1983;61:349-352.
199. Ratain MJ, Vardiman JW, Barker CM, Golomb HM. Prognostic variables in hairy cell leukemia after splenectomy as initial therapy. *Cancer* 1988;62:2420-2424.
200. Quesada JR, Reuben J, Manning JT, et al. Alpha interferon for induction of remission in hairy-cell leukemia. *N Engl J Med* 1984;310:15-18.
201. Foon KA, Maluish AE, Abrams PG, et al. Recombinant leukocyte A interferon therapy for advanced hairy cell leukemia. Therapeutic and immunologic results. *Am J Med* 1986;80:351-356.
202. Golomb HM, Jacobs A, Fefer A, et al. Alpha-2 interferon therapy of hairy-cell leukemia: a multicenter study of 64 patients. *J Clin Oncol* 1986;4:900-905.
203. Golomb HM, Fefer A, Golde DW, et al. Sequential evaluation of alpha-2b-interferon treatment in 128 patients with hairy cell leukemia. *Semin Oncol* 1987;14[Suppl 2]:13-17.
204. Golomb HM, Fefer A, Golde DW, et al. Report of a multi-institutional study of 193 patients with hairy cell leukemia treated with interferon-alfa 2b. *Semin Oncol* 1988;15[5 Suppl 5]:7-9.
205. Quesada JR, Hersh EM, Manning J, et al. Treatment of hairy cell leukemia with recombinant a-interferon. *Blood* 1986;68:493-497.
206. Ratain MJ, Golomb HM, Vardiman JW, et al. Treatment of hairy cell leukemia with recombinant alpha 2 interferon. *Blood* 1985;65:644-648.
207. Baker PK, Pettitt AR, Slupsky JR, et al. Response of hairy cells to IFN-a involves induction of apoptosis through autocrine TNF-a and protection by adhesion. *Blood* 2002;100:647-653.
208. Rai KR, Davey F, Peterson S, et al. Recombinant alpha-2b-interferon in therapy of previously untreated hairy cell leukemia: long term results of study by Cancer and Leukemia Group B. *Leukemia* 1995;9:1116-1120.
209. Damasio EE, Clavio M, Masoudi B, et al. Alpha-interferon as induction and maintenance therapy in hairy cell leukemia: a long-term follow-up analysis. *Eur J Haematol* 2000;64:47-52.
210. Bardawil RG, Ratain MJ, Golomb HM, et al. Changes in peripheral blood and bone marrow specimens during and after alpha 2b-interferon therapy for hairy cell leukemia. *Leukemia* 1987;1:340-343.
211. Naeim F, Jacobs AD. Bone marrow changes in patients with hairy cell leukemia treated by recombinant alpha 2-interferon. *Hum Pathol* 1985;16:1200-1205.
212. Lauria F, Raspadori D, Foa R, et al. Reduced hematologic response to alpha-interferon therapy in patients with hairy cell leukemia showing a peculiar immunologic phenotype. *Cancer* 1990;65:2233-2236.
213. Weiss K. Safety profile of interferon-a therapy. *Semin Oncol* 1998;25[Suppl 1]:9-13.
214. Golomb HM, Ratain MJ, Fefer A, et al. Randomized study of the duration of treatment with interferon alfa-2B in patients with hairy cell leukemia. *J Natl Cancer Inst* 1988;80:369-373.
215. Thompson JA, Kidd P, Rubin E, Fefer A. Very low dose alpha-2b interferon for the treatment of hairy cell leukemia. *Blood* 1989;73:1440-1443.
216. Spielberger RT, Mick R, Ratain MJ, Golomb HM. Interferon treatment for hairy cell leukemia. An



update on a cohort of 69 patients treated from 1983 to 1986. *Leuk Lymphoma* 1994;14[Suppl 1]:89-93.

217. Troussard X, Flandrin G. Hairy cell leukemia. An update on a cohort of 93 patients treated in a single institution. Effects of interferon in patients relapsing after splenectomy and in patients with or without maintenance treatment. *Leuk Lymphoma* 1994;14[Suppl 1]:99-105.

218. Capnist G, Federico M, Chisesi T, et al. Long term results of interferon treatment in hairy cell leukemia. Italian Cooperative Group of Hairy Cell Leukemia (ICGHCL). *Leuk Lymphoma* 1994;14:457-464.

219. Seymour JF, Estey EH, Keating MJ, Kurzrock R. Response to interferon- $\alpha$  in patients with hairy cell leukemia relapsing after treatment with 2-chlorodeoxyadenosine. *Leukemia* 1995;9:929-932.

220. Steis RG, Smith JW II, Urba WJ, et al. Resistance to recombinant interferon alfa-2a in hairy-cell leukemia associated with neutralizing anti-interferon antibodies. *N Engl J Med* 1988;318:1409-1413.

221. Spiegel RJ, Spicehandler JR, Jacobs SL, Oden EM. Low incidence of serum neutralizing factors in patients receiving recombinant alfa-2b interferon (Intron A). *Am J Med* 1986;80:223-228.

222. Steis RG, Smith JW II, Urba WJ, et al. Loss of interferon antibodies during prolonged continuous interferon- $\alpha$  2a therapy in hairy cell leukemia. *Blood* 1991;77:792-798.

223. Conlon KC, Urba WJ, Smith JW II, et al. Exacerbation of symptoms of autoimmune disease in patients receiving alpha-interferon therapy. *Cancer* 1990;65:2237-2242.

224. Abdi EA, Venner PM. Immune thrombocytopenia after alpha-interferon therapy in patients with cancer. *JAMA* 1986;255:1878-1879.

225. Akard LP, Hoffman R, Elias L, Saiers JH. Alpha-interferon and immune hemolytic anemia. *Ann Intern Med* 1986;105:306.

226. Kampmeier P, Spielberger R, Dickstein J, et al. Increased incidence of second neoplasms in patients treated with interferon alpha 2b for hairy cell leukemia: a clinicopathologic assessment. *Blood* 1994;83:2931-2938.

227. Pawson R, A'Hern R, Catovsky D. Second malignancy in hairy cell leukaemia: no evidence of increased incidence after treatment with interferon alpha. *Leuk Lymphoma* 1996;22:103-106.

228. Johnston JB, Begleiter A, Pugh L, et al. Biochemical changes induced in hairy-cell leukemia following treatment with the adenosine deaminase inhibitor 2'-deoxycoformycin. *Cancer Res* 1986;46:2179-2184.

229. Major PP, Agarwal RP, Kufe DW. Clinical pharmacology of deoxycoformycin. *Blood* 1981;58:91-96.

230. Begleiter A, Verburg L, Ashique A, et al. Comparison of antitumor activities of 2-chlorodeoxyadenosine and 9- $\beta$ -arabinosyl-2-fluoroadenine in chronic lymphocytic leukemia and marrow cells *in vitro*. *Leukemia* 1995;9:1875-1881.

231. Robertson LE, Chubb S, Meyn RE, et al. Induction of apoptotic cell death in chronic lymphocytic leukemia by 2-chloro-2'-deoxyadenosine and 9- $\beta$ -D-arabinosyl-2-fluoroadenine. *Blood* 1993;81:143-150.

232. Genini D, Adachi S, Chao Q, et al. Deoxyadenosine analogs induce programmed cell death in chronic lymphocytic leukemia cells by damaging the DNA and by directly affecting the mitochondria. *Blood* 2000;96:3537-3543.

233. Genini D, Budihardjo I, Plunkett W, et al. Nucleotide requirements for the *in vitro* activation of the apoptosis protein-activating factor-1-mediated caspase pathway. *J Biol Chem* 2000;275:29-34.

234. Grever M, Kopecky K, Foucar MK, et al. Randomized comparison of pentostatin versus interferon alfa-2a in previously untreated patients with hairy cell leukemia: an intergroup study. *J Clin Oncol* 1995;13:974-982.

235. Johnston JB, Eisenhauer E, Corbett WE, et al. Efficacy of 2'-deoxycoformycin in hairy-cell leukemia: a study of the National Cancer Institute of Canada Clinical Trials Group. *J Natl Cancer Inst*

1988;80:765-769.

236. Spiers AS, Moore D, Cassileth PA, et al. Remissions in hairy-cell leukemia with pentostatin (2'-deoxycoformycin). *N Engl J Med* 1987;316:825-830.
237. Kraut EH, Bouroncle BA, Grever MR. Pentostatin in the treatment of advanced hairy cell leukemia. *J Clin Oncol* 1989;7:168-172.
238. Catovsky D, Matutes E, Talavera JG, et al. Long term results with 2'deoxycoformcyinin hairy cell leukemia. *Leuk Lymphoma* 1994;14[Suppl 1]:109-113.
239. Rafel M, Cervantes F, Beltran JM, et al. Deoxycoformycin in the treatment of patients with hairy cell leukemia. *Cancer* 2000;88:352-357.
240. Ribeiro P, Bouaffia F, Peaud PY, et al. Long term outcome of patients with hairy cell leukemia treated with pentostatin. *Cancer* 1999;85:65-71.
241. Maloisel F, Benboubker L, Gardembas M, et al. Long-term outcome with pentostatin treatment in hairy cell leukemia patients. A French retrospective study of 238 patients. *Leukemia* 2003;17:45-51.
242. Seymour JF, Talpaz M, Kurzrock R. Response duration and recovery of CD4+ lymphocytes following deoxycoformycin in interferon-a resistant hairy cell leukemia: 7 year follow-up. *Leukemia* 1997;11:42-47.
243. Ho AD, Thaler J, Mandelli F, et al. Response to pentostatin in hairy-cell leukemia refractory to interferon-alpha. *J Clin Oncol* 1989;7:1533-1538.
244. Golomb HM, Dodge R, Mick R, et al. Pentostatin treatment of hairy cell leukemia patients who failed initial therapy with recombinant alpha-interferon: a report of CALGB study 8515. *Leukemia* 1994;8:2037-2040.
245. Dalal BI, Freier L, Johnston JB, et al. Peripheral blood and bone marrow changes following 2'-deoxycoformycin therapy in hairy cell leukemia. Results of 200 weeks' follow-up. *Cancer* 1989;63:14-22.
246. Thaler J, Grunewald K, Gattringer C, et al. Long-term follow-up of patients with hairy cell leukaemia treated with pentostatin: lymphocyte subpopulations and residual bone marrow infiltration. *Br J Haematol* 1993;84:75-82.
247. Matutes E, Meeus P, McLennan K, Catovsky D. The significance of minimal residual disease in hairy cell leukemia patients treated with deoxycoformycin: a long term follow-up study. *Br J Haematol* 1997;98:375-383.
248. Cassileth PA, Chevart B, Spiers AS, et al. Pentostatin includes durable remissions in hairy cell leukemia. *J Clin Oncol* 1991;9:243-246.
249. Kraut EH, Grever MR, Bouroncle BA. Long-term follow-up of patients with hairy cell leukemia after treatment with 2'-deoxycoformycin. *Blood* 1994;84:4061-4063.
250. Harding A, Daeninck PJ, Morales C, et al. Single institution experience with hairy cell leukemia: long-term follow-up of patients treated with 2'-deoxycoformycin. *Blood* 2002;100:354b.
251. Dearden CE, Matutes E, Hilditch BL, et al. Long-term follow-up of patients with hairy cell leukaemia after treatment with pentostatin or cladribine. *Br J Haematol* 1999;106:515-519.
252. Johnston JB, Eisenhauer E, Wainman N, et al. Long-term outcome following treatment of hairy cell leukemia with pentostatin (Nipent): a National Cancer Institute of Canada study. *Semin Oncol* 2000;27:32-36.
253. Flinn IW, Kopecky KJ, Foucar MK, et al. Long-term follow-up of remission duration, mortality, and second malignancies in hairy cell leukemia patients treated with pentostatin. *Blood* 2000;96:2981-2986.
254. Urba WJ, Baseler MW, Kopp WC, et al. Deoxycoformycin-induced immunosuppression in patients with hairy cell leukemia. *Blood* 1989;73:38-46.

255. Kraut EH, Neff JC, Bouroncle BA, et al. Immunosuppressive effects of pentostatin. *J Clin Oncol* 1990;8:848-855.
256. Cheson BD. Infectious and immunosuppressive complications of purine analog therapy. *J Clin Oncol* 1995;13:2431-2448.
257. Cheson BD, Vena DA, Foss FM, Sorensen JM. Neurotoxicity of purine analogs: a review. *J Clin Oncol* 1994;12:2216-2228.
258. Estey EH, Kurzrock R, Kantarjian HM, et al. Treatment of hairy cell leukemia with 2-chlorodeoxyadenosine (2-CdA). *Blood* 1992;79:882-887.
259. Tallman MS, Hakimian D, Variakojis D, et al. A single cycle of 2-chlorodeoxyadenosine results in complete remission in the majority of patients with hairy cell leukemia. *Blood* 1992;80:2203-2209.
260. Juliusson G, Liliemark J. Rapid recovery from cytopenia in hairy cell leukemia after treatment with 2-chloro-2'-deoxyadenosine (CdA): relation to opportunistic infections. *Blood* 1992;79:888-894.
261. Piro LD, Ellison DJ, Saven A. The Scripps Clinic experience with 2-chlorodeoxyadenosine in the treatment of hairy cell leukemia. *Leuk Lymphoma* 1994;14[Suppl 1]:121-125.
262. Lauria F, Rondelli D, Zinzani PL, et al. Long-lasting complete remission in patients with hairy cell leukemia treated with 2-CdA: a 5-year survey. *Leukemia* 1997;11:629-632.
263. Piro LD, Carrera CJ, Beutler E, Carson DA. 2-Chlorodeoxyadenosine: an effective new agent for the treatment of chronic lymphocytic leukemia. *Blood* 1988;72:1069-1073.
264. Cheson BD, Sorensen JM, Vena DA, et al. Treatment of hairy cell leukemia with 2-chlorodeoxyadenosine via the Group C protocol mechanism of the National Cancer Institute: a report of 979 patients. *J Clin Oncol* 1998;16:3007-3015.
265. Saven A, Burian C, Koziol JA, Piro LD. Long-term follow-up of patients with hairy cell leukemia after cladribine treatment. *Blood* 1998;92:1918-1926.
266. Hoffman MA, Janson D, Rose E, Rai KR. Treatment of hairy-cell leukemia with cladribine: response, toxicity, and long-term follow-up. *J Clin Oncol* 1997;15:1138-1142.
267. Siegel RS, Hakimian D, Spies W, et al. Technetium-99m sulfur colloid scanning and correlative magnetic resonance imaging in patients with hairy cell leukemia and hypocellular bone marrow biopsies after 2-chlorodeoxyadenosine. *Leuk Lymphoma* 1999;35:171-177.
268. Ellison DJ, Sharpe RW, Robbins BA, et al. Immunomorphologic analysis of bone marrow biopsies after treatment with 2-chlorodeoxyadenosine for hairy cell leukemia. *Blood* 1994;84:4310-4315.
269. Filleul B, Delannoy A, Ferrant A, et al. A single course of 2-chloro-deoxyadenosine does not eradicate leukemic cells in hairy cell leukemia patients in complete remission. *Leukemia* 1994;8:1153-1156.
270. Wheaton S, Tallman MS, Hakimian D, Peterson L. Minimal residual disease may predict bone marrow relapse in patients with hairy cell leukemia treated with 2-chlorodeoxyadenosine. *Blood* 1996;87:1556-1560.
271. Tallman MS, Hakimian D, Rademaker AW, et al. Relapse of hairy cell leukemia after 2-chlorodeoxyadenosine: long-term follow-up of the Northwestern University experience. *Blood* 1996;88:1954-1959.
272. Saven A, Piro LD. Complete remissions in hairy cell leukemia with 2-chlorodeoxyadenosine after failure with 2'-deoxycoformycin. *Ann Intern Med* 1993;119:278-283.
273. Liliemark J, Albertioni F, Hassan M, Juliusson G. On the bioavailability of oral and subcutaneous 2-chloro-2'-deoxyadenosine in humans: alternative routes of administration. *J Clin Oncol* 1992;10:1514-1518.
274. Raemaekers J, vt Veer M, Verhoef G, et al. HOVON-Group. Two-hours IV infusion of

2-chlorodeoxyadenosine (2-CdA) in hairy cell leukemia (HCL) is effective and may produce less CD4/CD8 ratio impairment. Results from the Hovon-23 study. *Blood* 1995;86:351a.

275. Robak, Blasińska-Morawiec, Krykowski E, et al. 2-Chlorodeoxyadenosine (CdA) in 2-hour versus 24-hour intravenous infusion in the treatment of patients with hairy cell leukemia. *Leuk Lymphoma* 1996;22:107-111.

276. Juliusson G, Heldal D, Hippe E, et al. Subcutaneous infections of 2-chlorodeoxyadenosine for symptomatic hairy cell leukemia. *J Clin Oncol* 1995;13:989-995.

277. Von Rohr A, Schmitz SF, Tichelli A, et al. Treatment of hairy cell leukemia with cladribine (2-chlorodeoxyadenosine) by subcutaneous bolus infection: a phase II study. *Ann Oncol* 2002;13:1641-1649.

278. Juliusson G, Lenkei R, Tjonnfjord G, et al. Low-dose cladribine for symptomatic hairy cell leukaemia. *Br J Haematol* 1995;89:637-639.

279. Lauria F, Bocchia M, Marotta G, et al. Weekly administration of 2-chlorodeoxyadenosine in patients with hairy-cell leukemia is effective and reduces infectious complications. *Haematologica* 1999;84:22-25.

280. Chacko J, Murphy C, Duggan C, et al. Weekly intermittent 2-CdA is less toxic and equally efficacious when compared to continuous infusion in hairy cell leukaemia. *Br J Haematol* 1999;105:1145-1146.

281. Legrand O, Vekhoff A, Marie JP, et al. Treatment of hairy cell leukaemia (HCL) with 2-chlorodeoxyadenosine (2-CdA): identification of parameters predictive of adverse effects. *Br J Haematol* 1997;99:165-167.

282. Saven A, Burian C, Adusumalli J, Koziol JA. Filgrastim for cladribine-induced neutropenic fever in patients with hairy cell leukemia. *Blood* 1999;93:2471-2477.

283. Seymour JF, Kurzrock R, Freireich EJ, Estey EH. 2-Chlorodeoxyadenosine induces durable remissions and prolonged suppression of CD4+ lymphocyte counts in patients with hairy cell leukemia. *Blood* 1994;83:2906-2911.

284. Juliusson G, Lenkei R, Liliemark J. Flow cytometry of blood and bone marrow cells from patients with hairy cell leukemia: phenotype of hairy cells and lymphocyte subsets after treatment with 2-chlorodeoxyadenosine. *Blood* 1994;83:3672-3681.

285. Zulian GB, Roux E, Tiercy JM, et al. Transfusion-associated graft-versus-host disease in a patient treated with cladribine (2-chlorodeoxyadenosine): demonstration of exogenous DNA in various tissue extracts by PCR analysis. *Br J Haematol* 1995;89:83-89.

286. Schroeder ML. Transfusion-associated graft-versus-host disease. *Br J Haematol* 2002;117:275-287.

287. Kraut EH, Hoo GC. Fludarabine phosphate in refractory hairy cell leukemia. *Am J Hematol* 1991;37:59-60.

288. Kantarjian HM, Schachner J, Keating MJ. Fludarabine therapy in hairy cell leukemia. *Cancer* 1991;67:1291-1293.

289. Maloney DG, Smith B, Rose A. Rituximab: mechanism of action and resistance. *Semin Oncol* 2002;29[1 Suppl 2]:2-9.

290. Byrd JC, Kitada S, Flinn IW, et al. The mechanism of tumor cell clearance by rituximab in vivo in patients with B-chronic lymphocytic leukemia: evidence of caspase activation and apoptosis induction. *Blood* 2002;99:1038-1043.

291. Manches O, Lui G, Chaperot L, et al. In vitro mechanisms of action of rituximab on primary non-Hodgkin's lymphomas. *Blood* 2003;101:949-954.

292. Hagberg H, Lundholm L. Rituximab, a chimaeric anti-CD20 monoclonal antibody, in the treatment of hairy cell leukaemia. *Br J Haematol* 2001;115:609-611.

293. Lauria F, Lenoci M, Annino L, et al. Efficacy of anti-CD20 monoclonal antibodies (Mabthera) in

- patients with progressed hairy cell leukemia. *Haematologica* 2001;86:1046–1050.
294. Kreitman RJ, Wilson WH, Robbins D, et al. Responses in refractory hairy cell leukemia to a recombinant immunotoxin. *Blood* 1999;94:3340–3348.
295. Kreitman RJ, Wilson WH, White JD, et al. Phase I trial of recombinant immunotoxin anti-Tac(Fv)PE38 (LMB-2) in patients with hematologic malignancies. *J Clin Oncol* 2000;18:1622–1636.
296. Kreitman RJ, Wilson WH, Bergeron K, et al. Efficacy of the anti-CD22 recombinant immunotoxin BL22 in chemotherapy-resistant hairy-cell leukemia. *N Engl J Med* 2001;345:241–247.
297. Krigel R, Liebes LF, Pelle E, Silber R. Chlorambucil therapy in hairy cell leukemia: effects on lipid composition and lymphocyte subpopulations. *Blood* 1982;60:272–275.
298. Golomb HM, Schmidt K, Vardiman JW. Chlorambucil therapy of twenty-four postsplenectomy patients with progressive hairy cell leukemia. *Semin Oncol* 1984;11[4 Suppl 2]:502–508.
299. Davis TE, Waterbury L, Abeloff M, Burke PJ. Leukemic reticuloendotheliosis: report of a case with prolonged remission following intensive chemotherapy. *Arch Intern Med* 1976;136:620–622.
300. Jansen J, den Ottolander GJ, Holdrinet RS, et al. Prognosis and therapy in hairy cell leukemia. *Semin Oncol* 1984;11:472–478.
301. McCarthy D, Catovsky D. Response to doxorubicin in hairy cell leukaemia. *Scand J Haematol* 1978;21:445–447.
302. Stewart DJ, Benjamin RS, McCredie KB, et al. The effectiveness of rubidazone in hairy cell leukemia (leukemic reticuloendotheliosis). *Blood* 1979;54:298–304.
303. Calvo F, Castaigne S, Sigaux F, et al. Intensive chemotherapy of hairy cell leukemia in patients with aggressive disease. *Blood* 1985;65:115–119.
304. Lusch CJ, Ramsey HE, Katayama I. Leukemic reticuloendotheliosis: report of a case with peripheral blood remission on androgen therapy. *Cancer* 1978;41:1964–1966.
305. Magee MJ, McKenzie S, Filippa DA, et al. Hairy cell leukemia. Durability of response to splenectomy in 26 patients and treatment of relapse with androgens in six patients. *Cancer* 1985;56:2557–2562.
306. Quesada JR, Hersh EM, Keating M, et al. Hairy cell leukemia: clinical effects of the methanol extraction residue (MER) of BCG, lithium carbonate and mononuclear cell-enriched leukocyte transfusions. *Leuk Res* 1981;5:463–476.
307. Glaspy JA, Baldwin GC, Robertson PA, et al. Therapy for neutropenia in hairy cell leukemia with recombinant human granulocyte colony-stimulating factor. *Ann Intern Med* 1988;109:789–795.
308. Cheever MA, Fefer A, Greenberg PD, et al. Treatment of hairy-cell leukemia with chemoradiotherapy and identical twin bone-marrow transplantation. *N Engl J Med* 1982;307:479–481.
309. Mielke CH, Jr., Dobbs CE, Winkler CF, Yam LT. Therapeutic leukapheresis in hairy cell leukemia. *Arch Intern Med* 1982;142:700–702.
310. Yam LT, Klock JC, Mielke CH. Therapeutic leukapheresis in hairy cell leukemia: review of literature and personal experience. *Semin Oncol* 1984;11[4 Suppl 2]:493–501.
311. Golomb HM, Kraut EH, Oviatt DL, et al. Absence of prolonged benefit of initial leukapheresis therapy for hairy cell leukemia. *Am J Hematol* 1983;14:49–56.
312. Weinmann M, Becker G, Einsele H, Bamberg M. Clinical indications and biological mechanisms of splenic irradiation in chronic leukaemias and myeloproliferative disorders. *Radiother Oncol* 2001;58:235–246.
313. Orringer EP, Varia MA. A role for radiation in the treatment of hairy cell leukemia complicated by massive lymphadenopathy: a case report. *Cancer* 1980;45:2047–2050.

314. Mercieca J, Matutes E, Emmett E, et al. 2-chlorodeoxyadenosine in the treatment of hairy cell leukaemia: differences in response in patients with and without abdominal lymphadenopathy. *Br J Haematol* 1996;93:409-411.
315. Bernstein L, Newton P, Ross RK. Epidemiology of hairy cell leukemia in Los Angeles County. *Cancer Res* 1990;50:3605-3609.
316. Kampmeier P, Spielberger R, Dickstein J, et al. Increased incidence of second neoplasms in patients treated with interferon alpha 2b for hairy cell leukemia: a clinicopathologic assessment. *Blood* 1994;83:2931-2938.
317. Pawson R, A'Hern R, Catovsky D. Second malignancy in hairy cell leukaemia: no evidence of increased incidence after treatment with interferon alpha. *Leuk Lymphoma* 1996;22:103-106.
318. Au WY, Klasa RJ, Gallagher R, et al. Second malignancies in patients with hairy cell leukemia in British Columbia: a 20-year experience. *Blood* 1998;92:1160-1164.
319. Kurzrock R, Strom SS, Estey E, et al. Second cancer risk in hairy cell leukemia: analysis of 350 patients. *J Clin Oncol* 1997;15:1803-1810.
320. Federico M, Zinzani PL, Frassoldati A, et al. Risk of second cancer in patients with hairy cell leukemia: long-term follow-up. *J Clin Oncol* 2002;20:638-646.

2004 Lippincott Williams & Wilkins  
John P. Greer, John Foerster, John N. Lukens  
George M. Rodgers, Frixos Paraskevas, Bertil Glader  
Wintrobe's Clinical Hematology

**HISTORICAL PERSPECTIVE**[Clinical Description](#)[Histopathology](#)[Immunology](#)[Molecular Genetics](#)**EPIDEMIOLOGY****CLINICAL PRESENTATION****CLASSIFICATION OF CUTANEOUS T-CELL LYMPHOMA****DIAGNOSTIC EVALUATION**[Tissue Handling](#)[Histopathology](#)[Immunophenotype](#)**DIFFERENTIAL DIAGNOSIS**[Benign Conditions](#)[Indolent Cutaneous T-Cell Lymphoma, Excluding Mycosis Fungoides and Sézary Syndrome](#)[Other Primary Cutaneous T-Cell Lymphomas](#)[Other Hematopoietic Neoplasms with Similar Cutaneous Presentations](#)**STAGING**[Bone Marrow](#)[Lymph Nodes](#)[Peripheral Blood](#)**PROGNOSIS****THERAPY**[Topical Chemotherapy](#)[Electron Beam Radiotherapy and Photon Beam Irradiation](#)[Systemic Chemotherapy](#)[Retinoids](#)[Interferon](#)[Photopheresis or Extracorporeal Photochemotherapy](#)[Combined Modality Therapy](#)[Immunotherapy](#)[Hematopoietic Stem Cell Transplantation](#)[Other Therapies](#)**SUMMARY AND FUTURE INVESTIGATIONS****ACKNOWLEDGMENT****REFERENCES**

Cutaneous lymphomas are a heterogeneous group of non-Hodgkin lymphomas (NHLs) of T- and B-cell origin where the skin is the primary organ of involvement. Primary cutaneous lymphomas usually present without signs of extracutaneous malignancy at onset of symptoms; they represent an entity distinct from nodal lymphomas with secondary cutaneous involvement. In 1975, Lutzner, Edelson, and associates introduced the term *cutaneous T-cell lymphoma* (CTCL) to describe the spectrum of skin-based lymphomas of T-cell origin, including classic mycosis fungoides (MF) and Sézary syndrome (SS) ( [1](#), [2](#) ). This chapter is a review of the history, epidemiology, clinicopathologic features, and therapy of these lymphomas.



## HISTORICAL PERSPECTIVE

### Clinical Description

The first clinical description of MF was in 1806 by Alibert, a French physician, who identified a 56-year-old man with skin tumors resembling mushrooms after having a desquamating rash over several months; the lesions waxed and waned for 5 years before the patient died with a “hectic” fever ( [3](#) ). In 1832, Alibert first used the term *mycosis fungoïde* to describe the mushroom-like tumors in his treatise on diseases of the skin ( [4](#) ). Bazin described the three classic cutaneous stages in 1870: (a) the premycotic stage, which can be localized or diffuse with superficial eczematous or erythematous lesions; (b) the infiltrative plaque stage; and (c) the tumor stage ( [5](#) ). The *mycosis d’emblée* variant was described by Vidal and Brocq in 1885 in which tumors rapidly develop without a preceding premycotic or plaque stage ( [6](#) ). In the early 1890s Besnier and Hallopeau described the erythrodermic variant, which later became known as SS ( [7](#), [8](#) ).

### Histopathology

By the end of the 19th century, most authorities agreed that the small round cells infiltrating the epidermis and forming tumors were lymphoid in origin ( [9](#) ). Although the French authorities considered the disease lymphadenomatous in nature, the German, English, and American authorities were divided between sarcomatous and granulomatous (infectious) etiologies ( [9](#), [10](#) ).

The unique appearance of the cells involved in CTCL was identified in 1938 by Sézary and Bouvrain, who reported a triad of erythroderma, leukemia with circulating mononuclear cells that had convoluted nuclei, and adenopathy infiltrated with the same cells ( [11](#) ). In the 1950s, SS was recognized in the English literature by several groups but was not described in the American medical literature until 1961 by Taswell and Winkelmann at the Mayo Clinic ( [12](#), [13](#) ). In 1968, Lutzner and Jordan extended the light microscopic description of the Sézary cell by using electron microscopy to visualize the serpentine or cerebriform cell nucleus ( [14](#) ).

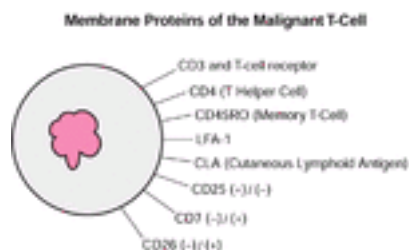
### Immunology

The 1970s witnessed the introduction of cellular immunology into the study of hematopoietic neoplasms and in 1971 Crossen et al. confirmed the lymphocyte origin of SS ( [15](#) ). In 1973, Broome et al. ( [16](#) ) and Brouet et al. ( [17](#) ) identified the neoplastic cell as a T cell, and Broder et al. demonstrated in 1976 that the cells usually are of the helper phenotype (CD4<sup>+</sup>) ( [18](#) ).

Studies performed in the early 1990s further characterized the circulating malignant T cells in patients with SS as “memory” helper T cells due to the expression of CD45RO<sup>+</sup> ( [19](#) ). In 1992, Vowels et al. detected a cytokine profile similar to that produced by murine Th2 cells from both stimulated peripheral blood mononuclear cells and serum from patients with SS ( [20](#) ). Additional studies identified a Th2 cytokine profile [interleukin-4 (IL-4), IL-5, IL-6, IL-10] to be present in the skin of patients with MF and SS ( [21](#), [22](#) and [23](#) ). Increased levels of IL-4 and IL-5 produced by the malignant T-cell clone may account for the eosinophilia and increased levels of immunoglobulin E (IgE) and IgA in the

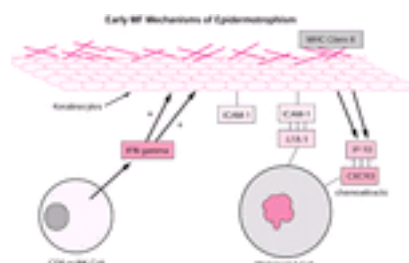
serum of patients with advanced CTCL ( [24](#) ).

Immunologic studies have addressed the pathogenesis of MF and SS by examining the complex interactions among malignant cerebriform T cells, keratinocytes, Langerhans cells, and other immunomodulating cells ( [24](#), [25](#) ). Lymphocytes, malignant and inflammatory, that home to cutaneous sites, differ from lymphocytes in noncutaneous infiltrates by expressing the cutaneous lymphoid antigen (CLA). CLA binds to the endothelial cell adhesion molecule E-selectin that is preferentially induced on cutaneous venules ( [19](#), [26](#), [27](#), [28](#), [29](#), [30](#), [31](#) and [32](#) ). Both circulating and skin-based malignant T cells from patients with MF and SS have been shown to express CLA, which may explain how the cells preferentially home into the skin ( [Fig. 94.1](#) ) ( [19](#), [28](#), [29](#), [30](#) and [31](#) ).



**Figure 94.1.** Membrane proteins of the malignant T cell. The cutaneous lymphoid antigen (CLA) is a membrane protein expressed by a vast majority of T cells found in inflamed skin, including cutaneous T-cell lymphoma. BE-2 is a tumor-related antigen late activation marker expressed on many cutaneous T-cell lymphoma cells. LFA-1 is a  $\beta_2$  integrin expressed by all mature white blood cells.

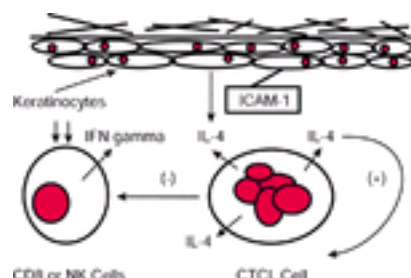
The epidermotropism of the malignant T cell is partially explained by the discovery of increased expression of intercellular adhesion molecule-1 (ICAM-1) by epidermal keratinocytes in early MF lesions ( [33](#) ). The binding of ICAM-1 to a lymphocyte function-associated protein expressed by lymphocytes may explain the histologic finding of atypical lymphocytes nesting within the epidermis ( [34](#) ). Some authorities speculate that the expression of ICAM-1 by keratinocytes is induced by the release of interferon- $\gamma$  (IFN- $\gamma$ ) from infiltrating CD8<sup>+</sup> T cells or natural killer (NK) cells responding to the malignant T-cell population within the dermis ( [Fig. 94.2](#) ) ( [24](#), [25](#), [35](#) ).



**Figure 94.2.** Early cutaneous T-cell lymphoma: mechanisms of epidermotropism. The release of interferon (IFN)- $\gamma$  by early, reactive CD8-cytotoxic T cells or natural killer (NK) cells leads to increased keratinocyte expression of intercellular adhesion molecule-1 (ICAM-1) and release of the C-X-C chemokine IP-10, which binds to the CXCR3 receptor and may lead to nesting of CTCL cells within the epidermis. CXCR3 is preferentially expressed on the Th1 subset of helper T cells.

Adhesion molecules other than ICAM-1 (CD54/CD18) have been implicated in the phenomenon of epidermotropism and include CD58/CD2, B7/CD28, CD49a (VLA-1), CD49c (VLA-3), CD49f (VLA-6), and E-cadherins ( [24](#), [36](#), [37](#)). Soluble chemotactic factors may also play a role in the epidermotropism of MF. The expression of the CXC chemokine IP-10 (IFN- $\gamma$ -inducible protein-10), which is chemotactic for CD4<sup>+</sup> lymphocytes, has been shown to be markedly increased by basal and suprabasal keratinocytes in MF lesions ( [35](#)). Several studies suggest that, in early MF, epidermal Langerhans cells convert to hyperstimulatory antigen-presenting cells (CD1a<sup>+</sup>, CD1b<sup>+</sup>, CD36<sup>+</sup>), with a high expression of class II major histocompatibility complex (MHC) molecules and adhesion molecules capable of activating tumor-infiltrating lymphocytes ( [24](#), [38](#), [39](#) and [40](#)).

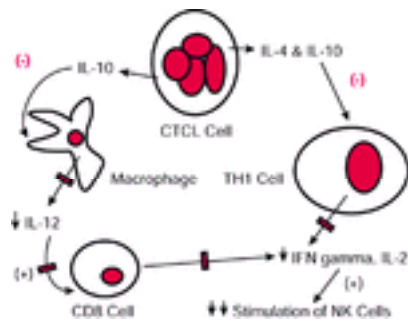
More advanced lesions of MF, characterized clinically as tumors or generalized erythroderma, often demonstrate a loss of epidermotropism with malignant T cells infiltrating the deep dermis ( [25](#)). In 1989, Nickoloff et al. found markedly diminished ICAM-1 expression by keratinocytes from a patient with SS ( [33](#)), and similar findings in tumor-stage patients were reported by Vejlsgaard et al. ( [41](#)). Rook et al. ( [25](#)) have suggested that unknown mechanisms lead to an evasion of the host immune response with subsequent expansion of the malignant clonal population and increased production of IL-4. Increased levels of IL-4 could inhibit the production of IFN- $\gamma$ , leading to decreased ICAM-1 expression by keratinocytes and, thus, reduced binding of malignant T cells within the epidermal compartment ( [25](#)) ( [Fig. 94.3](#)).



**Figure 94.3.** Late cutaneous T-cell lymphoma (CTCL): loss of epidermotropism. As the clonal population of CTCL cells expands, more interleukin-4 (IL-4) is released, which drives autocrine-induced proliferation of the CTCL cells and inhibition of CD8-cytotoxic T cells and natural killer (NK) cells. The impaired release of interferon (IFN)- $\gamma$  may lead to less intercellular adhesion molecule-1 (ICAM-1) expression and decreased keratinocyte-CTCL cell adhesion.

Recently, CXCR3, a T-cell chemokine receptor, has been shown to be expressed by lymphocytes in early-stage MF but is absent in cases of transformed MF, when epidermotropism is often absent ( [42](#)).

As the disease progresses, cell-mediated immunity, critical for tumor cell recognition and destruction, is slowly dismantled ( [Fig. 94.4](#)).



**Figure 94.4.** Dismantling of the immune system by cutaneous T-cell lymphoma (CTCL). The continued release of interleukin-4 (IL-4) and IL-10 by proliferating CTCL cells may impair cell-mediated immunity by inhibiting the functions of macrophages and Th1 helper T cells critical for tumor recognition and destruction. IFN gamma, interferon- $\gamma$ ; NK, natural killer.

IL-4 and IL-10 secreted by the malignant T cell may inhibit Th1 cells responsible for coordinating cell-mediated immune functions ( 2, 25, 43 ). Also, the inhibition of IL-12 secretion from macrophages may diminish the cytokine's stimulatory effect on CD8-cytotoxic T cells ( 24, 25, 44 ). With Th1 cells, CD8-cytotoxic T cells, macrophages, and NK cells partially disabled, the malignant clone can escape immune surveillance and proliferate.

### Molecular Genetics

Clonality in T-cell lymphoma was difficult to establish before the development of molecular genotyping methods in the 1980s. Initial evidence of clonality in MF/SS was provided by cytogenetic analysis ( 45, 46, 47, 48, 49 and 50 ). Several of these early studies demonstrated the same abnormal clone in separate lesions from skin, peripheral blood, lymph nodes, and bone marrow ( 46, 48, 50 ).

The identification of a defined cytogenetic abnormality would be a major advance in the diagnosis and understanding of the pathogenesis of MF/SS ( 51 ). Unfortunately, to date, no such abnormality has been identified consistently in MF, with most reported findings being largely of a random nature ( 51, 52 and 53 ). A few studies have suggested that complex cytogenetic abnormalities are found more commonly on chromosomes 1 and 2 (43% of SS cases) and 6 (38% of SS cases) ( 54 ) and may involve activation of oncogenes such as ERB-A, K-RAS, V-FPS, ICK, and C-MYC ( 52, 54, 55, 56, 57 and 58 ). Abnormalities in chromosome 10 have been correlated with progression to tumor stage, including loss of heterozygosity on 10q and microsatellite instability ( 59 ). In addition, using comparative genomic hybridization, the circulating tumor cells in SS, as opposed to circulating tumor cells in MF, have been shown to have a loss of chromosome 10q25-26, with possible candidate tumor-suppressor genes MXI 1 and DMBT 1 ( 60 ). Lastly, p16<sup>INK4a</sup>, a protein coded at the 9p21 locus, has been shown to be silenced in tumor-stage MF ( 61 ).

Overexpression of the tumor-suppressor gene p53 has been detected in some cases of high-grade CTCL, such as cutaneous anaplastic large cell lymphoma (ALCL), but rarely in low-grade CTCL ( 58, 62, 63 and 64 ). Fracchiolla et al. identified gene rearrangements of the nuclear factor-kappa B (NF- $\kappa$ B) transcription factor LYT-10 (NFKB2/p52), an important regulator of lymphocyte activation and gene expression, in 2% (5 of 228) of lymphoid malignancies, including CTCL ( 65 ). Two additional recent studies found LYT-10 gene rearrangements in a minority of CTCL cases ( 58, 66 ). Aberrant expression of the BCL-2

gene, which normally codes for an inner mitochondrial membrane protein, can suppress apoptosis, an important pathogenic mechanism in lymphomas ( [67](#) ). Although Dummer and colleagues detected BCL-2 expression in 22 of 26 MF patients, it was also present in five of six patients with benign inflammatory dermatoses ( [68](#) ).

In 1985, Aisenberg et al. and Weiss et al. independently described Southern blot analysis techniques using probes for the  $\beta$ -chain of the T-cell receptor (TCR) to establish clonality in T-cell lymphoproliferative disorders ( [69](#) , [70](#) ). Because earlier cytogenetic studies suggested that CTCL arises from a single malignant clone of mature T cells ( [45](#) , [46](#) , [47](#) , [48](#) , [49](#) and [50](#) ), the presence of TCR  $\beta$ -chain rearrangement in pathologically suspicious tissue has been considered the strongest evidence for the diagnosis of CTCL ( [71](#) , [72](#) , [73](#) , [74](#) , [75](#) , [76](#) , [77](#) and [78](#) ). However, in early lesions of MF, or the *patch stage*, where the number of infiltrating malignant T cells is minimal, the Southern blot technique fails to consistently detect clonal T-cell populations. Other limitations of the Southern blot technique include its necessity for large amounts of preserved DNA, as well as its extensive time and labor requirement ( [77](#) , [79](#) , [80](#) ). Therefore, the detection sensitivity of Southern blotting of DNA derived from skin biopsy specimens of early lesions is too low and may fail as a diagnostic test when the clinical and histologic diagnosis is most difficult ( [81](#) ).

More sensitive techniques involving the polymerase chain reaction (PCR) have been developed to evaluate clonality in CTCL and related skin diseases and are becoming more readily available ( [51](#) , [52](#) , [73](#) , [82](#) , [83](#) , [84](#) , [85](#) , [86](#) , [87](#) , [88](#) , [89](#) , [90](#) and [91](#) ). The PCR is an *in vitro* imitation of the enzymatic DNA repair and replication that takes place in all proliferating cells but amplifies short specific lengths of DNA in the order of  $10^9$  to  $10^{12}$  and, therefore, permits the use of very small amounts of starting DNA ( [51](#) ). Although the vast majority of CTCL express the  $\alpha/\beta$  TCR heterodimer, most labs using the PCR technique take advantage of the fact that all  $\alpha/\beta$  TCR-positive T cells also contain at least one rearranged allele of the TCR  $\gamma$ -chain gene ( [85](#) , [92](#) ). The  $\gamma$  gene contains only 8 V segments and 2 C regions, making it possible to use specific primers for all known TCR  $\gamma$  V segments ( [93](#) , [94](#) ). It is estimated that this PCR-based technique, in combination with high-resolution nondenaturing polyacrylamide gel electrophoresis, is 10 to 50 times more sensitive than conventional Southern blot analysis in the detection of small T-cell clones ( [88](#) ). A few groups have extended the PCR technique by incorporating a multiprobe RNAase protection assay ( [95](#) ) or a denaturing gradient gel electrophoresis.

## EPIDEMIOLOGY

The incidence of MF in the United States decreased slightly from 0.4 cases per 100,000 in 1984 to 0.36 cases per 100,000 in 1992, based on data from nine cancer registries that participate in the Surveillance, Epidemiology, and End Results Program of the National Cancer Institute (NCI) ( [96](#) , [97](#) ). During that period, MF represented 3% of all reported NHLs ( [96](#) , [97](#) ). Because the number of patients with early-stage MF is often not reported to tumor registries, the actual incidence may be higher. In a well-defined population such as Rochester, Minnesota, the annual incidence was 0.9 per 100,000 between 1970 and 1984 ( [98](#) ). Thus, the incidence of new cases in the United States in the 1990s is more than 1000 cases per year. The incidence of MF increases with advancing age, and the median age is usually between 60 and 70 years ( [99](#) , [100](#) , [101](#) and [102](#) ), with a specific estimate of 69 years during the period of 1989 through 1991 (National Center for Health Statistics, 1991). MF is rare in patients younger than 30 years; however, there have been several reports of children and adolescents affected with MF and SS ( [103](#) , [104](#) , [105](#) , [106](#) , [107](#) ,

[108](#), [109](#), [110](#), [111](#), [112](#) and [113](#)). One recent study found that 4% to 5% of patients with MF had onset of their eruption before 20 years of age ([107](#)).

Blacks are almost twice as likely to develop MF compared to whites and Asians, with the greatest racial differences seen among the younger patient populations. The male to female ratios are dependent on race, with Asian, black, and white ratios of 5.2, 2.3, and 1.8, respectively ([96](#), [97](#)). The etiology of MF/SS remains unknown, but genetic, environmental, and infectious agents have been implicated as possible factors triggering lymphocyte activation or transformation ([51](#), [52](#), [114](#)). A recent study found that, not only did the antioxidative effects of wine consumption fail to protect against the development of MF, but that patients consuming more than 24 g of alcohol per day demonstrated a higher incidence of MF than matched control groups (adjusted odds ratio = 3.02; 95% confidence interval = 1.34–6.79) ([115](#)). Also significant was that the alcohol effect remained constant regardless of beverage type.

Rare familial clusters of CTCL cases have been reported ([116](#), [117](#)), and an increased incidence has been noted in patients with certain histocompatibility antigens ([118](#), [119](#)). Early reports implicated an increased risk of developing CTCL in people employed in manufacturing occupations, particularly those related to petrochemicals, textiles, or metals, or in farming, with exposure to pesticides or herbicides ([120](#), [121](#) and [122](#)). However, two case-control studies have failed to confirm these observations ([123](#), [124](#)). Results of other studies have suggested that patients with MF have increased contact allergies, but Whittemore and colleagues were unable to substantiate the association in a case-control clinical study ([124](#)).

Human retroviruses have been suggested as possible etiologic agents in CTCL. Human T-cell lymphotropic virus type 1 (HTLV-1) was described initially in a CTCL patient who had an aggressive clinical course; however, this disease was later identified as adult T-cell leukemia/lymphoma (ATLL), which is endemic to Japan, the Caribbean, and other areas of the world but can have cutaneous lesions similar to CTCL (see [Chapter 90](#)) ([125](#)). Serologic findings for HTLV-1/2 in patients with CTCL are negative in a vast majority of patients ([126](#), [127](#), [128](#), [129](#), [130](#), [131](#) and [132](#)). In support of the association of HTLV-1/2 and MF, virus particles indistinguishable from HTLV-1 have been identified using electron microscopy on immortalized MF cells ([133](#)), and combined PCR/Southern blot analysis has demonstrated HTLV pol, tax, and/or rex sequences in peripheral blood mononuclear cell lysate extracts and lesional skin from patients with MF/SS ([126](#), [131](#), [134](#), [135](#), [136](#), [137](#), [138](#), [139](#), [140](#), [141](#), [142](#), [143](#), [144](#) and [145](#)). Further support of a potential HTLV-1/CTCL association was suggested after inoculation of immunosuppressed rats with peripheral blood mononuclear cell extracts from patients with MF/SS. A novel anti-HTLV-1 antibody was detected in the serum of 29% of the animals, whereas peripheral blood mononuclear cells from healthy controls did not elicit an anti-HTLV-1 antibody response. These findings lend further support to the role of HTLV-1 as being at least a cofactor in the pathogenesis of CTCL ([146](#)). Based on these studies, some authors contend that the strongest evidence of an etiologic and pathogenic factor for CTCL relates to the presence of a defective or variant HTLV-1 virus ([81](#), [135](#)). Other authorities ([132](#), [147](#), [148](#) and [149](#)), however, disagree, citing seven series that found no proviral HTLV-1 sequences in 332 CTCL patients ([130](#), [132](#), [141](#), [150](#), [151](#), [152](#) and [153](#)) and four studies that detected the proviral sequences in 10% of 176 patients. Future development ([134](#), [137](#), [144](#), [145](#)) of advanced molecular techniques should eliminate the difficulty of establishing with certainty the presence or absence of HTLV-1 proviral sequences in patients with CTCL (



## CLINICAL PRESENTATION

MF usually evolves over a long period, so patients often have a long premycotic or premalignant phase with eczematous skin eruptions 4 to 10 years before a histologic diagnosis is established ( 81, 99, 155 ). The differential diagnosis during this period includes chronic eczematous or atopic dermatitis, which may evolve slowly into eruptions clinically suggestive of parapsoriasis en plaque, poikiloderma atrophicans vasculare, or other benign papulosquamous skin diseases ( 99, 155, 156 ). Failure of the lesions to respond to standard topical therapy may be an early clue of a different diagnosis. However, initial lesions occasionally appear to improve after topical steroid application, which masks early recognition of the underlying malignancy ( 157 ). Because of the difficulty in diagnosis in the premycotic phase of MF, careful follow-up with serial skin biopsies is warranted in patients with suspect lesions (see [Diagnostic Evaluation](#)).

The earliest diagnostic phase of MF is the patch phase, characterized by scaly macules and patches that vary in size, tend to involve sun-protected sites, and are occasionally associated with pruritus ( [Fig. 94.5A](#) ) ( 5, 101, 156 ).



**Figure 94.5.** A–E: The cutaneous phases of cutaneous T-cell lymphoma (CTCL). **A:** Early patch stage lesions in a sun-protected region. **B:** Hyperpigmented diffuse patches on the back of a dark-skinned patient. **C:** Scattered thin and thick plaques on the back. **D:** Early keratoderma of the sole. **E:** Ulcerated tumor within a plaque on the posterior leg. **F:** Coalescing nodules and tumors with dermal thickening, forming “leonine facies” in this patient with transformed CTCL. See [Color Plate](#).

Other, less common early skin findings in CTCL include poikiloderma ( 158 ), hypopigmentation ( 159 ), hyperpigmentation ( [Fig. 94.5B](#) ), alopecia, pruritus alone ( 160, 161 and 162 ), and porokeratosis-like lesions ( 163 ). Recently, several cases of “invisible” MF were described. Afflicted patients presented only with persistent, generalized pruritus and no clinical eruption ( 160, 161 and 162 ). Random biopsies of “normal” skin confirmed the



diagnosis of MF.

Plaques are sharply demarcated, scaly, elevated lesions that may have annular, arcuate, or serpiginous borders ( Fig. 94.5C). Plaques with thick scales can mimic psoriasis or nummular eczema, whereas annular lesions with central clearing may be confused with tinea corporis ( 156 ). Ultraviolet radiation occasionally induces regression of patches and plaques, further delaying correct diagnosis. Prominent involvement of the palms or soles or both may result in hyperkeratosis, fissuring, or frank keratoderma ( Fig. 94.5D) ( 164 , 165 ).

The tumor phase is heralded by the onset of dome-shaped, deep red to violaceous nodules emerging in areas of uninvolved skin or in preexisting plaques ( 156 ). The tumors may ulcerate and become secondarily infected ( Fig. 94.5E), and there is a predilection for the body folds and face, where dermal thickening, coalescing plaques, and tumors may result in characteristic “leonine facies” ( Fig. 94.5F). The tumor stage is more clinically aggressive than the patch and plaque stages and may be associated with histologic transformation to a large cell process with a vertical growth phase (see [Histopathology and Prognosis](#)) ( 156 ). Rarely, patients with MF will present initially with tumors without the preceding patch and plaque phases (the mycosis *d’emblée* variant) ( 6 , 166 ). It is very common for more advanced patients to have patches, plaques, or tumors present simultaneously on different areas of their skin ( 81 ).

Generalized erythroderma may develop as the initial presenting sign of MF/SS or may accompany plaques and tumors ( 81 , 99 , 167 , 168 ). In SS, the leukemic variant of MF, erythroderma and circulating tumor cells, or *Sézary cells*, in the peripheral blood may be accompanied by generalized lymphadenopathy, splenomegaly, keratoderma, vitiligo-like hypopigmented patches ( 169 ), alopecia, ectropion, nail dystrophy, and ankle edema ( 155 , 167 , 170 ). Intense pruritus and cutaneous pain are common in SS, and when the palms and soles are affected with scaling and fissuring, walking and manual dexterity can become difficult ( 155 , 170 ).

## CLASSIFICATION OF CUTANEOUS T-CELL LYMPHOMA

The term CTCL is a general term that encompasses a variety of diseases, including MF and SS. In addition, there are other cutaneous T-cell lymphoproliferative disorders that appear to be specific entities with unique clinical, histologic, and prognostic features. In an effort to recognize the separate disease processes, proposals for classification of primary CTCL were formulated by the World Health Organization and the European Organization for Research and Treatment of Cancer ( Table 94.1) ( 171 , 172 and 173 ). The following sections focus on the histopathology and immunopathology of MF and SS. Other types of primary CTCL will be briefly discussed in the differential diagnosis section and in more detail in Chapters 90 and 91.

**TABLE 94.1. Comparison of Primary Cutaneous T-Cell Lymphoma Classification Schemes Proposed by the European Organization for Research and Treatment of Cancer (EORTC) and the World Health Organization (WHO)**

| EORTC             | WHO               |
|-------------------|-------------------|
| Indolent          |                   |
| Mycosis fungoides | Mycosis fungoides |

|  |   |
|--|---|
| Follicular mycosis fungoides                   | Mycosis fungoides   |
| Pagetoid reticulosis                           | Pagetoid reticulosis  |
| Lymphomatoid papulosis                         | Lymphomatoid papulosis  |
| Large cell CTCL, CD30 <sup>+</sup>             | Anaplastic large cell lymphoma, primary cutaneous type            |
| Aggressive                                     |   |
| Sézary syndrome                                | Sézary syndrome   |
| CTCL, large cell, CD30 <sup>-</sup>            | Peripheral T-cell lymphoma, NOS or natural killer/T-cell lymphoma |
| Provisional                                    |   |
| Granulomatous slack skin                       | Granulomatous slack skin  |
| Pleomorphic small to medium-sized CTCL         | Peripheral T-cell lymphoma, unspecified                           |
| Subcutaneous panniculitis-like T-cell lymphoma | Subcutaneous panniculitis-like T-cell lymphoma                    |

CTCL, cutaneous T-cell lymphoma; NOS, not otherwise specified.

Modified from Jaffe et al., Willemze et al., and the EORTC Classification of Primary Cutaneous Lymphomas, 171, 173.

---

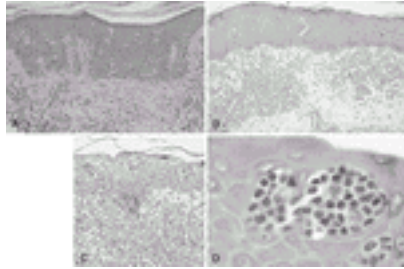
## DIAGNOSTIC EVALUATION

### Tissue Handling

Skin biopsies for diagnosis of MF/SS must be properly handled to maximize the diagnostic information obtained. These studies include routine histology, immunophenotyping, and molecular genotyping. Communication between the clinical staff, dermatologists, and pathologists is essential to ensure that the appropriate types of biopsies are done and are properly handled. In general, 6-mm punch biopsies are recommended. Multiple biopsies from different skin lesions may be necessary to establish a definitive diagnosis of MF/SS, particularly in early patch-stage lesions. It has been recommended that steroids be discontinued for 2 to 3 weeks before biopsy ([174](#)). A careful drug history should be taken before biopsy because certain drug eruptions can closely mimic early MF, particularly phenytoin and other anticonvulsants ([175](#)). Skin biopsies for possible CTCL should be sent to the pathology or dermatopathology lab fresh on saline-soaked gauze or in tissue culture media such as RPMI. These biopsies can then be divided for the various diagnostic studies. Punch biopsies can be divided into halves; one half for routine histology, and the other half for immunophenotyping or molecular diagnostic studies or both. Sections for routine histology should be fixed in a good nuclear fixative such as B5 to facilitate evaluation of nuclear morphology and recognition of characteristic cerebriform cells. If it is a large biopsy of a cutaneous tumor or a lymph node biopsy, it may provide adequate tissue to prepare cell suspensions for immunophenotyping by flow cytometry and for cytogenetic studies. The tissue for immunophenotyping by flow cytometry should be promptly delivered to the appropriate laboratory in cell culture media. Tissue for molecular studies should be snap-frozen in liquid nitrogen and stored at -70° C. For leukemic infiltrates, cytochemical stains can be performed on air-dried touch imprints from freshly cut surfaces. A small sliver of the biopsy can be shaved off and fixed in glutaraldehyde for electron microscopy if needed. Lymph nodes should be worked up as previously described ([176](#)).

## Histopathology

**CUTANEOUS FEATURES OF MYCOSIS FUNGOIDES AND SÉZARY SYNDROME** In general, the histologic diagnosis of MF/SS in skin biopsies is based on criteria similar to those used for the diagnosis of other lymphoid neoplasms, including the presence of an infiltrative or destructive growth pattern and cytologic atypia. The distribution of the infiltrate within the skin biopsy is also important ( [Fig. 94.6A](#)).



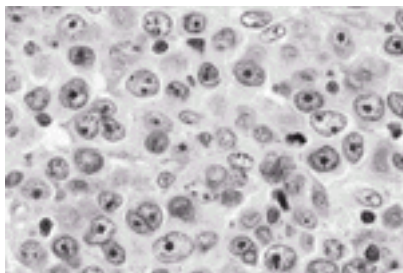
**Figure 94.6.** **A:** Mycosis fungoides (MF), patch stage. A bandlike lymphocytic infiltrate occupies the superficial papillary dermis with single-cell epidermotropism by atypical, “haloed” cerebriform T cells, preferentially involving the basal layer (hematoxylin and eosin,  $\times 50$ ). **B:** MF, plaque stage. A bandlike lymphocytic infiltrate occupies the papillary dermis with epidermotropism by atypical cerebriform T cells, focally forming small Pautrier microabscesses (hematoxylin and eosin,  $\times 25$ ). **C:** MF, thick plaque. A dense, bandlike lymphocytic infiltrate fills the papillary dermis and extends into the reticular dermis. Prominent epidermotropism by atypical, enlarged cerebriform T cells creates large Pautrier microabscesses (hematoxylin and eosin,  $\times 25$ ). **D:** MF, Pautrier microabscess. High magnification of a Pautrier microabscess shows characteristic small to medium-sized cerebriform T cells with highly convoluted nuclear folding. The Pautrier microabscess recapitulates normal interactions between components of the skin-associated lymphoid tissue [i.e., cutaneous T cells, Langerhans histiocytes (two cells with large, pale nuclei in the center), and keratinocytes] (hematoxylin and eosin,  $\times 500$ ). See [Color Plate](#).

The characteristic atypical lymphocytes in MF and SS are dysplastic cerebriform T cells (CTCs) with enlarged hyperchromatic nuclei and complex nuclear folding. Demonstration of cerebriform nuclear folding requires good fixation (we prefer B5 fixation), thin ( $4\ \mu\text{m}$ ) sections, and examination under  $100\times$  oil immersion. Others have used special methods, such as  $1\text{-}\mu\text{m}$  sections of plastic-embedded tissue, electron microscopy, or nuclear morphometry ( [177](#), [178](#) and [179](#)). Diagnostic criteria for cutaneous involvement by MF are best illustrated in plaque-stage lesions ( [Fig. 94.6B](#), [Fig. 94.6C](#)). The essential criteria for diagnosis are (a) a bandlike lymphocytic infiltrate in the superficial papillary dermis, (b) epidermotropism, and (c) atypical CTCs in the dermal and epidermal infiltrates ( [180](#)). Pautrier microabscesses ( [Fig. 94.6D](#)) are characteristic of MF but are often absent in patch-stage lesions, erythroderma, and nonepidermotropic tumors. Diagnosing early patch-stage lesions is often difficult. Histologic features that can be helpful in biopsies lacking Pautrier microabscesses include accumulation of “haloed” epidermotropic CTCs along the basal layer of the epidermis, medium to large cerebriform cells in the epidermis and clustered in the dermis, and a lack of fibrosis in the papillary dermis ( [180](#), [181](#)). Spongiosis should be minimal in relation to epidermotropism in MF and SS. Biopsies with prominent spongiosis must be differentiated from eczematous or spongiotic dermatitis. Eosinophils and plasma cells are often present in early patch- and plaque-stage MF and represent a nonspecific reactive component. It is important to understand that a definitive diagnosis of MF may not be possible in some early patch-stage lesions. Multiple biopsies of separate skin lesions, immunophenotyping, and TCR gene rearrangement studies may help confirm the diagnosis in difficult cases. However, even these ancillary studies may be inconclusive in early lesions. Tumor-stage MF is characterized histologically by a dense

dermal infiltrate involving the papillary and reticular dermis, often with extension into the subcutis. In contrast to patch- and plaque-stage lesions, MF tumors are often nonepidermotropic and may spare the dermal-epidermal interface. Furthermore, the malignant T cells in tumor-stage MF often display various degrees of histologic transformation with medium and large pleomorphic cells, immunoblastic large cells, and anaplastic large cells ( [182](#), [183](#) and [184](#)). The diagnosis of malignancy in the tumor stage is rarely in question, but recognition of MF origin for tumors with large cell transformation may be obscured by their resemblance to other NHLs. A careful search for dysplastic CTCs and residual foci of epidermal infiltration near the edges of tumors often provides histologic evidence of MF origin in difficult cases ( [182](#)). Previous or concurrent biopsies of earlier-stage lesions should confirm MF origin for tumors with large cell transformation. Generalized exfoliative erythroderma is characteristic of SS but may also occur in MF ( [155](#), [185](#)). Cutaneous biopsies of erythroderma in MF/SS often lack prominent epidermotropism. In one study, up to 17% of skin biopsies of patients with established SS were considered nondiagnostic due to insufficient epidermo-tropism ( [168](#)). However, Pautrier microabscesses may be found in many cases ( [185](#)). The dermal infiltrate in erythrodermic MF and SS patients may be similar to that found in patch and plaque stage MF; however, there may be a decrease in the density of the infiltrate. Evaluation of the peripheral blood for circulating tumor cells and or molecular analysis of the skin biopsy for a clonal rearrangement of the TCR may help establish the diagnosis of MF/SS in cases in which skin biopsies are histologically suspicious but nondiagnostic.

#### **LARGE CELL TRANSFORMATION OF MYCOSIS FUNGOIDES AND SÉZARY**

**SYNDROME** Approximately 20% of low-grade MF and SS undergo secondary transformation to high-grade large cell lymphoma with a predominance (>50%) of large transformed lymphocytes ( [Fig. 94.7](#)) ( [182](#), [186](#)).



**Figure 94.7.** Large cell transformation of cutaneous T-cell lymphoma. This represents secondary transformation of low-grade mycosis fungoides to high-grade immunoblastic large cell lymphoma. This tumor is composed of sheets of large transformed cells or immunoblasts with round to oval nuclei, dispersed chromatin, and prominent nucleoli. Several mitoses are present (hematoxylin and eosin,  $\times 500$ ). See [Color Plate](#).

Secondary large cell transformation of MF/SS may resemble immunoblastic large cell lymphoma, pleomorphic large cell lymphoma, or ALCL ( [182](#), [183](#), [187](#)). It has been shown that secondary large cell lymphoma is immunophenotypically and clonally related to earlier MF/SS biopsies taken before transformation ( [182](#), [188](#), [189](#)). Cutaneous large cell transformation usually occurs late in tumor-stage lesions but can occasionally be seen in plaques or erythrodermic MF and may be present in the initial diagnostic biopsy (mycosis *d'emblée* variant). Lymph nodes are the most common site of extracutaneous large cell transformation, but it may also occur in other extracutaneous sites. Approximately 50% of secondarily transformed large cell lymphomas express CD30 ( [182](#), [190](#)). It is important to distinguish secondary large cell transformation of MF/SS from unrelated primary cutaneous large cell lymphoma and secondary cutaneous involvement by systemic large cell lymphoma because of prognostic differences ( [191](#)). This is particularly true for secondary CD30<sup>+</sup> large cell lymphoma resulting from transformation of MF/SS, which has a poor prognosis, in contrast to primary cutaneous CD30<sup>+</sup> ALCL, which has a favorable

prognosis ( [182](#), [192](#), [193](#) and [194](#) ).

**EXTRACUTANEOUS MYCOSIS FUNGOIDES AND SÉZARY SYNDROME** Extracutaneous dissemination is generally considered to be a late occurrence in MF/SS because the disease is clinically limited to the skin for prolonged periods in most patients ( [195](#) ). However, histologic staging has documented extracutaneous disease in up to 50% of CTCL patients within 6 months of initial diagnosis ( [196](#), [197](#) ). Using more sensitive techniques such as cytogenetics, electron microscopy, and immunophenotypic studies, extracutaneous disease has been found in nearly 90% of MF/SS patients at initial staging ( [198](#) ). TCR gene rearrangement studies have confirmed a high frequency of lymph node involvement by MF/SS ( [69](#) ). Moreover, autopsy studies have histologically documented widespread extracutaneous disease in most patients ( [199](#), [200](#), [201](#) and [202](#) ). Extracutaneous MF/SS has histologic features, which are usually similar to those seen in the skin ( [199](#), [200](#) ). Dysplastic CTCs are the most helpful diagnostic feature for recognition as extracutaneous disease. Almost every organ has been involved by MF/SS in autopsy series, but the most frequent sites are the lymph nodes, liver, spleen, and lungs, which are involved in more than 50% of cases ( [199](#), [200](#), [201](#) and [202](#) ). Other common sites include kidney, bone marrow, thyroid, heart, pancreas, and gastrointestinal and central nervous systems. Lymph nodes also represent the most frequent site of extracutaneous disease in pathologic staging studies; up to 50% of lymph nodes are positive by light microscopy at initial staging ( [196](#) ). Visceral involvement is present in approximately 15% of initial-staging liver and bone marrow biopsies ( [182](#), [196](#), [203](#) ). In staging laparotomies, approximately 30% of spleens are microscopically involved by MF/SS ( [197](#) ). Extracutaneous CTCL, particularly visceral disease, is strongly associated with advanced-stage skin disease and SS ( [196](#), [197](#) and [198](#), [203](#) ). Because tumor-stage MF and generalized erythroderma are frequently nonepidermotropic, it has been suggested that loss of epidermotropism may play an important role in systemic dissemination ( [155](#) ).

**LYMPH NODE PATHOLOGY** With up to 50% of staging lymph node biopsies being microscopically involved by MF/SS, lymph nodes are the earliest and most common site of extracutaneous dissemination ( [196](#) ). Partially effaced nodes often have an interfollicular pattern with preservation of reactive follicular centers, but eventually most lymph nodes become completely effaced. As lymph nodes become progressively infiltrated, the CTCs tend to become larger and more pleomorphic, with increased numbers of large transformed cells ( [184](#), [204](#) ). More than 35% of positive lymph nodes show complete large cell transformation with pleomorphic, immunoblastic, or anaplastic large cell morphology ( [182](#), [184](#), [204](#) ). In contrast to MF, lymph nodes from patients with SS tend to be effaced by more monomorphic infiltrates of small to medium-sized CTCs ( [205](#), [206](#) ) but may also undergo large cell transformation in some cases ( [182](#), [190](#) ).

**BONE MARROW INVOLVEMENT** The bone marrow in MF and SS is generally thought to be spared until late in the course of the disease, including patients with large numbers of circulating Sézary cells ( [81](#), [196](#), [198](#), [207](#) ). Early studies suggested that antemortem marrow involvement occurred in less than 3% of MF/SS patients ( [195](#), [198](#) ), yet the marrow is involved in nearly 50% of patients at autopsy ( [199](#), [200](#), [201](#) and [202](#) ). Marrow involvement is usually manifested as nonparatrabecular lymphoid aggregates with cerebriform lymphocytes. In patients with Sézary syndrome, subtle small interstitial clusters of Sézary cells have been identified in up to 90% of cases, suggesting that most patients with circulating Sézary cells have early systemic dissemination of disease ( [203](#) ). Detection of these subtle interstitial infiltrates of Sézary cells requires careful examination under oil immersion (100×) to identify the cells with abnormal cerebriform nuclear folds, which can be facilitated with immunoperoxidase studies for T-cell markers such as CD3.

**OTHER EXTRACUTANEOUS SITES** Visceral involvement by MF and SS is most commonly documented by liver biopsy. Liver involvement in initial staging procedures has

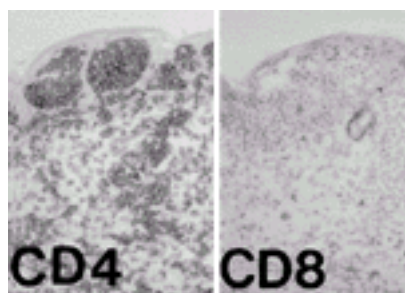


been found in 8% to 16% of cases ( [196](#), [197](#), [208](#) ). Disseminated MF and SS tend to form nodular infiltrates of atypical CTCs within the portal tracts or hepatic lobules. CTCs within the hepatic sinusoids without formation of focal aggregates are not considered diagnostic of liver involvement in the presence of peripheral blood involvement ( [208](#) ). Splenic infiltration was documented in 31% of staging laparotomies in one series ( [197](#) ). The atypical CTCs usually infiltrate the red pulp diffusely but may home to the periarteriolar lymphocyte sheath ( [200](#) ). Splenic rupture has been reported in a rare case with massive splenic involvement by CTCL ( [209](#) ). Antemortem pulmonary manifestations of MF and SS are generally uncommon but may occasionally present clinically as interstitial or nodular pulmonary infiltrates ( [210](#) ). However, the lungs are frequently involved by MF/SS at autopsy ( [199](#), [200](#), [201](#) and [202](#) ). Infiltrates of atypical CTCs usually spread along the alveolar septae with preservation of the alveolar architecture. In some cases, the infiltrates may also fill alveolar spaces.

**BLOOD INVOLVEMENT** In general, patients with at least 10% to 20% Sézary cells with large nuclear size ( $>15$  mm) and high nuclear contour index may be classified as having peripheral blood involvement. In one study, increased large Sézary cells correlated significantly with poorer survival ( [211](#) ). However, size criteria alone would fail to recognize the small Sézary cell variant, which is similar in size to a normal resting lymphocyte ( [212](#) ). Because of the inherent difficulties in diagnosing peripheral blood involvement by MF/SS on peripheral smear review, additional technologies are now used, including flow cytometry and molecular studies such as PCR. Either a CD4:CD8 ratio greater than 10:1 or an abnormal phenotype by flow cytometry along with a clonal population by PCR is now considered adequate evidence to constitute a positive peripheral blood for staging purposes ( [213](#) ). The proposal is to designate such involvement as blood stage B2.

### Immunophenotype

T-cell origin of the neoplastic cells in MF and SS is well established ( [17](#) ). Moreover, the vast majority are derived from T-helper cells ( [18](#), [214](#) ) which express CD4 and other T-cell-associated antigens, including CD2, CD3, CD5, and  $\alpha\beta$  TCRs ( [Fig. 94.8](#) ) ( [215](#), [216](#) ).



**Figure 94.8.** Frozen-section immunohistochemistry of a cutaneous plaque in a patient with mycosis fungoides shows a marked predominance of CD4<sup>+</sup> T-helper cells within Pautrier microabscesses and within the dermis. CD8 is essentially negative (diaminobenzidine and hematoxylin,  $\times 50$ ). See [Color Plate](#).

However, a small number of CD8<sup>+</sup> CTCLs ( [182](#), [215](#), [217](#) ) and ?d CTCLs have been reported ( [218](#), [219](#) ). In addition, it has been shown that MF/SS is a neoplasm of memory T cells, which are CD29<sup>+</sup> and CD45R0<sup>+</sup> ( [215](#), [220](#) ) and express CLA (HECA-452), the

cutaneous lymphoid antigen homing receptor ([30](#)). Activation-associated (HLA-DR, CD25, CD30, CD38) and proliferation-associated (CD71, Ki-67) antigens are also frequently expressed in MF/SS, particularly in advanced stages ([182](#), [221](#)).

Aberrant T-antigen expression is often seen in MF and SS, particularly advanced plaque- or tumor-stage lesions, and can be used to help differentiate reactive dermatitis from MF/SS ([215](#), [222](#), [223](#) and [224](#)). Aberrant T-cell phenotypes are defined as diminished or absent expression of pan T-cell antigens (CD2, CD3, or CD5), absent T-subset antigen expression (CD4<sup>-</sup> CD8<sup>-</sup>), or coexpression of T-subset antigens (CD4<sup>+</sup> CD8<sup>+</sup>). Diminished or absent CD7 expression is one of the most common aberrant T-cell phenotypes in tissue sections of MF and SS ([224](#), [225](#)). However, the isolated findings of loss of CD7 expression must be considered in the context of other clinical, histologic, and immunophenotypic findings in that expanded populations of CD7-negative T cells can also be seen in benign dermatitis ([215](#), [225](#)). Aberrant loss of TCR antigen expression may also occur in advanced-stage MF/SS and strongly supports a malignant T-cell proliferation ([216](#)).

Flow cytometry or frozen section immunohistochemistry or both on fresh or frozen tissue has been considered the preferred method for immunophenotyping in the past because these methods provided access to a broader range of antibodies than what was made available by immunohistochemistry on paraffin-fixed tissue. Recently, however, the number and quality of commercially available paraffin-reactive antibodies together with heat or microwave antigen retrieval techniques have dramatically improved paraffin section immunophenotyping of lymphoproliferative disorders. In cases in which the histologic diagnosis of lymphoma is established, these paraffin-reactive reagents can reliably differentiate between T-cell lymphomas, B-cell lymphomas, and Hodgkin disease. The most widely used paraffin-reactive T-cell antibodies include CD45RO (UCHL1), CD43, polyclonal CD3, CD4, CD8, CD5,  $\beta$ F1, and TCR  $\alpha\beta$ . Recently, a CD7 paraffin-reactive antibody has become commercially available and has been shown to be helpful in evaluating early MF biopsies in conjunction with other clinical histologic and molecular findings ([226](#), [227](#)). NK cell or cytotoxic lymphocyte markers (CD56, granzyme B, and TIA-1) are also available. L26 (CD20), CD79a, LN1 (CDw75), and CD45RA are the most widely used B-cell paraffin-reactive antibodies. Other useful paraffin-reactive antibodies for cutaneous lymphomas include CD45 (LCA), CD30 (Ber-H2), and CD15 (Leu-M1). When used in panels, these antibodies allow subclassification of most cutaneous lymphomas.

## DIFFERENTIAL DIAGNOSIS

The clinicopathologic differential diagnosis for MF/SS includes several forms of benign dermatitis, other primary low-grade CTCLs, and secondary cutaneous involvement by disseminated lymphomas or leukemias ([Table 94.2](#)). Differentiation of these mimickers from CTCL often requires careful correlation of clinical, histopathologic, immunophenotypic, and genotypic characteristics and may require multiple or serial biopsies. The following discussion describes methods to differentiate MF/SS from similar benign conditions—indolent CTCL and other primary CTCLs.

**TABLE 94.2. Clinicopathologic Differential Diagnosis for Cutaneous T-Cell Lymphoma**

---



1. Benign conditions
    - Small- and large-plaque parapsoriasis
    - Poikiloderma vasculare atrophicans
    - Pityriasis lichenoides et varioliformis acuta
    - Benign erythroderma
    - Actinic reticuloid
    - Follicular mucinosis
  2. CD30<sup>+</sup> lymphoproliferative disorders
    - Lymphomatoid papulosis
    - Primary cutaneous anaplastic large cell lymphoma
  3. Other primary cutaneous T-cell lymphomas
    - Pagetoid reticulosis
    - Granulomatous slack skin
    - Follicular mycosis fungoides
    - CD8<sup>+</sup> mycosis fungoides
    - Primary cutaneous  $\gamma\delta$  + T-cell lymphoma
    - Pleomorphic small/medium-sized CTCL
    - Subcutaneous panniculitic T-cell lymphoma
  4. Secondary lymphoma/leukemia
    - Adult T-cell leukemia/lymphoma
    - Peripheral T-cell lymphoma
    - Hodgkin lymphoma
    - Leukemia cutis
  5. B-cell lymphoma
    - Follicular lymphoma
    - Marginal zone lymphoma
    - Large B-cell lymphoma
    - Extramedullary plasmacytoma
    - Intravascular large B-cell lymphoma
- 

## Benign Conditions

Benign inflammatory skin lesions are most likely to be confused with early patch-stage MF. In general, these conditions have clinical presentations and courses that are different from MF, lack enlarged atypical CTCs, and lack epidermotropism, which is disproportionately increased in relationship to spongiosis. However, in difficult cases, immunophenotypic analysis and gene rearrangement studies may be necessary to look for aberrant T phenotypes or clonal TCR gene rearrangements. The benign inflammatory dermatoses that most closely resemble CTCL include small plaque parapsoriasis and large plaque parapsoriasis (LPP), poikiloderma vasculare atrophicans (PVA), pityriasis lichenoides et varioliformis acuta (PLEVA), benign erythroderma, contact dermatitis, persistent arthropod bite reactions, drug eruptions, lymphomatoid papulosis (LyP), and actinic reticuloid (AR) ([228](#)).

LPP is clinically indistinguishable from patch-stage MF. Because of clinical and histologic overlap, some authorities consider LPP to be an early stage of MF ([229](#)). Others consider LPP to be a latent form of MF ([230](#)) because approximately 10% of patients eventually develop overt MF ([231](#)). This view is supported by the recent demonstration of clonal TCR gene rearrangement in 50% of LPP biopsies ([85](#)). Furthermore, recent demonstration of clonal TCR gene rearrangements in small plaque parapsoriasis has suggested that this may be an abortive form of MF ([232](#)). Histologically, the lymphoid infiltrate of LPP is perivascular and less dense with less epidermotropism than MF; Pautrier microabscesses

are not seen in LPP. Furthermore, cytologically atypical CTCs with highly convoluted nuclei are inconspicuous or absent in LPP. However, immunophenotypic analysis is usually not helpful for differentiating LPP from patch-stage MF because both have a predominance of CD4<sup>+</sup> helper cells with absent CD7 and Leu 8 (CD62L) expression ( [158](#) ).

PVA can also present similarly to early MF. The macules and patches of PVA show the poikilodermatous features of hypopigmentation, hyperpigmentation, atrophy, and telangiectasias. PVA macules/patches also tend to be localized to sun-protected sites, most commonly appearing on the buttocks, breasts, and flexural areas, and, like LPP, some clinicians believe that PVA may potentially precede or coexist with MF ( [157](#) ). Histologically, the dermis in PVA demonstrates chronic, ill-defined inflammatory changes and is accompanied by a thin epidermis. Often, lymphoid cells form a bandlike pattern in the superficial dermis, with a limited number of these cells appearing in the epidermis.

PLEVA is a benign cutaneous disorder characterized by recurrent, self-healing papulonecrotic lesions ( [233](#) ). Biopsies may show slightly atypical CTCs with some epidermotropism, but vacuolar degeneration of the epidermal basilar layer and necrotic keratinocytes in PLEVA distinguish it from MF. The lymphoid infiltrate is predominantly composed of CD8<sup>+</sup> cells, as opposed to the typical CD4<sup>+</sup> phenotype of MF ( [233](#) ). The malignant potential of PLEVA is controversial. Some consider PLEVA to be a T-cell lymphoproliferative disorder related to LyP ( [234](#) ), and clonal TCR gene rearrangement has been demonstrated in a few cases ( [235](#) ). However, patients with PLEVA do not develop overt lymphoma ( [233](#) ).

Erythroderma may occur in a variety of benign dermatologic disorders, including psoriasis, pityriasis rubra pilaris, eczematous dermatitis, seborrheic dermatitis, severe contact dermatitis, and drug eruptions ( [167](#) ). These patients may also have circulating cerebriform cells and lymphadenopathy, further complicating the diagnosis. Erythroderma secondary to drug reactions, especially anticonvulsants such as phenytoin, can be particularly difficult to distinguish from MF/SS due to the presence of convoluted CTCs and the formation of Pautrier microabscesses ( [175](#) ). Differentiation of benign erythroderma from erythrodermic MF can usually be accomplished through careful evaluation of the history, biopsy of the more typical lesions of the underlying disease, and serial biopsies over time ( [167](#) ). Numerous eosinophils favor a drug reaction. Aberrant T phenotypes or clonal TCR gene rearrangements are usually not present in benign erythroderma.

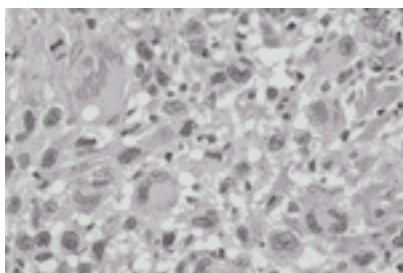
Subacute or chronic spongiotic dermatitis and interface dermatitis due to contact dermatitis, drug eruption, and persistent arthropod bite reaction may have atypical CTCs with epidermotropism and Pautrier-like microabscesses mimicking MF ( [228](#) ). Therefore, caution should be exercised in interpretation of epidermotropism associated with significant spongiosis ( [180](#) ). Immunophenotyping may be helpful in this differential diagnosis because cutaneous T-cell pseudolymphomas do not show aberrant loss of CD2, CD3, or CD5 expression, but may be negative for CD7 and CD62L (Leu 8), similar to MF ( [228](#) ). The utility of gene rearrangement studies in this setting is unclear because clonal TCR gene rearrangements have been reported in some cutaneous T-cell pseudolymphomas ( [92](#), [236](#) ). The following drugs have been implicated as causing pseudolymphoma: alprazolam, amitriptyline, atenolol, carbamazepine, cefixime, chlorpromazine, cimetidine, clarithromycin, clonazepam, clonidine, co-trimoxazole, cyclosporine, desipramine, diltiazem, doxepin, fluoxetine, furosemide, gemfibrozil, gold, lamotrigine, lithium, lorazepam, losartan, methotrexate, nizatidine, perphenazine, phenytoin, ranitidine, sulfamethoxazole, sulfasalazine, terfenadine, and thioridazine ( [237](#) ).

AR is a severe form of photosensitive dermatitis that may closely mimic MF or SS clinically and histologically when fully developed ( [238](#) ). AR is a chronic, persistent eruption that can be induced by a broad spectrum of light wavelengths. The skin lesions are typically plaques and papules on the sun-exposed areas of the face and hands but may extend to covered areas or even become generalized erythroderma. In contrast to MF, epidermotropism is not prominent, but small Pautrier microabscesses may be found in some cases. Severe cases of erythrodermic AR may have generalized lymphadenopathy and circulating Sézary cells mimicking the Sézary syndrome. Preferential involvement of sun-exposed areas, absence of large dysplastic CTCs, and a CD8<sup>+</sup> phenotype help distinguish AR from MF/SS. AR does not appear to be associated with progression to malignant lymphoma, and clonal TCR rearrangements have not been reported ( [238](#) ).

### Indolent Cutaneous T-Cell Lymphoma, Excluding Mycosis Fungoides and Sézary Syndrome

The differential diagnosis for suspected MF or SS also includes a variety of related conditions, which are equally concerning for their malignant or premalignant clinical course. These potentially malignant CTCL variants are discussed below and include pagetoid reticulosis (PR), granulomatous slack skin (GSS) disease, and LyP. Other related conditions discussed below include follicular mucinosis; follicular MF; CD8<sup>+</sup>, MF, ?d<sup>+</sup> T-cell lymphomas; and pleomorphic small to medium-sized CTCL.

LyP is a CD30 (Ki-1)-positive T-cell lymphoproliferative disorder characterized by chronically recurring, self-healing crops of mildly pruritic papulonodular lesions that are clinically benign but histologically malignant ( [239](#) ). LyP initially presents with crops of erythematous papules that wax and wane, becoming hemorrhagic and necrotic before undergoing spontaneous regression with scar formation. Individual lesions range from 2 mm to 2 cm in diameter (usually less than 1 cm) and have an average duration of 5 weeks, ranging from 2 weeks to 6 months ( [240](#) ). LyP is divided into three histologic types—type A, type B, and type C ( [241](#) ). LyP type A, the most common type, is characterized by a polymorphous infiltrate of eosinophils, neutrophils, and scattered anaplastic large transformed lymphocytes and binucleate Reed–Sternberg–like cells resembling ALCL ( [Fig. 94.9](#) ) ( [242](#) , [243](#) ).



**Figure 94.9.** Lymphomatoid papulosis, type A. Anaplastic large cells with abundant cytoplasm, reniform nuclei, and prominent nucleoli are scattered among small lymphocytes and eosinophils. Note occasional binucleate Reed–Sternberg–like cells (hematoxylin and eosin, ×250). The large cells were strongly positive for CD30 (not shown). See [Color Plate](#).

LyP type B is characterized by small to medium-sized CTCs resembling MF. LyP type C

is characterized by sheets of large, anaplastic CD30<sup>+</sup> cells and can be histologically identical to primary cutaneous ALCL. Atypical cells in all three types are CD4<sup>+</sup> T cells, which often have clonal rearrangement of the TCR gene, and absent or diminished expression of pan T-cell antigens ( 244 , 245 and 246 ). However, CD30 expression differs between the types; the large transformed cells in type A and C are CD30<sup>+</sup>, similar to CD30<sup>+</sup> ALCL, whereas the atypical CTCs in type B LyP do not express CD30 ( 240 , 247 , 248 ). Clinical behavior of both types of LyP is usually benign; however, overt lymphoma has been documented in approximately 10% to 20% of patients—usually MF, primary cutaneous ALCL, or Hodgkin lymphoma ( 240 , 249 , 250 ). The cumulative risk for malignant transformation of LyP over 15 years of disease may be as high as 80% ( 251 ). No clinical, histologic, immunophenotypic, or molecular genetic features have been identified that can predict cases in which patients will develop lymphoma, but two studies suggest that malignant transformation is more strongly associated with type A than type B LyP ( 240 , 250 ). Onset of LyP at a younger age may be associated with increased cumulative risk for overt lymphoma ( 251 ). The benign or malignant nature of LyP is controversial, but some authorities now consider LyP type A to be a latent or low-grade stage of primary cutaneous ALCL ( 171 , 230 ). Its clinical, histologic, and immunophenotypic similarities to primary cutaneous ALCL, aberrant T-cell antigen expression, clonal TCR gene rearrangements ( 252 , 253 ), and increased risk for transformation to malignant lymphoma support this view.

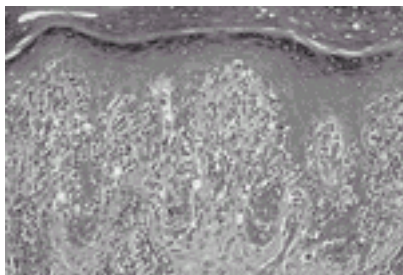
Differentiation of primary cutaneous CD30<sup>+</sup> large cell lymphoma from type A LyP and secondary CD30<sup>+</sup> large cell lymphoma resulting from large cell transformation of MF/SS is important because of differences in prognosis and therapy ( 243 , 254 ). Primary cutaneous ALCL has a good prognosis and can be effectively managed with local excision or radiation therapy or both ( 255 ), whereas secondary CD30<sup>+</sup> large cell lymphoma due to large cell transformation of MF/SS has a very poor prognosis requiring aggressive combination chemotherapy ( 191 , 192 , 254 ). LyP also has a good prognosis and can often be managed with no therapy or topical chemotherapy and phototherapy without the need for aggressive therapy ( 243 ). Furthermore, primary cutaneous ALCL must be differentiated from secondary cutaneous involvement by extracutaneous ALCL. Primary nodal ALCL and secondary cutaneous involvement by extracutaneous ALCL are more aggressive than primary cutaneous ALCL ( 192 , 256 ). A thorough dermatologic examination, history, and staging for extracutaneous disease are necessary to exclude secondary large cell transformation of low-grade MF or secondary cutaneous involvement by extracutaneous lymphoma before a case is accepted as primary cutaneous ALCL. Primary cutaneous ALCL is differentiated from LyP type A by cohesive sheets or more than 75% CD30<sup>+</sup> large transformed cells, fewer admixed neutrophils and eosinophils, a diffuse infiltrate that extends into the deep dermis versus a more superficial wedge-shaped infiltrate, larger solitary or localized nodules or tumors instead of crops of papules, and higher frequency of persistent or progressive cutaneous lesions with less frequent or incomplete spontaneous regression ( 243 , 254 , 257 ). Other aspects of ALCL are discussed in more detail in [Chapter 90](#).

### Other Primary Cutaneous T-Cell Lymphomas

Numerous subtypes of MF exist, and each must be considered in the differential diagnosis. These variants are described below and include PR, GSS disease, follicular mucinosis, folliculotropic MF, CD8<sup>+</sup> MF, pleomorphic small to medium-sized CTCL, and

subcutaneous panniculitic T-cell lymphoma (SPTL).

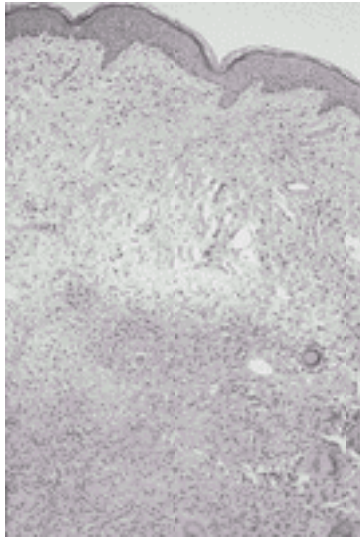
PR and GSS disease are low-grade clonal T-cell lymphomas that generally follow a benign course but may behave aggressively over time. Pagetoid reticulosis is a rare epidermotropic variant of MF, which usually presents as localized, hyperkeratotic, verrucous plaques on the hands or feet (Woringer-Kolopp disease) ( [258](#) ) but may also present with disseminated cutaneous plaques (Ketrón-Goodman disease). Localized PR may mimic ( [259](#) ) a more unusual variant of MF localized to the palms and soles known as *MF palmaris et plantaris* ( [260](#) ). Skin biopsies show pagetoid epidermotropism by enlarged, atypical CTCs, with relative sparing of the dermis ( [Fig. 94.10](#) ).



**Figure 94.10.** Pagetoid reticulosis. Note the pronounced pagetoid pattern of epidermotropism by enlarged, atypical, cerebriform T cells (hematoxylin and eosin,  $\times 50$ ). See [Color Plate](#).

Localized and disseminated PR may be CD4<sup>+</sup>, CD8<sup>+</sup>, or negative for both CD4 and CD8. However, in contrast to conventional MF and SS, which are CD4<sup>+</sup>, nearly half of PR cases are CD8<sup>+</sup> ( [261](#) ). In addition, they are often CD30<sup>+</sup>. PR may be derived from either  $\alpha\beta$  ( [261](#) ) or  $\gamma\delta$  T-cells ( [219](#), [262](#), [263](#) and [264](#) ) but express  $\gamma\delta$  TCR more frequently than either MF or SS ( [216](#), [218](#) ). Clonal TCR gene rearrangement and aberrant T-cell antigen expression support classification of PR as a form of CTCL ( [261](#), [265](#) ); however, localized PR has a clinically benign course with only rare reports of cutaneous dissemination of localized PR ( [261](#), [266](#), [267](#) ). Although rare, disseminated PR is usually indolent but may be aggressive, as reported in cases of  $\gamma\delta$ <sup>+</sup> PR ( [261](#), [262](#) ). Further studies are needed to confirm whether phenotypic differences in PR have clinical relevance. Local excision or radiation therapy are generally adequate treatment for PR, especially the localized form ( [261](#), [266](#) ).

GSS disease is a rare but distinctive variant of MF that begins with patches and plaques that steadily progress to characteristic pendulous, erythematous skin folds in the axilla and groin ( [268](#) ). GSS has histologic features of MF, including superficial papillary dermal and epidermotropic infiltrates of atypical CTCs, but also exhibits expansive infiltration into the deep dermis and subcutis with extensive elastolysis and a prominent granulomatous reaction with multinucleated giant cells ( [Fig. 94.11](#) ).



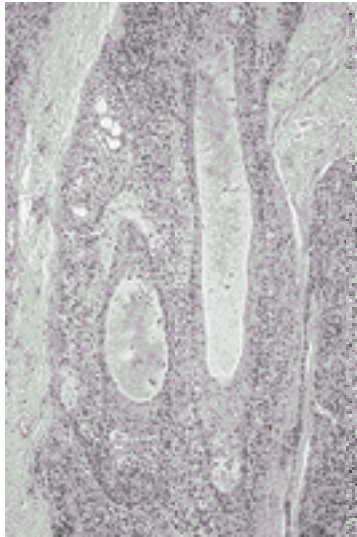
**Figure 94.11.** Granulomatous slack skin. This variant of mycosis fungoides shows a deep lymphocytic infiltrate with dermal edema, disruption of elastic fibers, and numerous foreign body giant cells (hematoxylin and eosin,  $\times 10$ ). See [Color Plate](#).

Similar to MF, GSS is a clonal proliferation of CD4<sup>+</sup> T-helper cells that frequently lack expression of CD7 and CD62L ([269](#)). GSS usually remains localized to the skin, although lymph node involvement and fatal systemic dissemination have been reported ([268](#)). Interestingly, GSS patients have an increased incidence of Hodgkin lymphoma ([268](#)).

Follicular mucinosis is frequently associated with MF, and this variant of MF must be differentiated from idiopathic follicular mucinosis or alopecia mucinosa ([270](#)). In general, alopecia mucinosa does not have atypical CTCs and has less lymphocytic infiltration of follicular epithelium than follicular mucinosis associated with MF. Clonal TCR gene rearrangement has been reported in some cases of follicular mucinosis and can be helpful in identifying cases associated with MF ([74](#)). A recent long-term follow-up study of seven patients with follicular mucinosis concluded that, despite the presence of a clonal TCR gene rearrangement, there was no evidence of progression to CTCL in any patient ([271](#)).

Follicular MF is another rare variant of CTCL with preferential perifollicular and folliculotropic infiltration by atypical CTCs with minimal or absent epidermotropism and mucin ([272](#), [273](#), [274](#), [275](#) and [276](#)) ([Fig. 94.12](#)).





**Figure 94.12.** Folliculotropic mycosis fungoides with follicular mucinosis. Note the preferential pattern of perifollicular infiltration by atypical cerebriform T cells with prominent folliculotropism forming small Pautrier microabscesses. Also note the bluish pools of mucin within the hair follicles (hematoxylin and eosin,  $\times 25$ ). See [Color Plate](#).

Folliculotropic CTCs are CD4<sup>+</sup> ([273](#), [274](#) and [275](#)) and may express an aberrant T-cell phenotype with loss of CD7 and other T-cell antigens ([273](#)). Differential up-regulation ICAM-1 (CD54) on follicular epithelium instead of epidermal keratinocytes has been implicated in the folliculotropic homing pattern of folliculotropic MF ([273](#)). Lymph node involvement and large cell transformation have also been described ([273](#)). Follicular MF, regardless of whether it exhibits follicular mucinosis, has shown a more aggressive course than classic MF. Approximately 7% of reported cases have demonstrated rapid lymph node involvement ([276](#), [277](#)). One case report describes a patient who bypassed traditional MF plaques and tumors, progressing directly from T1 stage to positive lymph node status in 3 months ([278](#)).

CD8<sup>+</sup> MF is an unusual immunophenotypic variant of MF, comprising up to 4% of CTCL in one series ([217](#)). Aggressive and indolent CD8<sup>+</sup> subtypes have been described ([278a](#)) ([217](#)). Both subtypes are strongly epidermotropic, with pagetoid features suggesting a relationship to PR. The indolent cases of CD8<sup>+</sup> MF have a clinical and histologic appearance similar to ordinary patch-stage MF, whereas the aggressive form appears to present with widespread eruptive papulonodular, ulcerative lesions with a predilection for involving the palms and soles of the feet. Aggressive CD8<sup>+</sup> MF is more likely to show large cell transformation and aberrant loss of expression of CD2 and other pan T-cell antigens than indolent cases ([182](#), [217](#)). The clinical heterogeneity of CD8<sup>+</sup> MF should be considered when planning therapy, as some cases do not require aggressive treatment.

CTCLs expressing the  $\gamma\delta$ <sup>+</sup> receptor are rare and have different clinicopathologic presentations, including lesions resembling MF, PR, peripheral T-cell lymphoma, unspecified, and SPTL ([218](#), [219](#), [262](#), [279](#), [280](#), [281](#), [282](#), [283](#) and [284](#)). In contrast to  $\alpha\beta$ <sup>+</sup> MF and SS,  $\gamma\delta$ <sup>+</sup> CTCL is typically negative for both CD4 and CD8, with rare CD8<sup>+</sup> cases ([283](#), [284](#)). Moreover, cytotoxic T-cell phenotypes have recently been documented for  $\gamma\delta$ <sup>+</sup> CTCL ([285](#), [286](#)) and  $\gamma\delta$ <sup>+</sup> SPTL ([279](#)). Most reports suggest that primary  $\gamma\delta$ <sup>+</sup> CTCL are



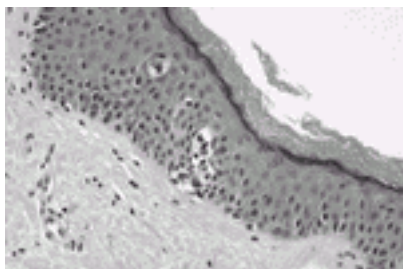
aggressive and poorly responsive to therapy ( [218](#), [280](#) ). Patients presenting with nodules, tumors, or plaques predominantly localized to the extremities should alert the clinician to  $\text{CD}^+$  CTCL. A recent series looking at  $\text{CD}^+$  CTCL found all 23 patients to have nodules or tumors on the extremities, with less than half exhibiting concurrent truncal lesions ( [283](#) ).

Pleomorphic small to medium-sized CTCL differs from ordinary MF and SS in its clinical presentation and histologic appearance ( [287](#), [288](#) ). This lymphoma presents initially with papulonodular lesions, tumors, or deep plaques without preceding erythematous patches. Most lesions do not exhibit epidermotropism, and the small pleomorphic lymphocytes do not have cerebriform nuclear convolutions. Similar to MF and SS, most pleomorphic small cell CTCL cases are clonal  $\text{CD4}^+$  T-cell proliferations with widespread cutaneous lesions. HTLV-1 testing should be performed to differentiate these lymphomas from cutaneous involvement by HTLV-1<sup>+</sup> ATLL. In contrast to the aggressive behavior of ATLL, pleomorphic small cell CTCL appears to follow an indolent course.

SPTL presents as tender, erythematous nodules or subcutaneous palpable masses mostly on the legs, trunk, arms, or face. This rare T-cell lymphoma appears histologically as a lipotrophic lymphohistiocytic infiltrate and typically follows one of two distinct clinical courses. The first involves a prolonged, recurrent panniculitis, and the second is marked by a rapid clinical decline secondary to hemophagocytic syndrome (HPS) ( [289](#) ). SPTL is one of several conditions associated with HPS. A review of 72 cases of SPTL found HPS to be present in 45% of all patients and to be associated with a grave prognosis (50% total case fatality rate and 81% HPS mortality rate) regardless of treatment modality ( [289](#), [290](#) ). Repeat biopsies may be necessary to confirm the diagnosis of SPTL. Once confirmed, early induction of combination chemotherapy with or without radiotherapy may yield remission and prevent the development of HPS ( [289](#) ). (For further discussion of SPTL, please refer to [Chapter 90](#).)

### Other Hematopoietic Neoplasms with Similar Cutaneous Presentations

Other lymphomas and hematopoietic tumors that may involve the skin include HTLV-1<sup>+</sup> ATCL ( [Fig. 94.13](#) ), angiocentric NK/T-cell lymphoma, Hodgkin lymphoma, cutaneous B-cell lymphomas, and leukemia cutis or granulocytic sarcoma.

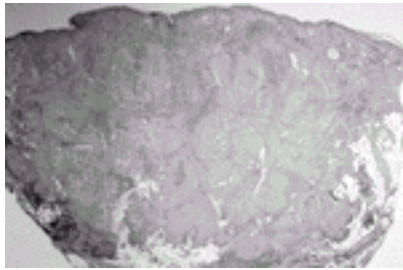


**Figure 94.13.** Cutaneous involvement by human T-cell lymphotropic virus type 1 (+) ATLL showing epidermotropism and formation of a Pautrier microabscess (hematoxylin and eosin,  $\times 50$ ). See [Color Plate](#).

Peripheral T-cell and NK/T-cell lymphomas are discussed in [Chapter 90](#). Hodgkin lymphoma is discussed in [Chapter 95](#). Cutaneous B-cell lymphoma, leukemia cutis, and

granulocytic sarcoma are discussed below.

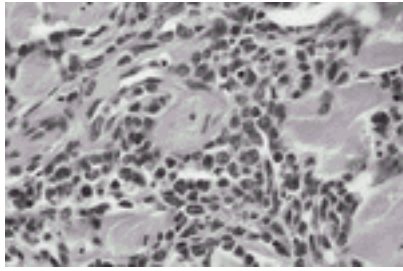
Primary cutaneous B-cell lymphomas are uncommon and must be differentiated from secondary cutaneous involvement by systemic B-cell lymphoma and cutaneous lymphoid hyperplasia of B-cell type. Primary cutaneous B-cell lymphomas include follicular lymphomas, marginal zone B-cell lymphoma of mucosa-associated lymphoid tissue type (immunocytoma), plasmacytoma, intravascular large B-cell lymphoma, and diffuse large B-cell or immunoblastic lymphoma ( [291](#), [292](#) ). Cutaneous B-cell lymphomas usually present as single or multiple violaceous nodules on the head and neck or trunk and tend to infiltrate the deeper portions of the dermis, sparing the epidermis (“bottom-heavy”). Follicular lymphomas are the most common cutaneous B-cell lymphoma. Cutaneous follicular lymphomas may have a nodular or a nodular and diffuse growth pattern and more frequently have a predominance of large noncleaved cells than their nodal counterparts ( [Fig. 94.14](#) ).



**Figure 94.14.** Primary cutaneous follicular large cell lymphoma. Note the back-to-back nodular pattern. The infiltrate extends from the superficial reticular dermis to the superficial subcutis in a “bottom-heavy” pattern sparing the papillary dermis and epidermis (hematoxylin and eosin,  $\times 2$ ). See [Color Plate](#).

In contrast to the aggressive behavior of nodal large cell follicular lymphomas, primary cutaneous large cell follicular lymphomas tend to be localized, follow an indolent course, and can often be managed with local excision and radiation therapy ( [293](#), [294](#) and [295](#) ). However, careful staging must be performed to exclude extracutaneous lymphoma before a case is classified as primary cutaneous B-cell lymphoma. When the large cell lymphoma is restricted to the legs, it is often referred to as *primary cutaneous large B-cell lymphoma of the legs*. Although there is still debate regarding whether this is a distinct entity, several reports show a poor prognosis and a clear predilection for the elderly (average age of onset, 78 years) ( [296](#), [297](#) ). A more detailed discussion of cutaneous B-cell lymphomas is beyond the scope of this chapter.

Leukemia cutis and granulocytic sarcoma are cutaneous infiltrates of myeloblasts and immature myeloid precursors that are often difficult to differentiate from cutaneous lymphoma ( [298](#), [299](#) ). Granulocytic sarcoma, also known as *extramedullary myeloid cell tumor*, usually presents as nodules or tumors that are often solitary, whereas leukemia cutis presents with multiple skin lesions with a varied clinical appearance, including papules, nodules, plaques, palpable purpura, or ulcerated lesions. Histologically, granulocytic sarcoma and leukemia cutis tend to infiltrate between collagen bundles and fat spaces in an interstitial pattern ( [Fig. 94.15](#) ).



**Figure 94.15.** Leukemia cutis. Clusters of myeloblasts with fine chromatin and scant cytoplasm infiltrate between collagen bundles in the reticular dermis (hematoxylin and eosin, × 250). See [Color Plate](#).

Cytologically, the myeloblasts of granulocytic sarcoma and leukemia cutis are medium-sized cells with finely dispersed chromatin, small or inconspicuous nucleoli, and scant cytoplasm. Occasionally, eosinophilic or neutrophilic granules may point to the cells' myeloid lineage. In difficult cases, immunohistochemistry, flow cytometry, and cytochemical stains usually confirm the diagnosis and exclude lymphoma. The most useful confirmatory antibodies for immunohistochemistry are myeloperoxidase, CD117, and lysozyme to confirm myeloid lineage and CD34 to confirm their precursor or stem cell level of maturation ( [300](#) ). Myeloperoxidase, Sudan black B, and chloroacetate esterase cytochemical stains can be used to confirm myeloid differentiation if air-dried touch imprints are available. Bone marrow and peripheral blood examination are also important.

## STAGING

In 1979, a staging system for CTCL was proposed by an international panel of experts who devised a tumor, node, metastasis (TNM) system ( [301](#) , [302](#) and [303](#) ) ( [Table 94.3](#) ).

**TABLE 94.3. Cutaneous T-Cell Lymphoma Workshop Staging Classification**

| T         | Skin   | N  | Lymph Nodes                       | M  | Visceral Organs      |
|-----------|--|----|-----------------------------------|----|----------------------|
| T1        | Limited plaques (<10% body surface area)   | N0 | No adenopathy; histology negative | M0 | No involvement       |
| T2        | Generalized plaques  | N1 | Adenopathy; histology negative    | M1 | Visceral involvement |
| T3        | Cutaneous tumors   | N2 | No adenopathy; histology positive |    |                      |
| T4        | Generalized erythroderma   | N3 | Adenopathy; histology positive    |    |                      |
| Stage I   | Limited (IA) or generalized plaques (IB) without adenopathy or histologic involvement of lymph nodes or viscera (T1N0M0 or T2N0M0)   |    |                                   |    |                      |
| Stage II  | Limited or generalized plaques with adenopathy (IIA) or cutaneous tumors with or without adenopathy (IIB); without histologic involvement of lymph nodes or viscera (T1-2N1M0, T3N0-1M0) |    |                                   |    |                      |
| Stage III | Generalized erythroderma with or without adenopathy; without histologic involvement of lymph nodes or viscera (T4N0-1M0)   |    |                                   |    |                      |
| Stage IV  | Histologic involvement of lymph nodes (IVA) or viscera (IVB) with any skin lesions and with or without adenopathy (T1-4N2-3 M0 for IVA; T1-4N0-3M1 for IVB)                              |    |                                   |    |                      |

*Stage I* refers to patients with only skin disease without adenopathy and is divided into IA for patients with less than 10% body surface area involvement (T1) and IB for more generalized patches and plaques (T2). Stage II has two unique categories: IIA patients have patches/plaques with palpable adenopathy (histology negative), whereas IIB patients have tumors with or without palpable adenopathy (histology negative). Patients with erythroderma are placed into stage III with or without palpable adenopathy (histology negative). Stage IV patients have biopsy-proven extracutaneous CTCL, with stage IVA patients having nodal involvement without visceral disease and IVB patients having visceral disease. In the original TNM staging system, peripheral blood involvement with more than 5% atypical circulating cells is indicated by a separate peripheral blood stage B1 (vs. B0) and does not affect the clinical stage designation. However, two large series have shown that blood involvement is more commonly seen in higher-stage disease, with 0% to 12% of patients with only plaques, 16% to 27% of patients with tumors, and more than 90% of patients with erythroderma, demonstrating peripheral blood involvement ( [196](#), [304](#), [305](#) ).

In 1984, the Mycosis Fungoides Cooperative Group recommended a staging system for CTCL based only on the extent of skin involvement and palpable adenopathy ( [306](#) ). Although clinically practical, this staging system has been seldom used in therapeutic trials ( [307](#) ), which would make it difficult to compare the results from studies using the TNM staging system.

After failing to find a significant difference in survival between patients with stage IB and IIA disease, as well as between those with stage IIB and III disease, Kashani-Sabet et al. recently challenged the TNM staging system by proposing several modifications ( [308](#) ) based on histologic discrimination between patches and plaques. Patch-stage MF displayed the following characteristics: papillary dermal fibrosis, psoriasiform epidermal hyperplasia, and sparse intraepidermal and papillary dermal infiltrate. Plaque-stage MF was distinguished by the presence of a more prominent lichenoid infiltrate and cellular atypia. Two major changes to the 1979 system were suggested after retrospective data analysis of 450 patients with stage I–III CTCL showed patients with plaques predicting a poorer prognosis when compared to patches or noninvolvement. The first modification involved further dividing those with T2 disease into subtypes according to their predominant lesion, with T2a describing patch predominance and T2b describing plaque predominance. The scope of stage IIA was therefore narrowed to include only T2a and stage IIB to include only T2b. The second modification involved splitting stage III into two subclasses: IIIA and IIIB. Accordingly, tumor stage (T3) was reclassified as IIIA instead of IIB, and generalized erythroderma was reclassified as IIIB ( [308](#) ). Further studies are needed to support a need to change the current staging system.

Staging procedures recommended by the international panel in 1979 included lymph node biopsy of a nonpalpable lymph node in patients without adenopathy and liver and bone marrow biopsies for advanced stages (II, III, IV) ( [302](#) ). These procedures may be considered in patients in clinical trials but are rarely helpful in those patients with limited skin disease and no lymphadenopathy. [Table 94.4](#) outlines staging procedures for CTCL adapted from the Proceedings of the 1993 International Symposium on Cutaneous T-Cell Lymphoma ( [309](#) ). All patients should have a complete physical examination with special attention to skin and lymph nodes. Careful mapping of skin involvement and total body photographs are recommended to document the initial extent of disease at diagnosis and to assess response to treatment ( [310](#) ). Laboratory studies should include serum chemistries, lactate dehydrogenase, complete blood count with differential, and Sézary cell count. A recent study showed there is no significant benefit in performing bone

marrow biopsies for staging purposes ( 311 ).

**TABLE 94.4. Staging Procedures for Cutaneous T-Cell Lymphoma**

---

|   |
|---|
| Complete history and physical examination   |
| Whole-body mapping of skin lesions  |
| Complete blood count, differential, platelet count, and Sézary cell count   |
| Serum chemistries (include liver and renal function tests, calcium, phosphorus, and uric acid)  |
| Chest radiograph  |
| Skin biopsy and lymph node biopsy (palpable node from draining area; cervical before axillary before inguinal)                        |
| Evaluation of other organs if foregoing tests suggest involvement; consider bone marrow biopsies from patients with stages III and IV |

---

The role of diagnostic imaging in the initial staging of CTCL has been examined by several authors ( 312 , 313 , 314 and 315 ). Kulin et al. studied the results of gallium citrate Ga 67 scintigraphy, liver-spleen scans, lymphangiography, and computed tomography (CT) used in the initial staging of 62 CTCL patients (85% with stage I or II disease) and found that none of the results added significantly to the information obtained from physical examination and routinely performed lymph node biopsy (73% of 62) ( 313 ). In contrast, a study of 63 CTCL patients (78% with stage I or II disease) who had staging body CT scans found positive findings in 18 (29%) patients, one-half of whom had clinically unsuspected advanced-stage disease ( 312 ). Eight of these 18 patients had biopsies with five of eight confirming extracutaneous CTCL ( 312 ). Of the 38 patients with stage I disease, however, only two had positive findings on CT scan ( 312 ). Another retrospective study of 33 CTCL patients (70% with stage I or II disease) who had CT scans found that 3 of the 20 patients with initial clinical stage I disease were staged higher on the basis of CT findings as stage II ( 314 ). Subsequent lymph node biopsies confirmed extracutaneous disease in all three patients (stage IVA) ( 314 ). In summary, pelvic, abdominal, and thoracic CT scans have a low yield in patients without palpable adenopathy (stage I) and are not necessary for staging these patients. The highest yield of CT scans appears to be in patients with non-MF/SS CTCL (nonepidermotropic, transformed CTCL, ALCL) and stage III disease (erythroderma), in contrast to stage II and IV patients, in whom CT findings often do not change treatment or stage ( 312 ). Most investigators agree that CT scanning is useful for accurate baseline assessment of advanced skin stage patients with palpable adenopathy and to follow for disease progression ( 316 ).

Positron emission tomography may provide an alternative staging and response-assessment tool for patients with CTCL. However, despite a case report detailing this procedure as a sensitive diagnostic modality in aggressive SPTL, other data are lacking ( 315 ). Invasive tests such as liver biopsy or staging laparotomy have added little diagnostic information for patients with early and advanced stage disease ( 197 , 208 , 317 ).

## **Bone Marrow**

Studies of bone marrow involvement in MF patients at initial staging found disease in 2% to 22% of patients (198, 203, 318). Histologic findings in involved marrows include clusters of CD3<sup>+</sup> atypical lymphocytes with cerebriform nuclei and occasional large dysplastic cells (203). Bone marrow involvement by MF is more common in higher-stage disease and correlates with a poorer prognosis; however, when other factors such as skin stage and visceral involvement were considered, bone marrow involvement was not shown to be an adverse prognostic factor (319). These findings were supported by a recent study that evaluated the prognostic significance of histologic and molecular evidence of bone marrow involvement at the time of diagnosis. This study also showed a correlation between histologic or molecular bone marrow involvement and clinical stage of disease, but bone marrow involvement failed to be an independent prognostic indicator (311). Therefore, despite being considered in initial staging of non-MF/SS lymphoma patients, routine staging bone marrow biopsies in patients with MF are not currently recommended.

### Lymph Nodes

Although the presence of palpable nodes has prognostic value, lymph node histology is even more important in staging and assessing prognosis, not only at diagnosis but also later in the course of the disease. Enlarged lymph nodes from MF/SS patients show either dermatopathic lymphadenopathy or involvement by MF/SS. Sausville et al. described a system of grading lymph nodes in CTCL patients [NCI-Veteran's Administration (NCI-VA) classification] that correlated well with prognosis: LN1, a few atypical cutaneous T cells; LN2, dermatopathic lymphadenopathy with small clusters (<6 cells) of atypical cutaneous T cells; LN3, dermatopathic lymphadenopathy with large clusters (>6 cells) of atypical cutaneous T cells; and LN4, partial or complete effacement of lymph node architecture (196, 304). Although clusters of atypical cutaneous T cells are present in grades LN2 and LN3, lymph node architecture is preserved. Only LN3 and LN4 lymph nodes are considered involved with CTCL (histology positive) for purposes of the TNM staging system (Table 94.5). The NCI-VA classification has been criticized because of the nonspecificity of grades LN1 through LN3 and because lymph nodes from patients with unrelated diseases can show similar findings, and many consider LN3 lymph nodes to be histologically borderline (187, 320, 321 and 322).

**TABLE 94.5. Histopathologic Grading Scheme for Cutaneous T-Cell Lymphoma with Lymph Node Involvement**

| Grade Histopathologic Features |   |
|--------------------------------|---|
| LN1                            | DL with occasional CTC  |
| LN2                            | DL with CTC singly or in small clusters (<6 cells)            |
| LN3                            | DL with numerous CTC, singly or in large clusters (>15 cells) |
| LN4                            | Partial or complete effacement by MF/SS ± DL                  |

CTC, cerebriform T cells; DL, dermatopathic lymphadenopathy; LN, lymph node; MF, mycosis fungoides; SS, Sézary syndrome.  
 Modified from Clendenning WE, Rappaport HW. Report of the committee on pathology of cutaneous T cell lymphoma. *Cancer Treat Rep* 1979;63:719-724.

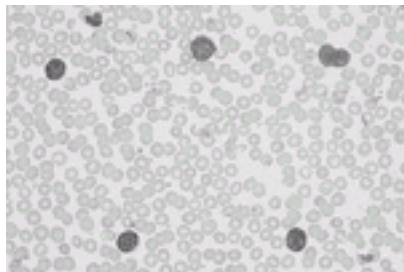


In general, there is good correlation between histologic and molecular evaluation of lymph nodes for involvement by MF/SS. Three studies have shown that most histologically negative lymph nodes (LN1–2) do not show TCR gene rearrangements, whereas approximately 90% or more histologically involved lymph nodes (LN4) do show clonal TCR gene rearrangements by Southern blot analysis ( [323](#), [324](#) and [325](#) ). All three studies also showed a mixture of clonal and polyclonal populations in histologically borderline cases (LN3 or histologically equivalent to LN3). Although not statistically significant in all studies, histologically borderline cases that have a positive TCR gene rearrangement tend to have a poorer prognosis, similar to cases with histologically involved lymph nodes (LN4) ( [323](#) ).

Fine-needle aspiration of lymph nodes to assess for involvement by MF/SS has been evaluated in a limited number of patients with good correlation between cytologic grade of the fine-needle aspiration specimen and histologic classification of the lymph node biopsy ( [322](#), [326](#) ). However, as with other types of lymphomas, there is an inherent risk of sampling only low-grade involvement and missing a focal area of transformation to a large cell lymphoma.

### Peripheral Blood

The Committee on Staging and Classification of Cutaneous T-Cell Lymphomas defined peripheral blood involvement by MF/SS as >5% peripheral blood lymphocytes with Sézary cell morphology ( [Fig. 94.16](#) ) ( [302](#) ); however, this criterion is not uniformly agreed upon.



**Figure 94.16.** Sézary syndrome. The peripheral blood shows lymphocytosis. Most lymphocytes are Sézary cells with enlarged, highly convoluted nuclei and scant cytoplasm (hematoxylin and eosin,  $\times 250$ ). See [Color Plate](#).

Because Sézary cells can be seen in the peripheral blood of patients with benign dermatitis or erythroderma ( [327](#) ), other investigators have suggested that 10% to 20% Sézary cells be used to define peripheral blood involvement ( [211](#) ). Most recently, the International Society for Cutaneous Lymphomas has recommended using two categories of peripheral blood involvement ( [213](#) ). Peripheral blood containing more than 5% Sézary cells is designated B1. A variety of findings are designated B2 and include (a) absolute Sézary cell count of 1000 cells/mm<sup>3</sup> or more, (b) a CD4:CD8 ratio of 10 or more due to an increase in CD3<sup>+</sup> or CD4<sup>+</sup> cells by flow cytometry, (c) aberrant expression of T-cell markers by flow cytometry (CD2, CD3, CD4, CD5) or decreased CD7 expression with an expansion of CD4<sup>+</sup> T cells, (d) an increased lymphocyte count with molecular evidence of a T-cell clone in the peripheral blood, or (e) a chromosomally abnormal T-cell clone. If a patient meets criterion 1, 2, or 4 but does not demonstrate MF/SS substantiated via skin



or lymph node biopsies, additional evidence of malignancy is required to avoid misdiagnosis.

In addition to the number of Sézary cells present, quantification of nuclear size and nuclear irregularity has been recommended to improve the specificity of Sézary cell counts ( [178](#) , [211](#) , [328](#) ).

Because of the inherent difficulties in diagnosing peripheral blood involvement by MF/SS on peripheral smear review, additional technologies are now used, including flow cytometry and molecular studies such as PCR. Flow cytometry analyzes the ratio of CD4<sup>+</sup> to CD8<sup>+</sup> T cells and looks for an aberrant phenotype. As discussed above, aberrant phenotypes include the absence of T-cell markers such as CD2, CD3, CD5, and CD7, which are usually expressed on normal T cells, or coexpression or absence of both CD4 and CD8. A CD4:CD8 ratio of greater than 10:1 or an aberrant phenotype constitutes an abnormal population. Because decreased CD7 expression on T cells has been seen in patients with benign skin conditions, the International Society for Cutaneous Lymphomas recommends that 40% or more of the CD4<sup>+</sup> T cells lack CD7 for it to be considered significant. Recently, PCR of peripheral blood has been shown to detect a clonal population of T cells in approximately one-third of patients with stage I–II disease and a majority of patients with stage III–IV disease ( [329](#) , [330](#) ). Recently, loss of CD26 expression on circulating CD4<sup>+</sup> T cells has been reported in most cases of MF and SS ( [331](#) , [332](#) ). The usefulness of this assay for diagnostic purposes needs to be confirmed, but it may provide a more sensitive way to use flow cytometry to evaluate peripheral blood for involvement by MF/SS.

## PROGNOSIS

Prognosis correlates with the extent of skin disease and status of the lymph nodes, blood, and visceral involvement. MF behaves in a manner similar to other low-grade or indolent NHLs with prolonged survival despite recurrent relapses (see [Chapter 90](#)). The median survival in the Stanford University series of 464 CTCL patients is nearly 10 years from the date of first visit, and the approximate percentage of patients surviving according to skin stage at 10 years are 85% for limited plaques (T1), 55% for generalized plaques (T2), 20% for tumors (T3), and 30% for erythroderma (T4) ( [99](#) ). Similarly, Zackheim et al. assessed relative (observed/expected) long-term survival among the four skin stages. Stage and survival data for 489 CTCL patients was extracted from a University of California, San Francisco, CTCL registry dated 1957 through 1994 and compared to a control group matched for age, sex, race, and geographic variables. Using the control group to generate expected survival values, researchers found a relative survival at 10 years for each group as follows: 100% for T1, 67% for T2, 40% for T3, and 41% for T4 ( [333](#) ).

The TNM staging system has correlated well with prognosis demonstrating the following 5-year survival rates: 95% for stage I, 76% for stage II, 45% for stage III, and 51% for stage IV ( [333](#) ). Data from a retrospective cohort analysis suggest that the long-term (30-year) survival of patients with stage IA (limited patch/plaque) MF is similar to the expected survival of a matched control population ( [334](#) ). Therefore, it is unlikely that stage IA MF will affect the life expectancy of afflicted patients.

Using histology to differentiate between patch and plaque predominance within stage T2, one study found plaque predominance to negatively influence relative survival ( [306](#) ). A retrospective analysis by Sausville et al. of 152 consecutively staged patients at the NCI identified advanced skin stage (T3, T4), palpable adenopathy, visceral involvement, blood

involvement, eosinophilia, and lymph node histopathology (NCI-VA classification LN3 or LN4) as significant univariate adverse prognostic factors ( [196](#) ). Skin stage (T3, T4 vs. T1, T2) and visceral involvement were the most significant independent predictors of survival, with palpable adenopathy and lymph node histopathology classification showing marginal significance using multivariate analysis ( [196](#) ). Three prognostic groups were identified, with the most favorable low-risk group having limited skin disease without visceral or blood involvement (TNM stages IA, IB, IIA) and the least-favorable high-risk group demonstrating effaced lymph nodes (NCI-VA LN4, TNM stage IVA) or visceral involvement (TNM stage IVB) ( [196](#) , [316](#) ). The intermediate-risk group includes all other patients (TNM stages IIB, III) and stage IVA patients with grade LN3 lymph node histopathology. As noted in the previous section on staging, several recent reports suggest that patients with grade LN3 lymph nodes with TCR  $\beta$  gene rearrangement have a worse prognosis than similar patients without evidence of gene rearrangement ( [323](#) , [324](#) ). It is reasonable to assume that patients who have grade LN3 lymph nodes with TCR  $\beta$  gene rearrangement would fall into the least-favorable high-risk prognostic group.

In a small series of 43 CTCL patients, 29 of whom received systemic chemotherapy, multivariate analysis indicated that skin stage (T) and the serum lactate dehydrogenase value influenced survival as independent variables in their clinical model, whereas skin stage and thickness of the skin infiltrate showed statistical significance in their clinicopathologic model ( [335](#) ). Extracutaneous spread lacked prognostic value in this series.

A more recent study of 57 patients demonstrated serum lactate dehydrogenase to reflect tumor burden in erythrodermic CTCL, with levels being inversely related to hematologic stage and survival ( [336](#) ). This study used a univariate model, which found lymph node stage and hematologic stage to poorly predict survival. On multivariate assessment, however, only lymph node stage served as an important prognostic indicator of survival.

The prognosis for patients with extracutaneous disease is poor, with median survivals between 1 and 2.5 years ( [99](#) ). Virtually all patients with extracutaneous disease die of CTCL as compared to nearly one-third of patients with generalized plaques and a majority of patients with tumors or erythroderma without visceral involvement ( [310](#) , [337](#) ). Very few patients with limited plaques (T1) actually die of MF, with most deaths due to cardiovascular events or other malignancies ( [99](#) , [310](#) ). Overall, illnesses directly attributed to CTCL or indirectly implicated via CTCL-related complications contribute up to a mere 19% of deaths in CTCL patients ( [333](#) ). Thus, the bulk of patients with CTCL do not die from their malignancy ( [99](#) , [100](#) ). Second malignancies other than skin cancers include NHL, Hodgkin disease, colon cancer, and lung cancer ( [338](#) ). Infection remains the most common cause of death in patients who die from CTCL, with *Staphylococcus aureus* and *Pseudomonas aeruginosa* as the most common pathogens infecting the skin, leading to bacteremia and sepsis ( [100](#) , [337](#) , [339](#) ). Visceral involvement with CTCL may lead to organ failure and, ultimately, death ( [99](#) , [310](#) ).

## THERAPY

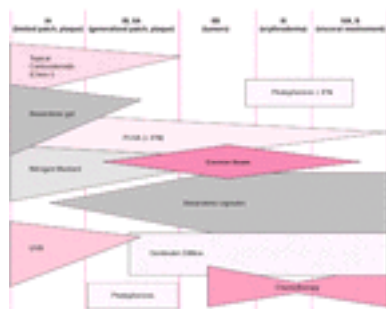
The mainstay of treatment of CTCL has been control of the cutaneous manifestations of disease with topical therapies in the hope of preventing spread to extracutaneous sites. However, due to the risk of progression to extracutaneous sites and worsening cutaneous symptoms, systemic agents alone or in combination with topical therapies have been studied to control more advanced disease. Therapy in MF/SS is based on the extent of disease, age, performance status, potential for remission, availability of treatments,

efficacy, and treatment toxicity ( 340 , 341 , 342 and 343 ). Because MF usually behaves as a low-grade or indolent lymphoma, controversial issues have involved the timing, selection, and intensity of systemic therapy ( 99 , 100 , 340 , 341 , 342 and 343 ). Unfortunately, there are few randomized clinical trials comparing the efficacy of the numerous therapeutic options available for patients with MF/SS ( Table 94.6 ) ( 333 ). The following discussion summarizes the efficacy and toxicity of each therapy and relates these parameters to the disease stage ( Fig. 94.17 ).

**TABLE 94.6. Therapy for Cutaneous T-Cell Lymphoma**

- Topical
  - Chemotherapy (HN<sub>2</sub>, BCNU)
  - Phototherapy (PUVA)
  - Electron beam radiotherapy (EBRT)
- Photon irradiation
- Systemic chemotherapy
  - Single agents
  - Combination chemotherapy
- Combined modality therapy
  - Chemotherapy + EBRT
  - Other
- Extracorporeal photochemotherapy
- Interferons
- Monoclonal antibody therapy
- Interleukin-2 and fusion toxin therapy
- Other agents

BCNU, bishloroethylnitrosourea; HN<sub>2</sub>, nitrogen mustard; PUVA, psoralen and ultraviolet A light.



**Figure 94.17.** Cutaneous T-cell lymphoma treatment algorithm. IFN, interferon; PUVA, psoralen and ultraviolet A light; UVB, ultraviolet B. (Adapted from Apisarnthanarax N, Talpur R, Duvic M. Treatment of cutaneous T cell lymphoma: current status and future directions. *Am J Clin Dermatol* 2002;3:193-215.)

## Topical Chemotherapy

Mechlorethamine hydrochloride, or nitrogen mustard (HN<sub>2</sub>), was introduced in 1947 as the first topical agent to demonstrate activity in treating MF ( 344, 345 ) and remains one of the major therapies of choice for early-stage MF ( 346 ). HN<sub>2</sub> is an alkylating agent that undergoes rapid degradation to an active ethylenimonium ion that has high antimitotic activity and a brief half-life ( 99 ). Studies have suggested that the mode of action of HN<sub>2</sub> may involve interference with the activation of M-phase promoting factor ( 347 ), gene-specific DNA cross-links ( 348 ), and blockage of transcription factor binding sites ( 349 ). Some investigators have suggested that immunogenic properties of HN<sub>2</sub> demonstrated by its propensity to induce delayed-type hypersensitivity contribute to its antineoplastic activity ( 346, 350 ). Topical HN<sub>2</sub> may be prepared in a variety of ways; initial studies involved dissolving HN<sub>2</sub> in water to reach a concentration of 10 to 20 mg/dl ( 351 ), whereas, more recently, HN<sub>2</sub> has been suspended in an emollient such as xipamide (Aquaphor) at concentrations of 0.01% and 0.02% ( 352, 353 ). Topical HN<sub>2</sub> is applied once daily to the entire skin surface with relative sparing of the eyelids, genitalia, rectum, lips, and intertriginous areas. The length of treatment is variable but usually involves daily applications until the patient achieves a complete or significant clearing of skin lesions followed by a maintenance regimen of daily or every-other-day applications for a period of 6 months to 2 years ( 354, 355 ). No author has advocated a maintenance regimen of indefinite HN<sub>2</sub> applications. Treatment may be intensified for localized lesions by increasing either the concentration or frequency of application ( 354 ).

The response rate of topical HN<sub>2</sub> is related to the morphology (patch/plaque vs. tumor) and extent of disease (T1 vs. T2). Three large series with more than 100 patients have been reported ( 355, 356 and 357 ). Overall response (OR) rates between the three studies are difficult to compare because of differences in the clinical stages treated, adjunctive therapies, and staging systems. The percentage of patients with early-stage MF achieving an initial complete remission (CR) ranged from 64% ( 356 ) and 75% ( 355 ) (stage I) to 50% ( 357 ) (stage I-III). More than 80% of patients with T1 skin stage can be expected to have significant clearing of skin lesions. The median time to achieve CR is shorter for stage I patients than more advanced stages. Disease progression to a higher skin stage has been recently reported in 12% and 17% of T1 and T2 patients, respectively, treated initially with HN<sub>2</sub> ( 357 ). The freedom-from-progression rates in this study at 10 years were 85% and 83% for T1 and T2 patients, respectively. Kim et al. observed relapses in 42% of 107 patients after an initial CR, all of which occurred within 5 years ( 357 ). Vonderheid et al. found a durable CR to HN<sub>2</sub> lasting more than 8 years occurring in 34 of 324 (10%) patients with early-stage CTCL ( 355 ).

The side effects of topical HN<sub>2</sub> include local allergic reactions, xerosis, hyperpigmentation, and secondary cutaneous cancers ( 346 ). Immediate hypersensitivity reactions manifesting as urticaria are rare but do occur in approximately 5% of patients using topical HN<sub>2</sub> and necessitate discontinuing treatment to avoid a potentially life-threatening anaphylactic reaction ( 346, 356, 358 ). Delayed-type hypersensitivity reactions (allergic contact dermatitis) manifesting as erythematous eczematous patches occur in up to 58% of patients treated with aqueous HN<sub>2</sub> ( 355, 356 ) but occur less frequently (<10%) with the ointment-based preparation ( 352, 354, 357 ). Some investigators have suggested that the delayed-type hypersensitivity reaction to topical HN<sub>2</sub> may have

a beneficial effect in clearing MF lesions ( [346](#), [350](#) ) and advocate topical desensitization ( [356](#), [359](#) ) rather than discontinuation of the HN<sub>2</sub> when delayed-type hypersensitivity reactions occur ( [346](#) ). Hyperpigmentation of the skin, especially in sites of MF involvement, occur commonly in patients using topical HN<sub>2</sub>, and patients should be reassured that the hyperpigmentation will spontaneously resolve within several months ( [346](#), [350](#), [360](#), [361](#) ).

In their study of 331 patients treated with HN<sub>2</sub>, Vonderheid et al. calculated an 8.6-fold (N = 31, 9%) and 1.8-fold (N = 27, 8%) increased risk for the development of squamous cell carcinoma and basal cell carcinoma of the skin, respectively, when compared to the general U.S. population ( [355](#) ). In contrast, Kim et al. found basal cell carcinoma or squamous cell carcinoma skin neoplasms in only 8 of 203 (4%) CTCL patients treated initially with HN<sub>2</sub> ( [357](#) ). Because HN<sub>2</sub> is a known radiomimetic agent ( [362](#), [363](#) ) its carcinogenic potential may be amplified with the simultaneous use of other agents, most notably ultraviolet therapy ( [346](#) ). To help minimize this risk, patients using HN<sub>2</sub> should adhere to strict protection from sun exposure ( [346](#), [355](#), [356](#) ). The risk of environmental contamination from topical HN<sub>2</sub> appears to be minimal, as there are no epidemiologic data of increased malignancy in family members of treated patients; however, treatment assistants should wear latex gloves and wash accidentally exposed skin thoroughly ( [364](#), [365](#) ).

Topical carmustine, a nitrosourea compound, is also used to treat early-stage MF, although experience is more limited than with topical HN<sub>2</sub> ( [346](#), [366](#) ). The use of topical nitrosoureas for the treatment of MF was first reported in 1972 ( [367](#) ), and its principal mode of action is alkylation ( [368](#) ). Patients mix a 5-ml (10-mg) aliquot of a 0.2% alcoholic stock solution with 60 cc of tap water and apply the solution only to the involved areas of MF ( [346](#) ). Applications are repeated daily for no more than 8 to 10 weeks at a time. Zackheim et al. reported a CR in 86% of stage T1 patients and 48% of stage T2 patients treated with topical carmustine solution ( [366](#) ). In their follow-up report of 188 early-stage MF patients treated with topical carmustine, 91% of stage T1 patients and 62% of stage T2 patients had not failed treatment after 36 months, and 5-year survivals were 97% and 80%, respectively ( [346](#) ). Side effects included erythema and skin tenderness in a great majority of patients, telangiectasia after less common severe cutaneous reactions, allergic cutaneous reactions (<10%), and mild leukopenia (4%) ( [346](#) ).

## Electron Beam Radiotherapy and Photon Beam Irradiation

Radiation was one of the earliest effective treatments for MF first reported in 1902 ( [369](#) ). In 1953, Trump et al. were the first to suggest using accelerated electrons for treatment ( [370](#) ). Modern total skin electron beam radiotherapy (TSEBRT) is among the most effective and well-studied therapies for CTCL ( [371](#), [372](#) ). The total skin surface can be treated by linear accelerator-generated electron beams that are scattered by a penetrable plate at the collimator site ( [100](#), [373](#) ). The usual depth of penetration is much less than 10 mm and is proportional to the energy of the electrons generated, allowing effective dosing to the skin and adnexal structures without internal organ toxicity ( [372](#) ). The most common technique uses a dual fixed-angle six-field or rotation methods with 4 to 9 MeV electrons. Total doses range between 2400 and 3600 cGy over an 8- to 10-week period ( [372](#), [374](#), [375](#) ). With this technique, relatively lower doses are delivered to the scalp, soles, and areas of self-shielding, such as the ventral penis, perineum, upper medial thighs, perianal skin,

inframammary folds, and folds under any pannus (99, 372). Only the eyes are routinely shielded, and unless there is involvement of the head and neck, a scalp shield is used after a dose of 2500 to 2600 cGy has been delivered to decrease the degree of alopecia (99, 372, 375). The hands, forearms, ankles, and dorsal penis may receive doses above 100%, and shielding all of these structures for part of TSEBRT is not uncommon (372, 376).

The long-term results of 561 MF patients treated at Stanford University and Hamilton Regional Cancer Centre from the mid-1950s to 1993 with TSEBRT alone were summarized by Jones et al. (372) (Table 94.7). More than 80% of stage IA patients can be expected to achieve a CR after TSEBRT with 40% to 60% remaining relapse free at 5 years (372). Less encouraging were the relapse-free rates at 2.5 years for stages IB (35% to 40%), IIA (21% to 37%), IIB (7% to 26%), and III (10% to 23%) (372). However, most patients who relapse with what is usually minimal disease will reenter remission with other topical therapies (372). Logistic regression analysis of data from 333 CTCL patients treated with varying doses and energies of TSEBRT found that skin stage (T1 > T2-4) and energy (=3.5 MeV) were independently associated with complete cutaneous remission ( $p < .0001$ ) (372). Similar analysis of 320 patients from Hamilton Cancer Centre found stage and dose, not energy, to be independently correlated with remission (372). Neither dose nor energy was associated with relapse-free survival for the 230 patients in remission from the same center. Skin stage T1, lower lymph node stage, and receiving TSEBRT for a new diagnosis of MF significantly predicted a greater relapse-free survival (372). Another report suggests that prognosis for tumor stage patients with less than 10% skin involvement treated with TSEBRT is significantly better than patients with more than 10% involvement (377).

**TABLE 94.7. Summary of Selected Series of Patients Treated with Total Skin Electron Beam Radiation Therapy (TSEBRT) Alone in Cutaneous T-Cell Lymphoma**

| Institution                     | No. of Patients (NCI-VA) | Stage     | Complete Response | Freedom from Relapse <sup>a</sup> (%) |      |       | Survival (Death from All Causes) (%) |       |       | Comments   |
|---------------------------------|--------------------------|-----------|-------------------|---------------------------------------|------|-------|--------------------------------------|-------|-------|--|
|                                 |                          |           |                   | 2.5-yr                                | 5-yr | 10-yr | 5-yr                                 | 10-yr | 15-yr |  |
| Stanford University (1958-1993) | 241                      | IA        | 25/26 (96%)       | 73                                    | 56   | 52    | 92                                   | 83    | 78    | Most patients treated since 1980 have received adjuvant topical HN <sub>2</sub> after TSEBRT. Since the mid-1970s, the standard dose was 3600 cGy (2.5-9.0 MeV). |
|                                 |                          | IB        | 29/52 (56%)       | 35                                    | 25   | 14    | 75                                   | 57    | 46    |  |
|                                 |                          | IIA       | 40/63 (63%)       | 21                                    | 13   | 11    | 71                                   | 56    | 33    |  |
|                                 |                          | IIB       | 11/46 (24%)       | 7                                     | 2    | NA    | 35                                   | 18    | 7     |  |
|                                 |                          | III       | 11/42 (26%)       | 10                                    | 10   | 7     | 46                                   | 37    | 17    |  |
|                                 |                          | IVA + IVB | 1/12 (8%)         | 8                                     | NA   | NA    | 25                                   | 13    | 13    |  |



|   |     |     |              |    |    |    |    |    |    |   |
|---|-----|-----|--------------|----|----|----|----|----|----|---|
| Hamilton Regional Cancer Centre (1969–1993) | 320 | IA  | 87/103 (84%) | 64 | 42 | 33 | 91 | 87 | 74 | Most patients without response or with relapse received subsequent topical HN <sub>2</sub> . Since 1980, the standard dose was 3500 cGy with 4.0 MeV electrons. |
|   |     | IB  | 76/94 (81%)  | 40 | 25 | 11 | 83 | 68 | 53 |   |
|   |     | IIA | 28/38 (74%)  | 37 | 16 | 16 | 54 | 39 | 39 |   |
|   |     | IIB | 23/44 (53%)  | 26 | 21 | 8  | 41 | 23 | 23 |   |
|   |     | III | 10/20 (50%)  | 23 | 23 | NA | 38 | 38 | 26 |   |
|   |     | IVA | 4/12 (33%)   | 25 | 0  | 0  | 49 | 39 | 39 |   |
|   |     | IVB | 2/9 (22%)    | 0  | 0  | 0  | 29 | 14 | 0  |   |

NA, not applicable; NCI–VA, National Cancer Institute–Veteran’s Administration.

<sup>a</sup> N = 117 for Stanford University and N = 230 for Hamilton Regional Cancer Centre.

Adapted from Jones GW, Hoppe RT, Glatstein E. Electron beam treatment for cutaneous T-cell lymphoma. *Hematol Oncol Clin North Am* 1995;9:1057–1076.

Acute cutaneous side effects peaking 1 to 2 weeks after TSEBRT include erythema, edema, dry or moist desquamation, tenderness, and rare blister formation that is most severe at sites of disease ( [372](#), [378](#), [379](#) and [380](#) ). Total-body alopecia and loss of nails occurs in all unshielded patients, but the skin appendages normally regrow within 6 months ( [372](#) ). During the first year, heat intolerance may develop due to the suppression of sweat gland production, which may be permanent ( [100](#), [381](#) ). Patients with erythroderma (T4) may experience more severe acute side effects from TSEBRT; however, radiation may be effective in stage III, especially with no blood involvement ( [340](#), [375](#), [382](#) ). When there is blood, lymph node, or visceral involvement in patients with erythroderma, combined modality therapies—in particular, photopheresis—should be explored ( [382](#), [383](#) ). Chronic cutaneous side effects most commonly include xerosis, superficial atrophy, telangiectasia, and dyspigmentation ( [99](#), [372](#), [384](#) ). The role of TSEBRT in the development of secondary cutaneous malignancies has not been clearly established, as most patients have received a variety of therapies, which could contribute to the development of skin cancer ( [372](#) ).

Two studies have evaluated the response and toxicity of multiple courses of TSEBRT for CTCL ( [385](#), [386](#) ). Wilson et al. ( [385](#) ) reported on 14 CTCL patients—five patients who received three courses of TSEBRT, and nine patients who received two courses. The total median dose was 5700 cGy (range, 4500 to 8200 cGy) with 86% (N = 12) achieving a CR after the second course of therapy (median relapse-free interval, 11.5 months) and three of five (60%) achieving a CR after a third course (limited follow-up) ( [385](#) ). Three patients developed skin cancers (basal cell carcinoma in three; one with squamous cell carcinoma) ( [385](#) ).

Because of the toxicities of TSEBRT and the effectiveness of topical therapies, most authorities recommend using TSEBRT for patients with progressive disease, those who do not respond to topical therapies, or those with extensive, deeply infiltrated plaques and tumors ( [100](#), [340](#), [343](#), [371](#), [372](#), [387](#) ). Due to the high relapse rates after TSEBRT, posttreatment with nitrogen mustard, photopheresis, and psoralen and ultraviolet A light



(PUVA) have been studied to maintain remissions ( [371](#) , [382](#) , [383](#) , [387](#) ).

Small-field megavoltage photon beam irradiation can be applied as palliation either to deep-seated cutaneous lesions in the tumor phase or for extracutaneous disease ( [388](#) ). Nearly all cutaneous lesions completely respond, with the risk of relapse (up to 45%) inversely proportional to the dose, and with recurrence usually developing within 2 years of treatment ( [389](#) ).

### Systemic Chemotherapy

Single- and multiagent chemotherapy are reserved for patients who have relapsed, have refractory disease, have extracutaneous disease at diagnosis, or are part of a clinical trial ( [341](#) , [390](#) , [391](#) ). Single-agent chemotherapy used for CTCL includes oral corticosteroids, alkylating agents, methotrexate, doxorubicin, bleomycin, vincristine, vinblastine, cisplatin, and etoposide and has resulted in an objective response in a majority of patients with CR ranging from 15% to 25% ( [390](#) , [392](#) ). However, median relapse-free intervals are usually short lasting—less than 6 months and ranging from 3 to 22 months ( [340](#) , [390](#) , [391](#) ). The majority of patients with CTCL advanced enough to justify the immunosuppressive and toxic side effects associated with systemic chemotherapy do not have significant improvement in long-term survival.

Low to intermediate weekly doses of oral methotrexate may result in long remissions for erythrodermic CTCL patients ( [393](#) ) and has been used in advanced-stage patients after induction with intravenous methotrexate followed by oral citrovorum factor, showing a median duration of response of 24 months ( [394](#) ). As an adjunct, methotrexate has also been used to treat patients with patch- or plaque-stage MF after other treatments have failed.

Combination chemotherapy has been studied primarily in small trials and has been reviewed with objective response rates of 60% to 100% ( [Table 94.8](#) ). The mean CR is 38% (range, <10% to 80%), and response ranges from 5 to 41 months ( [390](#) ). In contrast to prior reports of combination chemotherapy inducing longer durations of remission than single-agent chemotherapy, follow-up studies have shown little difference in survival between numerous single- and multiagent regimens ( [391](#) , [395](#) ).

**TABLE 94.8. Combination Chemotherapy Studies in the Treatment of Cutaneous T-Cell Lymphoma [a](#)**

| Study (Yr)              | Therapy                      | Patients (N) | Complete or Partial Responses (%) | Complete Responses (%) | Median Duration of Response (Mo) |
|-------------------------|------------------------------|--------------|-----------------------------------|------------------------|----------------------------------|
| Winkleman et al. (1974) | Chlorambucil + prednisone    | 21           | 11 (52)                           | 3 (14)                 | Not reported                     |
| Coors et al. (2000)     | Chlorambucil + fluocortolone | 13           | 13 (100)                          | 7 (54)                 | 12                               |
| Thomsen et al. (1979)   |                              |              |                                   |                        |                                  |
| Grozea et al. (1979)    | CVPB                         | 12           | 11 (92)                           | 2 (17)                 | 11.5                             |

|  |     |            |            |              |
|--|-----|------------|------------|--------------|
| Leavell et al. CVP<br>(1976)                   |     |            |            |              |
| Tirelli et al.<br>(1979)                       |     |            |            |              |
| Sentis et al.<br>(1985)                        | 29  | 22 (76)    | 12 (41)    | 16           |
| Molin et al.<br>(1980)                         |     |            |            |              |
| Grozea et al. CHOP/HOP<br>(1979)               | 12  | 12 (100)   | 5 (42)     | 5            |
| Doberauer et MBPE<br>al. (1989)                | 11  | 8 (73)     | 1 (9)      | 6            |
| Groth et al. BM<br>(1979)                      | 10  | 9 (90)     | 1 (10)     | 6            |
| Winkler et al. VAB-CMP<br>(1986)               | 26  | 17 (65)    | 6 (23)     | 7            |
| Hallahan et al. COPP or MOPP<br>(1988)         | 21  | 19 (70)    | 11 (52)    | 14           |
| Kaye et al. CAVE<br>(1989)                     | 52  | 47 (90)    | 20 (38)    | Not reported |
| Molin et al. CBP + retinoid<br>(1987)          | 12  | 7 (58)     | 3 (25)     | Not reported |
| Zachariae et CBP + retinoid +<br>al. (1982) TF | 10  | 8 (80)     | 8 (80)     | Not reported |
| Zackem et al. BAM<br>(1986)                    | 10  | 8 (80)     | 7 (70)     | 41           |
| Braverman et CAVE<br>al. (1987)                | 52  | 47 (90)    | 20 (38)    | Not reported |
| Zachariae et CBP + retinoid<br>al. (1987)      | 20  | 18 (90)    | 16 (80)    | 8            |
| Akpek et al. EPOCH<br>(1999)                   | 15  | 12 (80)    | 4 (27)     | 13.5         |
| Fierro et al. VICOP-B<br>(1997)                | 25  | 20 (80)    | 9 (36)     | 8.7          |
| Total  | 351 | 289 of 351 | 135 of 351 | 5-41         |

BAM, bleomycin, Adriamycin (doxorubicin), methotrexate; BM, bleomycin, methotrexate; CAVE, cyclophosphamide, Adriamycin (doxorubicin), vincristine, etoposide; CBP, cyclophosphamide, bleomycin, prednisone; CHOP, cyclophosphamide, Oncovin (vincristine), methotrexate, prednisone; COPP, cyclophosphamide, Oncovin (vincristine), procarbazine, prednisone; CVP, cyclophosphamide, vincristine, prednisone; CVPB, cyclophosphamide, vincristine, prednisone, bleomycin; HOP, hydroxydaunomycin, Oncovin (vincristine), prednisone; MBPE, methotrexate, bleomycin, prednisone, etoposide; MOPP, mechlorethamine, Oncovin (vincristine), procarbazine, prednisone; TF, transfer factor; VAB-CMP, vincristine, Adriamycin (doxorubicin), bleomycin alternating with cyclophosphamide, methotrexate, prednisone; EPOCH, etoposide, vincristine, doxorubicin, cyclophosphamide, oral prednisone; VICOP-B, vincristine, idarubicin, cyclophosphamide, etoposide, prednisone, bleomycin.

<sup>a</sup> Taken from the review of Broder and Bunn (reference [101](#)).

Modified from Bunn et al. (reference [390](#)).

SS has been successfully treated with chlorambucil, an alkylating agent. Prior studies have evaluated daily administration of chlorambucil and prednisone (Winkelmann regimen) or chlorambucil and fluocortolone ( [396](#), [397](#) and [398](#) ). Fluocortolone is favored, as it lacks a mineralocorticoid effect, while sharing a similar potency with prednisone. In a recent uncontrolled pilot study, 13 patients with erythrodermic CTCL were treated with chlorambucil (10 to 12 mg per day for 3 days) and fluocortolone (first day, 75 mg; second day, 50 mg; and third day, 25 mg). Initially, doses were pulsed every 2 weeks and then subsequently prolonged according to clinical status. Seven patients achieved a CR and six had a partial remission, with a mean duration of remission of 16.5 months. At the time of follow-up (mean 31.5, median 27 months), six patients remained in CR and three patients showed stable PR, with no treatment-related severe side effects observed among the group ( [398](#) ).

One class of antineoplastic agents that has shown activity in CTCL are the purine nucleoside analogs: 2-deoxycorformycin (dCF or pentostatin) ( [399](#), [400](#), [401](#), [402](#) and [403](#) ), cladribine ( [404](#), [405](#), [406](#) and [407](#) ), and fludarabine ( [408](#), [409](#) ). dCF inhibits adenosine deaminase, an enzyme of purine metabolism found in high concentration in T lymphocytes, whereas phosphorylated cladribine and fludarabine resist degradation by this enzyme and accumulate in cells inhibiting DNA synthesis and repair ( [404](#), [407](#), [410](#) ). Several small studies using dCF in heavily pretreated patients with MF and SS demonstrated an OR of 41% (range, 14% to 67%) with less than 7% CR and short response durations ( [390](#), [399](#), [402](#), [410](#) ). In a recent study of 20 patients, six with tumor-stage CTCL and 14 with SS, dCF treatment was administered intravenously at a starting dose of 3.75 to 5.0 mg/m<sup>2</sup> per day for 3 days every 3 weeks. Results of this study included an OR of 71% and a CR of 25% (median response duration, 2 to 3.5 months) ( [411](#) ).

Kuzel et al. ( [405](#) ) reported the results of a phase II trial of 2-chlorodeoxyadenosine used to treat 21 heavily pretreated MF/SS patients and found an OR in 28% and a CR in 14%, with a median duration of response of 4.5 months. 2-Chlorodeoxyadenosine was administered at a dose of 0.1 mg/kg per day as a continuous intravenous infusion for 7 days but was subsequently reduced to 5 days after hematologic toxicity occurred. Each cycle consisted of 28-day intervals. The most significant toxicities during this study were bone marrow suppression (62%) and infectious complications (62%) ( [405](#) ). Fludarabine alone has shown similar ORs ( [409](#) ) but, in combination with IFN, has demonstrated a higher response rate (51%) and a slightly longer median relapse-free interval of 5.8 months ( [408](#) ).

Gemcitabine, a pyrimidine antimetabolite, has shown low toxicity and prompt results when used experimentally on 30 patients refractory to other therapies ( [412](#) ). In this phase II trial, gemcitabine was given on days 1, 8, and 15 of a 28-day schedule at a dose of 1200 mg/m<sup>2</sup> intravenously over 30 minutes for a total of three courses. Patients with stage T3 and T4 disease yielded a 70% OR and a 10% CR. One to two cycles of gemcitabine were sufficient to induce tumor reduction in approximately 83% of patients with stage IIB MF. Side effects, although mild in extent, included neutropenia (34%), thrombocytopenia (25%), cutaneous hyperpigmentation (17%), and elevated liver enzymes (13%) ( [412](#) ). Several reports have implicated gemcitabine as the cause of isolated cases of cardiotoxicity, including atrial fibrillation, myocardial infarction, and congestive heart failure ( [412](#), [413](#) and [414](#) ).

Altering a drug's vehicle can improve its efficacy and lower its toxicity, as evidenced by

the new pegylated liposomal preparation of doxorubicin (415). A recent study treated 10 patients with stages IB, IIA, IIB, and IVA with relapsing or recalcitrant CTCL with pegylated liposomal doxorubicin. The drug was administered at a dosage of 20 mg/m<sup>2</sup> once a month, with an upper limit of 400 mg or eight infusions to induce a clinical response. Sixty percent of patients experienced a CR, 10% PR, and 10% stable disease after this monotherapy (416, 417).

Temozolomide, another novel systemic chemotherapeutic agent, although yet to complete phase II trials, has demonstrated promising efficacy in the treatment of CTCL. This alkylating agent produces O<sup>6</sup>-alkylguanine adducts, which are deactivated by O<sup>6</sup>-alkylguanine-DNA alkyltransferase, a DNA repair enzyme often found in tumor cells. Dolan et al. found that patients with MF demonstrated lower-than-expected levels of O<sup>6</sup>-alkylguanine-DNA alkyltransferase in tumor cells, thus emphasizing temozolomide's potential therapeutic efficacy in this specific malignancy (418). Phase I studies of temozolomide use in various malignancies, including CTCL, have shown myelotoxicity to be a dose-limiting factor (419, 420). Subsequently, the recommended dose for phase II trials is 150 mg/m<sup>2</sup> orally for 5 days (total dose, 750 mg/m<sup>2</sup>), and if no major myelosuppression is detected on day 22 of the 4-week cycle, the subsequent courses can be given at 200 mg/m<sup>2</sup> for 5 days (total dose, 1 g/m<sup>2</sup>) on a 4-week cycle. Using this 5-day schedule, one patient with MF achieved a CR lasting 7 months (419).

Depsipeptide is a histone deacetylase inhibitor, loosening DNA-histone contacts and thus rendering DNA vulnerable to damage. Depsipeptide inhibits class I enzymes, functioning as a stable prodrug. After uptake into cells, a glutathione-mediated step converts the drug into its active form. Thus, a benefit of depsipeptide lies in its ability to counteract glutathione-mediated drug resistance (421). *In vitro* and *in vivo*, depsipeptide is cytotoxic to both murine and human tumor cell lines. In a phase I trial of depsipeptide conducted at the NCI, three patients with CTCL had a PR and one patient with peripheral T-cell lymphoma, unspecified, had a CR. Doses were 12.7 or 17.8 mg/m<sup>2</sup> and were infused over 4 hours on days one and five of a 21-day cycle. After treatment, Sézary cells isolated from patients had increased histone acetylation (422). An ongoing phase II, multicenter, open-label trial is currently evaluating the activity and tolerability of depsipeptide in progressive or persistent CTCL. Depsipeptide is being dosed at 13 mg/m<sup>2</sup> on days 1, 8, and 15 of a 28-day cycle, and preliminary results are pending (422a). A likely role for depsipeptide in combination therapy has been suggested (422).

## Retinoids

Retinoids are a class of pharmaceuticals whose structure and function resemble vitamin A and its metabolites. Vitamin A and its analogs, the retinoids, have antiproliferative activity, may induce cellular maturation, and probably modulate immune response (423). Isotretinoin and etretinate, a monoaromatic retinoid compound, have demonstrated similar efficacy in the treatment of CTCL (424). Three clinical trials have demonstrated overall objective clinical responses in 66 of 113 patients (58%) treated with isotretinoin or etretinate, and a CR in 19% (424, 425 and 426). Median duration of response, however, has ranged from 3 to more than 8 months (424, 425 and 426). Etretinate is no longer available and has largely been replaced with acitretin because of its better safety profile. Acitretin may reduce the thick palmoplantar keratoderma of advanced MF or SS (423).

In 1999, the U.S. Food and Drug Administration approved the use of bexarotene capsules,

a novel retinoid, for the treatment of CTCL. Unlike isotretinoin and acitretin, which bind to nuclear RAR retinoid receptors, bexarotene binds to and activates nuclear RXR receptors and is therefore referred to as a *retinoid*. The RXR receptors are unique in that they form heterodimers with a vast array of nuclear receptors, including the RAR receptors and peroxisome proliferator activator receptors ( 392 ). The ultimate antiproliferative effect is mediated, in part, by the induction of apoptosis and expression of adhesion molecules ( 427 , 428 and 429 ). Two multicenter clinical trials established the optimal dose of 300 mg/m<sup>2</sup> per day with an OR rate of 45% ( 430 , 431 ). Higher response rates were seen in patients with higher initial doses (up to 650 mg/m<sup>2</sup>), but side effects of hypertriglyceridemia were dose limiting. Subsequent pancreatitis occurred in 4 of the 152 patients enrolled in the two clinical trials ( 430 , 431 ). The advanced-stage CTCL trial showed a relapse rate of 36%, but an impressive median duration of response of 299 days ( 428 ).

Talpur et al. recently summarized the experience of treating 70 patients with CTCL using bexarotene capsules as monotherapy combined with other modalities ( 432 ). Many of the patients participated in the two pivotal clinical trials. The OR rate seen in the monotherapy group (N = 54) was 48% in contrast to the 69% OR rate in the combination therapy group. Bexarotene was safely added to the photopheresis [extracorporeal photochemotherapy (ECP)], ECP/IFN, IFN/PUVA, and ECP/IFN/PUVA. Adverse effects were similar between the clinical trials and included hypertriglyceridemia (87%), central hypothyroidism requiring thyroid supplementation (80%), neutropenia (41%), skin peeling (43%), hypercholesterolemia (20%), and pancreatitis (3%). Seventy-eight percent of the monotherapy group (N = 54) and 100% of the combination therapy group (N = 16) required at least one lipid-lowering agent (LLA). Of the ten patients with diabetes, three had hypertriglyceridemia that could not be controlled with an LLA ( 432 ). In this series, atorvastatin and fenofibrate were the LLAs of choice. Interestingly, 9 out of 10 (90%) patients on bexarotene monotherapy taking two LLAs responded significantly higher than those groups on one or no LLA (  $p = .0001$  ). The explanation for this finding is not clear, but using two LLAs may allow patients to maintain maximum doses of bexarotene ( 432 ). Vigilance should be exercised when combining atorvastatin and fenofibrate to monitor for rhabdomyolysis. Gemfibrozil and drugs that inhibit the cytochrome P 3A4 enzyme are contraindicated with bexarotene to avoid elevated drug levels and worsened side effects.

Bexarotene is also available as a 1% gel. The gel formulation is most helpful in early-stage patients (IA) without prior therapies. Bexarotene 1% gel is applied only to lesional skin once daily the first week and twice daily the second week, tapering up to four times daily as tolerated ( 433 ). In the multicenter trial, patients achieved an OR rate of 63% and a clinical CR of 21%. Median projected time to onset of response was 20.1 weeks (range, 4.0 to 86.0 weeks), and the estimated median response duration from the start of therapy was 99 weeks ( 433 ). The most common side effect is irritation (retinoid dermatitis) at the sites of application, which can make it difficult to assess response to the drug.

## Interferon

IFNs are glycoproteins, naturally occurring or synthesized by recombinant DNA technology. These agents act as immunomodulators with both cytostatic and antiviral activity ( 340 , 434 ). Although three classes—alpha (IFN- $\alpha$ ), beta (IFN- $\beta$ ), and gamma (IFN- $\gamma$ )—are described, the alpha IFNs have been most extensively studied in MF and SS, and their efficacy was first reported by Bunn et al. in 1984 ( 435 ). The exact mechanism of action of IFN in MF and SS is unknown. IFN may act to inhibit IL-4 and IL-5 production by normal and aberrant T cells in patients with SS ( 20 , 25 ), induce myelomonocytic My7 antigen (CD13) in epidermal basal cells ( 436 ), induce the double-stranded RNA-dependent



enzyme 2'5'-oligoadenylate synthetase leading to cleavage of cellular RNAs, and phosphorylate eukaryotic initiation factor-2, a peptide elongation initiation factor that blocks protein synthesis ( 434 ). The pharmacokinetics of IFN delivered via the intramuscular and subcutaneous routes are equivalent, allowing patients the opportunity to self-administer the drug subcutaneously ( 437 ).

The phase II NCI trial reported by Bunn et al. in 1984 used high doses of recombinant IFN-a2a ( $50 \times 10^6$  units/m<sup>2</sup> = 50 MU/m<sup>2</sup> subcutaneously three times per week) in 20 heavily pretreated MF patients and demonstrated an objective response in 45%, including three patients (15%) who achieved a CR ( 435 , 438 , 439 ). Treatment of MF and SS with IFN-a has been reported in more than 200 patients, and the results have been summarized ( 390 , 434 ). Over three-fourths of the patients received IFN-a2a (Roferon-A, Hoffman-LaRoche, Nutley, NJ) although there were no apparent differences in clinical efficacy between IFN-a2a and IFN-a2b (Intron-A, Schering-Plough Research Institute, Kenilworth, NJ) ( 390 , 434 ). The OR rate for IFN-a alone was 52%, with a 17% CR among 207 MF and SS patients summarized by Bunn et al. ( 390 ). However, interpretation of pooled data is complicated by variations in initial dose, target dose, frequency, and length of therapy among study centers ( 434 ). There are conflicting reports regarding the impact of clinical stage on the likelihood of response to systemic IFN-a ( 434 , 440 , 441 and 442 ). In their study of 51 MF and SS patients, Jumbou et al. found that patients with early disease (stages I and II) demonstrated a higher response rate to IFN-a than those with advanced disease ( 443 ).

In an attempt to define the optimal dose of IFN-a in CTCL, a randomized study from Duke and Northwestern Universities was designed, comparing low-dose (3 MU per day) to escalating doses (up to 36 MU per day); however, because of slow patient accrual, the proposed study was terminated ( 440 ). For the 22 patients evaluated, the objective response rate was 64% and was greater, although not statistically significant for those receiving high doses (11 of 14) compared to those receiving low doses (three of eight), due in part to late responses in unresponsive patients who crossed over into the higher-dose arm ( 390 , 440 ). Of interest, two of the three CR patients were induced by the low-dose regimen, suggesting that patients could achieve a CR with 3 MU daily of IFN-a2a ( 434 , 440 ). An intermediate daily dose of 18 MU of IFN-a2a for 3 months followed by the same dose three times a week resulted in an impressive 80% objective response rate (27% CR, 53% PR) in 15 CTCL patients reported by Tura et al. ( 444 ).

Daily dosing of IFN-a2a for an induction period of several months was used by all of the larger studies of IFN-treated CTCL patients ( 435 , 440 , 441 and 442 , 444 ), whereas many fewer patients have been studied using an initial three-times-a-week schedule ( 445 , 446 , 447 , 448 and 449 ). Nonetheless, some authorities ( 390 ) recommend an optimal dose of 3 MU of IFN-a2a three times a week, based in part on randomized dose studies in B-cell indolent NHL showing no benefit to higher-dose IFN with respect to response rate or duration ( 450 ). Maximum daily dosing is dependent on several patient factors but, in general, should not exceed 15 MU ( 451 ). Two to 5 months is generally necessary to obtain an objective response with IFN, but a complete or maximal response can take much longer ( 434 , 440 , 442 ). Treatment is generally continued for approximately 1 year after a CR to prevent the high potential for relapse when treatment is discontinued before clearing ( 434 ). Three studies have reported a median duration of response to IFN-a as follows: 6 months ( 435 ), 8 months ( 441 ), and 14 months ( 442 ). Olsen et al. noted a mean duration of PR while on therapy of 7.9 months (range, 2.1 to 26.5 months) and durations of CR off therapy ranging from 4 to 28 months ( 434 , 440 ). Two NCI phase II trials combined IFN-a2a

with the adenosine analogs dCF and fludarabine to treat CTCL and demonstrated no clear advantage over either drug alone ( [400](#), [408](#) ). The numerous side effects associated with IFN have led to dose reductions in 50% to 86% of patients in some studies ( [440](#), [444](#) ).

Besides producing anti-IFN antibodies, patients with MF can also exhibit decreased responsiveness to IFN through acquired resistance to IFN- $\alpha$ -induced gene expression. Specifically, a resistant CTCL cell line exhibits disrupted signal transduction in a pathway that is normally activated by IFN- $\alpha$  when therapeutic. In particular, STAT1 expression is reduced in these cells, which interrupts the JAK/STAT signaling pathway ( [452](#) ).

In two studies, intralesional recombinant IFN- $\alpha$ 2b was injected into selected plaques of 15 MF patients over 4 weeks and resulted in clinical (not histologic) clearing in 83% of those treated ( [447](#), [453](#) ). A majority of patients (56% to 83%) experienced systemic side effects to the intralesional injections. Recombinant IFN- $\alpha$  and IFN- $\beta$  have been studied in many fewer CTCL patients, as they appear to offer no major advantage over IFN- $\alpha$  ( [454](#), [455](#), [456](#) and [457](#) ). IFN- $\beta$  has reportedly shown little effectiveness in treating CTCL ( [454](#) ), and IFN- $\gamma$  has been linked with more intense and frequent side effects than IFN- $\alpha$  ( [434](#) ).

### Photopheresis or Extracorporeal Photochemotherapy

Because of the development of resistance to conventional chemotherapy and radiation and the high potential for relapse in advanced-stage patients, new modalities to treat CTCL have been developed. Leukopheresis, which had been used in patients with high Sézary cell counts ( [458](#) ), was the forerunner for a new adaptation of PUVA called ECP or photopheresis. In the original protocol, patients ingested 8-methoxypsoralen before undergoing fractionation of their blood. A leukocyte-enriched blood fraction was then isolated and exposed to ultraviolet A in an extracorporeal system, which photoactivated the psoralen ( [459](#) ). The photopheresis procedure currently performed uses liquid 8-methoxypsoralen injected directly into the collection bag containing the enriched white blood cell fraction to achieve a concentration of 340 ng/ml within the collection bag. All treated and untreated blood products were then returned to the patient.

In 1987, Edelson et al. were the first to report responses in 27 of 37 patients (64%) with resistant CTCL treated with ECP, including eight of ten patients with lymph node involvement and 24 of 29 patients with erythroderma. However, patients with extensive plaques or tumors did not respond as well (three of eight patients) ( [459](#) ).

The immunomodulatory mechanism underlying patient response to ECP is still under debate. However, evidence currently supports the following two simultaneous and synergistic processes occurring during ECP: induction of apoptosis in malignant T cells, and a mass conversion of blood monocytes to dendritic cells ( [460](#), [461](#), [462](#), [463](#), [464](#), [465](#) and [466](#) ). Animal studies demonstrate that ECP induces a CD8<sup>+</sup> T-cell response against expanded clones of pathogenic T cells ( [464](#), [467](#) ), as well as an increased synthesis of class I MHC molecules on murine T-cell lymphoma cells ( [463](#) ). Recent *in vitro* studies using family-specific monoclonal antibodies and magnetic bead technology demonstrated a tumor-specific cytolytic CD8<sup>+</sup> T-cell response to distinctive class I surface peptides on CTCL tumor cells of four patients with advanced disease. These results suggest that reduced class I expression of relevant tumor antigen epitopes may limit the extent of CD8<sup>+</sup> T cell-mediated cytotoxicity ( [462](#) ). In support of this hypothesis, investigators have found a favorable response to correlate with the following two scenarios at the onset of ECP: normal or near-normal numbers of CD8<sup>+</sup> peripheral blood T cells ( [460](#) ) and a lower



CD4:CD8 ratio in the peripheral blood ( [468](#) ).

Other investigators have found that ECP and *in vitro* PUVA induce apoptosis in peripheral blood lymphocytes but not in monocytes ( [461](#) ). The apoptosis induction mechanism remains unknown but may be explained by the observation that a significant amount of tumor necrosis factor- $\alpha$ , which mediates various antitumor effects, is produced by macrophages after ECP ( [469](#) ). Berger et al. identified monocytes transitioning to immature dendritic cells during overnight incubation in gas-permeable bags of ECP-treated white blood cells from five patients with intractable CTCL ( [470](#) ). Both the initial leukapheresis step and the subsequent passage through the narrow photoactivation plate initiated and contributed to monocytes-to-dendritic cell differentiation ( [470](#) ). Edelson recently proposed that the innumerable encounters of monocytes with the plastic surface of the photoactivation plate activated the cells to begin differentiation to immature dendritic cells ( [465](#) ). An immature dendritic cell can engulf an apoptotic T cell and present tumor antigen via MHC class I molecules, which stimulates a potent antitumor CD8 T-cell response ( [465](#), [466](#), [470](#) ).

Treatment of CTCL with ECP has been reported in more than 400 patients ( [459](#), [471](#), [472](#), [473](#), [474](#), [475](#), [476](#), [477](#), [478](#), [479](#), [480](#) and [481](#) ) and has been recently summarized ( [482](#) ). The majority of CTCL patients treated with ECP have exhibited generalized erythroderma (skin stage T4), a finding most likely due to Edelson et al.'s encouraging preliminary study results ( [459](#) ). Combined analysis of five North American series ( [459](#), [471](#), [476](#), [477](#) and [478](#), [482](#) ) of ECP-treated CTCL patients (N = 157) demonstrates an objective response (greater than 25% improvement of skin lesions) in 67 of 111 stage T4 patients (60%), with approximately 20% achieving a CR. A long-term follow-up study of the original 29 erythrodermic CTCL patients in the report of Edelson et al. ( [459](#) ) demonstrated a median survival of 60 months, which compared favorably to historical controls ( [468](#) ). Investigators at an International Consensus Conference for Cutaneous T-Cell Lymphoma recommended that ECP be considered the first line of treatment for erythrodermic-stage patients ( [483](#) ). However, other authorities differ in their opinions regarding the role of ECP in the treatment of CTCL, stating that the data have been inconsistent ( [390](#), [484](#), [485](#) ).

Preliminary and long-term follow-up studies by Zic et al. on 20 refractory CTCL patients treated with ECP and adjunctive therapies demonstrated an objective response (greater than 50% clearing of skin lesions) in 9 of 14 (64%) stage T2 patients with CR in four ( [471](#), [486](#) ). Seven patients achieved a CR at some point in their treatment, with a median time to clearing of 11 months. The mean relapse-free interval for the seven patients weaned off of ECP was approximately 45 months (range, 20 to 64 months); two patients experienced a cutaneous relapse ( [486](#) ). Many patients received adjunctive therapy (IFN, topical nitrogen mustard, methotrexate, or PUVA phototherapy) after several months of ECP monotherapy to achieve their highest response rate ( [486](#) ). Observations by Rubegni et al. question the use of ECP to treat stage IB patients when less expensive and more widely accessible therapies are available ( [487](#) ).

ECP is well tolerated, with few complications or adverse effects ( [482](#) ). Uncommon adverse reactions are usually vascular related and include fluid-responsive hypotension and venipuncture-site hematomas ( [486](#) ). Rarely, adverse reactions have included exacerbation of congestive heart failure or arrhythmias ( [483](#) ), superficial thrombophlebitis ( [483](#) ), catheter-related sepsis ( [488](#) ), herpes infections ( [483](#) ), disseminated fungal infection

( 483 ), and a single episode of hemolysis ( 471 ).

Currently, few studies have focused on the effects of combining ECP with systemic chemotherapy, PUVA ( 471 ), IFN and other cytokines ( 471 , 489 , 490 , 491 and 492 ), radiation therapy ( 471 ), bexarotene ( 392 ), and nitrogen mustard ( 471 ).

### Combined Modality Therapy

Because there is no single therapy for CTCL that can consistently induce long-lasting remissions, various combinations of therapeutic modalities have been studied. The results of several small studies suggested that better survival could be achieved by combining TSEBRT with chemotherapy ( Table 94.9 ) ( 493 , 494 , 495 , 496 and 497 ). Hallahan et al. evaluated TSEBRT followed by combination chemotherapy for 21 patients with tumor-stage CTCL, demonstrating an objective response in 19 (90%) with a median duration of remission of 12 months, but all patients relapsed within 25 months ( 495 ). Two nonrandomized studies suggested a benefit for early-stage CTCL patients who receive TSEBRT followed by chemotherapy ( 493 , 496 ). A more recent study evaluated the combination of TSEBRT with the systemic retinoid etretinate and found no significant advantage to the combination, although the median follow-up was only 2 years ( 379 ). After TSEBT, subsequent PUVA therapy appears to aid in maintaining remission status in patients with CTCL. A significant benefit in disease-free survival but no statistically significant improvement in overall survival was observed; however, prospective, randomized data are needed to confirm these results. Incidentally, PUVA has also demonstrated its effectiveness as a salvage therapy after TSEBT in early-stage patients with recurrence and acceptable toxicity ( 498 ).

**TABLE 94.9. Combined Electron Beam Radiotherapy (EBRT) and Chemotherapy for Cutaneous T-Cell Lymphoma**

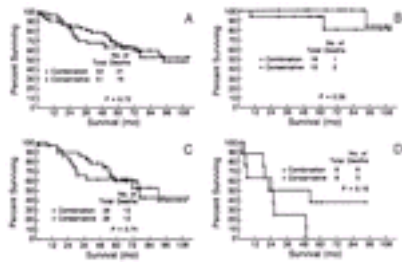
| Institution                     | Drug Agent(s)   | No. of Patients | Stage                        | Complete Response (%) | Complete Response + Partial Response (%) | Response Duration in Mo (median) | Comments  |
|---------------------------------|-----------------|-----------------|------------------------------|-----------------------|--|----------------------------------|---|
| University of Chicago (495)     | COPP or MOPP    | 21              | 15 T3 (IIB);<br>6 T3N3 (IVA) | 11 (50)               | 19 (90)                                  | 2–24 (12)                        | All patients relapsed with cutaneous plaques within 25 mos; median survival from initiation of EBRT was 6 yrs.        |
| National Cancer Institute (496) | Mechlorethamine | 13              | I                            | 10 (77)               | 13 (100)                                 | >48                              | Received 3000 cGy before chemotherapy. Overall 6-yr survival was 92%; six remain alive and disease-free beyond 6 yrs. |

|                                 |   |    |                           |         |         |             |   |
|---------------------------------|---|----|---------------------------|---------|---------|-------------|---|
| National Cancer Institute (496) | VAB/CMP   | 26 | II-IV                     | 6 (23)  | 23 (88) | (6.5)       | Received 2400 cGy before chemotherapy. Median disease-free survival for complete responding patients was 26 mos; overall 6-yr survival was 26%.   |
| National Cancer Institute (499) | Cyclophosphamide; doxorubicin, etoposide, vincristine | 52 | 11 I, 11 II, 1 III, 29 IV | 20 (38) | 47 (90) | 26-118 (75) | No survival benefit of combined method vs. conservative therapy (see text and <a href="#">Fig. 94.18</a> ); significant toxicity: 12 hospitalizations for febrile neutropenia; 5 congestive heart failure; 2 acute nonlymphocytic leukemia. |

COPP, cyclophosphamide, Oncovin (vincristine), procarbazine, prednisone; MOPP, mechlorethamine, Oncovin (vincristine), procarbazine, prednisone; VAB/CMP, vinblastine, doxorubicin, bleomycin/cyclophosphamide, methotrexate, prednisone.

---

The most significant study to evaluate the role of combined modality therapy was that of Kaye et al. at the NCI who compared TSEBRT and combination chemotherapy (cyclophosphamide, doxorubicin, etoposide, and vincristine) to conservative topical therapy (beginning with topical HN<sub>2</sub> followed sequentially, if needed, by PUVA, TSEBRT, and combination chemotherapy) in a randomized trial of 103 patients with MF ([499](#)). Although the rate of CR was significantly increased in the combined modality arm (38% vs. 10%,  $p = .032$ ), toxicity was greater and no significant difference was noted between the groups in disease-free or overall survival ([Fig. 94.18](#)).



**Figure 94.18.** Survival curves from randomized study at the National Cancer Institute comparing intensive combined therapy. **A:** Overall survival. **B:** Survival among low-risk patients (stage IA, IB, or IIB). **C:** Survival among intermediate-risk patients (stage IIB, III, or IVA). **D:** Survival among high-risk patients (stage IVB). (From Kaye FJ, et al. A randomized trial comparing combination electron beam radiation and chemotherapy with topical therapy in the initial treatment of mycosis fungoides. *N Engl J Med* 1989;321:1784, with permission.)

Thus, this study indicated that, similar to other low-grade lymphomas, early aggressive therapy in MF does not have a major impact on survival.

A nonrandomized study from Yale University compared relapse-free survival and overall survival between CTCL patients who achieved a CR after TSEBRT, with subsequent treatment consisting of either adjuvant chemotherapy (cyclophosphamide and doxorubicin; N = 77), photopheresis (N = 11), or no adjuvant therapy (N = 43) ([500](#)). Adjuvant therapy was also offered to 32 patients who achieved a “good PR” to TSEBRT. The statistical analysis found no appreciable impact on relapse-free survival among the patients receiving adjuvant chemotherapy or photopheresis when compared to patients receiving no adjuvant therapy. However, a marginally significant ( $p < .06$ ) improvement on overall survival was demonstrated when stage T3/T4 patients treated with adjuvant photopheresis (N = 7) were compared to stage T3/T4 patients receiving no adjuvant therapy (N = 22) ([500](#)).

Retinoids and IFN- $\alpha$  have been combined to treat CTCL in several open studies ([501](#), [502](#), [503](#), [504](#), [505](#), [506](#), [507](#), [508](#), [509](#) and [510](#)). Combined analysis of the results of 102 reported patients treated with retinoids and IFN- $\alpha$  showed that approximately 60% of patients respond and 10% achieve a CR, which is similar to the response for IFN- $\alpha$  alone ([390](#)). PUVA therapy has been combined with systemic retinoids to treat CTCL in two studies ([511](#), [512](#)) demonstrating response rates similar to PUVA alone. Bexarotene has been combined with ECP, PUVA phototherapy, and IFN- $\alpha$  in several patients with potential beneficial effects, as well as no increased toxicity ([432](#)).

The combination of PUVA and IFN- $\alpha$  has generated considerable interest recently with impressive CR ([513](#), [514](#), [515](#), [516](#), [517](#), [518](#) and [519](#)). In the combined analysis of the phase I and phase II trials of IFN- $\alpha$  and PUVA for CTCL at Northwestern University, 39 CTCL patients (stage IB, N = 14; IIA, N = 5; IIB, N = 6; III, N = 8; IVA, N = 5; IVB, N = 1) received intramuscular or subcutaneous IFN- $\alpha$ 2a three times a week at initial intermediate doses (6 MU, N = 3; 12 MU to 18 MU, N = 13; 21 MU to 30 MU, N = 23) with subsequent dose reduction in 19 patients due to apparent toxicity ([514](#)). IFN- $\alpha$  was continued for the planned 2-year period in only 10 of the 39 patients (26%), with eight patients receiving 4 or fewer months of IFN- $\alpha$  due to tumor progression, toxic effects, or patient request. PUVA was initiated three times per week and tapered to one monthly treatment indefinitely for patients achieving a CR. The overall objective response rate was 90%, with 24 patients (62%) achieving a pathologically confirmed CR, 15 of whom had early-stage disease (stage IB/IIA). Nineteen patients (54%) relapsed, demonstrating a median duration

of response of 28 months (range, 1 to 64 months). Median survival for the entire cohort was 62 months, with mean survivals for stage I/II and stage III/IV patients of 55 and 35 months, respectively ( [514](#) ). Although patients respond impressively, a majority of patients will relapse despite maintenance PUVA and will also experience nontrivial toxicities. In a smaller study, PUVA was discontinued approximately 2 months after clearing, and low-dose IFN- $\alpha$  was continued as maintenance therapy in 16 CTCL patients ( [518](#) ). Thirteen of 16 (81%) patients demonstrated an objective response with a CR in ten of the patients; however, within the short follow-up period of 10 to 40 months, 50% of the patients developed progressive disease, a cutaneous relapse, or Hodgkin lymphoma (N = 1) ( [518](#) ). The overall impact on survival of combined PUVA and IFN- $\alpha$  has yet to be determined.

A prospective phase II trial examined escalating doses of IFN- $\alpha$ 2a combined with PUVA in 63 symptomatic patients representing all stages of MF and SS ( [519](#) ). Fifty-one patients achieved a CR (74.6%) or PR (6%), with a median response duration of 32 months. The 5-year overall survival rate was 91% and included 17 patients with advanced disease ( [519](#) ). In another similar study, 25 stage I and II patients with MF received a target dose of 18 MU per week of IFN- $\alpha$ 2b combined with PUVA and demonstrated an OR rate of 96%. The projected probability of freedom from treatment failure was 82% at 12 months and 62% at 24 months, with a disease-free survival projected to 48 months of 75% ( [520](#) ).

Recently, Stadler and colleagues completed a prospective, randomized multicenter trial to compare IFN plus PUVA and IFN plus acitretin in stage I and II patients with CTCL (N = 82 evaluable patients) ( [521](#) ). IFN- $\alpha$ 2a was administered subcutaneously at 9 MU three times weekly and combined with either PUVA at an initial interval of five times weekly, or with acitretin up to 50 mg daily. IFN- $\alpha$  plus PUVA (N = 40) was significantly superior to the IFN plus acitretin (N = 42), as marked by a 70% complete remission rate in the former, versus a 38.1% complete remission rate in the latter ( [521](#) ).

## Immunotherapy

Over the past decade, researchers have developed immunotherapies to correct abnormalities in the immune response, cellular growth, and differentiation pathways in patients with CTCL. As described in previous sections, recombinant forms of natural cytokines such as IFNs and immunomodulation with photopheresis have shown promise in the treatment of CTCL, with tolerable toxicity profiles and reasonable efficacy. This section focuses on other cytokines and monoclonal antibody therapies for the treatment of CTCL.

Fusion toxin therapy takes advantage of the preferential expression of specific receptors on the surface of malignant cells. Conjugation (“fusion”) of a plant or bacterial toxin gene to a specific receptor ligand can guide the toxin gene to the target cell, where it can be internalized via receptor-mediated endocytosis and translocated into a toxic moiety in the cytosol ( [410](#) ). The IL-2 receptor (IL-2R) is present in low-, medium-, and high-affinity forms. The high-affinity form of the IL-2R is a three-subunit peptide, and one of the three subunits contains CD25. The high-affinity IL-2R has been a specific target that is commonly present on cells in ATLL ( [522](#) , [523](#) and [524](#) ) and on mature, activated T cells. Approximately 60% of patients with CTCL will show expression of IL-2R on their mature T cells, but there is both interpatient and inpatient variability of expression ( [525](#) ).

DAB<sub>486</sub>IL2 and DAB<sub>389</sub>IL2 were the first fusion toxins to be used in clinical trials and are composed of the nucleotide sequence of the enzymatically active and the membrane translocating domains of diphtheria toxin conjugated to the amino acid sequence of

human IL-2 ( [410](#), [522](#), [523](#), [526](#), [527](#), [528](#), [529](#), [530](#), [531](#) and [532](#) ). In a phase II trial of DAB<sub>486</sub>IL2 reported by Foss et al. ( [526](#) ), 3 of the 14 CTCL patients demonstrated an objective response (one patient with a PR, two patients with slightly less than 50% improvement). The authors observed that IL-2R expression was necessary, but not sufficient, to predict response. DAB<sub>389</sub>IL2 (denileukin diftitox), a second-generation molecule, replaced DAB<sub>486</sub>IL2 because it showed a more favorable pharmacokinetic profile.

A pivotal phase III trial evaluated the safety, efficacy, and pharmacokinetics of two dose levels of denileukin diftitox ( [533](#) ). This randomized, blinded, parallel-grouped study focused on the use of denileukin diftitox in the treatment of 71 patients with persistent or recurrent stage IB to IVA CTCL. For study inclusion, patients had to have detectable CD25 on at least 25% of their tissue biopsy lymphocytes via immunoperoxidase assay. After therapy, 30% of patients experienced an objective response (20% PR and 10% CR), whereas 32% experienced stable disease and 3% demonstrated progressive disease. Dosages of 9 and 18 µg/kg per day were compared and showed similar tolerability and no evidence of cumulative toxicity. There were no statistically significant differences found between the two dosing regimens with respect to response rate and duration of response (median, 6.9 months; range, 2.7 to 46.1+ months) ( [533](#) ). On stratification with respect to disease stage, 18 µg/kg per day of denileukin diftitox proved more effective in treating stage IIB patients (36% OR) than the lower dose (23% OR) ( [533](#) ). The U.S. Food and Drug Administration approved denileukin diftitox in 1999 for the treatment of patients with persistent or recurrent CTCL whose malignant cells express the CD25 component of the IL-2R.

Ongoing studies are examining the efficacy of denileukin diftitox in CTCL patients with less than 20% of their lymphocyte population expressing CD25. The effectiveness and tolerability of alternate dosing regimens is also being explored.

Another small phase III study focused on the use of steroid premedication to improve the tolerability of denileukin diftitox. Fifteen CTCL patients received prednisone or dexamethasone immediately before each dose of denileukin diftitox, which was administered at two dose levels (9 or 18 µg/kg/day) for 5 consecutive days every 3 weeks. This cycle was repeated up to eight times. After therapy, a significant decrease in the incidence of acute hypersensitivity reactions was noted, and a 60% response rate was observed. These findings prompted the authors to conclude that steroid premedication not only made denileukin diftitox more tolerable, but also performed this task without compromising clinical response ( [534](#) ).

Side effects of denileukin diftitox have included reversible elevated hepatic transaminases (61% total, 15% with grade 3 or 4) and flulike symptoms (fever/chills, nausea/vomiting, and arthralgias/myalgias) seen in 92% of patients in the pivotal trial. A delayed vascular leak syndrome (hypoalbuminemia, edema, and hypotension) was seen in 25% of patients in the same patient population. Increasing hydration may decrease the incidence of vascular leak syndrome, but this theory currently lacks supporting data. Acutely, hypersensitivity reactions during infusion may show as dyspnea, back pain, chest pain, and hypotension. As noted above, pretreatment of these patients with steroids make acute hypersensitivity reactions less likely. Bone marrow suppression or secondary immunosuppressive effects have not been noted as significant adverse events related to denileukin diftitox ( [410](#), [533](#) ). Infections were seen in 56% of subjects. However, 80% of these infections were typical in patients with advanced-stage or heavily pretreated CTCL, and were thus not attributed to therapy ( [533](#) ).

IL-12 supplementation has been the focus of recent immunotherapy techniques, as CTCL



patients experience substantially depressed cytokine production and subsequent impaired cell-mediated immunity. IL-12 is critical for antitumor cytotoxic T-cell responses. Subcutaneous and intralesional IL-12 has been studied in a phase I dose escalation trial of ten refractory patients with MF/SS and showed an OR rate of 50%, including two complete responders with plaque-stage disease ( 535 ). IL-12 was administered twice weekly. Side effects were minor, including headache and low-grade fever. Results supported the role of supplemental IL-12 in augmentation of cytotoxic T-cell responses to tumor cells ( 535 ).

The development of monoclonal antibodies directed at specific antigens on T cells led to trials of monoclonal antibodies for therapy and staging of CTCL ( 524 , 536 , 537 ). In a trial of high-dose T-101, a murine antibody directed against CD5, four of ten CTCL patients (40%) achieved a brief objective clinical response, and 50% of the CTCL patients developed human antimouse antibodies ( 536 ). To enhance cytotoxicity, toxic moieties have been conjugated to the antibodies ( 524 , 537 , 538 ). In a phase I trial by Rosen et al. ( 537 ), five CTCL patients received between 100 and 151 mCi of iodine-131-conjugated to T-101. All patients demonstrated a brief clinical remission initially, two patients responded to retreatment, and three patients experienced dose-related myelosuppression. LeMaistre et al. ( 538 ) conjugated ricin, a potent inhibitor of protein synthesis, to T-101 in a phase I trial of 14 CTCL patients and demonstrated a PR in 28% lasting 3 to 8 months. The toxicities of monoclonal antibody therapy are usually mild and reversible and include fever, pruritus, myalgia, dyspnea, hypoalbuminemia, weight gain, elevated liver function tests, a poorly understood capillary leak-like syndrome, and, rarely, anaphylaxis ( 410 ).

Similarly, CAMPATH-1H (alemtuzumab), a monoclonal antibody directed against CD52, has been studied in the treatment of advanced, low-grade NHL, including CTCL. This humanized antibody targets T and B lymphocytes and appears to have a predilection for circulating cells, relatively sparing those localized within lymph nodes ( 539 ). Dearden et al. reported a 100% response rate among three CTCL patients treated with alemtuzumab administered three times per week ( 540 ). Similarly promising, in a phase II study of eight patients with MF, four demonstrated significant responses, with two classified further as CR ( 541 ). However, the side effect profile for CAMPATH-1H includes significant neutropenia with subsequent increased susceptibility to opportunistic infections and bacterial septicemia, thus limiting its utility in the treatment of severely ill patients. Larger clinical trials are needed to clarify the role of alemtuzumab in the treatment of CTCL.

## Hematopoietic Stem Cell Transplantation

Because patients with advanced CTCL have a poor prognosis, with only a small chance of sustained remission, treatments as invasive as hematopoietic stem cell transplantation (HSCT) have been increasingly explored using various donor sources and therapeutic conditioning regimens. A more detailed discussion of HSCT is included in [Chapter 25](#).

Autologous bone marrow transplantation (ABMT) may have the lowest treatment-related mortality but the highest relapse rate. ABMT has been attempted in a small number of patients with advanced/erythrodermic MF ( 542 , 543 ). Although five of six patients with advanced CTCL achieved a CR after ABMT, three patients relapsed in less than 100 days, and two were alive with no evidence of disease at 12-month follow-up ( 542 ). In a more recent study, Olavarria et al. used various forms of myeloablation before ABMT and, of the nine subjects, seven relapsed, one died of sepsis, and one had a CR at 10 months. Despite disease recurrence in the seven patients, most relapsed into a less aggressive



disease course, responding favorably to conventional therapy ( [544](#) ).

Molina et al. obtained a CR within 30 to 100 days in six of six patients receiving allogeneic stem cell transplants for CTCL. Four of these patients had matched siblings as donors and two had unrelated matched donors. After HSCT, the authors repeated each patient's peripheral blood TCR gene rearrangement, cytogenetic, and flow cytometric studies, which demonstrated that the clonal T-cell populations originally found in four of the six patients became undetectable within 30 days of treatment and had not recurred at the time of abstract submission. Also, one of the six patients died secondary to graft-versus-host disease complications at 16 months' posttreatment ( [545](#) ).

Similarly, Guitart et al. reported three advanced-stage CTCL patients who each received a sibling HLA-matched allogeneic stem cell transplantation ( [546](#) ). Two patients exhibited complete and sustained remissions of 14 months and 4.5 years. The third patient exhibited a CR for 9 months followed by a limited low-grade recurrence localized to the skin. The authors hypothesized that, although allogeneic stem cell transplantations cannot ensure a sustained CR, progression beyond a localized cutaneous form could be prevented by an allogeneic graft-versus-tumor effect ( [546](#) ). Matched unrelated allogeneic transplant has been successful in a case of refractory disease ( [547](#) ). Further studies are needed to explore the use of HSCT in the treatment of advanced CTCL. Based on preliminary findings, allogeneic stem cell transplantation, albeit more toxic, appears more likely to induce long-standing remissions than autologous stem cell transplantation.

## Other Therapies

Other therapies have been effective in CTCL and include thymopentin ( [410](#) , [548](#) , [549](#) ) and antiviral therapy ( [390](#) , [550](#) , [551](#) and [552](#) ). The mechanism of action of each of these drugs in CTCL is poorly understood. The numbers of patients treated with these agents are relatively small; however, because the toxicities usually are mild and the mechanisms probably are different from chemotherapy, radiation, or IFN, these agents may be useful in combination with other methods.

## SUMMARY AND FUTURE INVESTIGATIONS

Molecular studies are unraveling the complex interactions of cytokines, adhesion molecules, and the immune system responsible for the pathogenesis of CTCL and are continuing to provide insight for novel approaches to treatment. As with other indolent lymphomas, an array of therapies can produce responses in CTCL but are generally not curative. In contrast to other lymphomas, however, is the high degree of efficacy of topical treatments (nitrogen mustard, TSEBRT, and PUVA) for patients with early-stage MF/SS. Because CTCL is not cured by systemic chemotherapy, initial management of early-stage disease should include skin-directed therapy. Ongoing clinical trials may define the roles of systemic therapy in managing more advanced-stage patients, including combinations of skin-directed therapies, chemotherapy agents, photopheresis, retinoids, monoclonal antibodies, IFN, and stem cell transplantation.

## ACKNOWLEDGMENT

This work is dedicated to Dr. Kevin E. Salhany, who provided photomicrographs for the histopathology.

## REFERENCES

1. Lutzner M, Edelson R, Schein P, et al. Cutaneous T-cell lymphomas: the Sézary syndrome, mycosis fungoides, and related disorders. *Ann Intern Med* 1975;83:534-552.
2. Edelson RL. Cutaneous T-cell lymphomas: clues of a skin-thymus interaction. *J Invest Dermatol* 1976;67:419-424.
3. Alibert JL. Description des Maladies de la Peau: Observées a l'Hospital St. Louis et Exposition des Meilleurs Methodes Suivies pour leur Traitement. Paris, Barrois l'aine et Fil 1806.
4. Alibert MLB. Monographie des Dermatoses. Vol. Tome Second. Paris, 1832:423.
5. Bazin E. Lecons sur le Traitement des Maldies Chroniques en General affections de la Peau en Particular par l'Emploi Compare des Eaux Minerales de l'Hydrotherapie et des Moyens Pharmaceutiques. Paris: Adrien Delahaye, 1870.
6. Vidal E, Brocq L. Etude sur le mycosis fongoide. *La France Me'dical* 1885;2:946,957,969,983,993,1005,1018.
7. Hallopeau H. Sur une e'rythrodermie chronique a' pousse'es aigue; de'but probable d'un mycosis fongoide. *Bull Soc Franc de Dermat et Syph* 1890;1:220.
8. Besnier E, Hallopeau H. On the erythrodermia of mycosis fungoides. *J Cutan Genito Urin Dis* 1892;10:453.
9. Stelwagon HW, Hatch JL. A study of mycosis fungoides with a report of two cases. *J Cutan Genito Urin Dis* 1892;10:57-64.
10. Tilden GH. So-called mycosis fongoide. *Boston Med Surg J* 1885;2:386-392.
11. Sézary A, Bouvraïn Y. Erythrodermia avec presence de cellules monstreuses dans le derme et le sang circulant. *Bull Soc Fr Dermatol Syphil* 1938;45:254.
12. Winkelmann RK, Caro WA. Current problems in mycosis fungoides and Sézary syndrome. *Annu Rev Med* 1977;28:251-269.
13. Taswell HF, Winkelmann RK. Sézary syndrome—a malignant reticulemic erythroderma. *JAMA* 1961;177:465.
14. Lutzner MA, Jordan HW. The ultrastructure of an abnormal cell in Sézary's syndrome. *Blood* 1968;31:719-726.
15. Crossen PE, Mellor JE, Finley AG, et al. The Sézary syndrome: cytogenetic studies and identification of the Sézary cell as an abnormal lymphocyte. *Am J Med* 1971;50:24-34.
16. Broome JD, Zucker-Franklin D, Weiner MS, et al. Leukemic cells with membrane properties of thymus-derived (T) lymphocytes in a case of Sézary's syndrome: morphologic and immunologic studies. *Clin Immunol Immunopathol* 1973;1:319-329.
17. Brouet JC, Flandrin G, Seligmann M. Indications of the thymus-derived nature of the proliferating cells in six patients with Sézary's syndrome. *N Engl J Med* 1973;289:341-344.
18. Broder S, Edelson RL, Lutzner MA, et al. The Sézary syndrome: a malignant proliferation of helper T cells. *J Clin Invest* 1976;58:1297-1306.
19. Heald PW, Yan SL, Edelson RL, et al. Skin-selective lymphocyte homing mechanisms in the pathogenesis of leukemic cutaneous T-cell lymphoma. *J Invest Dermatol* 1993;101:222-226.
20. Vowels BR, Cassin M, Vonderheid EC, et al. Aberrant cytokine production by Sézary syndrome

- patients: cytokine secretion pattern resembles murine Th2 cells. *J Invest Dermatol* 1992;99:90-94.
21. Saed G, Fivenson DP, Naidu Y, et al. Mycosis fungoides exhibits a Th1-type cell-mediated cytokine profile whereas Sézary syndrome expresses a Th2-type profile. *J Invest Dermatol* 1994;103:29-33.
  22. Vowels BR, Lessin SR, Cassin M, et al. Th2 cytokine mRNA expression in skin in cutaneous T-cell lymphoma. *J Invest Dermatol* 1994;103:669-673.
  23. Lessin SR, Vowels BR, Rook AH. Th2 cytokine profile in cutaneous T-cell lymphoma. *J Invest Dermatol* 1995;105:855-856.
  24. Hansen ER. Immunoregulatory events in the skin of patients with cutaneous T-cell lymphoma. *Arch Dermatol* 1996;132:554-561.
  25. Rook AH, Heald P. The immunopathogenesis of cutaneous T-cell lymphoma. *Hematol Oncol Clin North Am* 1995;9:997-1010.
  26. Bos JD, de Boer OJ, Tibosch E, et al. Skin-homing T lymphocytes: detection of cutaneous lymphocyte-associated antigen (CLA) by HECA-452 in normal human skin. *Arch Dermatol Res* 1993;285:179-183.
  27. Spetz AL, Strominger J, Groh-Spies V. T cell subsets in normal human epidermis. *Am J Pathol* 1996;149:665-674.
  28. Santamaria Babi LF, Moser R, Perez Soler MT, et al. Migration of skin-homing T cells across cytokine-activated human endothelial cell layers involves interaction of the cutaneous lymphocyte-associated antigen (CLA), the very late antigen-4 (VLA-4), and the lymphocyte function-associated antigen-1 (LFA-1). *J Immunol* 1995;154:1543-1550.
  29. Picker LJ, Treer JR, Ferguson-Darnell B, et al. Control of lymphocyte recirculation in man. II. Differential regulation of the cutaneous lymphocyte-associated antigen, a tissue-selective homing receptor for skin-homing T cells. *J Immunol* 1993;150:1122-1136.
  30. Picker LJ, Michie SA, Rott LS, et al. A unique phenotype of skin-associated lymphocytes in humans. Preferential expression of the HECA-452 epitope by benign and malignant T cells at cutaneous sites. *Am J Pathol* 1990;136:1053-1068.
  31. Picker LJ, Kishimoto TK, Smith CW, et al. ELAM-1 is an adhesion molecule for skin-homing T cells. *Nature* 1991;349:796-799.
  32. Rohde D, Schluter-Wigger W, Mielke V, et al. Infiltration of both T cells and neutrophils in the skin is accompanied by the expression of endothelial leukocyte adhesion molecule-1 (ELAM-1): an immunohistochemical and ultrastructural study. *J Invest Dermatol* 1992;98:794-799.
  33. Nickoloff BJ, Griffiths CE, Baadsgaard O, et al. Markedly diminished epidermal keratinocyte expression of intercellular adhesion molecule-1 (ICAM-1) in Sézary syndrome. *JAMA* 1989;261:2217-2221.
  34. Uccini S, Ruco LP, Monardo F, et al. Molecular mechanisms involved in intraepithelial lymphocyte migration: a comparative study in skin and tonsil. *J Pathol* 1993;169:413-419.
  35. Sarris AH, Esgleyes-Ribot T, Crow M, et al. Cytokine loops involving interferon-gamma and IP-10, a cytokine chemotactic for CD4+ lymphocytes: an explanation for the epidermotropism of cutaneous T-cell lymphoma? *Blood* 1995;86:651-658.
  36. Sterry W, Mielke V, Konter U, et al. Role of beta 1-integrins in epidermotropism of malignant T cells. *Am J Pathol* 1992;141:855-860.
  37. Wayner E, Hoffstrom B, Pittlekow M. T lymphocyte adhesion to keratinocytes: cooperative role for the integrin receptor alpha 3 beta 1 and E-cadherin (abstr). *J Invest Dermatol* 1994;102:524.
  38. Hansen ER, Baadsgaard O, Lisby S, et al. Cutaneous T-cell lymphoma lesional epidermal cells activate autologous CD4+ T lymphocytes: involvement of both CD1+OKM5+ and CD1+OKM5- antigen-presenting cells. *J Invest Dermatol* 1990;94:485-491.

39. Hansen ER, Bang B, Larsen JK, et al. In cutaneous T-cell lymphoma, class II MHC molecules on CD1+ antigen-presenting cells are upregulated in involved compared with uninvolved epidermis. *Br J Dermatol* 1994;131:780-788.
40. Lisby S, Baadsgaard O, Cooper KD, et al. Phenotype, ultrastructure, and function of CD1+DR+ epidermal cells that express CD36 (OKM5) in cutaneous T-cell lymphoma. *Scand J Immunol* 1990;32:111-119.
41. Vejlsgaard GL, Ralfkiaer E, Avnstorp C, et al. Kinetics and characterization of intercellular adhesion molecule-1 (ICAM-1) expression on keratinocytes in various inflammatory skin lesions and malignant cutaneous lymphomas. *J Am Acad Dermatol* 1989;20:782-790.
42. Lu D, Duvic M, Medeiros LJ, et al. The T-cell chemokine receptor CXCR3 is expressed highly in low-grade mycosis fungoides. *Am J Clin Pathol* 2001;115:413-421.
43. Dummer R, Schwarz T. Cytokines as regulatory proteins in lymphoproliferative skin infiltrates. *Dermatol Clin* 1994;12:283-294.
44. Rook AH, Kubin M, Cassin M, et al. IL-12 reverses cytokine and immune abnormalities in Sézary syndrome. *J Immunol* 1995;154:1491-1498.
45. Bunn PA Jr, Whang-Peng J, Carney DN, et al. DNA content analysis by flow cytometry and cytogenetic analysis in mycosis fungoides and Sézary syndrome. *J Clin Invest* 1980;65:1440-1448.
46. Edelson RL, Berger CL, Raafat J, et al. Karyotype studies of cutaneous T cell lymphoma: evidence for clonal origin. *J Invest Dermatol* 1979;73:548-550.
47. Mecucci C, Van Den Berghe H. OKT8-positive T-cell lymphoma associated with a chromosome rearrangement t(2;17) possibly involving the T8 locus. *N Engl J Med* 1985;313:185-186.
48. Nowell PC, Finan JB, Vonderheid EC. Clonal characteristics of cutaneous T cell lymphomas: cytogenetic evidence from blood, lymph nodes, and skin. *J Invest Dermatol* 1982;78:69-75.
49. Shah-Reddy I, Mayeda K, Mirchandani I, et al. Sézary syndrome with a 14:14 (q12;q31) translocation. *Cancer* 1982;49:75-79.
50. Whang-Peng J, Bunn PA Jr, Knutsen T, et al. Clinical implications of cytogenetic studies in cutaneous T-cell lymphoma (CTCL). *Cancer* 1982;50:1539-1553.
51. Slater DN. Review of investigative diagnostic techniques for cutaneous lymphoma. *Semin Dermatol* 1994;13:166-171.
52. Reinhold U, Abken H. Cutaneous T-cell lymphoma: molecular genetics, immunology and pathogenesis. *Eur J Cancer* 1995;31A:793-799.
53. Thangavelu M, Finn WG, Yelavarthi KK, et al. Recurring structural chromosome abnormalities in peripheral blood lymphocytes of patients with mycosis fungoides/Sézary syndrome. *Blood* 1997;89:3371-3377.
54. Limon J, Nedoszytko B, Brozek I, et al. Chromosome aberrations, spontaneous SCE, and growth kinetics in PHA-stimulated lymphocytes of five cases with Sézary syndrome. *Cancer Genet Cytogenet* 1995;83:75-81.
55. Su IJ, Kadin ME. Expression of growth factor/receptor genes in postthymic T cell malignancies. *Am J Pathol* 1989;135:439-445.
56. Tosca A, Linardopoulos S, Malliri A, et al. Implication of the ras and myc oncoproteins in the pathogenesis of mycosis fungoides. *Anticancer Res* 1991;11:1433-1438.
57. Berger R, Baranger L, Bernheim A, et al. Cytogenetics of T-cell malignant lymphoma. Report of 17 cases and review of the chromosomal breakpoints. *Cancer Genet Cytogenet* 1988;36:123-130.

58. Garatti SA, Roscetti E, Trecca D, et al. *bcl-1*, *bcl-2*, *p53*, *c-myc*, and *lyt-10* analysis in cutaneous lymphomas. *Recent Results Cancer Res* 1995;139:249-261.
59. Scarisbrick JJ, Woolford AJ, Russell-Jones R, Whittaker SJ. Loss of heterozygosity on 10q and microsatellite instability in advanced stages of primary cutaneous T-cell lymphoma and possible association with homozygous deletion of PTEN. *Blood* 2000;95:2937-2942.
60. Karenko L, Kahkonen M, Hyytinen ER, et al. Notable losses at specific regions of chromosomes 10q and 13q in the Sézary syndrome detected by comparative genomic hybridization. *J Invest Dermatol* 1999;112:392-395.
61. Navas IC, Algara P, Mateo M, et al. *p16(INK4a)* is selectively silenced in the tumoral progression of mycosis fungoides. *Lab Invest* 2002;82:123-132.
62. McGregor JM, Dublin EA, Levison DA, et al. *p53* immunoreactivity is uncommon in primary cutaneous lymphoma. *Br J Dermatol* 1995;132:353-358.
63. de Misa RF, Azana JM, Harto A, et al. Infrequent expression of protein *p53* in epidermotropic variants of cutaneous T-cell lymphoma. *J Dermatol* 1995;22:524-526.
64. Lauritzen AF, Vejlsgaard GL, Hou-Jensen K, et al. *p53* protein expression in cutaneous T-cell lymphomas. *Br J Dermatol* 1995;133:32-36.
65. Fracchiolla NS, Lombardi L, Salina M, et al. Structural alterations of the NF-kappa B transcription factor *lyt-10* in lymphoid malignancies. *Oncogene* 1993;8:2839-2845.
66. Thakur S, Lin HC, Tseng WT, et al. Rearrangement and altered expression of the *NFKB-2* gene in human cutaneous T-lymphoma cells. *Oncogene* 1994;9:2335-2344.
67. Hockenbery D, Nunez G, Millman C, et al. *Bcl-2* is an inner mitochondrial membrane protein that blocks programmed cell death. *Nature* 1990;348:334-336.
68. Dummer R, Michie SA, Kell D, et al. Expression of *bcl-2* protein and Ki-67 nuclear proliferation antigen in benign and malignant cutaneous T-cell infiltrates. *J Cutan Pathol* 1995;22:11-17.
69. Weiss LM, Hu E, Wood GS, et al. Clonal rearrangements of T-cell receptor genes in mycosis fungoides and dermatopathic lymphadenopathy. *N Engl J Med* 1985;313:539-544.
70. Aisenberg AC, Krontiris TG, Mak TW, et al. Rearrangement of the gene for the beta chain of the T-cell receptor in T-cell chronic lymphocytic leukemia and related disorders. *N Engl J Med* 1985;313:529-533.
71. Whittaker S. T-cell receptor gene analysis in cutaneous T-cell lymphomas. *Clin Exp Dermatol* 1996;21:81-87.
72. Whittaker SJ, Smith NP, Jones RR, et al. Analysis of beta, gamma, and delta T-cell receptor genes in mycosis fungoides and Sézary syndrome. *Cancer* 1991;68:1572-1582.
73. Lessin SR, Rook AH, Rovera G. Molecular diagnosis of cutaneous T-cell lymphoma: polymerase chain reaction amplification of T-cell antigen receptor beta-chain gene rearrangements. *J Invest Dermatol* 1991;96:299-302.
74. Zelickson BD, Peters MS, Muller SA, et al. T-cell receptor gene rearrangement analysis: cutaneous T cell lymphoma, peripheral T cell lymphoma, and premalignant and benign cutaneous lymphoproliferative disorders. *J Am Acad Dermatol* 1991;25:787-796.
75. Amagai M, Hayakawa K, Amagai N, et al. T cell receptor gene rearrangement analysis in mycosis fungoides and disseminated lymphocytoma cutis. *Dermatologica* 1990;181:193-196.
76. Bignon YJ, Roger H, Souteyrand P, et al. Study of T-cell antigen receptor gene rearrangement: a useful tool for early diagnosis of mycosis fungoides. *Acta Dermato-Venereol* 1989;69:217-222.

77. Dosaka N, Tanaka T, Fujita M, et al. Southern blot analysis of clonal rearrangements of T-cell receptor gene in plaque lesion of mycosis fungoides. *J Invest Dermatol* 1989;93:626-629.
78. Weiss LM, Wood GS, Hu E, et al. Detection of clonal T-cell receptor gene rearrangements in the peripheral blood of patients with mycosis fungoides/Sézary syndrome. *J Invest Dermatol* 1989;92:601-604.
79. Zelickson BD, Peters MS, Pittelkow MR. T-cell receptor gene rearrangement analysis in the early diagnosis of cutaneous T-cell lymphoma. *Dermatol Clin* 1994;12:335-340.
80. Ralfkiaer E, O'Connor NT, Crick J, et al. Genotypic analysis of cutaneous T-cell lymphomas. *J Invest Dermatol* 1987;88:762-765.
81. Diamandidou E, Cohen PR, Kurzrock R. Mycosis fungoides and Sézary syndrome. *Blood* 1996;88:2385-2409.
82. Weinberg JM, Rook AH, Lessin SR. Molecular diagnosis of lymphocytic infiltrates of the skin. *Arch Dermatol* 1993;129:1491-1500.
83. Algara P, Soria C, Martinez P, et al. Value of PCR detection of TCR gamma gene rearrangement in the diagnosis of cutaneous lymphocytic infiltrates. *Diagn Mol Pathol* 1994;3:275-282.
84. Bahler DW, Berry G, Oksenberg J, et al. Diversity of T-cell antigen receptor variable genes used by mycosis fungoides cells. *Am J Pathol* 1992;140:1-8.
85. Staib G, Sterry W. Use of polymerase chain reaction in the detection of clones in lymphoproliferative diseases of the skin. *Recent Results Cancer Res* 1995;139:239-247.
86. Theodorou I, Delfau-Larue MH, Bigorgne C, et al. Cutaneous T-cell infiltrates: analysis of T-cell receptor gamma gene rearrangement by polymerase chain reaction and denaturing gradient gel electrophoresis. *Blood* 1995;86:305-310.
87. Wood GS, Haeffner A, Dummer R, Crooks CF. Molecular biology techniques for the diagnosis of cutaneous T-cell lymphoma. *Dermatol Clin* 1994;12:231-241.
88. Yu RC, Alaibac M. Rapid polymerase chain reaction-based technique for detecting clonal t-cell receptor gene rearrangements in cutaneous t-cell lymphomas of both the alpha-beta and gamma-delta varieties. *Diagn Mol Pathol* 1996;5:121-126.
89. Bachelez H, Bioul L, Flageul B, et al. Detection of clonal T-cell receptor gamma gene rearrangements with the use of the polymerase chain reaction in cutaneous lesions of mycosis fungoides and Sézary syndrome. *Arch Dermatol* 1995;131:1027-1031.
90. Wood GS, Tung RM, Haeffner AC, et al. Detection of clonal T-cell receptor gamma gene rearrangements in early mycosis fungoides/Sézary syndrome by polymerase chain reaction and denaturing gradient gel electrophoresis (PCR/DGGE). *J Invest Dermatol* 1994;103:34-41.
91. Bottaro M, Berti E, Biondi A, et al. Heteroduplex analysis of T-cell receptor gamma gene rearrangements for diagnosis and monitoring of cutaneous T-cell lymphomas. *Blood* 1994;83:3271-3278.
92. Griesser H, Feller AC, Sterry W. T-cell receptor and immunoglobulin gene rearrangements in cutaneous T-cell-rich pseudolymphomas. *J Invest Dermatol* 1990;95:292-295.
93. LeFranc MP, Forster A, Baer R, et al. Diversity and rearrangement of the human T cell rearranging gamma genes: nine germ-line variable genes belonging to two subgroups. *Cell* 1986;45:237-246.
94. Trainor KJ, Brisco MJ, Wan JH, et al. Gene rearrangement in B- and T-lymphoproliferative disease detected by the polymerase chain reaction. *Blood* 1991;78:192-196.
95. Kono DH, Baccala R, Balderas RS, et al. Application of a multiprobe RNase protection assay and junctional sequences to define V beta gene diversity in Sézary syndrome. *Am J Pathol* 1992;140:823-830.
96. Weinstock MA, Gardstein B. Twenty-year trends in the reported incidence of mycosis fungoides and

associated mortality. *Am J Public Health* 1999;89:1240–1244.

97. Weinstock MA, Reynes JF. The changing survival of patients with mycosis fungoides: a population-based assessment of trends in the United States. *Cancer* 1999;85:208–212.

98. Chuang TY, Su WP, Muller SA. Incidence of cutaneous T cell lymphoma and other rare skin cancers in a defined population. *J Am Acad Dermatol* 1990;23:254–256.

99. Hoppe RT, Wood GS, Abel EA. Mycosis fungoides and the Sézary syndrome: pathology, staging, and treatment. *Curr Probl Cancer* 1990;14:293–371.

100. Kuzel TM, Roenigk HH Jr, Rosen ST. Mycosis fungoides and the Sézary syndrome: a review of pathogenesis, diagnosis, and therapy. *J Clin Oncol* 1991;9:1298–1313.

101. Broder S, Bunn PA Jr. Cutaneous T-cell lymphomas. *Semin Oncol* 1980;7:310–331.

102. Hamminga L, Hermans J, Noordijk EM, et al. Cutaneous T-cell lymphoma: clinicopathological relationships, therapy and survival in ninety-two patients. *Br J Dermatol* 1982;107:145–155.

103. Tay YK, Weston WL, Aeling JL. Treatment of childhood cutaneous T-cell lymphoma with alpha-interferon plus PUVA. *Pediatr Dermatol* 1996;13:496–500.

104. Hickman PR, McBurney EI, Fitzgerald RL. CTCL in patients under 20 years of age: a series of five patients. *Pediatr Dermatol* 1997;14:93–97.

105. Koch SE, Zackheim HS, Williams ML, et al. Mycosis fungoides beginning in childhood and adolescence. *J Am Acad Dermatol* 1987;17:563–570.

106. Meister L, Duarte AM, Davis J, et al. Sézary syndrome in an 11-year-old girl. *J Am Acad Dermatol* 1993;28:93–95.

107. Zackheim HS, McCalmont TH, Deanovic FW, et al. Mycosis fungoides with onset before 20 years of age. *J Am Acad Dermatol* 1997;36:557–562.

108. Peters MS, Thibodeau SN, White JW Jr, et al. Mycosis fungoides in children and adolescents. *J Am Acad Dermatol* 1990;22:1011–1018.

109. Taniguchi S, Horio T, Komura J. Mycosis fungoides in the tumor stage treated by PUVA: a successful trial in a 12-year-old girl. *Dermatologica* 1980;160:409–413.

110. Paller AS, Esterly NB, Baum ES, et al. Primary cutaneous T-cell lymphoma in a child. *Pediatr Dermatol* 1984;2:131–135.

111. Burns MK, Ellis CN, Cooper KD. Mycosis fungoides-type cutaneous T-cell lymphoma arising before 30 years of age. Immunophenotypic and clinicopathologic analysis of nine cases. *J Am Acad Dermatol* 1992;27:974–978.

112. Wilson AG, Cotter FE, Lowe DG, et al. Mycosis fungoides in childhood: an unusual presentation. *J Am Acad Dermatol* 1991;25:370–372.

113. Kawasaki H, Ito K, Matsushita T, et al. Primary non-Hodgkin's lymphoma of the skin in children. *Acta Paediatr* 1994;83:1315–1316.

114. Wood GS. Lymphocyte activation in cutaneous T-cell lymphoma. *J Invest Dermatol* 1995;105:105S–109S.

115. Morales Suarez-Varela MM, Olsen J, Kaerlev L, et al. Are alcohol intake and smoking associated with mycosis fungoides? A European multicenter case-control study. *Eur J Cancer* 2001;37:392–397.

116. Schneider BF, Christian M, Hess CE, et al. Familial occurrence of cutaneous t cell lymphoma—a case report of monozygotic twin sisters. *Leukemia* 1995;9:1979–1981.

117. Sandbank M, Katzenellenbogen I. Mycosis fungoides of prolonged duration in siblings. *Arch Dermatol*



1968;98:620-627.

118. Rosen ST, Radvany R, Roenigk H Jr, et al. Human leukocyte antigens in cutaneous T cell lymphoma. *J Am Acad Dermatol* 1985;12:531-534.

119. Safai B, Myskowski PL, Dupont B, et al. Association of HLA-DR5 with mycosis fungoides. *J Invest Dermatol* 1983;80:395-397.

120. Fischmann AB, Bunn PA Jr, Guccion JG, et al. Exposure to chemicals, physical agents, and biologic agents in mycosis fungoides and the Sézary syndrome. *Cancer Treat Rep* 1979;63:591-596.

121. Greene MH, Dalager NA, Lamberg SI, et al. Mycosis fungoides: epidemiologic observations. *Cancer Treat Rep* 1979;63:597-606.

122. Cohen SR, Stenn KS, Braverman IM, et al. Clinicopathologic relationships, survival, and therapy in 59 patients with observations on occupation as a new prognostic factor. *Cancer* 1980;46:2654-2666.

123. Tuyp E, Burgoyne A, Aitchison T, et al. A case-control study of possible causative factors in mycosis fungoides. *Arch Dermatol* 1987;123:196-200.

124. Whittemore AS, Holly EA, Lee IM, et al. Mycosis fungoides in relation to environmental exposures and immune response: a case-control study. *J Natl Cancer Inst* 1989;81:1560-1567.

125. Poiesz BJ, Ruscetti FW, Gazdar AF, et al. Detection and isolation of type C retrovirus particles from fresh and cultured lymphocytes of a patient with cutaneous T-cell lymphoma. *Proc Natl Acad Sci U S A* 1980;77:7415-7419.

126. Zucker-Franklin D, Pancake BA. The role of human T-cell lymphotropic viruses (HTLV-I and II) in cutaneous T-cell lymphomas. *Semin Dermatol* 1994;13:160-165.

127. Wantzin GL, Thomsen K, Nissen NI, et al. Occurrence of human T cell lymphotropic virus (type I) antibodies in cutaneous T cell lymphoma. *J Am Acad Dermatol* 1986;15:598-602.

128. Manzari V, Gismondi A, Barillari G, et al. HTLV-V: a new human retrovirus isolated in a Tac-negative T cell lymphoma/leukemia. *Science* 1987;238:1581-1583.

129. Saxinger WC, Wantzin GL, Thomsen K, et al. Occurrence of HTLV-I antibodies in Danish patients with cutaneous T-cell lymphoma. *Scand J Haematol* 1985;34:455-462.

130. Capesius C, Saal F, Maero E, et al. No evidence for HTLV-I infection in 24 cases of French and Portuguese mycosis fungoides and Sézary syndrome (as seen in France). *Leukemia* 1991;5:416-419.

131. Hall WW, Liu CR, Schneewind O, et al. Deleted HTLV-I provirus in blood and cutaneous lesions of patients with mycosis fungoides. *Science* 1991;253:317-320.

132. Bazarbachi A, Soriano V, Pawson R, et al. Mycosis fungoides and Sézary syndrome are not associated with HTLV-I infection: an international study. *Br J Haematol* 1997;98:927-933.

133. Zucker-Franklin D, Coutavas EE, Rush MG, et al. Detection of human T-lymphotropic virus-like particles in cultures of peripheral blood lymphocytes from patients with mycosis fungoides. *Proc Natl Acad Sci U S A* 1991;88:7630-7634.

134. D'Incan M, Southteyrand P, Bignon Y, et al. Retroviral sequences related to HTLV-I endemic areas. *Eur J Dermatol* 1992;2:363-371.

135. Khan ZM, Sebenik M, Zucker-Franklin D. Localization of human T-cell lymphotropic virus-1 tax proviral sequences in skin biopsies of patients with mycosis fungoides by in situ polymerase chain reaction. *J Invest Dermatol* 1996;106:667-672.

136. Pancake BA, Wassef EH, Zucker-Franklin D. Demonstration of antibodies to human T-cell lymphotropic virus-I tax in patients with the cutaneous T-cell lymphoma, mycosis fungoides, who are seronegative for antibodies to the structural proteins of the virus. *Blood* 1996;88:3004-3009.

137. Srivastava BI, Banki K, Perl A. Human T-cell leukemia virus type I or a related retrovirus in patients with mycosis fungoides/Sézary syndrome and Kaposi's sarcoma. *Cancer Res* 1992;52:4391-4395.
138. Saal F, Gessain A, Lasneret J, et al. Detection of retrovirus particles and reverse transcriptase activity in mid-term cultured peripheral blood and lymph node cells from a French woman with Sézary syndrome. *Nouv Rev Fr Hematol* 1989;31:333-337.
139. Detmar M, Pauli G, Anagnostopoulos I, et al. A case of classical mycosis fungoides associated with human T-cell lymphotropic virus type I. *Br J Dermatol* 1991;124:198-202.
140. Pancake BA, Zucker-Franklin D, Coutavas EE. The cutaneous T cell lymphoma, mycosis fungoides, is a human T cell lymphotropic virus-associated disease. A study of 50 patients. *J Clin Invest* 1995;95:547-554.
141. Lisby G, Reitz MS Jr, Vejlsgaard GL. No detection of HTLV-I DNA in punch skin biopsies from patients with cutaneous T-cell lymphoma by the polymerase chain reaction. *J Invest Dermatol* 1992;98:417-420.
142. Zucker-Franklin D, Hooper WC, Evatt BL. Human lymphotropic retroviruses associated with mycosis fungoides: evidence that human T-cell lymphotropic virus type II (HTLV-II) as well as HTLV-I may play a role in the disease. *Blood* 1992;80:1537-1545.
143. Ghosh SK, Abrams JT, Terunuma H, et al. Human T-cell leukemia virus type I tax/rex DNA and RNA in cutaneous T-cell lymphoma. *Blood* 1994;84:2663-2671.
144. Chan WC, Hooper C, Wickert R, et al. HTLV-I sequence in lymphoproliferative disorders. *Diagn Mol Pathol* 1993;2:192-199.
145. Whittaker SJ, Luzzatto L. HTLV-1 provirus and mycosis fungoides [letter; comment]. *Science* 1993;259:1470-1471.
146. Shohat M, Hodak E, Hannig H, et al. Evidence for the cofactor role of human T-cell lymphotropic virus type 1 in mycosis fungoides and Sézary syndrome. *Br J Dermatol* 1999;141:44-49.
147. Lessin SR, Rook AH, Li G, et al. HTLV-I and CTCL: the link is missing. *J Invest Dermatol* 1996;107:783-784.
148. Kikuchi A, Nishikawa T, Yamaguchi K. Absence of human T-cell lymphotropic virus type I in cutaneous T-cell lymphoma. *N Engl J Med* 1997;336: 296-297.
149. Kikuchi A. Clinical and histologic spectrum of human T-cell lymphotropic virus type I-associated lymphoma involving the skin. *J Am Acad Dermatol* 1997;36:133-134.
150. Li G, Vowels BR, Benoit BM, et al. Failure to detect human T-lymphotropic virus type-I proviral DNA in cell lines and tissues from patients with cutaneous T-cell lymphoma. *J Invest Dermatol* 1996;107:308-313.
151. Wood GS, Salvekar A, Schaffer J, et al. Evidence against a role for human T-cell lymphotropic virus type I (HTLV-I) in the pathogenesis of American cutaneous T-cell lymphoma. *J Invest Dermatol* 1996;107:301-307.
152. Bazarbachi A, Saal F, Laroche L, et al. HTLV-1 provirus and mycosis fungoides. *Science* 1993;259:1470-1471.
153. Boni R, Davis-Daneshfar A, Burg G, et al. No detection of HTLV-I proviral DNA in lesional skin biopsies from Swiss and German patients with cutaneous T-cell lymphoma. *Br J Dermatol* 1996;134:282-284.
154. Pancake BA, Zucker-Franklin D. The difficulty of detecting HTLV-1 proviral sequences in patients with mycosis fungoides. *J Acquir Immune Defic Syndr Hum Retrovirol* 1996;13:314-319.
155. Edelson RL. Cutaneous T cell lymphoma: mycosis fungoides, Sézary syndrome, and other variants. *J*

Am Acad Dermatol 1980;2:89-106.

156. Koh HK, Charif M, Weinstock MA. Epidemiology and clinical manifestations of cutaneous T-cell lymphoma. *Hematol Oncol Clin North Am* 1995;9:943-960.
157. Elmer KB, George RM. Cutaneous T-cell lymphoma presenting as benign dermatoses. *Am Fam Physician* 1999;59:2809-2813.
158. Lindae ML, Abel EA, Hoppe RT, et al. Poikilodermatous mycosis fungoides and atrophic large-plaque parapsoriasis exhibit similar abnormalities of T-cell antigen expression. *Arch Dermatol* 1988;124:366-372.
159. Lambroza E, Cohen SR, Phelps R, et al. Hypopigmented variant of mycosis fungoides: demography, histopathology, and treatment of seven cases. *J Am Acad Dermatol* 1995;32:987-993.
160. Pujol RM, Gallardo F, Llistosella E, et al. Invisible mycosis fungoides: a diagnostic challenge. *J Am Acad Dermatol* 2002;47:S168-171.
161. Hwong H, Nichols T, Duvic M. "Invisible" mycosis fungoides? *J Am Acad Dermatol* 2001;45:318.
162. Dereure O, Guilhou JJ. Invisible mycosis fungoides: a new case. *J Am Acad Dermatol* 2001;45:318-319.
163. Hsu WT, Toporcer MB, Kantor GR, et al. Cutaneous T-cell lymphoma with porokeratosis-like lesions. *J Am Acad Dermatol* 1992;27:327-330.
164. Stasko T, Vander Ploeg DE, De Villez RL. Hyperkeratotic mycosis fungoides restricted to the palms. *J Am Acad Dermatol* 1982;7:792-796.
165. Price NM, Fuks ZY, Hoffman TE. Hyperkeratotic and verrucous features of mycosis fungoides. *Arch Dermatol* 1977;113:57-60.
166. Blasik LG, Newkirk RE, Dimond RL, et al. Mycosis fungoides d'emblee: a rare presentation of cutaneous T-cell lymphoma. *Cancer* 1982;49:742-747.
167. King LE Jr, Dufresne RG Jr, Lovett GL, et al. Erythroderma: review of 82 cases. *South Med J* 1986;79:1210-1215.
168. Buechner SA, Winkelmann RK. Sézary syndrome. A clinicopathologic study of 39 cases. *Arch Dermatol* 1983;119:979-986.
169. Bouloc A, Grange F, Delfau-Larue MH, et al. Leucoderma associated with flares of erythrodermic cutaneous T-cell lymphomas: four cases. The French Study Group of Cutaneous Lymphomas. *Br J Dermatol* 2000;143:832-836.
170. Wieselthier JS, Koh HK. Sézary syndrome: diagnosis, prognosis, and critical review of treatment options. *J Am Acad Dermatol* 1990;22:381-401.
171. Willemze R, Beljaards RC, Meijer CJ. Classification of primary cutaneous T-cell lymphomas [see comments]. *Histopathology* 1994;24:405-415.
172. Willemze R, Kerl H, Sterry W, et al. EORTC classification of primary cutaneous lymphomas. *J Invest Dermatol* 1996;107:499.
173. Jaffe ES, HNL, Stein H, Vardiman JW, eds. *World Health Organization Classification of Tumours. Pathology and Genetics of Tumours of Haematopoietic and Lymphoid Tissues*. Lyon: IARC Press, 2001.
174. Nickoloff BJ. Light-microscopic assessment of 100 patients with patch/plaque-stage mycosis fungoides. *Am J Dermatopathol* 1988;10:469-477.
175. Rijlaarsdam JU, Scheffer E, Meijer CJ, et al. Cutaneous pseudo-T-cell lymphomas. A clinicopathologic study of 20 patients. *Cancer* 1992;69:717-724.
176. Collins RD. Lymph node examination. What is an adequate workup? *Arch Pathol Lab Med*

1985;109:797-799.

177. Willemze R, Cornelisse CJ, Hermans J, et al. Quantitative electron microscopy in the early diagnosis of cutaneous T-cell lymphomas. A long-term follow-up study of 77 patients. *Am J Pathol* 1986;123:166-173.

178. McNutt NS, Heilbron DC, Crain WR. Mycosis fungoides: diagnostic criteria based on quantitative electron microscopy. *Lab Invest* 1981;44:466-474.

179. Myrie C, Zucker-Franklin D, Ramsey D. Light-microscopic analysis of sectioned Sézary cells: an accurate alternative to electron microscopy. *Am J Pathol* 1980;99:243-252.

180. Smoller BR, Bishop K, Glusac E, et al. Reassessment of histologic parameters in the diagnosis of mycosis fungoides. *Am J Surg Pathol* 1995;19:1423-1430.

181. Santucci M, Biggeri A, Feller AC, et al. Efficacy of histologic criteria for diagnosing early mycosis fungoides: an EORTC cutaneous lymphoma study group investigation. European Organization for Research and Treatment of Cancer. *Am J Surg Pathol* 2000;24:40-50.

182. Salhany KE, Cousar JB, Greer JP, et al. Transformation of cutaneous T cell lymphoma to large cell lymphoma. A clinicopathologic and immunologic study. *Am J Pathol* 1988;132:265-277.

183. Cerroni L, Rieger E, Hodl S, et al. Clinicopathologic and immunologic features associated with transformation of mycosis fungoides to large-cell lymphoma. *Am J Surg Pathol* 1992;16:543-552.

184. Vonderheid EC, Diamond LW, Lai SM, et al. Lymph node histopathologic findings in cutaneous T-cell lymphoma. A prognostic classification system based on morphologic assessment. *Am J Clin Pathol* 1992;97:121-129.

185. Sentis HJ, Willemze R, Scheffer E. Histopathologic studies in Sézary syndrome and erythrodermic mycosis fungoides: a comparison with benign forms of erythroderma. *J Am Acad Dermatol* 1986;15:1217-1226.

186. Dmitrovsky E, Matthews MJ, Bunn PA, et al. Cytologic transformation in cutaneous T cell lymphoma: a clinicopathologic entity associated with poor prognosis. *J Clin Oncol* 1987;5:208-215.

187. Vonderheid EC, Diamond LW, van Vloten WA, et al. Lymph node classification systems in cutaneous T-cell lymphoma. Evidence for the utility of the Working Formulation of Non-Hodgkin's Lymphomas for Clinical Usage. *Cancer* 1994;73:207-218.

188. Wood GS, Bahler DW, Hoppe RT, et al. Transformation of mycosis fungoides: T-cell receptor beta gene analysis demonstrates a common clonal origin for plaque-type mycosis fungoides and CD30+ large-cell lymphoma. *J Invest Dermatol* 1993;101:296-300.

189. Wolfe JT, Chooback L, Finn DT, et al. Large-cell transformation following detection of minimal residual disease in cutaneous T-cell lymphoma: molecular and in situ analysis of a single neoplastic T-cell clone expressing the identical T-cell receptor. *J Clin Oncol* 1995;13:1751-1757.

190. Li G, Salhany KE, Rook AH, Lessin SR. The pathogenesis of large cell transformation of cutaneous T cell lymphoma is not associated with t(2;5)(p23;q35) chromosomal translocation. *J Cutan Pathol* 1997;24:403-408.

191. Greer JP, Salhany KE, Cousar JB, et al. Clinical features associated with transformation of cerebriform T-cell lymphoma to a large cell process. *Hematol Oncol* 1990;8:215-227.

192. Kaudewitz P, Stein H, Dallenbach F, et al. Primary and secondary cutaneous Ki-1+ (CD30+) anaplastic large cell lymphomas. Morphologic, immunohistologic, and clinical-characteristics. *Am J Pathol* 1989;135:359-367.

193. Greer JP, Kinney MC, Collins RD, et al. Clinical features of 31 patients with Ki-1 anaplastic large-cell lymphoma. *J Clin Oncol* 1991;9:539-547.

194. Willemze R. New concepts in the classification of cutaneous lymphomas [editorial; comment]. *Arch*

Dermatol 1995;131:1077-1080.

195. Cyr DP, Geokas MC, Worsley GH. Mycosis fungoides. Hematologic findings and terminal course. Arch Dermatol 1966;94:558-573.

196. Sausville EA, Eddy JL, Makuch RW, et al. Histopathologic staging at initial diagnosis of mycosis fungoides and the Sézary syndrome. Definition of three distinctive prognostic groups. Ann Intern Med 1988;109:372-382.

197. Variakojis D, Rosas-Urbe A, Rappaport H. Mycosis fungoides: pathologic findings in staging laparotomies. Cancer 1974;33:1589-1600.

198. Bunn PA Jr, Huberman MS, Whang-Peng J, et al. Prospective staging evaluation of patients with cutaneous T-cell lymphomas. Demonstration of a high frequency of extracutaneous dissemination. Ann Intern Med 1980;93:223-230.

199. Long JC, Mihm MC. Mycosis fungoides with extracutaneous dissemination: a distinct clinicopathologic entity. Cancer 1974;34:1745-1755.

200. Rappaport H, Thomas LB. Mycosis fungoides: the pathology of extracutaneous involvement. Cancer 1974;34:1198-1229.

201. Epstein EH Jr, Levin DL, Croft JD Jr, et al. Mycosis fungoides. Survival, prognostic features, response to therapy, and autopsy findings. Medicine (Baltimore) 1972;51:61-72.

202. Arai E, Katayama I, Ishihara K. Mycosis fungoides and Sézary syndrome in Japan. Clinicopathologic study of 107 autopsy cases. Pathol Res Pract 1991;187:451-457.

203. Salhany KE, Greer JP, Cousar JB, et al. Marrow involvement in cutaneous T-cell lymphoma. A clinicopathologic study of 60 cases. Am J Clin Pathol 1989;92:747-754.

204. Scheffer E, Meijer CJ, Van Vloten WA. Dermatopathic lymphadenopathy and lymph node involvement in mycosis fungoides. Cancer 1980;45:137-148.

205. Scheffer E, Meijer CJ, van Vloten WA, et al. A histologic study of lymph nodes from patients with the Sézary syndrome. Cancer 1986;57:2375-2380.

206. Buzzanga J, Banks PM, Winkelmann RK. Lymph node histopathology in Sézary syndrome. J Am Acad Dermatol 1984;11:880-888.

207. Edelson RL, Kirkpatrick CH, Shevach EM, et al. Preferential cutaneous infiltration by neoplastic thymus-derived lymphocytes. Morphologic and functional studies. Ann Intern Med 1974;80:685-692.

208. Huberman MS, Bunn PA Jr, Matthews MJ, et al. Hepatic involvement in the cutaneous T-cell lymphomas: results of percutaneous biopsy and peritoneoscopy. Cancer 1980;45:1683-1688.

209. Bennett SR, Greer JP, Stein RS, et al. Death due to splenic rupture in suppressor cell mycosis fungoides: a case report. Am J Clin Pathol 1984;82:104-109.

210. Wolfe JD, Trevor ED, Kjeldsberg CR. Pulmonary manifestations of mycosis fungoides. Cancer 1980;46:2648-2653.

211. Vonderheid EC, Sobel EL, Nowell PC, et al. Diagnostic and prognostic significance of Sézary cells in peripheral blood smears from patients with cutaneous T cell lymphoma. Blood 1985;66:358-366.

212. Lutzner MA, Emerit I, Durepaire R, et al. Cytogenetic, cytophotometric, and ultrastructural study of large cerebriform cells of the Sézary syndrome and description of a small-cell variant. J Natl Cancer Inst 1973;50:1145-1162.

213. Vonderheid EC, Bernengo MG, Burg G, et al. Update on erythrodermic cutaneous T-cell lymphoma: report of the International Society for Cutaneous Lymphomas. J Am Acad Dermatol 2002;46:95-106.

214. Berger CL, Warburton D, Raafat J, et al. Cutaneous T-cell lymphoma: neoplasm of T cells with helper

activity. *Blood* 1979;53:642–651.

215. Ralfkiaer E. Immunohistological markers for the diagnosis of cutaneous lymphomas. *Semin Diagn Pathol* 1991;8:62–72.

216. Michie SA, Abel EA, Hoppe RT, et al. Expression of T-cell receptor antigens in mycosis fungoides and inflammatory skin lesions. *J Invest Dermatol* 1989;93:116–120.

217. Agnarsson BA, Vonderheid EC, Kadin ME. Cutaneous T cell lymphoma with suppressor/cytotoxic (CD8) phenotype: identification of rapidly progressive and chronic subtypes. *J Am Acad Dermatol* 1990;22:569–577.

218. Ralfkiaer E, Wolff-Sneedorff A, Thomsen K, et al. T-cell receptor gamma delta-positive peripheral T-cell lymphomas presenting in the skin: a clinical, histological and immunophenotypic study. *Exp Dermatol* 1992;1:31–36.

219. Heald P, Buckley P, Gilliam A, et al. Correlations of unique clinical, immunotypic, and histologic findings in cutaneous gamma/delta T-cell lymphoma. *J Am Acad Dermatol* 1992;26:865–870.

220. Sterry W, Mielke V. CD4+ cutaneous T-cell lymphomas show the phenotype of helper/inducer T cells (CD45RA-, CDw29+). *J Invest Dermatol* 1989;93:413–416.

221. Kung E, Meissner K, Loning T. Cutaneous T cell lymphoma: immunocytochemical study on activation/proliferation and differentiation associated antigens in lymph nodes, skin, and peripheral blood. *Virchows Arch A Pathol Anat Histol* 1988;413:539–549.

222. Picker LJ, Weiss LM, Medeiros LJ, et al. Immunophenotypic criteria for the diagnosis of non-Hodgkin's lymphoma. *Am J Pathol* 1987;128:181–201.

223. van der Putte SC, Toonstra J, van Wichen DF, et al. Aberrant immunophenotypes in mycosis fungoides. *Arch Dermatol* 1988;124:373–380.

224. Bogen SA, Pelley D, Charif M, et al. Immunophenotypic identification of Sézary cells in peripheral blood. *Am J Clin Pathol* 1996;106:739–748.

225. Wood GS, Abel EA, Hoppe RT, et al. Leu-8 and Leu-9 antigen phenotypes: immunologic criteria for the distinction of mycosis fungoides from cutaneous inflammation. *J Am Acad Dermatol* 1986;14:1006–1013.

226. Ormsby A, Bergfeld WF, Tubbs RR, et al. Evaluation of a new paraffin-reactive CD7 T-cell deletion marker and a polymerase chain reaction-based T-cell receptor gene rearrangement assay: implications for diagnosis of mycosis fungoides in community clinical practice. *J Am Acad Dermatol* 2001;45:405–413.

227. Murphy M, Fullen D, Carlson JA. Low CD7 expression in benign and malignant cutaneous lymphocytic infiltrates: experience with an antibody reactive with paraffin-embedded tissue. *Am J Dermatopathol* 2002;24:6–16.

228. Rijlaarsdam JU, Willemze R. Cutaneous pseudolymphomas: classification and differential diagnosis. *Semin Dermatol* 1994;13:187–196.

229. Sanchez JL, Ackerman AB. The patch stage of mycosis fungoides. Criteria for histologic diagnosis. *Am J Dermatopathol* 1979;1:5–26.

230. Burg G, Dummer R, Dommann S, et al. Pathology of cutaneous T-cell lymphoma. *Hematol Oncol Clin North Am* 1995;9:961–995.

231. Lambert WC, Everett MA. The nosology of parapsoriasis. *J Am Acad Dermatol* 1981;5:373–395.

232. Burg G, Dummer R. Small plaque (digitate) parapsoriasis is an 'abortive cutaneous T-cell lymphoma' and is not mycosis fungoides. *Arch Dermatol* 1995;131:336–338.

233. Willemze R, Scheffer E. Clinical and histologic differentiation between lymphomatoid papulosis and pityriasis lichenoides. *J Am Acad Dermatol* 1985;13:418–428.

234. Weinman VF, Ackerman AB. Lymphomatoid papulosis. A critical review and new findings. *Am J Dermatopathol* 1981;3:129-163.
235. Weiss LM, Wood GS, Ellisen LW, et al. Clonal T-cell populations in pityriasis lichenoides et varioliformis acuta (Mucha-Habermann disease). *Am J Pathol* 1987;126:417-421.
236. Bignon YJ, Souteyrand P. Genotyping of cutaneous T-cell lymphomas and pseudolymphomas. *Curr Prob Dermatol* 1990;19:114-123.
237. Litt JZ. *Drug Eruption Reference Manual*. New York: The Parthenon Publishing Group, 2000.
238. Toonstra J. Actinic reticuloid. *Semin Diagn Pathol* 1991;8:109-116.
239. Macaulay WL. Lymphomatoid papulosis. A continuing self-healing eruption, clinically benign-histologically malignant. *Arch Dermatol* 1968;97:23-30.
240. el-Azhary RA, Gibson LE, Kurtin PJ, et al. Lymphomatoid papulosis: a clinical and histopathologic review of 53 cases with leukocyte immunophenotyping, DNA flow cytometry, and T-cell receptor gene rearrangement studies. *J Am Acad Dermatol* 1994;30:210-218.
241. Willemze R, Meyer CJ, Van Vloten WA, et al. The clinical and histological spectrum of lymphomatoid papulosis. *Br J Dermatol* 1982;107:131-144.
242. Kadin ME. Lymphomatoid papulosis, Ki-1+ lymphoma, and primary cutaneous Hodgkin's disease. *Semin Dermatol* 1991;10:164-171.
243. Willemze R, Beljaards RC. Spectrum of primary cutaneous CD30 (Ki-1)-positive lymphoproliferative disorders. A proposal for classification and guidelines for management and treatment. *J Am Acad Dermatol* 1993;28:973-980.
244. Willemze R, Scheffer E, Ruiter DJ, et al. Immunological, cytochemical and ultrastructural studies in lymphomatoid papulosis. *Br J Dermatol* 1983;108:381-394.
245. Ralfkiaer E, Stein H, Wantzin GL, et al. Lymphomatoid papulosis. Characterization of skin infiltrates by monoclonal antibodies. *Am J Clin Pathol* 1985;84:587-593.
246. Wood GS, Strickler JG, Deneau DG, et al. Lymphomatoid papulosis expresses immunophenotypes associated with T cell lymphoma but not inflammation. *J Am Acad Dermatol* 1986;15:444-458.
247. Kaudewitz P, Stein H, Burg G, et al. Atypical cells in lymphomatoid papulosis express the Hodgkin cell-associated antigen Ki-1. *J Invest Dermatol* 1986;86:350-354.
248. Ralfkiaer E, Bosq J, Gatter KC, et al. Expression of a Hodgkin and Reed-Sternberg cell associated antigen (Ki-1) in cutaneous lymphoid infiltrates. *Arch Dermatol Res* 1987;279:285-292.
249. Sanchez NP, Pittelkow MR, Muller SA, et al. The clinicopathologic spectrum of lymphomatoid papulosis: study of 31 cases. *J Am Acad Dermatol* 1983;8:81-94.
250. Beljaards RC, Willemze R. The prognosis of patients with lymphomatoid papulosis associated with malignant lymphomas. *Br J Dermatol* 1992;126:596-602.
251. Cabanillas F, Armitage J, Pugh WC, et al. Lymphomatoid papulosis: a T-cell dyscrasia with a propensity to transform into malignant lymphoma. *Ann Intern Med* 1995;122:210-217.
252. Weiss LM, Wood GS, Trela M, et al. Clonal T-cell populations in lymphomatoid papulosis. Evidence of a lymphoproliferative origin for a clinically benign disease. *N Engl J Med* 1986;315:475-479.
253. Kadin ME, Vonderheid EC, Sako D, et al. Clonal composition of T cells in lymphomatoid papulosis. *Am J Pathol* 1987;126:13-17.
254. Demierre MF, Goldberg LJ, Kadin ME, et al. Is it lymphoma or lymphomatoid papulosis. *J Am Acad*



Dermatol 1997;36:765-772.

255. Beljaards RC, Kaudewitz P, Berti E, et al. Primary cutaneous CD30-positive large cell lymphoma: definition of a new type of cutaneous lymphoma with a favorable prognosis. A European Multicenter Study of 47 patients. *Cancer* 1993;71:2097-2104.
256. de Bruin PC, Beljaards RC, van Heerde P, et al. Differences in clinical behaviour and immunophenotype between primary cutaneous and primary nodal anaplastic large cell lymphoma of T-cell or null cell phenotype. *Histopathology* 1993;23:127-135.
257. Kinney MC, Kadin ME. The pathologic and clinical spectrum of anaplastic large cell lymphoma and correlation with ALK gene dysregulation. *Am J Clin Pathol* 1999;111:S56-67.
258. Woringer F, Kolopp P. Lesion erythémato-squameuse polycyclique de l'avant-bras évoluant depuis 6 ans chez un garçonnet de 13 ans: histologiquement infiltrat intra épidermique d'apparence tumorale. *Ann Dermatol Syphil* 1939;10:945.
259. Ketron LW, Goodman MH. Multiple lesions of the skin apparently of epithelial origin resembling clinically mycosis fungoides. *Arch Dermatol* 1931;24:758.
260. McNiff JM, Schechner JS, Crotty PL, et al. Mycosis fungoides palmaris et plantaris or acral pagetoid reticulosis? *Am J Dermatopathol* 1998;20:271-275.
261. Mielke V, Wolff HH, Winzer M, et al. Localized and disseminated pagetoid reticulosis. Diagnostic immunophenotypical findings. *Arch Dermatol* 1989;125:402-406.
262. Berti E, Cerri A, Cavicchini S, et al. Primary cutaneous gamma/delta T-cell lymphoma presenting as disseminated pagetoid reticulosis. *J Invest Dermatol* 1991;96:718-723.
263. Alaibac M, Morris J, Yu R, et al. T lymphocytes bearing the gamma delta T-cell receptor: a study in normal human skin and pathological skin conditions. *Br J Dermatol* 1992;127:458-462.
264. Alaibac M. Gamma delta T-lymphocytes: relevance of the current studies to dermatology. *Int J Dermatol* 1992;31:157-159.
265. Wood GS, Weiss LM, Hu CH, et al. T-cell antigen deficiencies and clonal rearrangements of T-cell receptor genes in pagetoid reticulosis (Woringer-Kolopp disease). *N Engl J Med* 1988;318:164-167.
266. Burns MK, Chan LS, Cooper KD. Woringer-Kolopp disease (localized pagetoid reticulosis) or unilesional mycosis fungoides? An analysis of eight cases with benign disease. *Arch Dermatol* 1995;131:325-329.
267. Yagi H, Hagiwara T, Shirahama S, et al. Disseminated pagetoid reticulosis: need for long-term follow-up. *J Am Acad Dermatol* 1994;30:345-349.
268. LeBoit PE. Granulomatous slack skin. *Dermatol Clin* 1994;12:375-389.
269. LeBoit PE, Beckstead JH, Bond B, et al. Granulomatous slack skin: clonal rearrangement of the T-cell receptor beta gene is evidence for the lymphoproliferative nature of a cutaneous elastolytic disorder. *J Invest Dermatol* 1987;89:183-186.
270. Mehregan DA, Gibson LE, Muller SA. Follicular mucinosis: histopathologic review of 33 cases. *Mayo Clin Proc* 1991;66:387-390.
271. Brown HA, Gibson LE, Pujol RM, et al. Primary follicular mucinosis: long-term follow-up of patients younger than 40 years with and without clonal T-cell receptor gene rearrangement. *J Am Acad Dermatol* 2002;47:856-862.
272. Pereyo NG, Requena L, Galloway J, et al. Follicular mycosis fungoides: a clinicohistopathologic study. *J Am Acad Dermatol* 1997;36:563-568.
273. Gilliam AC, Lessin SR, Wilson DM, et al. Folliculotropic mycosis fungoides with large cell

- transformation presenting as dissecting cellulitis of the scalp. *J Cutan Pathol* 1997;24:169–175.
274. Lacour JP, Castanet J, Perrin C, et al. Follicular mycosis fungoides. A clinical and histologic variant of cutaneous T-cell lymphoma: report of two cases. *J Am Acad Dermatol* 1993;29:330–334.
275. Goldenhersh MA, Zlotogorski A, Rosenmann E. Follicular mycosis fungoides. *Am J Dermatopathol* 1994;16:52–55.
276. Kim SY. Follicular mycosis fungoides. *Am J Dermatopathol* 1985;7:300–301.
277. Bonta MD, Tannous ZS, Demierre MF, et al. Rapidly progressing mycosis fungoides presenting as follicular mucinosis. *J Am Acad Dermatol* 2000;43:635–640.
278. Klemke CD, Dippel E, Assaf C, et al. Follicular mycosis fungoides. *Br J Dermatol* 1999;141:137–140.
- 278a. Dummer R, Kamarashev J, Kempf W, et al. Junctional CD8+ cutaneous lymphomas with nonaggressive clinical behavior: a CD8+ variant of mycosis fungoides? *Arch Dermatol* 2002;138(2):199–203.
279. Salhany KE, Macon WR, Felgar RE, et al. Subcutaneous T-cell lymphoma: analysis of T-cell receptor and cytolytic granule protein expression. *Mod Pathol* 1997;10:134A.
280. Munn SE, McGregor JM, Jones A, et al. Clinical and pathological heterogeneity in cutaneous gamma-delta T-cell lymphoma: a report of three cases and a review of the literature. *Br J Dermatol* 1996;135:976–981.
281. Burg G, Dummer R, Wilhelm M, et al. A subcutaneous delta-positive T-cell lymphoma that produces interferon gamma. *N Engl J Med* 1991;325:1078–1081.
282. Avinoach I, Halevy S, Argov S, et al. Gamma/delta T-cell lymphoma involving the subcutaneous tissue and associated with a hemophagocytic syndrome. *Am J Dermatopathol* 1994;16:426–433.
283. Toro JR, Beaty M, Sorbara L, et al. Gamma delta T-cell lymphoma of the skin: a clinical, microscopic, and molecular study. *Arch Dermatol* 2000;136:1024–1032.
284. Toro JR, Liewehr DJ, Pabby N, et al. Gamma delta T-cell phenotype is associated with significantly decreased survival in cutaneous T-cell lymphoma. *Blood* 2003;101:3407–3412.
285. Cooke CB, Krenacs L, Stetler-Stevenson M, et al. Hepatosplenic T-cell lymphoma: a distinct clinicopathologic entity of cytotoxic gamma delta T-cell origin. *Blood* 1996;88:4265–4274.
286. Santucci M, Pimpinelli N, Massi D, et al. Cytotoxic/natural killer cell cutaneous lymphomas. Report of EORTC Cutaneous Lymphoma Task Force Workshop. *Cancer* 2003;97:610–627.
287. Friedmann D, Wechsler J, Delfau MH, et al. Primary cutaneous pleomorphic small T-cell lymphoma. A review of 11 cases. The French Study Group on Cutaneous Lymphomas. *Arch Dermatol* 1995;131:1009–1015.
288. Sterry W, Siebel A, Mielke V. HTLV-1-negative pleomorphic T-cell lymphoma of the skin: the clinicopathological correlations and natural history of 15 patients. *Br J Dermatol* 1992;126:456–462.
289. Weenig RH, Ng CS, Perniciaro C. Subcutaneous panniculitis-like T-cell lymphoma: an elusive case presenting as lipomembranous panniculitis and a review of 72 cases in the literature. *Am J Dermatopathol* 2001;23:206–215.
290. Salhany KE, Macon WR, Choi JK, et al. Subcutaneous panniculitis-like T-cell lymphoma: clinicopathologic, immunophenotypic, and genotypic analysis of alpha/beta and gamma/delta subtypes. *Am J Surg Pathol* 1998;22:881–893.
291. Willemze R, Beljaards RC, Meijer CJ, et al. Classification of primary cutaneous lymphomas. Historical overview and perspectives. *Dermatology* 1994;189:8–15.
292. Prince HM, Yap LM, Blum R, et al. Primary cutaneous B-cell lymphomas. *Clin Exp Dermatol*

2003;28:8-12.

293. Pimpinelli N, Santucci M, Bosi A, et al. Primary cutaneous follicular centre-cell lymphoma—a lymphoproliferative disease with favourable prognosis. *Clin Exp Dermatol* 1989;14:12-19.
294. Rijlaarsdam JU, Meijer CJ, Willemze R. Differentiation between lymphadenosis benigna cutis and primary cutaneous follicular center cell lymphomas. A comparative clinicopathologic study of 57 patients. *Cancer* 1990;65:2301-2306.
295. Pandolfino TL, Siegel RS, Kuzel TM, et al. Primary cutaneous B-cell lymphoma: review and current concepts. *J Clin Oncol* 2000;18:2152-2168.
296. Vermeer MH, Geelen FA, van Haselen CW, et al. Primary cutaneous large B-cell lymphomas of the legs. A distinct type of cutaneous B-cell lymphoma with an intermediate prognosis. Dutch Cutaneous Lymphoma Working Group. *Arch Dermatol* 1996;132:1304-1308.
297. Gellrich S, Rutz S, Golembowski S, et al. Primary cutaneous follicle center cell lymphomas and large B cell lymphomas of the leg descend from germinal center cells. A single cell polymerase chain reaction analysis. *J Invest Dermatol* 2001;117:1512-1520.
298. Su WPD. Clinical, histopathologic, and immunohistochemical correlations in leukemia cutis. *Semin Dermatol* 1994;13:223-230.
299. Neiman RS, Barcos M, Berard C, et al. Granulocytic sarcoma: a clinicopathologic study of 61 biopsied cases. *Cancer* 1981;48:1426-1437.
300. Traweek ST, Arber DA, Rappaport H, et al. Extramedullary myeloid cell tumors. An immunohistochemical and morphologic study of 28 cases. *Am J Surg Pathol* 1993;17:1011-1019.
301. Lamberg SI, Bunn PA Jr. Proceedings of the Workshop on Cutaneous T-Cell Lymphomas (Mycosis Fungoides and Sézary Syndrome). Introduction. *Cancer Treat Rep* 1979;63:561-564.
302. Bunn PA Jr, Lamberg SI. Report of the Committee on Staging and Classification of Cutaneous T-Cell Lymphomas. *Cancer Treat Rep* 1979;63:725-728.
303. Minna JD, Roenigk HH Jr, Glatstein E. Report of the Committee on Therapy for Mycosis Fungoides and Sézary Syndrome. *Cancer Treat Rep* 1979;63:729-736.
304. Sausville EA, Worsham GF, Matthews MJ, et al. Histologic assessment of lymph nodes in mycosis fungoides/Sézary syndrome (cutaneous T-cell lymphoma): clinical correlations and prognostic import of a new classification system. *Hum Pathol* 1985;16:1098-1109.
305. Schechter GP, Sausville EA, Fischmann AB, et al. Evaluation of circulating malignant cells provides prognostic information in cutaneous T cell lymphoma. *Blood* 1987;69:841-849.
306. Lamberg SI, Green SB, Byar DP, et al. Clinical staging for cutaneous T-cell lymphoma. *Ann Intern Med* 1984;100:187-192.
307. Duvic M, Lemark NA, Redman JR, et al. Combined modality therapy for cutaneous T-cell lymphoma. *J Am Acad Dermatol* 1996;34:1022-1029.
308. Kashani-Sabet M, McMillan A, Zackheim HS. A modified staging classification for cutaneous T-cell lymphoma. *J Am Acad Dermatol* 2001;45:700-706.
309. Herrmann JJ, Kuzel TM, Rosen ST, et al. Proceedings of the Second International Symposium on Cutaneous T-cell Lymphoma. Chicago, Illinois, Oct. 13-17, 1993. *J Am Acad Dermatol* 1994;31:819-822.
310. Abel EA, Wood GS, Hoppe RT. Mycosis fungoides: clinical and histologic features, staging, evaluation, and approach to treatment. *CA Cancer J Clin* 1993;43:93-115.
311. Sibaud V, Beylot-Barry M, Thiebaut R, et al. Bone marrow histopathologic and molecular staging in epidermotropic T-cell lymphomas. *Am J Clin Pathol* 2003;119:414-423.

312. Bass JC, Korobkin MT, Cooper KD, et al. Cutaneous T-cell lymphoma: CT in evaluation and staging. *Radiology* 1993;186:273-278.
313. Kulin PA, Marglin SI, Shuman WP, et al. Diagnostic imaging in the initial staging of mycosis fungoides and Sézary syndrome. *Arch Dermatol* 1990;126:914-918.
314. Miketic LM, Chambers TP, Lembersky BC. Cutaneous T-cell lymphoma: value of CT in staging and determining prognosis. *AJR Am J Roentgenol* 1993;160:1129-1132.
315. Shapiro M, Yun M, Junkins-Hopkins JM, et al. Assessment of tumor burden and treatment response by 18F-fluorodeoxyglucose injection and positron emission tomography in patients with cutaneous T- and B-cell lymphomas. *J Am Acad Dermatol* 2002;47:623-628.
316. Foss FM, Sausville EA. Prognosis and staging of cutaneous T-cell lymphoma. *Hematol Oncol Clin North Am* 1995;9:1011-1019.
317. Marti RM, Estrach T, Reverter JC, et al. Utility of bone marrow and liver biopsies for staging cutaneous t-cell lymphoma. *Int J Dermatol* 1996;35:450-454.
318. Merlo CJ, Hoppe RT, Abel E, Cox RS. Extracutaneous mycosis fungoides. *Cancer* 1987;60:397-402.
319. Graham SJ, Sharpe RW, Steinberg SM, et al. Prognostic implications of a bone marrow histopathologic classification system in mycosis fungoides and the Sézary syndrome. *Cancer* 1993;72:726-734.
320. Burke JS, Colby TV. Dermatopathic lymphadenopathy. Comparison of cases associated and unassociated with mycosis fungoides. *Am J Surg Pathol* 1981;5:343-352.
321. Wechsler J, Diebold J, Gerard-Marchant R. [Lymph node histopathologic aspects in cutaneous lymphomas of the mycosis fungoides or Sézary syndrome type. Retrospective study of 98 biopsies]. *Ann Pathol* 1987;7:122-129.
322. Galindo LM, Garcia FU, Hanau CA, et al. Fine-needle aspiration biopsy in the evaluation of lymphadenopathy associated with cutaneous T-cell lymphoma (mycosis fungoides/Sézary syndrome). *Am J Clin Pathol* 2000;113:865-871.
323. Bakels V, Van Oostveen JW, Geerts ML, et al. Diagnostic and prognostic significance of clonal T-cell receptor beta gene rearrangements in lymph nodes of patients with mycosis fungoides. *J Pathol* 1993;170:249-255.
324. Lynch JW Jr, Linoilla I, Sausville EA, et al. Prognostic implications of evaluation for lymph node involvement by T-cell antigen receptor gene rearrangement in mycosis fungoides. *Blood* 1992;79:3293-3299.
325. Kern DE, Kidd PG, Moe R, et al. Analysis of T-cell receptor gene rearrangement in lymph nodes of patients with mycosis fungoides. Prognostic implications. *Arch Dermatol* 1998;134:158-164.
326. Laforga JB, Chorda D, Sevilla F. Intramammary lymph node involvement by mycosis fungoides diagnosed by fine-needle aspiration biopsy. *Diagn Cytopathol* 1998;19:124-126.
327. Flaxman BA, Zelazny G, Van Scott EJ. Nonspecificity of characteristic cells in mycosis fungoides. *Arch Dermatol* 1971;104:141-147.
328. Willemze R, van Vloten WA, Hermans J, et al. Diagnostic criteria in Sézary's syndrome: a multiparameter study of peripheral blood lymphocytes in 32 patients with erythroderma. *J Invest Dermatol* 1983;81:392-397.
329. Fraser-Andrews EA, Woolford AJ, Russell-Jones R, et al. Detection of a peripheral blood T cell clone is an independent prognostic marker in mycosis fungoides. *J Invest Dermatol* 2000;114:117-121.
330. Muche JM, Lukowsky A, Ahnhudt C, et al. Peripheral blood T cell clonality in mycosis fungoides—an independent prognostic marker? *J Invest Dermatol* 2000;115:504-505.

331. Jones D, Dang NH, Duvic M, et al. Absence of CD26 expression is a useful marker for diagnosis of T-cell lymphoma in peripheral blood. *Am J Clin Pathol* 2001;115:885-892.
332. Bernengo MG, Novelli M, Quaglino P, et al. The relevance of the CD4+ CD26- subset in the identification of circulating Sézary cells. *Br J Dermatol* 2001;144:125-135.
333. Zackheim HS. Cutaneous T cell lymphoma: update of treatment. *Dermatology* 1999;199:102-105.
334. Zackheim HS, Amin S, Kashani-Sabet M, et al. Prognosis in cutaneous T-cell lymphoma by skin stage: long-term survival in 489 patients. *J Am Acad Dermatol* 1999;40:418-425.
335. Marti RM, Estrach T, Reverter JC, et al. Prognostic clinicopathologic factors in cutaneous T-cell lymphoma. *Arch Dermatol* 1991;127:1511-1516.
336. Scarisbrick JJ, Whittaker S, Evans AV, et al. Prognostic significance of tumor burden in the blood of patients with erythrodermic primary cutaneous T-cell lymphoma. *Blood* 2001;97:624-630.
337. Axelrod PI, Lorber B, Vonderheid EC. Infections complicating mycosis fungoides and Sézary syndrome. *JAMA* 1992;267:1354-1358.
338. Kantor AF, Curtis RE, Vonderheid EC, et al. Risk of second malignancy after cutaneous T-cell lymphoma. *Cancer* 1989;63:1612-1615.
339. Posner LE, Fossieck BE Jr, Eddy JL, et al. Septicemic complications of the cutaneous T-cell lymphomas. *Am J Med* 1981;71:210-216.
340. Holloway KB, Flowers FP, Ramos-Caro FA. Therapeutic alternatives in cutaneous T-cell lymphoma. *J Am Acad Dermatol* 1992;27:367-378.
341. Bunn PA Jr. Rational therapy for cutaneous T-cell lymphomas in the 1990s. Fact or fancy? *Arch Dermatol* 1995;131:603-605.
342. Jorg B, Kerl H, Thiers BH, et al. Therapeutic approaches in cutaneous lymphoma. *Dermatol Clin* 1994;12:433-441.
343. Zackheim HS. Treatment of cutaneous T-cell lymphoma. *Semin Dermatol* 1994;13:207-215.
344. Kierland RR, Watkins CH, Shullenberger CC. The use of nitrogen mustard in the treatment of mycosis fungoides. *J Invest Dermatol* 1947;9:195-201.
345. Haserick JR, Richardson JH, Grant DJ. Remission of lesions in mycosis fungoides following topical application of nitrogen mustard. *Cleve Clin Q* 1959;26:144-147.
346. Ramsay DL, Meller JA, Zackheim HS. Topical treatment of early cutaneous T-cell lymphoma. *Hematol Oncol Clin North Am* 1995;9:1031-1056.
347. O'Connor PM, Ferris DK, White GA, et al. Relationships between cdc2 kinase, DNA cross-linking, and cell cycle perturbations induced by nitrogen mustard. *Cell Growth Differ* 1992;3:43-52.
348. Futscher BW, Pieper RO, Dalton WS, et al. Gene-specific DNA interstrand cross-links produced by nitrogen mustard in the human tumor cell line Colo320HSR. *Cell Growth Differ* 1992;3:217-223.
349. Fabbri S, Prontera C, Broggin M. Differential inhibition of the DNA binding of transcription factors NF kappa B and OTF-1 by nitrogen mustard and quinacrine mustard: transcriptional implications. *Carcinogenesis* 1993;14: 1963-1967.
350. Van Scott EJ, Winters PL. Responses of mycosis fungoides to intensive external treatment with nitrogen mustard. *Arch Dermatol* 1970;102:507-514.
351. Van Scott EJ, Kalmanson JD. Complete remissions of mycosis fungoides lymphoma induced by topical nitrogen mustard (HN<sub>2</sub>). Control of delayed hypersensitivity to HN<sub>2</sub> by desensitization and by

- induction of specific immunologic tolerance. *Cancer* 1973;32:18–30.
352. Price NM, Deneau DG, Hoppe RT. The treatment of mycosis fungoides with ointment-based mechlorethamine. *Arch Dermatol* 1982;118:234–237.
353. Price NM, Hoppe RT, Deneau DG. Ointment-based mechlorethamine treatment for mycosis fungoides. *Cancer* 1983;52:2214–2219.
354. Hoppe RT, Abel EA, Deneau DG, et al. Mycosis fungoides: management with topical nitrogen mustard. *J Clin Oncol* 1987;5:1796–1803.
355. Vonderheid EC, Tan ET, Kantor AF, et al. Long-term efficacy, curative potential, and carcinogenicity of topical mechlorethamine chemotherapy in cutaneous T cell lymphoma. *J Am Acad Dermatol* 1989;20:416–428.
356. Ramsay DL, Halperin PS, Zeleniuch-Jacquotte A. Topical mechlorethamine therapy for early stage mycosis fungoides. *J Am Acad Dermatol* 1988;19:684–691.
357. Kim YH, Martinez G, Varghese A, et al. Topical nitrogen mustard in the management of mycosis fungoides: update of the Stanford experience. *Arch Dermatol* 2003;139:165–173.
358. Grunnet E. Contact urticaria and anaphylactoid reaction induced by topical application of nitrogen mustard. *Br J Dermatol* 1976;94:101–103.
359. Constantine VS, Fuks ZY, Farber EM. Mechlorethamine desensitization in therapy for mycosis fungoides. Topical desensitization to mechlorethamine (nitrogen mustard) contact hypersensitivity. *Arch Dermatol* 1975;111:484–488.
360. Waldorf DS. Mycosis fungoides—response to topical nitrogen mustard. *Arch Dermatol* 1968;97:608–609.
361. Zachariae H, Thestrup-Pedersen K, Sogaard H. Topical nitrogen mustard in early mycosis fungoides. A 12-year experience. *Acta Dermato-Venereol* 1985;65:53–58.
362. Epstein JH. Effects of mechlorethamine (HN<sub>2</sub>, nitrogen mustard) on UV-induced carcinogenesis in hairless mouse skin. *J Natl Cancer Inst* 1984;72:383–385.
363. Epstein JH. Nitrogen mustard (mechlorethamine) and UVB photocarcinogenesis: a dose response effect. *J Invest Dermatol* 1984;83:320–322.
364. Van Vloten WA, Cooijmans AC, Poel J, et al. Concentrations of nitrogen mustard in the air during topical treatment of patients with mycosis fungoides. *Br J Dermatol* 1993;128:404–406.
365. Breneman DL, Nartker AL, Ballman EA, et al. Topical mechlorethamine in the treatment of mycosis fungoides. Uniformity of application and potential for environmental contamination. *J Am Acad Dermatol* 1991;25:1059–1064.
366. Zackheim HS, Epstein EH Jr, Crain WR. Topical carmustine (BCNU) for cutaneous T cell lymphoma: a 15-year experience in 143 patients. *J Am Acad Dermatol* 1990;22:802–810.
367. Zackheim HS. Treatment of mycosis fungoides with topical nitrosourea compounds. *Arch Dermatol* 1972;106:177–182.
368. Mitchell EP, Schein PS. Contributions of nitrosoureas to cancer treatment. *Cancer Treat Rep* 1986;70:31–41.
369. Scholtz W. Ueber den Einfluss der Rontgenstrahlen auf die Haut in gesundem und krankem Zustande. *Arch Dermatol Syph* 1902;59:421–449.
370. Trump JG, Wright KA, Evans WW, et al. High energy electrons for the treatment of extensive superficial malignant lesions. *AJR Am J Roentgenol* 1953; 69:623–629.
371. Jones GW, Kacinski BM, Wilson LD, et al. Total skin electron radiation in the management of mycosis

fungoides: Consensus of the European Organization for Research and Treatment of Cancer (EORTC) Cutaneous Lymphoma Project Group. *J Am Acad Dermatol* 2002;47:364–370.

372. Jones GW, Hoppe RT, Glatstein E. Electron beam treatment for cutaneous T-cell lymphoma. *Hematol Oncol Clin North Am* 1995;9:1057–1076.

373. el-Khatib E, Hussein S, Nikolic M, et al. Variation of electron beam uniformity with beam angulation and scatterer position for total skin irradiation with the Stanford technique. *Int J Radiat Oncol Biol Phys* 1995;33:469–474.

374. Rosenblatt E, Kuten A, Levirov M, et al. Total skin electron irradiation in mycosis fungoides dose and fractionation considerations. *Leuk Lymphoma* 1998;30:143–151.

375. Hoppe RT. The management of mycosis fungoides at Stanford—standard and innovative treatment programmes. *Leukemia* 1991;5:46–48.

376. Tadros AA, Tepperman BS, Hryniuk WM, et al. Total skin electron irradiation for mycosis fungoides: failure analysis and prognostic factors. *Int J Radiat Oncol Biol Phys* 1983;9:1279–1287.

377. Quiros PA, Kacinski BM, Wilson LD. Extent of skin involvement as a prognostic indicator of disease free and overall survival of patients with T3 cutaneous t-cell lymphoma treated with total skin electron beam radiation therapy. *Cancer* 1996;77:1912–1917.

378. Desai KR, Pezner RD, Lipsett JA, et al. Total skin electron irradiation for mycosis fungoides: relationship between acute toxicities and measured dose at different anatomic sites. *Int J Radiat Oncol Biol Phys* 1988;15:641–645.

379. Jones G, McLean J, Rosenthal D, et al. Combined treatment with oral etretinate and electron beam therapy in patients with cutaneous T-cell lymphoma (mycosis fungoides and Sézary syndrome). *J Am Acad Dermatol* 1992;26:960–967.

380. Reddy S, Parker CM, Shidnia H, et al. Total skin electron beam radiation therapy for mycosis fungoides. *Am J Clin Oncol* 1992;15:119–124.

381. Price NM. Electron beam therapy. Its effect on eccrine gland function in mycosis fungoides patients. *Arch Dermatol* 1979;115:1068–1070.

382. Jones GW, Rosenthal D, Wilson LD. Total skin electron radiation for patients with erythrodermic cutaneous T-cell lymphoma (mycosis fungoides and the Sézary syndrome). *Cancer* 1999;85:1985–1995.

383. Wilson LD, Jones GW, Kim D, et al. Experience with total skin electron beam therapy in combination with extracorporeal photopheresis in the management of patients with erythrodermic (T4) mycosis fungoides. *J Am Acad Dermatol* 2000;43:54–60.

384. Jones GW, Tadros A, Hodson DI, et al. Prognosis with newly diagnosed mycosis fungoides after total skin electron radiation of 30 or 35 Gy. *Int J Radiat Oncol Biol Phys* 1994;28:839–845.

385. Wilson LD, Quiros PA, Kolenik SA, et al. Additional courses of total skin electron beam therapy of patients with recurrent cutaneous T-cell lymphoma. *J Am Acad Dermatol* 1996;35:69–73.

386. Becker M, Hoppe RT, Knox SJ. Multiple courses of high-dose total skin electron beam therapy in the management of mycosis fungoides. *Int J Radiat Oncol Biol Phys* 1995;32:1445–1449.

387. Kirova YM, Piedbois Y, Haddad E, et al. Radiotherapy in the management of mycosis fungoides: indications, results, prognosis. Twenty years experience. *Radiother Oncol* 1999;51:147–151.

388. Maingon P, Truc G, Dalac S, et al. Radiotherapy of advanced mycosis fungoides: indications and results of total skin electron beam and photon beam irradiation. *Radiother Oncol* 2000;54:73–78.

389. Cotter GW, Baglan RJ, Wasserman TH, Mill W. Palliative radiation treatment of cutaneous mycosis fungoides—a dose response. *Int J Radiat Oncol Biol Phys* 1983;9:1477–1480.

390. Bunn PA Jr, Hoffman SJ, Norris D, et al. Systemic therapy of cutaneous T-cell lymphomas (mycosis



fungoides and the Sézary syndrome). *Ann Intern Med* 1994;121:592–602.

391. Rosen ST, Foss FM. Chemotherapy for mycosis fungoides and the Sézary syndrome. *Hematol Oncol Clin North Am* 1995;9:1109–1116.

392. Apisarnthanarax N, Talpur R, Duvic M. Treatment of cutaneous T cell lymphoma: current status and future directions. *Am J Clin Dermatol* 2002;3:193–215.

393. Zackheim HS, Kashani-Sabet M, Hwang ST. Low-dose methotrexate to treat erythrodermic cutaneous T-cell lymphoma: results in twenty-nine patients. *J Am Acad Dermatol* 1996;34:626–631.

394. McDonald CJ, Bertino JR. Treatment of mycosis fungoides lymphoma: effectiveness of infusions of methotrexate followed by oral citrovorum factor. *Cancer Treat Rep* 1978;62:1009–1014.

395. Bunn PA Jr. Cutaneous T cell lymphomas. *BMJ* 1994;308:551–552.

396. Winkelmann RK, Diaz-Perez JL, Buechner SA. The treatment of Sézary syndrome. *J Am Acad Dermatol* 1984;10:1000–1004.

397. Harland CC, Balsitis M, Millard LG. Sézary-type cutaneous T-cell leukaemia. Response to Winkelmann regimen. *Acta Derm Venereol* 1990;70:251–253.

398. Coors EA, von den Driesch P. Treatment of erythrodermic cutaneous T-cell lymphoma with intermittent chlorambucil and fluocortolone therapy. *Br J Dermatol* 2000;143:127–131.

399. Cummings FJ, Kim K, Neiman RS, et al. Phase II trial of pentostatin in refractory lymphomas and cutaneous T-cell disease. *J Clin Oncol* 1991;9:565–571.

400. Foss FM, Ihde DC, Breneman DL, et al. Phase II study of pentostatin and intermittent high-dose recombinant interferon alfa-2a in advanced mycosis fungoides/Sézary syndrome. *J Clin Oncol* 1992;10:1907–1913.

401. Mercieca J, Matutes E, Dearden C, et al. The role of pentostatin in the treatment of T-cell malignancies: analysis of response rate in 145 patients according to disease subtype. *J Clin Oncol* 1994;12:2588–2593.

402. Monfardini S, Sorio R, Cavalli F, et al. Pentostatin (2'-deoxycoformycin, dCF) in patients with low-grade (B-T-cell) and intermediate- and high-grade (T-cell) malignant lymphomas: phase II study of the EORTC Early Clinical Trials Group. *Oncology* 1996;53:163–168.

403. Foss FM. Activity of pentostatin (Nipent) in cutaneous T-cell lymphoma: single-agent and combination studies. *Semin Oncol* 2000;27:58–63.

404. Lauria F. 2-Chlorodeoxyadenosine, a “novel” agent in the treatment of both lymphoid and myeloid malignancies. *Haematologica* 1992;77:443–445.

405. Kuzel TM, Hurria A, Samuelson E, et al. Phase II trial of 2-chlorodeoxyadenosine for the treatment of cutaneous T-cell lymphoma. *Blood* 1996;87:906–911.

406. O'Brien S, Kurzrock R, Duvic M, et al. 2-Chlorodeoxyadenosine therapy in patients with T-cell lymphoproliferative disorders. *Blood* 1994;84:733–738.

407. Saven A, Piro LD. 2-Chlorodeoxyadenosine: a new nucleoside agent effective in the treatment of lymphoid malignancies. *Leuk Lymphoma* 1993;10:43–49.

408. Foss FM, Ihde DC, Linnoila IR, et al. Phase II trial of fludarabine phosphate and interferon alfa-2a in advanced mycosis fungoides/Sézary syndrome. *J Clin Oncol* 1994;12:2051–2059.

409. Von Hoff DD, Dahlberg S, Hartstock RJ, et al. Activity of fludarabine monophosphate in patients with advanced mycosis fungoides: a Southwest Oncology Group study. *J Natl Cancer Inst* 1990;82:1353–1355.

410. Foss FM, Kuzel TM. Experimental therapies in the treatment of cutaneous T-cell lymphoma. *Hematol*

Oncol Clin North Am 1995;9:1127–1137.

411. Kurzrock R, Pilat S, Duvic M. Pentostatin therapy of T-cell lymphomas with cutaneous manifestations. *J Clin Oncol* 1999;17:3117–3121.
412. Zinzani PL, Baliva G, Magagnoli M, et al. Gemcitabine treatment in pretreated cutaneous T-cell lymphoma: experience in 44 patients. *J Clin Oncol* 2000;18:2603–2606.
413. Santini D, Tonini G, Abbate A, et al. Gemcitabine-induced atrial fibrillation: a hitherto unreported manifestation of drug toxicity. *Ann Oncol* 2000;11:479–481.
414. Kalapura T, Krishnamurthy M, Reddy CV. Acute myocardial infarction following gemcitabine therapy—a case report. *Angiology* 1999;50:1021–1025.
415. Gabizon AA. Selective tumor localization and improved therapeutic index of anthracyclines encapsulated in long-circulating liposomes. *Cancer Res* 1992;52:891–896.
416. Wollina U, Graefe T, Karte K. Treatment of relapsing or recalcitrant cutaneous T-cell lymphoma with pegylated liposomal doxorubicin. *J Am Acad Dermatol* 2000;42:40–46.
417. Wollina U, Graefe T, Kaatz M. Pegylated doxorubicin for primary cutaneous T-cell lymphoma: a report on ten patients with follow-up. *J Cancer Res Clin Oncol* 2001;127:128–134.
418. Dolan ME, McRae BL, Ferries-Rowe E, et al. O6-alkylguanine-DNA alkyltransferase in cutaneous T-cell lymphoma: implications for treatment with alkylating agents. *Clin Cancer Res* 1999;5:2059–2064.
419. Newlands ES, Blackledge GR, Slack JA, et al. Phase I trial of temozolomide (CCRG 81045; M&B 39831; NSC 362856). *Br J Cancer* 1992;65:287–291.
420. Brock CS, Newlands ES, Wedge SR, et al. Phase I trial of temozolomide using an extended continuous oral schedule. *Cancer Res* 1998;58:4363–4367.
421. Furumai R, Matsuyama A, Kobashi N, et al. FK228 (depsipeptide) as a natural prodrug that inhibits class I histone deacetylases. *Cancer Res* 2002;62:4916–4921.
422. Piekarczyk RL, Robey R, Sandor V, et al. Inhibitor of histone deacetylation, depsipeptide (FR901228), in the treatment of peripheral and cutaneous T-cell lymphoma: a case report. *Blood* 2001;98:2865–2868.
- 422a. Vigushin DM. FR-901228 Fujisacoa/National Cancer Institute. *Current Opin Invest Drugs* 2002;3(9):1396–1402.
423. Burg G, Dummer R. Historical perspective on the use of retinoids in cutaneous T-cell lymphoma (CTCL). *Clin Lymphoma* 2000;[1 Suppl 1]:S41–44.
424. Molin L, Thomsen K, Volden G, et al. Oral retinoids in mycosis fungoides and Sézary syndrome: a comparison of isotretinoin and etretinate. A study from the Scandinavian Mycosis Fungoides Group. *Acta Dermato-Venereol* 1987;67:232–236.
425. Thomsen K, Molin L, Volden G, et al. 13-cis-retinoic acid effective in mycosis fungoides. A report from the Scandinavian Mycosis Fungoides Group. *Acta Dermato-Venereol* 1984;64:563–566.
426. Kessler JF, Jones SE, Levine N, et al. Isotretinoin and cutaneous helper T-cell lymphoma (mycosis fungoides). *Arch Dermatol* 1987;123:201–204.
427. Zhang C, Hazarika P, Ni X, et al. Induction of apoptosis by bexarotene in cutaneous T-cell lymphoma cells: relevance to mechanism of therapeutic action. *Clin Cancer Res* 2002;8:1234–1240.
428. Apisarnthanarax N, Duvic M. Cutaneous T-cell lymphoma. New immunomodulators. *Dermatol Clin* 2001;19:737–748.
429. Sherman SI, Gopal J, Haugen BR, et al. Central hypothyroidism associated with retinoid X receptor-selective ligands. *N Engl J Med* 1999;340:1075–1079.

430. Duvic M, Hymes K, Heald P, et al. Bexarotene is effective and safe for treatment of refractory advanced-stage cutaneous T-cell lymphoma: multinational phase II-III trial results. *J Clin Oncol* 2001;19:2456-2471.
431. Duvic M, Martin AG, Kim Y, et al. Phase 2 and 3 clinical trial of oral bexarotene (Targretin capsules) for the treatment of refractory or persistent early-stage cutaneous T-cell lymphoma. *Arch Dermatol* 2001;137:581-593.
432. Talpur R, Ward S, Apisarnthanarax N, et al. Optimizing bexarotene therapy for cutaneous T-cell lymphoma. *J Am Acad Dermatol* 2002;47:672-684.
433. Breneman D, Duvic M, Kuzel T, et al. Phase 1 and 2 trial of bexarotene gel for skin-directed treatment of patients with cutaneous T-cell lymphoma. *Arch Dermatol* 2002;138:325-332.
434. Olsen EA, Bunn PA. Interferon in the treatment of cutaneous T-cell lymphoma. *Hematol Oncol Clin North Am* 1995;9:1089-1107.
435. Bunn PA Jr, Foon KA, Ihde DC, et al. Recombinant leukocyte A interferon: an active agent in advanced cutaneous T-cell lymphomas. *Ann Intern Med* 1984;101:484-487.
436. Dreno B, Fleischmann M, Valard S, et al. Induction of myelo-monocytic My7 antigen (CD13) expression by interferon-alpha in basal cells of cutaneous T-cell lymphomas. *Br J Dermatol* 1992;126:320-323.
437. Koeller JM. Biologic response modifiers: the interferon alfa experience. *Am J Hosp Pharm* 1989;46:S11-15.
438. Bunn PA Jr, Ihde DC, Foon KA. The role of recombinant interferon alfa-2a in the therapy of cutaneous T-cell lymphomas. *Cancer* 1986;57:1689-1695.
439. Foon KA, Roth MS, Bunn PA Jr. Interferon therapy of non-Hodgkin's lymphoma. *Cancer* 1987;59:601-604.
440. Olsen EA, Rosen ST, Vollmer RT, et al. Interferon alfa-2a in the treatment of cutaneous T cell lymphoma. *J Am Acad Dermatol* 1989;20:395-407.
441. Kohn EC, Steis RG, Sausville EA, et al. Phase II trial of intermittent high-dose recombinant interferon alfa-2a in mycosis fungoides and the Sézary syndrome. *J Clin Oncol* 1990;8:155-160.
442. Papa G, Tura S, Mandelli F, et al. Is interferon alpha in cutaneous T-cell lymphoma a treatment of choice? *Br J Haematol* 1991;79:48-51.
443. Jumbou O, N'Guyen JM, Tessier MH, et al. Long-term follow-up in 51 patients with mycosis fungoides and Sézary syndrome treated by interferon-alpha. *Br J Dermatol* 1999;140:427-431.
444. Tura S, Mazza P, Zinzani PL, et al. Alpha recombinant interferon in the treatment of mycosis fungoides (MF). *Haematology* 1987;72:337-340.
445. Dreno B, Godefroy WY, Fleischmann M, et al. Low-dose recombinant interferon-alpha in the treatment of cutaneous T-cell lymphomas. *Br J Dermatol* 1989;121:543-544.
446. Mughal TI. Role of interferon alfa-2b in the management of patients with advanced cutaneous T-cell lymphoma. *Eur J Cancer* 1991;27:S39-40.
447. Vonderheid EC, Thompson R, Smiles KA, et al. Recombinant interferon alfa-2b in plaque-phase mycosis fungoides. Intralesional and low-dose intramuscular therapy. *Arch Dermatol* 1987;123:757-763.
448. Dallot A, Feyeux C, Gorin I, et al. Interferon treatment in cutaneous lymphomas. *Int Soc Hematol Proc* 1988:267.
449. Estrach T, Marti R, Lecha M, et al. Treatment of cutaneous T cell lymphoma with recombinant alfa

2b interferon. *J Invest Dermatol* 1989;93:549.

450. VanderMolen LA, Steis RG, Duffey PL, et al. Low- versus high-dose interferon alfa-2a in relapsed indolent non-Hodgkin's lymphoma. *J Natl Cancer Inst* 1990;82:235-238.

451. Siegel RS, Kuzel TM. Cutaneous T-cell lymphoma/leukemia. *Curr Treat Options Oncol* 2000;1:43-50.

452. Sun WH, Pabon C, Alsayed Y, et al. Interferon-alpha resistance in a cutaneous T-cell lymphoma cell line is associated with lack of STAT1 expression. *Blood* 1998;91:570-576.

453. Wolff JM, Zitelli JA, Rabin BS, et al. Intralesional interferon in the treatment of early mycosis fungoides. *J Am Acad Dermatol* 1985;13:604-612.

454. Zinzani PL, Mazza P, Tura S. Beta interferon in the treatment of mycosis fungoides (MF). *International Symposium on Cutaneous Lymphoma, Copenhagen, October 28-30, 1988.*

455. Jimbow K, Yamana K, Ishida O, et al. [Evaluation of rIFN-gamma in the treatment of lymphoma and melanoma of the skin by systemic and intralesional administration]. *Gan to Kagaku Ryoho* 1987;14:152-158.

456. Kaplan EH, Rosen ST, Norris DB, et al. Phase II study of recombinant human interferon gamma for treatment of cutaneous T-cell lymphoma. *J Natl Cancer Inst* 1990;82:208-212.

457. Kobayashi Y, Urabe A. Gamma interferon therapy of cancer patients. *Gan To Kagaku Ryoko* 1988;15:804-809.

458. Pineda AA, Winkelmann RK. Leukapheresis in the treatment of Sézary syndrome. *J Am Acad Dermatol* 1981;5:544-549.

459. Edelson R, Berger C, Gasparro F, et al. Treatment of cutaneous T-cell lymphoma by extracorporeal photochemotherapy. Preliminary results. *N Engl J Med* 1987;316:297-303.

460. Wolfe JT, Lessin SR, Singh AH, et al. Review of immunomodulation by photopheresis: treatment of cutaneous T-cell lymphoma, autoimmune disease, and allograft rejection. *Artif Organs* 1994;18:888-897.

461. Yoo EK, Rook AH, Elenitsas R, et al. Apoptosis induction by ultraviolet light A and photochemotherapy in cutaneous T-cell lymphoma: relevance to mechanism of therapeutic action. *J Invest Dermatol* 1996;107:235-242.

462. Berger CL, Wang N, Christensen I, et al. The immune response to Class I-associated tumor-specific cutaneous T-cell lymphoma antigens. *J Invest Dermatol* 1996;107:392-397.

463. Moor AC, Schmitt IM, Beijersbergen van Henegouwen GM, et al. Treatment with 8-MOP and UVA enhances MHC class I synthesis in RMA cells: preliminary results. *J Photochem Photobiol B* 1995;29:193-198.

464. Perez M, Edelson R, Laroche L, et al. Inhibition of antiskin allograft immunity by infusions with syngeneic photoinactivated effector lymphocytes. *J Invest Dermatol* 1989;92:669-676.

465. Edelson RL. Cutaneous T cell lymphoma: the helping hand of dendritic cells. *Ann N Y Acad Sci* 2001;941:1-11.

466. Berger CL, Hanlon D, Kanada D, et al. Transimmunization, a novel approach for tumor immunotherapy. *Transfus Apheresis Sci* 2002;26:205-216.

467. Khavari PA, Edelson RL, Lider O, et al. Specific vaccination against photoinactivated cloned T cells. *Clin Res* 1988;36:662.

468. Heald P, Rook A, Perez M, et al. Treatment of erythrodermic cutaneous T-cell lymphoma with extracorporeal photochemotherapy. *J Am Acad Dermatol* 1992;27:427-433.

469. Vowels BR, Cassin M, Boufal MH, et al. Extracorporeal photochemotherapy induces the production of tumor necrosis factor-alpha by monocytes: implications for the treatment of cutaneous T-cell lymphoma

and systemic sclerosis. *J Invest Dermatol* 1992;98:686–692.

470. Berger CL, Xu AL, Hanlon D, et al. Induction of human tumor-loaded dendritic cells. *Int J Cancer* 2001;91:438–447.

471. Zic J, Arzubiağa C, Salhany KE, et al. Extracorporeal photopheresis for the treatment of cutaneous T-cell lymphoma. *J Am Acad Dermatol* 1992;27:729–736.

472. Marschalko M, Knobler R, Soos G, et al. [Extracorporeal photopheresis in the therapy of Sézary syndrome]. *Orvosi Hetilap* 1993;134:1253–1257.

473. Prinz B, Behrens W, Holzle E, et al. Extracorporeal photopheresis for the treatment of cutaneous T-cell lymphoma—the Dusseldorf and Munich experience. *Arch Dermatol Res* 1995;287:621–626.

474. Fimiani M, Rubegni P, et al. Extracorporeal photochemotherapy in the early treatment of cutaneous T-cell lymphoma. *J Am Acad Dermatol* 1994;31:828–830.

475. Owsianowski M, Garbe C, Ramaker J, et al. [Therapeutic experiences with extracorporeal photopheresis. Technical procedure, follow-up and clinical outcome in 31 skin diseases]. *Hautarzt* 1996;47:114–123.

476. Heald PW, Perez MI, Christensen I, et al. Photopheresis therapy of cutaneous T-cell lymphoma: the Yale–New Haven Hospital experience. *Yale J Biol Med* 1989;62:629–638.

477. Koh HK, Davis BE, Meola T, et al. Extracorporeal photopheresis for the treatment of 34 patients with cutaneous T cell lymphoma (CTCL). *J Invest Dermatol* 1994;102:567.

478. Duvic M, Hester JP, Lemark NA. Photopheresis therapy for the treatment of cutaneous T-cell lymphoma. *J Am Acad Dermatol* 1996;35:573–579.

479. Evans AV, Wood BP, Scarisbrick JJ, et al. Extracorporeal photopheresis in Sézary syndrome: hematologic parameters as predictors of response. *Blood* 2001;98:1298–1301.

480. Jiang SB, Dietz SB, Kim M, et al. Extracorporeal photochemotherapy for cutaneous T-cell lymphoma: a 9.7-year experience. *Photodermatol Photoimmunol Photomed* 1999;15:161–165.

481. Bisaccia E, Gonzalez J, Palangio M, et al. Extracorporeal photochemotherapy alone or with adjuvant therapy in the treatment of cutaneous T-cell lymphoma: a 9-year retrospective study at a single institution. *J Am Acad Dermatol* 2000;43:263–271.

482. Zic JA, Miller JL, Stricklin GP, et al. The North American experience with photopheresis. *Ther Apher* 1999;3:50–62.

483. Lim HW, Edelson RL. Photopheresis for the treatment of cutaneous T-cell lymphoma. *Hematol Oncol Clin North Am* 1995;9:1117–1126.

484. Russell–Jones R. Extracorporeal photopheresis in cutaneous T-cell lymphoma. Inconsistent data underline the need for randomized studies. *Br J Dermatol* 2000;142:16–21.

485. Zackheim HS, Koh HK, Weinstock MA. Assessing clinical outcomes in cutaneous T-cell lymphoma. *Hematol Oncol Clin North Am* 1995;9:1021–1029.

486. Zic JA, Stricklin GP, Greer JP, et al. Long-term follow-up of cutaneous T-cell lymphoma patients treated with extracorporeal photochemotherapy. *J Am Acad Dermatol* 1996;35:935–945.

487. Rubegni P, De Aloe G, Fimiani M. Extracorporeal photochemotherapy in long-term treatment of early stage cutaneous T-cell lymphoma. *Br J Dermatol* 2000;143:894–896.

488. Duvic M, Hagemester F, Hester J. Accelerated delivery of extracorporeal photopheresis in patients with cutaneous T-cell lymphoma. *J Invest Dermatol* 1989;92:423.

489. Vonderheid EC, Bigler RD, Greenberg AS, et al. Extracorporeal photopheresis and recombinant interferon alfa 2b in Sézary syndrome. Use of dual marker labeling to monitor therapeutic response. *Am J*

Clin Oncol 1994;17:255-263.

490. Suchin KR, Cucchiara AJ, Gottlieb SL, et al. Treatment of cutaneous T-cell lymphoma with combined immunomodulatory therapy: a 14-year experience at a single institution. *Arch Dermatol* 2002;138:1054-1060.
491. Rook AH, Gottlieb SL, Wolfe JT, et al. Pathogenesis of cutaneous T-cell lymphoma: implications for the use of recombinant cytokines and photopheresis. *Clin Exp Immunol* 1997;107:16-20.
492. Fritz TM, Kleinhans M, Nestle FO, et al. Combination treatment with extracorporeal photopheresis, interferon alfa and interleukin-2 in a patient with the Sézary syndrome. *Br J Dermatol* 1999;140:1144-1147.
493. Braverman IM, Yager NB, Chen M, et al. Combined total body electron beam irradiation and chemotherapy for mycosis fungoides. *J Am Acad Dermatol* 1987;16:45-60.
494. Griem ML, Tokars RP, Petras V, et al. Combined therapy for patients with mycosis fungoides. *Cancer Treat Rep* 1979;63:655-657.
495. Hallahan DE, Griem ML, Griem SF, et al. Combined modality therapy for tumor stage mycosis fungoides: results of a 10-year follow-up. *J Clin Oncol* 1988;6:1177-1183.
496. Winkler CF, Sausville EA, Ihde DC, et al. Combined modality treatment of cutaneous T cell lymphoma: results of a 6-year follow-up. *J Clin Oncol* 1986;4:1094-1100.
497. Bunn PA Jr, Fischmann AB, Schechter GP, et al. Combined modality therapy with electron-beam irradiation and systemic chemotherapy for cutaneous T-cell lymphomas. *Cancer Treat Rep* 1979;63:713-717.
498. Quiros PA, Jones GW, Kacinski BM, et al. Total skin electron beam therapy followed by adjuvant psoralen/ultraviolet-A light in the management of patients with T1 and T2 cutaneous T-cell lymphoma (mycosis fungoides). *Int J Radiat Oncol Biol Phys* 1997;38:1027-1035.
499. Kaye FJ, Bunn PA Jr, Steinberg SM, et al. A randomized trial comparing combination electron-beam radiation and chemotherapy with topical therapy in the initial treatment of mycosis fungoides. *N Engl J Med* 1989;321:1784-1790.
500. Wilson LD, Licata AL, Braverman IM, et al. Systemic chemotherapy and extracorporeal photochemotherapy for T3 and T4 cutaneous T-cell lymphoma patients who have achieved a complete response to total skin electron beam therapy. *Int J Radiat Oncol Biol Phys* 1995;32:987-995.
501. Dreno B, Celerier P, Litoux P. Roferon-A in combination with Tigason in cutaneous T-cell lymphomas. *Acta Haematol* 1993;89:28-32.
502. Dreno B. Roferon-A (interferon alpha 2a) combined with Tigason (etretinate) for treatment of cutaneous T cell lymphomas. *Stem Cells* 1993;11:269-275.
503. Dreno B, Claudy A, Meynadier J, et al. The treatment of 45 patients with cutaneous T-cell lymphoma with low doses of interferon-alpha 2a and etretinate. *Br J Dermatol* 1991;125:456-459.
504. Aviles A, Guzman R, Garcia EL, et al. Biological modifiers (etretinate and interferon alfa 2a) in the treatment of refractory cutaneous t-cell lymphoma. *Cancer Biother Radiopharm* 1996;11:21-24.
505. Torii H, Kaneko T, Matsuyama T, et al. Interferon-alpha (INF-alpha) and etretinate in the treatment of mycosis fungoides. *J Dermatol* 1994;21:767-770.
506. Zachariae H, Thestrup-Pedersen K. Interferon alpha and etretinate combination treatment of cutaneous T-cell lymphoma. *J Invest Dermatol* 1990;95:206S-208S.
507. Stravrianeas N, Katsambas A, Vareltzides A, et al. Treatment of mycosis fungoides with recombinant alpha 2B interferon in combination with etretinate. *J Invest Dermatol* 1989;93:580.
508. Altomare GF, Capella GL, Pigatto PD, et al. Intramuscular low dose alpha-2B interferon and

etretinate for treatment of mycosis fungoides. *Int J Dermatol* 1993;32:138-141.

509. Knobler RM, Trautinger F, Radaszkiewicz T, et al. Treatment of cutaneous T cell lymphoma with a combination of low-dose interferon alpha-2b and retinoids. *J Am Acad Dermatol* 1991;24:247-252.

510. Thestrup-Pedersen K, Hammer R, Kaltoft K, et al. Treatment of mycosis fungoides with recombinant interferon-alpha 2a2 alone and in combination with etretinate. *Br J Dermatol* 1988;118:811-818.

511. Serri F, De Simone C, Venier A, et al. Combination of retinoids and PUVA (Re-PUVA) in the treatment of cutaneous T cell lymphomas. *Curr Prob Dermatol* 1990;19:252-257.

512. Thomsen K, Hammar H, Molin L, et al. Retinoids plus PUVA (RePUVA) and PUVA in mycosis fungoides, plaque stage. A report from the Scandinavian Mycosis Fungoides Group. *Acta Dermato-Venereol* 1989;69:536-538.

513. Kuzel TM, Gilyon K, Springer E, et al. Interferon alpha-2a combined with phototherapy in the treatment of cutaneous T-cell lymphoma. *J Natl Cancer Inst* 1990;82:203-207.

514. Kuzel TM, Roenigk HH Jr, Samuelson E, et al. Effectiveness of interferon alpha-2a combined with phototherapy for mycosis fungoides and the Sézary syndrome. *J Clin Oncol* 1995;13:257-263.

515. Mostow EN, Neckel SL, Oberhelman L, et al. Complete remissions in psoralen and UV-A (PUVA)-refractory mycosis fungoides-type cutaneous T-cell lymphoma with combined interferon alpha and PUVA. *Arch Dermatol* 1993;129:747-752.

516. Otte HG, Herges A, Stadler R. [Combination therapy with interferon alpha 2a and PUVA in cutaneous T-cell lymphoma]. *Hautarzt* 1992;43:695-699.

517. Roenigk HH Jr, Kuzel TM, Skoutelis AP, et al. Photochemotherapy alone or combined with interferon alpha-2a in the treatment of cutaneous T-cell lymphoma. *J Invest Dermatol* 1990;95:198S-205S.

518. Stadler R, Otte HG. Combination therapy of cutaneous T cell lymphoma with interferon alpha-2a and photochemotherapy. *Recent Results Cancer Res* 1995;139:391-401.

519. Chiarion-Sileni V, Bononi A, Fornasa CV, et al. Phase II trial of interferon-alpha-2a plus psoralen with ultraviolet light A in patients with cutaneous T-cell lymphoma. *Cancer* 2002;95:569-575.

520. Rupoli S, Barulli S, Guiducci B, et al. Low dose interferon-alpha2b combined with PUVA is an effective treatment of early stage mycosis fungoides: results of a multicenter study. *Cutaneous-T Cell Lymphoma Multicenter Study Group. Haematology* 1999;84:809-813.

521. Stadler R, Otte HG, Luger T, et al. Prospective randomized multicenter clinical trial on the use of interferon a-2a plus acitretin versus interferon a-2a plus PUVA in patients with cutaneous T-cell lymphoma stages I and II. *Blood* 1998;92:3578-3581.

522. Williams DP, Parker K, Bacha P, et al. Diphtheria toxin receptor binding domain substitution with interleukin-2: genetic construction and properties of a diphtheria toxin-related interleukin-2 fusion protein. *Protein Eng* 1987;1:493-498.

523. Bacha P, Williams DP, Waters C, et al. Interleukin 2 receptor-targeted cytotoxicity. Interleukin 2 receptor-mediated action of a diphtheria toxin-related interleukin 2 fusion protein. *J Exp Med* 1988;167:612-622.

524. Waldmann TA. The IL-2/IL-2 receptor system: a target for rational immune intervention. *Trends Pharmacol Sci* 1993;14:159-164.

525. LeMaistre CF, Kuzel T, Foss F, et al. DAB389IL2 is well tolerated at doses inducing responses in IL-2R expressing lymphomas. *Blood* 1993;82:137a.

526. Foss FM, Borkowski TA, Gilliom M, et al. Chimeric fusion protein toxin DAB486IL-2 in advanced mycosis fungoides and the Sézary syndrome: correlation of activity and interleukin-2 receptor expression in a phase II study. *Blood* 1994;84:1765-1774.

527. Hesketh P, Caguioa P, Koh H, et al. Clinical activity of a cytotoxic fusion protein in the treatment of



cutaneous T-cell lymphoma. *J Clin Oncol* 1993;11:1682-1690.

528. Kiyokawa T, Williams DP, Snider CE, et al. Protein engineering of diphtheria-toxin-related interleukin-2 fusion toxins to increase cytotoxic potency for high-affinity IL-2-receptor-bearing target cells. *Protein Eng* 1991;4:463-468.

529. LeMaistre CF, Meneghetti C, Rosenblum M, et al. Phase I trial of an interleukin-2 (IL-2) fusion toxin (DAB486IL-2) in hematologic malignancies expressing the IL-2 receptor. *Blood* 1992;79:2547-2554.

530. LeMaistre CF, Craig FE, Meneghetti C, et al. Phase I trial of a 90-minute infusion of the fusion toxin DAB486IL-2 in hematological cancers. *Cancer Res* 1993;53:3930-3934.

531. Waters CA, Schimke PA, Snider CE, et al. Interleukin 2 receptor-targeted cytotoxicity. Receptor binding requirements for entry of a diphtheria toxin-related interleukin 2 fusion protein into cells. *Eur J Immunol* 1990;20:785-791.

532. Williams DP, Snider CE, Strom TB, et al. Structure/function analysis of interleukin-2-toxin (DAB486-IL-2). Fragment B sequences required for the delivery of fragment A to the cytosol of target cells. *J Biol Chem* 1990;265:11885-11889.

533. Olsen E, Duvic M, Frankel A, et al. Pivotal phase III trial of two dose levels of denileukin diftitox for the treatment of cutaneous T-cell lymphoma. *J Clin Oncol* 2001;19:376-388.

534. Foss FM, Bacha P, Osann KE, et al. Biological correlates of acute hypersensitivity events with DAB(389)IL-2 (denileukin diftitox, ONTAK) in cutaneous T-cell lymphoma: decreased frequency and severity with steroid premedication. *Clin Lymphoma* 2001;1:298-302.

535. Rook AH, Wood GS, Yoo EK, et al. Interleukin-12 therapy of cutaneous T-cell lymphoma induces lesion regression and cytotoxic T-cell responses. *Blood* 1999;94:902-908.

536. Dillman RO, Beauregard J, Shawler DL, et al. Continuous infusion of T101 monoclonal antibody in chronic lymphocytic leukemia and cutaneous T-cell lymphoma. *J Biol Response Mod* 1986;5:394-410.

537. Rosen ST, Zimmer AM, Goldman-Leikin R, et al. Radioimmunodetection and radioimmunotherapy of cutaneous T cell lymphomas using an <sup>131</sup>I-labeled monoclonal antibody: an Illinois Cancer Council Study. *J Clin Oncol* 1987;5:562-573.

538. LeMaistre CF, Rosen S, Frankel A, et al. Phase I trial of H65-RTA immunoconjugate in patients with cutaneous T-cell lymphoma. *Blood* 1991;78:1173.

539. Pangalis GA, Dimopoulou MN, Angelopoulou MK, et al. Campath-1H (anti-CD52) monoclonal antibody therapy in lymphoproliferative disorders. *Med Oncol* 2001;18:99-107.

540. Dearden CE, Matutes E, Catovsky D. Alemtuzumab in T-cell malignancies. *Med Oncol* 2002;19[Suppl]:S27-32.

541. Lundin J, Osterborg A, Brittinger G, et al. CAMPATH-1H monoclonal antibody in therapy for previously treated low-grade non-Hodgkin's lymphomas: a phase II multicenter study. European Study Group of CAMPATH-1H Treatment in Low-Grade Non-Hodgkin's Lymphoma. *J Clin Oncol* 1998;16:3257-3263.

542. Bigler RD, Crilley P, Micaily B, et al. Autologous bone marrow transplantation for advanced stage mycosis fungoides. *Bone Marrow Transplant* 1991;7:133-137.

543. Sterling JC, Marcus R, Burrows NP, et al. Erythrodermic mycosis fungoides treated with total body irradiation and autologous bone marrow transplantation. *Clin Exp Dermatol* 1995;20:73-75.

544. Olavarria E, Child F, Woolford A, et al. T-cell depletion and autologous stem cell transplantation in the management of tumour stage mycosis fungoides with peripheral blood involvement. *Br J Haematol* 2001;114:624-631.

545. Molina A, Arber JL, Murata-Collins JL, et al. Allogeneic hematopoietic stem cell transplantation (HSCT) induces clinical, molecular and cytogenetic remissions in patients with refractory Sézary syndrome

(SS) and advanced mycosis fungoides (MF). *Ann Oncol* 2002;[Suppl]:134(abst).

546. Guitart J, Wickless SC, Oyama Y, et al. Long-term remission after allogeneic hematopoietic stem cell transplantation for refractory cutaneous T-cell lymphoma. *Arch Dermatol* 2002;138:1359-1365.

547. Molina A, Nademanee A, Arber DA, Forman SJ. Remission of refractory Sézary syndrome after bone marrow transplantation from a matched unrelated donor. *Biol Blood Marrow Transplant* 1999;5:400-404.

548. Bernengo MG, Appino A, Bertero M, et al. Thymopentin in Sézary syndrome. *J Natl Cancer Inst* 1992;84:1341-1346.

549. Foss F, Sznol M, Urba W, et al. Biological activity of thymopentin in cutaneous T-cell lymphoma. *Proc Am Assoc Cancer Res* 1994;35:237.

550. Resnick L, Schleider-Kushner N, Horwitz SN, et al. Remission of tumor-stage mycosis fungoides following intravenously administered acyclovir. *JAMA* 1984;251:1571-1573.

551. Burg G, Klepzig K, Kaudewitz P, et al. Acyclovir in lymphomatoid papulosis and mycosis fungoides. *JAMA* 1986;256:214-215.

552. Resnick L, Schleider-Kushner N, Horwitz SN, Frost P. Acyclovir in lymphomatoid papulosis and mycosis fungoides. *JAMA* 1986;256:256.

2004 Lippincott Williams & Wilkins  
John P. Greer, John Foerster, John N. Lukens  
George M. Rodgers, Frixos Paraskevas, Bertil Glader  
Wintrobe's Clinical Hematology

[EARLY HISTORY](#)  
[EPIDEMIOLOGY AND ETIOLOGY](#)  
[HISTOPATHOLOGY](#)  
[CELL OF ORIGIN](#)  
[CYTOKINES IN HODGKIN DISEASE](#)  
[CLINICAL EVALUATION](#)  
[Physical Examination: Sites of Disease](#)  
[Pattern of Spread](#)  
[Symptoms: Clinical History](#)  
[Staging](#)  
[Prognosis](#)  
[OVERVIEW OF RADIATION THERAPY](#)  
[OVERVIEW OF CHEMOTHERAPY](#)  
[COMBINED MODALITY THERAPY](#)  
[OVERVIEW OF HODGKIN DISEASE TREATMENT](#)  
[Treatment of Limited Stage Disease](#)  
[Treatment of Stage IIIA Disease](#)  
[Treatment of Advanced Stage Disease](#)  
[Summary of Treatment of Hodgkin Disease](#)  
[SALVAGE CHEMOTHERAPY](#)  
[Stem Cell Transplantation as Salvage Therapy](#)  
[HODGKIN DISEASE AND HUMAN IMMUNODEFICIENCY VIRUS](#)  
[PEDIATRIC HODGKIN DISEASE](#)  
[HODGKIN DISEASE AND PREGNANCY](#)  
[MEDICAL-LEGAL ISSUES IN HODGKIN DISEASE](#)  
[FUTURE PROSPECTS](#)  
[REFERENCES](#)

*Hodgkin disease* is a lymphoproliferative malignancy that accounts for approximately 1% of newly diagnosed malignancies in the United States. However, the disease's importance to the field of medical oncology is out of proportion to its clinical incidence. From a historical point of view, Hodgkin disease was the first disease in which the curative potential of combination chemotherapy was demonstrated. Second, because Hodgkin disease is often a disease of young people, there is huge potential for adding years of productive life by curing patients with Hodgkin disease. Third, because patients with Hodgkin disease are often cured, Hodgkin disease serves as a clinical laboratory for investigating the late effects of cancer therapy.

Hodgkin disease usually presents as solitary or generalized lymphadenopathy and most commonly occurs in young adults, although any age group may be affected. The disease appears to spread in a contiguous fashion, and most patients present with disease limited to the lymph nodes or to the lymph nodes and spleen. Even when disease is advanced, cure is possible. Overall, cure can be achieved in approximately 80% of patients with Hodgkin disease. Treatment of limited disease generally incorporates radiation therapy, whereas treatment of advanced disease is more often limited to combination chemotherapy alone.

Although Hodgkin disease has been a success story of modern cancer medicine, this success has in some ways been paradoxical. First, successful therapy has been empirical and dependent on understanding prognostic features and patterns of spread. Clinical success has been independent of understanding the pathogenesis of Hodgkin disease or

its cell of origin. These latter subjects remain areas of controversy. Second, major clinical advances in Hodgkin disease depended on studies that used pathologic staging, including staging laparotomy. However, because both radiation therapy and chemotherapy are curative modalities, and because many relapsing patients can be cured, clinical staging rather than surgical staging is generally used as the basis for therapeutic planning without obvious negative clinical consequences. Staging laparotomy has become a procedure of historical interest rather than a key part of clinical practice. Third, the success of salvage therapy means that it is difficult to make a specific optimal treatment recommendation for many patients with Hodgkin disease. Therapies that produce superior disease-free survival may not necessarily be superior in the long term because therapy of relapsed disease can be curative, and late complications, including malignancy, can compromise the long-term efficacy of treatments that appear superior in the short run. As a result, when considering therapy for patients with Hodgkin disease, one must realize that valid alternatives exist in addition to what may be considered the “best therapy.”

That the management of Hodgkin disease is a subject of paradox and controversy is fitting. In 1832, Thomas Hodgkin made a major contribution to medical science by describing the primary lymphoid malignancy that bears his name. However, his report was based on gross findings at autopsy and did not include any microscopic evaluation. Some of the cases included in Hodgkin’s initial report were likely cases of tuberculous lymphadenopathy or even non-Hodgkin lymphoma.

## EARLY HISTORY

In 1832, Thomas Hodgkin presented a paper entitled *On Some Morbid Appearances of the Absorbent Glands and Spleen* (<sup>1</sup>). His report was an autopsy description of seven patients, and the major original thesis presented in the paper was that the entity he was describing was a *primary* process involving the lymph glands and spleen rather than a *reactive* inflammatory condition. In 1856, Samuel Wilks published a series of cases involving enlargement of the lymph glands (<sup>2</sup>) and noted Hodgkin’s original description. In 1865, Wilks wrote *Cases of Enlargement of the Lymphatic Glands and Spleen (or Hodgkin’s Disease) with Remarks*, updating and extending his findings (<sup>3</sup>). Thus, Thomas Hodgkin’s name became linked to the disorder.

After these gross pathologic descriptions, the first microscopic description of Hodgkin disease was reported by Langhans (<sup>4</sup>) in 1872. This report was followed by independent reports by Sternberg in 1898 (<sup>5</sup>) and by Reed in 1902 (<sup>6</sup>) describing the characteristic giant cells that came to be known as *Reed–Sternberg cells*. At the time of these early reports, all comments regarding the cause of Hodgkin disease were purely speculative. Not surprising, these early authors were divided over whether Hodgkin disease represented an infectious disease, an inflammatory disorder, or a malignancy involving the lymph glands. Considering that Hodgkin disease is a malignant disease for which there is epidemiologic evidence of a possible viral etiology and that the microscopic appearance is that of a small number of malignant cells surrounded by an exuberant host reaction, all of these opinions (malignant, inflammatory, infectious) may be partially correct.

## EPIDEMIOLOGY AND ETIOLOGY

Approximately 7500 new cases of Hodgkin disease are diagnosed in the United States each year. The male to female ratio is 1.3 to 1.4:1.0. In most economically developed countries, there is a bimodal age distribution, with one peak occurring in the third decade of life and the second peak occurring after age 50 years (<sup>7</sup>). The occurrence of Hodgkin disease in patients between the ages of 15 and 39 has been positively associated with increased maternal education, decreased numbers of siblings and playmates, and

single-family dwellings in childhood ( 8 ). In less economically developed countries, Hodgkin disease is less common but affects children, most of whom are boys; mixed cellularity Hodgkin disease and lymphocyte-depleted Hodgkin disease are more commonly seen ( 9 ). These data have been interpreted as supporting the hypothesis that Hodgkin disease is caused by an infectious agent, and it has been postulated that malignancy is more likely to occur when exposure to the agent in question is delayed until late adolescence or early adulthood ( 9 , 10 , 11 and 12 ). This concept of differential sequelae dependent on age at exposure to an infectious agent is similar to that used to explain the association of paralysis with poliovirus in susceptible populations.

The arguments for an infectious etiology of Hodgkin disease date back to the earliest descriptions of the disorder. *Mycobacterium tuberculosis* was the first organism to be suspected of causing Hodgkin disease ( 13 , 14 ). However, once it was known that Hodgkin disease is associated with immune defects, *M. tuberculosis* came to be seen as a consequence rather than a cause of Hodgkin disease. In the 1970s, the hypothesis of an infectious etiology for Hodgkin disease was supported by reports of clustering among exposed high school students in New York state ( 15 , 16 ). However, additional population-based studies have led to the conclusion that the apparent clustering was due to chance alone ( 17 ).

Epstein-Barr virus (EBV) has been another proposed cause of Hodgkin disease, and the circumstantial evidence is considerable. The incidence of Hodgkin disease is elevated among patients with a history of EBV infection ( 18 , 19 and 20 ). EBV has been associated with other related malignancies, including Burkitt lymphoma and the lymphomas that occur after organ transplantation. Using modern molecular biology techniques, EBV genome fragments have been found in Reed-Sternberg cells from approximately one-half of patients with Hodgkin disease ( 21 , 22 and 23 ) and, more commonly, in cases of mixed cellularity Hodgkin disease ( 23 ). Hodgkin disease occurring in early childhood or in older adults is more likely to be EBV associated than are cases of Hodgkin disease occurring in young adults ( 24 ). Additionally, the EBV DNA associated with Reed-Sternberg cells in Hodgkin disease has been shown to be monoclonal, establishing that EBV preceded the development of Hodgkin disease ( 21 and 22 ). However, the association of EBV with Hodgkin disease does not prove a causal relationship. The data are equally compatible with the fact that EBV may predispose patients to the development of Hodgkin disease. Further confusing the relationship between EBV and Hodgkin disease are two reports that prognosis is better in Hodgkin disease that is EBV positive, as compared to cases that are EBV negative ( 25 , 26 ). Although studies of the relationship between EBV and Hodgkin disease continue ( 27 ), this controversy is unlikely to be resolved in the near future.

The idea that Hodgkin disease may represent an uncommon host response to a common agent has received additional support in a study of monozygotic and dizygotic twins. Monozygotic twins, who would be expected to have similar immune responses, had a 99-fold increased risk of being concordant for having Hodgkin disease, supporting a role for genetic susceptibility or abnormal immune response, or both, in the etiology of Hodgkin disease ( 28 ). If an abnormal immune response is related to the development of Hodgkin disease, one might expect an increased incidence of Hodgkin disease in immunodeficient patients, including those patients infected with the human immunodeficiency virus (HIV). Although the initial data were mixed, it has become clear that the incidence of Hodgkin disease is elevated in patients with HIV and acquired immunodeficiency syndrome (AIDS) ( 29 , 30 , 31 , 32 , 33 and 34 ). An increased incidence of Hodgkin disease has been noted in recipients of allogeneic bone marrow transplants ( 35 ). Additionally, a patient has been reported with reversible methotrexate-associated

lymphoproliferative disorder that eventually evolved into Hodgkin disease ( 36 ).

## HISTOPATHOLOGY

Accurate histopathology plays a critical role in the management of the patient with Hodgkin disease because the diagnosis of Hodgkin disease requires biopsy of an involved lymph node or, rarely, of an involved extranodal site. Fortunately for clinicians, concordance between pathologists regarding the diagnosis of Hodgkin disease is high, often exceeding 90% ( 37 ). Hodgkin disease can be confused with atypical inflammatory reactions that can occur in some patients with infectious mononucleosis ( 38 ) or in patients receiving diphenylhydantoin ( 39 ). An additional problem in Hodgkin disease relates to surgical sampling of nodes. Nodes showing only inflammation may be interspersed with nodes showing Hodgkin disease, and if the surgeon chooses which node to biopsy solely on the basis of simplifying the procedure, the diagnosis may be missed ( 40 ). In general, it is probably worthwhile to biopsy the largest node in a patient suspected of having Hodgkin disease or non-Hodgkin lymphoma. However, a notable exception to this occurs in patients with inguinal adenopathy, which may reflect reactive processes and provide misleading information. Whenever the diagnosis of Hodgkin disease or non-Hodgkin lymphoma is considered, the handling of the biopsy should be coordinated between the operating room and the hematopathology laboratory so that the tissue is processed in a manner that minimizes artifact and maximizes the opportunity to obtain a diagnosis.

The grouping of lymphomas into the mutually exclusive categories of Hodgkin disease and non-Hodgkin lymphoma gives the impression that these disorders are totally separate. However, although the distinction between Hodgkin disease and non-Hodgkin lymphoma is clear in the majority of cases, the boundary between the disorders is indistinct in some areas. Patients with chronic lymphocytic leukemia can develop large transformed cell lymphomas (Richter syndrome) ( 41 , 42 ) that may resemble Hodgkin disease. The nodular subtype of lymphocyte-predominant Hodgkin disease may resemble low-grade non-Hodgkin lymphoma. Approximately one-fourth of cases originally classified as lymphocyte-depleted Hodgkin disease were reclassified as non-Hodgkin lymphoma when present classification criteria were used ( 43 ). Studies of Ki-1-positive anaplastic large cell lymphoma illustrate that Hodgkin disease and this subtype of non-Hodgkin lymphoma have marked morphologic similarities. However, the majority of studies have shown that the t(2;5) gene rearrangement occurs only in anaplastic large cell lymphoma ( 44 , 45 and 46 ).

Pathologically, Hodgkin disease is distinguished from other lymphomas by the presence of large binucleated or multinucleated cells (i.e., Reed-Sternberg cells) generally surrounded by a benign reactive host response consisting of lymphocytes, histiocytes, granulocytes, eosinophils, and plasma cells. Reed-Sternberg cells are large cells with abundant cytoplasm and generally contain two or more nuclei and two or more inclusionlike nucleoli. Variant forms of Reed-Sternberg cells exist, especially in the nodular sclerosis subtype of Hodgkin disease and the nodular form of lymphocyte-predominant Hodgkin disease. Reed-Sternberg cells are not absolutely specific for Hodgkin disease and have been noted in cases of infectious mononucleosis ( 47 ) and other malignancies including lymphoma, carcinomas, and sarcomas ( 48 ). Therefore, Reed-Sternberg cells are not sufficient to establish the diagnosis of Hodgkin disease because that diagnosis depends on the presence of both the characteristic Reed-Sternberg cells and the characteristic cellular environment in which the Reed-Sternberg cells are found. In addition to the use of standard hematopathologic criteria, immunostaining for CD-15 (Leu-M1) and CD-30 (Ki-1) may be helpful in confirming the diagnosis of Hodgkin disease. The neoplastic cells of Hodgkin disease, both classic Reed-Sternberg cells and Reed-Sternberg variants, tend

to stain positively with these antibodies ( [49](#), [50](#) ).

The subclassification of Hodgkin disease depends in large part on the ratio of neoplastic to reactive cells. The Jackson–Parker classification ( [51](#) ) proposed in 1947 is of historical interest only and divided Hodgkin disease into three subtypes: paraganuloma, granuloma, and sarcoma. Because 80% of the cases were granuloma, this subclassification was minimally helpful to clinicians. In 1966, Lukes and Butler ( [52](#) ) proposed a six–part classification of Hodgkin disease that was modified that same year at the Rye Conference ( [53](#) ) into a four–part system: lymphocyte predominance, nodular sclerosis, mixed cellularity, and lymphocyte depletion. Nearly all of the major clinical studies that form the basis of our present understanding of Hodgkin disease have used the Rye classification system. The only major modification to the Rye system relates to the proposal by German hematopathologists ( [54](#) ) to subclassify the lymphocyte predominance subtype into three categories: nodular, diffuse, and other.

The percent distribution of Hodgkin disease cases with respect to histologic subtype is shown in [Table 95.1](#). The data are taken from one large tumor registry ( [55](#) ) and three large series of referred patients ( [37](#), [56](#), [57](#) ) and are subject to any biases in the selection process. However, the general agreement among the series suggests that this is a fairly reliable estimate regarding the relative incidence of the subtypes of Hodgkin disease.

**TABLE 95.1. Relative Incidence of Histopathologic Subtypes of Hodgkin Disease**

| Author (Reference)               | Lymphocyte Predominant (%) | Nodular Sclerosis (%) | Mixed Cellularity (%) | Lymphocyte Depleted (%) |
|----------------------------------|----------------------------|-----------------------|-----------------------|-------------------------|
| Dorfman ( <a href="#">56</a> )   | 7                          | 74                    | 17                    | 2                       |
| Jones ( <a href="#">37</a> )     | 2                          | 65                    | 26                    | 6                       |
| Bernhards ( <a href="#">57</a> ) | 3                          | 74                    | 22                    | 1                       |
| Medeiros ( <a href="#">55</a> )  | 7                          | 63                    | 26                    | 4                       |

NOTE: Percentages refer to “classified” cases, as some studies contain cases of unclassified Hodgkin disease.

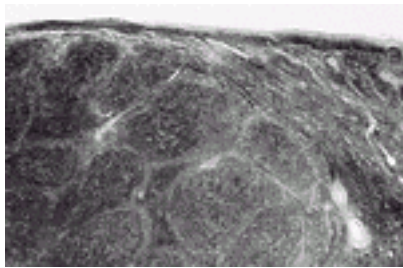
Because the subtypes of Hodgkin disease differ slightly with respect to common clinical features, the histopathologic subclassification of Hodgkin disease provides the clinician with some useful information. Lymphocyte–predominant Hodgkin disease is associated with the least tendency to have advanced disease and with the most favorable prognosis, whereas lymphocyte–depleted Hodgkin disease is associated with the greatest tendency to have advanced disease and the worst prognosis. Nodular sclerosing Hodgkin disease and mixed cellularity Hodgkin disease are intermediate in this regard, with nodular sclerosing Hodgkin disease being more favorable than mixed cellularity Hodgkin disease.

Prognostic differences between histologic subtypes of Hodgkin disease are largely dependent on stage. Although histopathologic subtype does have value in predicting prognosis, this is largely because stage co–varies with histologic subtype. Thus, if two patients have identical clinical presentations, and one has nodular sclerosing Hodgkin disease and the other has mixed cellularity Hodgkin disease, the patient with mixed cellularity Hodgkin disease is more likely to have advanced stage disease on completion of

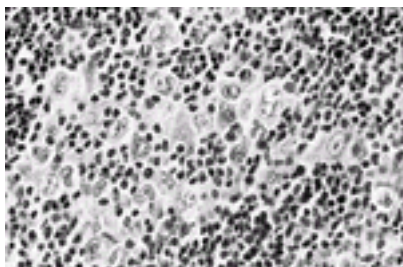


staging and is, therefore, more likely to have a poorer prognosis. However, if the patients are found to have the same stage on completion of staging, expected differences in prognosis would be minimal. When patients with Hodgkin disease have been stratified with respect to stage and have then received equivalent therapy, differences attributable to histologic subtype have been either trivial or nonexistent ( [58](#), [59](#), [60](#) and [61](#) ). Therefore, it is probably not of critical importance that concordance between pathologists regarding subclassification of Hodgkin disease has only been fair, 66 to 72% ( [37](#), [62](#) ), and that the major area of disagreement has involved distinguishing between the two most common types of Hodgkin disease—nodular sclerosing Hodgkin disease and mixed cellularity Hodgkin disease.

In lymphocyte-predominant Hodgkin disease ( [Fig. 95.1](#) ), Reed-Sternberg cells, eosinophils, and histiocytes are sparse, and the predominant cell is a small mature lymphocyte ( [Fig. 95.1](#) ). As a result, the disease may be mistaken for a diffuse small B-cell non-Hodgkin lymphoma. Variant lymphocytic and histiocytic cells are common. These cells have multilobated nuclei and have been called *popcorn cells* because of their resemblance to a popped kernel of corn ( [Fig. 95.2](#) ). Only 5 to 10% of cases of Hodgkin disease are of the lymphocyte predominance subtype. This subtype has the greatest tendency to present as stage I disease and is often associated with a prolonged clinical course even in the absence of cure ( [63](#) ). Death caused by lymphocyte predominance Hodgkin disease is uncommon ( [63](#) ). However, these patients appear to be at increased risk of developing non-Hodgkin lymphoma ( [64](#), [65](#) ).



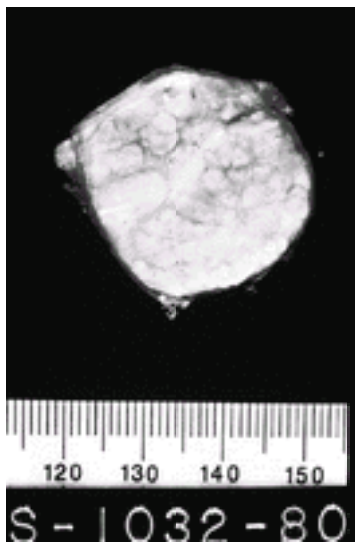
**Figure 95.1.** Lymphocyte-predominant Hodgkin disease, nodular type. Low magnification demonstrates a nodular growth pattern that compresses a rim of uninvolved node. See [Color Plate](#).



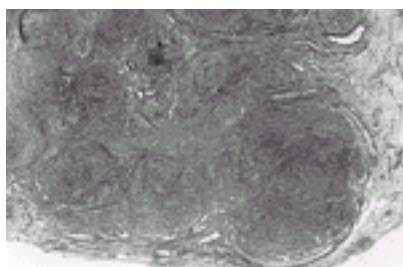
**Figure 95.2.** Lymphocyte-predominant Hodgkin disease. High magnification shows variant lymphocytic and histiocytic cells (L and H cells), which have “popcorn” nuclei. A background of small lymphocytes and histiocytes is present. See [Color Plate](#).

In nodular sclerosing Hodgkin disease, nodularity is produced by dense collagenous bands that divide the cellular portion of the node into sections ( [Fig. 95.3](#) and [Fig. 95.4](#) ). In this type of Hodgkin disease, Reed-Sternberg cell variants, rather than classic

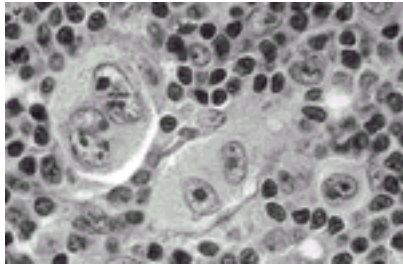
Reed–Sternberg cells, are commonly found in the cellular areas. These lacunar Reed–Sternberg cells have faintly stained cytoplasm and appear separated from adjacent cells by empty space, an artifact of formalin fixation ([Fig. 95.5](#)). Nodular sclerosing Hodgkin disease is the most distinctive form of Hodgkin disease. Although the other subtypes of Hodgkin disease may be regarded as a histologic continuum and transformation among other subtypes is commonly seen, when patients with the nodular sclerosing subtype of Hodgkin disease undergo repeat biopsies, the nodular sclerosing form of Hodgkin disease is confirmed in more than 90% of cases ([66](#)). This form of Hodgkin disease classically presents as stage I or II disease with cervical and mediastinal involvement in young adults, although more advanced stages of disease are not uncommon ([Table 95.2](#)).



**Figure 95.3.** Nodular sclerosing Hodgkin disease. Gross appearance of the cut surface of a resected node shows a thickened capsule, white fibrous bands, and yellow parenchymal nodules. See [Color Plate](#).



**Figure 95.4.** Nodular sclerosing Hodgkin disease. Low magnification shows a fibrous capsule and bands of sclerosis circumscribing abnormal lymphoid nodules. See [Color Plate](#).



**Figure 95.5.** Nodular sclerosing Hodgkin disease. High magnification shows Reed-Sternberg cells and lacunar variants in B5 fixed material. See [Color Plate](#).

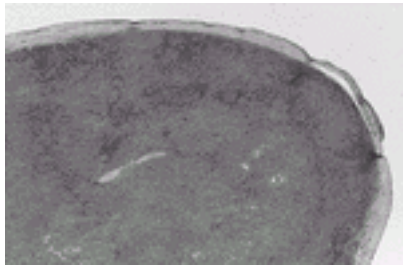
**TABLE 95.2. Relative Incidence of Each Stage of Hodgkin Disease for Each Histopathologic Subtype of Hodgkin Disease**

| Stage         | Histologic Subtype         |                       |                       |                         |
|---------------|----------------------------|-----------------------|-----------------------|-------------------------|
|               | Lymphocyte Predominant (%) | Nodular Sclerosis (%) | Mixed Cellularity (%) | Lymphocyte Depleted (%) |
| IA and IB     | 47                         | 8                     | 12                    | 9                       |
| IIA and IIB   | 38                         | 52                    | 34                    | 14                      |
| IIIA and IIIB | 14                         | 29                    | 41                    | 41                      |
| IVA and IVB   | 1                          | 11                    | 13                    | 36                      |
| Total         | 100                        | 100                   | 100                   | 100                     |

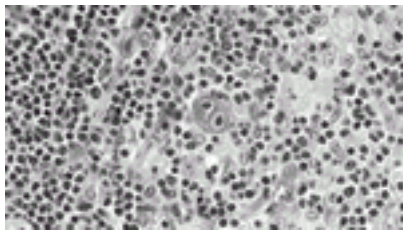
Modified from Kaplan HS. Hodgkin's disease, 2nd ed. Cambridge: Harvard University Press, 1980.

A “syncytial variant” of nodular sclerosing Hodgkin disease has been recognized in which numerous Reed-Sternberg cell variants have been observed in sheets and clusters. This variant of Hodgkin disease may be confused with non-Hodgkin lymphoma, thymoma, or metastatic cancer ([67](#)). Subclassification of nodular sclerosing Hodgkin disease into two subtypes based on cellularity of the nodules and the degree of sclerosis has been considered, but the value of this subclassification is not generally established ([68](#), [69](#) and [70](#)).

Hodgkin disease of the mixed cellularity pattern is a diffuse lymphoma ([Fig. 95.6](#)) composed of a mixture of cells including Reed-Sternberg cells ([Fig. 95.7](#)). Distinguishing mixed cellularity Hodgkin disease from diffuse mixed forms of non-Hodgkin lymphoma may be difficult. Because some lacunar cells may be present, cases that a consensus panel defines as mixed cellularity Hodgkin disease are often classified as nodular sclerosis Hodgkin disease by a minority of hematopathologists. This subtype of Hodgkin disease has a greater tendency than nodular sclerosing Hodgkin disease to be advanced at the time of presentation and associated with symptomatic disease. As a result, this subtype of Hodgkin disease is associated with a poorer prognosis. Mixed cellularity Hodgkin disease and nodular sclerosing Hodgkin disease make up the majority of Hodgkin disease cases.



**Figure 95.6.** Mixed cellularity-type Hodgkin disease. Low magnification shows obliteration of nodal architecture. See [Color Plate](#).

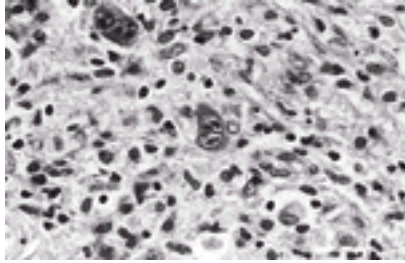


**Figure 95.7.** Mixed cellularity-type Hodgkin disease. High magnification shows a classic Reed-Sternberg cell in a mixed background of small lymphocytes, plasma cells, and eosinophils. See [Color Plate](#).

Lymphocyte-depleted Hodgkin disease is composed predominantly of histiocytes and lymphocytes with varying numbers of eosinophils and Reed-Sternberg cells ([Fig. 95.8](#) and [Fig. 95.9](#)). The host reaction is often scant relative to the number of malignant giant cells, making the diagnosis of Hodgkin disease difficult. A varying amount of fibrosis is generally present, and the original Lukes and Butler classification defined two forms of lymphocyte-depleted Hodgkin disease: reticular and diffuse fibrosis. The reticular subtype is composed of sheets of pleomorphic cells and resembles a large transformed cell non-Hodgkin lymphoma. The disease is the least common type of Hodgkin disease and tends to be advanced at diagnosis (i.e., stage III or IV). Most patients have B symptoms ([71](#)), retroperitoneal nodal involvement is common, and approximately one-half of patients have bone marrow involvement ([72](#), [73](#) and [74](#)). Because of the advanced stage of most patients, this subtype of Hodgkin disease has the worst prognosis, but advanced disease is probably as curable with chemotherapy as other histologies of Hodgkin disease. Many cases that would previously have been diagnosed as lymphocyte-depleted Hodgkin disease are now classified as peripheral T-cell lymphomas ([43](#)) or anaplastic large cell lymphomas ([75](#), [76](#)). As a result, any information regarding lymphocyte-depleted Hodgkin disease based on pathologic evaluations performed before 1985 must be regarded with caution.

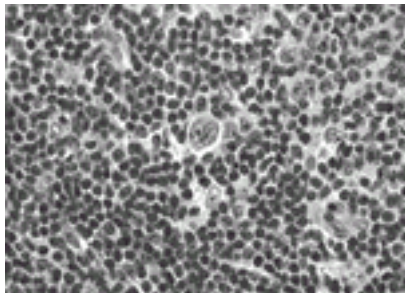


**Figure 95.8.** Lymphocyte-depleted type Hodgkin disease, diffuse fibrosis subtype. Low magnification shows depletion of cellularity of node and scattered large dysplastic cells. See [Color Plate](#).



**Figure 95.9.** Lymphocyte-depleted type Hodgkin disease, diffuse fibrosis subtype. Reed-Sternberg cells are easily found, and the background is depleted of cellularity and composed of amorphous eosinophilic connective tissue. See [Color Plate](#).

Because lymphocyte-predominant Hodgkin disease appears to be a B-cell neoplasm in most cases, the Revised European-American Lymphoma Classification system has proposed that Hodgkin disease be divided into nodular lymphocyte-predominant Hodgkin disease (NLPHD) and four types of “classic” Hodgkin disease: nodular sclerosis, mixed cellularity, lymphocyte-depleted, and lymphocyte-rich classic Hodgkin disease (LRCHD) ([77](#)). This latter category is considered a provisional category that includes cases of Hodgkin disease in which the background is primarily lymphocytes but in which the tumor cells have the characteristics of classic Reed-Sternberg cells (i.e., they are CD30 or CD15 positive but negative for the B-cell marker CD20) ([Fig. 95.10](#)).



**Figure 95.10.** Lymphocyte-rich “classic” Hodgkin disease. The background is primarily lymphocytes, and the Reed-Sternberg cells are usually CD15 and CD30 positive and negative for the B-cell marker CD20. See [Color Plate](#).

Although this separation of lymphocyte-predominant Hodgkin disease into two entities makes biologic sense, at the time this division was proposed, there were no clinical data supporting the relevance of the distinction. Since that time, a retrospective study of 426 cases initially classified as lymphocyte-predominant Hodgkin disease was reported ([78](#)). Of the 426 cases, adequate tissue was available for review in 379 cases. Of these 379 cases, 58% were reclassified as lymphocyte-predominant Hodgkin disease, 30% were classified as LRCHD, 5% were classified as other types of classic Hodgkin disease, 3% were classified as non-Hodgkin lymphoma, and 4% were considered to be reactive processes.



Both NLPHD and LRCHD patients had predominantly early stage disease: 81% were stage I and II disease for NLPHD, and 70% were stage I and II disease for LRCHD. Patients with LRCHD were significantly older (43 years of age vs. 35 years of age) and were more likely to have a mediastinal mass (15% vs. 7%). Disease-free survival and overall survival were similar for the two groups and similar to survival among patients with other types of Hodgkin disease and limited stage disease. The one difference of note was that multiple relapses occurred in 27% of patients with NLPHD and only 5% of patients with LRCHD. Because therapy in Hodgkin disease is generally based on stage rather than on histologic subtype, the clinical implications of these findings are not clear. However, these preliminary observations support efforts to distinguish NLPHD from LRCHD.

## CELL OF ORIGIN

The recognition that lymphomas are tumors of the immune system and could be rationally classified with respect to the cell of origin represented a major advance in the scientific classification of non-Hodgkin lymphoma. In the case of Hodgkin disease, however, this has led to controversy and confusion because, until recently, studies regarding the cell of origin of Hodgkin disease have yielded inconsistent results.

The Reed-Sternberg cell is presumed, but not proven, to be the malignant cell of origin of Hodgkin disease ([79](#)). It has been postulated at various times that the Reed-Sternberg cell is a B cell, a T cell, a histiocyte, or an interdigitating reticulum cell ([80](#), [81](#), [82](#), [83](#), [84](#) and [85](#)), and this complex area of research and speculation has been the subject of reviews ([86](#), [87](#)). Because the Reed-Sternberg cell represents only a minority of the cells in Hodgkin disease, work regarding the origin of the Reed-Sternberg cell has been difficult. However, recent studies have shown that some Reed-Sternberg cells express B-cell antigens, such as CD19, CD20, and CD22 ([88](#), [89](#), [90](#), [91](#) and [92](#)), or T-cell antigens, such as CD2, CD3, or CD4 ([88](#), [93](#)), whereas other Reed-Sternberg cells appear to lack markers of either cell lineage. The antigens most commonly associated with Hodgkin disease, CD15 (Leu M-1) and CD30 (Ki-1), do not help clarify the origin of the Reed-Sternberg cell because these antigens are not lineage specific. CD15 is present on normal granulocytes, and CD30 has been found on activated T cells and B cells and EBV-transformed cell lines, as well as on the malignant lymphocytes of anaplastic large cell lymphoma.

Reed-Sternberg cells have also been tested for gene rearrangements in an attempt to document the cell of origin. In a summary of published data ([94](#)), it was found that the majority of cases were germline in configuration, 14% demonstrated an immunoglobulin gene rearrangement, and 6% demonstrated T-cell receptor gene rearrangements. Another study of immunoglobulin gene rearrangement in patients with Hodgkin disease yielded the unexpected finding that although some cases of Hodgkin disease showed monoclonal rearrangements of immunoglobulin genes, other cases appeared to be polyclonal ([95](#)). However, this apparent polyclonality may be a technical artifact, as single-cell polymerase chain reaction studies have supported the association between Hodgkin disease and monoclonal immunoglobulin gene rearrangements ([96](#)).

Cytogenetic studies have not been helpful in establishing a cell of origin for Hodgkin disease. Because the Reed-Sternberg cell comprises a small proportion of the cells in Hodgkin disease, there is a technical problem in that any cytogenetic study largely involves benign reactive cells. Therefore, it is not surprising that most studies of chromosomes in Hodgkin disease have yielded normal results, although abnormal cytogenetic findings have been reported ([97](#), [98](#), [99](#), [100](#) and [101](#)). By combining the

techniques of fluorescence immunophenotyping with interphase cytogenetic analysis, chromosomes of CD30<sup>+</sup> cells can be studied. When this was done, numerical chromosome abnormalities were detected in the majority of CD30<sup>+</sup> cells in all 30 cases studied (102). However, as with other cytogenetic studies, no chromosomal abnormalities specific for Hodgkin disease have been identified.

The best data for a cell of origin for the Reed–Sternberg cell relate to the nodular variation of lymphocyte–predominant Hodgkin disease in which the cells consistently express CD20 and appear to be of B–cell origin (103, 104). Additionally, in this subtype of Hodgkin disease, monoclonal light chain mRNAs have been demonstrated within the Reed–Sternberg cells (104). Data for other subtypes of Hodgkin disease are less definitive. Whereas earlier studies demonstrated a trend for nodular sclerosis Hodgkin disease and mixed cellularity Hodgkin disease to express T–cell antigens (85, 93), more recent data have supported a B–cell origin for the majority of cases of classic Hodgkin disease (95, 105, 106 and 107).

Further information regarding the cell of origin of Hodgkin disease has come from studies of the well–known, but uncommon, association of Hodgkin disease and follicular non–Hodgkin lymphoma (108). Two reports (95, 109) have studied three patients who had both classic Hodgkin disease and non–Hodgkin lymphoma. In each of the patients, the same monoclonal immunoglobulin gene rearrangement was found in both neoplasms. This finding in cases with two distinct morphologic neoplasms does not establish that the Reed–Sternberg cell in all other cases of Hodgkin disease is of B–cell origin, but it strongly supports the hypothesis that Hodgkin disease is a B–cell neoplasm.

In summary, although the data are somewhat equivocal, recent evidence supports the hypothesis that the cell of origin of Hodgkin disease is a B cell. Clearly, further studies are necessary to clarify what type or types of B cell become a Reed–Sternberg cell. However, regardless of whether Hodgkin disease involves a single cell of origin or represents multiple common biologic pathways, the pathologic picture of Hodgkin disease and the body of clinical data concerning Hodgkin disease clearly justify its consideration as a clinical entity.

## CYTOKINES IN HODGKIN DISEASE

Because the inflammatory response is as much a part of Hodgkin disease as the cell of origin, it is not surprising that investigators have studied potential humoral mediators of the host response to the Reed–Sternberg cell. In studying humoral mediators, investigators have often studied Hodgkin disease–derived cell lines, although recent studies have involved isolated Reed–Sternberg cells. Although studies of cell lines provide a greater opportunity for manipulation, the relevance of such observations to *in vivo* phenomena is unknown.

Interleukin (IL)–1, a cytokine that might explain the fever and night sweats associated with Hodgkin disease, has been demonstrated in Hodgkin disease–derived cell lines (110), as has the CD25 antigen, which is the IL–2–receptor  $\alpha$ –chain. A Hodgkin disease–derived cell line has been described in which both  $\alpha$ – and  $\beta$ –chains of the IL–2 receptor have been detected (111). Tumor necrosis factor (TNF)– $\alpha$  and TNF– $\beta$  have also been shown to be produced by Hodgkin disease cell lines (110). TNF– $\alpha$ , also known as *cachexin*, might explain some of the weight loss associated with Hodgkin disease. Although the mechanism of fibrosis in Hodgkin disease is unknown, production of TNF– $\beta$  has been associated with a Hodgkin disease cell line (112, 113 and 114). TNF receptor–associated factor 1 (TRAF1),



which protects lymphoid cells from apoptosis, has also been shown to be elevated in Hodgkin disease ( [115](#)). Additionally, production of granulocyte colony-stimulating factor and granulocyte-macrophage colony-stimulating factor ( [116](#)), IL-5 ( [117](#), [118](#)), IL-6 ( [118](#), [119](#)), IL-7 ( [120](#)), and IL-13 ( [121](#)) has been shown to occur in Reed-Sternberg cells using mRNA probes or fluorescence *in situ* hybridization. Although this is a promising area for research ( [122](#)), overall, the relationship between these cytokines and the pathogenesis of Hodgkin disease remains speculative.

## CLINICAL EVALUATION

### Physical Examination: Sites of Disease

Staging, the basis for treatment planning in Hodgkin disease, begins with the physical examination. Hodgkin disease almost always presents as lymphadenopathy, and the involved nodes are usually freely movable with a rubbery consistency. Cases in which the microscopic appearance reveals fibrosis or sclerosis can be associated with hard, firm nodes. Although any lymph node group can be involved ( [Table 95.3](#)), cervical and supraclavicular adenopathy are the most common physical findings, and axillary presentations are not rare ( [123](#), [124](#)).

**TABLE 95.3. Frequency of Involvement of Nodal Sites in Hodgkin Disease**

| Site   | Frequency of Involvement (%) | Frequency of Involvement as Only Site of Disease (%) |
|--|------------------------------|--|
| Left cervical and/or supraclavicular nodes   | 70                           | 7  |
| Right cervical and/or supra-clavicular nodes | 62                           | 4  |
| Mediastinum                                  | 60                           | 1  |
| Spleen <sup>a</sup>                          | 36                           | 0  |
| Paraortic nodes <sup>a</sup>                 | 34                           | <1   |
| Left axillary nodes                          | 25                           | 1  |
| Right axillary nodes                         | 25                           | 1  |
| Hilar nodes                                  | 21                           | 0  |
| Iliac, inguinal, femoral nodes               | 16                           | 1  |

<sup>a</sup> Data based on surgically staged patients.

Modified from Kaplan HS. Contiguity and progression in Hodgkin's disease. *Cancer Res* 1971;31:1811-1813; and Kaplan HS, Dorfman RF, Nelsen TS, et al. Staging laparotomy and splenectomy in Hodgkin's disease: analysis of indications and patterns of involvement in 285 consecutive, unselected patients. *Natl Cancer Inst Monogr* 1973;36:291-301.

Mediastinal disease is often present, but it is rarely the only site of disease because it usually occurs in conjunction with cervical or supraclavicular disease. Hodgkin disease can present with iliac, inguinal, or femoral adenopathy, and in approximately 3% of cases, only subdiaphragmatic disease is present ( [125](#), [126](#)). However, in a large series of cases in

which the original diagnosis of Hodgkin disease was not confirmed on review, two features that predicted errors in diagnosis were primary extranodal disease and primary subdiaphragmatic disease ( [127](#) ). Thus, the pathologic diagnosis of Hodgkin disease should be considered very carefully in cases with subdiaphragmatic presentation. A complete physical examination of the patient with Hodgkin disease should include an evaluation of Waldeyer ring and epitrochlear nodes even though these sites are only rarely involved.

Splenomegaly is noted at presentation in approximately 10% of cases of Hodgkin disease. However, splenomegaly may be a nonspecific manifestation of the Hodgkin disease, and in only one-half of patients with splenomegaly is splenic involvement confirmed at laparotomy ( [124](#) ). Additionally, splenic involvement may occur in 20 to 30% of patients in the absence of splenomegaly ( [124](#) ) even when abdominal computed tomography (CT) scans are used to assess splenomegaly by three-dimensional measurements ( [128](#) ). This latter fact should not be surprising, because splenic involvement may be limited to a few microscopic nodules.

Extranodal disease can occur at any site. However, the central nervous system and the testis, which are not uncommon sites for non-Hodgkin lymphoma, are exceptionally rare sites for Hodgkin disease. At presentation, lung, liver, bone, and bone marrow are the most common extranodal sites of disease, with each of these sites seen in approximately 5 to 10% of cases ( [129](#) , [130](#) ). Disease at other individual sites occurs in less than 5% of cases, and as noted previously, primary extranodal Hodgkin disease should always lead the clinician to consider the possibility of an incorrect pathologic diagnosis.

### Pattern of Spread

Hodgkin disease tends to spread in a contiguous fashion ( [123](#) , [131](#) ). In fact, when one considers that the left supraclavicular area and the upper abdomen are contiguous (via the thoracic duct), a contiguous pattern of disease can be established at presentation in more than 90% of cases ( [123](#) ). For patients with only right supraclavicular involvement at presentation, abdominal disease is found in only 8% of cases; for patients with left supra-clavicular involvement at presentation, the incidence of abdominal involvement is 40%. Hilar involvement with Hodgkin disease does not occur unless mediastinal disease is present. Pulmonary involvement by Hodgkin disease does not occur in the absence of mediastinal and hilar involvement ( [132](#) ).

The spleen is the most commonly involved abdominal site of disease, possibly representing hematogenous spread. Liver involvement is uncommon at presentation in patients with Hodgkin disease, and it is exceptionally rare in the absence of splenic involvement ( [123](#) , [133](#) ). Within the abdomen, the pattern of disease detected at staging laparotomy suggests spread from the spleen in a contiguous fashion. In a series in which staging laparotomies were performed with rigorous attention to biopsy of all nodal groups, the spleen and contiguous nodes were involved in 71% of cases, the spleen and noncontiguous nodes were involved in 16% of cases, and lymph nodes were involved in the absence of splenomegaly in 13% of cases ( [134](#) ). It is unknown whether the cases of apparent discontinuous spread represent cases in which early hematogenous dissemination has occurred or cases in which Hodgkin disease has spread through a node without involving the node.

### Symptoms: Clinical History

Key aspects of the history include determining whether the patient has symptoms that have a prognostic significance, as well as focusing on any symptoms that suggest a

specific extranodal site (e.g., bone pain). Proof that extranodal disease is present may lead to a modification of therapy and establishes the need for follow-up studies on completion of treatment. Symptoms that are known to have prognostic value are unexplained fever, drenching night sweats, and weight loss equal to 10% of the patient's weight. Fever in Hodgkin disease can have any pattern, including continuous low-grade fever or occasional fever spikes. The pattern of recurrent episodes of daily high fevers separated by days without fever, Pel-Ebstein fever, was first associated with Hodgkin disease in 1885 ( [135](#), [136](#) ). However, it is uncommon and occurs only in very advanced disease. Because Hodgkin disease generally presents with palpable lymphadenopathy, Hodgkin disease is often not considered in the diagnosis of unexplained fever. However, patients with the lymphocyte-depleted subtype of Hodgkin disease may present with fever and disease limited to retroperitoneal nodes or the bone marrow, or both ( [72](#) ).

Pain at the site of Hodgkin disease in association with the ingestion of alcohol is well described and can be the first hint of a recurrence. The mechanism of this phenomenon is unknown and does not have prognostic significance. The occurrence of alcohol-induced pain has become less common in recent decades, perhaps in association with earlier diagnosis and more effective therapy. Pruritus may be a nonspecific manifestation of Hodgkin disease, but it is not considered when classifying patients as symptomatic or asymptomatic because it has no prognostic implications when it is the sole symptom. Similarly, fatigue and weakness may occur in patients with Hodgkin disease but do not cause a patient with Hodgkin disease to be classified as symptomatic.

Although the staging classification divides patients into categories A and B for asymptomatic and symptomatic, respectively, clinicians are well aware that this binary classification is an oversimplification and that the presence and absence of symptoms vary along a continuum ( [137](#), [138](#) ) with respect to their clinical significance. When patients with stage IB and stage IIB Hodgkin disease were reviewed, it was found that the presence of fevers was associated with a relative risk of relapse after treatment of 4.3. For weight loss alone, the relative risk of relapse after treatment was 2.4; for night sweats, the relative risk of relapse was 0.8 (i.e., not increased) ( [137](#) ). Nevertheless, the presence of symptoms may suggest advanced disease. Symptoms are found in less than 10% of patients with stage I disease and in approximately two-thirds of patients with stage IV disease ( [139](#) ). The presence of B symptoms in a patient with apparent stage I disease is, therefore, highly suggestive that further evaluation will lead to the discovery of more advanced stage disease.

## Staging

The stage of the patient is the main determinant of therapy and prognosis in Hodgkin disease. The current classification system is the Cotswold classification system ( [140](#), [141](#) ) ( [Table 95.4](#) ). Proposed in 1990, it uses the same criteria for defining four stages of Hodgkin disease and for defining symptomatic disease as the Ann Arbor classification system originally proposed in 1971 ( [142](#) ). However, the Cotswold classification system includes many of the modifications, such as anatomic substage of stage III disease, that had been proposed to the Ann Arbor classification system since that system was first proposed. Stage I disease is the involvement of a single lymph node region (or a single lymphoid structure). Stage II disease is the involvement of multiple lymph node regions (e.g., cervical nodes, supraclavicular nodes) but on only one side of the diaphragm. Stage III disease is the involvement of lymph node regions on both sides of the diaphragm and is further subdivided as to anatomic substage. Disease limited to the upper abdomen (i.e., spleen, splenic hilar nodes, celiac nodes, or porta hepatis nodes) in a patient with stage III disease is defined as substage III<sub>1</sub>. Patients with stage III disease in whom abdominal nodal involvement includes paraaortic, iliac, or inguinal nodes are classified as substage III

2. Stage IV disease is visceral involvement (e.g., lung, liver, or bone marrow) that is not due to direct extension from a nodal site. Direct extension from a nodal site, such as extension of a mediastinal mass directly into the lung, is represented by the subscript *E*: II<sub>E</sub> (129). The designations *A* and *B* are used to represent the absence and presence of symptoms (e.g., fever, drenching night sweats, and weight loss of 10% of body weight), respectively. The presence of “bulky” disease, defined as a mediastinal mass with a diameter greater than one-third the diameter of the chest as measured at the T5–T6 interspace on a posteroanterior chest x-ray, or any nodal mass with a greatest diameter of more than 10 cm, is represented by the designation *X* (143, 144). The terms *CS* and *PS* are used to designate *clinical stage* and *pathologic stage*, respectively (i.e., whether the stage has been determined by staging laparotomy or by biopsy of a site that establishes stage IV disease). The relative incidence of each stage of Hodgkin disease is shown in Table 95.5.

**TABLE 95.4. Cotswold Staging Classification for Hodgkin Disease**

|                  |   |
|------------------|---|
| Stage I          | Involvement of a single lymph node region or lymphoid structure (e.g., spleen, thymus, Waldeyer ring)   |
| Stage II         | Involvement of =2 lymph node regions on the same side of the diaphragm (the mediastinum is a single site; hilar lymph nodes are lateralized); number of anatomic sites should be indicated by a suffix (e.g., II <sub>3</sub> ) |
| Stage III        | Involvement of lymph node regions of structures on both sides of the diaphragm  |
| III <sub>1</sub> | With or without splenic hilar, celiac, or portal nodes  |
| III <sub>2</sub> | With paraaortic, iliac, or mesenteric nodes   |
| Stage IV         | Involvement of extranodal site(s) beyond that designated <i>E</i>   |
| A                | No symptoms   |
| B                | Fever, drenching sweats, weight loss  |
| X                | Bulky disease, >1/3 widening of the mediastinum, >10 cm maximum dimension of nodal mass   |
| E                | Involvement of a single extranodal site, contiguous or proximal to a known nodal site   |
| CS               | Clinical stage  |
| PS               | Pathologic stage  |

Modified from Lister TA, Crowther D. Staging for Hodgkin’s disease. *Semin Oncol* 1990;17:696–703.

**TABLE 95.5. Distribution of Hodgkin Disease Cases with Respect to Stage and Symptomatic Status**

| Stage | A (%) | B (%) | A and B (%) |
|-------|-------|-------|-------------|
| I     | 11.4  | 0.8   | 12.2        |
| II    | 34.1  | 12.4  | 46.5        |
| III   | 17.5  | 13.1  | 30.6        |
| IV    | 3.3   | 7.4   | 10.7        |

Total      66.3              33.7                              100.0

Modified from Kaplan HS. Hodgkin's disease, 2nd ed. Cambridge: Harvard University Press, 1980.

---

The purpose of clinical evaluation is not only to determine the stage of the patient as a basis for determining therapy, but also to establish a clinical baseline so that the completeness of remission can be assessed on completion of therapy. Staging should begin with a clinical history and a physical examination. The procedures that constitute the basic clinical evaluation are presented in [Table 95.6](#).

---

**TABLE 95.6. Recommended Staging Procedures for Patients with Hodgkin Disease**

---

History and physical examination

    Special attention to history of B symptoms (i.e., fever, night sweats, weight loss of >10% in past 6 mo)

    Examination of all peripheral lymph node regions, liver, and spleen

Radiologic studies

    Chest x-ray

    CT scan of thorax

    CT scan of abdomen and pelvis

Laboratory studies

    Hematocrit, white blood cell count, differential, platelet count

    Erythrocyte sedimentation rate

    Blood urea nitrogen, creatinine

    Bilirubin, alkaline phosphatase, lactic dehydrogenase, "hepatocellular" enzymes

Bone marrow aspiration and biopsy

Tests to be considered in selected circumstances

    Gallium scan or positron emission tomography scan

    Bone scan

CT, computed tomography.

---

Radiologic studies should include a chest x-ray and CT scans of the chest and abdomen. Thoracic CT scanning is useful in detecting pulmonary disease, pleural disease, pericardial disease, and extension into the chest wall ([132](#), [146](#), [147](#), and [148](#)). If present, these findings are of clinical significance because they may require modifications of the planned radiation ports or may lead to a change in the planned treatment modality from radiation therapy to chemotherapy or from chemotherapy alone to combined modality therapy.

The abdominal CT scan has become the standard approach to evaluating the presence or absence of abdominal Hodgkin disease. Abdominal CT scanning is less sensitive than lymphangiography in detecting abdominal nodal disease because CT scanning can only detect enlarged nodes, rather than detect effacement of internal nodal architecture ([149](#), [150](#) and [151](#)). However, as technical expertise in performing and interpreting

lymphangiography has diminished, the relative merits of the two procedures have become clinically irrelevant. In most settings, abdominal CT scanning has become the only procedure that is available to evaluate retroperitoneal adenopathy. Theoretically, CT scanning can evaluate nodes in the celiac axis, porta hepatis, and the mesentery, sites that are not well evaluated by lymphangiography. However, this advantage is of minimal clinical value because nodal involvement at these sites is often below the size at which CT scans can detect abnormalities ( [152](#) ).

The gallium scan is not specific and its use in evaluating abdominal disease is compromised because uptake can occur in normal liver, spleen, and bowel. Gallium scans have been advocated by some clinicians as an additional means of defining *baseline* involvement of the mediastinum ( [153](#) ), but the major use of the gallium scan has been in evaluating patients who have *residual* mediastinal disease after therapy. However, there has been little evidence regarding whether a positive gallium scan after treatment was likely to represent a true-positive or a false-positive finding. Recently, King et al. ( [154](#) ) reported a series of patients who underwent gallium scanning after completing therapy for Hodgkin disease. Except for residual mediastinal disease, there was no suggestion of tumor persistence or progression. In this series of 33 patients, 13 had a positive gallium scan, of whom 12 relapsed. Twenty patients had a normal scan, and in this group, only two patients relapsed. The positive predictive value (ability of a positive scan to predict relapse) in this series was 93%; the negative predictive value (ability of a negative scan to predict freedom from relapse) was 90%. These results were superior to results achieved with thoracic CT scans, for which the positive predictive value was 48% and negative predictive value was 83%. Because evaluation of patients with radiographic evidence of residual mediastinal disease can be a perplexing clinical problem, confirmation of these findings may establish the role of gallium scanning in the baseline staging as well as the clinical restaging of these patients.

Although preliminary studies have suggested that the use of high-dose gallium-67 single photon emission CT may provide more reliable data in this regard, projected estimates of predictive value are based on clinical assumptions regarding whether scans are true- or false-positives ( [155](#) ). Thus, the role of these scans in the routine staging and evaluation of Hodgkin disease remains uncertain. Similarly, the role of MRI scanning in the staging and reevaluation of Hodgkin disease remains undefined even though MRI scans can detect apparent sites of disease that are missed by thoracic CT scans ( [156](#) ).

More recent studies have supported the value of whole body PET (positron emission tomography) scanning using 18-fluorodeoxyglucose in the diagnosis of residual masses in patients with Hodgkin disease ( [157](#) , [158](#) and [159](#) ). In one study of 34 patients who had completed therapy for Hodgkin disease or non-Hodgkin lymphoma, 17 were found to have negative PET scans, and all of these patients remained disease free for a median follow-up of 62 weeks ( [157](#) ). In 17 patients, PET scans were positive on completion of therapy. In 7 of these 17 patients, the significance of the PET scan could not be determined because a biopsy was not performed and therapy was given when the results of the PET scan were noted. In seven of the other ten patients with positive PET scans, Hodgkin disease was confirmed by biopsy either at the time of the PET scan or shortly thereafter. Clearly, among patients with residual mediastinal masses on CT scans after the completion of therapy, the risk of relapse is greater among patients who have positive PET scans. However, relapses can occur in patients who have negative PET scans. Also, it is not clear what percent of patients with a positive PET scan have false-positive tests. Further clarification of the false-positive and false-negative rates will help define the role of PET scans in the staging and restaging of Hodgkin disease. Because follow-up PET scans are of value in determining the nature of residual masses detected by CT scans, a baseline PET scan should be obtained, when possible, to prove that the tumor is PET positive if there is a high likelihood that a follow-up PET scan will be performed on



completion of therapy.

Although generally supplanted by the more easily performed abdominal CT scan, lymphangiography can detect nodes that are not enlarged (and therefore not detectable by CT scan) but in which Hodgkin disease has disrupted the internal architecture of the node. Lymphangiography is generally uninterpretable in the inguinal regions and only visualizes nodes in the lower abdomen, below the level of the second lumbar vertebrae. The major drawback to lymphangiography is that the validity of the test is highly dependent on the physician who performs the procedure and who interprets the radiologic films. Thus, data in the literature citing an 80 to 90% accuracy of lymphangiography as reported from centers performing the test routinely in past decades ( [149](#), [152](#), [160](#), [161](#) ) are of limited relevance to a clinician at an institution where the procedure is not often used. At the present time, most institutions have either limited experience or no experience with lymphangiography. In such circumstances, a negative lymphangiogram may all but exclude disease in the lower abdominal lymph nodes, but a positive lymphangiogram may have a predictive value as low as 35% ( [162](#) ). Thus, despite its potential for providing useful information, lack of familiarity with the procedure and subjectivity of interpretation have made lymphangiography a technique of historical interest rather than a major part of clinical care. If lymphangiography is performed, the procedure should not be undertaken until after the chest x-ray film has been reviewed, as the procedure invariably causes embolization of dye to the lungs and thus may be tolerated poorly in patients with coexistent pulmonary disease or with extensive pulmonary or mediastinal involvement by Hodgkin disease.

Blood tests performed in the evaluation of the patient with Hodgkin disease should include a hematocrit, white blood cell count, and differential, as well as an erythrocyte sedimentation rate (ESR). Anemia is present at diagnosis in approximately 40% of patients with Hodgkin disease ( [139](#) ) and is more commonly observed in advanced stages of disease. The anemia is generally the normochromic normocytic anemia of chronic disease and is usually mild (i.e., hemoglobin between 10 and 12 g/dl). Coombs-positive hemolytic anemia has been reported in Hodgkin disease ( [163](#) ) but is rarely seen at diagnosis.

Mild leukocytosis, monocytosis, and lymphopenia may occur in patients with Hodgkin disease. As with anemia, the phenomena are more commonly seen in patients with advanced disease. Although the ESR has been shown to be a statistically significant predictor of relapse when CS stage I and II patients receive radiation therapy ( [164](#) ), the test has never been included in formal staging classifications. An unexplained rise in the ESR after therapy has been shown to be an indicator of relapse ( [165](#), [166](#) ). However, the test is nonspecific, and although an elevated ESR may justify evaluating a patient for the possibility of relapse, an elevated ESR, in itself, does not mean recurrent disease.

Similarly, elevated levels of  $\beta_2$ -microglobulin ( $\beta_2$ M) at presentation have been associated with a lower rate of relapse-free survival ( [167](#) ). Although levels of  $\beta_2$ M are more commonly elevated in patients with advanced disease,  $\beta_2$ M is a predictor of relapse even when patients are stratified by stage ( [167](#) ).

A bone marrow aspiration and biopsy should also be performed as part of initial staging, although these tests are rarely positive unless other evidence of advanced disease (at least stage III) is present ( [130](#), [168](#) ). The majority of patients with bone marrow involvement have B symptoms as well as abnormal blood counts ( [130](#), [168](#) ). Nevertheless, a bone marrow biopsy should be obtained at baseline in all patients because the results may not only influence the choice of initial therapy but also affect future decisions at the time of relapse [e.g., a decision on the feasibility of autologous bone marrow



transplantation (ABMT)]. Bone marrow involvement correlates with histologic subtype of Hodgkin disease because bone marrow involvement is seen more often in the mixed cellularity and lymphocyte-depleted subtypes of Hodgkin disease ( [74](#), [130](#), [168](#) ). Whereas the diagnosis of Hodgkin disease at extranodal sites generally requires the presence of Reed-Sternberg cells, this is not required for the diagnosis of Hodgkin disease involving the bone marrow. Reed-Sternberg cells are seen in the bone marrow of only two-thirds of cases of Hodgkin disease determined to have bone marrow involvement. The presence of marrow fibrosis in a patient with an established diagnosis of Hodgkin disease has long been accepted as a sufficient pathologic criterion for bone marrow involvement ( [130](#) ).

Biochemical tests that are routinely performed should include renal function tests (blood urea nitrogen and creatinine) and tests of hepatic status (bilirubin, albumin, lactate dehydrogenase, and hepatocellular enzymes). These latter tests are not specific for Hodgkin disease involving the liver and may be elevated as a nonspecific manifestation of Hodgkin disease or due to intercurrent problems. Therefore, the only means of establishing a diagnosis of Hodgkin disease involving the liver is to perform a liver biopsy.

In past years, a major controversy with respect to staging involved the performance of staging laparotomy ( [127](#), [169](#), [170](#) ). Staging laparotomy includes inspection of the abdomen, liver biopsies (wedge biopsy of the left lobe as well as needle biopsy of both lobes), splenectomy, and systematic biopsies of splenic hilar, celiac, porta hepatis, mesenteric, paraaortic, and iliac lymph nodes. Staging laparotomy is the most accurate means of determining the extent of abdominal involvement by Hodgkin disease. However, the major lesson from staging laparotomy is that the procedure is not needed as part of standard staging. Staging laparotomy can only be justified if the findings at laparotomy will improve the results of therapy. Given the available clinical options, including effective salvage therapy, there is no reason to suspect that staging laparotomy will lead to better long-term results than can be achieved with clinical staging, and there is certainly no evidence that it does so. As a result, in clinical practice, treatment is almost always based on clinical staging—including CT scans—without performing either a staging laparotomy or a lymphangiogram.

The early studies of staging laparotomy revealed that as many as one-third of patients with CS I or II disease were found to have abdominal disease at laparotomy and were therefore upstaged to stage III disease ( [127](#) ). This seemed a particularly cogent argument for performing routine staging laparotomy until reexamination of the data showed that for the majority of patients, this abdominal disease was limited to the upper abdomen (substage III<sub>1</sub>). Extended field radiation therapy, as might be given in the absence of a laparotomy, would likely be adequate to treat these patients. Thus, the percentage of patients who might benefit from laparotomy is much less than the percentage of patients whose stage would change by doing the procedure.

Some clinicians have advocated selective use of laparotomy and have noted that there are many subsets of patients for whom laparotomy is especially unlikely to change the CS ( [171](#), [172](#) ). For example, among patients with CS I disease, women, patients of either gender with disease limited to the mediastinum, and men with lymphocyte-predominant disease have such a low probability of having abdominal disease (<5%) that radiation therapy without laparotomy represents a justifiable strategy. Among patients with CS II disease, women younger than 27 years of age with fewer than three supradiaphragmatic sites are reasonable candidates for radiation therapy without staging laparotomy.

Staging laparotomy is associated with complications including pneumonia, pulmonary emboli, small bowel obstruction, wound infection, pancreatitis, and ileus in approximately 10% of patients ( [173](#), [174](#) and [175](#) ). Mortality has been zero in several published series ( [173](#),

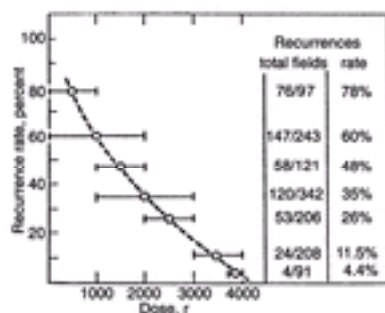
176), and even outside of major centers, the mortality should be less than 1%. However, the procedure places patients at an increased life-long risk of fatal sepsis due to *Streptococcus pneumoniae* and *Haemophilus influenzae* (177). These latter risks can be diminished, but not eliminated, by vaccination. Thus, even though staging laparotomy can provide some information about the extent of Hodgkin disease within the abdomen, it is no longer part of the routine staging of the patient with Hodgkin disease.

## Prognosis

As noted above, stage is the major prognostic factor in Hodgkin disease and the major basis on which therapy is determined. However, just as the international prognostic index has been used to stratify risk in patients with non-Hodgkin lymphoma, patients with Hodgkin disease can be stratified for risk on the basis of prognostic factors in addition to stage. In a study of 5141 patients with “advanced” Hodgkin disease, primarily stage III and IV disease, Hasenclever and associates (178) performed a multivariate analysis of risk factors. Seven independent factors that predicted freedom from progression (FFP) were identified: albumin less than 4.0 g/dl; hemoglobin less than 10.5 g/dl; male sex; 45 years of age or more; stage IV disease; leukocytosis at or above 15,000/mm<sup>3</sup>; and lymphocytopenia (lymphocytes =600/mm<sup>3</sup> and/or lymphocytes <8% of total white count). For patients with no risk factors (7% of all patients), FFP was 84%. For patients with one risk factor (22% of all patients), FFP was 77%. For patients with two risk factors (29% of all patients), FFP was 67%. For patients with three risk factors (23% of all patients), FFP was 60%. For patients with four risk factors (12% of all patients), FFP was 51%. For patients with five or more risk factors (7% of all patients), FFP was 42%. Of note, B symptoms did not have independent prognostic value in this model. Prospective use of this stratification system is needed to establish its clinical value.

## OVERVIEW OF RADIATION THERAPY

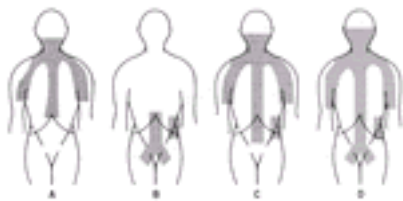
Six years after the discovery of x-rays by Roentgen in 1895, Pusey reported that x-rays could shrink enlarged nodes in patients with Hodgkin disease (179). However, given the orthovoltage techniques of the day, therapy was only palliative. The modern radiotherapy era began with the Swiss radiotherapist Gilbert in 1925 (180). Based on observed patterns of spread in patients with Hodgkin disease, Gilbert advocated treatment of both involved areas and adjacent apparently uninvolved areas. This approach was also adopted by Vera Peters who, in 1950, was the first to report that radiation therapy of Hodgkin disease could produce cures (181). Over the next two decades, the curability of Hodgkin disease was confirmed by Peters (182, 183), Eason and Russell (184), and Kaplan (185, 186), the latter investigator establishing the critical relationship between radiation dose and the risk of recurrence in the treatment field (Fig. 95.11).



**Figure 95.11.** Rate of recurrence in a given treatment field as a function of radiation dose delivered to that field. (From Kaplan HS. Evidence for a tumoricidal dose level in the radiotherapy of Hodgkin disease. *Cancer Res* 1966;26:1221–1224, with permission.)

Kaplan demonstrated that cure could be achieved within a given treatment field 95% of the time if a dose of 35 Gy was administered in 4 weeks and that cure within a given field could be achieved 98% of the time at a dose of 40 Gy ( [186](#) ). Because the response in each treatment field is independent, use of large treatment fields in patients with multiple sites of disease can be curative, although at a somewhat lower rate. For example, treatment of five areas (bilateral supraclavicular/cervical nodes, bilateral axillary nodes, mediastinum) would be projected by Kaplan's data to have a cure rate of  $0.98^5$  or 90% if 40 Gy were delivered to each field and a cure rate of  $0.95^5$  or 77% if 35 Gy were delivered to each field. From these calculations, it is easily seen how critical it is to deliver the appropriate dose to all involved areas when large fields are treated.

As originally suggested by Gilbert, the principle of treating involved and adjacent apparently noninvolved areas (i.e., extended field therapy) has become the standard radiotherapeutic approach to Hodgkin disease. With the advent of staging laparotomy and evidence that the retroperitoneum could represent a potentially involved adjacent area of disease, the concept of extended field therapy came to include the standard mantle, paraaortic/splenic, and pelvic radiation ports shown in [Figure 95.12](#) ( [187](#) ).



**Figure 95.12.** Treatment fields used as extended field irradiation of Hodgkin disease. **A:** Mantle field. **B:** Inverted Y field. **C:** Mantle and paraaortic field (extended mantle field). **D:** Total nodal field. The spleen is irradiated in conjunction with the fields in (B), (C), and (D), unless it has been surgically removed.

For the majority of patients who present with disease above the diaphragm, extended field therapy includes both the mantle and the paraaortic/splenic ports ( [Fig. 95.12](#) ). These ports are treated sequentially at many institutions but may be treated simultaneously as an “extended mantle port” ( [188](#) ), which obviates the need to match radiation fields over the spinal cord. For patients presenting with disease below the diaphragm, “inverted Y” therapy, which combines pelvic and paraaortic/splenic fields, is generally given. Sequential administration of all three fields constitutes total nodal radiotherapy (TNRT). Although TNRT may be used to treat stage III disease, the effectiveness of chemotherapy in patients who would otherwise be candidates for TNRT has limited the number of patients with Hodgkin disease receiving TNRT in recent years.

Optimal results using radiation therapy depend on careful staging and attention to technique ( [189](#) , [190](#) and [191](#) ). Technical aspects of radiation therapy have been well covered in reviews ( [192](#) , [193](#) ), but major principles of radiation therapy deserve emphasis. Attention must be paid to shaping fields with lead blocks to shield normal tissues (heart, lung, marrow, liver, and kidneys) while radiating involved and adjacent areas ( [193](#) ). Individualized lead shields should be constructed for each patient and may need to be modified during

treatment. For example, in a patient with a large mediastinal mass that shrinks during therapy, failure to modify the treatment ports might lead to delivery of a greater-than-intended dose to normal lung. Verification port films, generated by the treatment equipment, should be obtained to ensure proper alignment ( [193](#) ). Daily doses should not exceed 180 to 200 cGy, with a total dose of 35 to 44 Gy recommended for involved areas and 30 to 36 Gy recommended for adjacent clinically uninvolved areas ( [193](#) ). In treating the mantle port, equal delivery of dose from anterior and posterior fields is essential to limit the risk of pericardial and myocardial injury, which was substantial when this was not standard practice ( [194](#) ). A 6- to 10-MeV linear accelerator should be used to permit treatment of large fields at a distance that limits skin toxicity. If the spleen is treated, the entire spleen must be included in the therapeutic port. Thus, one advantage of staging laparotomy is that there is decreased radiation of the left kidney and the base of the left lung.

Complications of radiation therapy depend on technique, dose, and the volume of irradiated tissue. Common complications include hair loss within the treatment fields, radiation pneumonitis, radiation pericarditis, mediastinal fibrosis, and pulmonary fibrosis. Symptoms of radiation pneumonitis generally occur within 1 to 3 months of completing therapy and are nonspecific because they include dyspnea, cough, and fever. Such complications are rarely seen at lung doses less than 15 Gy and occur in less than 5% of patients receiving routine mantle irradiation. The presence of a large mediastinal mass or the concomitant use of chemotherapy essentially doubles the risk of radiation pneumonitis ( [195](#), [196](#) ). Although infection and recurrent Hodgkin disease must be considered in the differential diagnosis of radiation pneumonitis, radiation injury is likely to be confined to the area of the lung that was irradiated. Infiltrates with sharp borders, representing the edge of the radiation field, strongly suggest the presence of radiation pneumonitis. Because Hodgkin disease and its therapy are both associated with immunosuppression, whenever radiation injury is considered in the differential diagnosis of a patient with Hodgkin disease, one must also consider the diagnosis of *Pneumocystis carinii* pneumonia.

Cardiac toxicity of radiation therapy can include myocarditis, arrhythmias, pericarditis (including constrictive pericarditis and tamponade), valvular heart disease, and coronary artery disease ( [197](#), [198](#), [199](#), [200](#), [201](#), [202](#), [203](#), [204](#), [205](#), [206](#), [207](#) and [208](#) ). Although an increased risk of myocardial infarction appears to exist after radiation therapy ( [207](#) ), this risk is greater for patients who received radiation therapy before 1966, suggesting that modern treatment techniques have minimized this risk.

Spinal cord injury should not occur with modern radiation therapy techniques but may occur if radiation fields overlap. Splicing of fields over the spinal cord should be done with great care. The one neurologic problem that may occur despite the use of appropriate technique is the Lhermitte sign ( [139](#) ), which includes numbness and tingling in the arms, legs, or both and electrical sensations up and down the spine made worse by flexion of the head. This complication is usually transient and of no clinical consequence.

It is generally recognized that splenectomy, performed as part of staging laparotomy, places patients at risk of sepsis with encapsulated organisms. Less well recognized, but as well documented, is that administration of standard radiotherapy doses to the spleen as part of therapy for Hodgkin disease can produce functional hyposplenism. In an autopsy series of patients treated with splenic radiation, median splenic weights were significantly reduced, 75 g versus 210 g, in patients who had received radiotherapy to the spleen ( [209](#) ). Liver-spleen scans have confirmed functional hyposplenism in patients after radiotherapy ( [210](#) ), and the clinical significance of the phenomenon has been confirmed by the reporting

of fatal pneumococcal sepsis after splenic radiotherapy ( [209](#) ).

Hypothyroidism is a common complication of radiation therapy ( [211](#) ), with actuarial analysis indicating that 52% of patients develop hypothyroidism 20 years after radiation ( [211](#) ). Thyroid cancer is an uncommon complication, but, based on the hypothesis that chronic elevations of thyroid-stimulating hormone in patients after thyroid irradiation may lead to thyroid tumors, the administration of thyroid replacement has been advocated in patients with an elevated thyroid-stimulating hormone even if they are clinically euthyroid ( [211](#) ).

In addition to thyroid cancer, an increased risk of second malignancies, including lung cancer ( [212](#), [213](#) ), stomach cancer ( [212](#) ), melanoma ( [212](#), [214](#) ), and breast cancer ( [215](#), [216](#) and [217](#) ), has been noted in patients receiving radiation therapy for Hodgkin disease. These malignancies generally occur 10 to 20 years after radiation therapy, with the risk of second malignancies being increased in patients who have also received chemotherapy. Patients who received radiation therapy for Hodgkin disease have a disproportionate tendency for tumors to develop in the medial (radiated) area of the breast, as compared with the location of breast cancers in women who have never received radiation ( [216](#) ). Additionally, the relative risk of breast cancer secondary to radiation is age related. The relative risk of developing breast cancer is 38 for patients radiated before age 20; the relative risk is 17 for patients radiated between the ages of 20 and 29; the relative risk is 4 for patients radiated after the age of 30, a relative risk that is not significantly different from 1 ( [215](#) ). Fortunately, the baseline risk of breast cancer in patients younger than age 30 is low, muting the quantitative impact of this increase in relative risk. Nevertheless, it has been recommended that women who receive radiation therapy for Hodgkin disease should receive mammography starting 8 years after completion of therapy because 95% of such tumors occur more than 10 years after radiation ( [216](#) ).

## OVERVIEW OF CHEMOTHERAPY

The development of cancer chemotherapy arose from the observation of lymph node necrosis in soldiers exposed to nitrogen mustard gas during World War I. Therefore, it is not surprising that Hodgkin disease and non-Hodgkin lymphoma were among the first disorders treated with nitrogen mustard when the drug was developed for therapeutic use ( [218](#), [219](#) ). Since then, several chemotherapeutic agents in several classes of drugs have been shown to be effective in Hodgkin disease. Single agents generally produced partial rather than complete remissions, and unmaintained remissions rarely lasted more than 3 months, with maintained remissions lasting 8 to 10 months ( [Table 95.7](#) ) ( [220](#), [221](#), [222](#) and [223](#) ). During the 1960s, efforts were made to combine effective agents ( [224](#) ), culminating in the landmark demonstration by DeVita et al. that MOPP [Mustargen (mechlorethamine), Oncovin (vincristine), procarbazine, and prednisone] combination chemotherapy could cure advanced Hodgkin disease ( [225](#) ). In the initial publication reporting results achieved with the MOPP regimen ( [226](#) ), 81% of patients with advanced Hodgkin disease achieved a complete remission, and by actuarial analysis, 47% were projected to be long-term disease-free survivors. Follow-up studies ( [227](#), [228](#) ) confirmed that these long-term disease-free survivals were equivalent to cure and projected cure rates of 56% ( [228](#) ).

**TABLE 95.7. Results of Single Agent Therapy in Hodgkin Disease**

---

| Agent                     | Representative Dose and Route                    | Response Rate (%) |           |
|---------------------------|--|-------------------|-----------|
|                           |  | CR                | CR and PR |
| Nitrogen mustard          | 0.2–0.4 mg/kg IV, q4–6wk                         | 13                | 65        |
| Vincristine               | 0.2 mg/kg/wk IV                                  | 36                | 58        |
| Procarbazine              | 50–150 mg/kg/d PO                                | 38                | 69        |
| Prednisone                | 40–60 mg/d PO                                    | 0                 | 61        |
| Cyclophosphamide          | 2 mg/kg/d PO                                     | 12                | 54        |
| Chlorambucil              | 0.2 mg/kg/d PO                                   | 16                | 60        |
| Vinblastine               | 0.2 mg/kg/wk IV                                  | 30                | 68        |
| Bischloroethylnitrosourea | 100–200 mg/m <sup>2</sup> IV, q6wk               | 4                 | 47        |
| Doxorubicin               | 30–60 mg/m <sup>2</sup> IV, q3–4wk               | 8                 | 41        |
| Bleomycin                 | 5 mg/m <sup>2</sup> IV, varying schedules        | 6                 | 37        |
| DTIC                      | 200 mg/m <sup>2</sup> IV, daily × 5, variable    | 6                 | 56        |
| Etoposide                 | 50–120 mg/m <sup>2</sup> IV, daily × 5, variable | 7                 | 25        |
| Cisplatin                 | 75 mg/m <sup>2</sup> IV, q3–4wk                  | 8                 | 35        |

CR, complete response; PR, partial response.

Modified from Kaplan HS. Hodgkin's disease, 2nd ed. Cambridge: Harvard University Press, 1980:199–201.

This study of MOPP in advanced Hodgkin disease ([226](#)) established combination chemotherapy as the treatment of choice for advanced Hodgkin disease ([Table 95.8](#)) ([226](#), [227](#), [228](#), [229](#), [230](#), [231](#), [232](#), [233](#), [234](#), [235](#), and [236](#)). Additionally, by demonstrating the cumulative and synergistic efficacy of combining drugs with different mechanisms of action and—to a degree—separate toxicities, it established the rationale for the use of combination chemotherapy in other malignancies. The study also raised two issues that have remained critically important to the present day. If combination chemotherapy is the optimal approach to advanced Hodgkin disease, what specific regimen is the optimal regimen and what specific stage or stages of disease should be considered “advanced”? These issues are addressed in the sections on therapy for Hodgkin disease.

**TABLE 95.8. Combination Chemotherapy Regimens Effective in the Treatment of Hodgkin Disease**

| Regimen (Drugs)  | Recommended Dose (mg/m <sup>2</sup> ) | Route | Days |
|------------------|---------------------------------------|-------|------|
| <b>MOPP</b>      |                                       |       |      |
| Nitrogen mustard | 6                                     | IV    | 1, 8 |
| Vincristine      | 1.4                                   | IV    | 1, 8 |
| Procarbazine     | 100                                   | PO    | 1–14 |
| Prednisone       | 40                                    | PO    | 1–14 |
| <b>MVPP</b>      |                                       |       |      |
| Nitrogen mustard | 6                                     | IV    | 1, 8 |



|  |     |    |       |
|--|-----|----|-------|
| Vinblastine  | 6   | IV | 1, 8  |
| Procarbazine   | 100 | PO | 1–14  |
| Prednisone   | 40  | PO | 1–14  |
| <b>BCVPP</b>   |     |    |       |
| Bischloroethylnitrosourea (Carmustine)                     | 100 | IV | 1     |
| Cyclophosphamide   | 600 | IV | 1     |
| Vinblastine  | 5   | IV | 1     |
| Procarbazine   | 50  | PO | 1     |
|  | 100 | PO | 2–10  |
| Prednisone   | 60  | PO | 1–10  |
| <b>ChIVPP</b>  |     |    |       |
| Chlorambucil   | 6   | PO | 1–14  |
| Vinblastine  | 6   | IV | 1, 8  |
| Procarbazine   | 100 | PO | 1–14  |
| Prednisone   | 40  | PO | 1–14  |
| <b>ABVD</b>  |     |    |       |
| Doxorubicin  | 25  | IV | 1, 15 |
| Bleomycin  | 10  | IV | 1, 15 |
| Vinblastine  | 6   | IV | 1, 15 |
| Dacarbazine  | 375 | IV | 1, 15 |
| <b>MOPP/ABVD alternating</b>                               |     |    |       |
| Alternating months of MOPP and ABVD, administered as above |     |    |       |
| <b>MOPP/ABV hybrid</b>                                     |     |    |       |
| Nitrogen mustard   | 6   | IV | 1     |
| Vincristine  | 1.4 | IV | 1     |
| Procarbazine   | 100 | PO | 1–7   |
| Prednisone   | 40  | PO | 1–14  |
| Doxorubicin  | 35  | IV | 8     |
| Bleomycin  | 10  | IV | 8     |
| Vinblastine  | 6   | IV | 8     |
| <b>VBM</b>   |     |    |       |
| Vinblastine  | 6   | IV | 1, 8  |
| Bleomycin  | 10  | IV | 1, 8  |
| Methotrexate   | 30  | IV | 1, 8  |

NOTE: Each cycle lasts 28 days.

---

Just as there are technical considerations with respect to radiation therapy for Hodgkin disease, there are critical technical factors with respect to the use of chemotherapy in patients with Hodgkin disease. Standard chemotherapy regimens should not be altered arbitrarily without considering that reductions in dose may decrease the possibility for cure. Although it is generally stated that chemotherapy of Hodgkin disease requires six cycles of chemotherapy, the actual data indicate that one should administer a *minimum* of six cycles of chemotherapy and should treat until a complete remission, or maximal response, is achieved and then treat for two additional cycles ( [225](#), [226](#) ). If this policy is used, approximately one-fourth of patients receiving combination chemotherapy will receive more than six cycles. Although adding additional cycles to induction therapy is



standard treatment of Hodgkin disease, there is no evidence that routine consolidation or maintenance therapy has any clinical benefit in patients with Hodgkin disease ( [227](#), [237](#) ).

The primary toxicity of combination chemotherapy is hematologic, with neutropenia being more common than thrombocytopenia. Drug toxicity tends to be cumulative, with neutropenia having an increased degree and duration with each cycle of chemotherapy. Because there is evidence that giving the greatest dose over the shortest period is essential to achieving the best therapeutic results ( [228](#), [231](#), [238](#), [239](#) ), it is reasonable to support patients with granulocyte colony-stimulating factor to avoid delays of therapy. Drug doses should not be modified for minimal cytopenias (i.e., white blood cell counts  $>3000/\text{mm}^3$  or platelet counts  $>100,000/\text{mm}^3$  ).

Additional toxicity depends on the individual drugs used. Neurotoxicity with vincristine is generally limited to mild sensory neuropathy (tingling of fingers and toes). This should not lead to dose modifications unless the sensory neuropathy involves the entire fingers. Motor neuropathy and obstipation are indications for dose reduction, but to limit the need for this dose modification, patients receiving vincristine should receive prophylactic laxatives. Some clinicians cap the vincristine dose at 2.0 or 2.5 mg regardless of patient size, but there is no evidence that this can be done without compromising results. Alternatively, there is evidence that the efficacy of vincristine in Hodgkin disease is dose related ( [228](#), [238](#) ).

Bleomycin may produce pulmonary fibrosis, and doxorubicin may produce cardiac toxicity. However, these toxicities are related to total dose administered. Bleomycin lung toxicity is seen in approximately 10% of patients receiving more than  $250 \text{ mg}/\text{m}^2$  of bleomycin ( [240](#) ); clinical evidence of cardiac toxicity is observed in a similar percentage of patients receiving more than  $450 \text{ mg}/\text{m}^2$  of doxorubicin ( [241](#), [242](#) and [243](#) ). Thus, these toxicities are uncommon even when ABVD [Adriamycin (doxorubicin), bleomycin, vinblastine, and dacarbazine] is used and are rarely seen when hybrid regimens such as MOPP/ABV are administered. Even patients who receive eight cycles of MOPP/ABV chemotherapy at 100% of the planned dose would receive only  $80 \text{ mg}/\text{m}^2$  of bleomycin and  $280 \text{ mg}/\text{m}^2$  of doxorubicin. For patients receiving eight cycles of ABVD, the total cumulative doses would be  $160 \text{ mg}/\text{m}^2$  of bleomycin and  $400 \text{ mg}/\text{m}^2$  of doxorubicin, which would be much nearer the toxic threshold. The threshold for drug toxicity is not absolute, and evidence of drug toxicity may be observed at lower doses, especially in older patients or in patients who have received radiation therapy to ports that include the lung or heart. Unless there is reason to suspect preexistent heart or lung disease, clinical evaluation before and during treatment is adequate, and ancillary studies such as multigated cardiac output studies or pulmonary function studies generally are not necessary.

If the history or physical examination during ABVD therapy raises the suspicion of bleomycin pulmonary toxicity, a chest x-ray should be obtained, and tests such as a chest CT scan and pulmonary function tests with diffusing capacity of lung for carbon monoxide should be considered. Absolute criteria for the discontinuation of bleomycin have not been established, but we strongly caution against the continuation of bleomycin in the face of a corrected diffusing capacity of lung for carbon monoxide of less than or equal to 50%. In making a decision about further use of bleomycin, the clinician must consider the risks of further therapy as well as the risk of early discontinuation of an effective agent.

Sterility is another toxicity of Hodgkin disease that must be considered in planning therapy because this complication may have a significant impact on a patient's quality of life. Administration of three to six cycles of MOPP chemotherapy can produce

azoospermia in 90 to 100% of patients ( [244](#), [245](#) and [246](#) ). Even with long-term follow-up exceeding 10 years, recovery is uncommon when six cycles of MOPP are administered ( [246](#), [247](#) ). Limited data suggest that ABVD is associated with only transient azoospermia ( [248](#) ), whereas the VBM (vinblastine, bleomycin, and methotrexate) regimen, used as an adjuvant to radiation therapy for limited stage disease, has not been associated with infertility ( [249](#) ). MOPP alternating with ABVD (and, presumably, the MOPP/ABV hybrid) may be associated with permanent azoospermia. Although cryopreservation of semen before chemotherapy and artificial insemination have been successful in achieving pregnancy ( [250](#) ), the presence of decreased sperm counts and abnormal sperm motility before therapy in patients with Hodgkin disease limit this approach ( [251](#) ).

In women, the effects of chemotherapy appear to be highly dependent on the age of the patient. More than 50% of women become amenorrheic during chemotherapy, with hormonal findings consistent with a diagnosis of ovarian failure ( [252](#), [253](#) ). In younger women, recovery of menses and recovery of fertility are generally seen. In women older than age 35, menses may resume, but menopause may occur prematurely. In women who are premenopausal at the time of chemotherapy, menses may cease permanently ( [254](#) ). Although the detrimental effects of combination chemotherapy on fertility are well documented, neither the occurrence of infertility nor its persistence can be predicted with 100% certainty. Patients desiring to avoid pregnancy should be advised not to rely on chemotherapy as their only form of contraception. In addition to decreased fertility, hormonal effects of chemotherapy have been associated with decreased libido in both men and women receiving chemotherapy for Hodgkin disease ( [255](#), [256](#) ).

## COMBINED MODALITY THERAPY

With radiation therapy proven to be curative in limited stage disease and combination chemotherapy proven to be curative in advanced stage disease, it is only logical that combined modality therapy (radiotherapy plus combination chemotherapy) would be investigated in Hodgkin disease. The rationale for such an approach is that combination chemotherapy may fail to produce cures in bulky sites of disease, and radiation therapy may miss occult disease outside of treatment ports. Logical candidates for combined modality therapy would therefore be stage II–X patients with large mediastinal masses ( [143](#), [144](#) and [145](#) ) or patients whose disease was staged as stage IIB ( [138](#) ), stage IIIB ( [257](#) ), or stage III<sub>2</sub> ( [58](#), [134](#) )—on the basis that occult stage IV disease might be present. Other investigators have studied combined modality therapy in all patients with advanced (stage III and IV) disease ( [258](#), [259](#) and [260](#) ).

Studies in the early 1970s illustrated that full doses of MOPP could be administered after radiotherapy, including TNRT, in patients with Hodgkin disease ( [261](#), [262](#) and [263](#) ). Extensive radiation can be administered after MOPP chemotherapy, but this has been associated with marked tissue reactions as well as increased morbidity and mortality ( [264](#) ). Although combined modality therapy remains a primary treatment option, the major limitation to its use has been that it is associated with an increased risk of acute nonlymphocytic leukemia, which is often preceded by myelodysplasia. The risk of acute nonlymphocytic leukemia is almost nonexistent after radiotherapy alone ( [211](#), [265](#), [266](#), [267](#) and [268](#) ) and is minimal in patients receiving only chemotherapy ( [269](#), [270](#) and [271](#) ). It is also less common in patients receiving ABVD as compared with patients receiving MOPP ( [272](#) ). However, the risk of acute nonlymphocytic leukemia may be as high as 7 to 10% during the first 10 years after combined modality therapy if MOPP is combined with more than involved field

radiotherapy ( [265](#) , [266](#) , [267](#) , [268](#) , [269](#) , [270](#) , [271](#) and [272](#) ).

In addition to an increased incidence of acute nonlymphocytic leukemia, an increased incidence of non-Hodgkin lymphoma has been noted in patients receiving combined modality therapy for Hodgkin disease ( [273](#) , [274](#) ). These lymphomas tend to be intermediate- or high-grade lymphomas, appear to have a propensity to involve the bowel and retroperitoneum, and have an overall risk of approximately 2%. Proof that these non-Hodgkin lymphomas represent second neoplasms rather than a different morphologic appearance of the same neoplasm has been hampered by limited knowledge regarding the cell of origin and the molecular basis for the development of Hodgkin disease.

Although the risk of acute leukemia becomes minimal 10 years after completion of combined modality therapy ( [275](#) ), this high incidence of acute leukemia makes it impossible to justify combined modality therapy with full-dose chemotherapy and full-dose radiotherapy as a routine approach to all patients. Many of the patients previously treated with combined modality therapy are now treated with either radiotherapy or chemotherapy, with the other therapeutic modality reserved for treatment at the time of relapse. Alternatively, when combined modality therapy is administered, radiotherapy to a limited field or to a limited dose may be combined with combination chemotherapy ( [276](#) ). For patients in whom radiation therapy is considered the critical modality, combined modality therapy may use a chemotherapy regimen that might be considered suboptimal for advanced disease (VBM) but less leukemogenic and, therefore, safer as part of combined modality therapy ( [277](#) ).

## OVERVIEW OF HODGKIN DISEASE TREATMENT

Two effective treatment modalities—radiation therapy and combination chemotherapy—are curative in Hodgkin disease. Patients relapsing after radiation therapy can be *cured* by chemotherapy. Patients relapsing after chemotherapy can be *cured* by high-dose chemotherapy in conjunction with ABMT. These facts are good news for patients with Hodgkin disease and for the physicians who care for them, but they complicate the work of clinical investigators who attempt to perform or to summarize clinical trials ( [226](#) , [277](#) , [278](#) ). In other malignancies, relapse-free survival can be determined early in the course of a clinical trial and can be used as a reliable indicator of cure and of the superiority of a therapeutic approach. In Hodgkin disease, however, only long-term follow-up and determination of actual long-term survival can determine which of two therapeutic regimens is superior. In studies that use radiation therapy, this is further complicated by the fact that the mortality due to radiation therapy, such as the occurrence of second malignancies, may occur 10 to 20 years after the administration of radiation.

Thus, in choosing the optimal therapy for a patient with Hodgkin disease, one must consider the curative potential of the regimen, the long-term side effects of the regimen (including mortality), and the potential of salvage therapy to produce cure. Although the major cause of death in patients with Hodgkin disease has been said to be Hodgkin disease itself, mortality due to complications of therapy approaches the mortality due to Hodgkin disease ( [279](#) ). In patients with limited stage Hodgkin disease, a recent publication ( [280](#) ) demonstrated that fewer deaths were attributable to Hodgkin disease (60 deaths) than to second malignancies (59 deaths) and cardiac/pulmonary events (22 deaths). These latter deaths, many of which are treatment related, were primarily late events, as it was not until 14 years after diagnosis that deaths due to causes other than Hodgkin disease exceeded tumor mortality ( [280](#) ). Thus, therapeutic approaches that produce superior relapse-free survival in Hodgkin disease are not superior if an alternative regimen associated with a lower disease-free survival produces less morbidity and mortality. One

must also consider the fact that patients who relapse after therapy have an opportunity to achieve cure with salvage therapy, thus eliminating the apparent advantage of a regimen with increased relapse-free survival.

As a result of this complexity, there are only general guidelines rather than definitive recommendations for the treatment of each stage of Hodgkin disease ( [Table 95.9](#)). Fortunately, despite the controversies regarding optimal therapy of Hodgkin disease, as noted in [Table 95.10](#), these approaches provide for excellent overall survival for the patient with Hodgkin disease.

**TABLE 95.9. Therapeutic Options for Hodgkin Disease**

| Stage              | Therapeutic Options   |
|--------------------|---|
| IA and IIA         | Involved field radiation therapy plus abbreviated combination therapy (e.g., four cycles ABVD) <sup>a</sup><br>Extended field radiation therapy <sup>b</sup><br>Involved field radiation therapy <sup>b</sup><br>Combination chemotherapy |
| IB and IIB         | Involved field radiation therapy plus combination chemotherapy <sup>a</sup><br>Combination chemotherapy <sup>a</sup><br>Extended field radiation therapy plus combination chemotherapy<br>Extended field radiation therapy <sup>c</sup>   |
| IX and IIX         | Combination chemotherapy with involved field radiation therapy <sup>a</sup><br>Combination chemotherapy <sup>d</sup>  |
| III <sub>1</sub> A | Combination chemotherapy <sup>a</sup><br>Involved field radiation therapy plus combination chemotherapy <sup>a</sup><br>Extended field radiation therapy <sup>e</sup>   |
| III <sub>2</sub> A | Combination chemotherapy <sup>a</sup><br>Extended field radiation therapy plus combination chemotherapy <sup>f</sup>  |
| IIIB               | Combination chemotherapy <sup>a</sup><br>Extended field radiation therapy plus combination chemotherapy   |
| IVA and IVB        | Combination chemotherapy <sup>a</sup><br>Combination chemotherapy with radiation boost to large tumor masses <sup>a</sup>   |

<sup>a</sup> Authors' preference.

<sup>b</sup> Only selected patients may receive this option on the basis of clinical staging (see text).

<sup>c</sup> Omission of chemotherapy in a patient with B symptoms requires a staging laparotomy to rule out advanced stage disease.

<sup>d</sup> Only if combination chemotherapy produces a complete remission. If not, radiation therapy is indicated.

<sup>e</sup> Omission of chemotherapy requires staging laparotomy in these patients.

<sup>7</sup> Leukemogenic risk weighs heavily against this approach.

**TABLE 95.10. Estimated Probability of Cure as Related to Stage of Hodgkin Disease**

| Stage       | Probability of Cure (%) |
|-------------|-------------------------|
| IA and IIA  | 80–90                   |
| IB and IIB  | 80–85                   |
| IIIA        | 75–85                   |
| IIIB        | 60                      |
| IVA and IVB | 60                      |

### Treatment of Limited Stage Disease

**STAGE IA AND IIA** Radiation therapy is a standard approach to stage IA and IIA Hodgkin disease. Historically, the cure for Hodgkin disease using radiation therapy depended on radiating involved areas and adjacent apparently noninvolved areas ( [181](#), [182](#), [183](#), [184](#) and [185](#) ) (i.e., extended field radiotherapy). However, with the advent of curative salvage combination chemotherapy, the superiority of extended field therapy over involved field therapy with respect to survival has not been definitively established. Several studies ( [281](#), [282](#), [283](#), [284](#), [285](#) and [286](#) ) have compared extended field therapy (total lymphoid radiotherapy or subtotal lymphoid radiotherapy) to limited field radiation. Although freedom from relapse has been superior with extended field radiotherapy in some of these studies ( [281](#), [282](#) ), there has been no significant difference between the two approaches with respect to survival ( [Table 95.11](#) ). As expected, results are slightly inferior in patients with CS IA and IIA disease as compared with patients with PS IA and IIA disease, as the clinically staged patients would be expected to include a few more patients with more advanced disease. However, even in the CS IA and IIA patients, there is no proven survival advantage for extended field radiation therapy as compared with involved field radiotherapy. Nevertheless, because extended field radiation therapy provides the opportunity to achieve cure with one treatment effort, rather than having to use salvage therapy, extended field radiation therapy is more commonly used than involved field radiation.

**TABLE 95.11. Disease-Free Survival and Survival with Extended Field (EF) and Involved Field (IF) Radiation Therapy for Stage IA and IIA Hodgkin Disease**

| Author (Reference)                        | Staging | Disease-Free Survival (10 Yr) (%) |    | Survival (10 Yr) (%) |    |
|---|---------|-----------------------------------|----|----------------------|----|
|   |         | EF                                | IF | EF                   | IF |
| Rosenberg et al. ( <a href="#">281</a> )  | PS      | 80                                | 32 | 80                   | 79 |
| Fuller et al. ( <a href="#">282</a> )     | PS      | 66                                | 52 | 92                   | 87 |
| Hope-Stone et al. ( <a href="#">284</a> ) | PS      | 48                                | 50 | 78                   | 74 |
| Fuller et al. ( <a href="#">282</a> )     | CS      | 59                                | 32 | 79                   | 71 |
| Hope-Stone et al. ( <a href="#">284</a> ) | CS      | 43                                | 40 | 68                   | 68 |

CS, clinical staging; PS, pathologic staging.

Modified from Mauch PM. Controversies in the management of early stage Hodgkin's disease. Blood 1994;83:318–329.

The failure to establish the superiority of extended field radiation therapy depends on both the increased mortality of extended field radiation therapy and the ability of chemotherapy to salvage patients who relapse after involved field radiation. Therefore, in an attempt to improve on the results achieved with radiation therapy, many investigators have used limited field radiation therapy in conjunction with combination chemotherapy ( 287, 288, 289, 290 and 291 ) ( Table 95.12 ). Relapse-free survival has tended to be superior with combined modality therapy ( 281, 286, 287, 288, 289 and 290 ), and in some cases, the differences in favor of combined modality therapy are statistically significant ( 287, 289 ). However, survival has generally been equivalent with the two approaches to therapy.

**TABLE 95.12. Disease-Free Survival and Survival with Combined Modality Therapy (CMT) and Radiotherapy Alone (RT) in Stage I and II Hodgkin Disease**

| Author (Reference)       | Stage                      | Disease-Free Survival (5 Yr) (%) |    | Survival (5 Yr) (%) |    |
|--------------------------|----------------------------|----------------------------------|----|---------------------|----|
|                          |                            | CMT                              | RT | CMT                 | RT |
| Rosenberg et al. ( 281 ) | PS IA–IIA                  | 83                               | 66 | 84                  | 91 |
| Nissen et al. ( 287 )    | PS I–II                    | 90                               | 67 | 92                  | 93 |
| Jones et al. ( 288 )     | PS I–II                    | 82                               | 71 | 82                  | 86 |
| Anderson et al. ( 289 )  | PS I–II                    | 91                               | 67 | 95                  | 90 |
| Horning et al. ( 249 )   | PS I–II, IIIA <sup>a</sup> | 95                               | 70 | 100                 | 97 |

PS, pathologic staging.

NOTE: Chemotherapy was MOPP in all studies except Horning et al. ( 249 ), which used VBM. See Table 95.8 for details of chemotherapy regimens.

<sup>a</sup> All stage IIIA patients had “minimal” abdominal involvement (i.e., no mass >5 cm and <5 splenic nodules).

Modified from Mauch PM. Controversies in the management of early stage Hodgkin's disease. Blood 1994;83:318–329.

Because individual clinical trials may lack the power to find differences between treatment approaches, the therapy of limited stage Hodgkin disease has been studied in a metaanalysis of 3888 patients in 23 randomized clinical trials ( 292 ). Among patients receiving more extensive, as compared to less extensive, radiation therapy, the risk of treatment failure was reduced significantly from 43% to 31%,  $p < .00001$ . However, because of the effectiveness of salvage therapy, 10-year survival was equivalent for the two treatment groups: 77% in both treatment groups. In a second analysis presented in the same paper ( 292 ), the addition of chemotherapy to radiation therapy was found to significantly reduce the risk of relapse from 33% to 16%,  $p < .0001$ . However, with respect to survival, the effect of adding chemotherapy to radiation therapy was minimal. Survival at 10 years was 79% with combined modality therapy as compared to 77% with radiation therapy alone,  $p > .05$ . Whereas deaths due to Hodgkin disease were decreased by combined modality therapy as compared to radiation alone (12.3% vs. 15.4%,  $p > .05$ ), deaths due to other causes, such as secondary malignancies, were increased by combined modality therapy (12.4% vs. 10.0%,  $p > .05$ ). The overall conclusion from this major metaanalysis was that because of the efficacy of salvage therapy, it has yet to be shown



that survival in limited stage Hodgkin disease can be improved either by increasing the radiation fields or by adding chemotherapy. When combined modality therapy is used to treat limited stage Hodgkin disease, the question arises as to which combination chemotherapy regimen should be used. Many published studies of combined modality therapy have used a standard regimen such as 6 months of MOPP ( [281](#), [286](#), [287](#) and [288](#) ). However, if one is administering combination chemotherapy to deal with occult disease, rather than as the sole treatment for advanced stage disease, one might consider using less toxic chemotherapy regimens. Accordingly, investigators at Stanford have studied the combination of VBM in conjunction with involved field radiation ( [249](#) ), and other investigators have studied involved field radiation in conjunction with a limited number of cycles of MOPP or ABVD ( [291](#), [293](#) ). As with the use of radiation therapy and six cycles of MOPP, relapse-free survival tends to be better with these combined modality regimens than with radiotherapy alone. However, as with six cycles of MOPP therapy, a survival advantage for these combined modality regimens has not been established. It is worthy to note, however, that in a randomized trial, involved field radiation therapy plus VBM chemotherapy produced an actuarial 5-year relapse-free survival of 95%. This result compares favorably with involved field radiation, to which it was being directly compared, as well as to involved field therapy plus MOPP as administered in other studies. Thus, there is strong suggestive evidence that if combined modality therapy is used in limited stage Hodgkin disease, one does not need to use a regimen that would be regarded as standard therapy for advanced stage disease. With several effective therapeutic options available for stage I and II patients, one approach is to select therapy for each patient based on the presence or absence of clinical prognostic factors. Several clinical features have been identified as being associated with an increased risk of relapse or decreased survival in patients with PS IA and IIA disease. The most consistent unfavorable prognostic feature is the presence of a large mediastinal mass ( [294](#), [295](#) ). It is generally accepted that patients with a mediastinal mass having a maximal diameter greater than one-third the diameter of the chest are at such high risk of relapse that these patients and patients with extensive pericardial or pleural disease are not suitable candidates for radiation therapy alone. These patients should be treated with combination chemotherapy, usually in conjunction with limited field radiotherapy ( [278](#), [296](#) ), because there is evidence that chemotherapy alone places these patients at an increased risk for mediastinal recurrence and, perhaps, long-term treatment failure ( [226](#) ). Stage IA and IIA patients older than 40 years of age also have a significantly inferior survival. This might reflect an intrinsic change in the biology of Hodgkin disease in these older patients, or it might reflect a greater tendency of these patients to develop second malignancies after therapy. In any case, the inferior survival of patients older than 40 years of age has been used by some investigators to recommend staging laparotomy in these patients so that treatment can be limited to the minimal therapy necessary to achieve cure, thus decreasing the complications associated with therapy. Patients whose stage has been determined only by clinical staging rather than pathologic staging are another group of stage I and II patients with a relatively poor prognosis. For this reason, many radiation therapists are reluctant to treat patients with radiation therapy alone unless a staging laparotomy has been performed. A negative staging laparotomy can identify patients who are candidates for radiation therapy alone. Furthermore, there is evidence that a negative staging laparotomy can be used to justify the use of *mantle* radiotherapy, without paraaortic/splenic fields, in PS IA and IIA patients ( [285](#), [286](#), [297](#), [298](#) ), especially in patients with nodular sclerosis or lymphocyte-predominant Hodgkin disease who do not have bulky supradiaphragmatic disease ( [297](#) ). Certain subsets of patients with limited CS disease are at such low risk of having advanced stage disease found at laparotomy that they may be treated with radiation therapy alone without surgical staging. This includes CS IA women, CS IIA women younger than 27 years of age with fewer than three supradiaphragmatic sites of disease, and CS IA men with lymphocyte-predominant or nodular sclerosing Hodgkin disease or with disease limited to the mediastinum ( [172](#) ). Because the risk of abdominal disease in these patients is small but not absent, extended field radiation



therapy (mantle and paraaortic/splenic fields) is the most reasonable approach to these patients ( 172 ). However, these patients probably represent less than one-fourth of patients with CS IA and IIA disease. For other CS IA and IIA patients, the majority of clinicians are uncomfortable using radiation therapy alone without pathologic staging, and, as pathologic staging (i.e., laparotomy) has fallen out of favor, alternative clinical options are generally chosen for these patients ( Table 95.9 ). Faced with controversies regarding the optimal radiation ports, the role of combined modality therapy, and the role of staging laparotomy in patients with stage I and II disease, clinical investigators have attempted to get around these controversial issues by using chemotherapy alone as treatment for limited stage disease. Although the successful use of combination chemotherapy in advanced stage Hodgkin disease and the accumulating data regarding the late long-term effects of radiotherapy suggest that this is a reasonable approach, the data do not support the use of combination chemotherapy alone as the standard treatment of limited stage disease. Two randomized controlled trials of chemotherapy in limited stage Hodgkin disease have been conducted. In the study conducted at the National Cancer Institute (NCI) ( 299 ), relapse-free survival favored the MOPP chemotherapy group, and overall survival was better, approaching statistical significance, in the MOPP group. However, the study included patients with large mediastinal masses. For these patients, the radiotherapy alone option would generally be regarded as inadequate. When these patients were excluded from analysis, the trends for disease-free survival and for survival favoring MOPP were not statistically significant ( Table 95.13 ). However, MOPP therapy was significantly better for patients with large mediastinal masses or with stage III 1A disease.

**TABLE 95.13. Disease-Free Survival and Survival with Combination Therapy (CT) versus Extended Field Radiation Therapy (RT) in Stage I and II Hodgkin Disease**

| Author (Reference)   | Stage                        | Disease-Free Survival (%) |    | Survival (%) |    |
|----------------------|------------------------------|---------------------------|----|--------------|----|
|                      |                              | CT                        | RT | CT           | RT |
| Longo et al. ( 299 ) | PS IB, IIA, IIB <sup>a</sup> | 82                        | 67 | 90           | 85 |
| Biti et al. ( 301 )  | PS IA–IIA                    | 64                        | 76 | 56           | 93 |

<sup>a</sup> Excludes patients with large mediastinal masses.

Modified from Mauch PM. Controversies in the management of early stage Hodgkin's disease. *Blood* 1994;83:318–329.

In an Italian study, which compared combination chemotherapy with extended field radiotherapy for limited stage Hodgkin disease ( 300 , 301 ), relapse-free survival was similar in the two treatment arms. However, due to an exceptionally poor survival of only 15% after relapse in the patients treated with chemotherapy, overall survival was superior in the patients treated with radiation therapy. Although this result casts doubt on the role of combination chemotherapy in limited stage Hodgkin disease, it must be recognized that salvage approaches including ABMT might be expected to improve on the survival of patients who relapse after combination chemotherapy. As a result, although radiation therapy remains the standard therapy for limited stage Hodgkin disease, the role of combination chemotherapy as primary treatment in these patients cannot be totally rejected and must be regarded as an unresolved issue.

**STAGE IB AND IIB** The development of treatment recommendations for stages IB and IIB disease has been limited by the relative infrequency of these stages of disease. As noted previously ( Table 95.5 ), less than 1% of patients with Hodgkin disease have stage IB disease, and approximately 12% of patients have stage IIB disease. As the majority of patients with B symptoms have stage IIIB or IVB disease, one approach to patients with

CS IB or IIB disease has been to assume that more advanced disease is present and to treat the patients with chemotherapy alone or with combined modality therapy ( [289](#), [290](#), [302](#), [303](#) and [304](#) ) in the absence of surgical staging. However, when these patients have been evaluated with surgical staging, it has been shown that extended field radiation therapy can produce excellent results. In a retrospective review of stage IB and IIB patients treated at Stanford University and the Joint Center for Radiation Therapy at Harvard University, Crnkovich et al. ( [137](#) ) reported a 7-year relapse-free survival of 74% and a 7-year survival of 87% for patients receiving radiotherapy alone. Results were insignificantly different for concurrent patients receiving combined modality therapy. In those patients, the 7-year relapse-free survival was 84%, with a 7-year survival of 86%. These results are similar to those obtained in surgically staged patients with IA and IIA disease ( [281](#), [282](#), [283](#) and [284](#) ). The high relapse rate in stage IIB patients with large mediastinal masses (42% at 7 years) has been considered a strong argument that these patients should be treated with combined modality therapy rather than radiation therapy alone ( [137](#) ), even though salvage at the time of relapse is effective when radiotherapy *alone* has been used as initial treatment. This point is quantitatively significant because approximately 20 to 25% of stage IIB patients have large mediastinal masses (i.e., stage IIE by the Ann Arbor staging system or IIX by the Cotswald classification). Additionally, the presence of both fever and weight loss is associated with less than a 50% relapse-free survival, suggesting that patients in this subset of stage IB and IIB are poor candidates for radiotherapy alone and also that aggressive combination chemotherapy, rather than combined modality therapy, might be most appropriate for these patients ( [137](#) ). If one elects to treat a subset of stage IB and IIB patients with radiation therapy, it is necessary to perform a staging laparotomy to exclude the presence of stage IIIB or IVB disease. Combination chemotherapy is the critical therapeutic modality for stage IIIB and IVB patients. The administration of radiation therapy to one of these patients, under the incorrect assumption that the patient has stage IIB disease, may compromise the delivery of combination chemotherapy. This is an important consideration. Although only 40% of patients with Hodgkin disease have stage III or IV disease, among patients with B symptoms, the situation is reversed, and 60% of patients with B symptoms are found to have stage III or IV disease on completion of staging. If radiation therapy is administered to patients with stage IB or IIB disease, the question arises as to what is the appropriate radiation therapy port. Some radiation therapists favor the administration of TNRT, but in these surgically staged patients, the data support the use of mantle and paraaortic fields without the use of pelvic radiotherapy ( [137](#) ).

### Treatment of Stage IIIA Disease

With radiation therapy regarded as the key modality in the treatment of limited (stage I and II) disease and chemotherapy regarded as the key modality in the treatment of advanced (stage IV) disease, it is not surprising that the management of stage III Hodgkin disease has been a subject of controversy. As early as the late 1960s, investigators at Stanford University began studies comparing radiation therapy alone with radiation therapy plus chemotherapy (combined modality therapy). As with stage IA and IIA disease, it was clear that the use of radiation therapy alone was associated with a significantly increased risk of relapse compared with that observed with the use of combined modality therapy ( [305](#), [306](#) ) ( [Table 95.14](#) ). However, radiation therapy alone with chemotherapy used at the time of relapse produced overall survival similar to that achieved with combined modality therapy ( [305](#), [306](#) ). Because the use of radiotherapy alone would obviously spare 30 to 40% of patients from the need to receive chemotherapy, radiation therapy alone was advocated as the treatment of choice for stage IIIA patients ( [307](#) ).

**TABLE 95.14. Results of Therapy in Stage IIIA Hodgkin Disease Using Radiotherapy Alone (RT), Combined Modality Therapy (CMT), or Chemotherapy Alone (CT)**

| Author (Reference)                  | Stage              | Disease-Free Survival (%) |                 |                 | Overall Survival (%) |                 |    |
|-------------------------------------|--------------------|---------------------------|-----------------|-----------------|----------------------|-----------------|----|
|                                     |                    | RT                        | CMT             | CT              | RT                   | CMT             | CT |
| Rosenberg et al. ( 306)             | IIIA               | 67                        | 96 <sup>a</sup> |                 | 81                   | 90              |    |
| Stein et al. ( 311)                 | IIIA               | 49                        | 89 <sup>a</sup> |                 | 76                   | 89 <sup>a</sup> |    |
| Stein et al. ( 311)                 | III <sub>1</sub> A | 63                        | 96 <sup>a</sup> |                 | 91                   | 100             |    |
| Stein et al. ( 311)                 | III <sub>2</sub> A | 32                        | 76 <sup>a</sup> |                 | 56                   | 84 <sup>a</sup> |    |
| Hoppe et al. ( 312)                 | IIIA               | 66                        | 86 <sup>a</sup> |                 | 86                   | 89              |    |
| Hoppe et al. ( 312)                 | III <sub>1</sub> A | 64                        | 96 <sup>a</sup> |                 | 90                   | 88              |    |
| Hoppe et al. ( 312)                 | III <sub>2</sub> A | 69                        | 75              |                 | 88                   | 91              |    |
| Marcus et al. ( 313)                | III <sub>1</sub> A | 55                        | 94 <sup>a</sup> |                 | 70                   | 89              |    |
| Lister et al. ( 314) <sup>b</sup>   | IIIA               | 60                        |                 | 96 <sup>a</sup> | 85                   |                 | 91 |
| Crowther et al. ( 315) <sup>b</sup> | IIIA               |                           | 82              | 72              |                      | 88              | 85 |
| Grozea et al. ( 316) <sup>b</sup>   | IIIA               |                           | 84              | 81              |                      | 92              | 87 |
| Longo et al. ( 226, 228)            | IIIA, IVA          |                           |                 | 94              |                      |                 | 96 |

<sup>a</sup>  $p < .05$  when compared to other treatment modalities.

<sup>b</sup> Survival and relapse-free survival are estimated from life tables.

Despite the excellent results achieved at Stanford, several issues limited the acceptance of radiation therapy alone as the treatment of choice for stage IIIA Hodgkin disease. First, the results achieved at Stanford involved the use of special techniques such as whole-liver irradiation in the presence of splenic involvement and whole-lung irradiation in the presence of ipsilateral hilar involvement. This meant that the results achieved at Stanford were not necessarily achievable at other institutions. Second, although combined modality therapy was not significantly superior to radiation therapy alone with respect to survival, the trend for improved survival favored combined modality therapy. The possibility that a biologically significant result was being missed due to small sample size could not be excluded. On the other hand, with the demonstration that combined modality therapy was associated with an increased risk of acute leukemia, especially when wide field radiation was used, combined modality therapy could not be justified on the basis of an insignificant trend.

To analyze therapy of stage III Hodgkin disease, Desser et al. ( 134) proposed that stage III disease be divided into anatomic substages based on the extent of abdominal nodal involvement (see section [Staging](#)). After a number of studies suggesting that the extent of abdominal nodal disease was an important prognostic indicator of disease-free survival after radiation therapy ( 134, 308, 309, and 310), a large pooled retrospective analysis was performed ( 58, 311). This review strongly suggested that radiation therapy *alone* could be justified only for patients with stage III <sub>1</sub>A disease and only when the staging had been determined at laparotomy. For patients with stage III <sub>2</sub>A disease, radiotherapy plus chemotherapy produced significantly superior survival as compared with radiotherapy

alone. Even though these stage III<sub>2</sub>A patients had undergone staging laparotomies that did not establish stage IV disease, they were at substantial risk of early relapse after radiation therapy alone. The use of extended field radiation therapy in these patients compromised their ability to receive chemotherapy at the time of relapse and led to inferior long-term results.

In a similar examination of prognostic features in patients treated at Stanford, Hoppe et al. (312) did not confirm that substage was a prognostic factor. No subgroups of patients were found in whom the addition of chemotherapy to radiotherapy led to a significant improvement in survival. However, as noted previously, radiation therapy administered at Stanford included radiation of lung and liver in selected patients. As a result, stage III<sub>2</sub>A patients treated with radiation alone at Stanford did not have the risk of treatment failure associated with more conventional radiation therapy techniques (310, 311). Thus, this study (312) cannot be used to justify the use of standard radiation therapy alone in patients with stage III<sub>2</sub>A Hodgkin disease.

Larger series have suggested that even in stage III<sub>1</sub>A disease, radiotherapy alone may be inadequate therapy (313). In a large retrospective trial, survival was better, although only approaching statistical significance, for stage III<sub>1</sub>A patients receiving combined modality therapy (89%) as compared with survival in patients receiving either mantle/paraortic radiation (78%) or total nodal irradiation (70%).

If radiation therapy is inadequate for the majority of patients with stage III disease, the logical question is whether chemotherapy alone or combined modality therapy is the appropriate approach. However, only limited data are available to answer the question (Table 95.14). In a study in which treatment was partially randomized and partially stratified by substage, Lister et al. (314) found that chemotherapy produced superior relapse-free survival when compared with radiation therapy alone in patients with stage IIIA disease; survival in the two treatment groups was equivalent. Combined modality therapy was not used in that study. In a study comparing chemotherapy with chemotherapy followed by radiation therapy, Crowther et al. (315) observed no differences with respect to either relapse-free survival or overall survival. In a randomized study, Grozea et al. (316) found no difference between chemotherapy alone and combined modality therapy with respect to relapse-free survival or survival in patients with stage III disease. Further support for the use of chemotherapy alone comes from the long-term follow-up of patients receiving MOPP at the NCI. In patients with stage IIIA, IIIB, or IVA, overall survival at 15 years was 96% (226, 228).

Although a single specific optimal therapy cannot be advocated for patients with stage IIIA disease, the following conclusions can be drawn from the available data. Foremost is that the use of radiation therapy alone in stage IIIA Hodgkin disease can be justified only in patients with minimal (stage III<sub>1</sub>A) disease and only when a laparotomy has been performed and, even then, with some concerns that overall survival may be compromised (313). For patients with advanced stage III disease (stage III<sub>2</sub>A), there is support for the use of combined modality therapy (58, 311, 313, 314 and 315) or combination chemotherapy alone (226, 228, 314, 315 and 316). However, the use of combined modality therapy in stage III<sub>2</sub>A should logically require surgical staging to decrease the probability that stage IV disease is present. Because it is difficult to justify a staging laparotomy in patients for whom chemotherapy is acceptable treatment, a reasonable approach to stage IIIA disease is to use combination chemotherapy in all patients for whom there is clinical evidence of stage III disease in the absence of staging laparotomy. Although this might lead to unnecessary toxicity for some patients, there is no evidence that this approach

compromises long-term survival for any patient.

## Treatment of Advanced Stage Disease

**STAGES IIIB, IVA, AND IVB** Combination chemotherapy is the treatment of choice for advanced stage Hodgkin disease. As in other stages of disease, controversy regarding therapy exists; the specific issues for patients with advanced stage disease are the identification of the best specific regimen and the question of whether supplemental radiotherapy has any role in treating advanced stage disease. After the introduction of MOPP chemotherapy by DeVita et al. ([225](#)), the development of combination chemotherapy has included three general categories of regimens: (a) minor modifications of MOPP, (b) regimens composed of drugs non-cross-resistant to MOPP, and (c) regimens that combine—either in alternating cycles or in one hybrid regimen—both MOPP and a non-cross-resistant regimen. Doses and schedules for the commonly used regimens are presented in [Table 95.8](#). Results achieved using these regimens in representative studies ([227](#), [228](#), [229](#), [230](#) and [231](#), [234](#), [236](#), [299](#), [318](#), [319](#), [320](#) and [321](#)) are presented in [Table 95.15](#). Duration of follow-up differs among these studies but generally exceeds 5 years. Because more than 90% of relapses occur within 4 years of treatment, data regarding relapse-free survival are clinically meaningful. However, survival after chemotherapy for Hodgkin disease declines for 10 years after treatment. Thus, comparing survival data across regimens that report data for different periods of follow-up is of limited meaning. Only data from comparative trials can be given much credence in this regard.

**TABLE 95.15. Results of Combination Chemotherapy in Hodgkin Disease**

| Regimen (Author, Reference)                         | Complete Response (%) | Disease-Free Survival (%) (Yr) <sup>a</sup> | Survival (%) (Yr) <sup>a</sup> |
|---|-----------------------|---|--------------------------------|
| <b>MOPP and minor modifications of MOPP</b>         |                       |   |                                |
| MOPP (Longo, <a href="#">228</a> )                  | 84                    | 54 (15)                                     | 48 (10)                        |
| MOPP (Bakemeier, <a href="#">317</a> )              | 73                    | 35 (5)                                      | 61 (5)                         |
| MOPP (Longo, <a href="#">299</a> )                  | 91                    | 65 (12)                                     | 68 (12)                        |
| MOPP (Canellos, <a href="#">318</a> )               | 67                    | 50 (5)                                      | 66 (5)                         |
| MOPP (Bonadonna, <a href="#">234</a> )              | 74                    | 36 (8)                                      | 64 (8)                         |
| BVCPP (Durant, <a href="#">319</a> )                | 68                    | 48 (4)                                      | 58 (4)                         |
| BCVPP (Bakemeier, <a href="#">317</a> )             | 76                    | 49 (5)                                      | 67 (5)                         |
| MVPP (Sutcliffe, <a href="#">229</a> )              | 76                    |   | 65 (5)                         |
| MVPP (Radford, <a href="#">320</a> )                | 55                    |   | 71 (5)                         |
| ChIVPP (McElwain, <a href="#">230</a> )             | 76                    |   |                                |
| ChIVPP (Vose, <a href="#">231</a> )                 | 88                    | 76 (3)                                      |                                |
| <b>Non-cross-resistant regimens</b>                 |                       |   |                                |
| ABVD (Bonadonna, <a href="#">232</a> )              | 75                    |   |                                |
| SCAB (Wiernik, <a href="#">321</a> )                | 80                    | 68 (11)                                     | 75 (11)                        |
| ABVD (Canellos, <a href="#">318</a> )               | 82                    | 61 (5)                                      | 73 (5)                         |
| <b>Alternating regimens and hybrid regimens</b>     |                       |   |                                |
| MOPP/ABVD (Bonadonna, <a href="#">234</a> )         | 89                    | 65 (8)                                      | 84 (8)                         |
| MOPP/CABS alternating (Longo, <a href="#">299</a> ) | 92                    | 72 (12)                                     | 54 (12)                        |



|  |    |        |        |
|--|----|--------|--------|
| MOPP-ABV hybrid <sup>b</sup> (Klimo, <a href="#">236</a> ) | 97 | 88 (4) | 93 (4) |
| MOPP/ABVD alternating (Canellos, <a href="#">318</a> )     | 83 | 65 (5) | 75 (5) |
| ChIVPP/EVA hybrid (Radford, <a href="#">320</a> )          | 68 |        | 80 (5) |

<sup>a</sup> In many cases, results are estimated from graphs of actuarial survival and actuarial disease-free survival. Survival is determined by multiplying the complete remission rate by the percent relapse-free survival in those patients who obtained a complete remission.

<sup>b</sup> Results include patients who received consolidation radiotherapy to a solitary residual nodal abnormality after six cycles of chemotherapy.

Additionally, results achieved with combination chemotherapy depend not only on the regimen being used, but also on the patients who are treated. As discussed, over the past 10 to 15 years, it has been recognized that combination chemotherapy represents an appropriate approach to patients with stage III disease. Because a decision to use chemotherapy obviates the need to perform a staging laparotomy, recent chemotherapy studies are performed on patients who are clinically staged. Thus, in contrast to the original MOPP studies, in which the majority of patients receiving combination chemotherapy were PS IV, recent studies of combination regimens include patients in CS III and IV. This fact must be considered when results obtained with newer regimens are compared with older studies. Over the course of two decades, MOPP chemotherapy has been associated with complete remission rates between 67 and 91%. The best results have been achieved at the NCI ([228](#), [299](#)), where long-term disease-free survival has been 54 to 65%. Several controlled clinical trials have been conducted using MOPP as one of the regimens. Investigators in the Eastern Cooperative Oncology Group compared MOPP with BCVPP (bischloroethylnitrosourea, cyclophosphamide, vincristine, procarbazine, prednisone) ([317](#)). Similar complete remission rates were observed with the two regimens, but complete remissions and overall survival were longer in patients receiving BCVPP than in patients receiving MOPP. As with most studies using MOPP conducted outside the NCI, the MOPP schedule was modified from that initially used at the NCI. Specifically, the vincristine dose was capped at 2 mg, and the interval between cycles was increased. Although this limits the comparison to MOPP, it is nevertheless true that this was the first study to demonstrate that combination chemotherapy regimens other than MOPP could produce not only excellent complete remission rates, but also excellent long-term results. As noted in [Table 95.15](#), BCVPP is considered a minor modification of the MOPP regimen because it includes alkylating agents, a vinca alkaloid, procarbazine, and prednisone. By contrast, regimens thought to be non-cross-resistant to MOPP have been developed, specifically ABVD ([232](#)) and streptozotocin, CCNU, Adriamycin, and bleomycin (SCAB) ([321](#), [322](#)). SCAB has also been designated *CABS* ([299](#)). In uncontrolled observations ([232](#), [321](#)), these regimens produced results similar to those achieved with MOPP. Shortly thereafter, Goldie and Goldman ([323](#)) predicted that the use of alternating non-cross-resistant drug regimens would prevent drug resistance that might result from the use of a single combination regimen. This hypothesis led to the use of alternating cycles of MOPP and ABVD ([234](#)) as well as to an integrated hybrid regimen in which the drugs of the MOPP regimen were given on day 1 and ABV was given on day 8 ([236](#)) of each cycle. Comparative trials studying alternating regimens have been performed. In a large trial conducted by Cancer and Acute Leukemia Group B ([318](#)), MOPP (six to eight cycles) was compared to ABVD (six to eight cycles) and with MOPP/ABVD. The latter regimen consisted of a cycle of MOPP alternating with a cycle of ABVD for a total of 12

cycles. As compared with MOPP, complete remission rates as well as survival were significantly higher with both ABVD and MOPP/ABVD. Long-term follow-up of this trial has recently been published ([324](#)). With a median follow-up in excess of 13 years, relapse-free survival was superior for patients receiving ABVD and MOPP/ABVD as compared to MOPP. However, because of salvage therapy, survival was equivalent for all three treatment arms ([324](#)). Because the MOPP schedule had been attenuated from that used at the NCI, it is conceivable that MOPP as given at the NCI might be equivalent to ABVD or MOPP/ABVD. However, the MOPP dose modifications are not arbitrary and represent difficulties that investigators and patients have with the MOPP regimen as given at the NCI. It is therefore reasonable to conclude that ABVD and MOPP/ABVD represent rational alternatives to MOPP therapy. MOPP therapy, as it was given in this trial (which is the way MOPP is most often given in the community), is inferior to ABVD and MOPP/ABVD with respect to relapse-free survival, but not with respect to survival. Given that MOPP/ABVD was equivalent to ABVD in this randomized trial, the Goldie-Goldman hypothesis has not been confirmed in Hodgkin disease. Similarly, a trial comparing MOPP/CABS with MOPP showed no evidence for superiority of the alternating combination regimen ([299](#)). Despite the absence of confirmatory evidence, the Goldie-Goldman hypothesis remains attractive to clinical investigators. In that context, Klimo and Connors rationalized that if alternating cycles of combination chemotherapy could limit the development of drug resistance, alternating combinations within a given cycle might improve results even further. The result was the MOPP/ABV hybrid, which has been associated with superb clinical results ([236](#)). Using the MOPP/ABV hybrid, 97.5% of patients achieved a complete remission. The protocol allowed for involved field radiation to be administered to a solitary lymph node region if residual adenopathy was present after six cycles of chemotherapy. However, even if patients who received “consolidation radiotherapy” are excluded, the complete remission rate is 84%. More than 90% of patients achieving a complete remission were reported as disease free (median follow-up, 46 months), for a projected disease-free survival of 88%. Actuarial survival at 4 years was 93%. The MOPP/ABV hybrid regimen has been compared to sequential MOPP/ABVD in a randomized clinical trial ([325](#)). This study included patients with CS or PS III<sub>2</sub>, IIIB, IVA, or IVB disease, as well as well patients with stage III<sub>1</sub> disease and five splenic nodules. Patients randomized to sequential therapy initially received six cycles of MOPP. If a complete remission was achieved, patients received three cycles of ABVD. If a partial remission was achieved, two additional cycles of MOPP were given, and, if a CR was achieved, the patients then received three cycles of ABVD. Patients randomized to MOPP/ABV received therapy for two cycles beyond complete remission to a maximum of 12 cycles. Complete responses were significantly higher in the group receiving MOPP/ABV: 83% versus 75%,  $p = .02$ . Eight-year failure-free survival was significantly higher for the hybrid regimen: 64% versus 54%,  $p = .01$ . Furthermore, 8-year survival was significantly higher for patients receiving the MOPP/ABV hybrid regimen: 79% versus 71%,  $p = .02$ . Nine cases of acute myelogenous leukemia were observed in patients receiving the sequential regimen as compared to only one among patients receiving the hybrid regimen. MOPP/ABV has also been compared to ABVD in a large-scale randomized clinical trial. However, only preliminary results have been reported ([326](#)). With limited follow-up, response rates, freedom from relapse, and overall survival were not significantly different when the two regimens were compared. However, more toxicity was associated with the MOPP/ABV hybrid regimen, and this study was closed to accession earlier than had been planned. As a result, ABVD is generally considered the standard chemotherapy regimen for the treatment of Hodgkin disease. However, long-term follow-up of the patients entered on the study will be of interest to see if any survival differences emerge. Considering the favorable results achieved with stem cell transplantation as salvage chemotherapy, it is not surprising that dose-intense chemotherapy regimens have been investigated as initial therapy in patients with Hodgkin disease. Two such regimens are the BEACOPP (bleomycin, etoposide, Adriamycin, cyclophosphamide, vincristine, procarbazine, and prednisone) regimen reported by German investigators ([327](#)) and the Stanford V regimen reported by investigators at Stanford ([328](#)).



) ( [Table 95.16](#)). The BEACOPP regimen has been studied in a large-scale randomized trial in which it was compared to COPP alternating with ABVD ( [327](#)). In that study, two variants of BEACOPP were used—a standard dose and an escalated dose version. Radiation therapy was administered to patients with initial bulky disease or with suspected residual tumor. Although differences with respect to survival were not noted, response rates and freedom-from-treatment failure were superior for the pooled BEACOPP arms as compared to COPP/ABVD. Two-year freedom-from-treatment failure was 84% for the pooled BEACOPP arms of the study as compared to 75% for patients receiving COPP/ABV,  $p < .05$ . Further follow-up of this important study has been presented ( [328](#)), and 5-year survival has been found to be significantly higher with the escalated BEACOPP regimen (91%) as compared to BEACOPP (88%) or COPP/ABV (83%),  $p < .01$ . Favorable survival was observed in the escalated BEACOPP group even though this regimen was associated with a higher incidence of treatment-related myelo-dysplasia or acute leukemia. This increased toxicity raises concern as to whether escalated BEACOPP or standard BEACOPP is the optimal regimen.

**TABLE 95.16. Dose-Intense Therapy as Initial Treatment for Hodgkin Disease**

| Regimen (Drugs)                       | Recommended Dose<br>(mg/m <sup>2</sup> ) | Route | Days                                 |
|---------------------------------------|--|-------|--------------------------------------|
| <b>Stanford V (Bartlett, 329)</b>     |  |       |                                      |
| Nitrogen mustard                      | 6  | IV    | Day 1 of wk 1, 5, 9                  |
| Doxorubicin                           | 25                                       | IV    | Day 1 of wk 1, 3, 5, 7, 9, 11        |
| Vinblastine                           | 6  | IV    | Day 1 of wk 1, 3, 5, 7, 9, 11        |
| Vincristine                           | 1.4                                      | IV    | Day 1 of wk 2, 4, 6, 8, 10, 12       |
| Bleomycin                             | 5  | IV    | Day 1 of wk 2, 4, 6, 8, 10, 12       |
| Etoposide                             | 60                                       | IV    | Day 1 and 2 of wk 3, 7, 11           |
| Prednisone                            | 40                                       | PO    | q.o.d. × 9 wk, taper during wk 10–12 |
| <b>Escalated BEACOPP (Diehl, 327)</b> |  |       |                                      |
| Bleomycin                             | 10                                       | IV    | Day 8                                |
| Etoposide                             | 200                                      | IV    | Day 1, 2, 3                          |
| Doxorubicin                           | 35                                       | IV    | Day 1                                |
| Cyclophosphamide                      | 1200                                     | IV    | Day 1                                |
| Vincristine                           | 1.4 <sup>a</sup>                         | IV    | Day 8                                |
| Procarbazine                          | 100                                      | PO    | Day 1–7                              |
| Prednisone                            | 40                                       | PO    | Day 1–14                             |

<sup>a</sup> Maximum dose, 2.0 mg. Repeat on day 22.

Another dose-intense regimen studied as initial therapy in Hodgkin disease is the Stanford V regimen, which was initially studied in 65 patients with bulky mediastinal disease or stage III and IV disease ( [329](#)). In contrast to BEACOPP, which escalated drug doses, the Stanford V regimen achieved dose intensity by decreasing the interval between treatments; total doses of drugs were lower than those used in standard regimens. As in the BEACOPP trial, radiotherapy was given as consolidation to sites of bulky disease. In the initial single institution report, actuarial 5-year survival was 96%, and 5-year failure-free survival was 89% ( [330](#)). A feasibility trial has also been conducted in a

multiinstitutional setting ( 331 ). Results were essentially identical to those reported in the initial Stanford study. Overall survival was 96% at 2 years and 5 years; FFP was 87% at 2 years and 85% at 5 years ( 331 ). Because Stanford V is associated with excellent long-term results and involves lower total drug doses and, therefore, a potential for less long-term toxicity, it is a very intriguing regimen. An intergroup study comparing Stanford V to ABVD has been initiated. As noted above, as initially administered, the MOPP/ABV regimen included radiotherapy for patients with a solitary site of residual disease after chemotherapy. Other regimens, such as Stanford V and BEACOPP, include radiotherapy to initial sites of bulky disease ( 327 , 329 ). By contrast, some investigators have advocated that on completion of chemotherapy, moderate doses of radiotherapy should be administered to *a/* sites of disease that were initially present ( 332 , 333 , 334 , 335 , 336 and 337 ). Given that the investigators used effective chemotherapy regimens and that the administration of radiotherapy could not compromise the delivery of chemotherapy (because it was administered on completion of chemotherapy), it is not surprising that excellent results were obtained using radiotherapy on completion of chemotherapy. For example, Straus et al. reported an overall survival of 72% at 8 years using radiotherapy after completion of a number of chemotherapy regimens such as MOPP/ABVD ( 332 ). Prosnitz and associates reported a 15-year actuarial survival of 54% in patients who received radiotherapy after chemotherapy ( 335 ). However, 10% of patients treated in that series ( 335 ) developed second malignancies, with 6% of patients dying of these second malignancies. Thus, although these studies demonstrate the feasibility of a combined modality approach to patients with advanced Hodgkin disease, only a randomized trial can determine if such an approach is of value. To detect significant differences between chemotherapy and chemotherapy followed by radiation therapy requires such a large number of patients that it is unlikely that such a definitive large-scale prospective trial will ever be performed. However, a metaanalysis has been performed of studies that compared chemotherapy alone to combined modality treatment ( 338 ). Two clinical designs were noted. In the first group of trials, patients received a similar amount of chemotherapy in both arms, but one group received additional radiotherapy. In these trials, relapse-free survival was superior in the combined modality group, but overall survival was not significantly improved by the addition of radiotherapy. In the second group of trials, radiotherapy was substituted for chemotherapy; in these trials, the patients receiving radiotherapy received fewer cycles of chemotherapy. In these trials, tumor control was the same with both treatment approaches. However, overall survival was better in patients who were *not* receiving radiotherapy. Thus, although radiotherapy might produce effective local control, long-term hazards of combined modality therapy made this approach counterproductive. The authors concluded that combined modality therapy of advanced disease should be limited to specific indications ( 338 ). Although the authors did not clarify this point, it seems logical to conclude that equivocal complete remissions would be considered such a circumstance. However, it is reasonable to speculate that the future use of PET scans might markedly decrease the number of cases thought to have equivocal responses to chemotherapy.

## Summary of Treatment of Hodgkin Disease

With the recognition that effective salvage treatment of Hodgkin disease can produce cures, it has become harder to prove that a specific therapy is the best long-term option for a specific stage of Hodgkin disease. Nevertheless, based on an assessment of risks and benefits, several treatment recommendations can be made ( Table 95.9 ). Treatment decisions are almost always based on the results of clinical staging, as staging laparotomy has all but been abandoned. As a result, the use of radiation therapy alone for limited stage disease has been limited to a small subgroup of very favorable patients who are at minimal risk of occult abdominal disease. Radiation therapy with abbreviated combination chemotherapy has become the most widely used approach in limited stage (stage IA and IIA) patients. For patients with stage IX and IIX disease and a large mediastinal mass,

combination chemotherapy, usually ABVD, followed by radiation therapy, is the most logical approach. Anatomic substaging depends on staging laparotomy and is, therefore, of limited relevance when treatment planning is based on clinical staging. For patients with stage III or stage IV disease, combination chemotherapy is the treatment of choice, with the majority of data favoring the use of ABVD. The use of additional radiotherapy to large tumor masses is worth consideration but has not been proven to produce superior long-term results.

## SALVAGE CHEMOTHERAPY

As with the initial therapy, salvage therapy of Hodgkin disease is associated with significant morbidity and, possibly, mortality. Therefore, if relapse is suspected in a patient with Hodgkin disease, it should be confirmed by biopsy, whenever possible, before the initiation of salvage therapy. Although the choice of a salvage chemotherapy regimen depends primarily on the prior therapy that the patient has received, the response to salvage therapy depends on several additional factors including the initial stage of the patient, the response to that therapy, and the relapse-free interval.

After radiation therapy, the majority of relapses occur in the first 2 years after treatment; 95% of patients who remain free of disease for 4 years after radiation therapy are cured ( [337](#) ). Relapses may occur in previously irradiated sites, in areas adjacent to treatment fields (marginal recurrences), or in previously unirradiated areas. In patients who experience marginal recurrences or recurrences in unirradiated areas after radiation therapy, retreatment with radiation therapy can be considered. However, this approach rarely leads to long-term relapse-free survival ( [339](#) , [340](#) ). Most often, combination chemotherapy is considered for salvage therapy in patients who relapse after radiation.

Any of the regimens used as primary chemotherapy of Hodgkin disease are reasonable in the setting of relapse after radiation therapy. Although there is probably more published experience with MOPP in patients who relapse after receiving radiation therapy, the leukemogenic risk of using MOPP as part of combined modality therapy suggests that ABVD may be a more reasonable choice than MOPP in these patients. Empirical results support the use of ABVD in this context. In patients who relapsed or progressed after receiving radiation therapy, Santoro et al. reported responses in 75% of patients who received MOPP as compared with 91% of patients who received ABVD ( [341](#) ).

The initial stage of disease is an important prognostic indicator in patients who relapse after radiation therapy and who then receive chemotherapy. Mauch et al. ( [342](#) ) reported that patients who relapsed after receiving radiation therapy for stage IA, IIA, IIB, or III<sub>1</sub>A Hodgkin disease and then received salvage chemotherapy had a complete response rate of 86%, with 81% 4-year actuarial disease-free survival. By contrast, patients who initially presented with stage IIIB or III<sub>2</sub>A disease and who relapsed after receiving radiation therapy had a complete response rate of only 56% and a 42% 4-year disease-free survival when salvage chemotherapy was given. Thus, advanced stage of disease predicts not only an increased likelihood of relapse after radiation therapy, but also a decreased chance of responding to chemotherapy at the time of relapse.

For the patient who relapses after chemotherapy, radiation therapy can be considered ( [343](#) ) in the case of a focal nodal recurrence, but chemotherapy is generally the treatment of choice. Given the large number of drugs effective in Hodgkin disease, a wide variety of empirical combinations have been studied as salvage regimens in patients who relapse after receiving chemotherapy for Hodgkin disease ( [344](#) , [345](#) , [346](#) , [347](#) , [348](#) , [349](#) , [350](#) , [351](#) , [352](#) , [353](#) , [354](#) and [355](#) ). Recently, platinum based salvage regimens similar to those used in

non-Hodgkin lymphoma have been investigated ( [356](#) , [357](#) ), primarily in patients who were being considered for stem cell transplantation after such salvage chemotherapy. As would be expected from the fact that lymphocyte-predominant Hodgkin disease is a B-cell malignancy that is CD20 positive, preliminary reports have shown the effectiveness of rituximab in the treatment of this subtype of Hodgkin disease ( [358](#) ). Additionally, gemcitabine has recently been shown to be effective in heavily pretreated patients with Hodgkin disease, although patients who had previously undergone stem cell transplantation were excluded from the study ( [359](#) ).

The topic of salvage chemotherapy has been extensively reviewed ( [226](#) ). Doses of representative regimens are presented in [Table 95.17](#), and results obtained with some of the most commonly used regimens are presented in [Table 95.18](#). Although responses have been seen in more than half of the patients in some series, complete remission rates are generally between 30 and 40%, with long-term disease-free survival observed in only 15 to 20% of patients ( [346](#) , [360](#) ).

**TABLE 95.17. Chemotherapy Regimens Effective as Salvage Treatment of Hodgkin Disease**

| Regimen (Drugs)     | Recommended Dose (mg/m <sup>2</sup> ) | Route | Days                 |
|---------------------|---------------------------------------|-------|----------------------|
| <b>ABVD</b>         |                                       |       |                      |
| Doxorubicin         | 25                                    | IV    | 1, 15                |
| Bleomycin           | 10                                    | IV    | 1, 15                |
| Vinblastine         | 6                                     | IV    | 1, 15                |
| Dacarbazine         | 375                                   | IV    | 1, 15                |
| <b>B-CAVe</b>       |                                       |       |                      |
| Bleomycin           | 5                                     | IV    | 1, 28, 35            |
| CCNU                | 100                                   | PO    | 1                    |
| Doxorubicin         | 60                                    | IV    | 1                    |
| Vinblastine         | 5                                     | IV    | 1                    |
| <b>SCAB or CABS</b> |                                       |       |                      |
| Streptozotocin      | 500                                   | IV    | 1-5                  |
| CCNU                | 100                                   | PO    | 1                    |
| Doxorubicin         | 45                                    | IV    | 1                    |
| Bleomycin           | 15                                    | IV    | 1, 8                 |
| <b>ABDIC</b>        |                                       |       |                      |
| Doxorubicin         | 45                                    | IV    | 1                    |
| Bleomycin           | 5                                     | IV    | 1, 5                 |
| Dacarbazine         | 200                                   | IV    | 1-5                  |
| CCNU                | 50                                    | PO    | 1                    |
| Prednisone          | 40                                    | PO    | 1-5                  |
| <b>VABCD</b>        |                                       |       |                      |
| Vinblastine         | 6                                     | IV    | 1, 22                |
| Doxorubicin         | 40                                    | IV    | 1, 22                |
| Bleomycin           | 15                                    | IV    | 1, 8, 15, 22, 29, 36 |
| CCNU                | 80                                    | PO    | 1                    |
| Dacarbazine         | 800                                   | IV    | 1, 22                |

|                    |                  |        |     |
|--------------------|------------------|--------|-----|
| CEP                |                  |        |     |
| CCNU               | 80               | PO     | 1   |
| Etoposide          | 100              | PO     | 1–5 |
| Prednimustine      | 60               | PO     | 1–5 |
| EVA                |                  |        |     |
| Etoposide          | 100              | IV     | 1–3 |
| Vinblastine        | 6                | IV     | 1   |
| Doxorubicin        | 50               | IV     | 1   |
| ASHAP              |                  |        |     |
| Doxorubicin        | 10               | IV, CI | 1–4 |
| Methylprednisolone | 500 <sup>a</sup> | PO     | 1–5 |
| Ara-C              | 1500             | IV     | 5   |
| Cisplatin          | 25               | IV, CI | 1–4 |
| ICE                |                  |        |     |
| Ifosfamide         | 5000             | IV, CI | 2   |
| Mesna              | 5000             | IV, CI | 2   |
| Etoposide          | 100              | IV     | 1–3 |
| Carboplatin        | 5 <sup>b</sup>   | IV     | 2   |

CCNU, cyclohexylchloroethylnitrosourea; CI, continuous 24-hour infusion.

NOTE: Each cycle lasts 28 days, with the exceptions of BCaVe and VABCD, in which the cycle is 42 days.

<sup>a</sup> Methylprednisolone dose in ASHAP is 500 mg—not mg/m<sup>2</sup>.

<sup>b</sup> Carboplatin dose in ICE is based on area under curve = 5, with a maximum of 800 mg total dose.

Modified from Longo DL. The use of chemotherapy in the treatment of Hodgkin's disease. *Semin Oncol* 1990;17:716–735.

**TABLE 95.18. Results of Selected Salvage Chemotherapy Regimens in Hodgkin Disease**

| Regimen (Author, Reference) | Number of Patients | Complete Response (%) | Disease-Free Survival (Yr) |
|-----------------------------|--------------------|-----------------------|----------------------------|
| ABVD (Santoro, 344)         | 54                 | 59                    | —                          |
| ABVD (Straus, 345)          | 27                 | 4                     | —                          |
| ABVD (Harker, 346)          | 55                 | 38                    | 9% (6)                     |
| BCaVe (Harker, 346)         | 48                 | 44                    | 25% (6)                    |
| SCAB (Levi, 347)            | 17                 | 35                    | —                          |
| ABDIC (Tannir, 349)         | 34                 | 35                    | —                          |
| EVA (Canellos, 355)         | 45                 | 40                    | 29% (3)                    |

Despite extensive use of salvage chemotherapy, no single regimen has emerged as optimal. Results using a specific regimen have varied widely across studies, and comparison of regimens across series is further limited because relapsing patients are

heterogeneous with respect to important prognostic variables.

It is generally appreciated that the relapse-free interval is the major prognostic indicator in patients who relapse after initial chemotherapy ( [360](#) , [361](#) ). Age older than 30 years at the time of initial chemotherapy has also been found to be an unfavorable prognostic factor with respect to survival after relapse ( [346](#) ). Although some investigators have found a trend for visceral relapses to carry a worse prognosis than nodal relapses ( [345](#) ), this has not been observed in other studies ( [342](#) , [346](#) , [360](#) ).

The importance of relapse-free interval was first noted by Fisher et al. ( [361](#) ). They reported that among patients relapsing after MOPP therapy, retreatment with MOPP was associated with a complete response in 93% of patients whose complete remission had lasted more than 1 year, whereas only 29% of patients who experienced a shorter response achieved a second complete remission with MOPP ( [361](#) ). With extended follow-up ( [360](#) ), it has become clear that the probability of cure is much greater for patients whose second complete remission follows a long first complete remission. When the first complete remission to chemotherapy lasted less than 1 year, only 14% of patients achieving a second complete remission are projected to remain in complete remission for more than 4 years. By contrast, among patients whose first remission was greater than 1 year, 45% of second complete remissions were projected by actuarial analysis to last more than 20 years ( [360](#) ). Studies using other salvage regimens have confirmed that the duration of the initial response is a reliable predictor of the response to salvage therapy ( [346](#) ). Not surprising, patients who did not achieve a complete remission in response to primary treatment have been found to be relatively resistant to salvage therapy ( [226](#) , [360](#) ).

Thus, salvage chemotherapy offers the possibility of a second complete remission and possible cure to patients with Hodgkin disease. Although retreatment with the regimen used initially can be associated with good results, especially if the first complete remission was greater than 1 year, the general trend is to consider drugs not used in the initial regimen. With the increased use of MOPP alternating with ABVD or the hybrid MOPP/ABV regimen as primary therapy, this is a somewhat moot point, as nearly all of the drugs effective in Hodgkin disease will have already been used at the time of relapse. Although retreatment with a seven- or eight-drug combination is feasible in these patients, the more common policy in patients who relapse after receiving MOPP/ABV or MOPP alternating with ABVD is to move directly to high-dose therapy in conjunction with ABMT or autologous peripheral blood stem cell transplantation (ASCT).

### Stem Cell Transplantation as Salvage Therapy

Over the past decade, high-dose chemotherapy in conjunction with ASCT has become a standard salvage approach to the patient with relapsed Hodgkin disease. Numerous clinical studies have been conducted ( [362](#) , [363](#) , [364](#) , [365](#) , [366](#) , [367](#) , [368](#) , [369](#) , [370](#) , [371](#) , [372](#) , [373](#) , [374](#) and [375](#) ), and the subject has been extensively reviewed ( [376](#) , [377](#) ). Although this therapy is often called *ASCT*, it is the high-dose chemotherapy (or chemotherapy plus radiation therapy) that is effective in treating relapsed Hodgkin disease. The autologous bone marrow (or autologous peripheral blood committed progenitor cells) merely provides a source of blood cell progenitors so that the patient can survive the augmented dose therapy, which would otherwise cause lethal damage to the hematopoietic system. Because results are similar regardless of whether stem cells are obtained from bone marrow or from the peripheral blood, the terms *autologous bone marrow transplantation* and *autologous peripheral blood stem cell transplantation* are often used interchangeably.

ASCT is based on the fact that the dose-limiting toxicity of the drugs effective in



Hodgkin disease involves the bone marrow. By using frozen bone marrow, or peripheral blood progenitor cells, obtained from the patient before the administration of chemotherapy, doses of chemotherapeutic agents can be escalated to levels that would ordinarily be lethal. Because Hodgkin disease is a highly chemosensitive malignancy and patients who relapse after chemotherapy often respond to readministration of the same chemotherapeutic agents at the same doses, ASCT with augmented doses of drugs is a curative therapeutic approach for many patients.

Early studies of ABMT in heavily pretreated patients with Hodgkin disease were associated with a treatment-related mortality of approximately 40% ( 365 ). With improvements in supportive care and patient selection, treatment-related mortality on the order of 5% is now expected in experienced centers ( 373 , 375 ). A number of high-dose combination chemotherapy regimens have been used in conjunction with autologous transplantation; doses and schedules of CBV [cyclophosphamide, bischloroethylnitrosourea (carmustine), and VP16-213 (etoposide)], CBVP, and BEAM (bischloroethylnitrosourea, etoposide, ara-C, melphalan) ( 373 , 374 and 375 ), some of the commonly used regimens, are presented in [Table 95.19](#).

**TABLE 95.19. Chemotherapy Regimens Used in Conjunction with Autologous Bone Marrow Transplantation**

| Regimen (Drugs)      | Recommended Dose (mg/m <sup>2</sup> ) | Route | Days <sup>a</sup> |
|----------------------|---------------------------------------|-------|-------------------|
| <b>CBV</b>           |                                       |       |                   |
| Cyclophosphamide     | 1800                                  | IV    | 7, 6, 5, 4        |
| BCNU                 | 600                                   | IV    | 3                 |
| Etoposide            | 800                                   | IV    | 7, 6, 5           |
| <b>CBV</b>           |                                       |       |                   |
| Cyclophosphamide     | 1500                                  | IV    | 5, 4, 3, 2        |
| BCNU                 | 300                                   | IV    | 5                 |
| Etoposide            | 300                                   | IV    | 5, 4, 3           |
| <b>CBVP</b>          |                                       |       |                   |
| Cyclophosphamide     | 1800                                  | IV    | 6, 5, 4, 3        |
| BCNU                 | 500                                   | IV    | 2                 |
| Etoposide            | 2400                                  | IV    | 7 <sup>b</sup>    |
| Cisplatin            | 50                                    | IV    | 7, 6, 5           |
| <b>BEAM</b>          |                                       |       |                   |
| BCNU                 | 300                                   | IV    | 6                 |
| Etoposide            | 100-200                               | IV    | 5, 4, 3, 2        |
| Cytosine arabinoside | 200-400                               | IV    | 5, 4, 3, 2        |
| Melphalan            | 140                                   | IV    | 1                 |

BCNU, bischloroethylnitrosourea.

<sup>a</sup> For transplant regimens, the preparative chemotherapy regimen is routinely given with the day of transplant considered as day = 0.

<sup>b</sup> Given as a 36-hour infusion.



With a heterogeneous group of patients being treated with high-dose therapy in conjunction with ABMT or ASCT, results have been highly variable. Among the best results is the report of Reese et al. ([375](#)), which used CBV or CBVP as the treatment regimen. With a median follow-up of 2.3 years, the actuarial progression-free survival for the entire series of 58 patients treated in first relapse was 64%. Three major negative prognostic factors were identified in this study: B symptoms at relapse, initial complete remission less than 1 year, and extranodal disease at relapse. If none of these negative features was present, actuarial relapse-free survival was 100%; if all three negative features were present, actuarial relapse-free survival was 0%. If one considers only the relapse-free interval, actuarial relapse-free survival was 85% in patients whose first response lasted more than 1 year and 48% in patients whose initial complete remission was less than 1 year.

The majority of patients receiving ASCT for Hodgkin disease have received high-dose combination chemotherapy as the preparative regimen. The use of wide field radiation therapy as part of the initial treatment of Hodgkin disease often precludes the use of total body radiation therapy as part of the salvage therapy used in conjunction with ABMT. Recently, however, total body irradiation has been combined with cyclophosphamide and etoposide as the conditioning regimen in 22 patients who had not received prior radiation therapy. Both the toxicity and the results of therapy were similar to that achieved using a combination chemotherapy regimen of cyclophosphamide and etoposide along with bischloroethylnitrosourea ([378](#)). As chemotherapy alone becomes the initial therapeutic approach for a greater percentage of patients, especially those patients with advanced disease and a relatively greater risk of relapse, it is expected that the use of preparative regimens using total body irradiation will be applicable to more patients with relapsing Hodgkin disease.

With respect to autologous transplantation in general, it is not known whether bone marrow or peripheral blood represents the optimal source of stem cells. For patients with hypocellular bone marrows or with tumor involvement of the bone marrow, peripheral blood stem cells would appear to be the stem cell source of choice. The feasibility of this approach has been demonstrated ([374](#)), and, considering that relatively unfavorable patients were treated, results similar to the results of ABMT have been reported. Because of the ease of obtaining peripheral blood stem cells and the quicker recovery of peripheral blood counts when peripheral blood stem cells are used, peripheral blood has generally replaced bone marrow as a source of autologous stem cells for use in transplantation in patients with Hodgkin disease.

Whereas the curative potential of ASCT in patients with relapsed Hodgkin disease has been demonstrated, the major remaining issue is when the procedure should be used. In non-Hodgkin lymphoma, randomized trials of conventional salvage therapy versus ASCT have been performed to demonstrate the superiority of ASCT. However, such randomized trials have not been conducted in Hodgkin disease. It has, therefore, been argued that conventional dose salvage chemotherapy should be used before moving to high-dose therapy in conjunction with autologous transplantation. However, in view of the minimal mortality of autologous transplantation and the excellent results of autologous transplantation, autologous transplantation has been recommended as the treatment of choice for all patients relapsing after initial chemotherapy ([377](#)). When the majority of patients received a seven- or eight-drug regimen as initial chemotherapy for Hodgkin disease, the choice between autologous transplantation or salvage chemotherapy with drugs that had not been administered was moot, as the most effective drugs had already been administered. However, as ABVD becomes standard initial chemotherapy for Hodgkin disease, the question of using salvage chemotherapy or moving to autologous

transplantation at first relapse will become a clinically relevant issue.

The good results obtained using ASCT as salvage therapy have suggested that ASCT should be considered as consolidation therapy in patients with Hodgkin disease who are considered “high risk” ( [379](#), [380](#)). Not surprising, clinical studies have shown that this approach is feasible. However, if this approach is used in *high-risk patients*, defined as patients who are estimated to have a cure rate of 40 to 50% ( [380](#)), approximately half of patients treated in this manner are cured before receiving the ASCT. Such patients have the risk of fatal toxicity associated with ASCT, approximately 5%, with no benefit. The real issue is not whether such therapy is feasible, it is whether such therapy improves results over those that could be obtained if transplantation were used at the time of relapse. That question can only be answered by a randomized clinical trial. Such information is not available.

Another approach to the patient with relapsed Hodgkin disease is to use allogeneic bone marrow as the source of bone marrow stem cells. Allogeneic stem cells have the advantage that occult Hodgkin disease is not present in the marrow infusion. Additionally, there is the theoretic benefit of graft-versus-lymphoma effect. However, the risks of graft-versus-host disease are of considerable magnitude. As a result, although allogeneic bone marrow transplantation has been successfully used in patients with Hodgkin disease ( [367](#), [381](#), [382](#) and [383](#)), it has been studied much less extensively than ABMT and has been used in only limited circumstances, such as patients with bone marrow involvement, patients who have received pelvic radiation therapy, and patients with stem cell disorders resulting from prior treatment.

The International Bone Marrow Transplant Registry has reported results in 100 patients receiving allogeneic transplants for relapsed Hodgkin disease ( [384](#)). In this negatively selected group of patients, the 3-year probability of chronic graft-versus-host disease was 45%, the 3-year probability of relapse was 65%, and the 3-year disease-free survival was only 15%. Because the patients are not comparable with patients generally selected for ABMT, direct comparisons of these results to those obtained with ABMT are not appropriate. A different approach to transplantation has been taken by investigators at the Johns Hopkins Oncology Center who gave allogeneic transplantation priority over autologous transplantation in patients with relapsed Hodgkin disease ( [385](#)). This study, therefore, frees the allo-genetic transplant group from the handicap of negative prognostic features. In this study ( [385](#)), disease status (sensitive vs. resistant) and year of transplant were significant predictors of event-free survival after transplant. Allogeneic transplant versus autologous transplant did not predict event-free survival. In patients with sensitive disease at the time of transplant, however, there was a nonsignificant trend for relapse to occur less frequently in patients receiving allogeneic transplantation rather than autologous transplantation (34% vs. 51%), confirming the existence of a graft-versus-tumor effect. Additionally, secondary myelodysplasia or acute leukemia occurred only in the patients receiving autologous transplantation. However, despite these benefits of allogeneic transplantation, overall survival was no better in the patients receiving allogeneic transplantation because of the higher treatment-related mortality associated with allogeneic transplantation.

This paper ( [385](#)) adds more heat than light to the question of what is the role of allogeneic transplantation in Hodgkin disease. In “favorable” patients, with sensitive disease, the benefits of graft-versus-tumor effect were not shown to overcome the mortality associated with allogeneic transplantation, and results with autologous transplantation were equivalent to results obtained with allogeneic transplantation. In patients with “unfavorable” disease (i.e., disease resistant to chemotherapy), the high transplant-related mortality and high relapse rate did not justify the use of allogeneic transplantation. Thus, the question of when, if ever, to use allogeneic transplantation in

relapsed Hodgkin disease remains unanswered.

As for patients who relapse after undergoing autologous transplantation for Hodgkin disease, the diversity of such patients precludes any definitive recommendations for therapy. If the patient previously had a long response to a combination chemotherapy regimen, treatment with that regimen with palliative intent is a reasonable option. In a series of 17 patients who relapsed after an autologous transplant, vinblastine, 4 to 6 mg/m<sup>2</sup>, every 1 to 2 weeks, produced responses in 59% of patients, with 12% of those responses being complete remissions ( 386 ). Whereas median event-free survival in that series was only 8.3 months, median overall survival was 38.8 months. The two complete responders remained in remission at 4+ years and 9+ years at the time of publication. These results are impressive, but the relative role of this approach as compared to other salvage approaches, including allogeneic transplantation after autologous transplantation, is unknown.

## HODGKIN DISEASE AND HUMAN IMMUNODEFICIENCY VIRUS

Although Hodgkin disease is not considered an AIDS-defining illness, the incidence of Hodgkin disease is increased among patients with HIV infection ( 33 , 34 ). In contrast to patients without HIV infection, Hodgkin disease in patients with HIV infection is most commonly of the mixed cellularity subtype and is associated with B symptoms and with advanced stage, commonly due to bone marrow involvement ( 387 ). Despite the excellent results seen in patients with advanced stage Hodgkin disease in the absence of HIV infection, median survival in HIV-positive patients with Hodgkin disease is generally less than 2 years ( 387 ). In a group of patients who did not receive highly active antiretroviral therapy, the ABVD regimen was minimally effective, producing a median survival of only 18 months ( 388 ). In a group of patients treated with Stanford V and highly active antiretroviral therapy, 53% of patients were predicted to be disease free at 2 years ( 389 ). Because marked differences between ABVD and Stanford V have not been noted in patients who are HIV negative, these differences may indicate that the critical factor may well be the administration of highly active antiretroviral therapy in conjunction with chemotherapy. Alternatively, the differences may reflect selection bias in the two series. Further studies are needed to define the optimal approach to treatment in Hodgkin disease patients who are positive for HIV.

## PEDIATRIC HODGKIN DISEASE

The biology, natural history, and clinical considerations are similar for children with Hodgkin disease as compared with adults with Hodgkin disease ( 390 ), although some differences do exist. There is a slight increase in the percent of cases of the lymphocyte-predominant subtype in children with Hodgkin disease as compared with adults ( 391 , 392 and 393 ). The lymphocyte-predominant subtype represents 2 to 7% of adult cases of Hodgkin disease, but it represents approximately 20% of cases of childhood Hodgkin disease. There is a trend for stage I disease to be slightly more common in children than in adults ( 390 ). On a stage-by-stage basis, children with Hodgkin disease do slightly better than adults with the same stage of disease ( 139 ).

The involvement of specific sites of disease in children with Hodgkin disease is similar to that of adults ( 394 ) ( Table 95.20 ), and the tests recommended for staging of children with Hodgkin disease are the same as those recommended for adults. As in the case of adults, the role of staging laparotomy in children with Hodgkin disease remains controversial. Whereas the stage of the patient is likely to change in one-third of children based on

findings at laparotomy, it has not been established whether this information leads to a clinical benefit. Additionally, the risk of postsplenectomy sepsis may be greater in children than in adults, offsetting the potential benefits.

**TABLE 95.20. Frequency of Involvement of Nodal Sites in Children with Hodgkin Disease**

| Site   | Frequency of Involvement (%) |
|--|------------------------------|
| Left cervical and/or supraclavicular nodes         | 78                           |
| Right cervical and/or supraclavicular nodes        | 74                           |
| Mediastinum  | 60                           |
| Spleen   | 33                           |
| Right hilar nodes                                  | 28                           |
| Left axillary nodes                                | 26                           |
| Right axillary nodes                               | 22                           |
| Paraortic nodes, celiac nodes, splenic hilar nodes | 22                           |
| Left hilar nodes                                   | 20                           |

Based on a series of 129 surgically staged cases from Donaldson SS, Kaplan HS. A survey of pediatric Hodgkin's disease at Stanford University: results of therapy and quality of survival. In: Rosenberg SA, Kaplan HS, eds. Malignant lymphomas, etiology, immunology, pathology, treatment. New York: Academic Press, 1982:571-590.

The major difference between children and adults with Hodgkin disease is that high-dose large-volume irradiation is likely to be associated with impaired growth. Substantial height impairment has been documented in children who received high-dose radiation to the entire spine at a prepubertal age ( 395 ), with the greatest effect seen in boys radiated before 11 year of age and in girls radiated before 9 years of age ( 395 ). As a result, there is a general tendency to depend on chemotherapy, with or without low-dose involved field radiation therapy, in younger children.

Whereas preservation of fertility is often a concern in treating young adults, it is always a concern when treating children. As a result, oophoropexy during staging laparotomy is a reasonable approach if pelvic radiation is planned. Before menarche, women may be relatively, but not absolutely, protected from the infertility that may be caused by chemotherapy. There is no evidence, however, that prepubertal boys are spared the risks of infertility that are associated with chemotherapy. For this reason, ABVD might be a more logical choice than MOPP or MOPP/ABV when chemotherapy is used in children. However, the long-term cardiac effects of doxorubicin are not fully known, and this long-term risk must also be considered when a chemotherapy regimen is chosen.

The risks of second malignancies must also be considered when making therapeutic decisions in children. For the most part, this involves limiting the use of wide field radiation therapy and combination chemotherapy. However, in this regard, there is really no major difference between children and adults, as a secondary leukemia or a second tumor is no less devastating in a 50-year-old than in a teenager or young adult. The overall risk of solid tumors may be as high as 15% 20 years after treating patients for Hodgkin disease ( 396 , 397 ), and because the latent period for the development of tumors can exceed 20 years, long-term follow-up is mandatory for all children treated for

Hodgkin disease.

## HODGKIN DISEASE AND PREGNANCY

Because Hodgkin disease is commonly seen in women of childbearing years, it is not surprising that Hodgkin disease may occur in women who are pregnant. This problem has been extensively reviewed ([398](#)); although agreement regarding optimal management of these patients does not exist, several key observations have been made, and guidelines for therapy have been advocated. Pregnancy does not affect the course of Hodgkin disease as compared to age-adjusted controls with Hodgkin disease who are not pregnant ([399](#)).

Transmission of Hodgkin disease to the fetus occurs rarely, if at all. There is only one such case report in the literature ([400](#)), and considering that the case was reported in 1926, the accuracy of the pathologic diagnosis can be questioned.

Staging of the pregnant patient with Hodgkin disease must be modified to decrease the risks associated with radiation exposure of the fetus. Such an evaluation must be performed in the context of treatment planning. If the overall plan is to delay treatment until after delivery, unless bulky disease is found, then a modified approach to staging is reasonable. A chest x-ray, complete blood counts, liver and renal function tests, serum lactic dehydrogenase, and bone marrow biopsy are indicated. Abdominal ultrasound is probably adequate to establish or rule out the presence of extensive abdominal disease ([396](#)).

Although radiation therapy can be given during pregnancy if uterine shielding is used, the fact that patients have not been totally staged usually means that such treatment is a “holding action” and not definitive therapy. As such, unless bulky disease requires intervention, radiation therapy may be delayed until after delivery. In a patient who is thought to require radiation in the first trimester, therapeutic abortion is a consideration, although healthy infants have been born to women irradiated in the first trimester. The risk of fetal malformations is approximately 15% when chemotherapy is given in the first trimester and possibly no greater than normal when given in the second and third trimester ([401](#)). The risk of late sequelae of chemotherapy to the fetus is unknown. Therefore, unless disease is clearly bulky, symptomatic, or stage III or IV, one can consider following patients to term if disease is diagnosed in the late second or third trimester.

If a decision is made to delay therapy until after delivery, the patient should be monitored closely, and the clinical plan should be reevaluated if progressive disease is noted. If chemotherapy is given during pregnancy, it is probably best to avoid chemotherapy during the 3 weeks before delivery to avoid having the baby be neutropenic at birth.

## MEDICAL-LEGAL ISSUES IN HODGKIN DISEASE

In a litigious society, it should not be surprising that the diagnosis and management of Hodgkin disease are often the subject of malpractice suits. Having been consulted on numerous occasions as an expert witness, the senior author of this chapter (Richard S. Stein) has concluded that a substantial amount of time and effort could be saved if attorneys appreciated the following facts regarding Hodgkin disease.

The diagnosis of Hodgkin disease is often associated with a delay of several months after the first appearance of adenopathy. In many patients with Hodgkin disease, adenopathy



waxes and wanes, justifying a delay in performing a diagnostic biopsy. Additionally, in many patients with Hodgkin disease, the initial biopsy does not establish a diagnosis, and repeat biopsy, which may reasonably be delayed for months, may be necessary to establish a diagnosis.

A delay in diagnosis may lead to Hodgkin disease being diagnosed at a more advanced stage than was likely present at initial presentation. However, the impact of an increase in stage is less for Hodgkin disease than for other malignancies, such as breast cancer or lung cancer, in which advanced stage IV disease is almost certainly fatal. As shown in [Table 95.10](#), for the majority of patients with stage IV Hodgkin disease, the expectation is that cure will be achieved.

The use of combination chemotherapy, such as ABVD, in conjunction with radiation therapy is a rational approach to stage I Hodgkin disease. The argument that delay in diagnosis led to advanced stage disease, which required more extensive, toxic therapy, must be considered in the context of that fact.

For each stage of Hodgkin disease, there are many rational treatment options, all of which are consistent with the standard of care ([Table 95.9](#)). Treatment options that are associated with superior short-term results often have delayed toxicities, which render them equivalent, in the long term, to therapies that are associated with higher rates of early relapse. It is impossible for physicians to define a single “standard of care” treatment for each stage of Hodgkin disease.

Some patients with Hodgkin disease die of disease or of complications of therapy. The treatment of Hodgkin disease is one of the success stories of modern oncology. Additionally, the enthusiasm of physicians has led them to emphasize the high probability of cure. Nevertheless, the cure rate of Hodgkin disease is not 100%. Depending on the choice of therapy, up to 25% of patients with advanced disease have no success with initial therapy or relapse shortly after completion of therapy. Salvage therapy, such as high-dose therapy in conjunction with stem cell transplantation, is effective. However, this approach has a cure rate near 50% only for patients with sensitive disease at relapse. Not all patients have sensitive disease at relapse.

Finally, as physicians try to improve the imperfect results in Hodgkin disease with more intense initial therapies ([327](#), [328](#)), an increase in early deaths due to bacterial sepsis and opportunistic infections is likely to be observed, even if these regimens eventually lead to superior long-term clinical results.

## FUTURE PROSPECTS

Major advances in the curability of Hodgkin disease have been dependent on the use of standard approaches to staging and the rational selection of radiation therapy, combination chemotherapy, or combined modality therapy based on the stage of the disease. Because curative salvage therapy exists and newer therapeutic approaches can be tested only in patients who have not had success with presently available curative therapy, it is unlikely that major clinical advances are going to occur in the treatment of Hodgkin disease in the near future. Instead, results of ongoing clinical studies are likely to fine-tune present issues, such as determining whether dose-intense chemotherapy, such as Stanford V, is really superior to ABVD.

It should be recognized that the last two decades of clinical progress have occurred without a basic understanding of the biology of Hodgkin disease. Although there is considerable speculation regarding the role of EBV in the etiology of Hodgkin disease, the cause of Hodgkin disease is unknown, as is the nature of the cell or cells of origin. If

progress in Hodgkin disease is to occur in the next decade, it is likely to involve an increase in our understanding of the biology of Hodgkin disease. Even so, the present state of the art and science is such that caring for the patient with Hodgkin disease can be among the most satisfying experiences in medicine.

## REFERENCES

1. Hodgkin T. On some morbid appearances of the absorbent glands and spleen. *Trans Med Chir Soc Lond* 1832;17:68–114.
2. Wilks S. Cases of lardaceous disease and some allied affections, with remarks. *Guy's Hosp Rep* 1856;17 (Ser II, Vol 2):103–132.
3. Wilks S. Cases of enlargement of the lymphatic glands and spleen (or Hodgkin's disease), with remarks. *Guy's Hosp Rep* 1865;11:56–67.
4. Langhans T. Das Maligne Lymphosarkom (Pseudoleukämie). *Virchow's Arch F Path Anat* 1872;54:509–537.
5. Sternberg C. Über eine eigenartige unter dem Bilde der Pseudoleukämie verlaufende Tuberculose des lymphatischen Apparates. *Z Heilk* 1898;19:21–90.
6. Reed DM. On the pathological changes in Hodgkin's disease, with special reference to tuberculosis. *Johns Hopkins Hosp Rep* 1902;10:133–196.
7. MacMahon B. Epidemiological evidence of the nature of Hodgkin's disease. *Cancer* 1957;10:1045–1054.
8. Gutensohn N, Cole P. Childhood social environment and Hodgkin's disease. *N Engl J Med* 1981;304:135–140.
9. Correa P, O'Connor GT. Epidemiologic pattern of Hodgkin's disease. *Int J Cancer* 1971;8:192–201.
10. Glaser SL. Hodgkin's disease in black populations: a review of the epidemiologic literature. *Semin Oncol* 1990;17:643–659.
11. Mueller N, Evans A, Harris N, et al. Hodgkin's disease and Epstein Barr virus: altered antibody pattern before diagnosis. *N Engl J Med* 1989;320:689–695.
12. Gutensohn N. Social class and age at diagnosis of Hodgkin's disease: new epidemiologic evidence for the "two disease hypothesis." *Cancer Treat Rep* 1982;66:689–695.
13. Steiner P. Hodgkin's disease: search for infective agent and attempts at experimental reproduction. *Arch Pathol* 1934;17:749–763.
14. VanRooyan C. Etiology of Hodgkin's disease with special reference to *B. tuberculosis avis*. *Br Med J* 1933;1:50–51.
15. Vianna NJ, Greenwald P, Davies JNP. Extended epidemic of Hodgkin's disease in high school students. *Lancet* 1971;1:1209–1211.
16. Vianna JH, Polan AK. Epidemiological evidence for transmission of Hodgkin's disease. *N Engl J Med* 1973;289:499–502.
17. Grufferman S, Cole P, Levitan T. Evidence against transmission of Hodgkin's disease in high schools. *N Engl J Med* 1979;300:1006–1011.
18. Miller RW, Beebe GW. Infectious mononucleosis and the empirical risk of cancer. *J Natl Cancer Inst* 1973;50:315–321.
19. Connolly RR, Christene BW. A cohort study of cancer following infectious mononucleosis. *Cancer Res*



1974;34:1172-1178.

20. Rosdahl N, Larsen SO, Clemmesen J. Hodgkin's disease in patients with previous mononucleosis, 30 years' experience. *BMJ* 1974;2:253-256.
21. Weiss LM, Movahed AM, Warnke RA, Sklar J. Detection of Epstein-Barr viral genomes in Reed-Sternberg cells of Hodgkin's disease. *N Engl J Med* 1989;320:502-506.
22. Herbst H, Steinbrecher E, Niedobitek G, et al. Distribution and phenotype of Epstein-Barr virus-harboring cells in Hodgkin's disease. *Blood* 1992;80:484-491.
23. Gulley ML, Eagan PA, Quintanilla-Martinez L, et al. Epstein-Barr virus DNA is abundant and monoclonal in the Reed-Sternberg cells of Hodgkin's disease: association with mixed cellularity subtype and Hispanic American ethnicity. *Blood* 1994;83:1595-1602.
24. Jarrett RF, MacKenzie J. Epstein-Barr virus and other candidate viruses in the pathogenesis of Hodgkin's disease. *Semin Hematol* 1999;36:206-210.
25. Morente MM, Piris MA, Abaira A, et al. Adverse clinical outcome in Hodgkin's disease is associated with loss of retinoblastoma protein expression, high Ki67 proliferation index, and absence of Epstein-Barr virus latent membrane protein 1 expression. *Blood* 1997;90:2429-2436.
26. Murray PG, Billingham LI, Hassan HT, et al. Effect of Epstein-Barr virus infection on response to chemotherapy and survival in Hodgkin's disease. *Blood* 1999;94:442-447.
27. Flavell KJ, Murray PG. Hodgkin's disease and the Epstein-Barr virus. *Mol Pathol* 2000;53:262-269.
28. Mack TM, Cozen W, Shibata DK, et al. Concordance for Hodgkin's disease in identical twins suggesting genetic susceptibility to the young-adult form of the disease. *N Engl J Med* 1995;332:413-418.
29. Biggar RJ, Horm J, Lubin JH, et al. Cancer trends in a population at risk of acquired immunodeficiency syndrome. *J Natl Cancer Inst* 1985;74:793-797.
30. Harnly ME, Swan SH, Holly EA, et al. Temporal trends in the incidence of non-Hodgkin's lymphoma and selected malignancies in a population with a high incidence of acquired immunodeficiency syndrome (AIDS). *Am J Epidemiol* 1988;128:261-267.
31. Rabkin CS, Biggar RJ, Horm JW. Increasing incidence of cancers associated with the human immunodeficiency virus epidemic. *Int J Cancer* 1989;47:692-696.
32. Biggar RJ, Burnett W, Mikl J, Nasca P. Cancer among New York men at risk of AIDS. *Int J Cancer* 1989;43:979-985.
33. Hessol NA, Katz MH, Liu JY, et al. Increased incidence of Hodgkin's disease in homosexual men with HIV infection. *Ann Intern Med* 1992;117:309-311.
34. Lyter DW, Bryant J, Thackeray R, et al. Incidence of human immunodeficiency virus-related and nonrelated malignancies in a large cohort of homosexual men. *J Clin Oncol* 1995;13:2540-2546.
35. Rowlings PA, Curtis RE, Passweg JR, et al. Increased incidence of Hodgkin's disease after allogeneic bone marrow transplantation. *J Clin Oncol* 1999;17:3122-3127.
36. Moseley AC, Lindsley HB, Skikne BS, Tawfik O. Reversible methotrexate lymphoproliferative disease evolving into Hodgkin's disease. *J Rheumatol* 2000;27:810-813.
37. Jones SE, Butler JJ, Byrne GE. Histopathologic review of lymphoma cases from the Southwest Oncology Group. *Cancer* 1977;39:1071-1076.
38. Childs CC, Parham DM, Berard CW. Infectious mononucleosis. The spectrum of morphologic changes simulating lymphoma in lymph nodes and tonsils. *Am J Surg Pathol* 1987;11:122-133.
39. Saltzstein SI, Ackerman LV. Lymphadenopathy induced by anticonvulsant drugs and mimicking

clinically and pathologically malignant lymphomas. *Cancer* 1959;12:164–182.

40. Slaughter DP, Economou SG, Southwick SW. The surgical management of Hodgkin's disease. *Ann Surg* 1958;148:705–709.
41. Foucar K, Rydell RE. Richter's syndrome in chronic lymphocytic leukemia. *Cancer* 1980;46:118–134.
42. Long JC, Aisenberg AC. Richter's syndrome: a terminal complication of chronic lymphocytic leukemia with distinct clinicopathologic features. *Am J Clin Pathol* 1975;63:786–795.
43. Kant JA, Hubbard SM, Longo DL, et al. The pathologic and clinical heterogeneity of lymphocyte-depleted Hodgkin's disease. *J Clin Oncol* 1986;4:284–294.
44. Wellman A, Otsuki T, Vogelbruch M, et al. Analysis of the t(2;5)(p23;q35) translocation by reverse transcription-polymerase chain reaction in CD 30+ anaplastic large-cell lymphomas, in other non-Hodgkin's lymphomas of T-cell phenotype and in Hodgkin's disease. *Blood* 1995;86:2321–2328.
45. Sarris AH, Luthra R, Papadimitracopoulou V, et al. Amplification of genomic DNA demonstrates the presence of t(2;5)(p23;q25) in anaplastic large cell lymphoma, but not in other non-Hodgkin's lymphomas, Hodgkin's disease, or lymphomatoid papulosis. *Blood* 1996;88:1771–1779.
46. Stein H, Foss HD, Durkop H, et al. CD30(+) anaplastic large cell lymphoma: a review of its histopathologic, genetic, and clinical features. *Blood* 2000;96:3681–3695.
47. Lukes RJ, Tindle BH, Parker JW. Reed-Sternberg like cells in infectious mononucleosis. *Lancet* 1969;2:1003–1004.
48. Strum SB, Park JK, Rappaport H. Observations on cells resembling Sternberg-Reed cells in conditions other than Hodgkin's disease. *Cancer* 1970;26:176–190.
49. Hsu SM, Yang K, Jaffe ES. Phenotypic expression of Hodgkin's and Reed-Sternberg cells in Hodgkin's disease. *Am J Pathol* 1985;118:209–217.
50. Stein H, Mason DY, Gerdes J, et al. The expression of the Hodgkin's disease associated antigen Ki-1 in reactive and neoplastic lymphoid tissue. Evidence that Reed-Sternberg cells and histiocytic malignancies are derived from activated lymphoid cells. *Blood* 1985;66:848–858.
51. Jackson HJ, Parker FJ. Hodgkin's disease II. Pathology. *N Engl J Med* 1944;231:35–44.
52. Lukes RJ, Butler JJ, Hicks EB. Natural history of Hodgkin's disease as related to its pathologic picture. *Cancer* 1966;19:317–344.
53. Lukes RJ, Craver LF, Hall TC, et al. Report of the nomenclature committee. *Cancer Res* 1966;26:1311.
54. Poppema S, Kaiserling E, Lennert K. Nodular paraganuloma and progressively transformed germinal centers: ultrastructural and immunohistologic findings. *Virchows Arch B Cell Pathol Incl Mol Pathol* 1979;31:211–225.
55. Medeiros LJ, Greiner TC. Hodgkin's disease. *Cancer* 1995;75[Suppl 1]:357–369.
56. Dorfman RF. Relationship of histology to site of Hodgkin's disease. *Cancer Res* 1971;31:1786–1793.
57. Bernhards J, Fischer R, Hubner K, et al. Histopathological classification of Hodgkin's lymphomas. Results from the reference pathology of the German Hodgkin's trial. *Ann Oncol* 1992;3[Suppl 4]:31–33.
58. Stein RS, Golomb HM, Diggs CH, et al. Anatomic substages of Hodgkin's disease: a collaborative study. *Ann Intern Med* 1980;92:159–165.
59. Colby TV, Hoppe RT, Warnke RA. Hodgkin's disease: a clinicopathologic study of 659 cases. *Cancer* 1982;49:1848–1858.
60. Cornbleet MA, Vitolo U, Ultmann JE, et al. Pathologic stages IA and IIA Hodgkin's disease: results of

treatment with radiotherapy. *J Clin Oncol* 1985;3:758–768.

61. Mauch P, Goffman T, Rosenthal DS, et al. Stage III Hodgkin's disease: improved survival with combined modality therapy as compared with radiation therapy alone. *J Clin Oncol* 1985;3:1166–1173.
62. Correa P, O'Connor GT, Berard CW, et al. International comparability and reproducibility in histologic subclassification of Hodgkin's disease. *J Natl Cancer Inst* 1973;50:1429–1435.
63. Regula DP, Hoppe RT, Weiss LM. Nodular and diffuse types of lymphocyte predominance Hodgkin's disease. *N Engl J Med* 1988;318:214–219.
64. Trudel MA, Krikorian JG, Neiman RS. Lymphocyte predominance Hodgkin's disease: a clinicopathologic reassessment. *Cancer* 1987;59:99–106.
65. Miettinen M, Franssila KO, Saxen E. Hodgkin's disease, lymphocyte predominance nodular: increased risk for subsequent non-Hodgkin's lymphomas. *Cancer* 1983;51:2293–2300.
66. Strum SB, Rappaport H. Consistency of histologic subtypes in Hodgkin's disease in simultaneous and sequential biopsy specimens. *Natl Cancer Inst Monogr* 1973;36:253–260.
67. Strickler JG, Michie SA, Warnke RA, Dorfman RF. The "syncytial variant" of nodular sclerosing Hodgkin's disease. *Am J Surg Pathol* 1986;10:470–477.
68. Bennett MH, Tu A, Hudgson GV. Analysis of grade I Hodgkin's disease (Report No. 6): cellular subtypes related to prognosis. *Clin Radiol* 1981;32:491–498.
69. d'Amore ESG, Lee CKK, Aeppli DM, et al. Lack of prognostic value of histopathologic parameters in Hodgkin's disease, nodular sclerosis type. *Arch Path Lab Med* 1992;116:856–861.
70. Masih AS, Weisenberger DD, Vose JM, et al. Histologic grade does not predict prognosis in optimally treated, advanced stage nodular sclerosis Hodgkin's disease. *Cancer* 1992;69:228–232.
71. Bearman RM, Pangalis GA, Rappaport H. Hodgkin's disease, lymphocyte depletion type: a clinicopathologic study of 39 patients. *Cancer* 1978;41:293–302.
72. Nieman RS, Rosen PJ, Lukes RJ. Lymphocyte-depletion Hodgkin's disease: a clinicopathological entity. *N Engl J Med* 1973;288:751–755.
73. Kinney MC, Greer JP, Stein RS, et al. Lymphocyte depletion Hodgkin's disease: histopathologic diagnosis of marrow involvement. *Am J Surg Pathol* 1986;10:219–226.
74. Greer JP, Kinney MC, Cousar JB, et al. Lymphocyte-depleted Hodgkin's disease: a clinicopathologic review of 25 patients. *Am J Med* 1986;81:208–214.
75. Agnarsson BA, Kadin ME. Ki-1 positive large cell lymphoma, a morphologic and immunologic study of 19 cases. *Am J Surg Pathol* 1988;12:264–274.
76. Greer JP, Kinney MC, Collins RD, et al. Clinical features of 31 patients with Ki-1 anaplastic large-cell lymphoma. *J Clin Oncol* 1991;9:539–547.
77. Anagnostopoulos I, Hansmann M, Fransilla K, et al. European Task Force on Lymphoma project on lymphocyte predominance Hodgkin disease: histologic and immunohistologic analysis of submitted cases reveals 2 types of Hodgkin disease with a nodular growth pattern and abundant lymphocytes. *Blood* 2000;96:1889–1899.
78. Diehl V, Sextro M, Franklin J, et al. Clinical presentation, course, and prognostic factors in lymphocyte-predominant Hodgkin's disease: report from the European Task Force on Lymphoma project on lymphocyte-predominant Hodgkin's disease. *J Clin Oncol* 1999;17:776–783.
79. Wolf J, Diehl V. Is Hodgkin's disease an infectious disease? *Ann Oncol* 1994;5[Suppl 1]:105–111.
80. Kadin ME, Stites DP, Levy R, Warnke R. Exogenous immunoglobulin and the macrophage origin of

Reed–Sternberg cells in Hodgkin’s disease. *N Engl J Med* 1978;299:1208–1214.

81. Kaplan HS, Gartner S. Sternberg–Reed giant cells of Hodgkin’s disease: cultivation in vitro, heterotransplantation, and characterization as neoplastic macrophages. *Int J Cancer* 1977;19:511–525.

82. Delsol G, Meggetto F, Brousset P, et al. Relation of follicular dendritic reticulum cells to Reed–Sternberg cells of Hodgkin’s disease with emphasis on the expression of CD21 antigen. *Am J Pathol* 1993;142:1729–1738.

83. Kadin ME. Possible origin of the Reed–Sternberg cell from an interdigitating reticulum cell. *Cancer Treat Rep* 1982;66:601–608.

84. Leech J. Immunoglobulin positive Reed–Sternberg cells in Hodgkin’s disease. *Lancet* 1973;2:265–266.

85. Order SE, Chism SE, Hellman S. Studies of antigens associated with Hodgkin’s disease. *Blood* 1972;40:621–633.

86. Diehl V, vonKalle C, Fonatsch C, et al. The cell of origin of Hodgkin’s disease. *Semin Oncol* 1990;17:660–672.

87. Haluska FG, Brufsky AM, Canellos GP. The cellular biology of the Reed–Sternberg cell. *Blood* 1994;84:1005–1019.

88. Agnarsson BA, Kadin ME. The immunophenotype of Reed–Sternberg cells: a study of 50 cases of Hodgkin’s disease using fixed frozen tissues. *Cancer* 1989;63:2083–2087.

89. Casey TT, Olson SJ, Cousar JB, Collins RD. Immunophenotypes of Reed–Sternberg cells: a study of 19 cases of Hodgkin’s disease in plastic embedded sections. *Blood* 1989;74:2624–2628.

90. Brinker MG, Poppema S, Buys CH, et al. Clonal immunoglobulin gene rearrangements in tissues involved by Hodgkin’s disease. *Blood* 1987;70:186–191.

91. Weiss LM, Strickler JG, Hu E, et al. Immunoglobulin gene rearrangements in Hodgkin’s disease. *Hum Pathol* 1986;17:1009–1014.

92. Herbst H, Tippelmann G, Anagnostopoulos I, et al. Immunoglobulin and T–cell receptor gene rearrangements in Hodgkin’s disease and Ki–1 positive anaplastic large cell lymphoma: dissociation between genotype and phenotype. *Leuk Res* 1989;13:103–116.

93. Kadin ME, Muramoto L, Said J. Expression of T–cell antigens by Reed–Sternberg cells in Hodgkin’s disease. *Am J Pathol* 1988;130:345–353.

94. Angel CA, Pringle JH, Naylor J, et al. Analysis of antigen receptor genes in Hodgkin’s disease. *J Clin Pathol* 1993;46:337–340.

95. Hummel M, Ziemann K, Lammert H, et al. Hodgkin’s disease with monoclonal and polyclonal populations of Reed–Sternberg cells. *N Engl J Med* 1995;333:901–906.

96. Marafioti T, Hummel M, Anagnostopoulos I, et al. Classical Hodgkin’s disease and follicular lymphoma originating from the same germinal center B cell. *J Clin Oncol* 1999;17:3804–3809.

97. Rowley JD. Chromosomes in Hodgkin’s disease. *Cancer Treat Rep* 1982;66:639–643.

98. Fonatsch C, Diehl V, Schaadt M, et al. Cytogenetic investigations in Hodgkin’s disease: I. Involvement of specific chromosomes in marker formation. *Cancer Genet Cytogenet* 1986;20:39–52.

99. Schouten HC, Sanger WG, Duggan M, et al. Chromosomal abnormalities in Hodgkin’s disease. *Blood* 1989;73:2149–2154.

100. Tilly H, Bastard C, Delastre T, et al. Cytogenetic studies in untreated Hodgkin’s disease. *Blood* 1991;1298–1304.

101. Schlegelberger B, Weber–Matthiesen K, Himmler A, et al. Cytogenetic findings and results of

combined immunophenotyping and karyotyping in Hodgkin's disease. *Leukemia* 1994;8:72-80.

102. Weber-Matthiesen K, Deerberg J, Poetsch M, et al. Numerical chromosome aberrations are present within the CD 30+ Hodgkin and Reed-Sternberg cells in 100% of analyzed cases of Hodgkin's disease. *Blood* 1995;86:1464-1468.

103. Timens W, Visser L, Poppema S. Nodular lymphocyte predominance type of Hodgkin's disease is a germinal center lymphoma. *Lab Invest* 1986;54:457-461.

104. Hell K, Pringle JH, Hansmann ML, et al. Demonstration of light chain messenger RNA in Hodgkin's disease. *J Pathol* 1993;171:137-143.

105. LeBrun DP, Ngan BY, Weiss LM, et al. The bcl-2 oncogene in Hodgkin's disease arising in the setting of follicular non-Hodgkin's lymphoma. *Blood* 1994;83:223-230.

106. Hummel M, Marafioti T, Zieman K, et al. Ig rearrangement in isolated Reed-Sternberg cells: conclusions from four different studies. *Ann Oncol* 1996;7:31-35.

107. Kanzler H, Kueppers R, Hansmann ML, et al. Hodgkin and Reed-Sternberg cells in Hodgkin's disease represent the outgrowth of a dominant tumor clone derived from crippled germinal center B cells. *J Exp Med* 1996;184:1495-1505.

108. Gonzalez CL, Medeiros J, Jaffe ES. Composite lymphoma: a clinicopathologic analysis of nine patients with Hodgkin's disease and B-cell non-Hodgkin's lymphoma. *Am J Clin Pathol* 1991;96:81-89.

109. Brauninger A, Hansmann M, Strickler JG, et al. Identification of common germinal center B cell precursors in two patients with both Hodgkin's disease and non Hodgkin's lymphoma. *N Engl J Med* 1999;340:1239-1247.

110. Hsu S, Krupen K, Lachman LB. Heterogeneity of interleukin-1 production in cultured Reed-Sternberg cell lines HDLM-1, HDLM-1d, and KM-H2. *Am J Pathol* 1989;135:33-38.

111. Tesch H, Hermann T, Abts H, et al. Expression of high affinity IL-2 receptors on a Hodgkin cell line *Leuk Res* 1989;14:953-960.

112. Newcom SR, Kadin M, Ansari A, Diehl V. L428 nodular sclerosing Hodgkin's cell secretes a unique transforming growth factor beta active at physiologic pH. *J Clin Invest* 1988;82:1915-1921.

113. Kadin M, Butmark J, Elovic A, Wong D. Eosinophils are the major source of transforming growth factor b1 in nodular sclerosing Hodgkin's disease. *Am J Pathol* 1993;142:11-16.

114. Kadin ME, Agnarsson BA, Ellingsworth LR, Newcom SR. Immunohistochemical evidence of a role for transforming growth factor b in the pathogenesis of nodular sclerosing Hodgkin's disease. *Am J Pathol* 1990; 136:1208-1214.

115. Durkop H, Foss H, Demel G, et al. Tumor necrosis factor receptor associated factor 1 is overexpressed in Reed-Sternberg cells of Hodgkin's disease and Epstein-Barr virus transformed lymphoid cells. *Blood* 1999;93:617-623.

116. Byrne PV, Heit WF, March CJ. Human granulocyte-macrophage colony stimulating factor purified from a Hodgkin's tumor cell line. *Biochem Biophys Acta* 1986;874:266-273.

117. Samoszuk M, Nansen L. Detection of interleukin-5 messenger RNA in Reed-Sternberg cells of Hodgkin's disease with eosinophilia. *Blood* 1990;75:13-16.

118. Foss HD, Herbst H, Oelmann E, et al. Lymphotoxin, tumor necrosis factor, and interleukin-6 gene transcripts are present in Hodgkin's and Reed-Sternberg cells of most Hodgkin's disease cases. *Br J Haematol* 1993;84:627-636.

119. Tabibzadeh SS, Poubouridis D, May LT, Seghal PB. Interleukin-6 immunoreactivity in human tumors. *Am J Pathol* 1989;135:427-433.

120. Foss HD, Hummel M, Gottstein S, et al. Frequent expression of IL-7 gene transcripts in tumor cells

of classical Hodgkin's disease. *Am J Pathol* 1995;146:33–39.

121. Skinnider BF, Elia AJ, Gascoyne RD, et al. Interleukin 13 and interleukin 13 receptor are frequently expressed by Hodgkin and Reed–Sternberg cells of Hodgkin lymphoma. *Blood* 2001;97:250–255.
122. Teruya–Feldstein J, Jaffe ES, Burd PR, et al. Differential chemokine expression in tissues involved by Hodgkin's disease: direct correlation of eotaxin expression and tissue eosinophilia. *Blood* 1999;93:2463–2470.
123. Kaplan HS. Contiguity and progression in Hodgkin's disease. *Cancer Res* 1971;31:1811–1813.
124. Kaplan HS, Dorfman RF, Nelsen TS, Rosenberg SA. Staging laparotomy and splenectomy in Hodgkin's disease: analysis of indications and patterns of involvement in 285 consecutive, unselected patients. *Natl Cancer Inst Monogr* 1973;36:291–301.
125. Krikorian JG, Portlock CS, Mauch PM. Hodgkin's disease presenting below the diaphragm: a review. *J Clin Oncol* 1986;4:1551–1562.
126. Liebenhaut MH, Hoppe R, Varghese A, Rosenberg SA. Subdiaphragmatic Hodgkin's disease: laparotomy and treatment results in 49 patients. *J Clin Oncol* 1987;5:1050–1055.
127. Miller TP, Byrne GE, Jones SE. Mistaken clinical and pathologic diagnoses of Hodgkin's disease: a Southwest Oncology Group study. *Cancer Treat Rep* 1982;66:645–651.
128. Hancock SL, Scidmore NS, Hopkins KL, et al. Computed tomography assessment of splenic size as a predictor of splenic weight and disease involvement in laparotomy staged Hodgkin's disease. *Int J Radiat Oncol Biol Phys* 1994;28:93–99.
129. Musshoff K. Prognostic and therapeutic implications of staging in extranodal Hodgkin's disease. *Cancer Res* 1971;31:1814–1827.
130. Rosenberg SA. Hodgkin's disease of the bone marrow. *Cancer Res* 1971;31:1733–1736.
131. Mauch PM, Kalish L, Kadin M, et al. Patterns of presentation of Hodgkin's disease. *Cancer* 1993;71:2062–2071.
132. Diehl LF, Hopper KD, Giguere J, et al. The pattern of intrathoracic Hodgkin's disease assessed by computed tomography. *J Clin Oncol* 1991;9:438–443.
133. Fialk MA, Jarowski CI, Coleman M, Mouradian J. Hepatic Hodgkin's disease without involvement of the spleen. *Cancer* 1979;43:1146–1147.
134. Desser RK, Golomb HM, Ultmann JE, et al. Prognostic classification of Hodgkin disease in pathologic stage III, based on anatomic considerations. *Blood* 1977;49:883–893.
135. Pel PK. Zur symptomatiologie der sogenannten pseudo–leukamie. *Berl Klin Wochenschr* 1885;22:3.
136. Ebstein W. Das chronische ruckfallsfieber eine neue infection–skranheit. *Klin Wochenschr* 1887;24:565.
137. Crnkovich MJ, Leopold K, Hoppe RT, Mauch PM. Stage I to IIB Hodgkin's disease: the combined experience at Stanford University and the Joint Center for Radiation Therapy. *J Clin Oncol* 1987;5:1041–1049.
138. Rubin P, Constone L, Bennett JM. Hodgkin's disease IIB or not to be — using irradiation alone or in combination with chemotherapy? That is the question! *J Clin Oncol* 1986;4:455–457.
139. Kaplan HS. *Hodgkin's disease*, 2nd ed. Cambridge: Harvard University Press, 1980.
140. Lister TA, Crowther D, Sutcliffe SB, et al. Report of a committee convened to discuss the evaluation and staging of patients with Hodgkin's disease: Cotswolds meeting. *J Clin Oncol* 1989;7:1630–1636.

141. Lister TA, Crowther D. Staging for Hodgkin's disease. *Semin Oncol* 1990;17:696-703.
142. Carbone PP, Kaplan HS, Musshoff K, et al. Report of the committee on Hodgkin's disease staging classification. *Cancer Res* 1971;31:1860-1861.
143. Levi JA, Wiernik PH. Limited extranodal Hodgkin's disease: unfavorable prognosis and therapeutic implications. *Am J Med* 1977;63:365-372.
144. Mauch P, Goodman R, Hellman S. The significance of mediastinal involvement in early stage Hodgkin's disease. *Cancer* 1978;42:1039-1045.
145. Prosnitz LR, Curtis AM, Knowlton AH, et al. Supradiaphragmatic Hodgkin's disease: significance of large mediastinal masses. *Int J Radiat Oncol Biol Phys* 1980;6:809-813.
146. Rostock RA, Giangreco A, Whara, MD, et al. CT scan modification in the treatment of mediastinal Hodgkin's disease. *Cancer* 1982;49:2267-2275.
147. Castellino RA, Blank N, Hoppe RT, Cho C. Hodgkin's disease: contributions of chest CT in the initial staging of Hodgkin's disease. *Radiology* 1986;160:603-605.
148. Hopper KD, Diehl LF, Lesar M, et al. Hodgkin's disease: clinical utility of CT in initial staging and treatment of Hodgkin's disease. *Radiology* 1988;169:17-22.
149. Castellino RA. Diagnostic imaging evaluation of Hodgkin's disease and non-Hodgkin's lymphoma. *Cancer* 1991;67:1177-1180.
150. Jones SE, Tobias DA, Waldman RS. Computed tomographic scanning in patients with lymphoma. *Cancer* 1978;41:480-486.
151. Best JJK, Blackledge G, Forbes WSC, et al. Computed tomography of abdomen in staging and clinical management of lymphoma. *BMJ* 1978;2:1675-1677.
152. Castellino RA, Hoppe R, Blank N, et al. Computed tomography, lymphography, and staging laparotomy: correlations in initial staging of Hodgkin's disease. *AJR Am J Roentgenol* 1984;143:37-41.
153. Anderson KC, Leonard RCF, Canellos GP, et al. High-dose gallium imaging in lymphoma. *Am J Med* 1983;75:327-331.
154. King SC, Reiman RJ, Prosnitz LR. Prognostic importance of restaging gallium scans following induction chemotherapy for advanced Hodgkin's disease. *J Clin Oncol* 1994;12:306-311.
155. Even-Sapir E, Bar-Shalom R, Israel O, et al. Single-photon emission computed tomography quantitation of gallium citrate uptake for the differentiation of lymphoma from benign hilar uptake. *J Clin Oncol* 1995;13:942-946.
156. Carlsen SE, Bergin CJ, Hoppe RT. MR Imaging to detect chest wall and pleural involvement in patients with lymphoma: effect on radiation therapy planning. *AJR Am J Roentgenol* 1993;160:1191-1195.
157. DeWit M, Bumann D, Beyer W, et al. Whole body positron emission tomography (PET) for diagnosis of residual mass in patients with lymphoma. *Ann Oncol* 1997;8 [Suppl 1]:57-60.
158. Jerusalem G, Beguin Y, Fassotte MF, et al. Whole-body positron emission tomography using <sup>18</sup>F-fluorodeoxyglucose for posttreatment evaluation in Hodgkin's disease and non-Hodgkin's lymphoma has higher diagnostic and prognostic value than classical computed tomography scan imaging. *Blood* 1999;94:429-433.
159. Weihrauch MR, Re D, Scheidhauer K, et al. Thoracic positron emission tomography using <sup>18</sup>F-fluorodeoxyglucose for the evaluation of residual mediastinal Hodgkin's disease. *Blood* 2001;98:2930-2934.
160. Marglin S, Castellino R. Lymphographic accuracy in 632 consecutive, previously untreated cases of



Hodgkin's disease and non-Hodgkin's lymphoma. *Radiology* 1981;140:351-353.

161. Kademian MT, Wirtanen GW. Accuracy of bipedal lymphography in Hodgkin's disease. *AJR Am J Roentgenol* 1977;129:1041-1042.

162. Sombeck MD, Mendenhall NP, Kaude JV, et al. Correlation of lymphangiography, computed tomography, and laparotomy in the staging of Hodgkin's disease. *Int J Radiat Oncol Biol Phys* 1993;25:425-429.

163. Bowdler AJ, Glick IW. Autoimmune hemolytic anemia as the herald state of Hodgkin's disease. *Ann Intern Med* 1966;65:671-677.

164. Tubiana M, Henry-Amar M, Burgers MV, et al. Prognostic significance of erythrocyte sedimentation rate in clinical stages I-II of Hodgkin's disease. *J Clin Oncol* 1984;2:194-200.

165. Friedman S, Henry-Amar M, Cosset JM, et al. Evolution of erythrocyte sedimentation rate as predictor of early relapse in posttherapy early-stage Hodgkin's disease. *J Clin Oncol* 1988;6:596-602.

166. Henry-Amar M, Friedman S, Hayat M, et al. Erythrocyte sedimentation rate predicts early relapse and survival in early-stage Hodgkin disease. The EORTC Lymphoma Cooperative Group. *Ann Intern Med* 1991;114:361-365.

167. Dimopoulos MA, Cabanillas F, Lee J, et al. Prognostic role of serum B<sub>2</sub>-microglobulin in Hodgkin's disease. *J Clin Oncol* 1993;11:1108-1111.

168. Munker R, Hansenclever D, Brosteanu O, et al. Bone marrow involvement in Hodgkin's disease: an analysis of 135 consecutive cases. German Hodgkin's Lymphoma Study Group. *J Clin Oncol* 1995;13:403-409.

169. Hellman S. Current studies in Hodgkin's disease: what laparotomy has wrought. *N Engl J Med* 1974;290:894-898.

170. Rosenberg SA. Exploratory laparotomy and splenectomy for Hodgkin's disease: a commentary. *J Clin Oncol* 1988;6:574-575.

171. Mauch P, Larson D, Osteen R, et al. Prognostic factors for positive surgical staging in patients with Hodgkin's disease. *J Clin Oncol* 1990;8:257-265.

172. Liebenhaut MH, Hoppe RT, Efron B, et al. Prognostic indicators of laparotomy findings in clinical stage I-II supradiaphragmatic Hodgkin's disease. *J Clin Oncol* 1989;7:81-91.

173. Slavin R, Nelsen TS. Complications from staging laparotomy in Hodgkin's disease. *Natl Cancer Inst Monogr* 1973;36:457-459.

174. Brogadir S, Fialk MA, Coleman M, et al. Morbidity of staging laparotomy in Hodgkin's disease. *Am J Med* 1978;64:429-443.

175. Kaiser C. Complications from staging laparotomy in Hodgkin's disease. *J Surg Oncol* 1981;16:319-325.

176. Nelson PW, Townsend CM Jr, Eakin DL, Costanzi JJ. Is staging laparotomy for Hodgkin's disease still justified? *Am J Surg* 1982;143:288-292.

177. Ravry M, Maldonado N, Velez-Garcia E, et al. Serious infection after splenectomy for the staging of Hodgkin's disease. *Ann Intern Med* 1972;77:11-14.

178. Hasenclever D, Diehl V. A prognostic score for advanced Hodgkin's disease. *N Engl J Med* 1998;339:1506-1514.

179. Pusey W. Cases of sarcoma and Hodgkin's disease treated by exposures to x-rays: a preliminary report. *JAMA* 1902;38:166-169.

180. Gilbert R. La roentgentherapie de la granulomatose maligne. *J Radiol Electrol* 1925;9:509-514.

181. Peters M. A study of survivals in Hodgkin's disease treated radiologically. *AJR Am J Roentgenol* 1950;63:299-311.
182. Peters M, Middlemiss K. A study of Hodgkin's disease treated by irradiation. *AJR Am J Roentgenol* 1958;79:114-121.
183. Peters MV. Prophylactic treatment of adjacent areas in Hodgkin's disease. *Cancer Res* 1966;26:1232-1243.
184. Easson E, Russell M. The cure of Hodgkin's disease. *BMJ* 1963;1:1704-1707.
185. Kaplan HS. Role of intensive radiotherapy in the management of Hodgkin's disease. *Cancer* 1966;19:356-367.
186. Kaplan HS. Evidence for a tumoricidal dose level in the radiotherapy of Hodgkin's disease. *Cancer Res* 1966;26:1221-1224.
187. Salzman JR, Kaplan HS. Effect of prior splenectomy on hematologic tolerance during total lymphoid radiotherapy of patients with Hodgkin's disease. *Cancer* 1972;27:471-478.
188. Marks JE, Moran EM, Griem ML, Ultmann JE. Extended mantle radiotherapy in Hodgkin's disease and malignant lymphoma. *AJR Am J Roentgenol* 1974;121:772-788.
189. Kinzie J, Hanks G, Maclean C, Kramer S. Patterns of care study: Hodgkin's disease relapse rates and adequacy of portals. *Cancer* 1983;52:2223-2226.
190. Hoppe R, Hanlon A, Hanks G, Owen J. Progress in the treatment of Hodgkin's disease in the United States, 1973 versus 1983: the patterns of care study. *Cancer* 1994;74:3198-3203.
191. Carmel RJ, Kaplan HS. Mantle irradiation in Hodgkin's disease: an analysis of technique, tumor eradication, and complications. *Cancer* 1976;37:2813-2825.
192. Hoppe RT. Radiation therapy in the treatment of Hodgkin's disease. *Semin Oncol* 1980;7:144-154.
193. Hoppe RT. Radiation therapy in the treatment of Hodgkin's disease. *Semin Oncol* 1990;17:704-715.
194. Byhardt R, Brace K, Ruckdeschel I, et al. Dose and treatment factors in radiation-related pericardial effusion associated with the mantle technique for Hodgkin's disease. *Cancer* 1975;35:795-802.
195. Tarbell N, Thompson L, Mauch P. Thoracic irradiation in Hodgkin's disease: disease control and long term complications. *Int J Radiat Oncol Biol Phys* 1990;18:275-281.
196. Jochelson M, Mauch P, Balikian J, et al. The significance of the residual mediastinal mass in treated Hodgkin's disease. *J Clin Oncol* 1985;3:637-640.
197. Morton DL, Glancy DL, Joseph WL, Adkins PC. Management of patients with radiation-induced pericarditis with effusion: a note on the development of aortic regurgitation in two of them. *Chest* 1973;64:291-297.
198. Brosius FC, Waller BF, Roberts WC. Radiation heart disease: analysis of 16 young (aged 15 to 33 years) necropsy patients who received over 3500 rads to the heart. *Am J Med* 1981;70:519-530.
199. Applefeld MM, Cole JF, Pollock SH, et al. The late appearance of chronic pericardial disease in patients treated by radiotherapy for Hodgkin's disease. *Ann Intern Med* 1981;94:338-341.
200. Boivin JF, Hutchison GF. Coronary heart disease mortality after irradiation for Hodgkin's disease. *Cancer* 1982;49:2470-2475.
201. Gomez G, Park J, Panahon A, et al. Heart size and function after radiation therapy to mediastinum in patients with Hodgkin's disease. *Cancer Treat Rep* 1983;67:1099-1103.
202. Gottdiener JS, Katin MJ, Borer JS, et al. Late cardiac effects of therapeutic mediastinal irradiation.

N Engl J Med 1983;308:569–572.

203. Stewart JR, Fajardo LF. Radiation-induced heart disease. *Prog Cardiovasc Dis* 1984;27:173–194.
204. Mill WB, Baglan RJ, Kurichety P, et al. Symptomatic radiation-induced pericarditis in Hodgkin's disease. *Int J Radiat Oncol Biol Phys* 1984;10:2061–2065.
205. Pohjola-Sintonen S, Totterman KJ, Salmo M, Siltanen P. Late cardiac effects of mediastinal radiotherapy in patients with Hodgkin's disease. *Cancer* 1987;60:31–37.
206. Carlson RG, Mayfield WR, Normann S, Alexander JA. Radiation-associated valvular disease. *Chest* 1991;99:538–545.
207. Boivin JF, Hutchison GB, Lubin JH, Mauch P. Coronary artery disease mortality in patients treated for Hodgkin's disease. *Cancer* 1992;69:1241–1247.
208. Hancock SL, Donaldson SS, Hoppe R. Cardiac disease following treatment of Hodgkin's disease in children and adolescents. *J Clin Oncol* 1993;11:1208–1215.
209. Dailey MO, Coleman CN, Kaplan HS. Radiation-induced splenic atrophy in patients with Hodgkin's disease and non-Hodgkin's lymphomas. *N Engl J Med* 1980;302:215–217.
210. Coleman CN, McDougall IR, Dailey MO, et al. Functional hyposplenism after splenic irradiation for Hodgkin's disease. *Ann Intern Med* 1982;96:44–47.
211. Hancock SL, Cox RS, McDougall IR. Thyroid diseases after treatment of Hodgkin's disease. *N Engl J Med* 1991;325:599–605.
212. Tucker MA, Coleman CN, Cox RS, et al. Risk of second cancers after treatment for Hodgkin's disease. *N Engl J Med* 1988;318:76–81.
213. List AF, Doll DC, Greco FA. Lung cancer in Hodgkin's disease: association with previous radiotherapy. *J Clin Oncol* 1985;3:215–221.
214. Tucker MA, Misfeldt D, Coleman N, et al. Cutaneous malignant melanoma after Hodgkin's disease. *Ann Intern Med* 1985;102:37–41.
215. Hancock SL, Tucker MA, Hoppe RT. Breast cancer after treatment of Hodgkin's disease. *J Natl Cancer Inst* 1993;85:25–31.
216. Yahalom J, Petrek JA, Biddinger PW, et al. Breast cancer in patients irradiated for Hodgkin's disease: a clinical and pathological analysis of 45 events in 37 patients. *J Clin Oncol* 1992;10:1662–1665.
217. Carey RW, Linggood RM, Wood W, Blitzer PH. Breast cancer developing in four women cured of Hodgkin's disease. *Cancer* 1984;54:2234–2236.
218. Gilman A. An initial trial of nitrogen mustard. *Am J Surg* 1963;105:547.
219. Gold SL, Salvin LG, Salvin L. A comparative study with three alkylating agents: mechlorethamine, cyclophosphamide, and uracil mustard. *Cancer Chemother Rep* 1962;16:417–419.
220. Desser RK, Ultmann JE. The sensitivity of Hodgkin's disease to chemotherapeutic agents administered singly. *Ser Haematol* 1973;6:152–181.
221. O'Reilly SE, Mlimo P, Connors JM. The evolving role of etoposide in the management of Hodgkin's disease. *Cancer* 1991;67:271–280.
222. Cavalli F, Jungi WF, Nissen NI, et al. Phase II trial of *cis*-dichlorodiammineplatinum (II) in advanced malignant lymphoma: a study of the Cancer and Acute Leukemia Group B. *Cancer* 1981;48:1927–1930.
223. Goldsmith MA, Carter SK. Combination chemotherapy of advanced Hodgkin's disease: a review. *Cancer* 1974;33:1–8.

224. Lacher MJ, Durant JR. Combined vinblastine and chlorambucil therapy of Hodgkin's disease. *Ann Intern Med* 1965;62:468-476.
225. DeVita VT Jr, Serpick AA, Carbone PP. Combination chemotherapy in the treatment of advanced Hodgkin's disease. *Ann Intern Med* 1970;73:881-895.
226. Longo DL. The use of chemotherapy in the treatment of Hodgkin's disease. *Semin Oncol* 1990;17:716-735.
227. DeVita VT Jr, Simon RM, Hubbard SM, et al. Curability of advanced Hodgkin's disease with chemotherapy: long-term follow-up of MOPP-treated patients at the National Cancer Institute. *Ann Intern Med* 1980;92:587-595.
228. Longo DL, Young RC, Wesley M, et al. Twenty years of MOPP therapy for Hodgkin's disease. *J Clin Oncol* 1986;4:1295-1303.
229. Sutcliffe SB, Wrigley RF, Peto J, et al. MVPP chemotherapy regimen for advanced Hodgkin's disease. *BMJ* 1978;1:679-683.
230. McElwain TJ, Toy J, Smith E, et al. A combination of chlorambucil, vinblastine, procarbazine, and prednisolone for treatment of Hodgkin's disease. *Br J Cancer* 1977;36:276-280.
231. Vose J, Armitage J, Weisenburger D, et al. ChIVPP—an effective and well tolerated alternative to MOPP therapy for Hodgkin's disease. *Am J Clin Oncol* 1988;11:423-426.
232. Bonadonna G, Zucali R, Monfardini S, et al. Combination chemotherapy of Hodgkin's disease with Adriamycin, bleomycin, vinblastine, and imidazole carboximide versus MOPP. *Cancer* 1975;36:252-259.
233. Santoro A, Bonadonna G, Bonfante V, Valagussa P. Alternating drug combinations in the treatment of advanced Hodgkin's disease. *N Engl J Med* 1982;306:770-775.
234. Bonadonna G, Valagussa P, Santoro A. Alternating non-cross-resistant combination chemotherapy or MOPP in stage IV Hodgkin's disease. *Ann Intern Med* 1986;104:739-746.
235. Klimo P, Connors JM. MOPP/ABV hybrid program: combination chemotherapy based on early introduction of seven effective drugs for advanced Hodgkin's disease. *J Clin Oncol* 1985;3:1174-1182.
236. Klimo P, Connors JM. An update on the Vancouver experience in the management of advanced Hodgkin's disease treated with the MOPP/ABV hybrid program. *Sem Hematol* 1988;25[Suppl 2]:34-40.
237. Young RC, Canellos GP, Chabner BA, et al. Maintenance chemotherapy for advanced Hodgkin's disease in remission. *Lancet* 1973;1:1339-1343.
238. Carde P, MacKintosh FR, Rosenberg SA. A dose and time response analysis of the treatment of Hodgkin's disease with MOPP chemotherapy. *J Clin Oncol* 1983;1:146-153.
239. Pillai GN, Hagemester FB, Velasquez WS, et al. Prognostic factors for stage IV Hodgkin's disease treated with MOPP, with or without bleomycin. *Cancer* 1985;55:691-697.
240. Blum RH, Carter SK, Agre K. A clinical review of bleomycin—a new antineoplastic agent. *Cancer* 1973;31:903-914.
241. Von Hoff DD, Layard MW, Basa P, et al. Risk factors for doxorubicin induced congestive heart failure. *Ann Intern Med* 1979;91:710-717.
242. Alexander J, Dainiak N, Berger H, et al. Serial assessment of doxorubicin cardiotoxicity with quantitative radionuclide angiography. *N Engl J Med* 1979;300:278-283.
243. Doroshow JH. Doxorubicin-induced cardiac toxicity. *N Engl J Med* 1991;324:843-845.
244. Sherins RJ, DeVita VT. The effect of drug treatment for lymphoma on male reproductive capacity.

Ann Intern Med 1973;79:216–220.

245. Chapman RM, Sutcliffe SB, Rees LH, et al. Cyclical combination chemotherapy and gonadal function. Retrospective study in males. *Lancet* 1979;1:285–289.

246. daCunha MF, Meistrich ML, Fuller LM, et al. Recovery of spermatogenesis after treatment for Hodgkin's disease: limiting dose of MOPP chemotherapy. *J Clin Oncol* 1984;2:571–577.

247. Cunningham J, Mauch P, Rosenthal DS, Canellos GP. Long-term complications of MOPP chemotherapy in patients with Hodgkin's disease. *Cancer Treat Rep* 1982;66:1015–1022.

248. Viviani S, Santoro A, Ragni G, et al. Gonadal toxicity after combination chemotherapy for Hodgkin's disease: comparative results of MOPP vs. ABVD. *Eur J Cancer Clin Oncol* 1985;21:601–605.

249. Horning SJ, Hoppe R, Hancock SL, Rosenberg SA. Vinblastine, bleomycin, and methotrexate: an effective adjuvant in favorable Hodgkin's disease. *J Clin Oncol* 1988;6:1822–1831.

250. Redman JR, Bajorunas DR, Goldstein MC, et al. Semen cryopreservation and artificial insemination for Hodgkin's disease. *J Clin Oncol* 1987;5:233–238.

251. Vigersky RA, Chapman RM, Berenberg J, Glass AR. Testicular dysfunction in untreated Hodgkin's disease. *Am J Med* 1982; 73:482–486.

252. Chapman RM, Sutcliffe SB, Malpas JS. Cytotoxic-induced ovarian failure in women with Hodgkin's disease. I. Hormone function. *JAMA* 1979;242:1877–1881.

253. Whitehead E, Shalet SM, Blackledge G, et al. The effect of combination chemotherapy on ovarian function in women treated for Hodgkin's disease. *Cancer* 1983;52:988–993.

254. Horning SJ, Hoppe RT, Kaplan HS, Rosenberg SA. Female reproductive potential after treatment for Hodgkin's disease. *N Engl J Med* 1981;304:1377–1382.

255. Chapman RM, Sutcliffe SB, Malpas JS. Cytotoxic-induced ovarian failure in Hodgkin's disease. II. Effects on sexual function. *JAMA* 1979;242:1882–1884.

256. Clark ST, Radford JA, Crowther D, et al. Gonadal function following chemotherapy for Hodgkin's disease: a comparative study of MVPP and a seven drug hybrid regimen. *J Clin Oncol* 1995;13:134–139.

257. Goodman R, Mauch P, Piro A, et al. Stages IIB and IIIB Hodgkin's disease: results of combined modality therapy. *Cancer* 1977;40:84–89.

258. Prosnitz LR, Farber LR, Fischer JJ, et al. Long term remissions with combined modality therapy for advanced Hodgkin's disease. *Cancer* 1976;37:2826–2833.

259. Farber LR, Prosnitz LR, Cadman EC, et al. Curative potential of combined modality therapy for advanced Hodgkin's disease. *Cancer* 1980;46:1509–1517.

260. Straus DJ, Myers J, Passe S, et al. The eight-drug/radiation therapy program (MOPP/ABVD/RT) for advanced Hodgkin's disease: a follow-up report. *Cancer* 1980;46:233–240.

261. Moore MR, Bull JM, Jones SE, et al. Sequential radiotherapy and chemotherapy in the treatment of Hodgkin's disease: a progress report. *Ann Intern Med* 1972;77:1–9.

262. O'Connell MJ, Wiernik PH, Kirkland CB, et al. A combined modality approach to the treatment of Hodgkin's disease. *Cancer* 1975;35:1055–1065.

263. Rosenberg SA, Kaplan HS. The management of Stages I, II, and III Hodgkin's disease with combined radiotherapy and chemotherapy. *Cancer* 1974;35:38–56.

264. Kun LE, DeVita VT Jr, Young RC, Johnson RE. Treatment of Hodgkin's disease using intensive chemotherapy followed by radiation. *Int J Radiat Oncol Biol Phys* 1976;1:619–626.

265. Arsenau JC, Canellos GP, Johnson R, DeVita VT Jr. Risk of new cancers in patients with Hodgkin's

disease. *Cancer* 1977;40:1912–1916.

266. Pederson-Bjergaard J, Larsen SO. Incidence of acute nonlymphocytic leukemia, preleukemia, and acute myeloproliferative syndrome up to 10 years after treatment of Hodgkin's disease. *N Engl J Med* 1982;307:965–971.

267. Lavey RS, Eby NL, Prosnitz LR. Impact of second malignancy risk of the combined use of radiotherapy and chemotherapy for lymphomas. *Cancer* 1990;66:80–88.

268. Valagussa P, Santoro A, Fossati-Bellani F, et al. Second acute leukemia and other malignancies following treatment for Hodgkin's disease. *J Clin Oncol* 1986;4:830–837.

269. Andrieu JM, Ifrah N, Payen C, et al. Increased risk of secondary acute nonlymphocytic leukemia after extended field radiation therapy combined with MOPP chemotherapy for Hodgkin's disease. *J Clin Oncol* 1990;8:1148–1154.

270. Coltman CA Jr, Dixon DO. Second malignancies complicating Hodgkin's disease: a Southwest Oncology Group 10 year follow-up. *Cancer Treat Rep* 1982;66:1023–1033.

271. Mauch PM, Canellos GP, Rosenthal DS, Hellman S. Reduction of fatal complications from combined modality therapy in Hodgkin's disease. *J Clin Oncol* 1985;3:501–505.

272. Valagussa P, Santoro F, Fossati-Bellani F, Franchi F, et al. Absence of treatment-induced second neoplasms after ABVD in Hodgkin's disease. *Blood* 1982;59:488–494.

273. Krikorian JG, Burke JS, Rosenberg SA, Kaplan HS. Occurrence of non-Hodgkin's lymphoma after therapy for Hodgkin's disease. *N Engl J Med* 1979;300:452–458.

274. Jacquillat C, Khayat D, Desprez-Curely J, et al. Non-Hodgkin's lymphoma occurring after Hodgkin's disease. *Cancer* 1984;53:459–462.

275. Blayney DW, Longo DL, Young RC, et al. Decreasing risk of leukemia with prolonged follow-up after chemotherapy and radiotherapy for Hodgkin's disease. *N Engl J Med* 1987;316:710–714.

276. Fabian CJ, Mansfield CM, Dahlberg S, et al. Low-dose involved field radiation after chemotherapy in advanced Hodgkin's disease. *Ann Intern Med* 1994;120:903–912.

277. Mauch PM. Controversies in the management of early stage Hodgkin's disease. *Blood* 1994;83:318–329.

278. Hoppe RT. Radiation therapy in the management of Hodgkin's disease. *Semin Oncol* 1990;17:704–715.

279. Hancock SL, Hoppe RT, Horning SJ, Rosenberg SA. Intercurrent death after Hodgkin's disease therapy in radiotherapy and adjuvant MOPP trials. *Ann Intern Med* 1988;109:183–189.

280. Ng AK, Bernardo P, Weller E, et al. Long-term survival and competing causes of death in patients with early-stage Hodgkin's disease treated at age 50 or younger. *J Clin Oncol* 2002;20:2101–2108.

281. Rosenberg S, Kaplan H. The evolution and summary results of the Stanford randomized clinical trials of the management of Hodgkin's disease: 1962–1984. *Int J Radiat Oncol Biol Phys* 1985;11:5–22.

282. Fuller L, Hutchison G. Collaborative clinical trial for stage I and II Hodgkin's disease: significance of mediastinal and nonmediastinal disease in laparotomy and non-laparotomy staged patients. *Cancer Treat Rep* 1982;66:775–787.

283. Haybittle J, Easterling M, Bennett M, et al. Review of British National Lymphoma Investigation Studies of Hodgkin's disease and development of prognostic index. *Lancet* 1985;1:967–972.

284. Hope-Stone HF. The place of radiotherapy in the management of localized Hodgkin's disease. *Clin Radiol* 1981;32:519–522.

285. Carde P, Burgers J, Henry-Amar M, et al. Clinical stages I and II Hodgkin's disease: a specifically

tailored therapy according to prognostic factors. *J Clin Oncol* 1988;6:239–252.

286. Tubiana M, Henry–Amar M, Carde P, et al. Toward comprehensive management tailored to prognostic factors for patients with clinical stages I and II in Hodgkin's disease: the EORTC Lymphoma Group controlled clinical trials 1964–1987. *Blood* 1989;73:47–56.

287. Nissen N, Nordentoft A. Radiotherapy versus combined modality treatment of stage I and II Hodgkin's disease. *Cancer Treat Rep* 1982;66:799–803.

288. Jones S, Coltman C, Grozea P, et al. Conclusions from clinical trials of the Southwest Oncology Group. *Cancer Treat Rep* 1982;66:847–853.

289. Anderson H, Crowther D, Deakin DP, et al. A randomized study of adjuvant MVPP chemotherapy after mantle radiotherapy in pathologically staged IA–IIB Hodgkin's disease: 10-year follow-up. *Ann Oncol* 1991;2[Suppl 2]:49–54.

290. Tubiana M, Henri–Amar M, Hayat M, et al. The EORTC treatment of early stages of Hodgkin's disease: the role of radiotherapy. *Int J Radiat Oncol Biol Phys* 1984;10:197–210.

291. Fuller LM, Hagemester FB, North LB, et al. The adjuvant role of two cycles of MOPP and low dose lung irradiation in stage IA through IIB Hodgkin's disease: preliminary results. *Int J Radiat Oncol Biol Phys* 1988;14:683–692.

292. Specht L, Gray RG, Clarke MJ, Peto R. Influence of more extensive radiotherapy and adjuvant chemotherapy on long-term outcome of early-staged Hodgkin's disease: a meta-analysis of 23 randomized trials involving 3888 patients. International Hodgkin's Disease Collaborative Group. *J Clin Oncol* 1998;16:830–843.

293. Straus D, Yahalom J, Gaynor J, et al. Four cycles of chemotherapy and regional radiation therapy for clinical early stage and intermediate stage Hodgkin's disease. *Cancer* 1992;69:1052–1060.

294. Hoppe R, Coleman C, Cox R, et al. The management of stage I–II Hodgkin's disease with irradiation alone or with chemotherapy: the Stanford experience. *Blood* 1982;59:455–465.

295. Mauch P, Tarbell N, Weinstein H, et al. Stage IA and IIA supradiaphragmatic Hodgkin's disease: prognostic factors in surgically staged patients treated with mantle and paraaortic irradiation. *J Clin Oncol* 1988;6:1576–1583.

296. Behar RA, Horning SJ, Hoppe RT. Hodgkin's disease with bulky mediastinal involvement: effective management with combined modality therapy. *Int J Radiat Oncol Biol Phys* 1993;25:771–776.

297. Mauch PM, Canellos GP, Shulman LN, et al. Mantle irradiation alone for selected patients with laparotomy-staged IA to IIA Hodgkin's disease: preliminary results of a prospective trial. *J Clin Oncol* 1995;13:947–952.

298. Ganesan TS, Wrigley PF, Murray PA, et al. Radiotherapy for stage I Hodgkin's disease: 20 years of experience at St. Bartholomew's Hospital. *Br J Cancer* 1990;62:314–318.

299. Longo DL, Glatstein E, Duffey PL, et al. Radiation therapy versus combination chemotherapy in the treatment of early stage Hodgkin's disease: seven year results of a prospective randomized trial. *J Clin Oncol* 1991;9:906–917.

300. Cimino G, Biti GP, Anselmo A, et al. MOPP chemotherapy versus extended-field radiotherapy in the management of pathological stages I–IIA Hodgkin's disease. *J Clin Oncol* 1989;7:732–737.

301. Biti GP, Cimino G, Cartoni C, et al. Extended-field radiotherapy is superior to MOPP chemotherapy for the treatment of pathologic stage I–IIA Hodgkin's disease: eight-year update of an Italian prospective randomized study. *J Clin Oncol* 1992;10:378–382.

302. Timothy AR, Sutcliffe SBJ, Stansfield AG, et al. Radiotherapy in the treatment of Hodgkin's disease. *BMJ* 1978;1:1246–1249.

303. Mintz U, Miller JB, Golomb HM, et al. Pathologic stage I–II Hodgkin's disease 1968–1975. Relapses



and results of treatment. *Cancer* 1979;44:72–79.

304. Hagemester FB, Fuller LM, Velasquez WS, et al. Involved field radiotherapy versus extended-field radiotherapy versus involved field radiotherapy followed by six cycles of MOPP. *Cancer Treat Rep* 1982;66:789–798.

305. Rosenberg SA, Kaplan HS. The management of stage I, II, and III Hodgkin's disease with combined radiotherapy and chemotherapy. *Cancer* 1975;35:55–63.

306. Rosenberg SA, Kaplan HS, Glatstein EJ, Portlock CS. Combined modality therapy of Hodgkin's disease: a report on the Stanford trials. *Cancer* 1978;42:991–1000.

307. Rosenberg SA. The management of Hodgkin's disease. *N Engl J Med* 1978;299:1246–1247.

308. Levi JA, Wiernik PH. The therapeutic implications of splenic involvement in Hodgkin's disease. *Cancer* 1977;39:2158–2165.

309. Stein RS, Hillborn RM, Flexner JM, et al. Anatomical substages of stage III Hodgkin's disease: implications for staging, therapy, and experimental design. *Cancer* 1978;42:429–436.

310. Prosnitz LR, Montalvo PRL, Fischer DB, et al. Treatment of stage IIIA Hodgkin's disease: is radiation therapy alone adequate? *Int J Radiat Oncol Biol Phys* 1978;4:781–787.

311. Stein RS, Golomb HM, Wiernik PH, et al. Anatomic substages of stage IIA Hodgkin's disease: follow-up of a collaborative study. *Cancer Treat Rep* 1982;66:733–741.

312. Hoppe RT, Rosenberg SA, Kaplan HS, Cox RS. Prognostic factors in pathological stage IIIA Hodgkin's disease. *Cancer* 1980;46:1240–1246.

313. Marcus KC, Kalish LA, Coleman CN, et al. Improved survival in patients with limited stage IIIA Hodgkin's disease treated with combined radiation therapy and chemotherapy. *J Clin Oncol* 1994;12:2567–2572.

314. Lister TA, Dorreen MS, Faux M, et al. The treatment of stage IIIA Hodgkin's disease. *J Clin Oncol* 1983;1:745–749.

315. Crowther D, Wagstaff J, Deakin D, et al. A randomized study comparing chemotherapy alone with chemotherapy followed by radiotherapy in patients with pathologically staged IIIA Hodgkin's disease. *J Clin Oncol* 1984;2:892–897.

316. Grozea PN, DePersio EJ, Coltman CA Jr. A Southwest Oncology Group study: chemotherapy versus chemotherapy plus radiotherapy in the treatment of stage III Hodgkin's disease. *Recent Results Cancer Res* 1992;80:83–91.

317. Bakemeier RF, Anderson JR, Costello W, et al. BCVPP chemotherapy for advanced Hodgkin's disease: evidence for greater duration of complete remission, greater survival, and less toxicity than a MOPP regimen. *Ann Intern Med* 1984;101:447–456.

318. Canellos GP, Anderson JR, Propert KJ, et al. Chemotherapy of advanced Hodgkin's disease with MOPP, ABVD, or MOPP alternating with ABVD. *N Engl J Med* 1992;327:1478–1484.

319. Durant JD, Gams RA, Velez-Garcia E, et al. BCNU, velban, cyclophosphamide, procarbazine, and prednisone (BVCP) in advanced Hodgkin's disease. *Cancer* 1978;42:2101–2110.

320. Radford JA, Crowther D, Rohatiner AZS. Results of a randomized trial comparing MVPP chemotherapy with a hybrid regimen, ChVPP/EVA, in the initial treatment of Hodgkin's disease. *J Clin Oncol* 1995;13:2379–2385.

321. Wiernik PH, Schiffer CA. Long-term follow-up of advanced Hodgkin's disease patients treated with a combination of streptozotocin lomustine (CCNU), doxorubicin, and bleomycin (SCAB). *J Cancer Res Clin Oncol* 1988;114:105–107.

322. Diggs CH, Wiernik PH, Sutherland JC. Treatment of advanced Hodgkin's disease with SCAB—an

alternative to MOPP. *Cancer* 1981;47:224–228.

323. Goldie JH, Coldman AJ. A mathematical model for relating the drug sensitivity of tumors to their spontaneous mutation rate. *Cancer Treat Rep* 1979;63:1727–1733.

324. Canellos GP, Niedzwiecki D. Long-term follow-up of Hodgkin's disease trial. *N Engl J Med* 2002;346:1417–1418.

325. Glick JH, Young ML, Harrington D, et al. MOPP/ABV hybrid chemotherapy for advanced Hodgkin's disease significantly improves failure free and overall survival: the 8-year results of the intergroup trial. *J Clin Oncol* 1998;16:19–26.

326. Duggan D, Petroni J, Johnson J, et al. MOPP/ABV vs. ABVD for advanced Hodgkin's disease: a preliminary report of CALGB 8952 (with SWOG, ECOG, NCIC). *Proc Am Soc Clin Oncol* 1997;16:12a (abstr).

327. Diehl V, Franklin J, Hasenclever D, et al. BEACOPP, a new dose-escalated and accelerated regimen, is at least as effective as COPP/ABVD in patients with advanced stage Hodgkin's lymphoma: interim report from a trial of the German Hodgkin's Lymphoma Study Group. *J Clin Oncol* 1998;16:3810–3821.

328. Diehl V, Franklin J, Paulus U, et al. BEACOPP chemotherapy with dose escalation in advanced Hodgkin's disease: final analysis of the German Hodgkin's Lymphoma Study Group HD9 randomized trial. *Blood* 2000; 98:769a(abst).

329. Bartlett NL, Rosenberg SA, Hoppe RT, et al. Brief chemotherapy, Stanford V, and adjuvant radiotherapy for bulky or advanced stage Hodgkin's disease: a preliminary report. *J Clin Oncol* 1995;13:1080–1088.

330. Horning SJ, Hoppe RT, Breslin S, et al. Stanford V and radiotherapy for locally extensive and advanced Hodgkin's disease: mature results of a prospective clinical trial. *J Clin Oncol* 2002;20:630–637.

331. Horning SJ, Williams J, Bartlett NL, et al. Assessment of the Stanford V regimen and consolidative radiotherapy for bulky and advanced Hodgkin's disease: Eastern Cooperative Oncology Group pilot study E1492. *J Clin Oncol* 2000;18:972–980.

332. Straus DJ, Gaynor JJ, Myers J, et al. Prognostic factors among 185 adults with newly diagnosed advanced Hodgkin's disease treated with alternating potentially noncross-resistant chemotherapy and intermediate-dose radiation therapy. *J Clin Oncol* 1990;8:1173–1186.

333. Young CW, Straus DJ, Myers J, et al. Multidisciplinary treatment of advanced Hodgkin's disease by an alternating chemotherapeutic regimen of MOPP/ABVD and low-dose radiation therapy restricted to originally bulky disease. *Cancer Treat Rep* 1982;66:907–914.

334. Straus DJ, Myers J, Lee BJ, et al. Treatment of advanced Hodgkin's disease with chemotherapy and irradiation. Controlled trial of two versus three alternating, potentially non-cross-resistant drug combinations. *Am J Med* 1984;76:270–278.

335. Prosnitz LR, Farber LR, Kapp DS, et al. Combined modality therapy for advanced Hodgkin's disease: 15-year follow-up data. *J Clin Oncol* 1988;6:603–612.

336. Farber LR, Prosnitz LR, Cadman EC, et al. Curative potential of combined modality therapy for advanced Hodgkin's disease. *Cancer* 1980;46:1509–1517.

337. Kaplan HS. Prognostic significance of the relapse free interval after radiotherapy in Hodgkin's disease. *Cancer* 1968;22:1131–1136.

338. Loeffler M, Brosteanu O, Hasenclever D, et al. Meta-analysis of chemotherapy versus combined modality treatment trials in Hodgkin's disease. *J Clin Oncol* 1998;16:818–829.

339. Fox KA, Lippman SM, Cassady JR Jr, et al. Radiation therapy as salvage of Hodgkin's disease following chemotherapy failure. *J Clin Oncol* 1987;5:38–45.

340. Roach M III, Kapp DS, Rosenberg SA, Hoppe RT. Radiotherapy with curative intent: an option in selected patients relapsing after chemotherapy for advanced Hodgkin's disease. *J Clin Oncol*

1987;5:550–555.

341. Santoro A, Viviani S, Villarreal CJ, et al. Salvage chemotherapy in Hodgkin's disease irradiation failures: superiority of doxorubicin containing regimens over MOPP. *Cancer Treat Rep* 1986;70:343–348.

342. Mauch P, Ryback ME, Rosenthal D, et al. The influence of initial pathologic stage on the survival of patients who relapse from Hodgkin's disease. *Blood* 1980;56:892–897.

343. Young RC, Canellos GP, Chabner BA, et al. Patterns of relapse in advanced Hodgkin's disease treated with combination chemotherapy. *Cancer* 1978;42[Suppl 2]:1001–1007.

344. Santoro A, Bonfante V, Bonadonna G. Salvage chemotherapy with ABVD in MOPP-resistant Hodgkin's disease. *Ann Intern Med* 1982;96:139–143.

345. Straus DJ, Passe S, Koziner B, et al. Combination chemotherapy salvage of heavily pretreated patients with Hodgkin's disease: an analysis of prognostic features in two chemotherapy trials and the literature. *Cancer Treat Rep* 1981;65:207–211.

346. Harker WG, Kushlan P, Rosenberg SA. Combination chemotherapy for advanced Hodgkin's disease after failure of MOPP: ABVD and B-CAVe. *Ann Intern Med* 1984;101:440–446.

347. Levi JA, Wiernik PH, Diggs CH. Combination chemotherapy of advanced previously treated Hodgkin's disease with streptozotocin, CCNU, Adriamycin, and bleomycin. *Med Pediatr Oncol* 1970;3:33–40.

348. Einhorn LH, Williams SD, Stevens EE, et al. Treatment of MOPP-refractory Hodgkin's disease with vinblastine, doxorubicin, bleomycin, CCNU, and dacarbazine. *Cancer* 1983;51:1348–1352.

349. Tannir N, Hagemester F, Velasquez W, Cabanillas F. Long-term follow-up with ABDIC salvage chemotherapy of MOPP-resistant Hodgkin's disease. *J Clin Oncol* 1983;1:432–439.

350. Santoro A, Viviani S, Valagussa P, et al. CCNU, etoposide, and prednimustine in refractory Hodgkin's disease. *Semin Oncol* 1986;13[Suppl 1]:23–26.

351. Cervantes F, Reverter JC, Mostserrat E, Rozman C. Treatment of advanced resistant Hodgkin's disease with lomustine, etoposide, and prednimustine. *Cancer Treat Rep* 1986;70:665–667.

352. Hagemester FB, Tannir N, McLaughlin P, et al. MIME chemotherapy (methyl-GAG, ifosfamide, methotrexate, etoposide) as treatment for recurrent Hodgkin's disease. *J Clin Oncol* 1987;5:556–561.

353. Tseng A Jr, Jacobs C, Coleman CN, et al. Third line chemotherapy for resistant Hodgkin's disease with lomustine, etoposide, and methotrexate. *Cancer Treat Rep* 1987;71:475–478.

354. Pfreundschuh MG, Schoppe WD, Fuchs R, et al. Lomustine, etoposide, vindesine, and dexamethasone (CEVD) in Hodgkin's lymphoma refractory to cyclophosphamide, vincristine, procarbazine, and prednisone (COPP) and doxorubicin, bleomycin, vinblastine, dacarbazine (ABVD): a multicenter trial of the German Hodgkin's Study Group. *Cancer Treat Rep* 1987;71:1203–1207.

355. Canellos GP, Petroni GR, Barcos M, et al. Etoposide, vinblastine, and doxorubicin: an active regimen for the treatment of Hodgkin's disease in relapse following MOPP. *Cancer and Leukemia Group B. J Clin Oncol* 1995;13:2005–2011.

356. Rodriguez J, Rodriguez MA, Fayad L, et al. ASHAP: a regimen for cytoreduction of refractory or recurrent Hodgkin disease. *Blood* 1999;93:3632–3636.

357. Moskowitz CH, Nimer SD, Zelenetz AD, et al. A 2-step comprehensive high-dose chemoradiotherapy second-line program for relapsed and refractory Hodgkin disease: analysis by intent to treat and development of a prognostic model. *Blood* 2002;97:616–623.

358. Ekstrand BC, Lucas JB, Horwitz SM, et al. Rituximab in lymphocyte predominant Hodgkin's disease (LPHD): results of a phase II trial (abst). *J Clin Oncol* 2002;21:264a(abst).

359. Santoro A, Bredenfeld H, Devizzi L, et al. Gemcitabine in the treatment of refractory Hodgkin's

disease: results of a multicenter phase II study. *J Clin Oncol* 2000;18:2615–2619.

360. Longo DL, Duffey PL, Young RC, et al. Conventional-dose salvage combination chemotherapy in patients relapsing with Hodgkin's disease after combination chemotherapy: the low probability for cure. *J Clin Oncol* 1992;10:210–218.

361. Fisher RI, DeVita VT, Hubbard SP, et al. Prolonged disease-free survival in Hodgkin's disease with MOPP reinduction after first relapse. *Ann Intern Med* 1979;90:761–763.

362. Spitzer G, Dicke KA, Litam J, et al. High-dose combination chemotherapy with autologous bone marrow transplantation in adult solid tumors. *Cancer* 1980;45:3075–3085.

363. Douer D, Champlin RE, Ho WG, et al. High-dose combined-modality therapy and autologous bone marrow transplantation in resistant cancer. *Am J Med* 1981;71:973–976.

364. Gorin NC, David R, Stachowiak J, et al. High dose chemotherapy and autologous bone marrow transplantation in acute leukemias, malignant lymphomas and solid tumors. *Eur J Cancer* 1981;17:557–568.

365. Anderson CC, Goldstone AH, Souhami RL, et al. Very high-dose chemotherapy with autologous bone marrow rescue in adult patients with resistant relapsed lymphoma. *Cancer Chemother Pharmacol* 1986;16:170–175.

366. Rapaport AP, Rowe JM, Kouides PA. One hundred autotransplants for relapsed or refractory Hodgkin's disease and lymphoma: value of pretransplant disease status for predicting outcome. *J Clin Oncol* 1993;11:2351–2361.

367. Anderson JE, Litzow MR, Appelbaum FR, et al. Allogeneic, syngeneic, and autologous marrow transplantation for Hodgkin's disease: the 21-year Seattle experience. *J Clin Oncol* 1993;11:2342–2350.

368. Bierman PJ, Bagin RG, Jagannath S, et al. High dose chemotherapy followed by autologous hematopoietic rescue in Hodgkin's disease: long term followup in 128 patients. *Ann Oncol* 1993;4:767–773.

369. Weaver CH, Appelbaum FR, Petersen FB, et al. High-dose cyclophosphamide, carmustine, and etoposide followed by autologous bone marrow transplantation in patients with lymphoid malignancies who have received dose-limited radiation therapy. *J Clin Oncol* 1993;11:1329–1335.

370. Yahalom J, Gulati SC, Toia M, et al. Accelerated hyperfractionated total-lymphoid irradiation, high-dose chemotherapy, and autologous bone marrow transplantation for refractory and relapsing patients with Hodgkin's disease. *J Clin Oncol* 1993;11:1062–1070.

371. Crump M, Smith AM, Brandwein J, et al. High-dose etoposide and melphalan, and autologous bone marrow transplantation for patients with advanced Hodgkin's disease: importance of disease status at transplant. *J Clin Oncol* 1993;11:704–711.

372. Chopra R, McMillan AK, Linch DC, et al. The place of high-dose BEAM therapy and autologous bone marrow transplantation in poor-risk Hodgkin's disease. A single center eight-year study of 155 patients. *Blood* 1993;81:1137–1145.

373. Gribben JG, Linch DC, Singer CRJ, et al. Successful treatment of refractory Hodgkin's disease by high-dose chemotherapy and autologous bone marrow transplantation. *Blood* 1989;73:340–344.

374. Kessinger A, Bierman PJ, Vose JM, Armitage JO. High-dose cyclophosphamide, carmustine, and etoposide followed by autologous peripheral stem cell transplantation for patients with relapsed Hodgkin's disease. *Blood* 1991;77:2322–2325.

375. Reese DE, Connors JM, Spinelli JJ, et al. Intensive therapy with cyclophosphamide, carmustine, etoposide + cisplatin, and autologous bone marrow transplantation for Hodgkin's disease in first relapse after combination chemotherapy. *Blood* 1994;83:1193–1199.

376. Vose JM, Bierman PJ, Armitage JO. Hodgkin's disease: the role of bone marrow transplantation. *Semin Oncol* 1990;17:749–757.

377. Bierman PJ, Vose JM, Armitage JO. Autologous transplantation for Hodgkin's disease: coming of

age? Blood 1993;83:1161-1164.

378. Nademanee A, O'Donnell MR, Snyder DS, et al. High-dose chemotherapy with or without total body irradiation followed by autologous bone marrow and/or peripheral blood stem cell transplantation for patients with relapsed and refractory Hodgkin's disease: results in 85 patients with analysis of prognostic factors. Blood 1995;85:1381-1390.

379. Fleury J, Legros M, Colombat P, et al. High-dose therapy and autologous bone marrow transplantation in first complete or partial remission for poor prognosis Hodgkin's disease. Leuk Lymphoma 1996;20:259-266.

380. Nademanee A, Molina A, Fung H, et al. High-dose chemo/radiotherapy and autologous bone marrow or stem cell transplantation for poor risk advanced stage Hodgkin's disease during first partial or complete remission. Biol Blood Marrow Transplant 1999;5:292-298.

381. Appelbaum FR, Sullivan KM, Buckner CD, et al. Treatment of malignant lymphoma in 100 patients with chemotherapy, total body irradiation, and bone marrow transplantation. J Clin Oncol 1987;5:1340-1347.

382. Phillips GL, Reece DE, Barnett MJ, et al. Allogeneic marrow transplantation for refractory Hodgkin's disease. J Clin Oncol 1989;7:1039-1045.

383. Demirer T, Weaver CH, Buckner CD, et al. High-dose cyclophosphamide, carmustine and etoposide followed by allogeneic bone marrow transplantation in patients with lymphoid malignancies who had received prior dose limiting radiation therapy. J Clin Oncol 1995;13:506-602.

384. Gajewski JL, Phillips GL, Sobocinski KA, et al. Bone marrow transplantation from HLA-identical siblings in advanced Hodgkin's disease. J Clin Oncol 1996;14:572-578.

385. Akpek G, Ambinder RF, Piantadosi S, et al. Long-term results of blood and marrow transplantation for Hodgkin's lymphoma. J Clin Oncol 2001;19:4314-4321.

386. Little R, Wittes RE, Longo DL, Wilson WH. Vinblastine for recurrent Hodgkin's disease following autologous bone marrow transplant. J Clin Oncol 1998;16:584-588.

387. Levine AM. Hodgkin's disease in the setting of human immunodeficiency virus infection. J Natl Cancer Inst 1998;23:37-42.

388. Levine AM, Li P, Cheung T, et al. Chemotherapy consisting of DTIC with G-CSF in HIV infected patients with newly diagnosed Hodgkin's disease: a prospective multi-institutional AIDS Clinical Trials Group study (ACTG 149). J Acquir Immune Defic Syndr 2000;24:444-450.

389. Spina M, Gabarre E, Vaccher E, et al. Feasibility of integration of Stanford V chemotherapy regimen with highly active antiretroviral therapy and G-CSF in patients with Hodgkin's disease and HIV infection. Fifth International AIDS Malignancy Conference, April 23-25, 2001, Bethesda, MD. Abstract 24.

390. Donaldson SD. Hodgkin's disease in children. Semin Oncol 1990;17:736-748.

391. Parker BR, Castellino RA, Kaplan HS. Pediatric Hodgkin's disease I. Radiographic evaluation. Cancer 1976;37:2430-2435.

392. Poppema S, Lennert K. Hodgkin's disease in childhood: histopathologic classification in relation to age and sex. Cancer 1980;45:1443-1447.

393. Bayle-Weisgerber C, Lemercier N, Teillet F, et al. Hodgkin's disease in children; results of therapy in a mixed group of 178 clinical and pathologically staged patients over 13 years. Cancer 1984;54:215-222.

394. Donaldson SS, Kaplan HS. A survey of pediatric Hodgkin's disease at Stanford University: results of therapy and quality of survival. In: Rosenberg SA, Kaplan HS, eds. Malignant lymphomas, etiology, immunology, pathology, treatment. New York: Academic Press, 1982:571-590.

395. Willman KY, Cox RS, Donaldson SS. Radiation induced height impairment in pediatric Hodgkin's disease. Int J Radiat Oncol Biol Phys 1994;28: 85-92.

396. Meadows AT, Obringer AC, Marrero O, et al. Second malignant neoplasms following childhood

Hodgkin's disease: treatment and splenectomy as risk factors. *Med Pediatr Oncol* 1989;17:477-484.

397. Beaty O, Hudson MM, Greenwald C, et al. Subsequent malignancies in children and adolescents after treatment for Hodgkin's disease. *J Clin Oncol* 1995;13:603-609.

398. Portlock CS, Yahalom J. The management of Hodgkin disease during pregnancy. In: Mauch PM, Armitage JO, Diehl V, et al., eds. *Hodgkin's disease*. Philadelphia: Lippincott, Williams & Wilkins, 1999:693-699.

399. Barry RM, Diamond HD, Carver LF. Influence of pregnancy on the course of Hodgkin's disease. *Am J Obstet Gynecol* 1962;84:445-454.

400. Priesel A, Winkelbauer A. Placetrnare ubertagung des lymphogranulomas. *Virchows Arch* 1926;262:749-796.

401. Doll DC, Ringenberg QS, Yarbrow JW. Antineoplastic agents and pregnancy. *Semin Oncol* 1989;16:337-346.

2004 Lippincott Williams & Wilkins  
John P. Greer, John Foerster, John N. Lukens  
George M. Rodgers, Frixos Paraskevas, Bertil Glader  
Wintrobe's Clinical Hematology

## Practical Aspects of the Clinical Approach to Patients with Monoclonal Immunoglobulin Disorders

### GENERAL PRINCIPLES

#### IMMUNOGLOBULIN ABNORMALITIES: METHODS OF DETECTION

##### Clinical Scenarios

##### Protein Electrophoresis

##### Immunofixation, Immunoelectrophoresis, and Immunodiffusion

##### Quantitative Immunoglobulins (Nephelometry)

##### Free Light Chain Assays

##### Urine Studies

##### Diagnostic Algorithm: Key Questions

### DIAGNOSIS

#### Laboratory Tests

#### Bone Marrow Examination

#### BOX 1. Bone Marrow Plasma Cell Labeling Index (PCLI)

#### Radiologic Tests

### NEOPLASTIC IMMUNOGLOBULIN DISORDERS

#### Non-Immunoglobulin M Monoclonal Gammopathy of Undetermined Significance

#### Smoldering Multiple Myeloma (Asymptomatic Multiple Myeloma)

#### Multiple Myeloma

#### Special Conditions

#### Light Chain-Associated Amyloidosis

#### BOX 3. When to Suspect Amyloidosis

#### Macroglobulinemia and Other Immunoglobulin M-Producing Neoplasms

### NONNEOPLASTIC IMMUNOGLOBULIN DISORDERS

#### Polyclonal Gammopathy

#### Hypogammaglobulinemia

### SUGGESTED READING

### REFERENCES

This chapter presents a general and practical approach to the management of patients with immunoglobulin (Ig) disorders, with special emphasis on plasma cell neoplasms. Details about the specific diseases are provided in the chapters devoted to these diseases. The first step in the management of patients with monoclonal Igs is accurate diagnosis, including the correct classification into the different stages of the disorder (1). We review the general recommendations for the management of these disorders as a way of introducing the following chapters, which discuss the specific details of the biology and therapy of these disorders.

## GENERAL PRINCIPLES

Ig abnormalities can be classified as one of three main categories (Table 96.1): hypogammaglobulinemia, polyclonal Ig elevations, and monoclonal Ig disorders. For any of these abnormalities, a careful medical history and thorough laboratory evaluation are needed to confirm a suspected diagnosis, particularly because of the major implications of the diagnosis and potential prognosis for a person with a monoclonal Ig disorder. From the initial interview and examination of the patient and review of the laboratory studies, it



should be possible to address the following:

1. Is there an abnormality of the Igs—that is, are the levels increased or decreased?
2. If hypergammaglobulinemia is present, is it polyclonal or monoclonal?
  - a. If the protein is monoclonal, is it IgM or another type?
    - I. If it is IgM, is it
      - a. IgM monoclonal gammopathy of undetermined significance (MGUS)?
      - b. Waldenström macroglobulinemia?
      - c. Other (lymphoproliferative disorders or IgM myeloma)?
    - II. If it is not IgM, is it
      - a. Non-IgM MGUS?
      - b. Smoldering multiple myeloma (SMM)?
      - c. Multiple myeloma (MM)?
      - d. Plasmacytoma (intra- or extramedullary)?
    - III. Is there evidence of light chain-associated amyloidosis (AL)?
  - b. If the protein is polyclonal, is there
    - I. An underlying infectious, inflammatory, or neoplastic disorder?
    - II. Evidence of liver disease?
3. If hypogammaglobulinemia is present, is it
  - a. Hereditary?
  - b. Acquired?

**TABLE 96.1. Classification of Immunoglobulin Abnormalities**

---

1. Hypogammaglobulinemia
  - a. Manifested by encapsulated organism infections ( *Streptococcus pneumoniae*, *Staphylococcus sp.*, *Haemophilus influenzae* )
  - b. Childhood (Bruton X-linked)
  - c. Young adults (common variable immunodeficiency)
2. Polyclonal gammopathy
  - a. Inflammatory (chronic infections)
  - b. Autoimmune
  - c. Associated with neoplasms
  - d. Liver disease (cirrhosis, chronic hepatitis)
3. Monoclonal gammopathies
  - a. IgM type
    - (i) IgM MGUS (may also be biclonal)
    - (ii) Smoldering Waldenström macroglobulinemia
    - (iii) Waldenström macroglobulinemia
    - (iv) Other (including lymphoma and IgM MM)
  - b. Non-IgM type
    - (i) Non-IgM MGUS (may also be biclonal)
    - (ii) SMM
    - (iii) MM
    - (iv) Plasma cell leukemia
  - c. Amyloidosis complicating a B-cell neoplasm (AL)
  - d. Miscellaneous monoclonal gammopathy-associated conditions
    - (i) Osteosclerotic MM with peripheral neuropathy
    - (ii) POEMS syndrome
    - (iii) Cryoglobulinemia
    - (iv) Peripheral neuropathy associated with MGUS

- (v) Fanconi syndrome
- (vi) Castleman disease
- (vii) Scleromyxedema
- (viii) Necrobiotic xanthogranuloma
- (ix) Systemic capillary leak syndrome
- (x) Angioimmunoblastic lymphadenopathy with monoclonal protein
- (xi) Other

AL, amyloidosis; IgM, immunoglobulin M; MGUS, monoclonal gammopathy of undetermined significance; MM, multiple myeloma; POEMS, polyneuropathy, organomegaly, endocrinopathy, M protein, skin changes; SMM, smoldering multiple myeloma.

---

After these questions have been answered, the laboratory information is combined with information from the history and physical examination to narrow the diagnosis.

## IMMUNOGLOBULIN ABNORMALITIES: METHODS OF DETECTION

### Clinical Scenarios

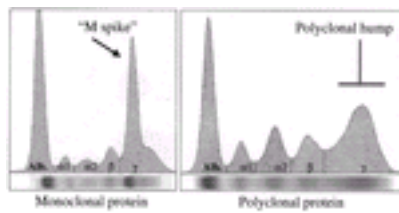
Increasingly, monoclonal Ig disorders are diagnosed in the asymptomatic stage, with many of the patients having MGUS or SMM ( [2](#), [3](#) ). These patients require no immediate therapy and must be distinguished from those with active MM. Also, the monoclonal protein may be detected when the clinical suspicion of MM is high. If the suspicion is high, one has to be alert to the possibility that in a small fraction of patients with MM (<2%), no monoclonal protein can be detected in the serum or urine.

In addition to situations in which a plasma cell neoplasm is suspected, there are others for which high-resolution agarose electrophoresis may be desirable. We recommend performing it if patients have unexplained weakness or fatigue, unexplained anemia, an elevated erythrocyte sedimentation rate, back pain, osteoporosis, osteolytic lesions, fractures, hypercalcemia, excretion of light chains in the urine (i.e., Bence Jones proteinuria), renal insufficiency, or recurrent infections.

**TIP:** Bence Jones proteinuria is used to describe light chains (? or ?), usually in the urine. However, if the patient has monoclonal light chains (no heavy chains) in the blood only (not in the urine) and no symptoms, the condition has been called *idiopathic Bence Jones proteinemia*.

### Protein Electrophoresis

The best method for detecting a monoclonal protein is high-resolution agarose gel electrophoresis. This test detects abnormalities in the migration of the proteins on electrophoresis. The test can be performed with samples from the serum (SPEP) or urine (UPEP). The resulting densitometric tracing shows a spike that is commonly referred to as the *monoclonal spike*, or *M spike* ( [Fig. 96.1](#) ). After a localized band or spike has been recognized on electrophoresis, immunofixation or immunosubtraction with capillary electrophoresis should be performed to determine the type of monoclonal protein.



**Figure 96.1.** Images of a serum protein electrophoresis depicting a monoclonal protein (**left**) and a polyclonal protein (**right**). Alb., albumin. (Figure courtesy of Drs. R. A. Kyle and J. A. Katzmann, Mayo Clinic.)

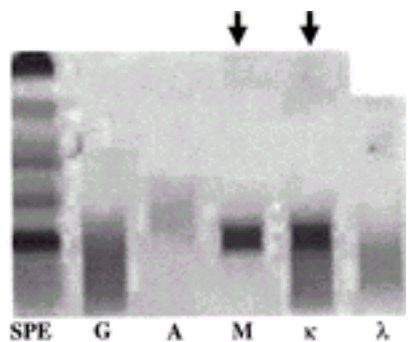
A monoclonal spike is seen as a discrete band that usually migrates to the  $\gamma$  or  $\beta$  region of the electrophoretic strip, and rarely the  $\alpha_2$  region. A polyclonal increase in Igs produces a broad-band or broad-based peak and is limited to the  $\gamma$  region. Two monoclonal proteins (biclonal gammopathy) occur in 8 to 9% of sera containing monoclonal protein abnormalities (4). Rarely, a triclonal gammopathy (three monoclonal proteins) is found.

Small amounts of monoclonal proteins may be detected using the SPEP or UPEP, even when the total concentration of the Igs is within the normal range. Occasionally, small amounts of monoclonal proteins may be detected only with sensitive techniques such as immunofixation. These proteins are usually found at concentrations of less than 5 g/L.

**TIP:** Monoclonal antibodies that migrate to the  $\gamma$  region may be of the IgG or any other isotype. Thus, migration to the  $\gamma$  region does not imply an IgG isotype, and an Ig isotype cannot be defined with SPEP alone. Also, it should be noted that not all monoclonal spikes arise from monoclonal IgM proteins and that the *M* refers only to the *monoclonal* nature of the patterns in the electrophoretic strip!

### Immunofixation, Immunoelectrophoresis, and Immunodiffusion

The structural type of a monoclonal protein is determined best by immunofixation (Fig. 96.2). Therefore, immunofixation should be performed whenever a monoclonal protein of unknown identity is detected with SPEP. Immunofixation may also be performed when a B-cell or plasma cell neoplasm is suspected but no monoclonal spike is apparent, as is frequently the case with AL or nonsecretory MM. Immunofixation may also be used to monitor for disease relapse in patients who have achieved a complete response to therapy. In the past, we used immunoelectrophoresis to characterize monoclonal proteins. This test is more difficult to perform, and it is not as sensitive as immunofixation. Other methods for characterizing monoclonal proteins include capillary zone electrophoresis and immunosubtraction. Monoclonal proteins of the IgD and IgE isotypes usually are measured by immunodiffusion.



**Figure 96.2.** Immunofixation study done to characterize the monoclonal protein as a monoclonal immunoglobulin M  $\kappa$  protein. The arrows indicate the lanes that show reactivity with the specific antibodies. The reactivity is consistent with the same migration seen in the left column that shows the electrophoresis (SPE). Thus, in this assay, the nature of the monoclonal protein seen in the electrophoresis is elucidated: isotype M and light chain  $\kappa$ . See [Color Plate](#).

### Quantitative Immunoglobulins (Nephelometry)

At the time of diagnosis and to monitor disease, Igs may be quantified directly with rate nephelometry. This test is frequently ordered as “quantitative Igs.” In addition to determining the serum concentration of the same isotype as the monoclonal protein, the test can detect a decrease in uninvolved, normal Igs. Nephelometry is rapid and reliable. However, it is not useful when the concentration of the monoclonal protein is low, because nephelometry cannot differentiate between monoclonal and polyclonal Igs.

**TIP:** It is important to compare the results of SPEP only with subsequent SPEP determinations, and nephelometry results with subsequent nephelometry determinations. One should not compare nephelometry to SPEP (or vice versa) because of the inherent technical differences in the techniques. Monitoring with both tests may be ideal.

It should be noted that the serum concentration of Igs may be falsely elevated as determined by nephelometry. For instance, IgM levels may be reported as much as 30 g/L higher than the value reported by SPEP; similar observations have been made in the case of IgG and IgA.

### Free Light Chain Assays

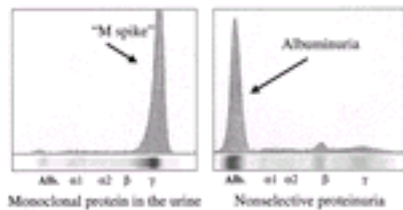
Tests for serum free light chains are an important part of the workup of patients with suspected plasma cell neoplasms or AL (5, 6). These tests measure both free  $\kappa$  and  $\lambda$  light chains and provide a ratio between them (5, 6). Excessive skewing indicates the possibility of a monoclonal protein. It is noteworthy that for serum free light chains, the ratio between  $\kappa$  and  $\lambda$  is skewed toward  $\kappa$  (5, 6).

### Urine Studies

Patients with monoclonal proteins in the serum are also likely to have monoclonal proteins in the urine. Although both heavy and light chains may be excreted, only light chains are common in the urine. Traditionally, the excretion of light chains in the urine has been referred to as *Bence Jones proteinuria*. If patients have measurable monoclonal Igs (usually  $\geq 10$  g/L) in the serum or if MM or AL are suspected, urine should be collected for determining protein excretion. A timed 24-hour collection is best. For patients in whom this is done for the first time, immunofixation is also recommended to characterize fully

the monoclonal protein present. Immunofixation is also recommended if no monoclonal protein is detected with UPEP.

Generally, the amount of monoclonal light chain in the urine reflects the tumor mass of the patient. However, the presence of Bence Jones proteinuria alone does not necessarily indicate a diagnosis of MM, as it also occurs in up to 30% of patients with MGUS. Patients with a pattern of nonselective proteinuria (i.e., albumin predominance) are more likely to have AL with kidney involvement ( [Fig. 96.3](#)).



**Figure 96.3.** Patterns of proteinuria indicative of those observed in patients with plasma cell proliferative disorders. **Left:** The electrophoresis shows excretion of a large amount of monoclonal protein, usually a light chain as seen in many patients with multiple myeloma. **Right:** A case of nonselective proteinuria, as commonly seen in amyloidosis, that results in massive excretion of albumin (Alb.). (Figure courtesy of Drs. R. A. Kyle and J. A. Katzmann, Mayo Clinic.)

### Diagnostic Algorithm: Key Questions

**IS THE HYPERGAMMAGLOBULINEMIA MONOCLONAL OR POLYCLONAL?** Commonly, abnormalities of Ig levels are first noted incidentally when quantitative Igs or SPEP is performed during diagnostic testing for an unrelated condition. The first—and most important—question that a clinician must answer when increased Ig levels are noted is whether the increase is monoclonal (i.e., neoplastic) or polyclonal (i.e., reactive) ( [Fig. 96.4](#) ). However, it should be noted that many monoclonal proteins are associated with nonmalignant conditions and, in the majority of patients, are never associated with complications or evolution to malignancy ( [Fig. 96.1](#) ). Once a monoclonal increase in Ig has been identified, a differential diagnosis is formulated to help make a final diagnosis.



**Figure 96.4.** Simple diagnostic algorithm for patients with immunoglobulin (Ig) abnormalities. CVID, common variable immunodeficiency; MGUS, monoclonal gammopathy of undetermined significance; MM, multiple myeloma; SMM, smoldering multiple myeloma.

**IS THE MONOCLONAL PROTEIN IMMUNOGLOBULIN M OR NON-IMMUNOGLOBULIN M?** The second question is, “What is the type of monoclonal protein? Is it IgM or another type?” Abnormal Igs are produced by differentiated B cells that become “professional antibody-producing cells,” that is, plasma cells. However, late in the process of differentiation, B cells are capable of producing IgM-type Igs. The type of protein

production immediately identifies the type of neoplastic problems for which the protein may be a marker. Patients with IgA or IgG (rarely IgE or IgD) monoclonal proteins most commonly have a monoclonal proliferation of plasma cells in the bone marrow. In contrast, IgM monoclonal proteins are produced preferentially by lymphocytic and lymphoplasmacytic cells residing in lymphoid organs (7). We suggest that clinicians think of two classes of monoclonal Igs: IgM or non-IgM monoclonal proteins (Table 96.2). Non-IgM monoclonal proteins are associated with non-IgM MGUS and MM, whereas IgM monoclonal proteins are associated with IgM MGUS, Waldenström macroglobulinemia, and other lymphoproliferative disorders.

**TABLE 96.2. Classification of Monoclonal Proteins**

| Condition                    | Non-IgM Monoclonal Proteins | IgM Monoclonal Proteins                                    |
|------------------------------|-----------------------------|--|
| Premalignant or undetermined | IgG, IgA, and other MGUSs   | IgM MGUS   |
| Intermediate                 | Smoldering multiple myeloma | Other lymphoproliferations<br>Smoldering macroglobulinemia |
| Malignant                    | Active multiple myeloma     | Waldenström macroglobulinemia                              |
|                              | Plasma cell leukemia        | Other  |

Ig, immunoglobulin; MGUS, monoclonal gammopathy of undetermined significance.

This classification has some exceptions, but they are rare. For example, MM of the IgM type has been reported (8, 9 and 10). How best to differentiate IgM MM from Waldenström macroglobulinemia with bone lesions or renal failure is a matter of debate. Some genetic markers may be able to differentiate the two disorders (11, 12). Also, patients with B-cell chronic lymphocytic leukemia (CLL) may have coexistent monoclonal Igs in the serum (13). The proportion of patients in whom this protein is produced by the CLL cells is not known, and in some cases at least, it may represent coexistent non-IgM MGUS and B-CLL. Patients who have monoclonal B-cell disorders that have morphologic and immunophenotypic similarities to Waldenström macroglobulinemia but produce IgG monoclonal proteins have also been described (14). **TIP:** Aside from a few exceptions, it is useful to think of monoclonal proteins as either IgM or non-IgM because of implications for the differential diagnosis.

## DIAGNOSIS

### Laboratory Tests

In addition to the tests for monoclonal proteins, other basic laboratory studies should be performed to assist in making an accurate diagnosis. At minimum, a basic laboratory profile should include a complete blood count, serum levels of calcium and creatinine, and  $\beta_2$ -microglobulin levels (see Chapter 98) (15). Other tests are considered according to the clinical suspicion raised by the history and physical examination findings.

The number of circulating monoclonal plasma cells should be quantified. Many studies have shown that a high number of circulating plasma cells is associated with progression from SMM to MM (16), and, in the case of MM, with shorter survival (17). In patients with a monoclonal IgM, serum viscosity may be determined, depending on the clinical

indications (see [Chapter 100](#)). Testing for rheumatoid factor, antinuclear factors, and other autoantibodies may be important in diagnosing the cause of a polyclonal gammopathy. In nonneoplastic disorders, liver function tests, imaging of the liver, and tests for infectious and inflammatory diseases are important. Tests for the human immunodeficiency virus may be necessary in some patients with nonneoplastic or neoplastic plasma cell disorders.

**TIP:** The erythrocyte sedimentation rate is elevated in the presence of monoclonal Igs, particularly monoclonal IgM; thus, it is not a reliable indicator of an underlying inflammatory condition.

### Bone Marrow Examination

For most patients with evidence of a monoclonal protein, an examination of the bone marrow is recommended. This examination should include both an aspirate and a biopsy sample and an MM-specific test. At our institution, we also include the plasma cell labeling index (PCLI). This is a reliable test for estimating the proportion of cells undergoing mitosis ( [Box 1](#)).

#### BOX 1. Bone Marrow Plasma Cell Labeling Index (PCLI)

We always perform a PCLI assay in the workup of patients with plasma cell neoplasms. The PCLI is a surrogate of cells undergoing mitosis and is the most useful prognostic marker in multiple myeloma. This is a slide-based test (one slide is labeled with anti-? and one with anti-? fluorescent antibodies) that scores the number of plasma cells (usually out of 500) that incorporate bromodeoxyuridine. Bromodeoxyuridine is taken up by cells undergoing DNA synthesis and can be detected with fluorescent-specific antibodies. The test can also be performed on blood samples mainly to detect circulating plasma cells. Because the test is also done with clone-specific fluorescent antibodies, it provides an estimate of the plasmacytosis and the ratio between ? and ? (to detect clonality). The test can provide information about clonality, plasmacytosis, and labeling index (mitotic activity).

The major limitation to the test is that it can be done only on samples incubated with bromodeoxyuridine at the time of bone marrow aspiration.

### Radiologic Tests

Patients with an IgM monoclonal protein should have abdominal and chest computed tomography to exclude organomegaly (hepatomegaly and splenomegaly) and bulky lymphadenopathy ( [18](#)). Patients with evidence of MM should have a radiologic examination of the axial and appendicular skeleton (“bone survey”). In some special circumstances, more sophisticated tests such as magnetic resonance imaging (MRI) have been recommended ( [19](#)). Other tests such as positron emission tomography are being explored ( [20](#)).

## NEOPLASTIC IMMUNOGLOBULIN DISORDERS

### Non-Immunoglobulin M Monoclonal Gammopathy of Undetermined Significance

**GENERAL PRINCIPLES** Most patients with a monoclonal gammopathy do not have MM ( [3](#) ). MGUS represents the earliest stage of a monoclonal plasma/lymphoid cell proliferation.



As mentioned above, it is critical to distinguish between IgM MGUS and non-IgM MGUS. IgM MGUS is discussed below with Waldenström macroglobulinemia.

**DIAGNOSIS** By definition, non-IgM MGUS is a discrete proliferation of monoclonal plasma cells ( 3 ). Multiple diagnostic criteria have been applied but the essence is the same—a discrete proliferation of plasma cells without evidence of the clone resulting in disease for the host. One criterion for diagnosis is fewer than 10% plasma cells in the bone marrow. Because of the heterogeneous nature of disease involving the bone marrow and different ways for determining the percentage of plasma cells (aspirate, biopsy, or PCLI—all of which possibly are contaminated by dilution), the size of the monoclonal proteins is usually considered a diagnostic criterion. Most people consider MGUS to have evolved into a more advanced plasma cell neoplasm if the serum monoclonal spike is greater than 30 g/L ( 3 ). An important focus of the physical examination in non-IgM MGUS is the search for bone disease. Percussion tenderness (spine and sternum) should raise the diagnostic possibility of MM. This is particularly important in patients with IgA MGUS, which may be more difficult to differentiate from MM. Also, clinicians must be aware of the classic signs and symptoms of AL (see below) ( 21 ). AL may be present even with the smallest concentration of monoclonal proteins (occasionally not even detectable), and this possibility should always be kept in mind.

**CLINICAL MANAGEMENT AND MONITORING** Because of the nonmalignant nature of MGUS, patients do not experience end-organ damage. Complications such as anemia, renal failure, hypercalcemia, bone lesions, or extramedullary growth in tissues should prompt a search for MM or other explanations ( 3 ). If a patient has evidence suggestive of possible bone disease (pain in the shaft of extremities that worsens with movement or weight bearing), a bone radiographic survey should be done. It has long been the practice not to examine the bone marrow of patients with suspected MGUS. Although the size of the monoclonal spike generally correlates with tumor burden, it is not precise enough to conclude definitively that the diagnosis is MGUS and not SMM. In older persons (e.g., >75 years), it may be reasonable to diagnose MGUS on the basis of laboratory findings alone, but bone marrow analysis is highly desirable for all others regardless of the size of the monoclonal spike ( Box 2 ). Monoclonal gammopathy of the IgD or IgE type presents unique problems because the size of the monoclonal spike is usually small and cannot be used to estimate tumor burden. In these cases, a bone marrow examination is mandatory. Patients with IgE monoclonal proteins often present with the most aggressive phenotype of plasma cell neoplasms, namely, plasma cell leukemia.

## BOX 2. How We Evaluate a Patient with a Monoclonal Gammopathy

Tests for patients presenting with a monoclonal gammopathy include the following:

- Hemoglobin and serum levels of calcium and creatinine
- Serum and urine protein electrophoresis and immunofixation
- Quantitative immunoglobulins
- Metastatic bone survey
- Bone marrow examination

Supplementary tests: lactate dehydrogenase,  $\beta_2$ -microglobulin, and C-reactive protein, magnetic resonance imaging of the lumbar spine or suspected areas of involvement, plasma cell labeling index, and circulating plasma cells

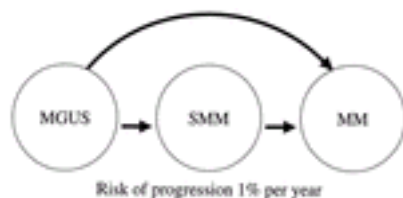
The diagnosis of monoclonal gammopathy of undetermined significance is favored in patients with a low level of M protein ( $<30$  g/L) and normal concentrations of hemoglobin, calcium, and creatinine. The diagnosis is confirmed when bone marrow examination shows less than 10% of monoclonal plasma cells.

Although MGUS includes the term “undetermined significance,” non-IgM MGUS clearly is the most important risk factor for the subsequent development of MM ( 3 ). MGUS is not

only a marker of persons at high risk for the development of MM, but, more important, is the latent, premalignant condition. When MGUS evolves to MM, the same Ig isotype is expressed in MGUS and MM. Patients should be followed indefinitely because the risk of progression to MM is never eliminated and has been estimated to be almost 1% per year ( [3](#), [22](#) ). Globally, the risk is greater for patients with higher concentrations of monoclonal proteins ( [3](#), [22](#) ). No good biologic markers are available that can discern or predict which patients will develop into MM. The need for long-term follow-up is implicit in the uncertainty of the diagnosis and the 1% risk annually for the development of MM or another serious disease of neoplastic plasma cells. For these patients the recommendation is to have a repeat SPEP in 6 months and, if that is normal, at least yearly thereafter. **TIP:** It is important to remind patients of the importance of having the monoclonal spike monitored at least annually. Because of the undetermined nature of the condition and the lack of symptoms, it is common for people to stop having screening tests after a few years, even more so for patients with complicated medical problems. By playing active roles in their medical care, patients can ensure monitoring.

### Smoldering Multiple Myeloma (Asymptomatic Multiple Myeloma)

**BIOLOGY** SMM is an intermediate stage between MGUS and MM ( [Fig. 96.5](#) ) ( [2](#) ).



**Figure 96.5.** Progression from monoclonal gammopathy of undetermined significance (MGUS) to multiple myeloma (MM). SMM, smoldering multiple myeloma.

Conceptually, SMM is almost identical to MGUS—a plasma cell neoplasm without disease in the host—but represents a more advanced clone than that found in MGUS, usually with little evidence of proliferation ( [23](#), [24](#) ). Diagnostic criteria have been proposed, including a clonal plasmacytosis greater than 10% or a serum monoclonal protein of 30 g/L or greater. For the diagnosis of SMM to be made, no anemia, hypercalcemia, bone disease, or renal insufficiency related only to the plasma cell neoplasm must be present. A related diagnosis is indolent MM, which is nearly identical to SMM but with a small number of discrete bone lesions ( [25](#) ).

**EVOLUTION TO MULTIPLE MYELOMA** It is important to note that plasma cell neoplasms do *not* need to go through all the stages in an orderly fashion, and patients may quickly advance to the malignant phase of the disease from MGUS without a recognizable SMM stage. Similarly, patients may present to the hematologist with MM, without MGUS having been recognized previously. We think that all patients go through a premalignant, often unrecognized stage, the duration of which has not been established. It is difficult to estimate the actual risk of progression to MM from SMM because the available evidence is scant (see [Chapter 98](#)) ( [3](#), [16](#), [22](#) ). Many patients who have had MGUS may have had SMM, because in many of them, the bone marrow had not been examined. Patients with SMM usually have a low PCLI, few or no circulating plasma cells, and normal radiologic findings ( [23](#), [24](#) ). Occasionally, radiographs may show nonspecific abnormalities, and differentiating SMM from MM may be difficult. The use of MRI to detect patients at high risk for disease progression is being explored ( [19](#) ). Patients with normal MRI findings are believed to be at lower risk for progression. Despite the low volume of bone disease or bone marrow plasma cells greater than 30%, such patients, if asymptomatic, may be observed carefully and may remain stable for years; it is nevertheless important to monitor these patients actively, regularly, and indefinitely.

**MONITORING** Because of the perceived higher risk of evolution to MM, patients with

SMM should be followed more closely than patients with non-IgM MGUS. Monitoring should occur every 3 months initially, and if the condition is stable, at least every 6 months thereafter. Follow-up tests should include a complete blood count, serum levels of calcium and creatinine, SPEP with measurement of the monoclonal spike, and quantitative measurement of the involved Ig (e.g., IgG levels in patients with IgG SMM).

**RISK OF EXPECTANT OBSERVATION** Of SMM, it is appropriate to say, “One does not want to treat too early, but also one does not want to treat too late.” The risk of expectant observation is that patients may have progression to MM and have a serious complication. The few data available suggest that serious progression is rare in SMM as long as monitoring is continued. The development of anemia is not a problem because it can be corrected readily with therapy, either supportive transfusions or the administration of erythropoietin. In the progression of SMM to active MM, the evolution to renal failure seems to be rare. The clinical presentation of renal insufficiency in patients with plasma cell neoplasms indicates that the monoclonal protein being produced has a nephrotoxic potential. Other factors, such as medications (e.g., nonsteroidal antiinflammatory drugs), contrast media, or volume depletion, augment this nephrotoxicity. The corollary to this is that patients who do not have renal impairment at diagnosis probably are less likely to develop it later in the course of the disease. Thus, it is important to recommend avoidance of renal insults and to provide an adequate intake of fluids in patients with SMM (urine output >2 L/day is commonly recommended). Also, the evolution to serious bone disease is unlikely but possible; careful attention to symptoms and a complete physical examination should minimize this possibility. The risks of expectant observation are counterbalanced by the immediate and long-term risks associated with MM therapy. Most agents have some immediate adverse effect, which may be lethal. For example, corticosteroid therapy may result in immunosuppression and opportunistic infections (*Pneumocystis carinii*), steroid myopathy, pancreatitis, aseptic necrosis of the femoral heads, and steroid-induced diabetes. Alkylators are associated with myelosuppression and the long-term risk of genotoxic damage to the bone marrow ( [26](#), [27](#), [28](#), [29](#) and [30](#) ). This can result in myelodysplasia and acute myelogenous leukemia, in time usually becoming refractory to treatment. Seemingly benign medications such as thalidomide also have important adverse effects, including somnolence, constipation, and, most notably, peripheral neuropathy ( [31](#) ).

**TIP:** One recommendation is for treatment to be initiated for patients in whom therapy is likely to be necessary during the next 6 months (Kyle RA, *personal communication*).

**TREATMENT** Bisphosphonates such as pamidronate or zoledronic acid have been used to prevent progression of bone disease in patients with MM ( [32](#) ) and have been used by some to treat SMM. However, there is no good evidence to recommend the widespread use of these agents, and the decision should be made by the treating physician and patient. Current evidence-based treatment guidelines suggest that the data are insufficient to recommend the universal use of bisphosphonates in patients with SMM ( [33](#) ). One limitation is that the distinction between SMM and MM may not be straightforward. On the basis of imaging evidence (radiography, MRI, or mineral bone density study), increased urinary excretion of markers of bone metabolism (urinary amino-terminal collagen type 1 telopeptide), or indeterminate radiologic evidence of other bone disease and the good safety profile of the drugs, some hematologists recommend initiating treatment with bisphosphonates for patients with possible bone disease. Prospective randomized studies are needed to address this therapeutic dilemma. The administration of any antitumor therapy to patients with SMM must be considered experimental. No benefit has been reported for the treatment of early disease. In a randomized prospective clinical trial, early treatment did not result in longer survival ( [34](#) ). It is expected that any treatment that has efficacy in MM will also have activity against SMM, but this is not sufficient evidence to recommend treatment ( [35](#) ). It is imperative that prospective randomized studies address the impact of any treatment to be given for SMM, particularly with regard to progression and overall survival. In many patients, what is now diagnosed as SMM would previously have been diagnosed as MGUS; thus, it is possible that SMM in these patients will never evolve to active MM. To prevent evolution of SMM to MM by

presently available therapeutic interventions, a long duration of treatment would likely be required; in addition, for reasons outlined previously, the number of patients needed to demonstrate significance in randomized trials is probably very large. Finally, the incidence of cumulative toxicity may be very high in patients treated for prolonged periods. In summary, better markers are needed to identify patients at high risk of progression to MM, and therapy for SMM should be administered only as part of a well-designed clinical trial.

## Multiple Myeloma

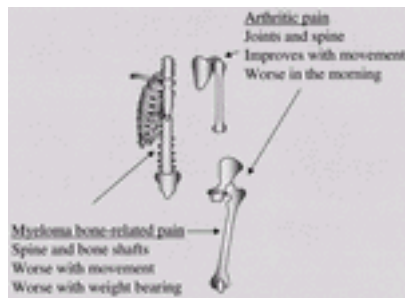
**MAGNITUDE OF THE PROBLEM** MM is the most common malignancy of plasma cells. It causes 11,000 deaths annually and is diagnosed in nearly 15,000 people each year in the United States alone ( [36](#) ). The diagnosis of MM is straightforward when the patient has advanced bone lesions and anemia. However, a high level of suspicion is needed to make the diagnosis promptly in a patient who presents with hypercalcemia or renal insufficiency ( [37](#) ).

### HYPERCALCEMIA

**Diagnosis** Hypercalcemia must be diagnosed and treated promptly in MM. The symptoms may be protean and difficult to recognize if the degree of suspicion is not high ( [37](#) ). A classic complex may include polydipsia, polyuria, nausea, constipation, somnolence, confusion, and anorexia. Patients may have this constellation of signs and symptoms and believe they have a viral infection of the upper respiratory tract. Although the workup of other causes of hypercalcemia may be needed, the possibility of MM should take precedence, and empirical treatment may be considered while the diagnosis is being confirmed. Confirmatory tests can be performed rapidly, and hypercalcemia should be treated as soon as possible, preferably within hours after its diagnosis if MM is suspected.

**Management** The treatment of hypercalcemia associated with MM is based on three tenets: hydrate the patient, initiate treatment with bisphosphonates, and start therapy for MM. Of these three, hydration is the simplest and usually most important step because it can be done immediately, even without a confirmatory diagnosis ( [38](#) ). It is gratifying for a physician to recognize and treat MM-related hypercalcemia before renal damage occurs (see [Chapter 98](#) ). Increased creatinine levels may be due to the volume depletion associated with hypercalcemia; this mandates prompt institution of volume replacement with normal saline. It is important to recognize that forced natriuresis will also force equimolar calciuria; thus, normal saline is the fluid replacement of choice. Loop diuretics should be given only when there is ample evidence of normal volume. Bisphosphonates have become the standard of care for the treatment of hypercalcemia of MM ( [39](#) ). Several preparations exist, but the prevailing view is that zoledronic acid may have a slight advantage in the rapidity with which it can control the hypercalcemia of malignancy ( [39](#) ). We also recommend instituting high-dose corticosteroid treatment for patients with suspected MM and hypercalcemia, even if the diagnosis is not firm ( [40](#) ). Corticosteroid treatment results in some of the most rapid and sustained improvement of hypercalcemia ( [40](#) ).

**BONE DISEASE** Bone destruction is an integral part of MM and is seen in at least 70% of patients ( [41](#) ). When more sensitive tests are used, nearly all patients have evidence of bone destruction, and its complications are some of the most devastating aspects of the disease ( [42](#) ). Bone disease associated with MM may involve the extremities, but most frequently it involves the spine. A characteristic feature is that movement and weight bearing exacerbate the pain ( [Fig. 96.6](#) ).



**Figure 96.6.** Clinical distinction between multiple myeloma bone disease and bone disease from arthritis. Patients seek a position that provides relief. Unlike arthritic pain, multiple myeloma pain is not localized to joint areas and does not improve with movement (“warming”).

## RENAL FAILURE

**Diagnosis** Renal failure must be recognized early. Patients may present because of symptoms of uremia and only later report other symptoms of MM such as extensive bone pain. It is critical to assess renal function quickly by measuring the serum level of creatinine. Renal function (e.g., creatinine clearance) may be investigated in detail after therapy has been initiated. Patients with MM and renal failure (assuming they are not oliguric) commonly have Bence Jones proteinuria in excess of 1 g/24 hours.

**Management** Because renal failure in MM is often reversible with prompt treatment, it needs to be managed aggressively ( 43, 44 ). The failure to correct renal failure early may result in permanent kidney damage that may severely limit therapeutic options and make patients dialysis-dependent ( 45 ). Patients with Bence Jones proteinuria are especially susceptible to MM cast nephropathy because the deleterious effects of dehydration and nephrotoxic agents are enhanced ( 44 ). Every effort should be made to ameliorate any insult to the kidneys. **TIP:** In MM, the kidney is much more susceptible to renal-offending agents, even at very low doses. Because of the common occurrence of bone pain in MM, it is important to recommend explicitly that patients avoid nonsteroidal antiinflammatory drugs. Also, reinforce the need for patients to keep adequately hydrated. Because acidification of the urine can exacerbate the nephrotoxic potential of Bence Jones proteins, vitamin C in large amounts should be avoided.

**BACK PAIN** Approximately 5 to 10% of patients with MM have back pain as a presenting feature ( 46 ). This pain may be severe and require hospitalization. Characteristically, it is movement related and aggravated by cough, sneeze, and strain. Patients may walk stiffly and have great difficulty getting onto and off the examination or x-ray table. MRI is the only reliable way to examine for a possible epidural tumor with potential spinal cord compression. **TIP:** As a rule of thumb, if spinal cord compression is possible, an MRI study of the back is performed. It is unwise to wait for signs of spinal cord compression to develop, such as bladder incontinence and reflex changes, because by then it may be too late. “If you think about it, do it.”

## Special Conditions

**SOLITARY PLASMACYTOMA** Plasma cell neoplasms may present as a localized growth of plasma cells referred to as *plasmacytomas* ( 47, 48 and 49 ). Plasmacytomas can occur in association with bony structures ( *medullary* ) or in other areas, most commonly the nasopharynx ( *extramedullary* ) ( 47, 48 and 49 ). The term *solitary plasmacytoma* is applied to tumor growth in patients with no other evidence of MM. Patients with plasmacytoma frequently present with back pain, and, subsequently, a vertebral mass is discovered. A site-directed biopsy is usually recommended except in patients with overt MM. It is important to remember that other neoplasms may occur in patients with MGUS (see below). Plasmacytomas that arise from bone marrow have a high propensity (approximately 75%) for progressing to MM, but those originating from extramedullary sites

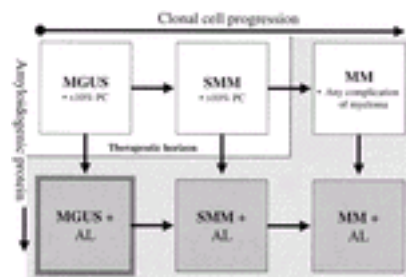


are less likely to do so ( 50 , 51 ). With the disappearance of a detectable monoclonal protein after radiation treatment for plasmacytoma, the likelihood of definitive control is higher ( 51 ).

**MULTIPLE MYELOMA MIMICRY** Because 2% of patients older than 50 years have MGUS, it is important to confirm the histologic features of masses believed to be plasmacytomas or other pathologic bone lesions. Without overt MM, it is erroneous to assume that a person with a monoclonal protein in the serum and a bone lesion identified on radiologic study has a plasmacytoma. Thus, needle aspiration or biopsy of the mass is recommended. A patient with metastatic cancer may present with lytic bone lesions.

### Light Chain-Associated Amyloidosis

AL is a serious complication of any B-cell neoplasm capable of producing a monoclonal protein ( Fig. 96.7 ) ( 21 ).



**Figure 96.7.** Relation between amyloidosis (AL) and other plasma cell (PC) neoplasms. MGUS, monoclonal gammopathy of undetermined significance; MM, multiple myeloma; SMM, smoldering multiple myeloma.

AL is associated most commonly with non-IgM MGUS and, in many cases, the amount of monoclonal protein may be minimal ( 21 ). One should be alert to the possibility of AL in any patient with a monoclonal protein. Although AL is slightly more common with  $\lambda$ -type light chains, it is also seen with  $\kappa$ -type light chains. AL should be suspected in a patient with a monoclonal protein and any of the following: nephrotic syndrome, restrictive cardiomyopathy, peripheral neuropathy, hepatomegaly, malabsorption, or a bleeding diathesis. Other features include the famous post proctoscopic periorbital purpura (4P sign), carpal tunnel syndrome, macroglossia, jaw claudication, orthostatic hypotension, diarrhea, and muscle pseudohypertrophy ( 21 ). Tissue diagnosis of AL should be sought, including Congo red staining of suspicious amyloid deposits. In some patients, AL is diagnosed on the basis of symptoms, and then tests for monoclonal protein are performed ( Box 3 ) (see Chapter 99).

### BOX 3. When to Suspect Amyloidosis

Amyloidosis should be suspected when evaluating older patients with the following:

- Nephrotic syndrome
- Congestive heart failure
- Peripheral neuropathy
- Carpal tunnel syndrome
- Orthostatic hypotension
- Hepatomegaly
- Malabsorption
- Mucosal and cutaneous bleeding

Serum and urine protein electrophoresis and immunofixation identify a monoclonal protein in 90% of patients with amyloidosis. A history of carpal tunnel syndrome or orthostatic hypotension is a strong clue for amyloidosis.

### Macroglobulinemia and Other Immunoglobulin M-Producing Neoplasms

IgM monoclonal gammopathy is rarely a presenting sign of MM and should immediately point to the possibility of a lymphoproliferative disorder, particularly Waldenström macroglobulinemia ( [18](#), [52](#) ).

#### IMMUNOGLOBULIN M MONOCLONAL GAMMOPATHY OF UNDETERMINED

**SIGNIFICANCE** A small proportion of patients with MGUS have an IgM monoclonal protein ( [7](#) ). In this case, lymphadenopathy, hepatomegaly, and splenomegaly are evidence of malignant disease, usually Waldenström macroglobulinemia, CLL, or a malignant lymphoma. All patients should have computed tomography of the abdomen and a bone marrow examination performed unless they are completely asymptomatic and the monoclonal protein level is less than 10 g/L. The probability of IgM MGUS evolving to one of these disorders is greater than 1% per year, nearly that of IgG monoclonal gammopathy ( [7](#) ).

**WALDENSTRÖM MACROGLOBULINEMIA** Hepatomegaly, lymphadenopathy, splenomegaly, epistaxis, retinal hemorrhages, tortuosity of the retinal veins and “sausaging” are clues to the diagnosis of Waldenström macroglobulinemia (see [Chapter 10](#)) ( [18](#), [52](#) ). These signs are characteristic of Waldenström macroglobulinemia and are distinctly uncommon in MM. In most patients with Waldenström macroglobulinemia, the bone marrow is replaced extensively by monoclonal lymphocytes or cells with lymphoplasmacytic differentiation ( [53](#), [54](#) ). In typical cases of Waldenström macroglobulinemia, the IgM monoclonal spike is greater than 30 g/L, although there is no reliable cut-off value for excluding or making the diagnosis ( [53](#), [54](#) ). Hyperviscosity is the hallmark of the disease, but it is clinically significant in only 15% of patients ( [55](#) ).

### NONNEOPLASTIC IMMUNOGLOBULIN DISORDERS

#### Polyclonal Gammopathy

By definition, polyclonal gammopathy represents an accumulation of nonneoplastic plasma cells ( [56](#) ). It is important to confirm with SPEP that the increased Igs are polyclonal; if the SPEP results are equivocal, immunofixation should be used. Polyclonal increases in the Igs can involve all or just one class of Igs ( [56](#) ). The evaluation of most patients who have polyclonal gammopathy should be straightforward. For most of them, no major



diagnostic workup is needed because the cause is apparent. For other patients, a complete history and physical examination may provide clues to the origin of the polyclonal gammopathy. An increase in the erythrocyte sedimentation rate may be due to the increase in Igs; it is not a good surrogate marker of inflammation. Other markers of inflammation, such as C-reactive protein, may be used. A special condition to keep in mind as a cause of polyclonal gammopathy is temporal arteritis, for which effective treatment is available. Even if liver enzyme abnormalities are mild, liver disease should be suspected.

### **Hypogammaglobulinemia**

In patients with recurrent encapsulated bacterial infections, humoral immune deficiency should be suspected. In these situations, it is advisable to perform SPEP and quantitative Igs. Knowing the age at onset of the problem facilitates diagnosis. In adults with recurrent sinus or pulmonary infections and low levels of IgG, IgA, and IgM, the most likely diagnosis is common variable immunodeficiency. Replacement therapy with intravenous Igs is corrective. The physician must be alert to the possibility of IgA deficiency in these patients because they are more likely to have adverse reactions to intravenously administered Ig. It is especially important to rule out MM in patients older than 50 years because Ig depression of the uninvolved Igs is frequently seen. This scenario is particularly common in patients with non-secretory MM. UPEP and immunofixation are also recommended because patients who have MM that produces only light chains may not have an apparent monoclonal protein in the serum. Children with hypogammaglobulinemia most likely have a hereditary condition such as Bruton type hypogammaglobulinemia, which is usually an X-linked recessive disorder.

### **SUGGESTED READING**

Dimopoulos MA, Galani E, Matsouka C. Waldenström's macroglobulinemia. *Hematol Oncol Clin North Am* 1999;13:1351-1366.

Fonseca R, Greipp PR. Multiple myeloma. *Conn's Current Therapy* 2001:466-469.

Gertz MA, Lacy MQ, Dispenzieri A. Amyloidosis. *Hematol Oncol Clin North Am* 1999;13:1211-1233.

Kyle RA, Rajkumar SV. Monoclonal gammopathies of undetermined significance. *Hematol Oncol Clin North Am* 1999;13:1181-1202.

Kyle RA, Therneau TM, Rajkumar SV, et al. A long-term study of prognosis in monoclonal gammopathy of undetermined significance. *N Engl J Med* 2002;346:564-569.

### **REFERENCES**

1. Kyle RA. Multiple myeloma: diagnostic challenges and standard therapy. *Semin Hematol* 2001;38:11-14.
2. Kyle RA, Greipp PR. Smoldering multiple myeloma. *N Engl J Med* 1980;302:1347-1349.
3. Kyle RA, Therneau TM, Rajkumar SV, et al. A long-term study of prognosis in monoclonal gammopathy of undetermined significance. *N Engl J Med* 2002;346:564-569.
4. Kyle RA, Robinson RA, Katzmann JA. The clinical aspects of bclonal gammopathies. Review of 57 cases. *Am J Med* 1981;71:999-1008.
5. Katzmann JA, Clark RJ, Abraham RS, et al. Serum reference intervals and diagnostic ranges for free kappa and free lambda immunoglobulin light chains: relative sensitivity for detection of monoclonal light chains. *Clin Chem* 2002;48:1437-1444.
6. Abraham RS, Clark RJ, Bryant SC, et al. Correlation of serum immunoglobulin free light chain

quantification with urinary Bence Jones protein in light chain myeloma. *Clin Chem* 2002;48:655–657.

7. Kyle RA, Garton JP. The spectrum of IgM monoclonal gammopathy in 430 cases. *Mayo Clin Proc* 1987;62:719–731.

8. Zarrabi MH, Stark RS, Kane P, et al. IgM myeloma, a distinct entity in the spectrum of B-cell neoplasia. *Am J Clin Pathol* 1981;75:1–10.

9. Takahashi K, Yamamura F, Motoyama H. IgM myeloma—its distinction from Waldenström's macroglobulinemia. *Acta Pathol Jpn* 1986;36:1553–1563.

10. Kondo H, Yokoyama K. IgM myeloma: different features from multiple myeloma and macroglobulinaemia. *Eur J Haematol* 1999;63:366–368.

11. Schop RF, Kuehl WM, Van Wier SA, et al. Waldenström macroglobulinemia neoplastic cells lack immunoglobulin heavy chain locus translocations but have frequent 6q deletions. *Blood* 2002;100:2996–3001.

12. Avet-Loiseau H, Garand R, Lode L, et al. Translocation t(11;14)(q13;q32) is the hallmark of IgM, IgE, and nonsecretory multiple myeloma variants. *Blood* 2003;101:1570–1571.

13. Kyle RA. “Benign” monoclonal gammopathy—after 20 to 35 years of follow-up. *Mayo Clin Proc* 1993;68:26–36.

14. Garand R, Sahota SS, Avet-Loiseau H, et al. IgG-secreting lymphoplasmacytoid leukemia: a B-cell disorder with extensively mutated VH genes undergoing Ig isotype-switching frequently associated with trisomy 12. *Br J Haematol* 2000;109:71–80.

15. Bataille R, Grenier J, Sany J. Beta-2-microglobulin in myeloma: optimal use for staging, prognosis, and treatment—a prospective study of 160 patients. *Blood* 1984;63:468–476.

16. Witzig TE, Kyle RA, O'Fallon WM, et al. Detection of peripheral blood plasma cells as a predictor of disease course in patients with smoldering multiple myeloma. *Br J Haematol* 1994;87:266–272.

17. Witzig TE, Gertz MA, Lust JA, et al. Peripheral blood monoclonal plasma cells as a predictor of survival in patients with multiple myeloma. *Blood* 1996;88:1780–1787.

18. Dimopoulos MA, Panayiotidis P, Moulopoulos LA, et al. Waldenström's macroglobulinemia: clinical features, complications, and management. *J Clin Oncol* 2000;18:214–226.

19. Mariette X, Zagdanski AM, Guermazi A, et al. Prognostic value of vertebral lesions detected by magnetic resonance imaging in patients with stage I multiple myeloma. *Br J Haematol* 1999;104:723–729.

20. Durie BG, Waxman AD, D'Agnolo A, et al. Whole-body (18)F-FDG PET identifies high-risk myeloma. *J Nucl Med* 2002;43:1457–1463.

21. Gertz MA, Lacy MQ, Dispenzieri A. Amyloidosis: recognition, confirmation, prognosis, and therapy. *Mayo Clin Proc* 1999;74:490–494.

22. Cesana C, Klersy C, Barbarano L, et al. Prognostic factors for malignant transformation in monoclonal gammopathy of undetermined significance and smoldering multiple myeloma. *J Clin Oncol* 2002;20:1625–1634.

23. Greipp PR, Kyle RA. Clinical, morphological, and cell kinetic differences among multiple myeloma, monoclonal gammopathy of undetermined significance, and smoldering multiple myeloma. *Blood* 1983;62:166–171.

24. Boccadoro M, Gavarotti P, Fossati G, et al. Low plasma cell 3(H) thymidine incorporation in monoclonal gammopathy of undetermined significance (MGUS), smoldering myeloma and remission phase myeloma: a reliable indicator of patients not requiring therapy. *Br J Haematol* 1984;58:689–696.

25. Alexanian R. Localized and indolent myeloma. *Blood* 1980;56:521–525.

26. Bergsagel DE, Bailey AJ, Langley GR, et al. The chemotherapy on plasma-cell myeloma and the

incidence of acute leukemia. *N Engl J Med* 1979;301:743–748.

27. Bergsagel DE. Plasma cell neoplasms and acute leukemia. *Clin Haematol* 1982;11:221–234.
28. Buckman R, Cuzick J, Galton DA. Long-term survival in myelomatosis. A report to the MRC working party on leukemia in adults. *Br J Haematol* 1982;52:589–599.
29. Cuzick J, Erskine S, Edelman D, et al. A comparison of the incidence of the myelodysplastic syndrome and acute myeloid leukemia following melphalan and cyclophosphamide treatment for myelomatosis. A report to the Medical Research Council's working party on leukemia in adults. *Br J Cancer* 1987;55:523–529.
30. Cardamone JM, Kimmerle RI, Marshall EY. Development of acute erythroleukemia in B-cell immunoproliferative disorders after prolonged therapy with alkylating drugs. *Am J Med* 1974;57:836–842.
31. Singhal S, Mehta J, Desikan R, et al. Antitumor activity of thalidomide in refractory multiple myeloma. *N Engl J Med* 1999;341:1565–1571.
32. Berenson JR, Lichtenstein A, Porter L, et al. Efficacy of pamidronate in reducing skeletal events in patients with advanced multiple myeloma. Myeloma Aredia Study Group. *N Engl J Med* 1996;334:488–493.
33. Berenson JR, Hillner BE, Kyle RA, et al. American Society of Clinical Oncology clinical practice guidelines: the role of bisphosphonates in multiple myeloma. *J Clin Oncol* 2002;20:3719–3736.
34. Hjorth M, Hellquist L, Holmberg E, et al. Initial versus deferred melphalan-prednisone therapy for asymptomatic multiple myeloma stage I—a randomized study. Myeloma Group of Western Sweden. *Eur J Haematol* 1993;50:95–102.
35. Rajkumar SV, Dispenzieri A, Fonseca R, et al. Thalidomide for previously untreated indolent or smoldering multiple myeloma. *Leukemia* 2001;15:1274–1276.
36. Simmonds MA. Cancer statistics, 2003: further decrease in mortality rate, increase in persons living with cancer. *CA Cancer J Clin* 2003;53:4.
37. Bataille R, Harousseau JL. Multiple myeloma. *N Engl J Med* 1997;336:1657–1664.
38. Gucalp R, Theriault R, Gill I, et al. Treatment of cancer-associated hypercalcemia. Double-blind comparison of rapid and slow intravenous infusion regimens of pamidronate disodium and saline alone. *Arch Intern Med* 1994;154:1935–1944.
39. Major P, Lortholary A, Hon J, et al. Zoledronic acid is superior to pamidronate in the treatment of hypercalcemia of malignancy: a pooled analysis of two randomized, controlled clinical trials. *J Clin Oncol* 2001;19:558–567.
40. Mundy GR, Wilkinson R, Heath DA. Comparative study of available medical therapy for hypercalcemia of malignancy. *Am J Med* 1983;74:421–432.
41. Pearce RN, Sordillo EM, Yaccoby S, et al. Multiple myeloma disrupts the TRANCE/osteoprotegerin cytokine axis to trigger bone destruction and promote tumor progression. *Proc Natl Acad Sci U S A* 2001;98:11581–11586.
42. Bataille R, Chappard D, Basle MF. Quantifiable excess of bone resorption in monoclonal gammopathy is an early symptom of malignancy: a prospective study of 87 bone biopsies. *Blood* 1996;87:4762–4769.
43. Bladé J, Fernández-Llana P, Bosch F, et al. Renal failure in multiple myeloma: presenting features and predictors of outcome in 94 patients from a single institution. *Arch Intern Med* 1998;158:1889–1893.
44. Knudsen LM, Hjorth M, Hippe E. Renal failure in multiple myeloma: reversibility and impact on the prognosis. Nordic Myeloma Study Group. *Eur J Haematol* 2000;65:175–181.
45. Torra R, Bladé J, Cases A, et al. Patients with multiple myeloma requiring long-term dialysis: presenting features, response to therapy, and outcome in a series of 20 cases. *Br J Haematol* 1995;91:854–859.

46. Kyle RA, Gertz MA, Witzig TE, et al. Review of 1027 patients with newly diagnosed multiple myeloma. *Mayo Clin Proc* 2003;78:21–33.
47. Dimopoulos MA, Moulopoulos A, Delasalle K, et al. Solitary plasmacytoma of bone and asymptomatic multiple myeloma. *Hematol Oncol Clin North Am* 1992;6:359–369.
48. Dimopoulos MA, Goldstein J, Fuller L, et al. Curability of solitary bone plasmacytoma. *J Clin Oncol* 1992;10:587–590.
49. Dimopoulos MA, Kiamouris C, Moulopoulos LA. Solitary plasmacytoma of bone and extramedullary plasmacytoma. *Hematol Oncol Clin North Am* 1999;13:1249–1257.
50. Jaffe JP, Bosch A, Raich PC. Sequential hemi-body radiotherapy in advanced multiple myeloma. *Cancer* 1979;43:124–128.
51. Liebross RH, Ha CS, Cox JD, et al. Solitary bone plasmacytoma: outcome and prognostic factors following radiotherapy. *Int J Radiat Oncol Biol Phys* 1998;41:1063–1067.
52. Gertz MA, Fonseca R, Rajkumar SV. Waldenström's macroglobulinemia. *Oncologist* 2000;5:63–67.
53. Pangalis GA, Boussiotis VA, Kittas C. Malignant disorders of small lymphocytes. Small lymphocytic lymphoma, lymphoplasmacytic lymphoma, and chronic lymphocytic leukemia: their clinical and laboratory relationship. *Am J Clin Pathol* 1993;99:402–408.
54. Owen RG, Johnson SA, Morgan GJ. Waldenström's macroglobulinaemia: laboratory diagnosis and treatment. *Hematol Oncol* 2000;18:41–49.
55. Gertz MA, Kyle RA. Hyperviscosity syndrome. *J Intensive Care Med* 1995;10:128–141.
56. Dispenzieri A, Gertz MA, Therneau TM, et al. Retrospective cohort study of 148 patients with polyclonal gammopathy. *Mayo Clin Proc* 2001;76:476–487.

2004 Lippincott Williams & Wilkins  
John P. Greer, John Foerster, John N. Lukens  
George M. Rodgers, Frixos Paraskevas, Bertil Glader  
Wintrobe's Clinical Hematology

## Monoclonal Gammopathy of Undetermined Significance and Smoldering Multiple Myeloma\*

### HISTORICAL BACKGROUND

#### MONOCLONAL GAMMOPATHY OF UNDETERMINED SIGNIFICANCE

##### Mayo Clinic Study

##### Long-Term Follow-Up in 1384 Monoclonal Gammopathy of Undetermined Significance Patients from Southeastern Minnesota

##### Follow-Up in Other Series

##### Predictors of Malignant Transformation in Monoclonal Gammopathy of Undetermined Significance

##### Life Expectancy and Cause of Death in Patients with Monoclonal Gammopathy of Undetermined Significance

##### Differential Diagnosis

##### Management

#### SMOLDERING (ASYMPTOMATIC) MULTIPLE MYELOMA

##### Prevalence of Smoldering Multiple Myeloma

##### Risk of Smoldering Multiple Myeloma Progression

##### Predictors of Smoldering Multiple Myeloma Progression

##### Management of Smoldering Multiple Myeloma

#### VARIANTS OF MONOCLONAL GAMMOPATHY OF UNDETERMINED SIGNIFICANCE

##### Biclonal Gammopathy

##### Triclonal Gammopathy

##### Benign Monoclonal Light-Chain (Idiopathic Bence Jones) Proteinuria

##### Immunoglobulin D Monoclonal Gammopathy of Undetermined Significance

#### ASSOCIATION OF MONOCLONAL GAMMOPATHY WITH OTHER DISEASES

##### Lymphoproliferative Disorders

##### Leukemia

##### Other Hematologic Diseases

##### Connective Tissue Disorders

##### Neurologic Disorders

##### Osteosclerotic Myeloma

##### Dermatologic Diseases

##### Immunosuppression

##### Miscellaneous Conditions

##### M-Proteins with Antibody Activity

#### REFERENCES

## HISTORICAL BACKGROUND

Waldenström introduced the term *essential hyperglobulinemia* in 1952 to describe patients with a small serum protein electrophoretic spike but no evidence of multiple myeloma (MM), Waldenström macroglobulinemia (WM), amyloidosis (AL), or related disorders. Since that time, many similar terms have been used, including idiopathic, asymptomatic, benign, nonmyelomatous, discrete, cryptogenic, and rudimentary monoclonal gammopathy; dysimmunoglobulinemia; lanthanic monoclonal gammopathy; idiopathic paraproteinemia; and asymptomatic paraimmunoglobulinemia. Waldenström (<sup>1</sup>) stressed the constancy of the size of the protein spike obtained by electrophoresis of serum, contrasting it with the increasing quantity of the monoclonal protein (M-protein) in MM patients. The term *benign monoclonal gammopathy* is misleading, because an M-protein may remain stable

and benign, or it may develop into symptomatic MM, WM, AL, or a related condition.

The term *monoclonal gammopathy of undetermined significance* (MGUS) denotes the presence of an M-protein in persons without evidence of MM, WM, AL, or related plasma cell proliferative disorders. MGUS is characterized by a serum M-protein concentration of less than 30 g/L; less than 10% plasma cells in the bone marrow; little or no M-protein in the urine; absence of lytic bone lesions; and no related anemia, hypercalcemia, or renal insufficiency related to the plasma cell disorder ( 2 ).

M-proteins occur without MM or WM in approximately 3% of persons older than 70 years in Sweden, the United States, and France ( 3 , 4 and 5 ). In 6995 persons older than 25 years from Sweden, an M-protein was found in 1% ( 3 ). In a community cluster of cases of MM in a small Minnesota community, M-protein was detected in 15 of 1200 persons aged 50 years or older (1.25%), and in France, 303 of 17,968 persons aged 50 years or older (1.7%) had an M-protein ( 4 , 5 ). The incidence of MGUS is higher in older patients. Crawford et al. ( 6 ) found that 10% of 111 patients older than 80 years had a detectable M-protein. Ligthart et al. ( 7 ) reported that 23% of 4039 patients aged 75 to 84 years had an M-protein. Cohen et al. ( 8 ) reported an incidence of MGUS of 3.6% in 816 patients aged 70 years or older in North Carolina.

The incidence of M-proteins is higher in blacks than in whites ( 9 ). In the study by Cohen et al. ( 8 ), the prevalence of an M-protein was 8.4% in 916 blacks compared with 3.6% in whites ( 8 ). Only 2.7% of elderly Japanese patients had a monoclonal gammopathy ( 10 ). Kurihara et al. ( 11 ) found an M-protein in 71 of 2007 inpatients and outpatients (3.5%) in a Japanese university hospital. After exclusion of the 13 patients with MM and WM, the incidence was 2.9%, which is higher than has been reported previously.

The monoclonal gammopathies are a group of disorders characterized by the proliferation of a single clone of plasma cells that produces a homogeneous monoclonal M-protein ( Table 97.1 ). Each M-protein consists of two heavy polypeptide chains of the same class and subclass and two light polypeptide chains of the same type. Polyclonal immunoglobulins are produced by many clones of plasma cells. The population of polyclonal immunoglobulins is heterogeneous with respect to heavy-chain classes and includes both light-chain types. The various types of immunoglobulins are designated by capital letters that correspond to the isotype of their heavy chains, which are designated by Greek letters: gamma (  $\gamma$  ) constitutes immunoglobulin G (IgG), alpha (  $\alpha$  ) is found in IgA, mu (  $\mu$  ) is present in IgM, delta (  $\delta$  ) occurs in IgD, and IgE is characterized by epsilon (  $\epsilon$  ); IgG1, IgG2, IgG3, and IgG4 are the subclasses of IgG; the subclasses of IgA are IgA1 and IgA2. Kappa (  $\kappa$  ) and lambda (  $\lambda$  ) are the two types of light chains. An intact immunoglobulin consists of two heavy chains of the same class and two light chains of the same type. A monoclonal increase in immunoglobulins results from a clonal process that is malignant or potentially malignant, and a polyclonal increase in immunoglobulins is caused by a reactive or inflammatory process.

**TABLE 97.1. Classification of Monoclonal Gammopathies**

---

|   |
|---|
| Monoclonal gammopathy of undetermined significance                      |
| Benign (IgG, IgA, IgD, IgM, and, rarely, free light chains)             |
| Associated with neoplasms of cell types not known to produce M-proteins |
| Biclonal gammopathy   |
| Idiopathic Bence Jones proteinuria                                      |

## Malignant monoclonal gammopathies

Multiple myeloma (IgG, IgA, IgD, IgE, and free  $\kappa$  or  $\lambda$  light chains)

Overt multiple myeloma

Smoldering multiple myeloma

Plasma cell leukemia

Nonsecretory myeloma

IgD myeloma

POEMS: *poly*neuropathy, *organomegaly*, *endocrinopathy*, *monoclonal protein*, *skin changes* (osteosclerotic myeloma)

Plasmacytoma

Solitary plasmacytoma of bone

Extramedullary plasmacytoma

Malignant lymphoproliferative disorders

Waldenström macroglobulinemia (primary macroglobulinemia)

Malignant lymphoma

Chronic lymphocytic leukemia or lymphoproliferative disorders

Heavy chain diseases

$\delta$  Heavy chain disease

$\alpha$  Heavy chain disease

$\mu$  Heavy chain disease

Amyloidosis

Primary amyloidosis

With multiple myeloma (secondary, localized, and familial amyloidosis with no M-protein)

Ig, immunoglobulin.

From Kyle RA, Rajkumar SV. Monoclonal gammopathies of undetermined significance. Rev Clin Exp Hematol 2002;6:225–252, by permission of Accademia Nazionale di Medicina.

---

Analysis of serum or urine requires a sensitive, rapid, dependable screening method to detect the presence of an M-protein and a specific assay to identify it according to its heavy-chain class and light-chain type ( [12](#), [13](#) ). Agarose gel electrophoresis is more sensitive than cellulose acetate and is the preferred method of detection. After recognition of a localized band on electrophoresis, immunofixation or immunoelectrophoresis must be done to confirm the presence of an M-protein and to determine its immunoglobulin heavy-chain class and its light-chain type. Immunofixation or immunoelectrophoresis should also be done when MM, WM, AL, or a related disorder is suspected, because small amounts of M-protein may not be detected with serum protein electrophoresis ( [14](#) ).

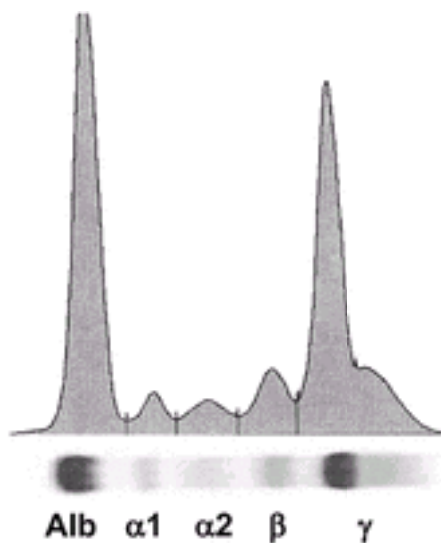
Serum protein electrophoresis should be done when MM, WM, or AL is suspected ( [15](#) ). In addition, electrophoresis is indicated for any patient who has unexplained weakness or fatigue, elevated erythrocyte sedimentation rate, anemia, unexplained back pain, osteoporosis, osteolytic lesions or fractures, hypercalcemia, Bence Jones proteinuria, renal insufficiency, or recurrent infections ( [16](#) ). Serum protein electrophoresis should also be performed in adults with unexplained sensorimotor peripheral neuropathy, carpal tunnel syndrome, refractory congestive heart failure, nephrotic syndrome, orthostatic hypotension, or malabsorption, because a localized band or spike suggests AL. Weight loss, change in the tongue or voice, paresthesias, numbness, increased bruising, bleeding,



and steatorrhea are additional indications for serum protein electrophoresis. Even when the serum protein electrophoretic pattern is nondiagnostic, immunofixation should be performed whenever MM, AL, or related disorders are suspected clinically.

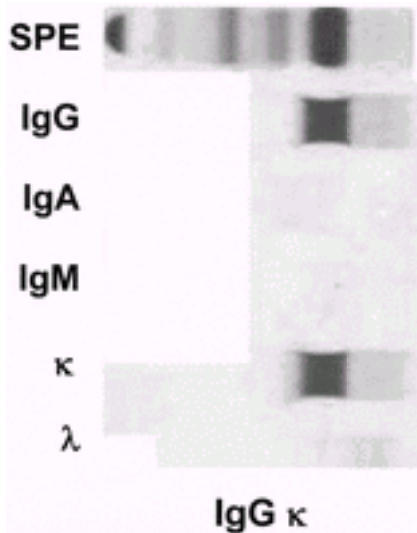
All patients with a localized band on agarose gel electrophoresis or a localized spike on the densitometer tracing require immunofixation to confirm the presence of an M-protein and determine its type. The agarose gel should always be examined directly by the interpreter.

An M-protein is usually visible as a localized band on the agarose gel electrophoretic strip or as a tall, narrow spike or peak in the  $\beta$  or  $\gamma$  region or, rarely, in the  $\alpha_2$ -globulin area of the densitometer tracing ( [Fig. 97.1](#)). A polyclonal increase in immunoglobulins produces a broad band or broad-based peak that migrates in the  $\gamma$  region.



**Figure 97.1. Top:** Monoclonal pattern of serum M-protein by densitometry after electrophoresis on agarose gel. Note tall, narrow-based peak of fast  $\gamma$  mobility. **Bottom:** Monoclonal pattern from electrophoresis of serum on agarose gel ( *anode on left*). Note dense localized band in fast  $\gamma$  area. Alb, albumin.

Immunofixation to determine the type of monoclonal protein may be performed by using commercial kits or systems such as Sebia, Pentafix, and 9-IF (Sebia, Norcross, GA) ( [Fig. 97.2](#)) ( [17](#) ).

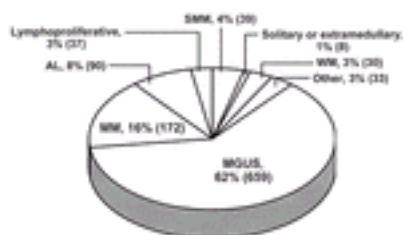


**Figure 97.2.** Immunofixation of serum with antisera to immunoglobulin G (IgG), IgA, IgM, κ, and λ shows a localized band with IgG and κ in the fast κ region indicating an IgG κ monoclonal protein (immunofixation). SPE, serum protein electrophoresis.

Quantitation of immunoglobulins is best performed with a rate nephelometer, because it is not affected by molecular size and measures accurately 7S IgM, polymers of IgA, and aggregates of IgG. However, levels of IgM obtained by nephelometry may be 10 to 20 g/L higher than those expected on the basis of the serum protein electrophoretic tracing. The quantitative IgG and IgA levels may be increased similarly (18).

Analysis of urine is essential for patients with monoclonal gammopathies. All patients with a serum M-protein concentration of more than 15 g/L should have electrophoresis and immunofixation done. In addition, electrophoresis should be done in all instances of MM, WM, AL, and heavy chain diseases or when these entities are suspected. Immunofixation of urine should also be done in the evaluation of older patients with a nephrotic syndrome of unknown cause to recognize the presence of AL or light-chain deposition disease. A 24-hour urine specimen should be collected so that the amount of M-protein can be measured. This is done by multiplying the percentage of the M-spike in the densitometer tracing by the total protein in the 24-hour specimen. The amount of M-protein in the urine provides an index of the patient's tumor mass and is useful subsequently in monitoring the course of the patient's disease. Urinary M-protein is seen as a dense localized band on the agarose gel or a tall, narrow homogeneous peak on the densitometer tracing.

In 2001, a total of 1068 cases of monoclonal gammopathy were identified at Mayo Clinic: 659 (62%), MGUS; 172 (16%), MM; 90 (8%), AL; 37 (3%), lymphoproliferative; 39 (4%), smoldering MM (SMM); 8 (1%), solitary or extramedullary; 30 (3%), WM; and 33 (3%), other (Fig. 97.3).



**Figure 97.3.** Causes of 1068 cases of monoclonal gammopathy, Mayo Clinic, 2001. AL, amyloidosis; MGUS, monoclonal gammopathy of undetermined significance; MM, multiple myeloma; SMM, smoldering multiple myeloma; WM, Waldenström macroglobulinemia. (From Kyle RA, Rajkumar SV. Monoclonal gammopathies of undetermined significance. *Rev Clin Exp Hematol* 2002;6:225–252. By permission of Accademia Nazionale di Medicina.)

## MONOCLONAL GAMMOPATHY OF UNDETERMINED SIGNIFICANCE

MGUS is characterized by the presence of a serum M-protein value less than 30 g/L, fewer than 10% plasma cells in bone marrow, little or no monoclonal light chain in the urine, absence of lytic bone lesions, and no related anemia, hypercalcemia, or renal insufficiency ( [Table 97.2](#)). The growth rate of the plasma cells (plasma cell labeling index) is low. MGUS may become evident unexpectedly during laboratory testing of an apparently normal person or may be found during evaluation for an unrelated disorder.

**TABLE 97.2. Mayo Clinic Criteria for the Diagnosis of Monoclonal Gammopathy of Undetermined Significance, Smoldering Multiple Myeloma, and Multiple Myeloma**

| Disorder | Criteria   |
|----------|--|
| MGUS     | Serum monoclonal protein <30 g/L <i>and</i> bone marrow plasma cells <10% <i>and</i> absence of anemia, renal failure, hypercalcemia, and lytic bone lesions.  |
| SMM      | Serum monoclonal protein <30 g/L <i>or</i> bone marrow plasma cells <10% <i>and</i> absence of anemia, renal failure, hypercalcemia, and lytic bone lesions.   |
| MM       | Presence of a serum or urine monoclonal protein, bone marrow plasmacytosis, <i>and</i> anemia, renal failure, hypercalcemia, or lytic bone lesions. Patients with primary systemic amyloidosis and <30% bone marrow plasma cells have both MM and amyloidosis. |

MGUS, monoclonal gammopathy of undetermined significance; MM, multiple myeloma; SMM, smoldering multiple myeloma.

Modified from Rajkumar SV, Dispenzieri A, Fonseca R, et al. Thalidomide for previously untreated indolent or smoldering multiple myeloma. *Leukemia* 2001;15: 1274–1276. By permission of Nature Publishing Group.

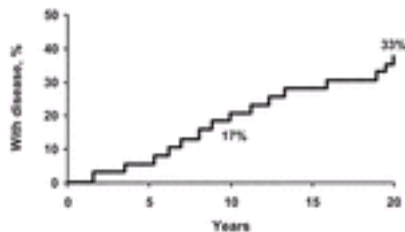
MGUS is a common finding in the medical practice of all physicians. It is important for both the patient and the physician to determine whether the monoclonal gammopathy remains benign or progresses to MM or related disorders.

### Mayo Clinic Study

The authors reviewed the medical records of all patients with monoclonal gammopathy who were seen at Mayo Clinic from 1956 through 1970. Patients with MM, WM, AL, lymphoma, or related disorders were excluded. Two hundred forty-one patients were eligible for long-term study.

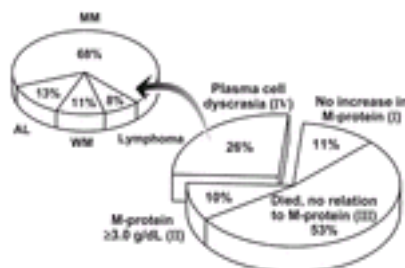
After 24 to 38 years of follow-up, the number of patients who were still living and whose M-protein level had remained stable and could be classified as having benign monoclonal gammopathy had decreased to 25 (10%). Twenty-six patients (11%) had an increase of the

M-protein level higher than 30 g/L, but MM, WM, and AL did not develop. One hundred twenty-seven patients (53%) died of unrelated causes without development of MM or related disorders. MM, WM, AL, or lymphoproliferative disease developed in 63 patients (26%). The actuarial rate at 10 years was 17%; at 20 years, 33% ( Fig. 97.4); and at 25 years, 40%.



**Figure 97.4.** Actuarial analysis of incidence of multiple myeloma, macroglobulinemia, amyloidosis, or lymphoproliferative disease after recognition of monoclonal protein in 241 patients with monoclonal gammopathy of undetermined significance. [From Kyle RA, Lust JA. The monoclonal gammopathies (paraproteins). *Adv Clin Chem* 1990;28:145–218. By permission of Academic Press.]

Forty-three of the 63 patients (68%) with progression had MM ( Fig. 97.5). Intervals from recognition of the M-protein to diagnosis of MM in the 43 patients ranged from 2 to 29 years (median, 10 years) ( Table 97.3). In nine patients, the diagnosis was made 20 years after recognition of the serum M-protein. Median survival after diagnosis of MM was 33 months, similar to the expected survival.



**Figure 97.5.** Evolution of monoclonal gammopathy in 241 patients, Mayo Clinic, 1956–1970. AL, amyloidosis; MM, multiple myeloma; WM, Waldenström macroglobulinemia. (Modified from Kyle RA, Rajkumar SV. Monoclonal gammopathies of undetermined significance. *Rev Clin Exp Hematol* 2002;6:225–252. By permission of Accademia Nazionale di Medicina.)

**TABLE 97.3. Development of Myeloma or Related Diseases in 63 Patients with Monoclonal Gammopathy of Undetermined Significance**

| Disease           | Number | Percent | Interval to Diagnosis (yr) <sup>a</sup> |       |
|-------------------|--------|---------|---|-------|
|                   |        |         | Median                                  | Range |
| Multiple myeloma  | 43     | 68      | 10                                      | 2–29  |
| Macroglobulinemia | 7      | 11      | 8.5                                     | 4–20  |
| Amyloidosis       | 8      | 13      | 9                                       | 6–19  |

|                              |    |     |      |      |
|------------------------------|----|-----|------|------|
| Lymphoproliferative disorder | 5  | 8   | 10.5 | 6–22 |
| Total                        | 63 | 100 | —    | —    |

<sup>a</sup> Actuarial rate was 17% at 10 years and 33% at 20 years.

From Kyle RA, Rajkumar SV. Monoclonal gammopathies of undetermined significance. *Rev Clin Exp Hematol* 2002;6:225–252, by permission of Accademia Nazionale di Medicina.

WM developed in seven patients. All had a serum IgM  $\kappa$  protein level ranging from 31 to 85 g/L at diagnosis. Systemic AL was found in eight patients 6 to 19 years (median, 9 years) after the recognition of an M-protein in the serum. A malignant lymphoproliferative process developed in five patients 6 to 22 years (median, 10.5 years) after detection of the M-protein ( [Fig. 97.5](#); [Table 97.3](#)).

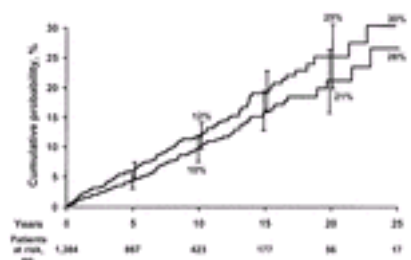
### Long-Term Follow-Up in 1384 Monoclonal Gammopathy of Undetermined Significance Patients from Southeastern Minnesota

A population-based study was done to confirm the findings of the original Mayo Clinic study, which consisted mainly of patients referred to a tertiary care center. A total of 1384 persons who resided in the 11 counties of southeastern Minnesota were identified as having MGUS, defined by a serum M-protein value of 30 g/L or less, less than 10% plasma cells in the bone marrow (if the test was done), little or no M-protein in the urine, and the absence of lytic bone lesions, anemia, hypercalcemia, or renal insufficiency related to the M-protein. The patients were evaluated at Mayo Clinic from January 1, 1960, through December 31, 1994 ( [19](#)). The median age at diagnosis of MGUS was 72 years. There were 753 men (54%) and 631 women (46%). Only 24 patients (2%) were younger than 40 years at diagnosis, compared with 810 (59%) who were aged 70 years or older. The M-protein level at diagnosis ranged from unmeasurable to 30 g/L. On the basis of the heavy-chain type of immunoglobulins, 70% of the M-proteins were IgG, 12% IgA, and 15% IgM. A biconal gammopathy was found in 45 patients (3%). The light-chain type was  $\kappa$  in 61% and  $\lambda$  in 39%. The electrophoretic mobility of the M-protein and its heavy-chain class and light-chain type was unchanged throughout the period of observation. A reduction of uninvolved (normal or background) immunoglobulins was found in 38% of 840 patients in whom quantitation of immunoglobulins was determined. Electrophoresis, immunoelectrophoresis, and immunofixation of urine were performed in 418 patients. Twenty-one percent had a monoclonal  $\kappa$  light chain, 10% had  $\lambda$  at the time of recognition of the abnormal monoclonal gammopathy, and 69% were negative. Only 71 of 418 patients (17%) had an M-protein excretion higher than 150 mg/24 hours.

One hundred sixty patients (12%) had a bone marrow examination performed at the time of detection of the M-protein. The median percentage of bone marrow plasma cells was 3% (range, 0 to 10%). The initial hemoglobin values ranged from 57 to 189 g/L. The hemoglobin level was less than 100 g/L in 7% and 120 g/L or less in 23%. The anemia was due to causes other than the plasma cell proliferative process (e.g., iron deficiency, renal insufficiency, or myelodysplasia) in each instance. The serum creatinine level was higher than 2 mg/dl in 6% of the patients and was attributable to unrelated causes such as diabetes, hypertension, and glomerulonephritis.

The 1384 patients were followed-up for a total of 11,009 person-years (median, 15.4 years; range, 0 to 35 years). Nine hundred sixty-three patients (70%) died. During follow-up, MM, primary AL, lymphoma with an IgM serum M-protein, WM, plasmacytoma, or chronic lymphocytic leukemia developed in 115 patients (8%) ( [Table 97.4](#)). The cumulative probability of progression to one of these disorders was 10% at 10 years, 21%

at 20 years, and 26% at 25 years ( Fig. 97.6). The risk of progression is approximately 1% per year; patients were at risk for progression even after 25 years or more of stable MGUS. In addition, 32 patients were identified in whom the M-protein value increased to higher than 30 g/L or the percentage of bone marrow plasma cells increased to more than 10% but in whom symptomatic MM did not develop. The cumulative probability of progression to MM or a related disorder plus an increase in M-protein to higher than 30 g/L or to more than 10% in bone marrow plasma cells was 12% at 10 years, 25% at 20 years, and 30% at 25 years ( Fig. 97.6). These findings confirmed the results of the initial Mayo Clinic study.



**Figure 97.6.** Probability of disease progression among 1384 residents of southeastern Minnesota in whom monoclonal gammopathy of undetermined significance (MGUS) was diagnosed from 1960 through 1994. The top curve shows the probability of progression to a plasma cell cancer (115 patients) or of an increase in the M-protein concentration to more than 30 g/L or in the proportion of plasma cells in the bone marrow to more than 10% (32 patients). The bottom curve shows only the probability of progression of MGUS to multiple myeloma, immunoglobulin M lymphoma, primary amyloidosis, macroglobulinemia, chronic lymphocytic leukemia, or plasmacytoma (115 patients). The error bars indicate 95% confidence intervals. (From Kyle RA, Rajkumar SV. Monoclonal gammopathies of undetermined significance. *Rev Clin Exp Hematol* 2002;6:225–252. By permission of Accademia Nazionale di Medicina.)

**TABLE 97.4. Risk of Progression Among 1384 Residents of Southeastern Minnesota in Whom Monoclonal Gammopathy of Undetermined Significance Was Diagnosed, 1960–1994**

| Type of Progression                       | Number of Patients |                       | Relative Risk<br>(95% CI) |
|---|--------------------|-----------------------|---------------------------|
|   | Observed           | Expected <sup>a</sup> |                           |
| Multiple myeloma                          | 75                 | 3.0                   | 25.0 (20–32)              |
| Lymphoma <sup>b</sup>                     | 19                 | 7.8                   | 2.4 (2–4)                 |
| Primary amyloidosis                       | 10                 | 1.2                   | 8.4 (4–16)                |
| Macroglobulinemia                         | 7                  | 0.2                   | 46.0 (19–95)              |
| Chronic lymphocytic leukemia <sup>c</sup> | 3                  | 3.5                   | 0.9 (0.2–3.0)             |
| Plasmacytoma                              | 1                  | 0.1                   | 8.5 (0.2–47.0)            |
| Total                                     | 115                | 15.8                  | 7.3 (6–9)                 |

CI, confidence interval.



<sup>a</sup> Expected numbers of cases were derived from the age- and sex-matched white population of the Surveillance, Epidemiology, and End Results program in Iowa [from Surveillance, Epidemiology, and End Results (SEER) Program Public Use Data (1973–1998). Bethesda, MD: National Cancer Institute, Cancer Statistics Branch, April 2001], except for primary amyloidosis, for which data are from Kyle RA, Linos A, Beard CM, et al. Incidence and natural history of primary systemic amyloidosis in Olmsted County, Minnesota, 1950 through 1989. *Blood* 1992;79: 1817–1822.

<sup>b</sup> All 19 patients had serum immunoglobulin M (IgM) monoclonal protein. If the 30 patients with IgM, IgA, or IgG monoclonal protein and lymphoma were included, the relative risk would be 3.9 (95% CI, 2.6–5.5).

<sup>c</sup> All three patients had serum IgM monoclonal protein. If all six patients with IgM, IgA, or IgG monoclonal protein and chronic lymphocytic leukemia were included, the relative risk would be 1.7 (95% CI, 0.6–3.7).

From Kyle RA, Therneau TM, Rajkumar SV, et al. A long-term study of prognosis in monoclonal gammopathy of undetermined significance. *N Engl J Med* 2002;346: 564–569, by permission of the Massachusetts Medical Society.

---

The number of patients with progression to a plasma cell disorder (115 patients) was 7.3 times the number expected on the basis of the incidence rates for those conditions in the general population ( [Table 97.4](#) ) ( [20](#) ). The risk of developing MM was increased 25-fold; WM, 46-fold; and AL, 8.4-fold ( [21](#) ). The risk of development of lymphoma was only modestly increased at 2.4, but this risk was underestimated because only lymphomas associated with an IgM protein counted in the observed number, whereas the incidence rates for lymphomas associated with IgG, IgA, and IgM proteins were used to calculate the expected number. The risk of development of chronic lymphocytic leukemia was only slightly increased ( [Table 97.3](#) ) when all six cases were included.

The 75 patients in whom MM developed accounted for 65% of the 115 patients who had progression to a plasma cell disorder. Four of the patients with MM had an initial plasmacytoma, and three other MM patients also had AL. In 24 patients (32%), the diagnosis of MM was made more than 10 years after detection of the M-protein, and five (7%) were recognized after 20 years of follow-up. The characteristics of these 75 MM patients were comparable to those of the 1027 patients with newly diagnosed MM referred to Mayo Clinic from 1985 to 1998, except that the southeastern Minnesota patients were older (median, 76 vs. 66 years) and less likely to be male (46% vs. 60%).

The mode of development of MM among the MGUS patients was variable. The M-protein level increased within 2 years of the recognition of MGUS in 11 patients, whereas the serum M-protein level was stable for more than 2 years and then increased within 2 years in 19 patients; in nine others, the M-protein level increased gradually after having been stable for at least 2 years. In nine patients, the M-protein level increased gradually during follow-up until the diagnosis of symptomatic MM was made. In ten patients, the serum M-protein level remained essentially stable; the diagnosis of MM was unequivocal in these ten patients because of an increase in bone marrow plasma cells, development of lytic lesions, or occurrence of anemia, renal insufficiency, or an increased level of urine M-protein. Seventeen patients had an insufficient number of serum M-protein measurements to determine the pattern of increase. In WM patients, the M-protein level showed a gradual increase in three, stable levels followed by a sudden increase in two, and insufficient data in two others.

The M-protein disappeared during follow-up in 66 patients (5%). All of these patients had



low initial values of M-protein; only 17 had a value higher than 5 g/L at diagnosis. Treatment caused the disappearance of the M-protein in 39 patients whose condition had progressed to MM or lymphoma or who had other disorders such as idiopathic thrombocytopenic purpura and vasculitis unrelated to the monoclonal gammopathy. The M-protein disappeared without an apparent cause in 27 patients (2%). Only six of these 27 patients (0.4% of all patients) had a discrete spike on the densitometer tracing of the initial electrophoresis (median, 12 g/L). Thus, spontaneous disappearance of M-protein after the diagnosis of MGUS was rare.

### Follow-Up in Other Series

In 20 years of follow-up, Axelsson ( [22](#) ) reported that 2 of 64 MGUS patients had died of MM and 1 died of lymphoma. Eleven percent of the patients with long-term follow-up had some evidence of progression of their “benign” monoclonal gammopathy. Carter and Tatarsky ( [23](#) ) found that 6.2% of 64 patients developed MM after a long period of stability. Paladini et al. ( [24](#) ) reported malignant transformations in 14% of 213 patients with MGUS followed up for 5 to 8 years and in 18% of 100 patients followed up for 13 years. Giraldo et al. ( [25](#) ) reported that the actuarial risk of development of MM, WM, or AL in 213 patients with MGUS was 4.5% at 5 years, 15% at 10 years, and 26% at 15 years. Malignant disease developed in 13 of 128 patients with MGUS who were followed up for a median of 56 months ( [26](#) ). The actuarial probability of the development of malignant disease was 8.5% at 5 years and 19.2% at 10 years.

Van de Poel et al. ( [27](#) ) found that 6.6% of 334 patients with MGUS had a malignant transformation after a median follow-up of 8.4 years. Baldini et al. ( [28](#) ) noted that 6.8% of 335 patients with MGUS had progression during a median follow-up of 70 months. In a series of 263 cases of MGUS, the actuarial probability of development of malignancy was 31% at 20 years ( [29](#) ). Eleven of 2192 persons older than 21 years (0.5%) in a New Zealand town had an M-protein ( [30](#) ). Hematologic malignancy developed in seven of the 11 patients (MM, four; WM, two; and lymphoma, one) after 31-year follow-up of the 2192 persons, 1065 of whom were aged 50 years or older. In a group of 1104 MGUS patients, more than 5% bone marrow plasmacytosis, presence of Bence Jones proteinuria, polyclonal immunoglobulin reduction, and high erythrocyte sedimentation rate were independent factors influencing MGUS transformation ( [31](#) ). In summary, all studies essentially confirm that the risk of progression from MGUS to MM or related disorders is approximately 1% per year. They also confirm that the risk does not disappear even after long-term follow-up.

### Predictors of Malignant Transformation in Monoclonal Gammopathy of Undetermined Significance

No findings at diagnosis of MGUS can distinguish the patients whose condition remains stable from those in whom a malignant condition may develop ( [32](#) , [33](#) ). When MM develops, the type of M-protein is the same as it was in MGUS.

**SIZE OF M-PROTEIN** In a series of 1384 patients with MGUS, the size of the M-protein at the time of diagnosis was the most important predictor of progression. Only the concentration and type of M-protein were independent factors among the evaluated baseline characteristics to predict progression of the monoclonal gammopathy; nonpredictors of progression included age; sex; presence of hepatosplenomegaly; levels of hemoglobin, serum creatinine, and serum albumin; presence, type, and amount of monoclonal urinary light chain; number of bone marrow plasma cells; and reduction in uninvolved immunoglobulins. The presence of a monoclonal urine protein (? or ?) ( [Table](#) )

97.5) and reduction of one or more uninvolved immunoglobulins also were not risk factors for progression ( Table 97.6).

**TABLE 97.5. Rates of Full Progression by Urinary Light Chain**

| Light Chain | Rate of Full Progression (%) |       |               | p Value |
|-------------|------------------------------|-------|---------------|---------|
|             | 10 yr                        | 20 yr | 25 yr         |         |
| ? or ?      | 12                           | 28    | Not available | .12     |
| Negative    | 11                           | 34    | 34            | —       |

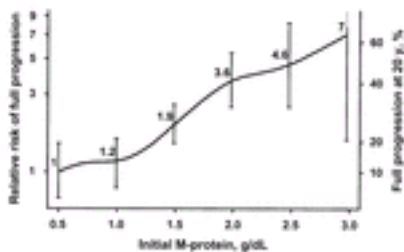
From Kyle RA, Rajkumar SV. Monoclonal gammopathies of undetermined significance. Rev Clin Exp Hematol 2002;6:225–252. By permission of Accademia Nazionale di Medicina.

**TABLE 97.6. Rates of Full Progression by Reduction of Uninvolved Immunoglobulins**

| Uninvolved Immunoglobulin Reduction (No.) | Rate of Full Progression (%) |       |       | p Value |
|---|------------------------------|-------|-------|---------|
|   | 10 yr                        | 20 yr | 25 yr |         |
| 1   | 12                           | 33    | 33    | .15     |
| 2   | 22                           | 22    | 22    | .09     |
| 0   | 8                            | 17    | 30    | —       |

From Kyle RA, Rajkumar SV. Monoclonal gammopathies of undetermined significance. Rev Clin Exp Hematol 2002;6:225–252. By permission of Accademia Nazionale di Medicina.

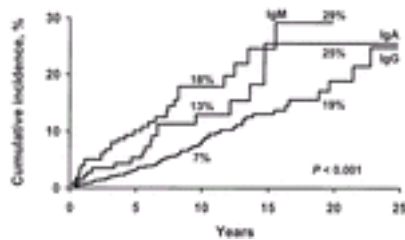
The initial concentration of the serum M-protein was the most important risk factor for progression to a plasma cell disorder. The relative risk of progression was directly related to the concentration of M-protein in the serum at the time of diagnosis of MGUS ( Fig. 97.7). The risk of progression to MM or a related disorder 10 years after diagnosis of MGUS was 6% for patients with an initial M-protein level of 5 g/L or less, 7% for 10 g/L, 11% for 15 g/L, 20% for 20 g/L, 24% for 25 g/L, and 34% for 30 g/L. Rates for progression at 20 years were 14%, 16%, 25%, 41%, 49%, and 64%, respectively. The risk of progression in a patient with an M-protein level of 15 g/L was almost two-fold greater than that in a patient with an M-protein level of 5 g/L, and the risk of progression in a patient with an M-protein level of 25 g/L was 4.6 times that of a patient with a 5 g/L spike.



**Figure 97.7.** Relative risk of full disease progression by serum M-protein level at baseline, 1960–1994. Error bars indicate 95% confidence intervals. (From Kyle RA, Rajkumar SV. Monoclonal gammopathies of undetermined significance. Rev Clin Exp Hematol 2002;6:225–252. By permission of Accademia Nazionale di Medicina.)

Carter and Tatarsky ( [23](#) ) noted that one-third of their patients with MGUS had an M-protein level higher than 30 g/L but showed no greater risk for evolution to malignant disease. Bladé et al. ( [26](#) ) also reported no increase in transformation in patients with an M-protein level higher than 30 g/L. They suggested that limits to define MGUS should be more flexible.

**TYPE OF IMMUNOGLOBULIN** In the southeastern Minnesota series, patients with IgM or IgA M-protein had an increased risk of progression compared with those with IgG M-protein (  $p = .001$  ) ( [Fig. 97.8](#) ). Bladé et al. ( [26](#) ) noted that MM developed more commonly in patients with an IgA M-protein than in the remainder.



**Figure 97.8.** Risk of full disease progression by type of M-protein, 1960–1994. (From Kyle RA, Rajkumar SV. Monoclonal gammopathies of undetermined significance. *Rev Clin Exp Hematol* 2002;6:225–252. By permission of Accademia Nazionale di Medicina.)

**BONE MARROW PLASMA CELLS** The number of plasma cells in the bone marrow may help predict progression. Cesana et al. ( [31](#) ) reported that more than 5% bone marrow plasma cells was an independent risk factor for progression. Ucci et al. ( [34](#) ) reported that a value of 20% bone marrow plasma cells was a reasonable level to distinguish MGUS from MM. Baldini et al. ( [28](#) ) reported that the malignant transformation rate was 6.8% when the bone marrow plasma cell level was less than 10% and 37% in the MGUS group with a bone marrow plasma cell level of 10 to 30%.

**OTHER PREDICTORS** In the 263 patients with MGUS reported by Pasqualetti et al. ( [29](#) ), a multivariate regression analysis showed that only age was associated significantly with the risk of developing a malignant immunoproliferative disease. Increased bone resorption is an early sign of malignancy in patients with apparent MGUS ( [35](#) ). The presence of Bence Jones proteinuria and high erythrocyte sedimentation rate have been reported as independent factors of progression of MGUS ( [19](#), [31](#) ).

### Life Expectancy and Cause of Death in Patients with Monoclonal Gammopathy of Undetermined Significance

It is important to know whether the presence of MGUS shortens the patient's life expectancy. Bladé et al. ( [26](#) ) found no statistically significant differences between the survival of patients with MGUS and that of a control population, but in the MGUS population, the trend was toward a shorter survival. Survival was significantly shorter among 241 patients with MGUS diagnosed before 1971 than among an age- and sex-adjusted 1980 U.S. population (13.7 vs. 15.7 years) ( [32](#) ). The median survival of the 1384 patients with MGUS was 8.1 years, compared with 11.8 years (  $p < .001$  ) that was expected for Minnesota residents of matched age and sex. The rates of death at 10 years were 6% for plasma cell disorders and 53% for non-plasma cell disorders (such as cardiovascular and cerebrovascular diseases and non-plasma cell cancers). At 20 years, the rates were 10% for plasma cell disorders and 72% for non-plasma cell disorders. At 25 years, the rate was 11% for plasma cell disorders compared with 76% for non-plasma cell diseases. In the study by van de Poel et al. ( [27](#) ), the long-term survival of 334 patients with MGUS was slightly shorter than the expected survival of an age- and sex-adjusted

population.

## Differential Diagnosis

The differentiation of a patient with MGUS from one with MM may be difficult. Helpful indicators include the size of the M-protein, hemoglobin value, percentage of bone marrow plasma cells, amount of M-protein in the urine, presence of hypercalcemia or renal insufficiency, and lytic bone lesions. The serum M-protein level is of some help because higher levels are associated with a greater likelihood of malignancy ([36](#)). A serum M-protein level higher than 30 g/L usually indicates the presence of overt MM or WM, but some exceptions, such as SMM, do exist.

Levels of the immunoglobulin classes not associated with the M-protein (normal polyclonal or background immunoglobulins) are not helpful in differentiating benign from malignant monoclonal gammopathies. In patients with MM, the levels of uninvolved immunoglobulins are reduced in more than 90% ([19](#)). However, reduction of uninvolved immunoglobulins occurs in patients with MGUS ([37](#)). In the authors' series of 241 patients with MGUS, uninvolved immunoglobulins were reduced in 29%, and they were reduced in 38% of the authors' 1384-patient MGUS cohort. The reduction of uninvolved immunoglobulins, however, did not identify patients with subsequent progression ([19](#)).

An M-protein in the urine (Bence Jones proteinuria) may suggest a neoplastic process, but it is present frequently in patients with MGUS ([38](#), [39](#)). In the authors' MGUS cohort from southeastern Minnesota, 31% of the 418 tested patients had a monoclonal light chain in the urine. The value was higher than 150 mg/24 hours in only 17% of patients. Thus, the presence of a monoclonal light chain in the urine was not a risk factor for the subsequent development of MM.

The presence of more than 10% plasma cells in the bone marrow suggests MM, but the condition of patients with a higher level of plasmacytosis may remain stable for long periods. By definition, patients with 10% or more bone marrow plasma cells were classified as having SMM if no signs or symptoms of MM were present. The plasma cells in MM are often atypical, but these morphologic features may also be seen in MGUS and SMM. Milla et al. ([40](#)) reported that the presence of nucleoli was the most important feature in differentiating MM from MGUS.

The presence of osteolytic lesions suggests strongly a diagnosis of MM, but metastatic carcinoma also may produce lytic lesions and plasmacytosis and be associated with an unrelated serum M-protein.

The plasma cell labeling index for detection of DNA synthesis is useful in differentiating MGUS or SMM from MM ([41](#)). An elevated plasma cell labeling index is strong evidence that MM is present or its development is imminent. However, approximately one-third of patients with symptomatic MM have a normal plasma cell labeling index. A good correlation exists between the plasma cell labeling index of peripheral blood and the bone marrow labeling index ([42](#)).

The presence of circulating plasma cells in the peripheral blood is a good marker of active disease. Plasma cells are infrequent in patients with MGUS or SMM ([43](#)).

Conventional cytogenetic studies are not useful in the differentiation of MGUS and MM, because abnormal karyotypes are seen rarely in MGUS on account of the small number of

plasma cells and the low proliferative rate. Fluorescence *in situ* hybridization studies showed that abnormalities can be detected in bone marrow plasma cells from most patients with MGUS ( [44](#), [45](#), [46](#), [47](#), [48](#) and [49](#)). Deletion of chromosome 13q occurs in patients with MGUS and is an early event in the development of monoclonal gammopathies ( [50](#)).

Magnetic resonance imaging (MRI) may be helpful in differentiating MGUS from MM. Bellaiche et al. ( [51](#) ) reported that the MRI scans were normal in all 24 patients with MGUS, but abnormalities were found in 86% of 44 patients with MM. Patients with MGUS had normal bone remodeling, but bone resorption increased and bone formation decreased in patients with stage III myeloma ( [52](#) ). Although C-terminal telopeptide of type I collagen, osteocalcin, and serum bone-specific alkaline phosphatase may be elevated in patients with MGUS, it is not reliable for differentiation ( [53](#) ).

Ocqueteau et al. ( [54](#) ) identified a population of polyclonal plasma cells with CD38 expression and low forward light scatter. The plasma cells expressed CD19 but were negative for CD56. The monoclonal plasma cell population showed a lower CD38 expression and a higher forward light scatter population and expressed CD56 but not CD19. Ninety-eight percent of patients with MGUS had more than 3% normal polyclonal plasma cells, but only 1.5% of patients with MM had the same findings.

The serum level of interleukin-6 (IL-6) may aid in the differentiation of monoclonal gammopathies. IL-6 levels are elevated commonly in patients with MM but infrequently in patients with MGUS ( [52](#), [55](#) ).

IL-1 $\beta$  is produced by plasma cells in all patients with MM but is undetectable in most patients with MGUS. IL-1 $\beta$  has strong osteoclast-activating factor activity, increases the expression of adhesion molecules, and induces paracrine IL-6 production. This activity parallels the development of osteolytic bone lesions, homing of myeloma cells to bone marrow, and IL-6-induced cell growth ( [56](#), [57](#) ).

Using immunohistochemical techniques to identify micro-vessels, Vacca et al. ( [58](#) ) reported that bone marrow angiogenesis was increased in patients with MM but not in those with MGUS. Studies done at the authors' institution confirm these findings, although this test has limited value in differentiating MGUS from MM because angiogenesis is not increased in approximately one-third of patients with MM ( [59](#) ).

$\beta_2$ -Microglobulin levels are not helpful in differentiating MGUS from low-grade MM, because values for the two entities overlap ( [60](#) ). Neither the presence of J chains in malignant plasma cells nor the acid phosphatase level in plasma cells is reliable for differentiation ( [61](#), [62](#) ). Reduced numbers of OKT4<sup>+</sup> T cells, increased numbers of monoclonal idiotype-bearing peripheral blood lymphocytes, and increased numbers of immunoglobulin-secreting cells in peripheral blood are characteristic of MM, but values overlap with MGUS ( [63](#), [64](#) and [65](#) ). Elevated telomerase activity was found in 21 of 27 patients with MM, and in one of five with MGUS ( [66](#) ). Methylation of p15(INK4b) and p16(IN4a) was found in similar frequencies in both MGUS and MM ( [67](#) ).

## Management

Regardless of the results of sophisticated laboratory tests, the differentiation between MGUS and MM is based on clinical factors, such as symptoms, anemia, hypercalcemia,

renal insufficiency, and lytic bone lesions. However, the presence of a high plasma cell labeling index in a patient with MGUS or SMM needs to be followed up more frequently for other evidence of progression. No single factor can differentiate a patient with a benign monoclonal gammopathy from one in whom a malignant plasma cell disorder develops subsequently. The serum M-protein level must be measured periodically, and clinical evaluation should be conducted to determine whether serious disease has developed.

In a patient with no features of MM or AL and a serum M-protein value less than 15 g/L, serum protein electrophoresis is repeated at annual intervals. Skeletal radiography, bone marrow examination, and 24-hour urine collection for immunofixation are not necessary in this situation.

If an asymptomatic patient has an M-protein level of 15 to 20 g/L, IgG, IgA, and IgM levels are measured, and a 24-hour urine specimen is collected for electrophoresis and immunofixation. The serum protein electrophoretic pattern should be determined again in 3 to 6 months, and if the pattern is stable, the test should be repeated in another 6 months and then annually (or sooner if symptoms occur). If the IgG or IgA serum M-protein value is higher than 20 g/L, a metastatic bone radiographic survey, including views of the humeri and femurs, should be done. Bone marrow aspiration and biopsy should also be performed. Cytogenetic studies, calculation of the plasma cell labeling index, and a search for circulating plasma cells in the peripheral blood should be done if available. If the patient has an IgM M-protein, aspiration and biopsy of the bone marrow and a computed tomographic scan of the abdomen may be useful for recognizing WM or a related lymphoproliferative disorder. Levels of  $\beta_2$ -microglobulin and C-reactive protein should be determined. If results of these tests are satisfactory, serum protein electrophoresis should be repeated in 3 months, and if the results are stable, the tests should be repeated at 6- to 12-month intervals.

## SMOLDERING (ASYMPTOMATIC) MULTIPLE MYELOMA

Patients with SMM have a serum M-protein level of 30 g/L or higher or 10% or more plasma cells in the bone marrow ( [Table 97.2](#)). Frequently, they have a small amount of M-protein in the urine and a reduction of uninvolved immunoglobulins in the serum. These findings are consistent with a diagnosis of MM, but anemia, renal insufficiency, and skeletal lesions are not present. In addition, the plasma cell labeling index is low. Consequently, these patients have a benign monoclonal gammopathy or MGUS from the biologic standpoint, but this diagnosis is not possible when the patient is seen initially, because most patients with this level of bone marrow plasma cell infiltration and size of M-protein in the serum have symptomatic MM ( [68](#)).

### Prevalence of Smoldering Multiple Myeloma

SMM accounts for less than 15% of all cases of newly diagnosed MM ( [69](#)). In a study conducted at the M. D. Anderson Cancer Center, 95 of 638 patients with myeloma (15%) were considered to have asymptomatic MM ( [70](#)). Other investigators have found a higher proportion of patients with SMM, but the sample size in these studies is small ( [71](#), [72](#)).

The prevalence estimates for SMM are distorted because many reports include asymptomatic patients with lytic bone lesions on skeletal survey. Some exclude patients with bone lesions on skeletal survey but include patients who have lytic lesions on MRI. Calculation of the true prevalence of SMM on the basis of strict criteria ( [Table 97.2](#)) is not available.



## Risk of Smoldering Multiple Myeloma Progression

Most patients with SMM progress eventually to symptomatic disease, and the risk of progression is higher than in those with MGUS (<sup>69</sup>). Some patients can remain free of progression for a number of years (<sup>68</sup>). The median time of progression to symptomatic disease is approximately 1 to 3 years. A recent study found the risk of progression to be only 20% at 6 years (<sup>31</sup>). However, this study considered patients to have SMM only if they demonstrated no disease progression after 1 year of follow-up.

## Predictors of Smoldering Multiple Myeloma Progression

The assessment of prognostic factors for SMM is hampered by varying diagnostic criteria used to define the cohort. Several studies include patients with lytic lesions as well. Future studies of SMM need to use more uniformly accepted criteria so that results can be compared.

Patients with abnormal monoclonal plasma cells in the peripheral blood, defined as an increase in the number or proliferative rate of circulating plasma cells by immunofluorescent assays, are at higher risk for earlier progression to MM. In a study of 57 patients, Witzig and colleagues (<sup>43</sup>) found the median time to progression was 9 months for those with abnormal circulating plasma cell values, versus 30 months for those with normal results ( $p < .01$ ). An elevated plasma cell labeling index is an adverse prognostic factor (<sup>42</sup>, <sup>73</sup>, <sup>74</sup>).

In a study conducted at the M. D. Anderson Cancer Center, the three most important prognostic factors for progression in SMM were a serum M-protein level higher than 30 g/L, the presence of an IgA subtype, and a urinary M-protein excretion of more than 50 mg/day. Patients with two or more of these features had a median time to progression of 17 months, those with one risk factor had a median time to progression of 40 months, and patients who had none of these factors had a progression time of 95 months (<sup>75</sup>). This study excluded patients with abnormalities on bone survey but did include patients with abnormal MRI results, which were present in 40% of patients. Abnormal MRI findings were associated with a shortened time to progression of 21 months.

Patients who undergo MRI studies for skeletal survey in the absence of lytic lesions often have abnormalities detected as a result (<sup>69</sup>, <sup>76</sup>). In such patients, abnormalities depicted on MRI are an adverse prognostic factor for progression (<sup>77</sup>). Whether patients who have MRI abnormalities should be defined as having SMM is debatable. Nevertheless, these patients can be observed without therapy, similar to those with SMM.

## Management of Smoldering Multiple Myeloma

The current standard of care in SMM is close follow-up once every few months without chemotherapy. This recommendation is based on the results of trials demonstrating no significant improvement in overall survival in patients who received immediate treatment with melphalan plus prednisone compared with those who received treatment at progression for stage I or asymptomatic MM. Hjorth and colleagues (<sup>78</sup>) randomly assigned 50 patients with asymptomatic stage I MM to observation versus chemotherapy with melphalan and prednisone. No differences were observed in overall survival between the two groups. Grignani and colleagues (<sup>79</sup>) reported similar survival time with immediate or deferred therapy in a series of 44 patients with asymptomatic MM. The



recommendation to observe closely without treatment until progression is also based on the toxic effects of therapy and the fact that disease may not progress for months or years ( [68](#), [80](#) ).

Investigational approaches may be considered for selected patients enrolled in appropriate clinical trials. Thalidomide is being studied as a single agent with a preliminary partial response rate of approximately 35% ( [81](#), [82](#) ). Other studies are evaluating the role of bisphosphonates, IL-1 $\beta$  inhibitors, clarithromycin, and dehydroepiandrosterone in an attempt to delay progression to symptomatic MM. Because the main goal of therapy in patients with SMM is to delay the need for chemotherapy, a phase 3 randomized trial is needed on the durability of response before this strategy can be recommended for standard clinical practice.

## VARIANTS OF MONOCLONAL GAMMOPATHY OF UNDETERMINED SIGNIFICANCE

### Biclonal Gammopathy

Biclonal gammopathies are characterized by the presence of two different M-proteins and occur in more than 5% of patients with monoclonal gammopathies. The two M-proteins may be caused by the proliferation of two different clones of plasma cells, each producing an unrelated M-protein, or by production of two M-proteins by a single clone of plasma cells.

Biclonal gammopathy of undetermined significance was found in 37 of 57 patients with a biclonal gammopathy ( [83](#) ). The age range was 39 to 93 years (median, 67 years). Twenty of the affected patients were women. The clinical findings of biclonal gammopathies are similar to those of monoclonal gammopathies ( [83](#) ). Thirty-five percent of the 57 patients had MM, WM, or another malignant lymphoproliferative disorder ( [83](#) ).

Riddell et al. ( [84](#) ) reported that 2.5% of 1135 patients with monoclonal gammopathy had a biclonal gammopathy. They postulated that complete class switching in a single plasma cell clone resulted in the production of two M-proteins, but in others the M-proteins arose from two separate plasma cell clones.

### Triclonal Gammopathy

Triclonal gammopathy was reported in a patient with plasma cell dyscrasia in whom the acquired immunodeficiency syndrome developed subsequently ( [85](#), [86](#) ). Grosbois et al. ( [87](#) ) also described a patient with a triclonal gammopathy (IgM ?, IgG ?, and IgA ?). The investigators reviewed a group of cases with triclonal gammopathy from the literature. Sixteen cases were associated with a malignant immunolymphoproliferative disorder, five appeared in nonhematologic diseases, and three were of undetermined significance.

### Benign Monoclonal Light-Chain (Idiopathic Bence Jones) Proteinuria

Benign monoclonal gammopathy of the light-chain type must be considered even though Bence Jones proteinuria is a recognized feature of MM, AL, WM, and other lymphoproliferative diseases. In one study, two patients with stable serum M-protein levels excreted 0.8 g/day or more of Bence Jones protein for more than 17 years without disease progression ( [88](#) ). Seven additional patients have been described who presented with Bence Jones proteinuria (>1 g/24 hours) but in whom no M-protein was found in the

serum and who had no evidence of MM or a related disorder ( [89](#) ). One of these patients has excreted up to 1.8 g/24 hours of  $\kappa$ -light chain for 30 years without developing symptomatic MM or a related disorder. Although idiopathic Bence Jones proteinuria may remain stable for years, MM or AL often results. These patients must be followed up indefinitely.

### Immunoglobulin D Monoclonal Gammopathy of Undetermined Significance

The presence of an IgD M-protein almost always indicates MM, AL, or plasma cell leukemia. However, IgD MGUS has been reported. O'Connor et al. ( [90](#) ) described a patient with an IgD  $\kappa$  protein level of 5 g/L who was followed up for more than 6 years without evidence of progressive disease. The authors have seen a patient at Mayo Clinic with an IgD  $\kappa$  MGUS who was followed up for more than 8 years without development of MM or AL ( [91](#) ).

## ASSOCIATION OF MONOCLONAL GAMMOPATHY WITH OTHER DISEASES

Certain diseases are associated with MGUS, as would be expected in an older population. The association of two diseases depends on the frequency with which each occurs independently. In addition, an apparent association may occur because of differences in the referral practice or in other selected patient groups. Valid epidemiologic and statistical methods help in evaluating these associations. The need for appropriate control populations cannot be overemphasized.

For example, the association of monoclonal gammopathy and hyperparathyroidism has been reported ( [92](#), [93](#) ). Among 911 patients who had hyperparathyroidism and who were aged 50 years or older, immunoelectrophoresis demonstrated MGUS in nine (1%), which was the expected number ( [94](#) ). This prevalence of MGUS was similar to the 1.25 to 1.70% found in studies of three normal populations ( [3](#), [4](#) ). In another report, 4 of 386 patients with primary hyperparathyroidism had MGUS ( [95](#) ). In a recent report, 20 of 101 patients with hyperparathyroidism but only 2 of 127 controls had an M-protein ( [96](#) ). Thus, controversy continues concerning the association of hyperparathyroidism and MGUS.

### Lymphoproliferative Disorders

In 1957, Azar et al. ( [97](#) ) reported that malignant lymphoma and lymphatic leukemia were associated with a myeloma-type serum protein. Kyle et al. ( [98](#) ) in 1960 described six patients with lymphoma who had serum electrophoretic patterns consistent with those of MM. Among 1150 patients with lymphoma, Alexanian ( [99](#) ) found M-proteins in 49 patients. M-proteins were reported in 29 of 640 patients (4.5%) with a diffuse lymphoproliferative disease (chronic lymphocytic leukemia, lymphocytic lymphoma, or reticulum cell sarcoma) but in none of 292 with a nodular lymphoma.

The authors reviewed the medical records of 430 patients in whom a serum IgM monoclonal gammopathy had been identified between 1956 and 1978 at Mayo Clinic ( [Table 97.7](#) ). The patients were classified as follows: (a) WM: IgM spike of 30 g/L or more in the serum protein electrophoretic pattern and an increase in lymphocytes or plasmacytoid lymphocytes in the bone marrow; (b) lymphoma: biopsy findings consistent with lymphoma and a lymph node or extranodal lymphoid tumor; (c) chronic lymphocytic leukemia: lymphocyte count higher than  $9.0 \times 10^9/L$ ; (d) AL: biopsy specimen containing amyloid; (e) MGUS: IgM protein value less than 30 g/L, absence of constitutional

symptoms, hepatosplenomegaly, and lymphadenopathy (no anemia or other findings requiring therapy); (f) malignant lymphoproliferative disease: not classified in the previous categories and characterized by an IgM protein value of less than 30 g/L, bone marrow infiltration with lymphocytes or plasmacytoid lymphocytes, and therapy required because of anemia or constitutional symptoms.

**TABLE 97.7. Classification of Immunoglobulin M Monoclonal Gammopathies among 430 Patients, 1956–1978**

| Classification                                     | Patients |         |
|--|----------|---------|
|  | Number   | Percent |
| Monoclonal gammopathy of undetermined significance | 242      | 56      |
| Waldenström macroglobulinemia                      | 71       | 17      |
| Lymphoma   | 28       | 7       |
| Chronic lymphocytic leukemia                       | 21       | 5       |
| Primary amyloidosis                                | 6        | 1       |
| Lymphoproliferative disease                        | 62       | 14      |
| Total  | 430      | 100     |

From Kyle RA, Garton JP. The spectrum of IgM monoclonal gammopathy in 430 cases. *Mayo Clin Proc* 1987;62:719–731, by permission of Mayo Foundation.

More than one-half of patients (56%) with an IgM protein had MGUS. During follow-up, 40 of the 242 (17%) with MGUS developed a malignant lymphoid disorder requiring therapy. In 22 patients, typical WM developed, nine others had a malignant lymphoproliferative process requiring chemotherapy, and lymphoma developed in six others. The median duration from the detection of the IgM protein until the diagnosis of lymphoid disease was more than 4 years (range, 0.4 to 22.0 years). In addition, ten patients (4%) with MGUS had an increase in serum M-protein level of more than 10 g/L, and nine others had an increase of 5 to 9 g/L. None of these 19 patients developed symptomatic WM or other lymphoid diseases requiring therapy.

The median survival of patients with WM and those with a malignant lymphoproliferative disease requiring therapy was similar (5.0 and 5.5 years, respectively). Consequently, no reason exists for differentiating patients with lymphoproliferative disease from those with WM. They can be included in future prospective studies of WM ([100](#)).

### Leukemia

M-proteins have been reported in the serum of patients with leukemia ([101](#)). The authors described 100 patients with chronic lymphocytic leukemia and an M-protein in the serum or urine ([102](#)). IgM accounted for 28%, and IgG was found in 51%. The size of the M-protein was modest, with a median concentration of 10 g/L. No major differences were apparent in patients with chronic lymphocytic leukemia, whether they had an IgG or an IgM M-protein. Monoclonal gammopathy has also been recognized in hairy cell leukemia ([103](#)) and adult T-cell leukemia ([104](#)). Guglielmi et al. ([105](#)) reported eight patients with chronic myelocytic leukemia (Philadelphia chromosome positive) who had a monoclonal gammopathy. The authors have also seen several patients with chronic myelocytic

leukemia and an M-protein in their serum, but an association between the two entities is unproven.

### Other Hematologic Diseases

Acquired von Willebrand disease is uncommon, but it is often associated with a monoclonal gammopathy ( [106](#), [107](#), [108](#), [109](#) and [110](#)). Patients with monoclonal gammopathy and a lupus anticoagulant activity have been reported ( [111](#)).

Monoclonal gammopathies have been reported with pernicious anemia ( [112](#)), congenital dyserythropoietic anemia type III ( [113](#)), and pure red cell aplasia ( [114](#)). Polycythemia vera ( [115](#)), myelofibrosis ( [116](#)), and myelodysplastic syndrome ( [117](#)) have been reported with monoclonal gammopathies. Pratt et al. ( [118](#)) found an IgG ? M-protein in 4 of 16 patients with Gaucher disease.

### Connective Tissue Disorders

Rheumatoid arthritis ( [119](#)) and seronegative erosive arthritis ( [120](#)) have been reported in patients with monoclonal gammopathies. In a series of 279 consecutive patients who had rheumatoid arthritis at our institution, no notable increase in the incidence of M-protein was found.

Lupus erythematosus and other connective tissue disorders have been reported with M-proteins ( [121](#), [122](#)). Polymyalgia rheumatica has been reported with monoclonal gammopathy, but both conditions occur more commonly in an older population, so the relationship is questionable ( [123](#)). Polymyositis has been reported with monoclonal gammopathy ( [124](#), [125](#)). Inclusion body myositis ( [126](#)) and discoid lupus erythematosus ( [127](#)) have been reported with an M-protein.

### Neurologic Disorders

The authors found 16 cases of MGUS in 279 patients (6%) with a sensorimotor peripheral neuropathy of unknown cause ( [128](#)). In another series, 16 of 56 patients with MGUS had a peripheral neuropathy ( [129](#)). In an unselected series of patients with MGUS, neuropathy was noted in 2 of 34 patients (6%) with IgG, 2 of 14 (14%) with IgA, and 8 of 26 (31%) with IgM. The neuropathy was subclinical in six patients ( [130](#)). Fourteen of 31 patients with an IgM MGUS had peripheral neuropathy ( [131](#)). An association exists between MGUS and peripheral neuropathy, although the incidence is variable and depends on patient selection bias, the vigor with which the presence of an M-protein is sought, and whether the diagnosis of peripheral neuropathy is made on clinical or electrophysiologic grounds. A monograph on neurologic disorders associated with plasma cell dyscrasias has been published ( [132](#)), and the association of neuropathies and monoclonal gammopathies has been the subject of excellent reviews ( [133](#), [134](#) and [135](#)).

The most common monoclonal gammopathy associated with a neuropathy is IgM, followed by IgG and IgA. In approximately one-half of patients with an IgM monoclonal gammopathy and peripheral neuropathy, the M-protein binds to myelin-associated glycoprotein (MAG) ( [136](#), [137](#)). The MAG-reactive polyneuropathies are characterized by a slowly progressive, mainly sensory neuropathy beginning in the distal extremities and extending proximally. Discriminative and proprioceptive modalities are more severely involved than touch, pain,

and temperature. Motor involvement is less prominent than sensory involvement. Cranial nerve and autonomic functions are intact ( [138](#) ). The clinical and electrodiagnostic manifestations resemble those of chronic inflammatory demyelinating polyneuropathy. Patients with sensorimotor peripheral neuropathy may have an IgM protein binding to various peripheral nerve components. An extensive review of antibodies associated with peripheral neuropathy has been published ( [139](#) ).

The authors reviewed their experience with 65 patients with MGUS and sensorimotor peripheral neuropathy at Mayo Clinic ( [140](#) ). Thirty-one patients had IgM, 24 had IgG, and ten had IgA. IgM was overrepresented in this group and was associated with sensory ataxia, slower nerve conduction, and more frequent dispersion of the compound muscle action potential compared with IgG or IgA neuropathies. Neither the amount of IgM nor the size of the monoclonal spike was associated with the severity of the neuropathy. In addition, the type and severity of neuropathy with anti-MAG were not greatly different from those without anti-MAG. The course of the neuropathy was progressive in more than two-thirds of patients ( [140](#) ). In a review of 40 patients with polyneuropathy associated with an IgM gammopathy, all but one had symmetric polyneuropathy. It was predominantly sensory in 13 and purely sensory in 17. Electrophysiologic studies revealed demyelination in 83% and axonal degeneration in 6%. Anti-MAG antibodies were found in 65% and were associated only with demyelinating polyneuropathies ( [141](#) ). The relationship of IgG and IgA M-proteins to peripheral neuropathy is less well documented ( [142](#) ).

MGUS neuropathies differ from those associated with AL in the following respects: (a) the lower extremities are peripherally affected in MGUS, but upper and lower extremities tend to be affected to a greater degree in AL; (b) the course in AL is always slowly progressive; and (c) although AL may appear to be a sensorimotor neuropathy, autonomic features (postural hypotension, sphincter dysfunction, anhidrosis) and organ (heart or kidney) failure often occur. Such autonomic features and organ failures do not occur in MGUS neuropathy.

The relationship between chronic inflammatory demyelinating polyradiculoneuropathy (CIDP) and CIDP with MGUS is unclear. In a comparison of 77 patients with CIDP and 26 with CIDP and MGUS, the latter group had a more indolent course, less severe weakness, and more frequent sensory loss. The outcome in the two groups was similar ( [143](#) ). In a comparison of 45 patients with CIDP and 15 with MGUS-associated neuropathy, the latter group had less severe weakness, greater imbalance (ataxia), vibration loss in the hands, and absent median and ulnar sensory potentials ( [144](#) ). CIDP may occur at any age, motor symptoms tend to predominate over sensory symptoms, the course tends to be relapsing, and M-proteins are not found.

The results of treatment of patients with peripheral neuropathy and monoclonal gammopathy have been disappointing. Plasmapheresis has been of benefit in some patients ( [145](#) ). Thirty-nine patients with peripheral neuropathy and MGUS of the IgG, IgA, or IgM type were randomly assigned to undergo plasmapheresis or sham plasmapheresis in a double-blind trial at Mayo Clinic ( [146](#) ). Plasma exchange prevented worsening of or ameliorated the neuropathy. Patients with IgG or IgA gammopathy had a better response to plasma exchange than those with IgM gammopathy. In another study, 8 of 13 patients with a monoclonal gammopathy and peripheral neuropathy obtained benefit from plasma exchange ( [147](#) ). Patients who do not respond to this program may be given chlorambucil when the M-protein is of the IgM type or melphalan and prednisone for IgG and IgA gammopathies.

Fludarabine has produced some benefit in patients with IgM peripheral neuropathy ( [148](#) ),

<sup>149</sup>). Rituximab is a monoclonal antibody directed against CD20, frequently found on the surface membranes of lymphocytes in lymphoma. Levine and Pestronk (<sup>150</sup>) reported all five patients with an IgM M-protein and neuropathy responded to rituximab. Intravenous immunoglobulin has been used, but the results have been disappointing (<sup>151</sup>).

Although several instances of monoclonal gammopathy and motor neuron disease have been reported, a causal effect is not proven. Eleven of 120 patients (9%) with motor neuron disease had an associated M-protein. Amyotrophic lateral sclerosis has been reported with MGUS (<sup>152</sup>, <sup>153</sup> and <sup>154</sup>). Myasthenia gravis has been associated with an M-protein (<sup>155</sup>, <sup>156</sup>). Ataxia-telangiectasia, an autosomal-recessive disorder, is characterized by cerebellar ataxia, and oculocutaneous telangiectasia has also been reported with monoclonal gammopathy (<sup>157</sup>, <sup>158</sup>).

### Osteosclerotic Myeloma

Osteosclerotic myeloma (or POEMS syndrome) is characterized by a chronic sensorimotor polyneuropathy with predominating motor disability (<sup>159</sup>). Bardwick et al. (<sup>160</sup>) suggested the acronym POEMS for this syndrome (*polyneuropathy, organomegaly, endocrinopathy, M-protein, and skin changes*). Single or multiple osteosclerotic lesions are important features. The cranial nerves are not involved, except for the occurrence of papilledema. Hepatosplenomegaly and lymphadenopathy may occur. Hyperpigmentation, hypertrichosis, gynecomastia, and testicular atrophy may be seen. Polycythemia or thrombocytosis may be a prominent feature. Almost all patients have an M-protein of the  $\lambda$ -light chain type. The M-protein level is almost always less than 30 g/L. In contrast to MM, this syndrome is rarely associated with Bence Jones proteinuria, renal insufficiency, hypercalcemia, and skeletal fractures. The bone marrow aspirate and biopsy specimen usually contain less than 5% plasma cells (<sup>161</sup>, <sup>162</sup>).

The cause of POEMS syndrome is unknown. Patients have higher levels of IL-1 $\beta$ , tumor necrosis factor- $\alpha$ , and IL-6 than patients with MM (<sup>163</sup>). Increased levels of vascular endothelial growth factor are frequently found and often decrease with successful therapy (<sup>164</sup>).

Single or multiple osteosclerotic lesions in a limited area should be treated with radiation in tumoricidal dosages of 40 to 50 cGy. More than one-half of patients have substantial improvement of the neuropathy. Improvement may be slow, and the authors have seen patients who continue to improve for 2 to 3 years after radiation therapy. If the patient has widespread osteosclerotic lesions, systemic therapy is necessary. Corticosteroids and plasma exchange generally have been of little benefit. Autologous stem cell transplantation after high-dose melphalan therapy is a consideration for younger patients with widespread osteosclerotic lesions.

### Dermatologic Diseases

Lichen myxedematosus (papular mucinosis, scleromyxedema) is a rare dermatologic condition frequently associated with a cathodal IgG  $\lambda$  protein (<sup>165</sup>). Scleredema (Buschke disease) has been noted with an M-protein, but the role of the M-protein is unknown (<sup>166</sup>). Pyoderma gangrenosum has been associated with M-proteins (<sup>167</sup>). Necrobiotic xanthogranuloma is frequently found with an IgG M-protein (<sup>168</sup>, <sup>169</sup>). Schnitzler syndrome is characterized by the presence of chronic urticaria and an IgM monoclonal gammopathy (<sup>170</sup>, <sup>171</sup> and <sup>172</sup>). Monoclonal gammopathy has been associated with diffuse plane



xanthomatosis or subcorneal pustular dermatosis ( [173](#), [174](#), [175](#) and [176](#)). A comprehensive review of monoclonal gammopathies and skin disorders has been published ( [177](#)).

More than a dozen patients have been described with an M-protein and Sézary syndrome; only two had MM ( [178](#)). Five patients with mycosis fungoides and monoclonal gammopathy have been described ( [179](#)). Thus, cutaneous T-cell lymphomas may be associated with monoclonal gammopathies. Several cases of Kaposi sarcoma and monoclonal gammopathy have been recognized ( [180](#)). Erythema elevatum diutinum has been reported with monoclonal gammopathy ( [181](#), [182](#)).

### Immunosuppression

M-proteins have been found in patients with acquired immunodeficiency syndrome. In a series of 130 homosexual men, human immunodeficiency virus (HIV) antibody was found in 65 patients, and four patients had an M-protein ( [183](#)). The appearance or disappearance of a monoclonal gammopathy in patients with HIV infection did not appear to be of prognostic importance ( [184](#)).

M-proteins were detected in 18 of 141 patients (12.7%) who had undergone renal transplantation ( [185](#)). In another series, 27 of 213 patients (12%) had a monoclonal or multiclonal gammopathy after renal transplantation ( [186](#)). Pollock et al. ( [187](#)) reported M-proteins in 4 of 110 patients with renal transplants. A monoclonal gammopathy was found in 70 of 232 patients (30%) who were receiving immunosuppressive therapy after renal transplantation. The incidence was ten times greater than that in a control group with chronic renal insufficiency who were receiving dialysis ( [188](#)). The presence of cytomegalovirus infection after renal transplantation in pediatric patients was associated with an increased incidence of M-proteins ( [189](#)). In another series of 182 renal transplantation patients, an M-protein was found in 30%. The authors concluded that the M-protein was a reflection of the T-cell immune defect ( [190](#)).

Hammarström and Smith ( [191](#)) found transient monoclonal gammopathies after bone marrow transplantation in 18 of 42 patients (43%); the gammopathy was most often of the IgG  $\lambda$  class. In another report, transient oligoclonal and monoclonal gammopathies were found in 31 of 60 patients (52%) who underwent allogeneic (57 cases) or syngeneic (three cases) bone marrow transplantation. M-proteins appeared frequently and as early as 6 weeks after bone marrow transplantation in 40 children. IgM, IgG3, and IgG1 were the most common isotypes ( [192](#)). In a report of 550 patients receiving autologous stem cell transplants, abnormal protein bands developed in 10%. Forty-eight additional patients had oligoclonal bands, and 23 had an isotope switch. The authors concluded that the oligoclonal bands and isotope switching were due to recovery of immunoglobulin production rather than to alteration in the biology of the malignant plasma cell clone ( [193](#)). In 12 of 47 patients, an M-protein developed after allogeneic bone marrow transplantation ( [194](#)).

In 57 of 201 patients (28%), an M-protein developed after liver transplantation. Five of seven patients in whom a posttransplantation lymphoproliferative disorder developed had an M-protein, whereas only 52 of 194 (27%) without a posttransplantation lymphoproliferative disorder had an M-protein ( [195](#)). In another series, 26 of 86 liver transplant recipients had an M-protein ( [196](#)).



## Miscellaneous Conditions

Gelfand et al. ( [197](#) ) described a patient with angioneurotic edema and acquired deficiency of C1 esterase inhibitor and reviewed the records of 14 other patients reported in the literature, including five with a 7S IgM M-protein. Pascual et al. ( [198](#) ) described two patients with acquired C1 inhibitor deficiency, an IgG ? protein, and recurrent episodes of febrile panniculitis and hepatitis. Lofdahl et al. ( [199](#) ) reported that eight of nine patients with systemic capillary leak syndrome had an M-protein in their serum. In some instances, the M-protein functions as an antibody that modifies the interaction between C1 inhibitor and its target protein ( [200](#) ). In a review of the literature, all 21 patients with a capillary leak syndrome had a monoclonal serum protein (IgG ? in 12; IgG ? in 7; IgA in 1; IgG with an unspecified light chain in 1) ( [201](#) ).

Although polyclonal increases in immunoglobulin are most common in liver disease, M-proteins have been noted in chronic active hepatitis ( [202](#) ). M-proteins have also been recognized in patients with primary biliary cirrhosis ( [203](#) ). Hepatitis C virus (HCV) infection and monoclonal gammopathies are associated. The incidence of HCV infection was 69% in 94 patients with mixed cryoglobulinemia and 14% in 107 patients without cryoglobulinemia ( [204](#) ). In another series of 102 cases of MM, WM, or MGUS, HCV infection was found in 16% of patients but in only 5% of controls ( [205](#) ). An M-protein was found in 11% of 239 HCV-positive patients but in only 1% of 98 HCV-negative patients. Thus, the prevalence of M-proteins in patients with HCV-related chronic liver diseases is high ( [206](#) ).

Also reported in association with monoclonal gammopathies were Henoch-Schönlein purpura ( [207](#) ), bacterial endocarditis ( [208](#) ), Hashimoto thyroiditis ( [209](#) , [210](#) ), septic arthritis ( [211](#) ), purpura fulminans ( [212](#) ), idiopathic pulmonary fibrosis ( [213](#) ), pulmonary alveolar proteinosis ( [214](#) ), idiopathic pulmonary hemosiderosis ( [215](#) ), sarcoidosis ( [216](#) ), thymoma ( [217](#) ), hereditary spherocytosis ( [218](#) ), Doyme macular heredodystrophy ( [219](#) ), eosinophilic fibrohistiocytic lesions of the bone marrow ( [220](#) ), corneal crystalline deposits ( [221](#) , [222](#) , [223](#) and [224](#) ), and hyperlipoproteinemia ( [225](#) ). The relationship of monoclonal gammopathy to these diseases is not clear and may be fortuitous.

Active glomerular lesions consisting of epithelial crescents and a rapidly progressive glomerulonephritis have been reported with monoclonal gammopathy ( [226](#) ). The association of proliferative glomerulonephritis with monoclonal gammopathy has been recognized in 25 cases, but the causal relationship is unknown ( [227](#) ).

The authors are not aware of any well-documented instances in which surgical removal of a nonhematologic tumor resulted in disappearance of the M-protein.

## M-Proteins with Antibody Activity

Of 612 patients in whom monoclonal immunoglobulins were studied for their antibody activity against actin, tubulin, thyroglobulin, myosin, myoglobin, fetuin, albumin, transferrin, and double-stranded DNA, 36 (5.9%) had antibody activity ( [228](#) ).

In some patients with MGUS, MM, or WM, the monoclonal immunoglobulin has exhibited unusual specificities to dextran ( [229](#) ), antistreptolysin O ( [230](#) ), antinuclear activity ( [231](#) ),

smooth muscle ( [232](#) ), riboflavin ( [233](#) , [234](#) ), von Willebrand factor ( [235](#) , [236](#) ), thyroglobulin ( [237](#) ), insulin ( [238](#) ), double-stranded DNA ( [239](#) ), apolipoprotein ( [240](#) ), thyroxine ( [241](#) ), cephalin ( [242](#) ), lactate dehydrogenase ( [243](#) ), anti-HIV ( [244](#) ), and antibiotics ( [245](#) ).

In one patient, xanthoderma-xanthotrichia (yellow discoloration of the skin and hair) was caused by an IgG  $\gamma$  protein with antiriboflavin antibody activity. Xanthoderma disappeared when the IgG level decreased to less than 20 g/L after chemotherapy ( [233](#) ). Another patient with similar clinical and laboratory features has been reported ( [234](#) ).

DiMinno et al. ( [246](#) ) described a patient with MM and a bleeding diathesis in whom an IgG1  $\gamma$  protein reacted with platelet glycoprotein IIIa. This produced a thrombasthenia-like state. An IgM  $\gamma$  M-protein that agglutinated platelets and produced a pseudothrombocytopenia has been reported ( [247](#) ).

The binding of calcium by M-protein may produce hypercalcemia without symptomatic or pathologic consequences ( [248](#) , [249](#) ). This situation must be recognized so that patients are not treated for hypercalcemia ( [250](#) ). Copper-binding M-protein has been found in two patients with MM ( [251](#) ). Hypercupremia was noted in a patient with a benign IgG  $\gamma$  M-protein and carcinoma of the lung ( [252](#) ). Binding of an M-protein with transferrin, producing a high serum iron level, has been reported ( [253](#) , [254](#) ). Hilgard et al. ( [255](#) ) described a patient with multiple thrombi from intravascular precipitation of an IgG  $\gamma$  monoclonal cryoglobulin with transferrin and fibrinogen. Pettersson et al. ( [256](#) ) described a patient with an IgG  $\gamma$  protein that bound phosphate, producing a spurious elevation of the serum phosphorus level. Two other similar patients, one with MM and one with MGUS, have been described with hyperphosphatemia, presumably from binding of serum phosphorus by the M-protein ( [257](#) ).

Transient M-proteins with antibody activity have been recognized after infection. One report described a newborn with congenital toxoplasmosis who had an IgG  $\gamma$  protein. The same protein was not found in the mother, and it did not display antibody activity ( [258](#) ).

Waldenström ( [259](#) ) also emphasized the antibody activity of M-proteins. M-proteins with antibody activity in plasma cell dyscrasias have been reviewed by Merlini et al. ( [260](#) ).

## REFERENCES

1. Waldenström J. Studies on conditions associated with disturbed gamma globulin formation (gammopathies). *Harvey Lect* 1960-1961;56:211-231.
2. Kyle RA. Monoclonal gammopathy of undetermined significance: natural history in 241 cases. *Am J Med* 1978;64:814-826.
3. Axelsson U, Bachmann R, Hallen J. Frequency of pathological proteins (M-components) in 6,995 sera from an adult population. *Acta Med Scand* 1966;179:235-247.
4. Kyle RA, Finkelstein S, Elveback LR, et al. Incidence of monoclonal proteins in a Minnesota community with a cluster of multiple myeloma. *Blood* 1972;40:719-724.
5. Saleun JP, Vicariot M, Deroff P, et al. Monoclonal gammopathies in the adult population of Finistère, France. *J Clin Pathol* 1982;35:63-68.
6. Crawford J, Eye MK, Cohen HJ. Evaluation of monoclonal gammopathies in the "well" elderly. *Am J*

Med 1987;82:39–45.

7. Ligthart GJ, Radl J, Corberand JX, et al. Monoclonal gammopathies in human aging: increased occurrence with age and correlation with health status. *Mech Ageing Dev* 1990;52:235–243.
8. Cohen HJ, Crawford J, Rao MK, et al. Racial differences in the prevalence of monoclonal gammopathy in a community-based sample of the elderly. *Am J Med* 1998;104:439–444.
9. Singh J, Dudley AW Jr, Kulig KA. Increased incidence of monoclonal gammopathy of undetermined significance in blacks and its age-related differences with whites on the basis of a study of 397 men and one woman in a hospital setting. *J Lab Clin Med* 1990;116:785–789.
10. Bowden M, Crawford J, Cohen HJ, et al. A comparative study of monoclonal gammopathies and immunoglobulin levels in Japanese and United States elderly. *J Am Geriatr Soc* 1993;41:11–14.
11. Kurihara Y, Shiba K, Fukumura Y, et al. Occurrence of serum M-protein species in Japanese patients older than 50 years based on relative mobility in cellulose acetate membrane electrophoresis. *J Clin Lab Anal* 2000;14:64–69.
12. Kyle RA, Garton JP. Laboratory monitoring of myeloma proteins. *Semin Oncol* 1986;13:310–317.
13. Whicher JT, Wallage M, Fifield R. Use of immunoglobulin heavy- and light-chain measurements compared with existing techniques as a means of typing monoclonal immunoglobulins. *Clin Chem* 1987;33:1771–1773.
14. Keren DF, Alexanian R, Goeken JA, et al. Guidelines for clinical and laboratory evaluation of patients with monoclonal gammopathies. *Arch Pathol Lab Med* 1999;123:106–107.
15. Kyle RA, Katzmann JA, Lust JA, et al. Clinical indications and applications of electrophoresis and immunofixation. In: Rose NR, Hamilton RG, Detrick B, eds. *Manual of clinical laboratory immunology*, 6th ed. Washington, DC: ASM Press, 2002:66–70.
16. Kyle RA. Sequence of testing for monoclonal gammopathies. *Arch Pathol Lab Med* 1999;123:114–118.
17. Kyle RA, Katzmann JA, Lust JA, et al. Immunochemical characterization of immunoglobulins. In: Rose NR, Hamilton RG, Detrick B, eds. *Manual of clinical laboratory immunology*, 6th ed. Washington, DC: ASM Press, 2002:71–91.
18. Riches PG, Sheldon J, Smith AM, et al. Overestimation of monoclonal immunoglobulin by immunochemical methods. *Ann Clin Biochem* 1991;28:253–259.
19. Kyle RA, Therneau TM, Rajkumar SV, et al. A long-term study of prognosis in monoclonal gammopathy of undetermined significance. *N Engl J Med* 2002;346:564–569.
20. Surveillance, Epidemiology, and End Results (SEER) Program Public Use Data (1973–1998). Bethesda, MD: National Cancer Institute, Cancer Statistics Branch, April 2001.
21. Kyle RA, Linos A, Beard CM, et al. Incidence and natural history of primary systemic amyloidosis in Olmsted County, Minnesota, 1950 through 1989. *Blood* 1992;79:1817–1822.
22. Axelsson U. A 20-year follow-up study of 64 subjects with M-components. *Acta Med Scand* 1986;219:519–522.
23. Carter A, Tatarsky I. The physiopathological significance of benign monoclonal gammopathy: a study of 64 cases. *Br J Haematol* 1980;46:565–574.
24. Paladini G, Fogher M, Mazzanti G, et al. Idiopathic monoclonal gammopathy: long-term study of 313 cases. *Recenti Prog Med* 1989;80:123–132.
25. Giraldo MP, Rubio-Felix D, Perella M, et al. Monoclonal gammopathies of undetermined significance: clinical course and biological aspects of 397 cases. *Sangre (Barc)* 1991;36:377–382.
26. Bladé J, Lopez-Guillermo A, Rozman C, et al. Malignant transformation and life expectancy in

monoclonal gammopathy of undetermined significance. *Br J Haematol* 1992;81:391–394.

27. van de Poel MH, Coebergh JW, Hillen HF. Malignant transformation of monoclonal gammopathy of undetermined significance among out-patients of a community hospital in southeastern Netherlands. *Br J Haematol* 1995;91:121–125.

28. Baldini L, Guffanti A, Cesana BM, et al. Role of different hematologic variables in defining the risk of malignant transformation in monoclonal gammopathy. *Blood* 1996;87:912–918.

29. Pasqualetti P, Festuccia V, Collacciani A, et al. The natural history of monoclonal gammopathy of undetermined significance: a 5- to 20-year follow-up of 263 cases. *Acta Haematol* 1997;97:174–179.

30. Carrell RW, Colls BM, Murray JT. The significance of monoclonal gammopathy in a normal population. *Aust N Z J Med* 1971;1:398–401.

31. Cesana C, Klersy C, Barbarano L, et al. Prognostic factors for malignant transformation in monoclonal gammopathy of undetermined significance and smoldering multiple myeloma. *J Clin Oncol* 2002;20:1625–1634.

32. Kyle RA. “Benign” monoclonal gammopathy—after 20 to 35 years of follow-up. *Mayo Clin Proc* 1993;68:26–36.

33. Kyle RA, Lust JA. The monoclonal gammopathies (paraproteins). *Adv Clin Chem* 1990;28:145–218.

34. Ucci G, Riccardi A, Luoni R, et al. Presenting features of monoclonal gammopathies: an analysis of 684 newly diagnosed cases: Cooperative Group for the Study and Treatment of Multiple Myeloma. *J Intern Med* 1993;234:165–173.

35. Bataille R, Chappard D, Basle MF. Quantifiable excess of bone resorption in monoclonal gammopathy is an early symptom of malignancy: a prospective study of 87 bone biopsies. *Blood* 1996;87:4762–4769.

36. Moller-Petersen J, Schmidt EB. Diagnostic value of the concentration of M-component in initial classification of monoclonal gammopathy. *Scand J Haematol* 1986;36:295–301.

37. Peltonen S, Wasastjerna C, Wager O. Clinical features of patients with a serum M component. *Acta Med Scand* 1978;203:257–263.

38. Dammacco F, Waldenström J. Bence Jones proteinuria in benign monoclonal gammopathies: incidence and characteristics. *Acta Med Scand* 1968;184:403–409.

39. Lindstrom FD, Dahlstrom U. Multiple myeloma or benign monoclonal gammopathy? A study of differential diagnostic criteria in 44 cases. *Clin Immunol Immunopathol* 1978;10:168–174.

40. Milla F, Oriol A, Aguilar J, et al. Usefulness and reproducibility of cytomorphologic evaluations to differentiate myeloma from monoclonal gammopathies of unknown significance. *Am J Clin Pathol* 2001;115:127–135.

41. Greipp PR, Witzig TE, Gonchoroff NJ, et al. Immunofluorescence labeling indices in myeloma and related monoclonal gammopathies. *Mayo Clin Proc* 1987;62:969–977.

42. Witzig TE, Gonchoroff NJ, Katzmann JA, et al. Peripheral blood B cell labeling indices are a measure of disease activity in patients with monoclonal gammopathies. *J Clin Oncol* 1988;6:1041–1046.

43. Witzig TE, Kyle RA, O’Fallon WM, et al. Detection of peripheral blood plasma cells as a predictor of disease course in patients with smoldering multiple myeloma. *Br J Haematol* 1994;87:266–272.

44. Zandecki M, Obein V, Bernardi F, et al. Monoclonal gammopathy of undetermined significance: chromosome changes are a common finding within bone marrow plasma cells. *Br J Haematol* 1995;90:693–696.

45. Drach J, Angerler J, Schuster J, et al. Interphase fluorescence in situ hybridization identifies chromosomal abnormalities in plasma cells from patients with monoclonal gammopathy of undetermined

significance. *Blood* 1995;86:3915–3921.

46. Avet-Loiseau H, Li JY, Morineau N, et al. Monosomy 13 is associated with the transition of monoclonal gammopathy of undetermined significance to multiple myeloma: Intergroupe Francophone du Myelome. *Blood* 1999;94:2583–2589.

47. Avet-Loiseau H, Facon T, Daviet A, et al. 14q32 translocations and monosomy 13 observed in monoclonal gammopathy of undetermined significance delineate a multistep process for the oncogenesis of multiple myeloma: Intergroupe Francophone du Myelome. *Cancer Res* 1999;59:4546–4550.

48. Avet-Loiseau H, Li JY, Facon T, et al. High incidence of translocations t(11;14)(q13;q32) and t(4;14)(p16;q32) in patients with plasma cell malignancies. *Cancer Res* 1998;58:5640–5645.

49. Fonseca R, Ahmann GJ, Jalal SM, et al. Chromosomal abnormalities in systemic amyloidosis. *Br J Haematol* 1998;103:704–710.

50. Konigsberg R, Ackermann J, Kaufmann H, et al. Deletions of chromosome 13q in monoclonal gammopathy of undetermined significance. *Leukemia* 2000;14:1975–1979.

51. Bellaiche L, Laredo JD, Liote F, et al. Magnetic resonance appearance of mono-clonal gammopathies of unknown significance and multiple myeloma: the GRI Study Group. *Spine* 1997;22:2551–2557.

52. Bataille R, Jourdan M, Zhang XG, et al. Serum levels of interleukin 6, a potent myeloma cell growth factor, as a reflect of disease severity in plasma cell dyscrasias. *J Clin Invest* 1989;84:2008–2011.

53. Vejlgaard T, Abildgaard N, Jans H, et al. Abnormal bone turnover in monoclonal gammopathy of undetermined significance: analyses of type I collagen telopeptide, osteocalcin, bone-specific alkaline phosphatase and propeptides of type I and type III procollagens. *Eur J Haematol* 1997;58:104–108.

54. Ocqueteau M, Orfao A, Almeida J, et al. Immunophenotypic characterization of plasma cells from monoclonal gammopathy of undetermined significance patients: implications for the differential diagnosis between MGUS and multiple myeloma. *Am J Pathol* 1998;152:1655–1665.

55. Pelliniemi TT, Iriala K, Mattila K, et al. Serum immunoreactive interleukin-6 (IL6) and acute phase proteins as prognostic factors in multiple myeloma. *Blood* 1993;82 [Suppl]:262a(abst).

56. Lust JA, Donovan KA. Biology of the transition of monoclonal gammopathy of undetermined significance (MGUS) to multiple myeloma. *Cancer Control* 1998;5:209–217.

57. Lacy MQ, Donovan KA, Heimbach JK, et al. Comparison of interleukin-1 beta expression by in situ hybridization in monoclonal gammopathy of undetermined significance and multiple myeloma. *Blood* 1999;93:300–305.

58. Vacca A, Ribatti D, Roncali L, et al. Bone marrow angiogenesis and progression in multiple myeloma. *Br J Haematol* 1994;87:503–508.

59. Rajkumar SV, Leong T, Roche PC, et al. Prognostic value of bone marrow angiogenesis in multiple myeloma. *Clin Cancer Res* 2000;6:3111–3116.

60. Garewal H, Durie BG, Kyle RA, et al. Serum beta 2-microglobulin in the initial staging and subsequent monitoring of monoclonal plasma cell disorders. *J Clin Oncol* 1984;2:51–57.

61. Bast EJ, Van Camp B, Boom SE, et al. Differentiation between benign and malignant monoclonal gammopathy by the presence of the J chain. *Clin Exp Immunol* 1981;44:375–382.

62. Tortarolo M, Cantore N, Grande M, et al. Plasma cell acid phosphatase as an adjunct in the differential diagnosis of monoclonal immunoglobulinemias. *Acta Haematol* 1981;65:103–107.

63. Spira G, Carter A, Tatarsky I, et al. Lymphocyte subpopulations in benign monoclonal gammopathy. *Scand J Haematol* 1983;31:78–84.

64. Carmagnola AL, Boccadoro M, Massaia M, et al. The idiotypic specificities of lymphocytes in human monoclonal gammopathies: analysis with the fluorescence activated cell sorter. *Clin Exp Immunol*

1983;51:173–177.

65. Shimizu K, Ohnishi K, Kunii A. Differentiation of benign monoclonal gammopathy and smoldering multiple myeloma from frank myeloma. *Clin Exp Immunol* 1982;50:596–600.
66. Xu D, Zheng C, Bergenbrant S, et al. Telomerase activity in plasma cell dyscrasias. *Br J Cancer* 2001;84:621–625.
67. Guillermin G, Gyan E, Wolowiec D, et al. p16(INK4a) and p15(INK4b) gene methylations in plasma cells from monoclonal gammopathy of undetermined significance. *Blood* 2001;98:244–246.
68. Kyle RA, Greipp PR. Smoldering multiple myeloma. *N Engl J Med* 1980;302:1347–1349.
69. Dimopoulos MA, Moulouopoulos LA, Maniatis A, et al. Solitary plasmacytoma of bone and asymptomatic multiple myeloma. *Blood* 2000;96:2037–2044.
70. Dimopoulos MA, Moulouopoulos A, Smith T, et al. Risk of disease progression in asymptomatic multiple myeloma. *Am J Med* 1993;94:57–61.
71. Riccardi A, Gobbi PG, Ucci G, et al. Changing clinical presentation of multiple myeloma. *Eur J Cancer* 1991;27:1401–1405.
72. Wisloff F, Andersen P, Andersson TR, et al. Has the incidence of multiple myeloma in old age been underestimated? The myeloma project of health region I in Norway, I. *Eur J Haematol* 1991;47:333–337.
73. Greipp PR, Kyle RA. Clinical, morphological, and cell kinetic differences among multiple myeloma, monoclonal gammopathy of undetermined significance, and smoldering multiple myeloma. *Blood* 1983;62:166–171.
74. Kyle RA, Rajkumar SV. Monoclonal gammopathies of undetermined significance. *Hematol Oncol Clin North Am* 1999;13:1181–1202.
75. Weber DM, Dimopoulos MA, Moulouopoulos LA, et al. Prognostic features of asymptomatic multiple myeloma. *Br J Haematol* 1997;97:810–814.
76. Moulouopoulos LA, Dimopoulos MA, Smith TL, et al. Prognostic significance of magnetic resonance imaging in patients with asymptomatic multiple myeloma. *J Clin Oncol* 1995;13:251–256.
77. Mariette X, Zagdanski AM, Guermazi A, et al. Prognostic value of vertebral lesions detected by magnetic resonance imaging in patients with stage I multiple myeloma. *Br J Haematol* 1999;104:723–729.
78. Hjorth M, Hellquist L, Holmberg E, et al. Initial versus deferred melphalan–prednisone therapy for asymptomatic multiple myeloma stage I—a randomized study: Myeloma Group of Western Sweden. *Eur J Haematol* 1993;50:95–102.
79. Grignani G, Gobbi PG, Formisano R, et al. A prognostic index for multiple myeloma. *Br J Cancer* 1996;73:1101–1107.
80. Greipp PR, Kyle RA. Staging, kinetics, and prognosis of multiple myeloma. In: Wiernik PH, Canellos GP, Dutcher JP, et al., eds. *Neoplastic diseases of the blood*, 3rd ed. New York: Churchill Livingstone, 1996:537–559.
81. Rajkumar SV, Dispenzieri A, Fonseca R, et al. Thalidomide for previously untreated indolent or smoldering multiple myeloma. *Leukemia* 2001;15:1274–1276.
82. Weber DM, Rankin K, Gavino M, et al. Angiogenesis factors and sensitivity to thalidomide in previously untreated multiple myeloma (MM). *Blood* 2000;96:168a(abst).
83. Kyle RA, Robinson RA, Katzmann JA. The clinical aspects of biclonal gammopathies: review of 57 cases. *Am J Med* 1981;71:999–1008.
84. Riddell S, Traczyk Z, Paraskevas F, et al. The double gammopathies: clinical and immunological

- studies. *Medicine (Baltimore)* 1986;65:135–142.
85. Ray RA, Schotters SB. Triclonal gammopathy in a patient with AIDS. *Clin Chem* 1986;32:2000.
86. Ray RA, Schotters SB, Jacobs A, et al. Triclonal gammopathy in a patient with plasma cell dyscrasia. *Clin Chem* 1986;32:205–206.
87. Grosbois B, Jego P, de Rosa H, et al. Triclonal gammopathy and malignant immunoproliferative syndrome. *Rev Med Interne* 1997;18:470–473.
88. Kyle RA, Maldonado JE, Bayrd ED. Idiopathic Bence Jones proteinuria—a distinct entity? *Am J Med* 1973;55:222–226.
89. Kyle RA, Greipp PR. “Idiopathic” Bence Jones proteinuria: long-term follow-up in seven patients. *N Engl J Med* 1982;306:564–567.
90. O'Connor ML, Rice DT, Buss DH, et al. Immunoglobulin D benign monoclonal gammopathy: a case report. *Cancer* 1991;68:611–616.
91. Bladé J, Kyle RA. IgD monoclonal gammopathy with long-term follow-up. *Br J Haematol* 1994;88:395–396.
92. Dexter RN, Mullinax F, Estep HL, et al. Monoclonal IgG gammopathy and hyperparathyroidism. *Ann Intern Med* 1972;77:759–764.
93. Schnur MJ, Appel GB, Bilezikian JP. Primary hyperparathyroidism and benign monoclonal gammopathy. *Arch Intern Med* 1977;137:1201–1203.
94. Mundis RJ, Kyle RA. Primary hyperparathyroidism and monoclonal gammopathy of undetermined significance. *Am J Clin Pathol* 1982;77:619–621.
95. Rao DS, Antonelli R, Kane KR, et al. Primary hyperparathyroidism and monoclonal gammopathy. *Henry Ford Hosp Med J* 1991;39:41–44.
96. Arnulf B, Bengoufa D, Sarfati E, et al. Prevalence of monoclonal gammopathy in patients with primary hyperparathyroidism: a prospective study. *Arch Intern Med* 2002;162:464–467.
97. Azar HA, Hill WT, Osserman EF. Malignant lymphoma and lymphatic leukemia associated with myeloma-type serum proteins. *Am J Med* 1957;23:239–249.
98. Kyle RA, Bayrd ED, Heck FJ. Diagnostic criteria for electrophoretic patterns of serum and urinary proteins in multiple myeloma: study of 165 multiple myeloma patients and of 77 non-myeloma patients with similar electrophoretic patterns. *JAMA* 1960;174:245–251.
99. Alexanian R. Monoclonal gammopathy in lymphoma. *Arch Intern Med* 1975;135:62–66.
100. Kyle RA, Garton JP. The spectrum of IgM monoclonal gammopathy in 430 cases. *Mayo Clin Proc* 1987;62:719–731.
101. Kyle RA, Bayrd EA, eds. *The monoclonal gammopathies: multiple myeloma and related plasma-cell disorders*. Springfield, IL: Charles C Thomas, 1976.
102. Noel P, Kyle RA. Monoclonal proteins in chronic lymphocytic leukemia. *Am J Clin Pathol* 1987;87:385–388.
103. Jansen J, Bolhuis RL, van Nieuwkoop JA, et al. Paraproteinaemia plus osteolytic lesions in typical hairy-cell leukaemia. *Br J Haematol* 1983;54:531–541.
104. Matsuzaki H, Yamaguchi K, Kagimoto T, et al. Monoclonal gammopathies in adult T-cell leukemia. *Cancer* 1985;56:1380–1383.
105. Guglielmi P, Davi F, Brouet JC. Prevalence of monoclonal Ig with lambda light chains in chronic



myelocytic leukaemia. *Br J Haematol* 1989;73:331–333.

106. Mant MJ, Hirsh J, Gauldi J, et al. Von Willebrand's syndrome presenting as an acquired bleeding disorder in association with a monoclonal gammopathy. *Blood* 1973;42:429–436.

107. Stewart AK, Glynn MF. Acquired von Willebrand disease associated with free lambda light chain monoclonal gammopathy, normal bleeding time and response to prednisone. *Postgrad Med J* 1990;66:560–562.

108. Scrobhaci ML, Daniel MT, Levy Y, et al. Expression of GpIb on plasma cells in a patient with monoclonal IgG and acquired von Willebrand disease. *Br J Haematol* 1993;84:471–475.

109. Keren DF. Coagulation disorders in patients with monoclonal gammopathies. *Hematol Oncol Clin North Am* 1993;7:1153–1159.

110. Federici AB, Stabile F, Castaman G, et al. Treatment of acquired von Willebrand syndrome in patients with monoclonal gammopathy of uncertain significance: comparison of three different therapeutic approaches. *Blood* 1998;92:2707–2711.

111. Bellotti V, Gamba G, Merlini G, et al. Study of three patients with monoclonal gammopathies and 'lupus-like' anticoagulants. *Br J Haematol* 1989;73:221–227.

112. Selroos O, von Knorring J. Immunoglobulins in pernicious anaemia: including a report on a patient with pernicious anaemia, IgA deficiency and an M component of kappa-type IgG. *Acta Med Scand* 1973;194:571–574.

113. Sandstrom H, Wahlin A, Eriksson M, et al. Intravascular haemolysis and increased prevalence of myeloma and monoclonal gammopathy in congenital dyserythropoietic anaemia, type III. *Eur J Haematol* 1994;52:42–46.

114. Resegotti L, Dolci C, Palestro G, et al. Paraproteinemic variety of pure red cell aplasia: immunological studies in 1 patient. *Acta Haematol* 1978;60:227–232.

115. Berner Y, Berrebi A. Myeloproliferative disorders and nonmyelomatous paraprotein: a study of five patients and review of the literature. *Isr J Med Sci* 1986;22:109–112.

116. Duhrsen U, Uppenkamp M, Meusers P, et al. Frequent association of idiopathic myelofibrosis with plasma cell dyscrasias. *Blut* 1988;56:97–102.

117. Economopoulos T, Economidou J, Giannopoulos G, et al. Immune abnormalities in myelodysplastic syndromes. *J Clin Pathol* 1985;38:908–911.

118. Pratt PW, Kochwa S, Estren S. Immunoglobulin abnormalities in Gaucher's disease: report of 16 cases. *Blood* 1968;31:633–640.

119. Zawadzki ZA, Benedek TG. Rheumatoid arthritis, dysproteinemic arthropathy, and paraproteinemia. *Arthritis Rheum* 1969;12:555–568.

120. Hurst NP, Smith W, Henderson DR. IgG (kappa) paraproteinaemia and arthritis. *Br J Rheumatol* 1987;26:142–146.

121. Michaux JL, Heremans JF. Thirty cases of monoclonal immunoglobulin disorders other than myeloma or macroglobulinemia: a classification of diseases associated with the production of monoclonal-type immunoglobulins. *Am J Med* 1969;46:562–579.

122. Porcel JM, Ordi J, Tolosa C, et al. Monoclonal gammopathy in systemic lupus erythematosus. *Lupus* 1992;1:263–264.

123. Iffeld D, Barzilay J, Vana D, et al. IgG monoclonal gammopathy in four patients with polymyalgia rheumatica. *Ann Rheum Dis* 1985;44:501.

124. Kiprov DD, Miller RG. Polymyositis associated with monoclonal gammopathy. *Lancet*

1984;2:1183–1186.

125. Telerman–Toppet N, Wittek M, Bacq M, et al. Benign monoclonal gammopathy and relapsing polymyositis. *Muscle Nerve* 1982;5:490–491.

126. Dalakas MC, Illa I, Gallardo E, et al. Inclusion body myositis and paraproteinemia: incidence and immunopathologic correlations. *Ann Neurol* 1997;41:100–104.

127. Powell FC, Greipp PR, Su WP. Discoid lupus erythematosus and monoclonal gammopathy. *Br J Dermatol* 1983;109:355–360.

128. Kelly JJ Jr, Kyle RA, O'Brien PC, et al. Prevalence of monoclonal protein in peripheral neuropathy. *Neurology* 1981;31:1480–1483.

129. Kahn SN, Riches PG, Kohn J. Paraproteinaemia in neurological disease: incidence, associations, and classification of monoclonal immunoglobulins. *J Clin Pathol* 1980;33:617–621.

130. Nobile–Orazio E, Barbieri S, Baldini L, et al. Peripheral neuropathy in monoclonal gammopathy of undetermined significance: prevalence and immunopathogenetic studies. *Acta Neurol Scand* 1992;85:383–390.

131. Baldini L, Nobile–Orazio E, Guffanti A, et al. Peripheral neuropathy in IgM monoclonal gammopathy and Waldenström's macroglobulinemia: a frequent complication in elderly males with low MAG–reactive serum monoclonal component. *Am J Hematol* 1994;45:25–31.

132. Kelly JJ Jr, Kyle RA, Latov N. *Polyneuropathies associated with plasma cell dyscrasias*. Boston: Martinus Nijhoff, 1987.

133. Latov N. Pathogenesis and therapy of neuropathies associated with monoclonal gammopathies. *Ann Neurol* 1995;37[Suppl1]:S32–S42.

134. Kissel JT, Mendell JR. Neuropathies associated with monoclonal gammopathies. *Neuromuscul Disord* 1996;6:3–18.

135. Ropper AH, Gorson KC. Neuropathies associated with paraproteinemia. *N Engl J Med* 1998;338:1601–1607.

136. Latov N, Hays AP, Sherman WH. Peripheral neuropathy and anti–MAG antibodies. *Crit Rev Neurobiol* 1988;3:301–332.

137. Hafler DA, Johnson D, Kelly JJ, et al. Monoclonal gammopathy and neuropathy: myelin–associated glycoprotein reactivity and clinical characteristics. *Neurology* 1986;36:75–78.

138. Kelly JJ, Adelman LS, Berkman E, et al. Polyneuropathies associated with IgM monoclonal gammopathies. *Arch Neurol* 1988;45:1355–1359.

139. Quarles RH, Weiss MD. Autoantibodies associated with peripheral neuropathy. *Muscle Nerve* 1999;22:800–822.

140. Gosselin S, Kyle RA, Dyck PJ. Neuropathy associated with monoclonal gammopathies of undetermined significance. *Ann Neurol* 1991;30:54–61.

141. Chassande B, Leger JM, Younes–Chennoufi AB, et al. Peripheral neuropathy associated with IgM monoclonal gammopathy: correlations between M–protein antibody activity and clinical/electrophysiological features in 40 cases. *Muscle Nerve* 1998;21:55–62.

142. Kelly JJ Jr. Polyneuropathies associated with plasma cell dyscrasias. *Semin Neurol* 1987;7:30–39.

143. Simmons Z, Albers JW, Bromberg MB, et al. Presentation and initial clinical course in patients with chronic inflammatory demyelinating polyradiculoneuropathy: comparison of patients without and with monoclonal gammopathy. *Neurology* 1993;43:2202–2209.

144. Gorson KC, Allam G, Ropper AH. Chronic inflammatory demyelinating polyneuropathy: clinical

features and response to treatment in 67 consecutive patients with and without a monoclonal gammopathy. *Neurology* 1997;48:321–328.

145. Haas DC, Tatum AH. Plasmapheresis alleviates neuropathy accompanying IgM anti-myelin-associated glycoprotein paraproteinemia. *Ann Neurol* 1988;23:394–396.

146. Dyck PJ, Low PA, Windebank AJ, et al. Plasma exchange in polyneuropathy associated with monoclonal gammopathy of undetermined significance. *N Engl J Med* 1991;325:1482–1486.

147. Mazzi G, Raineri A, Zucco M, et al. Plasma-exchange in chronic peripheral neurological disorders. *Int J Artif Organs* 1999;22:40–46.

148. Sherman WH, Latov N, Lange D, et al. Fludarabine for IgM antibody-mediated neuropathies. *Ann Neurol* 1994;36:326(abst).

149. Wilson HC, Lunn MP, Schey S, et al. Successful treatment of IgM paraproteinaemic neuropathy with fludarabine. *J Neurol Neurosurg Psychiatry* 1999;66:575–580.

150. Levine TD, Pestronk A. IgM antibody-related polyneuropathies: B-cell depletion chemotherapy using Rituximab. *Neurology* 1999;52:1701–1704.

151. Dalakas MC, Quarles RH, Farrer RG, et al. A controlled study of intravenous immunoglobulin in demyelinating neuropathy with IgM gammopathy. *Ann Neurol* 1996;40:792–795.

152. Younger DS, Rowland LP, Latov N, et al. Motor neuron disease and amyotrophic lateral sclerosis: relation of high CSF protein content to paraproteinemia and clinical syndromes. *Neurology* 1990;40:595–599.

153. Patten BM. Neuropathy and motor neuron syndromes associated with plasma cell disease. *Acta Neurol Scand* 1984;70:47–61.

154. Merlini G, Rutigliano L, Masnaghetti S, et al. Neuromuscular disorders associated with monoclonal immunoglobulins. In: *Biology, pathophysiology, prognosis, and treatment. International Conference on Multiple Myeloma. Bologna, Italy, June 19–22, 1989*:215(abst).

155. Bartoloni C, Scopetta C, Flamini G, et al. Waldenström's macroglobulinemia and myasthenia gravis. *J Clin Lab Immunol* 1981;6:275–278.

156. Galli M, Landi G, Restelli DL, et al. Myasthenia gravis with a monoclonal gammopathy—report of a case. *J Neurol Sci* 1980;45:103–108.

157. McDonald PS, Cora-Bramble D, De Palma L. Monoclonal gammopathy of the immunoglobulin A class in a two-year-old girl with ataxia telangiectasia. *Pediatr Dev Pathol* 1998;1:319–321.

158. Sadighi Akha AA, Humphrey RL, Winkelstein JA, et al. Oligo-/monoclonal gammopathy and hypergammaglobulinemia in ataxia-telangiectasia: a study of 90 patients. *Medicine (Baltimore)* 1999;78:370–381.

159. Kyle RA, Dyck PJ. Osteosclerotic myeloma (POEMS syndrome). In: Dyck PJ, Thomas PK, Griffin JW, et al., eds. *Peripheral neuropathy, 3rd ed, vol 2. Philadelphia: WB Saunders, 1993*:1288–1293.

160. Bardwick PA, Zvaifler NJ, Gill GN, et al. Plasma cell dyscrasia with polyneuropathy, organomegaly, endocrinopathy, M protein, and skin changes: the POEMS syndrome: report on two cases and a review of the literature. *Medicine (Baltimore)* 1980;59:311–322.

161. Takatsuki K, Sanada I. Plasma cell dyscrasia with polyneuropathy and endocrine disorder: clinical and laboratory features of 109 reported cases. *Jpn J Clin Oncol* 1983;13:543–555.

162. Kelly JJ Jr, Kyle RA, Miles JM, et al. Osteosclerotic myeloma and peripheral neuropathy. *Neurology* 1983;33:202–210.

163. Gherardi RK, Belec L, Soubrier M, et al. Overproduction of proinflammatory cytokines imbalanced by their antagonists in POEMS syndrome. *Blood* 1996;87:1458–1465.

164. Watanabe O, Maruyama I, Arimura K, et al. Overproduction of vascular endothelial growth factor/vascular permeability factor is causative in Crow–Fukase (POEMS) syndrome. *Muscle Nerve* 1998;21:1390–1397.
165. James K, Fudenberg H, Epstein WL, et al. Studies on a unique diagnostic serum globulin in papular mucinosis (lichen myxedematosus). *Clin Exp Immunol* 1967;2:153–166.
166. Ohta A, Uitto J, Oikarinen AI, et al. Paraproteinemia in patients with scleredema: clinical findings and serum effects on skin fibroblasts in vitro. *J Am Acad Dermatol* 1987;16:96–107.
167. Duguid CM, Powell FC. Pyoderma gangrenosum. *Clin Dermatol* 1993;11:129–133.
168. Mehregan DA, Winkelmann RK. Necrobiotic xanthogranuloma. *Arch Dermatol* 1992;128:94–100.
169. Nestle FO, Hofbauer G, Burg G. Necrobiotic xanthogranuloma with monoclonal gammopathy of the IgG lambda type. *Dermatology* 1999;198:434–435.
170. Doutre MS, Beylot C, Bioulac P, et al. Monoclonal IgM and chronic urticaria: two cases. *Ann Allergy* 1987;58:413–414.
171. Lebbe C, Rybojad M, Klein F, et al. Schnitzler’s syndrome associated with sensorimotor neuropathy. *J Am Acad Dermatol* 1994;30:316–318.
172. Puddu P, Cianchini G, Girardelli CR, et al. Schnitzler’s syndrome: report of a new case and a review of the literature. *Clin Exp Rheumatol* 1997;15:91–95.
173. Berard M, Antonucci M, Beaumont JL. Cytotoxic effect of serum on fibroblasts in one case of normolipidemic plane xanthoma and myeloma IgG lambda. *Atherosclerosis* 1986;62:111–115.
174. Jones RR, Baughan AS, Cream JJ, et al. Complement abnormalities in diffuse plane xanthomatosis with paraproteinaemia. *Br J Dermatol* 1979;101:711–716.
175. Ryatt KS, Dodman BA, Cotterill JA. Subcorneal pustular dermatosis and IgA gammopathy. *Acta Derm Venereol* 1981;61:560–562.
176. Lutz ME, Daoud MS, McEvoy MT, et al. Subcorneal pustular dermatosis: a clinical study of ten patients. *Cutis* 1998;61:203–208.
177. Daoud MS, Lust JA, Kyle RA, et al. Monoclonal gammopathies and associated skin disorders. *J Am Acad Dermatol* 1999;40:507–535.
178. Venencie PY, Winkelmann RK, Puissant A, et al. Monoclonal gammopathy in Sézary syndrome: report of three cases and review of the literature. *Arch Dermatol* 1984;120:605–608.
179. Venencie PY, Winkelmann RK, Friedman SJ, et al. Monoclonal gammopathy and mycosis fungoides: report of four cases and review of the literature. *J Am Acad Dermatol* 1984;11:576–579.
180. Strumia R, Roveggio C. Kaposi’s sarcoma and monoclonal gammopathy. *Dermatology* 1994;188:76–77.
181. Dowd PM, Munro DD. Erythema elevatum diutinum. *J R Soc Med* 1983;76:310–313.
182. Kavanagh GM, Colaco CB, Bradfield JW, et al. Erythema elevatum diutinum associated with Wegener’s granulomatosis and IgA paraproteinemia. *J Am Acad Dermatol* 1993;28:846–849.
183. Crapper RM, Deam DR, Mackay IR. Paraproteinemias in homosexual men with HIV infection: lack of association with abnormal clinical or immunologic findings. *Am J Clin Pathol* 1987;88:348–351.
184. Lefrere JJ, Debbia M, Lambin P. Prospective follow-up of monoclonal gam-mopathies in HIV-infected individuals. *Br J Haematol* 1993;84:151–155.
185. Renoult E, Bertrand F, Kessler M. Monoclonal gammopathies in HbsAg-positive patients with renal

transplants. *N Engl J Med* 1988;318:1205.

186. Stanko CK, Jeffery JR, Rush DN. Monoclonal and multiclonal gammopathies after renal transplantation. *Transplant Proc* 1989;21:3330-3332.

187. Pollock CA, Mahoney JF, Ibels LS, et al. Immunoglobulin abnormalities in renal transplant recipients. *Transplantation* 1989;47:952-956.

188. Radl J, Valentijn RM, Haaijman JJ, et al. Monoclonal gammopathies in patients undergoing immunosuppressive treatment after renal transplantation. *Clin Immunol Immunopathol* 1985;37:98-102.

189. Ginevri F, Nocera A, Bonato L, et al. Cytomegalovirus infection is a trigger for monoclonal immunoglobulins in pediatric kidney transplant recipients. *Transplant Proc* 1998;30:2079-2082.

190. Ducloux D, Carron P, Racadot E, et al. T-cell immune defect and B-cell activation in renal transplant recipients with monoclonal gammopathies. *Transpl Int* 1999;12:250-253.

191. Hammarström L, Smith CI. Frequent occurrence of monoclonal gammopathies with an imbalanced light-chain ratio following bone marrow transplantation. *Transplantation* 1987;43:447-449.

192. Gerritsen EJ, van Tol MJ, Lankester AC, et al. Immunoglobulin levels and monoclonal gammopathies in children after bone marrow transplantation. *Blood* 1993;82:3493-3502.

193. Zent CS, Wilson CS, Tricot G, et al. Oligoclonal protein bands and Ig isotype switching in multiple myeloma treated with high-dose therapy and hematopoietic cell transplantation. *Blood* 1998;91:3518-3523.

194. Hebart H, Einsele H, Klein R, et al. CMV infection after allogeneic bone marrow transplantation is associated with the occurrence of various autoantibodies and monoclonal gammopathies. *Br J Haematol* 1996;95:138-144.

195. Badley AD, Portela DF, Patel R, et al. Development of monoclonal gammopathy precedes the development of Epstein-Barr virus-induced posttransplant lymphoproliferative disorder. *Liver Transpl Surg* 1996;2:375-382.

196. Pageaux GP, Bonnardet A, Picot MC, et al. Prevalence of monoclonal immunoglobulins after liver transplantation: relationship with posttransplant lymphoproliferative disorders. *Transplantation* 1998;65:397-400.

197. Gelfand JA, Boss GR, Conley CL, et al. Acquired C1 esterase inhibitor deficiency and angioedema: a review. *Medicine (Baltimore)* 1979;58:321-328.

198. Pascual M, Widmann JJ, Schifferli JA. Recurrent febrile panniculitis and hepatitis in two patients with acquired complement deficiency and paraproteinemia. *Am J Med* 1987;83:959-962.

199. Lofdahl CG, Solvell L, Laurell AB, et al. Systemic capillary leak syndrome with monoclonal IgG and complement alterations: a case report on an episodic syndrome. *Acta Med Scand* 1979;206:405-412.

200. Pascual M, Mach-Pascual S, Schifferli JA. Paraproteins and complement depletion: pathogenesis and clinical syndromes. *Semin Hematol* 1997;34[Suppl 1]:40-48.

201. Droder RM, Kyle RA, Greipp PR. Control of systemic capillary leak syndrome with aminophylline and terbutaline. *Am J Med* 1992;92:523-526.

202. Heer M, Joller-Jemelka H, Fontana A, et al. Monoclonal gammopathy in chronic active hepatitis. *Liver* 1984;4:255-263.

203. Hendrick AM, Mitchison HC, Bird AG, et al. Paraproteins in primary biliary cirrhosis. *Q J Med* 1986;60:681-684.

204. Mussini C, Ghini M, Mascia MT, et al. HCV and monoclonal gammopathies. *Clin Exp Rheumatol* 1995;13[Suppl 13]:S45-S49.

205. Mangia A, Clemente R, Musto P, et al. Hepatitis C virus infection and monoclonal gammopathies not

associated with cryoglobulinemia. *Leukemia* 1996;10:1209–1213.

206. Andreone P, Zignego AL, Cursaro C, et al. Prevalence of monoclonal gammopathies in patients with hepatitis C virus infection. *Ann Intern Med* 1998;129:294–298.

207. Dosa S, Cairns SA, Mallick NP, et al. Relapsing Henoch–Schonlein syndrome with renal involvement in a patient with an IgA monoclonal gammopathy: a study of the results of immunosuppressant and cytotoxic therapy. *Nephron* 1980;26:145–148.

208. Fauchier C, Youinou P, Le Goff P, et al. Monoclonal immunoglobulins associated with bacterial endocarditis: two case reports (author's transl). *Sem Hop* 1979;55:1903–1904.

209. Groussin P, Fine JM, Leroux E, et al. Hashimoto's thyroiditis and monoclonal gammopathy (two cases) (author's transl). *Ann Endocrinol (Paris)* 1979;40:413–416.

210. Matsubayashi S, Tamai H, Nagai K, et al. Monoclonal gammopathy in Hashimoto's thyroiditis and malignant lymphoma of the thyroid. *J Clin Endocrinol Metab* 1986;63:1136–1139.

211. Norenberg DD, Bigley DV, Virata RL, et al. *Corynebacterium pyogenes* septic arthritis with plasma cell synovial infiltrate and monoclonal gammopathy. *Arch Intern Med* 1978;138:810–811.

212. Friedenberg WR, West M, Miech DJ, et al. Atypical purpura fulminans with benign monoclonal gammopathy. *Arch Dermatol* 1978;114:578–580.

213. Bonanni PP, Frymoyer JW, Jacox RF. A family study of idiopathic pulmonary fibrosis: a possible dysproteinemic and genetically determined disease. *Am J Med* 1965;39:411–421.

214. Mork JN, Johnson JR, Zinneman HH, et al. Pulmonary alveolar proteinosis associated with IgG monoclonal gammopathy. *Arch Intern Med* 1968;121:278–283.

215. Nomura S, Kanoh T. Association of idiopathic pulmonary haemosiderosis with IgA monoclonal gammopathy. *Thorax* 1987;42:696–697.

216. Sharma AM, Fried J, Sharma OP. Monoclonal gammopathy of undetermined significance in sarcoidosis: two case reports. *Sarcoidosis* 1992;9:70–72.

217. Soppi E, Eskola J, Roytta M, et al. Thymoma with immunodeficiency (Good's syndrome) associated with myasthenia gravis and benign IgG gammopathy. *Arch Intern Med* 1985;145:1704–1707.

218. Schafer AI, Miller JB, Lester EP, et al. Monoclonal gammopathy in hereditary spherocytosis: a possible pathogenetic relation. *Ann Intern Med* 1978;88:45–46.

219. Munteanu G. Doyme's macular heredodystrophy and benign monoclonal gammopathy: genetic and pathogenetic correlations (author's transl). *J Fr Ophthalmol* 1980;3:753–758.

220. Nagler A, Ben-Arieh Y, Brenner B, et al. Eosinophilic fibrohistiocytic lesion of bone marrow associated with monoclonal gammopathy and osteolytic lesions. *Am J Hematol* 1986;23:277–281.

221. Ormerod LD, Collin HB, Dohlman CH, et al. Paraproteinemic crystalline keratopathy. *Ophthalmology* 1988;95:202–212.

222. Bourne WM, Kyle RA, Brubaker RF, et al. Incidence of corneal crystals in the monoclonal gammopathies. *Am J Ophthalmol* 1989;107:192–193.

223. Kato T, Nakayasu K, Omata Y, et al. Corneal deposits as an alerting sign of monoclonal gammopathy: a case report. *Cornea* 1999;18:734–738.

224. Hutchinson K, Dal Pra M, Apel A. Immunoglobulin G crystalline keratopathy associated with monoclonal gammopathy. *Aust N Z J Ophthalmol* 1998;26:177–179.

225. Zadak Z, Tichy M. Hyperlipidemia and monoclonal gammopathy. *Neoplasma* 1987;34:169–172.

226. Meyrier A, Simon P, Mignon F, et al. Rapidly progressive (“crescentic”) glomerulonephritis and

monoclonal gammopathies. *Nephron* 1984;38:156–162.

227. Kebler R, Kithier K, McDonald FD, et al. Rapidly progressive glomerulonephritis and monoclonal gammopathy. *Am J Med* 1985;78:133–138.

228. Dighiero G, Guilbert B, Ferman J, et al. Thirty-six human monoclonal immunoglobulins with antibody activity against cytoskeleton proteins, thyroglobulin, and native DNA: immunologic studies and clinical correlations. *Blood* 1983;62:264–270.

229. Shimm DS, Cohen HJ. Transient monoclonal immunoglobulin G with anti-dextran activity. *Acta Haematol* 1978;59:99–103.

230. Kalliomaki JL, Granfors K, Toivanen A. An immunoglobulin G myeloma with antistreptolysin activity and a lifelong history of cutaneous streptococcal infection. *Clin Immunol Immunopathol* 1978;9:22–27.

231. Intrator L, Andre C, Chenal C, et al. A monoclonal macroglobulin with antinuclear activity. *J Clin Pathol* 1979;32:450–454.

232. Ruiz-Palomo F, Revilla Y, Gonzales Porque P, et al. Two IgM paraproteins bearing cryoglobulin and anti-smooth muscle activities in a patient with Waldenström's macroglobulinaemia. *J Intern Med* 1991;229:93–96.

233. Farhangi M, Osserman EF. Myeloma with xanthoderma due to an IgG lambda monoclonal anti-flavin antibody. *N Engl J Med* 1976;294:177–183.

234. Merlini G, Bruening R, Kyle RA, et al. The second riboflavin-binding myeloma IgG lambda DOT.I. Biochemical and functional characterization. *Mol Immunol* 1990;27:385–394.

235. Bovill EG, Ershler WB, Golden EA, et al. A human myeloma-produced monoclonal protein directed against the active subpopulation of von Willebrand factor. *Am J Clin Pathol* 1986;85:115–123.

236. Mohri H, Noguchi T, Kodama F, et al. Acquired von Willebrand disease due to inhibitor of human myeloma protein specific for von Willebrand factor. *Am J Clin Pathol* 1987;87:663–668.

237. Zouali M, Fine JM, Eyquem A. A human monoclonal IgG1 with anti-idiotypic activity against anti-human thyroglobulin autoantibody. *J Immunol* 1984;133:190–194.

238. Sluiter WJ, Marrink J, Houwen B. Monoclonal gammopathy with an insulin binding IgG(?) M-component, associated with severe hypoglycemia. *Br J Haematol* 1986;62:679–687.

239. Ferman J, Danon F, Brouet JC. Characterization of a human monoclonal IgM with antibody activity to dsDNA. *Clin Exp Immunol* 1985;59:467–474.

240. Kilgore LL, Patterson BW, Fisher WR. Immunologic comparison of the conformations of apolipoprotein B: investigation of methodologies for the reconstitution of delipidated and denatured apolipoprotein B with nonionic surfactants. *J Biol Chem* 1986;261:8842–8848.

241. Trimarchi F, Benvenega S, Fenzi G, et al. Immunoglobulin binding of thyroid hormones in a case of Waldenström's macroglobulinemia. *J Clin Endocrinol Metab* 1982;54:1045–1050.

242. Wisloff F, Michaelsen TE, Godal HC. Monoclonal IgM with lupus anticoagulant activity in a case of Waldenström's macroglobulinaemia. *Eur J Haematol* 1987;38:456–460.

243. Backer ET, Harff GA, Beyer C. A patient with an IgG paraprotein and complexes of lactate dehydrogenase and IgG in the serum. *Clin Chem* 1987;33:1937–1938.

244. Ng VL, Hwang KM, Reyes GR, et al. High titer anti-HIV antibody reactivity associated with a paraprotein spike in a homosexual male with AIDS related complex. *Blood* 1988;71:1397–1401.

245. del Carpio J, Espinoza LR, Lauter S, et al. Transient monoclonal proteins in drug hypersensitivity reactions. *Am J Med* 1979;66:1051–1056.

246. DiMinno G, Coraggio F, Cerbone AM, et al. A myeloma paraprotein with specificity for platelet



glycoprotein IIIa in a patient with a fatal bleeding disorder. *J Clin Invest* 1986;77:157–164.

247. Hoyt RH, Durie BG. Pseudothrombocytopenia induced by a monoclonal IgM kappa platelet agglutinin. *Am J Hematol* 1989;31:50–52.

248. Hazani A, Silvan I, Tatarsky I, et al. Non-symptomatic hypercalcemia in a myeloma patient. *Am J Med Sci* 1982;283:169–173.

249. Merlini G, Fitzpatrick LA, Siris ES, et al. A human myeloma immunoglobulin G binding four moles of calcium associated with asymptomatic hypercalcemia. *J Clin Immunol* 1984;4:185–196.

250. Annesley TM, Burritt MF, Kyle RA. Artifactual hypercalcemia in multiple myeloma. *Mayo Clin Proc* 1982;57:572–575.

251. Baker BL, Hultquist DE. A copper-binding immunoglobulin from a myeloma patient: purification, identification, and physical characterization. *J Biol Chem* 1978;253:1195–1200.

252. Martin NF, Kincaid MC, Stark WJ, et al. Ocular copper deposition associated with pulmonary carcinoma, IgG monoclonal gammopathy and hypercupremia: a clinicopathologic correlation. *Ophthalmology* 1983;90:110–116.

253. Westerhausen M, Meuret G. Transferrin-immune complex disease. *Acta Haematol* 1977;57:96–101.

254. Numata Y, Tanioka F, Yoshida K, et al. Ascertainment of IgA1 (kappa)-transferrin complex in a case of multiple myeloma associated with hypersiderinemia. *Jpn J Med* 1991;30:498–503.

255. Hilgard P, Linder KH, Wetter O. Monoclonal cryoglobulin of IgG (lambda) type interacting with transferrin. *Blut* 1981;43:217–225.

256. Pettersson T, Hortling L, Teppo AM, et al. Phosphate binding by a myeloma protein. *Acta Med Scand* 1987;222:89–91.

257. Pierce LE, Joshi H, Patel S, et al. Apparent affinity of multiple myeloma (MM) paraprotein for serum phosphate. *Blood* 1988;[72 Suppl]:253a(abst).

258. Van Camp B, Reynaert P, Van Beers D. Congenital toxoplasmosis associated with transient monoclonal IgG1-lambda gammopathy. *Rev Infect Dis* 1982;4:173–178.

259. Waldenström JG. Antibody activity of monoclonal immunoglobulins in myeloma, macroglobulinemia and benign gammopathy. *Med Oncol Tumor Pharmacother* 1986;3:135–140.

260. Merlini G, Farhangi M, Osserman EF. Monoclonal immunoglobulins with antibody activity in myeloma, macroglobulinemia and related plasma cell dyscrasias. *Semin Oncol* 1986;13:350–365.

\*Portions of this chapter were published in Kyle RA, Rajkumar SV. Monoclonal gammopathies of undetermined significance and smoldering multiple myeloma. In Gertz MA, Greipp PR, eds. *Hematologic malignancies: multiple myeloma and related plasma cell disorders*. Berlin: Springer-Verlag, 2004:1–33. By permission of Mayo Foundation.

2004 Lippincott Williams & Wilkins  
John P. Greer, John Foerster, John N. Lukens  
George M. Rodgers, Frixos Paraskevas, Bertil Glader  
Wintrobe's Clinical Hematology

**HISTORY**[Earliest Diagnoses and Diagnostic Methods](#)[Earliest Treatments for Multiple Myeloma](#)**INCIDENCE AND EPIDEMIOLOGY**[Epidemiology of Myeloma](#)[Etiologic Factors](#)**PATHOGENESIS AND PATHOPHYSIOLOGY**[Cytokines and Cell Signaling](#)[Bone Marrow Microenvironment](#)[Cell Cycle](#)**CLINICAL MANIFESTATIONS**[Anemia](#)[Monoclonal Proteins](#)[Bone Disease](#)[Hypercalcemia](#)[Renal Insufficiency](#)[Infection](#)[Hemostasis in Myeloma](#)[“Acute Terminal Phase of Plasma Cell Myeloma” and Cause of Death](#)[Special Cases of Myeloma](#)**HISTOPATHOLOGY****DIAGNOSIS****TREATMENT FOR MULTIPLE MYELOMA**[Systemic Therapy](#)**HEMATOPOIETIC STEM CELL TRANSPLANTATION**[Autologous Transplant](#)[Allogeneic Transplant](#)[Donor Lymphocyte Infusions](#)[Nonmyeloablative Allogeneic Transplant](#)[Radiation](#)**STAGING AND PROGNOSIS**[Individual Prognostic Markers with Standard Intensity Chemotherapy](#)[Significance of the Extent of Response after Therapy](#)**TREATMENT OF COMPLICATIONS AND SUPPORTIVE CARE**[Treatment of Myeloma Bone Disease](#)[Spinal Cord Compression](#)[Hypercalcemia](#)[Hematologic Complications, Including Anemia, Secondary Leukemia, Hyperviscosity, and Cryoglobulinemia](#)[Renal Failure](#)[Infection Management](#)**DIFFERENTIAL DIAGNOSIS**[Reactive Plasmacytosis and Polyclonal Hypergammaglobulinemia](#)[Monoclonal Gammopathy of Undetermined Significance](#)[Primary Systemic Amyloidosis](#)[Waldenström Macroglobulinemia](#)[Light Chain Deposition Disease](#)[Acquired Fanconi Syndrome](#)[Plasma Cell Leukemia](#)[Solitary Plasmacytomas](#)[Osteosclerotic Myeloma \(POEMS Syndrome\)](#)

## REFERENCES

Multiple myeloma is a neoplastic plasma cell dyscrasia (PCD) characterized by a clinical pentad: (a) anemia; (b) a monoclonal protein in the serum or urine, or both, (c) abnormal bone radiographs and bone pain; (d) hypercalcemia; and (e) renal insufficiency or failure. With the exception of monoclonal gammopathy of undetermined significance (MGUS), it is the most common PCD, with an incidence of approximately 4.5 per 100,000 per year in the United States. Solitary plasmacytoma and plasma cell leukemia (PCL) are recognized as separate entities and are much less prevalent. The underlying pathogenesis of the plasma cell malignancies is not well understood but is an area of active investigation. At present, according to World Health Organization and Revised European American Lymphoma Classification systems, there is only one category for multiple myeloma (1). Results of clinical trials are confounded by this underclassification. Emerging information about the disease, however, will likely change this deficiency.

The interactions among the plasma cells, their antibody product, the local bone and bone marrow environment, and the other organs are complex. There is no cure for multiple myeloma, but there are many effective treatments that prolong and improve the quality of life in patients with the disease.

## HISTORY

### Earliest Diagnoses and Diagnostic Methods

Samuel Solley reported the first well-documented case of myeloma in Sarah Newbury in 1844 (mollities ossium) (2, 3). Several years later, William MacIntyre described and recorded, from a case in Thomas Alexander McBean, the properties of the disease that is now called *multiple myeloma* (4). MacIntyre and Bence-Jones noted and described some of the peculiar urine properties of this same patient. On heating, the urine was found to “abound in animal matter,” which dissolved on the addition of nitric acid but reappeared after cooling. These urinary proteins became known as *Bence Jones proteins* (5). MacIntyre and Dalrymple described the postmortem examination of McBean's bones (4): The former described the affected bones as softened and fragile, with their interiors replaced with a soft “gelatin form” blood-red substance. Dalrymple suggested that the disease began in the cancellous bone and extended through the periosteum. The nucleated cells, which formed the bulk of the gelatinous material, were heterogeneous in size and shape, but the majority were round to oval. Many of the larger and more irregular cells frequently contained two or three nuclei (3). The term *multiple myeloma* was coined in 1873 by von Rustizky (3) who independently described a similar patient to emphasize the multiple bone tumors that were present.

In 1889, Professor Otto Kahler (3) described a case involving a 46-year-old physician with multiple myeloma and published a major review of the disease. He described the skeletal pain, the albuminuria, the pallor, the anemia, a precipitable urinary protein, and the findings on necroscopy and linked these findings as part of a clinical syndrome, which bears his name (multiple myeloma is also known as *Kahler disease*).

In 1898, Weber (6, 7) predicted the usefulness of roentgen x-rays in establishing the diagnosis (6) and later postulated that the Bence Jones protein was produced in the bone marrow (7). Wright (8) emphasized that multiple myeloma arose specifically from plasma cells of the marrow; Jacobson (9) recognized Bence Jones proteins in the bloodstream; and Walters (10) concluded that the Bence Jones protein was probably

derived from blood proteins through the action of the abnormal cells in the bone marrow. The technique of bone marrow aspiration ( [3](#) ) facilitated the diagnosis of multiple myeloma.

Bayne-Jones and Wilson ( [11](#) ) identified two similar but distinct groups of Bence Jones proteins by immunizing rabbits with Bence Jones proteins derived from patients. Precipitin tests on these Bence Jones preparations revealed two distinct groups: I and II. Using the Ouchterlony test, Korngold and Lipari showed that antisera to Bence Jones protein also reacted with myeloma proteins. The two classes of Bence Jones proteins have been designated *kappa* and *lambda* as a tribute to these two men. In 1962, Edelman and Gally ( [12](#) ) showed that the light chains prepared from an immunoglobulin (Ig) G monoclonal protein and the Bence Jones protein from the same patient's urine were identical.

Serum electrophoresis, described by Tiselius in 1937 ( [13](#) ), made it possible to separate serum proteins. Longsworth et al. ( [14](#) ) applied electrophoresis to the study of multiple myeloma and described the tall narrow-based "church spire" peak. The use of filter paper as a support for protein electrophoresis permitted the separation of protein into distinct zones that could be stained with various dyes ( [15](#) ). Because this technique was simple and less expensive, this test became universally available in clinical laboratories. Paper electrophoresis was supplanted by filter paper in 1957. Most recently, high-resolution electrophoresis on agarose gel is used in most laboratories. Immunoelectrophoresis ( [3](#) ) and immunofixation or direct immunoelectrophoresis ( [16](#) ) made it possible to detect small monoclonal light chains that were not recognizable by electrophoresis.

Kunkel ( [17](#) ) hypothesized that monoclonal proteins were the product of malignant plasma cells and were the equivalent of normal antibodies produced by normal plasma cells. Before 1960, the term *gamma globulin* was used for any protein that migrated in the gamma mobility region of the electrophoretic pattern; however, in 1959, Heremans ( [18](#) ) proposed the concept of a family of proteins with antibody activity. In 1961, in a Harvey Lecture ( [19](#) ), Waldenström distinguished between monoclonal and polyclonal hypergammaglobulinemia.

In 1928, Geschickter and Copeland ( [20](#) ) reported on the largest case series of multiple myeloma—13 cases—and reviewed the 412 cases reported in the literature since 1848. They documented a higher incidence in men than women and an overall survival of approximately 2 years. They emphasized six features: (a) involvement of the skeletal trunk, (b) pathologic rib fractures, (c) Bence Jones proteinuria in 65% of cases, (d) backache with early paraplegia, (e) anemia in 77% of cases, and (f) chronic renal disease. They did not note abnormalities of blood protein or an increased erythrocyte sedimentation rate ( [3](#) ). In 1931, Magnus-Levy ( [21](#) ) described amyloidosis as a complication of multiple myeloma. Salmon and Smith ( [22](#) ) and Durie and Salmon ( [23](#) ) developed methods to quantitate the total body burden of tumor cells ( [22](#) ) and to stage patients ( [23](#) ) in 1970 and 1975, respectively.

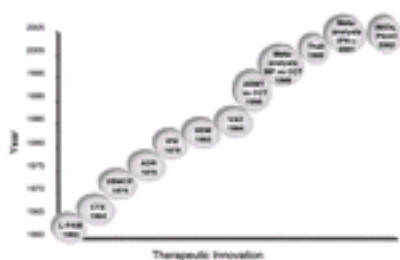
### Earliest Treatments for Multiple Myeloma

In 1947, Snapper ( [24](#) ) reported that stilbamidine along with a low-animal protein diet relieved myeloma pain in 14 of 15 patients. Subsequent studies did not confirm this benefit. Urethane was believed to be effective until 1966 ( [25](#) ). It was first used in the treatment of multiple myeloma by Alwall in 1947 ( [26](#) ) and then by Loge and Rundles in

1949 ( [27](#) ). Their early observations were encouraging, and the use of urethane became widespread. Toxic effects included severe anorexia, nausea, and vomiting. Leukopenia, thrombocytopenia, and hepatic damage also occurred ( [28](#) ). In 1966, however, Holland et al. ( [25](#) ) published the results of a randomized controlled trial of urethane versus placebo in 83 patients with symptomatic multiple myeloma. They found that there was no difference in any objective measurement of improvement between the two groups and that the median overall survival was higher in the placebo group. Previously untreated patients had a median survival of 12 or 5 months, depending on whether they received placebo or urethane, respectively.

In 1950, Thorn et al. ( [29](#) ) reported the first observations on the salutary effects of adrenocorticotrophic hormones on myeloma. During that decade, it was recognized that the adrenocorticotrophic hormones cortisone and prednisone were useful agents in patients with multiple myeloma. Corticosteroids decreased bone pain, improved hypercalcemia, increased hemoglobin values, and decreased abnormal serum and urine globulin concentrations ( [28](#) ). However, it was not until 1967 that high-dose corticosteroids were recognized as effective antineoplastic agents against multiple myeloma ( [30](#) ).

Blokhin et al. ( [31](#) ) reported benefits in three of six patients with multiple myeloma who were treated with sarcolysin (a racemic mixture of the *o*- and *l*-isomers of phenylalanine mustard). Subsequently, the *o*- and *l*-isomers were tested separately, and the antimyeloma activity was found to reside in the *l*-isomer, melphalan. Bergsagel et al. ( [32](#) ) reported significant improvement in 14 of 24 patients with multiple myeloma with the use of melphalan; this activity was quickly substantiated by others ( [33](#) ). Similar effectiveness was noted with cyclophosphamide ( [34](#) ). Subsequently, interferon- $\alpha$ , doxorubicin, carmustine (BCNU), and thalidomide have each been reported to have activity as a single agent in myeloma ( [35](#), [36](#), [37](#) and [38](#) ) ( [Fig. 98.1](#) ).



**Figure 98.1.** Landmark therapeutic innovations. ABMT, autologous bone marrow transplant; ADR, doxorubicin; CCT, conventional chemotherapy; CTX, cyclophosphamide; HDM, high-dose melphalan; IFN, interferon; IMiDs, immunomodulatory derivatives of thalidomide; L-PAM, melphalan; MP, melphalan and prednisone; PS341, proteasome inhibitor; Thali, thalidomide; VAD, vincristine, doxorubicin, and dexamethasone; VBMCP, vincristine, carmustine, melphalan, cyclophosphamide, and prednisone (M-2 regimen). (From Dispenzieri A, Lacy MQ, Greipp PR. Multiple myeloma. In: Gertz MA, Greipp PR, eds. Hematologic malignancies: multiple myeloma and related plasma cell disorders. Berlin: Springer-Verlag, 2004:53-109, with permission.)

## INCIDENCE AND EPIDEMIOLOGY

### Epidemiology of Myeloma

Approximately 14,400 new cases of multiple myeloma are diagnosed each year, and 11,200 deaths are recorded in the United States ( [39](#) ). Surveillance, Epidemiology, and End Results incidence–data age–adjusted rates from 1992 through 1998 show an overall incidence of 4.5 per 100,000 per year, with the incidence among whites being 4.2 per 100,000 per year and among blacks being 9.3 per 100,000 per year ( [40](#) ). The male to female ratio is 1.4 to 1 ( [40](#) ). The median age at diagnosis of myeloma is 71 years of age ( [39](#) ). Mortality rates are consistently higher among men than women and among blacks than whites in each age group ( [40](#) ). Myeloma accounts for 1% of all malignancies and 10% of all hematologic malignancies in whites and 20% of all hematologic malignancies in African Americans ( [40](#) ). International mortality data reveal that the highest rates of myeloma occur in Northern Europe, North America, Australia, and New Zealand, and the lowest rates are in Japan, Yugoslavia, and Greece ( [41](#) ). Geographic clusters ( [42](#) ) and familial clusters ( [43](#) , [44](#) , [45](#) , [46](#) , [47](#) and [48](#) ) of myeloma among first degree relatives have been documented. Modest increases in multiple myeloma rates were observed when incidence data from 1973 to 1992 were calculated in nine population–based cancer registries, with further projected increases by 2007 ( [49](#) ). Some of this increase could be due to a heightened awareness of the disease.

## **Etiologic Factors**

### **RADIATION EXPOSURES**

**Atomic Bomb Exposure** Reports of increased myeloma incidence and mortality among Japanese atomic bomb survivors have suggested an association between ionizing radiation and multiple myeloma. Evaluations of cancer incidence ( [50](#) ) and mortality ( [51](#) ) among Japanese atomic bomb survivors have demonstrated an increased risk of multiple myeloma with increasing radiation dose. However, with an additional 12 years of follow–up from the previous report, the findings of an increased myeloma risk associated with atomic bomb irradiation were not maintained ( [52](#) ).

**Radiation–Related Occupation** An excess of myeloma deaths among American radiologists was reported in the 1960s ( [53](#) ). Myeloma risk was considered to be two times higher among radiologists exposed to low doses of radiation than among physicians not exposed to radiation ( [54](#) ). However, among 27,000 Chinese diagnostic radiography workers, no excess incidence of myeloma was observed in a 30–year period ( [55](#) ). An analysis of 115,000 workers from the combined roster of four different nuclear plants showed a positive association between multiple myeloma and radiation exposure in older age groups ( [56](#) ). Increases in multiple myeloma incidence and mortality have been observed among British military men who participated in atmospheric nuclear weapons testing ( [57](#) ) but not among New Zealand military personnel who participated in similar nuclear weapons testing ( [58](#) ).

**Diagnostic and Therapeutic X-rays** Diagnostic x–ray exposure has not been linked clearly with the development of multiple myeloma in most epidemiologic studies ( [59](#) , [60](#) , [61](#) and [62](#) ). A large, multicenter, population–based, case–control study showed no evidence of excess risk of myeloma among individuals who reported exposure for ten or more diagnostic radiographs ( [63](#) ). One study reported that the overall risk for multiple myeloma was not high (risk ratio, 1.14) but that there was evidence of increasing risk with exposure to increasing numbers of radiographic procedures ( [64](#) ). Of historic interest is the finding of an association between myeloma and the use of Thorotrast ( [65](#) ). Studies of the effects of therapeutic irradiation on myeloma risk have shown conflicting results, but a study of 180,000 women treated for cervical cancer demonstrated no overall excess risk of developing myeloma ( [66](#) ). Similarly, a study of 14,000 patients who had ankylosing



spondylitis and were treated with radiation revealed no significant increase in the risk of developing myeloma ( [67](#) ).

## WORKPLACE EXPOSURES

***Agricultural Occupations and Exposures*** Several epidemiologic studies have evaluated the risk of myeloma among agricultural workers, with positive associations reported by many, but not all, of the studies ( [68](#), [69](#), [70](#), [71](#), [72](#), [73](#), [74](#), [75](#) and [76](#) ). Khuder and Mutgi ( [77](#) ) found a relative risk of 1.23 in a metaanalysis of several studies.

***Metal Industries*** Workers in various metal occupations and industries have been reported to have an increased myeloma risk ( [78](#), [79](#) and [80](#) ).

***Benzene*** Benzene has been suggested as a possible etiologic agent for multiple myeloma ( [81](#), [82](#) and [83](#) ). A comprehensive review of published literature found no evidence of a link between benzene exposure and myeloma ( [84](#) ). Subsequently, Sonoda et al. ( [85](#) ) conducted a metaanalysis of case-control studies and showed no excess risk for the development of multiple myeloma. A metaanalysis by Wong and Raabe ( [86](#) ) of more than 350,000 petroleum workers similarly showed no increased risk.

## LIFESTYLE FACTORS

***Cigarette Smoking and Alcohol Consumption*** Multiple studies to date have found no etiologic role for cigarette smoking or alcohol consumption in the development of multiple myeloma ( [87](#), [88](#), [89](#) and [90](#) ).

***Dietary Links*** Tavani et al. ( [91](#) ) suggested a dietary link for multiple myeloma and found a higher risk among people consuming large quantities of liver [odds ratio (OR), 2] and butter (OR, 2.8) and a lower risk among people consuming large amounts of vegetables (OR, 0.4). Coffee and alcohol had no association with multiple myeloma. No association between multiple myeloma and consumption of red meat has been found. Brown et al. ( [92](#) ) looked at diet and nutrition as risk factors for multiple myeloma among blacks and whites in the United States. Elevated risks were associated with obesity in comparison to people of normal weight. Obesity was more frequent in black than in white controls. Reduced risks were associated with the frequent intake of cruciferous vegetables, fish, and vitamin C supplements. The authors concluded that the greater use of vitamin C supplements by whites and the higher frequency of obesity among blacks may explain part of the higher incidence of multiple myeloma among blacks compared to whites in the United States.

***Socioeconomic Status*** Some investigators have reported that there is an inverse relationship between the risk of multiple myeloma and socioeconomic status ( [93](#) ) and that this inverse correlation may account for a substantial amount of the black and white differential of multiple myeloma incidence ( [94](#) ). Earlier studies did not show a link between socioeconomic status and myeloma ( [95](#) ).

***Hair Dyes*** Personal use of hair dyes was evaluated as a risk factor for myeloma ( [96](#) ), including two prospective studies ( [97](#), [98](#) ). Thun et al. ( [97](#) ) found that women using permanent hair dyes are not generally at increased risk of fatal cancer. Women with prolonged use of dark, particularly black, hair dyes may have increased risk of fatal non-Hodgkin lymphoma and multiple myeloma, but these women are a small fraction of hair dye users. A recent metaanalysis by Correa et al. ( [99](#) ) showed no increased risk.

## PRECURSOR MEDICAL CONDITIONS

***Monoclonal Gammopathy of Undetermined Significance*** MGUS is considered a potential precursor condition for multiple myeloma. In a long-term study of prognosis in MGUS, Kyle et al. ( [100](#) ) identified 1384 patients in southeastern Minnesota in whom MGUS was diagnosed. During 11,009 person-years of follow-up, 115 of the 1384 MGUS patients progressed to multiple myeloma, IgM lymphoma, primary amyloidosis, macroglobulinemia, chronic lymphocytic leukemia, or plasmacytoma. The risk of progression of MGUS to multiple myeloma-related disorders is thus approximately 1% per year ( [100](#) ). Among a group of 1231 patients in Italy with MGUS and smoldering multiple myeloma, cumulative transformation probability at 10 and 15 years was 14% and 30%, respectively ( [101](#) ).



**Chronic Antigenic Stimulation** Repeated or chronic antigenic stimulation of the immune system may lead to myeloma. Several case-control studies have suggested that myeloma risk is associated with past history of infections ( [89](#), [102](#), [103](#) ), inflammatory conditions, connective tissue disorders, autoimmune illnesses, and allergy-related disorders ( [69](#) ). Increased risks of myeloma have been observed in some conditions, such as allergies ( [104](#) ) and rheumatoid arthritis ( [105](#), [106](#) ). Other studies of individuals with these conditions have shown no increased risk of multiple myeloma ( [107](#), [108](#), [109](#) and [110](#) ).

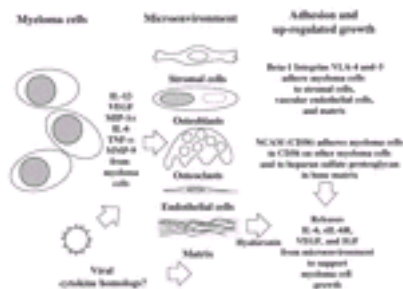
**Viral Infections** Patients with the human immunodeficiency virus may have an increased likelihood of developing myeloma ( [111](#), [112](#) ). In addition, myeloma and hepatitis C may be associated ( [113](#), [114](#) and [115](#) ). The finding of human herpesvirus 8 has been suggested as a possible etiologic agent ( [116](#), [117](#) ), but this has not been confirmed ( [118](#), [119](#), [120](#) and [121](#) ).

## PATHOGENESIS AND PATHOPHYSIOLOGY

To date, no single molecular defect can account for the pathogenesis of multiple myeloma. Malignant plasma cells are long-lived cells, typically with low proliferative rates and labeling indices ( [122](#), [123](#) ). A postgerminal cell origin is indicated by their somatically hypermutated, rearranged Ig genes ( [124](#) ). A multitude of abnormalities has been identified in signaling pathways, apoptotic mechanisms, the bone marrow microenvironment, and the cell cycle. Factors, including the level of gene expression, protein expression, and gene product phosphorylation status of cell cycle molecules, may all be relevant for the propagation of the malignant plasma cells. Extracellular signaling alterations include changes in stromal cell, osteoblast, osteoclast, vessel endothelial cell, and immune cell interactions. These changes may, in turn, result in activation, adhesion, and cytokine production that fuel myeloma cell proliferation and survival.

### Cytokines and Cell Signaling

The search for a growth factor for myeloma cells culminated in the identification of interleukin (IL)-6, formerly known as *B-cell growth factor* or *hybridoma growth factor* ( [125](#) ). IL-6 is among the most important proliferation and survival factors in myeloma ( [126](#) ). Predominantly produced by bone marrow stromal cells—macrophages, fibroblasts, osteoblasts, osteoclasts, and monocytes ( [Fig. 98.2](#) ) ( [127](#) )—it serves as a growth factor and as an antiapoptotic factor ( [128](#), [129](#) and [130](#) ). In the majority of cases, myeloma cells and cell lines are capable of producing IL-6 and the IL-6 receptor, resulting in autocrine stimulation ( [129](#), [131](#), [132](#) and [133](#) ). IL-6 transmits messages intracellularly through the signal-transducing protein gp130, which can activate two pathways: the JAK-STAT pathway ( [134](#) ) and the Ras-MAP kinase pathway ( [135](#) ). Through the former pathway, which includes JAK-2 and STAT3, the antiapoptotic proteins Mcl-1 ( [134](#) ) and Bcl-X<sub>L</sub> ( [136](#) ) are up-regulated; through the latter pathway, transcription factors, such as ELK-1, AP-1, and NF-IL-6 ( [134](#) ), are up-regulated. Nuclear factor- $\kappa$ B (NF- $\kappa$ B) ( [137](#) ) and IL-6 ( [138](#), [139](#) ) may also mediate the observed increase in the antiapoptotic proteins Bcl-2 ( [140](#), [141](#) ), Mcl-1 ( [138](#) ), and Bcl-X<sub>L</sub> ( [138](#), [139](#), [142](#), [143](#) ). The overall effect of these pathways is prevention of apoptosis and enhancement of multiple myeloma proliferation. In addition, the constitutive activation of STAT3 may also be important in the pathogenesis of multiple myeloma, independent of IL-6 ( [144](#) ). Moreover, CD40 activation of myeloma cells can alter the cell surface phenotype, triggering autocrine IL-6 secretion regulating myeloma cell cycle in a p53-dependent fashion ( [145](#) ).



**Figure 98.2.** Paracrine myeloma cell growth model. Putative pathogenic mechanisms in myeloma. IGF, insulinlike growth factor; IL, interleukin; MIP, macrophage inflammatory factor; MMP, metalloproteinase; NCAM, neural cell adhesion molecule; TNF, tumor necrosis factor; VEGF, vascular-derived endothelial growth factor; VLA, very late antigen. (From Dispenzieri A, Lacy MQ, Greipp PR. Multiple myeloma. In: Gertz MA, Greipp PR, eds. Hematologic malignancies: multiple myeloma and related plasma cell disorders. Berlin: Springer-Verlag, 2004:53–59, with permission.)

Other cytokines and growth factors produced by myeloma and stromal cells that maintain myeloma growth ( [146](#) ) include IL-1 $\beta$  ( [147](#) , [148](#) and [149](#) ), vascular-derived endothelial growth factor (VEGF), insulinlike growth factor ( [150](#) , [151](#) , [152](#) , [153](#) , [154](#) and [155](#) ), and tumor necrosis factor- $\alpha$  ( [156](#) , [157](#) ). Aberrant expression of IL-1 $\beta$  may be a critical step in the transition of MGUS to multiple myeloma ( [149](#) , [158](#) ). IL-1 $\beta$  up-regulates production of IL-6, changes expression of cell adhesion molecules, and has been shown to have osteoclast-activating factor activity. Although IL-1 $\beta$  does not stimulate myeloma cell proliferation directly, it induces production of IL-6 by virtue of its effect on stromal cells in the marrow ( [159](#) ). Myeloma cells are capable of expressing and secreting VEGF and responding to the cytokine in an autocrine fashion ( [160](#) , [161](#) ). Moreover, stromal and microvascular endothelial cell exposure to VEGF induces an increase in IL-6 secretion ( [160](#) ), which then further stimulates myeloma cells. The precise role basic fibroblast growth factor (bFGF), another potent angiogenic factor, plays in the growth of myeloma cells is under active investigation ( [162](#) ). Higher bFGF levels have been found in more advanced stages of multiple myeloma ( [162](#) ). Insulinlike growth factor, which is believed to signal through the phosphatidylinositol-3'-kinase pathway ( [150](#) ), is capable of directly stimulating myeloma cell growth, enhancing myeloma cell responsiveness to IL-6 through mitogen-activated protein kinase ( [153](#) ), and also inhibiting apoptosis by increasing expression of BAD ( [150](#) ).

### Bone Marrow Microenvironment

There is a synergistic, pathologic relationship between myeloma cells and the cells comprising the bone marrow microenvironment, including fibroblasts, osteoblasts, and osteoclasts. The stromal cells of the marrow of myeloma patients produce high levels of IL-6 *in vitro* ( [163](#) ). The IL-6 serves as a growth and survival factor for benign and malignant plasma cells, which produce IL-1 $\beta$  ( [158](#) , [159](#) ), VEGF, and macrophage inflammatory protein-1 $\alpha$  (MIP-1 $\alpha$ ) ( [160](#) , [161](#) ). In turn, IL-1 $\beta$  and MIP-1 $\alpha$  regulate and activate osteoclasts ( [158](#) , [164](#) , [165](#) ).

A cell adhesion molecule belonging to the Ig superfamily, CD56 (N-CAM), is strongly expressed in most plasma cells of myeloma patients ( [166](#) ) and is believed to play a role in myeloma homing and cell adhesion to the marrow. Increased levels of the adhesion molecules lymphocyte function-associated antigen-3 ( [167](#) ), lymphocyte

function-associated antigen-1 (CD11a) ( [168](#) ), and very late antigen-4 are expressed on the myeloma cells in the majority of patients. Very late antigen-4 may act to bind myeloma cells to fibronectin in bone marrow ( [169](#) ), which, under appropriate conditions, can significantly increase IL-6 production by stroma ( [156](#) ). Cell-cell contact between marrow stromal cells and myeloma cells via vascular cell adhesion molecule-1 and  $\alpha_4\beta_1$  integrin enhances production of osteoclast-stimulating activity ( [170](#) ). Hyaluronan, a glycosaminoglycan component of the bone marrow extracellular matrix, appears to be a survival and proliferation factor for myeloma cells ( [171](#) ).

The endothelial microvascular environment has also been shown to be important in multiple myeloma biology ( [172](#) ). There is a high correlation between the extent of bone marrow angiogenesis, evaluated as microvessel area, and the proliferating (S phase) fraction of marrow plasma cells in patients with multiple myeloma and in those with MGUS ( [172](#), [173](#) and [174](#) ). VEGF plays an important role in angiogenesis by acting as a potent inducer of vascular permeability as well as serving as a specific endothelial cell mitogen. Plasma cells in the bone marrow from multiple myeloma patients express VEGF, which can thereby interact with the Flt-1 and KDR high-affinity VEGF receptors highly expressed on bone marrow myeloid and monocytic cells surrounding the tumor ( [173](#) ).

## Cell Cycle

Regulatory signals underlying proliferation of myeloma cells include increased cyclin D1 expression, hypermethylation of the cyclin-dependent kinase (CDK) pathway regulatory gene p16 ( [175](#) ), mutations of the *ras* oncogene ( [176](#), [177](#) ), loss of p53 ( [178](#), [179](#) and [180](#) ), and, possibly, overexpression of c-*myc* in progressive disease ( [181](#) ).

Approximately one-third of myeloma patients have up-regulation of cyclin D1 by immunohistochemistry; the plasma cells of these same patients tend to have higher proliferative rates ( [182](#) ). The t(11;14)(q13;q32) translocation, which juxtaposes the Ig heavy chain promoter and the cyclin D1 gene, is seen in approximately 25% of multiple myeloma patients ( [183](#), [184](#), [185](#), [186](#) and [187](#) ).

p15 and p16 are important cell cycle inhibitors that suppress cell proliferation through inhibition of CDK4 or CDK6, or both, thereby preventing the phosphorylation of the retinoblastoma gene ( *RB* ). Although large deletions of p15 and p16 are rare in myeloma (0 to 12% of cases) ( [188](#), [189](#) and [190](#) ), selective methylation of these genes, a form of transcriptional inactivation, occurs in as many as 67% and 75% of cases, respectively ( [191](#), [192](#) and [193](#) ). Most data, including that of the authors ( [194](#) ), suggest that hyper-methylation of p16 or p15 is associated with disease progression ( [191](#), [193](#), [195](#), [196](#), [197](#) and [198](#) ).

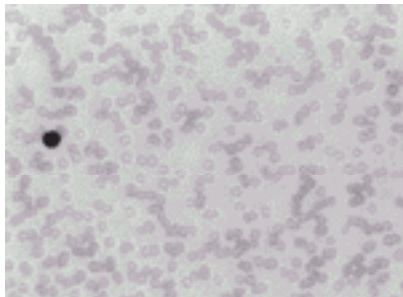
K- and N- *ras* mutations have been described in 25 to 100% of newly diagnosed multiple myeloma patients ( [177](#), [199](#) ), depending on the technique used for detection. A p53 tumor-suppressor gene deletion is present in less than one-third of plasma cells from newly diagnosed myeloma patients ( [180](#) ), and mutations are even less common ( [200](#), [201](#), [202](#) and [203](#) ). The c-*myc* protein and c-*myc* RNA are overexpressed in approximately 25% of multiple myeloma patients ( [204](#), [205](#) ). Rearrangements of c-*myc* gene are present in approximately 15% of patients with multiple myeloma or primary PCL ( [206](#) ). Dysregulation of c-*myc* appears to be caused principally by complex genomic rearrangements that occur during late stages of multiple myeloma progression ( [181](#) ).

## CLINICAL MANIFESTATIONS

The symptoms of multiple myeloma may be nonspecific and include fatigue, bone pain, easy bruising and bleeding, recurrent infections, manifestations of anemia, hypercalcemia, lytic bone lesions, hyperviscosity, thrombocytopenia, and hypogammaglobulinemia. Weakness, infection, bleeding, and weight loss are reported in as many as 82%, 13%, 13%, and 24% of patients, respectively ( [207](#), [208](#), [209](#) and [210](#) ). Hypercalcemia is present in 18 to 30% of patients ( [207](#), [208](#) and [209](#) ). One- to two-thirds of patients present with spontaneous bone pain ( [37](#), [38](#) and [39](#) ). “Tumor fever” is present in less than 1% of presenting patients.

### Anemia

The most common clinical feature of multiple myeloma is anemia. A hemoglobin concentration of less than 120 g/L occurs in 40 to 73% of patients at presentation ( [207](#), [208](#) and [209](#) ) and contributes to the weakness and fatigue observed in as much as 82% of patients ( [207](#), [208](#), [209](#) and [210](#) ). The anemia is normochromic, normocytic in most patients, but macrocytosis may be observed as well. When there are high concentrations of serum Ig, rouleau formation may be observed ( [Fig. 98.3](#) ). The combination of anemia and hyperproteinemia leads to a marked increase of the erythrocyte sedimentation rate in more than 90% of cases ( [211](#) ).



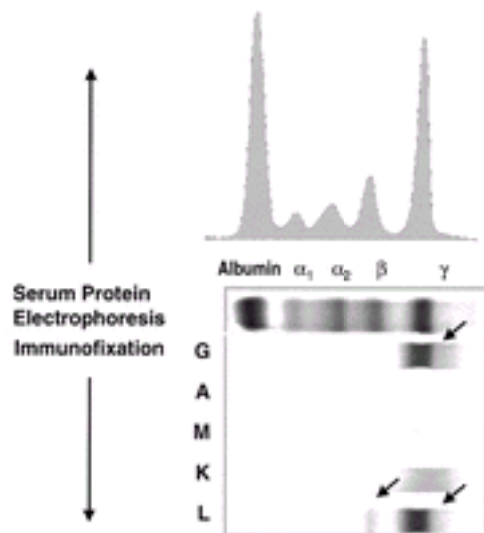
**Figure 98.3.** Rouleau formation. See [Color Plate](#). (From Dispenzieri A, Lacy MQ, Greipp PR. Multiple myeloma. In: Gertz MA, Greipp PR, eds. Hematologic malignancies: multiple myeloma and related plasma cell disorders. Berlin: Springer-Verlag, 2004:53–109, with permission.)

The anemia is related partially to direct infiltration and replacement of the bone marrow. Hemoglobin concentration is also correlated directly with the percentage of myeloma cells in S phase ( [212](#) ), suggesting that the bone marrow cytokine milieu, permissive for myeloma cell proliferation, is not conducive to efficient erythropoiesis. Cytokines, like tumor necrosis factor- $\alpha$  and IL-1, may inhibit erythropoiesis ( [213](#) ). Fas ligand-mediated erythroid apoptosis is also increased in patients with myeloma ( [214](#) ). Finally, relative erythropoietin deficiency from myeloma-induced renal insufficiency also contributes to the observed anemia.

### Monoclonal Proteins

The M protein (also known as *M component*, *myeloma protein*, or *M spike*) is a hallmark of the disease; 97% of myeloma patients have an intact Ig or a free light chain that can be

detected by protein electrophoresis ( [Fig. 98.4](#)), immunoelectrophoresis, or immunofixation studies of the serum or urine ( [208](#), [209](#)). Those cases without a detectable monoclonal protein are referred to as *nonsecretory myeloma*. Historically, monoclonal proteins have had a valuable role in the fields of immunology and molecular biology for distinguishing MGUS from myeloma and for calculating myeloma tumor burden and kinetics ( [22](#), [100](#), [215](#)). Practically, M protein concentrations are used to stage myeloma patients and to document their response to treatment.



**Figure 98.4.** Serum protein electrophoresis patterns and immunofixation patterns. (From Dispenzieri A, Lacy MQ, Greipp PR. Multiple myeloma. In: Gertz MA, Greipp PR, eds. Hematologic malignancies: multiple myeloma and related plasma cell disorders. Berlin: Springer-Verlag, 2004:53–109, with permission.)

An M protein represents overproduction of a homogeneous Ig or Ig fragment. In a series of 1027 newly diagnosed cases of myeloma, the Ig type was IgG, IgA, IgD, and free light chain only (Bence Jones myeloma) in 52%, 20%, 2%, and 16% of cases, respectively ( [208](#)). Fewer than 1% of myelomas are IgM; most IgM monoclonal proteins are associated with diagnoses of MGUS, lymphoma, Waldenström macroglobulinemia, or primary systemic amyloidosis ( [216](#)). Ninety-three percent of patients have a monoclonal protein detected in their serum. Approximately 90% of myeloma patients have reduction in at least one of their uninvolved Igs ( [216](#)). Approximately 70% of myeloma patients have a monoclonal protein—or fragment thereof—detected in the urine.

## Bone Disease

Approximately one-third to two-thirds of patients present with bone pain ( [207](#), [208](#), [209](#) and [210](#)). There is an uncoupling of the usually tightly regulated balance between osteoclastic and osteoblastic activity. Even before the development of bone lesions, enhanced osteoblastic recruitment with an increased generation of new osteoclasts is observed in early multiple myeloma ( [217](#)). Regardless of the initiating signal, whether IL-1 $\beta$ , IL-6 and sIL-6R, tumor necrosis factor- $\alpha$ , MIP-1 $\alpha$ , receptor activator of NF- $\kappa$ B ligand, or para-thyroid hormone-related protein ( [165](#)), the eventual outcome is bone destruction. Myeloma bone disease is a major source of morbidity and may present as an area of persistent pain or as a vague migratory bone pain, often in the lower back and pelvis. The

type, location, and duration of the pain have no characteristic features. At times, pain and tenderness may be sudden in onset, especially when associated with a pathologic fracture, and are most commonly precipitated by movement. Persistent localized pain may also be associated with a pathologic fracture.

A myelomatous lesion may extend through the cortex of a vertebral body and may cause nerve root or spinal cord compression in less than 2% of patients (207). Alternatively, the myeloma can disturb the mechanical integrity of a vertebral body, resulting in compression fracture with retropulsion of plasmacytoma or bony fragments into the spinal canal, again causing neurologic deficit.

Approximately 75% of patients have punched-out lytic lesions, osteoporosis, or fractures on conventional radiography. The vertebrae, skull, ribs, sternum, proximal humeri, and femora are involved most frequently (208, 209 and 210) (Fig. 98.5). A small subset of patients have *de novo* osteosclerotic lesions (218, 219 and 220), and, in a few patients, osteosclerosis is seen after therapy and may serve as a marker of healing.



**Figure 98.5.** Skeletal survey. **A:** Skull. **B:** Long bone. **C:** Compression fracture. **D:** Diffuse signal abnormality, thoracolumbar spine, with compression fracture. T1 (left); T2 (right). (From Dispenzieri A, Lacy MQ, Greipp PR. Multiple myeloma. In: Gertz MA, Greipp PR, eds. Hematologic malignancies: multiple myeloma and related plasma cell disorders. Berlin: Springer-Verlag, 2004:53–109, with permission.)

Because myelomatous bone lesions are characteristically lytic, conventional radiography is superior to technetium 99m bone scanning (221, 222). Approximately twice as many myelomatous bone lesions are detected by radiograph than by bone scan; an exception to this general finding is at the lumbar spine and the rib cage, where the two methods are equally reliable (222). There have been reports supporting the use of technetium 99m sestamibi scans. These scans are almost as sensitive as plain radiographs for bone disease in untreated patients (i.e., patients with active disease) (223). They may be able to distinguish active myelomatous bone lesions from inactive lesions (223) and are quite sensitive for bone marrow involvement (224, 225 and 226). There is a high concordance between scintigraphic findings and clinical status in patients undergoing chemotherapy or autologous stem cell transplantation (227, 228). Fluorodeoxyglucose positron emission



tomography also shows promise in the staging of myeloma, with sensitivity and specificity rates of 84 to 92% and 83 to 100%, respectively ( [229](#) ).

Computed tomography and magnetic resonance imaging (MRI) are more sensitive than conventional radiography. Both reveal specific lesions in 40% of stage I myeloma patients ( [230](#) ). The presence of lacunae larger than 5 mm with trabecular disruption on computed tomography appears to be sensitive and specific for myeloma. This information may be useful in distinguishing between senile and myelomatous osteoporosis and compression fractures ( [231](#) ). The finding of diffusely decreased signal intensity and a multinodular appearance on MRI ( [230](#) ) may also be a useful indicator of early disease. Among asymptomatic multiple myeloma patients with normal radiographs, 50% have tumor-related abnormalities on MRI of the lower spine ( [232](#) ). In patients with stage I myeloma, MRI can distinguish patients at higher and lower risks of progression ( [233](#) ). One-third of patients with an apparently solitary plasmacytoma of bone have evidence of other plasma cell tumors on MRI ( [234](#) ).

MRI is superior to radiographs for the detection of lesions in the pelvis and the spine, but, overall, it is inferior to radiographs for detecting bone involvement in multiple myeloma (79% vs. 87%, respectively) ( [235](#) ). On MRI, vertebral fractures due to spinal infiltration or osteoporosis are seen in 48% of patients with symptomatic myeloma, and spinal canal narrowing with impingement occurs in 20% ( [232](#) ). MRI has been said to have predictive value in patients newly diagnosed with myeloma and in patients who have received chemotherapy ( [236](#) , [237](#) ). Three patterns are described: focal lesions, diffuse involvement, and an inhomogeneous pattern of tiny lesions against a background of normal marrow (variegated) ( [237](#) , [238](#) ). Not surprisingly, there are correlations between MRI patterns of marrow involvement and bone marrow plasmacytosis ( [237](#) , [239](#) ), and the clinical stage ( [238](#) ). After treatment, resolution of marrow abnormality or persistent abnormality without enhancement corresponds to a complete response ( [236](#) ). In one analysis, the best independent prognosticators of survival were the MRI findings and C-reactive protein levels. Even though patients with the diffuse pattern had more bone marrow plasmacytosis, higher serum calcium values, higher  $\beta_2$ -microglobulin ( $\beta_2M$ ) values, and lower hemoglobin concentration, these factors were not significant on multivariate analysis ( [240](#) ). However, given the expense of MRI, it cannot be recommended for routine clinical use in all symptomatic patients.

## Hypercalcemia

Hypercalcemia occurs in 18 to 30% of patients. Approximately 13% have concentrations greater than 11 mg/dl. Rates of hypercalcemia at presentation have been decreasing since the 1980s, perhaps because of the earlier diagnosis of patients ( [207](#) , [208](#) , [209](#) and [210](#) ). Hypercalcemic patients may complain of fatigue, constipation, nausea, or confusion. Calcium can precipitate in the kidneys and can aggravate renal insufficiency. Inorganic phosphate is rarely decreased, except in cases of acquired Fanconi syndrome ( [241](#) ).

## Renal Insufficiency

Approximately 25% of myeloma patients have a serum creatinine value greater than 2 mg/dl at diagnosis. Another 25% have mildly elevated creatinine values ( [207](#) , [208](#) , [209](#) and [210](#) , [242](#) , [243](#) and [244](#) ). Patients with Bence Jones or IgD myeloma have the highest rates of renal insufficiency ( [243](#) , [245](#) ). Free light chain proteinuria is a risk factor for renal failure ( [246](#) ). Other contributing factors to the renal insufficiency include hypercalcemia,



dehydration, hyperuricemia, and the use of nephrotoxic drugs ( [247](#) ). If the renal insufficiency reverses with therapy, as it does in more than one-half of cases ( [246](#) , [248](#) ), survival is fourfold to sevenfold higher than in those in whom it does not ( [242](#) , [249](#) ). Factors predicting for renal function recovery include a serum creatinine of less than 4 mg/dl, serum calcium value of greater than 11.5 mg/dl, proteinuria of less than 1 g per 24 hours, and adequate rehydration ( [242](#) ). For those patients with multiple myeloma and severe renal failure who survive the first 2 months on dialysis, 40% have an objective response to chemotherapy and a median survival of almost 2 years ( [250](#) ).

The pathologic lesion of myeloma kidney consists of monoclonal light chains in the tubules in the form of dense, often laminated, tubular casts. These casts contain albumin and Tamm–Horsfall protein. Light chains are normally filtered by the glomeruli and are reabsorbed and catabolized in the nephron's proximal tubules. It is postulated that these systems become overwhelmed, and casts result. When other causes contributing to renal insufficiency are excluded, there is a good correlation between the extent of myeloma cast formation and the severity of renal insufficiency ( [251](#) , [252](#) ). Tubular atrophy and degeneration correlate well with renal dysfunction ( [253](#) ). The most common findings on autopsy include tubular atrophy and fibrosis (77%), tubular hyaline casts (62%), tubular epithelial giant cell reaction (48%), and nephrocalcinosis (42%). Evidence of acute and chronic pyelonephritis were observed in 20% and 23% of autopsy cases, respectively. Plasma cell infiltrates and amyloid may be observed in 10% and 5% of cases, respectively ( [210](#) ). Rarely, myeloma may be associated with the acquired Fanconi syndrome ( [241](#) ).

An important feature of myeloma kidney is that it is primarily a tubular, rather than a glomerular, disease ( [253](#) ). Glomerular function is preserved initially, and there is a predominance of Ig light chain protein in the urine instead of the nonspecific protein loss that is observed in glomerular disease. This feature helps predict the renal lesion: Nonspecific protein loss (i.e., mostly albumin) is more compatible with primary systemic amyloidosis, light chain deposition disease (LCDD) of the kidney, or proteinuria unrelated to PCD ( [251](#) ); a free light chain predominance is consistent with myeloma kidney.

## Infection

Patients with multiple myeloma are at high risk for bacterial infections and for dying of overwhelming bacteremia. Overall, the incidence of infection is from 0.8 to 1.4 per patient-year ( [254](#) , [255](#) and [256](#) ). During the first 2 months after initiating chemotherapy, the infection incidence is as high as 4.68 infections per patient-year ( [256](#) ) but decreases to 0.44 to 0.49 per patient-year in those reaching a plateau phase ( [255](#) , [256](#) ). Risk factors for infection are serum creatinine values greater than or equal to 2 mg/dl ( [254](#) , [256](#) ) and decreased levels of polyclonal serum Igs ( [255](#) , [256](#) ).

Since the 1960s, gram-negative bacilli have become more common pathogens than *Streptococcus pneumoniae* in patients with myeloma ( [257](#) ). At disease onset, infections with encapsulated organisms, such as *S. pneumoniae* and *Haemophilus influenzae*, are most common ( [257](#) ). After diagnosis, the proportion of infections due to gram-negative bacilli and *Staphylococcus aureus* increases markedly, and they are responsible for more than 90% of deaths from infection ( [257](#) ). The mechanism of the immunodeficiency observed in these patients is not understood completely.

## Hemostasis in Myeloma

Multiple myeloma can be associated with hemostatic abnormalities, more often bleeding than thrombosis. Bleeding as a complication of myeloma may be present in as many as one-third of patients ( [271](#) ) and is related to thrombocytopenia, uremia, hyperviscosity, and interference with the function of coagulation factors.

Rarely, myeloma proteins may also interact with coagulation proteins. The Ig may interfere with fibrin monomer aggregation ( [271](#) , [272](#) ) or may serve as a specific inhibitor of thrombin ( [273](#) ), von Willebrand factor ( [111](#) ), and factor VIII ( [271](#) ). Heparinlike anticoagulants have been observed ( [274](#) ). Nonspecific inhibitors may also be present, but, unlike the specific inhibitors, they do not correlate with clinically observed bleeding tendencies ( [271](#) ). Depression of clotting factors II, V, VII, VIII, and X and fibrinogen has been described ( [271](#) ).

The association with thrombosis is less clear because of coexisting factors, such as old age and immobility, that confound the interpretation of available data; however, the risk of thrombosis may be increased in myeloma patients ( [271](#) , [275](#) ). Individual cases of aberrance have been reported. Monoclonal proteins have been shown to be responsible for lupus anticoagulants ( [276](#) , [277](#) ), acquired protein S deficiency ( [278](#) , [279](#) ), acquired activated protein C resistance ( [280](#) ), and inhibition of tissue plasminogen activator ( [281](#) ).

Fewer than 7% of myeloma patients have a viscosity greater than 4 cP ( [208](#) , [209](#) ). Symptoms of hyperviscosity include bleeding (particularly of the oronasal areas), purpura, decrease in visual acuity, retinopathy, neurologic symptoms, dyspnea, expanded plasma volume, and congestive heart failure. Most patients become symptomatic when the serum viscosity is 6 or 7 cP (normal is less than or equal to 1.8 cP).

### “Acute Terminal Phase of Plasma Cell Myeloma” and Cause of Death

Bergsagel and Pruzanski ( [282](#) ) described the “acute terminal phase” of patients with myeloma, which they observed in approximately one-third of their preterminal patients. They defined the syndrome as *rapidly progressive disease* with an unexplained fever and pancytopenia and a hypercellular marrow. Extramedullary plasmacytomas are also not uncommon preterminally ( [283](#) ). As the disease progresses, and at autopsy, cutaneous, visceral, and even meningeal involvement is possible ( [283](#) ). Besides *progressive disease*, the most frequent causes of death are infection in 24 to 52% and renal failure in approximately 20% of patients ( [210](#) , [246](#) , [282](#) , [283](#) ). Acute leukemia, myelodysplastic syndromes, and hemorrhage are the causes of death in a minority of patients ( [210](#) , [282](#) , [283](#) ). In one autopsy series, 85% of patients had evidence of bacterial or fungal infection, and myelomatous involvement was found in the spleen, liver, lymph nodes, and kidneys in 45%, 28%, 27%, and 10% of patients, respectively. Other, less frequent areas of myelomatous involvement were lung, pleura, adrenal glands, pancreas, and testis ( [210](#) ).

### Special Cases of Myeloma

**NONSECRETORY MULTIPLE MYELOMA** Nonsecretory multiple myeloma accounts for 1 to 5% of myeloma cases ( [209](#) , [284](#) , [285](#) , [286](#) , [287](#) , and [288](#) ). Immunoperoxidase or immunofluorescence studies should be performed for all patients in whom nonsecretory myeloma is suspected. More than 85% of cases have a cytoplasmic monoclonal protein; in the remainder, no monoclonal protein can be detected in the cytoplasm ( [287](#) , [288](#) , and [289](#) ).

Individuals in this latter group are referred to as *nonproducers*. From a clinical standpoint, both are termed *nonsecretory*. With more sensitive testing, such as immunofixation ( [290](#) ) and free light chain assays ( [291](#) ), many of these so-called nonsecretory patients are found to be low secretors or oligosecretory. At presentation, hypercalcemia and anemia may be present. A reduction in background Igs is common ( [287](#) , [288](#) ). There is minimal to no risk of myeloma kidney ( [285](#) , [287](#) ). Lytic bone disease is present in most patients ( [284](#) , [285](#) , [286](#) and [287](#) ). Median survival of these patients is at least as good as for those with secretory myeloma ( [284](#) , [286](#) , [287](#) ). Response is difficult to document, but, with the new serum assays, quantitation of free light chains is possible in approximately two-thirds of these patients ( [291](#) ).

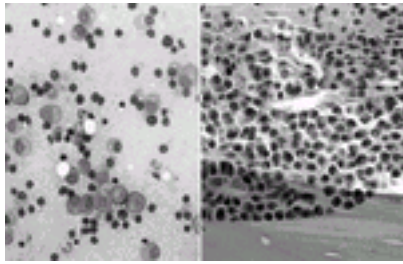
**IMMUNOGLOBULIN D MYELOMA** IgD myeloma accounts for approximately 2% of all cases of myeloma ( [292](#) ). The presence of a monoclonal IgD in the serum usually indicates myeloma, but three cases of IgD MGUS have been documented ( [285](#) ). Patients with IgD myeloma generally present with a small band or no evident M spike on serum protein electrophoresis. Their clinical presentation is similar to that of patients with Bence Jones myeloma (light chain myeloma) in that both have a higher incidence of renal insufficiency and coincident amyloidosis, as well as a higher degree of proteinuria than in IgG or IgA myeloma ( [292](#) ). IgD myeloma patients, however, appear to have a higher frequency of monoclonal ? light chain than ? light chains ( [292](#) ). With an incidence of 19 to 27%, extramedullary involvement is more prevalent in patients with IgD myeloma ( [293](#) , [294](#) and [295](#) ). Survival with IgD myeloma has been reported to be inferior to that with other forms of myeloma, with a median of 12 to 17 months ( [293](#) , [294](#) and [295](#) ). In the Mayo Clinic series, however, median survival was 31 months in patients diagnosed after 1980 ( [285](#) , [296](#) ).

**IMMUNOGLOBULIN E MYELOMA** IgE myeloma is a rare form of myeloma. A disproportionate number of cases are PCL, although the sample size is small, with only approximately 40 cases of IgE myeloma reported in the literature ( [297](#) , [298](#) ).

## HISTOPATHOLOGY

The bone marrow microenvironment is hospitable to malignant plasma cells that circulate through the blood. There is a complex interaction among the malignant clone, its surrounding stromal cells, and the remaining immune cells. The morphologic and immunologic phenotypes of myeloma cells can vary, and they often resemble normal plasma cells. Plasma cells are at least two to three times the size of peripheral lymphocytes and are round to oval, with one or more eccentrically placed nuclei ( [Fig. 98.6](#) ). The nucleus, which contains diffuse or clumped chromatin, is displaced from the center by an abundance of rough-surfaced endoplasmic reticulum—the site of specialized Ig synthesis. Intranuclear and cytoplasmic inclusions are not uncommon ( [258](#) ). There is a perinuclear clear zone that is the site of the Golgi apparatus, the machinery used for Ig packaging and glycosylation for secretion. Derangements of Ig secretion are responsible for an assortment of cytologic aberrations, including flaming cells, Mott cells, Russell bodies, and Gaucher-like cells. Flaming cells are plasma cells that have intensely eosinophilic cytoplasm with a magenta or carmine coloring of their margins, which is due to plugging of peripheral secretory channels by precipitated Ig or Ig fragments. These cells are most commonly seen in IgA myeloma. Thesauocytes are large flaming cells with a pyknotic nucleus that is pushed to the side. Mott cells (grape cells or morula forms) are plasma cells filled with dense spherical Ig inclusions; these inclusions are colorless, pink, or blue. Other inclusions are Russell bodies and their intranuclear counterparts (intranuclear dense bodies); these appear cherry red and can be as large as several microns in diameter. Gaucher-like cells are not uncommon in myeloma infiltrates; these cells are macrophages laden with sphingolipids released by the dying plasma cells ( [259](#) ). None of these interesting inclusions are specific for malignancy nor do they have

prognostic value.



**Figure 98.6.** Bone marrow: plasma cells on aspirate and biopsy specimen. See [Color Plate](#). (From Dispenzieri A, Lacy MQ, Greipp PR. Multiple myeloma. In: Gertz MA, Greipp PR, eds. Hematologic malignancies: multiple myeloma and related plasma cell disorders. Berlin: Springer-Verlag, 2004:53–109, with permission.)

In myeloma, there is often discordance between the nucleus and cytoplasm, the former appearing immature and the latter highly differentiated. Approximately 20% of myeloma cases have plasmablastic morphology: a diffuse chromatin pattern, a nucleus larger than 10  $\mu\text{m}$  or a nucleolus larger than 2  $\mu\text{m}$ , relatively less abundant cytoplasm, and a concentrically placed nucleus with little or no hof ( [123](#), [260](#) ). Diffuse and nodular infiltration patterns can be observed, although the former is more common. A minority of patients have plasma cells that have a lymphoplasmacytic appearance. Myeloma cells are commonly present in cords around bone marrow microvessels. There is a high correlation between the extent of bone marrow angiogenesis, evaluated as microvessel area, and the proliferating fraction of marrow plasma cells in patients with multiple myeloma ( [172](#), [261](#) ). Mild marrow fibrosis may be observed in as many as 27% of cases; extensive fibrosis is rare ( [262](#), [263](#) ). Less than 1% of cases have an extensive idiopathic granulomatous reaction ( [258](#) ). Growth patterns may be nodular or infiltrative, or both. In cases in which the marrow involvement is focal rather than diffuse, bone marrow specimens from alternate sites may vary.

The immunophenotype of myeloma cells is complex. In general, myeloma cells are CD45 negative and CD38 and CD138 positive ( [264](#) ). CD19 and CD20 are earlier B-cell antigens that are variably expressed on myeloma cells. CD56 is strongly positive in approximately 55 to 78% of myeloma cases ( [265](#), [266](#) ). CD56-negative myeloma cells tend to be present in more aggressive disease, such as end-stage myeloma or PCL ( [167](#), [266](#) ). Other surface antigens, such as CD10 (CALLA), CD28, c- *kit*, and CD20, are present on a minority of patients' myeloma cells ( [264](#), [267](#), [268](#) ).

The labeling index of bone marrow plasma cells can be used to identify plasma cell clonality and rate of division. This assay has some value in differentiating MGUS from myeloma and indolent myeloma from active myeloma ( [269](#), [270](#) ). This determination can be done by 5-bromo-2-deoxyuridine immunofluorescence staining, thymidine labeling, or flow cytometry. In general, myeloma is a low-growth fraction tumor with only a small percentage of cells in the S phase of the cell cycle at any given time.

No individual bone marrow finding, however, is pathognomonic for a malignant plasma cell process; the bone marrow diagnosis of myeloma relies on the percentage of clonal bone marrow plasma cells, with 10% accepted as a cutoff. The clinical diagnosis, of course, is

made from a synthesis of bone marrow findings and other clinical features.

## DIAGNOSIS

The definitions used to make a diagnosis of multiple myeloma have not been static. In 1973, the Chronic Leukemia–Myeloma Task Force (CLMTF) ( 299 ) set forth guidelines for the diagnosis of myeloma ( Table 98.1 ). These criteria, which by today’s standards are not stringent enough, have been replaced by a more modern definition ( Table 98.2 ) ( 269 , 300 , 301 ). In the last three decades, the terms and definitions of *MGUS*, *smoldering myeloma*, *indolent myeloma*, and *symptomatic multiple myeloma* ( 209 , 300 , 302 , 303 ) have evolved and are now to be replaced by the following designations: *MGUS*, *inactive (smoldering) myeloma*, and *active (or symptomatic) myeloma* ( 304 ) ( Fig. 98.7 ).

**TABLE 98.1. Chronic Leukemia–Myeloma Task Force Definition of Multiple Myeloma, 1972**

---

|  |
|--|
| If M protein is present in serum or urine, one or more of the following must be present:   |
| Marrow plasmacytosis =5% in absence of underlying reactive process   |
| Tissue biopsy demonstrating replacement and distortion of normal tissue by plasma cells  |
| More than 500 plasma cells per mm <sup>3</sup> in peripheral blood   |
| Osteolytic lesion unexplained by other causes  |
| If M protein is absent in serum and urine, there must be radiologic evidence of osteolytic lesions or palpable tumors, and one or more of the following must be present: |
| Marrow plasmacytosis of >20% from two sites in absence of reactive process   |
| Tissue biopsy demonstrating replacement and distortion of normal tissue by plasma cells  |

Modified from proposed Guidelines for Protocol Studies, Chronic Leukemia–Myeloma Task Force, National Cancer Institute. *Cancer Chemother Rep* 1972;4:141–173, with permission.

---

**TABLE 98.2. Criteria for Diagnosis of Monoclonal Gammopathy of Undetermined Significance, Smoldering Multiple Myeloma, and Multiple Myeloma, According to Kyle and Greipp**

---

|   |
|---|
| Monoclonal gammopathy of undetermined significance <sup>a</sup>                                 |
| Serum monoclonal protein (<3 g/dl)  |
| No anemia, renal failure, or hypercalcemia  |
| Bone lesions absent on radiographic bone survey <sup>b</sup>                                    |
| Bone marrow <10% plasma cells   |
| Smoldering multiple myeloma <sup>a</sup>  |
| Serum monoclonal protein (=3 g/dl) or =10% marrow plasma cells or aggregates on biopsy, or both |
| No anemia, renal failure, or hypercalcemia attributable to myeloma                              |
| Multiple myeloma  |
| Monoclonal protein present in serum or urine  |

=10% marrow plasma cells on biopsy or histologic evidence of plasmacytoma

Plus one or more of the following:

Anemia

Lytic lesions or osteoporosis and  $\geq 30\%$  plasma cells in marrow

Bone marrow plasma cell labeling index  $\geq 1\%$

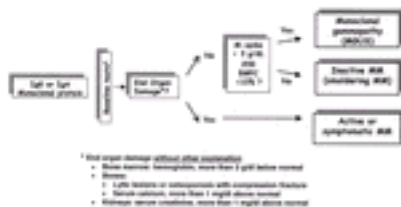
Renal insufficiency

Hypercalcemia

<sup>a</sup> Patients with monoclonal gammopathy of undetermined significance and smoldering multiple myeloma must not have solitary plasmacytoma, amyloidosis, or light-chain deposition disease.

<sup>b</sup> Computed tomography or magnetic resonance imaging may be needed to rule out skeletal lesions.

From Dispenzieri A, Lacy MQ, Greipp PR. Multiple myeloma. In: Gertz MA, Greipp PR, eds. Hematologic malignancies: multiple myeloma and related plasma cell disorders. Berlin: Springer-Verlag, 2004:53–109, with permission.



**Figure 98.7.** Diagnostic criteria. BMPC, bone marrow plasma cells; Ig, immunoglobulin; MGUS, monoclonal gammopathy of undetermined significance; MM, multiple myeloma. (From Dispenzieri A, Lacy MQ, Greipp PR. Multiple myeloma. In: Gertz MA, Greipp PR, eds. Hematologic malignancies: multiple myeloma and related plasma cell disorders. Berlin: Springer-Verlag, 2004:57–109, with permission.)

This internationally accepted classification schema is derived from more than three decades of experience of treating and studying multiple myeloma patients. Because multiple myeloma includes a spectrum of biologic features, physicians should not feel compelled to start treatment as a result of a single threshold value. The diagnosis of active myeloma is not a straightforward pathologic one; rather, it is a clinical diagnosis that requires thoughtful synthesis of multiple variables. Patients with Durie–Salmon stage I disease, who also meet the criteria for smoldering or asymptomatic myeloma, should be managed expectantly. Median progression-free survival in asymptomatic stage I patients, observed without any therapy, is 12 to more than 48 months ( [305](#) , [306](#) , [307](#) and [308](#) ); for similar stage II patients, progression-free survival is 12 months ( [305](#) ). No survival advantage has been demonstrated by treating asymptomatic myeloma patients ( [303](#) , [306](#) , [307](#) , [309](#) ).

## TREATMENT FOR MULTIPLE MYELOMA

Before starting therapy for multiple myeloma, a distinction must be made between inactive (smoldering, indolent, asymptomatic) myeloma and active myeloma, which requires therapy ( [Fig. 98.7](#) ). Approximately 20% of patients with multiple myeloma are recognized by chance without significant symptoms; such patients can be carefully monitored without instituting therapy. Risk factors for progression include a serum M



protein of greater than 3 g/dl, IgA isotype, and a Bence Jones protein excretion of greater than 50 mg/day. Patients with two or more of these features required treatment at a median of 17 months, whereas the absence of any adverse variables was associated with prolonged stability (median, 95 months) ( $p < .01$ ) (310). Patients with one or more lytic lesions (311) or circulating plasma cells (312) are also at higher risk for early progression.

Once the decision has been made to treat for symptomatic disease, a long-term plan for managing the disease should be formulated before instituting therapy. Figure 98.8 outlines a possible treatment algorithm. Because high-dose therapy with hematopoietic stem cell support has been accepted as an important treatment modality for patients younger than 65 years of age, alkylator-based therapy should be avoided before the collection of hematopoietic stem cells in patients considered candidates for high-dose therapy.



**Figure 98.8.** Suggested treatment algorithm for patients with newly diagnosed myeloma. At any point in the disease, consider clinical trial or investigational therapy directed at the particular phase of disease (*asterisk*). VAD, vincristine, doxorubicin, and dexamethasone. (From Dispenzieri A, Lacy MQ, Greipp PR. Multiple myeloma. In: Gertz MA, Greipp PR, eds. Hematologic malignancies: multiple myeloma and related plasma cell disorders. Berlin: Springer-Verlag, 2004:57–109, with permission.)

## Systemic Therapy

**GENERAL COMMENTS** Historically, the bifunctional alkylating agents, such as melphalan and cyclophosphamide, have been the foundation of standard therapy for multiple myeloma. Myeloma cells tend to proliferate slowly, and alkylators, whose effectiveness does not rely heavily on cell division and DNA replication, are useful therapeutic agents. Before the recognition of thalidomide's activity in myeloma (38), the bifunctional alkylators, nitrosoureas, doxorubicin, and glucocorticoids were the primary agents shown to have single-agent activity against multiple myeloma *in vivo* (313). These drugs and vincristine, singly or in combination, have been the mainstay of chemotherapy for myeloma from the early 1960s to the present (Fig. 98.1). Even though vincristine has not been shown to have significant single agent *in vivo* activity or to improve overall survival (314, 315, 316 and 317), it is included in multiple therapeutic regimens. Decades of study also suggest that the higher response rates seen with regimens that combine multiple active agents as part of initial therapy do not result in improved overall survival rates (318). Interferon- $\alpha$  has been incorporated into induction and maintenance protocols with modest benefit (35, 319, 320 and 321). Autologous and allogeneic stem cell transplantation have received considerable attention since the description, by McElwain and Powles in 1983 (322), of the benefit of dose intensification of melphalan in patients with multiple myeloma. With the recognition of thalidomide as a new agent with activity against multiple myeloma in 1999 (38) and exciting new agents, such as the immune modulatory drugs and



proteasome inhibitors ( 323, 324 ), there is hope that the next four decades of myeloma treatment will be even more promising than the last. Before discussing induction, transplantation, maintenance, and salvage therapies, two general concepts are reviewed: interpretation of study response data and the efficacy of single chemotherapeutic agents commonly used to treat myeloma. Table 98.3 serves as a 1 reference for commonly cited regimens.

**TABLE 98.3. Commonly Cited Regimens and Their Dosage Schedules**

| Drug Regimen  | VCR                                   | Mel   | CTX   | BCNU                         | ADR                              | Corticosteroid   |
|---|---------------------------------------|---|---|------------------------------|----------------------------------|--|
| MP  | —                                     | 9 mg/m <sup>2</sup> /d, d 1–4 q4wk, or 0.15 mg/kg/d, d 1–7 q6wk | —   | —                            | —                                | Prednisone, 100 mg/d, d 1–4 q4wk; or prednisone, 60 mg/d, d 1–7 q6wk |
| CP <sup>a</sup>   | —                                     | —   | 250 mg/m <sup>2</sup> /d, d 1–4, or 1000 mg/m <sup>2</sup> IV | —                            | —                                | Prednisone, 100 mg/d, d 1–4; or prednisone, 50 mg qod                |
| VMCP <sup>b</sup> ( 325)                                  | 1 mg, d 1                             | 6 mg/m <sup>2</sup> /d, d 1–4                                   | 125 mg/m <sup>2</sup> per d, d 1–4                            | —                            | —                                | Prednisone, 60 mg/m <sup>2</sup> /d, d 1–4                           |
| VBAP <sup>b</sup> ( 325)                                  | 1 mg, d 1                             | —   | —   | 30 mg/m <sup>2</sup> IV, d 1 | 30 mg/m <sup>2</sup> IV, d 1     | Prednisone, 60 mg/m <sup>2</sup> /d, d 1–4                           |
| ABCM <sup>c</sup> ( 326)                                  | —                                     | 6 mg/m <sup>2</sup> per d, d 1–4                                | 100 mg/m <sup>2</sup> per d, d 1–4                            | 30 mg/m <sup>2</sup> IV, d 1 | 30 mg/m <sup>2</sup> IV, d 1     | —  |
| M-2 or VBMCP <sup>a</sup> (ECOG modification) ( 327, 328) | 0.03 mg/kg IV, d 1                    | 0.25 mg/kg, d 1–7   | 10 mg/kg IV, d 1  | 0.5 mg/kg IV, d 1            | —                                | Prednisone, 1 mg/kg, d 1–7   |
| MOCCA <sup>a</sup> ( 329)                                 | 0.03 mg/kg IV, d 1                    | 0.25 mg/kg, d 1–7   | 10 mg/kg IV, d 1  | CCNU 40 mg po, d 1           | —                                | 0.8 mg/kg po, d 1–7  |
| VAD <sup>a</sup> ( 330)                                   | 0.2 mg/m <sup>2</sup> per d CI, d 1–4 | —   | —   | —                            | 9 mg/m <sup>2</sup> /d CI, d 1–4 | Dexamethasone, 40 mg/d, d 1–4, 9–12, and 17–20                       |
| VAMP <sup>a</sup> ( 331)                                  | 0.4 mg per d CI, d 1–4                | —   | —   | —                            | 9 mg/m <sup>2</sup> /d CI, d 1–4 | Methylprednisolone, 1 g/m <sup>2</sup> /d, d 1–4                     |

C-VAMP <sup>a</sup> (332) 0.4 mg — 500 mg — 9 Methylprednisolone, 1  
per d IV, d 1, 8, mg/m g/m <sup>2</sup>/d, d 1–4  
CI, d and 15 <sup>2</sup>/d CI,  
1–4 d 1–4

CI, continuous infusion; po, by mouth; q, every; qod, every other day.

<sup>a</sup> Repeated at 3-week intervals.

<sup>b</sup> VMCP and VBAP are commonly alternated every 3 weeks.

<sup>c</sup> AB and CM portions of regimen are given alternately every 3 weeks.

<sup>d</sup> Repeated every 5 weeks.

From Dispenzieri A, Lacy MQ, Greipp PR. Multiple myeloma. In: Gertz MA, Greipp PR, eds. Hematologic malignancies: multiple myeloma and related plasma cell disorders. Berlin: Springer-Verlag, 2004;57–109, with permission.

**INTERPRETING STUDY RESPONSE AND SURVIVAL DATA** Four points are emphasized regarding the interpretation and comparisons of the myeloma treatment literature. First, definitions of response vary ( Table 98.4). Second, definitions of patients who can be evaluated may be different. Third, concurrent corticosteroid therapy, as part of the regimen or for other indications, may confound interpretation of efficacy. Finally, patient population risk and prognosis may differ substantially. Lead-time bias and treatment of MGUS or smoldering myeloma can significantly distort survival figures, as can effective salvage regimens.

**TABLE 98.4. Response Criteria**

| Response                          | Study (Reference)         | Bone Marrow Plasma Cells (%) | M Protein  |                    | Duration (Wk) |
|-----------------------------------|---------------------------|------------------------------|--|--------------------|---------------|
|                                   |                           |                              | Serum  | Urine              |               |
| Complete response                 | CLMTF ( 299)              | Not defined                  |  |                    | —             |
|                                   | SWOG ( 333)               | <1 <sup>a</sup>              | IF —   | IF —               | 8             |
|                                   | ECOG ( 334)               | =3                           | IF —   | IF —               | 6             |
|                                   | IBMTR <sup>b</sup> ( 335) | <5                           | IF —   | IF —               | 6             |
| Objective response                | SWOG                      | —                            | ?=75% <sup>c</sup>   | ?=90%              | 8             |
| Improvement                       | SWOG                      | —                            | ?=50% <sup>c</sup>   | ?=75%              | 8             |
| Partial response                  | CLMTF <sup>d</sup>        | —                            | ?=50%  | ?=50% <sup>e</sup> | —             |
|                                   | ECOG                      | —                            | ?=50%  | ?=90%              | 6             |
|                                   | IBMTR                     | —                            | ?=50%  | ?=90% <sup>f</sup> | 6             |
| Stable, no change, or no response | SWOG                      | —                            | < ± 25% <sup>c</sup>   | < ± 25%            | —             |
|                                   | ECOG                      | —                            | Not complete response, near complete response, or partial response |                    | —             |
|                                   | IBMTR                     | —                            | Neither minimum response nor progression                           |                    | —             |
| Plateau                           | ECOG                      | —                            | < ± 20%  | < ± 20%            | 4             |
|                                   | IBMTR                     | —                            | < ± 25%  | < ± 25%            | 12            |

|             |       |   |                   |                   |   |
|-------------|-------|---|-------------------|-------------------|---|
| Progression | SWOG  | — | =25% <sup>c</sup> | =25%              | — |
|             | ECOG  | — | =50% <sup>g</sup> | =50% <sup>h</sup> | — |
|             | IBMTR | — | =25% <sup>i</sup> | =25% <sup>h</sup> | — |

IF, immunofixation.

NOTE: Other special categories include:

ECOG near complete response, which includes less than 5% bone marrow plasma cells or complete response by serum and urine tests but no confirmatory bone marrow testing performed.

IFM very good partial response, which includes greater than or equal to a 90% reduction of serum M protein ( 336).

IBMTR/ABMTR minimal response, which includes a 25 to 49% reduction of serum M protein and a 50 to 89% reduction of 24-hour urinary light chain excretion, which still exceeds 200 mg/24 hours.

<sup>a</sup> Clonal plasma cells as measured by cytoplasmic immunoglobulin flow cytometry.

<sup>b</sup> Makes allowance for nonsecretory myeloma and plasmacytomas.

<sup>c</sup> Change in synthetic index and *not* monoclonal protein concentration.

<sup>d</sup> Response also takes into account reduction in size of plasmacytomas, greater than 2 g/dl hemoglobin rise, weight gain, correction of calcium, renal function, and albumin.

<sup>e</sup> If the pretreatment value is greater than 1 g/24 hours, then decrease to 50% or less of pretreatment value; if the pretreatment value is 0.5 to 1 g/24 hours, then decrease to less than 0.1 g/24 hours; otherwise, if the pretreatment value is less than 0.5 g/24 hours, the variable should not be used to measure response.

<sup>f</sup> Or less than 200 mg/24 hours.

<sup>g</sup> Absolute increase must be at least 2 g/dl.

<sup>h</sup> Absolute increase must be greater than 200 mg/24 hours.

<sup>i</sup> Absolute increase must be greater than 0.5 g/dl.

From Dispenzieri A, Lacy MQ, Greipp PR. Multiple myeloma. In: Gertz MA, Greipp PR, eds. Hematologic malignancies: multiple myeloma and related plasma cell disorders. Berlin: Springer-Verlag, 2004:57–109, with permission.

The measurement of myeloma disease burden, and, therefore its response to therapy, is complex, and investigators have used different methods to define response ( Table 98.4). The four most common response criteria are those of the CLMTF ( 299 ), the Southwest Oncology Group (SWOG) ( 333 , 337 ), the Eastern Cooperative Oncology Group ( 334 ), and the Autologous Blood and Marrow Transplant Registry and the International Bone Marrow Transplant Registry ( 335 ). Although all take into account hemoglobin, calcium, bone changes, and bone marrow plasmacytosis, the main distinction among them is their consideration of the serum and urine M components. With the exception of the old SWOG criteria ( 333 , 337 ), a partial response has been considered to be a 50% reduction in serum M component and a greater than 50 to 90% reduction in urine M component. In the earliest literature, response included such factors as increasing hemoglobin concentration or performance status or decreasing blood urea nitrogen levels. Some authors have included a minimal response (25 to 49% reduction in serum M protein) as a response. Neither the CLMTF nor SWOG originally had a complete response category, because it was unusual for the M protein to disappear completely. It was not until the advent of high-dose melphalan that investigators, such as Selby et al. ( 338 ) and Gore et al. ( 339 ), began to define a complete remission category. Their definition, unlike more modern definitions, only included disappearance of M protein as determined by electrophoresis,

which is much less sensitive than immunoelectrophoresis or immunofixation. Subsequent definitions have required immunofixation negativity to qualify as complete remission (335). Until approximately 1990, a SWOG objective response was defined as a 75% reduction in the *tumor mass index* (not serum M protein) and improvement was defined as a 50 to 74% reduction in the *tumor mass index* (333). The Medical Research Council (MRC) Myelomatosis Trial evaluated the efficacy of treatment not by the degree of M component reduction but by the proportion of patients achieving a plateau phase (326). A new iteration of the SWOG response criteria uses the M component (rather than the tumor mass index) as the primary measurement of the plasma cell burden. In the current SWOG response criteria, the serum and urine protein response groups are defined as follows: (a) a partial response is a 50% reduction in the serum and urine M components, (b) a remission is a 75% reduction in the serum and a 90% reduction in the urine M components, and (c) a complete remission is the total absence of any monoclonal protein by immunofixation of the serum or urine (J. Crowley, *personal communication*, 2003). At the Mayo Clinic, the authors have adopted the Autologous Blood and Marrow Transplant Registry and International Bone Marrow Transplant Registry criteria, into which the authors incorporated the Intergroupe Français du Myélome (IFM) very good partial response category. The roving denominator also creates challenges in interpreting therapeutic studies. Often an intention-to-treat analysis is not used to describe response rates or survival, which artificially inflates these endpoints. Definitions of patients who can be evaluated may often include only those patients who received an adequate trial (3 or 6 months) of therapy, thereby excluding patients with early deaths or progression. In addition, in a steroid-responsive tumorlike myeloma, coincident use of prednisone or dexamethasone (340, 341) as an antiemetic or as therapy for hypercalcemia may seriously confound the results. Finally, the striking heterogeneity of prognoses in myeloma patients cannot be excluded as a major confounding factor in interpreting phase II and III trials. Several prognostic indicators have been identified, including stage,  $\beta_2$ M, labeling index, renal function, and chromosomal abnormalities. However, their predictive value is limited and only skims the surface of myeloma biology and prognosis.

#### EFFICACY OF SINGLE CHEMOTHERAPEUTIC AGENTS

**Melphalan** Bergsagel et al. (32) demonstrated the benefit of melphalan in 14 of 24 patients with multiple myeloma. Others (Table 98.5) have substantiated that melphalan as a single agent results in response rates of 20 to 34% and median overall survival duration of 15 to 27 months (33, 326, 342, 343, 345).

TABLE 98.5. Early (1969 to 1982) Randomized Trials: Untreated Myeloma

| Study                        | Agent           | Schedule                          | N  | Response Rate (%) | Overall Survival (mo)    |
|------------------------------|-----------------|-----------------------------------|----|-------------------|--------------------------|
| Rivers and Patno, 1969 (342) | CTX<br>Placebo  | 2 to 4 mg/kg/d                    | 54 | 21                | 11.5 <sup>a</sup><br>3.5 |
| Rivers and Patno, 1969 (342) | CTX             | 4 mg/kg/d                         | 49 | 28                | 13                       |
| Alexanian et al., 1969 (343) | M               | 0.1 mg/kg/d                       | 54 | 34                | 15.5                     |
|                              | M qd            | 0.025 mg/kg/d                     | 35 | 17                | 18                       |
|                              | M intermittent  | 0.25 mg/kg d 1-4                  | 69 | 32                | 18                       |
|                              | M alternating P | 0.25 mg/kg, d 1-4, and 1mg/kg MWF | 28 | 61                | 24                       |

|  |                           |   |                     |   |
|--|---------------------------|---|---------------------|---|
|  | M concurrently<br>P       | 0.25 mg/kg, d 1–4, and 2<br>mg/kg, d 1–4  | 51 65               | 17  |
| MRC, 1971 ( <a href="#">344</a> )              | CTX                       | 150 mg/d  | 114 NG              | 28 <sup>b</sup>   |
|  | M                         | 4 mg/d  | 105 NG              | 24 <sup>b</sup>   |
| Alexanian et al., 1972 ( <a href="#">337</a> ) | MP                        | M, 0.25 mg/kg and P, 2 mg/kg, d 1–4   | 83 52 <sup>a</sup>  | 21  |
|  | MP and procarbazine       | M, 0.2 mg/kg and P, 2 mg/kg, d 1–4; Pro, 3 mg/kg, d 2–10  | 79 41               | 23  |
| Costa et al., 1973 ( <a href="#">345</a> )     | M qd                      | 0.15 mg/kg × 7d, maintenance 0.05 kg/d  | 53 20               | 27 ( <a href="#">30</a> , <a href="#">21</a> ) <sup>c</sup> |
|  | M qd and P                | M, as stated previously; P, 1.25 mg/kg/d with taper over 8 wk   | 70 39               | NG ( <a href="#">53</a> , <a href="#">9</a> )               |
|  | M qd, P, and testosterone | M and P, as stated previously; testosterone, 10 g/kg/wk   | 56 43               | NG ( <a href="#">36</a> , <a href="#">4</a> )               |
| MRC, 1980 ( <a href="#">346</a> )              | MP <sup>d</sup>           | M, 10 mg/d, d 1–7; P, 40 mg/d, d 1–7 q3wk   | 174 NG <sup>d</sup> | 32 <sup>b, d</sup>  |
|  | CTX IV <sup>d</sup>       | 600 mg/m <sup>2</sup> q3wk  | 179 <sup>d</sup>    | 24  |
|  | MP <sup>e</sup>           | See previous schedule   | 71 NG <sup>e</sup>  | 6 <sup>b, d</sup>   |
|  | CMLP <sup>e</sup>         | C, 250 mg/m <sup>2</sup> po, d 1–3; M, 5 mg/m <sup>2</sup> , d 1–3; L, 50 mg/m <sup>2</sup> , d 4; P, 40 mg/m <sup>2</sup> , d 1–3 q4wk | 561 NG <sup>e</sup> | 6   |
| Cornwell et al., 1982 ( <a href="#">347</a> )  | MP                        | M, 0.15 mg/kg, d 1–7; P, 0.8 mg/kg with taper   | 100 44 <sup>f</sup> | 27  |
|  | Carmustine–P              | Carmustine, 150 mg/m <sup>2</sup> IV; P, 0.8 mg/kg with taper   | 124 34              | 21  |
|  | L–P                       | L, 100 mg/m <sup>2</sup> qd; P, 0.8 mg/kg with taper  | 137 30              | 21  |

C, cyclophosphamide; CTX, cyclophosphamide; IV, intravenous; L, lomustine; M, melphalan; NG, not given; P, prednisone; po, by mouth; qd, daily.

<sup>a</sup> Overall survival is significant at  $p = .03$ . No corticosteroids allowed in trial.

<sup>b</sup> Survival estimated from survival curves.

<sup>c</sup> Patients stratified for good and poor risk; median survival is given for all patients (good risk, poor risk). The authors note that a much quicker response was observed with prednisone, but there was a worse survival with prednisone in poor-risk patients.

<sup>d</sup> Patients were required to have blood urea nitrogen  $\leq 10$  mmol. Difference not significant ( $p = .16$ ).

<sup>e</sup> All patients had blood urea nitrogen  $\leq 10$  mmol.

<sup>f</sup> Response rate between melphalan and lomustine arms is significant. Median survival is not different.

From Dispenzieri A, Lacy MQ, Greipp PR. Multiple myeloma. In: Gertz MA, Greipp PR, eds. Hematologic malignancies: multiple myeloma and related plasma cell disorders. Berlin: Springer-Verlag, 2004:57–109, with permission.

**Cyclophosphamide** Korst et al. (34) were the first to report on the activity of oral cyclophosphamide. Twenty-four percent of multiple myeloma patients achieved a partial response (50% M protein reduction), and 48% had objective improvement—that is, an improvement in the peripheral blood values, bone marrow findings, or serum blood urea nitrogen. Median survival was 24.5 months in all 207 patients and 32 months in the group that received at least 2 months of cyclophosphamide therapy. The single-agent activity of cyclophosphamide (Table 98.5) has been demonstrated in a placebo-controlled trial (342), in multiple studies of previously untreated patients (344, 346), and in those who relapsed or had refractory disease (348).

**Glucocorticoids** In 1950, Thorn et al. (29) reported the first observations on the beneficial effects of adrenocorticotrophic hormone in myeloma. Adams and Skoog (28) observed a marked decrease in the myeloma serum protein in 18 of 26 patients treated with corticosteroids. Surprisingly, Mass (349) failed to show a difference between the survival of 55 patients randomly assigned to prednisone therapy or placebo, despite clinical improvement in the former group. Subsequently, high-dose corticosteroids (Table 98.6) have been shown to produce response rates of 40 to 50% in previously untreated patients, and 25% in refractory or relapsed patients (30, 331, 341, 350, 351, 352 and 353). Despite their contribution to quicker and more abundant responses, there are conflicting data as to whether corticosteroids prolong survival (343, 345, 355).

**TABLE 98.6. Corticosteroids**

| Study (Reference)            | Agent              | Schedule   | Disease Status       | N   | Response Rate (%) | Overall Survival (mo) |
|------------------------------|--------------------|--|----------------------|-----|-------------------|-----------------------|
| Adams and Skoog, 1957 (28)   | Corticosteroids    | Various  | All                  | NG  | NG                | NG                    |
| McIntyre et al., 1985 (350)  | Prednisone         | 1.2 mg/kg/d? 70-d taper  | Untreated            | 32  | 44                | 21                    |
| Alexanian et al., 1992 (351) | Dexamethasone      | 40 mg/d, d 1–4, 9–12, and 17–20; repeat every 42 d               | Untreated            | 112 | 43 <sup>a</sup>   | NG                    |
| Salmon et al., 1967 (30)     | Prednisone         | 200 mg qod × 8 wk ? 100 mg qod × 4 wk ? 50 mg qod                | Refractory, relapsed | 10  | 80                | NG                    |
| Alexanian et al., 1983 (341) | Prednisone         | 60 mg/m <sup>2</sup> , d 1–5, 9–14, and 17–21; repeat every 42 d | Refractory, relapsed | 11  | 19 <sup>a</sup>   | NG                    |
| Alexanian et al., 1986 (352) | Dexamethasone      | 40 mg, d 1–4, 9–12, and 17–20 q5wk                               | Refractory           | 30  | 27 <sup>a</sup>   | NG                    |
|                              |                    |  | Relapsed             | 19  | 21 <sup>a</sup>   |                       |
| Forgeson et al., 1988 (331)  | Methylprednisolone | 1 g/m <sup>2</sup> (max, 1.5 g), d 1–5 q21d                      | Resistant            | 10  | 10                |                       |
|                              |                    |  | Relapsed             | 4   | 25                |                       |

| Study (Reference)                     | Regimen  | N  | RR (%) | Overall Survival (mo) | $\rho$ (RR) | $\rho$ (Overall Survival) |
|---------------------------------------|--|----|--------|-----------------------|-------------|---------------------------|
| Gertz et al., 1995 ( 353 )            | Methylprednisolone 2 g tiw $\times$ 8 wk<br>? 2 g/wk | 20 | 25     | Refractory, relapsed  | NS          | NS                        |
| Tiplady and Summerfield, 2000 ( 354 ) | Dexamethasone 4 mg po qd $\times$ 3–6 mo ? 5 mg qod  | 15 | 40     | Refractory            | NS          | NS                        |

NG, not given; po, by mouth; q, every; qd, daily; qod, every other day; tiw, three times a week.

<sup>a</sup> According to SWOG response criteria, response according to tumor mass index.

Modified from Dispenzieri A, Lacy MQ, Greipp PR. Multiple myeloma. In: Gertz MA, Greipp PR, eds. Hematologic malignancies: multiple myeloma and related plasma cell disorders. Berlin: Springer-Verlag, 2004:57–109, with permission.

The mechanism of action of this drug class is complex. Corticosteroids suppress the production of cytokines that are important in myeloma growth, such as IL-6 and IL-1 $\beta$ , and reduce NF- $\kappa$ B activity, resulting in enhanced apoptosis ( 356 , 357 , 358 and 359 ).

**Vincristine** Alexanian et al. ( 360 , 361 ) suggested that regimens that included vincristine resulted in better patient outcome than protocols that did not include this agent. The theory behind its posited usefulness was that, after an initial kill of myeloma cells by alkylating agents, the subsequent increase in the mitotic index made myeloma cells more sensitive to vincristine ( 362 ). Reports by Lee et al. ( 363 ), Salmon ( 364 ), and Case et al. ( 327 ) have been cited as confirmatory evidence for activity of vincristine in myeloma.

However, several randomized controlled trials do not support this premise ( 315 , 316 , 347 , 365 ) ( Table 98.7 ). The most compelling of these is the fourth MRC Trial in Myelomatosis, which randomized 530 newly diagnosed myeloma patients to monthly melphalan and prednisone, with or without monthly vincristine. Median survival in both arms was 26 months ( 315 ). Although never evaluated as a single agent in newly diagnosed myeloma, vincristine has little activity as a single agent in refractory disease. Twenty-one patients were treated with a 0.5-mg bolus of vincristine followed by 0.25 to 0.50 mg/m<sup>2</sup>/day as a continuous infusion over 5 days on a 3-week schedule. Two patients had transient responses (1.2 and 2.2 months) ( 314 ). Finally, the activity credited to vincristine as a maintenance therapy is also ambiguous. Although a superior survival (35 months vs. 27 months,  $p = .003$ ) was reported in patients treated with single agent melphalan and maintained on bimonthly vincristine (1 mg/m<sup>2</sup>) and prednisone (0.6 mg/kg for 7 days), the benefit could easily be attributed to prednisone alone ( 386 ).

**TABLE 98.7. Melphalan and Prednisone versus Combination Chemotherapy as Induction: Selected Randomized Trials**

| Study (Reference)       | Regimen | N   | RR (%) <sup>a</sup> | Overall Survival (mo) | $\rho$ (RR) | $\rho$ (Overall Survival) |
|-------------------------|---------|-----|---------------------|-----------------------|-------------|---------------------------|
| SWOG 727/1972 ( 337 )   | MP      | 125 | 40 <sup>b</sup>     | 28                    | NS          | NS                        |
|                         | MP-Pcb  | 116 | 47                  | 31                    | —           | —                         |
| SECSG 343/1984 ( 366 )  | MP      | 187 | 29                  | 36                    | NS          | NS                        |
|                         | BCP     | 186 | 37                  | 36                    | —           | —                         |
| CALGB 7161/1979 ( 367 ) | MP      | 126 | 56                  | NG                    | .047        | NS                        |
|                         | MCBP    | 124 | 68                  | —                     | —           | —                         |
| NCI-C-MY1/1979 ( 368 )  | MP      | 125 | 40 <sup>b</sup>     | 28                    | NS          | NS                        |
|                         | MCBP    | 239 | 39                  | 31                    | —           | —                         |



|   |             |     |    |                          |        |                   |
|---|-------------|-----|----|--------------------------|--------|-------------------|
| ECOG 4472/1982 ( <a href="#">370</a> , <a href="#">371</a> )                | MP          | 92  | 40 | 19                       | NS     | NS                |
|   | BCP         | 96  | 50 | 25                       | —      | —                 |
| GATLA3-M-73/1980 and 1988 ( <a href="#">370</a> , <a href="#">371</a> )     | MP          | 67  | 40 | 38                       | NS     | NS                |
|   | CP-MeCCNU   | 83  | 40 | 30                       | —      | —                 |
| GATLA3-M-77/1984 and 1988 ( <a href="#">370</a> , <a href="#">372</a> )     | MP          | 145 | 33 | 42                       | NS     | NS                |
|   | MPCV-MeCCNU | 115 | 44 | 44                       | —      | —                 |
| Pavia MM-75/1986 ( <a href="#">373</a> )                                    | MP          | 39  | 41 | 54                       | NS     | .039              |
|   | Pept-VP     | 36  | 58 | 26                       | —      | —                 |
| SWOG 7704/1983 and 1986 ( <a href="#">325</a> , <a href="#">374</a> )       | MP          | 77  | 32 | <sup>b</sup> 23          | —      | —                 |
|   | VMCP/VCAP   | 80  | 58 | 43                       | .001   | .004 <sup>c</sup> |
| MDA7704/1984 ( <a href="#">361</a> )  | VMCP/VBAP   | 80  | 49 | 43                       | .028   | —                 |
|   | MP          | 30  | 53 | <sup>b</sup> 38          | NS     | NS                |
|   | VMCP/VCAP   | 42  | 55 | 27                       | —      | —                 |
| CALGB 7761/1986 ( <a href="#">375</a> )                                     | VMCP/VBAP   | 34  | 60 | 28                       | —      | —                 |
|   | MP (IV)     | 146 | 47 | 34                       | NS     | <sup>d</sup>      |
|   | MCBP        | 140 | 56 | 29                       | —      | —                 |
|   | Seq-MCBP    | 148 | 47 | 22                       | —      | —                 |
| IMMSG M-77/1985 ( <a href="#">316</a> )                                     | MCBPA       | 157 | 44 | 26                       | —      | —                 |
|   | MP          | 47  | 19 | <sup>b</sup> 30          | NS     | NS                |
|   | VMCP        | 53  | 19 | 45                       | —      | —                 |
| Gentofte, Denmark/1985 ( <a href="#">365</a> )                              | BC-Pept     | 33  | 3  | 58                       | —      | —                 |
|   | MP          | 31  | 45 | 21                       | NS     | NS                |
|   | VMP         | 32  | 73 | 30                       | —      | —                 |
| ECOG 2479/1997 ( <a href="#">328</a> )                                      | VBMCP       | 33  | 58 | 21                       | —      | —                 |
|   | MP          | 230 | 51 | 27                       | <.0001 | NS                |
| MRC MYEL-4/1985 ( <a href="#">315</a> )                                     | VBMCP       | 235 | 72 | 29                       | 1      | —                 |
|   | MP          | 261 | NG | 26                       | NS     | NS                |
| Finnish MM80/1987 ( <a href="#">329</a> )                                   | VMP         | 269 | —  | 26                       | —      | —                 |
|   | MP          | 66  | 54 | 41                       | <.02   | NS                |
| Norwegian Trial 1986 and 1988 ( <a href="#">376</a> , <a href="#">377</a> ) | MOCCA       | 64  | 75 | 45                       | —      | —                 |
|   | MP          | 48  | 48 | 29                       | NS     | NS                |
| MGCS stage III/1989 ( <a href="#">378</a> )                                 | VBMCP       | 44  | 54 | 33                       | —      | —                 |
|   | MP          | 44  | 61 | 28                       | NS     | NS                |
| GMTG MM01/1988 and 1991 ( <a href="#">379</a> , <a href="#">380</a> )       | VMCP/VBAP   | 42  | 52 | 24                       | —      | —                 |
|   | MP          | 170 | 33 | <sup>b</sup> 60% 4-yr OS | NS     | <.02 MP           |
| MGCS stage II/1990 ( <a href="#">381</a> )                                  | VMCP        | 150 | 33 | —                        | —      | —                 |
|   | MP          | 29  | 69 | 46                       | NS     | NS                |
| MGCS stage III/1990 ( <a href="#">381</a> )                                 | VMCP        | 25  | 56 | 33                       | —      | —                 |
|   | MP          | 55  | 58 | 26                       | NS     | NS                |
| IMMSG M-83/1991 ( <a href="#">382</a> )                                     | VMCP/VBAP   | 53  | 57 | 24                       | —      | —                 |
|   | MP          | 146 | 64 | 37                       | .02    | NS                |

|   |                      |      |    |                  |         |     |
|---|----------------------|------|----|------------------|---------|-----|
|   | VMCP/VBAP            | 158  | 77 | 32               | —       | —   |
| PETHEMA 85/1993 ( <a href="#">383</a> )                       | MP                   | 247  | 32 | 27               | .004    | NS  |
|   | VMCP/VBAP            | 241  | 45 | 32               | —       | —   |
| Pavia 1986/1994 ( <a href="#">306</a> , <a href="#">373</a> ) | MP                   | 87   | 24 | All 24           | NS      | NS  |
|   | Pept-VP              | 83   | 24 | —                | —       | —   |
| NMSG/1993 ( <a href="#">384</a> )                             | MP                   | 74   | 64 | 31               | NS      | .02 |
|   | NOP                  | 77   | 60 | 14               | —       | —   |
| GMTG MM02/1995 ( <a href="#">385</a> )                        | MP (IV) <sup>e</sup> | 99   | 43 | Approximately 37 | .01     | NS  |
|   | VBAMD <sup>e</sup>   | 105  | 64 | —                | —       | —   |
| Myeloma Trialists Collaborative Group 1988                    | MP vs. CCT           | 6633 | 53 | 29               | <.00001 | NS  |

NG, not given; NS, not significant; RR, response rate.

<sup>a</sup> Except where stated, response is according to Myeloma Task Force criteria or modification.

<sup>b</sup> SWOG response criteria.

<sup>c</sup> Significantly superior survival in combination chemotherapy arms compared to MP in the 174 stage III patients but not in the 74 stage I or II patients.

<sup>d</sup> The sequential arm was significantly worse than the MP ( $p = .01$ ) or the MCBP ( $p = .02$ ) arms and marginally worse than MCBPA arm ( $p = .09$ ).

<sup>e</sup> Part of an interferon trial; stage III patients only.

Modified from Myeloma Trialists' Collaborative Group. Combination therapy versus melphalan plus prednisone as treatment for multiple myeloma: an overview of 6,633 patients from 27 randomized trials. *J Clin Oncol* 1998;16:3832–3842.

**Anthracyclines** Doxorubicin is the most commonly used anthracycline in the treatment of myeloma, but it has not been studied as a single agent in newly diagnosed myeloma patients. Its activity as a single agent in relapsed or refractory disease is modest, with response rates of approximately 10% ( [36](#), [387](#) ). A phase II trial of mitoxantrone as a single agent (12 mg/m<sup>2</sup> every 3 weeks) yielded a partial response rate of 3% (1 of 35). An additional four patients showed clinical improvement lasting 4 to 7 months ( [388](#) ). Idarubicin is another anthracycline that has been studied in multiple myeloma. Response rates of 0 to 27% have been observed in relapsed and refractory patients with single agent oral regimens (30 mg per week in three divided doses given 3 of 5 weeks or 40 mg/m<sup>2</sup> every 3 weeks) ( [389](#), [390](#) ).

**Etoposide** In relapsed and refractory disease, single agent etoposide (200 to 250 mg/m<sup>2</sup> over 5 days) has minimal activity; in 85 patients, the response rate was less than 5% ( [391](#) ). Barlogie et al. ( [392](#) ) treated 14 patients with 200 mg/m<sup>2</sup> by continuous infusion, and two patients responded. In addition, there are two anecdotal reports of activity of low-dosage (25 to 50 mg/day) oral etoposide ( [393](#), [394](#) ).

**Nitrosoureas** The nitrosoureas have single-agent activity in myeloma. In a randomized trial of 361 previously untreated patients ( [Table 98.5](#) ), objective response frequency with BCNU (40%) and lomustine (CCNU) (42%) was lower than that of melphalan (59%), although the survivals for all groups were not significantly different ( [347](#) ).

**Interferon** Since the original report by Mellstedt et al. ( [35](#) ) of activity of human leukocyte interferon in patients with myeloma, multiple studies have confirmed the findings with daily human leukocyte interferon [3 to 9 million international units (MU) per day] ( [319](#), [395](#) )

and with recombinant interferon- $\alpha$  ( 321, 396 ). Although the earliest studies suggested response rates of as great as 60%, subsequent studies yielded rates of 15 to 20% ( 395, 397, 398 and 399 ). Toxicity was not inconsequential ( 399 ). *In vitro* activity had good predictive value for *in vivo* clinical response in 26 patients studied ( 397 ). However, interferon has a stimulatory effect in approximately one-third of myeloma samples tested *in vitro* ( 397 ).

**Thalidomide** Recognition of the role of increased angiogenesis in the pathogenesis and progression of myeloma ( 172 ) and evidence of thalidomide's antiangiogenic properties ( 400 ) led to clinical trials in multiple myeloma ( 38, 401 ). The observed responses in patients without high-grade angiogenesis suggest that thalidomide may act via mechanisms other than antiangiogenesis ( 402 ). The actual antitumor mechanism is likely complex. *In vitro* data suggest that the drug and its metabolites may inhibit angiogenesis but, in addition, may modulate adhesion molecules of myeloma cells and their surrounding stroma, may modulate cytokines, and may affect natural killer cells. There is recent evidence that thalidomide and its analogs induce apo-ptosis and G<sub>1</sub> growth arrest in myeloma cells ( 402 ). Multiple studies have confirmed the activity of thalidomide as a single agent in relapsed myeloma ( Table 98.8 ). Response rates are in the range of 25 to 45%, with a median response duration of 9 to 12 months and a 2-year progression-free survival rate of 10 to 20% ( 38, 404, 407, 408 and 409, 417 ). Thalidomide is now considered a standard therapy for multiple myeloma, although Food and Drug Administration approval for this indication is pending.

**TABLE 98.8. Thalidomide**

| Study (Reference)                                 | Thalidomide Dose (mg/d) | Dexamethasone   | Patients (No.) | Response Rate (%) |
|---|-------------------------|---|----------------|-------------------|
| Previously untreated myeloma                      |                         |   |                |                   |
| Weber et al. ( 403 )                              | 100–600                 | —   | 28             | 36                |
| Rajkumar et al. ( 404, 405 )                      | 200–800                 | —   | 16             | 38                |
| Rajkumar et al. ( 406 )                           | 200                     | 40 mg, d 1–4, 9–12, and 17–20 (odd cycles), d 1–4 (even cycles) | 50             | 64                |
| Weber et al. ( 403 )                              | 200–400                 | 20 mg/m <sup>2</sup> d 1–4, 9–12, and 17–20                     | 40             | 72                |
| Relapsed myeloma                                  |                         |   |                |                   |
| Barlogie et al. ( 407 ) and Singhal et al. ( 38 ) | 200–800                 | —   | 169            | 30                |
| Tosi et al. ( 408 )                               | 100–800                 | —   | 11             | 36                |
| Juliusson et al. ( 409 )                          | 200–800                 | —   | 23             | 43                |
| Weber et al. ( 410 )                              | 200–800                 | —   | 44             | 25                |
| Durie and Stepan ( 411 )                          | 50–400                  | —   | 33             | 24                |
| Rajkumar et al. ( 412 )                           | 200–800                 | —   | 32             | 38                |
| Kneller et al. ( 413 )                            | 200–800                 | —   | 17             | 65                |
| Rajkumar et al. ( 412 )                           | 200–800                 | —   | 16             | 25                |
| Palumbo et al. ( 414 )                            | 100                     | 40 mg, d 1–4 each month   | 77             | 41                |

|   |         |   |    |     |
|---|---------|---|----|-----|
| Dimopoulos et al. ( <a href="#">415</a> ) | 200–400 | 40 mg, d 1–4, 9–12, and 17–20, followed by d 1–4 monthly    | 44 | 55  |
| Coleman et al. ( <a href="#">416</a> )    | 50–200  | 40 mg every 2 wk and clarithromycin, 250–500 mg twice a day | 24 | 100 |
| Weber et al. ( <a href="#">410</a> )      | 200–800 | 20 mg/m <sup>2</sup> , d 1–5 and 15–18                      | 47 | 52  |

**Other Agents** Barlogie et al. ( [392](#) ) explored the usefulness of cisplatin therapy for patients with myeloma. Fourteen patients were treated with 10 mg/m<sup>2</sup> for 7 days by continuous infusion, and two patients responded. The drug has been incorporated into other regimens for relapsed disease ( [392](#), [418](#), [419](#) ) and induction therapy ( [420](#) ). Cytosine arabinoside ( [421](#) ), teniposide ( [422](#) ), topotecan ( [423](#) ), deoxycoformycin ( [424](#), [425](#) ), and paclitaxel ( [426](#), [427](#) ) have been reported to produce response rates of 7%, 28%, 16%, 0 to 15%, and 15 to 29%, respectively. Topotecan induces significant toxicity including grade 3 and greater granulocytopenia and thrombocytopenia in 93% and 53% of patients, respectively ( [423](#) ). Patients treated with paclitaxel were premedicated with 40 mg of dexamethasone every 21 days ( [426](#), [427](#) ), bringing into question whether the observed responses were attributable to dexamethasone or paclitaxel. Agents that do not appear to have any activity in myeloma include drugs that are interesting from a historical perspective and drugs that have known activity in other diseases. Agents in the former category include diamidines, such as stilbamidine; 1-aminocyclopentanecarboxylic acid; amsacrine ( [428](#), [429](#) ); aclarubicin ( [430](#) ); chlorozotocin ( [431](#) ); hexamethylmelamine ( [432](#) ); and azaserine ( [33](#) ). Other commonly used agents without activity against myeloma include methotrexate, 6-mercaptopurine, 6-thioguanine, 5-fluorouracil, fluorodeoxyuridine, hydroxy-urea, mitomycin C ( [33](#) ), vinblastine, vindesine ( [341](#) ), carboplatin ( [433](#) ), bleomycin ( [387](#) ), all- *trans*-retinoic acid, fludarabine ( [434](#) ), and 2-chlorodeoxyadenosine ( [435](#) ). Although Durie et al. ( [436](#) ) reported a 57% response rate with clarithromycin, subsequent reports did not corroborate this response rate, and the activity observed in the original report was attributed to concurrent corticosteroid therapy ( [437](#), [438](#) and [439](#) ).

## INDUCTION CHEMOTHERAPY REGIMENS

### *Single Agent with or without Corticosteroids for Induction*

**Melphalan as Induction Therapy** Since early reports by Blokhin et al. ( [31](#) ) and Bergsagel et al. ( [32](#) ), various schedules of melphalan have been tried, including continuous daily dose, 6 to 10 mg per day for 2 to 3 weeks, followed by maintenance therapy of 0.01 to 0.03 mg/kg per day; intermittent total doses of 0.25 mg per day given for 4 days every 4 to 8 weeks; or 0.15 mg/kg per day for 7 days every 6 weeks ( [343](#), [440](#) ). Several studies suggest that the intermittent schedule is superior to continuous daily dosing ( [343](#), [440](#) ). The combination of melphalan and prednisone ( [Table 98.5](#) and [Table 98.7](#) ) has been studied extensively ( [337](#), [345](#) ). Response rates are 40 to 60%, and anticipated median survivals are 18 to 42 months ( [306](#), [315](#), [318](#), [325](#), [328](#), [329](#), [337](#), [343](#), [345](#), [346](#), [361](#), [365](#), [366](#), [369](#), [370](#), [374](#), [375](#) and [376](#), [378](#), [379](#), [381](#), [382](#), [383](#), [384](#) and [385](#), [441](#) ). Because of the variable gastrointestinal tract absorption of melphalan, intravenous regimens of 15 to 25 mg/m<sup>2</sup> every 4 weeks along with oral prednisone or dexamethasone have been tried and resulted in response rates of 50 to 82% ( [385](#), [442](#) ). Not until the report by McElwain and Powles ( [322](#) ) on the successful use of high-dose melphalan (140 mg/m<sup>2</sup> intravenously) had dose intensity ( [Table 98.9](#) ) been studied in myeloma. In previously untreated patients, Selby et al. ( [338](#) ) confirmed a 78% response rate, including 27% of patients whose M component was no longer visible by protein electrophoresis. This dose intensity without stem cell

salvage was associated with prolonged, severe thrombocytopenia and leukopenia (lasting a median of 24 and 28 days, respectively). Treatment-related mortality was 19%. The benefit of melphalan dose intensification was confirmed by others who used attenuated doses (50 to 70 mg/m<sup>2</sup>) and reported response rates of 50 to 85% (444, 445, 447). These dose schedules are associated with 8 and 6 days of severe neutropenia and thrombocytopenia, respectively (445).

**TABLE 98.9. Intravenous Melphalan**

| Study (Reference)         | Agent   | Schedule  | Disease Status        | N   | Response Rate (%) | Overall Survival (mo) |
|---------------------------|---|---|-----------------------|-----|-------------------|-----------------------|
| McElwain and Powles (322) | Melphalan   | 100 to 140 mg/m <sup>2</sup> × 1  | Untreated, refractory | 9   | 100               | NG                    |
| Selby et al. (338)        | Melphalan   | 140 mg/m <sup>2</sup> × 1   | Untreated             | 41  | 78                | NG                    |
|                           |   |   | Relapsed              | 15  | 66                | —                     |
| Cornwell et al. (386)     | Melphalan and prednisone                            | Melphalan, 16 mg/m <sup>2</sup> q2wk × 3, then q4wk; prednisone, 0.8 mg/kg/d with taper | Untreated             | 195 | 38                | NG                    |
| Petrucci et al. (443)     | Melphalan   | 25 mg/m <sup>2</sup> , d 1  | Refractory            | 34  | 35                | 8                     |
| Peest et al. (385)        | Melphalan and prednisone                            | Melphalan, 15 mg/m <sup>2</sup> , d 1; prednisone, 60 mg, d 1–4                         | Untreated II          | 59  | 59                | NG                    |
|                           |   |   | Untreated III         | 43  | 36                | —                     |
| Tsakanikas et al. (444)   | Melphalan   | 50–70 mg/m <sup>2</sup>   | Refractory            | 18  | 50                | 11.5                  |
| Lokhorst et al. (445)     | Melphalan and granulocyte colony-stimulating factor | 70 mg/m <sup>2</sup> q6wk   | Untreated             | 21  | 85                | NG                    |
|                           |   |   | Relapsed              | 10  | 50                | —                     |
| Palumbo et al. (446)      | Melphalan and granulocyte colony-stimulating factor | 30 mg/m <sup>2</sup> q8wk   | Refractory            | 30  | 38                | NG                    |
| Schey et al. (442)        | Melphalan and dexamethasone                         | 25 mg/m <sup>2</sup> , d 1  | Untreated             | 33  | 82                | NG                    |
|                           |   | 40 mg, d 1–4 q4wk   | —                     | —   | —                 | —                     |

NG, not given.

**Cyclophosphamide as Induction Therapy** Since the original report by Korst et al. (34) of the usefulness of cyclophosphamide in myeloma patients, several single agent induction regimens have been studied. Despite documented equivalency for low-dose oral regimens

of cyclophosphamide and melphalan ( 344 ), induction therapies of melphalan and prednisone tend to be preferred over those of cyclophosphamide and prednisone. Most commonly, cyclophosphamide has been used in multidrug combinations for induction, for therapy in relapse, and for stem cell mobilization rather than as a single agent for induction, as has melphalan. For newly diagnosed myeloma, oral daily dosing of cyclophosphamide (150 mg per day) ( 344 , 448 , 449 ) or intravenous doses of 600 mg/m<sup>2</sup> every 3 weeks ( 346 ) with or without prednisone has resulted in a response rate of approximately 25% and median survival of 24 months.

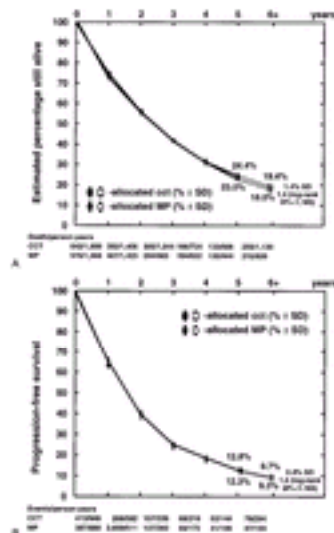
**Corticosteroids as Induction Therapy** In previously untreated patients, approximately 43% have a 75% decrement in their *tumor mass index* with single-agent high-dose dexamethasone therapy ( Table 98.6 ) ( 351 ), which is only 15% lower than for vincristine, doxorubicin (Adriamycin), and dexamethasone (VAD). Dexamethasone in lieu of VAD for induction in those patients destined for stem cell collection may be potentially advantageous. With single-agent dexamethasone, insertion of a long-term central venous catheter can be postponed until conditioning for the stem cell transplantation is required, thereby reducing the likelihood of catheter-related complications (i.e., thrombosis and infection) ( 351 ). This strategy has been used successfully, resulting in adequate collections of peripheral blood stem cells without any apparent adverse effects on complete remission rates or progression-free survival in a single-arm study ( 450 ).

**Interferon as Induction Therapy** Although the earliest studies of interferon suggested response rates of as great as 60%, subsequent studies produced rates of 15 to 20% ( 395 , 397 , 398 and 399 ). Ahre et al. ( 451 ) randomized 55 patients to melphalan and prednisone or interferon (3 to 6 MU daily); response rates in the melphalan and prednisone arm were significantly higher than in the interferon arm (44% vs. 14%,  $p < .001$ ). Interferon- $\alpha$  and dexamethasone have been combined as an induction regimen in patients with newly diagnosed myeloma and a low tumor mass. A retrospective comparison showed that the response rate of this regimen (57%) was similar to the response rate (48%) previously observed with dexamethasone alone ( 452 ).

**Thalidomide as Induction Therapy** Thalidomide represents a new and distinct class of agents with significant activity against myeloma ( Table 98.8 ). When thalidomide is used as a single agent in previously untreated patients, response rates of approximately 35% may be achieved ( 403 , 404 ). Rajkumar et al. ( 453 ) showed that combined thalidomide and dexamethasone therapy in previously untreated patients resulted in response rates of 64%. Limited use of thalidomide pre-stem cell mobilization does not impair stem cell collection or engraftment, although preliminary data suggest that there may be a problem with longer continuous use ( 454 , 454a ).

**Combination Chemotherapy for Induction** A combination of multiple active agents in an effort to achieve synergy was a logical corollary. For expediency, these regimens can be separated into four categories: alkylator-based without anthracyclines, anthracycline-containing regimens, anthracycline-containing regimens with intensified doses of corticosteroids, and induction regimens incorporating interferon. Thirty years of study indicate that multiagent combination chemotherapy as initial therapy results in higher response rates, but not longer overall survival rates, than standard melphalan and prednisone therapy ( 318 ) ( Table 98.7; Fig. 98.9 ). Although it has been suggested that patients with more advanced disease benefit from combination chemotherapy as compared to melphalan ( 326 , 362 , 367 , 375 , 455 ), this hypothesis has not been proven ( 306 , 318 ). In time, when physicians are better able to ascertain biologic differences ( 456 ) between myeloma patients and to classify them properly in a fashion similar to that used in lymphomas, a survival benefit with multiagent chemotherapy may be detected in particular subgroups.





**Figure 98.9.** Melphalan and prednisone (MF) versus combined chemotherapy (CC7) as induction. Results from 6633 patients from 27 randomized trials. **A:** Overall survival. **B:** Response duration. NS, not significant. (From Myeloma Trialists' Collaborative Group. Combination chemotherapy versus melphalan plus prednisone as treatment for multiple myeloma: an overview of 6,633 patients from 27 randomized trials. Myeloma Trialists' Collaborative Group. J Clin Oncol 1998;16:3832–3842, with permission.)

**Alkylator-Based Combination Chemotherapy without Anthracycline for Induction** The 1970s and 1980s were a testing ground for various combinations of alkylators, corticosteroids, and doxorubicin. Melphalan, cyclophosphamide, and prednisone (360); BCNU, cyclophosphamide, and prednisone (366, 369); melphalan, cyclophosphamide, BCNU, and prednisone (MCBP) (360, 367); and vincristine, melphalan, cyclophosphamide, and prednisone (VMCP) (360) resulted in response rates of 47%, 37 to 50%, 49 to 68%, and 62%, respectively. Median survivals with these regimens were 25 to 36 months (360, 366, 367, 369). Lee and Case (327) introduced the five-drug regimen of vincristine, BCNU, melphalan, cyclophosphamide, and prednisone (VBMCP or the M-2 regimen), which included the same four drugs as MCBP plus vincristine; dose intensities, however, were different in these two regimens. Response rate for VBMCP was approximately 85% in previously untreated patients with a median survival of 38 months (327, 457). The success of the VBMCP regimen supported the value of vincristine. However, the fourth MRC trial, which randomized 530 previously untreated patients with myeloma to melphalan and prednisone versus melphalan, vincristine, and prednisone, revealed no difference in response rate or overall survival between the two arms (315). VMCP has not produced any response or survival advantage over melphalan and prednisone (379, 380). Finally, the MOCCA regimen, which is essentially VBMCP, with CCNU replacing BCNU, results in response rates similar to those for VBMCP (75%), but, again, no survival benefit in comparison to melphalan and prednisone (329). Although subsequent randomized trials have substantiated the superior response rates of VBMCP over standard melphalan and prednisone (Table 98.7), they have not demonstrated superior survival (328, 365, 376, 377). In fact, the metaanalysis performed by the Myeloma Trialists' Collaborative Group (318), involving 6633 patients in 27 randomized trials, revealed a superior response rate (60.2% vs. 53.2%,  $p < .000001$ , two-tailed) but no survival benefit for combination chemotherapy over standard melphalan and prednisone (Fig. 98.9A). A prior metaanalysis of 18 published trials (3814 patients) also demonstrated no benefit for combination chemotherapy in terms of survival. There might be a survival advantage in the subgroup of patients with more aggressive disease (455), but this was not substantiated in the larger metaanalysis (318).

**Combination Chemotherapy with Anthracycline for Induction** The use of alkylator- and

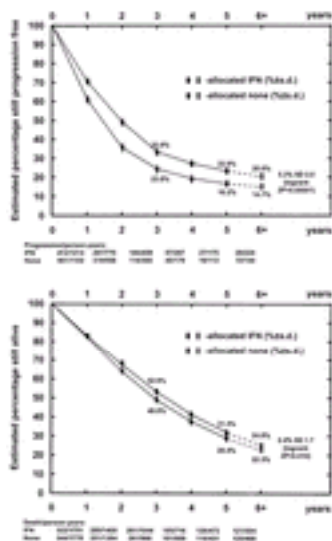


doxorubicin-based combination chemotherapy was stimulated by a report on the benefits of a combination of doxorubicin and BCNU in patients who had become resistant to melphalan ( 458 ). Regimens like melphalan, doxorubicin, and prednisone; cyclophosphamide, doxorubicin, and prednisone; vincristine, cyclophosphamide, doxorubicin (Adriamycin), and prednisone (VCAP); and vincristine, BCNU, doxorubicin (Adriamycin), and prednisone (VBAP) were tried; by SWOG response criteria, objective response rates were 41%, 46%, 64%, and 61%, respectively ( 360 , 459 ). Median survival ranged from 30 to 32 months; subsequent analysis demonstrated a superior median survival for the VBAP arm of 37 months ( 460 ). Enthusiasm for alternating VMCP and VBAP (or VCAP) was generated by the SWOG study of 237 patients randomized to melphalan and prednisone or the previously mentioned regimens ( Table 98.9 ) ( 325 , 374 ). Response rates were superior in the alternating combination chemotherapy arms compared to the melphalan arm. Survival was also superior in the combination chemotherapy arms (43 months vs. 23 months for melphalan and prednisone,  $p = .004$ ) ( 459 ). A subsequent analysis with longer follow-up showed less separation of the survival curves (median survival, 36 months vs. 25 months) ( 460 ). The survival benefits of this initial study were not reproducible in subsequent studies ( 361 , 378 , 381 , 382 and 383 , 461 , 462 ). The fifth MRC myelomatosis trial randomized patients to ABCM (VBAP/VMCP without the vincristine or prednisone) or melphalan as a single agent on the basis of findings emanating from the fourth MRC trial, which demonstrated a lack of benefit attributable to the addition of vincristine. Median survival in the ABCM group was superior to that of the melphalan-only arm (32 months vs. 24 months,  $p = .0003$ ) ( 326 ). When corrected for adverse prognostic factors, such as elevated  $\beta_2M$  values, low hemoglobin values, renal insufficiency, performance status, and stage, the significance of the survival difference was  $p = .003$  ( 317 ).

**Combination Chemotherapy with Doxorubicin and Dose-Intensive Corticosteroids for Induction** The next level of combination chemotherapy includes programs that contain anthracyclines and high-dose corticosteroids. VAD-like regimens are commonly used as induction therapy before stem cell collection and transplantation. These regimens include VAP ( 341 ); VAD ( 330 ); vincristine, doxorubicin (Adriamycin), and methylprednisolone (VAMP) ( 331 ); and cyclophosphamide, vincristine, doxorubicin (Adriamycin), and methylprednisolone (C-VAMP) ( 331 ), all of which had been tried with salutary effect in relapsed disease. Subsequently, several of these regimens were applied in previously untreated patients, and response rates were 50 to 84% ( 332 , 463 , 464 , 465 , 466 , 467 , 468 , 469 , 470 and 471 ). The complete response rate of C-VAMP is higher than that of VAMP alone, but survival is not different ( 332 ). Several other variations have been reported in which alternative anthracyclines or corticosteroids were used ( 384 ). Median survival for patients treated initially with VAD is approximately 36 months ( 472 ). In a randomized trial of 151 patients comparing the regimen of mitoxantrone (Novantrone), vincristine (Oncovin), and high-dose prednisone (NOP) to melphalan and prednisone, response rates were equivalent (approximately 60%), but overall survival was inferior in the NOP arm (14 months vs. 31 months,  $p = .02$ ) ( 384 ). Response rates of 80% have also been achieved using the cyclophosphamide, doxorubicin, and dexamethasone regimen ( 473 ). The addition of etoposide to cyclophosphamide, vincristine, doxorubicin (Adriamycin), and dexamethasone (CVAD) appears to contribute only toxicity ( 474 ).

**Combination Chemotherapy with Interferon for Induction** Interferon has been combined with melphalan and prednisone ( 475 , 476 , 477 , 478 , 479 , 480 , 481 and 482 ); VMCP ( 481 , 482 , 483 , 484 and 485 ); VMCP-VBAP ( 481 , 482 ); prednisone, cyclophosphamide, doxorubicin (Adriamycin), and BCNU ( 486 , 487 ); VAD ( 488 ); VBMCP ( 489 ); VBAP ( 481 , 482 ); and cyclophosphamide ( 490 ) as part of an induction regimen. Results have been mixed. Two metaanalyses have been performed in an attempt to reconcile these conflicting results ( 481 , 482 ). The first, reported in 2000 by Ludwig and Fritz ( 481 ), used published data and

included 17 induction trials ( 475, 476, 477, 478, 479, 480, 481 and 482, 484, 485, 486, 487 and 488, 490 ) with 2333 evaluated patients; the second, reported by the Myeloma Trialists' Collaborative Group in 2001 ( 482 ), used primary data from 12 induction trials ( 475, 476, 477, 478, 479, 480, 481 and 482, 484, 486, 487, 489, 490 and 491 ) involving 2469 patients. Overall, the results were similar. In the first metaanalysis, the benefits attributable to the addition of interferon to the induction regimen included a 6.6% higher response rate (  $p < .002$  ) and a 4.8-month and 3.1-month prolongation of relapse-free (  $p < .01$  ) and overall survival (  $p < .01$  ) ( 481 ). In the second metaanalysis, patients receiving interferon had a slightly better response rate (57.5% vs. 53.1%,  $p = .01$ ) and progression-free survival (30% vs. 25% at 3 years,  $p < .0003$ ), with a superior median time to progression of approximately 6 months. The survival advantage of 2 months, however, was not significant (  $p = 0.1$  ) ( 482 ). Figure 98.10 demonstrates progression-free survival and overall survival in patients receiving interferon as induction or maintenance versus those who received none ( 482 ).



**Figure 98.10.** Interferon (IFN) chemotherapy as induction or maintenance therapy influences progression-free and overall survival curves from the metaanalysis by the Myeloma Trialists' Collaborative Group. Results from 24 randomized trials and 4012 patients. IFN curves include patients who received IFN as part of induction or of maintenance program. **A:** Progression-free survival after 23 months with IFN and 17 months without. **B:** Overall median survival after 40 months with IFN and 36 months without. (From Myeloma Trialists' Collaborative Group. Interferon as therapy for multiple myeloma: an individual patient data overview of 24 randomized trials and 4012 patients. *Br J Haematol* 2001;113:1020–1034, with permission.)

These metaanalyses suggest that incorporation of interferon into induction provides a modest prolongation of response and, possibly, of survival. The question is whether these significant differences are clinically relevant. Wisloff et al. ( 492 ) evaluated the quality of life of 583 patients randomized to melphalan and prednisone or melphalan, prednisone, and interferon as induction. During the first year of treatment with interferon, the patients reported significantly more fever, chills, dry skin, fatigue, pain, nausea and vomiting, and appetite loss than the control patients. After the first year, however, the only symptom that was reported more often was dizziness. Although patients receiving interferon had a 5- to 6-month prolongation of the response and plateau phase, there was no late quality-of-life benefit observed to compensate for the early impairment. The authors questioned the clinical value of the plateau phase prolongation and reported that only 60% of patients continued to receive interferon after 24 months, suggesting that their data might underestimate the potential toxicity of the drug. A cost-effectiveness estimation for induction was also performed. The authors concluded that interferon administration and monitoring expenses amounted to \$41,319.28 to save a year of life of myeloma

patients, assuming a dosage of 12.1 MU per week ( [481](#) ). A study on patient preference also deserves mention. Ludwig et al. ( [493](#) ) surveyed cancer patients about acceptable toxicity of an unidentified drug, which had the toxicity profile of interferon, relative to its hypothetical benefit. Approximately 50% of surveyed patients accepted the toxicity of an unidentified drug if remission or survival, or both, would be improved by at least 6 months. Of those patients who rejected the 6-month hypothetical benefit, 25 to 50% were willing to accept the toxicities if the benefits were greater than or equal to 12 months.

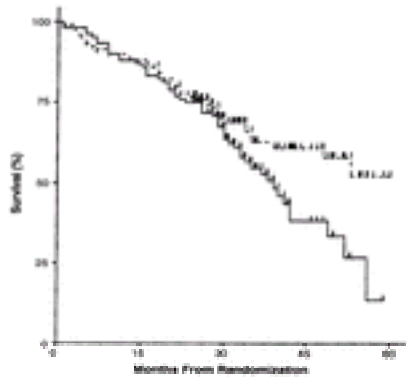
## HEMATOPOIETIC STEM CELL TRANSPLANTATION

### Autologous Transplant

To overcome resistance of the myeloma cells to conventional-dose chemotherapy, McElwain and Powles ( [322](#) ) pioneered the use of high-dose melphalan to treat multiple myeloma and PCL. The treatment was complicated by prolonged myelosuppression. Barlogie et al. ( [494](#) ) used a regimen combining high-dose melphalan with total body irradiation supported by autologous bone marrow transplantation in multiple myeloma patients refractory to VAD.

Cure rarely, if ever, occurs, and almost all patients relapse after autologous stem cell transplantation. Although high-dose therapy followed by autologous stem cell transplantation is not curative, it improves response rates and survival ( [465](#) , [494](#) , [495](#) , [496](#) , [497](#) , [498](#) , [499](#) , [500](#) and [501](#) ). Response rates with transplantation are 75 to 90%, and complete response rates are 20 to 40% ( [495](#) ). The results of single institution and phase II trials are difficult to analyze because selection of patients for transplantation is subject to selection bias regarding the stage of disease, performance status, age, and renal function. The Nordic Myeloma Study Group ( [502](#) ) prospectively evaluated the impact on survival of high-dose therapy in the entire population of myeloma patients younger than 60 years of age. Survival was compared with that of historic controls derived from previous Nordic population-based studies of conventional-dose chemotherapy. Survival was prolonged with the high-dose therapy. Median survival of the control group was 44 months, and the median was not yet reached for the high-dose therapy group at 60 months. Other historical comparisons have suggested that survival in good-risk patients receiving only conventional chemotherapy is similar to that reported in selected series of patients treated with autologous transplantation ( [503](#) ). These examples illustrate the need for prospective randomized trials.

The IFM ( [336](#) ) published the first randomized trial comparing high-dose chemotherapy followed by autologous bone marrow transplantation with conventional chemotherapy ( [Fig. 98.11](#) ). Two hundred patients with previously untreated multiple myeloma were randomized to receive high-dose chemotherapy followed by an autologous bone marrow transplantation or combination intravenous chemotherapy. The 5-year event-free survival (28% vs. 10%) and overall survival rates (52% vs. 12%) were higher in the transplantation group. An updated analysis with a median follow-up of 7 years confirmed that high-dose chemotherapy improves event-free survival (median, 28 months vs. 18 months) as well as overall survival (median, 57 months vs. 44 months) ( [504](#) ).



**Figure 98.11.** Attal transplant curve. (From Attal M, Harousseau JL, Stoppa AM, et al. A prospective, randomized trial of autologous bone marrow transplantation and chemotherapy in multiple myeloma. Intergroupe Français du Myélome. *N Engl J Med* 1996;335:91–97, with permission.)

The Spanish Cooperative Group ([505](#)) reported a prospective trial of 216 patients treated initially with four cycles of VBMCP and a regimen of vincristine, BCNU, doxorubicin, and dexamethasone. Responding patients were then randomized to receive eight additional courses of chemotherapy or intensification with high-dose therapy and stem cell transplantation. Among the 164 randomized patients, the complete response rate was significantly improved in the transplant recipients, but the progression-free survival and overall survival were not. These preliminary data have brought into question the magnitude of the survival benefit achieved with transplantation, but autologous stem cell transplantation is the current standard of care for eligible patients. These data are similar to those of the case-control study published by Alexanian et al. ([506](#), [507](#)). Sixty-eight patients with responsive disease received stem cell transplant within 1 year after the start of induction chemotherapy. Control patients were responsive to the same therapies but did not undergo stem cell transplantation because of refusal or economic hardship. The median overall survival of patients who underwent stem cell transplantation was 10 months longer than that of controls, but this did not reach statistical significance ( $p = .12$ ).

Autologous peripheral blood stem cell transplantation has replaced autologous bone marrow transplantation, because engraftment is more rapid and there is less contamination with myeloma cells ([501](#), [508](#), [509](#)). Hematopoietic stem cells should be collected before the patient is exposed to alkylating agents ([499](#), [510](#)), because prolonged melphalan exposure leads to an impaired harvest of peripheral blood stem cells when stem cells are mobilized with chemotherapy plus growth factor ([511](#)) or growth factor alone ([512](#)). Even after four to six cycles of VMCP-VBAP, which is a regimen containing low doses of melphalan, sufficient stem cells could not be collected for transplantation in approximately 10% of patients ([336](#)). In contrast, successful stem cell collection is achieved in 95 to 100% of multiple myeloma patients treated with VAD before mobilization with high-dose cyclophosphamide ([502](#)). The absolute number of CD34<sup>+</sup> cells per kilogram is the most reliable and practical method for determining the adequacy of a stem cell collection. The mortality rate from autologous stem cell transplantation is currently less than 5%. Age older than 65 years alone is not a contraindication for transplantation, although there are no randomized data proving or disproving the usefulness of transplantation in this age group. Such patients are candidates for transplantation if they have good functional status and limited comorbidities ([513](#), [514](#)).

**TRANSPLANTATION FOR PRIMARY REFRACTORY MYELOMA** In contrast to the

experience with malignant lymphoma, stem cell transplantation appears to be effective for patients with primary resistant disease ( 506 , 515 ). Patients with multiple myeloma in whom first-line therapy, such as VAD, fails can be sensitive to high-dose chemotherapy with stem cell reconstitution. Alexanian et al. ( 506 ) reported a decrease of 75% in tumor burden in 56% of patients and a marked improvement in survival compared to matched historical controls. Rajkumar et al. ( 515 ) also looked at stem cell transplantation in primary refractory disease and found no differences in overall and complete response rates between patients with primary refractory and relapsed disease. The median survival of the entire cohort from the time of diagnosis was 53 months.

**SINGLE VERSUS DOUBLE TRANSPLANTATION** The role of double or tandem autologous stem cell transplantation is controversial. Barlogie et al. ( 420 , 516 , 517 and 518 ) at the University of Arkansas advocate tandem (double) autologous stem cell transplantation to improve complete response rates and survival. In tandem transplantation, patients receive a second planned transplant on recovery from the first procedure. In a study of 231 patients with newly diagnosed myeloma, the overall survival with this approach was 68 months ( 420 ). Approximately 50% of patients in this cohort were 50 years of age or younger and had less than stage III disease. These results have prompted additional studies. Preliminary data from four different randomized trials indicated a slight increase in response rates and, possibly, event-free survival with tandem transplantation ( 504 ) but no clear improvement in overall survival ( Table 98.10 ). In the largest study, that is, the IFM 94 study, at 2-year follow-up, there was no difference in event-free or overall survival between double and single autologous stem cell transplants ( 523 ). In another evaluation of this study of 403 patients ( 504 ), a subgroup of patients, those receiving stem cells derived from the peripheral blood rather than the bone marrow, had a modest overall survival benefit with tandem transplantation. There was no obvious explanation for the observed difference in survival between the groups. Most recently, the authors have reported in abstract form that this study is finally positive. Although the response rate was not significantly different between the two groups (complete response and very good partial response 42% in the single-transplant arm vs. 50% in the double-transplant group,  $p = .15$ ), event-free survival and overall survival were improved in the double-transplant arm. Median survival in the two arms was not different, but the 7-year postdiagnosis probability of event-free survival was 20% [95% confidence interval (CI), 14 to 26] in the double-transplant arm versus 10% (95% CI, 5 to 15) in the single-transplant arm (  $p < .03$  ). Overall survival rates 7-years postdiagnosis were 42% (95% CI, 34 to 49) for double transplants and 21% (95% CI, 13 to 29) for single transplants (  $p < .01$  ). In this trial, four factors were associated with a longer survival: low  $\beta_2$ M levels at diagnosis (  $p < .01$  ), young age (  $p < .05$  ), low lactate dehydrogenase at diagnosis (  $p < .01$  ), and treatment arm (  $p < .05$  ). The final results of this trial and the other three trials ( Table 98.10 ) that are negative to date will provide a definitive answer to the question of tandem transplantation. Because the role of tandem or double transplantation is not settled, it is reasonable to harvest enough stem cells for two transplants.

**TABLE 98.10. Single versus Double Hematopoietic Stem Cell Transplantation, Randomized Trials**

| Study (Reference)  | N   | FU (mo) | % Event-Free Survival, (yr FU) |                |     | % Overall Survival (yr FU) |           |     |
|--------------------|-----|---------|--------------------------------|----------------|-----|----------------------------|-----------|-----|
|                    |     |         | Single                         | Double         | $p$ | Single                     | Double    | $p$ |
| IFM 94 ( 519 )     | 403 | 60      | 19 (6)                         | 28 (6)         | .03 | 26 (6)                     | 46 (6)    | .02 |
| Hovon ( 520 )      | 255 | 29      | 35 (3)                         | 36 (3)         | NS  | 47 (4)                     | 43 (4)    | NS  |
| Bologna 96 ( 521 ) | 178 | 30      | 21 mo (median)                 | 29 mo (median) | NS  | 74 (4)                     | 71 (4)    | NS  |
| MAG 95 ( 522 )     | 193 | 27      | 41 events                      | 43 events      | NS  | 27 deaths                  | 22 deaths | NS  |

FU, follow-up; NS, not significant.



Adapted from Dalton WS, Bergsagel PL, Kuehl WM, et al. Multiple myeloma. In: Schechter GP, Williams ME, eds. Hematology 2001. Washington, DC: American Society of Hematology, 2001;157–177.

---

**TIMING OF TRANSPLANTATION** The timing of the transplantation, up front as consolidation therapy or as salvage therapy at the time of relapse, is also a point of controversy. In one study ( [524](#) ), 185 patients were treated with one to two cycles of an intensified regimen of cyclophosphamide, hydroxydaunomycin, vincristine, and prednisone (CHOP) followed by peripheral blood stem cell collection and then randomized to three or four courses of VAMP followed by high-dose chemotherapy and autologous stem cell transplantation *or* to conventional chemotherapy (VMCP) until a stable plateau was reached, followed by autologous transplantation at disease progression. The median survival was essentially the same in both groups (65 months vs. 64 months). From the time of randomization, the median event-free survival in the early transplant group was 39 months compared to 13 months in the delayed transplant group. The main advantage of early transplantation was the avoidance of the inconvenience and cost of chemotherapy ( [524](#) ). The North American Intergroup Study (S9321) is a larger randomized trial comparing early to late transplantation. It met its accrual goal of approximately 1000 patients in October 2000. Results of this trial are not yet available.

**CONDITIONING THERAPY AND STEM CELL TRANSPLANTATION** In an effort to improve autologous stem cell transplantation, various preparative regimens have been used. There has been only one prospective randomized controlled trial comparing conditioning regimens in patients with myeloma ( [525](#) ). Moreau et al. ( [525](#) ) randomized 282 patients to receive melphalan (140 mg/m<sup>2</sup>) plus total body irradiation or melphalan alone (200 mg/m<sup>2</sup>). There was no difference in response rates or event-free survival. Survival at 45 months favored the melphalan alone arm (65.8% vs. 45.5%, *p* = .05). Toxicity with melphalan alone was significantly less. Most investigators have now discontinued the use of total body irradiation and give only melphalan (200 mg/m<sup>2</sup>) as the preparative regimen. Other regimens, including various combinations of melphalan, busulfan, cyclophosphamide, idarubicin, etoposide, or thiotepa, have been used ( [501](#) , [526](#) , [527](#) , [528](#) , [529](#) , [530](#) , [531](#) , [532](#) and [533](#) ) without any evidence of superiority of these regimens over melphalan 200 mg/m<sup>2</sup>. Innovative trials supplementing melphalan with skeletal targeted radiation [samarium 153-ethylenediaminetetramethylene phosphonate ( [534](#) ) and holmium 166-1,4,7,10-tetraazocyclodecane-1,4,7,10-tetramethylenephosphonic acid ( [535](#) )] are in progress.

**ROLE OF PURGING** It is unclear whether the purging of tumor cells from the collection of hematopoietic stem cells is beneficial. Purging marrow with cyclophosphamide derivatives ( [536](#) ) or with monoclonal antibodies ( [537](#) , [538](#) ) has proven feasible, although associated with prolonged myelosuppression after transplantation. CD34<sup>+</sup> selection of peripheral blood progenitor cells provided effective hematopoietic support in a group of 55 patients with advanced multiple myeloma after myeloablative chemotherapy ( [539](#) ). However, two large phase III randomized trials have shown no clinical benefit to using CD34<sup>+</sup>-selected autologous peripheral blood stem cells ( [540](#) , [541](#) ).

### Allogeneic Transplant

Allogeneic transplantation eliminates the problem of stem cell contamination by tumor cells that is inevitable with autologous stem cell transplantation. Furthermore, there is evidence of a graft-versus-myeloma effect with allografting ( [542](#) ). Allogeneic transplantation can lead to prolonged disease-free survival in a relatively small percentage of patients ( [543](#) , [544](#) ). The high treatment-related mortality (approximately

30%) and significant toxicity from graft-versus-host disease (GVHD) have limited the role of this procedure in the treatment of myeloma ( 543 , 545 , 546 ) ( Table 98.11 ). There have been four case-controlled or cohort-controlled studies comparing autologous to allogeneic stem cell transplants ( Table 98.11 ) ( 547 , 548 , 549 and 550 ). The largest of these is by Bjorkstrand et al. ( 547 ). In their retrospective analysis of data compiled by the European Blood and Marrow Transplantation Group, there was inferior survival for myeloma patients treated with allogeneic bone marrow transplants compared to case-matched controls treated with autologous transplants (18 months vs. 36 months) ( 547 ). The three smaller studies, which had relatively short follow-up, have shown mixed results with regard to progression-free survival and overall survival; transplant-related mortality, however, is consistently higher in the allogeneic groups (19 to 25%).

**TABLE 98.11. Nonrandomized Comparisons of Autologous and Allogeneic Hematopoietic Stem Cell Transplantation for Multiple Myeloma**

| Study (Reference)          | N  | Treatment- Related Mortality (%) | Median Survival (mo) | <i>p</i> |
|----------------------------|--|----------------------------------|----------------------|----------|
| Bjorkstrand et al. ( 547 ) | 189 autologous                             | 13                               | 34                   | .001     |
|                            | 189 allogeneic                             | 41                               | 18                   | —        |
| Varterasian et al. ( 548 ) | 24 autologous                              | 12                               | 33.5                 | NS       |
|                            | 24 allogeneic                              | 25                               | 38.6                 | —        |
| Couban et al. ( 549 )      | 40 autologous                              | 5                                | =48                  | <.001    |
|                            | 22 allogeneic                              | 27                               | 7                    | —        |
| Reynolds et al. ( 550 )    | 35 autologous                              | 6                                | =15                  | NS       |
|                            | 21 allogeneic                              | 19                               | =27                  | —        |
| Lokhorst et al. ( 551 )    | 50 autologous                              | 4                                | =44                  | NS       |
|                            | 11 allogeneic <sup>a</sup><br><sub>b</sub> | 18                               | =44                  | —        |

NS, not significant.

<sup>a</sup> Chemotherapy-sensitive patients only.

<sup>b</sup> T-cell-depleted allogeneic stem cells.

From Dispenzieri A, Lacy MQ, Greipp PR. Multiple myeloma. In: Gertz MA, Greipp PR, eds. Hematologic malignancies: multiple myeloma and related plasma cell disorders. Berlin: Springer-Verlag, 2004:57-109, with permission.

In an effort to reduce transplant-related mortality, Lokhorst et al. ( 551 ) compared autologous stem cell transplants to T-cell-depleted allogeneic stem cell transplants. Myeloma patients were eligible if they had chemotherapy-sensitive disease. Genetic randomization was used. After 44-month median follow-up, overall survival had not yet been reached in either group. Transplant-related mortality in the allogeneic group was 18% compared to 4% in the autologous group.

In one series, only 5 of 80 patients were alive without evidence of disease at 4 to 7 years



after an allogeneic bone marrow transplantation for multiple myeloma ( 543 ). It must be emphasized that the majority of these patients had chemotherapy-resistant disease before transplantation. Outcomes have improved over time ( 552 ). Of 690 allogeneic, matched, sibling donor transplants for multiple myeloma reported to the European Group for Blood and Marrow Transplantation registry, 334 were performed between 1983 and 1993 (all with bone marrow), and 356 were performed between 1994 and 1998. The 3-year overall survival was 35% for transplant recipients during the earlier period and 55% for recipients of bone marrow transplants during the later period. The improvement in survival since 1994 was the result of a significant reduction in transplant-related mortality, from 46 to 30% at 2 years ( 552 ).

Allogeneic transplantation produces higher rates of complete molecular responses. In a series of 229 myeloma patients, allogeneic transplantation resulted in a complete response of 38% compared to 22% after autologous transplantation (  $p < .01$  ) ( 553 ). Among patients achieving a clinical complete response, 50% of the allogeneic transplant group had a molecular complete response compared to only 17% of those who had received an autologous transplant ( 553 ). The median relapse-free survival for those who had a molecular complete remission was 110 months compared to 35 months for those who did not. Moreover, in those with a complete molecular remission, the relapse rate was only 16% in the allogeneic group and 41% in the autologous group. This is strong evidence that molecular complete responses are associated with a longer relapse-free survival.

### Donor Lymphocyte Infusions

A graft-versus-myeloma effect has been noted after the administration of donor peripheral blood mononuclear cells for relapse after allogeneic transplantation ( 542 ). Eight of 13 patients with myeloma relapse after an allogeneic bone marrow transplant responded to donor lymphocyte infusions. Four of the patients had a complete response ( 554 ). In a larger group of patients with a prolonged follow-up period, the factors that were correlated with response to donor lymphocyte infusions were a T-cell dose of more than  $1 \times 10^8$  cells/kg, a response to reinduction therapy, and chemotherapy-sensitive disease before allogeneic transplantation ( 555 ).

### Nonmyeloablative Allogeneic Transplant

Despite a significant decrease in the relapse rate and graft-versus-myeloma effects, allografts have been associated with inferior survival in nearly all comparisons because of high peritransplant mortality, late complications of chronic GVHD, and late infections. The mortality rate for allogeneic transplantation must be reduced before it can assume a major role in the treatment of multiple myeloma. Promising approaches include nonmyeloablative conditioning (mini) regimens, at relapse or immediately after autologous stem cell transplantation, for selected patients with myeloma ( Table 98.12 ).

**TABLE 98.12. Nonmyeloablative Regimens for Multiple Myeloma**

| Study (Reference) | N | Diagnosis to NMA, Mo (Range) | Sibling/ Matched Unrelated Donor Allograft | Age, Yr (Range) | NMA Regimen <sup>a</sup> | Median Follow-Up (mo) | Patients in Complete Response/ Partial Response (No.) | Treatment-Related Mortality |
|-------------------|---|------------------------------|--|-----------------|--------------------------|-----------------------|---|-----------------------------|
|-------------------|---|------------------------------|--|-----------------|--------------------------|-----------------------|---|-----------------------------|

|  |                                  |      |               |   |                 |       |       |
|--|----------------------------------|------|---------------|---|-----------------|-------|-------|
| Badros et al. ( <a href="#">556</a> , <a href="#">557</a> )  | 31 29 (8 to 164)                 | 25/6 | 56 (38 to 69) | Melphalan 100   | 6               | 12/10 | 9/31  |
| Giralt et al. ( <a href="#">558</a> , <a href="#">559</a> )  | 22 36 (3 to 135)                 | 13/9 | 51 (45 to 64) | FM  | 15              | 7/9   | 9/22  |
| Maloney et al. ( <a href="#">560</a> , <a href="#">561</a> ) | 54 <sup>2</sup> <sup>b, c</sup>  | NS   | 55 (39 to 71) | Auto ? NMA (total body irradiation 200 cGy; MMF)                | 18 <sup>d</sup> | NS    | 8/32  |
| Kroger et al. ( <a href="#">562</a> )                        | 17 <sup>11</sup> <sup>b, e</sup> | 9/8  | 51 (32 to 64) | Auto ? NMA (FM-antithymo-cyte globulin-MTX)                     | 17 <sup>d</sup> | 11/3  | 2/17  |
| Schaefer et al. ( <a href="#">563</a> )                      | 22 NS                            | 6/16 | 54 (32 to 66) | FC-200 cGy  | 5               | 1/8   | 7/22  |
| Peggs et al. ( <a href="#">564</a> )                         | 23 NS                            | 17/6 | 47 (34 to 58) | FM-Campath  | 5               | 5/NS  | 3/23  |
| Lalancette et al. ( <a href="#">565</a> )                    | 50 NS                            | 43/6 | 48 (33 to 62) | FM or fludarabine/Busulphan ± Campath or antithymocyte globulin | NS              | 17/19 | 16/50 |

FC, fludarabine and cyclophosphamide; FM, fludarabine and melphalan; MMF, mycophenolate mofetil; MTX nonmyeloablative transplant; NS, not stated.

<sup>a</sup> All studies used cyclosporine as part of the graft-versus-host prophylaxis program.

<sup>b</sup> Patients had nonmyeloablative transplant after induction (most commonly vincristine, doxorubicin, and autologous peripheral blood stem cell transplantation).

<sup>c</sup> Time between autologous and nonmyeloablative transplants.

<sup>d</sup> Time measured from autologous stem cell transplantation.

<sup>e</sup> Time to autologous transplant; time between transplants was 119 days.

Investigators from the University of Arkansas reported the results of nonmyeloablative allogeneic stem cell transplantation in 31 poor-risk myeloma patients ( [556](#), [557](#) ). Twenty-five were HLA-compatible siblings, and six of the recipient-donor pairs were unrelated but matched. The conditioning regimen consisted of melphalan at 100 mg/m<sup>2</sup> for related and melphalan at 100 mg/m<sup>2</sup> plus total body irradiation (250 cGy) plus fludarabine for unrelated allografts. Donor lymphocyte infusions were initially given on days 21, 42, and 112 to patients with no clinical evidence of GVHD. However, because of high rates of donor lymphocyte-induced GVHD, donor lymphocyte infusions were reserved for patients who needed to attain full donor chimerism or who required eradication of residual disease. All but one patient had received one or more than two prior autologous transplants. Fifty-five percent of the patients had progressive disease at the time of the allograft. Acute GVHD developed in 18 patients. Ten patients progressed to chronic GVHD, which was limited in six patients and extensive in four patients. Two patients failed to engraft even after a second allogeneic peripheral blood stem cell infusion. At a median follow-up of 6 months, 12 patients achieved complete remission, and another seven patients achieved nearly complete remission, whereas three patients achieved partial remission. There were three treatment-related deaths during the first 100 days and another six treatment-related deaths after 100 days, for an overall treatment-related mortality of 28%. Three patients died of progressive myeloma. Patients who received transplants with progressive disease or who had received more than one prior autograft had a statistically higher mortality rate. The authors also compared their nonmyeloablative transplant experience to their prior standard allogeneic experience and

found that the nonmyeloablative group had a lower mortality during the first year ( $p = .09$ ), most notably the subset who had received only one prior autologous transplant ( $p = .05$ ).

Maloney et al. ( [560](#), [561](#) ) reported results on 54 newly diagnosed myeloma patients who were treated with a planned tandem autologous–nonmyeloablative allogeneic stem cell transplantation ( [Table 98.12](#) ). After induction with four cycles of VAD chemotherapy, followed by autologous stem cell transplantation using melphalan  $200 \text{ mg/m}^2$  as conditioning, patients underwent a nonmyeloablative allograft. The conditioning for the second transplant was with total body irradiation ( $200 \text{ cGy}$ )  $\pm$  fludarabine. Matched sibling donor peripheral blood stem cells were infused immediately after the total body irradiation. Postgrafting immunosuppression included mycophenolate and cyclosporine. Fifty–two of the 54 patients received the planned nonmyeloablative transplant, with a median time between autologous and allogeneic transplant of 62 days. The granulocyte and platelet nadirs after the nonmyeloablative transplant were  $760 \text{ cells}/\mu\text{l}$  and  $95,000 \text{ cells}/\mu\text{l}$ , respectively. Acute GVHD was seen in 38% of patients and was grade 2 in all but four cases. Forty–six percent of patients developed chronic GVHD that required therapy. All patients achieved donor engraftment. Fifty–seven percent of patients who did not achieve a complete response after the first transplant achieved a complete response after the second transplant. With a median follow–up of surviving patients of 18 months, eight patients (15%) have died of transplant–related complications, two patients have died of progressive myeloma, and one patient died of lung cancer.

Kroger et al. ( [562](#) ) have applied a similar strategy of a planned standard–intensity autograft (melphalan,  $200 \text{ mg/m}^2$ ) followed by a dose–reduced regimen (fludarabine,  $180 \text{ mg/m}^2$ ; melphalan,  $100 \text{ mg/m}^2$ ; and antithymocyte globulin,  $10 \text{ mg/kg}$  on 3 days) before allografting ( [Table 98.12](#) ). GVHD prophylaxis included cyclosporine and mini methotrexate. Nine patients received allografts from related donors, and eight patients received allografts from unrelated donors. Acute GVHD stages II through IV occurred in six patients (38%). Chronic GVHD developed in 40% of the patients, but only one patient experienced extensive chronic GVHD requiring further immunosuppressive therapy. The 100–day mortality rate was 11%, and, with a median follow–up of 17 months after autologous transplantation and 13 months after allogeneic transplantation, 13 patients (76%) were alive. The rate of complete remission with negative immunofixation increased from 18% after autografting to 73% after allografting, and 12 patients remain free of relapse or progression.

Until further refinements are made and additional confirmatory studies with longer follow–up are completed, the role of nonmyeloablative allogeneic stem cell transplantation as initial therapy in myeloma must be considered investigational. See [Table 98.12](#) for additional preliminary data.

**MAINTENANCE THERAPY** Strategies for maintenance therapy can be divided into two broad categories: (a) continued induction therapy ad infinitum and (b) addition of a novel therapy after induction therapy. The former strategy was prevalent until recognition of the risk of developing alkylator–induced myelodysplastic syndromes and leukemia ( [368](#), [566](#), [567](#), [568](#), [569](#) and [570](#) ). The latter strategy has predominantly applied immune modulators, including prednisone, interferon, and cellular therapies. No benefit has been observed with maintenance levamisole ( [361](#), [374](#) ), azathioprine ( [571](#) ), or bacillus Calmette–Guérin ( [459](#) ). **Maintenance Chemotherapy** Through the 1970s and 1980s, several randomized studies established that alkylator–based maintenance therapy does not produce a survival benefit ( [306](#), [315](#), [317](#), [346](#), [376](#), [380](#), [571](#), [572](#) and [573](#) ). In general, patients not receiving maintenance had similar to slightly shorter remission duration than those receiving maintenance ( [306](#),

376, 380, 571, 573, 574) but had higher rates of second remission (573, 574). In some studies, there has been a trend toward longer survival in the former group (315, 317, 572). Unmaintained remissions tend to last approximately 12 months (571). Induction therapy is commonly discontinued after plateau is reached (no change in M protein of more than 25% for 4 to 6 months) (306, 315, 575). With standard therapy, the ability to achieve a plateau is as important, if not more important, than the degree of response achieved (306, 575, 576, 577 and 578). No benefit has been documented for treatment beyond 12 months (376), although it has been suggested—but not validated—that prolonged primary chemotherapy may be beneficial in patients achieving less than a partial response, that is, a minimal response or stable disease (579). Patients who relapse off chemotherapy have response rates of 25 to 80% with resumption of the original regimen (306, 459, 573, 574). Second response rates are lower in patients who progress or relapse during maintenance than in those who relapse without maintenance therapy (571, 574). In a study of 115 newly diagnosed patients treated with the M-2 regimen (VBMCP) for approximately 1 year, an initial response rate of 82% was achieved, with a median duration of response of 22 months. After a first relapse, 26 of 38 patients (68%) responded again and had a median duration of response of 11 months. After a second relapse, 7 of 16 patients (44%) responded, with a duration of response of 3.5 months (580).

**Corticosteroids as Maintenance Therapy** There are four studies that refer to the topic of corticosteroids as maintenance therapy. None justify a recommendation of prednisone as a standard maintenance regimen for all patients. The most recent study (SWOG 9210) compared prednisone, 10 mg every other day, to prednisone, 50 mg every other day, in patients who had responded (SWOG partial response or better) to 6 to 12 months of a VAD-based program—that is, a corticosteroid-intensive program. From the time of randomization to the two different alternate-day prednisone schedules, the median progression-free survival for the higher-dose prednisone arm was 14 months compared to 5 months for the lower dose ( $p = .003$ ). Survival also was marginally better at 37 and 26 months ( $p = .05$ ) (581). Although the more dose-intensive corticosteroid maintenance strategy does provide a longer progression-free survival in corticosteroid-responsive patients, these data cannot be generalized. By comparison, after alkylator-based therapy, the median unmaintained progression-free survival is 12 months in responding patients (571). An earlier randomized study, which compared dexamethasone maintenance to interferon maintenance after induction with melphalan and dexamethasone, demonstrated equivalence to inferiority of dexamethasone compared with interferon. Patients received maintenance treatment with interferon- $\alpha$  (3 MU three times a week) or dexamethasone (20 mg/m<sup>2</sup> orally daily for 4 days, repeated monthly) until relapse. Remission duration was identical (10 months); however, significantly more patients responded on reinstatement of the melphalan and dexamethasone at disease relapse in the interferon group than in the dexamethasone group (82% vs. 44%,  $p = .001$ ) (582). The Cancer and Leukemia Group B 7461 study addressed this issue less directly. Patients were treated initially with alkylator therapy and were randomized to observation or vincristine and prednisone as maintenance. Survival and response rates were significantly longer and higher in the vincristine-prednisone maintenance group who had received up-front melphalan (median, 35.3 months vs. 27.0 months;  $p = .003$ ) but not in patients who had received up-front BCNU or CCNU (386). Finally, SWOG 8624, which evaluated the influence of corticosteroid dose intensity on response and survival, indirectly provided data on corticosteroid maintenance. Higher, objective response rate and median survival were observed in patients who received prolonged administration of glucocorticoids (prednisone, 50 mg every other day) between chemotherapy courses. Patients given alternating VMCP and VBAP with and without alternate day prednisone had median overall survivals of 40 months versus 31 months, respectively ( $p = .02$ ). The survival advantage may have been confounded by the complexity of the study; different treatment plans were assigned after 12 months of induction therapy, determined by tumor response

([472](#)). Moreover, one could argue that the corticosteroid was a part of the induction rather than the maintenance program.

### ***Interferon as Maintenance Therapy***

***After Conventional Chemotherapy*** The initial positive findings by Mandelli et al. ([583](#)) in 1990 demonstrated a superior disease-free and overall survival in chemotherapy-responsive patients randomized to maintenance interferon- $\alpha$ . Subsequent studies have yielded divergent results. Ludwig and Fritz ([481](#)) analyzed 1615 patients in 13 maintenance trials ([385](#), [480](#), [481](#), [484](#), [583](#), [584](#), [585](#), [586](#), [587](#), [588](#), [589](#) and [590](#)); the Myeloma Trialists' Collaborative Group ([482](#)) used the individual data of 1543 patients enrolled in 12 randomized trials ([385](#), [472](#), [480](#), [484](#), [487](#), [584](#), [586](#), [588](#), [591](#), [592](#) and [593](#)). Results were similar in that the first group found a 4.4-month prolongation of relapse-free survival ( $p < .01$ ) and a 7-month increase in overall survival ( $p < .01$ ) ([481](#)). The latter group reported a 3-year progression-free survival of 27 months versus 19 months ( $p < .00001$ ) in favor of the interferon maintenance group. Interferon- $\alpha$  prolonged the overall survival by approximately 7 months ( $p = .04$ ) ([482](#)) ([Fig. 98.10](#)). Survival time from progression to death was significantly worse in the interferon group than in the control group (OR, 1.21;  $p = .007$ ). No analyzed factors predicted for the interferon benefit (i.e., pretreatment hemoglobin, calcium,  $\beta_2$ M, creatinine, sex, performance status, or Ig isotype). The level of response (complete response, partial response, stable disease) or interferon dose intensity ( $<12$  MU/week versus  $=12$  MU/week) also did not predict for interferon effect ([482](#)). In 2000, the cost of the 1-year survival benefit in patients treated with interferon as maintenance was \$18,968, assuming a dose of 11.6 MU/week ([481](#)).

***In Combination with Corticosteroids*** Corticosteroids have been added to maintenance interferon in an attempt to intensify the program. Small numbers of patients have been treated with standard maintenance interferon and dexamethasone ([594](#)) or prednisone ([471](#), [594](#)). In one small randomized study, the progression-free survival was longer in the corticosteroid-plus-interferon arm than in the interferon-only arm, although median survival was not different ([471](#)). The combination can also induce further partial remissions in more than one-half of responding patients so treated ([594](#)) and may also prolong the duration of a second remission ([595](#)).

***After High-Dose Chemotherapy with Stem Cell Support*** Fewer data are available about the usefulness of interferon after autologous stem cell transplantation. There is one small randomized trial of 85 patients and a larger retrospective analysis of registry data by the European Group for Blood and Marrow Transplantation. The use of interferon in this setting cannot be recommended outside of clinical trials. After high-dose chemotherapy with stem cell support, Cunningham et al. ([592](#)) randomly assigned 85 patients to interferon at  $3 \text{ MU/m}^2$  three times weekly or to observation. The median progression-free survival in the 43 patients randomized to interferon- $\alpha$  was 46 months compared to 27 months in the control patients ( $p < .025$ ). Although there was a significant survival advantage at 54 months, at which time 12% of patients in the interferon group and 33% of patients in the no interferon group had died ( $p = .006$ ), this survival advantage was no longer evident at a median follow-up of 77 months. The data from the European Group for Blood and Marrow Transplantation registry included 473 patients who had received maintenance and 419 patients who had not. However, the two groups were poorly matched. The patients who did not receive interferon had significantly more prior therapy, a higher stage at diagnosis, and a longer time to transplantation. They were also significantly older, and a higher percentage had received total body irradiation-containing conditioning regimens ([596](#)). Although these factors were "statistically corrected for" in the survival analysis, the imbalance makes interpretation of this retrospective collection of registry patients problematic. Prognostic factors, such as  $\beta_2$ M, C-reactive protein, cytogenetics, and plasma cell labeling index (PCLI), were not included in the analysis. Overall survival was significantly better in the patients who received interferon (78 months vs. 47 months,  $p = .007$ ). Paradoxically, there was a more prominent survival



benefit in those patients who achieved a partial response (97 months vs. 46 months for interferon vs. no interferon, respectively;  $p = .03$ ) rather than complete response (64 months vs. 51 months,  $p = .1$ ). Curiously, the partial response group had a better overall survival than the complete response group.

### ***Immunotherapy as Maintenance Therapy***

***Dendritic Cell–Based Vaccination*** In an effort to prolong duration of response and hopefully survival, idiotype–treated dendritic cell vaccines are being explored as a therapeutic modality for myeloma patients. B–cell malignancies, including multiple myeloma, are unique in their expression of Ig ( [362](#) ). The Ig on malignant cells can be distinguished from that on normal B cells or plasma cells by virtue of specific idiotypic determinants. Dendritic cells are the only known natural cells that can present antigen to naïve T cells ( [597](#) ). Antigen–pulsed dendritic cells can successfully induce humoral and cytotoxic cellular immune responses. Idiotypic vaccinations alone have met with limited success in human trials ( [598](#) , [599](#) and [600](#) ). However, dendritic cell–based vaccination appears to be a more potent way to induce antitumor immunity than vaccines with peptide alone ( [601](#) ). Trials looking at dendritic cell–based vaccinations for multiple solid tumors, as well as for myeloma, non–Hodgkin lymphoma, chronic myelogenous leukemia, and other hematologic malignancies, are ongoing. Preliminary evidence suggests that idiotype pulsed dendritic cells can stimulate antiidiotype responses ( [602](#) , [603](#) , [604](#) , [605](#) and [606](#) ). Clinical responses have also been observed by the authors and other investigators in the setting of relapsed disease and after hematopoietic stem cell transplantation ( [602](#) , [604](#) , [605](#) , [607](#) , [608](#) ).

**MANAGEMENT OF RELAPSED OR REFRACTORY DISEASE** Relapsed and refractory myelomas likely have distinct biologies but are commonly grouped together in discussions of chemotherapy regimens and trials. Differentiation between relapses occurring on therapy and off therapy should be made, with the former having a poorer prognosis. Similarly, primary refractory—the condition in which the disease has not responded to initial therapy—and secondary refractory (or resistant) disease should be differentiated. Finally, with the growing list of active agents now available, the class of agents or the treatment modality to which the patient is refractory should be specified. Before high–dose chemotherapy with stem cell support and thalidomide became common therapeutic strategies, treatment guidelines were more straightforward. If the relapse had occurred during an unmaintained remission, resumption of the patient’s original therapy was a good rule ( [574](#) ). Fifty percent to 60% of patients respond again to repeat treatment if relapse occurs after unmaintained remission ( [459](#) , [573](#) , [574](#) , [609](#) ). Median survival is approximately 10 months ( [574](#) , [610](#) ). The myeloma cell doubling time and duration of response tend to decrease with each subsequent course of therapy ( [282](#) , [580](#) ). In the cases of primary refractory disease or acquired resistance on therapy, the mainstays of treatment had been clinical trials—anthracycline–based, corticosteroid–based, and alkylator–based regimens.

***Single–Agent Glucocorticoids for Relapsed or Refractory Disease*** Salmon et al. ( [30](#) ) described clinical improvement in seven of nine relapsed or refractory patients treated with high–dose (200 mg) prednisone every other day. Subsequently, these observations ( [Table 98.6](#) ) were confirmed and extended using prednisone, methylprednisolone, and dexamethasone in pulsed or alternate–day schedules ( [341](#) , [352](#) , [353](#) ). Doses are typically high, with the exception of one small study in which continuous low–dose dexamethasone (4 mg per day) was administered to a small cohort of patients with a resultant 40% response rate ( [354](#) ). Overall, approximately 25% of relapsed or refractory patients respond; the median survival of responding patients is 16 to 22 months ( [341](#) , [352](#) , [353](#) ). In reviewing their experience with single agent dexamethasone and VAD, Alexanian et al. ( [352](#) ) noted that, in patients with refractory disease, response rates with single–agent dexamethasone were comparable to those with VAD (27% vs. 32%). In contrast, in relapsed disease, response rates achieved with single–agent dexamethasone are inferior to those

with VAD. These data are not randomized but, rather, serial observations. On occasion, patients who do not respond to high-dose dexamethasone can be salvaged with intermittent high-dose methylprednisolone ( 353 ).

**Thalidomide for Relapsed or Refractory Disease** The first published report of the usefulness of thalidomide in patients with relapsed myeloma was by Singhal et al. ( 38 ). Eighty-four patients with relapsed myeloma, 76 of whom had relapsed after high-dose chemotherapy with stem cell support, were treated with escalating doses of thalidomide. Patients were started on 200 mg each evening; the dose was escalated every 2 weeks, if tolerated, to a final maximal dose of 800 mg daily. Twenty-five percent of patients had at least a 50% reduction in their serum paraprotein. An additional six patients had a 25% reduction in their serum paraprotein (minimal response). Preliminary evidence of response was apparent within 2 months in more than three-quarters of the patients who did respond. An update of the original report by Barlogie et al. ( 407 ), including 169 patients with advanced myeloma, verified a 30% response rate (50% reduction in the myeloma protein). Two-year event-free and overall survival rates were 20% and 48%, respectively. Other investigators have confirmed a partial response rate of 25 to 58%, with an additional 6 to 26% achieving a minimal response ( Table 98.8 ) ( 401 , 408 , 409 , 413 , 417 , 611 , 612 and 613 ). The role of dose intensity in thalidomide effectiveness is unclear ( 613 , 614 ). In the original reports, the highest dose tolerated was administered ( 38 ). In high-risk patients there was a suggestion that response rates were higher and survival was longer in patients receiving high doses of thalidomide (=600 mg/day) ( 407 ). However, in some patients, responses may be seen with doses as low as 100 mg/day ( 614 ). There appears to be synergy between thalidomide and dexamethasone ( 403 , 453 ). Response rates of 41 to 55% ( 410 , 414 , 415 , 615 ) have been observed in patients with resistant myeloma. Doses of dexamethasone have ranged from 4 mg as a daily continuous dose ( 615 ) to 40 mg, days 1 through 4 of each month ( 414 , 415 ). Dimopoulos et al. ( 415 ) administered dexamethasone an additional 8 days (days 9 through 12 and 17 through 20) in the first month only. With these combination regimens, thalidomide dose levels have ranged between 100 and 400 mg/day, without any clear dose-response effect. Patients who are resistant to dexamethasone-based ( 410 , 415 ) or thalidomide-based ( 616 ) regimens can respond to the combination of these two agents. Coleman et al. ( 416 ) described a 100% response rate for relapsed or refractory disease treated with clarithromycin, low-dose thalidomide, and dexamethasone. These results have yet to be substantiated by other investigators, and clarithromycin alone is not an effective treatment ( 437 , 438 and 439 ). A combination of thalidomide, cyclophosphamide, etoposide, and dexamethasone has been reported to achieve a 68% response rate in relapsed and refractory patients ( 617 ); this program was associated with a 36% rate of severe infections. Toxicities associated with thalidomide include fetal malformations, constipation, weakness or fatigue, somnolence, skin problems, and sensory neuropathy in more than one-third of patients. There is also an increased risk of thrombosis in patients treated with thalidomide, which appears to be exacerbated by the use of concurrent combination chemotherapy, with rates as high as 28% ( 618 , 619 and 620 ). Other life-threatening complications have included Stevens-Johnson syndrome and hepatitis ( 621 , 622 ).

**Interferon for Relapsed or Refractory Disease** Despite the encouraging preliminary report by Mellstedt et al. ( 35 ) in untreated myeloma patients, results of single-agent interferon therapy in refractory myeloma are disappointing, with a response rate of only 10 to 20% ( 396 , 623 ). Duration of response varies from 2 months to 25 months. Several investigators have combined interferon with dexamethasone ( 472 , 624 ) or methylprednisolone ( 625 ) as therapy for patients with relapsed or refractory disease. With response rates of 29 to 66% ( 624 , 625 ), it is difficult to isolate the corticosteroid and interferon effects. There is no clear evidence that the response rate or the survival time improved compared to similar treatments without interferon ( 626 ).



**Chemotherapy for Relapsed or Refractory Disease** The subject of chemotherapy for relapsed or refractory disease is divided into four sections: alkylator-based regimens, anthracycline-based regimens with or without dose-intensified corticosteroids, and other, less commonly used regimens.

**Alkylator-Based Regimens for Relapsed or Refractory Disease** There is cross-resistance among the alkylators, but it is not absolute and may be circumvented by increasing dose intensity. Without extreme dose intensification, 5 to 20% of patients with melphalan-resistant disease respond to cyclophosphamide and BCNU as single agents or in combination with prednisone ( [32](#), [610](#), [627](#), [628](#), [629](#), [630](#) and [631](#) ). Response rates as high as 30 to 38% can be obtained if prednisone is administered with the cyclophosphamide ( [632](#), [633](#) and [634](#) ). Higher doses of cyclophosphamide (e.g., 600 mg/m<sup>2</sup> intravenously for 4 consecutive days) result in response rates of 29 to 43% ( [348](#), [635](#) ). Response duration and overall survival tend to be short, approximately 3 and 9 months, respectively ( [348](#), [635](#) ). Consolidating the chemotherapy into a 1-day schedule rather than a 4-day schedule did not improve response rate, but it did increase the toxicity ( [636](#) ). Similarly, administration of 3.6 g/m<sup>2</sup> over 2 days with prednisone appears to produce comparable responses ( [637](#) ). Dose intensification of melphalan ( [Table 98.8](#) ) can also be quite effective and is the basis for high-dose therapy with stem cell support ( [322](#) ). Selby et al. ( [338](#) ) reported that 66% of patients with resistant disease treated with 140 mg/m<sup>2</sup> without stem cell support responded, but median response duration was 6 months, with all patients relapsing within a year. Median times to leukocyte and platelet recovery were 42 and 37 days, respectively, and the regimen-related toxicity was 13%. Doses of 50 to 70 mg/m<sup>2</sup> result in a 50% response rate and leukocyte and platelet recovery times of 20 and 16 days, respectively ( [444](#), [445](#) ). Further reducing the intensity to 30 mg/m<sup>2</sup> every 2 months results in response rates of 38% and a progression-free survival of 10 months ( [446](#) ). VBMCP (the M-2 regimen) or MOCCA provides responses in 20 to 30% of refractory patients ( [329](#), [340](#), [638](#) ), with a median survival of approximately 11 months ( [340](#) ).

**Anthracycline-Based Regimens without Corticosteroid Dose Intensification for Relapsed or Refractory Disease** Various permutations of doxorubicin-containing chemotherapy regimens—doxorubicin and cyclophosphamide ( [458](#) ); doxorubicin, BCNU, cyclophosphamide, and prednisone ( [639](#) ); cyclophosphamide, doxorubicin, and prednisone ( [640](#) ); VCAP ( [459](#) ); VBAP ( [641](#), [642](#) ); and BCNU, doxorubicin, and prednisone (BAP) ( [640](#) )—have been tried in patients with relapsed and refractory disease, resulting in response rates of 7 to 28% ( [459](#), [639](#), [640](#) and [641](#) ). Response duration and survival tend to be short—less than 6 and 12 months, respectively. Responding patients tend to live 7 to 10 or even 22 months longer than nonresponders ( [640](#), [641](#) and [642](#) ). Patients who have relapsed disease, rather than resistant or refractory disease, have higher response rates (i.e., close to 30%).

**Anthracycline-Based Regimens with Corticosteroid Dose Intensification for Relapsed or Refractory Disease** Another approach to treating relapsed or refractory myeloma is supplementation of the anthracycline and vincristine with high-dose corticosteroids. Alexanian et al. ( [341](#) ) described a drug regimen of vincristine, doxorubicin (Adriamycin), and prednisone (VAP) (bolus vincristine, 1.5 mg on day 1; doxorubicin, 35 mg/m<sup>2</sup> on day 1; and prednisone, 45 mg/m<sup>2</sup> for 5 days, repeated every 8 days for three corticosteroid pulses); response rates according to SWOG response and improvement criteria were 47%. Barlogie et al. ( [330](#) ) published their experience with VAD, and numerous variants have followed. The overall response rate with VAD in 29 patients who had refractory or resistant disease was 59%, according to SWOG criteria. In the 20 patients who had not received prior doxorubicin, the response rate was 70%. VAD differed from VAP in that the former included continuous infusion vincristine and doxorubicin and a sixfold corticosteroid dose intensification ( [330](#) ). The activity of VAD has been substantiated by

others ( [643](#) , [644](#) and [645](#) ). Infection is the most important complication, with 38% of patients having fever and 28% having a documented infectious agent ( [330](#) ). Early catheter removal may occur in approximately 16% of patients as a result of thrombosis or infection ( [352](#) ). Variants of VAD include regimens that alter the type or dose of corticosteroid, the schedule of administration, and the type of anthracycline and that add additional drugs. The effectiveness of VAMP (methylprednisolone in place of dexamethasone) appears comparable to VAD, with a response rate and overall survival of 36% and 20 months in patients with resistant disease ( [331](#) ). Browman et al. ( [646](#) ) evaluated modified VAD, in which all of the vincristine and doxorubicin was given on day 1 over 2 hours, and the dexamethasone was given on days 1 through 4 and 15 through 18 only; the overall response rate was 27% (95% CI, 14 to 40%), and the median survival was 7.6 months. The authors expressed concern that this regimen might be less effective than standard VAD, but the confidence intervals of the response rate were large. The “inferiority” of the regimen could have been related to patient selection, a reduction in the efficacy of the drug combination produced by the shortened intravenous infusions, or the omission of one 4-day course of dexamethasone. Alternative anthracyclines have been tried, including mitoxantrone (NOP or a regimen of mitoxantrone, vincristine, and dexamethasone) ( [647](#) , [648](#) and [649](#) ), which have resulted in response rates of 25 to 40% ( [647](#) , [649](#) ), epirubicin ( [469](#) , [650](#) ), and liposomal doxorubicin ( [470](#) ). In one randomized study, plateau duration was significantly longer in the VAD group than in the mitoxantrone, vincristine, and dexamethasone group, but there was no difference in overall survival ( [649](#) ). Several investigators have added additional drugs to the VAD-base without measurable benefit. Concurrent interferon ( [488](#) , [626](#) ) adds nothing to response rate or overall survival. In single-arm studies, there does not appear to be any advantage to the addition of cyclophosphamide to VAD, VAMP, or the regimen of vincristine, epirubicin, and dexamethasone to derive CVAD, hyperCVAD, C-VAMP, or VECD ( [331](#) , [351](#) , [469](#) , [651](#) , [652](#) ).

**Other Regimens for Relapsed or Refractory Disease** After studying high-dose cytosine arabinoside, cisplatin, and etoposide as single agents, Barlogie et al. ( [392](#) ) did preliminary studies of dexamethasone, cytosine arabinoside, and cisplatin (Platinol) and later etoposide, dexamethasone, cytosine arabinoside, and cisplatin (Platinol) (EDAP). In patients with refractory disease, response rates with these treatments were 7%, 14%, 17%, 0%, and 40%, respectively. Median survival in patients treated with EDAP was 4.5 months. This regimen is extremely myelosuppressive, with more than one-half of treated patients requiring platelet transfusions and 80% requiring hospitalization for neutropenic fever. In the first month, treatment-related mortality was 15%. EDAP is part of Barlogie’s “Total Therapy II” In one report, before two cycles of EDAP, 55% and 9% of patients had achieved objective response and complete response, respectively; after EDAP, 65% and 15% had objective response and complete response, respectively ( [420](#) ). Dimopoulos et al. ( [653](#) ) explored a combination of high-dose cyclophosphamide (3 g/m<sup>2</sup>) and etoposide (900 mg/m<sup>2</sup>) followed by granulocyte-macrophage colony-stimulating factor. Of the 52 patients with advanced and refractory multiple myeloma treated, 42% responded. Median time to granulocyte recovery was 19 days, and the median duration of remission was 8 months. Combinations of cisplatin with BCNU, cyclophosphamide, and prednisone have produced response in heavily pretreated patients ( [419](#) ); however, the addition of cisplatin and bleomycin to VBAP did not appear to produce better outcomes than standard VBAP ( [392](#) , [418](#) , [419](#) ).

**Modulating Resistance** Interferon has been shown to modulate the multidrug resistance phenotype and to reinduce chemosensitivity in patients with chemoresistant multiple myeloma. In one study, nonresponding patients received the same chemotherapy to which they were resistant, preceded by a 5-day course of interferon. An objective response was achieved in 4 of 14 patients (28.6%) ( [654](#) ). Because patients with multiple myeloma refractory to alkylating agents frequently express P-glycoprotein, which is associated with the multidrug resistance phenotype, cyclosporine, a multidrug resistance reversal agent

has been combined with VAD in patients with refractory or progressive disease. No benefit was observed ( [655](#), [656](#) ). As a result of the findings of a phase I and II trial in patients with myeloma ( [657](#) ), PSC 833, a multidrug resistance glycoprotein modulator, has been incorporated into a phase III study of VAD versus VAD and PSC 833. Results are pending.

**CLINICAL TRIALS AND NEW AGENTS** Until myeloma is a curable disease in all patients, clinical trials will play a critical role in the treatment of these patients. They assist in defining a better classification system for the disease, clarify which treatments offer the most value, and bring new effective agents into standard clinical practice. The two most promising new agents for the treatment of multiple myeloma are PS-341 and CC-5013, both of which are still in clinical trials. PS-341 is a small molecule that selectively inhibits cellular proteasomes, offering a novel pathway for targeted anticancer therapy. The proteasome has a key role in protein degradation, cell cycle regulation, and gene expression. Tumor cells, including multiple myeloma, are heavily dependent on proteasome-regulated proteins for their growth and interaction with stromal cells. PS-341 generally has been well tolerated in phase I trials, with apparent clinical activity in patients with multiple myeloma. PS-341 represents a novel anticancer agent with an acceptable safety profile and evidence of antitumor activity in multiple myeloma. Monoclonal protein responses of a greater than 50% reduction are observed in 41% of patients with relapsed or refractory disease, or both ( [324](#) ). CC-5013, a small molecule derivative of thalidomide and a member of the immunomodulatory drug (IMiD) class, is more potent than thalidomide in mediating direct cytokine-related and immunomodulatory effects against human multiple myeloma cell lines and patient-derived cells *in vitro*. During the two recently completed phase I studies, activity has been documented in patients with refractory or relapsed multiple myeloma. Approximately 25% of relapsed or refractory patients have achieved a partial response. Another 25 to 35% of patients have had a minimal response (25 to 49% reduction in serum M component). No significant somnolence, constipation, or neuropathy has been seen ( [323](#), [658](#), [659](#) ). The human anti-CD20 antibody has demonstrated some effect in patients with myeloma. Approximately 20% of patients with myeloma have CD20 expression on their plasma cells. Preliminary data suggest that use of this agent may be beneficial in this subset of patients ( [660](#) ).

## Radiation

As early as the mid 1920s, there was recognition that external beam radiation therapy could promote immediate relief of pain, healing of pathologic fractures, and resolution of extramedullary plasmacytomas ( [20](#), [661](#), [662](#) ). Until the 1950s, radiation therapy was the only effective treatment available for the management of plasma cell tumors. With the advent of systemic chemotherapy, indications for irradiation were primarily palliation of bone pain and solitary plasmacytomas. Concern for maintaining bone marrow reserve also constrains the use of radiation in patients with multiple myeloma. Sykes et al. ( [663](#), [664](#) ) showed that radiation has long-term effects on the bone marrow; the majority of patients receiving concentrated local doses of 3500 cGy or more showed persistent localized marrow aplasia. One must administer enough radiation to provide palliation, without jeopardizing opportunities for further systemic therapy. In a retrospective review, Norin ( [665](#) ) has found that objective improvement was lacking when the tumor dose was below a cumulative dose (single-dose equivalent) of 1000 cGy. For palliation, the recommendation is, therefore, a cumulative dose of 1500 cGy, corresponding to a tumor dose of 3400 cGy in 10 to 15 fractions ( [665](#), [666](#) ). Leigh et al. ( [667](#) ) recommended a total cumulative dose of 1000 cGy in these same patients. There is controversy as to whether the duration of response correlates with the radiation dose in myeloma patients ( [667](#), [668](#) ).

In contrast, patients with solitary plasmacytoma of bone should receive higher doses in an

attempt at cure. Although the optimal dose has not been established by randomized controlled trials, 4000 to 5000 cGy, encompassing all disease with a margin of normal tissue, is recommended by most experts ( [669](#), [670](#) and [671](#) ).

**SEQUENTIAL HALF-BODY (HEMIBODY) IRRADIATION** The first report of using whole body irradiation to treat myeloma was by Medinger and Craver ( [672](#) ) in 1942. Partial or complete relief of pain was noted in the majority of patients. Once effective systemic chemotherapy came into wide use, this approach became less popular, until 1971, when Bergsagel ( [673](#) ) postulated that sequential hemibody radiation could be a means of debulking tumor. He suggested that if a dose of approximately 725 cGy were given to the upper half of the body and if 1000 cGy were given to the lower half, a theoretical 3-log kill could be achieved and survival prolonged. After a series of retrospective studies ( [589](#), [674](#), [675](#), [676](#), [677](#), [678](#), [679](#), [680](#) and [681](#) ) and a randomized study ( [462](#), [682](#) ) evaluating its role in the earlier phases of myeloma, hemibody irradiation has once again fallen out of favor. In patients who have end-stage disease, with poor pain control, this treatment may still be important. The majority of series involving hemibody or sequential hemibody radiation are retrospective and include patients who were resistant to or relapsing from alkylator-based therapy. Significant relief of bone pain occurred in 80 to 90% of patients ( [589](#), [674](#), [675](#), [676](#), [677](#), [678](#), [679](#), [680](#) and [681](#) ), and the median duration of survival was 5 months to 11 months ( [666](#), [676](#) ). Objective biochemical response occurred in 25 to 50% of patients ( [589](#), [676](#), [683](#) ). Pain relief typically occurred 1 to 2 days after institution of therapy, with a maximal response in 1 to 2 weeks ( [674](#) ). The most common side effects were moderate myelosuppression, pneumonitis, nausea, vomiting, diarrhea, and stomatitis ( [666](#), [674](#) ). If an oral lead shield was not used, mucositis also occurred ( [666](#) ). Nadirs occurred within 3 weeks ( [676](#) ), and white cell count and platelet count recovery occurred by approximately 6 weeks ( [666](#), [676](#) ). Decrements in pulmonary function of 20% occurred in approximately one-half of the treated patients ( [666](#) ). The most serious complication was radiation-induced pneumonitis, which was seen in 14% of patients ( [676](#) ). The option of sequential half-body radiation therapy must be balanced against unpredictable and varying degrees of pancytopenia and alternative treatment options ( [683](#) ). Bergsagel's postulate ( [673](#) ) and preliminary data from several small studies ( [675](#), [679](#), [680](#) ) led two cooperative group studies (SWOG 8229 and Cancer and Leukemia Group B 8003) to incorporate systemic radiation therapy as consolidation therapy ( [462](#), [682](#) ). Neither study demonstrated a meaningful advantage to patients receiving adjuvant hemibody radiation ( [462](#), [682](#) ), and hemibody radiation is used only for pain palliation in end-stage chemotherapy-refractory myeloma patients.

## STAGING AND PROGNOSIS

Survival of multiple myeloma patients varies from months to more than a decade ( [576](#), [684](#) ). There are no precise methods of identifying the subset of newly diagnosed patients who are best served by standard intensity therapies, maintenance therapies, novel therapies, or more intensive regimens, such as hematopoietic stem cell transplantation. Prognostic factors are needed for patient counseling, therapeutic decision making, and clinical trial stratification.

Staging is one form of prognostic modeling. The Durie-Salmon system ( [Table 98.13](#) ), which is the most widely accepted multiple myeloma staging system, separates patients predominantly by tumor burden and renal function ( [23](#) ). As the biology of myeloma is better understood, novel markers, reflecting myeloma cell kinetics, signaling, genetic aberrations, and apoptosis, have eclipsed the prognostic significance of tumor burden as a

predictor of survival.

**TABLE 98.13. Durie–Salmon Staging System**

| Criterion  | Measured Myeloma Cell Mass,<br>Cells × 10 <sup>12</sup> /m <sup>2</sup> |
|--|---|
| <b>Stage I</b>   |   |
| All of the following   | <0.6 (low)  |
| Hemoglobin =100 g/L  |   |
| Serum calcium <12 mg/dl  |   |
| On radiograph, normal bone structure (scale 0) <sup>a</sup> or solitary bone plasmacytoma only   |   |
| Low M component production rates   |   |
| IgG <50 g/L  |   |
| IgA <30 g/L  |   |
| Urine light chain M component on electrophoresis <4 g/24 h   |   |
| <b>Stage II</b>  |   |
| Fitting neither stage I or III   | 0.6–1.2 (intermediate)  |
| <b>Stage III</b>   |   |
| One or more of the following   | =1.2 (high)   |
| Hemoglobin <85 g/L   |   |
| Serum calcium =12 mg/dl  |   |
| Advanced lytic bone lesions  |   |
| High M component rates   |   |
| IgG =70 g/L  |   |
| IgA =50 g/L  |   |
| Urine light chain M component on electrophoresis >12 g/24 h  |   |
| <b>Subclassification</b>   |   |
| A: Serum creatinine <2 mg/dl   |   |
| B: Serum creatinine =2 mg/dl   |   |
| <sup>a</sup> Scale of bone lesions: normal bones, 0; osteoporosis, 1; lytic bone lesions, 2; extensive skeletal destruction and major fractures, 3.  |   |
| Adapted from Durie BG, Salmon SE. A clinical staging system for multiple myeloma: correlation of measured myeloma cell mass with presenting clinical features, response to treatment, and survival. <i>Cancer</i> 1975;36:842–854. |   |

Although the Durie–Salmon system has some prognostic value (23), other biologic variables appear to be more valuable (460, 685, 686, 687, 688, 689, 690 and 691). At the time of its inception, the Durie–Salmon staging system was an elegant system that incorporated information about Ig production and half-life, hemoglobin, calcium, creatinine, and extent of bone disease to derive mathematically the total myeloma cell burden (23). Quantification of bone lesions used in this staging system, however, is not always reliable as a prognostic factor (688) in that patients classified as stage III solely on the basis of



bone lesion criteria do not have a poorer prognosis.

Other variables, including patient age, performance status, serum albumin, Ig isotype, and bone marrow plasma cell infiltration, have long been recognized to predict survival (692, 693 and 694), and subsequent models have incorporated these factors (346, 576, 691, 695) (Table 98.14). Myeloma biology is better addressed by increased concentrations of serum  $\beta_2$ M, C-reactive protein, circulating plasma cells by peripheral blood labeling index, other serum markers, bone marrow PCLI, and chromosomal abnormalities (460, 685, 686, 689, 690 and 691, 695, 699, 700 and 701). When designing a new staging system, one must choose between readily available, inexpensive markers, which frequently describe the host more than the intrinsic properties of the myeloma, or more esoteric, expensive markers, which reflect the intrinsic biology of the individual patient's myeloma cells. Each of these systems has value, but the goal is to reach a consensus and to standardize discussions and comparisons among clinical trials and outcomes. An international consensus panel is addressing this. With these basic concepts in mind, various prognostic markers are discussed independently, and Table 98.14 summarizes several investigators' efforts to introduce more meaningful staging systems.

**TABLE 98.14. Prognostic and Staging Systems in Newly Diagnosed Multiple Myeloma Patients (Prognostic Categories Defined in Patients Treated with Standard Intensity Chemotherapy, Unless Stated Otherwise)**

| Study (Reference)                      | Patients (No.) | Risk or Stage      | Patients (%) | Features                              | Median Overall Survival (mo) |
|--|----------------|--------------------|--------------|---------------------------------------|------------------------------|
| Durie and Salmon, 1975, 1980 (23, 696) | 150            | IA                 | 11           | Defined in Table 98.13                | 61                           |
|  |                | IIA and IIB        | 27           |                                       | 54                           |
|  |                | IIIA               | 50           |                                       | 30                           |
|  |                | IIIB               | 13           |                                       | 15                           |
| MRC, 1980 (346)                        | 485            | Low                | 22           | BUN =8 mmol and Hb =100 g/L           | =48                          |
|  |                | Intermediate       | 56           | Not meeting other criteria            | ~ 34                         |
|  |                | High               | 22           | BUN =10 mmol and Hb =75 g/L           | ~ 24                         |
| Bartl et al., 1987 (695)               | 674            | Low grade          | 71           | Marschalko and small PC <sup>a</sup>  | 40                           |
|  |                | Intermediate grade | 28           | Cleaved, polymorphous asynchronous PC | 20                           |
|  |                | High grade         | 2            | Plasmablastic PC                      | 8                            |
| Greipp et al., 1988 (685)              | 100            | Low                | 30           | PCLI <0.4% and $\beta_2$ M <4 mg/L    | 48                           |
|  |                | Intermediate       | 25           | PCLI =0.4% or $\beta_2$ M =4 mg/L     | 29                           |
|  |                | High               | 45           | PCLI =0.4% and $\beta_2$ M =4 mg/L    | 12                           |

|   |      |                |    |  |      |
|---|------|----------------|----|--|------|
| Bataille et al.,<br>1992 ( <a href="#">689</a> )            | 162  | Low            | 50 | $\beta_2M$ and CRP <6 mg/L                                   | 54   |
|   |      | Intermediate   | 35 | $\beta_2M$ or CRP =6 mg/L                                    | 27   |
|   |      | High           | 15 | $\beta_2M$ and CRP =6 mg/L                                   | 6    |
| Greipp et al., 1993<br>( <a href="#">686</a> )              | 107  | Low            | 14 | PCLI < 1% and $\beta_2M$<br><2.7 mg/L                        | 71   |
|   |      | Intermediate   | 54 | PCLI =1% or $\beta_2M$ =2.7<br>mg/L                          | 40   |
|   |      | High           | 32 | PCLI =1% and $\beta_2M$<br>=2.7 mg/L                         | 17   |
| San Miguel et al.,<br>1995 ( <a href="#">691</a> )          | 120  | I <sup>b</sup> | 26 | RE <6 or SM: s(a-d) =<br>0                                   | = 80 |
|   |      | II             | 52 | 6 = RE = 8.5 or SM: 0 =<br>s(a-d) = 3                        | 36   |
|   |      | III            | 22 | RE = 8.5 or SM: s(a-d)<br>=4                                 | 9    |
| Finnish Leukaemia<br>Group, 1999 ( <a href="#">576</a> )    | 324  | I              | 61 | Hb =100 g/L and<br>BMPC <70%                                 | 57   |
|   |      | II             | 25 | Hb <100 g/L or BMPC<br>=70%                                  | 45   |
|   |      | III            | 14 | Hb <100 g/L and<br>BMPC =70%                                 | 25   |
| Konigsberg et al.,<br>2000 ( <a href="#">690</a> )          | 88   | Low            | 36 | No FISH del 13q and $\beta_2M$<br>=4 mg/L                    | 102  |
|   |      | Intermediate   | 40 | FISH del 13q or $\beta_2M$<br>=4 mg/L                        | 46   |
|   |      | High           | 24 | FISH del 13q and $\beta_2M$<br>=4 mg/L                       | 11   |
| Crowley et al.,<br>2001 ( <a href="#">460</a> )             | 1026 | I              | 13 | $\beta_2M$ <2.5 mg/L   | 53   |
|   |      | II             | 43 | $\beta_2M$ =2.5 but <5.5<br>mg/L                             | 41   |
|   |      | III            | 33 | $\beta_2M$ =5.5 mg/L and alb<br>=3 g/dl                      | 24   |
|   |      | IV             | 11 | $\beta_2M$ =5.5 mg/L and alb<br><3 g/dl                      | 16   |
| Fonseca et al.,<br>2003 ( <a href="#">697</a> )             | 275  | Low            | 39 | Absence of del 13q14,<br>t(4;14), t(14;16), and del<br>17p13 | 50   |
|   |      | Intermediate   | 37 | del 13q14  | 42   |
|   |      | High           | 24 | Presence of t(4;14),<br>t(14;16), or del 17p13               | 25   |
| Smadja et al.,<br>2001 ( <a href="#">698</a> ) <sup>c</sup> | 159  | Low            | 35 | $\beta_2M$ =3 mg/L and<br>nonhypodiploid <sup>d</sup>        | 52   |
|   |      | Intermediate   | 42 | $\beta_2M$ =3 mg/L or<br>hypodiploid <sup>d</sup>            | 30   |
|   |      | High           | 23 | $\beta_2M$ =3 mg/L and<br>hypodiploid <sup>d</sup>           | 11   |



|  |     |              |    |  |      |
|--|-----|--------------|----|--|------|
| Tricot et al., 1995<br>( 187) <sup>e</sup> | 155 | Low          | 76 | Absence of del 13q, del 13, and del 11q <sup>d</sup> | =48  |
|  |     | Intermediate | 17 | del 13q or 13 <i>or</i> del 11q <sup>d</sup>         | =50  |
|  |     | High         | 3  | del 13q or 13 <i>and</i> del 11q <sup>d</sup>        | 12   |
| Facon et al., 2001<br>( 699) <sup>f</sup>  | 110 | Low          | 20 | No FISH del 13q and $\beta_2$ M <2.5 mg/L            | =111 |
|  |     | Intermediate | 50 | FISH del 13q or $\beta_2$ M =2.5 mg/L                | 47   |
|  |     | High         | 30 | FISH del 13q and $\beta_2$ M =2.5 mg/L               | 25   |

Alb, albumin;  $\beta_2$ M,  $\beta_2$ -microglobulin; BMPC, bone marrow plasma cells; BUN, blood urea nitrogen; CRP, C-reactive protein; FISH, fluorescence *in situ* hybridization; Hb, hemoglobin; PC, plasma cells; PCLI, plasma cell labeling index; RE, risk equation; SM, simplified model.

<sup>a</sup> See text for details. The Bartl staging system is a plasma cell morphology-based staging system.

<sup>b</sup> From risk equation and simplified model: RE:  $(2.2 \times \%S \text{ phase PC}) + (0.8 \times \beta_2\text{-microglobulin}) + (1.2 \times \text{ECOG}) + (0.9 \times \text{age})$ . SM: (a) S phase =3% (+2); (b)  $\beta_2$ -microglobulin =6  $\mu\text{g/ml}$  (+1); (c) ECOG =3 (+1); (d) age =69 (+1); absence of each (+0).

<sup>c</sup> Patients received standard chemotherapy or high-dose chemotherapy with transplant.

<sup>d</sup> Metaphase cytogenetics.

<sup>e</sup> Tandem transplant study, rather than conventional chemotherapy.

<sup>f</sup> High-dose melphalan, single transplant, or tandem transplant.

Adapted from Dispenzieri A, Lacy MQ, Greipp PR. Multiple myeloma. In: Gertz MA, Greipp PR, eds. Hematologic malignancies: multiple myeloma and related plasma cell disorders. Berlin: Springer-Verlag, 2004:57-109.

## Individual Prognostic Markers with Standard Intensity Chemotherapy

**$\beta_2$ -MICROGLOBULIN**  $\beta_2$ M concentration is the strongest and most reliable prognostic factor for multiple myeloma that is routinely available ( [Table 98.14](#)). It depends not only on tumor burden, but also on renal function. Elevated  $\beta_2$ M values predict early death ( [686](#), [689](#), [702](#)). Formulas to correct the  $\beta_2$ M concentrations for the effects of renal insufficiency have not improved its predictive value ( [703](#)); the  $\beta_2$ M value is still prognostic in myeloma patients with normal renal function ( [685](#)). The British MRC has shown that, after 2 years of survival, the initial  $\beta_2$ M concentration loses its prognostic value ( [704](#)).  $\beta_2$ M value also predicts high-dose therapy outcome (i.e., event-free and overall survival) ( [336](#), [496](#), [705](#), [706](#), [707](#), [708](#) and [709](#)).

**C-REACTIVE PROTEIN** French investigators first showed that C-reactive protein was useful as a univariate ( [710](#)) and multivariate ( [689](#)) prognostic marker in multiple myeloma ( [Table 98.14](#)). These findings were substantiated in groups of patients from Mayo Clinic ( [686](#)) and Eastern Cooperative Oncology Group clinical trials ( [711](#)). C-reactive protein

concentration does not appear to be useful as a marker of disease status ( 712 ).

C-reactive protein value also predicts high-dose therapy outcome ( 187 ).

**LACTATE DEHYDROGENASE** Increased lactate dehydrogenase values identify a group of patients with poor prognosis and aggressive disease, sometimes a lymphomalike disease characterized by tumor masses and retroperitoneal adenopathy with a short clinical course ( 713 , 714 and 715 ). Only 7 to 11% of patients with newly diagnosed myeloma have an

increased concentration of lactate dehydrogenase ( 208 , 715 ), thereby limiting its utility.

**BONE MARROW PLASMA CELL NUMBER AND MORPHOLOGY** The quantity, growth patterns, and morphologic features of bone marrow plasma cells have been evaluated as prognosticators for patients with myeloma with variable results ( 695 , 716 , 717 , 718 and 719 ).

Although the estimation of percent bone marrow plasmacytosis is not always reproducible ( 716 , 717 ), investigators have reported prognostic significance ( 695 , 719 ). Bartl et al. ( 695 )

constructed an intricate study of bone marrow characteristics of myeloma patients (

Table 98.14). The architectural pattern of growth—including interstitial, interstitial-sheets,

interstitial-nodular, nodular, and packed—correlates with survival ( 695 , 719 ), as does the

plasma cell morphology ( 695 ). According to Bartl et al. ( 695 ), myeloma cell histologic

features can be classified into six types: (a) Marschalko type, which is characterized by

predominantly normal-appearing plasma cells with a mean size of 21  $\mu\text{m}$ ; (b) small cell

type, which is characterized by small, round, and lymphoplasmacytoid cells with a mean

size of 13  $\mu\text{m}$ ; (c) cleaved type, which is characterized by notched, cleaved, or even

convoluted nuclei of variable size; (d) polymorphous type, which is characterized by

marked cellular polymorphism and multinuclearity, with interspersed giant plasma cells and

cytoplasmic inclusions; (e) asynchronous type, which is characterized by marked

asynchronous maturation of the nucleus and cytoplasm, large eccentric nuclei, frequent

nucleoli, and a pronounced perinuclear hof; and (f) blastic type, which is characterized by

plasmablasts with large nuclei, prominent centrally located nucleoli with a moderate rim of

basophilic cytoplasm, and a faint perinuclear hof ( Table 98.14). Neither of these

morphologic features—architecture or plasma cell phenotype—has been applied widely.

Other investigators have demonstrated the powerful prognostic significance of immature

or plasmablastic plasma cells ( 123 , 260 , 687 , 720 , 721 , 722 , 723 and 724 ). Plasmablastic

morphology is associated with a high PCLI, a higher level of sIL-6R, and *ras* mutations (

687 ). Electron microscopy confirms that immature nuclear morphology and nuclear

cytoplasmic asynchrony correlate with one another and with poor prognosis ( 725 , 726 ).

Nuclear immaturity and three cytoplasmic abnormalities—scattered patterns of

mitochondria, single-sac looplike structures, and numerous intramitochondrial

granules—have been associated with poor outcome.

**PLASMA CELL LABELING INDEX** The PCLI of bone marrow plasma cells is a

reproducible and powerful prognostic factor in multiple myeloma ( 685 , 686 , 691 , 727 ) ( Table

98.14). The PCLI is determined from an immunofluorescence slide-based assay ( 123 ).

Cells in DNA S phase of the cell cycle incorporate bromodeoxyuridine, which can be

recognized by using a monoclonal antibody. S-phase cells are then marked with a second

antibody, and plasma cells are recognized by morphology and reactivity with antihuman Ig

?- and ?-light chains ( 728 ). An increased PCLI predicts a short remission and survival but

does not predict response to therapy. All large studies published to date have confirmed

the independent prognostic value of the PCLI for survival after treatment with

conventional chemotherapy ( 123 , 685 , 721 , 729 , 730 ) or high-dose therapy ( 709 ). Other

methods for determining proliferation include Ki67 immunohistochemical staining ( 731 , 732 )

and determination of S phase by flow cytometry ( 691 , 733 , 734 ). Witzig et al. ( 735 , 736 ) have

also demonstrated the prognostic value of the peripheral blood labeling index.

**CYTOGENETICS, FLUORESCENCE *IN SITU* HYBRIDIZATION, AND OTHER GENETIC**

**ABNORMALITIES** Nearly all myeloma patients have abnormal chromosomes by

fluorescence *in situ* hybridization (FISH), including deletions, aneuploidy, and

translocations ( 737 , 738 ), although abnormal karyotypes are seen in only 18 to 30% of

cases. This apparent contradiction is explained by the generally low proliferative rate of myeloma cells and the requirement of obtaining plasma cells (and not just the rapidly dividing normal myeloid precursors) in metaphase to generate conventional cytogenetics ( 698, 739, 740 ). Therefore, any abnormality in conventional cytogenetics identifies a group with a higher proliferative rate ( 741 ) and a particularly poor prognosis. There is an excellent correlation between abnormal conventional cytogenetics and a high plasma cell proliferative rate ( 741, 742 ). By interphase FISH, aneuploidy is present in the majority of newly diagnosed patients ( 743 ). Aneuploidy is characterized predominantly by a gain of chromosome numbers, but monosomy is not uncommon ( 743 ). With interphase FISH, several chromosomal abnormalities, such as Ig heavy chain translocations and deletion of chromosome 13, are observed at equal frequencies among the spectrum of plasma proliferative disorders, from MGUS to multiple myeloma to PCL ( 744, 745 ). Monoallelic loss of chromosome 13 (del 13) or its long arm (del 13q), when determined by metaphase cytogenetics, is a powerful adverse prognostic factor in patients treated with standard chemotherapy ( 746 ) or with high-dose chemotherapy and hematopoietic stem cell transplantation ( 187, 420, 518, 747 ) ( Table 98.14 ). Approximately 50% of newly diagnosed multiple myeloma patients have del 13 or del 13q by FISH ( 699, 742, 745 ). The authors' group has shown that del 13q is associated with specific biologic features, including a higher frequency of ?-type multiple myeloma, slight female predominance, higher PCL, and a higher frequency of a serum M component of less than 10 g/L ( 456 ). Patients with the deletion by FISH have a worse overall survival with standard chemotherapy ( 456, 690, 697, 742 ), high-dose therapy ( 699, 748 ), and interferon treatment ( 456 ). The absence of abnormalities of chromosomes 13 and 11 by conventional cytogenetics is associated with longer complete response duration, event-free survival, and overall survival in patients treated with high-dose therapy ( 420 ). The prognostic significance of del 13q by FISH is less than that for del 13 by conventional cytogenetics, because the latter test incorporates the chromosomal abnormality and a high rate of plasma cell proliferation, whereas the former captures only the chromosomal abnormality. Hypodiploid myeloma has a worse prognosis than diploid or hyperdiploid myeloma. This has been demonstrated by flow cytometric methods ( 749, 750 ) and metaphase cytogenetics ( 698, 746, 751, 752 and 753 ). Controversy exists about whether the deletion 13q adds any additional prognostic information to a hypodiploid karyotype ( 698, 752, 753 ). As much as 75% of patients with multiple myeloma have translocations involving the heavy chain gene on chromosome 14. These translocations include illegitimate switch recombinations of the variable regions of the Ig heavy chain gene at 14q32. Partners of the translocations into the IgH switch region on chromosome 14 include chromosomes 11, 4, 6, and 16 ( 754 ). The most common translocation in multiple myeloma is t(11;14)(q13;q32) ( 755 ), which increases expression of cyclin D1 ( 186 ), a protein involved in cell cycle progression. The prevalence of t(11;14)(q13;q32) is 16% in multiple myeloma ( 756 ). Previous publications had suggested that this translocation was associated with an adverse outcome in multiple myeloma ( 187, 690 ), but more recent data refute this hypothesis ( 756 ). The t(4;14)(p16.3;q32) is present in 10 to 20% of multiple myeloma patients ( 757, 758, 759, 760 and 761 ). This translocation results in the up-regulation of fibroblast growth factor receptor 3 and in the hybrid transcript IgH/MMSET ( 757, 758 ). The t(14;16)(q32;q23) is also seen in a small subset (approximately 5%) of patients with multiple myeloma ( 758, 697 ). In one study, there was a tight association of del 13 abnormalities and high  $\beta_2\text{M}$  values with the unfavorable t(4;14) and t(14;16) abnormalities ( 762 ). The frequency of high  $\beta_2\text{M}$  or del 13 was one-half that in patients with the t(11;14) abnormality. This suggests that the poor prognosis associated with del 13 may be because of other nonrandom, associated chromosomal abnormalities. Fonseca et al. ( 697 ) have recently demonstrated that three distinct staging groups can be defined by the presence of t(14;16)(q32;q23), t(4;14)(p16.3;q32), deletion 17p13, and del

13q by FISH ( [Table 98.13](#)). Trisomy is common by FISH and includes chromosomes 3, 6, 9, 11, and 15 ( [763](#)). In another study, trisomy of chromosomes 3, 7, and 11 accounted for more than 50% of the hyperdiploid cases ( [743](#)). Trisomy of chromosomes 6, 9, and 17 was associated with prolonged survival ( [764](#)). Mutations of *ras* have been noted in 30 to 50% of multiple myeloma patients, with increasing prevalence in the advanced stages of the disease ( [176](#)) and shorter survival (K- *ras*) ( [177](#)). Mutations of *ras* were first observed in fulminant disease ( [179](#)) but have also been observed in 27 to 39% of newly diagnosed cases ( [176](#), [177](#)). Patients with *ras* mutations had a median survival of 2.1 years versus 4 years for patients with wild-type *ras* ( [177](#)). Inactivating mutation of *p53*, locus 17p13, is rare in freshly explanted myeloma cells but is common in human myeloma cell lines and in patients with a terminal phase of myeloma ( [179](#)). Such mutations have been observed in approximately 5% of cases of early multiple myeloma versus 20 to 40% of cases of PCL ( [200](#), [201](#), [202](#), and [203](#)). Deletions of *p53* as detected by FISH are present in 9 to 33% of patients with newly diagnosed myeloma ( [178](#), [180](#)) and confer a poorer median survival (15.9 months vs. >38 months) ( [180](#)). Epigenetic phenomena, such as methylation of the *p16* (Met- *p16*) promoter region, have been associated with progression in the PCDs ( [195](#), [196](#), [197](#), and [198](#)). Met- *p16* is uncommon in MGUS and smoldering multiple myeloma, increases in frequency with advancing stages of the disease ( [194](#), [198](#)), and is common in extramedullary multiple myeloma, including PCL. Zhan et al. ( [765](#)) have studied the gene expression of 74 myeloma patients by using high-density oligonucleotide microarrays interrogating approximately 6800 genes. On hierarchical clustering analysis, four distinct subgroups of myeloma (MM1, MM2, MM3, and MM4) were identified. The expression pattern of MM1 was similar to normal PCs and MGUS, whereas MM4 was similar to multiple myeloma cell lines. Clinical variables linked to poor prognosis, including abnormal karyotype and high serum  $\beta_2M$  levels, were most prevalent in MM4. Overexpression of genes involved in DNA metabolism and cell cycle control were observed in MM4. Novel candidate multiple myeloma disease genes have been identified.

**ANGIOGENESIS** Several studies have demonstrated prognostic significance of increased microvessel density (i.e., angiogenesis) in multiple myeloma ( [172](#)). The first description was a comprehensive study of multiple myeloma and MGUS that showed a strong association with diagnosis and with an increased S phase fraction of plasma cells measured by the PCLI ( [172](#)). This finding was corroborated in a prospective clinical trial ( [766](#)). Median survivals were 4.4, 4, and 2 years in patients with low, intermediate, and high microvessel density, respectively. However, in this study of only 74 patients, there was no independent prognostic significance for angiogenesis in a model that included PCLI,  $\beta_2M$ , and the percentage of marrow plasma cells ( [766](#)). In another study, angiogenesis failed to predict survival ( [767](#)). It is not known whether levels of angiogenic cytokines, such as VEGF, bFGF, or hepatocyte growth factor, are associated with poor survival, although concentrations are reduced during effective chemotherapy ( [162](#)).

**LYMPHOCYTE SUBSETS** Low numbers of CD4 (helper T) cells at diagnosis are associated with a worse prognosis ( [768](#), [769](#)); the prognostic importance of CD4 T cells is present throughout the course of disease, including after the completion of chemotherapy and at relapse ( [770](#)). In the posttransplantation setting, the number of circulating lymphocytes appears to be an important prognostic factor. Porrata et al. ( [771](#)) demonstrated lower relapse rates and prolonged survival for patients with higher absolute lymphocyte counts after autologous stem cell transplantation, suggesting an early graft-versus-tumor effect. The median overall survival and progression-free survival for myeloma patients were significantly longer in patients with an absolute lymphocyte count of greater than or equal to 500 cells/ $\mu$ l on day 15 than for patients with an absolute lymphocyte count of less than 500 cells/ $\mu$ l (33 months vs. 12 months; 16 months vs. 8 months). Researchers at the University of Arkansas made a similar observation. In a trial

designed to evaluate the role of more intense conditioning, lymphocyte recovery, evaluated as a surrogate for immune recovery, was inferior in more intensively treated patients. Despite identical complete remission rates, event-free survival and overall survival were significantly decreased among patients receiving more intensive conditioning ( [772](#) ).

**OTHER PROGNOSTIC FACTORS** Other factors that have adverse prognostic value include decreased staining of bone marrow plasma cells for acid phosphatase ( [773](#) ), increased circulating plasma cells as measured by the peripheral blood labeling index ( [736](#) ), apoptotic index ( [270](#) ), increased sIL-6R ( [687](#), [774](#), [775](#) ), serum neopterin ( [776](#) ), a<sub>1</sub>-antitrypsin ( [777](#) ), C-terminal telopeptide of type 1 collagen ( [778](#), [779](#) and [780](#) ), serum bone sialoprotein ( [781](#) ), B<sub>12</sub> binding protein ( [782](#) ), soluble CD56 ( [783](#) ), soluble Fc receptor (CD16) ( [784](#) ), soluble syndecan or CD138 ( [785](#) ), and serum IL-6 levels ( [786](#), [787](#) and [788](#) ). Although IL-6 is known to have a major role in myeloma pathogenesis, C-reactive protein levels correlate well with this more expensive and less readily available prognostic test. There are mixed results on the prognostic value of serum thymidine kinase ( [789](#), [790](#) ).

**DRUG RESISTANCE** One form of drug resistance is marked by multidrug resistance-1 expression on plasma cells, as demonstrated by immunocytochemistry ( [791](#) ). The presence of this P-glycoprotein in the cell membrane of plasma cells of patients with multiple myeloma is associated with a poor prognosis. Drug resistance measured by immunocytochemical detection of lung resistance protein is highly correlated with failure of response to melphalan and poor subsequent survival ( [792](#) ).

## Significance of the Extent of Response after Therapy

### SIGNIFICANCE OF RESPONSE AFTER STANDARD INTENSITY CHEMOTHERAPY

Response is often used as a measure of efficacy, and it is often assumed that complete remissions are a prerequisite for cure. Indeed, patients treated with standard-intensity chemotherapy with responsive disease tend to live a median of 18 months longer than do patients with resistant disease ( [33](#), [337](#), [578](#) ). However, tumor response may speak more to a patient's tumor biology than it does to the therapy in question. Most standard-intensity chemotherapy studies suggest that the degree of response does not correlate with survival ( [578](#), [579](#), [793](#), [794](#) and [795](#) ). Rather, the ability to achieve a plateau of at least 6 months' duration is as important, if not more important, than the degree of response to therapy ( [575](#), [576](#) and [577](#) ). The data from only 3 ( [325](#), [326](#), [374](#) ) of 27 ( [318](#), [329](#), [365](#), [366](#), [372](#), [375](#), [377](#), [382](#), [441](#) ) randomized induction trials suggest that the observed higher response rate translates into longer overall survival ( [Table 98.7](#) ). The importance of response kinetics is also a controversial topic. Some data support the premise that those with the most rapid responses to alkylator-based therapy have a shorter remission duration and survival ( [573](#) ), whereas other data contradict this assumption ( [578](#) ).

**SIGNIFICANCE OF A COMPLETE RESPONSE AFTER HIGH-DOSE THERAPY** It is unclear whether the achievement of a complete response, as defined by the disappearance of the M protein by immunofixation of the serum and urine after high-dose therapy with hematopoietic stem cell support, is of prognostic value. Multiple studies have produced inconsistent results ( [336](#), [500](#), [517](#), [545](#), [546](#), [796](#), [797](#) ). Several of these studies ( [336](#), [545](#), [796](#) ) did not use the more stringent definition of *complete response*; they relied on the absence of an M protein on an electrophoretic pattern rather than immunofixation negativity. These studies should be interpreted with caution, because they do not include several of the most powerful determinants of prognosis—PCLI and conventional cytogenetics ( [187](#), [420](#), [685](#), [686](#), [691](#) ). One of these studies is a retrospective study of 344 patients with multiple myeloma treated with high-dose chemotherapy followed by autologous stem cell transplantation. Patients were not treated uniformly. The 5-year overall survival was 48% in those who had no M protein on immunofixation and 21% in



those with a persistent M protein (797). Alexanian et al. (507) reported on a series of 68 patients treated with dexamethasone-based induction therapy followed by early high-dose therapy; results were compared to those of 50 patients who were unable to receive high-dose therapy because of socioeconomic reasons. Patients who achieved an immunofixation-negative complete response by either means (i.e., high-dose or standard chemotherapy) had a superior overall survival compared to patients who achieved a partial response or less. The implication of these data is that a complete response may be an important surrogate marker of long survival and less aggressive myeloma biology. This study was also lacking important baseline prognostic information (i.e., PCLI and cytogenetics). In yet another study, Davies et al. (500) reported a series of 96 patients who received high-dose therapy and were assessed for the effect of response on survival. Although there was a trend toward an improved progression-free survival among patients with an immunofixation-negative complete response, compared to patients with a partial response (49.4 months vs. 41.1 months,  $p = .26$ ), there was no improvement in overall survival. Finally, Rajkumar et al. (798) reported a complete response in 33% of 126 multiple myeloma patients who underwent stem cell transplantation. There was no difference in the overall survival or progression-free survival between patients who achieved a complete response and those who did not; rather, overall survival was significantly influenced by the level of the PCLI.

## TREATMENT OF COMPLICATIONS AND SUPPORTIVE CARE

### Treatment of Myeloma Bone Disease

Myeloma bone disease is a significant contributor to morbidity. The standard method of following patients is with periodic (every 6 to 12 months) skeletal radiographs; the use of more sophisticated imaging modalities is being explored. Cross-linked N-telopeptides of type 1 collagen, which can be measured in the serum or urine, appear to be a sensitive indicator of bone turnover (799), and urinary levels show a strong positive correlation with the dynamic histomorphometric indices of bone resorption (800). Despite careful monitoring, patients are at risk for skeletal events.

Monthly intravenous administration of pamidronate has been shown to reduce the likelihood of a skeletal event by almost 50% in patients with multiple myeloma (801). In this study, 392 patients with stage III myeloma and at least one lytic lesion received placebo or pamidronate, 90 mg intravenously administered as a 4-hour infusion monthly for 21 cycles. Skeletal events (pathologic fracture, radiation or surgery, and spinal cord compression) and hypercalcemia were assessed monthly. The mean number of skeletal events per year was less in the pamidronate group (1.3) than in the placebo-treated patients (2.2;  $p = .008$ ), and the proportion of patients who developed any skeletal event was lower in the pamidronate group ( $p = .015$ ). A recent study demonstrated equivalency of pamidronate and zoledronic acid (802). Median time to the first skeletal-related event was approximately 1 year in each treatment group, and the proportion of patients with at least one skeletal-related event was similar in all treatment groups.

When a lytic bone lesion is present, significant risk factors for fracture of a long bone include increased pain with use, and the involvement of more than two-thirds of the diameter of the bone. These lesions should be treated prophylactically with surgery if they are situated in weight-bearing bones (803). Endosteal resorption of one-half the cortical width of the femur weakens the bone by 70%. Surgical treatment should be considered for these lesions as well (804). Once a bone has fractured, healing can occur, especially if proper internal fixation is performed and if the patient has an anticipated survival of greater than 6 months. Much of the data regarding malignant bone disease are derived from patients with carcinoma rather than multiple myeloma. In patients with

carcinoma metastatic to bone, modest postoperative radiation doses (=3000 cGy) as adjuvant therapy are associated with better healing ( 805 ), but the role of adjuvant radiation therapy in multiple myeloma patients is less clear. Multiple myeloma is often chemotherapy sensitive; adjuvant systemic chemotherapy in multiple myeloma patients may be more appropriate than adjuvant radiation therapy. In general, radiation therapy should be used for pain relief in chemotherapy–refractory disease, because it relieves pain in 80 to 90% of patients with bony metastases ( 806 ), with long–term relief in 55 to 70% ( 807 ).

Percutaneous vertebroplasty is occasionally an option for patients with vertebral body compression fracture. Pain relief is generally apparent within 1 to 2 days after injection and persists for at least several months to as long as several years ( 808 ). Complications are relatively rare, although some studies reported a high incidence of clinically insignificant leakage of bone cement into the paravertebral tissues. Compression of spinal nerve roots or neuralgia due to the leakage of polymer and pulmonary embolism have also been reported.

### Spinal Cord Compression

In a paper published in 1979, it was estimated that nearly 10% of patients with myeloma present with spinal cord compression or develop it during the course of the disease ( 809 ); with higher awareness of myeloma and better imaging technology, the incidence is likely lower now. Cord compression, however, remains an important and emergent subject. The usual standard treatment is high–dose corticosteroids and radiation therapy ( 810 , 811 , 812 and 813 ). On rare occasions, surgical decompression may be considered. Because most myelomatous lesions arise from the vertebral body, an anterior surgical approach is generally used, which may contribute additional morbidity. One small randomized trial addressing the question of radiation versus laminectomy and radiation showed no benefit attributable to laminectomy ( 811 ); similarly, a larger retrospective series found no benefit ( 810 ). If the deficit is due to compression by the plasma cell tumor (rather than a bone fragment retropulsed by a pathologic compression fracture), outcomes with radiation therapy are probably equal to (or superior to) surgical intervention in a radiosensitive tumor like myeloma ( 810 , 811 ).

High–dose corticosteroids may provide immediate pain relief and improvement in neurologic function ( 812 , 813 ). The optimal corticosteroid dose has not been established, but common dose schedules for metastatic disease include dexamethasone in an initial bolus of 10 mg intravenously, followed by 4 mg orally four times daily ( 814 ), or a 100–mg intravenous bolus followed by 96 mg in four divided doses for 3 days followed by tapering doses ( 812 , 813 ).

### Hypercalcemia

Patients with multiple myeloma are at risk of severe hypercalcemia that can precipitate acute renal failure, hypertension, nausea, vomiting, pancreatitis, cardiac arrhythmia, coma, and death. The extracellular volume depletion associated with hypercalcemia should be corrected by vigorous hydration ( 676 , 815 ), followed by an antiresorptive agent, such as intravenous bisphosphonate. Serum calcium values usually decline rapidly, reaching the normal range within 2 to 3 days in more than 80% of cases. Occasionally they go below normal at the nadir. Corticosteroids can also reduce serum calcium concentration in approximately 60% of patients with hypercalcemia ( 816 ).



Gallium nitrate, mithramycin, and calcitonin are interesting from a historical perspective. Since the advent of bisphosphonates, they are not often used. Gallium nitrate therapy has been shown to be superior to maximally approved doses of calcitonin for acute control of cancer-related hypercalcemia ( [817](#) ).

### **Hematologic Complications, Including Anemia, Secondary Leukemia, Hyperviscosity, and Cryoglobulinemia**

**ANEMIA** The anemia of multiple myeloma can result from many factors. When the anemia is due solely to myelomatous bone marrow infiltration, chemotherapy remedies the problem. Other patients have a relative erythropoietin deficiency related to renal injury due to the myeloma or age-related changes. In these patients, as in any patient with renal insufficiency, modest doses of recombinant erythropoietin are effective. For patients with chemotherapy-induced anemia, recombinant erythropoietin may be effective at higher doses (150 to 300 IU/kg thrice weekly or 40,000 units weekly). Two placebo-controlled trials in myeloma patients demonstrate significantly improved hemoglobin levels and a reduced number of red cell transfusions in patients receiving erythropoietin ( [818](#) , [819](#) ). An inappropriately low endogenous erythropoietin concentration is the most important factor predicting response ( [820](#) ).

**SECONDARY MYELODYSPLASIA AND ACUTE LEUKEMIA** The most ominous cause of anemia in the setting of previously treated multiple myeloma is a secondary myelodysplastic syndrome or acute leukemia. Kyle et al. ( [566](#) ) were among the first to recognize that cytotoxic agents can induce myelodysplasia and acute myeloid leukemia ( [567](#) , [568](#) and [569](#) ). The risk of a secondary myelodysplastic syndrome or acute leukemia is approximately 3% at 5 years and 10% at 8 to 9 years ( [821](#) , [822](#) ). Estimates range from an actuarial risk of 25% at 5 years ( [823](#) ) to 0.7% over 10 years ( [328](#) ), with multiple other estimates somewhere in between ( [368](#) , [570](#) ). A reasonable guideline is that the 10-year risk of myelodysplastic syndrome or acute myeloid leukemia is approximately 3% for every year of melphalan treatment ( [821](#) ). Some authors have suggested that higher cumulative doses of melphalan are implicated as a risk for acute leukemia ( [821](#) ). Others have shown no difference in incidence based on the number of courses of chemotherapy or the cumulative melphalan dose between the patients who did and did not develop acute leukemia ( [822](#) ). In the Finnish study, the mean number of chemotherapy cycles was 19.7 and 18.5 in patients with and without secondary leukemia; mean cumulative melphalan doses were 1440 mg and 1400 mg, respectively ( [822](#) ). Although cyclophosphamide has been shown to be leukemogenic, data suggest that it is less so than melphalan ( [821](#) , [824](#) , [825](#) ). After secondary leukemia is diagnosed, median survival tends to be short—approximately 2 months ( [822](#) ). The occurrence of multiple cases of concurrent acute leukemia in multiple myeloma suggests that there may be a proclivity for acute leukemia to develop in patients with myeloma ( [826](#) , [827](#) ). After stem cell transplantation for myeloma, the risk of myelodysplastic syndrome appears to be related to prior chemotherapy rather than to the transplant itself, at least in one retrospective series ( [828](#) ).

**CRYOGLOBULINEMIA** Approximately 5% of myeloma gamma globulins exhibit reversible precipitation in the cold, so-called cryoglobulins, forming a flocculent precipitate or a gel-like coagulum when the serum is cooled ( [829](#) ).

**HYPERVISCOSITY** Plasmapheresis relieves the symptoms of hyperviscosity, but the benefit of this treatment in the absence of concurrent chemotherapy is short lived ( [830](#) ).

## Renal Failure

Normal creatinine values are present in approximately 50% of multiple myeloma patients at diagnosis ( [207](#), [208](#), [209](#) and [210](#), [242](#), [243](#) and [244](#) ), and only 15 to 25% have a creatinine value of greater than 2 mg/dl ( [208](#), [248](#) ). Patients in whom the renal failure is reversed have a better overall survival than those without improvement ( [247](#), [249](#) ). Factors that increase renal tubular cast formation include dehydration, infection, and hypercalcemia. Maintaining a 24-hour fluid intake of at least 3 L can improve renal function ( [247](#) ).

Because light chains with the lowest isoelectric points tend to be more nephrotoxic in animal models, avoidance of a low or acidic urinary pH is recommended. Oral or intravenous bicarbonate is useful in the setting of acute renal failure ( [831](#) ). The MRC third myelomatosis trial randomized multiple myeloma patients with significant renal failure to oral sodium bicarbonate to neutralize urine pH (or not), and there was a trend toward better survival in the bicarbonate recipients ( [247](#) ).

The use of plasmapheresis in the setting of renal failure remains controversial. One small randomized study of patients with active myeloma and progressive renal failure suggested benefit in a subset of patients ( [832](#) ). Twenty-one patients were randomized to forced diuresis and chemotherapy (ten patients) or forced diuresis, chemotherapy, and plasmapheresis (11 patients). There was a trend toward better outcome in the plasmapheresis group, but the difference was not statistically significant. It is unclear whether the lack of significance is due to the small sample size or to an equivalence of the two therapeutic strategies. The study did demonstrate that the severity of myeloma cast formation directly correlated with lack of improvement regardless of treatment strategy.

Another randomized study in myeloma patients with severe renal compromise compared plasma exchange (and hemodialysis when needed) with peritoneal dialysis ( [833](#) ). All patients received chemotherapy and corticosteroids. Of the 29 patients in the study, 24 patients received dialysis, and five patients maintained serum creatinine concentrations of greater than 5 mg/dl without dialysis. Thirteen of the 15 patients in the plasmapheresis with or without hemodialysis group recovered renal function, reaching serum creatinine values of less than or equal to 2.5 mg/dl in most cases, whereas only two patients in the peritoneal dialysis group had enough improvement to stop dialysis. The 1-year survival rates were 66 and 28%, respectively (  $p < .01$  ). The study's design was flawed in that one group received peritoneal dialysis and the other hemodialysis; the question about the role of plasmapheresis is not adequately settled.

## Infection Management

Infections are a major cause of morbidity in myeloma patients ( [834](#), [835](#) ). Pneumonias and urinary tract infections caused by *S. pneumoniae*, *H. influenzae*, and *Escherichia coli* are most frequent ( [257](#), [836](#), [837](#) and [838](#) ). The susceptibility to infection varies with the phase of illness ( [256](#), [839](#) ). In one prospective study, the overall serious infection rate was 0.92 infections per patient-year and was four times higher during periods of active disease (1.90) than in plateau phase myeloma (0.49) ( [255](#) ). In a retrospective study evaluating the sequential incidence of infection, the first 2 months of initial chemotherapy emerged as a particularly high-risk period, with nearly one-half of the patients experiencing at least one clinically significant infection ( [256](#) ). Infections late in the course of multiple myeloma may be an inevitable result of long-standing immunosuppression and overwhelming tumor

burden. Prevention of infection is a critical goal for improving survival.

Prevention of infections by the use of vaccines is an attractive strategy. However, responses to vaccines are poor among myeloma patients ( [255](#), [840](#), [841](#) and [842](#) ). Patients with myeloma were investigated to assess whether immunologic risk factors predisposing to serious infection could be identified ( [255](#) ). Specific antibody titers to pneumococcal capsular polysaccharides and tetanus and diphtheria toxoids were significantly reduced compared to the control population. Low antipneumococcal and anti- *E. coli* titers correlated with risk of serious infection. In addition, among 41 immunized patients, responses to pneumococcus vaccine and tetanus and diphtheria toxoids were poor. IgG subclass levels were significantly reduced, and a poor IgG response to pneumococcus vaccine immunization was associated with an increased risk of septicemia. The predominant site of infection was the respiratory tract. Decreased concentrations of the uninvolved Igs were significantly associated with at least one serious infection ( [255](#) ).

The two most common prevention strategies consist of prophylaxis with antibiotics ( [843](#) ) or intravenous Ig (IVIg) ( [844](#) ). A randomized, placebo-controlled trial of trimethoprim-sulfamethoxazole (TMP-SMX) demonstrated a significant decrease in severe infections among newly diagnosed myeloma patients randomized to TMP-SMX compared to controls ( [843](#) ). Fifty-seven patients about to begin chemotherapy for multiple myeloma were randomly assigned to prophylaxis for 2 months or to no prophylaxis (control). Antibiotic prophylaxis consisted of TMP-SMX (160 and 800 mg orally every 12 hours) administered for the first 2 months of initial chemotherapy. Bacterial infection occurred in 11 control patients but in only two patients assigned to receive TMP-SMX (  $p = .004$  ). Eight severe infections occurred in controls compared to one severe infection in a TMP-SMX patient (  $p = .010$  ). Severe infections included five cases of pneumonia (three with sepsis), two urinary tract infections with complicating pneumonia or sepsis, one diverticulitis with perforation, and one staphylococcal scalded skin syndrome. The rate of bacterial infection was 2.43 per patient-year for controls and 0.29 per patient-year for the TMP-SMX group (  $p = .001$  ). Toxicity (skin rash in six patients, nausea in one patient) was not life-threatening but required discontinuation of TMP-SMX in 25% of patients. A randomized, double-blind, placebo-controlled trial demonstrated that IVIg significantly reduced the number of infections in high-risk patients with plateau phase multiple myeloma ( [844](#) ). Eighty-two such patients received IVIg (0.4 g/kg/month) or an equal volume of placebo for 1 year. There were no episodes of septicemia or pneumonia in patients receiving IVIg compared to ten episodes in placebo patients (  $p = .002$  ). There were 38 serious infections in 470 patient-months for the placebo group, compared to 19 serious infections in 449 patient-months for the IVIg group (  $p = .019$  ). A poor antibody response to pneumococcal vaccination (less than twofold increase) identified patients who had maximum benefit from IVIg. However, IVIg is expensive and inconvenient and can be associated with toxicity. Therefore, use of this agent is recommended only for patients with a significant history of severe infections.

## DIFFERENTIAL DIAGNOSIS

The diagnosis of multiple myeloma is made from a constellation of findings, including anemia, monoclonal proteins, bone lesions, renal complications, hypercalcemia, and bone marrow plasmacytosis. Often the diagnosis is straightforward, but other disease entities associated with hypergammaglobulinemia or monoclonal bone marrow plasma cells must also be considered. These include reactive plasmacytosis, MGUS, primary systemic amyloidosis, Waldenström macroglobulinemia, LCDD, acquired Fanconi syndrome, solitary plasmacytoma, osteosclerotic myeloma or POEMS ( *p*olyneuropathy, *o*rganomegaly, *e*ndocrinopathy, *M* protein, and *s*kin changes) syndrome, and PCL.

## Reactive Plasmacytosis and Polyclonal Hypergammaglobulinemia

Reactive plasmacytosis and polyclonal hypergammaglobulinemia must be distinguished from a clonal process. Patients with liver disease; chronic infections, including human immunodeficiency virus; connective tissue diseases; other lymphoproliferative disorders; and carcinoma can have increased bone marrow plasmacytosis (polyclonal) and hypergammaglobulinemia (polyclonal) ( [19](#), [110](#) ). These conditions should not be confused with multiple myeloma or MGUS, which are clonal processes.

## Monoclonal Gammopathy of Undetermined Significance

Two percent of patients older than 50 years of age have MGUS, which is a benign counterpart or precursor lesion of multiple myeloma ( [100](#) ). It is characterized by an M protein in the serum or urine, without evidence of multiple myeloma or other serious gammopathy-related disorder. MGUS patients do not have bone marrow suppression, lytic bone lesions, hypercalcemia, renal failure, or susceptibility to infection. Standard clinical features do not accurately predict which patients remain stable, and, in approximately 1% of patients per year, multiple myeloma develops ( [100](#) ). The clinical distinction between MGUS and asymptomatic multiple myeloma is derived from an arbitrary definition ( [Table 98.2](#) ), although the underlying biologic conditions may prove to be different.

The greatest challenges in differentiating MGUS from myeloma occur in patients who have MGUS and (a) senile osteoporosis, (b) renal insufficiency from another cause, or (c) hypercalcemia due to hyperparathyroidism. Approximately 50% of women older than 60 years of age have osteoporosis, and a fraction of these have vertebral compression fractures. Computed tomographic scan of the spine may help distinguish between senile osteoporosis and myelomatous bone disease. Similarly, renal insufficiency due to long-standing diabetes, hypertension, or nonsteroidal drug use is not uncommon. In such cases, a patient may still have MGUS (or asymptomatic myeloma, for that matter) and end-organ damage. The key is whether the damage is attributable to the plasma proliferative disorder or another cause. In some instances, renal biopsy may be required to clarify this issue.

## Primary Systemic Amyloidosis

Primary systemic amyloidosis is a rare disorder that is characterized by the deposition of amyloid fibrils. These fibrils are composed of Ig light chain fragments in a  $\beta$ -pleated sheet conformation. It should be suspected when a patient with a mono-clonal protein in the serum or urine presents with nephrotic-range proteinuria (primarily albumin) with or without renal insufficiency, cardiomyopathy, hepatomegaly, or peripheral neuropathy. Patients usually present with weight loss or fatigue. Anemia is rare at presentation. Symptoms related to the affected organ are also seen. A monoclonal light chain is found in the serum or urine in nearly 90% of patients with amyloidosis. Most of the remaining patients have monoclonal plasma cells detectable in the bone marrow; the median percentage of clonal plasma cells in these patients is only 5%. A histologic diagnosis is made by demonstrating the amyloid fibrils—green birefringence under polarized light by using a Congo red stain or 8- to 10-nm nonbranching fibrils by electron microscopy. The fat aspirate is positive 70 to 80% of the time. The bone marrow demonstrates amyloid deposits approximately one-half of the time. Nearly 90% of patients with amyloidosis have a bone marrow or fat aspirate specimen positive for amyloid deposits. In the remaining 10%, a biopsy specimen of the affected organ is positive.

## Waldenström Macroglobulinemia

Waldenström macroglobulinemia should not be confused with IgM myeloma, which comprises only approximately 1% of myeloma cases (208). Patients with Waldenström macroglobulinemia may have anemia, hyperviscosity, “B” symptoms, bleeding, and neurologic symptoms. Significant lymphadenopathy or splenomegaly may also be present. Lytic bone disease is markedly uncommon; if present, consider whether the patient has IgM myeloma. In Waldenström macroglobulinemia, bone marrow biopsy typically reveals infiltration with clonal lymphoplasmacytic cells (CD20 positive). The natural history and treatment options for Waldenström macroglobulinemia are different from those of multiple myeloma (845).

## Light Chain Deposition Disease

The nonamyloidogenic LCDD is due to pathologic protein deposition in various tissues and organs. Unlike the light chain deposits observed in patients with primary systemic amyloidosis, these infiltrates are not congophilic by light microscopy, and nonbranching fibrils are not observed by electron microscopy. Instead, amorphous nodular deposits are seen.

LCDD may occur with or without coexistent multiple myeloma. Renal involvement is most common, followed by cardiac and hepatic deposits. Clinically, LCDD can be differentiated from multiple myeloma and primary systemic amyloidosis by the following findings. As in primary systemic amyloidosis, early in the disease course, the light chain deposits have a predilection for the renal glomeruli rather than the tubules. This results in nonselective proteinuria, that is, a predominance of albuminuria, which is not usual in multiple myeloma. It is impossible, without tissue biopsy, to distinguish clinically the cardiomyopathy and hepatopathy from primary systemic amyloidosis. In LCDD, the underlying clone is more commonly monoclonal ? rather than ?.

The prognosis of patients who have this disorder depends on whether there is underlying multiple myeloma. In one retrospective study of 19 patients with LCDD, 5-year actuarial patient survival and survival free of end-stage renal disease were 70% and 37%, respectively (846).

## Acquired Fanconi Syndrome

Fanconi syndrome is a rare complication of PCDs characterized by diffuse failure in reabsorption at the level of the proximal renal tubule and resulting in glycosuria, generalized aminoaciduria, and hypophosphatemia. Fanconi first described the syndrome in children. Subsequently, acquired forms were described in adults. Acquired Fanconi syndrome is usually associated with MGUS. Overt hematologic malignancies may occur, such as multiple myeloma, Waldenström macroglobulinemia, or other lymphoproliferative disorders. The prognosis is good in the absence of overt malignant disease. Clinical manifestations include slowly progressive renal failure and bone pain due to osteomalacia. The diagnosis of Fanconi syndrome can be made when a patient with a monoclonal plasma cell disorder presents with aminoaciduria, phosphaturia, and glycosuria. Electrolyte abnormalities typically include hypokalemia, hypophosphatemia, and hypouricemia. Bence Jones proteinuria is usually present and is almost always of the ? type. Rare patients have been reported with Fanconi syndrome associated with ? Bence Jones proteinuria.

Treatment consists of supplementation with phosphorus, calcium, and vitamin D. Chemotherapy may benefit patients with rapidly progressive renal failure or symptomatic



malignancy.

## Plasma Cell Leukemia

PCL is a rare form of PCD. Between 2% and 4% ( [763](#), [847](#), [848](#) ) of malignant PCD cases are PCL. By definition, there are more than 20% plasma cells in the peripheral blood with an absolute plasma cell count of more than  $2 \times 10^9/L$ . Some authors accept the diagnosis with only one of these criteria ( [285](#) ). The presentation may be primary, *de novo*, or secondary, evolving from an existing case of myeloma as part of the terminal phase of the disease. Approximately 60 to 70% of cases are primary ( [847](#) ).

Although there is overlap, the phenotype of plasma cells from patients with primary PCL is different from those of myeloma patients. PCL plasma cells more frequently express the CD20 antigen ( [763](#) ) than those of multiple myeloma (50% vs. 17%), and they often lack CD56 antigen ( [265](#), [763](#) ), which is present on the majority of myeloma cells ( [763](#) ). CD56 is considered important in anchoring plasma cells to bone marrow stroma and is associated with a poor prognosis ( [167](#), [266](#) ). CD28 is more frequently expressed on malignant plasma cells in secondary than in primary PCL, which is consistent with an observation made in myeloma, that is, that acquisition of the CD28 antigen on plasma cells appears to correlate with an increased proliferative rate and disease progression ( [849](#) ).

PCL plasma cells have higher proliferative rates ( [763](#) ) and more complex karyotypes than myeloma plasma cells ( [848](#) ). By comparative genomic hybridization and by FISH techniques, losses on 13q ( [850](#), [851](#) ) and monosomy 13 ( [763](#) ) exist in more than 80% of PCL patients ( [850](#), [851](#) ). Losses on chromosome 16 also occur in approximately 80% of cases ( [851](#) ). Gains in 1q are present in approximately one-half of the patients by FISH ( [763](#) ), but in all by comparative genomic hybridization ( [851](#) ). In addition, PCL patients have unique losses of 2q and 6p ( [851](#) ). Overexpression of PRAD1/cyclin D1, which plays an important role in control of the cell cycle, has also been observed in PCL ( [852](#) ).

The clinical presentation of primary PCL is more aggressive than that of multiple myeloma, with a higher presenting tumor burden; higher frequencies of extramedullary involvement, anemia, thrombocytopenia, hypercalcemia, and renal impairment ( [763](#), [847](#), [848](#), [853](#) ); increased levels of serum lactate dehydrogenase and  $\beta_2M$ ; and plasma cell proliferative activity ( [763](#) ). The incidence of lytic bone lesions is slightly lower than that usually observed in multiple myeloma ( [763](#), [854](#) ).

Although the clinical and laboratory features of primary and secondary PCL are similar ( [854](#), [855](#) ), the response to therapy and overall survival in primary and secondary PCL go from poor to worse ( [847](#), [848](#), [854](#), [855](#) ). Higher response rates can be achieved with multiagent chemotherapy rather than single alkylator programs (47 to 66% vs. 8 to 13%) ( [763](#), [847](#), [848](#), [854](#) ). Regimens, such as VMCP-VBAP, VAD, and combination cyclophosphamide and etoposide, have resulted in median survivals of 18 to 20 months compared to 2 to 6 months when single-agent therapy is used ( [763](#), [847](#), [848](#), [854](#) ). Response and survival rates with secondary PCL remain low, however ( [854](#), [855](#) ). When thalidomide and dexamethasone are used, responses are possible ( *personal observation* ), which is not surprising, given the high response rates observed in patients with high PCLs in the authors' thalidomide trial ( [856](#) ). There are anecdotal reports of excellent responses and 2- to 3-year disease-free survivals after autologous stem cell

transplantation ( 857, 858, 859, 860 and 861 ). Two studies have independently noted the presence of an increased number of circulating large granular lymphocytes after stem cell transplantation ( 857, 862 ); disappearance of these cells in one patient coincided with relapse ( 857 ). The significance and implication of these observations are yet to be determined.

## Solitary Plasmacytomas

### SOLITARY PLASMACYTOMA OF BONE (INTRAMEDULLARY PLASMACYTOMA)

Solitary plasmacytoma of bone is a rare form of plasma proliferative disease. Its true incidence has not been described, but it accounts for approximately 2 to 5% of malignant PCDs treated at large referral centers ( 303, 863, 864 ). In most series, the definition has required the following characteristics: (a) histologic proof that the solitary lesion is a plasmacytoma; (b) no other bone lesions on metastatic bone survey; (c) less than 5% plasma cells from a random bone marrow biopsy site; and (d) the absence of anemia, hypercalcemia, or renal insufficiency that had no attributable cause. Some definitions allow for less than 10% bone marrow plasma cells ( 669 ), and others restrict the quantity of the serum or urine M spike. Some exclude patients who developed disseminated myeloma within a year after diagnosis of the solitary plasmacytoma ( 865 ). There is a clear male preponderance, and the median age is 55 years ( 669, 865, 866 ). Plasmacytomas most commonly arise from the axial skeleton, particularly the vertebral bodies. Pain is the usual presentation. Spinal cord or nerve root compression may also be present. If the patient also has evidence of a peripheral neuropathy, and especially if the bone lesion is sclerotic, one should consider the diagnosis of POEMS (see the following discussion). Monoclonal proteins are present in approximately 50% of patients ( 669, 865 ). Careful staging should be done in all patients, including a complete blood cell count, protein electrophoresis and immuno-fixation of the serum and urine, a complete radiographic skeletal survey, and random bone marrow aspiration and biopsy. At a minimum, immunohistochemical stains should be done on the bone marrow to identify a clone apart from the solitary plasmacytoma. MRI of the entire spine and pelvis should also be done to determine whether the lesion is solitary. Using MRI, Mouloupoulos et al. ( 234 ) found unexpected bone marrow involvement in 4 of 12 patients with apparently solitary plasmacytomas of bone. From a historical perspective, solitary plasmacytomas of bone were treated surgically with or without adjuvant radiation ( 867 ). Present day, single modality, definitive radiation therapy is the treatment of choice. Although the optimal dose has not been established by randomized controlled trials, 4000 to 5000 cGy encompassing all disease with a margin of normal tissue is recommended by most experts on the basis of retrospective local relapse rate data ( 669, 670 and 671, 868 ). Median 10-year disease-free survival is approximately 25 to 40% ( 669, 869 ). Median time to failure, that is, local relapse, appearance of another plasmacytoma, or disseminated myeloma, is approximately 2 years ( 669, 869 ). Risk factors for relapse include absence of a monoclonal protein at presentation (nonsecretory disease), depression of Ig values at presentation, and persistence of the monoclonal protein after treatment ( 869 ). The persistence of a monoclonal protein after radiation therapy does not guarantee relapse ( 303, 669 ), even after more than 10 years of follow-up ( 869 ). In rare instances, the maximum reduction of myeloma protein may take several years after completion of the radiation therapy ( 303, 669 ). Median survival for all patients presenting with solitary plasmacytoma of bone—based on data from patients staged before routine use of MRI and bone marrow clonality studies—was approximately 10 years ( 669, 864, 869, 870 ). For those who progressed to myeloma, the median survival was 44 months after the start of chemotherapy ( 303 ). Adjuvant chemotherapy has not been shown to produce a survival advantage and carries the risk of treatment-related myelodysplastic syndromes or acute leukemia; it cannot be



recommended. With increasingly sensitive diagnostic techniques, the incidence of solitary myeloma will decrease, but the relapse rate probably will, too.

**EXTRAMEDULLARY PLASMACYTOMA** Solitary extramedullary plasmacytomas represent approximately 3% of all plasma cell neoplasms (871). They most commonly affect men in their early 60s and occur in the upper respiratory tract (paranasal sinuses, nose, nasopharynx, and tonsils). They also occur in lymph nodes, lung, thyroid, gastrointestinal tract, liver, spleen, pancreas, testes, breast, or skin (872). Amyloid involvement of the plasmacytoma occurs on occasion. Although extramedullary plasmacytomas are not common in newly diagnosed multiple myeloma, classic myeloma must be excluded by thorough staging. A monoclonal protein in the serum and urine, lytic bone lesions, anemia, renal insufficiency, and hypercalcemia should be excluded. Histologically, an extramedullary plasmacytoma should be differentiated from reactive plasmacytosis, plasma cell granuloma, poorly differentiated neoplasms, and immunoblastic lymphoma. Some extramedullary plasmacytomas may represent marginal zone B-cell lymphomas that have undergone plasmacytic differentiation (873). Dimopoulos et al. (871) compiled 128 extramedullary plasmacytoma patients from eight published series (864, 872, 874, 875, 876, 877, 878, and 879) and summarized their clinical course. The local failure rate was 7%, multifocal extramedullary relapse occurred in 13%, and classic myeloma developed in 15%. Local radiation therapy is the treatment of choice, and adjuvant chemotherapy is not recommended. The 10-year disease-free survival is 70 to 80%.

### Osteosclerotic Myeloma (POEMS Syndrome)

Osteosclerotic myeloma is a rare variant of myeloma (=3.3% of cases) (880). There is a straight osteosclerotic variant that is similar to multiple myeloma in that anemia, significant bone marrow plasmacytosis, hypercalcemia, and renal insufficiency occur (218). Survival in these patients is comparable to that of classic multiple myeloma patients. There is, however, a more interesting form, which is known as *Crow-Fukase syndrome*, *PEF* (*FCD*, endocrinopathy, polyneuropathy) *syndrome*, *Takatsuki syndrome*, and *POEMS* (*polyneuropathy, organomegaly, endocrinopathy, M protein, and skin changes*) *syndrome* (219, 220, 881, 882). This variant is associated with multiple paraneoplastic phenomena, and its natural history is not similar to that of classic multiple myeloma. The acronym POEMS captures several of the dominant features of the syndrome, but it omits the sclerotic bone lesions, Castleman disease, papilledema, peripheral edema, ascites, polycythemia, thrombocytosis, fatigue, and clubbing commonly observed in the disorder (220, 882, 883 and 884). Not all features are required to make the diagnosis; at a minimum, however, a patient must have (a) peripheral neuropathy, (b) osteosclerotic myeloma (i.e., a clonal PCD and at least one sclerotic bone lesion) or Castleman disease, and (c) at least one of the other mentioned features (882). The peak incidence of POEMS syndrome is in the fifth and sixth decades of life, and there is a male predominance (881, 882, 885).

Although the precise mechanism of POEMS syndrome is unknown, VEGF appears to be a driving factor in this disorder (883, 886, 887). Despite the presence of osteosclerotic bone lesions, which microscopically contain clonal plasma cell infiltrates, bone marrow aspirate and biopsy of the iliac crest typically yield only approximately 5% monoclonal plasma cells (220, 882, 883).

Treatment for this disorder is far from standardized. Most agree that, for an isolated plasmacytoma, irradiation is the preferred treatment (888, 889, 890 and 891). Radiation therapy produces substantial improvement of the neuropathy in more than one-half of the patients who have a single lesion or multiple lesions in a limited area. If there are widespread lesions, chemotherapy and, potentially, peripheral blood stem cell

transplantation should be considered ( [882](#), [892](#), [893](#), [894](#), [895](#), [896](#) and [897](#) ). Responses of systemic symptoms and skin changes tend to precede those of the neuropathy, with the former beginning to respond within a month and the latter responding within 3 to 6 months.

The most common causes of death are cardiorespiratory failure, progressive inanition, infection, capillary leak-like syndrome, and renal failure ( [220](#), [882](#) ). The neuropathy may be unrelenting and may contribute to progressive inanition and eventual cardiorespiratory failure and pneumonia. Stroke and myocardial infarction, which may be related to the POEMS syndrome ( [882](#) ), are also observed causes of death. Patients do not die of classic myeloma (i.e., progressive bone marrow failure or hypercalcemia).

## REFERENCES

1. Harris NL, Jaffe ES, Stein H, et al. A revised European-American classification of lymphoid neoplasms: a proposal from the International Lymphoma Study Group. *Blood* 1994;84:1361-1392.
2. Dalrymple J. On the microscopical character of mollities ossium. *Dublin QJM* 1846;2:85-95.
3. Kyle RA. Multiple myeloma: an odyssey of discovery. *Br J Haematol* 2000;111:1035-1044.
4. Clump JR. Some aspects of the first recorded case of multiple myeloma. *Lancet* 1967;2:1354-1356.
5. Bence-Jones H. Chemical pathology. *Lancet* 1847;2:88-92.
6. Weber FP. General lymphadenomatosis of bones, one form of "multiple myeloma." *J Pathol Bacteriol* 1898;5:59-64.
7. Weber FP, Hutchison R, Macleod JJR. Multiple myeloma (myelomatosis), with Bence-Jones protein in the urine (myelopathic albumosuria of Bradshaw, Kahler's disease). *Am J Med Sci* 1903;126:644-665.
8. Wright JH. A case of multiple myeloma. *Bull Johns Hopkins Hosp* 1933;52:156.
9. Jacobson VC. Multiple myelomata. *J Urol* 1917;1:167-178.
10. Walters W. Bence-Jones proteinuria, a report of 3 cases with metabolic studies. *JAMA* 1921;76:641-645.
11. Bayne-Jones S, Wilson DW. Immunological reactions of Bence-Jones protein; differences between Bence-Jones proteins from various sources. *Bull Johns Hopkins Hosp* 1922;33:119-125.
12. Edelman GM, Gally JA. The nature of Bence-Jones proteins: chemical similarities to polypeptide chains of myeloma globulins and normal  $\gamma$ -globulins. *J Exp Med* 1962;116:207-227.
13. Tiselius A. Electrophoresis of serum globulin: electrophoretic analysis of normal and immune sera. *Biochem J* 1937;31:1464-1477.
14. Longworth LG, Shedlovsky T, MacInnes DA. Electrophoretic patterns of normal and pathological human blood serum and plasma. *J Exp Med* 1939;70:399-413.
15. Kunkel HG, Tiselius A. Electrophoresis of proteins on filter paper. *J Gen Physiol* 1951;35:89-118.
16. Wilson AT. Direct immunoelectrophoresis. *J Immunol* 1964;92:431-434.
17. Kunkel HG. The "abnormality" of myeloma proteins. *Cancer Res* 1968;28:1351-1353.
18. Heremans JF. Immunochemical studies on protein pathology: the immunoglobulin concept. *Clin Chim Acta* 1959;4:639-646.

19. Waldenström JG. Studies of conditions associated with disturbed gammaglobulin formation (gammopathies). *Harvey Lect* 1961;57:211–231.
20. Geschickter CF, Copeland MM. Multiple myeloma. *Arch Surg* 1928;16:807–863.
21. Magnus-Levy A. Bence-Jones-Eiweiss und Amyloid. *Z Klin Med* 1931;116:510–531.
22. Salmon SE, Smith BA. Immunoglobulin synthesis and total body tumor cell number in IgG multiple myeloma. *J Clin Invest* 1970;49:1114–1121.
23. Durie BG, Salmon SE. A clinical staging system for multiple myeloma: correlation of measured myeloma cell mass with presenting clinical features, response to treatment, and survival. *Cancer* 1975;36:842–854.
24. Snapper I. Stilbamidine and pentamidine in multiple myeloma. *JAMA* 1947;133:157–161.
25. Holland JR, Hosley H, Scharlau C, et al. A controlled trial of urethane treatment in multiple myeloma. *Blood* 1966;27:328–342.
26. Alwall N. Urethane and stilbamidine in multiple myeloma: report of 2 cases. *Lancet* 1947;2:388–389.
27. Loge JP, Rundles RW. Urethane (ethyl carbamate) therapy in multiple myeloma. *Blood* 1949;4:201–216.
28. Adams WS, Skoog WA. The management of multiple myeloma. *J Chronic Dis* 1957;6:446–456.
29. Thorn GW, Forsham PH, Frawley RF, et al. Medical progress; clinical usefulness of ACTH and cortisone. *N Engl J Med* 1950;242:824–834.
30. Salmon SE, Shadduck RK, Schilling A. Intermittent high-dose prednisone (NSC-10023) therapy for multiple myeloma. *Cancer Chemother Rep* 1967;51:179–187.
31. Blokhin N, Larionov L, Perevodchikova N, et al. Clinical experiences with sarcolysin in neoplastic diseases. *Ann N Y Acad Sci* 1958;68:1128–1132.
32. Bergsagel DE, Sprague CC, Austin C, et al. Evaluation of new chemotherapeutic agents in the treatment of multiple myeloma. IV. L-Phenylalanine mustard (NSC-8806). *Cancer Chemother Rep* 1962;21:87–99.
33. Bergsagel DE, Griffith KM, Haut A, et al. The treatment of plasma cell myeloma. *Adv Cancer Res* 1967;10:311–359.
34. Korst DR, Clifford GO, Fowler WM, et al. Multiple myeloma. II. Analysis of cyclophosphamide therapy in 165 patients. *JAMA* 1964;189:758–762.
35. Mellstedt H, Aahre A, Bjorkholm M, et al. Interferon therapy in myelomatosis. *Lancet* 1979;2:697.
36. Alberts DS, Salmon SE. Adriamycin (NSC-123127) in the treatment of alkylator-resistant multiple myeloma: a pilot study. *Cancer Chemother Rep* 1975;59:345–350.
37. Salmon SE. Nitrosoureas in multiple myeloma. *Cancer Treat Rep* 1976;60:789–794.
38. Singhal S, Mehta J, Desikan R, et al. Antitumor activity of thalidomide in refractory multiple myeloma. *N Engl J Med* 1999;341:1565–1571.
39. Greenlee RT, Hill-Harmon MB, Murray T, et al. Cancer statistics, 2001. *CA Cancer J Clin* 2001;51:15–36.
40. Howe HL, Wingo PA, Thun MJ, et al. Annual report to the nation on the status of cancer (1973 through 1998), featuring cancers with recent increasing trends. *J Natl Cancer Inst* 2001;93:824–842.

41. Cuzick J. Multiple myeloma. *Cancer Surv* 1994;19-20:455-474.
42. Schwartz GG. Multiple myeloma: clusters, clues, and dioxins. *Cancer Epidemiol Biomarkers Prev* 1997;6:49-56.
43. Lynch HT, Sanger WG, Pirruccello S, et al. Familial multiple myeloma: a family study and review of the literature. *J Natl Cancer Inst* 2001;93:1479-1483.
44. Loth TS, Perrotta AL, Lima J, et al. Genetic aspects of familial multiple myeloma. *Mil Med* 1991;156:430-433.
45. Shoenfeld Y, Berliner S, Shaklai M, et al. Familial multiple myeloma: a review of thirty-seven families. *Postgrad Med J* 1982;58:12-16.
46. Eriksson M, Bergstrom I. Familial malignant blood disease in the county of Jamtland, Sweden. *Eur J Haematol* 1987;38:241-245.
47. Grosbois B, Jegou P, Attal M, et al. Familial multiple myeloma: report of fifteen families. *Br J Haematol* 1999;105:768-770.
48. Brown LM, Linet MS, Greenberg RS, et al. Multiple myeloma and family history of cancer among blacks and whites in the U.S. *Cancer* 1999;85:2385-2390.
49. Bray I, Brennan P, Boffetta P. Recent trends and future projections of lymphoid neoplasms—a Bayesian age-period-cohort analysis. *Cancer Causes Control* 2001;12:813-820.
50. Ichimaru M, Ishimaru T, Mikami M, et al. Multiple myeloma among atomic bomb survivors in Hiroshima and Nagasaki, 1950-1976: relationship to radiation dose absorbed by marrow. *J Natl Cancer Inst* 1982;69:323-328.
51. Shimizu Y, Kato H, Schull WJ. Studies of the mortality of A-bomb survivors. 9. Mortality, 1950-1985: Part 2. Cancer mortality based on the recently revised doses (DS86). *Radiat Res* 1990;121:120-141.
52. Preston DL, Kusumi S, Tomonaga M, et al. Cancer incidence in atomic bomb survivors. Part III. Leukemia, lymphoma and multiple myeloma, 1950-1987. *Radiat Res* 1994;137:S68-S97.
53. Lewis EB. Leukemia, multiple myeloma, and aplastic anemia in American radiologists. *Science* 1963;142:1492-1494.
54. Matanoski GM, Seltser R, Sartwell PE, et al. The current mortality rates of radiologists and other physician specialists: specific causes of death. *Am J Epidemiol* 1975;101:199-210.
55. Wang JX, Boice JD Jr, Li BX, et al. Cancer among medical diagnostic x-ray workers in China. *J Natl Cancer Inst* 1988;80:344-350.
56. Wing S, Richardson D, Wolf S, et al. A case control study of multiple myeloma at four nuclear facilities. *Ann Epidemiol* 2000;10:144-153.
57. Darby SC, Kendall GM, Fell TP, et al. A summary of mortality and incidence of cancer in men from the United Kingdom who participated in the United Kingdom's atmospheric nuclear weapon tests and experimental programmes. *BMJ (Clin Res Ed)* 1988;296:332-338.
58. Pearce N, Prior I, Methven D, et al. Follow up of New Zealand participants in British atmospheric nuclear weapons tests in the Pacific. *BMJ* 1990;300:1161-1166.
59. Boffetta P, Stellman SD, Garfinkel L. A case-control study of multiple myeloma nested in the American Cancer Society prospective study. *Int J Cancer* 1989;43:554-559.
60. Cuzick J, De Stavola B. Multiple myeloma: a case-control study. *Br J Cancer* 1988;57:516-520.
61. Davis FG, Boice JD Jr, Hrubec Z, et al. Cancer mortality in a radiation-exposed cohort of

Massachusetts tuberculosis patients. *Cancer Res* 1989;49:6130–6136.

62. Friedman GD. Multiple myeloma: relation to propoxyphene and other drugs, radiation and occupation. *Int J Epidemiol* 1986;15:424–426.
63. Hatcher JL, Baris D, Olshan AF, et al. Diagnostic radiation and the risk of multiple myeloma (United States). *Cancer Causes Control* 2001;12:755–761.
64. Boice JD Jr, Morin MM, Glass AG, et al. Diagnostic x-ray procedures and risk of leukemia, lymphoma, and multiple myeloma. *JAMA* 1991;265:1290–1294.
65. Andersson M, Storm HH. Cancer incidence among Danish Thorotrast-exposed patients. *J Natl Cancer Inst* 1992;84:1318–1325.
66. Boice JD Jr, Day NE, Andersen A, et al. Second cancers following radiation treatment for cervical cancer: an international collaboration among cancer registries. *J Natl Cancer Inst* 1985;74:955–975.
67. Darby SC, Doll R, Gill SK, et al. Long term mortality after a single treatment course with x-rays in patients treated for ankylosing spondylitis. *Br J Cancer* 1987;55:179–190.
68. Heineman EF, Olsen JH, Pottern LM, et al. Occupational risk factors for multiple myeloma among Danish men. *Cancer Causes Control* 1992;3:555–568.
69. Riedel DA, Pottern LM. The epidemiology of multiple myeloma. *Hematol Oncol Clin North Am* 1992;6:225–247.
70. Semenciw RM, Morrison HI, Riedel D, et al. Multiple myeloma mortality and agricultural practices in the prairie provinces of Canada. *J Occup Med* 1993;35:557–561.
71. Cerhan JR, Cantor KP, Williamson K, et al. Cancer mortality among Iowa farmers: recent results, time trends, and lifestyle factors (United States). *Cancer Causes Control* 1998;9:311–319.
72. Nanni O, Falcini F, Buiatti E, et al. Multiple myeloma and work in agriculture: results of a case-control study in Forli, Italy. *Cancer Causes Control* 1998;9:277–283.
73. Pukkala E, Notkola V. Cancer incidence among Finnish farmers, 1979–1993. *Cancer Causes Control* 1997;8:25–33.
74. Wiklund K, Dich J. Cancer risks among male farmers in Sweden. *Eur J Cancer Prev* 1995;4:81–90.
75. Ronco G, Costa G, Lynge E. Cancer risk among Danish and Italian farmers. *Br J Ind Med* 1992;49:220–225.
76. Kristensen P, Andersen A, Irgens LM, et al. Incidence and risk factors of cancer among men and women in Norwegian agriculture. *Scand J Work Environ Health* 1996;22:14–26.
77. Khuder SA, Mutgi AB. Meta-analyses of multiple myeloma and farming. *Am J Ind Med* 1997;32:510–516.
78. Gallagher RP, Threlfall WJ. Cancer mortality in metal workers. *Can Med Assoc J* 1983;129:1191–1194.
79. Fritschi L, Siemiatycki J. Lymphoma, myeloma and occupation: results of a case-control study. *Int J Cancer* 1996;67:498–503.
80. McLaughlin JK, Malke HS, Linet MS, et al. Multiple myeloma and occupation in Sweden. *Arch Environ Health* 1988;43:7–10.
81. Rinsky RA, Smith AB, Hornung R, et al. Benzene and leukemia: an epidemiologic risk assessment. *N Engl J Med* 1987;316:1044–1050.
82. Decoufle P, Blattner WA, Blair A. Mortality among chemical workers exposed to benzene and other agents. *Environ Res* 1983;30:16–25.

83. Goldstein BD. Is exposure to benzene a cause of human multiple myeloma? *Ann N Y Acad Sci* 1990;609:225–230.
84. Bergsagel DE, Wong O, Bergsagel PL, et al. Benzene and multiple myeloma: appraisal of the scientific evidence. *Blood* 1999;94:1174–1182.
85. Sonoda T, Nagata Y, Mori M, et al. Meta-analysis of multiple myeloma and benzene exposure. *J Epidemiol* 2001;11:249–254.
86. Wong O, Raabe GK. A critical review of cancer epidemiology in the petroleum industry, with a meta-analysis of a combined database of more than 350,000 workers. *Regul Toxicol Pharmacol* 2000;32:78–98.
87. Brown LM, Everett GD, Gibson R, et al. Smoking and risk of non-Hodgkin's lymphoma and multiple myeloma. *Cancer Causes Control* 1992;3:49–55.
88. Brownson RC. Cigarette smoking and risk of myeloma. *J Natl Cancer Inst* 1991;83:1036–1037.
89. Gramenzi A, Buttino I, D'Avanzo B, et al. Medical history and the risk of multiple myeloma. *Br J Cancer* 1991;63:769–772.
90. Brown LM, Pottern LM, Silverman DT, et al. Multiple myeloma among blacks and whites in the United States: role of cigarettes and alcoholic beverages. *Cancer Causes Control* 1997;8:610–614.
91. Tavani A, La Vecchia C, Gallus S, et al. Red meat intake and cancer risk: a study in Italy. *Int J Cancer* 2000;86:425–428.
92. Brown LM, Gridley G, Pottern LM, et al. Diet and nutrition as risk factors for multiple myeloma among blacks and whites in the United States. *Cancer Causes Control* 2001;12:117–125.
93. Koessel SL, Theis MK, Vaughan TL, et al. Socioeconomic status and the incidence of multiple myeloma. *Epidemiology* 1996;7:4–8.
94. Baris D, Brown LM, Silverman DT, et al. Socioeconomic status and multiple myeloma among U.S. blacks and whites. *Am J Public Health* 2000;90:1277–1281.
95. Johnston JM, Grufferman S, Bourguet CC, et al. Socioeconomic status and risk of multiple myeloma. *J Epidemiol Community Health* 1985;39:175–178.
96. Brown LM, Everett GD, Burmeister LF, et al. Hair dye use and multiple myeloma in white men. *Am J Public Health* 1992;82:1673–1674.
97. Thun MJ, Altekruse SF, Namboodiri MM, et al. Hair dye use and risk of fatal cancers in U.S. women. *J Natl Cancer Inst* 1994;86:210–215.
98. Grodstein F, Hennekens CH, Colditz GA, et al. A prospective study of permanent hair dye use and hematopoietic cancer. *J Natl Cancer Inst* 1994;86:1466–1470.
99. Correa A, Jackson L, Mohan A, et al. Use of hair dyes, hematopoietic neoplasms, and lymphomas: a literature review. II. Lymphomas and multiple myeloma. *Cancer Invest* 2000;18:467–479.
100. Kyle RA, Therneau TM, Rajkumar SV, et al. A long-term study of prognosis in monoclonal gammopathy of undetermined significance. *N Engl J Med* 2002;346:564–569.
101. Cesana C, Klersy C, Barbarano L, et al. Prognostic factors for malignant transformation in monoclonal gammopathy of undetermined significance and smoldering multiple myeloma. *J Clin Oncol* 2002;20:1625–1634.
102. Gregersen H, Pedersen G, Svendsen N, et al. Multiple myeloma following an episode of community-acquired pneumococcal bacteraemia or meningitis. *APMIS* 2001;109:797–800.
103. Bourguet CC, Logue EE. Antigenic stimulation and multiple myeloma: a prospective study. *Cancer*

1993;72:2148–2154.

104. Lewis DR, Pottern LM, Brown LM, et al. Multiple myeloma among blacks and whites in the United States: the role of chronic antigenic stimulation. *Cancer Causes Control* 1994;5:529–539.

105. Katusic S, Beard CM, Kurland LT, et al. Occurrence of malignant neoplasms in the Rochester, Minnesota, rheumatoid arthritis cohort. *Am J Med* 1985;78:50–55.

106. Isomaki HA, Hakulinen T, Joutsenlahti U. Excess risk of lymphomas, leukemia and myeloma in patients with rheumatoid arthritis. *J Chronic Dis* 1978;31:691–696.

107. Gridley G, McLaughlin JK, Ekbohm A, et al. Incidence of cancer among patients with rheumatoid arthritis. *J Natl Cancer Inst* 1993;85:307–311.

108. Linet MS, Harlow SD, McLaughlin JK. A case-control study of multiple myeloma in whites: chronic antigenic stimulation, occupation, and drug use. *Cancer Res* 1987;47:2978–2981.

109. Koepsell TD, Daling JR, Weiss NS, et al. Antigenic stimulation and the occurrence of multiple myeloma. *Am J Epidemiol* 1987;126:1051–1062.

110. Dispenzieri A, Gertz MA, Therneau TM, et al. Retrospective cohort study of 148 patients with polyclonal gammopathy. *Mayo Clin Proc* 2001;76:476–487.

111. Goedert JJ. The epidemiology of acquired immunodeficiency syndrome malignancies. *Semin Oncol* 2000;27:390–401.

112. Grulich AE, Wan X, Law MG, et al. Risk of cancer in people with AIDS. *AIDS* 1999;13:839–843.

113. Montella M, Crispo A, Frigeri F, et al. HCV and tumors correlated with immune system: a case-control study in an area of hyperendemicity. *Leuk Res* 2001;25:775–781.

114. Gharagozloo S, Khoshnoodi J, Shokri F. Hepatitis C virus infection in patients with essential mixed cryoglobulinemia, multiple myeloma and chronic lymphocytic leukemia. *Pathol Oncol Res* 2001;7:135–139.

115. Yoshikawa M, Imazu H, Ueda S, et al. Prevalence of hepatitis C virus infection in patients with non-Hodgkin's lymphoma and multiple myeloma: a report from Japan. *J Clin Gastroenterol* 1997;25:713–714.

116. An J, Lichtenstein AK, Brent G, et al. The Kaposi sarcoma-associated herpesvirus (KSHV) induces cellular interleukin 6 expression: role of the KSHV latency-associated nuclear antigen and the AP1 response element. *Blood* 2002;99:649–654.

117. Rettig MB, Ma HJ, Vescio RA, et al. Kaposi's sarcoma-associated herpesvirus infection of bone marrow dendritic cells from multiple myeloma patients. *Science* 1997;276:1851–1854.

118. Cannon MJ, Flanders WD, Pellett PE. Occurrence of primary cancers in association with multiple myeloma and Kaposi's sarcoma in the United States, 1973–1995. *Int J Cancer* 2000;85:453–456.

119. Hjalgrim H, Frisch M, Melbye M. Incidence rates of classical Kaposi's sarcoma and multiple myeloma do not correlate. *Br J Cancer* 1998;78:419–420.

120. Tarte K, Chang Y, Klein B. Kaposi's sarcoma-associated herpesvirus and multiple myeloma: lack of criteria for causality. *Blood* 1999;93:3159–3163.

121. Tedeschi R, Kvarnung M, Knekt P, et al. A prospective seroepidemiological study of human herpesvirus-8 infection and the risk of multiple myeloma. *Br J Cancer* 2001;84:122–125.

122. Drewinko B, Alexanian R, Boyer H, et al. The growth fraction of human myeloma cells. *Blood* 1981;57:333–338.

123. Greipp PR, Raymond NM, Kyle RA, et al. Multiple myeloma: significance of plasmablastic subtype in morphological classification. *Blood* 1985;65:305–310.

124. Sahota SS, Leo R, Hamblin TJ, et al. Ig VH gene mutational patterns indicate different tumor cell



status in human myeloma and monoclonal gammopathy of undetermined significance. *Blood* 1996;87:746–755.

125. Nordan RP, Mock BA, Neckers LM, et al. The role of plasmacytoma growth factor in the in vitro responses of murine plasmacytoma cells. *Ann N Y Acad Sci* 1989;557:200–205.

126. Xu FH, Sharma S, Gardner A, et al. Interleukin-6-induced inhibition of multiple myeloma cell apoptosis: support for the hypothesis that protection is mediated via inhibition of the JNK/SAPK pathway. *Blood* 1998;92:241–251.

127. Klein B, Zhang XG, Jourdan M, et al. Paracrine rather than autocrine regulation of myeloma-cell growth and differentiation by interleukin-6. *Blood* 1989;73:517–526.

128. Frassanito MA, Cusmai A, Iodice G, et al. Autocrine interleukin-6 production and highly malignant multiple myeloma: relation with resistance to drug-induced apoptosis. *Blood* 2001;97:483–489.

129. Klein B, Zhang XG, Lu ZY, et al. Interleukin-6 in human multiple myeloma. *Blood* 1995;85:863–872.

130. Lichtenstein A, Tu Y, Fady C, et al. Interleukin-6 inhibits apoptosis of malignant plasma cells. *Cell Immunol* 1995;162:248–255.

131. Hata H, Xiao H, Petrucci MT, et al. Interleukin-6 gene expression in multiple myeloma: a characteristic of immature tumor cells. *Blood* 1993;81:3357–3364.

132. Kawano M, Hirano T, Matsuda T, et al. Autocrine generation and requirement of BSF-2/IL-6 for human multiple myelomas. *Nature* 1988;332:83–85.

133. Zhang XG, Bataille R, Widjenes J, et al. Interleukin-6 dependence of advanced malignant plasma cell dyscrasias. *Cancer* 1992;69:1373–1376.

134. Puthier D, Bataille R, Amiot M. IL-6 up-regulates mcl-1 in human myeloma cells through JAK/STAT rather than ras/MAP kinase pathway. *Eur J Immunol* 1999;29:3945–3950.

135. French JD, Tschumper RC, Jelinek DF. Dissection of the signaling requirements of interleukin-6-stimulated myeloma cell growth. *Acta Oncol* 2000;39:777–781.

136. Catlett-Falcone R, Landowski TH, Oshiro MM, et al. Constitutive activation of Stat3 signaling confers resistance to apoptosis in human U266 myeloma cells. *Immunity* 1999;10:105–115.

137. Mitsiades N, Mitsiades CS, Poulaki V, et al. Biologic sequelae of nuclear factor- $\kappa$ B blockade in multiple myeloma: therapeutic applications. *Blood* 2002;99:4079–4086.

138. Jourdan M, De Vos J, Mehti N, et al. Regulation of Bcl-2-family proteins in myeloma cells by three myeloma survival factors: interleukin-6, interferon- $\alpha$  and insulin-like growth factor 1. *Cell Death Differ* 2000;7:1244–1252.

139. Renner S, Weisz J, Krajewski S, et al. Expression of BAX in plasma cell dyscrasias. *Clin Cancer Res* 2000;6:2371–2380.

140. Ladanyi M, Wang S, Niesvizky R, et al. Proto-oncogene analysis in multiple myeloma. *Am J Pathol* 1992;141:949–953.

141. Miguel-Garcia A, Orero T, Matutes E, et al. Bcl-2 expression in plasma cells from neoplastic gammopathies and reactive plasmacytosis: a comparative study. *Haematologica* 1998;83:298–304.

142. Cheung WC, Van Ness B. The bone marrow stromal microenvironment influences myeloma therapeutic response in vitro. *Leukemia* 2001;15:264–271.

143. Dalton WS, Jove R. Drug resistance in multiple myeloma: approaches to circumvention. *Semin Oncol* 1999;26[Suppl 13]:23–27.

144. Rawat R, Rainey GJ, Thompson CD, et al. Constitutive activation of STAT3 is associated with the acquisition of an interleukin 6-independent phenotype by murine plasmacytomas and hybridomas. *Blood*

2000;96:3514–3521.

145. Anderson K. Advances in the biology of multiple myeloma: therapeutic applications. *Semin Oncol* 1999;26[Suppl 13]:10–22.
146. Van Riet I, De Greef C, Aharchi F, et al. Establishment and characterization of a human stroma-dependent myeloma cell line (MM5.1) and its stroma-independent variant (MM5.2). *Leukemia* 1997;11:284–293.
147. Lichtenstein A, Berenson J, Norman D, et al. Production of cytokines by bone marrow cells obtained from patients with multiple myeloma. *Blood* 1989;74:1266–1273.
148. Costes V, Portier M, Lu ZY, et al. Interleukin-1 in multiple myeloma: producer cells and their role in the control of IL-6 production. *Br J Haematol* 1998;103:1152–1160.
149. Lacy MQ, Donovan KA, Heimbach JK, et al. Comparison of interleukin-1 beta expression by in situ hybridization in monoclonal gammopathy of undetermined significance and multiple myeloma. *Blood* 1999;93:300–305.
150. Ge NL, Rudikoff S. Insulin-like growth factor I is a dual effector of multiple myeloma cell growth. *Blood* 2000;96:2856–2861.
151. Asosingh K, Gunthert U, Bakkus MH, et al. In vivo induction of insulin-like growth factor-I receptor and CD44v6 confers homing and adhesion to murine multiple myeloma cells. *Cancer Res* 2000;60:3096–3104.
152. Vanderkerken K, Asosingh K, Braet F, et al. Insulin-like growth factor-1 acts as a chemoattractant factor for 5T2 multiple myeloma cells. *Blood* 1999;93:235–241.
153. Jelinek DF, Witzig TE, Arendt BK. A role for insulin-like growth factor in the regulation of IL-6-responsive human myeloma cell line growth. *J Immunol* 1997;159:487–496.
154. Georgii-Hemming P, Wiklund HJ, Ljunggren O, et al. Insulin-like growth factor I is a growth and survival factor in human multiple myeloma cell lines. *Blood* 1996;88:2250–2258.
155. Freund GG, Kulas DT, Way BA, et al. Functional insulin and insulin-like growth factor-1 receptors are preferentially expressed in multiple myeloma cell lines as compared to B-lymphoblastoid cell lines. *Cancer Res* 1994;54:3179–3185.
156. Hideshima T, Chauhan D, Schlossman R, et al. The role of tumor necrosis factor alpha in the pathophysiology of human multiple myeloma: therapeutic applications. *Oncogene* 2001;20:4519–4527.
157. Jourdan M, Tarte K, Legouffe E, et al. Tumor necrosis factor is a survival and proliferation factor for human myeloma cells. *Eur Cytokine Netw* 1999;10:65–70.
158. Lust JA, Donovan KA. The role of interleukin-1 beta in the pathogenesis of multiple myeloma. *Hematol Oncol Clin North Am* 1999;13:1117–1125.
159. Carter A, Merchav S, Silvan-Draxler I, et al. The role of interleukin-1 and tumour necrosis factor-alpha in human multiple myeloma. *Br J Haematol* 1990;74:424–431.
160. Dankbar B, Padro T, Leo R, et al. Vascular endothelial growth factor and interleukin-6 in paracrine tumor-stromal cell interactions in multiple myeloma. *Blood* 2000;95:2630–2636.
161. Podar K, Tai YT, Davies FE, et al. Vascular endothelial growth factor triggers signaling cascades mediating multiple myeloma cell growth and migration. *Blood* 2001;98:428–435.
162. Sezer O, Jakob C, Eucker J, et al. Serum levels of the angiogenic cytokines basic fibroblast growth factor (bFGF), vascular endothelial growth factor (VEGF) and hepatocyte growth factor (HGF) in multiple myeloma. *Eur J Haematol* 2001;66:83–88.
163. Merico F, Bergui L, Gregoret MG, et al. Cytokines involved in the progression of multiple myeloma.

Clin Exp Immunol 1993;92:27-31.

164. Han JH, Choi SJ, Kurihara N, et al. Macrophage inflammatory protein-1alpha is an osteoclastogenic factor in myeloma that is independent of receptor activator of nuclear factor kappa B ligand. *Blood* 2001;97:3349-3353.
165. Roodman GD. Biology of osteoclast activation in cancer. *J Clin Oncol* 2001;19:3562-3571.
166. Van Camp B, Durie BG, Spier C, et al. Plasma cells in multiple myeloma express a natural killer cell-associated antigen: CD56 (NKH-1; Leu-19). *Blood* 1990;76:377-382.
167. Barker HF, Hamilton MS, Ball J, et al. Expression of adhesion molecules LFA-3 and N-CAM on normal and malignant human plasma cells. *Br J Haematol* 1992;81:331-335.
168. Ahsmann EJ, Lokhorst HM, Dekker AW, et al. Lymphocyte function-associated antigen-1 expression on plasma cells correlates with tumor growth in multiple myeloma. *Blood* 1992;79:2068-2075.
169. Uchiyama H, Barut BA, Mohrbacher AF, et al. Adhesion of human myeloma-derived cell lines to bone marrow stromal cells stimulates interleukin-6 secretion. *Blood* 1993;82:3712-3720.
170. Michigami T, Shimizu N, Williams PJ, et al. Cell-cell contact between marrow stromal cells and myeloma cells via VCAM-1 and alpha4beta1-integrin enhances production of osteoclast-stimulating activity. *Blood* 2000;96:1953-1960.
171. Vincent T, Jourdan M, Sy MS, et al. Hyaluronic acid induces survival and proliferation of human myeloma cells through an interleukin-6-mediated pathway involving the phosphorylation of retinoblastoma protein. *J Biol Chem* 2001;276:14728-14736.
172. Vacca A, Ribatti D, Roncali L, et al. Bone marrow angiogenesis and progression in multiple myeloma. *Br J Haematol* 1994;87:503-508.
173. Bellamy WT, Richter L, Frutiger Y, et al. Expression of vascular endothelial growth factor and its receptors in hematopoietic malignancies. *Cancer Res* 1999;59:728-733.
174. Rajkumar SV, Greipp PR. Angiogenesis in multiple myeloma. *Br J Haematol* 2001;113:565.
175. Ng MH, Wong IH, Lo KW. DNA methylation changes and multiple myeloma. *Leuk Lymphoma* 1999;34:463-472.
176. Neri A, Murphy JP, Cro L, et al. Ras oncogene mutation in multiple myeloma. *J Exp Med* 1989;170:1715-1725.
177. Liu P, Leong T, Quam L, et al. Activating mutations of N- and K-ras in multiple myeloma show different clinical associations: analysis of the Eastern Cooperative Oncology Group Phase III Trial. *Blood* 1996;88:2699-2706.
178. Avet-Loiseau H, Li JY, Godon C, et al. P53 deletion is not a frequent event in multiple myeloma. *Br J Haematol* 1999;106:717-719.
179. Portier M, Moles JP, Mazars GR, et al. p53 and RAS gene mutations in multiple myeloma. *Oncogene* 1992;7:2539-2543.
180. Drach J, Ackermann J, Fritz E, et al. Presence of a p53 gene deletion in patients with multiple myeloma predicts for short survival after conventional-dose chemotherapy. *Blood* 1998;92:802-809.
181. Shou Y, Martelli ML, Gabrea A, et al. Diverse karyotypic abnormalities of the c-myc locus associated with c-myc dysregulation and tumor progression in multiple myeloma. *Proc Natl Acad Sci U S A* 2000;97:228-233.
182. Lai R, Medeiros LJ, Wilson CS, et al. Expression of the cell-cycle-related proteins E2F-1, p53, mdm-2, p21waf-1, and Ki-67 in multiple myeloma: correlation with cyclin-D1 immunoreactivity. *Mod Pathol* 1998;11:642-647.

183. Chesi M, Bergsagel PL, Brents LA, et al. Dysregulation of cyclin D1 by translocation into an IgH gamma switch region in two multiple myeloma cell lines. *Blood* 1996;88:674-681.
184. Weh HJ, Bartl R, Seeger D, et al. Correlations between karyotype and cytologic findings in multiple myeloma. *Leukemia* 1995;9:2119-2122.
185. Fonseca R, Hoyer JD, Aguayo P, et al. Clinical significance of the translocation (11;14)(q13;q32) in multiple myeloma. *Leuk Lymphoma* 1999;35:599-605.
186. Hoyer JD, Hanson CA, Fonseca R, et al. The (11;14)(q13;q32) translocation in multiple myeloma: a morphologic and immunohistochemical study. *Am J Clin Pathol* 2000;113:831-837.
187. Tricot G, Barlogie B, Jagannath S, et al. Poor prognosis in multiple myeloma is associated only with partial or complete deletions of chromosome 13 or abnormalities involving 11q and not with other karyotype abnormalities. *Blood* 1995;86:4250-4256.
188. Tasaka T, Berenson J, Vescio R, et al. Analysis of the p16INK4A, p15INK4B and p18INK4C genes in multiple myeloma. *Br J Haematol* 1997;96:98-102.
189. Ogawa S, Hangaishi A, Miyawaki S, et al. Loss of the cyclin-dependent kinase 4-inhibitor (p16; MTS1) gene is frequent in and highly specific to lymphoid tumors in primary human hematopoietic malignancies. *Blood* 1995;86:1548-1556.
190. Zandecki M, Facon T, Preudhomme C, et al. The retinoblastoma gene (RB-1) status in multiple myeloma: a report on 35 cases. *Leuk Lymphoma* 1995;18:497-503.
191. Urashima M, Teoh G, Ogata A, et al. Role of CDK4 and p16INK4A in interleukin-6-mediated growth of multiple myeloma. *Leukemia* 1997;11:1957-1963.
192. Guillermin G, Gyan E, Wolowicz D, et al. p16(INK4a) and p15(INK4b) gene methylations in plasma cells from monoclonal gammopathy of undetermined significance. *Blood* 2001;98:244-246.
193. Ng MH, To KW, Lo KW, et al. Frequent death-associated protein kinase promoter hypermethylation in multiple myeloma. *Clin Cancer Res* 2001;7:1724-1729.
194. Winkler JM, Gonzalez-Paz N, McClure RF, et al. Deletion of the tumor suppressor gene p16 in multiple myeloma (MM) as determined by interphase fluorescent in-situ hybridization (FISH) and its relation to methylation of its promoter region. *Blood* 2001;98:174b(abst).
195. Ng MH, Kan A, Chung YF, et al. Combined morphological and interphase fluorescence in situ hybridization study in multiple myeloma of Chinese patients. *Am J Pathol* 1999;154:15-22.
196. Lo YM, Wong IH, Zhang J, et al. Quantitative analysis of aberrant p16 methylation using real-time quantitative methylation-specific polymerase chain reaction. *Cancer Res* 1999;59:3899-3903.
197. Arora T, Jelinek DF. Differential myeloma cell responsiveness to interferon-alpha correlates with differential induction of p19(INK4d) and cyclin D2 expression. *J Biol Chem* 1998;273:11799-11805.
198. Uchida T, Kinoshita T, Ohno T, et al. Hypermethylation of p16INK4A gene promoter during the progression of plasma cell dyscrasia. *Leukemia* 2001;15:157-165.
199. Kalakonda N, Rothwell DG, Scarffe JH, et al. Detection of N-Ras codon 61 mutations in subpopulations of tumor cells in multiple myeloma at presentation. *Blood* 2001;98:1555-1560.
200. Corradini P, Inghirami G, Astolfi M, et al. Inactivation of tumor suppressor genes, p53 and Rb1, in plasma cell dyscrasias. *Leukemia* 1994;8:758-767.
201. Mazars GR, Portier M, Zhang XG, et al. Mutations of the p53 gene in human myeloma cell lines. *Oncogene* 1992;7:1015-1018.
202. Neri A, Baldini L, Trecca D, et al. p53 gene mutations in multiple myeloma are associated with

advanced forms of malignancy. *Blood* 1993;81:128–135.

203. Preudhomme C, Facon T, Zandecki M, et al. Rare occurrence of P53 gene mutations in multiple myeloma. *Br J Haematol* 1992;81:440–443.

204. Selvanayagam P, Blick M, Narni F, et al. Alteration and abnormal expression of the c-myc oncogene in human multiple myeloma. *Blood* 1988;71:30–35.

205. Brown RD, Pope B, Luo XF, et al. The oncoprotein phenotype of plasma cells from patients with multiple myeloma. *Leuk Lymphoma* 1994;16:147–156.

206. Avet-Loiseau H, Gerson F, Magrangeas F, et al. Rearrangements of the c-myc oncogene are present in 15% of primary human multiple myeloma tumors. *Blood* 2001;98:3082–3086.

207. Riccardi A, Gobbi PG, Ucci G, et al. Changing clinical presentation of multiple myeloma. *Eur J Cancer* 1991;27:1401–1405.

208. Kyle RA, Gertz MA, Witzig TE, et al. Review of 1,027 patients with newly diagnosed multiple myeloma. *Mayo Clin Proc* 2003;78:21–33.

209. Kyle RA. Multiple myeloma: review of 869 cases. *Mayo Clin Proc* 1975;50:29–40.

210. Kapadia SB. Multiple myeloma: a clinicopathologic study of 62 consecutively autopsied cases. *Medicine (Baltimore)* 1980;59:380–392.

211. Osserman EF. Plasma-cell myeloma. II. Clinical aspects. *N Engl J Med* 1959;261:952–960.

212. Fossa A, Brandhorst D, Myklebust JH, et al. Relation between S-phase fraction of myeloma cells and anemia in patients with multiple myeloma. *Exp Hematol* 1999;27:1621–1626.

213. Musto P, Falcone A, D'Arena G, et al. Clinical results of recombinant erythropoietin in transfusion-dependent patients with refractory multiple myeloma: role of cytokines and monitoring of erythropoiesis. *Eur J Haematol* 1997;58:314–319.

214. Silvestris F, Cafforio P, Tucci M, et al. Negative regulation of erythroblast maturation by Fas-L(+)/TRAIL(+) highly malignant plasma cells: a major pathogenetic mechanism of anemia in multiple myeloma. *Blood* 2002;99:1305–1313.

215. Kyle RA, Finkelstein S, Elveback LR, et al. Incidence of monoclonal proteins in a Minnesota community with a cluster of multiple myeloma. *Blood* 1972;40:719–724.

216. Kyle RA, Garton JP. The spectrum of IgM monoclonal gammopathy in 430 cases. *Mayo Clin Proc* 1987;62:719–731.

217. Bataille R, Chappard D, Marcelli C, et al. Recruitment of new osteoblasts and osteoclasts is the earliest critical event in the pathogenesis of human multiple myeloma. *J Clin Invest* 1991;88:62–66.

218. Lacy MQ, Gertz MA, Hanson CA, et al. Multiple myeloma associated with diffuse osteosclerotic bone lesions: a clinical entity distinct from osteosclerotic myeloma (POEMS syndrome). *Am J Hematol* 1997;56:288–293.

219. Bardwick PA, Zvaifler NJ, Gill GN, et al. Plasma cell dyscrasia with polyneuropathy, organomegaly, endocrinopathy, M protein, and skin changes: the POEMS syndrome: report on two cases and a review of the literature. *Medicine (Baltimore)* 1980;59:311–322.

220. Nakanishi T, Sobue I, Toyokura Y, et al. The Crow-Fukase syndrome: a study of 102 cases in Japan. *Neurology* 1984;34:712–720.

221. Kyle RA, Jowsey J, Kelly PJ, et al. Multiple-myeloma bone disease. The comparative effect of sodium fluoride and calcium carbonate or placebo. *N Engl J Med* 1975;293:1334–1338.

222. Lindstrom E, Lindstrom FD. Skeletal scintigraphy with technetium diphosphonate in multiple

myeloma: a comparison with skeletal x-ray. *Acta Med Scand* 1980;208:289–291.

223. Catalano L, Pace L, Califano C, et al. Detection of focal myeloma lesions by technetium-99m-sestaMIBI scintigraphy. *Haematologica* 1999;84:119–124.

224. Alexandrakis MG, Kyriakou DS, Passam F, et al. Value of Tc-99m sestamibi scintigraphy in the detection of bone lesions in multiple myeloma: comparison with Tc-99m methylene diphosphonate. *Ann Hematol* 2001;80:349–353.

225. Balleari E, Villa G, Garre S, et al. Technetium-99m-sestaMIBI scintigraphy in multiple myeloma and related gammopathies: a useful tool for the identification and follow-up of myeloma bone disease. *Haematologica* 2001;86:78–84.

226. Fonti R, Del Vecchio S, Zannetti A, et al. Bone marrow uptake of 99mTc-MIBI in patients with multiple myeloma. *Eur J Nucl Med* 2001;28:214–220.

227. Pace L, Catalano L, Del Vecchio S, et al. Predictive value of technetium-99m sestamibi in patients with multiple myeloma and potential role in the follow-up. *Eur J Nucl Med* 2001;28:304–312.

228. Svaldi M, Tappa C, Gebert U, et al. Technetium-99m-sestaMIBI scintigraphy: an alternative approach for diagnosis and follow-up of active myeloma lesions after high-dose chemotherapy and autologous stem cell transplantation. *Ann Hematol* 2001;80:393–397.

229. Schirmeister H, Bommer M, Buck AK, et al. Initial results in the assessment of multiple myeloma using 18F-FDG PET. *Eur J Nucl Med Mol Imaging* 2002;29:361–366.

230. Laroche M, Assoun J, Sixou L, et al. Comparison of MRI and computed tomography in the various stages of plasma cell disorders: correlations with biological and histological findings. Myelome-Midi-Pyrenees Group. *Clin Exp Rheumatol* 1996;14:171–176.

231. Lecouvet FE, Vande Berg BC, Malghem J, et al. Magnetic resonance and computed tomography imaging in multiple myeloma. *Semin Musculoskelet Radiol* 2001;5:43–55.

232. Pertuiset E, Bellaiche L, Liote F, et al. Magnetic resonance imaging of the spine in plasma cell dyscrasias: a review. *Rev Rhum Engl Ed* 1996;63:837–845.

233. Mariette X, Zagdanski AM, Guermazi A, et al. Prognostic value of vertebral lesions detected by magnetic resonance imaging in patients with stage I multiple myeloma. *Br J Haematol* 1999;104:723–729.

234. Mouloupoulos LA, Dimopoulos MA, Weber D, et al. Magnetic resonance imaging in the staging of solitary plasmacytoma of bone. *J Clin Oncol* 1993;11:1311–1315.

235. Lecouvet FE, Malghem J, Michaux L, et al. Skeletal survey in advanced multiple myeloma: radiographic versus MR imaging survey. *Br J Haematol* 1999;106:35–39.

236. Mouloupoulos LA, Dimopoulos MA, Alexanian R et al. Multiple myeloma: MR patterns of response to treatment. *Radiology* 1994;193:441–446.

237. Mouloupoulos LA, Varma DG, Dimopoulos MA, et al. Multiple myeloma: spinal MR imaging in patients with untreated newly diagnosed disease. *Radiology* 1992;185:833–840.

238. Stabler A, Baur A, Bartl R, et al. Contrast enhancement and quantitative signal analysis in MR imaging of multiple myeloma: assessment of focal and diffuse growth patterns in marrow correlated with biopsies and survival rates. *AJR Am J Roentgenol* 1996;167:1029–1036.

239. Kusumoto S, Jinnai I, Itoh K, et al. Magnetic resonance imaging patterns in patients with multiple myeloma. *Br J Haematol* 1997;99:649–655.

240. Lecouvet FE, Vande Berg BC, Michaux L, et al. Stage III multiple myeloma: clinical and prognostic value of spinal bone marrow MR imaging. *Radiology* 1998;209:653–660.

241. Maldonado JE, Velosa JA, Kyle RA, et al. Fanconi syndrome in adults: a manifestation of a latent

form of myeloma. *Am J Med* 1975;58:354–364.

242. Bladé J, Fernandez-Llama P, Bosch F, et al. Renal failure in multiple myeloma: presenting features and predictors of outcome in 94 patients from a single institution. *Arch Intern Med* 1998;158:1889–1893.

243. Knudsen LM, Hippe E, Hjorth M, et al. Renal function in newly diagnosed multiple myeloma: a demographic study of 1353 patients. The Nordic Myeloma Study Group. *Eur J Haematol* 1994;53:207–212.

244. Medical Research Council's Working Party on Leukaemia in Adults. Report on the second myelomatosis trial after five years of follow-up. *Br J Cancer* 1980;42:813–822.

245. Irish AB, Winearls CG, Littlewood T. Presentation and survival of patients with severe renal failure and myeloma. *QJM* 1997;90:773–780.

246. MacLennan IC, Cooper EH, Chapman CE, et al. Renal failure in myelomatosis. *Eur J Haematol [Suppl]* 1989;51:60–65.

247. MRC Working Party on Leukaemia in Adults. Analysis and management of renal failure in fourth MRC myelomatosis trial. *BMJ (Clin Res Ed)* 1984;288:1411–1416.

248. Knudsen LM, Hjorth M, Hippe E. Renal failure in multiple myeloma: reversibility and impact on the prognosis. Nordic Myeloma Study Group. *Eur J Haematol* 2000;65:175–181.

249. Bernstein SP, Humes HD. Reversible renal insufficiency in multiple myeloma. *Arch Intern Med* 1982;142:2083–2086.

250. Torra R, Bladé J, Cases A, et al. Patients with multiple myeloma requiring long-term dialysis: presenting features, response to therapy, and outcome in a series of 20 cases. *Br J Haematol* 1995;91:854–859.

251. Hill GS, Morel-Maroger L, Mery JP, et al. Renal lesions in multiple myeloma: their relationship to associated protein abnormalities. *Am J Kidney Dis* 1983;2:423–438.

252. Montseny JJ, Kleinknecht D, Meyrier A, et al. Long-term outcome according to renal histological lesions in 118 patients with monoclonal gammopathies. *Nephrol Dial Transplant* 1998;13:1438–1445.

253. DeFronzo RA, Cooke CR, Wright JR, et al. Renal function in patients with multiple myeloma. *Medicine (Baltimore)* 1978;57:151–166.

254. Espersen F, Birgens HS, Hertz JB, et al. Current patterns of bacterial infection in myelomatosis. *Scand J Infect Dis* 1984;16:169–173.

255. Hargreaves RM, Lea JR, Griffiths H, et al. Immunological factors and risk of infection in plateau phase myeloma. *J Clin Pathol* 1995;48:260–266.

256. Perri RT, Heibel RP, Oken MM. Influence of treatment and response status on infection risk in multiple myeloma. *Am J Med* 1981;71:935–940.

257. Savage DG, Lindenbaum J, Garrett TJ. Biphasic pattern of bacterial infection in multiple myeloma. *Ann Intern Med* 1982;96:47–50.

258. Larson RS, Sukpanichnant S, Greer JP, et al. The spectrum of multiple myeloma: diagnostic and biological implications. *Hum Pathol* 1997;28:1336–1347.

259. Kapff CT, Jandl JH. *Blood: atlas and sourcebook of hematology*, 2nd ed. Boston: Little, Brown, and Company, 1991.

260. Bayrd ED. Bone marrow on sternal aspiration in multiple myeloma. *Blood* 1948;3:987–1018.

261. Rajkumar SV, Fonseca R, Witzig TE, et al. Bone marrow angiogenesis in patients achieving complete response after stem cell transplantation for multiple myeloma. *Leukemia* 1999;13:469–472.

262. Abildgaard N, Bendix-Hansen K, Kristensen JE, et al. Bone marrow fibrosis and disease activity in



multiple myeloma monitored by the aminoterminal propeptide of procollagen III in serum. *Br J Haematol* 1997;99:641–648.

263. Krzyzaniak RL, Buss DH, Cooper MR, et al. Marrow fibrosis and multiple myeloma. *Am J Clin Pathol* 1988;89:63–68.

264. San Miguel JF, Garcia-Sanz R, Gonzalez M, et al. Immunophenotype and DNA cell content in multiple myeloma. *Baillieres Clin Haematol* 1995;8:735–759.

265. Pellat-Deceunynck C, Barille S, Jegou G, et al. The absence of CD56 (NCAM) on malignant plasma cells is a hallmark of plasma cell leukemia and of a special subset of multiple myeloma. *Leukemia* 1998;12:1977–1982.

266. Van Riet I, De Waele M, Remels L, et al. Expression of cytoadhesion molecules (CD56, CD54, CD18 and CD29) by myeloma plasma cells. *Br J Haematol* 1991;79:421–427.

267. San Miguel JF, Gonzalez M, Gascon A, et al. Immunophenotypic heterogeneity of multiple myeloma: influence on the biology and clinical course of the disease. Castellano-Leones (Spain) Cooperative Group for the Study of Monoclonal Gammopathies. *Br J Haematol* 1991;77:185–190.

268. Ocqueteau M, Orfao A, Garcia-Sanz R, et al. Expression of the CD117 antigen (c-Kit) on normal and myelomatous plasma cells. *Br J Haematol* 1996;95:489–493.

269. Greipp PR, Kyle RA. Clinical, morphological, and cell kinetic differences among multiple myeloma, monoclonal gammopathy of undetermined significance, and smoldering multiple myeloma. *Blood* 1983;62:166–171.

270. Witzig TE, Timm M, Larson D, et al. Measurement of apoptosis and proliferation of bone marrow plasma cells in patients with plasma cell proliferative disorders. *Br J Haematol* 1999;104:131–137.

271. Lackner H. Hemostatic abnormalities associated with dysproteinemias. *Semin Hematol* 1973;10:125–133.

272. Saif MW, Allegra CJ, Greenberg B. Bleeding diathesis in multiple myeloma. *J Hematother Stem Cell Res* 2001;10:657–660.

273. Colwell NS, Tollefsen DM, Blinder MA. Identification of a monoclonal thrombin inhibitor associated with multiple myeloma and a severe bleeding disorder. *Br J Haematol* 1997;97:219–226.

274. Khoory MS, Nesheim ME, Bowie EJ, et al. Circulating heparan sulfate proteoglycan anticoagulant from a patient with a plasma cell disorder. *J Clin Invest* 1980;65:666–674.

275. Catovsky D, Iroku NB, Pitney WR, et al. Thromboembolic complications in myelomatosis. *BMJ* 1970;3:438–439.

276. Shinagawa A, Kojima H, Kobayashi T, et al. Lupus anticoagulant-like activity observed in a dimeric lambda protein produced by myeloma cells. *Int J Hematol* 2001;73:526–531.

277. Yasin Z, Quick D, Thiagarajan P, et al. Light-chain paraproteins with lupus anticoagulant activity. *Am J Hematol* 1999;62:99–102.

278. Deitcher SR, Erban JK, Limentani SA. Acquired free protein S deficiency associated with multiple myeloma: a case report. *Am J Hematol* 1996;51:319–323.

279. D'Angelo A, Mazzola G, Bergmann F, et al. Autoimmune protein S deficiency: a disorder predisposing to thrombosis. *Haematologica* 1995;80[Suppl]:114–121.

280. Zangari M, Saghafifar F, Anaissie E, et al. Activated protein C resistance in the absence of factor V Leiden mutation is a common finding in multiple myeloma and is associated with an increased risk of thrombotic complications. *Blood Coagul Fibrinolysis* 2002;13:187–192.

281. Gargan PE, Ploplis VA, Scheu JD. A fibrin specific monoclonal antibody which interferes with the

- fibrinolytic effect of tissue plasminogen activator. *Thromb Haemost* 1988;59:426–431.
282. Bergsagel DE, Pruzanski W. Treatment of plasma cell myeloma with cytotoxic agents. *Arch Intern Med* 1975;135:172–176.
283. McArthur JR, Athens JW, Wintrobe MM, et al. Melphalan and myeloma: experience with a low-dose continuous regimen. *Ann Intern Med* 1970;72:665–670.
284. Dreicer R, Alexanian R. Nonsecretory multiple myeloma. *Am J Hematol* 1982;13:313–318.
285. Bladé J, Kyle RA. Nonsecretory myeloma, immunoglobulin D myeloma, and plasma cell leukemia. *Hematol Oncol Clin North Am* 1999;13:1259–1272.
286. Bourantas K. Nonsecretory multiple myeloma. *Eur J Haematol* 1996;56:109–111.
287. Cavo M, Galièni P, Gobbi M, et al. Nonsecretory multiple myeloma: presenting findings, clinical course and prognosis. *Acta Haematol* 1985;74:27–30.
288. Rubio-Felix D, Giralt M, Giraldo MP, et al. Nonsecretory multiple myeloma. *Cancer* 1987;59:1847–1852.
289. Turesson I, Grubb A. Non-secretory or low-secretory myeloma with intracellular kappa chains: report of six cases and review of the literature. *Acta Med Scand* 1978;204:445–451.
290. Tormey WP. Low concentration monoclonal and oligoclonal bands in serum and urine using the Sebia Hydragel Protein Electrophoresis System. *Clin Chem Lab Med* 1998;36:253–254.
291. Drayson M, Tang LX, Drew R, et al. Serum free light-chain measurements for identifying and monitoring patients with nonsecretory multiple myeloma. *Blood* 2001;97:2900–2902.
292. Bladé J, Lust JA, Kyle RA. Immunoglobulin D multiple myeloma: presenting features, response to therapy, and survival in a series of 53 cases. *J Clin Oncol* 1994;12:2398–2404.
293. Shimamoto Y. IgD myeloma: clinical characteristics and a new staging system based on analysis of Japanese patients. *Cancer Detect Prev* 1995;19:426–435.
294. Jancelewicz Z, Takatsuki K, Sugai S, et al. IgD multiple myeloma: review of 133 cases. *Arch Intern Med* 1975;135:87–93.
295. Fibbe WE, Jansen J. Prognostic factors in IgD myeloma: a study of 21 cases. *Scand J Haematol* 1984;33:471–475.
296. Bladé J, Kyle RA. IgD monoclonal gammopathy with long-term follow-up. *Br J Haematol* 1994;88:395–396.
297. Kairemo KJ, Lindberg M, Prytz M. IgE myeloma: a case presentation and a review of the literature. *Scand J Clin Lab Invest* 1999;59:451–456.
298. Macro M, Andre I, Comby E, et al. IgE multiple myeloma. *Leuk Lymphoma* 1999;32:597–603.
299. Chronic Leukemia-Myeloma Task Force NCI. Proposed guidelines for protocol studies. I. Introduction. II. Plasma cell myeloma. III. Chronic lymphocytic leukemia. IV. Chronic granulocytic leukemia. *Cancer Chemother Rep* 3 1973;4:141–173.
300. Kyle RA, Greipp PR. Smoldering multiple myeloma. *N Engl J Med* 1980;302:1347–1349.
301. Kyle RA. Monoclonal gammopathy of undetermined significance and smoldering multiple myeloma. *Eur J Haematol Suppl* 1989;51:70–75.
302. Kyle RA, Greipp PR. 3. The laboratory investigation of monoclonal gammopathies. *Mayo Clin Proc* 1978;53:719–739.

303. Alexanian R. Localized and indolent myeloma. *Blood* 1980;56:521–525.
304. International Myeloma Working Group. Criteria for the classification of monoclonal gammopathies, multiple myeloma and related disorders: a report of the International Myeloma Working Group. *Br J Haematol* 2003;121:1–9.
305. Peest D, Deicher H, Coldewey R, et al. A comparison of polychemotherapy and melphalan/prednisone for primary remission induction, and interferon- $\alpha$  for maintenance treatment, in multiple myeloma: a prospective trial of the German Myeloma Treatment Group. *Eur J Cancer* 1995;31A:146–151.
306. Riccardi A, Ucci G, Luoni R, et al. Treatment of multiple myeloma according to the extension of the disease: a prospective, randomised study comparing a less with a more aggressive cystostatic policy. Cooperative Group of Study and Treatment of Multiple Myeloma. *Br J Cancer* 1994;70:1203–1210.
307. Hjorth M, Hellquist L, Holmberg E, et al. Initial versus deferred melphalan-prednisone therapy for asymptomatic multiple myeloma stage I: a randomized study. Myeloma Group of Western Sweden. *Eur J Haematol* 1993;50:95–102.
308. Facon T, Menard JF, Michaux JL, et al. Prognostic factors in low tumour mass asymptomatic multiple myeloma: a report on 91 patients. The Groupe d'Etudes et de Recherche sur le Myelome (GERM). *Am J Hematol* 1995;48:71–75.
309. Riccardi A, Mora O, Tinelli C, et al. Long-term survival of stage I multiple myeloma given chemotherapy just after diagnosis or at progression of the disease: a multicentre randomised study. Cooperative Group of Study and Treatment of Multiple Myeloma. *Br J Cancer* 2000;82:1254–1260.
310. Weber DM, Dimopoulos MA, Mouloupoulos LA, et al. Prognostic features of asymptomatic multiple myeloma. *Br J Haematol* 1997;97:810–814.
311. Dimopoulos MA, Mouloupoulos A, Smith T, et al. Risk of disease progression in asymptomatic multiple myeloma. *Am J Med* 1993;94:57–61.
312. Witzig TE, Kyle RA, O'Fallon WM, et al. Detection of peripheral blood plasma cells as a predictor of disease course in patients with smouldering multiple myeloma. *Br J Haematol* 1994;87:266–272.
313. Southeastern Cancer Study Group. Treatment of myeloma: comparison of melphalan, chlorambucil, and azathioprine. *Arch Intern Med* 1975;135:157–162.
314. Jackson DV, Case LD, Pope EK, et al. Single agent vincristine by infusion in refractory multiple myeloma. *J Clin Oncol* 1985;3:1508–1512.
315. MacLennan IC, Cusick J. Objective evaluation of the role of vincristine in induction and maintenance therapy for myelomatosis. Medical Research Council Working Party on Leukaemia in Adults. *Br J Cancer* 1985;52:153–158.
316. Tribalto M, Amadori S, Cantonetti M, et al. Treatment of multiple myeloma: a randomized study of three different regimens. *Leuk Res* 1985;9:1043–1049.
317. MacLennan IC, Kelly K, Crockson RA, et al. Results of the MRC myelomatosis trials for patients entered since 1980. *Hematol Oncol* 1988;6:145–158.
318. Myeloma Trialists' Collaborative Group. Combination chemotherapy versus melphalan plus prednisone as treatment for multiple myeloma: an overview of 6,633 patients from 27 randomized trials. Myeloma Trialists' Collaborative Group. *J Clin Oncol* 1998;16:3832–3842.
319. Gutterman JU, Blumenschein GR, Alexanian R, et al. Leukocyte interferon-induced tumor regression in human metastatic breast cancer, multiple myeloma, and malignant lymphoma. *Ann Intern Med* 1980;93:399–406.
320. Alexanian R, Gutterman J, Levy H. Interferon treatment for multiple myeloma. *Clin Haematol* 1982;11:211–220.

321. Quesada JR, Hawkins M, Horning S, et al. Collaborative phase I–II study of recombinant DNA–produced leukocyte interferon (clone A) in metastatic breast cancer, malignant lymphoma, and multiple myeloma. *Am J Med* 1984;77:427–432.
322. McElwain TJ, Powles RL. High–dose intravenous melphalan for plasma–cell leukaemia and myeloma. *Lancet* 1983;2:822–824.
323. Richardson PG, Schlossman RL, Weller E, et al. Immunomodulatory drug CC–5013 overcomes drug resistance and is well tolerated in patients with relapsed multiple myeloma. *Blood* 2002;100:3063–3067.
324. Richardson PG, Berenson J, Irwin D, et al. Phase II study of PS–341, a novel proteasome inhibitor, alone or in combination with dexamethasone in patients with multiple myeloma who have relapsed following front–line therapy and are refractory to their most recent therapy. *Blood* 2001;98:774a(abst).
325. Salmon SE, Haut A, Bonnet JD, et al. Alternating combination chemotherapy and levamisole improves survival in multiple myeloma: a Southwest Oncology Group Study. *J Clin Oncol* 1983;1:453–461.
326. MacLennan IC, Chapman C, Dunn J, et al. Combined chemotherapy with ABCM versus melphalan for treatment of myelomatosis. The Medical Research Council Working Party for Leukaemia in Adults. *Lancet* 1992;339:200–205.
327. Case DC Jr, Lee DJ III, Clarkson BD. Improved survival times in multiple myeloma treated with melphalan, prednisone, cyclophosphamide, vincristine and BCNU: M–2 protocol. *Am J Med* 1977;63:897–903.
328. Oken MM, Harrington DP, Abramson N, et al. Comparison of melphalan and prednisone with vincristine, carmustine, melphalan, cyclophosphamide, and prednisone in the treatment of multiple myeloma: results of Eastern Cooperative Oncology Group Study E2479. *Cancer* 1997;79:1561–1567.
329. Palva IP, Ahrenberg P, Ala–Harja K, et al. Treatment of multiple myeloma with an intensive 5–drug combination or intermittent melphalan and prednisone: a randomised multicentre trial. Finnish Leukaemia Group. *Eur J Haematol* 1987;38:50–54.
330. Barlogie B, Smith L, Alexanian R. Effective treatment of advanced multiple myeloma refractory to alkylating agents. *N Engl J Med* 1984;310:1353–1356.
331. Forgeson GV, Selby P, Lakhani S, et al. Infused vincristine and Adriamycin with high dose methylprednisolone (VAMP) in advanced previously treated multiple myeloma patients. *Br J Cancer* 1988;58:469–473.
332. Raje N, Powles R, Kulkarni S, et al. A comparison of vincristine and doxorubicin infusional chemotherapy with methylprednisolone (VAMP) with the addition of weekly cyclophosphamide (C–VAMP) as induction treatment followed by autografting in previously untreated myeloma. *Br J Haematol* 1997;97:153–160.
333. McLaughlin P, Alexanian R. Myeloma protein kinetics following chemotherapy. *Blood* 1982;60:851–855.
334. Oken MM, Kyle RA, Greipp PR, et al. Complete remission induction with combined VBMCP chemotherapy and interferon (rIFN alpha 2b) in patients with multiple myeloma. *Leuk Lymphoma* 1996;20:447–452.
335. Bladé J, Samson D, Reece D, et al. Criteria for evaluating disease response and progression in patients with multiple myeloma treated by high–dose therapy and haemopoietic stem cell transplantation. Myeloma Subcommittee of the EBMT. European Group for Blood and Marrow Transplant. *Br J Haematol* 1998;102:1115–1123.
336. Attal M, Harousseau JL, Stoppa AM, et al. A prospective, randomized trial of autologous bone marrow transplantation and chemotherapy in multiple myeloma. Intergroupe Français du Myélome. *N Engl J Med* 1996;335:91–97.
337. Alexanian R, Bonnet J, Gehan E, et al. Combination chemotherapy for multiple myeloma. *Cancer* 1972;30:382–389.
338. Selby PJ, McElwain TJ, Nandi AC, et al. Multiple myeloma treated with high dose intravenous

melphalan. *Br J Haematol* 1987;66:55–62.

339. Gore ME, Selby PJ, Viner C, et al. Intensive treatment of multiple myeloma and criteria for complete remission. *Lancet* 1989;2:879–882.

340. Oken MM, Lenhard RE Jr, Tsiatis AA, et al. Contribution of prednisone to the effectiveness of hexamethylmelamine in multiple myeloma. *Cancer Treat Rep* 1987;71:807–811.

341. Alexanian R, Yap BS, Bodey GP. Prednisone pulse therapy for refractory myeloma. *Blood* 1983;62:572–577.

342. Rivers SL, Patno ME. Cyclophosphamide vs melphalan in treatment of plasma cell myeloma. *JAMA* 1969;207:1328–1334.

343. Alexanian R, Haut A, Khan AU, et al. Treatment for multiple myeloma: combination chemotherapy with different melphalan dose regimens. *JAMA* 1969;208:1680–1685.

344. Medical Research Council's Working Party on Leukaemia in Adults. Myelomatosis: comparison of melphalan and cyclophosphamide therapy. *BMJ* 1971;1:640–641.

345. Costa G, Engle RL Jr, Schilling A, et al. Melphalan and prednisone: an effective combination for the treatment of multiple myeloma. *Am J Med* 1973;54:589–599.

346. Medical Research Council's Working Party on Leukaemia in Adults. Treatment comparisons in the third MRC myelomatosis trial. *Br J Cancer* 1980;42:823–830.

347. Cornwell GG III, Pajak TF, Kochwa S, et al. Comparison of oral melphalan, CCNU, and BCNU with and without vincristine and prednisone in the treatment of multiple myeloma. Cancer and Leukemia Group B experience. *Cancer* 1982;50:1669–1675.

348. Lenhard RE Jr, Oken MM, Barnes JM, et al. High-dose cyclophosphamide: an effective treatment for advanced refractory multiple myeloma. *Cancer* 1984;53:1456–1460.

349. Mass RE. A comparison of the effect of prednisone and a placebo in the treatment of multiple myeloma. *Cancer Chemother Rep* 1962;16:257–259.

350. McIntyre OR, Pajak TF, Kyle RA, et al. Response rate and survival in myeloma patients receiving prednisone alone. *Med Pediatr Oncol* 1985;13:239–243.

351. Alexanian R, Dimopoulos MA, Delasalle K, et al. Primary dexamethasone treatment of multiple myeloma. *Blood* 1992;80:887–890.

352. Alexanian R, Barlogie B, Dixon D. High-dose glucocorticoid treatment of resistant myeloma. *Ann Intern Med* 1986;105:8–11.

353. Gertz MA, Garton JP, Greipp PR, et al. A phase II study of high-dose methylprednisolone in refractory or relapsed multiple myeloma. *Leukemia* 1995;9:2115–2118.

354. Tiplady CW, Summerfield GP. Continuous low-dose dexamethasone in relapsed or refractory multiple myeloma. *Br J Haematol* 2000;111:381.

355. Palva IP, Ala-Harja K, Almqvist A, et al. Corticosteroid is not beneficial in multiple-drug combination chemotherapy for multiple myeloma. Finnish Leukaemia Group. *Eur J Haematol* 1993;51:98–101.

356. Feinman R, Koury J, Thames M, et al. Role of NF- $\kappa$ B in the rescue of multiple myeloma cells from glucocorticoid-induced apoptosis by bcl-2. *Blood* 1999;93:3044–3052.

357. Karadag A, Oyajobi BO, Apperley JF, et al. Human myeloma cells promote the production of interleukin 6 by primary human osteoblasts. *Br J Haematol* 2000;108:383–390.

358. De Bosscher K, Vanden Berghe W, Vermeulen L, et al. Glucocorticoids repress NF- $\kappa$ B-driven genes by disturbing the interaction of p65 with the basal transcription machinery, irrespective of

coactivator levels in the cell. *Proc Natl Acad Sci U S A* 2000;97:3919–3924.

359. Kawano M, Tanaka H, Ishikawa H, et al. Interleukin-1 accelerates autocrine growth of myeloma cells through interleukin-6 in human myeloma. *Blood* 1989;73:2145–2148.

360. Alexanian R, Salmon S, Bonnet J, et al. Combination therapy for multiple myeloma. *Cancer* 1977;40:2765–2771.

361. Alexanian R, Dreicer R. Chemotherapy for multiple myeloma. *Cancer* 1984;53:583–588.

362. Salmon SE. Immunoglobulin synthesis and tumor kinetics of multiple myeloma. *Semin Hematol* 1973;10:135–144.

363. Lee BJ, Sahakian G, Clarkson BD, et al. Proceedings: combination chemotherapy of multiple myeloma with Alkeran, Cytosan, vincristine, prednisone, and BCNU. *Cancer* 1974;33:533–538.

364. Salmon SE. Expansion of the growth fraction in multiple myeloma with alkylating agents. *Blood* 1975;45:119–129.

365. Hansen OP, Clausen NA, Drivsholm A, et al. Phase III study of intermittent 5-drug regimen (VBCMP) versus intermittent 3-drug regimen (VMP) versus intermittent melphalan and prednisone (MP) in myelomatosis. *Scand J Haematol* 1985;35:518–524.

366. Cohen HJ, Silberman HR, Tornyo K, et al. Comparison of two long-term chemotherapy regimens, with or without agents to modify skeletal repair, in multiple myeloma. *Blood* 1984;63:639–648.

367. Harley JB, Pajak TF, McIntyre OR, et al. Improved survival of increased-risk myeloma patients on combined triple-alkylating-agent therapy: a study of the CALGB. *Blood* 1979;54:13–22.

368. Bergsagel DE, Bailey AJ, Langley GR, et al. The chemotherapy on plasma-cell myeloma and the incidence of acute leukemia. *N Engl J Med* 1979;301:743–748.

369. Abramson N, Lurie P, Mielowski WL, et al. Phase III study of intermittent carmustine (BCNU), cyclophosphamide, and prednisone versus intermittent melphalan and prednisone in myeloma. *Cancer Treat Rep* 1982;66:1273–1277.

370. Pavlovsky S, Corrado C, Santarelli MT, et al. An update of two randomized trials in previously untreated multiple myeloma comparing melphalan and prednisone versus three- and five-drug combinations: an Argentine Group for the Treatment of Acute Leukemia Study. *J Clin Oncol* 1988;6:769–775.

371. Cavagnaro F, Lein JM, Pavlovsky S, et al. Comparison of two combination chemotherapy regimens for multiple myeloma: methyl-CCNU, cyclophosphamide, and prednisone versus melphalan and prednisone. *Cancer Treat Rep* 1980;64:73–79.

372. Pavlovsky S, Saslavsky J, Tezanos Pinto M, et al. A randomized trial of melphalan and prednisone versus melphalan, prednisone, cyclophosphamide, MeCCNU, and vincristine in untreated multiple myeloma. *J Clin Oncol* 1984;2:836–840.

373. Riccardi A, Merlini G, Montecucco C, et al. Peptichemio, vincristine and prednisone versus melphalan and prednisone as induction therapy in multiple myeloma. *Eur J Cancer Clin Oncol* 1986;22:787–791.

374. Durie BG, Dixon DO, Carter S, et al. Improved survival duration with combination chemotherapy induction for multiple myeloma: a Southwest Oncology Group Study. *J Clin Oncol* 1986;4:1227–1237.

375. Cooper MR, McIntyre OR, Propert KJ, et al. Single, sequential, and multiple alkylating agent therapy for multiple myeloma: a CALGB study. *J Clin Oncol* 1986;4:1331–1339.

376. Kildahl-Andersen O, Bjark P, Bondevik A, et al. Multiple myeloma in central and northern Norway 1981–1982: a follow-up study of a randomized clinical trial of 5-drug combination therapy versus standard therapy. *Eur J Haematol* 1988;41:47–51.

377. Kildahl-Andersen O, Bjark P, Bondevik A, et al. Multiple myeloma in central Norway 1981–1982: a randomized clinical trial of 5-drug combination therapy versus standard therapy. *Scand J Haematol*

1986;37:243–248.

378. Osterborg A, Ahre A, Bjorkholm M, et al. Alternating combination chemotherapy (VMCP/VBAP) is not superior to melphalan/prednisone in the treatment of multiple myeloma patients stage III: a randomized study from MGCS. *Eur J Haematol* 1989;43:54–62.

379. Peest D, Coldewey R, Deicher H. Overall vs. tumor-related survival in multiple myeloma. German Myeloma Treatment Group. *Eur J Cancer* 1991;27:672.

380. Peest D, Deicher H, Coldewey R, et al. Induction and maintenance therapy in multiple myeloma: a multicenter trial of MP versus VCMP. *Eur J Cancer Clin Oncol* 1988;24:1061–1067.

381. Hjorth M, Hellquist L, Holmberg E, et al. Initial treatment in multiple myeloma: no advantage of multidrug chemotherapy over melphalan-prednisone. The Myeloma Group of Western Sweden. *Br J Haematol* 1990;74:185–191.

382. Boccadoro M, Marmont F, Tribalto M, et al. Multiple myeloma: VMCP/VBAP alternating combination chemotherapy is not superior to melphalan and prednisone even in high-risk patients. *J Clin Oncol* 1991;9:444–448.

383. Bladé J, San Miguel JF, Alcalá A, et al. Alternating combination VCMP/VBAP chemotherapy versus melphalan/prednisone in the treatment of multiple myeloma: a randomized multicentric study of 487 patients. *J Clin Oncol* 1993;11:1165–1171.

384. Keldsen N, Bjerrum OW, Dahl IM, et al. Multiple myeloma treated with mitoxantrone in combination with vincristine and prednisolone (NOP regimen) versus melphalan and prednisolone: a phase III study. Nordic Myeloma Study Group (NMSG). *Eur J Haematol* 1993;51:80–85.

385. Peest D, Deicher H, Coldewey R, et al. A comparison of polychemotherapy and melphalan/prednisone for primary remission induction, and interferon-alpha for maintenance treatment, in multiple myeloma. A prospective trial of the German Myeloma Treatment Group. *Eur J Cancer* 1995;2:146–151.

386. Cornwell GG III, Pajak TF, Kochwa S, et al. Vincristine and prednisone prolong the survival of patients receiving intravenous or oral melphalan for multiple myeloma: Cancer and Leukemia Group B experience. *J Clin Oncol* 1988;6:1481–1490.

387. Bennett JM, Silber R, Ezdinli E, et al. Phase II study of Adriamycin and bleomycin in patients with multiple myeloma. *Cancer Treat Rep* 1978;62:1367–1369.

388. Alberts DS, Balcerzak SP, Bonnet JD, et al. Phase II trial of mitoxantrone in multiple myeloma: a Southwest Oncology Group Study. *Cancer Treat Rep* 1985;69:1321–1323.

389. Sumpter K, Powles RL, Raje N, et al. Oral idarubicin as a single agent therapy in patients with relapsed or resistant multiple myeloma. *Leuk Lymphoma* 1999;35:593–597.

390. Chisesi T, Capnist G, de Dominicis E, et al. A phase II study of idarubicin (4-demethoxydaunorubicin) in advanced myeloma. *Eur J Cancer Clin Oncol* 1988;24:681–684.

391. Gockerman JP, Bartolucci AA, Nelson MO, et al. Phase II evaluation of etoposide in refractory multiple myeloma: a Southeastern Cancer Study Group trial. *Cancer Treat Rep* 1986;70:801–802.

392. Barlogie B, Velasquez WS, Alexanian R, et al. Etoposide, dexamethasone, cytarabine, and cisplatin in vincristine, doxorubicin, and dexamethasone-refractory myeloma. *J Clin Oncol* 1989;7:1514–1517.

393. Tokiwa F, Utsunomiya A, Nakahara K, et al. A case of refractory multiple myeloma effectively treated with long-term oral etoposide [Japanese]. *Gan To Kagaku Ryoho* 1993;20:533–536.

394. Kato Y, Takeda H, Mihara H, et al. Oral low-dose etoposide therapy for refractory multiple myeloma with extramedullary involvement. *Intern Med* 1995;34:1023–1026.

395. Takeyama H, Yano K, Kataoka T, et al. Clinical study on the effect of human lymphoblastoid interferon in multiple myeloma [Japanese]. *Gan To Kagaku Ryoho* 1983;10:2043–2048.



396. Costanzi JJ, Cooper MR, Scarffe JH, et al. Phase II study of recombinant alpha-2 interferon in resistant multiple myeloma. *J Clin Oncol* 1985;3:654-659.
397. Brenning G, Ahre A, Nilsson K. Correlation between in vitro and in vivo sensitivity to human leucocyte interferon in patients with multiple myeloma. *Scand J Haematol* 1985;35:543-549.
398. Ahre A, Bjorkholm M, Mellstedt H, et al. Human leukocyte interferon and intermittent high-dose melphalan-prednisone administration in the treatment of multiple myeloma: a randomized clinical trial from the Myeloma Group of Central Sweden. *Cancer Treat Rep* 1984;68:1331-1338.
399. Ohno R, Kimura K, Amaki I, et al. Treatment of multiple myeloma with recombinant human leukocyte A interferon. *Cancer Treat Rep* 1985;69:1433-1435.
400. D'Amato RJ, Loughnan MS, Flynn E, et al. Thalidomide is an inhibitor of angiogenesis. *Proc Natl Acad Sci U S A* 1994;91:4082-4085.
401. Rajkumar SV, Fonseca R, Dispenzieri A, et al. Thalidomide in the treatment of relapsed multiple myeloma. *Mayo Clin Proc* 2000;75:897-901.
402. Rajkumar SV. Current status of thalidomide in the treatment of cancer. *Oncology (Huntingt)* 2001;15:867-874.
403. Weber D, Rankin K, Gavino M, et al. Thalidomide alone or with dexamethasone for previously untreated multiple myeloma. *J Clin Oncol* 2003;21:16-19.
404. Rajkumar SV, Dispenzieri A, Fonseca R, et al. Thalidomide for previously untreated indolent or smoldering multiple myeloma. *Leukemia* 2001;15:1274-1276.
405. Rajkumar SV, Hayman SR, Fonseca R, et al. Thalidomide plus dexamethasone (Thal/dex) and thalidomide alone (Thal) as first line therapy for newly diagnosed myeloma (MM) (abstract). *Blood* 2000;96:168a.
406. Rajkumar SV, Hayman SR, Gertz MA, et al. Combination therapy with thalidomide plus dexamethasone (THAL/DEX) for newly diagnosed myeloma (MM). *Blood* 2001;98:849a(abst).
407. Barlogie B, Desikan R, Eddlemon P, et al. Extended survival in advanced and refractory multiple myeloma after single-agent thalidomide: identification of prognostic factors in a phase 2 study of 169 patients. *Blood* 2001;98:492-494.
408. Tosi P, Ronconi S, Zamagni E, et al. Salvage therapy with thalidomide in multiple myeloma patients relapsing after autologous peripheral blood stem cell transplantation. *Haematologica* 2001;86:409-413.
409. Juliusson G, Celsing F, Turesson I, et al. Frequent good partial remissions from thalidomide including best response ever in patients with advanced refractory and relapsed myeloma. *Br J Haematol* 2000;109:89-96.
410. Weber DM, Gavino M, Delasalle K, et al. Thalidomide alone or with dexamethasone for multiple myeloma. *Blood* 1999;94[Suppl 1]:601a(abst).
411. Durie BGM, Stepan DE. Efficacy of low dose thalidomide (T) in multiple myeloma. *Blood* 1999;94[Suppl 1]:316a(abst).
412. Rajkumar SV, Fonseca R, Dispenzieri A, et al. A phase II trial of thalidomide in the treatment of relapsed multiple myeloma (MM) with laboratory correlative studies. *Blood* 2000;96:168a(abst).
413. Kneller A, Raanani P, Hardan I, et al. Therapy with thalidomide in refractory multiple myeloma patients—the revival of an old drug. *Br J Haematol* 2000;108:391-393.
414. Palumbo A, Giaccone L, Bertola A, et al. Low-dose thalidomide plus dexamethasone is an effective salvage therapy for advanced myeloma. *Haematologica* 2001;86:399-403.
415. Dimopoulos MA, Zervas K, Kouvatses G, et al. Thalidomide and dexamethasone combination for

refractory multiple myeloma. *Ann Oncol* 2001;12:991–995.

416. Coleman M, Leonard JP, Nahum K, et al. Non-myelosuppressive therapy with BLT-D (Biaxin, low dose thalidomide and dexamethasone) is highly active in Waldenström's macroglobulinemia and myeloma. *Blood* 2000;96:167a(abst).

417. Hus M, Dmoszynska A, Soroka-Wojtaszko M, et al. Thalidomide treatment of resistant or relapsed multiple myeloma patients. *Haematologica* 2001;86:404–408.

418. Bonnet JD, Alexanian R, Salmon SE, et al. Addition of cisplatin and bleomycin to vincristine–carmustine–doxorubicin–prednisone (VBAP) combination in the treatment of relapsing or resistant multiple myeloma: a Southwest Oncology Group study. *Cancer Treat Rep* 1984;68:481–485.

419. Broun GO Jr, Petruska PJ, Hiramoto RN, et al. Cisplatin, BCNU, cyclophosphamide, and prednisone in multiple myeloma. *Cancer Treat Rep* 1982;66:237–242.

420. Barlogie B, Jagannath S, Desikan KR, et al. Total therapy with tandem transplants for newly diagnosed multiple myeloma. *Blood* 1999;93:55–65.

421. Kantarjian H, Dreicer R, Barlogie B, et al. High-dose cytosine arabinoside in multiple myeloma. *Eur J Cancer Clin Oncol* 1984;20:227–231.

422. Tirelli U, Carbone A, Zagonei V, et al. Phase II study of teniposide (VM-26) in multiple myeloma. *Am J Clin Oncol* 1985;8:329–331.

423. Kraut EH, Crowley JJ, Wade JL, et al. Evaluation of topotecan in resistant and relapsing multiple myeloma: a Southwest Oncology Group study. *J Clin Oncol* 1998;16:589–592.

424. Grever MR, Crowley J, Salmon S, et al. Phase II investigation of pentostatin in multiple myeloma: a Southwest Oncology Group study. *J Natl Cancer Inst* 1990;82:1778–1779.

425. Belch AR, Henderson JF, Brox LW. Treatment of multiple myeloma with deoxycoformycin. *Cancer Chemother Pharmacol* 1985;14:49–52.

426. Dimopoulos MA, Arbutck S, Huber M, et al. Primary therapy of multiple myeloma with paclitaxel (Taxol). *Ann Oncol* 1994;5:757–759.

427. Miller HJ, Leong T, Khandekar JD, et al. Paclitaxel as the initial treatment of multiple myeloma: an Eastern Cooperative Oncology Group Study (E1A93). *Am J Clin Oncol* 1998;21:553–556.

428. Ahmann FR, Meyskens FL Jr, Jones SE, et al. Phase II evaluation of amsacrine (m-AMSA) in solid tumors, myeloma, and lymphoma: a University of Arizona and Southwest Oncology Group Study. *Cancer Treat Rep* 1983;67:697–700.

429. Greipp PR, Coleman M, Anderson K, et al. Phase II trial of amsacrine in patients with multiple myeloma. *Med Pediatr Oncol* 1989;17:76–78.

430. Gockerman JP, Silberman H, Bartolucci AA. Phase II evaluation of aclarubicin in refractory multiple myeloma: a Southeastern Cancer Study Group Trial. *Cancer Treat Rep* 1987;71:773–774.

431. Cornell CJ Jr, Pajak TF, McIntyre OR. Chlorozotocin: phase II evaluation in patients with myeloma. *Cancer Treat Rep* 1984;68:685–686.

432. Cohen HJ, Bartolucci AA. Hexamethylmelamine and prednisone in the treatment of refractory multiple myeloma. *Am J Clin Oncol* 1982;5:21–27.

433. Barlogie B, Crowley J, Salmon SE, et al. Phase II study of carboplatin (CBDCA) in refractory multiple myeloma: a Southwest Oncology Group study. *Invest New Drugs* 1994;12:53–55.

434. Kraut EH, Crowley JJ, Grever MR, et al. Phase II study of fludarabine phosphate in multiple myeloma. A Southwest Oncology Group study. *Invest New Drugs* 1990;8:199–200.

435. Dimopoulos MA, Kantarjian HM, Estey EH, et al. 2-Chlorodeoxyadenosine in the treatment of multiple

myeloma. *Blood* 1992;80:1626.

436. Durie BGM, Villarete L, Farvard A, et al. Clarithromycin (Biaxin) as primary treatment for myeloma. *Blood* 1997;90[Suppl 1]:579a(abst).
437. Moreau P, Huynh A, Facon T, et al. Lack of efficacy of clarithromycin in advanced multiple myeloma. *Intergroupe Français du Myélome (IFM). Leukemia* 1999;13:490–491.
438. Stewart AK, Trudel S, Al-Berouti BM, et al. Lack of response to short-term use of clarithromycin (Biaxin) in multiple myeloma. *Blood* 1999;93:4441.
439. Morris TC, Ranaghan L, Morrison J. Phase II trial of clarithromycin and pamidronate therapy in myeloma. *Med Oncol* 2001;18:79–84.
440. George RP, Poth JL, Gordon D, et al. Multiple myeloma—intermittent combination chemotherapy compared to continuous therapy. *Cancer* 1972;29:1665–1670.
441. Bergsagel DE. Treatment of plasma cell myeloma. *Annu Rev Med* 1979;30:431–443.
442. Schey SA, Kazmi M, Ireland R, et al. The use of intravenous intermediate dose melphalan and dexamethasone as induction treatment in the management of de novo multiple myeloma. *Eur J Haematol* 1998;61:306–310.
443. Petrucci MT, Avvisati G, Tribalto M, et al. Intermediate-dose (25 mg/m<sup>2</sup>) intravenous melphalan for patients with multiple myeloma in relapse or refractory to standard treatment. *Eur J Haematol* 1989;42:233–237.
444. Tsakanikas S, Papanastasiou K, Stamatelou M, et al. Intermediate dose of intravenous melphalan in advanced multiple myeloma. *Oncology* 1991;48:369–371.
445. Lokhorst HM, Sonneveld P, Wijermans PW, et al. Intermediate-dose melphalan (IDM) combined with G-CSF (filgrastim) is an effective and safe induction therapy for autologous stem cell transplantation in multiple myeloma. *Br J Haematol* 1996;92:44–48.
446. Palumbo A, Pileri A, Triolo S, et al. Multicyclic, dose-intensive chemotherapy supported by hemopoietic progenitors in refractory myeloma patients. *Bone Marrow Transplant* 1997;19:23–29.
447. Barlogie B, Dicke KA, Alexanian R. High dose melphalan for refractory myeloma—the M.D. Anderson experience. *Hematol Oncol* 1988;6:167–172.
448. Salokannel SJ, Palva IP, Timonen T, et al. Cyclophosphamide in the treatment of multiple myeloma. *Blut* 1971;23:129–132.
449. Choi OS, English A, Hilton JH, et al. Cyclophosphamide in the treatment of myelomatosis. *Can Med Assoc J* 1967;97:1133–1139.
450. Anagnostopoulos A, Aleman A, Williams P, et al. Autologous stem cell transplantation (ASCT) after nonmyelosuppressive induction therapy with dexamethasone alone is safe and effective for newly diagnosed multiple myeloma (MM) pts who receive high dose chemotherapy (HDC). *Blood* 2001;98:683a(abst).
451. Ahre A, Bjorkholm M, Osterborg A, et al. High doses of natural alpha-interferon (alpha-IFN) in the treatment of multiple myeloma—a pilot study from the Myeloma Group of Central Sweden (MGCS). *Eur J Haematol* 1988;41:123–130.
452. Dimopoulos MA, Weber D, Delasalle KB, et al. Combination therapy with interferon-dexamethasone for newly diagnosed patients with multiple myeloma. *Cancer* 1993;72:2589–2592.
453. Rajkumar SV, Hayman S, Gertz MA, et al. Combination therapy with thalidomide plus dexamethasone for newly diagnosed myeloma. *J Clin Oncol* 2002;20:4319–4323.
454. Ghobrial I, Dispenzieri A, Bundy K, et al. Pretransplant induction with thalidomide-dexamethasone does not adversely affect stem cell collection or engraftment in patients with multiple myeloma. *Prog Proc*

Am Soc Clin Oncol 2002;21:418a(abst).

- 454a. Ghobrial IM, Dispenzieri A, Bundy KL, et al. Effect of thalidomide on stem cell collection and engraftment in patients with multiple myeloma. *BMT* 2003;32:587–592.
455. Gregory WM, Richards MA, Malpas JS. Combination chemotherapy versus melphalan and prednisolone in the treatment of multiple myeloma: an overview of published trials. *J Clin Oncol* 1992;10:334–342.
456. Fonseca R, Harrington D, Oken MM, et al. Biological and prognostic significance of interphase fluorescence in situ hybridization detection of chromosome 13 abnormalities (delta13) in multiple myeloma: an Eastern Cooperative Oncology Group study. *Cancer Res* 2002;62:715–720.
457. Case DC Jr, Sonneborn HL, Paul SD, et al. Combination chemotherapy for multiple myeloma with BCNU, cyclophosphamide, vincristine, melphalan, and prednisone (M-2 protocol). *Oncology* 1985;42:137–140.
458. Alberts DS, Durie BG, Salmon SE. Doxorubicin/B.C.N.U. chemotherapy for multiple myeloma in relapse. *Lancet* 1976;1:926–928.
459. Alexanian R, Salmon S, Gutterman J, et al. Chemoimmunotherapy for multiple myeloma. *Cancer* 1981;47:1923–1929.
460. Crowley J, Jacobson J, Alexanian R. Standard-dose therapy for multiple myeloma: the Southwest Oncology Group experience. *Semin Hematol* 2001;38:203–208.
461. Durie BG, Stock-Novack D, Salmon SE, et al. Prognostic value of pretreatment serum beta 2 microglobulin in myeloma: a Southwest Oncology Group Study. *Blood* 1990;75:823–830.
462. Salmon SE, Tesh D, Crowley J, et al. Chemotherapy is superior to sequential hemibody irradiation for remission consolidation in multiple myeloma: a Southwest Oncology Group study. *J Clin Oncol* 1990;8:1575–1584.
463. Alexanian R, Barlogie B, Tucker S. VAD-based regimens as primary treatment for multiple myeloma. *Am J Hematol* 1990;33:86–89.
464. Samson D, Gaminara E, Newland A, et al. Infusion of vincristine and doxorubicin with oral dexamethasone as first-line therapy for multiple myeloma. *Lancet* 1989;2:882–885.
465. Attal M, Hugué F, Schlaifer D, et al. Intensive combined therapy for previously untreated aggressive myeloma. *Blood* 1992;79:1130–1136.
466. Kars A, Celik I, Kansu E, et al. Maintenance therapy with alpha-interferon following first-line VAD in multiple myeloma. *Eur J Haematol* 1997;59:100–104.
467. Anderson H, Scarffe JH, Ranson M, et al. VAD chemotherapy as remission induction for multiple myeloma. *Br J Cancer* 1995;71:326–330.
468. Segeren CM, Sonneveld P, van der Holt B, et al. Vincristine, doxorubicin and dexamethasone (VAD) administered as rapid intravenous infusion for first-line treatment in untreated multiple myeloma. *Br J Haematol* 1999;105:127–130.
469. Fossa A, Muer M, Kasper C, et al. Bolus vincristine and epirubicin with cyclophosphamide and dexamethasone (VECD) as induction and salvage treatment in multiple myeloma. *Leukemia* 1998;12:422–426.
470. Tsiara SN, Kapsali E, Christou L, et al. Administration of a modified chemotherapeutic regimen containing vincristine, liposomal doxorubicin and dexamethasone to multiple myeloma patients: preliminary data. *Eur J Haematol* 2000;65:118–122.
471. Salmon SE, Crowley JJ, Balcerzak SP, et al. Interferon versus interferon plus prednisone remission maintenance therapy for multiple myeloma: a Southwest Oncology Group Study. *J Clin Oncol* 1998;16:890–896.
472. Salmon SE, Crowley JJ, Grogan TM, et al. Combination chemotherapy, glucocorticoids, and

interferon alfa in the treatment of multiple myeloma: a Southwest Oncology Group study. *J Clin Oncol* 1994;12:2405–2414.

473. Szelenyi H, Kreuser ED, Keilholz U, et al. Cyclophosphamide, Adriamycin and dexamethasone (CAD) is a highly effective therapy for patients with advanced multiple myeloma. *Ann Oncol* 2001;12:105–108.

474. Giles FJ, Wickham NR, Rapoport BL, et al. Cyclophosphamide, etoposide, vincristine, Adriamycin, and dexamethasone (CEVAD) regimen in refractory multiple myeloma: an International Oncology Study Group (IOSG) phase II protocol. *Am J Hematol* 2000;63:125–130.

475. Corrado C, Pavlovsky S, Saslasky J, et al. Grupo Argentino de Tratamiento de la Leucemia Aguda (GATLA). Buenos Aires, Argentina. Randomized trial comparing melphalan–prednisone with or without recombinant  $\alpha$ -2 interferon (r  $\alpha$ 2IFN) in multiple myeloma. *Prog Proc Am Soc Clin Oncol* 1989;258(abst).

476. Montuoro A, De Rosa L, De Blasio A, et al. Alpha-2a-interferon/melphalan/prednisone versus melphalan/prednisone in previously untreated patients with multiple myeloma. *Br J Haematol* 1990;76:365–368.

477. Nordic Myeloma Study Group. Interferon- $\alpha$  2b added to melphalan–prednisone for initial and maintenance therapy in multiple myeloma. A randomized, controlled trial. *Ann Intern Med* 1996;124:212–222.

478. Osterborg A, Bjorkholm M, Bjoreman M, et al. Natural interferon- $\alpha$  in combination with melphalan/prednisone versus melphalan/prednisone in the treatment of multiple myeloma stages II and III: a randomized study from the Myeloma Group of Central Sweden. *Blood* 1993;81:1428–1434.

479. Cooper MR, Dear K, McIntyre OR, et al. A randomized clinical trial comparing melphalan/prednisone with or without interferon  $\alpha$ -2b in newly diagnosed patients with multiple myeloma: a Cancer and Leukemia Group B study. *J Clin Oncol* 1993;11:155–160.

480. Capnist G, Vespignani M, Spriano M, et al. Impact of interferon at induction chemotherapy and maintenance treatment for multiple myeloma. Preliminary results of a multicenter study by the Italian non-Hodgkin's Lymphoma Cooperative Study Group (NHLCSG). *Acta Oncol* 1994;33:527–529.

481. Ludwig H, Fritz E. Interferon in multiple myeloma—summary of treatment results and clinical implications. *Acta Oncol* 2000;39:815–821.

482. Myeloma Trialists' Collaborative Group. Interferon as therapy for multiple myeloma: an individual patient data overview of 24 randomized trials and 4012 patients. *Br J Haematol* 2001;113:1020–1034.

483. Ludwig H, Cohen AM, Huber H, et al. Interferon  $\alpha$ -2b with VMCP compared to VMCP alone for induction and interferon  $\alpha$ -2b compared to controls for remission maintenance in multiple myeloma: interim results. *Eur J Cancer* 1991;27:S40–S45.

484. Ludwig H, Cohen AM, Polliack A, et al. Interferon- $\alpha$  for induction and maintenance in multiple myeloma: results of two multicenter randomized trials and summary of other studies. *Ann Oncol* 1995;6:467–476.

485. Scheithauer W, Cortelezzi A, Fritz E, et al. Combined  $\alpha$ -2C-interferon/VMCP polychemotherapy versus VMCP polychemotherapy as induction therapy in multiple myeloma: a prospective randomized trial. *J Biol Response Mod* 1989;8:109–115.

486. Joshua DE, Penny R, Matthews JP, et al. Australian Leukaemia Study Group Myeloma II: a randomized trial of intensive combination chemotherapy with or without interferon in patients with myeloma. *Br J Haematol* 1997;97:38–45.

487. Aviles A, Alatraste S, Talavera A, et al. Alternating combination chemotherapy and interferon improves survival in poor prognosis multiple myeloma. *Clin Oncol* 1995;7:97–101.

488. Gertz MA, Kalish LA, Kyle RA, et al. Phase III study comparing vincristine, doxorubicin (Adriamycin), and dexamethasone (VAD) chemotherapy with VAD plus recombinant interferon  $\alpha$ -2 in refractory or relapsed multiple myeloma. An Eastern Cooperative Oncology Group study. *Am J Clin Oncol* 1995;18:475–480.

489. Oken MM, Leong T, Lenhard RE Jr, et al. The addition of interferon or high dose cyclophosphamide

- to standard chemotherapy in the treatment of patients with multiple myeloma: phase III Eastern Cooperative Oncology Group Clinical Trial EST 9486. *Cancer* 1999;86:957–968.
490. Aitchison R, Williams A, Schey S, et al. A randomised trial of cyclophosphamide with and without low dose alpha-interferon in the treatment of newly diagnosed myeloma. *Leuk Lymphoma* 1993;9:243–246.
491. Preis P, Scheithauer W, Fritz E, et al. VMCP chemotherapy with or without interferon-alpha-2 in newly diagnosed patients with multiple myeloma. *Onkologie* 1989;12:27–29.
492. Wisloff F, Hjorth M, Kaasa S, et al. Effect of interferon on the health-related quality of life of multiple myeloma patients: results of a Nordic randomized trial comparing melphalan-prednisone to melphalan-prednisone + alpha-interferon. The Nordic Myeloma Study Group. *Br J Haematol* 1996;94:324–332.
493. Ludwig H, Fritz E, Neuda J, et al. Patient preferences for interferon alfa in multiple myeloma. *J Clin Oncol* 1997;15:1672–1679.
494. Barlogie B, Hall R, Zander A, et al. High-dose melphalan with autologous bone marrow transplantation for multiple myeloma. *Blood* 1986;67:1298–1301.
495. Harousseau JL, Attal M. The role of autologous hematopoietic stem cell transplantation in multiple myeloma. *Semin Hematol* 1997;34[Suppl 1]:61–66.
496. Bjorkstrand B. European Group for Blood and Marrow Transplantation Registry studies in multiple myeloma. *Semin Hematol* 2001;38:219–225.
497. Cunningham D, Paz-Ares L, Milan S, et al. High-dose melphalan and autologous bone marrow transplantation as consolidation in previously untreated myeloma. *J Clin Oncol* 1994;12:759–763.
498. Anderson KC, Barut BA, Ritz J, et al. Autologous bone marrow transplantation therapy for multiple myeloma. *Eur J Haematol* 1989;51[Suppl]:157–163.
499. Gertz MA, Lacy MQ, Inwards DJ, et al. Early harvest and late transplantation as an effective therapeutic strategy in multiple myeloma. *Bone Marrow Transplant* 1999;23:221–226.
500. Davies FE, Forsyth PD, Rawstron AC, et al. The impact of attaining a minimal disease state after high-dose melphalan and autologous transplantation for multiple myeloma. *Br J Haematol* 2001;112:814–819.
501. Bensinger WI, Rowley SD, Demirer T, et al. High-dose therapy followed by autologous hematopoietic stem-cell infusion for patients with multiple myeloma. *J Clin Oncol* 1996;14:1447–1456.
502. Lenhoff S, Hjorth M, Holmberg E, et al. Impact on survival of high-dose therapy with autologous stem cell support in patients younger than 60 years with newly diagnosed multiple myeloma: a population-based study. Nordic Myeloma Study Group. *Blood* 2000;95:7–11.
503. Bladé J, San Miguel JF, Fontanillas M, et al. Survival of multiple myeloma patients who are potential candidates for early high-dose therapy intensification/autotransplantation and who were conventionally treated. *J Clin Oncol* 1996;14:2167–2173.
504. Dalton WS, Bergsagel PL, Kuehl WM, et al. Multiple myeloma. In: Schechter GP, Williams ME, eds. *Hematology* 2001. Washington, DC: American Society of Hematology, 2001;157–177.
505. Bladé J, Sureda A, Ribera JM, et al. High-dose therapy autotransplantation/intensification vs continued conventional chemotherapy in multiple myeloma patients responding to initial treatment chemotherapy: results of a prospective randomized trial from the Spanish Cooperative Group PETHEMA. *Blood* 2001;98:815a(abst).
506. Alexanian R, Dimopoulos MA, Delasalle KB, et al. Myeloablative therapy for primary resistant multiple myeloma. *Stem Cells* 1995;13[Suppl 2]:118–121.
507. Alexanian R, Weber D, Giralt S, et al. Impact of complete remission with intensive therapy in patients with responsive multiple myeloma. *Bone Marrow Transplant* 2001;27:1037–1043.
508. Harousseau JL, Attal M, Divine M, et al. Comparison of autologous bone marrow transplantation and

peripheral blood stem cell transplantation after first remission induction treatment in multiple myeloma. *Bone Marrow Transplant* 1995;15:963–969.

509. Larsson K, Bjorkstrand B, Ljungman P. Faster engraftment but no reduction in infectious complications after peripheral blood stem cell transplantation compared to autologous bone marrow transplantation. *Support Care Cancer* 1998;6:378–383.

510. Tricot G, Jagannath S, Vesole D, et al. Peripheral blood stem cell transplants for multiple myeloma: identification of favorable variables for rapid engraftment in 225 patients. *Blood* 1995;85:588–596.

511. Goldschmidt H, Hegenbart U, Wallmeier M, et al. Factors influencing collection of peripheral blood progenitor cells following high-dose cyclophosphamide and granulocyte colony-stimulating factor in patients with multiple myeloma. *Br J Haematol* 1997;98:736–744.

512. Kroger N, Zeller W, Hassan HT, et al. Successful mobilization of peripheral blood stem cells in heavily pretreated myeloma patients with G-CSF alone. *Ann Hematol* 1998;76:257–262.

513. Siegel DS, Desikan KR, Mehta J, et al. Age is not a prognostic variable with autotransplants for multiple myeloma. *Blood* 1999;93:51–54.

514. Badros A, Barlogie B, Siegel E, et al. Autologous stem cell transplantation in elderly multiple myeloma patients over the age of 70 years. *Br J Haematol* 2001;114:600–607.

515. Rajkumar SV, Fonseca R, Lacy MQ, et al. Autologous stem cell transplantation for relapsed and primary refractory myeloma. *Bone Marrow Transplant* 1999;23:1267–1272.

516. Vesole DH, Barlogie B, Jagannath S, et al. High-dose therapy for refractory multiple myeloma: improved prognosis with better supportive care and double transplants. *Blood* 1994;84:950–956.

517. Barlogie B, Jagannath S, Vesole DH, et al. Superiority of tandem autologous transplantation over standard therapy for previously untreated multiple myeloma. *Blood* 1997;89:789–793.

518. Desikan R, Barlogie B, Sawyer J, et al. Results of high-dose therapy for 1000 patients with multiple myeloma: durable complete remissions and superior survival in the absence of chromosome 13 abnormalities. *Blood* 2000;95:4008–4010.

519. Harousseau JL, Attal M. The role of stem cell transplantation in multiple myeloma. *Blood Rev* 2002;16:245–253.

520. Segeren CM, Sonneveld P, Van der Holt B, et al. Myeloablative treatment following intensified chemotherapy in untreated multiple myeloma: a prospective, randomized phase III study. *Blood* 2001;98:815a(abst).

521. Cavo M, Tosi P, Zamagni E, et al. The “Bologna 96” clinical trial of single versus double PBSC transplantation for previously untreated MM: results of an interim analysis(abst S16). Program and proceedings of the VIII International Myeloma Workshop; May 4–8, 2001; Banff, Alberta, Canada.

522. Femand JP, Marolleau JP, Alberti C, et al. In single versus tandem high dose therapy (HDT) supported with autologous blood stem cell (ABSC) transplantation using unselected or CD34 enriched ABSC: preliminary results of a two by two designed randomized trial in 230 young patients with multiple myeloma (MM). *Blood* 2001;98:815a(abst).

523. Attal M, Payen C, Facon T, et al. Single versus double transplant in myeloma: a randomized trial of the “Inter Groupe Français du Myélome” (IFM). *Blood* 1997;90[Suppl 1]:418a(abst).

524. Femand JP, Ravaud P, Chevret S, et al. High-dose therapy and autologous peripheral blood stem cell transplantation in multiple myeloma: up-front or rescue treatment? Results of a multicenter sequential randomized clinical trial. *Blood* 1998;92:3131–3136.

525. Moreau P, Facon T, Attal M, et al. Comparison of 200 mg/m<sup>2</sup> melphalan and 8 Gy total body irradiation plus 140 mg/m<sup>2</sup> melphalan as conditioning regimens for peripheral blood stem cell transplantation in patients with newly diagnosed multiple myeloma: final analysis of the Intergroupe



Francophone du Myélome 9,502 randomized trial. *Blood* 2002;99:731–735.

526. Ventura GJ, Barlogie B, Hester JP, et al. High dose cyclophosphamide, BCNU and VP-16 with autologous blood stem cell support for refractory multiple myeloma. *Bone Marrow Transplant* 1990;5:265–268.

527. Mansi J, da Costa F, Viner C, et al. High-dose busulfan in patients with myeloma. *J Clin Oncol* 1992;10:1569–1573.

528. Dimopoulos MA, Alexanian R, Przepiorka D, et al. Thiotepa, busulfan, and cyclophosphamide: a new preparative regimen for autologous marrow or blood stem cell transplantation in high-risk multiple myeloma. *Blood* 1993;82:2324–2328.

529. Alegre A, Lamana M, Arranz R, et al. Busulfan and melphalan as conditioning regimen for autologous peripheral blood stem cell transplantation in multiple myeloma. *Br J Haematol* 1995;91:380–386.

530. Long GD, Chao NJ, Hu WW, et al. High dose etoposide-based myeloablative therapy followed by autologous blood progenitor cell rescue in the treatment of multiple myeloma. *Cancer* 1996;78:2502–2509.

531. Tribalto M, Amadori S, Cudillo L, et al. Autologous peripheral blood stem cell transplantation as first line treatment of multiple myeloma: an Italian Multicenter Study. *Haematologica* 2000;85:52–58.

532. Meloni G, Capria S, Trasarti S, et al. High-dose idarubicine, busulphan and melphalan as conditioning for autologous blood stem cell transplantation in multiple myeloma: a feasibility study. *Bone Marrow Transplant* 2000;26:1045–1049.

533. Lahuerta JJ, Grande C, Bladé J, et al. Myeloablative treatments for multiple myeloma: update of a comparative study of different regimens used in patients from the Spanish registry for transplantation in multiple myeloma. *Leuk Lymphoma* 2002;43:67–74.

534. Dispenzieri A, Wiseman G, Lacy MQ, et al. A phase I/II dose escalation study of 153-samarium EDTMP (<sup>153</sup>Sm-EDTMP) with fixed dose melphalan peripheral stem cell transplantation (PBSCT) for multiple myeloma (MM). *Blood* 2001;98:682a.

535. Giralt M, Champlin R, Goodman M, et al. Preliminary results of a phase I/II study of multiple myeloma (MM) patients treated with <sup>166</sup>holmium-DOTMP in combination with high dose melphalan +/- total body irradiation (TBI) with autologous stem cell transplant (ASCT). *Blood* 2000;96:558a(abst).

536. Reece DE, Barnett MJ, Connors JM, et al. Treatment of multiple myeloma with intensive chemotherapy followed by autologous BMT using marrow purged with 4-hydroperoxycyclophosphamide. *Bone Marrow Transplant* 1993;11:139–146.

537. Anderson KC, Andersen J, Soiffer R, et al. Monoclonal antibody-purged bone marrow transplantation therapy for multiple myeloma. *Blood* 1993;82:2568–2576.

538. Gobbi M, Tazzari PL, Cavo M, et al. Autologous bone marrow transplantation with immunotoxin purged marrow for multiple myeloma: long term results in 14 patients with advanced disease. *Bone Marrow Transplant* 1991;7:30.

539. Schiller G, Vescio R, Freytes C, et al. Autologous CD34-selected blood progenitor cell transplants for patients with advanced multiple myeloma. *Bone Marrow Transplant* 1998;21:141–145.

540. Vescio R, Schiller G, Stewart AK, et al. Multicenter phase III trial to evaluate CD34+ selected versus unselected autologous peripheral blood progenitor cell transplantation in multiple myeloma. *Blood* 1999;93:1858–1868.

541. Stewart AK, Vescio R, Schiller G, et al. Purging of autologous peripheral-blood stem cells using CD34 selection does not improve overall or progression-free survival after high-dose chemotherapy for multiple myeloma: results of a multicenter randomized controlled trial. *J Clin Oncol* 2001;19:3771–3779.

542. Tricot G, Vesole DH, Jagannath S, et al. Graft-versus-myeloma effect: proof of principle. *Blood* 1996;87:1196–1198.

543. Bensinger WI, Buckner CD, Anasetti C, et al. Allogeneic marrow transplantation for multiple myeloma: an analysis of risk factors on outcome. *Blood* 1996;88:2787–2793.
544. Cavo M, Bandini G, Benni M, et al. High-dose busulfan and cyclophosphamide are an effective conditioning regimen for allogeneic bone marrow transplantation in chemosensitive multiple myeloma. *Bone Marrow Transplant* 1998;22:27–32.
545. Gahrton G, Tura S, Ljungman P, et al. Allogeneic bone marrow transplantation in multiple myeloma. European Group for Bone Marrow Transplantation. *N Engl J Med* 1991;325:1267–1273.
546. Gahrton G, Tura S, Ljungman P, et al. Prognostic factors in allogeneic bone marrow transplantation for multiple myeloma. *J Clin Oncol* 1995;13:1312–1322.
547. Bjorkstrand BB, Ljungman P, Svensson H, et al. Allogeneic bone marrow transplantation versus autologous stem cell transplantation in multiple myeloma: a retrospective case-matched study from the European Group for Blood and Marrow Transplantation. *Blood* 1996;88:4711–4718.
548. Varterasian M, Janakiraman N, Karanes C, et al. Transplantation in patients with multiple myeloma: a multicenter comparative analysis of peripheral blood stem cell and allogeneic transplant. *Am J Clin Oncol* 1997;20:462–466.
549. Couban S, Stewart AK, Loach D, et al. Autologous and allogeneic transplantation for multiple myeloma at a single centre. *Bone Marrow Transplant* 1997;19:783–789.
550. Reynolds C, Ratanatharathorn V, Adams P, et al. Allogeneic stem cell transplantation reduces disease progression compared to autologous transplantation in patients with multiple myeloma. *Bone Marrow Transplant* 2001;27:801–807.
551. Lokhorst HM, Sonneveld P, Cornelissen JJ, et al. Induction therapy with vincristine, Adriamycin, dexamethasone (VAD) and intermediate-dose melphalan (IDM) followed by autologous or allogeneic stem cell transplantation in newly diagnosed multiple myeloma. *Bone Marrow Transplant* 1999;23:317–322.
552. Gahrton G, Svensson H, Cavo M, et al. Progress in allogeneic bone marrow and peripheral blood stem cell transplantation for multiple myeloma: a comparison between transplants performed 1983–1993 and 1994–1998 at European Group for Blood and Marrow Transplantation centres. *Br J Haematol* 2001;113:209–216.
553. Martinelli G, Terragna C, Zamagni E, et al. Molecular remission after allogeneic or autologous transplantation of hematopoietic stem cells for multiple myeloma. *J Clin Oncol* 2000;18:2273–2281.
554. Lokhorst HM, Schattenberg A, Cornelissen JJ, et al. Donor leukocyte infusions are effective in relapsed multiple myeloma after allogeneic bone marrow transplantation. *Blood* 1997;90:4206–4211.
555. Lokhorst HM, Schattenberg A, Cornelissen JJ, et al. Donor lymphocyte infusions for relapsed multiple myeloma after allogeneic stem-cell transplantation: predictive factors for response and long-term outcome. *J Clin Oncol* 2000;18:3031–3037.
556. Badros A, Barlogie B, Morris C, et al. High response rate in refractory and poor-risk multiple myeloma after allotransplantation using a nonmyeloablative conditioning regimen and donor lymphocyte infusions. *Blood* 2001;97:2574–2579.
557. Badros A, Barlogie B, Siegel E, et al. Improved outcome of allogeneic transplantation in high-risk multiple myeloma patients after nonmyeloablative conditioning. *J Clin Oncol* 2002;20:1295–1303.
558. Giralt S, Aleman A, Anagnostopoulos A, et al. Fludarabine/melphalan conditioning for allogeneic transplantation in patients with multiple myeloma. *Bone Marrow Transplant* 2002;30:367–373.
559. Giralt S, Weber D, Cohen A, et al. Non-myeloablative conditioning with fludarabine (F)/Melphalan (M) for patients with multiple myeloma (MM) (abstract). *Prog/Proc Am Soc Clin Oncol* 1999;18:6a.
560. Maloney D, Sahebi F, Stockerl-Goldstein KE, et al. Combining an allogeneic graft-vs-myeloma effect with high-dose autologous stem cell rescue in the treatment of multiple myeloma (abstract). *Blood*

2001;98:434a.

561. Maloney DG, Sandmaier BM, Mackinnon S, et al. Non-myeloablative transplantation. *Hematology (Am Soc Hematol Educ Program)* 2002;392-421.

562. Kroger N, Schwerdtfeger R, Kiehl M, et al. Autologous stem cell transplantation followed by a dose-reduced allograft induces high complete remission rate in multiple myeloma. *Blood* 2002;100:755-760.

563. Schaefer H, Bader P, Hebart H, et al. Mini-allografts as salvage therapy in patients with heavily pretreated multiple myeloma (abstract). *Blood* 2000;96:306b.

564. Peggs KS, Williams CD, Chapra R, et al. Non-myeloablative allogeneic transplantation with adjuvant dose escalated donor lymphocyte infusions for multiple myeloma (abstract). *Blood* 2000;96:781a.

565. Lalancette M, Rezvani K, Szydlo R, et al. Excellent outcome of non-myeloablative stem cell transplant (NMSCT) for good risk myeloma: the EBMT experience (abstract). *Blood* 2000;96:204a.

566. Kyle RA, Pierre RV, Bayrd ED. Multiple myeloma and acute myelomonocytic leukemia. *N Engl J Med* 1970;283:1121-1125.

567. Nordenson NG. Myelomatosis: a clinical review of 310 cases. *Acta Med Scand Suppl* 1966;445:178-186.

568. Osserman EF, Takatsuki K, Talal N. Multiple myeloma. I. The pathogenesis of "amyloidosis." *Semin Hematol* 1964;1:3-85.

569. Edwards GA, Zawadzki ZA. Extrasosseous lesions in plasma cell myeloma: a report of six cases. *Am J Med* 1967;43:194-205.

570. Gonzalez F, Trujillo JM, Alexanian R. Acute leukemia in multiple myeloma. *Ann Intern Med* 1977;86:440-443.

571. Cohen HJ, Bartolucci AA, Forman WB, et al. Consolidation and maintenance therapy in multiple myeloma: randomized comparison of a new approach to therapy after initial response to treatment. *J Clin Oncol* 1986;4:888-899.

572. Southwest Oncology Group Study. Remission maintenance therapy for multiple myeloma. *Arch Intern Med* 1975;135:147-152.

573. Belch A, Shelley W, Bergsagel D, et al. A randomized trial of maintenance versus no maintenance melphalan and prednisone in responding multiple myeloma patients. *Br J Cancer* 1988;57:94-99.

574. Alexanian R, Gehan E, Haut A, et al. Unmaintained remissions in multiple myeloma. *Blood* 1978;51:1005-1011.

575. Corso A, Nozza A, Lazzarino M, et al. Plateau phase in multiple myeloma: an end-point of conventional-dose chemotherapy. *Haematologica* 1999;84:336-341.

576. Finnish Leukaemia Group. Long-term survival in multiple myeloma: a Finnish Leukaemia Group study. *Br J Haematol* 1999;105:942-947.

577. Nagura E, Ichikawa A, Kamiya O, et al. A randomized study comparing VMCP and MMPP in the treatment of multiple myeloma. *Cancer Chemother Pharmacol* 1997;39:279-285.

578. Bladé J, Lopez-Guillermo A, Bosch F, et al. Impact of response to treatment on survival in multiple myeloma: results in a series of 243 patients. *Br J Haematol* 1994;88:117-121.

579. Oivanen TM, Kellokumpu-Lehtinen P, Koivisto AM, et al. Response level and survival after conventional chemotherapy for multiple myeloma: a Finnish Leukaemia Group study. *Eur J Haematol* 1999;62:109-116.

580. Paccagnella A, Chiarion-Sileni V, Soesan M, et al. Second and third responses to the same induction

regimen in relapsing patients with multiple myeloma. *Cancer* 1991;68:975–980.

581. Berenson JR, Crowley JJ, Grogan TM, et al. Maintenance therapy with alternate-day prednisone improves survival in multiple myeloma patients. *Blood* 2002;99:3163–3168.

582. Alexanian R, Weber D, Dimopoulos M, et al. Randomized trial of alpha-interferon or dexamethasone as maintenance treatment for multiple myeloma. *Am J Hematol* 2000;65:204–209.

583. Mandelli F, Avvisati G, Amadori S, et al. Maintenance treatment with recombinant interferon alfa-2b in patients with multiple myeloma responding to conventional induction chemotherapy. *N Engl J Med* 1990;322:1430–1434.

584. Drayson MT, Chapman CE, Dunn JA, et al. MRC trial of alpha 2b-interferon maintenance therapy in first plateau phase of multiple myeloma. MRC Working Party on Leukaemia in Adults. *Br J Haematol* 1998;101:195–202.

585. Salmon SE, Beckord J, Pugh RP, et al. alpha-Interferon for remission maintenance: preliminary report on the Southwest Oncology Group Study. *Semin Oncol* 1991;18:33–36.

586. Browman GP, Bergsagel D, Sicheri D, et al. Randomized trial of interferon maintenance in multiple myeloma: a study of the National Cancer Institute of Canada Clinical Trials Group. *J Clin Oncol* 1995;13:2354–2360.

587. Westin J, Cortelezzi A, Hjorth M, et al. Interferon therapy during the plateau phase of multiple myeloma: an update of the Swedish study. *Eur J Cancer* 1991;27:S45–S48.

588. Bladé J, San Miguel JF, Escudero ML, et al. Maintenance treatment with interferon alpha-2b in multiple myeloma: a prospective randomized study from PETHEMA (Program for the Study and Treatment of Hematological Malignancies, Spanish Society of Hematology). *Leukemia* 1998;12:1144–1148.

589. McSweeney EN, Tobias JS, Blackman G, et al. Double hemibody irradiation (DHBI) in the management of relapsed and primary chemoresistant multiple myeloma. *Clin Oncol* 1993;5:378–383.

590. Powles R, Raje N, Cunningham D, et al. Maintenance therapy for remission in myeloma with Intron A following high-dose melphalan and either an autologous bone marrow transplantation or peripheral stem cell rescue. *Stem Cells* 1995;13[Suppl 2]:114–117.

591. Westin J. Interferon therapy during the plateau phase of multiple myeloma: an update of a Swedish multicenter study. *Semin Oncol* 1991;18:37–40.

592. Cunningham D, Powles R, Malpas J, et al. A randomized trial of maintenance interferon following high-dose chemotherapy in multiple myeloma: long-term follow-up results. *Br J Haematol* 1998;102:495–502.

593. Pulsoni A, Avvisati G, Petrucci MT, et al. The Italian experience on interferon as maintenance treatment in multiple myeloma: ten years after. *Blood* 1998;92:2184–2186.

594. Palumbo A, Boccadoro M, Garino LA, et al. Multiple myeloma: intensified maintenance therapy with recombinant interferon-alpha-2b plus glucocorticoids. *Eur J Haematol* 1992;49:93–97.

595. Palumbo A, Boccadoro M, Garino LA, et al. Interferon plus glucocorticoids as intensified maintenance therapy prolongs tumor control in relapsed myeloma. *Acta Haematol* 1993;90:71–76.

596. Bjorkstrand B, Svensson H, Goldschmidt H, et al. Alpha-interferon maintenance treatment is associated with improved survival after high-dose treatment and autologous stem cell transplantation in patients with multiple myeloma: a retrospective registry study from the European Group for Blood and Marrow Transplantation (EBMT). *Bone Marrow Transplant* 2001;27:511–515.

597. Banchereau J, Steinman RM. Dendritic cells and the control of immunity. *Nature* 1998;392:245–252.

598. Osterborg A, Yi Q, Henriksson L, et al. Idiotypic immunization combined with granulocyte-macrophage colony-stimulating factor in myeloma patients induced type I, major histocompatibility complex-restricted, CD8- and CD4-specific T-cell responses. *Blood* 1998;91:2459–2466.

599. Hsu FJ, Caspar CB, Czerwinski D, et al. Tumor-specific idiotype vaccines in the treatment of patients with B-cell lymphoma: long-term results of a clinical trial. *Blood* 1997;89:3129-3135.
600. Massaia M, Borrione P, Battaglio S, et al. Idiotype vaccination in human myeloma: generation of tumor-specific immune responses after high-dose chemotherapy. *Blood* 1999;94:673-683.
601. Hsu FJ, Benike C, Fagnoni F, et al. Vaccination of patients with B-cell lymphoma using autologous antigen-pulsed dendritic cells. *Nat Med* 1996;2:52-58.
602. Lim SH, Bailey-Wood R. Idiotypic protein-pulsed dendritic cell vaccination in multiple myeloma. *Int J Cancer* 1999;83:215-222.
603. Dabadghao S, Bergenbrant S, Anton D, et al. Anti-idiotypic T-cell activation in multiple myeloma induced by M-component fragments presented by dendritic cells. *Br J Haematol* 1998;100:647-654.
604. Titzer S, Christensen O, Manzke O, et al. Vaccination of multiple myeloma patients with idiotype-pulsed dendritic cells: immunological and clinical aspects. *Br J Haematol* 2000;108:805-816.
605. Reichardt VL, Okada CY, Liso A, et al. Idiotype vaccination using dendritic cells after autologous peripheral blood stem cell transplantation for multiple myeloma—a feasibility study. *Blood* 1999;93:2411-2419.
606. Cull G, Durrant L, Stainer C, et al. Generation of anti-idiotypic immune responses following vaccination with idiotype-protein pulsed dendritic cells in myeloma. *Br J Haematol* 1999;107:648-655.
607. Lacy MQ, Wettstein P, Gertz MA, et al. Dendritic cell-based idiotype vaccination in post transplant multiple myeloma (abstract). *Blood* 2000;96:374a.
608. Valone FH, Lacy MQ, MacKenzie M, et al. Immunotherapy of multiple myeloma using idiotype-loaded dendritic cells (APC8020) (abstract). *Prog/Proc Am Soc Clin Oncol* 2000;19:453a.
609. Paccagnella A, Cartei G, Fosser V, et al. Treatment of multiple myeloma with M-2 protocol and without maintenance therapy. *Eur J Cancer Clin Oncol* 1983;19:1345-1351.
610. Kyle RA, Gailani S, Seligman BR, et al. Multiple myeloma resistant to melphalan: treatment with cyclophosphamide, prednisone, and BCNU. *Cancer Treat Rep* 1979;63:1265-1269.
611. Bertolini F, Mingrone W, Alietti A, et al. Thalidomide in multiple myeloma, myelodysplastic syndromes and histiocytosis: analysis of clinical results and of surrogate angiogenesis markers. *Ann Oncol* 2001;12:987-990.
612. Bladé J, Esteve J, Rosinol L, et al. Thalidomide in refractory and relapsing multiple myeloma. *Semin Oncol* 2001;28:588-592.
613. Myers B, Crouch D, Dolan G. Thalidomide treatment in advanced refractory myeloma. *Br J Haematol* 2000;111:986.
614. Pini M, Baraldi A, Pietrasanta D, et al. Low-dose of thalidomide in the treatment of refractory myeloma. *Haematologica* 2000;85:1111-1112.
615. Myers B, Grimley C, Dolan G. Thalidomide and low-dose dexamethasone in myeloma treatment. *Br J Haematol* 2001;114:245.
616. Weber DM, Rankin K, Gavino M, et al. Thalidomide with dexamethasone for resistant multiple myeloma (abstract). *Blood* 2000;96:167a.
617. Moehler TM, Neben K, Benner A, et al. Salvage therapy for multiple myeloma with thalidomide and CED chemotherapy. *Blood* 2001;98:3846-3848.
618. Zangari M, Anaissie E, Barlogie B, et al. Increased risk of deep-vein thrombosis in patients with multiple myeloma receiving thalidomide and chemotherapy. *Blood* 2001;98:1614-1615.

619. Osman K, Comenzo R, Rajkumar SV. Deep venous thrombosis and thalidomide therapy for multiple myeloma. *N Engl J Med* 2001;344:1951–1952.
620. Camba L, Peccatori J, Pescarollo A, et al. Thalidomide and thrombosis in patients with multiple myeloma. *Haematologica* 2001;86:1108–1109.
621. Rajkumar SV, Gertz MA, Witzig TE. Life-threatening toxic epidermal necrolysis with thalidomide therapy for myeloma. *N Engl J Med* 2000;343:972–973.
622. Fowler R, Imrie K. Thalidomide-associated hepatitis: a case report. *Am J Hematol* 2001;66:300–302.
623. Jacobs P, Le Roux IM, Wood L, et al. Recombinant alpha-interferon as salvage therapy in multiple myeloma: a pilot study. *S Afr Med J* 1989;76:100–102.
624. San Miguel JF, Moro M, Bladé J, et al. Combination of interferon and dexamethasone in refractory multiple myeloma. *Hematol Oncol* 1990;8:185–189.
625. Ganjoo RK, Johnson PW, Evans ML, et al. Recombinant interferon-alpha 2b and high dose methyl prednisolone in relapsed and resistant multiple myeloma. *Hematol Oncol* 1993;11:179–186.
626. Alexanian R, Barlogie B, Gutterman J. Alpha-interferon combination therapy of resistant myeloma. *Am J Clin Oncol* 1991;14:188–192.
627. Kyle RA, Seligman BR, Wallace HJ Jr, et al. Multiple myeloma resistant to melphalan (NSC-8806) treated with cyclophosphamide (NSC-26271), prednisone (NSC-10023), and chloroquine (NSC-187208). *Cancer Chemother Rep* 1975;59:557–562.
628. Cohen HJ, Silberman HR, Larsen WE, et al. Combination chemotherapy with intermittent 1-3-bis(2-chloroethyl)1-nitrosourea (BCNU), cyclophosphamide, and prednisone for multiple myeloma. *Blood* 1979;54:824–836.
629. Buzaid AC, Garewal HS, Greenberg BR. Management of myelodysplastic syndromes. *Am J Med* 1986;80:1149–1157.
630. Bladé J, Feliu E, Rozman C, et al. Cross-resistance to alkylating agents in multiple myeloma. *Cancer* 1983;52:786–789.
631. Bergsagel DE, Cowan DH, Hasselback R. Plasma cell myeloma: response of melphalan-resistant patients to high-dose intermittent cyclophosphamide. *Can Med Assoc J* 1972;107:851–855.
632. Brandes LJ, Israels LG. Treatment of advanced plasma cell myeloma with weekly cyclophosphamide and alternate-day prednisone. *Cancer Treat Rep* 1982;66:1413–1415.
633. Wilson K, Shelley W, Belch A, et al. Weekly cyclophosphamide and alternate-day prednisone: an effective secondary therapy in multiple myeloma. *Cancer Treat Rep* 1987;71:981–982.
634. de Weerd O, van de Donk NW, Veth G, et al. Continuous low-dose cyclophosphamide-prednisone is effective and well tolerated in patients with advanced multiple myeloma. *Neth J Med* 2001;59:50–56.
635. Lenhard RE, Daniels MJ, Oken MM, et al. An aggressive high dose cyclophosphamide and prednisone regimen for advanced multiple myeloma. *Leuk Lymphoma* 1994;13:485–489.
636. Lenhard RE Jr, Kalish LA, Oken MM, et al. Timed-sequential high-dose cyclophosphamide and vincristine in the treatment of multiple myeloma. *Cancer* 1994;73:2113–2118.
637. Palumbo A, Boccadoro M, Bruno B, et al. Cyclophosphamide ( $3.6 \text{ g/m}^2$ ) therapy with G-CSF support for resistant myeloma. *Haematologica* 1994;79:513–518.
638. Cavo M, Galieni P, Tassi C, et al. M-2 protocol for melphalan-resistant and relapsing multiple myeloma. *Eur J Haematol* 1988;40:168–173.
639. Presant CA, Klahr C. Adriamycin, 1,3-bis (2-chloroethyl) 1 nitrosourea (BCNU, NSC No. 409962),

cyclophosphamide plus prednisone (ABC-P) in melphalan resistant multiple myeloma. *Cancer* 1978;42:1222-1227.

640. Kyle RA, Pajak TF, Henderson ES, et al. Multiple myeloma resistant to melphalan: treatment with doxorubicin, cyclophosphamide, carmustine (BCNU), and prednisone. *Cancer Treat Rep* 1982;66:451-456.

641. Bonnet J, Alexanian R, Salmon S, et al. Vincristine, BCNU, doxorubicin, and prednisone (VBAP) combination in the treatment of relapsing or resistant multiple myeloma: a Southwest Oncology Group study. *Cancer Treat Rep* 1982;66:1267-1271.

642. Bladé J, Rozman C, Montserrat E, et al. Treatment of alkylating resistant multiple myeloma with vincristine, BCNU, doxorubicin and prednisone (VBAP). *Eur J Cancer Clin Oncol* 1986;22:1193-1197.

643. Stenzinger W, Blomker A, Hiddemann W, et al. Treatment of refractory multiple myeloma with the vincristine-Adriamycin-dexamethasone (VAD) regimen. *Blut* 1990;61:55-59.

644. Monconduit M, Le Loet X, Bernard JF, et al. Combination chemotherapy with vincristine, doxorubicin, dexamethasone for refractory or relapsing multiple myeloma. *Br J Haematol* 1986;63:599-601.

645. Anderson H, Scarffe JH, Lambert M, et al. VAD chemotherapy—toxicity and efficacy—in patients with multiple myeloma and other lymphoid malignancies. *Hematol Oncol* 1987;5:213-222.

646. Browman GP, Belch A, Skillings J, et al. Modified Adriamycin-vincristine-dexamethasone (m-VAD) in primary refractory and relapsed plasma cell myeloma: an NCI (Canada) pilot study. The National Cancer Institute of Canada Clinical Trials Group. *Br J Haematol* 1992;82:555-559.

647. Gimsing P, Bjerrum OW, Brandt E, et al. Refractory myelomatosis treated with mitoxantrone in combination with vincristine and prednisone (NOP-regimen): a phase II study. The Nordic Myeloma Study Group (NMSG). *Br J Haematol* 1991;77:73-79.

648. Wisloff F, Gimsing P, Hedenus M, et al. Bolus therapy with mitoxantrone and vincristine in combination with high-dose prednisone (NOP-bolus) in resistant multiple myeloma. Nordic Myeloma Study Group (NMSG). *Eur J Haematol* 1992;48:70-74.

649. Phillips JK, Sherlaw-Johnson C, Pearce R, et al. A randomized study of MOD versus VAD in the treatment of relapsed and resistant multiple myeloma. *Leuk Lymphoma* 1995;17:465-472.

650. Vincent M, Goss G, Sinoff C, et al. Bi-weekly vincristine, epirubicin and methylprednisolone in alkylator-refractory multiple myeloma. *Cancer Chemother Pharmacol* 1994;34:356-360.

651. Adam Z, Elbl L, Vorlicek J, et al. Treatment of refractory multiple myeloma with vincristine, Adriamycin, dexamethasone, and with repeated application of cyclophosphamide (C-VAD). *Acta Med Austriaca* 1994;21:111-115.

652. Dimopoulos MA, Weber D, Kantarjian H, et al. Hyper CVAD for VAD-resistant multiple myeloma. *Am J Hematol* 1996;52:77-81.

653. Dimopoulos MA, Delasalle KB, Champlin R, et al. Cyclophosphamide and etoposide therapy with GM-CSF for VAD-resistant multiple myeloma. *Br J Haematol* 1993;83:240-244.

654. Iaffaioli RV, Facchini G, Tortoriello A, et al. Modulation of chemosensitivity by alpha interferon in multiple myeloma and non-Hodgkin's lymphoma. *J Exp Ther Oncol* 1996;1:226-230.

655. Sonneveld P, Suci S, Weijermans P, et al. Cyclosporin A combined with vincristine, doxorubicin and dexamethasone (VAD) compared with VAD alone in patients with advanced refractory multiple myeloma: an EORTC-HOVON randomized phase III study (06914). *Br J Haematol* 2001;115:895-902.

656. Weber D, Dimopoulos M, Sinicrope F, et al. VAD-cyclosporine therapy for VAD-resistant multiple myeloma. *Leuk Lymphoma* 1995;19:159-163.

657. Sonneveld P, Marie JP, Huisman C, et al. Reversal of multidrug resistance by SDZ PSC 833, combined with VAD (vincristine, doxorubicin, dexamethasone) in refractory multiple myeloma. A phase I study. *Leukemia* 1996;10:1741-1750.



658. Richardson PG, Schlossman RL, Hideshima T, et al. A phase 1 study of oral CC5013, an immunomodulatory thalidomide (Thal) derivative, in patients with relapsed and refractory multiple myeloma (MM). *Blood* 2001;98: 775a(abst).
659. Zangari M, Tricot G, Zeldis J, et al. Results of phase I study of CC-5013 for the treatment of multiple myeloma (MM) patients who relapse after high-dose chemotherapy (HDCT). *Blood* 2001;98:775a(abst).
660. Treon SP, Shima Y, Grossbard ML, et al. Treatment of multiple myeloma by antibody mediated immunotherapy and induction of myeloma selective antigens. *Ann Oncol* 2000;11:107-111.
661. Stone WJ. Multiple myelomata. *AJR Am J Roentgenol* 1924;12:543-545.
662. Jacox HW, Kahn EA. Multiple myeloma with spinal cord involvement. *AJR Am J Roentgenol* 1933;30:201-205.
663. Sykes MP, Savel H, Chu FCH, et al. Long-term effects of therapeutic irradiation upon bone marrow. *Cancer* 1964;17:1144-1148.
664. Sykes MP, Chu FCH, Savel H, et al. The effects of varying dosages of irradiation upon sternal-marrow regeneration. *Radiology* 1964;83:1084-1087.
665. Norin T. Roentgen treatment of myeloma with special consideration to the dosage. *Acta Radiol* 1957;47:46-54.
666. Rostom AY, O'Cathail SM, Folkes A. Systemic irradiation in multiple myeloma: a report on nineteen cases. *Br J Haematol* 1984;58:423-431.
667. Leigh BR, Kurtts TA, Mack CF, et al. Radiation therapy for the palliation of multiple myeloma. *Int J Radiat Oncol Biol Phys* 1993;25:801-804.
668. Adamietz IA, Schober C, Schulte RW, et al. Palliative radiotherapy in plasma cell myeloma. *Radiother Oncol* 1991;20:111-116.
669. Frassica DA, Frassica FJ, Schray MF, et al. Solitary plasmacytoma of bone: Mayo Clinic experience. *Int J Radiat Oncol Biol Phys* 1989;16:43-48.
670. Mendenhall CM, Thar TL, Million RR. Solitary plasmacytoma of bone and soft tissue. *Int J Radiat Oncol Biol Phys* 1980;6:1497-1501.
671. Mill WB. Radiation therapy in multiple myeloma. *Radiology* 1975;115:175-178.
672. Medinger FG, Craver LF. Total body irradiation with review of cases. *AJR Am J Roentgenol* 1942;48:651-671.
673. Bergsagel DE. Total body irradiation for myelomatosis. *BMJ* 1971;2:325.
674. Jaffe JP, Bosch A, Raich PC. Sequential hemi-body radiotherapy in advanced multiple myeloma. *Cancer* 1979;43:124-128.
675. Bosch A, Frias Z. Radiotherapy in the treatment of multiple myeloma. *Int J Radiat Oncol Biol Phys* 1988;15:1363-1369.
676. Singer FR, Ritch PS, Lad TE, et al. Treatment of hypercalcemia of malignancy with intravenous etidronate: a controlled, multicenter study. The Hypercalcemia Study Group. *Arch Intern Med* 1991;151:471-476.
677. Thomas PJ, Daban A, Bontoux D. Double hemibody irradiation in chemotherapy-resistant multiple myeloma. *Cancer Treat Rep* 1984;68:1173-1175.
678. Tobias JS, Richards JD, Blackman GM, et al. Hemibody irradiation in multiple myeloma. *Radiother*

Oncol 1985;3:11-16.

679. Troussard X, Roussel A, Reman O, et al. Hemibody irradiation in stage III multiple myeloma: results of 20 patients. *Nouv Rev Fr Hematol* 1988;30:213-218.

680. Rowland CG, Garrett MJ, Crowley FA. Half body radiation in plasma cell myeloma. *Clin Radiol* 1983;34:507-510.

681. Qasim MM. Techniques and results of half body irradiation (HBI) in metastatic carcinomas and myelomas. *Clin Oncol* 1979;5:65-68.

682. McIntyre OR, Tefft M, Propert K, et al. Melphalan and prednisone plus total bone marrow irradiation as initial treatment for multiple myeloma. *Int J Radiat Oncol Biol Phys* 1988;15:1007-1012.

683. Jacobs P, le Roux I, King HS. Sequential half-body irradiation as salvage therapy in chemotherapy-resistant multiple myeloma. *Am J Clin Oncol* 1988;11:104-109.

684. Kyle RA. Long-term survival in multiple myeloma. *N Engl J Med* 1983;308:314-316.

685. Greipp PR, Katzmann JA, O'Fallon WM, et al. Value of beta 2-microglobulin level and plasma cell labeling indices as prognostic factors in patients with newly diagnosed myeloma. *Blood* 1988;72:219-223.

686. Greipp PR, Lust JA, O'Fallon WM, et al. Plasma cell labeling index and beta 2-microglobulin predict survival independent of thymidine kinase and C-reactive protein in multiple myeloma. *Blood* 1993;81:3382-3387.

687. Greipp PR, Leong T, Bennett JM, et al. Plasmablastic morphology—an independent prognostic factor with clinical and laboratory correlates: Eastern Cooperative Oncology Group (ECOG) myeloma trial E9486 report by the ECOG Myeloma Laboratory Group. *Blood* 1998;91:2501-2507.

688. Rapoport BL, Falkson HC, Falkson G. Prognostic factors affecting the survival of patients with multiple myeloma: a retrospective analysis of 86 patients. *S Afr Med J* 1991;79:65-67.

689. Bataille R, Boccadoro M, Klein B, et al. C-reactive protein and beta-2 microglobulin produce a simple and powerful myeloma staging system. *Blood* 1992;80:733-737.

690. Konigsberg R, Zojer N, Ackermann J, et al. Predictive role of interphase cytogenetics for survival of patients with multiple myeloma. *J Clin Oncol* 2000;18:804-812.

691. San Miguel JF, Garcia-Sanz R, Gonzalez M, et al. A new staging system for multiple myeloma based on the number of S-phase plasma cells. *Blood* 1995;85:448-455.

692. Medical Research Council's Working Party on Leukaemia in Adults. Prognostic features in the third MRC myelomatosis trial. *Br J Cancer* 1980;42:831-840.

693. Alexanian R, Balcerzak S, Bonnet JD, et al. Prognostic factors in multiple myeloma. *Cancer* 1975;36:1192-1201.

694. Diem H, Fateh-Moghadam A, Lamerz R. Prognostic factors in multiple myeloma: role of beta 2-microglobulin and thymidine kinase. *Clin Invest* 1993;71:918-923.

695. Bartl R, Frisch B, Fateh-Moghadam A, et al. Histologic classification and staging of multiple myeloma: a retrospective and prospective study of 674 cases. *Am J Clin Pathol* 1987;87:342-355.

696. Durie BG, Salmon SE, Moon TE. Pretreatment tumor mass, cell kinetics, and prognosis in multiple myeloma. *Blood* 1980;55:364-372.

697. Fonseca R, Blood E, Rue M, et al. Clinical and biologic implications of recurrent genomic aberrations in myeloma. *Blood* 2003;101:4569-4575.

698. Smadja NV, Bastard C, Brigaudeau C, et al. Hypodiploidy is a major prognostic factor in multiple myeloma. *Blood* 2001;98:2229-2238.

699. Facon T, Avet-Loiseau H, Guillermin G, et al. Chromosome 13 abnormalities identified by FISH analysis and serum beta2-microglobulin produce a powerful myeloma staging system for patients receiving high-dose therapy. *Blood* 2001;97:1566-1571.
700. Greipp PR. Prognosis in myeloma. *Mayo Clin Proc* 1994;69:895-902.
701. Sirohi B, Powles R, Mehta J, et al. Complete remission rate and outcome after intensive treatment of 177 patients under 75 years of age with IgG myeloma defining a circumscribed disease entity with a new staging system. *Br J Haematol* 1999;107:656-666.
702. Bataille R, Magub M, Grenier J, et al. Serum beta-2-microglobulin in multiple myeloma: relation to presenting features and clinical status. *Eur J Cancer Clin Oncol* 1982;18:59-66.
703. Ortega F, Gonzalez M, Moro MJ, et al. Prognostic effect of beta 2-microglobulin in multiple myeloma [Spanish]. *Med Clin (Barc)* 1992;99:645-648.
704. Cuzick J, De Stavola BL, Cooper EH, et al. Long-term prognostic value of serum beta 2 microglobulin in myelomatosis. *Br J Haematol* 1990;75:506-510.
705. Lemoli RM, Martinelli G, Zamagni E, et al. Engraftment, clinical, and molecular follow-up of patients with multiple myeloma who were reinfused with highly purified CD34+ cells to support single or tandem high-dose chemotherapy. *Blood* 2000;95:2234-2239.
706. Majolino I, Vignetti M, Meloni G, et al. Autologous transplantation in multiple myeloma: a GITMO retrospective analysis on 290 patients. Gruppo Italiano Trapianti di Midollo Osseo. *Haematologica* 1999;84:844-852.
707. Tricot G, Spencer T, Sawyer J, et al. Predicting long-term (> or = 5 years) event-free survival in multiple myeloma patients following planned tandem autotransplants. *Br J Haematol* 2002;116:211-217.
708. Palumbo A, Bruno B, Boccadoro M, et al. Interferon-gamma in multiple myeloma. *Leuk Lymphoma* 1995;18:215-219.
709. Rajkumar SV, Fonseca R, Lacy MQ, et al. Beta2-microglobulin and bone marrow plasma cell involvement predict complete responders among patients undergoing blood cell transplantation for myeloma. *Bone Marrow Transplant* 1999;23:1261-1266.
710. Bataille R, Boccadoro M, Klein B, et al. C-reactive protein (CRP): a direct indicator of interleukin-6 (IL-6) and the best prognostic factor in multiple myeloma (MM). *Blood* 1991;78[Suppl]:174a(abst).
711. Greipp PR, Gaillard JP, Klein B, et al. Independent prognostic value for plasma cell labeling index (PCLI), immunofluorescence microscopy plasma cell percent (IMPCP), beta 2-microglobulin (β2M), soluble interleukin-6 receptor (sIL-6R), and C-reactive protein (CRP) in myeloma trial E9487. *Blood* 1994;84[Suppl 1]:385a(abst).
712. Brown RD, Snowdon L, Uhr E, et al. C-reactive protein (CRP) levels do not reflect disease status in patients with multiple myeloma. *Leuk Lymphoma* 1993;9:509-512.
713. Simonsson B, Brenning G, Kallander C, et al. Prognostic value of serum lactic dehydrogenase (S-LDH) in multiple myeloma. *Eur J Clin Invest* 1987;17:336-339.
714. Barlogie B, Smallwood L, Smith T, et al. High serum levels of lactic dehydrogenase identify a high-grade lymphoma-like myeloma. *Ann Intern Med* 1989;110:521-525.
715. Dimopoulos MA, Barlogie B, Smith TL, et al. High serum lactate dehydrogenase level as a marker for drug resistance and short survival in multiple myeloma. *Ann Intern Med* 1991;115:931-935.
716. Cavo M, Baccarani M, Gobbi M, et al. Prognostic value of bone marrow plasma cell infiltration in stage I multiple myeloma. *Br J Haematol* 1983;55:683-690.
717. Rajkumar SV, Fonseca R, Dispenzieri A, et al. Methods for estimation of bone marrow plasma cell involvement in myeloma: predictive value for response and survival in patients undergoing autologous stem

cell transplantation. *Am J Hematol* 2001;68:269–275.

718. Pasqualetti P, Collacciani A, Maccarone C, et al. Prognostic factors in multiple myeloma: selection using Cox's proportional hazard model. *Biomed Pharmacother* 1996;50:29–35.

719. Bartl R, Frisch B. Clinical significance of bone marrow biopsy and plasma cell morphology in MM and MGUS. *Pathol Biol (Paris)* 1999;47:158–168.

720. Goasguen JE, Zandecki M, Mathiot C, et al. Mature plasma cells as indicator of better prognosis in multiple myeloma: new methodology for the assessment of plasma cell morphology. *Leuk Res* 1999;23:1133–1140.

721. Rajkumar SV, Fonseca R, Lacy MQ, et al. Plasmablastic morphology is an independent predictor of poor survival after autologous stem-cell transplantation for multiple myeloma. *J Clin Oncol* 1999;17:1551–1557.

722. Grignani G, Gobbi PG, Formisano R, et al. A prognostic index for multiple myeloma. *Br J Cancer* 1996;73:1101–1107.

723. Carter A, Hocherman I, Linn S, et al. Prognostic significance of plasma cell morphology in multiple myeloma. *Cancer* 1987;60:1060–1065.

724. Paule B, Quillard J, Bisson M, et al. Prognostic significance of plasma cell morphology in multiple myeloma. *Nouv Rev Fr Hematol* 1988;30:209–212.

725. Kurabayashi H, Kubota K, Shirakura T, et al. Electron microscopic analysis of myeloma cells in relation to drug response and prognosis. *Ultrastruct Pathol* 1992;16:379–383.

726. Kurabayashi H, Kubota K, Shirakura T, et al. Prediction of prognosis by electron microscopic analysis of myeloma cells. *Ann Hematol* 1996;73:169–173.

727. Rajkumar SV, Greipp PR. Prognostic factors in multiple myeloma. *Hematol Oncol Clin North Am* 1999;13:1295–1314.

728. Greipp PR. Advances in the diagnosis and management of myeloma. *Semin Hematol* 1992;29:24–45.

729. Boccadoro M, Marmont F, Tribalto M, et al. Early responder myeloma: kinetic studies identify a patient subgroup characterized by very poor prognosis. *J Clin Oncol* 1989;7:119–125.

730. Greipp PR, Lust JA, Katzmann JA, et al. The role of beta 2-microglobulin, plasma cell labeling index, thymidine kinase and C-reactive protein as prognostic factors in 107 cases of multiple myeloma. *Blood* 1991;78[Suppl]:273a(abst).

731. Drach J, Gattringer C, Glassl H, et al. The biological and clinical significance of the Ki-67 growth fraction in multiple myeloma. *Hematol Oncol* 1992;10:125–134.

732. Girino M, Riccardi A, Luoni R, et al. Monoclonal antibody Ki-67 as a marker of proliferative activity in monoclonal gammopathies. *Acta Haematol* 1991;85:26–30.

733. Trendle MC, Leong T, Kyle RA, et al. Prognostic significance of the S-phase fraction of light-chain-restricted cytoplasmic immunoglobulin (cIg) positive plasma cells in patients with newly diagnosed multiple myeloma enrolled on Eastern Cooperative Oncology Group treatment trial E9486. *Am J Hematol* 1999;61:232–237.

734. Pope B, Brown R, Gibson J, et al. The bone marrow plasma cell labeling index by flow cytometry. *Cytometry* 1999;38:286–292.

735. Witzig TE, Dhodapkar MV, Kyle RA, et al. Quantitation of circulating peripheral blood plasma cells and their relationship to disease activity in patients with multiple myeloma. *Cancer* 1993;72:108–113.

736. Witzig TE, Gertz MA, Lust JA, et al. Peripheral blood monoclonal plasma cells as a predictor of survival in patients with multiple myeloma. *Blood* 1996;88:1780–1787.

737. Drach J, Angerler J, Schuster J, et al. Interphase fluorescence in situ hybridization identifies chromosomal abnormalities in plasma cells from patients with monoclonal gammopathy of undetermined significance. *Blood* 1995;86:3915–3921.
738. Zandecki M, Lai JL, Facon T. Multiple myeloma: almost all patients are cytogenetically abnormal. *Br J Haematol* 1996;94:217–227.
739. Dewald GW, Kyle RA, Hicks GA, et al. The clinical significance of cytogenetic studies in 100 patients with multiple myeloma, plasma cell leukemia, or amyloidosis. *Blood* 1985;66:380–390.
740. Sawyer JR, Waldron JA, Jagannath S, et al. Cytogenetic findings in 200 patients with multiple myeloma. *Cancer Genet Cytogenet* 1995;82:41–49.
741. Rajkumar SV, Fonseca R, Dewald GW, et al. Cytogenetic abnormalities correlate with the plasma cell labeling index and extent of bone marrow involvement in myeloma. *Cancer Genet Cytogenet* 1999;113:73–77.
742. Zojer N, Konigsberg R, Ackermann J, et al. Deletion of 13q14 remains an independent adverse prognostic variable in multiple myeloma despite its frequent detection by interphase fluorescence in situ hybridization. *Blood* 2000;95:1925–1930.
743. Drach J, Schuster J, Nowotny H, et al. Multiple myeloma: high incidence of chromosomal aneuploidy as detected by interphase fluorescence in situ hybridization. *Cancer Res* 1995;55:3854–3859.
744. Avet-Loiseau H, Li JY, Morineau N, et al. Monosomy 13 is associated with the transition of monoclonal gammopathy of undetermined significance to multiple myeloma. *Intergroupe Francophone du Myélome*. *Blood* 1999;94:2583–2589.
745. Fonseca R, Oken MM, Harrington D, et al. Deletions of chromosome 13 in multiple myeloma identified by interphase FISH usually denote large deletions of the q arm or monosomy. *Leukemia* 2001;15:981–986.
746. Seong C, Delasalle K, Hayes K, et al. Prognostic value of cytogenetics in multiple myeloma. *Br J Haematol* 1998;101:189–194.
747. Tricot G, Sawyer JR, Jagannath S, et al. Unique role of cytogenetics in the prognosis of patients with myeloma receiving high-dose therapy and autotransplants. *J Clin Oncol* 1997;15:2659–2666.
748. Worel N, Greinix H, Ackermann J, et al. Deletion of chromosome 13q14 detected by fluorescence in situ hybridization has prognostic impact on survival after high-dose therapy in patients with multiple myeloma. *Ann Hematol* 2001;80:345–348.
749. Barlogie B, Alexanian R, Dixon D, et al. Prognostic implications of tumor cell DNA and RNA content in multiple myeloma. *Blood* 1985;66:338–341.
750. Morgan RJ Jr, Gonchoroff NJ, Katzmann JA, et al. Detection of hypodiploidy using multi-parameter flow cytometric analysis: a prognostic indicator in multiple myeloma. *Am J Hematol* 1989;30:195–200.
751. Gould J, Alexanian R, Goodacre A, et al. Plasma cell karyotype in multiple myeloma. *Blood* 1988;71:453–456.
752. Shaughnessy J Jr, Tian E, Sawyer J, et al. Prognostic impact of cytogenetic and interphase fluorescence in situ hybridization-defined chromosome 13 deletion in multiple myeloma: early results of total therapy II. *Br J Haematol* 2003;120:44–52.
753. Debes-Marun CS, Dewald GW, Bryant S, et al. Chromosome abnormalities clustering and its implications for pathogenesis and prognosis in myeloma. *Leukemia* 2003;17:427–436.
754. Chesi M, Kuehl WM, Bergsagel PL. Recurrent immunoglobulin gene translocations identify distinct molecular subtypes of myeloma. *Ann Oncol* 2000;11:131–135.
755. Fonseca R, Harrington D, Oken MM, et al. Prognostic significance of 13q deletions and the t(11;14)(q13;q32) in myeloma (MM): an interphase FISH study of 351 patients entered into the Eastern

Cooperative Oncology Group E9487 clinical trial. *Blood* 2000;96:547a(abst).

756. Fonseca R, Blood EA, Oken MM, et al. Myeloma and the t(11;14)(q13;q32): evidence for a biologically defined unique subset of patients. *Blood* 2002;99:3735–3741.

757. Chesi M, Nardini E, Brents LA, et al. Frequent translocation t(4;14)(p16.3;q32.3) in multiple myeloma is associated with increased expression and activating mutations of fibroblast growth factor receptor 3. *Nat Genet* 1997;16:260–264.

758. Chesi M, Nardini E, Lim RS, et al. The t(4;14) translocation in myeloma dysregulates both FGFR3 and a novel gene, MMSET, resulting in IgH/MMSET hybrid transcripts. *Blood* 1998;92:3025–3034.

759. Richelda R, Ronchetti D, Baldini L, et al. A novel chromosomal translocation t(4;14)(p16.3; q32) in multiple myeloma involves the fibroblast growth-factor receptor 3 gene. *Blood* 1997;90:4062–4070.

760. Avet-Loiseau H, Li JY, Facon T, et al. High incidence of translocations t(11;14)(q13;q32) and t(4;14)(p16;q32) in patients with plasma cell malignancies. *Cancer Res* 1998;58:5640–5645.

761. Fonseca R, Conte G, Greipp PR. Laboratory correlates in multiple myeloma: how useful for prognosis? *Blood Rev* 2001;15:97–102.

762. Avet-Loiseau H. Nonrandom distribution of chromosomal abnormalities and correlation with clinical stage and prognostic presentation: a novel model for oncogenesis in multiple myeloma. Program and abstracts of the VIII International Myeloma Workshop, May 4–8, Banff, Alberta, Canada, 2001; Abstract S5:10–11.

763. Garcia-Sanz R, Orfao A, Gonzalez M, et al. Primary plasma cell leukemia: clinical, immunophenotypic, DNA ploidy, and cytogenetic characteristics. *Blood* 1999;93:1032–1037.

764. Perez-Simon JA, Garcia-Sanz R, Tabernero MD, et al. Prognostic value of numerical chromosome aberrations in multiple myeloma: a FISH analysis of 15 different chromosomes. *Blood* 1998;91:3366–3371.

765. Zhan F, Hardin J, Kordsmeier B, et al. Global gene expression profiling of multiple myeloma, monoclonal gammopathy of undetermined significance, and normal bone marrow plasma cells. *Blood* 2002;99:1745–1757.

766. Rajkumar SV, Leong T, Roche PC, et al. Prognostic value of bone marrow angiogenesis in multiple myeloma. *Clin Cancer Res* 2000;6:3111–3116.

767. Ahn MJ, Park CK, Choi JH, et al. Clinical significance of microvessel density in multiple myeloma patients. *J Korean Med Sci* 2001;16:45–50.

768. San Miguel JF, Gonzalez M, Gascon A, et al. Lymphoid subsets and prognostic factors in multiple myeloma. Cooperative Group for the Study of Monoclonal Gammopathies. *Br J Haematol* 1992;80:305–309.

769. Kay NE, Leong T, Bone N, et al. T-helper phenotypes in the blood of myeloma patients on ECOG phase III trials E9486/E3A93. *Br J Haematol* 1998;100:459–463.

770. Kay NE, Leong TL, Bone N, et al. Blood levels of immune cells predict survival in myeloma patients: results of an Eastern Cooperative Oncology Group phase 3 trial for newly diagnosed multiple myeloma patients. *Blood* 2001;98:23–28.

771. Porrata LF, Gertz MA, Inwards DJ, et al. Early lymphocyte recovery predicts superior survival after autologous hematopoietic stem cell transplantation in multiple myeloma or non-Hodgkin lymphoma. *Blood* 2001;98:579–585.

772. Desikan KR, Tricot G, Dhodapkar M, et al. Melphalan plus total body irradiation (MEL-TBI) or cyclophosphamide (MEL-CY) as a conditioning regimen with second autotransplant in responding patients with myeloma is inferior compared to historical controls receiving tandem transplants with melphalan alone. *Bone Marrow Transplant* 2000;25:483–487.

773. Saeed SM, Stock-Novack D, Pohlod R, et al. Prognostic correlation of plasma cell acid phosphatase and beta-glucuronidase in multiple myeloma: a Southwest Oncology Group study. *Blood* 1991;78:3281–3287.

774. Pulkki K, Pelliniemi TT, Rajamaki A, et al. Soluble interleukin-6 receptor as a prognostic factor in multiple myeloma. Finnish Leukaemia Group. *Br J Haematol* 1996;92:370-374.
775. Kyrtsolis MC, Dedoussis G, Zervas C, et al. Soluble interleukin-6 receptor (sIL-6R), a new prognostic factor in multiple myeloma. *Br J Haematol* 1996;93:398-400.
776. Boccadoro M, Battaglio S, Omede P, et al. Increased serum neopterin concentration as indicator of disease severity and poor survival in multiple myeloma. *Eur J Haematol* 1991;47:305-309.
777. Merlini G, Perfetti V, Gobbi PG, et al. Acute phase proteins and prognosis in multiple myeloma. *Br J Haematol* 1993;83:595-601.
778. Elomaa I, Virkkunen P, Risteli L, et al. Serum concentration of the cross-linked carboxyterminal telopeptide of type I collagen (ICTP) is a useful prognostic indicator in multiple myeloma. *Br J Cancer* 1992;66:337-341.
779. Fonseca R, Trendle MC, Leong T, et al. Prognostic value of serum markers of bone metabolism in untreated multiple myeloma patients. *Br J Haematol* 2000;109:24-29.
780. Turesson I, Abildgaard N, Ahlgren T, et al. Prognostic evaluation in multiple myeloma: an analysis of the impact of new prognostic factors. *Br J Haematol* 1999;106:1005-1012.
781. Woitge HW, Pecherstorfer M, Horn E, et al. Serum bone sialoprotein as a marker of tumour burden and neoplastic bone involvement and as a prognostic factor in multiple myeloma. *Br J Cancer* 2001;84:344-351.
782. Arnalich F, Zamorano AF, Martinez-Hernandez P, et al. Additional predictive value of serum unsaturated vitamin B<sub>12</sub> proteins in multiple myeloma. *J Med* 1990;21:277-286.
783. Kaiser U, Jaques G, Havemann K, et al. Serum NCAM: a potential new prognostic marker for multiple myeloma. *Blood* 1994;83:871-873.
784. Mathiot C, Galon J, Tartour E, et al. Soluble CD16 in plasma cell dyscrasias. *Leuk Lymphoma* 1999;32:467-474.
785. Seidel C, Sundan A, Hjorth M, et al. Serum syndecan-1: a new independent prognostic marker in multiple myeloma. *Blood* 2000;95:388-392.
786. Bataille R, Jourdan M, Zhang XG, et al. Serum levels of interleukin 6, a potent myeloma cell growth factor, as a reflect of disease severity in plasma cell dyscrasias. *J Clin Invest* 1989;84:2008-2011.
787. Nachbaur DM, Herold M, Maneschg A, et al. Serum levels of interleukin-6 in multiple myeloma and other hematological disorders: correlation with disease activity and other prognostic parameters. *Ann Hematol* 1991;62:54-58.
788. Pelliniemi TT, Irjala K, Mattila K, et al. Immunoreactive interleukin-6 and acute phase proteins as prognostic factors in multiple myeloma. Finnish Leukemia Group. *Blood* 1995;85:765-771.
789. Brown RD, Joshua DE, Nelson M, et al. Serum thymidine kinase as a prognostic indicator for patients with multiple myeloma: results from the MRC (UK) V trial. *Br J Haematol* 1993;84:238-241.
790. Back H, Jagenburg R, Rodger S, et al. Serum deoxythymidine kinase: no help in the diagnosis and prognosis of monoclonal gammopathy. *Br J Haematol* 1993;84:746-748.
791. Grogan TM, Spier CM, Salmon SE, et al. P-glycoprotein expression in human plasma cell myeloma: correlation with prior chemotherapy. *Blood* 1993;81:490-495.
792. Filipits M, Drach J, Pohl G, et al. Expression of the lung resistance protein predicts poor outcome in patients with multiple myeloma. *Clin Cancer Res* 1999;5:2426-2430.
793. Palmer M, Belch A, Hanson J, et al. Reassessment of the relationship between M-protein decrement



and survival in multiple myeloma. *Br J Cancer* 1989;59:110–112.

794. Baldini L, Radaelli F, Chiorboli O, et al. No correlation between response and survival in patients with multiple myeloma treated with vincristine, melphalan, cyclophosphamide, and prednisone. *Cancer* 1991;68:62–67.

795. Marmont F, Levis A, Falda M, et al. Lack of correlation between objective response and death rate in multiple myeloma patients treated with oral melphalan and prednisone. *Ann Oncol* 1991;2:191–195.

796. Bjorkstrand B, Ljungman P, Bird JM, et al. Autologous stem cell transplantation in multiple myeloma: results of the European Group for Bone Marrow Transplantation. *Stem Cells* 1995;13[Suppl 2]:140–146.

797. Lahuerta JJ, Martinez-Lopez J, Serna JD, et al. Remission status defined by immunofixation vs. electrophoresis after autologous transplantation has a major impact on the outcome of multiple myeloma patients. *Br J Haematol* 2000;109:438–446.

798. Rajkumar SV, Fonseca R, Dispenzieri A, et al. Effect of complete response on outcome following autologous stem cell transplantation for myeloma. *Bone Marrow Transplant* 2000;26:979–983.

799. Terpos E, Palermos J, Tsionos K, et al. Effect of pamidronate administration on markers of bone turnover and disease activity in multiple myeloma. *Eur J Haematol* 2000;65:331–336.

800. Abildgaard N, Glerup H, Rungby J, et al. Biochemical markers of bone metabolism reflect osteoclastic and osteoblastic activity in multiple myeloma. *Eur J Haematol* 2000;64:121–129.

801. Berenson JR, Lichtenstein A, Porter L, et al. Long-term pamidronate treatment of advanced multiple myeloma patients reduces skeletal events. Myeloma Aredia Study Group. *J Clin Oncol* 1998;16:593–602.

802. Rosen LS, Gordon D, Kaminski M, et al. Zoledronic acid versus pamidronate in the treatment of skeletal metastases in patients with breast cancer or osteolytic lesions of multiple myeloma: a phase III, double-blind, comparative trial. *Cancer J* 2001;7:377–387.

803. Mirels H. Metastatic disease in long bones: a proposed scoring system for diagnosing impending pathologic fractures. *Clin Orthop* 1989;249:256–264.

804. McBroom RJ, Cheal EJ, Hayes WC. Strength reductions from metastatic cortical defects in long bones. *J Orthop Res* 1988;6:369–378.

805. Gainor BJ, Buchert P. Fracture healing in metastatic bone disease. *Clin Orthop* 1983;178:297–302.

806. Allen KL, Johnson TW, Hibbs GG. Effective bone palliation as related to various treatment regimens. *Cancer* 1976;37:984–987.

807. Tong D, Gillick L, Hendrickson FR. The palliation of symptomatic osseous metastases: final results of the study by the Radiation Therapy Oncology Group. *Cancer* 1982;50:893–899.

808. Levine SA, Perin LA, Hayes D, et al. An evidence-based evaluation of percutaneous vertebroplasty. *Manag Care* 2000;9:56–63.

809. Benson WJ, Scarffe JH, Todd ID, et al. Spinal-cord compression in myeloma. *BMJ* 1979;1:1541–1544.

810. Gilbert RW, Kim JH, Posner JB. Epidural spinal cord compression from metastatic tumor: diagnosis and treatment. *Ann Neurol* 1978;3:40–51.

811. Young RF, Post EM, King GA. Treatment of spinal epidural metastases: randomized prospective comparison of laminectomy and radiotherapy. *J Neurosurg* 1980;53:741–748.

812. Greenberg HS, Kim JH, Posner JB. Epidural spinal cord compression from metastatic tumor: results with a new treatment protocol. *Ann Neurol* 1980;8:361–366.

813. Sorensen S, Helweg-Larsen S, Mouridsen H, et al. Effect of high-dose dexamethasone in carcinomatous metastatic spinal cord compression treated with radiotherapy: a randomised trial. *Eur J*

Cancer 1994;1:22-27.

814. Vecht CJ, Haaxma-Reiche H, van Putten WL, et al. Initial bolus of conventional versus high-dose dexamethasone in metastatic spinal cord compression. *Neurology* 1989;39:1255-1257.

815. Gucaip R, Theriault R, Gill I, et al. Treatment of cancer-associated hypercalcemia: double-blind comparison of rapid and slow intravenous infusion regimens of pamidronate disodium and saline alone. *Arch Intern Med* 1994;154:1935-1944.

816. Mundy GR, Wilkinson R, Heath DA. Comparative study of available medical therapy for hypercalcemia of malignancy. *Am J Med* 1983;74:421-432.

817. Warrell RP Jr, Israel R, Frisone M, et al. Gallium nitrate for acute treatment of cancer-related hypercalcemia: a randomized, double-blind comparison to calcitonin. *Ann Intern Med* 1988;108:669-674.

818. Garton JP, Gertz MA, Witzig TE, et al. Epoetin alfa for the treatment of the anemia of multiple myeloma: a prospective, randomized, placebo-controlled, double-blind trial. *Arch Intern Med* 1995;155:2069-2074.

819. Dammacco F, Castoldi G, Rodger S. Efficacy of epoetin alfa in the treatment of anaemia of multiple myeloma. *Br J Haematol* 2001;113:172-179.

820. Osterborg A, Boogaerts MA, Cimino R, et al. Recombinant human erythropoietin in transfusion-dependent anemic patients with multiple myeloma and non-Hodgkin's lymphoma—a randomized multicenter study. The European Study Group of Erythropoietin (Epoetin Beta) Treatment in Multiple Myeloma and Non-Hodgkin's Lymphoma. *Blood* 1996;87:2675-2682.

821. Cuzick J, Erskine S, Edelman D, et al. A comparison of the incidence of the myelodysplastic syndrome and acute myeloid leukaemia following melphalan and cyclophosphamide treatment for myelomatosis. A report to the Medical Research Council's Working Party on Leukaemia in Adults. *Br J Cancer* 1987;55:523-529.

822. Finnish Leukaemia Group study. Acute leukaemia and other secondary neoplasms in patients treated with conventional chemotherapy for multiple myeloma. *Eur J Haematol* 2000;65:123-127.

823. Bergsagel DE. Chemotherapy of myeloma: drug combinations versus single agents, an overview, and comments on acute leukemia in myeloma. *Hematol Oncol* 1988;6:159-166.

824. West WO. Acute erythroid leukemia after cyclophosphamide therapy for multiple myeloma: report of two cases. *South Med J* 1976;69:1331-1332.

825. Greene MH, Harris EL, Gershenson DM, et al. Melphalan may be a more potent leukemogen than cyclophosphamide. *Ann Intern Med* 1986;105:360-367.

826. Cleary B, Binder RA, Kales AN, et al. Simultaneous presentation of acute myelomonocytic leukemia and multiple myeloma. *Cancer* 1978;41:1381-1386.

827. Rosner F, Grunwald H. Multiple myeloma terminating in acute leukemia. Report of 12 cases and review of the literature. *Am J Med* 1974;57:927-939.

828. Govindarajan R, Jagannath S, Flick JT, et al. Preceding standard therapy is the likely cause of MDS after autotransplants for multiple myeloma. *Br J Haematol* 1996;95:349-353.

829. Wintrobe M, Buell M. Hyperproteinemia associated with multiple myeloma with report of case in which extraordinary hyperproteinemia was associated with thrombosis of retinal veins and symptoms suggesting Raynaud's disease. *Bull Johns Hopkins Hosp* 1933;52:156-165.

830. Siami GA, Siami FS. Plasmapheresis and paraproteinemia: cryoprotein-induced diseases, monoclonal gammopathy, Waldenström's macroglobulinemia, hyperviscosity syndrome, multiple myeloma, light chain disease, and amyloidosis. *Ther Apher* 1999;3:8-19.

831. Smolens P, Venkatachalam M, Stein JH. Myeloma kidney cast nephropathy in a rat model of multiple myeloma. *Kidney Int* 1983;24:192-204.

832. Johnson WJ, Kyle RA, Pineda AA, et al. Treatment of renal failure associated with multiple myeloma: plasmapheresis, hemodialysis, and chemotherapy. *Arch Intern Med* 1990;150:863–869.
833. Zucchelli P, Pasquali S, Cagnoli L, et al. Controlled plasma exchange trial in acute renal failure due to multiple myeloma. *Kidney Int* 1988;33:1175–1180.
834. Paradisi F, Corti G, Cinelli R. Infections in multiple myeloma. *Infect Dis Clin North Am* 2001;15:373–384.
835. Jacobson DR, Zolla-Pazner S. Immunosuppression and infection in multiple myeloma. *Semin Oncol* 1986;13:282–290.
836. Shaikh BS, Lombard RM, Appelbaum PC, et al. Changing patterns of infections in patients with multiple myeloma. *Oncology* 1982;39:78–82.
837. Meyers BR, Hirschman SZ, Axelrod JA. Current patterns of infection in multiple myeloma. *Am J Med* 1972;52:87–92.
838. Doughney KB, Williams DM, Penn RL. Multiple myeloma: infectious complications. *South Med J* 1988;81:855–858.
839. Rayner HC, Haynes AP, Thompson JR, et al. Perspectives in multiple myeloma: survival, prognostic factors and disease complications in a single centre between 1975 and 1988. *QJM* 1991;79:517–525.
840. Butler JC, Breiman RF, Campbell JF, et al. Pneumococcal polysaccharide vaccine efficacy. An evaluation of current recommendations. *JAMA* 1993;270:1826–1831.
841. Landesman SH, Schiffman G. Assessment of the antibody response to pneumococcal vaccine in high-risk populations. *Rev Infect Dis* 1981;3[Suppl]:S184–S197.
842. Lazarus HM, Lederman M, Lubin A, et al. Pneumococcal vaccination: the response of patients with multiple myeloma. *Am J Med* 1980;69:419–423.
843. Oken MM, Pomeroy C, Weisdorf D, et al. Prophylactic antibiotics for the prevention of early infection in multiple myeloma. *Am J Med* 1996;100:624–628.
844. Chapel HM, Lee M, Hargreaves R, et al. Randomised trial of intravenous immunoglobulin as prophylaxis against infection in plateau-phase multiple myeloma. The UK Group for Immunoglobulin Replacement Therapy in Multiple Myeloma. *Lancet* 1994;343:1059–1063.
845. Garcia-Sanz R, Montoto S, Torrequebrada A, et al. Waldenström macroglobulinaemia: presenting features and outcome in a series with 217 cases. *Br J Haematol* 2001;115:575–582.
846. Heilman RL, Velosa JA, Holley KE, et al. Long-term follow-up and response to chemotherapy in patients with light-chain deposition disease. *Am J Kidney Dis* 1992;20:34–41.
847. Kyle RA, Maldonado JE, Bayrd ED. Plasma cell leukemia: report on 17 cases. *Arch Intern Med* 1974;133:813–818.
848. Dimopoulos MA, Palumbo A, Delasalle KB, et al. Primary plasma cell leukaemia. *Br J Haematol* 1994;88:754–759.
849. Robillard N, Jego G, Pellat-Deceunynck C, et al. CD28, a marker associated with tumoral expansion in multiple myeloma. *Clin Cancer Res* 1998;4:1521–1526.
850. Avet-Loiseau H, Andree-Ashley LE, Moore D II, et al. Molecular cytogenetic abnormalities in multiple myeloma and plasma cell leukemia measured using comparative genomic hybridization. *Genes Chromosomes Cancer* 1997;19:124–133.
851. Gutierrez NC, Hernandez JM, Garcia JL, et al. Differences in genetic changes between multiple myeloma and plasma cell leukemia demonstrated by comparative genomic hybridization. *Leukemia*

2001;15:840–845.

852. Shimazaki C, Goto H, Araki S, et al. Overexpression of PRAD1/cyclin D1 in plasma cell leukemia with t(11;14)(q13;q32). *Int J Hematol* 1997;66:111–115.

853. Pruzanski W, Platts ME, Ogryzlo MA. Leukemic form of immunocytic dyscrasia (plasma cell leukemia): a study of ten cases and a review of the literature. *Am J Med* 1969;47:60–74.

854. Noel P, Kyle RA. Plasma cell leukemia: an evaluation of response to therapy. *Am J Med* 1987;83:1062–1068.

855. Pasqualetti P, Festuccia V, Collacciani A, et al. Plasma cell leukemia: a report on 11 patients and review of the literature. *Panminerva Med* 1996;38:179–184.

856. Rajkumar SV, Dispenzieri A, Lacy M, et al. Response rate and durability of response with thalidomide therapy for relapsed multiple myeloma (MM). *Blood* 2001;98:162a(abst).

857. Panizo C, Rifon J, Rodriguez–Wilhelmi P, et al. Long–term survival in primary plasma cell leukemia after therapy with VAD, autologous blood stem cell transplantation and interferon–alpha. *Acta Haematol* 1999;101:193–196.

858. Sica S, Chiusolo P, Salutari P, et al. Long–lasting complete remission in plasma cell leukemia after aggressive chemotherapy and CD34–selected autologous peripheral blood progenitor cell transplant: molecular follow–up of minimal residual disease. *Bone Marrow Transplant* 1998;22:823–825.

859. Hovenga S, de Wolf JT, Klip H, et al. Consolidation therapy with autologous stem cell transplantation in plasma cell leukemia after VAD, high–dose cyclophosphamide and EDAP courses: a report of three cases and a review of the literature. *Bone Marrow Transplant* 1997;20:901–904.

860. Yeh KH, Lin MT, Tang JL, et al. Long–term disease–free survival after autologous bone marrow transplantation in a primary plasma cell leukaemia: detection of minimal residual disease in the transplant marrow by third–complementarity–determining region–specific probes. *Br J Haematol* 1995;89:914–916.

861. Yang CH, Lin MT, Tsay W, et al. Autologous bone marrow transplantation for plasma cell leukemia: report of a case. *Transplant Proc* 1992;24:1531–1532.

862. Sajeve MR, Greco MM, Cascavilla N, et al. Effective autologous peripheral blood stem cell transplantation in plasma cell leukemia followed by T–large granular lymphocyte expansion: a case report. *Bone Marrow Transplant* 1996;18:225–227.

863. Conklin R, Alexanian R. Clinical classification of plasma cell myeloma. *Arch Intern Med* 1975;135:139–143.

864. Knowling MA, Harwood AR, Bergsagel DE. Comparison of extramedullary plasmacytomas with solitary and multiple plasma cell tumors of bone. *J Clin Oncol* 1983;1:255–262.

865. Dimopoulos MA, Mouloupoulos LA, Maniatis A, et al. Solitary plasmacytoma of bone and asymptomatic multiple myeloma. *Blood* 2000;96:2037–2044.

866. Woodruff RK, Malpas JS, White FE. Solitary plasmacytoma. II: Solitary plasmacytoma of bone. *Cancer* 1979;43:2344–2347.

867. Bataille R, Sany J. Solitary myeloma: clinical and prognostic features of a review of 114 cases. *Cancer* 1981;48:845–851.

868. Mill WB, Griffith R. The role of radiation therapy in the management of plasma cell tumors. *Cancer* 1980;45:647–652.

869. Liebross RH, Ha CS, Cox JD, et al. Solitary bone plasmacytoma: outcome and prognostic factors following radiotherapy. *Int J Radiat Oncol Biol Phys* 1998;41:1063–1067.

870. Bolek TW, Marcus RB, Mendenhall NP. Solitary plasmacytoma of bone and soft tissue. *Int J Radiat*

Oncol Biol Phys 1996;36:329–333.

871. Dimopoulos MA, Kiamouris C, Mouloupoulos LA. Solitary plasmacytoma of bone and extramedullary plasmacytoma. *Hematol Oncol Clin North Am* 1999;13:1249–1257.
872. Galièni P, Cavo M, Pulsoni A, et al. Clinical outcome of extramedullary plasmacytoma. *Haematologica* 2000;85:47–51.
873. Hussong JW, Perkins SL, Schnitzer B, et al. Extramedullary plasmacytoma: a form of marginal zone cell lymphoma? *Am J Clin Pathol* 1999;111:111–116.
874. Mayr NA, Wen BC, Hussey DH, et al. The role of radiation therapy in the treatment of solitary plasmacytomas. *Radiother Oncol* 1990;17:293–303.
875. Brinch L, Hannisdal E, Abrahamsen AF, et al. Extramedullary plasmacytomas and solitary plasma cell tumours of bone. *Eur J Haematol* 1990;44:132–135.
876. Shih LY, Dunn P, Leung WM, et al. Localised plasmacytomas in Taiwan: comparison between extramedullary plasmacytoma and solitary plasmacytoma of bone. *Br J Cancer* 1995;71:128–133.
877. Woodruff RK, Whittle JM, Malpas JS. Solitary plasmacytoma. I: Extramedullary soft tissue plasmacytoma. *Cancer* 1979;43:2340–2343.
878. Corwin J, Lindberg RD. Solitary plasmacytoma of bone vs. extramedullary plasmacytoma and their relationship to multiple myeloma. *Cancer* 1979;43:1007–1013.
879. Holland J, Trenkner DA, Wasserman TH, et al. Plasmacytoma: treatment results and conversion to myeloma. *Cancer* 1992;69:1513–1517.
880. Evison G, Evans KT. Sclerotic bone deposits in multiple myeloma (letter). *Br J Radiol* 1983;56:145.
881. Driedger H, Pruzanski W. Plasma cell neoplasia with peripheral polyneuropathy: a study of five cases and a review of the literature. *Medicine (Baltimore)* 1980;59:301–310.
882. Dispenzieri A, Kyle RA, Lacy MQ, et al. POEMS syndrome: definitions and long-term outcome. *Blood* 2003;101:2496–2506.
883. Soubrier MJ, Dubost JJ, Sauvezie BJ. POEMS syndrome: a study of 25 cases and a review of the literature. French Study Group on POEMS Syndrome. *Am J Med* 1994;97:543–553.
884. Miralles GD, O'Fallon JR, Talley NJ. Plasma-cell dyscrasia with polyneuropathy: the spectrum of POEMS syndrome. *N Engl J Med* 1992;327:1919–1923.
885. Takatsuki K, Sanada I. Plasma cell dyscrasia with polyneuropathy and endocrine disorder: clinical and laboratory features of 109 reported cases. *Jpn J Clin Oncol* 1983;13:543–555.
886. Hashiguchi T, Arimura K, Matsumuro K, et al. Highly concentrated vascular endothelial growth factor in platelets in Crow-Fukase syndrome. *Muscle Nerve* 2000;23:1051–1056.
887. Watanabe O, Arimura K, Kitajima I, et al. Greatly raised vascular endothelial growth factor (VEGF) in POEMS syndrome (Letter). *Lancet* 1996;347:702.
888. Morley JB, Schwieger AC. The relation between chronic polyneuropathy and osteosclerotic myeloma. *J Neurol Neurosurg Psychiatry* 1967;30:432–442.
889. Davis LE, Drachman DB. Myeloma neuropathy: successful treatment of two patients and review of cases. *Arch Neurol* 1972;27:507–511.
890. Philips ED, el-Mahdi AM, Humphrey RL, et al. The effect of the radiation treatment on the polyneuropathy of multiple myeloma. *J Can Assoc Radiol* 1972;23:103–106.
891. Iwashita H, Ohnishi A, Asada M, et al. Polyneuropathy, skin hyperpigmentation, edema, and

hypertrichosis in localized osteosclerotic myeloma. *Neurology* 1977;27:675–681.

892. Rovira M, Carreras E, Bladé J, et al. Dramatic improvement of POEMS syndrome following autologous haematopoietic cell transplantation. *Br J Haematol* 2001;115:373–375.

893. Hogan WJ, Lacy MQ, Wiseman GA, et al. Successful treatment of POEMS syndrome with autologous hematopoietic progenitor cell transplantation. *Bone Marrow Transplant* 2001;28:305–309.

894. Dispenzieri A, Lacy MQ, Litzow MR, et al. Peripheral blood stem cell transplant (PBSCT) in patients with POEMS syndrome. *Blood* 2001;98: 391b(abst).

895. Judge MR, McGibbon DH, Thompson RP. Angioendotheliomatosis associated with Castleman's lymphoma and POEMS syndrome. *Clin Exp Dermatol* 1993;18:360–362.

896. Ku A, Lachmann E, Tunkel R, et al. Severe polyneuropathy: initial manifestation of Castleman's disease associated with POEMS syndrome. *Arch Phys Med Rehabil* 1995;76:692–694.

897. Reitan JB, Pape E, Fossa SD, et al. Osteosclerotic myeloma with polyneuropathy. *Acta Med Scand* 1980;208:137–144.

\*This work was supported in part by grants CA 91561, CA 62242, and CA 2115 from the National Cancer Institute.

2004 Lippincott Williams & Wilkins  
John P. Greer, John Foerster, John N. Lukens  
George M. Rodgers, Frixos Paraskevas, Bertil Glader  
Wintrobe's Clinical Hematology

## Immunoglobulin Light-Chain Amyloidosis (Primary Amyloidosis)\*

### HISTORY

### CLASSIFICATION

### SUSPECTING PRIMARY AMYLOIDOSIS

### DIAGNOSING PRIMARY AMYLOIDOSIS

### DIFFERENTIATING PRIMARY AMYLOIDOSIS FROM OTHER FORMS

### PRESENTATION AND CLINICAL FEATURES

#### Cardiac

#### Renal

#### Hepatic

#### Gastrointestinal Tract

#### Nervous System

#### Respiratory Tract

#### Coagulation System

### PROGNOSTIC FEATURES

### TREATMENT

#### Supportive Therapy for Primary Amyloidosis

#### Nonchemotherapy Treatment

#### Measuring Responses in Primary Amyloidosis

#### Chemotherapy for Primary Amyloidosis

#### Stem Cell Transplantation

### CONCLUSION

### REFERENCES

## HISTORY

The term lardaceous change has... come more into use chiefly through the instrumentality of the Vienna School... The term, lardaceous changes... has but very little to do with these tumours, and rather refers to things, upon which the old writers... who were better connoisseurs in bacon than our friends in Vienna, would hardly have bestowed such a name... The appearance of such organs... are said to look like bacon, bears... a much greater resemblance to wax, and I have therefore now for a long time... made use of the term waxy change... These structures... by the simple action of iodine... assume just as blue a colour as vegetable starch... ( 1 ).

On April 17, 1858, Rudolph Virchow gave a lecture entitled “Amyloid Degeneration.” Virchow defined how amyloid deposits stained blue with iodine and sulfuric acid. This chemical reaction was a marker for starch. Virchow concluded the substance was composed of wax, and coined the term *amyloia* ( 2 ). Virchow also used the opportunity to criticize Karl von Rokitansky. Virchow headed the pathology department in Berlin; Rokitansky was his chief competitor in Vienna. Rokitansky believed that amyloid was the deposition of a lardlike substance in patients with syphilis, tuberculosis, or malaria ( 3 ), perhaps because the amyloid deposits were white and glistening. Virchow believed incorrectly that amyloid was made of starch because of the iodine-sulfuric acid reaction; Rokitansky believed it was a fatty substance ( 4 ). Matthias Schleiden, a German botanist, coined the term “amyloid” in 1838 to describe a normal constituent of plants ( 5 , 6 and 7 ).



It was 1859 when Friedreich, Nikolau, and Kekule recognized that the waxy spleen described by Virchow did not contain any starchlike substances and was probably derived from modified proteins. Kekule was famous in his own right at the time for describing the structure of benzene from his dream of a serpent biting its own tail. Friedreich also gave the first description of a form of ataxia that now bears his name ( [8](#), [9](#) ).

George Budd (1808–1882) analyzed the liver of a patient with amyloidosis and found that it had a low fat content and was not lardaceous; he also made original descriptions of rickets and scurvy ( [10](#) ). The first reported case of primary amyloidosis (AL) (“idiopathic” from the terminology of the day) was probably made by Sir Samuel Wilks, who reported on a 52-year-old patient with lardaceous change unrelated to an obvious cause ( [11](#), [12](#) and [13](#) ). Wilks was the first to use bromide for the treatment of epilepsy and made an original description of myasthenia gravis. The amino acid composition of amyloid was first described by Schmiedeberg in 1920 ( [14](#) ). The amyloid strongly resembled serum globulin and was therefore neither fat nor carbohydrate. The first description of Congo red as the specific stain for the detection of amyloid was made in 1922 by Hermann Bennhold ( [15](#) ). In 1927, green birefringence of amyloid-laden material under polarized light was reported by Divry and Florin in the brain of a patient with Alzheimer disease ( [16](#), [17](#) ). The recognition that the neurodegeneration of Alzheimer disease was associated with amyloid was forgotten for nearly 50 years. Magnus-Levy postulated that the Bence Jones protein was a precursor of the amyloid substance, noting a relationship among amyloid, the Bence Jones protein, and multiple myeloma ( [18](#) ).

The finding that amyloid represented a fibril is credited to Cohen and Calkins in 1959 ( [4](#) ). They found that all forms of amyloid were nonbranching and fibrillar. The fibril length varied and had a width of 9.5 nm. Apitz claimed that amyloid in the tissues was analogous to the excretion of immunoglobulin light chain proteins by the kidneys ( [19](#), [20](#) ). Apitz coined the term “paraprotein” to describe monoclonal immunoglobulins. The Bence Jones proteins were reported to have a direct role in the pathogenesis of AL by Osserman in 1964 ( [21](#) ). Normal proteins are configured as an alpha helix. Using x-ray diffraction, Eanes and Glenner ( [22](#) ) in 1968 reported that amyloid formed the alternate configuration of a beta-pleated sheet, a configuration found in silk ( [23](#) ). Silk is highly resistant to solvents. The resistance of amyloid to solubilization is used in its purification. Amyloid is repeatedly homogenized in saline, and the supernatant, which is soluble, is discarded. The residual pelleted material contains the amyloid and, when suspended in distilled water, yields a relatively pure preparation of amyloid fibrils. Pras first described the purification of amyloid in 1968 ( [24](#) ). Levin sequenced the first amyloid protein and labeled it amyloid A ( [25](#) ). Earl Benditt independently reported the same structural finding ( [26](#), [27](#) ). The first sequence reported of an immunoglobulin light-chain form of amyloid was in 1970 by Glenner ( [28](#) ). It was recognized to be a fragment of the N-terminus of the immunoglobulin light chain and not the intact immunoglobulin light chain ( [28](#), [29](#), [30](#), [31](#) and [32](#) ).

## CLASSIFICATION

The diagnosis of amyloid requires tissue biopsy proof of deposits that stain positively for Congo red ( [33](#) ). With hematoxylin and eosin staining, amyloid deposits are hyaline appearing. The deposits are always extracellular and appear amorphous. Apple-green birefringence is seen when Congo red-stained material is viewed under polarized light ( [34](#) ). False-positive results can occur, however, particularly if the stain is not used regularly. The Congo red stain can be technically difficult to use, for example, and can form precipitates, yielding false-positive results ( [35](#) ). All forms of amyloid have a fibrillar

appearance under the electron microscope and are rigid and nonbranching, but all fibrils so identified do not represent amyloid ( 36, 37 and 38 ). The finding of fibrils on the electron microscope is strongly suggestive, but in the absence of a positive Congo red stain and apple-green birefringence, the diagnosis remains unconfirmed.

The classification of amyloidosis has undergone revisions as the understanding of the pathophysiology of the disease has improved. In the nineteenth century, anatomic involvement of the liver, spleen, and kidneys was incorrectly thought to represent secondary amyloidosis (AA); amyloid that would involve the heart, tongue, and peripheral nerves was classified as primary amyloidosis (AL), or idiopathic in the nomenclature of the era. Later, amyloid was classified by the site of first deposition and was referred to as *pericollagenous* or *perireticular* ( 39, 40 ). Familial amyloidosis (AF) was recognized generally by the presentation of progressive painful peripheral neuropathy with an autosomal-dominant inheritance pattern ( 41, 42 ). Families with inherited renal amyloidosis were also described ( 43, 44 ). In the nineteenth century, when tuberculosis, leprosy, syphilis, and chronic infections were prevalent, the secondary form of amyloidosis was regularly seen. In the postantibiotic era, chronic inflammatory polyarthritis, including ankylosing spondylitis and juvenile rheumatoid arthritis, are more commonly associated with AA. Crohn disease and chronic osteomyelitis are also responsible for a small number of AA patients in the West ( 45 ). One hundred years ago, when “primary amyloid” referred to idiopathic amyloid and included all cases that were neither familial nor secondary, cases of unrecognized familial amyloid and secondary amyloid for which a cause could not be established were mistakenly labeled primary. AL now refers only to patients whose amyloidosis is immunoglobulin light-chain derived. A clonal plasma cell disorder exists in all instances, part of a spectrum extending from patients who have a small plasma cell clone to those with frank overt multiple myeloma ( 46 ). A classification of the various forms of amyloid is given in [Table 99.1](#).

**TABLE 99.1. Nomenclature of Amyloidosis**

| Protein           | Precursor                           | Clinical   |
|-------------------|-------------------------------------|--|
| AL or AH          | Immunoglobulin light or heavy chain | Primary or localized; myeloma or macroglobulinemia association |
| AA                | SAA                                 | Secondary or familial Mediterranean fever                      |
| ATTR              | Transthyretin                       | Familial and senile  |
| A                 | Fibrinogen                          | Familial renal amyloidosis (Ostertag)                          |
| AB <sub>2</sub> M | β <sub>2</sub> -Microglobulin       | Dialysis-associated carpal tunnel syndrome                     |
| AB                | ABPP                                | Alzheimer disease  |
| ApoAI, AII        | Apolipoprotein                      | Renal, nephrotic syndrome                                      |
| Lysozyme          | Lysozyme                            | Renal, hepatic rupture   |

AA, secondary amyloidosis; ABPP, amyloid β protein precursor; AH, immunoglobulin heavy chain amyloid; AII, apolipoprotein AII amyloid; AL, primary amyloidosis; ApoAI, apolipoprotein AI amyloid; ATTR, amyloid transthyretin; SAA, serum amyloid A.

From Gertz MA, Lacy MQ, Dispenzieri A. Immunoglobulin light chain amyloidosis (primary amyloidosis). In: Gertz MA, Greipp PR, eds. Hematologic malignancies: multiple myeloma and related plasma cell disorders. Berlin: Springer-Verlag, 2004:157-195. By permission of Mayo Foundation.

Human monoclonal immunoglobulin light chains can be converted to amyloid fibrils by digestion with pepsin *in vitro* ( [30](#) ). Amyloid fibrils can be produced synthetically by breaking the disulfide bonds of intact immunoglobulins. Originally, all forms of amyloid were thought to be related to misfolding of the fragments of immunoglobulin light chains, but heavy-chain fragments have also been found to produce amyloid and have been given the designation AH ( [47](#) ). AL patients have immunoglobulin light chains that have an abnormal tertiary structure and an abnormal amino acid sequence ( [48](#), [49](#) ). Generally, they tend to have a higher  $\beta$ -pleated sheet content than an  $\alpha$ -helical structure. If mice are injected with purified immunoglobulin light chains derived from the urine of patients with multiple myeloma who do not have amyloid, no renal dysfunction is seen ( [50](#) ). If light chains purified from the urine of patients with AL are injected, the mice develop deposits of human AL. In AL, three-fourths of the immunoglobulin light chains are of the  $\lambda$  group. In multiple myeloma and monoclonal gammopathy of undetermined significance, two-thirds of the light chains are of the  $\lambda$  group ( [45](#) ). The implication is that  $\lambda$  immunoglobulin light chains have a greater tendency to form a  $\beta$ -pleated sheet. The  $\lambda$   $\nu_1$  subgroup of immunoglobulin light chain is always associated with amyloid, suggesting that there are unique amino acid sequences that result in amyloidogenic proteins ( [51](#) ).

The distinction between amyloidosis and amyloidosis associated with multiple myeloma is somewhat arbitrary. Significant overlap exists. Finding a patient with amyloidosis who has widespread lytic bone disease, rib fractures, or lumbar spine compression fractures is uncommon ( [52](#) ). Renal insufficiency in an amyloid patient almost never owes to the formation of light-chain casts, as is the case in multiple myeloma. In patients with amyloid, the renal failure owes to tubular atrophy, a consequence of long-standing albuminuria ( [53](#), [54](#) ). Often the distinction among multiple myeloma associated amyloid and amyloid AL has been made on the basis of the percentage of plasma cells in the bone marrow ( [55](#) ). Serial bone marrow biopsies in patients with AL do not demonstrate a progressive increase in the plasma cell percentage. In amyloid, the process is clonal but is not typically proliferative, and the unrestrained growth associated with malignancy is not present. Patients with AL who have 10 to 30% plasma cells do not go on to develop multiple myeloma if it is not present at diagnosis. Less than one-half of 1% of amyloid patients go on to develop multiple myeloma ( [46](#) ). The authors have established an arbitrary threshold of 30% plasma cells to fulfill the criteria of multiple myeloma-associated amyloid if no other clinical features of multiple myeloma are present. In patients who have greater than 30% plasma cells in the bone marrow, the clinical course is dominated by their AL and not by myeloma bone disease or myeloma-induced anemia.

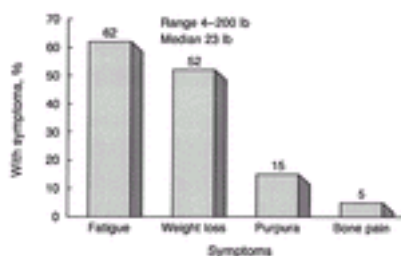
The incidence of AL is 8 per million per year and has been stable for more than 50 years ( [56](#) ). Multiple myeloma is four times more prevalent than amyloidosis ( [57](#) ). The incidence of amyloidosis, although considered rare, is similar to that of Hodgkin disease (nodular sclerosing variant), chronic granulocytic leukemia (Philadelphia chromosome-positive), and polycythemia rubra vera ( [58](#), [59](#) and [60](#) ). Bone marrow plasma cells from AL patients typically show chromosomal abnormalities ( [61](#) ). Trisomies of chromosomes 7, 9, 11, 15, and 18 were seen in 42%, 52%, 47%, 39%, and 33%, respectively. Fifty-four percent of men and 13% of women showed trisomy X; 72% of AL patients have deletion of chromosome 18. The finding of aneuploidy in the monoclonal plasma cells supports the neoplastic nature despite the fact that these plasma cells are nonproliferative and are present in small numbers (median, 5% plasma cells) ( [62](#) ). An early pathogenetic event in the development of multiple myeloma is translocation at the immunoglobulin heavy-chain locus (band 14q32) ( [63](#), [64](#) ). Sixteen of 29 AL patients showed definite translocations at the immunoglobulin heavy-chain locus (55%). An additional 17% demonstrated a pattern

compatible with a possible immunoglobulin H (IgH) translocation (65). Overall, an IgH translocation was seen in 21 of 29 patients by fluorescent *in situ* hybridization analysis. Of the 21, 16 were t(11;14)(q13;q32). Fifteen of the 16 patients demonstrated 11;14 translocations, with cyclin D1 overexpression accounting for 76% of all IgH translocations.

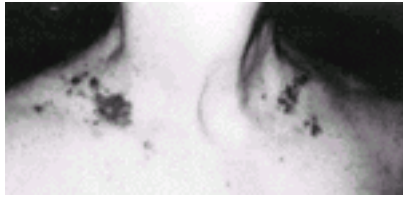
Light-chain amyloid AL is a monoclonal immunoglobulin plasma cell disorder. AL may be misdiagnosed as multiple myeloma because both have a monoclonal immunoglobulin, a high prevalence of proteinuria, and bone marrow plasmacytosis. AL should always be in the differential diagnosis when a patient is seen with monoclonal gammopathy of undetermined significance or is suspected of having multiple myeloma.

## SUSPECTING PRIMARY AMYLOIDOSIS

Weight loss, paresthesias, edema, dyspnea, and fatigue are the most common symptoms associated with AL (66) (Fig. 99.1). These complaints are nonspecific and provide little help to a clinician trying to evaluate patients. Patients with extreme degrees of weight loss frequently undergo an evaluation for an occult malignancy. The fatigue, which is usually caused by early cardiac involvement with AL, is generally not associated with overt congestive heart failure and can easily be diagnosed incorrectly as being stress related or functional (67). The authors have seen scores of patients undergo coronary angiography because of fatigue and breathlessness, and when the angiogram is normal, the evaluation frequently is stopped (68). Lightheadedness occurs frequently but is nonspecific because it is such a common complaint in the primary care setting. In AL, the etiology of lightheadedness is multifactorial (69). Patients with nephrotic syndrome developed dizziness owing to hypoalbuminemia and a significant intravascular volume contraction, which leads to orthostatic hypotension (70). Patients with cardiac AL have a low end-diastolic volume owing to restriction to filling during diastole (71). Cardiac AL patients have a low cardiac output but maintain a normal ejection fraction until late in the course of the disease. The echocardiographic finding of the normal ejection fraction can be highly misleading in recognizing AL. Patients can have orthostatic hypotension as a consequence of autonomic neuropathy, and syncope is not unusual (72, 73). The physical findings of amyloidosis are specific and diagnostic; however, they are present in only 15% of patients and may easily be overlooked. Amyloid purpura is seen in only one patient in six (Fig. 99.2) (74). Purpura may be periorbital but also can occur in the face, webbing of the neck, and upper chest. Purpura on the arms is not characteristic of AL, but petechial lesions on the eyelids should not be overlooked.



**Figure 99.1.** Prevalence of symptoms in patients with primary amyloidosis evaluated within 1 month before or after diagnosis at the Mayo Clinic, 1981–1992. (From Kyle RA, Gertz MA. Primary systemic amyloidosis. Clinical and laboratory features in 474 cases. *Semin Hematol* 1995;32:45–59, with permission.)



**Figure 99.2.** Classic truncal purpura in primary amyloidosis. (From Gertz MA, Lacy MQ, Dispenzieri A. Amyloidosis. *Hematol Oncol Clin North Am* 1999;13:1211–1233, with permission.)

The liver is palpable 5 cm below the right costal margin in only 10% of patients. Splenomegaly, if present, is usually of modest degree. Overall, any degree of hepatomegaly is present in one-fourth of patients ( [75](#) ).

Macroglossia is the most specific finding in AL ( [Fig. 99.3](#) ). In the authors' experience, enlargement of the tongue is never found in AF, AA, or senile systemic amyloidosis ( [76](#) ). Tongue enlargement is seen in one patient in eleven with AL and can be overlooked easily unless dental indentations are sought for on the underside of the tongue. Patients presenting with fatigue, edema, breathlessness, or paresthesias would not immediately alert the physician to examine the tongue. Tongue enlargement is almost always accompanied by concomitant enlargement of the submandibular salivary glands ( [77](#) ). This involvement of salivary glands with amyloid should not be misinterpreted as submandibular lymphadenopathy. Salivary gland involvement, major and minor, is responsible for the sicca syndrome that these patients frequently demonstrate. Sjögren syndrome has been reported with AL ( [78](#) ). Vascular involvement with amyloid without visceral organ dysfunction has been reported. Vascular involvement produces occlusion and ischemic symptoms, including jaw claudication when the temporal arteries are involved ( [79](#) ), and calf and limb claudication when microvasculature supplying the extremities is involved ( [80](#) ). The presence of a monoclonal protein in the serum can elevate the sedimentation rate, and it is not unusual for amyloid patients with jaw claudication to be misdiagnosed as having polymyalgia rheumatica ( [81](#) ). If a temporal artery biopsy is performed, amyloid deposits are found, but Congo red staining is not typically performed on temporal artery biopsy specimens ( [80](#), [82](#) ). The shoulder-pad sign is a consequence of periarticular infiltration with amyloid and may produce pseudohypertrophy. Although the musculature and the shoulder and hip girdles are enlarged, these patients present with diffuse muscular weakness ( [83](#), [84](#) ) and may have muscular atrophy owing to chronic vascular occlusion.



**Figure 99.3.** Tongue enlargement in primary amyloidosis. (From Gertz MA, Lacy MQ, Dispenzieri A. Amyloidosis. *Hematol Oncol Clin North Am* 1999;13:1211–1233, with permission.)

## DIAGNOSING PRIMARY AMYLOIDOSIS

When should a clinician suspect AL and begin a diagnostic algorithm to confirm the diagnosis? The symptoms and physical findings of AL are nonspecific and generally not helpful to the clinician. There are seven critical clinical syndromes commonly associated with amyloid that should trigger screening: (a) gastrointestinal tract symptoms of pseudoobstruction or steatorrhea, (b) tongue enlargement, (c) carpal tunnel syndrome, (d) hepatomegaly, (e) peripheral neuropathy, (f) nephrotic-range proteinuria, and (g) infiltrative cardiomyopathy with restrictive hemodynamics. The diagnosis of AL must be considered when any one of these syndromes is seen ( [Table 99.2](#)). Any patient in whom the diagnosis of multiple myeloma is being considered and who has associated, unexplained weight loss or fatigue or a percentage of plasma cells in the bone marrow that does not meet the criteria of multiple myeloma must be investigated for AL.

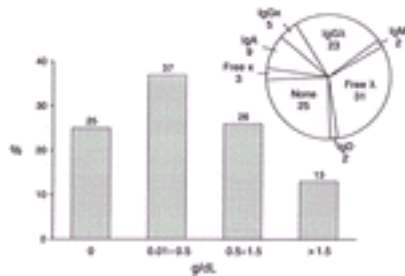
**TABLE 99.2. Syndromes in Primary Amyloidosis**

| Syndrome                                 | Patients (%) |
|--|--------------|
| Nephrotic or nephrotic and renal failure | 30           |
| Hepatomegaly                             | 24           |
| Congestive heart failure                 | 22           |
| Carpal tunnel                            | 21           |
| Neuropathy                               | 17           |
| Orthostatic hypotension                  | 12           |

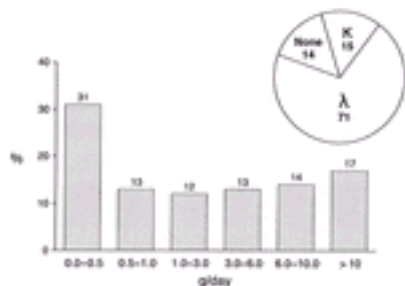
From Gertz MA, Lacy MQ, Dispenzieri A. Immunoglobulin light chain amyloidosis (primary amyloidosis). In: Gertz MA, Greipp PR, eds. *Hematologic malignancies: multiple myeloma and related plasma cell disorders*. Berlin: Springer-Verlag, 2004:157–195. By permission of Mayo Foundation.



The most important screening test in a patient with cardiomyopathy, neuropathy, hepatomegaly, or proteinuria is immunofixation of the serum and urine (85). A clonal population of plasma cells was seen in all AL patients (86). The insoluble, fibrillar  $\beta$ -pleated sheet of amyloid is derived from the monoclonal immunoglobulin light chains produced by a clonal population of plasma cells. In any patient with a compatible clinical syndrome that has a monoclonal gammopathy, the diagnosis of AL should be pursued aggressively. Electrophoresis of the serum is an inadequate screening test. To screen for AL, immunofixation of urine and serum is necessary. The urine must be evaluated because one-fourth of patients with AL fail to demonstrate a monoclonal light chain in the serum (Fig. 99.4). Serum electrophoresis is inadequate because the light chains in AL are frequently present in trace amounts in the serum and do not produce a spike on an electrophoretic pattern. Monoclonal proteins in the urine are frequently difficult to detect because the majority of patients have significant degrees of proteinuria, which can obscure small amounts of light chains (Fig. 99.5). If amyloid is being considered, immunofixation of serum or urine, or both, is essential.



**Figure 99.4.** Amount of serum monoclonal protein in patients with primary amyloidosis and immunofixation results. Ig, immunoglobulin. (From Gertz MA, Lacy MQ, Dispenzieri A. Amyloidosis. In: Mehta J, Singhal S, eds. Myeloma. London: Martin Dunitz, 2002:445-463, with permission.)



**Figure 99.5.** Distribution of 24-hour urine total protein and immunofixation results in primary amyloidosis. (From Gertz MA, Lacy MQ, Dispenzieri A. Amyloidosis. In: Mehta J, Singhal S, eds. Myeloma. London: Martin Dunitz, 2002:445-463, with permission.)

A monoclonal light chain can be detected in the serum or urine, or both, of nearly 90% of AL patients. In a patient with a suggestive clinical syndrome, immunofixation is the single best noninvasive screening test. In patients who do not have light chains in the serum or urine, the bone marrow demonstrates a clonal population of plasma cells by flow cytometry, immunofluorescence, or immunohistochemistry (87, 88). Such patients have light chains below the threshold of detection by immunofixation (89). This can occur because the levels are low or because the light chain fragments do not express antigenic



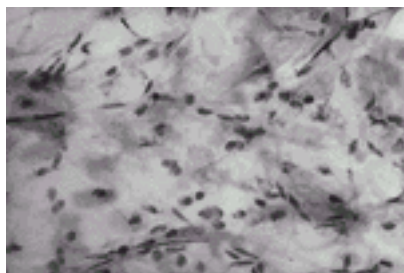
determinants that are recognizable by commercially available antisera. In patients with confirmed AL who did not have a detectable monoclonal protein in the serum or urine, 94% had a clonal population of plasma cells in the bone marrow with a slide-based immunofluorescence test to detect the expression of clonal cytoplasmic immunoglobulin. If the patient has neither a monoclonal protein in the serum or urine nor a clonal population of plasma cells in the bone marrow, the diagnosis of AL is in question. If amyloidosis is present, it is likely not immunoglobulin light chain-derived, and further evaluation for familial, secondary, or localized amyloidosis should be performed.

The nephelometric assay for serum free light chains has improved the authors' ability to recognize AL; it detects free immunoglobulin light chains not associated with an intact immunoglobulin molecule ( [90](#), [91](#) ). This test was performed in 100 consecutive AL patients. In patients with known ? amyloid, the free light chain assay had a sensitivity of 90%. In patients with known ? AL, a similar sensitivity was seen. In patients who had a known urinary light chain but did not have a detectable monoclonal protein on serum immunofixation, the free light chain assay found free light chains in the serum of 85% of patients with ? and 80% of patients with ? AL. In patients with AL who were carefully evaluated and had no monoclonal protein in the serum or in the urine by immunofixation, the nephelometric light chain assay found a free ? light chain in 86% of ? AL and 30% of ? AL. The free light chain assay is particularly important in patients who do not have light chains detectable by immunofixation. The serum assay is convenient and adds an important diagnostic tool for classifying and potentially monitoring AL patients.

All forms of amyloid contain the amyloid P component. Amyloid P component is structurally related to C-reactive protein, but is not an acute-phase reactant in humans ( [92](#) ). Amyloid P component is a pentagonal glycoprotein that can comprise as much as 10% of the amyloid fibril by weight. Amyloid P component is in dynamic equilibrium with the amyloid fibril and is not irreversibly bound. P component maintains a relatively stable plasma concentration throughout one's life and is found in all vertebrates. Because serum amyloid P (SAP) exchanges readily with the amyloid P component, amyloid deposits can be demonstrated visually via 123-iodine-labeled SAP scanning ( [93](#), [94](#) ). In addition, the clearance of the radiolabeled P components (125-iodine-labeled SAP) in the plasma can be used to assess the total body burden of amyloid and to evaluate the impact of therapy ( [95](#) ). Patients with high burdens of amyloid clear the radiolabeled P component quickly. Patients with only trace amounts of systemic amyloid have plasma clearances close to those of normal adults. The P component scan can be performed serially to assess whether patients are having increasing depositions of AL or improvement. The technique does not determine whether the amyloid is AL, AF, AA, or localized. The technique is not sensitive in detecting cardiac amyloid and is generally used in conjunction with echocardiography ( [96](#) ). Uptake is seen in the spleen, liver, and kidneys in 87%, 60%, and 25% of patients, respectively. Rapid plasma clearance of amyloid P component is associated with a shorter survival. Imaging does not regularly demonstrate deposits in the carpal tunnel, the kidney, and the gastrointestinal tract. In normal adults, there is 50 to 100 mg of amyloid P component in the extravascular and intravascular compartments, whereas patients with amyloid can have as much as 20,000 mg. There is a poor correlation between imaging and the extent of organ dysfunction assessed clinically. Amyloid distributes heterogeneously within individual organs. Iodine-labeled SAP scanning is not available in the United States.

The diagnosis of amyloidosis must always be confirmed by tissue biopsy ( [97](#) ). In patients who have neuropathy, nephrotic syndrome, cardiac failure, or hepatomegaly, the diagnosis could be established by direct biopsy of these organs ( [97](#) ), but an invasive visceral biopsy is usually not required to confirm AL. Because amyloid is widespread at diagnosis, and extensive vascular involvement is seen ( [98](#) ), less invasive biopsies can establish the diagnosis at lower risk and lower cost. When the authors see a patient with a syndrome

consistent with AL and the patient is confirmed to have a monoclonal protein, their diagnostic evaluation begins with a subcutaneous fat aspirate and bone marrow biopsy ( [99](#) ). The subcutaneous fat aspirate is a risk-free procedure performed by registered nurses ( [100](#) ) and has a sensitivity of 75%. Results are available within 24 hours ( [Fig. 99.6](#) ). Amyloid deposits are seen in one-half of the bone marrow biopsies performed in patients with AL, generally in blood vessels ( [101](#) ). Bone marrow biopsy is justified in any patient who has a monoclonal immunoglobulin light chain to exclude the diagnosis of multiple myeloma. Knowledge of the percentage of bone marrow plasma cells is prognostically important ( [102](#) ). [Table 99.3](#) gives the results when bone marrow biopsy and fat aspiration are performed in AL patients. With Congo red studies of fat and bone marrow, the diagnosis is established in 87%. In the remaining 13%, the diagnosis can be established by biopsy of the affected organ.



**Figure 99.6.** Subcutaneous fat aspirate demonstrates amyloid. (× 100.) (From Gertz MA, Lacy MQ, Dispenzieri A. Amyloidosis. In: Mehta J, Singhal S, eds. Myeloma. London: Martin Dunitz, 2002:445–463, with permission.)

**TABLE 99.3. Noninvasive Biopsies in Primary Amyloidosis**

| Finding |          | Patients (%) |
|---------|----------|--------------|
| Fat +   | Marrow + | 55           |
| Fat +   | Marrow – | 22           |
| Fat –   | Marrow + | 10           |
| Fat –   | Marrow – | 13           |

+, tissue positive for amyloid deposits; –, tissue negative for amyloid deposits.  
 Modified from Gertz MA, Lacy MQ, Lust JA, et al. Prospective randomized trial of melphalan and prednisone versus vincristine, carmustine, melphalan, cyclophosphamide, and prednisone in the treatment of primary systemic amyloidosis. *J Clin Oncol* 1999;17:262–267. By permission of the American Society of Clinical Oncology.

Other less invasive biopsies can establish a diagnosis of AL. It is recognized that xerostomia in amyloidosis owes to salivary gland infiltration, and lip biopsies have a high sensitivity ( [103](#), [104](#) ). In one study, this ranged as high as 87%. Subcutaneous blood vessels can be accessed via skin biopsy and may demonstrate AL deposits ( [105](#), [106](#) ). Amyloid was regularly confirmed by rectal biopsy in the 1970s and 1980s ( [107](#) ). Rectal biopsy is an outpatient procedure, although occasionally it could result in bleeding. Endoscopic biopsies are frequently inadequate because submucosa is essential for specimen

adequacy.

A typical clinical example of a patient coming to the Mayo Clinic would be a referral to a nephrologist for evaluation of nephrotic syndrome. Nephrologists there perform immunofixation of serum and urine as a screen in all nephrotic syndrome patients. If positive, a fat aspiration is performed, and this eliminates the need for a diagnostic renal biopsy in 70% of patients. The net result is a reduced risk of bleeding, hospitalization, and expense.

The Congo red stain is not easily done and interpreted. Congo red can precipitate in tissue, and this overstaining, particularly in subcutaneous fat, can produce a false-positive result ( [108](#) ). Skin and subcutaneous fat have a high content of elastin and collagen, which binds Congo red and can also be interpreted as positive ( [109](#) ). Rectal biopsy specimens containing amyloid can be misinterpreted as collagenous colitis if stained only with hematoxylin and eosin ( [110](#) ). With hematoxylin and eosin, renal amyloid can be misinterpreted as glomerular hyalinization. To recognize amyloid in the myocardium, our cardiac pathologists prefer a sulfated Alcian blue stain ( [111](#) ). The Peripheral Nerve Laboratory at the Mayo Clinic stains sural nerve biopsy specimens with crystal violet as a screen and confirms the diagnosis subsequently with Congo red ( [112](#) ).

## DIFFERENTIATING PRIMARY AMYLOIDOSIS FROM OTHER FORMS

It is important that the diagnosis of amyloid be confirmed as AL, AF, or AA because the therapy for the three syndromes is different ( [113](#), [114](#) ). Localized ( [115](#) ), familial ( [116](#) ), AA ( [117](#) ), and senile systemic forms of amyloid ( [118](#) ) are not associated with a plasma cell dyscrasia. Except in the rare instance of a patient with one of these forms of amyloid and an incidental monoclonal gammopathy of undetermined significance, only AL patients have monoclonal light chains in the serum and urine or clonal plasma cells in the marrow.

Patients with localized amyloidosis can present with hematuria ( [119](#) ), respiratory difficulties ( [120](#) ), and visual disturbances ( [121](#) ) and can easily be confused with those who have the systemic form. The localized amyloid syndrome, usually involving the skin, tracheobronchial tree, or urogenital tract, never becomes systemic. The fibrils of localized amyloid are immunoglobulin light chain derived ( [122](#) ), but a plasma cell dyscrasia is not seen in the bone marrow. It is thought that the production of localized amyloid owes to plasma cells at the site producing the insoluble light chains.

The location of the amyloid is an important clue in recognizing the amyloid as being localized. The most frequent sites of localized amyloid are respiratory tract, genitourinary tract, and skin ( [114](#), [123](#) ). Pulmonary amyloid can be subdivided into nodular, tracheobronchial, or diffuse interstitial. Only the last represents a manifestation of systemic AL ( [124](#) ). The diagnosis of tracheobronchial amyloidosis is via bronchoscopy while evaluating a patient with obstruction, cough, dyspnea, wheezing, or hemoptysis. The usual treatment is yttrium-aluminum-garnet laser resection of the tissue ( [125](#) ).

Tracheobronchial amyloid deposits are derived from immunoglobulin light chains ( [126](#) ). The nodular forms of amyloid present as solitary pulmonary nodules or multiple nodules. This does not represent the systemic form of AL ( [127](#) ). These nodules are not calcified and often require resection to exclude a diagnosis of malignancy. The diagnosis is made at thoracotomy or a video thoracoscopic surgical procedure. Amyloid can involve the vocal cords and false vocal cords, causing traction on the structures and leading to hoarseness. This form of laryngeal amyloid is always localized ( [128](#) ). Obstructive ureterovesicular amyloidosis is always localized. Patients present with hematuria. The prebiopsy diagnosis is cancer. Amyloid is found when cystoscopic biopsies are performed. Eighty-five percent

of patients present with hematuria. Partial cystectomy, fulguration, and transurethral resection have all been used ( [129](#) ). Dimethylsulfoxide instillation in the bladder has been reported to improve these deposits ( [130](#) ). Colchicine has also been reported to be beneficial.

Amyloid involving the renal pelvis or ureter is a localized amyloid syndrome ( [131](#) , [132](#) ). These patients present with colic owing to obstruction or hematuria. The deposits are found at surgery. Nephrectomy is commonly performed because of the concern that the ureteral mass would represent a transitional cell malignancy. The recognition of amyloid avoids nephrectomy. Amyloidosis can involve the urethra and present with dysuria and hematuria ( [133](#) ). The preoperative diagnosis is usually a urethral malignancy. Resection is the treatment of choice.

Three forms of cutaneous amyloidosis are recognized. The lichen and macular forms are localized ( [134](#) ). Nodular amyloidosis is associated with AL ( [135](#) ). The generated keratin fibrils are the source of macular and papular amyloid ( [136](#) ). Dermabrasion and other forms of local therapy are adequate for control. Lichen and macular amyloid usually is associated with a history of local skin trauma or inflammation. Lichen or macular amyloid is an innocuous condition. The nodular form, however, can be an important clinical clue to an underlying life-threatening process.

Carpal tunnel amyloidosis can be seen in systemic AL and AF and may be localized as well ( [137](#) , [138](#) ). If a patient presents with carpal tunnel syndrome as the only manifestation of amyloid, the median survival is 12 years. Virtually all of these patients have localized disease, and only two of 124 patients with localized carpal tunnel amyloid developed AL ( [139](#) ). The amino acid composition of localized carpal tunnel amyloid tends to be transthyretin (TTR). The conjunctiva and orbits are sites where localized amyloidosis is also seen. The best treatment is surgical excision. Amyloid has also been localized to the breast ( [140](#) ), mesenteric lymph nodes, colonic polyps, thyroid ( [141](#) ), retroperitoneum, and ovary. Localized deposits of amyloid are commonly seen in trace amounts within the cartilage on the hip surface after a total hip arthroplasty ( [142](#) ). A localized deposit is similarly found in resected knee arthroplasty specimens. These deposits are not associated with systemic disease ( [143](#) ).

AA is a consequence of long-standing systemic inflammation that is poorly controlled. AA is more common than AL in underdeveloped countries because of the persistence of tuberculosis ( [54](#) ), syphilis, malaria, and leprosy. AA, when seen in the United States, is not easily distinguished from AL. AA is not associated with a monoclonal protein or clonal marrow plasma cells. AA most commonly presents with nephrotic-range proteinuria ( [144](#) ). From a simple syndrome standpoint, it is quite similar in its presentation to AL. At the Mayo Clinic, AA accounts for only 2% of the patients seen ( [145](#) ). The underlying etiology of AA most commonly includes ankylosing spondylitis ( [146](#) ), juvenile rheumatoid arthritis ( [147](#) ), psoriatic arthritis ( [148](#) ), and rheumatoid arthritis ( [149](#) ). The underlying cause in most instances of AA is clear because the arthritis is disabling and is present a median of 15 years before the development of AA ( [150](#) ). Of patients with rheumatoid arthritis, 3.1% succumb to AA ( [151](#) ). Amyloidosis of the AA type is also seen in Crohn disease ( [152](#) ), bronchiectasis ( [153](#) ), and chronic osteomyelitis ( [154](#) ). These are conditions in which the infection is not amenable to surgical excision, and in which antibiotics result in poor control. In most patients, the inflammatory bowel disorder or infection has been present for decades. The first clinical manifestation is proteinuria. No monoclonal protein is detectable. AA has been described in individuals who subcutaneously inject contaminated

illegal substances ( [155](#), [156](#) ). Skin abscesses develop at the site of injection and result in the inflammation that is necessary for the development of AA. Patients with Hodgkin disease ( [157](#), [158](#) ) and hypernephroma ( [159](#), [160](#) ) have been described as having AA. Paraplegic patients who develop chronic infected decubitus ulcers or chronic urinary tract infection ( [161](#), [162](#) ) have been reported to develop AA. One-half of all patients who have had a spinal cord injury for 10 years or longer have amyloid deposits at autopsy ( [163](#) ). AA from Castleman disease has been recognized. Surgical excision leads to remission.

Inherited amyloid is more common than AA in the United States. The presentations of AF are clinically indistinguishable from AL and include cardiomyopathy ( [164](#), [165](#) ), neuropathy ( [166](#) ), and nephrotic syndrome ( [167](#) ). The most common form of inherited amyloidosis is a result of *TTR* mutations. Amyloid neuropathy has been reported involving more than 60 different mutations in the *TTR* gene ( [168](#) ). A positive family history is not found in nearly one-half of the patients with AF seen at the Mayo Clinic. The absence of a family history is a poor screen for excluding AF ( [169](#) ). The presence of amyloid neuropathy in the absence of a monoclonal protein or clonal plasma cell disorder should raise suspicion. Mutations in the *TTR* gene as well as wild-type *TTR* can be the source of cardiac amyloid deposition ( [170](#) ). In people older than 80 years, cardiac amyloid deposits occur in 8 to 25% ( [171](#) ). These deposits are a result of the deposition of normal TTR. In this form of senile systemic amyloid, only cardiac symptoms are seen.

Inherited amyloid involving the heart in the absence of a peripheral neuropathy was first described in a Danish kindred ( [172](#) ). Familial amyloid cardiomyopathy has been described throughout the world. Pedigrees in the United States usually develop symptoms after age 60 years. Familial amyloid cardio-myopathy presents with heart failure or arrhythmias, and the clinical picture is virtually indistinguishable from senile cardiac amyloid or AL. In patients older than 90 years, 21% were found to have senile systemic amyloid owing to normal sequence TTR deposition ( [173](#) ). The first description of a TTR Ile122 mutation was in an African-American man aged 68 years ( [174](#) ). The TTR Ile-122 allele is carried by 3.9% of African Americans, which translates to 1.3 million people in the United States ( [175](#) ). Ile122 is a major cause of an inherited cardiac amyloidosis in African Americans. The finding of cardiac amyloidosis in the absence of a monoclonal gammopathy should not be assumed to be AL, but could represent familial amyloid cardiomyopathy even without a positive family history ( [176](#) ).

Mutations in the fibrinogen ( [177](#) ), lysozyme ( [178](#) ), or apolipoprotein A-I and A-II ( [179](#), [180](#) and [181](#) ) molecules can produce inherited forms of renal amyloidosis. The amyloidosis associated with these mutations carries a much better prognosis than renal AL. The authors have regularly seen patients with proteinuria for more than a decade without renal failure and with easily controlled hypertension. Because these patients present with proteinuria and the renal biopsy demonstrates amyloid, it is easily confused with AL. The absence of a monoclonal immunoglobulin disorder or the absence of serum free light chains is an important distinguishing feature. Only immunohistochemical staining or sequencing of the amyloid can differentiate these entities definitively, however.

The treatment of TTR-derived AF includes liver transplantation, making the distinction between AF and AL critical ( [182](#) ). TTR is produced in the choroid plexus and the liver. Regression of amyloid deposits has been reported ( [183](#) ) when liver transplantation is performed before the development of disabling peripheral or autonomic neuropathy or advanced cardiomyopathy. Patients with the Val30Met mutation appear to have the best outcome after liver transplantation ( [184](#) ). Progressive cardiac amyloidosis has been



reported after liver transplantation in patients with other *TTR* mutations ( [185](#) ). Once mutant *TTR* is deposited in the myocardium, it can serve as a nidus for further deposition of native *TTR* produced by the transplanted liver. At autopsy, the heart demonstrates amyloid fibrils that contain both mutant and wild-type *TTR* ( [186](#) , [187](#) ).

In summary, any patient with amyloidosis who does not have a detectable monoclonal light chain in the serum or urine and does not have a clonal population of plasma cells in the bone marrow should be considered for AA, localized, or AF amyloid.

## PRESENTATION AND CLINICAL FEATURES

The authors reviewed all patients diagnosed with AL between June 1, 1988, and June 30, 1998, at the Mayo Clinic. All patients were diagnosed within 30 days of presentation at Mayo. All had a clonal plasma cell disorder and histologic proof of amyloid. Patients who had overt multiple myeloma were excluded. The male to female ratio was 2:1 (male, 67.3%). The male preponderance of AL has been a constant at their institution for 40 years, and the authors believe this reflects a true higher prevalence of the disorder in men and not a reflection of referral bias. Multiple myeloma is more common in men, but the ratio is 55:45. The age range of amyloidosis patients was 39 to 89 years (median, 67; standard deviation, 10 years). The authors have seen patients with amyloidosis as young as 27 years. The median age of patients presenting with AL in Olmsted County, Minnesota, is 73 years ( [56](#) ). The age difference suggests that there is referral bias to amyloidosis treatment centers. Presumably, younger patients are more likely to seek a second opinion at a referral center than older patients. The most common clinical manifestation of amyloidosis is cardiac amyloid, seen in 37.4% of patients. Congestive heart failure is present in only one-half of these patients; in the other one-half, the presenting symptom of cardiac amyloid is fatigue and dyspnea. These patients have poor cardiac filling and a low cardiac output state, but a preserved ejection fraction. Syncope and arrhythmias may also be seen. Echocardiography has led to improved recognition of cardiac AL ( [188](#) , [189](#) ).

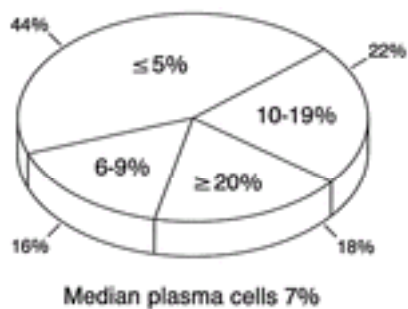
Renal amyloid is seen in 30% of presenting patients and is the second most common presentation. Nephrotic-range proteinuria is seen in 95% of patients with renal AL. The 5% who present with renal insufficiency have amyloid deposits only in the interstitium and mesangium, without glomerular deposits. Sensorimotor symmetric ascending peripheral neuropathy is present in 15.3% of AL patients ( [24](#) ); 17.7% of AL patients have palpable hepatomegaly, but amyloid presenting with a dominant hepatic syndrome is seen in only 4.6% of patients; 7.1% of patients present with intestinal bleeding, pseudo-obstruction, or diarrhea, a manifestation of gastrointestinal tract amyloid. The remaining 7.8% of patients have amyloid limited to the tongue, lung, joints, or soft tissues.

The exact classification of a dominant amyloid syndrome is sometimes arbitrary; 36.3% of patients present with two or more organs involved, and some judgment is required to determine which of the two organs is “dominant.” At the Mayo Clinic, 29.9% of patients had two or more organs involved; 6%, three organs; and 0.5%, four or more organs. When multiple organs were involved, the liver was the organ most likely to be associated.

Significant bleeding (excluding purpura) was present in only 2.3% of the authors’ patients ( [190](#) , [191](#) ). Congestive heart failure was seen in 22% of patients, and carpal tunnel syndrome was seen in 21% of patients ( [192](#) ). Edema was a sign in 44.8% and fatigue in 46.4%. Lower-extremity paresthesias, nephrotic-range proteinuria, orthostatic hypotension, and weight loss were seen in 34.9%, 21.0%, 12.5%, and 51.7%, respectively.

Amyloidosis is rarely associated with anemia ( [193](#) ). The hemoglobin value was greater than 100 and 120 g/L in 90% and 64.4% of patients, respectively. Only 1.5% had a

hemoglobin value less than 90 g/L, and the cause was usually active gastrointestinal tract bleeding or renal failure. The platelet count in amyloid ranges from 46 to 809 × 10<sup>9</sup>/L (median, 257). A platelet count greater than 500 × 10<sup>9</sup>/L is seen in 5.5%. The most common cause of thrombocytosis in AL is hepatic involvement with associated hyposplenism ( [194](#), [195](#) ). A serum creatinine value greater than or equal to 2 mg/dl was present in 13.6% of patients; 6.7% of patients had an alkaline phosphatase value greater than twice the normal value. This is close to the number of patients with clinical hepatic amyloid involvement. The bone marrow plasma cell percentage in AL ranges from 1 to 30% (median, 7%) ( [Fig. 99.7](#) ). Patients with more than 30% plasma cells were excluded from this analysis and diagnosed as having myeloma-associated amyloid. In 11.3% of patients with AL, more than 20% plasma cells were found in the bone marrow without other clinical evidence of multiple myeloma. Proteinuria is exceedingly common in AL, and the median 24-hour urine protein loss in all patients is 790 mg/24 hours ( [Fig. 99.5](#) ). A monoclonal  $\kappa$ ,  $\lambda$ , and no light chain was found in 70.1%, 18.9%, and 11%, respectively, in the serum or urine. The serum heavy chain was IgG, IgA, and IgM in 58%, 10%, and 8.2%, respectively, in those patients who had complete monoclonal gammaglobulins. The presence of an IgM monoclonal protein in 8.2% is important because the authors have seen many patients referred with a diagnosis of Waldenström macroglobulinemia in whom the amyloid syndrome was overlooked ( [196](#) ).



**Figure 99.7.** Distribution of bone marrow plasma cells in patients with primary amyloidosis. (From Gertz MA, Lacy MQ, Dispenzieri A. Amyloidosis. *Hematol Oncol Clin North Am* 1999;13:1211–1233, with permission.)

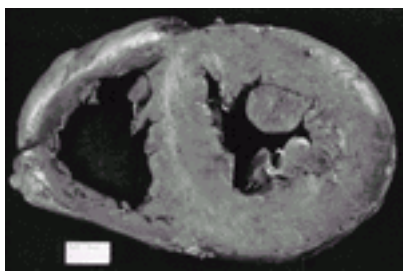
The use of echocardiography has dramatically increased the recognition of cardiac amyloidosis (see [Cardiac](#)). In a Cox statistical analysis, the variables that predict shortened survival include age, performance status, cardiac involvement as the dominant syndrome, and involvement of two or more organs. The median survival of our entire cohort was 12 months, with a 2- and 5-year survival of 33.6% and 14.9%, respectively.

## Cardiac

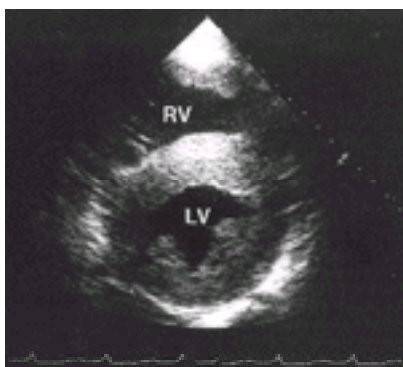
Prognostically, the heart is the most important organ determining the outcome of AL and is the organ most frequently involved ( [197](#), [198](#) and [199](#) ). Amyloid is deposited extracellularly and results in a noncompliant and thickened left ventricle ( [200](#), [201](#) ). The clinical presentation is infiltrative cardiomyopathy with restricted diastolic ventricular filling ( [Fig. 99.8](#) ). Many patients present only with fatigue and unexplained weight loss. Early cardiac AL produces diastolic dysfunction without systolic dysfunction ( [202](#), [203](#) ). In early AL, the chest radiograph shows no evidence of pulmonary vascular congestion or cardiomegaly. Moreover, the ejection fraction is preserved because this is an infiltrative process with diastolic dysfunction only ( [204](#) ). Indeed, owing to a low stroke volume, a hyperdynamic



myocardium may develop with an elevated ejection fraction. This constellation of findings is frequently misinterpreted and the presence of amyloid is overlooked completely. By echocardiography, contractility is normal, but because of poor diastolic filling, there is a resultant reduced end-diastolic volume and low cardiac output. The electrocardiogram shows low voltage, but this is also easily overlooked (205). The pseudoinfarction pattern of amyloid with loss of anterior forces in V<sub>1</sub> through V<sub>3</sub>, seen in nearly two-thirds of patients (205), can be misinterpreted as ischemic heart disease. As a result of the electrocardiogram, patients invariably undergo coronary arteriography on a suspicion of silent ischemic disease. The coronary angiogram is generally normal (206), and an endomyocardial biopsy is not performed. A characteristic echocardiogram shows wall thickening, thickened valves, diastolic dysfunction, and a “sparkling” myocardium (Fig. 99.9). The median septal thickness in patients with AL was 14 mm. The septal thickness was less than 15 mm in 52.9% and greater than or equal to 15 mm in 47.1% (188). The wall thickening is frequently misinterpreted as concentric left ventricular hypertrophy or asymmetric septal hypertrophy rather than infiltrative cardiomyopathy (207, 208 and 209). When ventricular hypertrophy is diagnosed from the thickened walls, the electrocardiogram typically shows low voltage and does not reflect hypertrophy, an important clinical clue (210). Screening for a monoclonal protein in the serum or urine should be done in any patient with diastolic heart failure, restrictive hemodynamics, or wall thickening.



**Figure 99.8.** Myocardial wall diffusely thickened with amyloid. The whitish deposits represent the amyloid and are the lardaceous changes first recognized by Rokitansky. (From Gertz MA, Kyle RA. Amyloidosis [AL]. In: Wiernik PH, Canellos GP, Kyle RA, et al., eds. Neoplastic diseases of the blood, 4th ed. New York: Cambridge University Press, 2003, with permission.)



**Figure 99.9.** Echocardiographic demonstration of concentric thickening of the left ventricular (LV) wall from amyloid. RV, right ventricle. [From Gertz MA, Kyle RA. Amyloidosis (AL). In: Wiernik PH, Canellos GP, Kyle RA, et al., eds. Neoplastic diseases of the blood, 4th ed. New York: Cambridge University Press, 2003, with permission.]

Cardiac amyloid patients have restriction to blood inflow that is characteristic of the disease. Doppler studies are best for assessing myocardial function accurately in AL patients. The Doppler filling patterns closely relate to the extent of amyloid infiltration ( [211](#) ). In advanced cardiac amyloid, there is a short deceleration time consistent with restrictive physiology. In early cardiac amyloidosis, there is abnormal relaxation ( [212](#) ). Decreased fractional shortening combined with ventricular wall thickness is the best predictor of outcome in AL. A wall thickness greater than 15 mm with a fractional shortening of less than 20% is associated with a median survival of 4 months. An important measurement is the deceleration time. A short deceleration time by Doppler study reflects restrictive physiology. A deceleration time of less than 150 milliseconds is associated with poorer outcomes than a deceleration time of more than 150 milliseconds.

Thickening of the right ventricular wall, septum, and left ventricular free wall is the most common echocardiographic feature. The size of the left ventricular cavity is reduced. Roughly 20% of patients have congestive heart failure, but twice that number have cardiac amyloid by echocardiography. Patients regularly present with mild symptoms of fatigue and dyspnea on exertion who would not fulfill the clinical criteria of heart failure, but have overt cardiac amyloidosis. The survival of cardiac amyloid patients, determined by whether the septal thickness is greater than or equal to 15 mm or less than 15 mm at diagnosis, is 1 year and 4 years, respectively. Almost one-third of patients with cardiac AL develop syncope with exercise. A median survival of 2 months has been reported with exercise-induced syncope in AL ( [213](#) ). Immunofixation of the serum and urine is required in any patient presenting with cardiomyopathy or congestive heart failure that does not have an obvious ischemic etiology ( [67](#) ). The echocardiogram is the standard for recognizing amyloid cardiomyopathy; occasionally a patient has a nondiagnostic echocardiogram with amyloid subsequently proven via endomyocardial biopsy, but these occurrences are rare ( [214](#) ).

A poor prognosis is associated with right ventricular dilatation and atrial systolic failure ( [215](#) ). In patients who have thickening of the ventricular walls and are assumed to have hypertrophy, the finding of thickening of the mitral and tricuspid valves is common and also an important clue, because it is not found in hypertensive cardiomyopathy ( [216](#) ). Valvular regurgitation is commonly seen by Doppler echocardiography but does not appear to be clinically significant in altering myocardial performance ( [216](#) ). Atrioventricular sequential pacing does not benefit cardiac hemodynamics ( [211](#) ). Distinguishing pericardial disease from restrictive cardiomyopathy may be difficult ( [217](#) ). It is rare for surgical pericardiectomy to provide clinical benefit to patients with AL. The hazards of surgery in these AL patients are well established ( [217](#) , [218](#) ). As discussed, bone marrow biopsy and fat aspirate provide the diagnosis of cardiac amyloid in the overwhelming majority, but when infiltrative cardiomyopathy is recognized, endomyocardial biopsy provides the correct diagnosis in 100% of patients when at least three endomyocardial specimens are obtained ( [219](#) ).

Ventricular thrombi can develop in AL patients owing to stasis of blood within the cardiac chambers. Embolism can result, and the first manifestation of AL may be a stroke ( [220](#) ). AL patients in sinus rhythm can develop atrial thrombi ( [221](#) ). Anticoagulation therapy is indicated for AL patients with atrial standstill. Most patients present with cardiac muscle infiltration and pump failure. Rarely, patients present because of deposition of amyloid in the coronary arteries, resulting in symptoms of exertional angina and myocardial infarction ( [222](#) ). Angiographic findings are normal because the epicardial coronary arteries are spared. In these patients, standard exercise testing reveals ischemia ( [206](#) ), but the

diagnosis of intracoronary amyloid is difficult to establish before death. Right ventricular myocardial biopsy may demonstrate amyloid deposits in small intramural vessels. The authors have reported on 11 AL patients presenting with angina or an unstable coronary syndrome ( [223](#) ). A classic low-voltage electrocardiogram was seen in only two patients. The median survival after symptom development was 18 months. Virtually all patients were diagnosed at autopsy, reflecting the difficulty in recognizing small-vessel coronary arteriolar amyloid.

All patients with cardiac amyloid do not have AL. Familial amyloid cardiomyopathy, particularly in elderly African-American men, must be distinguished from AL ( [176](#) ). The clinical presentations are similar ( [224](#) ). Patients with AF do not have a monoclonal protein in the serum and urine, and the most common mutation in the United States is *TTR* Ile-123. Senile cardiac amyloidosis must also be distinguished from AL ( [225](#) ). This syndrome results from the deposition of normal TTR. The echocardiographic features of AL, AF, and senile cardiac amyloidosis are indistinguishable. All the amyloid deposits are Congo red positive and exhibit apple-green birefringence under polarized light. The main distinguishing clinical feature is the presence of the monoclonal protein in patients with AL, lacking in the TTR forms of cardiac amyloid ( [171](#) ). The mechanism of deposition of amyloid in senile systemic amyloid is not understood. A quarter of patients older than 90 years have cardiac amyloid deposits. One must keep in mind that all forms of cardiac amyloidosis are not immunoglobulin light chain derived ( [173](#) ).

## Renal

When a patient has free monoclonal light chains in the urine, the differential diagnosis is cryoglobulinemia ( [226](#) ), amyloidosis, Randall-type light chain deposition disease ( [227](#) ), and myeloma cast nephropathy ( [228](#) ). The presence of proteinuria does not always equate with albuminuria. All patients presenting with proteinuria should have immunofixation of the urine performed on the first evaluation to exclude one of these light chain-associated syndromes. The kidney is affected in 28% of AL patients. The Italian group has reported that amyloid affects the kidney in one-half of their patients ( [229](#) ). In nondiabetic adults with the nephrotic syndrome, amyloidosis is seen in 12% of renal biopsies ( [230](#) ); 2.5 to 2.8% of all kidney biopsy specimens contain amyloid.

The serum creatinine value at diagnosis is important in predicting outcome. Patients with a creatinine value less than 1.3 mg/dl versus those with a creatinine value greater than 1.3 mg/dl have a median survival of 25.6 versus 14.9 months, respectively. Urinary protein loss has no impact on survival. Patients with higher levels of albumin loss have a shorter time from diagnosis to the development of end-stage renal disease ( [231](#) ). The presenting serum creatinine value exceeds 2 mg/dl in 14% of patients. The median urinary protein excretion for all AL patients is 0.75 g/24 hours. Thirty percent have more than 3 g of protein in the urine over 24 hours. Only 5% of AL patients have a urinary protein loss in the normal range. Patients with no protein in the urine generally have amyloid cardiomyopathy or neuropathy. Roughly two-thirds of patients have a detectable light chain in the urine, and two-thirds have a detectable light chain in the serum. A monoclonal light chain is more likely to be found if the urinary protein loss is high. If the urinary protein loss exceeds 1 g/day, a monoclonal light chain is found in 85%.

The ratio of patients with  $\lambda$  to  $\kappa$  light chains in the urine changes as the urinary protein excretion rises. The ratio of patients who have underlying  $\lambda$  clones compared to  $\kappa$  clones is 5:1 among those with nephrotic-range proteinuria. Urinary protein loss in  $\lambda$  amyloid is a median of 1.1 g/day. Median urinary protein loss in  $\kappa$  amyloid is 4.6 g/day. The presence of a  $\lambda$  light chain appears to predispose to a higher prevalence of renal involvement.

There is no difference in the frequency of renal failure in ? or ? amyloid. The median survival in patients who have a urinary ?, urinary ?, or no urinary light chain is 1 year, 2.5 years, and 2.5 years, respectively. Severe hypoalbuminemia is the result of nephrotic-range proteinuria ( [70](#) ). Intravascular oncotic pressure decreases as the serum albumin decreases. Edema is a consequence of plasma transuding into the extracellular space. Diuretics are typically required to control edema, but diuretics further aggravate intravascular volume contraction, increase hypotension, and decrease renal blood flow. Bilateral catheter embolization of the renal arteries has been reported to reduce the loss of urinary protein and increase the serum total protein in patients with advanced anasarca ( [232](#) ).

Continuous urinary protein loss results in tubular damage, and the principal long-term complication is end-stage renal disease ( [233](#) ). Patients destined to develop end-stage renal disease are predicted by the presenting serum creatinine value and the 24-hour urinary protein loss. The median time from the diagnosis of AL nephrotic syndrome to dialysis is 14 months. After the initiation of dialysis, the median survival is 8 months. Most deaths in dialysis patients with AL owe to cardiac amyloid. There is no recognizable survival difference between patients who have hemodialysis and those who have peritoneal dialysis ( [234](#) ). The 1-year survival from the start of dialysis is 68%.

Patients younger than 45 years have a better survival. The use of chemotherapy does slow progression to end-stage renal disease, and there is a trend to improved survival with the use of chemotherapy. In addition to age, serum calcium and creatinine concentrations at presentation favor longer survival. Heart failure, cardiac arrhythmias, and refractory hypotension are the key extrarenal complications of AL. Cardiac amyloid associated with renal failure regularly results in dialysis complicated by severe hypotension and represents a major management problem. The amount of protein in the urine and the extent of amyloid deposits seen on kidney biopsy correlate poorly ( [235](#) ). Severe nephrotic syndrome can be seen with small amyloid deposits. All patients with nephrotic syndrome undergo ultrasonography, and the kidneys in AL are virtually always normal size ( [236](#) ) and not enlarged as suggested in prior literature. The urine in AL shows fat or fatty acid crystals but no casts or red blood cells ( [237](#) ). Of 118 patients with a monoclonal gammopathy undergoing renal biopsy, AL was found in 30% ( [238](#) ). In this cohort, the median time from diagnosis to dialysis was 15 months, the median overall survival was 24 months, and the main cause of death was cardiac amyloid.

Only 2% of patients with amyloid develop proteinuria if it is not present at presentation. After cardiac transplantation and antirejection therapy for cardiac AL, the authors have seen two patients who developed the nephrotic syndrome. One can speculate whether these patients in the past would not have survived to develop renal amyloid nephrotic syndrome. Amyloid deposits penetrate the glomerular basement membrane and result in proteinuria ( [239](#) ). Adult Fanconi syndrome ( [240](#) ), renal vein thrombosis ( [241](#) ), and retroperitoneal fibrosis have all been reported with renal amyloid. Fibrillary (immunotactoid) glomerulopathy is a deposition that occurs in the kidney and can be confused with AL ( [242](#) ). The fibrils of fibrillary glomerulopathy are twice the width of amyloid fibrils on electron microscopy ( [243](#) ). Fibrillary glomerulopathy patients do not develop extrarenal disease. The deposits are Congo red negative. A monoclonal protein is typically not seen in the serum or in the urine. Randall-type light chain deposition disease represents granular deposition of nonamyloid immunoglobulin light chain along the glomerular basement membrane ( [244](#) ). It produces nephrotic syndrome and renal insufficiency. Light chain deposition and amyloid have been reported in the same patient ( [245](#) ). Electron microscopy in light chain deposition disease does not demonstrate fibrils.

Fifteen patients with systemic amyloid who had undergone renal transplantation had serum amyloid P scintigraphy studies ([246](#)). Abnormal uptake was seen in the transplanted kidney in four of ten patients. In all of these patients, treatment had not resulted in a reduction in the fibril precursor protein. Renal amyloidosis patients have a high prevalence of adrenal dysfunction. Of 22 patients with renal amyloid, poor cortisol reserve was found in seven and hypoadrenalism resulting in death in four. Amyloid deposits are regularly found at autopsy in the adrenal glands.

## Hepatic

One-fourth of patients with AL have hepatomegaly on physical examination ([247](#)). Hepatomegaly is not synonymous with hepatic involvement, because the high prevalence of right-sided heart failure can produce congestive hepatomegaly. A hepatic amyloid syndrome that is symptomatic is found in one-sixth of patients. Typically, an increased serum alkaline phosphatase or  $\gamma$ -glutamyltransferase value is found with unexplained hepatomegaly. Most clinicians suspect that the unexplained hepatomegaly owes to hepatic metastases; they perform scanning and find homogeneity by radionuclide imaging, computed tomography, or magnetic resonance imaging. A high proportion of patients with hepatic amyloid also has renal involvement.

Proteinuria in excess of 1 g/24 hours is present in one-half of the patients with hepatic amyloidosis. If a patient presents with an increased serum alkaline phosphatase value with proteinuria, this may suggest that the liver dysfunction owes to a systemic disorder such as amyloid. There are four key clues that are helpful in making the diagnosis of hepatic amyloidosis: (a) hepatomegaly out of proportion to the degree of liver function test abnormality; (b) presence of Howell-Jolly bodies in a peripheral blood film suggesting reduced splenic function, a consequence of splenic replacement with amyloid deposits; (c) a monoclonal protein by immunofixation in the serum or urine; and (d) proteinuria. Biochemically, hepatic amyloidosis patients tend to have low levels of aspartate aminotransferase and alanine transaminase, almost always less than twice normal at diagnosis. The bilirubin value is also virtually always normal. It is the increased alkaline phosphatase concentration that directs the clinician. Hyperbilirubinemia, when present, is usually a preterminal finding.

Splenic rupture is well recognized in patients with hepatic amyloid ([248](#), [249](#)). Hepatic rupture is rare, but results in massive intraabdominal hemorrhage and is generally fatal. Computed tomography is useful in diagnosing hepatic rupture with subcapsular hematoma ([250](#)). The median extent of the liver below the right costal margin at diagnosis of hepatic AL is 7 cm. Hepatomegaly is not present in one-tenth of patients with biopsy-proven liver AL involvement. These patients are diagnosed because of an increased alkaline phosphatase value. When patients have hepatic AL, splenomegaly is present in 11%. Thirty-six percent of patients with hepatic AL have a urinary protein excretion greater than 3 g/day. At diagnosis, the median increase of the serum alkaline phosphatase value is 2.3 times the upper limit of normal. When an AL patient is evaluated, the serum alkaline phosphatase value represents the most important screen in assessing whether clinically important hepatic involvement is present. Hepatic AL patients also have higher levels of C-reactive protein than patients without hepatic involvement ([251](#)). The proportion of hepatic AL patients whose amyloid is derived from  $\lambda$  clones is identical to that of patients with other organ involvements. It has been suggested by others that there is a higher incidence of  $\lambda$  light chain in hepatic AL, but this is not supported by the authors' data.

Although symptomatic hepatic amyloid is found in only 16% of AL patients, serum amyloid P scanning makes it clear that hepatic amyloid is present in virtually all AL patients ([252](#)).



Cholestatic jaundice is a preterminal finding ( [253](#) ). In hepatic AL, portal hypertension with varices and bleeding is rare ( [254](#) ). Presumably, patients succumb to hepatic or extrahepatic complications of AL before portal hypertension can develop ( [255](#) ). It is common to see ascites in patients with hepatic AL, but the majority of these patients have nephrotic-range proteinuria, hypoalbuminemia, or congestive heart failure, which are more likely causes of ascites, given the low incidence of portal hypertension. Amyloid deposits are found on liver biopsy specimens distributed in the portal tract and perisinusoidally ( [256](#) ). At autopsy, involvement of the portal triad vasculature is seen frequently but is not clinically important ( [257](#) ). After liver biopsy diagnosis of AL, the median survival is 1 year.

Scintigraphy is generally not useful in hepatic AL. The findings are nonspecific and include irregular distribution of the radionuclide, and occasionally splenic uptake is absent ( [258](#), [259](#) and [260](#) ). Sinusoidal amyloid deposits can compress branches of the hepatic artery, which results in the angiographic appearance of luminal irregularity and abrupt changes in vascular caliber ( [261](#) ).

Amyloidosis is not a contraindication to liver biopsy. Although spontaneous hepatic rupture is described, rupture after a percutaneous liver biopsy has not been reported. The risk of complications from liver biopsy ranges from 0.31 to 3.00%. It should be kept in mind that biopsy of the subcutaneous fat or the bone marrow demonstrates amyloid deposits in 90%; if amyloid is appropriately suspected, most liver biopsies are not required despite their relative safety.

In statistical analysis, the presence of hepatomegaly has a significant impact on survival within the first year after diagnosis. Part of the prognostic impact may be reflected by the fact that hepatomegaly may owe to congestive heart failure rather than hepatic infiltration. In an autopsy series of nine patients with amyloid and hepatomegaly, three did not have anatomic evidence of deposits, and the enlargement of the liver owed to passive congestion ( [262](#) ). In a second autopsy study, 20% of patients with palpable hepatomegaly and amyloid did not have deposits histologically.

In patients with AL, the finding of Howell–Jolly bodies is highly specific for splenic involvement. Hyposplenism is not a sensitive marker of splenic involvement, however ( [263](#) ). In a review of 12 patients with autopsy-proven diffuse splenic involvement, Howell–Jolly bodies were not found. Scanning of the spleen does not correlate well with the presence of Howell–Jolly bodies on the peripheral blood film.

In summary, the four cardinal features of hepatic AL are (a) hyposplenism, (b) a monoclonal protein in serum or urine, (c) proteinuria, and (d) increase of the alkaline phosphatase value with minimal increase in transaminases.

### **Gastrointestinal Tract**

There is no correlation between the presence of gastrointestinal amyloid and liver amyloid. Only 15% of the authors' gastrointestinal amyloid patients have hepatomegaly, and fewer than one-third have any elevation of the alkaline phosphatase value ( [264](#) ). When routine screening biopsies are performed on the rectum or intestinal tract, amyloid deposits are found in the majority of patients ( [107](#) ). Generally, deposits are vascular; occasionally, they are in the submucosa of the bowel but produce symptoms in only a minority of patients ( [265](#) ). Few patients with AL have symptoms (e.g., steatorrhea, nausea, vomiting, abdominal pain, hematemesis, or hematochezia) referable to their

gastrointestinal tract. Bowel dysfunction in AL can result from direct infiltration of the bowel lining or from a motility disturbance related to damage to the regulatory nerves of the intestinal tract ( [266](#) ). The high prevalence of anorexia and weight loss does not correlate with the presence of gastrointestinal tract amyloid. Typically, there is a delay between the onset of symptoms and the histologic recognition of AL. The median delay in patients with intestinal involvement was 7 months to a confirmed diagnosis, but in one patient, the diagnosis required 4 years. In 4 of the authors' 19 patients, a laparotomy was performed to evaluate the intestinal symptoms. In three of the four, the diagnosis was delayed because Congo red stains were not routinely performed on the surgical specimen ( [264](#) ).

Steatorrhea with increased fecal fat and low serum carotene is seen in less than 5% of patients. These patients are not clinically distinguishable from those with celiac sprue, Whipple disease, or bacterial overgrowth. A small bowel biopsy was performed and demonstrated deposits of AL in 19 patients seen at the Mayo Clinic. This constitutes only 1% of the authors' AL population ( [264](#) ), but does not include patients who had clinical evidence of malabsorption for whom a small bowel biopsy was not done because of evidence of widespread amyloid in other organs. Diarrhea, anorexia, dizziness, and abdominal pain were the most common symptoms. The median weight loss was 30 lb, and weight loss was seen in all patients. One-half of the patients had orthostatic hypotension. A prolongation of the prothrombin time primarily owing to malabsorption of vitamin K was present in one-fourth. Factor X deficiency was seen in one-fourth, but only 1 of the 19 patients had factor X activity below 30%. A multivariate analysis shows that the degree of weight loss and the hemoglobin value at diagnosis have an influence on survival. The median survival was 10 months in patients presenting with a weight loss in excess of 20 lb. Ten of the authors' 19 patients died as a consequence of nutritional failure, and one-fourth died of heart failure.

Barium studies demonstrate esophageal dysmotility or gastroesophageal reflux of the upper gastrointestinal tract ( [267](#) ). Multiple reports exist of patients who had surgical intervention for obstruction, only to have amyloid demonstrated histologically ( [268](#) ). The most frequent symptoms of pseudo-obstruction are nausea and vomiting ( [269](#) ). It is common to find abdominal distention and pain ( [270](#) ). The nausea is present even while fasting. Dilatation of small-bowel loops is rare ( [271](#) ). The typical findings on a barium study when intestinal amyloid is present include increased fluid accumulation in the small bowel, loop dilatation with delayed transit, and thickening or nodularity. Computed tomography may show mild splenomegaly or lymphadenopathy but is generally not helpful. Esophagitis, duodenitis, and gastritis are commonly found on endoscopic procedures ( [272](#) ). It is rare for these changes to cause symptomatic bleeding.

Rarely, ischemic colitis is the presenting feature of AL ( [273](#) ). The amyloid deposits under these circumstances obstruct the vessels of the muscularis mucosa and lamina propria. The obstructed blood supply leads to mucosal ischemia with sloughing of the bowel lining and hemorrhage ( [274](#) ). Barium studies demonstrate luminal narrowing, mucosal fold thickening, and ulcers. The most common location of ischemia is the rectosigmoid and descending colon ( [275](#) ). Vascular obstruction from AL has been reported to cause duodenal perforation. Hematemesis and hematochezia occur only rarely outside the transplant setting. The authors have not seen treatment of the underlying AL result in recovery of motility once pseudo-obstruction develops. In patients with pseudo-obstruction, extensive replacement of the muscularis propria by amyloid is prominent ( [276](#) ).



## Nervous System

In 1938, the first description of peripheral nerve amyloid was published ( [277](#) ). Fifteen percent to 20% of AL patients have paresthesias and neuropathy symptoms ( [278](#) ). The clinical picture is often dominated by cardiac or renal involvement, and the peripheral neuropathy is minimally symptomatic. Echocardiographic abnormalities are found in 44% of patients presenting with AL neuropathy. When a predominant neuropathy is seen in a patient with biopsy-proven amyloid, consideration of the possibility of AF should be given. The absence of a monoclonal protein in the serum or urine is a useful distinguishing clinical feature between AL and AF ( [279](#) ). Paresthesias, pain, numbness, muscle weakness, impotence, urinary retention, and orthostatic symptomatology are the most frequent symptoms of amyloid neuropathy ( [280](#) ). Twelve percent of patients have syncope. Dysesthesia manifest by distal burning is present in one-fourth of the patients. Autonomic neuropathy is seen in two-thirds of those patients with peripheral neuropathy, and lower-extremity involvement precedes upper-extremity involvement in nearly 90%. Involvement of the cranial nerves in AL is rare but is reported ( [281](#) , [282](#) ). In patients with amyloid peripheral neuropathy, carpal tunnel syndrome, a soft tissue manifestation of amyloid, coexists in one-half of the patients. Frequently, it is difficult to distinguish electrodiagnostically between upper-extremity neuropathy and carpal tunnel syndrome. Weight loss was recognized in one-third.

An important clue to the diagnosis of amyloid neuropathy is its association with autonomic neuropathy ( [283](#) ). Peripheral neuropathy associated with significant autonomic dysfunction is most commonly seen in diabetes and amyloidosis. When patients present with peripheral neuropathy, however, amyloid is usually not considered in the differential diagnosis. The delay between onset of paresthesias and biopsy proof of amyloid is a median of 29 months. The time between symptoms and diagnosis exceeds the median time from diagnosis to death.

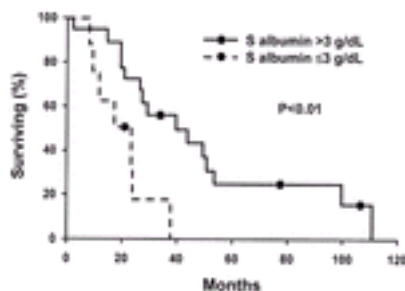
Amyloid preferentially causes loss of small myelinated and unmyelinated fibers. Electromyography is not good at detecting changes in small unmyelinated fibers. As a consequence, patients can have symptomatic amyloid neuropathy with a normal electromyogram. As it progresses, the neuropathy of amyloid is axonal and demyelinating. The loss of myelin results in an elevation of cerebrospinal fluid protein in one-third of patients. Axonal degeneration is detected on the electromyogram in 96% of patients so afflicted. Typical electromyogram changes consist of reduced amplitude of compound muscle action potentials, decreased or absent sensory responses, mild slowing of nerve conduction velocity, and fibrillation potentials on needle examination ( [284](#) ).

Although the sural nerve biopsy is the standard for the diagnosis of amyloid neuropathy, electromyogram nerve conduction velocities and less invasive biopsies like fat or bone marrow can confirm the diagnosis of amyloid neuropathy ( [280](#) ).

On sural nerve biopsy, amyloid deposits are found in the endoneurial capillaries or in the epineurium ( [285](#) ). Examination of teased fibers demonstrates axonal degeneration and a marked decrease in myelin fiber density. Although in the experience of the Mayo Clinic a sural nerve biopsy is the standard for diagnosis, it is not 100% sensitive. Nine patients were reported with amyloid neuropathy, of whom six had a negative sural nerve biopsy ( [286](#) ). One hypothesizes that amyloid has deposited at the level of the nerve root, which results in demyelination distally without recognizable deposits in the sural nerve. Amyloid deposits in the nerve are focal, and multiple sections of the sural nerve need to be

examined to confirm the diagnosis.

In AL patients who present with a dominant neuropathy, the median survival is 25 to 35 months ( [287](#), [288](#) ). Clinical improvement in peripheral neuropathy is rare with traditional chemotherapy and is infrequent even with high-dose therapy. The clinical course for most is progressive neuropathy over time. One-third of patients are ultimately bedridden, and three-fourths of the patients develop marked restriction in their mobility and a reduced ability to perform the activities of daily living. The serum albumin value is the only prognostic factor that is associated with survival in patients presenting with a dominant neuropathy. In neuropathy patients with an albumin value greater than 30 g/L, the median survival was 31 months compared to only 18 months in those whose serum albumin at presentation was less than 30 g/L ( [Fig. 99.10](#) ).



**Figure 99.10.** The impact of serum ( S ) albumin on the survival of patients with isolated amyloid peripheral neuropathy. (From Rajkumar SV, Gertz MA, Kyle RA. Prognosis of patients with primary systemic amyloidosis who present with dominant neuropathy. *Am J Med* 1998;104:232–237, with permission.)

All patients presenting with a peripheral neuropathy should be screened with immunofixation of serum and urine. A patient with a peripheral neuropathy and a monoclonal light chain has a restricted differential diagnosis that includes (a) amyloid; (b) cryoglobulinemia; (c) the polyneuropathy, organomegaly, endocrinopathy, M protein, and skin change syndrome (POEMS–osteosclerotic myeloma); and (d) a monoclonal gammopathy of undetermined significance–associated neuropathy.

## Respiratory Tract

The authors' experience with pulmonary deposition of amyloid has been reviewed ( [124](#) ). Most patients presenting with amyloid involving the respiratory tract only have localized tracheobronchial or nodular pulmonary amyloid deposits. Neither is associated with systemic disease and both have a good prognosis ( [196](#), [289](#), [290](#) ). In contrast, patients presenting with systemic amyloid may have diffuse, interstitial pulmonary involvement, most commonly with concomitant cardiac involvement that overshadows any respiratory symptoms ( [291](#) ). Gas exchange is preserved until amyloid deposition in the alveolar interstitial space is advanced ( [292](#) ). Diffuse alveolar septal amyloid can rarely cause hemoptysis ( [293](#) ). Skeletal muscle and diaphragmatic involvement can produce muscular weakness and ventilatory failure ( [294](#), [295](#) and [296](#) ). Rarely, pleural effusions owing to pleural deposits of amyloid have been reported ( [297](#), [298](#) ). Occlusive amyloid deposits in the pulmonary circulation can occasionally cause pulmonary hypertension with resultant right-sided cardiac failure ( [299](#), [300](#) ). After a diagnosis of diffuse interstitial pulmonary amyloidosis, the median survival was 16 months; in the small number of patients with

pulmonary hypertension, the median survival was 2.8 years.

Amyloidosis associated with an IgM monoclonal protein or Waldenström macroglobulinemia has a higher prevalence of pulmonary amyloid ( [196](#) ). A monoclonal protein is not seen in nodular, pulmonary, or tracheobronchial amyloid; only interstitial pulmonary amyloid is associated with free immunoglobulin light chains in serum or urine.

Pulmonary involvement as part of a systemic immunoglobulin light chain amyloid syndrome ( [301](#) ) manifests radiographically as an interstitial or reticulonodular pattern; the radiographic findings are not specific ( [302](#) ). Pleural effusion is uncommon. The diagnosis is easily obtainable with a transbronchial lung biopsy, which is not associated with excessive bleeding.

Minor salivary gland involvement is common in AL ( [303](#) ). It can be demonstrated in a high proportion of patients histologically, and xerostomia is reported by many ( [294](#) , [304](#) ). AL patients have been misdiagnosed as having Sjögren syndrome.

Autopsy studies of pulmonary amyloid have been published ( [305](#) ). In one study, 11 of 12 patients had histologic deposits in the lung. Deposition was seen in blood vessel walls and the alveolar septum ( [306](#) ). In this autopsy study, only 4 of the 12 had clinical dyspnea, and pulmonary amyloid was responsible for the death of only one patient.

Patients with unexplained dyspnea or fluid overload who have normal left ventricular diastolic and systolic function should be evaluated for pulmonary hypertension owing to AL.

## Coagulation System

Amyloidosis can be complicated by serious hemorrhage ( [191](#) ) or thrombosis. The most common manifestation of hemorrhage is purpura, a consequence of fragile blood vessels owing to infiltration of the vessel wall. A prolonged thrombin time is the most commonly seen abnormality in amyloid ( [307](#) ), and has been attributed to the presence of an inhibitor of fibrin polymerization in the plasma or the effects of prolonged nephrotic-range proteinuria with severe serum hypoalbuminemia.

Acquired factor X deficiency is an uncommon but well documented complication of AL amyloidosis ( [74](#) , [190](#) , [309](#) , [310](#) ), although bleeding is unlikely if factor X levels are higher than 25% of normal. Fewer than 5% of patients have a serious deficiency of factor X ( [74](#) , [190](#) ), and patients with cardiac and renal involvement in the absence of hepatic involvement do not demonstrate significant reductions in factor X levels. Serious bleeding complications can occur, however, especially in patients with ischemic colitis owing to vascular occlusions ( [309](#) , [310](#) ). Bleeding disorders due to low levels of a<sub>2</sub> plasmin inhibitors, increased levels of plasminogen activators, and abnormal platelet aggregation also have been reported ( [308](#) ).

In one study 36 AL patients underwent a coagulation workup ( [310a](#) ). Severe bleeding was seen in only one and mild to moderate hemorrhage in nine. The most common abnormalities were prolongation of the reptilase and thrombin times. A severe factor X deficiency was seen in only one patient. The activated partial thromboplastin time was prolonged in 25 and the prothrombin time in eight. A lupus anticoagulant was not detected

in any patients.

The authors also reported on patients with amyloid who had documented episodes of thromboembolism ( 310b). Of 2132 patients, 40 were so identified. Patients with myocardial infarction, peripheral vascular disease, and stroke were excluded. There were 19 women and 21 men who had a documented thromboembolus (median age, 65 years). In 11 of the 40, thromboembolism preceded a diagnosis of amyloid. In 9 of the 11, the event occurred 1 month or more before the diagnosis of amyloid. In 20 of the 40 patients, the thromboembolism occurred 1 month or more after the diagnosis of AL. The thrombosis was venous in 29 of the 40 and involved vessels in the calf, subclavian, popliteal, inferior vena cava, common femoral, and atrioventricular fistula, in decreasing order of frequency. Arterial thrombosis was seen in 11, involving femoral, popliteal, or multiple arteries, as well as the atria in two patients. Of the 40 patients, 37 had additional risk factors for thrombosis, including nephrotic syndrome in 20, immobilization in 13, tobacco use in six, heart failure in eight, estrogens in one, obesity in four, aortic aneurysm in one, prosthetic material in four, and disseminated intravascular coagulation in two. Five patients had activated protein C resistance. Eight patients died within a month of the thrombosis, and 18 of the 40 died within the first year. Thus, thrombosis appears to represent a significant predictor of imminent death within the first month and perhaps the first year after the event in patients with AL. The type of heavy or light chain and the organ distribution of amyloid did not predict the development of a thromboembolic event.

## PROGNOSTIC FEATURES

Once amyloid has been confirmed histologically with fat aspiration or bone marrow biopsy in a patient presenting with a compatible clinical syndrome and with a monoclonal protein in the serum or urine, the patient needs to be advised of his or her prognosis. Congestive heart failure caused by progressive cardiomyopathy or sudden death caused by asystole or ventricular fibrillation is the most common cause of death in AL. The most important determinant of clinical outcome is the extent of cardiac involvement. Recognized adverse predictors of survival include referral status, heart failure, a hyposplenic peripheral blood film, free urinary light chains, elevated serum creatinine, a bone marrow plasmacytosis greater than 30%, circulating plasma cells in the peripheral blood, an elevated bone marrow plasma cell labeling index, and increased  $\beta_2$ -microglobulin levels.

Congestive heart failure is associated with a median survival of approximately 6 months ( 66, 311). Exertional syncope is a harbinger of early death ( 213, 312). More subtle cardiac findings are also prognostic. Echocardiography is an important tool in assessing the prognosis of all patients with AL. In echocardiographic studies, two-dimensional and Doppler, 40% of AL patients have cardiac involvement. Only 17% actually have symptoms of heart failure, however. In a Mayo Clinic study of 64 patients ( 313), relaxation was abnormal in early amyloidosis, but in advanced amyloidosis there was restrictive filling and a shortened deceleration time ( 314). Doppler echocardiography can be performed serially to monitor diastolic dysfunction in cardiac AL. The 1-year survival of patients who by Doppler echocardiography have a deceleration time of greater than 150 milliseconds is 92%, in contrast to 49% for those with a deceleration time of less than 150 milliseconds. The Doppler-derived left ventricular diastolic filling parameters ( 313, 315) are also important independent prognostic features. Doppler studies of right ventricular diastolic function demonstrate filling abnormalities that correlate with the degree of amyloid infiltration measured by right ventricular free wall thickness ( 316, 317). Patients with elevations of serum cardiac troponin levels have a shortened overall survival ( 318).

When Howell-Jolly bodies are detected on a peripheral blood film, it reflects advanced splenic involvement usually associated with advanced hepatic involvement, and the

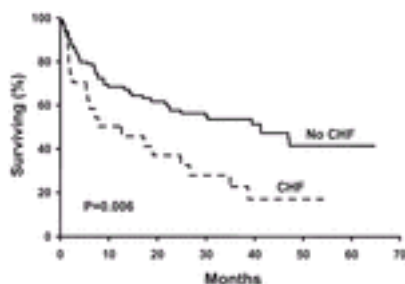
median survival is 4.4 months ( [319](#) ).

The findings on renal biopsy provide prognostic information ( [320](#) ). Patients with a lower percentage of glomerular capillary wall thickening and a higher incidence of amyloid deposits in vessels but not in glomerular capillaries, as well as deposits of IgG and C3 in mesangial and glomerular capillary walls, have a better prognosis. The serum creatinine value at diagnosis and the presence of a urinary light chain are both important prognostic indicators. If the serum creatinine value at diagnosis is abnormal, the median survival is 15 months. Patients who have a free light chain in the urine have a shorter survival than those who do not, at 12 versus 35 months, respectively.

In a multivariate analysis, heart failure and orthostatic hypotension were associated with a median survival of less than 1 year in a cohort of 229 patients ( [66](#) ). An analysis was performed for the presence of cytoplasmic immunoglobulin-positive plasma cells by a sensitive slide-based immunofluorescent technique on 147 AL patients. The percentage of circulating cytoplasmic immunoglobulin-positive cells was calculated on circulating monoclonal plasma cells. Circulating blood plasma cells were seen in 16% of AL patients. The median survival of patients with and without circulating cells was 10 and 29 months, respectively ( [321](#) ). Independent prognostic factors for survival included the presence of peripheral blood plasma cells and the serum  $\beta_2$ -microglobulin value. When AL patients with coexisting multiple myeloma and dominant cardiac amyloidosis were excluded, the test was of independent prognostic value.

The plasma cell labeling index is a slide-based immunofluorescent test capable of assessing the proliferative potential of the bone marrow plasma cells in patients with AL. More than 95% of patients with AL have clonally aberrant plasma cells in the bone marrow. Patients with AL and a labeling index of 0, reflecting no plasma cells in the S phase of the cell cycle, had a median survival of 30 months. If the labeling index exceeded 0, indicating plasma cells that were actively synthesizing DNA, the median survival decreased to 15 months ( [322](#) ).

When AL patients were compared for the level of serum  $\beta_2$  microglobulin, patients with normal values and patients with elevated values had median survivals of 33 and 11 months, respectively ( [323](#) ). The value of  $\beta_2$  microglobulin in assessing prognosis was independent of the presence of renal failure or heart failure. The median survival of patients who have normal renal function and an elevated  $\beta_2$ -microglobulin value was 9 months compared with 39 months for those patients with a normal  $\beta_2$ -microglobulin value. The presence of congestive heart failure and the serum  $\beta_2$ -microglobulin value remain important predictors of outcome ( [Fig. 99.11](#) ) ( [311](#) ).



**Figure 99.11.** Impact of congestive heart failure ( CHF ) on survival in patients with amyloidosis. (From Gertz M. Multiple myeloma and amyloidosis. In: Straus D, ed. 2002

Educational review manual in medical oncology. New York: Castle Connolly Graduate Medical Publishing, 2002, with permission.)

In a cohort of 153 patients with AL, the median survival of the entire group was 20 months; the 5-year survival was 20% ( 324 ). In these patients presenting with congestive heart failure, the 5-year survival was 2.4%, with a median survival of only 8 months. If peripheral neuropathy was the sole manifestation of the AL, the median survival was 40 months; the 5-year survival was 32%. When assessing the long-term prognosis, it is useful to classify patients into four groups: heart failure, peripheral neuropathy, nephrotic syndrome, and other. Women have a slightly longer survival than men.

Referral bias definitely exists at large amyloid treatment centers. To be seen at a distant center, the patient *a priori* must be physically able to travel. This type of information is important when attempting to interpret the results of clinical trials reported from a single center. In patients with amyloidosis evaluated at the Mayo Clinic, the median survival was 2 years. If the cohort is limited to patients who are evaluated within 30 days of diagnosis, however, the median survival decreases to 13 months ( 192 ).

When uniform statistical criteria were applied to a large cohort of patients with AL, the median survival of the entire group was 12 months. The range was 50 months for those with peripheral neuropathy to 4 months for those with congestive heart failure ( 311 ). Within the first year after diagnosis, the key prognostic factors that achieved statistical significance included heart failure, a urinary light chain, the presence of multiple myeloma, and hepatomegaly ( 311 ). After the first year, the predictors of poor outcome were an increased serum creatinine value, the presence of multiple myeloma, a monoclonal serum protein, and orthostatic hypotension. When studies of treatment outcomes are compared, stratification for variables that have an impact on survival is important.

All patients being assessed for AL should undergo echocardiography, including Doppler studies of diastolic performance, ejection fraction, and mitral deceleration time.

## TREATMENT

### Supportive Therapy for Primary Amyloidosis

**HEART AMYLOID** Diuretics are the mainstay of therapy for cardiac AL. Diuretic therapy is complicated because many patients have orthostatic hypotension and intravascular volume contraction, a consequence of the nephrotic syndrome ( 325 , 326 ). Diuretic therapy may precipitate a decrease in renal blood flow with an associated rise in serum creatinine concentration and can precipitate syncope ( 327 ). Loop diuretics are typically used for control of edema. Doses of furosemide may range as high as 120 mg three times a day. When loop diuretics fail to control edema, metolazone can be beneficial. Patients with recurrent syncope have received permanent pacemakers ( 328 , 329 ). Those patients with exertional syncope should be considered for the placement of an implantable defibrillator because most patients die within 2 months ( 213 , 312 ). The standard of management of patients with heart failure includes the use of orally administered angiotensin-converting enzyme inhibitors. Whether these agents have a role in the treatment of cardiac AL and result in similar survival benefits is unknown ( 330 , 331 ). Their use is difficult in AL patients because of the high incidence of associated hypotension. Because systolic dysfunction is seen only late in the course of cardiac AL, digoxin is not generally helpful ( 332 , 333 ). Digoxin does not appear to have any beneficial effect on the reduced diastolic filling and



restrictive physiology seen in AL ( 334 ). In addition, the literature suggests that digoxin is contraindicated in the management of amyloid heart disease ( 335 ) because of a perceived association with a high prevalence of sudden cardiac death. Sudden cardiac death is also well recognized ( 336 ), however, and common in cardiac amyloid patients who do not receive digoxin ( 337 , 338 and 339 ). It is therefore unclear whether the risk of sudden death is actually increased by this drug. Digoxin is effective in producing rate control when atrial fibrillation is present ( 340 ). Congestive heart failure may be precipitated by calcium channel blockers such as nifedipine and diltiazem in patients with cardiac AL. Amyloid fibrils selectively bind nifedipine, which could result in high intracellular levels of the drug ( 341 , 342 ). Fludrocortisone acetate in doses of 0.1 mg orally two to three times per day can be used to treat AL orthostatic hypotension ( 343 ). The dose has been escalated from 0.4 to 2.0 mg daily ( 344 ). Side effects of fludrocortisone include supine hypertension, increased fluid retention with aggravation of heart failure, severe hypokalemia, and edema ( 345 ). Fludrocortisone is not well tolerated in elderly AL patients. Midodrine is a second agent that has been used to treat hypotension in AL patients ( 346 ). Midodrine is started at 2.5 mg three times a day at 4-hour intervals. Supine hypertension is a side effect of midodrine, and the dose is normally given only during waking hours ( 347 ). The drug is rapidly absorbed from the intestinal tract, and peak serum levels are attained within 30 minutes. The initial dose can be increased, based on therapeutic endpoints. The maximum recommended daily dose for midodrine is 40 mg. Active metabolites of midodrine are excreted by the kidney, and the agent should be started at a reduced dose in patients with renal insufficiency. The toxicity of midodrine includes restlessness, supine hypertension, and tachycardia. Patients with cardiac AL have received donor hearts. Seven patients who received cardiac allografts had a mean age of 46 years ( 348 ). Five patients were alive a mean of 32 months after transplantation. Recurrent amyloid was reported in the allograft in two at 3.5 and 4.0 months. One of these two died 13 months posttransplantation. There was one operative death. One patient who had transplantation was functional class I at 1 year, but amyloid deposits were seen by posttransplantation endomyocardial biopsy 14 weeks after transplantation. A successor report of ten patients noted that only four of nine patients survived more than 1 month and a high prevalence of recurrent amyloid was found in the transplanted heart. One patient with amyloid has been reported as having survived 9 years after cardiac transplantation ( 349 ), and the authors have personal experience with a patient who is now 11 years post cardiac transplantation and doing well. A report on ten patients receiving cardiac transplants from 1984 to 1997 indicated a 20% perioperative mortality; the remaining eight patients were followed for up to 50 months ( 350 ). Endomyocardial biopsy demonstrated recurrent amyloid in the grafted heart in five of the eight at 5, 11, 12, 28, and 30 months. None of these biopsies were associated with echocardiographic evidence of amyloid. Overall, seven of the ten patients died 3 to 116 months posttransplantation (median, 32 months). Four of the seven who died developed extracardiac amyloid. The 1- and 5-year survival was 60% and 30%, respectively. The operative mortality of 20% was attributable to extracardiac amyloid. Heart transplantation is technically feasible, but treatment to eliminate the underlying plasma cell proliferative disorder is necessary for a favorable outcome ( 350 ). A patient with IgG  $\lambda$  cardiac AL was hospitalized with heart failure. At age 47 years, she received a heart allograft followed 6 months later by a stem cell transplant with melphalan at 200 mg/m<sup>2</sup>. A hematologic response occurred with a reduction in the G  $\lambda$  monoclonal serum protein, but a complete response was not achieved. Engraftment was poor, and the platelet count persisted at 25  $\times$  10<sup>9</sup>/L. The patient died 2 years after stem cell transplantation, and at autopsy amyloid deposits were found in the myocardium. Thirteen Mayo Clinic patients have received a heart transplant ( 351 ). The actuarial 5-year survival was 50%, which is inferior to patients transplanted for primary cardiomyopathy. Four cardiac transplant recipients have received stem cell transplants at Mayo. Two of the four remain alive.



**KIDNEY AMYLOID** Diuretics, compressive support hose, low-sodium diets, and selective use of albumin diuresis are the mainstays of renal therapy for amyloid. Angiotensin-converting enzyme inhibitors can reduce proteinuria in nephrotic syndrome patients. The mechanism appears to be postglomerular vasodilatation. Toxicity of angiotensin-converting enzyme inhibitors includes hyperkalemia and hypotension. Enalapril and lisinopril have been reported to decrease proteinuria and steroid-resistant nephrotic syndrome when owing to focal segmental glomerulosclerosis. The possibility that angiotensin-converting enzyme inhibitors may be active in amyloid nephropathy has not been explored ( [352](#), [353](#) ). The results of hemodialysis in AL patients are inferior to those seen in patients with primary kidney disorders. The 2-year survival for all dialysis patients was 76% compared with 53% for renal AL ( [354](#) ). The first report of continuous ambulatory peritoneal dialysis appeared in 1984; all three patients were alive from 10 to 18 months ( [355](#) ). One of these three received a renal transplant and survived 57 months. This patient died, and autopsy demonstrated widespread amyloid. In a review of 61 AL patients receiving dialysis, 18 died within a month of starting dialysis ( [356](#) ). At a median of 61 months after dialysis, 15 of the 43 remaining patients were alive. Hemodialysis and chronic ambulatory peritoneal dialysis had identical long-term survivals. Younger patients had a superior outcome. Patients most commonly succumb to the development of extrarenal amyloid in the gastrointestinal tract and heart. In the Mayo Clinic experience, two-thirds of the deaths of dialysis patients with AL are a result of extrarenal progression, the majority being cardiac. Most reports on the outcome of dialysis in renal amyloid are in patients with AA ( [246](#), [357](#), [358](#) ). In one report of 12 patients—two of whom had AL—only 4 of the 12 were alive 2 years after transplantation; and in two of the four survivors, renal biopsies demonstrated amyloid deposits. The development of amyloid in a transplanted kidney is well recognized ( [359](#) ). Eleven amyloid patients were followed after renal transplantation ( [360](#) ). Three amyloid recurrences were seen at 11, 28, and 37 months. After renal transplantation in two AL patients, one died as a result of renal failure owing to redepositing of amyloid into the grafted kidney. The second patient developed cardiac amyloidosis and died with stable renal function. Another 45 patients with amyloid were reported after kidney transplantation ( [361](#) ). The 3-year survival of these patients was 51%. Age older than 40 years is the major determinant of a poor outcome. The median age of AL patients is 62 years. Recurrent amyloid in the allograft was established histologically in four. The estimate was that after transplantation the chance of recurrence at 1 year was 20%. Two AL patients had renal biopsies demonstrating amyloid after transplantation ( [362](#) ). No factors predicted recurrence. Two additional AL patients receiving renal transplants were reported. Glomerular amyloid developed in one, resulting in renal failure and death. The second patient died of cardiac amyloid. Pasternack et al. ( [361](#) ) reported inferior survival of patients with renal AL.

**HEPATIC AND GASTROINTESTINAL TRACT AMYLOID** No specific supportive care measures are required for hepatic amyloid. As mentioned, the ascites seen in these patients is more commonly associated with concurrent right-sided heart failure or nephrotic syndrome. Diuresis and, on occasion, paracentesis are the mainstays of support. Patients with hepatic AL have been treated with transjugular intrahepatic portal systemic shunting ( [363](#) ). This has been reported to result in resolution of ascites and hydrothorax. In a patient with renal and hepatic amyloid, bilateral nephrectomy resulted in marked improvement in liver function, with normalization of a markedly increased bilirubin value ( [364](#) ). Amyloid deposits are commonly seen in the gastrointestinal tract. Intestinal symptoms include diarrhea and constipation that alternate within the same patient. Bowel disturbances can result from massive deposits in the gastrointestinal tract, with a malabsorption syndrome or dysmotility as a consequence of autonomic involvement. The therapy for diarrhea has included diphenoxylate, tincture of opium, loperamide, or paregoric but variable results are seen. Octreotide (a somatostatin analog) has been reported to reduce diarrhea. In the short-acting form, the dose is 200 to 300 µg/day divided into two or three doses. A long-acting depository form of octreotide, which comes

in 10-, 20-, and 30-mg doses, exists. An intergluteal dose can be given on a monthly basis for 2 months and then adjusted according to the response of the patient's diarrhea. Patients who are disabled as a result of diarrhea and fecal incontinence can be managed with a diverting colostomy, which can result in excellent patient satisfaction. Patients with intestinal AL can sometimes have such severe nutritional failure that long-term total parenteral nutrition is required. Cisapride has been reported to be effective for treating amyloid intestinal pseudo-obstruction, but the authors have not found cisapride, metoclopramide, or cholinergic agents to be effective.

**RESPIRATORY AMYLOID** For these patients with localized tracheobronchial or laryngeal amyloidosis, neodymium:yttrium-aluminum-garnet laser therapy is standard treatment.

Low-dose radiation has been reported to benefit obstructive symptoms ( [125](#) ). Nodular pulmonary amyloid can be treated with surgical excision. For patients with diffuse interstitial pulmonary amyloid with true disruption of the alveolar arterial gradient, low doses of prednisone produce symptomatic, although not radiographic, benefit. The therapy for pulmonary hypertension is vasodilators and calcium channel blockers. Many patients with amyloidosis are intolerant of these medicines because of associated orthostatic hypotension.

**FACTOR X DEFICIENCY** Therapy for factor X deficiency has included the use of oral melphalan and prednisone as well as stem cell transplantation ( [365](#) ). For a suitable patient, splenectomy results in improvement in factor X levels ( [366](#) ), and infusion of activated factor VII can temporarily normalize the coagulation factors to permit safe splenectomy ( [367](#) ).

## Nonchemotherapy Treatment

**DIMETHYL SULFOXIDE** *In vitro*, dimethyl sulfoxide (DMSO) can solubilize amyloid deposits ( [368](#) ). DMSO fed to mice who were stimulated to develop AA had decreased development of amyloid deposits ( [369](#) ). The best results reported with DMSO have been as topical applications in patients with cutaneous amyloid ( [370](#) ) and after cystoscopic treatment in patients with bladder amyloidosis ( [130](#), [371](#) ). DMSO is rarely used in the management of AL today ( [372](#) ).

**COLCHICINE** Familial Mediterranean fever (FMF) is associated with the development of AA amyloidosis with an autosomal-dominant inheritance pattern. Clinical features of FMF are pleuritis, peritonitis, synovitis, and migratory skin rash ( [373](#) ). This disorder is rarely seen in the West, affecting Sephardic Jews, Armenians, Arabs, and Turks. Recurrent attacks of polyserositis are not required for the development of amyloidosis. Fully one-fourth of patients in whom AA develops do not have any history of arthritis or polyserositis. In the Middle East, one-fourth of renal amyloid cases are related to FMF ( [70](#) ). With the introduction of colchicine, the median survival of FMF patients has improved from a dismal 25 months, with a 5-year survival of 20%. The clinical manifestation of AA in the setting of FMF is proteinuria, nephrotic syndrome, and dialysis-dependent renal failure. Colchicine has been shown to be effective in preventing attacks of familial amyloidosis in two double-blind placebo-controlled studies ( [374](#) ). In the two studies, the frequency of attacks was reduced by 82% and 78% ( [375](#) ). Colchicine decreased the incidence of renal amyloidosis by nearly two-thirds ( [376](#), [377](#) ). When patients were compliant with colchicine therapy, the development of amyloidosis was rare. Occasionally, colchicine in FMF can reverse the proteinuria associated with established renal amyloid. When 350 children younger than 16 years were given prophylactic colchicine, amyloidosis developed in none. After renal failure develops from AA in FMF, colchicine prevents recurrent amyloid deposition in the grafted kidney. Colchicine is safe in pregnancy and children ( [378](#) ). Colchicine has been used in the treatment of AL. One patient treated with colchicine showed a reduction in 24-hour urine protein loss from 6.7 to 1.4 g/day ( [379](#) ). A case-control study was performed comparing colchicine to historical controls for the

treatment of AL ( [380](#) ). Female sex and the time from diagnosis to initiation of colchicine did correlate with survival. The median survival for colchicine-treated patients was 17 months, compared with 6 months for non-colchicine-treated patients. Subsequent randomized studies ( [381](#) , [382](#) ) did not show any benefit for colchicine in the treatment of AL, however. Colchicine is rarely used today in patients with AL.

### Measuring Responses in Primary Amyloidosis

Surrogate measurements are typically used to assess responses in amyloidosis. Responses to treatment in amyloidosis can be defined by clinical improvement in organ dysfunction or by reduction of the amyloid precursor protein. The latter involves measuring the monoclonal protein component and using criteria that have been established for patients with multiple myeloma. The third method of defining response is via the serum amyloid P scan, but this technique is not widely available. All patients who have a serum or urine monoclonal protein need to have this variable monitored after any therapeutic intervention. A reduction in the size of the M peak suggests a reduction in amyloid precursor protein production. For those patients who have only a free light chain that cannot be quantified, immunofixation is performed to determine whether the monoclonal protein is present or absent. The use of the immunoglobulin free light chain nephelometric assay has been invaluable in allowing quantification of monoclonal proteins that previously could be classified only as present or absent. When M components are measurable by electrophoresis or by the free light chain assay, a response requires a 50% reduction in the size of the serum or urine monoclonal protein, criteria conventionally accepted for response in multiple myeloma. When the free light chain assay is negative and the M component is not measurable, a response requires disappearance of the light chain by immunofixation ( [383](#) ). A bone marrow specimen that demonstrates less than 5% plasma cells is supportive of a response. The median number of plasma cells at diagnosis is only 5%, however, making the estimation of plasma cell reductions difficult. In addition, even when the percentage of plasma cells is 1 or 2%, sophisticated studies including immunofluorescent studies for cytoplasmic immunoglobulin or gene rearrangement studies detect a clonal population, suggesting that true complete responses are rare ( [384](#) ).

Ideally, a response in amyloidosis should be accompanied by an improvement in the function of a previously involved organ. Organ response criteria have been defined. A 50% reduction in the 24-hour urine albumin excretion with no increase in serum creatinine and no decrease in serum albumin concentration is generally accepted in defining a response in renal amyloid nephrotic syndrome. A 50% reduction in the serum alkaline phosphatase with no increase in transaminase or bilirubin is considered an organ response for hepatic AL. An actual reduction in the size of the liver is less common. It is difficult to document echocardiographic regressions of amyloid in the heart. A reduction in wall thickness of 2 mm by two-dimensional echocardiography needs to be seen to confirm a response. There is significant interprocedural variability, however, and caution is required before confirming response or progression when based on echocardiographic criteria only. Although rare, a response in amyloid peripheral neuropathy should be documented by an improvement in nerve conduction velocities on electromyogram.

### Chemotherapy for Primary Amyloidosis

The successful use of cytotoxic chemotherapy to produce regression of AL was reported in 1972 ( [385](#) ). The use of alkylating agents to suppress the plasma cell clone in the bone marrow of AL patients followed the recognized success of these agents in the management of multiple myeloma ( [386](#) ). More recently, high doses of chemotherapy with peripheral blood support have been applied ( [387](#) ). Unlike multiple myeloma, recognizing a response in AL can take as long as 1 year. In the case of intermittent low-dose

chemotherapy, it therefore becomes quite difficult to distinguish those patients who are destined to respond but need longer exposure to therapy from those who are destined to fail therapy and should be offered an alternative therapeutic approach ( [388](#), [389](#) ). *In vitro* studies of the plasma cells from AL patients demonstrate aberrant light chain synthesis. In one study ( [390](#) ), the cytoplasm of the plasma cells contained light chain tetramers. After successful alkylating agent-based chemotherapy, light chain synthesis was suppressed, and a clinical response was demonstrated.

The three earliest reports of melphalan and prednisone therapy demonstrated responses and prolongation of survival in a minority of patients. Patients with renal, cardiac, or liver AL appeared to benefit, but  $\beta_2\text{M}$  levels and cardiac involvement were predictors of failure of response ( [391](#), [392](#) ).

Although melphalan-based therapy has been shown repeatedly to benefit a subgroup of patients with AL, the majority of patients fail to respond. Even with subset analysis, no cohort has been shown to have a response rate that exceeds 40%, and this includes patients who have single-organ renal involvement with a completely normal serum creatinine value. There was one case report of a patient with chronic polyarthritis unrelated to any hematologic problem who received melphalan and subsequently developed amyloidosis, demonstrating that melphalan could not prevent disease development. Moreover, even when patients demonstrated organ response, follow-up tissue biopsy demonstrated persistent deposits of amyloid ( [393](#) ). Because follow-up biopsies are done so infrequently, it is unclear whether clinical improvement is regularly associated with histologic regression. SAP scanning suggests, however, that these deposits can be mobilized and the total amyloid body burden reduced.

When the Mayo Clinic experience with melphalan and prednisone was reviewed, the overall response rate was only 18%. In patients in whom the serum creatinine value at the initiation of therapy exceeded 3 mg/dl, responses did not occur. Serum creatinine concentration also has an adverse impact on survival. The highest response rate was seen in the small group of patients with nephrotic syndrome, no extrarenal involvement, a normal serum creatinine, and a completely normal echocardiogram. In this group, the response rate was 39%. Responses were seen in patients with amyloid cardiomyopathy, suggesting a trial of therapy is warranted. The response rate, however, was only 15% ( [324](#) ). Clinical regression of neuropathic symptoms such as pain, paresthesias, and numbness is rare after melphalan-based chemotherapy. Although only 18% of patients responded to melphalan, their median survival was 89 months. The 5-year survival of this small subgroup was 78%. The median time to response was 1 year. Nonresponders had a median survival of 15 months. Therefore, it is difficult to know when to abandon low-dose melphalan-based therapy as a failure. If alternate therapies like high-dose chemotherapy with peripheral blood support are not viable, a trial of alkylating agent-based chemotherapy for AL can be beneficial and is a reasonable consideration for virtually any patient.

Long-term survival is seen in AL. Over a 21-year period, 841 patients with AL were reported ( [394](#) ). The actuarial survival for the patients at 1, 5, and 10 years was 51%, 16%, and 4.7%, respectively. The thirty 10-year survivors all had been treated with melphalan and prednisone. Fourteen had a documented hematologic response with an eradication of the M protein from the serum and urine. There were ten patients with nephrotic-range proteinuria, and four had a greater than 50% reduction in the urinary protein excretion. Unfavorable prognostic features for 10-year survival included heart failure, older age, creatinine value of greater than 2 mg/dl, bone marrow plasma cells greater than 20%, and platelet count greater than  $500 \times 10^9/\text{L}$ . In a report of ten patients with AL, eight were treated with cyclophosphamide and melphalan. Responses were seen in none ( [395](#) ). Four

of these patients received treatment with infusional vincristine, doxorubicin, and dexamethasone (VAD) over 96 hours. Two patients showed a 50% reduction in the serum M component. The use of infusional VAD is an option for patients with AL. The use of vincristine in patients with amyloid neuropathy and doxorubicin in patients with cardiomyopathy, however, may limit its applicability.

In a prospective study of melphalan, prednisone, and placebo, 55 patients with biopsy-proven AL were randomized to melphalan and prednisone therapy or placebo in a double-blind fashion ( [396](#) ). There was no survival difference between the two groups, but patients who received melphalan and prednisone for a longer time and received larger doses had a superior survival. Nephrotic syndrome disappeared in two, and proteinuria decreased by greater than 50% in eight additional patients. There were no such responses in the placebo arm. There were 13 AL patients who received 12 months of therapy with melphalan and prednisone; six improved, three were stable, and four progressed.

A subsequent randomized crossover study of melphalan and prednisone versus colchicine was reported ( [397](#) ). The 101 eligible patients were stratified by their clinical manifestation: heart failure, neuropathy, nephrotic syndrome, and other. Patients were also stratified by age. One-half received melphalan and prednisone, and eight crossed over to colchicine. The other one-half received colchicine, and 35 crossed over to melphalan and prednisone owing to progression. In the crossover study, there was no difference in survival; however, when patients receiving only one regimen were analyzed or when survival was analyzed from the time of study entry to death or progression, there were significant differences that favored melphalan and prednisone.

There have been two prospective, randomized noncrossover studies evaluating the value of melphalan and prednisone in AL. In one, 219 patients received (a) colchicine 0.6 mg twice daily with increasing doses (N = 72); (b) melphalan 0.15 mg/kg/day with prednisone 0.8 mg/kg/day for 7 days every 6 weeks, with melphalan dose escalation to produce mild mid-cycle myelosuppression (N = 70); or (c) the two regimens combined (N = 69) ( [381](#) ). Stratification was by age, gender, and clinical manifestation. One-half had nephrotic-range proteinuria, and 20% had heart failure. The median survival was significantly superior in the melphalan- and prednisone-containing groups compared to the colchicine group: 17 versus 8.5 months. Melphalan is a superior therapy in the treatment of AL.

The second study randomized 100 patients (50 to colchicine and 50 to a combination of melphalan, prednisone, and colchicine) ( [382](#) ). Stratification was a function of gender, time from diagnosis to study entry, and dominant organ system involvement. The overall survival of the patient group was 6.7 months in the colchicine group and 12.2 months in the melphalan group. A survival advantage was seen particularly for those patients presenting with peripheral neuropathy or "other" (e.g., nonrenal, noncardiac, nonhepatic). In a multivariate analysis, melphalan had a significant impact on survival when heart failure was not present.

The frequency of response with melphalan is low, however, and the treatment itself is potentially leukemogenic. Of 153 patients receiving melphalan, cytogenetic abnormalities were recognized in ten. All ten cytogenetic changes were consistent with damage to the hematopoietic stem cell. Eight of these ten died of pancytopenia and one of progressive renal amyloid, and one was alive. Morphologically, four had acute leukemia and five had myelodysplasia. Overall, bone marrow damage consistent with alkylator-induced toxicity was seen in 7% of the total patient population. The actuarial risk for developing myelodysplasia or acute leukemia in patients at 42 months after therapy was initiated was 21%. The median survival after the diagnosis of leukemia or myelodysplasia was 8 months



( 398 ).

Sixteen patients were treated with vitamin E because of an animal study suggesting that vitamin E could inhibit amyloid production ( 399 ). There were no objective responses in this cohort. The median survival was 19 months. A cohort of 15 patients was treated with subcutaneous injections of interferon  $\alpha$ -2b 3 times a week. No responses were seen in this cohort. Interferon is not a useful agent in the treatment of AL ( 400 ). VAD chemotherapy resulted in an objective response in a 45-year-old man with myeloma-associated amyloidosis proven with biopsies of the rectum and lip ( 401 ). A second patient received four cycles of VAD chemotherapy for renal amyloid nephrotic syndrome proven by kidney biopsy. The proteinuria rapidly diminished during chemotherapy. VAD was given to four patients with AL nephrotic syndrome. Three of the four obtained a partial response and were alive at 4.1, 6.5, and 9.3 years ( 402 ).

In view of the toxicities of vincristine and doxorubicin in AL patients, nine consecutive patients were treated with dexamethasone alone, given 40 mg on days 1 to 4, 9 through 12, and 17 through 20 every 5 weeks for 3 to 6 cycles, followed by maintenance interferon in a dose of 3 to 6 million units 3 times per week. Three of these patients received maintenance dexamethasone 40 mg days 1 through 4 monthly for 1 year. AL organ improvement was reported in eight of nine patients. Of seven with nephrotic-range proteinuria, six had a 50% reduction in proteinuria with a median time to response of only 4 months. Organ function improvement was reported in amyloid neuropathy, hepatic involvement, and gastrointestinal involvement. Both patients with heart failure did not improve ( 403 ). Dexamethasone has no tendency to cause leukemia. The responses are faster than melphalan and could be effective. When we treated 19 patients with high-dose dexamethasone in an identical regimen without interferon, only 3 of 19 showed an objective organ response. The median survival of the entire group was 11.2 months. When cardiac amyloid is not present, high-dose dexamethasone can produce benefit in some patients with AL. The authors have used dexamethasone as well when melphalan and prednisone therapy failed ( 404 ). Twenty-five patients received high-dose dexamethasone; three objective responses with organ-specific improvement were seen. The median survival of the entire group was 13.8 months. Dexamethasone can be beneficial in the treatment of a melphalan failure ( 405 ), but toxicity can be formidable, including fluid retention, gastrointestinal bleeding, and colonic perforation.

Because melphalan and prednisone produces survival benefit, a prospective randomized study of melphalan, prednisone, and vincristine versus carmustine, melphalan, cyclophosphamide, and prednisone was performed ( 406 ). One hundred one patients were randomized and were stratified by age, clinical manifestation, and the presence or absence of heart failure. The median overall survival for the entire group was 26.4 months, and of the 101, 77 have died. The median follow-up of survivors was 98 months (N = 24). There was no difference between the arms. It should be kept in mind that a median survival of 26 months is superior to the overall amyloid population, which has a survival of only 12 months. This suggests that those patients who enroll in chemotherapy treatment studies of AL have an inherently better outcome, presumably by virtue of their eligibility to participate in a clinical trial. The same holds true for patients who are eligible to receive stem cell transplant, as discussed in the following section. Of the 101, 18 patients ultimately received dialysis, and all but two have died. The most common cause of death while receiving dialysis was intractable hypotension related to cardiac involvement. Myelodysplasia was documented in eight, and all have died, including one who died after nonmyeloablative allogeneic transplant following diagnosis of myelodysplasia. All deaths were related to the myelodysplasia or acute leukemia, and the median survival from diagnosis of amyloid was 43 months.

4'-Iodo-4'-deoxydoxorubicin has been reported in the treatment of AL ( [407](#) ). Patients with visceral amyloid deposits have a lower response rate than those who have soft tissue amyloid ( [408](#) , [409](#) ). Of 45 patients treated with doxydoxorubicin, the response rate was 15% ( [410](#) ).

## Stem Cell Transplantation

Hematopoietic stem cell transplantation in AL is inherently different from transplantation in other hematologic malignancies ( [411](#) ). Patients with lymphoma, multiple myeloma, and leukemia typically have significant bone marrow abnormalities manifested by multiple cytopenias. In general, however, these patients have excellent cardiac, hepatic, and renal function and a performance status of 0 or 1. AL patients have opposite findings. Hematologic abnormalities such as anemia, leukopenia, or thrombocytopenia are uncommon. AL patients generally have significant visceral organ dysfunction, which puts them at a high risk for complications after high-dose chemotherapy.

Syngeneic transplantation was reported in the treatment of AL in 1995 ( [412](#) ). The patient received standard conditioning with cyclophosphamide (120 mg/kg) and total body irradiation (1200 cGy) ( [413](#) ). Monoclonal light chain synthesis disappeared from the serum and urine in this 32-year-old, who also had resolution of nephrotic syndrome and autonomic neuropathy. An amyloid P component scan showed a reduction in amyloid deposits. There have been two AL patients who had full-dose allogeneic bone marrow transplantation ( [414](#) , [415](#) ). The first who had purpura, macroglossia, and proteinuria of 1.4 g/day received 6 cycles of cyclophosphamide, vincristine, doxorubicin, and methylprednisolone. This patient had a hematologic response and then had an allogeneic transplant after melphalan 110 mg/m<sup>2</sup> and total body irradiation (1200 cGy). The patient continued a complete hematologic response and was alive at 29 months. The second patient received a sibling human leukocyte antigen identical transplant after melphalan 140 mg/m<sup>2</sup> and 800 cGy of total body irradiation. The urinary protein loss decreased from 9.15 to 1.3 g/day. This patient developed chronic graft-versus-host disease of the skin and liver but was alive at 18 months. It is unlikely that allogeneic or nonmyeloablative allogeneic transplantation will be applicable to a significant number of AL patients given the age restrictions and the need for good performance status and adequate renal function.

The majority of reported experiences using myeloablative chemotherapy involve progenitor cell replacement with peripheral blood stem cells. This occurs because of the ease of collection, reduced rate of tumor contamination, and faster engraftment seen with blood stem cells. Most AL patients who receive blood stem cells do demonstrate clonotypic cells in the apheresis product. CD34 cell selection to eliminate the clonotypic stem cells can be performed, but whether this has an impact on outcome is unknown ( [416](#) ). It is known that positive CD34 selection in multiple myeloma patients who are candidates for stem cell transplantation yields no survival benefit ( [417](#) ). There is no reason to believe the outcome would be different in AL transplants. Boston University first reported five patients with AL receiving stem cell transplants, and all five showed a clinical response ( [418](#) ). When expanding the cohort to 25 patients, a hematologic response was reported in 62% and an organ response in 65% of surviving patients ( [419](#) ). A report covering 250 patients receiving melphalan doses ranging from 100 to 200 mg/m<sup>2</sup> was published recently ( [420](#) ). The median age was 57 years; 53% had amyloid by echocardiography. The 3-month transplant-related mortality was 14%; 11% who initiated stem cell collection did not go on to transplantation owing to death or mobilization



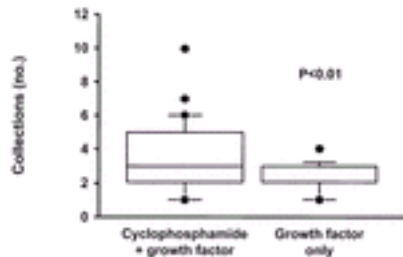
toxicities that would preclude safe transplantation. During mobilization, 23 patients experienced major morbidities, and 18 of them did not go on to stem cell transplantation. There were four reported cardiac arrests during stem cell infusion and six additional cardiac arrests during the weeks after transplantation. Sixty-two patients had febrile neutropenia; 17, gastrointestinal tract hemorrhage; and 12, progressive renal failure requiring dialysis. With a mean follow-up of 23 months, 66% of the patients were alive. The best responses were seen with isolated renal amyloid. Lower toxicities were observed in patients who received lower conditioning doses of melphalan ( $100 \text{ mg/m}^2$ ).

Multicenter surveys reporting the outcome of transplantation were first published in 1998 ([421](#)). In France, 21 patients received transplants, 18 with melphalan alone and three with total body irradiation-containing regimens. The death rate was 43%, with 9 of 21 dying within 1 month after transplantation. All nine deaths owed to multiorgan failure, including one case of intractable bleeding. Of the 12 survivors, 10 achieved a response. Patient selection clearly had a role because the median time from diagnosis to transplantation was 11 months. This suggests that patients who would be destined to die early from AL would not survive to the time of transplantation. Outcome was predicted by the number of organs involved at the time of transplantation. For patients with two or more clinical manifestations, the 4-year survival was 11%. The risk of a toxic death when two organs were involved was 75%, reflecting the need for careful patient selection. In the United Kingdom, 27 patients received high-dose melphalan. There were eight treatment-related deaths (30%) ([422](#)). These deaths owed to multiorgan failure in four, gastrointestinal tract hemorrhage in two, and sepsis and cardiac complications in one each. In spite of this high death rate, a clonal response of the bone marrow plasma cells was seen in 64% and organ regression in 57% of surviving patients. Seventeen of the 27 patients are alive. In nine patients who received a transplant, four died within a year of transplantation, for a treatment-related mortality of 44% ([423](#)). Five were alive, but the median follow-up was only 12.6 months. Of the five, four were responders and one patient progressed. Three of the four deaths were related to cardiac amyloid. The fourth death involved the kidney, nerve, and intestinal tract. Multiorgan failure and gastrointestinal tract bleeding are far more common in AL than in transplantation for any other indication. Gastrointestinal tract bleeding appears to be highly specific for AL.

When the authors reviewed the first 45 patients who received transplants for AL, 11 had died at a median of 2 months posttransplantation ([424](#)). Gastrointestinal tract bleeding was seen in nine (20%). The median day of onset of bleeding was transplant day +9; median platelet count was  $22 \times 10^9/\text{L}$ . Bleeding was seen in the upper gastrointestinal tract in two, lower tract in three, and both in four. Endoscopy was performed in five, and all demonstrated an inflamed friable gastric and esophageal mucosa. Four of the nine patients in whom bleeding developed died, three of multiorgan failure. Gastrointestinal tract bleeding was associated with female sex and poor engraftment of platelets. During the first 100 days posttransplantation, the median number of red blood cells administered was 20 in those with gastrointestinal tract bleeding. The exact mechanism underlying the bleeding in AL patients after stem cell transplantation is unknown. The widespread vascular deposits of amyloid can render the vessels rigid and friable, however. After high-dose chemotherapy, which causes significant mucosal damage, bleeding may result. In the authors' cohort, abnormalities of the coagulation system were not involved in the bleeding.

The authors have reported on three patients who did not proceed to stem cell infusion because of complications related to mobilization ([425](#)). Two of these three died of progressive amyloid at 1 and 3 months after mobilization. The authors have, in the past, used two different mobilization schemes. One was filgrastim alone ( $10 \mu\text{g/kg/day}$ ), commencing apheresis on day 5. The second was cyclophosphamide  $1.5 \text{ g/m}^2$  on 2

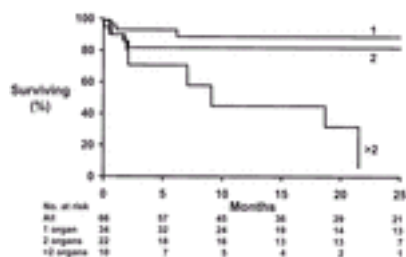
consecutive days followed by sargramostim (5 µg/kg/day), with apheresis beginning when the white blood cell count exceeded 1000/µl. The median overall CD34 yield was  $6.4 \times 10^6$  cells/kg. In the patients mobilized with cyclophosphamide, the median number of aphereses was three. In patients receiving filgrastim alone, the median number of aphereses was two, a statistically significant difference ( [Fig. 99.12](#)). The authors now use filgrastim alone.



**Figure 99.12.** Number of aphereses required to achieve the target stem cell numbers, using two mobilization schemes. (From Gertz MA, Lacy MQ, Dispenzieri A, et al. Stem cell transplantation for the management of primary systemic amyloidosis. *Am J Med* 2002;113:549–555, with permission.)

Of our first 20 patients who went on to transplantation, renal, cardiac, nerve, and liver amyloid were seen in 14, 12, 3, and 1, respectively. Five of the 20 died posttransplantation. Two additional patients died of progressive amyloid and 13 were alive, with 12 of them showing a hematologic or organ response. The authors recently reported our results in 66 patients; renal, cardiac, nerve, hepatic, and autonomic amyloid were present in 68%, 48%, 17%, 17%, and 6%, respectively. Fourteen percent of these patients had an ejection fraction of less than 60% at transplantation. One patient who died on day +6 was not evaluable for granulocyte engraftment. The median time to achieve 500 granulocytes in the remaining 65 patients was 12 days. There were six patients who died without achieving a platelet count of  $20 \times 10^9/L$ . One patient is alive with a platelet count of 10 to  $20 \times 10^9/L$  untransfused. Fifty-nine patients achieved a platelet count in excess of  $20 \times 10^9/L$  by a median of day 14. Patients who had received oral melphalan chemotherapy before stem cell collection have slower engraftment of their platelets. The treatment-related mortality was 14% and included cardiac arrhythmias, gastrointestinal tract bleeding with multiorgan failure, pulmonary embolus, disseminated fungus infection, pneumonia, and aspiration.

Nine of the patients required dialysis posttransplantation. Seven of them died. One had complete recovery, and one is alive on dialysis. Eight of the nine patients had recognized renal amyloid before transplantation. The median serum creatinine value was 1.7 mg/dl in those who ultimately required dialysis and 1.1 mg/dl in those who did not. The authors have seen one myelodysplastic syndrome develop posttransplantation. This patient had previously received melphalan therapy and died of pancytopenia. The median hospital duration was 14 days, and 15 patients were hospitalized for more than 1 month. Neutropenic bacteremia is common. The most frequently isolated organism was staphylococcus, seen in 35 patients. The fraction of patients surviving at 2 years with one-, two-, and three-organ involvement was 91%, 82%, and 31%, respectively ( [Fig. 99.13](#)).



**Figure 99.13.** Survival of 66 patients who received transplants for amyloidosis, stratified by number of organs involved pretransplantation. (From Gertz MA, Lacy MQ, Dispenzieri A, et al. Stem cell transplantation for the management of primary systemic amyloidosis. *Am J Med* 2002;113:549–555, with permission.)

In spite of the high morbidity and mortality, a hematologic or an organ response was seen in 42 of the 66 patients. The responses were renal in 19; hepatic in five; cardiac in three; renal and cardiac in two; renal and hepatic in one; cardiac, renal, and nerve in one; and autonomic in one. There were 26 patients with kidney amyloid who achieved a response overall. The median urinary protein loss decreased from 7.10 g/day to 1.44 g/day. Twelve patients had their urinary protein loss decrease below 1 g/day. The median time to response was 3.6 months, but in six, response took more than 1 year. The serum creatinine value and the number of organs involved pretransplantation were the most important predictors of survival ( [Fig. 99.13](#)).

The authors have now completed transplantation in 125 patients with AL, 94 of whom are alive. Hematologic responses have been documented in 67. Organ responses were seen in 52. Nineteen of the 125 died before day 100 (15%).

The toxicities associated with high-dose chemotherapy are listed in [Table 99.4](#). The response rate that the authors have observed exceeds their previous experience with conventional-dose chemotherapy. Patients, however, are highly selected to begin with, and one cannot be certain what the response rate or survival would be in an age- and organ-matched population. The most common type of response is the resolution of nephrotic syndrome. [Table 99.5](#) summarizes reported data on stem cell transplantation in nearly 300 patients.

**TABLE 99.4. Toxic Responses (Southwest Oncology Group =Grade 2)**

| Toxic Response   | Frequency, % (N)               |                                |
|------------------|--------------------------------|--------------------------------|
|                  | 200 mg/m <sup>2</sup> (N = 23) | 100 mg/m <sup>2</sup> (N = 27) |
| Nausea/vomiting  | 83 (19)                        | 52 (14)                        |
| Diarrhea         | 65 (15)                        | 48 (13)                        |
| Mucositis        | 91 (21)                        | 37 (10)                        |
| Pulmonary edema  | 35 (8)                         | 26 (7)                         |
| Peripheral edema | 48 (11)                        | 15 (4)                         |
| Non-GI bleeding  | 17 (4)                         | 0 (0)                          |
| GI bleeding      | 22 (5)                         | 7 (2)                          |
| Hepatic          | 13 (3)                         | 22 (6)                         |
| Renal            | 35 (8)                         | 19 (5)                         |
| Metabolic        | 35 (8)                         | 7 (2)                          |
| Sepsis           | 26 (6)                         | 11 (3)                         |

GI, gastrointestinal.

From Gertz MA, Lacy MQ, Dispenzieri A. Immunoglobulin light chain amyloidosis (primary amyloidosis). In: Gertz MA, Greipp PR, eds. Hematologic malignancies: multiple myeloma and related plasma cell disorders. Berlin: Springer-Verlag, 2004:157-195. By permission of Mayo Foundation.

**TABLE 99.5. Published Series of Autologous Transplants for Amyloidosis**

| Reference   | No. Patients                        | 100-day Treatment-Related Mortality                            | Overall Survival (Intention-to-Treat) | Evaluable Follow-Up | Hematologic Response            |
|---|-------------------------------------|--|---------------------------------------|---------------------|---------------------------------|
| Majolino et al. (426)                             | 1                                   | 1/1 (100%) CMV pneumonitis                                     | 0 at 74 d                             | 1                   | 74 d<br>PR at 2 weeks           |
| van Buren et al. (412)                            | 3 (1 syngeneic)                     | 0/3 (0%)   | 2/2 (100%) at 24 mo                   | 2                   | 12 mo<br>2/2 (100%) CR          |
| Amoura et al. (423)                               | 9                                   | 3/9 (33%) ARF, sepsis, arrhythmia                              | 5/9 (55%) at median 12.6 mo           | 5                   | Mean, 8.9 mo<br>Not reported    |
| Moreau et al. (421)                               | 21                                  | 9/21 (43%) multiorgan failure, bleeding, arrhythmia            | 12/21 (57%) at median 14 mo           | 12                  | Median, 14 mo<br>3/12 (25%) CR  |
| Schulenburg et al. (427)                          | 1                                   | 1/1 (100%) GI perforation                                      | 0 at 4 d                              | 0                   | NA<br>NA                        |
| Patriarca et al. (428)                            | 1                                   | 0  | 1/1 (100%) at 22 mo                   | 1                   | 22 mo<br>1/1 (100%) CR          |
| Saba et al. (429)                                 | 9                                   | 7/9 (78%) (3 during mobilization) arrhythmia, CHF, hypotension | 2/9 (22%) at >6 mo after referral     | 2                   | Not reported<br>Not reported    |
| Sezer et al. (430)                                | 1                                   | 0  | 1/1 (100%) at 3 mo                    | 1                   | 3 mo<br>1/1 (100%) CR           |
| Gertz et al. (425)                                | 23 (3 never received transplants)   | 4/20 (20%) pneumonia, multiorgan system failure, sudden death  | 13/23 (57%) at median 16 mo           | 20                  | Median, >13 mo<br>8/20 (40%) CR |
| Reich et al. (431)                                | 4                                   | 2/4 (50%) acute MI, diffuse alveolar hemorrhage                | 2/4 (50%) at 7 and 19 mo              | 2                   | 7 and 19 mo<br>1/2 (50%) PR     |
| Dember et al. (432) and Sanchorawala et al. (420) | 205 (20 never received transplants) | 28/205 (14%)   | 115/152 (76%) at >12 mo               | 115 at >12 mo       | >12 mo<br>54/115 (47%) CR       |

ARF, acute renal failure; CHF, congestive heart failure; CMV, cytomegalovirus; CR, complete response; GI, gastrointestinal; MI, myocardial infarction; NA, not applicable; PR, partial response.

From Gertz MA, Lacy MQ, Dispenzieri A. Immunoglobulin light chain amyloidosis (primary amyloidosis). In: Gertz MA, Greipp PR, eds. Hematologic malignancies: multiple myeloma and related plasma cell disorders. Berlin: Springer-Verlag, 2004:157-195. By permission of Mayo Foundation.

Comenzo and Gertz ( [433](#) ) published a risk-adapted strategy for selecting patients and assigning melphalan dose in AL patients. On review of four single-center studies, the day-100 mortality was 21%. The guidelines for selection of candidates for stem cell transplantation are given in [Table 99.6](#) and the risk-adapted approach in [Table 99.7](#).

**TABLE 99.6. Guidelines for Selection of Stem Cell Transplant Recipients**

- 
- Absolute contraindication
- Clinical congestive heart failure
  - Total bilirubin >3.0 mg/dl
  - Echocardiographic ejection fraction <45%
- Relative contraindication
- Serum creatinine >2.0 mg/dl
  - Interventricular septal thickness >15 mm
  - Age >65 yr
  - More than two visceral organs involved

From Gertz MA, Lacy MQ, Dispenzieri A. Immunoglobulin light chain amyloidosis (primary amyloidosis). In: Gertz MA, Greipp PR, eds. Hematologic malignancies: multiple myeloma and related plasma cell disorders. Berlin: Springer-Verlag, 2004:157-195. By permission of Mayo Foundation.

---

**TABLE 99.7. Risk-Adapted Approach**

- 
- Good risk (all of the following)
- One or two organs involved
  - No cardiac involvement
  - Creatinine clearance =51 ml/min
  - Any age
- Intermediate risk (all of the following)
- Age younger than 61 yr
  - One or two organs involved
  - Asymptomatic cardiac or compensated cardiac
  - Creatinine clearance <51 ml/min
- Poor risk (one of the following)
- Three organs involved [a](#)
  - Advanced cardiac involvement
- Melphalan dosing (mg/m<sup>2</sup>): based on risk group and age (yr)

---

|  | Good risk        | Intermediate risk | Poor risk        |
|--|------------------|-------------------|------------------|
|  | 200 if age =60   | 140 if age =50    | Standard therapy |
|  | 140 if age 61-70 | 100 if age 51-60  | Clinical trials  |

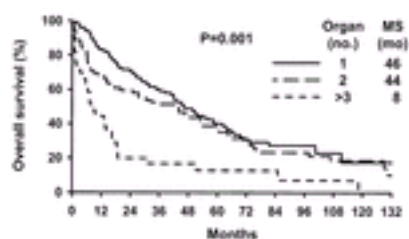
---

100 if age =71

<sup>a</sup> Organ involvement includes heart, kidney, nerve, liver, vascular, or soft tissue; does not include bone marrow, skin, tongue, or gastrointestinal tract involvement.

Modified from Comenzo RL, Gertz MA. Autologous stem cell transplantation for primary systemic amyloidosis. *Blood* 2002;99:4276–4282. By permission of the American Society of Hematology.

It must be kept in mind that transplant patients with AL are highly selected because of age, number of organs involved, the absence of advanced heart failure, and performance status. Therefore, a true control group is lacking for comparison. Dispenzieri et al. (434) reviewed 1288 AL patients seen at the Mayo Clinic from 1983 to 1997 to identify those eligible for stem cell transplantation using the criteria in Table 99.6. Patients had to have symptomatic amyloid, no multiple myeloma, age younger than 70 years, and an echocardiographic septal thickness less than or equal to 15 mm with an ejection fraction greater than 55%. In addition, the serum creatinine value had to be less than 2 mg/dl, and a direct bilirubin value had to be less than 2 mg/dl as well. Among the patients, only 229 (18%) were eligible for transplantation. The median survival of this nontransplantation cohort was 42 months, with 5- and 10-year survivals of 36 and 15%. Clearly, patients who are eligible for transplantation have much better outcomes than patients who are not eligible. The predictors of survival included the size of the M protein in the 24-hour urine measurement and the number of organs involved (Fig. 99.14). The alkaline phosphatase value, performance status, and weight loss were also factors that influenced survival. Patients eligible for stem cell transplantation are an inherently good risk population, and they will do well with oral melphalan and prednisone. Certainly, their anticipated median survival far exceeds the 18 months published for other cohorts of patients receiving melphalan and prednisone. The value of hematopoietic stem cell transplantation for amyloid will not be known until a randomized phase 3 study is completed.



**Figure 99.14.** Survival by number of organs involved in patients eligible for stem cell transplantation but treated with melphalan and prednisone. (From Dispenzieri A, Lacy MQ, Kyle RA, et al. Eligibility for hematopoietic stem-cell transplantation for primary systemic amyloidosis is a favorable prognostic factor for survival. *J Clin Oncol* 2001;19:3350–3356, with permission.)

## CONCLUSION

Amyloidosis should be considered in the differential diagnosis of any patient with nephrotic-range proteinuria, heart failure, neuropathy, or hepatomegaly. The symptoms of amyloid are vague and not useful in targeting a diagnosis. The pathognomonic physical findings are seen in fewer than one-fifth of patients and therefore are not sensitive. When a patient is seen with a compatible clinical syndrome, immunofixation of the serum and urine is the best screening test. Ninety percent of light chain amyloidosis patients have a

monoclonal light chain in the serum or urine. Noninvasive studies such as the fat aspiration and bone marrow biopsy confirm the diagnosis of AL in 90% of patients. In a patient with biopsy-proven amyloidosis without a detectable monoclonal protein, a nonimmunoglobulin form of amyloid should be considered. The prognosis should be assessed by two-dimensional echocardiography with Doppler. Systemic therapy is appropriate for most patients. Treatment with melphalan and prednisone provides marginal survival benefit in a minority of patients. The more aggressive plasma cell ablative approach can offer the potential for long-term benefit. Response rates with stem cell transplantation can approach 60%, and responders have the potential for long-term survival. High-dose dexamethasone therapy can offer benefit to a subset of patients. The role of thalidomide is investigational. Firm evidence-based data do not exist to prove the survival benefit of stem cell transplantation.

## REFERENCES

1. Virchow R. Cellular pathology, 2nd ed. (Translation by F Chance.) New York: Robert M. De Witt, 1860:409–413.
2. Cohen AS. History of amyloidosis. *J Intern Med* 1992;232:509–510.
3. Rokitsky MH. Virchow and Heschl on the problem of amyloidosis (a historical study) [German]. *Zentralbl Allg Pathol* 1968;111:103–107.
4. Sipe JD, Cohen AS. Review: history of the amyloid fibril. *J Struct Biol* 2000;130:88–98.
5. Franke WW. Matthias Jacob Schleiden and the definition of the cell nucleus. *Eur J Cell Biol* 1988;47:145–156.
6. Aterman K. A historical note on the iodine-sulphuric acid reaction of amyloid. *Histochemistry* 1976;49:131–143.
7. Toro I. Matthias Jacob Schleiden, born 175 years ago [Hungarian]. *Orv Hetil* 1979;120:2682–2685.
8. Hallett M. Early history of myoclonus. *Adv Neurol* 1986;43:7–10.
9. Le Soldat J. Kekule's dream: additional observations on the "benzol ring" [German]. *Psyche (Stuttg)* 1993;47:180–201.
10. Hughes RE. George Budd (1808–1882) and nutritional deficiency diseases. *Med Hist* 1973;17:127–135.
11. Kauntze R. Samuel Wilks. *Guys Hosp Rep* 1970;119:353–355.
12. Banerjee AK. Sir Samuel Wilks: a founding father of clinical science. *J R Soc Med* 1991;84:44–45.
13. Doyle L. Lardaceous disease: some early reports by British authors (1722–1879). *J R Soc Med* 1988;81:729–731.
14. Schmiedeberg O. Ueber die Beziehungen des Hyaloidins zu der Bildung der Chondroitinschwefelsäure, des Collagens und des Amyloids im Organismus. *Arch Exp Pathol Pharmacol* 1920;87:47–73.
15. Bock HE. 80th anniversary of Prof. Dr. Hans Hermann Bennhold on Sept. 11, 1973 [German]. *Med Welt* 1973;24:1341–1342.
16. Van Bogaert L. Paul Divry (1889–1967). *J Neurol Sci* 1967;5:191–192.
17. Reznik M. Paul Divry: the discovery of cerebral amyloidosis [French]. *Acta Neurol Belg* 1989;89:168–178.
18. Magnus-Levy A. Bence-Jones-Elweiss and Amyloid. *Z Klin Med* 1931;116:510–531.



19. Mey U. Immunology and oncology of paraproteins [German]. *Z Gesamte Inn Med* 1979;34:182–185.
20. Kuhn RA. The clinical valency of monoclonal immunoglobulins: attempt at a determination of their importance [German]. *Z Gesamte Inn Med* 1976;31:57–60.
21. Isobe T, Osserman EF. Patterns of amyloidosis and their association with plasma-cell dyscrasia, monoclonal immunoglobulins and Bence-Jones proteins. *N Engl J Med* 1974;290:473–477.
22. Eanes ED, Glenner GG. X-ray diffraction studies on amyloid filaments. *J Histochem Cytochem* 1968;16:673–677.
23. Lotz B, Colonna Cesari F. The chemical structure and the crystalline structures of *Bombyx mori* silk fibroin. *Biochimie* 1979;61:205–214.
24. Pras M, Schubert M, Zucker-Franklin D, et al. The characterization of soluble amyloid prepared in water. *J Clin Invest* 1968;47:924–933.
25. Levin M, Franklin EC, Frangione B, et al. The amino acid sequence of a major nonimmunoglobulin component of some amyloid fibrils. *J Clin Invest* 1972;51:2773–2776.
26. Benditt EP, Eriksen N. Amyloid. 3. A protein related to the subunit structure of human amyloid fibrils. *Proc Natl Acad Sci U S A* 1966;55:308–316.
27. Benditt EP, Eriksen N. Chemical similarity among amyloid substances associated with long standing inflammation. *Lab Invest* 1972;26:615–625.
28. Glenner GG, Harbaugh J, Ohma JI, et al. An amyloid protein: the amino-terminal variable fragment of an immunoglobulin light chain. *Biochem Biophys Res Commun* 1970;41:1287–1289.
29. Glenner GG, Terry W, Harada M, et al. Amyloid fibril proteins: proof of homology with immunoglobulin light chains by sequence analyses. *Science* 1971;172:1150–1151.
30. Glenner GG, Ein D, Eanes ED, et al. Creation of “amyloid” fibrils from Bence Jones proteins in vitro. *Science* 1971;174:712–714.
31. Glenner GG. The discovery of the immunoglobulin origin of amyloid fibrils and its pathogenetic significance. *Acta Pathol Microbiol Scand [A]* 1972;233:114–121.
32. Terry WD, Page DL, Kimura S, et al. Structural identity of Bence Jones and amyloid fibril proteins in a patient with plasma cell dyscrasia and amyloidosis. *J Clin Invest* 1973;52:1276–1281.
33. Steensma DP. “Congo” red: Out of Africa? *Arch Pathol Lab Med* 2001;125:250–252.
34. Elghetany MT, Saleem A, Barr K. The Congo red stain revisited. *Ann Clin Lab Sci* 1989;19:190–195.
35. Blumenfeld W, Hildebrandt RH. Fine needle aspiration of abdominal fat for the diagnosis of amyloidosis. *Acta Cytol* 1993;37:170–174.
36. Yang GC, Nieto R, Stachura I, et al. Ultrastructural immunohistochemical localization of polyclonal IgG, C3, and amyloid P component on the Congo red-negative amyloid-like fibrils of fibrillary glomerulopathy. *Am J Pathol* 1992;141:409–419.
37. Devaney K, Sabnis SG, Antonovych TT. Nonamyloidotic fibrillary glomerulopathy, immunotactoid glomerulopathy, and the differential diagnosis of filamentous glomerulopathies. *Mod Pathol* 1991;4:36–45.
38. Billis A, Homsí E. Nonamyloidotic fibrillary glomerulopathy: report of a case and review of the literature. *Int Urol Nephrol* 1991;23:295–301.
39. Langer BU, Missmahl HP. Symptoms of perireticular and pericollagenous amyloidoses [German]. *Fortschr Med* 1980;98:545–548.
40. Missmahl HP, Gelinsky P, Braun HJ, et al. Check-valve-mechanism in Waldenström’s

macroglobulinemia with pericollagen amyloidosis [German]. *Med Welt* 1969;1:39–41.

41. Coimbra A, Andrade C. Familial amyloid polyneuropathy: an electron microscope study of the peripheral nerve in five cases. I. Interstitial changes. *Brain* 1971;94:199–206.
42. Mahloudji M, Nissim J. Amyloid polyneuropathy, type II (Indiana, or Rukavina type). *Birth Defects Orig Artic Ser* 1971;7:100–101.
43. Weiss SW, Page DL. Amyloid nephropathy of Ostertag with special reference to renal glomerular giant cells. *Am J Pathol* 1973;72:447–460.
44. Lanham JG, Meltzer ML, De Beer FC, et al. Familial amyloidosis of Ostertag. *Q J Med* 1982;51:25–32.
45. Kyle RA, Rajkumar SV. Monoclonal gammopathies of undetermined significance. *Hematol Oncol Clin North Am* 1999;13:1181–1202.
46. Rajkumar SV, Gertz MA, Kyle RA. Primary systemic amyloidosis with delayed progression to multiple myeloma. *Cancer* 1998;82:1501–1505.
47. Eulitz M, Weiss DT, Solomon A. Immunoglobulin heavy-chain-associated amyloidosis. *Proc Natl Acad Sci U S A* 1990;87:6542–6546.
48. Wall J, Schell M, Murphy C, et al. Thermodynamic instability of human lambda 6 light chains: correlation with fibrillogenicity. *Biochemistry* 1999;38:14101–14108.
49. Odani S, Komori Y, Gejyo F. Structural analysis of the amyloidogenic kappa Bence Jones protein (FUR). *Amyloid* 1999;6:77–88.
50. Solomon A, Weiss DT, Pepys MB. Induction in mice of human light-chain-associated amyloidosis. *Am J Pathol* 1992;140:629–637.
51. Solomon A, Frangione B, Franklin EC. Bence Jones proteins and light chains of immunoglobulins: preferential association of the V lambda VI subgroup of human light chains with amyloidosis AL (lambda). *J Clin Invest* 1982;70:453–460.
52. Mizuno J, Nakagawa H, Tsuji Y, et al. Primary amyloidoma of the thoracic spine presenting with acute paraplegia. *Surg Neurol* 2001;55:378–382.
53. Dikman SH, Churg J, Kahn T. Morphologic and clinical correlates in renal amyloidosis. *Hum Pathol* 1981;12:160–169.
54. Shah VB, Phatak AM, Shah BS, et al. Renal amyloidosis—a clinicopathologic study. *Indian J Pathol Microbiol* 1996;39:179–185.
55. Kyle RA, Bayrd ED. Amyloidosis: review of 236 cases. *Medicine (Baltimore)* 1975;54:271–299.
56. Kyle RA, Linos A, Beard CM, et al. Incidence and natural history of primary systemic amyloidosis in Olmsted County, Minnesota, 1950 through 1989. *Blood* 1992;79:1817–1822.
57. Kyle RA, Beard CM, O'Fallon WM, et al. Incidence of multiple myeloma in Olmsted County, Minnesota: 1978 through 1990, with a review of the trend since 1945. *J Clin Oncol* 1994;12:1577–1583.
58. Linos A, Beard CM, Banks PM, et al. Malignant lymphoma in Olmsted County, Minnesota, 1970 through 1977. *Mayo Clin Proc* 1986;61:706–713.
59. Call TG, Noel P, Habermann TM, et al. Incidence of leukemia in Olmsted County, Minnesota, 1975 through 1989. *Mayo Clin Proc* 1994;69:315–322.
60. Ania BJ, Suman VJ, Sobell JL, et al. Trends in the incidence of polycythemia vera among Olmsted County, Minnesota residents, 1935–1989. *Am J Hematol* 1994;47:89–93.
61. Fonseca R, Rajkumar SV, Ahmann GJ, et al. FISH demonstrates treatment-related chromosome

- damage in myeloid but not plasma cells in primary systemic amyloidosis. *Leuk Lymphoma* 2000;39:391–395.
62. Fonseca R, Ahmann GJ, Jalal SM, et al. Chromosomal abnormalities in systemic amyloidosis. *Br J Haematol* 1998;103:704–710.
63. Perfetti V, Coluccia AM, Intini D, et al. Translocation t(4;14)(p16.3;q32) is a recurrent genetic lesion in primary amyloidosis. *Am J Pathol* 2001;158:1599–1603.
64. Hoyer JD, Hanson CA, Fonseca R, et al. The (11;14)(q13;q32) translocation in multiple myeloma: a morphologic and immunohistochemical study. *Am J Clin Pathol* 2000;113:831–837.
65. Hayman SR, Bailey RJ, Jalal SM, et al. Translocations involving the immunoglobulin heavy-chain locus are possible early genetic events in patients with primary systemic amyloidosis. *Blood* 2001;98:2266–2268.
66. Kyle RA, Greipp PR. Amyloidosis (AL): clinical and laboratory features in 229 cases. *Mayo Clin Proc* 1983;58:665–683.
67. Kingman A, Pereira NL. Cardiac amyloidosis. *J S C Med Assoc* 2001;97:201–206.
68. Stamato N, Cahill J, Goodwin M, et al. Cardiac amyloidosis causing ventricular tachycardia: diagnosis made by endomyocardial biopsy. *Chest* 1989;96:1431–1433.
69. Gaan D, Mahoney MP, Rowlands DJ, et al. Postural hypotension in amyloid disease. *Am Heart J* 1972;84:395–400.
70. Paydas S. Report on 59 patients with renal amyloidosis. *Int Urol Nephrol* 1999;31:619–631.
71. Clements IP, Olson LJ, Scanlon PD, et al. The effect of respiration on left ventricular diastolic filling as assessed by radionuclide ventriculography. *Nucl Med Commun* 2000;21:55–63.
72. Low PA. Autonomic neuropathies. *Curr Opin Neurol* 1998;11:531–537.
73. Kobayashi S, Katsube T, Yamaguchi S, et al. Dysautoregulation of the cerebral circulation in primary systemic amyloidosis. *J Cereb Blood Flow Metab* 1984;4:470–473.
74. Gamba G, Montani N, Anesi E, et al. Clotting alterations in primary systemic amyloidosis. *Haematologica* 2000;85:289–292.
75. Mohr A, Miehlke S, Klauck S, et al. Hepatomegaly and cholestasis as primary clinical manifestations of an AL-kappa amyloidosis. *Eur J Gastroenterol Hepatol* 1999;11:921–925.
76. Basak PY, Ergin S, Sezer MT, et al. Amyloidosis of the tongue with kappa light chain disease. *Australas J Dermatol* 2001;42:55–57.
77. Herold J, Nicholson AG. Fine needle aspiration cytology in the diagnosis of amyloid in the submandibular gland. *Br J Oral Maxillofac Surg* 1992;30:393–394.
78. Jardinet D, Westhovens R, Peeters J. Sicca syndrome as an initial symptom of amyloidosis. *Clin Rheumatol* 1998;17:546–548.
79. Gertz MA, Kyle RA, Griffing WL, et al. Jaw claudication in primary systemic amyloidosis. *Medicine (Baltimore)* 1986;65:173–179.
80. Schneider BF, Normansell D, Ayers CR, et al. Intermittent claudication as the presenting symptom in primary amyloidosis. *Acta Haematol* 1993;90:106–107.
81. Salvarani C, Gabriel SE, Gertz MA, et al. Primary systemic amyloidosis presenting as giant cell arteritis and polymyalgia rheumatica. *Arthritis Rheum* 1994;37:1621–1626.
82. Rao JK, Allen NB. Primary systemic amyloidosis masquerading as giant cell arteritis: case report and review of the literature. *Arthritis Rheum* 1993;36: 422–425.
83. Liepnieks JJ, Burt C, Benson MD. Shoulder-pad sign of amyloidosis: structure of an Ig kappa III

protein. *Scand J Immunol* 2001;54:404–408.

84. Roke ME, Brown WF, Boughner D, et al. Myopathy in primary systemic amyloidosis. *Can J Neurol Sci* 1988;15:314–316.

85. Perfetti V, Garini P, Vignarelli MC, et al. Diagnostic approach to and follow-up of difficult cases of AL amyloidosis. *Haematologica* 1995;80:409–415.

86. Gertz MA, Greipp PR, Kyle RA. Classification of amyloidosis by the detection of clonal excess of plasma cells in the bone marrow. *J Lab Clin Med* 1991;118:33–39.

87. Gertz MA, Lacy MQ, Dispenzieri A. Amyloidosis: recognition, confirmation, prognosis, and therapy. *Mayo Clin Proc* 1999;74:490–494.

88. Lantz O, Guettier C, Jouvin MH, et al. Diagnosis of AL amyloidosis in the absence of detectable serum or urinary monoclonal component [French]. *Nephrologie* 1986;7:204–206.

89. Chau EM, Cheung SC, Chow SL, et al. Nonsecretory immunoglobulin-derived amyloidosis of the heart: diagnosis by immunohistochemistry of the endomyocardium. *Clin Cardiol* 1997;20:494–496.

90. Drayson M, Tang LX, Drew R, et al. Serum free light-chain measurements for identifying and monitoring patients with nonsecretory multiple myeloma. *Blood* 2001;97:2900–2902.

91. Bradwell AR, Carr-Smith HD, Mead GP, et al. Highly sensitive, automated immunoassay for immunoglobulin free light chains in serum and urine. *Clin Chem* 2001;47:673–680.

92. Hawkins PN. The diagnosis, natural history and treatment of amyloidosis: the Goulstonian Lecture 1995. *J R Coll Physicians Lond* 1997;31:552–560.

93. Hawkins PN, Pepys MB. Imaging amyloidosis with radiolabelled SAP. *Eur J Nucl Med* 1995;22:595–599.

94. Hawkins PN, Lavender JP, Pepys MB. Evaluation of systemic amyloidosis by scintigraphy with <sup>123</sup>I-labeled serum amyloid P component. *N Engl J Med* 1990;323:508–513.

95. Hawkins PN. Diagnosis and monitoring of amyloidosis. *Baillieres Clin Rheumatol* 1994;8:635–659.

96. Hawkins PN, Aprile C, Capri G, et al. Scintigraphic imaging and turnover studies with iodine-131 labelled serum amyloid P component in systemic amyloidosis. *Eur J Nucl Med* 1998;25:701–708.

97. Murphy CL, Eulitz M, Hrnčić R, et al. Chemical typing of amyloid protein contained in formalin-fixed paraffin-embedded biopsy specimens. *Am J Clin Pathol* 2001;116:135–142.

98. Sezer O, Eucker J, Jakob C, et al. Diagnosis and treatment of AL amyloidosis. *Clin Nephrol* 2000;53:417–423.

99. Duston MA, Skinner M, Meenan RF, et al. Sensitivity, specificity, and predictive value of abdominal fat aspiration for the diagnosis of amyloidosis. *Arthritis Rheum* 1989;32:82–85.

100. Maruyama K, Ikeda S, Yanagisawa N, et al. Diagnostic value of abdominal fat tissue aspirate in familial amyloid polyneuropathy. *J Neurol Sci* 1987;81:11–18.

101. Stavem P, Larsen IF, Ly B, et al. Amyloid deposits in bone marrow aspirates in primary amyloidosis. *Acta Med Scand* 1980;208:111–113.

102. Perfetti V, Colli Vignarelli M, Anesi E, et al. The degrees of plasma cell clonality and marrow infiltration adversely influence the prognosis of AL amyloidosis patients. *Haematologica* 1999;84:218–221.

103. Fatihi E, Zahiri K, Hachim K, et al. Value of the biopsy of accessory salivary glands in amyloidosis [French]. *Rev Med Interne* 1999;20:759–761.

104. Lechapt-Zalcman E, Authier FJ, Creange A, et al. Labial salivary gland biopsy for diagnosis of

amyloid polyneuropathy. *Muscle Nerve* 1999;22:105–107.

105. Lee DD, Huang CY, Wong CK. Dermatopathologic findings in 20 cases of systemic amyloidosis. *Am J Dermatopathol* 1998;20:438–442.

106. Rubinow A, Cohen AS. Skin involvement in generalized amyloidosis: a study of clinically involved and uninvolved skin in 50 patients with primary and secondary amyloidosis. *Ann Intern Med* 1978;88:781–785.

107. Kyle RA, Spencer RJ, Dahlin DC. Value of rectal biopsy in the diagnosis of primary systemic amyloidosis. *Am J Med Sci* 1966;251:501–506.

108. Guy CD, Jones CK. Abdominal fat pad aspiration biopsy for tissue confirmation of systemic amyloidosis: specificity, positive predictive value, and diagnostic pitfalls. *Diagn Cytopathol* 2001;24:181–185.

109. Carson FL, Kingsley WB. Nonamyloid green birefringence following Congo red staining. *Arch Pathol Lab Med* 1980;104:333–335.

110. Gradwell E. Amyloid colitis mimicking collagenous colitis. *Histopathology* 1998;32:383.

111. Pomerance A, Slavin G, McWatt J. Experience with the sodium sulphate–Alcian blue stain for amyloid in cardiac pathology. *J Clin Pathol* 1976;29:22–26.

112. Elghetany MT, Saleem A. Methods for staining amyloid in tissues: a review. *Stain Technol* 1988;63:201–212.

113. Hoshii Y, Setoguchi M, Iwata T, et al. Useful polyclonal antibodies against synthetic peptides corresponding to immunoglobulin light chain constant region for immunohistochemical detection of immunoglobulin light chain amyloidosis. *Pathol Int* 2001;51:264–270.

114. Strege RJ, Saeger W, Linke RP. Diagnosis and immunohistochemical classification of systemic amyloidoses: report of 43 cases in an unselected autopsy series. *Virchows Arch* 1998;433:19–27.

115. Kennedy TL, Patel NM. Surgical management of localized amyloidosis. *Laryngoscope* 2000;110:918–923.

116. Cohen AS, Jones LA. Amyloid and amyloidosis. *Curr Opin Rheumatol* 1992;4:94–105.

117. Gillmore JD, Lovat LB, Persey MR, et al. Amyloid load and clinical outcome in AA amyloidosis in relation to circulating concentration of serum amyloid A protein. *Lancet* 2001;358:24–29.

118. Cornwell GG III, Murdoch WL, Kyle RA, et al. Frequency and distribution of senile cardiovascular amyloid: a clinicopathologic correlation. *Am J Med* 1983;75:618–623.

119. Tirzaman O, Wahner–Roedler DL, Malek RS, et al. Primary localized amyloidosis of the urinary bladder: a case series of 31 patients. *Mayo Clin Proc* 2000;75:1264–1268.

120. O'Regan A, Fenlon HM, Beamis JF Jr, et al. Tracheobronchial amyloidosis: the Boston University experience from 1984 to 1999. *Medicine (Baltimore)* 2000;79:69–79.

121. Lee HM, Naor J, DeAngelis D, et al. Primary localized conjunctival amyloidosis presenting with recurrence of subconjunctival hemorrhage. *Am J Ophthalmol* 2000;129:245–247.

122. Toyoda M, Ebihara Y, Kato H, et al. Tracheobronchial AL amyloidosis: histologic, immunohistochemical, ultrastructural, and immunoelectron microscopic observations. *Hum Pathol* 1993;24:970–976.

123. Wang WJ, Chang YT, Huang CY, et al. Clinical and histopathological characteristics of primary cutaneous amyloidosis in 794 Chinese patients. *Zhonghua Yi Xue Za Zhi (Taipei)* 2001;64:101–107.

124. Utz JP, Swensen SJ, Gertz MA. Pulmonary amyloidosis. The Mayo Clinic experience from 1980 to 1993. *Ann Intern Med* 1996;124:407–413.

125. Madden BP, Lee M, Paruchuru P. Successful treatment of endobronchial amyloidosis using Nd:YAG

laser therapy as an alternative to lobectomy. *Monaldi Arch Chest Dis* 2001;56:27–29.

126. Miura K, Shirasawa H. Lambda III subgroup immunoglobulin light chains are precursor proteins of nodular pulmonary amyloidosis. *Am J Clin Pathol* 1993;100:561–566.

127. Dundore PA, Aisner SC, Templeton PA, et al. Nodular pulmonary amyloidosis: diagnosis by fine-needle aspiration cytology and a review of the literature. *Diagn Cytopathol* 1993;9:562–564.

128. Hocevar-Boltezar I, Zidar N, Zargi M, et al. Amyloidosis of the larynx. *Wien Klin Wochenschr* 2000;112:732–734.

129. Oka N, Fukumori T, Takahashi M, et al. Secondary amyloidosis of the bladder causing macroscopic hematuria. *Int J Urol* 2001;8:330–332.

130. Nurmi MJ, Ekfors TO, Rajala PO, et al. Intravesical dimethyl sulfoxide instillations in the treatment of secondary amyloidosis of the bladder. *J Urol* 1990;143:808–810.

131. Hayashi T, Kojima S, Sekine H, et al. Primary localized amyloidosis of the ureter. *Int J Urol* 1998;5:383–385.

132. Dias R, Fernandes M, Patel RC, et al. Amyloidosis of renal pelvis and urinary bladder. *Urology* 1979;14:401–404.

133. Gepi-Attee S, Gingell JC, Rigby HS. Urethral amyloid. *Br J Urol* 1992;69:431–432.

134. Breathnach SM. Amyloid and amyloidosis. *J Am Acad Dermatol* 1988;18:1–16.

135. Badell A, Servitje O, Graells J, et al. Salivary gland lymphoplasmacytoid lymphoma with nodular cutaneous amyloid deposition and lambda chain paraproteinaemia. *Br J Dermatol* 1996;135:327–329.

136. Inoue K, Takahashi M, Hamamoto Y, et al. An immunohistochemical study of cytokeratins in skin-limited amyloidosis. *Amyloid* 2000;7:259–265.

137. Nakamichi K, Tachibana S. Histology of the transverse carpal ligament and flexor tenosynovium in idiopathic carpal tunnel syndrome. *J Hand Surg [Am]* 1998;23:1015–1024.

138. Subramaniam P, de la Harpe D, Corlett RJ. Focal tenosynovial amyloid deposition as a rare cause of median nerve compression at the wrist. *Aust N Z J Surg* 1997;67:138–139.

139. Kyle RA, Gertz MA, Linke RP. Amyloid localized to tenosynovium at carpal tunnel release: immunohistochemical identification of amyloid type. *Am J Clin Pathol* 1992;97:250–253.

140. Gluck BS, Cabrera J, Strauss B, et al. Amyloid deposition of the breast. *AJR Am J Roentgenol* 2000;175:1590.

141. Halliday BE, Silverman JF, Finley JL. Fine-needle aspiration cytology of amyloid associated with nonneoplastic and malignant lesions. *Diagn Cytopathol* 1998;18:270–275.

142. Athanasou NA, Sallie B. Localized deposition of amyloid in articular cartilage. *Histopathology* 1992;20:41–46.

143. Mitrovic DR, Stankovic A, Quintero M, et al. Amyloid deposits in human knee and hip joints. *Rheumatol Int* 1985;5:83–89.

144. Gertz MA, Kyle RA. Secondary systemic amyloidosis: response and survival in 64 patients. *Medicine (Baltimore)* 1991;70:246–256.

145. Hazenberg BP, van Rijswijk MH. Where has secondary amyloid gone? *Ann Rheum Dis* 2000;59:577–579.

146. Kovacovics-Bankowski M, Zufferey P, So AK, et al. Secondary amyloidosis: a severe complication of ankylosing spondylitis: two case reports. *Joint Bone Spine* 2000;67:129–133.

147. Hawkins PN, Richardson S, Vigushin DM, et al. Serum amyloid P component scintigraphy and turnover studies for diagnosis and quantitative monitoring of AA amyloidosis in juvenile rheumatoid arthritis. *Arthritis Rheum* 1993;36:842–851.
148. Ahmed Q, Chung–Park M, Mustafa K, et al. Psoriatic spondyloarthropathy with secondary amyloidosis. *J Rheumatol* 1996;23:1107–1110.
149. Chevrel G, Jenvrin C, McGregor B, et al. Renal type AA amyloidosis associated with rheumatoid arthritis: a cohort study showing improved survival on treatment with pulse cyclophosphamide. *Rheumatology (Oxford)* 2001;40:821–825.
150. Gertz MA. Secondary amyloidosis (AA). *J Intern Med* 1992;232:517–518.
151. Laakso M, Mutru O, Isomaki H, et al. Mortality from amyloidosis and renal diseases in patients with rheumatoid arthritis. *Ann Rheum Dis* 1986;45:663–667.
152. Knebel U, Arnold JC, Schilling D, et al. Therapy possibilities in AA amyloidosis in long–term Crohn disease [German]. *Dtsch Med Wochenschr* 2001;126:279–282.
153. Goldsmith DJ, Roberts IS, Short CD, et al. Complete clinical remission and subsequent relapse of bronchiectasis–related (AA) amyloid induced nephrotic syndrome. *Nephron* 1996;74:572–576.
154. Alabi ZO, Ojo OS, Odesanmi WO. Secondary amyloidosis in chronic osteomyelitis. *Int Orthop* 1991;15:21–22.
155. Tan AU Jr, Cohen AH, Levine BS. Renal amyloidosis in a drug abuser. *J Am Soc Nephrol* 1995;5:1653–1658.
156. Neugarten J, Gallo GR, Buxbaum J, et al. Amyloidosis in subcutaneous heroin abusers (“skin poppers’ amyloidosis”). *Am J Med* 1986;81:635–640.
157. Lanjewar DN, Raghuvanshi SR, Gupta D, et al. Systemic amyloidosis in Hodgkin’s disease. *Indian J Pathol Microbiol* 1998;41:169–171.
158. Tuzuner N, Avanoğlu Y, Aktuglu G, et al. Amyloidosis in Hodgkin’s disease. *Am J Med* 1992;92:446–448.
159. Coakley FV, Hricak H, Presti JC Jr, et al. Diffuse retroperitoneal amyloidosis due to renal cell carcinoma. *Br J Radiol* 1999;72:412–413.
160. Tang AL, Davies DR, Wing AJ. Remission of nephrotic syndrome in amyloidosis associated with a hypernephroma. *Clin Nephrol* 1989;32:225–228.
161. Silver JR. Pressure ulcer and amyloidosis. *Spinal Cord* 1998;36:293.
162. Barton CH, Vaziri ND, Gordon S, et al. Renal pathology in end–stage renal disease associated with paraplegia. *Paraplegia* 1984;22:31–41.
163. Hackler RH. A 25–year prospective mortality study in the spinal cord injured patient: comparison with the long–term living paraplegic. *J Urol* 1977;117:486–488.
164. Svendsen IH, Steensgaard–Hansen F, Nordvag BY. A clinical, echocardiographic and genetic characterization of a Danish kindred with familial amyloid transthyretin methionine 111 linked cardiomyopathy. *Eur Heart J* 1998;19:782–789.
165. Ranlov I, Alves IL, Ranlov PJ, et al. A Danish kindred with familial amyloid cardiomyopathy revisited: identification of a mutant transthyretin–methionine 111 variant in serum from patients and carriers. *Am J Med* 1992;93:3–8.
166. Plante–Bordeneuve V, Said G. Transthyretin related familial amyloid polyneuropathy. *Curr Opin Neurol* 2000;13:569–573.



167. Lobato L, Beirao I, Guimaraes SM, et al. Familial amyloid polyneuropathy type I (Portuguese): distribution and characterization of renal amyloid deposits. *Am J Kidney Dis* 1998;31:940–946.
168. Connors LH, Richardson AM, Theberge R, et al. Tabulation of transthyretin (TTR) variants as of 1/1/2000. *Amyloid* 2000;7:54–69.
169. Gertz MA, Kyle RA, Thibodeau SN. Familial amyloidosis: a study of 52 North American-born patients examined during a 30-year period. *Mayo Clin Proc* 1992;67:428–440.
170. Olson LJ, Gertz MA, Edwards WD, et al. Senile cardiac amyloidosis with myocardial dysfunction: diagnosis by endomyocardial biopsy and immunohistochemistry. *N Engl J Med* 1987;317:738–742.
171. Gertz MA, Kyle RA, Edwards WD. Recognition of congestive heart failure due to senile cardiac amyloidosis. *Biomed Pharmacother* 1989;43:101–106.
172. Husby G, Ranlov PJ, Sletten K, et al. The amyloid in familial amyloid cardiomyopathy of Danish origin is related to pre-albumin. *Clin Exp Immunol* 1985;60:207–216.
173. Smith TJ, Kyle RA, Lie JT. Clinical significance of histopathologic patterns of cardiac amyloidosis. *Mayo Clin Proc* 1984;59:547–555.
174. Jacobson DR, Gorevic PD, Buxbaum JN. A homozygous transthyretin variant associated with senile systemic amyloidosis: evidence for a late-onset disease of genetic etiology. *Am J Hum Genet* 1990;47:127–136.
175. Jacobson DR, Buxbaum JN. Genetic aspects of amyloidosis. *Adv Hum Genet* 1991;20:69–123.
176. Jacobson DR, Pastore RD, Yaghoubian R, et al. Variant-sequence transthyretin (isoleucine 122) in late-onset cardiac amyloidosis in black Americans. *N Engl J Med* 1997;336:466–473.
177. Hamidi Asl L, Fournier V, Billerey C, et al. Fibrinogen A alpha chain mutation (Arg554 Leu) associated with hereditary renal amyloidosis in a French family. *Amyloid* 1998;5:279–284.
178. Pepys MB, Hawkins PN, Booth DR, et al. Human lysozyme gene mutations cause hereditary systemic amyloidosis. *Nature* 1993;362:553–557.
179. Benson MD, Liepnieks JJ, Yazaki M, et al. A new human hereditary amyloidosis: the result of a stop-codon mutation in the apolipoprotein AII gene. *Genomics* 2001;72:272–277.
180. Caballeria J, Bruguera M, Sole M, et al. Hepatic familial amyloidosis caused by a new mutation in the apolipoprotein AI gene: clinical and pathological features. *Am J Gastroenterol* 2001;96:1872–1876.
181. Shaz BH, Lewis WD, Skinner M, et al. Livers from patients with apolipoprotein A-I amyloidosis are not suitable as “domino” donors. *Mod Pathol* 2001;14:577–580.
182. Viana JS, Bento C, Vieira H, et al. Requirements of circulatory support during liver transplantation: are patients with familial amyloidosis different from other patients? *Transplant Proc* 2000;32:2652–2653.
183. Ramirez P, De Mingo P, Andreu F, et al. Long-term results of liver transplantation in four siblings from the same family with familial amyloidotic polyneuropathy type I TTR Ala-71. *Transpl Int* 2000;13(Suppl 1):S171–S173.
184. Nishino M, Tagaya N, Lynch SV, et al. Liver transplantation for familial amyloidotic polyneuropathy in Australia. *J Hepatobiliary Pancreat Surg* 2000;7:312–315.
185. Garcia-Herola A, Prieto M, Pascual S, et al. Progression of cardiomyopathy and neuropathy after liver transplantation in a patient with familial amyloidotic polyneuropathy caused by tyrosine-77 transthyretin variant. *Liver Transpl Surg* 1999;5:246–248.
186. Stangou AJ, Hawkins PN, Heaton ND, et al. Progressive cardiac amyloidosis following liver transplantation for familial amyloid polyneuropathy: implications for amyloid fibrillogenesis. *Transplantation*

1998;66:229–233.

187. Dubrey SW, Davidoff R, Skinner M, et al. Progression of ventricular wall thickening after liver transplantation for familial amyloidosis. *Transplantation* 1997;64:74–80.

188. Cueto-Garcia L, Reeder GS, Kyle RA, et al. Echocardiographic findings in systemic amyloidosis: spectrum of cardiac involvement and relation to survival. *J Am Coll Cardiol* 1985;6:737–743.

189. Cueto-Garcia L, Tajik AJ, Kyle RA, et al. Serial echocardiographic observations in patients with primary systemic amyloidosis: an introduction to the concept of early (asymptomatic) amyloid infiltration of the heart. *Mayo Clin Proc* 1984;59:589–597.

190. Mumford AD, O'Donnell J, Gillmore JD, et al. Bleeding symptoms and coagulation abnormalities in 337 patients with AL-amyloidosis. *Br J Haematol* 2000;110:454–460.

191. Yood RA, Skinner M, Rubinow A, et al. Bleeding manifestations in 100 patients with amyloidosis. *JAMA* 1983;249:1322–1324.

192. Kyle RA, Gertz MA. Primary systemic amyloidosis. Clinical and laboratory features in 474 cases. *Semin Hematol* 1995;32:45–59.

193. Almirante Gragera B, Mirada Canals A. Anemia and primary amyloidosis [Spanish]. *Med Clin* 1985;84:165–166.

194. Jacobson IM, Isselbacher KJ. Amyloidosis and hyposplenism with leukocytosis and thrombocytosis. *Ann Intern Med* 1983;99:573.

195. Selroos O, Pettersson T. Platelet values in amyloidosis. *Scand J Rheumatol* 1973;2:97–100.

196. Gertz MA, Kyle RA, Noel P. Primary systemic amyloidosis: a rare complication of immunoglobulin M monoclonal gammopathies and Waldenström's macroglobulinemia. *J Clin Oncol* 1993;11:914–920.

197. Klein AL, Hatle LK, Talierecio CP, et al. Prognostic significance of Doppler measures of diastolic function in cardiac amyloidosis. A Doppler echocardiography study. *Circulation* 1991;83:808–816.

198. Klein AL, Hatle LK, Talierecio CP, et al. Serial Doppler echocardiographic follow-up of left ventricular diastolic function in cardiac amyloidosis. *J Am Coll Cardiol* 1990;16:1135–1141.

199. Klein AL, Hatle LK, Burstow DJ, et al. Doppler characterization of left ventricular diastolic function in cardiac amyloidosis. *J Am Coll Cardiol* 1989;13:1017–1026.

200. Chew C, Ziady GM, Raphael MJ, et al. Proceedings: functional defect in amyloid heart disease 'the stiff heart syndrome.' *Br Heart J* 1976;38:537.

201. Kilpatrick TR, Horack HM, Moore CB. "Stiff heart" syndrome. An uncommon cause of heart failure. *Med Clin North Am* 1967;51:959–966.

202. Klein AL, Canale MP, Rajagopalan N, et al. Role of transesophageal echocardiography in assessing diastolic dysfunction in a large clinical practice: a 9-year experience. *Am Heart J* 1999;138:880–889.

203. Moysakis I, Triposkiadis F, Rallidis L, et al. Echocardiographic features of primary, secondary and familial amyloidosis. *Eur J Clin Invest* 1999;29:484–489.

204. Kabbani SS, LeWinter MM. Diastolic heart failure. Constrictive, restrictive, and pericardial. *Cardiol Clin* 2000;18:501–509.

205. Hongo M, Yamamoto H, Kohda T, et al. Comparison of electrocardiographic findings in patients with AL (primary) amyloidosis and in familial amyloid polyneuropathy and anginal pain and their relation to histopathologic findings. *Am J Cardiol* 2000;85:849–853.

206. Ogawa H, Mizuno Y, Ohkawara S, et al. Cardiac amyloidosis presenting as microvascular angina—a case report. *Angiology* 2001;52:273–278.

207. Hemmingson LO, Eriksson P. Cardiac amyloidosis mimicking hypertrophic cardiomyopathy. *Acta Med Scand* 1986;219:421–423.
208. Sedlis SP, Saffitz JE, Schwob VS, et al. Cardiac amyloidosis simulating hypertrophic cardiomyopathy. *Am J Cardiol* 1984;53:969–970.
209. Masugata H, Mizushige K, Senda S, et al. Comparison of left ventricular diastolic filling with myocyte bulk modulus using Doppler echocardiography and acoustic microscopy in pressure-overload left ventricular hypertrophy and cardiac amyloidosis. *Clin Cardiol* 2000;23:115–122.
210. Celletti F, Fattori R, Napoli G, et al. Assessment of restrictive cardiomyopathy of amyloid or idiopathic etiology by magnetic resonance imaging. *Am J Cardiol* 1999;83:798–801, A10.
211. Elliott PM, Mahon NG, Matsumura Y, et al. Tissue Doppler features of cardiac amyloidosis. *Clin Cardiol* 2000;23:701.
212. Abdalla I, Murray RD, Lee JC, et al. Duration of pulmonary venous atrial reversal flow velocity and mitral inflow a wave: new measure of severity of cardiac amyloidosis. *J Am Soc Echocardiogr* 1998;11:1125–1133.
213. Chamarthi B, Dubrey SW, Cha K, et al. Features and prognosis of exertional syncope in light-chain associated AL cardiac amyloidosis. *Am J Cardiol* 1997;80:1242–1245.
214. Gertz MA, Grogan M, Kyle RA, et al. Endomyocardial biopsy-proven light chain amyloidosis (AL) without echocardiographic features of infiltrative cardiomyopathy. *Am J Cardiol* 1997;80:93–95.
215. Oki T, Fukuda N, Iuchi A, et al. Left atrial systolic performance in the presence of elevated left ventricular end-diastolic pressure: evaluation by transesophageal pulsed Doppler echocardiography of left ventricular inflow and pulmonary venous flow velocities. *Echocardiography* 1997;14:23–32.
216. Kohno I, Komori S, Yamamoto K, et al. Hypertrophic cardiomyopathy complicated with cardiac amyloidosis. *Intern Med* 2000;39:637–640.
217. Kornberg A, Rapoport M, Yona R, et al. Amyloidosis of the pericardium in multiple myeloma: an unusual cause of bloody pericardial effusion. *Isr J Med Sci* 1993;29:794–797.
218. Navarro JF, Rivera M, Ortuno J. Cardiac tamponade as presentation of systemic amyloidosis. *Int J Cardiol* 1992;36:107–108.
219. Pellikka PA, Holmes DR Jr, Edwards WD, et al. Endomyocardial biopsy in 30 patients with primary amyloidosis and suspected cardiac involvement. *Arch Intern Med* 1988;148:662–666.
220. Browne RS, Schneiderman H, Kayani N, et al. Amyloid heart disease manifested by systemic arterial thromboemboli. *Chest* 1992;102:304–307.
221. Dubrey S, Pollak A, Skinner M, et al. Atrial thrombi occurring during sinus rhythm in cardiac amyloidosis: evidence for atrial electromechanical dissociation. *Br Heart J* 1995;74:541–544.
222. Mueller PS, Edwards WD, Gertz MA. Symptomatic ischemic heart disease resulting from obstructive intramural coronary amyloidosis. *Am J Med* 2000;109:181–188.
223. Al Suwaidi J, Velianou JL, Gertz MA, et al. Systemic amyloidosis presenting with angina pectoris. *Ann Intern Med* 1999;131:838–841.
224. Jacobson DR, Gertz MA, Buxbaum JN. Transthyretin VAL107, a new variant associated with familial cardiac and neuropathic amyloidosis. *Hum Mutat* 1994;3:399–401.
225. Kyle RA, Spittell PC, Gertz MA, et al. The premortem recognition of systemic senile amyloidosis with cardiac involvement. *Am J Med* 1996;101:395–400.
226. Germain MJ, Anderson RW, Keane WF. Renal disease in cryoglobulinemia type II: response to

- therapy. A case report and review of the literature. *Am J Nephrol* 1982;2:221–226.
227. Randall RE, Williamson WC Jr, Mullinax F, et al. Manifestations of systemic light chain deposition. *Am J Med* 1976;60:293–299.
228. Lin J, Markowitz GS, Valeri AM, et al. Renal monoclonal immunoglobulin deposition disease: the disease spectrum. *J Am Soc Nephrol* 2001;12:1482–1492.
229. Bellotti V, Merlini G. Current concepts on the pathogenesis of systemic amyloidosis. *Nephrol Dial Transplant* 1996;11(Suppl9):53–62.
230. Yahya TM, Pingle A, Boobes Y, et al. Analysis of 490 kidney biopsies: data from the United Arab Emirates Renal Diseases Registry. *J Nephrol* 1998;11:148–150.
231. Gertz MA, Kyle RA. Prognostic value of urinary protein in primary systemic amyloidosis (AL). *Am J Clin Pathol* 1990;94:313–317.
232. Duda SH, Raible RT, Risler T, et al. Therapeutic bilateral renal artery embolization in the nephrotic syndrome [German]. *Dtsch Med Wochenschr* 1994;119:58–62.
233. Montseny JJ, Kleinknecht D, Meyrier A, et al. Long-term outcome according to renal histological lesions in 118 patients with monoclonal gammopathies. *Nephrol Dial Transplant* 1998;13:1438–1445.
234. Browning M, Banks R, Tribe C, et al. Renal involvement in systemic amyloidosis. *Proc Eur Dial Transplant Assoc* 1983;20:595–602.
235. Sasatomi Y, Kiyoshi Y, Uesugi N, et al. Prognosis of renal amyloidosis: a clinicopathological study using cluster analysis. *Nephron* 2001;87:42–49.
236. Buxbaum J, Gallo G. Nonamyloidotic monoclonal immunoglobulin deposition disease: light-chain, heavy-chain, and light- and heavy-chain deposition diseases. *Hematol Oncol Clin North Am* 1999;13:1235–1248.
237. Winer RL, Wuerker RB, Erickson JO, et al. Ultrastructural examination of urinary sediment. Value in renal amyloidosis. *Am J Clin Pathol* 1979;71:36–39.
238. Reference deleted.
239. Shiiki H, Shimokama T, Yoshikawa Y, et al. Renal amyloidosis: correlations between morphology, chemical types of amyloid protein and clinical features. *Virchows Arch A Pathol Anat Histopathol* 1988;412:197–204.
240. Rikitake O, Sakemi T, Yoshikawa Y, et al. Adult Fanconi syndrome in primary amyloidosis with lambda light-chain proteinuria. *Jpn J Med* 1989;28:523–526.
241. Liu YC, Liu P, Pan JS. Renal involvement in amyloidosis: analysis of 14 cases (Chinese). *Zhonghua Nei Ke Za Zhi* 1990;29:593–596; 636–637.
242. Kurosu M, Ando Y, Takeda S, et al. Immunotactoid glomerulopathy characterized by steroid-responsive massive subendothelial deposition. *Am J Kidney Dis* 2001;37:E21.
243. Looi LM. Fibrillary deposits: amyloids and tactoids. *Malays J Pathol* 1995;17:1–10.
244. Decourt C, Touchard G, Preud'homme JL, et al. Complete primary sequences of two lambda immunoglobulin light chains in myelomas with nonamyloid (Randall-type) light chain deposition disease. *Am J Pathol* 1998;153:313–318.
245. Stokes MB, Jagirdar J, Burchstin O, et al. Nodular pulmonary immunoglobulin light chain deposits with coexistent amyloid and nonamyloid features in an HIV-infected patient. *Mod Pathol* 1997;10:1059–1065.
246. Gillmore JD, Madhoo S, Pepys MB, et al. Renal transplantation for amyloid end-stage renal failure—insights from serial serum amyloid P component scintigraphy. *Nucl Med Commun* 2000;21:735–740.

247. Gertz MA, Kyle RA. Hepatic amyloidosis (primary [AL], immunoglobulin light chain): the natural history in 80 patients. *Am J Med* 1988;85:73–80.
248. Okazaki K, Moriyasu F, Shiomura T, et al. Spontaneous rupture of the spleen and liver in amyloidosis—a case report and review of the literature. *Gastroenterol Jpn* 1986;21:518–524.
249. Russell TJ, Ferrera PC. Spontaneous rupture of an amyloid spleen in a patient on continuous ambulatory peritoneal dialysis. *Am J Emerg Med* 1998;16:279–280.
250. Gastineau DA, Gertz MA, Rosen CB, et al. Computed tomography for diagnosis of hepatic rupture in primary systemic amyloidosis. *Am J Hematol* 1991;37:194–196.
251. Gertz MA, Kyle RA. Hepatic amyloidosis: clinical appraisal in 77 patients. *Hepatology* 1997;25:118–121.
252. Lovat LB, Persey MR, Madhoo S, et al. The liver in systemic amyloidosis: insights from <sup>123</sup>I serum amyloid P component scintigraphy in 484 patients. *Gut* 1998;42:727–734.
253. Rockey DC. Striking cholestatic liver disease: a distinct manifestation of advanced primary amyloidosis. *South Med J* 1999;92:236–241.
254. Itescu S. Hepatic amyloidosis: an unusual cause of ascites and portal hypertension. *Arch Intern Med* 1984;144:2257–2259.
255. Serra L, Poppi MC, Criscuolo M, et al. Primary systemic amyloidosis with giant hepatomegaly and portal hypertension: a case report and a review of the literature. *Ital J Gastroenterol* 1993;25:435–438.
256. Iwai M, Ishii Y, Mori T, et al. Cholestatic jaundice in two patients with primary amyloidosis: ultrastructural findings of the liver. *J Clin Gastroenterol* 1999;28:162–166.
257. Buck FS, Koss MN. Hepatic amyloidosis: morphologic differences between systemic AL and AA types. *Hum Pathol* 1991;22:904–907.
258. Koizumi K, Monzawa S, Shindo C, et al. Primary hepatic amyloidosis well delineated by Tc-99m DTPA galactosyl HSA liver SPECT. *Clin Nucl Med* 1999;24:271–273.
259. Rao BK, Padmalatha C, Au Buchon J, et al. Hepatic and splenic scintigraphy in idiopathic systemic amyloidosis. *Eur J Nucl Med* 1981;6:143–146.
260. Powsner RA, Simms RW, Chudnovsky A, et al. Scintigraphic functional hyposplenism in amyloidosis. *J Nucl Med* 1998;39:221–223.
261. Yaghoobian J, Pinck RL, Naidich J, et al. Angiographic findings in liver amyloidosis. *Radiology* 1980;136:332.
262. Levy M, Polliack A, Lender M, et al. The liver in amyloidosis. *Digestion* 1974;10:40–51.
263. Seo IS, Li CY. Hyposplenic blood picture in systemic amyloidosis. Its absence is not a predictable sign for absence of splenic involvement. *Arch Pathol Lab Med* 1995;119:252–254.
264. Hayman SR, Lacy MQ, Kyle RA, et al. Primary systemic amyloidosis: a cause of malabsorption syndrome. *Am J Med* 2001;111:535–540.
265. Gilat T, Spiro HM. Amyloidosis and the gut. *Am J Dig Dis* 1968;13:619–633.
266. Tada S, Iida M, Yao T, et al. Intestinal pseudo-obstruction in patients with amyloidosis: clinicopathologic differences between chemical types of amyloid protein. *Gut* 1993;34:1412–1417.
267. Tada S, Iida M, Yao T, et al. Gastrointestinal amyloidosis: radiologic features by chemical types. *Radiology* 1994;190:37–42.

268. Lau CF, Fok KO, Hui PK, et al. Intestinal obstruction and gastrointestinal bleeding due to systemic amyloidosis in a woman with occult plasma cell dyscrasia. *Eur J Gastroenterol Hepatol* 1999;11:681-685.
269. Domingo-Garcia P, Pardo-Garcia JL, Martinez-Albaladejo M, et al. Amyloid intestinal pseudo-obstruction as initial manifestation of IgA multiple myeloma [Spanish]. *An Med Interna* 1995;12:283-285.
270. Friedman S, Janowitz HD. Systemic amyloidosis and the gastrointestinal tract. *Gastroenterol Clin North Am* 1998;27:595-614.
271. Whitby EH, Peck RJ. Case report: ultrasound of primary generalised AL amyloid of the small bowel. *Clin Radiol* 1996;51:447-448.
272. Tada S, Iida M, Yao T, et al. Endoscopic features in amyloidosis of the small intestine. Clinical and morphologic differences between chemical types of amyloid protein. *Gastrointest Endosc* 1994;40:45-50.
273. Vernon SE. Amyloid colitis. *Dis Colon Rectum* 1982;25:728-730.
274. Levy DJ, Franklin GO, Rosenthal WS. Gastrointestinal bleeding and amyloidosis. *Am J Gastroenterol* 1982;77:422-426.
275. Racanelli V, D'Amore FP. Localized AL amyloidosis of the colon and clinical features of intestinal obstruction: a case report. *Ann Ital Med Int* 1999;14:58-60.
276. Koppelman RN, Stollman NH, Baigorri F, et al. Acute small bowel pseudo-obstruction due to AL amyloidosis: a case report and literature review. *Am J Gastroenterol* 2000;95:294-296.
277. De Navasquez S, Treble HA. Case of primary generalized amyloid disease with involvement of nerves. *Brain* 1938;61:116-128.
278. Yamada M, Hatakeyama S, Tsukagoshi H. Peripheral and autonomic nerve lesions in systemic amyloidosis: three pathological types of amyloid polyneuropathy. *Acta Pathol Jpn* 1984;34:1251-1266.
279. Schenone A, Primavera A, De Martini I, et al. Amyloid neuropathy in light chain multiple myeloma. *Clin Neuropathol* 1989;8:156-157.
280. Rinaldi R, Azzimondi G, Preda P, et al. Primary systemic amyloidosis presenting with polyneuropathy characterized by very long survival. *Acta Neurol Scand* 1995;91:511-513.
281. Braganza RA, Tien R, Hoffman HT, et al. Amyloid of the facial nerve. *Laryngoscope* 1992;102:1372-1376.
282. Katz B, Leja S, Melles RB, et al. Amyloid ophthalmoplegia: ophthalmoparesis secondary to primary systemic amyloidosis. *J Clin Neuroophthalmol* 1989;9:39-42.
283. Lingenfelser T, Linke RP, Dette S, et al. AL amyloidosis mimicking a preferentially autonomic chronic Guillain-Barré syndrome. *Clin Invest* 1992;70:159-162.
284. Rubin DI, Hermann RC. Electrophysiologic findings in amyloid myopathy. *Muscle Nerve* 1999;22:355-359.
285. Sommer C, Schroder JM. Amyloid neuropathy: immunocytochemical localization of intra- and extracellular immunoglobulin light chains. *Acta Neuropathol* 1989;79:190-199.
286. Simmons Z, Blaivas M, Aguilera AJ, et al. Low diagnostic yield of sural nerve biopsy in patients with peripheral neuropathy and primary amyloidosis. *J Neurol Sci* 1993;120:60-63.
287. Rajkumar SV, Gertz MA, Kyle RA. Prognosis of patients with primary systemic amyloidosis who present with dominant neuropathy. *Am J Med* 1998;104:232-237.
288. Duston MA, Skinner M, Anderson J, et al. Peripheral neuropathy as an early marker of AL

amyloidosis. *Arch Intern Med* 1989;149:358–360.

289. Tamura K, Nakajima N, Makino S, et al. Primary pulmonary amyloidosis with multiple nodules. *Eur J Radiol* 1988;8:128–130.

290. Srinivas P, Liam CK, Jayaram G. Localised nodular pulmonary amyloidosis in a patient with sicca syndrome. *Med J Malaysia* 2000;55:385–387.

291. Howard ME, Ireton J, Daniels F, et al. Pulmonary presentations of amyloidosis. *Respirology* 2001;6:61–64.

292. Looi LM. The pattern of amyloid deposition in the lung. *Malays J Pathol* 1999;21:29–35.

293. Road JD, Jacques J, Sparling JR. Diffuse alveolar septal amyloidosis presenting with recurrent hemoptysis and medial dissection of pulmonary arteries. *Am Rev Respir Dis* 1985;132:1368–1370.

294. Ashe J, Borel CO, Hart G, et al. Amyloid myopathy presenting with respiratory failure. *J Neurol Neurosurg Psychiatry* 1992;55:162–165.

295. Streeten EA, de la Monte SM, Kennedy TP. Amyloid infiltration of the diaphragm as a cause of respiratory failure. *Chest* 1986;89:760–762.

296. Santiago RM, Scharnhorst D, Ratkin G, et al. Respiratory muscle weakness and ventilatory failure in AL amyloidosis with muscular pseudohypertrophy. *Am J Med* 1987;83:175–178.

297. Bontemps F, Tillie-Leblond I, Coppin MC, et al. Pleural amyloidosis: thoracoscopic aspects. *Eur Respir J* 1995;8:1025–1027.

298. Kavuru MS, Adamo JP, Ahmad M, et al. Amyloidosis and pleural disease. *Chest* 1990;98:20–23.

299. Dingli D, Utz JP, Gertz MA. Pulmonary hypertension in patients with amyloidosis. *Chest* 2001;120:1735–1738.

300. Shiue ST, McNally DP. Pulmonary hypertension from prominent vascular involvement in diffuse amyloidosis. *Arch Intern Med* 1988;148:687–689.

301. Takashi S, Koizumi T, Yamazaki Y, et al. Diffuse pulmonary amyloidosis with monoclonal IgG-kappa gammopathy. *Intern Med* 1997;36:357–359.

302. Matsumoto K, Ueno M, Matsuo Y, et al. Primary solitary amyloidoma of the lung. Findings on CT and MRI. *Eur Radiol* 1997;7:586–588.

303. Itoh T, Ohashi S, Tsujino T, et al. Primary amyloidosis with dry eyes and dry mouth—a case report. *Jpn J Med* 1991;30:597–599.

304. Delevaux I, Andre M, Amoura Z, et al. Concomitant diagnosis of primary Sjögren's syndrome and systemic AL amyloidosis. *Ann Rheum Dis* 2001;60:694–695.

305. Cordier JF, Loire R, Brune J. Amyloidosis of the lower respiratory tract: clinical and pathologic features in a series of 21 patients. *Chest* 1986;90:827–831.

306. Hui AN, Koss MN, Hochholzer L, et al. Amyloidosis presenting in the lower respiratory tract: clinicopathologic, radiologic, immunohistochemical, and histochemical studies on 48 cases. *Arch Pathol Lab Med* 1986;110:212–218.

307. Gastineau DA, Gertz MA, Daniels TM, et al. Inhibitor of the thrombin time in systemic amyloidosis: a common coagulation abnormality. *Blood* 1991;77:2637–2640.

308. Chang JC, Kane KK. Pathologic hyperfibrinolysis associated with amyloidosis: clinical response to epsilon amino caproic acid. *Am J Clin Pathol* 1984;81:382–387.

309. Greipp PR, Kyle RA, Bowie EJ. Factor-X deficiency in amyloidosis: a critical review. *Am J Hematol*



1981;11:443-450.

310. Hoshino Y, Hatake K, Muroi K, et al. Bleeding tendency caused by the deposit of amyloid substance in the perivascular region. *Intern Med* 1993;32:879-881.

310a. Gastineau DA, Gertz MA, Daniels TM, et al. Inhibitor of the thrombin time in systemic amyloidosis: a common coagulation abnormality. *Blood* 1991;77:2637-2640.

310b. Black GS, Lacy M, Rajkumar SV, et al. Natural history of thromboembolism in amyloidosis (abstract). *Blood* 2001;98:54a.

311. Kyle RA, Greipp PR, O'Fallon WM. Primary systemic amyloidosis: multivariate analysis for prognostic factors in 168 cases. *Blood* 1986;68:220-224.

312. Fujii B, Matsuda Y, Ohno H, et al. A case of cardiac amyloidosis presenting with symptoms of exertional syncope. *Clin Cardiol* 1991;14:267-268.

313. Klein AL, Tajik AJ. Doppler assessment of diastolic function in cardiac amyloidosis. *Echocardiography* 1991;8:233-251.

314. Tei C, Dujardin KS, Hodge DO, et al. Doppler index combining systolic and diastolic myocardial performance: clinical value in cardiac amyloidosis. *J Am Coll Cardiol* 1996;28:658-664.

315. Klein AL, Oh JK, Miller FA, et al. Two-dimensional and Doppler echocardiographic assessment of infiltrative cardiomyopathy. *J Am Soc Echocardiogr* 1988;1:48-59.

316. Patel AR, Dubrey SW, Mendes LA, et al. Right ventricular dilation in primary amyloidosis: an independent predictor of survival. *Am J Cardiol* 1997;80:486-492.

317. Yamakado T, Fukui A, Kato N, et al. Analysis of left ventricular diastolic function by the pressure-volume relation in cases with idiopathic restrictive cardiomyopathy and amyloid restrictive cardiomyopathy. *Heart Vessels* 1990;5(Suppl):80-83.

318. Dispenzieri A, Kyle RA, Gertz MA, et al. Survival in patients with primary systemic amyloidosis and raised serum cardiac troponins. *Lancet* 2003;361: 1787-1789.

319. Gertz MA, Kyle RA, Greipp PR. Hyposplenism in primary systemic amyloidosis. *Ann Intern Med* 1983;98:475-477.

320. Surian M, Broggi L, Ferrari L, et al. Morphological, immunohistological and clinical findings in renal amyloidosis: correlations with prognosis in 16 patients. *Boll Ist Sieroter Milan* 1979;58:158-168.

321. McElroy EA Jr, Witzig TE, Gertz MA, et al. Detection of monoclonal plasma cells in the peripheral blood of patients with primary amyloidosis. *Br J Haematol* 1998;100:326-327.

322. Gertz MA, Kyle RA, Greipp PR. The plasma cell labeling index: a valuable tool in primary systemic amyloidosis. *Blood* 1989;74:1108-1111.

323. Gertz MA, Kyle RA, Greipp PR, et al. Beta 2-microglobulin predicts survival in primary systemic amyloidosis. *Am J Med* 1990;89:609-614.

324. Gertz MA, Kyle RA, Greipp PR. Response rates and survival in primary systemic amyloidosis. *Blood* 1991;77:257-262.

325. Nash KL, Brij SO, Clesham GJ. Cardiac amyloidosis and the use of diuretic and ACE inhibitor therapy in severe heart failure. *Int J Clin Pract* 1997;51:384-385.

326. Kawasaki T, Sugihara H, Sakamoto K, et al. Cardiac sympathetic denervation in amyloidosis. *Clin Nucl Med* 2001;26:560-561.

327. Rodriguez Reguero J, Iglesias Cubero G, et al. Primary amyloidosis and syncope. *Int J Cardiol* 1997;58:185-187.

328. Mathew V, Olson LJ, Gertz MA, et al. Symptomatic conduction system disease in cardiac amyloidosis. *Am J Cardiol* 1997;80:1491–1492.
329. Mathew V, Chaliki H, Nishimura RA. Atrioventricular sequential pacing in cardiac amyloidosis: an acute Doppler echocardiographic and catheterization hemodynamic study. *Clin Cardiol* 1997;20:723–725.
330. Habbal R, Noureddine M, Hachim K, et al. Heart failure and arterial hypertension disclosing amyloidosis [French]. *Nephrologie* 1997;18:91–94.
331. Mayr M, Dickenmann MJ. Further evidence for the renoprotective effect of ACE inhibitors: ramipril protects against the progression of chronic renal insufficiency in non-diabetic nephropathy with nephrotic proteinuria [German]. *Schweiz Med Wochenschr* 2000;130:491.
332. Artz G, Wynne J. Restrictive cardiomyopathy. *Curr Treat Options Cardiovasc Med* 2000;2:431–438.
333. Langlard JM. Restrictive cardiomyopathy [French]. *Arch Mal Coeur Vaiss* 1998;91(Suppl):59–64.
334. Rubinow A, Skinner M, Cohen AS. Digoxin sensitivity in amyloid cardiomyopathy. *Circulation* 1981;63:1285–1288.
335. Petzsch M, Pulya K, Anders O. Augmentation of left ventricular outflow tract gradient by digitalis glycosides in a case of cardiac (AL-) amyloidosis [German]. *Dtsch Med Wochenschr* 2001;126:909–912.
336. Buja LM, Khoi NB, Roberts WC. Clinically significant cardiac amyloidosis. Clinicopathologic findings in 15 patients. *Am J Cardiol* 1970;26:394–405.
337. Skadberg BT, Bruserud O, Karwinski W, et al. Sudden death caused by heart block in a patient with multiple myeloma and cardiac amyloidosis. *Acta Med Scand* 1988;223:379–383.
338. Lindholm PF, Wick MR. Isolated cardiac amyloidosis associated with sudden death. *Arch Pathol Lab Med* 1986;110:243–245.
339. Allen DC, Doherty CC. Sudden death in a patient with amyloidosis of the cardiac conduction system. *Br Heart J* 1984;51:233–236.
340. Levy S. Factors predisposing to the development of atrial fibrillation. *Pacing Clin Electrophysiol* 1997;20:2670–2674.
341. Gertz MA, Skinner M, Connors LH, et al. Selective binding of nifedipine to amyloid fibrils. *Am J Cardiol* 1985;55:1646.
342. Gertz MA, Falk RH, Skinner M, et al. Worsening of congestive heart failure in amyloid heart disease treated by calcium channel-blocking agents. *Am J Cardiol* 1985;55:1645.
343. Omboni S, Smit AA, van Lieshout JJ, et al. Mechanisms underlying the impairment in orthostatic tolerance after nocturnal recumbency in patients with autonomic failure. *Clin Sci (Lond)* 2001;101:609–618.
344. Freitas J, Santos R, Azevedo E, et al. Clinical improvement in patients with orthostatic intolerance after treatment with bisoprolol and fludrocortisone. *Clin Auton Res* 2000;10:293–299.
345. Kochar MS. Management of postural hypotension. *Curr Hypertens Rep* 2000;2:457–462.
346. Cruz DN. Midodrine: a selective alpha-adrenergic agonist for orthostatic hypotension and dialysis hypotension. *Expert Opin Pharmacother* 2000;1: 835–840.
347. Low PA. Update on the evaluation, pathogenesis, and management of neurogenic orthostatic hypotension: introduction. *Neurology* 1995;45 (Suppl 5):S4–S5.
348. Hosenpud JD, Uretsky BF, Griffith BP, et al. Successful intermediate-term outcome for patients with cardiac amyloidosis undergoing heart transplantation: results of a multicenter survey. *J Heart Transplant* 1990;9:346–350.

349. Hosenpud JD, DeMarco T, Frazier OH, et al. Progression of systemic disease and reduced long-term survival in patients with cardiac amyloidosis undergoing heart transplantation: follow-up results of a multicenter survey. *Circulation* 1991;84(Suppl 3):III338-III343.
350. Dubrey SW, Burke MM, Khaghani A, et al. Long term results of heart transplantation in patients with amyloid heart disease. *Heart* 2001;85:202-207.
351. Miller WL, Wright RS, McGregor CG, et al. Troponin levels in patients with amyloid cardiomyopathy undergoing cardiac transplantation. *Am J Cardiol* 2001;88:813-815.
352. Li J, Zhou C, Yu L, et al. Renal protective effects of blocking the intrarenal renin-angiotensin system. *Hypertens Res* 1999;22:223-228.
353. Nosrati SM, Khwaja S, el-Shahawy M, et al. Effect of angiotensin converting enzyme inhibition by perindopril on proteinuria of primary renal diseases. *Am J Nephrol* 1997;17:511-517.
354. Moroni G, Banfi G, Montoli A, et al. Chronic dialysis in patients with systemic amyloidosis: the experience in northern Italy. *Clin Nephrol* 1992;38:81-85.
355. Browning MJ, Banks RA, Harrison P, et al. Continuous ambulatory peritoneal dialysis in systemic amyloidosis and end-stage renal disease. *J R Soc Med* 1984;77:189-192.
356. Gertz MA, Kyle RA, O'Fallon WM. Dialysis support of patients with primary systemic amyloidosis. A study of 211 patients. *Arch Intern Med* 1992;152:2245-2250.
357. Kuhlback B, Falck H, Tornroth T, et al. Renal transplantation in amyloidosis. *Acta Med Scand* 1979;205:169-172.
358. Kilicturgay S, Tokyay R, Arslan G, et al. The results of transplantation of patients with amyloid nephropathy. *Transplant Proc* 1992;24:1788-1789.
359. Dorman SA, Gamelli RL, Benziger JR, et al. Systemic amyloidosis involving two renal transplants. *Hum Pathol* 1981;12:735-738.
360. Hartmann A, Holdaas H, Fauchald P, et al. Fifteen years' experience with renal transplantation in systemic amyloidosis. *Transpl Int* 1992;5:15-18.
361. Pasternack A, Ahonen J, Kuhlback B. Renal transplantation in 45 patients with amyloidosis. *Transplantation* 1986;42:598-601.
362. Helin H, Pasternack A, Falck H, et al. Recurrence of renal amyloid and de novo membranous glomerulonephritis after transplantation. *Transplantation* 1981;32:6-9.
363. Jalan R, Redhead DN, Simpson KJ, et al. Transjugular intrahepatic portosystemic stent-shunt (TIPSS): long-term follow-up. *QJM* 1994;87:565-573.
364. Bienz N, Franklin IM, Adu D, et al. Bilateral nephrectomy for uncontrollable nephrotic syndrome in primary amyloidosis, with subsequent improvement in hepatic function. *Clin Lab Haematol* 1994;16:85-88.
365. Choufani EB, Sanchowala V, Ernst T, et al. Acquired factor X deficiency in patients with amyloid light-chain amyloidosis: incidence, bleeding manifestations, and response to high-dose chemotherapy. *Blood* 2001;97:1885-1887.
366. Rosenstein ED, Itzkowitz SH, Penziner AS, et al. Resolution of factor X deficiency in primary amyloidosis following splenectomy. *Arch Intern Med* 1983;143:597-599.
367. Boggio L, Green D. Recombinant human factor VIIa in the management of amyloid-associated factor X deficiency. *Br J Haematol* 2001;112:1074-1075.
368. Hanai N, Ishihara T, Uchino F, et al. Effects of dimethyl sulfoxide and col-chicine on the resorption of experimental amyloid. *Virchows Arch A Pathol Anat Histol* 1979;384:45-52.

369. Eisenbud LE, Lerner CP, Chai CK. The effect of dimethyl sulfoxide (DMSO) upon spontaneous amyloidosis in mice. *Proc Soc Exp Biol Med* 1981;168:172-174.
370. Ozkaya-Bayazit E, Kavak A, Gungor H, et al. Intermittent use of topical dimethyl sulfoxide in macular and papular amyloidosis. *Int J Dermatol* 1998;37:949-954.
371. Nishiyama T, Gejyo F, Katayama Y, et al. Primary localized amyloidosis of the bladder: a case of AL (lambda) amyloid protein and combination therapy using dimethyl sulfoxide and cepharanthine. *Urol Int* 1992;48:228-231.
372. Komiya A, Kijima M, Takahashi M, et al. Amyloid associated muscle pseudohypertrophy: amelioration of motor dysfunction with plasmapheresis and dimethylsulphoxide. *J Neurol Neurosurg Psychiatry* 1996;60:591-592.
373. Grateau G. The relation between familial Mediterranean fever and amyloidosis. *Curr Opin Rheumatol* 2000;12:61-64.
374. Cabili S, Zemer D, Pras M, et al. The prevention of amyloidosis in familial Mediterranean fever with colchicine. *Proc Eur Dial Transplant Assoc Eur Ren Assoc* 1985;21:709-711.
375. Cakar N, Yalcinkaya F, Ozkaya N, et al. Familial Mediterranean fever (FMF)-associated amyloidosis in childhood: clinical features, course and outcome. *Clin Exp Rheumatol* 2001;19(Suppl 5):S63-S67.
376. Livneh A, Langevitz P. Diagnostic and treatment concerns in familial Mediterranean fever. *Baillieres Best Pract Res Clin Rheumatol* 2000;14:477-498.
377. Livneh A, Langevitz P, Zemer D, et al. The changing face of familial Mediterranean fever. *Semin Arthritis Rheum* 1996;26:612-627.
378. Rabinovitch O, Zemer D, Kukia E, et al. Colchicine treatment in conception and pregnancy: two hundred thirty-one pregnancies in patients with familial Mediterranean fever. *Am J Reprod Immunol* 1992;28:245-246.
379. Goddard IR, Jackson R, Jones JM. AL amyloidosis: therapeutic response in two patients with renal involvement. *Nephrol Dial Transplant* 1991;6:592-594.
380. Cohen AS, Rubinow A, Anderson JJ, et al. Survival of patients with primary (AL) amyloidosis. Colchicine-treated cases from 1976 to 1983 compared with cases seen in previous years (1961 to 1973). *Am J Med* 1987;82:1182-1190.
381. Kyle RA, Gertz MA, Greipp PR, et al. A trial of three regimens for primary amyloidosis: colchicine alone, melphalan and prednisone, and melphalan, prednisone, and colchicine. *N Engl J Med* 1997;336:1202-1207.
382. Skinner M, Anderson J, Simms R, et al. Treatment of 100 patients with primary amyloidosis: a randomized trial of melphalan, prednisone, and colchicine versus colchicine only. *Am J Med* 1996;100:290-298.
383. Bladé J, Samson D, Reece D, et al. Criteria for evaluating disease response and progression in patients with multiple myeloma treated by high-dose therapy and haemopoietic stem cell transplantation: Myeloma Subcommittee of the EBMT. European Group for Blood and Marrow Transplant. *Br J Haematol* 1998;102:1115-1123.
384. Billadeau D, Blackstadt M, Greipp P, et al. Analysis of B-lymphoid malignancies using allele-specific polymerase chain reaction: a technique for sequential quantitation of residual disease. *Blood* 1991;78:3021-3029.
385. Jones NF, Hilton PJ, Tighe JR, et al. Treatment of "primary" renal amyloidosis with melphalan. *Lancet* 1972;2:616-619.
386. Cohen HJ, Lessin LS, Hallal J, et al. Resolution of primary amyloidosis during chemotherapy: studies in a patient with nephrotic syndrome. *Ann Intern Med* 1975;82:466-473.

387. Gertz MA, Lacy MQ, Dispenzieri A, et al. Stem cell transplantation for the management of primary systemic amyloidosis. *Am J Med* 2002;113:549–555.
388. Bradstock K, Clancy R, Uther J, et al. The successful treatment of primary amyloidosis with intermittent chemotherapy. *Aust N Z J Med* 1978;8:176–179.
389. Schwartz RS, Cohen JR, Schrier SL. Therapy of primary amyloidosis with melphalan and prednisone. *Arch Intern Med* 1979;139:1144–1147.
390. Buxbaum JN, Hurley ME, Chuba J, et al. Amyloidosis of the AL type: clinical, morphologic and biochemical aspects of the response to therapy with alkylating agents and prednisone. *Am J Med* 1979;67:867–878.
391. Fielder K, Durie BG. Primary amyloidosis associated with multiple myeloma: predictors of successful therapy. *Am J Med* 1986;80:413–418.
392. Benson MD. Treatment of AL amyloidosis with melphalan, prednisone, and colchicine. *Arthritis Rheum* 1986;29:683–687.
393. Kyle RA, Wagoner RD, Holley KE. Primary systemic amyloidosis: resolution of the nephrotic syndrome with melphalan and prednisone. *Arch Intern Med* 1982;142:1445–1447.
394. Kyle RA, Gertz MA, Greipp PR, et al. Long-term survival (10 years or more) in 30 patients with primary amyloidosis. *Blood* 1999;93:1062–1066.
395. Levy Y, Belghiti-Deprez D, Sobel A. Treatment of AL amyloidosis without myeloma [French]. *Ann Med Interne* 1988;139:190–193.
396. Kyle RA, Greipp PR. Primary systemic amyloidosis: comparison of melphalan and prednisone versus placebo. *Blood* 1978;52:818–827.
397. Kyle RA, Greipp PR, Garton JP, et al. Primary systemic amyloidosis: comparison of melphalan/prednisone versus colchicine. *Am J Med* 1985;79:708–716.
398. Gertz MA, Kyle RA. Acute leukemia and cytogenetic abnormalities complicating melphalan treatment of primary systemic amyloidosis. *Arch Intern Med* 1990;150:629–633.
399. Gertz MA, Kyle RA. Phase II trial of alpha-tocopherol (vitamin E) in the treatment of primary systemic amyloidosis. *Am J Hematol* 1990;34:55–58.
400. Gertz MA, Kyle RA. Phase II trial of recombinant interferon alfa-2 in the treatment of primary systemic amyloidosis. *Am J Hematol* 1993;44:125–128.
401. Ichida M, Imagawa S, Ohmine K, et al. Successful treatment of multiple myeloma-associated amyloidosis by interferon-alpha, dimethyl sulfoxide, and VAD (Vincristine, Adriamycin, and Dexamethasone). *Int J Hematol* 2000;72:491–493.
402. Wardley AM, Jayson GC, Goldsmith DJ, et al. The treatment of nephrotic syndrome caused by primary (light chain) amyloid with vincristine, doxorubicin and dexamethasone. *Br J Cancer* 1998;78:774–776.
403. Dhodapkar MV, Jagannath S, Vesole D, et al. Treatment of AL-amyloidosis with dexamethasone plus alpha interferon. *Leuk Lymphoma* 1997;27:351–356.
404. Gertz MA, Lacy MQ, Lust JA, et al. Phase II trial of high-dose dexamethasone for untreated patients with primary systemic amyloidosis. *Med Oncol* 1999;16:104–109.
405. Gertz MA, Lacy MQ, Lust JA, et al. Phase II trial of high-dose dexamethasone for previously treated immunoglobulin light-chain amyloidosis. *Am J Hematol* 1999;61:115–119.
406. Gertz MA, Lacy MQ, Lust JA, et al. Prospective randomized trial of melphalan and prednisone versus vincristine, carmustine, melphalan, cyclophosphamide, and prednisone in the treatment of primary systemic

amyloidosis. *J Clin Oncol* 1999;17:262–267.

407. Gianni L, Capri G, Greco M, et al. Activity and toxicity of 4'-iodo-4'-deoxydoxorubicin in patients with advanced breast cancer. *Ann Oncol* 1991;2:719–725.

408. Merlini G, Anesi E, Garini P, et al. Treatment of AL amyloidosis with 4'-iodo-4'-deoxydoxorubicin: an update. *Blood* 1999;93:1112–1113.

409. Gianni L, Bellotti V, Gianni AM, et al. New drug therapy of amyloidoses: resorption of AL-type deposits with 4'-iodo-4'-deoxydoxorubicin. *Blood* 1995;86:855–861.

410. Gertz MA, Lacy MQ, Dispenzieri A, et al. A multicenter phase II trial of 4'-iodo-4'-deoxydoxorubicin (IDOX) in primary amyloidosis (AL). *Amyloid* 2002;9:24–30.

411. Gertz MA, Lacy MQ, Dispenzieri A. Myeloablative chemotherapy with stem cell rescue for the treatment of primary systemic amyloidosis: a status report. *Bone Marrow Transplant* 2000;25:465–470.

412. van Buren M, Hene RJ, Verdonck LF, et al. Clinical remission after syngeneic bone marrow transplantation in a patient with AL amyloidosis. *Ann Intern Med* 1995;122:508–510.

413. Guillaume B, Straetmans N, Jadoul M, et al. Allogeneic bone marrow transplantation for AL amyloidosis. *Bone Marrow Transplant* 1997;20:907–908.

414. Gillmore JD, Davies J, Iqbal A, et al. Allogeneic bone marrow transplantation for systemic AL amyloidosis. *Br J Haematol* 1998;100:226–228.

415. Reference deleted.

416. Comenzo RL, Michelle D, LeBlanc M, et al. Mobilized CD34+ cells selected as autografts in patients with primary light-chain amyloidosis: rationale and application. *Transfusion* 1998;38:60–69.

417. Stewart AK, Vescio R, Schiller G, et al. Purging of autologous peripheral-blood stem cells using CD34 selection does not improve overall or progression-free survival after high-dose chemotherapy for multiple myeloma: results of a multicenter randomized controlled trial. *J Clin Oncol* 2001;19:3771–3779.

418. Comenzo RL, Vosburgh E, Simms RW, et al. Dose-intensive melphalan with blood stem cell support for the treatment of AL amyloidosis: one-year follow-up in five patients. *Blood* 1996;88:2801–2806.

419. Comenzo RL, Vosburgh E, Falk RH, et al. Dose-intensive melphalan with blood stem-cell support for the treatment of AL (amyloid light-chain) amyloidosis: survival and responses in 25 patients. *Blood* 1998;91:3662–3670.

420. Sanchowala V, Wright DG, Seldin DC, et al. An overview of the use of high-dose melphalan with autologous stem cell transplantation for the treatment of AL amyloidosis. *Bone Marrow Transplant* 2001;28:637–642.

421. Moreau P, Leblond V, Bourquelot P, et al. Prognostic factors for survival and response after high-dose therapy and autologous stem cell transplantation in systemic AL amyloidosis: a report on 21 patients. *Br J Haematol* 1998;101:766–769.

422. Gillmore JD, Apperley JF, Craddock C, et al. High-dose melphalan and stem cell rescue for AL amyloidosis. In: RA Kyle, MA Gertz, eds. *Amyloid and Amyloidosis 1998: the proceedings of the VIIIth International Symposium on Amyloidosis, August 7–11, 1998, Rochester, Minnesota, USA*. New York: Parthenon Publishing Group, 1999:102–104.

423. Amoura Z, Leblond V, Azar N, et al. High-dose therapy and autologous stem cell transplantation (ASCT) for systemic amyloidosis (AL): report of 9 cases (abstract). *Arthritis Rheum* 1998;41:S234.

424. Kumar S, Dispenzieri A, Lacy MQ, et al. High incidence of gastrointestinal tract bleeding after autologous stem cell transplant for primary systemic amyloidosis. *Bone Marrow Transplant* 2001;28:381–385.

425. Gertz MA, Lacy MQ, Gastineau DA, et al. Blood stem cell transplantation as therapy for primary

systemic amyloidosis (AL). *Bone Marrow Transplant* 2000;26:963–969.

426. Majolino I, Marceno R, Pecoraro G, et al. High-dose therapy and autologous transplantation in amyloidosis-AL. *Haematologica* 1993;78:68–71.

427. Schulenburg A, Kalhs P, Oberhuber G, et al. Gastrointestinal perforation early after peripheral blood stem cell transplantation for AL amyloidosis. *Bone Marrow Transplant* 1998;22:293–295.

428. Patriarca F, Geromin A, Fanin R, et al. Improvement of amyloid-related symptoms after autologous stem cell transplantation in a patient with hepatomegaly, macroglossia, and purpura. *Bone Marrow Transplant* 1999;24:433–435.

429. Saba N, Sutton D, Ross H, et al. High treatment-related mortality in cardiac amyloid patients undergoing autologous stem cell transplant. *Bone Marrow Transplant* 1999;24:853–855.

430. Sezer O, Schmid P, Shweigert M, et al. Rapid reversal of nephrotic syndrome due to primary systemic AL amyloidosis after VAD and subsequent high-dose chemotherapy with autologous stem cell support. *Bone Marrow Transplant* 1999;23:967–969.

431. Reich G, Held T, Siegert W, et al. Four patients with AL amyloidosis treated with high-dose chemotherapy and autologous stem cell transplantation. *Bone Marrow Transplant* 2001;27:341–343.

432. Dember LM, Sanchorawala V, Seldin DC, et al. Effect of dose-intensive intravenous melphalan and autologous blood stem-cell transplantation on AL amyloidosis-associated renal disease. *Ann Intern Med* 2001;134:746–753.

433. Comenzo RL, Gertz MA. Autologous stem cell transplantation for primary systemic amyloidosis. *Blood* 2002;99:4276–4282.

434. Dispenzieri A, Lacy MQ, Kyle RA, et al. Eligibility for hematopoietic stem-cell transplantation for primary systemic amyloidosis is a favorable prognostic factor for survival. *J Clin Oncol* 2001;19:3350–3356.

\*Partial support provided by the Hematologic Malignancies Fund, Mayo Clinic. ©Copyright 2004, Lippincott, Williams & Wilkins.

2004 Lippincott Williams & Wilkins  
John P. Greer, John Foerster, John N. Lukens  
George M. Rodgers, Frixos Paraskevas, Bertil Glader  
Wintrobe's Clinical Hematology



**HISTORY****EPIDEMIOLOGY****DIAGNOSIS**[Routine Laboratory Tests](#)[Monoclonal Protein Determination](#)[Bone Marrow Pathology and Immunophenotype](#)[Pathology and Differential Diagnosis](#)[Radiologic Studies](#)**PATHOPHYSIOLOGY**[Normal Counterpart to Waldenström Macroglobulinemia Clonal Cells](#)[Relation to Monoclonal Gammopathy of Undetermined Significance](#)[Cytogenetics](#)[Molecular Genetics](#)**CLINICAL FEATURES**[Hyperviscosity Syndrome](#)[Paraneoplastic and Other Manifestations](#)**PROGNOSIS****TREATMENT OPTIONS**[Observation](#)[Alkylating Agent–Based Therapy](#)[Purine Nucleoside Analogs](#)[Rituximab](#)[Combination Therapy](#)[Corticosteroids](#)[Interferon](#)[Thalidomide](#)[Stem Cell Transplantation](#)[Other Therapeutic Interventions](#)**THERAPY-RELATED COMPLICATIONS****CONCLUSION****REFERENCES**

*Waldenström macroglobulinemia* (WM) is a pleomorphic lymphoproliferative disorder that is characterized by the production of a mono-clonal immunoglobulin M (IgM) protein and a lymphoplasmacytic infiltrate in the bone marrow (<sup>1</sup>, <sup>2</sup> and <sup>3</sup>). Classic features include anemia, hepatosplenomegaly, lymphadenopathy, and hyperviscosity (<sup>1</sup>, <sup>2</sup> and <sup>3</sup>). This chapter reviews the published literature on the biology and management of WM. Because WM is uncommon, research focused on its etiology, prognosis, and management is sparse.

**HISTORY**

Waldenström ( [Fig. 100.1](#)) first described the entity that bears his name in 1944 when he described two patients with bleeding from the mouth and nose, severe anemia, lymphadenopathy, an elevated serum concentration of a high-molecular-weight  $\gamma$ -globulin, and low fibrinogen (<sup>4</sup>). He noticed that the abnormal serum protein sedimented with a coefficient of 7S and distinguished this entity from multiple myeloma. Waldenström is well known for his description of this condition, but he also made the very important

observation that  $\gamma$ -globulin elevations can be monoclonal or polyclonal.



**Figure 100.1.** Photograph of Jan Gosta Waldenström (1906–1996). (From Kyle RA, Anderson KC. A tribute to Jan Gosta Waldenström. *Blood* 1997;89:4245–4247, with permission.)

## EPIDEMIOLOGY

WM is a rare disorder, with approximately 1500 cases per year in the United States ([5](#), [6](#)). This incidence is approximately one-sixth that of multiple myeloma ([7](#)). The median age at presentation is 63 years. Of all patients found to have a monoclonal IgM protein at Mayo Clinic, 17% had WM, and the remaining patients had IgM-monoclonal gammopathy of undetermined significance (IgM-MGUS) or other lymphoproliferative disorders ([8](#)). It is difficult to estimate the true prevalence of WM in the general population because of the rarity of the disease, lack of clear diagnostic criteria, and incomplete reporting. WM appears to be more common among whites and is rare in people of African or Mexican-mestizo descent ([1](#), [5](#), [6](#), [9](#)). Incidence and prevalence studies also suggest that the disease is slightly more common in men than in women ([5](#)). Age-adjusted incidence rates for WM (per 1 million person-years) have been reported at 3.4 for men and 1.7 for women, with the rates increasing sharply with age ([5](#)). Other studies have reported an age-standardized annual incidence rate of 6.1 per million in white men and 2.5 per million in white women ([6](#)).

Although WM is believed to be sporadic for the majority of patients, several reports in the literature suggest that some cases may have a familial component ([10](#), [11](#), [12](#), [13](#), [14](#), [15](#), [16](#), [17](#) and [18](#)), implying a single gene defect capable of producing the observed phenotype. In some reports, several family members were affected, and in others, monozygotic twins were both affected. Other reports describe family members of WM patients affected by other lymphoproliferative disorders associated with an elevated serum IgM level.

## DIAGNOSIS

The diagnosis of WM is based on the presence of classic signs and symptoms in association with the monoclonal proliferation of mature lymphocytes or plasmacytoid cells in the marrow and a monoclonal IgM protein in the serum ([1](#), [3](#)). Standardized diagnostic criteria have not yet been established ([19](#), [20](#)). The treating physician needs to consider the entire clinical and pathologic presentation to differentiate IgM-MGUS from WM or other B-cell lymphoproliferative disorders. The mere presence of a lymphoplasmacytic infiltrate of the bone marrow or a monoclonal IgM protein does not prove the diagnosis of WM, because other B-cell neoplasms may also have plasmacytic differentiation and

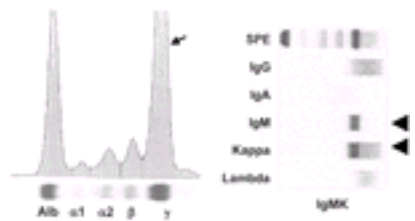
associated monoclonal proteins (M proteins) ( [8](#), [21](#) ).

## Routine Laboratory Tests

Patients with suspected WM should have baseline laboratory tests consisting of a complete blood count and determination of creatinine, bilirubin, aspartate transaminase, alkaline phosphatase, and calcium in serum. Serum  $\beta_2$ -microglobulin should also be measured, because it is a useful prognostic factor (see below) ( [22](#), [23](#) ). Patients with WM typically do not have peripheral blood lymphocytosis ( [19](#), [23](#), [24](#), [25](#), [26](#) and [27](#) ).

## Monoclonal Protein Determination

The monoclonal IgM can be quantified by serum protein electrophoresis (SPEP) or by nephelometry. Immunofixation is required to characterize the abnormal protein detected by SPEP ( [Fig. 100.2](#) ). It is also recommended that quantitative serum Igs be measured by nephelometry to quantify levels of IgG, IgA, and IgM at the time of initial diagnosis. Occasionally, there can be discrepancies in IgM quantitation between nephelometry and SPEP, especially with larger monoclonal spikes. This is due to underestimation of the true concentration of the paraprotein by SPEP. To monitor the disease status, the same test should be used consistently. Serum viscosity determination is helpful at baseline and in situations in which symptoms of hyperviscosity are present (see below); however, it is not required at each subsequent visit.



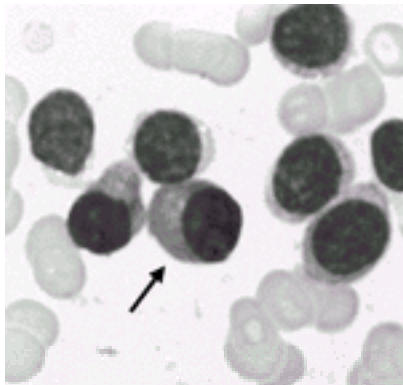
**Figure 100.2. A:** Electrophoretic pattern from a serum protein electrophoresis (SPEP) showing a prominent M spike in the  $\gamma$  region ( *arrow* ). **B:** Immunofixation documenting that the M spike on SPEP is a monoclonal immunoglobulin (Ig) M  $\gamma$  protein.

It has been proposed that a fixed minimum concentration of the serum M protein is needed to fulfill diagnostic criteria of WM. However, this would exclude patients early in the course of the disease who have a lower concentration of paraproteins but are symptomatic. Many consider a serum monoclonal IgM that exceeds 15 g/L as characteristic of WM and useful in differentiating WM from other lymphoid neoplasms with plasmacytoid differentiation ( [21](#) ). The serum IgM in symptomatic patients (i.e., those needing therapy) is typically high; for example, the median was 42 g/L in a recent large clinical trial in patients with previously untreated WM ( [28](#) ).

A 24-hour urine collection for protein electrophoresis and immunofixation should be performed to determine the presence and quantity of urine Bence Jones protein and to quantify total urinary protein. Approximately 40 to 80% of patients with WM have Bence Jones light chains in the urine (Bence Jones proteinuria) ( [8](#) ).

## Bone Marrow Pathology and Immunophenotype

A unilateral bone marrow aspirate and biopsy for the estimation of clonal involvement are routinely obtained at diagnosis and subsequently whenever there are changes in clinical status ( [23](#) ). The primary abnormality in WM is a clonal proliferation of IgM-producing lymphoplasmacytic cells infiltrating the bone marrow. Typically, the predominant infiltrate is lymphoplasmacytoid, with a small percentage of mature plasma cells; however, the morphologic features can range from predominantly lymphocytic to lymphoplasmacytoid or to overt plasma cells ( [29](#), [30](#) and [31](#) ) ( [Fig. 100.3](#) ). Mast cells are usually present and associated with the clonal lymphoplasmacytes ( [30](#), [31](#) and [32](#) ). Although the predominant site of the disease is the bone marrow, extensive infiltrates are possible in lymph nodes, spleen, and liver ( [21](#) ).



**Figure 100.3.** Bone marrow aspirate showing the malignant cells from a patient with Waldenström macroglobulinemia. The cells exhibit lymphoid and plasmacytoid morphology. The arrow indicates the monoclonal spike. See [Color Plate](#).

Flow cytometric studies can be performed on cells from the marrow aspirate to document monoclonality of the B cells and determine their immunophenotype. Extensive immunophenotyping is not necessary in classic cases of WM but is helpful in difficult cases to differentiate WM from B-cell chronic lymphocytic leukemia, mantle cell lymphoma, and other lymphoproliferative disorders ( [32](#), [33](#) and [34](#) ) ( [Table 100.1](#) ). The typical surface marker profile for patients with WM is defined by the presence of pan-B-cell surface markers (CD19, CD20, CD22), in association with monoclonal light-chain expression on the cell surface and in cytoplasm ( [2](#), [32](#), [33](#), [34](#) and [35](#) ) and CD79a ( [24](#) ). CD10 and CD23 are usually absent. Although limited data are available, CD138 (syndecan-1) can be detected on the plasma cell compartment ( [2](#), [32](#), [33](#), [34](#) and [35](#) ). Most pathologists believe that the malignant cells in WM do not express the T-cell marker CD5; however, some cases reported in the literature and cases observed at our institution (E. Remstein, personal communication, 2002) fulfill the criteria for the diagnosis of WM but express CD5 on the cell surface ( [2](#), [32](#), [33](#), [34](#) and [35](#) ). The proportion of patients with expression of CD5 has not been defined but is unlikely to exceed 10%, and in many of the CD5<sup>+</sup> cases, expression is limited to subpopulations of the clone.

**TABLE 100.1. Pathologic Features of Waldenström Macroglobulinemia Compared with Other Lymphoproliferative Disorders**

| Pathologic Feature          | MCL  | B-cell CLL   | FL   | MZL                               | WM  |
|-----------------------------|--|--|--|-----------------------------------|---|
| Paraprotein                 | None   | Small IgG or IgM   | Usually none                                 | ± Small IgM                       | IgM (large)                               |
| Morphology                  | Centrocyte-like; small-to-medium-sized lymphocytes | Small lymphocyte with clumped chromatin                      | Follicle center cells (follicular pattern)   | Monocytoid B cells, heterogeneous | Plasmacytoid lymphocytes and plasma cells |
| Surface Ig                  | +  | +  | +  | +                                 | +   |
| Cytoplasmic Ig              | -  | -  | -  | -                                 | ++  |
| CD19                        | +  | +  | +  | +                                 | +   |
| CD20                        | ++   | +  | ++   | +                                 | +   |
| CD23                        | -  | +  | ±  | -                                 | -   |
| CD22                        | +  | -  | -  | +                                 | +   |
| CD38                        | -  | ±  | -  | -                                 | +   |
| CD138                       | -  | -  | -  | -                                 | +   |
| CD5                         | +  | +  | -  | -                                 | Usually CD5 -                             |
| CD10                        | ±  | -  | +  | -                                 | -   |
| Cytogenetic aberrations     | t(11;14)(q13;q32), <i>cyclin D1</i> <sup>+</sup>   | 13q <sup>-</sup> , 6q <sup>-</sup> , +12, 11q23 <sup>-</sup> | t(14;18)(q32;q21), <i>bcl-2</i> <sup>+</sup> | t(11;18)(q21;q21), +3             | 6q <sup>-</sup>                           |
| Somatic hypermutation       | -  | +, 50%; -, 50%   | ++   | ++                                | +++                                       |
| Bone marrow involvement (%) | 25   | ~100   | 85   | 50                                | >90                                       |
| Bone lytic lesions          | No   | No   | No   | No                                | 5%  |

CLL, chronic lymphocytic leukemia; FL, follicular B-cell lymphoma; Ig, immunoglobulin; MCL, mantle cell lymphoma; MM, multiple myeloma; MZL, marginal zone B-cell lymphoma; WM, Waldenström macroglobulinemia; +, presence; -, absence.

<sup>a</sup> Unusual but can have IgD or IgE and IgM.

Modified from Winkler JM, Fonseca R. Waldenström macroglobulinemia. In: Gertz MA, Greipp PA, eds. Handbook of multiple myeloma and related cell disorders (primary amyloidosis, AL). Berlin: Springer-Verlag, *in press*.

The plasma cell labeling index determined by immunofluorescence microscopy (<sup>36</sup>) usually shows the clonal cells to be nonproliferating (0% in >80% of patients) (R. Fonseca, unpublished observations, 2002). The plasma cell labeling index is useful in determining monoclonal cytoplasmic light-chain expression by the lymphoplasmacytoid cells; however, this can also be performed by immunohistochemical techniques on biopsy material.

There is no known reason for performing standard cytogenetic studies at the time of diagnosis of WM, except when the diagnosis is in doubt. Karyotype analysis should be done in subsequent bone marrow samples if the patient has cytopenia(s) and has had exposure to alkylator drugs, because myelodysplasia can occur ( [28](#) ).

## Pathology and Differential Diagnosis

Because of its morphologic and immunophenotypic features, WM has been assigned the pathologic designation *lymphoplasmacytic lymphoma* (LPL) in the Revised European–American Lymphoma Classification ( [21](#) ). However, LPL is not always associated with paraproteinemia; thus, LPL without paraproteinemia appears to be distinct from WM as a pathologic entity. Indeed, in a recent study of patients with WM, those with a low paraprotein concentration fared worse, suggesting different biologic mechanisms ( [22](#) ) ( [Table 100.1](#) ).

Occasionally, it may be difficult to differentiate WM from marginal zone lymphomas on the basis of examination of bone marrow morphology. A key factor is the size of the IgM protein. Patients with higher–concentration (>30 g/L) M proteins likely have WM, whereas those with small M proteins more likely have marginal zone lymphomas. In addition, plasmacytoid morphology is more consistent with WM than marginal zone lymphoma.

The differentiation of WM from mantle cell lymphoma and B–cell chronic lymphocytic leukemia is usually straightforward, because both of these entities consistently express CD5 and have absent or low serum levels of monoclonal IgM. In addition, mantle cell lymphoma is usually associated with *cyclin D1* positivity on immunohistochemical analysis. With fluorescent *in situ* hybridization (FISH), a t(11;14)(q13;q32) translocation should always be present. Follicular B–cell lymphomas can be readily differentiated from WM by the architectural patterns on light microscopy, the strong positivity in the cells for *bcl-2*, cell surface expression of CD10, and the presence of a t(14;18)(q32;q21) translocation. Evolution of WM to more aggressive lymphoproliferative disorders has been reported previously ( [37](#), [38](#) ).

A rare entity was described in 2000 in which patients have features of WM but produce an excess amount of monoclonal IgG paraproteins rather than IgM, suggesting that the clonal cells have undergone isotype class switching ( [39](#) ). Although such patients may have hyperviscosity associated with clonal IgG or IgA M proteins, they are not normally considered to have WM. Likewise, cases of IgM myeloma have been reported ( [40](#), [41](#) and [42](#) ). The difference between IgM myeloma and WM has been difficult to discern. Recent information indicates that patients with WM almost never have IgH translocations ( [43](#) ), whereas those with IgM myeloma frequently do ( [44](#) ). Renal failure is reportedly more common among patients with IgM myeloma ( [40](#), [41](#) and [42](#) ).

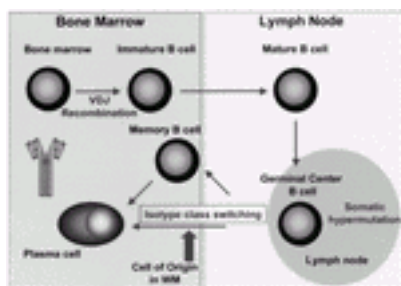
## Radiologic Studies

At baseline, it is useful to obtain a computed tomographic scan of the chest, abdomen, and pelvis to assess adenopathy and spleen and liver size. In contrast to myeloma, lytic bone disease is unusual in WM; therefore, routine skeletal radiographs or bone scans are not needed unless the patient reports bone pain ( [40](#), [41](#) and [42](#) ).

## PATHOPHYSIOLOGY

## Normal Counterpart to Waldenström Macroglobulinemia Clonal Cells

Although a precise definition of the normal counterpart of the malignant cell in WM has not been established, it is currently believed that the cells most resemble postgerminal center B cells without evidence of isotype class switching or memory B cells ( Fig. 100.4). There is evidence of somatic hypermutation in the clonal cells of WM and little intraclonal heterogeneity ( 45, 46, 47, 48 and 49). Southern blot analysis shows no rearrangements at the switch  $\mu$  regions, indicating the lack of isotype class switching consistent with the IgM isotype of the paraprotein in this disease ( 43). Studies using lymphoplasmacytoid cells from patients with WM demonstrate that they differentiate *in vitro* to mature IgM-secreting plasma cells ( 50).



**Figure 100.4.** Diagram of B-cell development. The malignant cells in Waldenström macroglobulinemia (WM) are believed to be either postgerminal center B cells before isotype class switching or memory B cells. VDJ, variable diversity joining.

## Relation to Monoclonal Gammopathy of Undetermined Significance

There is an ill-defined continuum between IgM-MGUS and active WM ( 34, 51) ( Table 100.2). The prevalence of IgM-MGUS is fourfold that of WM. IgM-MGUS is more likely to evolve to WM than to myeloma or amyloidosis ( 51). In fact, patients with IgM-MGUS have a 46-fold higher relative risk of WM than the general population. Therefore, it is believed that some patients with IgM-MGUS actually represent early stages of WM. Identification of the patients in whom IgM-MGUS will eventually transform to WM is not currently possible but is the subject of research. It is unclear how best to classify patients with paraprotein-associated complications such as demyelinating polyneuropathies or amyloid deposition.

**TABLE 100.2. Relationship between Immunoglobulin M-Monoclonal Gammopathy of Undetermined Significance (IgM-MGUS), Smoldering Waldenström Macroglobulinemia (SWM), and Waldenström Macroglobulinemia (WM)**

|  | IgM-MGUS        | SWM             | WM              |
|--|-----------------|-----------------|-----------------|
| Monoclonal serum protein concentration | Usually <15 g/L | Usually >15 g/L | Usually >30 g/L |
| Anemia                                 | Not seen        | Common but mild | Common          |
| Other cytopenia                        | Not seen        | Rare (15%)      | Rare (15%)      |



|                          |                |                |                     |
|--------------------------|----------------|----------------|---------------------|
| Organomegaly             | None           | May be present | ~15–20% of patients |
| Hyperviscosity           | None           | None           | ~15% of patients    |
| Constitutional symptoms  | None           | None           | Present             |
| Bone marrow clonal cells | Usually <5–10% | Usually >20%   | Usually >20%        |
| Therapy                  | Not needed     | Not needed     | Indicated           |

## Cytogenetics

Early reports described various cytogenetic abnormalities in WM patients, including the so-called W chromosome, but none of the abnormalities were specific for the disease, and most studies were done before G-banding analysis was available (52, 53, 54, 55, 56, 57, 58, 59, 60, 61, 62, 63, 64, 65, 66, 67, 68 and 69). In the majority of WM cases, the karyotype analyses are normal. Multicolor metaphase analysis in WM has been noncontributory so far (43). The only recurrent abnormality described in sporadic reports and small series is deletion of the long arm of chromosome 6 (68, 69 and 70). Interphase FISH is a useful technique for detecting chromosomal abnormalities in malignancies with low cellular proliferation rates such as WM. In a large cohort of WM patients studied by interphase FISH, a deletion of the long arm of chromosome 6 was observed in 40 to 60% of cases (43).

It is now believed that WM clonal cells lack IgH translocations. It has been reported that at least 50% of patients with LPL have a t(9;14)(p13;q32) translocation (71). The t(9;14)(p13;q32) results in up-regulation of *PAX-5* (72, 73), implicating this gene as a putative oncogene in the pathogenesis of LPL (74, 75 and 76). In the original series, none of the LPL patients with t(9;14)(p13;q32) had paraproteinemia. This finding is biologically plausible because up-regulation of *PAX-5* prevents expression of the high levels of Ig that result in paraproteinemia. Using interphase FISH, we were able to demonstrate absence of IgH translocations and t(9;14)(p13;q32) in a large cohort of patients with WM (43). This translocation should be readily detectable by karyotype analysis (43), and it has not been reported in studies of abnormal karyotypes of WM (43, 67, 68). Furthermore, these series failed to observe IgH translocations (43, 67, 68).

There are also sporadic reports of WM cases with the t(11;18)(q21;q21) translocation (77, 78), which is known to occur in extranodal marginal zone lymphomas (77, 78). This abnormality was not found in a large cohort of WM patients studied (43). In contrast to patients with multiple myeloma, those with WM rarely have 13q14 and 17p13.1 deletions at the time of diagnosis (79). The clonal cells of WM are usually diploid (43), and this has been confirmed by DNA content analysis in a small subset of patients (57).

## Molecular Genetics

Little is known about the molecular genetic nature of WM. Methylation of the tumor suppressor gene *p16* and mutations of *TP53* are rare (R. Fonseca, unpublished observations, 2002). Ongoing studies are addressing the role of gene expression profiles in patients with WM.

## CLINICAL FEATURES

The clinical features ( [Table 100.3](#)) associated with WM can be divided into characteristics that are related to compromise of the bone marrow and other organs and those that are secondary to the clonal proliferation, hyperviscosity, other effects of the paraprotein on peripheral blood, and paraneoplastic phenomena ( [3](#), [8](#), [23](#), [25](#)).

**TABLE 100.3. Clinical Features of Patients with Waldenström Macroglobulinemia**

| Series<br>(Reference)                         | Patients<br>(No.) | Criteria for<br>Diagnosis |                    | Study<br>Dates | Median<br>Age (yr)<br>(range) | Median<br>Overall<br>Survival<br>(mo)<br>(range) | M/F LAD<br>(%) | Spleen<br>(%) | Liver<br>(%) |    |
|---|-------------------|---------------------------|--------------------|----------------|-------------------------------|--|----------------|---------------|--------------|----|
|   |                   | M<br>protein<br>(g/L)     | Marrow             |                |                               |  |                |               |              |    |
| Newly diagnosed or untreated                  |                   |                           |                    |                |                               |  |                |               |              |    |
| Facon ( <a href="#">19</a> )                  | 167               | >5                        | >25% or<br>plymphs | 1969–1989      | —                             | 60   | 1.27           | 23            | 26           | 13 |
| Morel ( <a href="#">80</a> )                  | 232               | >5                        | >25% or<br>plymphs | 1964–1989      | 67<br>(30–100)                | —  | 2.46           | —             | 22           | 21 |
| Gobbi ( <a href="#">20</a> )                  | 144               | >10                       | >30%               | 1976–1991      | 61 (35–92)                    | —  | 1.09           | —             | —            | —  |
| Garcia-Sanz<br>( <a href="#">23</a> )         | 217               | >30                       | >20% or<br>plymphs | 1989–1999      | 69                            | —  | 2.00           | 25            | 19           | 24 |
| Kyrtsonis ( <a href="#">81</a> )              | 60                | >5                        | +                  | 1976–1999      | 65 (43–91)                    | 108<br>(86–136)                                  | 1.40           | 22            | 18           | 13 |
| Dhodapkar ( <a href="#">22</a> ) <sup>e</sup> | 118               | +                         | +                  | 1992–1998      | —                             | ~60  | 1.38           | 30            | 26           | 12 |
| Kyle ( <a href="#">28</a> )                   | 46                | +                         | +                  | 1971–1993      | 63                            | 64.8   | 2.33           | 15            | 20           | 24 |
| Relapsed and refractory disease               |                   |                           |                    |                |                               |  |                |               |              |    |
| Leblond ( <a href="#">82</a> )                | 92                | >5                        | Infiltrate         | 1993–1997      | 64<br>(34.6–75.0)             | 43   | 2.06           | 36            | 17           | 11 |
| Dhodapkar ( <a href="#">22</a> ) <sup>h</sup> | 64                | +                         | +                  | 1992–1995      | —                             | ~60  | 1.27           | 14            | 14           | 6  |
| Dimopoulos<br>( <a href="#">83</a> )          | 28                | +                         | +                  | —              | 60 (43–79)                    | 32   | 1.56           | 32            | 18           | —  |
| Leblond ( <a href="#">84</a> )                | 71                | >5                        | +                  | 1991–1995      | 68 (42–81)                    | 23   | —              | 53            | <sup>i</sup> | —  |
| Leblond ( <a href="#">82</a> )                | 92                | >5                        | +                  | 1993–1997      | 64.3<br>(34.6–75.0)           | 45   | 2.06           | 36            | 17           | 11 |
| Dimopoulos<br>( <a href="#">85</a> )          | 46                | —                         | —                  | 1990–1994      | 60 (34–81)                    | 28   | 0.85           | 46            | 28           | —  |
| Hellmann ( <a href="#">86</a> )               | 13                | >15                       | >30%               | —              | 61.3<br>(46.0–73.0)           | —  | 1.25           | 33            | 22           | —  |

+, positive; —, no data available; B-J, Bence Jones protein; Cryo, cryoglobulin; Hb, hemoglobin; LAD, lymphocyte to female ratio; M protein, monoclonal protein; PC, plasma cells; plymphs, plasmacytoid lymphocytes; Visc, viscosity.

<sup>a</sup> Measured in only 120 patients.

<sup>b</sup> Measured in only 70 patients.

<sup>c</sup> Defined as <120 g/L (women) and <135 g/L (men).

<sup>d</sup> Less than 100 in this series.

<sup>e</sup> Treatment-naïve arm.

<sup>f</sup> Defined as > 4 cP.

<sup>g</sup> Defined as <100 g/L.

<sup>h</sup> Previously treated arm.

<sup>i</sup> 53% with lymphadenopathy, splenomegaly, etc. combined.

Modified from Winkler JM, Fonseca R. Waldenström macroglobulinemia. In: Gertz MA, Greipp PA, eds. *Hematology and related cell disorders (primary amyloidosis, AL)*. Berlin: Springer-Verlag (*in press*).

---

Anemia is the most common cause for initiation of therapy in patients with WM and is due to clonal expansion in the bone marrow, increased plasma volume, and hyperviscosity. In patients previously treated with chemotherapy, myelosuppression is an additional cause of anemia. The anemia can vary from mild to severe and results in fatigue proportional to the level of anemia. Anemia (hemoglobin, <100 g/L) has been reported in 27 to 38% of patients ([19](#), [23](#)). Successful treatment of WM should lead to an improvement in hemoglobin, a reduced need for transfusions, and an improvement in performance status. If myelosuppressive chemotherapy is used, the hemoglobin does not achieve maximum improvement until after the chemotherapy is stopped. If anemia is the only symptom, it may be correctable with erythropoietin ([87](#)) (see cautionary note under [Hyperviscosity Syndrome](#)). Increased viscosity reduces erythropoietin production and contributes to the anemia of WM ([88](#)).

In addition to anemia caused by ineffective erythropoiesis and peripheral destruction, patients with WM may have hemodilution because large amounts of pentameric IgM in the blood result in a hemoglobin level that is lower than would be expected on the basis of the red cell mass ([1](#), [3](#)). Patients may thus be asymptomatic (and not require transfusions) at hemoglobin levels that would typically result in symptoms in other patients.

Because of the M protein, rouleaux formation of red cells is characteristically observed on peripheral blood smear examination ([29](#)). Likewise, the M protein increases the Westergren erythrocyte sedimentation rate (ESR), making the ESR useless for the evaluation of infection or systemic inflammation in these patients. The influence on ESR seems to be independent of the protein concentration, and large increases may be seen even with small quantities of M proteins. Occasionally, patients we evaluate have been treated for presumed polymyalgia rheumatica or temporal arteritis, although in fact the high ESR could be simply attributed to the M protein.

Clinically significant thrombocytopenia is unusual in patients with WM despite the extensive marrow involvement and is usually not encountered until late in the disease. The median platelet count in the series of Kyle and colleagues ([28](#)) was within normal

range, and only 9% of patients had a platelet count less than  $100 \times 10^9/L$ . Facon and associates (19) reported a thrombocytopenia prevalence of 22%. Other causes for thrombocytopenia include myelosuppressive chemotherapy and splenomegaly. In patients who have been previously treated, the possibility of myelodysplasia should be kept in mind. Thrombocytopenia, whenever present, potentiates the bleeding diathesis associated with hyperviscosity.

Organomegaly is seen in approximately one-third of patients with WM and includes hepatomegaly (20%) and splenomegaly (15%) (1, 8, 19, 23). The splenomegaly can produce hypersplenism and hence contribute to cytopenias. The liver involvement is usually not symptomatic and does not typically interfere with therapy. Fifteen to twenty percent of patients have lymphadenopathy ranging from mild to bulky (1, 8, 19, 23). Lung involvement in WM is unusual (89, 90).

### Hyperviscosity Syndrome

**FEATURES** One characteristic feature of WM is the hyperviscosity syndrome (91, 92 and 93), which is seen in approximately 15% of cases. The dominant features of the hyperviscosity syndrome include oronasal bleeding, retinal hemorrhage, and neurologic abnormalities (Table 100.4). *Viscosity* is defined as the intrinsic resistance of a fluid to flow. Hyperviscosity is believed to be more common in association with IgM paraproteins because of the difference in length and width of the pentamer, compared with that of IgG and IgA antibodies. The viscosity of normal plasma, compared with that of water, is 1.8. For further details regarding the rheology of hyperviscosity, the reader is referred to Gertz and Kyle (91).

**TABLE 100.4. Clinical Manifestations of Hyperviscosity Syndrome**

---

|                                 |
|---------------------------------|
| Mucosal hemorrhage              |
| Gingival                        |
| Epistaxis                       |
| Gastrointestinal bleeding       |
| Surgery-associated bleeding     |
| Visual                          |
| Blurring or vision loss         |
| Retinal vein thrombosis         |
| Retinal hemorrhage and exudates |
| Papilledema                     |
| Neurologic                      |
| Headache                        |
| Vertigo                         |
| Deafness                        |
| Syncope                         |
| Ataxia                          |
| Diplopia                        |
| Stupor or coma                  |
| Cerebral hemorrhage             |
| Seizure                         |
| Chorea                          |
| Cardiac                         |
| High-output failure             |

The syndrome does not necessarily correlate with the serum concentration of the M protein or serum viscosity ( [91](#), [92](#) and [93](#) ). Increased viscosity is not, in and of itself, an indication for plasmapheresis or treatment ( [91](#), [92](#) and [93](#) ). Some patients have no symptoms despite a high viscosity level, whereas others have prominent symptoms at similar levels. It is uncommon to see symptoms of hyperviscosity at values less than 4 cP. Most patients with a viscosity level of 5 to 8 cP are symptomatic, and nearly all patients with a viscosity greater than 8 cP are symptomatic ( [91](#), [92](#) and [93](#) ). Routine screening of viscosity in patients with an IgM less than 40 g/L is not recommended ( [91](#) ). Once a protein level at which symptomatic hyperviscosity occurs is determined, it can be used as a reference point at which symptoms of hyperviscosity may develop in the future ( [91](#) ). It is important to remember that viscosity can greatly increase if correction of anemia with red blood cell transfusions is overzealous; therefore, transfusions and erythropoietin therapy must be used with caution in patients at high risk for hyperviscosity syndrome. If a patient with hyperviscosity is in immediate need of blood transfusions, pretransfusion plasmapheresis may be necessary.

#### **NEUROLOGIC AND RETINAL COMPLICATIONS ASSOCIATED WITH HYPERVISCOSITY**

Patients with WM and hyperviscosity may have neurologic symptoms. Focal neurologic deficits, including facial nerve paralysis, deafness, and other cranial neuropathies, were originally described by Waldenström ( [94](#) ). The combination of a neurologic syndrome and WM has been referred to as the *Bing-Neel syndrome*. Hyperviscosity can manifest as profound fatigue, mental confusion, obtundation, stroke ( [95](#) ), or dementia ( [96](#) ); therefore, the presence of neurologic symptoms or signs in a patient with WM should result in an urgent investigation for hyperviscosity. Even milder symptoms, such as headache or light-headedness, can also be due to hyperviscosity ( [94](#) ). In this circumstance, there should be a low threshold for emergent plasmapheresis, and the subsequent clinical improvement can be immediate and dramatic. There are several peripheral nerve complications associated with WM, including demyelinating polyneuropathy with anti-myelin-associated glycoprotein (anti-MAG) antibodies, demyelinating neuropathies not associated with anti-MAG antibodies ( [97](#), [98](#) ), polyneuropathies with IgM not reactive to known epitopes, cryoglobulin-associated symptoms, and, last, neuropathies associated with amyloidosis. Patients with WM can develop IgM-associated peripheral neuropathies and other syndromes, as described in [Chapter 98](#), and such conditions have been reported in approximately 5% of cases. In many of these patients, the M protein has anti-MAG activity. This results in the binding of the M protein to the binding sheath and consequent demyelination ( [99](#) ). In one study, antimyelin activity of the monoclonal IgM was found in one-half of cases with neuropathy associated with WM ( [100](#) ). Patients with demyelinating polyneuropathies of the MAG type present with sensory deficits, including proprioception abnormalities that result in weakness and ataxia ( [101](#), [102](#) ). Treatments used for the control of WM, such as chlorambucil, may also be effective in controlling associated syndromes such as peripheral neuropathy, and cases of sustained neurologic improvement have been reported ( [103](#) ). Retinal complications include venous engorgement, retinal hemorrhage, cotton-wool spots, and, in extreme cases, retinal vein occlusion ( [104](#), [105](#) ).

#### **Paraneoplastic and Other Manifestations**

Patients with WM can develop clinical features of light-chain-associated amyloidosis ( [8](#),

106, 107). Such patients appear to have a stronger tendency to develop amyloid-associated cardiomyopathy than do other patients with amyloidosis (44% vs. 27%), and they have a higher incidence of pleural and pulmonary amyloidosis (106). In cases of WM-associated amyloidosis, the therapy should be designed to control the WM.

## PROGNOSIS

The prognosis of WM is quite variable. The median survival is approximately 5 years (28, 80), but approximately 10% of patients remain alive after 15 years (28). Other series have reported a median survival of 108 months (81).

Because the disease is indolent and predominantly affects the elderly, few data are available on disease-related survival and mortality that exclude other causes of death. Better information is needed. Furthermore, because of the wide range of survival, prognostic factors are important. By updating the series studied originally by Facon et al. (19), Morel and colleagues (80) developed a prognostic model (Table 100.5) for WM based on age, serum albumin, and blood count data from 232 patients treated before 1989 with alkylator agents (no purine nucleoside analogs). Age greater than 65 years, albumin less than 40 g/L, and presence of at least one cytopenia (hemoglobin, <120 g/L; platelet count, <150 × 10<sup>9</sup>/L; or white blood cell count, <4 × 10<sup>9</sup>/L) were determined to be important for prognosis. Patients with one cytopenia were assigned one point; those with two or more cytopenias were assigned two points. Patients were then grouped into three prognostic categories: low risk (zero to one point, 27% of patients), intermediate risk (two points, 27% of patients), or high risk (three to four points, 46% of patients). The proportion of patients alive at 5 years was 87% for the low-risk, 62% for the intermediate-risk, and 25% for the high-risk group (Table 100.5). The median actuarial overall survival was 61 months, and there was no difference in overall survival between the patients who were initially observed without therapy versus those who received immediate treatment.

**TABLE 100.5. Prognostic Models for Patients with Waldenström Macroglobulinemia**

| Model (Reference) | Prognostic Factors              |                     | 5-Year Patient Survival (%) |         |
|-------------------|---------------------------------|---------------------|-----------------------------|---------|
| Morel (80):       | Points <sup>a</sup>             |                     | Overall                     |         |
| Categories        |                                 |                     |                             |         |
| Low risk          | 0–1                             |                     | 87                          |         |
| Intermediate risk | 2                               |                     | 62                          |         |
| High risk         | 3–4                             |                     | 25                          |         |
| Dhodapkar (22):   | $\beta_2$ -microglobulin (mg/L) | Hemoglobinx and IgM | Progression-free            | Overall |
| Stages            |                                 |                     |                             |         |
| A                 | <3                              | Hemoglobin =120 g/L | 83                          | 87      |
| B                 | <3                              | Hemoglobin <120 g/L | 55                          | 64      |
| C                 | =3                              | Serum IgM =40 g/L   | 33                          | 53      |
| D                 | =3                              | Serum IgM <40 g/L   | 12                          | 22      |

Ig, immunoglobulin.

<sup>a</sup> Criteria for points in Morel model: age 65 or older, 1 point; albumin <40 g/L, 1 point; one cytopenia (hemoglobin, <120 g/L; platelet count, <150 × 10<sup>9</sup>/L; or white blood cell count, <4 × 10<sup>9</sup>/L), 1 point; two or three cytopenias, 2 points.

Modified from Winkler JM, Fonseca R. Waldenström macroglobulinemia. In: Gertz MA, Greipp PA, eds. Handbook of multiple myeloma and related cell disorders (primary amyloidosis, AL). Berlin: Springer-Verlag ( *in press*).

---

Other prognostic factors in a univariate model were  $\beta_2$ -microglobulin concentration greater than 3 mg/L, serum IgM, and plasma volume greater than 50 ml/kg. Factors not found to be prognostic were the presence of Bence Jones protein, splenomegaly, B symptoms, light-chain type, cryoglobulinemia, pattern of marrow involvement, and other cytologic features. When the analysis was restricted to patients younger than 65 years, only the presence of two cytopenias was important. Kyrtsolis and colleagues ( [81](#) ) confirmed the prognostic importance of the Morel scoring system.

The prognostic scoring system developed by Gobbi and colleagues ( [20](#) ) uses weight loss, cryoglobulinemia, anemia (hemoglobin, <100 g/L), and age older than 60 years. Low-risk patients have no or one adverse feature; high-risk patients have more than one. Last, Dhodapkar and colleagues ( [22](#) ) evaluated prognostic factors in a group of 182 patients who were treated with fludarabine. Serum  $\beta_2$ -microglobulin of 3 mg/L or greater, hemoglobin less than 12 g/dl, and IgM less than 40 g/L were significantly associated with shorter survival. The investigators used these three factors to develop a prognostic system that estimated 5-year treatment-free and overall survival ( [Table 100.5](#) ).

## TREATMENT OPTIONS

### Observation

Because WM is currently an incurable malignancy, the objectives of treatment should be to provide relief of symptoms and to prevent hyperviscosity and end-organ damage. The situation is analogous to that of smoldering myeloma ( [110](#) ), because patients who are asymptomatic can be carefully observed without immediate treatment. Waldenström himself raised the question regarding the need for therapy in asymptomatic patients ( [111](#) ). If a patient is asymptomatic and the disease incurable, then early treatment may result in side effects that reduce the patient's quality of life. Although observation is often an appropriate choice, it is important that all patients with WM be followed up at regular intervals with a history and physical examination, along with appropriate laboratory tests, to detect active disease before damage to vital organs. Treatment initiation must be dictated by symptoms and the trend of laboratory values, not merely the laboratory values alone.

### Alkylating Agent-Based Therapy

**SINGLE ALKYLATING AGENTS** Oral alkylating agents have been used as the mainstay of treatment for WM for 40 years ( [112](#) ) ( [Table 100.6](#) ). In 167 patients with WM treated with oral chlorambucil (0.1 mg/kg/day), the median survival was 5 years ( [19](#) ). Tumor burden did not predict response to therapy; therefore, neither a high degree of bone marrow involvement nor lymphadenopathy was a predictor of response to therapy. Kyle and colleagues ( [28](#) ) have reported the only prospective randomized trial assessing the use of



chlorambucil for the treatment of WM in symptomatic patients. Patients were randomly assigned to receive oral chlorambucil continuously (0.1 mg/kg/day) or in intermittent 7-day cycles every 6 weeks (0.3 mg/kg/day). Response rates were similar between the two treatment arms (79% of the continuous group vs. 68% of the intermittent group, not significant). The median overall survival from start of treatment was identical in the two arms at 5.4 years. Lessons learned from this trial were that responses may occur late and that a therapy period of at least 6 months is required to fully evaluate response (28). Because of myelosuppression, patients started on oral chlorambucil at 0.1 mg/kg/day usually require dose reductions. Others have also demonstrated the effectiveness of chlorambucil (81). Oral cyclophosphamide has also been used to treat WM (113).

**TABLE 100.6. Alkylating Agents in the Treatment of Waldenström Macroglobulinemia**

| Author (Reference) | Regimen  | Patients (No.) | Response Rate (%) | Median Response Duration (mo)        | Median Overall Survival (mo) | Median Event-Free Survival (mo) |
|--------------------|--|----------------|-------------------|--------------------------------------|------------------------------|---------------------------------|
| Facon (19)         | Chlorambucil, 0.1 mg/kg/d, continuous                                    | 128            | 75                | NR                                   | 60                           | NR                              |
| Kyle (28)          | Chlorambucil, 0.1 mg/kg/d, continuous <i>or</i>                          | 24             | 79                | 26 <sup>a</sup>                      | 65                           | NR                              |
|                    | Chlorambucil, 0.3 mg/kg/d × 7 d, repeat q6wk                             | 22             | 68                | 46 <sup>a</sup>                      | 65                           | NR                              |
| Case (108)         | Carmustine/CTX/vincristine, then Melph/Pred, repeated q5wk × 2 yr        | 33             | 82                | 39 (5 ± 114)/43 (15–60) <sup>b</sup> | NR <sup>c</sup>              | NR                              |
| Petrucci (109)     | Melph/CTX/Pred × 7 d, repeated q4–6wk × 12; then daily chlorambucil/Pred | 34             | 74                | NR <sup>d</sup>                      | NR <sup>d</sup>              | 66                              |
| Leblond (82)       | CTX + doxorubicin on day 1, then Pred (days 1–5), q4wk                   | 45             | 11                | 3                                    | 45 <sup>e</sup>              | ~5.5                            |

CTX, cyclophosphamide (Cytosan); Melph, melphalan; NR, not reported; Pred, prednisone.

<sup>a</sup> Based on 50% immunoglobulin M reduction.

<sup>b</sup> Partial responders/complete responders.

<sup>c</sup> Projected 10-year overall survival, 58%.

<sup>d</sup> Not reached at time of report.

<sup>e</sup> No significant difference compared with fludarabine as salvage.

Modified from Winkler JM, Fonseca R. Waldenström macroglobulinemia. In: Gertz MA, Greipp PA, eds. Handbook of multiple myeloma and related cell disorders (primary amyloidosis, AL). Berlin: Springer-Verlag (*in press*).

**MULTIPLE ALKYLATING AGENTS** Because of its activity in the treatment of multiple myeloma (114), the VBMCP regimen (vincristine, carmustine, melphalan, cyclophosphamide, and prednisone) has been used in WM in an attempt to improve survival. In the initial report of 14 patients, all patients responded, with two attaining a complete response. No patients required plasma exchange. A subsequent trial accrued 33 patients and used VBMCP every 5 weeks for 2 years, followed by VBMCP maintenance every 10 weeks (108). Twenty-one partial responses and six minor responses were observed, with a projected survival of 58% at 10 years. In another study of 34 patients,

melphalan, cyclophosphamide, and prednisone were given for 12 months, followed by continuous chlorambucil maintenance. An overall response rate of 74% (26% complete response) was observed (109). The toxicity was minimal, and the overall median event-free survival was 66 months. Leblond and colleagues (82) studied 92 patients with WM who were either resistant to (N = 42) or had relapsed after (N = 50) treatment with alkylating agents. The patients were randomly assigned to receive fludarabine, 25 mg/m<sup>2</sup> (days 1 through 5), or six cycles of cyclophosphamide, doxorubicin (Adriamycin), and prednisone (CAP). The overall response rate was 30% with fludarabine versus 11% with CAP (*p* = .019), and all responses in both arms were partial. The duration of response was 19 months with fludarabine versus 3 months for CAP (*p* < .01); however, there was no difference in overall survival. There was also no difference in hematologic or infectious toxicity between the two arms, but patients receiving CAP had more mucositis and alopecia.

### Purine Nucleoside Analogs

**FLUDARABINE** Purine nucleoside analogs have been demonstrated to be highly effective in the management of low-grade lymphomas and B-cell chronic lymphocytic leukemia and hence were also tested in the treatment of WM. The use of fludarabine (Table 100.7) was first reported in 1990 by Kantarjian and colleagues (115). Eleven patients (ten previously treated) were treated, and five responded, with a median time to response (50% reduction in M protein concentration) of 5.2 months and a median duration of response longer than 1 year. Dimopoulos and colleagues (83) treated 28 patients (26 previously treated) with fludarabine, achieving a response rate of 36% (31% in previously treated patients). Responses were durable, with a median duration of response of 38 months. In a study of 12 previously treated WM patients, five achieved a partial response with fludarabine (116). With a mean follow-up of 10 months, only one responding patient had relapsed. The Macroglobulinemia French Cooperative Group reported on fludarabine treatment in 71 previously treated patients (84). The median number of courses of fludarabine was six. Twenty-one patients (30%) responded, and the overall median survival of all treated patients was 23 months. The time to treatment failure for responders was 32 months.

**TABLE 100.7. Fludarabine in the Treatment of Waldenström Macroglobulinemia**

| Reference        | Fludarabine Regimen                                  | Patients (No.) | Response Rate (%) | Median Response Duration (mo) | Median Overall Survival (mo) | Median Event-Free Survival (mo) |
|------------------|--|----------------|-------------------|-------------------------------|------------------------------|---------------------------------|
| Kantarjian (115) | 30 mg/m <sup>2</sup> IV bolus qd × 5d, repeated q4wk | 11             | 45                | >12.0 <sup>a</sup>            | NR                           | NR                              |
| Leblond (82)     | 25 mg/m <sup>2</sup> IV bolus × 5d, q4wk             | 45             | 30                | 19.0                          | 41 <sup>b</sup>              | ~6.5                            |
| Dhodapkar (22)   | 30 mg/m <sup>2</sup> qd × 5d, repeated q28d          | 182            | 36                | NR                            | 60 <sup>c</sup>              | NR                              |

|  |   |    |    |                   |    |    |
|--|---|----|----|-------------------|----|----|
| Dimopoulos ( <a href="#">83</a> )              | 20–30 mg/m <sup>2</sup> IV × 5d <i>or</i><br>30 mg/m <sup>2</sup> qd<br>× 3d            | 28 | 36 | 38.0              | 32 | NR |
| Zinzani ( <a href="#">116</a> )                | 25 mg/m <sup>2</sup> /d<br>× 5d,<br>q21–28d ×<br>six courses                            | 12 | 41 | 10.5 <sup>d</sup> | NR | NR |
| Leblond ( <a href="#">84</a> )                 | 25 mg/m <sup>2</sup> IV<br>bolus × 5d,<br>repeated<br>q4wk until<br>maximum<br>response | 71 | 30 | 32.0              | 23 | NR |
| Thalhammer–Scherrer<br>( <a href="#">117</a> ) | 25 mg/m <sup>2</sup> /d<br>× 5d, repeat<br>q4wk   | 7  | 86 | 44.5              | NR | NR |
| Foran ( <a href="#">118</a> )                  | 25 mg/m <sup>2</sup> /d<br>× 5d, q4wk<br>to maximum<br>response +<br>two more<br>cycles | 19 | 79 | 30.0              | NR | NR |

IV, intravenous; NR, not reported.

<sup>a</sup> Four of five responders still in remission at study termination.

<sup>b</sup> No significant difference compared with CAP (cyclophosphamide, doxorubicin, and prednisone) as salvage.

<sup>c</sup> No difference between pretreated and naïve patients.

<sup>d</sup> Median follow-up only 6 months.

Modified from Winkler JM, Fonseca R. Waldenström macroglobulinemia. In: Gertz MA, Greipp PA, eds. Handbook of multiple myeloma and related cell disorders (primary amyloidosis, AL). Berlin: Springer-Verlag ( *in press*).

In another study, seven patients with WM (six previously untreated and one minimally treated) received fludarabine at 25 mg/m<sup>2</sup> daily for 5 days on a monthly schedule ( [117](#)). The median time from recognition of the M protein to the initiation of chemotherapy was 32.6 months. Most patients received six cycles of fludarabine. Six patients showed a marked reduction in IgM value and normalization of the hemoglobin, with a median time to response of 5.4 months. It is interesting that the maximum response was observed 17.3 months after the end of treatment. In six patients, the responses were sustained (from 20.8 to 55.2 months). Foran and colleagues ( [118](#)) studied fludarabine administered at 25 mg/m<sup>2</sup> daily for 5 days every 4 weeks in 19 patients with previously untreated WM. The response rate was 79% (15% complete response), with a median response duration of 30 months. The treatment-related mortality was 5% due to fludarabine-induced pancytopenia and infection in patients with reduced marrow reserve. The largest study of fludarabine in WM enrolled 231 patients, of whom 167 were previously untreated and 64 had received prior therapy ( [22](#)). Forty-nine of the previously untreated patients were observed because they were asymptomatic. A total of 182 patients were treated with four to eight

cycles of fludarabine at a dose of 30 mg/m<sup>2</sup> daily for 5 days, repeated monthly. The overall response rate was 36% (2% complete response). Patients older than age 70 years were significantly less likely to respond to fludarabine therapy. There was no difference in response rates between previously untreated patients and those with prior therapy. The primary toxicity was myelosuppression, and mortality from infections was 4%.

**2-CHLORODEOXYADENOSINE** The purine nucleoside analog 2-chlorodeoxyadenosine (2-CDA; cladribine) is structurally similar to fludarabine and has also been studied in the treatment of WM ( [Table 100.8](#)). Dimopoulos and colleagues ( [121](#)) treated 29 WM patients with a continuous intravenous infusion of 0.1 mg/kg/day of 2-CDA for 7 days for a total of two courses. They reported an overall response rate of 59% (100% in previously untreated patients; 40% in relapsed patients). Delannoy and colleagues ( [122](#)) reported similar results in 18 patients treated with 2-CDA with either 4.0 mg/m<sup>2</sup>/day for 7 days by continuous intravenous infusion (N = 5) or 5.6 mg/m<sup>2</sup> infused over 2 hours per day for 5 days (N = 13), with partial responses in 39% of patients (7 of 18). Grade 4 neutropenia developed in four patients (22%), and grade 4 thrombocytopenia developed in six patients (33%). In another study, 25 patients were treated with 2-CDA at a dose of 0.14 mg/kg/day for 5 consecutive days as a 2-hour intravenous infusion. The overall response rate was 64% (4% complete response) ( [125](#)).

**TABLE 100.8. 2-Chlorodeoxyadenosine (Cladribine) in the Treatment of Waldenström Macroglobulinemia**

| Author (Reference)                              | 2-Chlorodeoxyadenosine Regimen  | Patients (No.) | Response Rate (%) | Median Response Duration (mo) | Median Overall Survival (mo) |
|---|---|----------------|-------------------|-------------------------------|------------------------------|
| Liu ( <a href="#">119</a> )                     | 0.12 mg/kg/d (2-h bolus) × 5d, qmo × 3–8 cycles   | 20             | 55                | 28                            | NR                           |
| Betticher ( <a href="#">120</a> )               | 0.1 mg/kg SC bolus × 5d q4wk, max 6 cycles  | 25             | 40 <sup>a</sup>   | 8                             | NR                           |
| Dimopoulos ( <a href="#">121</a> )              | 0.1 mg/kg IV qd × 7d, 2 cycles  | 29             | 59                | NR                            | NR                           |
| Delannoy ( <a href="#">122</a> )                | 4.0 mg/m <sup>2</sup> /d IV × 7d or 5.6 mg/m <sup>2</sup> /d IV over 2 h × 5d   | 18             | 39                | 2 <sup>a, b</sup>             | NR                           |
| Dimopoulos ( <a href="#">123</a> ) <sup>c</sup> | 0.1 mg/kg/d IV × 7d continuous, 2 cycles  | 14             | 29                | 11                            | NR                           |
| Hellmann ( <a href="#">86</a> )                 | 0.14 mg/kg/d 2h bolus × 5d, repeated q28–35d for 3–5 cycles   | 22             | 41                | 12                            | NR                           |
| Laurencet ( <a href="#">124</a> )               | 0.1 mg/kg/d on days 1–3 + cyclophosphamide 500 mg/m <sup>2</sup> on day 1 + prednisone 40 mg/m <sup>2</sup> on days 1–5 | 3              | 100               | NR                            | NR                           |

NR, not reported.

<sup>a</sup> Excludes patients with disease stabilization.

<sup>b</sup> Continuous versus bolus infusions; no difference in outcome.

<sup>c</sup> Includes brief report of fludarabine failures and relapses.

Modified from Winkler JM, Fonseca R. Waldenström macroglobulinemia. In: Gertz MA, Greipp PA, eds. Handbook of multiple myeloma and related cell disorders (primary amyloidosis, AL). Berlin: Springer-Verlag ( *in press*).

Liu and colleagues ( [119](#) ) reported on the use of 2-CDA (0.12 mg/kg over 2 hours each day for 5 days per month), obviating the need for an intravenous central catheter. They treated 20 patients and found an overall response rate of 55% (one complete response and ten partial responses). The median duration of response was 28 months. As in other series, myelosuppression was the main toxicity, with grade 3 or 4 neutropenia seen in 60% of patients. Two patients had herpes zoster due to cellular immunosuppression. Hellmann and colleagues ( [86](#) ) treated 22 WM patients with a similar 2-hour infusion of 2-CDA for three cycles and achieved an overall response rate of 41% (all partial). Neutropenia occurred in 77% of patients and thrombocytopenia in 32%, including one fatal hemorrhage. It appears that when 2-CDA is used to treat WM, it should be limited to two cycles to avoid profound myelosuppression. In another study, 2-CDA was administered to ten previously untreated patients (0.12 mg/kg over 2 hours every day × 5 days per month × 4 cycles), followed by interferon maintenance ( [120](#) ). The overall response rate was 100% (one response was complete, eight were partial, and one was minor). To assess long-term 2-CDA use, a multiinstitutional trial was reported in which 25 previously treated patients received 2-CDA subcutaneously (0.1 mg/kg/day for 5 days) every month for a maximum of six cycles. The median number of cycles administered was three, and the overall response rate was 40% (all partial responses) with a median remission duration of 8 months. Grade 2 or greater infections developed in 16% of patients. As first-line treatment for WM, 2-CDA is effective but is also associated with myelosuppression and T-cell immunodeficiency ( [126](#) ). Attempts to assess whether 2-CDA and fludarabine are non-cross-resistant have been published ( [123](#) ). In one study, 14 patients who did not respond to fludarabine therapy were treated with two courses of 2-CDA. Only one of ten patients with fludarabine-resistant disease responded. Three of four patients who had progressed after a previous response to fludarabine responded. In another study, six patients who were resistant to 2-CDA were treated with fludarabine, and two responded ( [127](#) ). This suggests that, for patients resistant to one purine nucleoside analog, limited benefit is obtained from switching to another purine nucleoside analog.

## Rituximab

Because the majority of malignant cells in WM express surface membrane CD20, the recent availability of the anti-CD20 monoclonal antibody rituximab has allowed targeted immunotherapy ( [Table 100.9](#) ). Initial reports showed improvements in cytopenias ( [131](#) ) and neurologic symptoms ( [132](#) ) and disappearance of CD20<sup>+</sup> B cells from the bone marrow and peripheral blood ( [133](#) ). Byrd and colleagues ( [129](#) ) treated seven relapsed patients with either four or eight weekly infusions of rituximab. The medication was well tolerated without myelosuppression or infections. Partial responses were noted in three patients, with a median progression-free survival of 6.6 months.

**TABLE 100.9. Rituximab in the Treatment of Waldenström Macroglobulinemia**

| Author (Reference)                 | Rituximab Regimen  | Patients (No.) | Response Rate (%) | Median Response Duration (mo) | Median Overall Survival (mo) | Median Event-Free Survival (mo) |
|------------------------------------|--|----------------|-------------------|-------------------------------|------------------------------|---------------------------------|
| Dimopoulos ( <a href="#">128</a> ) | 375 mg/m <sup>2</sup> IV × 4 wk, repeated × 1 for responders | 27             | 44                | NR                            | NR                           | NR                              |

|                               |  |    |                 |    |    |     |
|-------------------------------|--|----|-----------------|----|----|-----|
| Byrd ( <a href="#">129</a> )  | 375 mg/m <sup>2</sup> IV<br>qwk × 4–8 wk | 7  | 43              | 11 | NR | 6.6 |
| Treon ( <a href="#">130</a> ) | 375 mg/m <sup>2</sup> IV<br>qwk × 4–8 wk | 30 | 60 <sup>a</sup> | 8  | NR | NR  |

IV, intravenous; NR, not reported.

Modified from Winkler JM, Fonseca R. Waldenström macroglobulinemia. In: Gertz MA, Greipp PA, eds. Handbook of multiple myeloma and related cell disorders (primary amyloidosis, AL). Berlin: Springer-Verlag ( *in press*).

<sup>a</sup> Includes partial and minor responses.

Treon and colleagues ( [130](#) ) treated 30 patients with previously treated WM with single-agent rituximab. Forty-seven percent (14 of 30) of patients had previously received a purine nucleoside analog. The median IgM values for all patients declined from 2403 to 1525 mg/dl. In addition, 63% of patients (19 of 30) had an increase in hematocrit, and 50% (15 of 30) had an increase in platelet count. Six of seven patients who were previously transfusion-dependent became independent after rituximab treatment. The overall response rate was 60% (18 of 30); 27% (8 of 30) were partial responses (>50% decline in the IgM), and 33% (10 of 30) were minor responses (>25% decline in the IgM). When repeat bone marrow examinations were performed after rituximab treatment (N = 17), the lymphoplasmacytic infiltration had decreased from 60% to 15%. The median time to treatment failure for responding patients was 8 months (5 months for stable patients).

Dimopoulos and associates ( [128](#) ) recently reported a prospective trial in 27 patients (15 untreated, 12 relapsed) treated with rituximab at 375 mg/m<sup>2</sup> weekly for 4 weeks. Patients who did not progress received an additional 4-week course 3 months after the first course. The overall response rate was 44%, with no difference between previously untreated and treated patients. The median time to response was 3.3 months, and the median time to progression was 16 months.

Because of these positive treatment responses, its acceptable toxicity profile, and the lack of therapy-associated myelosuppression and myelodysplasia, rituximab use has increased rapidly ( [134](#) ). Clearly, it is the most important new agent for WM. It is important to recognize that clinically meaningful responses to rituximab may occur several months after completion of therapy (personal communications, S. Treon, May 2002; M. Gertz, May 2002). In fact, the M protein concentration may initially increase at the end of rituximab administration or at the first evaluation point. These patients should be observed, if possible, because late responses can occur (128, personal observations). Currently unresolved questions regarding rituximab use in WM relate to its role in front-line therapy, in combination with myelosuppressive chemotherapy, and in maintenance therapy. These questions need to be addressed in future clinical trials.

Anti-CD20 radioimmunoconjugates have shown superior overall response rates in relapsed low-grade non-Hodgkin lymphoma when compared with rituximab; however, they have not been tested in WM.

### Combination Therapy

Attempts have been made to combine alkylating agents with purine nucleoside analogs. Laurecet and associates ( [124](#) ) combined 2-CDA administered subcutaneously at 0.1



mg/kg/day for 3 consecutive days with intravenous cyclophosphamide at 500 mg/m<sup>2</sup> and oral prednisone monthly for up to six courses. The overall response rate was 88%, with grade 4 neutropenia seen in 11% of patients (2 of 19) but no treatment-related deaths. A subsequent dose-escalation study of the combination was performed. 2-CDA was given at 5.6 mg/m<sup>2</sup>/day as a 2-hour intravenous infusion followed by a 1-hour infusion of cyclophosphamide on each of 3 days ( [135](#)). The dose of cyclophosphamide, which was 200 mg/m<sup>2</sup> initially, was escalated in 100-mg/m<sup>2</sup> increments. After 2-CDA at the 5.6-mg/m<sup>2</sup> dose, the maximal tolerated dose of cyclophosphamide was 300 mg/m<sup>2</sup>. The overall response rate was 58%. Dose-limiting toxicity was due to neutropenia, and severe infections were seen in 4% of cycles. Repeated cycles could not be given in 31% of patients because of prolonged thrombocytopenia.

### Corticosteroids

Although, historically, WM has not been considered a steroid-responsive malignancy, some reports suggest that steroid treatment alone can be beneficial in WM, particularly in patients with severe pancytopenia who are not candidates for cytotoxic therapy. Gomez and colleagues ( [136](#)) treated two WM patients with vincristine at 0.25 mg/m<sup>2</sup> and bleomycin at 5 units, given for 4 consecutive days, together with prednisone at 1000 mg/m<sup>2</sup>, given orally on alternate days. Both patients had a greater than 50% decrease in the M protein and a 50% decrease in bone marrow tumor cell infiltration (remission duration, 4 to >35 weeks). In another report, two patients with resistant WM demonstrated marked decreases in total M protein and viscosity after short periods of high-dose dexamethasone ( [137](#)). Because of its antiinflammatory properties and effect on immune complex vasculitis, steroid treatment has been reported to be particularly useful in patients with WM who have an associated cryoglobulin ( [138](#)).

### Interferon

Interferon treatment has been used in other lymphoproliferative disorders and therefore has been attempted in WM as well ( [139](#), [140](#)). In one study, three patients with WM were treated with recombinant human interferon- $\alpha$ -2b ( $3 \times 10^6$  units three times a week) ( [141](#)). After 4 months of treatment, a greater than 50% reduction of serum IgM was seen in all patients, with good tolerance. Low-dose interferon ( $1 \times 10^6$  units three times a week) was studied in 14 patients with WM ( [142](#)). The median duration of treatment was 10.3 months. Forty-three percent of patients (6 of 14) had an increase in their hemoglobin concentration of 9 g/L or more, and 29% (4 of 14) had a substantial decrease in the M component of more than 20%. The median response duration was 6 months. Treatment had to be discontinued because of toxicity in three patients.

A phase II trial was conducted using interferon in 88 patients whose IgM M protein was higher than 10 g/L. Forty-three percent (38 of 88) had an M component higher than 30 g/L and were classified as having WM. The treatment consisted of  $3 \times 10^6$  units/day for 1 month and then three times a week as maintenance. The M component was reduced by more than 50% in 12 of 38 patients (32%) and by 25 to 50% in an additional six patients (16%), for an overall response rate of 50%. Hyperviscosity symptoms improved, hemoglobin concentration increased, and the bone marrow lymphoplasmacytic infiltration decreased. Thus, interferon can produce meaningful clinical benefit in some patients ( [143](#)).

### Thalidomide



Thalidomide is an immunomodulatory and antiangiogenic agent that has been found to be effective in salvage therapy of multiple myeloma ( [144](#) ). Dimopoulos and colleagues ( [145](#) ) reported the results of a phase II trial of thalidomide in 20 patients (ten untreated, ten previously treated). Patients received thalidomide at doses of 200 to 600 mg/day. Five of 20 patients (two previously treated) responded, for an overall response rate of 25%. The time to progression was less than 3 months. It therefore appears that thalidomide as a single agent has limited activity in WM.

### Stem Cell Transplantation

There have been few reports of the efficacy of autologous or allogeneic stem cell transplantation in WM. In one report, six patients with WM were treated with high-dose chemotherapy and stem cell support ( [146](#) ). The median age was 52 years. Four patients had relapsed after purine nucleoside analog therapy. In two of the purine nucleoside analog-treated patients, mobilization failed initially and required repeating. The conditioning regimens included single-agent melphalan (200 mg/m<sup>2</sup>) in five patients, including one tandem transplant, and melphalan (140 mg/m<sup>2</sup>) with total body irradiation in one patient. There were no treatment-associated deaths, and all six patients achieved a partial response. Five of the six patients were alive and four were event free 2 to 52 months after receiving the transplant.

In another study, seven patients received two to three cycles of combined chemotherapy with dexamethasone, carmustine, etoposide, cytarabine, and melphalan (Dexa-BEAM) and stem cell collection, followed by high-dose cyclophosphamide and total body irradiation ( [147](#) ). There were no treatment-related deaths. All patients had decreased serum IgM values, but five had persistently positive detection of M protein after transplantation. All patients were alive without progression 3 to 30 months after receiving the transplant. An additional report described a patient who achieved a complete response persisting for more than 12 months ( [148](#) ).

There are even fewer reports of allogeneic transplantation ( [149](#) , [150](#) ). Because the median age of patients at onset of WM is 65 years, the overwhelming majority may not be eligible to be treated with this method. Two patients who underwent an allogeneic transplantation procedure were alive and disease free at 3 and 9 years ( [151](#) ). One report of a successful nonmyeloablative allogeneic transplant has been published ( [152](#) ).

Transplantation remains an experimental therapy for WM. If autologous stem cell transplantation is being considered, stem cells should be harvested early in the disease course before significant exposure to purine nucleoside analogs and alkylating agents.

### Other Therapeutic Interventions

**SPLENECTOMY** Although splenectomy does not address the bone marrow infiltration associated with WM, some patients with hypersplenic syndromes or spleen-dominant disease benefit from splenectomy ( [153](#) ). Splenectomy corrected a factor VIII deficiency associated with WM in one patient ( [154](#) ). In two patients with WM and massive splenomegaly refractory to chemotherapy, splenectomy was followed by disappearance of the monoclonal IgM from the serum. One patient was free of disease at 12 years; the other, at 13 years ( [155](#) ). Another patient with massive splenomegaly and WM underwent splenic irradiation, which transiently reduced the IgM level. After splenectomy, serum IgM values decreased, and peripheral blood cell counts normalized. The patient remained in

remission at 6-year follow-up ( [156](#) ). In another patient, who underwent a Richter transformation of WM limited to the spleen, splenectomy led to disease control persisting at 45 months ( [157](#) ).

**PLASMA EXCHANGE** Plasmapheresis with total plasma exchange is very useful for treatment of the symptoms of hyperviscosity syndrome but has no impact on the tumor burden. When acute hyperviscosity symptoms develop, usually with a viscosity value above 4 cP, exchange of a small volume of plasma can produce large reductions in serum viscosity. Serum viscosity is not linearly correlated with IgM. Thus, IgM reductions of as little as 20% can result in viscosity reductions of as much as 50% ( [158](#) ). Even small reductions in serum viscosity can have dramatic effects on symptoms. In a Canadian survey, WM was among the top five indications for plasma exchange from 1981 to 1997 ( [159](#) ). Plasma exchange has also been used as a long-term maintenance treatment in patients who become resistant to cytotoxic drugs ( [160](#) ).

## THERAPY-RELATED COMPLICATIONS

Patients with WM have baseline immunosuppression because of low levels of uninvolved Igs and treatment-related granulocytopenia. This increases the risk of infection. In addition, treatment with purine nucleoside analogs reduces levels of circulating CD4<sup>+</sup> T cells, increasing the risk of opportunistic infections such as *Pneumocystis carinii* pneumonia ( [161](#) ). Other infections, such as opportunistic viral enteric infections ( [162](#) ) and *Cryptococcus meningitis* ( [163](#) ), have been reported in patients with WM treated with fludarabine. 2-CDA interferes with lymphocyte proliferation and activity, with associated fever and infection ( [164](#) ). It is interesting that, as a result of the suppression of T-lymphocyte function, the emergence of autoimmune phenomena in patients exposed to 2-CDA is possible. Four patients with WM have been reported in whom immune-mediated hemolysis developed after 2-CDA therapy (median, 40 months after initial administration). One patient responded to oral corticosteroids, and two died ( [165](#) ). Renal, neurologic, and local skin reactions have also been reported ( [166](#) ).

Alkylating agents are well known to be mutagenic and to induce chromosomal changes. The development of myelodysplasia in acute myelogenous leukemia is clearly the greatest risk factor associated with alkylating agent therapy, but fortunately it occurs in a small minority of patients. Shortly after the introduction of alkylating agents for the management of WM, reports of acute erythroleukemia appeared ( [167](#) , [168](#) and [169](#) ). In a study of 46 patients, acute leukemia or refractory anemia developed in four patients ( [28](#) ). Acute myelomonocytic leukemia has also been reported with chlorambucil treatment ( [170](#) ). Two patients have been reported with myelodysplastic syndrome and chromosomal abnormalities monosomy 5 and monosomy 7 without any prior exposure to alkylating agents ( [171](#) ). A metabolite of cyclophosphamide, acrolein, is toxic to the urinary bladder, and bladder cancer has been reported in patients treated with oral cyclophosphamide (50 to 100 mg/day) ( [172](#) ).

## CONCLUSION

The mainstays of therapy for WM are alkylating agents and purine nucleoside analogs, usually administered singly and in sequence. The ultimate role of rituximab in the management of this disease remains to be defined, but rituximab is increasingly being considered as front-line treatment, particularly in younger patients. It is likely that a combination of rituximab with chemotherapy will be the next regimen to be tested in clinical trials for WM. Clear-cut guidelines for newly diagnosed, untreated patients with active disease cannot be provided because of the lack of randomized phase III studies.

Data that permit selection of one method over the other do not exist. Whether combinations of therapies will be shown to be superior to sequential single agents is not known.

## REFERENCES

1. Dimopoulos MA, Panayiotidis P, Mouloupoulos LA, et al. Waldenström's macroglobulinemia: clinical features, complications, and management. *J Clin Oncol* 2000;18:214–226.
2. Owen RG, Johnson SA, Morgan GJ. Waldenström's macroglobulinemia: laboratory diagnosis and treatment. *Hematol Oncol* 2000;18:41–49.
3. Gertz MA, Fonseca R, Rajkumar SV. Waldenström's macroglobulinemia. *Oncologist* 2000;5:63–67.
4. Waldenström J. Incipient myelomatosis or "essential" hyperglobulinemia with fibrinogenopenia: a new syndrome? *Acta Med Scand* 1944;117:216–247.
5. Groves FD, Travis LB, Devesa SS, et al. Waldenström's macroglobulinemia: incidence patterns in the United States, 1988–1994. *Cancer* 1998;82:1078–1081.
6. Herrinton LJ, Weiss NS. Incidence of Waldenström's macroglobulinemia. *Blood* 1993;82:3148–3150.
7. Kyle RA. Multiple myeloma: diagnostic challenges and standard therapy. *Semin Hematol* 2001;38[Suppl 3]:11–14.
8. Kyle RA, Garton JP. The spectrum of IgM monoclonal gammopathy in 430 cases. *Mayo Clin Proc* 1987;62:719–731.
9. Ruiz-Arguelles GJ, Ramirez-Cisneros FJ, Flores-Martinez J, et al. Waldenström's macroglobulinemia is infrequent in Mexican mestizos: experience of a hematological diseases referral center. *Rev Invest Clin* 2000;52:497–499.
10. Elves MW, Brown AK. Cytogenetic studies in a family with Waldenström's macroglobulinemia. *J Med Genet* 1968;5:118–122.
11. Brown AK, Elves MW, Gunson HH, et al. Waldenström's macroglobulinemia: a family study. *Acta Haematol* 1967;38:184–192.
12. Ogmundsdottir HM, Sveinsdottir S, Sigfusson A, et al. Enhanced B cell survival in familial macroglobulinemia is associated with increased expression of Bcl-2. *Clin Exp Immunol* 1999;117:252–260.
13. Blattner WA, Garber JE, Mann DL, et al. Waldenström's macroglobulinemia and autoimmune disease in a family. *Ann Intern Med* 1980;93:830–832.
14. Getaz EP, Staples WG. Familial Waldenström's macroglobulinemia: a case report. *S Afr Med J* 1977;51:891–892.
15. Renier G, Ifrah N, Chevailler A, et al. Four brothers with Waldenström's macroglobulinemia. *Cancer* 1989;64:1554–1559.
16. Custodi P, Cerrutti A, Cassani P, et al. Familial occurrence of IgMk gammopathy: no involvement of HCV infection. *Haematologica* 1995;80:484–485.
17. Taleb N, Tohme A, Abi Jirgiss D, et al. Familial macroglobulinemia in a Lebanese family with two sisters presenting with Waldenström's disease. *Acta Oncol* 1991;30:703–705.
18. Linet MS, Humphrey RL, Mehl ES, et al. A case-control and family study of Waldenström's macroglobulinemia. *Leukemia* 1993;7:1363–1369.
19. Facon T, Brouillard M, Duhamel A, et al. Prognostic factors in Waldenström's macroglobulinemia: a report of 167 cases. *J Clin Oncol* 1993;11:1553–1558.

20. Gobbi PG, Bettini R, Montecucco C, et al. Study of prognosis in Waldenström's macroglobulinemia: a proposal for a simple binary classification with clinical and investigational utility. *Blood* 1994;83:2939–2945.
21. Harris NL, Jaffe ES, Stein H, et al. A revised European–American classification of lymphoid neoplasms: a proposal from the International Lymphoma Study Group. *Blood* 1994;84:1361–1392.
22. Dhodapkar MV, Jacobson JL, Gertz MA, et al. Prognostic factors and response to fludarabine therapy in patients with Waldenström macroglobulinemia: results of United States Intergroup Trial (Southwest Oncology Group S9003). *Blood* 2001;98:41–48.
23. Garcia–Sanz R, Montoto S, Torreguebrada A, et al. Waldenström macroglobulinemia: presenting features and outcome in a series with 217 cases. *Br J Haematol* 2001;115:575–582.
24. Andriko JA, Aguilera NS, Chu WS, et al. Waldenström's macroglobulinemia: a clinicopathologic study of 22 cases. *Cancer* 1997;80:1926–1935.
25. Heinz R, Stacher A, Pralle H, et al. Lymphoplasmacytic/lymphoplasmacytoid lymphoma: a clinical entity distinct from chronic lymphocytic leukemia? *Blut* 1981;43:183–192.
26. Pangalis GA, Boussiotis VA, Kittas C. Malignant disorders of small lymphocytes: small lymphocytic lymphoma, lymphoplasmacytic lymphoma, and chronic lymphocytic leukemia: their clinical and laboratory relationship. *Am J Clin Pathol* 1993;99:402–408.
27. Pangalis GA, Nathwani BN, Rappaport H. Malignant lymphoma, well differentiated lymphocytic: its relationship with chronic lymphocytic leukemia and macroglobulinemia of Waldenström. *Cancer* 1977;39:999–1010.
28. Kyle RA, Greipp PR, Gertz MA, et al. Waldenström's macroglobulinemia: a prospective study comparing daily with intermittent oral chlorambucil. *Br J Haematol* 2000;108:737–742.
29. Carola T, Kapff JHJ. *Blood: atlas and sourcebook of hematology*, 2nd ed. Boston: Little Brown, 1991.
30. Dutcher TF, Fahey JL. The histopathology of the macroglobulinemia of Waldenström. *J Natl Cancer Inst* 1959;22:887–917.
31. Bartl R, Frisch B, Mahl G, et al. Bone marrow histology in Waldenström's macroglobulinemia: clinical relevance of subtype recognition. *Scand J Haematol* 1983;31:359–375.
32. Pangalis GA, Angelopoulou MK, Vassilakopoulos TP, et al. B–chronic lymphocytic leukemia, small lymphocytic lymphoma, and lymphoplasmacytic lymphoma, including Waldenström's macroglobulinemia: a clinical, morphologic, and biologic spectrum of similar disorders. *Semin Hematol* 1999;36:104–114.
33. Owen RG, Barrans SL, Richards SJ, et al. Waldenström macroglobulinemia: development of diagnostic criteria and identification of prognostic factors. *Am J Clin Pathol* 2001;116:420–428.
34. Feiner HD, Rizk CC, Finfer MD, et al. IgM monoclonal gammopathy/Waldenström's macroglobulinemia: a morphological and immunophenotypic study of the bone marrow. *Mod Pathol* 1990;3:348–356.
35. Kucharska–Pulczynska M, Ellegaard J, Hokland P. Analysis of leucocyte differentiation antigens in blood and bone marrow from patients with Waldenström's macroglobulinemia. *Br J Haematol* 1987;65:395–399.
36. Greipp PR, Lust JA, O'Fallon WM, et al. Plasma cell labeling index and beta 2–microglobulin predict survival independent of thymidine kinase and C–reactive protein in multiple myeloma. *Blood* 1993;81:3382–3387.
37. Abe M, Takahashi K, Mori N, et al. "Waldenström's macroglobulinemia" terminating in immunoblastic sarcoma: a case report. *Cancer* 1982;49:2580–2586.
38. Choi YJ, Yeh G, Reiner L, et al. Immunoblastic sarcoma following Waldenström's macroglobulinemia. *Am J Clin Pathol* 1979;71:121–124.

39. Garand R, Sahota SS, Avet-Loiseau H, et al. IgG-secreting lymphoplasmacytoid leukaemia: a B-cell disorder with extensively mutated VH genes undergoing Ig isotype-switching frequently associated with trisomy 12. *Br J Haematol* 2000;109:71-80.
40. Zarrabi MH, Stark RS, Kane P, et al. IgM myeloma, a distinct entity in the spectrum of B-cell neoplasia. *Am J Clin Pathol* 1981;75:1-10.
41. Takahashi K, Yamamura F, Motoyama H. IgM myeloma: its distinction from Waldenström's macroglobulinemia. *Acta Pathol Jpn* 1986;36:1553-1563.
42. Kondo H, Yokoyama K. IgM myeloma: different features from multiple myeloma and macroglobulinemia. *Eur J Haematol* 1999;63:366-368.
43. Schop RF, Kuehl WM, Van Wier SA, et al. Waldenström macroglobulinemia neoplastic cells lack immunoglobulin heavy chain locus translocations but have frequent 6q deletions. *Blood* 2002;100:2996-3001.
44. Avet-Loiseau H, Garand R, Lode L, et al. Translocation t(11;14)(q13;q32) is the hallmark of IgM, IgE, and nonsecretory multiple myeloma variants. *Blood (First Edition Paper)* prepublished online October 3, 2002; DOI 10.1182/blood-2002-08-2436.
45. Aoki H, Takishita M, Kosaka M, et al. Frequent somatic mutations in D and/or JH segments of Ig gene in Waldenström's macroglobulinemia and chronic lymphocytic leukemia (CLL) with Richter's syndrome but not in common CLL. *Blood* 1995;85:1913-1919.
46. Wagner SD, Martinelli V, Luzzatto L. Similar patterns of V kappa gene usage but different degrees of somatic mutation in hairy cell leukemia, prolymphocytic leukemia, Waldenström's macroglobulinemia, and myeloma. *Blood* 1994;83:3647-3653.
47. Sahota S, Hamblin T, Oscier DG, et al. Assessment of the role of clonogenic B lymphocytes in the pathogenesis of multiple myeloma. *Leukemia* 1994;8:1285-1289.
48. Ivanovski M, Silvestri F, Pozzato G, et al. Somatic hypermutation, clonal diversity, and preferential expression of the VH 51p1/VL kv325 immunoglobulin gene combination in hepatitis C virus-associated immunocytomas. *Blood* 1998;91:2433-2442.
49. Ciric B, VanKeulen V, Rodriguez M, et al. Clonal evolution in Waldenström macroglobulinemia highlights functional role of B-cell receptor. *Blood* 2001;97:321-323.
50. Levy Y, Labaume S, Gendron MC, et al. Modulation of spontaneous B-cell differentiation in macroglobulinemia by retinoic acid. *Blood* 1994;83:2206-2210.
51. Kyle RA, Therneau TM, Rajkumar SV, et al. A long-term study of prognosis in monoclonal gammopathy of undetermined significance. *N Engl J Med* 2002;346:564-569.
52. Bottur C. The genetic nature of Waldenström's macroglobulinemia [Spanish]. *Prensa Med Argent* 1966;53:223-224.
53. Benirschke K, Brownhill L, Ebaugh FG. Chromosomal abnormalities in Waldenström's macroglobulinemia [Letter]. *Lancet* 1962;1:594-595.
54. Blake MN. A chromosome abnormality associated with macroglobulinemia. *Australas Ann Med* 1966;15:162-168.
55. Bottura C, Ferrari I, Veiga AA. Chromosomal abnormalities in Waldenström's macroglobulinemia [Letter]. *Lancet* 1961;1:1170.
56. Broustet A, Veyret V, Moretti G. Chromosomal and cytochemical aspects of Waldenström's disease [French]. *Ann Biol Clin (Paris)* 1968;26:17-46.
57. Bunn PA Jr, Krasnow S, Makuch RW, et al. Flow cytometric analysis of DNA content of bone marrow cells in patients with plasma cell myeloma: clinical implications. *Blood* 1982;59:528-535.

58. Contrafatto G. Marker chromosome of macroglobulinemia identified by G-banding. *Cytogenet Cell Genet* 1977;18:370-373.
59. German JL, Biro CE, Bearn AG. Chromosomal abnormalities in Waldenström's macroglobulinemia [Letter]. *Lancet* 1961;2:48.
60. Forteza Bover G, Garcia-Conde F. A large supernumerary acrocentric chromosome in a case of Waldenström's disease [Spanish]. *Sangre (Barc)* 1966;11:305-314.
61. Goh KO, Swisher SN. Macroglobulinemia of Waldenström and the chromosomal morphology. *Am J Med Sci* 1970;60:237-244.
62. Han T, Sadamori N, Takeuchi J, et al. Clonal chromosome abnormalities in patients with Waldenström's and CLL-associated macroglobulinemia: significance of trisomy 12. *Blood* 1983;62:525-531.
63. Lawler SD. Chromosomes in haematology. *Br J Haematol* 1969;17:139-143.
64. Palka G, Geraci L, Santavenere E, et al. Chromosome anomalies and Waldenström's macroglobulinemia [Italian]. *Pathologica* 1983;75:861-866.
65. Spengler GA, Siebner H, Riva G. Chromosomal abnormalities in macroglobulinemia Waldenström: discordant findings in uniovular twins. *Acta Med Scand Suppl* 1966;445:132-139.
66. Patau K. Chromosomal abnormalities in Waldenström's macroglobulinemia [Letter]. *Lancet* 1961;2:600-601.
67. Louviaux I, Michaux L, Hagemeijer A, et al. Cytogenetic abnormalities in Waldenström's disease (WD): a single centre study of 45 cases. *Proc Ann Meet Am Soc Hematol* 1998;92:184b(abst).
68. Mansoor A, Medeiros LJ, Weber DM, et al. Cytogenetic findings in lymphoplasmacytic lymphoma/Waldenström macroglobulinemia: chromosomal abnormalities are associated with the polymorphous subtype and an aggressive clinical course. *Am J Clin Pathol* 2001;116:543-549.
69. Wong KF, So CC. Waldenström macroglobulinemia with karyotypic aberrations involving both homologous 6q. *Cancer Genet Cytogenet* 2001;124:137-139.
70. Jankovic GM, Colovic MD, Wiernik PH, et al. Multiple karyotypic aberrations in a polymorphous variant of Waldenström macroglobulinemia. *Cancer Genet Cytogenet* 1999;111:77-80.
71. Offit K, Parsa NZ, Filippa D, et al. t(9;14)(p13;q32) denotes a subset of low-grade non-Hodgkin's lymphoma with plasmacytoid differentiation. *Blood* 1992;80:2594-2599.
72. Stapleton P, Weith A, Urbanek P, et al. Chromosomal localization of seven PAX genes and cloning of a novel family member, PAX-9. *Nat Genet* 1993;3:292-298.
73. Ohno H, Furukawa T, Fukuhara S, et al. Molecular analysis of a chromosomal translocation, t(9;14)(p13;q32), in a diffuse large-cell lymphoma cell line expressing the ki-1 antigen. *Proc Natl Acad Sci U S A* 1990;87:628-632.
74. Iida S, Rao PH, Nallasivam P, et al. The t(9;14)(p13;q32) chromosomal translocation associated with lymphoplasmacytoid lymphoma involves the PAX-5 gene. *Blood* 1996;88:4110-4117.
75. Iida S, Rao PH, Ueda R, et al. Chromosomal rearrangement of the PAX-5 locus in lymphoplasmacytic lymphoma with t(9;14)(p13;q32). *Leuk Lymphoma* 1999;34:25-33.
76. Ohno H, Ueda C, Akasaka T. The t(9;14)(p13;q32) translocation in B-cell non-Hodgkin's lymphoma. *Leuk Lymphoma* 2000;36:435-445.
77. Hirase N, Miyamura T, Ishikura H, et al. Primary macroglobulinemia with t(11;18)(q21;q21) [Japanese]. *Rinsho Ketsueki* 1996;37:340-345.
78. Hirase N, Yufu Y, Abe Y, et al. Primary macroglobulinemia with t(11;18)(q21;q21). *Cancer Genet*

Cytogenet 2000;117:113–117.

79. Schop RF, Jalal SM, Van Wier SA, et al. Deletions of 17p13.1 and 13q14 are uncommon in Waldenström macroglobulinemia clonal cells and mostly seen at the time of disease progression. *Cancer Genet Cytogenet* 2002;132:55–60.

80. Morel P, Monconduit M, Jacomy D, et al. Prognostic factors in Waldenström macroglobulinemia: a report on 232 patients with the description of a new scoring system and its validation on 253 other patients. *Blood* 2000;96:852–858.

81. Kyrtsolis MC, Vassilakopoulos TP, Angelopoulou MK, et al. Waldenström's macroglobulinemia: clinical course and prognostic factors in 60 patients: experience from a single hematology unit. *Ann Hematol* 2001;80:722–727.

82. Leblond V, Levy V, Maloisel F, et al. Multicenter, randomized comparative trial of fludarabine and the combination of cyclophosphamide–doxorubicin–prednisone in 92 patients with Waldenström macroglobulinemia in first relapse or with primary refractory disease. *Blood* 2001;98:2640–2644.

83. Dimopoulos MA, O'Brien S, Kantarjian H, et al. Fludarabine therapy in Waldenström's macroglobulinemia. *Am J Med* 1993;95:49–52.

84. Leblond V, Ben-Othman T, Deconinck E, et al. Activity of fludarabine in previously treated Waldenström's macroglobulinemia: a report of 71 cases. *J Clin Oncol* 1998;16:2060–2064.

85. Dimopoulos MA, Weber D, Delasalle KB, et al. Treatment of Waldenström's macroglobulinemia resistant to standard therapy with 2-chlorodeoxyadenosine: identification of prognostic factors. *Ann Oncol* 1995;6:49–52.

86. Hellmann A, Lewandowski K, Zaucha JM, et al. Effect of a 2-hour infusion of 2-chlorodeoxyadenosine in the treatment of refractory or previously untreated Waldenström's macroglobulinemia. *Eur J Haematol* 1999;63:35–41.

87. Tsiara S, Kaiafas P, Kapsali E, et al. Recombinant human erythropoietin for the treatment of refractory anemia in lymphoproliferative disorders: preliminary results. *Eur J Haematol* 1998;60:317–319.

88. Singh A, Eckardt KU, Zimmermann A, et al. Increased plasma viscosity as a reason for inappropriate erythropoietin formation. *J Clin Invest* 1993;91:251–256.

89. Kobayashi H, Ii K, Hizawa K, et al. Two cases of pulmonary Waldenström's macroglobulinemia. *Chest* 1985;88:297–299.

90. Fadil A, Taylor DE. The lung and Waldenström's macroglobulinemia. *South Med J* 1998;91:681–685.

91. Gertz MA, Kyle RA. Hyperviscosity syndrome. *J Intensive Care Med* 1995;10:128–141.

92. Alexanian R. Blood volume in monoclonal gammopathy. *Blood* 1977;49:301–307.

93. MacKenzie MR, Lee TK. Blood viscosity in Waldenström macroglobulinemia. *Blood* 1977;49:507–510.

94. Waldenström J. Zwei interessante Syndrome mit Hyperglobulinämie. *Schweiz Med Wochenschr* 1948;78:927–928.

95. Pavy MD, Murphy PL, Virella G. Paraprotein-induced hyperviscosity: a reversible cause of stroke. *Postgrad Med* 1980;68:109–112.

96. Mueller J, Hotson JR, Langston JW. Hyperviscosity-induced dementia. *Neurology* 1983;33:101–103.

97. Dalakas MC, Engel WK. Polyneuropathy with monoclonal gammopathy: studies of 11 patients. *Ann Neurol* 1981;10:45–52.

98. Latov N, Braun PE, Gross RB, et al. Plasma cell dyscrasia and peripheral neuropathy: identification of the myelin antigens that react with human paraproteins. *Proc Natl Acad Sci U S A* 1981;78:7139–7142.



99. Vital C, Deminiere C, Bourgooin B, et al. Waldenström's macroglobulinemia and peripheral neuropathy: deposition of M-component and kappa light chain in the endoneurium. *Neurology* 1985;35:603-606.
100. Nobile-Orazio E, Barbieri S, Baldini L, et al. Peripheral neuropathy in monoclonal gammopathy of undetermined significance: prevalence and immunopathogenetic studies. *Acta Neurol Scand* 1992;85:383-390.
101. Dellagi K, Dupouey P, Brouet JC, et al. Waldenström's macroglobulinemia and peripheral neuropathy: a clinical and immunologic study of 25 patients. *Blood* 1983;62:280-285.
102. Nobile-Orazio E, Marmiroli P, Baldini L, et al. Peripheral neuropathy in macroglobulinemia: incidence and antigen-specificity of M proteins. *Neurology* 1987;37:1506-1514.
103. Dalakas MC, Flaum MA, Rick M, et al. Treatment of polyneuropathy in Waldenström's macroglobulinemia: role of paraproteinemia and immunologic studies. *Neurology* 1983;33:1406-1410.
104. Robinson MK, Halpern JI. Retinal vein occlusion. *Am Fam Physician* 1992;45:2661-2666.
105. Barras JP, Graf C. Hyperviscosity in diabetic retinopathy treated with Doxium (calcium dobesilate). *Vasa* 1980;9:161-164.
106. Gertz MA, Kyle RA, Noel P. Primary systemic amyloidosis: a rare complication of immunoglobulin M monoclonal gammopathies and Waldenström's macroglobulinemia. *J Clin Oncol* 1993;11:914-920.
107. Gertz MA, Lacy MQ, Dispenzieri A. Amyloidosis: recognition, confirmation, prognosis, and therapy. *Mayo Clin Proc* 1999;74:490-494.
108. Case DC Jr, Ervin TJ, Boyd MA, et al. Waldenström's macroglobulinemia: long-term results with the M-2 protocol. *Cancer Invest* 1991;9:1-7.
109. Petrucci MT, Avvisati G, Tribalto M, et al. Waldenström's macroglobulinemia: results of a combined oral treatment in 34 newly diagnosed patients. *J Intern Med* 1989;226:443-447.
110. Kyle RA, Greipp PR. Smoldering multiple myeloma. *N Engl J Med* 1980;302:1347-1349.
111. Waldenström J. To treat or not to treat, this is the real question. *Leuk Res* 1991;15:407-408.
112. Bayrd ED. Continuous chlorambucil therapy in primary macroglobulinemia of Waldenström: report of four cases. *Proc Staff Meet Mayo Clin* 1961;36:135-147.
113. Cass RM, Anderson BR, Vaughan JH. Waldenström's macroglobulinemia with increased serum IgG levels treated with low doses of cyclophosphamide. *Ann Intern Med* 1969;71:971-977.
114. Case DC Jr. Combination chemotherapy (M-2) protocol (BCNU, cyclophosphamide, vincristine, melphalan, and prednisone) for Waldenström macroglobulinemia: preliminary report. *Blood* 1982;59:934-937.
115. Kantarjian HM, Alexanian R, Koller CA, et al. Fludarabine therapy in macroglobulinemic lymphoma. *Blood* 1990;75:1928-1931.
116. Zinzani PL, Gherlinzoni F, Bendandi M, et al. Fludarabine treatment in resistant Waldenström's macroglobulinemia. *Eur J Haematol* 1995;54:120-123.
117. Thalhammer-Scherrer R, Geissler K, Schwarzingger I, et al. Fludarabine therapy in Waldenström's macroglobulinemia. *Ann Hematol* 2000;79:556-559.
118. Foran JM, Rohatiner AZ, Coiffier B, et al. Multicenter phase II study of fludarabine phosphate for patients with newly diagnosed lymphoplasmacytoid lymphoma, Waldenström's macroglobulinemia, and mantle-cell lymphoma. *J Clin Oncol* 1999;17:546-553.
119. Liu ES, Burian C, Miller WE, et al. Bolus administration of cladribine in the treatment of Waldenström macroglobulinemia. *Br J Haematol* 1998;103:690-695.

120. Betticher DC, Hsu Schmitz SF, Ratschiller D, et al. Cladribine (2-CDA) given as subcutaneous bolus injections is active in pretreated Waldenström's macroglobulinemia. *Br J Haematol* 1997;99:358-363.
121. Dimopoulos MA, Kantarjian H, Estey E, et al. Treatment of Waldenström macroglobulinemia with 2-chlorodeoxyadenosine. *Ann Intern Med* 1993;118:195-198.
122. Delannoy A, Ferrant A, Martiat P, et al. 2-Chlorodeoxyadenosine therapy in Waldenström's macroglobulinemia. *Nouv Rev Fr Hematol* 1994;36:317-320.
123. Dimopoulos MA, Weber DM, Kantarjian H, et al. 2 Chlorodeoxyadenosine therapy of patients with Waldenström macroglobulinemia previously treated with fludarabine. *Ann Oncol* 1994;5:288-289.
124. Laurencet FM, Zulian GB, Guetty-Alberto M, et al. Cladribine with cyclophosphamide and prednisone in the management of low-grade lymphoproliferative malignancies. *Br J Cancer* 1999;79:1215-1219.
125. Lewandowski K, Zaucha JM, Bieniaszewska M, et al. 2-Chlorodeoxyadenosine treatment of Waldenström's macroglobulinemia: the analysis of own experience and the review of literature. *Med Sci Monit* 2000;6:740-745.
126. Fridrik MA, Jager G, Baldinger C, et al. First-line treatment of Waldenström's disease with cladribine: Arbeitsgemeinschaft Medikamentöse Tumortherapie. *Ann Hematol* 1997;74:7-10.
127. Lewandowski K, Halaburda K, Hellmann A. Fludarabine therapy in Waldenström's macroglobulinemia patients treated previously with 2-chlorodeoxyadenosine. *Leuk Lymphoma* 2002;43:361-363.
128. Dimopoulos MA, Zervas C, Zomas A, et al. Treatment of Waldenström's macroglobulinemia with rituximab. *J Clin Oncol* 2002;20:2327-2333.
129. Byrd JC, White CA, Link B, et al. Rituximab therapy in Waldenström's macroglobulinemia: preliminary evidence of clinical activity. *Ann Oncol* 1999;10:1525-1527.
130. Treon SP, Agus DB, Link B, et al. CD20-directed antibody-mediated immunotherapy induces responses and facilitates hematologic recovery in patients with Waldenström's macroglobulinemia. *J Immunother* 2001;24: 272-279.
131. Weide R, Heymanns J, Koppler H. Induction of complete haematological remission after monotherapy with anti-CD20 monoclonal antibody (RITUXIMAB) in a patient with alkylating agent resistant Waldenström's macroglobulinemia. *Leuk Lymphoma* 1999;36:203-206.
132. Weide R, Heymanns J, Koppler H. The polyneuropathy associated with Waldenström's macroglobulinemia can be treated effectively with chemotherapy and the anti-CD20 monoclonal antibody rituximab. *Br J Haematol* 2000;109:838-841.
133. Treon SP, Shima Y, Preffer FI, et al. Treatment of plasma cell dyscrasias by antibody-mediated immunotherapy. *Semin Oncol* 1999;26[Suppl 14]:97-106.
134. Treon SP, Anderson KC. The use of rituximab in the treatment of malignant and nonmalignant plasma cell disorders. *Semin Oncol* 2000;27 [Suppl 12]:79-85.
135. Van Den Neste E, Louviaux I, Michaux JL, et al. Phase I/II study of 2-chloro-2' deoxyadenosine with cyclophosphamide in patients with pretreated B cell chronic lymphocytic leukemia and indolent non-Hodgkin's lymphoma. *Leukemia* 2000;14:1136-1142.
136. Gomez GA, Han T, Ozer H, et al. Treatment of refractory lymphoproliferative diseases with daily, low-dose vincristine, continuous infusion of bleomycin, and high-dose prednisone. *Med Pediatr Oncol* 1984;12:239-243.
137. Jane SM, Salem HH. Treatment of resistant Waldenström's macroglobulinemia with high dose glucocorticosteroids. *Aust N Z J Med* 1988;18:77-78.
138. O'Reilly RA, MacKenzie MR. Primary macrocryoglobulinemia: remission with adrenal corticosteroid

therapy. *Arch Intern Med* 1967;120:234–238.

139. Ohno R, Kodera Y, Ogura M, et al. Treatment of plasma cell neoplasm with recombinant leukocyte A interferon and human lymphoblastoid interferon. *Cancer Chemother Pharmacol* 1985;14:34–37.

140. Bhavnani M, Marples J, Yin JA. Treatment of Waldenström's macroglobulinemia with alpha interferon. *J Clin Pathol* 1990;43:437.

141. De Rosa G, De Renzo A, Buffardi S, et al. Treatment of Waldenström's macroglobulinemia with interferon. *Haematologica* 1989;74:313–315.

142. Legouffe E, Rossi JF, Laporte JP, et al. Treatment of Waldenström's macroglobulinemia with very low doses of alpha interferon. *Leuk Lymphoma* 1995;19:337–342.

143. Rotoli B, De Renzo A, Frigeri F, et al. A phase II trial on alpha-interferon (alpha IFN) effect in patients with monoclonal IgM gammopathy. *Leuk Lymphoma* 1994;13:463–469.

144. Singhal S, Mehta J, Desikan R, et al. Antitumor activity of thalidomide in refractory multiple myeloma. *N Engl J Med* 1999;341:1565–1571.

145. Dimopoulos MA, Zomas A, Viniou NA, et al. Treatment of Waldenström's macroglobulinemia with thalidomide. *J Clin Oncol* 2001;19:3596–3601.

146. Desikan R, Dhodapkar M, Siegel D, et al. High-dose therapy with autologous haemopoietic stem cell support for Waldenström's macroglobulinaemia. *Br J Haematol* 1999;105:993–996.

147. Dreger P, Glass B, Kuse R, et al. Myeloablative radiochemotherapy followed by reinfusion of purged autologous stem cells for Waldenström's macroglobulinaemia. *Br J Haematol* 1999;106:115–118.

148. Yang L, Wen B, Li H, et al. Autologous peripheral blood stem cell transplantation for Waldenström's macroglobulinemia. *Bone Marrow Transplant* 1999;24:929–930.

149. Anagnostopoulos A, Dimopoulos MA, Aleman A, et al. High-dose chemotherapy followed by stem cell transplantation in patients with resistant Waldenström's macroglobulinemia. *Bone Marrow Transplant* 2001;27:1027–1029.

150. Anagnostopoulos A, Giral S. Stem cell transplantation (SCT) for Waldenström's macroglobulinemia (WM). *Bone Marrow Transplant* 2002;29:943–947.

151. Martino R, Shah A, Romero P, et al. Allogeneic bone marrow transplantation for advanced Waldenström's macroglobulinemia. *Bone Marrow Transplant* 1999;23:747–749.

152. Ueda T, Hatanaka K, Kosugi S, et al. Successful non-myeloablative allogeneic peripheral blood stem cell transplantation (PBSCT) for Waldenström's macroglobulinemia with severe pancytopenia. *Bone Marrow Transplant* 2001;28:609–611.

153. Nagai M, Ikeda K, Nakamura H, et al. Splenectomy for a case with Waldenström macroglobulinemia with giant splenomegaly. *Am J Hematol* 1991;37:140.

154. Brody JI, Haidar ME, Rossman RE. A hemorrhagic syndrome in Waldenström's macroglobulinemia secondary to immunoadsorption of factor VIII: recovery after splenectomy. *N Engl J Med* 1979;300:408–410.

155. Humphrey JS, Conley CL. Durable complete remission of macroglobulinemia after splenectomy: a report of two cases and review of the literature. *Am J Hematol* 1995;48:262–266.

156. Takemori N, Hirai K, Onodera R, et al. Durable remission after splenectomy for Waldenström's macroglobulinemia with massive splenomegaly in leukemic phase. *Leuk Lymphoma* 1997;26:387–393.

157. Winter AJ, Obeid D, Jones EL. Long survival after splenic immunoblastic transformation of Waldenström's macroglobulinemia. *Br J Haematol* 1995;91:412–414.

158. Avnstorp C, Nielsen H, Drachmann O, et al. Plasmapheresis in hyperviscosity syndrome. *Acta Med*

Scand 1985;217:133–137.

159. Clark WF, Rock GA, Buskard N, et al. Therapeutic plasma exchange: an update from the Canadian Apheresis Group. *Ann Intern Med* 1999;131:453–462.

160. Buskard NA, Galton DA, Goldman JM, et al. Plasma exchange in the long-term management of Waldenström's macroglobulinemia. *Can Med Assoc J* 1977;117:135–137.

161. Fenchel K, Wijermans P, Mitrou P, et al. Fludarabine is an effective agent in immunocytic lymphoma. *Onkologie* 1994;17:508–513.

162. Bjorkholm M, Celsing F, Runarsson G, et al. Successful intravenous immunoglobulin therapy for severe and persistent astrovirus gastroenteritis after fludarabine treatment in a patient with Waldenström's macroglobulinemia. *Int J Hematol* 1995;62:117–120.

163. Costa P, Luzzati R, Nicolato A, et al. Cryptococcal meningitis and intracranial tuberculoma in a patient with Waldenström's macroglobulinemia treated with fludarabine. *Leuk Lymphoma* 1998;28:617–620.

164. Bryson HM, Sorkin EM. Cladribine: a review of its pharmacodynamic and pharmacokinetic properties and therapeutic potential in haematological malignancies. *Drugs* 1993;46:872–894.

165. Tetreault SA, Saven A. Delayed onset of autoimmune hemolytic anemia complicating cladribine therapy for Waldenström macroglobulinemia. *Leuk Lymphoma* 2000;37:125–130.

166. Baltz JK, Montello MJ. Cladribine for the treatment of hematologic malignancies. *Clin Pharm* 1993;12:805–813.

167. Cardamone JM, Kimmerle RI, Marshall EY. Development of acute erythroleukemia in B-cell immunoproliferative disorders after prolonged therapy with alkylating drugs. *Am J Med* 1974;57:836–842.

168. Petersen HS. Erythroleukaemia in a melphalan-treated patient with primary macroglobulinemia. *Scand J Haematol* 1973;10:5–11.

169. Horsman DE, Card RT, Skinnider LF. Waldenström macroglobulinemia terminating in acute leukemia: a report of three cases. *Am J Hematol* 1983;15:97–101.

170. Rodriguez JN, Fernandez-Jurado A, Martino ML, et al. Waldenström's macroglobulinemia complicated with acute myeloid leukemia: report of a case and review of the literature. *Haematologica* 1998;83:91–92.

171. Van Den Neste E, Louviaux I, Michaux JL, et al. Myelodysplastic syndrome with monosomy 5 and/or 7 following therapy with 2-chloro-2'-deoxyadenosine. *Br J Haematol* 1999;105:268–270.

172. Siddiqui A, Melamed MR, Abbi R, et al. Mucinous (colloid) carcinoma of urinary bladder following long-term cyclophosphamide therapy for Waldenström's macroglobulinemia. *Am J Surg Pathol* 1996;20:500–504.

2004 Lippincott Williams & Wilkins  
John P. Greer, John Foerster, John N. Lukens  
George M. Rodgers, Frixos Paraskevas, Bertil Glader  
Wintrobe's Clinical Hematology

## Cryoglobulinemia, Heavy Chain Diseases, and Monoclonal Gammopathy–Associated Disorders

### INTRODUCTION TO CRYOGLOBULINEMIA

### EPIDEMIOLOGY OF CRYOGLOBULINEMIA

### ETIOLOGY OF CRYOGLOBULINEMIA

#### Relationships among Predisposing Conditions and Cryoglobulinemia

#### Lymphoproliferative Disorders

#### Associations among Cryoglobulinemia, Hepatitis C Virus, Connective Tissue Disease, and Lymphoma

### CLINICAL PRESENTATION OF CRYOGLOBULINEMIA

#### Skin

#### Arthralgias

#### Nervous System

#### Kidney

#### Liver

### DIAGNOSIS OF CRYOGLOBULINEMIA

### TREATMENT OF CRYOGLOBULINEMIA

#### Treatment of Life-Threatening Disease

#### Interferon- $\alpha$

#### Other Therapies

### HEAVY CHAIN DISEASE

#### $\alpha$ -Heavy Chain Disease

#### $\mu$ -Heavy Chain Disease

#### $\gamma$ -Heavy Chain Disease

### REFERENCES

This chapter addresses two types of immunoglobulin (Ig)-based orphan diseases: cryoglobulinemia and heavy chain disease (HCD). These diseases are characterized by lymphoproliferative, lymphoplasmacytic proliferative, or plasmaproliferative disorders and specific serum Ig findings that serve as markers to define each entity. As understanding of the pathologic mechanisms progresses, the similarities between  $\alpha$ -HCD and cryoglobulinemia may prove to be greater than those among  $\alpha$ -HCD,  $\mu$ -HCD, and  $\gamma$ -HCD. Each entity is discussed separately in this chapter, with cryoglobulinemia discussed first and HCD second.

## INTRODUCTION TO CRYOGLOBULINEMIA

In 1933, Wintrobe and Buell (<sup>1</sup>) originally reported observing cryoglobulins in a serum sample from a patient with multiple myeloma. These cold precipitable Igs are observed in some patients who have vasculitis, viral infection, or lymphoproliferative disorders and are byproducts of lymphoid dysfunction—unchecked and misdirected stimulation and proliferation that cause dysfunction and pathologic changes. An understanding of cryoglobulins and the cells that produce them, along with their interaction with tissue matrix, systemic cytokines, and the remainder of the immune system, may provide insight into basic control pathways and the earliest steps of malignant transformation.

The term *cryoglobulin* was coined by Lerner and Watson (<sup>2</sup>) in 1947. Precipitation of cryoglobulins is dependent on temperature, pH, cryoglobulin concentration, and weak

noncovalent factors (3). Meltzer and others delineated a distinct syndrome of purpura, arthralgias, asthenia, renal disease, and neuropathy—often occurring with immune complex deposition, vasculitis, or both (4, 5). Brouet et al. (6) popularized a system of classifying cryoglobulinemia on the basis of the components of the cryoprecipitate: type I, isolated monoclonal Igs; type II, a monoclonal component, usually IgM, possessing activity toward polyclonal Igs, usually IgG; and type III, polyclonal Igs of more than one isotype. This classification provided a framework by which clinical correlations could be made. Associated conditions, such as lymphoproliferative disorders, connective tissue disorders, infection, and liver disease, were observed in some patients (Table 101.1) (13, 16). In several large series, 34 to 71% of cryoglobulinemia cases were not associated with other specific disease states and were termed *essentia* or *primary cryoglobulinemia* (6, 13, 17). In 1990, hepatitis C virus (HCV) was recognized as an etiologic factor for the majority of these cases (18, 19) (Fig. 101.1).

**TABLE 101.1. Cryoglobulinemia: Clinical and Experimental Associations**

| Infectious diseases                                | Autoimmune diseases   |
|--|---|
| <b>Viral</b>                                       | Systemic lupus erythematosus  |
| Epstein–Barr virus                                 | Nephritis, hypocomplementemia   |
| Cytomegalovirus                                    | Drug-induced lupus (procainamide)   |
| Hepatitis B virus                                  | Rheumatoid arthritis  |
| Hepatitis A virus                                  | Extraarticular disease, Felty syndrome, synovial fluid                      |
| Adenovirus   | Polyarteritis nodosa (positive or negative for hepatitis B surface antigen) |
| Hepatitis C virus (7, 8)                           | Kawasaki syndrome ( $\pm$ macroglobulinemia)                                |
| Human immunodeficiency virus (9, 10 and 11)        | Sjögren syndrome  |
| <b>Bacterial</b>                                   | Scleroderma   |
| Subacute bacterial endocarditis ( $\pm$ nephritis) | Sarcoidosis   |
| Lepromatous leprosy ( $\pm$ erythema nodosum)      | Thyroiditis   |
| Acute poststreptococcal nephritis                  | Henoch–Schönlein purpura  |
| Syphilis   | Behçet syndrome   |
| Lyme disease ( $\pm$ erythema chronicum migrans)   | Polymyositis  |
| After intestinal bypass with arthritis             | Inflammatory bowel disease  |
| Q fever (12)                                       | Celiac disease, ulcerative colitis, regional enteritis                      |
| <b>Fungal</b>                                      | Endomyocardial fibrosis   |
| Coccidioidomycosis                                 | Pulmonary fibrosis  |
| <b>Parasitic</b>                                   | Cutaneous vasculitis  |
| Kala-azar  | Pemphigus vulgaris  |
| Toxoplasmosis                                      | Erythema elevatum diutinum  |
| Tropical splenomegaly syndrome                     | Cold-induced urticaria  |
| Echinococcosis                                     | Epidermolysis bullosa acquisita   |
| Malaria  | Erythema multiforme   |
| Schistosomiasis                                    | POEMS syndrome  |
| Trypanosomiasis                                    | Pyoderma gangrenosum  |

|  |   |
|--|---|
| Lymphoproliferative disorders  | Liver diseases                            |
| Macroglobulinemia (primary and secondary) ( <a href="#">6</a> , <a href="#">13</a> , <a href="#">14</a> and <a href="#">15</a> ) | Cirrhosis (Laënnec, postnecrotic)         |
| Lymphoma (Hodgkin and non-Hodgkin) ( <a href="#">6</a> , <a href="#">13</a> , <a href="#">14</a> and <a href="#">15</a> )        | Biliary cirrhosis                         |
| Chronic lymphocytic leukemia   | Chronic hepatitis                         |
| Immunoblastic lymphadenopathy  | Essential                                 |
| Hairy cell leukemia  | Experimental                              |
| Renal disease  | Pneumococcal vaccines                     |
| Proliferative glomerulonephritis   | Streptococcal (A and C) hyperimmunization |
| Familial (symptomatic, asymptomatic)   | NZB/NZW, MRL/1, BXSB mice                 |

POEMS, polyneuropathy, organomegaly, endocrinopathy, M protein, and skin changes.  
 From Dispenzieri A, Gorevic PD. Cryoglobulinemia. *Hematol Oncol Clin North Am* 1999;13:1315–1349, with permission.



**Figure 101.1.** Relationship among underlying diseases, cryoglobulins, and symptoms of cryoglobulinemia. Question marks represent unknown contributing factors. HCV, hepatitis C virus. Dark arrows, symptomatic; light arrows, asymptomatic. [From Dispenzieri A, Gertz MA. Cryoglobulinemia. In: Gertz MA, Greipp PR, eds. *Hematologic malignancies: multiple myeloma and related plasma cell disorders (primary amyloidosis, AL)*. Berlin: Springer-Verlag, 2004:53–109, with permission.]

## EPIDEMIOLOGY OF CRYOGLOBULINEMIA

The prevalence of cryoglobulinemia is difficult to estimate because of its clinical polymorphism and because of the necessity of separating the laboratory finding of cryoglobulins from the symptomatic disease state. Although only a minority of patients with serum cryoglobulins have symptoms referable to them, cryoglobulins may be found in patients with cirrhosis (up to 45%), alcoholic hepatitis (32%), autoimmune hepatitis (40%), subacute bacterial endocarditis (90%), rheumatoid arthritis (47%), IgG myeloma (10%), and Waldenström macroglobulinemia (19%) ( [6](#), [13](#), [14](#), [15](#) and [16](#)). In some situations, cryoglobulins serve as harbingers of undiagnosed chronic infections such as subacute bacterial endocarditis, Lyme disease, and Q fever ( [16](#)). Case reports describe cryoglobulinemia associated with hepatitis A virus, hepatitis B virus, Hantavirus, cytomegalovirus, Epstein-Barr virus, human T-cell lymphotropic virus type I, hepatitis G virus, and human immunodeficiency virus ( [9](#), [16](#)). An association with HCV was reported in 1990 and 1991 ( [18](#), [19](#)), and it has become apparent that many patients (42 to 100%) with mixed cryoglobulinemia (MC) are infected with HCV ( [19](#), [20](#), [21](#), [22](#), [23](#), [24](#), [25](#), [26](#) and [27](#)).



By 2002, fewer than 10% of cryoglobulinemia cases were classified as “essential.”

Results of most studies show that the median age at diagnosis lies in the early to mid 50s. In some studies, the female predominance for cryoglobulinemia is greater than 2:1 ( [Table 101.2](#)). No racial preference has been noted, but the incidence is higher in regions where HCV occurs at higher frequencies (e.g., southern Europe). The most common causes of death include renal failure, infection, lymphoproliferative disorders, liver failure, cardiovascular complications, and hemorrhage ( [6](#), [13](#), [17](#), [29](#)).

**TABLE 101.2. Clinical Features of Cryoglobulinemia (Cryo) at Diagnosis**

| Authors<br>(Reference)                               | No. of<br>Patients to | Female<br>to<br>Male<br>Ratio | Patients (%)                   |              |     |     |                                  |                          |      |         |    |  |
|--|-----------------------|-------------------------------|--------------------------------|--------------|-----|-----|----------------------------------|--------------------------|------|---------|----|--|
|  |                       |                               | Essential<br>Cryo <sup>b</sup> | Cryo<br>Type |     |     | Lympho-proliferative<br>Disorder | Liver Sicca <sup>c</sup> | Skin | Raynaud |    |  |
|  |                       |                               |                                | I            | II  | III |                                  |                          |      |         |    |  |
| Meltzer et al. ( <a href="#">5</a> )                 | 29                    | 3:1                           | 41                             | 59           | 41  | 41  | 31                               | 72                       | 17   | 92      | —  |  |
| Brouet et al. ( <a href="#">6</a> )                  | 86                    | —                             | 34                             | 25           | 25  | 50  | 44                               | —                        | 9    | 55      | 50 |  |
| Gorevic et al. ( <a href="#">13</a> )                | 40                    | 1.7:1.0                       | 100                            | 0            | 32  | 68  | —                                | 70                       | 15   | 100     | 25 |  |
| Tarantino et al. <sup>i</sup> ( <a href="#">28</a> ) | 44                    | 1:7                           | 82                             | —            | —   | —   | 0                                | 14                       | 2    | 59      | 7  |  |
| Singer et al. ( <a href="#">29</a> )                 | 16                    | —                             | —                              | 12           | 63  | 25  | 6                                | —                        | —    | 94      | —  |  |
| Monti et al. ( <a href="#">30</a> )                  | 891                   | 2:1                           | 72                             | 6            | 62  | 32  | 6                                | 39                       | 5    | 76      | 19 |  |
| Ferri et al. ( <a href="#">31</a> )                  | 150                   | 3:1                           | —                              | —            | 100 | —   | 8                                | 69                       | 34   | 89      | 34 |  |
| Trejo et al. ( <a href="#">32</a> )                  | 206 <sup>h</sup>      | —                             | —                              | —            | —   | —   | 10                               | —                        | —    | 51      | 11 |  |
| Rieu et al. ( <a href="#">33</a> )                   | 49                    | 1.7:1.0                       | 12                             | 6            | 49  | 33  | 0                                | 43                       | 35   | 82      | 35 |  |

<sup>a</sup> Publications are listed chronologically, from oldest to most recent.

<sup>b</sup> Cryo without any identified predisposing condition. These values do not represent actual incidence but make-up of the population analyzed for symptoms.

<sup>c</sup> Patients with abnormal liver function tests, hepatomegaly, or both.

<sup>d</sup> Value is for types II and III combined.

<sup>e</sup> Symptoms of the essential mixed cryo (types II and III) population only.

<sup>f</sup> Series restricted to patients with renal involvement.

<sup>g</sup> Patients with multiple myeloma, Waldenström macroglobulinemia, and infection were excluded from this design.

<sup>h</sup> Only patients with a cryocrit =1% were included. The percentages were calculated on the basis of the 2 patients described by the authors.

<sup>i</sup> In this study, 12% of the patients were not typed.

Modified from Dispenzieri A, Gorevic PD. Cryoglobulinemia. *Hematol Oncol Clin North Am* 1999;13:1315–

---

## ETIOLOGY OF CRYOGLOBULINEMIA

Cryoglobulinemia is driven primarily by four classes of disease: liver disease (predominantly HCV), infection (again, predominantly HCV), connective tissue disease, and lymphoproliferative disorders. These diseases induce a seemingly nonspecific stimulation of B cells, frequently resulting in polyclonal hypergammaglobulinemia. When these various antibodies are produced, antibodies to autoantigens may also result. In animal models, a strong B-cell stimulus disrupts the sequential order of idiotype–antiidiotype interactions, resulting in both immunosuppression and idiotype–antiidiotype immune complexes ([34](#)). Furthermore, poorly regulated production and clearance of IgM rheumatoid factor (RF) contribute to immune complex formation ([3](#), [13](#)) and pathologic conditions, which include vasculitis, nephritis, and vascular occlusion.

Complement components, fibronectin, and lipoproteins have been found along with antigen–antibody complexes within cryoprecipitates. Although hepatitis B virus, Epstein–Barr virus, and bacterial products may also be present, by far the most common pathogen within cryoprecipitates is HCV ([35](#)). HCV RNA, HCV-specific proteins, and anti-HCV antibodies are found in the supernatant of the cryoprecipitate and in the cryoprecipitate itself in 42 to 98% of patients with essential MC ([21](#), [22](#), [23](#), [24](#), [25](#), [26](#) and [27](#)). Cryoprecipitates contain 20 to 1000 times more HCV RNA than is present in the supernatant ([36](#)). The IgG component to which the IgM–RF fraction binds is directed against the HCV proteins ([37](#)).

### Relationships among Predisposing Conditions and Cryoglobulinemia

**HEPATITIS C VIRUS** The exact relationship between HCV and cryoglobulinemia is unknown. It is clear, however, that (a) HCV serves as a chronic stimulus, (b) cryoglobulins are present in up to 50% of HCV-infected patients ([38](#), [39](#), [40](#) and [41](#)), (c) HCV is associated with autoimmune phenomena even in the absence of cryoglobulinemia, and (d) HCV may predispose patients to lymphoma ([16](#), [42](#), [43](#) and [44](#)). Predisposing factors for cryoglobulinemia in HCV patients are female sex, alcohol consumption, detectable serum HCV RNA, longer duration of hepatitis, higher serum ?-globulin levels, higher RF levels, and extensive liver fibrosis or cirrhosis ([16](#), [27](#), [38](#), [39](#), [45](#), [46](#) and [47](#)).

**CONNECTIVE TISSUE DISEASE** The incidence of cryoglobulinemia—most commonly type II or III—associated with specific connective tissue disease is quite variable ([5](#)). Among patients with systemic lupus erythematosus, 25% have detectable cryoglobulins ([48](#)), and cryoglobulins have been found in 12.5% of patients with systemic sclerosis ([14](#), [49](#)). Measurable amounts of cryoglobulins, usually polyclonal, can be found in up to 46% of patients with active rheumatoid arthritis ([50](#)). Among patients with Sjögren syndrome, 16 to 37% have serum cryoglobulins ([14](#), [51](#), [52](#)); conversely, 5 to 15% of patients with MC have Sjögren syndrome ([6](#), [13](#), [17](#)). Patients with Sjögren syndrome who have mixed cryoglobulins have a sevenfold increased risk of developing lymphoma, compared with patients without cryoglobulins (86.0% vs. 12.5%) ([51](#)).

## Lymphoproliferative Disorders

The relationship between cryoglobulinemia and lymphoproliferative disorders is complex; cause can be difficult to distinguish from effect. At a minimum, approximately 31% of all secondary cases of symptomatic cryoglobulinemia already carry a diagnosis of lymphoproliferative disorders when cryoglobulinemia is diagnosed (17). Higher percentages are found in series in which bone marrow biopsies, flow cytometry, Southern blot tests, and polymerase chain reaction are performed routinely (53, 54, 55, 56 and 57). In another 6 to 28% of patients, symptomatic lymphoma develops at follow-up (43, 56, 58, 59); 50% of these are intermediate- or high-grade lymphoma (59). The most common histologic diagnoses among the remaining low-grade lymphomas are immunocytoma (53, 60) followed by mucosa-associated lymphoid tissue and centrocytic follicular lymphoma (61). Among patients whose condition transforms to overt lymphoma, the malignant clone is derived from one of the dominant baseline B-cell clones in only a minority of patients (55), implying a predisposition for clonal production and evolution.

## Associations among Cryoglobulinemia, Hepatitis C Virus, Connective Tissue Disease, and Lymphoma

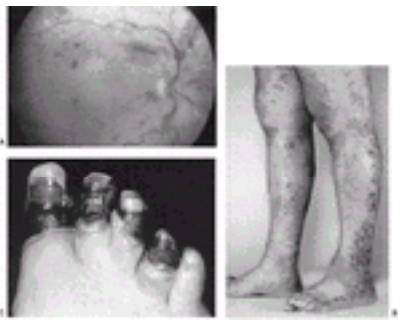
A recognized model for progression from chronic antigenic stimulation to benign or malignant lymphoproliferation is provided by *Helicobacter pylori*-associated and mucosa-associated lymphoid tissue lymphomas (62). HCV, Sjögren syndrome, cryoglobulinemia, and immunocytoma may follow a similar pattern. There is remarkable conservation of and homology among the antigen-combining sites (variable regions) of the IgM-? RFs in patients with HCV, HCV-associated lymphoma, or cryoglobulinemia (63, 64, 65, 66, 67, 68 and 69). Similar degrees of homology are seen between the Ig receptors in the lymphoproliferation of patients with Sjögren syndrome and those in the lymphomas of HCV-infected patients with or without type II MC (70). This finding supports the concept that the combination of chronic antigenic stimulation, ineffectively regulated autoreactive B cells (which make restricted RF), and continued B-cell proliferation may predispose B cells to subsequent oncogenic mutation and transformation to malignant lymphoma.

Among HCV-positive patients with MC, HCV RNA is detected in peripheral blood mononuclear cells in up to 81% of patients (71) and in bone marrow cells in up to 100% of patients (56, 72, 73, 74, 75 and 76). Clonal Ig gene rearrangements can be detected by reverse transcriptase polymerase chain reaction in all HCV-positive patients with type II MC and in 24% of HCV-infected patients without cryoglobulinemia (57). Productive t(14;18) translocations with resultant Bcl-2 overexpression occur in approximately 12 to 26% of HCV-positive patients without symptomatic cryoglobulinemia and in 39 to 86% of their cryoglobulin-positive counterparts (77, 78 and 79). Patients with cryoglobulinemia in whom lymphoma develops have been found to have genomic sequences of HCV in their lymphoma specimens (61, 80, 81 and 82). The non-Hodgkin lymphoma (NHL) subgroup most commonly observed in patients with HCV is a lymphoplasmacytoid lymphoma/immunocytoma (83). An increased rate of HCV infection (8 to 50%) has also been reported in idiopathic B-cell NHL by many investigators (16, 42, 43 and 44).

## CLINICAL PRESENTATION OF CRYOGLOBULINEMIA

Involvement of the skin, peripheral nerves, kidneys, and liver is common (Table 101.2).

Lymphadenopathy is present in approximately 17% of patients ( 5, 13). On autopsy, widespread vasculitis involving small and medium vessels in the heart, gastrointestinal tract, central nervous system, muscles, lungs, and adrenal glands may also be seen ( 13, 84). The interval between the onset of symptoms and the time of diagnosis varies considerably (range, 0 to 10 years) ( 13). Type I cryoglobulinemia is usually asymptomatic. When symptomatic, it most commonly causes occlusive symptoms rather than the vasculitis associated with types II and III ( 5, 6, 13). Symptoms of hyperviscosity may occur ( Fig. 101.2). Type II cryoglobulinemia is more frequently symptomatic (61% of patients) than type III (21% of patients) ( 85). The most common causes of death include renal failure, infection, lymphoproliferative disorders, liver failure, cardiovascular complications, and hemorrhage ( 6, 13, 17, 29, 33).



**Figure 101.2.** Cryoglobulin-associated physical findings. **A:** Hyperviscosity manifested as retinopathy with venous engorgement and hemorrhage. **B:** Purpura. **C:** Gangrene.

## Skin

Purpura is the most frequent symptom of MC, found in 55 to 100% of MC patients ( 6, 13, 17, 29) ( Table 101.2 and Fig. 101.2). The incidence varies from 15 to 33% in type I, from 60 to 93% in type II, and from 70 to 83% in type III ( 86). Petechiae and palpable purpura are the most common lesions, although ecchymoses, erythematous spots, and dermal nodules occur in as many as 20% of patients. Bullous or vesicular lesions are distinctly uncommon ( 6). Successive purpuric rashes, which may be preceded by a burning or itching sensation, occur most commonly on the lower extremities, gradually extending to the thighs and lower abdomen. Occasionally, the arms are involved, but the face and trunk are generally spared ( 6). Head and mucosal involvement, livedoid vasculitis, and cold-induced acrocyanosis of the helices of the ears are more frequently observed in type I; infarction, hemorrhagic crusts, or ulcers occur in 10 to 25% of all patients with MC ( 87). Showers of purpura last for 1 to 2 weeks and occur once or twice a month. Exposure to cold precipitates these lesions in only 10 to 30% of patients ( 6, 87). Raynaud phenomenon occurs in approximately 19 to 50% of cases ( 6, 13, 17, 29); in one-fourth of these, the symptoms may be severe, including necrosis of fingertips ( 6). Skin necrosis, urticaria, and livedo, all of which are rare, are more commonly associated with exposure to cold.

## Arthralgias

Arthralgias are common, affecting 35 to 92% of patients with cryoglobulinemia, with the highest incidence in type III cryoglobulinemia ( Table 101.2). The small distal joints are affected more frequently than the larger proximal joints. Symmetric poly-arthralgia is

often exacerbated by exposure to cold. Frank arthritis is rare ( [6](#), [13](#), [17](#), [29](#), [32](#) ).

## Nervous System

Peripheral neuropathy is the most common presentation, although central nervous system involvement may occur. In the largest clinical series, peripheral nerve involvement is described in 12 to 56% of patients ( [6](#), [13](#), [17](#), [29](#), [30](#), [32](#) ) ( [Table 101.2](#) ). Signs and symptoms of sensory neuropathy usually precede those of motor neuropathy ( [6](#) ). The presentation may be an acute or subacute distal symmetric polyneuropathy or a mononeuritis multiplex ( [88](#), [89](#) ) with a chronic or chronic-relapsing evolution ( [90](#) ). The neuropathy in essential MC is most often characterized by axonal degeneration. Epineurial vasculitis is a common finding on sural nerve biopsy ( [88](#), [89](#), [91](#), [92](#) and [93](#) ).

## Kidney

Approximately 21 to 39% of patients with MC have renal involvement ( [6](#), [31](#), [32](#) ) ( [Table 101.2](#) ). The incidence of renal injury is highest in patients with type II cryoglobulins ( [17](#), [94](#) ). Although renal and extrarenal manifestations may occur concurrently, renal involvement usually follows the onset of purpura by approximately 4 years ( [13](#), [95](#) ). Proteinuria greater than 0.5 g/day and hematuria are the most common features of renal disease at diagnosis (present in 50% of patients) ( [96](#) ); nephrotic syndrome affects approximately 20% of patients, and acute nephritic syndromes occur in approximately 25% of patients ( [95](#), [96](#) ). Although the diagnosis of a cryopathic membranoproliferative glomerulonephritis portends a poor prognosis ( [13](#), [14](#), [94](#), [96](#), [97](#) ), progression to end-stage renal failure due to sclerosing nephritis is uncommon ( [96](#) ). Among patients with MC-associated membranoproliferative glomerulonephritis followed up for a median of 11 years, 15% had disease progression to end-stage renal failure, and 43% died of cardiovascular, hepatic, or infectious causes ( [96](#) ).

## Liver

Approximately 39% of patients with symptomatic cryoglobulinemia ( [17](#) ) and as many as 77% with MC ( [13](#), [98](#) ) have documented liver abnormalities at the time of diagnosis ( [Table 101.2](#) ). Furthermore, hepatomegaly is present in up to 70% of patients, and splenomegaly is present in up to 52% of patients ( [4](#), [13](#), [28](#) ). Among patients with symptomatic cryoglobulinemia, liver failure has been identified as the cause of death in 5.6 to 29.0% of individuals succumbing to the disease ( [13](#), [30](#), [96](#) ).

Histologic findings include portal fibrosis, chronic persistent hepatitis, chronic active hepatitis, chronic active hepatitis with cirrhosis, and postnecrotic cirrhosis ( [98](#) ). Most specimens are characterized by a diffuse lymphocytic infiltrate ranging from minimal periportal to extensive infiltration with nodule formation. These changes correlate with the severity of other pathologic findings. Plasma-cell infiltration also has been noted in several specimens ( [85](#), [98](#) ). The lymphoid population in the liver may show the histologic and immunophenotypic findings of lymphoplasmacytoid lymphoma/immunocytoma, and, frequently, the lymphoid elements are arranged in pseudofollicular structures in the liver with morphologic features similar to those previously reported in chronic HCV without cryoglobulinemia ( [59](#) ). These liver lymphoid nodules contain B cells predominantly with a CD5<sup>+</sup>/Bcl-2<sup>+</sup>/Ki67<sup>-</sup> phenotype associated with low apoptotic and proliferative rates ( [99](#) ).

).

## DIAGNOSIS OF CRYOGLOBULINEMIA

By definition, all patients with cryoglobulinemia have serum cryoglobulins. The collection and processing of the specimens are critical because these cold-induced reversible precipitates can be lost with improper handling ( [16](#), [100](#) ). A minimum of 10 ml of blood is required, and the specimen must be allowed to clot at 37° C for 30 to 60 minutes before centrifugation. The serum supernatant is stored at 4° C for up to 7 days and inspected daily for the appearance of cryoprecipitates. Methods to evaluate the composition of the cryoglobulin include immunoelectrophoresis, immunofixation, immunoblotting, and capillary electrophoresis.

Concentrations of cryoglobulins tend to vary by type: type III, less than 1 mg/ml; type II, 1 mg/ml or greater; and type I, greater than 5 mg/ml ( [6](#), [101](#) ). The type or quantity does not reliably predict the presence or nature of symptoms. On serum protein electrophoresis, polyclonal hypergammaglobulinemia is the most common finding, although normal patterns or hypogammaglobulinemia may also be seen ( [5](#), [13](#) ). Even among patients with type II cryoglobulinemia, only 15% have a visible monoclonal spike on serum protein electrophoresis ( [13](#) ). Frequently, serum IgM levels are elevated; cryoprecipitable IgM may comprise up to one-third of the total serum IgM concentration ( [13](#) ). Hyperviscosity occurs only occasionally ( [4](#) ). Marked depression of complement CH50, C1q, and C4 in the presence of relatively normal C3 levels is usual ( [13](#), [32](#), [102](#) ). Neither C4 concentrations nor cryoglobulin levels correlate with overall clinical severity, although for individual patients, the cryoglobulin level can sometimes serve as a marker for disease activity ( [13](#), [102](#), [103](#) and [104](#) ). RF activity (i.e., anti-Fc activity) is detectable in the sera in 87 to 100% of patients with MC ( [5](#), [6](#), [30](#) ), and levels may decrease with response to therapy ( [105](#) ). An elevated erythrocyte sedimentation rate and a mild normochromic, normocytic anemia are fairly common ( [13](#), [104](#) ), but cryoglobulins with a high thermal amplitude may be associated with very low erythrocyte sedimentation rates. Cytopenias ( [4](#) ) have been described, as have pseudoleukocytosis and pseudothrombocytosis ( [106](#) ). Among patients with cryoglobulinemia, the antinuclear antibody results may be positive in as many as two-thirds of patients and in as many as one-third of HCV-positive patients ( [32](#) ). Because HCV is frequently concentrated in cryoglobulins ( [21](#) ), serial measurements of plasma or serum HCV RNA levels in these patients are not reliable ( [47](#) ).

## TREATMENT OF CRYOGLOBULINEMIA

It is well recognized that cryoglobulinemia has a fluctuating course with spontaneous exacerbation and remission. This feature makes controlled clinical trials essential in evaluating the response to therapy. However, such studies are rare in the field of cryoglobulinemia. With the exception of the interferon (IFN)- $\alpha$  trials of the 1990s ( [Table 101.3](#) ) ( [107](#), [108](#), [109](#), [110](#) and [111](#) ) and the small low-antigen diet trial performed in the 1980s ( [112](#) ), the remainder of the information about the treatment of symptomatic cryoglobulinemia is anecdotal. Most “accepted” or “standard” treatments are not based on the results of randomized trials, and several reported strategies have questionable, if any, benefit ( [Table 101.4](#) ) ( [16](#), [134](#) ). Finally, therapies, such as the use of H<sub>1</sub>- and H<sub>2</sub>-blockers and penicillamine, are based on sound scientific principles but have shown no clear clinical benefit ( [13](#), [16](#) ). [Figure 101.3](#) outlines a strategy for managing symptomatic



cryoglobulinemia.

TABLE 101.3. Use of Interferon in Randomized Trials

| Authors<br>(Reference)                         | No. of<br>Patients | Therapy  |  |                           | Comments  |
|--|--------------------|--|--|---------------------------|---|
|  |                    | Duration   | Induction<br>Dosage                            | RR<br>(%)<br><sup>a</sup> |   |
| Ferri et al. ( <a href="#">107</a> )           | 26                 | Crossover at 6 mo  | IFN (2 MU/d<br>× 1 mo, then<br>qod × 5 mo)     | 77                        | Rebound after IFN was<br>d/c.   |
|  |                    | Pred (stable dosage;<br>maximal, 10 mg/d)  |  | 0                         |   |
| Misiani et al. ( <a href="#">108</a> )         | 53                 | 5.5 mo   | IFN (1.5 MU/d<br>× 1 wk, then<br>3 MU 3 × /wk) | 60                        | Relapse occurred in all<br>patients when IFN was<br>d/c.                                      |
|  |                    | Prior Rx <sup>b</sup>  |  | 0                         |   |
| Dammacco et<br>al. ( <a href="#">109</a> )     | 65                 | 12 mo  | nIFN (3 MU<br>3 × /wk)                         | 66                        | Most rapid and durable<br>RR was with IFN/pred.   |
|  |                    | nIFN/pred (nIFN, 3<br>MU 3 × /wk; pred, 16<br>mg/d)  |  | 71                        |   |
|  |                    | Pred (16 mg/d)   |  | 22                        |   |
|  |                    | No Rx  |  | 13                        |   |
| Lauta and De<br>Sangro ( <a href="#">110</a> ) | 33                 | Indefinitely   | Pred (10<br>mg/d)                              | 27                        |   |
|  |                    | IFN/pred (pred, 10<br>mg/d ± IFN, 3 MU/d<br>until response, then 3<br>MU 3 × /wk) <sup>c</sup> |  | 83                        |   |
| Mazzaro et al.<br>( <a href="#">111</a> )      | 36                 | 6 mo   | IFN (3 MU<br>3 × /wk)                          | 78                        | Duration of 12 mo<br>provided better RR<br>and better long-term<br>response (22% vs.<br>11%). |
|  |                    | 12 mo  | IFN (3 MU<br>3 × /wk)                          | 89                        |   |

d/c, discontinued; IFN, interferon- $\alpha$ ; nIFN, natural interferon- $\alpha$ ; pred, prednisone; RR, response rate; Rx, treatment.

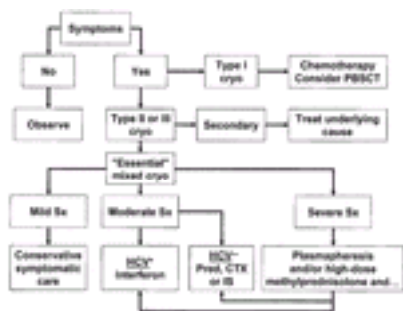
<sup>a</sup> All responses are based on *clinical responses*, which refer to symptomatic responses as defined by both clinical symptoms/signs and laboratory results known to correlate with symptomatic disease. Hepatitis C virus response is an antiviral response that is frequently measured in IFN trials.

<sup>b</sup> No therapy or stable low-dose therapy with pred (=0.2 mg/kg/day).

<sup>c</sup> Patients began receiving a maintenance dose of interferon when they achieved a complete response or when they achieved at least a minor response at 6 months.

Modified from Dispenzieri A, Gorevic PD. Cryoglobulinemia. *Hematol Oncol Clin North Am* 1999;13:1315–1349.





**Figure 101.3.** Possible treatment schema. If interferon therapy fails, combination therapy with interferon- $\alpha$  and ribavirin may help; however, contraindications for ribavirin should be considered. Cryo, cryoglobulin; CTX, cyclophosphamide; HCV, hepatitis C virus; IS, immunosuppressant; PBST, peripheral blood stem cell transplantation; pred, low-dose therapy with prednisone; Sx, symptoms.

**TABLE 101.4. Treatment Strategies for Symptomatic Cryoglobulinemia**

| Reference  | Treatment  | Response          | Quality of Data |
|--|--|-------------------|-----------------|
| See <a href="#">Table 101.3</a>                      | Interferon   | Effective         | RCT             |
| <a href="#">113</a>                                  | Ribavirin  | PU                | A               |
| <a href="#">112</a>                                  | Low-antigen diet   | PU (mild disease) | RCT             |
| <a href="#">104, 114, 115, 116, 117, 118 and 119</a> | Plasmapheresis, plasma exchange, cryoapheresis, and cryofiltration | PU                | A               |
| <a href="#">4, 13, 14, 28, 120, 121</a>              | Prednisone (1 mg/kg)   | PU                | A               |
| <a href="#">122, 123</a>                             | Methylprednisolone IV (1 g/wk or 1 g/d $\times$ 3 d)               | PU                | A               |
| <a href="#">114</a>                                  | Chlorambucil   | PU                | A               |
| <a href="#">119, 124, 125 and 126</a>                | CTX IV (750 mg/m <sup>2</sup> /mo); CTX orally (1–2 mg/kg/d)       | PU                | A               |
| <a href="#">120</a>                                  | Melphalan  | PU                | A               |
| <a href="#">13</a>                                   | Azathioprine orally (100 mg/d)                                     | PU                | A               |
| <a href="#">59, 127</a>                              | Cyclosporine (2.5 mg/kg/d)   | PU                | A               |
| <a href="#">128</a>                                  | Colchicine (1 mg/d)  | PNU               | A               |
| <a href="#">129, 130</a>                             | Immunoglobulin IV  | V <sup>a</sup>    | A               |
| <a href="#">131, 132</a>                             | Cladribine and fludarabine   | V                 | A               |
| <a href="#">4, 124</a>                               | Splenectomy  | V                 | A               |
| <a href="#">4</a>                                    | Chloroquine  | PNU               | A               |
| <a href="#">13</a>                                   | H <sub>1</sub> - and H <sub>2</sub> -blockers                      | PNU               | A               |
| <a href="#">13</a>                                   | Penicillamine  | PNU               | A               |

A, anecdotal or single-armed trial; CTX, cyclophosphamide; PNU, probably not useful; PU, probably useful; RCT, randomized controlled trial; V, variable.

<sup>a</sup> One case report of precipitating acute renal failure ( 129) and another of systemic vasculitis ( 133).

Modified from Dispenzieri A, Gorevic PD. Cryoglobulinemia. *Hematol Oncol Clin North Am* 1999;13:1315–1349.

---

For years, the standard treatment of mild symptomatic cryoglobulinemia (purpura, asthenia, arthralgia, and mild sensory neuropathy) has included bed rest, analgesics, low-dose corticosteroid therapy, low-antigen content diet, and protective measures against cold; the treatment of severe disease (glomerulonephritis, motor neuropathy, and systemic vasculitis) has included plasmapheresis, high-dose corticosteroid therapy, and cytotoxic chemotherapy. Since the association between HCV and MC was established, immunosuppressive therapy has been viewed less favorably, and IFN is generally considered to be first-line therapy for HCV-positive patients who are in nonemergent situations ( 107, 108, 109, 110 and 111, 135). For patients with symptomatic type I cryoglobulinemia, cytotoxic therapy appropriate for the lymphoproliferative disorder remains the therapy of choice. Similarly, treatment of underlying connective tissue disease or infection would be first-line therapy in appropriate situations. The importance of not overtreating patients must be emphasized. Clinical trials are needed to clarify these issues.

### Treatment of Life-Threatening Disease

The use of cytotoxic therapy, high-dose corticosteroid therapy, and plasmapheresis for patients with cryoglobulinemia with “uncontrolled features” has been the dogma, although no randomized clinical trials support this strategy. Plasma exchange or plasmapheresis alone can reverse serious complications, but most authors have recommended use of these procedures in combination with cytotoxic agents or corticosteroids for more durable responses ( 103, 114, 115 and 116). According to case reports, responses may be seen in 60 to 100% of patients ( 98, 114, 115 and 116). Skin manifestations and arthralgias usually respond most quickly, whereas the degree of neural and renal responses depends on the acuity of their occurrence, with poorer responses occurring in chronic cases ( 115). With combination immunosuppressive therapy and plasma exchange, reversal of catastrophic complications, such as encephalopathy and acute glomerulonephritis, has been documented ( 103, 115, 134). High-dose pulse therapy with methylprednisolone is also a favored therapeutic intervention for acute events, with 90% response rates reported in rapidly progressive glomerulonephritis ( 122, 136).

### Interferon- $\alpha$

Five randomized trials evaluating the efficacy of IFN therapy in HCV-positive patients with symptomatic type II MC have documented clinical responses in 60 to 89% of patients ( 107, 108, 109, 110 and 111) ( Table 101.3). However, a majority of patients relapse within 6 months after discontinuation of therapy ( 108, 109, 110 and 111, 135). If no response occurs after 3 to 4 months of therapy, it is unlikely that further therapy will be successful ( 135). Factors associated with a poor response to therapy or a rapid relapse include liver cirrhosis, advanced age ( 111), male sex ( 135), and high levels of HCV RNA at the onset of therapy ( 109, 138). Purpuric lesions and liver function abnormalities tend to respond rapidly (within weeks), but neuropathy and nephropathy respond more slowly ( 135, 137). Although no randomized trial data exist for treatment of acute nephritis, most authors

suggest initially supplementing IFN therapy with corticosteroids or plasmapheresis ( [95](#) ). Both peripheral neuropathy ( *personal observation*, [137](#) ) and ischemic manifestations may be exacerbated by IFN ( [139](#) ).

More frequent doses (daily instead of three times weekly) ( [137](#), [140](#) ) and longer duration of therapy (at least 1 year) may result in more rapid ( [137](#), [140](#) ) and durable responses, respectively ( [107](#), [108](#), [135](#) ). The use of prednisone as part of the induction strategy also may result in quicker and more durable responses, but care must be taken because serum HCV RNA levels may increase with the use of prednisone ( [109](#) ). If relapse occurs during therapy, resistance may result from antibodies to IFN; reinduction may be possible with natural IFN ( [137](#) ). Use of combination therapy, including IFN- $\alpha$  and ribavirin, may be another strategy for patients with symptomatic cryoglobulinemia ( [141](#), [142](#) ). More than 60% of patients with symptomatic MC who do not respond to IFN therapy alone respond to combined therapy, and 80% of patients who relapse with IFN- $\alpha$  therapy alone respond to combined therapy ( [141](#) ).

### Other Therapies

Although not formally studied, high-dose therapy with autologous stem cell transplantation may be considered for patients with symptomatic, refractory cryoglobulinemia associated with a plasmaproliferative disorder. There is an increased risk of lethal venoocclusive disease in patients with chronic HCV who are undergoing stem cell transplantation ( [143](#) ); for these patients, there are no data to support implementation of this therapy.

Dramatic reductions in the cryocrit and the cryoglobulinemic symptoms, including membranoproliferative glomerulonephritis, have been reported in several patients who underwent splenectomy for hypersplenism ( [124](#), [144](#), *personal observation* ). In contrast, in the series reported by Meltzer and Franklin ( [4](#) ), the patient who underwent splenectomy died of acute renal failure. Because this intervention has not been studied thoroughly, and because of the high risk involved, this intervention should not be considered as standard therapy but rather as a potential intervention for patients without cirrhosis who have disease that is difficult to manage because of cytopenias resulting from hypersplenism.

## HEAVY CHAIN DISEASE

The HCDs are a rare group of disorders with diverse clinical presentations. The three conditions ( $\alpha$ -HCD,  $\mu$ -HCD, and  $\gamma$ -HCD) are discussed together because they are lymphoproliferative or plasmaproliferative disorders that share the generation and secretion of an isolated heavy chain fragment ( [Table 101.5](#) ).  $\alpha$ -HCD (Mediterranean lymphoma or immunoproliferative small intestinal disease) is the most common and has the most uniform presentation;  $\mu$ -HCD and  $\gamma$ -HCD have variable clinical presentations and histopathologic features. In the majority of cases, the heavy chain fragment is not secreted in large quantities, and immunofixation or immunoelectrophoresis is required to detect the abnormality. Screening the serum and urine of patients with lymphoplasmacytoid NHL would most likely identify more patients with  $\mu$ -HCD. Cases of  $\mu$ -HCD and  $\gamma$ -heavy chain monoclonal gammopathy of unknown significance have been reported ( [149](#), [150](#) ).

### TABLE 101.5. Features of Heavy Chain Diseases

| Feature                    | Type of Heavy Chain Disease                       |                                      |   |
|----------------------------|---|--------------------------------------|---|
|                            | a   | ?                                    | μ   |
| Monoclonal heavy chain     | IgA   | IgG                                  | IgM   |
| Year described (reference) | 1968 ( <a href="#">145</a> )                      | 1964 ( <a href="#">146</a> )         | 1970 ( <a href="#">147</a> , <a href="#">148</a> )      |
| Incidence                  | Rare  | Very rare                            | Very rare   |
| Median age                 | Young adults                                      | 61 yr                                | 57 yr   |
| Associated diseases        | Bacterial overgrowth, malabsorption               | Autoimmune diseases                  | —   |
| Site                       | Small intestine, mesenteric lymph nodes           | Lymph nodes, bone marrow, and spleen | Liver, spleen, lymph nodes, and bone marrow             |
| Pathologic features        | Extranodal marginal zone lymphoma (MALT or IPSID) | Lymphoplasmacytoid lymphoma          | Small lymphocytic lymphoma/chronic lymphocytic leukemia |
| Therapy                    | Antibiotics, chemotherapy                         | Chemotherapy                         | Chemotherapy  |

Ig, immunoglobulin; IPSID, immunoproliferative small intestinal disease; MALT, mucosa-associated lymphoid tissue.

### a-Heavy Chain Disease

*Mediterranean lymphoma*, originally described in the 1960s as a condition in young adults, is a primary small intestinal lymphoma coupled with intestinal malabsorption ( [151](#) ). An isolated IgA heavy chain fragment was recognized in association with this condition. Because some patients had benign-appearing lymphocytes in their small bowel, the term a-HCD was preferred over *Mediterranean lymphoma* by some authors ( [152](#) ). A consensus panel in 1976 concluded that a-HCD and Mediterranean lymphoma represented a spectrum of disease with benign, intermediate, and overtly malignant stages, and the term *immunoproliferative small intestinal disease* came into use ( [153](#) ).

The majority of reported patients with a-HCD are from northern Africa, Israel, and surrounding Middle Eastern or Mediterranean countries, with fewer patients from central and southern Africa, eastern Asia, and South and Central America ( [154](#) ).

Patients present with malabsorption syndromes, weight loss, and abdominal pain. On physical examination, peripheral edema, clubbing, and abdominal masses are not uncommon findings ( [153](#), [154](#) and [155](#) ). On endoscopy of the small intestine, one may find thickened mucosal folds, nodules, ulcers, a mosaic pattern, or submucosal infiltration. Intestinal parasites and bacterial overgrowth in the small intestine are common. Anemia, vitamin deficiencies, and hypogammaglobulinemia are also seen frequently. The IgA level is generally not increased, but on immunofixation or immunoelectrophoresis, a monoclonal component is present, especially in the earlier phases of the disease, and can be identified as an IgA heavy chain without associated light chains. The monoclonal IgA fragment may be found in jejunal secretions as well as in the blood and urine ( [155](#) ). In patients with a-HCD, the monoclonal protein belongs to the a1 subclass and consists of

multiple polymers. The length of the basic polypeptide subunit is typically between one-half and three-fourths that of a normal  $\alpha$ -heavy chain; the shortening results from an internal deletion involving most of the V<sub>H</sub> and the C<sub>H</sub>1 domains (156). In approximately one-half of the cases, the electrophoretic pattern of  $\alpha$ -HCD protein consists of a broad band extending from the  $\alpha$ 2 region to the  $\beta$ -globulin region, a reflection of the tendency of these chains to polymerize. The remainder of the patients may have a normal serum protein electrophoretic pattern.

The histologic findings have been classified into three distinct stages: Stage A includes a diffuse, dense, compact, and apparently benign lymphoplasmacytic infiltration of the mucosal lamina propria. Stage B has the features of stage A but has the additional finding of an "immunoblastic" lymphoma pattern in intestinal or mesenteric lymph nodes. Stage C comprises a diffuse "immunoblastic" lymphoma with or without the benign-appearing lymphoplasmacytic infiltration seen in stage A (153). Villous broadening or effacement and shortened sparse crypts are also observed. These histopathologic findings can be distinguished from those of celiac sprue because celiac sprue includes total villous atrophy, hyperplastic and elongated crypts, intraepithelial lymphocytosis, and surface epithelial flattening. The lymphoma that arises from celiac sprue is a T-cell lymphoma (157) rather than a B-cell lymphoma, as in the case of  $\alpha$ -HCD.

The hypothesis that chronic antigenic stimulation by intestinal organisms is the cause of this disorder is credible and can be modeled after the mucosa-associated lymphoid tissue lymphoma paradigm. This hypothesis is further supported by the fact that  $\alpha$ -HCD (or immunoproliferative small intestinal disease) is most common in patients who live in areas with poor sanitation and who also have a high prevalence of intestinal microbial infestation, although the particular offending organisms have not been identified.

Although no data exist from randomized prospective studies, the standard accepted treatment for the early stage is broad-spectrum antibiotics with or without corticosteroids. This protocol has resulted in a clinical or histologic remission (in 33 to 71% of cases) that is generally short-lived but occasionally is durable (154). In the absence of a documented parasite or an intestinal bacterial overgrowth, therapy with tetracycline or metronidazole and ampicillin is appropriate (158, 159). Any documented parasite should be eradicated. Treatment of *H. pylori* has led to complete remission in two patients with  $\alpha$ -HCD (160), one of whom was unresponsive to prior combination chemotherapy. Response to antibiotics usually occurs promptly; however, a minimum 6-month trial of tetracycline (1 to 2 g/day) is recommended for establishing the responsiveness of the disease (161). In patients with more advanced disease or with unresponsive disease in its early stages, total abdominal radiation, combination chemotherapy, or both have been used (remission rate, 64%) (162, 163, 164, 165, 166 and 167). The overall 5-year survival rate is 60 to 70%. Immunotherapy with rituximab, an anti-CD20 monoclonal antibody, has been a major advance in the treatment of indolent NHL (168), but to date, there have been no reports of the use of rituximab in patients with  $\alpha$ -HCD.

### $\mu$ -Heavy Chain Disease

First described in 1970,  $\mu$ -HCD is a rare condition (147, 148). The median age of patients with  $\mu$ -HCD is approximately 57 years, and equal numbers of males and females are affected (149, 169). Common clinical presentations include splenomegaly and hepatomegaly. Lymphadenopathy is less common. Approximately one-third of patients have chronic lymphocytic leukemia. Some patients with  $\mu$ -HCD have features resembling those of lymphoma or multiple myeloma with amyloid arthropathy (170). Hypogammaglobulinemia is present in approximately one-half of the patients, and a free

monoclonal IgM fragment is found in the serum of all patients. The  $\mu$ -heavy chain is missing most, if not all, of its V<sub>H</sub> region (171). A free monoclonal light chain has been described in the urine in approximately one-half of the cases (149, 172). Lytic bone lesions or osteoporosis occurs in a minority of patients. Bone marrow plasma cells tend to be vacuolated. Survival ranges from less than 1 month to 11 years (median, 24 months) (149). There is no standard treatment for this disorder, but it is generally treated as a low-grade lymphoproliferative disease with observation alone for asymptomatic patients and low-intensity chemotherapy for symptomatic patients.

## ?-Heavy Chain Disease

First described in 1964 by Franklin et al. (146), ?-HCD has a diverse clinical phenotype. The median age of patients with ?-HCD is 61 years, with 54% of the patients being male (169, 173). Originally, ?-HCD was considered to be merely a lymphomalike illness; Kyle et al. (173) challenged this concept. Although most patients present with weakness, fatigue, fever, lymphadenopathy (62%), hepatomegaly (58%), splenomegaly (59%), and lymphoma, other features, such as autoimmune hemolytic anemia and idiopathic thrombocytopenic purpura, may also be seen (173). Cutaneous and subcutaneous involvement is not uncommon (174). Several cases have arisen in patients with long-standing connective tissue disorders such as rheumatoid arthritis (175, 176 and 177), lupus (178), keratoconjunctivitis sicca (179, 180), vasculitis (180), and myasthenia gravis (178). A normochromic anemia is a presenting feature in approximately 79% of patients. Approximately 10% have either an autoimmune Coombs-positive or a Coombs-negative hemolytic anemia (173, 180). Lymphopenia and lymphocytosis each occur in less than 10% of patients. Thrombocytopenia may be present in as many as 22% of patients (173).

The ?-chain in this disorder is truncated with deletions at the C<sub>H</sub>1 domain (169, 181). The mobility pattern of the Ig fragment on protein electrophoresis is quite variable, with the band found anywhere between the  $\alpha$ 1-globulin region and the slow ?-globulin region; most commonly, however, it runs in the  $\beta$  region (173). The subclass distribution is IgG1 in 76%, IgG2 in 19%, and IgG4 in 5% of cases. In a normal distribution of subclasses, one would expect to find 66% IgG1, 23% IgG2, 7% IgG3 and 4% IgG4 molecules; the absence of IgG3 ? heavy chains is noteworthy. Proteinuria can range from none to 20 g/day.

Bone marrow demonstrates an increase of plasma cells, lymphocytes, or plasmacytoid lymphocytes; occasionally, eosinophilia is seen. The lymph node is not uniform morphologically: Well-differentiated plasma cells and lymphocytes are most commonly described (182). Lytic bone disease occurs rarely. Amyloid deposits may be present (173).

The median survival is 12 months, with a range of 1 month to more than 264 months (173). Treatment is not standardized. Single-agent therapy with prednisone and combination chemotherapy with cyclophosphamide, vincristine, and prednisone have been used with benefit. Patients with aggressive lymphomas should receive a regimen containing anthracyclines.

## REFERENCES

1. Wintrobe MM, Buell MV. Hyperproteinemia associated with multiple myeloma: with report of case in which extraordinary hyperproteinemia was associated with thrombosis of retinal veins and symptoms suggesting Raynaud's disease. Bull Johns Hopkins Hosp 1933;52:156-165.

2. Lerner AB, Watson CJ. Studies of cryoglobulins: unusual purpura associated with the presence of a high concentration of cryoglobulin (cold precipitable serum globulin). *Am J Med Sci* 1947;214:410-415.
3. Grey HM, Kohler PF. Cryoimmunoglobulins. *Semin Hematol* 1973;10:87-112.
4. Meltzer M, Franklin EC. Cryoglobulinaemia: a study of twenty-nine patients. I. IgG and IgM cryoglobulins and factors affecting cryoprecipitability. *Am J Med* 1966;40:828-836.
5. Meltzer M, Franklin EC, Elias K, et al. Cryoglobulinaemia: a clinical and laboratory study. II. Cryoglobulins with rheumatoid factor activity. *Am J Med* 1966;40:837-856.
6. Brouet JC, Clauvel JP, Danon F, et al. Biologic and clinical significance of cryoglobulins: a report of 86 cases. *Am J Med* 1974;57:775-788.
7. Ferri C, Greco F, Longombardo G, et al. Antibodies against hepatitis C virus in mixed cryoglobulinaemia patients. *Infection* 1991;19:417-420.
8. Pasquali JL, Waltzinger C, Kuntz JL, et al. The majority of peripheral blood monoclonal IgM secreting cells are CD5 negative in three patients with mixed cryoglobulinaemia. *Blood* 1991;77:1761-1765.
9. Dimitrakopoulos AN, Kordossis T, Hatzakis A, et al. Mixed cryoglobulinaemia in HIV-1 infection: the role of HIV-1. *Ann Intern Med* 1999;130:226-230.
10. Antinori S, Galimberti L, Rusconi S, et al. Disappearance of cryoglobulins and remission of symptoms in a patient with HCV-associated type II mixed cryoglobulinaemia after HIV-1 infection. *Clin Exp Rheumatol* 1995;[Suppl 13]:S157-S159.
11. Morales E, Alegre R, Herrero JC, et al. Hepatitis-C-virus-associated cryoglobulinaemic membranoproliferative glomerulonephritis in patients infected by HIV. *Nephrol Dial Transplant* 1997;12:1980-1984.
12. Torley H, Capell H, Timbury M, et al. Chronic Q fever with mixed cryoglobulinaemia. *Ann Rheum Dis* 1989;48:254-255.
13. Gorevic PD, Kassab HJ, Levo Y, et al. Mixed cryoglobulinemia: clinical aspects and long-term follow-up of 40 patients. *Am J Med* 1980;69:287-308.
14. Invernizzi F, Galli M, Serino G, et al. Secondary and essential cryoglobulinaemias: frequency, nosological classification, and long-term follow-up. *Acta Haematol* 1983;70:73-82.
15. Osserman E. Plasma cell myeloma. *N Engl J Med* 1959;261:952-960.
16. Dispenzieri A, Gorevic PD. Cryoglobulinaemia. *Hematol Oncol Clin North Am* 1999;13:1315-1349.
17. Monti G, Galli M, Invernizzi F, et al. Cryoglobulinaemias: a multi-centre study of the early clinical and laboratory manifestations of primary and secondary disease. GISC, Italian Group for the Study of Cryoglobulinaemias. *QJM* 1995;88:115-126.
18. Pascual M, Perrin L, Giostra E, et al. Hepatitis C virus in patients with cryoglobulinemia type II. *J Infect Dis* 1990;162:569-570.
19. Ferri C, Greco F, Longombardo G, et al. Antibodies to hepatitis C virus in patients with mixed cryoglobulinemia. *Arthritis Rheum* 1991;34:1606-1610.
20. Disdier P, Harle JR, Weiller PJ. Cryoglobulinaemia and hepatitis C infection. *Lancet* 1991;338:1151-1152.
21. Agnello V, Chung RT, Kaplan LM. A role for hepatitis C virus infection in type II cryoglobulinaemia. *N Engl J Med* 1992;327:1490-1495.
22. Misiani R, Bellavita P, Fenili D, et al. Hepatitis C virus infection in patients with essential mixed



cryoglobulinemia. *Ann Intern Med* 1992;117:573-577.

23. Pechere-Bertschi A, Perrin L, de Saussure P, et al. Hepatitis C: a possible etiology for cryoglobulinaemia type II. *Clin Exp Immunol* 1992;89:419-422.
24. Bichard P, Ounanian A, Girard M, et al. High prevalence of hepatitis C virus RNA in the supernatant and the cryoprecipitate of patients with essential and secondary type II mixed cryoglobulinaemia. *J Hepatol* 1994;21:58-63.
25. Cacoub P, Fabiani FL, Musset L, et al. Mixed cryoglobulinaemia and hepatitis C virus. *Am J Med* 1994;96:124-132.
26. Munoz-Fernandez S, Barbado FJ, Martin Mola E, et al. Evidence of hepatitis C virus antibodies in the cryoprecipitate of patients with mixed cryoglobulinaemia. *J Rheumatol* 1994;21:229-233.
27. Tanaka K, Aiyama T, Imai J, et al. Serum cryoglobulin and chronic hepatitic C virus disease among Japanese patients. *Am J Gastroenterol* 1995;90:1847-1852.
28. Tarantino A, DeVecchi A, Montagnino G, et al. Renal disease in essential mixed cryoglobulinaemia: long-term follow-up of 44 patients. *QJM* 1981;50:1-30.
29. Singer DR, Venning MC, Lockwood CM, et al. Cryoglobulinaemia: clinical features and response to treatment. *Ann Med Interne (Paris)* 1986;137:251-253.
30. Monti G, Saccardo F, Pioltelli P, et al. The natural history of cryoglobulinemia: symptoms at onset and during follow-up: a report by the Italian Group for the Study of Cryoglobulinemias (GISC). *Clin Exp Rheumatol* 1995;[Suppl 13]:S129-S133.
31. Ferri C, LaCivita L, Longombardo G, et al. Mixed cryoglobulinaemia: a cross-road between autoimmune and lymphoproliferative disorders. *Lupus* 1998;7:275-279.
32. Trejo O, Ramos-Casals M, Garcia-Carrasco M, et al. Cryoglobulinemia: study of etiologic factors and clinical and immunologic features in 443 patients from a single center. *Medicine (Baltimore)* 2001;80:252-262.
33. Rieu V, Cohen P, Andre MH, et al. Characteristics and outcome of 49 patients with symptomatic cryoglobulinaemia. *Rheumatology (Oxford)* 2002;41:290-300.
34. Goldman M, Renversez JC, Lambert PH. Pathological expression of idiotypic interactions: immune complexes and cryoglobulins. *Springer Semin Immunopathol* 1983;6:33-49.
35. Wilson MR, Arroyave CM, Miles L, et al. Immune reactants in cryoproteins: relationship to complement activation. *Ann Rheum Dis* 1977;36:540-548.
36. Lunel F, Musset L, Cacoub P, et al. Cryoglobulinemia in chronic liver diseases: role of hepatitis C virus and liver damage. *Gastroenterology* 1994;106:1291-1300.
37. Sansonno D, Iacobelli AR, Cornacchiulo V, et al. Immunochemical and biomolecular studies of circulating immune complexes isolated from patients with acute and chronic hepatitis C virus infection. *Eur J Clin Invest* 1996;26:465-475.
38. Hartmann H, Schott P, Polzien F, et al. Cryoglobulinemia in chronic hepatitis C virus infection: prevalence, clinical manifestations, response to interferon treatment and analysis of cryoprecipitates. *Z Gastroenterol* 1995;33:643-650.
39. Wong VS, Egner W, Elsey T, et al. Incidence, character and clinical relevance of mixed cryoglobulinaemia in patients with chronic hepatitis C virus infection. *Clin Exp Immunol* 1996;104:25-31.
40. Galli M, Monti G, Monteverde A, et al. Hepatitis C virus and mixed cryoglobulinaemias [Letter]. *Lancet* 1992;339:989.
41. Cacoub P, Lunel F, Musset L, et al. Hepatitis C virus and cryoglobulinemia. *N Engl J Med*

1993;328:1121–1122.

42. Pioltelli P, Zehender G, Monti G, et al. HCV and non-Hodgkin lymphoma. *Lancet* 1996;347:624–625.
43. Zignego AL, Ferri C, Giannini C, et al. Hepatitis C virus infection in mixed cryoglobulinemia and B-cell non-Hodgkin's lymphoma: evidence for a pathogenetic role. *Arch Virol* 1997;142:545–555.
44. DeRosa G, Gobbo ML, DeRenzo A, et al. High prevalence of hepatitis C virus infection in patients with B-cell lymphoproliferative disorders in Italy. *Am J Hematol* 1997;55:77–82.
45. Fayyazi A, Schott P, Hartmann H, et al. Clinical, biochemical, and histological changes in hepatitis C virus infection-associated cryoglobulinemia. *Z Gastroenterol* 1997;35:921–928.
46. Lunel F. Hepatitis C virus and autoimmunity: fortuitous association or reality? *Gastroenterology* 1994;107:1550–1555.
47. Schmidt WN, Stapleton JT, LaBrecque DR, et al. Hepatitis C virus (HCV) infection and cryoglobulinemia: analysis of whole blood and plasma HCV-RNA concentrations and correlation with liver histology. *Hepatology* 2000;31:737–744.
48. Garcia-Carrasco M, Ramos-Casals M, Cervera R, et al. Cryoglobulinemia in systemic lupus erythematosus: prevalence and clinical characteristics in a series of 122 patients. *Semin Arthritis Rheum* 2001;30:366–373.
49. Husson JM, Druet P, Contet A, et al. Systemic sclerosis and cryoglobulinemia. *Clin Immunol Immunopathol* 1976;6:77–82.
50. Chattopadhyaya D, Ravindran B, Prakash K. Cryoglobulins in cases of rheumatoid arthritis. *Rheumatol Int* 1985;5:181–184.
51. Tzioufas AG, Manoussakis MN, Costello R, et al. Cryoglobulinemia in autoimmune rheumatic diseases: evidence of circulating monoclonal cryoglobulins in patients with primary Sjögren's syndrome. *Arthritis Rheum* 1986;29:1098–1104.
52. Ramos-Casals M, Cervera R, Yague J, et al. Cryoglobulinemia in primary Sjögren's syndrome: prevalence and clinical characteristics in a series of 115 patients. *Semin Arthritis Rheum* 1998;28:200–205.
53. Mussini C, Mascia MT, Zanni G, et al. A cytomorphological and immunohistochemical study of bone marrow in the diagnosis of essential mixed type II cryoglobulinemia. *Haematologica* 1991;76:389–391.
54. Perl A, Gorevic PD, Ryan DH, et al. Clonal B cell expansions in patients with essential mixed cryoglobulinaemia. *Clin Exp Immunol* 1989;76:54–60.
55. DeVita S, DeRe V, Gasparotto D, et al. Oligoclonal non-neoplastic B cell expansion is the key feature of type II mixed cryoglobulinemia: clinical and molecular findings do not support a bone marrow pathologic diagnosis of indolent B cell lymphoma. *Arthritis Rheum* 2000;43:94–102.
56. Pozzato G, Mazzaro C, Crovatto M, et al. Low-grade malignant lymphoma, hepatitis C virus infection, and mixed cryoglobulinemia. *Blood* 1994;84:3047–3053.
57. Franzin F, Efremov DG, Pozzato G, et al. Clonal B-cell expansions in peripheral blood of HCV-infected patients. *Br J Haematol* 1995;90:548–552.
58. Invernizzi F, Pioltelli P, Cattaneo R, et al. A long-term follow-up study in essential cryoglobulinemia. *Acta Haematol* 1979;61:93–99.
59. Monteverde A, Ballare M, Bertoncelli MC, et al. Lymphoproliferation in type II mixed cryoglobulinemia. *Clin Exp Rheumatol* 1995;[Suppl 13]:S141–S147.
60. Silvestri F, Barillari G, Fanin R, et al. Hepatitis C virus infection among cryoglobulinemic and non-cryoglobulinemic B-cell non-Hodgkin's lymphomas. *Haematologica* 1997;82:314–317.
61. Luppi M, Grazia Ferrari M, Bonaccorsi G, et al. Hepatitis C virus infection in subsets of neoplastic

lymphoproliferations not associated with cryoglobulinemia. *Leukemia* 1996;10:351–355.

62. Wotherspoon AC, Ortiz-Hidalgo C, Falzon MR, et al. *Helicobacter pylori*-associated gastritis and primary B-cell gastric lymphoma. *Lancet* 1991;338:1175–1176.
63. Silverman GJ, Goldfien RD, Chen P, et al. Idiotypic and subgroup analysis of human monoclonal rheumatoid factors: implications for structural and genetic basis of autoantibodies in humans. *J Clin Invest* 1988;82:469–475.
64. Crowley JJ, Goldfien RD, Schrohenloher RE, et al. Incidence of three cross-reactive idiotypes on human rheumatoid factor paraproteins. *J Immunol* 1988;140:3411–3418.
65. Fong S, Chen PP, Crowley JJ, et al. Idiotypic characteristics of rheumatoid factors. *Scand J Rheumatol Suppl* 1988;75:58–65.
66. DeRe V, DeVita S, Marzotto A, et al. Sequence analysis of the immunoglobulin antigen receptor of hepatitis C virus-associated non-Hodgkin lymphomas suggests that the malignant cells are derived from the rheumatoid factor-producing cells that occur mainly in type II cryoglobulinemia. *Blood* 2000;96:3578–3584.
67. Chan CH, Hadlock KG, Fong SK, et al. VH1–69 gene is preferentially used by hepatitis C virus-associated B cell lymphomas and by normal B cells responding to the E2 viral antigen. *Blood* 2001;97:1023–1026.
68. Sasso EH, Ghillani P, Musset L, et al. Effect of 51p1-related gene copy number (V1–69 locus) on production of hepatitis C-associated cryoglobulins. *Clin Exp Immunol* 2001;123:88–93.
69. Ivanovski M, Silvestri F, Pozzato G, et al. Somatic hypermutation, clonal diversity, and preferential expression of the VH 51p1/VL kv325 immunoglobulin gene combination in hepatitis C virus-associated immunocytomas. *Blood* 1998;91:2433–2442.
70. DeRe V, DeVita S, Gasparotto D, et al. Salivary gland B cell lymphoproliferative disorders in Sjögren's syndrome present a restricted use of antigen receptor gene segments similar to those used by hepatitis C virus-associated non-Hodgkin's lymphomas. *Eur J Immunol* 2002;32:903–910.
71. Ferri C, Monti M, LaCivita L, et al. Infection of peripheral blood mononuclear cells by hepatitis C virus in mixed cryoglobulinemia. *Blood* 1993;82:3701–3704.
72. Lau JY, Mizokami M, Kolberg JA, et al. Application of six hepatitis C virus genotyping systems to sera from chronic hepatitis C patients in the United States. *J Infect Dis* 1995;171:281–289.
73. Frangeul L, Musset L, Cresta P, et al. Hepatitis C virus genotypes and subtypes in patients with hepatitis C, with and without cryoglobulinemia. *J Hepatol* 1996;25:427–432.
74. Galli M, Zehender G, Monti G, et al. Hepatitis C virus RNA in the bone marrow of patients with mixed cryoglobulinemia and in subjects with noncryoglobulinemic chronic hepatitis type C. *J Infect Dis* 1995;171:672–675.
75. Zehender G, de Maddalena C, Monti G, et al. HCV genotypes in bone marrow and peripheral blood mononuclear cells of patients with mixed cryoglobulinemia. *Clin Exp Rheumatol* 1995;[Suppl 13]:S87–S90.
76. Willems M, Sheng L, Roskams T, et al. Hepatitis C virus and its genotypes in patients suffering from chronic hepatitis C with or without a cryoglobulinemia-related syndrome. *J Med Virol* 1994;44:266–271.
77. Zignego AL, Giannelli F, Marrocchi ME, et al. T(14;18) translocation in chronic hepatitis C virus infection. *Hepatology* 2000;31:474–479.
78. Kitay-Cohen Y, Amiel A, Hilzenrat N, et al. Bcl-2 rearrangement in patients with chronic hepatitis C associated with essential mixed cryoglobulinemia type II. *Blood* 2000;96:2910–2912.
79. Zuckerman E, Zuckerman T, Sahar D, et al. bcl-2 and immunoglobulin gene rearrangement in patients with hepatitis C virus infection. *Br J Haematol* 2001;112:364–369.
80. Ferri C, Monti M, LaCivita L, et al. Hepatitis C virus infection in non-Hodgkin's B-cell lymphoma

complicating mixed cryoglobulinaemia. *Eur J Clin Invest* 1994;24:781–784.

81. Gabrielli A, Manzin A, Candela M, et al. Active hepatitis C virus infection in bone marrow and peripheral blood mononuclear cells from patients with mixed cryoglobulinaemia. *Clin Exp Immunol* 1994;97:87–93.
82. Sansonno D, DeVita S, Cornacchiulo V, et al. Detection and distribution of hepatitis C virus-related proteins in lymph nodes of patients with type II mixed cryoglobulinemia and neoplastic or non-neoplastic lymphoproliferation. *Blood* 1996;88:4638–4645.
83. Silvestri F, Barillari G, Fanin R, et al. Impact of hepatitis C virus infection on clinical features, quality of life and survival of patients with lymphoplasmacytoid lymphoma/immunocytoma. *Ann Oncol* 1998;9:499–504.
84. Mendez P, Saeian K, Reddy KR, et al. Hepatitis C, cryoglobulinemia, and cutaneous vasculitis associated with unusual and serious manifestations. *Am J Gastroenterol* 2001;96:2489–2493.
85. Donada C, Crucitti A, Donadon V, et al. Systemic manifestations and liver disease in patients with chronic hepatitis C and type II or III mixed cryoglobulinaemia. *J Viral Hepat* 1998;5:179–185.
86. Montagnino G. Reappraisal of the clinical expression of mixed cryoglobulinemia. *Springer Semin Immunopathol* 1988;10:1–19.
87. Cohen SJ, Pittelkow MR, Su WP. Cutaneous manifestations of cryoglobulinemia: clinical and histopathologic study of seventy-two patients. *J Am Acad Dermatol* 1991;25:21–27.
88. Chad D, Pariser K, Bradley WG, et al. The pathogenesis of cryoglobulinemic neuropathy. *Neurology* 1982;32:725–729.
89. Nemni R, Corbo M, Fazio R, et al. Cryoglobulinaemic neuropathy: a clinical, morphological and immunocytochemical study of 8 cases. *Brain* 1988;111:541–552.
90. Cavaletti G, Petruccioli MG, Crespi V, et al. A clinico-pathological and follow-up study of 10 cases of essential type II cryoglobulinaemic neuropathy. *J Neurol Neurosurg Psychiatry* 1990;53:886–889.
91. Khella SL, Frost S, Hermann GA, et al. Hepatitis C infection, cryoglobulinemia, and vasculitic neuropathy: treatment with interferon alfa: case report and literature review. *Neurology* 1995;45:407–411.
92. Garcia-Bragado F, Fernandez JM, Navarro C, et al. Peripheral neuropathy in essential mixed cryoglobulinemia. *Arch Neurol* 1988;45:1210–1214.
93. Valli G, DeVecchi A, Gaddi L, et al. Peripheral nervous system involvement in essential cryoglobulinemia and nephropathy. *Clin Exp Rheumatol* 1989;7:479–483.
94. Cordonnier D, Vialtel P, Renversez JC, et al. Renal diseases in 18 patients with mixed type II IgM–IgG cryoglobulinemia: monoclonal lymphoid infiltration (2 cases) and membranoproliferative glomerulonephritis (14 cases). *Adv Nephrol Necker Hosp* 1983;12:177–204.
95. D’Amico G. Renal involvement in hepatitis C infection: cryoglobulinemic glomerulonephritis. *Kidney Int* 1998;54:650–671.
96. Tarantino A, Campise M, Banfi G, et al. Long-term predictors of survival in essential mixed cryoglobulinemic glomerulonephritis. *Kidney Int* 1995;47:618–623.
97. Gorevic PD, Frangione B. Mixed cryoglobulinemia cross-reactive idiotypes: implications for the relationship of MC to rheumatic and lymphoproliferative diseases. *Semin Hematol* 1991;28:79–94.
98. Levo Y, Gorevic PD, Kassab HJ, et al. Liver involvement in the syndrome of mixed cryoglobulinemia. *Ann Intern Med* 1977;87:287–292.
99. Monteverde A, Ballare M, Pileri S. Hepatic lymphoid aggregates in chronic hepatitis C and mixed cryoglobulinemia. *Springer Semin Immunopathol* 1997;19:99–110.

100. Kallemuchikkal U, Gorevic PD. Evaluation of cryoglobulins. *Arch Pathol Lab Med* 1999;123:119–125.
101. Cream JJ. Clinical and immunological aspects of cutaneous vasculitis. *QJM* 1976;45:255–276.
102. Tarantino A, Anelli A, Costantino A, et al. Serum complement pattern in essential mixed cryoglobulinaemia. *Clin Exp Immunol* 1978;32:77–85.
103. Ferri C, Moriconi L, Gremignai G, et al. Treatment of the renal involvement in mixed cryoglobulinemia with prolonged plasma exchange. *Nephron* 1986;43:246–253.
104. Frankel AH, Singer DR, Winearls CG, et al. Type II essential mixed cryoglobulinaemia: presentation, treatment and outcome in 13 patients. *QJM* 1992;82:101–124.
105. Ferri C, Marzo E, Longombardo G, et al. Interferon-alpha in mixed cryoglobulinemia patients: a randomized, crossover-controlled trial. *Blood* 1993;81:1132–1136.
106. DiGiovanni S, DeMatteis MA, Ciocca D, et al. Pseudothrombocytosis and pseudoleukocytosis in a case of essential mixed cryoglobulinemia (type II). *Clin Exp Rheumatol* 1986;4:143–145.
107. Ferri C, Marzo E, Longombardo G, et al. Interferon alfa-2b in mixed cryoglobulinaemia: a controlled crossover trial. *Gut* 1993;34:S144–S145.
108. Misiani R, Bellavita P, Fenili D, et al. Interferon alfa-2a therapy in cryoglobulinemia associated with hepatitis C virus. *N Engl J Med* 1994;330:751–756.
109. Dammacco F, Sansonno D, Han JH, et al. Natural interferon-alpha versus its combination with 6-methyl-prednisolone in the therapy of type II mixed cryoglobulinemia: long-term, randomized, controlled study. *Blood* 1994;84:3336–3343.
110. Lauta VM, De Sangro MA. Long-term results regarding the use of recombinant interferon alpha-2b in the treatment of II type mixed essential cryoglobulinemia. *Med Oncol* 1995;12:223–230.
111. Mazzaro C, Lacchin T, Moretti M, et al. Effects of two different alpha-interferon regimens on clinical and virological findings in mixed cryoglobulinemia. *Clin Exp Rheumatol* 1995;[Suppl 13]:S181–S185.
112. Ferri C, Pietrogrande M, Cecchetti R, et al. Low-antigen-content diet in the treatment of patients with mixed cryoglobulinemia. *Am J Med* 1989;87:519–524.
113. Durand JM, Cacoub P, Lunel-Fabiani F, et al. Ribavirin in hepatitis C related cryoglobulinemia. *J Rheumatol* 1998;25:1115–1117.
114. Geltner D, Kohn RW, Gorevic P, et al. The effect of combination therapy (steroids, immunosuppressives, and plasmapheresis) on 5 mixed cryoglobulinemia patients with renal, neurologic, and vascular involvement. *Arthritis Rheum* 1981;24:1121–1127.
115. Valbonesi M, Montani F, Mosconi L, et al. Plasmapheresis and cytotoxic drugs for mixed cryoglobulinemia. *Haematologia* 1984;17:341–351.
116. Sinico RA, Fornasieri A, Fiorini G, et al. Plasma exchange in the treatment of essential mixed cryoglobulinemia nephropathy: long-term follow-up. *Int J Artif Organs* 1985;[Suppl 2]:15–18.
117. Berkman EM, Orlin JB. Use of plasmapheresis and partial plasma exchange in the management of patients with cryoglobulinemia. *Transfusion* 1980;20:171–178.
118. McLeod BC, Sasseti RJ. Plasmapheresis with return of cryoglobulin-depleted autologous plasma (cryoglobulinpheresis) in cryoglobulinemia. *Blood* 1980;55:866–870.
119. Reik L Jr, Korn JH. Cryoglobulinemia with encephalopathy: successful treatment by plasma exchange. *Ann Neurol* 1981;10:488–490.
120. Ristow SC, Griner PF, Abraham GN, et al. Reversal of systemic manifestations of cryoglobulinemia:

treatment with melphalan and prednisone. *Arch Intern Med* 1976;136:467–470.

121. Volpe R, Bruce–Robertson A, Fletcher AA, et al. Essential cryoglobulinemia: review of the literature and report of a case treated with ACTH and cortisone. *Am J Med* 1956;20:533–553.

122. DeVecchi A, Montagnino G, Pozzi C, et al. Intravenous methylprednisolone pulse therapy in essential mixed cryoglobulinemia nephropathy. *Clin Nephrol* 1983;19:221–227.

123. Ponticelli C, Imbasciati E, Tarantino A, et al. Acute anuric glomerulonephritis in monoclonal cryoglobulinaemia. *Br Med J* 1977;1:948.

124. Mathison DA, Condemi JJ, Leddy JP, et al. Purpura, arthralgia, and IgM–IgM cryoglobulinemia with rheumatoid factor activity: response to cyclophosphamide and splenectomy. *Ann Intern Med* 1971;74:383–390.

125. Germain MJ, Anderson RW, Keane WF. Renal disease in cryoglobulinemia type II: response to therapy: a case report and review of the literature. *Am J Nephrol* 1982;2:221–226.

126. Quigg RJ, Brathwaite M, Gardner DF, et al. Successful cyclophosphamide treatment of cryoglobulinemic membranoproliferative glomerulonephritis associated with hepatitis C virus infection. *Am J Kidney Dis* 1995;25:798–800.

127. Ballare M, Bobbio F, Poggi S, et al. A pilot study on the effectiveness of cyclosporine in type II mixed cryoglobulinemia. *Clin Exp Rheumatol* 1995;[Suppl 13]:S201–S203.

128. Monti G, Saccardo F, Rinaldi G, et al. Colchicine in the treatment of mixed cryoglobulinemia. *Clin Exp Rheumatol* 1995;[Suppl 13]:S197–S199.

129. Barton JC, Herrera GA, Galla JH, et al. Acute cryoglobulinemic renal failure after intravenous infusion of gamma globulin. *Am J Med* 1987;82:624–629.

130. Boom BW, Brand A, Bavinck JN, et al. Severe leukocytoclastic vasculitis of the skin in a patient with essential mixed cryoglobulinemia treated with high–dose gamma–globulin intravenously. *Arch Dermatol* 1988;124:1550–1553.

131. Enzenauer RJ, Judson PH. Type II mixed cryoglobulinemia treated with fludarabine. *J Rheumatol* 1996;23:794–795.

132. Zaja F. Fludarabine in the treatment of essential mixed cryoglobulinaemia. *Eur J Haematol* 1996;57:259–260.

133. Odum J, D’Costa D, Freeth M, et al. Cryoglobulinaemic vasculitis caused by intravenous immunoglobulin treatment. *Nephrol Dial Transplant* 2001;16:403–406.

134. Dispenzieri A. Symptomatic cryoglobulinemia. *Curr Treat Options Oncol* 2000;1:105–118.

135. Migliaresi S, Tirri G. Interferon in the treatment of mixed cryoglobulinemia. *Clin Exp Rheumatol* 1995;[Suppl 13]:S175–S180.

136. D’Amico G. Is type II mixed cryoglobulinaemia an essential part of hepatitis C virus (HCV)–associated glomerulonephritis? *Nephrol Dial Transplant* 1995;10:1279–1282.

137. Casato M, Lagana B, Antonelli G, et al. Long–term results of therapy with interferon–alpha for type II essential mixed cryoglobulinemia. *Blood* 1991;78:3142–3147.

138. Cresta P, Musset L, Cacoub P, et al. Response to interferon alpha treatment and disappearance of cryoglobulinaemia in patients infected by hepatitis C virus. *Gut* 1999;45:122–128.

139. Cid MC, Hernandez–Rodriguez J, Robert J, et al. Interferon–alpha may exacerbate cryoglobulinemia–related ischemic manifestations: an adverse effect potentially related to its anti–angiogenic activity. *Arthritis Rheum* 1999;42:1051–1055.

140. Bonomo L, Casato M, Afeltra A, et al. Treatment of idiopathic mixed cryoglobulinemia with alpha

interferon. *Am J Med* 1987;83:726–730.

141. Calleja JL, Albillos A, Moreno-Otero R, et al. Sustained response to interferon-alpha or to interferon-alpha plus ribavirin in hepatitis C virus-associated symptomatic mixed cryoglobulinaemia. *Aliment Pharmacol Ther* 1999;13:1179–1186.

142. Donada C, Crucitti A, Donadon V, et al. Interferon and ribavirin combination therapy in patients with chronic hepatitis C and mixed cryoglobulinemia. *Blood* 1998;92:2983–2984.

143. Frickhofen N, Wiesneth M, Jainta C, et al. Hepatitis C virus infection is a risk factor for liver failure from veno-occlusive disease after bone marrow transplantation. *Blood* 1994;83:1998–2004.

144. Ubara Y, Hara S, Katori H, et al. Splenectomy may improve the glomerulopathy of type II mixed cryoglobulinemia. *Am J Kidney Dis* 2000;35:1186–1192.

145. Seligmann M, Danon F, Hurez D, et al. Alpha-chain disease: a new immunoglobulin abnormality. *Science* 1968;162:1396–1397.

146. Franklin EC, Lowenstein J, Bigelow B, et al. Heavy chain disease: a new disorder of serum  $\gamma$ -globulins: report of the first case. *Am J Med* 1964;37:332–350.

147. Ballard HS, Hamilton LM, Marcus AJ, et al. A new variant of heavy-chain disease ( $\mu$ -chain disease). *N Engl J Med* 1970;282:1060–1062.

148. Forte FA, Prelli F, Yount WJ, et al. Heavy chain disease of the gamma ( $\gamma$ M) type: report of the first case. *Blood* 1970;36:137–144.

149. Wahner-Roedler DL, Kyle RA.  $\mu$ -heavy chain disease: presentation as a benign monoclonal gammopathy. *Am J Hematol* 1992;40:56–60.

150. Galanti LM, Doyen C, Vander Maelen C, et al. Biological diagnosis of a  $\gamma$ 1-heavy chain disease in an asymptomatic patient. *Eur J Haematol* 1995;54:202–204.

151. Seijffers MJ, Levy M, Hermann G. Intractable watery diarrhea, hypokalemia, and malabsorption in a patient with Mediterranean type of abdominal lymphoma. *Gastroenterology* 1968;55:118–124.

152. Rambaud JC, Galian A, Matuchansky C, et al. Natural history of alpha-chain disease and the so-called Mediterranean lymphoma. *Recent Results Cancer Res* 1978;64:271–276.

153. Alpha-chain disease and related small-intestinal lymphoma: a memorandum. *Bull World Health Organ* 1976;54:615–624.

154. Fine KD, Stone MJ. Alpha-heavy chain disease, Mediterranean lymphoma, and immunoproliferative small intestinal disease: a review of clinicopathological features, pathogenesis, and differential diagnosis. *Am J Gastroenterol* 1999;94:1139–1152.

155. Rambaud JC, Halphen M, Galian A, et al. Immunoproliferative small intestinal disease (IPSID): relationships with alpha-chain disease and “Mediterranean” lymphomas. *Springer Semin Immunopathol* 1990;12:239–250.

156. Goossens T, Klein U, Kuppers R. Frequent occurrence of deletions and duplications during somatic hypermutation: implications for oncogene translocations and heavy chain disease. *Proc Natl Acad Sci U S A* 1998;95:2463–2468.

157. Loughran TP Jr, Kadin ME, Deeg HJ. T-cell intestinal lymphoma associated with celiac sprue. *Ann Intern Med* 1986;104:44–47.

158. Galian A, Lecestre MJ, Scotto J, et al. Pathological study of alpha-chain disease, with special emphasis on evolution. *Cancer* 1977;39:2081–2101.

159. Mir-Madjlessi SH, Mir-Ahmadian M. Alpha-chain disease: a report of eleven patients from Iran. *J Trop Med Hyg* 1979;82:229–236.



160. Zamir A, Parasher G, Moukarzel AA, et al. Immunoproliferative small intestinal disease in a 16-year-old boy presenting as severe malabsorption with excellent response to tetracycline treatment. *J Clin Gastroenterol* 1998;27:85-89.
161. Martin IG, Aldoori MI. Immunoproliferative small intestinal disease: Mediterranean lymphoma and alpha heavy chain disease. *Br J Surg* 1994;81:20-24.
162. Salimi M, Spinelli JJ. Chemotherapy of Mediterranean abdominal lymphoma: retrospective comparison of chemotherapy protocols in Iranian patients. *Am J Clin Oncol* 1996;19:18-22.
163. Ben-Ayed F, Halphen M, Najjar T, et al. Treatment of alpha chain disease: results of a prospective study in 21 Tunisian patients by the Tunisian-French Intestinal Lymphoma Study Group. *Cancer* 1989;63:1251-1256.
164. Akbulut H, Soykan I, Yakaryilmaz F, et al. Five-year results of the treatment of 23 patients with immunoproliferative small intestinal disease: a Turkish experience. *Cancer* 1997;80:8-14.
165. Price SK. Immunoproliferative small intestinal disease: a study of 13 cases with alpha heavy-chain disease. *Histopathology* 1990;17:7-17.
166. Shih LY, Liaw SJ, Dunn P, et al. Primary small-intestinal lymphomas in Taiwan: immunoproliferative small-intestinal disease and nonimmunoproliferative small-intestinal disease. *J Clin Oncol* 1994;12:1375-1382.
167. Malik IA, Shamsi Z, Shafquat A, et al. Clinicopathological features and management of immunoproliferative small intestinal disease and primary small intestinal lymphoma in Pakistan. *Med Pediatr Oncol* 1995;25:400-406.
168. McLaughlin P, Grillo-Lopez AJ, Link BK, et al. Rituximab chimeric anti-CD20 monoclonal antibody therapy for relapsed indolent lymphoma: half of patients respond to a four-dose treatment program. *J Clin Oncol* 1998;16:2825-2833.
169. Femand JP, Brouet JC. Heavy-chain diseases. *Hematol Oncol Clin North Am* 1999;13:1281-1294.
170. Pruzanski W, Hasselback R, Katz A, et al. Multiple myeloma (light chain disease) with rheumatoid-like amyloid arthropathy and mu-heavy chain fragment in the serum. *Am J Med* 1978;65:334-341.
171. Mihaesco E, Barnikol-Watanabe S, Barnikol HU, et al. The primary structure of the constant part of mu-chain-disease protein BOT. *Eur J Biochem* 1980;111:275-286.
172. Brouet JC, Seligmann M, Danon F, et al. mu-Chain disease: report of two new cases. *Arch Intern Med* 1979;139:672-674.
173. Kyle RA, Greipp PR, Banks PM. The diverse picture of gamma heavy-chain disease: report of seven cases and review of literature. *Mayo Clin Proc* 1981;56:439-451.
174. Lassoued K, Picard C, Danon F, et al. Cutaneous manifestations associated with gamma heavy chain disease: report of an unusual case and review of literature. *J Am Acad Dermatol* 1990;23:988-991.
175. Zawadzki ZA, Benedek TG, Ein D, et al. Rheumatoid arthritis terminating in heavy-chain disease. *Ann Intern Med* 1969;70:335-347.
176. Jacqueline F, Renversez JC, Gros Lambert P, et al. Gamma heavy chain disease during rheumatoid polyarthritis: a clinical and immunochemical study [French]. *Rev Rhum Mal Osteoartic* 1978;45:661-665.
177. Gaucher A, Bertrand F, Brouet JC, et al. Gamma heavy chain disease associated with rheumatoid arthritis: spontaneous disappearance of the pathologic protein [French]. *Sem Hop* 1977;53:2117-2120.
178. Westin J, Eyrich R, Falsen E, et al. Gamma heavy chain disease: reports of three patients. *Acta Med Scand* 1972;192:281-292.
179. Lyons RM, Chaplin H, Tillack TW, et al. Gamma heavy chain disease: rapid, sustained response to

cyclophosphamide and prednisone. *Blood* 1975;46:1-9.

180. Wager O, Rasanen JA, Lindeberg L, et al. Two cases of IgG heavy-chain disease. *Acta Pathol Microbiol Scand* 1969;75:350-352.

181. Frangione B, Franklin EC. Heavy chain diseases: clinical features and molecular significance of the disordered immunoglobulin structure. *Semin Hematol* 1973;10:53-64.

182. Wester SM, Banks PM, Li CY. The histopathology of gamma heavy-chain disease. *Am J Clin Pathol* 1982;78:427-436.

2004 Lippincott Williams & Wilkins  
John P. Greer, John Foerster, John N. Lukens  
George M. Rodgers, Frixos Paraskevas, Bertil Glader  
Wintrobe's Clinical Hematology

## APPENDIX A: Normal Blood and Bone Marrow Values in Humans

**REFERENCES**

**TABLE A.1. Hematology Reference Values in Normal Adults**

| Test   | Men  |   | Women                                      |   |
|--|--|---|--|---|
|  | Conventional Units                         | SI  | Conventional Units                         | SI  |
| Hemoglobin   | 14.0–17.4 g/dl                             | 140–175 g/L                               | 12.3–15.3 g/dl                             | 123–153 g/L                               |
| Hematocrit (volume of packed red cells)              | 41.5–50.4                                  | 0.415–0.504                               | 36–45                                      | 0.36–0.45                                 |
| Red cell count                                       | $4.5\text{--}5.9 \times 10^6/\mu\text{l}$  | $4.5\text{--}5.9 \times 10^{12}/\text{L}$ | $4.5\text{--}5.1 \times 10^6/\mu\text{l}$  | $4.5\text{--}5.1 \times 10^{12}/\text{L}$ |
| White cell count                                     | $4.4\text{--}11.3 \times 10^3/\mu\text{l}$ | $4.4\text{--}11.3 \times 10^9/\text{L}$   | $4.4\text{--}11.3 \times 10^6/\mu\text{l}$ | $4.4\text{--}11.3 \times 10^9/\text{L}$   |
| Mean corpuscular volume (fl)                         | 80–96                                      | 80–96                                     | 80–96                                      | 80–96                                     |
| Mean corpuscular hemoglobin (pg)                     | 27.5–33.2                                  | 27.5–33.2                                 | 27.5–33.2                                  | 27.5–33.2                                 |
| Mean corpuscular hemoglobin concentration            | 33.4–35.5 g/dl                             | 334–355 g/L                               | 33.4–35.5 g/dl                             | 334–355 g/L                               |
| Platelet count                                       | $150\text{--}450 \times 10^3/\mu\text{l}$  | $150\text{--}450 \times 10^9/\text{L}$    | $150\text{--}450 \times 10^3/\mu\text{l}$  | $150\text{--}450 \times 10^9/\text{L}$    |
| Reticulocyte count                                   | 0.5–2.5%                                   | 0.005–0.025                               | 0.5–2.5%                                   | 0.005–0.025                               |
| Reticulocyte count                                   | 22,500–147,500/mm <sup>3</sup>             | 22.5–147.5 $\times 10^9/\text{L}$         | 22,500–147,500/mm <sup>3</sup>             | 22.5–147.5 $\times 10^9/\text{L}$         |
| Sedimentation rate (Westergren) <50 yr of age (mm/h) | 0–15                                       | 0–15                                      | 0–20                                       | 0–20                                      |
| Z sedimentation rate                                 | 41–54                                      | 41–54                                     | 41–54                                      | 41–54                                     |

SI, Système International d'Unites.  
Values derived from references [1](#), [2](#) and [3](#).

**TABLE A.2. Automated Hematology Reference Values in Normal Men at 4500 Ft**

|  | Coulter S ± ST (80 Men) | Technicon H1 (64 Men) |
|--|-------------------------|-----------------------|
|--|-------------------------|-----------------------|

|  | Mean | Central 95% Range | Mean | Central 95% Range |
|--|------|-------------------|------|-------------------|
| White blood cells ( $\times 10^9/L$ )            | 6.6  | 3.5–9.8           | 6.7  | 4.4–8.2           |
| Platelets ( $\times 10^9/L$ )                    | 280  | 147–412           | 285  | 147–422           |
| Red blood cells ( $\times 10^{12}/L$ )           | 5.4  | 4.76–6.04         | 5.54 | 4.87–6.20         |
| Hemoglobin (g/dl)                                | 16.4 | 14.7–18.1         | 16.2 | 14.6–17.8         |
| Hematocrit (%)                                   | 48.7 | 43.7–53.6         | 48.7 | 43.6–53.8         |
| Mean corpuscular volume (fl)                     | 90.3 | 83.3–97.2         | 88.0 | 80.9–95.2         |
| Mean corpuscular hemoglobin (pg)                 | 30.5 | 28.1–32.9         | 29.3 | 27.0–31.7         |
| Mean corpuscular hemoglobin concentration (g/dl) | 33.8 | 33.0–34.6         | 33.3 | 32.1–34.6         |
| Red cell distribution width                      | 12.4 | 11.5–13.4         | 12.8 | 12.0–13.6         |
| Mean platelet volume                             | 8.4  | 6.8–10.0          | 8.9  | 7.6–10.2          |

NOTE: Data are based on measurements from healthy male medical students, 23 to 31 years of age, at an altitude of 4500 ft, January 1989.

TABLE A.3. Commonly Used Hematology Reference Values in Normal Adults

| Test                        | Men                             |                                    | Women                           |                                    |
|-----------------------------|---------------------------------|------------------------------------|---------------------------------|------------------------------------|
|                             | Conventional Units              | SI                                 | Conventional Units              | SI                                 |
| Serum iron                  | 60–150 $\mu\text{g}/\text{dl}$  | 10.7–26.9 $\mu\text{mol}/\text{L}$ | 60–150 $\mu\text{g}/\text{dl}$  | 10.7–26.9 $\mu\text{mol}/\text{L}$ |
| Total iron binding capacity | 250–435 $\mu\text{g}/\text{dl}$ | 44.8–77.7 $\mu\text{mol}/\text{L}$ | 250–435 $\mu\text{g}/\text{dl}$ | 44.8–77.7 $\mu\text{mol}/\text{L}$ |
| Ferritin                    | 15–200 ng/ml                    | 15–200 ng/ml                       | 12–150 ng/ml                    | 12–150 ng/ml                       |
| Serum B <sub>12</sub>       | 160–950 pg/ml                   | 118–701 pmol/L                     | 160–950 pg/ml                   | 118–701 pmol/L                     |
| Serum folate                | 2–25 ng/ml                      | 4–56 nmol/L                        | 2–25 ng/ml                      | 4–56 nmol/L                        |
| Red cell folate             | 140–640 ng/ml                   | 550–1450 nmol/L                    | 140–640 ng/ml                   | 550–1450 nmol/L                    |
| Hemoglobin A <sub>2</sub>   | 1.5–3.5%                        | 0.015–0.035                        | 1.5–3.5%                        | 0.015–0.035                        |
| Hemoglobin F                | <2%                             | <0.02                              | <2%                             | <0.02                              |

SI, Système International d'Unites.  
Values derived from 1–3.

TABLE A.4. Measures of Red Cell Concentration in Normal Adults at Sea Level

| Determination                       | Method              | Men  |           | Women |           |
|-------------------------------------|---------------------|------|-----------|-------|-----------|
|                                     |                     | Mean | 95% Range | Mean  | 95% Range |
| Erythrocytes ( $\times 10^{12}/L$ ) | Hematocytometer (4) | 5.4  | 4.5–6.3   | 4.8   | 4.2–5.5   |

|                                |                          |      |            |      |           |
|--------------------------------|--------------------------|------|------------|------|-----------|
| Hemoglobin (g/dl)              | Electronic ( 5)          | 5.2  | 4.4–6.0    | —    | —         |
|                                | Cyanmethemoglobin ( 4)   | 16.0 | 14.0–18.0  | 14.0 | 12.0–16.0 |
| Volume packed red cells (L/L)  | Macro ( 4)               | 0.47 | 0.40–0.54  | 0.42 | 0.37–0.47 |
|                                | Micro ( 5)               | 0.46 | 0.41–0.51  | —    | —         |
| Reticulocytes ( 6, 7)          |                          |      |            |      |           |
| %                              | New methylene blue       | 1.6  | 0.8–3.0    | 1.6  | 0.8–3.0   |
| $\times 10^9/L$                | —                        | 88   | 18–158     | 88   | 18–158    |
| %                              | Electronic               | 1.6  | 0.8–3.0    | 1.6  | 0.8–3.0   |
| $\times 10^9/L$                |                          | 57.7 | 30.5–101.2 | 46.8 | 22.0–94.0 |
| Sedimentation rate (mm/h) ( 8) | —                        |      |            |      |           |
| —                              | Wintrobe or Westergren 4 | —    | 0–15       | 10   | 0–20      |
| %                              | Z sedimentation rate     | —    | 40–52      | —    | 40–52     |

**TABLE A.5. Erythrocyte Indices in Normal Adults**

|  | Method                   | Mean | 95% Limits |
|--|--------------------------|------|------------|
| Mean corpuscular volume (fl)                         | RBC: hemacytometer       | 87   | 80–94      |
|  | VPRC: macro ( 4)         |      |            |
|  | RBC: electronic          | 90   | 83–97      |
|  | VPRC: micro ( 9)         |      |            |
|  | RBC: hemacytometer       | 85   | 77–93      |
|  | VPRC: micro ( 5)         |      |            |
|  | RBC: electronic          | 88   | 80–96      |
|  | VPRC: micro ( 5)         |      |            |
| Mean corpuscular hemoglobin (pg/cell)                | Coulter model STKS ( 10) | 91   | 78.5–98.0  |
|  | RBC: hemacytometer ( 4)  | 29   | 26–32      |
|  | Coulter model STKS ( 10) | 31   | 27–34      |
| Mean corpuscular hemoglobin concentration (g/dl RBC) | VPRC: macro              | 34   | 32–36      |
|  | VPRC: micro ( 5)         | 33   | 31–35      |
|  | Coulter model STKS ( 10) | 34   | 33.5–36.0  |

RBC, red blood cell; VPRC, volume of packed red cells.

**TABLE A.6. Effect of Altitude on Volume of Packed Red Cells (VPRC) in Normal Men**

| Altitude |                                  |
|----------|----------------------------------|
| Feet     | Meters N VPRC (L/L) <sup>a</sup> |

|        |      |     |       |
|--------|------|-----|-------|
| 0      | 0    | 721 | 0.47  |
| 4400   | 1340 | 744 | 0.495 |
| 7457   | 2280 | 100 | 0.51  |
| 12,240 | 3740 | 40  | 0.54  |
| 14,900 | 4540 | 32  | 0.61  |
| 17,800 | 5430 | 10  | 0.69  |

<sup>a</sup> Mean values in males.  
From reference [9](#).

**TABLE A.7. Effect of Pregnancy, with and without Iron Supplementation, on Values for Volume of Packed Red Cells and Hemoglobin**

| Wk of Gestation | Volume of Packed Red Cells (Mean, L/L) |                                       |                              | Hemoglobin (Mean, g/dl) |                                       |                              |
|-----------------|--|---------------------------------------|------------------------------|-------------------------|---------------------------------------|------------------------------|
|                 | No Supplement                          | Intramuscular Supplement <sup>a</sup> | Oral Supplement <sup>b</sup> | No Supplement           | Intramuscular Supplement <sup>a</sup> | Oral Supplement <sup>b</sup> |
| 0               | 0.420                                  | —                                     | —                            | 13.4                    | —                                     | —                            |
| 12              | 0.383                                  | 0.406                                 | 0.357                        | 12.5                    | 13.1                                  | 11.4                         |
| 16              | 0.395                                  | 0.379                                 | 0.363                        | 12.4                    | 12.1                                  | 11.4                         |
| 20              | 0.364                                  | 0.370                                 | 0.371                        | 11.7                    | 11.8                                  | 11.8                         |
| 24              | 0.356                                  | 0.363                                 | 0.371                        | 11.4                    | 11.8                                  | 11.8                         |
| 28              | 0.346                                  | 0.369                                 | 0.368                        | 11.0                    | 11.8                                  | 11.8                         |
| 32              | 0.341                                  | 0.372                                 | 0.370                        | 10.6                    | 12.1                                  | 11.8                         |
| 36              | 0.343                                  | 0.375                                 | 0.375                        | 10.7                    | 12.1                                  | 12.0                         |
| 40              | 0.349                                  | 0.385                                 | 0.387                        | 10.9                    | 12.7                                  | 12.4                         |
| Days Postpartum |  |                                       |                              |                         |                                       |                              |
| 2               | 0.336                                  | 0.371                                 | 0.373                        | 10.4                    | 12.2                                  | 11.9                         |
| 6               | 0.349                                  | 0.389                                 | 0.401                        | 10.7                    | 12.4                                  | 12.8                         |
| 21              | 0.381                                  | 0.420                                 | 0.411                        | 11.6                    | 13.6                                  | 13.0                         |
| 42              | 0.391                                  | 0.415                                 | 0.398                        | 11.9                    | 13.1                                  | 12.6                         |
| 180             | 0.392                                  | 0.401                                 | 0.408                        | 12.1                    | 12.4                                  | 12.9                         |

NOTE: Approximately 20 individuals were in each group.

<sup>a</sup> 1000 mg Fe as iron dextran administered IM.

<sup>b</sup> 39 mg elemental iron twice daily.

From reference [11](#).

**TABLE A.8. Estimation of Red Cell, Plasma, and Total Blood Volume in Adult Men and Women**

|  | Men | Women |
|--|-----|-------|
|--|-----|-------|

| Volume                             |      |      |         |     |      |         |
|------------------------------------|------|------|---------|-----|------|---------|
|                                    | a    | b    | SD (ml) | a   | b    | SD (ml) |
| Red blood cell volume <sup>a</sup> | 490  | 21.4 | 200     | 409 | 18.3 | 139     |
| Plasma volume <sup>b</sup>         | 1050 | 19.6 | 260     | 455 | 28.9 | 213     |
| Total blood volume <sup>b</sup>    | 1530 | 41.0 | 400     | 864 | 47.2 | 319     |

SD, standard deviation.

NOTE: Instructions for use of table: For a subject of given weight [  $w$  (kg)], a normal mean red blood cell, plasma, or total blood volume [  $V$  (ml)] can be calculated from the following formula:  $V = a \pm bw$  (using a and b values from the table). For example, in a 70-kg man, the mean red blood cell volume is  $490 \pm (21.4 \times 70) \pm 1988$  ml  $\pm 2$  SD, and the range is  $1988 \pm 400$ , or 1588 to 2388 ml. The expected normal range can be calculated from the following formula: range = mean  $\pm 2$  SD.

<sup>a</sup> Measured by <sup>51</sup>Cr method.

<sup>b</sup> Calculated from the red cell volume and volume of packed red cells without correction for trapped plasma or "body hematocrit" differences.

From references [12](#) and [13](#).

**TABLE A.9. Basic Ferrokinetic Measurements**

| Measurement                               | N  | Mean | 95% Range |
|---|----|------|-----------|
| Half-life <sup>59</sup> Fe (min)          | 66 | 87.5 | 38–137    |
| Plasma iron transport                     |    |      |           |
| mg/day                                    | 35 | 32.2 | 13–50     |
| mg/kg/day                                 | 10 | 0.56 | 0.46–0.75 |
| µg/dl blood/day                           | 31 | 0.69 | 0.41–0.97 |
| Red cell <sup>59</sup> Fe utilization (%) | 55 | 83.9 | 68–100    |
| Erythrocyte iron turnover                 |    |      |           |
| mg/day                                    | 34 | 27.6 | 11–43     |
| mg/kg/day                                 | 10 | 0.52 | 0.43–0.72 |
| µg/dl blood/day                           | 21 | 0.56 | 0.35–0.77 |

From references [14](#), [15](#), [16](#) and [17](#).

**TABLE A.10. Reference Ranges <sup>a</sup> for Porphyrins and Porphyrin Precursors in Feces, Urine, and Erythrocytes**

| Porphyrin or Precursor | Feces          | Urine                                  | Erythrocytes  |
|------------------------|----------------|--|---------------|
| Aminolevulinic acid    | —              | 1.5–7.5 mg/24 h<br>11.2–57.2 µmol/24 h | —             |
| Porphobilinogen        | —              | <1.0 mg/24 h<br><4.4 µmol/24 h         | —             |
| Uroporphyrin           | 0–0.06 mg/24 h | 10–30 µg/24 h                          | 0             |
| Coproporphyrin         | 0–500 µg/24 h  | 50–160 µg/24 h                         | 0–500 µg/24 h |



|                 |               |              |              |
|-----------------|---------------|--------------|--------------|
| Protoporphyrin  | 0–600 µg/24 h | —            | 0–60 µg/24 h |
| Total porphyrin | 4 mg/24 h     | <0.2 mg/24 h | —            |

<sup>a</sup> 95% confidence limit.

From reference [2](#).

**TABLE A.11. Measures of Hemoglobin Destruction**

| Measurement   | 95% Limits |
|---|------------|
| Icterus index (units) ( <a href="#">4</a> )             | 5.0–7.5    |
| Bilirubin, total (mg/dl)                                | 0.1–1.0    |
| Bilirubin, direct (mg/dl)                               | 0.01–0.12  |
| Urobilinogen, urine (Ehrlich units/day)                 | 0.5–4.0    |
| Urobilinogen, fecal                                     |            |
| Ehrlich units/day                                       | 80–280     |
| mg/day  | 40–200     |
| Bilirubin production (mg/kg/day) ( <a href="#">18</a> ) | 2.6–5.0    |
| Serum hemoglobin (mg/dl)                                | 0.5–5.0    |
| Serum haptoglobin (mg/dl)                               | 60–270     |
| Urine iron (mg/day)                                     | <0.1       |

Unless otherwise indicated, values derived from reference [2](#).

**TABLE A.12. Normal Values for Osmotic Fragility**

| Sodium Chloride (Concentration in g/dl) | % Hemolysis       |                  |
|---|-------------------|------------------|
|   | Before Incubation | After Incubation |
| 0.85                                    | 0                 | 0                |
| 0.75                                    | 0                 | 0–5              |
| 0.65                                    | 0                 | 0–10             |
| 0.60                                    | 0                 | 0–40             |
| 0.55                                    | 0                 | 15–70            |
| 0.50                                    | 0–5               | 40–85            |
| 0.45                                    | 5–45              | 55–95            |
| 0.40                                    | 50–90             | 65–100           |
| 0.35                                    | 90–99             | 75–100           |
| 0.30                                    | 97–100            | 85–100           |
| 0.20                                    | 97–100            | 95–100           |
| 0.10                                    | 100               | 100              |

From reference [19](#), with permission of ASCP Press.

**TABLE A.13. Automated Leukocyte Differential Counts and Reference Values in Normal**

## Male Adults

| Percentage                       | Coulter S + STKR (80 Men) |                   | Technicon H1 (64 Men) |                   |
|----------------------------------|---------------------------|-------------------|-----------------------|-------------------|
|                                  | Mean                      | Central 95% Range | Mean                  | Central 95% Range |
| Lymphocytes                      | 36.1                      | 22.3–49.9         | 31.3                  | 18.3–44.2         |
| Monocytes                        | 4.1                       | 0.7–7.5           | 5.5                   | 2.6–8.5           |
| Granulocytes                     | 59.7                      | 45.5–74.0         | —                     | —                 |
| Neutrophils                      | —                         | —                 | 58.8                  | 45.5–73.1         |
| Eosinophils                      | —                         | —                 | 1.9                   | 0.0–4.4           |
| Basophils                        | —                         | —                 | 0.7                   | 0.2–1.2           |
| LUCs                             | —                         | —                 | 1.8                   | 0.0–4.9           |
| Absolute numbers                 |                           |                   |                       |                   |
| Lymphocytes ( $\times 10^9/L$ )  | 2.4                       | 1.2–3.5           | 2.06                  | 0.9–3.22          |
| Monocytes ( $\times 10^9/L$ )    | 0.3                       | 0.0–0.5           | 0.37                  | 0.12–0.62         |
| Granulocytes ( $\times 10^9/L$ ) | 4.9                       | 1.4–6.6           | —                     | —                 |
| Neutrophils ( $\times 10^9/L$ )  | —                         | —                 | 4.01                  | 1.31–6.71         |
| Eosinophils ( $\times 10^9/L$ )  | —                         | —                 | 0.13                  | 0.00–0.30         |
| Basophils ( $\times 10^9/L$ )    | —                         | —                 | 0.05                  | 0.01–0.09         |
| LUCs ( $\times 10^9/L$ )         | —                         | —                 | 0.12                  | 0.00–0.31         |

LUC, large unstained cell.

NOTE: Data based on measurements from healthy male students, 23 to 31 years of age, at an altitude of 4500 ft.

**TABLE A.14. Scoring Criteria for Leukocyte Alkaline Phosphatase**

| Precipitated Azo Dye in Cytoplasm |                     |                  |                    |                             |
|-----------------------------------|---------------------|------------------|--------------------|-----------------------------|
| Cell Rating                       | Amount <sup>a</sup> | Granule Size     | Staining Intensity | Background of Cytoplasm     |
| 0                                 | 0                   | None             | —                  | No staining                 |
| ±1                                | 50                  | Small            | Faint to moderate  | Colorless to very pale pink |
| ±2                                | 40–80               | Small to medium  | Moderate to strong | Colorless to pale pink      |
| ±3                                | 80–100              | Medium to large  | Strong             | Colorless to pink           |
| ±4                                | 100                 | Medium and large | Brilliant          | Nonvisible                  |

<sup>a</sup> Percentage of volume of cytoplasm occupied by dye precipitate.

From reference [20](#), with permission of Williams & Wilkins.

**TABLE A.15. Leukocyte Alkaline Phosphatase Scores in Normal Subjects**

| Group  | Number | Mean | 95% Limits |
|--------|--------|------|------------|
| Male   | 51     | 73   | 22–124     |
| Female | 50     | 91   | 33–149     |

Total 101 82 25–139  
 From reference 9, with permission of Grune & Stratton.

**TABLE A.16. Differential Counts of Bone Marrow Aspirates from 12 Healthy Men**

|                               | Mean (%) | Observed Range (%) | 95% Confidence Limits (%) |
|-------------------------------|----------|--------------------|---------------------------|
| Neutrophilic series (total)   | 53.6     | 49.2–65.0          | 33.6–73.6                 |
| Myeloblasts                   | 0.9      | 0.2–1.5            | 0.1–1.7                   |
| Promyelocytes                 | 3.3      | 2.1–4.1            | 1.9–4.7                   |
| Myelocytes                    | 12.7     | 8.2–15.7           | 8.5–16.9                  |
| Metamyelocytes                | 15.9     | 9.6–24.6           | 7.1–24.7                  |
| Band                          | 12.4     | 9.5–15.3           | 9.4–15.4                  |
| Segmented                     | 7.4      | 6.0–12.0           | 3.8–11.0                  |
| Eosinophilic series (total)   | 3.1      | 1.2–5.3            | 1.1–5.2                   |
| Myelocytes                    | 0.8      | 0.2–1.3            | 0.2–1.4                   |
| Metamyelocytes                | 1.2      | 0.4–2.2            | 0.2–2.2                   |
| Band                          | 0.9      | 0.2–2.4            | 0–2.7                     |
| Segmented                     | 0.5      | 0–1.3              | 0–1.1                     |
| Basophilic and mast cells     | 0.1      | 0–0.2              | —                         |
| Erythrocytic series (total)   | 25.6     | 18.4–33.8          | 15.0–36.2                 |
| Pronormoblasts                | 0.6      | 0.2–1.3            | 0.1–1.1                   |
| Basophilic                    | 1.4      | 0.5–2.4            | 0.4–2.4                   |
| Polychromatophilic            | 21.6     | 17.9–29.2          | 13.1–30.1                 |
| Orthochromatic                | 2.0      | 0.4–4.6            | 0.3–3.7                   |
| Lymphocytes                   | 16.2     | 11.1–23.2          | 8.6–23.8                  |
| Plasma cells                  | 1.3      | 0.4–3.9            | 0–3.5                     |
| Monocytes                     | 0.3      | 0–0.8              | 0–0.6                     |
| Megakaryocytes                | 0.1      | 0–0.4              | —                         |
| Reticulum cells               | 0.3      | 0–0.9              | 0–0.8                     |
| Monocyte to erythrocyte ratio | 2.3      | 1.5–3.3            | 1.1–3.5                   |

**TABLE A.17. Red Blood Cell Values at Various Ages: Mean and Lower Limit of Normal (–2 SD)**

| Age                | Hemoglobin (g/dl) |       | Hematocrit (%) |       | Red Cell Count (10 <sup>12</sup> /L) |       | Mean Corpuscular Volume (fl) |       | Mean Corpuscular Hemoglobin (pg) |       | Mean Corpuscular Hemoglobin Concentration (g/dl) |       |
|--------------------|-------------------|-------|----------------|-------|--------------------------------------|-------|------------------------------|-------|----------------------------------|-------|--|-------|
|                    | Mean              | –2 SD | Mean           | –2 SD | Mean                                 | –2 SD | Mean                         | –2 SD | Mean                             | –2 SD | Mean   | –2 SD |
| Birth (cord blood) | 16.5              | 13.5  | 51             | 42    | 4.7                                  | 3.9   | 108                          | 98    | 34                               | 31    | 33   | 30    |

|                         |      |      |    |    |     |     |     |    |    |    |    |    |
|-------------------------|------|------|----|----|-----|-----|-----|----|----|----|----|----|
| 1 to 3 days (capillary) | 18.5 | 14.5 | 56 | 45 | 5.3 | 4.0 | 108 | 95 | 34 | 31 | 33 | 29 |
| 1 wk                    | 17.5 | 13.5 | 54 | 42 | 5.1 | 3.9 | 107 | 88 | 34 | 28 | 33 | 28 |
| 2 wk                    | 16.5 | 12.5 | 51 | 39 | 4.9 | 3.6 | 105 | 86 | 34 | 28 | 33 | 28 |
| 1 mo                    | 14.0 | 10.0 | 43 | 31 | 4.2 | 3.0 | 104 | 85 | 34 | 28 | 33 | 29 |
| 2 mo                    | 11.5 | 9.0  | 35 | 28 | 3.8 | 2.7 | 96  | 77 | 30 | 26 | 33 | 29 |
| 3 to 6 mo               | 11.5 | 9.5  | 35 | 29 | 3.8 | 3.1 | 91  | 74 | 30 | 25 | 33 | 30 |
| 0.5 to 2.0 yr           | 12.0 | 0.5  | 36 | 33 | 4.5 | 3.7 | 78  | 70 | 27 | 23 | 33 | 30 |
| 2 to 6 yr               | 12.5 | 11.5 | 37 | 34 | 4.6 | 3.9 | 81  | 75 | 27 | 24 | 34 | 31 |
| 6 to 12 yr              | 13.5 | 11.5 | 40 | 35 | 4.6 | 4.0 | 86  | 77 | 29 | 25 | 34 | 31 |
| 12 to 18 yr             |      |      |    |    |     |     |     |    |    |    |    |    |
| Female                  | 14.0 | 12.0 | 41 | 36 | 4.6 | 4.1 | 90  | 78 | 30 | 25 | 34 | 31 |
| Male                    | 14.5 | 13.0 | 43 | 37 | 4.9 | 4.5 | 88  | 78 | 30 | 25 | 34 | 31 |
| 18 to 49 yr             |      |      |    |    |     |     |     |    |    |    |    |    |
| Female                  | 14.0 | 12.0 | 41 | 36 | 4.6 | 4.0 | 90  | 80 | 30 | 26 | 34 | 31 |
| Male                    | 15.5 | 13.5 | 47 | 41 | 5.2 | 4.5 | 90  | 80 | 30 | 26 | 34 | 31 |

SD, standard deviation.

These data were compiled from several sources. Emphasis is on recent studies using electronic counters and on the selection of populations that are likely to exclude individuals with iron deficiency. The mean  $\pm 2$  SD can be expected to include 95% of the observations in a normal population.

From Dallman PR. In: Rudolph A, ed. Pediatrics, 16th ed. New York: Appleton-Century-Crofts, 1977; and Lubin BH. Reference values in infancy and childhood. In: Nathan DG, Oski FA, eds. Hematology of infancy and childhood, 4th ed. Philadelphia: WB Saunders, 1993 (22).

**TABLE A.18. Full-Term Infants: Normal Values of Hemoglobin, Hematocrit, Erythrocyte Count, Mean Corpuscular Hemoglobin, Mean Corpuscular Volume, and Mean Corpuscular Hemoglobin Concentration**

|   | Age (mo)        |                 |                 |                 |                 |                 |                 |
|---|-----------------|-----------------|-----------------|-----------------|-----------------|-----------------|-----------------|
|   | 0.5 (N = 232)   | 1 (N = 240)     | 2 (N = 241)     | 4 (N = 52)      | 6 (N = 52)      | 9 (N = 56)      | 12 (N = 56)     |
| Hemoglobin (mean $\pm$ SE) (g/dl)                 | 16.6 $\pm$ 0.11 | 13.9 $\pm$ 0.10 | 11.2 $\pm$ 0.06 | 12.2 $\pm$ 0.14 | 12.6 $\pm$ 0.10 | 12.7 $\pm$ 0.09 | 12.7 $\pm$ 0.09 |
| $\pm 2$ SD  | 13.4            | 10.7            | $\pm 9.4$       | 10.3            | 11.1            | 11.4            | 11.3            |
| Hematocrit (mean $\pm$ SE) (%)                    | 53 $\pm$ 0.4    | 44 $\pm$ 0.3    | 35 $\pm$ 0.2    | 38 $\pm$ 0.4    | 36 $\pm$ 0.3    | 36 $\pm$ 0.3    | 37 $\pm$ 0.3    |
| $\pm 2$ SD  | 41              | 33              | 28              | 32              | 31              | 32              | 33              |
| Red blood cell count (mean $\pm$ SE) ( $10^2/L$ ) | 4.9 $\pm$ 0.03  | 4.3 $\pm$ 0.03  | 3.7 $\pm$ 0.02  | 4.3 $\pm$ 0.06  | 4.7 $\pm$ 0.05  | 4.7 $\pm$ 0.04  | 4.7 $\pm$ 0.04  |
| $\pm 2$ SD  | 3.9–5.9         | 3.3–5.3         | 3.1–4.3         | 3.5–5.1         | 3.9–5.5         | 4.0–5.3         | 4.1–5.3         |
| Mean corpuscular hemoglobin (mean $\pm$ SE) (pg)  | 33.6 $\pm$ 0.1  | 32.5 $\pm$ 0.1  | 30.4 $\pm$ 0.1  | 28.6 $\pm$ 0.2  | 26.8 $\pm$ 0.2  | 27.3 $\pm$ 0.2  | 26.8 $\pm$ 0.2  |

|   |             |             |            |            |            |            |            |
|---|-------------|-------------|------------|------------|------------|------------|------------|
| ±2 SD   | 30          | 29          | 27         | 25         | 24         | 25         | 24         |
| Mean corpuscular volume (mean ± SE) (fl)                    | 105.3 ± 0.6 | 101.3 ± 0.3 | 94.8 ± 0.3 | 86.7 ± 0.8 | 76.3 ± 0.6 | 77.7 ± 0.5 | 77.7 ± 0.5 |
| ±2 SD   | 88          | 91          | 84         | 76         | 68         | 70         | 71         |
| Mean corpuscular hemoglobin concentration (mean ± SE) (g/L) | 314 ± 1.1   | 318 ± 1.2   | 318 ± 1.1  | 327 ± 2.7  | 350 ± 1.7  | 349 ± 1.6  | 343 ± 1.5  |
| ±2 SD   | 281         | 281         | 283        | 288        | 327        | 324        | 321        |

SD, standard deviation; SE, standard error.

NOTE: These values were obtained from a selected group of 256 healthy term infants followed at the Helsinki University Central Hospital who were receiving continuous iron supplementation and who had normal values for transferrin saturation and serum ferritin. Values at the ages of 0.5, 1, and 2 months were obtained from the entire group, and those at the later ages were obtained from the iron-supplemented infant group after exclusion of iron deficiency.

From references [22](#) and [23](#).

**TABLE A.19. Leukocyte Count and Differential Count Reference Values in Children**

| Age   | Total Leukocytes |           | Neutrophils |          |    | Lymphocytes |          | Monocytes |      | Eosinophils |     |   |
|-------|------------------|-----------|-------------|----------|----|-------------|----------|-----------|------|-------------|-----|---|
|       | Mean             | Range     | Mean        | Range    | %  | Mean        | Range    | %         | Mean | %           |     |   |
| Birth | 18.1             | 9.0–30.0  | 11.0        | 6.0–26.0 | 61 | 5.5         | 2.0–11.0 | 31        | 1.1  | 6           | 0.4 | 2 |
| 12 h  | 22.8             | 13.0–38.0 | 15.5        | 6.0–28.0 | 68 | 5.5         | 2.0–11.0 | 24        | 1.2  | 5           | 0.5 | 2 |
| 24 h  | 18.9             | 9.4–34.0  | 11.5        | 5.0–21.0 | 61 | 5.8         | 2.0–11.5 | 31        | 1.1  | 6           | 0.5 | 2 |
| 1 wk  | 12.2             | 5.0–21.0  | 5.5         | 1.5–10.0 | 45 | 5.0         | 2.0–17.0 | 41        | 1.1  | 9           | 0.5 | 4 |
| 2 wk  | 11.4             | 5.0–20.0  | 4.5         | 1.0–9.5  | 40 | 5.5         | 2.0–17.0 | 48        | 1.0  | 9           | 0.4 | 3 |
| 1 mo  | 10.8             | 5.0–19.5  | 3.8         | 1.0–9.0  | 35 | 6.0         | 2.5–16.5 | 56        | 0.7  | 7           | 0.3 | 3 |
| 6 mo  | 11.9             | 6.0–17.5  | 3.8         | 1.0–8.5  | 32 | 7.3         | 4.0–13.5 | 61        | 0.6  | 5           | 0.3 | 3 |
| 1 yr  | 11.4             | 6.0–17.5  | 3.5         | 1.5–8.5  | 31 | 7.0         | 4.0–10.5 | 61        | 0.6  | 5           | 0.3 | 3 |
| 2 yr  | 10.6             | 6.0–17.0  | 3.5         | 1.5–8.5  | 33 | 6.3         | 3.0–9.5  | 59        | 0.5  | 5           | 0.3 | 3 |
| 4 yr  | 9.1              | 5.5–15.5  | 3.8         | 1.5–8.5  | 42 | 4.5         | 2.0–8.0  | 50        | 0.5  | 5           | 0.3 | 3 |
| 6 yr  | 8.5              | 5.0–14.5  | 4.3         | 1.5–8.0  | 51 | 3.5         | 1.5–7.0  | 42        | 0.4  | 5           | 0.2 | 3 |
| 8 yr  | 8.3              | 4.5–13.5  | 4.4         | 1.5–8.0  | 53 | 3.3         | 1.5–6.8  | 39        | 0.4  | 4           | 0.2 | 2 |
| 10 yr | 8.1              | 4.5–13.5  | 4.4         | 1.8–8.0  | 54 | 3.1         | 1.5–6.5  | 38        | 0.4  | 4           | 0.2 | 2 |
| 16 yr | 7.8              | 4.5–13.0  | 4.4         | 1.8–8.0  | 57 | 2.8         | 1.2–5.2  | 35        | 0.4  | 5           | 0.2 | 3 |
| 21 yr | 7.4              | 4.5–11.0  | 4.4         | 1.8–7.7  | 59 | 2.5         | 1.0–4.8  | 34        | 0.3  | 4           | 0.2 | 3 |

NOTE: Numbers of leukocytes are in thousands/mm<sup>3</sup>, ranges are estimates of 95% confidence limits, and percentages refer to differential counts. Neutrophils include band cells at all ages and a small number of metamyelocytes and myelocytes in the first few days of life.

From Dallman PR. In: Rudolph AM, ed. Pediatrics, 16th ed. New York: Appleton-Century-Crofts, 1977; and Lubin BH. Reference values in infancy and childhood. In: Nathan DG, Oski FA, eds. Hematology of infancy and childhood, 4th ed. Philadelphia: WB Saunders, 1993 ([22](#)).

TABLE A.20. Bone Marrow Cell Populations of Normal Infants

| Cell Type                        | Mo              |                 |                 |                  |                 |                 |                 |                 |                  |                 |                 |
|----------------------------------|-----------------|-----------------|-----------------|------------------|-----------------|-----------------|-----------------|-----------------|------------------|-----------------|-----------------|
|                                  | 0 (N = 57)      | 1 (N = 71)      | 2 (N = 48)      | 3 (N = 24)       | 4 (N = 19)      | 5 (N = 22)      | 6 (N = 22)      | 9 (N = 16)      | 12 (N = 18)      | 15 (N = 12)     | 18 (N = 19)     |
| Small lymphocytes                | 14.42<br>± 5.54 | 47.05<br>± 9.24 | 42.68<br>± 7.90 | 43.63<br>± 11.83 | 47.06<br>± 8.77 | 47.19<br>± 9.93 | 47.55<br>± 7.88 | 48.76<br>± 8.11 | 47.11<br>± 11.32 | 42.77<br>± 8.94 | 43.55<br>± 8.56 |
| Transitional cells               | 1.18<br>± 1.13  | 1.95<br>± 0.94  | 2.38<br>± 1.35  | 2.17<br>± 1.64   | 1.64<br>± 1.01  | 1.83<br>± 0.89  | 2.31<br>± 1.16  | 1.92<br>± 1.39  | 2.32<br>± 1.90   | 1.70<br>± 0.82  | 1.99<br>± 1.00  |
| Proerythroblasts                 | 0.02<br>± 0.06  | 0.10<br>± 0.14  | 0.13<br>± 0.19  | 0.10<br>± 0.13   | 0.05<br>± 0.10  | 0.07<br>± 0.10  | 0.09<br>± 0.12  | 0.07<br>± 0.09  | 0.02<br>± 0.04   | 0.07<br>± 0.12  | 0.08<br>± 0.13  |
| Basophilic erythroblasts         | 0.24<br>± 0.25  | 0.35<br>± 0.33  | 0.57<br>± 0.41  | 0.40<br>± 0.33   | 0.24<br>± 0.24  | 0.47<br>± 0.33  | 0.32<br>± 0.24  | 0.31<br>± 0.24  | 0.30<br>± 0.25   | 0.38<br>± 0.37  | 0.50<br>± 0.34  |
| Early erythroblasts              | 0.27<br>± 0.26  | 0.44<br>± 0.42  | 0.71<br>± 0.51  | 0.50<br>± 0.38   | 0.28<br>± 0.30  | 0.55<br>± 0.36  | 0.41<br>± 0.30  | 0.39<br>± 0.28  | 0.39<br>± 0.27   | 0.46<br>± 0.36  | 0.59<br>± 0.34  |
| Polychromatic erythroblasts      | 13.06<br>± 6.78 | 6.90<br>± 4.45  | 13.06<br>± 3.48 | 10.51<br>± 3.39  | 6.84<br>± 2.58  | 7.55<br>± 2.35  | 7.30<br>± 3.60  | 7.73<br>± 3.39  | 6.83<br>± 3.75   | 6.04<br>± 1.56  | 6.97<br>± 3.56  |
| Orthochromatic erythroblasts     | 0.69<br>± 0.73  | 0.54<br>± 1.88  | 0.66<br>± 0.82  | 0.70<br>± 0.87   | 0.34<br>± 0.30  | 0.46<br>± 0.51  | 0.38<br>± 0.56  | 0.39<br>± 0.48  | 0.37<br>± 0.51   | 0.50<br>± 0.65  | 0.44<br>± 0.49  |
| Extruded nuclei                  | 0.47<br>± 0.46  | 0.16<br>± 0.17  | 0.26<br>± 0.22  | 0.19<br>± 0.12   | 0.16<br>± 0.17  | 0.14<br>± 0.11  | 0.16<br>± 0.22  | 0.22<br>± 0.25  | 0.23<br>± 0.25   | 0.17<br>± 0.12  | 0.21<br>± 0.19  |
| Late erythroblasts               | 14.22<br>± 7.14 | 7.60<br>± 4.84  | 13.99<br>± 3.82 | 11.40<br>± 3.43  | 7.34<br>± 2.54  | 8.16<br>± 2.58  | 7.85<br>± 4.11  | 8.34<br>± 3.31  | 7.42<br>± 4.11   | 6.72<br>± 1.80  | 7.62<br>± 3.63  |
| Early to late erythroblast ratio | 1:50            | 1:15            | 1:18            | 1:22             | 1:23            | 1:15            | 1:17            | 1:19            | 1:17             | 1:15            | 1:10            |
| Fetal erythroblasts              | 14.48<br>± 7.24 | 8.04<br>± 5.00  | 14.70<br>± 3.86 | 11.90<br>± 3.52  | 7.62<br>± 2.56  | 8.70<br>± 2.69  | 8.25<br>± 4.31  | 8.72<br>± 3.34  | 7.81<br>± 4.26   | 7.18<br>± 1.95  | 8.21<br>± 37.1  |
| Blood reticulocytes              | 4.18<br>± 1.46  | 1.06<br>± 1.13  | 3.39<br>± 1.22  | 2.90<br>± 0.91   | 1.65<br>± 0.73  | 1.38<br>± 0.65  | 1.74<br>± 0.80  | 1.67<br>± 0.52  | 1.79<br>± 0.79   | 2.10<br>± 0.91  | 1.84<br>± 0.46  |
| Neutrophils                      |                 |                 |                 |                  |                 |                 |                 |                 |                  |                 |                 |
| Promyelocytes                    | 0.79<br>± 0.91  | 0.76<br>± 0.65  | 0.78<br>± 0.68  | 0.76<br>± 0.80   | 0.59<br>± 0.51  | 0.87<br>± 0.80  | 0.67<br>± 0.66  | 0.41<br>± 0.34  | 0.69<br>± 0.71   | 0.67<br>± 0.58  | 0.64<br>± 0.59  |
| Myelocytes                       | 3.95<br>± 2.93  | 2.50<br>± 1.48  | 2.03<br>± 1.14  | 2.24<br>± 1.70   | 2.32<br>± 1.59  | 2.73<br>± 1.82  | 2.22<br>± 1.25  | 2.07<br>± 1.20  | 2.32<br>± 1.14   | 2.48<br>± 0.94  | 2.49<br>± 1.39  |
| Early neutrophils                | 4.74<br>± 3.43  | 3.27<br>± 1.94  | 2.81<br>± 1.62  | 3.00<br>± 2.18   | 2.91<br>± 2.01  | 3.60<br>± 2.50  | 2.89<br>± 1.71  | 2.48<br>± 1.46  | 3.02<br>± 1.52   | 3.16<br>± 1.19  | 3.14<br>± 1.75  |

|                                |                    |                    |                    |                     |                    |                    |                    |                    |                    |                    |                    |
|--------------------------------|--------------------|--------------------|--------------------|---------------------|--------------------|--------------------|--------------------|--------------------|--------------------|--------------------|--------------------|
| Metamyelocytes                 | 19.37<br>±<br>4.84 | 11.34<br>±<br>3.59 | 11.27<br>±<br>3.38 | 11.93<br>±<br>13.09 | 6.04<br>±<br>3.63  | 11.89<br>±<br>3.24 | 11.02<br>±<br>3.12 | 11.80<br>±<br>3.90 | 11.10<br>±<br>3.82 | 12.48<br>±<br>7.45 | 12.42<br>±<br>4.15 |
| Bands                          | 28.89<br>±<br>7.56 | 14.10<br>±<br>4.63 | 13.15<br>±<br>4.71 | 14.60<br>±<br>7.54  | 13.93<br>±<br>6.13 | 14.07<br>±<br>5.48 | 14.00<br>±<br>4.58 | 14.08<br>±<br>4.53 | 14.02<br>±<br>4.88 | 15.17<br>±<br>4.20 | 14.20<br>±<br>5.23 |
| Mature neutrophils             | 7.37<br>±<br>4.64  | 3.64<br>±<br>2.97  | 3.07<br>±<br>2.45  | 3.48<br>±<br>1.62   | 4.27<br>±<br>2.69  | 3.77<br>±<br>2.44  | 4.85<br>±<br>2.69  | 3.97<br>±<br>2.29  | 5.65<br>±<br>3.92  | 6.94<br>±<br>3.88  | 6.31<br>±<br>3.91  |
| Late neutrophils               | 55.63<br>±<br>7.98 | 29.08<br>±<br>6.79 | 27.50<br>±<br>6.88 | 31.00<br>±<br>11.17 | 31.30<br>±<br>7.80 | 29.73<br>±<br>7.19 | 29.86<br>±<br>6.74 | 29.86<br>±<br>7.36 | 30.77<br>±<br>8.69 | 34.60<br>±<br>7.35 | 32.93<br>±<br>7.01 |
| Early to late neutrophil ratio | 1:12               | 1:9                | 1:9                | 1:9                 | 1:11               | 1:8                | 1:10               | 1:12               | 1:10               | 1:10               | 1:10               |
| Total neutrophils              | 60.37<br>±<br>8.66 | 32.35<br>±<br>7.68 | 30.31<br>±<br>7.27 | 34.01<br>±<br>11.95 | 34.21<br>±<br>8.61 | 33.12<br>±<br>8.34 | 32.75<br>±<br>7.03 | 32.33<br>±<br>7.75 | 33.79<br>±<br>8.76 | 37.76<br>±<br>7.32 | 36.06<br>±<br>7.40 |
| Total eosinophils              | 2.70<br>±<br>1.27  | 2.61<br>±<br>1.40  | 2.50<br>±<br>1.22  | 2.54<br>±<br>1.46   | 2.37<br>±<br>4.13  | 1.98<br>±<br>0.86  | 2.08<br>±<br>1.16  | 1.74<br>±<br>1.08  | 1.92<br>±<br>1.09  | 3.39<br>±<br>1.93  | 2.70<br>±<br>2.16  |
| Total basophils                | 0.12<br>±<br>0.20  | 0.07<br>±<br>0.16  | 0.08<br>±<br>0.10  | 0.09<br>±<br>0.09   | 0.11<br>±<br>0.14  | 0.94<br>±<br>0.13  | 0.10<br>±<br>0.13  | 0.11<br>±<br>0.13  | 0.13<br>±<br>0.15  | 0.27<br>±<br>0.37  | 0.10<br>±<br>0.12  |
| Total myeloid cells            | 63.19<br>±<br>9.10 | 35.03<br>±<br>8.09 | 32.90<br>±<br>7.85 | 36.64<br>±<br>12.26 | 36.69<br>±<br>8.91 | 35.40<br>±<br>8.54 | 34.93<br>±<br>7.52 | 34.18<br>±<br>8.13 | 35.83<br>±<br>8.84 | 41.42<br>±<br>7.43 | 38.86<br>±<br>7.92 |
| Monocytes                      | 0.88<br>±<br>0.85  | 1.01<br>±<br>0.89  | 0.91<br>±<br>0.83  | 0.68<br>±<br>0.56   | 0.75<br>±<br>0.75  | 1.29<br>±<br>1.06  | 1.21<br>±<br>1.01  | 1.17<br>±<br>0.97  | 1.46<br>±<br>1.52  | 1.68<br>±<br>1.09  | 2.12<br>±<br>1.59  |
| Miscellaneous                  |                    |                    |                    |                     |                    |                    |                    |                    |                    |                    |                    |
| Megakaryocytes                 | 0.06<br>±<br>0.15  | 0.05<br>±<br>0.09  | 0.10<br>±<br>0.13  | 0.06<br>±<br>0.09   | 0.06<br>±<br>0.06  | 0.08<br>±<br>0.09  | 0.04<br>±<br>0.07  | 0.09<br>±<br>0.12  | 0.05<br>±<br>0.08  | 0.00<br>±<br>0.00  | 0.07<br>±<br>0.12  |
| Plasma cells                   | 0.00<br>±<br>0.02  | 0.02<br>±<br>0.06  | 0.02<br>±<br>0.05  | 0.00<br>±<br>0.02   | 0.01<br>±<br>0.03  | 0.05<br>±<br>0.11  | 0.03<br>±<br>0.07  | 0.01<br>±<br>0.03  | 0.03<br>±<br>0.07  | 0.07<br>±<br>0.12  | 0.06<br>±<br>0.08  |
| Unknown blasts                 | 0.31<br>±<br>0.31  | 0.62<br>±<br>0.50  | 0.58<br>±<br>0.50  | 0.63<br>±<br>0.60   | 0.56<br>±<br>0.53  | 0.50<br>±<br>0.37  | 0.56<br>±<br>0.48  | 0.42<br>±<br>0.50  | 0.37<br>±<br>0.33  | 0.46<br>±<br>0.32  | 0.43<br>±<br>0.45  |
| Unknown cells                  | 0.22<br>±<br>0.34  | 0.21<br>±<br>0.25  | 0.16<br>±<br>0.24  | 0.19<br>±<br>0.21   | 0.23<br>±<br>0.25  | 0.17<br>±<br>0.22  | 0.10<br>±<br>0.15  | 0.14<br>±<br>0.17  | 0.11<br>±<br>0.14  | 0.13<br>±<br>0.18  | 0.20<br>±<br>0.23  |
| Damaged cells                  | 5.79<br>±<br>2.78  | 5.50<br>±<br>2.46  | 5.09<br>±<br>1.78  | 4.75<br>±<br>2.30   | 4.80<br>±<br>2.29  | 4.86<br>±<br>1.25  | 5.04<br>±<br>1.08  | 4.89<br>±<br>1.60  | 5.34<br>±<br>2.19  | 4.99<br>±<br>1.96  | 5.05<br>±<br>2.15  |
| Total                          | 6.38<br>±<br>2.84  | 6.39<br>±<br>2.63  | 5.94<br>±<br>1.94  | 5.63<br>±<br>2.36   | 5.66<br>±<br>2.30  | 5.66<br>±<br>1.41  | 5.78<br>±<br>1.16  | 5.55<br>±<br>1.74  | 5.90<br>±<br>2.03  | 5.65<br>±<br>2.02  | 5.81<br>±<br>2.16  |



NOTE: Percentages of cell types [means  $\pm$  standard deviation (SD)] in tibial bone marrow of infants from birth to 18 months of age. Data were obtained from normal American infants of black, white, and Asian racial origin. The changes in the marrow during the first 18 months of postnatal life are based on differential counts of 1000 cells classified on stained smears on each of ten serial marrow samples aspirated from the same population of infants. Criteria for including bone marrow data in this study consisted of absence of any clinical evidence of disease, normal rate of growth, and normal serum proteins and transferrin saturations. N values are expressed in round figures for facilitating comparison. Means  $\pm$  SD were calculated from values obtained in individual infants, and statistical comparisons were performed.

N, number of infants studied at each stage.

From references [22](#) and [24](#).

**TABLE A.21. Flow Cytometry Values of Peripheral Blood Leukocytes**

|                      | Leukocyte Antigen  | Reference Range (%) <sup>a</sup> |
|----------------------|--|----------------------------------|
| T-cell               | CD2  | 68–89                            |
|                      | CD3  | 60–87                            |
|                      | CD4  | 31–58                            |
|                      | CD5  | 61–88                            |
|                      | CD7  | 73–94                            |
|                      | CD8  | 13–40                            |
| B-cell               | CD10   | 0–2                              |
|                      | CD19   | 6–23                             |
|                      | CD20   | 5–15                             |
|                      | Kappa  | 3–10                             |
|                      | Lambda   | 1–5                              |
| Myelocytic/monocytic | CD13   | 0–2                              |
|                      | CD14   | 0–2                              |
| Natural killer       | CD16 <sup>+</sup> , CD56 <sup>+</sup> , and CD3 <sup>-</sup> | 4–26                             |
|                      | CD34   | 0–1                              |

<sup>a</sup> Flow cytometry reference ranges taken from the ARUP Laboratory Flow Cytometry Laboratory.

**TABLE A.22. Iron and Copper in Plasma**

| Measurement          | Mean           | Lower Limit of Normal <sup>a</sup> | Upper Limit of Normal <sup>a</sup> |
|----------------------|----------------|------------------------------------|------------------------------------|
| Plasma iron<br>µg/dl | 122 (men)      | 71 (43–112)                        | 201 (112–276)                      |
|                      | 109<br>(women) | 60 (28–101)                        | 173 (130–202)                      |
| µmol/L               | 21.8 (men)     | 12.7 (7.7–20.0)                    | 35.9 (20.0–49.3)                   |

|                                    |                 |                  |                  |
|------------------------------------|-----------------|------------------|------------------|
|                                    | 19.5<br>(women) | 107 (5.0–18.0)   | 30.9 (23.2–36.1) |
| Plasma total iron-binding capacity |                 |                  |                  |
| µg/dl                              | 340             | 250 (224–306)    | 400 (429–472)    |
| µmol/L                             | 60.7            | 44.8 (40.0–54.6) | 71.6 (66.6–84.3) |
| Transferrin saturation (%)         | 35              | 20               | 55               |
| Plasma copper                      |                 |                  |                  |
| µg/dl                              | 114             | 70               | 155              |
| µmol/L                             | 18.1            | 11               | 24               |

<sup>a</sup> Range of values from several laboratories given in parentheses.  
From references [2](#) and [25](#), [26](#) and [27](#).

**TABLE A.23. Serum Folate, Vitamin B<sub>12</sub>, and Related Determinations**

| Measurement                          | Mean | Lower Limit of Normal <sup>a</sup> | Upper Limit of Normal <sup>a</sup> |
|--------------------------------------|------|------------------------------------|------------------------------------|
| Serum vitamin B <sub>12</sub> (ng/L) | 450  | 160 (100–270)                      | 950 (750–1200)                     |
| Serum folate (µg/L)                  | 8.1  | ±5 (2.3–7.5)                       | 25 (9–28)                          |
| Erythrocyte folate (µg/L)            | 274  | 166 (50–325)                       | 640 (300–875)                      |
| Urinary methylmalonate (mg/day)      | —    | —                                  | 9                                  |
| Urinary formiminoglutamate (mg/day)  | —    | 0.1                                | 3                                  |

<sup>a</sup>Range of values from several laboratories given in parentheses.  
From references [2](#) and [28](#).

**TABLE A.24. Vitamin B<sub>12</sub> Absorption by Urinary Excretion Method (Schilling Test)**

| Oral Vitamin B <sub>12</sub> Dose (µg) | Urinary Vitamin B <sub>12</sub> Excretion (%) |                   |
|--|---|-------------------|
|  | 24 h <sup>a</sup>                             | 48 h <sup>b</sup> |
| 0.5                                    | 26 (16–40)                                    | 37 (21–48)        |
| 1.0                                    | 22 (11–39)                                    | 29 (14–46)        |
| 2.0                                    | 11 (5–17)                                     | 17 (11–34)        |

<sup>a</sup> With 24-hour collections, one injection of 1000 µg “cold” B<sub>12</sub> was administered.

<sup>b</sup> With 48-hour collections, two injections of 1000 µg “cold” B<sub>12</sub> were administered at 24-hour intervals.

From references [26](#) and [28](#).

**TABLE A.25. Human Erythrocyte Enzymes in Normal Adults**

| Enzyme (Synonym)   | Enzyme Activity (IU/g Hemoglobin) |
|--|-----------------------------------|
| Acetylcholinesterase   | 36.9 ± 3.83                       |
| Adenosine deaminase  | 1.11 ± 0.23                       |
| Adenylate kinase   | 258 ± 29.3                        |
| Bisphosphoglyceromutase (2,3-diphosphoglyceromutase)                                       | 4.78 ± 0.65                       |
| Catalase   | 15.3 ± 2.39 × 10 <sup>4</sup>     |
| Fructose-bisphosphate aldolase (aldolase)  | 3.19 ± 0.86                       |
| Galactokinase  | 0.079 ± 0.006                     |
|  | 0.029 ± 0.006                     |
| Galactose-1-phosphate uridylyl-transferase   | 28.4 ± 6.94                       |
| Glucose-6-phosphate dehydrogenase  | 8.34 ± 1.59                       |
| Glucose phosphate isomerase (phosphoglucose isomerase)                                     | 60.8 ± 11.0                       |
| ?-Glutamyl-cysteine synthetase   | 0.43 ± 0.04                       |
| Glutathione peroxidase   | 31.4 ± 2.97                       |
| Glutathione reductase [nicotinamide adenine dinucleotide (phosphate)]                      | 7.18 ± 1.09                       |
| Glutathione synthetase   | 0.19 ± 0.03                       |
| Hexokinase   | 1.16 ± 0.17                       |
| Hypoxanthine phosphoribosyltransferase (hypo-xanthine guanosine-phosphoribosyltransferase) | 1.72 ± 0.3                        |
|  | 2.60 ± 0.71                       |
| Methemoglobin reductase  | 2.60 ± 0.71                       |
| 6-Phosphofructokinase  | 11.0 ± 2.33                       |
| Phosphogluconate dehydrogenase (decarboxylating)   | 8.78 ± 0.78                       |
| Phosphoglycerate kinase  | 320 ± 36.1                        |
| Pyrimidine 5'-nucleotidase   | 0.11 ± 0.03                       |
| Pyruvate kinase  | 15.0 ± 1.96                       |
| Triosephosphate isomerase  | 2111 ± 397                        |
| Uroporphyrinogen I synthase  | 2.52                              |
| From references <a href="#">22</a> and <a href="#">26</a> .                                |                                   |

**TABLE A.26. Concentrations of Immunoglobulins in Serum of Normal Subjects at Different Ages**

| Age     | Number of Subjects | Level of ?G <sup>a</sup> |                  | Level of ?M <sup>a</sup> |                  | Level of ?A <sup>a</sup> |                  | Level of Total ?-Globulin <sup>a</sup> |                  |
|---------|--------------------|--------------------------|------------------|--------------------------|------------------|--------------------------|------------------|--|------------------|
|         |                    | mg/dl (range)            | % of Adult Level | mg/dl (range)            | % of Adult Level | mg/dl (range)            | % of Adult Level | mg/dl (range)                          | % of Adult Level |
| Newborn | 22                 | 1031 ± 200               | 89 ± 17          | 11 ± 5 (5-30)            | 11 ± 5           | 2 ± 3 (0-11)             | 1 ± 2            | 1044 ± 201                             | 67 ± 13          |
|         |                    | (645-1244)               |                  |                          |                  |                          |                  | (660-1439)                             |                  |
| 1-3 mo  | 29                 | 430 ± 119 (272-762)      | 37 ± 10          | 30 ± 11 (16-67)          | 30 ± 11          | 21 ± 13 (6-56)           | 11 ± 7           | 481 ± 127 (324-699)                    | 31 ± 9           |

|          |    |                          |          |                     |                      |                      |          |                          |          |
|----------|----|--------------------------|----------|---------------------|----------------------|----------------------|----------|--------------------------|----------|
| 4-6 mo   | 33 | 427 ± 186<br>(206-1125)  | 37 ± 16  | 43 ± 17<br>(10-83)  | 43 ± 17<br>(10-83)   | 28 ± 18<br>(8-93)    | 14 ± 9   | 498 ± 204<br>(228-1232)  | 32 ± 13  |
| 7-12 mo  | 56 | 661 ± 219<br>(279-1533)  | 58 ± 19  | 54 ± 23<br>(22-147) | 55 ± 23<br>(22-147)  | 37 ± 18<br>(16-98)   | 19 ± 9   | 752 ± 242<br>(327-1687)  | 48 ± 15  |
| 13-24 mo | 59 | 762 ± 209<br>(258-1393)  | 66 ± 18  | 58 ± 23<br>(14-114) | 59 ± 23<br>(14-114)  | 50 ± 24<br>(19-112)  | 25 ± 12  | 870 ± 258<br>(398-1586)  | 56 ± 16  |
| 25-36 mo | 33 | 892 ± 183<br>(419-1274)  | 77 ± 16  | 61 ± 19<br>(28-113) | 62 ± 19<br>(28-113)  | 71 ± 37<br>(19-235)  | 36 ± 19  | 1024 ± 205<br>(419-1418) | 65 ± 14  |
| 3-5 yr   | 28 | 929 ± 228<br>(569-1597)  | 80 ± 20  | 56 ± 18<br>(22-100) | 57 ± 18<br>(22-100)  | 93 ± 27<br>(55-152)  | 47 ± 14  | 1078 ± 245<br>(730-1771) | 69 ± 17  |
| 6-8 yr   | 18 | 923 ± 256<br>(559-1492)  | 80 ± 22  | 65 ± 25<br>(27-118) | 66 ± 25<br>(27-118)  | 124 ± 45<br>(54-221) | 62 ± 23  | 1112 ± 293<br>(640-1725) | 71 ± 20  |
| 9-11 yr  | 9  | 1124 ± 235<br>(779-1456) | 97 ± 20  | 79 ± 33<br>(35-132) | 80 ± 33<br>(35-132)  | 131 ± 60<br>(12-208) | 66 ± 30  | 1334 ± 254<br>(966-1639) | 85 ± 17  |
| 12-16 yr | 9  | 946 ± 124<br>(726-1085)  | 82 ± 11  | 59 ± 20<br>(35-72)  | 60 ± 20<br>(35-72)   | 148 ± 63<br>(70-229) | 74 ± 32  | 1153 ± 169<br>(833-1284) | 74 ± 12  |
| Adults   | 30 | 1158 ± 305<br>(569-1919) | 100 ± 26 | 99 ± 27<br>(47-147) | 100 ± 27<br>(47-147) | 200 ± 61<br>(61-330) | 100 ± 31 | 1457 ± 353<br>(730-2365) | 100 ± 24 |

<sup>a</sup> Mean is ±1 standard deviation.

From reference [29](#), with permission.

**TABLE A.27. Reference Values for Tests of Hemostasis and Blood Coagulation**

| Test   | Normal Range (±2 Standard Deviations) |
|--|---------------------------------------|
| Partial thromboplastin time                        |                                       |
| Standard   | 68-82 sec <sup>a</sup>                |
| Activated  | 32-46 sec <sup>a</sup>                |
| Plasma prothrombin time                            | 11-15 sec <sup>a</sup>                |
| Plasma thrombin time                               | 10-16 sec <sup>a</sup>                |
| Fibrinogen assay                                   | 150-350 mg/dl                         |
| Euglobulin clot lysis time                         | >2 h                                  |
| Fibrin degradation products                        | >8 µg/dl                              |
| Plasminogen activity                               | 74-124%                               |
| Antithrombin III activity                          | 85-122%                               |
| Antithrombin III antigen                           | 27-35 mg/dl                           |
| Protein C  | 60-150%                               |
| Protein S  | 66-122%                               |
| Ristocetin cofactor activity                       | 0.5-1.6 U/ml                          |
| von Willebrand factor antigen                      | 43-150%                               |
| Specific assays for individual coagulation factors | 50-150% of normal                     |

NOTE: References to methods used are included in [Chapter 51](#).

<sup>a</sup> Significant variations depend on reagent used.

---

## REFERENCES

1. Lee GR, Bitnell TC, Foerester J, et al. *Wintrobe's clinical hematology*, 9th ed. Philadelphia: Lea & Febiger, 1993.
2. Henry JB. *Clinical diagnosis and management by laboratory methods*, 19th ed. Philadelphia: WB Saunders, 1996.
3. Beutler E, Lichtman MA, Coller BS, Kipps TJ. *William's hematology*, 5th ed. New York: McGraw-Hill, 1995.
4. Wintrobe MM. Macroscopic examination of the blood. *Am J Med Sci* 1933;185:58-64.
5. Greenadyke RM, Meriwether WA, Thomas ET, et al. A suggested revision of normal values for hemoglobin, hematocrit, and erythroid count in healthy adult men. *Am J Clin Pathol* 1962;37:429-436.
6. von Houte AJ, Bartels PCM, Schoorl M, Mulder C. Methodology-dependent variations in reticulocyte counts using a manual and two different flow cytometric procedures. *Eur J Clin Chem Clin Biochem* 1994;32:859-863.
7. Tarello P, Humbert JC, Mahassen P, et al. Reticulocytes: biological variations and reference limits. *Eur J Haematol* 1994;53:11-15.
8. Miller A, Green M, Robinson D. Simple rule for calculating normal erythrocyte sedimentation rate. *BMJ* 1983;286:266-271.
9. Cartwright GE. *Diagnostic laboratory hematology*, 4th ed. New York: Grune & Stratton, 1968.
10. Stroop DM, Triplett RC, Perrotta G, et al. Comparison of the Abbott cell DYN 3000 SL and the Coulter STKS hematology analyzers. *Ann Clin Lab Sci* 1994;24:250-258.
11. deLeeuw NKM, Lowenstein L, Hsieh YS. Iron deficiency and hydremia in normal pregnancy. *Medicine* 1996;45:291-315.
12. Brown E, Hopper J, Hodges JL, et al. Red cell, plasma, and blood volume in healthy women measured by radiochromium cell-labeling and hematocrit. *J Clin Invest* 1962;41:2182-2190.
13. Wennesland R, Brown E, Hopper J, et al. Red cell, plasma, and blood volume in healthy men measured by radiochromium ( $Cr^{51}$ ) cell tagging and hematocrit: influence of age, somatotype and habits of physical activity on the variance after regression volumes to height and weight combined. *J Clin Invest* 1959;38:1065-1077.
14. Bohanan RA, Hutchison JL, Townsend SR. The use of radioiron in the study of anemia. *Ann Intern Med* 1961;55:975-988.
15. Bush JA, Ashenbrucker H, Cartwright GE, Wintrobe ME. The anemia of infection. The kinetics of iron metabolism in the anemia associated with chronic infection. *J Clin Invest* 1956;35:89-97.
16. Giblett ER, Coleman DH, Pirzio-Biroli G, et al. Erythrokinetics: quantitative measurements of red cell production and destruction in normal subjects and patients with anemia. *Blood* 1956;11:291-309.
17. Hosain F, Marsaglia G, Finch CA. Blood ferrokinetics in normal man. *J Clin Invest* 1967;46:1-9.
18. Berk PD, Howe RB, Bloomer JR, Berlin NI. Studies of bilirubin kinetics in normal adults. *J Clin Invest*

1969;48:2176–2190.

19. Kjeldsberg C, Foucar K, McKenna R, et al. Practical diagnosis of hematologic disorders, 2nd ed. Chicago: ASCP Press, 1995.
20. Kaplow LS. Cytochemistry of leukocyte alkaline phosphatase. *Am J Clin Pathol* 1963;39:439–449.
21. Mentzer WC. Blood and blood-forming tissues. In: Rudolph AM, Hoffman JIE, Rudolph CD, eds. *Rudolph's pediatrics*, 20th ed. Stamford: Appleton & Lange, 1996.
22. Lubin BH. Reference values in infancy and childhood. In: Nathan DG, Oski FA, eds. *Hematology of infancy and childhood*, 4th ed. Philadelphia: WB Saunders, 1993:1–19.
23. Saarien UM, Siimes MA. Developmental changes in red blood cell counts and indices of infants after exclusion of iron deficiency by laboratory criteria and continuous iron supplementation. *J Pediatr* 1978;92:414–416.
24. Rosse C, Kraemer MJ, Dillon TL, et al. Bone marrow cell populations of normal infants: the predominance of lymphocytes. *J Lab Clin Med* 1977;89:1225–1240.
25. Beale RN, Bostrom JO, Taylor RF. Improved rapid methods for the determination of iron content and binding capacity of serum. *J Clin Pathol* 1962;15:156–160.
26. Beutler E, Blume KG. Human erythrocytes, enzymes and intermediate metabolites related to clinical disorders. In: Altman PL, Dittmer-Katz DS, eds. *Human health and disease*. Bethesda: Federation of American Societies for Experimental Biology, 1977.
27. Ramsay WNM. The determination of iron in blood plasma or serum. *Biochem J* 1953;53:227–231.
28. Chanarin I. *The megaloblastic anemias*, 3rd ed. Chicago: Year Book Medical Publishers, 1990.
29. Stiehm ER, Fudenberg HH. Serum levels of immune globulins in health and disease. *Pediatrics* 1966;37:715–725.

2004 Lippincott Williams & Wilkins  
John P. Greer, John Foerster, John N. Lukens  
George M. Rodgers, Frixos Paraskevas, Bertil Glader  
Wintrobe's Clinical Hematology

[WEB SITES](#)  
[REFERENCES](#)  
[SUGGESTED READINGS](#)

According to Hawkey ([1](#)), there are over 4200 living species of mammals. Adequate hematologic characterization of these mammals has generally been done only for humans and, to a lesser extent, the common laboratory animals and domestic species. Despite voluminous databases for these three categories, the age (young or adult), prandial state, blood collection procedures, and, for nonhuman species, the housing and environmental conditions and the strain of the species are rarely stated in literature reports.

[Table B.1](#) and [Table B.2](#) list some hematologic variables reported by different investigators in a variety of vertebrate species. The tabulated data are representative but certainly are not exhaustive; an attempt was made to primarily include reports describing studies involving a large number of animals, but this limitation was not always possible. Many references for the various species are not cited in the text or tables but are presented unnumbered under each species to offer valuable information on additional data, techniques, or procedures. Also included in the References section are several extensive monographs on comparative hematology, including those of Archer and Jeffcott ([2](#)), Feldman et al. ([3](#)), Harvey ([4](#)), Hawkey and Dennett ([5](#)), Jain ([6](#)), Meyer et al. ([7](#)), Mitruka and Rawnsley ([8](#)), Reagan et al. ([9](#)), Sanderson and Phillips ([10](#)), Wintrobe ([11](#)), and Wolford et al. ([12](#)). Some of these references contain good descriptions and illustrations of the blood cells of various species. Because mean corpuscular volume is more commonly determined in clinical and toxicologic studies than red cell diameter, the latter is not reported in these tables. However, some of the older literature and many of the monographs referenced contain this information for various species.

**TABLE B.1. Hematologic Values in Selected Species of Mammals**

| Species   | Author                                  | RBC<br>( $\times 10^6/\mu\text{l}$ ) | HGB<br>(g/dl)  | VPRC<br>(ml/dl) | MCV<br>(fl)    | MCH<br>(pg)    | MCHC<br>(g/dl) | Retics<br>(%) |
|-----------|---|--------------------------------------|----------------|-----------------|----------------|----------------|----------------|---------------|
| Armadillo |   |                                      |                |                 |                |                |                |               |
| 7-banded  | Cuba-Capara<br>( <a href="#">18</a> )   | $6.00 \pm 0.10$                      | $16.1 \pm 0.7$ | $40.5 \pm 1.3$  | $67.3 \pm 1.9$ | $26.9 \pm 1.1$ | $40.1 \pm 1.9$ | —             |
| 7-banded  | Cuba-Capara<br>( <a href="#">18</a> )   | $5.96 \pm 0.20$                      | $16.8 \pm 0.5$ | $39.7 \pm 1.4$  | $68.0 \pm 3.7$ | $28.7 \pm 1.2$ | $42.7 \pm 1.6$ | —             |
| 9-banded  | D'Addamio et al. ( <a href="#">19</a> ) | $6.7 \pm 1.4$                        | $14.0 \pm 1.8$ | $48.3 \pm 5.8$  | 72.1           | 20.9           | 29.0           | —             |
| 9-banded  | D'Addamio et al. ( <a href="#">19</a> ) | $6.8 \pm 1.5$                        | $13.8 \pm 1.8$ | $48.8 \pm 7.1$  | 71.8           | 20.3           | 28.3           | —             |
| Bear      |   |                                      |                |                 |                |                |                |               |
| Grizzly   | Sedgwick et al. ( <a href="#">20</a> )  | —                                    | —              | 40              | —              | —              | —              | —             |



|               |                        |                          |            |            |            |            |            |           |
|---------------|------------------------|--------------------------|------------|------------|------------|------------|------------|-----------|
| Black         | Sedgwick et al. (20)   | —                        | —          | 52         | —          | —          | —          | —         |
| Caribou       | McEwan (21)            | 10.4 ± 2.5               | 16.8 ± 1.9 | 46.7 ± 5.6 | 46.1 ± 5.9 | 16.5 ± 1.8 | 35.8 ± 2.2 | —         |
| Barren ground | Jain (6)               | 9.5–11.8                 | 11.5–16.5  | —          | —          | —          | —          | —         |
| Cat           |                        |                          |            |            |            |            |            |           |
| Mixed         | Meyer et al. (7)       | 5–10                     | 8–15       | 24–45      | 37–49      | —          | 30–36      | —         |
| Germfree      | Rohovsky et al. (22)   | 8 ± 1                    | 11.6 ± 1.5 | 34.7 ± 4.2 | 43.2       | 14.4       | 33.4       | —         |
| Cattle        |                        |                          |            |            |            |            |            |           |
| Beef          | Adams et al. (23)      | 8.17 ± 1.30              | 10.9 ± 2.1 | 34 ± 6     | 41.0 ± 2.8 | —          | 32.1 ± 0.8 | —         |
| Beef          | Adams et al. (23)      | 8.86 ± 0.70              | 11.3 ± 1.0 | 35 ± 3     | 39.1 ± 1.9 | 12.8 ± 0.8 | 32.8 ± 1.6 | —         |
| Mixed         | Meyer et al. (7)       | 5–8                      | 8–14       | 26–42      | 37–54      | —          | 26–36      | —         |
| Mixed         | Jain (6)               | 5–10                     | 8–15       | 24–46      | 40–60      | 11–17      | 30–36      | 0         |
| Cheetah       |                        |                          |            |            |            |            |            |           |
|               | Sedgwick et al. (20)   | —                        | —          | 41.8 ± 4.7 | —          | —          | —          | —         |
| Chinchilla    |                        |                          |            |            |            |            |            |           |
|               | Strike (24)            | 7.3 ± 1.3                | 11.7 ± 1.9 | 38.7 ± 7.0 | 53         | 16         | 30.2       | —         |
|               | Strike (24)            | 6.6 ± 0.7                | 11.7 ± 1.4 | 38.3 ± 5.8 | 58         | 17.7       | 30.5       | —         |
|               | Jain (6)               | 5.8–10.3                 | 8.0–15.1   | 27–54      | —          | —          | —          | —         |
|               | Jain (6)               | 5.2–9.9                  | 8.8–15.4   | 25–52      | —          | —          | —          | —         |
| Coyote        |                        |                          |            |            |            |            |            |           |
|               | Hawkey (1)             | 6.1                      | 15.4       | 48         | 78.6       | 24.9       | 31.3       | 0.6       |
| Deer          |                        |                          |            |            |            |            |            |           |
| Mule          | Jain (6)               | 8.8 ± 0.2                | 16.4 ± 0.3 | 46.7 ± 0.6 | —          | —          | —          | —         |
| Whitetail     |                        |                          |            |            |            |            |            |           |
|               | Jain (6)               | 17–20                    | 17–21      | 55–61      | —          | —          | —          | —         |
|               | Hawkey (1)             | 5.5                      | 14.3       | 42.5       | 77.5       | 26.6       | 33.2       | 0.7       |
| Dolphin       |                        |                          |            |            |            |            |            |           |
|               | Hawkey (1)             | 3.7                      | 14.5       | 39         | 103        | 38.5       | 37.2       | 3.2       |
| Dog           |                        |                          |            |            |            |            |            |           |
| Beagle        | Michaelson et al. (25) | —                        | 15.8 ± 1.3 | 47.1 ± 3.4 | —          | —          | —          | 1.0 ± 0.6 |
| Beagle        | Ragan et al.           | <sup>b</sup> 7.05 ± 0.40 | 15.6 ± 0.9 | 45.2 ± 2.9 | 64.0 ± 2.1 | 22.2 ± 0.6 | 34.6 ± 0.7 | —         |
| Beagle        | Ragan et al.           | <sup>b</sup> 6.98 ± 0.50 | 15.9 ± 1.2 | 45.8 ± 3.4 | 65.5 ± 1.3 | 22.8 ± 0.4 | 34.8 ± 0.7 | —         |

|            |  |             |            |            |            |            |            |           |
|------------|--|-------------|------------|------------|------------|------------|------------|-----------|
| Beagle     | Ragan et al. <sup>b</sup>  | 5.16 ± 0.60 | 10.5 ± 1.7 | 34.2 ± 4.6 | 66.2 ± 2.3 | 20.4 ± 1.0 | 30.8 ± 1.1 | —         |
| Beagle     | Ragan et al. <sup>b</sup>  | 5.34 ± 0.70 | 11.1 ± 1.9 | 35.7 ± 5.3 | 66.8 ± 2.9 | 20.7 ± 1.2 | 30.9 ± 1.2 | —         |
| Basenji    | Jain ( <a href="#">6</a> )   | 6.91 ± 0.6  | 15.9 ± 1.2 | 49.3 ± 3.4 | 71.1 ± 4.0 | 23.0 ± 0.8 | 32.3 ± 1.2 | 0.8 ± 0.9 |
| Mixed      | Meyer et al. ( <a href="#">5</a> – <a href="#">8</a> – <a href="#">5</a> ) |             | 12–18      | 37–55      | 60–72      | —          | 31–37      | —         |
| Mixed      | Jain ( <a href="#">6</a> )   | 5.5–8.5     | 12–18      | 37–55      | 60–77      | 19.5–24.5  | 32–36      | 0–1.5     |
| Donkey     | Jain ( <a href="#">6</a> )   | 6.65 ± 1.05 | 13.1 ± 1.7 | 38 ± 5     | 57.9 ± 5.5 | 19.9 ± 1.9 | 34.3 ± 1.1 | —         |
| Elephant   | Hawkey ( <a href="#">1</a> )   | 3.3         | 13.6       | 41         | 125        | 41         | 32.5       | 0.1       |
| Indian     | Nirmalan et al. ( <a href="#">26</a> )                                     | 2.5 ± 0.4   | 10.2 ± 2.4 | 34.8 ± 4.8 | 142 ± 13   | 41.9 ± 9.3 | 29.7 ± 7.3 | —         |
| Asian      | Jain ( <a href="#">6</a> )   | 3.18 ± 1.01 | 12.1 ± 2.2 | 33.3 ± 2.0 | —          | —          | —          | —         |
| Ferret     | Lee et al. ( <a href="#">27</a> )  | —           | 14.3 ± 2.2 | 43.4 ± 6.5 | —          | —          | —          | —         |
|            | Lee et al. ( <a href="#">27</a> )  | —           | 15.9 ± 0.7 | 48.4 ± 1.8 | —          | —          | —          | —         |
|            | Thornton et al. ( <a href="#">28</a> )                                     | 10.2        | 17.8       | 55.4       | 54         | 17.6       | 32.2       | 4         |
|            | Thornton et al. ( <a href="#">28</a> )                                     | 8.1         | 16.2       | 49.2       | 61         | 19.9       | 32.8       | 5.3       |
| Fox        |  |             |            |            |            |            |            |           |
| Arctic     | Hawkey ( <a href="#">1</a> )   | 8.1         | 14.6       | 48         | 59.6       | 18.1       | 29.9       | 0.3       |
| Kit        | Jain ( <a href="#">6</a> )   | 8.4 ± 0.8   | 14.9 ± 1.5 | 46.9 ± 3.9 | 54.4 ± 3.6 | 18.2 ± 0.9 | 32.0 ± 2.1 | —         |
| Gerbil     |  |             |            |            |            |            |            |           |
| Mongolian  | Dillon et al. ( <a href="#">29</a> )                                       | 8.42 ± 0.40 | 14.8 ± 0.4 | 47.5 ± 1.0 | 54.6 ± 2.1 | 17.7 ± 0.8 | 32.4 ± 0.8 | 3.1 ± 0.8 |
| Mongolian  | Dillon et al. ( <a href="#">29</a> )                                       | —           | 14.1 ± 0.5 | 45.8 ± 1.3 | —          | —          | —          | 3.3 ± 0.9 |
| Mongolian  | Mays ( <a href="#">30</a> )  | 8.85 ± 0.51 | 15.9 ± 0.6 | 49.3 ± 2.0 | 54.5 ± 3.7 | 17.5 ± 1.1 | 32.3 ± 0.7 | —         |
| Mongolian  | Mays ( <a href="#">30</a> )  | 8.85 ± 0.51 | 15.0 ± 0.4 | 46.8 ± 1.4 | 54.5 ± 3.7 | 16.9 ± 1.1 | 32.1 ± 0.7 | —         |
| Goat       |  |             |            |            |            |            |            |           |
| Miniature  | Ragan et al. ( <a href="#">31</a> )  | 11.6 ± 1.1  | 9.7 ± 0.8  | 27.8 ± 1.9 | 24.1 ± 2.7 | 8.4 ± 0.9  | 33.5 ± 2.8 | —         |
| Miniature  | Ragan et al. ( <a href="#">31</a> )  | 14.9 ± 0.9  | 9.7 ± 0.6  | 29 ± 2     | 19.3 ± 1.2 | 6.5 ± 0.3  | 33.6 ± 2.3 | —         |
| Standard   | Jain ( <a href="#">6</a> )   | 8–18        | 8–12       | 22–38      | 16–25      | 5.2–8.0    | 30–36      | 0         |
| Standard   | Stevens et al. ( <a href="#">32</a> )                                      | 15.8 ± 2.3  | 10.3 ± 1.5 | 31.5 ± 5.4 | 20.0 ± 2.3 | 6.6 ± 0.7  | 33.0 ± 1.8 | —         |
| Guinea pig | Hawkey ( <a href="#">1</a> )   | 5           | 13         | 41.3       | 79.1       | 24.9       | 31         | 1.4       |

|                |  |                              |                         |                     |                     |                        |                        |                |
|----------------|--|------------------------------|-------------------------|---------------------|---------------------|------------------------|------------------------|----------------|
| Hairless       | Waner et al. ( <a href="#">33</a> )                                | 5.79 ± 0.30                  | 15.8 ± 0.6              | 45.7 ± 2.0          | 78.8 ± 1.6          | 27.2 ± 0.7             | 34.5 ± 0.9             | —              |
| Haired         | Waner et al. ( <a href="#">33</a> )                                | 4.81 ± 0.40                  | 13.4 ± 1.1              | 40.4 ± 3.1          | 84.1 ± 2.1          | 27.9 ± 0.6             | 33.2 ± 0.8             | —              |
| Hamster        |  |                              |                         |                     |                     |                        |                        |                |
| Syrian Golden  | Dontenwill et al. ( <a href="#">34</a> )                           | 7.32 ± 0.56                  | 16.2 ± 1.1              | 46.0 ± 3.4          | —                   | —                      | —                      | —              |
| Syrian Golden  | Dontenwill et al. ( <a href="#">34</a> )                           | 7.71 ± 0.50                  | 18.0 ± 1.0              | 50.5 ± 3.3          | —                   | —                      | —                      | —              |
| Species        | Author   | RBC ( × 10 <sup>6</sup> /μl) | HGB (g/dl)              | VPRC (ml/dl)        | MCV (fl)            | MCH (pg)               | MCHC (g/dl)            | Retics (%)     |
| Syrian Golden  | Ragan et al.   | <sup>b</sup> 8.74 ± 0.40     | 16.8 ± 0.7              | 48.8 ± 1.8          | 55.9 ± 1.1          | 19.2 ± 0.4             | 34.4 ± 0.6             | —              |
| Syrian Golden  | Ragan et al.   | <sup>b</sup> 8.57 ± 0.30     | 16.8 ± 0.6              | 48.2 ± 1.8          | 56.4 ± 1.4          | 19.4 ± 0.3             | 34.6 ± 0.5             | —              |
| European       | Emminger et al. ( <a href="#">35</a> )                             | 7.97 ± 0.63                  | —                       | —                   | —                   | —                      | —                      | —              |
| European       | Emminger et al. ( <a href="#">35</a> )                             | 7.84 ± 0.54                  | —                       | —                   | —                   | —                      | —                      | —              |
| Horse          |  |                              |                         |                     |                     |                        |                        |                |
| Thoroughbred   | Jain ( <a href="#">6</a> )   | 9.0 ± 1.2                    | 14.4 ± 1.7              | 41.0 ± 4.5          | 45.5 ± 4.3          | 15.9 ± 1.5             | 35.2 ± 1.4             | —              |
| Standard Mixed | Hawkey ( <a href="#">1</a> )<br>Meyer et al. ( <a href="#">7</a> ) | 7.3<br>7–13                  | 13.8<br>11–19           | 38<br>32–52         | 51.9<br>36–50       | 18.6<br>—              | 35.3<br>31–38          | 0<br>—         |
| Hyena          | Sedgwick et al. ( <a href="#">20</a> )                             | —                            | —                       | 43                  | —                   | —                      | —                      | —              |
| Jackal         | Hawkey ( <a href="#">1</a> )                                       | 5.2                          | 13.7                    | 40.5                | 77.8                | 28.4                   | 34                     | 1.6            |
| Leopard        | Sedgwick et al. ( <a href="#">20</a> )                             | —                            | —                       | 48                  | —                   | —                      | —                      | —              |
| Llama          | Jain ( <a href="#">6</a> )<br>Jain ( <a href="#">6</a> )           | 10.6–17.2<br>10.5–17.2       | 12.5–19.2<br>11.7–19.1  | 28–45<br>17–45      | 23–30<br>23–29      | 10.0–12.7<br>10.3–12.5 | 40.0–46.7<br>39.9–48.7 | 0–0.3<br>0–0.5 |
| Mink           | Kubin et al. ( <a href="#">36</a> )<br>Jain ( <a href="#">6</a> )  | 7.45 ± 1.00<br>5.7–9.3       | 15.1 ± 1.4<br>13.5–17.5 | 50.3 ± 5.3<br>41–57 | 68.3 ± 8.0<br>62–82 | 20.4 ± 1.6<br>—        | 30.2 ± 2.2<br>—        | 5.9 ± 3.8<br>— |
| Mouse          |  |                              |                         |                     |                     |                        |                        |                |
| Ha/ICR         | Henderson et al. ( <a href="#">37</a> )                            | —                            | 15.1 ± 0.9              | 48.4 ± 2.7          | —                   | —                      | 31.2                   | —              |
| Ha/ICR         | Henderson et al. ( <a href="#">37</a> )                            | —                            | 14.6 ± 0.7              | 45.9 ± 2.3          | —                   | —                      | 31.8                   | —              |
| Swiss Webster  | Ragan et al. ( <a href="#">38</a> )                                | 8.53 ± 0.5                   | 14.5 ± 1.1              | 39.7 ± 2.1          | 46.9 ± 1.5          | 17.1 ± 0.6             | 34.8 ± 1.1             | 3.2 ± 1.3      |
| B6C3F1         | Ragan et al.   | <sup>b</sup> 10.93 ± 0.40    | 16.3 ± 0.6              | 48.6 ± 1.6          | 46.6 ± 1.6          | 15.7 ± 0.2             | 33.6 ± 0.7             | 1.8 ± 0.8      |
| B6C3F1         | Ragan et al.   | <sup>b</sup> 10.54 ± 0.30    | 16.7 ± 0.4              | 49.4 ± 2.0          | 46.8 ± 1.8          | 15.8 ± 0.3             | 33.7 ± 1.0             | 2.2 ± 0.8      |

|               |                       |             |              |            |            |            |            |            |
|---------------|-----------------------|-------------|--------------|------------|------------|------------|------------|------------|
| Grasshopper   | Swindle et al. (39)   | 7.76        | 14.5         | 45         | 57.7       | 18.4       | 31.9       | 2.5        |
| Opossum       | Wintrobe (41)         | 4           | 10.1         | 31.9       | 79         | 26         | 32         | —          |
| Short-tailed  | Cothran et al. (40)   | 7.09 ± 1.10 | 14.9 ± 1.7   | 42.9 ± 3.5 | 59.0 ± 4.1 | 20.9 ± 1.1 | 35.5 ± 2.1 | —          |
| Pig           |                       |             |              |            |            |            |            |            |
| Sinclair Mini | Burks et al. (41)     | 6.96 ± 0.90 | 12.4 ± 1.1   | 38.5 ± 3.1 | 56 ± 7     | 18.0 ± 2.3 | 32.1 ± 1.6 | —          |
| Sinclair Mini | Burks et al. (41)     | 6.58 ± 0.90 | 12.4 ± 1.1   | 38.5 ± 3.1 | 59.3 ± 7.0 | 19.2 ± 2.3 | 32.3 ± 1.6 | —          |
| Sinclair Mini | Burks et al. (41)     | 7.68 ± 1.20 | 14.1 ± 1.8   | 42.1 ± 3.4 | 55.4 ± 5.4 | 18.6 ± 2.3 | 33.5 ± 2.3 | —          |
| Sinclair Mini | Burks et al. (41)     | 7.53 ± 1.10 | 15.6 ± 1.0   | 45.9 ± 3.4 | 61.6 ± 7.0 | 21.0 ± 2.3 | 34.2 ± 2.3 | —          |
| Sinclair Mini | Burks et al. (41)     | 6.75 ± 0.90 | 14.4 ± 1.6   | 40.2 ± 3.9 | 59.9 ± 5.4 | 21.5 ± 2.3 | 35.8 ± 1.6 | —          |
| Sinclair Mini | Burks et al. (41)     | 6.96 ± 0.70 | 16.19 ± 1.30 | 45.1 ± 3.1 | 65.2 ± 5.4 | 23.4 ± 1.6 | 35.9 ± 1.6 | —          |
| Yucatan Mini  | Dungan et al. (42)    | 4.22 ± 0.40 | 9.0 ± 1.3    | 27.3 ± 3.4 | 77.0 ± 7.0 | 21.2 ± 1.0 | 32.9 ± 0.5 | —          |
| Hanford Mini  | Ragan et al. (43)     | 6.80 ± 0.70 | 14.4 ± 1.3   | 40.6 ± 3.6 | 59.5 ± 2.2 | 21.3 ± 0.8 | 35.9 ± 0.5 | 0.7 ± 0.5  |
| Hanford Mini  | Ragan et al. (43)     | 3.70 ± 0.6  | 9.4 ± 1.2    | 28.8 ± 3.7 | 77.2 ± 6.5 | 25.5 ± 1.9 | 32.7 ± 1.2 | 17.5 ± 4.8 |
| Mixed         | Meyer et al. (7)      | 5–8         | 10–18        | 33–50      | 50–67      | —          | 30–34      | —          |
| Primate       |                       |             |              |            |            |            |            |            |
| Baboon        | Hainsey et al. (44)   | 5.05 ± 0.32 | 12.9 ± 0.7   | 39.0 ± 2.3 | 76.0 ± 2.6 | 25.4 ± 0.9 | 33.1 ± 0.7 | —          |
| Baboon        | Hainsey et al. (44)   | 4.86 ± 0.30 | 12.3 ± 0.8   | 37.4 ± 2.5 | 77.1 ± 3.1 | 25.3 ± 1.0 | 32.8 ± 0.6 | —          |
| Baboon        | Hack et al. (45)      | 4.55 ± 0.40 | 11.7 ± 0.7   | 38 ± 2     | 83 ± 4     | 26 ± 2     | 32 ± 1     | 1.2 ± 0.4  |
| Baboon        | Hack et al. (45)      | 4.97 ± 0.30 | 12.6 ± 0.9   | 40 ± 2     | 80 ± 5     | 26 ± 2     | 32 ± 1     | 1.2 ± 0.4  |
| Baboon        | Hack et al. (45)      | 5.06 ± 0.40 | 13.4 ± 1.0   | 41 ± 4     | 82 ± 4     | 26 ± 1     | 33 ± 2     | 1.1 ± 0.3  |
| Chimpanzee    | Hainsey et al. (44)   | 5.44 ± 0.60 | 14.5 ± 1.3   | 44.2 ± 3.9 | 81.4 ± 4.5 | 26.7 ± 1.4 | 32.8 ± 0.5 | —          |
| Chimpanzee    | Hainsey et al. (44)   | 5.02 ± 0.50 | 13.4 ± 1.2   | 41.0 ± 3.2 | 81.9 ± 4.0 | 26.7 ± 1.3 | 32.6 ± 0.6 | —          |
| Chimpanzee    | Huser (46)            | 4.57 ± 0.60 | 12.5 ± 1.5   | 39.7 ± 5.0 | 86.0 ± 8.2 | —          | 31.2 ± 2.2 | 0.3 ± 0.2  |
| Gibbon        | Hawkey (1)            | 5.2–6.4     | 9.7–14.2     | 34–43      | 62–74      | 18–22      | 28–32      | 0–1.5      |
| Gorilla       | Hawkey (1)            | 3.8–4.8     | 10.4–12.9    | 34–38      | 83–90      | 25–33      | 29–36      | 0.2–1.5    |
| Monkeys       |                       |             |              |            |            |            |            |            |
| Grivet        | Hambleton et al. (47) | 4.89 ± 0.50 | 13.6 ± 2.1   | —          | 86.6 ± 7.5 | —          | —          | —          |

|                       |   |                                  |               |                 |               |               |                |               |
|-----------------------|---|----------------------------------|---------------|-----------------|---------------|---------------|----------------|---------------|
| Macaque<br>Pig-tailed | Hawkey ( <a href="#">1</a> )                | 4.3–7.0                          | 10.3–15.5     | 35–47           | 74–82         | 19–26         | 28–32          | 0–1.4         |
| Macaque<br>Rhesus     | Huser ( <a href="#">46</a> )                | 5.61 ±<br>0.60                   | 12.3 ±<br>1.1 | 42.1 ±<br>3.2   | 76.0 ±<br>6.5 | —             | 29.1 ±<br>2.0  | 0.5 ±<br>0.4  |
| Marmoset              | Hawkey ( <a href="#">1</a> )                | 5.8–6.3                          | 12.5–15.3     | 41–51           | 66–78         | 21–26         | 31–34          | 0.4–0.7       |
| Owl karyotype<br>V    | Malaga et al.<br>( <a href="#">48</a> )     | 6.4 ± 0.5                        | 17.1 ±<br>1.3 | 52.2 ±<br>3.7   | 81.3 ±<br>4.1 | 26.6 ±<br>1.6 | 32.8 ±<br>0.6  | —             |
| Owl karyotype I       | Malaga et al.<br>( <a href="#">49</a> )     | 6.2 ± 0.6                        | 16.3 ±<br>1.6 | 49.7 ±<br>4.4   | 79.8 ±<br>3.5 | 26.2 ±<br>1.6 | 32.8 ±<br>1.1  | —             |
| Patas                 | Hawkey et al.<br>( <a href="#">50</a> )     | 5.95 ±<br>0.20                   | 16.1 ±<br>1.1 | 51.1 ±<br>3.9   | 85.7 ±<br>4.1 | 27.0 ±<br>1.1 | 31.5 ±<br>0.3  | 0.7 ±<br>0.3  |
| Patas                 | Hawkey et al.<br>( <a href="#">50</a> )     | 5.19 ±<br>0.20                   | 13.4 ±<br>0.3 | 44.4 ±<br>1.2   | 85.5 ±<br>3.8 | 25.9 ±<br>1.3 | 30.2 ±<br>1.0  | 0.9 ±<br>0.2  |
| Titi                  | Roberts et<br>al. ( <a href="#">51</a> )    | 5.07 ±<br>0.50                   | 14.7 ±<br>1.3 | 44.8 ±<br>3.5   | 78.7 ±<br>2.1 | 25.7 ±<br>0.8 | 32.7 ±<br>0.8  | —             |
| Tamarin               | Wadsworth<br>et al. ( <a href="#">52</a> )  | 7.0 ± 0.3                        | 17.4 ±<br>0.7 | 52 ±<br>3       | 74 ±<br>4     | 25.0 ±<br>1.3 | 33 ± 1         | 2.6 ±<br>0.5  |
| Tamarin               | Wadsworth<br>et al. ( <a href="#">52</a> )  | 6.9 ± 0.5                        | 16.6 ±<br>1.4 | 51 ±<br>4       | 73.0 ±<br>3.5 | 24.0 ±<br>1.4 | 33.0 ±<br>1.1  | 2.6 ±<br>1.1  |
| Species               | Author                                      | RBC<br>( × 10 <sup>6</sup> /μl ) | HGB<br>(g/dl) | VPRC<br>(ml/dl) | MCV<br>(fl)   | MCH (pg)      | MCHC<br>(g/dl) | Retics<br>(%) |
| Tupaia                | Huser ( <a href="#">46</a> )                | 6.82 ±<br>0.30                   | 12.9 ±<br>0.9 | 40.8 ±<br>1.8   | 59.8 ±<br>5.3 | —             | 32.0 ±<br>1.4  | —             |
| Vervet                | Wall et al. ( <a href="#">53</a> )          | 5.28 ±<br>0.70                   | 13.5 ±<br>1.7 | 39 ±<br>5       | 73 ±<br>6     | 25.7 ±<br>1.5 | 35 ± 2         | —             |
| Rabbit                |   |                                  |               |                 |               |               |                |               |
| New Zealand           | Bortolotti et<br>al. ( <a href="#">54</a> ) | 5.7 ± 0.4                        | 12.1 ±<br>1.0 | 36 ±<br>3       | 62 ±<br>1     | 21.2 ±<br>0.4 | 33.7 ±<br>0.1  | —             |
| New Zealand           | Gadarowski<br>et al. ( <a href="#">55</a> ) | 5.22 ±<br>0.10                   | —             | 33.4 ±<br>0.6   | —             | —             | —              | —             |
| New Zealand           | Hawkey ( <a href="#">1</a> )                | 4.5–5.8                          | 9.6–13.1      | 31–41           | 62–82         | 18–27         | 28–32          | 0.8–5.0       |
| New Zealand           | Kabata et al.<br>( <a href="#">56</a> )     | 6.40 ±<br>0.4                    | 14.0 ±<br>0.6 | 43 ±<br>2       | 65 ±<br>4     | 21 ± 1        | 32.5 ±<br>4.0  | 24.4<br>± 4.0 |
| New Zealand           | Kabata et al.<br>( <a href="#">56</a> )     | 6.0 ± 0.6                        | 12.7 ±<br>0.6 | 39 ±<br>2       | 66 ±<br>2     | 22 ± 1        | 32.8 ±<br>3.0  | 24 ±<br>4     |
| Raccoon               |   |                                  |               |                 |               |               |                |               |
|                       | Hawkey ( <a href="#">1</a> )                | 7                                | 12.6          | 41.5            | 60            | 18.2          | 29.9           | 0.4           |
|                       | Jain ( <a href="#">6</a> )                  | 9.6–13.3                         | 11–12         | —               | —             | —             | —              | —             |
| Rat                   |   |                                  |               |                 |               |               |                |               |
| Nude (rnu)            | Hougen et al.<br>( <a href="#">57</a> )     | 6.29 ±<br>0.30                   | 9.2 ±<br>0.1  | 36 ±<br>1       | 58 ±<br>1     | —             | 25 ± 0         | —             |
| Long-Evans            | Kozma et al.<br>( <a href="#">58</a> )      | —                                | 15.3 ±<br>0.5 | 45.0 ±<br>1.6   | —             | —             | 34             | —             |
| Long-Evans            | Kozma et al.<br>( <a href="#">58</a> )      | —                                | 14.6 ±<br>1.9 | 47.6 ±<br>5.4   | —             | —             | 30.6           | —             |
| BDIX                  | Lovell et al. ( <a href="#">59</a> )        | 7.09                             | 14.5          | 43.7            | 61.8          | 20.5          | 33.2           | —             |
| LH                    | Lovell et al. ( <a href="#">59</a> )        | 7.01                             | 14.9          | 45.6            | 65.1          | 21.2          | 32.6           | —             |

|                |                                       |                 |                |                |                |                |                |   |
|----------------|---------------------------------------|-----------------|----------------|----------------|----------------|----------------|----------------|---|
| PVG            | Lovell et al. ( <a href="#">61</a> )  | 6.18            | 13.6           | 41.5           | 67.1           | 22             | 32.7           | — |
| WA             | Lovell et al. ( <a href="#">61</a> )  | 6.57            | 13.8           | 42.7           | 65             | 21             | 32.3           | — |
| WAG/LAX        | Lovell et al. ( <a href="#">61</a> )  | 6.86            | 14             | 43.2           | 63.2           | 20.4           | 32.4           | — |
| Fischer 344    | Ragan et al. $b7.29 \pm 0.70$         | $13.7 \pm 1.0$  | $41.6 \pm 2.5$ | $58.2 \pm 3.3$ | $18.8 \pm 0.6$ | $33.0 \pm 1.2$ | $5.7 \pm 2.4$  |   |
| Fischer 344    | Ragan et al. $b7.75 \pm 0.70$         | $14.4 \pm 1.0$  | $43.9 \pm 2.8$ | $57.1 \pm 3.4$ | $18.8 \pm 0.6$ | $32.9 \pm 1.4$ | $4.3 \pm 2.5$  |   |
| Fischer 344    | Ragan et al. $b8.37 \pm 0.50$         | $15.4 \pm 0.6$  | $46.1 \pm 2.0$ | $55.2 \pm 3.2$ | $18.5 \pm 0.6$ | $33.5 \pm 1.5$ | $2.6 \pm 1.0$  |   |
| Fischer 344    | Ragan et al. $b8.47 \pm 0.40$         | $15.8 \pm 0.5$  | $47.4 \pm 2.2$ | $56.4 \pm 3.2$ | $18.7 \pm 0.6$ | $33.3 \pm 1.7$ | $1.7 \pm 0.7$  |   |
| Fischer 344    | Ragan et al. $b9.03 \pm 0.30$         | $15.1 \pm 0.5$  | $45.4 \pm 1.8$ | $50.3 \pm 2.6$ | $17.9 \pm 4.3$ | $33.3 \pm 1.6$ | $2.0 \pm 0.7$  |   |
| Fischer 344    | Ragan et al. $b8.52 \pm 0.40$         | $15.3 \pm 0.7$  | $45.9 \pm 2.5$ | $53.9 \pm 2.7$ | $19.0 \pm 3.9$ | $33.4 \pm 1.6$ | $1.7 \pm 0.7$  |   |
| Fischer 344    | Smith et al. ( <a href="#">60</a> )   | $7.3 \pm 0.3$   | $13.9 \pm 0.5$ | 38.0           | —              | —              | —              | — |
| Fischer 344    | Smith et al. ( <a href="#">60</a> )   | $7.6 \pm 0.2$   | $14.4 \pm 0.4$ | 38.1           | —              | —              | —              | — |
| CrI:CD (SD) BR | Walter ( <a href="#">61</a> )         | $8.47 \pm 1.0$  | $15.2 \pm 1.5$ | $44.7 \pm 4.5$ | $53.0 \pm 1.7$ | $18.0 \pm 0.7$ | $33.9 \pm 0.4$ | — |
| CrI:CD (SD) BR | Walter ( <a href="#">61</a> )         | $7.1 \pm 1.3$   | $14.3 \pm 2.4$ | $42.3 \pm 7.1$ | $59.8 \pm 1.9$ | $20.2 \pm 0.7$ | $33.8 \pm 0.7$ | — |
| Sprague-Dawley | Ragan et al. ( <a href="#">62</a> )   | $6.74 \pm 0.40$ | $13.9 \pm 0.7$ | $42.8 \pm 2.0$ | $63.6 \pm 3.4$ | $20.8 \pm 1.2$ | $32.5 \pm 0.6$ | — |
| Sprague-Dawley | Ragan et al. ( <a href="#">62</a> )   | $6.86 \pm 0.40$ | $14.2 \pm 0.6$ | $43.0 \pm 1.7$ | $63.0 \pm 3.1$ | $20.7 \pm 1.4$ | $32.9 \pm 1.0$ | — |
| Sprague-Dawley | Ragan et al. ( <a href="#">62</a> )   | $7.35 \pm 0.80$ | $14.6 \pm 1.5$ | $43.8 \pm 4.6$ | $60.0 \pm 3.2$ | $19.9 \pm 1.0$ | $33.3 \pm 0.8$ | — |
| Sprague-Dawley | Ragan et al. ( <a href="#">62</a> )   | $6.94 \pm 0.50$ | $14 \pm 1$     | $41.5 \pm 2.8$ | $60.0 \pm 2.4$ | $20.2 \pm 1.0$ | $33.8 \pm 0.9$ | — |
| Sprague-Dawley | Ragan et al. ( <a href="#">62</a> )   | $8.55 \pm 0.60$ | $15.3 \pm 0.8$ | $45.0 \pm 2.3$ | $52.9 \pm 4.8$ | $18.0 \pm 1.6$ | $33.9 \pm 0.9$ | — |
| Sprague-Dawley | Ragan et al. ( <a href="#">62</a> )   | $7.75 \pm 0.50$ | $14.5 \pm 0.6$ | $43.2 \pm 1.7$ | $56.1 \pm 4.0$ | $18.9 \pm 1.4$ | $33.6 \pm 0.7$ | — |
| Buffalo        | Smith et al. ( <a href="#">60</a> )   | $6.8 \pm 0.3$   | $13.1 \pm 0.7$ | 37.3           | —              | —              | —              | — |
| Wistar         | Smith et al. ( <a href="#">60</a> )   | $8.4 \pm 0.5$   | $14.4 \pm 0.8$ | 44.3           | —              | —              | —              | — |
| Wistar         | Smith et al. ( <a href="#">60</a> )   | $6.7 \pm 0.1$   | $12.6 \pm 2.6$ | 38.1           | —              | —              | —              | — |
| Seal           | Hawkey ( <a href="#">1</a> )          | 4.5             | 16.6           | 52.5           | 108            | 35.2           | 31.4           | 1 |
| Sheep Suffolk  | Hackett et al. ( <a href="#">63</a> ) | $10.9 \pm 0.2$  | $10.8 \pm 0.3$ | $35 \pm 1$     | 32.1           | 9.9            | 30.9           | — |
| Mixed          | Meyer et al. ( <a href="#">7</a> )    | 8–15            | 8–16           | 24–49          | 23–48          | —              | 29–35          | — |
| Mixed Skunk    | Jain ( <a href="#">6</a> )            | 9–15            | 9–15           | 27–45          | 28–40          | 8–12           | 31–34          | 0 |

|              |                                 |     |      |      |      |      |      |     |
|--------------|---------------------------------|-----|------|------|------|------|------|-----|
|              | Wintrobe ( <a href="#">11</a> ) | 10  | 15.1 | 51.4 | 54   | 16   | 30   | —   |
| Whale        |                                 |     |      |      |      |      |      |     |
| Killer       | Hawkey ( <a href="#">1</a> )    | 4   | 16.2 | 45   | 113  | 40.5 | 36   | —   |
| Wolf         |                                 |     |      |      |      |      |      |     |
| Mexican wild | Drag ( <a href="#">64</a> )     | 6.6 | 53.5 | 16.7 | 71.3 | 23.3 | 32.9 | —   |
| Mexican wild | Drag ( <a href="#">64</a> )     | 7.4 | 17.2 | 53.5 | 72.3 | 23.7 | 32.9 | —   |
| Zebra        |                                 |     |      |      |      |      |      |     |
|              | Hawkey ( <a href="#">1</a> )    | 8.5 | 14.2 | 39   | 46.1 | 16.5 | 34.3 | 0.1 |

Baso, basophils; Eos, eosinophils; F, female; HGB, hemoglobin; Lymph, lymphocytes; M, male; MCH, mean corpuscular hemoglobin; MCV, mean corpuscular volume; Mono, monocytes; Neutro, neutrophils; RBC, red blood cells; Retics, reticulocytes

<sup>a</sup> Leukocyte differential in percent.

<sup>b</sup> Ragan HA, Debban KH, Romsos CO, et al. Hematology and clinical chemistry values in common laboratory animals. *J Natl Med Assoc*. 1978;70(12):1000-1004.  
NOTE: Data presented as mean  $\pm$  one standard deviation unless a range is indicated.

**TABLE B.2. Hematology of Various Vertebrates Other Than Mammals**

| Species         | Author                               | RBC<br>( $\times 10^6/\mu\text{l}$ ) | HGB<br>(g/dl)  | VPRC<br>(ml/dl) | MCV (fl)     | MCH<br>(pg)    | MCHC<br>(g/dl) | WBC<br>( $\times 10^3/\mu\text{l}$ ) | Neutro<br>( $\times 10^3/\mu\text{l}$ ) |
|-----------------|--------------------------------------|--------------------------------------|----------------|-----------------|--------------|----------------|----------------|--------------------------------------|---|
| <b>Amphibia</b> |                                      |                                      |                |                 |              |                |                |                                      |   |
| Amphiuma        | Wintrobe ( <a href="#">11</a> )      | 0.03                                 | 9.4            | 40              | 13,860       | 3290           | 24             | 8                                    | —                                       |
| Cryptobranchus  | Wintrobe ( <a href="#">11</a> )      | 0.07                                 | 13.3           | 49              | 7425         | 2010           | 27             | 1.9                                  | 1                                       |
| Frog            | Wintrobe ( <a href="#">11</a> )      | 0.44                                 | 7.8            | 29.3            | 670          | 179            | 27             | 3                                    | 0.15                                    |
| Toad            | Biswas et al. ( <a href="#">65</a> ) | 0.68 $\pm$ 0.02                      | 11.2 $\pm$ 0.2 | 32.2 $\pm$ 0.6  | 480 $\pm$ 13 | 34.7 $\pm$ 0.5 | —              | —                                    | —                                       |
| <b>Reptiles</b> |                                      |                                      |                |                 |              |                |                |                                      |   |
| Alligator       | Wintrobe ( <a href="#">11</a> )      | 0.67                                 | 8.2            | 30              | 450          | 123            | 27             | —                                    | —                                       |
| Lizard          | Wintrobe ( <a href="#">11</a> )      | 0.81                                 | 4.4            | 13.8            | 171          | 54             | 32             | —                                    | —                                       |
| Snake           | Wintrobe ( <a href="#">11</a> )      | 1.05                                 | 8.5            | 28              | 267          | 82             | 31             | —                                    | —                                       |
| Turtle          | Wintrobe ( <a href="#">11</a> )      | 0.74                                 | 6.2            | 22.1            | 300          | 85             | 28             | —                                    | —                                       |
| <b>Birds</b>    |                                      |                                      |                |                 |              |                |                |                                      |   |
| Chicken         | Lucas et al. ( <a href="#">67</a> )  | 2.96                                 | 10.7           | 31.9            | 107.7        | 36.1           | 33.5           | 28.9                                 | 6.8                                     |
| Duck            | Magath et al. ( <a href="#">66</a> ) | 3.06                                 | 15.6           | —               | —            | —              | —              | 23.4                                 | 5.7                                     |
| Goose           | Wintrobe ( <a href="#">11</a> )      | 2.82                                 | 12.7           | 44.6            | 160          | 45             | 29             | 6                                    | —                                       |



|                   |                           |                |               |               |         |           |       |                |         |
|-------------------|---------------------------|----------------|---------------|---------------|---------|-----------|-------|----------------|---------|
| Guinea            | Wintrobe<br>( 11)         | 3.69           | 14            | 50            | 136     | 38        | 28    | 8              | 1.6     |
| Pigeon            | Magath<br>et al. ( 66)    | 3.53           | 14.4          | —             | —       | —         | —     | 16.7           | 0.6     |
| Turkey            | Wintrobe<br>( 11)         | 1.93           | 11.2          | 39.2          | 203     | 58        | 29    | —              | —       |
| Fish              |                           |                |               |               |         |           |       |                |         |
| Carp              | Field et<br>al. ( 68)     | 0.84           | 10.5          | 31.3          | 311     | 72        | 34    | —              | —       |
| Dogfish           | Wintrobe<br>( 11)         | 0.07           | 1.4           | 7.3           | 1010    | 195       | 19    | 45             | —       |
| Dogfish           | Reznikoff<br>et al. ( 70) | 0.39           | 4.4           | —             | —       | 112       | —     | 83.5           | 4.2     |
| Flounder          | Wintrobe<br>( 11)         | 0.78           | 2.1           | 8.4           | 108     | 28        | 25    | 6              | 0.12    |
| Mackerel          | Martins<br>et al. ( 69)   | 3.48 ±<br>0.80 | 11.1<br>± 1.6 | 47.0<br>± 5.4 | 135     | 31.9      | 23.6  | 37.9 ±<br>30.3 | 0.71    |
| Rock cod          | Wintrobe<br>( 11)         | 1.49           | 5.2           | 23.8          | 159     | 35        | 22    | —              | 0       |
| Skate             | Wintrobe<br>( 11)         | 0.1            | 1.6           | 9.9           | 952     | 153       | 16    | —              | —       |
| Striped bass      | Hrubec<br>et al. ( 72)    | 4.05           | 8.7           | 35            | 86      | 21.4      | 25    | 71.5           | 1.6     |
| Tilapia (culture) | Hrubec<br>et al. ( 71)    | 1.91–2.83      | 7.0–9.8       | 27–37         | 115–183 | 28.3–42.3 | 22–29 | 21–154         | 0.6–9.8 |
| Trout             | Field et<br>al. ( 68)     | 1.01           | 8.5           | 27.2          | 314     | 75        | 31    | —              | —       |

Baso, basophils; Eos, eosinophils; HGB, hemoglobin; Lymph, lymphocytes; MCH, mean corpuscular hemoglobin concentration; MCV, mean corpuscular volume; Mono, monocytes; Neutro, neutrophils; RBC, red blood cells.

<sup>a</sup> Leukocyte values in percent.

For those interested in the use of laboratory animals in regulated toxicity and safety studies, a joint international committee from ten scientific organizations was formed to provide recommendations for harmonization of clinical pathology testing ( 13).

Much of the tabular data is from animals kept under laboratory conditions (e.g., nonhuman primates, dogs, miniature swine, rats, mice, and hamsters) and generally should not be considered representative of values that one may encounter from all “normal” animals of that species. Controlled environmental conditions in laboratories vary and may have a profound influence on the hemogram. Even animals from the same supplier, but from different shipments, may manifest very significant differences in hematologic values. Therefore, except in the clinical setting, use of hematologic data from intracurrent control animals is imperative for comparison with data from treated experimental groups, rather than relying totally on historical data. Clinically, however, a database of expected normal values for the sex and age of each species should be established by individual laboratories

or clinics.

With the exception of the elliptical, nucleated red cells of birds, fish, reptiles, and amphibians, circulating erythrocytes of most vertebrates are discoidal, nonnucleated, and quite similar cytologically to those of humans. However, tremendous variation is noted in the diameter and volume ranges of the red cells when interspecies comparisons are made, and the erythrocyte count tends to vary inversely with the mean corpuscular volume. Some unique species differences may also be present such as the refractile bodies noted as inclusions in cat erythrocytes. Polychromasia of the red cells is a common finding in rats and, particularly, in mice and may become evident with even minimal bone marrow stress. Values for red cell mass and red cell lifespan, although not included in the tables, may be found in many of the references. Several in-depth studies concerning hemoglobins of various animals have been performed, and references are present in the Suggested Readings for the appropriate species.

The cytologic and staining characteristics of the various leukocytes often are unique for a given species, and, in some cases, they differ considerably from those in humans, but their functions are similar to those of comparable human cells. For instance, in rabbits, guinea pigs, and birds, neutrophils have rather large eosinophilic granules that Ehrlich named *pseudo-eosinophils* or *heterophils*, and the blood of guinea pigs contains a large number of mononuclear cells with peculiar inclusions called *Kurloff corpuscles*. Neutrophils are commonly doughnut- and U-shaped in the blood of mice and some other rodents, and those in rabbits are hypersegmented. Elephant blood contains an unusual type of white cell that has a bilobed nucleus and cytoplasmic staining characteristics intermediate between those of lymphocytes and monocytes. Enzyme cytochemical analysis also reveals differences in reactivity among the mammalian species. In some species, such as rats, mice, rabbits, hamsters, pigs, and cattle, the neutrophil to lymphocyte ratio is reversed from that of humans. Leukocyte differential values in the tables are reported as absolute values when the original reports contained these data or if the conversion could validly be made; otherwise, they are cited as relative values or, in some cases, as ranges as in the original papers.

Platelet cytology in the common laboratory and domestic species is similar to that in humans, but the blood of some species may commonly manifest “giant” platelets. Further, mean platelet counts in rats and mice are normally approximately two to four times those in humans. In birds and amphibians, thrombocytes (i.e., nucleated cells) are present that have an appearance similar to normoblasts. The response of platelets and thrombocytes to various aggregating agents varies considerably with the species, and results should be extrapolated to humans with caution when using animal models in coagulation studies. Several of the references contain values for coagulation parameters in various species. In addition, there are some comparative coagulation studies on multiple species, including the proceedings of a Workshop on Animal Models of Thrombosis and Hemorrhagic Diseases, which contain many pertinent references for nonhuman species ([14](#)), a monograph by Lewis ([15](#)) on comparative hemostasis, and studies by Didisheim et al. ([16](#)) and Rowsell and Mustard ([17](#)).

For valid results, obtaining good-quality blood samples and then handling them appropriately before and during processing are imperative. Blood collection from animals may often be left to inexperienced or inadequately trained personnel who proceed under the misconception that getting “something red” in the collection tube is adequate. Blood collection techniques often are unique for a given species and vary considerably depending on the species. The Suggested Readings section contains numerous citations regarding blood collection procedures for various species. Finally, rigid quality control procedures must be instituted and followed at each laboratory or clinic. A study that is otherwise well conducted may easily be invalidated if sampling techniques and quality control procedures are ignored. The last section of the Suggested Readings contains

several general publications on quality control methods in the clinical pathology laboratory.

## WEB SITES

• <http://link.springer.de/link/service/journals/00580> (Free table of contents service to *Comparative Clinical Pathology*. Full script of articles requires a subscription.)

• <http://www.vetclinpathjournal.org/pages/currentissue.html> (Free table of contents and abstract service to *Veterinary Clinical Pathology*. Full script of articles requires a subscription.)

• <http://www.bloodline.net/vet/index> (Online source for hematology education and news.)

• <http://www.azvt.org/hemo.htm> (Multiple references for numerous mammalian and nonmammalian species.)

• <http://www.google.com> (Once site is opened, request search for “animal hematology” or “hematology + a selected species.”)

## REFERENCES

1. Hawkey CM. Comparative mammalian haematology: cellular components and blood coagulation of captive wild animals. London: William Heinemann Medical Books, 1975.
2. Archer RK, Jeffcott LB. Comparative clinical hematology. Oxford: Blackwell Scientific, 1977.
3. Feldman BV, Zinkl JG, Jain NC, eds. Schalm's Veterinary Hematology, 5th ed. Philadelphia: Williams & Wilkins, 2000.
4. Harvey JW. Atlas of veterinary hematology: blood and bone marrow of domestic animals. Philadelphia: W.B. Saunders, 2001.
5. Hawkey CM, Dennett TB. Color atlas of comparative veterinary hematology. Ames, IA: Iowa State University Press, 1989.
6. Jain N. Essentials of veterinary hematology, 5th ed. Philadelphia: Lea & Febiger, 1993.
7. Meyer DJ, Coles EH, Rich LJ. Veterinary laboratory medicine: interpretation and diagnosis. Philadelphia: W.B. Saunders, 1992.
8. Mitruka BV, Rawnsley HM. Clinical, biochemical and hematological reference values in normal experimental animals and normal humans. New York: Masson, 1981.
9. Reagan WJ, Sanders TG, DeNicola, DB. Veterinary hematology: atlas of common domestic species, 1st ed. Ames, IA: Iowa State Press, 1998.
10. Sanderson JH, Phillips EC. An atlas of laboratory animal hematology. Oxford: Clarendon Press, 1981.
11. Wintrobe MM. Variations in the size and hemoglobin content of erythrocytes in the blood of various vertebrates. *Folia Haematol* 1933;51:32.
12. Wolford ST, Schroer RA, Gohs FX, et al. Reference range data for serum chemistry and hematology values in laboratory animals. *J Toxicol Environ Health* 1986;18:161.
13. Weingand K, Brown G, Hall R, et al. Harmonization of animal clinical pathology testing in toxicity and safety studies. *Fundam Appl Toxicol* 1996;29:198.
14. Dodds WJ, Bowie EJW, Brinkhouse KM, et al., eds. Workshop on animal models of thrombosis and hemorrhagic diseases. Washington, DC: National Academy of Sciences, 1975.

15. Lewis JH. Comparative hemostasis in vertebrates. New York: Plenum Press, 1996.
16. Didisheim P, et al. Hematologic and coagulation studies in various animal species. *J Lab Clin Med* 1959;53:866.
17. Rowsell HC, Mustard JF. Blood coagulation in some common laboratory animals. *Lab Anim Care* 1963;13:752.
18. Cuba-Caparo A. Some hematologic and temperature determinations in the 7-banded armadillo (*Dasyus hybridus*). *Lab Anim Sci* 1976;26:450.
19. D'Addamio GH, Walsh GP, Harris L, et al. Hematologic parameters for wild and captive nine-banded armadillos (*Dasyus novetninctus*). *Lab Anim Sci* 1978;28:607.
20. Sedgwick CJ, Simpson JG, Schalm OW. Clinical hematology in zoo animals. I. Hemograms. *Am J Vet Clin Pathol* 1967;1:105.
21. McEwan EH. Hematological studies of barren-ground caribou. *Can J Zool* 1968;46:1031.
22. Rohovsky MW, Griesemer RA. The hematology of the germfree cat. *Lab Anim Sci* 1969;19:60.
23. Adams R, Garry FB, Aldridge BM, et al. Hematologic values in newborn beef calves. *Am J Vet Res* 1992;53:944.
24. Strike TA. Hemogram and bone marrow differential of the chinchilla. *Lab Anim Care* 1970;20:33.
25. Michaelson SM, Scheer K, Gilt S. The blood of the normal beagle. *J Am Vet Med Assoc* 1966;148:532.
26. Nirmalan G, Nair SG, Simon KJ. Hematology of the Indian elephant (*Elephas maximus*). *Can J Physiol Pharmacol* 1967;45:985.
27. Lee EJ, Moore WE, Fryer HC, Minocha HC. Haematological and serum chemistry profiles of ferrets (*Mustela putorius furo*). *Lab Anim* 1982;16:133.
28. Thornton PC, Wright PA, Sacra PJ, Goodier TEW. The ferret, *Mustela putorius furo*, as a new species in toxicology. *Lab Anim* 1979;13:119.
29. Dillon WG, Glomski CA. The Mongolian gerbil: qualitative and quantitative aspects of the cellular blood picture. *Lab Anim* 1975;9:283.
30. Mays A. Baseline hematological and blood biochemical parameters of the Mongolian gerbil (*Meriones unguiculatus*). *Lab Anim Care* 1969;19:838.
31. Ragan HA, Horstman VG, McClellan RO, Bustad LK. Application of miniature goats in ruminant research. *Am J Vet Res* 1966;27:161.
32. Stevens JB, Anderson KL, Correa MT, et al. Hematologic, blood gas, blood chemistry, and serum mineral values for a sample of healthy adult goats. *Vet Clin Pathol* 1994;23:19.
33. Waner T, Avidar V, Peh HC, et al. Hematology and clinical chemistry values of normal and euthymic hairless adult male Dunkin-Hartley guinea pigs (*Cavia porcellus*). *Vet Clin Pathol* 1996;25:61.
34. Dontenwill W, Chevalier HJ, Harke HP, et al. Biochemical and haematological investigations in Syrian golden hamsters after cigarette smoke inhalation. *Lab Anim* 1974;8:217.
35. Emminger A, Reznik G, Reznik-Schuller H, Mohr U. Differences in blood values depending on age in laboratory-bred European hamsters (*Cricetus aecetus*). *Lab Anim* 1975;9:33.
36. Kubin R, Mason M. Normal blood and urine values for mink. *Cornell Vet* 1948;38:79.
37. Henderson JD, Titus JL. Hematologic and serum protein values in germfree and conventional mice.

Mayo Clin Proc 1968;43:530.

38. Ragan HA, Phillips RD, Buschbom RL, et al. Hematologic and immunologic effects of pulsed microwaves in mice. *Bioelectromagnetics* 1983;4:383.
39. Swindle MM, Hulebak KC, Yarbrough BA. Haematology and pathology of captive southern grasshopper mice ( *Onychomys torridus*). *Lab Anim* 1985;19:195.
40. Cothran EG, Haines CK, VandeBerg JL. Age effects on hematologic and serum chemical values in gray short-tailed opossums ( *Monodelphis domestica*). *Lab Anim Sci* 1990;40:192.
41. Burks MF, Tumbleson ME, Hicklin KW, et al. Age and sex related changes of hematologic parameters in Sinclair (S-1) miniature swine. *Growth* 1977;41:51.
42. Dungan LJ, Wiest DB, Fyfe DA, et al. Normal hematology, serology, and serum protein electrophoresis values in fetal Yucatan miniature swine. *Lab Anim Sci* 1995;45:285.
43. Ragan HA, Phillips RD, Anderson LE. Biological studies of swine exposed to 60-hz electric fields: hematology and serum chemistry. Final report to Electric Power Research Institute (Report EA 4318), Vol. 5. Palo Alto, CA, 1985.
44. Hainsey BM, Hubbard GB, LeLand MM, Brasky KM. Clinical parameters of the normal baboons ( *Papio* sp.) and chimpanzees ( *Pan troglodytes*). *Lab Anim Sci* 1993;43:236.
45. Hack CA, Gleiser CA. Hematologic and serum chemical reference values for adult and juvenile baboons ( *Papio* sp). *Lab Anim Sci* 1982;32:502.
46. Huser H. Atlas of comparative primate hematology. New York: Academic Press, 1970.
47. Hambleton P, Harris-Smith PW, Baskerville A, et al. Normal values for some whole blood and serum components of Grivet monkeys ( *Cercopithecus aethiops*). *Lab Anim* 1979;13:87.
48. Malaga CA, Weller RE, Buschbom RL, Ragan HA. Hematology of the wild-caught karyotype V owl monkey ( *Aotus vociferous*). *Lab Anim Sci* 1995;45:574.
49. Malaga CA, Weller RE, Buschbom RL, Ragan HA. Hematology of the wild caught karyotype I owl monkey ( *Aotus nancyma*). *Lab Anim Sci* 1990;40:204.
50. Hawkey CM, Dean S, Hart MG. The influence of anesthetics on the haematology of the Patas monkey, *Erythrocebus patas*. *Lab Anim* 1978;12:167.
51. Roberts J, Mendoza SP. Hematologic and serum chemistry values in *Callicebus moloch cupreus*. *Lab Anim Sci* 1989;39:163.
52. Wadsworth PF, Hiddleston WA, Jones DV, et al. Haematological, coagulation and blood chemistry data in red-bellied tamarin, *Saguinus labiatus*. *Lab Anim* 1982;16:327.
53. Wall HS, Warthman C, Else JG. Effects of ketamine anaesthesia, stress and repeated bleeding on the haematology of vervet monkeys. *Lab Anim* 1985;19:138.
54. Bortolotti A, Castelli D, Bonati M. Hematology and serum chemistry values of adult, pregnant, and newborn New Zealand rabbits ( *Oryctolagus cuniculus*). *Lab Anim Sci* 1989;39:437.
55. Gadarowski JJ, Esce JD. Acute systemic changes in blood cells proteins, coagulation, fibrinolysis and platelet aggregation after frostbite injury in the rabbit. *Cryobiology* 1974;21:359.
56. Kabata J, Gratwohl A, Tichelli A, et al. Hematologic values of New Zealand white rabbits determined by automated flow cytometry. *Lab Anim Sci* 1991;41:613.
57. Hougen HP, Klausen B. Effects of homozygosity of the nude (rnu) gene in an inbred strain of rat: studies of lymphoid and non-lymphoid organs in different age groups of nude rats of LEW background at a state in the gene transfer. *Lab Anim Sci* 1984;18:7.

58. Kozma CK, Weisbroth SH, Stratman SL, Conejeros M. Normal biological values for Long-Evans rats. *Lab Anim Care* 1969;19:746.
59. Lovell DP, Archer RK, Riley J, Morgan RK. Variation in hematological parameters among inbred strains of rat. *Lab Anim* 1981;15:243.
60. Smith D, Bronson R. Clinical chemistry and hematology profiles of the aging rat. *Lab Anim* 1992;21:32.
61. Walter GL. Effects of carbon dioxide inhalation on hematology, coagulation, and serum chemistry values in rats. *Toxicol Pathol* 1999;27:217.
62. Ragan HA, Buschbom RL, Pipes MJ, et al. Hematologic and serum chemistry studies in rats exposed to 60-Hz electric fields. *Bioelectromagnetics* 1983;4:79.
63. Hackett PL, Gaylor DW, Bustad LK. Blood constituent in Suffolk ewes and lambs. *Am J Vet Res* 1957;18:338.
64. Drag MD. Hematologic values of captive Mexican wolves. *Am J Vet Res* 1991;53:1891.
65. Biswas HM, Patra PB, Bonal MC. Body fluid and hematologic changes in the toad exposed to 48h of simulated high altitude. *J Appl Physiol* 1981;51:794.
66. Magath TB, Higgins GM. The blood of the normal duck. *Folia Haematol* 1934;51:230.
67. Lucas AM, Jamroz C. Atlas of avian hematology. Monograph 25. Washington, DC: U.S. Department of Agriculture, 1961.
68. Field JB, Elvehjem CA, Juday C. A study of the blood constituents of carp and trout. *J Biol Chem* 1943;148:261.
69. Martins JM, Pitombeira MS. High leukocyte count in fishes. *Rev Bras Pesquisas Med Biol* 1968;1:89.
70. Reznikoff P, Reznikoff DG. Hematologic studies in the dogfish (*Mustelus canis*). *Biol Bull* 1934;66:115.
71. Hrubec TC, Cardinale JL, Smith SA. Hematology and plasma chemistry reference intervals for cultured Tilapia (*Oreochromis* hybrid). *Vet Clin Pathol* 2000;29:7.
72. Hrubec TC, Smith SA, Robertson JL. Age-related changes in hematology and plasma chemistry values of hybrid striped bass (*Morone chrysops X Morone saxatilis*). *Vet Clin Pathol* 2001;30:8.

## SUGGESTED READINGS

Baillie AJ, Sim AK. Activation of the fibrinolytic enzyme system in laboratory animals and in man: a comparative study. *Thromb Haemost* 1971;25:499.

Cowell RL, Tyler RD. Diagnostic cytology of the dog and cat. Goleta, CA: American Veterinary Publishers, 1989.

Dunaway PB, Lewis LL. Taxonomic relation of erythrocyte count, mean corpuscular volume, and body-weight in mammals. *Nature* 1965;205:481.

Eccleston E. Normal hematologic values in rats, mice and marmosets. In: Archer RK, Jeffcott LB, eds. *Comparative clinical hematology*. Oxford: Blackwell Scientific, 1977.

Finch CA, Ragan HA, Dyer IA, Cook JD. Body iron loss in animals. *Proc Soc Exp Biol Med* 1978;159:335.

Fowler JSL. Animal clinical chemistry and hematology for the toxicologist. *Arch Toxicol* 1982;5:152.

Green RA. Hemostasis and disorders of coagulation. *Vet Clin North Am* 1981;11:289.

Holman HH. A negative correlation between size and number of the erythrocytes in cows, sheep, goats and horses. *J Pathol* 1952;64:379.

Irons RD. Toxicology of the blood and bone marrow. New York: Raven, 1985.

Jensen EC. Comparative veterinary hematology: a bird's eye view. *Am J Med Technol* 1981;47:985.

Jones TC, Ward JM, Mohr U, Hunt RD, eds. Hematopoietic system. International Life Sciences Institute monograph on pathology of laboratory animals. New York: Springer-Verlag, 1990.

Keller P, Freudiger U. Atlas of hematology of the dog and cat. Berlin: Paul Parey, 1983.

Kitchen H, Easley CW. Structural comparison of the hemoglobins of the genus *Equus* with those of ruminants. *J Biol Chem* 1969;244:6533.

McGrath J. Assessment of hemolytic and hemorrhagic anemias in preclinical safety assessment studies. *Toxicol Pathol* 1993;21:158.

Morton DB, Abbot D, Barclay R, et al. Removal of blood from laboratory mammals and birds. First report of the BPA/FAME/RSPCA/AFAW Joint Working Group on Refinement. *Lab Anim* 1993;27:1.

Rowley AF, Ratcliffe HA. Vertebrate blood cells. New York: Cambridge University Press, 1988.

Tvedten HW. Reference values in small animal clinical diagnosis by laboratory methods. In: Willard MD, Tvedten HW, Turnwald GH, eds. Small animal clinical diagnosis by laboratory methods, 2nd ed. Philadelphia: W.B. Saunders, 1994.

## Mammals

### Miscellaneous and Rare Mammals and Articles Describing More Than One Species

Adams WH, Graves IL, Pyakural S. Hematologic observations on the yak (38613). *Proc Soc Exp Biol Med* 1975;148:701.

Andreasen CB, Gerros TC, Lassen ED. Evaluation of bone marrow cytology and stainable iron content in healthy adult llamas. *Vet Clin Pathol* 1994;23:38.

Campbell T. Hematology of birds, reptiles, and fish. *Top Vet Med* 1992;3:4.

Hem A, Smith AJ, Solberg P. Saphenous vein puncture for blood sampling of the mouse, rat, hamster, gerbil, guinea pig, ferret and mink. *Lab Anim* 1998;32: 364.

Kaplan HM. Techniques of collection in ectotherms of body fluids, excreta and vital products for laboratory examination. *Lab Anim Sci* 1968;18:131.

Kieffer J, Winkler G, Van Hove L, et al. Evaluation of the CELL-DYN 3500 haematology instrument for the analysis of the mouse and rat blood. *Comp Haematol Inter* 1999;9:92.

Kiehl AR, Schiller CA. A study of manatee leukocytes using peroxidase stain. *Vet Clin Pathol* 1994;23:50.

Prado JC, Kloetzel JK. Normal hematologic values of various age groups of *Calomys callosus* (*Rodentia cricetidae*). *Lab Anim Sci* 1995;45:558.

Runkel D, Dresler SL, Brimhall B, Jones RT. The tryptic peptides of coyote (*Canis latrans*) hemoglobin. *Biochem Genet* 1974;12:467.

Tvedten H, Korcal D. Automated differential leukocyte count in horse, cattle, and cats using the Technicon H-1E hematology system. *Vet Clin Pathol* 1996;25:14.



## Armadillo

Lewis JH, Doyle AP. Coagulation, protein and cellular studies on armadillo blood. *Comp Biochem Physiol* 1964;12:61.

Moore DM. Venipuncture sites in armadillos (*Dasypus noveminctus*). *Lab Anim Sci* 1983;33:384.

## Camel

Cohen WD, Terwilliger NB. Marginal bands in camel erythrocytes. *J Cell Sci* 1979;36:97.

Lin KT, Bhowan AS, Chernoff AI. Studies on camel hemoglobin. *Biochim Biophys Acta* 1976;434:110.

## Cat

Altman NH, Melby EC, Squire RA. Intraerythrocytic crystalloid bodies in cats. *Blood* 1972;39:801.

Gilmore CE, Gilmore VH, Jones TC. Bone marrow and peripheral blood of cats: technique and normal values. *Pathol Vet* 1964;1:18.

Jain NC. A staining technique to demonstrate erythrocyte refractile bodies in cat blood. *Br Vet J* 1969;125:437.

Keller P, Freudiger U. Atlas of hematology of the dog and cat. Berlin: Paul Parey, 1983.

Perkins PC, Grindem CB. Evaluation of six cytometric methods for reticulocyte enumeration and differentiation in the cat. *Vet Clin Pathol* 1995;24:37.

Prasse KW, Kaeberle ML, Ramsey FK. Blood neutrophilic granulocyte kinetics in cats. *Am J Vet Res* 1973;34:1021.

Schryver HF. The bone marrow of the cat. *Am J Vet Res* 1963;24:1012.

## Cattle

Abt DA, Ipsen J, Hare WCD. Circadian and seasonal variations in the hemogram of mature dairy cattle. *Cornell Vet* 1966;56:479.

DeFilippi LJ, Hultquist DE. The green hemoproteins of bovine erythrocytes. *J Biol Chem* 1978;253:2946.

Estergreen VL, Van Demark NL. Adrenalectomy of the calf and its effects on various blood constituents. *J Dairy Sci* 1961;44:928.

Gartner RJW, Ryley JW, Beattie AW. The influence of degree of excitation on certain blood constituents in beef cattle. *Aust J Exp Biol Med Sci* 1965;43:713.

Kaneko JJ, Mills R. Hematological and blood chemical observations in neonatal normal and porphyric calves in early life. *Cornell Vet* 1970;60:52.

Osburn BL, Glenn BL. Acquired Pelger-Huet anomaly in cattle. *J Am Vet Med Assoc* 1968;152:11.

Schroeder WA, Shelton JR, Shelton JB, et al. Amino acid sequence of the  $\alpha$ -chain of bovine fetal hemoglobin. *Arch Biochem Biophys* 1967;120:124.

Tennant B, Asbury AC, Laben RC, et al. Familial polycythemia in cattle. *J Am Vet Med Assoc* 1967;150:1493.

Wingfield WE, Tumbleson ME. Hematologic parameters as a function of age in female dairy cattle. *Cornell*

Vet 1973;63:72.

## Chinchilla

Paolini RV, Rossman JE, Patel V, Stanievich JF. A reliable method for large volume blood collection in the chinchilla. *Lab Anim Sci* 1993;43:524.

Tappa B, Amao H, Takahashi A. A simple method for intravenous injection and blood collection in the chinchilla (*Chinchilla laniger*). *Lab Anim* 1989;23:73.

## Deer

Catley A, Kock RA, Hart MG, et al. Hematology of clinically normal and sick captive reindeer (*Rangifer tarandus*). *Vet Rec* 1990;126:239.

Houston TE, Plese CF, Girling RL, et al. Crystallography and oriented single crystal electron microscopy of deer hemoglobin. II. A hemoglobin that exhibits matchstick-shaped erythrocytes. *Biochim Biophys Acta* 1978;535:413.

Kitchen H, Putnam FW, Taylor WJ. Hemoglobin polymorphism in white-tailed deer. Subunit basis. *Blood* 1967;29:867.

Mohri M, Aslani MR, Shahbazian N. Haematology of Persian Fallow Deer (*Dana mesopotamica*). *Comp Haematol Int* 2000;10:183.

Simpson CF, Taylor WJ. Ultrastructure of sickled deer erythrocytes. I. The typical crescent and holly leaf forms. *Blood* 1974;43:899.

Whitten CF. Innocuous nature of the sickling (pseudosickling) phenomenon in deer. *Br J Haematol* 1967;13:650.

Wong SC, Huisman THJ. Viscosity and gelation studies in deer hemoglobins. *Proc Soc Exp Biol Med* 1975;150:581.

## Dog

Calvo W, Flidner TM, Herbst EW, Fache I. Regeneration of blood-forming organs after autologous leukocyte transfusion in lethally irradiated dogs. I. Distribution and cellularity of the bone marrow in normal dogs. *Blood* 1975;46:453.

Carter JM, Brobst D. A comparison of the pH of canine capillary, arterial, and venous blood. *J Comp Lab Med* 1969;3:19.

Clermons RM, Meyers KM. Acquisition and aggregation of canine blood platelets: basic mechanisms of function and differences because of breed origin. *Am J Vet Res* 1984;45:137.

Deavers S, Smith EL, Huggins RA. Changes in red cell volume, venous hematocrit and hemoglobin concentration in growing beagles. *Proc Soc Exp Biol Med* 1971;137:299.

Deubeleiss KA, Dancey JT, Harker LA, et al. Marrow erythroid and neutrophil cellularity in the dog. *J Clin Invest* 1975;55:825.

Deubeleiss KA, Dancey JT, Harker LA, Finch CA. Neutrophil kinetics in the dog. *J Clin Invest* 1975;55:833.

Dodds WJ, Packham MA, Rowsell HC, Mustard JF. Factor VII survival and turnover in dogs. *Am J Physiol* 1968;213:36.

Ewing GO. Familial nonspherocytic hemolytic anemia of basenji dogs. *J Am Vet Med Assoc* 1969;154:503.

Feldman BF, Madewell BR, O'Neill S. Disseminated intravascular coagulation: antithrombin, plasminogen

and coagulation abnormalities in 41 dogs. J Am Vet Med Assoc 1981;179:151.

Hai NP. Technical notes on long-term vascular access for more than 12 months in conscious dogs. J Pharmacol Meth 1982;7:57.

Hall DE. Blood coagulation and its disorders in the dog. Baltimore: Williams & Wilkins, 1972.

Hovell GJR. Jugular puncture in the dog. Vet Rec 1968;21:289.

Keller P, Freudiger U. Atlas of hematology of the dog and cat. Berlin: Paul Parey, 1983.

Lilliehook I. Diurnal variation of canine blood leukocyte counts. Vet Clin Pathol 1997;26:113.

Lund JE. Hemoglobin crystals in canine blood. Am J Vet Res 1974;35:575.

Madewell BR, Feldman BF, O'Neill S. Coagulation abnormalities in dogs with neoplastic disease. Thromb Haemost 1980;44:35.

Middleton DJ, Watson ADJ. Activated coagulation times of whole blood in normal dogs and dogs with coagulopathies. J Small Anim Pract 1978;19:417.

Pinkerton PH, Fletch SM, Brueckner PJ, Miller DR. Hereditary stomatocytosis with hemolytic anemia in the dog. Blood 1974;44:557.

Pryor WH, Bradbury RP. *Haemobartonella canis* infection in research dogs. Lab Anim Sci 1975;25:566.

Reese MA, McDonald TP, Jones JB. Platelet function studies in dogs with cyclic hematopoiesis. Proc Soc Exp Biol Med 1976;153:324.

Stokol T, Parry BW, Mansell PD. Factor VIII activity in canine von Willebrand disease. Vet Clin Pathol 1995;24:81.

Swisher SN, Young LE. The blood grouping systems of dogs. Physiol Rev 1961;41:495.

Tvedten H, Haines C. Canine automated differential leukocyte count: study using a hematology analyzer system. Vet Clin Pathol 1994;23:90.

Wilkerson MJ, Shuman W. Alterations in normal canine platelets during storage in EDTA anticoagulated blood. Vet Clin Pathol 2001;30:107.

Wilkerson RD, Conran PB, Greene SL. Activated coagulation time test: a convenient monitor of heparinization for dogs used in cardiovascular research. Lab Anim Sci 1984;34:62.

Woodward KT, Berman AR, Michaelson SM, Odland LT. Plasma, erythrocyte, and whole blood volume in the normal beagle. Am J Vet Res 1968;29:1935.

Yale CE, Balish E. Blood and serum chemistry values of gnotobiotic beagles. Lab Anim Sci 1976;26:633.

Dolphins, Whales, and Seals

Asper ED. The bottlenose dolphin. San Diego: Academic Press, 1990.

Hendrick MS. Hematology of 7 marine mammals. J Zool London 1991;225:273.

Lincoln DR, Edmunds DT, Gribble TJ, Schwartz HC. Studies on the hemoglobins of pinnipeds. Blood 1973;41:163.

Medway W, Gerac JR. Hematology of the bottlenose dolphin (*Tursiops truncatus*). Am J Physiol 1964;207:1367.

## Elephant

Simon KJ. Hematological studies on elephants. *Indian Vet J* 1961;38:241.

## Ferret

Bleakley SP. Simple technique for bleeding ferrets ( *Mustela putorius furo*). *Lab Anim* 1980;14:59.

Fox JG, Hemes K, Memi SM. Retro-orbital technique for blood collection from the ferret ( *Mustela putorius furo*). *Lab Anim Sci* 1984;34:198.

Marini RP, Jackson LR, Esteves MI, et al. Effect of isoflurane on hematologic variables in ferrets. *Am J Vet Res* 1994;55:1479.

## Goat

Blunt MH, Huisman TH, Lewis JP. The production of haemoglobin C in adult sheep and goats. *Aust J Exp Biol Med Sci* 1969;47:601.

Fitzsimmons WM, Sansom BF, Sellwood SA, Mathews PRJ. Blood transfusion and red cell survival in the goat. *Br Vet J* 1967;123:192.

Lewis JH. Comparative hematology: studies on goats. *Am J Vet Res* 1976;37:601.

Nienhuis AW, Bunn HF. Hemoglobin switching in sheep and goats. *Science* 1974;185:946.

Wrightstone RN, Wilson JB, Miller A, Huisman TH. The structure of goat hemoglobins. *Arch Biochem Biophys* 1970;138:451.

## Guinea Pig

Bullock CP. Repetitive blood sampling from guinea pigs ( *Cavia porcellus*). *Lab Anim Sci* 1983;33:70.

Hochman D, Blanchard J. Simplified method for intravenous dosing and serial blood sampling of unanesthetized guinea pigs. *J Pharm Sci* 1983;72:975.

Hudson G. Eosinophil populations in blood and bone marrow of normal guinea pigs. *Am J Physiol* 1960;198:1171.

Lopez H, Novia J. A technique for repeated collection of blood from the guinea pig. *Lab Anim Sci* 1977;24:522.

Sawitsky A, Meyer LM. Bone marrow of normal guinea pigs. *Blood* 1948;3:1050.

Smith E. Certain characteristics of the leukocytes of guinea pig blood with particular reference to the Kurloff body. *Blood* 1947;[Suppl 1]:125.

Whorton JA. Collecting blood via the anterior vena cava in the guinea pig. *Lab Anim* 1982;11:66.

## Hamster

Terpstra AH, Brandt CW, Opitz R, et al. A procedure to secure a jugular vein catheter system onto the neck of the hamster. *Lab Animals* 1999;33:68.

Yasuokochi Y. Multiple hemoglobins in the golden hamster. *Biochim Biophys Acta* 1970;221:1.

## Horse

Bunn HF, Kitchen H. Hemoglobin function in the horse. *Blood* 1973;42:471.

Kitchen H, Easley CW. Structural comparison of the hemoglobins of the genus *equus* with those of ruminants. *J Biol Chem* 1969;244:6533.

Marcilese NA, Figueiras HD, Kremenchuzky S, et al. Red cell survival time in the horse determined with diisopropyl-phosphofluoridate- $P^{32}$ . *Am J Physiol* 1966;211:281.

Marcilese NA, Figueiras HD, Valsecchi RM, et al. Erythrokinetics in the horse. *Am J Physiol* 1965;209:727.

## Mink

Meyers KM, Holmsen H, Seachord CL, et al. Characterization of platelets from normal mink and mink with the Chediak-Higashi syndrome. *Am J Hematol* 1979;7:137.

## Mouse

Boggs DR. The total marrow mass of the mouse: a simplified method of measurement. *Am J Hematol* 1984;16:277.

Ehrenstein GV. The life span of the erythrocytes of normal and of tumour-bearing mice as determined by glycine- $C^{14}$ . *Acta Physiol Scand* 1958;44:80.

Frankenberg L. Cardiac puncture in the mouse through the anterior thoracic aperture. *Lab Anim* 1979;13:311.

Frith CH, Suber RL, Umholtz R. Hematologic and clinical chemistry findings in control BALB/c and C57BL/6 mice. *Lab Anim Sci* 1980;30:835.

Harleman JH. The haemoglobin types of mice. *Lab Anim* 1977;11:105.

Hodge DE, Shalev M. Dual cannulation: a method for continuous intravenous infusion and repeated blood sampling in unrestrained mice. *Lab Anim Sci* 1992;42:320.

Lewis VJ, Thacker WC, Mitchell SH, Baer GM. A new technic for obtaining blood from mice. *Lab Anim Sci* 1976;26:211.

Ragan HA, Pipes MJ, Kaune WT, Phillips RD. Clinical pathologic evaluations in rats and mice chronically exposed to 60-Hz electric fields. In: *Biological effects of extremely low frequency electromagnetic fields*. Conf-781016. NTIS, Springfield, VA, 1979.

Rugh R, Somagyi G. Pre- and postnatal normal mouse blood cell counts. *Proc Soc Exp Biol Med* 1968;127:1267.

Russell ES et al. Comparison of normal blood picture of young adults from 18 inbred strains of mice. *Proc Soc Exp Biol Med* 1951;78:761.

Wilkinson K, Fikes J, Wojcik S. Improved mouse blood smears using the DiffSpin slide spinner. *Vet Clin Path* 2001;30:197.

## Opossum

Moore DM. A simple technique for blood collection in the opossum (*Didelphis virginiana*). *Lab Anim* 1984;18:52.

Robinson ES, VandeBerg JL. Blood collection and surgical procedures for the laboratory opossum (

*Monodelphis domestica*). Lab Anim Sci 1994;44:63.

Waterman MR, Stenzel P. Physical and chemical properties of opossum hemoglobin. Biochim Biophys Acta 1974;359:401.

## **Pig**

Brown JR, Tyeryar EA, Harrington DG, Hilmas DE. Femoral venipuncture for repeated blood sampling in miniature swine. Lab Anim Sci 1978;28:339.

Bush JA, Jensen WN, Cartwright GE, Wintrobe MM. Blood volume studies in normal and anemic swine. Am J Physiol 1955;181:9.

Damm BI, Pedersen LJ, Ladewig J, Jensen KH. A simplified technique for non-surgical catheterization of the vena cava cranialis in pigs and the evaluation of the method. Lab Anim 1999;34:182.

Egell AK, Framstad T, Morberg H, Tverdal A. Evaluation of piglet blood utilizing the Technicon H\*1. Vet Clin Pathol 1998;27:123.

McClellan RO, Vogt GS, Ragan HA. Age-related changes in hematological and serum biochemical parameters in miniature swine. In: Swine in Biomedical Research. Seattle: Frayn Printing, 1965.

Olsen, AK, Bladbjerg EM, Jensen AL, Hansen AK. Effect of pre-analytical handling on haematologic variables in minipigs. Lab Anim 2000;35:147.

Ragan HA. Platelet agglutination induced by ethylenediamine tetraacetic acid in blood samples from a miniature pig. Am J Vet Res 1972;33:2601.

Ragan HA, Gillis MF. Restraint, venipuncture, endotracheal intubation, and anesthesia of miniature swine. Lab Anim Sci 1975;25:409.

Smith CA, Fichen MD. Non-surgical cannulation of the vena cava for chronic blood collection in mature swine. Lab Anim Sci 1991;41:274.

## **Primates (Nonhuman)**

Abildgaard CF, Harrison J, Johnson CA. Comparative study of blood coagulation in nonhuman primates. J Appl Physiol 1971;30:400.

Banucot NA, Jolly CJ. Haemoglobin polymorphism in the orangutan and an animal with four major haemoglobins. Nature 1966;210:640.

Boyer SH, Crosby EF, Thurmon TF, et al. Hemoglobins A and A<sub>2</sub> in New World primates: comparative variation and its evolutionary implications. Science 1969;166:1428.

Burns KF, Ferguson FG, Hampton SH. Compendium of normal blood values for baboons, chimpanzees, and marmosets. Am J Clin Pathol 1967;48:484.

Calhoun ML. A cytological study of costal marrow. Am J Vet Res 1954;15:181.

Guilietti M, La Torre R, Pace M, et al. Reference blood values of iron metabolism in cynomolgus macaques. Lab Anim Sci 1991;41:606.

Hampton JW, Mathews C. Similarities between baboon and human blood clotting. J Appl Physiol 1966;21:1713.

Kitchen H, Eaton JW, Stenger VG. Hemoglobin types of adult, fetal, and newborn subhuman primates: *Macaca speciosa*. Arch Biochem Biophys 1968;123:227.

Loeb WF, Mackey B. A comparative study of platelet aggregation in primates. J Med Prim 1973;2:195.

Malaga CA, Weller RE, Buschbom RL, Ragan HA. Hematology of the wild-caught karyotype I owl monkey (*Aotus nancyma*). *Lab Anim Sci* 1990;40:205.

Schiffer SP, Gillett CS, Ringler DH. Activated coagulation time for Rhesus monkeys (*Macaca mulatta*). *Lab Anim Sci* 1984;34:191.

Switzer JW, Valerio DA, Martin DP, et al. Hematologic changes associated with pregnancy and parturition in *Macaca mulatta*. *Lab Anim Care* 1970;20:930.

Weber HW, et al. The baboon in medical research: baseline studies in fourteen hundred baboons and pathological observations. In: *Defining the laboratory animal*. Washington, DC: National Academy of Sciences, 1971.

## Rabbit

Ishibashi S, Niu LC, Yuh YH, et al. Evidence for dimorphism in rabbit hemoglobins. *Proc Soc Exp Biol Med* 1968;128:879.

Paulsen R, Valentine JL. A procedure for intravenous administration of drugs and repeated arterial blood sampling in the rabbit. *Lab Anim* 1984;13:34.

Perry-Clark LM, Meunier LD. Vascular access ports for chronic serial infusion and blood sampling in New Zealand white rabbits. *Lab Anim Sci* 1991;41:495.

Smith GN, Mollison PL. Normal red cell survival in the rabbit. *Scand J Haematol* 1973;11:188.

Tillman P, Normal C. Droperidol-fentanyl as an aid to blood collection in rabbits. *Lab Anim Sci* 1983;33:181.

## Rat

Angelov O, Schroer RA, Heft S, et al. A comparison of two methods of bleeding rats: the venous plexus of the eye versus the vena sublingualis. *J Appl Toxicol* 1984;4:258.

Archer RK, Riley J. Standardized method for bleeding rats. *Lab Anim* 1981;15:25.

Berlin N. A simple method for repeated bone marrow aspirations in rats. *Proc Soc Exp Biol Med* 1948;69:53.

Bickhardt K, Buttner D, Muschen U, Plonait H. Influence of bleeding procedure and some environmental conditions on stress-dependent blood constituents of laboratory rats. *Lab Anim* 1983;17:161.

Cocchetto DM, Bjornosson TD. Methods for vascular access and collection of body fluids from the laboratory rat. *J Pharm Sci* 1983;72:465.

Dameron GW, Weingand KW, Duderstadt JM, et al. Effect of bleeding site on clinical laboratory testing of rats: orbital venous plexus versus posterior vena cava. *Lab Anim Sci* 1992;42:299.

Fluttert M, Dalm S, Oitzl M. A refined method for sequential blood sampling by tail incision in rats. *Lab Anim* 2000;34:372.

Frith CH, Ward JM, Chandra M. The morphology, immunochemistry, and incidence of hematopoietic neoplasms in mice and rats. *Toxicol Pathol* 1993;21:206.

Gilman JG, Datta MC. Rat hemoglobin heterogeneity: genetic variation affecting hemoglobin preparations. *Hemoglobin* 1982;6:439.

Godwin KO, et al. Haematological observations in healthy (SPF) rats. *Br J Exp Pathol* 1964;45:514.

Khan KNM, Komocsar WJ, Lazzaro NC, et al. Effect of bleeding site on clinical pathologic parameters in



Sprague-Dawley rats: retro-orbital plexus versus abdominal aorta. *Contemp Top* 1996;35:63.

Kim JC, Yun HI, Lim K, et al. Haematologic values during normal pregnancy in Sprague-Dawley rats. *Comp Haematol Int* 2000;10:74.

LaBorde JB, Wall KS, Bolon B, et al. Haematology and serum chemistry parameters of the pregnant rat. *Lab Anim* 1999;33:275.

Mahl A, Heining P, Ulrich P, et al. Comparison of clinical pathology parameters with two different blood sampling techniques in rats: retrobulbar plexus versus sublingual vein. *Lab Anim* 2000;34:351.

Marit GB, Young SM, Hadick CL. Anatomic and physiologic characterization of the WF/PmWP-“f<sub>2</sub>” (Fuzzy) rat. *Lab Anim Sci* 1995;45:184.

Mohr U. International classification of rodent tumours. Part I—The rat. 4. Haematopoietic system. IARC Scientific Publications No. 122. Lyon, France, 1993.

Nahas K, Provost J-P. Blood sampling in the rat: current practices and limitations. *Comp Clin Pathol* 2002;11:14.

Nahas K, Provost J-P, Baneux PH, Rabemampianina Y. Effects of acute blood removal via the sublingual vein on haematologic and clinical parameters in Sprague-Dawley rats. *Lab Anim* 2000;34:362.

Putchá L, Bruckner JV, Muralidhara S, Feldman S. A simple method for repetitive blood sampling from rats. *J Pharmacol Methods* 1982;8:145.

Ragan HA, Pipes MJ, Kaune WT, Phillips RD. Clinical-pathologic evaluations in rats and mice chronically exposed to 60-Hz electric fields. In: *Biological effects of extremely low frequency electromagnetic fields*. Conf-781016, NTIS. Springfield, VA, 1979.

Reese ME. An investigation of the effects of tobacco smoke and nicotine on rat blood platelet functions. Ph.D. Thesis. Ann Arbor, MI: Ann Arbor University Microfilms, 1974

Saad A, Palm M, Widell S, et al. Differential analysis of rat bone marrow by flow cytometry. *Comp Haematol Int* 2000;10:97.

Shek PN, Howe SA. A novel method for the rapid bleeding of rats from the tail vein. *J Immunol Methods* 1982;53:255.

Snitily MU, Gentry MJ, Mellencamp MA, Preheim LC. A simple method for collection of blood from the rat foot. *Lab Anim Sci* 1991;41:285.

Upton PK, Morgan DJ. The effect of sampling technique on some blood parameters in the rat. *Lab Anim* 1975;9:85.

Urizar RE, Cerda J, Dodds WJ, et al. Age-related renal, hematologic, and hemostatic abnormalities in FH/Wjd rats. *Am J Vet Res* 1984;45:1624.

van Herck H, Baumans V, Brandt CJ, et al. Blood sampling from the retro-orbital plexus, the saphenous vein and the tail vein in rats: comparative effects on selected behavioral and blood variables. *Lab Anim* 2001;35:131.

van Herck H, Baumans V, Brandt CJ, et al. Orbital sinus blood sampling in rats as performed by different animal technicians: the influence of technique and experience. *Lab Anim* 1998;32:377.

Walter GL. Effects of carbon dioxide inhalation on haematology, coagulation, and serum chemistry values in rats. *Toxicol Pathol* 1999;27:217.

Wiegmann TB, Antzer D. Use of an extracorporeal anterior venous shunt and capillary tubes for frequent micro-blood sampling in rats. *J Pharmacol Methods* 1983;9:7.

Zeller W, Weber H, Panoussis B, et al. Refinement of blood sampling from the sublingual vein of rats. *Lab*

Anim 1998;32:369.

## Sheep

Battaglia FC, Behrman RE, De Lannoy CW, et al. Exposure to high altitude of sheep with different haemoglobins. Q J Exp Physiol Cogn Med Sci 1969;54:423.

Blunt MH, Huisman TH, Lewis JP. The production of haemoglobin C in adult sheep and goats. Aust J Exp Biol Med Sci 1969;47:601.

Georgi JR, Hertzendorf II. Simultaneous erythrocyte and plasma volume measurements in sheep using iron-59. Cornell Vet 1964;54:510.

Nienhuis AW, Bunn HF. Hemoglobin switching in sheep and goats. Science 1974;185:946.

Todd JR, Ross JG. Biochemical and haematological changes in the blood of normal sheep following repeated phlebotomy. Br Vet J 1968;124:353.

## Vertebrates Other Than Mammals Amphibians and Reptiles

Alleman AR, Jacobson ER, Raskin RE. Morphological and cytochemical characteristics of blood cells from desert tortoise (*Gopherus agassizii*). Am J Vet Res 1992;53:1645.

Baranowski-Smith LL, Smith DJ. A simple method of obtaining blood samples from mature frogs. Lab Anim Sci 1983;33:386.

Bergman RAM. The erythrocyte of snakes. Folia Haematol 1957;75:92.

Campbell TW. Clinical pathology. In: Mader DM, ed. Reptile medicine and surgery. Philadelphia: W.B. Saunders, 1996.

Caxton-Martins AE. Cytochemistry of blood cells in peripheral smears of some West African reptiles. J Anat 1977;124:393.

Friar W. Sea turtle red blood cell parameters correlated with carapace lengths. Comp Biochem Physiol 1977;56A:467.

Friar W. Turtle red blood cell packed volumes, sizes, and numbers. Herpetologica 1977;33:167.

Gottdenker NL, Jacobson ER. Effects of venipuncture sites on hematologic and clinical biochemical values in desert tortoises (*Gopherus agassizii*). Am J Vet Res 1995;56:19.

Herman CA, Caputo F, Magliola L, deRoos R. An improved cannulation technique for prolonged blood sampling of the American bullfrog. Lab Anim Sci 1978;28:335.

Raphael BL, Klemens MW, et al. Blood values in free-ranging Pancake Tortoises (*Malacochersus tornieri*). J Zoo Wildl Med. 1994;25:63.

Sullivan B. Oxygenation properties of snake hemoglobin. Science 1967;57:1308.

Sullivan B, Riggs A. The subunit dissociation properties of turtle hemoglobins. Biochem Biophys Acta 1967;140:274.

## Birds

Bearhop S, Griffiths R, Orr K, Furness W. The normal haematology of Great Skuas (*Catharacta skua*) in the wild. Comp Haematol Inter 1999;9:107.

Bienzle D, Smith DA. Heterophilic leucocytosis and granulocytic hyperplasia associated with infection in a

cockatoo. *Comp Haematol Int* 1999;9:193.

Campbell TW. *Avian hematology and cytology*, 2nd ed. Ames, IA: Iowa State University Press, 1995.

D'Amelio V. The globins of adult and embryonic chick hemoglobin. *Biochim Biophys Acta* 1966;27:59.

Dorrestein GM, Blaauboer BJ, Miltenburg NA, Deley PP. A modified method of blood sampling from birds. *Lab Anim* 1978;12:193.

Fraser R, Horton B, Dupourque D, Chernoff A. The multiple hemoglobins of the chick embryo. *J Cell Physiol* 1972;80:79.

Johnston PM. Hematocrit values for the chick embryo at various ages. *Am J Physiol* 1955;180:361.

Nazifi S, Tadjalli M, Mohaghheghzadeh M. Normal haematopoiesis cellular components and M/E ratio in the bone marrow of Japanese Quail (*Coturnix coturnix japonica*). *Comp Haematol Int* 1999;9:188.

Newman SH, Mazet JK, Ziccardi MH, et al. Haematologic changes and anemia associated with captivity and petroleum exposure in seabirds. *Comp Haematol Int* 1999;9:60.

Rodnan GP, Ebaugh FG, Fox MRS. The life span of the red blood cell and the red blood cell volume in the chicken, pigeon, and duck as estimated by the use of  $\text{Na}_2\text{Cr}^{51}\text{O}_4$ . *Blood* 1957;12:355.

## Fish

Amend DF, Smith L. Pathophysiology of infectious hematopoietic necrosis virus disease in rainbow trout (*Salmo gairdneri*): early changes in blood and aspects of the immune response after injection of IHN virus. *J Fish Res Board Can* 1974;31:1371.

Binotti I, Giovenco S, Giardina B, et al. Studies on the functional properties of fish hemoglobins. II. The oxygen equilibrium of the isolated hemoglobin components from trout blood. *Arch Biochem Biophys* 1971;142:274.

Blaxhall PC. The haematological assessment of the health of freshwater fish: a review of selected literature. *J Fish Biol* 1972;4:593.

Coburn CB Jr, Fischer BA. Red blood cell hematology of fishes: a critique of techniques and a compilation of published data. *J Marine Sci* 1973;2:37.

Doi Y, Sugita Y, Yoneyama Y. The self-association and oxygen equilibrium of hemoglobin from the lamprey, *Entoshenus japonicus*. *J Biol Chem* 1973;248:2354.

Hawkins R, Mawdesley-Thomas LE. Fish haematology—a bibliography. *J Fish Biol* 1972;4:193.

McLeay DJ, Gordon MR. Leucocrit: a simple hematological technique for measuring acute stress in *Salmonia* fish, including stressful concentrations of pulp mill effluent. *J Fish Res Board Can* 1977;34:2164.

Rumen NM, Love WE. The six hemoglobins of the sea lamprey (*Petromyzon marinus*). *Arch Biochem Biophys* 1963;103:24.

Stokes EE, Firkin BG. Studies of the peripheral blood of the Port Jackson shark (*Heterodontus portusjacksoni*) with particular reference to the thrombocyte. *Br J Haematol* 1971;20:427.

Van Dam L, Scholander PF. Concentration of hemoglobin in the blood of deep sea fishes. *J Cell Comp Physiol* 1953;41:1.

Weber RE, Sullivan B, Bonaventura J, Bonaventura C. The hemoglobin system of the primitive fish *Amia calva*: isolation and functional characterization of the individual hemoglobin components. *Biochim Biophys Acta* 1976;434:18.

## Quality Control

Bishop J, Nix ABJ. Comparison of quality control rules used in clinical chemistry laboratories. *Clin Chem* 1993;39:1638.

Carakostas MC, Banerjee AK. Interpreting rodent clinical laboratory data in safety assessment studies: biological and analytical components of variation. *Fundam Appl Toxicol* 1990;15:744.

Cembrowski GS, Westgard JO. Quality control of multichannel hematology analyzers. *Am J Clin Pathol* 1985;83:337.

Freeman KP, Gruenwaldt J. Quality control in veterinary laboratories. *Vet Clin Pathol* 1999;28:150.

Henry JB, Giegel JL, eds. *Quality control in laboratory medicine*. New York: Masson, 1977.

Howitz PJ, Howitz JH. *Laboratory quality assurance*. New York: McGraw-Hill, 1987.

Levey S, Jennings ER. The use of control charts in the clinical laboratory. *Am J Clin Pathol* 1950;20:1059.

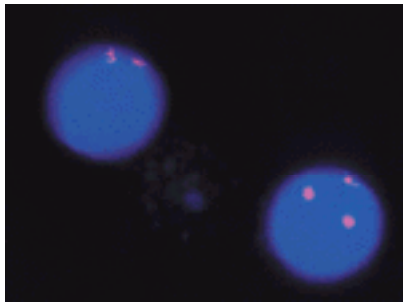
Lumsden JH. "Normal" or reference values: questions and comments. *Vet Clin Pathol* 1998;27:102.

Westgard JO, Klee GG. Quality management. In: Burtis CA, Ashwood ER, eds. *Tietz textbook of clinical chemistry*, 2nd ed. Philadelphia: W.B. Saunders, 1994.

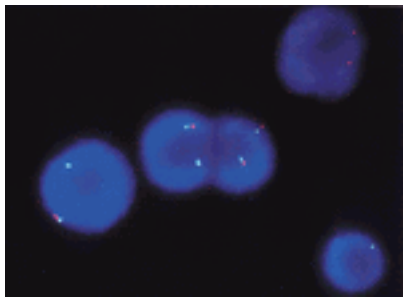
Westgard JO, Barry PL, Hunt MR, Groth T. A multi-rule Shewhart chart for quality control in clinical chemistry. *Clin Chem* 1981 27:493.

2004 Lippincott Williams & Wilkins  
John P. Greer, John Foerster, John N. Lukens  
George M. Rodgers, Frixos Paraskevas, Bertil Glader  
Wintrobe's Clinical Hematology

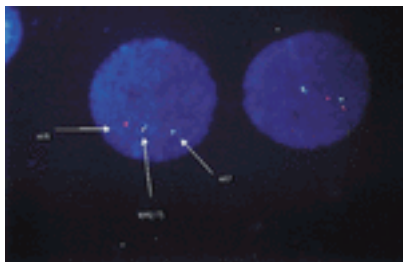
## Color Plate



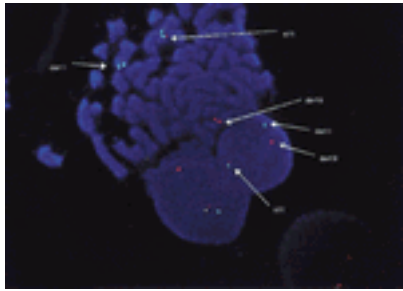
**Color Plate 4.6** Trisomy 12 in an interphase cell (*right*) demonstrated by fluorescence *in situ* hybridization with a chromosome 12 centromeric probe. An interphase cell with two chromosome 12 signals is also seen (*left*). (This figure is printed in black and white as [Figure 4.6.](#))



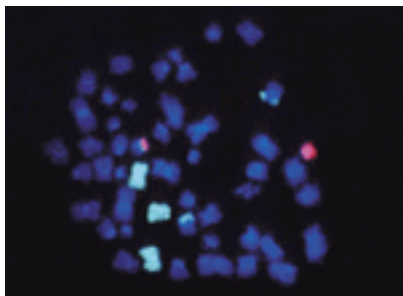
**Color Plate 4.7**  $\text{del}(13q)$  is demonstrated by fluorescence *in situ* hybridization with locus-specific probes to two regions of chromosome 13q in two cells (*left* and *center*). A normal cell is also seen (*right*). (This figure is printed in black and white as [Figure 4.7.](#))



**Color Plate 4.11** PML-retinoic acid receptor (RAR)-a fusion demonstrated in an interphase cell (*left*) by fluorescence *in situ* hybridization with locus-specific probes for the PML and RAR-a genes. A normal cell is also seen (*right*). (This figure is printed in black and white as [Figure 4.11.](#))



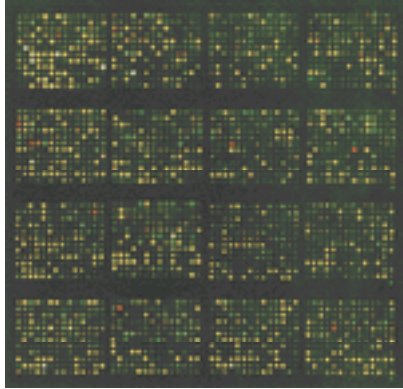
**Color Plate 4.12** Chromosomal translocation involving the MLL gene on chromosome 11 (11q23) demonstrated by fluorescence *in situ* hybridization with a locus-specific probe for MLL. The normal MLL gene is seen as overlapping or adjacent red and green signals. When MLL is involved in a translocation, the red and green signals separate. (This figure is printed in black and white as [Figure 4.12.](#))



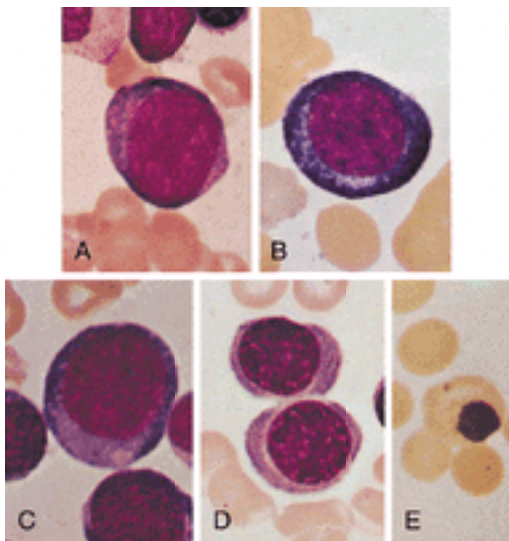
**Color Plate 4.13** A metaphase spread showing the use of whole chromosome paints to confirm the origin of marker chromosomes. Chromosome 11 (*green*) is present as three intact chromosomes and as two translocation regions. Chromosome 20 (*red*) is seen as one intact chromosome and as a translocation region. (This figure is printed in black and white as [Figure 4.13.](#))



**Color Plate 4.14** Spectral karyotype of a normal male cell (A) and of a cell with marker chromosomes (B). (This figure is printed in black and white as [Figure 4.14.](#))

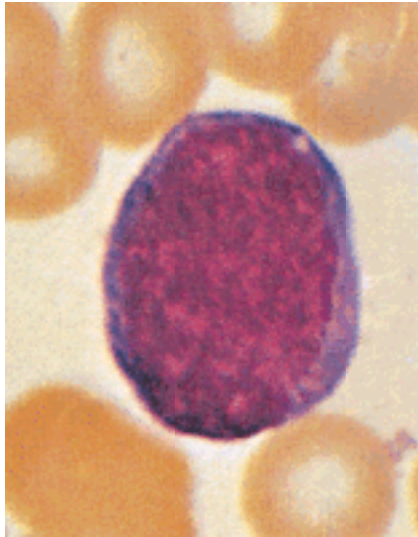


**Color Plate 5.7** Microarray analysis. Shown is a portion of a complementary DNA (cDNA) microarray that has been competitively hybridized with cDNA made from human leukemic cell RNA and labeled with the fluorochrome Cy3 and cDNA prepared from a pool of human RNAs (reference RNA) and labeled with a different fluorochrome, Cy5. Each spot corresponds to one of a total of 11,000 cDNAs affixed on this array. Its color (red, green, or yellow) on laser-scanning analysis provides information about the abundance of specific RNAs in the leukemic blasts. (This figure is printed in black and white as [Figure 5.7](#).)

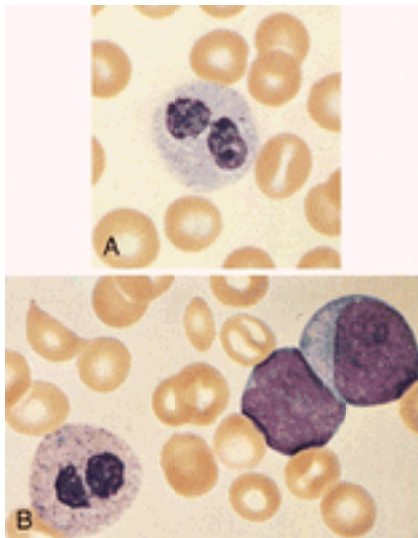


**Color Plate 7.6** Normoblasts. Pronormoblast (A); basophilic normoblast (B); early (C) and late (D) polychromatophilic normoblasts; orthochromatic normoblast with stippling (E). Magnification,  $\times 1000$ ; Wright stain. (This figure is printed in black and white as [Figure 7.6](#).)

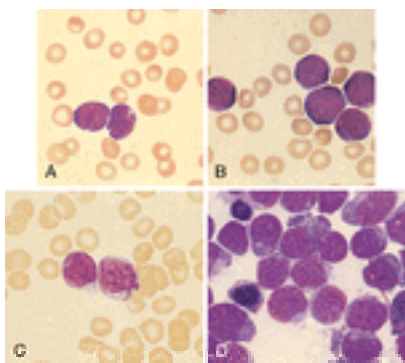




**Color Plate 10.2** Myeloblast ( $\times 1000$ , Wright stain). (This figure is printed in black and white as [Figure 10.2](#).)

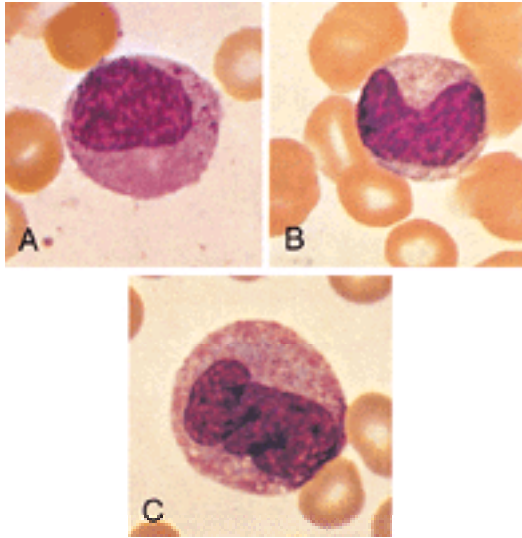


**Color Plate 10.4 A, B:** Pseudo-Pelger-Huët cells, the latter from the blood of a patient with acute myeloblastic leukemia ( $\times 1000$ , Wright stain). (This figure is printed in black and white as [Figure 10.4](#).)

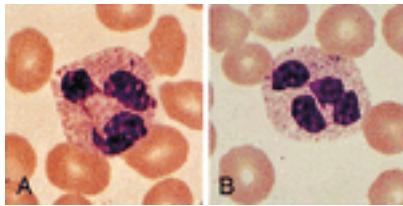


**Color Plate 10.5 A:** L1 lymphoblastic leukemia, blood. **B:** L2 lymphoblastic leukemia, blood. **C:** Acute leukemia, M1 blood ( $\times 1500$ ). **D:** Acute leukemia, M1 marrow ( $\times 1500$ ). (This

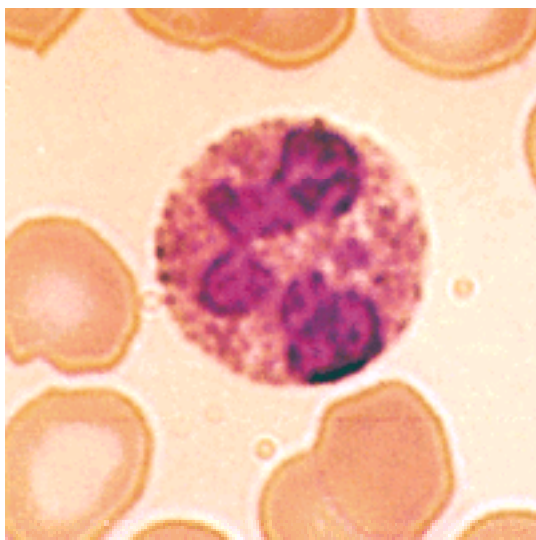
figure is printed in black and white as [Figure 10.5.](#))



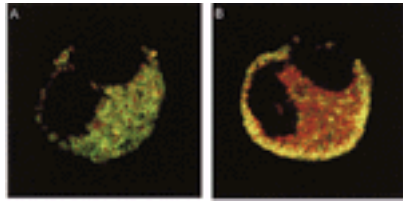
**Color Plate 10.8** A: Late myelocyte or early metamyelocyte. B: Metamyelocyte. C: Monocyte ( $\times 1000$ , Wright stain). (This figure is printed in black and white as [Figure 10.8.](#))



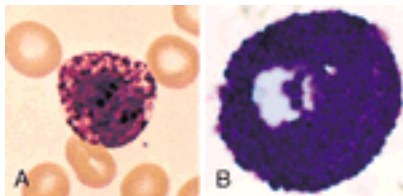
**Color Plate 10.9** A, B: Polymorphonuclear neutrophils. (This figure is printed in black and white as [Figure 10.9.](#))



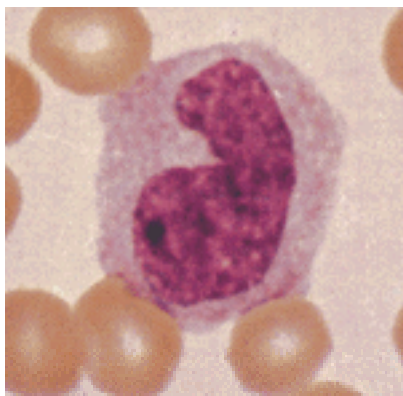
**Color Plate 11.1** Photomicrograph of a peripheral blood eosinophil stained with May-Grünwald-Giemsa. (This figure is printed in black and white as [Figure 11.1.](#))



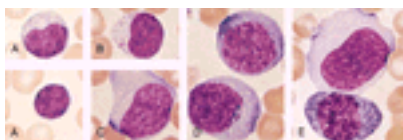
**Color Plate 11.7** Translocation of the chemokine RANTES (regulated on activation, normal T-cell expressed and secreted) in human eosinophils activated by interferon- $\gamma$  *in vitro*. Immunoreactivities for RANTES ( *green fluorescence*) and eosinophil major basic protein (MBP) ( *red fluorescence*) are shown in control (A) and IFN- $\gamma$ -stimulated (10 minutes, 500 U/ml) (B) cells. The yellow color (B) resulted from co-localization of green and red immunofluorescence stains. Note that immunoreactivity for MBP remained associated with the cores of the crystalloid granules in both cells, whereas the green label for RANTES translocated toward the cell membrane. RANTES was proposed to be released from eosinophils by piecemeal degranulation. (Experimental conditions described in Lacy P, Mahmudi-Azer S, Bablitz B, et al. Rapid mobilization of intracellularly stored RANTES in response to interferon-gamma in human eosinophils. *Blood* 1999;94:23-32.) (This figure is printed in black and white as [Figure 11.7](#).)



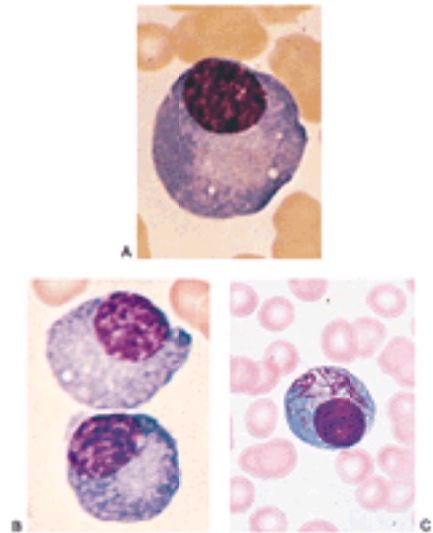
**Color Plate 12.2 A:** Human peripheral blood basophil stained with Wright. (From Lee G, Bithell T, Foerster J, et al., eds. *Wintrobe's clinical hematology*, 9th ed. Philadelphia: Lea & Febiger, 1993, with permission.) **B:** Rat peritoneal mast cell stained with May-Grunwald Giemsa. (This figure is printed in black and white as [Figure 12.2](#).)



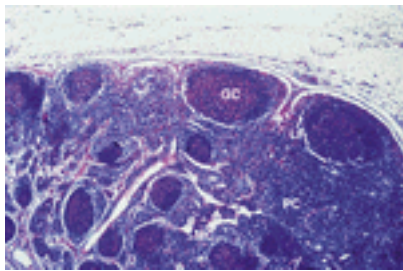
**Color Plate 13.3** Monocyte  $\times 1000$  (approximately). Wright stain. (This figure is printed in black and white as [Figure 13.3](#).)



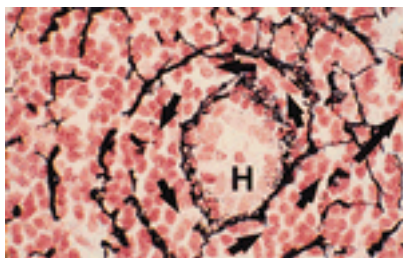
**Color Plate 15.1** Morphologic heterogeneity of human peripheral blood lymphocytes. **A:** Giemsa-stained blood smears: small and large lymphocytes. **B:** Large granular lymphocyte with azurophilic granules. **C:** Atypical lymphocyte. **D:** Lymphocytes resembling plasma cells (plasmacytoid) from the blood of a patient with viral pneumonia. **E:** One atypical lymphocyte and one plasmacytoid lymphocyte from peripheral blood. (This figure is printed in black and white as [Figure 15.1.](#))



**Color Plate 15.7** Plasma cells. **A:** Normal plasma cell. **B:** Plasmacytes with vacuoles from the bone marrow of a patient with infection and arthritis. **C:** Needle type of inclusions in plasma cell. (C used by permission of the American Society of Hematology Slide Bank, 3rd ed, 1990.) (This figure is printed in black and white as [Figure 15.7.](#))

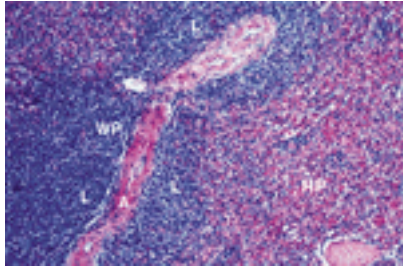


**Color Plate 15.12** Cross-section of a normal lymph node. GC, germinal centers; LF, lymphocytic follicles; MC, medullary cords; PC, paracortical lymphoid areas. (This figure is printed in black and white as [Figure 15.12.](#))

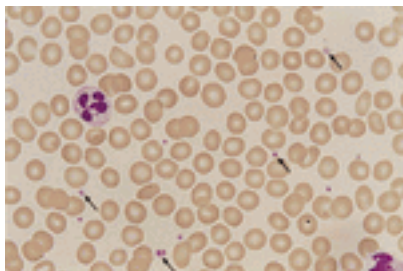


**Color Plate 15.16** Cross section of a paracortical cord showing the corridor, outlined by reticular fibers stained by Gomori stain. The corridor encircles the high endothelial venule

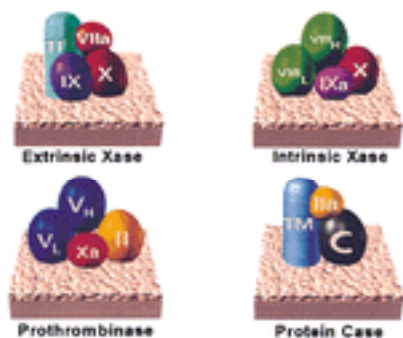
in the center (*H*). (From Gretz JE, Anderson AO, Shaw S. Cords, channels, corridors, and conduits: critical architectural elements facilitating cell interactions in the lymph node cortex. *Immunol Rev* 1997; 156:11–24, with permission.) (This figure is printed in black and white as [Figure 15.16](#).)



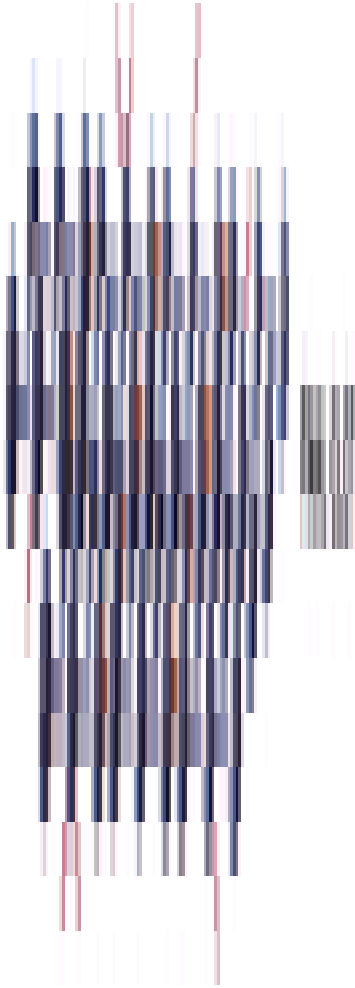
**Color Plate 15.20** Section of the spleen. White pulp (*WP*): lymphocytes (*L*) packed around an arteriole (*A*). Red pulp (*RP*) surrounds the white pulp and consists mainly of sinusoids, the cords, and cordal spaces. (This figure is printed in black and white as [Figure 15.20](#).)



**Color Plate 19.2** A human peripheral blood smear stained with Wright–Giemsa. Platelets, indicated by arrows, are interspersed between erythrocytes and a few leukocytes. The pale, grayish–blue cytoplasm contains purple–red granules. Original magnification of 35–mm slide =  $\times 100$ . (This figure is printed in black and white as [Figure 19.2](#).)

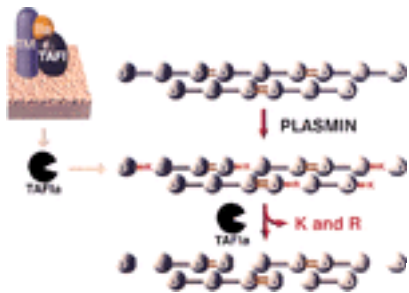


**Color Plate 21.4** Vitamin K-dependent complexes. Three procoagulant complexes (extrinsic tenase, intrinsic tenase, and prothrombinase) and one anticoagulant complex (protein C) are illustrated. (From Mann KG. *Coagulation explosion*. Vermont Business Graphics, 1977, with permission.) (This figure is printed in black and white as [Figure 21.4](#).)



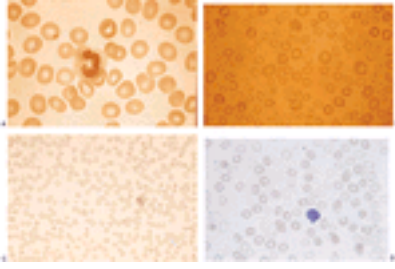
the procoagulant response. Four vitamin K-dependent  
 extrinsic tenase, the intrinsic tenase, prothrombinase, and  
 Coagulation explosion. Vermont Business Graphics, 1997,  
 s printed in black and white as [Figure 21.6.](#))

**Color Plate 21.15** Schematic representation of whole blood fibrin formation. (From Brummel KE, Butenas S, Mann KG. An integrated study of fibrinogen during blood coagulation. *J Biol Chem* 1999;274:22862–22870, with permission.) (This figure is printed in black and white as [Figure 21.15.](#))

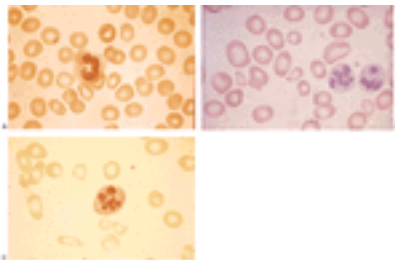


**Color Plate 21.21** Mechanism of thrombin-activatable fibrinolysis inhibitor (TAFI) effects toward fibrinolysis. (From Mann KG. *Coagulation explosion*. Vermont Business Graphics, 1997, with permission.) (This figure is printed in black and white as [Figure 21.21.](#))

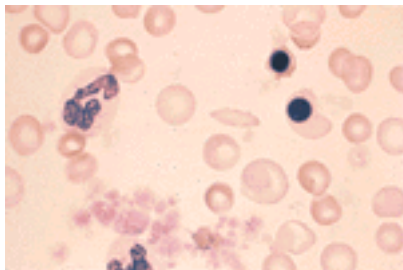




**Color Plate 27.4** Peripheral blood smear of erythrocytes in a variety of hypochromic microcytic anemia. **A:** Normal red cells. **B:** Dimorphic population of cells in iron deficiency anemia responding to treatment. **C:** Thalassemia minor. The cells are thin and appear pale but nearly normal in diameter. Note the basophilic stippling in one red corpuscle. **D:** Sideroblastic anemia. A hypochromic, microcytic population of cells is mixed with a slightly macrocytic one. (This figure is printed in black and white as [Figure 27.4.](#))

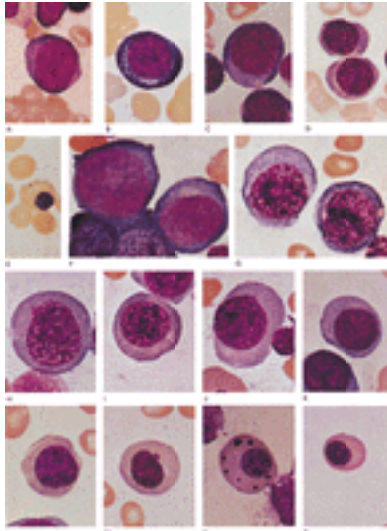


**Color Plate 27.5** Megaloblastic anemia. **A:** Normal red cells. **B:** Macro-ovalocytes in pernicious anemia. **C:** Hypersegmented neutrophils seen in patient with megaloblastic anemia. (This figure is printed in black and white as [Figure 27.5.](#))

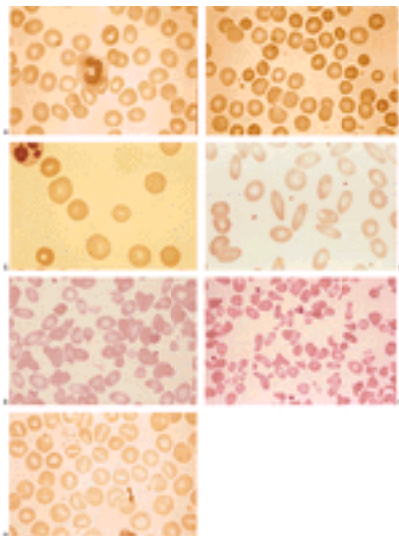


**Color Plate 27.6** Peripheral blood smear. A leukoerythroblastic response seen in patient with myeloid metaplasia. (This figure is printed in black and white as [Figure 27.6.](#))

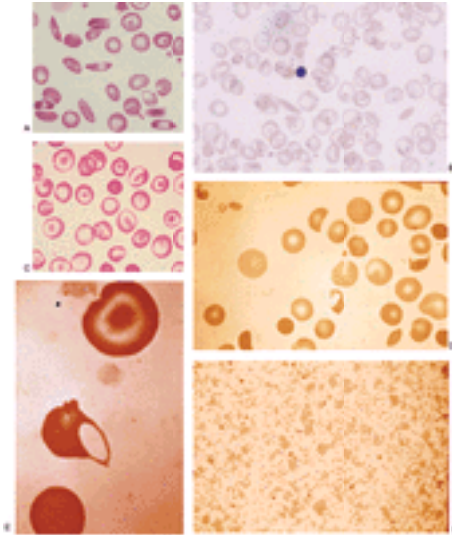




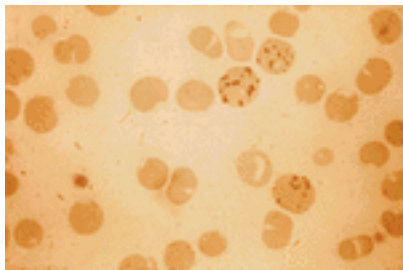
**Color Plate 27.8** Normoblasts and megaloblasts contrasted (Wright stain  $\times 1000$ ). **A–E:** Normoblasts. **A:** Pronormoblast. **B:** Basophilic normoblast. **C:** Early polychromatophilic normoblast. **D:** Late polychromatophilic normoblast. **E:** Orthochromatic normoblast with stippling. **F–O:** Megaloblasts. **F:** Promegaloblast ( *left*) and basophilic megaloblast ( *right*). **G–K:** Polychromatophilic megaloblasts. **L–O:** Orthochromatic megaloblasts. (This figure is printed in black and white as [Figure 27.8.](#))



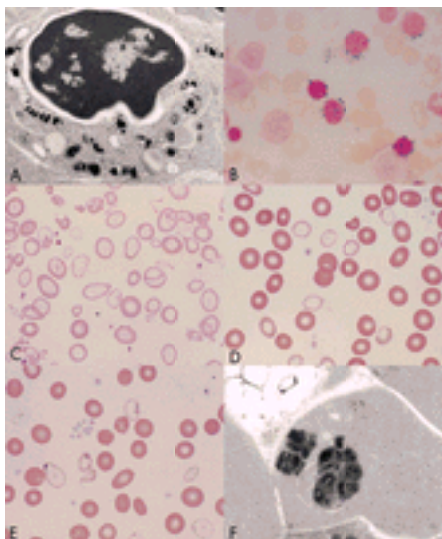
**Color Plate 27.18** Red blood cell abnormalities associated with hemolysis. **A:** Normal red blood cells for comparison. **B:** Microspherocytes from patient with hereditary spherocytosis. **C:** Spherocytes from patient with autoimmune hemolytic anemia. **D:** Hereditary elliptocytosis—common variant with minimal or no hemolysis. **E:** Hereditary elliptocytosis—hemolytic variant. **F:** Hereditary elliptocytosis—pyropoikilocytosis variant. **G:** Hereditary stomatocytosis. (This figure is printed in black and white as [Figure 27.18.](#))



**Color Plate 27.19** **A:** Sick cell anemia. **B:** Sick cell  $\beta$ -thalassemia. **C:** Target cells in hemoglobin C disease. **D:** Schistocytes in patient with thrombotic thrombocytopenic purpura. **E:** Blister cell from oxidative assault in patient with glucose-6-phosphate dehydrogenase deficiency. **F:** Autoagglutination in cold agglutinin disease. (This figure is printed in black and white as [Figure 27.19.](#))



**Color Plate 27.21** Heinz bodies (seen with brilliant cresyl blue supravital stains of blood during hemolytic episodes). (This figure is printed in black and white as [Figure 27.21.](#))



**Color Plate 29.1** Morphologic features of sideroblastic anemia. **A:** Electron micrograph of an erythroblast with iron-laden mitochondria. **B:** Bone marrow smear (Prussian blue stain) with ring sideroblasts. **C,D:** Blood smears (Wright stain) of severe and mild sideroblastic

: stain). **F:** Electron micrograph of a Pappenheimer body in a figure is printed in black and white as [Figure 29.1.](#))



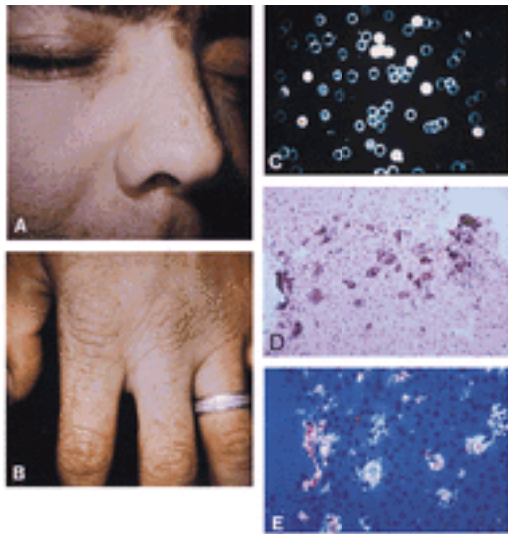
gy of the iron overload in hereditary sideroblastic anemia. r-old man with moderate hemochromatosis. **C,D:** Autopsy man with micronodular cirrhosis and hemochromatosis. **E,F:** latter patient with marked hemosiderosis. (**A, C, and E:** Prussian blue stain.) (This figure is printed in black and

**Color Plate 29.9** Hypochromia and red cell stippling in lead poisoning. (This figure is printed in black and white as [Figure 29.9.](#))

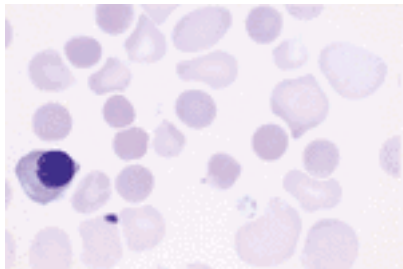


**Color Plate 31.3** Porphyria cutanea tarda in a 60-year-old man. Note denuded skin areas over the fingers, an erosion, blisters, and milia. (This figure is printed in black and white as

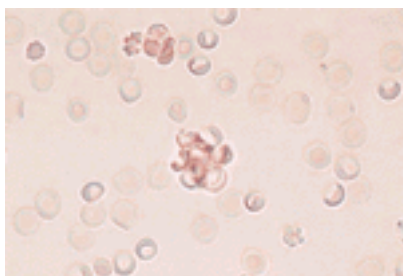
Figure 31.3.)



**Color Plate 31.4** Protoporphyria. **A** and **B**: In a 29-year-old man. Note cobblestonelike, flesh-colored, lichenoid papules over the nose and dorsum of the hand joints. **C**: Dilute suspension of erythrocytes under the fluorescence microscope. Note a fraction of fluorescing cells. (Courtesy of Dr. Maureen Poh-Fitzpatrick, Columbia University, NY.) **D** and **E**: Needle biopsy section of liver. Note deposits of protoporphyrin pigment in the parenchyma and a portal triad (**D**), and birefringence of the deposits, including a dark Maltese cross figure near the left center (**E**). (This figure is printed in black and white as [Figure 31.4.](#))

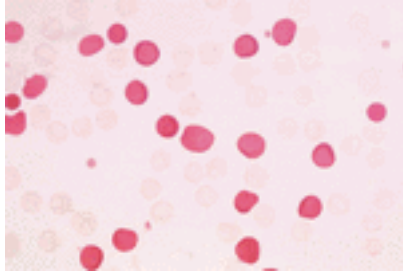


**Color Plate 36.1** ABO hemolytic disease of the newborn (HDN). Peripheral blood from an infant with ABO HDN, with numerous spherocytes, occasional nucleated red cells, anisocytosis, and polychromasia (Wright-Giemsa stain). (©American Society for Clinical Pathology. Used with permission.) (This figure is printed in black and white as [Figure 36.1.](#))

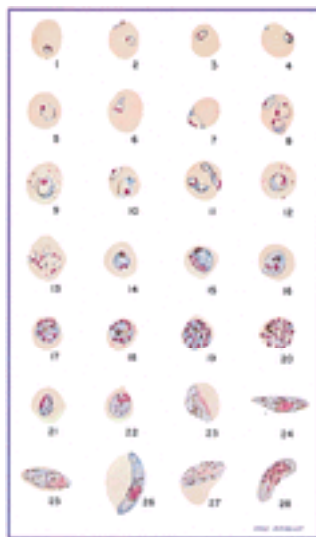


**Color Plate 36.2** Rosette assay for fetal-maternal hemorrhage (FMH). D-positive red cells are identified in a background of D-negative red cells by the formation of rosettes in this

screening test for FMH. There are two rosettes in this field—a large one in the center and a smaller one above it; unagglutinated red cells appear as refractile, biconcave (unstained) disks. (This figure is printed in black and white as [Figure 36.2.](#))



**Color Plate 36.3** Kleihauer–Bethke acid elution for fetal hemoglobin (Hb). Cord blood was mixed with blood from a healthy adult to simulate fetal–maternal hemorrhage, and a Kleihauer–Bethke was performed. Red cells containing HbF are deeply stained red; red cells containing HbA appear as pale pink ghosts. (This figure is printed in black and white as [Figure 36.3.](#))



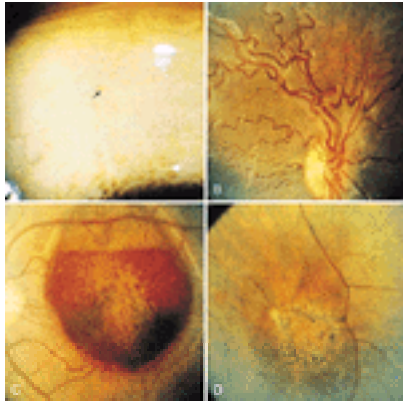
**Color Plate 38.3** *Plasmodium falciparum*. **1:** Very young ring form trophozoite. **2:** Double infection of single cell with young trophozoites, one a marginal form, the other a signet ring form. **3, 4:** Young trophozoites showing double chromatin dots. **5–7:** Developing trophozoites. **8:** Three medium trophozoites in one cell. **9:** Trophozoite showing pigment in a cell containing Maurer spots. **10, 11:** Two trophozoites in each of two cells, showing variation of forms that parasites may assume. **12:** Almost mature trophozoite showing haze of pigment throughout cytoplasm. **13:** Aestivo–autumnal slender forms. **14:** Mature trophozoite, showing clumped pigment. **15:** Parasite in the process of initial chromatin division. **16–19:** Various phases of the development of the schizont. **20:** Mature schizont. **21–24:** Successive forms in the development of the gametocyte, usually not found in the circulation. **25:** Immature macrogametocyte. **26:** Mature macrogametocyte. **27:** Immature microgametocyte. **28:** Mature microgametocyte. (From Wilcox A. Manual for the microscopical diagnosis of malaria in man. National Institutes of Health Bulletin No. 180, with permission.) (This figure is printed in black and white as [Figure 38.3.](#))



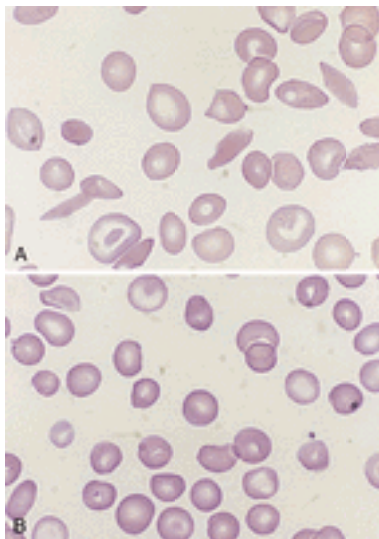
findings characteristic of hemolytic anemia caused by  
**A:** Heinz bodies (seen with brilliant cresyl blue supravital  
ic episodes). **B:** “Bite cells” (seen in routine Wright–stained  
that look as if a semicircular bite has been taken from one  
ghosts (seen in routine Wright–stained blood smear)  
ifted to one side of the cell, leaving the other side clear.  
ontain a coagulum of hemoglobin that has separated from  
ained non–hemoglobin–containing cell membrane. [See  
/siology of hemolysis in glucose–6–phosphate  
min *Hematol* 1990;27(1):1–40.] ( **C** courtesy of Dr. Lawrence  
rinted in black and white as [Figure 38.4.](#))

**Color Plate 38.5** Schistocytes in patients with **(A)** thrombotic thrombocytopenic purpura, **(B)** disseminated intravascular coagulation, **(C)** aortic valve replacement, and **(D)** hemolytic uremic syndrome. (This figure is printed in black and white as [Figure 38.5.](#))

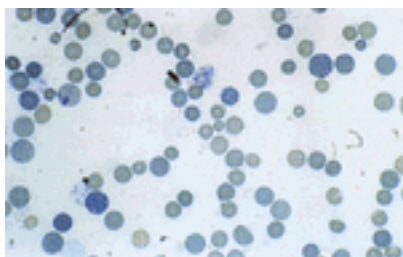




**Color Plate 40.10** Ocular abnormalities in sickle cell anemia. **A:** “Comma” vascular sign: superficial conjunctival vessel that contains densely packed sickled cells (*arrow*). **B:** Widened veins and tortuous large vessels of the retina. **C:** Large preretinal hemorrhage of approximately 2 weeks’ duration. There is partial resorption and exposure of a darkened area that was the probable site of intraretinal hemorrhage. **D:** Old pigmented chorioretinal scar. (Photographs by Professor Mansour Armaly, The George Washington University Medical Center.) (This figure is printed in black and white as [Figure 40.10.](#))

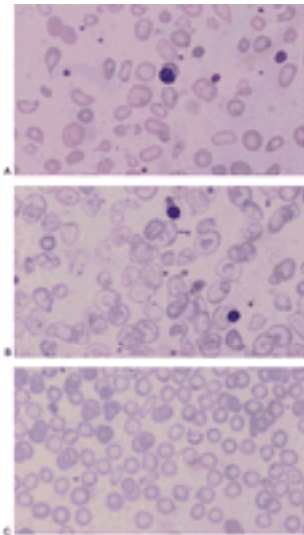


**Color Plate 40.12** Blood smears of patients with hemoglobin (Hb) SS (**A**) and Hb SC (**B**) disease. (This figure is printed in black and white as [Figure 40.12.](#))

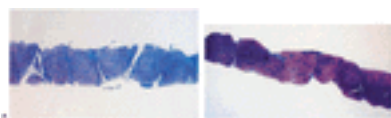


**Color Plate 42.4** Hemoglobin H inclusion bodies. (This figure is printed in black and white as [Figure 42.4.](#))

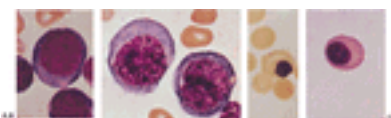




**Color Plate 42.7** Peripheral blood smears in  $\beta$ -thalassemia major (A) and intermedia (B) and in heterozygous  $\beta$ -thalassemia (C). (This figure is printed in black and white as [Figure 42.7](#).)



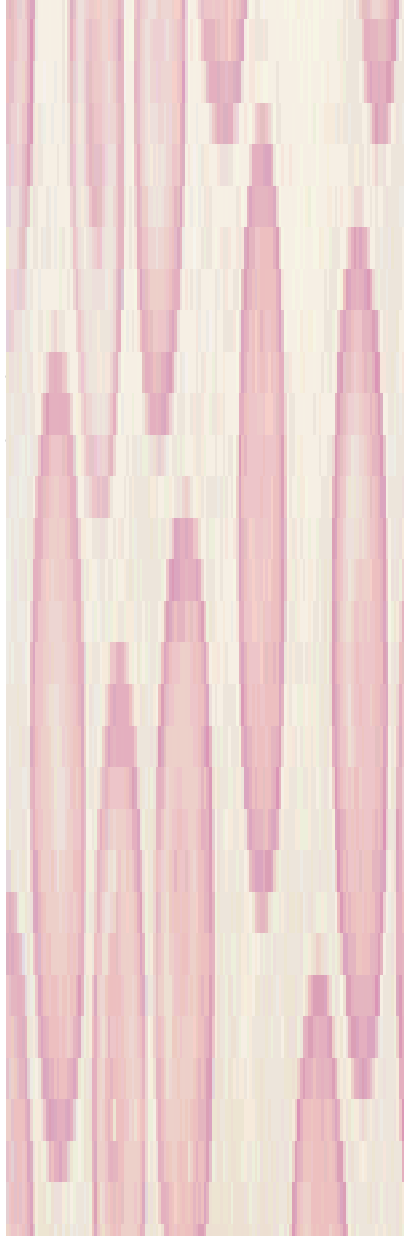
**Color Plate 42.10** Liver biopsies before (A) and after (B) bone marrow transplantation demonstrating reversal of liver cirrhosis. (From Muretto P, Angelucci E, Lucarelli G. Reversibility of cirrhosis in patients cured of thalassemia by bone marrow transplantation. *Ann Intern Med* 2002;136:669, with permission.) (This figure is printed in black and white as [Figure 42.10](#).)



**Color Plate 43.5** Normal and megaloblastic precursor cells in the bone marrow. A: Pronormoblast. B: Megaloblastic equivalent of cell in A. C: Late normoblast. D: Megaloblastic equivalent of cell in C. (From Lee RG, Foerster J, Lukens J, et al., eds. *Wintrobe's clinical hematology*, 10th ed. Philadelphia: Lippincott Williams & Wilkins, 1999: 913, with permission.) (This figure is printed in black and white as [Figure 43.5](#).)



**Color Plate 43.6** Normal peripheral blood cells compared with megaloblastic cells. Normal red blood cells (A); macroovalocytic red blood cells with poikilocytosis (B); and a normal neutrophil with a larger, hypersegmented one (C). (From Lee RG, Foerster J, Lukens J, et al., eds. *Wintrobe's clinical hematology*, 10th ed. Philadelphia: Lippincott Williams & Wilkins, 1999: 910, 1895, with permission.) (This figure is printed in black and white as [Figure 43.6](#).)



nia bone marrow histology. A bone marrow biopsy obtained nia shows the characteristic hypocellularity. Note the ular elements are comprised primarily of lymphocytes. (This /hite as [Figure 44.1.](#))

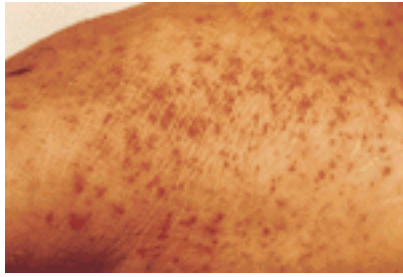
cells in renal disease ( $\times 1500$ ). **B:** Burr cells in renal disease d in black and white as [Figure 47.5.](#))

**Color Plate 47.6** Macrocytes and target cells in liver disease ( $\times 1500$ ). (This figure is printed in black and white as [Figure 47.6.](#))

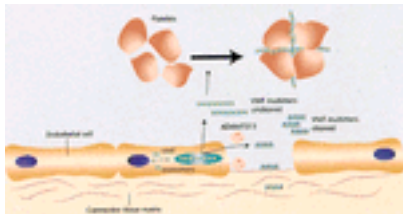


**Color Plate 51.2** Large dissecting hematoma of thigh in a patient with hemophilia A. The lesion resulted from a slight bump to the inguinal area and spread to involve the entire thigh. (Courtesy of Dr. John Lukens.) (This figure is printed in black and white as [Figure](#)

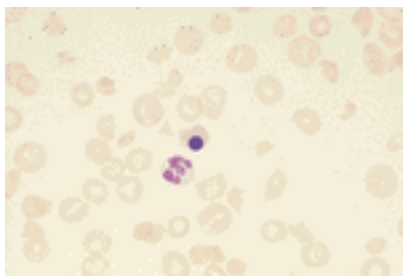
51.2.)



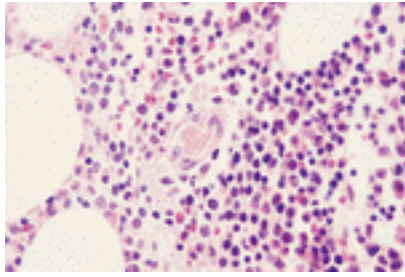
**Color Plate 53.4** Petechiae. Pinpoint, nonblanching erythematous capillary bleeding sites are most common in dependent body areas or pressure points. (This figure is printed in black and white as [Figure 53.4.](#))



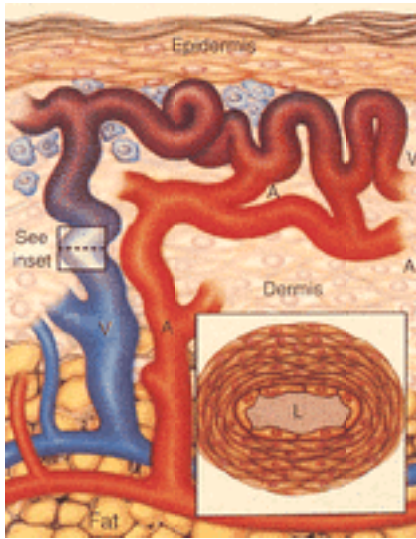
**Color Plate 54.1** von Willebrand factor (VWF) is synthesized in endothelial cells as a monomer that is subsequently made into multimers that are secreted. Large multimers best support platelet adhesion to collagen, but the largest multimers have high affinity for platelets and may cause platelets to agglutinate. It is hypothesized that ADAMTS13, a metalloprotease, cleaves secreted VWF to limit the size of the multimers and prevent platelet agglutination in the circulation. (This figure is printed in black and white as [Figure 54.1.](#))



**Color Plate 54.2** Peripheral blood smear from a patient with acute thrombotic thrombocytopenic purpura. Polychromasia, a nucleated red blood cell, and numerous schistocytes are present ( $\times 1000$ ; Wright-Giemsa stain). (This figure is printed in black and white as [Figure 54.2.](#))



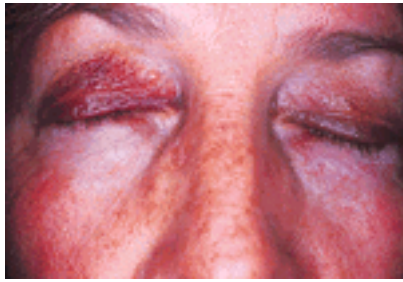
**Color Plate 54.3** Bone marrow biopsy in a patient with acute thrombotic thrombocytopenic purpura. There is a hyaline thrombus within one of the arterioles in the bone marrow ( $\times 1000$ ; hematoxylin and eosin stain). (This figure is printed in black and white as [Figure 54.3](#).)



**Color Plate 56.1** Arteriovenous malformations in hereditary hemorrhagic telangiectasia. In a fully developed cutaneous telangiectasia, the venule ( *V* ) and its branches have become dilated and convoluted throughout the dermis. The connecting arterioles ( *A* ) have also become dilated and communicate directly with the venules without intervening capillaries. A perivascular infiltrate is present. The thickened wall of a dilated postcapillary venule is also shown. L, lumen of the vessel. (From Guttmacher AE, Marchuk DA, White RI. Hereditary hemorrhagic telangiectasia. *N Engl J Med* 1995;333:918–924, with permission.) (This figure is printed in black and white as [Figure 56.1](#).)



**Color Plate 56.2** Telangiectasias of the tongue and lower lip in a patient with hereditary hemorrhagic telangiectasia. (From Guttmacher AE, Marchuk DA, White RI. Hereditary hemorrhagic telangiectasia. *N Engl J Med* 1995;333:918–924, with permission.) (This figure is printed in black and white as [Figure 56.2](#).)



**Color Plate 56.3** Periorbital purpura in a 58-year-old female with immunoglobulin A ? plasma cell dyscrasia associated with secondary amyloidosis. This photograph was kindly provided by Drs. Theresa Scholz and Pamela Nemzer (Department of Dermatology, University of Utah Health Sciences Center). (This figure is printed in black and white as [Figure 56.3.](#))



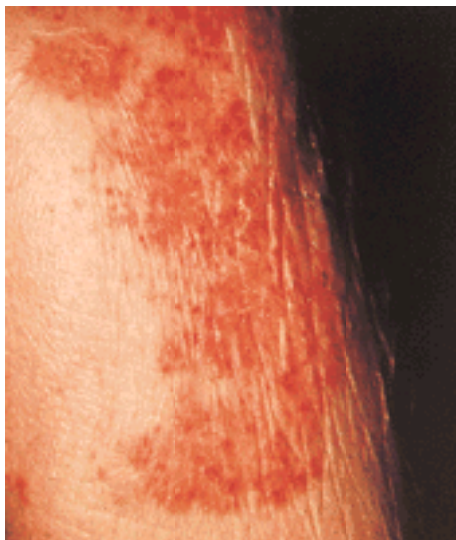
**Color Plate 56.7** Senile purpura (also known as *Bateman purpura*) in a 70-year-old man. This photograph was kindly provided by Dr. Kappa Meadows (Department of Dermatology, University of Utah Health Sciences Center). (This figure is printed in black and white as [Figure 56.7.](#))



**Color Plate 56.8** Lower extremity palpable purpura in a patient with Henoch-Schönlein purpura. (From Van Hale HM, Gibson LE, Schroeter AL. Henoch-Schönlein vasculitis: direct immunofluorescence study of uninvolved skin. *J Am Acad Dermatol* 1986;15:665-670, with permission.) (This figure is printed in black and white as [Figure 56.8.](#))



**Color Plate 56.9** Skin lesions of hands and feet associated with papular-purpuric gloves (A) and socks syndrome (B). (From Harms M, Feldmann R, Saurat J-H. Papular-purpuric “gloves and socks” syndrome. *J Am Acad Dermatol* 1990;23:850-854, with permission.) (This figure is printed in black and white as [Figure 56.9](#).)



**Color Plate 56.10** Skin lesions associated with Schamberg progressive pigmentary dermatosis. Note the irregular patches of punctate hemorrhagic lesions with yellow-brown discoloration of hemosiderin deposits. (From Sherertz EF. Pigmented purpuric eruptions. *Semin Thromb Hemost* 1984;10:190-195, with permission.) (This figure is printed in black and white as [Figure 56.10](#).)



**Color Plate 56.11** Pigmented purpura in a child. This photograph was kindly provided by



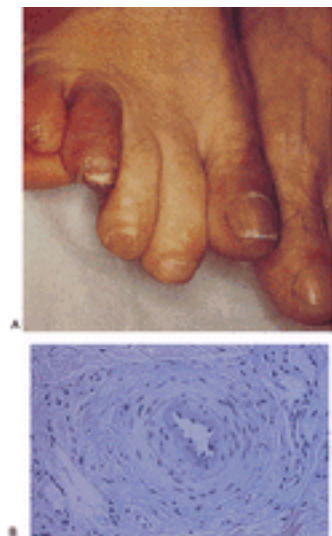
Drs. Payem Tristani-Firouzi and Sheryll Vanderhooft (Department of Dermatology, University of Utah Health Sciences Center). (This figure is printed in black and white as [Figure 56.11.](#))



**Color Plate 56.12** A fixed drug eruption lesion. This 30-year-old woman developed this thigh lesion after taking ibuprofen. This photograph was kindly provided by Dr. Pamela Nemzer (Department of Dermatology, University of Utah Health Sciences Center). (This figure is printed in black and white as [Figure 56.12.](#))



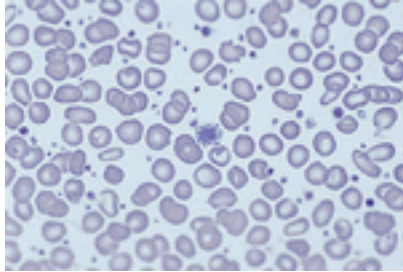
**Color Plate 56.13** Skin lesion of psychogenic purpura (autoerythrocyte sensitization) induced by administration of intradermal autologous blood. A saline control elicited no response. [From Berman DA, Roenigk HH, Green D. Autoerythrocyte sensitization syndrome (psychogenic purpura). *J Am Acad Dermatol* 1992;27:829–832, with permission.] (This figure is printed in black and white as [Figure 56.13.](#))



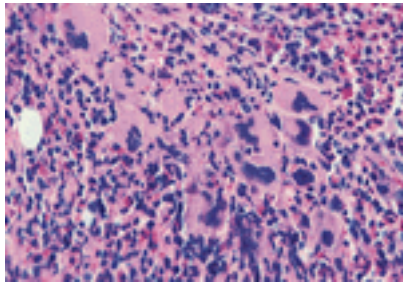
**Color Plate 57.1** Patient with erythromelalgia secondary to essential thrombocythemia. **A:** There are painful, erythematous toes on both feet. **B:** Biopsy of affected region demonstrates smooth muscle cell hyperplasia of the arteriole ( $\times 430$ ; hematoxylin and



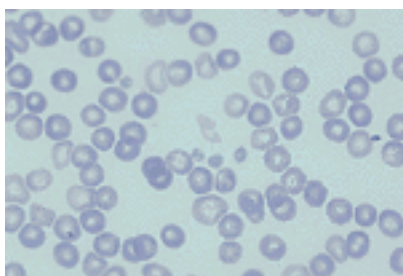
eosin stain). (From Naldi L, Brevi A, d'Oro LC, et al. Painful distal erythema and thrombocytosis. Arch Dermatol 1993;129: 105–106,109, with permission.) (This figure is printed in black and white as [Figure 57.1](#).)



**Color Plate 57.2** Peripheral blood smear from a patient with newly diagnosed essential thrombocythemia and a platelet count of 2 million/ $\mu\text{l}$ . A significant increase in platelets and one giant platelet can be seen in this field ( $\times 1000$ ; Wright–Giemsa stain). (This figure is printed in black and white as [Figure 57.2](#).)



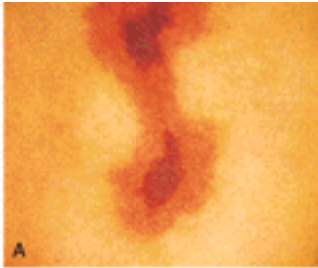
**Color Plate 57.3** Bone marrow biopsy from the patient with newly diagnosed essential thrombocythemia and a platelet count of 2 million/ $\mu\text{l}$  presented in Color Plate 57.2. Megakaryocytes are increased in number and present in clusters ( $\times 1000$ ; Wright–Giemsa stain). (This figure is printed in black and white as [Figure 57.3](#).)



**Color Plate 58.4** Gray platelet syndrome platelets. Giant platelets in the gray platelet syndrome ( $\times 1200$ , Wright stain). (This figure is printed in black and white as [Figure 58.4](#).)



**Color Plate 59.3** Hemophilic arthropathy. This figure illustrates the sequelae of recurrent joint bleeding. (This figure is printed in black and white as [Figure 59.3](#).)

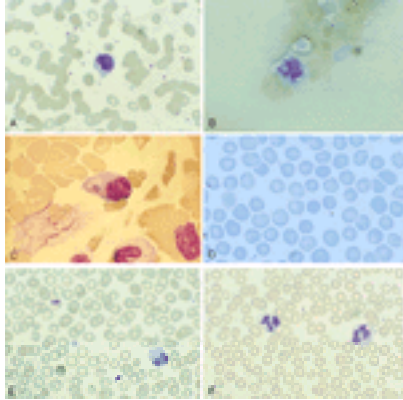


**Color Plate 60.4** Purpura fulminans in infection-associated disseminated intravascular coagulation. Early lesions (**A**) are circumscribed; progressive lesions (**B**) may become necrotic. (From Dudgeon DL, Kellogg DR, Gilchrist GS, et al. Purpura fulminans. *Arch Surg* 1971;103:351-358; copyright 1971, American Medical Association, with permission.) (This figure is printed in black and white as [Figure 60.4](#).)

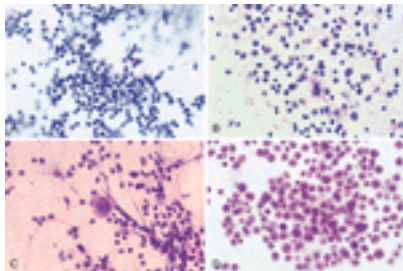


**Color Plate 60.6** Soft-tissue hemorrhage in a 76-year-old man with a high-titer factor VIII inhibitor. This patient has a history of ischemic cardiomyopathy and diabetes and

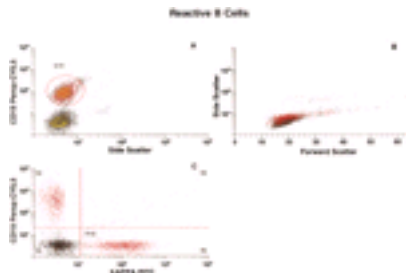
developed spontaneous extremity bruising as shown. The antihuman factor VIII antibody titer was 10 Bethesda units. (Courtesy of Alan Grosset.) (This figure is printed in black and white as [Figure 60.6.](#))



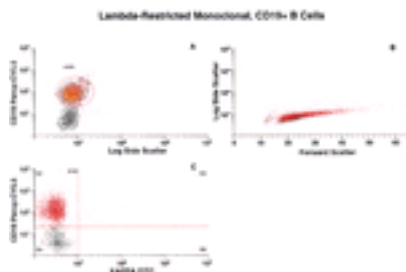
**Color Plate 62.2** Wright–stained peripheral blood smears demonstrating (A) *Mycobacteria tuberculosis* as negative staining rods in monocyte from patient with human immunodeficiency virus infection, (B) *Histoplasma capsulatum* with three intracellular yeast forms in monocyte at feather edge of smear in patient with acquired immunodeficiency syndrome, (C) *Ehrlichia chaffeensis* as single basophilic cytoplasmic inclusion (photomicrogram courtesy of Dr. Charles Coleman, University of Missouri), (D) Babesia as single intracellular ring forms in two erythrocytes (photomicrograph courtesy of Dr. Ahn Dao, Vanderbilt University), (E) *Malassezia furfur* as extracellular budding yeasts (one of which is overlying an erythrocyte) in an infant on total parenteral alimentation, (F) intracellular bacteria in neutrophil with adjacent vacuolated neutrophil in patient with septicemia. (This figure is printed in black and white as [Figure 62.2.](#))



**Color Plate 62.3** High power of hematoxylin eosin–stained touch preps of lymph node biopsies demonstrating (A) predominance of small lymphocytes in an adult with a small B–cell lymphoma; (B) mixed pattern of small and large lymphocyte macrophages, plasma cells, and neutrophils in a child with reactive adenitis; (C) mixed population of small and large lymphocytes with occasional large dysplastic cells in a patient with Hodgkin disease; and (D) predominance of large lymphocytes (many with polylobate nuclei) in a patient with large B–cell lymphoma of the mediastinum. (This figure is printed in black and white as [Figure 62.3.](#))

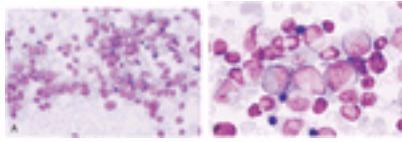


**Color Plate 62.4** Flow cytometry of reactive B cells. **A:** Histogram (picture) of anti-CD19 antibody expression versus log side scatter (signal of cellular complexity), which is used to define and identify the B-cell lymphocytes. The CD19<sup>+</sup> population is then focused on by using an isolation mechanism or *gate* (*R1*) to further describe this population. **B:** Histogram shows lymphocytes based on forward scatter signal (size) versus log side scatter signal (cell complexity or granularity). The red population represents the CD19<sup>+</sup> B cells and their location in relation to the CD19<sup>-</sup> population (*black dots*). **C:** A two-parameter histogram of fluorescein isothiocyanate (FITC) a light-chain found on the antibody molecule, versus anti-Lambda phycoerythrin, another light-chain found on the antibody molecule. Red dots are the CD19<sup>+</sup> B cells from histogram **A**; the black dots represent the CD19<sup>-</sup> population. The pattern shown includes statistics of each population. The *R2 area* represents the anti-Lambda, CD19<sup>+</sup> population and equals approximately 16.5% of the total cells present. The *R3 area* represents the anti-Kappa positive, anti-Lambda positive CD19<sup>+</sup> population. This population is usually negative. The *R5 area* represents the anti-Kappa, CD19<sup>+</sup> population and equals approximately 27.7% of the total cells present. *R4* represents the anti-Kappa- and anti-Lambda-negative population. Percp, peridinin chlorophyll protein. (Diagrams courtesy of Bruce Grieg, MT, Vanderbilt University.) (This figure is printed in black and white as [Figure 62.4](#).)

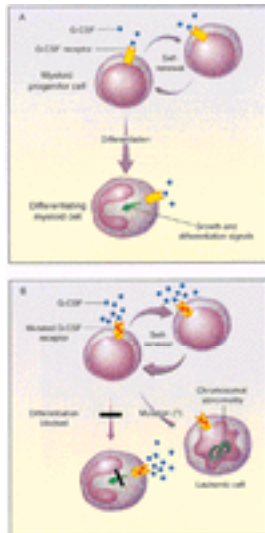


**Color Plate 62.5** Flow cytometry of monotypic B cells. This set of pictures demonstrates CD19<sup>+</sup> B cells that have a dominant expression of one particular light chain and is an example of monoclonal light-chain restriction. **A:** Histogram (picture) of anti-CD19 antibody expression versus log side scatter (signal of cellular complexity), which is used to define and identify the B-cell lymphocytes. The CD19<sup>+</sup> population is then focused on by using an isolation mechanism or *gate* (*R1*) to further describe this population. Subsequent R1+ events are shown as red dots. Black dots represent CD19<sup>-</sup> non-B cells. **B:** Histogram shows lymphocytes based on forward scatter signal (size) versus log side scatter signal (cell complexity or granularity). The red population represents the CD19<sup>+</sup> B cells and their location in relation to the CD19<sup>-</sup> population (*black dots*). **C:** A two-parameter histogram of anti-Kappa fluorescein isothiocyanate (FITC) versus anti-Lambda phycoerythrin. Red dots are the CD19<sup>+</sup> B cells from histogram **A**; the black dots represent the CD19<sup>-</sup> population. The pattern shown includes statistics of each population. The *R2 area* represents the anti-Lambda, CD19<sup>+</sup> population and equals

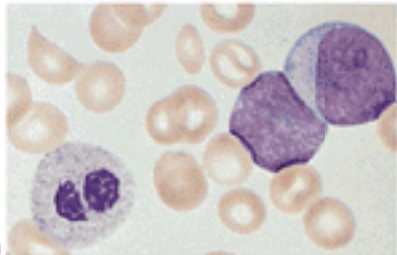
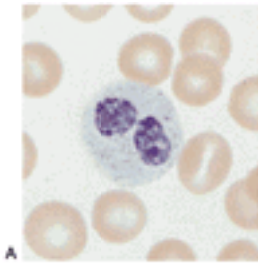
approximately 80% of the total cells present. The *R5 area* represents the anti-Kappa, CD19<sup>+</sup> population and in this case is <1% of the total cells present. Percp, peridinin chlorophyll protein. (Diagrams courtesy of Bruce Grieg, MT, Vanderbilt University.) (This figure is printed in black and white as [Figure 62.5.](#))



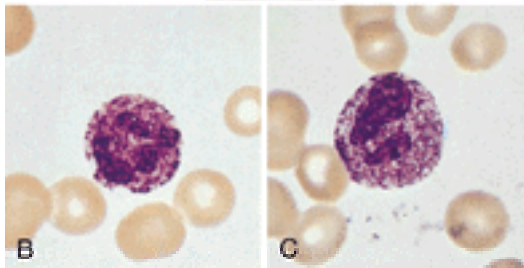
**Color Plate 63.3** Bone marrow findings in severe congenital neutropenia (Kostmann neutropenia). Shown are a low-power view ( $\times 40$ ) (A) and a high-power view ( $\times 100$ ) (B) of a bone marrow aspiration from a child with severe congenital neutropenia. Note a cellular specimen with an apparent maturation arrest of myeloid differentiation at the promyelocyte stage. (Photomicrographs courtesy of David Kelly, M.D.) (This figure is printed in black and white as [Figure 63.3.](#))



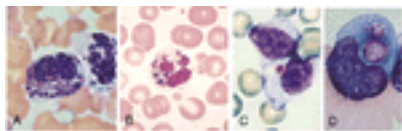
**Color Plate 63.4** Possible mechanism for leukemic transformation. During normal, steady-state hematopoiesis (A), only a small proportion of myeloid progenitors renew themselves. The majority differentiate into mature granulocytes. Granulocyte colony-stimulating factor (G-CSF) plays a major part in the process through an interaction with the G-CSF receptor that transmits the growth and differentiation signals. In cells with mutated G-CSF receptors (B), more G-CSF is needed to activate the receptor. Abnormal proliferative signaling causes an accumulation of immature cells that do not differentiate. One such cell, constantly stimulated by G-CSF, may undergo a random mutation and acquire neoplastic properties. (From Naparstek E. G-CSF, congenital neutropenia and acute myeloid leukemia. *N Engl J Med* 1995;333:517, with permission.) (This figure is printed in black and white as [Figure 63.4.](#))



**Color Plate 64.2** **A:** Pseudo-Pelger-Huët cells. **B:** From a patient with acute myeloblastic leukemia. (This figure is printed in black and white as [Figure 64.2.](#))



**Color Plate 64.3** Neutrophils with Alder-Reilly bodies (**A**) compared with neutrophils exhibiting toxic granulation (**B,C**). (This figure is printed in black and white as [Figure 64.3.](#))

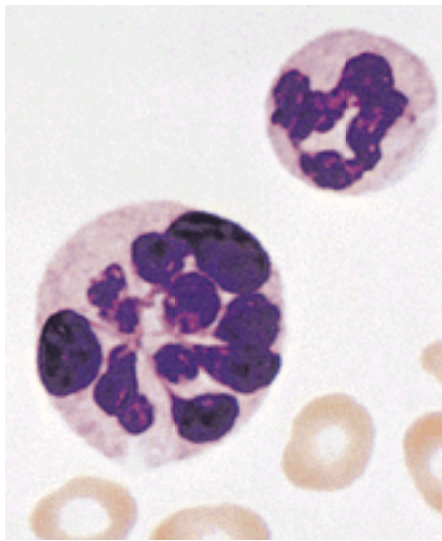


**Color Plate 64.5** Inclusion bodies in Chédiak-Higashi anomaly. **A** and **B** in neutrophils; **C** in a lymphocyte; **D** in a monocytyoid cell. (This figure is printed in black and white as [Figure 64.5.](#))





**Color Plate 64.6** The characteristic silver-gray hair of a child (*left*) with Chédiak–Steinbrinck–Higashi anomaly contrasted with that of her mother. (Courtesy of Dr. Dorothy Windhorst, National Institutes of Health.) (This figure is printed in black and white as [Figure 64.6.](#))

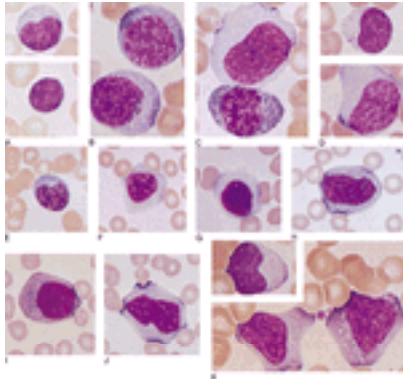


**Color Plate 64.7** Hypersegmented neutrophil. (This figure is printed in black and white as [Figure 64.7.](#))

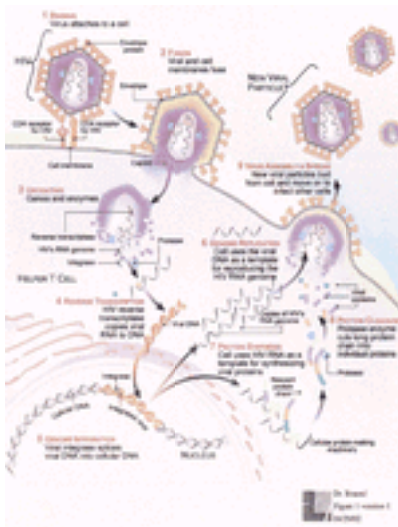


**Color Plate 66.5** Erythematous maculopapular rash in a boy with disseminated Langerhans cell histiocytosis. (From Esterly NB, Maurer HS, Gonzalez–Crussi F. Histiocytosis X: a seven year experience at a children's hospital. *J Am Acad Dermatol* 1985;13:481–496, with permission.) (This figure is printed in black and white as [Figure 66.5.](#))





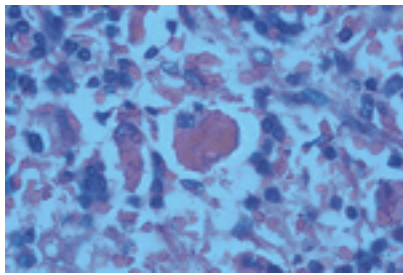
**Color Plate 67.11** Lymphocytes and cells of infectious mononucleosis. **A:** Large and small lymphocytes from the blood of normal subjects. **B:** Lymphocytes resembling plasma cells (“plasmacytoid” cells) in the blood of a patient with viral pneumonia. **C:** Somewhat atypical lymphocyte and plasmacytoid lymphocytes in blood. **D:** Lymphocytes from the blood of a patient with viral infection; azurophilic granules are clearly seen in one of the cells. **E–J:** Infectious mononucleosis; lymphocytes showing increasing levels of atypia. **E:** Downey type I. **F, G:** Downey type II. **H–J:** Downey type III. **K:** Lymphocytes from blood of patient with infectious mononucleosis. (This figure is printed in black and white as [Figure 67.11](#).)



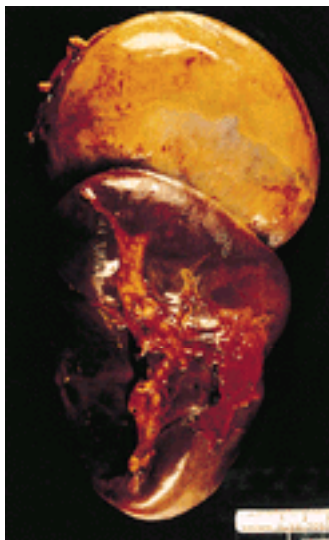
**Color Plate 69.1** Human immunodeficiency virus ( *HIV* ) life cycle, deciphered with the help of genomic analyses, is unusually complex in its details, but all viruses undergo the same basic steps to infect cells and reproduce. (This figure is printed in black and white as [Figure 69.1](#).)



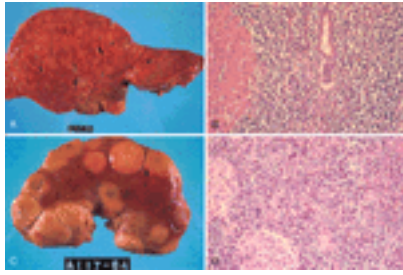
**Color Plate 70.5** Gross photograph of spleen in 35-year-old woman with marked splenomegaly from splenic hemangioma. The arrow demonstrates central hemangioma with surrounding uninvolved splenic parenchyma. This benign tumor had caused significant thrombocytopenia resulting in spontaneous bleeding before splenectomy. (This figure is printed in black and white as [Figure 70.5](#).)



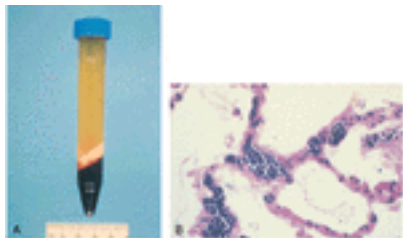
**Color Plate 72.2** In the center of the field, two macrophages are stuffed with red blood cells (hemophagocytosis) in this high magnification view of spleen involved by a hepatosplenic T-cell lymphoma (hematoxylin and eosin stain). (Courtesy of Dr. William R. Macon, Department of Pathology, Mayo Medical Center, Rochester, MN.) (This figure is printed in black and white as [Figure 72.2](#).)



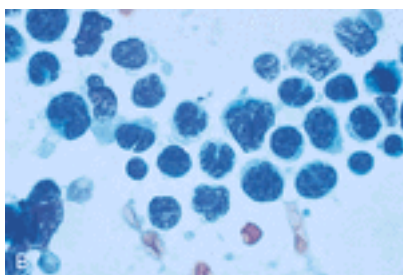
**Color Plate 70.6** Large symptomatic splenic pseudocyst developing after blunt trauma to the spleen. (This figure is printed in black and white as [Figure 70.6](#).)



**Color Plate 72.3** Systemic involvement of lymphoma at autopsy. **A:** Pale nodules of follicular small cleaved cell are present on the cut surface of the liver. **B:** Microscopically, the liver shows a pronounced periportal lymphocytic infiltrate that surrounds a residual bile duct (hematoxylin and eosin stain) (*upper center*). **C:** Numerous lymphomatous nodules are also present on the external surface of the kidney. **D:** Extensive interstitial lymphocytic infiltrates obliterate the renal tubules, whereas two residual glomeruli can be seen on the left (hematoxylin and eosin stain). (Courtesy of Dr. William R. Macon, Department of Pathology, Mayo Medical Center, Rochester, MN.) (This figure is printed in black and white as [Figure 72.3](#).)



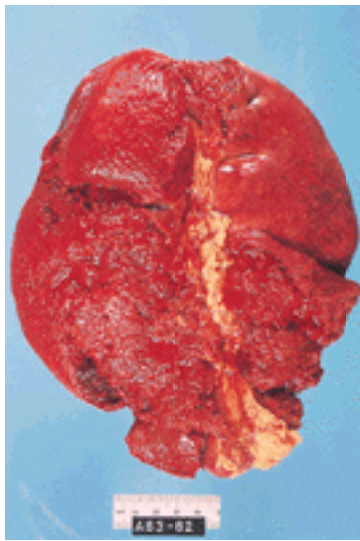
**Color Plate 72.4** Hyperleukocytosis and leukostasis. **A:** An elevated leukocrit is present in this tube of centrifuged peripheral blood from a patient with T-cell acute lymphoblastic leukemia who had a peripheral blood blast count of 250,000/ $\mu$ l. **B:** Pulmonary alveolar capillaries are expanded by leukocyte aggregates indicative of leukostasis in a patient with acute myeloid leukemia (hematoxylin and eosin stain). (This figure is printed in black and white as [Figure 72.4](#).)



**Color Plate 72.8** Pleural fluid cytology (Papanicolaou stain) shows numerous convoluted lymphoblasts characteristic of T-cell lymphoblastic lymphoma, a diagnosis confirmed by flow cytometric phenotypic analysis of the effusion. (Courtesy of Dr. Michael T. Lomis, Department of Pathology, Vanderbilt University School of Medicine, Nashville, TN.) (This figure is printed in black and white as [Figure 72.8](#).)



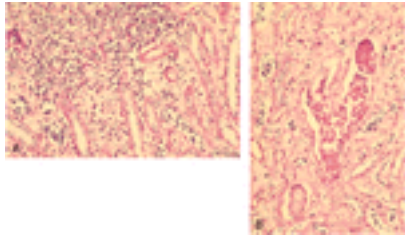
**Color Plate 72.9** A large mass near the ileocecal valve produced symptoms of intestinal obstruction in a patient with small noncleaved cell (Burkitt) lymphoma. (Courtesy of Dr. William R. Macon, Department of Pathology, Mayo Medical Center, Rochester, MN.) (This figure is printed in black and white as [Figure 72.9.](#))



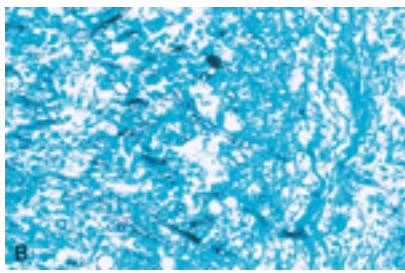
**Color Plate 72.10** Spontaneous rupture of this friable spleen caused exsanguination of a patient with acute lymphocytic leukemia. (Courtesy of Dr. William R. Macon, Department of Pathology, Mayo Medical Center, Rochester, MN.) (This figure is printed in black and white as [Figure 72.10.](#))



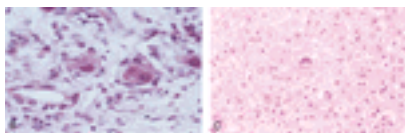
**Color Plate 75.2** *Fusarium* sepsis, manifesting as fever and a nodular, erythematous skin rash in an autologous bone marrow transplant recipient. (Photograph courtesy of S. Antony.) (This figure is printed in black and white as [Figure 75.2.](#))



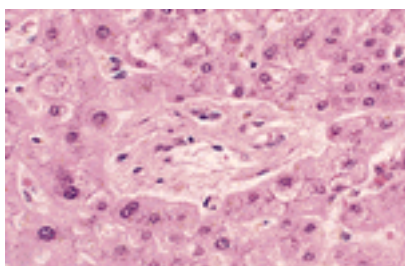
**Color Plate 72.11** **A:** Karyorrhectic lymphoblast nuclei are present throughout the kidney in a patient with acute tumor lysis syndrome in whom cytolysis was initiated by administration of corticosteroids. **B:** Renal tubules contain calcium phosphate precipitates that contributed to acute tumor lysis–associated renal failure (hematoxylin and eosin stain). (Courtesy of Dr. William R. Macon, Department of Pathology, Mayo Medical Center, Rochester, MN.) (This figure is printed in black and white as [Figure 72.11.](#))



**Color Plate 75.5** Photomicrograph of characteristic 45–degree–angle branching of septate hyphal forms of *Aspergillus* invading lung parenchyma (Gomori methenamine silver stain,  $\times 400$ ). (Courtesy of M. Scott.) (This figure is printed in black and white as [Figure 75.5.](#))

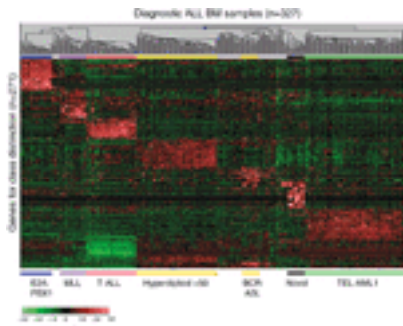


**Color Plate 75.7** The spectrum of cytomegalovirus (CMV) disease in the abnormal human host. **B:** CMV inclusion disease of the colon. Typical infected cells show cellular ballooning with dense primary nuclear inclusions surrounded by a thin, cleared rim; secondary inclusions appear as cytoplasmic granules after the nucleus has filled with virions. **C:** CMV hepatitis demonstrated on liver biopsy. Viral cytopathic effect may be difficult to establish, but rare viral inclusions with surrounding parenchymal changes are diagnostic of CMV. Hematoxylin/eosin stains,  $\times 400$ . (Photomicrographs courtesy of M. Scott.) (This figure is printed in black and white as [Figure 75.7.](#))

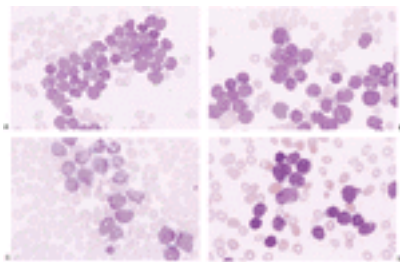


**Color Plate 75.9** Regimen–related organ toxicity. Vasoocclusive disease of the liver with nonthrombotic fibrous occlusion of central veins and small venules (Hematoxylin/eosin stain,  $\times 400$ ). (Photomicrograph courtesy of M. Scott.) (This figure is printed in black and white as [Figure 75.9.](#))

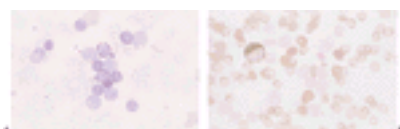




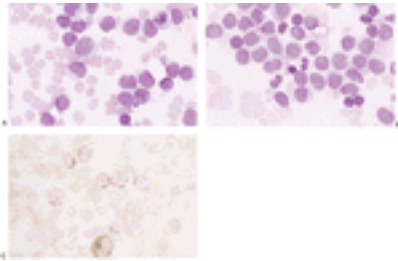
**Color Plate 76.9** Microarray analysis of pediatric acute lymphocytic leukemia (ALL). Hierarchical clustering of 327 diagnostic ALL samples (columns) versus 271 genes (rows). The genes used in this analysis are the top 40 genes chosen by a chi-square statistic that are most highly correlated with the seven specific class distinctions. The normalized expression value for each gene is indicated by a color, with red representing high expression and green representing low expression, with the scale shown at the bottom. (From Yeoh E-J, Ross ME, Shurtleff SA, et al. Classification, subtype discovery, and prediction of outcome in pediatric acute lymphoblastic leukemia by gene expression profiling. *Cancer Cell* 2002;1:133–143, with permission.) (This figure is printed in black and white as [Figure 76.9](#).)



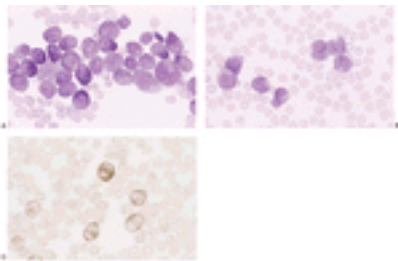
**Color Plate 77.2** Acute lymphoblastic leukemia (ALL) cytologic appearance, Wright stain. **A:** French/American/British (FAB) L1 lymphoblasts, marrow. The blasts are small with folded or clefted nuclei, fine to condensed chromatin, and scant cytoplasm. Nucleoli are inconspicuous. **B:** FAB L2 lymphoblasts, marrow. The blasts are larger with more cytoplasm. Most nuclei are irregular or folded and chromatin is dispersed. Nucleoli are prominent. **C:** FAB L3 lymphoblasts, marrow. The blasts are medium to large with abundant vacuolated basophilic cytoplasm. The nuclei are round with dispersed chromatin and prominent nucleoli. **D:** ALL with cytoplasmic granules, marrow. These granules were Sudan black negative with this stain, and had a typical ALL immunophenotype (CD19<sup>+</sup>, CD10<sup>+</sup>, CD34<sup>+</sup>, TdT<sup>+</sup>). (This figure is printed in black and white as [Figure 77.2](#).)



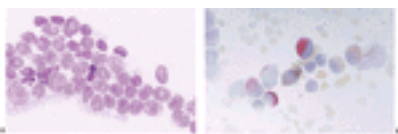
**Color Plate 77.3** Acute lymphoblastic leukemia (ALL) cytochemical studies. **A:** Precursor B ALL. Blasts have coarse granular and block periodic acid-Schiff positivity. **B:** Precursor B ALL. Blasts are Sudan black negative. A residual normal myeloid cell is positive. (This figure is printed in black and white as [Figure 77.3](#).)



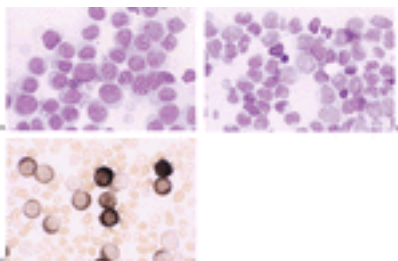
**Color Plate 77.4** Acute myeloid leukemia, minimally differentiated [French/American/British (FAB) M1] and differentiated (FAB M2), marrow. Wright stain and cytochemical studies. **A:** FAB M1. Myeloblasts predominate with few maturing myeloid elements. **B:** FAB M2. Blasts show maturation beyond the blast stage. Numerous Auer rods are present. **C:** FAB M2. Blasts are Sudan black positive. (This figure is printed in black and white as [Figure 77.4](#).)



**Color Plate 77.5** Acute promyelocytic leukemia (APL), French/American/British (FAB) M3, M3v. Wright stain and cytochemical studies ( **A**, marrow; **B** and **C**, blood). **A:** Typical hypergranular APL (FAB M3h) has hypergranulated promyelocytes. **B:** The microgranular variant, FAB M3v has promyelocytes with folded, indented, or U-shaped nuclei and abundant cytoplasm with scant, fine, pink granules. These may be confused with myelomonoblasts. **C:** FAB M3v. The promyelocytes are strongly Sudan black positive and chloroacetate esterase positive. (This figure is printed in black and white as [Figure 77.5](#).)

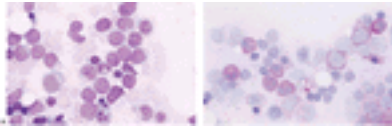


**Color Plate 77.6** Acute myelomonocytic leukemia, French/American/British (FAB) M4, marrow. Wright stain and cytochemical studies. **A:** The blasts have myeloid and monocytic differentiation. **B:** Combined esterase stains show chloroacetate esterase reactivity ( *red*) in myeloblasts and nonspecific esterase reactivity ( *black*) in monoblasts. (This figure is printed in black and white as [Figure 77.6](#).)

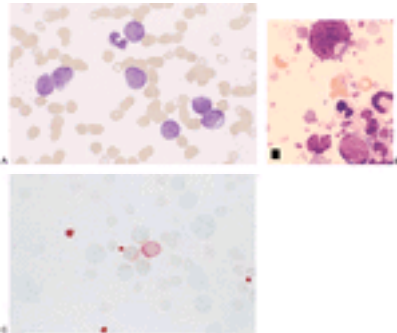




**Color Plate 77.7** Acute monocytic leukemia, French/American/British (FAB) M5, marrow. Wright stain and cytochemical studies. **A:** FAB M5a. Predominant cell is a monoblast. **B:** FAB M5b. Blasts show differentiation to promonocytes and monocytes. **C:** FAB M5a. Nonspecific esterase is strongly positive. The reaction is inhibitable with fluoride treatment (not shown). (This figure is printed in black and white as [Figure 77.7](#).)



**Color Plate 77.8** Erythroleukemia, French/American/British (FAB) M6, marrow. Wright stain and cytochemical studies. **A:** FAB M6 has a mixture of myeloblasts and erythroid precursors. Auer rods are present. Erythroid cells have dysplastic features, including megaloblastic change, lobated nuclei, and cytoplasmic vacuolization. **B:** The pronormoblasts have strong, coarse, blocklike periodic acid–Schiff staining and later stage erythroids are diffusely positive. (This figure is printed in black and white as [Figure 77.8](#).)



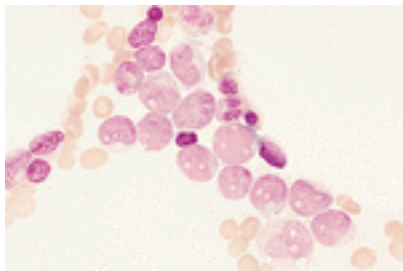
**Color Plate 77.9** Megakaryocytic leukemic French/American/British (FAB) M7, marrow. Wright stain and immunoalkaline phosphatase staining. **A:** Megakaryoblasts often have dense chromatin and little cytoplasm, as shown here. **B:** Some megakaryoblasts have cytoplasmic blebs. **C:** The megakaryoblastic origin is confirmed by demonstrating CD41 expression using immunoalkaline phosphatase staining. (This figure is printed in black and white as [Figure 77.9](#).)



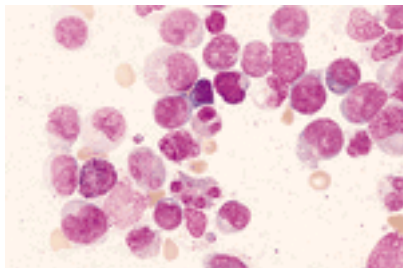
**Color Plate 79.3** Leukemia cutis manifesting as subcutaneous nodules. (Courtesy of Dr. Michael Smith, Department of Dermatology, Vanderbilt University Medical Center.) (This figure is printed in black and white as [Figure 79.3](#).)



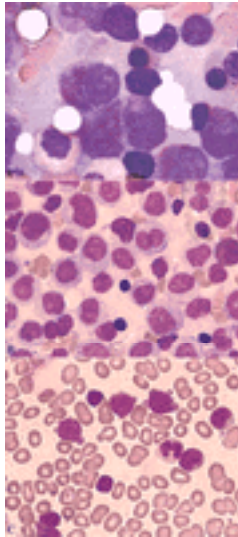
**Color Plate 79.4** Swollen and spongy gums in a patient with acute leukemia. (Courtesy of Dr. Stuart Salmon, Department of Hematology/Oncology, Vanderbilt University Medical Center.) (This figure is printed in black and white as [Figure 79.4.](#))



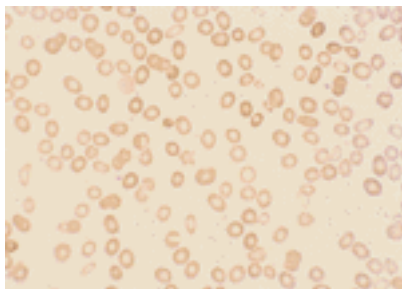
**Color Plate 79.5** Wright-stained marrow smear from acute myeloid leukemia-M2 with  $t(8;21)$ . Blasts are associated with maturing myeloid elements and numerous eosinophils with salmon-colored granules. (This figure is printed in black and white as [Figure 79.5.](#))



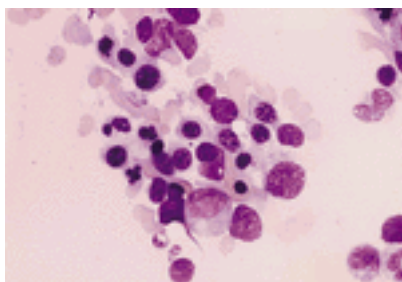
**Color Plate 79.7** Wright-stained marrow smear from patient with M4Eo and an  $inv(16)$ . Myeloblasts, monoblasts, and abnormal eosinophils with large basophilic granules, as illustrated here, are typically present in this variant. (This figure is printed in black and white as [Figure 79.7.](#))



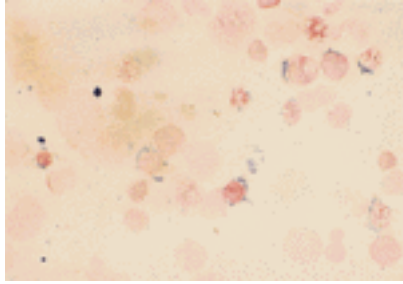
**Color Plate 82.2** Morphologic subtypes of acute promyelocytic leukemia. **A:** “Classic” M3 is characterized by heavily granulated promyelocytes with abundant Auer rods. **B:** Microgranular variant (M3v) has fine granulation with a bilobed, folded nucleus. **C:** Hyperbasophilic variant has few granules, intense basophilia, and small cytoplasmic projections or buds reminiscent of micromegakaryocytes (100 ×, MacNeal Tetrachrome). (This figure is printed in black and white as [Figure 82.2](#).)



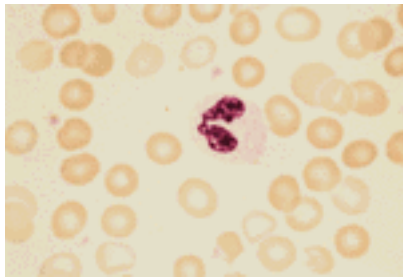
**Color Plate 83.1** Oval macrocytes, hypochromic cells, and acanthocytes in refractory anemia with ringed sideroblasts (hematoxylin and eosin stain, × 1250). (This figure is printed in black and white as [Figure 83.1](#).)



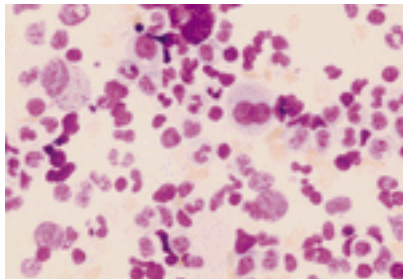
**Color Plate 83.2** Dyserythropoiesis with nuclear budding and megaloblastoid erythropoiesis in refractory anemia (Wright–Giemsa stain, × 1250). (This figure is printed in black and white as [Figure 83.2](#).)



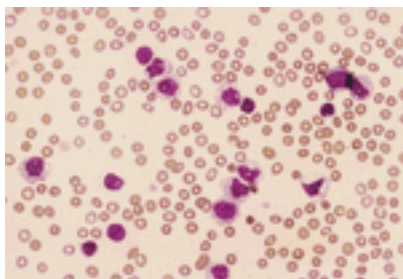
**Color Plate 83.3** Ringed sideroblasts in refractory anemia with ringed sideroblasts (Prussian blue stain,  $\times 1250$ ). (This figure is printed in black and white as [Figure 83.3](#).)



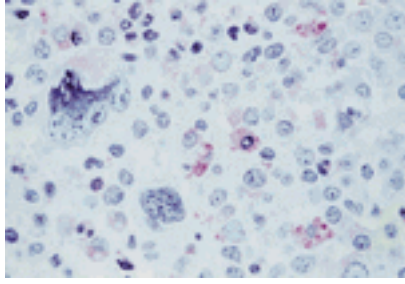
**Color Plate 83.4** Pseudo-Pelger-Huet anomaly in a patient with refractory anemia (hematoxylin and eosin stain,  $\times 1250$ ). (This figure is printed in black and white as [Figure 83.4](#).)



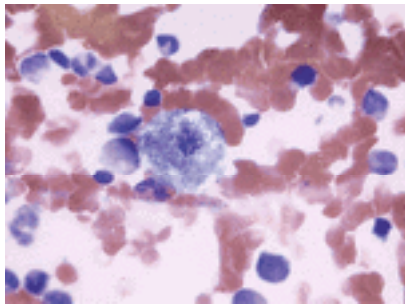
**Color Plate 83.5** Micromegakaryocytes in a patient with refractory anemia with excess blasts (Wright-Giemsa stain,  $\times 1250$ ). (This figure is printed in black and white as [Figure 83.5](#).)



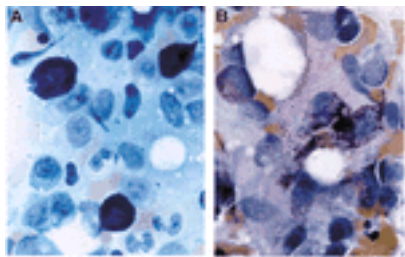
**Color Plate 83.6** Monocytes in a patient with chronic myelomonocytic leukemia (hematoxylin and eosin stain,  $\times 1250$ ). (This figure is printed in black and white as [Figure 83.6](#).)



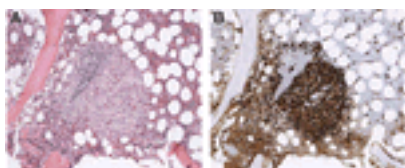
**Color Plate 83.7** Hypercellular core biopsy with trilineage dysplasia in refractory anemia with excess blasts in transformation. Note atypical megakaryocytes (periodic acid–Schiff stain,  $\times 1250$ ). (This figure is printed in black and white as [Figure 83.7](#).)



**Color Plate 83.8** Sea blue histiocyte in refractory anemia (Wright–Giemsa stain,  $\times 1250$ ). (This figure is printed in black and white as [Figure 83.8](#).)

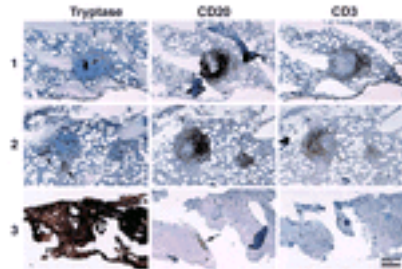


**Color Plate 87.1** Morphologic features of mast cells from normal versus mastocytosis bone marrow aspirate. Panel **A** shows staining of a control bone marrow aspirate from an individual with aplastic anemia using toluidine blue stain (magnification,  $40\times$ ). Panel **B** shows a hematoxylin and eosin stain of a bone marrow aspirate acquired from a patient with indolent systemic mastocytosis and illustrates representative spindle-shaped mast cells with an eccentric nucleus (magnification,  $40\times$ ). (Provided courtesy of Dr. Cem Akin, National Institute of Allergy and Infectious Diseases, National Institutes of Health.) (This figure is printed in black and white as [Figure 87.1](#).)

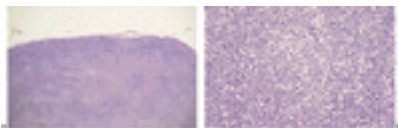


**Color Plate 87.2** Bone marrow histopathology showing focal mast cell infiltrates in a bone marrow biopsy taken from a patient with indolent systemic mastocytosis. Panel **A** shows staining of a representative mast cell lesion with hematoxylin and eosin stain

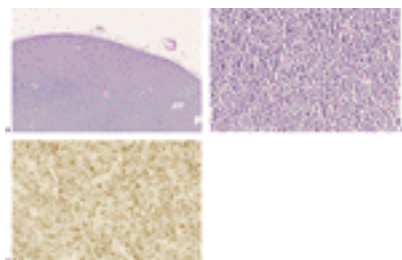
(magnification, 10 ×), and panel **B** shows staining of the same section with antitryptase antibody (magnification, 10 ×). (Provided courtesy of Dr. Cem Akin, National Institute of Allergy and Infectious Diseases, National Institutes of Health.) (This figure is printed in black and white as [Figure 87.2](#).)



**Color Plate 87.3** Immunohistochemical staining of lymphoid aggregates in two patients with a focal ( **1** and **2**) and one patient with a diffuse ( **3**) increase in mast cells. Antibodies are shown on top of each column. Nodular lesions shown in **1** and **2** contain a central core of mast cells ( *arrows*) surrounded by B cells (CD20) and a peripheral rim of T cells (CD3). Diffuse mast cell infiltrates ( **3**) are seen in association with a small B-cell collection ( *arrow*) and scattered single T cells. The bar represents 200 μm. (From Akin C, Jaffe ES, Raffeld M, et al. An immunohistochemical study of the bone marrow lesions of systemic mastocytosis. *Am J Clin Pathol* 2002;118:242–247, by permission of Dr. Cem Akin, National Institute of Allergy and Infectious Diseases, National Institutes of Health and the *American Journal of Clinical Pathology*.) (This figure is printed in black and white as [Figure 87.3](#).)

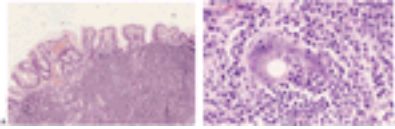


**Color Plate 88.2** Lymph node: small lymphocytic lymphoma/chronic lymphocytic leukemia. **A:** Low magnification showing diffuse alteration of architecture with pale areas corresponding to mounds or proliferation centers. **B:** A higher power of a growth center composed of intermediate-sized cells with small nucleoli surrounded by small round lymphocytes. (This figure is printed in black and white as [Figure 88.2](#).)

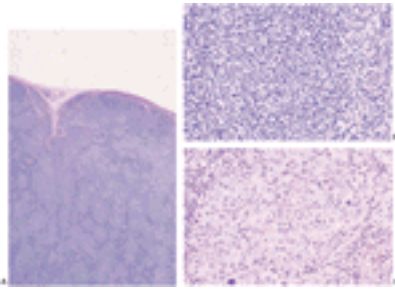


**Color Plate 88.3** Lymph node: mantle cell lymphoma **A:** Low magnification showing diffuse architectural effacement, which, on higher magnification in **B**, is composed of sheets of small irregular lymphocytes with few large cells. **C:** Small lymphocytes exhibit nuclear staining for cyclin D1. (This figure is printed in black and white as [Figure 88.3](#).)

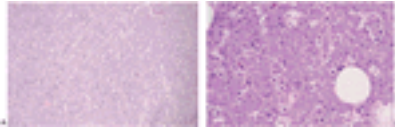




**Color Plate 88.4** Stomach: extranodal marginal zone lymphoma of mucosa-associated lymphoid tissue. **A:** The submucosa contains a diffuse infiltrate of small lymphocytes. **B:** Centrocyte-like cells with moderate amounts of clear cytoplasm invade gastric glands, producing lymphoepithelial lesions. (This figure is printed in black and white as [Figure 88.4](#).)



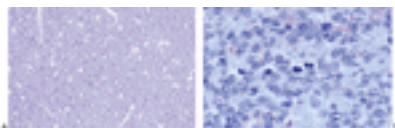
**Color Plate 88.5** Lymph node: follicular lymphoma. **A:** Low magnification demonstrating effacement of architecture by a nodular process. **B:** In a higher magnification, the nodules are composed almost entirely of small cleaved cells (follicular lymphoma grade 1), whereas, in **C** from another patient, the nodules are dominated by large cells (follicular grade 3). (This figure is printed in black and white as [Figure 88.5](#).)



**Color Plate 88.6** Lymph node: Burkitt lymphoma. **A:** The architecture is totally effaced by a diffuse infiltrate with a “starry sky” appearance. **B:** High power showing a monotonous population of small transformed or noncleaved lymphocytes with round to oval nuclei and variable cytoplasm. Mitotic figures are frequent. Numerous tingible body macrophages are present. (This figure is printed in black and white as [Figure 88.6](#).)

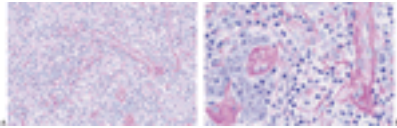


**Color Plate 88.7** Lymph node: diffuse large B-cell lymphoma. **A:** On low magnification, the architecture is replaced by neoplastic process with a diffuse growth pattern. **B:** On high magnification, the tumor cells have large nuclei with dispersed chromatin, small nucleoli, and a variable amount of cytoplasm. Mitotic figures are easily identified. (This figure is printed in black and white as [Figure 88.7](#).)

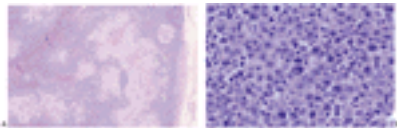




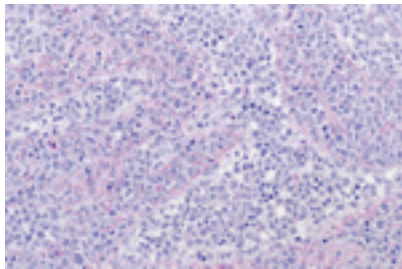
**Color Plate 88.8** Lymph node: precursor T-cell lymphoblastic lymphoma. **A:** The nodal architecture is completely effaced by a diffuse lymphoid infiltrate. The interspersed macrophages help impart a “starry sky” appearance. **B:** The neoplastic cells are intermediate in size, have delicate chromatin characteristic of blasts, indistinct nucleoli, and scant cytoplasm. Frequent mitoses are present (*center*). (This figure is printed in black and white as [Figure 88.8.](#))



**Color Plate 88.9** Lymph node: angioimmunoblastic T-cell lymphoma. **A:** There is a diffuse lymphoproliferation associated with prominent periodic acid–Schiff (PAS) staining high endothelial venules (HEVs). **B:** Perivascular clusters of “clear cell” immunoblasts (*left*) are admixed with small lymphocytes and PAS staining HEVs. (This figure is printed in black and white as [Figure 88.9.](#))



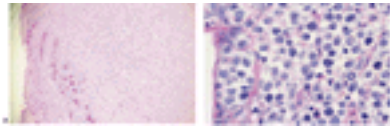
**Color Plate 88.10** Lymph node: anaplastic large cell lymphoma. **A:** Pale staining tumor cell infiltrates with a cohesive appearance fill the sinuses. **B:** The lymphoma is composed of pleomorphic large lymphocytes, some of which have the characteristic horseshoe- or doughnut-shaped nuclei (*center*) characteristic of “hallmark” cells of anaplastic large cell lymphoma. (This figure is printed in black and white as [Figure 88.10.](#))



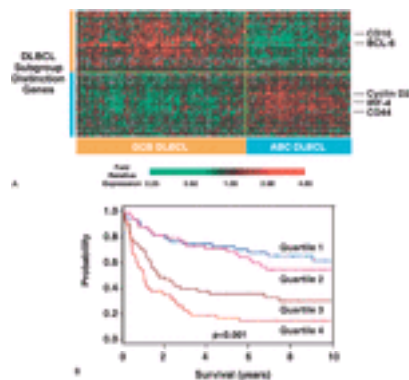
**Color Plate 88.11** Spleen: hepatosplenic T-cell lymphoma. Intermediate-size lymphocytes are present throughout the splenic red pulp and markedly expand its sinuses. (This figure is printed in black and white as [Figure 88.11.](#))



**Color Plate 88.12** Skin: subcutaneous panniculitis-like T-cell lymphoma. **A:** There is a lobular panniculitic lymphocytic infiltrate that is confined to the subcutaneous tissue with complete sparing of the dermis. **B:** Pleomorphic tumor cells fill the interstitium and rim some of the fat spaces. (This figure is printed in black and white as [Figure 88.12.](#))



**Color Plate 88.13** Small intestine: enteropathy-type T-cell lymphoma. **A:** The small intestinal features are markedly distorted by a lymphomatous infiltrate. There is also loss of the villous pattern at the luminal surface (left). **B:** Pleomorphic tumor cells with clear cytoplasm fill the mucosa and replace the glandular epithelium. (This figure is printed in black and white as [Figure 88.13.](#))

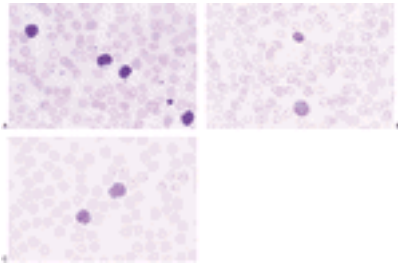


**Color Plate 89.4 A:** Subgroups of diffuse large B-cell lymphoma (DLBCL) defined by gene expression profiling. Hierarchical clustering of 188 lymph node biopsies from DLBCL patients, according to the gene expression levels of 100 selected genes. Shades of red indicate higher expression, shades of green indicate lower expression, and black indicates median expression. Each column represents one tumor sample, and each row represents a single gene. The germinal center B-cell-like DLBCLs (GCB DLBCLs) (see text) show high expression of genes that are characteristically expressed in germinal center B cells (e.g., CD10 and BCL6), whereas activated B-cell-like DLBCLs (ABC DLBCLs) express genes normally induced during *in vitro* activation of B cells (e.g., cyclin D2, IRF4, and CD44). **B:** A gene expression-based outcome predictor in 240 DLBCL patients. Each case of DLBCL was assigned an outcome predictor score calculated from gene expression averages of the model components (see text for details). Patients were ranked according to their scores and divided into quartiles. The 5-year survival rates for these quartile groups are shown in the Kaplan-Meier plot. (Adapted from Rosenwald A, Wright G, Chan WC, et al. The use of molecular profiling to predict survival after chemotherapy for diffuse large-B-cell lymphoma. *N Engl J Med* 2002;346:1937-1947, with permission.) (This figure is printed in black and white as [Figure 89.4.](#))

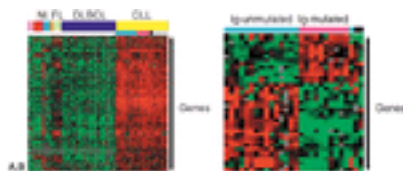


**Color Plate 90.2** Peripheral blood, adult T-cell leukemia/lymphoma. A neoplastic lymphocyte shows the cloverleaf nuclear lobations that are characteristic of circulating adult T-cell leukemia/lymphoma cells. [From Robert-Guroff M, Gallo RC. Establishment of an etiologic relationship between the human T cell leukemia/lymphoma virus (HTLV) and

adult T cell leukemia. Blut 1983;47:1–12, with permission.] (This figure is printed in black and white as [Figure 90.2](#).)



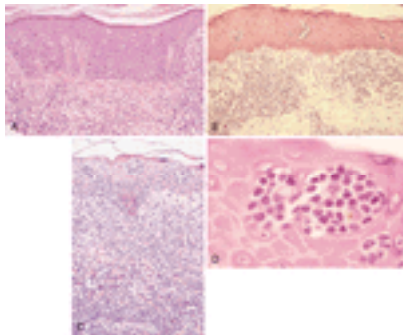
**Color Plate 90.12** Mature T-cell and natural killer-cell leukemias. **A:** Peripheral blood, T-cell granular lymphocytic leukemia. Two lymphocytes that have oval-shaped nuclei, condensed chromatin, inconspicuous nucleoli, and abundant pale cytoplasm that contains azurophilic granules are in the center of the field. These lymphocytes have the characteristic morphology of large granulocytes that are normal constituents of the peripheral blood or that can be seen in large granular lymphocytic leukemia or in some reactive states. **B:** Peripheral blood, peripheral T-cell lymphoma of cytotoxic (natural killer-like) T-cell phenotype. A neoplastic large lymphocyte that has clumpy chromatin, a discernible nucleolus, and a modest amount of basophilic cytoplasm that contains a few azurophilic granules is associated with a smaller peripheral blood lymphocyte. The lymphoma had a CD56<sup>+</sup> and perforin<sup>+</sup> T-cell phenotype. **C:** Peripheral blood, T-cell prolymphocytic leukemia, small (“knobby”) cell variant. Small lymphocytes with markedly irregular (“knobby”) nuclear profiles, coarse chromatin, variably discernible nucleoli, and scant agranular cytoplasm are characteristic of the small cell variant of T-cell prolymphocytic leukemia (“T-cell chronic lymphocytic leukemia”). (Courtesy of William Macon, Mayo Clinic, Rochester, MN.) (This figure is printed in black and white as [Figure 90.12](#).)



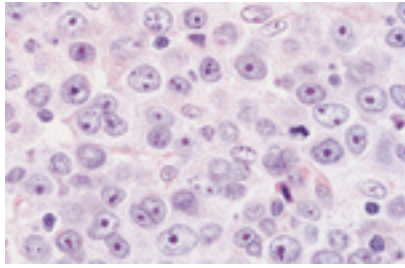
**Color Plate 92.3** Microarray analysis in chronic lymphocytic leukemia ( *CLL* ). **A:** The expressions of 247 “signature” genes differentiates CLL cells from diffuse large B cell lymphoma (DLBCL), follicular lymphomas ( *FLs* ) and most normal ( *N* ) lymphocytes. The “signature” genes are expressed by CLL cases with or without *IgV* gene mutations. **B:** CLL patients can be differentiated into those with or without mutations of the *IgV* gene by the expressions of 56 genes (see Abraham RS, Clark RJ, Bryant SC, et al. Correlation of serum immunoglobulin free light chain quantification with urinary Bence Jones protein in light chain myeloma. Clin Chem 2002;48:655–657). Ig, immunoglobulin. (From Staudt LM. Gene expression profiling of lymphoid malignancies. Annu Rev Med 2002;53: 303–318, with permission.) (This figure is printed in black and white as [Figure 92.3](#).)



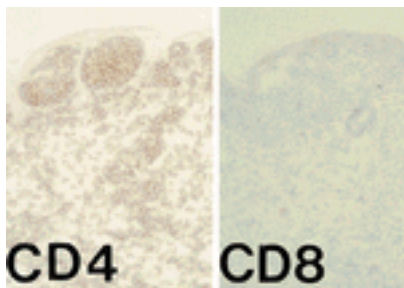
**Color Plate 94.5 A–E:** The cutaneous phases of cutaneous T-cell lymphoma (CTCL). **A:** Early patch stage lesions in a sun-protected region. **B:** Hyperpigmented diffuse patches on the back of a dark-skinned patient. **C:** Scattered thin and thick plaques on the back. **D:** Early keratoderma of the sole. **E:** Ulcerated tumor within a plaque on the posterior leg. **F:** Coalescing nodules and tumors with dermal thickening, forming “leonine facies” in this patient with transformed CTCL. See text for full description. (This figure is printed in black and white as [Figure 94.5](#).)



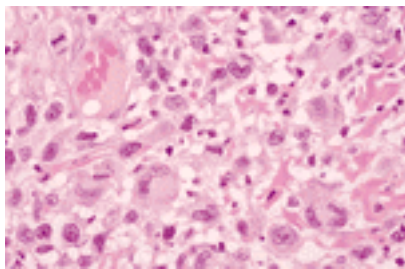
**Color Plate 94.6 A:** Mycosis fungoides (MF), patch stage. A bandlike lymphocytic infiltrate occupies the superficial papillary dermis with single-cell epidermotropism by atypical, “haloed” cerebriform T cells, preferentially involving the basal layer (hematoxylin and eosin,  $\times 50$ ). **B:** MF, plaque stage. A bandlike lymphocytic infiltrate occupies the papillary dermis with epidermotropism by atypical cerebriform T cells, focally forming small Pautrier microabscesses (hematoxylin and eosin,  $\times 25$ ). **C:** MF, thick plaque. A dense, bandlike lymphocytic infiltrate fills the papillary dermis and extends into the reticular dermis. Prominent epidermotropism by atypical, enlarged cerebriform T cells creates large Pautrier microabscesses (hematoxylin and eosin,  $\times 25$ ). **D:** MF, Pautrier microabscess. High magnification of a Pautrier microabscess shows characteristic small to medium cerebriform T cells with highly convoluted nuclear folding. The Pautrier microabscess recapitulates normal interactions between components of the skin-associated lymphoid tissue [i.e., cutaneous T cells, Langerhans histiocytes (two cells with large, pale nuclei in the center), and keratinocytes] (hematoxylin and eosin,  $\times 500$ ). (This figure is printed in black and white as [Figure 94.6](#).)



**Color Plate 94.7** Large cell transformation of cutaneous T-cell lymphoma. This represents secondary transformation of low-grade mycosis fungoides to high-grade immunoblastic large-cell lymphoma. This tumor is composed of sheets of large transformed cells or immunoblasts with round to oval nuclei, dispersed chromatin, and prominent nucleoli. Several mitoses are present (hematoxylin and eosin,  $\times 500$ ). (This figure is printed in black and white as [Figure 94.7](#).)

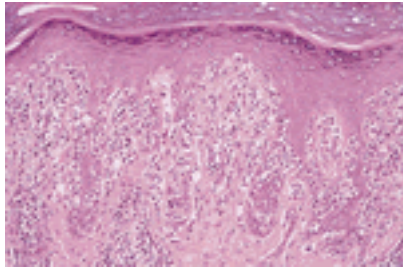


**Color Plate 94.8** Frozen-section immunohistochemistry of a cutaneous plaque in a patient with mycosis fungoides shows a marked predominance of CD4<sup>+</sup> T-helper cells within Pautrier microabscesses and within the dermis. CD8 is essentially negative (diaminobenzidine and hematoxylin,  $\times 50$ ). (This figure is printed in black and white as [Figure 94.8](#).)

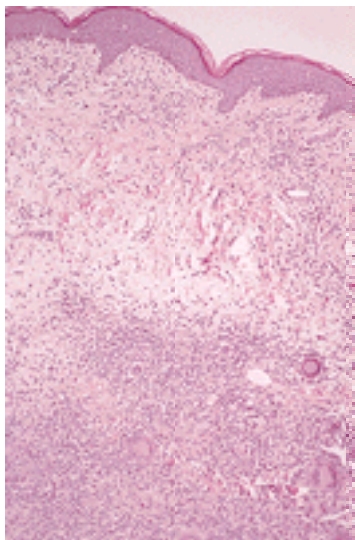


**Color Plate 94.9** Lymphomatoid papulosis, type A. Anaplastic large cells with abundant cytoplasm, reniform nuclei, and prominent nucleoli are scattered among small lymphocytes and eosinophils. Note occasional binucleate Reed-Sternberg-like cells (hematoxylin and eosin,  $\times 250$ ). The large cells were strongly positive for CD30 (not shown). (This figure is printed in black and white as [Figure 94.9](#).)

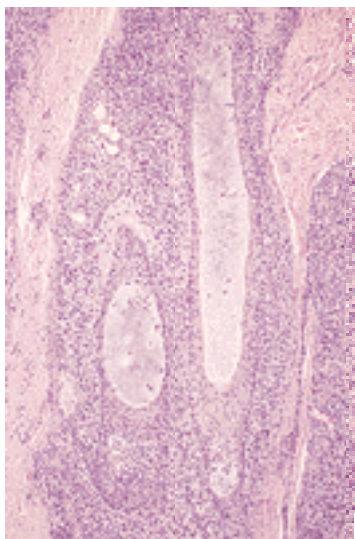




**Color Plate 94.10** Pagetoid reticulosis. Note the pronounced pagetoid pattern of epidermotropism by enlarged, atypical, cerebriform T cells (hematoxylin and eosin,  $\times 50$ ). (This figure is printed in black and white as [Figure 94.10](#).)

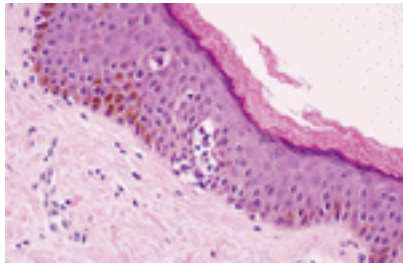


**Color Plate 94.11** Granulomatous slack skin. This variant of mycosis fungoides shows a deep lymphocytic infiltrate with dermal edema, disruption of elastic fibers, and numerous foreign body giant cells (hematoxylin and eosin,  $\times 10$ ). (This figure is printed in black and white as [Figure 94.11](#).)

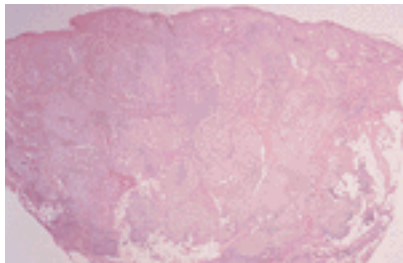


**Color Plate 94.12** Folliculotropic mycosis fungoides with follicular mucinosis. Note the preferential pattern of perfollicular infiltration by atypical cerebriform T cells with prominent folliculotropism forming small Pautrier microabscesses. Also note the bluish

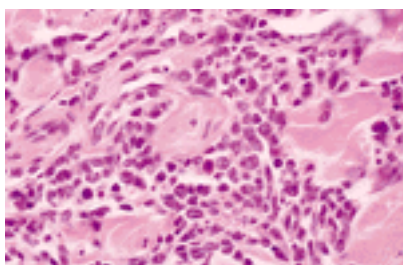
pools of mucin within the hair follicles (hematoxylin and eosin,  $\times 25$ ). (This figure is printed in black and white as [Figure 94.12.](#))



**Color Plate 94.13** Cutaneous involvement by human T-cell leukemia virus type 1 (+) adult T-cell leukemia/lymphoma showing epidermotropism and formation of a Pautrier microabscess (hematoxylin and eosin,  $\times 50$ ). (This figure is printed in black and white as [Figure 94.13.](#))

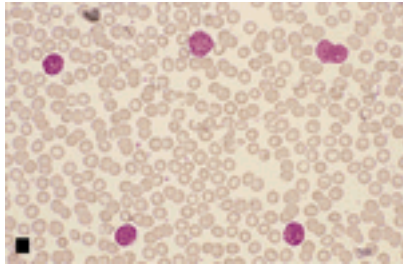


**Color Plate 94.14** Primary cutaneous follicular large-cell lymphoma. Note the back-to-back nodular pattern. The infiltrate extends from the superficial reticular dermis to the superficial subcutis in a “bottom-heavy” pattern sparing the papillary dermis and epidermis (hematoxylin and eosin,  $\times 2$ ). (This figure is printed in black and white as [Figure 94.14.](#))

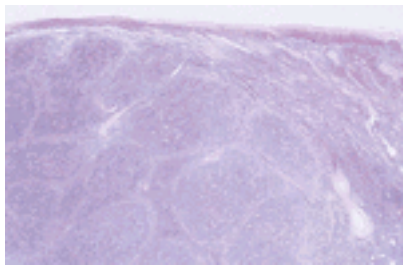


**Color Plate 94.15** Leukemia cutis. Clusters of myeloblasts with fine chromatin and scant cytoplasm infiltrate between collagen bundles in the reticular dermis (hematoxylin and eosin,  $\times 250$ ). (This figure is printed in black and white as [Figure 94.15.](#))

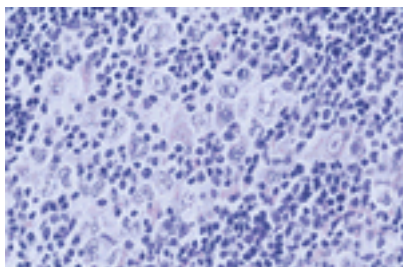




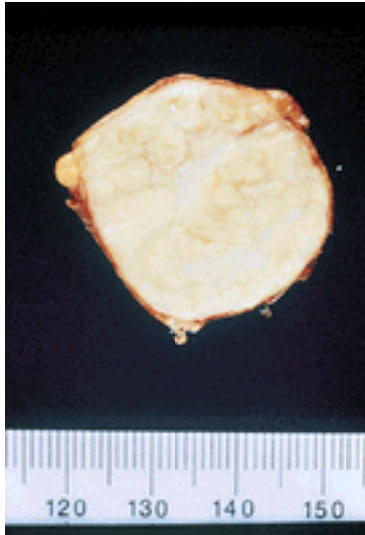
**Color Plate 94.16** Sézary syndrome. The peripheral blood shows lymphocytosis. Most lymphocytes are Sézary cells with enlarged, highly convoluted nuclei and scant cytoplasm (hematoxylin and eosin,  $\times 250$ ). (This figure is printed in black and white as [Figure 94.16.](#))



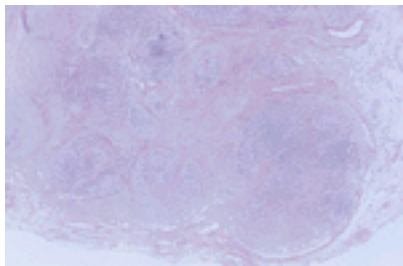
**Color Plate 95.1** Lymphocyte-predominant Hodgkin disease, nodular type. Low magnification demonstrates a nodular growth pattern that compresses a rim of uninvolved node. (This figure is printed in black and white as [Figure 95.1.](#))



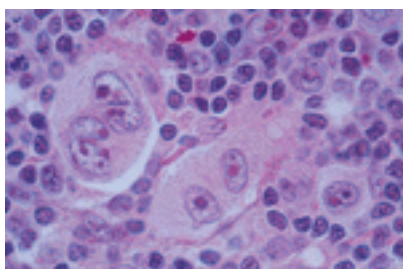
**Color Plate 95.2** Lymphocyte-predominant Hodgkin disease. High magnification shows variant lymphocytic and histiocytic cells (L and H cells), which have "popcorn" nuclei. A background of small lymphocytes and histiocytes is present. (This figure is printed in black and white as [Figure 95.2.](#))



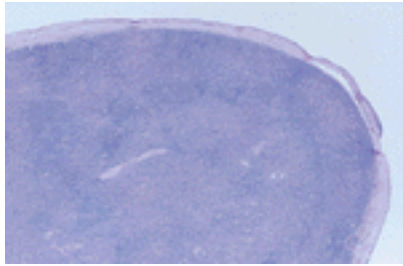
**Color Plate 95.3** Nodular sclerosing Hodgkin disease. Gross appearance of the cut surface of a resected node shows a thickened capsule, white fibrous bands, and yellow parenchymal nodules. (This figure is printed in black and white as [Figure 95.3](#).)



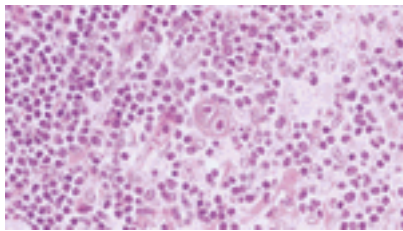
**Color Plate 95.4** Nodular sclerosing Hodgkin disease. Low magnification shows a fibrous capsule and bands of sclerosis circumscribing abnormal lymphoid nodules. (This figure is printed in black and white as [Figure 95.4](#).)



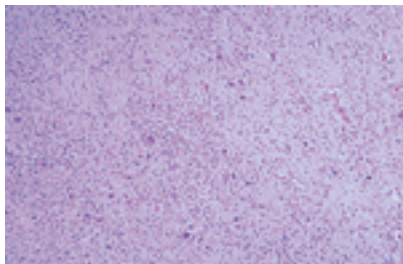
**Color Plate 95.5** Nodular sclerosing Hodgkin disease. High magnification shows Reed-Sternberg cells and lacunar variants in B5 fixed material. (This figure is printed in black and white as [Figure 95.5](#).)



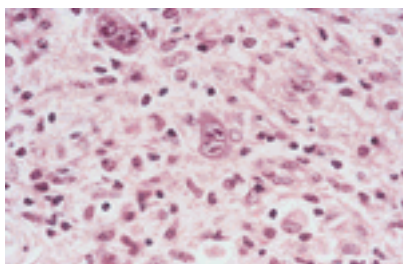
**Color Plate 95.6** Mixed cellularity-type Hodgkin disease. Low magnification shows obliteration of nodal architecture. (This figure is printed in black and white as [Figure 95.6](#).)



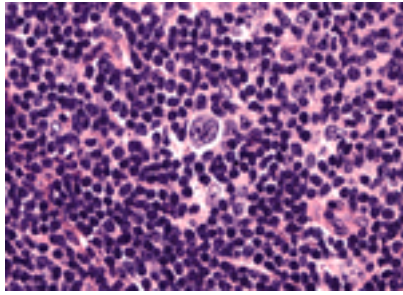
**Color Plate 95.7** Mixed cellularity-type Hodgkin disease. High magnification shows a classic Reed-Sternberg cell in a mixed background of small lymphocytes, plasma cells, and eosinophils. (This figure is printed in black and white as [Figure 95.7](#).)



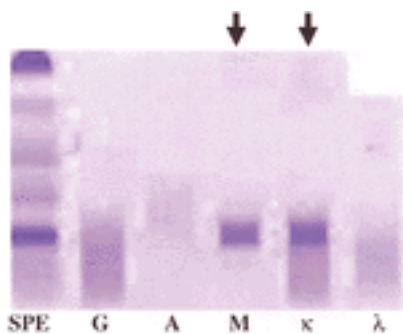
**Color Plate 95.8** Lymphocyte-depleted type Hodgkin disease, diffuse fibrosis subtype. Low magnification shows depletion of cellularity of node and scattered large dysplastic cells. (This figure is printed in black and white as [Figure 95.8](#).)



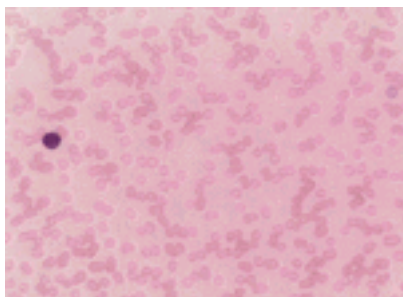
**Color Plate 95.9** Lymphocyte-depleted type Hodgkin disease, diffuse fibrosis subtype. Reed-Sternberg cells are easily found, and the background is depleted of cellularity and composed of amorphous eosinophilic connective tissue. (This figure is printed in black and white as [Figure 95.9](#).)



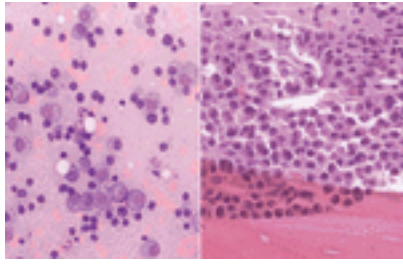
**Color Plate 95.10** Lymphocyte-rich “classic” Hodgkin disease. The background is primarily lymphocytes, and the Reed–Sternberg cells are usually CD15 and CD30 positive and negative for the B-cell marker CD20. (This figure is printed in black and white as [Figure 95.10.](#))



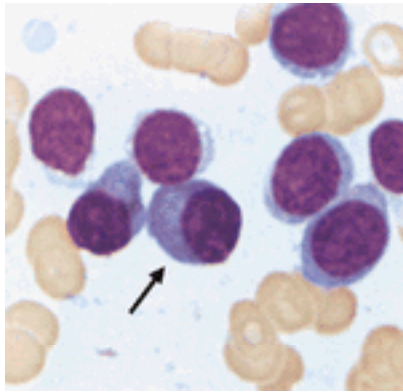
**Color Plate 96.2** Immunofixation study done to characterize the monoclonal protein as a monoclonal immunoglobulin M  $\lambda$  protein. The arrows indicate the lanes that show reactivity with the specific antibodies. The reactivity is consistent with the same migration seen in the extreme left column that shows the electrophoresis ( *SPE*). Thus, in this assay, the nature of the monoclonal protein seen in the electrophoresis is elucidated: isotype M and light chain  $\lambda$ . (This figure is printed in black and white as [Figure 96.2.](#))



**Color Plate 98.3** Rouleaux. (From Dispenzieri A, Lacy MQ, Greipp PR. Multiple myeloma. In: Gertz MA, Greipp PR, eds. handbook of multiple myeloma and related cell disorders. Berlin: Springer–Verlag, *in press*. By permission of the publisher.) (This figure is printed in black and white as [Figure 98.3.](#))



**Color Plate 98.6** Bone marrow. Plasma cells on aspirate and biopsy specimen. (From Dispenzieri A, Lacy MQ, Greipp PR. Multiple myeloma. In: Gertz MA, Greipp PR, eds. handbook of multiple myeloma and related cell disorders. Berlin: Springer-Verlag, *in press*. By permission of the publisher.) (This figure is printed in black and white as [Figure 98.6](#).)



**Color Plate 100.3** Bone marrow aspirate showing the malignant cells from a patient with Waldenström macroglobulinemia. The cells exhibit lymphoid and plasmacytoid morphology. (This figure is printed in black and white as [Figure 100.3](#).)

2004 Lippincott Williams & Wilkins  
John P. Greer, John Foerster, John N. Lukens  
George M. Rodgers, Frixos Paraskevas, Bertil Glader  
Wintrobe's Clinical Hematology